

University of California
At Los Angeles
The Library

Form L 1

~~QP
4A
586
cop. 2~~

This book is DUE to be returned below

APR 19 1900

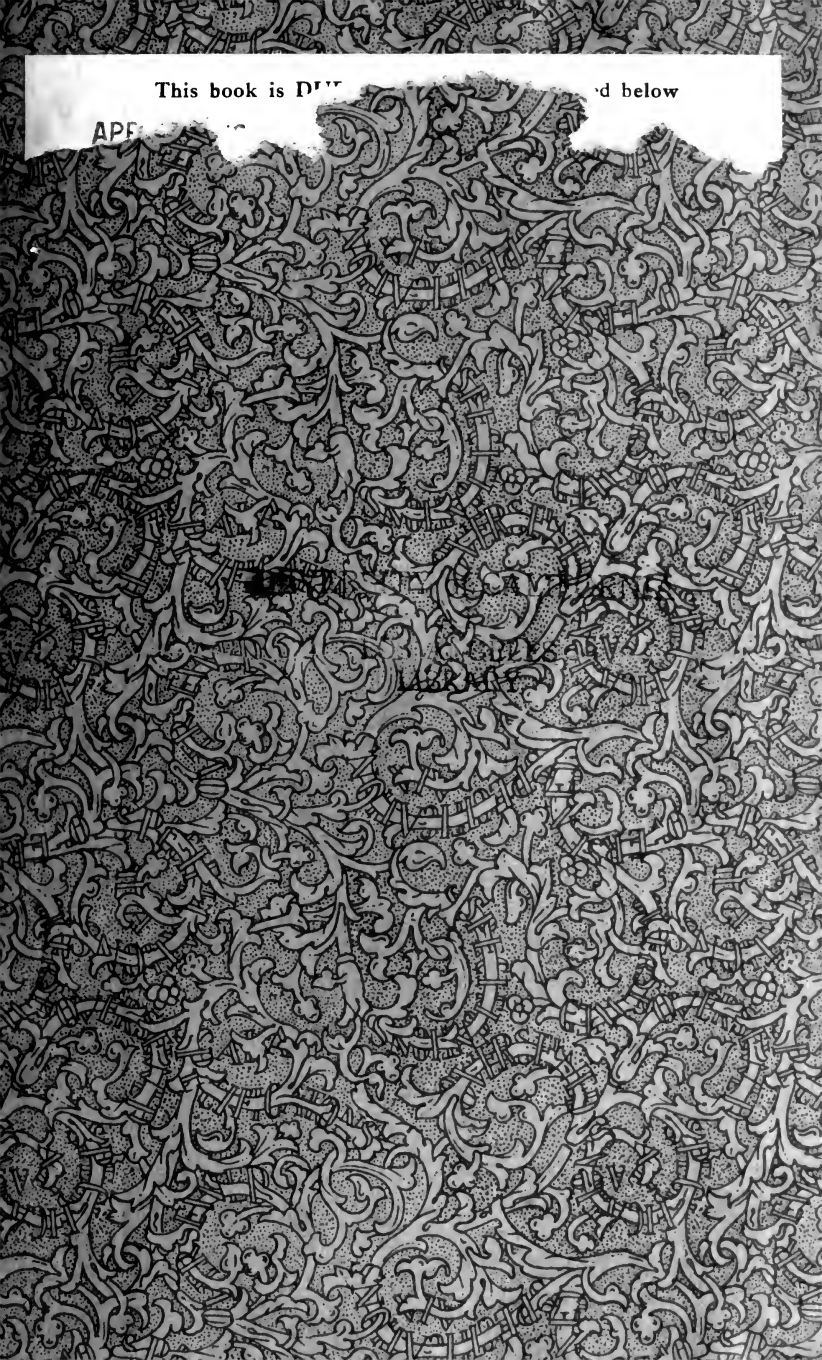

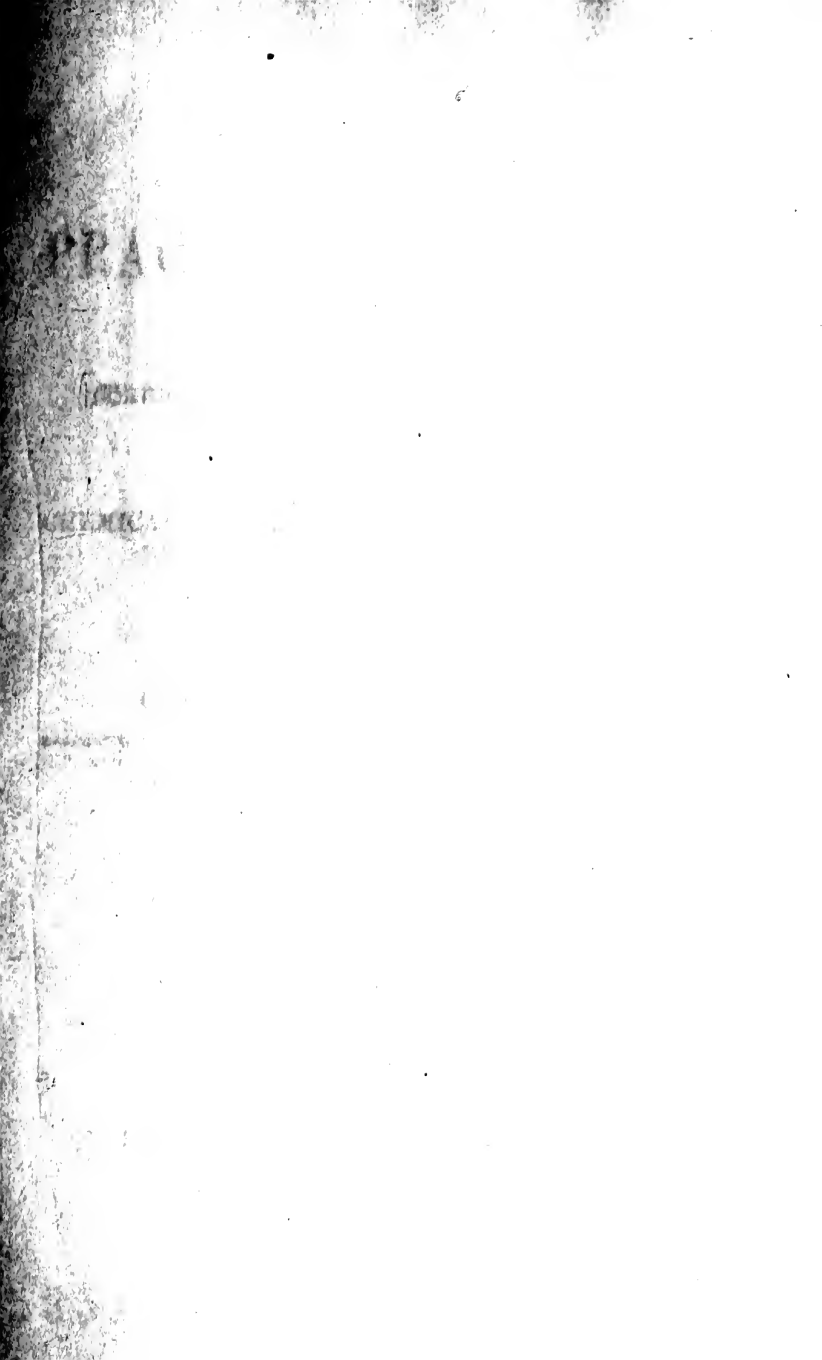

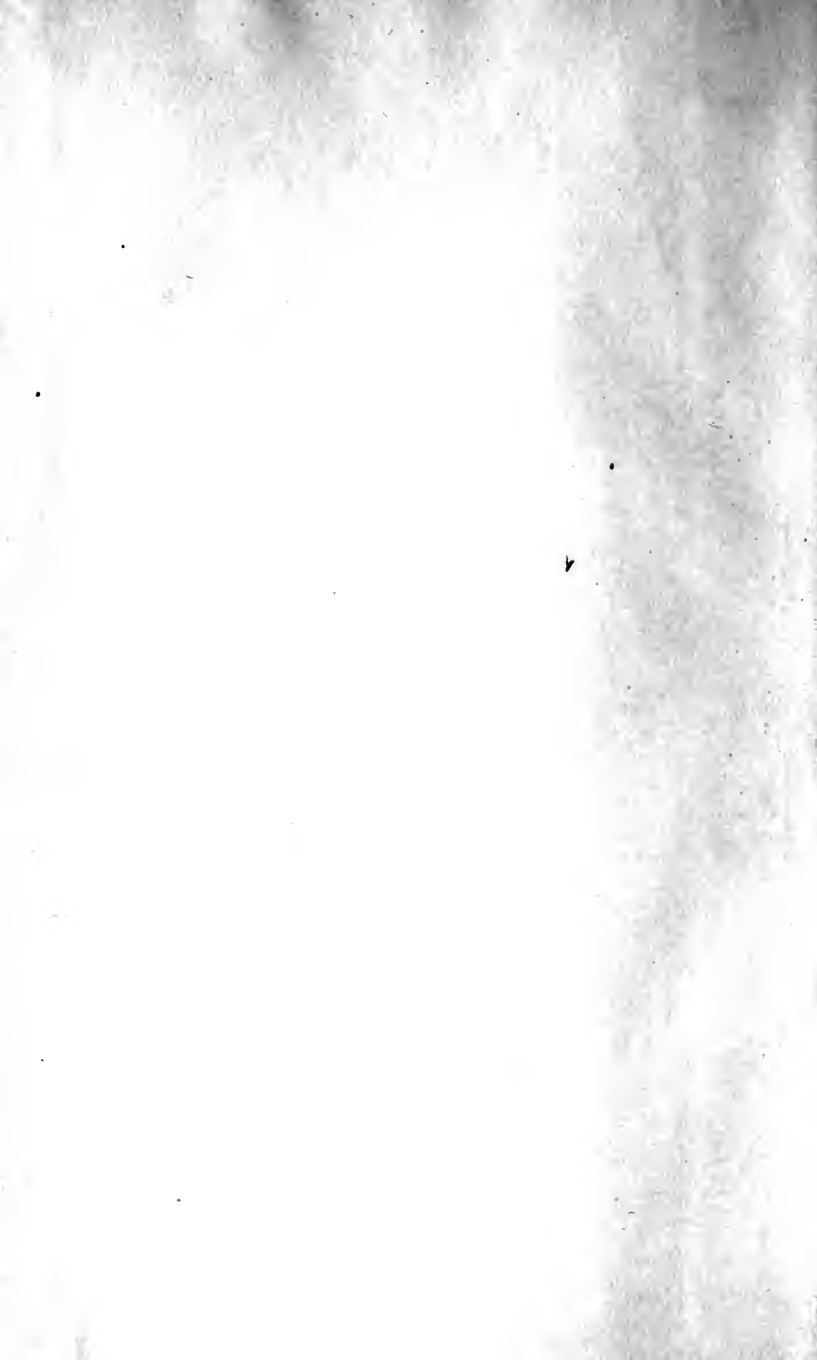

OUTLINES

OF

PRACTICAL PHYSIOLOGY

BEING A

Manual for the Physiological Laboratory,

INCLUDING

**CHEMICAL AND EXPERIMENTAL PHYSIOLOGY, WITH
REFERENCE TO PRACTICAL MEDICINE.**

BY

WILLIAM STIRLING, M.D., Sc.D.,

**BRACKENBURY PROFESSOR OF PHYSIOLOGY AND HISTOLOGY IN THE OWENS COLLEGE,
AND PROFESSOR IN VICTORIA UNIVERSITY, MANCHESTER; EXAMINER IN
PHYSIOLOGY IN THE UNIVERSITIES OF EDINBURGH AND LONDON.**

THIRD EDITION, REVISED AND ENLARGED.

With 289 Illustrations.

PHILADELPHIA:

P. BLAKISTON'S SON & CO.,

1012 WALNUT STREET.

1905.

38477

SECRET

CONFIDENTIAL

CONFIDENTIAL

SECRET

CONFIDENTIAL

SECRET

CONFIDENTIAL

SECRET

CONFIDENTIAL

SECRET

8364

Biomedical
Library

QT
25
S8610
1895

QT
44
S86
cop. 2
11

In Memoriam

CARL LUDWIG,

MY REVERED AND BELOVED MASTER.

BORN AT WITZENHAUSEN, 29TH DECEMBER, 1816.

DIED AT LEIPZIG, 23RD APRIL, 1895.

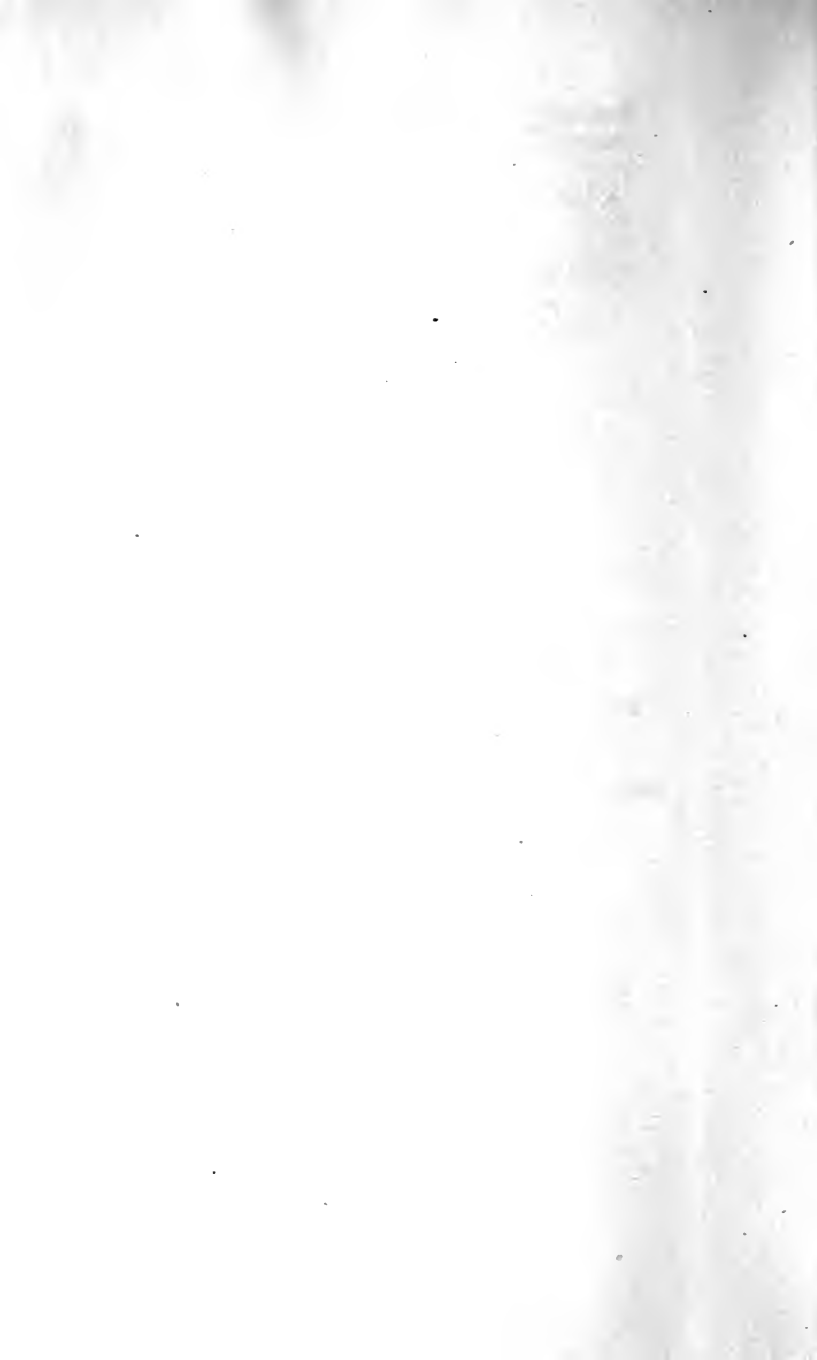

PREFACE TO THE THIRD EDITION.

IN the light of extended experience in teaching Practical Physiology, I venture to submit a Third Edition of this little work. The essential features remain unchanged; but there has been some re-arrangement of the subject-matter, and many additions have been made, including a short Appendix on Recording Apparatus.

In preparing the Chemical Part, I have made use of the Text-books of Gamgee, Halliburton, Neumeister, and Salkowski; while, for the Experimental Part, I found numerous valuable suggestions in the practical works and syllabuses of my friends, Professors Gotch, Halliburton, Fredericq, and Dr Schenk. I have to express my thanks to Professor Fick of Würzburg for several improvements in the Lessons on Muscle.

A large number of new woodcuts have been added (chiefly in the Experimental Part); and for communications and several original drawings—some of the latter illustrating new methods described by their authors—I am indebted to my friends and colleagues,

Professors Birch, Gotch, Rutherford, and Schäfer, Dr Bayliss, Dr Gregor Brodie, and C. Herbert Hurst, Ph.D. The sources of the other illustrations and methods are acknowledged elsewhere.

I have also to thank my pupils, Messrs Moore, Halstead, and J. H. Sheldon, for some of the drawings, and my Senior Demonstrator, Dr J. A. Menzies, for reading the proof sheets, and for other kind assistance and suggestions.

WILLIAM STIRLING.

PHYSIOLOGICAL LABORATORY, OWENS COLLEGE,
MANCHESTER, *August 1895.*

CONTENTS.



PART I.—CHEMICAL PHYSIOLOGY.

LESSON	PAGES
I. THE PROTEIDS	1-12
II. THE ALBUMENOIDS AND SOME NITROGENOUS DERIVATIVES OF PROTEIDS	13-14
III. THE CARBOHYDRATES.	15-29
IV. FATS, BONE, AND EXERCISES	29-33
V. THE BLOOD—COAGULATION—ITS PROTEIDS	33-43
VI. THE COLOURED BLOOD-CORPUSCLES—SPECTRA OF HÆMOGLOBIN AND ITS COMPOUNDS	43-55
VII. WAVE-LENGTHS — DERIVATIVES OF HÆMOGLOBIN—ESTIMATION OF HÆMOGLOBIN	55-67
VIII. SALIVARY DIGESTION	67-71
IX. GASTRIC DIGESTION	71-79
X. PANCREATIC DIGESTION	79-86
XI. THE BILE	87-90
XII. GLYCOGEN IN THE LIVER	91-94
XIII. MILK, FLOUR, AND BREAD	94-99
XIV. MUSCLE	99-103
XV. SOME IMPORTANT ORGANIC SUBSTANCES	103-104
XVI. THE URINE	104-110
XVII. THE INORGANIC CONSTITUENTS OF THE URINE	110-116
XVIII. ORGANIC CONSTITUENTS OF THE URINE	117-120
XIX. VOLUMETRIC ANALYSIS FOR UREA	120-127
XX. URIC ACID—URATES—HIPPURIC ACID—KREATININ	127-136
XXI. ABNORMAL CONSTITUENTS OF THE URINE	136-139
XXII. BLOOD, BILE, AND SUGAR IN URINE	140-143
XXIII. QUANTITATIVE ESTIMATION OF SUGAR	143-147
XXIV. URINARY DEPOSITS, CALCULI, GENERAL EXAMINATION OF THE URINE, AND APPENDIX	147-156

PART II.—EXPERIMENTAL PHYSIOLOGY.

LESSON	PAGES
XXV. GALVANIC BATTERIES AND GALVANOSCOPE	157-160
XXVI. ELECTRICAL KEYS—RHEOCHORD.	160-166
XXVII. INDUCTION MACHINES—ELECTRODES	166-170
XXVIII. SINGLE INDUCTION SHOCKS—INTERRUPTED CURRENT—BREAK EXTRA-CURRENT—HELMHOLTZ'S MODIFICATION	171-176
XXIX. PITHING — CILIARY MOTION — NERVE-MUSCLE PREPARATION— NORMAL SALINE	176-179
XXX. NERVE-MUSCLE PREPARATION — STIMULATION OF NERVE — MECHANICAL, CHEMICAL, AND THERMAL STIMULI	179-183
XXXI. SINGLE AND INTERRUPTED INDUCTION SHOCKS—TETANUS— CONSTANT CURRENT	183-187
XXXII. RHEONOM—TELEPHONE EXPERIMENT—DIRECT AND INDIRECT STIMULATION OF MUSCLE—RUPTURING STRAIN OF TENDON— MUSCLE SOUND—DYNAMOMETERS	187-189
XXXIII. INDEPENDENT MUSCULAR EXCITABILITY—ACTION OF CURARE— ROSENTHAL'S MODIFICATION—POHL'S COMMUTATOR	190-194
XXXIV. THE GRAPHIC METHOD—MOIST CHAMBER—SINGLE CONTRACTION —WORK DONE	194-200
XXXV. CRANK-MYOGRAPH—AUTOMATIC BREAK	200-203
XXXVI. ISOTONIC AND ISOMETRIC CONTRACTIONS—WORK DONE—HEAT- RIGOR	203-206
XXXVII. PENDULUM-MYOGRAPH — SPRING-MYOGRAPH — TIME-MARKER — SIGNAL	206-213
XXXVIII. INFLUENCE OF TEMPERATURE, LOAD, AND VERATRIA ON MUSCULAR CONTRACTION	213-216
XXXIX. ELASTICITY AND EXTENSIBILITY OF MUSCLE—BLIX'S MYOGRAPH	216-218
XL. TWO SUCCESSIVE SHOCKS—TETANUS	219-223
XLI. FATIGUE OF MUSCLE	223-224
XLII. FATIGUE OF NERVE—SEAT OF EXHAUSTION	225-226
XLIII. MUSCLE WAVE—THICKENING OF A MUSCLE—WILD'S APPARATUS	226-229
XLIV. MYOGRAPHIC EXPERIMENTS ON MAN—ERGOGRAPH—DYNAMO- GRAPH	229-231
XLV. DIFFERENTIAL ASTATIC GALVANOMETER — NON-POLARISABLE ELECTRODES—SHUNT—CURRENTS IN MUSCLE	231-237
XLVI. NERVE-CURRENTS—ELECTRO-MOTIVE PHENOMENA OF THE HEART —CAPILLARY ELECTROMETER	237-238
XLVII. GALVANI'S EXPERIMENT—SECONDARY CONTRACTION AND TETANUS —PARADOXICAL CONTRACTION—KÜHNE'S EXPERIMENT	239-243
XLVIII. ELECTROTONUS—ELECTROTONIC VARIATION OF EXCITABILITY .	243-247

LESSON	PAGES
XLIX. PFLÜGER'S LAW OF CONTRACTION—ELECTROTONIC VARIATION OF THE ELECTRO-MOTIVITY—RITTER'S TETANUS	247-250
L. VELOCITY OF NERVE-IMPULSE IN MOTOR NERVES OF FROG AND MAN—KÜHNE'S GRACILIS EXPERIMENT	250-254
LI. CONDITIONS AFFECTING EXCITABILITY OF NERVE	254-258
LII. THE FROG'S HEART—BEATING OF THE HEART—EFFECT OF HEAT AND COLD—SECTION OF THE HEART	259-262
LIII. GRAPHIC RECORD OF THE FROG'S HEART-BEAT—EFFECT OF TEMPERATURE	262-265
LIV. SUSPENSION METHODS FOR HEART — GASKELL'S HEART-LEVER AND CLAMP	266-270
LV. STANNIUS'S EXPERIMENT — INHIBITION — LATENT PERIOD OF HEART-MUSCLE	270-273
LVI. CARDIAC VAGUS AND SYMPATHETIC OF THE FROG AND THEIR STIMULATION	273-276
LVII. ACTION OF DRUGS AND CONSTANT CURRENT ON HEART—DESTRUCTION OF CENTRAL NERVOUS SYSTEM	277-279
LVIII. PERFUSION OF FLUIDS THROUGH THE HEART—PISTON-RECORDER	279-281
LIX. ENDO-CARDIAL PRESSURE—APEX-PREPARATION—TONOMETER	281-284
LX. HEART-VALVES—ILLUMINATED HEART—STETHOSCOPE—CARDIOGRAPH—POLYGRAPH—INHIBITION OF HEART	284-291
LXI. THE PULSE -- SPHYGMOGRAPHS — SPHYGMOSCOPE — PLETHYSMOGRAPH	291-295
LXII. RIGID AND ELASTIC TUBES—THE PULSE-WAVE—SCHEME OF THE CIRCULATION—RHEOMETER	295-300
LXIII. CAPILLARY BLOOD-PRESSURE—LYMPH HEARTS—BLOOD-PRESSURE AND KYMOGRAPH	300-306
LXIV. PERFUSION THROUGH BLOOD-VESSELS	306-307
LXV. MOVEMENTS OF THE CHEST WALL—ELASTICITY OF THE LUNGS—HYDROSTATIC TEST	308-311
LXVI. VITAL CAPACITY—EXPIRED AIR—PLEURAL PRESSURE—GASES OF BLOOD AND AIR	311-314
LXVII. LARYNGOSCOPE—VOWELS	315-317
LXVIII. REFLEX ACTION—ACTION OF POISONS—KNEE-JERK	318-322
LXIX. SPINAL NERVE ROOTS	322
LXX. REACTION TIME—CEREBRAL HEMISPHERES	323-328
LXXI. FORMATION OF AN IMAGE—DIFFUSION—ABERRATION—ACCOMMODATION — SCHEINER'S EXPERIMENT — NEAR AND FAR POINTS—PURKINJE'S IMAGES—PHAKOSCOPE—ASTIGMATISM—PUPIL	329-337
LXXII. BLIND SPOT—FOVEA CENTRALIS—DIRECT VISION—CLERK-MAXWELL'S EXPERIMENT—PHOSPHENES—RETINAL SHADOWS	337-343
LXXIII. PERIMETRY—IRRADIATION—IMPERFECT VISUAL JUDGMENTS	344-350

CONTENTS.

LESSON	PAGES
LXXIV. KÜHNE'S ARTIFICIAL EYE--MIXING COLOUR SENSATIONS--COLOUR BLINDNESS	350-363
LXXV. THE OPHTHALMOSCOPE--INTRAOCULAR PRESSURE--OPHTHALMO- TONOMETER	364-367
LXXVI TOUCH, SMELL, TASTE, HEARING	367-372



APPENDIX	373
INDEX	392

LIST OF ILLUSTRATIONS.



FIG.		PAGE
1.	Apparatus for coagulation temperature. (<i>Gamgee.</i>)	4
2.	Apparatus for fractional heat coagulation. (<i>Halliburton.</i>)	11
3.	Potato starch	17
4.	Potato starch viewed with crossed Nicols. (<i>Stirling.</i>)	18
5.	Dextrose. (<i>Hill.</i>)	20
6.	Phenyl-glucosazon. (<i>Stirling.</i>)	21
7.	Maltose. (<i>Hill.</i>)	23
8.	Phenyl-maltosazon. (<i>Stirling.</i>)	23
9.	Lactose. (<i>Hill.</i>)	24
10.	Phenyl-lactosazon. (<i>Stirling.</i>)	24
11.	Cane sugar. (<i>Hill.</i>)	24
12.	Laurent's polarimeter. (<i>Laurent.</i>)	26
13.	Wild's polaristrobometer. (<i>Hermann and Pfister.</i>)	27
14.	Interference lines, seen with fig. 13	28
15.	Gad's experiment. (<i>Stirling, after Gad.</i>)	30
16.	Exsiccator. (<i>Gscheidlen.</i>)	40
17.	Apparatus for obtaining clear serum. (<i>Drechsel.</i>)	41
18.	Bernard's apparatus for estimating sugar. (<i>Stirling.</i>)	42
19.	Incineration of a deposit. (<i>Gscheidlen.</i>)	43
20.	Gower's hæmocyto-meter	44
21.	Rat's hæmoglobin crystals. (<i>Stirling.</i>)	45
22.	Spectroscope. (<i>Browning.</i>)	46
23.	Platinum wire support for sodium flame. (<i>Gscheidlen.</i>)	46
24.	Spectra of hæmoglobin. (<i>Landois and Stirling.</i>)	47
25.	Absorption by oxy-hæmoglobin. (<i>Rollett.</i>)	48
26.	Absorption by reduced hæmoglobin. (<i>Rollett.</i>)	48
27.	Hermann's hæmatoscope. (<i>Rollett.</i>)	50
28.	Spectra of derivatives of hæmoglobin. (<i>Landois and Stirling.</i>)	51
29.	Hæmochromogen apparatus. (<i>Stirling.</i>)	52
30.	Spectrum of methæmoglobin. (<i>V. Jaksch.</i>)	52
31.	Spectroscope for wave-lengths. (<i>Landois and Stirling.</i>)	55
32.	Wave-lengths of hæmoglobin and its compounds. (<i>Preyer and Gamgee.</i>)	57
33.	Spectra of derivatives of hæmoglobin. (<i>Preyer and Gamgee.</i>)	58
34.	Hæmin crystals. (<i>V. Jaksch.</i>)	59
35.	Hæmoglobinometer of Gowers	60
36.	Fleischl's hæmometer	61
37.	Bizzozero's chromo-cytometer	62
38.	Several parts of fig. 37	63
39.	Micro-spectroscope of Zeiss	66

FIG.	PAGE
40. Part of fig. 39. (<i>Zeiss.</i>)	66
41. Saliva and buccal secretion. (<i>V. Jaksch.</i>)	67
42. Digestion bath. (<i>Stirling.</i>)	73
43. Kühne's dialyser. (<i>Stirling.</i>)	78
44. Crystals of tyrosin. (<i>Stirling.</i>)	86
45. Crystals of cholesterin. (<i>Stirling.</i>)	89
46. Double-walled funnel. (<i>Gscheidlen.</i>)	90
47. Hot air-oven. (<i>Gscheidlen.</i>)	92
48. Milk and colostrum. (<i>Stirling.</i>)	94
49. Porous cell for filtering milk. (<i>Stirling.</i>)	96
50. Lactoscope	98
51. Kreatin. (<i>Brunton.</i>)	101
52. Urinometer. (<i>Landois and Stirling.</i>)	105
53. Deposit in acid urine. (<i>Landois and Stirling.</i>)	108
54. Deposit in alkaline urine. (<i>Landois and Stirling.</i>)	109
55. Stellar phosphate. (<i>V. Jaksch.</i>)	114
56. Triple phosphate	114
57. Triple phosphate. (<i>V. Jaksch.</i>)	115
58. Burette meniscus	115
59. Erdmann's float	116
60. Urea and urea nitrate. (<i>Landois and Stirling.</i>)	118
61. Urea oxalate	119
62. Dupré's urea apparatus	121
63. Steele's apparatus for urea	122
64. Ureameter of Doremus. (<i>Southall.</i>)	123
65. Hüfner's apparatus. (<i>V. Jaksch.</i>)	125
66. Gerard's urea apparatus. (<i>Gibbs, Cuxson & Co.</i>)	126
67. Uric acid	128
68. Uric acid	129
69. Hippuric acid. (<i>Landois and Stirling.</i>)	132
70. Kreatinin zinc-chloride. (<i>Landois and Stirling.</i>)	133
71. Esbach's tube. (<i>V. Jaksch.</i>)	139
72. Johnson's picro-saccharimeter	144
73. Einhorn's fermentation saccharometer. (<i>Stirling.</i>)	145
74. Sacchar-ureameter. (<i>Gibbs, Cuxson & Co.</i>)	146
75. Hand centrifuge. (<i>Muencke.</i>)	148
76. Oxalate of lime	149
77. Acid urate of ammonium. (<i>V. Jaksch.</i>)	149
78. Cystin	150
79. Leucin and tyrosin	150
80. Daniell's cell. (<i>Stirling.</i>)	157
81. Grove's cell	158
82. Bichromate cell	159
83. Detector. (<i>Elliott.</i>)	159
84. Du Bois Reymond's key	161
85. Scheme of 84. (<i>Stirling.</i>)	161
86. Scheme of 84. (<i>Stirling.</i>)	161
87. Morse key. (<i>Stewart and Gee.</i>)	162
88. Spring key. (<i>Elliott.</i>)	162
89. Plug key	162

FIG.	PAGE
90. Simple rheochord. (<i>Stirling.</i>)	163
91. Simple rheochord. (<i>Stirling.</i>)	164
92. Rheochord, Oxford pattern. (<i>Stirling.</i>)	165
93. Reverser. (<i>Elliott.</i>)	165
94. Du Bois Reymond induction coil. (<i>Elliott.</i>)	166
95. Ewald's sledge coil. (<i>Hurst.</i>)	168
96. Vertical inductorium	169
97. Hand-electrodes. (<i>Stirling.</i>)	169
98. Du Bois electrodes	170
99. Induction coil for single shocks. (<i>Stirling.</i>)	171
100. Du Bois coil	173
101. Break extra-current. (<i>Stirling.</i>)	173
102. Helmholtz's modification	174
103. Equalised make and break shocks. (<i>Stirling.</i>)	175
104. Brodie's rotating key	175
105. Frog's leg-muscles. (<i>Ecker.</i>)	178
106. Frog's sciatic nerve. (<i>Ecker.</i>)	178
107. Nerve-muscle preparation	180
108. Straw-flag. (<i>Stirling.</i>)	181
109. Scheme for single induction shocks. (<i>Stirling.</i>)	183
110. Scheme of constant current. (<i>Stirling.</i>)	185
111. Frog's sartorius and thigh muscles. (<i>Ecker.</i>)	186
112. Rheonom. (<i>Stirling.</i>)	188
113. Pohl's commutator. (<i>Elliott.</i>)	193
114. Scheme of curare experiment	194
115. Revolving cylinder of Ludwig	195
116. Scheme of moist chamber. (<i>Stirling.</i>)	197
117. Record of make and break contractions. (<i>Stirling.</i>)	199
118. Muscle curve. (<i>Stirling.</i>)	200
119. Crank myograph. (<i>Stirling.</i>)	201
120. Arrangement for automatic break. (<i>Stirling.</i>)	202
121. Simple muscle curve. (<i>Stirling.</i>)	204
122. Isotonic and isometric muscle curves. (<i>Gad.</i>)	204
123. Scheme of Fick's tension recorder. (<i>Schenk.</i>)	205
124. Apparatus for heat-rigor. (<i>Ludwig.</i>)	206
125. Pendulum-myograph	207
126. Pendulum-myograph curve. (<i>Stirling.</i>)	208
127. Spring-myograph	208
128. Revolving drum for time relations of muscle curve	209
129. Electric signal. (<i>Stirling.</i>)	210
130. Chronograph. (<i>Cambridge Scientific Instrument Co.</i>)	210
131. Chronograph writing horizontally. (<i>Marey.</i>)	211
132. Simple myograph. (<i>Marey.</i>)	211
133. Myograph. (<i>Fredericq.</i>)	212
134. Effect of temperature on muscle curve. (<i>Stirling.</i>)	213
135. Muscle curve with load. (<i>Stirling.</i>)	214
136. Veratria curve. (<i>Stirling.</i>)	215
137. Veratria curve. (<i>Stirling.</i>)	215
138. Elasticity of a frog's muscle. (<i>Stirling.</i>)	217
139. Elasticity of india-rubber. (<i>Stirling.</i>)	217

FIG.	PAGE
140. Blix's myograph. (<i>Fick</i> .)	218
141. Curve of superposed contractions. (<i>Stirling</i> .)	219
142. Scheme for tetanus. (<i>Stirling</i> .)	220
143. Tetanus (incomplete) curves. (<i>Stirling</i> .)	220
144. Tetanus interrupter. (<i>Stirling</i> .)	221
145. Metronome. (<i>Petzold</i> .)	222
146. Magnetic interrupter. (<i>Cambridge Scientific Instrument Co.</i>)	223
147. Fatigue curve. (<i>Stirling</i> .)	224
148. Fatigue curve, slow drum. (<i>Stirling</i> .)	224
149. Muscle wave apparatus	227
150. Marey's registering tambour	228
151. Pince myographique. (<i>Marey</i> .)	228
152. Wild's apparatus. (<i>Stirling</i> .)	229
153. Fick's tension myograph. (<i>Schenk</i> .)	230
154. Mosso's ergograph	231
155. Thomson's galvanometer. (<i>Elliott</i> .)	232
156. Lamp and scale for 155	232
157. Non-polarisable electrodes	232
158. Shunt. (<i>Elliott</i> .)	234
159. Scheme for galvanometer. (<i>Stirling</i> .)	234
160. Brush electrodes. (<i>V. Fleischl</i> .)	236
161. D'Arsonval's electrodes. (<i>Verdin</i> .)	236
162. Non-polarisable nerve electrodes	238
163. Galvani's experiment. (<i>Stirling</i> .)	239
164. Secondary contraction	240
165. Scheme of secondary contraction. (<i>Stirling</i> .)	241
166. Scheme of paradoxical contraction. (<i>Stirling</i> .)	241
167. Kühne's experiment. (<i>Stirling</i> .)	243
168. Scheme of electrotonic excitability. (<i>Stirling</i> .)	244
169. Scheme of electrotonus. (<i>Stirling</i> .)	244
170. Curve of electrotonus. (<i>Stirling</i> .)	245
171. Scheme of electrotonus. (<i>Landois and Stirling</i> .)	246
172. Pohl's commutator with cross-bars	246
173. Scheme of Pflüger's law of contraction. (<i>Stirling</i> .)	247
174. Scheme for cathodic stimulation	249
175. Du Bois Reymond's rheochord	250
176. Scheme of velocity of nerve-energy. (<i>Stirling</i> .)	251
177. Kühne's gracilis experiment. (<i>Stirling</i> .)	253
178. Scheme for unequal excitability of a nerve. (<i>Stirling</i> .)	255
179. Scheme for Grünhagen's experiment	257
180. Frog's heart from the front. (<i>Ecker</i> .)	260
181. Frog's heart from behind. (<i>Ecker</i> .)	260
182. Simple frog's heart lever	263
183. Tracing of frog's heart. (<i>Stirling</i> .)	263
184. Effect of temperature on frog's heart tracing. (<i>Stirling</i> .)	264
185. Marey's heart lever	265
186. François-Frank's lever for heart of tortoise. (<i>Verdin</i> .)	265
187. Gaskell's lever. (<i>Stirling</i> .)	266
188. Tracing of frog's heart taken with 186. (<i>Stirling</i> .)	266
189. Heart-tracing, varying speed of drum. (<i>Stirling</i> .)	267

FIG.	PAGE
190. Heart-tracing, effect of heat and cold. (<i>Stirling</i>)	267
191. Gaskell's clamp. (<i>Stirling</i>)	268
192. Tracing of auricles and ventricle. (<i>Stirling</i>)	268
193. Gotch's arrangement for excised heart. (<i>Stirling</i>)	269
194. Tracing inhibition of heart. (<i>Stirling</i>)	272
195. Latent period of vagus. (<i>Stirling</i>)	273
196. Scheme of frog's vagus. (<i>Stirling</i>)	274
197. Vagus curve of frog's heart. (<i>Stirling</i>)	275
198. Scheme of frog's sympathetic. (<i>Gaskell</i>)	276
199. Effect of muscarine and atropine on the heart. (<i>Stirling</i>)	278
200. Support for frog's heart. (<i>Stirling</i>)	278
201. Staircase heart-tracing	278
202. Kronecker's frog's heart cannula	280
203. Heart-tracing during perfusion. (<i>Stirling</i>)	281
204. Scheme of Kronecker's manometer. (<i>Stirling</i>)	282
205. Scheme of Roy's tonometer. (<i>Stirling</i>)	283
206. Tonometer. (<i>Cambridge Scientific Instrument Co.</i>)	283
207. Illuminated ox-heart. (<i>Fredericq after Gad.</i>)	286
208. Marey's cardiograph	287
209. Polygraph of Rothe	288
210. Cardiac impulse tracing. (<i>Knoll</i>)	289
211. Rothe's tambour	289
212. Radial pulse and respirations. (<i>Knoll</i>)	290
213. Radial pulse and cardiac impulse. (<i>Knoll</i>)	250
214. Marey's sphygmograph. (<i>Bramwell</i>)	292
215. Sphygmograms. (<i>Marcy</i>)	292
216. Dudgeon's sphygmograph	293
217. Sphygmogram. (<i>Dudgeon</i>)	293
218. Ludwig's sphygmograph	293
219. Arm support for 217	294
220. Gas-sphygmoscope	295
221. Marey's scheme of rigid and elastic tubes	298
222. Rheometer	299
223. Capillary pressure apparatus (<i>V. Kries</i>)	301
224. Lymph-hearts. (<i>Ecker</i>)	301
225. Simple kymograph (made by <i>Verdin</i>)	302
226. Nerves in neck of rabbit. (<i>Cyon</i>)	303
227. Shielded electrodes as made by <i>Verdin</i>	303
228. Blood-pressure tracing of dog	304
229. Blood-pressure tracing of dog. (<i>Stirling</i>)	305
230. François-Frank's cannula. (<i>Verdin</i>)	306
231. Marey's respiration double tambour	308
232. Stethographic tracing. (<i>Stirling</i>)	309
233. Marey's stethograph (<i>Verdin</i>)	309
234. Stethographic tracing. (<i>Knoll</i>)	310
235. Müller's valves. (<i>Stirling</i>)	312
236. Heywood's experiment. (<i>Stirling</i>)	313
237. Gases collected over mercury. (<i>Gscheidlen</i>)	313
238. Hempel's apparatus for expired air	314
239. Hempel's absorption pipette	314

FIG.	PAGE
240. View of larynx	316
241. Larynx during vocalisation	316
242. König's apparatus	317
243. Reaction time, pendulum method. (<i>Rutherford.</i>)	324
244. Result obtained with 243. (<i>Rutherford.</i>)	324
245. Reaction time for touch, sight, hearing. (<i>Rutherford.</i>)	325
246. Reaction time. (<i>Stirling.</i>)	326
247. Neuramœbimeter. (<i>Obersteiner.</i>)	326
248. Frog's brain. (<i>Landois and Stirling.</i>)	327
249. Scheiner's experiment	332
250. Diffusion. (<i>Helmholtz.</i>)	332
251. Phakoscope	334
252. Model of plates of ophthalmometer. (<i>Auber.</i>)	334
253. Apparatus for vision of a point. (<i>Ludwig.</i>)	337
254. Mariotte's experiment	338
255. Mariotte's experiment (another way)	338
256. Blind spot. (<i>Helmholtz.</i>)	338
257. Volkman's experiment on the blind spot	339
258. Bergmann's experiment. (<i>Helmholtz.</i>)	340
259. Disc for Talbot's law. (<i>Helmholtz.</i>)	342
260. Charpentier's disc for "black band"	343
261. Charpentier's disc for coloured field	343
262. Priestley Smith's perimeter	344
263. Scheme for wheel movements of eye. (<i>Hering.</i>)	345
264. Irradiation. (<i>Helmholtz.</i>)	346
265. Irradiation. (<i>Helmholtz.</i>)	346
266. Irradiation. (<i>Helmholtz.</i>)	346
267. Imperfect visual judgments of letters	347
268. Zöllner's lines	347
269. Imperfect visual judgment of size	348
270. Perception of size. (<i>Helmholtz.</i>)	349
271. Spiral disc for radial movement. (<i>Helmholtz.</i>)	350
272. Kühne's artificial eye, as made by Jung	351
273. Apparatus to mix coloured light. (<i>Hering.</i>)	352
274. Scheme of 273. (<i>Hering.</i>)	352
275. Rothe's rotatory apparatus	353
276. Disc for contrast. (<i>Helmholtz.</i>)	355
277. Disc for simultaneous contrast. (<i>Helmholtz.</i>)	356
278. Ragona Scina's experiment. (<i>Rood.</i>)	356
279. Hering's apparatus for 278. (<i>Hering.</i>)	357
280. Apparatus for simultaneous contrast. (<i>Hering.</i>)	357
281. Simultaneous contrast apparatus. (<i>Hering.</i>)	357
282. Bird and cage experiment	361
283. Spectrum top. (<i>Hurst.</i>)	363
284. Spectrum top with spiral. (<i>Hurst.</i>)	363
285. Michel's carriage for rabbit. (<i>Stirling.</i>)	365
286. Priestley Smith's demonstrating ophthalmoscope	366
287. Aristotle's experiment	368
288. Sherrington's drum as made by Palmer	385
289. Birch's drum and recording apparatus. (<i>Birch.</i>)	386

PRACTICAL PHYSIOLOGY.

PART I.—CHEMICAL PHYSIOLOGY.

LESSON I.

THE PROTEIDS.

As a type of the group of proteids we may take white of egg, egg-white, or egg-albumin. In nature they occur only as constituents or products of living organisms. In animals they form the principal solids of the muscular, nervous, and glandular tissues of blood-serum and lymph. The bile, urine, tears, and sweat, are the only animal fluids which normally do not contain proteids. Their elementary composition varies within the following limits:—

	C.	H.	N.	O.	S.
From	50	6.8	15.0	22.8	0.4 per cent.
To	55	7.3	18.2	24.1	5.0 „

They are amorphous, and for the most part colloid bodies. They possess certain chemical reactions in common, and are closely related to each other. They are insoluble in alcohol and ether, some are soluble in water, others insoluble, while others are soluble in weak saline solutions. They all rotate the ray of polarised light to the left, and are thus lævorotatory. In strong acids and alkalis they are dissolved, but they mostly undergo decomposition in the process. When decomposed, they yield a very large number of other bodies, so that their constitution is exceedingly complex. In the body, after undergoing a series of metabolic changes, they are excreted chiefly in the form of urea, and a number of more or less closely related nitrogenous bodies. Besides the general characters stated below, most of them yield aromatic bodies, such as tyrosin and phenol.

1. Preparation of a Solution of Egg-Albumin—Soluble in Water.—Place the unboiled white of an egg in a porcelain capsule (taking care that none of the yolk escapes), and cut it freely many times with scissors to disintegrate the membranes, and thus liberate the albumin. Add twenty volumes of distilled water, shake the mixture vigorously in a flask until it froths freely. Cork the flask and invert it, mouth downwards, over a porcelain capsule; the froth and *débris* float to the surface, and, after a time, if the cork be gently withdrawn to allow the fluid to escape, a slightly opalescent fluid is obtained. The opalescence is due to the precipitation of a small quantity of globulins. If the fluid be too opalescent, strain through flannel or several folds of muslin. Such a solution filters slowly, so that it is better to employ several small filters if a clearer solution be required. If the fluid be alkaline, neutralise it with 2 per cent. acetic acid. Egg-white contains about 11–12 per cent. of egg-albumin, together with small quantities of globulins, grape-sugar, and mineral matter.

General Reactions.—(A.) Colour Reactions.

(a.) **Xanthoproteic Reaction.**—Add strong nitric acid = a white precipitate, which on being boiled turns yellow. After cooling add ammonia = the yellow colour or precipitate becomes orange.

(b.) **Millon's Test** = a whitish precipitate which becomes brick-red on boiling. A red colour of the fluid is obtained if only a trace of proteid be present.

Preparation of Millon's Reagent.—Dissolve mercury in its own weight of strong nitric acid, specific gravity 1.4, and to the solution thus obtained add two volumes of water. Allow it to stand, and afterwards decant the clear fluid; or take one part of mercury, add two parts nitric acid, specific gravity 1.4 in the cold, and heat over a water-bath till complete solution occurs. Dilute with two volumes of water, and decant the clear fluid after twelve hours.

(c.) **Piotrowski's Reaction.**—Add excess of strong solution of caustic soda (or potash), and then a drop or two of *very dilute* solution of cupric sulphate (1 per cent.) = a *violet* colour. The reaction occurs more quickly if heat is applied, and the colour deepens.

The peptones and albumoses give a *rose-pink* colour, instead of a violet, if only a trace of copper sulphate is used.

(B.) **Precipitation.**—Peptones and albumoses are exceptions in many cases.

(d.) The solution is precipitated by (i.) lead acetate; (ii.) mercuric chloride; (iii.) picric acid; (iv.) strong acids, *e.g.*, nitric; (v.) tannin; (vi.) alcohol.

(e.) Make a portion strongly acid with acetic acid, and add potassic ferrocyanide = a white precipitate.

(f.) Saturate it with ammonium sulphate by adding crystals of

the salt, and shaking vigorously in a tube or flask. This precipitates all proteids except peptones. Filter; the filtrate contains no proteids.

(g.) By hydrochloric acid in a solution saturated with common salt.

(h.) By alcohol, except in the presence of a free alkali.

(i.) Precipitate a portion with (i.) meta-phosphoric acid; (ii.) phosphotungstic acid, after acidulating with HCl.

N.B.—Peptones are not precipitated by (e.) and (f.).

(C.) Coagulation by Heat.

(j.) Heat the fluid to boiling—there is no coagulum of albumin formed—and then add, drop by drop, dilute acetic acid (2 per cent.), until a flaky coagulum of coagulated insoluble albumin separates.

The coagulum comes down about 70° C. Unless the fluid be acidulated, the albumin does not coagulate.

(k.) Boil and add nitric acid = a white or yellowish coagulum.

(l.) Acidify strongly with acetic acid, add an equal volume of a saturated solution of sodic sulphate, and boil = coagulation. This precipitates all proteids except peptones. This method and the foregoing (j.) are used for separating the albumin in a liquid containing it.

(D.) (m.) **Indiffusibility.**—Place some of the solution either in a dialyser or in a sausage-tube made of parchment-paper, and suspend the latter by means of a glass rod thrust through the tube just below the two open ends (Lesson IX.) in a tall glass jar filled with distilled water, so that the two open ends are above the surface of the water. The salts (crystalloids) diffuse readily (test for chlorides by nitrate of silver and nitric acid), but on applying any of the above tests no proteids are found in the diffusate. They belong to the group of *Colloid* bodies. (Peptones, however, are diffusible through animal membranes.)

(E.) (n.) **Reaction of Adamkiewicz.**—To white of egg add glacial acetic acid, and heat to get it in solution; gradually add concentrated sulphuric acid = a violet colour with slight fluorescence.

(o.) **Liebermann's Reaction.**—Wash finely powdered albumin first with alcohol and then with cold ether, and heat the washed residue with concentrated hydrochloric acid = a deep violet-blue colour. This is best done in a white porcelain capsule, or on a filter-paper in a funnel; in the latter case, the boiling acid is poured gently down the side of the filter-paper.

For other colour reactions with cobalt sulphate and NH_4HO , and KHO see Pickering, *Journ. of Phys.*, vol. xiv.

2. Presence of Nitrogen and Sulphur in Albumin.

(a.) Place some powdered dried albumin in a reduction tube, and into the mouth of the tube insert (1) a red litmus paper, and (2) a lead acetate paper. On heating the tube, the former becomes blue from the escape of ammonia, which can also be

smelt (odour of burned feathers), and the latter black from the formation of lead sulphide.

(b.) Heat some dry proteid with excess of soda-lime in a hard dry tube; ammonia vapour is evolved.

(c.) Place a few grains of the dry proteid, with a small piece of metallic sodium, in a dry hard tube, and heat slowly at first, and then strongly. After cooling, add carefully 3 cc. of water to the NaCy residue, filter, and to the filtrate add a few drops of ferric chloride and ferrous sulphate, and then add excess of hydrochloric acid. If nitrogen be present, there is a precipitate of Berlin blue, sometimes only seen after standing for a time.

(d.) To a solution of albumin add an equal volume of solution of caustic potash and a few drops of lead acetate and boil for some time = slowly a brownish colouration, due to lead sulphide.

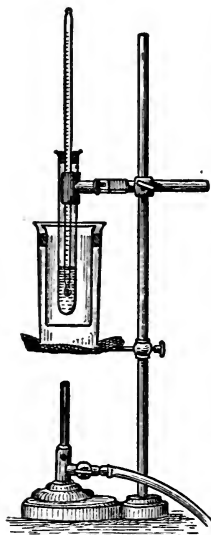

FIG. 1.—Apparatus for Determining the Coagulation Temperature of Proteids.

3. Determination of Temperature of Coagulation (fig. 1).—The reaction of the fluid must be neutral or feebly acid. "A glass beaker containing water is placed within a second larger beaker also containing water, the two being separated by a ring of cork. Into the water contained in the inner beaker there is immersed a test-tube, in which is fixed an accurately graduated thermometer, provided with a long narrow bulb. The solution of the proteid, of which the temperature of coagulation is to be determined, is placed in the test-tube, the quantity being just sufficient to cover the thermometer bulb. The whole apparatus is then gradually heated, and the experimenter notes the temperature at which the liquid first shows signs of opalescence" (*Gamgee*).

4. Circumstances Modifying the Coagulating Temperature.—Place 5 cc. of the solution of albumin in each of three test-tubes, colour them with a neutral solution of litmus, and label them A, B, C. To A add a drop of very dilute acetic acid (0.1 per cent. acetic acid diluted five or six times); to B add a very dilute solution of caustic soda (0.1 per cent. of soda or potash similarly diluted); C is neutral for comparison. Place all three tubes in a beaker with water and heat them gradually, noting that coagulation occurs first in A, next in C, and not at all in B, the alkaline solution.

CLASSIFICATION OF PROTEIDS.

5. I. Native Albumins are *soluble in water*, in dilute saline solutions, in saturated solutions of sodic chloride, and magnesium sulphate, and are not precipitated by alkaline carbonates, sodic chloride, or very dilute acids. They are precipitated by saturating their solutions with ammonium sulphate. These solutions are coagulated by heat at 70° to 73° C., although the temperature

varies considerably with a large number of conditions. When dried at 40° C. they yield a clear yellow coloured mass, "soluble albumin," which is soluble in water.

(1.) **Egg-Albumin.**—Prepare a solution (Lesson I. 1.).

(a.) Evaporate some of the fluid to dryness at 40° C. over a water-bath to obtain "soluble albumin." Study its characters, notably its solubility in water. This solution gives all the tests of egg-albumin. It is more convenient to purchase this substance.

(b.) The fluid gives all the general proteid reactions.

(c.) Precipitate portions of the fluid with strong mineral acids, including sulphuric and hydrochloric acids.

(d.) Precipitate other portions by each of the following:—Mercuric chloride, basic lead acetate, tannic acid, alcohol, picric acid.

(e.) Take 5 cc. of the fluid, add twice its volume of 0.1 per cent. sulphuric acid, and then add ether. Shake briskly = coagulation after a time, at the line of junction of the fluids.

(f.) The solution is *not precipitated* on saturation with crystals of sodic chloride or magnesian sulphate, but it is completely precipitated on saturation with ammonium sulphate $(\text{NH}_4)_2\text{SO}_4$ (compare "Globulins").

(g.) A solution containing 1–3 per cent. of salts coagulates at about 56° C.

(2.) **Serum-Albumin.**—Blood-serum (see "Blood") contains serum-albumin and serum-globulin. Dilute blood-serum until it has the same specific gravity as the egg-albumin solution. A slight opalescence, due to precipitation of serum-globulin, is obtained. Neutralise the solution with very dilute acid until a faint haziness is obtained.

Repeat the tests for egg-albumin, and, in addition, with undiluted blood-serum.

(h.) Add crystals of MgSO_4 to saturation, shaking the flask vigorously to do so = a white precipitate of serum-globulin. Filter. The filtrate contains serum-albumin.

(i.) Saturate serum with $(\text{NH}_4)_2\text{SO}_4$ = white precipitate of both serum-albumin and serum-globulin. Filter. The filtrate contains no proteids.

EGG-ALBUMIN.

(i.) Readily precipitated by hydrochloric acid, but the precipitate is not readily soluble in excess.

(ii.) A non-alkaline solution is coagulated by ether.

SERUM-ALBUMIN.

(i.) It is also precipitated by hydrochloric acid, but not so readily, while the precipitate is soluble in excess.

(ii.) It is not coagulated by ether.

EGG-ALBUMIN.

(iii.) The precipitate with nitric acid is soluble with difficulty in excess of the acid.

(iv.) The precipitate obtained by boiling is but slightly soluble in boiling nitric acid.

(v.) Its solution is not precipitated by $MgSO_4$, but is completely precipitated by $(NH_4)_2SO_4$.

[(vi.) When injected under the skin, or introduced in large quantities into the stomach or rectum, it is given off by the urine.]

SERUM-ALBUMIN.

(iii.) The corresponding precipitate is much more soluble in excess of acid.

(iv.) The corresponding precipitate is soluble in strong nitric acid.

(v.) Gives the same reactions as in (5, I. f.).

[(vi.) When injected under the skin, it does not appear in the urine.]

(3.) Lact-Albumin, see "Milk."

6. II. Globulins are insoluble in pure water, *soluble in dilute saline solutions*—e.g., $NaCl$, $MgSO_4$, $(NH_4)_2SO_4$ —but insoluble in concentrated or saturated solutions of neutral salts. Their solutions in these salts are coagulated by heat. They are soluble in dilute acids and alkalis, yielding acid- and alkali-albumin respectively. Most of them are precipitated from their saline solution by saturation with sodic chloride, magnesium sulphate, and some other neutral salts.

(r.) **Serum-Globulin.**—It forms about half of the total proteids of blood-serum. It is insoluble in water, readily soluble in dilute saline solutions ($NaCl$, $MgSO_4$). Its solutions give the general reactions for proteids. Its $NaCl$ solution coagulates at about $75^\circ C$.

(a.) Neutralise 5 cc. of blood-serum with a few drops of dilute sulphuric acid (0.1 per cent.), then add 75 cc. of distilled water, and allow the precipitate to settle. Pour off the fluid and divide the precipitate into two portions, noting that it is insoluble in water, but soluble in excess of acid.

(b.) Boil a portion of the neutralised fluid = coagulation.

(c.) Saturate blood-serum in a test-tube with magnesium sulphate, shaking briskly for some time. Serum-globulin separates out and floats on the surface. Filter, and test the filtrate for serum-albumin.

(d.) Place 5 cc. of blood-serum in a tube, and pour a saturated solution of magnesium sulphate down the side of the tube to form a layer at the bottom of the tube. Where the two fluids meet there is a white deposit of serum-globulin.

(e) Saturate blood-serum with crystals of sodium chloride or neutral ammonium sulphate = separation of serum-globulin, which floats on the surface.

(f) Precipitate the serum-globulin with magnesium sulphate, and filter. To the filtrate add sodium sulphate in excess, which gives a further precipitate. The filtrate may still give the reactions for proteids.

(2.) **Fibrinogen**, see "Blood."

(3.) **Myosin**, see "Muscle."

(4.) **Vitellin**.—Shake the yolk of an egg with water and ether, as long as the washings show a yellow colour. Dissolve the residue in a minimal amount of 10 per cent. sodium chloride solution. Pour it into a large quantity of water, slightly acidulated with acetic acid = white precipitate of impure vitellin.

(a.) Dissolve some of the precipitate in a very weak saline solution, and observe that it is not reprecipitated by saturation with sodic chloride.

(b.) Test some of the weak saline solution = coagulation about 75° C.

(c.) The precipitate is readily soluble in .1 per cent. hydrochloric acid, and also in weak alkalies.

(5.) **Crystallin** is obtained from the crystalline lens.

(6.) **Globin** the proteid constituent of hæmoglobin.

7. III. **Derived Albumins (Albuminates)** are compounds of proteids with mineral substances. Those produced by the action of acids or alkalies on albumins and globulins, yield respectively acid-albumin and alkali-albumin. They are insoluble in pure water and in solutions of sodium chloride, but readily soluble in dilute hydrochloric acid and dilute alkalies. The solutions are not coagulated by heat.

(1.) **Alkali-Albumin or Alkali-Albuminate.**

(a.) To dilute egg-albumin add a few drops of 0.1 per cent. caustic soda, and keep it at 40° C. for 5–10 minutes = **alkali-albumin**. Boil the fluid; it does not coagulate.

(b.) Test the reaction; it is alkaline to litmus paper.

(c.) Cool some of the alkali-albumin, colour it with litmus solution, and neutralise carefully with 0.1 per cent. sulphuric acid = a precipitate on neutralisation, which is soluble in excess of the acid, or of alkali.

(d.) Repeat (c.); but, before neutralising, add a few drops of sodium phosphate solution (10 per cent.), and note that the alkaline phosphates prevent the precipitation on neutralisation, until at least sufficient acid is added to convert the basic phosphate into acid phosphate. The solution must be decidedly acid before a precipitate is obtained.

(e.) Precipitate by saturating it with crystals of common salt or magnesium sulphate.

(f.) **Lieberkühn's Jelly** is a strong solution of alkali-albumin.

Place undiluted egg-white in a test-tube, and add strong caustic potash. The whole mass becomes a jelly, so that the tube can be inverted without the mass falling out.

(g.) Its solution gives the general reactions for proteids under 1 (A.).

(2.) **Acid-Albumin** [or **Syntonin**].

Preparation—(A.) To dilute egg-albumin, add 0.1 per cent. sulphuric acid, and warm gently for several minutes = **acid-albumin**.

(B.) To finely-minced muscle, *e.g.*, of frog, add ten times its volume of dilute hydrochloric acid (4 cc. of acid in 1 litre of water), and allow it to stand for several hours, taking care to stir it frequently; filter, the filtrate is a solution of a globulin combined with an acid, and has been called **syntonin**.

(C.) Allow concentrated hydrochloric acid to act on fibrin for a time, and filter.

(D.) It may be prepared by dissolving myosin in excess of .1 per cent. HCl, and after a time neutralising the solution with sodic carbonate.

(E.) To undiluted egg-white, add acetic acid = a jelly of acid-albumin.

Use the clear filtrate from (A.) or (B.) for testing.

(a.) The reaction is acid to litmus paper.

(b.) Boil the solution; it does not coagulate.

(c.) Add litmus solution, and neutralise with very dilute caustic soda = a precipitate soluble in excess of the alkali or acid.

(d.) Repeat (c.), but add sodium phosphate before neutralising; the acid-albumin is precipitated when the fluid is neutralised; so that sodium phosphate does not interfere with its precipitation.

(e.) Add strong nitric acid = a precipitate which dissolves on heating, producing an intense yellow colour.

(f.) It is precipitated like globulins by saturation with neutral salts, *e.g.*, NaCl, MgSO₄, (NH₄)₂SO₄.

(g.) Boiled with lime-water = partial coagulation.

8. IV. **Caseinogen**, the chief proteid of milk was formerly regarded as a derived albumin. It is precipitated by acid. Like globulins it is precipitated by saturating milk with NaCl or MgSO₄, but it is not coagulated by heat. (See "Milk.")

9. V. **Proteoses** or **Albumoses**.—In the peptic and tryptic digestion of proteids these bodies are formed as intermediate products. In peptic digestion of albumin, acid-albumin is first formed, and finally peptone. Between the two is the group of proteoses or albumoses. There are several of them, and they were formerly grouped together as **hemi-albumose**. These proteoses have been subdivided into albumoses, globuloses, caseoses, &c., according as they are derived from albumin, globulin, or casein. (See "Digestion.") Witte's peptone usually contains a small amount of

peptone, and much albumose. Dissolve some of this body in warm water, or preferably in 10 per cent. sodium chloride.

(a.) They are soluble in water; not coagulated by heat; and are precipitated by saturation with neutral ammonium sulphate. The precipitate with $(\text{NH}_4)_2\text{SO}_4$ partly disappears on heating, and reappears on cooling. They are precipitated but not coagulated by alcohol.

(b.) Add nitric acid = a white precipitate which dissolves with heat (yellow fluid) and reappears on cooling. Run tap water on the tube, the precipitate reappears. This is a characteristic reaction, and occurs best in the presence of NaCl.

(c.) It, like peptone, gives a *rosy-pink* with Piotrowski's test.

(d.) It is precipitated by acetic acid and ferrocyanide of potassium, but the precipitate disappears on heating, and reappears on cooling.

(e.) It is precipitated by acetic acid and saturation with NaCl. The precipitate disappears on heating, and reappears on cooling.

10. VI. Peptones are hydrated proteids, and are usually produced by the action of proteolytic ferments on proteids. They are exceedingly soluble in water. Their solutions are not precipitated by sodic chloride, acids, or alkalis, nor are they coagulated by heat. They are precipitated by tannic acid, and with difficulty by a large excess of absolute alcohol. Not precipitated by $(\text{NH}_4)_2\text{SO}_4$.

Preparation (see "Digestion").—For applying the tests dissolve a small quantity of Darby's fluid meat or commercial peptone in warm water. Commercial peptone contains only a small amount of peptone, and much albumose.

(a.) Boil a portion; it is not coagulated.

(b.) **Xanthoproteic Reaction.**—Add nitric acid, and boil = a faint yellowish colour, and rarely any previous precipitate; cool, and add ammonia = orange colour.

(c.) Acidify strongly with acetic acid, and add ferrocyanide of potassium = no precipitate.

(d.) Test separate portions with tannic acid; potassio-mercuric iodide; mercuric chloride; picric acid (saturated solution); and lead acetate. Each of these causes a precipitate. In the case of picric acid the precipitate disappears on heating, and reappears on cooling.

(e.) **Biuret Reaction.**—Add excess of caustic soda, and then a few drops of *very dilute* solution of copper sulphate = a *rose* colour; on adding more copper sulphate, it changes to a violet.

(f.) Add a drop or two of Fehling's solution = a *rose* colour; add more Fehling's solution it changes to violet.

(g.) Neutralise another portion = no precipitate.

(h.) Add excess of absolute alcohol = a precipitate of peptone, but not in a coagulated form.

(i.) It is not precipitated by saturation with sodic chloride or magnesian sulphate, nor by boiling with sodic sulphate and acetic acid.

(j.) Pure peptone is not precipitated by saturation with neutral sulphate of ammonia. *N.B.*—The other proteids are. Hence this salt is a good reagent for separating other proteids, and thus leaving the peptones in solution.

(k.) It also gives Millon's test.

(l.) **Diffusibility of Peptones.**—Place a solution of peptones in a dialyser covered with an *animal* membrane, as directed in Lesson I. 1 (D.) (m.), and test the diffusate after some time for peptones. Peptones do not diffuse through a parchment tube.

(m.) Saturate the solution of commercial peptones with $(\text{NH}_4)_2\text{SO}_4$ = a precipitate of albumoses or proteoses. Filter. The filtrate contains the pure peptone.

11. VII. Coagulated Proteids are insoluble in water, weak acids, and alkalis, and are dissolved when digested at 35° to 40° C. in gastric juice (acid medium), or pancreatic juice (alkaline medium), forming first proteoses and finally peptones. They give Millon's reaction.

There are two subdivisions:—

(A.) Proteids coagulated by Heat.

Preparation.—Boil white of egg hard, and chop up the white.

(a.) Test its insolubility in water, weak acids, and alkalis.

(b.) It is partially soluble in acids and alkalis, when boiled for some time.

(c.) Bruise some of the solid boiled white of egg, diffuse it in water, and test it with Millon's reagent.

(d.) For the effect of the digestive juices see "Digestion."

(B.) Proteids coagulated by Ferment Action.

(i.) Fibrin is insoluble in water and in weak solutions of common salt. When prepared from blood, and washed, it is a white, fibrous, soft, and very elastic substance, which exhibits fibrillation under a high magnifying power (see "Blood").

(a.) Place well-washed fibrin in a test-tube, add 0.1 per cent. hydrochloric acid. The fibrin swells up and becomes clear in the cold, but does not dissolve.

(b.) Repeat (a.), but keep on a water-bath at 60° C. for several hours; filter, and test the filtrate for acid-albumin by neutralisation with very dilute potash.

(c.) To a very dilute solution of copper sulphate in a test-tube, add fibrin. The latter becomes greenish, while the fluid is decolourised. Add caustic soda, the flake becomes violet.

(d.) For the effect of a dilute acid and pepsin (see "Digestion"). These "digest" fibrin, and convert it into proteose, and ultimately into peptone.

(e.) It decomposes hydric peroxide, and turns freshly-prepared tincture of guaiacum blue (see "Blood").

(f.) Digest fibrin in 10 per cent. sodium chloride for two days. A small part is dissolved; boil the fluid = coagulation.

(ii.) MYOSIN (see "Muscle").

(iii.) CASEIN (see "Milk").

(iv.) GLUTEN (see "Bread").

12. VIII. Lardacein, or Amyloid Substance.—This occurs in organs, *e.g.*, liver and kidney, undergoing the pathological degeneration known as amyloid, waxy or wax like, or albumenoid disease. It is insoluble in dilute acids or alkalies, and it is not acted on by the gastric juice. It gives several distinct reactions, not stains, with certain staining fluids.

(a.) A solution of iodine in iodide of potassium gives a deep brown or mahogany stain when poured on a section of a fresh waxy organ.

(b.) With iodine and sulphuric acid occasionally a blue reaction is obtained.

(c.) Methyl-violet and gentian-violet give a rose-pink reaction with the waxy parts, while others, *i.e.*, the healthy parts of an organ, give different shades of blue or purple.

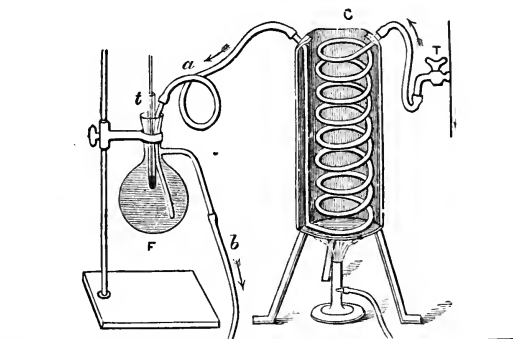

FIG. 2.—Apparatus of Halliburton for Fractional Heat Coagulation of Proteids. *T.* Tap for Water; *C.* Copper vessel with spiral tube; *a.* Inlet, and *b.* Outlet-tube to the flask; *t.* Test tube, with fluid and thermometer.

13. Fractional Heat Coagulation, *e.g.*, of blood-serum.—The serum or other fluid containing proteid is heated until a flocculent precipitate occurs. Filter. The filtrate is again heated to a higher temperature, until a similar precipitate appears. This precipitate is filtered off, and the above process repeated, until the liquid is free of proteid.

The arrangements shown in fig. 1 may be used, but the rise of temperature takes place rather too slowly, and it is difficult to maintain the temperature constant for a considerable length of time when one is investigating a large number of fluids. The following apparatus used by Halliburton (fig. 2) is more convenient. "A glass flask supported on a stand; down its neck is placed a test-tube, in which again is placed the liquid under investigation in sufficient quantity to cover the bulb of a thermometer placed in it. The flask is kept filled with hot water, and this water is constantly flowing." It enters by (*a*), passing to the bottom of the flask, and leaves at (*b*). The

water is heated by passing through a coil of tubing contained in a copper vessel, not unlike Fletcher's hot-water apparatus. The fluid to be tested must be well stirred by the thermometer during the progress of the experiment.

In carrying out the experiment the following precautions are necessary, viz., to keep the fluid under investigation as nearly as possible always of the same reaction, as one of the important conditions influencing the temperature of coagulation of a liquid is the amount of free acid present.

Use 2 per cent. acetic acid, and place it in a burette. It is dropped into the fluid from the burette. The proportion is about one drop of this dilute acid—after neutrality is reached—to 3 cc. of liquid. The acidity of the liquid is tested by sensitive litmus papers. The liquid must be kept at a given temperature for at least five minutes, to ensure complete precipitation of the proteid at that temperature.

On heating certain solutions containing certain proteids, as the temperature of the fluid is raised, a faint opalescence appears first, and then, at a higher temperature, masses or flocculi separate out, usually somewhat suddenly, from the fluid.

The temperature at which coagulation of what is apparently one and the same proteid occurs varies with a large number of conditions. Not only have different proteids different coagulating points, which, however, can hardly in the light of recent researches be called "specific coagulation temperatures," but the coagulating temperature of any one proteid varies with the rapidity with which coagulation takes place; the proteid coagulates at a higher temperature when the fluid is heated quickly than if it be heated slowly. It also varies with the amount of dilution, the coagulating point being raised by dilution. The effects of salts and acids in altering the coagulation point are well known.

14. Removal of Proteids.—The following, amongst other methods, are used for removing proteids from liquids containing them. In this way other substances present may be more easily detected.

Wenz's Method.—Saturate with $(\text{NH}_4)_2\text{SO}_4$. This precipitates all proteids except peptones.

By Boiling.—Acidulate faintly with acetic acid and boil. This removes globulins and albumins.

Brücke's Method.—Acidulate with HCl, and then add potassio-mercuric iodide (see "Liver").

By Alcohol.—Acidify feebly with acetic acid, add several volumes of absolute alcohol. After 24 hours all proteid is precipitated.

Girgensohn's Method.—Mix the solution with half its volume of a saturated solution of sodium chloride, and add tannic acid in slight excess. This precipitates all proteids.

There are other methods in use.

LESSON II.

THE ALBUMENOIDS.

THE group of albumenoids includes a number of bodies which in their general characters and elementary composition resemble proteids, but differ from them in many respects. They are amorphous. Some of them contain sulphur, and others do not. The decomposition-products resemble the decomposition-products of proteids.

1. I. Gelatin is obtained by the prolonged boiling of connective tissues, *e.g.*, tendon, ligaments, bone, and from the substance "Collagen," of which fibrous tissue is said to consist.

Preparation of a Solution.—Make a watery solution (5 per cent.) by allowing it to swell up in water, and then dissolving it with the aid of heat.

(A.) (a.) It is insoluble, but swells up in about six times its volume of cold water.

(b.) After a time heat the gelatin swollen up in water; it dissolves. Allow it to cool; it gelatinises.

(B.) With General Proteid Tests.

(c.) Xanthoproteic Test.—Add nitric acid and boil = a light yellow colour with no previous precipitate; the fluid becomes orange or rather lemon-coloured on adding ammonia.

(d.) Millon's Reagent = no pinkish-red precipitate on boiling. This shows the absence of the tyrosin group in the gelatin molecule. This reaction may be obtained with commercial gelatin, but not with pure gelatin, so that the reaction if obtained is due to impurities.

(e.) It gives a blue-violet, rather than a violet colour, with NaHO and CuSO_4 .

(f.) It is not precipitated by acetic acid and potassic ferrocyanide (unlike albumin).

(g.) It is not coagulated by heat (unlike albumin).

(h.) It is not coagulated by boiling with sodic sulphate and acetic acid (unlike albumin).

(i.) It is precipitated by saturation with MgSO_4 or $(\text{NH}_4)_2\text{SO}_4$.

(C.) Special Reactions.

(j.) It is not precipitated by acids (acetic or hydrochloric), or alkalis, or lead acetate.

(k.) Add mercuric chloride = no precipitate (unlike albumose and peptone).

(*l.*) Add tannic acid = copious white precipitate, insoluble in excess.

(*m.*) Add picric acid (saturated solution) = yellowish-white precipitate, which disappears on heating and reappears on cooling.

(*n.*) It is precipitated by alcohol, and also by platinic chloride.

2. II. **Chondrin** is obtained by the prolonged boiling of cartilage, which largely consists of the substance "**Chondrigen**."

Preparation.—Costal cartilages freed of their perichondrium and cut into small pieces are boiled for several hours in water, when an opalescent fluid, which gelatinises on cooling, is formed.

(*a.*) Add acetic acid = a white precipitate, soluble in great excess.

(*b.*) Dilute mineral acids = white precipitate, readily soluble in excess.

(*c.*) It is not precipitated by acetic acid and potassic ferrocyanide.

3. III. **Mucin**, see "**Saliva**." It is also found in the ground substance of connective tissue and tendon. There are probably several mucins. On heating with dilute H_2SO_4 they yield a reducing sugar, and they are regarded as glucosides, compounds of a proteid (globulin?) with animal gum.

(*a.*) They make fluids viscid and slimy.

(*b.*) Cut a tendon into pieces and place it for 3 days in lime-water. The lime-water dissolves the mucin. Add acetic acid = precipitate of mucin.

4. IV. **Elastin** occurs in elastic tissue, ligamentum nuchæ, and ligamenta subflava, &c.

PREPARATION.—Boil the fresh ligamentum nuchæ of an ox successively in alcohol, ether (to remove the fats), water (to remove the gelatin), and finally in acids and alkalies. This substance must be previously prepared so that the student can test its reactions.

(*a.*) It is insoluble in water, but is soluble in strong caustic soda.

(*b.*) It gives the xanthoproteic tests.

(*c.*) It is precipitated from a solution by tannic acid.

5. V. **Keratin** occurs in epithelial structures, *e.g.*, surface layers of the epidermis, hairs, horn, hoof, and nails. It is characterised by the large percentage of sulphur it contains; part of the latter is loosely combined. It is very insoluble and resists putrefaction for a long time. A closely-allied body, **Neuro-Keratin**, is found in nerve fibres and the central nervous system.

(*a.*) Burn a paring of horn, and note the characteristic smell.

(*b.*) Heat a paring of nail or horn with strong caustic soda and lead acetate = black or brown colouration, due to lead sulphide.

(*c.*) Test for the presence of sulphur. (Lesson I. 2.)

LESSON III.

THE CARBOHYDRATES.

THE term Carbohydrate, first used by C. Schmidt, is applied to a large and important group of substances, which occur especially in plants, and some of which, such as starch and sugar, make up a large part of their organs; while cellulose, another member of the group, forms the chief material from which many parts of plants are constructed. Carbohydrates also occur, but to a much smaller extent, in animals, in which they are chiefly represented by glycogen and some forms of sugar.

In elementary composition they are non-nitrogenous, and consist of C, H, and O, with the H and O in the same proportion as in water, *i.e.*, 2 atoms of H to 1 atom of O. As this proportion obtains in many other substances which certainly do not belong to the carbohydrate group, *e.g.*, acetic acid ($C_2H_4O_2$), lactic acid ($C_3H_6O_3$), the definition must be somewhat extended. The group is understood to include those substances that do not contain less than 6 atoms of carbon, although many carbohydrates contain multiples of this. To every 6 atoms of C there are at least 5 atoms of O, so that on the one hand acetic acid is excluded, and pyrogallic acid ($C_6H_6O_3$) on the other.

They have certain general characters. They are indifferent bodies, with a neutral reaction, which form only loose combinations with other bodies, specially with bases. Other general characters they possess directly, *e.g.*, dextrose, or they can be readily converted into bodies which have the following features in common. One or other character may fail, but, as a group, they have the following:—

(a.) The property of *reducing alkaline metallic solutions*, and of being coloured **yellow** by alkalis.

(b.) They *rotate the plane of polarised light*.

(c.) In contact with yeast they split up into alcohol and carbon dioxide, *i.e.*, undergo *fermentation*. (Some do not undergo fermentation.)

(d.) On heating with HCl or H_2SO_4 they are decomposed with the formation of *lævulinic acid*, humin substance, and formic acid.

(e.) They give a deposit of yellow needles with *phenyl-hydrazin*.

(f.) Various *colour reactions* with acids and aromatic alcohols.

(g.) Some, *e.g.*, cellulose and starch, are quite *insoluble* in water, while others are very *soluble*. Those which are very insoluble in water can usually be rendered soluble by heating them with an

acid. This is a process of hydrolysis. They are less soluble in alcohol the more concentrated it is. In absolute alcohol (and ether) almost all the carbohydrates are soluble with difficulty, or insoluble.

(*h.*) When strongly heated they are decomposed, charred, and yield a variety of products. Inosite, which, however, is not a true carbohydrate, alone undergoes partial sublimation (*Tollens*).

Classification of some Carbohydrates:—

I. Glucoses or Monosaccharids, $C_6H_{12}O_6$.	II. Saccharoses or Disaccharids, $C_{12}H_{22}O_{11}$.	III. Amyloses or Polysaccharids, $n(C_6H_{10}O_5)$.
+ Dextrose. - Lævulose. + Galactose Inosite(?).	+ Cane-sugar. + Lactose. + Maltose.	+ Starch. + Dextrin. + Glycogen. Cellulose. Gums.

The + and - signs indicate that, as regards polarised light, the substances are dextro- and lævorotatory respectively.

The amyloses are anhydrides of the glucoses [$n(C_6H_{12}O_6) - nH_2O = (C_6H_{10}O_5)_n$], while the saccharoses are condensed glucoses [$(C_6H_{12}O_6 + C_6H_{12}O_6 - H_2O = C_{12}H_{22}O_{11})$]. The saccharoses are converted into glucoses on boiling with dilute sulphuric acid.

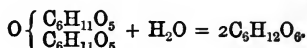

Emil Fischer has shown that the monosaccharids are aldehydes or ketones of a hexatomic alcohol, $C_6H_8(OH)_6$. Just as aldehyde C_2H_4O is formed by oxidising ethylic alcohol C_2H_6O , so from mannitic alcohol the simplest carbohydrate $C_6H_{12}O_6$ is formed. When two molecules of such monosaccharids polymerise with the loss of water, they form the disaccharids, which may split up again and yield monosaccharids. When there is further polymerisation with loss of water we get bodies with molecules of larger size—the simpler members being dextrans, the more complex starch and glycogen, forming the group of polysaccharids. These in turn may break down and yield monosaccharid or disaccharid molecules. Thus the transformation undergone by carbohydrates in the organism, their conversion from one form to another, are rendered more easy of comprehension.

1. **I. Starch** ($C_6H_{10}O_5$)_n.—The *n* in this case is not less than 4, and may be 10 or 20; indeed, Brown and Heron suggest the formula $100(C_{12}H_{20}O_{10})$. Starch is one of the most widely distributed substances in plants, and it may occur in all the organs of plants, either (*a.*) as a direct or indirect product of the assimilation of CO_2 in the leaves of the plant, or (*b.*) as reserve material in the roots, seeds, or shoots for the later periods of generation or vegetation.

Preparation.—Wash a potato thoroughly, and grate it on a grater into water in a tall cylindrical glass. Allow the suspended particles to subside, and after a time note the deposit; the lowest stratum consists of a white powder or starch, and above it lie coarser fragments of cellulose and other matters. Decant off the supernatant fluid which becomes brown on standing.

(*a.*) **Microscopical Examination.**—Examine the white deposit of starch, noting that each starch-granule shows an eccentric hilum



FIG. 3.—Potato Starch.

with concentric markings (fig. 3). Add a very dilute solution of iodine. Each granule becomes blue, while the concentric markings become more distinct.

(*b.*) Compare the microscopical characters of other varieties of starch—*e.g.*, rice, arrowroot, &c. Each granule consists of an outer layer of cellulose enclosing alternating layers of granulose and cellulose, so that they present a laminated appearance. There are very great varieties in the shape and size of starch grains.

(*c.*) Squeeze some dry starch powder between the thumb and forefinger, and note the peculiar crepitation sound and feeling.

(*d.*) **Polariscope.**—Examine starch granules with a polarisation microscope. With crossed Nicol's, when the field is dark, each granule shows a dark cross on a white refractive ground. They are doubly refractive. If a plate of mica be placed on the stage of the microscope under the starch grains, the latter, with polarised light, exhibit interference colours (fig. 4).

2. **Prepare a Solution.**—Place 1 gram of starch in a mortar, rub it up with a little cold water, and then add 50 cc. of boiling water. Boil until an opalescent imperfect solution is obtained.

(a.) Add powdered dry starch to cold water. It is insoluble. Filter, and test the filtrate with iodine. It gives no blue colour.

(b.) Boil starch with water = opalescent solution, which if strong gelatinises or sets on cooling = starch paste.

(c.) Add a solution of iodine¹ = a blue colour, which disappears on heating (the iodide of starch is dissociated by heat) and reappears on cooling—provided it has not been boiled too long. Direct a stream of cold water upon the test-tube to cool it.



FIG. 4. — Potato Starch Granules. View in polarised light with crossed Nicol's, $\times 300$.

(d.) Render some of the starch solution alkaline by adding caustic soda solution. Add iodine solution. No blue colour is obtained.

(e.) Acidify (d.) with dilute sulphuric acid, then add iodine = blue colour is obtained.

(f.) To another portion of the solution add a few drops of dilute cupric sulphate and caustic soda, and boil = no reaction (compare "Grape-sugar").

(g.) To another portion of the solution add Fehling's solution, and boil = no reaction.

(h.) Add tannic acid = yellowish precipitate, which dissolves on heating.

3. Starch is a Colloid.—Place some strong starch solution in a dialyser or parchment tube, and the latter in distilled water. Allow it to stand for some time, and test the water for starch; none will be found.

(a.) **Does not filter.**—Two dry filter papers are placed in two funnels about 5 cm. in diameter and filled with 2 per cent. solution of starch. Let one remain as a control, and to the other add any diastatic ferment—*e.g.*, saliva or liquor pancreaticus. The starch begins to filter, being converted into sugar.

4. II. Dextrin (British Gum) ($C_6H_{10}O_5$) is an intermediate product in the hydration of starch. There are two varieties—**Erythro-dextrin**, which gives a red colour with iodine; and **Achroodextrin**, which gives no colour with iodine solution (see "Saliva").

Examine its naked eye characters. It is gummy and amorphous. Smell it. Dissolve some dextrin in boiling water, and observe that the solution is not opalescent.

(a.) This proves its solubility in water.

(b.) Add iodine solution = reddish-brown colour, which disappears on heating and returns on cooling. [The student ought to use two test-tubes, placing the dextrin solution in one, and an equal

¹ **Solution of Iodine.**—Dissolve 2 grams of potassic iodide in 100 cc. of water, add 1 gram of iodine, and shake well.

volume of water in the other. Add to both an equal volume of solution of iodine, and thus compare the difference in colour.]

(c.) Precipitate some of its solution by adding alcohol.

(d.) Render some of the dextrin solution alkaline by adding caustic soda solution. No red-brown colour is obtained with iodine. Acidify and the reddish-brown colour appears.

(e.) It is not precipitated by basic acetate of lead alone (unlike glycogen).

(f.) Precipitation occurs on adding ammonia and basic acetate of lead. The ammonia gives a white precipitate with lead acetate which carries down dextrin.

There are several varieties of dextrin :—

5. Prepare Dextrin from Starch.—Make 10 grams of starch into a paste with 20 cc. of water, add 30 cc. of a 20 per cent. solution of sulphuric acid. Mix, and heat in a water-bath at 90° C. Cool and precipitate the dextrin by alcohol. Collect the white deposit, wash with alcohol, and dry it.

6. III. Cellulose ($C_6H_{10}O_5$)_n occurs in every tissue of the higher plants, where it forms the walls of cells, and the great mass of the hard parts of wood. Cotton-wool may be used to test its reactions.

(a.) It is insoluble in water and all the feebler solvents.

(b.) It is soluble in Schweitzer's reagent, or a solution of ammonio-cupric oxide. This is prepared by dissolving slips of copper in ammonia in an open flask, or by dissolving precipitated hydrated oxide of copper in 20 per cent. ammonia. The former is prepared by precipitating a solution of sulphate of copper by soda in the presence of ammonium chloride.

(c.) It is soluble in concentrated acids, and a gelatinous precipitate—called amyloid—falls on the addition of water. The substance precipitated gives a blue colour with iodine. It is also soluble in zinc chloride.

(d.) It gives a blue colour with sulphuric acid and iodine, but not with the latter alone.

7 IV. Glycogen or Animal Starch $n(C_6H_{10}O_5)$.—Prepare a solution (see "Liver"). Note the characters of the dry white powder.

(a.) Note that the solution is *opalescent* (unlike dextrin); add iodine solution = red-brown or port-wine red colour. As in the dextrin test, use two test-tubes, one with water and the other with glycogen, to compare the difference in colour. The colour disappears on heating and reappears on cooling. It also disappears on the addition of alkalies, which break up the feeble compound.

(b.) Add caustic soda and copper sulphate solution = a blue solution, boil = no reduction.

(c.) Add basic lead acetate = a precipitate (unlike dextrin).

(d.) Add ammonia and basic lead acetate = a precipitate, as in 1 f.

(e.) Boil with dilute hydrochloric acid = a reducing sugar. Neutralise the acid with dilute caustic soda, and test with Fehling's solution for a reducing sugar, dextrose = a yellow precipitate.

(*f.*) The solution is precipitated by alcohol (2 parts absolute alcohol to 1 part of the solution).

(*g.*) Heated with potash or acetic acid the opalescence diminishes, and the solution becomes clear.

(*h.*) Its solutions (even .6 per cent.) are powerfully dextro-rotatory ($\alpha_D = 211^\circ$ (*Külz*)).

8. V. Glucose, Dextrose, or Grape-Sugar ($C_6H_{12}O_6$).—In commerce it occurs in warty uncrystallised masses of a yellowish or yellowish-brown colour. It exists in fruits, and in small quantities in the blood and other fluids and organs. It is the form of sugar found in diabetic urine. It is readily soluble in water. Prepare a solution by dissolving a small quantity in water.

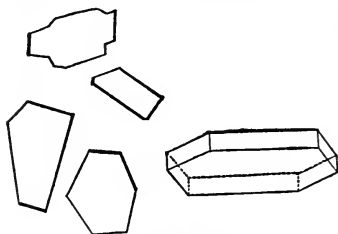

FIG. 5.—Dextrose.

(*a.*) Taste the glucose, and note that it is not so sweet as cane-sugar.

(*b.*) Add iodine solution = no reaction.

(*c.*) Heat the solution with sulphuric acid = darkens slowly.

(*d.*) Dissolve some in boiling absolute alcohol. It crystallises in transparent prisms when the alcohol cools (fig. 5).

As to the tests, they have been classified as follows:—

(A.) Yellow Colouration with Caustic Soda or Potash.

(*e.*) **Moore's Test.**—Heat the solution with half its volume of caustic soda = a yellow or brown colour due to the formation of glucic and melassic acids. The non-appearance of a yellow colour indicates the absence of dextrose, but the following substances also give a yellow colour with $NaHO$:—All the glucoses, together with milk-sugar and lactose.

(B.) Tests Depending on Reduction.

(*f.*) **Trommer's Test.**—To the solution add a few drops of a dilute solution of copper sulphate (10 per cent.), and afterwards add caustic soda (or potash) in excess, *i. e.*, until the precipitate first formed is re-dissolved, and a clear blue fluid is obtained. The hydrated oxide of copper precipitated from the copper sulphate is held in solution in presence of dextrose (and of all the glucoses). Heat slowly, turning the tube in the flame. A little below the boiling point, if grape-sugar be present the blue colour disappears, and a yellow (cuprous hydrate) or red (cuprous oxide) precipitate is obtained. Boil the upper surface of the fluid, and when the yellow precipitate occurs it contrasts sharply with the deep blue-coloured stratum below. The precipitate is first yellow, then yellowish-red,

and finally red. It is better seen in reflected than transmitted light. If no sugar be present, only a black colour may be obtained.

(g.) Add Fehling's solution; boil—a yellow or yellowish-red precipitate of cuprous oxide or hydrate. [For the method of making Fehling's solution, the precautions to be observed in using it, and for some other tests for glucose, see "Urine."]

(h.) **Barfoed's Solution.**—To 200 cc. of a solution of neutral acetate of copper, containing 1 part of the salt to 15 of water, add 5 cc. of a 38 per cent. solution of acetic acid. When heated with dextrose some red cuprous oxide is precipitated, while lactose, cane-sugar, maltose, and dextrin, when they are boiled with it for a short time, give no reaction. Hence this substance has been used to distinguish dextrose from maltose.

(i.) **Böttger's Bismuth Test.**—Heat the fluid with caustic soda and a small quantity of dry basic bismuth nitrate—a grey or black reduction product of bismuth oxide. For Nylander's modification, see "Urine." In all reactions depending on reduction, one must recollect that some substances which are by no means related to the glucoses—*e.g.*, uric acid, kreatinin, phenyl-hydrazine—may cause reduction, and thus lead one into error.

(C.) Other Reactions.

(j.) **Phenyl-Hydrazine Test.**—Two parts of phenyl-hydrazine hydrochloride and three of acetate of soda are mixed in a test-tube with 6–10 cc. of the dextrose solution. Boil for 20–30 minutes, and then place the tube in cold water. If sugar be present, a yellow crystalline deposit is formed, which, microscopically, consists of yellow needles either detached or arranged in rosettes (fig. 6). The substance formed is **phenyl-glucosazone** ($C_{18}H_{22}N_4O_4$), with a melting-point of $204^\circ C$.

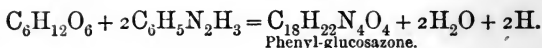

FIG. 6.—Crystals of Phenyl-Glucosazone, $\times 120$.

The arrangement of the acicular crystals I find frequently varies. Sometimes they are in rosettes (see "Urine"), and at other times more feathery. They are soluble in alcohol, and may be recrystallised from it.

This is an extremely important and reliable reaction. The best proportions for the ingredients are 1 part dextrose, 2 hydrochloride of phenyl-hydrazine, 3 sodic acetate, and 20 water. The substance

formed is but slightly soluble in water. According to E. Fischer, the following is the reaction which takes place:—



(k.) **Molisch's Test.**—(i.) To the solution add a drop or two of a 15-20 per cent. alcoholic solution of α -naphthol, and 1-2 vols. of concentrated sulphuric acid. The colour which first appears is violet; water causes a bluish-violet deposit. (ii.) If, instead of the naphthol, an alcoholic solution of thymol be used, a red colour is obtained. Seegen, however, points out that this reaction can be obtained with other substances, *e.g.*, albumin, which, however, is denied by Molisch. It is not a reliable test.

9. Conversion of Starch into Glucose.—Boil starch solution with a few drops of 20 per cent. sulphuric acid, until the fluid becomes clear. After neutralising with sodium carbonate, test the fluid for glucose by the tests (b.) or (c.).

A large number of intermediate products, however, are formed. They are as follows (see also "Saliva") :—

Starch	}	Blue with iodine.
Soluble starch (amidulin or amyloextrin)	}	
Varieties of Dextrin	} Erythroextrin		Iodine gives violet and red.
	} Achroodextrin		No reaction with iodine.
Maltose	}	Fehling's solution reduced.
		}	Barfoed's not.
Dextrose	}	Both are reduced.

Estimation of Glucose (see "Urine").

10. VI. Maltose ($C_{12}H_{22}O_{11}$).—It forms a fine white warty mass of needles, and is the chief sugar formed by the action of diastatic ferments on starch. See "Saliva," and "Pancreatic Juice."

(a.) Mix 1 gram of ground malt with ten times its volume of water, and keep it at 60° C. for half an hour. Boil and filter; the filtrate contains maltose and dextrin.

(b.) Test for a reducing sugar with Fehling's solution or other suitable test. (See also "Salivary digestion.")

(c.) Boiled for 1½ hours with the phenyl-hydrazine test it yields phenyl-maltosazone ($C_{24}H_{32}N_4O_9$). It crystallises in yellow needles (fig. 8).

(d.) It is soluble in water and alcohol. Examine its crystals (fig. 7). Its specific rotatory power is +150°, *i.e.*, it is greater than that of dextrose, but its reducing power (on Fehling's solution) is only two-thirds of that of dextrose.

(e.) With Barfoed's reagent, *i.e.*, when boiled with half its volume of copper acetate, acidulated with acetic acid = no reduction. In this respect, and in some others, it differs from dextrose.

(f.) Preparation of Maltose.—Take 1 part of potato-starch and make it into a paste with 10 of water. Digest the paste with a filtered extract of low-dried malt (200 grams to 1 litre of water) for an hour at 57–60° C., filter, evaporate, precipitate the dextrin with alcohol, concentrate the filtrate to a syrup, and allow the maltose to crystallise.

11. Estimation of Maltose.—(i.) Determine its reducing power on 10 cc. of Fehling's solution (see "Urine").

(ii.) Convert it into dextrose by boiling ($\frac{1}{2}$ an hour) 50 cc. of the solution with 1 cc. of H_2SO_4 . Cool and bring the solution to the original volume (50 cc.) by adding water. Again determine its reducing power by Fehling's solution. If x = cc. of maltose solution necessary to reduce 10 cc. of Fehling's solution, then as

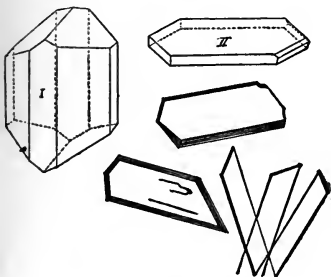

FIG. 7.—Crystals of Maltose.

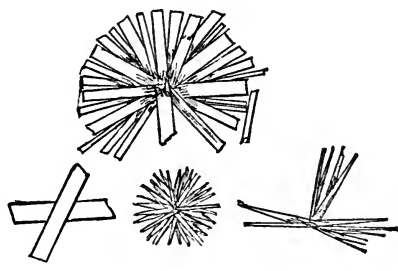

FIG. 8.—Crystals of Phenyl-Maltosazone, $\times 120$.

the respective reducing powers of glucose and maltose are as 2 : 3 $\frac{2x}{3}$ = cc. of dextrose solution necessary for the same purpose. As 10 cc. of Fehling correspond to 0.05 grms. dextrose, the strength of the maltose solution can easily be calculated.

12. VII. Lactose (Milk-Sugar), $C_{12}H_{22}O_{11} + H_2O$ (see "Milk").

(a.) Note its whiteness and hardness. It is not so sweet as cane-sugar. Microscopically it occurs in rhombic prisms (fig 9).

(b.) It is less soluble in water than cane- or grape-sugar, and insoluble in alcohol.

(c.) Heat its solution carefully with sulphuric acid = chars slowly.

(d.) Add excess of caustic soda, and a few drops of copper sulphate solution, and heat = yellow or red precipitate (like dextrose).

(e.) Test with Fehling's solution = reduction like dextrose, but its reducing power is not so great as dextrose. It requires 10 parts of lactose to reduce the amount of Fehling's solution that will be reduced by 7 of dextrose.

(f.) It is precipitated from its saturated watery solution by absolute alcohol.

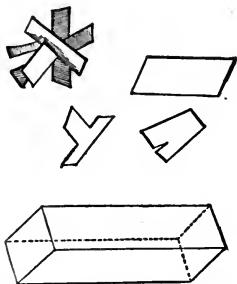

FIG. 9.—Crystals of Lactose.

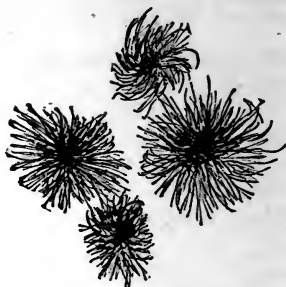

FIG. 10.—Crystals of Phenyl-lactosazone, X 120

(g.) The phenyl-hydrazine test (fig. 10), it yields phenyl-lactosazone ($C_{24}H_{32}N_4O_9$).

13. Preparation of Lactose ($C_{12}H_{22}O_{11} + H_2O$).—Acidulate milk with acetic acid = precipitate of caseinogen and fat; filter; boil filtrate to precipitate albumin, and filter again; evaporate the filtrate to small bulk; set aside to crystallise.

Milk-sugar is soluble in 6 parts of cold and $2\frac{1}{2}$ parts of hot water, but not in alcohol.

14. VIII. Cane-Sugar ($C_{12}H_{22}O_{11}$).

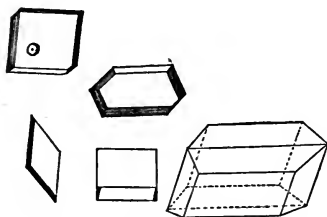

FIG. 11.—Crystals of Cane-sugar.

(a.) Observe its crystalline form (fig. 11) and sweet taste.

(b.) Its solutions do not reduce Fehling's solution. (many of the commercial sugars, however, contain sufficient reducing sugar to do this).

(c.) Trommer's test: add excess of caustic soda, and a drop of solution of copper sulphate (it gives a clear blue fluid), and heat. With

a pure sugar there should be no reduction.

(d.) Pour strong sulphuric acid on cane-sugar in a beaker, add a few drops of water; the whole mass is quickly charred.

(e.) Heat the solution with caustic soda = it darkens slowly.

(f.) It is practically insoluble in absolute alcohol, but its solubility greatly increases with the dilution of the alcohol.

(g.) Inversion of Cane-Sugar.—Boil a strong solution of cane-sugar in a flask with one-tenth of its volume of strong hydrochloric acid. After prolonged boiling the cane-sugar is "inverted,"

and the solution contains a mixture of dextrose and lævulose. Test its reducing power with Fehling's solution.

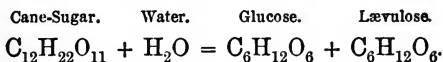

(h.) **Estimation of Cane-Sugar.**—Take 10 cc. of the cane-sugar solution, add 1 cc. of a 25 per cent. solution of H_2SO_4 . Boil for half an hour, and then make up bulk of fluid to its original volume. The cane-sugar is converted into a reducing sugar, dextrose. Place the fluid in a burette, and estimate its reducing power on Fehling's solution (see "Urine.") 95 parts of glucose correspond to 100 parts of cane-sugar.

15. Invert Sugar—a mixture of grape-sugar and fruit-sugar—is widely distributed throughout the vegetable kingdom, and is so called because it rotates the plane of polarised light to the left, the specific rotatory power of the lævulose being greater than that of dextrose at ordinary temperatures.

16. Conversion of Starch into a Reducing Sugar.—Place 50 cc. of starch solution in a flask on wire gauze over a Bunsen burner, add one drop of strong sulphuric acid, and boil from five to ten minutes, observing the spluttering that occurs, the liquid meantime becoming clear and limpid.

(a.) Test a portion of the liquid for glucose, taking care that sufficient alkali is added to neutralise the surplus acid.

(b.) Add iodine = blue colour, showing that some soluble starch (amidulin) remains unconverted into a reducing sugar.

ADDITIONAL EXERCISES.

Polarimeters.

17. Circumpolarisation.—Certain substances when dissolved possess the power of rotating the plane of polarised light, *e.g.*, the proteids, sugars, &c. The extent of the rotation depends on the amount of the active substance in solution. The direction of rotation—*i.e.*, to the right or the left—is constant for each active substance. Of course, light of the same wavelength must be used. The light obtained from the volatilisation of common salt is used.

The term "specific rotatory power," or "specific rotation" of a substance, is used to indicate the amount of rotation expressed in degrees of the plane of polarised light which is produced by 1 gram of the substance dissolved in 1 cc. of liquid, when examined in a layer 1 decimetre thick.

Those substances which cause specific rotation are spoken of as "*optically active*;" those which do not, as "*inactive*."

If α = the observed rotation ;

p = the weight in grams of the active substance contained in 1 cc. of liquid ;

l = the length of the tube in decimetres ;

$(\alpha)_D$ = the specific rotation for light corresponding to the light of a sodium flame ;

then

$$(\alpha)_D = \pm \frac{\alpha}{pl}$$

The sign + or - indicates that the substance is dextro- or levo-rotatory. Various instruments are employed. Use

Laurent's Polarimeter. — This instrument is a so-called "half-shadow polarimeter," and must be used in a dark room (fig. 12).

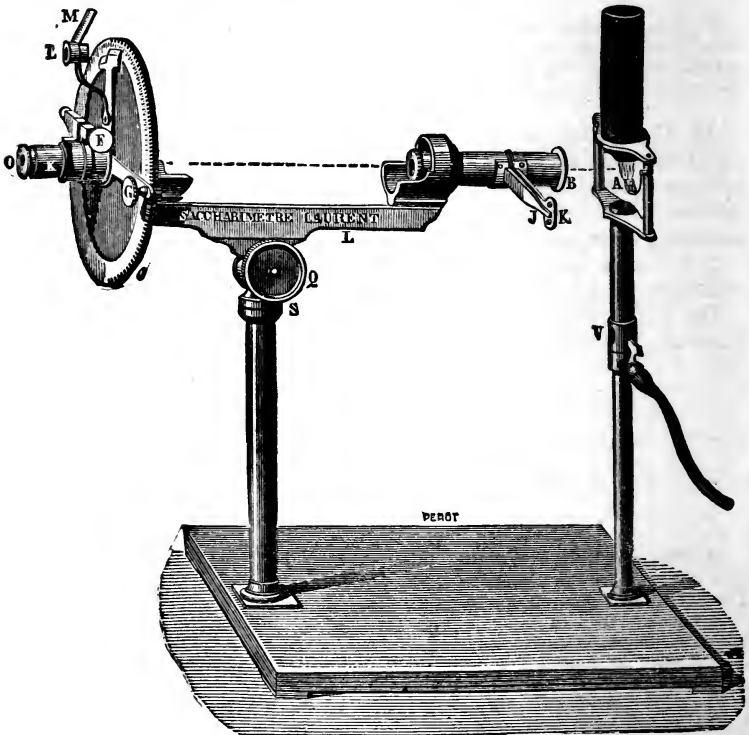

FIG 12.—Laurent's Half-Shadow Polarimeter.

18. Determination of the Specific Rotatory Power of Dextrose.

(a.) Fill one of the decimetre tubes with distilled water, taking care that

no air-bubbles get in. Slip on the glass disc horizontally, and screw the brass cap on the tube, taking care not to do so too tightly. Place the tube in the instrument, so that it lies in the course of the rays of polarised light.

(b.) Place some common salt (or fused common salt and soda carbonate) in the platinum spoon (A), and light the Bunsen's lamp, so that the soda is volatilised. If a platinum spoon is not available, tie several platinum wires together, dip them into slightly moistened common salt, and fix them in a suitable holder, so that the salt is volatilised in the outer part of the flame. In the newer form of the instrument supplied by Laurent, there are two Bunsen-burners, placed the one behind the other, which give very much more light. Every part of the apparatus must be scrupulously clean.



FIG. 13.—Wild's Polaristrobometer.

(c.) Bring the zero of the vernier to coincide with that of the scale. On looking through the eye-piece (O), and focussing the vertical line dividing the field vertically into two halves, the two halves of the field should have the same intensity when the scale reads zero. If this is not the case, then adjust the prisms until it is so, by means of the milled head placed for that purpose behind the index dial and above the telescope tube. It is well to work with the field not too brightly illuminated.

(d.) Remove the water-tube, and substitute for it a similar tube containing the solution of the substance to be examined—in this case a *perfectly clear solution* of pure dextrose. Place the tube in position, and proceed as before. The two halves of the field are now of unequal intensity. Rotate the eye-piece until equality is obtained.

(e.) Repeat the process several times, and take the mean of the readings. The difference between this reading and the first at (c.), when the tube

was filled with distilled water—*i.e.*, zero—is the rotation due to the dextrose= a .

(*f.*) Place 10 cc. of the solution of dextrose in a weighed capsule, evaporate to dryness over a water-bath, let the capsule cool in a desiccator, and weigh again. The increase in weight gives the amount of dextrose in 10 cc.; so that the amount in 1 cc. is got at once= p .

(*g.*) Calculate the specific rotatory power by the above formula. It is about $+53^\circ$.

For practice, begin with a solution of dextrose containing 11 grams per 100 cc. of water. Make several readings of the amount of rotation, and take the mean.

Example.—In this case, the mean of the readings was 11.6° .

$$(a)_D = \frac{11.6^\circ}{.11 \times 2} = 53^\circ.$$

Repeat the process with a 4 and 2 per cent. solution. It is necessary to be able to read to two minutes, but considerable practice is required to enable one to detect when the two halves of the field have exactly the same intensity.

Test the rotatory power of corresponding solutions of cane-sugar, and any other sugar you please.

Test also the rotatory power of a proteid solution.

The following indicate the S.R. for yellow light:—

Proteids.—Egg-albumin -35.5° ; serum-albumin -56° ; syntonin -72° ; alkali-albumin prepared from serum-albumin -86° , when prepared from egg-albumin -47° .

Carbohydrates.—Glucose $+56^\circ$; maltose $+150^\circ$; lactose $+52.5^\circ$.

N.B.—A complication sometimes arises in connection with carbohydrates, as the S.R. is sometimes much altered by the temperature; thus the S.R. of lævulose, when heated from $20-90^\circ$ C., falls in the proportion of 3:2. It is best, therefore, to work at a constant temperature, say 20° C. Again, some solutions have not the same S.R. when they are first dissolved that they have twenty-four hours afterwards. This is called birotation, and it is therefore well to use the solution twenty-four hours after it is made.



FIG. 14.—*a.* Interference-lines seen with fig. 13.

Wild's Polaristrobometer.—Between the polariser (which can be rotated) and analyser of this instrument is placed a Savart's polariscope, which produces in the field a number of parallel dark interference-lines.

A framework H, which can be moved on a brass support F, carries the analyser and polariser. The light from a soda-flame enters at D, traverses a Nicol's prism which is fixed to and moves with the graduated index K. The polarised rays then traverse the fluid contained in a tube placed in L, and reach the fixed ocular parts containing the so-called polariscope. The latter is composed of two prisms, which give rise to the interference-lines, which are viewed by means of a lens of short focus. Between M and N is a diaphragm with X-shaped cross lines. Beyond M, which is designed to protect the eye

of the observer from extraneous light, is the other Nicol's prism. The polariser can be rotated by means of C. In order to read off the scale, there is a telescope B. In S is a small mirror which reflects the flame of a movable source of light upon the nonius. Usually the instrument is made for a column of fluid 220 mm. long.

(1.) Light the movable gas-flame opposite Q. Estimate the zero-point of the instrument by placing an empty tube in the instrument, and focus until the lines of the cross are sharply seen. Rotate the polariser by means of C until the illuminated field is seen to be traversed by dark interference-lines (fig. 14, *a*). On rotating still further, the lines become paler, until ultimately a clear space without lines occupies the field. Try to get this in the middle of the field as in fig. 14, *b*.

(2.) Replace the empty tube with the fluid to be investigated, when the interference-lines reappear. Suppose the substance is dextro-rotatory, then rotate the Nicol to the left until the lines disappear; but from the arrangement of the apparatus, the milled-head C is moved in the same direction as the direction of rotation of the substance. It is well to make readings in all four quadrants of the instrument. It is best to use the instrument in a dark room.

LESSON IV.

FATS—BONE—EXERCISES ON THE FOREGOING.

NEUTRAL FATS.

The neutral fats of the adipose tissue of the body generally consist of a mixture of the neutral fats stearin, palmitin, and olein, the former two being solid at ordinary temperatures, while olein is fluid, and keeps the other two in solution at the temperature of the body.

Neutral fats are derivatives of the triatomic alcohol glycerin,

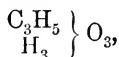

and are glycerides or compound ethers of palmitin, stearin, and olein, in which three of the hydrogen atoms of the glycerin are replaced by as many equivalents of the acid radical.

I. Reactions.

(*a*.) They are lighter than water; sp. gr. .91-.94.

(*b*.) Use almond or olive oil or lard, and observe that fat is *soluble* in ether, chloroform, and hot alcohol, but *insoluble* in water.

(*c*) Dissolve a little fat in 3 cc. ether. Let a drop of the

etheral solution fall on paper, *e.g.*, a cigarette paper = a greasy stain on the paper, which does not disappear with strong heat.

(*d.*) To olive oil or suet add caustic potash, and boil. Stearin is present in the suet and is glycerin-stearate, while olein in olive oil is glycerin-oleate. When stearin is boiled with a caustic alkali, *e.g.*, potash, a potassic stearate or soap is formed, and glycerin is set free. This is the process of **saponification**.

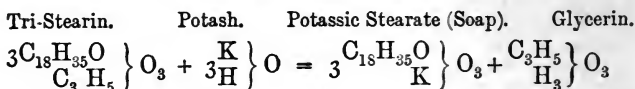

(*e.*) Heat lard and caustic soda solution in a capsule to form a soap; decompose the latter by heating it with dilute sulphuric acid, and observe the liberated fatty acids floating on the top.

(*f.*) Proceed as in (*d.*), and add to the soap solution crystals of sodium chloride until the soaps separate.

(*g.*) Shake oil containing a fatty acid, *e.g.*, De Jongh's cod-liver oil, with a few drops of a dilute solution of sodic carbonate. The whole mass becomes white = **emulsion**. Examine it microscopically, and compare it with milk, which is a typical emulsion.

In an emulsion the particles of the oil are broken up into innumerable finer particles, which remain discrete, *i.e.*, do not run together again.

(*h.*) Shake up olive oil with a solution of albumin in a test-tube = an emulsion. Examine it microscopically.

(*i.*) **Gad's Emulsion Experiment.**—Place in a watch-glass a solution of sodic carbonate (.25 per cent.), and on the latter place a drop of rancid oil.

The drop comes to rest, but soon the oil drop shows a white rim, and at the same time a white milky opacity extends over the soda solution. With the microscope, note the lively movement in the neighbourhood of the fat-droplet, due to the separation of excessively minute particles of oil. The white fluid is a fine and uniform emulsion (fig. 15). This experiment has an important bearing on the formation of an emulsion in the intestine in connection with the pancreatic digestion of fats.

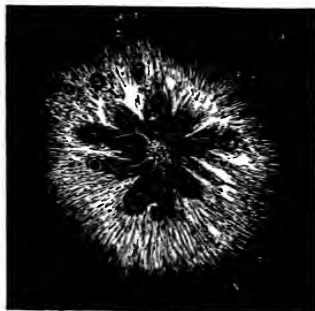

FIG. 15.—Gad's Experiment.

(*j.*) **Ranvier's Emulsion Experiment.**—Ranvier has shown that if a drop of lymph taken from the peritoneal cavity of a frog be mixed on a microscopical slide with a drop of olive oil, on examining with a microscope where the two fluids come into

contact, one sees emulsification going on before one's eyes, with the formation of fine particles of oil like the molecular basis of chyle (*Comptes rendus*, 1894).

(k.) Heat in a porcelain capsule for an hour or more some lard mixed with plumbic oxide and a little water. The fat is split up, yielding glycerin and a lead-soap.

BONE.

2. (A.) Organic Basis of Bone.

(a.) **Decalcify Bone.**—Place a small thin dry bone in dilute hydrochloric acid (1 : 8) for a few days. Its mineral matter is dissolved out, and the bone, although retaining its original form, loses its rigidity, and becomes pliable, and so soft as to be capable of being cut with a knife. What remains is the **organic matrix** or **ossein**. Keep the solution obtained.

(b.) Wash the decalcified bone thoroughly with water, in which it is insoluble; place it in a solution of sodium carbonate and wash again. Boil it in water, and from it gelatin will be obtained. Neutralise with sodium carbonate. The solution gelatinises. Test the solution for gelatin (Lesson II. 1).

(c.) Decalcify a small portion of a dry bone with picric acid.

(B.) Mineral Matter in Bone.

(a.) Examine a piece of bone which has been incinerated in a clear fire. At first the bone becomes black from the carbon of its organic matter, but ultimately it becomes white. What remains is **calcined bone**, having the form of the original bone, but now it is quite brittle. Powder some of the white bone-ash.

(b.) Dissolve a little of the powdered bone-ash in hydrochloric acid, observing that bubbles of gas (CO_2) are given off, indicating the presence of a carbonate; dilute the solution, add excess of ammonia = a white precipitate of **phosphate of lime** and **phosphate of magnesia**.

(c.) Filter, and to the filtrate add ammonium oxalate = a white precipitate of oxalate of lime, showing that there is lime present, but not as a phosphate.

(d.) To the solution of mineral matters 2 (A.) (a.) add acetate of soda until there is free acetic acid present, recognised by the smell; then add ammonium oxalate = a copious white precipitate of lime salts.

(e.) Use solution of mineral matters obtained in 2 (A.) (a.) Render a part alkaline with NH_4HO = copious precipitate, redissolve this in acetic acid, which dissolves all except a small flocculent residue of phosphate of iron (perhaps in part derived from the blood of bone). Filter; use a small part to test for phosphoric acid and the rest for calcium and magnesium (Filtrate A.).

(i.) The undissolved flocculent precipitate is washed and dissolved in a few cc. dilute HCl, and the presence of *iron oxide* proved by adding ferrocyanide of potassium (= blue), and that of *phosphoric acid* by molybdate of ammonium (see "Urine").

(ii.) With the filtrate A. test for *phosphoric acid* by uranium acetate = yellowish-white precipitate of-uranium phosphate $(\text{UO}_2)\text{HPO}_4$.

(iii.) *Calcium*, by adding ammonium oxalate $\text{Ca}_2\text{C}_2\text{O}_4 + \text{H}_2\text{O}$. Filter, and when the filtrate is clear and gives no longer a precipitate with ammonium oxalate, make it alkaline with NH_4HO = after a time crystalline precipitate of ammonio - magnesium phosphate $\text{MgNH}_4\text{PO}_4 + 6\text{H}_2\text{O}$, showing presence of *magnesium*.

3. EXAMINATION OF A SOLUTION FOR PROTEIDS AND CARBOHYDRATES.

I. Physical Characters.

(a.) Note colour and transparency. Glycogen solution is opalescent, starch and some proteid solutions less so.

(b.) Taste. Salt solution may contain globulin. A sweet taste indicates a sugar.

(c.) Smell. The beef-tea odour of albumose and peptone solution, and the smell of British gum are characteristic.

(d.) Other characters. Thus a persistent froth is suggestive of an albuminous solution.

II. Test for proteids by xanthoproteic and Millon's tests. If present:

1. Test reaction to litmus paper. If acid or alkaline, test for acid- or alkali-albumin, and if either is present, neutralise, and filter off precipitate. Test filtrate for proteoses and peptones as in 4 and 5.

2. If original solution is neutral, acidulate faintly, and boil. A coagulum may consist of native albumin, or globulin, or both. Filter; and test filtrate for proteoses and peptones as in 4 and 5.

3. Distinguish between albumin and globulin by (a.) dropping solution into water, precipitate indicates globulin, (b.) saturating solution with MgSO_4 , precipitate = globulin, but may also contain proto- and hetero-albumose. If precipitate obtained by (b), filter and boil filtrate, coagulum = native-albumin. Distinguish between egg- and serum-albumin by ether test.

4. Add excess of NaHO , then, drop by drop, very dilute CuSO_4 , pink colour indicates proteoses, or peptones, or both.

5. Separate proteoses from peptones by saturating solution with Am_2SO_4 . Precipitate = proteoses. Filter; and to filtrate add *large*

excess of syrupy solution of NaHO, then dilute CuSO_4 . Pink colour indicates **peptones**.

[6. **Gelatin** (albuminoid), gives Xanthoproteic and Millon's reactions, gives a *violet* colour with NaHO and CuSO_4 , is not coagulated by boiling, and is not precipitated by acetic acid and potassium ferrocyanide.]

III. Test for Carbohydrates. First remove derived albumins by neutralising and filtering, and native albumin and globulin by boiling and filtering.

1. Acidulate if necessary and add iodine.

(a.) *Blue* colour, disappearing on heating and returning on cooling, indicates **starch**.

(b.) *Mahogany-brown* colour, disappearing on heating and returning on cooling, indicates **glycogen** or **dextrin**. Add basic lead acetate, precipitate (if proteids are absent) = **glycogen**.

2. Test for **reducing sugar** by Trommer's test. If present, distinguish glucose, maltose, and lactose, by the phenyl-hydrazine test (p. 21).

3. If no starch, dextrin, glycogen or reducing sugar, examine for **cane-sugar** by inversion test.

LESSON V.

THE BLOOD—COAGULATION—ITS PROTEIDS.

1. **Reaction.**—Constrict the base of one finger by means of a handkerchief. When the finger is congested, with a clean sewing needle prick the skin at the root of the nail. Touch the blood with a strip of dry, smooth, neutral litmus paper, highly *glazed* to prevent the red corpuscles from penetrating into the test paper. Allow the blood to remain on it for a short time; then wash it off with a stream of distilled water, when a blue spot upon a red or violet ground will be seen, indicating its *alkaline* reaction, due chiefly to sodium phosphate (Na_2HPO_4) and sodium carbonate.

2. **Blood is Opaque.**

(a.) Place a thin layer of defibrinated blood on a glass slide; try to read printed matter through it. This cannot be done.

3. **To make Blood Transparent or Laky.**—Place 10 cc. of defibrinated blood in each of three test-tubes, labelled A, B, and C. A is for comparison.

(a.) To B add 5 volumes of water, and warm slightly, noting the change of colour by reflected and transmitted light. By re-

flected light, it is much darker, it looks almost black—but by transmitted light it is transparent. Test this by looking as in 2 (a.) at printed matter.

(b.) To C add a watery solution of taurocholate of soda. Test the transparency of the mixture. In 2, the hæmoglobin is still within the blood corpuscles. In the others—3 (a.), (b.)—it is dissolved out, and in solution.

4. **Specific Gravity of Blood.**—(a.) Make a number of solutions of sulphate of soda, varying in sp. gr. from 1.050–1.075. At least twenty separate solutions are required, each with a definite sp. gr. Pour a small quantity of the solutions into small glass thimbles. A thin glass tube is drawn out in a gas-flame to form a capillary tube, which is bent at a right angle, and closed above with a small caoutchouc cap. A drop of blood is obtained from a finger, and by pressing lightly on the caoutchouc cap a quantity of the freshly-shed blood is drawn up into the capillary part of the tube. The tip of the fine capillary tube is at once immersed in one of the solutions of sodic sulphate, and a drop of the blood expressed into the saline solution, and it is noted whether it sinks or floats. The operation is repeated with other solutions until one is found in which the blood neither sinks nor floats. The sp. gr. of blood varies from 1045–1075, the average sp. gr. being 1056–1059.

(b.) **Haycraft's Method.**—Make a mixture of toluol (s. g. 800) and benzyl chloride (s. g. 1100) to obtain a fluid with a s. g. of 1070. Label this A. Make another with the s. g. 1025. Label this B.

Method.—With a pipette place a measured quantity of A in a warm cylindrical glass. Add a drop of the blood. It will float; now add B until the blood neither floats nor sinks.

Suppose 1.5 cc. of B has been added to 1 cc. of A, then

	1 cc. of A (1070) = 1,070
1.5.	<u>1.5 cc. of B (1025) = 1,537</u>
	2.5 cc. 2,607

Divide this by the total volume 2.5 cc. = 1043, the s. g. of the blood.

5. Action of a Saline Solution.

(a.) To 2 cc. of defibrinated blood in a test-tube (D) add 5 volumes of a 10 per cent. solution of sodium chloride. It changes to a very bright, florid, brick-red colour. Compare its colour with that in A, B, and C. It is opaque.

6. **Red Corpuscles.**—Add to defibrinated ox blood (or, better, dog's blood), 20 volumes of a dilute solution of NaCl (.5–2 per cent.). The red corpuscles subside, and the supernatant fluid can be poured off. Wash the corpuscles several times in this way. They will be required for the preparation of hæmoglobin (p. 65).

7. Hæmoglobin does not Dialyse.

(a.) Place a watery solution of defibrinated blood in a dialyser (a bulb form or a parchment tube), and suspend it in a large vessel of distilled water. Test the dialyser beforehand to see

that there are no holes in it. If there are any fine pores, close them with a little white of egg, and coagulate it with a hot iron.

(b.) After several hours observe that no hæmoglobin has passed into the water.

(c.) Test the diffusate for chlorides ($\text{AgNO}_3 + \text{HNO}_3$).

8. Phenomena of Coagulation.—Decapitate a rat, and allow the blood to flow into a small porcelain capsule. Within a few minutes the blood **congeals**, and when the vessel is tilted the blood no longer moves as a fluid, but as a **solid**. It then **coagulates** completely. Allow it to stand, and after an hour or so, pale-yellow coloured drops of fluid—the **serum**—are seen on the surface, being squeezed out of the red mass, the latter being the **clot**, which consists of fibrin and the corpuscles.

9. Formation of Clot and Serum.—Draw out a glass tube into a fine capillary pipette at both ends, leaving a bulb in the middle, and suck some uncoagulated blood, either from one's finger, or from the heart of a frog, into it, seal up the ends of the tube, allow the blood to coagulate, and examine the tube under a microscope. Observe the small red shrunken clot, and the serum squeezed out of the latter.

10. Frog's Blood—Coagulation of the Plasma.—Place 5 cc. of normal saline (0.75 per cent. salt solution) in a test-tube surrounded with ice. Expose the heart of a pithed frog, and open the ventricle, allowing the blood as it escapes to flow into the normal saline. Mix, and the corpuscles (owing to their greater specific gravity) after a time subside. After they have subsided remove the supernatant fluid—the plasma mixed with normal saline—by means of a pipette. Place it in a watch-glass, and observe that it coagulates.

11. Mammalian Blood.

(A.) Study coagulated blood obtained from the slaughter-house. Collect the blood of a sheep or ox in a perfectly dry cylindrical vessel, and allow it to coagulate. Set it aside for two days, and then observe the **serum** and the **clot**. Pour off the pale, straw-coloured serum, and note the red clot, which has the shape of the vessel, although it is smaller than the latter.

(B.) If the blood of a horse can be obtained, study it, noting that the upper layer of the clot is paler in colour; this is the **buffy coat**.

12. Circumstances Influencing Coagulation.

Effect of Cold.—Place a small platinum capsule—a brass or glass thimble will do quite well—on a freezing mixture of ice and salt, decapitate a frog or rat, and allow the blood to flow directly into the cooled vessel. At once it becomes solid or congeals, but it is not coagulated. As soon as the blood becomes solid, remove the thimble and thaw the blood by placing it on the palm of the hand, when the blood becomes fluid, so that it can be poured into a watch-glass; if the vessel be once more placed on the freezing mixture, the blood again congeals and solidifies, and on its being removed becomes fluid. Observe at the same time that the colour and transparency of the blood are

altered. The blood becomes darker in colour and transparent. This is the *laky* condition due to the discharge of the hæmoglobin from the corpuscles. Place the vessel with the fluid blood on the table, and it clots or forms a firm jelly.

13. Salted Plasma—Influence of Neutral Salts on Coagulation.—At the slaughter-house, allow blood to run into an equal volume of saturated solution of sodium sulphate (or one quarter of its volume of a saturated solution of magnesium sulphate); mix. The blood does not clot, but remains fluid. Place the vessel aside on ice, and note that the corpuscles subside, leaving a narrow clear yellowish layer on the surface—the plasma mixed with the saline solution, and known as **salted plasma**. To obtain sufficient plasma, the blood must be “centrifugalised” (page 43), to separate the corpuscles from the plasma.

(a.) Heat undiluted salted plasma to 60° C. The fibrinogen is precipitated at 56° C. Filter. The filtrate will not coagulate, even after the addition of fibrin-ferment and CaCl_2 , as there is no fibrinogen present.

(b.) Place 15 cc. of the salted plasma in a tall, narrow, cylindrical, stoppered glass tube. Add crystals of sodium chloride, and shake the whole vigorously, when a white flocculent precipitate is thrown down. Allow the precipitate to subside. Decant the supernatant fluid. Filter through a filter moistened with a *saturated* solution of sodic chloride, and wash the precipitate on the filter with a saturated solution of sodic chloride. This is the **plasmine** of Denis. With a spatula, scrape the washed precipitate off the filter.

Dissolve the plasmine in a small quantity of distilled water, and filter quickly. The filtrate, if set aside, will clot after a time. It is better to do the several operations rapidly to ensure success, but I have frequently found coagulation occur when the plasmine was not dissolved in water until many hours after it was deposited.

14. Oxalate Plasma.—Oxalate of potassium prevents blood from coagulating when present to the extent of 0.2 per cent. Dissolve 1 gram of potassium oxalate in 10–20 cc. of normal saline, place it in a vessel capable of holding 500 cc., and allow blood to run in to fill the vessel. Mix the two fluids. The blood does not coagulate, but remains fluid. Centrifugalise it to obtain the oxalate plasma, which may be siphoned off. The oxalate precipitates—as oxalate of lime—the calcium which is necessary for coagulation.

(a.) To oxalate plasma, add a few drops of a 2 per cent. calcium chloride solution = coagulation, and more quickly at 40° C.

15. Defibrinated Blood.—In a slaughter-house allow the blood from an animal to run into a vessel, and with a bundle of twigs beat or whip the blood steadily for some time. Fine white fibres of fibrin collect on the twigs, while the blood remains fluid. This is defibrinated blood, which does not coagulate spontaneously.

16. Fibrin.—Wash away the colouring-matter with a stream of water from the twigs until the fibrin becomes quite white.

(a.) **Physical properties:** it is a white, fibrous, elastic substance. Stretch some fibres to observe their extensibility; on freeing them, they regain their shape, showing their elasticity.

(b.) Place a few fibres in absolute alcohol to rob them of water. They become brittle and lose their elasticity.

(c.) Place a small quantity of fibrin in a test-tube with some 0.2 per cent. hydrochloric acid *in the cold*. It swells up and becomes clear and transparent, but does not dissolve.

(d.) Repeat (c.), but place the test-tube in a water-bath at 60° C.; part of the fibrin is dissolved, forming acid-albumin. Test for the latter (Lesson I. 7).

(e.) Place some hydric peroxide over fibrin in a watch-glass; bubbles of oxygen are given off. Immerse a flake in freshly-prepared tincture of guaiacum (5 per cent. solution of the pure resin in alcohol), and then in hydric peroxide, when a blue colour is developed, due to the ozone liberated by the fibrin striking a blue with the resin. If the fibrin contains much water, it is preferable to place it first of all for a short time in rectified spirit to remove the water. [Other substances give a blue colour under similar conditions.]

(f.) Place some fibrin in water in a test-tube. Note that it gives the xanthoproteic reaction and Millon's test (Lesson I. 1).

(g.) Prick a finger with a needle, collect a drop of blood on a microscopic slide, cover, and examine under a microscope ($\times 350$). After a time, observe the formation of threads of fibrin between the rouleaux of coloured blood-corpuscles.

17. II. Blood-Serum.—By means of a pipette remove the serum from the coagulated blood or siphon it off (Lesson V. 8). If a centrifugal apparatus is available, any suspended blood-corpuscles can easily be separated by it. Note its straw-yellow colour and musky odour. Its reaction *alkaline*. Its sp. gr. = 1.034.

General Proteid Reactions.

(a.) Dilute 1 volume of serum with 10 volumes of normal saline or salt solution.

(b.) Test separate portions by neutralisation and heat = coagulation; nitric acid and the subsequent addition of ammonia; acetic

acid and ferrocyanide of potassium; Millon's reagent; and the NaHO and CuSO_4 reaction (Lesson I. 1). Alcohol causes coagulation.

(c.) Saturate it with ammonium sulphate. This precipitates all the proteids, globulin and albumin. Filter, the filtrate is proteid-free.

Study its individual proteids.

(A.) Preparation of Serum-Globulin (Paraglobulin).

(a.) A. Schmidt's Method.—To 10 cc. of serum add 200 cc. of ice-cold water, and pass a stream of carbon dioxide through it for some time—a white precipitate of serum-globulin. This method does not precipitate it entirely. No precipitate is obtained unless the serum be diluted.

(b.) Panum's Method.—Dilute 1 cc. of serum with 15 cc. of water; add 5 drops of a 2 per cent. solution of acetic acid—a white precipitate of serum-globulin, or, as it was called, "serum-casein." All the serum-globulin is not precipitated.

(c.) Hammarsten's Method.—Saturate serum with magnesium sulphate, and shake briskly for some time. An abundant precipitate of serum-globulin is obtained. Allow the excess of the salt and the precipitate to settle. The undissolved crystals fall to the bottom, and on their surface is precipitated a dense white flocculent mass of serum-globulin. Filter. Wash the precipitate on the filter with a saturated solution of magnesium sulphate, add a little distilled water to the precipitate. It is dissolved, *i.e.*, it is a globulin, and is insoluble in excess of a neutral salt, but is dissolved by a weak solution of the same. The solution does not coagulate spontaneously. It gives all the reactions for proteids with the special reactions of a globulin.

(d.) Kauder's Method.—Add to serum half its volume of a saturated solution of ammonium sulphate (*i.e.*, half saturate it)=precipitate of the globulin. Complete saturation precipitates the albumin as well.

Only methods (c) and (d) are now used. Kauder's method enables one rapidly to separate the globulin and then the albumin by the use of one salt.

(e.) Allow a few drops of serum to fall into a large quantity of water, and observe the milky precipitate due to the presence of a globulin=serum-globulin. This is best observed by placing a dead black surface behind the vessel of water. We can then trace the "milky way" of the falling drops of serum as they traverse the water.

(B.) Serum-Albumin.—From (A.), (c.), filter off the precipitate, and test the filtrate for the usual proteid reactions. It is evident that the filtrate still contains a proteid, which is serum-albumin (Lesson I. 5, 2). To the filtrate add sodic sulphate, when serum-

albumin is precipitated. Sodic sulphate alone, however, gives no precipitate with pure serum.

18. Precipitation of Serum Proteids by Other Salts.

(a.) Precipitate blood-serum with potassic phosphate. All the proteids are thrown down after prolonged shaking.

(b.) Precipitate blood-serum with magnesian sulphate and sodic sulphate, or the double salt sodio-magnesian sulphate. All the proteids are thrown down.

19. **Coagulation Temperature of Serum-Proteids.**—Saturate serum with $MgSO_4$. Filter, keep the filtrate, label it B. Wash the precipitate, *i.e.*, the serum-globulin with saturated solution of magnesium sulphate until the washings give no reaction for albumin. This takes a long time, and had better be done previously by the demonstrator. Dissolve the precipitate in distilled water, which gives an opalescent solution. Label it A. Acidify it slightly with a drop of 2 per cent. acetic acid, and determine the temperature at which it coagulates by the method stated on p. 11. The liquid in the test-tube should just cover the bulb of the thermometer. Coagulation takes place about $75^\circ C$.

The filtrate B contains the serum-albumin. Dilute it with an equal volume of water, faintly acidify and heat, as above. A precipitate falls about $77-79^\circ C$. (B), and on filtering this off, and again acidifying, another precipitate is obtained on heating to $84-86^\circ C$.

20. **Preparation of Fibrinogen from Hydrocele Fluid**, which does not coagulate spontaneously.

(a.) Dilute 10 cc. of hydrocele fluid with 150 to 200 cc. of water, and pass through it for a considerable time a stream of carbon dioxide, when there is precipitated a small quantity of a somewhat slimy white body, fibrinogen. (Schmidt's method.)

(b.) Half saturate hydrocele fluid with sodium chloride solution by adding to it an equal volume of saturated solution of sodium chloride. Fibrinogen is precipitated in small amount. Filter. and on adding $MgSO_4$, serum-globulin is precipitated, so that hydrocele fluid contains both fibrinogen and serum-globulin.

21. Coagulation Experiments.

(a.) **Andrew Buchanan's Experiment.**—Mix 5 cc. fresh serum (preferably from horse's blood) with 5 cc. hydrocele fluid and keep the mixture at $35^\circ C$. for some hours, when coagulation occurs, a clear pellucid clot of fibrin being obtained. Coagulation takes place, and is due to the action of fibrin-ferment on fibrinogen and not to the presence of serum-globulin, as hydrocele fluid in addition to fibrinogen contains this body.

(b.) To 5 cc. of hydrocele fluid add some solution of fibrin-ferment, and keep in a water-bath at 40° C., coagulation takes place.

(c.) To 2 cc. of salted plasma, prepared as in Lesson V. 13 (which is known to clot slowly on the addition of water), add 10 volumes, *i.e.*, 20 cc. of a watery solution of fibrin-ferment, prepared by the demonstrator = coagulation.

(d.) Add to oxalate-plasma (Lesson V. 14) a few drops of a 2 per cent. calcium chloride solution. It coagulates, and more quickly at 40° C. The CaCl_2 supplies the calcium necessary for the formation of fibrin.

(e.) **Effect of Temperature on Coagulation.**—Dilute sodium sulphate plasma with 10 volumes of water, and place some in test-tubes A, B, C, D.

A clots slowly or not at all.

Place B in water-bath at 40° C. It clots more quickly.

To C add a small quantity of fibrin-ferment (p. 40), dissolved in a little calcium chloride.

To D add serum. Keep C and D at 40° C. They coagulated rapidly, because of the abundance of fibrin-ferment.

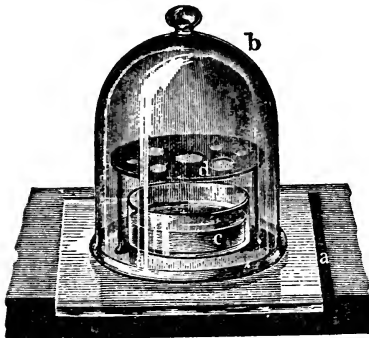
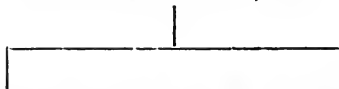

FIG. 16.—Exsiccator for Drying a Precipitate over Sulphuric Acid. *b*. Glass bell-jar, covering vessel with sulphuric acid (*c*), and support (*d*) for the deposit or precipitate.

with absolute alcohol, and allow it to stand at least a month, when the proteids are rendered insoluble. Dry the precipitate at 35° C., and afterwards over sulphuric acid (fig. 16). Keep it as a dry powder in a well-stoppered bottle. When a solution is required, extract some of the dry powder with 100 volumes of water; filter. The filtrate contains the ferment.

23. Salts and Sugar of Serum.—The usual salts may be tested for directly with serum diluted with water, or the following method may be adopted:—

Dilute blood and boil it; filter.



Colourless filtrate, which can be tested for salts and sugar.

Coagulum coloured brown by hæmatin.

22. Preparation of Fibrin-Ferment.—It must be kept in stock. Precipitate blood-serum with a large excess of alcohol, collect the copious precipitate, consisting of the proteids and fibrin-ferment. Cover it

The blood is heated with 6 to 8 times its volume of water, and slightly acidulated. The filtrate is evaporated to a small bulk. When a drop of the concentrated filtrate is placed on a slide, cubes of common salt separate out.

To the colourless filtrate of 23

(a.) Add silver nitrate = white curdy precipitate soluble in ammonia, but insoluble in nitric acid = *chlorides*.

(b.) Add barium chloride = white, heavy precipitate insoluble in nitric acid = *sulphates*.

(c.) Add nitric acid and molybdate of ammonium and heat = yellow precipitate = *phosphates*.

(d.) Test with Fehling's solution or CuSO_4 and NaHO and boil = red cuprous oxide = *reducing sugar*, which is glucose.

ADDITIONAL EXERCISES.

24. To Obtain Clear Serum.—The best way to obtain this is by means of a centrifugal apparatus; but if the serum contain blood-corpuscles, a fairly clear fluid may be obtained by placing it in a vessel like (fig. 17). It consists of the separated top of a wide flask provided with a cork in the neck, and in the cork is an adjustable tube provided with a clip. When the serum is placed in the apparatus, it must be above the level of the tube. On opening the clip, the clear serum can be drawn off without disturbing the deposit.

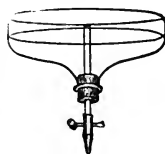

FIG. 17. — Apparatus for Obtaining Clear Serum.

25. Preparation of Serum - Albumin and Serum-Globulin.—Dilute clear serum with three volumes of a saturated solution of neutral ammonium sulphate, and add crystals of the same salt to complete saturation.

Filter. The deposit contains the two above-mentioned substances, and is washed with a saturated solution of $(\text{NH}_4)_2\text{SO}_4$. The deposit is then dissolved in the smallest possible amount of water and dialysed in a parchment tube. In proportion as the salt dialyses, the serum-globulin is deposited as a white powder in the dialysing tube, whilst the serum-albumin remains in solution. It is not difficult to devise an apparatus whereby the water is kept flowing, and even the dialysis tube kept in motion in the running water, provided one has some motor power at hand. (S. Lea, *Journal of Physiology*, xi. p. 226).

After complete dialysis the fluid is filtered, the deposited serum-globulin is collected and washed. The filtrate—which contains the serum-albumin—is carefully neutralised with ammonia, again dialysed, filtered and concentrated at 40°C . After it is cold, the serum-albumin is precipitated *at once* by strong alcohol, expressed, washed with ether and alcohol, and dried.

Serum-albumin is completely precipitated from its solution by ammonium sulphate, but not at all by magnesian sulphate. A solution, free from serum-globulin, containing 1-1.5 per cent. of salts, coagulates at about 50°, with 5 per cent. of NaCl at 75°-80° C.

26. Estimation of Grape-Sugar in Blood.—(a.) Place 20 grams of crystallised sodic sulphate in each of three porcelain capsules, and to each add exactly 20 grams of the blood to be investigated. Mix the blood and salt together. Boil them until the froth above the clot becomes white, and the clot itself does not present any red specks. Weigh again, and make up the loss by evaporation by the addition of water. The whole is then placed in a small press, and the fluid part expressed, collected in a capsule, and afterwards filtered. The filtrate is placed in a burette.

In a flask place 1 cc. of Fehling's solution, and to it add a few small pieces of caustic potash and 20 cc. of distilled water. Boil this fluid, and from the burette allow the clear filtrate of the blood to drop into the boiling dilute Fehling's solution until the latter loses every trace of its blue colour (fig. 18). As in all sugar estimations, the process must be repeated several times to get accurate results. Hence the reason why several capsules are prepared.

Read off, on the burette, the number of cc. of the filtrate used, e.g. = n cc. The formula

$$S = \frac{8}{n} =$$

in grams the weight of sugar per kilogram of blood. (Bernard.)

(b.) In Seegen's Method, which may be taken as the type of the newer methods, the proteids are precipitated by ferric acetate. The blood is diluted with 8-10 times its volume of water, acidulated with acetic acid, and heated. When the precipitation of proteids commences, render the mixture strongly acid by the addition of acetate of soda and perchloride of iron; then add sufficient sodic carbonate until the mixture is faintly acid, and boil. Allow it to cool, and filter it through a fine cloth filter, free from starch. The filtrate ought to be clear. The residue on the filter is washed several times with water, and the

remaining fluid in it expressed by means of a small hand-press. The expressed fluid is then mixed with the clear filtrate. If the mixture has a slight reddish tint from the admixture of a small quantity of blood-pigment. Add a drop or two of perchloride of iron to precipitate the last traces of the proteids. Filter again. The sugar in the filtrate is estimated in the usual way by means of Fehling's solution.

27. Ash of Hæmoglobin.—Incinerate a small quantity of oxy-hæmoglobin in a platinum capsule. This is done in the manner shown in fig. 19, where the capsule is placed obliquely, and its contents heated in a Bunsen-flame until only the ash remains. The ash is red, and consists of oxide of iron.

(a.) Dissolve a little in hydrochloric acid; add potassic sulphocyanide = a red precipitate, + ferrocyanide of potassium = a blue precipitate.

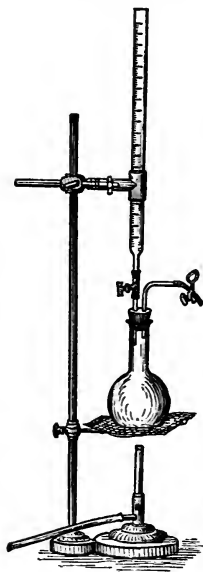

FIG. 18.—Bernard's Apparatus for Estimating the Sugar in Blood.

28. **The Centrifugal Machine.**—Precipitates or very minute particles suspended in a fluid, *e.g.*, blood-corpuscles in serum may be readily separated by this apparatus.

The liquid is placed in strong glass tubes, and these are in turn placed in metallic cases, which can move on a horizontal axis, the cases themselves being placed in a horizontal disc which is driven at the rate of 1000 revolutions per minute; this causes the tubes to take a horizontal position, and after 30-40-60 minutes rotation the precipitate or other suspended particles are found at the outer end of the tube. The serum can thus be obtained perfectly corpuscleless.

There are various forms of this apparatus. Some can be driven by the hand and yield small quantities of fluid, such as those sold by Muencke of Berlin (see Stirling's *Outlines of Practical Histology*, p. 94, 2 Ed. 1893) or that made by Watson & Laidlaw of Glasgow. When large quantities of fluid are required, that made by Fr. Runne of Basel is one of the best. It requires a water or gas-motor to drive it. At the present time Runne's "Werkstätte f. prac. Mechanik" are situated in Heidelberg.

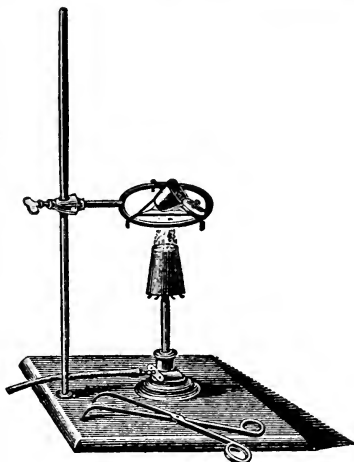

FIG. 19.—Method of Incinerating a Deposit to Obtain the Ash.

LESSON VI.

THE COLOURED BLOOD CORPUSCLES.

SPECTRA OF HÆMOGLOBIN AND ITS COMPOUNDS.

Enumeration of the Corpuscles.—Several forms of instruments are in use, *e.g.*, those of Malassez, Zeiss, Bizzozero, and Gowers.

1. **The Hæmocytometer of Gowers** (fig. 20) can be used with any microscope, and consists of—

- (a.) A small pipette, which, when filled to the mark on its stem, holds 995 c.mm. (fig. 20, A).
- (b.) A capillary tube to hold 5 c.mm. (B).
- (c.) A small glass jar in which the blood is diluted (D).
- (d.) A glass stirring rod (E).
- (e.) Fixed to a brass plate a cell $\frac{1}{5}$ of a millimetre deep, and with

its floor divided into squares $\frac{1}{10}$ mm., in which the blood-corpuscles are counted.

(f.) The diluting solution consists of a solution of sodic sulphate in distilled water—sp. gr. 1025.

2. Mode of Using the Instrument.

(a.) By means of the pipette (A) place 995 c.mm. of the diluting solution in the mixing jar (D).

(b.) Puncture a finger near the root of the nail with the lancet projecting from (F), and with the pipette (B) suck up 5 c.mm. of

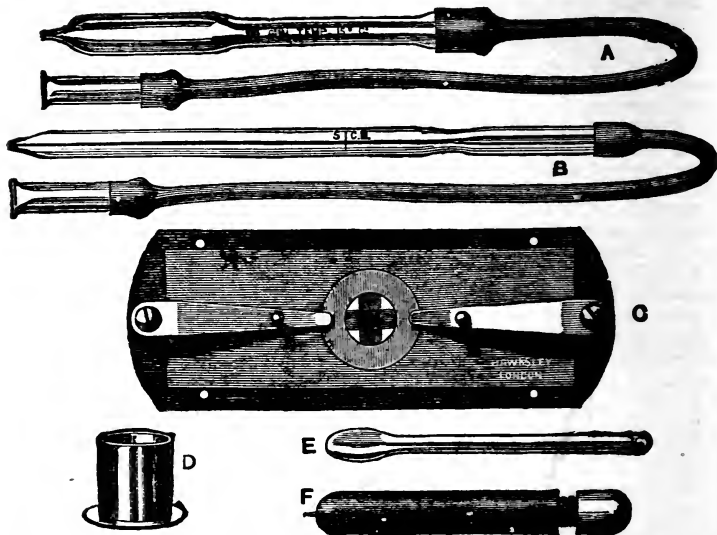

FIG. 20.—Gowers' Haemocytometer. A. Pipette for measuring the diluting solution; B. For measuring the blood; C. Cell with divisions on the floor, mounted on a slide, to which springs are fixed to secure the cover-glass; D. Vessel in which the solution is made; E. Spud for mixing the blood and solution; F. Guarded spear-pointed needle.

the blood, and blow it into the diluting solution, and mix the two with the stirrer (E).

(c.) Place a drop of the mixture on the centre of the glass cell (C), see that it exactly fills the cell, and cover it gently with the cover-glass, securing the latter with the two springs. Place the cell with its plate on the stage of a microscope, and focus for the squares ruled on its base.

(d.) When the corpuscles have subsided, count the number in ten squares, and this, when multiplied by 10,000, gives the number in a cubic millimetre of blood.

(e.) Wash the instrument, and in cleaning the cell do this with a stream of distilled water from a wash-bottle. Take care not to brush the cell with anything rougher than a camel's-hair pencil, to avoid injuring the lines.

Each square has an area of $\frac{1}{100}$ of a square mm., so that 10 squares have an area of $\frac{1}{10}$ of a square mm. As the cell is $\frac{1}{5}$ mm. deep, the volume of blood in 10 squares is $\frac{1}{10} \times \frac{1}{5} = \frac{1}{50}$ c.mm. On counting the number of corpuscles in 10 squares, and multiplying by 50, this will give the number in 1 c.mm. of the *diluted* blood. On multiplying this by $\frac{1000}{5}$, we get the number in 1 c.mm. before dilution. Thus we arrive at the reason why we multiply the number in 10 squares by 10,000 to get the number of corpuscles in 1 c.mm. of blood.

HÆMOGLOBIN AND ITS DERIVATIVES.

3. Preparation of Hæmoglobin Crystals, ($C_{600}H_{960}N_{154}O_{179}SFe$).

(a.) **Rat's Blood.**—Place a drop of defibrinated rat's blood on a slide, add three or four drops of water, mix, and cover with a cover-glass. Examine with a microscope; after a few minutes small crystals of oxy-hæmoglobin will begin to form, especially at the edges of the preparation, and gradually grow larger in the form of thin rhombic plates arranged singly or in groups (fig. 21).

(b.) **Guinea-Pig's Blood.**—Treat the blood of a guinea-pig as directed for the blood of a rat. Tetrahedral crystals are obtained. Mount some defibrinated blood in Canada balsam. Crystals form.

(c.) **Dog's Blood.**—To 15 cc. of defibrinated dog's blood add, drop by drop, 1 cc. or so of ether, shaking the tube after each addition of ether. By this means the blood is rendered *laky*, a condition which is recognised by inclining the tube, and observing that the film of blood left on it, on bringing the tube to the vertical again, is transparent. Add no more ether, but place the tube in a freezing mixture of ice and salt; as the temperature falls, crystals of hæmoglobin separate. If the crystals do not separate at once, keep the tube in the freezing mixture for one or two days. Examine the crystals microscopically. Arthus finds that dog's blood, containing 1 per cent. of sodic fluoride, after standing for several days, according to the surrounding temperature, deposits crystals of Hb.

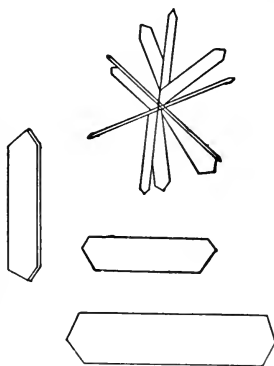

FIG. 21.—Hæmoglobin Crystals from Rat's Blood.

4. **Ozone Test for Hæmoglobin.**—Mix some freshly-prepared alcoholic solution of guaiacum with ozonic ether; the mixture becomes turbid, and on adding even a dilute solution of hæmoglobin, a blue colour results, due to oxidation of the resin by the ozone liberated from the ozonic ether by the hæmoglobin.

5. **Spectroscopic Examination of Blood.**—Use a small Browning's straight-vision spectroscope (fig. 22).



FIG. 22.—Browning's Straight-Vision Spectroscope

Preliminary.—Observe the solar spectrum by placing the spectroscope before the eye, and directing it to bright daylight. Note the spectrum from the red to the violet end, with the intermediate colours, and focus particularly the dark Fraunhofer's lines,

known as D in the yellow, E in the green, *b*, and F, their position and relation to the colours. Make a diagram of the colours, and the dark lines, indicating the latter by their appropriate letters.

(a.) Fix the spectroscope in a suitable holder, and direct it to a gas-flame, the edge of the flame being towards the slit in the spectroscope, noting that the spectrum shows no dark Fraunhofer lines.

(b.) Fuse a piece of platinum wire in a glass tube, and make a loop at the free end of the wire (fig. 23). Dip the platinum wire in water and then in common salt, and burn the salt in the gas-

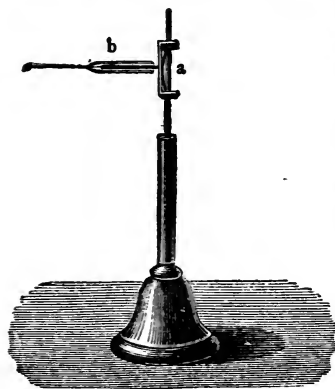

FIG. 23.—Stand for Platinum Wire for Sodium Flame.

flame, having previously directed the spectroscope towards the gas-flame, and so arranged the latter that it is seen edge-on. Note the position of the bright yellow sodium line in the position of the line D.

6. I. Spectrum of Oxy-hæmoglobin.

(a.) Begin with a strong solution and gradually dilute it. Place some defibrinated blood in a test-tube, and observe its opacity and bright scarlet colour.

(b.) Adjust the spectroscope as follows:—Light a fan-tailed gas burner, fix the spectroscope in a suitable holder, and between the light and the slit of the spectroscope place a test-tube containing the blood or its solution. Focus the *long image* of the gas-flame on the slit of the spectroscope. The focal point can be readily ascertained by holding a sheet of white paper behind the test-tube.

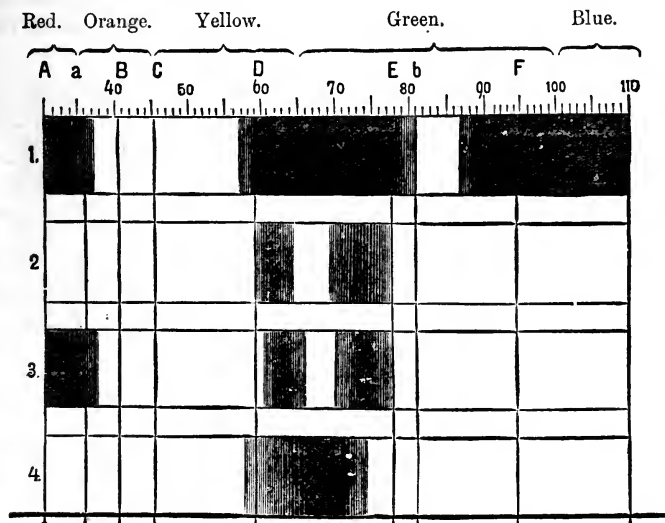

FIG. 24.—Spectra of Hæmoglobin, and its Compounds. 1. Oxy-hæmoglobin, 0.8 per cent.; 2. Oxy-hæmoglobin, 0.18 per cent.; 3. Carbonic oxide hæmoglobin; 4. Reduced hæmoglobin.

(c.) Add 10 to 15 volumes of water, and note that only the red part of the spectrum is visible. Make a sketch of what you see, noting the dilution.

(d.) Add more water until the green appears, and observe that a single dark absorption-band appears between the red and green (fig. 24, 1). Continue to dilute until this single broad band is resolved into two by the transmission of yellow-green light. Burn a bead of sodic chloride in the gas-flame, to note distinctly the position of the D line, and observe that of the two absorption bands the one nearest D, conveniently designated by the letter *a*, is more sharply defined and narrower; while the other, con-

veniently designated by the letter β , nearer the violet end, is broader and fainter. At the violet end the spectrum is shortened by absorption (fig. 24, 2).

(e.) Continue to dilute the solution, and note that the band near the violet end is the first to disappear.

Using coloured chalks or pencils, sketch the appearances seen with each dilution, and indicate opposite each the degree of the latter.

(f.) A very instructive method is to make a pretty strong solution of blood, showing only one undivided band. Place a little of this in a test-tube, and pour in water, so that the water mixes but slightly with the upper strata of the blood. Examine the solution spectroscopically, moving the tube so as to examine first

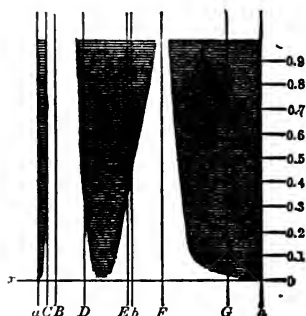

FIG. 25.—Graphic Representation of the Absorption of Light in a Spectrum by Solutions of Reduced Hb, of different strengths. The shading indicates the amount of absorption of the spectrum, and the numbers at the side the strength of the solution.

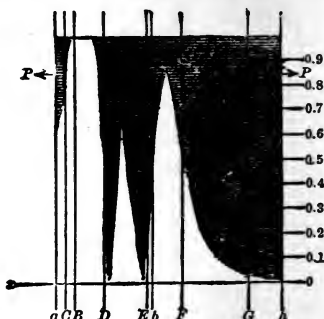

FIG. 26.—Graphic Representation of the Absorption of Light in a Spectrum by Solutions of Oxy-hæmoglobin, of different strengths. The shading indicates the amount of absorption of the spectrum, and the numbers at the side the strength of the solution.

the deeper strata of fluid until the surface is reached. At first a single band is seen; but as the solution is more dilute above, the two bands begin to appear, and as the solution gets weaker above, the β -band disappears, until, finally, with a very weak solution, such as is obtained in the upper strata only, the α -band alone is visible.

Fig 26 shows the amount of light absorbed by solutions of oxy-hæmoglobin (1 cm. in thickness) and of various strengths.

7. II. Hæmoglobin.

(a.) To a solution of oxy-hæmoglobin showing two well-defined absorption-bands, add a few drops of ammonium sulphide, and warm *gently*, when the solution becomes *purplish* or *claret-coloured*.

(b.) Study the spectrum, and note that the two absorption-

bands of oxy-hæmoglobin are replaced by one absorption-band between D and E, not so deeply shaded, and with its edges less defined (fig. 24, 4). By shaking the solution very vigorously with air, and looking at once, the two bands may be caused to reappear for a short time. Observe the absorption of the light at the red and violet ends of the spectrum according to the strength of the fluid.

(c.) Dilute the solution, and observe that the single band is not resolved into two bands, but gradually fades and disappears.

(d.) To a similar solution of oxy-hæmoglobin, showing two well-defined bands, add Stokes's fluid, and observe the single absorption-band of hæmoglobin. Shake the mixture with air and the two bands reappear.

(e.) Use a solution of oxy-hæmoglobin where the two bands can *just be seen*, and reduce it with either ammonium sulphide or Stokes's fluid, and note that, perhaps, no absorption-band of hæmoglobin is to be seen, or only the faintest shadow of one.

(f.) Compare the relative strengths of the solution of oxy-hæmoglobin and hæmoglobin. The latter must be considerably stronger to give its characteristic spectrum.

Fig. 25 shows the amount of light absorbed by solutions of reduced hæmoglobin (1 cm. in thickness), and of various strengths.

Stokes's Fluid.—Make a solution of ferrous sulphate; to it add ammonia after the previous addition of sufficient tartaric acid to prevent precipitation. Add about three parts by weight of tartaric acid to two of the iron salt. *Make it fresh when required.*

8. Reduction of HbO₂ by Putrefying Bodies.—Fill a test-tube with a dilute solution of oxy-hæmoglobin or blood, add a drop of putrid meat infusion, cork the vessel tightly to make it air-tight, and allow it to stand. The oxy-hæmoglobin is *reduced* to hæmoglobin, the colour changes to purple-red, and the fluid shows the spectrum of hæmoglobin. A better plan is to seal up the blood in a tube. It need not be mixed with putrid matter in order to observe after a time the reduction.

9. Hæmatinometer.—For accurate observation, instead of a test-tube the blood is introduced into a vessel with parallel sides, the glass plates being exactly 1 cm. apart (fig. 31 D). Study this instrument.

10. Hæmatoscope (fig. 27).—By means of this instrument the depth of the stratum of fluid to be investigated can be varied, and the variation of the spectrum, with the strength of the solution, or the thickness of the stratum through which the light passes, at once determined. Study this instrument.

11. III. Carbonic Oxide-Hæmoglobin.—Through a diluted solution of oxy-hæmoglobin or defibrinated blood pass a stream of carbonic oxide—or coal gas—until no more CO is absorbed. Note the florid cherry-red colour of the blood.

(a.) Dilute the solution in a test-tube and observe its spectrum, noting that a stronger solution is required than with HbO_2 , to show the absorption-bands. Two absorption-bands nearly in the same position as those of HbO_2 , but very slightly nearer the violet end (fig. 24, 3). Make a map of the spectrum and bands.

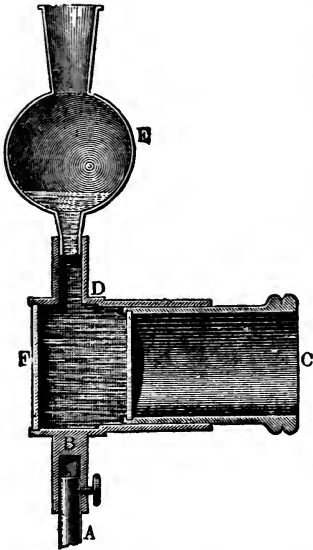

FIG. 27.—Hæmatoscope of Hermann. *E.* Glass plate; *C.* Piston-like tube, closed by a glass plate. By moving *C* the space *BF* can be increased or diminished, and the thickness of the stratum of fluid varied. *E.* Vessel for holding surplus fluid. *A.* Support.

(b.) The bands are not affected by the addition of a reducing agent, e.g., ammonium sulphide or Stokes's fluid. Add these fluids to two separate test-tubes of the solution of COHb , and observe that the two absorption bands are not affected thereby. There is no difference on shaking the solution with air, as the compound is so very stable.

(c.) To a fresh portion of the solution of carbonic oxide hæmoglobin add a 10 per cent. solution of caustic soda and boil—cinnabar-red colour. Compare this with a solution of oxy-hæmoglobin similarly treated. The latter gives a brownish-red mass.

(d.) Dilute 1 cc. of blood with 20 cc. of water + 20 cc. of caustic soda (sp. gr. 1.34). If the blood contains CO , the fluid first becomes white and cloudy, and presently red. When allowed to stand, flakes form and settle on the surface. Normal blood gives a dirty brown colouration.

(e.) Non-Reduction of HbCO .—Repeat the above experiment (VI. 8) with carbonic oxide hæmoglobin, and note that this body is not reduced by putrefaction. Or seal up the blood in a tube.

12. IV. Acid-Hæmatin.

(a.) To diluted defibrinated blood add a few drops of glacial acetic acid, and warm *gently*, when the mixture becomes brownish owing to the formation of acid hæmatin.

(b.) The spectrum shows one absorption-band to the red side of *D* near *C* (fig. 28, 5), and there is considerable absorption of the blue end of the spectrum.

(c.) The single band is not affected by ammonium sulphide or Stokes's fluid. Note that sulphur is precipitated if Am_2S is used. If the fluid is made alkaline hæmochromogen is formed.

N.B.—If acetic acid alone be used to effect the change, observe that only one absorption-band is seen.

13. Acid-Hæmatin in Ethereal Solution.

(a.) To undiluted defibrinated blood add glacial acetic acid, which makes the mixture brown. Extract with ether, shake vigorously, and a dark-brown ethereal solution of hæmatin is obtained. Pour it off and—

(b.) Observe the spectrum of this solution—*four* absorption bands are obtained. The one in the red between C and D, corresponding to the watery acid-hæmatin solution; and on diluting further with ether a narrow faint one near D, one between D and E, and a fourth between *b* and F (fig. 28, 5). The last three bands are seen only in ethereal solutions, and require to be looked for with care.

14. V. Alkali-Hæmatin.

(a.) To diluted blood add a drop or two of solution of caustic potash, and warm gently. The colour changes to a brownish-green, and the solution is dichroic. Or use a solution of acid-hæmatin; neutralise it with caustic soda until there is a precipitate of hæmatin; on adding more soda and heating gently, the precipitate is re-dissolved, and alkali-hæmatin is formed.

(b.) Shake (a.) with air to obtain oxy-alkali-hæmatin. Observe its spectrum, one absorption-band just to the *red* side of the D line. It is much nearer D than that of acid hæmatin (fig. 28). Much of the blue end of the spectrum is cut off.

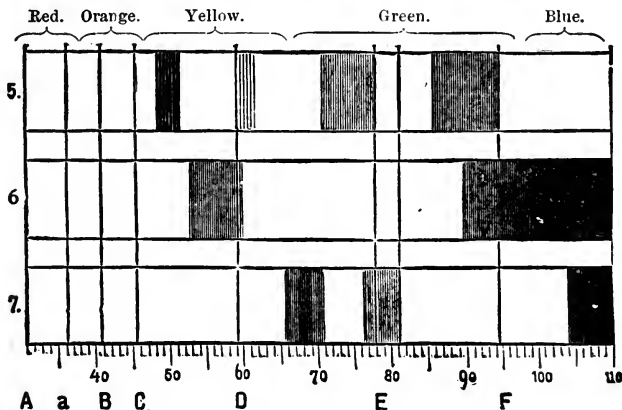

FIG. 28.—Spectra of Derivatives of Hæmoglobin. 5. Hæmatin in ether with sulphuric acid; 6. Hæmatin in an alkaline solution; 7. Reduced hæmatin.

15. Reduced Alkali-Hæmatin or Hæmochromogen.

(a.) Add to a solution of alkali-hæmatin a few drops of ammonium sulphide and warm gently. Note the change of colour = reduced

alkali-hæmatin, Stokes's reduced hæmatin or hæmochromogen, and observe its spectrum; two absorption-bands between D and E, as with HbO_2 and HbCO , but they are nearer the violet end. The first band to the violet side of the D line is well defined, while the second band, still nearer the violet end (in fact, it nearly coincides with the E line), is less defined. They disappear on shaking vigorously with air, and reappear on standing, provided sufficient ammonium sulphide be added.



Hæmochromogen and Hæmatin.—Seal up in a glass tube a solution of oxy-hæmoglobin with caustic soda. Hoppe-Seyler recommends the following method but it is unnecessary. Arrange a tube as in fig. 29. Place some hæmoglobin solution in A, and into a narrower cup-shaped glass tube (B), with a long stem place some NaHO , and place B inside A, as shown in the figure. Draw out the end of tube A in a gas-flame, and seal it in the flame. Mix the two solutions. At the end of three weeks break off the narrow end of the tube, and shed the contents upon a white plate. The contents consist of red hæmochromogen, but the latter, as soon as it is exposed to the air, becomes brown, and is converted into hæmatin.

16. VI. Methæmoglobin (fig. 30).

(a.) To a medium solution of oxy-hæmoglobin add a few drops of a freshly-prepared strong solution of ferricyanide of potassium (or a 1 per cent. solution of potassic permanganate), warm gently, observe the change of colour, and examine it with a spectroscope. If the two bands of oxy-hæmoglobin are still present, allow it to stand for some time and examine again. If they persist, carefully add more ferricyanide until the two bands disappear. Note one absorption-band in the red near C, nearly in the same position, but nearer D than the band of acid hæmatin; the violet end of the spectrum is much shaded. Three other bands are

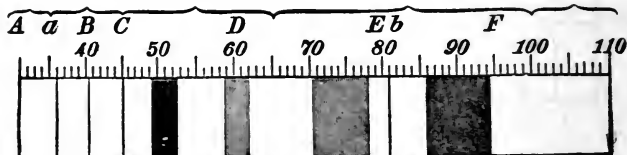

FIG. 30.—Spectrum of Methæmoglobin in Acid and Neutral Solutions.

described, two in the green, and one in the blue, especially in dilute solutions. On adding ammonia to render the solution alkaline, the band in the red disappears, and is replaced by a faint band near D.

Observe the many-banded spectrum of a solution of potassic permanganate.

(*b.*) To an alkaline solution of methæmoglobin add ammonium sulphide. This gives the spectrum first of oxy-hæmoglobin and then of hæmoglobin; and on shaking with air, oxy-hæmoglobin is formed.

(*c.*) To a solution of oxy-hæmoglobin add a crystal or two of potassic chlorate; dissolve it with the aid of gentle heat; after a short time the spectrum of methæmoglobin is obtained.

(*d.*) **Action of Nitrites.**—To diluted defibrinated ox-blood, or preferably that of a dog, add a few drops of an alcoholic solution of amyl nitrite. The blood immediately assumes a chocolate colour (*Gamgee*).

(*e.*) To another portion of diluted blood add a solution of potassic or sodic nitrite. Observe the chocolate colour.

(*f.*) To portions of (*d.*) and (*e.*) add ammonia; the chocolate gives place to a red colour.

(*g.*) Observe the spectrum of (*d.*) and (*e.*). The band in the red is distinct, and is best seen when the solution is of such a strength that only the red rays are transmitted. On dilution, other bands are seen in the green. Add ammonia, and with the change of colour described in (*f.*) the spectrum changes as described in (*a.*). Add ammonium sulphide or Stokes's fluid, the spectrum of reduced hæmoglobin appears, and on shaking up with air, the bands of oxy-hæmoglobin appear.

(*h.*) **Crystals of Methæmoglobin.**—To a litre of concentrated solution of hæmoglobin add 3-4 cc. of a concentrated solution of ferricyanide of potassium and also a quarter of a litre of alcohol, and freeze the mixture. After two days, brown crystals of methæmoglobin separate.

(*i.*) To a few cc. of defibrinated blood (rat, guinea-pig), add an equal number of drops of amyl nitrite, and shake the mixture vigorously for a minute or two = dark chocolate tint of methæmoglobin. A drop of this fluid transferred at once to a slide, and covered, yields crystals of methæmoglobin (*Halliburton*).

17. VII. Hæmatoporphyrin (iron-free hæmatin $C_{10}H_{18}N_2O$).

(*a.*) To some strong sulphuric acid in a test-tube add a few drops of undiluted blood (about 5 drops of blood to 8-10 cc. of H_2SO_4); mix by shaking, when a clear violet-red or purple-red fluid is obtained.

(*b.*) Observe two absorption-bands, one close to and on the red side of D, and a second half-way between D and E.

(*c.*) To some of this violet-red solution add a large excess of water, which throws down part of the hæmatoporphyrin in the form of a brown precipitate, which is more copious if the acid be neutralised with an alkali, *e.g.*, caustic soda. Dissolve some of the brown deposit in caustic soda, and examine it spectroscopically.

(*d.*) The spectrum shows four absorption-bands; a faint band midway between C and D, another similar one between D and E, but close to D; a third band near E; and a fourth one, darkest of all, occupying the greater part of the space between *b* and F, but nearer the former.

In all cases make drawings of what you see, and compare them with the table of characteristic spectra suspended in the laboratory.

18. Picro-Carmine.—Its spectrum closely resembles that of HbO_2 , but the two bands are much nearer the violet end, one being midway between D and E, and the other to the violet side of E. The bands are unchanged on addition of Am_2S or Stokes's fluid. The solution does not give proteid reactions.

ADDITIONAL EXERCISES.

19. Prolonged Action of Methæmoglobin-forming Reagents.—Allow KMnO_4 , K_3FeCy_6 , iodine, amyl or potassium nitrite or glycerine to act on HbO_2 for some days at 40°C . Methæmoglobin is first formed, then hæmatin. The latter is partially precipitated. Precipitate may be washed with water and dissolved in dilute acid or alkali. In the case of K_3FeCy_6 the solution becomes cherry-red, and contains cyan-hæmatin. Its spectrum shows one broad band, like that of Hb, between D and E, unchanged on shaking with air. In the case of amyl nitrite the final product in solution has a spectrum like that of HbO_2 , unchanged on treatment with Am_2S (? HbNO).

HbO_2 solution or dilute blood left on the water-bath at 40°C . for some days shows first a partial formation of methæmoglobin and later becomes Hb. It does not become converted into hæmatin (*J. A. Menzies*).

20. Effect of Sodium Fluoride.—To HbO_2 solution or diluted blood, add a few drops of 1 per cent. NaFl solution, and keep at 40°C . until the colour changes from scarlet to a rich crimson. Examine the spectrum. In addition to traces of the HbO_2 bands, there will be seen two bands, one very distinct to the red side of D, slightly nearer the red than the band of alkali-hæmatin, the other, not easily seen, to the violet side of E. On addition of Am_2S , the spectrum changes first to that of HbO_2 , then Hb.

21. Effect of Acids.—(*a.*) To 15 cc. dilute blood which gives a well-marked spectrum of HbO_2 , add 5 drops of 1 per cent. HCl (or other acid). The colour changes to brown, and the spectrum to that of acid hæmatin. Add ammonia, the spectrum becomes that of alkaline methæmoglobin, and, on addition of Am_2S , the solution changes to HbO , then Hb. But, if Am_2S be added without previous addition of ammonia, the spectrum becomes that of hæmochromogen first becoming Hb on standing, and then HbO_2 appears on shaking the solution with air.

(*b.*) Place 15 cc. of solution of pure HbO_2 with well-marked spectrum in each of five test-tubes. To these add 1, 2, 5, 10, and 15 drops of 1 per cent. HCl respectively. Place all on a water-bath at 40°C . for 24 hours, or longer if necessary. In some of the tubes a precipitate of hæmatin will be found, and in one of these the supernatant fluid will be colourless, and will give proteid reactions. Decant the colourless fluid, and collect and wash with water the

hæmatin precipitate. Dissolve the hæmatin in water containing a trace of HCl. It will give the spectrum of acid-hæmatin. To one portion add some of the decanted fluid and a few drops Am_2S , to another add Am_2S only. In the former case the hæmochromogen formed will gradually become partially converted into Hb (prove by shaking with air and obtaining spectrum of HbO_2), in the latter case the hæmochromogen will remain unaltered.

LESSON VII.

WAVE-LENGTHS—DERIVATIVES OF HÆMOGLOBIN—ESTIMATION OF HÆMOGLOBIN.

Spectroscopic Determination of Wave-Lengths.—Use Zeiss's spectroscope, which is provided with an illuminated scale for this purpose.

1. W.L. of Absorption-Bands of Oxy-Hæmoglobin.

(a.) Arrange the apparatus as shown in fig. 31. A is the

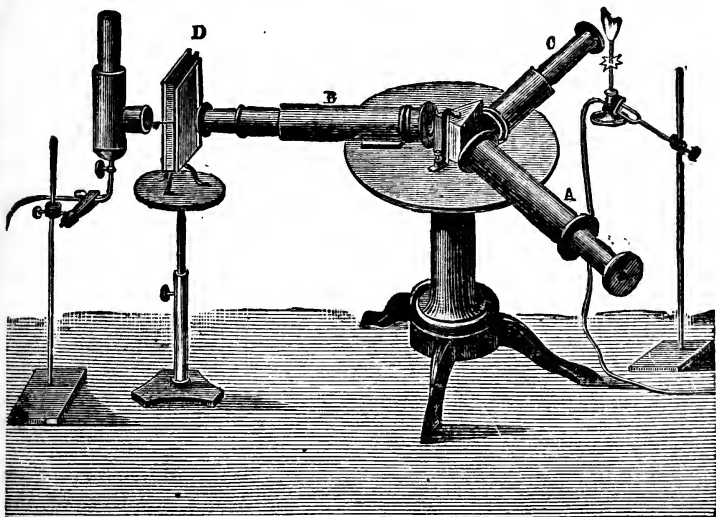

FIG. 31.—Arrangement of the Spectroscope for Determining Wave-Lengths. A. Telescope; B. Collimator tube; C. Scale tube; D. Hæmatinometer.

telescope through which the observer looks at the spectrum obtained by the light passing through B, and dispersed by the

flint-glass prism in the centre of the apparatus. In C is fixed a scale photographed on glass and illuminated by a fan-tailed burner. D is the hæmatinometer containing the dilute blood.

(b.) Throw a piece of black velvet over the prism; light both lamps; look through A; adjust the slit in B, and the telescope in A, so as to get a good view of the spectrum, and over it the image of the scale. D is supposed not to be in position at first. On platinum wire, burn common salt in the flame to get the yellow sodium line D. Adjust the scale so that this line corresponds to the figures 58.9 on the scale, and fix the spectroscope tubes (A and C) in this position; the scale is now accurately adjusted for all other parts of the spectrum.

“The numbers on the scale indicate wave-lengths expressed in one hundred thousandths of a millimetre, and each division indicates a difference in wave-length equal to one hundred thousandth of a millimetre” (*Gamgee.*)

Thus, Fraunhofer's line, D, which corresponds to division 58.9 of the scale, has a wave-length of 589 millionths of a millimetre. The wave-lengths of Fraunhofer's lines are:—A = 760.4, B = 687.4, C = 656.7, D = 589.4, E = 527.3, F = 486.5.

(c.) Using one of the blank maps supplied with Zeiss's spectroscope—the maps correspond to the scale seen in the spectroscope—fill in, in wave-lengths, the position of Fraunhofer's lines B to F.

(d.) Use a dilute solution of blood or hæmoglobin—1 part in 1000 of water is best—and place it in the hæmatinometer, D, which is placed in position between the flame and the spectroscope, as shown in fig. 31. The distance between the parallel faces of D is 1 cm. The spectrum shows the two absorption-bands of oxy-hæmoglobin between D and E. The narrower, sharper, and blacker band near D has its centre corresponding with the W.L. 579, and it may conveniently be expressed by the letter *a* of the oxy-hæmoglobin spectrum.

The other absorption-band near E, and conveniently designated *β*, is broader, not so dark, and has less sharply defined edges than *a*. Its centre corresponds to the W.L. 543.8. Notice that the other parts of the spectrum are seen, there being only slight cutting off of the red, and a slightly greater absorption of the violet end.

(e.) Work with a stronger solution of blood, and observe how the two bands become fused into one, while more and more of the red and violet ends of the spectrum are absorbed as the solution is made stronger, until finally only a little red light is transmitted.

2. W.L. of Absorption-Band of Reduced Hb.

(a.) Adjust the apparatus as before, but reduce the oxy-hæmo-

globin solution with Stokes's fluid—noticing the change of the colour to that of purplish or claret—until a solution is obtained which gives the single characteristic absorption-band of reduced Hb. This is usually obtained with a solution of Hb of about 0.2 per cent.

(b.) Observe the single absorption-band less deeply shaded, and with less defined edges between D and E, conveniently designated by the letter *a*. It extends between W.L. 595 and 538, and is not quite intermediate between D and E; is blackest opposite W.L. 550, so that it lies nearer D than E. Both ends of the spectrum are more absorbed than with a solution of oxy-hæmoglobin of the same strength. On further dilution of the solution, the band does not resolve itself into two bands, but simply diminishes in width and intensity (fig. 32, 5).

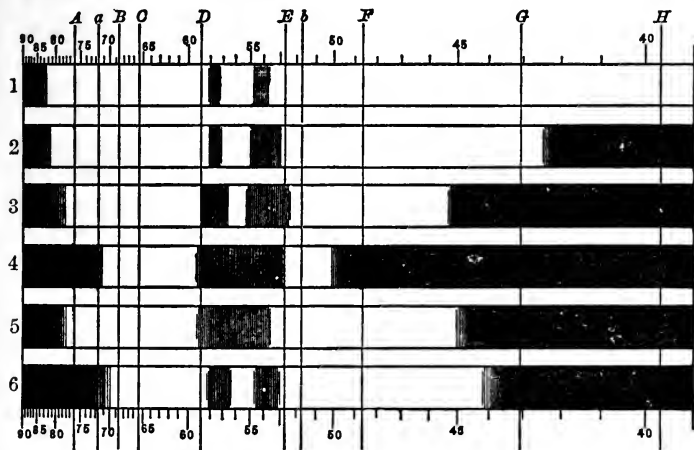

FIG. 32.—The Spectra of Oxy-Hæmoglobin (1, 2, 3, 4), 1=0.1, 2=0.2, 3=.37, 4=.8 per cent. of Oxy-Hæmoglobin, Hæmoglobin (5), and Carbonic Oxide Hæmoglobin (6). Wave-lengths added. The numbers attached to the scale indicate wave-lengths expressed in 100,000ths of a millimetre.

3. W.L. of the Spectrum of Carbonic Oxide Hæmoglobin.

(a.) Use a dilute solution of carbonic oxide hæmoglobin of such strength as to give the two characteristic absorption-bands.

(b.) Observe the two bands, *a* and *β*, like those of HbO₂, but both are *very slightly* more towards the violet end of the spectrum. *a* extends from about W.L. 587 to 564, and *β* from 547 to 529.

(c.) No reduction is obtained by reducing agents (fig. 32, 6).

4. Preparation of Hæmatin ($C_{32}H_{33}N_4O_4Fe$).

(a.) Make defibrinated blood into a paste with potassic carbonate and dry it on a water-bath. Place the paste in a flask, add 4 volumes of alcohol, and boil on a water-bath. Filter, and an alkaline brown solution of hæmatin is obtained. Re-extract the residue several times with boiling alcohol, and mix the alcoholic extracts. The solution is dichroic.

(b.) Acidify the alkaline filtrate of (a.) with dilute sulphuric acid, filter, and keep the filtrate. Observe the spectrum of acid hæmatin in the filtrate (figs. 28, 5, and 33, 5).

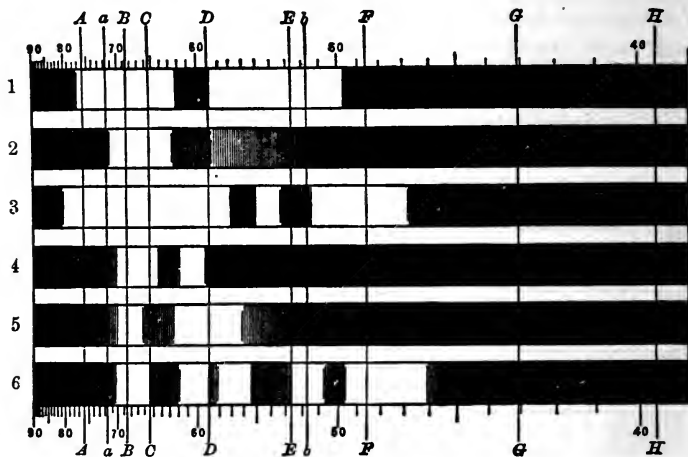

FIG. 33.—Spectra of some of the Derivatives of Hæmoglobin. 1. Hæmatin in alkaline solution; 2. The same, but more concentrated; 3. Hæmochromogen; 4. Methæmoglobin; 5. Acid hæmatin (acetic acid); 6. Acid hæmatin in ethereal solution.

(c.) Add excess of ammonia to the acid filtrate of (b.), and filter off the precipitate, keep the filtrate, and observe that it is dichroic. Observe the spectrum of alkali hæmatin in the filtrate (fig. 28, 6).

(d.) Evaporate the filtrate from (c.) to dryness on a water-bath. Extract the residue with boiling water. The black residue is washed on a filter with distilled water, alcohol, and ether, and dried in a hot chamber at $120^{\circ} C$. This is nearly pure hæmatin.

(e.) It is convenient to keep in stock hæmatin prepared as follows:—Extract defibrinated blood or blood-clot (ox or sheep) with rectified spirit containing pure sulphuric acid (1 : 20.) Filter; the solution gives the spectrum of acid hæmatin. Add an equal volume of water and then chloroform. The chloroform becomes brown, and there is a precipitate of proteids. Separate the chloroform extract, wash it with water to remove the acid. Separate the chloroform, and allow it to evaporate. The dark brown residue is impure hæmatin. When dissolved in alcohol and caustic soda it gives the spectrum of alkali hæmatin, and on adding ammonium sulphide that of hæmochromogen. If it is dissolved in H_2SO_4 , and filtered through asbestos, the red filtrate gives the spectrum of hæmato-porphyrin (*MacMunn*).

5. **Hæmin Crystals.**—Place some powdered dried blood on a glass slide, or smear some blood on a slide, allow it to dry, add a crystal of sodium chloride, and a few drops of *glacial* acetic acid. Cover with a cover-glass, and heat until bubbles of gas are given off. After cooling, brown or black rhombic crystals of hæmin are seen with a microscope (fig. 34). To preserve them irrigate with water, dry and mount in Canada balsam.



FIG. 34.—Hæmin Crystals.

6. **Detection of Blood-Stains.**—Use a piece of rag stained with blood.

(a.) Moisten a part of the stain with glycerine, and after a time express the liquor, and observe it microscopically for blood-corpuscles.

(b.) Tie a small piece of the stained cloth to a thread, place the cloth in a test-tube with a few drops of distilled water, and leave it until the colouring-matter is extracted. Withdraw the cloth by means of the thread. Observe the coloured fluid spectroscopically.

(c.) Boil some of the extract with hydrochloric acid, and add potassic ferrocyanide; a blue colour indicates the presence of iron.

(d.) Use the stain for the hæmin test, doing the test in a watch-glass.

7. **The Hæmoglobinometer** of Gowers is used for the clinical estimation of hæmoglobin (fig. 35). The tint of the dilution of a given volume of blood with distilled water is taken as the index of the amount of hæmoglobin. The colour of a dilution of average normal blood (one hundred times) is taken as the standard. The quantity of hæmoglobin is indicated by the amount of distilled water needed to obtain the tint with the same volume of blood under examination as was taken of the standard. On account of the instability of a standard dilution of blood, tinted glycerin jelly is employed instead. The apparatus consists of two glass tubes of exactly the same size. One contains (D) a standard of the tint of a dilution of 20 c.mm. of blood, in 2 cc. of water (1 in 100). The second tube (C) is graduated, $100^{\circ} = 2$ cc. (100 times 20 c.mm.).

(a.) Place a few drops of distilled water in the bottom of the graduated tube (C).

(b.) Puncture the skin at the root of the nail with the shielded lancet (F), and with the pipette (B) suck up 20 c.mm. of the blood, and eject it into the distilled water, and rapidly mix them.

(c.) Distilled water is then added drop by drop (from the pipette stopper of a bottle (A) supplied for that purpose) until the tint of the dilution is the same as that of the standard. The amount of water which has been added (*i.e.*, the degree of dilution) indicates the amount of hæmoglobin.

“Since average normal blood yields the tint of the standard at 100° of dilution, the number of degrees of dilution necessary to

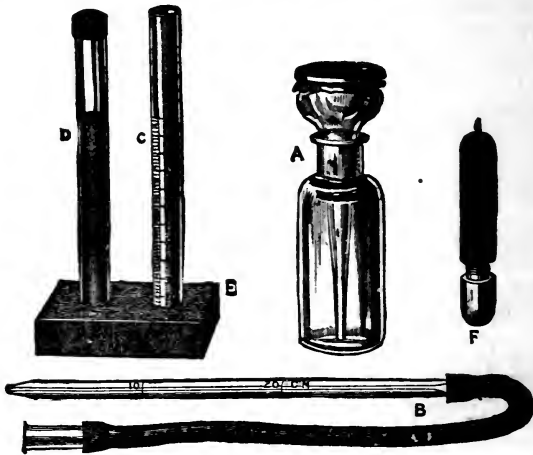

FIG. 35.—A. Pipette bottle for distilled water; B. Capillary pipette; C. Graduated tube. D. Tube with standard dilution; F. Lancet for pricking the finger.

obtain the same tint with a given specimen of blood is the percentage proportion of the hæmoglobin contained in it, compared to the normal. For instance, the 20 c.mm. of blood from a patient with anæmia gave the standard tint of 30° of dilution. Hence it contained only 30 per cent. of the normal quantity of hæmoglobin. By ascertaining with the hæmacytometer the corpuscular richness of the blood we are able to compare the two. A fraction of which the numerator is the percentage of hæmoglobin, and the denominator the percentage of corpuscles, gives at once the average value per corpuscle. Thus the blood mentioned above containing 30 per cent. of hæmoglobin contained 60 per cent. of corpuscles; hence the average value of each corpuscle was $\frac{30}{60}$ or half of the normal. Variations in the amount of hæmoglobin may be recorded on the same chart as that employed for the corpuscles.”

“In using the instrument, the tint may be estimated by holding the tubes between the eye and the window, or by placing a piece of white paper behind the tubes; the former is perhaps the best.

In practice it will be found that, during 6 or 8 degrees of dilution, it is difficult to distinguish a difference between the tint of the tubes. It is therefore necessary to note the degree at which the colour of the dilution ceases to be deeper than the standard, and also that at which it is distinctly paler. The degree midway between these two will represent the hæmoglobin percentage."

ADDITIONAL EXERCISES.

8. Fleischl's Hæmometer.—This apparatus (fig. 36) consists of a horse-shoe stand with a pillar bearing a reflecting surface (S) and a platform. Under the table or platform is a slot carrying a glass wedge stained red (K), and moved by a wheel (R). On the platform (M) is a small cylindrical vessel (G),

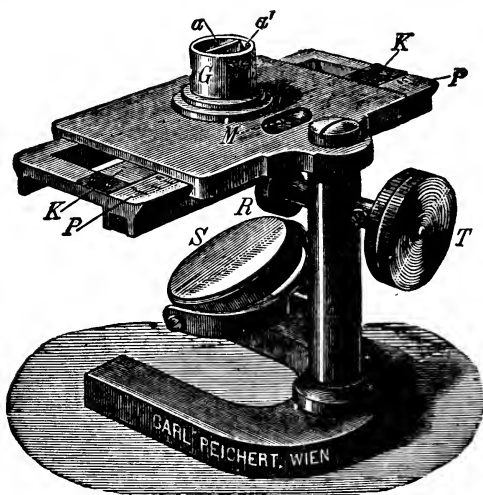

FIG. 36.—Fleischl's Hæmometer.

divided into two compartments (*a* and *a'*) by a vertical septum. In one compartment is placed pure water, and in the other the blood to be investigated. A scale (P) on the slot of the instrument enables one to read off directly the percentage of hæmoglobin.

(*a.*) Fill with a pipette the compartment (*a'*) over the wedge with distilled water, and see that the surface of the water is quite level with the top of the cylinder. Fill the other compartment (*a*), that for the blood, about one-quarter with distilled water.

(b.) Prick the finger as in 7 with the instrument supplied for the purpose. Fill the short automatic capillary pipette tube with blood. Its capacity is 6.5 c.mm. In filling the tube, hold it horizontally. See that no blood adheres to the surface of the tube. This can be done by having the pipette slightly greasy on the outer surface.

(c.) Dissolve the blood obtained in (b.) in the water of the blood-compartment (a), washing out every trace of blood from the pipette. Mix the blood and water thoroughly. Clean the pipette. Then fill the blood compartment exactly to the surface with distilled water, seeing that its surface also is perfectly level.

(d.) Arrange a candle in front of the reflector (S)—which is white, and with a smooth matt surface made of plaster-of-Paris—so as to throw a beam of light vertically through both compartments. Look down vertically upon both compartments, and move the wedge of glass by the milled head (T) until the colour in the two compartments is identical. Read off the scale, which is so constructed as to give the percentage of hæmoglobin.

9. Bizzozero's Chromo-Cytometer.—The chief part of the instrument consists of two tubes (fig. 37, *ab*, *cd*), working one within the other, and closed at the same end by glass discs, while the other ends are open. The one tube

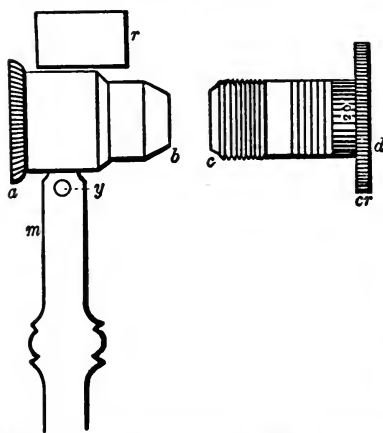

FIG. 37.—General View of the Chromo-Cytometer. *ab* and *cd*. Two tubes, the one fits inside the other; *r*. Reservoir communicating with the space between *c* and *b* when *cd* is screwed into *ab*; *cr*. Milled-head and index scale to the left of it, for the tinted glass; *m*. Handle.

can be completely screwed into the other, so that both glasses touch. Connected with the outer tube is a small open reservoir (*r*), from which fluid can pass into the variable space between the two glass plates at the ends of the tubes. By rotating the inner tube, the space between the two glass plates can be increased or diminished, on the principle of Hermann's hæmatoscope, and the screw is so graduated as to indicate the distance between the two plates, *i.e.*, the thickness of fluid between them. Each complete turn of the screw = 0.5 mm., and the subdivisions on it are so marked—25 to one turn (index fig. 37 *cd*)—that each subdivision of the index = $\frac{0.5}{25}$

= 0.02 mm. When the inner tube is screwed home and touches the glass disc in the outer tube, the index stands at 0 on the scale.

If the instrument is to be used merely as a cytometer, these parts suffice; but if it is to be used as a chromometer, the coloured glass must be used. The instrument is also provided with small glass thimbles with flat bottoms, containing 2 and 4 cc. respectively; a pipette graduated to hold $\frac{1}{2}$ and 1 cc., and another pipette for 10 and 20 c.mm., the latter provided with an india-rubber tube, to enable the fluid to be sucked up readily; a bottle to hold the saline solution, and a glass stirrer.

Method of Using the Instrument as a Cytometer.—1. By means of the pipette place 0.5 cc. in normal saline solution in a glass thimble.

2. With a lancette or needle puncture the skin of the finger at the edge of the nail.

3. With the pipette suck up exactly 10 c. mm. of blood. Mix this blood with the .5 c. cm. saline solution, and suck part of the latter several times into the capillary tube, so as to remove every trace of blood from the pipette. Mix the fluids thoroughly. Carefully cleanse the pipette with water.

4. Pour the mixture into the reservoir (*r*) of the instrument. Gradually rotate the inner tube, and as the two glass discs separate, the fluid passes into the space between them.

5. In a dark room light a stearin candle, place it at

a distance of $1\frac{1}{2}$ metres, and, taking the instrument in the left hand, bring the open end of the tubes to the right eye. With the right hand rotate the inner tube to vary the thickness of the column of fluid, and so adjust it until the outlines of the upper three-fourths of the flame can be distinctly seen through the stratum of fluid. Vary the position of the inner screw so as to determine accurately when this occurs. Read off on the scale the thickness of the stratum of fluid.

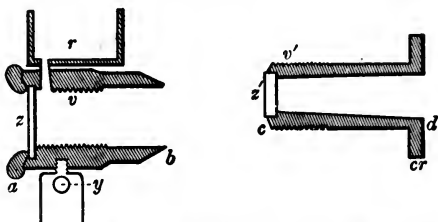

FIG. 38.—Showing how *cd* fits into *ab*. *zz*. Plates of glass closing the ends of *ab* and *cd*; other letters as in fig. 37.

Graduation of the Instrument as a Cytometer.—In this instrument the graduation is obtained from the thickness of the layer of blood itself, and the amount of hæmoglobin is calculated directly from the thickness of the layer of blood which is necessary to obtain a certain optical effect, viz., through the layer of blood-corpuscles to see the outlines of a candle-flame placed at a certain distance.

From a number of investigations it appears that in healthy blood the outlines of the flame of a candle are distinctly seen through a layer of the mixture of blood $\frac{110}{100}$ mm. in thickness.

Let the number 110 correspond to 1, or to 100 parts of hæmoglobin; then it is easy to calculate the relative value of the subdivisions of the scale on the tube of the instrument. Let *g* = the degree of the scale for normal blood; *g'*, that for the blood being investigated; *e*, amount of hæmoglobin in the former; and *e'*, the amount sought for in the latter.

Assuming that the product of the quantity of hæmoglobin and the thickness of the stratum of blood is constant, so that

$$eg = e'g'$$

Then we have

$$e' = \frac{eg}{g'}$$

Let us assume that the blood investigated gave the number 180; then using the above data, we have:—

$$e' = \frac{100 \times 110}{180} = \frac{11,000}{180} = 61.1.$$

The blood, therefore, contains 61.1 hæmoglobin. The following table gives the proportion of hæmoglobin, the normal amount of hæmoglobin being taken as = 100 :—

Cytometer Scale.	Hæmoglobin	Cytometer Scale.	Hæmoglobin.
110 . . .	100.0	170 . . .	64.7
120 . . .	91.6	180 . . .	61.1
130 . . .	84.6	190 . . .	57.9
140 . . .	78.5	200 . . .	55.0
150 . . .	73.3	210 . . .	52.4
160 . . .	68.7	220 . . .	50.0

Using the Instrument as a Chromometer.—The blood is mixed with a known volume of water, whereby the hæmoglobin is dissolved out of the red corpuscles and the fluid becomes transparent. The quantity of hæmoglobin is calculated from the thickness of the stratum of fluid required to correspond exactly to the colour-intensity of a coloured glass accompanying the instrument. The latter is coloured of a tint similar to a solution of hæmoglobin, and is fixed to the instrument by means of a suitable brass fixture.

1. Fix the coloured glass with its brass frame in the instrument.
2. Mix 10 c.mm. blood with .5 cc. distilled water. In a few seconds a transparent solution of hæmoglobin is obtained.
3. Pour this solution into the reservoir (*r*), and rotate the inner tube so that the fluid passes between the two glasses. Direct the instrument towards a white light or the sky, not towards the sun, and compare the colour of the solution with the standard coloured glass, a procedure which is facilitated by placing a milky glass between the source of light and the layer of blood, so as to obtain diffuse white light. When the two colours appear to have as near as possible the same intensity, read off on the scale the thickness of the layer of blood, and from this, by means of the accompanying table, ascertain the corresponding amount of hæmoglobin.

This is done in the same way as for the cytometer, but the graduation is different, as in the one case we have to do with a candle-flame, and in the other with a coloured glass.

In very pronounced cases of *anæmia*, even with a layer of blood 6 mm. in thickness, owing to the limits of the instrument, the intensity of the mixture of blood may be less than that of the coloured glass. In such a case, instead of 10 c.mm. of blood, use 20 c.mm.

Graduation of the Chromometer.—As the coloured glass has not absolutely the same intensity of colour in all chromometers, one must first of all estimate the colour-intensity of the glass itself. This is most easily done by ascertaining in a given specimen of blood what degree of the chromometer corresponds to the scale of the cytometer of the same blood.

Suppose that a specimen of blood by means of the cytometer gave 110, and by the chromometer 140; the number 110 of the cytometer = 100 hæmoglobin, so that the chromometer number 140 must also be = 100. With the aid of the formula (p. 63) a similar table can be constructed for the chromometer. Suppose the blood investigated = 280; then by the aid of the formula and the data from normal blood we have—

$$e' = \frac{100 \times 140}{280} = \frac{14,000}{280} = 50.$$

This blood, therefore, contains 50 parts of hæmoglobin.

Example.—Blood gives 130 with the cytometer and 190 with the chromometer; what is the initial number of the chromometer graduation corresponding to 100 parts of hæmoglobin?

If 130 (cytometer) corresponds to 190 (chromometer) then 110 cytometer (*i.e.*, graduation corresponding to 100 parts of hæmoglobin) corresponds to a chromometer graduation :

$$130 : 190 = 110 : x \therefore x = \frac{190 \cdot 110}{130} = \frac{20,900}{130} = 160.7.$$

Blood containing 100 parts hæmoglobin will correspond to 160 of the chromometer scale, and beginning with this number as a basis, with the aid of our formula it is easy to construct a table showing the relation.

Whilst the value of the cytometer scale remains the same for every instrument, the chromometer scale varies with each instrument, as the colour-intensity of the glass is not necessarily the same in all. But it is easy to construct a scale for each instrument by investigating a specimen of blood and comparing it with the cytometer graduation as indicated in the foregoing paragraph.

Precautions to be Observed in Using the Instrument.—The exact quantity of the several fluids must be carefully measured ; evaporation must be prevented by covering the blood-mixture. Further, do not look at the fluid too long at a time, as the eye becomes rapidly fatigued. Further, the operation must be carried out not too slowly, as the saline solution only retards the coagulation of the blood, and does not arrest it.

In cases of leukæmia, where there is a large number of white corpuscles rendering the mixed fluid opaque, the corpuscles may be made to disappear by adding a drop of a very dilute caustic potash. If the opacity does not disappear by the addition of this substance, then the opacity is due to the presence of fatty granules in the blood, so that by this means we can distinguish lipæmia from leukæmia.

Bizzozero claims that when the instrument is used as a cytometer the mean error is not greater than 0.3 per cent.

10. Preparation of Hæmoglobin (*dog's or horse's blood*).—Centrifugalise filtered fresh defibrinated dog's blood, and when the corpuscles have subsided pour off the clear serum. Mix the corpuscles with .5-2 per cent. solution of NaCl, and centrifugalise again. Repeat the process until the washings contain only a trace of proteid, or begin to be tinged red from the solution of the blood-corpuscles.

Mix the magma of corpuscles with 2-3 volumes of water saturated with acid-free ether. The corpuscles swell up, become almost invisible, and the solution becomes clear. With the utmost care add, stirring all the time, 1 per cent. solution of acid sodic sulphate until the blood appears turbid like fresh blood. The stromata of the corpuscles are thereby caused to shrivel, and when they are centrifugalised for a long time, they run together, and can thus be separated. Pour off the clear fluid, cool it to 0°, add one-fourth of its volume of pure alcohol previously cooled to 0° or lower. Shake up the whole, and let it stand for twenty-four hours at 5°-15°. As a rule, the whole passes into a glittering crystalline mass. Place it in a filter cooled to 0°, and wash it with ice-cold 25 per cent. alcohol. Redissolve the crystals in a small quantity of water, and recrystallise with alcohol as before. The crystals are spread on plates of porous porcelain, and dried in a vacuum over sulphuric acid.

11. Amount of Hæmoglobin in Blood—Colorimetric Method (Hoppe-Seyler's method).—A standard solution of pure hæmoglobin diluted to a known strength is used, and with this is compared the tint of the blood diluted with a known volume of distilled water.

(a.) A standard solution of hæmoglobin of known strength is supplied (*supra*).

(b.) Spread a sheet of white paper on a table in a good light opposite a window, and on it place two hæmatinometers side by side (fig. 31, D). See that they are water-tight. If not, anoint the edges of the glass plates with vaseline to make them water-tight.

(c.) Take 10 cc. of the standard solution of hæmoglobin and dilute it with 50 cc. of water, and place it in one of the hæmatinometers.

(d.) Weigh 5 grams of the blood to be investigated, and dilute it with water exactly to 100 cc.

(e.) Place 10 cc. of this deeper tinted blood (d.) into the second hæmatinometer.

(f.) Fill an accurately graduated burette with distilled water, place it over the second hæmatinometer (e.), and dilute the blood in it until it has precisely the same tint as the standard solution in the other hæmatinometer. Note the amount of water added. The two solutions must now contain the same amount of hæmoglobin.

Example (*Hoppe-Seyler*).—20.186 grams of defibrinated blood were diluted with water to 400 cc. To the 10 cc. of this placed in a hæmatinometer, 38

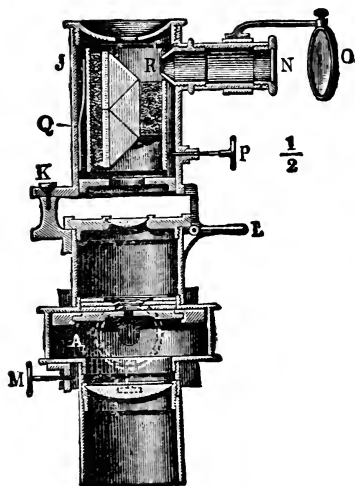

FIG. 39.—Zeiss's Microspectroscope after Albe.

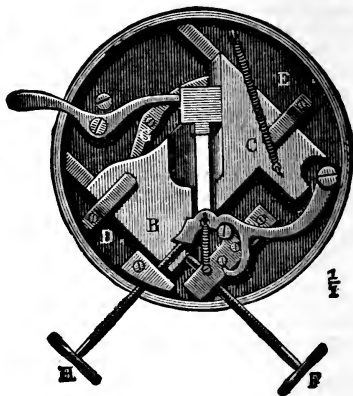

FIG. 40—Adjustable Slit in Fig. 39, A.

cc. of water had to be added to obtain the same tint as that of the standard solution, so that the volume of water which would require to be added to dilute the whole 400 cc. would be 1520 cc., thus—

$$10 : 400 :: 38 : x \\ x = 1520 \text{ cc.}$$

By adding 1520 cc. of distilled water to the 400 cc. of blood solution, we get 1920 cc. of the same tint or degree of dilution as the standard solution.

The standard solution on analysis was found to contain 0.145 grams of hæmoglobin in 100 cc., so that the total amount of hæmoglobin in the diluted blood is found, thus—

$$100 : 1920 :: 0.145 : x \\ x = 2.784 \text{ grams.}$$

Since, however, this amount of hæmoglobin was obtained from 20.186 grams of the original blood, the amount in 100 parts will be found as follows:—

$$20.186 : 100 :: 2.784 : x$$

$$x = 13.79 \text{ grams per cent.}$$

12. Microspectroscopes.—When very small quantities of fluid are to be examined, they are placed in small vessels made by fixing short lengths of barometer tubing to a glass slide. Use either the instrument of Browning or that of Zeiss (figs. 39, 40).

The instrument is in reality an eyepiece with a slit mechanism adjustable between the field-glass and eye-glass of an ocular. The instrument is fitted into the tube of a microscope in place of the eyepiece. It consists of a drum (A) with a slit adjustable by means of the screws H and F (fig. 40). Within the drum there is also a prism whereby light admitted at the side of the drum is totally reflected towards the eye of the observer. Above the eye-glass is placed an Amici prism of great dispersion, which turns aside on the pivot (K) to allow of the adjustment of the object. It is retained in position by the catch (L). At N is placed the scale of wave-lengths, and its image can be projected on the spectrum by the mirror (O). The scale is adjusted relative to the spectrum by the screw P. The scale is set by the observer so that Fraunhofer's line D corresponds to 58.9 of the scale.

The fluid to be examined is placed in a suitable vessel on the stage of the microscope, and light is transmitted through it.

LESSON VIII.

SALIVARY DIGESTION.

1. To Obtain Mixed Saliva.—Rinse out the mouth with water an hour or two after a meal. Inhale the vapour of ether, glacial acetic acid, or even cold air through the mouth, which causes a reflex secretion of saliva. In doing so, curve the tongue so as to place its tip behind the incisor teeth of the upper jaw. Or chew a piece of caoutchouc. In a test-glass collect the saliva with as few air-bubbles as possible. If it be turbid or contain much froth, filter it through a small filter (p. 69).

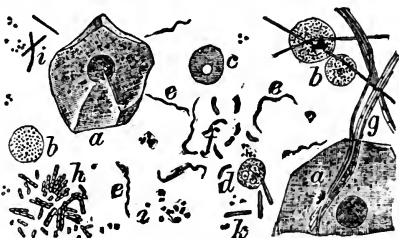

FIG. 41.—Microscopic Appearances of Saliva.

2. I. Microscopic Examination.—With a high power observe the presence of (1) squamous epithelium, (2) salivary corpuscles,

(3) perhaps *débris* of food, (4) possibly air-bubbles, and (5) fungi—especially various forms of bacteria (fig. 41).

II. Physical and Chemical Characters (sp. gr. 1002-1006).

(a.) Observe its appearance—it is colourless and either transparent or translucent—and that when poured from one vessel to another it is glairy, and more or less sticky. On standing, it separates into two layers; the lower one is cloudy and turbid, and contains in greatest amount the morphological constituents.

(b.) Its **reaction** is alkaline to litmus paper.

(c.) Add acetic acid = a precipitate of **mucin** not soluble in excess. Filter.

(d.) With the filtrate from (c.), test for traces of **proteids** (serum-albumin and globulin) with the xanthoproteic reaction and Millon's test.

(e.) To a few drops of saliva in a porcelain vessel add a few drops of *dilute* acidulated ferric chloride = a red colouration due to **potassic sulpho-cyanide**. The colour does not disappear on heating, or on the addition of an acid, but is discharged by mercuric chloride. Meconic acid yields a similar colour, but it is not discharged by mercuric chloride. The sulpho-cyanide is present only in parotid saliva, and is generally present in mixed saliva.

(f.) Test a very dilute solution of potassic sulpho-cyanide to compare with (e.).

(g.) **Gscheidlen's method**. Dip filter paper in weak acidulated (HCl) ferric chloride solution, and allow it to dry. Contact with a drop of saliva gives a reddish stain.

(h.) The **salts** are tested for in the usual way (see "Urine"). Test for chlorides (HNO_3 and AgNO_3), carbonates (acetic acid), and sulphates (barium chloride and nitric acid).

(i.) Nitrites are often present in saliva. Add a little of the saliva to starch paste, containing a little sulphuric acid and iodide of potassium, when, if nitrites be present, an intense blue colour is produced.

(j.) To diluted saliva add a few drops of sulphuric acid, and then metadiamido-benzol. Yellow colour indicates the presence of nitrites. This reaction does not succeed in all cases.

3. Digestive Action.

Starch Solution.—Place 1 gram of pure potato starch in a mortar, add a few cc. of cold water, and mix well with the starch. Add 200 cc. of boiling water, stirring all the while. Boil the fluid in a flask for a few minutes. This gives .5 per cent. solution.

Action of Saliva on Starch (Ptyalin, a diastatic enzyme).

(a.) Dilute the saliva with five volumes of water, and filter it.

This is best done through a filter perforated at its apex by a pin-hole. In this way all air-bubbles are got rid of. Label three test-tubes A, B, and C. In A place starch mucilage, in B saliva, and in C 1 volume of saliva and 3 volumes of starch mucilage. Place them in a water-bath at 40° C. for ten minutes. Test for a reducing sugar in portions of all three, by means of Fehling's solution. A and B give no evidence of sugar, while C reduces the Fehling, giving a yellow or red deposit of cuprous oxide. Therefore, starch is converted into a reducing sugar by the saliva. This is done by the ferment **ptyalin** contained in it.

(b.) Test a portion of C with solution of iodine; no blue colour is obtained, as all the starch has disappeared, being converted into a reducing sugar or **maltose**.

(c.) Make a *thick* starch mucilage, place some in test-tubes labelled A and B. Keep A for comparison, and to B add saliva, and expose both to 40° C. A is unaffected, while B soon becomes fluid—within two minutes—and loses its opalescence; this liquefaction is a process quite antecedent to the saccharifying process which follows.

4. Stages between Starch and Maltose.—Mix starch and saliva as in 3 (a.) C, and place in a water-bath at 40° C. At intervals of a minute test small portions with iodine. Do this by taking out a drop of the liquid by means of a glass rod. Place the drop on a white porcelain plate, and with another glass rod add a drop of iodine solution.

Note the following stages:—At first there is pure blue with iodine due to the **soluble starch** formed giving also a blue with iodine, later a deep violet, showing the presence of **erythro-dextrin**, the violet resulting from a mixture of the red produced by the dextrin and the blue of the starch. Then the blue reaction entirely disappears, and a reddish-brown colour, due to erythro-dextrin alone, is obtained. After this the reaction becomes yellowish-brown, and finally there is no reaction with iodine at all, **achroo-dextrin** being formed, along with a reducing sugar or **maltose**. The latter goes on forming after iodine has ceased to react with the fluid, and its presence is easily ascertained by Fehling's solution. The soluble starch is precipitated by alcohol, while maltose is not. In this way this body may be separated.

5. Effect of Different Conditions on Salivary Digestion.

(a.) Label three test-tubes A, B, and C. Into A place some saliva, boil it, and add some starch mucilage. In B and C place starch mucilage and saliva, to B add a few drops of hydrochloric acid, and to C caustic potash. Place all three in a water-bath at 40° C., and after a time test them for sugar by Fehling's solution. No sugar is formed—in A because the ferment was de-

stroyed by boiling, and in B and C because strong acids and alkalies arrest the action of ptyalin on starch.

(b.) If a test-tube containing starch mucilage and saliva be prepared as in 3 (a.) C, and placed in a freezing mixture, the conversion of starch into a reducing sugar is arrested; but the ferment is not destroyed, for on placing the test-tube in a water-bath at 40° C., the conversion is rapidly effected.

(c.) Mix raw starch with saliva and keep it at 40° C. Test it after half an hour, when little or no sugar will be found.

6. Starch is a Colloid, but Sugar is a Crystalloid and dialyses.

(a.) Place in a sausage parchment tube (p. 78), 20 cc. of starch mucilage (A), and into another, some starch mucilage with saliva (B). Suspend A and B in distilled water in separate vessels.

(b.) After some hours test the diffusate in the distilled water. No starch will be found in the diffusate of either A or B, but sugar will be found in that of B, proving that sugar dialyses, while starch does not. Hence the necessity of starch being converted into a readily diffusible body during digestion.

7. Action of Malt-Extract on Starch.

(a.) Rub up 10 grams of starch with 30 cc. of distilled water in a mortar, add 200 cc. of boiling water, and make a strong starch mucilage.

(b.) Powder 5 grams of pale *low-dried* malt, and extract it at 50° C. for half an hour with 30 cc. of distilled water, and filter. Keep the filtrate.

(c.) Place the starch paste of (a.) in a flask, and cool to 60° C., add the extract of (b.), and place the flask in a water-bath at 60° C.

(d.) Observe that the paste soon becomes fluid, owing to the formation of soluble starch, and if it be tested from time to time (as directed in 4), it gives successively the tests for starch and erythro-dextrin. Continue to digest it until no colour is obtained with iodine—*i.e.*, until all starch and erythro-dextrin have disappeared.

(e.) Take a portion of (d.) and precipitate it with alcohol = achroo-dextrin. The liquid also contains maltose (f.).

(f.) Boil the remainder of the fluid, cool, filter, and evaporate the filtrate to 20 cc. Add 6 volumes of 90 per cent. spirit to precipitate the dextrin; boil, filter, and concentrate to dryness on a water-bath, and dissolve the residue in distilled water. The solution is maltose ($C_{12}H_{22}O_{11} + H_2O$). If the alcoholic solution be exposed to air, crystals of maltose are formed.

ADDITIONAL EXERCISES.

8. Compare the Reducing Power of Maltose and Dextrose.

(a.) With Fehling's solution estimate the reducing power of the solution obtained in 7 (f.). (See "Urine.")

(b.) Boil in a flask for half an hour 50 cc. of the solution of maltose with 5 cc. of hydrochloric acid. Neutralise with caustic soda, and make up the volume, which has been reduced by the boiling, to 50 cc., and determine by Fehling's solution the reducing power. The acid has converted the maltose into dextrose, and the ratio of the former estimation (a.) to the present one should be 65 to 100.

(c.) A solution of pure dextrose treated as in (b.) is not affected in its reducing power.

Saliva has practically the same effect on starch as malt-extract, and may be used instead of the latter.

9. **Tetra-Paper, and Oxidising Power of Fluids, e.g., Saliva.**—The papers known as tetra-paper are used to estimate the oxidising power of a fluid, such as saliva. They are impregnated with tetra-methyl-paraphenylene-dianiline. This body, with 1 atom of oxygen assumes a violet tint, and a larger number of atoms of oxygen enfeebles or discharges the colour so produced. C. Wurster has made this the basis for the measurement of the oxidising power of fluids, the ozone of the air, or nitrous acid. Seven times as much oxygen is required to destroy the colour formed as is necessary to form it from the original tetra-base. The shades of colour in the empirical scale, which is supplied with the tetra-papers, are obtained by means of a solution of iodine. A certain depth of tint on the scale corresponds to a certain amount of active oxygen (ozone) per litre of the fluid. The papers and scale are supplied by Dr. Theodor Schuchardt, Görlitz.

(a.) Fold the paper and place it on a white porcelain background. If the fluid to be tested is alkaline, moisten the paper previously with a drop of pure glacial acetic acid, and allow a few drops of the fluid, e.g., saliva, to run on the paper. Compare the colour of the paper with the Roman numbers on the scale; this indicates the amount of ozone per litre. If the process be done in a test-tube, the tetra-substance is dissolved out and the fluid becomes bluish.

LESSON IX.

GASTRIC DIGESTION.

1. Preparation of Artificial Gastric Juice.

(a.) Take part of the cardiac end of the pig's stomach, which has been previously opened and washed rapidly in cold water, and spread it, mucous surface upwards, on the convex surface of an inverted capsule. Scrape the mucous surface firmly with the handle of a scalpel, and rub up the scrapings in a mortar with fine sand. Add water, and rub up the whole vigorously for some time, and filter. The filtrate is an artificial gastric juice.

(b.) **V. Wittich's Method.**—From the cardiac end of a pig's stomach detach the mucous membrane in shreds, dry them between folds of blotting-paper, place them in a bottle, and cover them with strong glycerine for several days. The glycerine dissolves the pepsin, and on filtering, a glycerine extract with high digestive properties is obtained.

(c.) **Kühne's Method.**—Take 130 grams of the cardiac mucous membrane of a pig's stomach, and place it in 5 litres of water containing 80 cc. of 25 per cent. hydrochloric acid (*i.e.*, .2 per cent.). Heat the whole for twelve hours at 40° C. Almost all the mucous membrane is dissolved. Strain through flannel and then filter. This is a powerfully peptic fluid, but it contains a small quantity of peptones. It can be kept for a long time. The test of an active preparation of gastric juice is that a thread of fibrin, when placed in the fluid and warmed, should be dissolved in a few minutes.

(d.) Instead of (a.) or (b.) use Bengier's liquor pepticus, or the pepsin of Burroughs, Wellcome, & Co., or that of Park, Davies, & Co.

All the above artificial juices, when added to hydrochloric acid of the proper strength, have high digestive powers.

2. Pepsin and Acid (HCl) are necessary for Gastric Digestion.

(a.) Take three beakers or large test-tubes, label them A, B, C. Put into A water and a few drops of glycerin extract of pepsin or powdered pepsin. Fill B two-thirds full of hydrochloric acid 0.2 per cent., and fill C two-thirds full with 0.2 per cent. of hydrochloric acid, and a few drops of glycerin extract of pepsin. Put into all three a small quantity of well-washed fibrin, and place them all in a water-bath at 40° C. for half an hour.

(b.) Examine them. In A, the fibrin is unchanged; in B, the fibrin is clear and swollen up; in C, it has disappeared, having first become swollen up and clear, and completely dissolved, being finally converted into peptones. Therefore, both acid and ferment are required for gastric digestion.

The results obtained, all the tubes being at 40° C., are:—

TUBE A.	TUBE B.	TUBE C.
Water. Pepsin. Fibrin.	Water. Hydrochloric acid. Fibrin.	Water. Pepsin. Hydrochloric acid. Fibrin.
AFTER TWENTY MINUTES.		
Unchanged.	Fibrin begins to swell up becomes clear, and small quantity of acid albumin formed.	Acid albumin formed (precipitated on neutralisation), albumoses formed (precipitated by $(\text{NH}_4)_2\text{SO}_4$), and small quantity of peptones.
AFTER ONE HOUR.		
Unchanged.	More acid-albumin formed.	Small amount (or no) acid-albumin; albumoses, and much peptone.

3. Hydrochloric Acid of 0.2 per cent.—Add 6.5 cc. of ordinary commercial hydrochloric acid to 1 litre of distilled water.

4. Products of Peptic Digestion and its Conditions.

(a.) Half fill three large test-tubes, labelled A, B, C, with hydrochloric acid 0.2 per cent. Add to each five drops of glycerin extract of pepsin. Boil B, and make C faintly alkaline with sodic carbonate. The alkalinity may be noted by adding previously some neutral litmus solution. Add to each an equal amount—a few threads of well-washed fibrin—which has been previously steeped for some time in 0.2 per cent. hydrochloric acid, so that it is swollen up and transparent. Keep the tubes in a water-bath (fig. 42) at 40° C. for an hour, and examine them at intervals of twenty minutes.

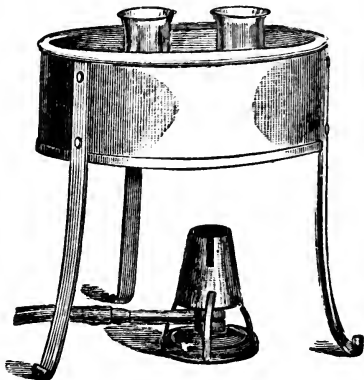

FIG. 42.—Digestion-Bath.

(b.) After five to ten minutes, or less, the fibrin in A is dissolved, and the fluid begins to be turbid. In B and C there is no change. Even after long exposure to 40° C. there is no change in B and C. After three-quarters of an hour filter A and part of B and C. Keep the filtrates.

(c.) Carefully neutralise the filtrate of A with dilute caustic soda = a precipitate of acid-albumin. Filter off this precipitate, dissolve it in 0.2 per cent. hydrochloric acid. It gives proteid reactions (Lesson I. 7).

(d.) Test the filtrate of (c.) for *albumose* or *proteose*. Repeat all the tests for albumose (Lesson I. 10). Albumose is soluble in water, and gives all the ordinary proteid reactions. It is precipitated by nitric acid in the cold in presence of NaCl, but the precipitate is redissolved with the aid of heat, and reappears on cooling. This is a characteristic reaction. It is precipitated by acetic acid and ferrocyanide of potassium; by acetic acid and a saturated solution of sodic sulphate; and by metaphosphoric acid: while peptones are not. It gives the biuret reaction (like peptone). Like peptones, it is soluble in water.

(e.) To part of the filtrate of (c.) add neutral ammonium sulphate to saturation. This precipitates all the albumoses, while the peptones are not precipitated, but remain in solution. Filter and test the filtrate for peptones (Lesson I. 10). In the biuret

reaction owing to the presence of $(\text{NH}_4)_2\text{SO}_4$ a great excess of soda has to be added.

(f.) Neutralise part of the filtrates of B and C. They give no precipitate, nor do they give the reactions for peptones. In B the ferment pepsin was destroyed by boiling, while in C the ferment cannot act in an alkaline medium.

(g.) If to the remainder of C acid be added, and it be placed again at 40°C ., digestion takes place, so that neutralisation has not destroyed the activity of the ferment.

Instead of fibrin white of egg may be used.

The methods used by Kühne to isolate the varieties of albumose are purposely omitted here (p. 78).

Products of Gastric Digestion.

To 50 grams well-washed and boiled fibrin + 250 cc. 0.2 per cent. HCl. Digest for twenty-four hours at 40°C . Neutralise with sodium carbonate.

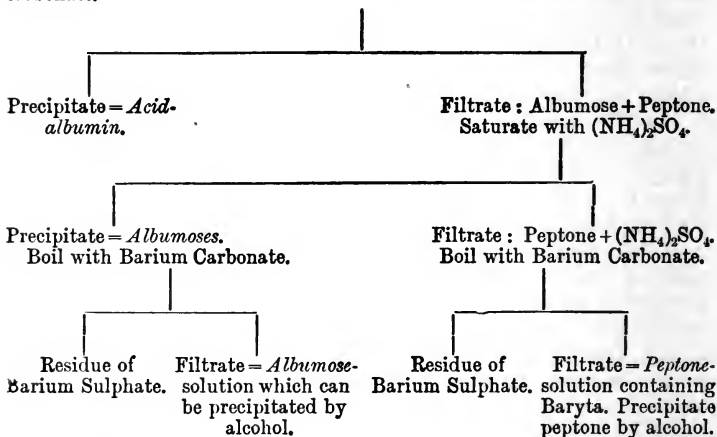

5. Tests for Albumose (Lesson I. 10).—It is precipitated by the following substances : Nitric acid ; acetic acid and NaCl ; acetic acid and ferrocyanide of potassium. The precipitates are soluble on heating and reappear on cooling. In all these respects it differs from peptone. Like peptone, however, it gives the biuret reaction, and is not coagulated by heat.

6. Test for Peptones (Lesson I. 10, VI.).

The following table from Halliburton shows at a glance the chief

characters of the final product peptone, and the intermediate albumoses in contrast with those of a native proteid like albumin.

Variety of Proteid.	Action of Heat.	Action of Alcohol.	Action of Nitric acid.	Action of $(\text{NH}_4)_2\text{SO}_4$.	Action of $\text{NaHO} + \text{CuSO}_4$.	Diffusibility.
<i>Albumin.</i>	Coagulated.	↓ Then coagulated.	↓ In cold, not readily soluble on heating.	Precipitated.	Violet colour.	Nil.
<i>Proteoses Albumoses.</i>	Not coagulated.	↓ But not coagulated.	↓ In cold, soluble on heating, re-appearing on cooling.	Precipitated.	Rose-red colour (biuret reaction).	Slight.
<i>Peptones.</i>	Not coagulated.	↓ But not coagulated.	Not precipitated.	Not precipitated.	Rose-red colour (biuret reaction).	Great.

(The ↓ indicates precipitated.)

7. Action of Gastric Juice on Milk.

(a.) Mix 5 cc. of fresh milk in a test-tube with a few drops of *neutral* artificial gastric juice; keep at 40°C . In a short time the milk curdles, so that the tube can be inverted without the **curd** falling out. By-and-by **whey** is squeezed out of the clot. The curdling of milk by the rennet ferment present in the gastric juice is quite different from that produced by the "souring of milk," or by the precipitation of caseinogen by acids. Here the casein (carrying with it most of the fats) is precipitated in a neutral fluid.

(b.) To the test-tube add 5 cc. of 0.4 per cent. hydrochloric acid, and keep at 40°C . for two hours. The pepsin in the presence of the acid digests the casein, gradually dissolving it, forming a straw-yellow-coloured fluid containing peptones. The "peptonised milk" has a peculiar odour and bitter taste.

(c.) **Peptonised Milk.**—To 5 cc. of milk in a test-tube add a few drops of Benger's liquor pepticus, and place in a water-bath. Observe how the caseinogen first clots, and is then partially dissolved to form a yellowish-coloured fluid, with a bitter taste and peculiar odour. There generally remains a very considerable clot of casein; and, in fact, the gastric digestion of milk is slow, especially if compared with its tryptic digestion (Lesson X. 11). Test the fluid for peptones with the biuret reaction, and observe the light-pink colour obtained. The bitter taste renders milk "peptonised" by gastric juice unsuitable for feeding purposes.

8. Action of Rennet on Milk.—(Rennin the enzyme.)

(a.) Place milk in a test-tube, add a drop or two of rennet, and

place the tube in a water-bath at 40° C. Clark's commercial rennet will do. Rennet is obtained from the fourth stomach of the calf. The milk becomes solid in a few minutes, forming a curd, and by-and-by the curd of casein contracts and squeezes out a fluid—the whey.

(b.) Repeat the experiment, but previously boil the rennet. No such result is obtained as in (a.), because the rennet ferment or rennin is destroyed by heat.

9. Comparison of Mineral and Organic Acids.

(a.) Take two test-tubes A and B. Place in A 10 cc. of a 0.2 per cent. solution of hydrochloric acid, and in B 10 cc. of a 2 per cent. solution of acetic acid. To both add a few drops of oo-Tropæolin dissolved in alcohol. The very dilute mineral acid in A renders it rose-pink, while the organic acid does not affect its colour. Or, what is perhaps a better method, allow a drop of a saturated alcoholic solution to evaporate on a white porcelain slab at 40° C., and while at this temperature add a drop of the acid solution. On evaporation a violet tint indicates an inorganic acid, .005 HCl can be thus detected (*Langley*). It is stated not to be quite a reliable test in the presence of certain organic matters.

(b.) Repeat (a.), but add to the acids a dilute watery solution of methyl-violet, and note the change of colour produced by the mineral acid. It becomes blue and then green. If a strong solution of acid be used, the colour is discharged, but this is never the case with the percentage of acid in the stomach. The peptones in gastric juice may be precipitated by the previous addition of 10 per cent. tannic acid, and then the test can be applied. In the presence of proteids in gastric juice it does not give absolutely reliable results.

(c.) Repeat (a.) with the same acids, but use paper stained with congo-red, and observe the change of colour to blackish-blue or intense blue produced by the hydrochloric acid. Wash in ether; if the red colour reappears the acid is organic, if not, mineral. Organic acids make it violet, not blue.

(d.) Phloro-Glucin and Vanillin (*Günzburg*).—Dissolve 2 grams of phloro-glucin and 1 gram of vanillin in 100 cc. alcohol. Mix equal quantities of this with the fluid to be tested, and evaporate the mixture in a watch-glass on a water-bath. Do not allow the fluid to boil. The presence of HCl is shown by the formation of a delicate rose-red tinge or stain, or, if there be much hydrochloric acid, of red crystals. This reaction will detect .06 per cent. HCl, and is said not to be impeded by organic acids, albumin, or peptone. The test is an expensive one.

(e.) Benzo-Purpurin 6 B.—Use blotting-papers soaked in a saturated watery solution of this fluid and dried. HCl (.4 gm. in 100 cc.) makes them dark blue, while organic acids make them brownish-violet. If both HCl and organic acids be present, the stain is brownish-black; but if the stain be suspected to be partly due to HCl, wash the paper in a test-tube with sulphuric ether, which removes the stain due to the organic acid, leaving that

due to the HCl unaffected. The sulphuric ether does not affect the mineral acid stain.

(f.) **Mohr's Test.**—Mix together 2 cc. of a 10 per cent. solution of sulphocyanide of potassium, 0.5 cc. of a neutral solution of ferric acetate, and 8.5 cc. water. Place a few drops of this ruby-red fluid on a porcelain capsule, and allow a few drops of the gastric juice to mix with it = a light violet colour at the point of contact, and a mahogany brown when the fluids mix. It is less sensitive than the aniline tests.

(g.) Shake up a mixture of dilute HCl and an organic acid, *e.g.*, lactic, with ether. Remove the ether, and on evaporating it, it will be found to have dissolved the organic acid, but not the mineral one. On this fact is based Richet's method of determining the amount of an organic acid in presence of a mineral acid.

These reactions for a mineral acid are specially to be noted, as they are used clinically for ascertaining the presence or absence of hydrochloric acid, *e.g.*, in a vomit. This acid is frequently absent from the gastric juice in cancer of the stomach. In gastric catarrh the HCl may be greatly diminished and lactic acid abundant. The presence of peptones interferes with the delicacy of some of these reactions. The reactions (c.), (d.), (e.), are the most to be depended on.

10. Carbol-Chloride of Iron Test for Lactic Acid (Uffelmann).—Prepare a fresh solution by mixing 10 cc. of a 4 per cent. solution of carbolic acid with 20 cc. of distilled water, and 1 drop of liquor ferri perchloridi. The amethyst-blue solution thus obtained is changed to *yellow* by lactic acid, while it is not affected by 0.2 per cent. HCl; but alcohol, sugar, and phosphate, yield a similar reaction.

A faintly yellow-coloured solution of ferric chloride (2-5 drops to 50 cc. water) is not affected by the addition of HCl, acetic, or butyric acid, but it is intensified in the presence of dilute lactic acid.

ADDITIONAL EXERCISES.

[Proteids, *e.g.*, albumin, are split up by certain acids and ferments, as shown by Kühne, into an anti-group and a hemi-group. In the case of ferments, the following scheme represents the results:—

Action of Enzymes (Ferments).

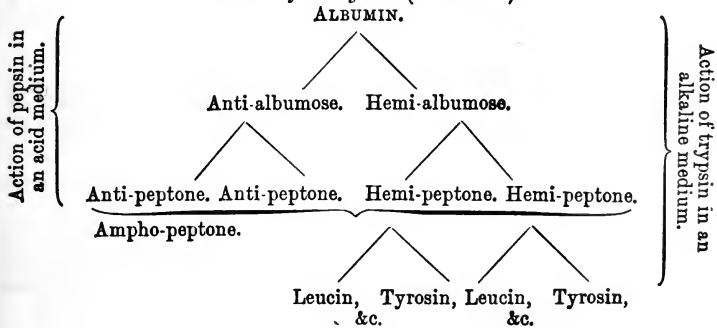

The anti-group is not further split up, but the hemi-group, although not split up by peptic digestion, is split up by tryptic digestion into leucin, tyrosin, and other products.

The substance hitherto called hemi-albumose has been shown by Kühne to consist of three albumoses, viz., proto-albumose, hetero-albumose, and deutero-albumose. The first two are precipitated by NaCl, and the last by NaCl and acetic acid. For separation of these bodies—which can be obtained most easily from Witte's peptone—see 13.

11. To Prepare Albumose and Gastric Peptones in Quantity.

(a.) Place 10 grams of fresh, well-washed, expressed fibrin in a porcelain capsule, cover it with 300 cc. of 0.2 per cent. hydrochloric acid, and keep the whole at 40° C. in a water-bath until the whole of the fibrin is so swollen up as to become converted into a perfectly clear, jelly-like mass, and it becomes so thick that a glass rod is supported erect in it.

(b.) Add 1 or 2 cc. of glycerin pepsin extract or the artificial gastric juice, 1 (c.), and stir the mass. Within a few minutes the whole becomes fluid.

(c.) After a short time—fifteen to twenty minutes—before the peptonisation is complete, filter and exactly neutralise the filtrate with ammonia or caustic soda, which precipitates the acid albumin with a small quantity of the albumoses. Filter; the filtrate contains the albumoses, which can be precipitated by saturation with crystals of neutral ammonium sulphate. To get rid of this salt the precipitate must be dialysed in a Kühne's dialyser (fig. 43).]

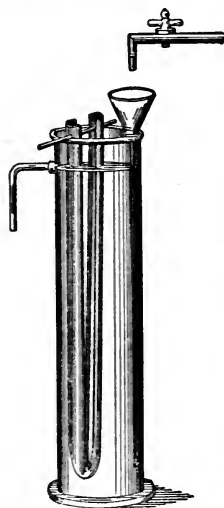

FIG. 43.—Kühne's Dialyser. A parchment tube, such as is used for sausages, is suspended in a vessel through which water is kept continually flowing.

12. Comparative Digestive Power of Pepsins, e.g., the various pepsins found in the market, or the comparative digestive power of glycerine extracts of the stomach. Chop up well-washed and boiled fibrin, and stain it with ammoniacal carmine (24 hours). Wash thoroughly and preserve under ether. Place in the requisite number of beakers .2 per cent. HCl., equal amounts of the carmine fibrin, and then add the pepsin whose strength is to be tested; keep at 40° C. As the fibrin is digested the carmine is set free, so that the most deeply-stained liquid contains the most active pepsin (*Grützner's Method*).

13. Albumoses.—Dissolve Witte's peptone in 10 per cent. sodium chloride solution and filter. This solution does not coagulate on heating, but gives the ordinary proteid reactions, together with biuret and nitric acid tests (Lesson I.).

(a.) Saturate the solution with $(\text{NH}_4)_2\text{SO}_4$ = precipitate of albumoses. Filter. The peptone is in the filtrate and can be precipitated by alcohol.

(b.) Dialyse another portion of the solution; *hetero-albumose* is precipitated.

(c.) Faintly acidify another portion of the solution, and then saturate it with sodium chloride = precipitate of proto-albumose and hetero-albumose. Filter. The filtrate contains the deutero-albumose and peptone. Precipitate the *deutero-albumose* by saturating with ammonium sulphate.

14. Chemical Examination of the Gastric Contents, e.g., Vomit.

- (a.) Test the reaction.
- (b.) Determine the acidity (e.g., of 10 cc.) by means of a deci-normal solution of caustic soda. (See "Urine.")
- (c.) Test 10 cc. for the presence of pepsin (digest with fibrin and HCl), and rennet (milk).
- (d.) Use the tests 9 (c.), (d.), (e.), for determining the presence of free HCl.
- (e.) Make a rough estimate of the presence of lactic, butyric, and acetic acids by the method 9 (g.).
- (f.) Examine for proteids, e.g., albumin, albumoses, and peptone.
- (g.) Test for sugar and its digestive products.
- (h.) Distil some of the fluid, extract the remainder with sulphuric ether, and in the latter estimate the lactic acid which it contains.
- (i.) Test Meal.—When it is desired to know if digestion is normal a test-meal is given. Ewald recommends a roll of stale bread taken on an empty stomach, with tea or water. After an hour the contents of the stomach are pumped out by means of a stomach pump, and examined as above.
-

LESSON X.**PANCREATIC DIGESTION.****1. Preparation of Artificial Pancreatic Juice.**

(a.) Mince a portion of the pancreas of an ox twenty-four hours after death, rub it up with well-washed fine sand in a mortar, and digest it with cold water, stirring vigorously. After a time strain through muslin, and then filter through paper. The filtrate has digestive properties, chiefly upon starch. Instead of water, a more potent solution is obtained by digesting the pancreas at 40° C. for some hours with a 2 per cent. solution of sodic carbonate. To prevent the putrefactive changes which are so apt to occur in all pancreatic fluids, add a little 10 per cent. alcoholic solution of thymol.

(b.) Make a glycerin extract of the pancreas (pig) in the same way as described for the stomach (Lesson IX. 1, b). Before putting it in glycerin, it may be placed for two days in absolute alcohol to remove all the water. The glycerin extract acts on starch and proteids.

(c.) For most experiments use the "liquor pancreaticus" of Benger, or of Savory & Moore, or Burroughs, Wellcome & Co.

(d.) Weigh the pancreas taken from a pig just killed, rub it up with sand in a mortar, and add 1 cc. of a 1 per cent. solution of acetic acid for every gram of pancreas. Mix thoroughly, and after a quarter of an hour add 10 cc. of glycerin for every gram of pancreas. After five days filter off the glycerin extract. The acetic acid is added to convert the unconverted "zymogen" into trypsin.

(e.) **Kühne's Dry Pancreas Powder.**—This is obtained by thoroughly extracting a pancreas with alcohol and ether, and drying the residue. The extraction must be done in an ether fat-extracting apparatus; and as the process is somewhat tedious, it is better to buy the substance. It can be obtained from Dr. Grüber of Leipzig. Extract the dry pancreas powder with five parts of a .2 per cent. solution of salicylic acid, and keep it at about 40° C. for eight or ten hours. Use 20 grams of the dry pancreas to 100 cc. of salicylic acid fluid. Strain it through muslin, and press out all the fluid from the residue. The hands must be well washed, as pancreatic digests are so liable to undergo putrefaction. It is well to cover the vessel with paper moistened with an alcoholic solution of thymol. A dense, tough, elastic residue is obtained. Re-extract the latter for several hours at 90° C. with sodic carbonate solution (.25 per cent.), adding a few drops of alcoholic solution of thymol. Filter the first extract and allow it to stand. Very probably a large mass of crystals of tyrosin will separate. Filter off the deposit and mix the salicylic and alkaline extracts. The extract has only proteolytic properties. I find this extract acts much more energetically than those prepared in other ways. What remains after the action of salicylic acid and sodic carbonate contains leucin and tyrosin.

(f.) **Solution of Pancreatic Enzymes.**—Apart from the fat-splitting ferment or enzyme, the other ferments are readily extracted from the gland—under certain conditions by (i.) glycerin, (ii.) saturated watery solution of chloroform (*Roberts*), but the chloroform extract interferes with the reaction for grape-sugar. Harris and Gow find that a saturated solution of common salt extracts all the pancreatic enzymes (save the fat-splitting). Roberts found that by extracting the pancreas with a solution containing a mixture of boracic acid and borax a serviceable extract was obtained.

2. I. Action on Starch (Amylopsin the ferment).

(a.) To thick starch mucilage in a test-tube add glycerin extract of pancreas or liquor pancreaticus, and place it in a water bath at 40° C. Rapidly the starch paste becomes fluid, loses its opalescence, and becomes clear. Within a few minutes some of the starch is converted through intermediate stages (p. 69) into maltose. Test for sugar (Lesson III. 8, V.).

(b.) **Pancreatic Juice and Bile.**—Repeat A, but add a little bile, the starch disappears more quickly. Prove by testing on a white porcelain slab, as in Lesson VIII. 4.

3. The same conditions obtain as for saliva (Lesson VIII. 5).

4. II. Proteolytic Action and its Conditions (Trypsin the ferment).

(a.) Half-fill three test-tubes A, B, C, with 1 per cent. solution of sodium carbonate, and add 5 drops of glycerin pancreatic extract or liquor pancreaticus in each. Boil B, and make C acid with dilute hydrochloric acid. Place in each tube an equal amount of well-washed fibrin, plug the tubes with cotton-wool, and place all in a water-bath at 40° C.

(b.) Examine them from time to time. At the end of one, two, or three hours there is no change in B and C, while in A the fibrin is gradually being *eroded*, and finally disappears, but it does not swell up, the solution at the same time becoming slightly turbid. After three hours, still no change is observable in B and C.

(c.) Filter A, and carefully neutralise the filtrate with very dilute hydrochloric or acetic acid = a precipitate of alkali-albumin. Filter off the precipitate, and on testing the filtrate, peptones are found. The intermediate bodies, the albumoses, are not nearly so readily obtained from pancreatic as from gastric digests.

(d.) Filter B and C, and carefully neutralise the filtrates. They give no precipitate. No peptones are found.

(e.) Test the proteolytic power of an extract of Kühne's "pancreas powder" (Lesson X., 1, e). For this purpose the salicylic and alkaline extracts are mixed with well-washed fibrin and digested at 40° C. for ten hours or longer. The vessel is covered with thymolised paper. Strain through linen and then filter. Test the digest for peptones. It is difficult to get any albumoses after this time; the anti-albumoses are already converted into anti-peptones, the hemi-albumose into hemi-peptone, and some of the latter is decomposed into leucin and tyrosin.

As putrefaction takes place with great rapidity in pancreatic digests, it is essential to prevent this either by the addition of an alcoholic solution of thymol or chloroform water (5 cc. chloroform to 1 litre water). To get satisfactory results it is better to do it on a somewhat larger scale (*Salkowski*).

Tryptic Digestion.

50 grams fibrin + 200 cc. alkaline (carbonate of soda 1 per cent.) chloroform water + liq. pancreaticus digested for 36 hours; then boil and filter.

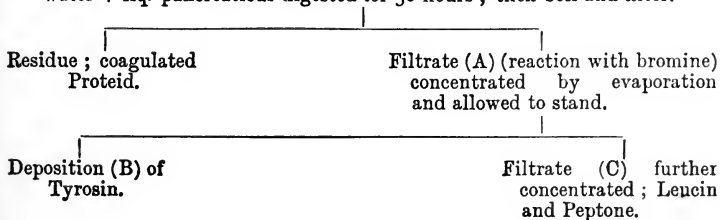

5. Products other than Peptones.—Leucin ($C_6H_{13}NO_2$) and Tyrosin ($C_9H_{11}NO_3$).

(a.) Place 300 cc. of a 1 per cent. solution of sodic carbonate in a flask, add 5 grams of fibrin, 5 cc. of glycerine extract of pancreas, and a few drops of an alcoholic solution of thymol. Keep all at $38^\circ C.$ on a water-bath for ten to sixteen hours, shaking frequently. After sixteen hours take a portion of the mixture, filter, and to the filtrate cautiously add dilute acetic acid to precipitate any alkali-albumin that may be present in it. Filter, and evaporate the filtrate to a small bulk, and precipitate the peptones by a considerable volume of alcohol. Filter to remove the peptones, and evaporate the alcoholic filtrate to a small bulk, and set it aside, when tyrosin and leucin separate out. Keep them for microscopic examination (figs. 44, 79).

(b.) A much better method of obtaining leucin and tyrosin is to digest, at $40^\circ C.$, for twenty-four to thirty-six hours, equal parts of fresh moist fibrin and ox-pancreas in 1 litre of 1 per cent. sodium carbonate solution to which some thymol has been added, or, an ox-pancreas is digested in the same way, the white of an egg being added every ten hours (Digest A). Make another digest; but do not add thymol. Digestion and putrefaction take place, the latter causing a most disagreeable smell (Digest B). Filter the digest A, and to some of it add Millon's reagent, which precipitates any albumin. Filter, boil the filtrate, a red colour indicates tyrosin.

Concentrate some of the filtered digest A by boiling it to a small bulk on a water-bath. After several hours examine a drop microscopically for leucin and tyrosin. Precipitate the peptones in some of the filtered digest A by alcohol. Filter. Concentrate the filtrate on a water-bath, when a sticky deposit of leucin is formed.

The digest A yields the chlorine or "bromine reaction."

The digest B is to be used for testing for the products of putrefaction.

(c.) Examine the crystals of leucin and tyrosin microscopically (figs. 44, 79). The former occurs as brown balls, often with radiating lines, not unlike fat, but much less refractive, and the latter consists of long white shining needles arranged in sheaves or in a stellate manner, or somewhat felted. (See "Urine.")

(d.) **Test for Tyrosin (Hofmann).**—Dissolve some crystals by boiling them in water, add Millon's reagent, and boil, which gives a red colour. The deposit which is sometimes formed in Benger's liquor pancreaticus consists of tyrosin.

(e.) Test a solution of tyrosin, obtained by the prolonged boiling of horn-shavings and sulphuric acid, with Millon's reagent as in (d.).

6. Putrefactive Products of Pancreatic Digestion.—These include indol, skatol, phenol, volatile fatty acids, CO_2 , H_2S , CH_4 , and H .

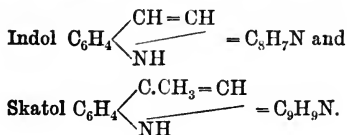

Indol is one of the many putrefactive products of the decomposition of proteids. Take equal parts of fresh fibrin and finely-divided ox-pancreas, add ten times the volume of water, and keep the whole continuously at a temperature of 40°C . for three or four days. Intensely disagreeable-smelling gases are given off. Strain through linen, acidulate (acetic acid), and distil the filtrate. The filtered distillate is made alkaline by KHO or NaHO , and shaken thoroughly with its own volume of ether. Distil the ether, and the oily substance which remains behind, on being dissolved in water, is allowed to crystallise. The solution yields the following tests.

Tests for Indol.—Use either the watery solution of indol or the filtered offensive-smelling fluid before it is distilled.

(a.) Warm the liquid, and add first a drop or two of dilute sulphuric acid to some of the filtered liquid, and then a *very dilute nitrite* solution. A red colour indicates the presence of indol. This test is very readily obtained with the products of digestion by Kühne's dry pancreas (Lesson X. 1, e). One must be careful to regulate the strength of the acid, as too strong nitrous acid prevents the reaction.

(b.) Acidify strongly with hydrochloric acid a small quantity of the highly offensive fluid or the watery solution, and place in it a shaving of wood or a wooden match with its head removed and soaked in strong hydrochloric acid. The match is coloured red, sometimes even an intense red. The match can be dried, and it keeps its colour for a long time, although the colour darkens and becomes somewhat dusker on drying.

(c.) **Chlorine Reaction.**—Add to some of the digestive fluid (5, b, preferably digest B), drop by drop, chlorine water; it strikes a rosy-red tint. Or add very dilute bromine water (1 to 2 drops to 60 cc. water), the fluid first becomes pale red, then violet, and ultimately deep violet (Kühne).

7. III. The Action on Fats is Twofold.

(A.) Emulsification.

(a.) Rub up in a mortar which has been warmed in warm water a little olive-oil or melted lard, and some pieces of fresh pancreas. A creamy persistent emulsion is formed. Examine the emulsion under the microscope. Or use a watery extract of the fresh pancreas, and do likewise; but in this case the result will not be nearly so satisfactory.

(b.) Rub up oil as in (a.); but this time use an extract of the fresh pancreas made with 1 per cent. sodic carbonate. A very perfect emulsion is obtained, even if the sodic carbonate extract is boiled beforehand. This shows that its emulsifying power does not depend on a ferment.

(c.) The presence of a little *free fatty acid* greatly favours emulsification. Take two samples of cod-liver oil, one *perfectly neutral* (by no means easily procured), and an ordinary brown oil—*e.g.*, De Jongh's. The latter contains much free fatty acid. Place 5 cc. of each in two test-tubes, and pour on them a little solution of sodic carbonate (1 per cent.). The neutral oil is not emulsified, while the rancid one is at once, and remains so. Many oils that do not taste rancid contain free fatty acids, and only some of them give up their acid to water, just according as the fatty acid is soluble or not in water.

8. (B.) The Fat-Splitting Action of Pancreatic Juice (Steapsin or pialyn, the ferment).

(a.) Prepare a Perfectly Neutral Oil.—A perfectly *neutral* oil is required, and as all commercial oils contain free fatty acids, they must not be used. Place olive or almond oil in a porcelain capsule, mix it with not too much baryta solution, and boil for some time. Allow it to cool. The unsaponified oil is extracted with ether, the ethereal extract separated from the insoluble portion, and the ether evaporated over warm water. The oil should now be perfectly neutral (*Krukenberg*).

(b.) Mix the oil with finely-divided, perfectly fresh pancreas (not a watery extract), and keep it at 40° C. After a time its reaction becomes acid, owing to the formation of a fatty acid. This experiment is by no means easy to perform, and some observers deny altogether the existence of a fat-splitting ferment. The free fatty acids thus liberated unite with the alkaline bases of bile, and form soaps.

9. IV. Milk-Curdling Ferment.

(a.) Add a drop or two of the brine extract of the pancreas prepared for you to 5 cc. of warm milk in a test-tube, and keep it at 40° C. Within a few minutes a solid coagulum forms, and thereafter the whey begins to separate.

(b.) Repeat (a.), but add a grain or less of bicarbonate of soda to the milk. Coagulation occurs just as before, so that this ferment is active in an alkaline medium.

(c.) Boil the ferment first. Its power is destroyed.

10. Action on Milk.

(a.) Place cow's milk diluted with 5 volumes of water in a test-tube, add a drop or two of pancreatic extract or liquor pancreaticus. Keep at 40° C. for half an hour. The caseinogen is first curdled and then dissolved, and as this occurs, the milk changes from a white to a yellowish colour.

(b.) Divide (a.) into two portions, A and B. To A add dilute acetic acid; there is no precipitation of caseinogen, which has been converted into peptones. To B add caustic soda and dilute copper sulphate, which give a rose colour, proving the presence of peptones.

11. To Peptonise Milk.—A pint of milk is diluted with a quarter of a pint of water, and heated to a lukewarm temperature, about 140° F. (60° C.). Or the diluted milk may be divided into two equal portions, one of which may be heated to the boiling-point and then added to the cold portion, the mixture will then be of the required temperature. Two tea-spoonfuls of liquor pancreaticus, together with about fifteen grains, or half a level tea-spoonful, of bicarbonate of soda, are then mixed therewith. The mixture is next poured into a jug, covered, and placed in a warm situation to keep up the heat. In a few minutes a considerable change will have taken place in the milk, but in most cases it is best to allow the digestive process to go on for ten or twenty minutes. The gradually increasing bitterness of the digested milk is unobjectionable to many palates; a few trials will, however, indicate the limit most acceptable to the individual patient; as soon as this point is reached, the milk should be either used or boiled to prevent further change. From ten minutes to half an hour is the time generally found sufficient. It can then be used like ordinary milk.

ADDITIONAL EXERCISES.

12. Preparation of Indol.—Place 1 kilogram of fresh fibrin in a 6-litre jar with 4 litres of water (to which 1 gram KH_2PO_4 and .5 gram MgSO_4 are added). Mix this with 200 cc. cold saturated solution of sodic carbonate, and add to the whole a quantity of putrefying flesh-juice and some pieces of the putrid flesh as well. Cork the vessel, a vent-tube being placed in the cork, and place it aside for 5–6 days at a temperature of 40 – 42° C. Distil and acidify the strongly ammoniacal distillate with HCl, add some copper sulphate, and filter. Shake up equal volumes of the distillate and ether in a separation funnel. Allow the filtrate to settle, run it off, add some fresh filtrate, and shake again with the same ether. Distil the ethereal extract to about one-fourth of its volume, shake up the residue very thoroughly with caustic soda (to remove phenol and traces of acids). Distil the ether, and after the addition of caustic soda distil the oily indol. The distillate is shaken up with ether, and the ethereal extract is evaporated at a low temperature, when crystals or plates of indol separate. This preparation usually contains some skatol. (*Drechsel* after *Salkowski*.)

SOME NITROGENOUS DERIVATIVES OF THE FOREGOING.

13. Leucin or α -Amido-isobutylic acid, $\text{C}_6\text{H}_{13}\text{NO}_2 = 2(\text{CH}_3)\text{CH}-\text{CH}_2-\text{CH}(\text{NH}_2)\text{CO.OH}$, and **Tyrosin** or **Paraoxyphenyl- α -Amidopropionic acid**, $\text{C}_9\text{H}_{11}\text{NO}_3 = \text{C}_6\text{H}_4 < \begin{matrix} \text{OH} \\ \text{C}_2\text{H}_3 \end{matrix} (\text{NH}_2)\text{CO.OH}$.—These two bodies are obtained together from nearly all proteids when the latter are decomposed by the action of acids. The former belongs to the fatty bodies, and tyrosin to the aromatic group, and is a derivative of benzene (C_6H_6).

Preparation of Leucin and Tyrosin.—Place 2 parts of horn shavings ($\frac{1}{2}$ –1 kilo.) in a mixture of 5 parts of concentrated sulphuric acid and 13 parts of water. Boil for twenty-four hours in a vessel placed in connection with a condenser. Add thin milk of lime until a feebly alkaline reaction is obtained, filter through flannel, re-extract the residue with water, mix the filtrate and washings and slightly acidulate them with oxalic acid. Filter to remove the oxalate of lime, and evaporate the filtrate until a scum forms on the surface. Cool and repeat the evaporation process until crystallisation ceases to take

place in the mother-fluid. Collect the mass of crystals, dissolve them in boiling water with the addition of ammonia, and add lead acetate until the resulting precipitate is no longer brown, but becomes white. Filter, acidulate the acid filtrate feebly with dilute sulphuric acid, filter off the lead sulphate and allow the fluid to cool, when tyrosin in an almost pure form crystallises out.

The mother-liquor, freed from tyrosin, is treated with sulphuretted hydrogen to get rid of the lead, filtered, evaporated, and boiled for a few minutes with freshly precipitated hydrated copper oxide, which forms a dark blue solution. The latter, when filtered and evaporated, yields blue

crystals and an insoluble compound of leucin-copper oxide. This deposit and the crystals are decomposed in water by H_2S -solution, the filtrate when necessary decolorised by boiling with animal charcoal, again filtered and evaporated to crystallisation, when leucin crystallises out. It is obtained pure by recrystallisation from boiling alcohol (*Drechsel*).

14. Tyrosin is insoluble in alcohol and in 1000 parts of cold water.

(a.) Observe microscopically its crystalline form, as fine long silky needles arranged in sheaf-like bundles (fig. 44).

(b.) Boil a hot watery solution with Millon's reagent (avoid excess)—a red colour (*Hoffman's test*).

15. Leucin.—(a.) Under the microscope observe it in the form of brown balls, with radiating and concentric lines if it is impure; and, when it is pure, as white shining lamellæ, with a fatty glance. It is soluble in 27 parts of cold water, and much less soluble in alcohol.

(b.) Heated in a tube it sublimes unchanged in very fine clouds with the odour of amylamine. A part is decomposed into CO_2 and $C_6H_{13}N$ (amylamine).

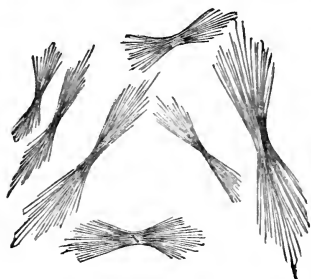

FIG. 44.—Crystals and Sheaves of Tyrosin.

LESSON XI.

BILE.

1. Use ox-bile obtained from the butcher, and, if possible, human bile.

(a.) The colour in man is a brownish-yellow, in the ox greenish, but often it is reddish-brown when it stands for a short time. Note its bitter taste, peculiar smell, and specific gravity (1010-1020).

(b.) It is alkaline or neutral to litmus paper.

(c.) Pour some ox-bile from one vessel to another, and note that strings of so-called **mucin** connect one vessel with the other.

(d.) Acidulate bile with acetic acid, which precipitates **mucinoid** substance coloured with pigments. Filter off this precipitate. Test the filtrate.

(e.) It gives no reactions for albumin.

(f.) Add hydrochloric acid and potassic ferrocyanide. A blue colour indicates the presence of iron. Test for chlorides and other salts.

(g.) Fresh human bile gives no spectrum, although the bile of the ox, mouse, and some other animals does.

2. **Bile-Salts or Bilin** (glycocholate and taurocholate of sodium).

(a.) Concentrate ox-bile to one-fourth of its bulk, mix with animal charcoal in a mortar to form a thick paste. Evaporate to complete dryness over a water-bath.

(b.) To the dry charcoal-bile mixture, add five volumes of absolute alcohol. Shake the mixture from time to time, and after half an hour filter. To the filtrate add much ether, which gives a white precipitate of the bile-salts. If no water be present, sometimes the bile-salts are thrown down crystalline; but not unfrequently they go down merely as a milky opalescence, which quickly forms resinous masses. It is best to allow the mixture to stand for a day or two, to obtain the glancing needles which constitute **Plattner's Crystallised Bile**.

Scheme for Bile-Salts, etc.

200 cc. of ox-bile, dried, mixed with animal charcoal, are extracted with absolute alcohol by the aid of heat; filter.

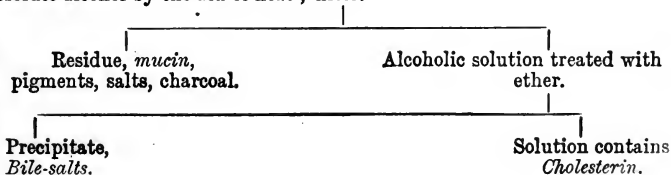

3. Pettenkofer's Test for Bile-Acids (Salts) and Cholic Acid.

(a.) To bile in a test-tube, add a drop or two of syrup of cane-sugar. Pour in *concentrated* sulphuric acid, at the line of junction of the two fluids a *purple* colour is obtained. Furfuraldehyde is formed from the action of sugar and sulphuric acid, and the purple compound is due to the aldehyde compound with cholalic acid. The white deposit seen above the line of junction is precipitated bile-acids. They are insoluble in water.

(b.) A better way of doing the test is as follows:—After mixing the bile and syrup, shake the mixture until the upper part of the tube is filled with froth. Pour sulphuric acid down the side, and a purple-red colour is struck in the froth.

(c.) Make a film of bile on a porcelain capsule, add a drop of syrup of cane-sugar, and then a drop of sulphuric acid = purple colour.

(d.) Or, after mixing the syrup with the bile, add the strong sulphuric acid drop by drop, mixing it thoroughly. Heat gently, and the fluid becomes a deep purple colour. Take care not to add too much syrup, and not to over-heat the tube. If the requisite amount of sulphuric acid be added, the temperature becomes sufficiently high (70° C.) without requiring to heat the tube.

(e.) Strassburger's Modification (*e.g.*, for bile in urine).—To the urine add a little syrup and mix. Dip filter-paper into the fluid and dry the paper. On placing a drop of sulphuric acid on the latter, after some time a purple spot which has eaten into the paper is observed.

(f.) Repeat any or all of the above processes with a watery solution of the bile-salts and with acid-albumin.

(g.) In place of sugar furfural (*Mylius*) may be used. Add 1 drop of furfural solution (1 per 1000) and 1 cc. of concentrated H_2SO_4 .

4. Similar purple colour reactions are obtained with many other substances—*e.g.*, albumin and α -naphthol, but the spectra differ somewhat.

Albumin and Sulphuric Acid.—To a solution of acid-albumin and syrup add strong sulphuric acid, a similar tint is obtained. The spectra, however, are different, the red-purple fluid from bile gives two absorption-bands, one between E and F, and another between D and E. In the albuminous solutions only one absorption-band exists between E and F.

5. Action of Bile or Bile-Salts in Precipitating Sulphur.

(a.) In one beaker (A) place diluted bile and in the other (B) water. Pour flowers of sulphur on both. The sulphur falls in a shower through the fluid of A, while none passes through B.

(b.) Test to what extent bile may be diluted before it loses this property, which is due to the diminution of the surface tension by the bile-salts (*M. Hay*).

(c.) Repeat with a solution of the bile-salts.

Bile-Pigments.—The chief are bilirubin (red), biliverdin (green), and urobilin.

6. Gmelin's Test for Bile-Pigments.

(a.) Place a few drops of bile on a *white* porcelain slab. With a glass rod place a drop or two of strong *nitric acid containing nitrous acid* near the drop of bile, bring the acid and bile into contact. Notice the play or succession of colours, beginning with *green* and passing into blue, red, and dirty yellow.

(b.) Place a little impure nitric acid in a test-tube. Slant the tube and pour in bile, a similar play of colours occurs—green above, blue, red, and yellow below. It is better to do this reaction after removal of the mucin by acetic acid (Lesson XI. 1, d). Or add the nitric acid, and shake after the addition of every few drops; the successive colours from green to yellow are obtained in great beauty. For a modification applicable to urine, see "Urine."

(c.) To green bile + amm. sulphide and shake = reduction to bilirubin.

(d.) To yellow bile + KHO and heat, acidulate with HCl = green due to oxidation of bilirubin.

7. Cholesterin and Gall-Stones.

(a.) **Preparation.**—Powder a gall-stone and extract it with ether or boiling alcohol. Heat the test-tube in warm water, and see that no gas is burning near it. Drop the solution on a glass-slide, and examine the crystals microscopically. They are flat plates, with an oblong piece cut out of one corner (fig. 45). Ethereal solution gives needles, but a hot alcoholic solution gives the typical plates.

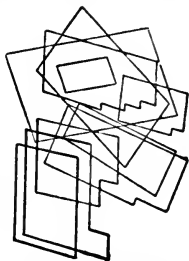

FIG. 45.—Crystals of Cholesterin.

(b.) Heat crystals in a watch-glass with a few drops of moderately strong sulphuric acid, and then add iodine; a play of colours, passing through violet, blue, green, red, and brown, occurs.

(c.) Dissolve crystals in chloroform, add an equal volume of *concentrated* sulphuric acid, and shake the mixture. When the chloroform solution floats on the top, it becomes blood-red, but changes quickly on exposure to the air, passing through violet and blue to green and yellow. A trace of water decolorises it at once. The layer of sulphuric acid shows a green fluorescence.

(d.) The crystals when acted on by strong sulphuric acid become red. Do this on a slide under the microscope.

(e.) Examine microscopically crystals of cholesterin found in hydrocele fluid. The crystals may not be quite perfect, but their characters are quite distinct.

8. Action of Bile in Digestion.

(a.) **Action on Starch.**—Test if bile converts starch mucilage into a reducing sugar, as directed for saliva (Lesson VIII.).

(b.) **Action on Fats.**—Mix thoroughly 10 cc. bile with 2 cc. almond-oil, and observe both by the naked eye and the microscope to what extent emulsion occurs, and how long it lasts. Compare a similar mixture of oil and water. In the former case a pretty fair emulsion will be obtained. In the latter the oil and water separate rapidly.

(c.) Mix 10 cc. of bile with 2 cc. of almond-oil, to which some oleic acid is added. Shake well, and keep the tube in a water-bath at 40° C. A very good emulsion is obtained. The bile dissolves the fatty acids, and the latter decompose the salts of the bile-acids; the bile-acids are liberated, while the fatty acid unites with the alkali of the bile-salts to form a soap. The soap is soluble in the bile, and serves to increase the emulsifying power, as an emulsion once formed lasts much longer in a soapy solution than in water.

(d.) **Favours Filtration and Absorption.**—Place two small funnels exactly the same size in a filter-stand, and under each a beaker. Into each funnel put a filter-paper; moisten the one with water (A), and the other with bile (B); pour into both an equal volume of almond-oil; cover with a slip of glass to prevent evaporation. Set aside for twelve hours, and note that the oil passes through B, but scarcely any through A.

(e.) **Effect on the Proteid Products of Gastric Digestion.**—Digest some fibrin in artificial gastric juice, filter, and to the filtrate add drop by drop ox-bile, or a solution of bile-salts. It causes a white precipitate of peptones and acid-albumin. The acid of the gastric juice splits up the bile-salts, so that the bile-acids are also thrown down.

(f.) **Action on Acid-Albumin.**—Prepare acid-albumin in solution (Lesson I.), and add a few drops of bile—be careful not to add too much—or bile-salts. This causes curdling of the whole mass. In (e.) and (f.) it is better to add bile-salts, because free hydrochloric acid gives a precipitate with bile.

ADDITIONAL EXERCISES.

9. **Preparation of Taurin** (β -amidoethyl-sulphuric acid $C_2H_7NSO_3$).—Mix ox-bile with an excess of strong hydrochloric acid, filter from the slimy deposit, and evaporate the mixture—just under boiling-point—whereby a

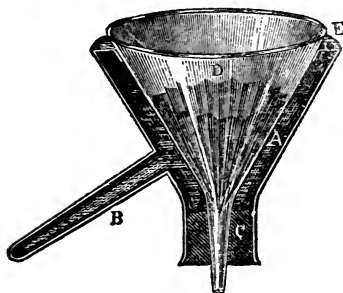

FIG. 46.—Double-Walled Filter for Filtering Hot Solutions.

tough brownish resinous body separates—choloidinic acid. Pour off the acid watery fluid, concentrate it still further, until the greater part of the common salt crystallises out. Mix the cold mother-liquid with strong alcohol, whereby taurin is precipitated along with some common salt. Wash the precipitate with alcohol, dry it, and dissolve it in a small quantity of boiling water. On cooling, taurin separates in four-sided prisms.

10. **Cholesterin.**—Boil powdered pale gall-stones in water, and then extract them with boiling alcohol. Filter through a double-walled filter kept hot with boiling water (fig. 46).

The filtrate on cooling precipitates impure cholesterin. Recrystallise it from boiling alcohol containing potash, wash it with alcohol and water, and dry the residue over sulphuric acid (fig. 16).

Scheme for Gall-Stones (Salkowski).

Powdered gall-stones are extracted with ether; filter.

Solution evaporated
Cholesterin (A).

Residue (B) treated on the
filter with dilute HCl.

Solution (C) *Lime salts*.

Residue (D) washed with water,
dried, treated with chloroform;
Bilirubin.

LESSON XII.

GLYCOGEN IN THE LIVER.

1. Preparation.

(a.) Feed a rabbit on carrots for a day or longer, or a rat on oats, and five or six hours after the last meal decapitate it or kill it by bleeding. *Rapidly* open the abdomen, remove the liver, cut one half of it in pieces, and throw it into boiling water slightly acidulated with acetic acid. Lay the other half aside, keeping it moist in a warm place for some hours. After boiling the first portion for a time, pound it in a mortar with sand, and boil again. Filter while hot. The filtrate is milky or *opalescent*, and is a watery solution of glycogen and other substances. The acetic acid coagulates the proteids, while the boiling water destroys either a ferment in the liver or the liver cells, which would convert the glycogen into grape-sugar.

(b.) **Brücke's Method.**—Feed a rabbit on carrots, and after five or six hours kill it by bleeding. Open the abdomen, rapidly remove the liver. Some wash out its blood-vessels with a stream of normal saline. Divide it into two portions. Cut one half as rapidly as possible into small pieces, and throw the pieces into boiling water.

Boil them, and afterwards pound them in a mortar and boil again. Filter while hot, and observe the *opalescent* filtrate, which is a solution of glycogen and proteids. The filtrate should flow into a cooled beaker, placed in a mixture of ice and salt. Precipitate the proteids by adding alternately hydrochloric acid and potassio-mercuric iodide (p. 93), until all the proteids are precipitated. Filter off the proteids, and the opalescent filtrate is an imperfect solution of glycogen. *To separate the glycogen.* Evaporate the fluid to a small bulk, and precipitate the glycogen by adding 96 per cent. alcohol until the solution contains over 60 per cent. of alcohol. The glycogen is precipitated as a white flocculent powder, which is collected on a filter, washed with alcohol and ether, and then dried in an oven at 100° C. (fig. 47).

(c.) **Külz's Method.**—Feed a rabbit for two days on carrots or boiled rice. Five or six hours after the last full meal decapitate it, open the abdomen, rapidly remove the liver (weigh it), cut it quickly into pieces, and throw the latter into a large porcelain capsule (400 cc. water to 100 grams liver) of water boiling briskly. Boil the pieces for about half an hour. Remove the pieces, rub them up into a pulp in a mortar (this may be aided by

rubbing with well-washed white sand). Replace the pulp in the boiling water and add 3-4 grams of caustic potash (*i.e.*, for 100 grams liver). Heat on a water-bath and evaporate until about 20 cc. of fluid remains for 100 grams liver. If a pellicle forms on the surface, heat the whole in a beaker covered with a watch-glass until the pellicle is dissolved. Allow to cool. Neutralise with dilute hydrochloric acid and precipitate the proteids by adding alternately hydrochloric acid and potassio-mercuric iodide in small quantities, until no further precipitation occurs. Filter through a thick filter to remove the deposit of proteids. Remove the deposit from the filter with a spatula, and rub it up in a mortar with water containing hydrochloric acid and potassio-mercuric iodide, and again filter the pulp. Repeat this process several times to get out all the glycogen. Mix the filtrates and add 2 volumes of 96 per cent. alcohol, stirring briskly all the time; this precipitates the glycogen. Allow it to stand in a cool place for a night; filter, and wash the precipitate thoroughly, first with 62 per cent. and then with 96 per cent.

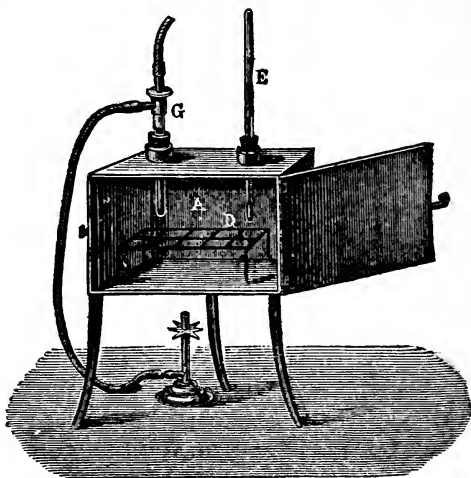

FIG. 47.—Hot-Air Oven. *G.* Gas regulator; *E.* Thermometer.

alcohol. Usually the glycogen contains a trace of albumin. To remove the latter, redissolve the moist glycogen in warm water, and after cooling, reprecipitate with HCl and potassio-mercuric iodide and proceed as above. Wash the glycogen with alcohol and then with ether, and dry it by exposure to the air. This method gives the most satisfactory results.

(*d.*) Instead of a rat or rabbit's liver, use oysters or the edible mussel, and prepare a solution of glycogen by methods (*a.*) or (*b.*).

(*e.*) Use the other half of the liver of the rat or rabbit that has been kept warm, and make a similar extract of it.

2. Precipitate the Glycogen.—Evaporate the filtrate of (*a.*) or (*b.*) to a small bulk, and precipitate the glycogen as a white powder by adding a large amount of alcohol—at least 60 per cent.

must be added. Filter; wash the precipitate on the filter with absolute alcohol and ether, and dry it over sulphuric acid or in a hot-air oven (fig. 47).

3. Preparation of Potassio-Mercuric Iodide or Brücke's Reagent.—Precipitate a saturated solution of potassic iodide with a similar solution of mercuric chloride; wash the precipitate, and dissolve it to saturation in a hot solution of potassic iodide.

4. Tests for Glycogen.

(a.) To the opalescent filtrate add iodine solution = a port wine red or mahogany-brown colour (like that produced by dextrin). If much glycogen be present the colour disappears, and more iodine has to be added. Heat the fluid; the colour disappears, but reappears on cooling.

N.B.—In performing this test, make a *control-experiment*. Take two test-tubes, A and B. In A place glycogen solution; in B, an equal volume of water. To both add the same amount of iodine solution. A becomes red, while B is faint yellow.

(b.) To another portion add lead acetate = a precipitate (unlike dextrin). The solution must be free from proteids and mercuric salts.

(c.) To another portion add lead acetate and ammonia; the glycogen is precipitated (like dextrin).

(d.) Test a portion of the glycogen solution for grape-sugar. There may be none, or only the faintest trace.

(e.) To a portion (A) of the glycogen solution add saliva or liquor pancreaticus, and to another portion (B) add blood, and place both in a water-bath at 40° C. After ten minutes test both for sugar. (A) will be transparent, and give no reaction with iodine. Perhaps both will give the sugar reaction; but certainly (A) will, if care be taken that the solution is not acid after adding the saliva. The ptyalin converts the glycogen into a reducing sugar.

(f.) Boil some glycogen solution with dilute hydrochloric acid in a flask; neutralise with caustic soda, and test with Fehling's solution for sugar.

5. Test the watery extract of the other half of the liver.

(a.) Perhaps no glycogen reaction, or only a slight one.

(b.) It contains much reducing sugar.

6. Extract of a Dead Liver.

(a.) Mince a piece of liver from an animal which has been dead for 24 hours. Boil the liver either in water or a saturated solution of sodic sulphate. Filter; the filtrate is clear and yellowish in tint, but not opalescent.

(b.) Its reaction is acid to litmus paper.

(c.) Test with iodine after neutralisation with sodic carbonate and filtration = no glycogen.

(d.) Test for grape-sugar = much sugar.

After death the glycogen is transformed into grape-sugar unless precautions be taken to prevent this transformation (p. 91).

LESSON XIII.

MILK, FLOUR, AND BREAD.

1. **Milk.**—Use fresh cow's milk.

(a.) Examine the "naked-eye" characters of milk.

(b.) Examine a drop of milk **microscopically**, noting numerous small, highly-refractive oil-globules floating in a fluid (fig. 48).

(i.) Add dilute caustic soda. The globules run into groups.

(ii.) To a fresh drop add osmic acid. The globules first become brown and then black.

(iii.) If a drop of colostrum is obtainable, observe the "colostrum corpuscles" (fig. 48, C).

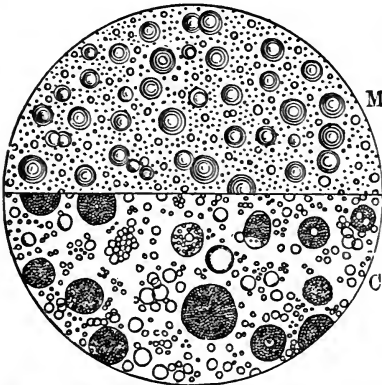

FIG. 48.—Microscopic Appearance of Milk. The upper half, *M*, is milk; the lower half, colostrum, *C*.

(c.) Test its reaction with litmus paper. It is usually neutral or slightly alkaline.

(d.) Take the **specific gravity** of perfectly fresh unskimmed milk with the lactometer. It is usually between 1028–1034. Take the specific gravity next day after the cream has risen to the surface, or after the cream is removed. The specific gravity is increased (1033–37) by the removal of the lightest constituent—the cream.

(e.) Dilute milk with ten times its volume of water, carefully neutralise it with *dilute* acetic acid, and observe that at first there is no precipitate, as the caseinogen is prevented from being precipitated by the presence of alkaline phosphates (Lesson I.). Cautiously add acetic acid until there is a copious

granular-looking precipitate of **caseinogen**, which, as it falls, entangles the greater part of the fat in it. Precipitation is hastened by heating to 70° C.

(*f.*) Filter (*e.*) through a moist plaited filter. Keep the residue on the filter. The filtrate is clear. Divide it into two portions. Take one portion, divide it into two, and boil one = a precipitate of **lactalbumin** (serum-albumin). Filter, and keep the filtrate to test for sugar. To the remainder add potassic ferrocyanide, which also precipitates serum-albumin.

(*g.*) Test the second half of the filtrate for **milk-sugar**. Instead of proceeding thus, test for the presence of a reducing sugar with the filtrate of (*f.*) after the separation of the serum-albumin.

(*h.*) Scrape off the residue of casein and fat from the filter (*f.*); wash it with water from a wash-bottle, and exhaust the residue with a mixture of ether and alcohol. On placing some of the ethereal solution on a slide, and allowing it to evaporate, a greasy stain of fat is obtained.

(*i.*) To *fresh* milk add a drop of tincture of guaiacum, which strikes a blue colour; boiled milk is said not to do so.

Separation of the Chief Constituents of Milk (Salkowski).

Milk diluted with water, precipitated with acetic acid and filtered.

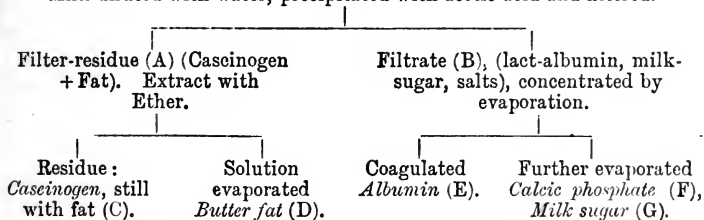

2. Separation of Caseinogen by Salts.—Saturate milk with magnesium sulphate or sodium chloride.

The caseinogen and fat separate out, rise to the surface, and leave a clear fluid beneath. Caseinogen, like globulins, is precipitated by saturation with NaCl, or $MgSO_4$, but it is not coagulated by heat. It was at one time supposed to be an alkali-albumin, but the latter is not coagulated by rennet. It appears to be a nucleo-albumin (?), *i.e.*, a compound of a proteid with nuclein, the latter a body rich in phosphorus.

Precipitation of Caseinogen by $MgSO_4$.

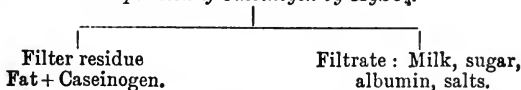

Collect the precipitate of caseinogen and fat on a filter and wash it with a

saturated solution of $MgSO_4$. Add distilled water, which in presence of the $MgSO_4$ dissolves the caseinogen, which passes through the filter and is collected. From the solution of caseinogen in weak $MgSO_4$ precipitate the caseinogen by excess of acetic acid. To get the caseinogen quite pure it must be redissolved in weak alkali or lime water, and precipitated and redissolved several times.

The filtrate after precipitation of caseinogen contains the lactalbumin, and can be completely precipitated by saturation with sodium sulphate. It coagulates between 70° and 80° C., and does not seem to be separated into several proteids by fractional heat coagulation.

The fluid contains lactose, salts, and serum-albumin. Filter.

3. Separation of Caseinogen and Fat by Filtration.—Using a Bunsen's pump, filter milk through a porous cell of porcelain. The particulate matters—caseinogen and fat—remain behind, while a clear filtrate containing the other substances passes through. The porous cell is left empty and fitted with a caoutchouc cork with two glass tubes tightly fitted into it. One tube is closed with a clip (fig. 49), and the other is attached to the pump. Place the porous cell in an outer vessel containing milk. On exhausting the porous cell a clear watery fluid slowly passes through. Test it for proteids and sugar. Notice the absence of fat and caseinogen.



FIG. 49.—Porous Cell for the Filtration of Milk.

4. Souring of Milk.—Place a small quantity of milk in a vessel in a warm place for several days, when it turns sour and curdles. It becomes acid—test this (Lesson IX. 10)—having undergone the lactic acid fermentation, the lactose being split up by a micro-organism into lactic acid.

5. Butter.—Place a little milk in a narrow, cylindrical, stoppered bottle; add half its volume of caustic soda and some ether, and shake the mixture. Put the bottle in a water-bath at a low temperature; the milk loses its white colour, and an ethereal solution of the fats floats on the surface. On evaporating the ethereal solution, the butter is left behind.

6. Curdling of Milk.

(a.) By an Acid.—Place some milk in a flask; warm it to 40° C., and add a few drops of acetic acid. The mass clots or curdles, and separates into a solid curd (caseinogen and fat), and a clear fluid, the whey, which contains the lactose. Filter.

(b.) By Rennet Ferment.—Take 5 cc. of fresh milk in a test-tube, heat it in a water-bath to 40° C., and add to it a small quantity of extract of rennet, or an equal volume of a glycerin extract of the gastric mucous membrane, which has been neutralised with dilute sodic carbonate, and place the tube again in the water-bath at 40° C.

Observe that the whole mass curdles in a few minutes, so that

the tube can be inverted without the curd falling out. By-and-by the curd shrinks, and squeezes out a clear slightly-yellowish fluid, the whey. Filter.

(c.) Using commercial rennet extract, repeat (b.), but boil the rennet first; it no longer effects the change described above. The rennet ferment is destroyed by heat.

(d.) Boil the milk and allow it to cool, then add rennet; in all probability no coagulation will take place. Boiled milk is far more difficult to coagulate with rennet than unboiled milk.

(e.) Take some of the curd of 6 (a.). Dissolve one part in caustic soda and the other in lime-water. Add rennet to both, warm to 40° C. The lime solution coagulates, the soda solution does not. (The ferment of rennet has been called *rennin*.)

7. The Salts.

(a.) Using the filtrate of 6 (a.), add magnesia mixture—Lesson XVII. 7, (g.), *i.e.*, ammonio-sulphate of magnesia, which gives a precipitate of *phosphates*. Calcium phosphate is the most abundant salt. There is a little magnesium phosphate.

(b.) Silver nitrate gives a precipitate insoluble in nitric acid, indicating *chlorides* (chiefly potassium and sodium).

8. Boil milk in a porcelain capsule for a time to cause evaporation. It is not coagulated, but a pellicle forms on the surface. Remove it and boil again; another pellicle is formed.

9. Coagulation of Milk.—Calcium salts seem to play an important part in this process.

(i.) Halliburton's Method.—Prepare pure caseinogen by saturating milk with powdered $MgSO_4$. Allow it to stand for a few hours and filter. Keep the filtrate (A). The filter residue consists of caseinogen + fat; wash this with saturated solution of $MgSO_4$ until the washings contain no albumin. On adding water to the precipitate, it dissolves, the fat remaining in the filter.

Precipitate the solution of caseinogen in weak $MgSO_4$ by acetic acid. Collect the precipitate on a filter and wash the acid away with distilled water. Dissolve the precipitate in lime water, rubbing it up in a mortar, filter = opalescent solution of caseinogen.

Place some of this opalescent solution of caseinogen in two tubes A and B.

To A add rennet and keep at 40° C. = no coagulation.

To B add rennet and a few drops of phosphoric acid (.5 per cent.). Heat to 40° C. = coagulation, *i.e.*, casein is formed from caseinogen in the presence of calcic phosphate.

(ii.) Ringer's Method to show the conversion of caseinogen into casein.—Precipitate caseinogen (+ fat) with acetic acid. Collect and wash the precipitate, and grind it up in a mortar with calcium carbonate. Throw the mixture into excess of distilled water. The fat floats, the excess of calcium carbonate falls to the bottom, while the very opalescent solution contains the caseinogen. Divide the fluid into three tubes A, B, C. Keep all at 40° C.

To A add rennet = no clot of casein.

To B a few drops of 10 per cent. solution of calcium chloride—no clot of casein.

To C rennet and calcium chloride—clot of casein.

10. Opacity of Milk—Vogel's Lactoscope.

Apparatus required.—A graduated cylindrical cc. measure to hold 200 cc. ; a lactoscope, with parallel glass sides, 5 mm. apart (fig. 50) ; a burette finely graduated : a stearin candle.

Method.—(a.) Be certain, by microscopical examination, that the milk contains no starch, or chalk, or other granular impurity.

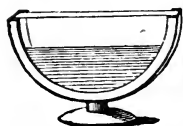

FIG. 50.—Lactoscope.

(b.) Mix 3 cc. of milk with 100 cc. of water in the cylindrical measuring glass.

(c.) In a dark room place the lactoscope on a table, and 1 metre distant from it a lighted stearin candle. Fill the lactoscope with the diluted milk, and look at the candle flame through the glass. If the contour of the flame can be seen distinctly, pour back the diluted milk into the bottle, and add another cc. of milk. Mix again. Test the mixture again, and repeat until, on looking through the glass, the outline of the candle-flame can no longer be recognised. Add together the quantities of milk used. An empirical table constructed by Vogel gives the percentage of fat.

11. Wheaten Flour.—According to Martin, gluten as such does not exist in flour. It appears that the two proteids which it contains—vegetable myosin and an albumose—when mixed with water undergo certain changes, and become converted into the insoluble proteid gluten.

(a.) **Gluten.**—Moisten some flour with water until it forms a tough tenacious dough ; tie it in a piece of muslin, and knead it in a vessel containing water until all the starch is separated. There remains on the muslin a greyish-white, sticky, elastic mass of "crude gluten," consisting of the insoluble albumenoids, some of the ash, and the fats. Draw out some of the gluten into threads, and observe its tenacious characters.

(b.) Dry some of the gluten, and heat it strongly in a test-tube ; an ammoniacal odour similar to that of burned feathers is evolved. Water, which is alkaline (due to ammonia), condenses in the upper part of the tube.

(c.) Extract 10 grams of wheaten flour with 50 cc. of water in a large flask. Shake it from time to time, and allow it to stand for several hours. Filter. If the filtrate is not quite clear, filter again. Heat a part of the clear filtrate, and observe the coagulation of *vegetable albumin*.

(d.) Test another portion of the filtrate from (c.) for the xanthoproteic reaction.

(e.) Another portion of (c.) is to be precipitated by acetic acid and ferro-cyanide of potassium.

(f.) Test a third portion of (c.) for the reaction with NaHO and

CuSO_4 . This is best seen on slightly heating. Take care not to boil the liquid, or the reaction for sugar will be got instead.

(g.) Extract some wheaten flour with a 10 per cent. solution of common salt for twelve hours. Filter, and drop some of the clear filtrate into a large vessel of water; a milky precipitate of a *globulin* is obtained.

(h.) On saturating some of the filtered saline extract (g.) with powdered NaCl or MgSO_4 , a precipitate of a globulin is thrown down.

(i.) **Fats.**—Shake up some wheaten flour with ether in a cylindrical stoppered vessel or test-tube, with a tight fitting cork. Allow the mixture to stand for an hour, shaking it from time to time. Filter off the ether; place some of it on a perfectly clean watch-glass, and allow it to evaporate spontaneously, when a greasy stain will be left.

(j.) The chief salt is potassium phosphate. The watery extract gives a yellow precipitate with platinic chloride, showing the presence of potassium; while heating it with molybdate of ammonium and nitric acid gives a canary-yellow precipitate, proving the presence of phosphates.

12. Pea-Meal.

(a.) Make corresponding watery and saline extracts, and perform the same experiments with them as in Lesson XIII. 11, (c.), (d.), (e.), (f.), (g.), (h.).

(b.) Observe the copious precipitate on boiling the watery extract.

(c.) Note specially the copious deposit of globulin on adding the saline extract to water.

13. Bread.

(a.) Make a watery extract with warm water, filter, and test the filtrate. Its reaction is alkaline.

(b.) Test for starch and sugar.

(c.) The insoluble residue gives the xanthoproteic and other proteid reactions.

LESSON XIV.

MUSCLE.

1. Reaction.

(a.) Arrange two strips of glazed litmus-paper, one red and one blue, side by side. Pith a frog; cut out the gastrocnemius, remove as much blood as possible, divide the muscle transversely, and press the cut ends on the litmus-paper; a faint blue patch is pro-

duced on the red paper, showing that the muscle is *alkaline* during life. The blue paper is not affected.

(b.) Test the reaction of a piece of butcher's meat ; it is intensely acid, due to sarco-lactic acid.

(c.) Dip the other gastrocnemius into water at 50° C. until *rigor caloris* sets in. Test its reaction ; now it is *acid*.

(d.) Boil some water, and plunge into it any other muscle of the same frog ; it is *alkaline*.

(e.) Tetanise a muscle for a long time ; its reaction becomes acid.

2. Watery and Saline Extracts.

(a.) Mince some perfectly fresh muscles from a rabbit or dog. Extract with water, stirring from time to time. After half an hour, pour off, and filter the watery extract. Re-extract the remainder with water until the extract gives no proteid reactions. For the purposes of this exercise, half an hour is sufficient. Keep the filtrate, which contains the substances *soluble in water*.

(b.) Take some perfectly fresh muscle from a rabbit, rub it up with sand in a mortar, and extract it with a large volume of 13 p.c. solution of ammonium chloride, or 10 p.c. NaCl, or 5 p.c. MgSO₄. Stir occasionally, and allow it to extract for an hour. A stronger extract is obtained if it be left until next day. Pour off the fluid, keep it, as it contains the substances *soluble in saline* solutions—the globulins.

3. With the filtrate of 2 (a.)—

(a.) Test for proteids, *e.g.*, serum-albumin.

(b.) Test the coagulating point of the proteids it contains (45° and 75° C.).

(c.) Add crystals of ammonium sulphate to saturation, which precipitates all the proteids.

4. With the filtrate of 2 (b.)—

(a.) Pour a few drops into a large quantity of water ; observe the milky deposit of **myosinogen**. The precipitate is redissolved by adding a strong solution of common salt.

(b.) Test the coagulating point. Four proteids are coagulated by heat at 47°, 56°, 63°, and 73° C., an albumose being left in solution. The fluid is acid in reaction.

(c.) Saturate the filtrate with crystals of sodic chloride or ammonium chloride. The myosinogen is precipitated.

(d.) Collect some of the precipitate of 4 (c.), dissolve it with a weak solution of common salt, and test for proteid reactions (Lesson I. 1). Repeat 3 (c.).

(e.) Suspend in the fluid a crystal of rock-salt ; the latter soon becomes coated with a deposit of myosinogen.

5. **The Extractives of Muscle.** — Prepare Kreatin ($C_4H_9N_3O_2 + H_2O$) omitting the others.

(a.) Make a strong watery solution of Liebig's extract of meat. Cautiously add lead acetate until precipitation ceases, avoiding excess of the lead. Filter, pass sulphuretted hydrogen through the filtrate to get rid of the lead. A pellicle is very apt to form on the surface. Filter, and evaporate the filtrate to a syrup on a water-bath, and set it aside in a cool place to crystallise. Crystals of kreatin separate out.

(b.) After several days, when the kreatin has separated, pour off the mother-liquor, add to it 5 volumes of 90 per cent. alcohol to precipitate more kreatin. Filter, wash the crystals with alcohol, redissolve them in boiling water, allow them to recrystallise, and examine them with the microscope (fig. 51).

Sarkin and xanthin may be prepared from the alcoholic filtrate of (b.).

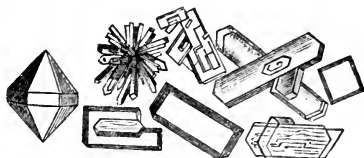
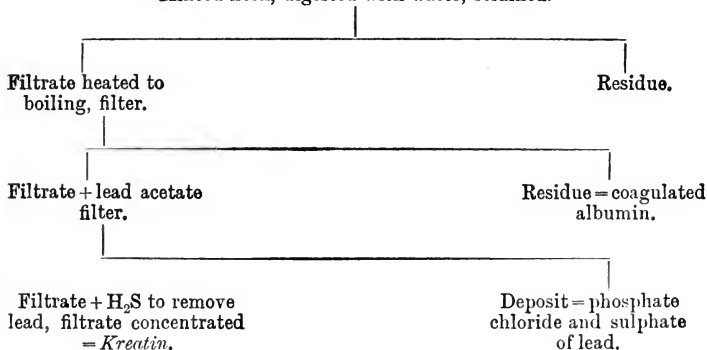

FIG. 51.—Crystals of Kreatin.

The following scheme after Salkowski shows the process of making it from flesh.

Preparation of Kreatin.

Minced flesh, digested with water, strained.



6. **Liebig's Extract of Meat.**

(a.) Test it for proteids; they are absent.

(b.) Test it for glycogen, doing a control test. It usually contains a small quantity.

(c.) Test it for kreatinin (see "Urine"). Weyl's test usually succeeds.

(d.) Examine it microscopically; in addition to a few crystals of common salt, a few clear knife-rest forms, there are numerous crystals of kreatin.

ADDITIONAL EXERCISES.

7. **Muscle-Plasma.**—Kill a rabbit by bleeding from the carotids, open the abdomen, insert a cannula in the aorta, and wash out all the blood from the lower limbs by means of a stream of cold saline solution (0.6 per cent., NaCl). The solution is made cold enough by placing lumps of ice in it. Skin the limbs quickly, cut off pieces of the muscle and plunge them into a mixture of salt and ice (1° – 2° C.), where they quickly become quite hard and frozen. When they are frozen remove them from the mixture, wipe them with blotting-paper, and place them on a plate kept cold by ice and salt mixture. Cut them into fine slices (cutting parallel to the direction of the fibres). Wrap the slices in linen and squeeze them in a pair of cooled enamelled iron lemon-squeezers; a yellowish, viscid alkaline plasma is obtained, which sets in the course of an hour or so into a solid jelly, with the simultaneous appearance of an acid reaction. By-and-by a clear clot of myosin and a fluid muscle-serum is obtained, just as in a blood-clot. The muscle-plasma contains several proteids. For full details of these see Halliburton, *Journal of Physiology*, viii. p. 133.

8. **Halliburton's Researches on Proteids of Muscle.**—With a stream of normal saline solution wash out the blood-vessels of a rabbit just killed. Do this by placing a cannula in the aorta. Remove the muscles quickly, chop them up and extract for a day with 5 per cent. solution of magnesium sulphate. This is done by the demonstrator. Use this fluid.

(a.) It is probably acid due to lactic acid. Test for this (p. 78).

(b.) *Coagulation.* Dilute some with 4 vols. of water, divide it into two parts, keep one at 40° C. (rapid coagulation) and the other at the ordinary temperature (coagulation, but slower). Clot of myosin formed in both.

(c.) Remove the clotted myosin from (b.); it is readily soluble in 0.2 per cent. HCl, forming syntonin; and also in 10 per cent. sodium chloride.

(d.) Add a few drops of 2 per cent. acetic acid to some of the extract—stringy precipitate of myosinogen.

(e.) Perform fractional heat coagulation (*Halliburton*), p. 11.

“(i.) With the original extract coagula are obtained at 47° , 56° , 63° , 73° C.

“(ii.) With liquid (salted muscle-serum) from (b.), after separation of the clot, coagula are obtained at 63° and 73° C.

“(iii.) With muscle-extract which has been saturated with $MgSO_4$ and filtered. The globulins are thus separated. Coagulation now occurs at 73° C., but the coagulum is small.”

The following table from Halliburton shows these facts:—

Name of Proteid.	Coagulation Temperature.	Action of $MgSO_4$.	Is it globulin or albumin?	Fate.
Myosinogen	47° C.	Precipitated.	Globulin.	} These form muscle-clot or <i>Myosin</i> .
Myosinogen.	56° C.	“	“	
Myo-globulin.	63° C.	“	“	} These are left in <i>muscle-serum</i> .
Myo-albumin.	73° C.	Not precipitated.	Albumin.	

9. **Pigments of Muscle.**

(a.) Notice the difference between the red (semi-tendinosus) and pale muscles (adductor magnus) of the rabbit.

(b.) The muscular part of the diaphragm shows the spectrum of oxy-hæmoglobin, even after the blood-vessels have been washed out by salt solution (*Kühne*).

(c.) A piece of the great pectoral muscle of a pigeon, either fresh or which has been placed in glycerine to render it more transparent, on being pressed between two pieces of glass shows absorption bands of *myo-hæmatin*. (*Mac-Munn.*) Map out their position with the spectroscope.

LESSON XV.

SOME IMPORTANT ORGANIC SUBSTANCES.

1. **Hydrochloride of Glycosamin.**—The chitinous parts of crabs and lobsters are freed as much as possible from their soft parts, dried, and divided into small pieces, which are decalcified in dilute hydrochloric acid. Gently boil the decalcified parts for 3-4 hours with hydrochloric acid, then evaporate and allow to crystallise. On cooling, a dark brown humus substance and crystals separate out. Filter, dissolve the crystals in water, and re-evaporate until crystallisation takes place. The hydrochloride of glycosamin ($C_6H_{13}NO_5HCl$) separates in colourless glancing crystals about the size of a pea, which readily reduce Fehling's solution on boiling. They have a somewhat sweet taste like sugar.

2. **Nuclein of Yeast.**—Mix 1 part of fresh German yeast with 4 parts of water, allow the deposit to subside. Pour off the turbid fluid from the solid deposit of yeast, place the latter in .5 per cent. caustic potash, stir for some time, and filter directly into dilute hydrochloric acid. The deposit is filtered off, washed with dilute hydrochloric acid, and then with alcohol. It is then boiled with alcohol and dried over sulphuric acid.

(a.) It is an amorphous powder, insoluble in water and dilute acids, but readily soluble in alkalis.

(b.) Fuse a little with sodic carbonate and nitrate of potash = a mass with a strongly acid reaction due to phosphoric acid.

3. **Lecithin.**

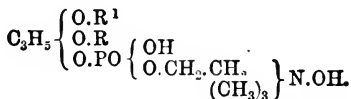

Extract the fresh yellow of eggs free from white, with ether, until the latter takes up no more. Distil off the ether, dissolve the residue in petroleum ether, and filter. Extract the filtrate in a separation filter several times with 75 per cent. alcohol. Mix the alcohol extracts, let them stand until they become clear, separate any petroleum ether, and filter. The rest of the petroleum ether is got rid of by distillation, and the residue is exposed for several days to the air in a cool place, whereby a deposit separates. The clear fluid is decanted and filtered. Decolorise it by boiling with animal charcoal, filter and evaporate to a thick syrup at 50-60°. Dissolve the syrup in ether and evaporate, and the nearly pure lecithin remains behind (*Drechsel*).

¹ R = radical of palmitic acid ($C_{15}H_{31}CO$), stearic acid ($C_{17}H_{35}CO$), or oleic acid ($C_{17}H_{33}CO$).

(a.) It is a soft doughy indistinctly crystalline body. Place a little under a microscope, add a drop of water, and observe the oil-like drops assuming worm-like forms, so-called "myelin-forms."

(b.) Heat some on platinum, either alone or with sodic carbonate and potassic nitrate = a residue, strongly acid, in which phosphoric acid is readily detected.

(c.) Action on Polarised Light.—Examine a little under a polarisation microscope. With crossed Nicol's each granule of the substance shows a dark cross on a white ground, just like starch (*Dastre*).

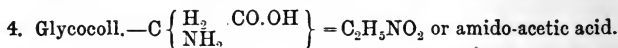

Preparation.—Boil 1 part of hippuric acid with 4 parts of dilute sulphuric acid (1 : 6 water) for ten to twelve hours in connection with a condenser. Carefully pour the mass into a capsule and let it stand for twenty-four hours. Filter, wash the benzoic acid in the filter with cold water, concentrate the filtrate by evaporation, and free it from the last traces of benzoic acid by shaking it with ether. Dilute strongly the acid solution, and neutralise it exactly with baryta water. Allow the precipitate to subside, decant, wash the precipitate with warm water, again concentrate the filtrate until crystals begin to separate on its surface. Allow it to stand twenty-four hours, pour off the mother-liquid, and again evaporate the latter until other crystals are formed. The crystals are recrystallised from water.

Glycocoll forms clear colourless crystals, with a sweet taste, readily soluble in water, and insoluble in alcohol.

5. Guanin Reaction.—Guanin occurs in very considerable quantity in the skin of fishes and frogs. Heat a small piece of the skin from the belly of a frog, and heat it on a porcelain capsule with HNO_3 , as for the murexide test (p. 128). Add caustic soda = orange to cherry-red colour. There is no reaction with ammonia. If there be very little guanin, add dilute caustic potash, and blow on the stain to cool it, when the latter will pass through several *nuances* from blue to orange.

6. Nucleo-Albumin, called "tissue-fibrinogen" by Wooldridge, is best prepared by Halliburton's method.

Sodium Chloride Method.—The finely divided thymus gland is ground up in a mortar with an equal volume of sodium chloride. The viscous mass, on being poured into excess of distilled water, forms stringy masses which rise to the surface. Collect and dissolve these in 1 per cent. sodium carbonate solution. A few cc. of a clear filtered solution injected into the blood-vessels of a rabbit produce extensive intra-vascular clotting, especially in the veins.

LESSON XVI.

THE URINE.

1. Urine is a transparent light-straw or amber-coloured watery secretion derived from the kidneys, containing nitrogenous or azotised matters, salts, and gases. The most abundant constituents are water, urea, and sodium chloride. It has a peculiar odour, bitter saltish taste, and acid reaction.

2. Quantity.—*Normal.*—About $2\frac{1}{2}$ pints (50 ounces) or 1500 cc. in twenty-four hours, although there may be a considerable variation even in health, the quantity being regulated by the amount of fluid taken, and controlled by the state of the tissues, the pulmonary and cutaneous excretions.

Collection.—It should be collected in a tall graduated glass cylinder of a capacity of 2500 cc. with a ground glass top to exclude impurities. Samples of the mixed urine of the 24 hours are used for examination.

Increased by drinking water (*urina potus*) or diuretics; when the skin is cool, its blood-vessels are contracted, and the cutaneous secretion is less active; after a paroxysm of hysteria, and some convulsive nervous diseases; in *diabetes insipidus* and *d. mellitus*; some cases of hypertrophy of the left ventricle, and some kidney diseases. The increase may be temporary or persistent, the former as the effect of cold, diuretics, or nervous excitement; the latter in diabetes and certain forms of kidney-disease.

Diminished after profuse sweating, diarrhoea; early stage of acute Bright's disease; some forms of Bright's disease, the last stages of all forms of Bright's disease; in general dropsies; in acute febrile and inflammatory diseases.

3. Colour.—*Normal.*—Light-straw to amber-coloured. The colour varies greatly even in health, and is due to the presence of a mixture of pigments, probably largely derived from the decomposition of hæmoglobin. Of these pigments **urobilin**, an iron-free derivative of Hb, is the chief. The colour largely depends on the degree of dilution of the urine pigments.

Pale after copious drinking, in diabetes, anæmia, and chlorosis; after paroxysmal nervous attacks (hysteria). *N.B.*—Pale urines indicate the absence of fever.

High-coloured after severe sweating, violent muscular exercise, diarrhoea, or during febrile conditions.

Pathological pigments, purpurine or uro-erythrine in febrile disorders; bile pigments; blood.

Medicinal Substances.—Creosote and carbolic acid make urine nearly black. This is due not to carbolic acid, but to hydrochinon. Sometimes these urines become almost black on standing exposed to the air. Rhubarb (gamboge-yellow); senna (brownish).

4. Specific Gravity.—*Normal*, s.g. 1020 (1015–1025).—This is taken by means of the urinometer (fig. 52). The instrument ought to be tested by placing it in a cylindrical vessel filled with distilled water to ascertain that its zero is correct.

(a.) Fill a tall cylindrical vessel with urine, and place the



FIG. 52.
Urinometer.

urinometer in it. Bring the vessel to the level of the eye, and as soon as the instrument comes to rest, read off the mark on its stem opposite the lower surface of the meniscus against a bright back-ground.

Precautions.—1. The vessel must be so wide that the urinometer can float freely and not touch the sides. 2. The instrument must be dry before being placed in the fluid. 3. The urine itself must be clear and free from air-bubbles on the surface; the latter can be readily removed by means of a fold of blotting-paper. *N.B.*—It is always necessary to take the specific gravity of the “mixed” urine of twenty-four hours.

Low S.G.—Under normal conditions the s.g. varies inversely as the quantity of urine passed. All causes which increase the water of the urine only, *e.g.*, drinking on an empty stomach; after hysteria; in *diabetes insipidus* or *polydipsia*. *N.B.*—If continually below 1015, suspect *diabetes insipidus* or chronic Bright’s disease.

High S.G.—When the urine is concentrated, *diabetes mellitus*, due to a large amount of grape-sugar; first stages of acute fevers; rapid wasting of the tissues, especially if associated with sweating or diarrhœa. It is highest normally three to four hours after a meal; and as it varies during the day, it is necessary to mix the urine of the twenty-four hours, and test the specific gravity of a sample of the “mixed urine.” *N.B.*—If above 1025 and the urine be pale, suspect saccharine diabetes.

5. Estimation of the Amount of Solids from the S.G.—By *Christison’s formula* (“*Häser-Trapp’s coefficient*”), “multiply the last two figures of a specific gravity expressed in four figures by 2.33. This gives the quantity of solid matter in every 1000 parts,” *i.e.*, the number of grams in 1000 cc. ($33\frac{1}{2}$ oz.).

Example.—Suppose a patient to pass 1200 cc. of urine in twenty four hours, and the sp. gr. to be 1022, then

$$22 \times 2.33 = 51.26 \text{ grams in 1000 cc.}$$

To ascertain the amount in 1200 cc.

$$1000 : 1200 :: 51.26 : x = \frac{51.26 \times 1200}{1000} = 61.51 \text{ grams.}$$

This formula is purely empirical, and is not applicable where the variations are very marked, as in saccharine diabetes and some cases of Bright’s disease, where there is a great diminution of urea.

The normal quantity of solids, or the **total solids**—sometimes spoken of as “solid urine”—is about 70 grams (2 oz.) in twenty-four hours, *i.e.*, 1000 to 1050 grains. Parkes gives an average of 945 grains per day for an average adult male between twenty and forty years of age. The latter estimate gives about 20 grains of solids per fluid ounce of urine, or about 4 per cent. of solids.

6. Odour is “peculiar” and “characteristic,” somewhat aromatic in health.

Certain medicinal and other substances influence it—turpentine (violets); cubeb, copaiba, and sandal-wood oil give a characteristic odour, and so do asparagus, valerian, assafoetida, garlic, &c. In *disease*, note the ammoniacal odour of putrid urine and the so-called “sweet” odour in saccharine diabetes.

7. Reaction.—*Normal.*—Slightly acid, it turns blue litmus-paper slightly red, and does not affect red litmus-paper. The acidity is chiefly due to acid sodium phosphate (NaH_2PO_4), acid urates, and very slightly to free acids—lactic, acetic, oxalic, &c. A *neutral* urine does not alter either blue or red litmus-paper. A *very acid* urine turns blue litmus-paper very red.

(a.) Test with appropriate litmus-paper a normal, very acid, neutral, and alkaline urine.

(b.) Test also with violet litmus-paper.

(c.) That the acidity is not due to a free acid is shown by its giving no precipitate with sodium hyposulphite, and also by the fact that it has no action on congo-red. The colour of the latter body is violet or inky, with a solution containing 1 part of free hippuric acid in 50,000 of distilled water.

8. Variations in Acidity during the Day.—*During digestion, i.e.*, two or three hours after a meal, the urine becomes neutral or alkaline. The cause of the alkalinity, is a fixed alkali, probably derived from the basic alkaline phosphates taken with the food (*Roberts*), the “*alkaline-tide*.” According to others, the formation of free acid in the stomach liberates a corresponding amount of bases in the blood, which pass into the urine, and diminish its acidity or even render it alkaline. The “*acid-tide*” occurs after fasting.

Nature of the Food.—With a vegetable diet the excess of alkali causes an alkaline urine. In herbivora it is alkaline, in carnivora very acid. Herbivora (rabbits) whilst fasting have a clear acid urine, because they are practically living on their own tissues. Perhaps this is one of the reasons why the urine is so acid in fevers. Inanition renders the urine *very acid* (*Chossat*). In herbivorous animals and vegetarians, the excess of alkaline salts of citric, tartaric, and other acids being oxidised into carbonates render it alkaline.

Medicines.—*Acids* slightly increase the acidity. *Alkalies* and their carbonates are more powerful than acids, and soon cause alkalinity; alkalies, *e.g.*, the alkaline salts of citric, tartaric, malic, acetic, and lactic acids, appear as carbonates (*Wöhler*).

9. Alkalinity may be due to the Presence of a Fixed or a Volatile Alkali.—In the former case, the blue colour of the litmus-paper does not disappear on heating; in the latter it does, and the paper assumes its original red colour.

(a.) Test with two pieces of red litmus-paper two samples of urine, one alkaline from a fixed alkali, and the other from a volatile one. Both papers become blue.

(b.) Place both side by side on a glass slide, heat them carefully, and note that the blue colour of the one disappears (volatile alkali), the red being restored, while the blue of the other remains (fixed alkali).

The alkalinity may be caused by the presence of ammonium carbonate (volatile), derived from the decomposition of urea; the urine may be ammoniacal when passed, in which case there is always disease of the urinary mucous membrane; or it may become so on standing—from putrefaction—when it is always turbid, and contains a sediment consisting of amorphous phosphate of lime and triple-phosphate, and sometimes urate of ammonium; it has an offensive ammoniacal odour, and is very irritating to the mucous membrane.

The acidity is increased during the resolution of febrile diseases; is excessive in gout and acute rheumatism, and whenever much uric acid is given off (uric acid diathesis); in saccharine diabetes; when certain acids are taken with the food (CO_2 , benzoic).

The amount of the acidity may be determined by using a standard solution of caustic soda (p. 110).

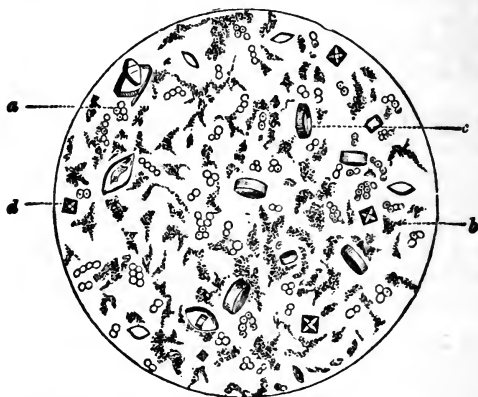
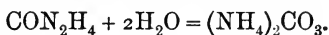

FIG. 53.—Deposit in "Acid Fermentation" of Urine. a. Fungus; b. Amorphous sodium urate; c. Uric acid; d. Calcium oxalate.

10. Transparency.—Observe whether the urine is quite transparent or contains any suspended particles, rendering it more or less turbid, either when it is passed, or some time afterwards.

11. Fermentation of Urine.—When urine is freely exposed to the air it undergoes two fermentations—(1) the *acid*; (2) the *alkaline*. The urine at first becomes slightly *more acid*, from the formation of lactic and acetic acids (although this is denied by some observers), then it gradually becomes *neutral*, and finally *alkaline* from putrefaction. It becomes lighter in colour, turbid, and a whitish heavy precipitate occurs; a pellicle forms on the surface, it

swarms with bacteria, and it has an ammoniacal odour, which is due to the splitting up of the urea, thus—



The urea is split up by a ferment formed by the *micrococcus ureæ*. The carbonate of ammonium makes the urine alkaline, and the earthy phosphates are precipitated because they are insoluble in an alkaline urine. The phosphate of lime is precipitated as such (amorphous), while the phosphate of magnesia unites with the ammonia and is precipitated as ammonio-magnesium phosphate or triple phosphate ($\text{MgNH}_4\text{PO}_4 + 6\text{H}_2\text{O}$). Part of the ammonia escapes, and in addition to that united to the magnesian phosphate, some unites with uric acid to form urate of ammonium.

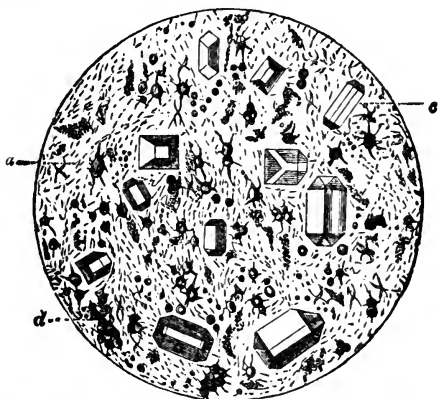

FIG. 54.—Deposit in Ammoniacal Urine (Alkaline Fermentation). *a*. Ammonio-magnesium phosphate; *d*. Acid ammonium urate; *c*. Bacterium ureæ.

N.B.—Although urine may be kept “sweet” for a long time in perfectly clean vessels, still when mixed with decomposing matter it rapidly putrefies. Insist that all urinary vessels be scrupulously clean; and that all instruments introduced into the bladder be properly purified by carbolic acid or other antiseptic.

(*a*.) Place some normal urine aside for some days, in a warm place. Observe it from day to day, noting its reaction, change of colour, transparency, odour, and any deposits that may form in it. Examine the deposit microscopically (figs. 53, 54).

Fermentation is *hastened* by a high temperature, and especially if the urine be passed into a contaminated vessel, or the urine itself contain blood, much mucus or pus. It is *retarded* in a very acid and concentrated urine.

ADDITIONAL EXERCISE.

12. Estimation of the Acidity.—This is done by ascertaining the amount of caustic soda required to exactly neutralise 100 cc. of urine. As the soda solution cannot be prepared by weighing the soda because of the varying amount of water contained in it, the soda solution must be titrated with a standard solution of oxalic acid. Make a *normal* solution of oxalic acid by dissolving 63 grams of dry crystallised oxalic acid in 1000 cc. water, $C_2H_2O_4 + 2H_2O = 126$ (*i.e.*, half the quantity is taken because the acid is dibasic). A normal solution of caustic soda would contain 40 grams per litre (NaHO), *i.e.*, Na = 23, H = 1, O = 16) = 40). 1 cc. = 40 milligrams or .04 gram. Dissolve 150 grams of caustic soda in about 1000 cc. water.

(a.) **Preparation of Normal Caustic Soda.**—Place 10 cc. of normal oxalic acid solution in a beaker, add a few drops of alcoholic solution of rosolic acid (orange solution), and allow the caustic soda solution to drop from a burette until the rosolic acid gives a rosy-red tint. Suppose that to saturate the acid 9.2 cc. of the soda solution are added, then to every 9.2 cc. 0.8 cc. must be added to obtain a solution of which 1 cc. will correspond to 1 cc. of acid, so that for 1000 cc. of caustic soda $9.2 : 1000 :: 0.8 : x$ $\left(\frac{1000 \times 0.8}{9.2} = 86.9 \right)$ 86.9 cc. water must be added.

(b.) **Determine the Acidity of Urine.**—Place 100 cc. of urine in a beaker, and add to it from a burette the normal soda solution (1 cc. = 0.063 oxalic acid). It is better, however, to dilute the soda solution to obtain a *deci-normal solution* $\frac{N}{10}$ *i.e.*, one tenth as strong). In this case, 1 cc. = .0063 oxalic acid. Place strips of red litmus-paper in the fluid, drop in the caustic soda, stir, and add caustic soda until the litmus begins to turn blue. Suppose 15 cc. of the dilute $\left(\frac{N}{10} \right)$ solution are used, then the acidity of 100 cc. urine = $15 \times 0.0063 = 0.0945$; and suppose the total quantity of urine passed to be 1500 cc., then the total acidity of the urine passed in twenty-four hours expressed as oxalic acid = 1.417 grams. The result is merely approximative.

LESSON XVII.

THE INORGANIC CONSTITUENTS OF URINE.

THE constituents of the urine may be classified as follows:—

- (1.) *Water and inorganic salts.*
- (2.) *Urea and relative nitrogenous bodies; uric acid, xanthin, guanin, kreatinin, allantoin, oxaluric acid.*
- (3.) *Aromatic substances; ether-sulpho-acids of phenol, cresol, pyrocatechin, hippuric acid, &c.*
- (4.) *Fatty non-nitrogenous bodies; oxalic, lactic, and glycerin-phosphoric acid.*
- (5.) *Pigments.*
- (6.) *Gases.*

The ratio of inorganic to organic constituents is 1 to 1.2-1.7. The amount of salts excreted in twenty-four hours is 16 to 24 grams ($\frac{1}{2}$ to $\frac{3}{4}$ oz.).

1. **Water** is derived from the food and drink, a small quantity being formed in the body (normal quantity 1500 cc., or about 50 oz.).

2. **Chlorides** are chiefly those of sodium (by far the most abundant) with a little potassium and ammonium, derived chiefly from the food, and amount to 10 to 13 grams (150 to 195 grains), or a mean of 12 grams (180 grains). Sodid chloride crystallises usually in cubes and octahedra. It sometimes forms a combination with urea, and then it crystallises in rhombic plates.

(a.) Test with a few drops of AgNO_3 (1 pt. to 8 distilled water) = white, cheesy, or curdy precipitate in lumps insoluble in HNO_3 . The phosphate of silver is also thrown down, but it is soluble in HNO_3 .

Estimation.—A rough estimate may be formed of the amount by allowing the precipitate to subside, and comparing its bulk from day to day.

Variations, increased in amount when the urine is secreted in excess, although the NaCl usually remains very constant ($\frac{3}{4}$ per cent.); lessened in febrile affections, and where a large amount of exudation has taken place, as in acute pneumonia, when chlorides may be absent from the urine. The reappearance of chlorides in the urine is a good symptom, and indicates an improvement in the condition of the lung. *N.B.*—The urine ought to be tested daily for chlorides in cases of pneumonia.

(b.) Evaporate a few drops of urine on a slide = octahedral or rhombic crystals, a compound of NaCl and urea.

(c.) Test urine from a case of pneumonia, and compare the amount of the precipitate with that of a normal urine.

3. **Quantitative Estimation of Chlorides.**—(1.) *Standard Silver Nitrate.*—Dissolve 29.075 grams fused silver nitrate in 1000 cc. distilled water. 1 cc. = 0.01 NaCl .

(2.) *Saturated Solution of Neutral Potassic Chromate.*

(a.) Dilute 10 cc. of not too dark-coloured urine with 100 cc. water, and place it in a beaker; add a few drops of (2). Allow the silver solution to drop in, stirring all the time until a faint orange tint indicates that there is an end of the reaction. Deduct 1 from the number of cc. of the silver solution added.

4. **Sulphates** are chiefly those of sodium and potassium. The total quantity of sulphates (45 to 60 grs.) is 3 to 4 grams daily. Only a small amount of them enters the body with the food, so that they are chiefly formed from the metabolism of proteids in the body. They have no clinical significance. Sulphuric acid, how-

ever, exists in urine not only in combination with alkalis, as indicated above, so-called "preformed sulphuric acid," but also with organic radicles, phenol, skatol, and other aromatic substances forming aromatic ether-sulpho-compounds, or "ethereal sulphates," the "combined sulphuric acid." The latter form about $\frac{1}{10}$ th of the total sulphates, and originate from putrefactive processes in the intestine. The chief ethereal sulphates are phenol-sulphate of potassium and indoxyl-sulphate of potassium or indican (C_8H_6N) KSO_4 .

(a.) Test with a soluble salt of barium (the nitrate or chloride) = white heavy precipitate of barium sulphate, insoluble in HNO_3 .

(b.) To separate the combined (ethereal) sulphuric acid.—Mix 50 cc. of urine with an equal bulk of "baryta mixture." Stir and filter. This removes the ordinary sulphuric acid as sulphate of barium. Add 10 cc. HCl , and keep in a water-bath at $100^\circ C$. for an hour and then allow the ethereal or combined sulphates to settle.

5. The Phosphates consist of *alkaline* and *earthy* salts in the proportion of 2 to 1. The latter are insoluble in an alkaline medium, and are precipitated when the urine becomes alkaline. They are insoluble in water, but soluble in acids; in urine they are held in solution by free CO_2 . The *alkaline* phosphates are very soluble in water, and they *never form urinary deposits*.

The composition of the phosphates in urine varies. In acid urine, the acid salts NaH_2PO_4 and $Ca(H_2PO_4)_2$ are generally present. In neutral urine in addition Na_2HPO_4 , $CaHPO_4$, and $MgHPO_4$. In alkaline urine there may be also Na_3PO_4 , $Ca_3(PO_4)_2$, $Mg_3(PO_4)_2$.

6. The *Earthy Phosphates* are phosphates of calcium (Ca_3PO_4)₂ (abundant) and magnesium (scanty) $MgHPO_4 + 7H_2O$. Quantity 1 to 1.5 grams (15 to 23 grs.). They are precipitated when the urine is alkaline, although not in the form in which they occur in the urine (Lesson XVI. 11). They are insoluble in water, readily soluble in acetic and carbonic acid, and are precipitated by ammonia.

(a.) To clear filtered urine add nitric acid, boil, and add baric chloride, and boil again = a precipitate of baric sulphate. Filter, and to the cool filtrate add ammonia = a precipitate of baric phosphate.

Clinical Significance.—They are *increased* in osteomalacia and rickets, in chronic rheumatoid arthritis, after prolonged mental fatigue, and by food and drink, and *diminished* in renal diseases and phthisis.

7. The *Alkaline Phosphates* are chiefly acid sodium phosphate (NaH_2PO_4), with traces of acid potassium phosphate (KH_2PO_4); they

are soluble in water, and not precipitated by alkalies, and never occur as urinary deposits. The quantity is 2 to 4 grams (30 to 60 grs.). They are chiefly derived from the food, and perhaps a small amount from the oxidation of the phosphorus of nerve-tissues.

(a.) To fresh, clear-filtered urine add ammonia, caustic soda, or potash, and heat gently until the phosphates begin to separate; let it stand for some time = a white precipitate of the earthy phosphates. Allow it to stand, and estimate approximately the proportion of the deposit. [If a high-coloured urine be used, the phosphates may go down coloured.]

(b.) To urine add about half its volume of nitric acid, and then add solution of ammonium molybdate and boil = a canary-yellow crystalline precipitate of ammonium phospho-molybdate. *N.B.*—The molybdate is apt to decompose on keeping.

(c.) To urine add half its volume of ammonia, and allow it to stand = a white precipitate of *earthy phosphates*. Filter and test the filtrate as in 7 (b.).

(d.) It gives the reaction for phosphates. This method separates the alkaline from the earthy phosphates.

(e.) To urine add half its volume of baryta mixture [Lesson XIX. 12 (c.)] = a copious white precipitate. Filter and test the filtrate as in 7 (c.). It gives no reaction for phosphoric acid, showing that all the phosphates are precipitated.

(f.) To urine add excess of ammonium chloride, and ammonia = a white precipitate of *earthy phosphates* and oxalate of lime. Filter, and to the filtrate add a solution of magnesian sulphate = a precipitate of the alkaline phosphates as *triple phosphate*. If the filtrate be tested for phosphoric acid by 7 (c.), no precipitate will be obtained.

(g.) Instead of 7 (f.), use *magnesia mixture*, composed of magnesian sulphate and ammonium chloride, each 1 part, distilled water 8 parts, and liquor ammoniæ 1 part. It gives the same result as in 7 (f.).

(h.) To urine add a few drops of acetic acid, and then uranium acetate or nitrate = bright yellow or lemon-coloured precipitate of uranium and ammonium double phosphate— $2(U_2O_3)NH_4PO_4$. This reaction forms the basis of the process for the volumetric estimation of the phosphoric acid.

The other fact connected with the volumetric estimation of phosphoric acid is, that when a uranic salt is added to a solution of potassium ferrocyanide, a reddish-brown colour is obtained.

(i.) To a very dilute solution of uranium acetate add potassium ferrocyanide = a brown colour.

8. In some pathological urines the phosphates are deposited on boiling.

(a.) Boil such a urine = a precipitate. It may be phosphates or albumin. An albuminous precipitate falls before the boiling-point is reached, and phosphates when the fluid is boiled. Add a drop or two of nitric or acetic acid. If it is phosphates, the precipitate is dissolved ; if albumin, it is unchanged.

9. **Microscopic Examination.**—As the alkaline phosphates are all freely soluble in water, they do not occur as a urinary deposit. The earthy phosphates, however, may be deposited.

(a.) Examine a preparation or a deposit of **calcic phosphate**, which may exist either in the *amorphous* form or the crystalline condition, when it is known as "*stellar phosphate*" (fig. 55).

(b.) Prepare "*stellar phosphate*" crystals by adding some calcium chloride to normal urine, and then nearly neutralising.



FIG. 55.—Stellar Phosphate.

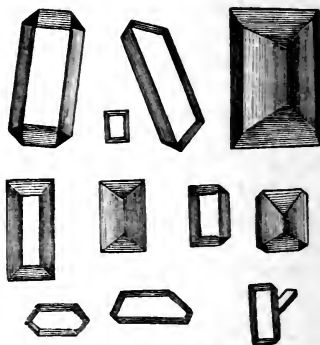

FIG. 56.—Various Forms of Triple Phosphate.

On standing, crystals exactly like the rare clinical form of stellar phosphate are obtained.

(c.) **Triple Phosphate** or ammonio - magnesian phosphate $Mg(NH_4)PO_4 + 6H_2O$ never occurs in normal urine, and when it does occur, indicates the decomposition of urea to give the ammonia necessary to combine with magnesium phosphate to form this compound. It forms large, clear "*knife-rest*" crystals (fig. 56).

(d.) If ammonia be added to urine, the ammonio-magnesian phosphate is thrown down in a *feathery* form, which is very rarely met with in the investigation of human urine clinically (fig. 57).

10. General Rules for all Volumetric Processes.

(a.) The burette must be carefully washed out with the titrating solution, and must be fixed vertically in a suitable holder.

(b.) All air-bubbles must be removed from the burette as well as from the outflow tube. The latter must be quite filled with the titrating solution.

(c.) Fill the burette with the solution up to zero, and always remove the funnel with which it is filled.

(d.) Read off the burette always in the same manner, and always allow a short time to elapse before doing so, in order to allow the fluid to run down the sides of the tube.

(e.) The titrating fluid and the fluid being titrated must always be thoroughly well mixed.

(f.) It is well to make two estimations, the first approximate, the second exact.



FIG. 57.—Feathery Forms of Triple Phosphate.

11. Volumetric Process for Phosphoric Acid, with Ferrocyanide of Potassium as Indicator.—1 cc. of the SS. (Uranium acetate) = .005 gram of phosphoric acid.

Solutions Required.—**Sodium Acetate Solution.**—Dissolve 100 grams of sodium acetate in 100 cc. pure acetic acid, and dilute the mixture with distilled water to 1000 cc.

Potassium Ferrocyanide Solution.—Dissolve 1 part of the salt in 20 parts of water.

Uranium Nitrate Solution (1 cc. = .005 gram H_3PO_4).—Dissolve 35 grams of uranium nitrate in strong acetic acid, and dilute the solution to 1 litre.

Apparatus Required.—Mohr's burette, fitted in a stand, and provided with a Mohr's clip; piece of white porcelain; tripod stand and wire-gauze; small beaker; two pipettes, one to deliver 50 cc., the other 5 cc.; glass rod.

(a.) Collect and carefully measure the urine passed during twenty-four hours.

(b.) Place 50 cc. of the mixed and filtered urine in a beaker. Do this with a pipette. Place the beaker under a burette.

(c.) To the urine add 5 cc. of the solution of sodium acetate; mix thoroughly.

(d.) Fill a Mohr's burette with the SS. of uranium acetate up to zero, or to any mark on the burette. See that the Mohr's clip is tilted, and that the out-

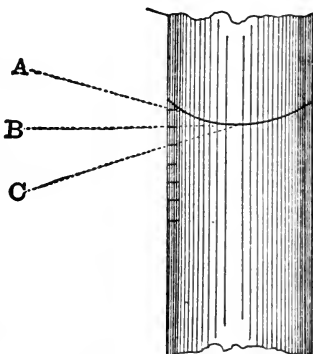

FIG. 58.—Burette Meniscus.

flow tube is filled with the SS. Note the height of the fluid in the burette. Heat the urine in the beaker to about 80° C. Drop in the SS. ("Standard Solution") of uranium acetate from the burette. Mix thoroughly. Test a drop of the mixture from time to time, until a drop gives a faint brown colour when mixed with a drop of potassium ferrocyanide. Do this on a white plate.

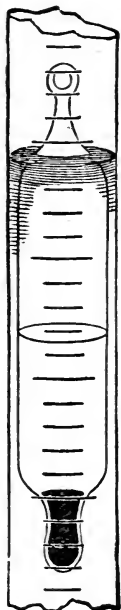

FIG. 59.
Erdmann's Float.

13. Erdmann's Float (fig. 59) consists of a glass vessel loaded with mercury, so that it will float vertically. It is used to facilitate the reading off of the burette. It has a horizontal line engraved round its middle, and must be of such a width as to allow it just to float freely in the burette. Read off the mark on the burette which coincides with the ring on the float.

14. Carbonates and bicarbonates of the alkalies are generally present in alkaline urine, and are most abundant in the urine of herbivora and vegetarians. They are derived from the oxidation of the organic vegetable acids. Carbonate of lime is not normally present in human urine, though it is sometimes found as a urinary deposit.

15. The Lime, Magnesia, Iron, and other inorganic urinary constituents are comparatively unimportant, and have no known clinical significance.

(e.) Boil the mixture and test again. If necessary, add a few more drops of the SS., until the brown colour reappears on testing with the indicator. [Paper may be dipped in the indicator solution and tested with a drop of the mixture.] Read off the number of cc. used.

Example.—Suppose 17 cc. of the SS. are required to precipitate the phosphates in 50 cc. of urine; as 1 cc. of SS. = .005 gram of phosphoric acid, then $.005 \times 17 = .085$ gram of phosphoric acid in 50 cc. of urine. Suppose the patient passed 1250 cc. of urine in twenty-four hours, then $50 : 1250 :: .085 : x$ $\frac{1250 \times .085}{50} = 2.12$ grams of phosphoric in twenty-four hours.

12. Reading off the Burette.—In the case of the burette being filled with a watery fluid, note that the upper surface of the water is concave. Always bring the eye to the level of the same horizontal plane as the bottom of the meniscus curve. Fig. 58 shows how different readings may be obtained if the eye is placed at different levels, A, B, C.

LESSON XVIII.

ORGANIC CONSTITUENTS OF THE URINE.

1. Urea (CON_2H_4) is the most important organic constituent in urine, and is the chief end-product of the oxidation of the nitrogenous constituents of the tissues and food. It crystallises in silken four-sided prisms, with obliquely-cut ends (rhombic system), and when rapidly crystallised, in delicate white needles. It has no effect on litmus; odourless, weak cool-bitter taste, like saltpetre. It is very soluble in water and in alcohol, and almost insoluble in ether. It is isomeric with—*i.e.*, it has the same empirical, but not the same structural formula as ammonium cyanate (NH_4)CNO. It may

be regarded as a diamid of CO_2 or as carbamid = $\text{CO} \begin{cases} \text{NH}_2 \\ \text{NH}_2 \end{cases}$.

Urea represents the final stage of the metamorphosis of albuminous substances within the body. More than nine-tenths of all the N taken in is excreted in the form of urea.

2. Preparation from Urine.—Take 20 cc. of fresh filtered human urine, add 20 cc. of baryta mixture—Lesson XIX. 12 (c.)—to precipitate the phosphates. Filter, evaporate the filtrate to dryness in an evaporating chamber, and extract the residue with boiling alcohol. Filter off the alcoholic solution, place some of it on a slide, and allow the crystals of urea, usually long, fine, transparent needles, to separate out. This is best done by allowing spontaneous evaporation of the solution to go on in a warm place. Examine them microscopically (fig. 60, a).

3. Combinations.—Urea combines with acids, bases, and salts. Evaporate human urine to one-sixth its bulk, and divide the residue into two portions, using one for the preparation of nitrate, and the other for oxalate of urea.

4. Urea Nitrate ($\text{CH}_4\text{N}_2\text{O}$, HNO_3).

(a.) To the concentrated urine add strong *pure* nitric acid = a precipitate of glancing scales of urea nitrate, which, being almost insoluble in HNO_3 , separate out in rhombic plates or six-sided tables, with a mother-of-pearl lustre, and often imbricate arrangement.

(b.) Examine the crystals microscopically (fig. 6o).

(c.) If only traces of urea are present, concentrate the fluid supposed to contain the urea, place a drop on a slide, put into the drop one end of a thread, apply a cover-glass, and put a drop of *pure* nitric acid on the free end of the thread. The acid will pass into the fluid, and microscopic crystals of urea nitrate will be formed on the thread. After a time examine the preparation microscopically.

5. Urea Oxalate ($\text{CH}_4\text{N}_2\text{O}$)₂ $\text{C}_2\text{H}_2\text{O}_4 + \text{H}_2\text{O}$.

(a.) To the other half of the concentrated urine add a concentrated solution of oxalic acid. After a time crystals of oxalate of urea separate.

(b.) Examine them microscopically (fig. 61).

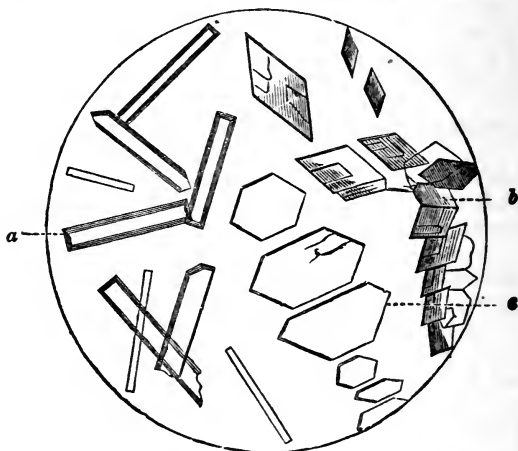

FIG. 6o.—a. Urea; b. Hexagonal plates; and c. Smaller scales, or rhombic plates of urea nitrate.

(c.) Add oxalic acid to a concentrated solution of urea = a precipitate of urea oxalate, which may have many forms—rhombic plates, crystalline scales, easily soluble in water.

(d.) Do the same test as described for urea nitrate (4, c.), but substitute oxalic for the nitric acid.

6. Urea and Mercuric Nitrate ($2\text{CON}_2\text{H}_4 + \text{Hg}(\text{NO}_3)_2 + 3\text{HgO}$).

(a.) To urine (after removing the phosphates by baryta mixture) or urea solution add mercuric nitrate = a white, cheesy precipitate, a compound of urea and mercuric nitrate. Liebig's method for the estimation of urea is founded on this reaction.

7. Other Reactions of Urea.—Make a strong watery solution of urea, and with it perform the following tests:—

(a.) Allow a drop to evaporate on a slide, and examine the crystals which form (fig. 60, a).

(b.) To a strong solution of urea add *pure* nitric acid = a precipitate of urea nitrate (fig. 60, b).

(c.) To a strong solution of urea add ordinary nitric acid tinged yellow with *nitrous acid*, or add *nitrous acid* itself; bubbles of gas are given off, consisting of carbon dioxide and nitrogen.

(d.) Add caustic potash, and heat. The urea is decomposed, ammonia is evolved, and Ammonium carbonate is formed:— $\text{CON}_2\text{H}_4 + 2\text{H}_2\text{O} = (\text{NH}_4)_2\text{CO}_3$.

(e.) Mercuric nitrate gives a greyish-white cheesy precipitate.

8. With Crystals of Urea perform the following experiments:—

(a.) **Biuret Reaction.**—Heat a crystal in a hard tube; the crystal melts, ammonia is given off, and is recognised by its smell and its action on litmus, while a white sublimate of cyanuric acid ($\text{C}_3\text{H}_3\text{N}_3\text{O}_3$) is deposited on the upper cool part of the tube. Heat the tube until there is no longer an odour of ammonia. Allow the tube to cool, add a drop or two of water to dissolve the residue, a few drops of caustic soda or potash, and a little very dilute solution of cupric sulphate = a *pink* colour (biuret reaction). Two molecules of urea yield one of biuret.

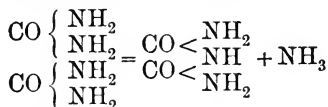

(b.) Place a large crystal of urea in a watch-glass, cover it with a saturated freshly prepared watery solution of *furfural*, and at once add a drop of strong hydrochloric acid, when there occurs a rapid play of colours, beginning with yellow and passing through green, purple, to violet or brown. This test requires care in its performance.

9. **Quantity.**—An adult excretes 30 to 40 grams (450 to 600 grs.) daily; a woman less, and children relatively more. It varies, however, with

(a.) *Nature of the Food.*—It increases when the nitrogenous matters are

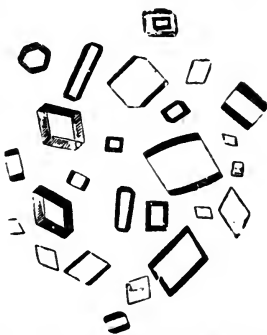

FIG. 61.—Crystals of Oxalate of Urea from Urine.

increased in the food, and is diminished by vegetable diet. It is increased by copious draughts of water, salts. It is still excreted during starvation.

(b.) *Muscular Exercise* has little effect on the amount.

(c.) *In Disease*.—In the acute stage of fevers and inflammation there is an increased formation and discharge, also in saccharine diabetes (from the large quantities of food consumed). It is diminished in anæmia, cholera, by the use of morphia, in acute and chronic Bright's disease. If it is retained within the body, it gives rise to uræmia, when it may be excreted by the skin, or be given off by the bowel.

10. *Occurrence*.—Urea occurs in the blood, lymph, chyle, liver, lymph glands, spleen, lungs, brain, saliva, amniotic fluid. The chief seat of its formation is very probably the liver. It also occurs in small quantity in the urine of birds, reptiles, and herbivora, but it is most abundant in that of carnivora.

LESSON XIX.

VOLUMETRIC ANALYSIS FOR UREA.

1. Before performing the volumetric analysis for urea, do the following reactions, which form the basis of this process:—

(a.) To a solution of sodic carbonate add mercuric nitrate = a yellow precipitate of mercuric hydrate.

(b.) To urine add sodic carbonate, and then mercuric nitrate = first of all a white cheesy precipitate; on adding more mercuric nitrate, a yellow is obtained, *i.e.*, no yellow is obtained until the mercuric nitrate has combined with the urea, and there is an excess of the mercuric salt.

(c.) To urine add *hypobromite of soda*. At once the urea is decomposed, and bubbles of gas—N—are given off.

2. Estimation of Urea by Hüfner's Hypobromite Method.

The principle of this method depends on the fact that urea is decomposed by alkaline solution of sodium hypobromite, yielding water, CO₂ and N. The CO₂ is absorbed by the caustic soda, the N, which is disengaged in bubbles, is collected and measured in a suitable apparatus.

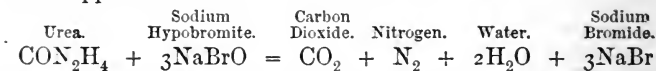

Every 0.1 gram of urea contains .046 gram N; this at the ordinary temperature and pressure = 37.3 cc. of nitrogen. In practice only 35.43 cc. are obtained. It is an accurate method, and the one generally used for clinical purposes. Many different forms of apparatus have been devised, including those of Knop and Hüfner, Russel and West, Graham Steele, Simpson, Dupré, Charteris, Gerrard, &c.

3. Apparatus and Solutions required.

- (i.) A 40 per cent. solution of caustic soda.
- (ii.) Tubes containing 2 and 4 cc. of bromine. This is far more convenient than the fluid bromine.
- (iii.) A strong glass cylinder with a glass stopper.
- (iv.) A 5 cc. pipette.
- (v.) Urea apparatus, *e.g.*, of Dupré, or Gerrard.

4. *Make the hypobromite solution:* Place 23 cc. of the caustic soda solution in the glass-stoppered cylinder, drop into it gently a tube containing 2 cc. of bromine. Shake the cylinder so as to break the bromine tube; the soda combines with the bromine. These bromine tubes can be purchased. The solution spoils by keeping, so that it should be made fresh for each estimation.

5. **Dupré's Apparatus.**¹—In this apparatus (fig. 62) the graduation on the collecting tube represents either the percentage of urea or cc. of N. The collecting tube, which is clamped above, is placed in a tall vessel containing water, and connected with a small glass flask containing a short test-tube.

(a.) Remove the short test-tube from the flask, and in the latter place 25 cc. of the hypobromite solution.

(b.) With a pipette measure off 5 cc. of the clear filtered urine, and place it in the short test-tube attached to the india-rubber stopper, and seen on the left side of fig. 62. This is preferable to the pipette shown in the fig. Place the caoutchouc stopper in the flask.

(c.) Test to see if all the connections are tight. Open the clamp at the upper end of the collecting tube, depress the tube in the water until the water inside and outside the tube is at zero of the graduation. Close the clamp, and raise the collecting tube. If the apparatus be tight, no air will pass in

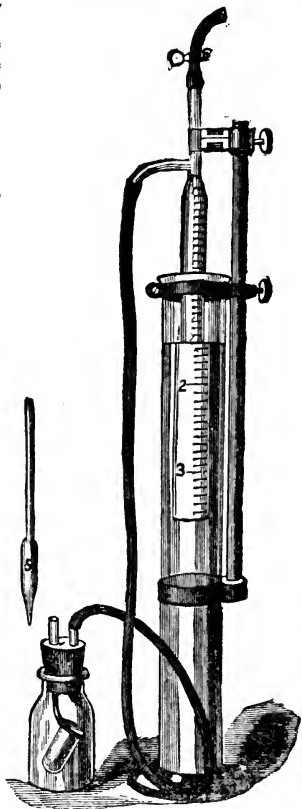

FIG. 62.—Dupré's Urea Apparatus.

¹ Made by George J. Smith, 73 Farringdon Street.

and on lowering the collecting tube the water will stand at zero inside and outside the tube.

(d.) Mix the urine gradually with the hypobromite solution by gently tilting over the flask. Gas is rapidly given off, the CO_2 is absorbed by the caustic soda, while the N is collected in the graduated measuring tube.

(e.) Place the flask in a jar of water at the same temperature as that in the tall jar, and slightly lower the measuring tube. After

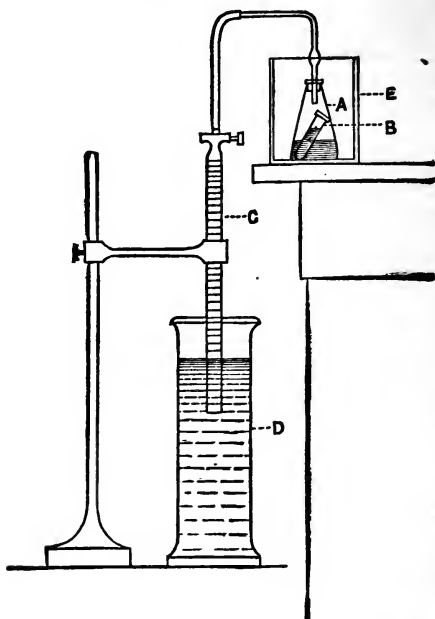

FIG. 63.—Steele's Apparatus for Urea. A. Flask for hypobromite; B. Tube for urine; C. Burette; D. Vessel with water; E. Vessel with water to cool A.

all effervescence has ceased, and when the N collected in the collecting tube has cooled to the temperature of the room—*i.e.*, in five to ten minutes—raise the collecting tube until the fluid inside and outside stands at the same level. Read off the graduated tube; this gives the percentage of urea. Or if the burette be graduated in cc. read off the number of cc. and calculate the amount of urea from the amount of N evolved.

It is to be remembered that other bodies in the urine, such as uric acid (urates) and kreatinin—but not hippuric acid—also yield

nitrogen by this process; further, that only about 92 per cent. of the N of the urea is given off in the above processes. These sources of fallacy are, however, taken into account in graduating the apparatus.

6. Steele's Apparatus (fig. 63).—In this apparatus the collecting tube is a graduated burette graduated in cc.

(a.) Use this apparatus in a similar manner. The tube B is introduced into the flask A by means of a pair of forceps.

(b.) Read off the number of cc. of N evolved, and from this calculate the amount of urea. Every 35.4 cc. N = 0.1 gram urea.

7. Ureameter of Doremus (fig. 64).—It consists of a graduated bulb-tube, closed at one end. Hypobromite of sodium solution is poured into the tube up to a certain mark, and diluted with water to fill the long arm and bend. The urine to be tested is drawn into the pipette to the graduation. The pipette is then passed into the ureameter, as far as the bend, and the nipple is compressed slowly. The urine will then rise through the hypobromite solution, and the gas evolved will collect in the upper part of the tube.

Each division indicates .001 gram of urea in 1 cc. of urine. The percentage of urea present in the urine is found by simply multiplying the result of the test by 100.

8. Study also Charteris's apparatus. The bromine and caustic soda are mixed in a marked measure, so that the hypobromite is always fresh, while the collecting tube for the N is so graduated as to indicate a certain percentage of urea.

9. Study Squibb's apparatus. In all these cases directions are supplied with the apparatus.

10. Liebig's Volumetric Process for Urea with Sodic Carbonate as Indicator.—1 cc. of the SS. (mercuric nitrate) = .01 gram or 10 milligrams of urea. This method has been largely supplanted by the hypobromite process.

11. Solutions Required.

Baryta Mixture.—Prepared as in Lesson XIX. 12 (c).

Mercuric Nitrate Solution.—(1 cc. = .01 gram urea). Dissolve with the aid of gentle heat 77.2 grams of pure dry oxide of mercury in as small a quantity as possible of HNO_3 , evaporate to a syrup, and then dilute with

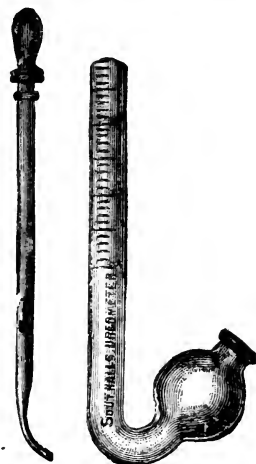

FIG. 64.—Ureameter of Doremus with Pipette.

water to 1 litre. A few drops of HNO_3 will dissolve any of the basic salt left undissolved. *N.B.*—The exact strength of this solution must be estimated by titrating it with a standard 2 per cent. solution of urea.

Sodic Carbonate Solution.—20 grains to the ounce of water.

12. Apparatus Required.—Burette fixed in a stand, funnels, beakers, filter-paper, glass rod, plate of glass, and three pipettes, 10, 15, and 20 cc.

(a.) Collect the urine of the twenty-four hours, and measure the quantity.

(b.) If albumin be present, separate it by acidification (acetic acid), boiling, and filtration.

(c.) Mix 40 cc. of urine with 20 cc., *i.e.*, half its volume, of a solution of barium nitrate and barium hydrate (composed of one volume of solution of barium nitrate and two volumes of barium hydrate, both saturated in the cold). This precipitates the phosphates, sulphates, and carbonates.

(d.) Filter through a *dry* filter to get rid of the above salts. While filtration is going on, fill the burette with the standard solution (SS.) of mercuric nitrate up to the mark 0 on the burette. See that there are no air-bubbles, and that the outflow tube is also filled.

(e.) With a pipette take 15 cc. of the clear filtrate and place it in a beaker. *N.B.*—This corresponds to 10 cc. of urine. Place a few drops of the sodic carbonate solution (the indicator) on a piece of glass resting on a black background.

(f.) Note the height of the fluid in the burette. Run in the SS. of mercuric nitrate from the burette into the 15 cc. of the mixture, in small quantities at a time, until the precipitate ceases. Stir and mix thoroughly with a glass rod. After each addition, with the glass rod lift out a drop of the mixture and place it on one of the drops of sodic carbonate until a pale *yellow* colour is obtained. This indicates that all the urea has been precipitated, and that there is an excess of mercuric nitrate. Read off the number of cc. of the SS. used.

(g.) Repeat the experiment with a fresh 15 cc. of the filtrate, but run in the greater part of the requisite SS. at once before testing with sodic carbonate.

Read off the number of cc. of the SS. used, and *deduct* 2 cc.; multiply by .01, which gives the amount (in grams) of urea in 10 cc. of urine.

Example.—Suppose 27 cc. of the SS. were used, and the patient passed 1200 cc. of urine in twenty-four hours: then $25 \times .01 = .25$ gram urea in 10 cc.

$$10 : 1200 :: .25 : x \cdot \frac{1200 \times .25}{10} = 30 \text{ grams of urea in twenty-four hours.}$$

This method yields approximately accurate results only when the amount of urea is about 2 per cent. With a greater or less percentage of urea, certain modifications have to be made.

Correction for Sodic Chloride.—Two cc. were deducted in the above process. Why? On adding mercuric nitrate to a solution containing sodic chloride, the mercuric nitrate is decomposed and mercuric chloride formed, and as long as any sodic chloride is present, there is no free mercuric nitrate to combine with the urea. Proofs of this:—

(a.) To a solution of sodic chloride (normal saline) add mercuric nitrate = no precipitate.

(b.) To a solution of sodic chloride (normal saline) add a few crystals of urea, then add mercuric nitrate. At first there is no precipitate, or, if there is, it is redissolved; but by-and-by a white precipitate is obtained.

(c.) To a solution of urea (acid) add mercuric chloride = precipitate.

ADDITIONAL EXERCISES.

13. Hufner's Apparatus (fig. 65).—It consists of a stout fusiform glass cylinder (B) (capacity 100 cc.), connected below by means of a glass tap with a smaller tube (capacity 5 cc.). The capacity of A is important, as it contains the urine, so that it must be previously calibrated. The remainder of the

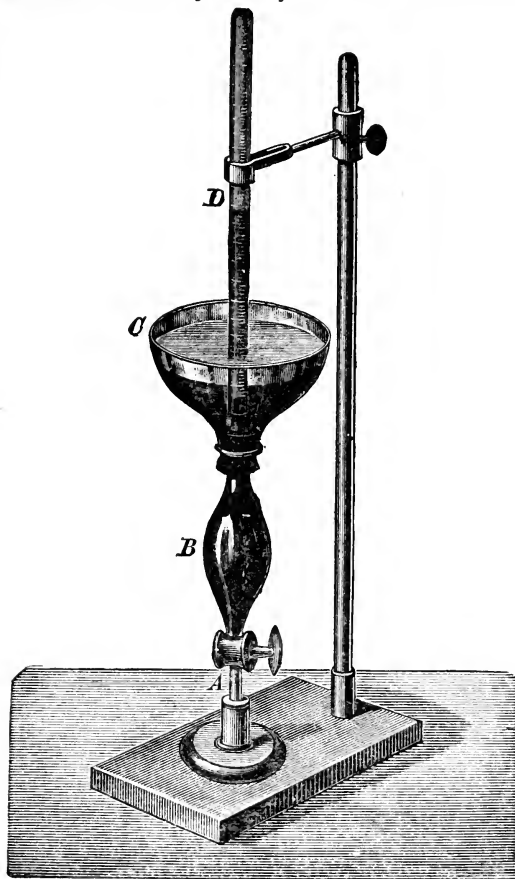

FIG. 65.—Hufner's Urea Apparatus.

apparatus consists of a glass bowl (C) fitted by means of a caoutchouc stopper upon the upper end of B. Above this is a graduated gas-collecting tube (D); 40 cm. long and 2 cm. wide, and graduated into 0.2 cm. in units of capacity.

By means of a long funnel fill the vessel A with urine, close the tap, and

wash every trace of urine out of B. Place C in position, fill B with a freshly-prepared solution of hypobromite, and place a concentrated solution of common salt in C to the depth of 1 cm. Fill D also with the salt solution, avoiding the presence of air-bubbles. Insert D over B. Open the tap when the hypobromite mixes with the urine and the gases are evolved. The quantity of urea is calculated from the volume of N evolved.

14. Gerrard's Apparatus (fig. 66).

Method of Using.—Pour into the tube 5 cc. of the urine to be examined, and in the bottle (a) 25 cc. or 6 fluid drachms of sodium hypobromite solution. Place the tube carefully inside the bottle, as shown in the illustration, avoiding spilling any of the contents. Fill the glass tubes (b, c) with water, so that

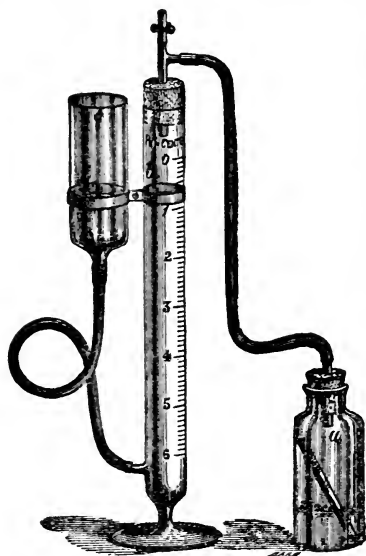

FIG. 66.—Gerrard's Urea Apparatus, as made by Gibbs, Cuxson, & Co., Wednesbury.

the level reaches the zero-line, taking care that when this is done the tube (c) contains only a little water by being placed high—it having to receive what is displaced from (b) by the nitrogen evolved. Now connect the india-rubber tubing to the bottle, and noting lastly that the water is exactly at zero, upset the contents of the tube into the hypobromite solution. Nitrogen is evolved, and depresses the water in (b). When this ceases, lower (c) until the level of the water in both tubes is equal. To be exact, dip (a) into cold water to cool the gas before taking a reading, and note the result, which shows percentage of urea.

The solution of hypobromite of soda is made by dissolving 100 grams of caustic soda in 250 cc. of water, then adding 22 cc. of bromine.

To avoid the danger of the bromine vapour, the bromine is sold in hermetically sealed glass tubes, containing 2.2 cc.; one of these placed in the large bottle with 25 cc. of the soda solution gives, when broken with a sharp shake, the exact

quantity of hypobromite for one estimation of urea, and all bad odour is avoided.

15. Synthetic Preparation of Urea.—Heat coarsely-powdered ferrocyanide of potassium ($\text{FeCy}_2 \cdot 4\text{KCy} + 3\text{H}_2\text{O}$, about 250 grams) over a fire in a large porcelain vessel. Stir constantly, and heat until the whole assumes a white colour, and the larger pieces when broken up show no trace of yellow. If it be over-heated the powder becomes brown. The white mass is finely powdered and mixed with half its volume of dry, finely-powdered, black oxide of manganese. The whole is heated in a black metal pot in a draught chamber until it begins to scintillate, and the mass becomes doughy. The mass is heated until a small portion of it, when dissolved in water and after acidulation with hydrochloric acid, is no longer rendered blue by ferric

chloride. Cool and extract with cold water, and add to the solution dry ammonium sulphate to the extent of three-fourths of the weight of potassic ferrocyanide used. Filter, evaporate on a water-bath at about 60° - 70° C. (at which temperature ammonium cyanate passes into urea). At first potassic sulphate crystallises out; remove it from time to time. Lastly, evaporate to dryness, and extract the urea from the residue by absolute alcohol. The urea crystallises from the alcoholic solution at a moderate temperature (*Drechsel*).

16. Estimation of Total Nitrogen (*Pflüger und Bohland's Approximative Method*.—(i.) Take 10 cc. of urine, add Liebig's mercuric nitrate until a faint yellow is obtained with a drop of the mixture when the latter is tested with sodic carbonate. The number of cc. of the SS. used multiplied by 0.04 gives the total N.

(ii.) *Kjeldahl's Method*.—This method, when once the standardised solutions are prepared, and the apparatus set up, can be carried out in about an hour, and several estimations can be carried out simultaneously. In this method the organic matter is destroyed by prolonged heating of the substance with sulphuric acid, until the originally blackish fluid becomes clear and yellow coloured. After it cools, caustic soda is added, the flask is corked, and the mixture is distilled, whereby the ammonia passes over into a standardised solution of sulphuric acid. The ammonia is calculated by titrating the sulphuric acid with standard caustic soda. (See Sutton's *Volumetric Analysis*, p. 68, 5th edit., 1886.)

LESSON XX.

URIC ACID—URATES—HIPPURIC ACID— KREATININ, &c.

1. Uric Acid ($C_5H_4N_4O_3$) contains 33.33 per cent. of N, and, next to urea, is the constituent of the urine whereby the largest quantity of N of the body is excreted, whilst in birds, reptiles, and insects it forms the chief nitrogenous excretion. The proportion of urea to uric acid is 45 : 1.

The following structural formula show its relation to urea, and the results of its decomposition :—

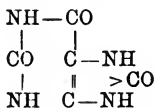

2. Quantity.—0.5 gram (7-10 grs.) daily. It is dibasic, colourless, and crystallises, chiefly in rhombic plates, and when the obtuse angles are rounded the "whetstone" form is obtained. It often crystallises spontaneously in rosettes from saccharine diabetic urine. It is tasteless, reddens litmus, and is very insoluble in water (18,000 parts of cold and 15,000 of warm water), insoluble in alcohol and ether. In the urine it occurs chiefly in the form of acid urates of soda ($C_5H_2N_4O_3$, HNa) and potash.

(a.) In a conical glass, add 5 parts of HCl to 20 parts of urine, put it in a cool place for twenty-four hours. Yellow or brownish-coloured crystals of uric acid are deposited on the sides of the glass, or form a pellicle on the surface of the fluid like fine grains of cayenne-pepper. Both uric acid and its salts (urates), when they occur as sediments in urine, are coloured, and the colour is deeper the more coloured the urine. The slow separation of the uric acid is probably due to the presence of phosphatic salts.

(b.) Collect some of the crystals and examine them microscopically. The crystals assume many forms, but are chiefly rhombic. They may be whetstone, lozenge-shaped, in rosettes, quadrilateral



FIG. 67.—Uric Acid. a. Rhombic tables (whetstone form); b. Barrel form; c. Sheaves; d. Rosettes of whetstone crystals.

prisms, &c. They are *yellowish* in colour, although their tint may vary from yellow to red or reddish-brown, depending on the depth of the colour of the urine (figs. 67, 68).

(c.) The crystals are soluble in caustic soda or potash. Observe this under the microscope.

(d.) With the aid of heat dissolve some serpent's urine—which is solid, and consists chiefly of ammonium urate—in a 10 per cent. solution of caustic soda. Add water, and allow it to stand. Pour off the clear fluid, and precipitate the uric acid with dilute hydrochloric acid. Collect the deposit and use it for testing.

3. Reactions and Tests.

(a.) **Murexide Test.**—Place uric acid in a porcelain capsule add nitric acid, and heat gently, taking care that the temperature

is not too high—not above 40° C. Very disagreeable fumes are given off, while a yellow or reddish stain remains. Allow it to cool, and bring a rod dipped in ammonia near the stain, or moisten it with strong ammonia, when a purple-red colour of murexide, $C_8H_8(NH_4)N_5O_6$, appears. It turns violet on adding caustic potash.

(b.) Repeat the experiment, but act on the residue with caustic soda or potash, when a violet-blue colour—discharged by heat—is obtained. The latter distinguishes it from guanin. When uric acid is acted on by nitric acid, alloxantin ($C_8H_4N_4O_7$) is formed, which, on being further heated, yields alloxan ($C_4H_2N_2O_4$); the latter strikes a purple colour—murexide—with ammonia.

(c.) Place uric acid on a microscopic slide, and dissolve it in liquor potassæ. Heat, if necessary; add hydrochloric or nitric acid just to excess, and examine with the microscope the crystals of uric acid which form. They may be transparent rhombs with obtuse angles, dumb-bells, or in rosettes.

(d.) Dissolve uric acid in caustic soda, add a drop or two of Fehling's solution—or dilute cupric sulphate and caustic soda—and boil = a white precipitate of cupric urate, which after a time becomes greenish.

(e.) Schiff's Test.—Dissolve uric acid in a small quantity of sodium carbonate. Place, by means of a glass rod, a drop of solution of silver nitrate on filter-paper, and on this place a drop of the uric acid solution. A dark brown or black spot of reduced silver appears.

(f.) Heat some uric acid in a test-tube. It blackens and gives off the smell of burnt feathers.

(g.) Garrod's Microscopic Test.—Add 6 to 8 drops of glacial acetic acid to 5 cc. urine in a watch-glass, put into it a few silk threads, and allow the whole to stand for twenty-four hours, taking care to prevent evaporation by

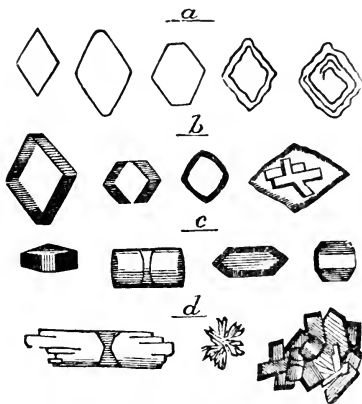

FIG. 68.—Uric Acid. a. Rhomboidal, truncated, hexahedral, and laminated crystals; b. Rhombic prism, horizontally truncated angles of the rhombic prism; c. Prism with a hexahedral basic surface, barrel-shaped figure, prism with a hexahedral basal surface; d. Cylindrical figure, stellate and superimposed groups of crystals.

covering it with another watch-glass or small beaker. Examine the threads microscopically for the characteristic crystals of uric acid, which are soluble in KHO. A similar reaction may be done on a microscopic slide.

4. Uric Acid Salts (Urates, "Lithates").—Uric acid forms salts (chiefly acid), with various bases, which are soluble with difficulty in cold, but readily soluble in warm water. HCl and acetic acid decompose urates, and then the uric acid crystallises.

Urates form one of the commonest and least important deposits in urine. There is usually a copious precipitate, varying in colour from a light pink or brick-red to purple. They occur in catarrhal affections of the intestinal canal, after a debauch, in various diseases of the liver, in rheumatic and feverish conditions. They frequently occur as the "milky" deposit in the urine of children. Urates constitute the "lateritious" deposit or "critical" deposit of the older writers. Urates frequently occur even in health, especially when the skin is very active (in summer), or after severe muscular exercise; when much water is given off by the skin and a small quantity by the kidneys. The following are the formulæ of the more common urates:—

Acid sodic urate	$C_5H_3N_4O_3Na.$
Neutral sodic urate	$C_5H_2N_4O_3Na_2.$
Acid ammonium urate	$C_5H_3N_4O_3(NH_4).$
Acid potassic urate	$C_5H_3N_4O_3K.$

When the urine is passed it is quite clear, but on standing for a time it becomes turbid, and a copious reddish-yellow—sometimes like pea-soup—or purplish precipitate occurs, because urates are more soluble in warm water than in cold; and when there is only a small quantity of water to hold the urates in solution, on the urine cooling they are precipitated. Their occurrence is favoured by an acid reaction, a concentrated condition of the urine, and a low temperature.

The urates deposited in urine consist chiefly of sodic urate mixed with a small amount of ammonium urate.

5. Tests for "Urates" or "Lithates" in urine.

(a.) Observe the naked-eye characters. The deposit is usually copious = yellowish-pink, reddish, or even shading into purple. The deposit moves freely on moving the vessel, and its upper border is fairly well defined.

(b.) Place some in a test-tube. Heat gently the upper stratum. It becomes clear, and on heating the whole mass of fluid, it also becomes clear, as the urates are dissolved by the warm liquid.

(c.) Place some of the deposit on a glass slide, add a drop of hydrochloric acid, and uric acid is deposited in one or more of its many crystalline forms. Examine the crystals microscopically.

(d.) Examine the deposit microscopically. The urates are usually "amorphous," but the urate of soda may occur in the form

of small spheres covered with spines, and the ammonium urate, of spherules often united together (fig. 77).

(e.) Make a saturated solution of uric acid in caustic soda. Place a drop of the mixture on a slide, allow it to evaporate. Examine it microscopically, when the urate of soda in the form of spheres covered with spines will be obtained.

(f.) The same result as in (e.) is obtained by dissolving the ordinary deposit of urates with caustic soda, and allowing some of it to evaporate on a slide.

6. Uric Acid from Serpent's Excrement.—Heat the powdered excrement in a porcelain vessel with 15–20 vols. of water just to boiling, add carefully small quantities of caustic potash or soda until the whole is dissolved and there is no further odour of ammonia given off. Filter, and saturate the filtrate with CO_2 , which causes at first a gelatinous and then a finely-granular precipitate of acid alkaline urate. Separate the latter by syphoning off the fluid, wash it with small quantities of iced water, place it in a boiling dilute solution of hydrochloric acid, and boil the mixture for some time. After it cools, uric acid crystallises out, the latter is washed with cold water and dried.

7. Hippuric Acid, $\text{C}_9\text{H}_9\text{NO}_3$ (benzoyl-amido-acetic acid or benzoyl-glycin).—This substance is so called because it occurs in large quantity in the urine of the horse and many herbivora, chiefly in the form of alkaline hippurates (sodium hippurate). It belongs to the aromatic series. It dissolves readily in hot alcohol, but is sparingly soluble in water.

Quantity in man .5 to 1 gram daily. It is a conjugate acid, which, when boiled with alkalis and acids, takes up water and splits into benzoic acid and glycin. It occurs in colourless four-sided prisms, usually with two or four bevelled surfaces at their ends. It has a bitter taste. Benzoic acid, oil of bitter almonds, benzamid, cinnamic acid, and toluol reappear in the urine as hippuric acid. The benzoic acid unites with the elements of glycocoll (glycin), and is excreted as hippuric acid in the urine.

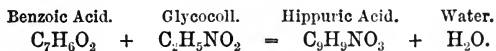

The amount is *increased* by eating pears, apples with their skins, cranberries, and plums. Nothing is known of its clinical significance. It seems to be formed chiefly from the husks or cuticular structures.

Tests and Reactions.

(a.) Heat some crystals in a dry tube. Oily red drops are deposited in the tube, while a sublimate of benzoic acid and ammonium benzoate are given off. The latter is decomposed, giving the odour of ammonia, while there is an aromatic odour of oil of bitter almonds.

(b.) Examine the colourless four-sided prisms with the microscope (fig. 69).

(c.) Boil with HNO_3 , and heat to dryness = odour of nitro-benzene. Benzoic acid gives a similar reaction.

8. Preparation of Hippuric Acid.—(a.) Take 100 cc. of cow's or horse's urine, and evaporate it to one-sixth its bulk; add hydrochloric acid, and set it aside. The brown mass is collected, dried between folds of blotting-paper, redissolved in a very small quantity of water, and mixed with charcoal, then filtered and set aside to crystallise. It is not quite pure and contains a brownish colouring-matter.

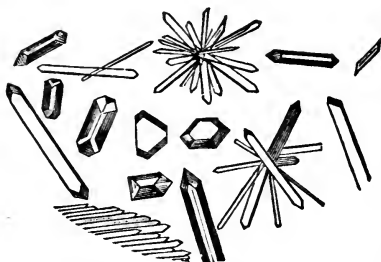

FIG. 69.—Hippuric Acid.

(b.) Boil horse's urine with milk of lime—a copious precipitate. Filter off the bulk of the precipitate through flannel, and filter again through paper. Concentrate the filtrate to one-sixth of its volume and add hydrochloric acid—a copious precipitate of prismatic crystals of hippuric acid. After twenty-four hours decant the fluid from the crystals, redissolve the latter in hot water, and filter through animal charcoal.

9. Kreatinin ($C_4H_7N_3O$) is related to the kreatin of muscle. If kreatin be boiled with acids or with water for a long time, it loses water, and becomes converted into a strong base—kreatinin.

Quantity, 0.5 to 1 gram (7 to 15 grs.). It is easily soluble in water and alcohol, and forms colourless oblique rhombic crystals. It unites with acids, and also with salts, chiefly with $ZnCl_2$; the kreatinin-zinc-chloride is used as a microscopic test for its presence. It rarely occurs as a deposit, and nothing is known of its clinical significance.

10. Preparation of Kreatinin.—(a.) Take 250 cc. of urine, precipitate it with milk of lime, and filter. Evaporate the filtrate to a syrupy consistence, and extract it with alcohol. Filter, and to the filtrate add a drop or two of a neutral solution of zinc chloride, and set the vessel aside. After a time kreatinin-zinc-chloride ($C_4H_7N_3O, ZnCl_2$) is deposited on the sides of the vessel.

(b.) To half a litre of urine add baryta-mixture (p. 124) until no further precipitation takes place; filter, and evaporate the filtrate to a thin syrup on a water-bath, add to this an equal volume of alcohol, allow it to stand for twenty-four hours in the cold, whereby the salts are separated, filter, and to the filtrate add 1–2 cc. of a concentrated alcoholic solution of zinc-chloride. After a time kreatinin-zinc-chloride separates as a yellow crystalline powder. After two to three days filter, wash with alcohol, and dissolve in warm water, and decompose it by boiling for half an hour with hydrated lead oxide or carbonate of lead. Filter while hot, decolorise the filtrate with animal charcoal, filter again, evaporate to dryness, and extract the kreatinin from the residue with alcohol in the cold. A small quantity of kreatinin remains undissolved.

11. Tests and Reactions of Kreatinin.

(a.) **Jaffe's Test.**—Examine the deposit of the zinc compound microscopically. It forms round brownish balls, with radiating lines (fig. 70).

(b.) **Weyl's Test.**—To urine add a very dilute solution of sodium nitro-prusside, and very cautiously caustic soda = a ruby-red colour, which is evanescent, passing into a straw colour.

(c.) A solution of kreatinin reduces an alkaline solution of cupric oxide, *e.g.*, Fehling's solution.

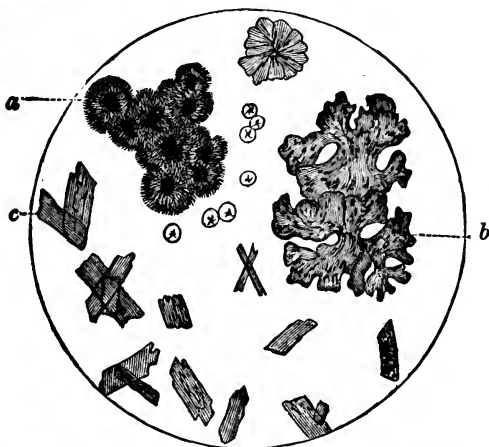

FIG. 70.—Kreatinin-zinc-chloride. a. Balls with radiating marks; b. Crystallised from water; c. Rarer forms from an alcoholic extract.

12. Colouring-Matters of the Urine.—(1.) **Normal Urobilin**, which is the principal colouring matter in normal urine. Add to urine neutral and basic lead acetate = a precipitate of lead salts, which carry down with them the colouring matter, leaving the solution nearly colourless. Filter. Extract the pigment from the filtrate by alcohol acidulated with H_2SO_4 . Filter = alcoholic extract of deep yellow colour, which can be extracted by chloroform. On evaporation of the chloroform it is deposited as a yellow-brown mass, which in an acid solution, shows with the spectroscope one absorption band close to and inclosing F at the junction of the blue and green. On adding an alkali the band disappears (*MacMunn*). Its spectrum and composition are practically identical with choletelin $C_{16}H_{18}N_2O_3$, and it is regarded as an iron-free derivative of hæmoglobin on the supposition that it is modified

bile-pigment absorbed from the intestinal canal and excreted by the urine.

(2.) [Febrile Urobilin.—This gives the dark colour to urines in fever. It seems to be a less oxidised form of urobilin, is isolated in the same way, its spectrum shows the band near F, and two additional bands, one near D and one between D and E.]

(3.) Indigo-forming Substance (Indican).—This is derived from indol, C_8H_7N , which is developed in the intestinal canal from the pancreatic digestion of proteids, and also from the putrefaction of albuminous bodies. It may also be formed from bilirubin. In urine it is a yellow pigment, and is more plentiful in the urine of the dog and horse. It exists in the urine as a conjugated sulpho-acid salt of potassium, viz., as indoxyl-sulphate of potassium ($C_8H_6NSO_4K$).

13. General Reactions for Urine Pigments.

(a.) Add to normal urine a quarter of its volume of HCl, and boil = a fine pink or yellow colour.

(b.) Add nitric acid = a yellowish-red colour, usually deeper than the original colour.

(c.) To two volumes of sulphuric acid in a test-tube add one of urine, but drop the latter from a height. The mixture becomes more or less garnet-red if indican be present.

(d.) Add acetate of lead = a precipitate of chloride, sulphate, and phosphate of lead. Filter; the filtrate is an almost colourless solution. This substance is used to decolorise urine for the saccharimeter.

(e.) Filter urine through animal charcoal; the urine will be decolorised.

(f.) If possible, obtain a dark-yellow coloured urine, and perform the following test:—Take 40 drops of urine + 3 to 4 cc. of strong HCl and 2 to 3 drops of HNO_3 ; on heating, a *violet red* colour with the formation of true rhombic crystals of indigo-blue indicates the presence of indican.

(g.) Test for Indican.—Mix equal volumes of urine and HCl, add, drop by drop, a saturated solution of chloride of lime (*i.e.*, bleaching powder, which also contains hypochlorite of calcium) = a blue colour. Shake up with chloroform and the blue colour is absorbed by the latter.

14. Phenol (carbolic acid), C_6H_6O , occurs in the urine as phenol-sulphate of potassium, $C_6H_5O - SO_3 - OK$. There is a corresponding salt of Cresol, most abundant in the urine of herbivora. Add sulphuric acid to urine until the latter contains 5 per cent. of the acid. Distil as long as the distillate becomes cloudy with bromine water. Test the distillate as follows:—

(a.) Bromine water = precipitate of tri-bromo-phenol ($C_6H_2Br_3OH$).

(b.) Neutralise and add neutral ferric chloride = violet colour.

(c.) Heated with Millon's reagent it gives a red colour. (See also p. 82.)

The pathological pigments—bile, blood, &c.—occurring in urine will be referred to later.

15. Mucus.—A trace of mucus occurs normally in urine. Collect fresh urine in a tall vessel, and allow it to stand for some time, when fine clouds (“mucous clouds”) like delicate cotton-wool appear. These consist of mucus entangling a few epithelial scales.

(a.) If the urine contain an excess of mucus, on adding a saturated solution of citric acid to form a layer at the bottom of the test-tube, a haziness at the line of junction of the urine and acid indicates mucus. There is no deposit with healthy, freshly-passed urine. Citric acid is used because it is heavier than acetic.

16. Ferments in Urine.—There is no doubt that urine contains pepsin. Some observers state that it also contains trypsin and a sugar-forming ferment; but the latter statement is denied.

(a.) Select the morning urine, place in it for several hours fresh well-washed and boiled fibrin. The latter absorbs the ferment, and on placing it in .2 per cent. HCl at 40° C., the pepsin is dissolved and peptones are formed. Test for the peptones by the biuret reaction.

17. Reactions of Normal Urine towards Reagents.

(1.) Add 5 cc. of HCl to 100 of urine. After twenty-four hours crystals of uric acid separate out.

(2.) Add caustic soda or ammonia—precipitate of the phosphates of the alkaline earths, partly in an amorphous state, partly in acicular crystals.

(3.) Acidulate with nitric acid and heat with phospho-molybdic acid—blue coloration due to urates.

(4.) Add mercuric nitrate—white cloudiness, which disappears on shaking. This is a precipitate due to the formation of sodium nitrate and mercuric chloride ($\text{Hg}(\text{NO}_3)_2 + 2\text{NaCl} = 2\text{NaNO}_3 + \text{HgCl}_2$), soluble in acid urine. After all the NaCl is decomposed—but not until then—a permanent precipitate, a compound of urea and the mercury salt, forms.

(5.) Silver nitrate—white precipitate of AgCl and Ag_3PO_4 ; the latter falls first, and afterwards all the silver combines with the chlorine. The precipitate is insoluble in HNO_3 but soluble in NH_4HO .

(6.) Barium chloride—white precipitate of BaSO_4 and $\text{Ba}_3(\text{PO}_4)_2$.

(7.) Lead acetate—whitish precipitate of PbSO_4 , PbCl_2 , $\text{Pb}_3(\text{PO}_4)_2$, and the pigments.

(8.) Ferric chloride after acidulation with acetic acid—precipitate of $\text{Fe}_2(\text{PO}_4)_2$.

(9.) An ammoniacal solution of cupric oxide is decomposed and decolorised at the boiling-point by the urates.

(10.) Tannic acid—no precipitate (*Krukenberg*).

18. Estimation of Uric Acid.—This is sometimes done by the method (2, a), but it is not accurate. (a.) Haycraft’s Method depends on the formation of urate of silver, which is practically insoluble in water or acetic acid (*British Medical Journal*, 1885). The urate of silver is of a slimy nature and must be washed on an asbestos filter. The titration of the silver compound is by means of Volhard’s ammonium thio-cyanate method (*Sutton’s Volumetric Analysis*, 5th edit., 1886, pp. 116, 324).

(b.) **Hopkin's Method.**—Saturate the fluid with crystals of ammonium chloride=ammonium urate. Collect the precipitate and dissolve it in weak alkali. Reprecipitate by HCl=precipitate of uric acid, which is dried and weighed.

19. *Average Amount of the Several Urinary Constituents Passed in Twenty-four Hours by a Man Weighing 66 kilos.*

		Grams.
Water	1500
Total solids	72
<i>Organic solids—</i>		
	Grams.	
Urea	33.18	
Uric acid	.55	
Hippuric acid	.40	
Kreatinin	.91	
Pigment and other substances	10.00	
<i>Inorganic solids—</i>		
		Grams.
Sulphuric acid		2.01
Phosphoric acid		3.16
Chlorine		7.00
Ammonia		0.77
Potassium		2.50
Sodium		11.09
Calcium		0.26
Magnesium		0.21
<i>—Parkes.</i>		

LESSON XXI.

ABNORMAL CONSTITUENTS OF THE URINE.

SOME of the substances referred to in the subsequent lessons are present in excessively minute traces in normal urine—*e.g.*, sugar; and in the urine of a certain percentage of persons *apparently* enjoying perfect health, minute traces of albumin are sometimes present. When, however, these substances occur in considerable quantity, then their presence is of the utmost practical and diagnostic value, and is distinctly abnormal. It is quite certain that serum-albumin is never found in any considerable amount in normal urine.

1. **Albumin in Urine.**—When albumin occurs in notable quantity in the urine, it gives rise to the condition known as **albuminuria**. Albuminous urine is not unfrequently of low s.g., and froths readily.

Various forms of proteid bodies may occur in the urine. The chief one is serum-albumin; but, in addition, serum-globulin, albumose, peptone, acid-albumin, and fibrin may be found.

2. **Tests.**—In every case the urine must be clear before testing, which can be secured by careful filtration.

(a.) **Coagulation by Heat.**—If the urine is acid place 10 cc.

of urine in a test-tube and boil. Near the boiling-point, if albumin be present in small amount, it will give a haziness; if in large amount, a distinct coagulum. On standing, the coagulum is deposited. Some prefer to boil the top of a long column of urine in a test-tube. If the urine be acid, then any haziness formed is readily seen against the clear subnatant fluid.

Precautions.—(i.) Always test the reaction of the urine, for albumin is only precipitated by boiling in a neutral or acid medium. Hence if the urine be alkaline, boiling will not precipitate any albumin that may be present. (ii.) Boil the upper stratum of the fluid first of all, holding the tube obliquely, taking care that the coagulum does not stick to the glass, else the tube is liable to break. (iii.) Heat, by driving off the CO_2 , also precipitates *earthly phosphates* if they are present in large amount, hence a turbidity on boiling is not sufficient proof of the presence of albumin. The points of distinction are, that albumin goes down before the boiling-point is reached (coagulated at 75°C .), while phosphates are precipitated at the boiling-point. Again, the phosphatic deposit is soluble in an acid—*e.g.*, acetic or nitric—while the albuminous coagulum is insoluble in these fluids. Some, therefore, advise that the test be done in the following manner:—

(b.) Acidulate the urine with a few drops of dilute acetic or nitric acid, and then boil. If nitric acid be used, add one-tenth to one-twentieth of the volume of urine.

Precautions.—If the urine contain only very minute traces of albumin, the latter may not be precipitated if too much nitric acid be added, as the acid albumin is kept in solution. If too little acid be added, the albumin may not be precipitated, as only a part of the basic phosphates are changed into acid phosphates, and the albumin remains in solution as an albuminate (a compound of the albumin with the base). On heating the urine of a person who is taking *copaiba*, a deposit may be obtained, but its solubility in alcohol at once distinguishes it from coagulated albumin. This test acts with serum-albumin and globulin, and if the deposit occurs only after cooling, also with albumose, but not with peptone.

(c.) **Heller's Cold Nitric Acid Test.**—Take a conical test-glass, and place in it 15 cc. of the urine. Incline it, and pour slowly down its side strong nitric acid = a white cloud at the line of junction of the fluids.

Precautions.—A *crystalline* deposit of urea nitrate is sometimes, though very rarely, obtained with a very concentrated urine. If the urine contain a large amount of urates, they may be deposited by the acid, but the deposit in this case occurs above the line of junction, and disappears on heating. It is not obtained if the urine be diluted beforehand.

(d.) Acidulate 10 cc. of urine with acetic acid, add one-fifth of its bulk of a saturated solution of magnesium or sodium sulphate, and boil = a precipitate.

(e.) **Acetic Acid and Potassium Ferrocyanide.**—Acidify strongly with acetic acid, and add a solution of potassium ferrocyanide = a white precipitate, varying in amount with the albumin present. The reaction may be done as follows:—Mix a few cc. of moderately strong acetic acid with some solution of potassium ferrocyanide, and pour this over some urine in a test-tube

by the contact method (*d.*). The presence of albumin is indicated by a white deposit in the form of a ring at the line of junction of the fluids. A solution of platino-potassium cyanide may be used instead of the ferrocyanide. The solution of the former is colourless. This test precipitates serum-albumin, globulin, albumose, but not peptone.

(*f.*) **Picric Acid.**—Use a saturated watery solution, and apply it by the contact method of Heller (*c.*). The urine is below, and the picric acid on the top. A rapidly-formed deposit at the line of junction of the fluids indicates the presence of a proteid; the deposit is not dissolved by heat.

N.B.—Picric acid precipitates all the forms of proteid which occur in urine. It also precipitates mucin, but in this case the deposit usually forms slowly and after a time. If a person be taking quinine, a haziness is obtained in the urine on adding picric acid, but it disappears on heating. Dr. Johnson and Professor Grainger Stewart recommend it as one of the most reliable tests for albumin we possess.

(*g.*) Metaphosphoric Acid completely precipitates albumin, but it must be freshly prepared, and is difficult to keep. Hence it is not satisfactory.

(*h.*) Acidulated Brine, as suggested by Roberts, consisting of a saturated solution of sodium chloride with 5 per cent. of dilute hydrochloric acid (B.P.), may be used, but it sometimes gives a precipitate with normal urine. Nor is potassio-mercuric-iodide satisfactory (*Tanret*). In cases of doubt, use several tests, especially 2 (*b.*), (*c.*), (*e.*), and (*f.*).

(*i.*) **Trichloroacetic Acid** precipitates albumin in urine.

(*j.*) **Salicyl-Sulphonic Acid** gives a white precipitate with proteids, which is soluble on heating in the case of albumose and peptone (*M'William*).

3. Dry Tests.

(*a.*) Use the ferrocyanic pellets introduced by Dr. Pavy.

(*b.*) Use the test-papers—citric acid and ferrocyanide of potassium—introduced by Dr. Oliver.

4. **Globulinuria.**—Serum-globulin is present in nearly every albuminous urine. It gives the reactions described under 2.

(*a.*) Fill a tall glass with water. Drop the urine into the water, and observe if a milkiness is seen in the water, indicating the presence of a globulin. This body is not soluble in pure water, but in weak saline solutions (Lesson I. 6), hence on diluting the urine it is precipitated.

(*b.*) Test the urine by the contact method with a saturated solution of magnesian sulphate.

(*c.*) This body is completely precipitated on saturating the urine with ammonium sulphate.

If globulin be present along with serum-albumin add an equal volume of a saturated solution of ammonium sulphate. A white flocculent precipitate indicates globulin.

5. **Albumosuria.**—Hemi-albumose, which, however, is really a mixture of three different proteids, has been found in cases of osteomalacia. If such a urine can be procured, do test 2 (b.), using nitric acid; the deposit only takes place after a long time or on cooling, and in fact the urine sometimes becomes almost solid, but is dissolved by heat. If there is a deposit, filter and test the filtrate for proteid reactions, *e.g.*, the biuret test. It will give a precipitate with acetic acid and potassic ferrocyanide. Then saturate a portion of the urine with sodium chloride, and acidify with acetic acid—a precipitate, which dissolves on adding much acetic acid and heating, and reappears on cooling (p. 73).

6. **Peptonuria.**—Peptone is frequently present in albuminous urine. Peptone is most frequently present in urine in cases where there is an accumulation and breaking up of leucocytes or pus-corpuscles, as in the stage of resolution of pneumonia, suppurative processes, and in other diseases. Procure such a urine. It is well to get rid of the albumin by acidification with acetic acid and boiling.

(a.) Put some urine in a test-tube, and by the contact method pour on some Fehling's solution. At the line of junction a phosphatic cloud is formed, and, if peptones be present, above it a rose-pink colour. If albumin also be present, a violet colour is obtained. Hemi-albumose gives the same reaction.

7. **Quantitative Estimation of Albumin.**—This can only be done accurately by precipitating the albumin, drying and weighing it; but as this is a tedious process, and requires much time, it is not suitable for the physician.

8. Esbach's Albuminometer (fig. 71).

A. **The Reagent.**—Dissolve 10 grams of picric acid and 20 grams of citric acid in 800 cc. of boiling water, and make up the solution to a litre.

Dr. Johnson finds that a solution of picric acid in boiling water (5 grains to the ounce) gives the same result.

B. **Process.**—Pour urine into the tube (6 inch \times $\frac{5}{8}$ inch) up to the mark U, then the reagent up to the mark R, mix thoroughly. Set the tube aside for twenty-four hours, and then read off on the scale the height of the coagulum. The figures indicate the grams of dried albumin in a litre of urine—*i.e.*, the percentage is obtained by dividing by ten. If the coagulum is above 4, or if the original s.g. of the urine is above 1010, dilute the urine first with one or two volumes of water, and then multiply the resulting figure by 2 or 3 as the case may be. If the urine be alkaline, it must first be acidulated by acetic acid. If the amount of albumin be less than 0.5 grams per litre, it cannot be accurately estimated by this method.

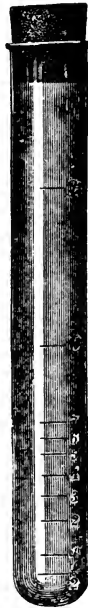

FIG. 71.
Esbach's Tube.

LESSON XXII.

BLOOD, BILE, AND SUGAR IN URINE.

1. Blood in Urine (Hæmaturia).

The Blood may come from any part of the urinary apparatus.

If from *kidney*, it is usually small in amount and well mixed with the urine, and the microscope may reveal the presence of "blood-casts," *i.e.*, blood-moulds of the renal tubules. Large coagula are never found, and the urine not unfrequently is "smoky." From the *bladder* or *urethra*, usually the urine is bright red, and relatively large coagula are frequently present. In all forms, blood-corpuscles are to be detected by the microscope, and albumin by its tests.

(a.) Examine the naked-eye characters of a specimen. It may be any tint from red to brown, but if the blood is well mixed with the urine, the latter usually has a "smoky" appearance.

(b.) **Microscope.**—Collect any deposit and examine it microscopically for blood-corpuscles, which, however, are frequently discoloured or misshapen.

(c.) **Spectrum.**—Examine for the spectrum of oxy-hæmoglobin or met-hæmoglobin (Lesson VI. 6, 1).

(d.) **Guaiacum Test.**—Mix some freshly prepared tincture of guaiacum with urine, and pour on it some ozonic ether; a blue colour indicates the presence of hæmoglobin. This reaction may be done on filter-paper.

(e.) **Heller's Blood Test.**—Make the urine strongly alkaline with caustic soda, and boil. On standing, a deposit of earthy phosphates, coloured red or brown by hæmatin, occurs, the deposit carrying down the altered colouring-matter of the blood with it. This is not a satisfactory test.

(f.) The urine gives the reactions of albumin.

2. Hæmoglobinuria.

This term is applied to that condition where hæmoglobin is excreted through the kidney as such, and is not contained within the blood-corpuscles. The urine contains hæmoglobin, but not the blood-corpuscles as such. It occurs when blood-corpuscles are destroyed within the blood-vessels, as after the transfusion of the blood of one species into the blood-vessels of another species; after the transfusion of warm water; the injection of a solution of hæmoglobin into a vein; and after extensive destruction of the skin by burning. It also occurs in purpura, scurvy, often in typhus or scarlet fever, pernicious malaria, in "periodic hæmoglobinuria," and after the inhalation of arseniuretted hydrogen.

(a.) The urine gives the same reactions as in hæmaturia, but no blood-corpuscles are detected by the microscope.

3. Bile in Urine.—The biliary constituents appear in the urine in cases of jaundice and in poisoning with phosphorus. One may test for the *bile-pigments*, or the *bile-acids*, or both.

A. Bile-Pigments.

(a.) **Colour.**—The urine has usually a yellow or yellowish-green colour, and it froths very easily when shaken. Filter-paper dipped into it gives a yellow stain on drying.

(b.) **Gmelin's Test** (Nitric acid containing Nitrous acid).—(1.) Place a few drops of the suspected urine on a white porcelain plate, and near it a few drops of the impure nitric acid; let the fluids run together and the usual play of colours is observed (Lesson XI. 6).

(2.) Take urine in a test-tube, pour in the *impure* HNO_3 until it forms a stratum at the bottom; if bile-pigments be present, at the line of junction of the fluids a play of colours takes place—from above downwards—green, blue, violet or dirty red, and yellow. Nearly all urines give a play of colours, but *green* is the necessary and characteristic colour to prove the presence of bile-pigments.

(3.) **Rosenbach's Modification.**—Filter the urine several times through the same filter, dry the filter-paper, and to it apply the impure nitric acid, when the same play of colours is observed.

(c.) A solution of methyl-violet poured on icteric urine by the contact method gives a bright carmine ring at the point of contact.

(d.) If much bile-pigment be present, the following test succeeds:—Mix the urine with caustic potash (1 KHO to 3 water), and add hydrochloric acid. The fluid becomes green, due to the formation of biliverdin.

B. Bile-Acids (Glycocholic and Taurocholic acids).

(a.) **Pettenkofer's Test.**—Add to urine a few drops of syrup of cane-sugar (8 per cent.), mix them, and pour strong sulphuric acid down the side of the tube until it forms a layer at the bottom. The temperature must not rise above 70°C ., nor must the urine contain albumin. At the line of junction a *cherry-red* or *purple-violet* colour indicates the presence of the bile-acids. Or proceed as follows:—Shake the tube with the urine and the syrup to get a froth, and when the sulphuric acid is added the froth shows the colour. *N.B.*—The test in this simple form often fails with urine, and in fact there is no satisfactory simple test for minute quantities of these acids in urine.

(b.) **Strasburger's Modification.**—Dissolve cane-sugar in the suspected urine, dip into it filter-paper, and allow this to dry. Touch the paper with a glass rod dipped in strong sulphuric acid, a purple-violet colour indicates the presence of the bile-pigments.

(c.) **Sulphur Test.**—Try this (Lesson XI. 5).

4. Sugar in Urine (Glycosuria).—Brücke maintains that the merest trace of *glucose* or *grape-sugar* is normally present in urine.

In *diabetes mellitus*, however, it occurs in considerable amount, and is, of course, then quite abnormal.

Characters of Diabetic Urine.

(1.) The patient usually passes a very large *quantity* of urine, even to 10,000 cc., and although the quantity of fluid is large

(2.) The *specific gravity* is high—1030 to 1045—due to the presence of the grape-sugar. *N.B.*—When the quantity of urine is above normal, and the specific gravity reaches 1030, suspect the presence of grape-sugar.

(3.) The *colour* is usually a very pale straw, from the dilution—not diminution—of the urine pigments. The urine is often somewhat turbid.

(4.) It has a heavy sweet *smell*, and usually froths when poured from one vessel into another.

5. Tests for Grape Sugar.—In all cases remove any albumin present, *i.e.*, acidulate with acetic acid, boil, and filter.

(a.) **Moore's Test.**—To urine add an equal volume of caustic soda or potash, and boil the upper stratum of the fluid. If much sugar be present, a dark sherry or bistre-brown colour is obtained. The colour may vary from a light yellow to a dark brown (due to the formation of glucic and melassic acids), according to the amount of sugar present. This is not a delicate test.

(b.) **Trommer's Test.**—Add to the urine one-third its bulk of caustic soda solution, and then a *few drops* of a solution of cupric sulphate, and a clear blue solution of the hydrated oxide is obtained. Boil the upper stratum of the fluid. If sugar be present, a yellow or yellowish-red ring of reduced cuprous oxide is obtained.

(c.) **Fehling's Solution** is alkaline potassio-tartrate of copper ($K_2Cu_2C_4H_4O_6$). Place some Fehling's solution in a test-tube and boil it. If no discoloration (yellow) takes place, it is in good condition. Add a few drops of the suspected urine and boil, when the mixture suddenly turns to an opaque yellow or red colour, which indicates the presence of a reducing sugar.

(d.) **Böttger's Test.**—Mix the urine with an equal volume of sodium carbonate solution, add a little basic bismuth nitrate, and boil for a short time. A grey or black deposit indicates the presence of a reducing sugar.

(e.) **Picric Acid.**—To the urine add an equal volume of a saturated watery solution of picric acid, and then caustic potash. Boil, an intensely deep red or reddish-brown colour indicates the presence of a reducing sugar. The larger the amount of sugar, the deeper the tint. The colouration is due to the formation of picramic acid.

(f.) **Phenyl-Hydrazin.**—Repeat this as described in Lesson III. This is a reliable test.

(g.) **Indigo-Carmine Test.**—To the urine add sodium carbonate solution and indigo-carmine solution until a blue colour appears. Boil, and a yellow colour is obtained, if sugar be present, owing to the reduction of indigo-blue to indigo-white. Pour the fluid into a cold test-tube, when the blue colour is restored, a beautiful play of colours intervening between the yellow and the blue. This is not a satisfactory test.

(h.) Repeat Molisch's test (Lesson I.).

6. Preparation of Fehling's Solution.—*Solution A.* 34.64 grams of pure crystalline cupric sulphate are powdered and dissolved in 500 cc. of distilled water. *Solution B.* In another vessel dissolve 173 grams of Rochelle salts (sodio-potassium tartrate) in 100 cc. of pure caustic soda, sp. gr. 1.34, and add water to make 500 cc. Keep the two solutions separate in stoppered bottles, and mix them as required. On mixing equal quantities of A and B, a clear deep blue fluid is obtained, the Rochelle salt holding the cupric hydrate in solution.

N.B.—Fehling's solution ought not to be kept too long; it is apt to decompose, and should therefore be kept away from the light, or protected with opaque paper pasted on the bottle. Some other substances in urine—*e.g.*, uric and glycuronic acids—reduce cupric oxide. *In all cases see that there is an excess of the test present.*

LESSON XXIII.

QUANTITATIVE ESTIMATION OF SUGAR.

1. By the Saccharimeter.

Study the use of some form of saccharimeter. The portable form made by Zeiss is very convenient. A coloured urine must first be decolorised by acetate of lead [Lesson XX. 13 (d.)].

2. Diabetic Urine. Volumetric Analysis by Fehling's Solution.
—10 cc. of Fehling's solution = .05 gram of sugar.

(a.) Ascertain the quantity passed in twenty-four hours.

(b.) Filter the urine, and remove any albumin present by boiling and filtration.

(c.) Dilute 10 cc. of Fehling's solution with about five to ten times its volume of distilled water, and place it in a white porcelain capsule on a wire gauze support under a burette. [It is diluted because any change of colour is more easily observed.]

(d.) Take 5 cc. of the diabetic urine, add 45 cc. of distilled water, and place the *diluted* urine in a burette. Diabetic urine usually contains 4 p.c. or more of dextrose, and as the solution to be tested should not contain more than 0.5 p.c. of dextrose, hence the necessity for diluting the urine.

(e.) Boil the diluted Fehling's solution, and whilst it is boiling gradually add the diluted urine from the burette until all the cuprous oxide is precipitated as a reddish powder, and the super-

natant fluid has a straw-yellow colour, not a trace of blue remaining. This is best seen when the capsule is tilted. It is not advisable to spend too much time in determining when the blue colour disappears, as it is apt to return on cooling. It is sometimes difficult to determine when all the blue colour has disappeared.

The following process is useful. Filter a little of the hot fluid, acidulate with acetic acid and add potassic ferrocyanide. If copper is present a brown colour or precipitation is produced. If this be so, add more urine until no brown colour is produced.

[Pavy's modification of Fehling's solution is sometimes used. In it ammonia holds the copper in solution, so that there is no yellow or red precipitate formed, as the ammonia holds the oxide in solution. The reduction is complete when the blue colour disappears. 10 cc. Pavy's Fehling = 1 cc. Fehling = 5 milligrams of dextrose.]

(f.) Read off the number of cc. of *dilute* urine employed. If 18 cc. were used, this, of course, would represent 1.8 cc. of the original urine.

(g.) Make a second determination, using the data of the first, and in this case run in at once a little less of the dilute urine than was required at first.

Example.—Suppose the patient passes 8550 cc. of urine, then as 1.8 cc. of urine reduced all the cupric oxide in the 10 cc. of Fehling's solution, it must contain 0.5 gram sugar; hence

$$1.8 : 8550 :: .05 : \frac{8550 \times .05}{1.8} = 237.5 \text{ grams of}$$

sugar passed in twenty-four hours.

3. Picro-Saccharimeter of G. Johnson.

Solutions Required.

(1.) A solution of ferric acetate the colour of which is equal to that yielded by a solution of sugar containing $\frac{1}{4}$ grain per fluid ounce.

(2.) Saturated solution of picric acid.

(3.) Liquor potassæ (B.P.).

(a.) Measure 1 fluid drachm of urine into the boiling tube, add 30 minims of liquor potassæ and 80 minims of the saturated solution of picric acid. Make up to the 4-drachm mark on the tube with distilled water. Boil for one minute.

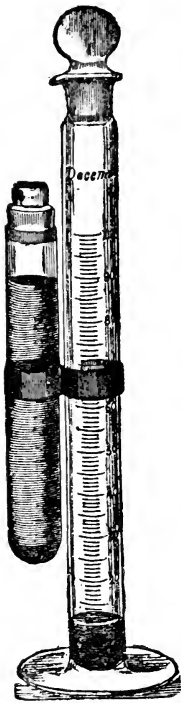

FIG. 72.—Picro-Saccharimeter.

(b.) Dip the tube in cold water to cool it. The volume must be exactly 4 drachms. If it is less, add water; if more, evaporate it. If the colour of the boiled liquid is the same as that of the ferric acetate $\frac{1}{4}$ -grain standard, or paler, the urine contains 1 grain of sugar per fluid ounce, or less.

(c.) Should the colour be *darker* than the standard, place some of the boiled liquid in the graduated stoppered tube (fig. 72) to fill ten divisions of the scale, while the stoppered tube affixed to the former is filled with the SS. of ferric acetate. Fill up the graduated tube with distilled water until the dark red liquid has the same colour as that of the SS. These tints are best compared in the flat-bottomed tubes supplied with the apparatus.

(d.) Read off the level of the fluid in the saccharimeter, each division above 10 = 0.1 grain per fluid oz. Thus, 13 divisions = .3 grains per fluid oz.

(e.) If more than 8 grains per oz. are present, further dilution is required. Full instructions are supplied with the apparatus.

4. Fermentation Method.—Sir William Roberts has devised a method depending on the diminution of the specific gravity which the fluid undergoes during fermentation. Every degree lost in the sp. gr. corresponds to 1 grain of sugar in a fluid ounce. Recently a modification of this method has been introduced in Germany under the title of Einhorn's Fermentation Saccharometer (fig. 73). Estimate the specific gravity of the urine, which is diluted according to the specific gravity as follows. If the urine have a

Sp. gr. 1018-1022,	dilute it with 2 vols. water.		
" 1022-1028,	" "	5 "	"
" 1028-1038,	" "	10 "	"

Measure 10 cc. of the urine, and, by means of a pipette, place it in the apparatus. Add 1 gram of yeast to the urine in the tube, incline the latter until the fluid flows into the limb of the latter. Let the apparatus stand at the ordinary temperature for fifteen hours, and then the quantity of CO_2 given off is read off. The scale on the tube is empirical, and indicates directly the percentage of sugar in the urine.

5. Acme Sacchar-Ureometer (fig. 74).—This is a simple apparatus for the direct estimation of sugar and urea in urine; the former by the fermentation test, the latter by the hypobromite.

Estimation of Sugar.—Measure 1 volume of the urine in the tube so marked, and pour it into the bottle *a*. Wash out with water, and add to the urine. Dilute further with water if the urine contains much sugar. Acidify the urine with tartaric acid until acid to test-paper ($\frac{1}{3}$ -1 per cent. of free acid). Add a few grains of yeast, and connect up the apparatus. The measuring-tube *b* is filled to zero with a saturated solution of common salt (the CO_2 is soluble in water). When *b* is full, *c* must be empty. Place the whole in a moderately warm place—the surrounding temperature should be such as to enable it to rise to 92°-94° F. When the fermentation ceases—or from time to time during the time of fermentation—lower *c* until the levels of *b* and *c* are equal. Allow it to cool, and read off the result.



FIG. 73.—Einhorn's Fermentation Saccharometer.

6. Aceto-Acetic Acid is found in certain diabetic urines, but not in all.

(a.) To the urine add ferric chloride; a red colour is obtained if this acid be present. If there is a deposit of phosphates, filter. The colour disappears on heating.

If a diabetic urine containing aceto-acetic acid be distilled, this acid is decomposed, and acetone is obtained.

7. Tests for Acetone (C_3H_6O).—To obtain the acetone, acidulate half a litre of urine with HCl. The distillate will give the following reactions:—

(a.) Lieben's Test.—To a weak, watery solution of acetone add solution of iodine dissolved with the aid of potassium iodide, and then caustic soda. A yellow precipitate of iodoform is obtained. The precipitate is generally described as forming hexagonal plates or radiate stars, but I have generally found it to be amorphous or granular. Other substances give the iodoform reaction.

(b.) Smell the peculiar ethereal odour of acetone.

(c.) Legal's Test.—Add caustic soda solution, and then a solution of freshly-prepared sodium nitroprusside and acetic acid = a red colour.

In all cases employ both tests, but they only give a decided reaction in urine when the acetone is in considerable amount. To be



FIG. 74.—Sacchar-Ureometer, made by Messrs. Gibbs, Cuxson & Co., Wednesbury.

quite certain that acetone is present, a considerable amount of the urine must be distilled, and the tests applied to the distillate.

8. Tests for Phenol.—The method of obtaining phenol from its compound in the urine is given at p. 134. To a watery solution of phenol—

(a.) Add ferric chloride = a bluish-violet colour.

(b.) Add bromine water = a yellow (or rather white) precipitate of bromine compounds.

(c.) Add Millon's reagent = a beautiful red colour or deposit. This reaction is aided by heat.

9. Pyrocatechin is sometimes found in urine. The method of obtaining it requires too much time to be done in this course.

Tests.

(a.) To a dilute solution add ferric chloride = a *green* colour, which becomes *violet* on the addition of sodic bicarbonate.

(b.) Add ammonia and silver nitrate, which give a *black* precipitate of reduced silver.

LESSON XXIV.

URINARY DEPOSITS—CALCULI AND GENERAL EXAMINATION OF THE URINE.

1. Mode of Collecting Urinary Deposits.—(i.) Place the urine in a conical glass, cover it, and allow it to stand for twelve hours. Note the reaction before and after standing. With a pipette remove some of the deposit and examine it microscopically.

(ii.) Dr. Harris has published the following (*Brit. Med. Jour.*, 1894, vol. i. p. 1356):—The urine is placed in a tube drawn to a fine point, and fixed in a vertical position in a clamp. The pointed end is down, and after being filled it is corked tight. After the deposit subsides and collects in the lower pointed end of the tube, a small quantity of it may be obtained by clasping the tube with the warm hand or by pushing in the cork slightly.

(iii.) Centrifuge.—By means of a small hand centrifuge (fig. 75, reduced to $\frac{1}{5}$), as made by Muencke of Berlin, any deposit in urine is readily collected at the bottom of a test-tube. The disc I, bearing the tubes G, can be made to rotate 3000 to 5000 times per minute. Fig. II. shows the disc in full rotation, and III. the form of glass vessel used.

There are two classes of deposits, *organised* and *unorganised*.

ORGANISED DEPOSITS.

- | | |
|----------------------|-------------------------------|
| 1. Pus (p. 147). | 5. Spermatozoa. |
| 2. Blood (p. 140). | 6. Micro-organisms. |
| 3. Epithelium. | 7. Elements of morbid growths |
| 4. Renal tube casts. | and entozoa. |

2. Pus in Urine (Pyuria) produces a thick creamy yellowish-white sediment after standing, although its appearance varies with the reaction of the urine. If the urine be *acid*, the precipitate is loose, and the pus-corpuscles discrete; if *alkaline*, and especially from ammonia, it forms a thick, tough, glairy mass. The urine is usually alkaline, and is always albuminous, and rapidly undergoes decomposition. Pus is found in the urine in leucorrhœa in the female, gonorrhœa, gleet, cystitis, pyelitis, from bursting of an abscess into any part of the urinary tract, &c.

(a.) **Donne's Test.**—Filter off the fluid, and add to the deposit a small piece of caustic potash, or a few drops of strong solution of caustic potash; the deposit becomes ropy and gelatinous, and cannot be dropped from one vessel into another—due to the formation of alkali-albumin; the deposit is pus. The same reagent with *mucus* causes the deposit to become more fluid and limpid, to clear up, and look like unboiled white of egg.

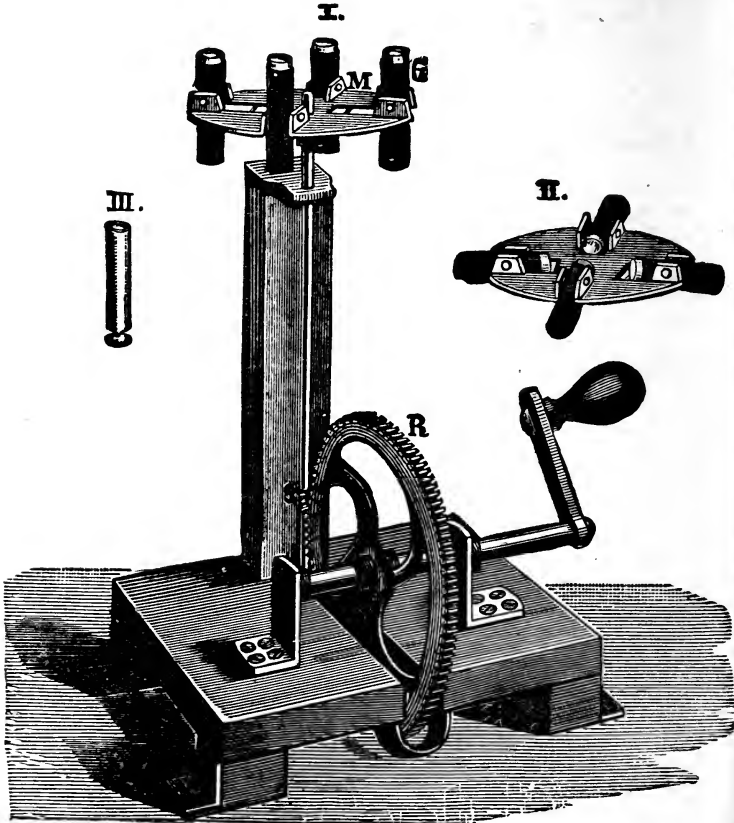

FIG. 75.—Hand Centrifuge made by Muencke, Luisen Strasse, 58, Berlin, N.W.
Cost, £3, 10/.

(b.) With the microscope numerous pus-corpuscles are seen, which, when acted on by acetic acid, show a bi- or tri-partite nucleus. This test is not absolutely conclusive.

(c.) Urine containing pus gives the reactions for albumin, while, if mucus alone be present, it gives only those for mucin.

UNORGANISED DEPOSITS.

A. IN ACID URINE.

1. *Amorphous.*

(a.) **Urates.**—Soluble when heated, redeposited in the cold; when hydrochloric acid is added microscopic crystals of uric acid are formed = urates.

(b.) **Tribasic Phosphate of Lime.**—Not dissolved by heat, but disappears without effervescence on adding acetic acid. It is probably tribasic phosphate of lime ($\text{Ca}_3\text{P}_2\text{O}_4$).

(c.) **Oil Globules.**—Very small highly refractive globules, soluble in ether (very rare).

2. *Crystalline.*

(a.) **Uric Acid.**—Recognised by the shape and colour of the crystals and their solubility in KHO.

(b.) **Oxalate of Lime.**—Octahedral crystals, insoluble in acetic acid (fig. 76).

(c.) **Cystin (very rare).**—Hexagonal crystals, soluble in NH_4HO (fig. 78).

(d.) **Leucin and Tyrosin (very rare).** (Fig. 79.)

(e.) **Cholesterin (very rare).** (Fig. 40.)

3. Urinary Calculi.

They are composed of urinary constituents which form urinary deposits, and may consist of one substance or of several, which are usually deposited in

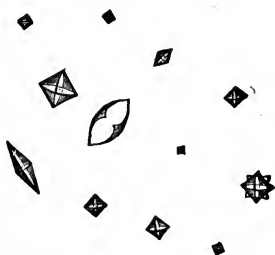

FIG. 76.—Oxalate of Lime. Octahedra and Hour-glass forms.

B. IN ALKALINE URINE.

1. *Amorphous.*

(a.) **Tribasic Phosphate of Lime** dissolves in acids without effervescence.

(b.) **Carbonate of Lime.** (See (c.) below.)

2. *Crystalline.*

(a.) **Triple Phosphate.**—Shape of the crystals (knife-rest or coffin-lid), soluble in acids.

(b.) **Acid Ammonium Urate.**—Small dark balls, often covered with spines, and also amorphous granules (fig. 77).

(c.) **Carbonate of Lime.**—Small colourless balls, often joined to each other; effervescence on adding acids (microscope).

(d.) **Crystalline Phosphate of Lime.**

(e.) **Leucin and Tyrosin (very rare).** (Fig. 79.)



FIG. 77.—Acid Urate of Ammonium.

layers, in which case the most central part is spoken of as the "nucleus." The nucleus not unfrequently consists of some colloid substance—mucus, a

portion of blood-clot, or some albuminoid matter—in which crystals of oxalate of lime or globular urates become entangled. Layer after layer is then deposited. In certain cases the nucleus may consist of a foreign body introduced from without. Calculi are sometimes classified as *primary* and *secondary*; the former are due to some general alteration in the composition of the urine, whilst the latter are due to ammoniacal decomposition of the urine, resulting in the precipitation of phosphates on stones already formed. This of course has an important bearing on the treatment of calculous disorders. Calculi occur in acid and alkaline urine. A *highly acid* urine favours the formation of *uric acid* calculi, because that substance is most insoluble in very acid urine. A *highly alkaline* urine favours the formation of calculi consisting of *calcium phosphate* or *triple phosphate*, as these substances are insoluble in alkaline urine.

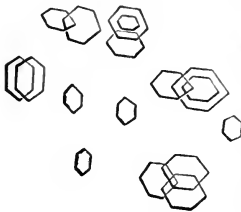

FIG. 78.—Cystin.

mation of calculi consisting of *calcium phosphate* or *triple phosphate*, as these substances are insoluble in alkaline urine.

4. Method of Examining a Calculus

(a.) Make a section in order to see if it consists of one or more substances; examine it with the naked eye, and a portion microscopically.

(b.) Scrape off a little, and heat it to redness on platinum foil over a Bunsen-burner.

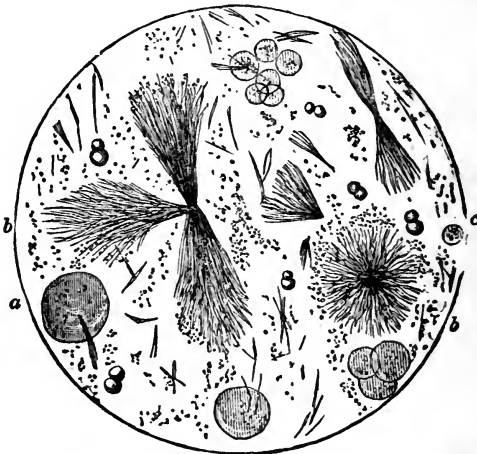

FIG. 79.—a.a. Leucin balls; b.b. Tyrosin sheaves; c. Double balls of ammonium urate.

(A.) If it be *entirely combustible*, or almost so, it may consist of uric acid or urate of ammonium, xanthin, cystin, coagulated fibrin or blood, or ureostealith.

(B.) If *incombustible*, or if it leaves *much ash*, it may consist of urates with a fixed base (Na, Mg, Ca), oxalate, carbonate, or phosphate of lime, or triple phosphate.

5. A. Combustible.—Of this group, uric acid and urate of ammonium give the *murexide test*.

(i.) **Uric Acid** is by far the most common form, and constitutes five-sixths of all renal concretions. Concretions the size of a split-pea, or smaller, may be discharged as *gravel*. When retained in the bladder, they are usually spheroidal, elliptical, and somewhat flattened; are tolerably hard; the surface may be smooth or studded with fine tubercules; the colour may be yellowish, reddish, reddish brown, or very nearly white. When cut and polished, they usually exhibit a concentric arrangement of layers. Not unfrequently a uric acid calculus is covered with a layer of phosphates, and some calculi consist of alternate layers of uric acid and oxalate of lime. Its *chemical relations*: nearly insoluble in boiling water; soluble in KHO, from which acetic acid precipitates uric acid crystals (microscopic); gives the murexide test (Lesson XX. 3).

(ii.) **Urate of Ammonium Calculi** are very rare, and occur chiefly in the kidneys of children; they form small irregular, soft, fawn-coloured masses, easily soluble in hot water.

(iii.) If the calculus is combustible and gives no murexide test, it may consist of **xanthin**, which is very rare, and of no practical importance.

(iv.) **Cystin** is very rare, has a smooth surface, dull yellow colour, which becomes greenish on exposure to the air; and a glistening fracture with a peculiar soapy feeling to the fingers; soft, and can be scratched with the nail. It occurs sometimes in several members of the same family. It is soluble in ammonia and after evaporation it forms regular microscopic hexagonal plates (fig. 78).

The other calculi of this group are very rare.

6. (A.) Group.—*Apply the Murexide Test.*

It is obtained	{ Treat the original powder with potash.	{ No odour	= Uric acid.
		{ Odour of NH_3	= Ammonium urate.
The residue is not coloured, but becomes yellowish-red on adding caustic potash			= Xanthin.
The residue is not coloured either by KHO or NH_4HO ; the original substance is soluble in ammonia, and on evaporation yields hexagonal crystals			= Cystin.
On heating, it gives an odour of burned feathers; the substance is soluble in KHO, and is precipitated therefrom by excess of HNO_3			= Proteid.

7. B. Incombustible.

(i.) Urates (Na, Ca, Mg), are rarely met with as the sole constituent. They give the murexide test.

(ii.) Oxalate of Lime or mulberry calculi, so called because their surface is usually tuberculated or warty; they are hard, dark-brown, or black. These calculi, from their shape, cause great irritation of the urinary mucous membrane. When in the form of gravel, the concretions are usually smooth, variable in size, pale-grey in colour. Layers of oxalate of lime frequently alternate with uric acid. When heated it blackens, but does not fuse, and then becomes white, being converted into the carbonate and oxide. The white mass is alkaline to test-paper, and when treated with HCl, it effervesces (CO₂). Oxalate of lime is not dissolved by acetic acid.

(iii.) Carbonate of Lime.—Rare in man; when met with, they usually occur in large numbers. Dissolve with effervescence in HCl. Sometimes crystals occur as a deposit. They are common in the horse's urine.

(iv.) Basic Phosphate of Lime Calculi are very rare, and are white and chalky.

(v.) Mixed Phosphates (Fusible Calculus) consist of triple-phosphate and basic phosphate of lime. They indicate that the urine has been ammoniacal for some time, owing to decomposition of the urea. They are usually of considerable size, and whitish; the consistence varies. When triple-phosphate is most abundant, they are soft and porous, but when the phosphate of lime is in excess, they are harder. A *whitish* deposit of phosphates is frequently found coating other calculi. This occurs when the urine becomes ammoniacal, hence in such cases regard must always be had to the condition of the urinary mucous membrane. Such calculi are incombustible, but, when exposed to a strong heat, fuse into a white enamel-like mass, hence the name, fusible calculi.

8. (B.) Group.

(i.) *The substance gives the murexide reaction, indicates urates.*

The residue is treated with water.

It is soluble, and the solution is alkaline . . .	{	Neutralise; add platonic chloride, a yellow precipitate	} = Potassium.
		The residue yields a yellow flame	
Scarcely soluble; the solution is scarcely alkaline; soluble in acetic acid . . .	{	Ammonium oxalate gives a white crystalline precipitate	} = Calcium.
		Ammonium oxalate gives no precipitate, but on adding ammonium chloride, sodic phosphate, and ammonia, there is a crystalline precipitate of triple-phosphate	

(ii.) *The original substance does not give the murexide test.*

Treat the original substance with hydrochloric acid.

It dissolves with effervescence	=	$\left. \begin{array}{l} \text{Calcium carbonate.} \\ \text{Magnesium carb.} \end{array} \right\}$
It dissolves without effervescence. Heat the original substance, and treat it with HCl	$\left\{ \begin{array}{l} \text{It dissolves with effervescence} \\ \text{There is no efferv's'ce. Heat in a capsule} \end{array} \right\}$	$= \text{Calcium oxalate.}$
	$\left\{ \begin{array}{l} \text{It melts.} \\ \text{The original stone treated with KHO} \\ \text{It does not melt on heating} \end{array} \right\}$	$\left. \begin{array}{l} \text{Evolves } \left. \begin{array}{l} \text{NH}_3 \\ \text{NH}_3 \end{array} \right\} = \text{Triple phosphate.} \\ \text{Evolves no } \left. \begin{array}{l} \text{NH}_3 \end{array} \right\} = \text{Neut. calc. phosp.} \end{array} \right\}$
	= Acid calc. phosp.

9. General Examination of the Urine.

- (i.) Quantity in twenty-four hours (normal 50 oz., or 1500 cc.).
- (ii.) Colour, Odour, and Transparency (if bile or blood be suspected, test for them).
- (iii.) Specific Gravity of the mixed urine (if above 1030, test for sugar).
- (iv.) Reaction (normally slightly acid; if alkaline, is the alkali volatile or fixed?).
- (v.) Heat.
 - (a.) If a turbid urine becomes clear = *urates*.
 - (b.) If it becomes turbid = *earthy phosphates* or *albumin*.
 Albumin is precipitated before the boiling-point is reached (73° C.), whilst phosphates are thrown down about the boiling-point. It is necessary, however, to add HNO₃, which will dissolve the phosphates, but not the albumin. A case may occur where both urates and albumin are present; on carefully heating, the urine will first become clear (urates), and then turbid, which turbidity will not disappear on adding HNO₃ (albumin). Estimate approximately the amount of albumin present.
- (vi.) Test for Chlorides, with HNO₃ and AgNO₃ (if albumin be present, it must be removed by boiling and filtration).
- (vii.) If sugar be suspected, test for sugar (Moore's, Trommer's, or Fehling's test), and if albumin be present, remove it.
- (viii.) Make naked-eye, microscopic, and chemical examinations of the sediment.

APPENDIX.

Exercises on the Foregoing.

A. The student must practise the **analysis of fluids** containing one or more of the substances referred to in the foregoing Lessons.

No hard and fast rule can be laid down for the examination of the fluids met with in physiological work at all comparable with the method employed in inorganic chemistry. To begin with, the student must be largely guided by the **physical characters**,—colour, smell, taste, etc.—of the fluid he is dealing with, and these will usually give him a satisfactory clue as to the chemical tests he should employ.

N.B.—In all cases concentrate some of the fluid for subsequent use if required, and complete the concentration on a water-bath to avoid overheating or charring.

A *colourless* solution should be examined for proteids and carbohydrates by the method described in Lesson IV., p. 32. Marked opalescence will indicate milk or glycogen, less distinct opalescence may suggest the presence of starch or certain proteids. Colourless solutions may also contain urea, bile-salts, leucin, tyrosin or ferments.

Colour:—A *red* colour will suggest blood, a *green* tint bile, a *yellow* urine, a *brown* methæmoglobin or hæmatin. If blood-pigment or one of its derivatives is suspected, use the spectroscope at once, and observe the spectrum of (*a*) the original solution, (*b*) the same shaken with air, and (*c*) after the addition of $(\text{NH}_4)_2\text{S}$.

The *smell* may give an indication as to the presence of bile or urine. Do chemical tests accordingly.

Taste:—If *salt*, examine for globulins or urea, if *bitter* for bile-salts, if *sweet* for sugars.

Following the indications obtained from the physical characters, select from the following chemical tests those applicable to the fluid which is being examined.

1. Test for *proteids* by xanthoproteic and Millon's tests, and for *carbohydrates* by iodine and Trommer's test. The tests for special proteids and carbohydrates have been already described (p. 32).

2. *Blood*:—Test chemically for proteid constituents.

3. *Bile*:—Do Gmelin's test for bile-pigments, and, if proteids are absent, Pettenkofer's test for bile-acids. If proteids (not proteoses and peptones) are present, neutralise, boil, filter, and test filtrate for bile-salts. Remove proteoses and peptones, if present, by precipitation with alcohol, filter and test filtrate for bile-salts.

4. *Tyrosin* :—Add Millon's reagent and boil. A red colour in the solution indicates the presence of tyrosin.

5. *Urea* :—(1.) Add sodium hypobromite or impure nitric acid (containing HNO_2). If no bubbles of gas, no urea is present. If gas given off (2.) remove phosphates and sulphates by addition of baryta mixture and filtration, and remove proteids (see 3.), concentrate the filtrate if necessary, place a drop on each of two slides, allow one to evaporate slowly under a cover-glass, and to the other add a drop of strong pure HNO_3 and cover. Examine the former for crystals of urea, and the latter for crystals of urea nitrate. For other tests see Lesson XVIII., p. 119).

6. *Uric acid* :—If in solution, is in the condition of a urate. (1.) Add a drop of HCl and allow to stand for 24 hours. Examine deposit for crystals of uric acid. (2.) Concentrate original solution (after removal of any proteids present), and apply the murexide test to a small quantity.

7. *Kreatinin* :—Add a drop of dilute solution of nitroprusside of sodium and excess of caustic soda. A burgundy-red colour indicates kreatinin.

8. *Ferments* :—(a.) *Digestive ferments*.—Place 5 cc. of the suspected fluid in each of four test-tubes. Label these A, B, C, and D. Neutralise the fluid in C and D, if necessary. To A add 5 cc. .4 per cent. HCl and a thread of boiled fibrin, to B 5 cc. of 2 per cent. sodium carbonate solution and a thread of boiled fibrin, to C 5 cc. starch solution, and to D 5 or 10 cc. milk. Place the four tubes, along with four control tubes A', B', C', D' (the contents of which are the same as those of A, B, C, and D, but without the suspected solution) on a water-bath at 40°C . After a time (10 to 30 mins.) examine the tubes. Digestion in A, B, or C, or coagulation of the milk in D, indicates, if there is no corresponding change in the control tube, the presence of *pepsin*, *trypsin*, *amylolytic ferment* or *rennin* respectively.

(b.) *Blood ferment*.—If the solution is suspected to be salted plasma, or if it be oxalate plasma, in the former case dilute with water and place in a water-bath. (Lesson V. 21.) In the latter add calcium chloride (Lesson V. 14), and observe if coagulation occurs. This will also show presence of fibrinogen.

N.B.—In all cases make a note of what you do, the result thereof, and your inferences. The following form is convenient :—

<i>Experiment.</i>		<i>Observation</i>		<i>Inference.</i>
--------------------	--	--------------------	--	-------------------

B. Examination of Solid substances.**Physical characters.**

1. The *colour* may suggest blood-pigment, or one of its derivatives, or bile-pigment.
2. *Taste* may indicate bile-salts, urea, or sugar.
3. Examine **microscopically** to see whether amorphous or crystalline. If the latter, the substance may be recognised by its crystalline form, *e.g.*, urea, uric acid, urates, leucin, tyrosin, cholesterin, &c.
4. Burn some in a tube; smell it to detect any odour. Observe if it leaves an ash.
5. Examine its *solubility* in cold and warm water, caustic soda, dilute acid, saline solutions, alcohol and ether. Test the solution in the first four reagents as directed under examination of fluids. Examine the ethereal solution for *fats* and *cholesterin*.

Cholesterin.:—(1.) Evaporate a little of the ethereal solution in a watch-glass, and add a drop of strong H_2SO_4 . A red colour indicates cholesterin. (2.) Examine microscopically. Cholesterin crystallises from ethereal solution in colourless needles, from solution in boiling alcohol in its characteristic plates.

C. Analysis of Urine.—The student must also practise the analysis of urines containing one or more abnormal constituents, and he must also practise the estimation of the quantity of the more important substances present. Both sets of processes must be done over and over again, in order that he may perfect himself in the methods in common use.

PART II.—EXPERIMENTAL PHYSIOLOGY.

Instruments, &c., to be provided by each Student.—*Before beginning the experimental part of the course, each student must provide himself with the following:—A large and a small pair of scissors; a large and a fine pointed pair of forceps; a small scalpel; a blunt needle or “seeker” in a handle; pins; fine silk thread; watch-glasses; narrow glass rod drawn out at one end to act as a “seeker”; two camel’s-hair brushes of medium size. It is convenient to have them all arranged in a small case.*

PHYSIOLOGY OF MUSCLE AND NERVE.

LESSON XXV.

GALVANIC BATTERIES AND GALVANOSCOPE.

1. **Daniell’s Cell** consists of a glazed earthenware pot with a handle (fig. 80), and containing a saturated solution of copper sulphate. Crystals of copper sulphate are placed in it to keep the solution saturated. The pot is about 18 cm. high, and 9 cm. in diameter. In the copper solution is placed a roll of sheet-copper, provided with a binding screw. Within is a porous unglazed cylindrical cell containing 10 p.c. solution of sulphuric acid. A well amalgamated rod of zinc, provided at its free end with a binding screw, is immersed in the acid. The zinc is the negative pole or **Cathode** (–), and the copper the positive pole or **Anode** (+).

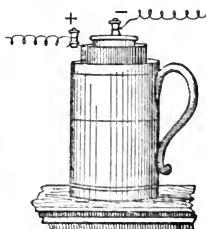

FIG. 80.—Daniell's Cell.

2. **Wilke's Pole-Reagent Paper.**—This is a convenient method for determining the (-) pole in any combination. Moisten one of the papers, place it on a clean piece of glass, and touch the surface with the two wires coming from the battery ; a red spot indicates the negative pole.

3. **Amalgamation of the Zinc.**—(a.) The zinc should always be well amalgamated. When a cell hisses the zinc requires to be amalgamated. Dip the zinc in 10 p.c. sulphuric acid until effervescence commences. Lift it out and place it on a shallow porcelain plate. Pour some mercury on the zinc, and with a piece of cloth rub the mercury well over the zinc. Dip the zinc in the acid again, and then scrub the surface with a rag under a stream of water from the tap. Collect all the surplus mercury and place it in the bottle labelled "**Amalgamation Mixture.**" Take care that none of the mercury gets into the soil-pipe. A

very convenient method is to dip the zinc into a thick-walled glass tube containing mercury and sulphuric acid. For convenience the tube is fixed in a block of wood.

(b.) The following is another convenient "**Amalgamation Mixture**":—With the aid of gentle heat dissolve 4 parts of mercury in 5 parts of nitric acid and 15 parts of hydrochloric acid, and then add 20 parts of hydrochloric acid. The zincs, after being well cleaned, as directed above, are dipped into this mixture, or the mixture may be applied to the clean zinc by means of a brush.

N.B.—After using a battery the zincs must be washed and dried, the porous cells must be carefully washed, and completely immersed in a large quantity of water, frequently renewed.

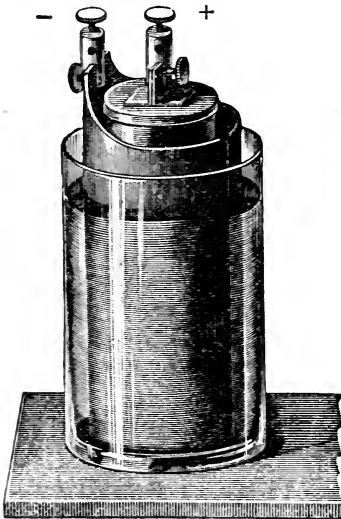

FIG. 81.—Large Grove's Element.

4. **Grove's Cell** (fig. 81) consists of an outer glazed earthenware, glass, or ebonite jar, containing amalgamated zinc and 10 p.c. sulphuric acid. In the inner porous cell is placed platinum foil with strong nitric acid. The platinum is the + positive pole or anode, the zinc the - negative pole or cathode. For physiological purposes, the small Grove's cells, about 7 cm. in diameter and 5 cm. in height, are very convenient. When in use the battery ought to

be placed in a draught chamber to prevent the nitrous fumes from affecting the experimenter.

5. **Bichromate Cell** (fig. 82).—This consists of a glass bottle containing one zinc and two carbon plates immersed in the following mixture:—Dissolve 1 part of potassic bichromate in 8 parts of water, and add 1 part of sulphuric acid. The zinc is attached to a rod, which can be raised when it is desired to stop the action of the battery. This cell is convenient enough when it is not necessary to use a current of perfectly constant intensity.

6. **Leclanché Cell**.—The positive plate is zinc in ammonium chloride solution (Zinc - pole). The negative plate is carbon with manganese dioxide in the same solution (Carbon + pole).

Other forms of batteries are used, but the foregoing are sufficient for the purposes of these exercises.

7. The Galvanoscope or Detector.

(a.) Charge a Daniell's cell and attach a copper wire to the negative pole (zinc), and another to the positive pole (copper). On bringing the free ends of the two wires together the circuit is made, and a current of continuous, galvanic, or voltaic electricity circulates outside the battery from the + to the - pole. Prove the existence of this current by its effect on a magnetic needle.

(b.) Use a vertical galvanoscope or detector (fig. 83), in which the magnetic needle is so loaded as to rest in a vertical position. A needle attached to this moves over a semicircle graduated into degrees. Connect the wires from the + and - poles of the Daniell's battery with the binding screws of this instrument, and note that when the circuit is made the needle is deflected from its vertical into a more or less horizontal position, but the angle

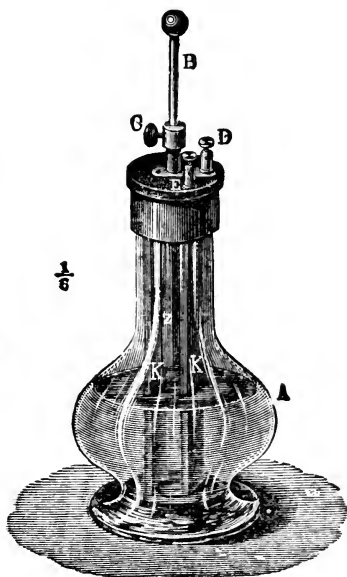

FIG. 82.—Bichromate Cell. A. The glass vessel; K, K. Carbon; Z. Zinc; D, E. Binding screws for the wires; B. Rod to raise or depress the zinc in the fluid; C. Screw to fix B.

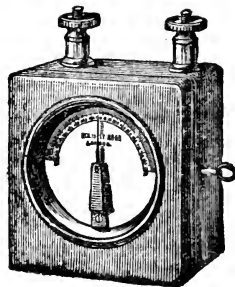

FIG. 83.—Detector.

of deflection is not directly proportional to the current passing in the instrument. Break the circuit by removing one wire, and notice that the needle travels to zero and resumes its vertical position. The detector made by Stöhrer, of Leipzig, is a convenient form.

8. Effect of Constant or Voltaic Current on the Tongue.—Apply the free ends of the wires to the top of the tongue and note the effect of the current; or a key may be placed in the circuit. The physiological effects of a moderate constant current are but slight on the sensory nerves of the tongue, there being perhaps a slight metallic taste.

Electrical Units are:—The unit of current is an ampère, the unit of resistance an ohm, and the unit of pressure a volt. The pressure or potential of a Daniell's cell is about 1 volt. One ampère current is obtained by 1 volt pressure through 1 ohm resistance, through 20 ohms $\frac{1}{20}$ ampère. The internal resistance of an ordinary cell varies from 1 to 10 ohms.

LESSON XXVI.

ELECTRICAL KEYS—RHEOCHORD.

It is convenient to make or break—*i.e.*, close or open—a current by means of keys, of which there are various forms.

1. Du Bois Key (fig. 84).—It consists of a plate of vulcanite, attached to a wooden or metallic framework which can be screwed to a table. Two oblong brass bars (II. and III.), each provided with two binding screws, are fixed to the ebonite, while a movable brass bar (IV.) with an ebonite handle is fixed to one of the bars, and can be depressed so as to touch the other brass bar.

Two Ways of Using the Du Bois Key.

2. (1.) When the key is closed the current is made, and when it is opened the current is broken (fig. 85). **Apparatus.**—Daniell's cell and detector, three wires, and a Du Bois key screwed to a table.

(a.) As in the scheme (fig. 85) connect one wire from - pole of the battery to one brass bar of the key. Connect the other brass bar with one binding screw of the detector. Connect by means of the third wire the other binding screw of the detector with the + pole of the cell.

(b.) On depressing the key (*i.e.*, making the circuit) the needle is deflected, on raising it (*i.e.*, breaking the circuit) the needle

passes to zero. This method of using the key we may call that for "making and breaking a current."

3. (2.) When the key is closed the current is said to be "short-circuited."

Apparatus.—Daniell's cell, detector, four wires, and a Du Bois key.

(a.) As in scheme (fig. 86) connect the + pole of the battery to the outer binding screw of one brass bar of the key, and the - pole to the outer binding screw of the other brass bar. Then connect the inner binding screws of both brass bars with the detector.

(b.) Observe when the key is depressed or closed, there is no deflection of the needle, *i.e.*, when the current is cut off from the circuit beyond the key or bridge; when the key is raised, the needle is deflected. When the key is depressed, the current is said to be "short-circuited," for the key acts like a bridge, and so a large part of the current passes through it back to the battery, while only an excessively feeble current passes through the wires beyond the key; so feeble is it that it does not affect a nerve. On raising the key, the whole of the current passes

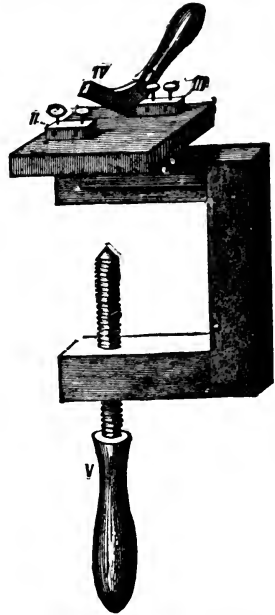

FIG. 84.—Du Bois-Reymond's Key.

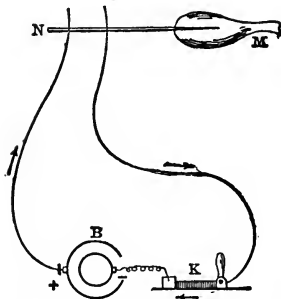

FIG. 85.—Scheme of Du Bois Key.
B. Battery; K. Key; N. Nerve;
M. Muscle.

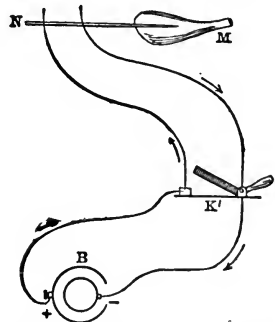

FIG. 86.—Scheme of Du Bois Key
for Short-Circuiting. N. Nerve;
M. Muscle; B. Battery; K'. Key

through the detector or nerve, as the case may be. This method of using the key is called the method of "short-circuiting."

(c.) Test the effect of a galvanic current by applying the electrodes to the tip of the tongue.

N.B.—In using the key to apply an induction current to excite a nerve or muscle, always use this key by the second method, *i.e.*, always place a short-circuiting key in the secondary circuit.

4. **Mercurial Key.**—Where a *fluid* contact is required the wires dip into mercury. Study the use of this key. It is used in the same way as a Du Bois key.

5. **Morse Key** (fig. 87).—If it is desired to make or break a current rapidly, this key is very convenient. If this key be used to make and break the primary circuit, connect the wires to B and C; when the style of the lever, *l*, is in contact with *c*, the current does not pass in the primary circuit. On depressing the handle, *K*, the primary circuit is made. If, however, the wires be connected to A and B, the current passes and is broken on depressing *K*.

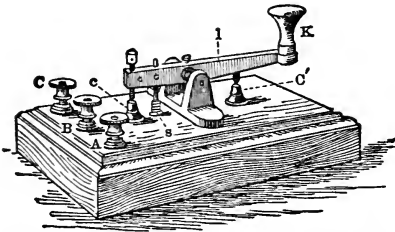

FIG. 87.—Morse Key. The connections are concealed below, but are B to *l*, A to *c*, C to *C*'.

To use this key as a short-

circuiting key, connect the wires from the battery to A and B, and those of the electrodes to A and C. The current is short-circuited until *K* is depressed, when the current passes from C to A through the electrode wires.

6. The **Contact- or Spring-Key** (fig. 88) is also very useful for

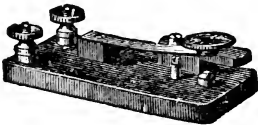

FIG. 88.—Spring-Key.

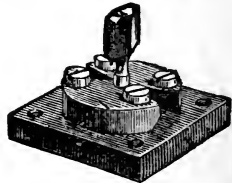

FIG. 89.—Plug-Key.

rapidly making and breaking a circuit, or for giving a single shock, as in estimating the work done during the contraction of a muscle. The current can only pass between the binding screws when the metallic spring is pressed down. The left end of the spring is in metallic contact with the upper binding screw, while the second

binding screw is similarly connected with the little metallic peg at the right-hand end of the fig.

7. **Plug-Key** (fig. 89).—Two brass bars are fixed to a piece of vulcanite. The circuit is made or broken by inserting a brass plug between the bars. Each brass bar is provided with two binding screws, to which one or two wires may be attached, so that it can be used like a Du Bois key, either by the first or second method.

8. The "Trigger or Turn-Over Key" is referred to in Lesson XXXV.

9. For Brodie's "Rotating Key," see Lesson XXVIII.

Means of Graduating a Galvanic Current.—Besides altering the number, arrangement, or size of the cells themselves, we can use a simple rheochord to divide the current itself, the battery remaining constant, so that weak constant currents of varying strength can thus be easily obtained.

10. The **Simple Rheochord** consists of a brass or German-silver wire, about 20 ohms resistance and 1 metre in length, stretched longitudinally along a board, and with its ends connected to binding screws and insulated (fig. 90). On the wire there is a "slider" which can be pushed along as desired. **Apparatus.**—Simple rheochord, Daniell's cell, detector, Du Bois key, five wires.

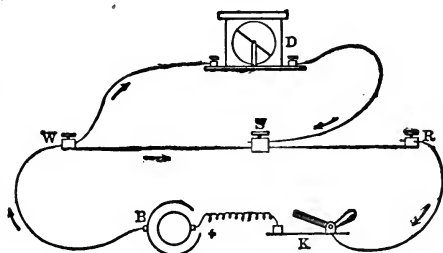

FIG. 90.—Scheme of Simple Rheochord. *B.* Battery; *K.* Key; *W, R.* Wire; *S.* Slider; *D.* Detector.

(a.) Arrange the experiment as in fig. 90. When the slider *S* is hard up to *W*, practically all the electricity passes along the wire (*W, R*) back to the battery.

(b.) Pull the slider away from *W*, and in doing so, the resistance in the detector circuit is diminished, and some of the electricity passes along the detector circuit or the "deriving circuit" and deflects the needle. The deflection is greater—but not proportionally so—the further the slider is removed from *W*. The deflection is nearly proportional to the distance of the slider from *W*, when the resistance in the detector circuit is great compared with that of the rheochord, which is, of course, the case when a tissue occupies the place of the detector.

(c.) Make a table showing the extent of deflection of the needle of the detector according to the distance of S from W.

11. The wire of the rheochord may be arranged as in fig. 91; a slider, S, S, consisting of an ebonite cup filled with mercury, can be moved along the wires. Make connections as in fig. 91. Observe as the mercury cup is pulled away from the binding

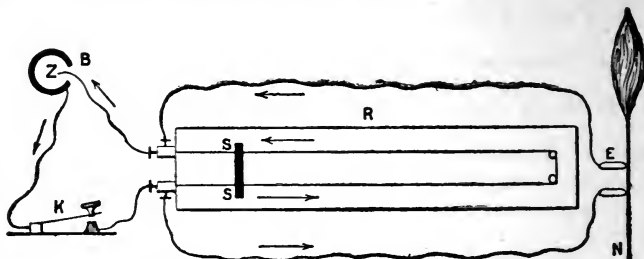

FIG. 91.—Rheochord with Hg-Slider, S. S. B. Battery; K. Contact Spring-Key; E. Electrodes; N. Nerve or Detector.

screws there is a greater deflection of the needle, but the deflection is not in proportion to the distance of the cup. Make a table of your results.

Distance of Hg-Bridge in cm.	Deflection of Galvanometer.
1	1
2	2.5
3	4
4	6
10	9.5
15	11
20	12.5
30	14

The resistance in the rheochord circuit is low as compared with that in the principal circuit. By means of the slider the resistance in the deriving circuit can be increased or diminished, and, consequently, the magnitude of the current diverted into the principal circuit. The rheochord also affords a means of dividing a current into two parts, according to the respective resistances in the two circuits. A rheochord is also used to compensate any current of injury in nerve and muscle in rheotonic experiments.

12. **Simple Rheochord.**—The most convenient form is that shown in fig. 92, and is that used in the Physiological Laboratory

of Oxford. It consists of a German-silver wire about 20 ohms resistance, wound round ebonite pegs fixed at equal distances at the opposite ends of a wooden board. The board is divided into oblongs, so that each division represents $\frac{1}{100}$ part of the whole length of the wire, which ends in two block terminals, A, B, each provided with two binding screws. One of the terminals of the electrodes is attached to one terminal of the wire (A), and the other to the movable block S, which represents a slider, and which can be applied to any part of the wire, at any distance from A. Owing to the great resistance of the nerve as compared with that of the wire, the current through the nerve or muscle is in proportion to the length of wire between the slider S and the block.

(a.) Connect a Daniell's cell as in fig. 92 with the two block terminals (A, B) interposing a spring-key (K). Of the electrode wires one is connected to A, and the other to the slider S.

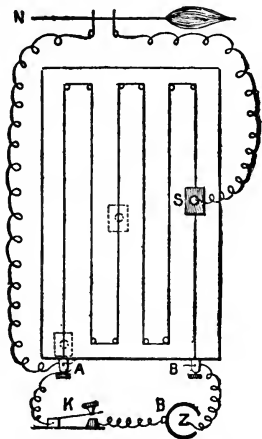

FIG. 92.—Simple Rheochord as used in Oxford.
B. Battery; K. Spring-Key; A. B. Terminals of Rheochord Wire; S. Slider; N. Nerve.

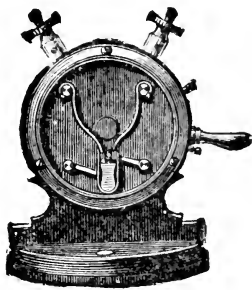

FIG. 93.—Thomson's Reverser.

Expose the sciatic nerve of a frog, and place the electrodes under it, or make a nerve-muscle preparation and stimulate the nerve. Place the slider close to A, there is no response either at make or break. Place the slider at different distances from A, and note when contraction occurs at make.

13. Pohl's Commutator. — Sometimes it is desired to send a current through either of two pairs of wires. This is done by means of Pohl's commutator *without the cross-bars* (Lesson XXXIII., fig. 112). At other times it is desired to reverse the direction of a current. This is done by Pohl's commutator with cross-bars.

14. Thomson's Reverser (fig. 93) may be used to reverse the direction of a constant current. The wires from the battery are connected to the two lower, and those from the electrodes to the upper binding screws. The binding screws are four in number, and placed behind the circular disc seen in the figure. When the handle is horizontal the current is shut off from the electrodes, while the direction of the current is reversed by raising or lowering the handle. This instrument is used solely for reversing the direction of a current.

LESSON XXVII.

INDUCTION MACHINE--ELECTRODES.

1. Induced or Faradic Electricity is most frequently employed for physiological purposes. Induction shocks are of short duration, while they are physiologically very active, and they may be employed as single shocks, or a succession of shocks may be applied. Indeed, the fact that the application of successive induction shocks

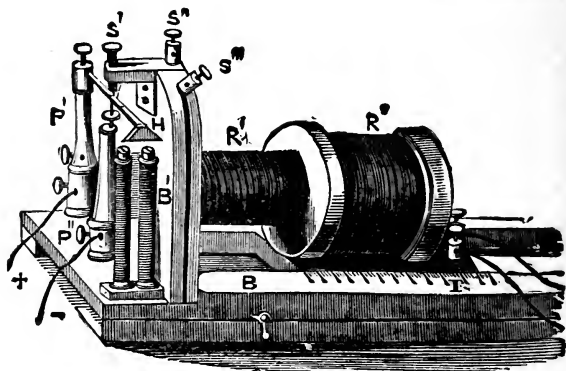

FIG. 94.—Induction Apparatus of Du Bois-Reymond. *R'*. Primary, *R''*. Secondary spiral; *B*. Board on which *R''* moves; *I*. Scale; + -. Wires from battery; *P*, *P'*. Pillars; *H*. Neef's hammer; *E*. Electro-magnet; *S*. Binding screw touching the steel spring (*H*); *S'*, and *S''*. Binding screws to which are attached wires when Neef's hammer is not required.

but slightly impairs the physiological activity of the tissues, and that the intensity of these shocks can be accurately graduated, make induced electricity so valuable as a stimulus in physiological experiments.

2. Induction Apparatus of Du Bois-Reymond.—In fig. 94 the primary coil (*R'*) consists of about 150 coils of thick insulated copper wire, the wire being thick to offer slight resistance to the

galvanic current. The secondary coil (R'') consists of 6000 turns of thin insulated copper wire arranged on a wooden bobbin; the whole spiral can be moved along the board (B) to which a millimetre scale (I) is attached, so that the distance of the secondary from the primary spiral may be ascertained. At one end of the apparatus is a Wagner's hammer as adapted by Neef, which is an automatic arrangement for making and breaking the primary circuit. When Neef's hammer is used to obtain what is called an interrupted current, or "repeated shocks," the wires from the battery are connected as in the figure, but when single shocks are required, the wires from the battery are connected with a key, and this again with the two terminals of the primary spiral, S'' and S''' .

Suppose we place the secondary coil hard up over the primary, and consider this as zero, then an index on the side of the slot will give the distance in millimetres of the secondary from the primary coil, the current being strongest when the secondary coil is completely over the primary, and diminishing as the secondary is removed from the primary.

3. **New Form of Inductorium.**—Fig. 96 shows an inductorium where the secondary spiral moves vertically in a slot, and is compensated by means of a counterpoise, so that it moves easily. It is used in the same way as the other form.

4. **Graduated Induction Apparatus.**—In the ordinary apparatus the distance between the secondary and primary spirals is indicated by a millimetre scale attached to the instrument. When the secondary spiral is moved along equal distances, there is not a corresponding increase or decrease in the induced current; on the contrary, the strength of the induced currents undergoes a very unequal change. Fick and Kronecker use a graduated induction apparatus; one side of the slot is provided with a millimetre scale, and the other is divided into units.

5. **Bowditch's Rotating Secondary Spiral.**—The secondary spiral is withdrawn from the primary to the unit mark 30 on the scale. The secondary spiral rotates on a vertical axis, so that it can be placed at varying angles with the primary. In proportion as it is rotated from its conaxial position the current is diminished. The student may test this by removing the secondary spiral from the slot and placing it at variable angles to the primary spiral.

6. **Ewald's Sledge Coil.**—This coil is, with the exception of the interrupting arrangement, in every respect similar to the ordinary Du Bois-Reymond coil; the iron core (fig. 95, K) is arranged movable, and the secondary coil slides over the primary and can be adjusted in any position by means of a rack and pinion arrangement. The interrupter consists of an upright electro-magnet, over the poles of which swings a small steel bar-magnet; this magnet forms the bottom end of a pendulum which swings with very little friction, and is counterbalanced on its upper end by a small weight.

The electro-magnet, when traversed by the current, becomes magnetised in such a way that its poles are the same as those of the little bar-magnet above it, thus repelling the latter, the swing of which is limited by the stop spring B .

The magnetic circuit now being broken, the pendulum swings back until it again touches the contact D, when it is repelled again, and so on.

According to the position which is given to the spring by means of the milled head A, the amplitude and speed of the interrupter swings can be varied between the limits of 1 and 200 per second.

Z, Z are the battery terminals; P and S the terminals for primary and secondary current (fig. 95).

7. Hand-Electrodes (fig. 97).—(a.) Take a piece of double or twin wire (No. 16) enclosed in gutta-percha (that used for electric bells), about 6–7 cm. long ($2\frac{1}{2}$ –3 inches). Remove the gutta-percha from the ends. By means of a file taper one pair of ends to blunt points, to the other ends solder pieces 60–90 cm. long (2–3 feet) of thin copper wire. Coil the thin wires round a glass or wooden rod to make them into a spiral, and to their free unattached ends solder thicker copper wire 1 inch long.

(b.) Take two pieces of flexible gutta-percha coated wire (No. 20) 60 cm. long, and two pieces of thick glass tubing 8 cm. long, having a bore sufficient to admit the wire. Push a wire through each tube, and allow

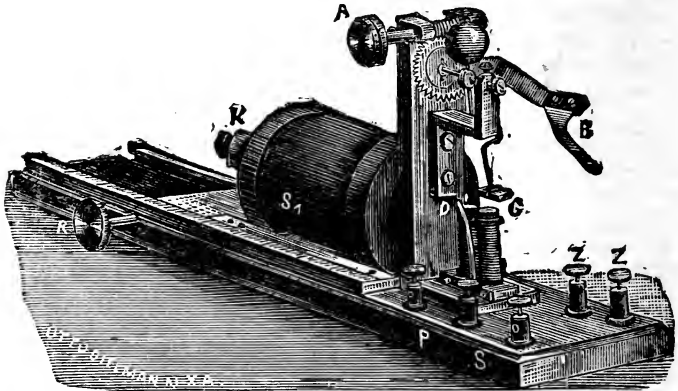

FIG. 95.—Ewald's Sledge Inductorium. S. Secondary coil moved by milled head R; K. Core of primary coil; A. Milled head to alter position of stop B; C. Magnet; Z, Z. Battery terminals; P and S. Those for primary and secondary current. (It is made by A. Hurst and Co., 66 Fenchurch Street, London, and costs £4, 10s.)

the end of the wire to project 2 cm. beyond the tube; scrape the gutta-percha off the free ends of both wires. Fix the wires in the glass tubes with sealing-wax, and with a well-waxed thread bind the two tubes together. Or use two pieces of No. 20 gutta-percha coated wire, each 10 cm. in length, fix them in glass tubes, as shown in the figure, by means of gutta-percha cement. To the ends of the copper wires solder thin silk-covered wires, and to the free ends of the latter solder a short length (2 cm.) of thick uncoated copper wire. A very handy holder is made by thrusting two fine insulated wires (No. 36) through the bone handle of a crotchet-needle.

8. Shielded Electrodes.—For some purposes, *e.g.*, stimulation of the vagus, these electrodes are used, *i.e.*, the platinum terminals are exposed only on one side, the other being sunk in a piece of vulcanite (figs. 197, 226). A pair

of shielded electrodes is easily made by fixing the ends of two fine wires—arranged parallel to each other and about one-eighth of an inch apart—in a thin layer of gutta-percha cement. A little of the cement is scraped off to expose a small piece of both wires.

9. Du Bois-Reymond Electrodes (fig. 98).—The two wires end in triangular pieces of platinum (P) which rest on a glass plate. The whole is supported on a stand (V), and can be moved in any direction by the universal joint (B).

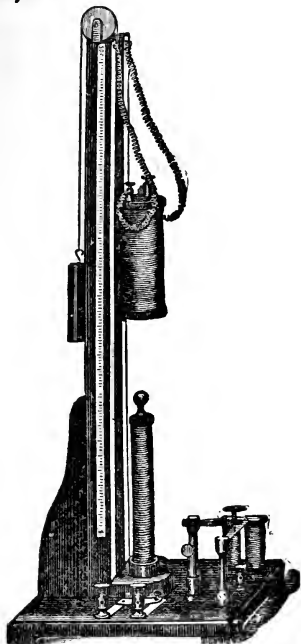

FIG. 96.—Inductorium with Secondary Coil Moving in a Vertical Slot.



FIG. 97.—Hand-Electrodes, such as a Student is required to make for himself.

10. Polarisation of Electrodes.—When a constant current is led through a nerve for some time it causes electrolysis where the metallic wires come into contact with the liquids of the nerve. The excitability of the nerve is altered by the secondary electromotive changes thus produced, so that the nerve is thereby excited, and the muscle is thrown into contraction. Apparatus.—Electrodes (fig. 97), two wires, Du Bois key, Daniell's cell, frog.

(a.) Pith a frog (Lesson XXIX. 1), lay it belly downwards on a frog-plate, and expose one sciatic nerve.

(b.) Screw the Du Bois key to the table, place the copper electrodes under the sciatic nerve, and connect their other ends each with the outer binding screw of the brass bars of the Du Bois key. Close the key, and observe that no contraction of the leg muscles occurs.

(c.) Connect a Daniell's cell with the Du Bois key. Open the key to allow the constant current to pass through the nerve for

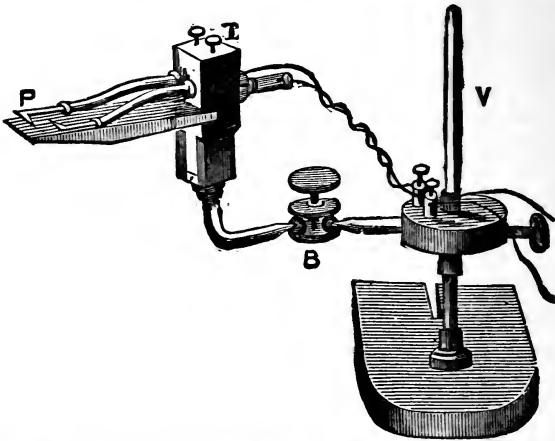

FIG. 98.—Du Bois-Reymond's Platinum Electrodes. The nerve is placed over the two pieces of platinum, *P*, which rest on glass; *B*. Universal joint; *V*. Support.

three or four minutes, and observe that there is no contraction as long as the constant current is passing. Close the key, *i.e.*, short-circuit the battery, and at once a contraction occurs. Remove the battery, close and open the key. Contractions occur, but they gradually get feebler as the polarisation ceases. The contractions are due to polarisation of the electrodes.

(d.) If non-polarisable electrodes are used, this does not happen.

11. Non-Polarisable Electrodes. See Lesson XLI.

LESSON XXVIII.

SINGLE INDUCTION SHOCKS — INTERRUPTED CURRENT—BREAK EXTRA-CURRENT — HELMHOLTZ'S MODIFICATION.

1. Single Induction Shocks.—Apparatus.—Daniell's cell, induction machine, wires, two Du Bois keys (or one Du Bois and one spring or mercury key), and electrodes.

(a.) Make connections as in fig. 99. The key in the primary circuit—preferably a mercury key—is used to make or break the primary current. To the binding screws of the secondary coil attach two wires, and connect them to the short-circuiting Du Bois key, and to the latter the electrodes.

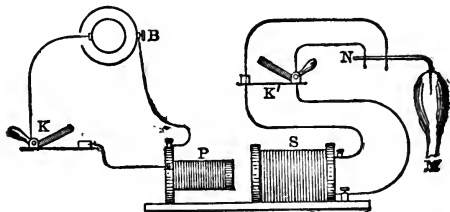

FIG. 99.—Scheme for Single Induction Shocks. *B.* Battery; *K, K'* Keys; *P.* Primary, and *S.* Secondary coil of the induction machine; *N.* Nerve; *M.* Muscle.

(b.) Effect on Tongue of Single Induction Shocks.—Open the short-circuiting key, push the secondary coil pretty near to the primary, and place the points of the electrodes on the tip of the tongue, or hold them between the forefinger and thumb moistened with water. Close the key in the primary circuit, *i.e.*, make the circuit, and instantaneously at the moment of making, a shock or prick—the closing or make induction shock—is induced in the secondary coil, *S*, and is felt on the tip of the tongue or finger. All the time the key is closed the galvanic current is circulating in the primary coil, but it is only when the primary current is made or broken that a shock is induced in the secondary coil.

(c.) Break the primary current by raising the key, and instantaneously a shock—the opening or break induction shock—is felt.

(d.) The *break is stronger than the make shock*. Push the secondary coil a long distance from the primary, and, while the electrodes are on the tongue, make and break the primary circuit. Gradually move the secondary near the primary coil. The break shock is felt first, and on pushing the secondary nearer the primary

coil both shocks are felt, but the break is stronger than the make shock.

Note that:—

- (i.) The break shock is the stronger.
- (ii.) On approximating the secondary to the primary coil, a shock is felt at make also, *i.e.*, when the primary circuit is made.
- (iii.) If the primary circuit be kept closed, *i.e.*, made, no shock is felt.
- (iv.) The shocks increase in intensity the nearer the secondary coil is to the primary

N.B.—Make a table of the results showing the distance of the secondary coil from the primary when testing the relative effects of M. and B. shocks.

Single M. and B. Induction Shocks (1 Daniell).

Distance of Secondary Coil from Primary in cm.	Effect on Tongue.	
	M.	B.
19	○	○
18	○	Slight shock.
17	○	Stronger shock.
...
...
...
...
9	Slight shock.	Maximum shock.
8	Stronger shock.	„ „
7	Maximum shock.	„ „

(*e.*) Remove the secondary spiral from its slot, and place it in line with and about 15 cm. from the primary. Rotate the secondary coil so as to place it at variable angles with the primary. Make and break the primary circuit, and test how the strength of the induced current varies with the extent of rotation of the secondary spiral.

2. Interrupted Current, *i.e.*, Repeated Shocks, by using Neef's Hammer—(Alternating Currents)—Faradisation.

(*a.*) Connect the battery wires (fig. 100) to P' (+) and P'' (-). Introduce a Du Bois key as for the make and break arrangement. The automatic vibrating spring, or Neef's hammer, is now included in the primary circuit. Set the spring vibrating. Close the key in the primary circuit. The spring, H, is attracted by the temporary magnet, B', thus breaking the contact between the spring, H, and the screw, S', and causing a break shock in the secondary coil. B' is instantly demagnetised, the spring recoils and makes connection with S', and causes a make shock. Thus a series of make and break induction shocks following each other with great rapidity is obtained, but the make and break shocks are in alternately opposite directions.

(b.) **Effect on Tongue.**—While Neef's hammer is vibrating, apply the electrodes to the tongue as before, noting the effect produced and how it varies on altering the distance between the secondary and primary coils.

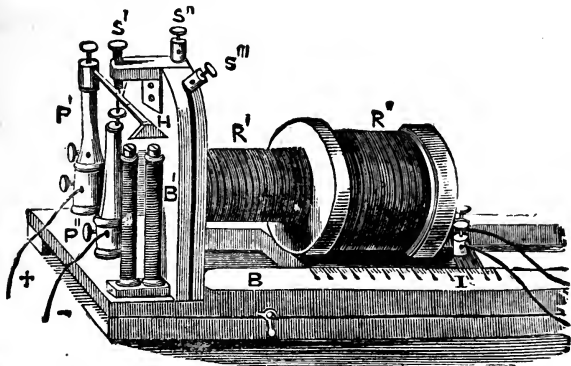

FIG. 100. —Induction Coil arranged for interrupted or repeated shocks, with Neef's Hammer in the Primary Circuit.

(c.) Note also how the strength of the induced shocks varies with the angular deviation of the secondary spiral, the distance between the two spirals being kept constant (p. 172).

3. The Break Extra-Current of Faraday.—When a galvanic current traversing the primary coil of an induction machine is made or broken, each turn of the wire exerts an inductive influence on the others. When the current is *made*, the direction of the extra-current is *against* that of the battery current, but at *break* it is in the same direction as the battery current. **Apparatus.**—Daniell's cell, two Du Bois keys, five wires, primary coil of induction coil, electrodes (or nerve-muscle preparation).

(a.) Arrange the apparatus according to the scheme (fig. 101). Notice that both keys and the primary coil of the induction machine are in the primary circuit, the keys being so arranged that either the primary coil, P, or the electrodes attached to key K', can be short-circuited.

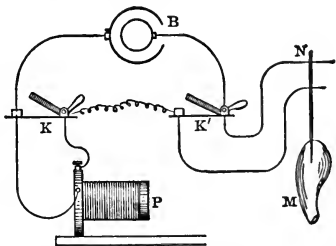

FIG. 101.—Scheme of the Break Extra-Current B. Battery; K. and K'. Keys; P. Primary coil; N. Nerve; M. Muscle.

FIG. 101.—Scheme of the Break Extra-Current B. Battery; K. and K'. Keys; P. Primary coil; N. Nerve; M. Muscle.

(b.) Test (a) either by electrodes applied to the tongue, or (β) by means of a nerve-muscle preparation (β to be done after the student has learned how to make a nerve-muscle preparation).

(c.) Close the key K, thus short-circuiting the coil. Open and close key K'. There is very little effect.

(d.) Open K, the current passes continuously through the primary coil. Open key K'; a marked sensation is felt, due to the break extra-current.

4. Helmholtz's Modification.—The break shock is stronger than the make, and to equalise them Helmholtz devised the following modification:—

(a.) Connect the battery wires as before to the two pillars (fig. 100), P' and P'', or to *a* and *e* (fig. 102). In fig. 102 connect a wire—"Helmholtz's side wire"—from *a* to *f*, thus bridging or "short-circuiting" the interrupter. Elevate the screw (*f*) out of reach of the spring (*c*), but raise the screw (*d*) until it touches the spring at every vibration. By this means the make and break shocks are nearly equalised. Test this on the tongue. Both shocks, however, are weaker, so that it is necessary to use a stronger battery. The primary circuit is never entirely broken, it is merely weakened.

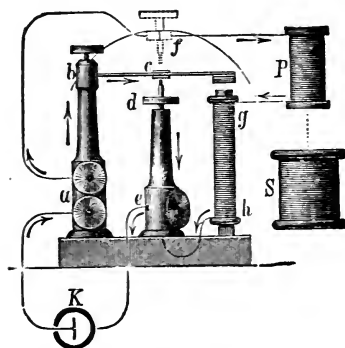

FIG. 102. — Helmholtz's Modification of Neef's Hammer. As long as *c* is not in contact with *d*, *g h* remains magnetic; thus *c* is attracted to *d*, and a secondary circuit, *a, b, c, d, e*, is formed; *c* then springs back again, and thus the process goes on. A new wire is introduced to connect *a* with *f*. K. Battery.

It is always advantageous, when using faradic shocks for physiological purposes, to use make and break shocks of nearly equal intensity, *i.e.*, use Helmholtz's side wire. Why?

Because any "polarisation" produced by the one current is neutralised by the other. This is not the case with the ordinary arrangement, where the break shock is stronger than the make, whereby there is a progressive summation of the polarisation effects of the break shocks.

5. To Approximately Equalise Single Make and Break Induction Shocks.

As we have seen, the extra-current is the cause of the greater intensity of the break shock. If, however, the intensity of the

extra-current be the same at make and break, this inequality will disappear.

(a.) Connect the terminals of a Daniell's cell with the top binding screws of an induction coil, as in fig. 103, and to the

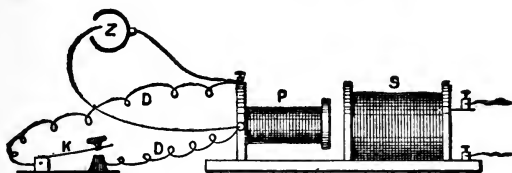

FIG. 103.—Arrangement to approximately equalise M. and B. shocks. P. Primary, S. Secondary coil; K. Key in deriving circuit, D. D.

same induction coil terminals connect two other wires with a make and break key (K) in their circuit ("deriving circuit," D, D). Thus the primary current is never broken.

(b.) Arrange the secondary coil with short-circuiting key and electrodes.

(c.) On closing the key in the deriving circuit the current in the primary coil is diminished, and on opening it the primary current is increased. Induced currents of opposite directions are thereby produced, which, though weaker than the make induction shock, are approximately equal to each other.

6. To Eliminate either M. or B. Shocks.—For this purpose the "Rotating Key" devised by Gregor Brodie is most useful. It consists of a horizontal axis supported on two ebonite uprights fixed to an ebonite base (fig. 104).

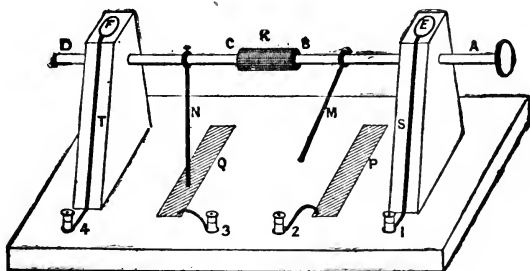

FIG. 104.—Brodie's "Rotating Key" to eliminate the M. or B. shock.

This axis consists of two metal rods, A B and C D, united together by an insulating piece of ebonite, K. A B passes through a cup, E, cut in the upright and filled with mercury. The other rod, C D, is similarly connected to the

second upright. Two stout wires, S, T, lead from the two mercury cups, E, F, to two binding screws, 1 and 4 respectively. Attached to the two rods are two metal arms, M and N, which can be rotated round the rods and clamped in any position. These dip into two mercury troughs, P and Q, which are respectively attached by stout wire to two binding screws, 2 and 3.

The action for which the key was devised is as follows :--

The primary circuit is connected with the two screws 3 and 4 ; the secondary and a pair of electrodes with the screws 1 and 2. Then, as the axis, A D, is rotated, the arm, M, first dips into the trough, P, and the secondary circuit is thereby short-circuited, and remains so during the whole time the arm, M, is in the mercury. While this is still in the mercury the second arm, N, enters the mercury, Q, and the primary circuit is thus closed, but, as the secondary is short-circuited, the make induced current does not reach the electrodes. On rotating a little further, the arm, M, leaves the mercury, and shortly after the arm, N, leaves the mercury, Q, and the current is broken. The break induced current can now pass through the electrodes since the secondary circuit is not now short-circuited.

By reversing the rotation only make shocks can pass through the electrodes, the break shocks being short-circuited.

The key may also be used in other ways. By placing the two arms, M and N, parallel to one another, the key may be used to close two circuits simultaneously, *e.g.*, a primary current, and a current working a signal.

Further, by altering the angular distance between M and N, and having the axis driven at a constant rate, the key may be used for sending in two successive stimuli at different intervals of time.

LESSON XXIX.

PITHING—CILIARY MOTION—NERVE-MUSCLE PREPARATION—NORMAL SALINE.

1. Pith a Frog.—Wrap the body, fore and hind legs, in a towel, leaving the head projecting. Grasp the towel enclosing the frog with the little, ring, and middle fingers and thumb of the left hand, leaving the index-finger free. With the index-finger bend down the frog's head over the radial surface of the second finger until the skin over the back of the neck is put on the stretch. With the nail of the right index-finger feel for a depression where the occiput joins the atlas, marking the position of the occipito-atlantoid membrane. With a sharp, narrow knife held in the right hand, divide the skin, membrane, and the medulla oblongata. Withdraw the knife, thrust a "seeker" into the brain cavity through the opening just made, and destroy the brain. To prevent oozing of blood, a piece of a wooden match may be thrust into the brain cavity. If it is desired, destroy also the spinal cord with the seeker or a wire. The knife used must not have too broad a

blade, else two large blood-vessels will be injured. The operation should be performed without losing any blood.

2. Ciliary Motion.

(a.) Destroy the brain and spinal cord of a frog. Place the frog on its back on a frog-plate covered with cork well-waxed or coated with paraffin. Divide the lower jaw longitudinally, and carry the incision backwards through the pharynx and œsophagus. Pin back the flaps. Moisten the mucous membrane, if necessary, with normal saline.

(b.) Make a small cork flag, and rest it on the mucous membrane covering the hard palate between the eyes. It will be rapidly carried backwards by ciliary motion towards the stomach. Repeat the experiment, and determine the time the flag takes to travel a given distance.

(c.) Apply heat to the preparation, and observe that the cork travels much faster.

(d.) Grains of charcoal or Berlin blue are carried backwards in a similar manner.

(e.) With a hot wire cauterise superficially a small area of the mucous membrane in a preparation bestrewn with grains of charcoal. The ciliary movement stops not only at the cauterised area, but also in a triangular area whose apex is at the burned point, and whose base is directed towards the œsophagus. It would seem, therefore, that the movements of the cilia in individual cells are not independent of the movements in neighbouring cells.

3. **Anatomy of the Nerve-Muscle Preparation.**—Before making this preparation, the student must familiarise himself with the anatomy of the hind limb of the frog. On a dead frog study the arrangement of the muscles, as shown in fig. 105. The skin of the frog is removed, the frog placed on its belly, and the muscles viewed from behind. On the outside of the thigh, the *triceps femoris* (*tr*), composed of the *rectus anterior* (*ra*), the *vastus externus* (*ve*), and the *vastus internus*, not seen from behind. On the median side, the *semi-membranosus* (*sm*), and between the two the small narrow *biceps* (*b*). The biceps is readily observed, at the lateral margin of the large semi-membranosus, by its shining tendon in the middle of the lower half of the thigh. Notice, also, the *coccygeo-iliacus* (*ci*), the *gluteus* (*gl*), the *pyriformis* (*p*), and the *rectus internus minor* (*ri*). In the leg, the *gastrocnemius* (*g*), with its tendo Achillis, the *tibialis anticus* (*ta*), and the *peroneus* (*pe*).

4. Make a Dissection.

(a.) Remove the skin from the leg of a dead frog; with a blunt needle, called a "seeker" or a "finder," or a glass rod drawn out to

a point, gently tear through the fascia covering the thigh muscles, and with the blunt point of the finder separate the semi-membranosus from the biceps, and in the interval between them observe the *sciatic nerve* and the *femoral vessels*. Carefully isolate both, beginning at the knee, where the nerve divides into two branches—the tibial and peroneal—and work upwards (fig. 106).

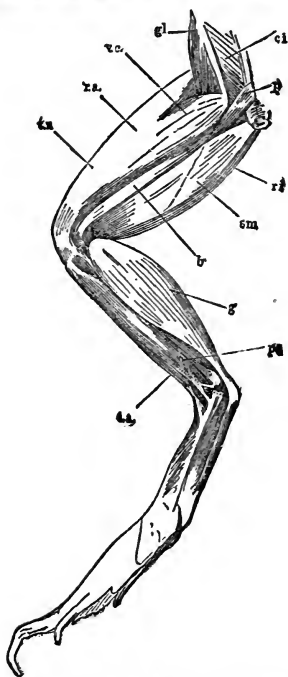

FIG. 105.—The Muscles of the Left Leg of a Frog from behind. *ci*. Coccygo-iliacus; *gl*. Gluteus; *p*. Pyriformis; *ra*. Rectus anterior; *ve*. Vastus externus; *tr*. Triceps; *ri*. Rect. int. minor; *sm*. Semi-membranosus; *b*. Biceps; *g*. Gastrocnemius; *ta*. Tibialis anticus; *pe*. Peroneus.

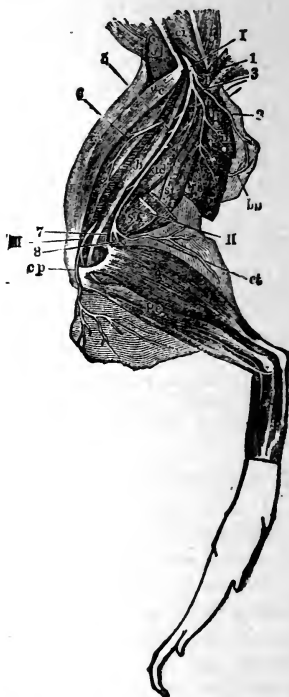

FIG. 106.—Distribution of the Sciatic Nerve (I.) of the Frog (see also fig. 105). *st*. Semitendinosus; *ad* Adductor magnus; (II.) its tibial, and (III.) peroneal divisions.

The tibial branch passes over the knee-joint towards the middle line, and enters the under surface of the gastrocnemius; the peroneal branch passes between the lateral tendinous origin of the gastrocnemius and the tendon of the biceps, and then under the latter.

(b.) Follow the nerve right upwards to its connection with the vertebral column, and observe that it is necessary to divide the

pyriformis (*p*), and also the ilio-coccygeal muscle, when the three spinal nerves—the 7th, 8th, and 9th—which form the sciatic nerve, come into view. It can be seen from the abdominal side after opening the belly and removing the viscera, including the kidneys. On its way from the sacral plexus to the thigh, it gives off cutaneous and muscular branches for the pelvis and thigh.

5. Double Semi-Membranosus and Gracilis (*Fick's Method*).—I am indebted to Prof. Fick and Dr Schenk of Würzburg, for showing me the method of preparing this—one of the most convenient of preparations.

(*a.*) After pithing a frog, and removing its skin to expose the muscles of the hind limbs, remove the few fibres of the rectus internus minor which are torn across when the skin is torn off. Divide the fascia at the outer margins of the semi-membranosus and gracilis, until the insertion of these two muscles into the knee is reached, then, with strong scissors, divide the leg bone just under the knee-joint, so that the osseous insertion of both muscles is retained. Divide the femur just above the knee-joint, and separate all the muscles inserted into it, save the two muscles one is isolating. Separate the two muscles from the other muscles of the thigh up to the symphysis. Leave the two muscles in connection with the symphysis, divide the other muscles, disarticulate the femur at the acetabulum. In preparing the muscles in this way the semi-tendinosus, which lies between the two on the side towards the bone, is usually left. It is easy to separate it by dividing its insertion into the femur, and then its two heads at the pelvis.

(*b.*) Make a similar dissection on the opposite side. Bore a hole with an awl through both acetabula. Through this a hook can be placed.

Thus we have two muscles with nearly straight fibres which can be placed "side by side," thus giving a short muscle with great sectional area, or they can be placed "one behind the other," a piece of bone, the symphysis intervening, thus giving a long muscle with half the sectional area. This preparation is extensively used by Prof. Fick, and has many advantages.

6. Indifferent Fluids—Normal Saline.—Dissolve 6 grams of dried sodic chloride in 1000 cc. of water. This is the best fluid to use to moisten tissues when a large quantity is required. For nerve the aqueous humor of the frog's eye is the best. It can readily be obtained by perforating the cornea with a fine glass pipette.

LESSON XXX.

NERVE-MUSCLE PREPARATION — STIMULATION OF NERVE—MECHANICAL, CHEMICAL, AND THERMAL STIMULI.

1. Nerve-Muscle Preparation. — Apparatus. — Frog, seeker, narrow-bladed scalpel, a small and a large pair of scissors, forceps, towel, and a porcelain plate.

(*A.*) (*a.*) Pith a frog, destroying the brain and spinal cord, and place the frog on its belly on a frog-plate. With scissors make an

incision through the skin along the back of one thigh—say the left—from the knee to the lower end of the coccyx, and prolong the incision along the back a little to the left of the urostyle. Reflect the skin, and expose the muscles shown in fig. 105.

(b.) Gently separate the semi-membranosus and biceps with the "seeker," and bring into view the sciatic nerve and femoral vessels. Some use a glass rod drawn to a thin prolonged point, instead of a "seeker." Still working with the seeker and beginning near the knee, clear the sciatic nerve, but do not scratch or stretch the nerve, or touch it with forceps. Divide the pyriformis and ilio-coccygeus, and trace the nerve up to the vertebral column.

(c.) Divide the spinal column above the seventh lumbar vertebra; seize the tip of the urostyle with forceps, raise it, and with the strong scissors cut it clear from all its connections as far as the last lumbar vertebra, and then divide the urostyle itself. Divide the left iliac bone above and below, and remove it with the muscles attached to it. The lumbar plexus now comes into view. Bisect lengthways the three lower vertebræ, and use the quadrilateral piece of bone by which to manipulate the nerve. With forceps lift the fragment of bone, and with it the sciatic nerve; trace the latter downwards to the knee, dividing any branches with fine scissors. Keep the parts moist with normal saline.

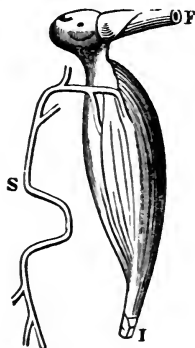

FIG. 107. — Nerve - Muscle Preparation. *S.* Sciatic nerve—the fragment of the spinal column is not shown; *F.* Femur; and *I.* Tendo Achillis.

(d.) Divide the skin over the gastrocnemius, and expose this muscle. Divide the tendo Achillis below its fibro-cartilage, lift the tendon with forceps and detach the gastrocnemius from its connections as far up as the lower end of the femur. Cut across the knee-joint, and remove the tibia and fibula with their attached muscles. Taking care to preserve the sciatic nerve from injury, clear the muscles away from the lower end of the femur, and then divide the femur itself about its middle. This preparation (fig. 107) consists of the gastrocnemius, and the whole length of the sciatic nerve, to which is attached a fragment of bone, by which the preparation can be manipulated

without injuring the nerve. *N.B.*—The nerve must not be touched with instruments, neither stretched nor scratched, nor allowed to come into contact with the skin, and it must be kept moist with normal saline.

(B) (a.) Another method is sometimes adopted. Destroy a frog's brain and spinal cord. With the left hand seize the hind limbs and hold the frog

with its belly downwards. With one blade of a sharp-pointed pair of scissors transfix the body immediately behind the shoulder-blades, and divide the spinal column. The head now hangs down, and by its weight it pulls the ventral from the dorsal parts.

(b.) With the scissors divide the wall of the abdomen on both sides parallel to the vertebral column, and remove the abdominal viscera. With the left hand seize the upper end of the divided spinal column, and with the right the skin covering it, and pull. The lower end of the trunk and the lower limbs are denuded of skin.

(c.) Take the thigh muscles between the thumb and forefinger of the left hand, and with the point of one blade of a pair of scissors tear through the fascia between the biceps and semi-membranosus to expose the sciatic nerve, and then proceed as directed in 1.

2. Stimuli may be classified as follows:—

(1.) Mechanical, *e.g.*, cutting or pinching a nerve or muscle.

(2.) Chemical, *e.g.*, by dipping the end of a nerve in a saturated solution of common salt or glycerin.

(3.) Thermal, *e.g.*, applying the end of a heated wire to the nerve.

(4.) Electrical— $\left\{ \begin{array}{l} (a.) \text{ Continuous current.} \\ (b.) \text{ Single induction shocks.} \\ (c.) \text{ Interrupted current or repeated shocks.} \end{array} \right.$

3. Stimulation of Muscle and Nerve.—It is convenient to modify somewhat the physiological limb, in order to render the muscular contraction more visible. Apparatus.—Seeker, scalpel, scissors, forceps, straw flag, pins, muscle-forceps, camel's-hair brush, saturated solution of common salt in a glass thimble, ammonia, copper wire, spirit lamp or gas-flame.

4. Mechanical Stimulation.

(a.) Destroy the brain and spinal cord of a frog (Lesson XXX. 1). Prepare a nerve-muscle preparation, isolating the sciatic nerve, but modify the subsequent details as follows:—

(b.) After the nerve is cleared as far as the spine, clear the muscles away from the femur, and divide the latter about its middle. Divide the sciatic nerve as high up as possible. Pin a straw flag to the toes by means of two pins. Fix the femur in a clamp or pair of muscle-forceps, supported on a stand (fig. 108), taking care that the gastrocnemius is upwards. The nerve hangs down, and must be manipulated with a camel's-hair brush dipped in normal saline, or by means of a hooked glass rod.

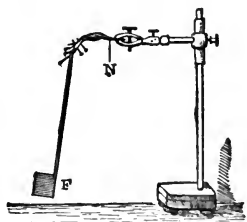

FIG. 108.—Straw Flag attached to a Frog's Leg fixed in a Clamp. N. Nerve; F. Flag.

(c.) Pinch the free end of the nerve sharply with forceps; the muscles contract and the straw flag is suddenly raised. Cut off the dead part of the nerve, contraction also occurs.

(d.) Prick the muscle with a needle; it contracts.

For the purposes of the student it is sufficient to expose one sciatic nerve *in situ*, and observe the movements of the foot and leg.

Mechanical stimulation is rarely employed, as the part stimulated is apt to be injured by the stimuli. Heidenhain in 1856 devised what he called a Tetanomotor for this purpose. It consisted of a Wagner or Neef's hammer, with one end prolonged and carrying a small ivory hammer, which beat the nerve placed under it. Recently v. Uexküll has devised apparatus for this purpose (*Zeits. f. Biol.*, Bd. xxxi.).

(e.) Mechanical Stimulation by removal of pressure.—Place the nerve of a nerve-muscle preparation on a moist glass plate, press the nerve slowly and steadily with a curved 1 mm. thick glass hook. If pressure be applied steadily and uniformly the nerve is not excited, but on suddenly removing the pressure the muscle contracts (v. Uexküll).

5. Thermal Stimulation.

(a.) To the same preparation apply, either to muscle or nerve, a wire or needle heated to a dull heat; a contraction results in either case. Cut off the dead part of the nerve.

6. Chemical Stimulation.

(a.) Place saturated solution of common salt in a glass thimble, or on a glass slide, and allow the free end of the nerve to dip into it. Owing to the high specific gravity of the saline solution, the nerve floats on the surface, but sufficient salt diffuses into the nerve to stimulate it. After a few moments, the joints of the toes twitch, and by-and-by the whole limb is thrown into irregular, flickering spasms, which terminate in a more or less continuous contraction, constituting *tetanus*. Cut off the part of the nerve affected by the salt; the spasms cease. Some apply finely powdered salt to the nerve, others glycerin.

(b.) Using a similar preparation, cover the leg with the skin of the frog, or wrap it in blotting-paper saturated with normal saline. Expose the fresh-cut end of the nerve to the vapour of strong ammonia. The ammonia must not act directly on muscle, hence the glass vessel must be placed above the nerve, and the nerve raised to the ammonia. There is no contraction of the muscle, but the ammonia kills the nerve.

Instead of doing this, the whole leg may be laid on a card, covered with blotting-paper moistened with normal saline, with a hole in it just sufficient to allow the sciatic nerve to pass through it. The card is placed over a test-tube containing a drop of ammonia; the nerve hanging in the vapour of the latter is speedily killed, but there is no contraction of the muscle. Apply ammonia to the muscle; it contracts.

Note that although ammonia applied directly to a motor nerve does not cause contraction of the corresponding muscle, yet when it is applied to the central end of the divided vagus of a rabbit it causes marked reflex movements of the respiratory muscles.

7. Drying.—If the nerve be allowed to hang freely in the air for some time, it gradually dries, and the muscles twitch irregularly, as when a nerve is stimulated chemically. Moisten the nerve with normal saline and the twitching *may* cease. It may be that glycerin acts as a stimulus through absorbing water.

LESSON XXXI.

SINGLE AND INTERRUPTED INDUCTION SHOCKS —TETANUS—CONSTANT CURRENT.

1. Electrical Stimulation—Single Induction Shocks.—Apparatus.—Daniell's cell, induction machine, two Du Bois keys (or one spring key or mercury key and one Du Bois key), five wires, electrodes.

(a.) Arrange a cell and induction machine for single induction shocks as in fig. 109. A spring contact-key or Hg-key is more

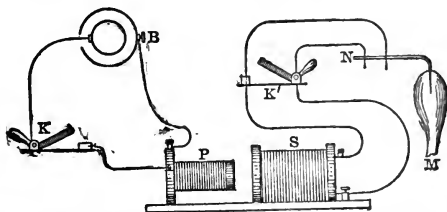

FIG. 109.—Scheme for Single Induction Shocks. B. Battery; K, K'. Keys; P. Primary, and S. Secondary coil of the induction machine; N. Nerve; M. Muscle.

convenient in the primary circuit. Electrodes are fixed to the short-circuiting key (K') in the secondary circuit, and over them the nerve is to be placed.

(b.) Expose the sciatic nerve in a pithed frog, place it on electrodes—preferably a pair fixed in ebonite, and so shielded that only one surface of their platinum terminals is exposed under it. Or use the simple shielded electrodes described in Lesson XXVII. 6. Pull the secondary coil (S) far away from the primary (P), raise the short-circuiting key (K'), make and break the primary circuit

by means of the key (K). At first there may be no contraction, but on approximating the secondary to the primary coil a single muscular contraction will be obtained, first with the break shock, and on approaching the secondary nearer to the primary coil, also with the make. The one is called a make and the other a break contraction. Enter in a note-book the results obtained. *N.B.*—In all cases the student should keep an account of the experiment, and especially of all numerical data connected therewith, *e.g.* :—

*Single make and break shocks—Du Bois inductorium with
I Daniell.*

Distance of Primary from Secondary Circuit in cm.	Response at Make (M).	Response at Break (B).
45	o	o
44	o	Min. twitch.
43	o	Slight "
42	o	Stronger "
41	o	" "
20	o	Max. "
19	Slight twitch.	" "
18	Max. "	" "

Compare Ordinary with Helmholtz Arrangement, and tabulate the results as follows, to show the distance of the secondary coil at which mechanical response first occurs.

	Ordinary Du Bois-Reymond Coil.	With Helmholtz's Modification.
Nerve make, .		
„ break, .		

The same may be done by applying the electrodes directly to the gastrocnemius muscle, *i.e.*, direct stimulation, that through the nerve being indirect stimulation.

	Ordinary Du Bois-Reymond Coil.	With Helmholtz's Modification.
Muscle make, .		
„ break, .		

2. Interrupted Current or Repeated Shocks.

(a.) Arrange the induction machine so as to cause Neef's hammer to vibrate as directed in Lesson XXVIII. 2. On applying the electrodes to the sciatic nerve or gastrocnemius muscle, at once the muscle is thrown into a state of rigid spasm or continuous contraction, called **tetanus**, this condition lasting as long as the nerve or muscle is stimulated, or until exhaustion occurs.

3. Constant Current.—Apparatus.—Daniell's cells, Du Bois key (or, preferably, a simple make and break key), four wires, electrodes, forceps, and nerve-muscle preparation, or simply expose the sciatic nerve *in situ*.

(a.) Use two Daniell's cells. If two or more Daniell's cells be used, always connect them in series, *i.e.*, the + pole of one cell with the - pole of the next. Connect two wires, as in fig. 110, to the free + and - poles of the battery B, and introduce a Du Bois key (K') to short-circuit the battery circuit. Fix two shielded electrodes in the other binding-screws of the Du Bois key, and having prepared a nerve-muscle preparation, lay the divided sciatic nerve (N) across them, as shown in fig. 110. A simple key to make or break the current is preferable to the short-circuiting key, as the latter allows polarisation currents to pass when it is closed.

(b.) Make and break the current, and a **single muscular contraction** or **twitch** is obtained, either at making or breaking, or both at making and breaking. Notice that if the key be raised to allow the current to flow continuously through the nerve, no contraction occurs, provided there be no variation in the intensity of the current. The electrodes may also be applied to the muscle directly.

(c.) Rapidly make and break the current by opening and closing the key; a more or less perfect *tetanus* is produced.

(d.) If it be desired to test the effect of a constant current on muscle alone, then the terminations of the motor nerves in the muscle must have been paralysed previously by curare, so that in this case the electrodes must be applied directly to the muscle.

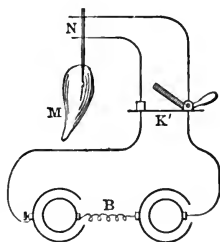

FIG. 110.—Scheme of Constant Current. B, Battery; K', Short-circuiting key; N, Nerve; M, Muscle.

4. Muscle on Mercury.—Lay the muscle of a nerve-muscle preparation on the surface of mercury. Stimulate the nerve, the

muscle contracts, but does not elongate: it shows little tendency to elongate unless it be weighted.

5. **Dead Muscle and Nerve.**—Immerse a nerve-muscle preparation for a few minutes in water at 40° C. Both are killed, and none of the above stimuli cause contraction.

6. **The Sartorius.**—One gets a clear idea of the shortening and thickening which occur when a muscle contracts by using the sartorius, as its fibres are arranged in a parallel manner.

(a.) Pith a frog, lay it on its back, and dissect off the long narrow sartorius from the inner side of the thigh. The thin narrow sartorius (fig. 111) stretching from the ilium to the tibia is best seen if it be moistened with blood, which differentiates its edges. To isolate the sartorius the best way is to cut the other parts away from it. Raise its tibial tendon, and round it tie a fine silk thread. Gradually raise the muscle by means of the thread, and with fine scissors cut it free from its fascial connections right up to the ilium. Cut it out with the ilium attached. Its nerve enters it on its under surface about the middle of the muscle. When it is divided the muscle contracts. Stretch it on a slip of glass or hang it up by its ilium bony attachment in a clamp.

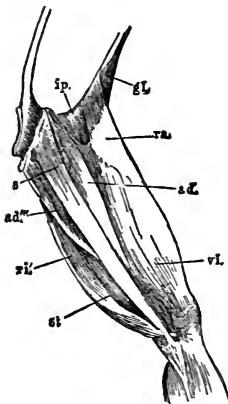

FIG. 111.—Muscles of the Left Leg of a Frog seen from the Front. *ip.* Ileo-psoas; *s.* Sartorius; *ad.* Adductor longus; *vi.* Vastus internus. (See figs. 105 and 106.)

(b.) Stimulate the muscle first at its ends and afterwards at its centre or equator, as in Lesson XXXI. 1, 2, with (i.) a single induction shock, and (ii.) afterwards with an interrupted current. Observe the shortening and thickening, which are much greater in (ii.) than (i.). The muscle may be extended again, and stimulated as frequently as desired, if it be kept moist.

7. **Unipolar Stimulation.**—**Apparatus.**—Daniell's cell, induction machine, Du Bois keys, (muscle-chamber), wires, electrodes.

A. (a.) Expose the sciatic nerve of a frog, and place the frog on a dry cork plate, or glass, or block of paraffin. Arrange an induction apparatus for faradisation with the electrodes short-circuited, and placed under the sciatic nerve clear of all adjoining muscles. Open the short-circuit key and find a strength of current (secondary coil at 25–30 cm.) which on faradisation gives feeble tetanus.

(b.) Disconnect one of the electrode wires from the preparation, so that only one terminal is in connection with the nerve. There is no contraction when the secondary key is open. Insulate the preparation by placing it on a block of paraffin or on a dry beaker.

(c.) Try to find the distance of the secondary coil (8–10 cm.)

at which no response is obtained with unipolar stimulation, but a response is obtained when the preparation is touched with finger. Why is there a response? Because by touching the preparation one suddenly diminishes the resistance to the passage of the induction currents to earth.

Or B. (a.) Set up a cell and induction coil with electrodes for single shocks. Disconnect one of the electrodes of the secondary coil, the other one being under the sciatic nerve or the nerve of a nerve-muscle preparation which is insulated on a glass plate. If the frog is on a frog-plate put the frog-plate on a dry beaker to insulate it. No contraction occurs at make or break.

(b.) Connect the disconnected electrode to a gas-pipe and so to the earth. Contraction takes place at make or break. It is in order to avoid unipolar stimulation that the Du Bois key is used to short-circuit the secondary circuit.

Or C. (a.) Connect the Daniell to the primary coil of the induction machine either for single shocks or tetanus, introducing a Du Bois key in the circuit. Connect one wire with the secondary coil, and attach it to one of the binding screws on the platform of the muscle-chamber, to which the nerve electrodes are attached. See that the battery and induction machine are perfectly insulated by supporting them on blocks of paraffin.

(b.) Prepare a nerve-muscle preparation, and arrange it in the muscle-chamber in the usual way, laying the nerve over the electrodes. One of the electrodes will therefore be connected with the secondary circuit.

(c.) Make and break the primary circuit; there is no contraction.

(d.) Destroy the insulation of the preparation by touching the muscle, or what does better, allow the brass support of the muscle to touch a piece of moist blotting-paper on the inner surface of the glass shade of the chamber. Every time the brass binding of the shade is touched, or the brass support itself, the muscle contracts. Touch the secondary coil and contraction results.

LESSON XXXII.

RHEONOME—TELEPHONE EXPERIMENT—DIRECT AND INDIRECT STIMULATION OF MUSCLE—RUPTURING STRAIN OF TENDON—MUSCLE SOUND—DYNAMOMETERS.

1. Fleischl's Rheonome and Law of Excitation.—This instrument (fig. 112) is useful for showing Du Bois-Reymond's law, that it is not the absolute intensity of a galvanic current flowing through a nerve which excites it, but the rapidity of the variations in the intensity of the current which excite a motor nerve. It

consists of a square ebonite base, with a grooved circular channel in it, and two binding screws, with zinc attached, and bent over so as to dip into the groove, which is filled with a saturated solution of zinc sulphate. A vertical arm, with binding screws attached to two bent strips of zinc, moves on a vertical support. It is a kind of revolving rheochord.

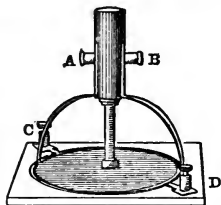

FIG. 112.—Fleischl's Rheonom.

(a.) Connect two or three Daniell's cells (copper to zinc) with the binding screws A and B, introducing a Du Bois key in one wire. Attach the electrodes, introducing a Du Bois key to short-circuit them, to the binding screws, C and D. Fill the groove with a saturated solution of zinc sulphate.

(b.) Arrange the nerve of a nerve-muscle preparation over the electrodes, or simply expose the sciatic nerve of a frog *in situ*. Pass a constant current through the nerve, observing the usual effects, viz., contraction at make or break, or both, but none when the current is passing. Then suddenly rotate the handle with its two zinc arms; this is equivalent to a sudden variation of the intensity of the current; the current, of course, continuing to pass all the time. The muscle suddenly contracts.

When the two ends of the zinc arc stand as in the fig., *i.e.*, opposite C and D, then, on closing the current, most of the current goes through the zinc arc to the preparation, and only a small part through the zinc sulphate solution from C to D. Thus the muscle contracts according to the direction and intensity of the current, either on closing or opening the key, or at both. Turn the handle so that the zinc arc is vertical to a line joining C and D. There is no current, so that the preparation does not respond either on closing or opening.

If, while the zinc arc is in this position, the circuit be closed, and the zinc arc suddenly rotated into the position of the line C, D, the muscle contracts, provided in the first experiment a closing, *i.e.*, make, contraction was obtained. If it be rotated slowly then there is no response. Thus one can allow the current to glide or slide into the nerve ("*einschleichen*") without causing excitation.

2. Direct and Indirect Stimulation of Muscle.—When the stimulus is applied directly to the muscle itself, we have **direct stimulation**; but when it is applied to the nerve, and the muscle contracts, this is **indirect stimulation** of the muscle.

(i.) *Induced Current.*—(a.) Arrange a nerve-muscle preparation, and an induction machine for single or repeated shocks (Lesson XXXI. 1).

(b.) Test first the strength of current—as measured by the distance between the secondary and primary coils—which causes

the muscle to contract when the stimulus is applied to the nerve, *i.e.*, for indirect stimulation.

(c.) Then with the secondary still at the same distance from the primary, try if a contraction is obtained on stimulating the muscle directly. It will not contract; but make the current stronger, and it will do so. The excitability of muscle to direct stimulation is best done after the nerve-terminations have been paralysed by curare (Lesson XXXIII.).

(ii.) *Constant Current.*—Connect the electrodes with two Daniell's cells, placing a Hg-key in the circuit. Place the electrodes under the nerve. Contraction occurs at make only, and at break only if the preparation is very excitable, but there is no contraction when the current is passing through the nerve.

ADDITIONAL EXERCISES.

3. Muscle Sound.

(a.) Insert the tips of the index-fingers into the auditory meatuses, forcibly contracting the biceps muscles. A low rumbling sound is heard.

(b.) When all is still at night, firmly close the jaws, and, especially if the ears be stopped, the sound is heard.

4. Telephone Experiment.

(a.) Arrange a nerve-muscle preparation with its nerve over a pair of electrodes. Connect the latter with a short-circuiting Du Bois key. To the key attach the two wires from a telephone.

(b.) Open the short-circuiting key; shout into the telephone, and observe that on doing so the muscle contracts vigorously.

5. Rupturing Strain of Muscle and Tendon.

(a.) Dissect out the femur and gastrocnemius with the tendo Achillis of a frog. Fix the femur in a strong clamp on a stand, preferably one with a heavy base. To the tendo Achillis tie a short stout thread, and hang a scale-pan on to it.

(b.) Place weights in the scale-pan, and note the weight required to rupture the tendon or muscle. Usually the muscle is broken. The weight added will be 1 kilo., more or less, according to the size of the frog.

(c.) Compare the rupturing strain of a frog's gastrocnemius which has been dead for forty-eight hours. A much less weight is required.

6. Dynamometers.

(a.) *Hand.*—Test the force exerted first by the right hand and then by the left, by means of Salter's dynamometer.

(b.) *Arm.*—Using one of Salter's dynamometers, test the strength of the arm when exerted in pulling, as an archer does when drawing a bow.

LESSON XXXIII.

INDEPENDENT MUSCULAR EXCITABILITY—ACTION OF CURARE—ROSENTHAL'S MODIFICATION—POHL'S COMMUTATOR.

1. Independent Muscular Excitability and the Action of Curare.—Curare paralyzes the intra-muscular terminations of the motor nerves.—Apparatus.—Daniell's cell, induction machine, two keys, five wires, shielded electrodes, scissors, fine-pointed forceps, fine aneurism-needle, or fine sewing-needle fixed in a handle, with the eye free to serve as an aneurism-needle, fine threads, pithing-needle, 1 per cent. watery solution of curare, hypodermic syringe or glass pipette.

(a.) Arrange the battery and induction machine for an interrupted current with a key in the primary circuit, and a Du Bois key to short-circuit the secondary, as in Lesson XXXI. 2.

(b.) Destroy the brain of a frog, and by means of a hypodermic syringe or a fine glass pipette inject into the ventral or dorsal lymph-sac two drops of a 1 p.c. watery solution of curare. [The curare of commerce is only partly soluble in water, but its active constituent curarin is. Rub up 1 gram curare in 100 cc. water and filter]. The poison is rapidly absorbed. At first the frog draws up its legs, in a few minutes it ceases to do so, and will lie in any position in which it is put, while the legs are not drawn up on being pinched, and the animal lies flaccid and paralysed.

(c.) Expose the heart, and observe that it is still beating.

(d.) Expose one sciatic nerve.

(i.) Stimulate the sciatic nerve with interrupted shocks (faradisation); there is *no contraction*.

(ii.) Apply the electrodes to the muscles; they *contract*.

Therefore curare has paralysed some part of the motor nerves, but not the muscles.

In curare poisoning the nerve-trunk itself is not inexcitable, but the nerve-endings in the skeletal muscles are so affected, *i.e.*, paralysed, as to prevent the excitatory state of the nerve being propagated from the nerve to the muscle. The following experiment proves this:—

2. On what Part of the Motor Nerve does Curare Act?

(a.) Induction apparatus as in the previous experiment.

(b.) Destroy the brain of a frog. Expose the sciatic nerve and the accompanying artery and vein on one side, *e.g.*, the *left*, taking great care not to injure the blood-vessels. Isolate the sciatic

nerve, and then tie a stout ligature round all the other structures of the thigh. In this way none of the poison can pass by a collateral circulation into the parts below the ligature.

(c.) Inject a few drops of a 1 p. c. solution of curare into the ventral lymph-sac. The poison will be carried to every part of the body except the left leg below the ligature. The animal is rapidly paralysed (20-30 mins.), but if the non-poisoned leg (left) is pinched, it is drawn up, while the poisoned leg (right) is not, *i.e.*, there is a reflex movement of the non-poisoned limb, so that the afferent (sensory) nerves, spinal centre and motor nerves are still unaffected.

(d.) Wait until the animal is thoroughly under the influence of the poison, *i.e.*, when all reflexes cease, and then expose *both sciatic nerves* as far up as the vertebral column and as far down as the knee.

(i.) Stimulate the *right* sciatic nerve. There is no contraction. Therefore the poison has acted either on nerve or muscle.

(ii.) Stimulate the *right* gastrocnemius muscle; it contracts. Therefore the poison has acted on some part of the nervous path, but not on the muscle.

(iii.) Stimulate the *left* sciatic *above* the *ligature*; the left leg contracts. The part of the nerve above the ligature was supplied with poisoned blood, so that the nerve-trunk itself is not paralysed, as may be proved by stimulating any part of the *left* sciatic as far down as its entrance into the gastrocnemius. Stimulating any part of the left nerve causes contraction. Therefore neither nerve-trunk nor muscle is affected. The nerve-impulse is blocked somewhere, in all probability by paralysis of the terminations of the motor nerves within the muscle.

(e.) Apply several drops of a strong solution of curare to the *left* gastrocnemius, and after a time stimulate the left sciatic nerve; there is no contraction, but on stimulating the muscle itself contraction takes place.

The independent excitability of muscle is further proved by other experiments, all of which we owe to W. Kühne.

- (1) The Sartorius experiment (p. 191).
- (2) Kühne's Curare experiment (p. 194).
- (3) The Gracilis experiment (Lesson L.).

3. Kühne's Sartorius Experiment.

(a.) Isolate the sartorius (fig. 111) by the method given at p. 186. Suspend the muscle by the thread tied around its tibial attachments, *i.e.*, with its iliac end downwards.

(b.) Allow the iliac end to dip into a drop of pure glycerin placed on a greasy surface. The muscle gives no response. Why?

Because it is devoid of nerve-fibres. Then cut across the muscle about 4 mm. higher up and dip the fresh transverse section into the glycerin. Soon the muscle twitches. Why? As glycerin stimulates nerve and not muscle, there is no response until the glycerin is either directly applied to nerve-fibres, or is diffused so as to affect them.

Kühne used this experiment to demonstrate the independent excitability of muscle and nerve.

4. Comparative Excitability of Muscle and Nerve.

(a.) Prepare a frog as for the curare experiment, *i.e.*, ligature one leg all except the sciatic nerve on that side, then inject curare into a lymph-sac. After the curare has acted, expose both sciatic nerves and both gastrocnemius muscles.

(b.) Note the approximation of the secondary coil to the primary required to obtain a mechanical response or contraction to—

- (i.) Single make induction shocks.
- (ii.) Single break induction shocks.
- (iii.) Faradisation.

When the electrodes are applied to the sciatic nerve of the ligatured limb, *i.e.*, the protected side, tabulate the results.

(c.) Apply the electrodes directly to the gastrocnemius muscle of the opposite side, *i.e.*, the poisoned limb, which is practically nerveless, as curare paralyses the terminations of the motor nerves. It will be found that a stronger shock is required to cause the muscle to contract than is necessary through the intervention of the nerve, *i.e.*, muscle is less excitable than nerve.

Direct Stimulation of Nerveless Muscle.		Distance of Primary from Secondary Coil in cm.		Stimulation of Nerve of Ligatured Limb.	
M.	B.			M.	B.
o	o	22	30	o	C
o	C	21	29	o	C
o	C	20	28	o	C
C	C	19	27	C	C

Faradisation.

Nerveless Muscle.	Distance of P from S.	Ligatured Limb.
o	35	C
o	34	C
o	33	C
C	32	C

5. Pohl's Commutator (fig. 113) is used for sending a current along two different pairs of wires, or for reversing the direction of the current in a pair of wires. It consists of a round or square wooden or ebonite block with six cups, each in connection with a binding screw. Between two of these stretches a bridge insulated in the middle. The battery wires are always attached to the cups connected with this (1 and 2). When it is used to pass a current through different wires, the cross-bars are removed and wires are attached to all six cups, 3 and 4, 5 and 6. On turning the bridge to one side or other, the current is sent through one or other pair of wires. To reverse the direction of a current, only one pair of wires, besides the battery wires, is attached to the mercury cups, e.g., to 3 and 4, or 5 and 6, the cross-bars remaining in.

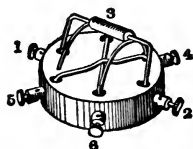

FIG. 113.—Pohl's Commutator with Cross-bars.

ADDITIONAL EXERCISES.

6. Curare and Rosenthal's Modification.

(a.) Prepare a frog as in the previous experiment, ligature the left leg—all except the sciatic nerve—and inject curare. After complete paralysis occurs, dissect out both legs with the nerves attached. Attach straw flags (NP and P) of different colours to the toes of both legs by pins, and fix both femora in muscle-forceps (F) with the gastrocnemii uppermost (fig. 114). Place the nerves (N) on the platinum points of Du Bois-Reymond's electrodes (fig. 98).

(b.) Arrange the induction apparatus as in fig. 114, connecting the terminals of the secondary coil with the piers of a Pohl's commutator (fig. 113) without cross-bars (H). Two other wires pass from two other binding screws of the commutator to the electrodes (N), while two *thin* wires pass from the other two binding screws (C), and their other ends are pushed through the gastrocnemii muscles. The commutator enables the tetanising currents to be passed either through both nerves or both muscles. It is more convenient if the secondary circuit have a key, so that it may be short-circuited when desired.

(i.) Set Neef's hammer going, and turn the handle of the commutator so that the current passes through *both nerves*; only the non-poisoned leg (NP) contracts.

(ii.) Reverse the handle and pass the current through *both muscles*; *both contract*.

(iii.) Rosenthal's Modification.—Push the secondary spiral far away from the primary, and pass the current through *both muscles*. At first, if the coils be sufficiently far apart, there is no contraction in either muscle. Gradually push up the secondary coil, and notice on doing so that *the non-poisoned limb contracts* first, and that, on continuing to push up the secondary coil, both muscles ultimately contract.

7. Action of Curare—Bernard's Method.—Prepare two nerve-muscle preparations, and dip the nerve of one (A) and the muscle of the other (B) into a

solution of curare in two watch-glasses. On stimulating the nerve of A, its muscle contracts; on stimulating the nerve of B, its muscle does not contract,

but the muscle contracts when it is stimulated directly. In A, although the poison is applied directly to the nerve-trunk, the nerve is not paralysed.

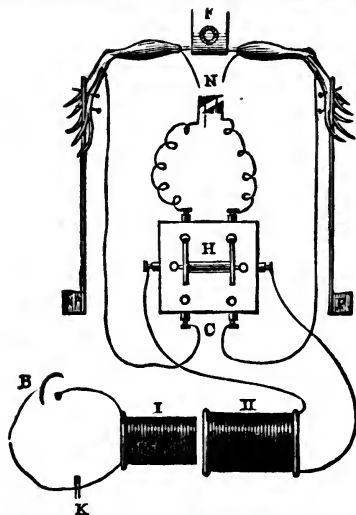

FIG. 114.—Scheme of the Curare Experiment. B. Battery; I. Primary, II. Secondary spiral; N. Nerves; F. Clamp; NP. Non-poisoned leg; P. Poisoned leg; C. Commutator; K. Key. The short-circuiting key in the secondary circuit is omitted in the diagram.

divided muscle the muscle was stimulated directly.

(c.) If a curarised sartorius be experimented on in the same way, all the parts contract at once, because all the motor nerves in the muscle are paralysed.

8. Kühne's Curare Experiment.

—(a.) To the margin of a meat-plate fix two copper slips, to serve as attachments for the electrodes, and between the copper terminals place a strip of filter-paper moistened with normal saline.

(b.) Excise the sartorius of a large frog, and cut it transversely into five pieces of nearly equal length. Place them in their original order on the filter-paper, numbering them 1 to 5. Pass a feeble tetanising current through the muscle, and note that the central parts, *i.e.*, 2, 3, and 4, contract, while 1 and 5 remain quiescent. On making the current stronger the terminal parts also contract. Why? Because there are no nerves at the end of the sartorius, and in the first instance the muscular fibres are really excited by stimulation of the intramuscular terminations of the nerves, while in the case of the end parts of the

LESSON XXXIV.

THE GRAPHIC METHOD—MOIST CHAMBER—SINGLE CONTRACTION.

1. Recording Apparatus.—Use a revolving brass cylinder or other moving surface covered with smoked glazed paper. The velocity of the moving surface is usually determined by recording simultaneously the vibrations of a tuning-fork of known rate of vibration, or an electro-magnetic time-marker, or by a vibrating reed (p. 211). It does not matter particularly what form of

recording drum is used, provided it moves smoothly and evenly, and is capable of being made to move at different speeds as required. In Hawksley's form of drum this is accomplished by placing the drum on different axles, moving at different velocities. In Ludwig's form (fig. 115) this is done by moving a small wheel, *n*, on a large brass disc, *D*. Where a number of men have to be taught at once, one must have recourse to an arrangement of shafting, moved, say, by a water-motor or turbine, from which several drums can be driven by cords. Or one may use a small gas-engine as the motive power, and cords passing over pulleys to

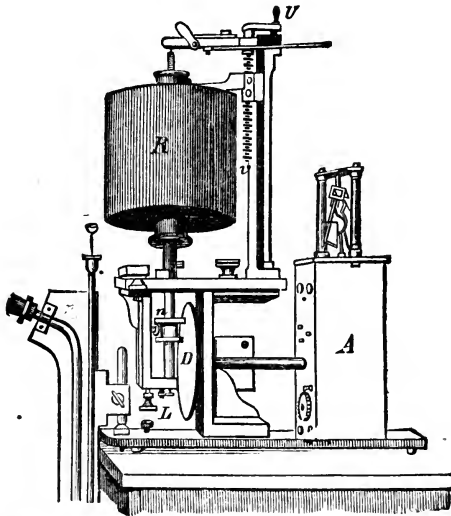

FIG. 115.—Ludwig's Revolving Cylinder, *R*, moved by the clockwork in the box *A*, and regulated by a Foucault's regulator on the top of the box. The disc *D*, moved by the clockwork, presses upon the wheel *n*, which can be raised or lowered by the screw *L*, thus altering the position of *n* on *D*, so as to cause the cylinder to rotate at different rates. The cylinder itself can be raised by the handle *U*. On the left side of the figure is a mercurial manometer.

move the drums. This is the arrangement adopted in the Physiological Department of Owens College, so that a number of men can work at the same time, each being provided with recording apparatus for himself. The Thirlmere water-motor may also be used for actuating a number of recording cylinders.

2. Fixing and Smoking the Paper.—The paper is glazed on one surface, and is cut to the necessary size to suit the drum. The drum can be removed from the clockwork or other motor

which moves it, and is then covered with a strip of paper, the latter being laid on evenly to avoid folds, glazed side outermost. One edge of the paper is gummed, and slightly overlaps the other edge. Leave it for a few minutes until the gum dries. The paper has then to be blackened, by holding the drum and keeping it moving over a fan-tailed or bat's wing gas-burner, or paraffin lamp—the former is preferable. Take care that the soot from the flame is deposited evenly and lightly, and see that it is not burned into the paper. The drum is then placed in position in connection with its motor. (See Appendix.)

To obtain a very fine film of soot, Hürthle has invented a "smoke-spray." The soot from the flame of a turpentine lamp is blown by means of an elastic ball-bellows against the paper.

3. General Rules for Graphic Experiments.

(1.) Arrange the apparatus completely, cover the drum with paper, and smoke it, before beginning the dissection.

(2.) Test all the connections stage by stage as they are made.

(3.) Each tracing is to be inscribed with the name of the individual who made it, the date, what it shows, and then it is varnished.

4. **Myographs.**—Various forms are in use, but most of them consist of a light lever which is raised by the contracting muscle, and so arranged as to record its movement on a smoked surface of paper or glass. Such curves are called "isotonic" by Fick. The movements of the muscle are thereby magnified and rendered visible to the eye. Or the lever may record its movements on a moving surface. Taking advantage of the fact that a muscle when it contracts becomes both shorter and thicker, myographs have been constructed on three principles:—

(α) Shortening of muscle attached to a lever.

(β) Thickening of muscle on which the lever rests.

But suppose a muscle to be so fixed that during activity it cannot contract, then we have changes in tension, so that we can record changes of tension by the so-called "isometric" method introduced by Fick (Lesson XXXVI.).

(γ) Changes in tension.

The recording surface on which the style of the lever writes may be—

(1.) Stationary (*Pflüger's*).

(2.) Rotatory (*Helmholtz's*).

(3.) Swinging pendulum (*Fick's*).

(4.) Moved from side to side by a spring, either vertically (*Du Bois-Reymond*) or horizontally.

5. **Muscle-Lever** (change in length of muscle).—It is customary to use such a muscle-lever as is shown in fig. 116, with the weight attached directly under the point of attachment of the muscle to the lever. This has its disadvantages, as it is set into vibration by the rapid rise of the lever. Fick has shown that by using a light straw lever, the muscle itself being made tense not by a weight applied directly under the point of attachment of the muscle to the lever, but by attaching the weight over a small pulley fixed to the steel axis to which the lever is attached, by this arrangement the weight is raised but little, and even with a rapid contraction does not move quickly.

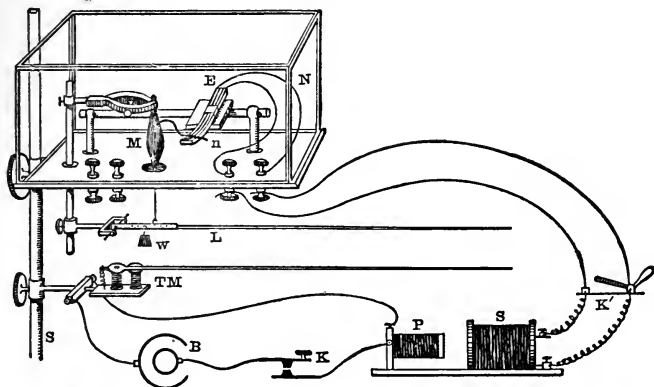

FIG. 116.—Moist Chamber. *N.* Glass shade; *E.* Electrodes; *L.* Lever; *W.* Weight; *TM.* Time-marker; other letters as in previous figures.

6. **Moist Chamber** (fig. 116).—To prevent a preparation from getting dry, enclose it in a moist chamber, which is merely a glass shade placed over the preparation. To keep the air and the preparation moist, cover the sides of the shade with blotting-paper moistened with normal saline.

7. **Varnish for Tracings**.—The tracing is drawn through the varnish and then hung up to dry.

(a.) A good varnish consists of gum mastic or white shellac dissolved to saturation in methylated spirit.

(b.) Where a large quantity is used, and economy is an object, gum juniper may be used instead of mastic.

(c.) Dissolve 4 oz. of sandarac in 15 oz. of alcohol, and add half an oz. of chloroform.

8. **Single Contraction or Twitch**.—**Apparatus**.—Recording drum, Daniell's cell, Hg-key, induction coil, Du Bois key, wires,

electrodes, moist chamber and lever (or crank-myograph), moist blotting-paper, stout ligatures, hook, pins, lead weight (20 grams).

(a.) Cover the drum with glazed paper, smoke it, and arrange it to move slowly.

(b.) Arrange the apparatus:—Daniell's cell and a mercury key in the primary circuit, the secondary circuit short-circuited, and with wires going to the binding screws on the platform of the moist chamber on the myograph (fig. 116). [The muscle may be caused to contract either by stimulating it directly, in which case the electrodes are made of thin wires, and merely pushed through the two ends of the gastrocnemius, or indirectly through the nerve. It is convenient to use the latter method (Lesson XXXII.).]

(c.) Make a nerve-muscle preparation, leaving the lower end of the femur in connection with the gastrocnemius, and cut away the tibia and fibula. With the point of a sharp pair of small scissors make a small hole in the tendo Achillis, and insert in it an S-shaped hook, made by bending a pin. Arrange the preparation in the moist chamber by fixing the femur in the muscle clamp, and by means of a stout thread attach the hook in the tendo Achillis to the writing-lever. See that the muscle or ligature goes clear through the hole in the stage, and that the hook does not catch on anything. Place the nerve over the electrodes, and cover the whole preparation with the glass shade lined on three sides with moist blotting-paper. Load the lever either directly or by means of a scale-pan near where the muscle is attached to it by a weight of about 20 grams, and make the lever itself write horizontally on the cylinder. The writing-style on the tip of the lever may be made of very thin copper foil or parchment paper, fastened to the lever with sealing-wax or telegraph composition.

As here arranged the primary circuit is made and broken by hand.

According as the recording surface is stationary or moving when the muscle contracts and raises the lever, either an upward line or a curve will be made upon the paper. In the latter case the form of the curve will vary with the velocity of the drum.

A. Simple twitch with the recording cylinder stationary.

By this arrangement one registers only the lift or height of the contraction, and its relation to the strength of the stimulus; yielding minimal and maximal contractions. A light (isotonic) lever is chosen, such as will amplify the movement 6-8 times, while the weight to be lifted is such that the tension of the muscle is about 8-10 grams.

(a.) Push the secondary coil away from the primary, open the key in the secondary circuit, and make and break the primary

circuit. There may be no contraction at either M. or B. Close the secondary circuit key.

(b.) Open the short-circuiting key, gradually push up the secondary coil, and break the primary circuit by means of the key in it. Observe when the first feeble single contraction or twitch is obtained = **minimal contraction**. Make the primary circuit, there is no contraction. The *break shock is stronger than the make*. Record under each contraction whether it is a make (M.) or break (B.) shock, and the distance in centimetres of the secondary from the primary coil. The minimal contraction may first be obtained when the secondary coil is 35-40 cm. from the primary. Move the drum a short distance with the hand; the lever inscribes a base line or abscissa.

(c.) Push up the secondary coil .5 cm. at a time. Test the effect of the make and break shocks, after each test moving the cylinder with the hand, and recording the result as to M. or B., and the distance in centimetres of the secondary from the primary coil. After a time a M. contraction appears, and on pushing up the secondary coil the M. contraction becomes as high as the B. (fig. 117).



FIG. 117.—Contractions obtained with make (M.) and break (B.) induction shocks. The numbers indicate the distance of the secondary from the primary coil. The cylinder is stationary during each contraction and is then moved a little distance by hand.

(d.) Increase the stimulus by bringing the secondary nearer the primary coil, and notice that the contractions do not become higher = **maximal contraction**. In each case keep the M. and B. contractions obtained with each strength of current close together. Their relative heights can then be readily compared (fig. 117).

B. Twitch with Cylinder revolving (fast speed).—Arrange the experiment as in A, but allow the cylinder to revolve about 50 centimetres per second.

(a.) Select a strength of stimulus (break shock only) which is known to cause a contraction, and while the cylinder is revolving, cause the muscle to contract.

(b.) Study the muscle-curve obtained, a so-called "isotonic" curve (fig. 121).

C. Vary the velocity of the cylinder, and observe how the form of the curve varies with the variation in velocity of the cylinder (fig. 118). Use only the break shock, and record the

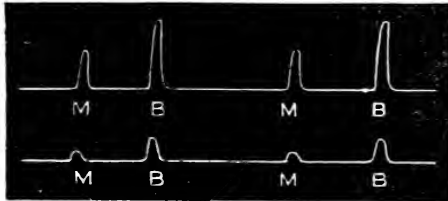

FIG. 113—Frog's Gastrocnemius Stimulated by a Single Make (M.) and Break (B.) Shock, the distance between the primary and secondary coil being the same for both shocks. In the lower figure the muscle was somewhat fatigued. Slow rate of speed.

contractions either (i.) all on one abscissa, or (ii.) record each contraction on a different abscissa, recording a time-curve under each (Lesson XXXV.).

D. Remove the tracings and varnish them.

9. Relation of "Lift" to Strength of Stimulus. —

Suppose one uses only break shocks, and, beginning with the first effective stimulus ("Minimal Contraction") and gradually increasing the strength of the stimulus, one obtains a gradual increase in the height of the "lift" until a certain maximum of lift ("Maximal Contraction") is reached, above which, even though the stimulus be increased, there is no further shortening of the muscle. If a muscle be stimulated directly (*i.e.*, the electrodes applied to the muscle direct), the difference between the first effective stimulus (minimal) and the first effective maximal stimulus is considerably greater than by indirect stimulation (*i.e.*, when the stimulus is applied through the nerve).

LESSON XXXV.

CRANK-MYOGRAPH—AUTOMATIC BREAK.

Instead of the muscle-lever shown in fig. 116, very frequently the crank-myograph is used (fig. 119). The muscle placed on it can be kept moist by a cover of blotting-paper moistened with normal saline.

1. The Crank-Myograph (fig. 119) is fixed on a suitable support, so that it can be adjusted to any height desired.

After-Load.—In the crank-myograph, under the lever, is a screw on which the horizontal arm of the bell-crank rests (fig. 119,

a), so that the muscle is loaded only during its contraction. Thus a muscle may be "loaded" or "after-loaded"; in the former case, the muscle is loaded with a weight, both when it is at rest and when contracting, but in an "after-loaded" muscle the muscle raises the weight only during contraction, and is not stretched by it when at rest. The experiment is arranged in the same way as in Lesson XXXIV. 8.

(a.) Make a preparation of the gastrocnemius with the lower end of the femur attached. Pin the femur firmly to the cork plate of the myograph covered with blotting-paper moistened by normal saline. Tie a stout ligature round the tendo Achillis, by a hook fix the ligature to the short arm of the lever, add a weight of 10-20 grams to the lever, and see that the lever itself is horizontal. Thrust two fine wires—which act as electrodes—from the Du Bois key in the secondary circuit through the upper and lower end of the gastrocnemius muscle.

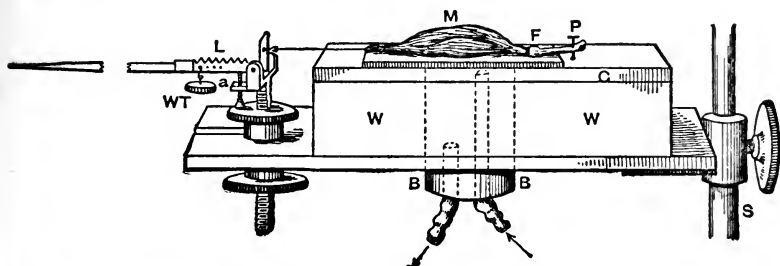

FIG. 119.—Crank-Myograph. W, W. Block of wood; M. Muscle; F. Femur; P. Pin to fix F; L. Lever; WT. Weight; a. Screw for after-load; C. Cork; B, B. Brass box.

(b.) Arrange the style of the lever so that it writes on the cylinder, and repeat, if desired, the experiments of the previous Lesson.

(c.) Use different weights—5—20—50 grams—and observe how the form of the curve varies on increasing the weight attached to the lever.

2. Automatic Break, i.e., Method of Excitation.—It is convenient to use a single break induction shock, i.e., the secondary coil is at such a distance from the primary that only the break shock is effective. One may, of course, break the primary circuit by the hand, as in the previous experiments, but this is not convenient. It is better to have an "automatic break" (fig. 120) done by the drum itself as it revolves, the drum being introduced into the primary circuit. Two binding screws are placed on the stand, but

one is insulated. The axis of the drum carries a horizontal (adjustable) arm or "striker" carrying a platinum wire which touches a wire fixed on a support on the insulated binding screw. Thus every time the drum revolves a shock is induced, and always at the same moment, so that successive shocks can be recorded on the same abscissa and the moment of stimulation can be found at once.

3. Simple Muscle-Curve with Crank-Myograph and Automatic Break.—Apparatus required.—(1) Recording-drum moving at a fast rate (about 50 cm. per second); (2) crank-myograph; (3) chronograph vibrating 100 times per second; coil; keys.

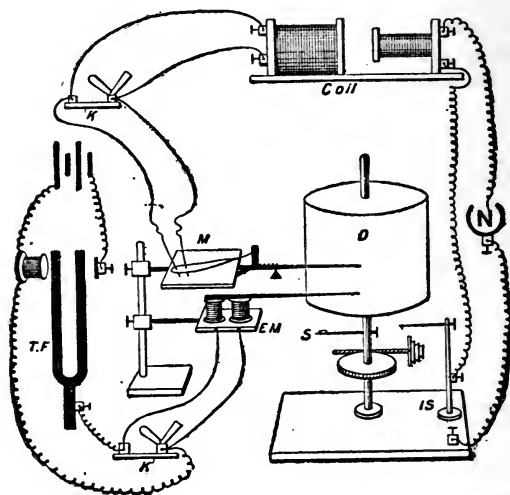

FIG. 120.—Arrangement for analysis of Muscle-Curve by means of Crank-Myograph (M) with "Automatic Break" Arrangement in Primary Circuit. S. Striker on axis of D cylinder; P.C. Primary, and S.C. Secondary circuits; T.C. Time-circuit with E.M. Electro-magnet; I.S. Insulated support in P.C.

(a.) Arrange the apparatus as in fig. 120. The cylinder (D) is placed in the primary circuit. When the horizontal arm or striker (S) fixed to the vertical spindle touches the upright, the primary circuit is made and broken and induction shocks are induced in the secondary circuit. Select a break shock, *i.e.*, when the make is not yet effective. The vertical support (I.S) is insulated from the base of the drum support.

(b.) Short-circuit the secondary current, arrange a nerve-muscle preparation on a crank-myograph (M), place the nerve on the

electrodes, arrange the weighted writing-lever to write on the drum.

(c.) Arrange the lever of a chronograph (vibrating 100 times per second and actuated by a Grove's cell in circuit with a tuning-fork, T.C time-circuit) so that the one writing point records exactly under the other.

Make base lines and ordinates—muscle-lever and time-lever—on the cylinder to mark the relative positions of the two writing points, or cause one to write exactly over the other.

(d.) Adjust the position of the break key in order to have the tracing near the middle of the paper and not near where it is gummed. Open the short-circuiting key, set the chronograph vibrating, and the cylinder in motion during one revolution. When the striker (S) comes in contact with support (I.S) a break induction shock is obtained, and the muscle records a simple muscle-curve. Close the short-circuiting key.

(e.) Record the moment of stimulation by bringing S into contact with the style on I.S. The distance between this point and the beginning of the curve indicates the latent period.

(f.) Study the "muscle-curve" (fig. 121), noting particularly the latent period, the ascent and descent. The latent period may be represented by a distance of 4 or 5 millimetres, but this delay does not represent the actual latent period, which is really much shorter. The long latent period is really largely due to the apparatus and therefore instrumental. Estimate, by means of the tuning-fork vibrations, the duration of each of the phases.

LESSON XXXVI.

ISOTONIC AND ISOMETRIC CONTRACTIONS— WORK DONE—HEAT-RIGOR.

1. *Isometric v. Isotonic Contraction* (Fick).—In the ordinary way of recording a simple muscular response or twitch, as just described, a light lever (with a light weight attached) records its movements, so that the muscle is constantly stretched by and contracts against a small constant resistance during its contraction. Such a curve is *isotonic* (fig. 121).

If, however, the muscle contracts by pulling on a strong spring of great resistance,—such a spring, for example, as requires about 500 grams to bend it slightly,—then the curve obtained is *isometric*. The curves obtained by clinical dynamometers are of this class.

For isometric curves Fick attached a muscle to the short arm of a lever, the other arm being prevented from moving much by the resistance of a strong spring. In this way one obtains a curve, which shows little change of form, but indicates the increase and decrease of *tension* during the contraction, the length of the muscle remaining nearly constant, and for this reason Fick called it "isometric." Of course an absolutely isometric curve cannot be recorded.

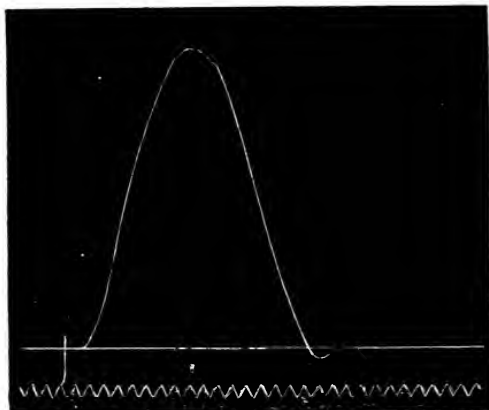

FIG. 121.—Muscle-Curve of Frog's Gastrocnemius. The lower line indicates time, and each double vibration (D. V.) = $\frac{1}{10}$ sec.

If one compares an isotonic and isometric curve from the same muscle, one finds that the apex of the isometric curve lies nearer the beginning of the contraction than that of the isotonic curve, *i.e.*, the length remaining the same, the isometric curve reaches the maximum of its tension sooner than it, the tension being the same, reaches the maximum of its shortening. Moreover, the isometric curve is flat-topped, so that it remains for some time in contraction (fig. 122).

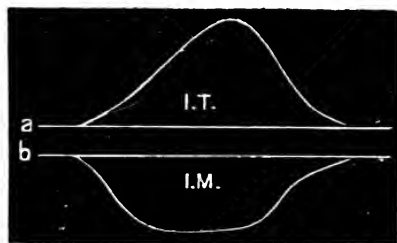

FIG. 122.—a. Diagram of isotonic, b, isometric muscle-curves.

2. Registration of Tension of a Muscle (Fick).—

When the two ends of a muscle are so fixed that during activity they cannot approximate towards each other, then the muscle does

not change its length but only its tension. Fick calls this an "isometric" method.

One can record the change in tension by means of a "tension-

recorder" devised by Fick (fig. 123). One end of the muscle is fixed, the other is attached by means of an inextensible thread which passes round a small pulley fixed on a steel axis (A). This axis carries (1) a long light recording lever (Z), and (2) a horizontally placed steel spring (F) whose free end rests on a support (u). When the muscle contracts, the spring (F) is pressed against the support (u). In consequence of the opposing tension of the spring the axis can only be turned slightly, but this movement is greatly amplified by the recording lever.

Schönlein has devised a myograph (*Pflüger's Archiv*, Bd. 52, p. 112), which is so arranged that one can record either isotonic contractions or isometric contractions. The isometric curves so obtained have been called "tonograms." The apparatus is made by W. Siedentopf in Würzburg.

3. Work Done during a Single Contraction.—Arrange a gastrocnemius to record on a cylinder, but record only the "lift," as in

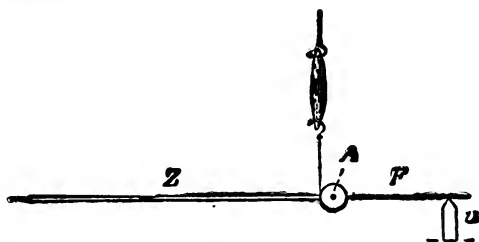

FIG. 123.—Scheme of Fick's Tension-recorder. A. Axis movement; F. Strong spring resting on support u; Z. Writing-lever.

Lesson XXXIV., the cylinder being stationary, moving the cylinder with the hand as required. On the lever under the muscle attachment place a scale-pan, and in this place weights of known value. With each twitch the muscle lifts the weight, and thus does a certain amount of work which is easily calculated.

(a.) Measure the height of the tracing from the base line or abscissa. This is conveniently done by a paper millimetre scale fixed to a microscopic slide. The work done (W) is equal to the weight (w) lifted multiplied by the height (h) to which it is lifted—

$$W = wh.$$

But, of course, a long lever being used, the tracing is much higher than the actual shortening of the muscle.

(b.) To determine the exact amount of the lift, one must know the length of the lever and the ratio between its arms. Suppose the one to be ten times as long as the other, then the total work in gram-millimetres must be divided by 10.

(c.) To determine the greatest amount of work obtainable, various heights must be tried to get the largest product, care being taken not to fatigue the muscle.

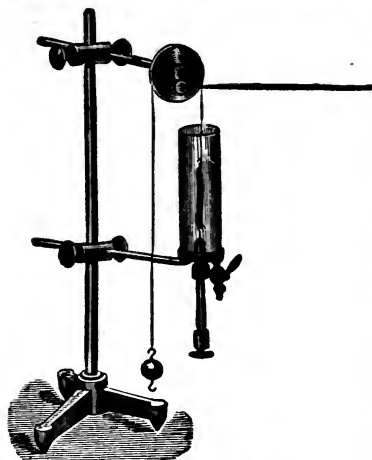

FIG. 124.—Apparatus for obtaining the curve of a sartorius in heat-rigor.

curve of muscle. Or a string may be made to swell by dipping in hot water and then soaking in concentrated glycerin. This can then be heated in air and the movements recorded.

4. Curve of Heat-Rigor. — (a.) Arrange a frog's gastrocnemius to record by means of a crank-myograph on a slow-revolving drum, weighting it with 30-50 grams. Inscribe the continuous change of form of the muscle produced by pouring water at 70° C. on the muscle.

(b.) Or, use the following apparatus devised by Ludwig, where, however, the sartorius is used in place of the gastrocnemius, as it has parallel fibres (fig. 124).

5. Chordogram. — Engelmann (Croonian Lecture, R. S. 1895) has shown that, when a short length (5 cm.) of an E violin string, previously swollen in water, is fixed so as to record any alteration in its length, on suddenly heating the string the lever rises, and on cooling the lever falls and a curve is recorded just like a contraction

LESSON XXXVII.

PENDULUM-MYOGRAPH—SPRING-MYOGRAPH—DESPRETZ SIGNAL.

1 Pendulum-Myograph Muscle-Curve.

(a.) Cover the oblong glass plate with glazed paper, smoke its surface, and fix it to the pendulum. The plate must be so adjusted that the pendulum, on being set free from the "detent" (fig. 125, C), shall be held by the "catch" (C). Test this.

(b.) Arrange the primary circuit for single shocks as in fig. 125, interposing the trigger-key or knock-over key of the pendulum-myograph (K'). Short-circuit the secondary coil.

(c.) Fix the femur of a nerve-muscle preparation in the clamp, attach the tendo Achillis to the writing-lever (S), and place the

nerve over the electrodes in a moist chamber or use a crank-myograph. Load the lever with 20 grams, and direct its point to the side to which the pendulum swings. Fix the pendulum with the detent, and adjust the writing-style of the lever on the smoked surface. Connect the electrodes (or wires) from muscle or nerve to the short-circuiting key in the secondary circuit (omitted in fig. 125).

After opening the secondary circuit, with the hand break the primary circuit to make certain that the muscle responds at break.

(d.) Close the trigger-key (K') in the primary circuit, and open the key in the secondary circuit. Allow the pendulum to swing; as it does so, it knocks over the key in the primary circuit and breaks the current, thus inducing a shock in the secondary circuit, whereby the muscle is stimulated and caused to record its contraction or muscle-curve on the smoked surface.

(e.) **Abscissa**, *i.e.*, the base line. Rotate the stand supporting the muscle to remove the writing point of the lever from the recording surface. Bring the pendulum back to the detent, adjust the writing-style, close the trigger-key, and keep the secondary circuit short-circuited. Allow the pendulum to swing. This records the base line.

(f.) **Latent period**.—Bring the pendulum to the detent, short-circuit the secondary circuit, and withdraw the writing-style as in (e.). Close the trigger-key, with a finger of the left hand keep it closed, allow the lever to touch the glass plate in its original position, and with the right hand bring the knife-edge of the pendulum in contact with the trigger-key, so as just to open it. A curved line is inscribed on the stationary plate, which indicates the moment of stimulation.

(g.) **Time-Curve**.—Remove the muscle-lever, place the pendulum in the detent, close the trigger-key, take a tuning-fork, vibrating,

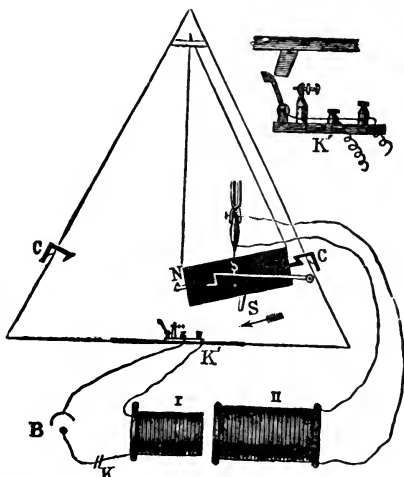

FIG. 125.—Scheme of the Arrangement of the Pendulum. B . Battery; I . Primary, II . Secondary spiral of the induction machine; S . Tooth; K' . Key; C, C . Catches; K' in the corner, Scheme of K' ; K . Key in primary circuit. It is well to have a short-circuiting key in the secondary circuit.

say, 120 or 250 double vibrations per second, and adjust its writing-style in the position formerly occupied by the style of the muscle-lever. Set the fork vibrating, either electrically or by striking it. Allow the pendulum to swing, when the vibrating

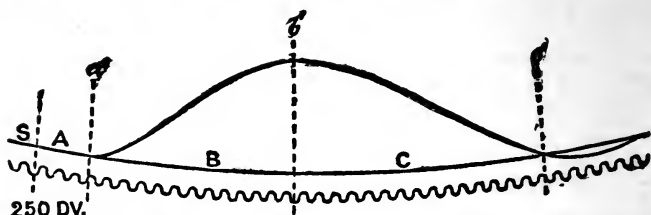

FIG. 126.—Pendulum-Myograph Curve. *S.* Point of stimulation; *A.* Latent period; *B.* Period of shortening, and *C.* of relaxation.

tuning-fork will record the time-curve under the muscle-curve (fig. 126, 250 DV). All the conditions must be exactly the same as when the muscle-curve was taken.

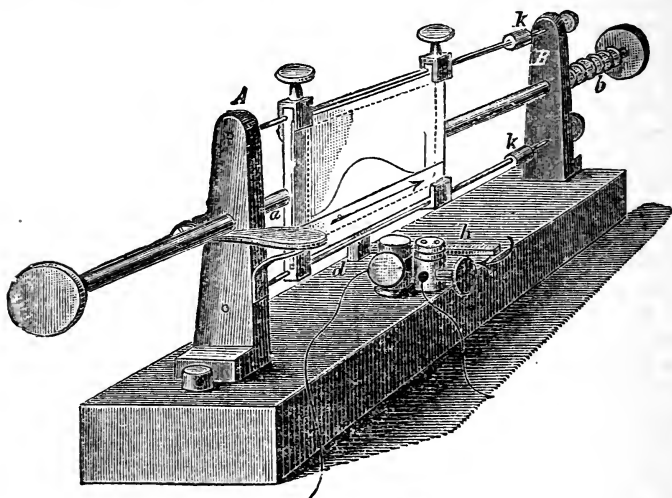

FIG. 127.—Spring-Myograph.

(*h.*) Varnish the curve, and measure its phases. Bring ordinates vertical, *a', b', c'*, to the abscissa, and measure the "latent period" (fig. 126, *A*), the duration of the shortening (*B*), the phase of relaxation (*C*), and the contraction remainder.

2. Spring-Myograph (fig. 127).—The arrangements are exactly

the same as for the pendulum-myograph, the trigger-key of the myograph being placed in the primary circuit.

(a.) Cover the glass with glazed paper, smoke it, and fix it in the frame. Push the plate to one side, and fix it with the catch. Close the trigger-key (h).

(b.) Make a nerve-muscle preparation, and arrange it to write on the glass plate. Open the secondary circuit.

(c.) Press on the thumb-plate (a), thus liberating the spring, when the glass plate shoots to the other side, when the tooth (d) on its under surface breaks the primary circuit, and the muscle-curve is recorded.

(d.) Short-circuit the secondary circuit, push back the plate, and fix it with the catch; close the trigger-key, and shoot the plate again to record the abscissa.

(e.) Make a time-curve. Push the plate back again, and fix it; close the trigger-key—in order that the conditions may be exactly the same as before—set a tuning-fork in vibration (120 double vibrations per second), and adjust its writing-style under the abscissa. Shoot the plate again, and record the time-curve.

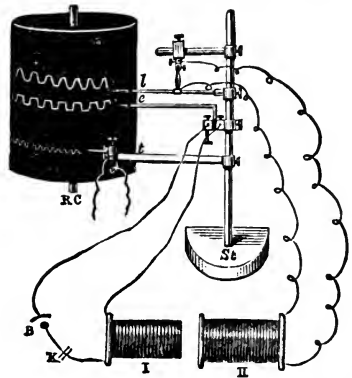

FIG. 128.—Arrangement for Estimating the Time-Relations of a Single Muscular Contraction. *B.* Battery; *K.* Key in primary circuit; *I.* Primary, *II.* Secondary coil, without a short-circuiting key; *L.* Muscle-lever; *e.* Electro-magnet in primary circuit; *t.* Electric signal; *St.* Support; *RC.* Revolving cylinder. Introduce a short-circuiting key into the secondary circuit.

ADDITIONAL EXERCISES.

3. Study the improved form of this instrument recently introduced by Du Bois-Reymond in which the glass plate is set free, and the tuning-fork vibrations are recorded simultaneously when a handle is pressed. It has a simple mechanism for adjusting the writing-styles for the muscle and abscissa.

4. Analysis of Twitch on a Revolving Drum.

(a.) Arrange the drum to move at a fast speed (50 cm. per sec.).

(b.) Arrange an induction coil for single B. shocks, the secondary circuit short-circuited, and arranged to stimulate a nerve attached to a muscle placed in a moist chamber, or on a crank-myograph, as directed for the foregoing experiments. In the primary circuit introduce, besides the spring-key, an electro-magnet with a marking lever (figs. 116, 128, e), and cause its point to

write exactly under the muscle-lever. Arrange, with its point exactly under the other two, a Despretz chronograph or signal, in circuit with a tuning-fork of known rate of vibration, and driven by means of a Grove's cell (fig. 129). The three recording levers are all fixed on the same stand, which should

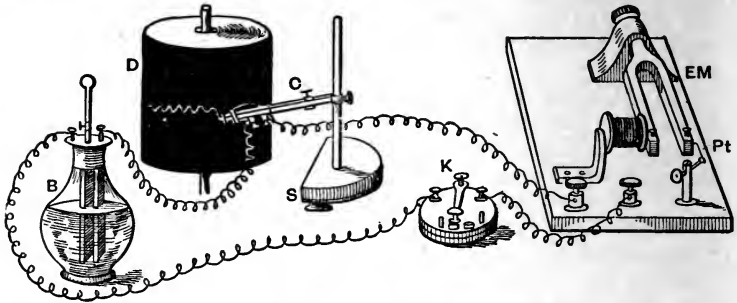

FIG. 129.—Signal and Vibrating Tuning-Fork in an Electric Circuit. *D.* Drum; *C.* Signal; *EM.* Electric tuning-fork; *Pt.* Platinum contact.

preferably be a tangent one, *i.e.*, the rod bearing the recording styles can by means of a handle be made to rotate so as to bring the writing-styles in contact with the recording surface.

On opening the secondary circuit and breaking the primary one, the muscle contracts, and at the same time the style of the electro-magnet is attracted and records the exact moment of stimulation (fig. 116).

5. Despretz Signal (figs. 129, 130).—This small electro-magnet has so little inertia that, if it be introduced into an electric circuit, its armature, which

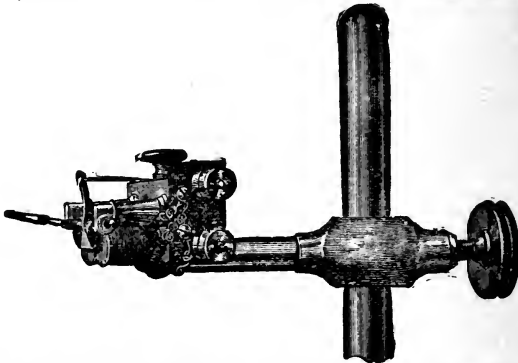

FIG. 130.—Despretz Electric Signal or Chronograph, as made by the Cambridge Scientific Instrument Company.

is provided with a very light writing point, vibrates simultaneously with the vibrations of an electric tuning-fork introduced into the same circuit. Arrange the signal and tuning-fork as in fig. 129. The drum must move more rapidly, the more rapid the vibrations of the tuning-fork used. Use a

Grove's cell. The analysis may also be done by means of the "automatic break" arrangement attached to the revolving drum (Lesson XXXV.).

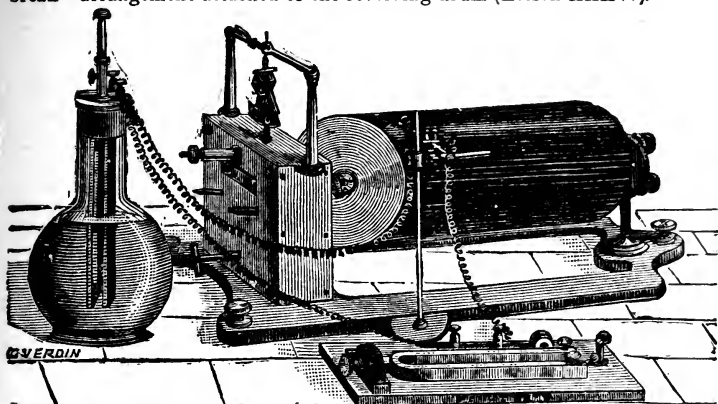

FIG. 131.—Chronograph arranged to Write on a Horizontal Cylinder, as made by Verdin.

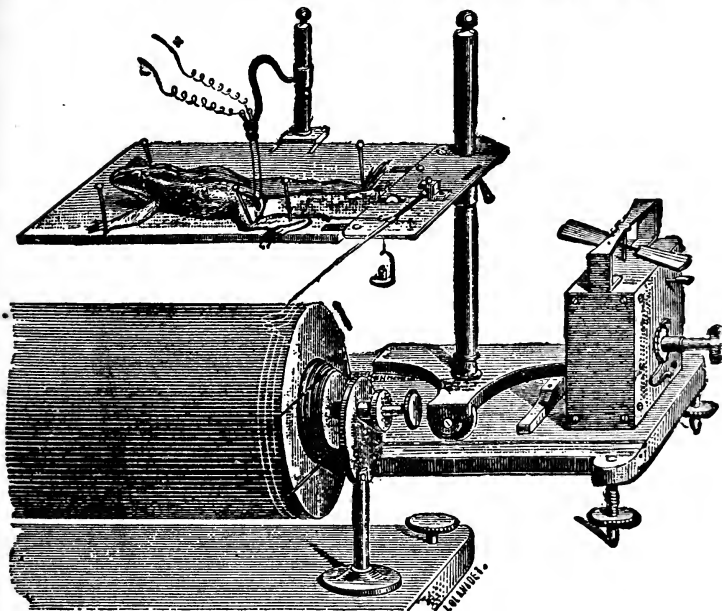

FIG. 132.—Marey's Simple Myograph, as made by Verdin.

6. Vibrating Reed as a Chronograph.—For measuring small intervals of time this is very convenient. The arrangement was first adopted by Grun-

mach, acting on the suggestion of Kronecker. A steel tongue, vibrating a hundred times per second, covers an oblong aperture placed at the lower part of a gradually-narrowing brass tube, closed at the narrow end. To the tongue is attached a stylette, which records the movements of the former. To

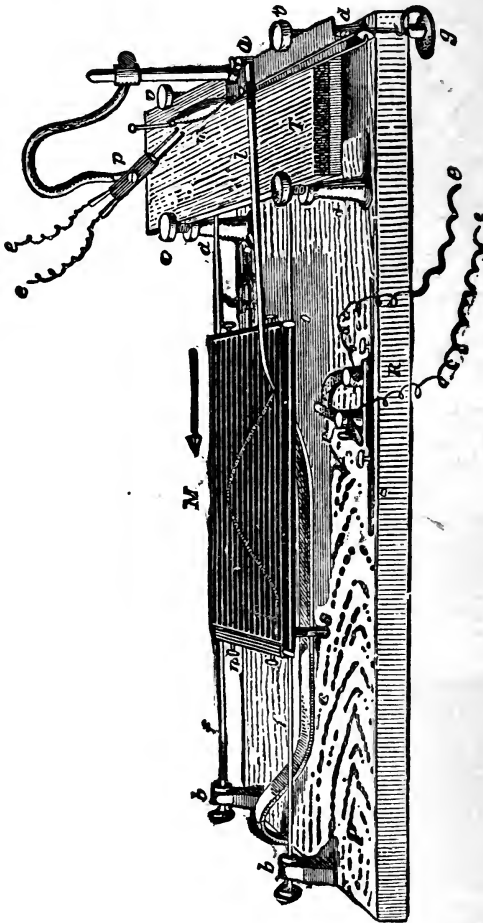

FIG. 133.—Horizontal Myograph of Fredericq. *M.* Glass plate, moving on the guides *f, f*; *l.* Lever; *m.* Muscle; *P, e.* Electrodes; *T.* Cork plate; *a.* Counterpoise to lever; *R.* Key in primary circuit.

the open end of the brass tube of the instrument is attached a brass ball or resonator, and to the latter a caoutchouc tube. When air is sucked through the apparatus, the reed (and with it the stylette) is set vibrating. It may be kept vibrating by means of an aspirator placed in connection with a water-tap.

7. **Marey's Myograph** (fig. 132).—The pithed frog is pinned on a cork plate, the tendon of the *gastrocnemius* is dissected out and attached to a writing-lever, which is weighted with a counterpoise; the sciatic nerve is dissected out and stimulated in the ordinary way. The cylinder moves on a horizontal axis. The muscle can be stimulated while it is still *in situ*, and is under more normal conditions than in the case of an excised muscle. It is useful for the study of the action of poisons on muscle.

8. **Spring-Myograph of Fredericq** (fig. 133).—This is arranged in the same way as the spring-myograph, but the glass plate is placed horizontally. The glass plate is pulled along rapidly by a band of caoutchouc. A key in the primary circuit is opened by means of a pin attached to the frame carrying the glass plate when the plate is discharged. In an improved form of the instrument, a steel rod made to vibrate at the moment the plate is discharged records a time-curve beside the muscle-curve.

LESSON XXXVIII.

INFLUENCE OF TEMPERATURE, LOAD, AND VERATRIA ON MUSCULAR CONTRACTION.

1. Influence of Temperature on Muscular Contraction.

(a.) Arrange the nerve-muscle preparation on a crank-myograph—after-loaded—as in Lesson XXXV., using the automatic key by means of the drum. All the curves are thus taken on the same abscissa. Take a tracing at the normal temperature of the room. Mark the moment of stimulation.

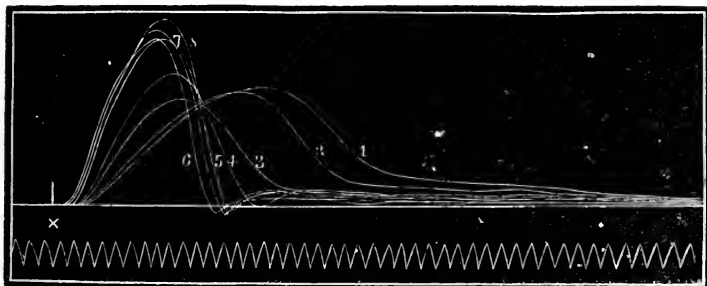

FIG. 134.—Showing how the form of a Muscle-Curve varies with the temperature of the water flowing through the box, shown in fig. 119. 1 at 5° C.; 2 at 10°; 3 at 15°; 4 at 20°; 5 at 25°; 6 at 30°; 7 at 35°; and 8 at 40° C. The lowest tracing indicates time, 100 D.V. per second, x the moment of stimulation, by automatic break.

(b.) Place ice upon the skin over the *gastrocnemius* for some time, or pour iced salt solution on the exposed *gastrocnemius*, and then take another tracing on the same abscissa, noting the differences

in the result. The contraction is both much longer and lower, and the latent period is also longer.

(c.) Pour on to the muscle warm salt solution and take another tracing. Observe the result. Do not overheat the muscle or heat-rigor results (fig. 134).

Other Methods.—(d.) Adjust a piece of wire gauze over the leg, and allow it to project beyond the end of the plate of the myograph. Heat the gauze with a spirit-lamp. Take a tracing. The contraction is shorter than in 1 (b.). Do not overheat the muscle.

(e.) A piece of lead-piping of narrow diameter ($\frac{1}{8}$ inch) can be bent into the form of a cylinder, and the muscle placed within it. Water of various temperatures can then be passed through it.

(f.) The muscle may be attached to an ordinary horizontal writing-lever. Surround the muscle with a double-walled box, with an inflow and outflow tube, through which water at different temperatures can be passed. A delicate thermometer is placed in the chamber with the muscle.

(g.) A convenient method is to allow the muscle to rest on a small circular brass box, fitted into the wooden plate of the crank-myograph. The box (B, B) is provided with an inflow and an outflow tube, through which water of the desired temperature can be passed.

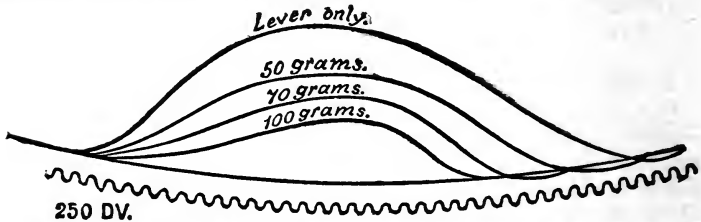

FIG. 135.—Pendulum-Myograph Curves, showing the Influence of the Load on the Form of the Curve.

2. Influence of Load on Form of Muscle-Curve.

(a.) Arrange an experiment with the pendulum-myograph as in Lesson XXXVII., using either a muscle-lever or a crank-myograph. Or, arrange a crank-myograph (after-loaded) to write on a cylinder, the cylinder being arranged to break automatically the primary circuit as at p. 202. Take all the curves on the same base line.

(b.) Take a tracing with the muscle weighted with the lever only.

(c.) Then load the lever successively with different weights (5, 20, 50, 70 . . . 100 grams), and in each case record a curve and observe how the form of the curve varies (fig. 135).

(d.) In each case record the abscissa and time-curve.

3. Influence of Veratria on Contraction.

(a.) Destroy the brain of a frog, and inject into the ventral lymph-sac a few drops of a 1 p.c. solution of sulphate of veratria.

When the frog is under the influence of the drug, discharge a reflex act by mechanically stimulating the skin of the leg. The limbs are extended, and remain so for several seconds, due to the prolonged contraction of the extensors overcoming the flexors and thus causing extension of the legs.

(b.) Arrange the induction machine for single shocks to make and break the primary circuit by the hand by means of a contact-



FIG. 136.—Muscle-Curve from a "Veratrised" Muscle, recorded on a Slow-moving Drum. A. Abscissa; T. Time in seconds.

key. Short-circuit the secondary. Do not stimulate the muscle often, as the veratria effect diminishes with activity of the muscle.

(c.) Make a nerve-muscle preparation and fix it on a crank-myograph. On dividing the spinal cord notice the prolonged extension of the legs.

Arrange the muscle-lever to record its movements on a slow-revolving drum (1-2 cm. per second). Take a tracing. Note that the muscle contracts quickly enough, but the contraction is very high compared with that of a non-poisoned muscle, while the

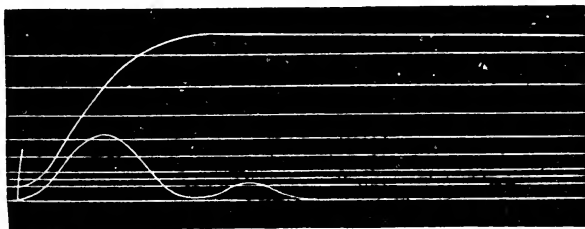

FIG. 137.—Veratria Curve (Upper). Normal Muscle-Curve (Lower). Quick-moving drum.

muscle relaxes very slowly indeed. The relaxation phase may last several seconds, *i.e.*, a kind of "contracture." Record half-seconds or seconds under the tracing. The tracing may show an uneven curve, due to irregular spasms of the muscular fibres, or an initial contraction as in fig. 136.

(d.) Take a tracing with a quick-moving drum, and such a curve

as fig. 137 will be obtained, where the drum goes round several times before the relaxation is complete.

(e.) Note that, if the "veratrised" muscle be made to contract several times, the effect passes off—only a simple twitch being obtained—but is re-established after rest. A high temperature also causes it to disappear.

(f.) The direct action of veratria on muscular tissue may also be studied by the apparatus described in Lesson XLIII., and by this method it is easy to compare the form of the curve before and after the action of the poison (fig. 137). The drum makes many revolutions before the lever comes to the abscissa again.

(g.) Investigate the effect of heat and cold in modifying the curves obtained. Under heat the veratria influence passes off.

LESSON XXXIX.

ELASTICITY AND EXTENSIBILITY OF MUSCLE— BLIX'S MYOGRAPH.

1. Extensibility and Elasticity of Muscle.

(a.) Dissect out the gastrocnemius of a frog with the femur attached, fix the femur in a strong clamp, attach the tendon to a muscle-lever with a scale-pan attached. Neglect the weight of the pan, and see that the lever writes horizontally on a drum. It is better to do the experiment with the sartorius (or with the semi-membranosus and gracilis, Lesson XXIX.), as they have parallel fibres.

(b.) Place in the scale-pan, successively, different weights (10, 20, 30, 40 . . . 100 grams). On adding 10 grams, the lever descends; remove the weight and the lever ascends. Move the drum a certain distance (about 3°), and add 20 grams to the scale-pan. This time the vertical line drawn is longer, indicating greater extension of a muscle by a greater weight, but nevertheless the muscle-lever will rise to its original height on removing the weight. Repeat this with other weights. With the heavier weights see that everything is securely clamped. If the apices of all the lines obtained be joined, they form a *hyperbola*. The muscle, therefore, has not a large amount of elasticity, *i.e.*, it is easily extended by light weights, and on removal of the weight it regains its original length, so that its elasticity is said to be perfect. The *hyperbola* obtained shows further that the increase in length

is not directly proportional to the weight, but diminishes as the weights increase (fig. 138).

(c.) Repeat the same experiment with a strip of *india-rubber*. In this case equal increments of weight give an equal elongation, so that a line joining the apices of the vertical lines drawn after each weight is a *straight line* (fig. 139).

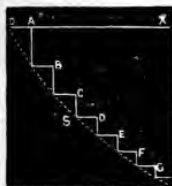

FIG. 138.—Curve of Elasticity of a Frog's Muscle.

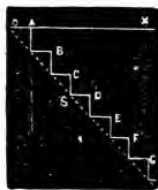

FIG. 139.—Curve of Elasticity of India-rubber.

2. The Extensibility of Muscle is Increased during Contraction, its Elasticity is Diminished.

(a.) Fix the gastrocnemius—or preferably semi-membranosus and gracilis—in a strong clamp, connecting it to a lever to record on a drum, and adjust an interrupted current to stimulate the muscle, either directly or indirectly.

(b.) Load the lever with 50 grams, and in doing so allow the drum to move slowly. Remove the load and observe the curve obtained.

(c.) Tetanise the muscle, and, while it is contracted to its greatest extent, again load the lever with 50 grams while the drum is in motion, and remove the load. Observe the curve.

(d.) Compare the two curves. The second curve will, of course, begin higher, but notice that its absolute descent is greater than the first curve, and that it does not rise to the horizontal again.

(e.) It is better to begin the experiment with the drum stationary, and then to record the tracing with the drum in motion, or it may be done with a stationary drum.

3. Blix's Myograph.—

Although this myograph was described many years ago, it seems to be but little used in this country. Personally, I am indebted to Prof. Fick of Würzburg for his kindness in showing it to me. By means of it one can readily record the curve of extensibility of a passive or an active muscle. The following summary is based on the description given by Schenk.

In the myograph (fig. 140) the muscle-clamp and the part to which the steel lever is attached form a rectangular piece, S S, which glides in a slot formed by the guides, R R and R' R'. The slider, S S, carries at *a* the axis of the lever *a b*, and also a lateral piece, A, placed at right angles for the attachment of the muscle, and one end of which is fixed to the lever at *b*. The weight is represented by P, which by means of the collar, *r*, presses on the lever. This collar, *r*, moves to and fro—not from side to side—between two pairs of fixed studs, *t t* and *t₁ t₁*.

Suppose the slider to be pushed as far to the left that the axis, a , just lies opposite to the collar, r —a point which is adjusted on the apparatus—then the tension of the muscle is nil. On moving the slider with the hand towards the right, so that the weight, P , acts on points of the lever more and more removed from a , then the tension of the muscle increases steadily, when the writing point, p , records the curve of extension, p , on a horizontally placed and stationary wooden board or glass plate covered with smoked glazed paper. In using the apparatus, board, slot, and slider are placed horizontally, the weight, P , is not applied directly to f , but to the latter the weight is attached indirectly by means of a cord which passes over a pulley.

Apparatus.—Blix's myograph, induction coil arranged for repeated shocks, the electrodes being directly connected with the muscle. The best preparation to use is the double semi-membranosus and gracilis (Lesson XXIX. 5) placed side by side and firmly attached to the lever. For these muscles taken from a large *Rana esculenta* a weight of 2 kilos is used, and for the corresponding gastrocnemius 1 kilo.

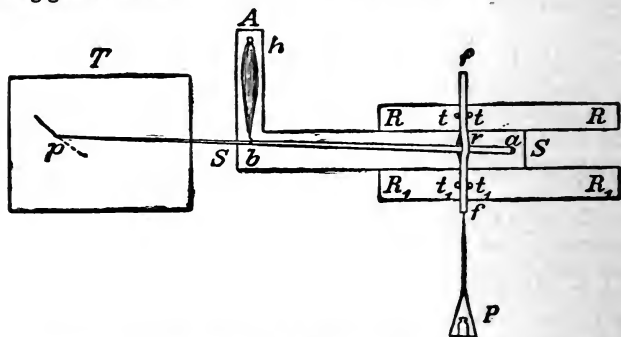

FIG. 140.—Scheme of Blix's Myograph. S, S Slider; R, R and R', R' Guides for slider; a, b Lever; A for muscle; P , Weight; r , Collar; t, t and t_1, t_1 Guides for collar carrying weight; p , Recording point.

(a.) Take a curve of a *passive* muscle from the point of greatest tension to nil tension.

(b.) Take a similar curve from a *tetanis*ed muscle. Compare the two curves, and it will be found that the curve of extensibility of the passive muscle is less steep than that of the tetanis^{ed} muscle, *i.e.*, a contracted muscle is more extensible than a passive one.

(c.) On a tetanis^{ed} muscle, move the slider so that the tension is increased from nil to the greatest possible, *i.e.*, the muscle is more and more "loaded," and then reverse this, so that from the greatest tension there is gradually "unloading." The two curves so obtained do not coincide: the latter lies considerably below the former. It would therefore appear, as far as the contraction is concerned, that it is not a matter of indifference whether the muscle is being gradually "loaded" or "unloaded."

4. **Elasticity of an Artery.**—Test the elasticity of a strip of *sorta* in the same way.

LESSON XL.

TWO SUCCESSIVE SHOCKS—TETANUS—
METRONOME.

1. **Two Successive Shocks.**—The primary current may be broken by means of a revolving drum, *i.e.*, using the automatic key (fig. 120). Two strikers can easily be arranged on the same support (IS), and their angular deviation can easily be adjusted to give any required interval between the two successive shocks.

Fig. 141 shows several tracings indicating the effect of summation or superposition of one contraction on another, and how the result varies with the particular period or phase of the contraction at which the second shock or stimulus is applied.

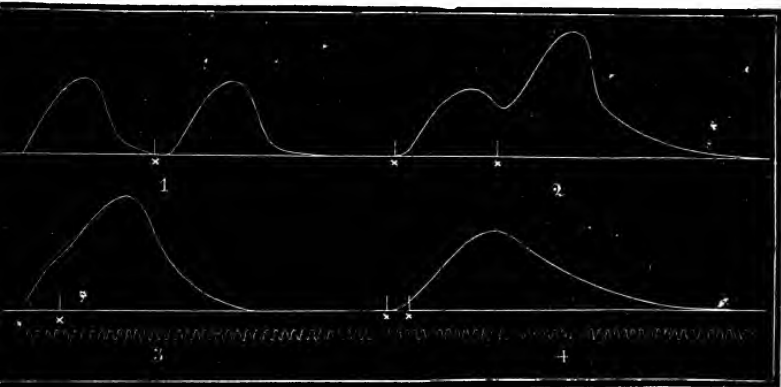

FIG. 141.—Effects of two Successive Shocks on a Muscle. 1. Second stimulus applied at \times ; 2. Second stimulus applied at the second \times ; 3. Second stimulus applied at \times ; 4. Second stimulus applied at the second \times .

Make four successive experiments, using break shocks.

(i.) Arrange the two closures for stimulation so that they are a full muscle-curve apart. The second is usually slightly higher than the first (fig. 141, 1).

(ii.) Arrange on a different part of the cylinder, but on the same abscissa, so that the second stimulus comes in on the relaxation of the foregoing contraction. As the second contraction occurs before the first one has ended, it starts from a higher level (fig. 141, 2).

(iii.) If the second stimulus is so arranged as to be thrown in on the ascent of the first curve, and before the apex is reached, the

second curve is superposed on the first, and the height of the compound is greater than the original muscle-curve (fig. 141, 3).

(iv.) Apply the second stimulus within the latent period of the first contraction. There is practically no alteration in the height of the curve (fig. 141, 3).

2. Tetanus.—A tetanising current may be obtained by Neef's hammer, or by means of a vibrating rod. **Apparatus.**—Daniell's

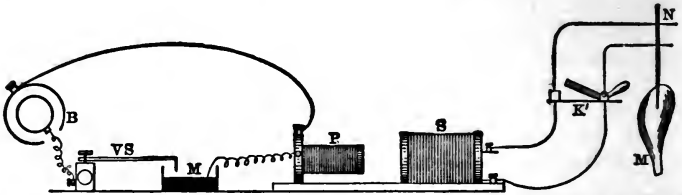

FIG. 142.—Scheme of arrangement for Tetanus. VS. Vibrating spring; M. Cup for mercury. Other letters as before.

cell, five wires, flat spring, cup of mercury in a wooden stand, induction coil, Du Bois key, drum moving at the rate of 5 cm. per second,—i.e., the cylinder moves once round in ten seconds,—crank-myograph.

(a.) Arrange the experiment as in fig. 142; the induction coil for single shocks, short-circuiting the secondary circuit. Place in the primary circuit the flat metallic spring, held in a clamp. One end of the spring has a needle fixed at right angles to it, which dips into a cup of mercury. The needle hangs just above the mercury cup

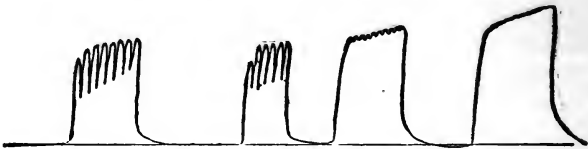

FIG. 143.—Curves of incomplete and almost complete Tetanus.

when the spring is at rest, but dips in and out of the mercury when it vibrates. The clamped end of the spring is connected with the battery, while the mercury cup is connected with the induction coil. Cover the mercury with alcohol and water (1 : 3), to prevent oxidation, and to keep the resistance more uniform. Select a strength of shock which gives response only at break, thus eliminating the make shock.

(b.) Arrange a nerve-muscle preparation as in fig. 119 to record on a slow-moving drum. Let the writing-lever be a short one.

(c.) Fix the flat spring firmly in the clamp, with ten inches projecting. Allow the drum to revolve, set the spring vibrating, and while it is doing so, open the key in the secondary circuit, and before the spring ceases to vibrate short-circuit the secondary current.

(d.) Shorten the vibrating spring and repeat the experiment, making the tracing follow the previous one.

(e.) Make several more tracings on the same abscissa, and let them follow each other at regular intervals, always shortening the springs until the tracing no longer shows any undulations, *i.e.*, until it has passed from the phase of "incomplete" to "complete tetanus."

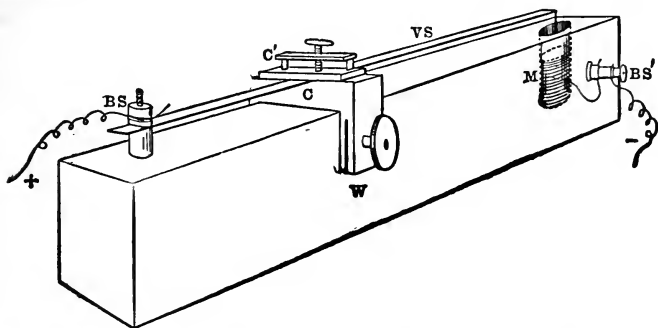

FIG. 144.—Tetanus Interrupter. W. Wood block; VS. Vibrating spring; BS, BS'. Binding screws; C. Movable clamp; C'. Clamp to fix spring; M. Cup of Mercury.

(f.) Take a tetanus-curve by introducing Neef's hammer (Helmholtz's side wire) instead of the vibrating flat spring.

(g.) Study the tracings. The first tracings are indented, but gradually there is more and more fusion of the teeth, until a curve unbroken by depressions is obtained. In the curve of complete tetanus the ascent is at first steep, then slightly more gradual, speedily reaching a maximum, when the lever practically records a horizontal line parallel to the abscissa. When the current is shut off the descent is very steep at first, and towards the end very slow.

3. Number of shocks required to produce tetanus depends on the animal, the muscle, and the condition of the latter; the more fatigued a muscle is, the slower it contracts, and, therefore, the more readily does fusion of contractions take place. A fresh frog's gastrocnemius requires about 27-30 shocks per

second to produce complete tetanus. The following table shows approximately the number of shocks per second required to produce tetanus.

	Shocks per second.	
Tortoise,	2	(Marey).
Frog (hyoglossus),	10-15	
„ (gastrocnemius),	27-30	
Lobster (claw),	20	(Richet).
„ (tail),	40	(Richet).
Rabbit (red muscle),	4-10	} (Kronecker and Stirling).
„ (white „),		
Bird,	100	(Richet).
Insects,	300-400	(Marey).

If the muscle be fatigued, then more or less complete fusion takes place with a smaller number of shocks per second.

4. Take a tracing with 10 or 15 vibrations per second, and then test the effect of different temperatures on the form of the tracing. Pour on the muscle normal saline at the required temperature. Notice how cold helps the fusion, while heat makes the tetanus less complete.

5. If Ewald's coil be used (fig. 95) any number of shocks from 1 to 200 per second can be obtained.

ADDITIONAL EXERCISES.

6. Interruption by a Metronome.—Instead of the vibrating rod or Neef's hammer, introduce into the primary circuit a metronome (fig. 145), provided with a wire which dips into a mercury cup introduced into the primary circuit. Vary the rate of vibration of the metronome, and observe the effect on the muscle-curve.

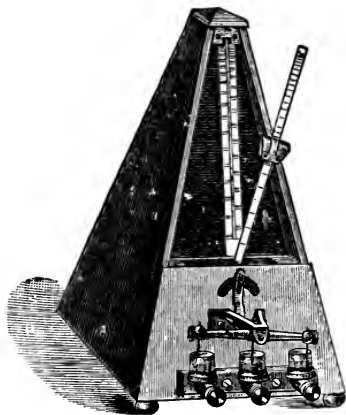

FIG. 145.—Metronome.

7. Instead of using the spring held in a clamp, a convenient form is shown in fig. 144. The spring is kept vibrating by an electro-magnet actuated by two Grove cells.

8. Magnetic Interrupting Tuning-Fork.—Instead of a vibrating spring, the primary current may be interrupted by means of a tuning-fork of known rate of vibration, and kept in motion by means of an electro-magnet. The instrument (fig. 146) is introduced into the primary circuit, and every time the style on one of the arms of the tuning-fork dips into and comes out

of the mercury placed in a small cup, the primary current is made and broken.

One of the most important points in connection with the use of this instrument is to keep the surface of the mercury clean and bright. This is necessary in

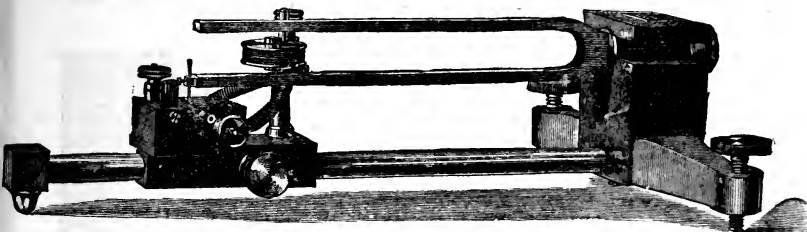

FIG. 146.—Magnetic Interrupter with Tuning-Fork, as made by the Cambridge Scientific Instrument Company.

order to have the successive shocks of equal intensity. Kronecker has devised such an apparatus. The vibrating rod is so adjusted that stimuli from 1 to 50 or 60 per second can be obtained therewith.

LESSON XLI.

FATIGUE OF MUSCLE.

1. Fatigue of Excised Muscle.

(a.) Arrange an induction coil for break shocks, but interrupt the primary circuit automatically by means of the drum key (fig. 120).

(b.) Fix a nerve-muscle preparation on a crank-myograph, with a long lever and a weight of 40-50 grams, lay the nerve over the electrodes from the short-circuited secondary coil, and let the lever record on the drum. A break shock is obtained each time the drum revolves. The myograph should be supported on a tangent stand. If a tangent support be used for the muscle-lever, then, although the muscle contracts at each revolution of the cylinder, one may record every tenth or fifteenth contraction just as one pleases (fig. 147).

(c.) Observe that the height of the curves falls, while their duration is longer. In nearly every case fatigue-curves from muscle show a "staircase" character (fig. 148), the second curve being higher than the first one, and the third than the second.

2. Fatigue-Curve of Excised Muscle.—(a.) Use a slow-revolving drum on which to record the muscle tracings, so slow that the ascent and descent of the lever form merely one line. Let the primary current be broken at regular intervals by means of a revolving drum with a platinum style attached to its spindle, to make and break the primary current at every revolution (fig. 148). In this way a curve such as fig. 148 is obtained.

(b.) Note the "staircase" character of the curve, *i.e.*, the second contraction is higher than the first, the third than the second, and so on for a certain number of contractions. After that the height of the contraction falls

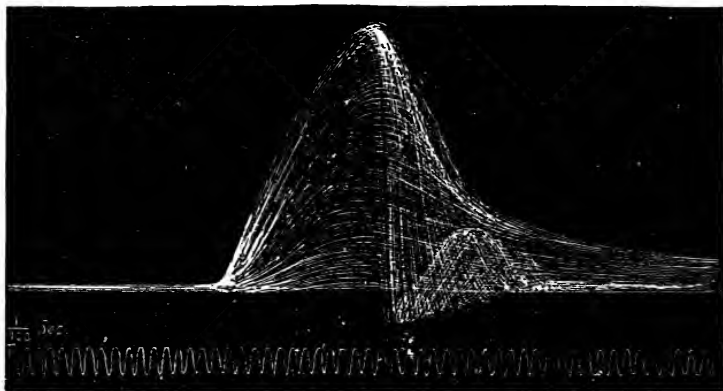

FIG. 147.—Tetanus-Curve produced with break shocks stimulation every second by means of an automatic break key in the primary circuit. *T.* Time-curve, 100 D.V. per second.

steadily, so that a line uniting the apices of all the contractions forms a straight line approximately.

In a fatigue-curve, where only the "lift" is recorded, note that the rise of the lever increases with the number of stimuli—the strength of the stimulus remaining constant, so that one gets the phenomenon of the "Treppe" or "staircase." After a time it falls steadily until the excitability is extinguished (fig. 148). Note also that in the phase of relaxation the lever does not reach the abscissa, *i.e.*, relaxation takes place so slowly as if one had to



FIG. 148.—Fatigue-Curve of an Excised Frog's Muscle recorded on a Slow-moving Drum.

deal with a so-called "contracture." If the march of events be arrested, and time given for repose, then, on stimulating, the lift increases, but the effect lasts only for a short time.

LESSON XLII.

FATIGUE OF NERVE—SEAT OF EXHAUSTION.

1. **Can Nerve be Fatigued?**—We have seen that a muscle manifests fatigue, *i.e.*, its store of material and energy are gradually used up, so that it shows a diminished capacity to respond to stimulation. Does a nerve manifest such phenomena? Reasoning *a priori*, from the fact that the only known sign obtainable during the activity of a nerve is the “negative variation of the nerve-current,” one is led to suppose that very probably nerve-fibres partake but little if at all in the phenomena of fatigue. In fact, we shall find that nerve is practically inexhaustible.

Suppose one stimulated a nerve of a nerve-muscle preparation with maximal induction shocks until the muscle ceased to respond to indirect stimulation. This would afford no proof that the muscle itself was fatigued. Why? Stimulate the muscle directly, and it will respond. Therefore the seat of fatigue in this case is not primarily in the muscle, but must be sought for either in the nerve itself or at the end-plates where the nerve comes into relation with the muscular substance.

2. **Seat of Exhaustion—**is it in Muscle, Nerve or End-Plates?

A. *Not primarily in Muscle.*—(a.) Arrange an induction coil for repeated shocks. Connect the secondary coil with a Pohl’s commutator without cross-bars.

(b.) Prepare a nerve-muscle preparation, with a straw flag, or use a crank-myograph, and place its nerve over Du Bois electrodes attached to the commutator. Pass two fine wires through the gastrocnemius and attach them to the other two binding screws of the commutator.

(c.) Tetanise the nerve until the tetanus ceases. Then reverse the commutator and stimulate the muscle. It contracts. Therefore, *the seat of fatigue is not in the muscle.*

B. *Not in the Nerve (Nerve is practically inexhaustible).*—(a.) Arrange a nerve-muscle preparation in connection with a coil for repeated shocks as before. Place the nerve over the electrodes from the secondary coil.

(b.) Arrange a Daniell’s cell connected to N.P. electrodes, and short-circuited for a constant current—the “polarising current” (Lesson XLVIII.)—and place the N.P. electrodes next the muscle, so that the — pole is next the muscle, *i.e.*, with the polarising current descending. The “polarising current” so lowers the excitability of the nerve as to “block” the passage of a nerve impulse through this part of the nerve. The tetanising electrodes are placed near the upper cut end of the nerve.

(c.) See that the muscle responds when the stimulating current acts on the nerve, then throw in the polarising current, when at once the muscle ceases to respond, because the nerve impulse is blocked. Go on stimulating the nerve for an hour or longer. We know that if there had been no “block” the muscle would long ere this have ceased to respond to indirect stimulation.

(d.) Close the key of the polarising circuit, *i.e.*, remove the block. The muscle responds at once. Therefore the loss of excitability or *seat of exhaustion is not in the nerve (Bernstein)*. Where is it, then? It must lie primarily somewhere between the nerve and muscle, *i.e.*, *it is in the end-plates*, or where nerve joins muscle. Moreover, Bowditch has shown that the sciatic nerve of a curarised cat may be stimulated for hours, there being no muscular response, but as soon as the effect of curare, which is known to paralyse the nerve-terminals in striped muscle, passes off, the muscles of the foot respond.

C. The two results of B and C may be combined thus:—

(a.) Dissect out two nerve-muscle preparations (A and B) from a frog, clamp both femurs in one clamp, and attach straw flags of different colours to both legs (fig. 114). Lay both nerves over a pair of Du Bois electrodes. Cover them, keep them moist.

(b.) Attach the electrode wires to two of the binding screws of the commutator without cross-bars, turning the handle, so that the current can be passed through both nerves when desired.

(c.) To the nerve of B, between the Du Bois electrodes and the muscle, apply a "polarising current" with its - pole next the muscle.

(d.) Pass an interrupted current through *both nerves*; A will become tetanic while B remains quiescent; the impulse cannot pass because of the "block" produced by the "polarising current."

(e.) Continue to stimulate the nerves until A ceases to respond. Break the polarising current, *i.e.*, remove the block on B; B becomes tetanic.

As both nerves have been equally stimulated, both are equally fatigued or non-fatigued. As B becomes tetanic, the seat of the fatigue is not in the nerve-trunk.

As in A the seat of fatigue was not in the muscle, and as B shows that nerve-fibres practically do not manifest the signs of fatigue, it would seem that its seat must be somewhere between muscle and nerve, in all probability in the end-plates.

LESSON XLIII.

MUSCLE WAVE—MUSCLE THICKENING—WILD'S APPARATUS.

1. This is best done by the method originally used by v. Bezold, and modified in a simple form by Biedermann. A muscle with parallel fibres—preferably a sartorius—is fixed a little to one side of the middle line in a cork clamp so that the *direct* transference of the change of muscle form, but not the excitation process in the muscle, is prevented from passing, *i.e.*, one part of the muscle is stimulated while the other part records.

(a.) Arrange an induction machine in connection with a commutator without cross-bars and two pairs of thin wires, so as to be able to send a single maximum break shock through either pair of wires as in the curare experiment (Lesson XXXIII.). Let the primary current be broken by the automatic drum key. Arrange

a recording crank-myograph. Arrange time marking apparatus ($\frac{1}{100}$ ").

(b.) Dissect off with great care the sartorius of a *curarised* frog (p. 186), and connect its tibial end with the myograph-lever.

(c.) Clamp the muscle a little to the tibial side of the middle line in a cork clamp, made by pushing two pins parallel to each other through two thin pieces of cork; the points of the pins project and serve to fix the preparation on the cork plate of the myograph (fig. 149).

(d.) Thrust two pins through the muscle close to the clamp and two near its free end. These act as electrodes and are connected with the thin wires from the commutator, so that the muscle can be stimulated either near the clamp or far away from it. Stimulate the muscle first near the clamp and record the contraction, reverse the commutator, excite it away from the clamp and record. Two curves, one rising later than the other. The distance between the two indicates the time taken by the wave of contraction to pass

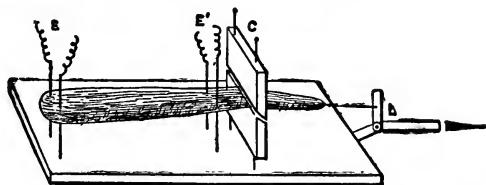

FIG. 149.—Arrangement for study of Muscle Wave. E, E'. Pin electrodes; C. Cork clamp; L. Lever.

over the distance from the far to the near electrodes. Measure the distance between the electrodes and calculate its velocity. It varies from 1 to 2 metres per second.

(e.) Test the effect of cold normal saline in slowing its rate.

2. (a.) Arrange two long straw levers on a cork frog-plate so that the two free ends of the levers record exactly over each other on a revolving drum. Record time ($\frac{1}{100}$ ").

(b.) Remove the double semi-membranosus and gracilis (p. 179) of the thigh from a *curarised* frog, together with their bony attachments, and place them under the levers, the levers lying across them, and as far apart as possible. Let the muscles rest on paraffined paper. Fix the muscles through their bony attachments by means of pins. Through one end of the muscles push two pins attached to wires to act as electrodes. Some prefer the two sartorii muscles, fastened together, the one lying on the other and fixed by means of pins.

(c.) Stimulate with a maximal break induction shock and note that two curves on different abscissæ are obtained, the one a little

later than the other. The distance between the two indicates the time taken by the contraction to pass from the one lever to the other. Test the effect of cold normal saline.

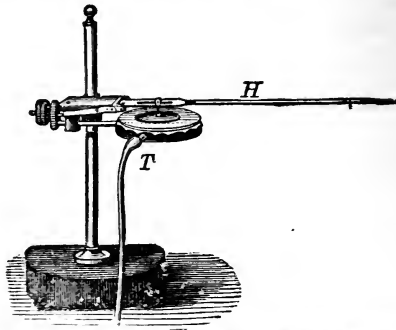

FIG. 150.—Marey's Registering Tambour. Metallic capsule, *T*, covered with thin india-rubber, and bearing an aluminium disc, which acts on the writing-lever, *H*.

3. Thickening of a Muscle during Contraction.

(a.) Arrange a Marey's tambour to write on a pendulum-myograph (fig. 150).

(b.) Fix Marey's *pince myographique* (fig. 151) so as to compress the adductor muscles between the thumb and the metacarpal bone of the index-finger, keeping the two arms together with an elastic band. Or use a pair of toy bellows, to the arms of which plate-like electrodes are fitted and connected with binding screws. Keep the handles of the bellows pressed upon the adductor muscles by means of an elastic band. Connect the receiving tambour of the pince or the nozzle of the bellows with the recording tambour, introducing a valve or T-tube with a screw clamp into the connecting elastic tube, to regulate the pressure of air within the system of tubes.

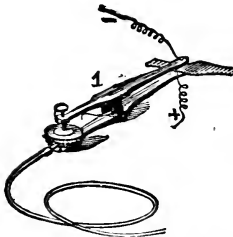

FIG. 151.—Marey's *Pince Myographique*, as made by Verdin.

(c.) Arrange an induction machine with the trigger-key of the pendulum-myograph in the primary circuit, and the pince or bellows in the secondary. Take a tracing. The time relations of the contraction are determined in the manner already stated (Lesson XXXVII.).

4. Wild's Apparatus consists of a glass cylinder made by inverting the neck-end of a two-ounce phial. The neck is fitted with a cork, the upper end is open (fig. 152, B). A wire connected with a key (*K'*) short-circuiting the secondary coil of an induction machine perforates the cork. Arranged above is a light lever (*L*) provided with an after-load (*a'*), and moving on an axis, the short arm projecting over the mouth of the jar. The whole arrangement is fixed to a platform (*P*), with an adjustable stand (*S*) bearing the fulcrum of the lever and the after-load. The cork must be renewed with each new drug used.

(a.) Dissect out the gastrocnemius, divide the femur with the *gastrocnemius*

attached just above the attachment of the latter, and the tibia below the knee-joint. Pass a fine metallic hook through the knee-joint or its ligaments, and attach it to the projecting hook of fine wire fixed to the short arm of the lever. Fix the tendo Achillis to a hook connected with the wire passing through the cork in the neck of the glass cylinder.

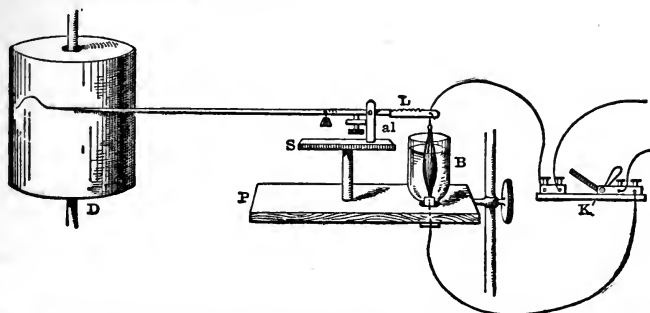

FIG. 152.—Wild's Apparatus for Studying the Action of Poisons on Muscle. D. Drum; P. Platform; S. Stand; al. After-load; L. Lever; B. Bottle with muscle; K. Key.

(b.) Fill the glass cylinder—which encloses the muscle—not quite full with normal saline. Stimulate the muscle directly with a break shock, using a mercury key in the primary circuit, and take a tracing.

(c.) Remove the normal saline with a pipette, and replace it with a solution of the drug whose action you wish to study, e.g., veratria 1 in 5000, or barium chloride 1 in 1000. Study the veratria tracing (fig. 137).

5. Interference-Phenomenon in Nerve-Muscle Preparation.—Arrange a nerve-muscle preparation in a moist chamber, and weight the recording lever with 20 grams. Place the central end of the nerve over platinum electrodes, and allow a portion of the nerve nearer the muscle to hang in the form of a loop in contact with strong glycerin, when the muscle becomes tetanic. When tetanus occurs throw in an interrupted current, when the tetanus is diminished. Is this interference-phenomenon an inhibitory one? (Kaiser, *Zeitsch. f. Biol.*, 1891, p. 417.)

LESSON XLIV.

MYOGRAPHIC EXPERIMENTS ON MAN— ERGOGRAF AND DYNAMOGRAF.

1. Myographic Experiments on Man.

Fick has devised a simple apparatus for this purpose, using isometric curves. The muscle investigated is the *Abductor indicis* or *interosseus dorsalis primus* of the hand. It arises by two heads from the adjacent surfaces of the metacarpal bones of the thumb and index-finger, and is inserted into the dorsal aponeurosis of the latter.

Apparatus.—In a prismatic piece of wood, H, firmly fixed to a base, a hole is cut down to the level, K, through which one can conveniently place one's hand (fig. 153); the ulnar surface of the hand rests on the rounded lower end

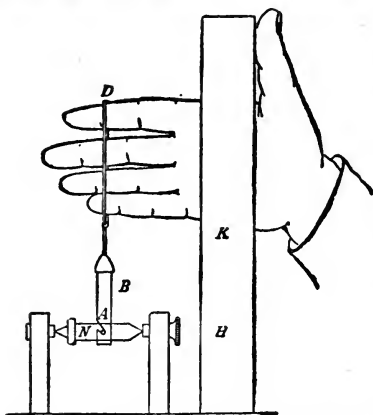

FIG. 153.—Fick's Apparatus for Studying Tension of Abductor Indicis. H. Wooden rod with hole, K, for hand; D. Iron-wire collar, acting through B on an axle, N, to which a lever is attached. Seen from the end.

of the hole, while the thumb rests against the lateral wall of the hole, so that in this way the hand is sufficiently fixed. Over the index-finger is placed a collar made of strong iron wire, and through this collar project the three other fingers, which hang free, the collar itself lying over the joint between the second and third phalanges. To the collar is attached a strip of iron with a notch in it, by means of which it is attached to the axis of the lever, which is one so arranged as to give isometric contractions as in fig. 153.

When one attempts to raise the index-finger, the muscle records an isometric curve. As the collar can at most move only 1 mm., and as the muscle itself acts on a lever about five times shorter than the distance of the point of attachment of the collar from the axis of rotation of the index-finger, the muscle can at most contract $\frac{1}{5}$ mm. The muscle records on a revolving

surface. (From the description of Schenk. See Fick, *Pflüger's Archiv*, Bd. 41, p. 176.)

With this apparatus one can study (1) The force of contraction; (2) The effect of fatigue and recovery; (3) One may excite the muscle by means of electricity; (4) One may compare the mechanical response elicited by electrical (tetanic) and the normal physiological stimulus, and learn that during a voluntary contraction there is a greater contraction, *i.e.*, a greater liberation of energy than during the strongest contraction elicited by electrical stimulation.

2. Mosso's Ergograph for Fatigue and Work.—This is a most useful instrument (fig. 154), by means of which the student can study the process of fatigue on himself, the conditions that predispose to it, and the process of recovery, as well as the effect of various conditions on the fatigue-curve. By means of this instrument also the amount of work done is recorded graphically, and can be estimated in terms of kilogrammetres, the contractions in this case being isotonic. The forearm is fixed by means of clamps upon an iron framework, while the hand also is firmly fixed, the index and ring fingers being placed in brass hollow cylinders, while the middle finger is free. The forearm is placed in a half-supinated position. To the middle finger is attached a cord, passing to the writing-style, and to the latter is attached a weight, which can be varied. The style writes upon a recording drum moving horizontally. The forearm is fixed in the apparatus, and the middle finger attached to the writing apparatus, and to the latter is added a load of known weight, *e.g.*, 2-3 kilos. The experimenter flexes the middle finger, lifts the load, and as soon as the contraction is over the load extends the

finger. The experimenter contracts the muscles, moving his middle finger at a given rate, say once every two seconds, either by listening to the beat of a metronome, or observing the motion of a pendulum vibrating a definite number of times per minute. (A. Mosso, "Fatigue of human muscle," *Du Bois-Reymond's Archiv*, 1890, and *Die Ermüdung*, Leipzig, 1892; Warren P. Lombard, "Some of the influences which affect the power of voluntary muscular contraction," *Journal of Physiology*, xiii. 1.)

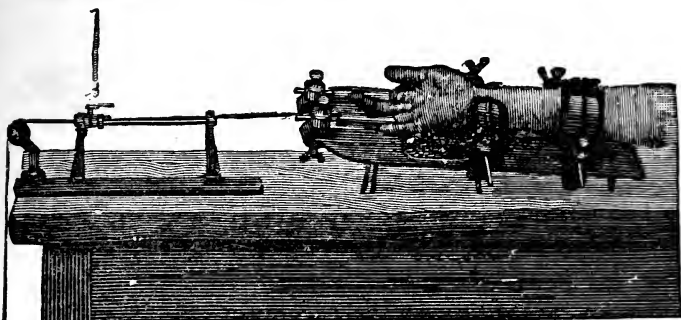

FIG. 154.—Mosso's Ergograph.

3. Dynamograph.—Waller has devised a simple form of this. To the vertical arm of a dynamometer of Salter (p. 189), a strong steel spring with a long recording arm is attached, the record being made on a very slow-moving drum, *e.g.*, a cylinder placed vertically on the hour-spindle of an American clock. The dynamograph is so arranged that it can be clamped to a table. The observer, by grasping the handles of the instrument, makes a series of maximal efforts, say 30 per minute,—*i.e.*, each lasting two seconds,—then he takes one minute's rest, and repeats the experiment.

In this way one can measure the muscular strength and how it declines with each contraction or series of contractions, together with its recovery during rest. We have a series of isometric contractions.

LESSON XLV.

DIFFERENTIAL ASTATIC GALVANOMETER—NON-POLARISABLE ELECTRODES—SHUNT—DEMAR-CATION AND ACTION-CURRENTS IN MUSCLE.

ELECTRO-MOTIVE PHENOMENA OF MUSCLE AND NERVE.

1. Thomson's High-Resistance Differential Astatic Galvanometer.

(a.) Place the galvanometer (fig. 155) upon a stand unaffected

by vibrations, *e.g.*, on a slate slab fixed into the wall, or on a solid stone pillar fixed in the earth, taking care that no iron is near.

(*b.*) Let the galvanometer face *west*, *i.e.*, with the plane of the coils in the magnetic meridian, the magnetic meridian being ascertained by means of a magnetic needle. As the galvanometer is a differential one, to convert it into a single one, connect the two

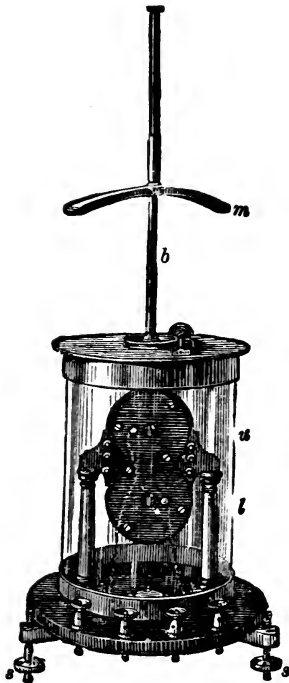

FIG. 155.—Sir William Thomson's Reflecting Galvanometer. *u.* Upper, *l.* Lower coil; *s, s.* Levelling screws; *m.* Magnet on a brass support, *b.*

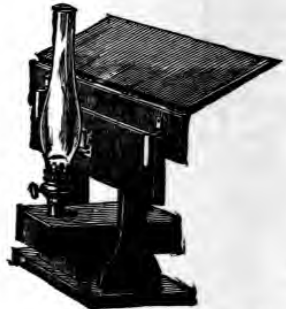

FIG. 156.—Lamp and Scale for Thomson's Galvanometer.

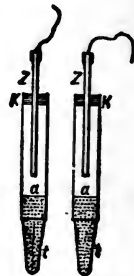

FIG. 157.—Non-Polarisable Electrodes. *Z.* Zincs; *K.* Cork; *a.* Zinc sulphate solution; *t, t.* Clay points.

central binding screws on the ebonite base by means of a copper wire.

(*c.*) By means of the three screws level the galvanometer.

(*d.*) Take off the glass cover and steadily raise the small milled head on the top of the upper coils, which frees the mirror, and allows it to swing free. Replace the glass shade.

(*e.*) Place the scale (fig. 156) also in the magnetic meridian and

1 metre from the mirror, taking care that it is at the proper height. Instead of a slit in the scale, it is better to fix in it a thin wire, and by means of a lens of short focal distance to bring the image of the wire to a focus in the middle of the illuminated disc of light reflected from the mirror upon the scale.

(f.) Light the paraffin lamp, place the edge of the flame towards the slit, darken the room, and see that the centre of the scale, its zero, the slit in the scale, the flame of the lamp, and the centre of the mirror, are all in the same vertical plane, so that a good light is thrown on the mirror in order to obtain a good image on the scale.

(g.) Make the needle all but astatic by means of the magnet attached to the bar above the instrument. The needle is *most sensitive when it swings slowly*.

(h.) Test the sensitiveness of the galvanometer by applying the tips of two moist fingers to the two outer binding screws of the instrument, when at once the beam of light passes off the scale.

2. Non-Polarisable Electrodes.—One may use the old form of Du Bois-Reymond, the simple tube electrodes, or the "brush electrodes" of V. Fleischl (fig. 160).

(A.) (a.) Use glass tubes about 3 cm. long and 5 mm. in diameter, tapering somewhat near one end, and see that they are perfectly clean.

(b.) Plug the tapered end of the glass tube with a plug of china clay, made by mixing kaolin into a paste with normal saline. Push the clay into the lower third or thereby of the tube; plug the latter, using a fresh-cut piece of wood or thin glass rod to do so; allow part of the clay to project beyond the tapered end of the tube (fig. 157, *t*, *t*).

(c.) With a clean pipette half fill the remainder of the tube with a *saturated* neutral solution of zinc sulphate. Make *two* such electrodes.

(d.) Into each tube introduce a well-amalgamated piece of zinc wire with a thin copper wire soldered to its upper end (*Z*, *Z*), fix the electrodes in suitable holders in a moist chamber, and attach the wires of the zincs to the binding screws on the stage of the moist chamber. The zinc should not touch the clay.

(B.) Some prefer a U-shaped glass tube held in a suitable holder attached to a vulcanite rod in the moist chamber (B. Sanderson's pattern). The tube contains a saturated solution of zinc sulphate as before. Into one limb of the tube is placed the rod of amalgamated zinc. In the other free limb is placed a straight tube with a slight flange at its upper end filled with kaolin moistened with normal saline, the kaolin projecting as a cap above

the level of the U-shaped tube. The muscle is placed on the two corresponding kaolin caps.

3. Shunt.—This is an arrangement by which a greater or less proportion of a current can be sent through the galvanometer (fig. 158). The brass bars on the upper surface are marked with the numbers $\frac{1}{9}$, $\frac{1}{99}$, $\frac{1}{999}$, indicating the ratio between their resistance and that of the galvanometer, so that when the plug is inserted in the several positions, $\frac{1}{10}$, $\frac{1}{100}$, or $\frac{1}{1000}$ of the whole current may be sent through the galvanometer.

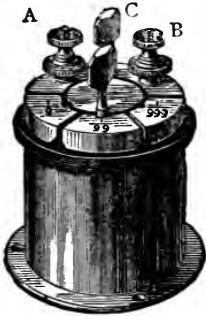

FIG. 158.—The Shunt.

4. Muscle Demarcation-Current (Current of Injury).

(a.) Arrange the apparatus according to the scheme (fig. 159).

(b.) Place a shunt between the N.P. electrodes and the galvanometer. Connect two wires from the electrodes to the binding screws (A, B) of the shunt, and from the same binding screws attach two wires to the galvanometer. Insert a plug (C) between

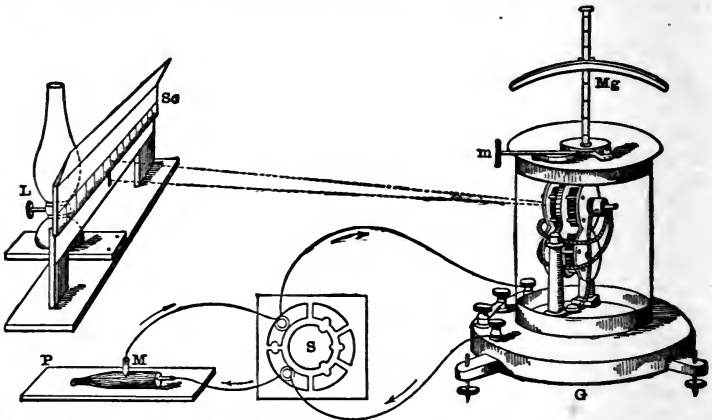

FIG. 159.—Arrangement of Apparatus for the Demarcation-Current of Muscle. *M.* Muscle on a glass plate, *P*; *S.* Shunt; *G.* Galvanometer; *Mg.* Its magnet moved by the milled head, *m*; *L.* and *Sc.* Lamp and scale.

A and B, thus short-circuiting the muscle-current. When working with muscle, keep a plug in the hole opposite $\frac{1}{9}$ on the shunt. Arrange the lamp and scale so as to have a good image of

the mirror on the zero of the scale; adjusting, if necessary, by means of the magnet moved by the milled head on the top of the glass shade (fig. 159, *m*).

(*c.*) Test the electrodes, either by bringing them together or by joining them with a piece of silk thread covered with china-clay paste. After removing all the plugs from the shunt, there ought to be no deflection of the spot of light. If there is none, there is no polarity, and the electrodes are perfect.

(*d.*) **Ascertain the Direction of Current in Galvanometer.**—Make a small Smee's battery with a two-ounce bottle. Place in the bottle dilute sulphuric acid (1 : 20) and two wires of zinc (-) and copper (+), with wires soldered to them. Connect them with the galvanometer. Arrange the shunt so that $\frac{1}{100}$ or $\frac{1}{1000}$ part of the current thus generated goes through the galvanometer. Note the deflection and its direction. Arrange the N.P. electrodes in the same way, and observe which is the negative and which the positive pole corresponding to the zinc and copper of the battery.

(*e.*) **Prepare a Muscle.**—Dissect out either the sartorius or semi-membranosus of a frog, which consist of parallel fibres, but avoid touching the muscle with the acid skin of the frog. Lay the muscle on a glass plate or block of paraffin under the moist chamber.

(*f.*) Keep one plug in the shunt at C, to short-circuit the electrodes, and the other plug at $\frac{1}{9}$. Cut a fresh transverse section at one end of the muscle, and adjust the point of one electrode exactly over the centre (equator) of the longitudinal surface of the muscle. Apply the other electrode exactly to the centre of the freshly divided transverse surface (fig. 159).

(*g.*) **Current of Injury.**—Remove the short-circuiting plug, C, from the shunt, keep one plug in at $\frac{1}{9}$, so that $\frac{1}{10}$ of the total current from the muscle goes through the galvanometer. Note the direction and extent of the deflection. By noting the direction, and from the observation already made (*d*), one knows that the longitudinal surface of the muscle is +, and the transverse section -. Replace the plug-key (C), and allow the needle to come to rest at zero. The deflection was caused by the current of injury, and it flows from the equator or middle of the muscle towards the cut ends. It is also called the demarcation-current. The injured part of a muscle is negative to the uninjured part, and the current in the galvanometer is from the longitudinal (+) surface to the injured negative transverse surface.

(*h.*) Bring the N.P. electrode on the longitudinal surface nearer to the end of the muscle, and note the diminution of the deflection of the needle. Replace plug C.

(i.) Vary the position of the electrodes and note the variation in the deflection. If they be equidistant from the equator, there is no deflection. The greatest deflection takes place when one electrode is over the equator and the other over the centre of the transverse section of a muscle composed of parallel fibres. The deflection, *i.e.*, the electro-motive force, diminishes as the electrodes are moved from the equator or the centre of the transverse section. In certain positions no deflection is obtained.

5. Negative Variation of the Muscle-Current.



FIG. 160.—Brush Electrodes of V. Fleischl.

(a.) Use the same muscle preparation, or isolate the gastrocnemius with the sciatic nerve attached. Divide the muscle transversely, and lay the artificial transverse section on one electrode, and the longitudinal surface on the other. Observe the extent of the deflection.

(b.) Adjust an induction coil for repeated shocks, placing it at some distance from the galvanometer.

(c.) Take the demarcation-current, observing the deflection, and allow the spot of light to take up its new position on the scale. Tetanise the muscle through its nerve, and observe that the spot of light travels

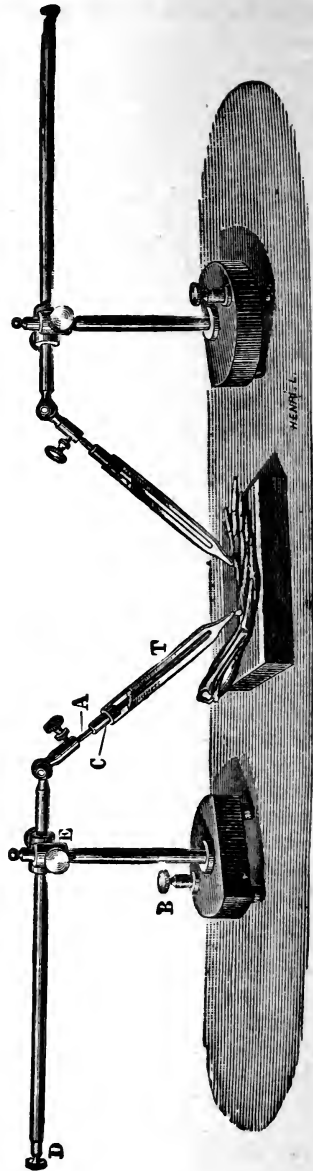

FIG. 161.—D'Arsonval's Non-Polarisable Electrodes, as made by Verdin.

towards zero. This is the "negative variation of the muscle-current." If the gastrocnemius be used, stimulate the sciatic nerve. Care must be taken that the muscle does not shift its position on the electrodes. According to Hermann's theory, it is brought about as follows:—An injured part of a muscle (or nerve) is negative to an uninjured part—"negativity of injury," and similarly an active part of a muscle is negative to an inactive part—"negativity of activity." The demarcation-current or injury-current passing in the galvanometer: from the longitudinal + to the transverse - surface is diminished, because, when the muscle contracts, there is a current set up—**action-current**—in the opposite direction, which diminishes the total current acting on the galvanometer.

ADDITIONAL EXERCISES.

6. Brush Electrodes of V. Fleischl (fig. 160) consist of glass tubes 5 mm. in diameter and 4 cm. long. Into one end is fitted a perfectly clean camel's-hair pencil, and into the other dips a well-amalgamated rod of zinc with a binding screw at its free end. Place some clay in the lower part of the tube, and then fill it with a saturated solution of zinc sulphate. A piece of india-rubber tubing fits as a cap over the upper end of the glass tube. The brushes are moistened with a mixture of kaolin and normal saline.

7. D'Arsonval's Non-Polarisable Electrodes (fig. 161).—The electrodes consist of a silver wire coated with fused silver chloride. The silver wire is held in a suitable stand, while the silver chloride coated part is placed in a tube tapering to a point below and filled with normal saline. At the lower tapered end there is a small aperture into which is introduced a thick thread. The tube is closed above with a cork (C), through which passes the silver electrode (A). The tapered points are brought into contact with the tissues. They should be kept in the dark.

Vertical Electrodes of Fick.—Into a vertical glass tube the amalgamated zinc is introduced from below, the tube is filled with a saturated solution of $ZnSO_4$, but the nerve rests on a hammer-shaped piece of baken porcelain, such as is used for porous cells for batteries. It is soaked with salt solution, and has a process which dips into the zinc sulphate. Several of these can be arranged side by side in a suitable holder.

LESSON XLVI.

NERVE-CURRENTS — ELECTRO-MOTIVE PHENOMENA OF THE HEART—CAPILLARY ELECTRO-METER.

1. Demarcation-Current of Nerve.

(a.) Render the galvanometer as sensitive as possible by adjusting at a suitable height the north pole of the magnet over the north pole of the upper needle.

(b.) Prepare N.P. electrodes for a nerve. In this case the electrodes are hook-shaped, and one is adjusted over the other. The upper hooked electrode has a groove on its concavity communicating with the interior of the tube (fig. 162). Place only one plug in the shunt between A and B.

(c.) Dissect out a long stretch of the sciatic nerve, make a fresh transverse section at both ends, hang it over the upper N.P. electrode (N), and resting with its two cut ends on the lower electrode (C), thus doubling the strength of the current (fig. 162).

(d.) Remove the plug from C in the shunt and pass the whole of the demarcation nerve-current through the galvanometer, noting the deflection.

(e.) Instead of adjusting the nerve as in (c.), it may be so placed on the ordinary tube N.P. electrodes that the cut end rests on one electrode and the longitudinal surface on the other, thus leaving part of the nerve free. Observe the deflection in this way.

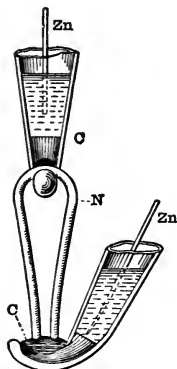

FIG. 162.—Nerve N.P. Electrodes. N. Nerve; C. Clay of electrodes; Zn. Zincs.

2. Action-Current of Nerve.

(a.) Observe the amount of deflection as in (1. e.). Stimulate with an interrupted current the free end of the nerve, and observe that the spot of light travels towards zero. This was formerly called the "negative variation" of the nerve-current.

3. Electro-Motive Phenomena of the Heart.—The arrangement of the apparatus is the same as in Lesson XLV.

(a.) Make a Stannius preparation of the heart, using only the first ligature (Lesson LV. 1) to arrest the heart's action. Lead off with brush N.P. electrodes from base and apex of the quiescent uninjured heart; there is no deflection.

(b.) Pinch the apex so as to injure it; it becomes negative; a difference of potential is at once set up and now the spot of light oscillates with each beat of the heart.

(c.) Excise a heart so as to get a spontaneously beating ventricle; lead off from the base and apex of the latter; observe the so-called "negative variation" with each contraction.

(d.) See also Lesson XLVII. 6 for secondary contraction excited by the beating heart.

4. Capillary Electrometer.

(a.) Lead off a muscle to the two binding screws of a capillary electrometer. The fine thread of mercury must be observed with a microscope.

By means of the capillary electrometer Waller has shown the diphasic variation of the heart-current in man and in a living dog.

LESSON XLVII.

GALVANI'S EXPERIMENT—SECONDARY CONTRACTION AND TETANUS—PARADOXICAL CONTRACTION—KÜHNE'S EXPERIMENTS.

1. Galvani's Experiment.

(a.) Destroy the brain of a frog, divide the spine about the middle of the dorsal region, cut away the upper part of the body, and remove the viscera. Remove the skin from the hind-legs, divide the iliac bones and urostyle, avoid injuring the lumbar plexus, which will remain as the only tissue connecting the lower end of the vertebral column with the legs. Thrust an S-shaped copper hook through the lower end of the spine and spinal cord (fig. 163).

(b.) Hook the frog to an iron tripod. Tilt the tripod so that the legs come in contact with one of the legs of the tripod; vigorous contractions occur whenever the frog's legs touch the tripod.

(c.) With the frog hanging perpendicularly without touching the tripod, make a U-shaped piece of wire composed of a copper and zinc wire soldered together. Touch the nerves above with the copper (or zinc) end, and the muscles below with the zinc (or copper), when contraction occurs at make, or break, or both.

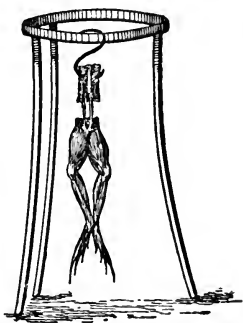

FIG. 163.—Galvani's Experiment.

2. Contraction without Metals.

(a.) Make a fresh nerve-muscle preparation, leaving the leg attached to the femur, and having the sciatic nerve as long as possible. Hold the femur in one hand, lift the nerve on a camel's-hair pencil or glass rod moistened with normal saline, and allow it to fall upon the gastrocnemius, when the muscle will contract. Contraction occurs because the nerve is suddenly stimulated, owing to the surface of the muscle having different potentials.

(b.) Or remove the skin from the hind legs of a frog, and dissect out the sciatic nerve in its whole extent. Divide it at its upper end. If the nerve be lifted on a glass rod and allowed to fall longitudinally on the triceps muscle there is no contraction.

Make a transverse cut across the triceps, and so arrange the nerve that its cut end rests on the transverse section of the muscle, and its longitudinal surface on the longitudinal surface of the muscle. As soon as this interval is bridged over, the leg muscles contract.

There is a large difference in potential between the transversely cut muscle and its longitudinal surface—there is a “muscle-current” in the muscle from the artificial transverse section to the longitudinal surface, so when the nerve bridges over these surfaces, there is an external derivation-current passing in the nerve, whereby the latter is stimulated.

Thus the “physiological rheoscope” is used to show the presence of electrical currents in muscle under certain conditions.

3. Secondary Contraction or Twitch and Secondary Tetanus.

(a.) Arrange an induction coil for single make and break shocks. Make two nerve-muscle preparations.

(b.) Place the left sciatic nerve (A) over the right gastrocnemius (B) or thigh muscles, and the right sciatic nerve over the electrodes (E) (fig. 164).

(c.) Stimulate the nerve of B with single induction shocks—the muscles of both B and A contract. The contraction in A is called a **secondary contraction**. A is the rheoscopic limb as by its contraction it shows the existence of an electrical current in B. When B contracts, there is a sudden diminution of its muscle-current, which circulates in the nerve of A. This sudden diminution—negative variation—is tantamount to a stimulus, and so the nerve of A is stimulated.

(d.) Arrange the induction coil for repeated shocks, and stimulate the nerve of B. B is tetanised, and so is A simultaneously. This is **secondary tetanus**. The nerve of A is stimulated by the sudden series of negative variations

of the muscle-current during the contraction of B. So that the electrical change during tetanus is interrupted and not continuous like the change in form of the muscle, and with 50 shocks per second each electrical change must reach its maximum and subside in $\frac{1}{100}$ ”.

(e.) Ligate the nerve of A near the muscle, stimulate the nerve of B; there is no contraction of A although B contracts.

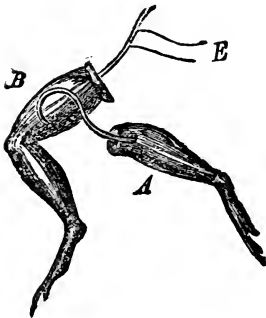

FIG. 164.—Secondary Contraction.

(f.) Prepare another limb and adjust it in place of A, ligature the nerve of B. On stimulating the nerve of B, no contraction takes place either in A or B.

4. Secondary Contraction from Nerve.

(a.) Make a nerve-muscle preparation and place it on a glass plate (B). Dissect out the sciatic nerve of the opposite side (A). Lay 1 cm. of the isolated sciatic nerve (A) on a similar length of the nerve of the nerve-muscle preparation (B) (fig. 165).

(b.) Stimulate A with a single induction shock; the muscle of B contracts. Stimulate A with an interrupted current; the muscle of B is thrown into tetanus.

(c.) Ligature A and stimulate again. B does not contract. Therefore its contraction was not due to an escape of the stimulating current. The "secondary contractions" in B are due to the sudden variations of the electro-motivity produced in A when it is stimulated.

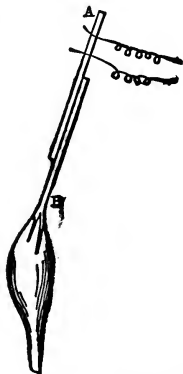

FIG. 165.—Scheme of Secondary Contraction.

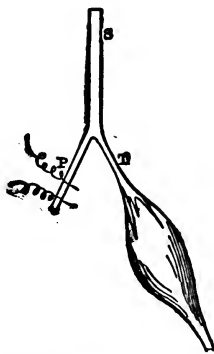

FIG. 166.—Scheme of Paradoxical Contraction.

5. Paradoxical Contraction.

(a.) **Arrangement.**—Arrange a Daniell's cell and key for giving a galvanic current, or use repeated induction shocks.

(b.) Pith a frog, expose the sciatic nerve down to the knee (fig. 166, S). Trace the two branches into which it divides. Divide the outer or peroneal branch as near as possible to the knee, and stimulate its *central end* (P) by a faradic current. A certain strength of current will be found whereby the muscles supplied by the other division of the nerve are thrown into tetanus (T). The tibial nerve to the gastrocnemius is stimulated by escape or spread of "electrotonic" currents from the excited nerve.

(c.) Instead of induction shocks, use a shock from a Daniell's cell. There is a paradoxical twitch.

No paradoxical response is produced by stimulation other than electrical stimuli, *e.g.*, section of a nerve, salt. It is still produced even if the peroneal nerve be ligatured on the central side of the seat of stimulation.

6. Frog's Heart-Current (Secondary contraction).

(a.) **Injured Heart.**—A quiescent uninjured heart gives no current, but an active heart does, and so does an injured one. The action-current of an injured heart is easily shown when a nerve of a nerve-muscle preparation is placed on a beating rabbit's heart inside the thorax. In the frog, it requires some care to show this. It is easy, however, to obtain a secondary contraction from a beating injured frog's heart.

Prepare a nerve-muscle preparation or rheoscopic limb. Excise the heart of a pithed frog, and place it on a dry glass plate, removing the surplus blood. Cut off the apex of heart, and to it apply the transverse section of the divided sciatic nerve, letting a part of the longitudinal surface of the nerve rest on the uninjured ventricle. With each beat of the heart there is a twitch of the rheoscopic limb or muscle.

(b.) **Action-Current of Uninjured Frog's Heart.**—On placing the nerve of a nerve-muscle preparation along the exposed frog's heart from apex to base, one sometimes gets a muscular response to each beat of the heart, but the experiment does not always succeed. It is easier to do it on a Stanniused heart; with each contraction of the heart excited artificially, there is a secondary contraction.

ADDITIONAL EXERCISES.

7. Kühne's Nerve-Current Experiment.

(a.) Invert an earthenware bowl (B), and with wax fix to its base a piece of glass 10 cm. square (fig. 167, G).

(b.) Make two rolls of kaolin (moistened with normal saline), about 1 cm. in diameter and 6 cm. in length (P, P'), bend them at a right angle, and hang them over the glass plate about 6 mm. apart.

(c.) Make a nerve-muscle preparation, lay the muscle on the glass plate, and the nerve (N) over the rolls of china clay.

(d.) Fill a small glass vessel (C) with normal saline, and allow the two free ends of the clay to dip into it. With each dip the muscle contracts. In this case the nerve is stimulated by the completion of the circuit of its own demarcation-current, and this in turn indirectly stimulates the muscle.

8. Kühne's Muscle-Press—Secondary Contraction from Muscle to Muscle.

—Prepare two sartorius muscles of a frog. Place the end of one muscle

over the end of the other, both muscles being in line with each other, and the overlapping portion so arranged that they can be pressed together by means of the small screw-press devised by Kühne for this purpose.

On stimulating—by electrical, chemical, or other stimuli—the free end of either muscle, so as to cause that muscle to contract, the second muscle also contracts. The negative variation of the muscle-current stimulates the second muscle. This result does not take place if a thin layer of tinfoil be placed between the two muscles.

9. Biedermann's Modification of Secondary Muscular Contraction.

If a frog be denuded of its skin and left exposed to the air for twenty-four

hours—the time varying with the temperature, amount of moisture in the air, &c.—on causing one muscle to contract, other muscles contract secondarily. On placing the two sartorius muscles in direct contact with each other, when one muscle is made to contract, the other does so secondarily without the use of a muscle-press.

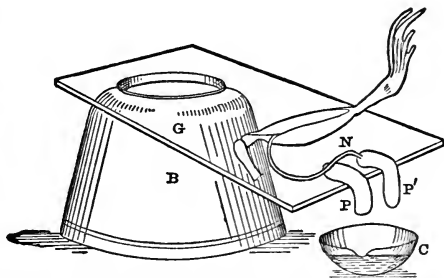

FIG. 167.—Kühne's Experiment. B. Bowl; G. Glass plate; N. Nerve on P, P', Pads of clay; C. Capsule.

LESSON XLVIII.

ELECTROTONUS—ELECTROTONIC VARIATION OF THE EXCITABILITY.

Electrotonus.—When a nerve is traversed by a constant current, its so-called “vital” properties are altered, *i.e.*, its excitability, conductivity, and electro-motivity. The region of the nerve affected by the positive pole is said to be in the anelectrotonic, and that by the negative in the kathelectrotonic condition. Therefore we have to study the—

- I. Electro-motive alteration of the *excitability* and *conductivity*.
- II. Electro-motive alteration of the *electro-motivity*.

1. Electrotonic Variation of the Excitability.

A. (a.) Connect two small Grove's cells or two Daniell's to a Pohl's commutator *with cross-bars* (fig. 168), introducing a Du Bois key to short-circuit the battery. From two of the binding screws connect wires with two N.P. electrodes or the platinum electrodes of Du Bois, introducing a short-circuiting key in the electrode circuit (fig. 168).

(b.) Make a nerve-muscle preparation, attach a straw flag to the foot, and fix the femur in a clamp, as in fig. 168. Lay the nerve over the electrodes. Trace the direction of the current, and make a mark to guide you as to when the current in the nerve is descending or ascending, *i.e.*, whether the negative or positive pole is next the muscle.

(c.) Place a drop of a saturated solution of common salt on the nerve between the electrodes and the muscle. In a minute or less

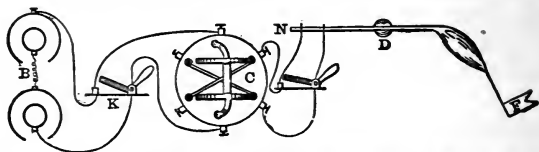

FIG. 168.—Scheme of Electrotonic Variation of Excitability. *D.* Drop of strong solution of salt on the nerve, *N*; *F.* Flag on the muscle.

the toes begin to twitch, and by-and-by the muscles of the leg become tetanic, so that the flag is raised and kept in the horizontal position.

(d.) Turn the commutator, so that the positive pole is next the muscle; the straw sinks, *i.e.*, the excitability of the nerve in the region of the positive pole is so diminished as to “block” the impulse passing to the muscle, showing that the positive pole lowers the excitability.

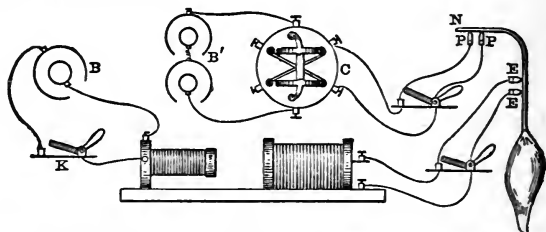

FIG. 169.—Scheme of Electrotonic Variation of Excitability. *P, P.* Polarising, and *E, E.* Stimulation current.

(e.) Reverse the commutator, so that the negative pole is next the muscle. The limb becomes tetanic, the negative pole (*kathelctrotonic area*) increases the excitability.

2. Another Method.—Apparatus.—Three Daniell's cells, two pairs of N.P. electrodes, two Du Bois keys, a spring-key, commutator *with cross-bars*, induction coil, wires, moist chamber, drum.

B. (a.) Arrange the apparatus according to the scheme (fig. 169). Prepare two pairs of N.P. electrodes for the nerve.

(b.) Connect two Daniell's cells with a Pohl's commutator *with cross-bars* (C); connect the commutator—a short-circuiting key intervening—to one pair of the N.P. electrodes. This is the "polarising current" (P, P).

(c.) Arrange an induction coil for tetanising shocks; use N.P. electrodes and short-circuit the secondary circuit. This is the "exciting current" (E, E).

(d.) Make a nerve-muscle preparation with the nerve as long as possible, and arrange it to write on a drum. Place the nerve on the two pairs of electrodes in the moist chamber, the "polarising" pair being next the cut end of the nerve (P, P), and about 1 centimetre apart. Between the polarising pair and the muscle apply the "exciting" pair of electrodes to the nerve (E, E).

(e.) With the polarising current short-circuited, pull away the secondary from the primary coil, and find the minimum distance at which a feeble contraction of the muscle is obtained. Push the secondary coil up until a weak contraction is obtained, and take a tracing. Previously arrange the commutator to send a *descending* current through the nerve. While the muscle is contracting feebly, throw in the descending polarising current; at once the contraction becomes much *stronger*. Reverse the commutator to send an *ascending* polarising current through the nerve, and the contraction will *cease*.

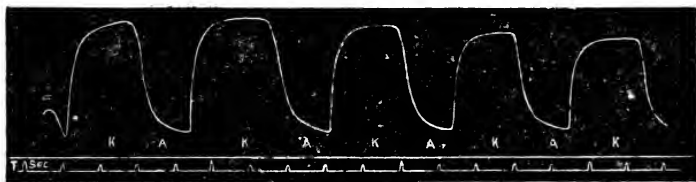

FIG. 170.—Tracing showing effect of Anode and Kathode on Excitability of Nerve, the latter stimulated with repeated shocks. T. Time in seconds.

(f.) Repeat the experiment, using Neef's hammer, selecting a strength of stimulus just insufficient to give tetanic response when the + pole of the polarising current is next the muscle. Reverse the commutator, and at once the previously inadequate shocks become adequate and tetanus results as shown in fig. 170, where the effect of + and - poles are shown alternately.

In the first case, the area influenced by the exciting electrodes was affected by the negative pole, *i.e.*, was in the condition of kathelectrotonus, and the tetanus was increased; therefore, *the kathelectrotonic condition increases the excitability of a nerve*. In the second, the nerve next the exciting electrodes was in the condition of anelectrotonus, and the contractions ceased; therefore, *the anelectrotonic condition diminishes the excitability of a nerve* (fig. 171).

3. Rheochord—use salt as stimulus.—The experiment may also be done by using a rheochord to graduate the polarising current, salt again being used as the stimulus.

(a.) Arrange two N.P. electrodes in a moist chamber, provided with a recording lever, placing the N.P.'s about 1 cm. apart.

(b.) Connect the terminals of two Daniell's cells (arranged in circuit) to the central screws of a Pohl's commutator (with cross-bars) as in fig. 172, placing a mercury key in the circuit. Connect the wires, *x*, *y*, to the two blocks on

the rheochord shown in fig. 92. By reversing the commutator the current through the rheochord can be reversed. Then connect one N.P. electrode with one terminal of the rheochord, while the other N.P. is connected with the movable block or slider (S) of the rheochord.

(c.) Notice which pole is next the muscle according to the position of the commutator and make a mark to guide you. Make a long nerve-muscle and arrange it over the electrodes, attaching the muscle to a recording lever (crank).

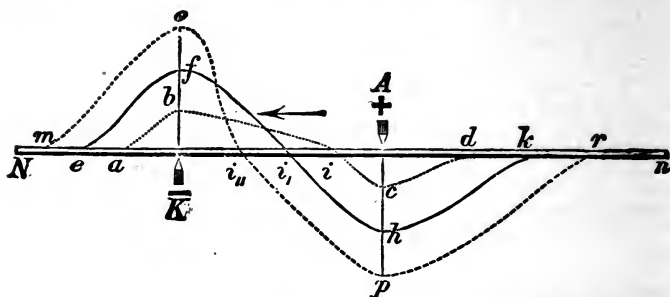

FIG. 171.—Scheme of Electrotonic Variation of Excitability in a Nerve. K. Kathode; A. Anode; N, n. Nerve. The curve above the line indicates increase, and that below the line decrease of excitability.

(d.) Begin with the slider (S) close up to the zero terminal, and gradually slide it along until, on closing the battery circuit, the muscle responds at make whether the + or - pole is next the muscle, *i.e.*, whether the current is ascending or descending.

(e.) Open the circuit, place on the nerve near the muscle either a drop of saturated solution of common salt or fine moist crystals of salt. Wait till the salt produces occasional short spasmodic movements of the limb. Close the key, place the - pole next the muscle, at once the limb becomes tetanic owing to the increase of excitability under the influence of the - pole (*kath-electrotonus*). Open the current, the limb becomes quiescent.

(f.) Open the key, and after a short time, when the spasms reappear, reverse the commutator so that the + pole is next the muscle. Close the current, the limb becomes quiescent, due to the fall of excitability under the influence of the + pole (*anelectrotonus*). Break the current, the muscle becomes tetanic. Thus it is shown that the appearance of kathelectrotonus and the disappearance of anelectrotonus are accompanied by increase of excitability, while the disappearance of kathelectrotonus and the appearance of anelectrotonus are accompanied by diminution of excitability.

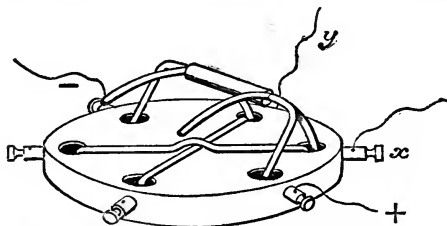

FIG. 172.—Pohl's Commutator with cross-bars, arranged for reversing the direction of a current.

appearance of kathelectrotonus and the disappearance of anelectrotonus are accompanied by increase of excitability, while the disappearance of kathelectrotonus and the appearance of anelectrotonus are accompanied by diminution of excitability.

4. Conductivity is impaired in the Intra-Polar Region.—Arrange the experiment as in 3, but place the salt on the nerve as far as possible from the muscle. When the salt causes tetanic spasms, close the current through the electrodes, and whether this current be ascending or descending, the spasms cease, because the excitatory change is "blocked" in the intra-polar area.

LESSON XLIX.

PFLÜGER'S LAW OF CONTRACTION—ELECTROTONIC VARIATION OF THE ELECTROMOTIVITY—RITTER'S TETANUS.

1. Pflüger's Law of Contraction.—Apparatus.—Several Daniell or small Grove cells, commutator with cross-bars, Du Bois and Hg-key, rheochord, N.P. electrodes, moist chamber, wires, recording apparatus.

(a.) Arrange the apparatus as in the scheme (fig. 173). Connect two Daniell or small Grove cells to a Pohl's commutator *with cross-*

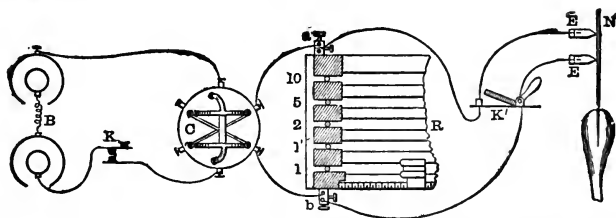

FIG. 173.—Scheme for Pflüger's Law. R. Rheochord; B. Battery; C. Commutator; K. Mercury key; K'. Du Bois key; E. N.P. Electrodes; N. Nerve.

bars, and introduce a mercury key (K) into the circuit: connect the commutator with the rheochord (R). Connect the rheochord with N.P. electrodes, introducing a short-circuiting key. Fix to a recording lever a nerve-muscle preparation—with a long nerve—in the moist chamber, and lay the nerve over the electrodes.

(b.) Begin with all the plugs in position in the rheochord and the slider hard up to the brass blocks. Place the commutator to give an ascending current, make and break the current—gradually adjusting the slider—until a contraction occurs at make and none at break. Reverse the commutator to get a descending current, make and break, observing again a contraction at make and none at break. This represents the effect of a *weak* current. Sometimes

the current so obtained is not weak enough. The simple rheochord should then be used (p. 163).

(c.) Pull the slider farther away and remove one or more plugs until contraction is obtained at make and break, both with an ascending and descending current. This represents the effect of a *medium* current.

(d.) Use six small Grove's cells, take out all the plugs from the rheochord, and with the current ascending, contraction occurs at break only; while with a descending current, contraction occurs only at make. This represents the effect of a *strong* current. Tabulate the results in each case.

For this experiment very fresh and strong frogs are necessary, and several preparations may be required to work out all the details of the law. Instead of reversing the commutator after testing the effect of an alteration of the direction of the current, the student may use one preparation to test at intervals the effect of weak, medium, and strong currents when the current is ascending, and a second preparation to test the results with currents of varying intensity when the current is descending. The results may be tabulated as follows: R=rest; C=contraction:—

STRENGTH OF CURRENT.	ASCENDING.		DESCENDING.	
	On Making.	On Breaking.	On Making.	On Breaking.
Weak, . . .	O	R	C	R
Medium, . .	O	O	C	C
Strong, . . .	R	O	C	R

2. Electrotonic Variation of the Electro-motivity.

(a.) Arrange a long nerve on N.P. electrodes, as for determining its demarcation-current. Place the free end of the nerve on a pair of N.P. electrodes—the polarising current—arranged as in Lesson XLVIII., so that the current can be made ascending or descending.

(b.) Take the deflection of the galvanometer needle or demarcation-current when the polarising current is shut off. Throw in a descending polarising current, and observe that the spot of light travels towards zero. Reverse the commutator and throw in an ascending current, the spot of light shows a greater positive variation than before. From this we conclude that *kathelctrotonus diminishes the electro-motivity, while anelectrotonus increases it*. In the extra-polar cathodic region an electrotonic current appears when the polarising current is closed. It has the same direction as the polarising current. In the anodic region the direction is also that of the polarising current; but the electrotonic current is stronger than the cathodic current. If a demarcation-current exists already, the electrotonic currents are superposed on it.

3. Ritter's Tetanus.

(a.) Connect three Daniell's cells with N.P. electrodes, short-circuiting with a Du Bois key. Make a nerve-muscle preparation, and apply the electrodes to the nerve so that the + pole is next the muscle, *i.e.*, the current is ascending in the nerve. Allow the current to circulate in the nerve for some time (usually about five minutes is sufficient), no contraction takes place. Short-circuit, and the muscle becomes tetanic.

(b.) Divide the nerve between the electrodes, and the tetanus does not cease; but on dividing it between the + pole and the muscle, the tetanus ceases. Therefore the tetanus is due to some condition at the positive pole, *i.e.*, the stimulation proceeds from the positive pole at break.

4. Kathodic Stimulation is the more powerful.

(a.) Let the M. and B. shocks be made approximately equal by the arrangement shown in fig. 174. In the secondary circuit place a Pohl's commutator

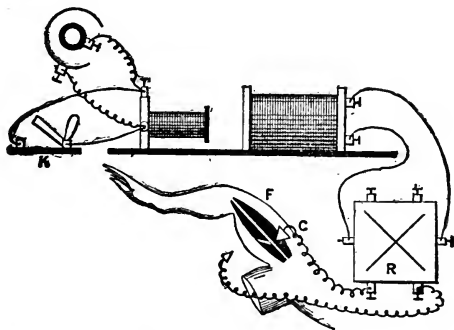

FIG. 174.—Scheme to show that Kathodic Stimulation is the more powerful. *K.* Key; *R.* Commutator; *F.* Frog's leg; *c.* One electrode.

with cross-bars (*R*). Place one electrode (*c*) under the sciatic nerve, and the other on another part of the body.

(b.) Suppose *c* to be the cathode, select a strength of shock, *i.e.*, distance of secondary from primary coil, so that there is response on breaking the primary current. Reverse the commutator so that *c* becomes the anode. There is no muscular response at break, but it occurs at make, as *c* is then the cathode.

5. Rheochord of Du Bois-Reymond is used to vary the amount of a constant current applied to a muscle or nerve (fig. 175). It consists of a long box, with German-silver wire—of varying length, and whose resistance is accurately graduated—stretched upon it. At one end are a series of brass blocks disconnected with each other above, but connected below by a German-silver wire passing round a pin. These blocks, however, may be connected directly by brass plugs, S_1, S_2, \dots, S_5 . From the blocks 1 and 2 two platinum wires pass from *A* to the opposite end of the box (*Y*), where they are insulated. Between the wires is a "slider" (*L*), consisting of two brass cups containing mercury, which slide along the wires.

In using the instrument, connect a Daniell's cell to the binding screws A and B, and to the same screws attach the wires of the electrodes over

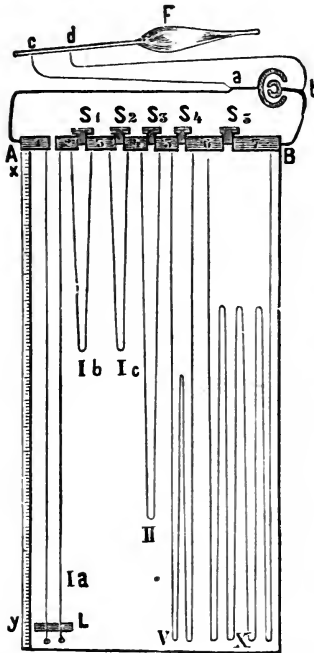

FIG. 175.—Rheochord of Du Bois-Reymond.

which the nerve (*c d*) of the muscle (*F*) is laid. We have two circuits (*a c d b* and *a A B b*); the wires of the rheochord are introduced into the latter.

Push up the slider with its cups (*L*) until it touches the two brass plates 1 and 2, and insert all the plugs (*S₁-S₅*) in their places, thus making the several blocks of brass practically one block. In this position, the zero of the instrument, the resistance offered by the rheochord circuit is so small as compared with that including the nerve, that practically all the electricity passes through the former and none through the latter.

Move the slider away from *A*, when a resistance is thrown into the rheochord circuit, according to the length of the platinum wires thus introduced into it, and so a certain fraction of the current is sent through the electrode circuit. If the plug *S₁* be taken out, more resistance is introduced, that due to the German-silver wire (*I b*), and, therefore, a certain amount of the current is made to pass through the electrode circuit. By taking out plug after plug more and more resistance is thrown into the rheochord circuit. The plugs are numbered, and the diameter and length of the German-silver wires are so selected in making the instrument, that the resistances represented

by the several plugs when removed are all multiples of the resistance in the platinum wires on which the slider moves. Proceed taking out plug after plug, and note the result. The result, and explanation thereof, are referred to in Lesson XLIX. 1.

LESSON L.

VELOCITY OF NERVE-IMPULSE IN FROG, MAN— DOUBLE CONDUCTION IN NERVE—KÜHNE'S GRACILIS EXPERIMENT, &c.

1. Velocity of Nerve-Energy in a Frog's Motor Nerve.

The rate of propagation of a nerve-impulse or excitatory change may be estimated by either the pendulum or spring-myograph.

With slight modifications the two processes are identical, only in using the spring-myograph it is necessary to use such a coiled spring as will cause the glass plate to move with sufficient rapidity to give an interval long enough for the estimation of the latent period. It may be done also on a revolving drum provided the drum moves with sufficient rapidity.

(a.) Use the spring-myograph and arrange the experiment according to the scheme (fig. 176), *i.e.*, an induction coil for single shocks with the trigger-key of the myograph (1, 2) in the primary circuit; in the secondary circuit (which should be short-circuited, not represented in the diagram) place a Pohl's commutator *without cross-bars* (C). Two pairs of wires from the commutator pass to two pairs of electrodes (*a, b*), arranged on a bar in the moist chamber. Measure the distance between the electrodes.

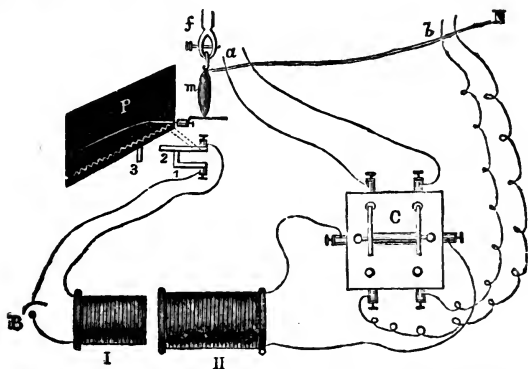

FIG. 176.—Scheme for Estimating the Velocity of Nerve-Energy.

(b.) Make a nerve-muscle preparation with a long nerve (N), clamp the femur (*f*), attach the tendon (*m*) to a writing-lever, and lay the nerve over the electrodes, the distance between them being known. It is well to *cool* the nerve by iced normal saline, as the velocity of the impulse is thereby much diminished.

(c.) Arrange the glass plate covered with smoked paper, adjust the lever to mark on the glass, close the trigger-key in the primary circuit, and unshort-circuit the secondary. Turn the bridge of the commutator so that the stimulus will be sent through the electrodes next the muscle (*a*). Press the thumb plate, the glass plate shoots across. The tooth (3) breaks the primary circuit, and a curve is inscribed on the plate.

(d.) Short-circuit again, replace the glass plate, close the trigger-key, reverse the commutator. This time the stimulus will pass

through the electrodes away from the muscle (*b*). Unshort-circuit the secondary circuit, and shoot the glass plate, when another curve will be inscribed, this time a *little later* than the first one.

(*e*.) Replace the glass plate, close the trigger-key, short-circuit the secondary circuit, and shoot the plate. This makes the abscissa.

(*f*.) Replace the glass plate, close the trigger-key, and bring the tooth of the glass plate (3) just to touch the trigger-key; raise the writing-lever to make a vertical mark. This indicates the moment when the stimulus was thrown into both points of the nerve.

(*g*.) Remove the moist chamber, push up the glass plate, close the trigger-key, and arrange a tuning-fork vibrating 250 D.V. per second to write under the abscissa. Shoot the plate again and the time-curve will be obtained. Fix the tracing, draw ordinates from the beginning of the curves obtained by the stimulation of *a* and *b* respectively, measure the time between them from the time-curve (this gives the time the impulse took to travel from *b* to *a*), and calculate the velocity from the data obtained.

Example.—Suppose the length of nerve to be 4 cm., and the time required for the impulse to travel from *b* to *a* to be $\frac{1}{750}$ sec. Then we have $4 : 100 : \frac{1}{750}'' : \frac{1}{30}''$, or 30 metres (about .98 feet) per second, as the velocity of nerve-energy along a nerve.

2. Repeat the observation with the **pendulum-myograph**. Practically the same arrangements are necessary.

If it be desired to test the effect of heat or cold on the rapidity of propagation, the nerve must be laid on ebonite electrodes, made in the form of a chamber, and covered with a lacquered copper plate on which the nerve rests. Through the chamber water at different temperatures can be passed, and the effect on the rate of propagation observed.

3. Velocity of Motor Nerve-Impulse in Man.

(*a*.) Use a pendulum-myograph. Connect two Daniell's cells with the primary circuit of an induction coil and interpose in the circuit the trigger-key of the myograph, which the pendulum opens in swinging past. Place a short-circuiting key in the secondary circuit, and to the short-circuiting key attach a pair of rheophores moistened with strong solution of salt.

(*b*.) Arrange Marey's "*pince myographique*" (fig. 151) to compress the adductor muscles of the thumb when the latter is in the abducted position. Connect the "*pince*" by means of an india-rubber tube with a Marey's tambour (fig. 150) arranged to record its movements on glazed paper fixed to the plate of the pendulum-myograph.

(*c*.) The nerve supplying the adductor muscles of the thumb

must be stimulated first near the ball of the thumb, and secondly at the bend of the elbow. Contraction takes place sooner from the former than from the latter position. Suppose the right thumb to be used, apply one rheophore to the right side of the chest, and the other to just over the ball of the thumb. Allow the pendulum to swing. Take a tracing. Replace pendulum, short-circuit the secondary circuit, close the trigger-key.

(d.) Open the secondary circuit. Apply the arm rheophore to the median nerve at the bend of the elbow and record another contraction.

(e.) Record a base-line and mark the point of stimulation on the myograph plate. Make a time-tracing under the two muscle curves.

(f.) Measure the distance between (i.) the two arm electrodes; (ii.) the beginning of the two curves; (iii.) note the time-value of (ii.) as indicated by the time curve; and from these data calculate the time the nervous impulse took to travel from the elbow to the nerve supplying the muscles of the ball of the thumb.

ADDITIONAL EXERCISES.

4. **Double Conduction in Nerve—Kühne's Experiment on the Gracilis.**—The gracilis is divided into a larger and smaller portion (L) by a tendinous inscription (K) running across it (fig. 177). The nerve (N) enters at the hilum in the larger half, and bifurcates, giving a branch (k) to the smaller portion, and another to the larger portion of the muscle, but neither branch reaches quite to the end of either half of the muscle.

(a.) Remove the gracilis (rectus internus major and minor) (Ecker). The method of removing semi-membranosus and gracilis together has already been described (Lesson XXIX. 5). Place a pithed and skinned frog on its back. In order to see the outline of the thigh muscles better, moisten them with blood. The sartorius by its inner margin lies in relation with the gracilis near its lower attachment, the gracilis itself lying on the ventral surface of the inner part of the thigh, having its origin at the symphysis, and its insertion at the tibia. The small part—minor—is attached to the skin and is usually torn through when the skin is removed. By its other margin it is in contact with the semi-membranosus. The muscle is detached from below upwards. Its tendinous inscription or intersection is readily visible on a black surface.

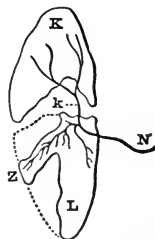

FIG. 177.—Kühne's Experiment on the Gracilis.

(b.) Cut it as in fig. 177, avoiding injury to the nerves, so that only the nerve twig (*k*) connects the larger and smaller halves, and in one tongue (*Z*) terminates a nerve. After excision lay it on a glass plate with a *black* background, else one does not see clearly the inscription and the course of the nerves.

(c.) Stimulate the tongue (*Z*) with fine electrodes about 1 mm. apart, and contraction occurs in both *L* and *K*. This, according to Kühne, is due to centripetal conduction in a motor nerve. This experiment is adduced by him as the best proof of double conduction in nerve fibres. Mays has shown that the nerve fibre divides and supplies both halves of the muscle.

(d.) If the muscle be exposed in a curarised frog, on stimulating either half of the muscle with repeated shocks, only that half responds, as the inscription blocks the passage of the muscle-wave.

(e.) If an uncurarised muscle is used, stimulation of the muscle near its ends causes response only in its own half. Why? Because there are no nerves there; but stimulation near the inscription causes response in both halves. Why? Because they are excited through their nerves, as shown definitely by (c.).

5. Action of a Constant Current.—*In muscle and nerve, stimulation occurs only at the kathode when the current is made (closed), and at the anode when it is broken (opened)*—(*V. Bezold*). This is most readily seen in fatigued muscles.

(A.) Engelmann's Experiment.—(a.) Suspend vertically a curarised sartorius of a frog, and pass a constant current through its upper extremity. On making the current, the muscle moves towards the side of the kathode, because contraction occurs at the kathode on making. At break, it inclines to the anode.

(b.) Slit up the muscle longitudinally, so that it looks like a pair of trousers, and keep the two legs, as it were, asunder by an insulating medium; at make, the kathodic half alone contracts; at break, the anodic half.

(B.) Another Method.—Dissect out the sartorius of a curarised frog, but remove it with its bony attachments, clamp it at its centre, and arrange it either vertically as in fig. 191, attaching its ends to two recording levers placed one above it and the other below it, or fix it on a double crank-myograph. Pass thin wires from the battery through the two ends of the muscle; on making the current, the lever attached to the kathode rises before the other, *i.e.*, where the current leaves the muscle. On breaking the current, the anodic lever rises first, showing that the anodic half contracts before the kathodic half.

LESSON LI.

OTHER CONDITIONS AFFECTING THE EXCITABILITY OF NERVE—CHEMICAL, TEMPERATURE, &c.

1. Unequal Excitability of Different Portions of a Motor Nerve.—Apparatus.—Cell, two keys, wires, commutator, induction coil, either for single or faradic shocks, two pairs of electrodes.

(a.) Arrange the apparatus as in fig. 178. Dissect out the whole length of the sciatic nerve with the leg attached. Lay the nerve on two pairs of electrodes, A and B, one near the muscle and the other away from it, and as far apart as possible. Two pairs of wires thrust through a cork will do quite well.

(b.) Stimulate at A with a current that gives a minimal contraction. Reverse the commutator. Stimulate at B, a stronger contraction is obtained, because the excitability of a nerve is greater farther from a muscle or nearer the centre. Instead of using single shocks, repeated shocks by means of Neef's hammer may be used.

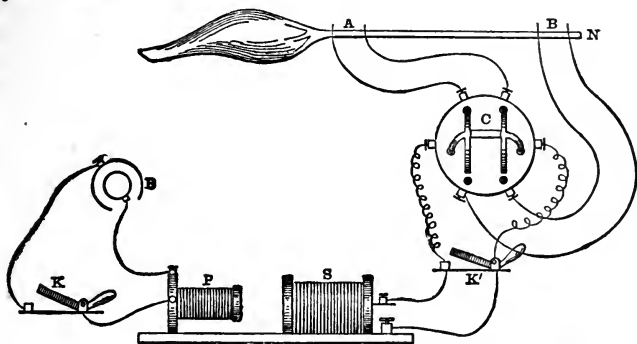

FIG. 178.—Scheme for the Unequal Excitability of a Nerve.

2. Effect of Temperature on Excitability of a Nerve.

(a.) Fix a nerve-muscle preparation on a crank-myograph, so as to record on a revolving cylinder provided with an automatic break-key placed in the primary circuit of an induction coil, and so arranged as to give only feeble break shocks.

(b.) Bring a test-tube filled with water at 80–90° C. near the nerve, where the electrodes lie on it. Soon the contraction increases and may become maximal.

(c.) Remove the source of heat and the contractions become less, *i.e.*, the excitability falls.

(d.) Similar results may be obtained by the direct application of warm normal saline to a nerve.

(For other kinds of nerve fibres see "Effects of stimulation and of changes in temperature upon irritability and conductivity of nerve fibres," by Howell and others, *Journal of Physiology*, xvi. p. 298.)

3. Salt Increases the Excitability of a Nerve.

(a.) Arrange a nerve-muscle preparation as in 2, and determine

the distance of the secondary from the primary coil to obtain a minimal stimulus, *i.e.*, response. Apply a drop of saturated solution of common salt to the nerve between the electrodes and the muscle. Almost at once the excitability of the nerve is increased, as shown by the height of the contraction, so that the excitability increases at once.

(*b.*) After several minutes the muscles begin to twitch, the salt acting as a chemical stimulus. It is thus evident that the excitability is early increased, but before muscular response to chemical stimulation is elicited a considerable time elapses.

4. Effect of Section on the Excitability of a Nerve.

(*a.*) Arrange a coil for single shocks, expose the sciatic nerve in a pithed frog, and under it, near its central end, place insulated electrodes, using single break shocks. Ascertain the distance of the secondary from the primary coil at which the break shock is just too weak to cause the muscles to respond (sub-minimal).

(*b.*) With a sharp pair of scissors divide the sciatic nerve on the central side of the electrodes. The stimulus (previously sub-minimal) now causes a strong contraction.

(*c.*) Ascertain the distance (perhaps several cm.) to which the secondary coil must be pushed away from the primary in order to obtain again a sub-minimal stimulus. The condition of increased excitability lasts for some time.

5. Excitability of Flexors and Extensors (Rollett).

Arrange a coil for repeated shocks. Expose either the sciatic nerve or the sciatic plexus in a pithed frog. Select a weak current, and flexion of the leg muscles is obtained; on pushing up the secondary coil, the extensors prevail.

6. Functions of Different Motor Nerves (Sciatic Plexus).

Strip off the skin from the hind-legs of a pithed frog. Open the abdomen and expose the sciatic plexus, the frog being placed on its back. Stimulate with faradic electricity—selecting a strength of current just adequate to yield a muscular response—each of the three cords forming the sciatic plexus. The upper cord supplies muscles acting chiefly on the hip-joint, the lowest acts chiefly on the muscles moving the ankle and toes, and the middle one on the muscles acting on the knee-joint.

7. Conductivity *v.* Excitability (Grünhagen's Experiment).

(*a.*) Pass the nerve of a frog's leg through a glass tube (fig. 179), sealing the ends with clay, but not compressing the nerve. The tube is supplied with an inlet and outlet, to which elastic tubes can

be attached and through which vapours or gases can be passed, and also with electrodes so that the nerve can be stimulated within or outside the tube. Use a Pohl's commutator for this purpose.

(b.) Pass CO_2 from a Kipp's apparatus through the tube; on stimulating the nerve at A with repeated shocks, there is no response, but on stimulating at B there is. Find a strength of stimulus which just excites the nerve at A and B. On passing CO_2 A no longer responds to this stimulus, but requires a stronger stimulus, or it may not respond at all. It would seem that the excitatory change set up at B is propagated through A, although its excitability is very feeble or nil. It thus seems to conduct, even though it is inexcitable.

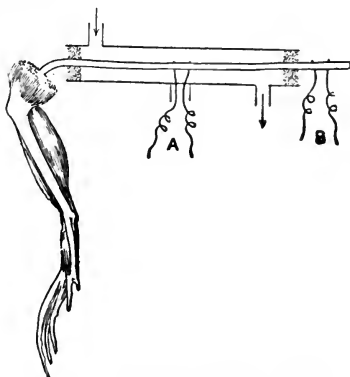

FIG. 179.—Grunhagen's Experiment on Conductivity v. Excitability.

(c.) On passing the vapour of alcohol the conductivity appears to vanish before the excitability. It is better to suck the vapour through by means of any form of exhaust pump. The results, however, may be capable of a different interpretation. (Gad, *Du Bois-Reymond's Archiv*, 1888, p. 395, and 1889, p. 350; Piotrowski, "Trennung d. Reizbark. v. Leitungsfah. d. Nerven," *ibid.*, 1893, p. 205.)

(d.) Cold.—Apply cold to a nerve as in 8, *i.e.*, lay the nerve over a glass tube through which cold water is conducted. Cold, like CO_2 , abolishes or diminishes the excitability, but not the conductivity.

The action of other substances, such as chloroform, ether, and CO , have been investigated.

ADDITIONAL EXERCISES.

8. Influence of Localised Cold upon Excitability (Gotch).

A. Upon Nerve.

The influence of changes in temperature upon excitability can be investigated by arranging in the moist chamber a glass tube placed at right angles to the nerve of a nerve-muscle preparation, and situated so that a small portion of the nerve shall lie athwart the tube. Through the tube water at temperatures varied at will from 10° to 30° C. is allowed to flow.

The alteration in temperature causes a marked alteration in the electrical

resistance of the tissue, this being lowered by warmth and raised by cold ; in order to get rid of this purely physical change, it is essential that a large resistance should be introduced into the exciting circuit. This is most simply done by using non-polarisable electrodes with threads attached to the ends of the electrodes kept moist by normal saline solution. The threads are now arranged so as to touch the nerve where it lies on the tube, one thread being placed so that the contact shall be on the edge of the cooling tube nearest the muscle. The simplest method of exciting the nerve is by means of a weak galvanic current. For this purpose the rheochord is used and a weak current employed of such direction that it shall descend the nerve and thus excite this at the cathodic contact on the distal edge of the glass tube.

In order to ensure that the galvanic current is always of the same duration, it is desirable to close the current by an automatic arrangement, either a revolving drum carrying a striker which shall at each revolution strike a stretched wire, or a metronome ; but the influence of the temperature alteration may be obtained without this arrangement, the closure being effected by a Pohl's reverser without cross lines as a double make mercurial key worked by the hand.

The nerve-muscle preparation having been made and the muscle attached to an appropriate lever, so as to record its contraction upon a very slowly moving surface, an intensity of current is ascertained, which, with the nerve at the normal temperature of the room, is only just adequate to evoke a very weak minimal muscular response whenever the circuit is closed.

The temperature of the nerve is now raised by allowing water at 30° C. to pass through the tube, when the response will disappear ; the temperature is now lowered by allowing water at 10° C. or less to flow—the response is now very marked. Localised cold thus increases the excitability of nerve to this form of stimulus. Similar effects can be obtained with the condenser discharge, with mechanical and with chemical stimuli. If the induction current is used instead of the galvanic current, a reverse effect is obtained, the nerve-muscle preparation responding better when the excited nerve is at 30° C. ; and this favourable influence of warmth persists even when a very large external resistance is introduced into the circuit.

B. Upon Muscle.

The sartorius muscle of the frog is used for this experiment, the threads of the exciting electrodes being placed upon the broad "nerveless" pelvic end of the muscle under which the tube of the cooling arrangement is fixed. It is then found that the muscle responds better when cooled to every form of stimulus applied to the cooled region, including the induction current. If the electrodes be shifted to the "nerved" portion of muscle, the response, being indirect, is disfavoured by cold when the induction current is used.—(Communicated by Professor Gotch.) See also *Journal of Phys.*, XII.

PHYSIOLOGY OF THE CIRCULATION.

LESSON LII.

THE FROG'S HEART—BEATING OF THE HEART— EFFECT OF HEAT AND COLD—SECTION OF THE HEART.

1. Heart of the Frog and how to Expose it.

(a.) Pith a frog, and lay it on its back and pin out its legs on a frog-plate. Make a median incision through the skin over the sternum, continue the incision upwards and downwards, and from the middle of the sternum make transverse incisions.

(b.) Reflect the four flaps of skin, raise the lower end of the episternum with a pair of forceps, and cut through the sternal cartilage just above its lower end, to avoid wounding the epigastric vein. With a strong pair of scissors cut along the margins of the sternum, and divide it above. Do not injure the heart, which is exposed still beating within its pericardium.

(c.) With a fine pair of forceps carefully lift up the thin transparent pericardium, and cut it open, thus exposing the heart.

2. General Arrangement of the Frog's Heart.

(a.) Observe its shape, noting the two auricles above (fig. 180, *Ad*, *As*), and the conical apex of the single ventricle below (*v*), the auricles being mapped off from the ventricle by a groove which runs obliquely across its anterior aspect. The ventricle is continuous anteriorly with the bulbus aortæ (*B*), which projects in front of the right auricle, and divides into two aortæ—right and left, the left being the larger.

(b.) Tilt up the ventricle and observe the sinus venosus (fig. 181, *s.v.*) continuous with the right auricle, and formed by the junction of the large inferior vena cava (*c.i.*) and the two (smaller) superior venæ cavæ (*c.s.s.*, *c.s.d.*).

3. Note the sequence of contraction of the several parts, viz., sinus venosus, auricles, ventricle, and bulbus arteriosus.

This sequence of events is difficult to note, but what can be easily observed is the relative condition of vascularity of the ventricle. The frog's ventricle has no blood-vessels supplying its muscular walls. Note that during systole of the ventricle, *i.e.*, during its contraction, it becomes pale, and immediately thereafter,

during its diastole, it is distended with blood and has a red appearance, the blood flowing into it being propelled by the contracting auricles. Notice also how the position of the auriculo-ventricular groove moves upwards and downwards during each cardiac cycle.

Note the normal rhythm, *i.e.*, the number of beats per minute.

4. Effect of Temperature (Heart *in situ*).

(a.) By means of a pipette allow a few drops of normal saline at 20° - 25° C. to bathe the heart, and note how rapidly the number of beats, *i.e.*, rhythm, is increased, and how each individual beat is quicker.

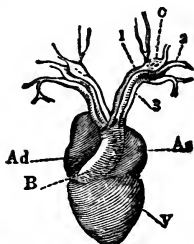

FIG. 180. — Frog's Heart from the Front. *v.* Single ventricle; *Ad*, *As*. Right and left auricles; *B.* Bulbus arteriosus; *1.* Carotid; *2.* Aorta; *3.* Pulmo-cutaneous arteries; *C.* Carotid gland.

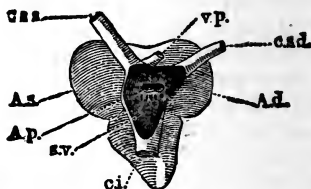

FIG. 181. — Heart of Frog from Behind. *s.v.* Sinus venosus opened; *c.v.* Inferior, *c.s.d.*, *c.s.s.* Right and left superior venæ cavæ; *v.p.* Pulmonary vein; *A.d.*, and *A.s.* Right and left auricles; *A.p.* Communication between the right and left auricle.

(b.) Then apply normal saline at 10° C. or 5° C., and note the opposite effect on the rate or rhythm, together with the slower contraction of each individual beat.

5. An Excised Heart Beats.

(a.) With a seeker tilt up the apex of the ventricle, and observe that a thin thread of connective tissue, called the "frænum," containing a small vein, passes from the pericardium to the posterior aspect of the ventricle. Tie a fine silk thread round the frænum and divide it dorsal to the ligature. Count the number of beats per minute. By means of the silk thread raise the heart as a whole, and with a sharp pair of scissors cut out the heart by dividing the inferior vena cava, the two superior venæ cavæ, and the two aortæ. Place the excised heart in a watch-glass, and cover it with another watch-glass.

(b.) The heart goes on beating. Count the number of beats per minute. Therefore its beat is automatic, and the heart contains within itself the mechanism for originating and keeping up its rhythmical beats.

(c.) Place the heart on a microscopical slide and note that during diastole it is soft and flaccid, and adjusts itself to any surface it may rest on. During systole, *i.e.*, when it contracts, its apex is raised and erected.

6. Heat and Cold on the Excised Heart.

(a.) Place the watch-glass containing the beating heart on the palm of the hand, and the heart beats faster; or place it on a beaker containing warm water, which must not be above 40° C. Note that, as the temperature of the heart rises, it beats faster--there are more beats per minute--therefore each single beat is faster.

(b.) Place the watch-glass and heart over a beaker containing iced water, the number of beats diminishes, each beat being executed more slowly and sluggishly.

7. Section of the Heart.

(a.) Expose the heart, divide the pericardium, and ligature the frænum, and by means of it gently raise the heart. With scissors excise the whole heart, including the sinus venosus. The heart still beats.

(b.) Cut off the sinus; it continues to beat. The rest of the heart ceases to beat for a time, but by-and-by it commences to beat rhythmically.

(c.) Sever the auricles from the ventricle; the ventricle ceases to beat. The ventricle, however, has not lost the power of beating rhythmically. To prove this, stimulate it mechanically, *e.g.*, by pricking it with a needle. After an appreciable latent period, it executes one--generally several--beats, and then becomes quiescent. Stimulate with a single induction shock, this also causes it to discharge one or more beats.

(d.) Cut off the apex of the ventricle; it remains quiescent; but if it be stimulated, either mechanically or electrically, it makes a single beat--not a series, as in the case of (c.).

(e.) Divide the ventricle of another heart below the auriculo-ventricular groove. The auricles, with the upper part of the ventricle attached, continue to beat, while the lower two-thirds no longer beats spontaneously. If it be pricked with a needle, however, it contracts as often as it is stimulated mechanically. It responds by a single contraction to a single stimulus, but a single stimulus does not excite a series of rhythmical contractions.

(f.) With scissors divide longitudinally the auricles with the attached portion of the ventricle. Each half contracts spontaneously, although the rhythm may not be the same in both.

(g.) Instead of cutting, one may use a ligature, or the heart apex may be separated by Bernstein's method, *viz.*, compress the heart above its apex

by forceps, so as to break the physiological continuity but not the physical, both parts remaining connected with each other. In a pulsating heart, all pulsates except the apex. If the bulbus aortæ be compressed so as to raise the pressure within the apex, the apex also beats.

8. Movements of the Heart.—Expose the heart of a freshly pithed frog as directed in Lesson LII., or better still, destroy only the brain and then curarise the frog. Observe

(a.) That the auricles contract synchronously and force their blood into the ventricle, which, from being pale and flaccid, becomes red, turgid, and distended with blood.

(b.) That immediately thereafter the ventricle suddenly contracts, and forces the blood into the bulbus aortæ, at the same time becoming pale, while its apex is tilted forwards and upwards. As the auricles continue to fill during the systole of the ventricle, on superficial observation it might seem as if the blood were driven to and fro between the auricles and ventricle, but careful observation will soon satisfy one that this is not the case. Observe very carefully how the position of the auriculo-ventricular groove varies during the several phases of cardiac activity.

(c.) The slight contraction of the bulbus aortæ immediately following the ventricular systole.

(d.) The diastolic phase or pause when the whole heart is at rest before the auricles begin to contract. Ligature the frænum and divide it, gently raise up the ventricle by the ligature attached to the frænum, and observe the sinus venosus.

(e.) The peristaltic wave, or wave of contraction, begins at the upper end of the vena cava inferior and sinus venosus; it extends to the auricles, which contract, then comes the ventricular systole and that of the bulbus aortæ, and finally the pause; when the whole sequence of events begins again with the systole of the sinus.

(f.) Before the ventricular systole is complete the sinus is full, while the auricles are filling.

All this is easier to describe than to observe, and it requires patient and intelligent observation to assure oneself of the succession of events.

LESSON LIII.

GRAPHIC RECORD OF THE FROG'S HEART- BEAT—EFFECT OF TEMPERATURE.

1. Graphic Record of the Frog's Heart (Direct registration with lever).

(a.) Destroy the brain of a frog; curarise it. Expose the heart,

still within its pericardium, and arrange a heart-lever so that it rests lightly on the pericardium over the beating heart. Adjust the lever to write on a revolving cylinder, moving at a suitable rate (5-6 cm. per second). Take a tracing of the beating of the heart.

(b.) Before commencing the experiment, make a suitable heart-lever with a straw about 12 inches long, or a thin strip of wood about the same length. Thrust a needle transversely either through the straw or through a piece of cork slipped over the straw about 2 inches from one end of the lever. The needle forms the fulcrum of the lever, and works in bearings, whose height can be adjusted. To the end of the lever nearest this is attached, at right angles, a needle with a small piece of cork on its free end. The lever is so adjusted that the cork on the needle rests on the heart. The long arm of the lever is provided with a writing-style of copper-foil, or a writing point made of parchment paper, fixed to it with sealing-wax. By using a long lever a sufficient excursion is obtained. Another form of heart-lever is shown in fig. 182. It consists of a thin glass rod, fixed as shown in the figure. The frog is laid on its back on a frog-plate covered with cork. The heart-lever is fixed into the cork by means of the two pins (*b*), while *C* is so adjusted as to rest on the heart.

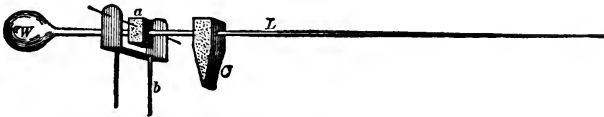

FIG. 182.—Simple Frog's Heart-Lever. *a*. Fulcrum; *L*. Glass lever with knob to act as counterpoise; *b*. To fix the apparatus into the cork of a frog-plate; *C*. Cork to rest on the heart.

(c.) Open the pericardium, expose the heart, and adjust the cork on the lever. To obtain a good tracing, it is well to put a resistant body behind the heart. Raise the ventricle, ligature the frænum, and divide the latter dorsal to the ligature; behind the heart place a pad of blotting-paper moistened with normal saline, or a thin glass-cover slip. Adjust the cork pad of the lever on the junction of the auricles and ventricle, to write on the drum, moving at a slow rate (5-6 cm. per second), and take a tracing. Fix the tracing (fig. 183).

(d.) In the tracing note a first ascent, due to the auricular contraction, and succeeding this a second ascent, due to the contraction of the ventricle, followed by a slow subsidence, due to the continuation of the ventricular systole, and then a sudden descent, due to the diastolic relaxation of the heart.

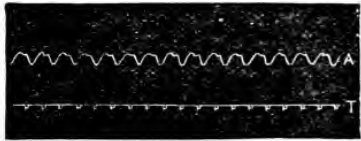

FIG. 183.—Tracing taken with a Frog's Heart-Lever resting on the Auriculo-ventricular Groove. *A*. Heart tracing; *T*. Time; each interval represents one second.

2. **Auricular Contraction.**—Take a tracing with the lever adjusted on the auricles alone, and avoid the bulbus aortæ. Note the smaller excursion of the lever.

3. **Ventricular Contraction.**—Adjust the lever so as to obtain a tracing of the ventricular movements only.

4. In the above experiments arrange an electro-magnetic time-marker or chronograph under the recording lever, so that the points of the recording lever and time-marker write exactly in the same vertical line. Thus one can calculate the time-relations of any part of the curve.

5. Effect of Temperature on the Excised Heart.

(a.) Excise the heart of a pithed frog, lay it on an apparatus like that in fig. 119. Fix india-rubber tubes to the inlet and outlet tubes of the cooling-box, the inlet tube passing from a funnel fixed



FIG. 184.—Parts of a Tracing taken from an Excised Frog's Heart. The temperature was increased gradually from left to right of the curve.

in a stand above the box, and the outlet tube discharging into a vessel below it. Adjust the heart-lever to record the movements of the contracting ventricle on a slowly-revolving drum. If the heart tends to become dry, moisten it with normal saline mixed with blood. Adjust a time-marker. Take a tracing.

(b.) Pass water from 10° – 20° C. through the cooling-box, noting the effect on the number of contractions, and the duration, height, and form of each single beat.

(c.) The heart may be placed on a metallic support and gradually heated by means of a spirit-lamp or other means. Fig. 184 shows how the shape, size, amplitude, and number of heart-beats varies with a rise of temperature, the temperature being lowest towards the left end of the tracing, and rising as the tracing was taken.

ADDITIONAL EXERCISES.

6. Another form of heart-lever is shown in fig. 185.

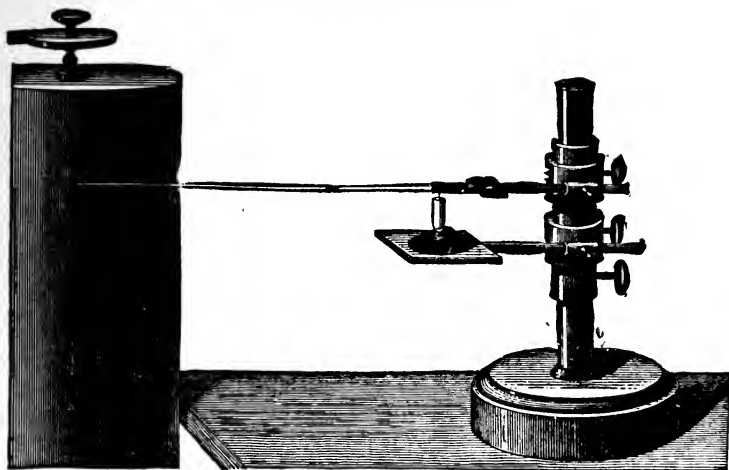

FIG. 185.—Marey's Heart-Lever, as made by Verdin.

7. In order to record simultaneously the contractions of auricles and ventricle, and to study the relations of these events one to the other, a lever must be placed on the auricles and another on the ventricle, and the points

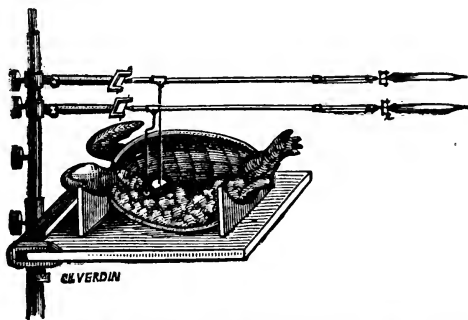

FIG. 186.—Auricular and Ventricular Lever for the Heart of a Turtle or Tortoise. Made by Verdin.

of both must be arranged so that the one writes directly over the other as shown in fig. 186, in the heart of a turtle or tortoise.

LESSON LIV.

SUSPENSION METHODS FOR HEART—GASKELL'S HEART-LEVER AND CLAMP.

1. Gaskell's Heart-Lever (Suspension Methods).

(a.) This lever is extremely convenient (fig. 187). Expose the heart of a pithed frog, ligature and divide the frænum, tie a fine silk thread to the apex of the ventricle, and attach the thread to the writing-lever placed above it. The lever is kept in position by a thin thread of elastic, which raises the lever after the contraction of the heart has depressed it.

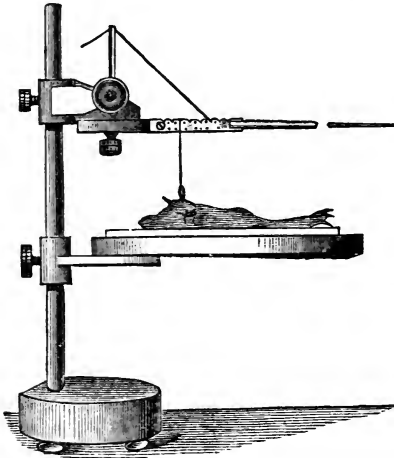

FIG 187.—Showing the Arrangement of the Frog and Lever for a Heart-Lever, supported by a fine elastic thread.

(b.) Record the movements on a drum moving at a slow rate. Record time in seconds.

(c.) First the auricles contract and pull down the lever slightly, then the greater contraction of the ventricle pulls the lever down further, and when the ventricle relaxes, the lever is raised by the elastic thread.

Fig. 188 shows tracing obtained when the heart is free and no clamp is applied.

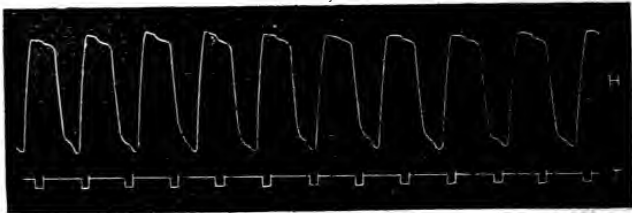

FIG. 188.—Tracing of a Frog's Heart taken with Apparatus shown in Fig. 187. H. Heart-tracing; T. Time in seconds.

A weak spiral spring may be used instead of the elastic thread.

By this method, also, the effect of heat, cold, drugs on the heart can be ascertained.

N.B.—If it is desired to ascertain the action of a drug on the heart by this method, then make a snip in the heart so that the blood may flow out and the drug act directly on the cardiac muscle.

2. Varying Speed of Cylinder and Effect of Temperature.

(a.) By means of Gaskell's lever record the form of the heart-beat with varying rates of speed, marking time in seconds in each case (fig. 189).

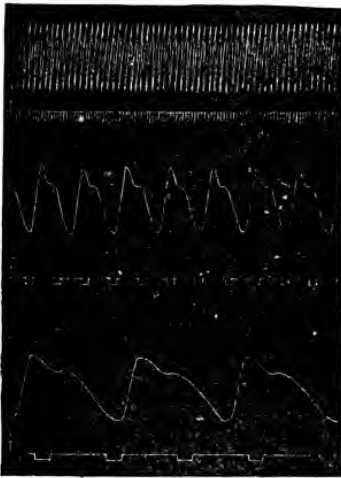

FIG. 189.—Shows how Heart Curve varies with rate of Drum. In 1, 2, 3, T' = time in seconds. Gaskell's Lever.



FIG. 190.—Shows the effect of Normal Saline directly applied to the Heart (at 0° , 15° and 30° C.). T' time in seconds. Gaskell's Lever.

(b.) Then ascertain effect of temperature on the rate of beat and form of heart curve by applying normal saline, say at 0° , 15° , and 30° C., directly to the heart (fig. 190).

3. Gaskell's Clamp.

(a.) On a suitable support arrange two recording long light levers of the same length, and with their writing points exactly in the same vertical line, recording on a slow-moving drum, the levers being about 12 cm. apart. About midway between the two place

a Gaskell's clamp (fig. 191, C), fixed in an adjustable arm attached to the same stand. To support the upper lever, fix to it a fine thread of caoutchouc (E), and attach the latter to a slit or other arrangement on the top of the support. The clamp consists of two

fine narrow strips of brass, like the points of a fine pair of forceps, which can be approximated by means of a screw.

(b.) Expose the heart of a pithed frog. Tie a fine silk thread to the apex of the ventricle, and another to the upper part of the auricles, and excise the heart. Tie the auricular thread to the upper lever and the ventricular one at a suitable distance to the lower lever.

(c.) Adjust the clamp (fig. 191, C) so as to clamp the heart in the auriculo-ventricular groove, but at first take care not to tighten it too much, or merely just as much as will support the heart in position. After fixing the heart by means of the clamp, fix the two levers so that both are horizontal, and adjust the caoutchouc thread attached

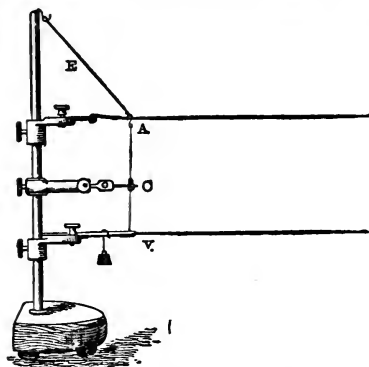

FIG. 191.—Gaskell's Clamp. C. Heart in clamp; A. Auricular, and V. Ventricular lever; E. Elastic to raise A after it is pulled down.

lar groove, but at first take care not to tighten it too much, or merely just as much as will support the heart in position. After fixing the heart by means of the clamp, fix the two levers so that both are horizontal, and adjust the caoutchouc thread attached

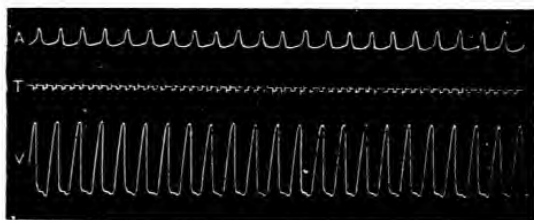

FIG. 192.—Tracing from Auricle (A) and Ventricle (V) by Gaskell's Method. T. Time in seconds.

to the upper one, so that it just supports the upper lever, and when its elasticity is called into play by the contracting auricles pulling down the lever, it will, when the auricles relax, raise it to the horizontal position again.

(d.) Adjust a time-marker to write exactly under the writing

points of the two levers. Moisten the heart from time to time with serum or dilute blood.

(e.) After obtaining a tracing where the auricle and ventricle contract alternately (fig. 192), screw up the clamp slightly until the ratio of auricular to ventricular contraction alters, *i.e.*, until, by compressing the auriculo-ventricular groove, the impulse from the auricles to the ventricle is "blocked" to a greater or less extent, when the auricles will contract more frequently than the ventricle.

4. Excised Heart (Gotch's Arrangement).

By this method all the parts are fixed to a T-piece which is clamped in a stand, so that the whole, preparation, electrodes and everything, can be easily adjusted (fig. 193).

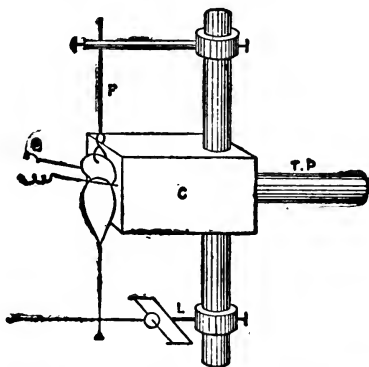

FIG. 193.—Gotch's Arrangement for Excised Heart. All parts are fixed on one T-piece, T.P. F. Clamp-forceps for heart; C. Cork; L. Lever.

(a.) Excise a frog's heart, suspend it by clamp-forceps (F) to a horizontal rod attached to a T-piece (T.P.). On the T-piece is a cork into which the electrodes are fixed, while the heart pulls on a counterpoised lever.

(b.) By means of this arrangement we can (1) with a Stannius heart show (i.) the latent period of cardiac muscle or cardiac delay, (ii.) the delay of transmission of an impulse from auricle to ventricle in the groove; (2) with a beating heart, the refractory period, rhythm, inhibition from the sinus (crescent), effect of atropine, muscarine, &c.

5. Place a frog on a crank-myograph, attach the apex of the heart still *in situ* to the crank-lever and record its movements.

6. **Writing Point of Bayliss.**—When it is necessary to diminish friction as much as possible, this style is most excellent. Fix to a straw a piece of gummed paper, and to this attach a bit of peritoneal membrane (same as is used for oneometers) and a bit of capillary glass tube fused to a little ball at the end, and attached to the peritoneal membrane by Prout's glue. The membrane is made broad to give rigidity in the direction of movement of the lever.

7. Put a glass tube in the œsophagus and leave the heart attached. Pass water at different temperatures through the tube and observe its effect on the heart.

(Engelmann, "Versuche am suspendirten Herzen," *Pflüger's Archiv.*, lii. lvi., lix.; Kaiser, *Zeits. f. Biol.*, xxxii., 1895.)

LESSON LV.

STANNIUS'S EXPERIMENT—INHIBITION—LATENT PERIOD OF HEART-MUSCLE.

1. **Stannius's Experiment.**—Pith a frog, and expose its heart.

(a.) With a seeker clear the two aortæ from the auricles, and with an aneurism needle pass a moist silk thread between the two aortæ and the superior venæ cavæ; turn up the apex of the heart, divide the frænum, and raise the whole heart to expose its posterior surface, and the crescent or line of junction of the sinus venosus and the right auricle. Bring the two ends of the ligature round the heart—call this for convenience No. 1 ligature—tie them, and tighten the ligature just over the "crescent," so as to constrict the line of junction of the sinus venosus with the right auricle. Before tightening the ligature, observe that the heart is beating freely. On tightening the ligature, the auricles and ventricle cease to beat, and remain in a state of relaxation, while the sinus venosus continues to beat at the same rate as before. After a time, if left to itself, the ventricle may begin to beat, but with an altered rhythm. If the relaxed ventricle be pricked, it executes a single contraction, *i.e.*, a single stimulation produces a single contraction.

(b.) When the heart is still relaxed, take a second ligature (No. 2), and preferably of a different colour, to distinguish it from No. 1; place it round the heart, and tighten it over the auriculo-ventricular groove, so as to separate the ventricle from the auricles. Immediately the ventricle begins to beat again, while the auricles remain relaxed or in diastole.

(c.) Instead of applying No. 2 ligature, the ventricle may be cut off from the auricles by means of a pair of scissors. Immediately after it is amputated, the ventricle begins to beat. Stannius ligature is of practical importance (i.) for arresting the uninjured ventricle to measure its electro-motivity (Lesson XLVI.), (ii.) for ascertaining the latent period of cardiac muscle (p. 272) (Hofmann, "Function d. Scheidewandnerven d. Froschherzens," *Pflüger's Archiv.*, Bd. 60, p. 139).

2. Staircase Character of the Heart-Beats.

Stannius a heart as above, *i.e.*, arrest the beating of the auricles and ventricle by tightening a ligature over the sino-auricular groove. Attach the apex of the heart by means of a silk thread to a recording lever, as in fig. 187, and record on a slow-moving drum.

The heart is quiescent. Stimulate it with a single induction shock at intervals of 5 seconds. Notice that the first beat is lower than the second, the second than the third, so that each beat exceeds its predecessor in amplitude until a maximum beat is obtained. The amount of increase gradually decreases towards the end of the series. This is the "Staircase" of Bowditch.

3. Intracardiac Inhibitory Centre.

(a.) Expose the heart in a pithed frog, tie a fine silk ligature round the frænum, and divide the latter between the ligatured spot and the pericardium. Gently raise the whole heart upwards to expose the somewhat whitish V-shaped "crescent" between the sinus venosus and the right auricle.

(b.) Arrange previously an induction coil for repeated shocks. Place the electrodes—which must be fine, and their points not too far apart (2 millimetres)—upon the crescent, and faradise it for a second; if the current be sufficiently strong, after a period of delay, the auricles and ventricle cease to beat for a time, but they begin to beat even in spite of continued stimulation. The electrodes are conveniently supported on a short cylinder of lead. They can be fixed to the lead by modeller's wax.

(c.) Stimulate the auricles; there is no inhibition or arrest.

(d.) Apply a drop of sulphate of atropine solution (Lesson LVII., 1) to the heart. Stimulation of the crescent no longer arrests the heart. The atropine paralyses the inhibitory fibres of the vagus.

4. Inhibitory (Crescent) Arrest Recorded.

(a.) Take a tracing with Gaskell's lever. Stimulate the crescent for 1-2 seconds with induction shocks as in 3, and observe the arrest of the heart's beat (fig. 194). In the primary circuit place

a small electro-magnetic signal. This will begin to vibrate when the primary circuit is closed, and mark the period of stimulation as a white patch on the black surface. Make its point record exactly under the heart-lever. Take a time-tracing in seconds.

(b.) After a pause the beat begins, the contraction travelling as a wave from sinus, through auricles to ventricle.

(c.) Stimulate the auricles. During inhibition the sinus beats, but the auricles and ventricle do not, because the excitability of the auricles is so lowered that they do not propagate the excitatory process.

(d.) Stimulate the ventricle mechanically, the heart beats in the reverse order from ventricle, auricles to sinus.

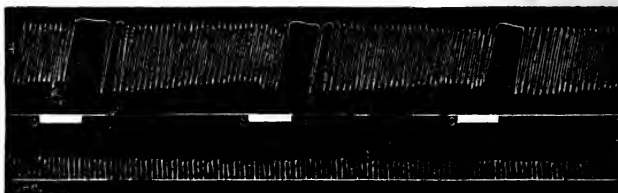

FIG. 104.—Arrest of the Frog's Heart-Beat by Electrical Stimulation of the Crescent.
Sec. Time in seconds; H. Heart-beats; S. Stimulation.

5. Seat of the Motor Centres.

(a.) Expose a pithed frog's heart, cut out the ventricle with the auricles attached to it, and observe that the heart continues to beat. Divide the ventricle vertically by two parallel cuts into three portions. The middle portion contains the auricular septum, in which lie ganglionic cells. It continues to beat while the right and left lateral parts do not beat spontaneously, but respond by means of a single contraction if they are stimulated.

6. Latent Period of Cardiac Muscle (Cardiac Delay).—This is ascertained in the same way as in a skeletal muscle, but there is this difference, the heart beats rhythmically while the skeletal muscle is at rest until excited. Therefore the heart-beat must be brought to a standstill. This can be done by a Stannius ligature.

(a.) Arrange an induction coil to give single shocks, putting in the primary coil an electro-magnet which records its movement on a slow-revolving drum. This will indicate the moment of stimulation.

(b.) Expose the heart in a pithed frog, "Stannius" its heart (Lesson LV.). This will arrest its beat. Then tie a silk thread to the apex of the ventricle, and attach the thread to a Gaskell's heart-lever. Arrange the heart-lever so that it records on a drum exactly above the electro-magnet.

(c.) Adjust a lever marking time in seconds exactly over the electro-magnet lever.

(d.) There will be recorded two horizontal lines; stimulate with a single induction shock,—the moment of stimulation will be indicated by the second lever, and shortly after, the heart will

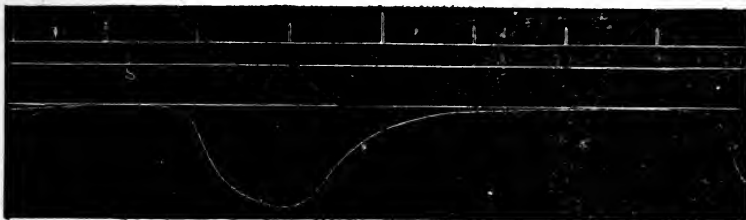

FIG. 195.—Tracing of Stanniused Heart of Frog, stimulated at *S* with a single Maximum Induction Shock. *T*. Time in seconds. Gaskell's Lever.

respond; the interval represents the “latent period”—which may be about half a second according to temperature and other conditions (fig. 195).

(e.) Stimulate the auricle and observe the longer “delay”; the wave of contraction takes longer to travel, and is delayed at the groove.

LESSON LVI.

CARDIAC VAGUS AND SYMPATHETIC OF THE FROG AND THEIR STIMULATION.

1. **Cardiac Vagus of the Frog—To Expose it.**—Make a preliminary dissection before attempting to stimulate the vagus.

Pith a frog, or destroy its brain and curarise it. Lay it on its back on a frog-plate. Expose the heart, remove the sternum and pull the fore-legs well apart. Introduce a small test-tube or stick of sealing-wax into the œsophagus to distend it; the nerves leaving the cranium are better seen winding round from behind when the œsophagus is distended. Remove the muscles covering the petrohyoid muscles, which reach from the petrous bone to the posterior horn of the hyoid bone (fig. 196). Three nerves are seen coursing round the pharynx parallel to these muscles. The lowest is the hypoglossal (Hg), easily recognised by tracing it forward to

the tongue, above it is the vagus in close relation with a blood-vessel (V), and still further forward is the glosso-pharyngeal (GP). Observe the laryngeal branch of the vagus (L). The vagus, as exposed outside the cranium, is the *vago-sympathetic*. The glosso-pharyngeal and vagus leave the cranium through the same foramen in the ex-occipital bone, and through the same foramen the sympathetic enters the skull.

2. Stimulation of the Cardiac Vagus.

(a.) Adjust a Gaskell's heart-lever to record the contractions of the heart on a revolving drum moving at a slow rate.

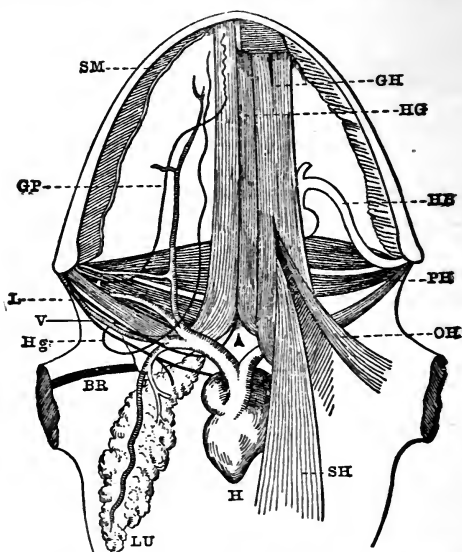

FIG. 196.—Scheme of the Dissection of the Frog's Vagus. SM. Submentalis; LU. Lung; V. Vagus; GP. Glosso-pharyngeal; Hg. Hypoglossal; L. Laryngeal; PH, SH, GH, OH. Petro-, Sterno-, Genio-, Omo-hyoid; HB. Hyoid; HG. Hyoglossus; H. Heart; BR. Brachial plexus.

(b.) Place well-insulated electrodes under the trunk of the vagus. Take a normal tracing, and then stimulate the vagus with an interrupted current, and observe that the whole of the heart is arrested in diastole. The best form of electrodes is the fine shielded electrodes shown in fig. 227. Although the faradisation is continued, the heart recommences beating. The arrest, or *period of inhibition*, is manifest in the curve by the lever recording merely a straight line. If the laryngeal muscles contract, and thereby affect

the position of the heart, divide the laryngeal branches of the vagus.

(c.) Note that when the heart begins to beat again, the beats are small at first and gradually rise to normal. In some instances, however, they are more vigorous and quicker (fig. 197).

3. Latent Period or Delay of Vagus.—For this purpose a time-marker and an arrangement to indicate when the stimulus is thrown into the nerve are required.

(a.) Arrange the heart-lever as before, and adjust a time-marker to write exactly under the heart-lever.

(b.) Arrange an induction coil for repeated shocks, and keep Neef's hammer vibrating. Into the *secondary circuit* introduce an electro-magnet with a writing-lever attached to it; so adjust the electro-magnet that its writing-style writes exactly under the heart-lever, and arrange that when the writing-style on the electro-magnet

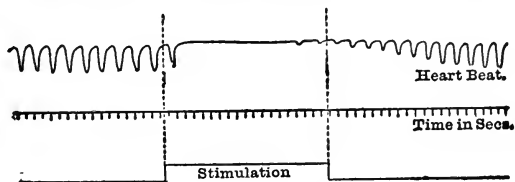

FIG. 197.—Vagus Curve of Frog's Heart.

is depressed—*e.g.*, by means of a weight—the secondary circuit is short-circuited, so that no stimulus is sent along the electrodes under the trunk of the vagus.

(c.) When all is ready, lift the weight off the electro-magnet, whereby the secondary current is un-short-circuited, the electro-magnet lever rises up, records its movements on the cylinder, and at the same moment the induction shocks are sent through the vagus. Observe that the heart is not arrested immediately, but a certain time elapses—the *latent period*—usually about one beat of the heart (1.5 sec.), before the heart is arrested.

(d.) Short-circuit the secondary current again, and observe how the heart gradually resumes its usual rhythm—sinus venosus, auricles, and ventricle.

(e.) Repeat (c.) several times, noting that the heart after arrest goes on beating in spite of continued stimulation.

(f.) An electro-magnet may be introduced into the primary circuit to mark the moment of stimulation just as in Lesson I.IV. 6.

4. Action of the Sympathetic on the Heart of the Frog.

(a.) Pith a frog, or preferably a toad, cut away the lower jaw, and continue the slit from the angle of the mouth downwards for a short distance. Turn

the parts well aside, and expose the vertebral column where it joins the skull. Remove the mucous membrane covering the roof of the mouth. The sympathetic is found before it joins the vagus emerging from the cranium (fig. 198). Carefully isolate the sympathetic. It lies immediately under the levator anguli scapulae, which must be carefully removed with fine forceps, when the nerve comes into view, usually lying under an artery. The nerve is usually pigmented. Put a ligature round it as far away from the skull as practicable, and cut the nerve below the ligature.

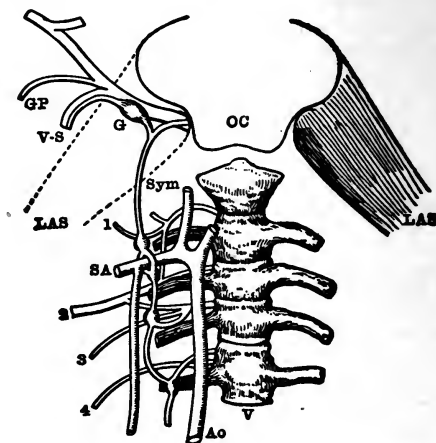

FIG. 198.—Scheme of the Frog's Sympathetic. *L.A.S.* Levator anguli scapulae; *Sym.* Sympathetic; *GP.* Glosso-pharyngeal; *V-S.* Vago-sympathetic; *G.* Ganglion of the vagus; *Ao.* Aorta; *SA.* Subclavian artery (*Gaskell*).

(*b.*) Expose the heart and attach its apex to a lever supported by an elastic thread as in *Gaskell's* method. Record several contractions, and then stimulate the sympathetic with weak interrupted shocks by means of fine electrodes. The heart beats quicker. If the heart is beating quickly, reduce the number of beats by cooling it with ice.

(*c.*) If desired, the vagus may be isolated and stimulated, and the effects of the two nerves compared (although the vagus outside the skull is really the vago-sympathetic).

Stimulation of the intracranial vagus—*i.e.*, before it is joined by the sympathetic—is somewhat too difficult for the average student, and is therefore omitted here.

N.B.—It is important to note that the effect of vagus stimulation on the heart varies with the season of the year, and is often different in the two vagi. In some animals one vagus is inactive.

LESSON LVII.

DRUGS AND CONSTANT CURRENT ON HEART
—DESTRUCTION OF CENTRAL NERVOUS
SYSTEM.

1. **Action of Drugs on the Heart—Muscarine, Atropine, and Nicotine.**—Either the excised heart, placed in a watch-glass, or the heart *in situ* may be used, or Gotch's method may be employed (p. 269). The heart may be attached to a Gaskell's lever (fig. 187) and the result recorded. The last is the best plan, for by this means a tracing can readily be obtained.

(a.) **Muscarine.**—Pith a frog, expose its heart, and if desired attach its apex to a Gaskell's lever recording its movements. Record the result (fig. 199). To get the full effect of the drug on cardiac action snip the heart to allow the blood to run out. With a fine pipette apply a few drops of serum or normal saline (0.6 p.c.) containing a trace of **muscarine**, which rapidly arrests the rhythmical action of the heart, the ventricle being relaxed—*i.e.*, in diastole—and—if uncut—distended with blood. Before it stands still the heart-beats become less and less vigorous. (This is a good method of collecting a considerable quantity of frog's blood when it is wanted for any purpose from the heart.)

(b.) When the ventricle is completely relaxed in the diastolic phase, it is very inexcitable, responding only to strong stimuli, and perhaps the auricles not at all.

Atropine.—To the heart arrested with muscarine,

(c.) After a few minutes, with another pipette apply a few drops of a 0.5 per cent. solution of **sulphate of atropia** in normal saline. The heart gradually again begins to beat rhythmically. Thus the atropine undoes the effect of the muscarine. This is sometimes spoken of as "Antagonistic action" of drugs (fig. 199).

(d.) Faradise the crescent or inhibitory centre of the atropinised heart; the heart is no longer arrested, because the atropine has paralysed the intracardiac inhibitory mechanism.

(e.) **Pilocarpine.**—In another frog, arrest the action of the heart with **pilocarpine**, and then apply atropine to antagonise it, observing that the heart beats again after the action of atropine.

(f.) **Nicotine.**—Apply **nicotine** (.2 milligram). Stimulation of the vagus no longer arrests the heart's action, but stimulation of the sinus venosus does; so that nicotine paralyses the fibres of the vagus, and leaves the intracardiac inhibitory mechanism intact.

2. Constant Current on the Heart.

(a.) Pith a frog. Cut out the heart, dividing it below the auriculo-ventricular groove, thus obtaining an "apex" preparation which does not beat spontaneously.



FIG. 199.—Tracing of Heart attached to Gaskell's Lever, arrested by Muscarine, and Rhythm restored by Atropine. *M.* Muscarine effect; *A.* Atropine applied, *T.* Time in seconds.

(b.) By means of sealing-wax, fix a cork to a lead base 5 cm. square, cover the upper end of the cork with sealing-wax, and thrust through it two wires to serve as electrodes, about 4 mm. apart (fig. 200), or by means of sealing-wax fix two fine wires upon an ordinary microscopic glass slide to act as electrodes. Cover the whole with a beaker lined with moist blotting-paper. Place the heart apex with its base against one electrode, and its apex against the other.

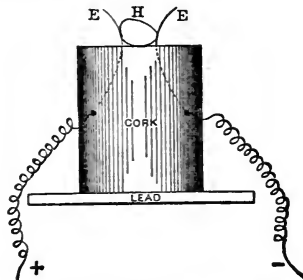

FIG. 200.—Support for Frog's Heart.
E. Electrodes; *H.* Heart.



FIG. 201.—Staircase Character of Heart-Beat.

(c.) Arrange two Daniell's cells in circuit, connect them with a key, and to the latter attach the electrodes. Pass a continuous current in the direction of the apex. The heart resumes its rhythmical beating, and continues to do so as long as the constant current passes through the living preparation.

3. The Staircase.

(a.) To a microscopical glass slide (3×1) fix with sealing-wax two copper wires in the long axis of the slide, their free ends being about 3 millimetres

apart. They will act as electrodes. Connect the other ends of the wires to a Du Bois key introduced into the secondary circuit of an induction machine. Arrange the primary coil for single induction shocks, introducing a Morse key in the circuit.

(b.) Make an "apex preparation," and place it on the electrodes on the glass slide. Rest on the heart a heart-lever properly balanced and arranged to record its movements on a slow-moving drum (5 mm. per second). The preparation does not contract spontaneously, but responds to mechanical or electrical stimulation.

(c.) Stimulate the apex preparation with single break induction shocks at intervals of about ten seconds. To do this, un-short-circuit the secondary circuit, depress the Morse key, short-circuit the secondary circuit, and close the Morse key again. Repeat this at intervals of ten seconds, and note that the amplitude of the second contraction is greater than the first, that of the third than the second, the fourth than the third, and then the successive beats have the same amplitude (fig. 201). Allow the heart apex to rest for a few minutes, and repeat the stimulation. Always the same result is obtained. From the graduated rise of the first three or four beats after a period of rest, the phenomenon is known as the "staircase." The increment is not equal in each successive beat, but diminishes from the beginning to the end of the series.

(d.) If, while the apex is relaxing, it be stimulated by a closing shock, it contracts again, so that the lever does not immediately come to the abscissa.

(e.) If the Morse key be rapidly tapped to interrupt the primary current, the contractions become more or less fused, and the lever remains above the abscissa writing a sinuous line.

4. Effect of Destruction of the Nervous System on the Heart and Vascular Tonus.

(a.) Destroy the brain of a frog, and expose its heart in the usual way, taking care to lose no blood; note how red and full the heart is with blood.

(b.) Suspend the frog, or leave it on its back, introduce a stout pin into the spinal canal, destroy the spinal cord, and leave the pin in the canal to prevent bleeding. Observe that the heart still continues to beat, but it is *pale* and *collapsed*, and apparently *empty*; it no longer fills with blood. The blood remains in the greatly dilated abdominal blood-vessels, and does not return to the arterial system, so that the heart remains without blood. If the belly be opened, the abdominal veins are seen to be filled with blood.

(c.) Amputate one limb, perhaps not more than one or two drops of blood will be shed, while in a frog with its spinal cord still intact, blood flows freely after amputation of a limb.

LESSON LVIII.

PERFUSION OF FLUIDS THROUGH THE HEART —PISTON-RECORDER.

1. Perfusion of Fluids through the Heart.

The Fluid.—(a.) Take two volumes of normal saline, add one volume of defibrinated sheep's blood, mix, and filter. See that

the blood is thoroughly shaken up with air before mixing it. This is the best fluid to use.

(b.) **Ringer's Fluid.**—Take 99 cc. of .6 per cent. NaCl solution, saturate it with calcic phosphate, and add 1 cc. of a 1 per cent. solution of potassic chloride.

(c.) Rub up in a mortar 4 grams of dried ox-blood (this can be purchased) with 60 cc. of normal saline. Allow it to stand some time, add 40 cc. of water, and filter.

2. Preparation of the Heart.

(a.) Pith a frog, expose its heart, ligature and divide the frænum behind the ligature.

(b.) Take a two-wayed cannula (fig. 202), attach india-rubber tubing to each tube, and fill the tubes and cannulæ with the fluid to be perfused. Pinch the india-rubber tubes with fine bull dog forceps to prevent the escape of the fluid.

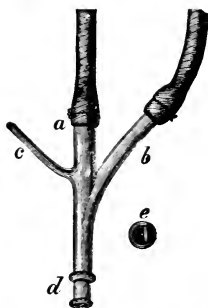

FIG. 202. — Kronecker's Cannula for Frog's Heart.

(c.) Tie a fine thread to the apex of the ventricle. To this thread a writing-lever is to be attached.

(d.) By means of the frænum ligature raise the heart, with a pair of scissors make a cut into the sinus, and through the opening introduce the double cannula passed through a cork, until its end is well within the ventricle. Tie it in with a ligature, the ligature constricting the auricles above the auriculo-ventricular groove, thus making what is known as a "heart-preparation." Cut out the heart with its cannula.

(e.) In a filter-stand arrange a glass funnel, with an india-rubber tube attached, at a convenient height (6-7 inches above the heart), fill it with the perfusion fluid, clamp the tube. Attach this tube to one of the tubes—the inflow—connected with one stem of the cannula, taking care that no air-bubbles enter the tube. Adjust the height of the reservoir so that the fluid can flow freely through the heart, and pass out by the other tube of the cannula. Place a vessel to receive the outflow fluid. After a short time the heart will begin to beat.

(f.) Place the heart in a cylindrical glass tube, fixed on a stand, and arranged so that the cork in which the cannula is fixed fits into the mouth of the tube. A short test-tube does perfectly well. The lower end of the glass tube has a small aperture in it through which the thread (c) is passed, and attached to a writing-lever arranged on the same stand as the glass vessel. See that

the lever is horizontal, and writes freely on a slow-moving recording drum. Every time the heart contracts it raises the lever, and during diastole the lever falls (fig. 203).

In this way it is possible to use various fluids for perfusion. The fluids may be placed in separate reservoirs, each communicating with the inlet tube, and capable of being shut off or opened by clamps as required. Further, by poisoning the supply fluid with atropine, muscarine, sparteine, or other drug, one can readily ascertain the effect of these drugs on the heart, or the antagonism of one drug to another.

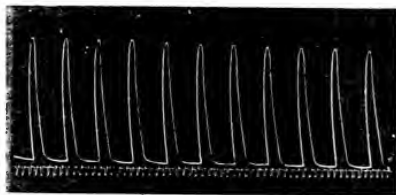

FIG. 203. — Tracing obtained from a Frog's Heart, through which Dilute Blood was perfused. The contracting heart raised a registering lever. The lower line indicates seconds.

Instead of a glass funnel as a reservoir for the fluid, one may use a Marriotte's flask (fig. 204), the advantage being that the pressure of the fluid in the inflow tube is constant. Another simple arrangement is to have a bird's water-bottle, with a curved tube leading from it to the inflow tube of the cannula.

3. Piston-Recorder (of Schäfer).

The heart is tied to a two-way cannula as before, and is introduced into a horizontal tube with a dilatation on it. The tube of the recorder is filled with oil, and as the heart dilates it forces the oil along the tube and moves a light piston resting on it. When systole takes place, the oil recedes, and with it the piston. The piston records on a slow-moving drum placed horizontally and gives excellent results.

LESSON LIX.

ENDOCARDIAL PRESSURE—APEX PREPARATION —TONOMETER.

1. Endocardial Pressure in the Heart of a Frog.

(a.) Proceed as in the previous experiment (a.), (b.) (omit c.), (d.).

(b.) Arrange a frog's mercury manometer provided with a writing-style as in fig. 204. Attach the inlet tube of the cannula to the Marriotte's flask (a, b), and connect the outflow with the tube of the mercury manometer. It is well to have a T-tube between the heart and the manometer, but in the heart apparatus, as shown and used, the exit tube is preferable. See that

no air-bubbles are present in the system. Every time the heart contracts the mercury is displaced and the writing style is raised, and records its movements on a slow-moving drum.

(c.) Take a tracing with the outflow tube and Marriotte's flask shut off, so that the whole effect of the contraction of the heart is exerted upon the mercury in the manometer. Take another tracing when the fluid is allowed to flow continuously through the heart. The second Marriotte's flask shown in the figure is for the perfusion of fluid of a different nature, and by means of the stopcock (*s*) one can pass either the one fluid or the other through the heart. The little cup (*d*) under the heart can be raised or lowered, and filled with the nutrient fluid, and in it the heart is bathed.

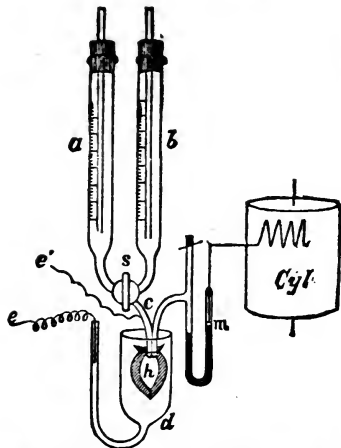

FIG. 204.—Scheme of Kronecker's Frog Manometer.

in the glass cup, into which the heart is lowered.

(c.) By introducing an electro-magnet with a recording lever into the primary circuit, and having a time-marker recording at the same time, one can determine the latent period of the apex preparation. It is about 0.15 sec.

(d.) If desired, the effect of a constant current may be studied in this way instead of by the method described in Lesson LVI. 2. The apex beats rhythmically under the influence of the constant current.

3. Roy's Frog-Heart Apparatus or Tonometer.—This apparatus registers the change of volume of the contracting heart. Fig. 205 shows a scheme of the apparatus, and fig. 206 the apparatus itself. The apparatus consists of a small bell-jar, resting on a circular brass plate about 2 inches in diameter, and fixed to a stand adjustable on an upright. In the brass plate are two openings, the small one leads into an outlet tube (*e*), provided with a stopcock. The other is in the centre of the plate, and leads into a short cylinder 1 cm. in length by 1 cm. in internal diameter. A groove runs round the outside of this cylinder near its lower edge, to permit of a membrane being tied

2. Apex Preparation.—In this preparation of the heart only the apex of the heart is used. As a rule, it does not beat spontaneously until sufficient pressure is applied to its inner surface by the fluid circulating through the heart.

(a.) Proceed as in Lesson LVIII. 2 (a.), (b.) (omit c.), (d.), with this difference, that in (d.) the cannula is placed deeper into the ventricle, and the ligature is tied round the ventricle below the auriculo-ventricular groove. Excise the heart and cannula, and attach it to the heart apparatus as in the previous experiment.

(b.) If the "heart apex" preparation does not contract spontaneously, stimulate it by, e.g., single induction shocks, either make or break. To this end adjust an induction machine, the wires from the secondary coil being attached, one to the cannula itself, while the other is placed in the fluid

on to it. In this cylinder works a light aluminium piston (*p*), slightly less in diameter than the cylinder.

Around the lower aperture of the cylinder is tied a piece of flexible animal membrane, the ligature resting in the grooved collar. The free part of the membrane is tied to the piston, from the centre of whose under-surface (*p*) a needle passes down to be attached to a light writing-lever (*l*) fixed below the stage. The bell-jar is filled with oil (*o*), while in its upper opening is fitted a short glass stopper, perforated to allow the passage of a two-wayed heart-cannula with the heart attached (*h*). In using the instrument proceed as follows:—

(a.) Fix the bell-jar to the circular brass plate by the aid of a little stiff grease. Tie a piece of the delicate transparent membrane—such as is used by perfumers for covering the corks of bottles—in the form of a tube round

the lower end of the grooved cylinder; afterwards the lower end of the membrane is fixed to the piston, taking care that

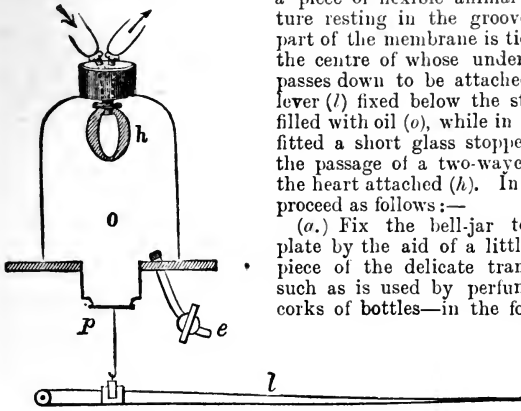

FIG. 205.—Scheme of Roy's Tonometer.

the needle attached to the piston hangs towards the recording lever. Drop in a little glycerin to moisten the membrane.

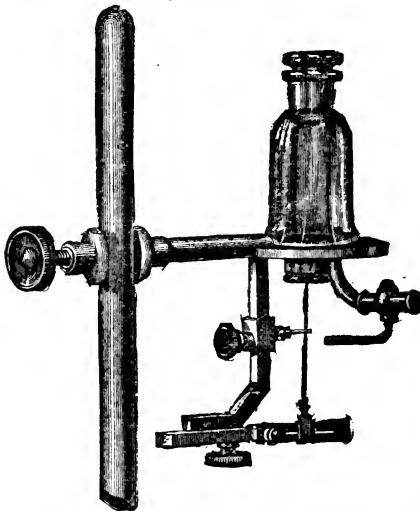

FIG. 206.—Roy's Tonometer, as made by the Cambridge Scientific Instrument Company.

(b.) Fill the jar with olive-oil, and have the recording apparatus ready adjusted. Prepare the heart of a large frog [Lesson LVIII. (a.), (b.) (omit c.),

(*d.*) the cannula used being one fixed in the glass stopper of the bell-jar, and attach the inlet tube of the cannula to the reservoir of nutrient fluid, while the outlet tube is arranged so as to allow fluid which has passed through the heart to drop into a suitable vessel.

(*c.*) Introduce the cannula, with the heart attached, into the oil, and see that the stopper is securely fixed. Open the stopcock (*e*), and allow some oil to flow out of *o*, thus rendering the pressure within sub-atmospheric; and as soon as the pressure has fallen sufficiently, and the little piston is gradually drawn up to the proper height, close the stopcock. Attach the needle of the piston to the recording light lever, and take a tracing.

LESSON LX. .

HEART-VALVES—ILLUMINATED HEART—STETHOSCOPE—CARDIOGRAPH—POLYGRAPH—MEIOCARDIA—REFLEX INHIBITION OF THE HEART.

1. **Action of Heart-Valves.**—This is of value in order that the student may obtain a knowledge of the mechanical action of the valves. The heart and lungs of a sheep—with the pericardium still unopened—must be procured from the butcher.

(*a.*) Open the pericardium, observe its reflexion round the blood-vessels at the base of the heart. Cut off the lungs moderately wide from the heart. Under a tap wash out any clots in the heart by a stream of water entering through both auricles. Prepare from a piece of glass tubing, 15 mm. in diameter, a short tube, 8 cm. in length, with a flange on one end of it, and another about 60 cm. long. Fix a ring to hold a large funnel on a retort stand.

(*b.*) Tie the short tube into the superior vena cava, the flanged end being inserted into the vessel. It must be tied in with well-waxed stout twine. In the pulmonary artery (P.A.)—separated from its connections with the aorta, which lies behind it—tie the long tube, the flange securing it completely. Ligature the inferior vena cava, and the left azygos vein opening into the right auricle. Connect the short tube by means of india-rubber tubing with the reservoir or funnel in the retort stand. Keep the level of the water in the funnel below the upper surface of the P.A. tube. Fill the funnel with water; it distends the right auricle, passes into the right ventricle, and rises to the same height in the P.A. tube as the level of the fluid in the funnel. Compress the right ventricle with the hand; the fluid rises in the P.A. tube; and observe on relaxing the pressure that the fluid remains stationary in the P.A. tube as it is supported by the closed semilunar valves. If the right

ventricle be compressed rhythmically, the fluid will rise higher and higher, until it is forced out at the top of the P.A. tube, and a vessel must be held to catch it. Observe that the column of fluid is supported by the semilunar valves, and above the position of the latter observe the three bulgings corresponding to the position of the sinuses of Valsalva.

(c.) Repeat (*b.*), if desired, on the left side, tying the long tube into the aorta, and the short tube into a pulmonary vein, ligaturing the others.

(*d.*) Cut away all the right auricle, hold the heart in the left hand, and pour in water from a jug into the tricuspid orifice. The water runs into the right ventricle, and floats up the three cusps of the tricuspid valve; notice how the three segments come into apposition, while the upper surfaces of the valves themselves are nearly horizontal.

(*e.*) With a pair of forceps tear out one of the three segments of the semilunar valve of the P.A. Tie a short tube into the P.A., and to it attach an india rubber tube communicating with a funnel supported on a retort stand. Pour water into the funnel, and observe that it flows into the right ventricle, floats up, and securely closes the tricuspid valve. The semilunar valves have been rendered incompetent through the injury. Turn the heart any way you please, there is no escape of fluid through the tricuspid valve.

(*f.*) Take a funnel devoid of its stem and with its lower orifice surrounded by a flange, and tie it into the aorta. Cut out the aorta and its semilunar valves, leaving a considerable amount of tissue round about it. Place the funnel with the excised aorta in a filter stand, and pour water into the funnel; much of it will escape through the coronary arteries; ligature these. The semilunar valves are quite competent, *i.e.*, they allow no fluid to escape between their segments. Hold a lighted candle under the valves, and observe through the water in the funnel how they come together and close the orifice; observe also the triradiate lines, and the lunules in apposition projecting vertically.

(*g.*) Slit open the P.A., and observe the form and arrangement of the semilunar valves.

[**T.S. Ventricles.**—Make a transverse section through both ventricles, and compare the shape of the two cavities and the relative thickness of their respective walls.

Casts of Heart.—Study two casts of the heart-ventricles (by Ludwig and Hesse), (1) in diastole, and (2) in systole.

Effect of Ligature.—Ligature any large vessel attached to the heart; one feels the sensation of something giving way when the ligature is tightened. Cut away the ligature, open the blood-vessel, and observe the rupture of the coats produced by the ligature.]

2. Illuminated Ox-Heart (Gad).

This must be arranged previously by the demonstrator. Two brass tubes with glass windows are tied, one into the left auricle (*d*) (7 cm. diameter) and the other (*c*) into the aorta (5 cm. diameter). These are connected with a large reservoir (*R*), as shown in the figure. The interior of the heart is illuminated by a small electric lamp (*l*) pushed in through the apex of the heart, and served

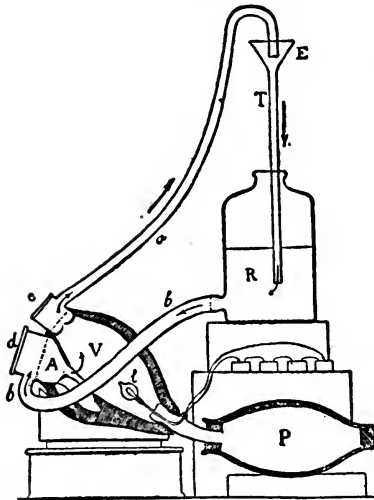

FIG. 207.—Scheme of Gad's Apparatus to show the play of the Valves of the Heart. *A*. L. auricle; *d*. Its window, and communicating with *b*, the inlet tube for water from the reservoir, *R*; *V*. L. ventricle, illuminated by the electric lamp, *l*, and communicating with the elastic bag, *P*; *c*. Glass window fixed in tube in aorta; *a*. Tube carrying fluid to the reservoir.

by several small Grove cells. Into the apex is tied a brass tube, which is connected with a large india-rubber bag with thick walls (*P*). Fill the whole with water. On compressing the elastic bag, fluid is driven onwards, when the play of the valves can be beautifully studied. On relaxation, the mitral valves open and the aortic valves close.

After each demonstration, remove the glass windows of the cannulæ and the caoutchouc tubes, and preserve the heart in 10 p.c. chloral hydrate.

3. The Stethoscope — Heart Sounds.

(*a*.) Place the patient or fellow-student in a quiet room, and let him stand erect and expose his chest. Feel for the cardiac impulse, apply the small end of the

stethoscope over this spot, and apply the ear to the opposite end of the instrument. The left hand may be placed over the carotid or radial artery to feel the pulse in either of those arteries; compare the time-relations of the pulse with what is heard over the cardiac impulse.

(*b*.) Two sounds are heard—the *first* or *systolic* coincides with the impulse, and is followed by the *second* or *diastolic*. After this there is a pause, and the cycle again repeats itself. The first sound is longer and deeper than the second, which is of shorter duration and sharper.

(*c*.) Place the stethoscope over different parts of the præcordia,

noting that the first sound is heard loudest at the apex beat, while the second is heard loudest at the second right costal cartilage at its junction with the sternum.

4. Cardiograph.—Several forms of this instrument are in use, including those of Marey, B. Sanderson, and the pansphygmograph of Brondgeest. Use any of them.

(a.) Place the patient on his back with his head supported on a pillow. Feel for the cardiac impulse between the fifth and sixth ribs on the left side, and about half an inch inside the mammary line.

(b.) Arrange the cardiograph by connecting it (fig. 208) with thick-walled india-rubber tubing to a recording Marey's tambour adjusted to write on a drum (fig. 150). It is well to have a valve or a T-tube capable of being opened and closed between the receiving and recording tambours, in order to allow air to escape if the pressure be too great.

(c.) Adjust the ivory knob of the cardiograph (*p*) over the cardiac impulse where it is felt most, and take a tracing. Fix, varnish, and study the tracing or cardiogram.

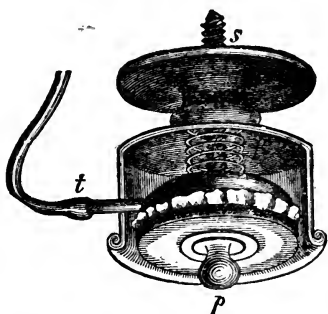

FIG. 208.—Marey's Cardiograph. *p*. Button placed over cardiac impulse; *s*. Screw to regulate the projection of *p*; *t*. Tube to other tambour.

5. Effect of Swallowing on the Heart-Beats (Man).

With a watch in front of you, count the number of your own pulse-beats per minute, and then slowly sip a glass of water, still keeping your finger on the pulse. Count the increase in the number of pulse-beats during the successive acts of swallowing. This is due to the inhibitory action of the vagus being set aside.

6. Reflex Inhibition of the Heart (Rabbit).

Place one hand over the chest of a rabbit and feel the beating of the heart. With the other hand suddenly close its nostrils, or bring a little ammonia near the nostrils, so as to cause the animal to close them. Almost at once the heart is felt to cease beating for a time, but it goes on again.

7. Goltz's Tapping Experiment (Frog).

(a.) Destroy the cerebrum and optic lobes of a frog. Pin it out on a frog-plate, and expose its heart, or attach the heart to a Gaskell's lever. Expose

the intestines and tap them several times with the handle of a scalpel. The heart ceases to beat for a time, being arrested reflexly. The afferent nerve is the sympathetic from the abdomen, and the efferent the vagus. The

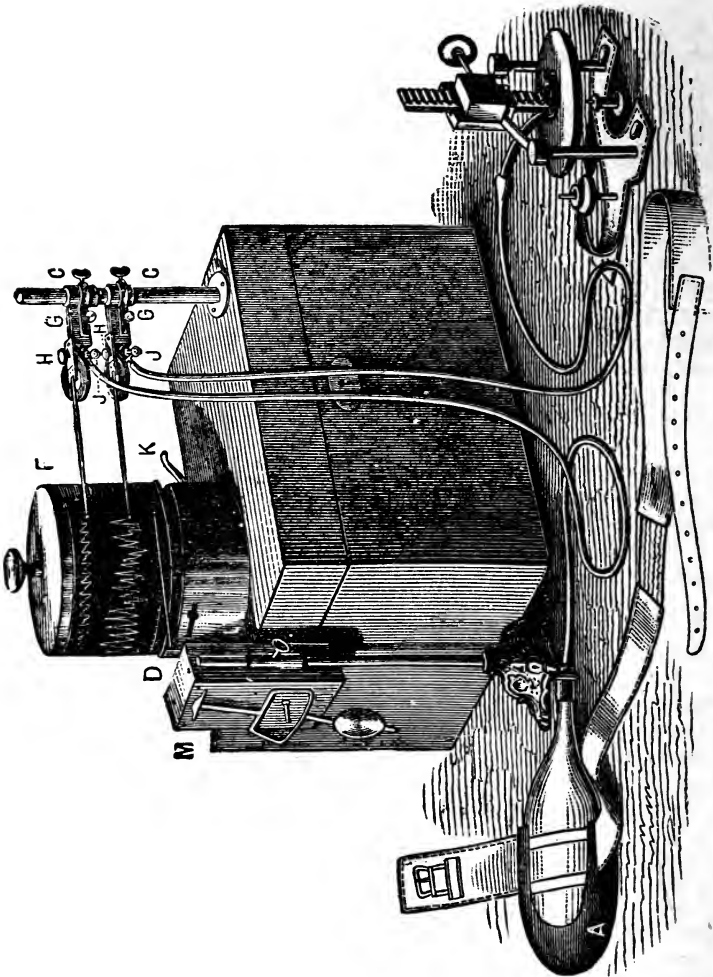

FIG. 209.—Polygraph of Rothe. A. Bag for respiratory movements; B. Receiving tambour; C. Supports for H, H, H, the recording tambours; F. Drum; D. Clockwork; and K. Detent for liberating D; M. Time-marker.

tapping succeeds more promptly if the intestines are slightly inflamed by exposure to the air.

(b.) It suffices to exert digital pressure over the abdomen to produce this reflex arrest of the heart.

ADDITIONAL EXERCISES.

8. Polygraph of Knoll and Rothe.—This is a most convenient apparatus, both for work in the laboratory and at the bedside. Moreover, it is so arranged that two tracings can be taken simultaneously. It is made by H. Rothe, Wenzelbad, Prague. It can be used to take simultaneously

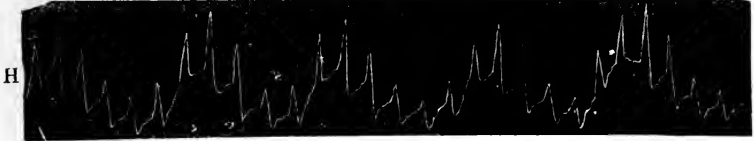

FIG. 210.—H. Tracing of the cardiac impulse, the respiratory movements of the chest not being arrested.

cardiac impulse and a pulse tracing, or respiratory movements and a pulse tracing, or two pulse tracings.

Fig. 209 shows the arrangement of the apparatus. It consists of a drum (F) moved by clockwork within the box D. K is a catch for setting D in

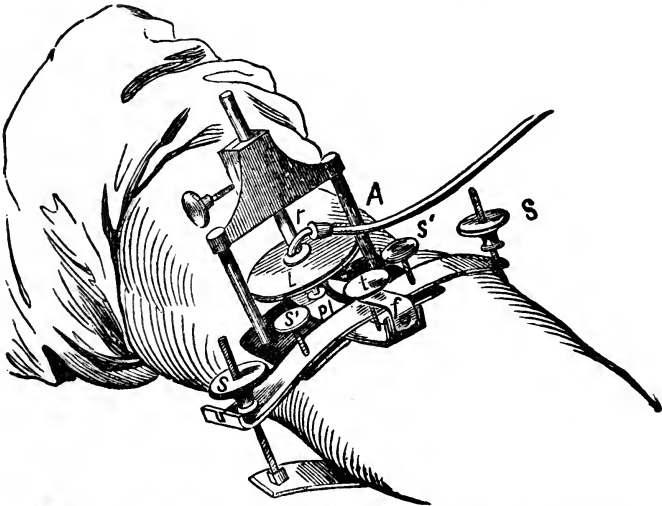

FIG. 211.—Showing the Method of Fixing the Receiving Tambour of Rothe's Polygraph on an Artery.

motion. M is a time-marker beating seconds. H, H are two Marey's registering tambours adjustable on the stand C. B is a tambour which can be fixed over an artery or over the cardiac impulse, while A is a bottle-shaped caoutchouc bag which can be strapped to the body for studying the respiratory movements.

(a.) Adjust the tambour (B) over the cardiac impulse, and fix the bag (A) on the abdomen so as to record simultaneously the cardiac impulse and the respirations (fig. 210). The experimenter may also take a tracing of the cardiac impulse while the respiration is arrested.

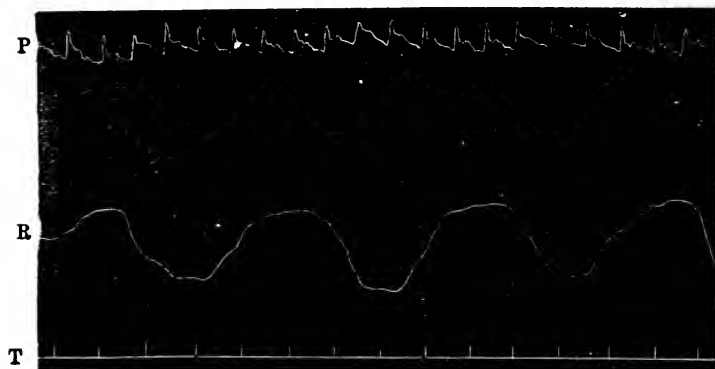

FIG. 212.—*P.* Tracing of radial pulse; *R.* Respirations; *T.* Time in seconds.

(b.) Take a tracing of the radial pulse and the respiratory movements. Fig. 211 shows how the receiving tambour is adjusted over an artery. At the same time record the respirations, and note in the tracing (fig. 212) how

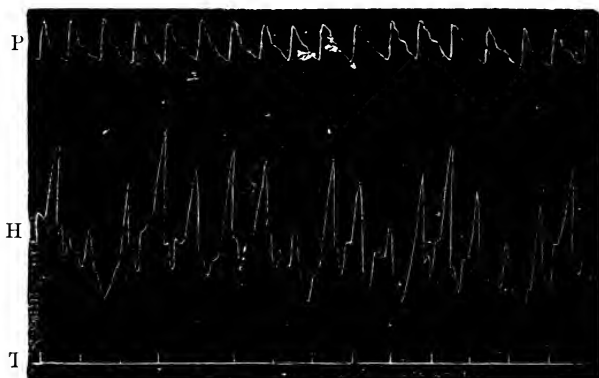

FIG. 213.—*P.* Tracing of the radial pulse; *H.* Of the cardiac impulse; *T.* Time in seconds.

the number and form of the pulse-beats vary during inspiration and expiration—the number being greater during inspiration.

(c.) Take a tracing of the radial pulse and the cardiac impulse simultaneously (fig. 213).

9. Meiocardia and Auxocardia (Ceradini).

(a.) Bend a glass tube about 20 mm. in diameter into a semicircle, with a diameter of about 6-8 inches. Taper off one end in a gas-flame to fit a nostril, and draw out the other end of the tube to about the same size. Round off the edges of the glass in a gas-flame.

(b.) Fill the tube with tobacco-smoke, place one end of it in one nostril, close the other nostril, cease to breathe, but *keep the glottis open*. Observe that the smoke is moved in the tube, passing out in a small puff during *auxocardia*, *i.e.*, when the heart is largest; while it is drawn farther into the tube during *meiocardia*, *i.e.*, when the heart is smallest.

These movements, sometimes called the "*cardio-pneumatic movements*," are due to the variations of the size of the heart during its several phases of fulness altering the volume of air in the lungs.

LESSON LXI.

PULSE—SPHYGMOGRAPHS—SPHYGMOSCOPE—PLETHYSMOGRAPH.

1. The Pulse.

(a.) Feel the radial pulse of a fellow-student, count the number of beats per minute; compare its characters with your own pulse, including its volume and compressibility. Observe how its characters and frequency are altered by (1) muscular exercise; (2) a prolonged and sustained deep inspiration; (3) prolonged expiration; and (4) other conditions.

(b.) Feel the radial pulse-beat and heart-beat (the latter over the cardiac impulse) simultaneously. Note that the former is not synchronous with the latter, the pulse-beat at the wrist occurring about $\frac{1}{8}$ second after the heart-beat, *i.e.*, the pulse-wave takes this time to travel from the heart to the radial artery.

(c.) Listen to the heart-sounds at the same time that the radial pulse is being felt. Note that the pulse is felt after the first sound about midway between the first and second sounds.

(d.) By appropriate recording apparatus one can readily show that the pulse is not simultaneous throughout the arterial system: thus the carotid precedes the femoral, &c.

2. Sphygmograph.—Many forms of this instrument are in use. Study the forms of Marey and Dudgeon.

Marey's Sphygmograph (fig. 214)—Application of.

(a.) Cause the patient to seat himself beside a low table, and place his forearm on the double-inclined plane (fig. 214), which, in the improved form of the instrument, is the lid of the box so

made as to form this plane. The fingers are to be semiflexed, so that the back of the wrist, resting on the plane, makes an angle of about 30° with the dorsal surface of the hand.

(b.) Mark the position of the radial artery with ink or an aniline

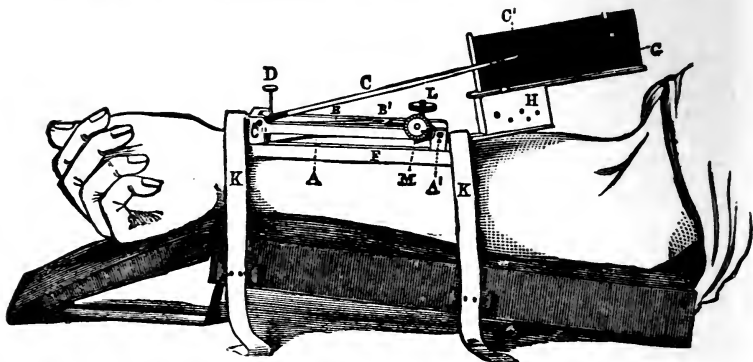

FIG. 214.—Marey's Sphygmograph applied to the Arm.

pencil. Wind up the clock (H), apply the ivory pad of the instrument exactly over the radial artery where it lies on the radius, and fix it to the arm by the non-elastic straps (K, K). The sphygmograph must be parallel to the radius, and the clockwork next the elbow. Cover the slide with enamelled paper, smoke it, fix it in position, and arrange the writing-style (C') to write upon the smoked surface (G) with the least possible friction. Regulate the

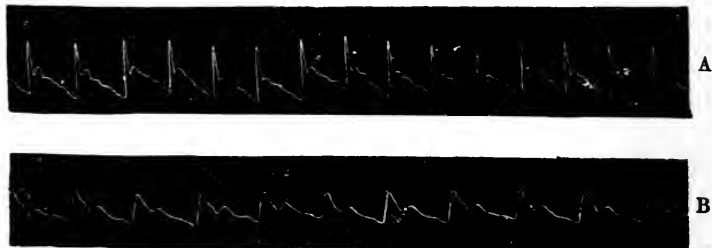

FIG. 215.—Tracing taken from the Radial Artery by means of Marey's Sphygmograph. A. A hard, and B, a softer pulse.

pressure upon the artery by means of the milled head (L), *i.e.*, until the greatest amplitude of the lever is obtained.

(c.) Set the clockwork going, and take a tracing. Fix it, write the name, date, and pressure, and study the tracing (fig. 215).

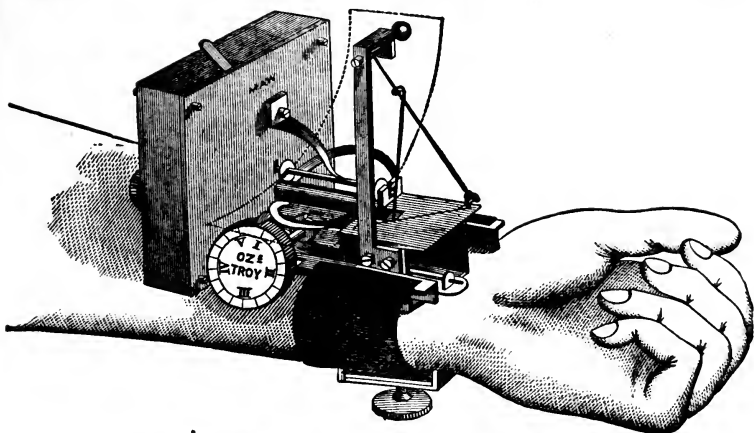

FIG. 216.—Dudgeon's Sphygmograph.

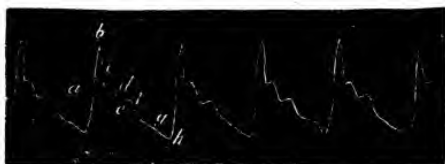

FIG. 217.—Tracing of Radial Pulse taken with Dudgeon's Sphygmograph.

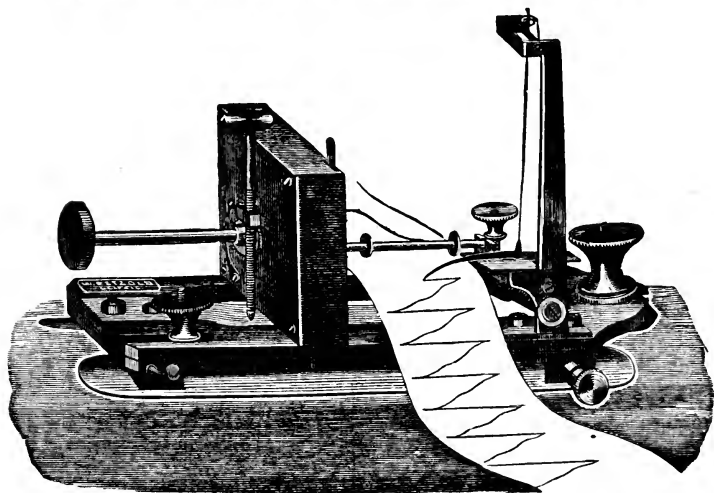

FIG. 218.—Ludwig's Sphygmograph, made by Petzold of Leipzig.

3. Dudgeon's Sphygmograph (fig. 216).

Adjust the instrument on the radial artery by means of an elastic strap, carefully regulating the pressure—which can be graduated from 1–5 ounces—by means of the milled head. Smoke the band of paper, insert it between the rollers, and take a tracing. Study the tracing (fig. 217).

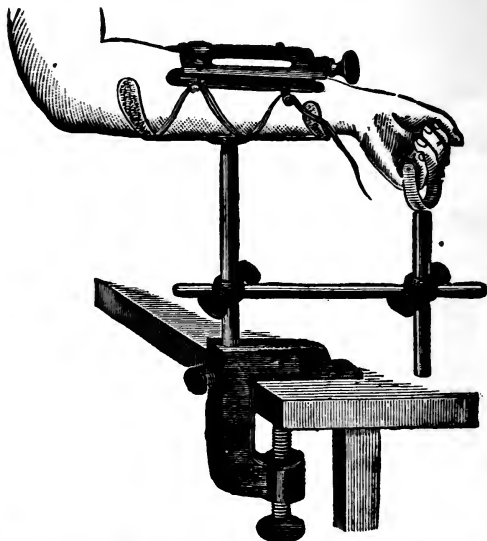

FIG. 219.—Ludwig's Support for Arm for the Sphygmograph.

4. Ludwig's Sphygmograph.—Use this instrument (fig. 218). It is not unlike a Dudgeon's sphygmograph, but there is a frame adapted to the arm, and an arrangement for keeping the arm steady while the hand grasps a handle for the purpose.

By the device shown in fig. 219 the arm is kept quite steady and always in the same position. In fact, we find it most convenient for taking tracings with either Dudgeon's or Ludwig's sphygmograph. It has also been found most valuable for clinical work. It is made by Petzold of Leipzig.

ADDITIONAL EXERCISES.

5. Action of Amyl Nitrite.

(a.) With the sphygmograph adjusted, take a tracing, and then place *two drops—not more*—of amyl nitrite on a handkerchief, and inhale the vapour.

Within fifteen to thirty seconds or thereby it will affect the pulse, lowering the tension, the tracing presenting all the characters of a soft-pulse tracing, with a well-marked dicrotic wave.

6. Gas Sphygmoscope (fig. 220).

Connect the inlet tube of the instrument with the gas supply, light the gas-flame (*b*). Apply the caoutchouc membrane (*a*) over the radial artery, and observe how the flame rises and falls with each pulse-beat. Take a deep expiration, and observe the dicrotism in the gas-flame.

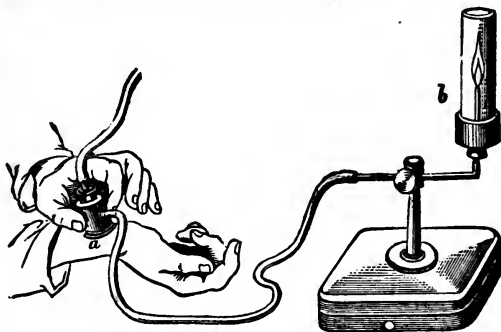

FIG. 220.—Sigmund Mayer's Gas Sphygmoscope, made by Rothe of Prague.

7. Plethysmograph.—Use the air-piston recorder of Ellis, and take a plethysmographic tracing of the variations of the volume of a finger. The piston of the recorder must be lubricated with an essential oil, *e.g.*, clove.

8. Delépine's Gas Sphygmoscope is convenient. (*Brit. Med. Jour.*, July 1891.)

9. Influence of the Respiration on the Pulse.

(i.) **Müller's Experiment.**—Close the mouth and nostrils and then make a forced prolonged inspiratory effort. Before doing so, feel the pulse, and keep feeling it. Note now the cessation of the pulse-beat. The intrathoracic vessels are filled with blood, and the distended auricles are unable to contract.

(ii.) **Valsalva's Experiment.**—Make the experiment as before, but make a prolonged vigorous expiration. Note fall in pulse-beats.

LESSON LXII.

**RIGID AND ELASTIC TUBES — PULSE-WAVE —
SCHEME OF THE CIRCULATION — RHEOMETER.**

1. Rigid and Elastic Tubes.—To the vertical stem of a glass U-tube or three-way tube, 1 cm. in diameter, fix an elastic pump whose opposite end dips into a vessel of water. To the other

slightly curved ends of the tube fix a glass tube, 90 cm. or thereby in length, and to the open end of the tube attach a small short piece of india-rubber tubing with a clamp over it. To the other limb attach an india-rubber tube of the same diameter and length as the glass tube, and fix a clamp over its outflow end. Pump water through the system. The pump may be compressed directly by the hand, or it may be placed between the two blades of a "lemon-squeezer," and the extent of the excursion of the latter regulated by a screw.

(a.) **Rigid Tube.**—Clamp off the elastic tube near the U-piece. Work the pump about forty beats per minute, and force water into the glass tube. The water flows out *in jets* in an intermittent stream corresponding to each beat. Gradually clamp the outflow tube, and keep pumping; the water still flows out in an intermittent stream, and no amount of diminution of the outflow orifice will convert it into a continuous stream; as much water flows out as is forced in. All that happens is, that less flows out, and, of course, less enters the tube. Instead of the clamp at the outflow, a tube drawn to a fine point may be inserted.

(b.) **Elastic Tube.**—Clamp off the glass tube near the U-piece, and unclamp the flexible one so as to have no resistance at its outflow end. Work the pump; the outflow takes place in jets corresponding to each beat of the pump. Pump as rapidly as possible and the outflow stream will still be intermittent. While pumping, gradually clamp the tube at its outflow so as to introduce resistance there—to represent the resistance in the small arterioles—and when there is sufficient resistance at the outflow, the stream becomes a uniform and *continuous* one. Feel the tube; with each beat a pulse-beat is felt. The resistance at the periphery brings the *elasticity* of the tube into play between the beats, and thus converts the interrupted into a uniform flow. This apparatus serves also to demonstrate why there is no pulse in the capillaries, and under what circumstances a pulse is propagated into the capillaries and veins.

2. Velocity of the Pulse-Wave.

(a.) Take 3 metres of india-rubber tubing 6 mm. in diameter. To one end of the tube attach the ball of a Higginson's syringe (elastic pump) to imitate the heart, while the other end of the tube is left open, with a clamp lightly fixed on it. Arrange to pump water through the tube. Arrange two light levers on one stand, and place a part of the tube near the pump under the lower lever, and resting on a suitable support, while part of the tube near the outflow end is similarly arranged under the upper lever. Regulate the pressure of the lever upon the tube by means of lead weights.

(b.) Arrange on the same stand a Despretz's chronograph to record the vibrations of an electro-tuning-fork (30 or 50 D.V. per second), with the writing points of the two levers and chronograph writing upon the drum in the same vertical line.

(c.) Set the tuning-fork vibrating, allow the drum to move, compress the elastic pump interruptedly—to imitate the action of the heart—and propel water through the tube. The compression may be done by means of a lemon-squeezer, the extent of the excursion being regulated by a screw, and, to secure regularity, arrange the number of pulsations to the beating of a metronome. On doing so, as one pumps in water, the tube distends and raises the lever; in the interval between the beats, as the water flows out at the other end, the tube becomes smaller, and the levers fall. Feel the tube; with each contraction of the pump, a beat—the pulse-beat—can be felt.

(d.) Fix and study the tracing. The tracing due to the rise of the lever next the pump begins sooner, and is higher than the one from the lever near the outflow. Make two ordinates to intersect the three tracings, one where the lower pulse-curve rises from the abscissa, and the other where the upper curve begins. Count the number of D.V. of the tuning-fork between these lines. Measure the length of the tube between the two levers, and from these data it is easy to calculate the velocity of the pulse-wave in feet per second.

3. Scheme of the Circulation.—Use either Rutherford's scheme or the major schema. In the latter, the heart is represented by an elastic pump (Higginson's syringe), the arteries by long elastic tubes dividing into four smaller tubes with clamps on them; two of the tubes leading into tubes filled with sponge to represent the capillaries. The capillaries lead into a tube with thinner walls representing the veins. The inflow tube into the heart and the outflow tube at the vein are placed in a basin of water, and the whole system is filled with water.

(a.) Use two mercury manometers, connect one with the arterial, and the other with the venous tube. Adjust a float on each, and cause the writing points of the two floats to write exactly one below the other in the same vertical line on a drum.

(b.) Unclamp all the arteries, and work the pump, regulating the number of beats by means of a metronome beating thirty per minute, and compress the heart to the same extent each time with a lemon-squeezer. Both manometers will oscillate nearly to the same extent with each beat. Take a tracing on a slow-moving drum.

(c.) Gradually clamp the arteries to offer resistance, and continue to pump; the pressure in the arterial manometer will rise more and more with each beat until it reaches a mean level with a slight oscillation with each beat. The pressure in the venous manometer rises much less, and the oscillations are very slight or absent.

(d.) While the mean arterial pressure is high, cease pumping; this will represent the arrest of the heart's action, brought about by stimulation of the peripheral end of the vagus; the arterial blood-pressure falls rapidly.

(e.) Begin pumping again until the mean arterial pressure is restored, and then unclamp gradually the small arteries. The steady fall of the blood-pressure represents the fall obtained when the central end of the depressor nerve is stimulated (the vagi being divided).

(f.) Two sphygmographs may be adjusted on the arterial tube, one near the heart and the other near the capillaries, tracings being taken and compared.

ADDITIONAL EXERCISES.

4. **Rigid and Elastic Tubes.**—Arrange an experiment as shown in fig. 221. The flask should at least hold a litre, and be arranged as a Marriotte's flask. The tubes—one of glass and the other of caoutchouc—have the same diameter, and the outflow orifices are of the same size. The glass tube is attached by a short elastic tube to the lead tube coming from the reservoir. As the fluid

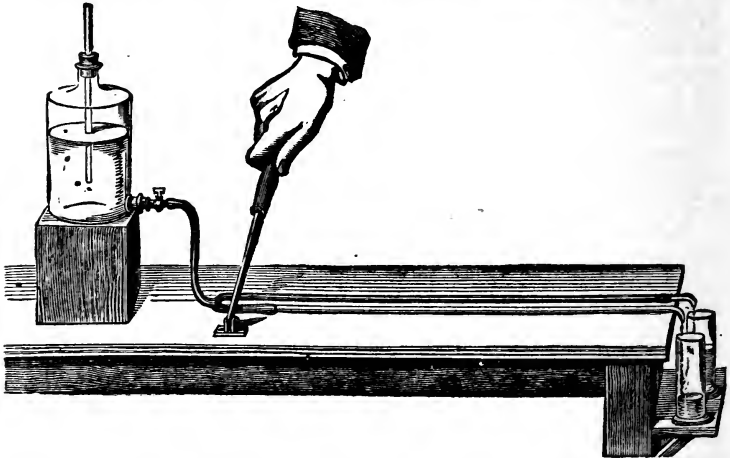

FIG. 221.—Marey's Scheme for showing that in the Case of Rigid and Elastic Tubes of the same Calibre, under certain Conditions, the Elastic Tube delivers more Fluid than the Rigid one.

flows into the tubes, they are compressed rhythmically to imitate the interrupted beat of the heart. Observe that more fluid is discharged by the elastic than by the rigid tube.

5. The Rheometer (fig. 222) is used to measure the amount of blood flowing through a vessel in a given time, and, therefore, the diameter of the vessel being known, to estimate the velocity or rate of blood-flow through an artery. The nozzles of the instrument are inserted and tied into the artery of an animal, but as the student is not permitted to do this, use an india rubber tube to represent the artery.

(a.) To represent the heart—or the weight of a column of fluid—arrange a Mariotte's flask or funnel on a stand, and to the outflow tube attach a narrow india-rubber tube, and clamp it after filling it with normal saline (to represent defibrinated blood). Fill one bulb of the instrument with defibrinated blood, the other with almond oil, and close the top of the instrument with a glass plug.

(b.) Suppose the tube to represent an exposed artery; about the middle of the tube apply two ligatures about an inch apart (or two clamps). Divide the part of the tube included between the two ligatures, and tie into either end the nozzles provided with the instrument. Call the one next the reservoir or heart *h*, and the other one *k*. Fix the instrument into the nozzles, the bulb A being filled with oil and in connection with *h*, B with defibrinated blood and connected with *k*. The instrument is fixed in position by a support provided with it, while a handle which fits into two tube-sockets on the upper surface of the disc (*e*, *e*₁) is used to rotate the one disc on the other.

(c.) All being now ready, take the clamp off the reservoir of blood and the clamps or ligatures off the artery. The defibrinated blood flows into the bulb A, displaces the oil in it towards B, the defibrinated blood of B being forced out into the artery and caught in a suitable vessel. Of course, in the animal this blood simply passes into the artery. As soon as the bulb A is filled with blood, which is indicated by a mark on the glass, the disc is suddenly rotated by the hand, whereby B communicates with *h*, and A with *k*. The blood now flows into B, displacing the oil in it into A, and as soon as this takes place, the disc is again rotated. This process is repeated several times. Count the number. The bulbs have the same capacity and are exactly calibrated.

The time is most conveniently measured by connecting the rheometer with an electro-magnet registering on a drum each rotation of the disc, and under this a time-marker records seconds.

Example.—Suppose each bulb holds 5 cc., and suppose the bulbs to be filled ten times with blood during 100 seconds, *i.e.*, 50 ccm. flowed from the tube in 1 second. Suppose the diameter of the tube to be 2 mm. (*i.e.*, radius = 1 mm.), this would give a sectional area of 3.14 mm.

The velocity (*V*) is calculated by the ratio of the quantity discharged (*Q*) to the sectional area (*S*), *i.e.*, the quantity of fluid flowing across any section in unit of time ÷ area of that section. Hence—

$$V = \frac{Q}{S}$$

.5 cc., or what is the same thing, 500 cmm., are discharged in one second;

therefore the velocity is $= \frac{500}{3.14} = 159$ mm., or about six inches per second.

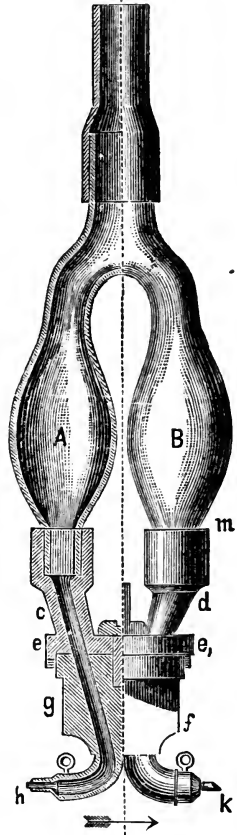

FIG. 222.—Rheometer.

6. To familiarise himself with this calculation, the student would do well to estimate the amount of water discharged from a tube of known diameter. Let the tube be attached to a litre-bottle arranged as a Marriotte's flask. Estimate the amount of fluid discharged in a given time, and from this calculate the velocity of the flow in the tube.

LESSON LXIII.

CAPILLARY BLOOD-PRESSURE—LYMPH-HEARTS —BLOOD-PRESSURE AND KYMOGRAPH.

1. Blood-Pressure in the Capillaries.

(a.) Make the following apparatus (fig. 223), consisting of a disc of glass, 2 cm. long, 3 to 4 mm. broad, and 1 mm. thick, and on its under surface fix with cement a glass plate (*a*), with a surface of 5 mm. square. Two threads supporting a paper scale-pan are attached to the glass disc. Arrange the glass plate (*a*) over the skin on the dorsal surface of the middle finger, just at the root of the nail. Add weights to the scale-pan until the skin becomes pale. Note the weight necessary to bring this about, but observe that the skin does not become pale all at once.

(b.) Test how altering the position of the hand affects the pressure in the capillaries.

2. Destroy the brain of a frog. Very slightly curarise it. Examine microscopically the circulation in the web of its foot and in its mesenteric vessels.

Apply a drop of croton oil or mustard for a minute or less. Observe the inflammation thereby produced, and the changes in the appearance of the blood-vessels and the blood-flow, until the latter is finally arrested in a condition of stasis, and exudation takes place.

3. Posterior Lymph-Hearts.

(a.) Destroy the brain of a frog, place it on its belly, and watch the beating of the posterior pair of lymph-hearts, which are situated one on each side of the urostyle in the triangle between coccygeo-iliacus (*ic*), gluteus (*gl*), origin of the vastus externus (*ve*) and pyramidalis (*p*) muscles (fig. 224).

(b.) Remove the skin covering them, taking care not to cut too far outwards, else a cutaneous vein will be injured and bleed freely. Count the number of beats per minute, noting that the rhythm is

not synchronous with the blood-heart, whose movements can usually be distinguished without opening the chest.

(c.) Destroy the posterior part of the spinal cord with a seeker or wire, and observe that the rhythmical automatic movements of the lymph-hearts cease.

4. Estimation of the Blood-Pressure by Ludwig's Kymograph.

—As students are not permitted to perform experiments upon live animals, the most they can do in this experiment is to arrange the necessary apparatus as for an experiment, and to make the necessary dissection on a dead animal.



FIG. 223. — Apparatus used by V. Kries for Estimating the Capillary Blood-Pressure.

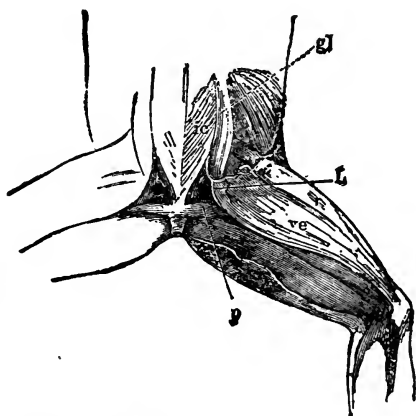

FIG. 224. — Posterior Pair of Lymph-Hearts (*L*) of the Frog.

A. (a.) Arrange the recording apparatus for a continuous tracing. The clockwork is wound up, and the drum is so adjusted that, when it moves, it unwinds the continuous white paper from a brass bobbin placed near it. Arrange a time-marker connected with a clock, provided with an electric interrupter, to mark seconds at the lower part of the paper. It is usual to use a pen-writer charged with a solution of aniline (red or blue), to which a little glycerin is added to make it flow freely.

(b.) Partially fill the manometer with dry clean mercury, and in the open limb of the manometer place the float, provided with a pen or sable brush moistened with aniline ink containing a little glycerin. See that the float rests on the convex surface of the mercury (fig. 225).

(c.) The closed or proximal side of the manometer at its upper part is like a T-tube, the stem of which is connected by thick india-rubber tubing to a piece of flexible lead tubing; on the free end of the latter is tied a glass cannula of considerable size, and over the india-rubber tubing connecting the cannula with the lead tube is placed a clamp. The proximal end of the

manometer is filled by means of a syringe with a saturated solution of sodium carbonate as high as the stem of the T-piece. To it is attached a long india-rubber tube, which is connected with a pressure-bottle filled with a saturated solution of sodium carbonate, and kept in position by a cord passing over a pulley fixed in the roof. A clamp compresses the india-rubber tube just above the manometer. Open this clamp and also the one at the end of the lead pipe. The alkaline solution fills the whole system, and after it does

so, and no air-bubbles are present, close the clamp at the end of the lead tube, and then the one on the pressure-bottle tube. It is well to have an inch or more of positive pressure in the manometer. See that the writing-style writes smoothly on the paper, and that it is kept in contact with the latter by a silk thread with a shot attached to its lower end.

B. Insert the Cannula.—(a.) *Arrange the necessary instruments in order on a tray—scissors, scalpels, forceps (coarse and fine), seeker, well-waxed ligatures, small aneurism needle, bull-dog forceps, cannulae, sponges.*

(b.) *Make the necessary dissection on a dead rabbit. Fix the rabbit in a Czermak's holder, as would be done if the animal were alive. Clip away with a pair of scissors the hair over the neck, and with a moist sponge moisten the skin to prevent any loose hair from flying about. Pinch up the skin on one side of the trachea, between the left thumb and forefinger, and divide it with a sharp scalpel. This exposes the fascia, which is then torn through with forceps; draw the sternomastoid aside, and gently separate the muscles with a "seeker" until the carotid, accompanied by the vagus, depressor, and sympathetic nerves, is seen. The dissection is made below the level of the larynx.*

Lying just external to the carotid are seen two fine nerves; the more internal and finer one is the depressor or superior cardiac branch of the vagus (fig. 226), the other is the sympathetic. Note that the smallest of the three nerves is the depressor, which is easily isolated from the sympathetic by means of a seeker. If in doubt, trace the sympathetic upwards until it merges into the large swelling of the superior cervical sympathetic ganglion. The depressor should be tied low down in the neck and divided below the ligature, as if for an experiment on its function. It is an afferent nerve, and therefore its central end must be stimulated.

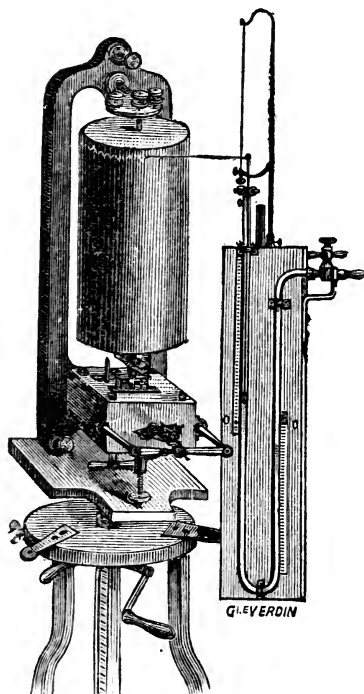

FIG. 225.—Simple Form of Kymograph. On the right is the manometer, the float recording the movements of the mercury on a simple revolving cylinder.

The vagus should also be isolated and ligatured as if for experiment. It is well to use shielded electrodes, such as are shown in fig. 227. The vagus is tied and divided, and if its peripheral end is to be stimulated, the peripheral end is drawn through the shielded electrodes, which are then connected with the secondary coil of an induction machine. To complete the arrangements, an induction machine ought to be set up.

(c.) Open the sheath, and with the seeker carefully isolate about an inch of the carotid. Pass a ligature under the artery by means of a fine aneurism needle, withdraw the needle, and ligature the artery. About an inch on the cardiac side of the latter, clamp the artery with bull-dog forceps. Raising the artery slightly by the ligature, with a fine-pointed pair of scissors make an oblique V-shaped slit in the artery, and into it introduce a suitable glass cannula with a short piece of india-rubber tubing tied on to it. Place another ligature round the artery, and tie it round the artery and over the shoulder of the cannula. The point of the cannula is of course directed towards the heart. Fill the cannula with the soda solution, and into the cannula slip the glass nozzle at the end of the lead pipe, tying it in securely. Unscrew the clamp at the end of the elastic tubing. Set the clockwork going; if one were operating on a living animal, the next thing to do would be to remove the clamp or forceps between the cannula in the artery and the heart. At once the swimmer would begin to move and record its oscillations on the paper moving in front of it.

(d.) Before joining the lead tube to the cannula, isolate the vagus, the largest of the three nerves; put a ligature round it, and divide it above the ligature. Isolate also the depressor nerve, put a ligature round it low down in the neck, and divide it between the ligature and the heart. The latter is easily distinguished from the sympathetic, as it is the smallest of the three nerves accompanying the carotid. In the dead rabbit the depressor may be traced up to its origin by two branches, one from the vagus, and the other from the superior laryngeal (fig. 226). Moreover, if the sympathetic be traced upwards, a ganglion will be found on it. This is merely to be regarded as an exercise for practice.

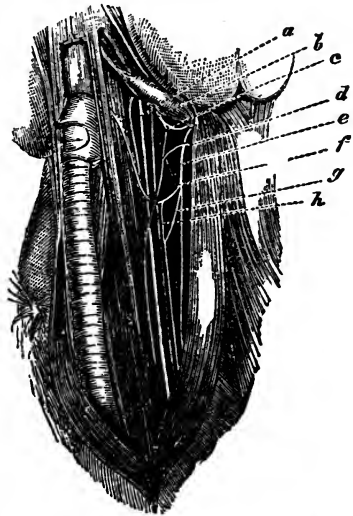

FIG. 226.—Nerves in the Neck of the Rabbit. a. Sympathetic; b. Hypoglossal, with c. its descending branch (*descendens noni*); d. Branch of a cervical nerve joining c; e. Vagus, with f, its superior laryngeal branch; g and h. The origins of the superior cardiac or depressor nerve.

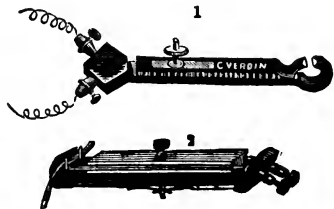

FIG. 227.—Forms of Shielded Electrodes for Stimulating the Vagus or a Deeply-Seated Nerve.

(e.) In every case a base line or line of no pressure must be recorded on the continuous paper. This indicates the abscissa, or when the mercury is at the same height in the two limbs of the manometer.

(f.) **Measure a Blood-Pressure Tracing.**—Lay the tracing on a table. Take a right-angled triangle made of glass or wood, and place one of the sides bounding its right angle upon the abscissa, the other side at right angles to this has engraved on it a millimetre scale. Or use a millimetre scale as in fig. 228. Read off the height in millimetres from the base line to the lowest point in the curve

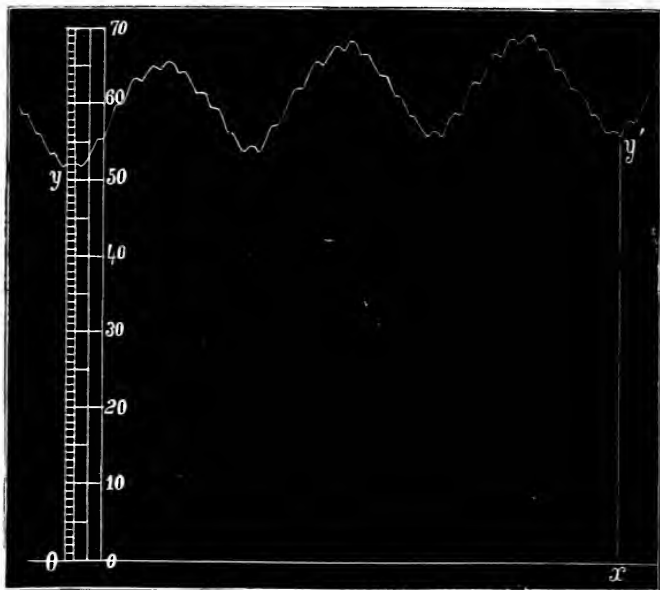

FIG. 228.—Blood-Pressure Tracing of the Carotid of a Dog, taken with Ludwig's Mercurial Manometer.

and also to its highest point; take the mean of the two, and multiply by two, this will give the *mean arterial pressure*. Instead of measuring only two ordinates, measure several, and take the mean of the number of measurements. In all cases the result has to be multiplied by two.

(g.) Measure the blood-pressure tracing (fig. 229) of the carotid of a dog from the base line T. It represents the effect of stimulation of the vagus, and the arrest of the heart-beat, and the consequent great fall of the blood-pressure.

(h.) In every kymograph tracing, notice the smaller undulations due, each one, to a single beat of the heart, and the larger ones due to the respiratory movements (fig. 229). In a blood-pressure tracing taken from a dog with the vagi not divided, observe that the size of the heart-beats on the descent of the respiratory wave is greater, while the number of beats is less than on the ascent.

(i.) Study blood-pressure tracings obtained by stimulation of

- (i.) The peripheral end of the vagus (fig. 229).
- (ii.) The central end of the depressor.
- (iii.) The central end of a sensory nerve.

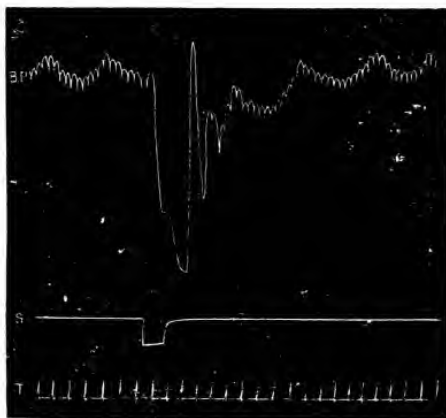

FIG. 229.—B.P. Blood-pressure tracing of dog's carotid, stimulation of the vagus at the indent in the line *S*; *T* indicates time in seconds, and is the abscissa.

5. **Make a Glass Cannula.**—Heat in the flame of a blowpipe a piece of hard glass tubing about 5 mm. in diameter. When it is soft, take it out of the flame, draw it out gently for about 3 cm. Allow it to cool; make the gas-jet smaller, heat the thin drawn-out part of the tube, and draw it out very slightly. This makes a shoulder. With a triangular file just scratch the narrow part obliquely beyond the second constricted part, and break it off. A cannula with a shoulder and an oblique narrow orifice is thus obtained. Round off the oblique edges either by a file, rubbing them on a whetstone, or heating slightly in a gas-flame. Tie a piece of india-rubber on the other end, and the cannula is complete. Instead of a straight glass cannula with a shoulder, the form shown in fig. 230 may be used. It has a lateral tube, which is closed by means of a caoutchouc tube, and is useful in this respect, that the large bulb prevents clotting of the blood, while if clotting does occur, the clot can readily be washed out by means of the pressure bottle through the lateral tube.

6. **Effect of Vagus on Heart.**—The student is not permitted to do this experiment on a living animal. It can, however, be shown on a rabbit or cat

just killed. Expose the vagus rapidly, open the chest and observe the heart beating, or thrust a long needle through the unopened chest in the heart, then

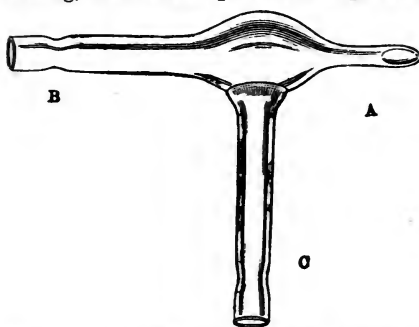

FIG. 230.—Improved Form of Arterial Cannula, by François-Frank. *A* is tied into the artery; *B* is attached to the lead tube of the manometer; and *C*, the lateral tube, is closed with an elastic (clamped) tube.

One compresses the artery until the pulse beyond is obliterated, and then reads off directly the pressure required to do this.

on stimulating the peripheral end of the vagus with an interrupted current the movements of the heart are arrested for a short time—the heart itself being in diastole.

7. Effect of Swallowing on the Heart (p. 312).

8. *B. P. in Man v. Basch's Sphygmomanometer.*—This consists of a brass capsule covered on its open end with sheets of caoutchouc, and connected by means of a tube with a manometer constructed on the principle of an aneroid barometer. It is best to apply it to the superficial temporal artery, as there is a bony support behind that.

LESSON LXIV.

PERFUSION THROUGH BLOOD-VESSELS.

Perfusion through Blood-Vessels.—By perfusing fluids through the blood-vessels of the body as a whole, or by perfusing blood or other fluids through isolated “surviving” organs, much may be learned regarding the action of drugs and other conditions on the blood-vessels. The blood-vessels of the frog and tortoise, the excised kidney, and other organs have been used for this purpose.

Perfusion through Blood-Vessels of Frog.

(a.) Pith a frog, expose its heart, snip one aorta, and allow the blood to flow out. Previously a fine glass cannula with a shoulder on it must have been prepared. Tie the cannula into one aorta, and let the ligature also include the other aorta.

(b.) Attach the cannula to an india-rubber tube containing normal saline and connected with a glass funnel filled with normal saline and held in a suitable holder, *e.g.*, a ring on a retort stand, placed about 6–7 inches above the heart. See that there is no air in the connections, and that the cannula is filled with normal saline by means of a fine pipette before it is connected up with the pressure tube. Put a clip on the pressure tube.

(c.) Make a snip in the sinus venosus or venæ cavæ to let the fluid run out. Hang up the frog on a suitable holder. Take the clip off the pressure tube, allow the normal saline, or Ringer's fluid, to run into the blood-vessels and to wash out all the blood, until the saline runs clear from the veins. Collect the outflow in a funnel which is placed in a graduated measure.

(d.) After the Ringer's fluid runs clear, collect, measure, and record the amount, when it is constant, every five minutes.

(e.) Substitute normal saline or Ringer's fluid, to which some drug has been added, and perfuse it. Note the effect. If there is an increased outflow, the blood-vessels, chiefly the arterioles, have been dilated. If less, they have been contracted. Record the results, and if necessary make a chart to show the result.

The water-tortoise is a very convenient animal to use, the perfusion cannula being fixed in the third or fourth aorta, the others being tied. It is conveniently placed in a glass funnel when perfusion is being carried on.

In the frog, after a time, there is considerable œdema of the lymph-sacs.

It is most important that the student should keep notes of his results. From the results obtained, plot a curve on paper divided into squares. Make the base line represent time, and the vertical lines, or ordinates, the amount of outflow.

Some substances greatly *contract* the blood-vessels, e.g., very dilute nitric acid, and extract of the suprarenal capsules. The latter is specially powerful in constricting the arterioles. (*Schäfer & Oliver.*) Others *dilate* the vessels, especially the nitrites, $\frac{1}{1000}$.

PERFUSION EXPERIMENTS.

Water-Tortoise. Fluid been running 60'. Pressure, 7 inches.		Water-Tortoise. Fluid been running 60'. Pressure, 7 inches.		Frog. Fluid been running 20'. Pressure, 7 inches.			
Time.	Amount of Out-flow in c.c.	Time.	Amount of Out-flow in c.c.	Time.	Amount of Out-flow in c.c.		
1.0	= 0	cord intact.	3.0	= 15	normal saline.	2.50	= 14.5
1.10	= 12		3.5	= 13		2.55	= 15.5
1.15	= 15		3.10	= 11		3.0	= 15.5
1.20	= 15		3.15	= 8		3.10	= 15.5
1.25	= 11		3.20	= 8		3.15	suprarenal extract. ¹
1.30	= 7		3.25	= 8		3.20	= 2.5
1.35	= 7		3.30	= 8		3.25	= 2.0
1.40	= 6.5		3.35	= 8		3.30	= 2.0
1.45	= 5.5		3.40	= 8		3.35	ceased.
1.50	= 4.5		3.45	= 18			
1.55	= 4.5	3.50	= 24				
2.0	= 6.5	3.55	= 24				
2.5	= 6.5	4.0	= 22				
2.10	= 5.5	4.5	= 22				
2.15	= 5	4.10	= 21				
		4.15	= 19				
		4.20	= 17				
		4.25	= 14				
		4.30	= 12.5				
		4.35	= 11				
		4.40	= 9.5				
		4.45	= 8				
		4.50	= 9				
		4.55	= 10				
		5.0	= 10				

¹ Made by Messrs Willows, Francis & Butler, chemists, Holborn, London.

PHYSIOLOGY OF RESPIRATION.

LESSON LXV.

MOVEMENTS OF THE CHEST WALL—ELASTICITY OF LUNGS—HYDROSTATIC TEST.

1. Movements of the Chest Walls—Stethograph.

A. Rabbit.—(a.) Arrange a drum and time-marker. Fix a rabbit conveniently, *e.g.*, on Czermak's rabbit-holder, or use the simpler form of Malassez or Steinach, and with tapes tie on its chest Marey's double tambour (fig. 231), connecting the latter with a recording

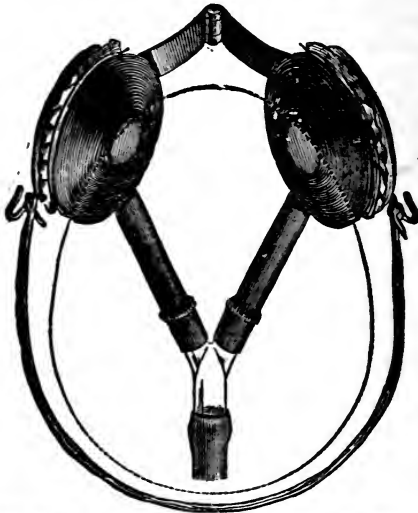

FIG. 231.—Marey's Double Tambour, to be tied round the chest of a rabbit.

tambour adjusted to write on the drum. Introduce between the receiving and recording tambours either the valve usually supplied with Marey's apparatus or a T-tube with a screw clamp, whereby the pressure within the system of tubes can be regulated. Take a tracing. If one of the receiving tambours be placed over the

cardiac impulse, the tracing will show also the number of beats of the heart (fig. 232).

B. Man.—(b.) Stethograph (Marey's).—Cause a person to expose his chest. Raise the screw (*g*) of the stethograph, and fix

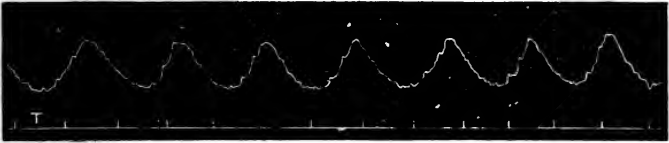

FIG. 232.—Stethograph Tracing of a Rabbit. The tracing shows undulations due to the beats of the heart. *T* indicates time in seconds.

the plate (*f*) of the instrument on the exposed chest, with tapes attached to *c* and *d*. Depress *g*, connect the tube (*a*) with a recording tambour, with the same precautions as in 1, A., and take a tracing (fig. 234). Examine the tracing, noting the relation between inspiration and expiration.

(c.) **Polygraph (Rothe).**—Use the polygraph of Rothe, record

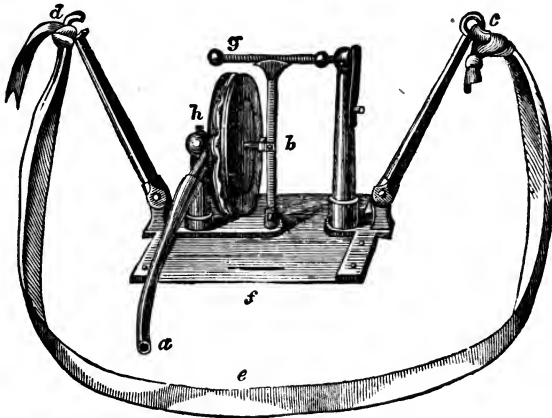

FIG. 233.—Marey's Stethograph.

the respiratory movements by means of the bag (fig. 208, A), and study the tracing (fig. 234).

2. Elasticity of the Lungs.

Remove the whole of the front of the chest in the rabbit already used. Observe the collapsed lungs. To the tracheal

cannula attach an india-rubber bag such as is used with a spray-producer, and inflate the lungs. Cease to pump air into the lungs, and observe how they collapse.

3. Hydrostatic Test.

Cut out the lungs and the heart. Place them in a vessel of water. The whole will float, as the lungs contain so much air. Cut off a small piece of one lung, throw it into water, it floats. This is the hydrostatic test. Compare a piece of pneumonic lung; the latter sinks.

4. Apnoea.—Count the number of your own respirations per minute. Take a series of rapid inspirations. Note that several seconds elapse before the next inspiration. This is the period of apnoea.

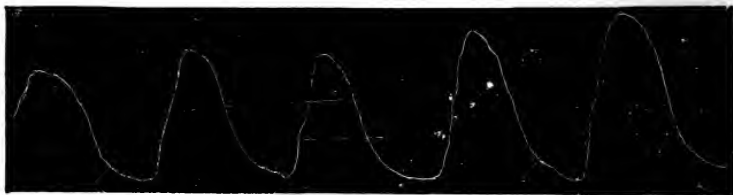

FIG. 234.—Stethograph Tracing, taken with Rothe's Polygraph.

5. Deglutition Apnoea.

(a.) Test how long you can "hold your breath." Note the time.

(b.) After a time, sip water without breathing, and note that, under this condition, the time the breath can be held is nearly doubled. The successive acts of deglutition influence the respiratory centre in the medulla oblongata, as well as the cardio-inhibitory centre (*Kronecker*). The latter is referred to at p. 312. Other centres are influenced by sipping.

6. Voluntary Respiration.—Test in yourself how long this can be kept up. As a rule, one cannot continue it for more than two minutes.

7. Stethometer of Burdon-Sanderson.

(a.) Prepare a drum and time-marker as in the previous experiments. Cause a person to expose his chest, and seat himself conveniently. The instrument is suspended by a broad band placed round the neck, the horizontal bar being behind the body.

(b.) The most important diameters of the chest to measure are—"Those connecting the eighth rib in the axillary line with the same rib on the oppo-

site side, the manubrium sterni with the third dorsal spine, the lower end of the sternum with the eighth dorsal spine, and the ensiform cartilage with the tenth dorsal spine." Measure only the first. Adjust the knob of the tambour on one side against the eighth rib, as above, while the movable bar with its knob is placed against the opposite corresponding rib. Connect the tambour with the recording tambour, introducing a T-piece, the stem of which is provided with an india-rubber bag and screw clamp to regulate the pressure within the air-system.

8. Intra-Thoracic Pressure.—For practice this can be done on a dead rabbit.

(a.) Fix the dead rabbit in Czermak's rabbit-holder. Expose the trachea, tie into it a knee-shaped glass cannula. Make a small water-manometer or bent U-tube with a millimetre scale attached, fill it about half full with coloured water, and to the proximal limb attach an india-rubber tube with a T-piece and screw clamp, as in other experiments. Connect the tracheal cannula with the manometer tube, tighten the screw clamp, and see that the water stands at the same level in both limbs of the manometer.

(b.) Open both pleuræ without injuring the lungs. The lungs collapse and the water is depressed in the proximal side of the manometer, and rises in the open limb.

9. Respiratory Movements of Frog.—In the frog the air is forced into the lungs.

(a.) Observe rhythmical movements of the muscles of the floor of the mouth and of the muscles attached to the hyoid bone, the cavity of the mouth is thus diminished. Coincident with these are

(b.) Movements resulting in closure of the external nares, and thus the air is forced into the lungs. At the same time, the glottis is opened, but the mouth must be opened to see this.

(c.) The act of expiration is performed by movements of the muscles of the flanks compressing the visceral contents.

LESSON LXVI.

VITAL CAPACITY — EXPIRED AIR — PLEURAL PRESSURE—GASES OF BLOOD AND AIR.

1. Vital Capacity.—Estimate this on Hutchinson's spirometer, *i.e.*, take the deepest possible inspiration, and then make the deepest possible expiration, expiring into the mouthpiece of the spirometer. The average vital capacity is about 3700 cc. (230 cubic inches), but it varies with age, height, sex, and practice in using the instrument, &c.

2. Changes in Expired Air.

(a.) **Black's Experiment.**—Place equal quantities of lime-water in two vessels (A and B). Take a deep breath, close the nostrils, and expire through a bent glass tube into A. The lime-water soon

becomes milky, owing to the large amount of carbonic acid expired combining with the lime to form carbonate of lime. With the elastic pump of a spray-producer pump the air of the room through B. B remains clear and does not become turbid. Therefore the carbonic acid must have been added to the inspired air in the respiratory organs.

(b.) **Müller's Valves.**—Arrange two flasks (A and B) and tubes as in fig. 235 with some lime-water in both. Close the nostrils, apply the mouth to the tube, and inspire. The air passes in through A, and is freed of any CO_2 it may contain. Expire, and the air goes out through B, in which the lime-water becomes turbid.

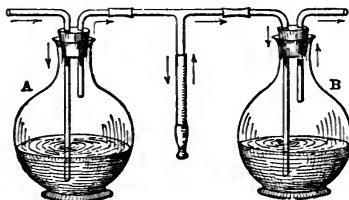

FIG. 235.—Müller's Valves.

(c.) **Heywood's Experiment.**—Place about two litres of water in a basin, and in it put erect a bell-jar. Ascertain that a lighted taper burns in the jar. Renew the air, place in the neck of the jar a glass tube with a piece of india-rubber tubing attached. Close the nostrils, apply the mouth to the tube, and inspire.

The water rises in the bell-jar. Then expire, the water sinks, and the air which was originally present above the water has been taken into and expelled again from the respiratory passages. Remove the cork, and place a lighted taper in the expired air. The taper is extinguished (fig. 236).

3. Swallowing.—Test on yourself how rapidly (few seconds) you can swallow a large glass of water. In swallowing liquids, the liquid is projected through the pharynx and œsophagus right into the stomach chiefly by the contraction of the mylohyoid muscles in the floor of the mouth (*Kronecker and Meltzer*).

ADDITIONAL EXERCISES.

4. Pressure within the Pleura.—Fix one end of a caoutchouc tube to a water-manometer (water coloured red), and the other end to a trocar and cannula. Thrust the trocar obliquely through an intercostal space until the point of the trocar lies in the space between the two layers of the pleura. Observe how the level of the water rises in the proximal limb of the manometer, indicating the negative pressure in the pleural cavity.

5. Blood Gases.—Blood yields about sixty volumes per cent. of gases to a vacuum. The gases in the blood— CO_2 , O, and N—are extracted from it by means of a gas-pump. Various forms have been constructed, including those of Ludwig, Pflüger, and Alvergniat. Study these various forms and the principle of their construction. It requires a considerable amount of time to become thoroughly acquainted with the practical working of these instruments but this is not necessary from a student's point of view.

(a.) Suppose the gases of the blood to be extracted ; they are collected in a eudiometer over mercury (fig. 237). Or, for practice, and merely to grasp the principle how the relative proportion of the gases in a mixture is ascertained, the student may use air containing a small quantity of carbon dioxide.

(b.) Fuse a ball of potash on the end of platinum wire (best done in a bullet-mould). Introduce this under the mercury into the gases in the eudiometer. The caustic potash absorbs all the CO_2 (twenty-four hours), and the diminution in volume represents the proportion of CO_2 in the mixture.

(c.) With a curved pipette introduce a solution of pyrogallic acid into the eudiometer containing the remainder of the gases ; this unites with the potash to form pyrogallate of potash, which rapidly absorbs the oxygen. The decrease in volume represents the amount of O. The remainder of the gas present represents N.



FIG. 236.—Heywood's Experiment.

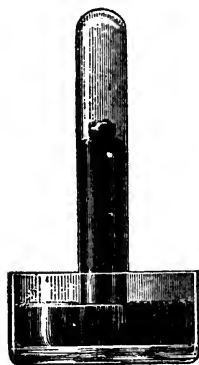

FIG. 237.—Gases collected over mercury. A ball of caustic potash absorbing the CO_2 .

There are other methods of estimating the proportion of the gases, but this simple experiment is sufficient to explain the general principle on which such estimations are made. Of course there are corrections for temperature and pressure, and other precautions which require to be taken, but we do not enter into these here. (See Appendix.)

A simple form of gas-pump has been devised by L. Hill (*Journ. of Phys.*, xvii. p. 353), by means of which results of sufficient accuracy are obtained from 10 cc. of blood.

6. Analysis of Expired Air by Hempel's Method.¹

A burette, A (fig. 238), containing 100 cc., and graduated into tenths of a cc., is used to measure the expired air. It communicates below by means of an india-rubber tube with the movable tube or reservoir for water, B. Above, A is connected to an absorption pipette by means of a short india-rubber tube of 1–2 mm. diameter with thick walls, and provided with a Mohr's clip. The tube, A, is placed in connection successively with the pipettes, *px*, which contain a solution of caustic potash to absorb the CO_2 and fig. 239, which contains sticks of red phosphorus in water to absorb the O.

¹ *Methods of Gas Analysis*, by W. Hempel. London, 1892.

Suppose the gas to be collected in A ; measure its amount when B is so placed that the level of the acidulated water is equal in both.

Remove the Mohr's clip from *a*, raise B, and force all the air into *p*. Then lower B, and withdraw unabsorbed air from *p*. Measure the volume of air.

Connect A now with the phosphorus pipette and force the air into it by again raising B. Lower B, and estimate the remaining volume of air. In each case the difference of the volume of air corresponds to the quantity of gas absorbed.

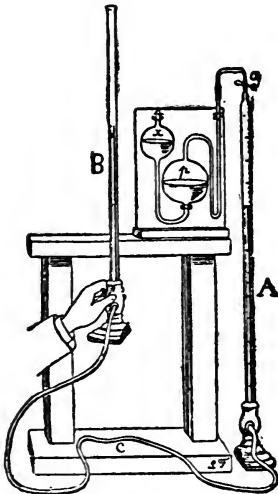

FIG. 238.—Hempel's Burette connected with a Potash Pipette to absorb the CO_2 .

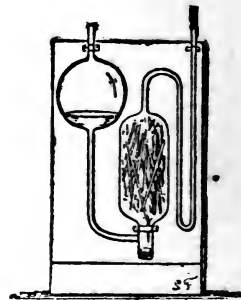

FIG. 239.—Pipette with Phosphorus to absorb the Oxygen.

The temperature of A can be kept constant by placing it in a wide tube through which water is kept circulating as in a Liebig's condenser.

7. Waller's modification of Zuntz's apparatus is very convenient (Waller's *Human Physiology*, 2nd Ed., p. 123). In this apparatus, the measuring tube is filled by means of a bulb, and not a long tube, and the measuring tube has on it above a bulb which communicates by means of three tubes guarded by simple taps ; two of these—horizontal—go to the two absorption (O and CO_2) pipettes, while the vertical one is an outlet tube. (The apparatus is made by Baird & Tatlock.)

LESSON LXVII.

LARYNGOSCOPE—VOWELS.

1. The Laryngoscope is used to investigate the condition of the pharynx, larynx, and trachea. Various forms are in use, but they all consist of—(1) One or more small, usually circular, plane mirrors fixed to a metallic rod at an angle of 120° ; the metallic rod fits into a suitable handle, and is fixed by means of a screw. (2) A large concave mirror of about 20 cm. focus, perforated with a hole in the centre, and secured to the operator's forehead by means of a circular band passing round the head. The mirror itself is fixed in a ball-and-socket joint, so that it can be moved freely in every direction.

A. Practise first of all on a model of the head and larynx provided for the purpose.

B. On a Living Person.—(a.) Place the patient upright in a chair. A good source of artificial light—*e.g.*, a suitable Argand lamp—is placed near the side of the patient's head, a little above the level of his mouth. The incandescent lamp gives a brilliant, clear, and steady light. Mackenzie's rack-movement lamp is a most convenient form. The observer seats himself opposite and close to the patient; places the large mirror on his forehead, and either looks through the central hole in it with one eye, or raises it so that he can just see under its lower edge.

(b.) Seated in front of the patient, the observer directs a beam of light until the lips of the patient are brightly illuminated. The patient is then directed to incline his head slightly backwards, to open his mouth wide, and protrude his tongue. Place a clean handkerchief over the tongue, and give the patient the handkerchief to hold, which secures that the tongue is kept protruded and well forward. Move the large mirror until the uvula and back of the throat are brightly illuminated, the operator moving his head slightly to and from the patient until the greatest brightness is obtained.

(c.) Take the small laryngeal mirror in the right hand, and warm it gently over the lamp to prevent the condensation of moisture on its surface. Test its temperature on the skin of the cheek or the back of the hand. Holding the handle of the mirror as one does a pen, rapidly carry it horizontally backwards, avoiding contact with any structures in the mouth, until its back rests against the base of the uvula. At the same time, direct the beam of light upon the

laryngeal mirror, when an inverted image of the larynx will be seen more or less perfectly.

(d.) By moving the laryngeal mirror, not, however, pressing too much on the uvula, or continuing the observation for too long a time, one may explore the whole of the larynx. Perhaps only the posterior part of the *dorsum of the tongue* is seen at first; if so, slightly depress the handle of the mirror, when the curved fold of the slightly yellowish *epiglottis* and its cushion, with the *glosso-epiglottidean folds*, come into view. In the middle line are the *true vocal cords*, which are pearly white and shining, and best seen when a high note is uttered, and between them the chink of the *glottis*. Above these are the *false vocal cords*, which are red or pink, the *ary-epiglottidean folds*, with on each side the *cartilages of Wrisberg* farthest out, the *cartilages of Santorini* internal to this, and the *arytenoid cartilages* near the middle line (figs. 240, 241).

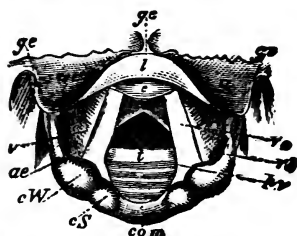

FIG. 240.—View of the Larynx during a Deep Inspiration. *g.e.* Glosso-epiglottidean fold; *l.c.* Lip and cushion of epiglottis; *a.e.* Ary-epiglottic fold; *c.W.*, *c.S.* Cartilages of Wrisberg and Santorini; *v.c.* Vocal cord; *v.b.* Ventricular band; *p.v.* Processus vocalis; *c.r.* Cricoid cartilage; *t.* Rings of trachea.

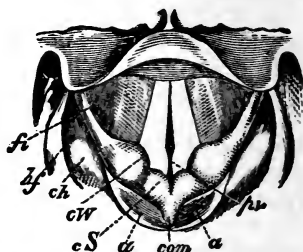

FIG. 241.—Larynx during Vocalisation. *f.i.* Fossa innominata; *h.f.* Hyoid fossa; *com.* Arytenoid commissure.

(e.) Make the patient sing a deep or high note, or inspire feebly or deeply, and observe the change in the shape of the glottis. On uttering a deep note, the rings of the trachea may be seen. *N.B.*—Remember that what is seen by the observer in the laryngeal mirror on his right or left corresponds to the *patient's* left and right. The lower part of the mirror gives an image of the more posterior structures, while the anterior structures are reflected in its upper part.

2. Auto-Laryngoscopy.—The student should learn to use the laryngoscope on himself. The student sits in a chair, fixes the large reflecting mirror in a suitable holder about eighteen inches in front of, and on a level with his mouth. Behind and to one side of this an ordinary plane mirror is placed vertically. On one side of his head he places the source of light. The light

is reflected on to the uvula by the reflecting mirror, and, on introducing the small laryngeal mirror, by a little adjustment one sees the image of the larynx in the plane mirror. Or one may use in a similar way the apparatus of Foulis. In Dr George Johnson's method, the ordinary reflector is strapped on to the forehead, and the observer places himself in front of a toilet mirror. In a line with and slightly behind the mirror, and on one side of the observer

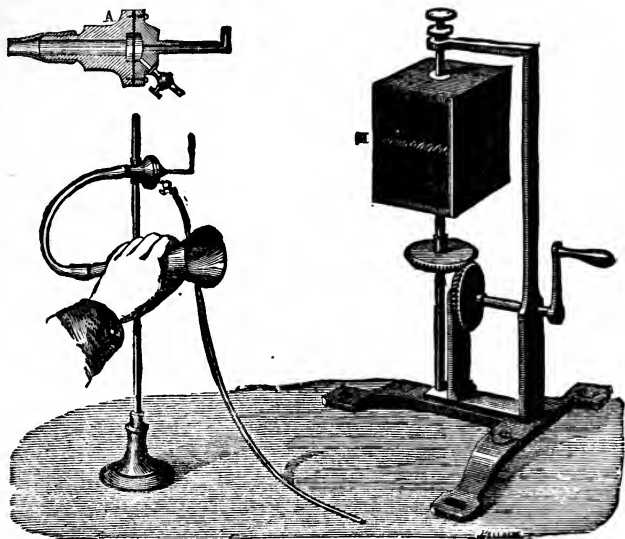

FIG. 242.—König's Manometric Flame Apparatus.

place a lamp. By means of the reflector, the image of the fauces seen in the mirror is illuminated. Introduce the laryngeal mirror, when the image of the larynx is seen in the toilet mirror.

3. Analysis of Vowel Sounds.

Use König's apparatus, as shown in fig. 242. Connect the tube of the capsule with the gas supply, light the gas-jet, and sing the vowels A, E, I, O, U in front of the open trumpet-shaped tube shown in the figure. With the other hand rotate the mirror (M), and observe the serrated reflection of the flame in the mirror, noticing how the image in the mirror varies with each vowel sounded.

PHYSIOLOGY OF THE CENTRAL NERVOUS SYSTEM.

LESSON LXVIII.

REFLEX ACTION—ACTION OF POISONS— KNEE-JERK.

1. **Reflex Action.**—Destroy the brain of a frog down as far as the medulla oblongata, which should be done without loss of blood. Place under a bell-jar a normal frog for comparison. Immediately the frog is pithed, on pinching one of its toes, very probably the leg will not be drawn up. After half an hour or more (by this time it has recovered from the shock of the operation), observe—

(a.) Its *attitude*: the head of the pithed frog lies on the plate on which it is placed, while in the intact frog the head is erect, the body and head forming an acute angle with the surface on which the frog rests.

(b.) Its eyes are closed, while those of the intact frog are open. The fore-limbs are either flexed and drawn under the chest, or spread out, so that the body is no longer supported on the nearly vertical fore-limbs, as in the intact frog, but lies flat upon the surface of support. The legs are pulled up towards the body.

(c.) The absence of respiratory movements in the nostrils and throat. It makes no spontaneous movements, if left entirely to itself.

(d.) Turn it on its back; it lies in any position it is placed. Do this with a normal frog; the latter regains its equilibrium at once. Extend one of the legs; it will be drawn up again towards the body. Pinch the flank with a pair of forceps; the leg of the same side is rapidly extended, then drawn up towards the spot stimulated. Pinch sharply the skin round the anus with forceps. Immediately both legs are pushed out and pulled up towards the body, as if to dislodge the offending body.

2. Bend a long (6 cm.) straight pin into the form of a hook, and push it through the tips of both jaws, and by means of the hook hang up the frog vertically on a suitable support. At first

the legs may make a few movements, but they soon cease to do so, and hang motionless.

(a.) Pinch the tip of any toe of the right leg; the right leg is drawn up. If a toe of the left leg be pinched, the left leg is drawn up. These are unilateral reflex movements.

(b.) **Mechanical Stimuli.**—Pinch the tip of one toe very feebly, perhaps only the foot will be flexed at the ankle-joint. Pinch more strongly, and a greater reflex movement will be obtained. It is evident, therefore, that the reflex movement varies not only with the part of the skin stimulated (1, *d.*), but also with the intensity of the stimulus. Very violent stimulation may cause reflex movements in all the other limbs. This is due to irradiation of the reflex movement in the cord.

3. The Latent Period (Türck's Method). Summation of Stimuli.

(a.) Prepare and label dilutions of sulphuric acid containing 1, 2, 3, and 4 cc. per litre—*i.e.*, 0.1, 0.2, 0.3, and 0.4 per cent of sulphuric acid (by volume)—and place some of each in four shallow glasses. Arrange also a large beaker of water to wash the frog. Adjust a metronome to beat one hundred times per minute. Cause it to beat.

(b.) Hold the frog in the left hand by means of the hook, and in the right take a glass rod to hold one leg aside. Dip the other leg up to the ankle into the 0.1 per cent. acid, and on doing so count the number of beats before it is withdrawn from the acid. After the leg is withdrawn, wash the leg in water to remove the acid. Note the time in hundredths of a minute, *i.e.*, the latent period. Allow the frog to rest at least five minutes, and repeat the experiment. Take the mean of the two observations—or, if you prefer it, of three or more observations—and this will give the "latent period."

(c.) Repeat with suitable intervals of repose the same experiment with acid of 0.2, 0.3, and 0.4 per cent., noting that, as the strength of the acid increases, the latent period becomes shorter, but not in the ratio in which the acid is stronger.

(d.) If only the longest toe is dipped into the acid, then the summation of stimuli takes place more slowly.

4. Chemical Stimulation. (Purposive Characters of Reflex.)

(a.) In a small glass place some strong acetic acid and a few pieces of filter-paper 3 mm. square. Either when the frog is lying on its back or while it is suspended, apply with a pair of forceps one of the pieces of paper moistened with acid—the surplus

removed—to the skin on the inner side of the thigh. At once the leg on that side is violently drawn up, perhaps both legs are drawn up, and the foot of the leg first drawn up is swept over the spot stimulated, as if to remove the piece of paper, *i.e.*, purposive, co-ordinated movements are executed. At once dip the frog in water to remove the acid; allow it to rest for some time. It is much easier to obtain irradiation of the reflex movements by chemical than by mechanical stimuli.

(*b.*) After five minutes repeat the experiment, but hold the leg to which the acid is applied. Probably the other leg will move, and the opposite foot will remove the irritating acid paper. Wash the frog and allow it to rest.

(*c.*) Test further, by applying papers to the flank, the skin over the gastrocnemius, &c., and in all cases characteristic but different reflex movements will be elicited, if sufficient interval for recovery (five minutes at least) be allowed between the successive experiments.

(*d.*) Destroy the spinal cord, all reflex action is abolished. The nerves and muscles retain their excitability and the heart continues to beat. Expose the heart: it beats. Muscle and nerve respond to electrical and other stimuli.

5. Action of Strychnine.

(*a.*) Using a frog with its brain destroyed, inject with a fine glass pipette or a hypodermic syringe into the dorsal lymph-sac a drop of dilute solution of acetate of strychnine (0.5 per cent.).

(*b.*) Observe that as soon as the poison is absorbed—*i.e.*, within a few minutes—cutaneous stimulation of any part of the body, even tapping the table, excites general violent tetanic spasms, and not co-ordinated muscular responses, of the whole body. During the convulsive paroxysm the limbs are extended, hard, and rigid, while the trunk is similarly affected. The extensor muscles are more affected than the flexors. The tetanic paroxysm passes off, to be soon followed by another on the slightest stimulation. The excitability has been so greatly increased that even the slightest stimulus applied to the skin discharges a reflex spasm, *i.e.*, provokes muscular responses which are maximal, so that a minimal stimulus produces a maximal response.

(*c.*) Destroy the spinal cord with a seeker or long pin. At once the spasms cease. Strychnia, therefore, acts on the cord directly, and not on the muscles and nerves.

(*d.*) In another frog, divide the cord below the bulb, the brain in front being destroyed, but the cord intact. Apply a crystal of sulphate of strychnia to the cord. It soon causes tetanic spasms, thus showing that strychnine affects the cord.

6. Action of Potassium Chloride or Bromide or Chloral.

Prepare a reflex frog as in Lesson LXVIII. 1. Test the latent period with dilute sulphuric acid, 0.2 per cent., until constant results are obtained. Inject 2 minims of a 1 per cent. solution of KCl or KBr or C_2HCl_3O , and after ten minutes time again test the latent period. Within a short time the latent period will be greatly prolonged. Plot a curve of the results, the abscissa to mark time and the ordinates the length of the latent period.

7. Electrical Stimulation.

(A.) *Single Induction Shocks.*

(a.) From the secondary coil (key interposed) apply two fine wire metallic electrodes, in the form of two loops, to the skin of the leg, the electrodes being about .5-1 cm. apart.

(b.) Stimulate with different strengths of current. No reflex response. A single induction shock does not discharge a reflex movement.

(B.) *Repeated Shocks.*

(a.) Leave the electrodes *in situ*, but adjust the coil for repeated shocks. On applying a succession of even feeble shocks, a reflex response is readily obtained. Make a table of the results obtained.

(b.) Expose the sciatic nerve without injuring the adjacent parts; on stimulating the skin of the foot or leg as before, a reflex response is readily obtained, but on stimulating the sciatic nerve directly under the same conditions, there may be no response until the current is made distinctly stronger. This result is explained (?) by stating that the peripheral terminals are more excitable than the nerve trunk, while others assume that in the sciatic nerve, besides excito-motor (reflex) fibres, there are nerve-fibres which inhibit the action of such fibres. It is said that very strong stimulation of cutaneous nerves also excites the reflex-inhibitory fibres.

(c.) Isolate any one of the nerves traversing the dorsal lymph-sac of a frog, but leave a small square of skin attached corresponding to the terminals of the nerve. Apply repeated shocks directly to the nerve, in all probability there will be no reflex response, but if the skin be touched with dilute acetic acid, response will probably take place. If, however, strong sulphuric acid be applied to the skin, there will be no response.

8. Knee-Jerk.

(a.) Sit on a chair and cross the right leg over the left one. With the tips of the fingers or a percussion-hammer strike the right ligamentum patellæ. The right leg will be raised and thrown forward with a jerk, owing to the contraction of the quadriceps muscle. An appreciable time elapses between the striking of the tendon and the jerk. The knee-jerk is almost invariably absent in cases of locomotor ataxia, while it is greatly exaggerated in some

other nervous affections; so that its presence or absence is a most important clinical symptom.

(b.) The knee-jerk is readily obtained in a rabbit.

9. By means of the hand compress the abdominal aorta of a rabbit for a few minutes. There results temporary paralysis of both hind-legs or paraplegia. Soon after the circulation is restored in the cord and lower limbs, the paraplegia disappears.

LESSON LXIX.

SPINAL NERVE-ROOTS.

1. **Functions of the Roots of the Spinal Nerves.**—To expose the roots, destroy the brain of a frog, lay it on its belly, and make a median incision in the skin of the back, from the neck to the upper end of the urostyle. Turn back the flaps of skin, and carry the incision down to the spines of the vertebræ. With a scraper or blunt knife remove the muscles along each side of the vertebral column, so as to lay bare the arches of the vertebræ. With a blunt-pointed pair of scissors, or two saw-blades parallel to each other and fitted at a suitable distance into a handle, as devised by Ludwig, cut through the arches of the eighth or last vertebra, taking care not to injure the nerves within the spinal canal. Remove successively from below upwards the seventh, sixth, and fifth vertebral arches, when the tenth, ninth, and eighth spinal nerve-roots will come into view. The posterior roots are larger, come first into view, and cover the anterior. The roots may be separated by a seeker. Select the largest posterior root—the ninth—and with an aneurism needle carefully place a fine silk thread (say a red one) under it.

(a.) Tighten the ligature near the cord, and observe movement in some part of the body. Divide the nerve between the cord and the ligature, and observe further movements on division.

(b.) With the thread gently lift up the *peripheral* or distal end of the nerve-root, place it on well-protected electrodes, and stimulate it with an interrupted current. No movement is observed in the muscles of the limb.

(c.) Select the posterior root of the eighth nerve, ligature it at some distance from the cord, and divide it on the distal side of the ligature. There is neither contraction of the muscles of the leg nor movement of the body. Place the *central* stump, *i.e.*, the part still connected with the cord, on the electrodes, and stimulate it, when movements will take place in several parts of the body.

(d.) Divide the posterior roots from the seventh to the tenth nerves. Observe that the leg on that side has become insensible. Turn aside the roots of the divided nerves, and expose the anterior roots, which are very thin and slender. Repeat the preceding experiments on the anterior root of the ninth nerve, *i.e.*, place a ligature round it, tighten the ligature, and divide the nerve between the cord and the ligature. Stimulate the *distal* end with an interrupted current; this causes contraction of the muscles supplied by this root.

From the effects of section and stimulation of the nerve-roots, one concludes that the anterior are motor, and the posterior are sensory. (E. Steinach, "Motorische Functionen hint. Spinalnervenwurzeln," *Pflüger's Arch.*, Bd. 66, p. 593.)

LESSON LXX.

REACTION-TIME—CEREBRAL HEMISPHERES.

Reaction-Time is the interval that elapses between the application of a stimulus to a sense-organ and the moment the stimulus is responded to by the individual. For simple reaction-time, or sensori-motor reaction-time, all *discrimination* and *choice* are eliminated by repeating the same sensation and using the same response. Rutherford's results (*Proc. Roy. Soc. Edin.*, July 10, 1894) give rather longer periods than some German observers. He finds the pendulum-myograph very advantageous in experiments on hearing and touch, as successive curves can be superimposed. The mean reaction-time he found to be, for sight, 0.20"—0.22"; hearing, 0.15"—0.16"; touch, 0.14"—0.15" (cheek), 0.15"—0.18" (skin of finger).

Reaction-Time for Touch in Man.**1. Pendulum-Myograph Method (*Rutherford*).**

Two persons are required, and the observed person should not see what the observer is doing.

(a.) Arrange the apparatus as in fig. 243. The stimulation is done always at the same moment when the pendulum in its swing breaks the primary circuit. It is convenient, as shown in the figure, to use an electro-magnet for releasing the pendulum.

(b.) The electrodes from the secondary coil are applied to any part of the skin, and the observer, when he feels the shock, closes the "response key," whereby a mark is made on the glass plate. Time should be recorded on the plate beforehand (60 or 100 D.V. per second).

(c.) If it is desired for sound, a telephone is placed in the secondary circuit and the observed person responds when he hears the click at the moment of breaking the primary circuit.

Fig. 244 shows the result obtained for the reaction-times for touch by the pendulum-myograph method (fig. 243), chronograph 60 D.V. per second. The vertical line indicates the moment at which an induction shock was given to (1) skin of left cheek; (2) left side of neck; (3) left upper arm at insertion of deltoid; (4) left little finger; (5) dorsum of left foot at root of toes. Response signal was always given by right forefinger. The vibrations following each signal of response result from the momentum of the lever (*Rutherford*).

2. Recording on Drum (also for sight and hearing).

(a.) Another method is to cause two electro-magnets with writing-styles to record on a rapidly moving drum arranged as in fig. 243. One signal is interposed in the primary circuit of an induction coil, with a contact-key also in the circuit. This is the "stimulating key."

(b.) The other electro-magnet is in connection with a battery, a contact-key being in the circuit—the "response key." If this

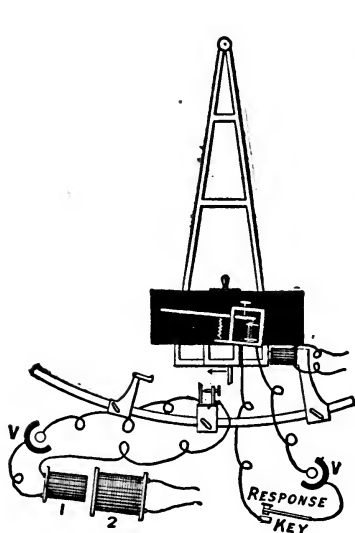

FIG. 243.—Rutherford's Scheme of using Pendulum-Myograph for Estimating Simple Reaction-Time.

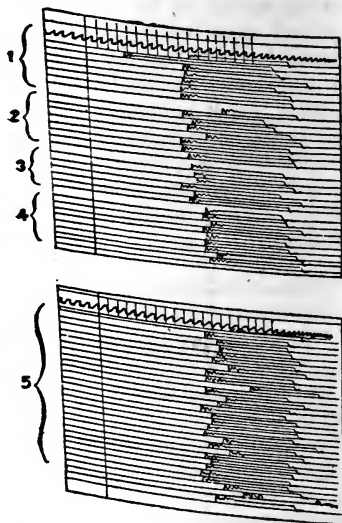

FIG. 244.—Result obtained for Simple Reaction-Time with Pendulum-Myograph (Rutherford). Shock applied in (1) To skin of left cheek; (2) Left side of neck; (3) Left upper arm near deltoid; (4) Left little finger; (5) Dorsum of left foot.

method be used for touch, the electrodes from the secondary coil are applied to some part of the skin, and the person marks response with the response key.

(c.) If for sight, a white piece of paper (Rutherford) is placed on the electro-magnet style in the primary circuit, and the person responds when he sees this move, which it does when the primary circuit is made.

(d.) If for hearing, then a telephone is introduced into the stimulating circuit. The observer puts the telephone to his ear,

and responds when he hears in the telephone the click of the induction shock due to closure of the primary circuit. Of course, a chronograph records time.

3. Reaction-Time for Touch in Man.—Two persons and the following apparatus are required: coil, batteries, wires, two Du Bois keys, two electro-magnets to record, and tuning-fork vibrating 100 D.V. per second.

(a.) Arrange the experiment as in fig. 246, *i.e.*, in the primary circuit (single shocks), two keys arranged in the course of one wire, and a recording electro-magnet. Under the latter is placed a chronograph recording $\frac{1}{100}$ ", the point of the one exactly under the other, the cylinder moving at a rapid rate.

(b.) Of the two persons, A and B, suppose B to be experimented on. The electrodes are placed say on the back of the hand or cheek of B, and he has control of key marked P, while A controls O. Begin with O open, and P closed. The observer closes O, this completes the primary circuit, the style of the chronograph is attracted, descends and makes a slightly oblique mark on the paper, which indicates the moment of stimulation. As

soon as B feels this he opens key P, the primary current is broken and the recording lever rises.

(c.) Measure the time value between the down and up movements of the recording lever. In this case the individual operated on knows the spot to be stimulated, but even with all his attention the results may not be constant. The time varies with the individual, his state of attention, fatigue, part stimulated, and many other factors.

4. The Dilemma.—When the individual has to make a deliberate choice between what parts of the body are stimulated, then the reaction-time is considerably longer.

The experiment is arranged as in fig. 246, save that the wires

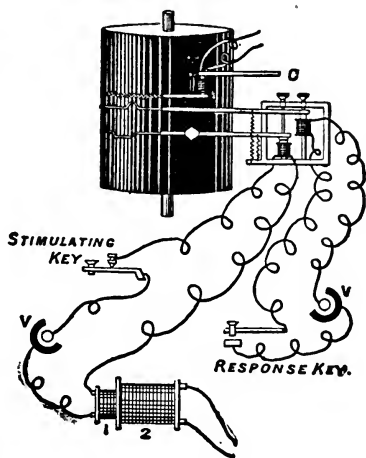

FIG. 245.—Arrangement for Simple Reaction-Time (Rutherford).

from the secondary coil pass to a Pohl's commutator *without cross-bars*, and provided with two pairs of electrodes. Thus at will the observer can pass the induced shock either through the one pair or the other, the individual experimented on not knowing when the reverser is changed.

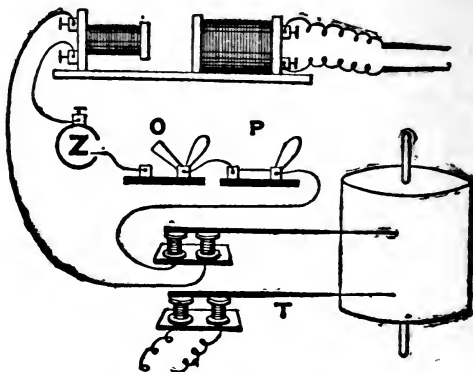

FIG. 246.—Reaction-Time for Touch in Man. *T*. Time signal in circuit with a tuning-fork, vibrating 100 D. V. per second.

5. The Neuramoebimeter (*Exner*), or Psychodometer (*Oberstein*), consists of two uprights (*S*), with a horizontal axis carrying a spring (*F*)—which vibrates 100 D. V. per second—with a writing-style at its free end (fig. 247). A brass plate (*B-b*) moves in a slot, and carries a smoked glass plate (*T*), a catch (*DG*), and a handle (*H*). The handle (*H*) pushes up the glass plate and

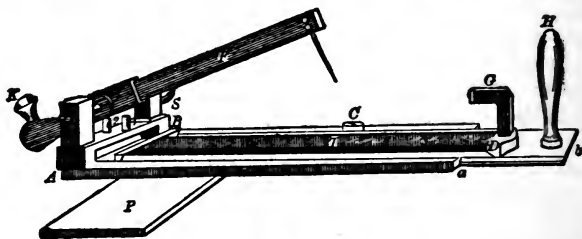

FIG. 247.—The Neuramoebimeter.

catch (*G*) until the latter meets the spring (*F*), and puts (*F*) on the stretch. When the catch (*G*) is withdrawn, (*F*) vibrates, and if the style be arranged to touch the glass, a curve is obtained on the latter.

(*a.*) It requires two persons. The observed person places a finger on the knob (*K*), while the catch (*G*) and glass plate are pushed up, the former to catch on (*F*), and the style is arranged to write on the glass. The observed person must not look, but close his eyes and listen.

(b.) The observer suddenly pulls on (H), thus discharging the spring (F), which vibrates and produces a note. The moment the observed person hears the sound, he presses the knob (K) and raises the writing-style. Of course, a curve is recorded, and it is easy to calculate the time which has elapsed between the emission of the sound and the reaction by the observed person. Numerous observations must be made, and the mean taken.

(c.) The instrument may also be used for vision, *i.e.*, when the slide (B—b) on being moved uncovers a painted disc.

(d.) In the more complete form of the apparatus, a key is fixed on one side of the apparatus, so that an electrical current is made or broken at the moment the spring begins to vibrate. The key is placed in the primary circuit of the induction-machine, and the electrodes of the secondary battery are applied to any part of the skin, the observed person depressing the knob (K) when he feels the stimulus. One can thus make numerous experiments on the "Reaction-Time" from different parts of the body.

W. G. Smith has devised another simple method (see *Journal of Physiology*, xvii.; *Proceedings of Physiological Society*, Nov. 1894).

6. Inhibition of Equilibration Movements.

Take an uninjured frog, place it on its back, and observe that it will not lie in this position, but immediately rights itself. Tie pretty firmly a thick string round each upper arm. This in no way interferes with the movements of the frog; but on placing the animal on its back, it no longer rights itself, but continues to lie in this position for a long time. It may be moved or pulled by the legs, yet it does not regain its normal attitude. Notice the modification of the respiratory movements.

7. Kircher's Experimentum Mirabile.

(a.) Take a hen and gently restrain its movements. Bring its bill in contact with a table. With a piece of white chalk draw a line directly outwards from its bill. Hold the animal steadily for a few seconds, and on removing the hands gently, it will be found that the hen lies quiescent and does not move for a considerable time. It may be rolled to one side or the other, yet it lies quiescent.

(b.) Take a hen, gently restrain its movements, then lay a straw or white thread over the base of its bill. In a short time the animal becomes quiescent. Note the alteration of the heart-beat and the depth and number of the respirations.

8. Reactions of Frog without Cerebral Hemispheres.

In the frog, as shown in fig. 248, the parts of the brain are arranged one behind the other. The guide on the surface of the skull to the posterior end of the cerebral hemispheres is a line connecting the front margins of the two exposed tympanic membranes. The brain may be exposed in a narcotised frog either by means of a small trocar or by severing the parts with a knife. After removal of the cerebral hemispheres, place a little cotton wool in the wound to prevent bleeding. The student is not permitted to do this operation.

(a.) Immediately after the operation the frog lies flat on any surface with its legs extended, but after the shock of the operation, *i.e.*, in about an hour, it draws up its legs and assumes the attitude and appearance of an intact frog, but it

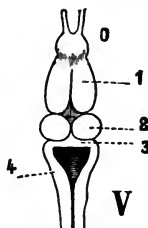

FIG. 248.—Brain of Frog from above; 0. Olfactory bulb; 1. Cerebral hemispheres; 2. Optic lobes; 3. Cerebellum; 4. Medulla oblongata.

makes no spontaneous movements, although it responds readily to external stimulation.

(b.) Its eyes are open and its respiratory movements continue (p. 311).

(c.) If placed on its back, it immediately rights itself. If placed on the palm of the hand, or on a rough board held horizontally, it sits immovable, but if the board be tilted, or the hand rotated, then, when a certain angle is reached, its equilibrium is disturbed, and it begins to crawl up, until it comes to the top, where its equilibrium is restored, and there it sits motionless.

(d.) If placed in water it makes continuous swimming movements.

(e.) It will avoid an opaque object placed in front of it, when one causes it to jump by pinching its hind-legs.

(f.) If held up between the thumb and forefinger of the right hand behind the forearm, and if it be pinched, then it responds to every pressure by a "croak." This is due to reflex excitation of the croaking centre. It also croaks on stroking the skin of the back or flanks.

(g.) It does not feed itself.

9. Optic Lobes (Inhibition).

(a.) Expose the optic lobes in a frog, after removing the cerebral hemispheres. After recovery, determine the latent period of a reflex mechanical response of the legs by Türck's method (Lesson LXVIII.).

(b.) Apply a crystal of common salt to the optic lobes, and then determine the latent period. It is greatly increased, or the reflex may be suppressed altogether.

PHYSIOLOGY OF THE SENSE ORGANS.

LESSON LXXI.

FORMATION OF IMAGE — DIFFUSION — ABERRATION — ACCOMMODATION — SCHEINER'S EXPERIMENT — NEAR AND FAR POINTS—PURKINJE'S IMAGES—PHAKOSCOPE—ASTIGMATISM—PUPIL.

1. Formation of an Inverted Image on the Retina.

(a.) From the fresh excised ox-eye remove the sclerotic from that part of its posterior segment near the optic nerve. Roll up a piece of blackened paper in the form of a tube, black surface innermost, and place the eye in it with the cornea directed forwards. Look at an object—*e.g.*, a candle-flame—and observe the *inverted* image of the flame shining through the retina and choroid, and notice how the image moves when the candle is moved.

(b.) Focus a candle-flame or other object on the ground-glass plate of an ordinary camera for photographic purposes, and observe the small inverted image.

(c.) Fix the fresh excised eye of an albino rabbit in Du Bois-Reymond's apparatus provided for you, and observe the same phenomenon. The eye is fixed with moist modeller's clay. Observe the effect on the retinal image when a convex or concave lens is placed in front of the cornea. These lenses rotate in front of the cornea, and are attached to the instrument.

2. Diffusion.

(a.) Fix a long needle in a piece of wood, or use a pencil or penholder, close one eye, and bring the needle or pencil gradually nearer to the other eye. After a time, when the needle is five to six inches distant, it will no longer be distinct, but blurred, dim, and larger.

(b.) Prick a smooth hole in a card with a needle, arrange the needle at the proper distance to obtain the previous diffusion effect, and now introduce the card between the needle and the eye, bringing the card near the eye, and looking through the hole in the card. The needle will appear distinct and larger; it is distinct because the diffusion circles are cut off, and larger because the object is nearer the eye.

(c.) In a dark room place a lighted candle or gas-burner conveniently, and by means of a convex lens focus the image of the flame on a sheet of white paper. It is better to introduce a blackened cardboard screen with a narrow hole in it between the light and the lens. Observe that a sharp image is obtained only at a certain distance from the lens. If the white screen be nearer or farther away, the image is blurred.

3. Spherical Aberration.

Make a hole in a blackened piece of cardboard with a needle, look at a light placed at a greater distance than the normal distance of accommodation. One will see a radiate figure, with four to eight radii. The figures obtained from opposite eyes will probably differ in shape.

4. Chromatic Aberration.—Coloured Fringes.

(a.) With one eye fix steadily the limit between a white and black surface (*e.g.*, fig. 265), and while doing so bring an opaque card between this eye and the object (the other eye being closed). Let the edge of the card be parallel to the limit between the white and black surfaces, so as to cover the larger part of the pupil. The margin next the black appears with a yellowish-red fringe when the part of the pupil which lies next the black surface is covered, while there is a bluish-violet fringe in the opposite condition.

(b.) Make a pin-hole in a blackened card, and behind the hole place a cobalt glass. Look at a gas-flame through this arrangement. The cobalt glass allows only the red and violet rays to pass through it. Accommodate for the violet rays or approach the light, the flame appears violet, surrounded with a reddish halo; on accommodating for the red, or on receding, the centre is reddish with a violet halo.

(c.) Place a strip of red paper and one of blue on a black surface. The red appears nearer than the blue, because one makes a greater effort to accommodate for the less refrangible red rays than for the more refrangible blue or violet, and hence the red is judged to be nearer.

(d.) V. Bezold's Experiment.—Make a series (10–12) of concentric circles, black and white alternately, each 1 mm. thick, the diameter of the whole being about 15 mm. On looking at these circles when they are placed within the focal distance, one sees the white become pink; to some eyes it appears yellow or greenish. The same is seen on looking at concentric black and white circles, or parallel black and white lines from a distance outside the far point of vision; the white appears red and the black bluish.

(e.) Wheatstone's Fluttering Hearts.—(i.) Make a drawing of a red-coloured heart on a bright blue ground. In a dark room lighted by a candle hold the picture below the level of the eyes, and give it a gentle to and fro motion.

On continuing to look at the hearts, it will appear to move or flutter over the blue background.

(ii.) On a bright blue ground make a square with black lines and subdivide it into smaller squares. On the same ground make a series of small squares—not coinciding with the previous ones—with red boundaries. On moving the figure to and fro in the shade below the level of one's eyes, one sees the red squares moving to and fro over the black ones. Some see the black moving behind the red. ("Zur Erklärung d. flatternden Herzen," A. Szili, *Du Bois Archiv*, 1891, p. 157.)

5. Accommodation.

(a.) Standing near a source of light, close one eye, hold up both forefingers not quite in a line, keeping one finger about six or seven inches from the other eye, and the other forefinger about sixteen to eighteen inches from the eye. Look at the *near* finger; a distinct image is obtained of it, while the far one is blurred or indistinct. Look at the *far* image; it becomes distinct, while the near one becomes blurred. Observe that in accommodating for the near object one is conscious of a distinct effort.

(b.) Ask some one to note the diameter of your pupil when you accommodate for the near and distant object respectively. In the former case the pupil contracts, in the latter it dilates. Ask a person to accommodate for a distant object, and look at his eye from the side and somewhat from behind; the half of the pupil projects beyond the margin of the cornea. When he looks at a near object in the same line, and without moving the eyeball, observe that the whole pupil and a part of the iris next the observer are projected forwards, owing to the increased curvature of the anterior surface of the lens.

(c.) Hold a thin wooden rod or pencil about a foot from the eyes, and look at a distant object. Note that the object appears double. Close the right eye; the left image disappears, and *vice versa*.

(d.) At a distance of six inches from the eyes hold a veil or thin gauze in front of some printed matter placed at a distance of two feet or thereby. Close one eye, and with the other one soon sees either the letters distinctly or the fine threads of the veil, but one cannot see both equally distinct at the same time. The eye, therefore, can form a distinct image of a near or distant object, but not of both at the same time; hence the necessity for accommodation.

6. Scheiner's Experiment (fig. 249).

(a.) Prick two smooth holes in a card at a distance from each other less than the diameter of the pupil. Fix two long fine needles or straws in two pieces of wood or cork. Fix the card-board in a piece of wood with a groove made in it with a fine saw, and see that the holes are horizontal. Place the needles in line with the holes, the one about eight inches and the other about eighteen inches from the card.

(b.) Close one eye, and with the other look through the holes at the *near* needle, which will be seen distinctly, while the far needle will be double, but both images are somewhat dim.

(c.) With another card, while accommodating for the *near* needle, close the right-hand hole; the right-hand image disappears; and if the left-hand hole be closed, the left-hand image disappears.

(d.) Accommodate for the *far* needle; the near needle appears double. Close the right-hand hole, and the left-hand image disappears; and on closing the left-hand hole, the right-hand image disappears.

(e.) Instead of using a card perforated with two holes, use an apparatus so constructed that one hole is covered with a green and the other with a red glass. Repeat the previous observations, noting the disappearance of the red or green image, as the case may be.

(f.) If desired, the holes in the card may be made one above the other, but in this

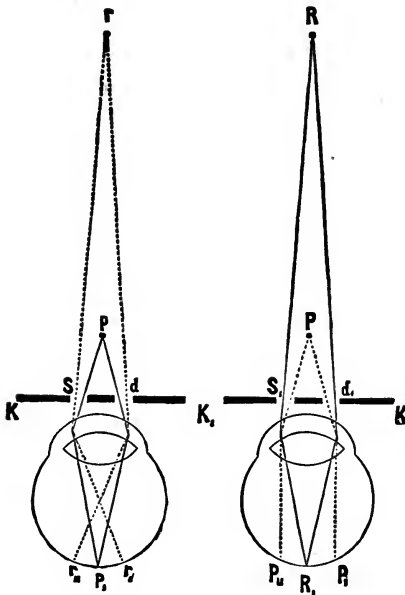

FIG. 249.—Scheiner's Experiment.

case the pin looked at must be horizontal.

(g.) Make three holes in a piece of cardboard, as in fig. 250, *a*, so that they can be brought simultaneously before one eye, and look at a pin or needle. One sees three images of the needle. On looking at a near object, the needles are in the position *b*, and at a distant object in that shown in *c*.



FIG. 250.

(h.) Miles' Experiment.

(i.) Look at a pin through a pin-hole in a card. Accommodate for the pin, move the card to and fro, and note that the pin appears immovable.

(ii.) Accommodate for a distant object beyond the pin,

and note that the pin appears to move in the opposite direction to that of the card.

(iii.) Accommodate for a nearer object, and note that the pin appears to move in the same direction as the card.

7. Determination of Near and Far Points.

(a.) Hold a pin vertically about ten inches in front of one eye, the other eye being closed. Look through the two holes in the card used for Scheiner's experiment, and when one distinct image of the needle is seen, gradually approximate the needle to the cardboard; observe that it becomes double at a certain distance from the eye. This indicates the **near point of accommodation**.

(b.) Hold the card in front of one eye, and gradually walk backwards while looking at the needle, observing when it becomes double. This indicates the **far point of accommodation**. *N.B.*—The experiment (b.) succeeds best in short-sighted individuals.

(c.) Determine the near point with a vertical needle and card with horizontal holes, and again with a horizontal needle and a card with the holes vertical. The two measurements do not usually coincide, because the curvature of the cornea is usually different in the two meridians.

8. Purkinje-Sanson's Images.

(a.) In a dark room light a candle, and hold it to one side of the observed eye and on a level with it. Ask the person to accommodate for a distant object, and look into his eye from the side opposite to the candle, and three reflected images will be seen. At the margin of the pupil, and superficially, one sees a small bright *erect* image of the candle-flame reflected from the *anterior surface of the cornea*. In the middle of the pupil there is a second less brilliant, larger, and not sharply defined *erect* image. It is reflected from the *anterior surface of the lens*. The third image, which lies most posteriorly and towards the opposite margin of the pupil, is the smallest of the three, and is an *inverted* image reflected from the *posterior surface of the lens*. Ask the person to accommodate for a near object, and observe that the pupil contracts, while the middle image—that from the anterior surface of the lens—becomes smaller and comes nearer to the corneal image. This shows that the anterior surface of the lens becomes more convex during accommodation.

(b.) Instead of using a candle-flame, cut two small square holes (10 mm. square) in a piece of cardboard, and behind each place a gas-flame, and observe the three pairs of square reflected images.

(c.) *Physical Experiment.*—Place in a convenient position on a table a large bi-convex lens, supported on a stand. Standing in front of it, hold a watch-glass in the left hand in front of the lens and a few inches from it. Move a lighted candle at the side of this arrangement, and observe the three images described above. Substitute a convex lens of shorter focus, and observe how the images reflected from the lens become smaller.

9. The Phakoscope of Helmholtz is used to demonstrate the

change in curvature of the lens, more especially of the anterior surface, during accommodation (fig. 251).

(a.) Place the phakoscope in a convenient position, and darken the room. Two persons are required. The observed eye (patient) looks through a hole in the box opposite to *c*, while the observer looks through the hole (*a*) at the side. Light a lamp, place it some distance from the two prisms (*b*, *b'*) in such a position that its light is thrown clearly upon the observed eye, and the observer sees two small bright square images of light, when the observed eye looks straight ahead at a distant object. These are the *corneal images*. He should also see in the observed eye two larger less distinct images, from the *anterior surface of the lens*, and two smaller much dimmer images, from the *posterior surface of the lens*. The last are seen with difficulty.

(b.) Ask the patient to accommodate for a near object, viz., the pin above *c*, keeping the eye unmoved. Observe that the middle image becomes smaller and goes nearer to the corneal one, while the other two undergo no perceptible change. At the same time the pupil becomes smaller.

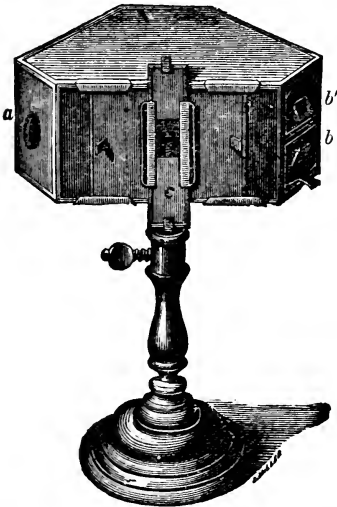

FIG. 251.—Phakoscope. *a*. Hole for observer's eye; *b*, *b'*. Prisms; *c*. Carries a pin for the observed eye to fix as its near point.

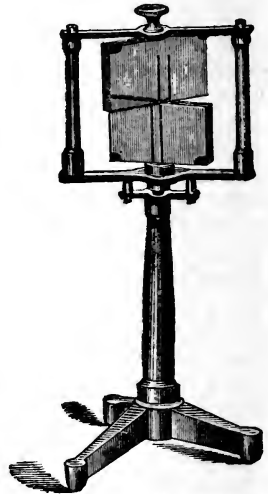

FIG. 252.—Auer's Model to show the principle of the Ophthalmometer.

10. Principle of Helmholtz's Ophthalmometer.—The student may conveniently learn the principle of this instrument from the apparatus of Auer (fig. 252) (made by Petzold of Leipzig). By means of the ophthalmometer Helmholtz measured the size of Sanson's images and the changes in size during accommodation. If one looks at an object through a plate of glass in a direction at right angles to the surface of the glass, the object is seen single and in its exact position. If, however, one looks at it obliquely or displaces the glass, then the image appears displaced to the right or left according to the inclination of the glass plate. In Helmholtz's instrument two glass plates, as in fig.

252, were placed one above the other, and could be rotated in opposite directions round a vertical axis. One looks through the glass plates at two black lines painted on a sheet of glass. On looking at the two lines through the two glass plates, and on rotating the latter in opposite directions, one image is displaced to the right and the other to the left, and the object appears double. One rotates the plates until the inner edge of the one image coincides with the corresponding edge of the other, so that each image has been displaced exactly to the extent of the size of the object. The size of the image can be calculated, provided one knows the refractive index of the glass plates, their thickness, and the angle formed by them. In the ophthalmometer the extent of rotation is read off on a disc placed outside the box which contains the glass plates.

11. Line of Accommodation, *i.e.*, the eye does not accommodate for a point, but for a series of points, all of which are equally sharply perceived with a certain accommodation.

(*a.*) Stretch a white thread about a metre long on a blackened wooden board. Through two narrow slits, about 2 mm. apart, in a blackened card, focus with one eye a particular part of the thread, which must be in the optic axis. A part of the thread on the far and near side of the point focussed is quite distinct and linear, but beyond or nearer than this the thread is double, and diverges from the point focussed.

(*b.*) Make a small black spot with ink on a glass plate, and hold it in front of any printed matter. Bring the eye as close as possible to the glass plate without losing distinct definition of the point. At one and the same time only one of the objects can be seen; but not the point and the print equally sharply defined. Remove the eye gradually from the glass plate, and ultimately at a certain distance both the point and print will be equally distinct; the point and print mark the extreme limits of the line of accommodation.

12. Astigmatism is usually due to unequal curvatures of the cornea in different meridians, *i.e.*, the surface of the cornea is not part of a perfect sphere. Astigmatism is not uncommon, and usually the curvature of the cornea is greater in the vertical than in the horizontal meridian. This is "regular astigmatism." In such a "spoon-shaped" cornea a point of light is not focussed as a point—"pin focus," but is linear or "line focus."

(*a.*) Draw on a card two black lines of equal thickness, intersecting each other at right angles. Fix it vertically at the far limit of accommodation and look at it, when probably either the vertical or the horizontal line will be seen more distinctly. Test each eye separately. The line most distinct corresponds to the meridian of least curvature of the cornea.

(*b.*) Instead of a cross, construct a star, the lines radiating at equal angles from the centre, and being of equal thickness. Repeat the previous observations, observing in which meridian the lines are most distinct.

(*c.*) Repeat these observations with the "astigmatic clock" suspended on the wall, or with appropriate illustrations given in *Snellen's* "Test-types."

(*d.*) Construct a series of concentric circles of equal thickness and tint, about one-eighth of an inch apart upon a card. Make a small hole in the centre of the card. Look steadily at the centre of the card held at some

distance. All the parts will not be equally distinct. Approach the card towards you, noting in which diameter the lines appear most distinct.

(e.) This card may be used in another way. Hold the card in front of, and with the circles directed towards the eye of another person—especially one with astigmatism; place your own eye behind the hole in the card and look into the observed eye, noting the reflection of the circles to be seen in the eye. Observe in which meridian the circles are most distinct, and if there be any perceptible difference in the thickness and distinctness of the circles.

(f.) Draw a series of parallel, vertical, and horizontal lines of equal tint and thickness, and about one-eighth of an inch apart. Fix the card vertically at a distance, and move towards it, noting whether the vertical or horizontal lines are most distinct.

(g.) Fix a fine wire or needle vertically in a piece of wood moving in a slot, and similarly fix another needle or wire horizontally. Move the needles until both can be seen distinctly at the same time, when it will be found that the needles are some distance apart; usually the horizontal one is the nearer.

13. Diplopia Monophthalmica.

Make a small hole in a black card, hold it at some distance, and with one eye look through it at a luminous point, the eye being accommodated for a distant object. One sees either several objects (feeble light) or an irregular radiate figure with four or eight rays. Move the paper, and the long rays remain in the same position. Compare the figure obtained from the other eye. It will very likely be different.

14. **Movements of Iris.**—(i.) It is an extremely beautiful experiment, and one that can easily be made by looking at the white shade of an ordinary reading-lamp, to look through a pin-hole in a card at a uniform white surface. With the right eye look through the pin-hole, the left eye being closed. Note the size of the (slightly dull) circular visual field. Open the left eye, the field becomes brighter and *smaller* (contraction of pupil), close the left eye, after an appreciable time, the field (now slightly dull) is seen gradually to expand. One can thus see and observe the rate of movements of one's own iris.

(ii.) Pupil-Reflex.

Place a person in front of a bright light opposite a window, and let him look at the light, or place oneself opposite a well-illuminated mirror. Close one eye with the hand and observe the diameter of the other pupil. Then suddenly remove the hand from the closed eye, light falls upon it; at the same time, the pupil of the other eye **contracts**.

15. **Pupil of Albino Rabbit.**—The pupil in albinos appears red, although in other animals it is black. In the albino it is red owing to the absence of pigment in the choroid and iris, so that light is admitted through the sclerotic and choroid and is reflected from the interior of the eyeball through the pupil to the eye of the observer.

Place in front of the eye of an albino rabbit a black screen with a hole in it of exactly the same size as the pupil. Let the hole and pupil correspond in position to each other. The pupil then appears black, as the card arrests the lateral rays that fall upon the eyeball.

16. The Pupil Appears Larger than it is in Reality.

To see the pupil at its exact size, an excised eyeball must be observed in water. If a glass model of a pupil be taken, and then be covered by another thick concavo-convex glass in shape like the cornea, the pupil at once appears larger.

17. Ludwig's Apparatus for Vision of a Point.

The black plate (fig. 253) is fixed in the slot so that either a slit or a hole is just above the handle of the instrument. Remove from the instrument the carrier with the steel point, and on the bar of the instrument place the vertical slit of the black plate (visual) near the eye. There is a movable black plate with a small hole in it. On looking at this small hole through a vertical slit it appears oval from above downwards, while with a horizontal slit the round hole appears drawn out laterally. If there be two small holes near each other in the visual plate, then at a certain distance two are seen in the movable plate. If the movable plate be removed, and the steel point put in its place, on using the large hole in the visual plate, and bringing the steel point towards the eye, after a time one ceases to see it distinctly, or if seen it is blurred. On using the small hole in the visual plate, the rod appears distinct (fig. 253).

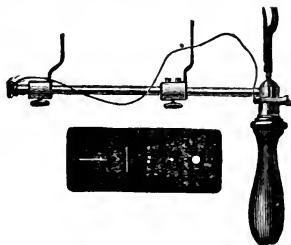

FIG. 253.—Ludwig's Apparatus for Vision of a Point.

18. Listing's Reduced Eye.—The various dioptric media of the eye may be considered as equal to a single substance with a refractive index of 1.35 and a single spherical surface of radius 5.1248 mm. The position of the nodal point is 5 mm. behind the refractive surface, and the principal focus 15 mm. behind this. This latter value is of special importance in enabling one to calculate the size of a retinal image—the size and distance of the object being known.

LESSON LXXII.

BLIND SPOT—FOVEA CENTRALIS—DIRECT VISION—CLERK-MAXWELL'S EXPERIMENT—PHOSPHENES—RETINAL SHADOWS.

1. The Blind Spot.

(a.) Marriotte's Experiment.—As in fig. 254, on a white card, make a cross and a large dot, either black or coloured. Hold the card vertically about 10 inches from the right eye, the left being

closed. Look steadily at the cross with the right eye, when both the cross and the circle will be seen. Gradually approach the card towards the eye, keeping the axis of vision fixed on the cross. At a certain distance the circle will disappear, *i.e.*, when its image falls on



FIG. 254.—Marriotte's Experiment.

the entrance of the optic nerve. On bringing the card nearer, the circle reappears, the cross of course being visible all the time.

(*b.*) Perform the experiment in this way. Place the flat hand vertical to the face, and with its edge touching the nose so as to form a septum between the two fields of vision. Fix the cross in fig. 255, keep both eyes open, and



FIG. 255.

on moving the paper to and fro at a certain distance both black dots will disappear.

(*c.*) Close the left eye, and fix the point *a* (fig. 256); on moving the paper a certain distance (about 16 cm.), one sees a complete cross, and to most observers the horizontal bar appears uppermost.

a
+

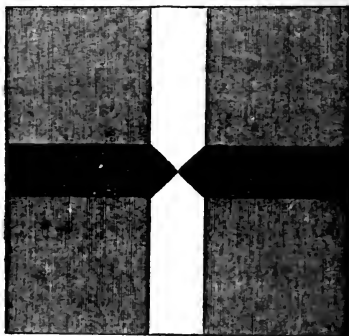

FIG. 256

(*d.*) Volkmann's Experiment on the Blind Spot.

Look at the spot *a* (fig. 257) with one eye, the gap, *b c*, disappears when it falls on the blind spot and the line looks continuous; the points *b* and *c* appear as if placed in the same point of the field of vision, so that the parts of the

retina in the periphery of the blind spot behave as if two diametrically opposite points approached each other.

2. Map out the Blind Spot.

Make a cross on the centre of a sheet of white paper, and place it on a table about 10 or 12 inches from you. Close the left eye, and look steadily at the cross with the right. Wrap a penholder in white paper, leaving only the tip of the pen-point projecting; dip the latter in ink, or dip the point of a white feather in ink, and keeping the head steady and the axis of vision fixed, place the pen-point near the cross, and gradually move it to



FIG. 257.—Volkmann's Experiment on the Blind Spot.

the right until the black becomes invisible. Mark this spot. Carry the blackened point still farther outwards until it becomes visible again. Mark this outer limit. These two points give the outer and inner limits of the blind spot. Begin again, moving the pencil first in an upward and then in a downward direction, in each case marking where the pencil becomes invisible. If this be done in several diameters, an outline of the blind spot is obtained, even little prominences showing the retinal vessels being indicated.

3. Calculate the Size of the Blind Spot.

Helmholtz gives the following formula for this purpose:—When f is the distance of the eye from the paper, F the distance of the second nodal point from the retina—usually 15 mm.— d the diameter of the sketch of the blind spot drawn on the paper, and D the corresponding size of the blind spot:—

$$\frac{f}{F} = \frac{d}{D}$$

4. Acuity of Vision of the Fovea Centralis.

(a.) On a horizontal plane—a blackboard—describe a semicircle with a radius equal to that of the near point of vision, and fix in the semicircle pins at an angular distance of 5° apart. Close one eye, and with the other look at the central pin; the pins on each side will be seen distinctly; those at 10° begin to be indistinct, while those at 30° to 40° are not seen at all.

(b.) At a distance of 5 feet look at a series of vertical parallel lines alternately black and white, each .5 mm. wide. A normal eye will distinguish them; if not, approach the object until they are seen distinctly.

5. Direct Vision.—When the image of an object falls on the fovea centralis, we have “direct vision.” When it falls on any other part of the retina, it is called “indirect vision.” Vision is most acute at the fovea centralis of the yellow spot.

(a.) Standing about 2 feet from a wall, hold up a pen at arm's length between you and the wall. Look steadily at a fixed spot on the wall, seeing the pen distinctly all the time. Move the pen gradually to one side; first one fails to see the hole in the nib, and as the pen is carried outwards one fails to recognise it as a pen.

Hence, in looking at a large surface, to see it distinctly one must unconsciously move his eyeballs over the surface to get a distinct impression thereof.

(b.) Make two black dots on a card quite close together, so that when looked at they are seen as two. Hold up the left index-finger, look steadily at it, and place the card with the dots beside the finger. Move the card outwards, inwards, upwards, and downwards successively, and note that as the dots are moved towards the periphery they appear as one, but not at equal distances from the fixed point in all meridians. For convenience, the card may be moved along a rod, movable on a vertical support.

6. Clerk-Maxwell's Experiment—The Yellow Spot.

A strong, watery, clear solution of chrome alum is placed in a clear glass bottle with flat sides. Close the eyes for a minute or so, open them, and, while holding the chrome alum solution between one eye and a white cloud, look through the solution. An elliptical spot, rosy in colour, will be seen in the otherwise green field of vision. The pigment in the yellow spot absorbs the blue-green rays, hence the remaining rays which pass through the chrome alum give a rose colour.

7. Bergmann's Experiment.—Make a series of parallel vertical black lines, 2 mm. in diameter, on white paper, with equal white areas intervening between them. Look at them in a good light,

at a distance of 2 to 3 yards. In a short time the lines will appear as in fig. 258, A. Why? Because of the manner in which the images of the lines fall on the cones in the yellow spot, as shown in B.

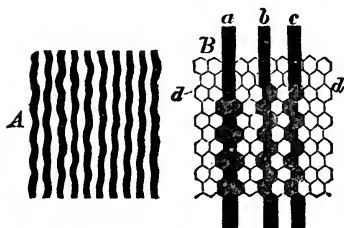

FIG. 258.—Bergmann's Experiment.

closed eye. A brilliant circular patch, with a steel-grey centre and yellow circumference, is seen in the *field of vision* and on the opposite side. It has the same shape as the compressing body. Press any other part of the eyeball; the same spectrum is seen, and always on the opposite side. Impressions made on the terminations of the optic nerve are referred outside the eye, *i.e.*, beyond into space. The phosphene is seen in the upper half if the lower is pressed, and *vice versa*.

8. Phosphenes.

Press the tip of the finger firmly, or the end of a pencil, against the inner corner of the

9. Shadows of the Fovea Centralis and Retinal Blood-Vessels.

Move, with a circular motion, a blackened card with a pin-hole in its centre in front of one eye, looking through the pin-hole at a white cloud. Soon a punctated field appears with the outlines of the capillaries of the retina. The oval shape of the yellow spot is also seen, and it will be noticed that the blood-vessels do not enter the fovea centralis. Move the card vertically, when the horizontal vessels are more distinct. On moving it horizontally, the vertical ones are most distinct. Some observers recommend that a slip of blue glass be held behind the hole in the opaque card; but this is unnecessary.

10. Purkinje's Figures.

In a dark room light a candle, and stand in front of a monochromatic wall. If this is not available, hang up a large white sheet, and while looking steadily with one eye towards the wall or sheet, accommodating the eye for a distant object, hold the candle close to the side of that eye, well out of the field of vision,—downwards and laterally from the eye,—and move the candle up and down. It is better to direct the eye outwards, keeping it accommodated for a distant object. Ere long, dark somewhat red-brown branching lines, shadows of the retinal vessels, will be seen on a red background, due to the shadows cast by the retinal vessels on the percipient parts of the retina. Therefore the parts of the retina stimulated by light must lie behind the retinal blood-vessels. If the candle be moved in a vertical plane, the shadows move upwards or downwards with the light. If the light be moved horizontally, the shadows move in an opposite direction.

Entoptical Vision.—By this is meant the visual perception of objects situated within our own eye. There are many such phenomena.

11. *Muscæ Volitantes*.

(a.) Light a candle in a dark room; at a distance from it place a black screen with a pin-hole in it. Focus by means of a convex lens the image of the flame upon the hole in the screen. Look through the hole with one eye, and on the illuminated part of the lens will be seen images of dots and threads due to objects within the eyeball.

(b.) Rays of light proceeding from a point at or preferably within the anterior focus of the eye, *i.e.*, 13 mm. or less from the cornea, cast a shadow of any object within the eyeball, because the rays fall parallel on the retina.

Make a pin-hole in a card, place it close to the eyeball, and through the hole look at an illuminated surface, *e.g.*, a white lamp-shade, or white sky. The margins of the aperture become luminous, *i.e.*, they are the luminous body.

One sees such floating objects as are present in the media of one's eye, the "muscæ volitantes."

12. Inversion of Shadows thrown on the Retina.

Make three pin-holes in a card, and arrange them in a triangle close to each other. Hold the card 4 or 5 inches from the right eye, and look through the holes at a bright sky or lamp. Close the left eye, and in front of the right hold a pin so that it just touches the eyelashes. An inverted image of the pin will be seen in each pin-hole. Retinal images, as we have seen, are inverted on the retina, shadows on the retina are erect, and therefore the latter, on being projected outwards into space, are seen inverted.

13. Duration of Impressions.

On a circular white disc, about half-way between the centre and circumference, fix a small black oblong disc, and rapidly rotate it by means of a rotating wheel. There appears a ring of grey on the black, showing that the impression on the retina lasts a certain time.

14. Talbot's Law.—A grey once produced is not changed by increased rapidity of rotation of the disc exciting the sensation. The intensity of the light impression is quite independent of the absolute duration of the periods of illumination and shade.

Rotate a disc like fig. 259 twenty-five times per second, then the period in which illumination and shade alternately lasts for the inner zone is $\frac{1}{4}$ sec., for the middle $\frac{1}{5}$, and for the outer zone $\frac{1}{6}$ sec. In all three zones the period of illumination lasts exactly one-half of the period, and the three zones have exactly the same brightness. Rotate more quickly, and no further effect is produced. The number of rotations is readily determined by Harding's improved counter.

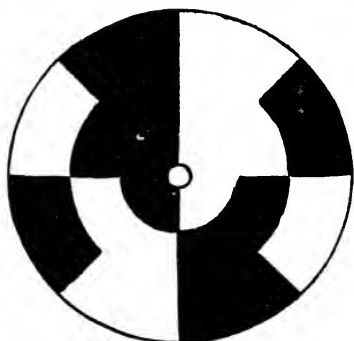

FIG. 259.

15. Charpentier's Experiments (slow-moving discs).

(i.) "Black-band Experiment."

—Make a disc $\frac{1}{6}$ white, cause it to revolve (once in two seconds) in bright direct sunshine. On the white sector will be seen a narrow "black band" or sector near the black edge that has

just passed in front of the eye, but separated from that edge by a narrow white sector (fig. 260). The black band always appears at the same time from the moment the white sector appears in the field. The time is equal to $\frac{1}{80}$ to $\frac{1}{70}$ second, *i.e.*, 0.014" to 0.016". It is independent of the velocity of the disc. Sometimes there are two or three successive fainter bands, but they are difficult to make out.

The first effect is white, followed by an after-effect which is black even *during* the continued white stimulus. Thus there seems to be a slow oscillatory process in the retino-cerebral apparatus, showing a positive and a negative phase, each phase lasting 0.014" to 0.016".

The negative phase of oscillation takes place after the shortest possible illumination, and appears to be a general phenomenon. Charpentier suggests that it is possible that a single bright stimulus, e.g., an electric spark, appears as a double or reduplicated bright sensation (*Archives de Physiologie*, 1892, p. 541). Another form of the experiment is given in a later paper (p. 629).

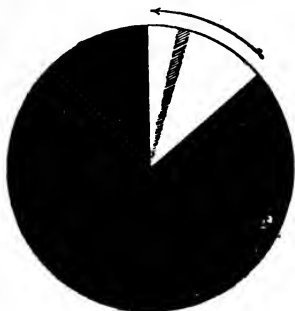

FIG. 260.—Charpentier's Disc for "Black Band." The arrow shows the direction of rotation.

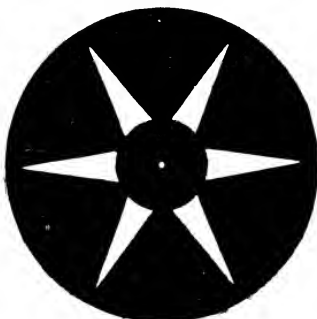

FIG. 261.—Charpentier's Disc for Vision of Purple Background.

(ii.) On a large black disc (40 cm. diameter) gum near its circumference a piece of white paper (1 cm. and angular deviation 1° - 2°), and cause the disc to revolve twice per second. The observer has a sensation of a white *ribbed* streak (about $\frac{1}{4}$ of the entire circle) on the black surface. There is not a uniform tint, and the ribbed appearance is due to an oscillatory process in the retino-cerebral apparatus.

(iii.) Arrange a black disc with narrow open equidistant sectors, to rotate opposite to a white surface illuminated by direct sunlight. The sectors have their apices towards the periphery and their bases at the centre (fig. 261). On rotating the disc before the eyes so that the retina is stimulated 40-60 times per second, *i.e.*, when each stimulus occurs during the negative after-effect of the preceding stimulus, one gets a sensation of a purple-violet field, but the field is colourless at lower or higher rates of stimulation. Charpentier thinks that the coloured sensation is due to entoptical vision of the retinal purple.

LESSON LXXIII.

PERIMETRY—IRRADIATION—IMPERFECT VISUAL JUDGMENTS.

1. To Map out the Field of Vision, or Perimetry.

(a.) A rough method is to place the person with his back to a window, ask him to close one eye, stand in front of him about 2 feet distant, hold up the forefingers of both hands in front of and

in the plane of your own face. Ask the person to look steadily at your nose, and as he does so observe to what extent the fingers can be separated horizontally, vertically, and in oblique directions before they disappear from his field of vision.

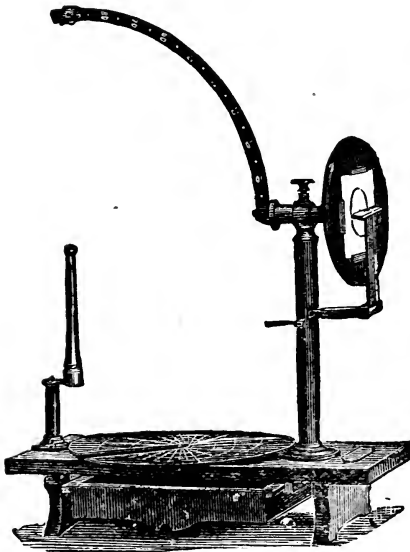

FIG. 262.—Priestley Smith's Perimeter.

(b.) Priestley Smith's Perimeter (fig. 262).—Let the observer seat himself near a table on which the perimeter is placed at a convenient height. Suppose the right eye is to be examined, fix a blank chart for the right eye behind the wooden circular disc. A mark on the hand-wheel shows which way the chart is to be placed.

(c.) The patient rests his right cheek against the knob on the wooden pillar in such a position that the knob is about

an inch directly under his right eye, the other eye is closed either voluntarily or with a shade, while the observer looks steadily with the right eye at the white spot on the end of the axis of the instrument.

(d.) The observer turns the quadrant with his right hand by means of the wooden wheel, first to one and then to another meridian. With his left he moves the white mark along the quadrant, beginning at the periphery and gradually approaching centralwards until it is just seen by the right eye. A prick is then made in the chart corresponding to the angle read off on the quadrant, at which the observer can see the white spot.

(e.) Turn the quadrant to another meridian and determine the limit of the visual field as before. This is repeated for four or more meridians, and then

the pricks on the chart are joined by a continuous line, when we obtain an oval field more extensive in the outer and lower portions. Test, if desired, the left eye, substituting a blank chart for that eye.

(f.) Test the field of vision for colours, substituting for the white travelling disc blue, red, and green. Mark each colour-field on the chart with a pencil of similar colour. Notice that the field for blue is nearly as large as the normal visual field. It is smallest for green, red being intermediate between green and blue.

(g.) With Ludwig's apparatus test when red, yellow, blue, and other coloured glasses cease to be distinguished as such in the field of vision.

2. Binocular Vision.

(a.) Hold in front of each eye a blackened tube. On looking through both tubes two fields will be seen. Gradually cause the tubes to converge at their free ends, and the two fields of vision will be seen to meet and form a single field.

(b.) Continue the convergence, and note that two fields reappear, but they are crossed. In these "secondary positions" there is no rotation of the eyeball on its antero-posterior axis.

(c.) If the eyeball be turned in any other direction (tertiary positions) the after-image appears inclined, or at an angle with the vertical or horizontal stripes, according to the original position of the red fixation-object.

3. Wheel Movements (False) of the Eyeballs (Secondary and Tertiary Positions).

(a.) On a grey sheet of stout paper, at least 1 metre square, rule a number of vertical and horizontal faint black lines. Fix on the centre of the paper a strip of red paper on a level with the eyes, the eyes being in the primary position, *i.e.*, looking straight ahead. Gaze steadily at the latter, keeping the head fixed. After a time suddenly direct the eyeballs to another part of the grey surface; a green-blue after-image is seen which retains its same relative position with regard to the vertical and horizontal lines, provided the eyeballs be moved directly upwards, downwards, inwards, or outwards, *i.e.*, if the eyeball is moved up, along vertical or horizontal meridians, the after-image is still vertical. Turn the eyeball upwards and to the right, or downwards and to the left, the after-image appears tilted to the right; if the eyes are directed upwards and to the left or downwards and to the right, the after-image appears tilted to the left. A similar result occurs with a horizontal strip of paper,

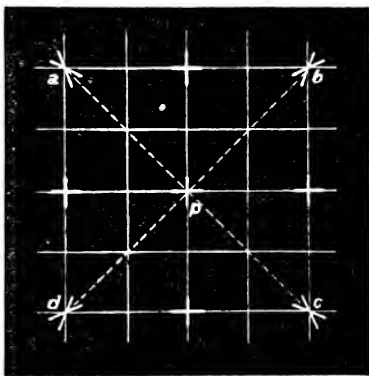

FIG. 263.—Appearance of a Cross in False Wheel Movements of Eyeballs.

but the after-images are inclined against the inclination of the vertical images.

Suppose we look at a rectangular red cross (p) under the same circumstances (fig. 263), on turning the eyes, *i.e.*, the visual line, to any vertical or horizontal line passing through p , the after-image is a rectangular cross, but it appears oblique, and its angles are neither horizontal nor vertical when the eyes look obliquely, *i.e.*, when the point of vision diverges considerably from the above-named lines. The *apparently* displaced crosses are shown in a , b , c , d .

These oblique after-images were formerly regarded as showing that the eyeball rotated on its antero-posterior axis, *i.e.*, "*wheel movements.*" This is not the case, the movements are only *apparent*. If they were real the after-images ought to move in the same direction with both vertical and horizontal strips, but they do not.

4. Irradiation.—By irradiation is meant the fact that, under certain circumstances, objects appear larger than they should be according to their absolute size and distance from the eye, larger than other objects of greater or less brightness of the same size and at the same distance.

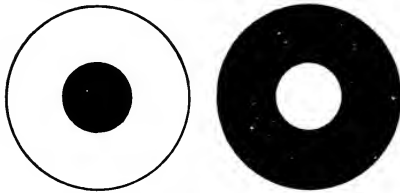

FIG. 264.—Irradiation.

(*a.*) Cut out two circles as in fig. 264, or two squares of exactly the same size, of white and of black paper. Place the white patch on a black, and the black on a

white sheet of paper. Hold them some distance from the eye, and, especially if they be not distinctly focussed, the white circle will appear larger than the black one.

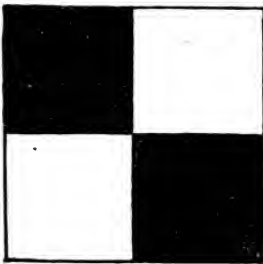

FIG. 265.



FIG. 266.

(*b.*) Divide a square into four, as shown in fig. 265, two of the smaller squares being white and two black. Hold the figure at some distance from you. The two white squares appear larger, and

they appear to run into each other and to be joined together by a white bridge.

(c.) Look at fig. 266, placed at such a distance that the accommodation is imperfect. The white stripe, which is of equal breadth throughout, appears wedge-shaped, being wider below between the broad black patches, and narrower above. To me also the narrow black patches appear to be broader above and narrower below.

(d.) Gum on to a sheet of white paper two strips of black paper 5 mm. wide, and parallel to each other, leaving a white interspace of 8 mm. between them. Look at the object, and, especially if it be not sharply focussed, the smaller black strips will appear broader than the white one.

5. Imperfect Visual Judgments.

(a.) Make three round black dots, A, B, C, of the same size, in the same line, and let A and C be equidistant from B. Between A and B make several more dots of the same size. A and B will then appear to be farther apart than B and C.

(b.) Make on a white card two squares of equal size, omitting the outlines. Across the one draw *horizontal* lines at equal dis-

S S S S S S S S 8 8 8 8 8 8 8 8

FIG. 267.

tances, and in the other make similar *vertical* lines. Hold them at some distance. The one with horizontal lines appears higher than it really is, while the one with vertical lines appears broader, *i.e.*, both appear oblong.

(c.) Look at the row of letters (S) and figures (8). To some the upper halves of the letters and figures may appear to be the same size as the lower halves, to others the lower halves may appear larger. Hold the figure upside down, and observe that there is a considerable difference between the two, the lower half being considerably larger (fig. 267).

(d.) **Zöllner's Lines.**—Make two lines parallel to each other. Note that one can judge very accurately as to their parallelism. Draw short oblique lines through them. The lines now no longer appear to be parallel, but seem to slope inwards or outwards, according to the direction of the oblique lines.

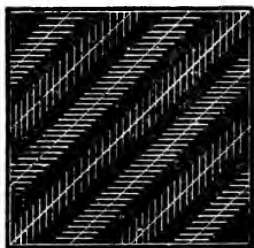

FIG. 268.—Zöllner's Lines.

(e.) Look at fig. 268; the long lines do not appear to be parallel, although they are so.

(f.) The length of a line appears to vary according to the angle and direction of certain other lines in relation to it (fig. 269). The length of the two vertical lines is the same, yet one appears much longer than the other. (A large number of similar illusions will be found in *Du Bois-Reymond's Archiv*, 1890, p. 91, by F. C. Müller-Leyer, and Láska, p. 326.)

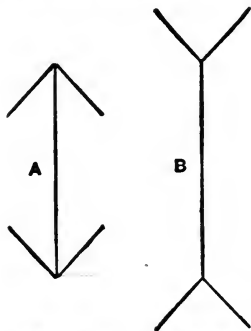

FIG. 269.—To show False Estimate of Size.

6. Imperfect Judgment of Distance.

(a.) Close one eye, and hold the left forefinger vertically in front of the other eye, and try to strike it with the right forefinger. On the first trial one will probably fall short of the mark, and fail to touch it. Close one eye, and rapidly try to dip a pen into an inkstand, or put a finger into the mouth of a bottle placed at a convenient distance. In both cases one will not succeed at first. In these cases one loses the impressions produced by the convergence of the optic axes, which are important factors in judging of distance.

(b.) Hold a pencil vertically about 15 cm. from the nose, fix it with both eyes, close the left eye, and then hold the right index-finger vertically, so as to cover the lower part of the pencil. With a sudden move try to strike the pencil with the finger. In every case one misses the pencil and sweeps to the right of it.

(c.) Fix a wire ring about 3 inches in diameter into the end of a rod about 2 feet in length. Hold the rod at arm's-length, close one eye, try to put into the ring a vertical process attached to a rod of similar length held in the other hand.

7. Imperfect Judgment of Direction.

As the retina is spherical, a line beyond a certain length when looked at always shows an appreciable curvature.

(a.) Hold a straight edge just below the level of the eyes. Its upper margin shows a slight concavity.

(b.) In indirect vision the appreciation of direction is still more imperfect. While leaning on a large table fix a point on the table, and then try to arrange three small pieces of coloured paper in a straight line. Invariably, the papers, being at a distance from the fixation-point, and being seen by indirect vision, are arranged not in a straight line, but in the arc of a circle with a long radius.

8. Perception of Size.

Fix the centre of fig. 270 at a distance of 3 to 4 cm. from

the eye, when by indirect vision the broad white and black areas of the peripheral parts, bounded by hyperbolic curves, will appear as small and the lines bounding them as straight as the smaller areas in the middle zone.

9. Convergence of the Visual Axes Influences one's Conceptions of Size and Distance.

(a.) Place a blackened paper tube before each eye, look at a fixed object, and then gradually converge the tubes ; the object appears larger and nearer.

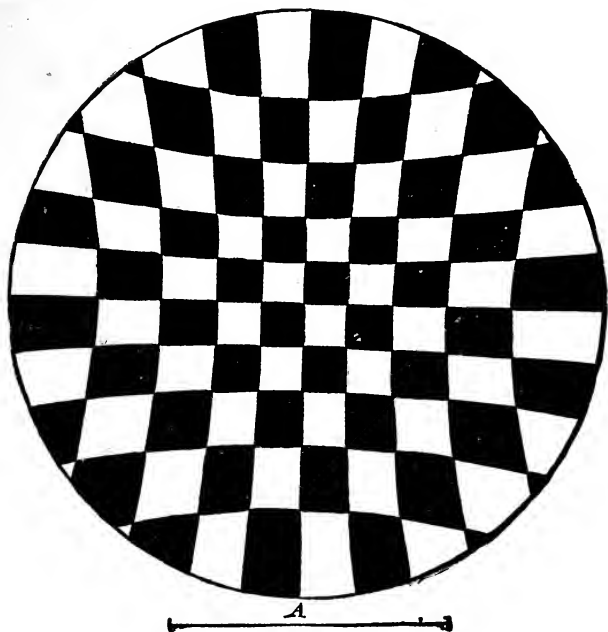

FIG. 270.

(b.) Look at an object through two pieces of glass ($2\frac{1}{2} \times 2\frac{1}{2} \times \frac{1}{4}$ in.), held at first in the same plane, one in front of each eye. Let the adjoining edges of the two plates of glass be moved each on a vertical axis, so that they form either a more or less obtuse angle with each other. In order to see the object distinctly the axes of the eyeballs must converge to a greater or less extent, as the case may be, with the result that the object appears larger or smaller, or appears to approach or recede as the plates are rotated. Special forms of apparatus contrived by Rollett, and another by Landois, are used for this purpose.

10. Apparent Movements.

(a.) Strobic Discs. — Give the discs a somewhat circular but rapid movement and observe that the rings appear to move, each one on its own axis.



FIG. 271.

move in an opposite direction. When the eye does not move, we judge that a body is in motion when the image of that body falls successively on different points of the retina, and at the same time are conscious that the ocular muscles have not contracted (*Beaunis*).

(b.) Radial Movement. —

While another person rotates a disc like fig. 271 on the rotating wheel, look steadily at the centre of the disc. One has the impression as if the disc were covered with circles which, arising in the centre and gradually becoming larger, disappear at the periphery. After long fixation look at printed matter or at a person's face; the letters appear to move towards the centre, while the person's face appears to become smaller and recede. If the disc be rotated in the opposite direction, the opposite results are obtained.

(c.) Fix an object, turn the head rapidly, and note that the object appears to

LESSON LXXIV.

KÜHNE'S ARTIFICIAL EYE — MIXING COLOUR SENSATIONS—COLOUR-BLINDNESS.

1. Kühne's Artificial Eye (fig. 272).

(a.) Fill the instrument with water, and place it in a darkened room with the cornea directed to a hole in a shutter, through which sunlight is directed by means of a heliostat. If this is not available, use an oxy-hydrogen lamp or electric light to throw parallel rays of light on the cornea. If these cannot be had, use a fan-tailed gas-burner, but in this case the illumination and images will be feeble. To enable one to observe the course of the rays of light, pour some eosin or fluorescein into the water in the instrument.

(b.) Formation of an image on the retina. Observe the course of the rays of light, which come to a focus behind the lens—the principal posterior focus. Move the ground glass representing the retina, and get a clear inverted image of the source of light. *N.B.*—In this instrument accommodation is effected not by altering the curvature of the lens, as in the normal eye, but by moving the retina.

(c.) Place convex and concave lenses between the source of light and the cornea ; observe how each alters the course of the rays and their focus.

(d.) After having an image well focussed upon the retina, move the latter away from the lens, when the image becomes blurred owing to diffusion. If, however, a slip of zinc, with a hole cut in it to act as a diaphragm to cut off some of the marginal rays, be interposed, the image is somewhat improved.

(e.) After seeing that the light is sharply focussed on the retina, remove the lens—to imitate the condition after removal of the lens for cataract—and observe that the rays are focussed quite behind the retina.

(f.) Place the removed lens in front of the cornea, the principal focus is now much in front of the retina, so that a much weaker lens than the one removed has to be used after removal of the lens for cataract.

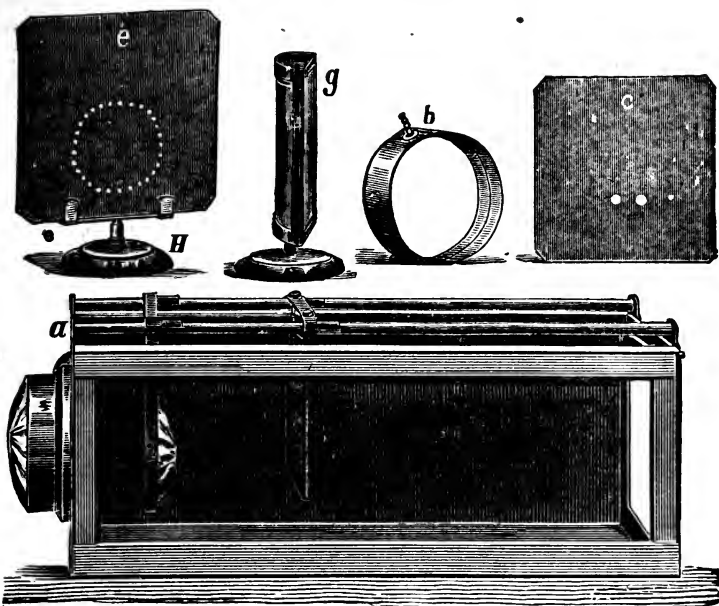

FIG. 272.—Kühne's Artificial Eye, as made by Jung of Heidelberg.

(g.) Astigmatism.—Fill the plano-convex glass (*g*)—to imitate a cylindrical lens—with water, and place it in front of the cornea. Between the cornea and the cylindrical lens place a sheet of zinc with a cross cut out in it, or with a number of holes in a horizontal line. One cannot obtain a distinct image of the cross or the holes, as the case may be.

(h.) Scheiner's Experiment.—With the light properly adjusted, place in front of the cornea a piece of zinc perforated with two holes (*c*), 1 cm. in diameter, in a horizontal line, the distance between the holes being less than the diameter of the pupil. Find the position of the retina—and there is only one position—in which the two beams of light are brought to a focus. Move the retina towards the cornea, and observe two images ; close the right-hand

hole and the right-hand image disappears. Bring the retina posterior to the principal focus, and again there are two images. On closing the right-hand hole the left-hand image disappears, and *vice versa*.

2. Hering's Apparatus for Mixing the Colours of Coloured Glasses.

By mixing two primary colours (red, yellow, green, blue), one may obtain all intermediate hues, and by mixing three colours (red, green, and blue, or yellow, green, and violet), one can obtain white. The apparatus consists of a box *k* (fig. 273), two pieces of mirror glass (*s* and *s*₁), each placed at an angle of 45° to the horizontal plane as shown in fig. 274. The base of the box consists of a coloured glass (*f*₂), while the lower half of the right lateral wall is filled with the coloured glass plate (*f*₁), and the upper half of the left wall by the coloured glass plate (*f*). The white glass plates (*W*, *W*₁, *W*₂) reflect light through the coloured glasses (fig. 273). The light transmitted from below,

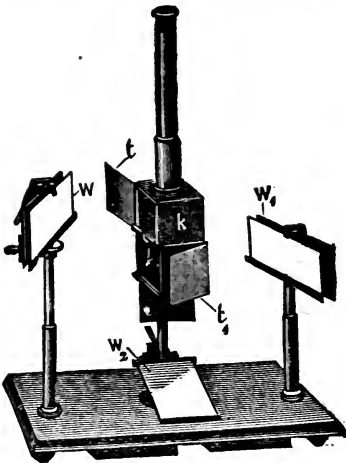

FIG. 273.—Hering's Apparatus for Mixing Coloured Light. *k*. Box; *t*, *t*₁. Lids; *W*, *W*₁, *W*₂. White reflecting surfaces.

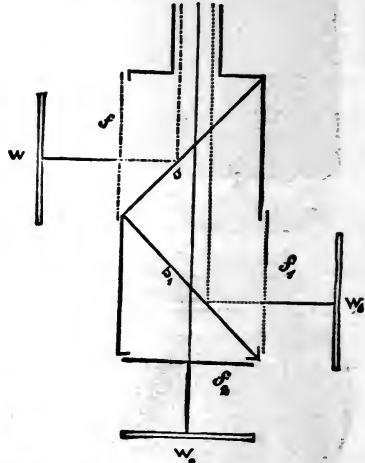

FIG. 274.—Scheme of Fig. 273. *f*, *f*₁, *f*₂. Coloured glasses. *W*, *W*₁, *W*₂. White reflecting surfaces; *s*, *s*₁. Glass plates.

and that from the two sides, is transmitted by a tube to the observer's eye. The brightness can be varied by adjusting the white reflecting surfaces, which are placed opposite a well-lighted window. By means of three small metallic doors (*t*, *t*₁) any one of the colours can be cut off. Thus any combination of coloured lights can be made, as the glasses are movable. The writer has found it best to put the violet or blue lowermost.

3. Mixing Colour Sensations.

(a.) Lambert's Method.—On a black background place a blue wafer or square of blue paper, and 6 or 7 inches behind it a yellow square or wafer. Hold a plate of clear glass vertically, about 10 inches above and midway between the two squares. Look obliquely through the glass, and get the reflected image of

yellow to overlap the blue, seen directly through the glass; where they overlap appears *white*. Hering has arranged a large form of this apparatus suitable for class purposes.

(b.) Arrange on the spindle of the rotating apparatus the disc with coloured sectors provided for you (fig. 275). On rotating the disc rapidly, observe that it appears grey or whitish. The disc is provided with sectors corresponding to the colours of the spectrum, and arranged in varying proportions.

(c.) Arrange three of Clerk-Maxwell's colour discs—red, green, and violet—upon the spindle of the rotating apparatus. Adjust the relative amounts of these three colours, so that on rapidly rotating them they give rise to the sensation of grey or white. Each disc is of a special colour, and has a radial slit from the centre to the circumference. This slit enables a disc of a different colour to be slipped over the other, and thus many discs can be superposed, and the amount of each colour exposed regulated in any desired proportion.

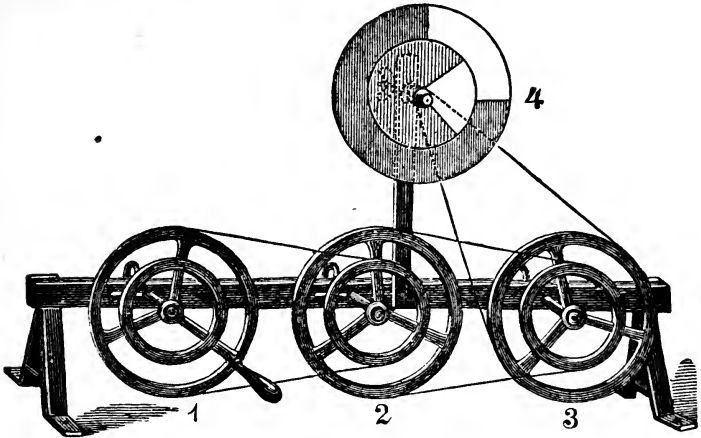

FIG. 275.—Rothe's Rotatory Apparatus for Colour Discs. It is so arranged as to give various rates of rotation by combining the motions of 1, 2, and 3.

(d.) Combine a chrome-yellow disc and a blue one in various proportions, and on rotating, the resultant colour is never green, but a yellowish- or reddish-grey.

(e.) Arrange two coloured discs of vermilion and bluish-green in the proportion of 36 of the former to 64 of the latter. On the same spindle arrange a white and a black disc—with a diameter a little more than half that of the former pair—the white being in the proportion of 21.3 to 78.7 of the black. On rotating, a grey colour is obtained from both sets of discs.

4. To Test Colour-Blindness.—On no account is the person being tested to be asked to name a colour. In a large class of students one is pretty sure to find some who are more or less colour-blind. The common defects are for red and green.

(a.) Place **Holmgren's worsteds** on a white background in a good light. Select, as a test colour, a skein of a light green colour, such as would be obtained by mixing a pure green with white. Ask the examinee to select and pick out from the heap all those skeins which appear to him to be of the same colour, whether of lighter or darker shades. A colour-blind person will select amongst others some of the confusion-colours, *e.g.*, pink, yellow. A coloured plate showing these should be hung up in the laboratory. Any one who selects all the greens and no confusion-colours has normal colour vision. If, however, one or more confusion-colours be selected, proceed as follows:—Select, as a test colour, a skein of pale rose. If the person be red-blind, he will chose blue and violet; if green-blind, grey and green.

(b.) Select a bright red skein. The red-blind will select green and brown: the green-blind picks out reds or lighter brown.

5. Contrast and Simultaneous Contrast.

The following are examples of simultaneous contrast where stimulation of the retino-cerebral apparatus modifies the sensations excited by a different portion of the retina when the compared objects—light or colour—are looked at simultaneously. Contrast phenomena were carefully studied by Chevreul in relation to the effects produced by colours juxtaposed in tapestry in the Gobelin's factory of Paris. Contrast may apply to size, light, colour, and it may be simultaneous or successive.

(a.) Place a small white square or oblong piece of paper or cross on a dull, black surface. Stare steadily at the white square, and observe that the edges appear whiter than the centre; indeed, the centre by contrast may appear greyish. A white strip of paper placed between two black strips, looks white at the margin near the black.

(b.) Look with one eye at the sky through a 1-inch blackened tube, both eyes being open. The field of vision looks much brighter when seen through the tube than is the case with the other eye.

(c.) Place side by side a white and black surface. Cut two oblong ($1\frac{1}{2}'' \times \frac{1}{2}''$) pieces of grey, yellow, or other coloured paper of exactly the same size, and lay one piece of the grey on the white background, and the other on the black. Observe how much brighter the latter looks owing to contrast. Reverse the pieces, and notice that the same result occurs. Repeat with other colours.

(d.) On the rotating machine cause a disc, as in fig. 276, to rotate with moderate rapidity, when several zones will be seen, the innermost black, while each one farther outwards is lighter in tint. Each zone, where it abuts against the inner darker zone, is lighter

than the rest of the same zone, and shades off gradually to the outer part of the zone.

(e.) Take two pieces of different coloured paper (say pale red and pale green) and place them side by side. Fix two similar strips apart from each other and distant from the other two. The two slips juxtaposed differ in colour from the isolated pieces. In the juxtaposed slips the colour of the one influences the colour of the other, *i.e.*, each one looks as if it were mixed with a certain amount of the complementary colour of the juxtaposed slip (*Cleureul*).

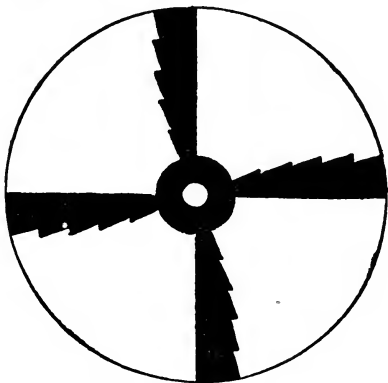

FIG. 276.—Disc for Contrast.

(f.) Place on a table a small sheet ($4'' \times 4''$) of red and one of green paper. Cut out of a sheet of red paper two pieces about 1 inch square, and place them on the two large squares. Observe that the small red square on the green ground appears far brighter and more saturated than the red square on the red ground.

(g.) Cut a small hole (5×5 mm.) in a piece of coloured paper, *e.g.*, red, and look through the hole at a sheet of white paper, the hole appears greenish.

(h.) On a mirror place a slip of transparent coloured glass, *e.g.*, red or green. Hold in front of the coloured glass a narrow strip of white paper; by adjusting the position of the glass in relation to the light, we see two images reflected from the anterior and posterior surface of the mirror; one has the same colour as the coloured glass, while the other or posterior one has the complementary colour; if a red glass be used the latter is green, if a green glass it is red. Hold in front of the red glass a piece of white paper with black printed matter on it. The black print is seen green in the posterior image. Gum a few narrow strips of white paper (1 mm. in diameter) on black paper, and on holding it up in front of the red glass, as before, the anterior image appears in the complementary colour of the glass, *viz.*, green.

(i.) Place four lighted candles in a dark room before a white surface, and push between the candles and the screen towards the centre of the series an opaque screen, *e.g.*, cardboard, with a clean-cut vertical edge. A part of the white surface is illuminated by all four candles, then a vertical area illuminated by three, and so on, and finally a part not illuminated by any of the candles. Each of these areas is throughout its entire extent equally illuminated, yet on the side where each area abuts against a darker area it appears lighter, on the other side darker, and gradually shaded between its outer and inner limits. This is due to the fact that strong stimulation of one part of the retina diminishes the excitability in the other parts, and the parts most affected are those next the excited area. Thus a change in the excitability of one part of the retina is brought about by stimulation of an adjacent part.

(j.) **H. Meyer's Experiments** on simultaneous contrast.

(i.) Cut out a small oblong of white, or preferably of grey, paper, and put it on a large piece of bright green paper (4 inches square); the grey suffers no change. Cover the whole with a thin semi-transparent sheet of tissue paper. The grey oblong appears *pink*.

(ii.) Instead of green paper place the grey slip on red, and cover it as before; a greenish-blue contrast colour is seen.

(iii.) Repeat (a.), but place a red square on a grey ground; the red square will appear greenish.

(iv.) A grey square upon blue appears yellow; a yellow upon blue appears white, when covered with tissue paper.

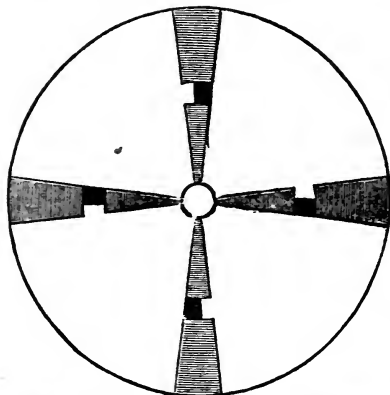

FIG. 277.—Disc for Simultaneous Contrast.

All the above are modifications of H. Meyer's experiment. The tissue paper is used, as contrast colours are far more readily excited by pale than by saturated colours, so that differences of sensation are much greater with weak than with strong stimulation.

(v.) Surround the small square with a broad black line, each square appears in its own colour. The effect of contrast is destroyed.

(k.) Place side by side two strips of paper, green and red (6×3 in.). Over the line of junction place a strip of grey paper ($\frac{1}{4} \times 6$ in.), and cover the whole with tissue paper, as before. The grey appears pink on the green side, and greenish on the red. This contrast is also set aside by running a black margin round the grey strip. Do the same with yellow and blue.

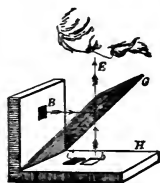

FIG. 278.—Ragona Scina's Experiment.

(l.) Arrange a disc like fig. 277 on the rotating wheel. On a white disc fix four narrow, coloured (e.g., green) sectors, and interrupt each in the middle, as in the figure, with a black and white stripe. On rotating the disc, the ring, which one might expect to be grey from the black and white, appears reddish, i.e., the complementary colour of the greenish ground.

(m.) Place a strip of grey paper on a black background and a corresponding strip on a white ground. The former will appear much lighter, the grey on white much darker. Fix the eyes for a minute on a point midway between the strips; close and cover the eyes. The after-images will show a great difference in luminosity.

(n.) **Ragona Scina's Experiment.**—Two pieces of wood fixed at right angles to each other are covered by white paper, while a coloured sheet of glass is held at an angle of 45° between them (fig. 278), or the apparatus of Hering (fig.

279, may be used. Look vertically through the glass at the horizontal white paper, and observe a pale red tint. Attach a small black square to the centre of the vertical arm at B, the image of this square is seen at *b* as a deep red image. Place a similar black square on the horizontal board at C, it should appear grey; but a grey on a red ground causes contrast, and so one sees a greenish-blue square alongside a red one.

6. Hering's Apparatus for Simultaneous Contrast.

(a.) By means of one or two doubly refractive prisms (fig. 280, P, P) a double image is obtained of narrow strips of coloured paper placed either on a white or a coloured background. If blue be placed on yellow, the double image is bluish, and if yellow be placed on blue, the double image is yellowish (*Pflüger's Archiv*, vol. 47, p. 237).

(b.) The apparatus of Hering (fig. 281) is also useful for simultaneous contrast. Coloured glasses (e.g., blue and red) are placed in P and P', and light is reflected through them by the adjustable white surfaces (W, W'). On looking at a narrow black strip (S) on a white ground, one sees contrast phenomena according to the colours of the glass used.

The white surface in front of the red glass, when looked at with one eye, is red, just as that in front of the blue glass is blue under the same conditions. Focus the eyes for an object nearer than the black strip on the white ground.

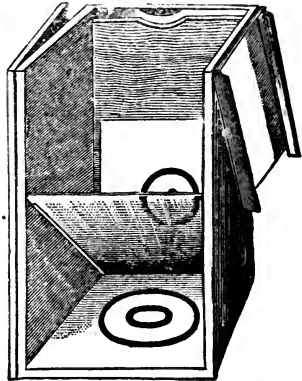

FIG. 279.—Hering's Apparatus for Contrast.



FIG. 280.—Hering's Apparatus for Simultaneous Contrast with Binocular Vision by two Doubly Refractive Prisms, P, P. G. Glass to avoid reflection.

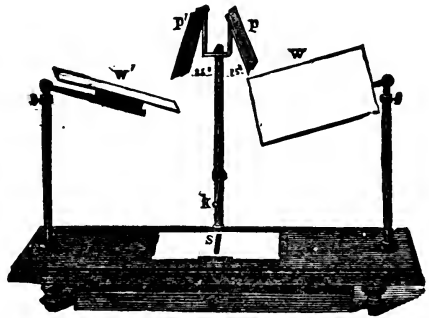

FIG. 281.—Hering's Apparatus for Simultaneous Contrast. P, P'. Coloured glasses; W, W'. White reflectors; S. Black line on white surface.

This is done by looking at a bead (*k*) fixed on the point of a rod (supplied with the instrument), the latter being held between the eyes and the white ground. The black strip seen under these conditions forms a double image, i.e. its image is formed on two non-corresponding parts of the retina. The

two images are in strong contrast, while the two surrounding areas scarcely contrast at all. (Hering's apparatus is made by Rothe, Wenzelbad, Prague.)

There are two theories of contrast, viz., that of Helmholtz, the "psychological theory," and the "physiological theory," of which Hering is the chief supporter. Hering has devised many experiments in support of his contention. The former theory represents contrast as due to an error of judgment. On the physiological theory, Hering supposes that there are material chemical changes in a hypothetical retino-cerebral "vision-stuff" ("Seh-stoff"). These changes may be assimilative (anabolic) (black, blue, green), or dissimilative (katabolic) (white, yellow, red). A change in one area may influence the retino-cerebral apparatus outside the area directly affected by the stimulus.

7. Hering's Experiment on Simultaneous Contrast.

Divide a large quadrilateral sheet of paper vertically into halves, and make one half black and the other white. Near the centre of the vertical division gum two V-shaped pieces of grey paper (one on the black and the other on the white half) with their apices together. The V on the black looks lighter by contrast than that on the white. Fix the V's for a minute, and then look at a uniform surface. Even after the after-image of the back grounds has disappeared, the after-image of the V on the black ground looks darker than that of the V on the light ground. This, Hering contends, must be due to a material change taking place in a localised part of the retino-cerebral apparatus. It seems difficult to explain this result as dependent upon an error of judgment due to the influence of the background. Hering regards this as a fundamental experiment in support of his theory. Similar experiments may be made with coloured papers.

8. Successive Light Induction (Hering).

(a.) Look for one minute at a small white circular disc on a black background, e.g., velvet. Close and cover the eyes. A negative after-image of the disc appears, but it is darker and blacker than the visual area, and it has a peculiar light area round it, brightest close to the disc, and fading away from it.

(b.) Look at two small white square patches of paper placed one-eighth of an inch apart on a black background. On closing the eyes, the black space between them looks brighter than the other three sides of the squares.

(c.) Look at a black strip on a white ground. On closing the eyes there is no partial darkening of the white ground, but only an intensely bright image of the strip.

9. Coloured Shadows.

(a.) Place an opaque vertical rod (1 inch in diam.) in front of a white background. Admit not too bright daylight to cast a shadow of the rod. Place a lighted candle behind one side of the rod, the shadow caused by the yellow-

red light of a candle, and illuminated by the daylight, appears blue, *i.e.*, a purely subjective blue, the complementary colour of the yellow-red light of the candle, which casts a yellow light. The effect is more pronounced the darker both shadows are. To show that the blue is purely subjective, roll up a sheet of black paper—black surface innermost—in the form of a tube about $\frac{1}{4}$ inch or less in diameter. At a distance of 18 inches look at the centre of the blue shadow, and let an observer cut off the light from the candle by means of an opaque screen. On removing the screen no change is visible, but if the tube be directed to the line of junction of the blue shadow, with the illuminated background just beyond it, the blue appears.

(b.) In a window-shutter of a dark room cut two square holes (10 cm.) on the same horizontal plane, and 2 feet apart. In one fix a piece of clear glass to admit ordinary white light, and into the other fit a red or green coloured glass. Both openings must be provided with a movable shutter to regulate the amount of light admitted. At 3-4 feet distance place a rod or flat piece of wood vertically against a white surface. Observe two shadows. Suppose the glass to be red, then the shadow due to the ordinary light is red, that of the red glass is greenish. Substitute for the red light that of a lighted candle. The shadow then appears blue.

10. Choroidal Illumination.

(a.) In a dark room light an ordinary lamp or fan-tailed gas-burner. Place the source of light at the right side, about 2 feet from an open book or sheet of paper. Partly separate the fingers of the left hand and place them over the face, so that different portions of the paper are seen by each eye. That half of the page seen with the right eye has a *greenish* tint, the other part seen with the left eye is red or *pinkish*. Change the source of light to the left side, the colours are reversed.

(b.) With the conditions as in (a.), hold a piece of paper (3-4 cm. wide), or a visiting-card, between the eyes with its flat surface towards the face, the same phenomena are seen.

(c.) Cut in a piece of black cardboard two rectangular holes (4×10 mm.), separated by a distance about equal to that between the pupils, with the conditions as in (a.). Hold the cardboard about 10 inches or more from you, and look through the holes at a white surface; four images of the two holes will be seen; the inner right and outer left images are impressions from the right eye, the inner left and outer right from the left eye. This is easily proved by closing either eye, when the images belonging to that eye disappear. If the source of light be on the right side, the former pair of images is greenish in colour, the latter is pale pink. Change the light to the left side and the colours are reversed (*H. Sewall*). The colour-phenomena occur without the aid of objective colour, and are due to light passing through the sclerotic and choroid coats.

11. Binocular Contrast.

Place a white strip of paper on a black surface, look at the white paper and squint so as to get a double image. In front of the right eye hold a blue glass, and in front of the left one a grey (smoked) glass. The image of the right eye will be blue, that of the left yellow. Instead of the grey glass, a card with a small hole in it placed in front of the left eye does perfectly well. The yellow of the left eye is a contrast sensation.

12. Positive After-Images.

(a.) In a room, not too brightly illuminated, rest the retina by closing the eyes for a minute. Suddenly look for two seconds at a

gas-jet surrounded with a white globe, then close the eyes. An image corresponding to that looked at will be seen.

(b.) Rest the retina by closing the eyes, then look at a gas-flame surrounded with a coloured glass, or look at a gas-flame in which some substance is burned to give a characteristic flame, *e.g.*, common salt. Then look at a white surface, when a positive after-image of the same colour will be seen. In all these cases the image moves as the eye is moved, showing that we have to do with a condition within the eye.

13. Negative After-Images. These are regarded as a sign of retino-cerebral fatigue.—**Successive Contrast.**

(a.) Rest the retina, and then stare steadily for half a minute or less at a small white square or white cross on a black ground. To ensure fixation of the eyeballs, make a small mark in the centre of the white paper, and fix this steadily. Then suddenly slip a sheet of white paper over the whole, a *black* square or cross will appear on the white background. I find that the best black surface to use is the dull black of the "Tuch-papier," such as is used by opticians for lining optical apparatus. Notice also while staring at the white paper that its margins appear much brighter than the centre, owing to contrast.

(b.) The black negative after-image may also be seen by closing the eyes.

(c.) Look at a black square or cross on a white ground. Turn to a grey surface, when a white square or cross will appear.

(d.) Stare intensely at a bright red square on a black surface for twenty seconds, and then look at a white surface: a bluish-green patch on the white is seen. It waxes and wanes, and finally vanishes.

(e.) A green stared at in the same way gives a red, *i.e.*, in each case the complementary colour is obtained as a "negative coloured after-image."

(f.) Place a small red and a small green square side by side on a black background, stare at them, and quickly cover the whole with a sheet of white paper: a greenish-blue after-image will appear in place of the red, and a reddish-purple instead of the green.

These negative after-images are examples of so-called "Successive Contrast."

14. Haploscope ($\acute{\alpha}\pi\lambda\omicron\omicron\varsigma$ —single).

Place the eyeballs in the primary position, *i.e.*, look straight ahead at a hypothetical object on a level with the eyes, but placed at the horizon. The visual axes are parallel, and we have two distinct and separate fields of vision. On looking through two

parallel tubes placed one in front of each eye, one obtains two different retinal pictures. Nevertheless, single vision is the result, and the two different pictures are combined to give an illusory sensation of one object. One gets approximately haploscopic vision with a stereoscope.

Haploscopic vision may be illustrated by vertical lines, parts of circles (Hering, *Hermann's Handbuch d. Physiologie*, iii. p. 355), or by the familiar bird and cage experiment (fig. 282). Hold the figure

close to the eyes, separate the two fields of vision by a card held vertically in the mesial plane between the eyes, and look beyond the picture, *i.e.*,

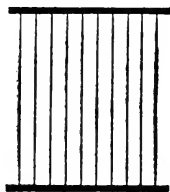

FIG. 282.—To illustrate Haploscopic Vision.

allow the eyeballs gradually to diverge from the point of convergence. On doing so, as the visual axes become less convergent, one has on the right visual field a bird, on the left a cage,—the bird appears to move into the cage, and in consciousness we have the illusion as if the bird were in the cage.

15. Stereoscope.

(a.) Examine a series of stereoscopic slides to show the combination of the images obtained by the right and left eyes respectively.

(b.) **Struggle of the Fields of Vision.**—Place in a stereoscope a slide of glass with vertical lines ruled on one half of it and horizontal lines on the other half. Look at the two dissimilar images; note that they are not combined, but sometimes one sees it may be only the horizontal, at another only the vertical lines. It may be done also with coloured slides.

(c.) **Lustre.**—Use a stereoscopic slide, preferably a geometrical pattern, *e.g.*, a crystal where the boundary-lines are white and the surfaces black. Such a slide shows glance or lustre.

16. Lustre in Coloured Objects.

This may be shown by looking at a green patch (electric green) on a red ground through coloured glass, *e.g.*, a blue glass before one eye and a red one before the other eye. Other combinations may be made.

17. Stereoscopy Dependent on Differences of Colour.

(a.) Difference of colour may be the cause of an apparent difference in distance. If one looks from a distance of 3 metres at red and blue letters (8 × 4 cm.) on a black background, to most observers the red appears nearer than the blue. It is usual to explain this by difference of accommodation, more effort being required to focus for the red letters than for the blue; and

hence the red is regarded as nearer. This is not a sufficient explanation, as many see the blue nearer than the red. The apparent difference disappears on closure of one eye, but on opening the other eye, the difference of distance asserts itself. Is this due to stereoscopy? Einthoven supposes that it is. (Einthoven, "On the Production of Shadow and Perspective Effects by Difference of Colour," *Brain*, 1893, p. 191.)

(b.) Brücke showed that the retinal images of differently coloured points are shifted with respect to one another. Fix on a black background a narrow vertical strip of paper, the upper and lower thirds being red and the middle third blue. On looking at the strip with one eye the blue part deviates to one side and the red to the other side. "By covering either eye alternately a deviation of the red and blue parts in opposite directions will be observed; and on both eyes being used, the notion of a difference in distance is proved by the combination of the two images in such a way that the parts that deviate to the nasal-side constitute the nearer image, the parts that deviate to the temporal side, the further image." Einthoven finds that the stereoscopic effect is more marked with the coloured letters.

(c.) The relative removal of the differently coloured images is due to the excentricity of the pupil. The pupils may be made highly excentric by covering them partially. With a nasal excentric pupil (*i.e.*, covered on the temporal side) a shifting of the differently coloured images in one direction will be observed; with a temporal excentric pupil (*i.e.*, nasal side covered) the shifting will be in the other direction.

Let any one who sees the red letters before the blue "cover his pupils symmetrically on the temporal side, the red letters retreat and soon appear to be behind the blue. On covering the pupils symmetrically on the nasal side, the red letters come forward more and more."

The bearing of these experiments is fully discussed by Einthoven in the paper already referred to.

17. Benham's Spectrum Top.

(a.) A cardboard circular disc, about 4 inches in diameter, is made with one half black and the other half white. On the white are a number of arcs of concentric circles of different radius. On rotating this disc, coloured lines are seen whose order is reversed when the disc is made to rotate in an opposite direction. The experiment is best performed by artificial light.

(b.) Modification by Hurst.

On a circular disc, 4 or 5 inches in diameter, half white and half black, draw in black on the white half and in white on the black half arcs of various lengths and thicknesses. as, for instance, the arcs shown in fig. 283. Mount the disc on a peg and spin it. The arcs appear as circles of various colours, the colour of each depending on its position and length, on the velocity of rotation, and on the kind and intensity of illumination. The two outermost lines on the disc figured when the disc is turned to the left and seen in very bright lamp-light appear purple-grey, becoming, as the rotation becomes slower, brighter and redder, and then in succession bright crimson, scarlet, and orange-vermilion. By very bright direct sunlight the earlier shades are brighter than the later ones, the colour being at first usually a very pure blue. When the disc is turned to the right, the colours are in succession dark green, indigo fringed with pale blue, black, by lamplight, while by bright sunlight the colour is first dull red, then brown, and finally dark blue. They appear, however, very different to different observers.

The colours of the white lines are almost entirely yellow, orange-pink, puce, and "electric blue."

If, instead of arcs of circles, a spiral-line is drawn as in fig. 284, the disc exhibits, when spun at a suitable speed, a broad band of colour, consisting of

a complete series of all the colours of the spectrum in their normal order, red being on the outer and violet on the inner side of the band when the disc is turned to the left, and in the reverse order when it is turned to the right. The purity of the colours seen depends very greatly on the light used. With bright daylight no trace of a spectrum is seen, but a series of colours ranging from purple through brown to green, or other series according to intensity of light and velocity of rotation. Even under the best conditions, namely, bright lamp-light, slow rotation, and the eyes too fatigued to follow the line round or sufficiently practised to remain motionless, the colours are not all brightest at the same moment. The violet has merged into black before the rotation has become slow enough to give the brightest red and orange.

Beyond the limits of the spectrum-coloured band are two fringes, a purple or violet one beyond the red, and luminous pale blue on the violet side. These

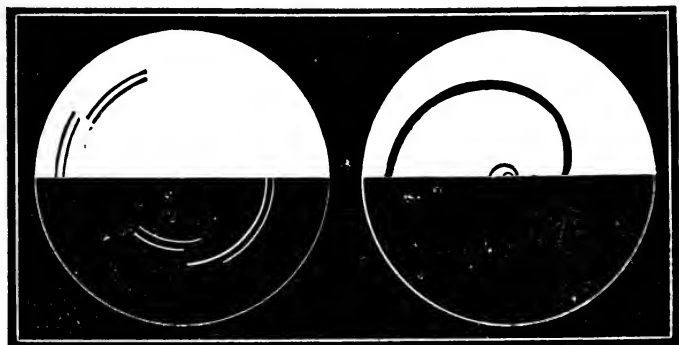

FIGS. 283 and 284.—Modifications of Discs for Benham's Spectrum Top (*Hurst*).

fringes, as well as the spectral band, change somewhat in colour as the speed of rotation changes.

The spiral is most easily drawn with a brush full of black paint, by drawing it lightly across a rotating *white* disc while the disc is spinning. A suitable portion of the curve is chosen and the other half of the disc is blacked. Dull black paint, such as water-colour "lamp-black," is best.

A very different colour-band is produced by a similarly shaped spiral curve of white drawn on the black half of the disc. The colours are "electric" blue, pink, yellow, the blue being outermost when the disc is spun to the left. Spirals of various "itches" may be used, the line itself being not more than one-fifth of the breadth of the space between two successive turns of the spiral. —(*Communicated by C. Herbert Hurst, Ph.D.*)

The appearances presented when the tops are viewed in monochromatic light are quite as surprising as those described above (see Abney, *Nature*, vol. 51, p. 292, 1895).

18. Anaglyph.

The pictures of one object are printed on one card in different colours, say pale red and blue. The two pictures are slightly displaced relative to each other. On looking at the picture through a blue and a red glass, *i.e.*, a blue glass in front of one eye, and a red one in front of the other, one sees a nearly colourless object, but the whole is stereoscopic.

LESSON LXXV.

OPHTHALMOSCOPE—INTRAOCULAR PRESSURE—
FICK'S OPHTHALMOTONOMETER.

The Ophthalmoscope.—Two methods are employed, and the student must familiarise himself with both, by examining the eye of another person, or that of a rabbit, or an artificial eye.

1. Direct—giving an upright image.
2. Indirect—giving an inverted image.

A. Human Eye.—(1.) Direct Method.

(a.) About twenty minutes before the examination is commenced, instil a drop of solution of sulphate of atropine (2 grains to the ounce of water) into, say, the *right* eye of a person with normal vision. The pupil is dilated and accommodation for near objects is paralysed, owing to the paralysis of the ciliary muscle. The patient is seated in a darkened room, and the observer seats himself in front of him, and on a slightly higher level. Place a brilliant light, obscured everywhere except in front, on a level with the left eye of the patient.

(b.) The observer takes the ophthalmoscope mirror in his right hand, resting its upper edge upon his eyebrow, holds it in front of his own eye, looking through the central hole in it, and directs a beam of light into the observed eye, when a red glare—the reflex—is observed. The patient is told to look upwards and inwards, which is conveniently accomplished by telling him to look to the little finger of the operator's right hand. The operator then moves the mirror, with his eye still behind it, and looks through the hole until the mirror is within *two to three inches* from the observed eye, taking care all the time that the beam of light is kept steadily thrown into the eye. If the eyes of the observer and patient be normal, the observer has simply to relax his accommodation, *i.e.*, look as it were at a distant object, when the retina comes into view as an erect or upright object.

(c.) Observe the *retinal blood-vessels* running in different directions on a red ground. Move the mirror about to find the *optic disc*, with the central artery emerging from it. Trace the course of the veins accompanying the arteries across the disc.

(2.) The Indirect Method, giving an inverted image.

(a.) The patient, the light, and the observer are as before.

The observer places himself about 20 to 18 inches from the patient, and, holding the mirror in his right hand, by means of it throws a beam of light into the eye of the patient. When the eye is illuminated, he takes a small biconvex lens of 2 to 3 inches focus in his unemployed hand—the left in this case—holding it between his thumb and index-finger, placing it vertically 2 or 3 inches from the observed eye. To ensure that the lens is held steadily, rest the little finger upon the temple or forehead of the patient. Keep the lens steady, and move the mirror until the optic disc is seen, with the details already described.

In the direct method only a small part of the retina is seen at one time, but it is considerably magnified; while by the indirect method, although more of the retina is seen at once, it is magnified only slightly.

If the observed or observer's eye is abnormal, suitable glasses to be fixed behind the mirror are supplied with every ophthalmoscope. In some forms of ophthalmoscope, such as that of Gowers and others, these lenses (convex +, and concave -) are fixed to a rotating disc behind the mirror. As the disc is rotated, lens after lens can be brought to lie exactly behind the hole in the mirror, and thus correct any anomaly of refraction.

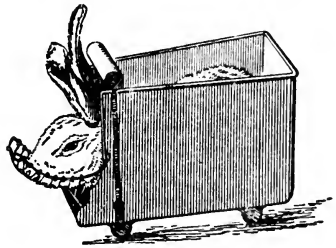

FIG. 285.—Carriage for Rabbit.

3. Eye of a Living Rabbit.

Instil atropine as before, or use an atropinised gelatine disc to effect the same result. Place the rabbit in a suitable cage to keep it from moving. A suitable one was devised by Michel; use it (fig. 285). Examine the eye by the direct and indirect methods. *N.B.*—If an albino rabbit be used the observer sees the large choroidal vessels.

4. Perrin's Artificial Eye.

Use this until a clear image of the fundus is obtained by both methods. In fact, it is well for the student to begin with this. In this model, eye-caps to fit on to the eye are supplied, so as to render the eye-model either myopic or hypermetropic. Afterwards test these, and use the necessary lenses behind the mirror to correct these errors in the shape of the eyeball.

Frost's artificial eye, as made by Curry and Paxton, is also useful, as is also that of Priestley Smith.

5. Kühne's Method.—If an artificial eye is not at hand, a very suitable arrangement is that devised by Kühne. Paint a disc to resemble the normal fundus when it is seen with the ophthalmo-

scope. Remove the eye-piece—long one—from an ordinary microscope. Screw out the lower lens of the eye-piece, fix in the painted disc, and block up the lower aperture with a piece of cork. Fix the eye-piece in a suitable holder, and use it instead of an eye to be examined.

6. Demonstrating Ophthalmoscope (*Priestley Smith*).

The general arrangement of this instrument is shown in fig. 286. At one end of the horizontal bar is a chin support for the patient; at the other a perforated glass mirror, capable of steady adjustment to any position. The transverse arm near to the mirror carries a candle, provided with a light metal screen on either side of it; one of these hides the candle from the patient, the other hides it from the observer, and enables him at any moment to cut off the light from the mirror, and thus to protect the patient's eye from unneces-

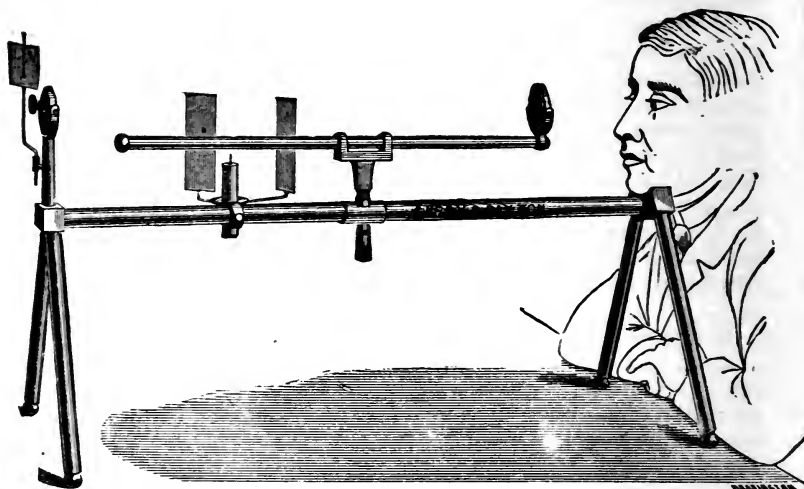

FIG. 286. —Demonstrating Ophthalmoscope. Made by Pickard and Curry. Cost, £3, 10s.

sary illumination without disturbing the adjustment of the instrument. A wire placed in the pillar of the mirror, and movable to either side, carries a piece of white paper, which serves as a fixation point for the patient's eye. At the middle point of the horizontal bar is a jointed support carrying a light rod, one end of which is held in the hand of the observer, while the other holds the lens. By means of this rod the observer can place the lens in any desired position in relation to the patient's eye.

- (1.) Arrange the instrument as in fig. 286.
- (2.) Adjust the patient's seat so as to bring his chin comfortably on the support; let him rest his arms upon the table.
- (3.) Place the rod quite horizontal, and then raise or lower the central support until the centre of the lens is on a level with the patient's pupil.
- (4.) Push the lens to one side and adjust the mirror so as to throw the light

upon the patient's eye, telling him to look, *not at the mirror*, but at the paper placed upon the wire. The paper must be on the opposite side to the eye.

(5.) Take the rod in the hand and adjust the position of the lens so as to bring the optic disc into view.

(6.) In changing places with another observer, cut off the light from the mirror by means of the candle-screen.

7. Intraocular Pressure.—Fick's Ophthalmotonometer.

This instrument is extensively used in German eye-hospitals, and consists of a small brass plate (6 mm. diameter), which is attached by means of a metallic spring to a base, which also carries a scale which indicates the amount of pressure applied. One presses the disc of the instrument against the eyeball until it flattens the part to which it is applied, when the pressure is read off in grammes. The experiment may be done first on a rabbit, as most of them remain quite passive. Place a person with his left shoulder next the window, ask him to turn his eyeballs to the right and open his eyelids, whereby sufficient of the eyeball is made visible for the application of the instrument.

8. The Pupil.—Normally the pupil in man, rabbits, and other animals is black, but in albinos it is reddish. Why?

(1.) Select an albino rabbit, and exactly in front of its pupil hold up a black card with a hole in it the size of the pupil. Direct the pupil to the light, and arrange the shade so that all light is kept from the eye except that which enters it by the pupil. The albino pupil then appears black.

This shows that the blackness of the pupils is not due to the light entering the eyeball being absorbed by the pigment of the fundus of the eye, but that light entering the eye can only emerge by the pupil when the iris and the neighbouring parts of the choroid, in virtue of their pigmentation, do not permit light to pass through them. The construction of the dioptric apparatus of the eye is such that light from the fundus of the eye must be reflected back to the source from which it came, *i.e.*, to the focus. As we emit no light from our eye none can come to us from the observed eye, so we see the pupil black because we do not illuminate the fundus with our body (*Schenk*).

LESSON LXXVI.

TOUCH—SMELL—TASTE—HEARING.

1. Touch—The Sense of Locality.

(a.) Ask a person to shut his eyes, touch some part of his body with a pin, and ask him to indicate the part touched.

(b.) *Æsthesiometer*.—Use a small pair of wooden compasses, or an ordinary pair of dividers with their points guarded by a small piece of cork, or Sieveking's *Æsthesiometer*. Apply lightly the points of the compasses simultaneously to different parts of the body, and ascertain at what distance apart the points are felt as two. The following is the order of sensibility:—Tip of tongue

(1.1 mm.), tip of the middle finger (2.3), palm (8 to 9), forehead (22), back of hand (31.6), back (66).

(c.) Test as in (b.) the skin of the arm, beginning at the shoulder and passing downwards. Observe that the sensibility is greater as one tests towards the fingers, and also in the transverse than in the long axis of the limb. In all cases compare the results obtained on both sides of the body.

(d.) By means of a spray-producer spray the back of the hand with ether, and observe how the sensibility is abolished.

(e.) V. Frey's Method.—A hair of the head or beard (20–40 mm. long) is fixed to a wooden match. On pressing the point of the hair against the skin it may or may not be felt as a tactile sensation. This depends on the pressure exerted on the hair, and this in turn on the sectional area and stiffness of the hair itself. One can measure the pressure exerted by pressing the hair on a balance and from the sectional area of the hair deduce the pressure per sq. mm. According to v. Frey the sensibility of the cornea and conjunctiva is distributed in a punctiform manner, insensible areas existing between: pain alone, according to v. Frey, being experienced from stimulation of the cornea with the exception of its margin and the teeth, or rather the dentine and pulp. (V. Frey, "Beiträge z. Physiologie d. Schmerzsinns," and "Beit. z. Sinnesphysiologie d. Haut," *Bericht. a. d. math.-phys. Classe d. Königl. Sächs. Gesell. d. Wissen.* Leipzig, Dec. 1894, and March 1895. Criticism by Nagel, *Pflüger's Archiv*, Bd. 59, p. 563, 1895.)

(f.) Illusions—Aristotle's Experiment.—Cross the middle over the index-finger, as in fig. 287, roll a small ball between the fingers; one has a distinct impression of two balls. Or, cross the fingers in the same way, and rub them against the point of the nose. The same illusion is experienced.



FIG. 287.

2. The Sense of Temperature.

(a.) Ask the person experimented on to close his eyes. Use two test-tubes, one filled with cold and the other with hot water, or two spoons, one hot and one cold. Apply one or other to different parts of the surface, and ask the person to say whether the touching body is hot or cold. Test roughly the sensibility of different parts of the body with cold and warm metallic-pointed rods.

(b.) Touch fur, wood, and metal. The metal feels coldest, although all the objects are at the same temperature.

(c.) Plunge the hand into water at 36° C. One experiences a feeling of heat. Then plunge it into water at 30° C., at first it feels cold, because heat is abstracted from the hand. Plunge the other hand direct into water at 30° C. without previously placing it in water at 36° C., it will feel pleasantly warm.

(*d.*) Hold one hand for a time in water at 10° C., and afterwards place it in water at 20° C., at first the latter causes a sensation of heat, which soon gives place to that of cold.

(*e.*) Test with the finger the acuteness of the sense of temperature, *i.e.*, in two given fluids of different temperatures, what fraction of a degree C. can be distinguished. One can usually distinguish $\frac{2}{3}^{\circ}$, although the acuteness is greater when the fluids are about 30° C.

(*f.*) Use two brass tubes (5 cm. long and 1 cm. in diam.), terminating in a point. Cover both, all except the point, with india-rubber tubing. Fill one with warm water and the other with cold. Test the position of the warm and cold points on another person on various parts of the skin.

(*g.*) Warm and Cold Spots.

With a blunt metallic point touch different parts of the skin. Certain points excite the sensation of warmth, others of cold, although the temperatures of the skin and the instrument remain constant. Map the position of the cold and hot spots by means of different colours.

3. Sense of Pressure.

(*a.*) Rest the back of the hand on a table, cover a small area of the palm with a non-conducting material, *e.g.*, a wooden disc. On the latter place different weights. Estimate the smallest difference of weight which can be appreciated.

(*b.*) Dip the hand or a finger into mercury. The greatest sensation is felt at the plane of the fluid in the form of a ring, but even this is best felt on moving the hand up and down.

4. Peripheral Projection.

(*a.*) Press the ulnar nerve at the elbow, the prickling feeling is referred to the skin on the ulnar side of the hand.

(*b.*) Dip the elbow in ice-cold water; at first one feels the sensation of cold owing to the effect on the cutaneous nerve-endings. Afterwards, when the trunk of the ulnar nerve is affected, the pain is felt in the skin of the ulnar side of the hand where the nerve terminates.

5. Reference of Tactile Impressions to the Exterior.—Generally speaking, the sensation of touch is referred to our cutaneous surfaces. In certain cases, however, it is referred even beyond this.

(*a.*) Holding firmly in one hand a cane or a pencil, touch an object therewith; the sensation is referred to the extremity of the cane or pencil.

(*b.*) If, however, the cane or pencil be held loosely in one's hand, one experiences two sensations, one corresponding to the object touched, and the other due to the contact of the rod with the skin. The process of mastication affords a good example of the reference of sensations to and beyond the periphery of the body.

6. Sense of Contact.

Touch your forehead with your forefinger, the finger appears to feel the contact; but on rubbing the forefinger, or any other digit, rapidly over the forehead, it is the latter which is interpreted as "feeling" the finger.

7. Weber's Circles.

Cut short lengths from glass tubing of various sizes, varying from a quarter of an inch to two inches or more in diameter, and provide glass vessels of similar size, each with a glass base. Press the smaller circles and corresponding size of vessel on the cheek and forehead and the larger ones on the thorax or abdomen. It is impossible when the eyes are shut to determine whether a closed or open vessel is pressed on the skin. The size of the vessel to obtain this result varies with the cutaneous surface experimented on.

8. Illusions.

(a.) Place a thin disc of *cold* lead the size of a florin on the forehead of a person whose eyes are closed, remove the disc, and on the same spot place two warm discs of equal size. The person will judge the latter to be about the same weight, or lighter, than the single cold disc.

(b.) Compare two similar wooden discs, and let the diameter of one be slightly greater than that of the other. Heat the smaller one to over 50° C., and it will be judged heavier than the larger cold one.

(c.) Lay on different parts of the skin a small square piece of paper with a small central hole in it. Let the person close his eyes, while another person gently touches the uncovered piece of skin with cotton wool, or brings near it a hot body. In each case ask the observed person to distinguish between them. He will always succeed on the volar side of the hand, but occasionally fail on the dorsal surface of the hand, the extensor surface of the arm, and very frequently on the skin of the back.

(d.) Estimation of the distance of two neighbouring parts depends on the size of the sensory circles. If the points of a pair of compasses about 1 cm. apart are placed on the skin in front of the ear and moved towards the lips, the points feel as if they diverged.

9. The Muscular Sense.

(a.) With the arm and hand unsupported, the eyelids closed, and the same precautions as in 3 (a.), determine the smallest difference which can be perceived between two weights. It will be less than in cartridges filled with a known weight of shot, and tested by the pressure-sense alone. The cartridges, e.g., 100 grms., are numbered, and they are so made as to have a small increasing increment of weight. They are alike in external appearance.

(b.) Take two equal iron or lead weights, heat one and leave the other cold. The cold one will feel the heavier.

10. Taste and Smell.—Prepare a strong solution of sulphate of quinine, with the aid of a little sulphuric acid to dissolve it (*bitter*),

a 5 per cent. solution of sugar (*sweet*), a 10 per cent. solution of common salt (*saline*), and a 1 per cent. solution of acetic acid (*acid*).

(a.) Wipe the tongue dry, lay on its tip a crystal of sugar. It is not tasted until it is dissolved.

(b.) Apply a crystal of sugar to the tip and another to the back of the tongue. The sweet taste is more pronounced at the tip.

(c.) Repeat the process with sulphate of quinine in solution. It is scarcely tasted on the tip, but is tasted immediately on the back part of the tongue.

(d.) Test where salines and acids are tasted most acutely.

(e.) Connect two zinc terminals with a large Grove's battery, apply them to the upper and under surface of the tongue, and pass a constant current through the tongue. An acid taste will be felt at the positive, and an alkaline one at the negative pole.

(f.) Close the nostrils, shut the eyes, and attempt to distinguish by taste alone between an apple and a potato.

(g.) *Gymnema Sylvestre*.—Use a 5 p.c. decoction of the leaves and apply it to limited areas of the tongue by means of a camel-hair pencil. In 20-30 seconds wash out the mouth and then test the action of glycerin (5-10 p.c.), quinine (1 p.c. with .01 p.c. of H_2SO_4), H_2SO_4 (.05 p.c.), NaCl (.5 p.c.).

The sweet and bitter tastes are readily prevented in all regions; but acid and saline tastes are not influenced (L. E. Shore, "A Contribution to our Knowledge of Taste Sensations," *Journ. of Phys.*, xiii. p. 191). It has no effect on tactile sensations.

11. Ear. Hearing.

(a.) Hold a ticking watch between your teeth, or touch the upper incisors with a vibrating tuning-fork, close both ears, and observe that the ticking is heard louder. Unstop one ear, and observe that the ticking is heard loudest in the stopped ear.

(b.) Hold a vibrating tuning-fork on the incisor teeth until you cannot hear it sounding. Close one or both ears and you will hear it.

(c.) Listen to a ticking watch or a tuning-fork kept vibrating electrically. Close the mouth and nostrils, and take either a deep inspiration or deep expiration so as to alter the tension of the air in the tympanum; in both cases the sound is diminished.

(d.) Connect two telephones in circuit with a vibrating Neef's hammer of an induction machine, and place a telephone to each ear; one hears the sound as if it came from within one's own head in the vertical median plane.

(e.) With a blindfolded person test his sense of the direction of sound, e.g., by clicking two coins together. It is very imperfect. Let a person press both auricles against the side of the head, and hold both hands vertically in front of each meatus. On a person

making a sound in front, the observed person will refer it to a position behind him.

(*f.*) Test the highest audible sound by means of Galton's whistle.

12. Dissection of the Middle Ear.—It is most important for the student to do this. Use the head of a sheep. Remove the lower jaw, expose the temporal bulla. Open this and thus reach the tympanic cavity, when the various structures situated in the middle ear are readily brought into view.

13. Influence of Excitation of one Sense-Organ on the other Sense-Organs.—Urbantschitsch has made a large number of experiments on this subject.

(*a.*) Small coloured patches whose shape and colour are not distinctly visible may become so when a tuning-fork is kept vibrating near the ears. In other individuals the visual impressions are diminished by the same process.

(*b.*) On listening to the ticking of a watch, the ticking sounds feebler or stronger on looking at a source of light through glasses of different colours.

(*c.*) If the finger be placed in cold or warm water the temperature appears to rise when a red glass is held in front of the eyes.

APPENDIX.

I.

SOME WORKS USEFUL IN THE LABORATORY.

R. Gscheidlen, Physiologische Methodik, 1876 (incomplete).—**E. Cyon**, Methodik der physiologischen Experimente u. Vivisektionen, with Atlas, 1876 (only one part issued).—**Ott**, The Actions of Medicines, Phil., 1878.—**Claude Bernard and Huette**, Précis iconographique de médecine opératoire et d'anatomie chirurgicale, with 113 plates, 1873; also Leçons de physiologie opératoire (edited by Duval), Paris, 1879.—**Sanderson, Foster, Klein, and Brunton**, Handbook for the Physiological Laboratory (Text and Atlas). The French edition contains additional matter. — **Meade-Smith**, Trans. of Hermann's Toxicol.—**J. Burdon-Sanderson**, Practical Exercises in Physiology, London, 1882.—**Foster and Langley**, Pract. Phys., London, 1884.—**B. Stewart and Gee**, Pract. Physics. — **Vierordt**, Anat. Physiol. u. Physik. Daten u. Tabellen, Jena, 1888.—**Müller-Pouillet**, Lehrb. d. Physik., 8th ed., Braunschweig.—**Wüllner**, Lehrb. d. exp. Physik.—**Livon**, Manuel de Vivisect., Paris, 1882.—**Harris and Power**, Manual for the Phys. Lab., 5th ed., 1892.—**Straus-Durckheim**, Anat. descrip. comp. du chat, Paris, 1845.—**W. Krause**, Die Anatomie des Kaninchens, Leipzig, 2nd ed., 1883.—**A. Ecker**, Die Anatomie des Frosches, 1864—1882, 2nd ed., pt. i., 1888.—**Biolog. Memoirs**, edited by **Burdon-Sanderson**.—**Helmholtz**, Physiol. Optik, 2nd ed.—**Hermann**, Handbuch der Physiologie (by various authors).—**Gad**, Real-Lexikon d. Med. Propädeutik, Wien, 1893 (not yet completed).—**L. Fredericq**, Manipulations de Physiologie, 1892.—**Langendorff**, Physiol. Graphik.—**Gotch**, Practical Exercises in Physiology.—**Halliburton**, Syllabus of Experimental Lessons, 1893.—**Schenck**, Physiologisches Practicum, Stuttgart, 1895.—**W. Biedermann**, Elektrophysiologie, Jena, 1895 (a most useful work, chiefly dealing with Muscle and Nerve).—**Richet**, Dictionnaire de Physiologie, vol. i., Paris, 1895.

The above list takes no account of the various Physiological Journals.

II.

SOME WORKS OF REFERENCE ON CHEMICAL
PHYSIOLOGY.

Hoppe-Seyler, *Physiologische Chemie*, Berlin, 1892-94. — **Lehmann**, *Lehrb. d. phys. Chem.*, 3rd edit., Leipzig, 1853; and *Handbuch*, 1859. — **Leo**, *Liebermann, Grundzüge der Chemie des Menschen*, Stuttgart, 1880. — **Robin and Verdeil**, *Traité de chem. anat. et phys.* (with Atlas), Paris, 1853. This Atlas contains beautiful plates with figures, many coloured, of all the most important organic crystalline bodies. — **A. Wynter Blyth**, *Foods*, 1887. — **Gorup-Besanez**, *Anleitung zur Zoo-chemischen Analyse*, 1871. — **Gautier**, *Chimie appliqué à la Physiologie*, 1874. — **Lehmann's Phys. Chem.** (translated by Cavendish Soc., 1851-1854), with Atlas of O. Funke's plates. These plates contain some histological figures, and many coloured plates of blood-crystals, deposits in urine, &c. — **Kingzett**, *Animal Chem.*, 1878. — **Thudichum**, *Ann. of Chem. Med.*, 1879. — **A. Gamgee**, *Physiological Chemistry of the Animal Body*, vol. i., 1880; vol. ii., *Chemistry of Digestion*, 1893. — **Hoppe-Seyler**, *Medicinische Chemische Untersuchungen*, Berlin. This contains a number of special memoirs by the pupils of the author. — **Hoppe-Seyler**, *Zeitschrift für physiologische Chemie*, Strassburg, 1877, and continued until the present. — **Watts' Dictionary of Chemistry**, second supplement, London, 1875. — **Ralfe**, *Clinical Chemistry*, London, 1880; and *Clinical Chem.*, 1883. — **Wurtz**, *Traité de chim. biol.*, Paris, 1880. — **Parkes' Hygiene**, 7th edit. — **T. C. Charles**, *Physiological and Pathological Chemistry*, London, 1884. — **Maly's Jahresb. ii. Thierchemie**. This gives a *résumé* of the most important memoirs published during the year. — **Articles in Hermann's Handbuch d. Physiologie**, 1879-1884, and the various Text-books on Organic Chemistry. — **Roscoe and Schorlemmer**, (*Organic*) *Chem.*, 1884-1889. — **Beilstein**, *Handb. d. organ. Chem.* — **Krukenberg**, *Grundriss d. med. chem. Analyse*, 1884. — **MacMunn**, *The Spectroscope in Medicine*, 1880; *Clinical Chemistry*, 1890. — **Drechsel**, *Anleit. z. Darstell. phys. Chem. Präparate*, 1889. — **Ladenburg**, *Handwörterbuch d. Chemie*. This consists of special articles, and is on the plan of **Watts' Dictionary of Chemistry**. — **Kossel**, *Leitfaden für med. chem. Course*, 1889. — **Röhmnn**, *Anleitung z. chem. Arbeiten*, 1890. — **Landolt**, *Das optisches Drehungsvermögen* is the standard work on polariscopic methods. — **MacMunn**, on the Spectroscope. This work has good lithographed and coloured spectra. — **Tollens**, *Handbuch d. Kohlenhydrate*, Breslau, 1883. This is the best work on the Carbohydrates. — **Sutton**, *Volumetric Analysis*. This work gives all the most important methods for this process. — **Bunge**, *Phys. and Path. Chem.*, trans. by **Wooldridge**, 1890, 4th German ed., 1894. — **V. Jaksch**, *Clinical Diagnosis*, trans. by **Cagney**, 2nd ed. — **Halliburton**, *Chemical Phys. and Path.*, 1891. — **Hammarsten**, *Lehrb. d. Physiol. Chem.*, 2nd ed., Wiesbaden, 1891. —

S. Lea, *The Chemical Basis of the Animal Body*, 1892.—**Salkowski**, *Practicum d. phys. u. path. Chemie*, Berlin, 1893.—**Armand Gautier**, *Cours de Chemie*; *Chimie Biologique*, vol. iii., Paris, 1892.—**Hempel**, *Gas Analyse*, translated by L. M. Dennis.—**Neumeister**, *Lehrb. d. phys. Chem.*, pt. i., 1892.—**Chittenden**, *Digestive Proteolysis*, New Haven, Conn., 1895.

The literature on the "Urine" is necessarily very large, and may readily be obtained on consulting any of the standard works on that subject.

The following are the CHIEF JOURNALS AND PERIODICALS containing physiological literature.

Proceedings and Transactions of the Royal Society.

Journal of Anatomy and Physiology (Humphry, Turner & M'Kendrick) from 1868.

The Journal of Physiology (Foster, and presently Langley) since 1878.

Archiv für Anatomie und Physiologie (Müller 1834-1858, du Bois-Reymond) from 1859.

Zeitschrift für Biologie (Kühne & Voit from 1865).

Archiv für die gesammte Physiologie (Pflüger from 1868).

Archiv für path. Anat. und Physiologie (Virchow from 1847).

Archiv für exp. Path. und Pharmacologie (Naunyn & Schmiedeberg from 1873).

Skandinavisches Archiv für Physiologie (Holmgren from 1889).

Zeitschrift für Physiol. Chemie (Hoppe-Seyler from 1877).

Sitzungsberichte der. Acad. d. Wissenschaften, of Berlin from 1836, of Vienna from 1848.

Ludwig's Arbeiten Leipzig from 1866-1877 (continued in du Bois Archiv from 1877).

Comptes rendus de l' Acad. des Sciences from 1835.

Comptes rendus de la Société de Biologie from 1850.

Berichte d. deutsch. chem. Gesellschaft.

Journal de la Physiologie (Brown-Séguard from 1858-1863).

Archives de Physiologie (formerly Brown-Séguard, now Bouchard, Chauveaux & Marey) from 1868.

Journal de l'Anat. et de la Physiol. (Robin, Pouchet, now Mathias Duval) from 1864.

Archives Italiennes de Biologie (Mosso from 1882).

GENERAL REFERENCES AND ABSTRACTS.

Schmidt's *Jahrbucher* (from 1834). Canstadt's *Jahresbericht*; Hoffmann & Schwalbe's *Jahresbericht* (from 1873, now by Hermann). Maly's *Jahresbericht ü. d. Fortschritte d. Thier Chemie* (chiefly physiological chemistry). Hayem, *Revue des Sciences medicales*. Reports of the Chemical Society.

CARBOHYDRATES

		Solubility.	Relation to Iodo-iodide of Potassium Solution.	Rotation $[\alpha]$ D.
Polysaccharides. ($C_6H_{10}O_5$) _n Colloid.	Cellulose.	Insoluble in water, dilute acids, and alkalies; soluble in ammonio-oxide of copper.	After treatment with H_2SO_4 . Blue.	
	Starch.	Swells up in water, dissolves in warm water.	Blue.	+ 197
	Glycogen.	Soluble in water, opalescent.	Brown or port wine.	+ 211
	Dextrin.	} Readily soluble in water; soluble with difficulty in strong alcohol.	Brown.	+ 174.5
Disaccharides or Saccharoses. $C_{12}H_{22}O_{11}$.	Cane-Sugar. $C_{12}H_{22}O_{11}$.		} Uncoloured	+ 66.5
	Milk-Sugar. $C_{12}H_{22}O_{11} + H_2O$.			+ 52.53 Birotaion.
	Maltose. $C_{12}H_{22}O_{11} + H_2O$.			+ 140 Half-rotation.
Monosaccharides or Glucoses. $C_6H_{12}O_6$.	Dextrose. $C_6H_{12}O_6 [+ H_2O]$.			+ 52.74 Birotaion.
	Lævulose. $C_6H_{12}O_6$.			- 71.4
	Galactose. $C_6H_{12}O_6$.			+ 80.5 Birotaion.

(after Tollens).

By Hydrolysis on Boiling with Dilute Acids. Action of Ferments. Arises		Yeast and Similar Fungi.	Reducing Power.	Phenyl-hydrazin Compounds.
Arabinose, Galactose, and other bodies.	No action.	No action.		
Dextrose.	By diastase into Dextrin and Maltose.	No action.		
	By diastase slowly into Dextrose.			
Dextrose and Lævulose.	By invertin Dextrose and Lævulose.	After invertin ferments by Yeast.		Phenyl-glucosazon.
Dextrose and Galactose.	By ferment of Kefyrs, Dextrose, and Galactose.	Ferments with Kefyrs.	Reduce alkaline copper and bismuth solution.	-Lactosazon M.P. 200°
Dextrose.	By diastase Dextrose [?].	Fermentation by Yeast.		-Maltosazon 206°
				-Glycosazon 204/5°
				-Lævulosazon 204°
		Non-fermentation by Yeast.		-Galactosazon 193°

BODIES OF THE

THE AROMATIC COMPOUNDS OF THE URINE AND THEIR

<p style="text-align: center;">Tyrosin.</p> $\text{C}_6\text{H}_4\begin{matrix} \text{OH} \\ \\ \text{CH}_2 \end{matrix} \cdot \text{CH} \cdot \text{NH}_2 \cdot \text{COOH}.$ <p><i>From albumin—</i> By trypsin. By putrefaction. By fusing with KHO.</p> <p><i>In urine—</i> In acute yellow atrophy of the liver and phosphorus poisoning.</p>	<p style="text-align: center;">Oxyphenyloxypropionic Acid.</p> <p>[Oxyhydroparacumaric acid.]</p> $\text{C}_6\text{H}_4\begin{matrix} \text{OH} \\ \\ \text{CH}_2 \end{matrix} \cdot \text{CH} \cdot \text{OH} \cdot \text{COOH}.$ <p>In the urine of the rabbit after feeding with tyrosin. In human urine, after acute yellow atrophy of the liver and phosphorus poisoning.</p>	<p style="text-align: center;">Oxyphenylpropionic Acid.</p> <p>[Hydroparacumaric acid.]</p> $\text{C}_6\text{H}_4\begin{matrix} \text{OH} \\ \\ \text{CH}_2 \end{matrix} \cdot \text{CH}_2 \cdot \text{COOH}.$ <p>Normal constituent of urine, decomposition product of tyrosin. When given to an animal, part is excreted unchanged, part is oxidised to</p> <p style="text-align: center;">Paraoxybenzoic acid.</p> $\text{C}_6\text{H}_4\begin{matrix} \text{OH} \\ \\ \text{COOH} \end{matrix}$ <p>which passes into the urine as</p> <p style="text-align: center;">Paraoxybenzuric acid.</p> $\text{C}_6\text{H}_4\begin{matrix} \text{OH} \\ \\ \text{CO} \cdot \text{NH} \cdot \text{CH}_2 \end{matrix} \cdot \text{COOH}.$
<p style="text-align: center;">Phenylamidopropionic Acid.</p> $\text{C}_6\text{H}_5 \cdot \text{CH}_2 \cdot \text{CH} \cdot \text{NH}_2 \cdot \text{COOH}.$ <p>Decomposition of albumin in seedlings.</p>	<p style="text-align: center;">Phenylpropionic Acid.</p> $\text{C}_6\text{H}_5 \cdot \text{CH}_2 \cdot \text{CH}_2 \cdot \text{COOH}.$ <p>Decomposition product of albumin, oxidised in the organism to</p> <p style="text-align: center;">Benzoic acid.</p> $\text{C}_6\text{H}_5 \cdot \text{COOH}.$ <p>which passes into the urine as</p> <p style="text-align: center;">Hippuric acid.</p> $\text{C}_6\text{H}_5 \cdot \text{CO} \cdot \text{NH} \cdot \text{CH}_2 \cdot \text{COOH}.$	<p style="text-align: center;">Phenylamidoacetic Acid.</p> $\text{C}_6\text{H}_5 \cdot \text{CH} \cdot \text{NH}_2 \cdot \text{COOH}.$ <p>Yields during putrefaction</p> <p style="text-align: center;">Amygdalic acid.</p> $\text{C}_6\text{H}_5 \cdot \text{CH} \cdot \text{OH} \cdot \text{COOH}.$

AROMATIC SERIES.

RELATION TO THE DECOMPOSITION PRODUCTS OF ALBUMIN.

Oxyphenylacetic Acid.

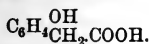

Putrefactive product of tyrosin; normal urinary constituent. When given to an animal, it leaves the organism unchanged.

Parakresol.



Putrefactive product of tyrosin; occurs in urine as

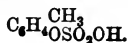

Phenol.



Putrefactive product of tyrosin; occurs in urine as

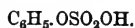

In the organism, it is partly oxidised into

Pyrocatechin.



which occurs as a constituent of horses' urine, partly as an ether sulpho-compound, and partly free.

Phenylacetic Acid.

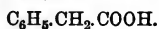

Putrefactive product of phenylamidopropionic acid and of albumin, passes into the urine as

Phenaceturic acid.



Indol.

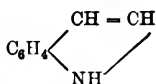

Obtained from albumin by putrefaction, and heating with caustic potash.

In the organism it is oxidised to

Indoxyl.

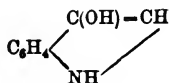

Passes into the urine as

Indoxylsulphuric acid.

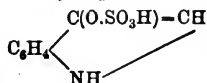

Skatol.

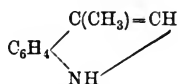

Putrefactive product of albumin, passes into the urine as

(Skatoxylsulphuric acid).

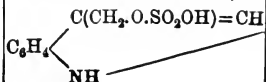

SOME PRODUCTS OF TRYPTIC PROTEOLYSIS—LYSIN,
LYSATIN.

In Lesson X., 5, Leucin and Tyrosin are stated to be products formed by the action of the tryptic enzyme on proteids. These substances, as well as others, viz., aspartic acid and glutamic acid, have long been known as decomposition products of vegetable proteids, *e.g.*, as cleavage products by boiling with dilute acids. Aspartic acid is amido-succinic acid, $\text{COOH.CH}_2\text{CH}(\text{NH}_2).\text{COOH}$, and is also a product of pancreatic digestion of fibrin, while glutamic acid, $\text{COOH.C}_3\text{H}_5(\text{NH}_2).\text{COOH}$, is amido-pyrotartaric acid. Both acids belong to the fatty acid series.

Drechsel has recently discovered two new nitrogenous bases—lysin and lysatinin or lysatin—products of the decomposition of proteids (*e.g.*, casein, gelatin, egg-albumin) when the latter are boiled with HCl and stannous chloride. These bodies result from the simple hydrolytic cleavage of the proteid molecule, and it has recently been shown by Hedin that they are also formed in trypsin-proteolysis.

Lysin, $\text{C}_6\text{H}_{14}\text{N}_2\text{O}_2$, is a diamido-caproic acid, and is a representative of the fatty acid group, and has intimate chemical relationships with leucin.

Lysatinin or Lysatin, $\text{C}_6\text{H}_{13}\text{N}_3\text{O}_2$.—Its composition is less accurately known, but it has the composition of a creatin. The special interest which attaches to this body is that, as a product of trypsin-proteolysis, it can by simple hydrolytic decomposition break down into urea. Thus trypsin-proteolysis yields cleavage products, from one or more of which comes the substance lysatin, which behaves like creatin in this respect, viz., that when boiled with baryta-water, it yields sarkosin and urea. Thus chemists have found a series of cleavage products the result of hydrolytic decomposition between proteid and urea. (Chittenden, *Digestive proteolysis*, p. 103, New Haven, 1895. Cartwright Lectures.)

XANTHIN BODIES.

<p>Xanthin. C₅H₄N₄O₂.</p> $\begin{array}{c} \text{NH} - \text{C} = \text{N} \\ \diagup \quad \quad \diagdown \\ \text{CO} \quad \quad \text{C} - \text{NH} \\ \diagdown \quad \quad \diagup \\ \text{NH} - \text{CH} \end{array}$	<p>Guanin. C₅H₅N₅O.</p> $\begin{array}{c} \text{NH} - \text{C} = \text{N} \\ \diagup \quad \quad \diagdown \\ \text{C} = \text{NH} \quad \text{C} - \text{NH} \\ \diagdown \quad \quad \diagup \\ \text{NH} - \text{CH} \end{array}$
<p>Heteroxanthin. C₆H₆N₄O₂.</p>	<p>Adenin. C₅H₄N₄.OH.</p>
<p>Theobromin. C₇H₈N₄O₂.</p> $\begin{array}{c} \text{N}(\text{CH}_3) - \text{C} = \text{N} \\ \diagup \quad \quad \diagdown \\ \text{CO} \quad \quad \text{C} - \text{N}(\text{CH}_3) \\ \diagdown \quad \quad \diagup \\ \text{NH} - \text{CH} \end{array}$	<p>Hypoxanthin. C₅H₄N₄O.</p> <p>Carnin. C₇H₈N₄O.</p>
<p>Theophyllin. C₇H₈N₄O₂.</p> $\begin{array}{c} \text{N}(\text{CH}_3) - \text{C} = \text{N} \\ \diagup \quad \quad \diagdown \\ \text{CO} \quad \quad \text{C} - \text{NH} \\ \diagdown \quad \quad \diagup \\ \text{N}(\text{CH}_3) - \text{CH} \end{array}$ <p>Paraxanthin. C₇H₈N₄O₂.</p>	
<p>Caffein. C₈H₁₀N₄O₂.</p> $\begin{array}{c} \text{N}(\text{CH}_3) - \text{C} = \text{N} \\ \diagup \quad \quad \diagdown \\ \text{CO} \quad \quad \text{C} - \text{N}(\text{CH}_3) \\ \diagdown \quad \quad \diagup \\ \text{N}(\text{CH}_3) - \text{CH} \end{array}$	<p>(Rohmann.)</p>

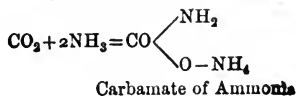
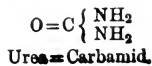
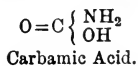
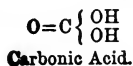
RELATION OF UREA TO THE CO₂ DERIVATIVES AND THE CY-COMPOUNDS.

On heating to 130-140° C. :—

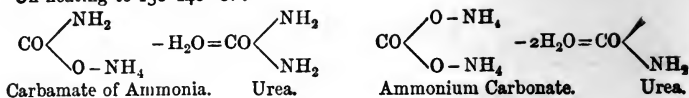

By heating with strong mineral acids or alkalis :—

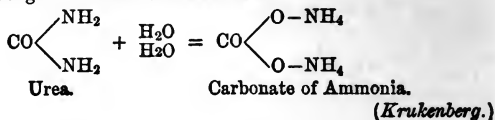

CORRECTION FOR TEMPERATURE AND PRESSURE IN THE HYPOBROMITE METHOD (LESSON XIX.).

Theoretically 1 gram of urea evolves 372.7 cubic centimetres of N, but in practice it is found from urine that about 343 cc. are obtained. Suppose 25 cc. of N passes over into the gas-collecting tube, and that the temperature of the room (t) = 10° C. and the barometric pressure 755 mm. Hg, what is the volume at standard temperature and pressure ?

Let V be the required volume at 0° C. and 760 mm. Hg; v be the volume read off; P = pressure of 760 mm. Hg; p the barometric pressure of the room; T the absolute temperature = -273°; t = the temperature of the room (in degrees Centigrade + 273); then

$$VPt = v p T \therefore v = \frac{VPt}{pT} \text{ and } V = \frac{vpT}{Pt}$$

$$V = \frac{25 \times 755 \times 273}{760 \times 283} = 23.95 \text{ cc.}$$

Next to urea, uric acid is the most important substance present in urine which is decomposed by hypobromite of sodium. It yields 47.7 per cent. of its N. But as the quantity of uric acid present in urine is very small, for practical purposes it may be neglected.

CORRECTION FOR TEMPERATURE AND PRESSURE OF THE VOLUME OF A GAS, *e.g.*, THE GASES OF THE BLOOD.

The volume of a gas must be reduced to the standard pressure, 760 mm. of mercury, and standard temperature, 0° C., according to the formula :—

$$V = \frac{V^1 \times h}{760 (1 + at)}$$

V —the required volume at standard temperature, 0° C., and 760 mm. Hg.

V^1 —the volume at the observed temperature and pressure.

h —the observed pressure.

a —the coefficient of expansion, which is a constant (.003665).

t —the observed temperature.

The formula is obtained as follows:—

With reference to the correction of the given volume for *temperature* :

$$1 + at : 1 :: V^1 : V$$

$$\therefore V = \frac{V^1}{1 + at}$$

and for *pressure* :

$$V : \frac{V^1}{1 + at} :: h : 760$$

$$\therefore V = \frac{V^1 \times h}{760 (1 + at)}$$

Example.—Suppose the volume of gas to be corrected for temperature and pressure, *i.e.*, $V^1 = 30$ cc., the observed barometric pressure, *i.e.*, $h = 740$ mm., and the temperature of the room, *i.e.*, $t = 15^{\circ}$ C., then the required volume will be :

$$V = \frac{30 \times 740}{760 (1 + .003665 \times 15)} = \frac{22200}{801.78100} = 27.6 \text{ cc.}$$

i.e., 30 cc. of a gas at 740 mm. pressure and 15° C. are reduced to 27.6 cc. at standard pressure and temperature (760 mm. and 0° C.).

SOLUBILITIES IN WATER AT 15° TO 18° C.

Ammonium chloride,	36 per 100.
Sodium chloride,	36 " "
Ammonium sulphate,	50 " "
Magnesium sulphate,	125 " "

IV.

RECORDING APPARATUS.

There are many forms of recording apparatus in use, and some of them are described in the text (Lesson XXXIV.). When a number of students have to be taught to record graphically the results obtained in an experiment, then

drums moved by some kind of motor are essential. Drums moved by clockwork, however convenient for individual work, are not suitable for students' purposes. Hence various devices are used so that many men are enabled to work at separate drums at the same time.

Motor.—One has first to consider what form of motor one should use to drive the drums. Some use a small gas-engine, others use a water-motor, as, for example, the Swiss form of motor made by Schmidt, or the Thirlmere form, while others prefer an electric motor where electricity is available. Such an electric motor is made by Siemens and Halske, Berlin, but the initial cost of this apparatus is considerable.

Transmission of Motion.—Next arises the question as to how the motion is to be transmitted to the drum. This is done in various ways. In the Cambridge system, which is adopted for some of the drums in the Physiological Department of Owens College, the motion is transmitted from the motor—gas-engine or Thirlmere water-motor placed in the basement—by means of an endless quick-running cord. This method is extremely convenient, and the drums are so made that they can be readily arrested, and can also be made to move at different speeds.

Some use shafting fixed on a support on the wall or ceiling or on a table. To the shaft are fixed coned pulleys, *i.e.*, wheels of different diameters, whereby a good range of speeds can be obtained.

Recording Drum.—Next comes the form of drum to be used. In the Cambridge arrangement the drum can be raised or lowered on a vertical axis by means of a clutch, while the drum itself can be set in motion or arrested by means of a handle on the driving pulley. The rate of movement can also be changed as desired.

Prof. Schäfer has also designed a form of drum which is moved by a short cord passing over coned pulleys fixed to a long rod placed on bearings fixed to a table and moved by a water-motor. It is made by Backhouse, Physiological Department, University College, London.

The Oxford pattern is somewhat different from this, and is made by Butler, Physiological Department, Oxford.

In Hering's large kymographion there is a long sheet of paper (2 metres) stretched over an iron framework, which is moved by clockwork driven by a weight. In University College, London, to this framework a small cogwheel is adapted whereby this arrangement can easily be driven by an ordinary motor. It is specially useful for research work where a moderate or slow speed of the recording surface is required.

In the "physiological recording drum" (fig. 288), as made for Dr Sherrington, the cylinder is 6 inches by 6 inches, and is so arranged that it can be used in a vertical or horizontal position, and has a lever by which it can be instantly started or stopped at any portion of a revolution. The cone pulley gives a good range of speeds. The brass cylinder is turned perfectly true in a self-acting lathe, and has about 5 inches vertical adjustment. It is easily removed for the purpose of blacking, and can be run by any light motor or clockwork, as desired. The whole is mounted upon a substantial cast-iron

base, so as to stand firm without clamping down. It is made by C. F. Palmer, 5 Kellett Road, Brixton, S. W.

It costs as above	£5	12	6
Or with levelling screws (vertical and horizontal)	6	3	0
Extra for automatic break-key (as shown in position)	9	8	6

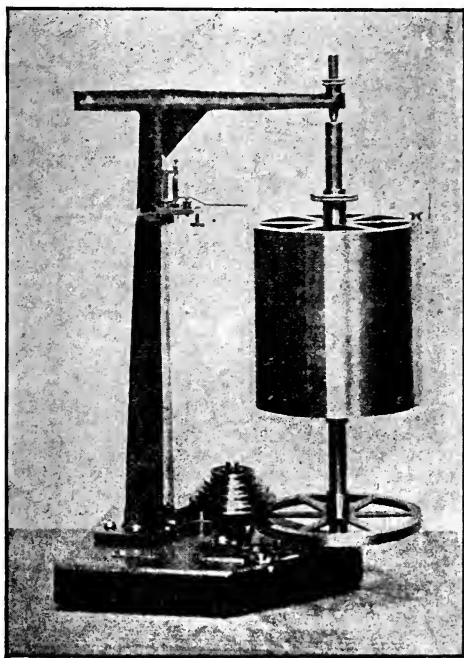

FIG. 288.—Sherrington's Drum.

Professor de B. Birch's System of Recording Apparatus.—The following description applies to a system of recording apparatus devised for the Experimental Laboratory in the New Medical School buildings of the Yorkshire College. The motive power, a small Chicagos top, is geared for reduction of speed to a 54-inch bicycle wheel, and this again by a cord to a piece of shafting, 19 feet long, running on ball bearings and supported by brackets fixed to the wall of the Laboratory. The shafting carries step cones (I, fig. 289), to these the drums are geared by cords which run over guide pulleys suspended from the ceiling in convenient positions. The tension on these cords is kept constant by counter weights (L), which allow the former the play required in shifting from one speed to another on the cones when changing the rate of revolution

Prof de B. Birch's System - Yorkshire College.

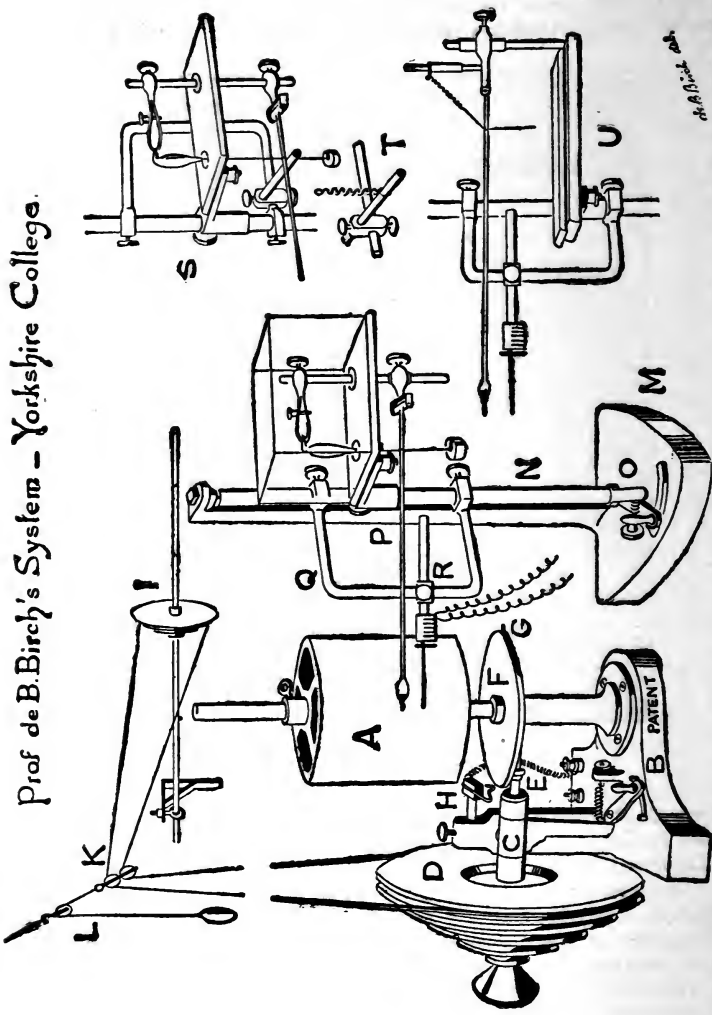

FIG. 289.—A. Drum; B. Starting and stopping lever which actuates C. The rocker; D. Driving cone; E. Driving pulley, which propels F. the Disc on the drum axle; G. Pin for striking the contact H; I. Cone on power shaft, cord connection to drum over guide pulleys K; L. Tension pulley and counter-weight; M. Stand for muscle and nerve experiments; N. Pillar rotated by O, the lever with adjusting screw and stop; P. Bracket for supporting a muscle-chamber or frog heart plate; Q. Stirrup carrying a time-marker in a clamp, R; S. Spring for isometric muscle-curve; U. Arrangement with frog heart plate.

of the drums. An inverted cone outside the pulley (D) reduces the chance of the cord being liberated from (D) during the latter operation.

The drums can be run in practically any position on their table, and they can be removed from the latter without trouble, the gearing cords when not in use being attached to hooks on the wall close to the shafting. The tables are thus left completely free for other purposes. The drums are provided with a starting and stopping contrivance (B) which is independent of the gearing cord. The driving spindle, which carries the cone (D) and pulley (E), runs in ball bearings in a rocking carrier which is tilted by the lever (B) either into contact with or free of (F), a disc attached on the cylinder axle. This axle is also on ball bearings. The drum can be readily adjusted for height or removed for covering and smoking without stopping the driving spindle.

The running parts are throughout the system either on centres or on ball bearings. The resultant diminution of friction is so considerable that the small motor already mentioned turns eight to twelve cylinders easily with a 25-pound water pressure.

The disc (F) has holes bored into its edge into which a pin or pins can be fixed for making contact with (H) when automatic stimulation is required at a definite epoch in the revolution of the cylinder.

The stand (M)¹ lends itself to most experiments on frog muscle, nerve, and heart. The bracket (P), adjustable on the pillar (N), will carry any ordinary form of muscle-chamber, &c., with slight adaptation. For the support of a time-marker the "stirrup" (Q) is provided. This turned behind the muscle-chamber will hold a rod upon which the muscle-lever can be rested in an after-load experiment, or to which a spring can be attached for the muscle to pull upon in taking an isometric myogram. The same can be accomplished with the stirrup in the front position by using a second clamp and bent metal rod.

The points of the writing-levers, after being adjusted by hand, can be finely adjusted or lifted off the paper by means of the adjusting screw and lever (O). Stability is conferred by the weight of metal in the stand (*Birch*).

MICRO-CHEMICAL DETECTION OF GLYCOGEN, IRON AND PHOSPHORUS IN VARIOUS CELLS.

Glycogen in Liver Cells.—The essential part of this process is that, as glycogen is soluble in water, the liver or other tissue supposed to contain the glycogen must *not be placed in water*. Feed a rabbit on carrots, and 5-6 hours afterwards kill it; cut part of the liver into small pieces and harden them in absolute alcohol. Cut hand sections, moistening the razor with

¹ Since this stand was devised about three years ago, Dr Birch has become acquainted with the fact that Runne of Basle makes a stand of somewhat similar construction which he calls the Basler stativ.

alcohol, or embed and cut in paraffin. Get rid of the paraffin by means of turpentine, and treat both the paraffin and alcohol sections with chloroform in which iodine is dissolved, and mount in chloroform balsam containing some iodine. The brown stain in the liver cells indicates glycogen, which is deposited chiefly in the cells around the hepatic vein (*Delépine*).

Iron.—(a.) The tissue—liver of young animal, or spleen—must be hardened in alcohol. The sections are transferred to a freshly-prepared solution of potassium ferrocyanide acidulated with hydrochloric acid. The granules of iron become blue (*Tizzoni*).

(b.) Harden the liver in 65 p.c. alcohol, then in 90 p.c. alcohol to which a few drops of sulphuretted hydrogen are added. After twenty-four hours the iron granules become green (*Zaleski*).

Phosphorus.—Place sections of the fresh organ for half an hour in a strong solution of ammonium molybdate, and then transfer them to a 20 p.c. solution of pyrogallic acid dissolved in ether. After a few minutes pass them through spirit and clove oil, and mount in Canada balsam. A compound containing phosphorus is stained yellow or brown, and such compounds are usually found in the nuclei. It is stated that by this method nucleo-albumin may be distinguished from mucin (*Lilienfeld and Monti*).

KJELDAHL'S METHOD OF ESTIMATING NITROGEN.

1. **Destruction of Organic Matter.**—Place in a boiling flask of 100 cc. capacity 0.1–1 gramme of the powdered dry substance. To destroy the organic matter add 10–20 cc. of the following mixture: 200 cc. pure oil of vitriol, 50 cc. Nordhausen oil of vitriol, phosphoric acid in sticks, 2 grammes, all free from ammonia. Heat on a wire gauze with a Bunsen-burner, but keep the temperature below boiling. To hasten the destruction a little potassium permanganate may be added. Heat for 1–2 hours until the fluid becomes clear and greenish.

2. **Neutralisation.**—Cool the flask, add a little water, and wash the contents, with as little water as possible, into a large flask of 700 cc. capacity. Neutralise with pure caustic soda or potash (S.G. 1.13). Add a little metallic zinc to prevent bumping during the subsequent distillation.

3. **Distillation.**—Rapidly close the flask with a perforated caoutchouc stopper through which passes a tube with two 1 inch bulbs blown upon it. The bulbs are to collect and prevent the passage of soda spray. The tube above the bulbs passes through a condenser, and the delivery tube end of the condenser tube passes into a flask containing a measured excess of standard acid (HCl). Distil the mixture about an hour in the flask, and the ammonia passes over into the acid.

4. Titration.—Determine the amount of acidity in the distillate by titration with a standard solution of caustic soda or potash, methyl orange being used as an indicator of the end of the reaction. Methyl orange gives a pink with an acid, and yellow with an alkali.

The apparatus used in the Physiological Laboratory of Owens College is that made by Messrs Baird and Tatlock (see their catalogue), and is so arranged that several estimations can be made simultaneously. Other modifications are in use.

Example.—Suppose 0.15 gramme of the N-substance has been treated with acid, neutralised, and the ammonia distilled over and received by 100 cc. of a decinormal solution of HCl (= 10 cc. normal acid). The distillate is then treated with decinormal caustic soda, and suppose it is found that the neutral point is reached when 60 cc. of the decinormal soda has been added. The remaining 40 cc. must therefore have been neutralised by the ammonia obtained from the nitrogenous substance investigated. This 40 cc. of decinormal acid = 4 cc. of normal acid = 4 cc. of normal ammonia = $4 \times 0.017 = 0.068$ gramme of ammonia ; 0.15 gramme of the substance, therefore, yields 0.068 gramme of ammonia, and this amount contains 0.056 gramme of nitrogen ; 100 grammes of the substance investigated will therefore contain $\frac{100 + 0.056}{0.15} = 37.3$ grammes of nitrogen.—
(From Sutton's *Volumetric Analysis* by Warington.)

MEASURES OF LENGTH.

Metric System.

The standard is the metre ; for multiples of the metre prefixes deca- hecto- and kilo- are used ; for subdivisions thereof, milli- centi- and deci- are used just as in the case of the gramme in the table below.

1 millimetre	= 0.001 metre	= 0.03937 inch.
1 centimetre	= 0.01	„ = 0.3937 „
1 decimetre	= 0.10	„ = 3.93707 inches.
1 metre		= 39.37079 „

English System.

1 inch	= 25.4 millimetres.
1 foot = 12 inches	= 304.8 „

MEASURES OF CAPACITY.

Metric System.

A litre is the standard, and is equal to 1000 cubic centimetres (1000 cc.); each cubic centimetre is the volume of 1 gramme of distilled water at 4° C.

1 cubic centimetre (1 cc.) = 16.931 minims.

1 litre = 1000 cc. = 1 pint 15 oz. 2 drs. 11 min. (35.2154 oz.)

English System.

1 minim	=	0.059	cubic centimetre.
1 fluid drachm = 60 minims	=	3.549	cubic centimetres.
1 fluid ounce = 8 fluid drachms	=	28.398	„ „
1 pint = 20 fluid ounces	=	567 936	„ „
1 gallon = 8 pints	=	4.54837	litres.

WEIGHTS.

Metric System.

1 milligramme =	0.001 gram.	=	0.015432 grain.
1 centigramme =	0.01 „	=	0.154323 „
1 decigramme =	0.1 „	=	1.543235 „
1 gramme =	1 „	=	15.43235 grains.
1 decagramme =	10 grams.	=	154.3235 „
1 hectogramme =	100 „	=	1543.235 „
1 kilogramme =	1000 „	=	15432.35 „
		=	2 lb. 3 oz. 119.8 „

[For practical purposes the kilogramme or kilo is taken at 2.2 lbs.]

English System.

1 grain	=	0.0648	gramme.
1 ounce = 437.5	grains =	28.3595	grammes.
1 lb. = 16 oz. = 7000	„ =	435.5925	„

THERMOMETRIC SCALES.

Fahrenheit scale,	freezing point of water	32°	boiling point	212°
Réaumur	„	„	„	0°
Centigrade	„	„	„	0°
				80°
				100°

To convert degrees F. into degrees C. subtract 32 and multiply by $\frac{5}{9}$ or $C = (F - 32) \frac{5}{9}$. To convert C° into F° the formula is $F = \frac{9}{5} C + 32$.

SOME OF THE INSTRUMENT-MAKERS WHO SUPPLY
PHYSIOLOGICAL APPARATUS.

Backhouse, University College, London.
 Butler, Physiological Laboratory, Oxford.
 Cambridge Scientific Instrument Co.
 Hume, Lothian Street, Edinburgh.
 Kershaw, Cankerwell Lane, Leeds.
 Meyer (J. F.), Seilergraben 7, Zurich.
 Palmer, 5 Kellett Road, Brixton, London.
 Petzold, Bayerische Strasse, Leipzig.
 Rothe, Wenzelbad, Prague.
 Siedentopf, Würzburg.
 Runne, Basel and Heidelberg.
 Verdin, Rue Linné 7, Paris.
 Zimmermann, Leipzig.

INDEX.

- Aberration**—Chromatic, 330.
 " spherical, 330.
Absorption-bands, 47.
Accommodation, 331.
 " line of, 335.
Aceto-acetic acid, 146.
Aceton, 146.
Achroo-dextrin, 18, 22, 69.
Acid-albumin, 8, 73.
Acid-hæmatin, 50.
Acidulated brine, 138.
Acme sacchar-ureameter, 145.
Action-current of muscle, 237.
 " nerve, 238.
Acuity of vision, 339.
Adamkiewicz, reaction of, 3.
Æsthesiometer, 367.
After-images, 359.
After-load, 200.
Air expired, 311.
 " analysis of, 313.
Albumenoids, 13.
Albumin, 1.
 " coagulation temperature
 of, 4.
 " derived, 7.
 " egg, 14.
 " general reactions, 2.
 " native, 4.
 " nitrogen in, 3.
 " serum, 5.
 " soluble, 4.
 " sulphur in, 3.
 " vegetable, 98.
Albumin—Estimation of, 139.
 " in urine, 136.
 " tests for, 137.
Albuminates, 73.
Albuminimeter, 139.
Albuminuria, 136.
Albumoses, 8, 73, 78.
Albumosuria, 139.
Alkali-albumin, 7.
Alkali-hæmatin, 51.
 " reduced, 51.
Alkaline phosphates, 112.
Amalgamation of zinc, 158.
 " mixture, 158.
Amidulin, 22.
Ammonium carbonate, 109, 382.
 " urate, 151.
Ampère, 160.
Amyl nitrite, 294.
Amyloid substance, 11.
Amylopsin, 80.
Amyloses, 16.
Anaglyph, 363.
Analysis of a fluid, 32.
 " solid, 156.
Animal starch, 19.
Anode, 157.
Apex-preparation, 282.
Apnoea, 310.
Apparent movements, 350.
Aromatic compounds, 378.
Arterial pressure, 301.
Artificial eye, 350, 365.
 " gastric juice, 71.
 " pancreatic juice, 79.
Aristotle's experiment, 368.
Astigmatism, 335.
Atropin on heart, 277.
Auto-laryngoscopy, 316.
Automatic break excitation, 201.
Auxocardia, 291.
Barfoed's solution, 2.
Baryta mixture, 124.
Bayliss' writing-point, 270.
Benham's top, 362.
Benzoic acid, 131.
Benzo-purpurin, 76.
Bergmann's experiment, 340.
Bernard's method for curare, 193.

- Bernstein's method for heart, 261.
 Bezold's experiment, 330.
 Bichromate cell, 159.
 Biedermann's modification, 243.
 Bile, 87.
 " acids, 87.
 " actions of, 89.
 " cholesterin in, 89.
 " crystallised, 87.
 " Gmelin's test, 88, 141.
 " in urine, 141.
 " Pettenkofer's test, 88, 141.
 " pigments, 88.
 " salts, 87.
 Bile-acids in urine, 141.
 Bile-pigments in urine, 141.
 Bilin, 87.
 Bilirubin, 88.
 Biliverdin, 88.
 Binocular contrast, 359.
 " vision, 345.
 Biuret reaction, 9, 119.
 Bismuth test, 21.
 Black-band experiments, 342.
 Black's experiment, 311.
 Blind spot, 337.
 Blix's myograph, 217.
 Blood, 33.
 " acids on, 55.
 " action of saline solution, 34.
 " Buchanan's experiments, 39.
 " clot, 35.
 " coagulation of, 35.
 " corpuscles, 43.
 " defibrinated, 37.
 " grape-sugar in, 42.
 " laky, 33.
 " mammalian, 35.
 " nitrites on, 53.
 " plasma, 35.
 " reaction, 33.
 " red corpuscles of, 34.
 " serum of, 35, 37.
 " sodium fluoride on, 54.
 " specific gravity of, 34.
 " spectroscopy of, 46.
 " stains, 59.
 " transparent, 33.
 Blood in urine, 140.
 Blood-corpuscles, 43.
 " numeration of, 43.
 Blood-gases, 312.
 Blood-pressure, 300, 306.
 " tracings, 304.
 Bone, 31.
 Böttger's test, 21, 142.
 Bowditch's rotating coil, 167.
 Bread, 99.
 Break extra-current, 173.
 Break-shock, 171.
 Brine-test, 138.
 British gum, 18.
 Brücke's method for glycogen, 91.
 Brush electrodes, 237.
 Bucharan's experiments, 39.
 Buffy coat, 35.
 Burette, 116.
 Calcium phosphate, 112.
 Calculi, urinary, 149.
 Cane-sugar, 24.
 " estimation of, 25.
 " inversion of, 24.
 Cannula, 305.
 Capillaries, pressure in, 300.
 Capillary electrometer, 233.
 Carbohydrates, 15, 376.
 " classification of, 16
 " general characters, 15.
 " rotatory power, 28.
 Carbolo-chloride of iron test, 77.
 Carbonic-oxide hæmoglobin, 47.
 " spectrum of, 57.
 Cardiac delay, 272.
 Cardiograph, 287.
 Casein, 11.
 Caseinogen, 8, 95.
 Cathode, 157.
 " as stimulus, 249.
 Cellulose, 19.
 Centrifugal machine, 43, 147.
 Charpentier's experiments, 342.
 Chemical stimulation, 182.
 Chloral, 321.
 Cholesterin, 89, 90.
 Cholic acid, 88.
 Chondrin, 14.
 Chondrigen, 14.
 Chordogram, 206.
 Choroidal illumination, 359.
 Christison's formula, 106.
 Chromatic aberration, 330.
 Chromo-cytometer, 62.
 Chronograph, 211.
 Ciliary motion, 177.
 Circulation, scheme of, 297.
 " microscopic examination
 of, 300.
 Circumpolarisation, 25.
 Clerk-Maxwell's experiment, 340.
 Coagulated proteids, 10.
 Coagulation of blood 35.

- Coagulation, action of neutral salts, 36.
 " " of cold, 35, 40.
 " experiments, 39.
 " oxalates, 36.
 Cold—Effects on blood, 35.
 " " heart, 264.
 " " muscle, 213.
 " " nerve, 257.
 Cold spots, 369.
 Collagen, 13.
 Colloid, 19.
 Colorimetric method, 65.
 Colour-blindness, 353.
 " sensations, 352.
 Coloured fringes, 330.
 " shadows, 358.
 Combined sulphuric acid, 112.
 Commutator, 165.
 Conduction in nerve, 247, 256.
 Congo-red, 76.
 Constant current, 160.
 " " action of, 254.
 " " " on heart, 278.
 Contact key, 162.
 " sense of, 370.
 Contraction—maximal, 199.
 " minimal, 198.
 " paradoxical, 241.
 " secondary, 241.
 " without metals, 239.
 Contrast, 354.
 " binocular, 359.
 Crank-myograph, 200.
 Crystallin, 7.
 Curare, 190, 193.
 Curdling of milk, 96.
 Current, demarcation, 234, 237.
 " of heart, 242.
 " of injury, 234.
 Cystin, 151.
 Daniell's cell, 157.
 Darby's fluid meat, 9.
 D'Arsonval's N. P. electrodes, 237.
 Defibrinated blood, 37.
 Deglutition apnœa, 310.
 Demarcation currents, 234.
 Deposits in urine—organised, 147.
 " unorganised, 147.
 Depressor nerve, 302.
 Derived albumins, 7.
 Despretz's signal, 210.
 Detector, 159.
 Deutero-albumose, 78.
 Dextrin, 18.
 " preparation of, 19.
 Dextrin, varieties of, 22.
 Dextrose, 20.
 " reducing power of, 70.
 " rotatory power of, 26.
 Diabetes, 143.
 Dialyser, 78.
 Diffusion, 329.
 Digestion—Biliary, 87.
 " gastric, 71.
 " pancreatic, 79.
 " salivary, 67.
 Diplopia monophthalmica, 336.
 Direct stimulation, 188.
 " vision, 339.
 Direction, judgment of, 348.
 Disaccharides, 16.
 Distance, judgment of, 348.
 Donné's test, 148.
 Double conduction in nerve, 253.
 Du Bois electrodes, 169.
 " induction coil, 166.
 " key, 160.
 " rheochord, 249.
 Dudgeon's sphygmograph, 294.
 Dupré's apparatus, 121.
 Duration of impressions, 342.
 Dynamometers, 189.
 Ear, 371.
 Earthy phosphates, 112.
 Egg-albumin, 4.
 Elasticity of artery, 218.
 " lungs, 309.
 " muscle, 216.
 Elastin, 14.
 Electrical keys—Brodie's, 175.
 " Contact, 162.
 " Du Bois, 160.
 " mercury, 162.
 " Morse, 162.
 " plug, 163.
 " spring, 162.
 " trigger, 162.
 Electrical constant current, 184.
 " repeated shocks, 184.
 " single shocks, 183.
 " stimulation, 183.
 " stimuli, 181.
 Electrodes, 168.
 " d'Arsonval's, 237.
 " brush, 237.
 " Du Bois, 169.
 " for nerve, 304.
 " non-polarisable, 233.
 " polarisation of, 169.
 Electrometer, capillary, 238.

- Electro-motive phenomena of muscle, 235.
 Electro-motive phenomena of heart, 238, 242.
 Electro-motive phenomena of electro-tonic variation, 248.
 Electro-tonic variation of excitability, 243.
 " " electro-motivity, 248.
 Electrotonus, 243.
 Ellis' air piston recorder, 295.
 Emulsion, 30, 83.
 Endocardial pressure, 281.
 Engelmann's experiment, 254.
 Entoptical vision, 341.
 Enzymes, 68, 75.
 Erdmann's float, 116.
 Ergograph, 230.
 Erythro-dextrin, 18, 22, 69.
 Esbach's albuminimeter, 139.
 Ewald's coil, 167.
 Examination of a fluid for proteids and carbohydrates, 32, 154.
 Examination of a solid, 156.
 Excitability, muscular, 190.
 " v. conductivity, 256.
 " of nerve, 254, 256.
 Exhaustion in nerve and muscle, 225.
 Experimentum mirabile, 327.
 Expired air, 311.
 Extensibility of muscle, 216.
 Extensors, excitability of, 256.
 Extra-current, 173.
 Far point, 333.
 Faradic electricity, 166.
 Faradisation, 172.
 Fatigue of muscle, 223.
 " nerve, 225.
 Fats, neutral, 29.
 Fehling's solution, 142.
 Ferments—Amylopsin, 80.
 " fibrin, 40.
 " milk curdling, 84, 96.
 " pancreatic, 80.
 " pepsin, 72.
 " pialyn, 84.
 " ptyalin, 68.
 " rennet, 75.
 " steapsin, 84.
 " trypsin, 81.
 " in urine, 135.
 Fibrin, 10, 37.
 Fibrin-ferment, 40.
 Fibrinogen, 7, 36, 39.
 Field of vision, 344.
 Flexors, excitability of, 256.
 Flour, 98.
 Fovea centralis, 339.
 " shadows on, 341.
 Fractional heat-coagulation, 11.
 Furfurol, 88.
 Gad's emulsion experiment, 30.
 Gall stones, 89.
 Galvanic electricity, 157.
 Galvani's experiment, 239.
 Galvanometer, 251.
 Galvanoscope, 159.
 Garrod's test, 129.
 Gas-sphygmoscope, 295.
 Gases in blood, 312.
 Gaskell's clamp, 267.
 " heart lever, 266.
 Gastric action on milk, 75.
 " contents, examination of, 79.
 " digestion, 72.
 " juice, 72.
 " peptones, 74.
 " products of, 73.
 Gelatin, 13.
 Gerrard's urea apparatus, 126.
 Globin, 7.
 Globulins, 6.
 Globulinuria, 133.
 Glucose, 20.
 " in blood, 42.
 " to prepare, 22.
 " rotatory power of, 26.
 Glucoses, 16.
 Gluten, 11, 98.
 Glycerin, 29.
 Glycin, 104.
 Glyco-cholic acid, 87.
 Glyocol, 104.
 Glycogen, 19, 91.
 " preparation of, 91.
 " tests for, 93, 387.
 Glycosamin, 103.
 Glycosuria, 141.
 Gmelin's test, 88.
 Goltz's tapping experiment, 287.
 Gotch's arrangement for excised heart, 269.
 Gotch's localised cold nerve, 258.
 Gracilis, experiment on, 253.
 Grape-sugar, 20, 42.
 Graphic method, 194.
 Grove's cell, 158.
 Grünhagen's experiment, 256.
 Guaiacum test, 140.

- Guanin, 104.
 Gymnema sylvestre, 371.
- Hæmatin**, 52.
 „ preparation of, 53.
- Hæmatinometer, 49.
 Hæmatoporphyrin, 53.
 Hæmatoscope, 49.
 Hæmaturia, 140.
 Hæmin, 59.
 Hæmochromogen, 51.
 Hæmocytometer, 43.
 Hæmoglobin, 34.
 „ ash of, 43.
 „ carbonic oxide, 49, 57.
 „ crystals of, 45.
 „ estimation of, 59.
 „ nitrites on, 53.
 „ non-diffusibility, 34.
 „ oxy-, 47.
 „ ozone test, 46.
 „ preparation of, 45, 65.
 „ reduced, 48, 56.
 „ spectrum of, 47, 55.
- Hæmoglobinometer, 59.
 Hæmoglobinuria, 140.
 Hæmometer, 60.
 Hand-electrodes, 168.
 Haploscope, 360.
 Häser-Trapp's coefficient, 106.
 Haycraft's method for S. G. of blood,
 34.
 „ uric acid, 136.
- Hearing, 371.
- Heart—Action of drugs on, 277.
 „ apex, 282.
 „ atropin on, 277.
 „ casts of, 285.
 „ clamp, 267.
 „ cold on, 261.
 „ constant current on, 278.
 „ current of frog, 242.
 „ endocardial pressure, 281.
 „ excised, 260, 269.
 „ frog's, 259.
 „ graphic record of, 262.
 „ heat on, 261.
 „ inhibition of, 271.
 „ inhibitory centre, 271.
 „ latent period, 272.
 „ lever, 263.
 „ mammal's, 286.
 „ motor centres, 272.
 „ movements of, 262.
 „ muscarine, 277.
 „ nervous system on, 279.
- Heart—effect of temperature on, 260.
 264, 267.
 „ nicotin on, 277.
 „ ox, 286.
 „ perfusion, 279.
 „ pilocarpin on, 277.
 „ record of, 262.
 „ reflex inhibition, 271, 287.
 „ section of, 261.
 „ sounds of, 286.
 „ staircase of, 271, 278.
 „ Stannius's experiment, 270.
 „ suspension methods, 266.
 „ swallowing on, 287.
 „ sympathetic on, 275.
 „ tonometer, 282.
 „ tortoise's, 265.
 „ vagus on, 273, 305.
 „ valves of, 284.
- Heat—Effect on cilia, 177.
 „ „ heart, 264.
 „ „ muscle, 214.
 „ „ nerve, 255.
- Heat-rigor of muscle, 206.
- Heller's test, 137.
 „ blood test, 140.
- Helmholtz's modification, 174.
- Hemialbumose, 8, 78.
- Hempel's method, 314.
- Hering's apparatus for contrast, 357.
- Hetero-albumose, 78.
- Heywood's experiment, 313.
- Hippuric acid, 131.
- Holmgren's worsteds, 354.
- Hot spots, 369.
- Hüfner's urea apparatus, 120, 125.
- Hydrocele fluid, 39.
- Hydrostatic test, 310.
- Hypobromite method, 120.
- Hypobromite of sodium, 121.
- Illuminated ox heart, 286.
- Illusions connected with skin, 370.
- Image, formation of, 329.
- Impressions, duration of, 342.
- Independent muscular excitability,
 190.
- Indican, 134.
- Indifferent fluid, 179.
- Indigo-forming substance, 134.
- Indirect stimulation, 188.
 „ vision, 339.
- Indol, 83, 85.
- Induced electricity, 166.
- Induction coil, 166.
 „ Ewald's form, 167.

- Induction, new form of, 166.
 " graduated form of, 167.
 " shocks, effects of, 171.
 Inflammation, 300.
 Inhibition of rabbit's heart, 287.
 Inhibitory heart arrest, 271, 287.
 Interrupted current, 172.
 Intra-ocular pressure, 367.
 Intra-pleural pressure, 312.
 Intra-thoracic pressure, 311.
 Inverted image, 329.
 Invert-sugar, 25.
 Iodine solution, 18.
 Iris, movements, 326.
 Iron, test for, 388.
 Irradiation, 346.
 Isometric contraction, 203.
 Isotonic " 203.
- Jaffé's test**, 133.
 Judgment of direction, 348.
 " of distance, 348.
 " of size, 348.
- Keratin**, 14.
 Key—Brodie's, 175.
 " Du Bois-Reymond's, 160.
 " mercury, 162.
 " Morse, 162.
 " plug, 163.
 " spring or contact, 162.
 " trigger, 163.
- Kjeldahl's method, 127, 388.
 Knee-jerk, 321.
 Koenig's flames, 317.
 Kreatin, 101.
 Kreatinin, 132.
 Kühne's — Curare experiment, 132, 194.
 " nerve current experiment, 242.
 " eye, 350.
 " gastric juice, 71.
 " gracilis experiment, 253.
 " muscle-press, 242.
 " pancreas powder, 80.
 " sartorius experiment, 191.
- Külz's method for glycogen, 91.
 Kymograph, 301.
- Lact-albumin**, 6, 95.
 Lactic acid, 77.
 Lactoscope, 98.
 Lactose, 23, 95.
 Lambert's method, 352.
 Lardacein, 11.
- Laryngoscope, 315.
 Latent period of heart, 272.
 " reflex, 319.
 " vagus, 275.
- Laurent's polarimeter, 26.
 Lecithin, 103.
 Legal's test, 146.
 Leucin, 82, 85.
 Lieben's test, 146.
 Lieberkühn's jelly, 7.
 Liebermann's reaction, 3.
 Liebig's extract of meat, 101.
 Ligature, effect of, 285.
 Liquor pancreaticus, 80.
 " pepticus, 72.
 Listing's reduced eye, 337.
 Lithates, 130.
 Liver, extracts of, 93.
 Load on muscle, 214.
 Locality, sense of, 367.
 Ludwig's kymograph, 301.
 " sphygmograph, 294.
- Lungs, elasticity of, 309.
 Lustre, 361.
 Lymph-hearts, 300.
 Lysatinin, 380.
 Lysin, 380.
- Magnesia mixture**, 113.
 Magnetic tuning-fork, 222.
 Make shocks, 171.
 Malt extract, 70.
 Maltose, 22, 69.
 " estimation of, 23.
 " reducing power, 23.
 " salivary digestion, 69.
- Manometric flames, 317.
 Marey's myograph, 213.
 " sphygmograph, 291.
 " tambour, 228.
- Marriotte's experiment, 337.
 Maximal contraction, 198.
 Maxwell's experiment, 340.
 Measures of capacity, 390.
 " length, 389.
- Meat, extract of, 101.
 Mechanical stimulation, 181.
 Meiocardia, 291.
 Mercurial key, 162.
 Metaphosphoric acid, 138.
 Methæmoglobin, 52, 54.
 Methyl violet, 76.
 Meyer on contrast, 356.
Metronome, 222.
Micro-spectroscopes, 17.

- Milk, 94.
 „ caseinogen of, 95.
 „ coagulation of, 97.
 „ curdling, of, 96.
 „ fat of, 96.
 „ gastric juice on, 75.
 „ lactalbumin of, 95.
 „ opacity of, 98.
 „ pancreatic juice on, 84.
 „ to peptonise, 75, 85.
 „ rennet on, 75.
 „ salts of, 97.
 „ souring of, 96.
 „ sugar of, 95.
 Milk-curdling ferment, 96.
 Milk-sugar, 23, 95.
 Millon's reagent, 2.
 Mineral *v.* organic acids, 76.
 Minimal contraction, 199.
 Mohr's test, 77.
 Moist chamber, 197.
 Molisch's test, 22.
 Monosaccharides, 16.
 Moore's test, 20.
 Morse key, 162.
 Mosso's ergograph, 230.
 Mucin, 14.
 Mucus in urine, 135.
 Mulberry calculus, 152.
 Müller's valves, 312.
 „ experiment, 295.
 Murexide test, 128.
 Muscæ volitantes, 341.
 Muscarin on heart, 277.
 Muscle—Action current of, 237.
 „ action of heat, 214.
 „ „ veratria, 214.
 „ curve of, 203.
 „ demarcation current, 234.
 „ direct stimulation of, 188.
 „ effect of load, 214.
 „ „ two shocks, 219.
 „ elasticity, 216.
 „ electrical stimulation, 181.
 „ excitability, 192.
 „ extensibility of, 226.
 „ extractives of, 161.
 „ extracts of, 100.
 „ fatigue, 223.
 „ independent excitability of, 190.
 „ indirect stimulation of, 188.
 „ lever, 197.
 „ load, 214.
 „ on mercury, 185.
 „ pigments of, 102.
 Muscle—plasma of, 102.
 „ press, 242.
 „ proteids, 102.
 „ reaction of, 99.
 „ rupturing strain, 189.
 „ serum, 102.
 „ single contraction, 184, 197.
 „ sound, 189.
 „ stimulation of, 183.
 „ successive shocks on, 219.
 „ temperature on, 213.
 „ tension of, 204.
 „ tetanus, 220.
 „ thickening of, 228.
 „ twitch, 198.
 „ veratria on, 214.
 „ wave, 226.
 „ work of, 205.
 Muscular contraction, 213.
 „ load on, 214.
 „ sense, 370.
 „ temperature on, 213.
 „ veratria on, 214.
 Myelin-forms, 104.
 Myographic experiments on man, 229.
 Myographs, 196.
 „ Blix's, 217.
 „ crank, 200.
 „ Fredericq's, 213.
 „ Marey's, 213.
 „ pendulum, 206.
 „ spring, 208.
 Myosin, 7, 11, 102.
 Myosinogen, 100.
 Native albumins, 4.
 Neef's hammer, 172.
 Negative variation, 236.
 „ after-images, 360.
 Nerve-muscle preparation, 177, 179.
 Nerves—action current, 238.
 „ cold on, 257.
 „ demarcation current, 237.
 „ double conduction, 253.
 „ excitability of, 192.
 „ fatigue of, 225.
 „ localised cold on, 258.
 „ salt on, 255.
 „ section of, 256.
 „ unequal excitability, 254.
 „ velocity of energy, 250.
 Neuramœbimeter, 326.
 Neuro-keratin, 14.
 Nicotin on heart, 277.
 Nitrites, 53.
 „ in saliva, 68.
 Nitrogen, estimation of, 388.

- Non-polarisable electrodes, 233, 237.
 Normal saline, 179.
 " soda solution, 110.
 " urobilin, 133.
 Nuclein, 103.
 Nucleo-albumin, 104.
Ohm, 160.
 Oils, chemistry of, 29.
 Olein, 29.
 Ophthalmoscope, 364.
 Ophthalmotonometer, 367.
 Organic acids as tests, 76.
 Organised deposits in urine, 147.
 Ossein, 30.
 Ox-heart, 286.
 Oxalate plasma, 36.
 Oxalate of lime, 152.
 Oxy-hæmoglobin, 47.
 " crystals of, 45.
 " reduction of, 49.
 " spectrum of, 47, 49.
Palmitin, 29.
 Pancreatic action on fats, 83.
 " " on proteids, 81.
 " " on starch, 80.
 " digestion, 79.
 " extracts, 80.
 " juice, 79.
 " milk, 84.
 " peptones, 81.
 Paradoxical contraction, 241.
 Paraglobulin, 38.
 Pavy's solution, 144.
 Pea-meal, 99.
 Pendulum myograph, 206.
 Pepsin, 72, 78.
 Peptones, 9, 74, 78.
 " diffusibility of, 10.
 " tests for, 9.
 " Witte's, 8.
 Peptonised milk, 75.
 Peptonuria, 139.
 Perfusion, 279, 306.
 Perimetry, 344.
 Peripheral projection, 369.
 Perrin's eye, 365.
 Pettenkofer's test, 88.
 Pflüger's law of contraction, 247.
 Phakoscope, 333.
 Phenol in urine, 134.
 " tests for, 146.
 Phenyl-glucosazon, 21.
 " tests for, 146.
 " hydrazin test, 15, 21.
 " maltosazon, 22.
 Phloro-glucin vanillin, 76.
 Phosphenes, 340.
 Phosphoric acid, 115.
 " volumetric process for, 115.
 Phosphorus, test for, 388.
 Physiological apparatus, list of makers
 of, 391.
 " rheoscope, 240.
 Picric acid, 138.
 Picro-carmine, spectrum of, 54.
 Picro-saccharimeter, 144.
 Pigments of bile, 88.
 " urine, 134.
 Pilocarpin on heart, 277.
 Pince myographique, 228.
 Piotrowski's reaction, 2.
 Piston-recorder, 281.
 Pithing, 176.
 Plasma of blood, 36.
 " of muscle, 102.
 " salted, 36.
 Plasmine, 36.
 " of muscle, 102
 Plattner's bile, 87.
 Plethysmograph, 295.
 Plug key, 163.
 Pohl's commutator, 165, 193.
 Poisons on heart, 277.
 " on muscle, 214.
 " on spinal cord, 320.
 Polarimeters, 25.
 Polarisation of electrodes, 169.
 Polaristrobometer, 28.
 Polygraph, 289.
 Polysaccharides, 16.
 Positive after-images, 359.
 Potassio-mercuric iodide, 93.
 Potassium bromide, 321.
 " chloride, 321.
 " sulphocyanide, 68.
 Preformed sulphuric acid, 112.
 Pressure sense, 369.
 Proteids, 1.
 " classification of, 4.
 " coagulated, 10.
 " general reactions, 2.
 " non-diffusibility, 3.
 " removal of, 12.
 " rotatory power, 28.
 Proteoses, 8, 73.
 Proto-albumose, 78.
 Ptyalin, 68.
 Pulse, 291.
 Pulse-wave, 296.
 Pupil, 367.
 " albino, 336.

- Pupil reflex, 336.
 Purkinje's figures, 341.
 " Sanson's images, 280.
 Pus in urine, 147.
 Putrefactive products of pancreatic digestion, 83.
 Pyrocatechin, 147.
 Pyuria, 147.
- Quantitative estimation of acidity,**
 110.
 111. " " chlorides,
 115. " " phosphates,
 143. " " sugar,
 " " urea, 120.
 135. " " uric acid,
- Radial movement,** 350.
 Ragona Scina, 356.
 Ranvier's emulsion experiment, 80.
Reaction, biuret, 9.
 " of Adamkiewicz, 3.
 " of Liebermann, 3.
 " of Piotrowski, 2.
 " of Uffelmann, 77.
 " xanthoproteic, 2.
Reaction-time, 323.
Recording apparatus, 194, 383.
Reduced alkali-hæmatin, 52.
 " hæmoglobin, 48.
 " " spectrum of, 49.
Reflex action, 318.
Rennet, 75.
Repeated shocks, 172.
Respiration, voluntary, 310.
 " on pulse, 295.
Respiratory movements, 308.
 " of frog, 311.
Retinal shadows, 341.
Reverser, 166.
Rheochords, 163, 245, 249.
Rheometer, 298.
Rheonome, 187.
Rheoscopic frog, 240.
Rigor mortis, 100.
Ringer's fluid, 280.
Ritter's tetanus, 249.
Rosenthal's modification, 193.
Roy's tonometer, 282.
- Saliva,** 67.
 " digestive action of, 68.
 " oxidising power of, 71.
Salivary digestion, 68.
 " effects on, 69.
Saponification, 30.
Sartorius of frog, 186.
Scheiner's experiment, 331.
Schiff's test, 129.
Secondary contraction, 240, 241.
 " Biedermann's modification, 243.
 " tetanus, 241.
Semi-membranosus and gracilis preparation, 179.
Serum of blood, 35, 37.
 " proteids of, 38.
 " to obtain, 41.
Serum, salts of, 40.
 " sugar of, 40.
Serum-albumin, 5, 38, 41, 136
 " globulin, 6, 38, 41, 138.
 " -proteids, 38.
 " coagulation of, 39.
Shadows, coloured, 358.
 " on retina, 341.
Shielded electrodes, 168.
Shunt, 234.
Simple muscle curve, 202.
Simultaneous contrast, 354.
Single contraction, 185.
Single induction shocks, 171.
Size, 348.
Skatol, 83.
Smell, 370.
Soap, 30.
Soluble albumin, 4.
Soluble starch, 69.
Solubilities, table of, 383.
Specific rotation, 25.
Spectroscope, 46.
Spherical aberration, 330.
Sphygmographs, 291.
Sphygmomanometer, 306.
Sphyngoscope, 295.
Spinal nerve roots, 322.
Spirometer, 311.
Spring key, 162.
Spring myograph, 208, 213.
Staircase, 271, 278.
Stannius's experiment, 270.
Starch, 17.
 " action of malt, 70.
 " animal, 19.
 " colloid, 18, 70.
 " conversion to sugar, 22.
- Saccharimeter,** 143.
Saccharoses, 16.

- Starch, potato-, 18.
 " soluble, 22.
 " stages to glucose, 22, 25.
 " stages to maltose, 69.
 " under microscope, 17.
 " under polariscope, 18.
 Stearin, 29.
 Steele's apparatus, for urea, 123.
 Stellar phosphate, 114.
 Stereoscope, 361.
 Stethographs, 308.
 Stethometer, 310.
 Stethoscope, 286.
 Stimuli, 181.
 Stokes's fluid, 49.
 Strasburger's test, 88.
 Strobic discs, 350.
 Struggle of fields of vision, 361.
 Strychnia, 320.
 Successive light induction, 358.
 Successive shocks, 219.
 Sugar in urine, estimation of, 142,
 143, 145.
 Sugar fermentation method, 137.
 " tests for, 142.
 Sulphocyanides, 68.
 Sulphur test for bile, 88.
 Suprarenal extract, 307.
 Swallowing on heart, 287, 312.
 Sympathetic of frog, 275.
 " rabbit, 302.
 Syntonin, 8.

 Talbot's law, 342.
 Tambour, 228.
 Tapping experiment, 287.
 Taste, 370.
 Taurin, 90.
 Taurocholic acid, 87.
 Telephone experiment, 189.
 Temperature, sense of, 368.
 " on muscle, 213.
 Tendon, to rupture, 189.
 Tension of muscle, 204.
 " recorder, 205.
 Test meal, 79.
 Test types, 282.
 Tetanomotor, 182.
 Tetanus, 220, 221.
 " secondary, 241.
 Tetra paper, 71.
 Thermal stimulation, 182.
 Thermometric scales, 391.
 Time-markers, 210.
 Tissue-fibrinogen, 104.
 Tonometer, 282.

 Total N., estimation of, 127.
 Touch, 367.
 Trichloracetic acid, 138.
 Trigger key, 162.
 Triple phosphate, 114.
 Trommer's test, 20, 142.
 Tropæolin, 76.
 Trypsin, 81.
 Tryptic digestion, 81.
 Tubes, rigid and elastic, 295, 298.
 Türk's method, 319.
 Twitch, 185, 198.
 Tyrosin, 82, 86.

 Uffelmann's reaction, 77.
 Unipolar stimulation, 186.
 Unorganised deposits in urine, 149.
 Urates, 130.
 Urea, 117.
 " nitrate, 117.
 " oxalate, 118.
 " preparation, 117.
 " quantity, 119.
 " reactions of, 119.
 " synthesis of, 126.
 " volumetric analysis, 120, 123
 Ureameter, 123, 126.
 " of Doremus, 123.
 Uric acid, 127.
 " estimation of, 135.
 " reactions, 128.
 " salts of, 130.
 " quantity, 127.
 " tests, 128.
 Urinary calculi, 149.
 " deposits, 147, 149.
 Urine, 104.
 " abnormal constituents, 186.
 " acidity, 107, 110.
 " albumin in, 136.
 " alkalinity, 107.
 " bile in, 141.
 " blood in, 140.
 " chlorides, 111.
 " colour, 105.
 " colouring-matters, 133.
 " diabetic, 142.
 " deposits in, 147, 149.
 " fermentations of, 108.
 " ferments in, 135.
 " general examination of, 153.
 " inorganic bodies, 110.
 " mucus in, 135.
 " odour, 106.
 " organic bodies, 117.
 " phenol in, 184.

- Urine, phosphates in, 112.
 ,, pigments of, 134.
 ,, pus in, 147.
 ,, quantity, 105.
 ,, reaction, 107.
 ,, reaction to reagents, 135.
 ,, solids in, 106.
 ,, specific gravity, 105.
 ,, sugar in, 142.
 ,, sulphates in, 111.
 ,, transparency, 108.
 ,, urates in, 130.
 ,, urea in, 117.
 ,, uric acid in, 127.
 Urinometer, 105.
 Urobilin, 133.
 ,, febrile, 134.
- Vagus of frog, 273.
 ,, ,, latent period of, 275.
 ,, rabbit, 302.
 ,, on heart, 305.
- Valsalva's experiment, 295.
 Valves of heart, 234.
 Vanillin, 76.
 Varnish, 197.
 Vascular tonus, 279.
 Veratria, 214.
 Vibrating reed, 211.
 Vision, physiology of, 329.
 Visual axes, 349.
 ,, judgments, 347.
 Vital capacity, 311.
 Vitellin, 7.
 Vogel's lactoscope, 98.
 Volkmann's experiment, 338.
- Volt, 160.
 Volumetric process, 114.
 ,, for phosphoric acid, 115.
 ,, for sugar, 143.
 ,, for urea, 120, 123
 Vomit, examination of, 79.
 Vowel-sounds, 317.
- Wave-lengths, 55.
 Wave of muscle, 228.
 Weber's circles, 370.
 Weights, 390.
 Weyl's test, 133.
 Wheaten flour, 98.
 Wheatstone's fluttering hearts, 330.
 Wheel movements, 345.
 Whistle, Galton's, 372.
 White of egg, 1, 2.
 Wild's apparatus, 228.
 ,, polaristrobometer, 28.
 Wilke's reagent paper, 158.
 Witte's peptones, 8.
 Wittich's method, 71.
 Work done by muscle, 205.
 Writing point of Bayliss, 270.
- Xanthin, 101.
 ,, bodies, 381.
 Xanthoproteic reaction, 2
- Yellow spot, 340.
- Zöllner's lines, 347.
 Zymogen, 80.

W. B. B. B.



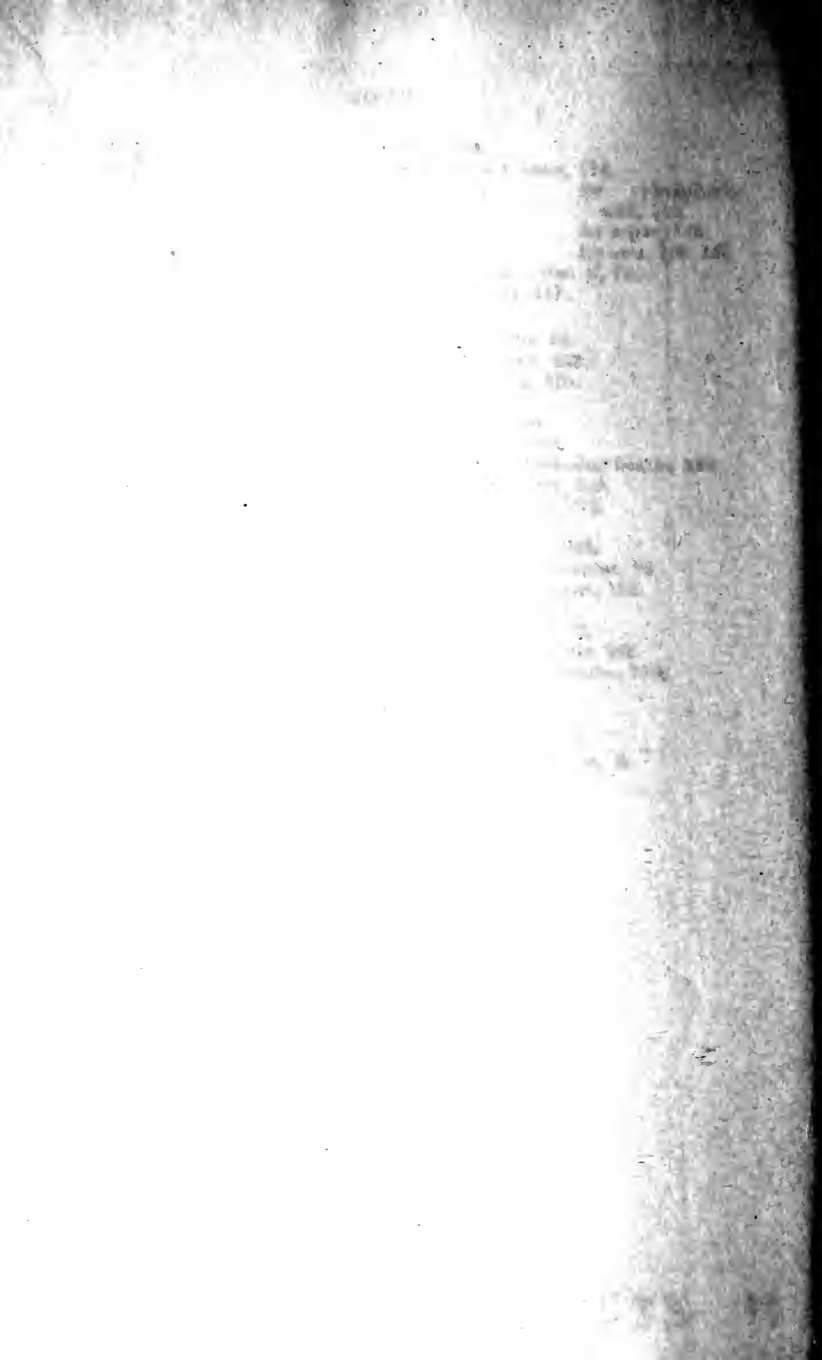



UNIVERSITY OF CALIFORNIA LIBRARY
Los Angeles

This book is DUE on the last date stamped below.

QT
25
58616
1895

MAR 2 - 1955

NOV 26 1962

OCT 19 1964

OCT 29 RECD

~~RECD~~ AUG 19 1969

~~RECD~~

RECEIVED AUG 28 1978

RECEIVED OCT 2 1979



3 1158 00353 8914

