

UNIV. OF  
TORONTO  
LIBRARY



Digitized by the Internet Archive  
in 2009 with funding from  
University of Toronto



PROCEEDINGS OF THE  
SECTION OF SCIENCES

---

VOLUME XVII

---

14615<sup>3</sup>  
51618

JOHANNES MÜLLER :—: AMSTERDAM  
:=====: JUNE 1915 :=====:

Q  
57  
A48  
v.17  
pt.1

KONINKLIJKE AKADEMIE  
VAN WETENSCHAPPEN  
-:- TE AMSTERDAM -:-

PROCEEDINGS OF THE  
SECTION OF SCIENCES

---

VOLUME XVII  
( — 1<sup>ST</sup> PART — )

---

JOHANNES MÜLLER :—: AMSTERDAM  
:=====: DECEMBER 1914 :=====:

(Translated from: Verslagen van de Gewone Vergaderingen der Wis- en Natuurkundige Afdeeling van 30 Mei 1914 tot 28 November 1914. Dl. XXII.)



# C O N T E N T S.



	Page
Proceedings of the Meeting of May 30, 1914 . . . . .	1
» » » » June 27 » . . . . .	133
» » » » September 26 » . . . . .	467
» » » » October 31 » . . . . .	631
» » » » November 28 » . . . . .	719





# CONTENTS.

---

- A B E L's** polynomia (On **HERMITE's** and). 192.
- ABSORPTION LINES**  $D_1$  and  $D_2$  (On the structure of the). 720.
- AIR-BLADDER** (The physiology of the) of fishes. 1088.
- ALBUMINOUS FLUIDS** (The identification of traces of bilirubin in). 807.
- ALKALIES** (The coloration of some derivatives of Picryl-methylamide with). 647.
- ALLOTROPY** (The) of cadmium. II. 54. III. 122. IV. 638. V. 1050.
- of zinc. II. 59. III. 641.
  - of copper. II. 60.
  - of antimony. I. 645.
  - of lead. I. 822. Note. 1055.
  - of potassium. I. 1115.
  - of bismuth. II. 1236.
  - (The application of the theory of) to electromotive equilibria. II. 37. III. 680.
  - (The metastability of metals in consequence of) and its significance for Chemistry, Physics and Technics. 200. III. 926. IV. 1238.
  - (The metastable continuation of the mixed crystal series of pseudo-components in connection of the phenomenon). II. 672.
- ALMOND** (Gummosis in the fruit of the) and the Peachalmond as a process of normal life. 810.
- AMIDES** of  $\alpha$ -oxyacids (Action of sodium-hypochlorite on). 1163.
- AMMONIA** (On the interaction of) and methylamine on 2,3,4-trinitrodimethylaniline. 1034.
- AMMONIA-water** (The system). 182.
- AMORPHOUS CARBON** (The decoloration of fuchsin-solutions by). 1322.
- Anatomy.** P. RĚTHIG and C. U. ARIËNS KAPPERS: "Further contributions to our knowledge of the brain of *Myxine glutinosa*". 2.
- C. WINKLER: "A case of occlusion of the arteria cerebelli posterior inferior". 914.
  - J. BOEKE: "On the termination of the efferent nerves in plain muscle-cells, and its bearing on the sympathetic (accessory) innervation of the striated muscle-fibre". 982.
  - J. BOEKE: "On the mode of attachment of the muscular fibre to its tendonfibres in the striated muscles of the vertebrates". 959.
  - H. A. VERMEULEN: "The vagus area in Camelidae". 1119.
- ANOMALIES** (On SEELIGER's hypothesis about the) in the motion of the inner planets. 23.
- ANTIBODIES** (On the formation of) after injection of sensitized antigens. II. 318.

- ANTIGENS (On the formation of antibodies after injection of sensitized). II. 318.
- ANTIMONY (The allotropy of). I. 645.
- APOPHYLLITE (On the real symmetry of cordierite and). 430.
- ARIËNS KAPPERS (C. U.). v. KAPPERS (C. U. ARIËNS).
- ARSENIC TRISULPHIDE SOLS (The connection between the limit value and the concentration of). 1158.
- ARSENIOUS OXIDE (Compounds of). I. 1111.
- ARTERIA cerebelli posterior inferior (A case of occlusion of the). 914.
- Astronomy.** J. WOLTJER JR.: "On SEELIGER's hypothesis about the anomalies in the motion of the inner planets". 23.
- W. DE SITTER: "Remarks on Mr. WOLTJER's paper concerning SEELIGER's hypothesis". 33.
- W. DE SITTER: "The figure of the planet Jupiter". 1047.
- W. DE SITTER: "On the mean radius of the earth, the intensity of gravity and the moon's parallax". 1291.
- W. DE SITTER: "On isostasy, the moments of inertia and the compression of the earth". 1295.
- W. DE SITTER: "The motions of the lunar perigee and node and the figure of the moon". 1309.
- A T E N (A. H. W.) and A. SMITS. The application of the theory of allotropy to electro-motive equilibria. II. 37. III. 680.
- ATLANTIC OCEAN (On the relation between departures from the normal in the strength of the trade-winds of the) and those in the waterlevel and temperature in the Northern European seas. 1147.
- ATOMIC FORCES (The calculation of the molecular dimensions from the supposition of the electric nature of the quasi-elastic). 877.
- B A A T (W. C. D E) and F. A. H. SCHREINEMAKERS. The system: copper sulphate, copper chlorid, potassium sulphate, potassium chlorid and water at 30° C. 533.
- On the quaternary system  $KCl-CuCl_2-BaCl_2-H_2O$ . 781.
- Compounds of the arsenious oxide. I. 1111.
- B A C K E R (H. J.) and A. P. N. FRANCHIMONT. The coloration of some derivatives of pierylmethylamide with alkalis. 647.
- *z*-Sulpho-propionic acid and its resolution into optically active isomerides. 653.
- B A K H U Y Z E N (H. G. V A N D E S A N D E). Comparison of the Dutch platinum-iridium Metre N<sup>o</sup>. 27 with the international Metre *M* as derived from the measurements by the Dutch Metre Commission in 1879 and 1880, and a preliminary determination of the length of the measuring-bar of the French base apparatus in international metres. 311.
- N. WILDEBOER and J. W. DIEPERINK: "Comparison of the measuring bar used in the base measurement at Stroe with the Dutch Metre N<sup>o</sup>. 27. 300.
- BASE MEASUREMENT (Comparison of the measuring bar used in the) at Stroe with the Dutch Metre No. 27. 300.
- B E E G E R (N. G. W. H.). On HERMITE's and ABEL's polynomia. 192.
- BENZENE DERIVATIVES (The replacement of substituents in). 1027.

- BENZENES** (The nitration of the mixed dihalogen). 846.
- BEIJERINCK (M. W.)**. Gummosis in the fruit of the Almond and the Peachalmond as a process of normal life. 810.
- BILIRUBIN** (The identification of traces of) in albuminous fluids. 807.
- BINARY MIXTURES** (Isothermals of monatomic substances and their). XVI. 275.  
— (Isothermals of di-atomic substances and their). XV. 950. XVI. 959.
- BINARY SYSTEM** (On unmixing in a) for which the three-phase pressure is greater than the sum of the vapour tensions of the two components. 834.
- BISMUTH** (The allotropy of). II. 1236.
- BOEKE (J.)**. On the termination of the efferent nerves in plain muscle-cells and its bearing on the sympathetic (accessory) innervation of the striated muscle-fibre. 982.  
— On the mode of attachment of the muscular fibre to its tendonfibres in the striated muscles of the vertebrates. 939.  
— presents a paper of Dr. A. B. DROOGLEEVER FORTUYN: "The decoloration of fuchsin-solutions by amorphous carbon". 1322.
- BOER (S. DE)** On the heart-rhythm. 1075 II. 1135.
- BÖESEKEN (J.)**. On catalyse. 546.  
— and W. D. COHEN. The reduction of aromatic ketones. III. Contribution to the knowledge of the photochemical phenomena. 849.
- BOILING POINTS** (The influence of the hydration and of the deviations from the ideal gas-laws in aqueous solutions of salts on the solidifying and the). 1036.
- BOIS (H. DU)**. Modern electromagnets, especially for surgical and metallurgic practice. 468.  
— The universality of the ZEEMAN-effect with respect to the STARK-effect in canal-rays. 873.
- BOKHORST (S. C.)** and A. SMITS. On the vapour pressure lines in the system phosphorus. II. 678. III. 962.  
— Further particulars concerning the system phosphorus. 973.
- BOLK (L.)** presents a paper of Dr. P. RÖTHIG and Dr. C. U. ARLËNS KAPPERS: "Further contributions to our knowledge of the brain of *Myxine glutinosa*". 2.  
— presents a paper of Dr. H. A. VERMEULEN: "The vagus area in *Camelidae*". 1119.
- BOSCH (J. C. VAN DEN)** and ERNST COHEN. The allotropy of antimony. I. 645.
- Botany**. Miss LUCIE C. DOYER: "Energy transformations during the germination of wheat-grains". 62.  
— M. W. BEIJERINCK: "Gummosis in the fruit of the Almond and the Peachalmond as a process of normal life". 810.  
— C. E. B. BREMEKAMP: "The mutual influence of phototropic and geotropic reactions in plants". 1278.
- BRAIN of *Myxine glutinosa*** (Further contributions to our knowledge of the). 2.
- BRAVAIS** (The theory of) (on errors in space) for polydimensional space with applications to correlation (Continuation). 150.
- BREMEKAMP (C. E. B.)**. On the mutual influence of phototropic and geotropic reactions in plants. 1278.

- BROUWER (H. A.). On the granitic area of Rokan (Middle-Sumatra) and on contact phenomena in the surrounding schists. 1190.
- BRUIN (G. DE). A crystallized compound of isoprene with sulphur dioxide. 585.  
— and ERNST COHEN. The metastability of the metals in consequence of allotropy, and its significance for Chemistry, Physics and Technics. III. 926.
- BÜCHNER (E. H.) and L. K. WOLFF. On the behaviour of gels towards liquids and the vapours thereof. II. 92.
- CADMIUM (The allotropy of). II. 54. III. 122. IV. 638. V. 1050.
- CAMELIDÆ (The vagus area in). 1119.
- CANAL-RAYS (The universality of the ZEEMAN-effect with respect to the STARK-effect in). 873.
- CAPILLARY PRESSURE (On the measurement of the) in a soap-bubble. 946.
- CAPILLARITY (Measurements on the) of liquid hydrogen. 528.
- CATALYSE (On). 546.
- CHEMICAL CONSTANT (The) and the application of the quantumtheory by the method of the natural vibrations to the equation of state of an ideal monatomic gas. 20.
- Chemistry.** A. SMITS and A. H. W. ATEN: "The application of the theory of allotropy to electromotive equilibria". II. 37. III. 680.  
— E. COHEN and W. D. HELDERMAN: "The allotropy of cadmium. II. 54. III. 122. IV. 638. V. 1050.  
— E. COHEN and W. D. HELDERMAN: "The allotropy of zinc." II. 59. III. 641.  
— E. COHEN and W. D. HELDERMAN: "The allotropy of copper". II. 60.  
— F. A. H. SCHREINEMAKERS: "Equilibria in ternary systems". XV. 70. XVI. 169. XVII. 767. XVIII. 1260.  
— L. K. WOLFF and E. H. BÜCHNER: "On the behaviour of gels towards liquids, and the vapours thereof". II. 92.  
— A. SMITS and S. POSTMA: "The system ammonia-water". 182.  
— ERNST COHEN: "The metastability of the metals in consequence of allotropy and its significance for Chemistry, Physics and Technics". 200.  
— F. M. JAEGER and ANT. SRMEK: "Studies in the field of Silicate-chemistry". II. 239. III. 251.  
— F. M. JAEGER: "The temperature-coefficients of the free surface-energy of liquids at temperatures from  $-80^{\circ}$  to  $1650^{\circ}$  C. I. 329. F. M. JAEGER and M. SMIT. II. 365. III. 386. F. M. JAEGER and J. KAHN. IV. 395. F. M. JAEGER. V. 405. VI. 416. VII. 555. VIII. 571.  
— F. A. H. SCHREINEMAKERS and Miss W. C. DE BAAT: "The system: copper sulphate, copper chlorid, potassium sulphate, potassium chlorid and water at  $30^{\circ}$  C." 533.  
— J. BÜSEKEN: "On catalyse". 546.  
— G. DE BRUIN: "A crystallized compound of isoprene with sulphur dioxide". 585.  
— H. R. KRUYT: "Current potentials of electrolyte solutions". 615.  
— H. R. KRUYT: "Electric charge and limit value of colloids". 623.  
— ERNST COHEN and J. C. VAN DEN BOSCH: "The allotropy of antimony". I. 645.

- Chemistry.** A. P. N. FRANCHIMONT and H. J. BACKER: "The coloration of some derivatives of Picrylmethylamide with alkalis". 647.
- A. P. N. FRANCHIMONT and H. J. BACKER: " $\alpha$  Sulpho-propionic acid and its resolution into optically active isomerides". 653.
- A. SMITS: "The metastable continuation of the mixed crystal series of pseudo-components in connection with the phenomenon allotropy". II. 672.
- A. SMITS and S. C. BOKHORST: "On the vapour pressure lines of the system phosphorus". II. 678.
- F. E. C. SCHEFFER: "On gas equilibria and a test of Prof. v. D. WAALS JR.'s formula". I. 695. II. 1011.
- W. REINDERS: "Equilibria in the system Pb-S-O, the roasting reaction process". 703.
- F. A. H. SCHREINEMAKERS and Miss W. C. DE BAAT: "On the quaternary system  $KCl-CuCl_2-BaCl_2-H_2O$ ". 781
- ERNST COHEN and W. D. HELDERMAN: "The allotropy of lead". 822. Note. 1055.
- A. F. HOLLEMAN: "The nitration of the mixed dihalogenbenzenes". 846.
- J. BÖESEKEN and W. D. COHEN: "The reduction of aromatic ketones. III. Contribution to the knowledge of the photo-chemical phenomena". 849.
- ERNST COHEN and G. DE BRUIN: "The metastability of the metals in consequence of allotropy and its significance for Chemistry, Physics and Technics". III. 926.
- A. SMITS and S. C. BOKHORST: "On the vapour pressure lines of the system phosphorus". II. 678. III. 962.
- A. SMITS and S. C. BOKHORST: "Further particulars concerning the system phosphorus". 973.
- A. F. HOLLEMAN: "The replacement of substituents in benzene derivatives". 1027.
- P. VAN ROMBURGH and Miss D. W. WENSINK: "On the interaction of ammonia and methylamine on 2,3,4-trinitrodimethylaniline". 1034.
- C. H. SLUITER: "The influence of the hydration and of the deviations from the ideal gas-laws in aqueous solutions of salts on the solidifying and the boiling points". 1036.
- Miss ADA PRINS: "On critical end-points and the system ethanenaphtalene". 1095.
- F. A. H. SCHREINEMAKERS and Miss W. C. DE BAAT: "Compounds of the arsenious oxyde". 1111.
- ERNST COHEN and S. WOLFF: "The allotropy of potassium". I. 1115.
- H. R. KRUYT and JAC. VAN DER SPEK: "The connection between the limit value and the concentration of arsenic trisulphide sols". 1158.
- R. A. WEERMAN: "Action of sodium hypochlorite on amides of  $\alpha$ -oxyacids". 1163.
- F. M. JAEGER: "Researches on PASTEUR's principle of the connection between molecular and physical dissymmetry". I. 1217.
- ERNST COHEN: "The allotropy of bismuth". II. 1236.
- ERNST COHEN and W. D. HELDERMAN: "The metastability of the metals in consequence of allotropy and its significance for Chemistry, Physics and Technics". IV. 1238.

- Chemistry.** A. W. K. DE JONG: "Action of sunlight on the cinnamic acids". 1274.
- CINNAMIC ACIDS (Action of sunlight on the). 1274.
- CIRCLES (Systems of) determined by a pencil of conics. 1107.
- COHEN (ERNEST). The metastability of the metals in consequence of allotropy, and its significance for Chemistry, Physics and Technics. II. 200.
- presents a paper of Dr. H. R. KRUYT: "Current potentials of electrolyte solutions". 615.
  - presents a paper of Dr. H. R. KRUYT: "Electric charge and limit value of colloids". 623.
  - presents a paper of Dr. H. R. KRUYT and JAC. VAN DER SPEK: "The connection between the limit value and the concentration of arsenic trisulphide sols". 1158.
  - The allotropy of bismuth. II. 1236.
  - and J. C. VAN DEN BOSCH. The allotropy of antimony. I. 645.
  - and G. DE BRUIN. The metastability of the metals in consequence of allotropy and its significance for Chemistry, Physics and Technics. III. 926.
  - and W. D. HELDERMAN. The allotropy of Cadmium. II. 54. III. 122. IV. 638. V. 1050.
  - The allotropy of zinc. II. 59. III. 541.
  - The allotropy of copper. II. 60.
  - The allotropy of lead. I. 822. Note 1055.
  - The metastability of the metals in consequence of allotropy and its significance for Chemistry, Physics and Technics. IV. 1238.
  - and S. WOLFF. The allotropy of potassium. I. 1115.
- COHEN (W. D.) and J. BÖESEKEN. The reduction of aromatic ketones. III. Contribution to the knowledge of the photochemical phenomena. 849.
- COLLOIDS (Electric charge and limit value of). 623.
- COLORATION (The) of some derivatives of Picrylmethylamide with alkalies. 647.
- COLOURS (On FRESNEL's coefficient for light of different). 1<sup>st</sup> part. 415.
- COMPOUND (A crystallized) of isoprene with sulphur dioxide. 585.
- COMPOUNDS of arsenious oxide. I. 1111.
- CONCENTRATION (The connection between the limit value and the) of arsenic trisulphide sols. 1158.
- CONGRUENCE (A bilinear) of rational twisted quintics. 1250.
- CONGRUENCES (Some particular bilinear) of twisted cubics. 1256.
- CONICS (Systems of circles determined by a pencil of). 1107.
- CONTACT-PHENOMENA (On the granitic area of Rokan (Middle Sumatra) and on) in the surrounding schists. 1190.
- COPPER (The allotropy of). II. 60.
- (Measurements on the specific heat of lead between 14° and 80° K. and of) between 15° and 22° K. 894.
- COPPER SULPHATE, Copper chlorid (The system :), potassium sulphate, potassium chlorid and water at 30°. 533.
- CORDIERITE and Apophyllite (On the real symmetry of). 430.



- CORRELATION** (The theory of BRAVAIS (on errors in space) for polydimensional space, with applications to) (Continuation). 150.
- CORRESPONDING STATES** (Contribution to the theory of). 840.
- CRITICAL POINT** (Vapour pressures of oxygen and) of oxygen and nitrogen. 950.
- CRITICAL QUANTITIES** (A new relation between the) and on the unity of all substances in their thermic behaviour. 451.  
— (Some remarks on the values of the) in case of association. 598.
- CROMMELIN** (C. A.). Isothermals of monatomic substances and their binary mixtures. XVI. 275.  
— Isothermals of di-atomic substances and their binary mixtures. XVI. Vapour pressures of nitrogen between the critical point and the boiling point. 959.  
— E. MATHIAS and H. KAMERLINGH ONNES. The rectilinear diameter of nitrogen. 953.
- CRYSTAL SERIES** (The metastable continuation of the mixed) of pseudo-components in connection with the phenomenon allotropy. II. 672.
- CRYSTALS** (On a new phenomenon accompanying the diffraction of RÖNTGEN rays in birefringent). 1204.
- CUBE** (The different ways of floating of an homogeneous). 224.
- CUBICS** (Some particular bilinear congruences of twisted). 1256.
- CURVES** (Characteristic numbers for nets of algebraic). 935.  
— (Characteristic numbers for a triply infinite system of algebraic plane). 1055.
- DECOLORATION** (The) of fuchsin-solutions by amorphous carbon. 1322.
- DEEP reflexes** (Exaggeration of). 885.
- DENSITY** (On the manner in which the susceptibility of paramagnetic substances depends on the). 110.  
— (Accidental deviations of) and opalescence at the critical point of a single substance. 793.
- DIAMETER** (The rectilinear) of nitrogen. 953.
- DIEPERINK** (J. G.), N. WILDEBOER and H. G. VAN DE SANDE BAKHUYZEN. Comparison of the measuring bar used in the base measurement at Stroe with the Dutch Metre N<sup>o</sup>. 27. 300.
- DIFFRACTION** (On a new phenomenon accompanying the) of Röntgen rays in birefringent crystals. 1204.
- DIFFUSION COEFFICIENT** (The) of gases and the viscosity of gas-mixtures. 1068.
- DISCONTINUITIES** (On apparent thermodynamic) in connection with the value of the quantity  $b$  for infinitely large volume. 605.
- DISSYMMETRY** (Researches on PASTEUR's principle of the connection between molecular and physical). I. 1217.
- DORSMAN** (C.), H. KAMERLINGH ONNES and G. HOLST. Isothermals of di-atomic substances and their binary mixtures. XV. Vapour pressures of oxygen and critical point of oxygen and nitrogen. 950.
- DOYER** (LUCIE C.). Energy transformations during the germination of wheat-grains. 62.
- DROOGLEEVER FORTUYN** (A. B.). v. FORTUYN (A. B. DROOGLEEVER).
- DROSTE** (J.). On the field of a single centre in EINSTEIN's theory of gravitation. 998.

- EARTH (The mean radius of the), the intensity of gravity and the moon's parallax. 1291.  
 — (On isostasy, the moments of inertia and the compression of the). 1295.
- EHRENFEST (P.) and H. KAMERLINGH ONNES. Simplified deduction of the formula from the theory of combinations which PLANCK uses as the basis of his radiation-theory. 870.  
 — On interference phenomena to be expected when RÖNTGEN rays pass through a di-atomic gas. 1184.  
 — On the kinetic interpretation of the osmotic pressure. 1241.
- EHRENFEST (T.)—AFANASSJEW. Contribution to the theory of corresponding states. 840.
- EINSTEIN'S theory of gravitation (On the field of a single centre in). 998.
- EINTHOVEN (On the theory of the string-galvanometer of). 784.
- ELASTIC DEFORMATION (On the lowering of the freezing point in consequence of an). 732.
- ELECTRIC CHARGE and limit value of colloids. 623.
- ELECTRODES (The effect of magnetisation of the) on the electromotive force. 745.
- ELECTROLYTE SOLUTIONS (Current potentials of) 615.
- ELECTROMAGNETS (Modern), especially for surgical and metallurgic practice. 468.
- ELECTROMETER (A new) specially arranged for radio-active investigations. 659.
- ELECTROMOTIVE FORCE (The effect of magnetisation of the electrodes on the). 745.
- ELIAS (G. J.). On the structure of the absorption lines  $D_1$  and  $D_2$ . 720.  
 — On the lowering of the freezing point in consequence of an elastic deformation. 732.  
 — The effect of magnetisation of the electrodes on the electromotive force. 745.
- END-POINTS (On critical) and the system ethane-naphtalene. 1095.
- ENERGY-SURFACE (The temperature-coefficients of the free) of liquids at temperatures from  $-80^\circ$  C. to  $1650^\circ$  C. I. 329. II. 365. III. 386. IV. 395. V. 405. VI. 416. VII. 555. VIII. 571.
- ENERGY-TRANSFORMATIONS during the germination of wheat-grains. 62.
- ENTROPY CONSTANT (Theoretical determination of the) of gases and liquids. 1167.
- EQUATION OF STATE (The chemical constant and the application of the quantum theory by the method of the natural vibrations to the) of an ideal monatomic gas. 20.
- EQUILIBRIA (The application of the theory of allotropy to electromotive). II. 37. III. 680.  
 — in the system Pb—SO, the roasting reaction process. 703.  
 — in ternary systems. XV. 70. XVI. 169. XVII. 767. XVIII. 1260.
- ERRATUM. 944. 1073. 1202.
- ERRORS IN SPACE (The theory of BRAVAIS, on) for polydimensional space with applications to correlation. (Continuation). 150.
- ETHANE-naphtalene (On critical end-points and the system). 1095.
- EUROPEAN SEAS (On the relation between departures from the normal in the strength of the trade-winds in the Atlantic Ocean and those in the waterlevel and temperature in the Northern). 1147.
- EYKMAN (C.) presents a paper of Dr. L. K. WOLFF: "On the formation of antibodies after injection of sensitized antigens". II. 318.

- FISHES (The physiology of the air-bladder of). 1088.
- FLOATING (The different ways of) of an homogeneous cube. 224.
- FLORES (On the tin of the island of). 474.
- FOLMER (MISS H.). A new electrometer, specially arranged for radio-active investigations. 659.
- FONTAINE SCHLUITER (J. J. DE LA), v. SCHLUITER (J. J. DE LA FONTAINE).
- FORTUYN (A. B. DROOGLEEVER). The decoloration of fuchsin-solutions by amorphous carbon. 1322.
- FRANCHIMONT (A. P. N.) presents a paper of Dr. R. A. WEERMAN: "Action of sodium hypochlorite on amides of  $\alpha$ -oxyacids". 1163.
- and H. J. BACKER. The coloration of some derivatives of Picrylmethylamide with alkalies. 647.
- $\alpha$ -sulpho-propionic acid and its resolution into optically active isomerides. 653.
- FREEZING POINT (On the lowering of the) in connection of an elastic deformation. 732.
- FREQUENCIES (The treatment of) of directed quantities. 586.
- FRESNEL'S coefficient (On) for light of different colours. 445.
- FUCHSIN-SOLUTIONS (The decoloration of) by amorphous carbon. 1322.
- FUNCTIONS of HERMITE (On the). 1<sup>st</sup> part. 139.
- GALLÉ (P. H.). On the relation between departures from the normal in the strength of the trade-winds of the Atlantic Ocean and those in the waterlevel and temperature in the Northern European seas. 1147.
- GAS (The chemical constant and the application of the quantum theory by the method of the natural vibrations to the equation of state of an ideal monatomic). 20.
- (On interference phenomena to be expected when Röntgen rays pass through a di-atomic). 1184.
- GASES (The diffusion-coefficient of) and the viscosity of gas-mixtures. 1068.
- (Theoretical determination of the entropy constant of) and liquids. 1167.
- GAS EQUILIBRIA (On) and a test of Prof. v. D. WAALS JR.'s theorem. I. 695. II. 1011.
- GAS-LAWS (The influence of the hydration and of the deviations from the ideal) in aqueous solutions of salts on the solidifying and the boiling points. 1036.
- GAS-MIXTURES (The diffusion-coefficient of gases and the viscosity of). 1068.
- GELS (On the behaviour of) towards liquids and the vapours thereof. II. 92.
- Geodesy. H. G. VAN DE SANDE BAKHUYZEN, N. WILDEBOER and J. W. DIEPERINK: "Comparison of the measuring bar used in the base-measurement at Stroe, with the Dutch Metre No. 27". 300.
- H. G. VAN DE SANDE BAKHUYZEN: "Comparison of the platinum-iridium Metre No. 27 with the international Metre M as derived from the measurements by the Metre-Commission in 1879 and 1880, and a preliminary determination of the length of the measuring-bar of the French base-apparatus in international metres". 311.
- Geology. H. A. BROUWER: "On the granitic area of Rokan (Middle-Sumatra) and on contact-phenomena in the surrounding schists". 1190.
- Geophysics. J. P. VAN DER STOK: "The treatment of frequencies of directed quantities". 586.

- Geophysics.** P. H. GALLÉ: "On the relation between departures from the normal in the strength of the trade-winds of the Atlantic Ocean and those in the waterlevel and temperature in the Northern European seas". 1147.
- GEOTROPIC REACTIONS** (On the mutual influence of phototropic and) in plants. 1278.
- GERMINATION** (Energy transformations during the) of wheat-grains. 62.
- GRANITIC AREA** (On the) of Rokan (Middle-Sumatra) and on contact-phenomena in the surrounding schists. 1190.
- GRAVITATION** (On the field of a single centre in EINSTEIN'S theory of). 998.
- GRAVITY** (The mean radius of the earth, the intensity of) and the moon's parallax. 1291.
- GUMMOSIS** in the fruit (of the Almond and the Peachalmond as a process of normal life. 810.
- HAGA** (H.) presents a paper of Miss H. J. FOLMER: "A new electrometer, especially arranged for radio-active investigations". 659.
- presents a paper of Prof. F. M. JAEGER: "On a new phenomenon accompanying the diffraction of Röntgenrays in birefringent crystals". 1204.
- and F. M. JAEGER. On the real symmetry of cordierite and apophyllite. 430.
- HAMBURGER** (H. J.) presents a paper of Dr. E. LAQUEUR: "On the survival of isolated mammalian organs with automatic function". 270.
- presents a paper of Prof. A. A. HYMANS VAN DEN BERGH and J. J. DE LA FONTAINE SCHLUITER: "The identification of traces of bilirubin in albuminous fluids". 807.
- Phagocytes and respiratory centre. 1325.
- HEART-RHYTHM** (On the). 1075. II. 1135.
- HELDERMAN** (W. D.) and ERNST COHEN. The allotropy of cadmium. II. 54. III. 122. IV. 638. V. 1050.
- The allotropy of zinc. II. 59.
- The allotropy of copper. II. 60.
- The allotropy of lead. I. 822. Note. 1055.
- The metastability of the metals in consequence of allotropy and its significance for Chemistry, Physics and Technics. IV. 1238.
- HELIUM** (Further experiments with liquid). I. 12. 278. K. 283. L. 514. N. 520. M. 760.
- HERMITE** (On the functions of). 1<sup>st</sup> part. 139.
- and ABEL'S polynomia (On). 192.
- HOF** (K) and H. KAMERLINGH ONNES. Further experiments with liquid helium. N. 520.
- HOLLEMAN** (A. F.) presents a paper of Dr. L. K. WOLFF and Dr. E. H. BÜCHNER: "On the behaviour of gels towards liquids and the vapours thereof. II. 92.
- presents a paper of Prof. J. BÖESEKEN: "On catalyse". 546.
- The nitration of the mixed dihalogen benzenes. 846.
- presents a paper of Prof. J. BÖESEKEN and W. D. COHEN: "The reduction of aromatic ketones. III. Contribution to the knowledge of the photochemical phenomena". 849.
- The replacement of substituents in benzene derivatives. 1027.
- presents a paper of Dr. C. H. SLUITER: "The influence of the hydration and

- of the deviations from the ideal gas-laws in aqueous solutions of salts on the solidifying and the boiling points". 1036.
- HOLLEMAN** (A. F.) presents a paper of Miss **ADA PRINS**: „On critical end-points and the system ethane-naphthalene". 1095.
- HOLST** (G.) and **H. KAMERLINGH ONNES**. The measurement of very low temperatures. XXIV. The hydrogen and helium thermometers of constant volume down to the freezing point of hydrogen compared with each other and with the platinum-resistance thermometer. 501.
- On the electrical resistance of pure metals. IX. 508.
- Further experiments with liquid helium. M. 760.
- **H. KAMERLINGH ONNES** and **C. DORSMAN**. Isothermals of di-atomic substances and their binary mixtures. XV. Vapour pressures of oxygen and critical point of oxygen and nitrogen. 950.
- HOOGWERFF** (S.) presents a paper of Prof. **W. REINDERS**: "Equilibria in the system Pb-S-O, the roasting reactionprocess. 703.
- HULSHOF** (H.). On the thermodynamic potential as a kinetic quantity. 1st part. 85.
- HYDRATION** (The influence of the) and of the deviations from the ideal gas-laws in aqueous solutions of salts on the solidifying and the boiling points. 1036.
- HYDROGEN** (Measurements of isotherms of) at 20° C. and 15.°5 C. 203.
- (Measurements on the capillarity of liquid). 528.
- HYDROGEN ISOTHERMS** (The) of 20° C. and of 15.°5 C. between 1 and 2200 atms. 217.
- Hydrostatics**. **D. J. KORTEWEG**: "The different ways of floating of an homogeneous cube". 224.
- HYMANS VAN DEN BERGH** (A. A.) and **J. J. DE LA FONTAINE SCHLUITER**. The identification of traces of bilirubin in albuminous fluids. 807.
- INERTIA** (On isostasy, the moments of) and the compression of the earth. 1295.
- INNERVATION** (On the termination of the efferent nerves in plain muscle-cells and its bearing on the sympathetic (accessory)) of the striated muscle-fibre. 982.
- INTEGRAL EQUATIONS** (On some). 286.
- INTEGRAL-FORMULA** (On an) of **STIELTJES**. 829.
- INTERFERENCE-PHENOMENA** (On) to be expected when Röntgen-rays pass through a di-atomic gas. 1184.
- INVOLUTION** (A cubic) of the second class. 105.
- (A triple) of the third class. 134.
- ISOMERIDES** ( $\alpha$ -Sulpho-propionic acid and its resolution into optically active). 653.
- ISOPRENE** (A crystallized compound of) with sulphur dioxide. 585.
- ISOSTASY** (On), the moments of inertia and the compression of the earth. 1295.
- ISOTHERMALS** of di-atomic substances and their binary mixtures. XV. Vapour pressures of oxygen and critical point of oxygen and nitrogen. 950. XVI. Vapour-pressures of nitrogen between the critical point and the boiling point. 959.
- of monatomic substances and their binary mixtures. XVI. 275.
- ISOTHERMS** (The hydrogen) of 20° C. and of 15.°5 C. between 1 and 2200 atms. 217.
- of hydrogen (Measurements of) at 20° C. and 15.°5 C. 203.

- JAEGER (F. M.). The temperature-coefficients of the free surface-energy of liquids at temperatures from  $-80^{\circ}$  C. to  $1650^{\circ}$  C. I. 329. V. 405. VI. 416. VII. 555. VIII. 571.
- On a new phenomenon accompanying the diffraction of Röntgenrays in birefringent crystals. 1204.
  - Researches on PASTEUR'S principle of the connection between molecular and physical dissymmetry. I. 1217.
  - and H. HAGA. On the real symmetry of cordierite and apophyllite. 430.
  - and JUL. KAHN. The temperature coefficients of the free surface-energy of liquids at temperatures from  $-80^{\circ}$  C. to  $1650^{\circ}$  C. IV. 395.
  - and ANT. SIMEK. Studies in the field of silicate-chemistry. II. 239. III. 251.
  - and M. J. SMIT. The temperature-coefficients of the free surface energy of liquids at temperatures from  $-80^{\circ}$  C. to  $1650^{\circ}$  C. II. 365. III. 386.
- JONG (A. W. K. DE). Action of sunlight on the cinnamic acids. 1274.
- JUPITER (The figure of the planet). 1047.
- KAHN (JUL.) and F. M. JAEGER. The temperature-coefficients of the free surface-energy of liquids at temperatures from  $-80^{\circ}$  C. to  $1650^{\circ}$  C. IV. 395.
- KAMERLINGH ONNES (H.). v. ONNES (H. KAMERLINGH).
- KAPPERS (C. U. ARIËNS) and P. RÖTHIG. Further contributions to our knowledge of the brain of *Myxine glutinosa*. 2.
- KAPTEYN (J. C.) presents a paper of Prof. M. J. VAN UVEN: "The theory of BRAVAIS (on errors in space) for polydimensional space, with applications to correlation". Continuation. 150.
- KAPTEYN (W.). On the functions of HERMITE. 1<sup>st</sup> part. 139.
- presents a paper of Dr. N. G. W. H. BEEGER: "On HERMITE'S and ABEL'S polynomia". 192.
  - On some integral equations. 286.
  - presents a paper of Prof. M. J. VAN UVEN: "The theory of the combination of observations and the determination of the precision, illustrated by means of vectors". 490.
- KEESOM (W. H.). The chemical constant and the application of the quantum theory by the method of the natural vibrations to the equation of state of an ideal monatomic gas. 20.
- On the matter in which the susceptibility of paramagnetic substances depends on the density. 110.
  - and H. KAMERLINGH ONNES. The specific heat at low temperatures. I. Measurements on the specific heat of lead between  $14^{\circ}$  and  $80^{\circ}$  K. and of copper between  $15^{\circ}$  and  $22^{\circ}$  K. 894.
- KETONES (The reduction of aromatic). III. Contribution to the knowledge of the photochemical phenomena. 849.
- KINETIC INTERPRETATION (On the) of the osmotic pressure. 1241.
- KINETIC QUANTITY (On the thermodynamic potential as a). 1<sup>st</sup> part. 85.
- KLUYVER (J. C.). On an integral formula of STIELTJES. 829.

- KOHNSTAMM (PH.) and K. W. WALSTRA. Measurements of isotherms of hydrogen at 20° C. and 15°·5 C. 203.
- KORTEWEG (D. J.). The different ways of floating of an homogeneous cube. 224.
- KRUYT (H. R.). Current potentials of electrolyte solutions. 615.  
 — Electric charge and limit value of colloids. 623.  
 — and JAC. VAN DER SPEK. The connection between the limit value and the concentration of arsenic trisulphide sols. 1158.
- KUENEN (J. P.). On the measurement of the capillary pressure in a soap-bubble. 946.  
 — The diffusion-coefficient of gases and the viscosity of gas-mixtures. 1068.
- KUIPER JR. (K.). The physiology of the air-bladder of fishes. 1088.
- KUYPERS (H. A.) and H. KAMERLINGH ONNES. Measurements on the capillarity of liquid hydrogen. 528.
- LAAR (J. J. VAN). A new relation between the critical quantities and on the unity of all substances in their thermic behaviour. 451.  
 — Some remarks on the values of the critical quantities in case of association. 598.  
 — On apparent thermodynamic discontinuities in connection with the value of the quantity  $b$  for infinitely large volume. 606.  
 — The calculation of the molecular dimensions from the supposition of the electric nature of the quasi-elastic atomic forces. 877.
- LAQUEUR (E.). On the survival of isolated mammalian organs with automatic function. 270.
- LEAD (The allotropy of). I. 822. Note. 1055.  
 — (Measurements on the specific heat of) between 14° and 80° K. and of copper between 15° and 22° K. 894.
- LIGHT (On FRESNEL's coefficient for) of different colours. 445.
- LIMIT VALUE (Electric charge and) of colloids. 623.  
 — (The connection between the) and the concentration of arsenic trisulphide sols. 1158.
- LIQUIDS (On the behaviour of gels towards) and the vapours thereof. II. 92.  
 — (Theoretical determination of the entropy constant of gases and). 1167.  
 — (The temperature-coefficients of the free energy-surface of) at temperatures from —80° C. to 1650° C. I. 329. II. 365. III. 389. IV. 395. V. 405. VI. 416. VII. 555. VIII. 571.
- LORENTZ (H. A.) presents a paper of Dr. J. J. VAN LAAR: "A new relation between the critical quantities and on the unity of all substances in their thermic behaviour". 451.  
 — presents a paper of Dr. J. J. VAN LAAR: "Some remarks on the values of the critical quantities in case of association". 598.  
 — presents a paper of Dr. J. J. VAN LAAR: "On apparent thermodynamic discontinuities in connection with the value of the quantity  $b$  for infinitely large volume". 606.  
 — presents a paper of Dr. G. J. ELIAS: "On the structure of the absorption lines  $D_1$  and  $D_2$ ". 720.

- LORENTZ (H. A.) presents a paper of Dr. G. J. ELIAS: "On the lowering of the freezing point in consequence of an elastic deformation". 732.
- presents a paper of Dr. G. J. ELIAS: "The effect of magnetisation of the electrodes on the electromotive force". 745.
- presents a paper of Dr. L. S. ORNSTEIN: "On the theory of the string galvanometer of EINTHOVEN". 784.
- presents a paper of Dr. L. S. ORNSTEIN and Dr. F. ZERNIKE: "Accidental deviations of density and opalescence at the critical point of a single substance". 793.
- presents a paper of Mrs. T. EHRENFEST—AFANASSJEW: "Contribution to the theory of corresponding states". 840.
- presents a paper of Dr. J. J. VAN LAAR: "The calculation of the molecular dimensions from the supposition of the electric nature of the quasi-elastic atomic forces". 877.
- presents a paper of Mr. J. DROSTE: "On the field of a single centre in EINSTEIN's theory of gravitation". 998.
- presents a paper of Mr. H. TETRODE: "Theoretical determination of the entropy constant of gases and liquids". 1167.
- presents a paper of Prof. P. EHRENFEST: "On interference-phenomena to be expected when RÖNTGEN rays pass through a di-atomic gas". 1184.
- presents a paper of Prof. P. EHRENFEST: "On the kinetic interpretation of the osmotic pressure". 1241.
- LUNAR PERIGEE (The motions of the) and node and the figure of the moon. 1309.
- MAGNETISATION (The effect of) of the electrodes on the electromotive force. 745.
- MAMMALIAN ORGANS (On the survival of isolated) with automatic function. 270.
- Mathematics.** JAN DE VRIES: "A cubic involution of the second class". 105.
- JAN DE VRIES: "A triple involution of the third class". 134.
- W. KAPTEYN: "On the functions of HERMITE". 3th part. 139.
- M. J. VAN UVEN: "The theory of BRAVAIS (on errors in space) for polydimensional space with applications to correlation". (Continuation). 150.
- M. J. VAN UVEN: "Combination of observations with and without conditions and determination of the weights of the unknown quantities, derived from mechanical principles". 157.
- N. G. W. H. BERGER: "On HERMITE's and ABEL's polytonia". 192.
- W. KAPTEYN: "On some integral equations". 286.
- M. J. VAN UVEN: "The theory of the combination of observations and the determination of the precision, illustrated by means of vectors". 490.
- J. C. KLUYVER: "On an integral formula of STIELTJES". 829.
- JAN DE VRIES: "Characteristic numbers for nets of algebraic curves". 935.
- JAN DE VRIES: "Characteristic numbers for a triple infinite system of algebraic plane curves". 1055.
- JAN DE VRIES: "Systems of circles determined by a pencil of conics". 1107.
- W. VAN DER WOUDE: "On NÖTHER's theorem". 1245.
- JAN DE VRIES: "A bilinear congruence of rational twisted quintics". 1250.



- Mathematics.** JAN DE VRIES: "Some particular bilinear congruences of twisted cubics". 1256.
- MATHIAS (E.), H. KAMERLINGH ONNES and C. A. CROMMELIN. The rectilinear diameter of nitrogen. 953.
- MEASUREMENT (The) of very low temperatures. XXIV. The hydrogen and helium thermometers of constant volume, down to the freezing point of hydrogen compared with each other and with the platinum-resistance thermometer. 501.
- MEASUREMENTS on the capillarity of liquid hydrogen, 528.  
— of isotherms of hydrogen at  $26^{\circ}$  C. and  $15^{\circ}5$  C. 203.  
— on the specific heat of lead between  $14^{\circ}$  and  $80^{\circ}$  K. and of copper between  $15^{\circ}$  and  $22^{\circ}$  K. 894.
- MEASURING BAR (Comparison of the) used in the base measurement at Stroe with the Dutch Metre No. 27. 300.  
— (Comparison of the Dutch platinum-iridium Metre No. 27 with the international Metre *M* as derived from the measurements by the Dutch Metre-Commission in 1879 and 1880, and a preliminary determination of the length of the) of the French base-apparatus in international metres. 311.
- MECHANICAL PRINCIPLES (Combination of observations with and without conditions and determination of the weights of the unknown quantities derived from). 157.
- METALS (The metastability of) in consequence of allotropy, and its significance for Chemistry, Physics and Technics. 200. III. 926. IV. 1238.  
— (On the electrical resistance of pure). IX. 508.
- METASTABILITY (The) of metals in consequence of allotropy and its significance for Chemistry, Physics and Technics. 200. III. 926. IV. 1238.
- METHYLAMINE (On the interaction of ammonia and) on 2, 3, 4-trinitrodimethylaniline. 1034.
- METRE No. 27 (Comparison of the Dutch platinum-iridium) with the international metre *M* as derived from the measurements by the Dutch Metre-Commission in 1879 and 1880, and a preliminary determination of the length of the measuring bar of the French baseapparatus in international metres. 311.
- Mineralogy.** H. HAGA and F. M. JAEGER: "On the real symmetry of cordierite and apophyllite". 430.  
— C. E. A. WICHMANN: "On the tin of the island of Flores". 474.
- MOLECULAR DIMENSIONS (The calculation of the) from the supposition of the electric nature of the quasi-elastic atomic forces. 877.
- MOLENGRAAFF (G. A. F.) presents a paper of Dr. H. A. BROUWER: "On the granitic area of Rokan (Middle-Sumatra) and on contact-phenomena in the surrounding schists". 1190.
- MOON (The motions of the lunar perigee and node and the figure of the). 1309.
- MOON'S PARALLAX (The mean radius of the earth, the intensity of gravity and the). 1291.
- MUSCLE-CELLS (On the termination of the efferent nerves in plain) and its bearing on the sympathetic (accessory) innervation of the striated muscle-fibre. 982.
- MUSCULAR FIBRE (On the mode of attachment of the) to its tendontibres in the striated muscles of the vertebrates. 989.

- MYXINE GLUTINOSA (Further contributions to our knowledge of the brain of). 2.
- NERVE-DISTRIBUTION (On the) in the trunk-dermatoma. 632.
- NERVES (On the termination of the efferent) in plain muscle cells and its bearing on the sympathetic (accessory) innervation of the striated muscle-fibre. 952.
- NETS (Characteristic numbers for) of algebraic curves. 935.
- NITRATION (The) of the mixed dihalogen benzenes. 846.
- NITROGEN (Vapour pressures of oxygen and critical point of oxygen and). 950.
- (The rectilinear diameter of). 953.
- (Vapour pressures of) between the critical point and the boiling point. 959.
- NÖTHER'S theorem (On). 1245.
- OCCCLUSION (A case of) of the arteria cerebelli posterior inferior. 914.
- ONNES (H. KAMERLINGH). Further experiments with liquid helium. J. 12. 278. K. 283. L. 514.
- presents a paper of Dr. W. H. KEESOM: "The chemical constant and the application of the quantum-theory by the method of the natural vibrations to the equation of state of an ideal monatomic gas". 20.
- presents a paper of Dr. W. H. KEESOM: "On the matter in which the susceptibility of paramagnetic substances depends on the density". 110.
- presents a paper of Dr. C. A. CROMMELIN: "Isothermals of monatomic substances and their binary mixtures". XVI. 275.
- presents a paper of Dr. C. A. CROMMELIN: "Isothermals of di-atomic substances and their binary mixtures". XVI. 959.
- C. DORSMAN and G. HOLST. Isothermals of di-atomic substances and their binary mixtures. XV. Vapour pressures of oxygen and critical point of oxygen and nitrogen. 950.
- and P. EHBENFEST. Simplified deduction of the formula from the theory of combinations which PLANCK uses as the basis of his radiation theory. 870.
- and K. HOF. Further experiments with liquid helium. N. 520.
- and G. HOLST. The measurement of very low temperatures. XXIV. The hydrogen and helium thermometers of constant volume down to the freezing point of hydrogen compared with each other and with the platinum-resistance thermometer. 501.
- On the electrical resistance of pure metals. IX. 508.
- Further experiments with liquid helium. M. 760.
- and W. H. KEESOM. The specific heat at low temperatures. I. Measurements on the specific heat of lead between 14° and 80° K. and of copper between 15° and 22° K. 894.
- and H. A. KUYPERS. Measurements on the capillarity of liquid hydrogen. 528.
- E. MATHIAS and C. A. CROMMELIN. The rectilinear diameter of nitrogen. 953.
- OPALESCECE (Accidental deviations of density and) at the critical point of a single substance. 793.
- ORNSTEIN (L. S.). On the theory of the stringgalvanometer of EINTHOVEN. 784.
- and F. ZERNIKE. Accidental deviations of density and opalescence at the critical point of a single substance. 793.

- OSMOTIC PRESSURE (On the kinetic interpretation of the). 1241.
- OXYGEN (Vapour pressures of) and critical point of oxygen and nitrogen. 950.
- PARAMAGNETIC SUBSTANCES (On the matter in which the susceptibility of) depends on the density. 110.
- PASTEUR'S principle (Researches on) of the connection between molecular and physical dissymmetry. I. 1217.
- PEACHALMOND (Gummosis in the fruit of the Almond and the) as a process of normal life. 810.
- Petrography.** A. WICHMANN: "On some rocks of the island of Taliabu (Sula islands). 226.
- PHAGOCYTES and respiratory centre. 1325.
- PHOSPHORUS (On the vapour pressure lines of the system). II. 678. III. 962.  
— (Further particulars concerning the system). 973.
- PHOTOCHEMICAL phenomena (Contribution to the knowledge of the). 849.
- PHOTOTROPIC and geotropic reactions (On the mutual influence of) in plants. 1278.
- Physics.** H. KAMERLINGH ONNES: "Further experiments with liquid helium". J. 12. 278. K. 283. L. 514. N. 520. M. 760.  
— W. H. KEESOM: "The chemical constant and the application of the quantum-theory by the method of the natural vibrations to the equation of state of an ideal monatomic gas". 20.  
— H. HULSHOF: "On the thermodynamic potential as a kinetic quantity". 1<sup>st</sup> part. 85.  
— W. H. KEESOM: "On the manner in which the susceptibility of paramagnetic substances depends on the density". 110.  
— PH. KOHNSTAMM and K. W. WALSTRA: "Measurement of isotherms of hydrogen at 20° C. and 15°5 C." 203.  
— K. W. WALSTRA: "The hydrogen isotherms of 20° C. and of 15°5 C. between 1 and 2200 atm." 217.  
— C. A. CROMMELIN: "Isothermals of monatomic substances and their binary mixtures". XVI. 275.  
— P. ZEEMAN: "FRESNEL'S coefficient for light for different colours". 1<sup>st</sup> part. 445.  
— J. J. VAN LAAR: "A new relation between the critical quantities and on the unity of all substances in their thermic behaviour". 451.  
— H. DU BOIS: "Modern electromagnets, especially for surgical and metallurgic practice". 468.  
— H. KAMERLINGH ONNES and G. HOLST: "On the measurement of very low temperatures. XXIV. The hydrogen and helium thermometers of constant volume, down to the freezing-point of hydrogen compared with each other and with the platinum resistance thermometer". 501.  
— H. KAMERLINGH ONNES and G. HOLST: "On the electrical resistance of pure metals etc.". IX. 508.  
— H. KAMERLINGH ONNES and H. A. KUYPERS: "Measurements on the capillarity of liquid hydrogen". 528.  
— J. J. VAN LAAR: "Some remarks on the values of the critical quantities in case of association". 598.

- Physics J. J. VAN LAAR: "On apparent thermodynamic discontinuities in connection with the value of the quantity  $b$  for infinitely large volume". 606.
- Miss H. J. FOLMER: "A new electrometer, especially arranged for radio-active investigations". 659.
- G. J. ELIAS: "On the structure of the absorptionlines  $D_1$  and  $D_2$ ". 720.
- G. J. ELIAS: "The lowering of the freezing point in consequence of an elastic deformation". 732.
- G. J. ELIAS: "The effect of magnetisation of the electrodes on the electromotive force". 745.
- L. S. ORNSTEIN: "On the theory of the string-galvanometer of EINTHOVEN". 784.
- L. S. ORNSTEIN and F. ZERNIKE: "Accidental deviations of density and opalescence at the critical point of a single substance". 793.
- F. E. C. SCHEFFER: "On unmixing in a binary system for which the three phase pressure is greater than the sum of the vapour tensions of the two components". 834.
- Mrs. T. EHRENFEST—AFANASSJEW: "Contribution to the theory of corresponding states". 840.
- P. EHRENFEST and H. KAMERLINGH ONNES: "Simplified deduction of the formula from the theory of combinations which PLANCK uses as the basis of his radiationtheory". 870.
- H. DU BOIS: "The universality of the ZEEMAN-effect with respect to the STARK-effect in canal-rays". 873.
- J. J. VAN LAAR: "The calculation of the molecular dimensions from the supposition of the electric nature of the quasi-elastic atomic forces". 877.
- W. H. KEESOM and H. KAMERLINGH ONNES: "The specific heat at low temperatures. I. Measurements on the specific heat of lead between  $14^\circ$  and  $80^\circ$  K. and of copper between  $15^\circ$  and  $22^\circ$  K." 894.
- J. P. KUENEN: "On the measurement of the capillary pressure in a soap-bubble". 946.
- H. KAMERLINGH ONNES, C. DORSMAN and G. HOLST: "Isothermals of di-atomic substances and their binary mixtures. XV. Vapour pressures of oxygen and critical point of oxygen and nitrogen". 950.
- E. MATHIAS, H. KAMERLINGH ONNES and C. A. CROMMELIN: "The rectilinear diameter of nitrogen". 953.
- C. A. CROMMELIN: "Isothermals of di-atomic substances and their binary mixtures. XVI. Vapour pressures of nitrogen between the critical point and the boiling point". 959.
- J. DROSTE: "On the field of a single centre in EINSTEIN's theory of gravitation". 998.
- J. P. KUENEN: "The diffusion coefficient of gases and the viscosity of gas-mixtures". 1068.
- H. TETRODE: "Theoretical determination of the entropy constant of gases and liquids". 1167.

- Physics.** P. EHRENFEST: "On interference phenomena to be expected when Röntgen rays pass through a di-atomic gas". 1184.
- F. M. JAEGER: "On a new phenomenon accompanying the diffraction of Röntgen rays in birefringent crystals". 1204.
- P. EHRENFEST: "On the kinetic interpretation of the osmotic pressure". 1241.
- Physiology.** E. LAQUEUR: "On the survival of isolated mammalian organs with automatic function". 270.
- L. K. WOLFF: "On the formation of antibodies after injection of sensitized antigens". II. 318.
- G. VAN RIJNBEEK: "On the nerve-distribution in the trunk-dermatoma". 632.
- A. A. HYMANS VAN DEN BERGH and J. J. DE LA FONTAINE SCHLUITER: "The identification of traces of bilirubin in albuminous fluids". 807.
- I. K. A. WERTHEIM SALOMONSON: "Exaggeration of deep reflexes". 885.
- S. DE BOER: "On the heart-rhythm". 1075. II. 1135.
- A. B. DROOGLEEVER FORTUYN: "The decoloration of fuchsin-solutions by amorphous carbon". 1322.
- H. J. HAMBURGER: "Phagocytes and respiratory centre". 1325.
- PICRYLMETHYLAMIDE (The coloration of some derivatives of) with alkalis. 647.
- PLANCK (Simplified deduction of the formula from the theory of combinations which uses as the basis for his radiation theory. 870.
- PLANET Jupiter (The figure of the). 1047.
- PLANETS (On SEELIGER's hypothesis about the anomalies in the motion of the inner). 23.
- PLANTS (On the mutual influence of the phototropic and geotropic reactions in). 1278
- POLYNOMIA (On HERMITE's and ABEL's). 192.
- POSTMA (s.) and A. SMITS. The system Ammonia-water. 182.
- POTASSIUM (The allotropy of). I. 1115.
- POTASSIUM SULPHATE, potassium chlorid (The system: copper sulphate, copper chlorid and water at 30°. 533.
- POTENTIAL (On the thermodynamic) as a kinetic quantity. 1st part. 85.
- POTENTIALS (Current) of electrolyte solutions. 615.
- PRECISION (The theory of the combination of observations and the determination of the), illustrated by means of vectors. 490.
- PRINS (Miss ADA). On critical end-points and the system ethane-naphthalene. 1095.
- PSEUDO-COMPONENTS (The metastable continuation of the mixed crystal series of) in connection with the phenomenon allotropy. II. 672.
- QUANTITY  $b$  (On apparent thermodynamic discontinuities in connection with the value of the) for infinitely large volume. 606.
- QUANTUM-THEORY (The chemical constant and the application of the) by the method of the natural vibrations to the equation of state of an ideal monatomic gas). 20
- QUATERNARY SYSTEM  $KCl-CuCl_2-BaCl_2-H_2O$  (On the). 781.
- QUINTICS (A bilinear congruence of rational twisted). 1250.
- RADIATION THEORY (Simplified deduction of the formula from the theory of combinations which PLANCK uses as the basis for his). 870.

- RADIO-ACTIVE investigations (A new electrometer, specially arranged for). 659.
- REFLEXES (Exaggeration of deep). 885.
- REINDERS (W.). Equilibria in the system Pb-S-O, the roasting reaction process. 703.
- RESISTANCE (On the electrical) of pure metals. IX. 508.
- RESPIRATORY CENTRE (Phagocytes and). 1325.
- ROASTING REACTION PROCESS (Equilibria in the system Pb-S-O, the). 703.
- ROCKS (On some) of the island of Taliabu (Sula islands). 226.
- ROKAN (Middle-Sumatra) (On the granitic area of) and on contact phenomena in the surrounding schists. 1190.
- ROMBURGH (P. VAN) presents a paper of Prof. F. M. JAEGER and Dr. ANT. SIMEK: "Studies in the field of silicate-chemistry". II. 239. III. 251.
- presents a paper of Prof. F. M. JAEGER: "The temperature-coefficients of the free surface-energy of liquids at temperatures from  $-80^{\circ}$  to  $1650^{\circ}$  C." I. 329. II. 365. III. 386. IV. 395. V. 405. VI. 416. VII. 555. VIII. 571.
- presents a paper of Mr. G. DE BRUIN: "A crystallized component of isoprene with sulphur dioxide". 585.
- presents a paper of Prof. F. M. JAEGER: "Researches on PASTEUR's principle of the connection between molecular and physical dissymmetry". I. 1217.
- presents a paper of Dr. A. W. K. DE JONG: "Action of sunlight on the cinnamic acids". 1274.
- and Miss D. W. WENSINK. On the interaction of ammonia and methylamine on 2,3,4-trinitrodimethylaniline. 1034.
- RÖNTGEN RAYS (On interference phenomena to be expected when) pass through a di-atomic gas. 1184.
- (On a new phenomenon accompanying the diffraction of) in birefringent crystals. 1204.
- RÖTHIG (P.) and C. U. ARIËNS KAPPERS. Further contributions to our knowledge of the brain of *Myxine glutinosa*. 2.
- RIJNBERK (G. VAN). On the nerve-distribution of the trunk-dermatoma. 632.
- SALOMONSON (J. K. A. WERTHEIM). Exaggeration of deep reflexes. 885.
- presents a paper of Dr. S. DE BOER: "On the heart-rhythm". 1075. II. 1135.
- SALTS (The influence of the hydration and of the deviations from the ideal gas-laws in aqueous solutions of) on the solidifying and the boiling point. 1036.
- SANDE BAKHUYZEN (H. G. VAN DE). v. BAKHUYZEN (H. G. VAN DE SANDE).
- SCHEFFER (F. E. C.). On gas equilibria and a test of Prof. v. D. WAALS' JR.'s theorem. I. 695. II. 1011.
- On unmixing in a binary system for which the three-phase pressure is greater than the sum of the vapour tensions of the two components. 834.
- SCHLUITER (J. J. DE LA FONTAINE) and A. A. HYMANS VAN DEN BERGH. The identification of traces of bilirubin in albuminous fluids. 807.
- SCHREINEMAKERS (F. A. H.). Equilibria in ternary systems. XV. 70. XVI. 169. XVII. 767. XVIII. 1260.
- and Miss W. C. DE BAAT. The system: copper sulphate, copper chlorid, potassium sulphate, potassium chlorid and water at  $30^{\circ}$  C. 533.

- SCHREINEMAKERS (F. A. H.) and Miss W. C. DE BAAT. On the quaternary system  $\text{KCl-CuCl}_2\text{-BaCl}_2\text{-H}_2\text{O}$ . 781.  
 — Compounds of the arsenious oxide. I. 1111.
- SEELIGER'S hypothesis (On) about the anomalies in the motion of the inner planets. 23.  
 — (Remarks on Mr. WOLTJER'S paper concerning). 33.
- SILICATE-CHEMISTRY (Studies in the field of). II. 239. III. 251.
- SIMEK (A. N. T.) and F. M. JAEGER. Studies in the field of silicate-chemistry. II. 239. III. 251.
- SITTER (W. DE) presents a paper of Mr. J. WOLTJER JR.: "On SEELIGER'S hypothesis about the anomalies in the motion of the inner planets". 23.  
 — Remarks on Mr. WOLTJER'S paper concerning SEELIGER'S hypothesis. 33.  
 — The figure of the planet Jupiter. 1047.  
 — On the mean radius of the earth, the intensity of gravity and the moon's parallax. 1291.  
 — On isostasy, the moment of inertia and the compression of the earth. 1295.  
 — The motions of the lunar perigee and node and the figure of the moon. 1309.
- SLUITER (C. H.). The influence of the hydration and of the deviations from the ideal gas-laws in aqueous solutions of salts on the solidifying and the boiling-point. 1036.
- SMIT (M.) and F. M. JAEGER. The temperature-coefficients of the free-surface-energy of liquids at temperatures from  $-80^\circ\text{C}$ . to  $1650^\circ\text{C}$ . II. 365. III. 381.
- SMITS (A.). The metastable continuation of the mixed crystal series of pseudo-components in connection with the phenomenon allotropy. II. 672.  
 — and ATEN (A. H. W.). The application of the theory of allotropy to electro-motive equilibria. II. 37. III. 680.  
 — and S. C. BOKHORST. On the vapour pressure lines in the system phosphorus. II. 678. III. 962.  
 — Further particulars concerning the system phosphorus. 973.  
 — and S. POSTMA. The system ammoniawater. 182.
- SOAP-BUBBLE (On the measurement of the capillary pressure in a). 946.
- SODIUM-HYPOCHLORITE (Action of) on amides of  $\alpha$ -oxyacids. 1163.
- SPECIFIC HEAT (The) at low temperatures. I. Measurements on the specific heat of lead between  $14^\circ$  and  $80^\circ\text{K}$ . and of copper between  $15^\circ$  and  $22^\circ\text{K}$ . 894.
- SPEK (JAC. VAN DER) and H. R. KRUYT. The connection between the limit value and the concentration of arsenic trisulphide sols. 1158.
- STARK-effect (The universality of the ZEEMAN-effect with respect to the) in canal-rays. 873
- STIELTJES (On an integral-formula of). 829.
- STOK (J. P. VAN DER). The treatment of frequencies of directed quantities. 586.  
 — presents a paper of Mr. P. H. GALLÉ: "On the relation between departures from the normal in the strength of the trade-winds in the Atlantic Ocean and those in the waterlevel and temperature in the Northern European seas." 1147.
- STRING-GALVANOMETER (On the the theory of the) of EINTHOVEN. 784.
- STROE (Comparison of the measuring bar used in the base measurement at) with the Dutch Metre n<sup>o</sup> 27. 300.
- SUBSTANCES (Isothermals of monatomic) and their binary mixtures. XVI. 275.  
 — (Isothermals of di-atomic) and their binary mixtures. XV. 950. XVI. 959.

- SUBSTANCES (A new relation between the critical quantities and on the unity of all) in their thermic behaviour. 451.
- SUBSTITUENTS (The replacement of) in benzene derivatives. 1027.
- $\alpha$ -SULPHO PROPIONIC ACID and its resolution into optically active isomerides. 653.
- SULPHUR DIOXIDE (A crystallized compound of isoprene with). 535.
- SUNLIGHT (Action of) on the cinnamic acids. 1274.
- SYSTEM *P*-*S*-*O* (Equilibria in the), the roasting reaction process. 703.
- (The) copper sulphate, copper chlorid, potassium sulphate, potassium chlorid and water at 30° C. 533.
  - (Characteristic numbers for a triply infinite) of algebraic plane curves. 1055.
  - ammonia—water (The). 182.
  - ethane—naphthalene (On critical endpoints and the). 1095.
  - phosphorus (On the vapour pressure lines in the). II. 673. III. 962.
  - phosphorus (Further particulars concerning the). 973.
- TALIABU (Sula islands) (On some rocks of the island of) 226.
- TEMPERATURE (On the relation between departures from the normal in the strength of the trade-winds of the Atlantic Ocean and those in the waterlevel and) in the Northern European seas. 1147.
- TEMPERATURE-COEFFICIENTS (The) of the free energy surface of liquids at temperatures from -80° C. to 1650° C. I. 329. II. 365. III. 386. IV. 395. V. 405. VI. 416. VII. 555. VIII. 571.
- TEMPERATURES (The measurement of very low). XXIV. The hydrogen and helium thermometers of constant volume down to the freezing point of hydrogen compared with each other and with the platinum-resistance thermometer. 501.
- (The specific heat at low). I. Measurements on the specific heat of lead between 11° and 80° K. and of copper between 15° and 22° K. 894.
- TENDONFIBRES (On the mode of attachment of the muscular fibre to its) in the striated muscles of the vertebrates. 989.
- TERNARY SYSTEMS (Equilibria in). XV. 70. XVI. 169. XVII. 767. XVIII. 1260.
- TETRODE (H.). Theoretical determination of the entropy constant of gases and liquids. 1167.
- THEORY of allotropy (The application of the) to electromotive equilibria. II. 37. III. 680.
- of BRAVAIS (The) (on errors in space) for polydimensional space with applications to correlation. (Continuation). 150.
  - (The) of the combination of observations and the determination of the precision, illustrated by means of vectors. 490.
  - of combinations (Simplified deduction of the formula from the) which PLANCK uses as the basis of his radiation theory. 870.
  - of corresponding states (Contribution to the). 840.
  - of gravitation (On the field of a single centre in EINSTEIN'S). 993.
- THERMOMETERS (The hydrogen and helium) of constant volume, down to the freezing point of hydrogen compared with each other, and with the platinum-resistance thermometer. 501.
- THREE-PHASE PRESSURE (On unmixing in a binary system for which the) is greater than the sum of the vapour tensions of the two components. 834.



- TIN (On the) of the island of Flores. 474.
- TRADE-WINDS (On the relation between departures from the normal in the strength of the) in the Atlantic Ocean and those in the waterlevel and temperature in the Northern European seas. 1147.
- TRINITRODIMETHYLANILINE (On the interaction of ammonia and methylamine on 2.3.4.-). 1034.
- TRUNK-DERMATOMA (On the nerve-distribution in the). 632.
- UNMIXING (On) in a binary system for which the three-phase pressure is greater than the sum of the vapour tensions of the two components. 834.
- UVEN (M. J. VAN). The theory of BRAVAIS (on errors in space) for polydimensional space with applications to correlation. (Continuation). 150.
- Combination of observations with and without conditions and determination of the weights of the unknown quantities, derived from mechanical principles. 157.
  - The theory of the combination of observations and the determination of the precision, illustrated by means of vectors. 490.
- VAGUS AREA (The) in Camelidae. 1119.
- VAPOUR PRESSURE LINES (On the) in the system phosphorus. II. 678. III. 962.
- VAPOUR PRESSURES of oxygen and critical point of oxygen and nitrogen. 950.
- of nitrogen between the critical point and the boiling point. 959.
- VAPOUR TENSIONS (On unmixing in a binary system for which the three-phase pressure is greater than the sum of the) of the two components. 834.
- VECTORS (The theory of the combination of observations and the determination of the precision, illustrated by means of). 490.
- VERMEULEN (H. A.). The vagus area in Camelidae. 1119.
- VERTEBRATES (On the mode of attachment of the muscular fibre to its tendonfibres in the striated muscles of the). 959.
- VISCOSITY of gas-mixtures (The diffusion-coefficient of gases and the). 1068.
- VRIES (JAN DE). A cubic involution of the second class. 105.
- A triple involution of the third class. 134.
  - presents a paper of Prof. M. J. VAN UVEN: "Combination of observations with and without conditions and determination of the weights of the unknown quantities, derived from mechanical principles". 157.
  - Characteristic numbers for nets of algebraic curves. 935.
  - Characteristic numbers for a triple infinite system of algebraic plane curves. 1055.
  - Systems of circles determined by a pencil of conics. 1107.
  - presents a paper of Dr. W. VAN DER WOUDE: "On NÖTHER's theorem". 1245.
  - A bilinear congruence of rational twisted quintics. 1250.
  - Some particular bilinear congruences of twisted cubics. 1256.
- WAALS (J. D. VAN DER) presents a paper of Prof. A. SMITS and Dr. A. H. W. ATEN: "The application of the theory of allotropy to electromotive equilibria". II. 37. III. 680.
- presents a paper of Dr. H. HULSHOF: "On the thermodynamic potential as a kinetic quantity", 1st. part. 85.
  - presents a paper of Prof. A. SMITS and S. POSTMA: "The system ammonia-water." 182.

- W A A L S (J. D. VAN DER) presents a paper of Prof. PH. KOHNSTAMM and K. W. WALSTRA: "Measurements of isotherms of hydrogen at 20° C. and 15°5 C." 203.
- presents a paper of Mr. K. W. WALSTRA: "The hydrogen isotherms of 20° C. and of 15°5 C. between 1 and 2200 atm." 217.
- presents a paper of Prof. A. SMITS: "The metastable continuation of the mixed crystal series of pseudo-components in connection with the phenomenon allotropy". II. 672.
- presents a paper of Prof. A. SMITS and S. C. BOKHORST: "The vapour pressure lines of the system phosphorus". II. 678. III. 962.
- presents a paper of Dr. F. E. C. SCHEFFER: "On gas equilibria and a test of Prof. VAN DER WAALS Jr.'s formula". I. 695. II. 1011.
- presents a paper of Dr. F. E. C. SCHEFFER: "On unmixing in a binary system for which the three-phase pressure is greater than the sum of the vapour tensions of the components". 834.
- presents a paper of Prof. A. SMITS and S. C. BOKHORST: "Further particulars concerning the system phosphorus". 973.
- W A A L S JR's theorem (On gas equilibria and a test of Prof.). I. 695. II. 1011.
- W A L S T R A (K. W.). The hydrogen isotherms of 20° C. and of 15°5 C. between 1 and 2200 atm. 217.
- and PH. KOHNSTAMM. Measurements of isotherms of hydrogen at 20° C. and 15°5 C. 203.
- W A T E R (The system ammonia-). 182.
- (The system: copper sulphate, copper chlorid, potassium sulphate, potassium chlorid and) at 30°. 533.
- W A T E R L E V E L (On the relation between departures from the normal in the strength of the trade-winds in the Atlantic ocean and those in the) and temperature in the Northern European seas. 1147.
- W E B E R (M A X) presents a paper of Dr. K. KUIPER JR.: "The physiology of the air-bladder of fishes". 1058.
- W E E R M A N (R. A.). Action of sodium hypochlorite on amides of  $\alpha$ -oxyacids. 1163.
- W E I G H T S (Combination of observations with and without conditions and determination of the) of the unknown quantities, derived from mechanical principles. 157.
- W E N S I N K (Miss D. W.) and P. VAN ROMBURGH. On the interaction of ammonia and methylamine on 2,3,4.-trinitrodimethylaniline. 1034.
- W E N T (F. A. P. C.) presents a paper of Miss LUCIE C. DOYER: "Energy transformations during the germination of wheat-grains". 62.
- presents a paper of Dr. C. E. B. BREMEKAMP: "On the mutual influence of phototropic and geotropic reactions in plants". 1278.
- W E R T H E I M S A L O M O N S O N (I. K. A.). v. SALOMONSON (I. K. A. WERTHEIM).
- W H E A T - G R A I N S (Energy transformations during the germination of). 62.
- W I C H M A N N (A.). On some rocks of the island of Taliabu (Sula islands). 226.
- On the tin of the island of Flores. 474.
- W I L D E B O E R (N.), J. G. DIEPERINK and H. G. VAN DE SANDE BAKHUYZEN. Comparison of the measuring bar used in the base measurement at Stroe with the Dutch Metre No. 27. 300.

- WINKLER (C.) presents a paper of Prof. G. VAN RIJNBEEK: "On the nerve-distribution of the trunkdermatoma." 632.
- A case of occlusion of the arteria cerebelli posterior inferior. 914.
- WOLFF (L. K.). On the formation of antibodies after injection of sensitized antigens. II. 318.
- and E. H. BÜCHNER. On the behaviour of gels towards liquids and the vapours thereof. II. 92.
- WOLFF (S.) and ERNST COHEN. The allotropy of potassium. I. 1115.
- WOLTJER JR. (J.). On SEELIGER's hypothesis about the anomalies in the motion of the inner planets. 23.
- WOUDE (W. VAN DER). On NÖTHER's theorem. 1245.
- ZEEMAN (P.). On FRESNEL's coefficient for light of different colours. 445.
- ZEEMAN-effect (The universality of the) with respect to the STARK-effect in canal-rays. 873.
- ZERNIKE (F.) and L. S. ORNSTEIN. Accidental deviations of density and opalescence at the critical point of a single substance. 793.
- ZINC (The allotropy of). II. 59. III. 641.
- Zoology. K. KUIPER JR.: "The physiology of the air-bladder of fishes." 1088.
-







KONINKLIJKE AKADEMIE VAN WETENSCHAPPEN  
TE AMSTERDAM.

PROCEEDINGS OF THE MEETING  
of Saturday May 30, 1914.

VOL XVII.

*President:* Prof. H. A. LORENTZ.

*Secretary:* Prof. P. ZEEMAN.

(Translated from: Verslag van de gewone vergadering der Wis- en Natuurkundige  
Afdeling van Zaterdag 30 Mei 1914, Dl. XXIII).

C O N T E N T S.

- P. RÖTHIG and C. U. ARIENS KAPPERS: "Further contributions to our knowledge of the brain of *Myxine glutinosa*". (Communicated by Prof. L. BOLK), p. 2. (With 2 pl.).
- H. KAMERLINGH ONNES: "Further experiments with liquid helium. J. The imitation of an AMPÈRE molecular current or of a permanent magnet by means of a supra-conductor", p. 12.
- W. H. KEESOM: "The chemical constant and the application of the quantum-theory by the method of the natural vibrations to the equation of state of an ideal monatomic gas". (Communicated by Prof. H. KAMERLINGH ONNES), p. 20.
- J. WOLTJER JR.: "On SEELIGER's hypothesis about the anomalies in the motion of the inner planets". (Communicated by Prof. W. DE SITTER), p. 23.
- W. DE SITTER: "Remarks on Mr. WOLTJER's paper concerning SEELIGER's hypothesis", p. 33.
- A. SMITS and A. H. W. ATEN: "The application of the theory of allotropy to electromotive equilibria". II. (Communicated by Prof. J. D. VAN DER WAALS), p. 37.
- ERNST COHEN and W. D. HELDERMAN: "The allotropy of Cadmium". II, p. 54.
- ERNST COHEN and W. D. HELDERMAN: "The allotropy of Zinc". II, p. 59.
- ERNST COHEN and W. D. HELDERMAN: "The allotropy of Copper". II, p. 60.
- LUCIE C. DOYER: "Energy transformations during the germination of wheat grains". (Communicated by Prof. F. A. F. C. WENT), p. 62.
- F. A. H. SCHREINEMAKERS: "Equilibria in ternary systems." XV, p. 70.
- H. HULSHOF: "On the thermodynamic potential as a kinetic quantity". (First part). (Communicated by Prof. J. D. VAN DER WAALS), p. 85.
- L. K. WOLFF and E. H. BÜCHNER: "On the behaviour of gels towards liquids and the vapours thereof". (Communicated by Prof. A. F. HOLLEMAN), p. 92.
- JAN DE VRIES: "The quadruple involution of the cotangential points of a cubic pencil", p. 102.
- JAN DE VRIES: "A cubic involution of the second class", p. 105.
- W. H. KEESOM: "On the manner in which the susceptibility of paramagnetic substances depends on the density." (Communicated by Prof. H. KAMERLINGH ONNES), p. 110.
- ERNST COHEN and W. D. HELDERMAN: "The allotropy of Cadmium III", p. 122.

**Anatomy.** — “*Further contributions to our knowledge of the brain of Myxine glutinosa.*” By P. RÖTHIG (Berlin) and C. U. ARIËNS KAPPERS (Amsterdam). (Communicated by Prof. L. BOLK).

(Communicated in the meeting of March 28, 1914).

The former of us has given a description of the motor roots and nuclei in *Myxine glutinosa* and in some Amphibia in Vol. XVI of these Proceedings (p. 296).

For *Myxine* the topography of the V—VII nucleus and the spino-occipital column has been discussed, and mention was made of the absence of the eyemuscle-nuclei and the motor glossopharyngens.

For the discussion of the vagus roots reference was made to further researches not yet completed at that time, which we should accomplish in conjunction.

It is known that the vagus of *Myxine glutinosa* has caused many difficulties, and before giving our own results we wish to review the opinions of former authors, because such a review clearly shows the points which give rise to different interpretations.

It is obvious that in doing so we shall be obliged to deal again with other roots of the cranial nerves in *Myxine*.

The first description of the central nervous system of *Myxine glutinosa* was given by ANDERS RETZIUS<sup>1)</sup>, who mentions three nerves of the Oblongata, the Vagus, a nerve of the labyrinth (Table VI l. c. Fig. 7), a cutaneous branch of this labyrinth nerve (Table VI, Fig. 8) and several branches of the V (p. 397, 400 and 401.)

After A. RETZIUS, JOHANNES MÜLLER<sup>2)</sup> gave an elaborate description of the origin and periferal course of the cranial nerves in *Petromyzon*, *Bdellostoma* and *Myxine*. For *Myxine* he gave a description of the Trigemini, Facialis, Acusticus and Vagus (comp. Fig. 4, 4 and 6 on Table III l. c. 1838).

It is interesting that he mentions a cutaneous branch of the VII (p. 193 l. c. 1838), which still wants affirmation, specially since Miss WORTHINGTON<sup>3)</sup> could not find any but visceral sensory and

1) A. RETZIUS, Beitrag zur Anatomie des Ader- und Nervensystems der *Myxine Glutinosa* (Lin.) (Aus d. Abhandlg. d. Königl. Schwedischen Akademie der Wissenschaften Jahrgang 1822 H. 2) Meikel's Archiv für Anatomie u. Physiologie 1826 S. 386—404.

2) J. MÜLLER, Ueb. d. eigentümlichen Bau des Gehörorgans bei den Cyclostomen, mit Bemerkungen über die ungleiche Ausbildung der Sinnesorgane bei den Myxinoiden Abhandlg. d. Kgl. Akad. d. Wissensch. Berlin 1837 (25. IV. 1836), und: Vergleichende Neurologie d. Myxinoiden, ibidem, 1838 (15. II. 1838).

3) J. WORTHINGTON: Descriptive Anatomy of the Brain and cranial nerves of *Bdellostoma dombeyi* (p. 169) Quart. Journ. Miscr. Science Vol. 49, 1906.



motor fibres in the facial nerve of the American Myxinoid *Bdellostoma dombeyi*.

After JOH. MÜLLER, GUSTAF RETZIUS<sup>1)</sup> gave very valuable contributions which appeared abundantly illustrated in 1881 and 1893. It is just the excellent descriptions given by G. RETZIUS that show how difficult the interpretation of this brain is, for G. RETZIUS himself emphasizes at the end of his elaborate description of 1893 (p. 63) that — though he had been gathering the data concerning the brain of this animal for several years, he had not yet succeeded in obtaining a complete idea of its exact relations.

G. RETZIUS mentions, as did P. RÖTHIG in his contribution (l. c.), the absence of the trochlearis, oculomotorius and abducens. The most frontal nerve roots, according to him, are two trigeminal branches (p. 60 and Table 24, Fig. 1—3) each provided with a spindle-shaped ganglion.

Following on this he finds a small nerve without ganglion (a motor nerve consequently) which he considers to be — like JOH. MÜLLER — the facial nerve. Close to this nerve he finds a third ganglionated root, which he supposes to be a third trigeminal root and behind these the two roots of the octavus occur which he had already described before (1881): the Ramus anterior and ramus posterior acustici. Much more backward the vagus roots appear without ganglion. Dorsally from these he, however, finds a small sensory root with an oval ganglion, which he considers to be a sensory vagus root (p. 59).

After G. RETZIUS SANDERS<sup>2)</sup> took up this subject. Since this work was not available for us, we can only quote from it what HOLM has cited (l. c. infra).

According to this author SANDERS found the V, VII, VIII and X nerves, but differs in so far from G. RETZIUS that he considers some roots entering the brain behind the vagus of RETZIUS still as vagus roots, whilst the latter mentions them as spino-occipital nerves.

It is SANDERS' merit to have first given a detailed description of the oblongata-nuclei, which he divides into two cellgroups of which one has an entirely central position near the dorsal raphe: "ganglia centralia", and another near the periphery of the bulb: "ganglia latero-

<sup>1)</sup> G. RETZIUS. Das Gehörorgan d. Wirbeltiere Bd. I, Stockholm, 1881; Ueb. d. Hypophyse von Myxine Biolog. Untersuchg. Bd. VI; Das Rückenmark von Myxine Biolog. Untersuchg. N. F. Bd. W. 1891; Das Gehirn und das Auge von Myxine Biolog. Untersuchg. N. F. Bd. A 1893

<sup>2)</sup> SANDERS. Researches on the nervous system of *Myxine glutinosa*. 1894, Williams and Norgate, London.

ventralia'', the latter of which extending (varying in size) from the entrance of the V to the X.

In GEGENBAUR'S Festschrift FÜRBRINGER<sup>1)</sup> describes the spinal, occipito-spinal and vagal roots (p. 616 et seq.) and gives a drawing of the roots of the American Myxinoid: *Bdellostoma* (Text figure 1). According to him the vagus leaves the brain with 1—4 rootlets (he draws 2) and possesses a prevailing motor character (p. 619).

FÜRBRINGER states that this also holds good for *Myxine*. He considers the glossopharyngeus — not mentioned by preceding authors — as represented by elements of the nervus pharyngeus X, although he states that a branchial sack innervated by the IX is failing in Myxinoids. In other words he grants the absence of an independent IX, but supposes that elements of it are included in the pharyngeus branch of the X.<sup>2)</sup>

FÜRBRINGER emphasizes that the spino-occipital roots are shifted in a frontal direction in *Myxine*. This holds good as well for his first sensory spino-occipital root as for his second spino-occipital root. The first in his opinion enters the brain on the level of the ramus acusticus posterior, the second near the level of the vagus roots. FÜRBRINGER points out that, in contrast to *Myxine*, in *Petromyzon* the spino-occipital roots are located on a fairly large distance behind the vagus roots.

This difference between *Myxine* and *Petromyzon*, according to him, can be explained in two ways, either the first spino-occipital root of *Myxine* is lacking in *Petromyzon*, or the spino-occipital roots are shifted forward in *Myxine*. FÜRBRINGER believes that the

1) FÜRBRINGER, Ueber die spino-occipitalen Nerven der Selachier und Holocephalen und ihre vergleichende Morphologie. Festschrift für GEGENBAUR Teil III 1897 p. 349-766.

We do not deal here with the paper of RANSOM and D'ARCY THOMPSON (quoted by FÜRBRINGER) because it contains very little on our subject. Compare: On the spinal and visceral nerves of *Cyclostomata*. *Zoölogischer Anzeiger* No. IX, 1886 p. 421.

2) We may add here that Miss WORTHINGTON, to whom we owe such an excellent series of papers on the American Myxinoid *Bdellostoma*, considers this branch as a real IX (l. c. p. 172), "lying so close to the X that it is difficult to distinguish one from the other". She also mentions that they have a common foramen and that (p. 173) "the glossopharyngeus runs in the same sheath with the vagus as far as the second branchial arch". Consequently — as far as these points are concerning — the presence of a real glossopharyngeus is not very conspicuous either in *Bdellostoma* nor in *Myxine* — Since its periferal territory also is fairly well atrophied — (see the following pages) these arguments for the presence of a IX seem to be open to criticism, though in a very rudimentary way it may be present.

first is true, and that consequently the first sensory spino-occipital root of *Myxine* is lacking in the Lamprey.

We may remark here that, in our opinion, FÜRBRINGER is mistaken when he considers the first root here mentioned as being a spino-occipital one. We are more inclined to believe that in *Myxine* the same relation is found as in *Bdellostoma*, for which Miss WORTHINGTON has pointed out that FÜRBRINGER's first spino-occ. root is the Acusticus *b*, i. e. a lateralis root.<sup>1)</sup>

The topographical difference in the spino-occipital roots between *Myxine* and *Petromyzon* consequently is not so considerable as FÜRBRINGER thought, since the spino-occipital roots of *Myxine* do not reach as far frontally as the acusticus.

Still there is a conspicuous frontal displacement of spino-occipital elements in *Myxine*, as appears from a comparison of Fig. 2 with Fig. 1. In our opinion the transitory region between oblongata and cervical cord is shifted in a frontal direction.

The vago-spino-occipital region of the oblongata has approached the trigemino-facial region, the otic and postotic part of the bulb being reduced. This frontal shifting of the vago-spino-occipital region of the brain is accompanied by a frontal displacement of the spino-occipital nucleus and roots, but the vagusroots (see fig. 2) are not so much displaced as their nucleus and remain behind, perhaps on account of their lying on the ear capsula.

In consequence the spino-occipital and vagus roots have considerably approached and the vagusroots appear crowded together on the level of the caudal extremity of the nucleus, instead of being divided fairly regularly over the level of the whole nucleus as is the case in *Petromyzon*.

That the whole vago-spino-occipital region of the bulb has shifted frontally and not only the spino-occipital region, appears from the fact that the spino-occipital column does not overlap the vagal column in *Myxine* more than in *Petromyzon*.

As already said, this process is accompanied, if not partly caused, by a reduction of the acoustic region of the brain. That the acoustico-lateral system in *Myxinoids* is not very much developed results also from the researches of AYERS and WORTHINGTON<sup>2)</sup> (see further below). We shall now proceed to the description of the nuclear topography of the bulb and discuss at the same time the paper published by

<sup>1)</sup> Compare: Quarterly Journal of Microscopical Science Vol. 49, 1906 p. 171 and 175.

<sup>2)</sup> AYERS and WORTHINGTON: The finer anatomy of the brain of *Bdellostoma dombeyi* I. The acustico-lateral system. American Journal of Anatomy vol. VIII, 1908.

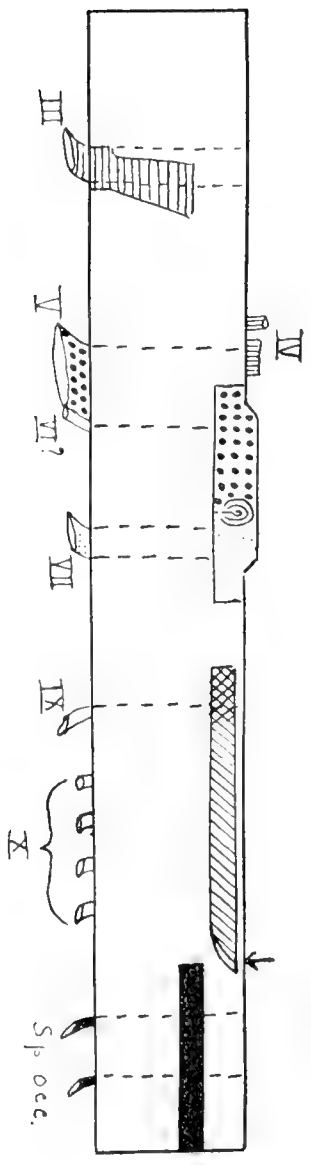

Fig. 1. Petromyzon.

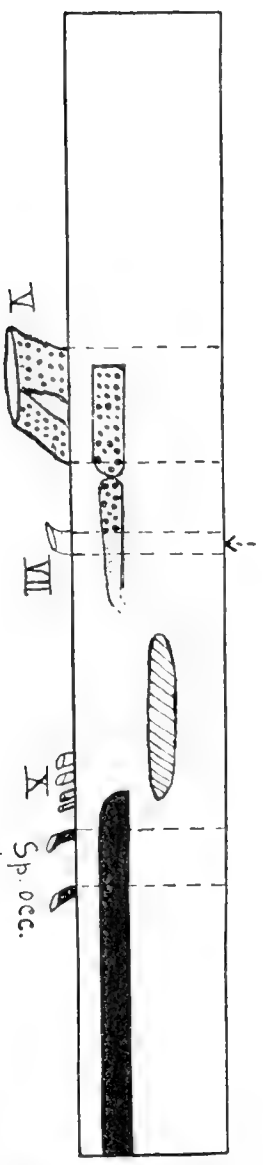

Fig. 2. Mivinita.

**P. RÖTHIG (Berlin) and C. U. ARIËNS KAPPERS (Amsterdam). Further contributions to our knowledge of the brain of *Myxine glutinosa*.**

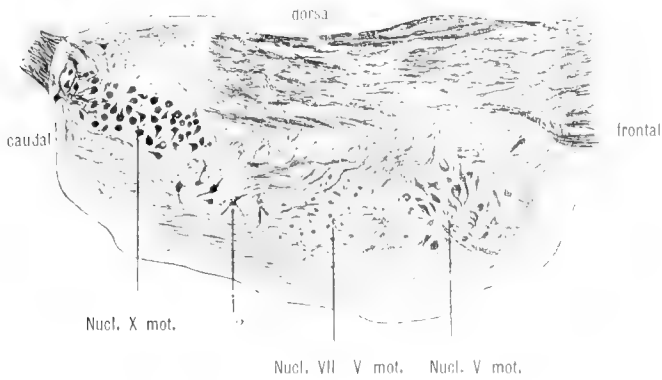

Fig. 3.

*Myxine glutinosa* Sagittal Section. Magn. 30 : 1.



Fig. 4.

*Myxine glutinosa* Magn. 20 : 1.

Frontal Section through the frontal part of the motor V nucleus.

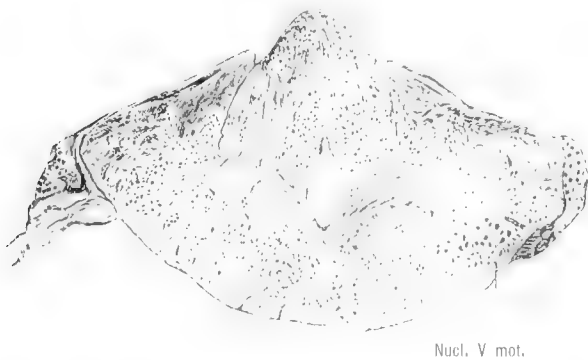

Fig. 5.

*Myxine glutinosa*. Magn. 20 : 1.

Frontal Section through the middle part of the mot. V-nucl. (caudally from Fig. 4).



P. RÖTHIG (Berlin) and C. U. ARIËNS KAPPERS (Amsterdam). Further contributions to our knowledge of the brain of *Myxine glutinosa*.

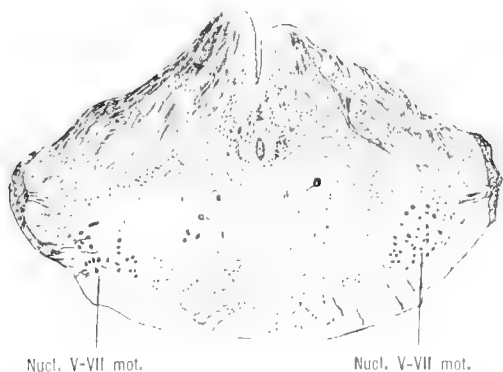

Fig. 6.  
*Myxine glutinosa*. Magn. 20 : 1.  
 Frontal Section through the mot. V—VII-nucleus.

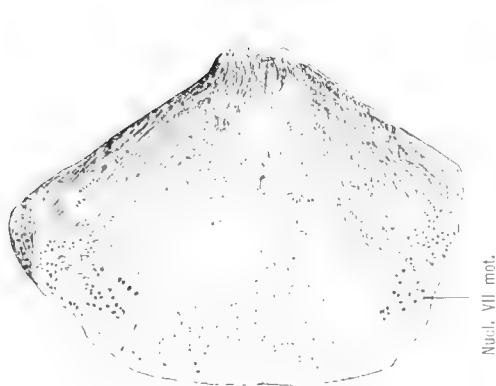

Fig. 7.  
*Myxine glutinosa*. Magn. 20 : 1.  
 Frontal Section through the mot. VII nucl.,  
 caudally from Fig. 6.

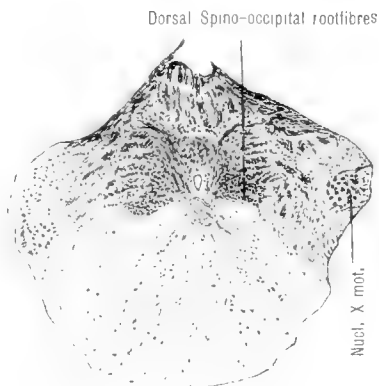

Fig. 8  
*Myxine glutinosa*. Magn. 20 : 1  
 Frontal Section through the mot. X nucl.

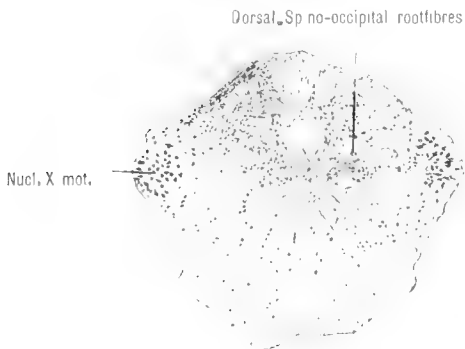

Fig. 9.  
 Frontal Section through the Nucl. X mot.  
 Magn. 20 : 1 (caudally from Fig. 8).



Fig. 10.  
*Myxine glutinosa*. Magn. 20 : 1.  
 Frontal Section through the spino  
 occip. column.





HOLM<sup>1)</sup> on this subject in 1902, which is certainly the best description as yet given of the motor nuclei in *Myxine glutinosa*.

HOLM points out that the motor column of the spinal cord (comp. our Fig. 10) can be traced frontally in the bulb.

Laterally from it lies the posterior extremity of what SANDERS has called the lateral or latero-ventral cell group (comp. our Fig. 9).

HOLM divides this latero-central column of the bulb, which we shall call the visceromotor column, into two divisions, a frontal and a caudal one.

He again divides the frontal division into two, the caudal one into three subdivisions.

We can only follow him in so far as we also divide the visceromotor column into two divisions (see Fig. 2 and Fig. 3) of which however only the frontal one is again divided into two subdivisions. The caudal visceromotor division, in our opinion, is continuous (see Fig. 2 and 3 nucl. X mot.) and does not exhibit subdivisions.

Apart from this column HOLM mentions a group of cells located next the ventricle in the rostral part of the oblongata from which he thinks that a part of the motor trigeminus originates. Another part of the motor trigeminus should originate from a nucleus in the lateral part of the oblongata on the level of the acoustic ganglion.

The nuclei of the trigeminus thus would be located at a fairly great distance from each other, one lying near the ventricle, the other near the periphery of the bulb. (Comp. his Fig. 20 on Plate 21: Ne I m. N V and Ne II m. N V).

We do not agree with this description, nor with his statements concerning the motor facialis.

Also the facialis — according to HOLM's opinion — should have two nuclei (l. c. p. 389) and from his description it clearly appears that he considers our frontal motor V nucleus as a VII nucleus, for the axones of this nucleus — as shown in his drawings — (Fig. 21 Plate 21) constitute the most frontal root of the bulb.

No doubt the two VII roots described by HOLM (VII $\alpha$  and VII $b$ ) are V roots, since only this nerve leaves the bulb with two motor roots<sup>2)</sup>, whereas the motor VII root is single and very small. Our opinion is confirmed by his description of the corresponding nuclei.

The first VII nucleus described by this author lies in the frontal part of the bulb near the periphery, and consists of large cells. His

1) J. F. HOLM. The finer Anatomy of the nervous system of *Myxine glutinosa*. Morpholog. Jahrbuch Bnd. 29, 1902.

2) This separation of the motor V in two roots is only visible near the entrance. Soon after it they unite.

second V nucleus according to his description is located in the caudal elongation of the first, is not completely separated from it and consists of smaller cells, which description is perfectly in accordance with the two V nuclei (see Fig. 3) of which the second, consisting of smaller cells and not completely separated from the frontal nucleus, gives also rise to the VII root. (Comp. also Fig. 4—7).

Like HOLM we were first inclined to consider the second (caudal) nucleus only as a VII nucleus, but a more scrupulous examination of the V fibres showed that in this nucleus also the second motor V root found its origin.

Summarizing we state that the motor V nuclei mentioned by HOLM are no motor V nuclei, and that of the two VII nuclei mentioned by this author the frontal one is a pure V nucleus, whilst the caudal more parvocellular one contains root cells of the V and VII.

This union of motor V cells and VII cells is in perfect harmony with the condition found in *Petromyzon* (comp. Fig 1), where the motor VII cells also form the caudal continuation of the V nucleus and are a little smaller.

Since we only wish to deal with the motor nuclei in this description, we shall pass the acustico-lateral system, which for the American Myxinoid *Bdellostoma dombeyi* has been so minutely described by AYERS and WORTHINGTON<sup>1)</sup> and proceed to the motor X nucleus of Myxine.

It is obvious that, without an examination of the periferal nervous system and its muscles, the question of the presence or absence of a motor glossopharyngeus cannot be settled.

We can only state that our researches show a reduction of the number of root fibers of the motor X group, which in Myxine only consists of 3 or 4 rootlets, whereas in *Petromyzon* it contains together with the glossopharyngeus at least 5 rootlets.

This combined with the fact that the posterior visceromotor column has suffered a reduction in its frontal part is in harmony with the opinion defended by JOHNSTON<sup>2)</sup> that the glossopharyngeus and perhaps even the first motor X root *sensu strictiori* are either very much reduced or absent. A comparison of Fig. 1a and 2a shows that this reduction is only probable for the frontal pole of the column,

<sup>1)</sup> AYERS and WORTHINGTON: They finer anatomy of the brain of *Bdellostoma dombeyi*. I. The acustico-lateral system. American Journal of Anatomy Vol. VIII, 1908.

<sup>2)</sup> JOHNSTON: Note on the presence or absence of the glossopharyngeal nerve in Myxinooids. Anatomical Record Vol. II, 1908.

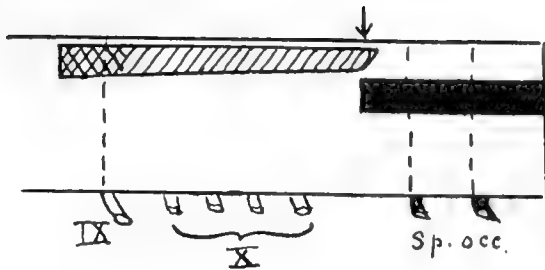

Fig. 1a.

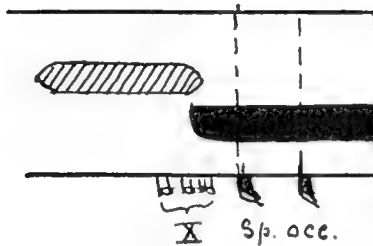

Fig. 2a.

Showing the reduction in the frontal part of the vagal column.

since the overlapping of the caudal part of the vagal column and spino-occipital column, as well as the topography of the posterior extremity of the vagal column to the spino-occipital roots, are the same in both *Petromyzon* and *Myxine*.

The reduction of the roots and of the frontal part of the vagal column in *Myxine* is also in harmony with STOCKARD'S observation that in *Myxinoids*, at least in its American form *Bdellostoma*, the branchial sacks behind the hyomandibular arch are atrophied.<sup>1)</sup>

The vagal column begins fairly near the posterior extremity of the mixed V—VII nucleus, lying in a somewhat more dorsal position (Comp. Fig. 3, 7 and 8). A few scattered cells lie between them, thus constituting a sort of broken link.

The size of the vaguscells is considerably smaller than that of the frontal V nucleus, more like the cells of the mixed V—VII nucleus, specially the smaller caudal cells of the latter.

In its frontal part the vagus nucleus is rather small and the cells do not attain their largest size here. The nucleus as well as the cells attain their maximum development in the middle part. We have not been able however, to state a division of the nucleus in three parts as HOLM did.

<sup>1)</sup> STOCKARD: The development of the Mouth and Gills in *Bdellostoma Stouti*. American Journal of Anatomy Vol. V 1906, specially p. 511 and fig. 33--36. Compare also for further knowledge of these animals:

AYERS. *Bdellostoma dombeyi*. Woodshole lectures for 1893.

WORTHINGTON. Contribution to our knowledge of the *Myxinoids*. American Naturalist Vol. 39, 1905.

On the other hand we agree with HOLM that the small ventrolateral root that leaves the bulb in the posterior part of the vagal region and is considered by SANDERS to be a vagalroot, is certainly a spino-occipital one (Cf. HOLM p. 395), as much on account of its position as on account of its central connection.

That the spino-occipital column extends for a short distance in the vagal region is a general feature in vertebrates and has been shown before to occur also in *Myxine* by EDINGER<sup>1)</sup> (l. c. p. 28).

We also agree with HOLM that the dorsal sensory root entering on this level is a sensory spino-occipital or spinal root and not a sensory Vagusroot, as results from the facts 1. that the size of its fibres corresponds with those of the sensory spinal rootfibres, 2. that the line of entrance and the ascending character of the fibres during their intramedullary course are the same as in the spinal sensory roots and 3. because they are joined by the latter during this course.

Finally we wish to call attention to the fact that not only the topography of the nuclei, but also the general morphology of this brain shows the compression which the brain has suffered.

Similar to the other ventricles of the brain the 4<sup>th</sup> ventricle is reduced to a minimum. This is complicated by the peculiarity that the caudal end of the midbrain (a cerebellum does not occur in this animal) protrudes a considerable distance between the dorsolateral walls of the oblongata and is so closely adjacent to it that only the pial membrane can follow it. Behind the caudal extremity of the midbrain the dorsolateral walls of the oblongata unite.

One cannot speak here of a real calamus scriptorius caused by a widening of the ventricle itself. The lateral deviation of the walls takes place only under the influence of the midbrain, but the 4<sup>th</sup> ventricle itself remains a small split underneath it. The dotted arrow in figure 2 indicates the place of this pseudo-calamus. Since in this animal, with atrophic eyes, there is no question of an enlargement of the midbrain being the cause of this telescoping, the only reason of it can be found in the compression of the whole brain in its longitudinal axis, which is also exhibited by the approach of the vago-occipital part of the oblongata to the trigemino-facial part.

This longitudinal compression probably finds its chief reason in the pressure exercised on the frontal part of the brain by the olfactory pit and dorsal lip, the influence of which on the form

<sup>1)</sup> EDINGER: Das Gehirn von *Myxine glutinosa*. Abhandlungen der Preussischen Akademie der Wiss. 1906.

of the brain in Cyclostomes is already mentioned by SCOTT<sup>1)</sup> in Petromyzon.

As stated above, the telescoping is the more obvious in the oblongata on account of the reduction in the acustico-lateral system of the bulb.

Everything indeed shows that in Myxine we have to do with considerable secondary modifications.

Also the topography of the motor nuclei is by no means a primitive one.

The primitive location of the V, VII. and X nuclei in Cyclostomes is near the ventricular ependyma where the matrix of the nerve cells is, and where they are still found in Petromyzon. In Myxine, however, the V—VII nucleus has a ventro-lateral periferal position and the X nucleus a lateral periferal position, a condition that can only be caused by secondary influences originating in the functional reflectory relations of this animal.

The influence which has caused this secondary position is certainly the considerable development of the descending sensory V, which has a dominating influence on the structures of the oblongata, an influence which is the more prevailing since the other sensory and reflectory paths are either atrophied or poorly developed in this animal. We know that in animals with a well-developed dorsal viscerosensory nucleus the motor vagal column generally has a dorsal position, adjacent to its sensory grey (Selachians), which is still the case even in Petromyzon.

On account of these facts we cannot agree with HOLM in his statement that Myxine has a more primitive character than Petromyzon.

Summarizing our results we conclude :

In Myxine the eye-muscle nuclei are absent.

The motor V nucleus is incompletely divided into two parts corresponding to the central division of the motor root into two parts.

In the continuation of the caudal V nucleus also the motor VII cells are found, as is also the case in Petromyzon. These nuclei have a ventrolateral position very near the concomitating grey substance of the sensory root. A central V nucleus (HOLM) has not been found.

The posterior visceromotor column, and also the spino-occipital motor column has shifted considerably frontally. By the adjacency of the earcapsule this shifting could only be partly followed, by the motor X roots, which are crowded together on the earcapsula.

<sup>1)</sup> SCOTT. The embryology of Petromyzon. Journal of Morphology Vol. 1, 1887

The spino-occipital roots have, however, followed the shifting of their nucleus and have come very near the vagus roots.

The posterior visceromotor column is considerably shortened at its frontal extremity, which most probably results from the absence or extreme reduction of the motor IX, and perhaps even of the frontal motor X root (JOHNSTON) in connection with the absence or reduction of the two posthyomandibular branchial sacks (STOCKARD).

**Physics.** — *“Further experiments with liquid helium. J. The imitation of an AMPÈRE molecular current or of a permanent magnet by means of a supra-conductor.”* Communication N<sup>o</sup>. 104b from the Physical Laboratory at Leiden. By Prof. H. KAMERLINGH ONNES.

(Communicated in the meeting of April 24, 1914).

§ 1. *Introduction.* If a current is generated in a closed supraconductor, from which no other work is required than what is necessary to overcome the possible remaining micro-residual resistance of the conductor, it follows, from the small value that the micro-residual resistance can have at the most, that the current will continue for a considerable time after the electromotive force that set it in motion has ceased to work. The time of relaxation  $\tau$  in which the current decreases to  $e^{-1}$ <sup>th</sup> of its value is given by the ratio  $\frac{L}{r}$  of the self-induction  $L$  and the resistance  $r$  of the circuit. When  $r$  approaches zero, this period may rise to very high values. Whereas the time of relaxation is extremely small in ordinary cases (for the coil with which we are about to deal for instance, of the order of a hundredthousandth of a second) when the resistance in the supraconducting condition becomes say 1,000,000 or even 1,000,000,000 times smaller it may increase so much, that the disappearance of the current can be observed; it may even take place extremely slowly.

From the moment that I had found in mercury a supra-conductor at the lower temperatures which can be obtained with liquid helium, I was desirous to demonstrate the persistence of a current in a conductor of this kind, and amongst other things to take advantage of it in the further investigation of the microresidual resistance of the supra-conductor<sup>1)</sup>. But it was only after the previous study of various

<sup>1)</sup> For the sake of brevity we use the word resistance here in the sense of quotient of potential difference and current strength. In supra-conductors (see Comm. No. 133) we can at present only speak of current and potential difference; whether the relation between these two can be expressed by means of the conception of specific resistance, has still to be investigated. (Comp. note 1 § 3).

problems, which were also of value for the knowledge of the conditions which had to be considered, that I arrived at the simple experiment which I am now able to describe, and which confirms what I have adduced in a convincing way.

For this experiment a conductor was available whose constants, in so far as they were needed in designing the experiment, were known: I refer to the coil of lead wire *Pb<sub>XII</sub>* which has several times been mentioned in previous papers. A thousand turns of lead wire of  $\frac{1}{70}$  sq. mm. in section are wound on a small brass tube of 8 mm. in diameter in a layer 1.1 cm. thick and 1.1 cm. long. At the ordinary temperature the coil has a resistance of 734  $\Omega$  and as the inductance is 10 milli-henries, the relaxation time may be put at about 1 : 70000 of a second. The micro-residual resistance at 1° S K. had been found to be more than  $2 \times 10^{10}$  times smaller than the resistance at the ordinary temperature; the relaxation time therefore must be at least of the order of a day. The limit to which the current may be raised before ordinary resistance is suddenly generated, had also been determined; at 1° S K. this limit was 0.8 amp.; it is clear that a lower current than that is sufficient to make the coil into a powerful little magnet. Finally the threshold value of the magnetic field, below which no resistance is produced in the coil was known: at 1° S K. it had been found to be about 1000 gauss. It was ascertained (cf. § 3), that it was unnecessary to use a field of that strength to be able to make the experiment by means of generating a current by induction in the conductor. The conductor after having been tested as to its superconductivity had to be closed in itself in a superconductive way. This was effected by fusing the ends of the lead wire together: in previous experiments it had been found, that this treatment did not lead to the production of ordinary resistance. In view of all the data I could be assured, that all the conditions necessary for the success of the experiment were fulfilled.

§ 2. *Arrangement of the experiment.* The coil was fitted up in the same cryostat which had served for the previous experiments with the plane of the windings vertical in such a manner, that it could be raised and lowered, as well as turned round a vertical axis. Fig. 1 shows the arrangement diagrammatically.

As the coil was closed the current in it was generated by induction. A large WEISS-electromagnet, at hand for the experiments of Comm. N°. 140*d* could be moved on casters towards the cryostat to a position in which the cryostat with the coil was in the interferrum.

In order to obtain an unambiguous result it is advisable to be

able to test the magnetic condition of the coil while no other magnetic objects are in the neighbourhood; it is also necessary to prevent the induction currents which are generated when the field is produced and when it disappears from partly or completely neutralising each other (cf. § 4).

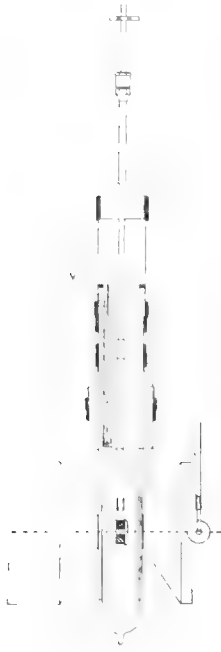

Fig. 1.

It can therefore be easily seen that the following procedure is advisable: the field is put on, while the coil is in the cryostat at the centre of the interferrum, everything being prepared for siphoning the liquid helium into the cryostat. The current generated at the production of the field is then immediately dissipated by the ordinary resistance of the coil before the helium is poured over. Care is taken to keep the field below the threshold-value of the production of ordinary resistance, which holds for the temperature at which the experiment is going to be made. The coil is then cooled by letting in liquid helium, the field remaining unchanged. In this manner a supra-conducting coil is obtained, closed in itself without a current placed in the magnetic field. If the field is now put off and the apparatus which have produced it are removed, a current will remain in the coil which is smaller than or in the limit equal to the threshold-value corresponding to the temperature of the coil. The presence of this current

can be established by its magnetic action outside the cryostat.

In order to obtain a strong current it is advisable to cool the coil as far down as possible, as thereby the threshold-value of the field to be used for the induction and the threshold-value of the current are both made as high as possible. For that reason the first experiment was made at a temperature of  $1^{\circ}.8$  K, the lowest temperature which can be reached comparatively easily and maintained for a long time.

§ 3. *Calculation of the experiment.* Assuming that the field diminishes proportionally to the time  $t$  from  $H_0$  to 0 and calling  $M$  the magnetic potential of the coil in the field  $H$ ,  $\frac{dM}{dt}$  will be constant during the period of the disappearance of the field and the equation<sup>1)</sup>

$$L \frac{di}{dt} + ri = \frac{dM}{dt}$$

<sup>1)</sup> Here is supposed that  $r$  is independent of  $i$  below the threshold value  $i_D$  of  $i$ .



with  $i = 0$  at the beginning gives

$$i = \frac{1}{r} \frac{dM}{dt} \left( 1 - e^{-\frac{r}{L} t} \right),$$

and for small values of  $\frac{r}{L}$  and  $t$ , as long as  $M$  has not reached zero, with sufficient approximation

$$i = \frac{1}{L} \frac{dM}{dt} t,$$

so that, if  $M$  reaches 0 while  $t$  is still small,

$$i = -\frac{M_0}{L}$$

will be the final value of the current.

In our experiment the constants were  $H_0 = 400$ ,  $M_0 = 1,26 \times 10^6$ ,  $L = 10^7$ , so that  $i$  could rise to 0,126 C. G. S. or 1,26<sup>1)</sup> Amps. The current can therefore reach the threshold-value 0,8 Amp. even with a field of rather more than half the strength assumed in the calculation (cf. one of the experiments in § 4). From the moment at which this value is reached ordinary resistance appears and  $\frac{r}{L}$  will be no longer small: the further increase of  $i$  above the threshold value  $i_D$  follows a different law from below  $i_D$ .

For an accurate calculation of the process above  $i_D$ , it would be necessary to take into account the complicated law of increase of the resistance with the current beyond  $i_D$ . For our purpose it is sufficiently accurate to assume, that when  $i_D$  is exceeded by a small amount, the resistance becomes suddenly  $r'$  of the order of magnitude above the vanishing point.

In that case,  $\frac{dM}{dt}$  remaining the same as before, the current will be able to rise by a small amount  $i - i_D = \frac{1}{r'} \frac{dM}{dt}$ , which will soon be reached, will then become constant and, on  $M$  and  $\frac{dM}{dt}$  becoming zero, disappear again in a short time. In view of the value of  $M$  and  $r'$  we may, if  $M$  does not change very rapidly, disregard  $i - i_D$ , unless we intend an explanation of all the details of the experiment.

We therefore come to the conclusion, that,  $M_0$  being sufficiently

<sup>1)</sup> The more accurate data given here differ somewhat from those in the Dutch text.

large, the current (Fig. 2) on  $M$  diminishing to 0 will reach the threshold-value, belonging to the temperature of the experiment, and

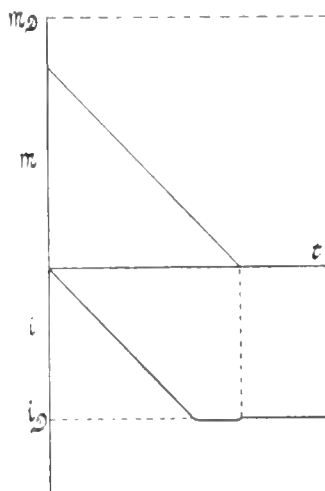

Fig. 2.

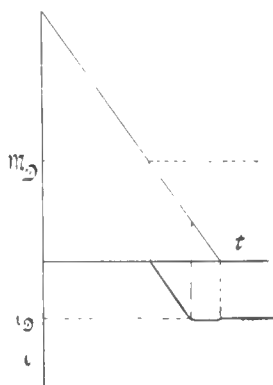

Fig. 3.

after the induction being completed will continue, while only after a long time  $t'$  according to the relation

$$i' = i_D e^{-\frac{r}{L} t'}$$

in accordance with the large value of the time of relaxation  $\frac{L}{r}$  an appreciable diminution of  $i$  will be observed.

The case, that the initial value of  $M$  is above the threshold-value of the production of resistance  $M_D$ , is represented in Fig. 3, which after the foregoing needs no special elucidation. The result is apparently again dependent on the threshold-value of the current (see also one of the experiments in § 4).

As appears from the values given above an initial field much smaller than  $M_D$  was sufficient in our experiment.

According to the above calculation it was to be expected, that the examination of the magnetic action of the coil could be performed with a simple compass-needle brought near the cryostat.

§ 4. *Details of the observations.* The result proved the correctness of the discussion contained in the previous sections. The field was taken at 400 gauss. In 10 seconds it was reduced to 200 gauss and immediately afterwards the electromagnet was rolled away in 5 seconds. The compass-needle which was then placed beside the cryostat to the East of it on a level with the coil and at a distance

from it of 8 cms pointed almost at right angles<sup>1)</sup> to the meridian. When the action on the magnet was compensated by means of a second coil placed on the other side (West) of it of about the same dimensions as the experimental coil and of 800 turns, it was found that the coil was carrying a current of about 0.5 to 0.6 amp.<sup>2)</sup> This was further confirmed by turning the coil and by moving the compass-needle to various positions about the cryostat<sup>3)</sup>. During an hour the current was observed not to decrease perceptibly (as far as could be judged by the deviation of the needle with an accuracy of 10%). During the last half hour the coil was no longer at 1° 8 K. but at 4° 25 K. the temperature of helium boiling under normal atmospheric pressure. Undoubtedly even at this temperature the observation might have been continued much longer without much diminution of the current. A coil cooled in liquid helium and provided with current at Leiden, might, if kept immersed in liquid helium, be conveyed to a considerable distance and there be used to demonstrate the permanent magnetic action of a supra-conductor carrying a current. I should have liked to show the phenomenon in this meeting (Kon. Acad. Amsterdam), in the same way as I brought liquid hydrogen here in 1906, but the appliances at my disposal do not yet allow the transportation of liquid helium.

Whereas the experiment, so far as described, shows, that a current when started in a supra-conducting wire continues to flow, the process is immediately stopped as soon as ordinary resistance is generated in the circuit. When the coil is lifted out of the helium, the current is instantaneously destroyed. The temperature of the coil is thereby very quickly raised above the vanishing point of lead (6° K) and the very long relaxation-time is replaced by a very short one. Reimmersion of the coil, if not too soon after the lifting out, does not again produce magnetic action.

If the experiment is made with the windings of the coil parallel to the field, no effect<sup>4)</sup> is to be expected. This expectation was in so far confirmed as only a slight effect was observed: this effect can

1) The field of the earth being distorted by machinery the action of the latter was compensated by magnets and there resulted a weaker field (note added in the translation.)

2) [Calculated from the moment, comp. N<sup>o</sup>. 140d § 8, end. Added in the translation]. The coil has a magnetic moment of about 180 C.G.S. and behaves as if the lead possessed remanent magnetisation of some 200 C.G.S. units.

3) On repeating the experiment at 4° 25 K. nearly 0.5 amp. was obtained; a later experiment with larger initial field at 2° 3 K. gave 0.7 amp. (see further down).

4) Nearer consideration points to a small effect Comp. N<sup>o</sup>. 140c (Note added in the translation).

be sufficiently explained by assuming that the attempt to place the windings exactly parallel to the field had not succeeded.<sup>1)</sup>

If the initial value of the field is higher than the threshold-value,  $M_D$  the result is the same. This case is represented in fig. 3. In one experiment the initial field was 5000 gauss and the observed magnetic moment corresponded to a current  $i = 0.7$  amp.

If the field through the supraconducting coil is first put on and subsequently put off again by bringing the excited electromagnet to its position at the cryostat and then removing it, according to the above reasoning (disregarding the exceedingly slow diminution with the time) no resultant current ought to remain, if no account had to be taken of the threshold-value of the current. Indeed for the second period the relation  $i - i_0 e^{-\frac{L}{r}t} = \frac{M_1 - M}{L}$  holds, if  $L$  is

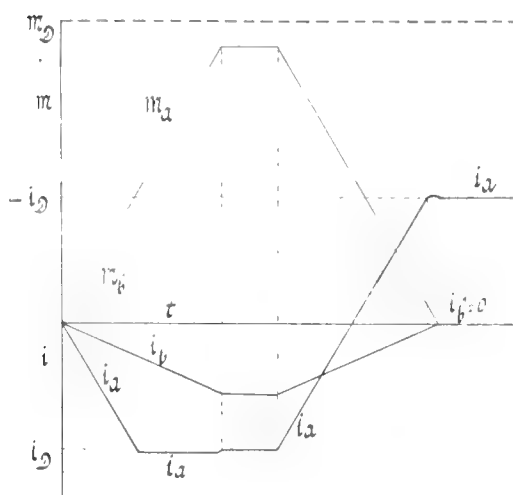

Fig. 4.

the current obtained in the first period during the generation of  $M_1$ . This case will be realized, if care is taken, that the threshold-value of the current is not exceeded. It is represented in fig. 4 by the lines which give the field  $M_b$  and the current  $i_b$  as functions of the time. If during the increase of  $M$  the threshold-current is reached, the current will not grow appreciably on further rise of  $M$ ; from the moment,

that the increase of  $M$  stops, the current assumes the threshold-value and stays there, until  $M$  begins to decrease: it then begins to fall and becomes zero, before the field has disappeared; on the further diminution of the field, the current assumes the opposite sign and the resultant current will be that which has been formed at the moment that  $M = 0$ , if it remains below the threshold-value, or the threshold-current itself, if that is reached before  $M$  has disappeared. In the latter case the current will exceed the threshold-value by

<sup>1)</sup> This experiment had been made some days before the main experiment, although it had not been the intention to make it with that position of the coil. So far it has not been repeated. At the moment of making this first communication it had not been repeated. [It has been repeated since; again a rest was found. (Note added in the translation, Comp. Comm. N<sup>o</sup>. 140c)].

a very small amount from the moment, that the threshold-value is reached, until  $M = 0$ . In fig. 4 this case is represented by the lines which give the relation between the field  $M_n$  and the current  $i_a$ .

An instance of the case represented by  $a$  is given by an experiment, in which the field brought to the cryostat was 400 gauss. A strong resultant current was observed as in the case, when the coil was first free of current in the field of 400, was then made superconductive and was finally charged with current by the removal of the field. An instance approximately corresponding to case  $b$  was obtained, when the same experiment as  $a$  was carried out with a field of 190 gauss. Even in this case the compensation was not quite complete and a little more favourable, when the field was made to approach slowly, than with a rapid approach.

With a rising field account has to be taken also of the complication arising out of the influence of the field of the current itself on the threshold-values of the field and current. In fact this was not the only feature in the experiments which could not be fully explained yet: naturally as they were performed for the first time, the arrangements were still imperfect <sup>1)</sup>. Taken together however they may be said to confirm the main experiment which shows that it is possible in a conductor without electromotive force or leads from outside <sup>2)</sup> to maintain a current permanently and thus approximately to imitate a permanent magnet or better a molecular current as imagined by AMPÈRE.

The electrons once set in motion in the conductor continue their course practically undisturbed, the electrokinetic energy, represented by MAXWELL by the mechanism of the rotating masses coupled to the current, retains its value, the rotating fly-wheels go on with their velocities unchanged, as long as no other than superconductors come into play: the application of a small ordinary resistance however stops the mechanism instantaneously. Although the experiment mainly confirmed my deductions as to what had to be expected,

<sup>1)</sup> One of the first questions still to be answered is, what part a possible magnetisation of lead or brass may have played in the phenomena: so far no proof has been given, that this may be neglected. However, even now from the experiment, in which the windings were parallel to the lines of force, we may draw the conclusion, in view of the small amount of the action in that case, that the magnetisation of the material of the coil can only play a very subordinate part compared to the electromagnetism of the current, to which I have above ascribed the deviation of the compass-needle.

<sup>2)</sup> It may be mentioned here, that it will be possible, by a change of temperature of a small part of the conductor, to insert a resistance in the circuit which can be very delicately regulated without touching it.

a deep impression is made by the very striking realisation which it gives of the mechanism imagined by MAXWELL completed by the conception of electrons.

It is obvious that the subject will lead to further discussions<sup>1)</sup> and plans, but in this paper I may be allowed to confine myself to the simple description of the experiment carried out.

**Physics.** — *“The chemical constant and the application of the quantum-theory by the method of the natural vibrations to the equation of state of an ideal monatomic gas.”* By Dr. W. H. KEESOM. Supplement N<sup>o</sup>. 36*b* to the Communications from the Physical Laboratory at Leiden. (Communicated by Prof. H. KAMERLINGH ONNES).

(Communicated in the meeting of March 28, 1914).

§ 1. In Suppl. N<sup>o</sup>. 33 (Dec. 1913) the expression for the entropy,  $S$ , of a gas was discussed, as it follows from the application of the quantum-theory to the molecular translatory motion by the method of the natural vibrations. Molecular rotations and intramolecular motions were not taken into account there. As was observed, the chemical constant is connected with the additive constant which occurs in the development of  $S$  for high temperatures. The object of this paper is to show that the value of the chemical constant, which in that manner is deduced from the expression for the entropy (an expression which had already been given by TETRODE), is in satisfactory agreement with values of this constant which correspond to the experimental data concerning vapour pressures of monatomic gases.

§ 2. We shall confine ourselves in this paper to the consideration of monatomic gases. If for the energy distribution one of the temperature functions is assumed which occur in the quantum-theory, one may suppose that the molecular rotatory motion, particularly for the molecules of a monatomic gas, is in thermal equilibrium say with the translatory motion. If in particular that temperature function (given by PLANCK) is assumed which implies a zero point energy, the molecular rotations in a monatomic gas also, at the temperatures at which they have been investigated, represent a considerable amount of energy in proportion to the molecular trans-

<sup>1)</sup> Compare also MAXWELL, Electricity and Magnetism II, Ch. VI.

latory motions. The characteristic temperatures ( $\Theta_r$ , cf. Suppl. N<sup>o</sup>. 32*a*), which according to that hypothesis govern the rotatory energy, are, however, owing to the small moment of inertia of the monatomic molecules, so high, that at the temperatures mentioned the energy of rotation of the molecules does not yet deviate appreciably from the corresponding zero point energy. The same applies to the motions within the atom. The contributions to the entropy due to these rotations of and motions within the atom may then be counted as zero. We limit ourselves to the temperature range within which this is the case<sup>1</sup>).

We shall further assume that we are dealing with an *ideal* monatomic gas, so that terms due to the influence of the real volume or of the mutual attraction of the molecules need not to be considered.

The entropy of such a gas is then, on the basis of the hypotheses of Suppl. N<sup>o</sup>. 30*a*, determined by the expressions given in Suppl. N<sup>o</sup>. 33 § 2*a*.

§ 3. In the first place, as was already observed in Suppl. N<sup>o</sup>. 33 § 2*aβ*, the introduction of the zero point energy makes no change in the value which is found for the chemical constant. Hence a comparison of the value calculated for this constant, e.g. with the value which was found by SACKUR to agree with experimental data, cannot furnish a test between PLANCK'S formula with or without zero point energy<sup>2</sup>).

§ 4. If the development of  $S$  for high temperatures: equation (14) Suppl. N<sup>o</sup>. 33, is written in the form

$$S = C_s + Nk \ln v + \frac{3}{2} Nk \ln T + \left. \begin{array}{l} \\ + \text{ terms of smaller order of magnitude} \end{array} \right\}, \dots \dots (1)$$

then

$$C_s = Nk \left( 4 + \frac{3}{2} \ln \beta M \right). \dots \dots (2)$$

1) According to measurements by PIER of the specific heat of argon, this temperature range extends for this gas to at least 2300° C. As Prof. EINSTEIN pointed out in a discussion, the investigation at high temperatures of the specific heat of a monatomic gas with high atomic weight, such as mercury, would be of great interest.

2) Prof. SOMMERFELD asks me to say, that he wishes the sentence: "Nebenbei sei bemerkt etc. on p. 139 of: Vorträge über die kinetische Theorie der Materie und der Elektrizität," Leipzig und Berlin 1913, to be omitted.

From equation (13) of Suppl. N<sup>o</sup>. 33 with equation (18a) of Suppl. N<sup>o</sup>. 30 it follows that

$$p^3 = \frac{3}{5Nk} \frac{k^2}{h^2} \left( \frac{4\pi}{9N} \right)^{2/3} \dots \dots \dots (3)$$

From these formulae follows for the entropy constant

$$C_s = Nk \left\{ 4 + \ln \frac{4\pi}{9} \frac{k^3}{Nh^3} \left( \frac{3M}{5Nk} \right)^{3/2} \right\} \dots \dots \dots (4)$$

With the values  $N = 6.85 \cdot 10^{23}$  (according to PERRIN),  $k = 1.21 \cdot 10^{-16}$ ,  $\frac{h}{k} = 4.86 \cdot 10^{-11}$ , which were accepted in Suppl. N<sup>o</sup>. 30a, equation (4) with  $Nk = R$  passes into

$$C_s = R \left\{ \frac{3}{2} \ln M - 7.43 \right\} \dots \dots \dots (5a)$$

If we take MILLIKAN'S<sup>1)</sup> values  $N = 6.06 \cdot 10^{23}$ ,  $k = 1.37 \cdot 10^{-16}$ ,  $\frac{h}{k} = 4.83 \cdot 10^{-11}$ , we find

$$C_s = R \left\{ \frac{3}{2} \ln M - 7.285 \right\} \dots \dots \dots (5b)$$

For the chemical constant  $C_{NE}$ , which is derived from  $C$ , by means of the relation<sup>2)</sup>

$$C_{NE} = \frac{C_s - 2.5R + R \ln Nk}{R \ln 10}$$

we find

$$C_{NE} = \frac{3}{2} \log M + 3.60 \left. \vphantom{\frac{3}{2} \log M + 3.60} \right\} \dots \dots \dots (6a)$$

and

$$C_{NE} = \frac{3}{2} \log M + 3.67 \left. \vphantom{\frac{3}{2} \log M + 3.67} \right\} \dots \dots \dots (6b)$$

respectively.

These values differ from those which SACKUR has compared with the vapour pressures of mercury and argon and which he found fairly well confirmed, only by 0.35 and 0.28 respectively. This agreement may be called very satisfactory considering the uncertainty which yet exists with regard to several of the quantities used in that comparison on the one hand, and the approximate character of some of the hypotheses on which the deduction of the expression for the entropy was founded on the other hand.

<sup>1)</sup> R. A. MILLIKAN, Physik. ZS. 14 (1913), p. 796.

<sup>2)</sup> Cf. O. SACKUR, Ann. d. Phys. (4) 40 (1913), p. 79.



§ 5. The relation (4) also follows from equation (19a) of the paper by SOMMERFELD (p. 134), quoted in note 2 p. 21, if  $a$  occurring there is put equal to  $\frac{10}{9}$ , as has been supposed in the relations (3) and (4) given above, and if in SOMMERFELD'S expression  $h$  is replaced by  $\frac{1}{2} h^1$ ). The latter change is connected with the fact, that in deriving the expressions given here the supposition was made that in considering the molecular translatory motion in an ideal monatomic gas we have to deal with energy elements of a magnitude  $\frac{1}{2} h\nu$ , as we tried to make probable in Suppl. N<sup>o</sup>, 30a § 2.

The fact that in § 4 a satisfactory agreement with experimental data was obtained, may, if the validity of the other hypotheses is admitted as sufficiently approximate, be regarded as a confirmation of the above supposition concerning the magnitude of the energy elements.

**Astronomy.** — “On SEELIGER'S hypothesis about the anomalies in the motion of the inner planets.” By J. WOLTJER JR. (Communicated by Prof. W. DE SITTER).

(Communicated in the meeting of April 24, 1914).

To explain the differences between observation and calculation in the secular perturbations of the elements of the four inner planets, SEELIGER<sup>2)</sup> worked out the hypothesis that these are caused by masses of matter, which by reflection of sunlight offer the aspect of the zodiacal light. He imagines these masses to have the form of a flat disc surrounding the sun and extending nearly in the direction of the orbital planes of the planets and reaching outside the orbit of the earth; the density of the matter within the disc has its greatest value in the proximity of the sun, though it is very small even there. For the calculation of the attraction of the mass of matter special hypotheses on its constitution are introduced; we imagine a number of very flattened ellipsoids of revolution with the sun at the centre, the inclinations of the equatorial planes to the orbital planes of the planets being small. It is evident that by the superposition of a number of such ellipsoids we get a flat disc within which the density varies

1) This confirms at the same time the fact, that the introduction of the zero point energy does not produce a change in the value of the entropy constant.

2) Das Zodiakallicht und die empirischen Glieder in der Bewegung der innern Planeten. Sitzungsberichte der Bayerischen Akademie, XXXVI 1906.

after a certain law from the centre outwards. SEELIGER arrived at the conclusion that two ellipsoids suffice, one of which is wholly contained within the orbit of Mercury, the other reaching outside the orbit of the earth. There appears to exist a certain liberty in choosing the values of the ellipticities and the quantities determining the position of the second ellipsoid. As quantities to be determined so as to account for the differences which are to be explained SEELIGER introduces the densities of both ellipsoids, the inclination and the longitude of the ascending node of the equatorial plane of the first ellipsoid with reference to the ecliptic, and a quantity not connected with the attraction of the masses of matter, but relating to the deviation of the system of coordinates used in astronomy from a so called "inertial system".

Last year Prof. DE SITTER drew my attention to the necessity of testing SEELIGER's hypothesis by calculating the influence of the masses admitted by SEELIGER on the motion of the moon and the perturbation of the obliquity of the ecliptic, which SEELIGER did not consider<sup>1)</sup>. I performed the calculations and arrived at the conclusion that the perturbation of the ecliptic changes the sign of NEWCOMB's<sup>2)</sup> residual and makes its absolute value a little larger; further that the perturbations of the motion of the moon are insensible. I may be allowed to thank Prof. DE SITTER for the introduction into this subject and the interest shown in its further development. — One could take the formulae required for the last mentioned purpose from SEELIGER's publication; I did not do so, but developed them anew. I give them here on account of small differences in derivation. First I shall give this derivation and the results; after that I shall do the same for the motion of the moon.

### I. *Perturbations of the ecliptic.*

Let  $x, y, z$  be coordinates in a system the origin of which is at the centre of the ellipsoid, while the axis of rotation is the axis of  $z$ ,  $k^2$  the constant of attraction,  $q$  the density of the ellipsoid,  $a, a$  and  $c$  its axes, then the potential  $V$  at the point  $x, y, z$  is given by the expression:

$$V = k^2 \pi q a^2 c \int_0^z \left( 1 - \frac{x^2 + y^2}{a^2 + u} - \frac{z^2}{c^2 + u} \right) \frac{du}{(a^2 + u)\sqrt{c^2 + u}};$$

<sup>1)</sup> See DE SITTER, the secular variations of the elements of the four inner planets, *Observatory*, July 1913.

<sup>2)</sup> *Astronomical Constants* p. 110.

for a point outside the ellipsoid  $\lambda$  is the positive root of the equation  $1 - \frac{x^2 + y^2}{a^2 + \lambda} - \frac{z^2}{c^2 + \lambda} = 0$ ; for a point inside  $\lambda$  is zero.

Putting  $V = k^2 \pi q a^2 c \Omega$  and  $x^2 + y^2 + z^2 = r^2$  we have :

$$\Omega = \int_0^{\infty} \left( 1 - \frac{r^2}{a^2 + u} - \frac{z^2(a^2 - c^2)}{(a^2 + u)(c^2 + u)} \right) \frac{du}{(a^2 + u)\sqrt{c^2 + u}}$$

$$1 - \frac{r^2}{a^2 + \lambda} - \frac{z^2(a^2 - c^2)}{(a^2 + \lambda)(c^2 + \lambda)} = 0.$$

*Perturbations caused by the first ellipsoid.*

I develop in powers of  $z^2 = \xi$ ,  $\xi$  being a small quantity ; for that purpose we need (neglecting terms of the third order) :

$$\left( \frac{\partial \Omega}{\partial \xi} \right)_0 = - (a^2 - c^2) \int_{r^2 - a^2}^{\infty} \frac{du}{(a^2 + u)^2 (c^2 + u)^{3/2}}$$

$$\left( \frac{\partial^2 \Omega}{\partial \xi^2} \right)_0 = \frac{(a^2 - c^2)^2}{r^4 (r^2 - a^2 + c^2)^{3/2}}.$$

I put  $r = a_1 (1 + \xi)$  and develop the part of  $\Omega$  independent of  $\xi$  besides the coefficients of the different powers of  $\xi$  in powers of  $\xi$ .

Introducing the quantities :

$$C_1 = \int_{a_1^2 - a^2}^{\infty} \frac{du}{(a^2 + u)\sqrt{c^2 + u}} \quad C_2 = \int_{a_1^2 - a^2}^{\infty} \frac{du}{(a^2 + u)^2 \sqrt{c^2 + u}} \quad C_3 = \int_{a_1^2 - a^2}^{\infty} \frac{du}{(a^2 + u)^2 (c^2 + u)^{3/2}}$$

$$a_1^2 - a^2 + c^2 = p^2 \quad \frac{a_1^2}{p^2} = \gamma$$

we get :

$$\Omega = C_1 - a_1^2 C_2 - 2 a_1^2 C_2 \xi + (2 - p a_1^2 C_2) \frac{\xi^2}{p} + \left( -\frac{2}{3} - \frac{2}{3} \gamma \right) \frac{\xi^3}{p} +$$

$$+ \left( \frac{1}{2} + \frac{1}{3} \gamma + \frac{1}{2} \gamma^2 \right) \frac{\xi^4}{p} + \xi \frac{a^2 - c^2}{a_1^2 p^3} \left\{ - C_3 a_1^2 p^3 + 2 \xi + (-3 - 3\gamma) \xi^2 + \right.$$

$$+ (4 + 5\gamma + 5\gamma^2) \xi^3 + \left. \left( -5 - \frac{27}{4} \gamma - \frac{15}{2} \gamma^2 - \frac{35}{4} \gamma^3 \right) \xi^4 \right\} +$$

$$+ \frac{1}{2} \xi^2 \frac{(a^2 - c^2)^2}{a_1^4 p^5}.$$

Let  $v$  be the true anomaly of the planet,  $\varphi$  the angular distance between the ascending node of the equatorial plane of the ellipsoid on the orbital plane of the planet and the perihelion of the orbit,

$J$  the inclination of the equatorial plane to the orbital plane, then we have :

$$\begin{aligned} z &= -a_1(1 + \xi) \sin(v + \psi) \sin J \\ \xi &= a_1^3(1 + \xi)^2 \sin^2(v + \psi) \sin^2 J. \end{aligned}$$

For the calculation of the secular portion of the perturbative function we thus need the secular portions of  $\xi^p$ ,  $\xi^p \sin^2(v + \psi)$  and  $\sin^4(v + \psi)$  for different values of  $p$ . I get (denoting the secular portion by the letter  $S$ ) :

$$\begin{aligned} S\xi &= \frac{e^2}{2} & S\xi^2 &= \frac{e^2}{2} & S\xi^3 &= \frac{3}{8}e^4 & S\xi^4 &= \frac{3}{8}e^4 \\ S \sin^2(v + \psi) &= \frac{1}{2} - \left(\frac{3}{8}e^2 + \frac{1}{16}e^4\right) \cos 2\psi \\ S\xi \sin^2(v + \psi) &= \frac{1}{4}e^2 \left(1 - \frac{3}{2} \cos 2\psi\right) + \frac{1}{16}e^4 \cos 2\psi \\ S\xi^2 \sin^2(v + \psi) &= \frac{1}{4}e^2 \left(1 - \frac{1}{2} \cos 2\psi\right) - \frac{1}{16}e^4 \cos 2\psi \\ S\xi^3 \sin^2(v + \psi) &= e^4 \left(\frac{3}{16} - \frac{1}{4} \cos 2\psi\right) \\ S\xi^4 \sin^2(v + \psi) &= e^4 \left(\frac{3}{16} - \frac{1}{8} \cos 2\psi\right) \\ S \sin^4(v + \psi) &= \frac{3}{8}. \end{aligned}$$

Substituting in the expression for  $\Omega$  we find :

$$\begin{aligned} S\Omega &= C_1 - a_1^2 C_2 + \frac{e^2}{p} \left(1 - \frac{3}{2} a_1^2 C_2 p\right) + \frac{e^4}{p} \left(-\frac{1}{16} - \frac{1}{8} \gamma + \frac{3}{16} \gamma^2\right) + \\ &+ \frac{a^2 - e^2}{p^3} \sin^2 J \left[ -\frac{1}{2} C_3 a_1^2 p^3 + e^2 \left\{ \frac{3}{4} - \frac{3}{4} \gamma - \frac{3}{4} C_3 a_1^2 p^3 + \right. \right. \\ &+ \left. \left. \cos 2\psi \left( -\frac{7}{8} + \frac{3}{8} \gamma + \frac{5}{4} C_3 a_1^2 p^3 \right) \right\} + e^4 \left\{ -\frac{9}{64} \gamma + \frac{45}{32} \gamma^2 - \right. \right. \\ &\left. \left. - \frac{105}{64} \gamma^3 + \cos 2\psi \left( \frac{1}{16} + \frac{13}{32} \gamma - \frac{25}{16} \gamma^2 + \frac{35}{32} \gamma^3 \right) \right\} \right] + \frac{3}{16} \frac{(a^2 - e^2)^2}{p^5} \sin^4 J. \end{aligned}$$

Let  $i$ ,  $\tilde{\omega}$  and  $\Omega$  be the inclination, the longitude of the perihelion and the longitude of the ascending node of the orbital plane of the planet,  $J_0$  and  $\Psi$  the inclination and the longitude of the node of the equatorial plane of the ellipsoid all with reference to a fixed fundamental plane, e.g. the ecliptic of a certain epoch ; then we have :

$$\begin{aligned} \sin J \cos(\Psi - \tilde{\omega} + \Omega) &= -\cos J_0 \sin i + \sin J_0 \cos i \cos(\Omega - \Psi) \\ \sin J \sin(\Psi - \tilde{\omega} + \Omega) &= \sin(\Omega - \Psi) \sin J_0. \end{aligned}$$

From these expressions we can determine  $\frac{\partial J}{\partial \Omega}, \frac{\partial J}{\partial i}, \frac{\partial \Psi}{\partial \Omega}, \frac{\partial \Psi}{\partial i}$  the quantities required for the computation of the derivatives of  $\Omega$  with regard to these elements. In view of the calculation of the perturbation of the obliquity of the ecliptic I do not use the elements  $i$  and  $\Omega$ , but the elements  $p$  and  $q$  thus defined :

$$p = \tan i \sin \Omega \quad q = \tan i \cos \Omega$$

I get :

$$\frac{\partial J}{\partial p} = \cos i \left\{ \cos^2 \frac{i}{2} \sin(\Psi - \tilde{\omega}) + \sin^2 \frac{i}{2} \sin(\Psi - \tilde{\omega} + 2\Omega) \right\}$$

$$\frac{\partial J}{\partial q} = -\cos i \left\{ \cos^2 \frac{i}{2} \cos(\Psi - \tilde{\omega}) - \sin^2 \frac{i}{2} \cos(\Psi - \tilde{\omega} + 2\Omega) \right\}$$

$$\sin J \frac{\partial \Psi}{\partial p} = -\sin J \tan \frac{i}{2} \cos i \cos \Omega + \cos J \cos i \left\{ \cos^2 \frac{i}{2} \cos(\Psi - \tilde{\omega}) + \sin^2 \frac{i}{2} \cos(\Psi - \tilde{\omega} + 2\Omega) \right\}$$

$$\sin J \frac{\partial \Psi}{\partial q} = \sin J \tan \frac{i}{2} \cos i \sin \Omega + \cos J \cos i \left\{ \cos^2 \frac{i}{2} \sin(\Psi - \tilde{\omega}) - \sin^2 \frac{i}{2} \sin(\Psi - \tilde{\omega} + 2\Omega) \right\}.$$

The differential equations for  $p$  and  $q$  are<sup>1)</sup>:

$$\frac{dp}{dt} = \frac{1}{na_1^2 \sqrt{1-e^2 \cos^2 i}} \frac{\partial V}{\partial q}$$

$$\frac{dq}{dt} = -\frac{1}{na_1^2 \sqrt{1-e^2 \cos^2 i}} \frac{\partial V}{\partial p}.$$

To verify these formulae I have used them for the computation of some of the perturbations of  $i$  and  $\Omega$ , which are given by SEELIGER<sup>2)</sup>.

To compute the perturbation of the obliquity of the ecliptic I take:

$$V = -k^2 \pi q a^2 c \frac{\sin^2 J}{2} (a^2 - c^2) C_3 a_1^2.$$

According to SEELIGER's data  $a = 0.2400$ ,  $c = 0.0239$ ,  $J = 6^\circ 57'.0$ : I get  $C_3 = 0.426$ ; taking as unit of mass the mass of the sun, as unit of time the mean solar day I get  $\log q = 0.7119 - 5$  and I find:

1) TISSERAND, *Traité de Mécanique Céleste* I p. 171.

2) For Mercury I get:  $\frac{di}{dt} = +0''.573$ ;  $\sin i \frac{d\tilde{\gamma}}{dt} = -0''.049$ ; SEELIGER gives:

$+0''.574$  and  $-0''.049$ . For Venus I get:  $\frac{di}{dt} = +0''.163$ ;  $\sin i \frac{d\tilde{\gamma}}{dt} = +0''.091$ ;

SEELIGER:  $+0''.159$  and  $+0''.088$ ; the small difference is owing to the value I get for  $C_3 = 2.286$ , while from SEELIGER's data follows  $C_3 = 2.217$ .

$$\frac{\partial V}{\partial} = -k^2 \pi q a^2 c (a^2 - c^2) C_3 \sin J \cos J \frac{\partial J}{\partial} = -[0.5986-8] \frac{\partial J}{\partial}$$

where the number within brackets is a logarithm.

Further:

$$\frac{\partial J}{\partial p} = -\sin \Phi; \quad \frac{\partial J}{\partial q} = -\cos \Phi; \quad \Phi = 40^\circ 1'.8;$$

therefore

$$\frac{\partial J}{\partial p} = -[0.8083-1]; \quad \frac{\partial J}{\partial q} = -[0.8841-1];$$

therefore

$$\frac{\partial R}{\partial p} = +[0.4069-8]; \quad \frac{\partial R}{\partial q} = +[0.4827-8];$$

from which follows, taking as unit of time the century:

$$\frac{dp}{dt} = +0''.065; \quad \frac{dq}{dt} = -0''.054.$$

*Perturbations caused by the second ellipsoid.*

Here the calculation is much simpler. Introducing:

$$E_1 = \int_0^\infty \frac{du}{(a^2+u)\sqrt{c^2+u}} \quad E_2 = \int_0^\infty \frac{du}{(a^2+u)^2\sqrt{c^2+u}} \quad E_3 = \int_0^\infty \frac{du}{(a^2+u)^2(c^2+u)^{3/2}}$$

we find:

$$S\Omega = E_1 - a_1^2 E_2 - \frac{3}{2} a_1^2 E_2 e^2 - (a^2 - c^2) a_1^2 E_3 \sin^2 J \left\{ \frac{1}{2} + \frac{3}{4} e^2 - \frac{5}{4} e^2 \cos 2\psi \right\}.$$

As a verification I have here also computed the perturbations of the inclination and longitude of the node for some of the other planets<sup>1)</sup>.

To compute the perturbation of the obliquity of the ecliptic I take:

$$V = -k^2 \pi q a^2 c (a^2 - c^2) E_3 a_1^2 \frac{\sin^2 J}{2}.$$

According to SEELIGER's data  $a = 1.2235$  and  $c = 0.2399$ ; I get

1) For Mercury I find:  $\frac{di}{dt} = -0''.060$ ;  $\sin i \frac{d\Omega}{dt} = -0''.013$ ; SEELIGER gives:  $-0''.057$  and  $-0''.016$ . For Venus I find:  $\frac{di}{dt} = +0''.007$ ;  $\sin i \frac{d\Omega}{dt} = +0''.153$ ; SEELIGER:  $+0''.009$  and  $+0''.144$ ; the results differ somewhat; however, calculating according to SEELIGER's formulae, for Venus I find:  $\sin i \frac{d\Omega}{dt} = +0''.154$ .

$$E_s = 2.445; \log q = 0.8582 - 9;$$

$$\frac{\partial V}{\partial} = - [0.3401 - 7] \frac{\partial J}{\partial}; \Phi = 74^\circ 22' (1900.0), J = 7^\circ 15';$$

therefore

$$\frac{\partial J}{\partial p} = - [0.9836 - 1]; \frac{\partial J}{\partial q} = - [0.4305 - 1];$$

therefore

$$\frac{\partial V}{\partial p} = + [0.3237 - 7]; \frac{\partial V}{\partial q} = + [0.7706 - 8];$$

from which, taking as unit of time the century, I get:

$$\frac{dp}{dt} = + 0''.125; \frac{dq}{dt} = - 0''.447.$$

Therefore the perturbation caused by both ellipsoids together is:

$$\frac{dp}{dt} = + 0''.190; \frac{dq}{dt} = - 0''.501.$$

Let  $\varepsilon$  be the obliquity of the ecliptic for the time  $t$ ,  $\varepsilon_0$  the same for the time  $t_0$ ,  $i$  and  $\Omega$  inclination and longitude of the node of the ecliptic for  $t$  with reference to the ecliptic for  $t_0$ , then:

$$\cos \varepsilon = \cos i \cos \varepsilon_0 - \sin i \sin \varepsilon_0 \cos \Omega,$$

from which, differentiating, we get:

$$- \sin \varepsilon \frac{d\varepsilon}{dt} = - \sin i \cos \varepsilon_0 \frac{di}{dt} - \sin \varepsilon_0 \frac{d}{dt} (\sin i \cos \Omega)$$

therefore for  $t = t_0$ :

$$\frac{d\varepsilon}{dt} = \frac{dq}{dt}.$$

The perturbation of the obliquity of the ecliptic thus is  $\frac{d\varepsilon}{dt} = - 0''.501$ .

The difference between observation and theory given by NEWCOMB is  $- 0''.22 \pm 0.18$  (probable error); this thus becomes  $+ 0''.28$ . The addition to the planetary precession  $\alpha$  is given by:

$$\frac{d\alpha}{dt} = \frac{1}{\sin \varepsilon} \frac{dp}{dt} = + 0''.478.$$

## II. *Perturbations of the motion of the moon.*

We shall now proceed to the formulae for the computation of the perturbation of the motion of the moon. As the perturbative force in the motion of the moon we have to take the difference between the attractions of the ellipsoid on the moon and on the earth. Suppose a system of coordinates, the sun at the origin, the axis of  $z$  perpendicular to the ecliptic; let  $x, y, z$  be the coordinates

of the earth in this system,  $x + \xi$ ,  $y + \eta$ ,  $z + \zeta$  those of the moon, then the projections of the perturbative force on the three axes are given by the expressions:

$$\left(\frac{\partial V}{\partial x}\right)_{x+\xi} - \frac{\partial V}{\partial x}, \quad \left(\frac{\partial V}{\partial y}\right)_{y+\eta} - \frac{\partial V}{\partial y}, \quad \left(\frac{\partial V}{\partial z}\right)_{z+\zeta} - \frac{\partial V}{\partial z};$$

The ratio of the distances sun-earth and earth-moon being very large, I develop in powers of  $\xi$ ,  $\eta$ ,  $\zeta$ , neglecting second and higher powers. Then the expressions for the perturbative forces are:

$$\frac{\partial^2 V}{\partial x^2} \xi + \frac{\partial^2 V}{\partial x \partial y} \eta + \frac{\partial^2 V}{\partial x \partial z} \zeta, \quad \frac{\partial^2 V}{\partial x \partial y} \xi + \frac{\partial^2 V}{\partial y^2} \eta + \frac{\partial^2 V}{\partial y \partial z} \zeta, \quad \frac{\partial^2 V}{\partial x \partial z} \xi + \frac{\partial^2 V}{\partial y \partial z} \eta + \frac{\partial^2 V}{\partial z^2} \zeta$$

and one can introduce as the perturbative function the function

$$R = \frac{1}{2} \left[ \xi^2 \frac{\partial^2 V}{\partial x^2} + \eta^2 \frac{\partial^2 V}{\partial y^2} + \zeta^2 \frac{\partial^2 V}{\partial z^2} + 2\xi\eta \frac{\partial^2 V}{\partial x \partial y} + 2\xi\zeta \frac{\partial^2 V}{\partial x \partial z} + 2\eta\zeta \frac{\partial^2 V}{\partial y \partial z} \right].$$

Here for  $x, y, z$  are to be substituted their expressions in elliptic elements and then the secular portion of  $R$  is to be taken. Since the powers and products of  $\xi, \eta, \zeta$ , contain only the elements of the orbit of the moon, the coefficients on the contrary only the elements of the orbit of the earth we can take the secular portion of each separately and multiply these together.

Besides the system just mentioned suppose another system  $x', y', z'$ , the sun also being at the origin, but the axis of  $z'$  perpendicular to the equatorial plane of the ellipsoid. Then we have

$$z' = x \sin \Phi \sin J_0 - y \cos \Phi \sin J_0 + z \cos J_0,$$

therefore

$$\frac{\partial z'}{\partial x} = \sin \Phi \sin J_0; \quad \frac{\partial z'}{\partial y} = -\cos \Phi \sin J_0; \quad \frac{\partial z'}{\partial z} = \cos J_0.$$

### *Perturbations caused by the first ellipsoid*

From the expression given for  $\Omega = \frac{V}{k^2 \pi q a^2 c}$  we deduce, neglecting the terms having  $\sin^2 J$  as a factor:

$$\frac{\partial^2 \Omega}{\partial x^2} = -2 \int_{\lambda}^{\xi} \frac{du}{(a^2+u)^2 (c^2+u)^{1/2}} + \frac{4x^2}{(a^2+\lambda)^2 (c^2+\lambda)^{1/2}}$$

$$\frac{\partial^2 \Omega}{\partial x \partial y} = \frac{4xy}{(a^2+\lambda)^2 (c^2+\lambda)^{1/2}}$$

$$\frac{\partial^2 \Omega}{\partial x \partial z} = \frac{4xz'}{(a^2+\lambda)^2 (c^2+\lambda)^{1/2}} - 2(a^2-c^2) \sin \Phi \sin J_0 \int_{\lambda}^{\infty} \frac{du}{(a^2+u)^2 (c^2+u)^{3/2}}$$



$$\frac{\partial^2 \Omega}{\partial y^2} = -2 \int_0^\infty \frac{du}{(a^2+u)^2 (c^2+u)^{1/2}} + \frac{4y^2}{(a^2+\lambda)^2 (c^2+\lambda)^{1/2}}$$

$$\frac{\partial^2 \Omega}{\partial y \partial z} = \frac{4yz'}{(a^2+\lambda)^2 (c^2+\lambda)^{3/2}} (a^2-c^2) + 2(a^2-c^2) \cos \Phi \sin J_0 \int_0^\infty \frac{du}{(a^2+u)^2 (c^2+u)^{3/2}}$$

$$\frac{\partial^2 \Omega}{\partial z^2} = -2 \int_0^\infty \frac{du}{(a^2+u)^2 (c^2+u)^{1/2}} - 2(a^2-c^2) \int_0^\infty \frac{du}{(a^2+u)^2 (c^2+u)^{3/2}}$$

Substituting the elements of the orbit of the earth for  $x, y, z$  and neglecting the second and higher power of the excentricity I get :

$$\frac{\partial^2 \Omega}{\partial x^2} = -2C_2 + \frac{2}{a_1^2 p} = \frac{\partial^2 \Omega}{\partial y^2}; \frac{\partial^2 \Omega}{\partial x \partial y} = 0;$$

$$\frac{\partial^2 \Omega}{\partial x \partial z} = \frac{2(a^2-c^2)}{a_1^2 p^3} \sin \Phi \sin J_0 - 2(a^2-c^2) C_3 \sin \Phi \sin J_0$$

$$\frac{\partial^2 \Omega}{\partial y \partial z} = -\frac{2(a^2-c^2)}{a_1^2 p^3} \cos \Phi \sin J_0 + 2(a^2-c^2) C_3 \cos \Phi \sin J_0$$

$$\frac{\partial^2 \Omega}{\partial z^2} = -2C_2 - 2(a^2-c^2) C_3.$$

Let  $\rho$  be the radius vector,  $v$  the true anomaly,  $\tilde{\omega}$  the longitude of the perigee,  $\Omega$  the longitude of the node,  $i$  the inclination of the orbit of the moon, then we have :

$$\tilde{\xi} = \rho [\cos(v + \tilde{\omega} - \Omega) \cos \Omega - \sin(v + \tilde{\omega} - \Omega) \sin \Omega \cos i]$$

$$\eta = \rho [\cos(v + \tilde{\omega} - \Omega) \sin \Omega + \sin(v + \tilde{\omega} - \Omega) \cos \Omega \cos i]$$

$$\tilde{\zeta} = \rho \sin(v + \tilde{\omega} - \Omega) \sin i.$$

I write these expressions thus :

$$\tilde{\xi} = \rho (A \cos v + B \sin v)$$

$$\eta = \rho (C \cos v + D \sin v)$$

$$\tilde{\zeta} = \rho (E \cos v + F \sin v),$$

$A, B, C, D, E, F$  being expressions not containing the true anomaly.

For the formation of the required products we need the secular portion of  $\rho^2 \cos^2 v$  and  $\rho^2 \sin^2 v$ ; I get :

$$S \rho^2 \cos^2 v = a_1'^2 (\frac{1}{2} + 2e^2) \quad S \rho^2 \sin^2 v = \frac{1}{2} a_1'^2 (1 - e^2)$$

$a_1'$  being the semi-major axis of the lunar orbit.

Thus we get expressions as :

$$\frac{\tilde{\xi}^2}{a_1'^2} = A^2 (\frac{1}{2} + 2e^2) + B^2 (\frac{1}{2} - \frac{e^2}{2}).$$

Neglecting terms like  $e^2 \sin^2 \frac{i}{2}$ ,  $e^2 \sin^4 \frac{i}{2}$  we get :

$$\begin{aligned} \frac{\mathfrak{S}^2}{a_1'^2} &= \frac{1}{2} - \frac{1}{4} \sin^2 i (1 - \cos 2\Omega) + e^2 \left( \frac{3}{4} + \frac{5}{4} \cos 2\tilde{\omega} \right) \\ \frac{\mathfrak{S}_l}{a_1'^2} &= \frac{1}{4} \sin^2 i \sin 2\Omega_0 + \frac{5}{4} e^2 \sin 2\tilde{\omega} \\ \frac{\mathfrak{S}_l^2}{a_1'^2} &= -\frac{1}{2} \sin i \sin \Omega_0 + e^2 \sin \frac{i}{2} \left\{ \frac{5}{2} \sin(2\tilde{\omega} - \Omega) - \frac{3}{2} \sin \Omega_0 \right\} \\ \frac{\mathfrak{H}^2}{a_1'^2} &= \frac{1}{2} - \frac{1}{4} \sin^2 i (1 + \cos 2\Omega) + e^2 \left( \frac{3}{4} - \frac{5}{4} \cos 2\tilde{\omega} \right) \\ \frac{\mathfrak{H}_l^2}{a_1'^2} &= \frac{1}{2} \sin i \cos \Omega_0 + e^2 \sin \frac{i}{2} \left\{ -\frac{5}{2} \cos(2\tilde{\omega} - \Omega) + \frac{3}{2} \cos \Omega_0 \right\} \\ \frac{\mathfrak{S}^2}{a_1'^2} &= \frac{1}{2} \sin^2 i. \end{aligned}$$

Substituting in  $R$  these expressions we get :

$$\begin{aligned} \frac{k^2 \pi q a^2 c}{R} &= \frac{1}{2} \frac{a_1'^2}{a_1'^2} \left[ -2C_2 a_1'^2 + \frac{2}{p} + 3c^2 \left( \frac{1}{p} - C_2 a_1'^2 \right) + 4 \sin^2 \frac{i}{2} \left( -\frac{1}{p} - C_3 (a^2 - c^2) a_1'^2 \right) \right. \\ &\quad \left. + 2(a^2 - c^2) \sin J \sin i \cos (\Omega_0 - \Phi) \left( a_1'^2 C_3 - \frac{1}{p^3} \right) \right]. \end{aligned}$$

The only perturbations to be considered are those of the longitude of the perigee and of the node.

The differential equations required are :

$$r \frac{d\tilde{\omega}}{dt} = \frac{1}{na_1'^2} \frac{\partial R}{\partial e} \quad \sin i \frac{d\Omega_0}{dt} = \frac{1}{na_1'^2} \frac{\partial R}{\partial i}.$$

One easily perceives that the last term in the expression for  $R$  gives no sensible perturbation on account of the factor  $a^2 - c^2$ , the value of which is about  $\frac{6}{100}$ , and of the fact that  $\Omega_0$  has a period of  $18\frac{1}{2}$  years so that the coefficient we get by integration is about thirty times as small as would have been the case if  $\Omega_0$  had been absent. In the same way I omit the term  $C_3(a^2 - c^2)a_1'^2$  in the coefficient of  $\sin^2 \frac{i}{2}$  and thus we have the following expression for  $R$  :

$$\frac{R}{k^2 \pi q a^2 c} = \frac{1}{2} \frac{a_1'^2}{a_1'^2} \left[ 3c^2 \left( \frac{1}{p} - C_2 a_1'^2 \right) - \frac{4}{p} \sin^2 \frac{i}{2} \right].$$

I get  $C_2 = 0.678$ ;  $\frac{1}{p} = 1.030$  from which follows taking as unit of time the century :

$$\frac{d\tilde{\omega}}{dt} = + 2'' \cdot 28 \quad ; \quad \frac{d\Omega_6}{dt} = - 2'' \cdot 22.$$

- *Perturbations caused by the second ellipsoid.*

I find:

$$\begin{aligned} \frac{\partial^2 \Omega}{\partial x^2} &= \frac{\partial^2 \Omega}{\partial y^2} = -2E_2; \quad \frac{\partial^2 \Omega}{\partial x \partial y} = 0; \\ \frac{\partial^2 \Omega}{\partial x \partial z} &= -2(a^2 - c^2) E_3 \sin \Phi \sin J; \quad \frac{\partial^2 \Omega}{\partial y \partial z} = 2(a^2 - c^2) E_3 \cos \Phi \sin J; \\ \frac{\partial^2 \Omega}{\partial z^2} &= -2E_2 - 2(a^2 - c^2) E_3 \end{aligned}$$

from which follows:

$$\frac{R}{k^2 \pi q a^2 c} = \frac{1}{2} \frac{a_1'^2}{a_1^2} [-2E_2 a_1'^2 - 3E_2 a_1'^2 c^2 - E_3 (a^2 - c^2) a_1'^2 \sin^2 i + 2(a^2 - c^2) a_1'^2 E_3 \sin J \sin i \cos (\lambda - \Phi)].$$

Although the term  $a^2 - c^2$  is not small, yet it is allowed to omit the periodic term.

I get  $E_2 = 0.684$ ,  $E_3 = 2.445$  from which follows taking as unit of time the century:

$$\frac{d\tilde{\omega}}{dt} = - 0'' \cdot 16 \quad ; \quad \frac{d\Omega}{dt} = - 0'' \cdot 28.$$

Thus both ellipsoids together give:

$$\frac{d\tilde{\omega}}{dt} = + 2'' \cdot 12 \quad ; \quad \frac{d\Omega}{dt} = + 2'' \cdot 5.$$

both insensible amounts.

**Astronomy.** — “*Remarks on Mr. WOLTJER’s paper concerning SEELIGER’s hypothesis.*” By Prof. W. DE SITTER.

(Communicated in the meeting of April 24, 1914).

SEELIGER’s explanation of NEWCOMB’s anomalies in the secular motions of the four inner planets consists of three parts, viz:

a. The attraction of an ellipsoid entirely within the orbit of Mercury. The light reflected by this ellipsoid is, on account of the neighbourhood of the sun, invisible to us.

b. The attraction of an ellipsoid which incloses the earth’s orbit. The light reflected by this ellipsoid appears to us as the zodiacal light.

c. A rotation of the empirical system of co-ordinates with reference

to the "Inertialsystem". This rotation is equivalent with a correction to the constant of precession. The value of this constant which is implied in NEWCOMB's anomalies is that used in his first fundamental catalogue (Astr. Papers Vol I). In "The Observatory" for July 1913 I have shown that this constant requires a correction of  $+1''.24$  (per century). Consequently, of SEELIGER's rotation  $r$  only the part  $r_1 = r - 1''.24$  can be considered as a real rotation.

The position of the equatorial plane of the ellipsoid  $a$  was determined by SEELIGER from the equations of condition: he found it not much different from the sun's equator. For the ellipsoid  $b$  the sun's equator was adopted as the equatorial plane.

It is important to consider the part which is contributed by each of the three hypotheses towards the explanation of the anomalies: By the way in which SEELIGER has published his results this is very easy. It then appears that the ellipsoid  $a$  is practically only necessary for the explanation of the anomaly in the motion of the perihelion of Mercury, and has very little influence on the other elements. Similarly the ellipsoid  $b$  affects almost exclusively the node of Venus. The rotation  $r$  of course has the same effect on all perihelia and nodes. In the following Table are given NEWCOMB's anomalies together with the residuals which are left unexplained by SEELIGER's hypothesis. In addition to SEELIGER's residuals I also give residuals which are derived:  $A$ . by rejecting the rotation  $r_1$ <sup>1)</sup>, and  $C$ . by omitting the second ellipsoid. The constants implied in the three sets of residuals are thus

SEELIGER	$q_1 = 2.18 \times 10^{-11}$	$q_2 = 0.31 \times 10^{-14}$	$r_1 = +4''.61$
$A$	2.42	0.93	0
$C$	2.03	0	+6.85,

where  $q_1$  and  $q_2$  are the densities of the two ellipsoids expressed in the sun's density as unit.

SEELIGER did not compute the value of  $\frac{di}{dt}$  for the earth. The residual given in the table is derived from the preceding paper by Mr. WOLTJER.

From the table it appears that the residuals  $C$  are quite as satisfactory as those of SEELIGER. Consequently the ellipsoid  $b$  is *not* a

<sup>1)</sup> The residuals  $A$  have already been given in the above quoted paper in "The Observatory". The density  $q_2$  is there erroneously given as 0.37 instead of 0.93 (the correction to SEELIGER's value having been taken as 0.2 times this value, instead of 2.0). I have used the figures as published by SEELIGER. The small deviations found by Mr. WOLTJER are of no importance.

necessary part of the explanation. Of the residuals  $A$  on the other hand there are, amongst the 10 quantities which were considered

		Mercury	Venus	Earth	Mars
$\frac{de}{dt}$	NEWCOMB	$-0''.88 \pm 0''.50$	$+0''.21 \pm 0''.31$	$+0''.02 \pm 0''.10$	$+0''.29 \pm 0''.27$
$e \frac{d\tilde{\omega}}{dt}$	NEWCOMB	$+8.48 \pm 0.43$	$-0.05 \pm 0.25$	$+0.10 \pm 0.13$	$+0.75 \pm 0.35$
	SEELIGER	$-0.01$	$-0.10$	$+0.03$	$+0.16$
	$A$	$0.00$	$-0.05$	$+0.18$	$+0.52$
	$C$	$-0.02$	$-0.12$	$-0.04$	$0.00$
$\sin i \frac{d\Omega}{dt}$	NEWCOMB	$+0.61 \pm 0.52$	$+0.60 \pm 0.17$	. . . . .	$+0.03 \pm 0.22$
	SEELIGER	$-0.04$	$+0.02$	. . . . .	$-0.20$
	$A$	$+0.55$	$+0.01$	. . . . .	$-0.11$
	$C$	$-0.31$	$+0.05$	. . . . .	$-0.24$
$\frac{di}{dt}$	NEWCOMB	$+0.38 \pm 0.80$	$+0.38 \pm 0.33$	$-0.22 \pm 0.27$	$-0.01 \pm 0.20$
	SEELIGER	$-0.14$	$+0.21$	$(+0.28)$	$+0.01$
	$A$	$-0.12$	$+0.17$	$+1.18$	$+0.05$
	$C$	$-0.15$	$+0.23$	$-0.17$	$-0.01$

by SEELIGER, 3 residuals exceeding their mean error. This in itself would not be sufficient to condemn the hypothesis, but the residual for the secular variation of the inclination of the ecliptic ( $+1''.18$ ) is entirely inadmissible. We conclude therefore that the rotation  $r_1$  is a vital part of the explanation.

The great influence of the ellipsoid  $b$  on the ecliptic is, of course, due to the large inclination of its equator. If this equator was e.g. supposed to coincide with the invariable plane of the solar system, instead of with the sun's equator, this influence would be much smaller. It is impossible to decide a priori whether it will be found possible so to adjust the position of the equator and the density of this ellipsoid that it has the desired effect on the node of Venus without appreciably affecting the earth's orbit.

The motion of the node of the earth's orbit is the planetary precession. Calling this  $\lambda$ , we have, for  $t = t_0$

$$\Delta\lambda \cdot \sin \varepsilon = \frac{dp}{dt},$$

where  $p$  is the quantity so called by Mr. WOLTJER. We thus find for the three hypotheses

SEELIGER	$\Delta\lambda = + 0''.47$
A	$+ 1.13$
C	$+ 0.15$

NEWCOMB did not include a deviation between observation and theory for this quantity. At the time of the publication of the "Astronomical Constants" (1895) it was of course entirely correct to consider a determination of the planetary precession from observations as impossible. Since that time however very accurate investigations of the precession have been executed by NEWCOMB himself (Astr. Papers, Vol. VIII) and by BOSS (Astr. Journal, Vol. XVI, Nrs. 612 and 614). Now the precession in right-ascension depends on the planetary precession, but that in declination does not. We have

$$\begin{aligned} m &= l \cos \varepsilon - \lambda \\ n &= l \sin \varepsilon \end{aligned}$$

$l$  being the lunisolar precession.

NEWCOMB determined  $l$  from the right-ascensions and the declinations separately, and found a large difference in the results. If this were interpreted as a correction to the planetary precession, we should find

$$\Delta\lambda = + 0''.47.$$

BOSS determined  $m$  and  $n$  separately, the latter both from right-ascensions and from declinations. From his results I find (applying the correction of the equinox  $\Delta e = + 0''.30$ , adopted by both BOSS and NEWCOMB):

$$\Delta\lambda = + 0''.85 \pm 0''.22$$

The mean error does not contain the uncertainty of the correction  $\Delta e$ . Its true value probably is about  $= + 0''.25$ . The mean error of the value of  $\Delta\lambda$  derived from NEWCOMB's work is difficult to estimate; we may assume it to be equal to that of BOSS. The mean of the two determinations would then be

$$\Delta\lambda = + 0''.66 \pm 0''.18^1).$$

---

<sup>1)</sup> Also L. STRUVE (A. N. Vol. 159, page 383) finds a difference in the same sense. Neglecting the systematic correction  $\nu$ , I find from his results

$$\Delta\lambda = + 0''.93 \pm 0''.80.$$

The m. e. again is too small as it does not contain the effect of the uncertainty of the correction  $\nu$ .

Now it is certainly very remarkable that this correction is of the same sign and the same order of magnitude as the planetary precession derived from the attraction of SEELIGER's ellipsoids. It must however be kept in mind that it is very well possible to explain the discrepancy between the determinations of the constant of precession from right-ascensions and from declinations (or from  $m$  and from  $n$ ) by the hypothesis of systematic proper motions of the stars. Thus HOUGH and HALM (M. N. Vol. LXX page 586) have from the hypothesis of unequal distribution of the stars over the two streams derived a systematic difference which is equivalent (for NEWCOMB)<sup>1)</sup> to a correction

$$\Delta\lambda = + 0''.56.$$

As the effect of the attraction of SEELIGER's ellipsoids on the motion of the moon Mr. WOLTJER finds a secular motion of both the perigee and the node. Both of these are due chiefly to the inner ellipsoid and are thus not much altered if SEELIGER's hypothesis is replaced by either of the hypotheses A or C. We find

SEELIGER	$\frac{d\tilde{\omega}}{dt} = + 2''.11$	$\frac{d\delta\epsilon}{dt} = - 2''.50$
A	+ 2.04	- 3.30
C	+ 2.10	- 2.06

All these quantities are well within the limits of uncertainty of the observed values.

**Chemistry.** — *“The application of the theory of allotropy to electromotive equilibria.”* II. By Dr. A. SMITS and Dr. A. H. W. ATEN. (A preliminary communication). (Communicated by Prof. J. D. VAN DER WAALS).

(Communicated in the meeting of April 24, 1914).

1. In the first communication<sup>2)</sup> under the above title it has been demonstrated that the theory of allotropy applied to the electromotive equilibrium between metal and electrolyte, teaches that a metal that exhibits the phenomenon of allotropy and is therefore built up of different kinds of molecules immersed in an electrolyte, will emit different kind of ions.

The different kinds of ions assumed by the theory of allotropy, need not be per se different in size, as was remarked before. They

<sup>1)</sup> For STRUVE's stars the correction would be  $+ 0''.77$ . For BOSS the corresponding computation has of course not been executed by HOUGH and HALM.

<sup>2)</sup> These Proc. Dec. 27, 1913, XVI. p. 699.

may be equal in size, but different in structure. There can, however, be another difference besides, viz. in electrical charge. In the preceding communication the molecule kinds  $M$  and  $M_2$  were assumed, and for simplicity's sake the circumstance that part of these molecules are electrically charged also in the metal, was not mentioned. This circumstance need not be taken into account, because the electrical charge of the atom  $M$  in one ion  $M_2^{3+}$  was put equal to that in the other ion ( $M^{3+}$ ). If it had then been our intention to indicate the total equilibrium in the metal, we might have drawn up the following scheme:

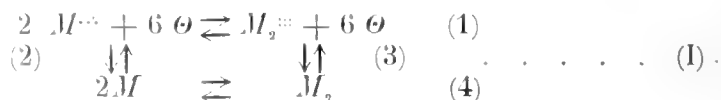

from which follows that the system would then be pseudoquaternary.

For an explanation of the electromotive disturbances of the equilibrium mentioned in the preceding communication, a consideration of the equilibrium (1) or (4) sufficed. Then equation (4) was chosen and  $2M$  and  $M_2$  were therefore called the pseudo components, though of course we might as well have taken  $2M^{3+} + 6\Theta$  and  $M_2^{3+} + 6\Theta$ .

Now it is clear that when in the metal ions of equal structure occur, but of different value, the scheme of equilibrium can be as follows.



The system is then pseudo ternary, but in most of the cases it will be sufficient to consider the pseudo binary system, indicated by equation (1), and assume  $M^{3+} + 2\Theta$  and  $M^{2+} + 3\Theta$  as pseudo components. A similar equilibrium will have to be assumed, when the metal can go in solution with different valency under different circumstances. This case is probably of frequent occurrence.

Of course the metal phase is already complex, when metal ions occur by the side of uncharged molecules, but this complexity does not suffice to explain the peculiar electromotive behaviour of the metals, whereas schemes I and II are competent to do so.

In connection with the foregoing considerations it could be shown that the unary electromotive equilibrium finds its proper place in the  $\Delta, x$  figure of a pseudo system, which can clearly appear under certain circumstances, when we namely succeed in bringing the metal out of the state of internal equilibrium. Thus it was e.g. shown



that when a metal is brought to solution by an electrolytic way, so when it is made into an anode, the internal equilibrium will be disturbed, and the metal will become superficially enobled, at least when the velocity of solution is greater than the velocity with which the internal equilibrium sets in. In this case therefore the dissolving metal will have to become positive with respect to an auxiliary electrode of the same metal which is superficially in internal equilibrium. If reversely the metal is made to deposit electrolytically, the reverse will take place, and the separating metal will be less noble and therefore negative with respect to the auxiliary electrode.

The anodic disturbance of equilibrium being attended with a diminution of the more active kinds of molecules, this process will bring about a diminution of the chemical activity. This is therefore the reason that this anodic state of disturbance is a more or less passive state of the metal.

At the cathode the disturbance lies exactly in the other direction, and a more active state will be brought about.

The degree in which a metal is thrown out of its state of equilibrium in case of electrolytic solution or deposition, will depend on the current density at constant temperature, and it was therefore of importance to study the discussed phenomenon at different current densities.

What may be expected is this that the internal equilibrium will generally be able to maintain itself for very small current densities. Then the tension with respect to the auxiliary electrode will be *zero*, both when the metal is anode and cathode. With greater current densities the metal will get superficially more and more removed from the state of internal equilibrium on increase of the current density, and the tension with respect to the auxiliary electrodes will greatly increase.

As the metal surface gets further removed from the state of internal equilibrium, so becomes more metastable, the velocity of reaction which tries to destroy the metastability, increases however in consequence of the change of concentration in the homogeneous phase; and we may therefore expect that the potential difference between metal and auxiliary electrode will vary with the current density in the way indicated in Fig. 1.

When the velocity with which the internal equilibrium sets in, is small, the part *ab* will lie at exceedingly small current densities, and if the measurements are not exceedingly delicate, we shall get the impression that this piece is entirely wanting.

It is clear that the tension which is represented here as function

of the current density means the tension with respect to the auxiliary electrodes. This tension, which is also called polarisation tension, is

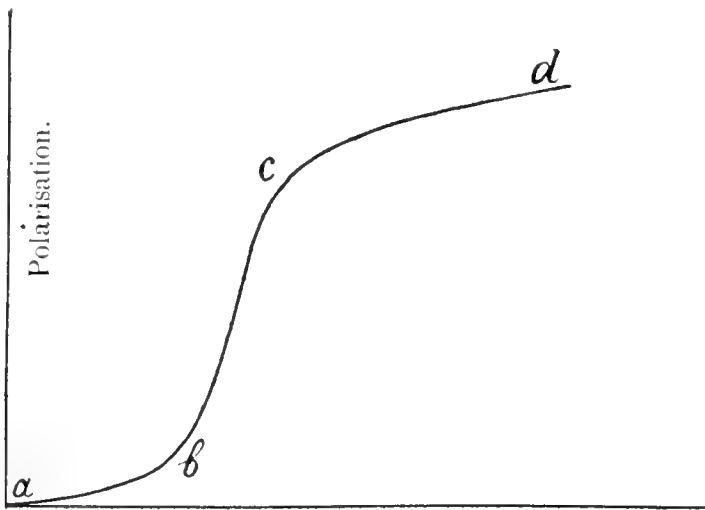

Fig. 1.

positive when the metal is anode, and negative, when it is used as cathode.

Further this possibility was still to be foreseen that when the metal assumes internal equilibrium very slowly a distinct change of the potential difference would have to be demonstrated even after the current had been interrupted.

Now it should be noted here that when a base metal has become noble during its use as anode, and the difference of potential between the metal and electrolyte has risen to the tension of liberation of the oxygen, at the anode two processes will begin to proceed side by side; besides the going in solution of the metal we get also the discharge of the  $\text{OH}'$ -ions and the possible formation of oxide skins, the influence of which should be examined.

We get something of the same kind at the cathode. When viz. the difference of tension metal-electrolyte at the cathode has become greater than the tension of liberation of the hydrogen, besides discharge of metal ions, also discharge of  $\text{H}'$ -ions will take place there.

#### *Method of Investigation.*

The measurement of the polarisation tensions took place in the following way (see Fig. 2). Two electrodes of the metal that is to be investigated, in the shape of wire or rods, were placed in a solution

of a salt of the metal, generally the nitrate. The two electrodes were connected by a variable resistance and an Ampèremeter with a number of accumulators, so that the strength of the polarizing current is easily changed and measured. To measure the tension of polarisation at one of the electrodes a beakshaped bent glass tube was brought into the solution, whose capillary point was placed as close as possible against the polarized electrode. In this glass tube a third (auxiliary) electrode of the same metal was brought. This auxiliary electrode, which is currentless, exhibits the normal potential difference with respect to the solution. As there is no loss of tension in the liquid of the auxiliary electrode, and its point is close against the polarized electrode, the potential difference between the auxiliary

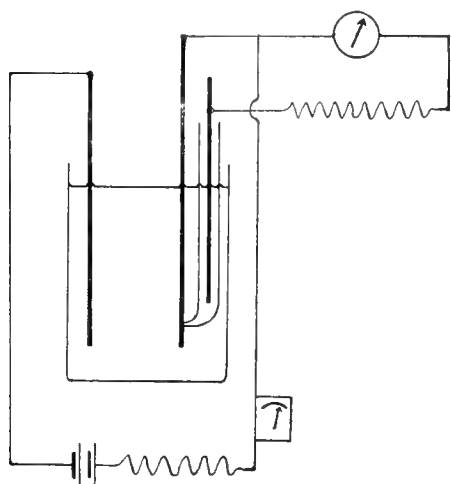

Fig. 2.

electrode and the polarized electrode gives directly the deviation which the potential difference of the polarized electrode presents from the normal potential difference, so the *polarisation tension*. The measurement of this potential difference took place by reading the deviation which was obtained by connecting the auxiliary electrode and the polarized electrode by means of a resistance of some meg. ohms with a galvanometer. The value of the scalar divisions in Volts was determined by connecting the galvanometer with a normal element.

### *Silver, Copper, Lead.*

2. The investigation of different metals, undertaken in this direction, has shown us that as was to be expected, they represent the most different types.

There are metals which in contact with an electrolyte, assume internal equilibrium very quickly; there are those that do so very slowly, and there are those that lie between these extremes.

Beginning with the metals which quickly assume internal equilibrium, we may first mention the metals: *silver, copper* and *lead*.

The result of the investigation of these metals is found in the following tables.

After the current had been interrupted, no potential difference with the auxiliary electrode was to be perceived.

In the first column the current density is found expressed in milli-ampères per  $\text{cm}^2$ . In the second column the potential difference with the auxiliary electrode is indicated in Volts, the metal serving as *anode* (anodic polarisation tension); and in the third column the same is given for the case that the metal served as *cathode* (cathodic polarisation tension).

TABLE I.  
Silver electrode immersed in  $\frac{1}{2}$  N. Ag  $\text{NO}_3$ -solution.

$i = \frac{\text{m.A.}}{\text{cm}^2}$	V-anode	V-cathode
25	+ 0.03	- 0.006
50	+ 0.03	- 0.012
100	+ 0.04	- 0.014
200	+ 0.05	- 0.015
300	+ 0.05	- 0.016
400	+ 0.06	- 0.018
750	+ 0.09	- 0.020

It is seen from this table that the silver is not materially nobler during the solution, and not materially baser during the deposition than the auxiliary electrode, which is entirely in internal equilibrium. The polarisation is therefore exceedingly slight here, from which we may deduce that the metal silver very quickly assumes internal equilibrium. Under these circumstances it is of course out of the

TABLE 2.  
Copper electrode in  $\frac{1}{2}$  N. Cu  $(\text{NO}_3)_2$ -solution.

$i = \frac{\text{m.A.}}{\text{cm}^2}$	V-anode	V-cathode
14	+ 0.016	- 0.016
29	+ 0.026	- 0.026
57	+ 0.032	- 0.035
114	+ 0.048	- 0.063
171	+ 0.048	- 0.082
230	+ 0.050	- 0.088

question that a potential difference could still be demonstrated after the current had been broken, which accordingly was by no means the case.

For *copper* the following values were found. (See table 2 p. 42).

This is, therefore, the same result as was obtained for silver, and lead behaves in an analogous way, as appears from the following table.

TABLE 3.  
Lead electrode in  $\frac{1}{2}$  N.  $\text{Pb}(\text{NO}_3)_2$ -solution.

$\frac{i}{0} = \frac{\text{m.A}}{\text{cm}^2}$	V-anode	V-cathode
36	+ 0.010	- 0.006
140	+ 0.033	- 0.010
280	+ 0.046	- 0.013
570	+ 0.082	- 0.017
1000	+ 0.126	- 0.020

After the current had been interrupted no potential difference with the auxiliary electrode could be demonstrated.

#### *Nickel.*

3. A splendid example for an internal equilibrium setting in very slowly is furnished by *nickel*, as appears from the following result.

TABLE 4.  
Nickel electrode immersed in  $\frac{1}{2}$  N.  $\text{Ni}(\text{NO}_3)_2$ -solution.

$\frac{i}{0}$	V-anode	V-cathode
27 -	+ 1.61	- 0.95
45 -	+ 1.64	- 1
90 -	+ 1.68	- 1.25
180 +	+ 1.77	- 1.40
360	+ 1.83	- 1.66
540	+ 1.88	- 1.77

Nickel shows therefore an enormous anodic and cathodic polarisation, which we must ascribe to the very slow setting in of the internal equilibrium, the more so, as we found that even *after the*

current had been interrupted a great potential difference with the auxiliary electrode could still be demonstrated viz. an anodic polarisation tension of 0,95 Volt. and a cathodic polarisation tension of 0,5 Volt. These tensions decreased with diminishing velocity to 0, as a proof that the metal assumes internal equilibrium by the aid of the electrolyte. As on account of the oscillations of the mirror of the galvanometer the said tensions could not be observed quickly enough after the current had been interrupted, the above values give the tensions some seconds after the interruption of the current. Immediately after the interruption they will have been + 1,88 V resp. — 1,77 V. Hence nickel, used as anode, becomes superficially a metal nobler than platinum as we know it.

#### *Cadmium.*

4. *Cadmium* is a metal lying between silver, copper, and lead on one side and nickel on the other side with regard to the velocity with which its internal equilibrium sets in.

For this metal we found what follows:

TABLE 5.  
Cadmium electrode in  $\frac{1}{2}$  N. Cd(NO<sub>3</sub>)<sub>2</sub>-solution.

$\frac{i}{0}$	V-anode	V-cathode
21	+ 0.093	— 0.127
72	+ 0.186	— 0.186
144	+ 0.290	— 0.220
286	+ 0.380	— 0.220
428	+ 0.507	— 0.220

Besides that the polarisation is smaller here than for nickel, it is noteworthy that while for nickel the anodic and cathodic polarisation tension differ little, this difference becomes pretty considerable for cadmium, at least for large current densities. This peculiarity may be explained in a simple way by means of the  $\Delta, x$ -figure given in the preceding communication. (See Fig. 3.<sup>1</sup>)

Suppose that with unary electromotive equilibrium at the given temperature the electrolyte  $L$  and the metal phase  $S$  coexist, then the

<sup>1</sup>) Here the potential difference of the metal with respect to the electrolyte has been given.

metal phase in case of anodic polarisation will move from  $S$  to  $b$ , and over this range  $\frac{d\Delta}{dx}$  is great.

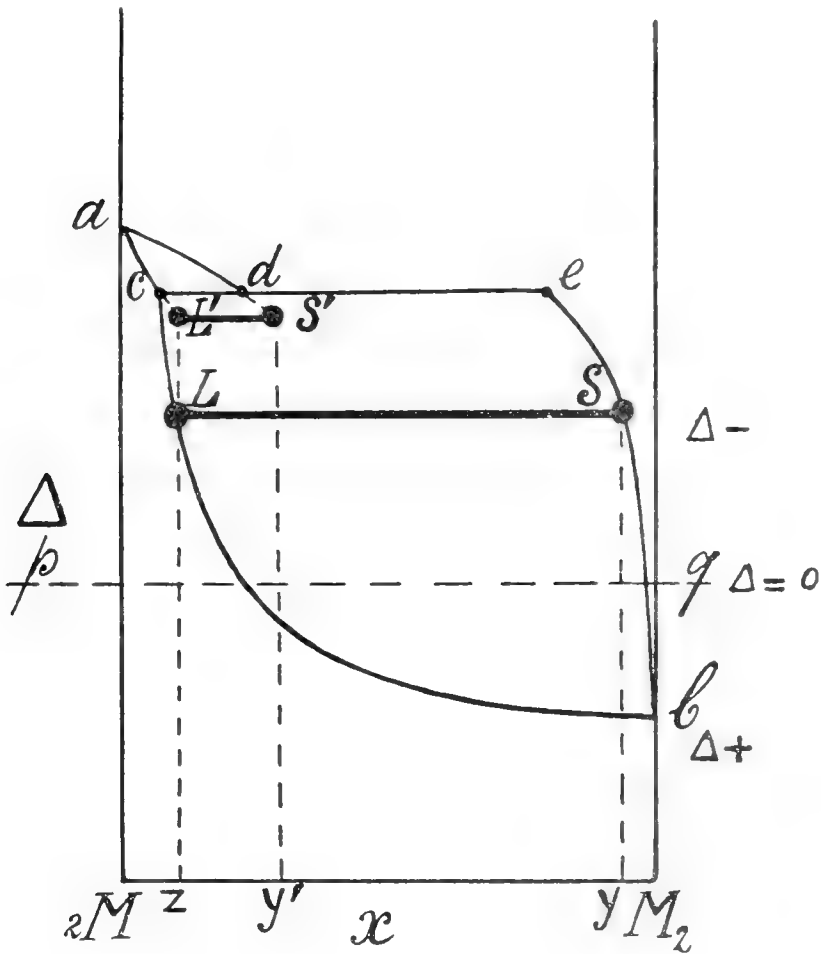

Fig. 3.

In case of cathodic polarisation the metal phase moves from  $S$  upwards along the line  $SC$ , but here we see now that the quantity  $\frac{d\Delta}{dx}$  will continually decrease and can become very small in consequence of the ever increasing curvature of the line  $SC$ , which can be even a great deal more pronounced than has been drawn here.

It now follows from the observations that the metal cadmium assumes internal equilibrium pretty rapidly, and in harmony with this is the fact that after the current had been broken the polarisation had soon entirely vanished.

It was besides noticed in this investigation that the metal which

served as anode, was gradually covered with a skin of basic salt. It was, however, easy to demonstrate that this skin could not have caused the observed phenomena through increase of the resistance, for the phenomena remained the same also when this skin, which could be very easily removed, was taken away during the electrolysis. Moreover it appeared that when this metal with skin was made to cathode, the cathodic polarisation was the same as in the absence of this skin. The formation of the skin is therefore a secondary phenomenon, as was also expected (see under 1).

*Bismuth.*

5. Bismuth is a metal that very clearly seems to be catalytically influenced, as appears from the following table.

TABLE 6.  
Bismuth in  $\frac{1}{2}$  NBi(NO<sub>3</sub>)<sub>2</sub>-solution.

$i$	V-anode	V-cathode
0		
35	+ 0.02	- 0.02
60	+ 0.04	- 0.03
133	+ 0.05	- 0.03
260	+ 1.14	- 0.03

The anodic polarisation presents this particularity that though it is exceedingly small up to a current density of 133 milli Ampères per cm<sup>2</sup>, as for silver, it becomes pretty considerable for a current density of 260 milli Ampères. Now it is worthy of note that the anodic polarisation was at first also small for a current density of 260, but it increased slowly, so that it amounted to +1.14 volts after a few minutes. For smaller current densities, however, no rise of the polarisation tension took place in course of time. The explanation of the observed phenomenon is probably as follows. The Bismuth, which gets positively charged in the used solution, assumes internal equilibrium very quickly at first. At the greatest density of current, however, this internal equilibrium is no longer able to maintain itself, and then generation of oxygen seems to take place, which oxygen evidently exercises a negative, catalytic influence, which renders the metal still nobler. This phenomenon being attended with the formation



of a white skin (probably of basic salt) we have again examined what influence this skin exercises on the phenomenon. For this purpose the current was suddenly reversed, after a thick layer of the basic salt had formed, in which however, only a cathodic polarisation of 0,18 Volt was observed as a proof that this skin, indeed, increased the resistance somewhat, as was expected, but that this could have been only of slight influence on the amount of the anodic polarisation tension<sup>1)</sup>. What the negative catalytic influence here consists in, cannot be said with certainty, but as has been stated, it seems probable to us that the oxygen, dissolved in the metal to an exceedingly slight degree, retards the setting in of the internal equilibrium.

### *Iron.*

6. If we now proceed to the metal iron we meet again with phenomena, and very pronounced ones too, which in our opinion point to catalytic influences.

We found the following result :

TABLE 7.  
Iron electrode immersed in  $\frac{1}{2}$  N.FeSO<sub>4</sub>-solution.

$\frac{i}{0}$	V-anode
50	0.026
100	0.038
130	0.044
160	0.064
190	0.075
250	0.113
300	0.164
400	2.25
600	2.47
800	2.53

from which it appears that in this transition of a current density from 300 to 400 the iron has suddenly become very noble. This

<sup>1)</sup> For it can hardly be assumed here that the skin offers a different resistance to currents of different direction.

phenomenon, which has been already often observed, and is called the becoming passive of iron, has not been accounted for in a satisfactory way.

In the light of these new considerations the explanation, as was already observed, is not difficult.<sup>1)</sup> The iron, which shows this sudden increase of the anodic polarisation, is entirely free from so-called annealing colours and perfectly reflecting, so that an oxide skin is out of the question.

If we, however, assume that the metal dissolves a little oxygen, and this oxygen retards in a high degree the setting in of the internal equilibrium, the sudden considerable enobling of the metal is explained in a simple way.

Up to now it has been lost sight of too much that the phenomenon of passivity, arisen by an electrolytic way, and that called into existence by a purely chemical way, must be explained from one and the same point of view. By a purely chemical way iron is made passive by being simply immersed in strong nitric acid for a few moments. If then the iron is put in a solution of copper sulphate, the copper does not deposit. By a slight shake, the application of a magnetic field etc. this passive state can, however, at once be destroyed, and the iron is covered with a coat of copper.

If we consider the passive iron to be iron that is superficially very far from the state of internal equilibrium, in which superficially the easily reacting molecules are practically entirely wanting, and assume that this state can be maintained for some time on account of the negative catalytic action of oxygen under certain circumstances, which state, however, outside the cell, can be destroyed by vibrations, a magnetic field etc., the phenomenon of passivity of iron becomes less unintelligible.<sup>2)</sup>

Returning to the experiment, we will show in the first place what was found when smaller current densities were worked with after the iron had become "passive" at higher current density.

This table exhibits therefore the great difference between the passive and the active iron. As appears from the last table but one, the active iron yields a difference of tension with the auxiliary electrode of 0,026 Volts for a density of current of 50; the passive iron yields a difference of tension of 2,18 Volts for the same current density.

<sup>1)</sup> SMITS, These Proc January 25, 1913, XVI. p. 191.

<sup>2)</sup> We have probably to do here with metal ions of different valency. (We shall return to this later on.)

TABLE 8.

Iron electrode, immersed in  $\frac{1}{2}$  NFeSO<sub>4</sub>-solution.

$\frac{i}{0}$	V-anode	V-cathode
800	2.53	0.50
600	2.47	0.47
400	2.40	0.44
200	2.30	0.42
100	2.24	0.37
50	2.18	0.27

It is now remarkable that, as has also been found by others, contact with hydrogen can annihilate the passivity. When we reversed the current and made the passive anode the cathode for a moment, and then reversed the current again at a density of 400 m.A., the difference of tension with the auxiliary electrode amounted at first only to 0,12 Volt, but this tension rose at first rather slowly to 0,6 Volt and then rapidly to 2,27 Volts.

It therefore appears from this experiment that hydrogen is a positive catalyst for the setting in of the internal equilibrium of iron, which also accounts for the fact that the cathodic polarisation, as appears from the last table, is extremely small in comparison with the anodic polarisation. The difference between anodic and cathodic polarisation is therefore so great here, because for the anodic polarisation a negative catalyst, and for the cathodic polarisation a positive catalyst come into play.

That for nickel the anodic and the cathodic polarisation are about the same proves that the oxygen and the hydrogen do not act noticeably catalytically on this metal.

It should finally still be pointed out that when at the moment that the passive iron had reached an anodic tension of polarisation of 2.27 Volts, the current was broken, still a tension of polarisation was observed of 1,07 Volts, which tension, however, pretty quickly fell to 0. So it appeared just as for nickel that the iron without passage of the current soon assumes internal equilibrium by the aid of the electrolyte, and becomes active. We see from this that the negative catalytic action is maintained by the current: when the current is broken the active iron above the liquid will, however,

promote the setting in of the internal equilibrium in the at first passive part, and this will be the explanation of the fact that the iron becomes active after the current has been broken.

Also after the use of the iron electrodes as cathode the current was broken, and as was to be expected, the much smaller cathodic polarisation tension of  $\pm 0,15$  appeared to run very rapidly back to 0.

### *Aluminium.*

7. As far as its electromotive behaviour is concerned, aluminium is undoubtedly one of the most interesting metals. For anodic polarisation the current density decreased regularly, and the tension increased, as is shown in the following table.

TABLE 9.  
Aluminium electrode in  $\frac{1}{2}$   $\text{NaAl}_2(\text{SO}_4)_3$ -solution.

$i$	V-anode
0	
0.8	+ 2.56
0,53	+ 3.48
0,46	+ 3.84
0,36	+ 4.12

Accordingly we find anodic polarisation tensions of about 4 Volts for this metal already at very small current densities, which points to the fact that here a layer of great resistance must have been formed.

Up to now it has been tried to explain this strong anodic polarisation for aluminium by the formation of an insulating skin of  $\text{Al}_2\text{O}_3$ . With greater densities of current the anode is really covered with an oxide skin, and it is therefore natural to assume the formation of this skin also for smaller densities of current, and attribute the observed phenomenon to this skin of  $\text{Al}_2\text{O}_3$  with great resistance. There are however objections to adopting this explanation, for in our experiments no trace of annealing colours was to be observed, and the metal remained beautifully reflecting.

To ascertain whether in our experiments a skin of great resistance had formed round the anode, we made the following experiment.

The bottom of the vessel with the  $\text{Al}^2(\text{SO}_4)_3$  solution was covered with a layer of mercury, and the aluminium electrode was anodi-

ally polarized. When this electrode was now covered with a skin of great resistance, an immersion of one extremity of the aluminium electrode in the mercury should not exert any influence on the difference of tension between the aluminium anode and the auxiliary electrode. If, however, this skin does not exist, the aluminium electrode will get into contact with the mercury during the just described manipulation, and the said difference of tension will be modified.

The result was that when *during* the anodic polarisation the aluminium anode was immersed in the mercury, and the current was then broken, the difference of tension with the auxiliary electrode was absolutely unchanged, which proved therefore that the aluminium electrode did not get in contact with the mercury, but was surrounded with a coat of electrolyte. This appeared to be no specific property of the anode, for the same thing was observed after cathodic polarisation. An unpolarized Al-wire, immersed from the electrolyte in the mercury layer, immediately assumed the potential of the mercury, from which therefore follows that the gas layer on the aluminium retains the electrolyte with great force.

In this way the question of the skin could therefore not be solved. What is remarkable is this that the skin formed during anodic polarisation, immediately seems to disappear again by cathodic polarisation. The assumption of a film of  $\text{Al}_2\text{O}_3$  is attended with great difficulties, in the first place this oxide cannot be reduced under these circumstances by H in status nascens, and in the second place it appears, that nothing is to be perceived of this skin, at least with the naked eye, as no annealing colours are to be observed, and the metal remains clearly reflecting. It seems therefore not too hazardous to us to conclude in virtue of this that the skin cannot be an oxide layer, and the only thing left to us is to assume, as we did for iron, that the oxygen dissolves in the aluminium during anodic polarisation, and that this solution possesses a great electric resistance *for aluminium*. In this way we come to the assumption of a layer with great resistance, of which it is, however, to be understood, that it entirely disappears on cathodic polarisation to make room for a solution of hydrogen and aluminium. Accordingly this layer is metallic, and can amalgamate in course of time when in contact with mercury, through which the resistance disappears. The result at which we arrive is therefore this that the anodically measured tension is so extraordinarily great for aluminium, much greater than the liberation tension of  $\text{O}_2$  can be here, because the dissolved oxygen not only retards the setting in of the internal equilibrium, but also a layer of great electric resistance is formed.

At greater current densities  $\text{Al}_2\text{O}_3$  can separate from this solution of oxygen in aluminium, but then the electrode is no longer reflecting, and it cannot be made reflecting again by cathodic polarisation. This layer of  $\text{Al}_2\text{O}_3$  can also possess a great resistance, but the primary feature of the phenomenon is in all cases the formation of a solution of oxygen in aluminium, which possesses a great resistance.

If we now proceed to the description of the experiments with amalgamated aluminium, we will begin with stating that when in the just described experiment the aluminium electrode was raised out of the mercury, after amalgamation had set in, and the lower opening of the auxiliary electrode was placed against the extremity of the aluminium wire, this part of the aluminium had undergone a great change, and had become negatively electrical with respect to the auxiliary electrode. The tension difference amounted to  $-0.9$  Volt, and still increased slowly. At the place where the aluminium had been in contact with the mercury, it had therefore become much baser, and had visibly become somewhat amalgamated.

That amalgamated aluminium is baser than the non-amalgamated metal, was known, but the exact value of this difference in tension was not met with in the literature. To determine this difference in tension, an aluminium electrode was amalgamated by immersion in a solution of  $\text{HgCl}_2$ , after which this electrode was compared with the auxiliary electrode. We found that the amalgamated Al obtained in this way was still baser than the just mentioned Al, for the tension of this electrode with respect to the auxiliary electrode amounted now to  $-1.27$  Volts.

That the amalgamation for aluminium has a very particular effect follows moreover from this that amalgamated aluminium possesses a much greater chemical reactive power than the ordinary aluminium. Amalgamated aluminium immersed in water gives a very considerable generation of hydrogen, and it oxidizes so rapidly when exposed to the air that the metal is immediately covered with a layer of oxide, the liberated heat raising the temperature of the metal very noticeably.

In consideration of all this it seems more than probable to us that the action of mercury is here positively catalytic, and that mercury therefore, when dissolving in aluminium, brings the metal in internal equilibrium, which condition corresponds to a greater concentration of the simpler, so more reactive kinds of molecules.

The anodic polarisation of the amalgamated state is almost as slight as for silver, as a proof that the internal equilibrium sets in

much more quickly here than for pure Al, but not yet so rapidly as for Ag.

*Amalgamated Aluminium.*

<i>i</i> o	<i>V</i> -anode	<i>V</i> -cathode
2	+ 0.03	
5	+ 0.07	— 0.05
17	+ 0.15	— 0.20
33	+ 0.18	— 0.33
47	+ 0.34	

That the amalgamated aluminium goes into solution much more rapidly than the non-amalgamated aluminium also appears from what follows. If a new aluminium electrode is put in the just mentioned mercury layer, which covers the bottom of the vessel with the  $\text{Al}_2(\text{SO}_4)_3$ -solution, this electrode assumes the mercury potential. The tension difference with the auxiliary electrode is then namely + 0,6 Volt, which tension difference is also found when a platinum electrode is used instead of an aluminium electrode. If the same experiment is, however, made with an amalgamated Al-electrode, the tension difference with the auxiliary electrode is — 0,78 Volt. It follows from this that if the ordinary aluminium partially immersed in mercury, failed entirely to maintain its potential difference with respect to the electrolyte in consequence of too slow solution, the amalgamated aluminium does not quite succeed in this either, but it almost succeeds, for instead of — 1,27 Volts its tension with respect to the auxiliary electrode has namely become — 0,78 Volt.

It is perhaps not superfluous to elucidate this phenomenon in a few words. With immersion of the aluminium electrode in the mercury a short circuited element aluminium-electrolyte-mercury is obtained, in which the aluminium is the negative pole, and therefore sends ions into solution. If now the setting in of the internal equilibrium took place with great rapidity, the aluminium would be able to maintain its unary potential difference, and in this case the tension of this electrode with respect to the auxiliary electrode would have remained — 1.27 Volts. Now we find — 0,78 Volt, proving that the state of internal equilibrium was disturbed to a certain extent after all, and the metal has become a little less base by dissolving. If, as was described, the same experiment is made with

ordinary aluminium, which is therefore an enobled state of aluminium, we get what follows.

The ordinary aluminium is at first the negative pole with respect to the mercury. It becomes, however, noble by the dissolving, and it is soon as noble as mercury. Nobler than mercury it can, however, not become then, since in this case, the current would be reversed, which would change the state of the aluminium again in the base direction. This is the reason that ordinary non-amalgamated aluminium immersed in mercury, assumes the potential of the mercury. This experiment can however not be continued for any length of time, because the aluminium in contact with mercury slowly amalgamates, as we have seen, in consequence of which finally also the part which is not in contact with the electrolyte, will become active, so that the same things will be observed as in case of well-amalgamated aluminium.

In a following communication the investigation of the other metals will be treated, after which a critical summary will be given of the theories which have been proposed by others up to now as an explanation of some of the facts discussed here.

#### S U M M A R Y.

In the foregoing pages the theory of allotropy was applied to the electromotive behaviour of the metals *Ag, Cu, Pb, Ni, Cd, Bi, Fe, Al*.

We have come to the conviction that the newly obtained point of view, as we hope to prove further, enables us to survey the widely divergent cases, and gives a deeper insight into the significance of the observed phenomena.

*Anorg. Chem. Lab. of the University.*

*Amsterdam, April 23, 1914.*

**Chemistry.** — “*The Allotropy of Cadmium.*” II. By Prof. ERNST COHEN and W. D. HELDERMAN.

(Communicated in the meeting of April 24, 1914).

1. In our first paper on this subject<sup>1)</sup> we concluded from measurements with the pycnometer and the dilatometer that cadmium has a transition temperature at 64°.9 and that this metal as we have known it until now, is a metastable system in consequence of the very strongly marked retardation which accompanies the reversible

<sup>1)</sup> These Proc. **16**, 485 (1913).



change of these allotropic modifications both below and above their transition points. As we pointed out in our papers on the allotropy of copper and zinc, the possibility that there might be present at the same time more than two allotropic forms had to be taken into account.

If this were the case, a variation in the previous thermal history might have an influence on the transition temperature.

The samples which had given  $64^{\circ}.9$  as their transition point (Vide § 11 of our first paper) only differed by the fact, that the second one had been in the dilatometer at  $100^{\circ}$  in contact with paraffin oil for 36 hours after having given  $64^{\circ}.9$ . At the end of this time the measurements were made, which are given in Table II. On continuing our investigations we got the impression that this difference in the thermal history of the samples might not have been large enough to determine whether a third modification can be formed. As a result of the following considerations we carried out some new experiments.

2. If in our sample  $K_2$  (first paper) there had been present originally more than two modifications, it might be possible that the greater part of the modification(s) which is (are) stable at higher temperatures had been changed into the  $\beta'$ -form, as the sample had been heated at  $101^{\circ}$  C. for 24 hours in contact with a solution of cadmium sulphate. In this case the heating at  $100^{\circ}$ , which followed the first experiment with the dilatometer, might have had no perceptible influence on the transition point which is in accordance with the results given in tables I and II.

3. We now varied the previous thermal history of  $K_2$  very markedly. For this purpose the metal was taken out of the dilatometer and chilled by throwing it into water. After this it was put into a new dilatometer *without previously treating it with a solution of cadmium sulphate at  $101^{\circ}$* . The dilatometer was then kept at  $70^{\circ}.0$ ; the temperature remained constant within 0.003 degrees. The meniscus *fell* in  $3\frac{3}{4}$  hours 143 mm. while we observed formerly (first paper) a strongly marked *increase* of volume at the same temperature.

4. In order to control this result, we carried out the following experiment :

A fresh quantity of the metal ("KAHLBAUM" — Berlin) weighing about 300 grams ( $K_2$ ) was melted and chilled. We then turned it into thin shavings on a lathe and put it into a dilatometer; the bulb

was filled up with paraffin oil and a quantity of small glass-beads. (Vide our first paper § 10). At no temperature between 50 and 100° (vide § 4 of our first paper) did any change occur. We then added 100 grams of the same material  $K_3$  which had been in contact with a solution of cadmium sulphate (at 50°) during 12 hours. We now observed that the meniscus of the dilatometer

fell 167 mm. in  $5\frac{1}{2}$  hours at 50°.0  
 ,, 213 ,, ,,  $7\frac{1}{2}$  ,, ,, 70°.0.

This result is in perfect accordance with the observations of § 3.

5. The following experiments prove in a more quantitative way that the previous thermal history of the metal has an influence on the transition temperature.

A fresh quantity of the metal ( $K_4$ ) was divided into two parts [ $(K_4)_I$  and  $(K_4)_{II}$ ] of 500 grams each.

$(K_4)_I$  was reduced into turnings on a lathe and immediately put into a dilatometer. At 69°.9 we observed a *decrease* of volume (456 mm.) in  $25\frac{1}{4}$  hours.

$(K_4)_{II}$  was converted into turnings in the same way and kept for 5 days and nights at 100° in a solution of cadmium sulphate.

After having it put into a dilatometer (bore of capillary tube 1 mm.) we made the following readings (Table I).

TABLE I.

Temperature.	Duration of the observations in hours.	Increase of the level in mm.	Increase of the level in mm. per hour
49.6	$\frac{1}{6}$	— 100	— 600
60.4	$\frac{1}{2}$	— 125	— 250
62.5	$\frac{2}{3}$	— 14	— 21
63.1	$\frac{1}{3}$	+ 15	+ 45
63.7	$\frac{1}{3}$	+ 83	+ 249
69.6	$\frac{1}{12}$	+ 225	+ 2700

The transition point is 62°.8.

6. The metal was now kept at 100° in contact with a solution of cadmium sulphate for 7 days and nights. After this it was put

again into a dilatometer which was heated for 24 hours at  $145^{\circ}$ , then for 24 hours at  $270^{\circ}$  (that is only 50 degrees below the melting point of the metal).

We only succeeded in "bringing it into motion" by heating it for 48 hours at  $50^{\circ}$  in a solution of cadmium sulphate.

We then got the following results (Table II):

TABLE II.

Temperature.	Duration of the observations in hours.	Increase of the level in mm.	Increase of the level in mm. per hour
$60.0^{\circ}$	$\frac{1}{2}$	- 105	- 210
63.0	$\frac{1}{3}$	- 11	- 33
63.5	$1\frac{1}{6}$	- 8	- 6
64.0	$1\frac{1}{6}$	+ 22	+ 18
69.0	$\frac{1}{6}$	+ 58	+ 348

The transition point has been changed to  $63^{\circ}.4$ .

7. In this way we carried out a great many experiments with samples of different previous thermal history<sup>1)</sup>. The extreme limits which were found for this (apparent) transition temperature were  $69^{\circ}.3$  and  $61^{\circ}.3$ .

8. As it is almost impossible to fix the real transition point of the pure modifications in this way, we tried to prepare a sharply defined modification of cadmium avoiding high temperatures. For this purpose we electrolyzed an ammoniacal solution of cadmium sulphate between an electrode of platinum and one of pure cadmium. (40 Volt, 20—25 Ampère; surface of the electrodes  $26 \text{ cm}^2$ ).

We kept the temperature of the solution below  $40^{\circ}$ , cooling the vessel with ice. The solution was kept homogeneous by a glass-stirrer (WITT), which was kept in motion by a small motor. The cadmium which was formed at the electrode was washed with dilute sulphuric acid, then with water, alcohol, and ether. After this it was dried at  $40^{\circ}$ .

170 grams of this material were put into a dilatometer. As it is very finely divided, great care must be taken in order to remove the air from the dilatometer. We used a GAEBDE-pump for the purpose.

<sup>1)</sup> The details will be given in full in our paper in the Zeitschrift f. physik. Chem.

The paraffin oil was boiled on this pump with finely divided cadmium. If there had been formed during the electrolysis only one modification of cadmium, we might expect that no transformation would occur in the dilatometer, in consequence of the absence of germs of a second form. From our earlier experiments (first paper § 4) we know that even if a second modification were present the retardation may be very strongly marked.

We found in our first experiment that neither at 50°, nor at 80°, nor at 100° did any change occur.

After having removed the paraffin oil we washed the metal with ether and brought it into contact with a solution of cadmium sulphate (12 hours at 100°; 48 hours at 50°). After this the dilatometer gave the following results (Table III).

TABLE III.

Temperature	Duration of observations in hours	Increase of level in mm.	Increase of level in mm. per hours
71.0	$\frac{3}{4}$	- 351	- 468
94.8	$\frac{1}{4}$	+ 132	+ 528
70.5	$5\frac{3}{4}$	- 267	- 46
70.5	11	+ 47	+ 4
60.0	24	- 138	- 6
70.0	$1\frac{1}{2}$	+ 70	+ 46
65.0	$1\frac{1}{2}$	- 53	- 38

*There is a change in the direction of motion of the meniscus at a constant temperature (70°.5). The transition point is now between 65 and 70°.*

This change proves therefore that now (viz. after the treatment at 100° and 50° with a solution of cadmium sulphate) there are simultaneously present more than two modifications.

9. Finally it may be pointed out here that the pyknometer cannot be used to determine with exactness the density of the modifications of cadmium formed by electrolysis, as this material always includes constituents of the solution which has been electrolyzed. The water may be driven out by melting the metal; the salt will then flow on to the surface of the metal and may be washed away, but for exact determinations this material cannot be used.

*Utrecht, April 1914.*

*VAN 'T HOFF-Laboratory.*

**Chemistry.** — “*The allotropy of Zinc.*” II. By Prof. ERNST COHEN and W. D. HELDERMAN.

(Communicated in the meeting of April 24, 1914).

1. In our first paper on the allotropy of zinc<sup>1)</sup> we called attention to the “atomized” metals which may be prepared by the new method of M. U. SCHOOP of Zurich.

We then pointed out that this method forms an ideal way of producing chilled metal. As a result of our investigations on the metastability of the metals as a consequence of allotropy we may expect that “atomized” zinc will contain two or more allotropic forms at the same time.

From a technical standpoint we thought it interesting to prove this more directly: if the “atomized” metal really contains two or more modifications at the same time, it will disintegrate in the long run when stabilisation occurs.

2. Mr. SCHOOP supplied us with one kilo of zinc, which had been “atomized” in the way described in our first paper on the subject. As the material is very finely divided one would expect that an eventual change would proceed in such a way that it could be measured easily. On the other hand much care must be taken to remove air from the very finely divided material after having brought it into the dilatometer.

3. About 750 grams of the metal and a small quantity of glassbeads which had been heated beforehand<sup>2)</sup> were put into a dilatometer. *The material had not been in contact with an electrolyte.* The capillary (bore 1 mm.) was bent horizontally and put in connection with a GAEBDE pump. In order to remove the air as completely as possible the dilatometer remained in connection with the pump for 1—1½ hours. After this the paraffin oil was filled in; it had been carefully boiled on the pump at 200° in contact with some “atomized” zinc. In this way the instrument was made perfectly free of air as many experiments proved.

4. In a preliminary experiment we found that a contraction of the metal occurs at 25°.0. We then carried out a fresh one, the “atomized” metal having been kept at 15° in a dry state for three

<sup>1)</sup> These Proc. **16**, 565 (1913).

<sup>2)</sup> These Proc., **16**, 485 (§ 10) [1913].

months. We used a special thermostat, which will be before long described. The temperature was determined by means of a BECKMANN thermometer. It remained constant within some thousandths of a degree.

The results are shown in Table I.

TABLE I.  
Temperature 25°.00.

Time in hours	Level of the meniscus (mm.)
0	526
$\frac{1}{3}$	425
$2\frac{2}{3}$	252
$4\frac{2}{3}$	219
$11\frac{2}{3}$	181

A strongly marked contraction at *constant* temperature occurs.

5. As the metal contains a certain amount of zinc oxide in consequence of its fine state of division, the question might arise whether the contraction observed may be attributed to some chemical reaction between the oxide and the paraffin oil.

In order to investigate this point more closely we filled a dilatometer (100 cc.) with zinc oxide and the same paraffin oil we had used in the experiment described above. After having evacuated it at the GAEDE pump we put it into a thermostat at 25°.00. The meniscus did not show any change in 24 hours. The contraction observed in our first experiment has consequently to be attributed to a change in the metal. We intend continuing our investigations on the different modifications of zinc present in the "atomized" metal.

Utrecht, April 1914.

VAN 'T HOFF-Laboratory.

**Chemistry.** — "*The allotropy of Copper*". II. By Prof. ERNST COHEN and W. D. HELDERMAN.

1. We have also continued our investigations on the allotropy of copper in the direction indicated in our second paper on the allotropy of cadmium.

The dilatometer had shown (§ 4 of our first paper) that there is a transition point at 71°.4. We used the same method described in our second communication on cadmium in order to determine if

this point changes by a change in the previous thermal history of the metal.

2. The sample the transition point of which had been fixed at  $71^{\circ}.7$  (§ 6 of our first paper) had not been treated with an electrolyte. It was removed from the dilatometer, washed with ether and kept in contact for some days with a solution of copper sulphate. This material ( $\text{Cu}_{\text{II}}$ ) then gave the following results:

TABLE I.

Temperature.	Duration of measurements in hours	Rise of level in mm.	Rise of level in mm. per hour
$61^{\circ}.7$	$\frac{1}{6}$	- 78	- 468
74.6	$\frac{1}{6}$	+225	+1350
69.6	$\frac{1}{4}$	- 38	- 152
72.1	$\frac{1}{6}$	+ 67	+ 402
70.3	1	- 38	- 38
71.6	$\frac{2}{3}$	+ 84	+ 126
70.8	$\frac{1}{2}$	+ $13\frac{1}{2}$	+ 27
70.6	$1\frac{1}{6}$	- 10	- $8\frac{1}{2}$
70.7	$5\frac{1}{6}$	+ 36	+ 7

The transition point has thus been altered from  $71^{\circ}.7$  to  $70^{\circ}.65$ .

3. As far as the measurements we carried out with samples of very different previous thermal history are concerned, we only mention here that we found as upper limit of the transition temperature  $71^{\circ}.7$ , as lower one  $69^{\circ}.2$ .<sup>1)</sup>

4. We merely give here some details concerning a sample ( $\text{Cu}_{\text{III}}$ ) which had been made by mixing a certain weight of  $\text{Cu}_{\text{II}}$  (Transition point  $70^{\circ}.65$ ) with an equal quantity of the original material (Kupfer-KAHLBAUM, Elektrolyt, geraspelt), which as we were told when purchasing it, had been melted after electrolysis.  $\text{Cu}_{\text{III}}$  had been at  $50^{\circ}$  for 10 days and nights in contact with paraffin oil. The results are given in table II.

<sup>1)</sup> The description of our experiments will be given in full in our paper in the Zeitschr. f. physik. Chem.

TABLE II.

Temperature.	Duration of measurements	Rise of level in mm.	Rise of level in mm. per hour
68.0	$2\frac{1}{3}$	- 15	- 6
75.0	$1\frac{1}{2}$	+ 46	+ 30
72.0	$\frac{5}{6}$	+ 14	+ 17
70.0	$5\frac{1}{4}$	+ 10	+ 2
69.5	58	+243	+ 4
69.5	31	- 36	- 1

At *constant* temperature (69°.5) the direction of motion of the meniscus has changed. This change proves that also in this case there are more than two modifications present at the same time.

5. How extraordinarily marked the retardations are which may occur, is shown by the behaviour of a sample  $\text{Cu}_{\text{IV}}$  (comp. § 7 of our first paper); it was not possible to "bring it into motion" even after treating it with a solution of copper sulphate. However, it ought to be pointed out that there was no finely divided powder present, which was the case with the other samples we investigated.

*Utrecht, April 1914.*

VAN 'T HOFF-Laboratory.

**Botany.** — "*Energy transformations during the germination of wheat-grains*". By LUCIE C. DOYER. (Communicated by Prof. F. A. F. C. WENT).

(Communicated in the meeting of April 24, 1914).

The reserve materials of seeds represent a large quantity of chemical energy. In germination these substances are split into compounds with a much smaller number of atoms and partly by the process of respiration completely oxydized to carbon dioxide. In consequence of these exothermic processes a considerable quantity of energy is set free, which can be used for the various vital-processes.

In order to obtain a conception of these transformations of energy during germination, I have made some observations on germinating



wheat-grains, on which I now wish to make a short preliminary communication.

The germination of the wheat-grains under observation always took place at about 20° C. in the dark, there could therefore be no energy taken up from without by assimilation of carbon dioxide; all the energy needed for the processes of germination had therefore to be provided by means of the reserve materials.

At the commencement of germination imbibition chiefly takes place, in this way heat is already liberated, therefore energy; then there follow very soon a series of exothermic processes, in wheat-grains more especially decomposition of starch to sugars and complete oxydation of this material of respiration to carbon dioxide. The energy set free in this manner is now applied to various ends: 1<sup>st</sup>. for all kinds of synthetic processes by means of which plastic materials are formed for the growing plant, 2<sup>nd</sup>. for the production of osmotic pressure, 3<sup>rd</sup>. for the overcoming of internal and external resistances, and 4<sup>th</sup>. energy is given off in the form of heat-radiation.

The methods used to obtain an insight into these various energy-relations were the two following:

1<sup>st</sup>. Determination of the heat of combustion before germination, and after the germination had been progressing for some time.

2<sup>nd</sup>. Determination of the quantity of heat produced during germination.

As regards the first point, it must be pointed out that the internal chemical energy during a certain length of germination must decrease; a measure of this loss can be found by determining the difference in the heat of combustion. The energy which will no longer be shown by this heat of combustion, is that which is utilized osmotically, for overcoming resistances and which is lost by the giving out of heat. The energy, however, which is used up during germination for synthetic processes is again fixed as chemical energy and is indeed represented by the heat of combustion.

The loss of energy, that is found by determinations of the heat of combustion, does not give therefore the total amount of energy, which has played a part during germination, for a considerable part of this energy has again been withdrawn from observation by the synthetic processes.

The BERTHELOT-bomb was used for determining the heat of combustion. In it a weighed quantity of wheat-grains, germinated or ungerminated and previously dried for a long time at 100°. were burnt; by the rise of temperature of the water in which the bomb

was placed, in combination with the water-value of the respective parts, the amount of energy which was set free by combustion, could be calculated.

This heat of combustion was always calculated for the weight of 1 gram of ungerminated wheat (initial-weight); this was done in the case of both germinated and ungerminated wheat. In this way comparable values were obtained; the difference in heat of combustion after a definite period of germination gave therefore the loss of energy above referred to.

Heat of combustion of wheat calculated per gram of the initial-weight, expressed in gram-calories.

The germination took place at $\pm 20^{\circ}$ C.	Average values	Loss of energy
Ungerminated 3748—3774—3778—3794—3797 <sup>1)</sup>	3778	
After 1 day's germin:		4 . . . . . 1st day
" 2 " "   3756—3793	3774	. . . . . 2nd day
" 3 " "   3740	3740	34 . . . . . 3rd day
" 4 " "   3653—3681—3682 3707—3707	3686	54 . . . . . 4th day
" 5 " "   3594	3594	92 . . . . . 5th day
" 6 " "   3498	3498	96 . . . . . 6th day
" 7 " "   3318	3318	180 . . . . . 7th day

It is clear from these values, which were found for the heat of combustion, that the loss of energy during germination steadily increased. The loss of energy in the first two days was slight; probably imbibition had chiefly taken place at this stage, whilst the chemical transformations had then only subsidiary importance.

It can be further deduced from the figures that between the 2<sup>nd</sup> and 3<sup>rd</sup> day especially the loss of energy greatly increased, and after that continued to rise.

If these values for the loss of energy after different lengths of germination are summarized graphically, a curve is obtained, which begins almost horizontally, and rises more and more steeply.

The loss of energy per hour per kilogram of initial-weight can be roughly calculated from the loss of energy during the different days.

The loss of energy per gram of initial-weight was after two days 4 calories.

<sup>1)</sup> The figures are arranged in ascending values, and not chronologically.

During the 1<sup>st</sup> and 2<sup>nd</sup> days the loss of energy per hour per kilogram of the initial-weight was therefore roughly  $\frac{1000}{48} \times 4 = 83$  cal.

The same for the 3 <sup>rd</sup> day	$\frac{1000}{24} \times 34 = 1417$	„
„ „ „ „ 4 <sup>th</sup> „	„ $\times 54 = 2250$	„
„ „ „ „ 5 <sup>th</sup> „	„ $\times 92 = 3833$	„
„ „ „ „ 6 <sup>th</sup> „	„ $\times 96 = 4000$	„
„ „ „ „ 7 <sup>th</sup> „	„ $\times 180 = 7500$	„

This amount of lost chemical energy corresponds therefore in all probability to that which is applied to osmotic purposes, to the overcoming of resistances and to the evolution of heat.

In a second series of observations I also attempted to determine directly the amount of heat that is given off. The principle, that underlay these determinations, was briefly as follows: air, saturated with water-vapour, which had been brought to a constant known temperature, was passed over germinating wheat-grains at a constant velocity; these acted as a continuous source of heat; the air which passed over it therefore rose in temperature.

If the difference of temperature between the air streaming in and out were measured, when the latter passed at a known rate, then in the ideal case when absolutely no other heat conduction took place, the amount of heat set free could be calculated from the known heat-capacity of the air. Moreover for this the space in which the seedlings were placed would have to be completely saturated with water-vapour; if this were not so, evaporation would take place on germination, in which way heat would be withdrawn from the observation.

The apparatus with which I conducted these experiments consisted of a copper vessel placed in a waterbath of constant temperature. Through this copper vessel, in which a large number of germinating wheat-grains were placed, a current of air was directed at the rate of 3 litres per hour; the air had had for a large part of its course an opportunity to take up the constant temperature of the water. A set of thermal needles served to measure the difference between the temperatures of the air entering and leaving; the current resulting from this difference in temperature was led through a very sensitive mirror-galvanometer, whilst a spot of light was thrown by the mirror on a scale and so made it possible to compare accurately the deflections.

The apparatus was for the most part composed of materials which

conduct heat very easily, thus making the ideal case described above very far from being realised.

If a source of heat were introduced into the vessel while a regulated stream of air was passed through, only a part of the heat liberated could be used to raise the air-temperature; the remainder would pass into the surrounding water by conduction.

It was to be expected that, when a definite source of heat was present, a maximum difference of temperature between the in- and out-streaming air would arise after some time; with the given rate of passage of the air this difference of temperature caused by this source of heat, could not become greater. A calculation as to how great this maximum difference of temperature would be for different amounts of heat, would be very complicated, if not entirely impossible. For this reason the simplest way was to calibrate the apparatus by introducing a source of heat of known magnitude. For this purpose a manganin-wire was placed inside the apparatus over as wide an extent as possible, in the place where later the germinating wheat-grains were to be put. This wire formed a metallic contact with two copper rods which projected above the lid of the apparatus. An electric current could be passed through the manganin-wire by connecting these rods with the two poles of an accumulator. The resistance of the manganin-wire was accurately determined, whilst a milliamperèmeter, placed in the circuit, served to measure the strength of the current. By taking the current from 1, 2, and 3 accumulators alternately, sources of heat of different magnitude could be introduced into the apparatus.

When in this way a source of heat of known magnitude occupied the apparatus, air was passed through and at regular intervals the (double) deflection of the spot of light on the scale was read till this ultimately remained constant and therefore had reached a maximum. These observations were conducted at temperatures of 20°, 30°, and 40° of the surrounding water, and also therefore of the entering air.

These calibration-experiments showed: 1<sup>st</sup> that the maximum deflection of the spot of light, or in other words the difference of temperature between the in- and out-going air was roughly in proportion to the source of heat which was placed in the apparatus, 2<sup>nd</sup> that this proportionality was maintained at a surrounding temperature of 20°, 30°, and 40°, 3<sup>rd</sup> that the absolute magnitude of the deflection was independent of this temperature, 4<sup>th</sup>, that a deviation of 1 centimetre corresponded to a *development of about 11.5 calories per hour*.

As the apparatus was now calibrated it was possible conversely, by reading the deflection of the spot of light, to calculate the magnitude of any source of heat, which was in the apparatus. For such an unknown source of heat germinating wheat-grains were used. (The number of these was always 500).

In the course of the experiments however it became plain that in this case the deflection of the light spot could not be looked upon as showing exclusively the heat-evolution which took place in germination. For when 500 germinated wheat-grains, which had previously been killed by heating to  $100^{\circ}$ , were placed in the apparatus, then it was seen that the spot of light inevitably passed the zero; in various experiments of this kind a deflection of about 8 centimetres was always found.

In order to ascertain whether the dead seedlings did not after all give off some heat possibly as a result of a continued enzyme-action, the apparatus was filled by way of control with quantities of filterpaper previously soaked in water. In this case there could be no question of heat-evolution by the filterpaper. Also with this arrangement of the experiments the spot of light invariably passed the zero, reaching finally a maximum deflection corresponding to that obtained when dead seedlings were placed in the apparatus. The extent of this deflection was independent of the temperature of the surrounding water (fixed at  $25^{\circ}$  and  $35^{\circ}$ ), in other words, with this arrangement of the experiment there arose always a constant difference of temperature between the in- and out-going current of air.

Since in these cases no direct evolution of heat by means of the substances used was possible, another cause for the rise of temperature in the experiment described had to be found. The most probable thing was that condensation of water-vapour must have taken place in some way and that the heat thus set free caused an increase of temperature in the out-going air and in consequence of this of the upper thermal needle. In the calibration-experiments the spot of light had remained at zero when there was no heat-source in the apparatus; the difference in conditions then and during the experiments just described was, that the space within was in the latter case for a great part filled with a completely imbibed mass.

The many efforts made to eliminate this irregularity were practically without results; I was therefore compelled, in experimenting with living seedlings, to adopt a correction, the amount of which was experimentally fixed while theoretically it had to be left partly unexplained.

Since it was therefore found that by filling the apparatus with

very moist substances a difference in temperature between the two needles arose when the current of air passed through, it had to be assumed that this would be also the case when living seedlings were present. The deflection found in that case would have to be attributed partly to this physical cause, partly to generation of heat which actually took place in germination. It was therefore necessary to subtract from the deflection found in this arrangement the amount of deflection found in the experiments with dead seedlings, the remainder then being the measure of the heat generated in germination. This latter was observed at different temperatures and in different stages of germination. In consequence of the complications mentioned higher up the sources of error were relatively very numerous and this was, especially noticeable in the few parallel-determinations which were carried out, so that in the values summarized in the table below an approximation to the amounts of heat given off must be expected rather than an exact measure thereof. These influences are proportionately very large in the lower values.

Number of calories given off per hour calculated per kilogram  
of the initial weight.

Temp.	On the 2 <sup>nd</sup> day of germination	On the 3 <sup>rd</sup> day of germination	On the 4 <sup>th</sup> day of germination	On the 5 <sup>th</sup> day of germination	On the 6 <sup>th</sup> day of germination	On the 7 <sup>th</sup> day of germination
20°		710	2143	2790		2869
25°	363	540	2938	2977 3455	4341	
30°			4999 6313	6790		
35°		752		7326	7575	
40°				5689	6847	

It appeared therefore from the values found that the generation of heat on the 2<sup>nd</sup> and 3<sup>rd</sup> days was still small in comparison to that in later stages of germination. The generation of heat shows a great and sudden increase between the 3<sup>rd</sup> and 4<sup>th</sup> day and it is probable that it continued to increase slowly during the following

days, but the relatively small differences from the 4<sup>th</sup> to the 7<sup>th</sup> day justify the calculation of an average for this period of germination.

Number of calories given off per hour calculated per kilogram of the initial weight.

Temp.	On the 4 <sup>th</sup> day	5 <sup>th</sup> day	6 <sup>th</sup> day	7 <sup>th</sup> day	Average
20°	2143	2790		2869	2601
25°	2938	2977 3455	4341		3428
30°	4999 6313	6790			6034
35°		7326	7575		7450
40°		5689	6847		6268

The generation of heat, therefore, was much influenced by the surrounding temperature; by a rise of 10°, the quantity of heat evolved, increased to more than double. The generation of heat was diminished at 40°, a proof of the harmful influence of this temperature.

Finally a comparison can be made between the number of calories pro kilogram of initial weight given off as heat and the loss of energy deduced from the heat of combustion. This comparison could only be made for a temperature of 20° because at this temperature germination had always taken place, so that the heat of combustion referred to processes at this temperature only.

Loss of energy per hour per kilogram of the initial weight.

At 20°	By heat given off	Calculated from the heat of combustion
On the 2nd day		83 Cal.
" " 3rd "	710 Ca.	1417 "
" " 4th "	2143 "	2250 "
" " 5th "	2790 "	3833 "
" " 6th "		4000 "
" " 7th "	2869 "	7500 "

The total amount of chemical energy which was set free in germination was therefore always larger than the quantity of energy given off as heat to the surroundings. A part of the free energy which became available in the process of germination was therefore evidently used for other purposes (osmosis etc.) than for heat-evolution only.

This was however doubtful only on the second day, the evolution of heat on that day was not determined; the loss of energy, calculated from the heat of combustion, was however so small in this period that it is very possible that the evolution of heat at that moment was larger. If afterward it should appear that this is really the case, it would be very intelligible. For in the beginning of germination imbibition will principally take place so that in this case evolution of heat is not at all necessarily connected with chemical transformations.

The results of this investigation may therefore be summarized as follows.

The loss of energy calculated from the heat of combustion as well as the evolution of heat increase with the duration of germination.

Both are small at the beginning of germination and greatly increase, chiefly on the 3<sup>d</sup> day.

The evolution of heat is greatly dependent on the surrounding temperature.

The optimum of heat-evolution is roughly 35°.

The total loss of energy during germination at 20° exceeds the loss of energy by evolution of heat at the same temperature.

*Utrecht, 1914.*

*Botanical Laboratory.*

**Chemistry.** — “*Equilibria in ternary systems XV*”. By Prof. F. A. H. SCHREINEMAKERS.

(Communicated in the meeting of April 24, 1914).

In our previous considerations on saturationcurves under their own vapourpressure and on boilingpointcurves we have considered the general case that each on the three components is volatile and occurs consequently in the vapour. Now we shall assume that the vapour contains only one or two of the components. Although we may easily deduce all appearances occurring in this case from the general case, we shall yet examine some points more in detail.



The vapour contains only one component.

We assume that of the components  $A$ ,  $B$ , and  $C$  the first two are extremely little volatile, so that practically we can say that the vapour consists only of  $C$ . This shall e.g. be the case when  $A$  and  $B$  are two salts and  $C$  a solvent, as water, alcohol, benzene, etc.

Theoretically the vapour consists always of  $A + B + C$ ; the quantity of  $A$  and  $B$ , however, is generally exceedingly small, compared with the quantity of  $C$ , so that the vapour consists practically completely of  $C$ .

When, however, we consider complexes in the immediate vicinity of the side  $AB$ , circumstances change. A complex or a liquid situated on this side has viz. always a vapourpressure, although this is sometimes immeasurably small; consequently there is also always a vapour, consisting only of  $A + B$  without  $C$ . When we take a complex in the immediate vicinity of the side  $AB$ , the quantity of  $C$  in the vapour is, therefore, yet also exceedingly small in comparison with the quantity of  $A + B$ .

Considering equilibria, not situated in the vicinity of the side  $AB$ , we may, therefore, assume that the vapour consists only of  $C$ ; when, however, these equilibria are situated in the immediate vicinity of the side  $AB$ , we must also take into consideration the volatility of  $A$  and  $B$  and we must consider the vapour as ternary.

Considering only the occurrence of liquid and gas, as we have formerly seen, three regions may occur, viz. the gasregion, the liquid-region and the region  $L-G$ . This last region is separated from the liquid-region by the liquid-curve and from the vapour-region by the vapourcurve.

As long as the liquid-curve is not situated in the immediate vicinity of  $AB$ , this last curve, as a definite vapour of the vapour-curve is in equilibrium with each liquid of the liquid-curve, will be situated in the immediate vicinity of the anglepoint  $C$ . Therefore, the gas-region is exceedingly small and is reduced, just as the gas-curve, practically to the point  $C$ . Consequently we distinguish within the triangle practically only two regions, which are separated by the liquid-curve, viz. the liquid-region and the region  $L-G$ ; the first reaches to the side  $AB$ , the last to the anglepoint  $C$ . The conjugation-lines liquid-gas come together, therefore, practically all in the point  $C$ .

When, however, the liquid-curve comes in the immediate vicinity of the side  $AB$ , so that there are liquids which contain only exceedingly little  $C$ , then in the corresponding vapours the quantity of  $A$  and  $B$  will be large with respect to  $C$ . The vapour-curve will

then also be situated further from the anglepoint  $C$  and closer to the side  $AB$ , so that also the vapour region is large. At a sufficient decrease of pressure or increase of temperature, the vapour-region shall even cover the whole components-triangle. Consequently it is absolutely necessary that we must distinguish the three regions, of which the movement, occurrence, and disappearance were already formerly treated.

When the equilibrium  $F + L + G$  occurs, we may now deduce this in the same way as it was done formerly for a ternary vapour.

a) The solid substance is a ternary compound or a binary compound, which contains the volatile component  $C$ .

For fixing the ideas we shall assume that in the triangle  $ABC$  of fig. 1 which is partly drawn, the point  $C$  represents water,  $F$  an aqueous doublesalt,  $F'$  and  $F''$  binary hydrates. In accordance with our previous general deductions we now find the following.

The saturationcurves under their own vapour-pressure are circum- or expanded at temperatures below  $T_s$  ( $T_s =$  minimum meltingpoint of the solid substance under consideration). The corresponding vapour-curves are reduced to the point  $C$ . When these substances melt with

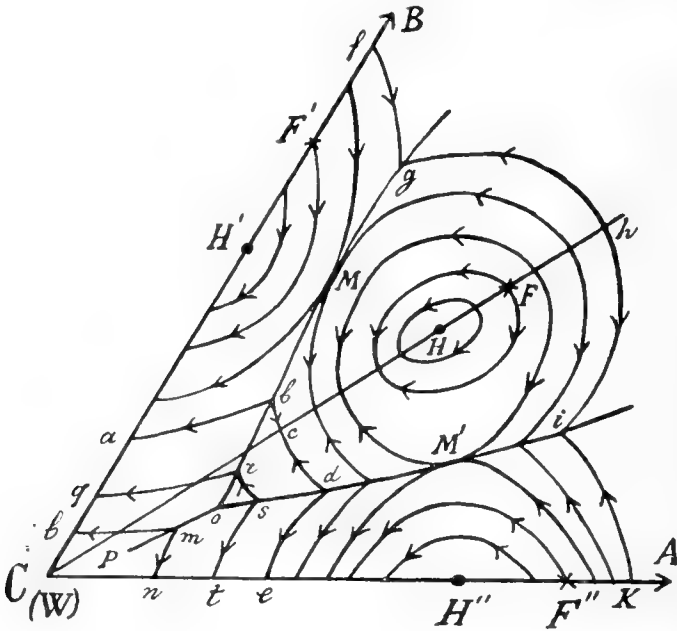

Fig. 1.

increase of volume, the points  $H$ ,  $H'$  and  $H''$  are situated with respect to  $F$ ,  $F'$  and  $F''$  as in fig. 1; when they melt with decrease of volume, these points are situated on the other side.

In fig. 1 different saturationcurves are completely or partly drawn: the pressure increases along them in the direction of the arrows. Further it is apparent that along the saturationcurve of  $F$  the pressure is maximum or minimum in its points of intersection with the line  $CF$ ; the point of maximumpressure is situated closest to  $C$ . On the curve  $bcdihg$  of fig. 1, which is only partly drawn,  $c$  is, therefore, a point of maximum-,  $h$  a point of minimumpressure.

The pressure along a saturationcurve of the binary hydrate  $F'$  (or  $F''$ ) is highest in the one and lowest in the other end, without being however in these terminating points maximum or minimum. On the curve  $abgf$  of fig. 1 which is only partly drawn, the pressure in  $a$  is the highest and in  $f$  the lowest.

This is also in accordance with the rule, formerly deduced, that the pressure is maximum or minimum, when the phases  $F$ ,  $L$ , and  $G$  are situated on a straight line, but that this is no more the case when this line coincides with a side of the triangle.

As the vapour has always the composition  $C$  here the point of maximum- and that of minimumpressure of the saturationcurve of  $F$  are, therefore, always situated on the line  $CF$ ; the saturationcurves of  $F'$  and  $F''$  can, however, not have a point of maximum- or minimum-pressure.

As we may obtain all solutions of the line  $Ch$  ( $CB$  and  $CA$ ) by adding water to  $F$  ( $F'$  and  $F''$ ) or removing water from  $F$  ( $F'$  and  $F''$ ), we shall call the solutions of  $Ch$  ( $CB$  and  $CA$ ) pure solutions of  $F$  ( $F'$  and  $F''$ ). Further we call the solutions of  $CH$  ( $CH'$  and  $CH''$ ) rich in water and those of  $Hh$  ( $H'B$  and  $H''A$ ) solutions poor in water. Consequently in fig. 1  $a$ ,  $c$  and  $e$  represent pure solutions rich in water and  $f$ ,  $h$  and  $k$  pure solutions poor in water. We may express now the above in the following way:

Of all solutions saturated at constant  $T$  with a binary or ternary hydrate, the pure solution rich in water has the greatest and the pure solution poor in water the lowest vapourpressure. Therefore, the pressure increases along the saturationcurve from the pure solution poor in water towards the pure solution rich in water. When the solid substance is a ternary hydrate, the highest pressure is at the same time a maximum- and the lowest pressure also a minimum pressure.

We see that this is in accordance with the direction of the arrows in fig. 1.

*b)* The solid substance is the component  $A$  or  $B$  or a binary compound of  $A$  and  $B$ ; therefore, it does not contain the volatile component  $C$ .

In fig. 2 some saturationcurves under their own vapourpressure of  $A$  ( $ak, bl, cm, on$ ) and of  $B$  ( $hi, gl, fm, pm$ ) are completely or partly drawn. When in one of the binary systems, e.g. in  $CB$ , there exists a point of maximumtemperature  $H'$ , then also there occur saturationcurves as the dotted curve  $qr$ . As long as we consider solutions, not situated in the vicinity of  $AB$ , the vapour region is represented by point  $C$ . When we consider, however, also solutions in the vicinity of  $AB$ , the vapour region expands over the triangle.

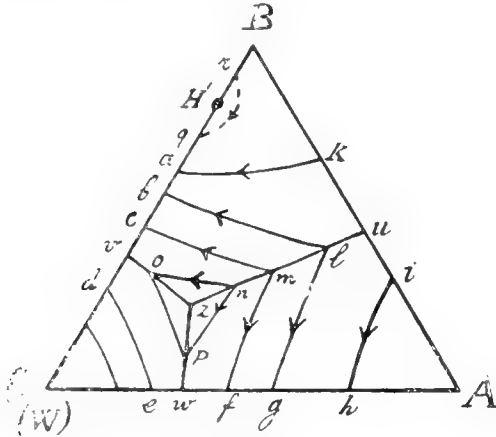

Fig. 2.

as  $H'$  is situated in the vicinity of  $B$ , also to the curves in the vicinity of  $H'$ .

It follows from the deduction of the saturationcurves that the pressure, e.g. along  $ak$ , continues to decrease from  $a$ ; only in the vicinity of  $k$ , a point of minimumpressure may perhaps be situated. As the pressure in  $b$  and consequently also in the minimum possibly occurring is exceedingly small and practically zero, we can say: along the saturationcurve of a component the pressure increases from the solution free from water ( $k$ ) towards the pure solution ( $a$ ). The pressure of the solution free from water is practically zero.

Let us now take a binary compound of  $A$  and  $B$  (for instance an anhydric double-salt); it may be imagined in fig. 2 to be represented by a point  $F$  on  $AB$ . When we leave out of account saturationcurves in the vicinity of  $F$ , we may say that the saturationcurves under their own vapourpressure have two terminatingpoints, both situated on  $AB$ . As the pressure is again very small in both the terminatingpoints, it follows: along the saturationcurve of an anhydric double-salt, the pressure increases from each of the solutions free from water towards the pure solution.

c) The solid substance contains the volatile component  $C$  only.

This is for instance the case when an aqueous solution of two

Consequently, when we deduce the saturationcurves under their own vapour-pressure, assuming that the vapour is represented by  $C$ , we may do this only for solutions, not situated in the vicinity of  $AB$ . For points of the curves in the vicinity of  $AB$  we take the case, treated already in communication XIII that the vapour is ternary. The same applies,

salts is in equilibrium with ice; the saturation- or icecurve under its own vapourpressure has then, as curve  $ed$  in fig. 2, one terminatingpoint on  $CA$  and one on  $CB$ . We find further: along an icecurve under its own vapourpressure the pressure is the same in all points and it is equal to the pressure of sublimation of the ice.

We may deduce the previous results also in the following way. As the vapour consists only of  $C$ , we equate, in order to find the conditions of equilibrium for the system  $F + L + G$  in (I) (II)  $x_1 = 0$  and  $y_1 = 0$ . We then find:

$$Z - x \frac{\partial Z}{\partial x} - y \frac{\partial Z}{\partial y} = Z_1 \text{ and } Z_1 + \alpha \frac{\partial Z}{\partial x} + \beta \frac{\partial Z}{\partial y} = \xi \quad . \quad . \quad . \quad (1)$$

For the saturationcurve of  $F$  under its own vapourpressure we find:

$$(x r + y s) dx + (x s + y t) dy = - C dP \quad . \quad . \quad . \quad (2)$$

$$(\alpha r + \beta s) dx + (\alpha s + \beta t) dy = -(A + C) dP \quad . \quad . \quad (3)$$

which relations fellow also immediately from 8 (II) and 9 (II). In order that the pressure in a point of this curve should be maximum or minimum,  $dP$  must be 0. This can be the case only, when

$$\alpha y = \beta x \quad . \quad . \quad . \quad . \quad . \quad (4)$$

This means that the liquid is situated in the point of intersection of the curve with the line  $CF$ , consequently, that the liquid is a pure solution of  $F$ . Consequently we find: along a saturationcurve under its own vapourpressure of a ternary substance, the pressure is maximum or minimum in the pure solutions.

In order to examine for which of the two pure solutions the pressure is maximum and for which it is minimum, we add to the first part of (2) still the expressions:

$$\frac{1}{2} \left( r + x \frac{\partial r}{\partial x} + y \frac{\partial s}{\partial x} \right) dx^2 + \left( s + x \frac{\partial r}{\partial y} + y \frac{\partial s}{\partial y} \right) dx dy + \frac{1}{2} \left( t + x \frac{\partial s}{\partial y} + y \frac{\partial t}{\partial y} \right) dy^2 + \dots$$

and to the first term of (3):

$$\frac{1}{2} \left( \alpha \frac{\partial r}{\partial x} + \beta \frac{\partial s}{\partial x} \right) dx^2 + \left( \alpha \frac{\partial r}{\partial y} + \beta \frac{\partial s}{\partial y} \right) dx dy + \frac{1}{2} \left( \alpha \frac{\partial s}{\partial y} + \beta \frac{\partial t}{\partial y} \right) dy^2 + \dots$$

Now we subtract (2) from (3), after that (2) is multiplied by  $\alpha$  and (3) by  $x$ . Substituting further their values for  $A$  and  $C$ , we find:

$$\frac{1}{2} \alpha (r dx^2 + 2s dx dy + t dy^2) = [(x - \alpha) V_1 + \alpha V - x \alpha] dP \quad . \quad (5)$$

Representing the change of volume, when one quantity of vapour

arises at the reaction between the phases  $F$ ,  $L$  and  $G$ , by  $\Delta V_1$  (5) passes into:

$$\frac{1}{2} \alpha (rdx^2 + 2sdx dy + tdy^2) = (x - \alpha) \Delta V_1 \times dP \quad . \quad . \quad (6)$$

Let us consider now in fig. 1 the pure solutions of  $F$ , therefore the solutions of the line  $Ch$ . For points between  $C$  and  $F$   $x - \alpha < 0$ , for the other points  $x - \alpha > 0$ . Considering only the solutions of the line  $Ch$ , we can consider the system  $F + L + G$  as binary. Imagining a  $P, T$ -diagram of this system,  $H$  is the point of maximum-temperature. From this it is apparent that  $\Delta V_1$  is negative between  $H$  and  $F$ , positive in the other points of the line  $Ch$ . From this it follows:

( $x - \alpha$ )  $\Delta V_1$  is negative in points between  $C$  and  $H$ , therefore for the solutions of  $F$  rich in water.

( $x - \alpha$ )  $\Delta V_1$  is positive in the other points of this line, therefore, for the solutions of  $F$  poor in water.

The same applies also when the point  $H$  is situated on the other side of  $F$ .

Let us take now a pure solution rich in water of  $F$ , for instance solution  $c$  of the fig. 1; as the first term of (6) is positive and ( $x - \alpha$ )  $\Delta V_1$  is negative, it follows:  $dP$  is negative. This means that the pressure is a maximum in  $c$ .

When we take a pure solution poor in water of  $F$ , for instance solution  $h$  of figure 1, ( $x - \alpha$ )  $\Delta V_1$  is positive, therefore, the pressure is a minimum in  $h$ .

In accordance with the previous considerations, we find, therefore, that the pressure along the saturationcurve of a ternary compound is a minimum for the pure solution poor in water and a maximum for the pure solution rich in water.

When the solid substance is a binary compound, as  $F''$  in fig. 1 or 3, we must equate  $\alpha = 0$ . (Of course  $\beta = 0$  for the compound  $F''$ ). (2) and (3) pass now into:

$$(xr + ys) dx + (xs + yt) dy = -C dP \quad . \quad . \quad . \quad (7)$$

$$\beta s dx + \beta t dy = -(A + C) dP, \quad . \quad . \quad . \quad (8)$$

From this we find:

$$\beta x (rt - s^2) dx = [(xs + yt)(A + C) - \beta C] dP \quad . \quad . \quad (9)$$

From this it is apparent that  $dP$  can never be zero or in other words: on the saturationcurve of a binary hydrate never a point of maximum- or of minimumpressure can occur.

In the terminatingpoint of a saturationcurve on  $BC$   $x = 0$ ; as

$\lim r = \frac{RT}{x}$ , while  $t$  and  $s$  remain finite, it follows, when we replace also  $A$  and  $C$  by their values:

$$\beta \cdot RT \cdot dx = [(y - \beta) V_1 + \beta V - yv] dP. \quad (10)$$

Representing by  $\Delta V_1$  the change of volume, when one quantity of vapour arises at the reaction between the three phases ( $F'$ ,  $L$  and  $G$ ), (10) passes into:

$$\beta RT \cdot dx = (y - \beta) \Delta V_1 \cdot dP \quad (11)$$

For solutions between  $C$  and  $F'$  is  $y - \beta < 0$ , between  $F'$  and  $B$  is  $y - \beta > 0$ . Imagining a  $P, T$ -diagram of the binary system  $F' + L + G$ ,  $H'$  is the point of maximum temperature;  $\Delta V_1$  is consequently negative between  $H'$  and  $F'$ , positive in the other points of  $CB$ . From this it follows:  $(y - \beta) \Delta V_1$  is negative in points between  $C$  and  $H'$ , therefore, for the solutions rich in water;  $(y - \beta) \Delta V_1$  is positive in points between  $H'$  and  $B$ , therefore for the solutions of  $F'$  poor in water.

From (11) it now follows:  $dP$  is negative for liquids on  $CH'$ , positive for liquids on  $H'B$ . In accordance with our former results consequently we find: along the saturationcurve of a binary hydrate the pressure increases from the pure solution poor in water towards the pure solution rich in water.

When  $F'$  is one of the components, which are not volatile, e.g.  $B$  in fig. 2, then  $\alpha = 0$  and  $\beta = 1$ . From (11) then follows:

$$RT \cdot dx = (y - 1) \Delta V_1 \cdot dP. \quad (12)$$

We now imagine a  $P, T$ -diagram of the binary system  $B + L + G$ ; this may have either a point of maximumtemperature  $H'$  in the vicinity of the point  $B$  or not. When a similar point does not exist,  $\Delta V_1$  is always positive; when a similar point does exist,  $\Delta V_1$  is positive between  $C$  and  $H'$ , negative between  $H'$  and  $B$ . As we leave, however, here out of account points, situated in the vicinity of  $B$ ,  $\Delta V_1$  is positive. As  $y - 1$  is always negative, it follows from (12) that  $dP$  is negative. In accordance with our former results we find therefore: along the saturationcurve of a component the pressure decreases from the pure solution towards the solution free from water.

When  $F'$  is the volatile component, as for instance in the equilibrium  $ice + L + G$ , then  $\alpha = 0$  and  $\beta = 0$ . The second of the conditions of equilibrium (I) passes now into:  $Z_1 = \xi$ . This means that not a whole series of pressures belongs to a given temperature, but only one definite pressure, viz. the pressure of sublimation of the ice. Therefore we find again: along an icecurve under its own

vapour pressure the pressure is the same in all points and equal to the pressure of sublimation of the ice.

Now we shall consider the boilingpointcurves; in general the same applies to them as to the saturationcurves under their own vapourpressure, which we have considered above.

Now we assume that the curves in fig. 1 represent boilingpointcurves; the point  $H$  no longer represents a point of maximum temperature, but a point of maximum pressure; consequently it is always situated between  $C$  and  $B$ . This point of maximumpressure  $H$  is always situated closer to  $C$  than the point of maximum temperature  $H$ ; the same applies to the points  $H'$  and  $H''$  in the figs. 2 and 3. Wishing to indicate by arrows the direction in which the temperature increases, we must give the opposite direction to the arrows in the figs. 1-3.

We saw before that on the side  $CB$  of fig. 2 a point of maximumtemperature  $H'$  may either occur or not; on this side, however, always a point of maximumpressure is situated. The same applies to the side  $CA$ . We now find the following.

*a)* of all solutions saturated under constant  $P$  with a binary or ternary hydrate, the pure solution rich in water has the lowest — and the pure solution poor in water the highest boilingpoint. Therefore, the boilingpoint increases along the boilingpointcurve from the pure solution rich in water towards the pure solution poor in water. When the solid substance is a ternary hydrate, the highest boilingpoint is at the same time a maximum- and the lowest at the same time a minimumboilingpoint.

*b)* along the boilingpointcurve of a component or of an anhydric double-salt the boilingpoint increases from the pure solution. When the solid substance is an anhydric double-salt, the boilingpoint of the pure solution is at the same time a minimum.

*c)* along the curve of the solutions saturated with ice under a constant pressure the boilingpoint is the same in all the points and it is equal to the sublimationpoint of the ice.

The icecurve under its own vapourpressure of the temperature  $T$  and the boilingpointcurve of the ice under the pressure  $P$  coincide, therefore, when  $P$  is the pressure of sublimation of the ice at the temperature  $T$ .

The following is amongst others apparent from what precedes. We take a pure solution of a solid substance (component, binary or ternary compound). Through this solution pass a saturationcurve



under its own vapourpressure and a boilingpointcurve. Generally we now have: when the vapour pressure at a constant  $T$  decreases (or increases) from the pure solution, the boilingpoint under a constant  $P$  will increase (or decrease).

This, however, is no more the case for solutions between the point of maximumpressure and the point of maximumtemperature. The point of maximumpressure is situated viz. closer to the point  $C$  than the point of maximumtemperature. When we take a solution between these points, it is a solution rich in water with respect to the saturationcurve under its own vapourpressure, a solution poor in water, however, with respect to the boilingpointcurve. Consequently as well the pressure along the saturationcurve as the temperature along the boilingpointcurve will decrease from this solution.

We may express the foregoing also in the following way: the vapourpressure (at constant  $T$ ) and the boilingpoint (under constant  $P$ ) change from a pure solution generally in opposite directions. When, however, the pure solution is situated between the point of maximumpressure and the point of maximumtemperature, then as well the vapourpressure as the boilingpoint decrease from this solution.

Formerly we have already considered the saturationcurve under its own vapourpressure of two solid substances (viz. the equilibrium  $F + F' + L + G$ ); now we shall discuss some points more in detail. It should be kept in mind in this case that all deductions apply also now to points, which are not situated in the vicinity of  $AB$ . The deductions discussed already formerly apply to points in the vicinity of this line.

Let us take the solution  $m$  of fig. 2 saturated with  $A + B$ , therefore, the equilibrium  $A + B + L_m + G$ . As the pressure increases from  $m$  towards  $c$  and towards  $f$ , we may say: the solution saturated with two components has a smaller vapourpressure than the pure solution of each of the components separately.

When we consider the solution  $p$  of fig. 2 saturated with  $ice + A$  and when we imagine curve  $np$  to be extended up to  $CA$ , it appears: the solution saturated with  $ice + A$  has a greater vapourpressure than the solution saturated with  $A + B$  and a smaller vapourpressure than the metastable pure solution of  $A$ .

In the previous communication we have already discussed the curves  $zu$ ,  $zv$ , and  $zw$ ;  $zu$  represents the solutions of the equilibrium  $A + B + L + G$ ,  $zv$  those of the equilibrium  $ice + A + L + G$  and  $zw$  these of the equilibrium  $ice + B + L + G$ ,  $w$  and  $v$  are binary,  $z$  is the ternary cryohydric point under its own vapourpressure.

Let us now contemplate the solution  $m$  of fig. 3 saturated with the hydrates  $F' + F''$ ; it is apparent from the figure that solution  $m$  has a smaller vapourpressure than  $l$  or  $n$ . When we take however

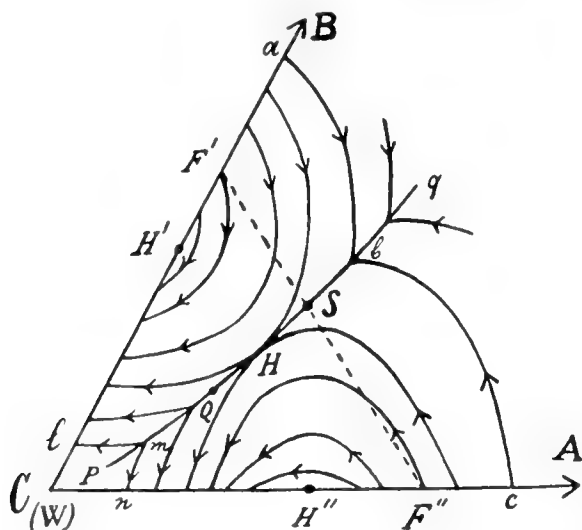

Fig. 3.

the solution  $b$ , saturated with these hydrates, this has a larger vapourpressure than the solutions  $a$  and  $c$ .

Curve  $pq$  represents the solutions of the equilibrium  $F + F' + L + G$ ; point  $H$  is the point of maximum temperature of this curve. In accordance with our previous definitions we call the liquids of branch  $pH$  rich in water and those of branch  $Hq$  poor in water. We then may express what precedes in this way:

the solution saturated with two components or with their hydrates has in the region rich in water always a smaller vapourpressure, in the region poor in water always a greater vapourpressure than the pure solution of each of the substances separately.

Let us now take a liquid saturated with a double salt and one of its limit-substances. [In fig. 1 the series of solutions saturated with  $F'$  of curve  $bcd$  is limited in  $b$  by the occurrence of  $F'$  and in  $d$  by the occurrence of  $F''$ . Therefore we shall call  $F'$  and  $F''$  the limit-substances of the double-salt  $F'$ ]. Curve  $po$  represents the solutions of the equilibrium  $F + F' + L + G$ , curve  $og$  those of the equilibrium  $F' + F + L + G$  and curve  $oi$  those of the equilibrium  $F'' + F + L + G$ .  $M$  and  $M'$  are points of maximum temperature of these curves. In accordance with previous definitions we call solutions of  $oM$  and  $oM'$  rich in water and those of  $Mg$  and  $M'i$  poor in water.

The following is apparent from the direction of the arrows in fig. 1.

*a.* In the region of the liquids rich in water. When a doublesalt is soluble in water without decomposition, the solution saturated with this double-salt and with one of its limit-substances has a smaller vapourpressure than the pure solution of the doublesalt and also than that of the limit-substance.

When a double-salt is decomposed by water, the solution saturated with this double-salt and one of its limit-substances has a smaller vapour pressure than the pure solution of the limit-substance. The solution saturated with double-salt and with the limit-substance, which is not separated, has a smaller vapour-pressure than the solution, saturated with double-salt and with the limit-substance, which is separated.

*b.* In the region of the liquids poor in water the opposite takes place.

As a special case a liquid can be saturated with two substances of such a composition, that one of these may be formed from the other

by addition of water. They are represented then by two points  $F'$  and  $F''$ , which are situated with  $C$  on a straight line. In fig. 4 this line  $CF'F''$  does not coincide with one side of the triangle. In this figure  $aecf'$  is a saturationcurve under its own vapourpressure of  $F'$ , curve  $bedf''$  one of  $F''$ ; the arrows indicate the direction, in which the pressure increases. Both the curves can be circum- or expanded

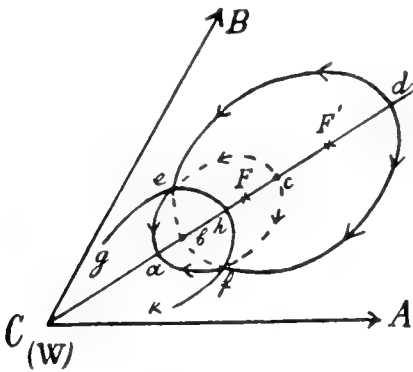

Fig. 4.

and they either intersect or they do not. In fig. 4 they intersect in  $e$  and  $f$ , so that the equilibria  $F' + F'' + L_e + G$  and  $F' + F'' + L_f + G$  occur. Now we can prove that the vapour pressure of those two equilibria is the same, therefore  $P_e = P_f$ . When we remove viz. the liquid from both the equilibria, we retain  $F' + F'' + G$ . As between these three phases the reaction  $F' \rightleftharpoons F'' + G$  is possible, we can consider  $F' + F'' + G$  as a binary system. We then have two components in three phases, so that the equilibrium is monovariant. At each temperature  $F' + F'' + G$  has, therefore, only one definite vapourpressure, from which immediately follows:  $P_e = P_f$ .

Curve  $gehfk$  in fig. 4 indicates the solution of the equilibrium  $F + F' + L + G$ ; when in a  $P, T$ -diagram we draw the curve  $F + F' + G$  (consequently the curve of inversion  $F \rightleftharpoons F' + G$ ) and curve  $F + F' + L + G$ , then they coincide.

In fig. 5 the line  $CFF'$  coincides with the side  $BC$  of the triangle; we assume viz. that the component  $B$  and its hydrate  $F$  occur as solid substances; further we have also assumed that the component  $A$  occurs as solid substance. The curves  $bc$ ,  $fg$  and  $ik$  are saturation-curves under their own vapourpressure of  $A$ ,  $ih$  and  $ef$  of  $B$ ,  $ab$  and  $de$  of the hydrate  $F$ ; the arrows indicate again the direction in which the pressure increases.

It is apparent from the figure that  $rz$  represents the solutions of the equilibrium  $A + F + L + G$ ,  $zw$  those of  $A + B + L + G$  and  $zu$  those of  $B + F + L + G$ . Consequently in  $z$  the invariant equilibrium  $A + B + F + L + G$  occurs. Curve  $zu$  terminates on side  $BC$  in the quadruplepoint  $u$  with the phases  $B + F + L + G$  of the binary system  $CB$ . When we remove the liquid  $L_e$  from the equilibrium  $B + F + L_e + G$  occurring at the temperature  $T_e$  and under the pressure  $P_e$ , we retain the monovariant binary equilibrium  $B + F + G$ .

When we draw in a  $P, T$ -diagram the curve  $B + F + G$  (therefore the curve of inversion  $F \rightleftharpoons B + G$ ) and curve  $B + F + L + G$ , these two curves coincide. We can say, therefore:

the vapourpressure of a solution, saturated with a component and with its hydrate, is equal to the pressure of inversion of the hydrate (the pressure of the reaction  $F \rightleftharpoons B + G$ ).

From the direction of the arrow on  $de$  it follows that the pressure in  $e$  is smaller than in  $d$ . We can say, therefore:

the solution saturated with a component and with one of its hydrates has a lower pressure than the pure solution of the hydrate.

The same considerations apply also when two hydrates of a same component occur.

We may summarise the previous results in the following way. Through each solution saturated with two solid substances go two saturationcurves; when we limit ourselves to the stable parts of

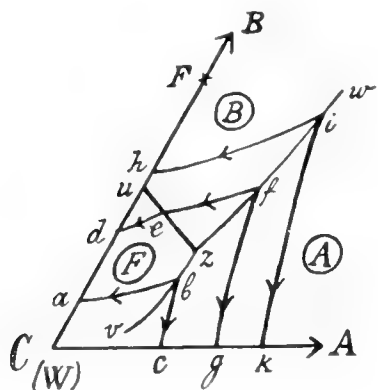

Fig 5.

these curves, we may say that two saturationcurves proceed from such a solution. Then we may say :

1. The two solid substances are situated in opposition with respect to the line  $LG$ .

*a.* The solution saturated with these substances is rich in water.

The pressure increases from this solution along the two saturationcurves.

*b.* The solution saturated with these substances is poor in water. The pressure decreases from this solution along the two saturationcurves.

2. The two solid substances are situated in conjunction with respect to the line  $LG$ .

*a.* The solution saturated with these substances is rich in water.

The pressure decreases from this solution along the saturationcurve of that solid substance which is situated closest to the line  $LG$ ; the pressure increases along the other saturationcurve.

*b.* The solution saturated with these substances is poor in water.

The same as sub 2<sup>a</sup>.; we must take however the changes of pressure in opposite direction.

3. The two solid substances are situated on a straight line with the vapour.

The pressure increases from the solution saturated with these substances along the saturationcurve of the substance with the largest amount of water, it decreases along the saturationcurve of the substance with the smallest amount of water.

We find examples of 1<sup>a</sup> in the equilibria :

$F + F' + L_b + G$  (fig. 1),  $F + F'' + L_d + G$  (fig. 1),  $A + B + L_m + G$  (figs. 1 and 2),  $F' + F'' + L_m + G$  (fig. 3),  $A + B + L_b + G$  (fig. 5) and  $F' + A + L_f + G$  (fig. 5).

We find examples of 1<sup>b</sup> in the equilibria :  $F + F' + L_g + G$  (fig. 1),  $F + F'' + L_i + G$  (fig. 2) and  $F' + F'' + L_b + G$  (fig. 3).

An example of 2<sup>a</sup> is found in the equilibrium  $F + F' + L_e + G$  (fig. 1).

We find examples of 3 in the equilibria :  $F + F' + L_e + G$  (fig. 4),  $F + F' + L_f + G$  (fig. 4) and  $B + F' + L_e + G$  (fig. 5).

We may deduce the above-mentioned rules also in the following way. We shall viz., while the temperature remains constant, change the volume of the system  $F + F' + L + G$ , so that a reaction takes place between the phases and there remains at last a three-phase-equilibrium. As this reaction is determined by the position of the four points with respect to one another, we may immediately distinguish the above-mentioned cases 1, 2, and 3. When we call

the change of volume, when one quantity of vapour is formed at the reaction,  $\Delta V_1$ , then  $\Delta V_1$  is always positive, except when the liquid is represented by a point of the fourphase-curve between the point of maximum temperature and the intersecting point of this curve with the line  $F'F''$ . When we now apply the rule: "the equilibria, which arise at increase (decrease) of volume, are stable under lower (higher) pressure", we may easily refine the above-mentioned rules.

When we take as an example fig. 3 in which the case sub 1 occurs, the equilibrium  $F' + F'' + L + G$  is represented by curve  $pq$ , which intersects the line  $F'F''$  in  $S$ ;  $H$  is the point of maximum temperature of this curve. Consequently  $\Delta V_1$  is positive on  $pH$  and  $Sq$ , negative on  $HS$ ; the solutions of  $pH$  are rich in water, those of  $Hq$  poor in water. When we take a liquid rich in water, the reaction is:

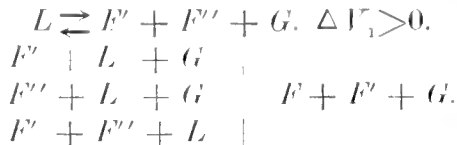

As the reaction proceeds from left to right with increase of volume ( $\Delta V_1 > 0$ ), the equilibrium to the right of the vertical line occurs on decrease of pressure and the equilibria to the left of the vertical line occur on increase of pressure. Therefore, from each point of branch  $pQ$  the equilibria  $F' + L + G$  and  $F'' + L + G$  proceed towards higher pressures; consequently we find the rule 1<sup>a</sup>.

When we take a liquid poor in water, this is situated on  $HS$  or on  $Sq$ . When it is situated on  $HS$ , the above-mentioned reaction applies also, but  $\Delta V_1 < 0$ . Therefore, from each point of branch  $HS$  the equilibria  $F' + L + G$  and  $F'' + L + G$  proceed towards lower pressures; this is in accordance with rule 1<sup>b</sup>.

When we take a solution of branch  $Sq$ , the reaction is:

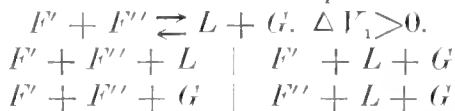

As the reaction proceeds from left to right with increase of volume the equilibria to the right of the line occur with increase of volume.

In accordance with rule 1<sup>b</sup> we find, therefore, that the equilibria  $F' + L + G$  and  $F'' + L + G$  proceed from each point of the branch  $Sq$  towards lower pressures.

Now we have deduced the rules 1<sup>a</sup> and 1<sup>b</sup> assuming that point  $H$  is situated on branch  $pS$ ; we may act in a similar way when point  $H$  is situated on branch  $qS$ . In a similar way we can also deduce the rules 2 and 3.

Considering, instead of the saturationcurves the boiling point curves, the same applies to these in general. We must then replace on the fourphase-curve the point of maximumtemperature by the point of maximum pressure. In fig. 3 besides the point of maximum-temperature  $H$ , also the point of maximum-pressure  $Q$  is drawn. We imagine further that the saturationcurves are replaced in the diagrams by boilingpointcurves. We then refind the rules 1, 2, and 3, with this difference, however, that increase of pressure must be replaced by decrease of the boilingpoint and decrease of pressure by increase of the boilingpoint.

From each point of the four-phase curve proceed two saturation-curves and two boilingpointcurves. When this solution is to be considered as rich in water or as poor in water with respect to the saturationcurves, it is also the same with respect to the boiling-pointcurves. Only the solutions between the point of maximum-pressure and the point of maximumtemperature make an exception; these are rich in water when we consider the saturationcurves, poor in water when we consider the boilingpointcurves. Now we find: from a solution saturated with two solid substances the vapour-pressure (along one of the saturationcurves) and the boilingpoint (along the corresponding boilingpointcurve) change generally in opposite direction. When, however, this solution is situated between the point of maximumpressure and the point of maximumtemperature, vapourpressure and boilingpoint change in the same direction.

*(To be continued).*

**Physics.** — “*On the thermodynamic potential as a kinetic quantity*”. (First part). By Dr. H. HULSHOF. (Communicated by Prof. J. D. VAN DER WAALS).

(Communicated in the meeting of April 24, 1914).

In a communication published in These Proc. II p. 389 of Jan. 27 1900<sup>1)</sup> it has been set forth by me that in the capillary layer the molecular pressure must have a different value in different directions as a direct consequence of the attraction of the particles, whereas the thermic pressure (the sum of the molecular and the

<sup>1)</sup> I expressly call attention to this date, because some time after, this subject was treated in the same way by a writer who had informed me of his own accord that he was going to publish an article on this subject in the Zeitschrift für phys. Chemie, and that he should of course, cite my paper there, but who has failed to do so.

internal pressure) must be the same in all directions. Hence a condition occurs in the capillary layer in which the external pressure in the direction of this layer  $p_2$  has a quite different value from the pressure normal to this layer  $p_1$  i.e. the pressure in the homogeneous vapour and liquid phases. In the surface a tension appeared to exist:

$$\int (p_1 - p_2) dh.$$

The molecular pressure could be easily defined so that the surface tension was in agreement with the capillary energy determined by Prof. VAN DER WAALS by a thermodynamic way:

$$\int \varrho(\varepsilon - T_1 \eta + p_1 v - \mu M) dh,$$

in which  $\varrho = \frac{1}{v}$  and  $v$  is the volume for a molecular quantity of  $M$  grams and

$$\varepsilon = C - a\varrho - \frac{c_2}{2} \frac{d^2 \varrho}{dh^2} - \frac{c_4}{4!} \frac{d^4 \varrho}{dh^4}.$$

The two integrals, which must be extended over the full height of the transition layer, are equal, and this is also the case with two corresponding elements so that:

$$\varrho(\varepsilon - T_1 \eta + p_1 v - \mu M) = p_1 - p_2$$

from which immediately follows

$$\varepsilon - T_1 \eta + p_2 v = \mu M.$$

As  $p_2$ , the pressure in the direction of the capillary layer, has the same value in the homogeneous vapour and liquid phases as  $p_1$ , it holds for the quantity

$$\varepsilon - T_1 \eta + p_2 v$$

that it has a constant value both in the homogeneous vapour and liquid phase and in the capillary layer. This property leads us at once to expect that it will play an important part especially for kinetic considerations, and that it will express that the number of particles that two arbitrary phases will exchange in the same time, will be equally great. It will, in fact appear that this quantity makes the capillary layer accessible for the considerations developed by Prof. VAN DER WAALS in his paper on the kinetic significance of the thermodynamical potential. Assuming that really in the direction of the capillary layer the pressure  $p_2$  is different from the pressure  $p_1$ , and besides entirely different in different layers, the neglect of this circumstance will make it impossible to derive the thermodynamic conditions of equilibrium for the capillary layer from kinetic con-



siderations. A particle, namely, that begins a new path at some place, is subjected to the influence of the pressure  $p_2$  prevailing there, and in the layer, where it terminates this path, it is subjected to the in general entirely different pressure  $p_2$  of this layer.

VAN DER WAALS' first equation runs:

$$\frac{1}{2}mNu_n^2 + pv_1 - \frac{a}{v_1} = \frac{1}{2}mNu'_n{}^2 + pv_2 - \frac{a}{v_2} \dots \dots (1')$$

The expression  $pv_2 - \frac{a}{v_2} - \left( pv_1 - \frac{a}{v_1} \right)$  is for a monatomic fluid the heat of evaporation for the molecular weight,  $\epsilon_2 + pv_2 - (\epsilon_1 + pv_1)$ . We shall now have to apply a modification to this equation, when the layers between which the interchange of particles takes place, are taken in the capillary layer. Here we shall have, as it were, an evaporation from a space under the pressure  $p_2$  towards a space under the pressure  $p'_2$ , and a condensation in opposed direction. Hence our first equation becomes:

$$\frac{1}{2}mNu_n^2 + p_2v - aQ - \frac{c_2}{2} \frac{d^2Q}{dh^2} = \frac{1}{2}mNu'_n{}^2 + p'_2v' - aQ' - \frac{c_2}{2} \frac{d^2Q'}{dh^2} \dots (1)$$

The equation which expresses that for a stationary state a group of particles from one layer will be replaced by a group of particles from the other layer becomes just as VAN DER WAALS puts:

$$\frac{1}{v-b} e^{-\frac{u_n^2}{a^2}} u_n du_n = \frac{1}{v'-b} e^{-\frac{u'_n{}^2}{a^2}} u'_n du'_n$$

Now from (1) follows:

$$u_n du_n = u'_n du'_n$$

and our second relation becomes therefore:

$$\frac{1}{v-b} e^{-\frac{u_n^2}{a^2}} = \frac{1}{v'-b} e^{-\frac{u'_n{}^2}{a^2}} \dots \dots \dots (2)$$

hence:

$$\log \frac{v'-b}{v-b} = \frac{\frac{1}{2}mNu_n^2 - \frac{1}{2}mNu'_n{}^2}{\frac{1}{2}mNa^2} = \frac{\left( p'_2v' - aQ' - \frac{c_2}{2} \frac{d^2Q'}{dh^2} \right) - \left( p_2v - aQ - \frac{c_2}{2} \frac{d^2Q}{dh^2} \right)}{MRT}$$

or

$$-aQ - \frac{c_2}{2} \frac{d^2Q}{dh^2} - MRT \log(v-b) + p_2v = -aQ' - \frac{c_2}{2} \frac{d^2Q'}{dh^2} - MRT \log(v'-b) + p'_2v' = M\mu \dots (3)$$

or

$$\varepsilon - T_1 \eta + p_2 v = \varepsilon' - T_1 \eta' + p_2' v' = M\mu. \quad (3')$$

The validity of the relations (2) and (3) may be established by means of BOLTZMANN'S equation modified by VAN DER WAALS

$$\frac{1}{v-b} = \frac{1}{v'-b} e^{-\frac{M \int (Xdx + Ydy + Zdz)}{MRT}},$$

in which  $M \int (Xdx + Ydy + Zdz)$  represents the work done on the molecular quantity on transition from a layer with density  $\frac{1}{v}$  to a layer with density  $\frac{1}{v'}$ .

When in a point of the capillary layer at  $h$  the energy with omission of the constant amounts to

$$- aQ - \frac{c_2}{2} \frac{d^2 Q}{dh^2} - \frac{c_4}{4!} \frac{d^4 Q}{dh^4}$$

the molecular pressure in this point in the direction of the layer can be represented by  $-Q\varepsilon = aQ^3 + \frac{c_2}{2} Q \frac{d^2 Q}{dh^2} + \frac{c_4}{4!} Q \frac{d^4 Q}{dh^4}$ . As

$$p_2 + aQ^3 + \frac{c_2}{2} Q \frac{d^2 Q}{dh^2} (\text{enz.}) = p + aQ^3,$$

in which  $p$  represents the pressure belonging to the homogeneous phase of the density  $Q$ , we have

$$p - p_2 = \frac{c_2}{2} Q \frac{d^2 Q}{dh^2}.$$

If we substitute  $p_2$  from this relation in (3), the latter passes into:

$$- aQ - \frac{c_2}{2} \frac{d^2 Q}{dh^2} - MRT \log(v-b) + pv = \mu M.$$

This equation, which we have derived by the aid of kinetic considerations, is the condition of equilibrium, at which Prof. VAN DER WAALS arrives in his "Thermodynamical theory of capillarity".

Following in Prof. VAN DER WAALS'S steps, Dr. A. VAN ELDIK has given a thermodynamic theory of the capillarity for a mixture of two substances. By applying that the total free energy must be a minimum for all variations of  $Q$  and  $x$ , which satisfy  $\int Qx dh = \text{constant}$  and  $\int Q(1-x) dh = \text{constant}$ , he found for the variation with respect to  $Q$

$$f(\varrho, x) + \varrho \frac{\partial f}{\partial \varrho} - u_1 M_1 (1-x) - u_2 M_2 x - c_{11} (1-x) \frac{d^2 \varrho (1-x)}{dh^2} - c_{12} (1-x) \frac{d^2 \varrho x}{dh^2} - c_{12} x \frac{d^2 \varrho (1-x)}{dh^2} - c_{22} x \frac{d^2 \varrho x}{dh^2} = 0.$$

In this  $f(\varrho, x)$  is the free energy of a homogeneous phase with the  $x$  and  $\varrho$  existing in  $h$ , and hence

$$-MRT \log(v - b_x) - \frac{a_x}{v} + MRT \{(1-x) \log(1-x) + x \log x\},$$

$$\varrho \frac{\partial f}{\partial \varrho} = pv.$$

The energy for  $M_1$  grams of the first component amounts to

$$\varepsilon_1 = C_1 - a_{11} \varrho (1-x) - a_{12} \varrho x - \frac{1}{2} c_{11} \frac{d^2 \varrho (1-x)}{dh^2} - \frac{1}{2} c_{12} \frac{d^2 \varrho x}{dh^2}$$

and for  $M_2$  grams of the second component:

$$\varepsilon_2 = C_2 - a_{12} \varrho (1-x) - a_{22} \varrho x - \frac{1}{2} c_{12} \frac{d^2 \varrho (1-x)}{dh^2} - \frac{1}{2} c_{22} \frac{d^2 \varrho x}{dh^2}.$$

We get therefore for our equations (1) for the first component:

$$\begin{aligned} & \frac{1}{2} m_1 N u_{1_n}^2 + \frac{{}_1\tau_2}{\varrho(1-x)} - a_{11} \varrho (1-x) - a_{12} \varrho x - \frac{1}{2} c_{11} \frac{d^2 \varrho (1-x)}{dh^2} - \frac{1}{2} c_{12} \frac{d^2 \varrho x}{dh^2} = \\ & = \frac{1}{2} m_1 N u'_{1_n}{}^2 + \frac{{}_1\tau'_2}{\varrho'(1-x')} - a_{11} \varrho' (1-x') - a_{12} \varrho' x' - \frac{1}{2} c_{11} \frac{d^2 \varrho' (1-x')}{dh^2} - \frac{1}{2} c_{12} \frac{d^2 \varrho' x'}{dh^2}. \quad (1) \end{aligned}$$

and for the other component:

$$\begin{aligned} & \frac{1}{2} m_2 N u_{2_n}^2 + \frac{{}_2\tau_2}{\varrho x} - a_{12} \varrho (1-x) - a_{22} \varrho x - \frac{1}{2} c_{12} \frac{d^2 \varrho (1-x)}{dh^2} - \frac{1}{2} c_{22} \frac{d^2 \varrho x}{dh^2} = \\ & = \frac{1}{2} m_2 N u'_{2_n}{}^2 + \frac{{}_2\tau'_2}{\varrho' x'} - a_{12} \varrho' (1-x') - a_{22} \varrho' x' - \frac{1}{2} c_{12} \frac{d^2 \varrho' (1-x')}{dh^2} - \frac{1}{2} c_{22} \frac{d^2 \varrho' x'}{dh^2}. \quad (1_2) \end{aligned}$$

In this  $\tau$  represents the *partial* pressure so that in the homogeneous phase  ${}_1\tau$  is the partial pressure for the first component, and  ${}_2\tau$  the partial pressure for the second component.  ${}_1\tau + {}_2\tau = p$ . In the direction of the capillary layer these partial pressures are represented by  ${}_1\tau_2$  and  ${}_2\tau_2$ , so that  ${}_1\tau_2 + {}_2\tau_2 = p_2$ .

The expression  $\frac{{}_1\tau_2}{\varrho(1-x)}$  or  $\frac{{}_1\tau_2 v}{1-x}$ , therefore, represents the work done on a quantity  $M_1$  of grams of the first component when it leaves the phase. The phase being composed of  $M_1(1-x) + M_2 x$  grams in a volume  $v$ ,  $M_1$  grams of the first component will occupy a volume  $\frac{v}{1-x}$ .

The equations (2) which express that for each of the components a group of particles from one phase is replaced by a group of particles from another phase, become for the first component:

$$\frac{1-x}{v-b_x} u_{1_n} du_{1_n} e^{-\frac{\frac{1}{2}m_1 N u_{1_n}^2}{\frac{1}{2}m_2 N \alpha_1^2}} = \frac{1-x'}{v'-b_{x'}} u'_{1_n} du'_{1_n} e^{-\frac{\frac{1}{2}m_1 N u'_{1_n}^2}{\frac{1}{2}m_1 N \alpha_1^2}} \quad (2_1)$$

and for the second component:

$$\frac{x}{v-b_x} u_{2_n} du_{2_n} e^{-\frac{\frac{1}{2}m_2 N u_{2_n}^2}{\frac{1}{2}m_2 N \alpha_2^2}} = \frac{x'}{v'-b_{x'}} u'_{2_n} du'_{2_n} e^{-\frac{\frac{1}{2}m_2 N u'_{2_n}^2}{\frac{1}{2}m_2 N \alpha_2^2}} \quad (2_2)$$

Taking into consideration that  $u_{1_n} du_{1_n} = u'_{1_n} du'_{1_n}$  and  $u_{2_n} du_{2_n} = u'_{2_n} du'_{2_n}$ , and that  $\frac{1}{2} m_1 N \alpha_1^2 = \frac{1}{2} m_2 N \alpha_2^2 = MRT$ , we may write for (2<sub>1</sub>) and (2<sub>2</sub>):

$$\log \left( \frac{v'-b_{x'}}{v-b_x} \cdot \frac{1-x}{1-x'} \right) = \frac{\frac{1}{2}m_1 N u_{1_n}^2 - \frac{1}{2}m_1 N u'_{1_n}^2}{MRT}$$

and

$$\log \left( \frac{v'-b_{x'}}{v-b_x} \cdot \frac{x}{x'} \right) = \frac{\frac{1}{2}m_2 N u_{2_n}^2 - \frac{1}{2}m_2 N u'_{2_n}^2}{MRT}$$

from which then follows for the first component in connection with (1<sub>1</sub>) and (1<sub>2</sub>)

$$\left. \begin{aligned} & -MRT \log \frac{v-b_x}{1-x} + \frac{{}_1\pi_2}{\varrho(1-x)} - a_{11}\varrho(1-x) - a_{12}\varrho x - \frac{1}{2}c_{11} \frac{d^2\varrho(1-x)}{dh^2} - \\ & - \frac{1}{2}c_{12} \frac{d^2\varrho x}{dh^2} = -MRT \log \frac{v'-b_{x'}}{1-x'} + \frac{{}_1\pi'_2}{\varrho'(1-x')} - a_{11}\varrho'(1-x') - a_{12}\varrho'x' - \\ & - \frac{1}{2}c_{11} \frac{d^2\varrho'(1-x')}{dh^2} - \frac{1}{2}c_{12} \frac{d^2\varrho'x'}{dh^2} = \varepsilon_1 - T\eta_1 + \frac{{}_1\pi_2}{1-x} = \mu_1 M_1 \end{aligned} \right\} \quad (3_1)$$

and for the second component:

$$\left. \begin{aligned} & -MRT \log \frac{v-b_x}{x} + \frac{{}_2\pi_2}{\varrho x} - a_{12}\varrho(1-x) - a_{22}\varrho x - \frac{1}{2}c_{12} \frac{d^2\varrho(1-x)}{dh^2} - \\ & - \frac{1}{2}c_{22} \frac{d^2\varrho x}{dh^2} = -MRT \log \frac{v'-b_{x'}}{x'} + \frac{{}_2\pi'_2}{\varrho'x'} - a_{12}\varrho'(1-x') - a_{22}\varrho'x' - \\ & - \frac{1}{2}c_{12} \frac{d^2\varrho'(1-x')}{dh^2} - \frac{1}{2}c_{22} \frac{d^2\varrho'x'}{dh^2} = \varepsilon_2 - T\eta_2 + \frac{{}_2\pi_2}{x} = \mu_2 M_2 \end{aligned} \right\} \quad (3_2)$$

The expressions:

$$\varepsilon_1 - T\eta_1 + \frac{{}_1\pi_2}{1-x} = \mu_1 M_1 \quad \text{and} \quad \varepsilon_2 - T\eta_2 + \frac{{}_2\pi_2}{x} = \mu_2 M_2$$

have a constant value throughout the vessel. For every component they give us the thermodynamic potential in its kinetical signification.

When we now write the value of  $\mu_1 M_1(1-x) + \mu_2 M_2 x$ , we find for it, at the height of  $h$  with density  $\rho$  and concentration  $x$

$$\begin{aligned} & -MRT \log(v-b_x) + MRT \{(1-x) \log(1-x) + x \log x\} + p_2 v - a_x \rho - \\ & - \frac{1}{2} c_{11} (1-x) \frac{d^2 \rho (1-x)}{dh^2} - \frac{1}{2} c_{12} (1-x) \frac{d^2 \rho x}{dh^2} - \frac{1}{2} c_{12} x \frac{d^2 \rho (1-x)}{dh^2} - \\ & - \frac{1}{2} c_{22} x \frac{d^2 \rho x}{dh^2} = \mu_1 M_1 (1-x) + \mu_2 M_2 x; \end{aligned}$$

for

$$\frac{1^{\tau_2}}{\rho} + \frac{2^{\tau_2}}{\rho} = p_2 v.$$

The pressure  $p_2$  can be expelled from this relation when we consider that  $p_2 + \mathcal{M}_2$  (molecular pressure in the direction of the capillary layer)  $= p + a_x \rho^2$ , in which  $p$  represents the pressure belonging to an homogeneous phase of the same density and concentration. In general  $\mathcal{M}_2 = -\rho \{\epsilon_x - C_1(1-x) - C_2 x\}$  holds, in which  $\epsilon_x = \epsilon_1(1-x) + \epsilon_2 x$ , hence the energy for the quantity of the mixture  $M_1(1-x) + M_2 x$ . Now:

$$\begin{aligned} \epsilon_x = C_1(1-x) + C_2 x - a_x \rho - \frac{1}{2} c_{12} (1-x) \frac{d^2 \rho (1-x)}{dh^2} - \\ - \frac{1}{2} c_{12} (1-x) \frac{d^2 \rho x}{dh^2} - \frac{1}{2} c_{12} x \frac{d^2 \rho (1-x)}{dh^2} - \frac{1}{2} c_{22} x \frac{d^2 \rho x}{dh^2}. \end{aligned}$$

hence:

$$p - p_2 = \frac{1}{2} c_{11} (1-x) \frac{d^2 \rho (1-x)}{dh^2} + \frac{1}{2} c_{12} (1-x) \frac{d^2 \rho x}{dh^2} + \frac{1}{2} c_{12} x \frac{d^2 \rho (1-x)}{dh^2} + \frac{1}{2} c_{22} x \frac{d^2 \rho x}{dh^2}$$

If this value of  $p_2$  is introduced, the found relation passes into

$$\begin{aligned} & -MRT \log(v-b_x) + MRT \{(1-x) \log(1-x) + x \log x\} + p v - a_x \rho - \\ & - c_{11} (1-x) \frac{d^2 \rho (1-x)}{dh^2} - c_{12} (1-x) \frac{d^2 \rho x}{dh^2} - c_{12} x \frac{d^2 \rho (1-x)}{dh^2} - c_{22} x \frac{d^2 \rho x}{dh^2} = \\ & = \mu_1 M_1 (1-x) + \mu_2 M_2 x. \end{aligned}$$

This relation, which we have derived by means of kinetic considerations only, is the first of the two conditions for the equilibrium determined by VAN ELDIK by a thermodynamic way.

For the two homogeneous phases, which are in equilibrium with each other, the following form holds:

$$-MRT \log(v-b_x) + MRT \{(1-x) \log(1-x) + x \log x\} + p v - a_x \rho = \mu_1 M_1 (1-x) + \mu_2 M_2 x$$

or

$$\psi + p v = \mu_1 M_1 (1-x) + \mu_2 M_2 x.$$

As the kinetic theory teaches that the pressure in the two phases must be constant, it follows immediately from this that:

$$\psi - \frac{\mu_1 M_1 (1-x) + \mu_2 M_2 x}{v} = -p_1.$$

**Chemistry.** — “*On the behaviour of gels towards liquids and the vapours thereof.*” II. By Dr. L. K. WOLFF and Dr. E. H. BÜCHNER. (Communicated by Prof. A. F. HOLLEMAN).

(Communicated in the meeting of April 24, 1914).

In continuing the experiments mentioned in our first communication about this subject<sup>1)</sup>, we hit upon two observations which have given us the key to the solution of the problem. Firstly it was found that, when leading saturated water vapour over gelatine which at the same temperature had swollen in water, the weight of the gelatine does not change; secondly it appeared that the amount of decrease with the experiments made in the previously described way — in desiccators according to VAN BEMMELEN — depended upon the size of the desiccator, and besides that in this way of experimenting pure water also lost in weight. These things found, we came to the following conception of VON SCHROEDER's phenomenon:

1. the state attained in water vapour is *no* equilibrium; even though the quantity of water absorbed does not visibly increase for days and days, one must suppose an extremely slow absorption still to be taking place, at least if the experiment is made in the exact way which will be presently described. However, it may be several years, before the true equilibrium is reached, which in liquid water appears within some days. So the so called vapourequilibrium is only a “false equilibrium”.

2. the curve which indicates the connection between the water content and the vapour-tension, runs almost horizontally as soon as the point which represents the vapour equilibrium, is passed; the tension being taken as ordinate, the concentration as abscissa.

3. The observation formerly advanced by VON SCHROEDER, BANCROFT, and also by us against the hypothesis mentioned under 1, viz. that the watercontent of gelatine swollen in the liquid, decreased again in vapour, (from which was concluded that the “equilibrium” was attained from two sides), is founded on an unsatisfactory way of experimenting. This conception seems to give a satisfactory explanation of the whole of the phenomena; we can support it by a great number of experiments.

We shall now first of all treat the proof of the third thesis. As

<sup>1)</sup> These Proc. 15, 1078 (1912/13).

We doubted about the exactness of the method with desiccators, we made experiments in another way. We let a piece of gelatine swell under water until the equilibrium was attained, put it into a U-tube with ground stopcocks, hung this tube in a thermostat, and sucked a stream of air saturated with watervapour through it. In order to fully saturate the air with watervapour, we let it pass in extremely fine bubbles through four tubes of water which were also hanging in the thermostat. We made sure of the vapour really being saturated by placing a U-tube filled with water before the U-tube with gelatine, and by also weighing the former before and after the air had been led through.

T A B L E I.

Time	Weight of U-tube + water	Weight of U-tube + gelatine	
	30.130	30.779	
24 hours	30.127	30.781	Temp. 19°.0
26 "	30.126	30.779	(in thermostat)
18 "	30.123	30.778	
72 "	30.117	30.780	

It will be seen, that the gelatine, contrary to our former experiments, showed no decrease of weight: it was in equilibrium and it remained so, and there was not the slightest abnormality. Now which method, the old or the new one, is more reliable? The answer cannot be dubious, for we succeeded in improving the old method to such an extent that it gives the same results as the new one.

Formerly we used to place little dishes of gelatine in a SCHEIBLER-desiccator, at the bottom of which was some water, and which stood in a room of a fairly constant temperature. In order to exclude the possibility that the water from the gelatine, under the influence of gravity, should distill to the water at the bottom, we have now, instead of pouring the water into the desiccator, placed a dish of water at the same level as that with gelatine. And, thinking of FOOTE's experiments mentioned in our first communication, we also weighed this dish, expecting, of course, that the water lost by the gelatine, should be found back here. However it appeared that both gelatine and water equally decreased in weight; (it is to be noticed that the desiccator was not evacuated).

TABLE II.

Time	Weight of dish + water	decrease	Weight of dish + gelatine	decrease	
	47.458		48.391		temp. 22° (room).
24 hours	47.238	.220	48.209	.182	
24 "	47.031	.207	48.009	.200	
24 "	46.868	.163	47.863	.146	
48 "	46.567	.301	47.525	.338	

2<sup>nd</sup> experiment (three dishes of water).

time	weight n <sup>o</sup> 1	decrease	weight n <sup>o</sup> 2	decrease	weight n <sup>o</sup> 3	decrease	
	81.129		64.399		45.888		temp. 22° (room).
24 hours	80.868	.261	64.041	.358	45.591	.297	
24 "	80.601	.267	63.709	.332	45.291	.300	

We see from this that, in taking the experiment in this way, a dish of water decreases in weight 200 to 300 mG. in 24 hours, and that consequently the experiments thus made with gelatine, do not prove anything whatever.

It is not quite easy to say where this water goes to. It might be thought that it serves to saturate the whole space of the desiccator with vapour; but for this a much smaller quantity suffices, 1 L. saturated watervapour of 22° only weighing 19 mG. Nor are differences of temperature probable, because the changes we have found always go in one direction, and because we cannot think why the water in the middle of the desiccator should always be warmer than the walls thereof. Besides the temperature in the room was rather high<sup>1)</sup>, only varying within 0.5°, and so the dishes, after being weighed, would sooner enter colder than warmer. It was also controlled if a loss of weight occurred during the weighing and the preparations for it; by working quickly however, this loss could easily be kept under 1 mG. The only explanations left are, either the watervapour diffuses to the outside, passing through the layer of grease which is between the desiccator and the lid, or water is adsorbed at the great glass surface of the desiccator. The latter explanation will be most probable, as in smaller

<sup>1)</sup> Except in two series of table III, where the differences are equally great all the same.



T A B L E III.  
Small desiccator of FRESSENIUS; temp. room 22°.

Time	weight dish 1 + water	decrease	weight dish 2 + water	decrease	
	33.798		21.409		
48 hours	33.745	.053	21.382	0.027	Volume of the desiccator: 700 c.c.
48 "	33.722	.023	21.360	.022	
	dish 3 + gelatine		dish 4 + water		
	31.584		27.566		
24 hours	31.573	.011	27.545	.021	
24 "	31.561	.012	27.527	.018	
24 "	31.549	.012	27.510	.017	
120 "	31.505	.044	27.471	.039	
	water		water		
	31.621		27.834		
24 hours	31.605	.016	27.819	.015	temp. room 14°
24 "	31.585	.020	27.800	.019	
48 "	31.565	.020	27.777	.023	
	gelatine				
	27.764		27.777		
72 hours	27.741	.023	27.759	.018	temp. room 16°5
48 "	27.724	.017	27.739	.020	

Bell-jar in pail; temp. room 22°.

Time	weight of weighing-bottle + gelatine	decrease	Time	weight of weighing-bottle + water	decrease
	36.116			40.407	
90 hours	36.052	.064	5 hours	40.411	(+.004)
30 "	36.026	.026	48 "	40.250	.161
18 "	36.009	.017	24 "	40.122	.128

desiccators — model FRESSENIUS — we found much smaller decreases, and as we also found a loss of weight when making the experiment differently. A glass bell-jar, in which was hanging a weighing-bottle with gelatine swollen in water, was partly placed in a pail of water, so that the gelatine remained some cm. above the water surface. There can here be no question of diffusion to the outside. Yet the adsorption hypothesis is not without its difficulties; for in taking the above mentioned experiments the desiccator or the belljar were first well rinsed out and moistened with water, so that one should think the glass surface to be entirely covered with a layer of water. Perhaps the two last mentioned causes of decrease of weight are cooperating.

Whatever may be the cause of decrease, we can distinctly see by this table that both water and swollen gelatine decrease. So if we wished to really confirm VON SCHROEDER's observation, we first ought to have an arrangement with which water only does not diminish in weight.

A series of experiments, undertaken in consequence of FOOTE's communication which has been mentioned before several times, will illustrate how hard it is to make exact observations by the statical method. In a glass tube were two small tubes filled with water above one another, which had been weighed before. The tube was closed with a rubberstopper or it was sealed in the flame, and then placed in a thermostat; after two days the tube was opened, and the little tubes were quickly put in weighing bottles, and were weighed.

T A B L E IV.

Time	weight lower tube	decrease	weight upper tube	decrease	
	22.098		24.000		
48 hours	22.090	.008	23.992	.008	temp. 18°.0
48 "	22.081	.009	23.980	.012	rubberstopper
2nd experiment.					
	22.060		23.923		
48 "	22.051	.009	23.918	.005	id. id.
3rd experiment.					
	10.108		36.289		
48 "	10.098	.010	36.244	.045	sealed

So we again found a decrease of weight in all cases, be it less than with the experiments made before. As the amounts are so much smaller here, another circumstance, except the one of adsorption at the glass walls, must be taken into consideration, which, as we have found with the apparatus presently to be described, can account for differences to an amount of some mG.<sup>1)</sup> The tubes were opened outside the thermostat; the outer walls then cooled down a few degrees, while the inner tubes remained a little warmer. In those few moments a small quantity of water could distill to the wall of the great tube, and this may be the cause of the loss of weight.

Now in order to exclude adsorption we have passed on to another arrangement. We had a cylindrical box made of brass (measures: diameter 7.5 cm., height 7.5 cm., volume 320 c.c.), which was closed by an exactly fitting brass lid that could be still more strongly fixed on by screws. Both the box and the lid were silvered at the inside. The apparatus was entirely plunged into a thermostat, kept constant within 0°.1. In this apparatus too we began with weighing-bottles, which only contained water; we again had to state a loss of weight. With these experiments the vessel was taken out of the thermostat, and was quickly unscrewed after which the weighing-bottles were taken out and weighed with their stoppers closed. When a closed weighing-bottle with water was placed in the vessel, the weight remained constant; when taking it out, some slight moisture was to be seen against the stopper. A refrigeration evidently took place here, by a colder stream of air entering when the lid was taken off. In order to avoid this as much as possible, we placed the apparatus rather high in the thermostat; when it had to be opened we made the water run out of the thermostat through a siphon, so far that the lid appeared just above the watersurface. Meanwhile the screws were unscrewed so that the lid could be taken off as soon as it was above the waterlevel; in this way the whole kept the same temperature until the very last moment. The then obtained results were satisfactory (cp. table V), and we therefore repeated our experiments with gelatine-water, agar-water, and celloidin-alcohol in this way.

From these experiments we learn that *gelatine, agar, and celloidin swollen in a liquid, do not undergo a loss of weight when placed in saturated vapour*, if the experiment is made rigorously. The results with the celloidin-alcohol system are not so good as with the others, it is true, but the decrease which reached an amount of 100—200

<sup>1)</sup> The greater difference in the upper tube of the 3rd experiment is evidently due to the heating during the sealing process.

T A B L E V.  
Temperature 19°.0; weighings every 24 hours.

	weight of weighing- bottle 1 + water	decrease	weight of weighing- bottle 2 + water	decrease
1st series	26.045		25.096	
water	26.033	.012	25.088	.008
vessel opened	26.025	.008	25.081	.007
outside the	26.012	.013	25.069	.012
thermostat				
2nd series	25.772		27.837	
water	25.768	.004	27.834	.003
vessel opened				
in the thermostat				
	weighing- bottle + gelatine			
	20.136			
3rd series	20.135	.001		
gelatine	20.135	0		
	20.135	0		
	20.133	.002		
			The gelatine had been swelling for a fortnight in water at a temperature of 19°.0, and had been dried with filter paper before the experiment.	
			(after 3 × 24 hours).	
	Temperature 21°.4.			
	24.575			
4th series	24.580	(+ .005)		
agar	24.582	(+ .002)		
	24.581	.001		
			The agar had been swelling for 8 days under water at the same temperature, and had been dried as said above.	
	Temperature 21°.4.			

	No. 1		No. 2		No. 3		No. 4		
5th series	12.202		12.122		12.389		11.310		
celloïdin-	12.200	.002	12.108	.014	12.379	.010	11.304	.006	after
alcohol			12.095	.013	12.370	.009	11.301	.003	42 hours
									74 "
	Temperature 0°.								
	12.248		12.115		12.397				
6th series	12.255	(+ .007)	12.113	.002	12.399	(+ .002)			after 61 hours
celloïdin	12.249	.006	12.109	.004	12.396	.003		" 30 "	
	12.249	0	12.109	0	12.395	.001		" 24 "	

mG. with the old method, has been reduced to some mG. only; we must herewith remember that the vapour tension of alcohol is considerably greater than that of water. Therefore the 6<sup>th</sup> series of experiments was undertaken at 0°; according to our expectations the results were better than at 21.4°.

The experiments communicated here have taken away every actual ground of existence from the opinion expressed first by VOX SCHROEDER, viz. that here was a conflict with the second law of thermodynamics; the second law, as one might think, remains untouched. Of course the phenomenon of several substances swelling more in liquids than in vapours, remains; but we think this can be sufficiently explained by assuming that the absorption in vapour occurs extremely slowly in the end. We have also investigated if not totally swollen gelatine and celloidin placed in vapour, would absorb more water in our new apparatus, and would come to the real equilibrium. This appeared not to be the case; e.g. with gelatine of the following compositions: 1 gelatine to 26 parts of water (in weight); 1:24,2; 1:18,8; 1:15,8; 1:6,5, (the "false vapourequilibrium" is about 1:0.7) no change of weight was found for five days<sup>1)</sup>. So it goes without saying that the absorption takes place exceedingly slowly.

This is most probably connected with the fact that the vapour tension of gelatine (and numerous other substances) is already very near to that of pure water when they have only absorbed a rather small quantity of water<sup>2)</sup>; consequently all the further water absorption of any importance is only of slight influence upon the vapour tension. Or in other terms, the difference of the vapour tension of pure water and of gelatine in "vapourequilibrium" is very small, and consequently the absorption velocity will also be very small. That it is yet very great in liquid water, may be easily explained from the density which is 50000 times greater.

We just wish to state that the determinations meant here have all been obtained by the statical method, the deficiency of which we have proved; a true opinion can only be possible if the experiments are taken along the dynamical way<sup>3)</sup>, and if the real equilibrium has been proved by placing the jellies alternately in vapour of higher and lower tension. The values given for the composition of the substances swollen in the vapour of pure water are never true

---

<sup>1)</sup> These experiments were also made in the dynamical method with U-tubes, yielding the same result.

<sup>2)</sup> KATZ, these Proc. **13**, 958 (1910 11).

<sup>3)</sup> Or in the apparatus described above.

equilibria; one ought to state the value which is attained in liquid water<sup>1</sup>).

The explanation of the phenomenon becomes somewhat different, if we do not let the gelatine (celloidin) swell in pure water (alcohol) but in solutions. In case of the dissolved substance being volatile (example: celloidin-alcohol-water), the circumstances are exactly the same as above mentioned; but, if the substance is e.g. a salt, the thing changes. VON SCHROEDER has made some experiments about this question, and he ascertains that  $\frac{1}{1,000,000}$ -norm. sulphate solution already lowers the vapour-tension of gelatine so much, that there is not even a decrease in vapour, but an increase. After the results described above, VON SCHROEDER's argument loses all weight, and his result is sure to be due to chance.

It is a fact we have repeatedly observed, that gelatine (celloidin) which had swollen in the vapour of a salt solution (NaCl in water, resp. HgCl<sub>2</sub> in alcohol) absorbs much more still, when brought into the liquid; 1 Gr. celloidin e.g. gains 1,77 Gr. in weight in a solution of 4% sublimate in alcohol of 96%, whereas only 0.89 Gr. is absorbed in the vapour of alcohol, and consequently still less in the vapour of a solution in alcohol. The difference between the swelling in a pure liquid and in a solution finds its cause in a substance, when in the vapour of a solution, never being able to absorb anything but the solvent, as long as the dissolved substance is not volatile; when placed in the liquid itself, it also absorbs the dissolved substance.

This is a wellknown fact about gelatine; we have ascertained by the experiments with celloidin mentioned above, that this substance too had not only absorbed alcohol, but also sublimate. So in *these* cases it is clear for other reasons, that a substance swollen in vapour, when brought into the liquid phase, must still absorb more, and that the state attained in vapour is not a true equilibrium<sup>2</sup>). In vapour e.g. celloidin passes into celloidin + alcohol, until the vapour-tension of this phase has become equal to that of the liquid phase: alcohol + HgCl<sub>2</sub>. Now if one brings the celloidin phase under the liquid, the HgCl<sub>2</sub> diffuses into the celloidin; diminishes so to say the vapour-tension of the alcohol which is contained therein, and consequently a further absorption of alcohol must take place. If we

<sup>1</sup>) Strictly speaking one must not speak of pure water, but of a saturated solution of gelatine, agar etc. in water; of course, the difference really is exceedingly minute.

<sup>2</sup>) Cf. TOLMAN's views, J. Amer. Chem. Soc. **35**, 307 (1913). We have assumed with TOLMAN that every substance evaporates somewhat, no matter how little; if one objects to this, one must speak of an equilibrium which lies differently in consequence of passive resistances (GIBBS).

represent this by a figure, we obtain in the vapour a state  $a$ ; and after this the state  $b$  is reached in the liquid along an exactly horizontal line, for the vapour-tension remains absolutely the same; only the composition of the celloidin changes.  $a$  lies of course at a lower pressure than  $a'$  in the figure, which stands for pure alcohol; in the latter  $a'b'$  is only approximately horizontal.

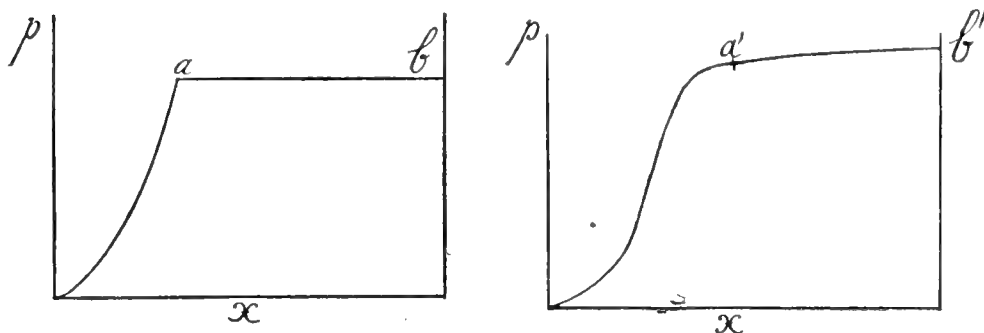

It is evident that in this case the greater absorption in the liquid must be connected with the solubility of the salt in the gelatine or celloidin. According to the colloid absorbing more salt, the difference between the vapour and the liquid equilibrium will be all the greater. We believe a closer study of this subject may probably bear fruit with a view to the knowledge of the behaviour of jellies in different solutions. We intend to start experiments about this with celloidin, which, as to stability, has great advantages over gelatine with which suchlike experiments have been made up to the present<sup>1)</sup>. We do not consider skinpowder an ideal substance for this purpose either<sup>2)</sup>.

As a summary we think, we can say that the pretended conflict with the second law of thermodynamics has been put an end to, and that VON SCHROEDER'S phenomenon in the principal case is due to a slowly coming equilibrium; one may expect it in all cases where the vapour-tension already approaches the tension of the pure liquid very nearly, a long time before the equilibrium has been attained. If the liquid absorbed is a solution of a nonvolatile substance, another explanation must be given.

*Path. Anat. and Inorg. Chem. Lab.  
 University of Amsterdam.*

<sup>1)</sup> HOFMEISTER, among others.

<sup>2)</sup> HERZOG and ADLER, *Koll. Zeitschr.* 2, Supplem. heft 2, (1908).

**Mathematics.** -- "The quadruple involution of the cotangential points of a cubic pencil." By Professor JAN DE VRIES.

(Communicated in the meeting of April 24, 1914).

1. We consider a pencil of cubics ( $q^3$ ), with the nine base-points  $B_k$ . On the curve  $q^3$ , passing through an arbitrary point  $P$ , lie three points  $P', P'', P'''$ , which have the *tangential point*<sup>1)</sup> in common with  $P$ ; in this way the points of the plane may be arranged in quadruples of an *involution* ( $P^1$ ) of *cotangential points*. We shall suppose, that the pencil is general, consequently contains *twelve* curves with a node  $D_h$ . On such a curve  $d^3$  all the groups of the ( $P^1$ ) consist of two cotangential points and the point  $D$ , which must be counted twice. Apparently the 12 points  $D$  are the only *coincidences* of the involution; as the connector of the neighbouring points of  $D$  is quite indefinite, the coincidences have no definite support. The points  $D_h$  are at the same time to be considered as *singular points*; to each of them an involution of pairs  $P, P'$  is associated, lying on the curve  $d_h^3$ , which has  $D_h$  as node.

2. The nine base-points  $B_k$  are also *singular*; to each point  $B_k$  a triple involution of points  $P', P'', P'''$  is associated, lying on a curve  $\beta_k$ , of which we are going to determine the order.

To each curve  $q^3$  we associate the line  $b$ , which touches it in  $B$ ; in consequence of which a projectivity arises between the pencil of rays ( $b$ ) and the cubic pencil ( $q^3$ ). The curve  $\tau^1$  produced is the locus of the tangential points of  $B$  (*tangential curve* of  $B$ ).

The line  $b$ , which touches a  $q^3$  in  $B$ , cuts it moreover in the tangential point of  $B$ ; this is apparently the only point that  $b$  has in common with  $\tau^1$  apart from  $B$ . So  $\tau^1$  has a *triple point* in  $B$ ; there are three lines  $b$ , which have in  $B$  three points in common with the corresponding curve  $q^3$ ; i. e.  $B$  is *point of inflection* of three curves  $q^3$ .

Let us now consider the tangential curves  $\tau^1_1$  and  $\tau^1_2$ , belonging to  $B_1$  and  $B_2$ . Both pass through the remaining seven base-points, consequently have apart from the points  $B$ , three points in common; so there are three curves  $q^3$ , on which  $B_1$  and  $B_2$  have the same tangential point. Hence it ensues that the singular curve  $\beta_1$  belonging to  $B_1$ , has triple points in each of the remaining eight points  $B$ ; it does not pass through  $B_1$  because ( $P^1$ ) has coincidences in  $D_h$ .

1) The *tangential point* of  $P$  is the intersection of  $\varphi^3$  with the straight line touching it in  $P$ .



only. With an arbitrary  $q^3$ ,  $\beta_1$  has moreover in common the three points which form a quadruple with  $B_1$ ; consequently 27 points in all. So the triplets of  $(P')$  belonging to  $B_1$  lie on a curve of order nine, which passes three times through each of the remaining base-points.

We found that  $B_1$  and  $B_2$  belong to three quadruples; the three pairs, which those quadruples contain besides, belong to the singular curves  $\beta_1^3$  and  $\beta_2^3$ . They have moreover in the seven remaining points  $B_k$ , 63 points in common; the remaining 12 common points are found in the singular points  $D_h$ .

3. The locus of the points of inflection  $I$  of  $(q^3)$  has triple points in  $B_k$ , has therefore with an arbitrary  $q^3$ ,  $9 \times 3 + 9 = 36$  points in common; it is consequently a curve of order twelve,  $\iota^{12}$ . On a curve  $\sigma^3$  lie only 3 points of inflection; we conclude from this, that  $\iota^{12}$  has nodes in the twelve points  $D_h$ ; in each of those points  $\iota^{12}$  and  $\sigma^3$  have the same tangents.

The points  $P'$ ,  $P''$ ,  $P'''$ , which have  $I$  as tangential point, lie in a straight line, the harmonic polar line  $h$  of  $I$ . So  $\iota^{12}$  is the locus of the points, which in  $(P^3)$  are associated to linear triplets.

The curves  $\beta_1^3$  and  $\iota^{12}$  have in the singular points  $B$  and  $D$   $8 \times 3^2 + 12 \times 2 = 96$  points in common; on  $\beta_1^3$  lie therefore 12 points  $I$ , so that  $B_2$  belongs to 12 linear triplets. From this it ensues by the way, that the involution  $(P^3)$  lying on  $\beta_1^3$  has a curve of involution  $(p)$  of class twelve; for the line  $p = P'P''$  will only pass through  $B_1$  if  $P'''$  is a point of inflection, while  $P$  lies in  $B_1$ . As  $B_1$  is point of inflection of three  $q^3$ ,  $(P^3)$  has three linear triplets, consequently  $(p)_{12}$  three triple tangents.

The locus  $\lambda$  of the linear triplets has, as was shown, 9 dodecuple points  $B$ ; as  $q^3$  bears nine points of inflection, therefore 9 linear triplets, it has with  $\lambda$   $9 \times 12 + 9 \times 3 = 135$  points in common.

Consequently the linear triplets lie on a curve  $\lambda^{15}$ .

4. We shall now consider the curve  $q$ , into which a straight line  $r$  is transformed, if a point  $P$  of  $r$  is replaced by the points  $P'$ , which form a quadruple with  $P$ ; for the sake of brevity we shall speak of the transformation  $(P, P')$ . If we pay attention to the intersections of  $r$  with  $\beta_k^3$  and with  $\sigma_h^3$ , we arrive at the conclusion that  $q$  has nonuple points in  $B_k$  and triple points in  $D_h$ . It has therefore with a  $q^3$  in  $B_k$  81 points in common; further these curves cut moreover in the three triplets which correspond with the intersections of  $q^3$  and  $r$ . Consequently  $q$  is a curve of order thirty.

On an arbitrary straight line lie therefore *fifteen pairs of cotangential points*.

By the transformation  $(P, P')$ , the curve  $\lambda^{45}$ , which contains the linear triplets, is transformed into a figure of order 1350. It consists of twice  $\lambda$  itself, three times  $\iota^{12}$ , twelve times the curves  $\beta^9$  and seven times the singular curves  $\delta^3$ . For  $2 \times 45 + 3 \times 12 + 9 \times 12 \times 9 = 1098$ ; the points  $D$  produce therefore a figure of order 252. From this it ensues that  $\lambda^{45}$  has *septuple points* in the 12 singular points  $D$ .

The pairs  $P, P'$ , which are collinear with a point  $E$ , lie on a curve  $\epsilon^{33}$ , on which  $E$  is a triple point; the tangents in  $E$  go to the points of the triplet of the  $(P')$ , determined by  $E$ . The line  $EB_k$  cuts  $\beta_k^9$  in 9 points  $P$ , which form with  $B_k$  pairs of the  $(P)$ ; hence  $\epsilon^{33}$  has *nonuple points* in  $B_k$ .

The locus of the pairs  $P'', P'''$ , belonging to the pairs  $P, P'$  of  $\epsilon^{33}$ , we shall indicate by  $\epsilon_{\#}$ . As  $E$  is collinear with 12 pairs of the involution  $(P'')$  lying on  $\beta_1^9$ ,  $B_1$  is a *dodecuple point* of  $\epsilon_{\#}$ .

On an arbitrary  $q^3$  the cotangential points form three involutions of pairs and the supports of the pairs of each of those involutions envelop a curve of class three (curve of CAYLEY). Consequently  $E$  is collinear with 9 pairs  $P, P'$  of  $q^3$ , and this curve contains 9 pairs of  $\epsilon_{\#}$ . As the two curves in  $B_k$  have moreover  $9 \times 12$  points in common, consequently 126 points in all,  $\epsilon_{\#}$  is a *curve of order 42*.

The curves  $\epsilon^{33}$  and  $\beta_1^9$  have in the points  $B_k (k \neq 1) 8 \times 9 \times 3$  points in common; moreover they meet in 9 points of  $EB_1$  and in the 12 pairs  $P, P'$  mentioned above. The remaining 48 common points must lie in  $D_n$ ; so  $\epsilon^{33}$  has *quadruple points* in the 12 singular points  $D$ .

The curves  $\epsilon_{\#}^{42}$  and  $\beta_1^9$  have in  $B_k (k \neq 1) 8 \times 12 \times 3$  intersections; further they meet in the 9 pairs  $P'', P'''$ , belonging to the 9 points  $P'$  lying on  $EB_1$ , and in the 12 points  $P''$ , belonging to the 12 pairs  $P, P'$  of  $\beta_1^9$ , which are collinear with  $E$ . So they must have 60 intersections in  $D_n$ ;  $\epsilon_{\#}^{42}$  has consequently *quintuple points* in the 12 singular points  $D$ .

The curves  $\epsilon_{\#}^{42}$  and  $\iota^{12}$  have in  $B_k 9 \times 12 \times 3$ , in  $D_n 12 \times 5 \times 2$  intersections, together 444; the remaining 60 lie in points of inflection, of which the harmonic polar lines pass through  $E$ . In such a point of inflection  $I$ ,  $\epsilon_{\#}^{42}$  will have a *triple point*, for the corresponding polar line  $h$  contains a linear triplet, so three pairs of  $\epsilon^{33}$ , so that  $I$  appears three times as point of  $\epsilon_{\#}$ . Consequently  $E$  bears 20 straight lines  $h$ : the *harmonic polar lines of  $q^3$  envelop a curve of class twenty*.

**Mathematics.** — “A cubic involution of the second class.” By  
 PROF. JAN DE VRIES.

(Communicated in the meeting of April 24, 1914).

1. By the *class* of a cubic involution in the plane we shall understand the number of pairs of points on an arbitrary straight line<sup>1)</sup>. In a paper presented in the meeting of February 28<sup>th</sup>, 1914<sup>2)</sup> I considered the cubic involutions of the *first class*, and proved that they may be reduced to *six* principally differing sorts.

The triangles  $\Delta$ , which have the triplets of an involution of the first class as vertices, belong at the same time to a cubic involution of lines; the sides of each  $\Delta$  form one of its groups.

The cubic involutions of the *second class* possess the characteristic quality of determining an involution of pairs i. e. an involutive birational correspondence of points. For, let  $X, X', X''$  be a group of an involution ( $X^3$ ) of the second class; on the line  $X'X''$  lies another pair  $Y', Y''$ ; the point  $Y$ , completing this pair into a triplet, is apparently involutively associated to  $X$ . In the following sections I shall consider a definite ( $X^3$ ) of the second class and inquire into the associated involutive correspondence ( $XY$ ).

2. We start from a pencil of conics  $q^2$  with the base-points  $A, B_1, B_2, B_3$  and a pencil of cubics  $q^3$  with the base-points  $B_1, B_2, B_3, C_h$  ( $h = 1$  to 6). The curves  $q^2$  and  $q^3$ , which pass through an arbitrary point  $X$ , intersect moreover in two points  $X', X''$ , which we associate to  $X$ . As the involutions  $I^2$  and  $I^3$ , which are determined on a straight line by the pencils ( $q^2$ ) and ( $q^3$ ), have two pairs  $X', X''$  and  $Y', Y''$  in common, a cubic involution ( $X^3$ ) of the *second class* arises here.

The ten base-points are *singular points*, for they belong each to  $\infty^1$  groups; on the other hand is a singular point certainly a base-point of one of the pencils.

The pairs of points which with the singular point  $A$  determine triangles of involution  $\Delta$ , lie apparently on the curve  $a^3$  of the pencil ( $q^3$ ), passing through  $A$ . As they are produced by the pencil ( $q^2$ ), they form a central involution, i. e. the straight lines  $x \equiv X'X''$  pass through a point  $T$  of  $a^3$  (*opposite point* of the quadruple  $AB_1B_2B_3$ ).

Analogously the pairs  $X', X''$ , which are associated to  $C_h$ , lie on

<sup>1)</sup> This corresponds to the denomination introduced by CAVORALI for involutive birational transformations. (*Rend. Acc. Napoli*, 1879, p. 212).

<sup>2)</sup> “Cubic involutions in the plane”. These Proceedings vol. XVI, p. 974.

the conic  $\gamma_h^2$  passing through  $C_h$ , which conic belongs to  $(q^2)$ ; the straight lines  $x$  intersect in a point  $M_h$ , the centre of the  $I^2$ .

In order to find the locus of the pairs, corresponding to  $B_1$ , we associate to each  $q^3$  the  $q^2$ , which touches it in  $B_1$ . The pencils being projective on this account produce a *curve of order five*,  $\beta_1^5$ , which has a triple point in  $B_1$ , nodes in  $B_2, B_3$  and passes through  $A$  and  $C_h$ . If the straight line  $x = X'X''$  is associated to the straight line, which touches the corresponding curves  $q^3$  and  $q^2$  in  $B_1$ , a correspondence (1, 1) arises between the "curve of involution" enveloped by  $x$  and the pencil of rays  $B_1$ ; from this it ensues that  $(x)$  must be a rational curve. As no other lines  $x$  can pass through  $B_1$  but the tangents at  $\beta_1^5$  in the triple point  $B_1$ ,  $(x)$  is a *rational curve of the third class*, has consequently a bitangent; on it lie two pairs of  $(X^3)$ . To the tangents of  $(x)_3$  belong the lines  $AB_2$  and  $AB_3$ .

There are *three singular straight lines*  $b_k = AB_k$ ; each of them bears a  $I^2$  of pairs  $X', X''$ . The corresponding points  $X$  lie on the line  $b_{mn} = B_m B_n$ .

**3.** The *curve of coincidences* (locus of the points  $X \equiv X'$ ) has *triple points* in  $B_k$  and passes through  $A$  and  $C_h$ . With the singular curve  $\gamma_1^2$  it has 10 intersections in  $A$  and  $B_k$ ; as it touches it in  $C_1$  and at the same time contains the coincidences of the involution  $(X', X'')$  lying on  $\gamma_1^2$ , it is a curve of *order seven*<sup>1)</sup>, which will be indicated by  $\sigma^7$ . It passes through the 12 nodes of  $(\varphi^3)$  and the 3 points  $(b_k b_{lm})$ .

As  $\sigma^7$  has six points in common with  $q^3$ , apart from  $B_k$  and  $C_h$ , the involution  $I^3$  of the  $\Delta$  inscribed in  $q^3$  possesses *six coincidences*. In the same way it appears that the involutions  $I^2$  lying on  $a^3$  and  $\beta_k^5$  possess *four coincidences* each.

The supports of the coincidences envelop a curve  $(d)$  of *class eight*; for through  $A$  pass in the first place the lines  $b_k$ , each bearing two coincidences, and which consequently are bitangents of  $(d)$  and further the tangent in  $A$  at  $a^3$ , which will touch  $(d)$  in  $A$ .

**4.** To the points  $X$  of a straight line  $l$  correspond the pairs of points  $X'$  and  $X''$  of a curve  $\lambda$ , which has in common with  $l$  the two pairs of the  $(X^3)$  lying on  $l$ , besides the points of intersection of  $l$  and  $\sigma^7$ ; hence  $\lambda$  is a curve of *order eleven*. By paying attention to the intersections of  $l$  with the singular curves  $a^3$ ,  $\beta_k^5$ , and  $\gamma_h^2$ , we see that  $\lambda^{11}$  passes *three times* through  $A$ , *five times* through  $B_k$  and two times through  $C_h$ .

<sup>1)</sup> This corresponds to this well known proposition: the locus of the points where a curve  $\varphi^m$  of a pencil is touched by a curve  $\varphi^n$  of a second pencil is a curve of order  $2(m+n)-3$ .

On  $\lambda^1$ ,  $X'$  and  $X''$  form a pair of an involution; of the straight lines  $x = X'X''$  six pass through  $A$ . Three of them are indicated by the intersections  $X$  of  $l$  and  $\alpha^3$ ; here  $X'$  lies every time in  $A$ . The remaining three are the lines  $b_k$ ; for each of them contains a pair  $X', X''$  corresponding to the point  $X = (b_{mn})$ .

The curve  $(\nu)_6$  enveloped by  $x$  is rational, because we can associate  $x$  to  $X$ ; it has therefore *ten bitangents*. As such a bitangent bears two pairs  $X', X''$  and  $Y', Y''$  it follows that the *involution*  $(X, Y)$  contains ten pairs on  $l$ , and consequently is of the *tenth class*.

5. Let a straight line  $l$  be revolved round a point  $E$ ; the pairs  $X', X''$  and  $Y', Y''$  lying on it describe then a curve  $\varepsilon^6$ , which passes twice through  $E$  and is touched there by the straight lines  $EE'$  and  $EE''$ . On  $EA$  lie two points  $X'$  and  $Y'$ , each forming with  $E$  a pair of the  $(X^3)$ ; so  $A$  is a node of  $\varepsilon^6$ . For the same reason  $\varepsilon^6$  has nodes in  $B_k$ ; it also contains the points  $C_h$ . In consequence of the existence of 5 *nodes*,  $\varepsilon^6$  is of class 20, so that  $E$  lies on 16 of its tangents. Of these 8 contain each a coincidence of the  $(X^3)$ ; the remaining 8 are represented by *four bitangents*, being straight lines  $s$ , on which both pairs belonging to  $(X^3)$  have coincided. From this it ensues that the lines  $s$  envelop a curve  $(s)_4$  of the *fourth class*. Apparently the straight lines  $s$ , passing through  $A$ , are tangents to  $\alpha^3$ . In the same way the four tangents out of  $B_k$  to  $\beta k^5$  are the straight lines  $s$ , which may be drawn through  $B_k$ .

Apart from the singular points  $\varepsilon^6$  and  $\delta^7$  have 16 points in common; to them belong the 8 coincidences of which the supports  $d$  pass through  $E$ . The remaining 8 must be points  $X'$ , coinciding with the corresponding point  $X$  without  $d$ 's passing through  $E$ ; i.e. they belong to the locus  $\varepsilon_{**}^6$  of the points  $X$ , which complete the pairs lying on  $\varepsilon^6$  into groups of  $(X^3)$ .

As  $E$  lies on three of the straight lines  $x = X'X''$  belonging to  $B_k$ ,  $B_k$  is a *triple point* of  $\varepsilon_{**}^6$ ; analogously  $A$  and  $C_h$  are simple points of that curve, so that the latter has  $2 + 3 \times 2 \times 3 + 6 = 26$  intersections with  $\varepsilon^6$  in the singular points. Besides the 8 points of  $\delta^7$  indicated above they have moreover the points  $E', E''$  in common; so we conclude that  $\varepsilon_{**}^6$  must be a curve of the *sixth order*. To the intersections  $X$  of  $\varepsilon_{**}^6$  and  $l$  correspond lines  $x$ , which pass through  $E$ ; from this it ensues again that  $x$  envelops a curve of the sixth class, when  $X$  describes the straight line  $l$ .

6. If  $E$  is laid in  $C_1$ ,  $\varepsilon^6$  is replaced by the figure composed of the singular conic  $\gamma_1^2$  and a curve  $\gamma_1^4$ , which has a node in  $C_1$  and passes through the points  $A, B_k, C_h$ . The two curves have apart

from  $A$  and  $B_k$  two more points  $E', E''$  in common; the lines  $C_1 E', C_1 E''$  touch  $\gamma_1$  in  $C_1$  and are apparently the only possible lines  $s$  passing through  $C_1$ ; hence  $C_1$  is a *node* on the curve  $(s)_4$ .

The curve  $\varepsilon_{\#}^6$  belonging to  $C_1$  is represented by the figure composed of  $\gamma_1^2$  and a curve  $\approx \gamma_1^4$ , which has nodes in  $B_k$ . This may be found independently of what is mentioned above. The transformation replacing a point  $X$  by the corresponding points  $X', X''$ , transforms a straight line  $l$  into a curve  $\gamma^{11}$ , consequently the curve  $\gamma_1^4$  into a figure of order  $44$ . It consists of  $\gamma_1^4$  itself (for this curve bears  $\infty^1$  pairs  $X, X'$ ), twice  $\gamma_1^2$ , the curves  $\alpha^3, \beta_k^5 \gamma_k^2$  and twice the locus of  $X''$ ; the latter is therefore of order four.

If  $E$  is brought into the centre  $M_1$  of the  $I^2$  lying on  $\gamma_1^2$ ,  $\varepsilon^6$  passes into  $\gamma_1^2$  and a curve  $\mu_1^4$  with node  $M_1$ . Of the latter 6 tangents pass through  $M_1$ , whereas this point lies on 2 tangents of  $\gamma_1^2$ ; from this it ensues anew that the lines  $d$  envelop a curve of the *eighth class*. As  $\gamma_1^2$  apart from  $A$  and  $B_k$  has with  $\mu_1^4$  four points in common, which must form two pairs of the  $I^2$ , and so determine two lines  $s$ ,  $M_1$  too is a *node* of the curve  $(s)_4$ .

If  $E$  lies in  $A$ ,  $\varepsilon^6$  consists apparently of  $\alpha^3$ , and the three lines  $b_k$ ; whereas  $\varepsilon_{\#}^6$  is the figure composed of an  $\alpha^3$  and the three lines  $b_{mn}$ . For  $E$  in  $T$   $\varepsilon^6$  is replaced by the figure formed by  $\alpha^3$  and a curve  $\tau^3$ , also passing through  $T$  and having with  $\alpha^3$  besides the four points  $A, B_k$  two more pairs collinear with  $T$ ; consequently  $T$  is also a *node* of  $(s)_4$ .

For  $B_k$   $\varepsilon^6$  consists of  $\beta_k^5$  and the line  $B_k A$ ;  $\varepsilon_{\#}^6$  of  $\beta_k^5$  and  $B_m B_n$ .

**7.** Passing on to the consideration of the involutive correspondence  $(X, Y)$  we cause  $X$  to describe the straight line  $l$ , and we try to find the locus of the corresponding points  $Y$ . On each line  $X' X''$  lies a second pair  $Y', Y''$ ; the curves  $q^2$  and  $q^3$ , which intersect in the points  $Y', Y''$  we shall associate to each other. In order to determine the characteristic numbers of this correspondence, we consider the involutions  $I^3$ , which are formed on a curve  $q^2$  or  $q^3$  by groups of  $(X^3)$ .

The sides of the  $\Delta$  described in a  $q^2$  envelop a conic; among the 12 tangents, which this curve has in common with the curve of involution  $(x)_6$  belonging to  $\lambda^{11}$  must be reckoned the two lines  $X', X''$ , for which  $X$  is one of the intersections of  $l$  and  $q^2$ . The remaining 10 contain each a pair  $Y', Y''$ ; consequently each  $q^2$  is in the said correspondence associated to 10 curves  $q^3$ .

The involution  $I^3$  on a  $q^3$  possesses a curve of involution of the third class; for  $B_1$  bears in the first place the line  $b_1$ , which contains

a pair of the  $I^3$ , then the lines joining  $B_1$  to the two points, determined by the  $q^2$ , which touches  $q^3$  in  $B_1$ . The intersections of  $l$  and  $q^3$  procure three common tangents of  $(x)_3$  and  $(x)_6$ ; there are consequently 15 straight lines, which bear a pair  $Y', Y''$ , so that the said correspondence associates 15 curves  $q^2$  to  $q^3$ .

By means of this correspondence the points of a straight line  $r$  are arranged into a correspondence (30, 30). For to the  $q^2$  passing through a point  $R$  of  $r$  correspond the 30 intersections  $R'$  of  $r$  with the 10 curves  $q^3$  associated to  $q^2$ ; on the other hand the  $q^3$  passing through  $R'$  procures 30 points  $R$ , by means of the corresponding 15  $q^2$ . The intersections of the corresponding curves form therefore a figure of order 60; it consists, however, of two parts: the locus of the pairs  $Y', Y''$ , which lie on the tangents of the  $(x)_6$ , and the locus of the points  $Y$ .

The former may also be produced by the pencil ( $q^2$ ) and the system of rays  $(r)_6$ . To each  $q^2$ , in virtue of the consideration mentioned above, a number of ten straight lines is associated, which are each coupled to one  $q^2$  only; hence a (10, 12) arises now on  $r$ , so that the pairs of points  $Y', Y''$  are lying on a figure of order 22.

For the points  $Y$  we find therefore a figure of order 38; it is composed of the three lines  $b_{mn}$  and a curve of order 35. For to the intersection  $X$  of  $l$  and  $B_1B_2$  corresponds a pair  $X', X''$  on  $AB_2$ ; but this line bears  $\infty^1$  pairs  $Y', Y''$  and the corresponding points  $Y$  of  $B_1B_2$  are all associated to  $X$ . Apart from these three lines the line  $l$  is transformed by means of the birational correspondence  $(X, Y)$  into a curve of order 35,  $\lambda^{35}$ . It cuts  $l$  in 10 pairs  $X, Y$  (§ 4) and in 15 coincidences  $X \equiv Y$ . There is consequently a *curve of coincidences* of order fifteen. The figure of order 22 found above consists of the three lines  $b_k$  and a curve  $\lambda^{10}$ , for to the conic  $(b_3, b_{12})$  corresponds the tangent  $b_3$  of  $(x)_6$ .

**8.** We shall now determine the *fundamental curves* which are associated to the fundamental points  $A, B_k, C_h$ . The curves of involution  $(x)_3$  belonging to  $\beta_1^5$  and  $\beta_2^5$  (§ 2) have 9 tangents in common, there are consequently 9 lines, for which  $X$  lies in  $B_1$  and  $Y$  in  $B_2$ . Therefore the fundamental curve of  $B_1$  has nonuple points in  $B_2$  and  $B_3$ . No other point  $Y$  of the line  $B_2B_3$  can correspond to a point  $X$  lying in  $B_1$ ; the said curve is therefore of *order* 18. It has a nonuple point in  $B$  too and passes three times through each of the points  $A$  and  $C_h$ ; for through  $T$  or  $M_h$  passes *one* line, bearing a pair  $X', X''$  of  $\beta_1^5$  and a pair  $Y', Y''$  of  $\alpha^3$  or  $\gamma_h^2$ ; through which then  $B_1 \equiv X$  corresponds to a point  $Y$  lying in  $A$  or  $C_h$ .

The fundamental curve of  $A$  is apparently identical with the curve  $\varepsilon_{\#}^4$  (§ 5) belonging to the point  $T$ ; we shall indicate it by  $\alpha^6$ . As  $\alpha^5$  has two pairs in common with  $\tau^3$  (§ 6)  $A$  is a node of  $\alpha^5$ . That  $\alpha^6$  passes through the points  $C_h$  and has triple points in  $B_k$  ensues from the consideration of the lines  $TM_h$  and of the tangents out of  $T$  to the  $(v)_3$  belonging to  $B_k$ .

It appears analogously that the fundamental curve of  $C_1$  has triple points in  $B_k$  and a node in  $C_1$ ; it passes through  $A$  and the remaining points  $C_h$  and is of *order six*. This curve is at the same time the  $\varepsilon_{\#}^6$  belonging to  $M_1$ .

We can now prove once more that the birational correspondence is of *order 35*. To the intersection  $X$  of two lines  $l$ , corresponds the point  $Y$ , which the two curves  $\lambda$ , apart from the fundamental points, have in common. As appears from what was mentioned above  $\lambda$  passes 18 times through  $B_k$  and 6 times through  $A$  and  $C_h$ ; from  $1 + 3 \times 18^2 + 7 \times 6^2 = 1225 = 35^2$  it appears now that  $\lambda$  is a curve of order 35.

**Physics.** — “*On the manner in which the susceptibility of paramagnetic substances depends on the density.*” By Dr. W. H. KEESOM Supplement N<sup>o</sup>. 36c to the Communications from the Physical Laboratory at Leiden. Communicated by Prof. H. KAMERLINGH ONNES.

(Communicated in the meeting of April 24, 1914).

§ 1. *Introduction.* In Suppl. N<sup>o</sup>. 32a (Oct. '13) an expression was developed for the molecular rotatory energy in a system of freely rotating molecules as a function of the temperature. This expression was introduced into the theories of LANGEVIN and WEISS, on the supposition that, when the equipartition laws are deviated from, the statistics of the molecules under the action of an exterior directing field, in this case a magnetic field, is determined by the value  $u_r$  of the rotatory energy in the same way as for equipartition it is by  $kT$ . It then appeared that different experimental results can be represented very satisfactorily in that way <sup>1)</sup>.

<sup>1)</sup> The expressions developed in the above-mentioned paper appear to be also suitable to give a quantitative representation (as far as observations are available) of the decrease of the temperature of the CURIE-point by the addition of a diamagnetic metal to a ferromagnetic one, with which it forms mixed crystals, on the supposition that the diamagnetic metal exerts no other influence than that the mutual action of the ferromagnetic molecules is lessened in consequence of the



In the communication mentioned above the system of molecules

increase of their distance, as regards the molecular field in particular according to the supposition mentioned further on in this note. In fig. 1 the points ++ repre-

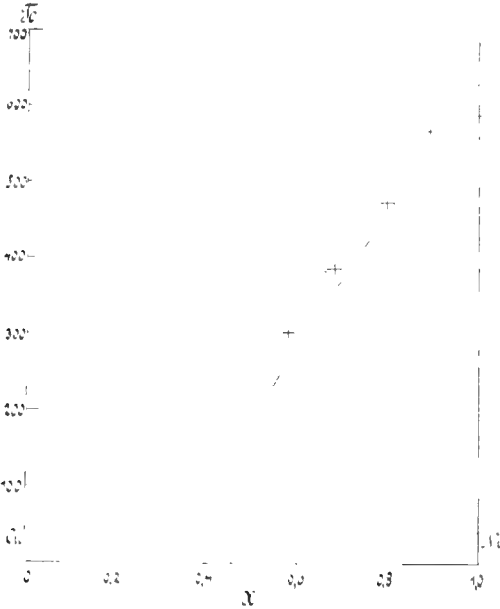

Fig. 1.

sent the temperature  $T_c$  of the CURIE-point of alloys of nickel and copper as a function of the mass-composition  $x$  of nickel according to W. GUERTLER and G. TAMMANN, ZS anorg. Chem. 52 (1907), p. 25 [the quantity  $x$  introduced here is not to be confused with that of equation (4)]. The curve represents the results of the calculation. In this I started from equation (16) of Suppl. N<sup>o</sup>. 32a, applied to the nickel molecules :

$$u_{re} = \frac{N_m n Q u^2}{3} \dots \dots \dots (a)$$

The density of the different alloys of nickel and copper was assumed to be equal, so that the density of the nickel in the alloy may be put equal to  $\varrho = \varrho_1 x$  (the index 1 indicates that the quantity concerned corresponds to  $x = 1$ , that is in our case to nickel). Further the coefficient of the molecular field,  $N_m$ , is assumed not to depend on the composition. This assumption involves, that the molecular field, the magnetisation per unit of mass being kept constant, is proportional to the first power of the density of the ferromagnetic component; this relationship differs from the result obtained by WEISS, C.R. 157 (1913), p. 1405, with alloys of the two ferromagnetic metals nickel and cobalt from the manner in which the constant of the molecular field, derived on the assumption of equipartition, depends on the composition.

Further  $\theta_0$  has been put (cf § 5 of this paper) proportional to  $x^{2/3}$  :

$$\theta_0 = \theta_{0,1} x^{2/3} \dots \dots \dots (b)$$

The equation which determines the value of  $T_c$  which corresponds to a given

was always<sup>1)</sup> supposed to be contained in the same volume, and in the comparison with experimental data no account was taken of the influence which the relatively small changes of density connected with the temperature changes exert on the parameter  $\theta_0$ , which occurs in the formulae of that communication, and which I will call *the characteristic zero-temperature*.

Since then the measurements by PERRIER and KAMERLINGH ONNES<sup>2)</sup> concerning the susceptibility of liquid mixtures of oxygen and nitrogen have furnished very important data, which, when considered from the point of view taken in the paper quoted above, allow a conclusion as to the manner in which the characteristic zero-temperature  $\theta_0$  depends on the composition of those mixtures. If it is further assumed with PERRIER and KAMERLINGH ONNES, that to a first approximation the presence of the nitrogen molecules in these mixtures does not exert a direct influence on the statistical distribution of the orientations, nor on the magnetic moment of the oxygen molecules, so that it is only the changes in density of the oxygen, which determine the changes in the susceptibility, then those measurements furnish at the same time data for a discussion of the question how  $\theta_0$  depends on the density.

We will in the first place treat the question whether the results of the measurements by PERRIER and KAMERLINGH ONNES mentioned above can be represented with the aid of the relations of Suppl.

value of  $x$ , may then be put into the form:

$$\frac{u_{1c}}{u_{10}} = \frac{u_{rc1}}{u_{rc,1}} \cdot x^{1/3} \quad . \quad . \quad . \quad . \quad . \quad . \quad (c)$$

For nickel ( $T_{c1} = 633$ ,  $\theta_{0,1} = 2100$ , cf. Suppl. N<sup>o</sup>. 32a § 4)  $\frac{u_{rc1}}{u_{rc,1}} = 1,30$ . From

$\frac{u_{1c}}{u_{10}}$  the value of  $\frac{T_c}{\theta_0}$  can be derived, and then with  $\theta_0$  from (b) the value of  $T_c$  corresponding to  $x$  can be found.

A continuation of the investigation of the magnetisation of alloys such as those mentioned above, particularly for compositions, for which the CURIE-point lies below 0° C., would be of great interest, on the one hand for putting the application of the quantum-theory to a test (according to this with such alloys the different cases indicated in Fig. 3 of Suppl. N<sup>o</sup>. 32b might be realised), on the other hand for increasing our knowledge of the molecular field [In the meantime I have received an article by P. WEISS, Ann. de physique (9) 1 (Febr. 1914) p. 134, in which is mentioned, that, with a view to the investigation of the molecular field, a series of measurements concerning alloys of nickel and copper has already been undertaken. (Added in correcting the proof of the Dutch edition)].

1) With the exception of the note added in Leiden Comm.: note 2, p. 6.

2) ALB. PERRIER and H. KAMERLINGH ONNES. Comm. No. 139d (Febr. '14).

Nº. 32a<sup>1)</sup>). It is shown in § 2 that the answer is in the affirmative, in § 3 the same appears to be the case for the measurements concerning the susceptibility of liquid oxygen over a wider range of temperatures. § 4 contains the conclusion which follows from §§ 2 and 3. Finally in the following §§ are treated the consequences concerning the dependence of  $\theta_0$  on the density, which follow from the results of those measurements<sup>2)</sup>).

§ 2. *The susceptibility of the liquid mixtures of oxygen and nitrogen and the application of the quantum-theory to paramagnetism.* As a preliminary to the question whether the results of the measurements by PERRIER and KAMERLINGH ONNES can be represented with the aid of the relations of Suppl. Nº. 32a, in so far as these are applicable to paramagnetic substances, the specific susceptibility of the oxygen in the mixtures (Table I, Comm. Nº. 139d) was compared with the specific susceptibility for pure oxygen in the gaseous state at the same temperature, which would follow from the measurements by WEISS and PICCARD if CURIE-LANGEVIN'S law remained valid down to that temperature (cf. table I, Comm. Nº. 139d). This value we will call the equipartition value  $\chi_{\text{eq}}$ .

On the assumption mentioned in § 1, that the presence of the nitrogen molecules does not cause a change in the magnetic moment of the oxygen molecules, the (paramagnetic) specific susceptibility of the oxygen in the mixture is determined by OOSTERHUIS'S relation :

$$\chi_{\text{O}_2 \text{ in mixture}} = \frac{n\mu^2}{3u_r} \cdot \cdot \cdot \cdot \cdot \cdot \cdot \quad (1)$$

In this relation  $n$  represents the number of oxygen molecules in 1 gram of oxygen,  $\mu$  is the magnetic moment of an oxygen molecule,  $u_r$  the mean rotatory energy (about two axes  $\perp$  to the magnetic one) of a molecule of oxygen in the mixture at the temperature and density considered. According to LANGEVIN

$$\chi_{\text{eq}} = \frac{n\mu^2}{3kT} \cdot \cdot \cdot \cdot \cdot \cdot \cdot \quad (2)$$

Division gives

1) For a detailed discussion of those measurements on the basis of the assumption of a negative molecular field, as well as a consideration of the other circumstances which may have an influence, we refer to the paper by PERRIER and KAMERLINGH ONNES quoted above.

2) The principal results of this paper were already inserted in the translation of Comm. No. 139d; p. 915 note 2

$$x_{O_2 \text{ in mixture}} \frac{z_{eq.}}{kT} = \frac{u_r}{kT} \dots \dots \dots (3)$$

If for  $u_r$  we assume the temperature function, developed in Suppl. N<sup>o</sup>. 32*a*, and determined by

$$\left( \frac{u_r}{u_{r0}} \right)^{1/2} = 1 + \frac{8}{x^4} \int_0^x \frac{\xi^3 d\xi}{e^{\xi} - 1} \left\{ \dots \dots \dots (4) \right.$$

$$\frac{T}{\theta_0} = \frac{1}{x} \left( \frac{u_r}{u_{r0}} \right)^{1/2}$$

where

$$u_{r0} = \frac{3}{8} k\theta_0, \dots \dots \dots (5)$$

at each value of  $x$  the mutually corresponding values of  $\frac{u_r}{kT}$  and  $\frac{T}{\theta_0}$  can be calculated. The value of  $\frac{T}{\theta_0}$  corresponding to the value of  $u_r/kT$  given by equation (3) can then be found by graphical interpolation, after which  $\theta_0$  immediately follows.

From the data of Table I Comm. N<sup>o</sup>. 139*d* by PERRIER and KAMERLINGH ONNES the following values of  $\theta_0$  were in that way obtained :

TABLE I.							
Values of $\theta_0$							
	$\varrho$	$t = -195.65$	$t = -202.23$	$t = -208.84$	Mean	$\Delta \left( = \frac{2}{15} \theta_0 \right)$	
Mixture	I	0.7458	165	161	159	162	21.6
	II	0.4010	97.5	99.5	97.1	98.0	13.1
	III	0.2304	53.9	55.1	[61.0]	54.5	7.3
	IV	0.1380	25.0	21.3	23.6	23.3	3.1
	V	0.0801	7.5 <sup>5</sup>		10.6	9.1	1.2

From the fact, that the individual values of  $\theta_0$  vary irregularly about the mean values, the conclusion may be drawn that the obser-

vations can be represented with sufficient accuracy by the equations (1) and (4). This is confirmed by Table II which gives the values of  $\chi$  calculated with the aid of the mean values of  $\theta_0$  given in table I. Table II also contains the deviations  $O - C$  between observed and calculated values.

T A B L E II.

Calculated specific susceptibilities of oxygen.  
Comparison with observed values.

	$\rho$	$t = -195.65$	$O - C$	$t = -202.23$	$O - C$	$t = -208.84$	$O - C$	
Mixture	I	0.7458	296.2	- 1.7	313.9	+ 0.6	334.5	+ 2.0
	II	0.4010	336.2	- 0.2	361.2	- 1.6	390.1	+ 0.5
	III	0.2304	363.6	+ 0.5	393.8	- 0.8	429.2	[- 5.7]
	IV	0.1380	384.6	- 1.0	418.8	+ 1.6	460.1	- 0.3
	V	0.0801	393.7	+ 1.3			473.2	- 1.2

Table II confirms the conclusion that the observations concerning the specific susceptibility of oxygen in the liquid mixtures of nitrogen and oxygen can be represented within the degree of accuracy of those observations by substituting the expression  $kT'$  in LANGEVIN'S theory by an expression for the molecular rotatory energy which is derived from the quantum-theory with the assumption of a zero-point energy <sup>1)</sup>.

These observations do not therefore furnish a decision between the assumption just mentioned and that, in which the expression  $kT'$  in LANGEVIN'S theory is left unchanged, but the assumption of a negative molecular field is added, which was found by PERRIER and KAMERLINGH ONNES (Comm. N<sup>o</sup>. 139*d*) to be in sufficient agreement with the observations. In the mean time it must be mentioned that on the assumption investigated in this paper the inclination of the  $\chi^{-1}$ ,  $T'$ -lines for the mixtures with small density of the oxygen approaches to the equipartition value for oxygen, which follows from the measure-

<sup>1)</sup> Dr. OOSTERHUIS tells me, that calculations made in the way indicated above, but in which for  $\mu$  the expression is taken which was assumed by him in Suppl. N<sup>o</sup> 31, lead to the same result Cf. note 2 p. 915, Comm. N<sup>o</sup>. 139*d*

ment by WEISS and PICCARD, whereas, as was found by PERRIER and KAMERLINGH ONNES, on the assumption of a negative molecular field with unchanged molecular rotatory energy a correspondence of the inclinations can only be obtained by the aid of a new hypothesis (unless the difference in inclination should be ascribed to a systematic difference of experimental origin).

§ 3. *The susceptibility of liquid oxygen and the application of the quantum-theory to paramagnetism.* The susceptibility of liquid oxygen being measured over a considerably larger temperature range (from 65.°25 K. to 90.°1 K.: KAMERLINGH ONNES and PERRIER, Comm. N°. 116; from 70.°2 K. to 90°1 K.: KAMERLINGH ONNES and OOSTERHUIS, Comm. N°. 132e), than was possible for the mixtures treated in § 2, it is important to investigate whether the data which are available about liquid oxygen can be represented also with the aid of the relations (1) and (4). In table III the corresponding data have been put together.

As PERRIER and KAMERLINGH ONNES observe, account has to be taken of the change in density of liquid oxygen. For the reduction of  $\theta_0$  to the same density use was made of the result which will be derived in § 5 from the observations concerning the above mixtures considered in connection with those concerning oxygen, *viz.* that at these large densities  $\theta_0$  is proportional to  $\rho^{2/3}$ .

T A B L E IIIa.

Specific susceptibility of liquid oxygen  
(KAMERLINGH ONNES and PERRIER).

$T$	$\chi \cdot 10^6$	$\theta_{0,\rho}$	$\rho$	$\theta_{0,\rho=1,235}$	$\chi_{\text{calc.}} \cdot 10^6$ with $\theta_0 = 232 \cdot \left(\frac{\rho}{1.235}\right)^{2/3}$	O-C
64.25	284.9	232.5	1.267	229	282.6	+ 2.3
70.86	271.4	232.7	1.235	233	271.7	- 0.3
77.44	259.6	231.3	1.204	235	261.3	- 1.7
90.1	241.1	220.2	1.143	232	240.9	+ 0.2

mean 232.

The agreement between observation and calculation may be considered sufficient. This conclusion is supported by the observations

of KAMERLINGH ONNES and OOSTERHUIS:

T A B L E IIIb.

Specific susceptibility of liquid oxygen (KAMERLINGH ONNES and OOSTERHUIS).				
$T$	$\chi \cdot 10^6$	$\theta_{0,f} = 232 \left( \frac{\rho}{1.235} \right)^{2/3}$	$\chi_{\text{calc.}} \cdot 10^6$	$O-C$
70.2	270.7	232.65	272.8	- 2.1
79.1	258.1	227.4	258.8	- 0.7
90.1	241.1	220.2	241.0	+ 0.1

§ 4. *Conclusion.* The data treated in §§ 2 and 3 lead to the following conclusion:

The susceptibility of oxygen in liquid mixtures of oxygen and nitrogen as well as that of liquid oxygen can be represented within the degree of accuracy of the observations with the aid of the application of the quantum-theory to paramagnetism as expressed by equations (1) and (4).

The agreement between observation and calculation (particularly if the susceptibility of liquid oxygen is also considered over the whole range of temperatures) is somewhat better with the application of the quantum-theory than with the introduction of a negative molecular field *alone*: indeed PERRIER and KAMERLINGH ONNES find it necessary for the mixtures of oxygen and nitrogen also to change the value of the CURIE-constant. Calculations made for liquid oxygen support this conclusion. Nevertheless it is quite possible that for liquid oxygen also if a changed CURIE-constant is assumed just as good an agreement may be obtained by the introduction of a negative molecular field.

§ 5. *Dependence of the characteristic zero-temperature on the density.* Table IV shows more particularly the manner in which  $\theta_0$  depends on the density  $\rho$  of the oxygen.

From the last column the conclusion may be drawn that for the higher densities  $\frac{\Delta \log \theta_0}{\Delta \log \rho}$  approaches to  $2/3$ . For those densities we may therefore write as a limiting law:

$$\theta_0 = a\rho^{2/3} \dots \dots \dots (6)$$

TABLE IV.

$\rho$	$\theta_0$	$\frac{\Delta \log \theta_0}{\Delta \log \rho}$
0.0801	9.1	1.73
0.1381	23.3	1.66
0.2304	54.5	1.06
0.4010	98.0	0.82
0.7458	162	0.71
1.235	232	

where  $a$  is a constant (for a definite substance). This dependence of  $\theta_0$  on the density quite agrees with that, which in Suppl. N<sup>o</sup>. 30a was derived for the molecular translatory motions from the hypotheses assumed there, cf. equation (18b) of that paper.

This result can be interpreted as indicating, that the proportionality factor in the relation

$$c = u_r^{1/2},$$

(cf. Suppl. N<sup>o</sup>. 32a § 2), in which  $c$  represents the velocity of the "rotational waves" considered in the paper mentioned, is independent not only of the temperature but also of the density, as according to Suppl. N<sup>o</sup>. 30a equation (7) is the case for the corresponding "translational waves".

In Fig. 2 the points indicated by small circles represent the values of  $\theta_0$  derived from the observations as a function of  $\rho$ . The curve

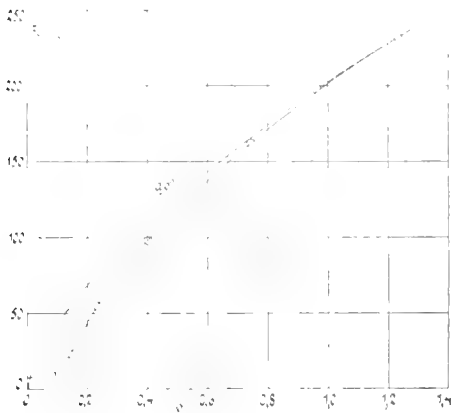

Fig. 2.

---- gives  $a\rho^{2/3}$ , where  $a$  is chosen so as to obtain agreement for the higher values of  $\rho$ . This agreement is in fact very good for  $\rho > 1$ , as results from the fact that the two curves do not intersect here at a definite value of  $\rho$ , but coincide over a certain range of densities.

For values of  $\rho$  smaller than 1 a deviation begins to show itself; this deviation at first increases regularly in proceeding to lower values of  $\rho$ .



It is natural to ascribe this agreement at higher, and this deviation at lower densities to the following<sup>1)</sup>. At larger densities the rotations of the oxygen molecules are continually disturbed by collisions, or at least interactions with the other oxygen molecules, so that the periods of revolution of the oxygen molecules cannot play a part in the determination of the frequencies in the system which govern the distribution of energy.

For those densities the frequencies are determined by the analysis according to JEANS of the molecular rotatory motions in the system into natural vibrations; the relations given in Suppl. N<sup>o</sup>. 32a § 2 are then valid as approximations.

At small densities, however, at which every molecule performs in the mean a certain number of revolutions before its rotation is disturbed by the collision (interaction) with another molecule, it is the numbers of revolutions of the individual molecules in the unit of time which govern the distribution of energy. These frequencies are then determined at the limit by EINSTEIN'S relation<sup>2)</sup>.

$$u_{r, \nu} = \frac{1}{2} I (2\pi\nu)^2$$

and are independent of the density.

Between these two extremes a transition range lies.

If (for  $T = 85$ ) the number of collisions, which an oxygen molecule undergoes in 1 sec. at  $q = 1$  (the molecular diameter  $\sigma = 3.10^{-8}$  derived from the viscosity), is compared with the number of revolutions per sec. (distance of the oxygen atoms being assumed  $= 0.7.10^{-8}$ , derived from the moment of inertia calculated according to HOLM<sup>3)</sup> from  $\Delta = 1$ , which value was assumed according to Fig. 2 for oxygen in the gaseous state), one finds that in the mean the oxygen molecule makes 0.4 revolution between two successive collisions. It is, however, not necessary to assume that the number of times that the rotatory motion is disturbed in a second, coincides with the number of times that this is the case with the translatory motion. Some room is thus left for an average number of revolutions between two successive disturbances of the rotatory motion other than the number just mentioned. But if we assume that the order of magnitude will not be essentially different, the result of the calculation mentioned above is such as to be quite consistent with the theory developed above that at  $q = 1$  a transitional region begins in which the

<sup>1)</sup> Cf. the note quoted p. 112 note 1.

<sup>2)</sup> Rapports conseil Solvay 1911, p. 433.

<sup>3)</sup> E. HOLM. Ann. d. Phys. (4) 42 (1913, p. 1319. The  $\delta$  used by HOLM corresponds to  $\underline{\epsilon}$  in this paper.

frequencies of the individual molecules begin to play a part for the energy distribution.

This theory involves that for smaller densities  $u_r$  is no longer determined by the relations of Suppl. N<sup>o</sup>. 32*a*, equations (4) and (5) of this paper. Notwithstanding that, in consequence of the relative insensibility of the way in which  $u_r$  depends on  $T$  for the special assumption about the distribution of the frequencies (cf. Suppl. N<sup>o</sup>. 31 § 7 by OOSTERHUIS), a good agreement may still be obtained by those relations with the observations considered in this paper, but then the values of  $\theta_0$ , which give such an agreement, do not have the meaning laid down by the theory in Suppl. N<sup>o</sup>. 32*a*.

Meanwhile the part for the smaller densities ( $\rho < 0.15$ ) of the  $\theta_0, \rho$ -curve of Fig. 2 may be given a simple meaning by supposing the curve for this region to represent  $\frac{15}{2} \Delta$ , if  $\Delta$  is determined by the fact that the  $u_r, T$ -curve on the side of the high temperatures approaches asymptotically to

$$u_r = k(T + \Delta).$$

As according to the relations of Suppl. N<sup>o</sup>. 32*a* § 2 (cf. Suppl. N<sup>o</sup>. 32*b* § 5)  $\theta_0 = \frac{15}{2} \Delta$ , the curve has also this meaning for  $\rho > 1$ . For a nearer interpretation of the intermediate region the theory will have to be further developed.

On the side of the small densities the curve in Fig. 2 has been extrapolated (indicated by dots) to a part that terminates parallel to the  $\rho$ -axis, in agreement with the theory given above, that at small densities the frequencies of rotation are no longer dependent on the density.

In this region of densities the rotatory energy is determined as in the simplified scheme of EINSTEIN and STERN or of OOSTERHUIS, in which to all the molecules the same velocity of rotation was ascribed, or better in the more elaborate theory of HOLM<sup>1)</sup>, in which the

<sup>1)</sup> E. HOLM. Ann. d. Phys. (4) 42 (1913), p. 1311. This theory, in which in the system of rotating molecules all frequencies occur, and for the distribution of the molecules according to the frequencies, in a way analogous to that which PLANCK in his recent theory followed for linear oscillators, the plane in which the condition of a molecule rotating about one axis is represented by the values of its azimuth and moment of momentum, is divided into regions of constant probability limited by energy curves  $u = n \frac{h\nu}{2}$ , is consistent with the results of BJERRUM and E.

V. BAHR concerning the discontinuous character of absorption spectra in the infra-red of gases of not too high densities, if it is assumed that the absorption

distribution of the velocities of rotation over the molecules is taken into account.

Resuming we may conclude, that the observations by PERRIER and KAMERLINGH ONNES concerning the susceptibility of liquid mixtures of oxygen and nitrogen, although they do not furnish an experimentum crucis between the theory of the negative molecular field and the application of the quantum-theory on paramagnetism, nevertheless fit without any constraint <sup>1)</sup> into the whole scheme which can be built up on the basis of this application.

§ 6. The results of the former § concerning the dependence of  $\theta_0$  on the density lead to the following inference regarding the influence of the rotatory motion on the external pressure. For those densities at which  $u_r$  is determined by the equations (4) and (5), and at which  $\theta_0 = q^{2/3}$ , the energy  $u_r$  and also the entropy  $s_r$  for the rotatory motion are represented by the same functions (only with another value of  $\theta_0$ ) as the corresponding quantities for the translatory motion in an ideal gas.

In that case the rotatory motion gives a contribution to the external pressure similar to that of the translatory motion. The ratio of this contribution, for one degree of freedom, to that which in an ideal gas is due to the translatory motion, approaches to 1 at increasing temperature <sup>2)</sup>.

At small densities, however, *viz.* in the region in which  $\theta_0$  does not depend on  $q$ , the rotatory motion does not give a contribution to the external pressure. This agrees with what has always been

of radiation energy supplied from outside only occurs when the representative point has arrived at one of the limiting curves mentioned above (for instance in consequence of the probability of emission on reaching a limiting curve, cf. PLANCK, Theorie der Wärmestrahlung, 2te Aufl., § 151, being changed by the presence of the radiation from outside) The observations by E. v. BAHR, Verh. d. D. physik. Ges. 1913, p. 1150, concerning hydrochloric acid seem to be more favourable to this view than to a distribution, in which, in the plane mentioned above, only the energy curves  $\left(n + \frac{1}{2}\right) \frac{h\nu}{2}$  are covered with points, which is the assumption alluded to in the note quoted p. 112, note 1.

<sup>1)</sup> The views advanced in this § about the coming into the foreground of the frequencies of rotation of the individual molecules are in fact, as will appear again in § 6, a necessary complement for small densities to the theory of Suppl. N<sup>o</sup>. 32a.

<sup>2)</sup> I find that A. WOHL, ZS. physik. Chem. 87 (1914), p. 9, by quite different considerations was also led to the suggestion that at large densities the molecular rotatory motion may give a contribution to the external pressure. (Note added in the translation).

derived for an ideal gas, *e. g.* from BOLTZMANN's entropy principle, cf. Suppl. N<sup>o</sup>. 24a § 4, or from the virial theorem. Conversely it necessarily follows from this, that in Fig. 2 the  $\theta_0$ ,  $q$ -curve at the small densities must change its direction to one parallel to the  $q$ -axis, as is clearly indicated by the point  $q = 0.08$ .

In conclusion we will return for a moment to the assumption rigidly adhered to in this paper, *viz.* that the presence of the nitrogen molecules does not exert any influence on the distribution of the rotatory energy of the oxygen molecules. The following mechanism would be in accordance with this supposition: the oxygen molecules behave at a collision (at least with the nitrogen molecules) as rigid smooth spheres, they carry a (magnetic) doublet (or have according to Suppl. N<sup>o</sup>. 32b § 7 a magnetic moment in consequence of a rotation about an axis of small moment of inertia with zero-point energy in the temperature region considered); the nitrogen molecules have a structure such that they do not exert a directive force on the oxygen molecules. The object of this suggestion is, however, no other than to show that the assumption mentioned above is not an impossible one.

**Chemistry.** — “*The Allotropy of Cadmium. III*”. By Prof. ERNST COHEN and W. D. HELDERMAN.

*The electromotive behaviour of Cadmium.*

1. The dilatometric measurements made with cadmium which had been deposited electrolytically, had shown <sup>1)</sup> that this material is a modification which is not stable at room temperature. This corresponds with the result found by ERNST COHEN and E. GOLDSCHMIDT <sup>2)</sup> in their investigations on the electrolysis of solutions of tin salts. When such a solution is electrolysed below 18° C. there is not formed *grey* tin as might be expected, but the modification which is metastable at this temperature is deposited.

In the following pages we give an abbreviated account on the investigations we have carried out in order to identify the product which is formed during the electrolysis of solutions of cadmium salts.

2. Some years ago HULETT <sup>3)</sup> described “a low voltage standard cell”, represented by the following scheme:

<sup>1)</sup> These Proc. p. 54.

<sup>2)</sup> Zeitschr. f. physik. Chemie **50**, 225 (1905).

<sup>3)</sup> Trans. Americ. Electrochem. Society **7**, 353 (1905).

Cd		Solution of cadmium sulphate	Cd-amalgam
		of arbitrary concentration	12.5% of Cd by weight

The electromotive force of this combination is 0.0505 Volt at 25°.0. The reproducibility is about 0.5 millivolt. The cadmium electrode of this cell has to be electrolytically deposited, as Th. W. RICHARDS and LEWIS<sup>1)</sup> have proved, that only this kind of electrodes give a definite potential. ERNST COHEN and SINNIG<sup>2)</sup>, who used these cells in their piezochemical investigations also found that they are reproduceable.

3. Some points in the construction of such cells which play an important rôle in the experiments, to be described below, may be given here. (Fig. 1 A).

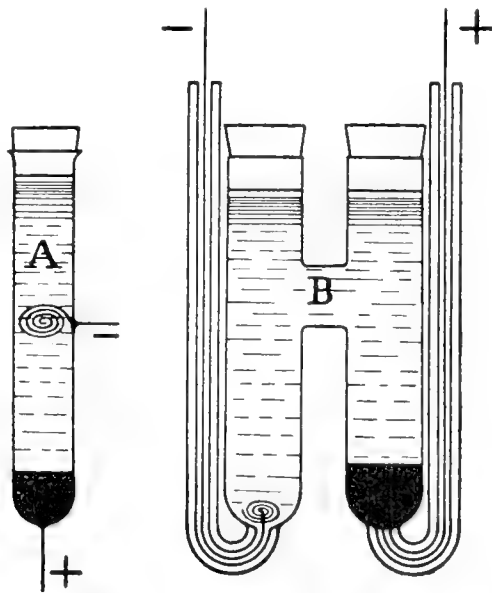

Fig. 1.

The glass part is a thin walled tube about 8—10 mm. in diameter, closed at one end and provided with a platinum wire; two or three centimeters above the closed end is a platinum spiral, with its end fused through the side of the tube (the wires are thoroughly cleaned with aqua regia before filling the cell).

In filling, the spiral is pressed to one side and some 0.5 cc. of 12.5 percent cadmium amalgam is brought into the lower part and melted (carefully avoid bringing the amalgam in contact with the

<sup>1)</sup> Zeitschr. f. physik. Chemie **28**, 1 (1899).

<sup>2)</sup> Zeitschr. f. physik. Chemie **67**, 1 (1909).

platinum spiral). The spiral is then pressed down into a horizontal position. The tube is now filled up with a solution of cadmium sulphate of arbitrary concentration (the E. M. F. of the cell is independent of the strength of the solution).

In order to produce the cadmium electrode a current of 1 or 2 milliamp. (1 or 2 milligrams Cd per hour) is passed from the amalgam to the platinum spiral. At least 18 milligrams must be deposited. The cell may then be sealed off.

4. We specially call attention to the following passage in HULETT's paper: "The electromotive force of these cells is high when the cadmium is freshly deposited, and the length of time required to reach the normal value seems to depend on the thickness of the deposit. Air free cells and those saturated with  $\text{Cd}(\text{OH})_2$  behave like the others and I have as yet no explanation of the high E. M. F. of newly constructed cells." Our table I shows this decrease of potential of newly constructed cells. It amounts to about 1 millivolt.

T A B L E I.  
Temperature  $25^{\circ}\text{C}$ .  
E. M. F. in Volts.

Number of cell.	Immediately after formation	After 1	After 2	After 3	After 4	After 5	After 7	After 8
		day	days	days	days	days	days	days
a.	0.05156	0.05105	0.05084	0.05078	0.05070	0.05065	0.05052	0.05052
b.	0.05143	0.05099	0.05082	0.05076	0.05068	0.05067	0.05054	0.05056
c.	0.05154	0.05103	0.05084	0.05076	0.05070	0.05067	0.05056	0.05058
d.	0.05151	0.05099	0.05082	0.05076	0.05070	0.05067	0.05056	0.05056
e.	0.05162	0.05113	0.05090	0.05084	0.05074	0.05070	0.05058	0.05058

5. These determinations and those to be described below were carried out by the POGGENDORFF compensation method. The resistances used had been checked by the Physikalisch-Technische Reichsanstalt at Charlottenburg-Berlin. The same was the case with the thermometers used. Our two standard elements (WESTON) were put into a thermostat which was kept at  $25^{\circ}\text{C}$ . We used as a zero instrument a DESPREZ-D'ARSONVAL galvanometer. It was mounted on a vibration free sus-

pension (JULIUS). The readings were made by means of a telescope and scale; 0.02 millivolt could easily be measured.

6. As it was very important for us to get rid of this variation of E. M. F. we tried to find its cause. We thought it might be found in the electromotive behaviour of the cadmium amalgams, which has been studied particularly by H. C. BIL<sup>1)</sup>.

Fig. 2 contains his results as far as they play a rôle in our investigations. The curves represent the E. M. F. (ordinates) of cells which are constructed according to the following scheme:

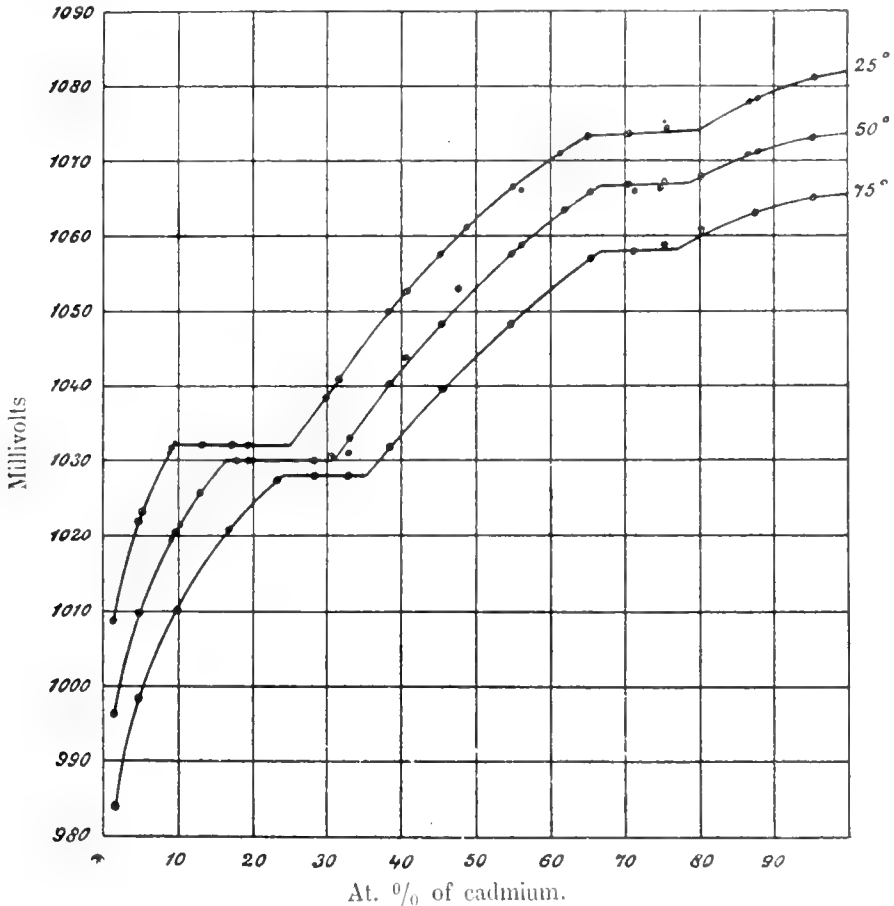
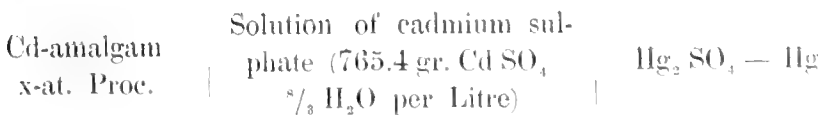

Fig. 2.



The abscissae represent atom per cents of cadmium.

<sup>1)</sup> Zeitschr. f. physik. Chemie **41**, 641 (1902).

From the drawing it can be seen that the E.M.F. of these cells at  $25^{\circ}\text{C}$  is independent of the concentration of the amalgam when its concentration lies between 9.0 and 24.4 at.percents (i. e. 5.9 and 15.4 percent by weight). As soon as the concentration decreases below  $5.9\%$  by weight (when we pass from the heterogeneous amalgams to the homogeneous, (c.f. BIL's paper Fig. 3) the E.M.F. varies with the amount of cadmium present in the amalgam, the potential against pure cadmium *increasing* with *decrease* in the percentage of cadmium.

7. In the light of these facts the high E.M.F. of freshly constructed cells becomes intelligible.

During electrolysis the cadmium which is deposited on the spiral is withdrawn from the upper layer of the  $12.5\%$  (or stronger) amalgam, which was originally a two phase system. It is thus possible for this layer to become a monophase system and if this is the case the E.M.F. will *increase* when electrolysis is continued. After the formation of the cell its E.M.F. will then be too high. In the long run cadmium will diffuse to the upper layer: this becomes again a twophase system and the E.M.F. will decrease and finally becomes constant.

8. In order to check this supposition we carried out the following experiment: We put two platinum spirals into the *H*-shaped tube *B* (Fig. 1). Into the right-side tube we put some  $1\%$  (by weight) cadmium amalgam (99 parts by weight of mercury, 1 part of cadmium). This amalgam is a fluid monophase system at ordinary temperature. We filled the tubes with a dilute solution of cadmium sulphate (half saturated at  $15^{\circ}\text{C}$ ). After this the cell was formed in the way described above. (1 milliampère).

After having deposited 20 or 25 milligrams of cadmium on the left-hand spiral, the capillary tube on the right was brought into connection with a waterpump in order to remove the amalgam. A number of small pieces of the  $12.5\%$  amalgam were then substituted for this.

These cells give at once an E.M.F. of 0.0503 Volt when they are put into a thermostat at  $25^{\circ}\text{C}$ . It is evident that our assumption made above (§ 7) is correct.

9. All the cells we investigated have been produced in the way described; it is now possible to measure their E.M.F. at once without waiting for 8 to 14 days before their becoming constant.

10. Our dilatometric measurements with cadmium which had been



electrolytically deposited gave the result that this material only undergoes transformation at temperatures below  $100^{\circ}$ , if it has been in contact at  $50^{\circ}$  ( $100^{\circ}$ ) with a solution of cadmium sulphate.

The probable and obvious conclusion is that by electrolysis we get exclusively  $\gamma$ -cadmium, the modification which is stable at high temperatures. If this were the case, the  $\gamma$ -cadmium would be transformed into  $\beta$ -cadmium at  $100^{\circ}$ , into  $\alpha$ -cadmium at  $50^{\circ}$  in contact with the solution of the sulphate.

If now the  $\gamma$ -modification is really generated by electrolysis, (analogous to what happens with solutions of tin salts) the HULETT cells which have been measured until now would contain this material as the negative electrode.

If this modification happened to be transformed into the modification which is stable at ordinary temperatures and pressures (1 atm.), this would manifest itself by a *decrease* in the E.M.F.

On the one hand we are working in this case under extraordinarily favourable circumstances for stabilisation (change into the  $\alpha$ -modification) as the material formed electrolytically is in a very fine state of division and surrounded by an electrolyte, while the quantity which has to undergo transformation is so very small (20 or 30 milligrams), that the transformation, if it occurs, will be finished in a short space of time.

On the other hand, and this is to be borne in mind in researches of this kind, the possibility exists that the transformation which has to take place *spontaneously*, may be suspended, if the metal deposited by electrolysis forms only one single modification, as the germs needed for transformation are then absent.

11. That the stabilisation generally does not occur is shown by our dilatometric observations as well as by many other facts i.e. by the experiments of W. JAEGER,<sup>1)</sup> ERNST COHEN,<sup>2)</sup> BJEL<sup>3)</sup> and HULETT,<sup>4)</sup> who all found the same E.M.F. (50 millivolt at  $25^{\circ}$  C.) for cells which were constructed according to the scheme:

Cd electrolytically deposited	Solution of cadmium sulphate	Cd-amalgam 12,5 per cent by weight.
-------------------------------------	------------------------------------	---

How obstinately the transformation may be delayed might also

<sup>1)</sup> Wied. Ann. **65**, 106 (1898).

<sup>2)</sup> Zeitschr. f. physik. Chemie **34**, 612 (1900).

<sup>3)</sup> Zeitschr. f. physik. Chemie **41**, 641 (1902).

<sup>4)</sup> Trans. Amer. Electrochem. Soc. **7**, 333 (1905).

be inferred from HULETT's<sup>1)</sup> words: "many of these cells are still in good order after five years."

This would be in perfect accordance with our own experiences: CLARK-cells which contain  $\text{ZnSO}_4 \cdot 6\text{H}_2\text{O}$  as solid depolariser preserved their E.M.F. for five years notwithstanding their having been standing at room temperature, i. e. 25 degrees below the transition point of  $\text{ZnSO}_4 \cdot 6\text{H}_2\text{O}$ . As in the case of HULETT's cells they had been sealed up after formation.

12. On account of these observations it might be expected that even under circumstances favourable to a transformation (stabilisation) of the negative electrode only a certain number of HULETT cells would show the transformation.

On December 11<sup>th</sup> 1913 we prepared three H.C. (N<sup>o</sup>. 1, 2 and 5) in the way described above (§ 3) at room temperature (30 mgr. Cd on the spirals). We then substituted a 12.5 percent cadmiumamalgam for the 1 percent. The E.M.F. was now 0.0503 Volt. After standing for two months at room temperature the cells were measured again on February 26<sup>th</sup> 1914. The E.M.F. of 1, 2 and 5 had *decreased* to 0.0475 Volt at 25<sup>o</sup>.0 C. and this value remained unchanged. As might have been expected the E.M.F. had *decreased* by stabilisation of the cadmium.

13. We prepared two new cells (nos. 6 and 7) in the same way as 1, 2, and 5. Immediately after the preparation their E.M.F. were 0.04847 and 0.04795 Volt respectively. Some days later these values became constant: 0.04788 and 0.04778 Volt. Stabilisation had begun already during electrolysis.

14. In order to determine whether  $\alpha$ -cadmium is formed during electrolysis if, this modification is present on the spirals before electrolysis begins, we shunted the cells 6 and 7 in a current of 1 milliampère. In this way we deposited upon the  $\alpha$ -cadmium which was present, a fresh quantity of 30 mgr.

After formation we put a fresh (12.5 percent) amalgam into the cell, while a fresh solution of cadmium sulphate was also introduced.

Subsequent to this treatment the E.M.F. at 25<sup>o</sup>.0 C. was again 0.05026 Volt which proves that  $\gamma$ -cadmium had been formed on the old layer of  $\alpha$ -cadmium.

15. On continuing our experiments we found that on one occasion

<sup>1)</sup> Trans. Amer. Electrochem. Soc. **15**, 435 (1909).

cells of 0.047 Volt E.M.F, on another, cells of 0.050 Volt E.M.F. were obtained.

As our dilatometric measurements had shown that stabilisation occurs with great velocity at  $50^{\circ}$ , we prepared cells (C and O) at  $47^{\circ}.9$ . The dilute amalgam was then taken out and an 8.5 percent (by weight) amalgam was put in, while a fresh solution of cadmium sulphate was used. We substituted an 8.5 per cent amalgam for a 12.5 percent as our intention was to measure these cells also at  $0^{\circ}$  C.; At this temperature the 12.5 percent amalgam is a monophasic system and such a system must not be used.

In this way we found at  $25^{\circ}.0$  C.

Cell C: 0.04745 Volt.

Cell O: 0.05022 ,,

The cadmium in cell C had thus been stabilised at  $47^{\circ}.9$ .

16. In order to check the results found up to this point we also determined the E. M. F. of our stable and metastable cells at  $0^{\circ}$  C. If the differences in E. M. F. at  $25^{\circ}.0$  between the different cells were really to be ascribed to the presence of  $\alpha$ -cadmium (cell C) and  $\gamma$ -cadmium (cell O) the difference which was at  $25^{\circ}.0$  C. 2.8 millivolt ought to increase at  $0^{\circ}$  C. as we are at that temperature at a greater distance from the metastable transition point  $\alpha$ -cadmium  $\rightleftharpoons$   $\gamma$ -cadmium.

The measurements at  $0^{\circ}$  C. gave the following results:

cell C: 0.05225 Volt.

cell O: 0.05626 ,,

While the difference was 2.8 millivolt at  $25^{\circ}.0$  C. it has increased as might be expected to 4.0 millivolt at  $0^{\circ}$  C.

17. Several phenomena which are described by HULETT, but which are obscure until now may find an explanation in the light of our experiments. HULETT says: "A number of cells were made with addition of  $\text{Cd}(\text{OH})_2$  thinking this might make a more uniform cadmium deposit; also the air was completely removed from three before sealing, and in others the air was removed and the cell saturated with nitrogen and with hydrogen. All of these gave very variable results, but in each case only 10 milligrams of cadmium had been deposited on the spiral, and I have lately learned this is too little cadmium, since some cells prepared as above described, excepting that only 10 mg. of cadmium was deposited on each spiral, showed the same irregularities and tendency to constantly decreasing electromotive force. These cells were recently all discharged and then reversing

the current about 26 mg. of cadmium was deposited on each platinum spiral, and they seem to be all coming together nicely and to the value indicated by the old cells".

18. Our observations agree perfectly with those of HULETT but we have to add the following restrictions: A number of our cells in which only 10 mgrs. of cadmium were deposited indicated immediately after formation an E. M. F. of 0.0502 Volt at 25°0 which *decreased* during 2 days. Then it became constant: 0.047 Volt. Transformation into  $\alpha$ -cadmium had consequently occurred; the fact that only a small quantity of cadmium is present causes the E. M. F. to reach very soon its definite lowest value. The phenomenon observed by HULETT is therefore the quick stabilisation of  $\gamma$ -cadmium.

19. Prof. HULETT has been kind enough to communicate to us the following facts: "Twelve cells which had been sealed after formation remained unchanged from March 18<sup>th</sup> 1905 to May 7<sup>th</sup> 1914, i. e. during 9 years. Their E. M. F. has been during all this time 0.0505 Volt. The quantity of cadmium on the spirals varies between 3.7 and 13.7 mgrs. of cadmium".

20. The decrease of E. M. F. which had been observed with cells which contain only 10 mgrs. of cadmium is consequently not to be ascribed to the minute quantity of metal<sup>1)</sup> deposited on the spirals; this quantity is much less in the cells which have been constant during 9 years. The reason of the decrease in E. M. F. of those cells is the transformation of  $\gamma$ -cadmium into  $\alpha$ -cadmium.

21. In order to check this conclusion we prepared a number of cells (at room temperature) which only contained 5 mgrs. of cadmium on the spirals. Some of these remained metastable (0.050 Volt) while others were transformed into the stable form (0.047 Volt) after some days.

22. Although the discussion of a number of questions must be delayed until a subsequent paper, we will mention here the behaviour of cadmium which has not been formed by electrolysis.

In our second paper we stated that a piece of cadmium chosen at random which had been produced from the molten metal contains three modifications:  $\alpha$ ,  $\beta$  and  $\gamma$ -cadmium. If such is the case, it might

1) OBERBECK found [Wied. Ann. 31, 337 (1887)] that a layer of metal A of  $2 \times 10^{-6}$  mm. suffices to give to a metal on which it has been deposited the potential of A. As the surface of the spirals in the H. C. was 0.28 cm<sup>2</sup> the layer of cadmium deposited is much thicker.

be expected that the potential of such a material against cadmium which has been formed by electrolysis should be zero. In order to test this conclusion we carried out the following experiment: We prepared a certain quantity of electrolytic cadmium (Prep. A) (Comp. our second paper § 8) and determined (at 40°) the potential difference between this material in a solution of cadmium sulphate which was half-saturated at 15° C. and:

1. Cadmium, which we received from KAHLBAUM (molten) in a finely divided state (Prep. B).

2. Cadmium which we had used in our dilatometric measurements: in this material the presence of  $\gamma$ -cadmium was presumed. (Prep. C).

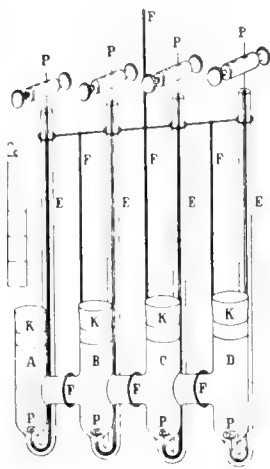

Fig. 3.

Utrecht, May 1914.

Making use of the small apparatus shown in Fig. 3 we first determined the potential difference between two samples of the same material, subsequently that between samples of different preparations. In this way we found:

E. M. K. of A against A = 0.000037 Volt.

„ B „ B = 0.000018 Volt.

„ C „ C = 0.00000 Volt.

E. M. K. „ A „ B = 0.000037 Volt.

„ A „ C = 0.000037 Volt.

From these measurements we see that  $\gamma$ -cadmium is really present in our preparations, as the dilatometer had shown.

VAN 'T HOFF-Laboratory.



KONINKLIJKE AKADEMIE VAN WETENSCHAPPEN  
TE AMSTERDAM.

PROCEEDINGS OF THE MEETING  
of Saturday June 27, 1914.  
VOL. XVII.

*President:* Prof. H. A. LORENTZ.  
*Secretary:* Prof. P. ZEEMAN.

(Translated from: Verslag van de gewone vergadering der Wis- en Natuurkundige  
Afdeling van Zaterdag 27 Juni 1914, Dl. XXIII).

CONTENTS.

- JAN DE VRIES: "A triple involution of the third class", p. 134.  
W. KAPTEYN: "On the functions of HERMITE." (Third part), p. 139.  
M. J. VAN UVEN: "The theory of BRAVAIS (on errors in space) for polydimensional space, with applications to correlation." (Continuation). (Communicated by Prof. J. C. KAPTEYN), p. 150.  
M. J. VAN UVEN: "Combination of observations with and without conditions and determination of the weights of the unknown quantities, derived from mechanical principles." (Communicated by Prof. JAN DE VRIES), p. 157.  
F. A. H. SCHREINEMAKERS: "Equilibria in ternary systems." XVI, p. 169.  
A. SMITS and S. POSTMA: "The system ammonia-water". (Communicated by Prof. J. D. VAN DER WAALS), p. 182.  
N. G. W. H. BEEGER: "On HERMITE's and ABEL's polynomia." (Communicated by Prof. W. KAPTEYN), p. 192.  
ERNST COHEN: "The metastability of the metals in consequence of allotropy and its significance for Chemistry, Physics and Technics". II, p. 200.  
PH. KOHNSTAMM and K. W. WALSTRA: "Measurements of isotherms of hydrogen at 20° C. and 15.5 C." (Communicated by Prof. J. D. VAN DER WAALS), p. 203.  
K. W. WALSTRA: "The hydrogen isotherms of 20° C. and of 15.5 C. between 1 and 2200 atms." (Communicated by Prof. J. D. VAN DER WAALS), p. 217.  
D. J. KORTEWEG: "The different ways of floating of an homogeneous cube", p. 224.  
A. WICHMANN: "On some rocks of the island of Taliabu (Sula-Islands)", p. 226.  
F. M. JAEGER and A. SIMER: "Studies in the Field of Silicate-Chemistry". II. On the Lithiumaluminumsilicates whose composition corresponds to that of the Minerals Eucryptite and Spodumene, p. 239. Ibid III. On the Lithiumaluminumsilicates, whose composition corresponds to that of the Minerals Eucryptite and Spodumene. (Continued), (Communicated by Prof. P. VAN ROMBURGH) p. 251.  
E. LAQUEUR: "On the survival of isolated mammalian organs with automatic function", (Communicated by Prof. H. J. HAMBURGER), p. 270.  
C. A. CROMMELIN: "Isothermals of monatomic substances and their binary mixture. XVI. New determination of the vapour-pressures of solid argon down to -205°." (Communicated by Prof. H. KAMERLINGH ONNES), p. 275.  
II. KAMERLINGH ONNES: "Further experiments with liquid helium. J. The imitation of an AMPÈRE molecular current or a permanent magnet by means of a supra-conductor", (Cont.) p. 278.  
II. KAMERLINGH ONNES: "Further experiments with liquid helium. K. Appearance of beginning paramagnetic saturation", p. 283.

- W. KAUTEYN: "On some integral equations", p. 286.
- H. G. VAN DE SANDE BAKHUYZEN, N. WILDEBOER and J. W. DIEPERINK: "Comparison of the measuring bar used in the base-measurement at Stroe with the Dutch Metre No. 27", p. 300.
- II. G. VAN DE SANDE BAKHUYZEN: "Comparison of the Dutch platinum-iridium Metre No. 27 with the international Metre M, as derived from the measurements by the Dutch Metro-Commission in 1879 and 1880, and a preliminary determination of the length of the measuring-bar of the French base-apparatus in international Metres", p. 311.
- L. K. WOLFF: "On the formation of antibodies after injection of sensitized antigens". II. (Communicated by Prof. C. EYKMAN), p. 318.
- F. M. JAEGER: "The Temperature-coefficients of the free Surface-energy of Liquids at Temperatures from  $-80^{\circ}$  to  $1650^{\circ}$  C. I. Methods and Apparatus. (Communicated by Prof. P. VAN ROMBURGH). (With two plates), p. 329.
- F. M. JAEGER and M. J. SMIT: Ibid II. "Measurements of some Aliphatic Derivatives," p. 365. Ibid III. "Measurements of some Aromatic Derivatives." (Communicated by Prof. P. VAN ROMBURGH), p. 386.
- F. M. JAEGER and JUL. KAHN: Ibid IV. "Measurements of some Aliphatic and Aromatic Ethers". (Communicated by Prof. P. VAN ROMBURGH), p. 395.
- F. M. JAEGER: Ibid V. "Measurements of homologous Aromatic Hydrocarbons and some of their Halogenderivatives", p. 405. Ibid VI. "General Remarks". (Communicated by Prof. P. VAN ROMBURGH), p. 416.
- II. HAGA and F. M. JAEGER: "On the real Symmetry of Cordierite and Apophyllite". (With two plates), p. 430.
- P. ZEEMAN: "FRESNEL'S coefficient for light of different colours". (First part). (With one plate), p. 445.
- J. J. VAN LAAR: "A new relation between the critical quantities, and on the unity of all substances in their thermic behaviour". (Conclusion). (Communicated by Prof. H. A. LORENTZ), p. 451.

**Mathematics.** — "*A triple involution of the third class.*" By  
Professor JAN DE VRIES.

(Communicated in the meeting of May 30, 1914).

1. I consider the projective nets of conics represented by

$$\lambda a_x^2 + \lambda' a_x'^2 + \lambda'' a_x''^2 = 0 \text{ and } \lambda b_x^2 + \lambda' b_x'^2 + \lambda'' b_x''^2 = 0 \quad (1)$$

The points of intersection of corresponding conics form a quadruple involution <sup>1)</sup>.

On the straight line  $YZ$ , which we may represent by  $x_k = \rho y_k + \sigma z_k$ , the two nets determine the pairs of points, indicated by

$$\sum_3 \lambda (\rho^2 a_y^2 + 2\rho\sigma a_y a_z + \sigma^2 a_z^2) = 0 \text{ and } \sum_3 \lambda (\rho^2 b_y^2 + 2\rho\sigma b_y b_z + \sigma^2 b_z^2) = 0.$$

These equations produce the same pair of points, as soon as the relations

$$\sum_3 \lambda a_y^2 = \tau \sum_3 \lambda b_y^2, \quad \sum_3 \lambda a_y a_z = \tau \sum_3 \lambda b_y b_z, \quad \sum_3 \lambda a_z^2 = \tau \sum_3 \lambda b_z^2.$$

are satisfied.

By elimination of  $\lambda, \lambda', \lambda''$  we find from this system the relation

$$| a_y^2 - \tau b_y^2, \quad a_y a_z - \tau b_y b_z, \quad a_z^2 - \tau b_z^2 | = 0 \quad (2)$$

<sup>1)</sup> This involution is an intersection of the linear congruence of elliptic twisted quartics, which I have considered in my communication in vol. XIV, p. 1127 of these Proceedings.



from which it appears that  $YZ$  contains three pairs of the involution ; the latter is consequently of the *third class*.

2. We shall now suppose that the two nets have a common base point  $A$  ; they produce then a *triple involution* of the *third class*. We choose the base point  $A$  for vertex  $O_3$  of a triangle of co-ordinates.

Through  $O_3$  pass  $\infty^1$  conics of the first net, which are touched there by the corresponding conics. For we have the conditions

$$\sum_3 \lambda a_{13} = \tau \sum_3 \lambda b_{13} \text{ and } \sum_3 \lambda a_{23} = \tau \sum_3 b_{23},$$

so that the parameters  $\lambda, \lambda', \lambda''$  are connected by the relation

$$\begin{vmatrix} \sum_3 a_{13} \lambda & \sum_3 b_{13} \lambda \\ \sum_3 a_{23} \lambda & \sum_3 b_{23} \lambda \end{vmatrix} = 0. \quad \dots \dots \dots (3)$$

Now we find from (1)

$$\lambda = \begin{vmatrix} a_r'^2 & a_x''^2 \\ b_x'^2 & b_x''^2 \end{vmatrix} \text{ etc.}$$

If we substitute these formulae  $\lambda, \lambda', \lambda''$  in (3), an equation of the eighth order will arise. The locus of the pairs  $X', X''$  of the triple involution  $(X^3)$  associated to  $O_3 = A$  is therefore a curve of the *eighth order*, which we shall indicate by  $\alpha^8$  ;  $A$  is a *singular point of order eight*.

By (3) two projective systems with index two are separated from the two nets, which systems produce the curve  $\alpha^8$ . Their intersections with the arbitrary straight line  $r$ , are the coincidences of the  $(4,4)$ , which the two systems determine on  $r$ . If  $r$  is laid through  $A$ , the free points of intersection are connected by a  $(2,2)$  ; one of the 4 coincidences of this correspondence lies in  $A$ , because two homologous conics touch each other and  $r$  in  $A$ . Hence it appears that the *singular curve*  $\alpha^8$  has a *quintuple point* in  $A$ . This corresponds to the fact that  $(X^3)$  must be of the third class ; the three pairs on a straight line  $r$  laid through  $A$  are formed by  $A$  with the three points in which  $r$  is moreover cut by  $\alpha^8$ . The line  $x = X'X''$  envelops a curve of the *fifth class* ; for of the system  $(x)$  only the lines which touch  $\alpha^8$  in  $A$  pass through  $A$ .

3.  $A$  is not the only singular point of  $(X^3)$ . The homologous conics intersecting in a point  $Y$  are determined by

$$\sum_3 \lambda a_y^2 = 0 \quad \text{and} \quad \sum_3 \lambda b_y^2 = 0.$$

If these equations are dependent,  $Y$  becomes a singular point.

Through  $\gamma$  pass then two projective pencils of conics, which determine a quartic represented by

$$| a_y^2 \quad a_x^2 \quad b_x^2 | = 0, \quad . \quad . \quad . \quad . \quad . \quad . \quad (4)$$

or also by

$$| b_y^2 \quad b_x^2 \quad a_x^2 | = 0. \quad . \quad . \quad . \quad . \quad . \quad (4^*)$$

The singular points are determined by the relations

$$\left\| \begin{matrix} a_y^2 & a_y'^2 & a_y''^2 \\ b_y^2 & b_y'^2 & b_y''^2 \end{matrix} \right\| = 0 \quad . \quad . \quad . \quad . \quad . \quad (5)$$

Now the curves  $a_y^2 b_y''^2 = a_y''^2 b_y^2$  and  $a_y^2 b_y'^2 = a_y'^2 b_y^2$  have apart from the point  $O_3$  (which is node on both) 12 points in common. To them belong the three points, which  $a_y^2 = 0$  and  $b_y^2 = 0$  have in common apart from  $O_3$ ; they do not lie, however, on the curve  $a_y'^2 b_y''^2 = a_y''^2 b_y'^2$ . There are therefore, besides the singular point  $A$ , nine more singular points  $B_k$ ; the pairs of points, which form with  $B_k$  groups of the involution  $(X^3)$  lie on a curve  $\beta_k^4$ , so that  $B_k$  is a singular point of order four.

The singular curve  $\beta_k^4$  is produced by two projective pencils with common base points  $A$  and  $B_k$ ; it has therefore nodes in these two points. From (4) and (5) it appears that this curve also passes through the remaining singular points. The straight lines  $x$ , which contain the pairs  $X', X''$  lying on  $\beta_k^4$ , envelop a conic.

As  $\beta_k^4$  passes through  $A$  twice, there are in  $(X^3)$  two groups in which the pair  $A, B_k$  occurs; so  $B_k$  belongs twice to  $\alpha^8$ . This singular curve has therefore besides its quintuple point  $A$ , nine more nodes  $B_k$ , is consequently of genus two and of class 18.

On each of the 8 tangents of  $\alpha^8$ , passing through  $A$ , two pairs of the  $(X^3)$  coincide; from this it ensues that the straight lines  $s$  on which two pairs have coincided, envelop a curve of class eight, which we indicate by  $(s)_8$ .

4. We can now determine the order  $x$  of the locus  $\lambda$  of the pairs of points  $X', X''$ , which form groups of the  $(X^3)$  with the points  $X$  of a straight line  $l$ . As  $\alpha^8$  contains eight points of  $l$ ,  $\lambda$  passes eight times through  $A$ ; analogously it has quadruple points in  $B_k$ . The  $x$  points of intersection of  $\lambda$  with an other straight line  $l^*$  are vertices of triangles of involution, of which a second vertex lies on  $l$ , so that the third vertex must be a common point of  $\lambda$  and  $\lambda^*$ . As these curves, besides in two vertices of the triangle determined by the point  $l^*$  and the  $x$  points mentioned, can only intersect moreover in the singular points, we have for the deter-

mination of  $x$ , the relation  $x^2 = x + 2 + 8^2 + 9 \times 4^2$ ; hence  $x = 15$ .

The transformation  $(X, X')$ , which replaces each point by the two points, which  $(X^3)$  associates to it, transforms therefore a straight line into a curve of order fifteen with an octuple point and nine quadruple points.

As  $l$  contains three pairs  $X, X'$ , which supply six intersections with  $\lambda^{15}$ , the curve of coincidences  $\sigma$  is of order nine. Apparently  $\sigma^9$  has a quintuple point in  $A$  and nodes in  $B_k$ .

With  $\alpha^8$ ,  $\sigma^9$  has  $5 \times 6 + 9 \times 4 = 66$  intersections in  $A$  and  $B_k$ ; the remaining six are coincidences of the involution of pairs lying on  $\alpha^8$ . Analogously we find that  $l^2$  has four coincidences on  $\beta_k^4$ .

The supports  $d$  of the coincidences envelop a curve of the tenth class  $(d)_{10}$ , which has a quintuple point in  $A$ .

5. The locus of the pairs  $X', X''$ , which are collinear with a point  $E$ , is a curve  $\varepsilon^8$ , passing twice through  $E$  where it is touched by the lines to the points  $E'$  and  $E''$ , which form a triangle of involution with  $E$ . It is clear that  $\varepsilon^8$  will pass three times through  $A$  and twice through each point  $B$ ; it is consequently of class 30.

To the 26 tangents of  $\varepsilon^8$ , passing through  $E$ , belong 10 lines  $d$ ; the remaining ones are represented by 8 bitangents, which are straight lines  $s$ .

If  $E$  is brought in  $A$ , then  $\varepsilon^8$  passes into  $\alpha^8$ . For a point  $B_k$   $\varepsilon^8$  consists of  $\beta_k^4$  and a curve  $\varepsilon_k^4$ , which passes through  $A$  and the points  $B_l$  and has a node in  $B_k$ . The two curves have 14 intersections in the singular points; the remaining two are points  $E'$  and  $E''$ , belonging to  $E \equiv B_k$ . The 6 tangents passing through  $B_k$  at  $\varepsilon_k$  are supports of coincidences; the curve  $(d)_{10}$  has  $B_k$  for node.

The curve  $\varepsilon^8$  has with  $\sigma^9$  51 intersections in  $A$  and  $B_k$ ; of the remaining common points 10 lie in the coincidences mentioned above, of which the supports  $d$  pass through  $E$ . Consequently there lie on  $\varepsilon^8$  11 coincidences  $X \equiv X'$ , of which the supports do not pass through  $E$ , whereas  $X'$  and  $X''$  are collinear with  $E$ . These 11 points belong to the curve  $\varepsilon_*$ , which contains the points  $X$ , for which the line  $x = X'X''$  passes through  $E$ . The curves  $\varepsilon^8$  and  $\varepsilon_*$  also have the points  $E'$  and  $E''$  in common, forming a triangle of involution with  $E$ . As  $E$  is collinear with 5 pairs of the  $l^2$  lying on  $\alpha^8$  and with 2 pairs of the  $l^2$  lying on  $B_k$ ,  $\varepsilon_*$  passes five times through  $A$  and twice through  $B_k$ . Consequently  $\varepsilon^8$  and  $\varepsilon_*$  have in all  $3 \times 5 + 9 \times 2 + 13 = 64$  points in common; the locus of  $X$  is therefore a curve  $\varepsilon_*^8$ .

As  $E$  is collinear with 5 pairs<sup>1)</sup>  $X', X''$  of  $\alpha^8$ , and with two pairs of  $\beta_k^2$ ,  $\epsilon_*^8$  has a quintuple point in  $A$  and nodes in  $B_k$ .

If  $E$  is brought in  $A$ ,  $\epsilon_*^8$  coincides with  $\alpha^8$ .

For  $B_1$   $\epsilon_*^8$  consists of the curve  $\beta_1^4$  and a curve  $*\beta_1^4$ , which passes three times through  $A$  and once through the 8 points  $B_k$ .

The intersections  $X$  of  $\epsilon_*^8$  with the straight line  $l$  determine 8 lines  $x = X'X''$  passing through  $E$ ; we conclude from this that  $x$  envelops a curve of the eighth class  $(l)_8$ , when  $X$  describes the straight line  $l$ . In confirmation of this result we observe that with the 8 intersections  $X$  of  $l$  and  $\alpha^8$  correspond the 8 straight lines passing through  $A(X'')$  to the associated points  $X'$ .

As  $(l)_8$  must be rational, consequently possesses 21 bitangents,  $l$  contains 21 pairs  $X, Y$ , for which the corresponding points  $X', X''$ ;  $Y', Y''$  are collinear.

6. An arbitrary straight line contains three pairs  $(X', X'')$ ,  $(Y', Y'')$ ,  $(Z', Z'')$  of  $X^3$ ; the corresponding points  $X, Y, Z$  apparently form a group of a *new triple involution*<sup>2)</sup>, which we shall indicate by  $(XYZ)$ ; it appears to be of class 21.

Apparently  $(XYZ)$  has singular points in  $A$  and  $B_k$ . Let  $x$  be the order of the curve  $\alpha$ , which contains the pairs  $Y, Z$ , belonging to  $X \equiv A$ ; let further  $y$  be the order of the corresponding curve  $\beta_k$  belonging to  $B_k$ .

Let the straight line  $l$  be described by a point  $Z$ , the associated pair  $X'Y'$  will then describe a curve  $\lambda$ , the order of which we shall indicate by  $z$ . If attention is paid to the points of intersection of  $l$  with  $\alpha$  and  $\beta_k$ , it will be seen that  $\lambda$  must have an  $x$ -fold point in  $A$ , a  $y$ -fold point in  $B_k$ .

In order to determine the numbers  $x, y, z$ , we may obtain three equations.

We consider in the first place the intersections of the curves  $\lambda$  and  $\mu$ , which are determined by the straight lines  $l$  and  $m$ . To them belong the two points which form a triplet with  $lm$ , further  $z$  points  $Z$ , for which  $X$  lies on  $l$  and  $Y$  on  $m$ ; the remaining intersections lie in the singular points. So we have the relation

$$z^2 = 2 + z + x^2 + 9y^2 \dots \dots \dots (6)$$

Let the curve  $\alpha^8$  be described by  $Z$ , then the figure of order  $8z$ ,

<sup>1)</sup> The curves  $\alpha^8$  and  $\epsilon^8$  have  $3 \times 5 + 9 \times 2 \times 2 = 51$  intersections in the singular points; they have 3 more points in common on  $EA$ ; the remaining 10 intersections form 5 points  $X', X''$  collinear with  $E$ . From this appears anew that the curve of involution  $\alpha^3$  is of class 5.

<sup>2)</sup> This property is characteristic of the triple involutions of the *third* class.

which is described by the pair  $X, Y$ , will be the combination of twice  $\alpha^8$ , five times  $\alpha^x$  and twice  $\beta_k^y$ .

Hence

$$8z = 16 + 5x + 18y \quad . \quad . \quad . \quad . \quad . \quad (7)$$

If  $Z$  describes the curve  $^*\beta_1^4$ , the corresponding figure of order  $4z$  consists of the curve  $\beta_1^4$ , of three times  $\alpha^x$ , and of the 8 curves  $\beta_k^y$  ( $k \neq 1$ ). Hence :

$$4z = 4 + 3x + 8y \quad . \quad . \quad . \quad . \quad . \quad (8)$$

Out of (6), (7), (8) we find by elimination of  $x$  and  $y$ ,

$$z^2 - 77z + 882 = 0;$$

so  $z$  is equal to 63 or 14. The second value, however, must be rejected; for we have proved above, that  $(XYZ)$  is of the class 21, so that  $l$  has 42 points in common with  $\lambda$  at the least. So we find the values

$$z = 63, \quad x = 40, \quad y = 16.$$

For the involution  $(XYZ)$ ,  $A$  is a *singular point* of order 40,  $B_k$  a *singular point* of order 16.

As  $l$  and  $\lambda$  besides the 21 pairs already mentioned can only have coincidences in common, the *curve of coincidences*  $(XYZ)$  is of order 21,  $d^{21}$ .

Apparently  $\alpha^{40}$  has in  $A$  a 20-fold point,  $\beta_k^{16}$  in  $B_k$  an eight-fold point; in these points  $d^{21}$  has the tangents in common with  $\alpha^{40}$  and  $\beta_k^{16}$ .

If  $X$  is placed in  $A$  and  $Y$  in  $B_k$ ,  $x = X'X''$  envelops a curve of the 5<sup>th</sup> class,  $y = Y'Y''$  a conic; so there are 10 straight lines  $x = y$ . From this it ensues that the singular curve  $\alpha^{40}$  has ten-fold points in  $B_k$ . In a similar way we find that the curve  $\beta_k^{16}$  has quadruple points in  $B_l$ ; it passes ten times through  $A$ , eight times through  $B_k$ .

**Mathematics.** — “*On the functions of HERMITE.*” (Third part).

By Prof. W. KAPTEYN.

(Communicated in the meeting of May 30, 1914).

12. After having written the preceding pages, we met with two important, newly published papers, on the same subject. The first by Mr. H. GALBRUN: “*Sur un développement d’une fonction à variable réelle en série de polynômes*” (Bull. de la Soc. math. de France T. XLI p. 24), the second by Prof. K. RUNGE “*Ueber eine besondere Art von Integralgleichungen*” (Math. Ann. Bd. 75 p. 130).

In this section we will give their principal results though not altogether after their methods, and make some additional remarks.

13. Mr. GALBRUN considers the question of the expansion of a function between the limits  $a$  and  $b$ , in a series

$$f(x) = A_0 H_0(x) + A_1 H_1(x) + . . .$$

where

$$A_n = \frac{1}{2^n n!} \frac{1}{\sqrt{\pi}} \int_a^b e^{-x^2} f(\alpha) H_n(\alpha) d\alpha.$$

He finds that this expansion is possible when  $f(x)$  satisfies the conditions of DIRICHLET between the limits  $a$  and  $b$ . This agrees with our result in Art. 7, the only difference being that our limits were  $-\infty$  and  $+\infty$ . This difference however is not essential, for considering a function which has the value zero for all values  $a > x > b$  Art. 7 gives immediately the expansion of Mr. GALBRUN.

His proof rests on two interesting relations which may be easily deduced from the formulæ in the first part of this paper.

The first relation

$$\sum_0^n \frac{H_p(x) H_p(\alpha)}{2^p p!} = \frac{1}{2^{n+1} n!} \frac{H_{n+1}(x) H_n(\alpha) - H_n(x) H_{n+1}(\alpha)}{x - \alpha} \quad (29)$$

may be established in this way.

According to (5) we have

$$\begin{aligned} 2x H_n(x) &= H_{n+1}(x) + 2n H_{n-1}(x) \\ 2\alpha H_n(\alpha) &= H_{n+1}(\alpha) + 2n H_{n-1}(\alpha) \end{aligned} \quad (n > 0)$$

Multiplying these equations by  $H_n(\alpha)$  and  $H_n(x)$  we find by subtracting

$$\begin{aligned} 2(x - \alpha) H_n(x) H_n(\alpha) &= H_{n+1}(x) H_n(\alpha) - H_n(x) H_{n+1}(\alpha) \\ &\quad - 2n [H_n(x) H_{n-1}(\alpha) - H_{n-1}(x) H_n(\alpha)]. \end{aligned}$$

Hence, putting for  $n$  successively  $0, 1, 2, \dots, n$ , we get

$$\begin{array}{l} 1 \quad | \quad 2(x-\alpha)H_0(x)H_0(\alpha) = H_1(x)H_0(\alpha) - H_0(x)H_1(\alpha) \\ \\ \frac{1}{2 \cdot 1!} \quad | \quad \begin{aligned} &2(x-\alpha)H_1(x)H_1(\alpha) = H_2(x)H_1(\alpha) - H_1(x)H_2(\alpha) - 2[H_1(x)H_0(\alpha) - H_0(x)H_1(\alpha)] \\ &2(x-\alpha)H_2(x)H_2(\alpha) = H_3(x)H_2(\alpha) - H_2(x)H_3(\alpha) - 4[H_2(x)H_1(\alpha) - H_1(x)H_2(\alpha)] \\ &\dots \dots \dots \end{aligned} \\ \\ \frac{1}{2^n \cdot n!} \quad | \quad \begin{aligned} &2(x-\alpha)H_n(x)H_n(\alpha) = H_{n+1}(x)H_n(\alpha) - H_n(x)H_{n+1}(\alpha) - \\ &\qquad \qquad \qquad - 2n[H_n(x)H_{n-1}(\alpha) - H_{n-1}(x)H_n(\alpha)]. \end{aligned} \end{array}$$

Multiplying these relations with the different factors written on the left, the addition of these products immediately gives the formula in question.

The second relation

$$\sum_1^{\infty} \frac{H_n(x)H_{n-1}(x)}{2^n \cdot n!} = e^{x^2} \int_0^x e^{-x^2} dx. \quad \dots \quad (30)$$

may be obtained by introducing (9) into the first member.

Thus we get

$$\begin{aligned} \sum_1^{\infty} \frac{H_n(x)H_{n-1}(x)}{2^n \cdot n!} &= \\ &= -\frac{e^{2x^2}}{\pi} \sum_1^{\infty} \frac{1}{2^n \cdot n!} \int_0^{\infty} e^{-\frac{u^2}{4}} u^n \cos\left(xu - \frac{n\pi}{2}\right) du \int_0^{\infty} e^{-v^2} v^{n-1} \sin\left(xv - \frac{n\pi}{2}\right) dv \end{aligned}$$

where

$$\begin{aligned} \frac{1}{v} \sum_1^{\infty} \frac{u^n v^n}{2^n \cdot n!} \cos\left(xu - \frac{n\pi}{2}\right) \sin\left(xv - \frac{n\pi}{2}\right) &= \\ &= \frac{\cos xu \sin xv}{v} \sum_1^{\infty} \frac{u^{2k} v^{2k}}{2^{2k} (2k)!} - \frac{\sin xu \cos xv}{v} \sum_1^{\infty} \frac{u^{2k+1} v^{2k+1}}{2^{2k+1} (2k+1)!} \\ &= \frac{\cos xu \sin xv}{v} \left(\frac{e^{\frac{uv}{2}} + e^{-\frac{uv}{2}}}{2} - 1\right) - \frac{\sin xu \cos xv}{v} \left(\frac{e^{\frac{uv}{2}} - e^{-\frac{uv}{2}}}{2}\right). \end{aligned}$$

Substituting this value, it is evident, according to the formulae of Art. 6, that all the terms of this sum vanish except only the term corresponding to  $-1$ .

Hence

$$\sum_1^{\infty} \frac{H_n(x)H_{n-1}(x)}{2^n \cdot n!} = \frac{e^{2x^2}}{\pi} \int_0^{\infty} \int_0^{\infty} e^{-\frac{u^2+v^2}{4}} \frac{\cos xu \sin xv}{v} du dv,$$

and because

$$\int_0^{\infty} e^{-\frac{u^2}{4}} \cos xu du = \sqrt{\pi} e^{-x^2} \quad \dots \quad (a)$$

$$\sum_1^{\infty} \frac{H_n(x)H_{n-1}(x)}{2^n \cdot n!} = \frac{1}{\sqrt{\pi}} e^{x^2} \int_0^{\infty} e^{-\frac{v^2}{4}} \frac{\sin xv}{v} dv.$$

If now we multiply the equation (a) by  $dx$  and integrate between 0 and  $x$ , we have

$$\int_0^x e^{-\frac{u^2}{4}} \frac{\sin xu}{u} du = \sqrt{\pi} \int_0^x e^{-x^2} dx,$$

thus finally

$$\sum_1^{\infty} \frac{H_n(x)H_{n-1}(x)}{2^n \cdot n!} = e^{x^2} \int_0^x e^{-x^2} dx.$$

14. Prof. RUNGE gives the solution of the integral equation

$$f(u) = \int_{-\infty}^{\infty} K(x) \varphi(u+x) dx \dots \dots \dots (31)$$

where  $f(u)$  and  $K(x)$  are given functions and  $\varphi(x)$  is required, by means of HERMITE'S functions.

He assumes

$$K(x) = e^{-x^2} [a_0 H_0(x) + a_1 H_1(x) + a_2 H_2(x) + \dots]$$

$$\varphi(x) = e^{-x^2} [b_0 H_0(x) + b_1 H_1(x) + b_2 H_2(x) + \dots]$$

which gives

$$f(u) = \sum a_m b_n \int_{-\infty}^{\infty} e^{-x^2} H_m(x) e^{-(u+x)^2} H_n(u+x) dx$$

or, after some reductions

$$f(u) = \frac{\sqrt{\pi}}{\sqrt{2}} \sum_0^x (-1)^m a_m b_n e^{-\frac{u^2}{2}} \frac{H_{m+n}\left(\frac{u}{\sqrt{2}}\right)}{(\sqrt{2})^{m+n}}.$$

If now, the given function  $f(u)$  is expanded in this form

$$f(u) = \frac{\sqrt{\pi}}{\sqrt{2}} e^{-\frac{u^2}{2}} \left[ c_0 + c_1 \frac{H_1\left(\frac{u}{\sqrt{2}}\right)}{\sqrt{2}} + c_2 \frac{H_2\left(\frac{u}{\sqrt{2}}\right)}{(\sqrt{2})^2} + \dots \right]$$

we have from (31)

$$c_0 = a_0 b_0, \quad c_1 = a_0 b_1 - a_1 b_0, \quad c_2 = a_0 b_2 - a_1 b_1 + a_2 b_0, \dots$$

and it is evident that from these relations the coefficients  $b$  may be determined. If  $f(u)$  and  $\varphi(x)$  were the given functions, the same relations would be sufficient to determine the function  $K(x)$ .

15. The preceding reduction rests on the formula

$$H_n\left(\frac{x+y}{\sqrt{2}}\right) = \frac{1}{(\sqrt{2})^n} [H_n(x) + C_1^n H_{n-1}(x)H_1(y) + C_2^n H_{n-2}(x)H_2(y) + \dots + C_n^n H_n(y)] \quad (32)$$



where  $C_i^h$  are the binomial coefficients. This relation may be obtained in the following way.

According to Art. 8 II we have

$$e^{-2hz-h^2} = 1 - h H_1(z) + \frac{h^2}{2!} H_2(z) - \frac{h^3}{3!} H_3(z) + \dots \quad (p)$$

and, expanding by TAYLOR'S theorem

$$F(x+k, y+k)$$

where

$$F(x, y) = e^{-x^2-y^2}$$

$$e^{-(x+k)^2-(y+k)^2} \cdot e^{x^2+y^2} = e^{x^2+y^2} \left[ e^{-x^2-y^2} + k \left\{ e^{-y^2} \frac{d}{dx} (e^{-x^2}) + e^{-x^2} \frac{d}{dy} (e^{-y^2}) \right\} + \frac{k^2}{2!} \left\{ e^{-y^2} \frac{d^2}{dx^2} (e^{-x^2}) + 2 \frac{d}{dx} (e^{-x^2}) \frac{d}{dy} (e^{-y^2}) + e^{-x^2} \frac{d^2}{dy^2} (e^{-y^2}) \right\} + \dots \right]$$

which may be written

$$e^{-2kx-2ky-2k^2} = 1 - k[H_1(x) + H_1(y)] + \frac{k^2}{2!}[H_2(x) + 2H_1(x)H_1(y) + H_2(y)] + \dots \quad (q)$$

Putting now  $z = \frac{x+y}{\sqrt{2}}$  in (p) and  $k = \frac{h}{\sqrt{2}}$  in (q) we get

$$e^{-(x+y)h\sqrt{2}-h^2} = 1 - h H_1\left(\frac{x+y}{\sqrt{2}}\right) + \frac{h^2}{2!} H_2\left(\frac{x+y}{\sqrt{2}}\right) - \dots$$

$$e^{-(x+y)h\sqrt{2}-h^2} = 1 - \frac{h}{\sqrt{2}} [H_1(x) + H_1(y)] + \frac{h^2}{(\sqrt{2})^2 2!} [H_2(x) + 2H_1(x)H_1(y) + H_2(y)] + \dots$$

Comparing the coefficients of  $\frac{h^n}{n!}$  in the second members we obtain the required relation (31).

Proceeding to the reduction of the integral

$$M = \int_{-\infty}^{\infty} e^{-x^2} H_m(x) e^{-(u+x)^2} H_n(u+x) dx$$

we put, according to (2)

$$H_m(x) = (-1)^m e^{x^2} \frac{d^m}{dx^m} (e^{-x^2})$$

then

$$M = (-1)^m \int_{-\infty}^{\infty} \frac{d^m}{dx^m} (e^{-x^2}) \cdot e^{-(u+x)^2} H_n(u+x) dx.$$

Now, integrating by parts we have generally

$$\int U \frac{d^m V}{dx^m} dx = (-1)^m \int V \frac{d^m U}{dx^m} dx + \left[ U \frac{d^{m-1} V}{dx^{m-1}} - \frac{dU}{dx} \frac{d^{m-2} V}{dx^{m-2}} + \dots + (-1)^{m-1} \frac{d^{m-1} U}{dx^{m-1}} V \right]$$

thus, assuming

$$U = e^{-(u+x)^2} H_n(u+x), \quad V = e^{-x^2}$$

and introducing the limits  $-\infty$  and  $\infty$

$$\begin{aligned} M &= \int_{-\infty}^{\infty} e^{-x^2} \frac{d^m}{dx^m} [e^{-(u+x)^2} H_n(u+x)] dx \\ &= (1)^n \int_{-\infty}^{\infty} e^{-x^2} \frac{d^{m+n}}{dx^{m+n}} (e^{-(u+x)^2}) dx \\ &= (-1)^m \int_{-\infty}^{\infty} e^{-x^2 - (u+x)^2} H_{m+n}(u+x) dx \end{aligned}$$

or, adopting

$$u = v\sqrt{2} \quad x = \frac{\xi - v}{\sqrt{2}}$$

$$M = \frac{(-1)^m}{\sqrt{2}} e^{-v^2} \int_{-\infty}^{\infty} e^{-\xi^2} H_{m+n}\left(\frac{\xi+v}{\sqrt{2}}\right) d\xi.$$

Applying now the relation (32), it is evident that the integral reduces to the first term, thus

$$M = \frac{(-1)^m}{\sqrt{2}} e^{-v^2} \frac{H_{m+n}(v)}{(\sqrt{2})^{m+n}}$$

or finally

$$M = \frac{(-1)^m}{\sqrt{2}} e^{-\frac{u^2}{2}} \frac{H_{m+n}\left(\frac{u}{\sqrt{2}}\right)}{(\sqrt{2})^{m+n}}.$$

16. We will now compare the preceding solution of the integral-equation (31) with the formal solution given by Prof. K. SCHWARZSCHILD (*Astr. Nachr.* Bd. 185 N<sup>o</sup>. 4422).

Putting

$$t = e^{-u}, \quad s = e^{-x}$$

the equation

$$\int_0^{\infty} A(t, s) F(s) ds = B(t)$$

takes the form

$$\int_{-\infty}^{\infty} A(e^{-(u+x)}) F(e^{-x}) e^{-x} dx = B(e^{-u})$$

or, assuming

$$e^{-x} F(e^{-x}) = K(x)$$

$$A(e^{-(u+x)}) = \varphi(u+x)$$

$$B(e^{-u}) = f(u)$$

$$\int_{-\infty}^{\infty} K(x) \varphi(u+x) dx = f(u).$$

Now SCHWARZSCHILD multiplies this equation by  $e^{-i\lambda u} du$  and integrates between the limits  $-\infty$  and  $+\infty$ , thus

$$\begin{aligned} \int_{-\infty}^{\infty} f(u) e^{-i\lambda u} du &= \int_{-\infty}^{\infty} K(x) dx \int_{-\infty}^{\infty} \varphi(u+x) e^{-i\lambda u} du \\ &= \int_{-\infty}^{\infty} K(x) e^{i\lambda x} dx \int_{-\infty}^{\infty} \varphi(v) e^{-i\lambda v} dv \end{aligned}$$

and puts

$$f(u) = \int_{-\infty}^{\infty} F(\lambda) e^{i\lambda u} du \quad \text{thus} \quad F(\lambda) = \frac{1}{2\pi} \int_{-\infty}^{\infty} f(u) e^{-i\lambda u} du$$

$$K(x) = \int_{-\infty}^{\infty} L(\lambda) e^{i\lambda x} dx \quad ,, \quad L(\lambda) = \frac{1}{2\pi} \int_{-\infty}^{\infty} K(x) e^{-i\lambda x} dx$$

$$\varphi(v) = \int_{-\infty}^{\infty} \Phi(\lambda) e^{i\lambda v} dv \quad ,, \quad \Phi(\lambda) = \frac{1}{2\pi} \int_{-\infty}^{\infty} \varphi(v) e^{-i\lambda v} dv$$

therefore

$$F(\lambda) = 2\pi L(-\lambda) \Phi(\lambda)$$

or

$$L(\lambda) = \frac{1}{2\pi} \frac{F(-\lambda)}{\Phi(-\lambda)}$$

Multiplying again by  $e^{i\lambda x} d\lambda$  and integrating between  $-\infty$  and  $+\infty$  this relation, he obtains

$$K(x) = \frac{1}{2\pi} \int_{-\infty}^{\infty} \frac{F(-\lambda)}{\Phi(-\lambda)} e^{i\lambda x} d\lambda.$$

If now we compare this result with the preceding, we have

$$F(\lambda) = \frac{1}{2\pi} \int_{-\infty}^{\infty} f(u) e^{-i\lambda u} du$$

or

$$F(\lambda) = \frac{1}{2\pi} \frac{\sqrt{\pi}}{\sqrt{2}} \int_{-\infty}^{\infty} e^{-i\lambda u} e^{-\frac{u^2}{2}} \left( c_0 + c_1 \frac{H_1\left(\frac{u}{\sqrt{2}}\right)}{\sqrt{2}} + c_2 \frac{H_2\left(\frac{u}{\sqrt{2}}\right)}{(\sqrt{2})^2} + \dots \right) du.$$

The general term in the series of the second member being

$$P_n = \int_{-\infty}^{\infty} e^{-\frac{u^2}{2}} H_n\left(\frac{u}{\sqrt{2}}\right) e^{-i\lambda u} du = \sqrt{2} \int_{-\infty}^{\infty} e^{-v^2} H_n(v) e^{-i\lambda v \sqrt{2}} dv$$

it is obvious that for  $n = 2k$  the imaginary part and for  $n = 2k + 1$  the real part of this integral vanishes. Thus for  $n = 2k$

$$P_{2k} = \sqrt{2} \int_{-\infty}^{\infty} e^{-v^2} H_{2k}(v) \cos(\lambda v \sqrt{2}) dv,$$

where according to Art. 8 II

$$\cos(\lambda v \sqrt{2}) = e^{-\frac{\lambda^2}{2}} \sum_0^{\infty} (-1)^p \frac{\lambda^{2p}}{2^p (2p)!} H_{2p}(v)$$

thus

$$P_{2k} = (-1)^k 2^{\frac{2k+1}{2}} \sqrt{\pi} e^{-\frac{\lambda^2}{2}} \lambda^{2k}.$$

In the same way, we get

$$P_{2k+1} = -i (-1)^k 2^{k+1} \sqrt{\pi} e^{-\frac{\lambda^2}{2}} \lambda^{2k+1}$$

and therefore

$$\begin{aligned} F(\lambda) &= \frac{e^{-\frac{\lambda^2}{2}}}{2\sqrt{2\pi}} \left[ \sum \frac{c_{2k}}{2^k} P_{2k} - i \sum \frac{c_{2k+1}}{2^{\frac{2k+1}{2}}} P_{2k+1} \right] \\ &= \frac{1}{2} e^{-\frac{\lambda^2}{2}} [\sum (-1)^k c_{2k} \lambda^{2k} - i \sum (-1)^k c_{2k+1} \lambda^{2k+1}]. \end{aligned}$$

In the same manner we find

$$\Phi(\lambda) = \frac{1}{2\sqrt{\pi}} e^{-\frac{\lambda^2}{4}} [\sum (-1)^k b_{2k} \lambda^{2k} - i \sum (-1)^k b_{2k+1} \lambda^{2k+1}]$$

and finally

$$K(x) = \frac{1}{2\sqrt{\pi}} \int_{-\infty}^{\infty} e^{-\frac{j^2}{4}} \frac{\Sigma(-1)^k c_{2k} \lambda^{2k} + i \Sigma(-1)^k c_{2k+1} \lambda^{2k+1}}{\Sigma(-1)^k b_{2k} \lambda^{2k} + i \Sigma(-1)^k b_{2k+1} \lambda^{2k+1}} e^{ix} dx.$$

If now the conditions

$$c_0 = a_0 b_0 \quad c_1 = a_0 b_1 - a_1 b_0 \quad c_2 = a_0 b_2 - a_1 b_1 + a_2 b_0, \dots$$

are satisfied,  $K(x)$  must be reducible to

$$e^{-x^2} [a_0 H_0(x) + a_1 H_1(x) + a_2 H_2(x) + \dots]$$

It is easy to show, that this is the case; for if the conditions are satisfied we have

$$\frac{\Sigma(-1)^k c_{2k} \lambda^{2k} + i \Sigma(-1)^k c_{2k+1} \lambda^{2k+1}}{\Sigma(-1)^k b_{2k} \lambda^{2k} + i \Sigma(-1)^k b_{2k+1} \lambda^{2k+1}} = a_0 - a_2 \lambda^2 + a_4 \lambda^4 \dots - i(a_1 \lambda - a_3 \lambda^3 + \dots)$$

thus

$$\begin{aligned} K(x) &= \frac{1}{2\sqrt{\pi}} \int_{-\infty}^{\infty} e^{-\frac{j^2}{4}} [\Sigma(-1)^k a_{2k} \lambda^{2k} - i \Sigma(-1)^k a_{2k+1} \lambda^{2k+1}] (\cos \lambda x + i \sin \lambda x) d\lambda \\ &= \frac{1}{2\sqrt{\pi}} \int_{-\infty}^{\infty} e^{-\frac{j^2}{4}} [\cos \lambda x \Sigma(-1)^k a_{2k} \lambda^{2k} + \sin \lambda x \Sigma(-1)^k a_{2k+1} \lambda^{2k+1}] d\lambda. \end{aligned}$$

or, introducing (9)

$$H_{2k}(x) e^{-x^2} = \frac{(-1)^k}{\sqrt{\pi}} \int_{-\infty}^{\infty} e^{-\frac{j^2}{4}} \lambda^{2k} \cos \lambda x d\lambda$$

$$H_{2k+1}(x) e^{-x^2} = \frac{(-1)^k}{\sqrt{\pi}} \int_{-\infty}^{\infty} e^{-\frac{j^2}{4}} \lambda^{2k+1} \sin \lambda x d\lambda$$

$$K(x) = e^{-x^2} [a_0 H_0(x) + a_1 H_1(x) + a_2 H_2(x) + \dots].$$

17. From the relation (32) another important result may be deduced. For multiplying by  $e^{-y^2} dy$  and integrating between  $-\infty$  and  $\infty$ , this relation gives

$$\int_{-\infty}^{\infty} e^{-y^2} H_n\left(\frac{x+y}{\sqrt{2}}\right) dy = \frac{\sqrt{\pi}}{(\sqrt{2})^n} H_n(x).$$

or, putting

$$x + y = a\sqrt{2}$$

$$\int_{-\infty}^{\infty} e^{-(x-a\sqrt{2})^2} H_n(a) da = \frac{\sqrt{\pi}}{(\sqrt{2})^{n+1}} H_n(x).$$

Therefore, assuming

$$f_n(x) = \frac{1}{2^{\frac{n}{2}} \sqrt{n!} \sqrt{\pi}} e^{-\frac{x^2}{2}} H_n(x)$$

we obtain

$$f_n(x) = \frac{(\sqrt{2})^{n+1}}{\sqrt{\pi}} \int_{-\infty}^{\infty} e^{-\frac{3}{2}\left(x^2 - \frac{4}{3}xx\sqrt{2} + z^2\right)} f_n(\alpha) d\alpha$$

thus, in the same way as in Art. 9

$$\lambda_n = (\sqrt{2})^{n+1}, \quad K(x, \alpha) = \frac{1}{\sqrt{\pi}} e^{-\frac{3}{2}\left(x^2 - \frac{4}{3}xx\sqrt{2} + z^2\right)}.$$

Here the value of the function  $K(x, \alpha)$  is finite for  $x$  and  $\alpha \pm \infty$ . In the same manner as in Art. 9, therefore

$$K(x, \alpha) = \sum_0^{\infty} \frac{f_n(x) f_n(\alpha)}{\lambda_n}$$

or

$$e^{-(x^2 - 2xx\sqrt{2} + z^2)} = \sum_1^{\infty} \frac{H_n(x) H_n(\alpha)}{2^{\frac{3n+1}{2}} n!}$$

which may be verified by (9).

18. Now, according to the theory of the integral equations the determinant  $D(\lambda)$  of the kernel  $K(x, \alpha)$  must vanish for the values  $\lambda = (\sqrt{2})^{n+1}$  ( $n = 0, 1, 2, \dots$ ).

To examine this, we write  $D(\lambda)$  in the form which is given by PLEMELJ<sup>1)</sup>

$$\frac{D'(\lambda)}{D(\lambda)} = -(a_1 + a_2\lambda + a_3\lambda^2 + \dots)$$

where

$$a_1 = \int_{-\infty}^{\infty} K(x, x) dx, \quad a_2 = \int_{-\infty}^{\infty} K_1(x, x) dx, \quad a_3 = \int_{-\infty}^{\infty} K_2(x, x) dx, \dots$$

$$K_n(x, \alpha) = \int_{-\infty}^{\infty} K(x, y) K_{n-1}(y, \alpha) dy \quad (n = 1, 2, 3, \dots)$$

and

$$K_0(x, \alpha) = K(x, \alpha)$$

From  $K(xy)$ , which may be written

$$K(xy) = Ae^{-hx^2 + 2kxy - ly^2}$$

<sup>1)</sup> Monatshefte f. Math. und Phys. 1904 p 121.

the functions  $K_n(xy)$  which have the same form

$$K_n(xy) = A_n e^{-h_n x^2 + 2k_n xy - l_n y^2},$$

may be easily deduced, for

$$K_n(x, \alpha) = A_n A_{n-1} \int_{-\infty}^{\infty} e^{-(l+h_{n-1})y^2 + 2(kx+k_{n-1}\alpha)y - (hx^2+l_{n-1}\alpha^2)} dy$$

and

$$\begin{aligned} \int_{-\infty}^{\infty} e^{-fy^2+2gy-h} dy &= e^{\frac{g^2-fh}{f}} \int_{-\infty}^{\infty} e^{-f\left(y-\frac{g}{f}\right)^2} dy \\ &= e^{\frac{g^2-fh}{f}} \frac{\sqrt{\pi}}{\sqrt{f}}. \end{aligned}$$

Hence

$$\begin{aligned} A_n e^{-h_n x^2 + 2k_n x \alpha - l_n \alpha^2} &= \\ &= \frac{A_n A_{n-1}}{\sqrt{h+h_{n-1}}} \sqrt{\pi} e^{-\left(h-\frac{k^2}{l+h_{n-1}}\right)x^2 + 2\frac{k k_{n-1}}{l+h_{n-1}} x \alpha - \left(l_{n-1}-\frac{k_{n-1}^2}{l+h_{n-1}}\right)\alpha^2} \end{aligned}$$

which gives

$$A_n = \frac{A_n A_{n-1}}{\sqrt{h+h_{n-1}}} \sqrt{\pi}, \quad h_n = h - \frac{k^2}{l+h_{n-1}}, \quad k_n = \frac{k k_{n-1}}{l+h_{n-1}}, \quad l_n = l_{n-1} - \frac{k_{n-1}^2}{l+h_{n-1}}.$$

Now, we know

$$A = \frac{1}{\sqrt{\pi}}, \quad h = \frac{3}{2}, \quad k = \sqrt{2}, \quad l = \frac{3}{2}$$

thus

$$A_1 = \frac{1}{\sqrt{3\pi}}, \quad h_1 = \frac{5}{6}, \quad k_1 = \frac{2}{3}, \quad l_1 = \frac{5}{6}$$

$$A_2 = \frac{1}{\sqrt{7\pi}}, \quad h_2 = \frac{9}{14}, \quad k_2 = \frac{2\sqrt{2}}{7}, \quad l_2 = \frac{9}{14}$$

$$A_3 = \frac{1}{\sqrt{15\pi}}, \quad h_3 = \frac{17}{30}, \quad k_3 = \frac{4}{15}, \quad l_3 = \frac{17}{30}$$

and

$$A_n = \frac{1}{\sqrt{(2^{n+1}-1)\pi}}, \quad h_n = \frac{2^{n+1}+1}{2(2^{n+1}-1)} = l_n, \quad k_n = \frac{2^{\frac{n+1}{2}}}{2^{n+1}-1}.$$

This gives

$$a_{n+1} = \int_{-\infty}^{\infty} K_n(x) dx = \frac{1}{\sqrt{(2^{n+1}-1)\pi}} \int_{-\infty}^{\infty} e^{-\frac{2^{\frac{n+1}{2}}-1}{2^{\frac{n+1}{2}}+1}x^2} dx = \frac{1}{2^{\frac{n+1}{2}}-1}$$

Constructing now, according to WEIERSTRASS, an integral function  $f(\lambda)$ , with the assigned zeros

$$\lambda = \sqrt{2}, \quad \lambda = (\sqrt{2})^2, \quad \lambda = (\sqrt{2})^3 \dots$$

we obtain

$$\frac{f'(\lambda)}{f'(\infty)} = e^{G(\lambda)} \prod_{n=0}^{\infty} \left(1 - \frac{\lambda}{(\sqrt{2})^{n+1}}\right)$$

or, assuming  $f'(\infty) = 1$ ,  $G(\lambda) = 0$ ,  $\frac{1}{\sqrt{2}} = r$

$$f'(\lambda) = \prod_{n=0}^{\infty} (1 - \lambda r^{n+1}).$$

Thus

$$-\frac{f''(\lambda)}{f'(\lambda)} = \frac{r}{1-r\lambda} + \frac{r^2}{1-r^2\lambda} + \frac{r^3}{1-r^3\lambda} + \dots$$

and expanding the fractions of the second member

$$-\frac{f''(\lambda)}{f'(\lambda)} = \sum_1^{\infty} r^{\nu} + \lambda \sum_1^{\infty} r^{2\nu} + \lambda^2 \sum_1^{\infty} r^{3\nu} + \dots$$

Comparing this with

$$-\frac{D'(\lambda)}{D(\lambda)} = a_1 + a_2 \lambda + a_3 \lambda^2 + \dots$$

we see that  $f'(\lambda) = D(\lambda)$ , for  $f'(\infty) = D(\infty) = 1$  and

$$a_{n+1} = \sum_{\nu=1}^{\infty} r^{(n+1)\nu} = \frac{r^{n+1}}{1-r^{n+1}} = \frac{1}{2^{\frac{n+1}{2}}}$$

**Mathematics.** — “*The theory of BRAVAIS (on errors in space) for polydimensional space, with applications to correlation.*” (Continuation). By Prof. M. J. VAN UVEN. (Communicated by Prof. J. C. KAPTEYN.)<sup>1)</sup>

(Communicated in the meeting of April 24, 1914).

In the theory of correlation the mean values of the products  $x_j x_k$  are to be considered; denoting these by  $\eta_{jk}$ , we have

<sup>1)</sup> The list of authors who have treated upon the same subject, may be supplemented with: CH. M. SCHOLS. Théorie des erreurs dans le plan et l'espace. Annales de l'Ecole Polytechnique de Delft, t II (1886) p. 123.



$$\eta_{jk} = \frac{\sum x_j x_k}{n} = \sqrt{\frac{E}{\pi^2}} \int_{-\infty}^{+\infty} \dots \int_{-\infty}^{+\infty} x_j x_k e^{-(b_{11}x_1^2 + 2b_{12}x_1x_2 + \dots + b_{\tau\tau}x_\tau^2)} dx_1 \dots dx_\tau.$$

To integrate in the first place over all the variables  $x$  except  $x_j$  and  $x_k$  comes to the same thing as to drop the  $q-2$  linear relations  $x_l = \sum_1^{\tau} a_{li} v_i$  ( $l = j, k$ ). Thus we start, as it were, only from the two equations

$$\begin{aligned} x_j &= a_{j1}v_1 + a_{j2}v_2 + \dots + a_{j\tau}v_\tau, \\ x_k &= a_{k1}v_1 + a_{k2}v_2 + \dots + a_{k\tau}v_\tau. \end{aligned}$$

and find therefore

$$\eta_{jk} = \frac{\sqrt{E'}}{\pi} \int_{-\infty}^{+\infty} \int_{-\infty}^{+\infty} x_j x_k e^{-(b_{jj}'x_j^2 + 2b_{jk}'x_jx_k + b_{kk}'x_k^2)} dx_j dx_k,$$

where

$$E' = \frac{1}{\Sigma D'^2} = \begin{vmatrix} b_{jj}' & b_{jk}' \\ b_{jk}' & b_{kk}' \end{vmatrix}$$

$D'$  representing a determinant of the matrix

$$M' = \begin{vmatrix} a_{j1} & a_{j2} & \dots & a_{j\tau} \\ a_{k1} & a_{k2} & \dots & a_{k\tau} \end{vmatrix}$$

Besides

$$\begin{aligned} D_j' &= a_{k1}, \quad a_{k2}, \dots, a_{k\tau}, \\ D_k' &= a_{j1}, \quad a_{j2}, \dots, a_{j\tau}, \end{aligned}$$

hence

$$\begin{aligned} b_{jj}' &= \frac{\Sigma a_{ki}^2}{\Sigma D'^2} = E' \Sigma a_{ki}^2, \\ b_{jk}' &= -E' \Sigma a_{ji} a_{ki}, \\ b_{kk}' &= E' \Sigma a_{ji}^2. \end{aligned}$$

By performing the integration we obtain for  $\eta_{jk}$

$$\eta_{jk} = -\frac{b_{jk}'}{2E'} = +\frac{\Sigma a_{ji} a_{ki}}{2}.$$

and similarly

$$\eta_{jj} = \frac{\Sigma x_j^2}{n} = \frac{\sqrt{E'}}{\pi} \int_{-\infty}^{+\infty} \int_{-\infty}^{+\infty} x_j^2 e^{-(b_{jj}'x_j^2 + 2b_{jk}'x_jx_k + b_{kk}'x_k^2)} dx_j^2 = \frac{\Sigma a_{ji}^2}{2}.$$

Now the correlation-coefficient  $r_{jk}$  of  $x_j$  and  $x_k$  is defined by the expression

$$r_{jk} = \frac{\eta_{jk}}{\sqrt{\eta_{jj}\eta_{kk}}}.$$

This correlation-coefficient can therefore also be written in the following form

$$r_{jk} = \frac{\sum a_{jl} a_{kl}}{\sqrt{\sum a_{jl}^2 \cdot \sum a_{kl}^2}}$$

or

$$r_{jk} = \frac{B_{jk}}{\sqrt{B_{jj} \cdot B_{kk}}}.$$

Introducing the coefficients  $a_{jl}$ , we find

$$r_{jk} = \frac{\sum \epsilon_l^2 a_{jl} a_{kl}}{\sqrt{\sum \epsilon_l^2 a_{jl}^2 \cdot \sum \epsilon_l^2 a_{kl}^2}}.$$

We now will imagine the variable  $u_i$  to be connected with some cause  $Q_i$ . To express our meaning more clearly: we suppose the quantity  $x_j$  to be built up of some variables  $u_l$ , viz. as the sum of these variables, in such a way, that in this sum the term  $u_l$  is lacking if  $x_j$  is not subject to the influence of the cause  $Q_l$ .

So in the relation

$$x_j = a_{j1} u_1 + a_{j2} u_2 + \dots + a_{jl} u_l + \dots + a_{j\tau} u_\tau$$

we have

$$a_{jl} = 1, \quad \text{when } Q_l \text{ does act upon } x_j,$$

$$a_{jl} = 0, \quad \text{when } Q_l \text{ does not act upon } x_j.$$

Thus in  $\sum_{l=1}^{\tau} \epsilon_l^2 a_{jl}^2$  only those terms  $\epsilon_{r_1}^2, \epsilon_{r_2}^2, \dots, \epsilon_{r_j}^2$  occur which correspond to the variables  $u_{r_1}, u_{r_2}, \dots, u_{r_j}$ , due to the causes  $Q_{r_1}, Q_{r_2}, \dots, Q_{r_j}$ , actually influencing  $x_j$ ; on the other hand those terms are lacking, which owe their existence to the causes *not* contributing to  $x_j$ .

In the sum  $\sum_{l=1}^{\tau} \epsilon_l^2 a_{jl} a_{kl}$  only those terms  $\epsilon_l^2$  occur, for which both  $a_{jl} = 1$  and  $a_{kl} = 1$ , that is to say: the terms, which derive from the causes  $Q_l$ , acting both upon  $x_j$  and  $x_k$ .

The expression  $\eta_{jk} = \sum_{l=1}^{\tau} \epsilon_l^2 a_{jl} a_{kl}$  therefore may be called the square of the mean value of those elements of  $x_j$  and  $x_k$ , which are due to the common causes.

Introducing for  $\sqrt{\eta_{jk}}$  the name: "mean error common to  $x_j$  and  $x_k$ ", we may define the correlation-coefficient of the quantities  $x_j$  and

$x_k$  in the following manner, proposed by Prof. J. C. KAPTEYN <sup>1)</sup>.

The correlation-coefficient  $r_{jk}$  of  $x_j$  and  $x_k$  is that part of the square of the mean error common to  $x_j$  and  $x_k$  which is due to the common causes.

Supposing every quantity  $u_i$  to have the same mean error, or

$$\varepsilon_1 = \varepsilon_2 = \dots = \varepsilon_r,$$

we find for  $r_{jk}$

$$r_{jk} = \frac{\sum a_{jl} a_{kl}}{\sqrt{\sum a_{jl}^2 \cdot \sum a_{kl}^2}}.$$

Now  $\sum a_{jl}^2$  apparently equals the number  $N_j$  of the causes acting upon  $x_j$ ,  $\sum a_{kl}^2$  the number  $N_k$  of the causes influencing  $x_k$  and  $\sum a_{jl} a_{kl}$  the number  $N_{jk}$  of the causes contributing both to  $x_j$  and  $x_k$ .

Thus, in the case of equal mean errors, we have

$$r_{jk} = \frac{N_{jk}}{\sqrt{N_j N_k}},$$

in other words: for  $\varepsilon_1 = \varepsilon_2 = \dots = \varepsilon_r$  the correlation-coefficient equals the quotient of the number of common causes, divided by the geometrical mean of the numbers of the causes, which act upon  $x_j$  and  $x_k$  resp.

If both  $x_j$  and  $x_k$  are subjected to an equal number ( $N_j = N_k = N$ ) of causes,  $N_{jk}$  of which act both upon  $x_j$  and  $x_k$ , then

$$r_{jk} = \frac{N_{jk}}{N},$$

in other words: the correlation-coefficient is that part of the causes of  $x_j$  (resp.  $x_k$ ) which also contributes to  $x_k$  (resp.  $x_j$ ).

The expressions for the correlation-coefficients admit of a very simple geometrical illustration.

Calling *spherical simplex*  $S_\varrho$  a ( $\varrho$ -dimensional)  $\varrho$ -gon lying on a  $\varrho$ -dimensional hypersphere (extension of the spherical triangle in 3-dimensional space) we may state that a spherical simplex  $S_\varrho$  has  $\varrho$  vertices  $P_1, P_2, \dots, P_\varrho$  and  $\frac{\varrho(\varrho-1)}{2}$  edges  $p_{jk} = P_j P_k$ .

Opposite to the vertex  $P_i$  we find, in the ( $\varrho-1$ )-dimensional linear space  $\pi_i$ , the (curved) ( $\varrho-2$ )-dimensional face of  $S_\varrho$ , which contains the remaining  $\varrho-1$  vertices  $P_j$  ( $j \neq i$ ).

Further we denote by  $\alpha_{jk}$  the angle between the linear spaces  $\pi_j$  and  $\pi_k$  [consequently also between the ( $\varrho-2$ )-dimensional faces

<sup>1)</sup> J. C. KAPTEYN. Definition of the correlation-coefficient; Monthly Notices of R. A. S., vol. 72 (1912), p. 518.

$(P_1, P_2, \dots, P_{j-1}, P_{j+1}, \dots, P_{\hat{r}})$  and  $(P_1, P_2, \dots, P_{k-1}, P_{k+1}, \dots, P_{\hat{r}})]$ .

Building the positive-definite determinant

$$\Gamma = \begin{vmatrix} 1 & , & \cos p_{12} & , & \cos p_{13} & , & \dots & , & \cos p_{1\hat{r}} \\ \cos p_{12} & , & 1 & , & \cos p_{23} & , & \dots & , & \cos p_{2\hat{r}} \\ \cos p_{13} & , & \cos p_{23} & , & 1 & , & \dots & , & \cos p_{3\hat{r}} \\ \vdots & & \vdots & & \vdots & & \dots & & \vdots \\ \cos p_{1\hat{r}} & , & \cos p_{2\hat{r}} & , & \cos p_{3\hat{r}} & , & \dots & , & 1 \end{vmatrix}$$

and representing by  $C_{jk}$  the minor of  $\cos p_{jk}$ , we have by the theory of the spherical simplexes

$$\cos \Pi_{jk} = - \frac{C_{jk}}{\sqrt{C_{jj} C_{kk}}}.$$

Substituting

$$b_{jj} = q_j^2 \quad , \quad b_{jk} = q_j q_k \cos p_{jk}$$

the quadratic form  $H$  in the expression for the probability  $W$  transforms to

$$H = \sum b_{jj} x_j^2 + 2 \sum b_{jk} x_j x_k = \sum (q_j x_j)^2 + 2 \sum \cos p_{jk} (q_j x_j) (q_k x_k).$$

This form is positive-definitive, when

$$\Gamma > 0,$$

or, in other words: *when the arcs  $p_{jk}$  are the edges of a  $q$ -dimensional spherical simplex.*

Furthermore

$$E = \prod_1^{\hat{r}} q_i^2 \cdot \Gamma$$

and

$$B_{jk} = \frac{\prod_1^{\hat{r}} q_i^2}{q_j q_k} \times C_{jk},$$

whence

$$r_{jk} = \frac{B_{jk}}{\sqrt{B_{jj} B_{kk}}} = \frac{C_{jk}}{\sqrt{C_{jj} C_{kk}}} = - \cos \Pi_{jk}.$$

So, putting  $H$  in the form

$$H = \sum (q_j x_j)^2 + 2 \sum \cos p_{jk} (q_j x_j) (q_k x_k),$$

the arcs  $p_{jk}$  must be the edges of a  $q$ -dimensional simplex and moreover: *the correlation-coefficients are, but for the sign, equal to the cosines of the "opposite angles"  $\Pi_{jk}$ .*

In the case of "errors in a plane" only a circle-triangle  $P_1 P_2$  is to be considered. Then the arc  $P_1 P_2 = p_{12}$  equals the angle  $\Pi_{12}$

included by the opposite spaces (straight lines, radii of the circle)  $\sigma_1 = OP_2$  and  $\sigma_2 = OP_1$ ,  $O$  being the centre of the circle.

So, in the case of two variables  $x_1$  and  $x_2$  with the quadratic form

$$H = b_{11} x_1^2 + 2 b_{12} x_1 x_2 + b_{22} x_2^2$$

we have to put

$$b_{11} = q_1^2 \quad , \quad b_{22} = q_2^2 \quad , \quad b_{12} = q_1 q_2 \cos p_{12},$$

whence

$$E = q_1^2 q_2^2 \sin^2 p_{12}.$$

The correlation-coefficient  $r_{12}$  now takes the value

$$r_{12} = -\cos H_{12} = -\cos p_{12} = -\frac{b_{12}}{\sqrt{b_{11} b_{22}}}.$$

Considering the errors in 3-dimensional space, the spherical simplex is a spherical triangle  $P_1 P_2 P_3$ .

The quadratic form  $H$ , after being transformed, reads

$$H = q_1^2 x_1^2 + q_2^2 x_2^2 + q_3^2 x_3^2 + 2q_2 q_3 x_2 x_3 \cos p_{23} + 2q_3 q_1 x_3 x_1 \cos p_{13} + 2q_1 q_2 x_1 x_2 \cos p_{12}.$$

The opposite angle  $H_{23}$  of the edge (or side)  $p_{23}$  now merely is the angle  $P_1$  of the triangle. Denoting, for the present, the edges (or sides) by  $p_1, p_2, p_3$ , so that

$$p_1 = p_{23} \quad , \quad p_2 = p_{13} \quad , \quad p_3 = p_{12},$$

we have

$$r_{23} = -\cos P_1 \quad , \quad r_{13} = -\cos P_2 \quad , \quad r_{12} = -\cos P_3$$

and

$$\cos p_{23} = \cos p_1 = \frac{\cos P_1 + \cos P_2 \cos P_3}{\sin P_2 \sin P_3} = -\frac{r_{23} - r_{13} r_{12}}{\sqrt{(1-r_{13}^2)(1-r_{12}^2)}} \quad \text{etc.,}$$

$$\begin{aligned} \Gamma &= 1 - \cos^2 p_{23} - \cos^2 p_{13} - \cos^2 p_{12} + 2 \cos p_{23} \cos p_{13} \cos p_{12} \\ &= 1 - \cos^2 p_1 - \cos^2 p_2 - \cos^2 p_3 + 2 \cos p_1 \cos p_2 \cos p_3. \end{aligned}$$

Putting further

$$p_1 + p_2 + p_3 = 2s \quad , \quad P_1 + P_2 + P_3 = 2S,$$

we may reduce  $\Gamma$  to

$$\begin{aligned} \Gamma &= 4 \sin s \cdot \sin (s-p_1) \cdot \sin (s-p_2) \cdot \sin (s-p_3) \\ &= \left[ \frac{-4 \cos S \cdot \cos (S-P_1) \cdot \cos (S-P_2) \cdot \cos (S-P_3)}{\sin P_1 \sin P_2 \sin P_3} \right]^2. \end{aligned}$$

The relation

$$\eta_{jk} = \frac{\sum a_{ji} a_{ki}}{2} = \frac{B_{jk}}{2E}$$

here involves

$$\eta_{11} = \frac{B_{11}}{2E} = \frac{\begin{vmatrix} b_{23} & b_{23} \\ b_{23} & b_{33} \end{vmatrix}}{2E} = \frac{q_2^2 q_3^2 \sin^2 p_1}{2E}.$$

Now

$$\sin^2 p_1 = \frac{-4 \cos S \cdot \cos(S-P_1) \cdot \cos(S-P_2) \cdot \cos(S-P_3)}{\sin^2 P_2 \sin^2 P_3},$$

hence

$$\eta_{11} = 2 \left[ -4 \cos S \cdot \cos(S-P_1) \cdot \cos(S-P_2) \cdot \cos(S-P_3) \right] \times \frac{1}{q_1^2}.$$

Putting

$$-4 \cos S \cdot \cos(S-P_1) \cdot \cos(S-P_2) \cdot \cos(S-P_3) = Q,$$

we obtain

$$\eta_{11} = \frac{\sin^2 P_1}{2Q q_1^2},$$

whence

$$q_1 = \frac{\sin P_1}{\sqrt{2Q\eta_{11}}}.$$

Further we find, after reduction,

$$Q = 1 - \cos^2 P_1 - \cos^2 P_2 - \cos^2 P_3 - 2 \cos P_1 \cos P_2 \cos P_3,$$

consequently

$$Q = 1 - r_{23}^2 - r_{13}^2 - r_{12}^2 + 2r_{23}r_{13}r_{12}.$$

Finally

$$E = q_1^2 q_2^2 q_3^2 \cdot F = \frac{q_1^2 q_2^2 q_3^2 Q^2}{\sin^2 P_1 \sin^2 P_2 \sin^2 P_3} = \frac{1}{8\eta_{11}\eta_{22}\eta_{33}Q}.$$

Introducing the mean errors  $\eta_1$ ,  $\eta_2$  and  $\eta_3$  of  $x_1$ ,  $x_2$  and  $x_3$ , which satisfy the equations

$$\eta_1^2 = \eta_{11} \quad , \quad \eta_2^2 = \eta_{22} \quad , \quad \eta_3^2 = \eta_{33},$$

we find

$$q_i = \frac{\sin P_i}{\eta_i \sqrt{2Q}} \quad , \quad (i = 1, 2, 3)$$

$$E = \frac{1}{8 \eta_1^2 \eta_2^2 \eta_3^2 Q}.$$

and

$$W = \frac{1}{2Q} \left[ \frac{1-r_{23}^2}{\eta_1^2} \xi_1^2 + \dots - 2 \frac{r_{23}-r_{13}r_{12}}{\eta_2 \eta_3} \xi_2 \xi_3 - \dots \right] d\xi_1 \cdot d\xi_2 \cdot d\xi_3.$$

**Mathematics.** — “*Combination of observations with and without conditions and determination of the weights of the unknown quantities, derived from mechanical principles.* By Prof. M. J. VAN UVEN. (Communicated by Prof. JAN DE VRIES).

(Communicated in the meeting of May 30, 1914).

The theory of the combination of observations by the method of least squares has already been the object of numerous geometrical and mechanical illustrations. In the geometrical representations the leading part is usually played by vectors (L. VON SCHRUTKA<sup>1</sup>), C. RODRIGUEZ<sup>2</sup>); the mechanical ones are taken partly from the theory of the “pedal barycentre” (Y. VILLARCEAU<sup>3</sup>), M. D’OCAGNE<sup>4</sup>), partly from the theory of elasticity (S. FINSTERWALDER<sup>5</sup>) R. D’EMILIO<sup>6</sup>), S. WELLISCH, PANTOFLIČEK<sup>7</sup>), F. J. W. WHIPPLE<sup>8</sup>), M. WESTERGAARD<sup>9</sup>), G. ALBENGA<sup>10</sup>)).

In the following paper we will try to develop a mechanical analogy of the solution of the equations furnished by observation, supposing that no conditions are added, as well as for the case that besides the *approximate* equations of condition (called by us:

1) L. VON SCHRUTKA. Eine vectoranalytische Interpretation der Formeln der Ausgleichsrechnung nach der Methode der kleinsten Quadrate. Archiv der Math. u. Physik, 3. Reihe Bd. 21 (1913), p. 293.

2) C. RODRIGUEZ. La compensacion de los Errores desde el punto de vista geometrico. Mexico, Soc. Cientif. “Antonio Alzate”, vol. 33 (1913—1914), p. 57.

3) Y. VILLARCEAU. Transformations de l’astronomie nautique. Comptes Rendus, 1876 I, 531.

4) M. D’OCAGNE. Sur la détermination géométrique du point le plus probable donné par un système de droites non convergentes. Comptes Rendus, 1892 I, p. 1415. Journal de l’Ecole Polytechn. Cah. 63 (1893), p. 1.

5) S. FINSTERWALDER. Bemerkungen zur Analogie zwischen Aufgaben der Ausgleichsrechnung und solchen der Statik. Sitzungsber. der K. B. Akad. d. Wissensch. zu München, Bd. 33 (1903), p. 683.

6) R. D’EMILIO. Illustrazioni geometriche e meccaniche del principio dei minimi quadrati. Atti d. R. Istituto Veneto di scienze, lettere ed arti, T. 62 (1902—1903), p. 363.

7) S. WELLISCH. Fehlerausgleichung nach der Theorie des Gleichgewichts elastischer Systeme. PANTOFLIČEK. Fehlerausgleichung nach dem Prinzipie der kleinsten Deformationsarbeit. Oesterr. Wochenschrift f. d. öf. Baudienst, 1908, p. 428.

8) F. J. W. WHIPPLE. Prof. Bryan’s mean rate of increase. A mechanical illustration. The mathematical Gazette, vol. 3 (1905), p. 173.

9) M. WESTERGAARD. Statisk Fejludjævning. Nyt Tidsskrift for Matematik, B, T. 21 (1910), pp. 1 and 25.

10) G. ALBENGA. Compensazione grafica con la figura di errore (Punti determinati per intersezione). Atti d. R. Accad. d. Sc. di Torino, T. 47 (1912), p. 377.

“equations of observation”) also *rigorous* equations of condition are given.

Moreover, in either of these cases also the weights of the unknown quantities will be derived from mechanical considerations.

The method here developed is founded on the statics of a point acted upon by elastic forces and is in principle closely related to the procedure of the last-mentioned mathematicians.

To obtain general results, we will operate with an arbitrary number ( $N$ ) of unknown quantities or variables, which are considered as coordinates in  $N$ -dimensional space. In order to render the results more palpable, we shall, at the end, recapitulate them for the case of two variables.

I. To determine the  $N$  unknown quantities

$$x, y, z, \dots (N)$$

the  $n$  (approximate) equations of condition or equations of observation

$$a_i x + b_i y + c_i z + \dots + m_i = 0 \quad (i = 1, \dots, n),$$

are given, with the weights  $g_i$  resp.

In the sums, frequently occurring in the sequel, we will denote by  $\Sigma$  a summation over the coordinates  $x, y, z, \dots$  or over the corresponding quantities (for inst. their coefficients  $a_i, b_i, c_i, \dots$ ) and by  $\lfloor \rfloor$  a summation over the  $n$  equations of observation, thus over  $i$  from 1 to  $n$ .

Putting accordingly

$$a_i^2 + b_i^2 + c_i^2 + \dots = \Sigma a_i^2$$

and introducing

$$\alpha_i = \frac{a_i}{\sqrt{\Sigma a_i^2}}, \beta_i = \frac{b_i}{\sqrt{\Sigma a_i^2}}, \gamma_i = \frac{c_i}{\sqrt{\Sigma a_i^2}}, \dots, \mu_i = \frac{m_i}{\sqrt{\Sigma a_i^2}},$$

we may write the equations of observation in the following form

$$V_i \quad \alpha_i x + \beta_i y + \gamma_i z + \dots + \mu_i = 0 \quad (i = 1, \dots, n)$$

or

$$V_i = \Sigma \alpha_i x + \mu_i = 0 \quad (i = 1, \dots, n).$$

These equations have resp. the weights

$$p_i = g_i \Sigma a_i^2.$$

The equations  $V_i = 0$  represent  $(N-1)$ -dimensional linear spaces; their normals have the direction cosines  $(\alpha_i, \beta_i, \gamma_i, \dots)$  resp.

In consequence of the errors of observation, the approximate equations  $V_i = 0$  are incompatible; in other words: the  $n$  linear spaces  $V_i = 0$  do not meet in the same point. By substituting the coordinates  $x, y, z, \dots$  of an arbitrary point  $P$  in the expressions



$V_i$ , the latter obtain the values  $v_i$ , representing the distances of the point  $P$  to the spaces  $V_i=0$ .

The distance from  $V_i=0$  to  $P$  is to be considered as a vector  $v_i$  with tensor  $v_i$  and direction cosines  $\alpha_i, \beta_i, \gamma_i, \dots$

We now imagine a force  $\mathfrak{F}_i$  acting upon  $P$  (in  $N$ -dimensional space) in the direction of the normal  $v_i$  (from  $P$  to  $V_i=0$ ) and the magnitude of which is proportional to the distance  $v_i$  and a factor  $p_i$  characteristic of the space  $V_i$ . (The space  $V_i=0$ , for instance, may be considered as the position of equilibrium of a space  $V_i=v_i$  passing through  $P$  by elastic flexion.)

So the space  $V_i$  acts upon  $P$  with the force

$$\mathfrak{F}_i = -p_i v_i.$$

All the spaces  $V_i (i=1, \dots, n)$  combined consequently exert on  $P$  a resultant force, amounting to

$$\bar{\delta} = [\bar{\delta}_i] = -[p_i v_i].$$

This resultant force depends on the position of the point  $P$ . Hence we have in  $N$ -dimensional space a vector-field  $\bar{\delta}$ , determined by the above equation.

Now the question to be answered, is: at which point  $P$  are these forces  $\bar{\delta}_i$  in equilibrium? For this point  $P$  we have

$$\bar{\delta} = 0$$

or

$$[p_i v_i] = 0.$$

The "components" of this vector-equation in the directions of the axes are

$$[p_i v_i \alpha_i] = 0, [p_i v_i \beta_i] = 0, [p_i v_i \gamma_i] = 0, \dots$$

Substituting for  $v_i$  the expression  $V_i = \sum a_i x + \mu_i$ , we obtain

$$[p_i a_i^2] x + [p_i a_i \beta_i] y + [p_i a_i \gamma_i] z + \dots + [p_i a_i \mu_i] = 0,$$

$$[p_i \beta_i a_i] x + [p_i \beta_i^2] y + [p_i \beta_i \gamma_i] z + \dots + [p_i \beta_i \mu_i] = 0,$$

$$[p_i \gamma_i a_i] x + [p_i \gamma_i \beta_i] y + [p_i \gamma_i^2] z + \dots + [p_i \gamma_i \mu_i] = 0,$$

$$\dots \dots \dots$$

or by

$$a_i = \frac{a_i}{\sqrt{\sum a_i^2}}, \beta_i = \frac{b_i}{\sqrt{\sum a_i^2}}, \gamma_i = \frac{c_i}{\sqrt{\sum a_i^2}}, \dots, \mu_i = \frac{m_i}{\sqrt{\sum a_i^2}}, p_i = g_i \sum a_i^2,$$

$$[g_i a_i^2] x + [g_i a_i b_i] y + [g_i a_i c_i] z + \dots + [g_i a_i m_i] = 0,$$

$$[g_i b_i a_i] x + [g_i b_i^2] y + [g_i b_i c_i] z + \dots + [g_i b_i m_i] = 0,$$

$$[g_i c_i a_i] x + [g_i c_i b_i] y + [g_i c_i^2] z + \dots + [g_i c_i m_i] = 0,$$

$$\dots \dots \dots$$

In this way the "normal equations" are found.

The force  $\mathfrak{F}_i = -p_i v_i$  has the potential

$$U_i = \frac{1}{2} p_i v_i^2 = \frac{1}{2} p_i V_i^2;$$

for

$$(F_i)_x = -\frac{\partial U_i}{\partial x} = -p_i V_i \frac{\partial V_i}{\partial x} = -p_i v_i a_i \text{ etc.}$$

The whole potential therefore amounts to

$$U = [U_i] = \frac{1}{2} [p_i V_i^2].$$

As the equation  $V_i \equiv \Sigma a_i x + \mu_i = 0$  has the weight  $p_i$ , the mean error of weight 1 is determined by

$$\varepsilon^2 = \frac{[p_i v_i^2]}{n - N},$$

hence

$$\varepsilon^2 = \frac{2U}{n - N}.$$

At the point  $P$  satisfying the normal equations the potential and consequently also  $\varepsilon^2$  is a minimum. The "weight" of the distance  $v_i$  was  $p_i$ . This weight may be determined a posteriori, if we know the influence of the space  $V_i$  alone acting upon any point. We then have but to divide the amount  $F_i$  of the force  $\mathfrak{F}_i$  by  $v_i$ .

II. In order to find the weights of the unknown quantities, we now remove the origin by translation to the point  $P$ , which satisfies the normal equations.

Calling the minimum potential  $U_0$ , denoting the new coordinates by  $x', y', z', \dots$  and introducing

$$V_i' \equiv a_i x' + \beta_i y' + \gamma_i z' + \dots = \Sigma a_i x',$$

we obtain

$$[p_i V_i'^2] = 2(U - U_0) = 2U'.$$

So  $U'$  is the difference of potential existing between a point  $(x', y', z', \dots)$  and the *minimum point*  $P$ .

The equation  $[p_i V_i'^2] = 2U'$  represents a quadratic  $(N - 1)$ -dimensional space  $\Omega$ , closed (ellipsoidal) and having  $P$  as centre. This space is an equipotential space and at the same time the locus of the points of equal  $\varepsilon$ . We shall call these spaces  $\Omega$  briefly *hyperellipsoids*. The hyperellipsoids  $\Omega$  are homothetic round  $P$  as centre of similitude.

Introducing the principal axes as axes of the coordinates  $X, Y, Z, \dots$  we obtain for  $\Omega$  an equation of the form

$$AX^2 + BY^2 + CZ^2 + \dots = 2U'.$$

The components of  $\mathfrak{F}$  in the directions of the principal axes are found to be

$$F_X = -\frac{\partial U'}{\partial X} = -AX, F_Y = -\frac{\partial U'}{\partial Y} = -BY, F_Z = -\frac{\partial U'}{\partial Z} = -CZ, \text{ etc.}$$

We may therefore attribute these components to attractive forces of the spaces  $X=0, Y=0, Z=0, \dots$  (principal diametral spaces), which are perpendicular to these spaces and proportional to the "principal weights"  $A, B, C, \dots$

For a point on the principal axis of  $X$  holds

$$F_X = -AX, F_Y = 0, F_Z = 0, \text{ etc.}$$

Consequently the principal weight  $A$  may be determined by dividing the force at a point of the principal axis of  $X$  by the distance  $X$  of that point to the principal diametral space  $X=0$ . To determine the weight of another direction  $l$ , only those points are required, at which the direction of the force coincides with the direction  $l$ , i. e. the points the normals of which to the hyperellipsoids  $\Omega$  have the direction  $l$ . When dividing the amount of the force existing at such a point  $Q$  by the distance of the tangent space of  $Q$  to the centre  $P$ , the quotient found is equal to the weight of the given direction.

So, in order to determine the weight  $q_x$  of the direction of the original  $x'$ -axis (or of the  $x$ -axis), we only have to turn back to the coordinate system  $x', y', z', \dots$ , relatively to which the equipotential spaces have the equation

$$[p_i V_i'^2] = 2U'$$

For a point  $Q(x', y', z', \dots)$  at which the normal to the equipotential space, passing through  $Q$ , is parallel to the  $x'$ -axis (or to the  $x$ -axis), we have

$$F_{x'} = -g_x x', F_{y'} = 0, F_{z'} = 0, \text{ etc.}$$

or

$$\frac{\partial U'}{\partial x'} = g_x x', \frac{\partial U'}{\partial y'} = 0, \frac{\partial U'}{\partial z'} = 0, \text{ etc.}$$

hence

$$[p_i \alpha_i V_i'] = g_x x', [p_i \beta_i V_i'] = 0, [p_i \gamma_i V_i'] = 0, \text{ etc.}$$

or

$$\begin{aligned} [p_i \alpha_i^2] x' + [p_i \alpha_i \beta_i] y' + [p_i \alpha_i \gamma_i] z' + \dots &= g_x x', \\ [p_i \beta_i \alpha_i] x' + [p_i \beta_i^2] y' + [p_i \beta_i \gamma_i] z' + \dots &= 0, \\ [p_i \gamma_i \alpha_i] x' + [p_i \gamma_i \beta_i] y' + [p_i \gamma_i^2] z' + \dots &= 0, \\ \dots & \dots \end{aligned}$$

or

$$\begin{aligned} [p_i \alpha_i^2] \frac{1}{g_x} + [p_i \alpha_i \beta_i] \frac{y'}{g_x x'} + [p_i \alpha_i \gamma_i] \frac{z'}{g_x x'} + \dots - 1 &= 0, \\ [p_i \beta_i \alpha_i] \frac{1}{g_x} + [p_i \beta_i^2] \frac{y'}{g_x x'} + [p_i \beta_i \gamma_i] \frac{z'}{g_x x'} + \dots + 0 &= 0, \end{aligned}$$

$$[p_i \gamma_i \alpha_i] \frac{1}{g_x} + [p_i \gamma_i \beta_i] \frac{y'}{g_x x'} + [p_i \gamma_i^2] \frac{z'}{g_x x'} + \dots + 0 = 0,$$

or

$$[g_i \alpha_i^2] \frac{1}{g_x} + [g_i \alpha_i \beta_i] \frac{y'}{g_x x'} + [g_i \alpha_i c_i] \frac{z'}{g_x x'} + \dots - 1 = 0,$$

$$[g_i \beta_i \alpha_i] \frac{1}{g_x} + [g_i \beta_i^2] \frac{y'}{g_x x'} + [g_i \beta_i c_i] \frac{z'}{g_x x'} + \dots + 0 = 0,$$

$$[g_i c_i \alpha_i] \frac{1}{g_x} + [g_i c_i \beta_i] \frac{y'}{g_x x'} + [g_i c_i^2] \frac{z'}{g_x x'} + \dots + 0 = 0,$$

So  $\frac{1}{g_x}$  is apparently found as the first unknown quantity in the "modified" normal equations, modified in this way, that the constant terms are replaced by  $-1, 0, 0, \dots$  resp.

Considering  $U$  (c.q.  $U_i$ ) as an  $(N + 1)$ th coordinate perpendicular to the  $N$ -dimensional space  $(x, y, z, \dots)$ , the equation

$$p_i V_i^2 = 2U_i$$

represents a quadratic space of  $N$  dimensions, built up of  $\infty(N-1)$ -dimensional linear generator-spaces, all parallel to  $(V_i = 0, U = 0)$ , the intersections of which with the planes perpendicular to  $(V_i = 0, U = 0)$  are congruent parabolae. The parameter of these congruent parabolae is  $\frac{1}{p_i}$ .

The quadratic space  $p_i V_i^2 = 2U_i$  will briefly be called a *parabolic cylindric space with parameter*  $\frac{1}{p_i}$ .

The equation

$$[p_i V_i^2] = 2U$$

represents a quadratic space  $\Psi$  of  $N$  dimensions, the centre of which is at  $U = \infty$ , and the intersections of which with the  $N$ -dimensional spaces  $U = \text{const.}$  are hyperellipsoids  $\Omega$ . Thus  $\Psi$  is the extension of the elliptic paraboloid.

The point  $T$  of  $\Psi$  with minimum  $U(U_0)$ , and hence closest to  $U = 0$ , which is called the *summit* of  $\Psi$ , is projected on  $U = 0$  in the point  $P$ , satisfying the normal equations.

By displacing the system of coordinate axes  $(x, y, z, \dots, U)$  (by translation) from  $O$  to  $T$ ,  $\Psi$  obtains the equation

$$[p_i V_i'^2] = 2U' = 2(U - U_0).$$

By constructing the enveloping cylindric space, the vertex of which

coincides with the set of points of the space  $x = 0$  at infinity, thus the tangent cylindric space, the generator-spaces of which are parallel to the  $x$ -axis, we find for this cylindric space the equation

$$g_x x'^2 = 2 U.$$

Its parameter is  $\frac{1}{g_x}$ , or the reciprocal value of the weight of the direction  $x$ .

III. We now suppose, that the variables  $x, y, z, \dots$  must at the same time satisfy the following  $r$  rigorous equations of condition

$$\Phi_j(x, y, z, \dots) = 0 \quad (j = 1, \dots, r)$$

Then the point  $P$  is constrained to the common  $(N - r)$ -dimensional space  $\Phi$  of intersection of the  $r$   $(N - 1)$ -dimensional spaces  $\Phi_j$ .

Now the point  $P$ , subjected to the elastic forces  $\tilde{\delta}_i$ , is in equilibrium, when the resultant  $\tilde{\delta} = [\tilde{\delta}_i]$  is perpendicular to  $\Phi$ .

Let the normal at  $P$  to  $\Phi_j$  have the direction cosines

$$\alpha_j' = \frac{\frac{\partial \Phi_j}{\partial x}}{\sqrt{\sum \left(\frac{\partial \Phi_j}{\partial x}\right)^2}}, \quad \beta_j' = \frac{\frac{\partial \Phi_j}{\partial y}}{\sqrt{\sum \left(\frac{\partial \Phi_j}{\partial y}\right)^2}}, \quad \gamma_j' = \frac{\frac{\partial \Phi_j}{\partial z}}{\sqrt{\sum \left(\frac{\partial \Phi_j}{\partial z}\right)^2}}, \quad \text{etc.}$$

The normals at  $P$  to the spaces  $\Phi_j$  form a linear  $r$ -dimensional space. In this space  $\tilde{\delta}$  must lie, which means:  $\tilde{\delta}$  can be resolved in the directions of these normals, the unit-vectors of which will be denoted by  $w_j$ .

So we have

$$\tilde{\delta} = [q_j w_j]'$$

where  $[ ]'$  signifies the summation over  $j$  from 1 to  $r$ .

The components of this vector-equation are

$$[p_i v_i \alpha_i] + [q_j \alpha_j'] = 0, [p_i v_i \beta_i] + [q_j \beta_j'] = 0, [p_i v_i \gamma_i] + [q_j \gamma_j'] = 0, \text{ etc.}$$

or

$$\begin{aligned} [p_i \alpha_i^2] x + [p_i \alpha_i \beta_i] y + [p_i \alpha_i \gamma_i] z + \dots + [p_i \alpha_i u_i] + [q_j \alpha_j'] &= 0, \\ [p_i \beta_i \alpha_i] x + [p_i \beta_i^2] y + [p_i \beta_i \gamma_i] z + \dots + [p_i \beta_i u_i] + [q_j \beta_j'] &= 0, \\ [p_i \gamma_i \alpha_i] x + [p_i \gamma_i \beta_i] y + [p_i \gamma_i^2] z + \dots + [p_i \gamma_i u_i] + [q_j \gamma_j'] &= 0, \\ \dots &\dots \dots \dots \dots \dots \dots \dots \dots \dots \dots \end{aligned}$$

Putting

$$q_j' = q_j \sqrt{\sum \left(\frac{\partial \Phi_j}{\partial x}\right)^2}, \quad (j = 1, \dots, r)$$

we may write the above equations in the form

$$[g_i \alpha_i^2] x + [g_i \alpha_i \beta_i] y + [g_i \alpha_i \gamma_i] z + \dots + [g_i \alpha_i u_i] + [q_j' \frac{\partial \Phi_j}{\partial x}] = 0,$$

$$\begin{aligned}
 & [g_i b_i a_i] x + [g_i b_i^2] y + [g_i b_i c_i] z + \dots + [g_i b_i m_i] + [q_j' \frac{\partial \Phi_j}{\partial y}]' = 0, \\
 & [g_i c_i a_i] x + [g_i c_i b_i] y + [g_i c_i^2] z + \dots + [g_i c_i m_i] + [q_j' \frac{\partial \Phi_j}{\partial z}]' = 0, \\
 & \dots \dots \dots
 \end{aligned}$$

These  $N$  equations serve, together with the  $r$  conditions  $\Phi_j = 0$ , to determine the  $N$  variables  $x, y, z, \dots$  and the  $r$  auxiliary quantities  $q_j'$ .

Now the solution of the problem is not represented by the centre of the hyperellipsoids  $\Omega$ , but by the point, in which the intersection space  $\Phi$  (space of conditions) is *touched* by an individual of the set of the hyperellipsoids  $\Omega$ .

The analytical treatment of the problem is simplified by taking the coordinates so small, that in the expressions  $\Phi_j$  homogeneous linear forms suffice. The geometrical meaning of this is that a new origin  $O'$  ( $x_0, y_0, z_0, \dots$ ) is chosen in the space of conditions  $\Phi$  near the probable position of the required point. So the spaces  $\Phi_j$  are replaced by their tangent spaces  $R_j$ , and the space of conditions by its tangent space  $R$  of  $N-r$  dimensions, intersection of the tangent spaces  $R_j$ .

Denoting the coordinates obtained by translation to  $O'$  by  $\xi, \eta, \zeta, \dots$ , so that  $x = x_0 + \xi, \dots$  and putting

$$a_i x_0 + \beta_i y_0 + \gamma_i z_0 + \dots + \mu_i = \bar{\mu}_i, \quad a_i x_0 + b_i y_0 + c_i z_0 + \dots + m_i = \bar{m}_i,$$

we find

$$2U = [p_i(a_i x + \beta_i y + \gamma_i z + \dots + \mu_i)^2] = [p_i(a_i \xi + \beta_i \eta + \gamma_i \zeta + \dots + \bar{\mu}_i)^2]$$

or, putting

$$\begin{aligned}
 a_i \xi + \beta_i \eta + \gamma_i \zeta + \dots + \bar{\mu}_i &= \bar{V}_i, \\
 2U &= [p_i \bar{V}_i^2].
 \end{aligned}$$

The equations  $\Phi_j(x, y, z, \dots) = 0$  may now be written:

$$\Phi_j(x_0, y_0, z_0, \dots) + \left( \frac{\partial \Phi_j}{\partial x} \xi + \frac{\partial \Phi_j}{\partial y} \eta + \frac{\partial \Phi_j}{\partial z} \zeta + \dots \right) + \dots = 0$$

or, since  $O'$  is assumed in  $\Phi_j = 0$ , and higher powers of  $\xi, \eta, \zeta, \dots$  are to be neglected,

$$\frac{\partial \Phi_j}{\partial x} \xi + \frac{\partial \Phi_j}{\partial y} \eta + \frac{\partial \Phi_j}{\partial z} \zeta + \dots = 0 \quad (j = 1, \dots, r)$$

or

$$W_j - \alpha_j' \xi + \beta_j' \eta + \gamma_j' \zeta + \dots = \Sigma \alpha_j' \xi = 0. \quad (j = 1, \dots, r).$$

So the normal equations appear in the following form

$$\begin{aligned}
 [g_i a_i^2] \xi + [g_i a_i b_i] \eta + [g_i a_i c_i] \zeta + \dots + [g_i a_i \bar{m}_i] + [q_j \alpha_j'] &= 0, \\
 [g_i b_i a_i] \xi + [g_i b_i^2] \eta + [g_i b_i c_i] \zeta + \dots + [g_i b_i \bar{m}_i] + [q_j \beta_j'] &= 0,
 \end{aligned}$$

$$[g_i c_i a_i] \xi + [g_i c_i b_i] \eta + [g_i c_i^2] \zeta + \dots + [g_i c_i \bar{m}_i] + [q_j \gamma_j]' = 0,$$

.....

IV. To determine the weights of the directions  $x, y, z, \dots$ , we again begin by shifting the origin (by translation) from  $O'$  to the point  $P$ , satisfying the normal equations and  $W_j = 0$ .

Calling  $U_0$  the potential in  $P$ ,  $U - U_0 = U'$  the difference of potential relatively to  $P$ ,  $\xi', \eta', \zeta', \dots$  the coordinates with respect to  $P$ , and putting finally

$$\alpha_i \xi' + \beta_i \eta' + \gamma_i \zeta' + \dots = \bar{V}_i', \quad \alpha_j' \xi' + \beta_j' \eta' + \gamma_j' \zeta' + \dots = W_j'$$

we find

$$2U' = [p_i \bar{V}_i'^2] - 2[q_j W_j'].$$

This equation represents the set of equipotential spaces  $\Omega$ .  $U' = 0$  furnishes the hyperellipsoid  $\Omega_0$  touching  $\Phi$  (or  $R$ ) in  $P$ .

Now those points must be found at which the force can only be resolved into an (inactive) component perpendicular to  $R$  and a component parallel to the  $x$ -axis.

For such a point we have

$$F_{\xi'} = - \frac{\partial U'}{\partial \xi'} = [r_j \alpha_j'] - g_{\xi} \xi',$$

$$F_{\eta'} = - \frac{\partial U'}{\partial \eta'} = [r_j \beta_j'] + 0,$$

$$F_{\zeta'} = - \frac{\partial U'}{\partial \zeta'} = [r_j \gamma_j'] + 0,$$

.....

or

$$[p_i \bar{V}_i' \alpha_i] - [q_j \alpha_j'] = - [r_j \alpha_j'] + g_{\xi} \xi',$$

$$[p_i \bar{V}_i' \beta_i] - [q_j \beta_j'] = - [r_j \beta_j'],$$

$$[p_i \bar{V}_i' \gamma_i] - [q_j \gamma_j'] = - [r_j \gamma_j'],$$

.....

or putting

$$r_j - q_j = s_j,$$

$$[p_i \alpha_i \bar{V}_i'] + [s_j \alpha_j'] = g_{\xi} \xi', \quad [p_i \beta_i \bar{V}_i'] + [s_j \beta_j'] = 0, \quad [p_i \gamma_i \bar{V}_i'] + [s_j \gamma_j'] = 0, \text{ etc.}$$

whence

$$[p_i \alpha_i^2] \xi' + [p_i \alpha_i \beta_i] \eta' + [p_i \alpha_i \gamma_i] \zeta' + \dots + [s_j \alpha_j'] = g_{\xi} \xi',$$

$$[p_i \beta_i \alpha_i] \xi' + [p_i \beta_i^2] \eta' + [p_i \beta_i \gamma_i] \zeta' + \dots + [s_j \beta_j'] = 0,$$

$$[p_i \gamma_i \alpha_i] \xi' + [p_i \gamma_i \beta_i] \eta' + [p_i \gamma_i^2] \zeta' + \dots + [s_j \gamma_j'] = 0,$$

.....

or

$$[g_i a_i^2] \frac{1}{g_{\xi}} + [g_i a_i b_i] \frac{\eta'_i}{g_{\xi} \xi'_i} + [g_i a_i c_i] \frac{\zeta'_i}{g_{\xi} \xi'_i} + \dots + \left[ \frac{s_j}{g_{\xi} \xi'_i} \cdot \alpha'_j \right] - 1 = 0,$$

$$[g_i b_i a_i] \frac{1}{g_{\xi}} + [g_i b_i^2] \frac{\eta'_i}{g_{\xi} \xi'_i} + [g_i b_i c_i] \frac{\zeta'_i}{g_{\xi} \xi'_i} + \dots + \left[ \frac{s_j}{g_{\xi} \xi'_i} \cdot \beta'_j \right] + 0 = 0,$$

$$[g_i c_i a_i] \frac{1}{g_{\xi}} + [g_i c_i b_i] \frac{\eta'_i}{g_{\xi} \xi'_i} + [g_i c_i^2] \frac{\zeta'_i}{g_{\xi} \xi'_i} + \dots + \left[ \frac{s_j}{g_{\xi} \xi'_i} \cdot \gamma'_j \right] + 0 = 0,$$

the conditions

$$\alpha'_j \frac{1}{g_{\xi}} + \beta'_j \frac{\eta'_i}{g_{\xi} \xi'_i} + \gamma'_j \frac{\zeta'_i}{g_{\xi} \xi'_i} + \dots = 0 \quad (j = 1 \dots r).$$

also being satisfied.

From the above  $N + r$  equations with the  $N$  unknown quantities  $\frac{1}{g_{\xi}}, \frac{\eta'_i}{g_{\xi} \xi'_i}, \frac{\zeta'_i}{g_{\xi} \xi'_i}, \dots$  and the  $r$  unknown quantities  $\frac{s_j}{g_{\xi} \xi'_i}, \frac{1}{g_{\xi}}$  can be solved.

The method of solution of HANSEN is found again by introducing

$$\begin{aligned} \frac{g_i \sum a_i \xi'_i}{g_{\xi} \xi'_i} &= k_i \quad ; \quad \frac{s_j}{g_{\xi} \xi'_i} = k'_j ; \\ \frac{\xi'_i}{g_{\xi} \xi'_i} &= \frac{1}{g_{\xi}} = A \quad , \quad \frac{\eta'_i}{g_{\xi} \xi'_i} = B \quad , \quad \frac{\zeta'_i}{g_{\xi} \xi'_i} = C, \dots, \end{aligned}$$

whence

$$\frac{k_i}{g_i} = \frac{\sum a_i \xi'_i}{g_{\xi} \xi'_i} = \sum a_i A \quad (i = 1, \dots, n)$$

Then the modified normal equations furnish

$$\begin{aligned} [g_i a_i^2] A + [g_i a_i b_i] B + [g_i a_i c_i] C + \dots + [k'_j \alpha'_j]' &= 1, \\ [g_i b_i a_i] A + [g_i b_i^2] B + [g_i b_i c_i] C + \dots + [k'_j \beta'_j]' &= 0, \\ [g_i c_i a_i] A + [g_i c_i b_i] B + [g_i c_i^2] C + \dots + [k'_j \gamma'_j]' &= 0, \\ \dots & \dots \end{aligned}$$

or

$$\begin{aligned} [g_i a_i (\sum a_i A)] + [k'_j \alpha'_j]' &= 1, \quad [g_i b_i (\sum a_i A)] + [k'_j \beta'_j]' = 0, \\ [g_i c_i (\sum a_i A)] + [k'_j \gamma'_j]' &= 0, \text{ etc.} \end{aligned}$$

or

$$[k_i a_i] + [k'_j \alpha'_j]' = 1, \quad [k_i b_i] + [k'_j \beta'_j]' = 0, \quad [k_i c_i] + [k'_j \gamma'_j]' = 0, \text{ etc.,}$$

and the (rigorous) equations of condition run

$$\sum a'_j A = 0 \quad (j = 1, \dots, r).$$

From the set of equations

$$\sum a_i A = \frac{k_i}{g_i} \quad (i = 1, \dots, n)$$

$$\sum a'_j A = 0 \quad (j = 1, \dots, r)$$

$[k_i a_i] + [k'_j \alpha'_j]' = 1, [k_i b_i] + [k'_j \beta'_j]' = 0, [k_i c_i] + [k'_j \gamma'_j]' = 0, \text{ etc.}$  ( $N$  in number) the  $N$  variables  $A, B, C, \dots$ , the  $n$  unknown quantities  $k_i$  and the  $r$  auxiliary quantities  $k'_j$  can now be solved.



The weight of  $x$  is thus defined by

$$g_x = g_\xi = \frac{1}{A}.$$

It may also be found by the following calculation

$$\begin{aligned} \left[ \frac{k_i^2}{g_i} \right] &= [\Sigma k_i a_i A] = \Sigma A [k_i a_i] = A [k_i a_i] + B [k_i b_i] + C [k_i c_i] + \dots \\ &= A - A [k_j' a_j'] - B [k_j' \beta_j'] - C [k_j' \gamma_j'] - \dots \\ &= A - [k_j' \Sigma a_j' A] = A = \frac{1}{g_\xi}, \end{aligned}$$

so that  $g_x$  is also determined by

$$g_x = \frac{1}{\left[ \frac{k_i^2}{g_i} \right]}.$$

By considering the quantity  $U$  as  $(N+1)$ th coordinate perpendicular to the  $N$ -dimensional space  $(x, y, z, \dots)$ , the equation

$$[\rho_i \bar{V}_i'^2] - 2 [q_j W_j'] = 2U'$$

represents the quadratic space  $\mathcal{P}$ . The origin of the coordinates  $\xi, \eta, \zeta, \dots, U'$  now lies at the point  $S$ , the projection of which on  $U' = -U_0$  ( $U = 0$ ) is the required point. Now this point  $S$  is *not* the summit of  $\mathcal{P}$ .

The linear space of conditions  $R$  of  $N-r$  dimensions is now joined to the point  $U' = \infty$  by an  $(N-r+1)$ -dimensional space  $R_1$ , which passes through  $S$  and intersects the quadratic space  $\mathcal{P}$  in a quadratic space  $\mathcal{P}_1$  having the same character as  $\mathcal{P}$ , in that it also has its centre in  $U' = \infty$ , but is of fewer dimensions, viz.  $N + (N-r+1) - (N+1) = N-r$ . The quadratic space  $\mathcal{P}_1$  has its summit in  $S$ .

We now have to determine the points  $Q$  in  $\mathcal{P}_1$ , at which the  $((r+1)$ -dimensional) spaces of normals are parallel to the  $x$ -axis. In such a point  $Q$   $\mathcal{P}_1$  is also enveloped by a parabolic cylindric space, the generator-spaces of which are parallel to the  $x$ -axis, and which therefore has an equation of the form

$$g_x \xi'^2 = 2U'.$$

Its parameter is  $\frac{1}{g_x}$ .

In other words:  $\frac{1}{g_x}$  is the parameter of the parabolic cylindric space, which has its generator-spaces parallel to the  $x$ -axis and envelops the quadratic space  $\mathcal{P}_1$ .

V. We conclude this paper with a short summary of the results for the case of *two* variables  $x$  and  $y$ .

The equations of observation are represented by the straight lines

$$V_i = \alpha_i x + \beta_i y + \mu_i = 0 \quad (\text{weight } p_i) \quad (i = 1, \dots, n).$$

The point  $P(x, y)$  is subjected to the force

$$\delta = [\delta_i] = -[p_i v_i]$$

in which  $v_i$  represents, in amount and direction, the distance of the line  $V_i = 0$  to the point  $P$ .

The point  $P$  remains at rest, if its coordinates satisfy the equations

$$\begin{aligned} [p_i \alpha_i^2] x + [p_i \alpha_i \beta_i] y + [p_i \alpha_i \mu_i] &= 0, \\ [p_i \beta_i \alpha_i] x + [p_i \beta_i^2] y + [p_i \beta_i \mu_i] &= 0. \end{aligned}$$

Denoting here the potential  $U$  by  $z$ , we obtain

$$[p_i (\alpha_i x + \beta_i y + \mu_i)^2] = 2z.$$

This equation represents an elliptic paraboloid  $\mathcal{P}$ , being the sum-surface of the parabolic cylinders

$$p_i (\alpha_i x + \beta_i y + \mu_i)^2 = 2z_i,$$

which have the plan  $z = 0$  as summit-tangent-plane along the generator  $\alpha_i x + \beta_i y + \mu_i = 0$ ,  $z = 0$ , and which are obtained by translating the parabola

$$v_i^2 = \frac{2}{p_i} z_i,$$

lying in the normal plane of  $V_i$   $\alpha_i x + \beta_i y + \mu_i = 0$ , perpendicularly to  $V_i = 0$ . The parameter of this parabola is  $\frac{1}{p_i}$ .

The summit  $T$  of the elliptic paraboloid  $\mathcal{P}$  ( $[p_i V_i^2] = 2z$ ) is projected on  $z = 0$  into the point  $P$ , satisfying the normal equations.

By constructing the tangent cylinder, the vertex of which lies upon the  $x$ -axis at infinity, we obtain a parabolic cylinder, the perpendicular transverse section of which has a parameter equal to the reciprocal value of the weight  $p_x$  of the variable  $x$ .

There being only two variables, only one (rigorous) equation of condition  $\Phi(x, y) = 0$  may be added;  $\Phi(x, y) = 0$  represents the curve to which the point  $P$  is constrained.

We now have to determine that particular ellipse of the homothetic set  $[p_i V_i^2] = \text{const.}$ , which touches the curve  $\Phi$ . The point of contact is the point  $P$  required.

In  $\Phi$ , near the probable position of  $P$ , the new origin  $O'$  is taken. We have thus only to operate with linear functions of the coordinates. So we really replace  $\Phi$  by its tangent  $R$  at  $P$ .

The elliptic paraboloid  $\mathcal{P}$  is cut by the vertical of  $P$  in the point  $S$ . The vertical plane  $R_1$ , which intersects  $z = 0$  along  $R$ , pierces the paraboloid  $\mathcal{P}$  along the parabola  $\mathcal{P}_1$ , having  $S$  as summit.

We now construct the cylinder having its vertex at the point

at infinity of the  $x$ -axis and having the parabola  $\Psi_1$  as directrix (i.e.: enveloping the parabola  $\Psi_1$ ). The parameter (of the perpendicular transverse section) of this cylinder is the reciprocal value of the weight  $g_x$  of the variable  $x$ .

The equipotential lines in  $z = 0$  are the homothetic ellipses  $[p_i V_i^2] = \text{const.}$  Such an ellipse is the locus of the points of equal  $\epsilon$ .

When the (rigorous) equation of condition is:  $x = \text{const.}$ , the parabola  $\Psi_1$  is parallel to the plane  $x = 0$ . The tangent cylinder is then infinitely narrow; its parameter is 0, the weight of  $x$  is infinite.

**Chemistry.** — “*Equilibria in ternary systems.* XVI. By Prof. F. A. H. SCHREINEMAKERS.

(Communicated in the meeting of May 30, 1914).

Now we shall consider the case that the vapour contains two components.

We assume that of the components  $A$ ,  $B$ , and  $C$  only the component  $B$  is exceedingly little volatile, so that practically we may say that the vapour consists only of  $A$  and  $C$ . This is for instance the case when  $B$  is a salt, which is not volatile, and when  $A$  and  $C$  are solvents, as water, alcohol, etc.

Theoretically the vapour consists only of  $A + B + C$ ; herein the quantity of  $B$  is however exceedingly small in comparison with the quantity of  $A$  and  $C$ , so that the vapour consists practically totally of  $A$  and  $C$ .

When, however, we consider complexes in the immediate vicinity of the point  $B$ , the relations become otherwise. The solid or liquid substance has viz. always a vapour-pressure, although this is sometimes immeasurably small; therefore, a vapour exists however, which consists only of  $B$ , without  $A$  and  $C$ . When we now take a liquid or a complex in the immediate vicinity of point  $B$ , the quantity of  $B$  in the vapour is then still also large and is not to be neglected in comparison with that of  $A$  and  $C$ .

Consequently, when we consider equilibria, not situated in the vicinity of point  $B$ , then we may assume that the vapour consists only of  $A$  and  $C$ ; when these equilibria are situated, however, in the immediate vicinity of point  $B$ , we must also take into consideration the volatility of  $B$  and we must consider the vapour as ternary.

When we consider only the occurrence of liquid and gas, then, as we have formerly seen, three regions may occur, viz. the gas-region, the liquid-region and the region  $L-G$ . This last region is

separated by the liquid-curve from the liquid-region and by the vapour-curve from the vapour-region. As long as the liquid-curve is not situated in the vicinity of point  $B$ , the corresponding vapour-curve will be situated in the immediate vicinity of the side  $AC$ . Consequently the vapour-region is exceedingly small and is reduced just as the vapour-curve, practically to a part of — or to the whole side  $AC$ . Therefore we shall call this vapour-curve the straight vapourline of the region  $\bar{L} - G$  in the following. Consequently we distinguish within the triangle practically only two regions, which are separated by the liquid-curve, viz. the liquid-region and the region  $L - G$ ; the first reaches to the point  $B$ , the latter to the side  $AC$ . The conjugation-lines liquid-gas end, therefore, all practically on the side  $AC$ .

When the liquid-curve comes, however, in the immediate vicinity of point  $B$ , so that there are liquids, which contain only exceedingly little  $A$  and  $C$ , then the quantity of  $B$  in the corresponding vapours will no more be negligible with respect to  $A$  and  $C$ . The vapour-curve will then also be situated further from the side  $AC$ , so that also the vapour-region becomes larger. At sufficient decrease of pressure or increase of temperature the vapour-region will cover even the entire component-triangle. In that case we must, therefore, certainly distinguish between the three regions, of which the movement, occurrence and disappearance have been treated already previously.

In order to deduce the equilibrium  $F + L + G$ , we may act now in the same way as we did before for a ternary vapour. We distinguish the following cases.

1. The solid substance is a ternary compound.
2. The solid substance is a binary compound of two volatile components.
3. The solid substance is a binary compound of one volatile and one non-volatile component.
4. The solid substance is one of the components.

1. We consider firstly the case sub 1, viz. that the solid substance is a ternary compound; this is for instance the case with the compound  $\text{Fe}_2\text{Cl}_6 \cdot 2\text{HCl} \cdot 12\text{H}_2\text{O}$ .

Now we imagine for instance in fig. 7, 11, 12, or 13 (I) the component-triangle  $ABC$  to be drawn in such a way that the point  $F$  is situated within this triangle. Curve  $Mm$  can then again represent the saturation-curve under its own vapour-pressure of  $F$ ,

the corresponding vapourcurve  $M_1m_1$  is then, however, no more a curve situated within the triangle  $ABC$ , but it becomes a straight line, which is situated on one of the sides of the triangle. We shall call this line the straight vapourline of the compound  $F$ . When  $A$  and  $C$  are the two volatile components, then this straight vapourline is situated on the side  $AC$ . As not a single liquid of curve  $Mm$  can be in equilibrium with a vapour, which consists of pure  $A$  or of pure  $C$ , the points  $A$  and  $C$  can never be situated on the straight vapourline. From this follows: the straight vapourline of the ternary compound  $F$  covers only partly the side  $AC$  and in such a way that it covers neither  $A$  nor  $B$ .

2. The solid substance is a binary compound, of two volatile components. We take a binary compound  $F$  of  $B$  and  $C$  (fig. 1) so that  $B$  and  $C$  now represent the two volatile components and  $A$  the non-volatile component.

In order to deduce the saturationcurve under its own vapour-pressure we may act again in the same way as we did before for the general case. For this we take a definite temperature  $T$  and a pressure  $P$  in such a way that no vapour can be formed and the isotherm consists only of the saturationcurve of  $F$ . This is represented in fig. 1 by  $pq$ .

At decrease of  $P$  the region  $L-G$  occurs; such a region is represented in fig. 1 by  $Cdee_1$  with the liquid-curve  $de$  and the straight vapourline  $Ce_1$ . The liquid  $e$  is in equilibrium with the vapour  $e_1$ , the liquid  $d$  with the vapour  $C$  and with each liquid of curve  $ed$  a definite vapour of the straight vapourline  $Ce_1$  is in equilibrium.

We may distinguish three cases with respect to the occurrence of this region  $L-G$ .

*a.* In the equilibrium  $L-G$  of the binary system  $BC$  a point of maximum-pressure occurs. The heterogeneous region  $L-G$  arises in a point of the side  $BC$ .

*b.* In the equilibrium  $L-G$  of the binary system  $BC$  a point of minimum-pressure occurs; one heterogeneous region arises in  $B$  and one in  $C$ , which come together at decrease of  $P$  in a point of  $BC$ .

*c.* In the equilibrium  $L-G$  of the binary system  $BC$  neither a point of maximum- nor a point of minimumpressure occurs; the heterogeneous region arises in  $B$  or in  $C$ .

Here we consider only the last case and we assume in this case that  $C$  is more volatile than  $B$ ; after this the reader can easily

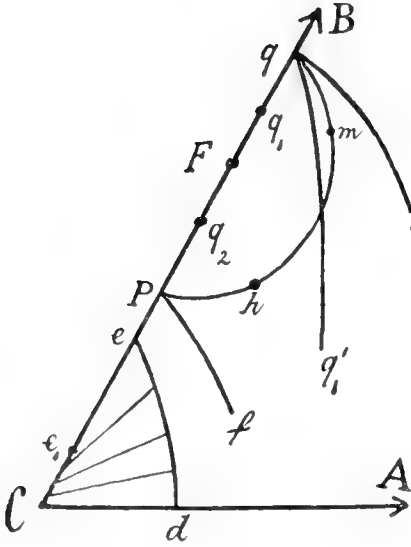

Fig. 1.

deduce the two other cases. At decrease of  $P$  the heterogeneous region arises, therefore, in the angular point  $C$  (fig. 1) and it expands, while curve  $pq$  changes of course its form and position, over the triangle. Under a definite pressure the terminating point  $e$  of the liquid-curve coincides with the terminating point  $p$  of the saturation-curve, under a definite other pressure  $e$  coincides with  $q$ .

When  $e$  coincides with  $q$ , we may imagine in fig. 1 that the liquid-curve is represented by  $qq'_2$  or by  $qq'_1$ ; in the latter case it intersects the curve  $qp$ , in the first

case it is situated outside this curve. When  $e$  coincides with  $p$ , we may imagine that the liquid-curve is represented either by  $pf$  (fig. 1) or by a curve, not drawn in the figure, which intersects  $pq$ . Now we shall examine which of these cases may occur.

To the equilibrium between a ternary liquid  $x, y, 1-x-y$ , and a binary vapour  $y_1, 1-y_1$  the conditions are true:

$$Z - x \frac{\partial Z}{\partial x} - (y - y_1) \frac{\partial Z}{\partial y} = Z_1 \text{ and } \frac{\partial Z}{\partial y} = \frac{\partial Z_1}{\partial y_1} \dots \dots (1)$$

Let us firstly consider the region  $L-G$  in the immediate vicinity of the point  $C$ . As  $x, y$ , and  $y_1$  are then infinitely small, we put:

$$Z = U + RTx \log x + RTy \log y \text{ and } Z_1 = U_1 + RTy_1 \log y_1$$

The two conditions (1) pass then into:

$$U - x \frac{\partial U}{\partial x} - y \frac{\partial U}{\partial y} - U_1 + y_1 \frac{\partial U_1}{\partial y_1} - RT(x + y - y_1) = 0 \dots (2)$$

$$\frac{\partial U}{\partial y} + RT \log y = \frac{\partial U_1}{\partial y_1} + RT \log y_1 \dots \dots (3)$$

Under a pressure  $P_C$  the region  $L-G$  in fig. 1 consists only of the point  $C$ , and, therefore,  $x = 0, y = 0$  and  $y_1 = 0$ ; then the unary equilibrium: liquid  $C$  + vapour  $C$  occurs. This is fixed by  $Z = Z_1$  or  $U = U_1$ , wherein  $x = 0, y = 0$  and  $y_1 = 0$ .

Let in fig. 1 the region  $Clee_1$  make its appearance under a pressure  $P_C + dP$ ; the points  $e_1, e$ , and  $d$  are then situated in the imme-

mediate vicinity of  $C$ ; now we equate  $x = \xi, y = \eta$  and  $y_1 = \eta_1$ . From (3) follows:

$$\eta_1 = K\eta \dots \dots \dots (4)$$

wherein  $K$  is a constant fixed by (3). When we assume, as in fig. 1, that  $C$  is more volatile than  $B$ , the point  $e_1$  is situated between  $C$  and  $e$  and  $K$  is, therefore, smaller than 1.

Now we equate in (1)  $P = P_c + dP, x = \xi, y = \eta$  and  $y_1 = \eta_1$ ; as in the point  $C$   $U = U_1$  is satisfied, it follows, that:

$$-RT[\xi + \eta - \eta_1] + [V - V_1] dP = 0$$

or

$$\xi + (1 - K)\eta = -\frac{V_1 - V}{RT} dP \dots \dots \dots (5)$$

In the immediate vicinity of the angular point  $C$  (fig. 1) curve  $cd$  is, therefore, a straight small line. We find from (5) for the length of the parts  $Cd$  and  $Ce$ :

$$Cd = -\frac{V_1 - V}{RT} dP \text{ and } Ce = -\frac{V_1 - V}{RT(1 - K)} dP \dots \dots \dots (6)$$

As  $V_1 - V > 0$  and  $1 - K > 0$ , it follows from (6) that  $Cd$  and  $Ce$  are positive, when  $dP$  is negative. At decrease of pressure curve  $cd$  shifts therefore, within the triangle. From (6) follows:  $Cd : Ce = (1 - K) : 1$  or, as  $K = \eta_1 : \eta = Ce_1 : Ce$ , we find:  $Cd = ee_1$ .

In order to examine the liquidcurves going through the points  $p$  and  $q$  (fig. 1) in the vicinity of these points, we put in (1):

$$Z = U + RT x \log x \dots \dots \dots (7)$$

we then find:

$$U - x \frac{\partial U}{\partial x} - (y - y_1) \frac{\partial U}{\partial y} - RT x - Z_1 = 0 \text{ and } \frac{\partial U}{\partial y} = \frac{\partial Z_1}{\partial y_1} \dots \dots \dots (8)$$

For the liquidcurve of the region  $L-C'$  we find from this:

$$[xs + (y - y_1)s + RT] dx + [xs + (y - y_1)t] dy = 0 \dots \dots \dots (9)$$

For the direction of this liquidcurve in its end on the side  $BC$  (therefore  $x = 0$ ) we find:

$$\frac{dy}{dx} = -\frac{(y - y_1)s + RT}{(y - y_1)t} \dots \dots \dots (10)$$

When we call  $\varphi$  the angle, which this tangent forms with the side  $BC$  (taken in the direction from  $B$  towards  $C$ ), we have, when we imagine the componenttriangle rectangular in  $C$ :

$$t \sin \varphi = \frac{(y - y_1)t}{(y - y_1)s + RT} \dots \dots \dots (11)$$

For the saturationcurve under a constant pressure of  $F$ , consequently for curve  $pq$ , we find:

$$Z - x \frac{\partial Z}{\partial x} + (\beta - y) \frac{\partial Z}{\partial y} - \zeta = 0 \quad . . . . . (12)$$

or after substitution of the value of  $Z$  from (7):

$$[xr + (y - \beta) s + RT] dx + [xs + (y - \beta) t] dy = 0 \quad . . . (13)$$

When we call  $\psi$  the angle which forms the tangent in  $p$  or  $q$  with the side  $BC$  (taken in the direction from  $B$  towards  $C$ ), we find:

$$tg \psi = \frac{(y - \beta) t}{(y - \beta) s + RT} \quad . . . . . (14)$$

Let us now consider these two tangents in the point  $p$  of fig. 1. In this point  $y - \beta < 0$  and  $y - y_1 > 0$ .

The denominators of (11) and (14) have, therefore, either opposite sign or they are both positive, so that we may distinguish three cases. In each of these cases we find  $q < \psi$ ; the liquidcurve of the region  $L-G$  and the saturationcurve of  $F$  under a constant pressure are, therefore, situated in the vicinity of point  $p$  with respect to one another in the same way as the curves  $pf'$  and  $pq$  in fig. 1.

Curve  $pf'$  can also no more intersect curve  $pq$  in its further course; we may see this also in the following way.

At decrease of  $P$  the two curves must touch one another under a definite pressure  $P_h$  somewhere in a point  $h$  within the component-triangle; therefore imagining the liquidcurve of this pressure  $P_h$  to be represented by  $ed$  (fig. 1), we must imagine  $ed$  to be drawn in such a way that it touches  $pq$  in  $h$ . For this point  $h \frac{dy}{dx}$  from (9)

must be equal to  $\frac{dy}{dx}$  from (13); then holds:

$$\frac{xr + (y - y_1) s + RT}{xs + (y - y_1) t} = \frac{xr + (y - \beta) s + RT}{xs + (y - \beta) t} \quad . . . . . (15)$$

or

$$y_1 = \beta \quad . . . . . (16)$$

As  $y_1$  indicates the vapour conjugated with liquid  $h$ , (16) means: the liquid-curve of the region  $L-G$  and the saturationcurve under a constant pressure of  $F$  touch one another in a point  $h$ , when the vapour belonging to this liquid  $h$  is represented by the point  $F$ .

As all vapours belonging to curve  $ed$  (fig. 1) are represented by



$Cc_1$ , and consequently no vapour exists of the composition  $F'$ , the curves  $ed$  and  $pq$ , therefore, cannot touch one another.

Let us now consider the tangents to the liquid-curve and to the saturationcurve under a constant pressure in the point  $q$  (fig. 1): as the vapour, belonging to this liquid, may be represented either by a point  $q_1$  situated between  $q$  and  $F'$  or by a point  $q_2$  between  $F'$  and  $C$ , we must distinguish two cases.

When the vapour is represented by  $q_1$ , then we have  $y - \beta > 0$  and  $y - y_1 > 0$ . As  $y - \beta > y - y_1$ , the denominators of (11) and (14) have either the same sign or the denominator of (11) is positive, while that of (14) is negative. In each of these three cases we find  $\varphi < \psi$ ; the liquid-curve of the region  $L-G'$  and the saturationcurve under a constant pressure of  $F'$  are, therefore, situated in the vicinity of point  $q$  with respect to one another as the curves  $qp$  and  $qq'_1$ .

When the vapour corresponding with liquid  $q$  is represented by  $q_2$ , then  $y - \beta < 0$  and  $y - y_1 > 0$ ; in absolute value  $(y - \beta)s$  is always smaller than  $(y - y_1)s$ . The denominators of (11) and (14) have, therefore, either the same sign or the denominator of (11) is negative, while that of (14) is positive. In each of these three cases we find  $\varphi > \psi$ ; the liquid-curve of the region  $L-G'$  and the saturationcurve under a constant pressure of  $F'$  are, therefore, situated in the vicinity of point  $q$  with respect to one another as the curves  $qp$  and  $qq'_2$ .

With the aid of the preceding considerations we may easily deduce now the saturationcurves under their own vapour-pressure of  $F'$ ; for this we shall assume that the solid substance melts with increase of volume. We distinguish three cases.

1. The temperature is lower than the point of maximum-sublimation  $T_K$  of the binary substance  $F'$ .

In a similar way as we have deduced the general case fig. 11 (I) we now find with the aid of fig. 1 for the saturationcurve under its own vapourpressure a diagram as is drawn in fig. 2; in this figure a part only of the componenttriangle is drawn. Curve  $h a c m b n$  is the saturationcurve under its own vapourpressure,  $h_1 a_1 c_1 F_1 b_1 n_1$  is the corresponding straight vapourline. In this figure are indicated the equilibria:  $F' + L_h + G_{h_1}$ ,  $F' + L_a + G_{a_1}$ ,  $F' + L_c + G_{c_1}$ ,  $F' + L_m + G_{E}$ ,  $F' + L_b + G_{b_1}$ , and  $F' + L_n + G_{n_1}$ ;  $L_h$  and  $L_n$  are binary liquids. As we have assumed that the temperature is lower than the point of maximum-sublimation  $T_K$  of the solid

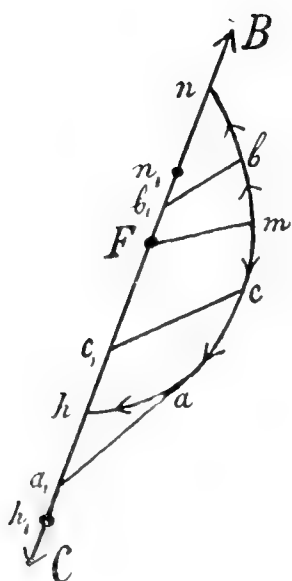

Fig. 2.

It follows from this deduction that the pressure is a minimum in the point  $m$  of fig. 2 and increases from  $m$  in the direction of the arrows, consequently towards  $n$  and  $h$ . Further it is evident that the vapour pressure in  $h$  is higher than in  $n$ .

2. The temperature is higher than the point of maximum sublimation  $T_K$  and lower than the minimum-meltingpoint  $T_F$  of the substance  $F$ .

In a similar way as we have deduced the general case fig. 7 (I), we now find with the aid of fig. 1 a diagram as fig. 3. Curve  $hacbn$  is the saturationcurve under its own vapour-pressure,  $h_1 a_1 c_1 b_1 n_1$  is the corresponding straight vapour-line. As we have assumed that the temperature is higher than  $T_K$  but lower than  $T_F$ ,  $F$  must, as in fig. 3, be situated between  $n$  and  $n_1$ . Therefore, here we have the case that the vapour, corresponding in fig. 1 with the liquid  $q$ , is represented by  $q_2$ ; the liquid-curve of the region  $L-G$  going through the point  $q$  may, therefore, be represented by  $qq'_2$  (fig. 1). It follows from this position of  $qq'_2$  that on further decrease of pressure the liquid-curve of the region  $L-G$  no more intersects curve  $pq$ .

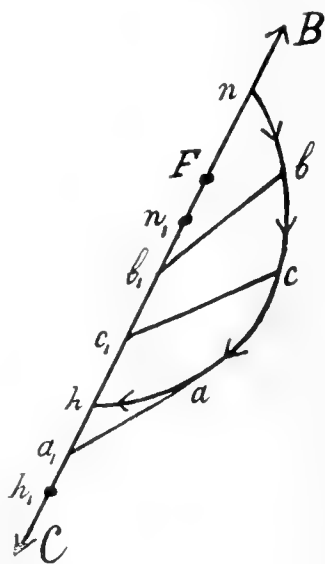

Fig. 3.

From this deduction it follows that the pressure increases along curve  $hn$  in the direction of the arrows, therefore, from  $n$  towards  $h$  and that on this curve  $hn$  neither a point of maximum- nor a point of minimum pressure occurs.

3. The temperature is higher than the minimum-meltingpoint  $T_F$  and lower than the point of maximum-temperature  $T_{II}$  of the binary equilibrium  $F + L + G$ .

In a similar way as we have deduced the general case fig. 12 (I) we now find for the saturationcurve under its own vapour-pressure an expanded curve, in fig. 4 a similar curve is represented by the curve  $hn$  indicated by 5; the pressure increases in the direction of the arrow, consequently from  $n$  towards  $h$ .

In fig. 4 the saturationcurves under their own vapour-pressure of  $F$  are drawn for several temperatures ( $T_1 - T_6$ ). When we take  $T_1$  and  $T_2$  lower than  $T_K$ , then a point of minimum-pressure must occur on the curves, indicated by 1 and 2. When we take  $T_4$  between  $T_K$  and  $T_F$  and  $T_5$  between  $T_K$  and  $T_{II}$ , then the saturationcurves

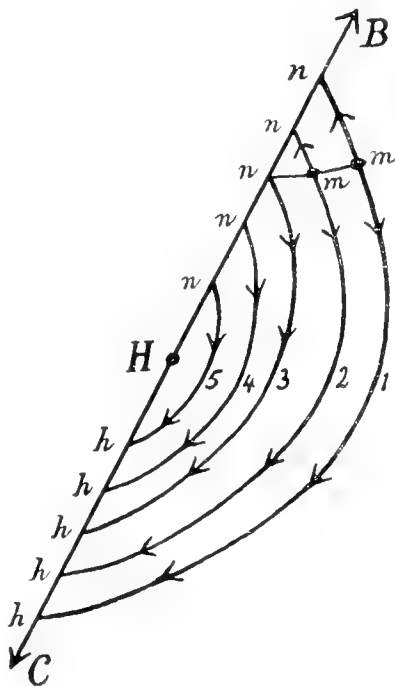

Fig. 4.

under their own vapourpressure have a position as the curves  $hn$  indicated by 4 and 5, on which no point of minimum pressure occurs. At  $T_{II}$  the saturationcurve disappears in a point  $H$  and the corresponding straight vapourline in a point  $H_1$  (not drawn in the figure).

On the saturationcurve of the temperatures  $T_1$  and  $T_2$  we find a point of minimum-pressure  $m$ , this point has disappeared on the saturationcurve of the temperature  $T_3$ ; between these two temperatures we consequently find a temperature  $T_3$ , at which the point  $m$  coincides with the terminating point  $n$  of the saturationcurve under its own vapourpressure. As the vapour belonging to a point of minimum-pressure has always the composition  $F$ , this case occurs when the liquid  $n$  can be in equilibrium with a vapour  $F$ . As then the binary equilibrium  $F + L +$  vapour  $F$  can occur this temperature  $T_3$

consequently is the maximum temperature of sublimation  $T_K$  of the substance  $F$ .

Now we will deduce in another way the saturation curves under their own vapour pressure of  $F$ . The conditions of equilibrium are:

$$Z - x \frac{\partial Z}{\partial x} - (y - \beta) \frac{\partial Z}{\partial y} = \xi \quad Z_1 - (y_1 - \beta) \frac{\partial Z_1}{\partial y_1} = \xi \quad \frac{\partial Z}{\partial y} = \frac{\partial Z_1}{\partial y_1} \quad (17)$$

These conditions follow also from the equations 1 (II) when we equate herein  $\alpha = 0$  and  $x_1 = 0$  and when we consider  $Z_1$  as independent of  $x_1$ . We put

$$Z = U + RTx \log x \dots \dots \dots (18)$$

The three conditions (17) pass then into:

$$U - x \frac{\partial U}{\partial x} - (y - \beta) \frac{\partial U}{\partial y} - RTx = \xi = 0 \dots \dots \dots (19)$$

$$Z_1 - (y_1 - \beta) \frac{\partial Z_1}{\partial y_1} - \xi = 0 \dots \dots \dots (20)$$

$$\frac{\partial U}{\partial y} - \frac{\partial Z_1}{\partial y_1} = 0 \dots \dots \dots (21)$$

From this follows:

$$\begin{aligned} [xs + (y - \beta)s + RT] dx + [xs + (y - \beta)t] dy = \\ = \left[ V - x \frac{\partial V}{\partial x} - (y - \beta) \frac{\partial V}{\partial y} - v \right] dP \dots \dots \dots (22) \end{aligned}$$

$$(y_1 - \beta)t_1 dy_1 = \left[ V_1 - (y_1 - \beta) \frac{\partial V_1}{\partial y_1} - v \right] dP \dots \dots \dots (23)$$

$$s dx + t dy - t_1 dy_1 = \left( \frac{\partial V_1}{\partial y_1} - \frac{\partial V}{\partial y} \right) dP \dots \dots \dots (24)$$

With the aid of (23) we may also write for (24):

$$(y_1 - \beta) s dx + (y_1 - \beta) t dy = \left[ V_1 - (y_1 - \beta) \frac{\partial V}{\partial y} - v \right] dP \quad (25)$$

so that for the relation between  $dx$ ,  $dy$ ,  $dy_1$ , and  $dP$  we shall consider the equations (22), (23), and (25).

In order to examine if a point of maximum- or of minimum-pressure is possible on the saturation curve under its own vapour-pressure, we take (23). From this follows  $dP = 0$  when

$$y_1 - \beta \dots \dots \dots (26)$$

In order to examine if the pressure for this point is a maximum or a minimum, we develop (20) further into a series; when we equate herein  $y_1 = \beta$ , we find:

$$(V_1 - v) dP = \frac{1}{2} t_1 dy_1^2 \dots \dots \dots (27)$$

As  $V_1 - v$  and  $t_1$  are both positive, it is apparent that the pressure is a minimum. In accordance with our previous considerations (see fig. 2) we find therefore: on the saturationcurve under its own vapourpressure of the solid substance  $F$  the pressure is a minimum in a point  $m$ , when the vapour corresponding with this liquid has the composition  $F$ .

In order to examine the change of pressure along the saturationcurve in the vicinity of its extreme ends  $h$  and  $n$  (fig. 2, 3, and 4) we equate  $x = 0$ ; from (22) and (25) we then obtain:

$$[(y - \beta) s + RT] dx + (y - \beta) t dy = [V - (y - \beta) \frac{\partial V}{\partial y} - v] dP \dots (28)$$

$$(y_1 - \beta) s dx + (y_1 - \beta) t dy = [V_1 - (y_1 - \beta) \frac{\partial V}{\partial y} - v] dP \dots (29)$$

From this follows:

$$(y_1 - \beta) RT dx = [(y_1 - \beta) V + (\beta - y) V_1 + (y - y_1) v] dP \dots (30)$$

When  $\Delta V_1$  is the change of volume, which occurs when between the three phases of the binary equilibrium  $F + L + G$  a reaction occurs, in which one quantity of vapour arises, then we may write for (30):

$$dP = - \frac{\beta - y_1}{\beta - y} \cdot \frac{RT}{\Delta V_1} \cdot dx \dots \dots \dots (31)$$

Now  $\Delta V_1$  is always positive in the binary system  $F + L + G$ , except between the minimum-melting point  $T_F$  and the point of maximumtemperature  $T_H$ , where  $\Delta V_1$  is negative. In fig. 4  $\Delta V_1$  is consequently negative for liquids between  $F$  and  $H$ , positive for all other liquids on the side  $BC$ .

$\beta - y$  is positive, when the liquid is situated between  $F$  and  $C$ , negative when the liquid is situated between  $F$  and  $B$  (figs. 2—4).

$\beta - y_1$  is positive, when the vapour is situated between  $F$  and  $C$ , negative when the vapour is situated between  $F$  and  $B$  (figs 2—4).

In the points  $h$  of figs. 2—4 is  $\Delta V_1 > 0$ ,  $\beta - y > 0$  and  $\beta - y_1 > 0$ ; from (31) follows therefore  $dP < 0$ . From each of the points  $h$  the pressure must, therefore, decrease along the saturationcurves, we see that this is in accordance with the direction of the arrows in the vicinity of the points  $h$  (figs. 2—4).

In the point  $n$  of fig. 2 is  $\Delta V_1 > 0$ ,  $\beta - y < 0$  and  $\beta - y_1 < 0$ ; from (31) follows, therefore  $dP < 0$ . Consequently we find that

the pressure in fig. 2 must decrease from  $n$  along the saturation-curve, which is in accordance with fig. 2.

In the point  $n$  of figure 3 is  $\Delta V_1 > 0$ ,  $\beta - y < 0$  and  $\beta - y_1 > 0$ ; from (31) follows, therefore  $dP > 0$ . Consequently the pressure must increase from the point  $n$  in fig. 3 along the saturation-curve, which is in accordance with fig. 3.

In the point  $n$  of curve 5 in fig. 4 is  $\Delta V_1 < 0$ ,  $\beta - y > 0$  and  $\beta - y_1 > 0$ ; from (31) follows, therefore  $dP > 0$ . Consequently the pressure must increase from  $n$  along curve 5, which is in accordance with the direction of the arrows.

We may summarise the above-mentioned results also in the following way: when to the binary equilibrium  $F + L + G$  (in which  $F$  is a compound of two volatile components) at a constant temperature we add a substance, which is not volatile, then the pressure increases when the binary equilibrium is between the point of maximum-sublimation  $T_K$  and the point of maximum temperature  $T_H$ ; in all other cases the pressure decreases.

In the consideration of the general case, that the vapour contains the three components (XI and XII) we have deduced that the saturation-curves under their own vapour-pressure can disappear in two ways at increase of pressure.

1. The saturation-curve of the temperature  $T_H$  disappears in the point  $H$  on the side  $BC$  [fig. 5 (XI)].

2. The saturation-curve of the temperature  $T_H$  touches the side  $BC$  in the point  $H$  and is further situated within the triangle; at further increase of  $T$  it forms a closed curve situated within the triangle, which disappears at  $T_R$  in a point within the triangle [fig. 6 (XI)].

In the case now under consideration, that the vapour consists only of  $B$  and  $C$ , only the case 1 occurs; this has already been discussed above and is represented in fig. 4. It follows already immediately from the following that the case 2 cannot occur. On a closed saturation-curve under its own vapour-pressure a point of maximum- and a point of minimum-pressure occurs. On the curves now under consideration only, as we saw before, a point of minimum-pressure can occur, so that closed saturation-curves are impossible.

We may deduce this also in the following way and we may prove at the same time these curves, just as in the general case, to be parabolas in the vicinity of  $H$ .

When we consider the binary equilibrium  $B + \text{liquid } H + \text{vapour}$ , then  $x = 0$ ; we equate  $y = y_0$ ,  $y_2 = y_{1,0}$  and the pressure  $= P_H$ . To this equilibrium applies:

$$\left. \begin{aligned} i^r - (y_0 - \beta) \frac{\partial U}{\partial y} - \xi = 0 & \quad Z_1 - (y_{1.0} - \beta) \frac{dZ_1}{dy_1} - \xi = 0 \\ \frac{\partial U}{dy} &= \frac{\partial Z_1}{\partial y_1} \end{aligned} \right\} \quad (32)$$

further we have:

$$(y_{1.0} - \beta) V + (\beta - y_0) V_1 + [y_0 - y_{1.0}] v = 0 \quad . . . \quad (33)$$

which condition we may also write:

$$\frac{V - v}{y_0 - \beta} = \frac{V_1 - v}{y_{1.0} - \beta} = \frac{V_1 - V}{y_{1.0} - y_0} = \mu \quad . . . \quad (34)$$

For a ternary equilibrium  $P + L + G$ , the liquid of which is situated in the vicinity of point  $H$ , the pressure is equal to  $P_H + \pi$ ,  $x = \xi$ ,  $y = y_0 + \eta$  and  $y_1 = y_{1.0} + \eta_1$ .

The three equations (17) pass then, when we use the conditions (22) into:

$$RT\xi + [v - V]\pi + \frac{1}{2}r\xi^2 + \frac{1}{2}t\eta^2 + \frac{1}{2}\left(\frac{\partial v}{\partial P} - \frac{\partial V}{\partial P}\right)\pi^2 + s\xi\eta + \dots + (y - \beta)L = 0 \quad (35)$$

$$[v - V_1]\pi + \frac{1}{2}t_1\eta_1^2 + \frac{1}{2}\left(\frac{\partial v}{\partial P} - \frac{\partial V_1}{\partial P}\right)\pi^2 + \dots + (y_1 - \beta)L_1 = 0 \quad (36)$$

$$L = L_1 \quad . . . \quad (37)$$

Herein is:

$$\left. \begin{aligned} L = s\xi + t\eta + \frac{\partial V}{\partial y}\pi + \frac{1}{2}\frac{\partial s}{\partial x}\xi^2 + \frac{1}{2}\frac{\partial t}{\partial y}\eta^2 + \frac{1}{2}\frac{\partial^2 V}{\partial y \partial P}\pi^2 + \\ + \frac{\partial s}{\partial y}\xi\eta + \frac{\partial^2 V}{\partial x \partial y}\xi\pi + \frac{\partial^2 V}{\partial y^2}\eta\pi + \dots \end{aligned} \right\} \quad (38)$$

$$L_1 = t_1\eta_1 + \frac{\partial V_1}{\partial y_1}\pi + \frac{1}{2}\frac{\partial t_1}{\partial y_1}\eta_1^2 + \frac{1}{2}\frac{\partial^2 V_1}{\partial y_1 \partial P}\pi^2 + \frac{\partial^2 V_1}{\partial y_1^2}\eta_1\pi + \dots \quad (39)$$

In (35) and (36)  $y_0$  and  $y_{1.0}$  are replaced by  $y$  and  $y_1$ ; we shall do the same in the following equations. When we multiply (35) by  $y_1 - \beta$  and (36) by  $y - \beta$ , then it follows with the aid of (37) that:

$$\begin{aligned} (y_1 - \beta) RT\xi + \frac{1}{2}(y_1 - \beta)r\xi^2 + \frac{1}{2}(y_1 - \beta)t\eta^2 - \frac{1}{2}(y - \beta)t_1\eta_1^2 \\ + \frac{1}{2}\left[ (\beta - y_1) \frac{dV}{dP} + (y - \beta) \frac{\partial V_1}{\partial P} + (y_1 - y) \frac{\partial v}{\partial P} \right] \pi^2 + (y_1 - \beta)s\xi\eta = 0. \end{aligned} \quad (40)$$

From (36), (37), and (40) it follows that this can be satisfied by:  $\eta_1$  of the order  $\pi$ ,  $\eta$  of the order  $\pi$  and  $\xi$  of the order  $\pi^2$ .

From (35), (36) and (37) then follows:

$$t\eta = \left(\mu - \frac{\partial V}{\partial y}\right)\pi \quad \text{and} \quad t_1\eta_1 = \left(\mu - \frac{\partial V_1}{\partial y_1}\right)\pi \quad . . . \quad (41)$$

Substituting these values in (40) we find:

$$2 (y_1 - \beta) RT \xi = a \tau^2 \dots \dots \dots (42)$$

wherein  $a$  has the same value as in (21) (XII).

From this it follows with the aid of the first relation (41) that:

$$2 (y_1 - \beta) RT \xi = \frac{a t^2}{\left( u - \frac{\partial V}{\partial y} \right)^2} \eta^2 \dots \dots \dots (43)$$

In the same way as in (XII) we find that we may write for this:

$$2 RT \xi = \frac{t^3 (y - \beta) (y_1 - y) \frac{d^2 l}{dP^2}}{(y_1 - \beta) \left( u - \frac{\partial V}{\partial y} \right)^2} \eta^2 \dots \dots \dots (44)$$

wherein  $\frac{d^2 l}{dP^2}$  is fixed by (24) (XII). From this it follows that the curve going in fig. 4 through the point  $H$  is parabolically curved in this point and touches the side  $BC$  in this point.

As in this point  $y - \beta < 0$ ,  $y_1 - y < 0$ ,  $y_1 - \beta < 0$  and  $\frac{d^2 l}{dP^2} > 0$ ,  $\xi$  is always negative. From this it follows that this parabola has only the point  $H$  in common with the triangle and is further situated completely outside the triangle. Consequently only the point  $H$  represents a liquid; its other points have no meaning.

(To be continued).

**Chemistry.** — “*The system Ammonia-water*”. By Prof. A. SMITS and S. POSTMA. (Communicated by Prof. J. D. v. D. WAALS).

(Communicated in the meeting of May 30, 1914).

After the preliminary communication <sup>1)</sup> on this subject the investigation of the system  $\text{NH}_3\text{-H}_2\text{O}$  has been continued in different directions, and it has now been completed.

The continued research was directed in the first place to the *accurate* determination of the meltingpoint lines, corresponding with the pressure of one atmosphere. These determinations, which were now carried out by means of a gauged resistance thermo-

<sup>1)</sup> These Proc. XII, p. 186.



meter<sup>1)</sup>, as is in use in this laboratory<sup>2)</sup>, gave the following result.  
(Method of procedure: supercooling a little and then seeding).

Concentration mixture	Initial point of solidification	Final point of solidification
100 mol. % NH <sub>3</sub>	- 77.6°	
94.7	- 80.9	
90.4	- 83.7	
86.5	- 87.2	
81.55	- 92.4	
	- 92.6	- 92.5°
78.45	- 88.7	- 92.5
73.5	- 82.2	- 92.6
71.1	- 80.3	
69.9	- 79.7	
66.7	- 78.8	
65.8	- 78.9	
64.6	- 79.2	
62.0	- 81.0	
61.3	- 81.7	- 86.0
60.7	- 82.3	- 86.0
60.3	- 82.9	- 86.0
59.0	- 85.2	- 85.8
57.0	- 84.1	- 85.8
53.0	- 80.2	
50.2	- 79.1	
50.1	- 79.0	
49.3	- 79.0	
43.9	- 83.0	
42.2	- 86.0	

<sup>1)</sup> Gauging points were: melting ice 0°, melting mercury - 38.85°. Boiling CO<sub>2</sub> + alcohol - 78.34° + 0.20 (B-76). Boiling point of oxygen - 182.8° + 0.36 (B-76).

<sup>2)</sup> Cf. DE LEEUW, Zf. phys. Chem. 77, 303 (1911).

Concentration mixture	Initial point of solidification	Final point of solidification
40.6	— 88.2	
39.8	— 90.7	
39.1	— 91.7	
35.75	— 97.1	
34.5		— 100.3
34.0	— 96.7	
32.6	— 89.2	
29.7	— 74.2	
28.7	— 68.8	
27.6	— 63.7	
26.55	— 59.4	
23.0	— 43.5	
20.2	— 34.9	
17.9	— 28.6	
4.46	— 4.8	
0.0	0.0	

This result is expressed in Fig. 1.

From this  $T-X$  fig. follows:

for the point of solidification of the compound  $2 \text{NH}_3 \cdot \text{H}_2\text{O}$ — $78^\circ.9$ .

“ “ “ “ “ “ “ “ “ “  $\text{NH}_2 \cdot \text{H}_2\text{O}$ — $79^\circ.0$ .

Further the eutectic point of  $\text{NH}_3 + 2 \text{NH}_3 \cdot \text{H}_2\text{O} + \text{L}$  appears to lie at  $81.4\%$   $\text{NH}_3$  and  $-92.5^\circ$ .

“ “ “ “ “ “ “ “ “ “ of  $2 \text{NH}_3 \cdot \text{H}_2\text{O} + \text{NH}_3 \cdot \text{H}_2\text{O} + \text{L}$  appears to lie at  $58.5\%$   $\text{NH}_3$  and  $-86.0^\circ$ .

“ “ “ “ “ “ “ “ “ “ of  $\text{NH}_3 \cdot \text{H}_2\text{O} + \text{H}_2\text{O} + \text{L}$  appears to lie at  $34.7\%$   $\text{NH}_3$  and  $-100.3^\circ$ .

Great difficulties were experienced in the case of the mixtures with less than  $50\%$   $\text{NH}_3$ , in consequence of the great viscosity of these mixtures at low temperature.

Shortly after our just mentioned preliminary communication a treatise on the same subject by RUPERT<sup>1)</sup> appeared in Journ. Am. Chem. Soc. **31** 866 (Aug. 1909).

<sup>1)</sup> Further communication Journ. Am. Chem. Soc. **32**. 748 (1910).

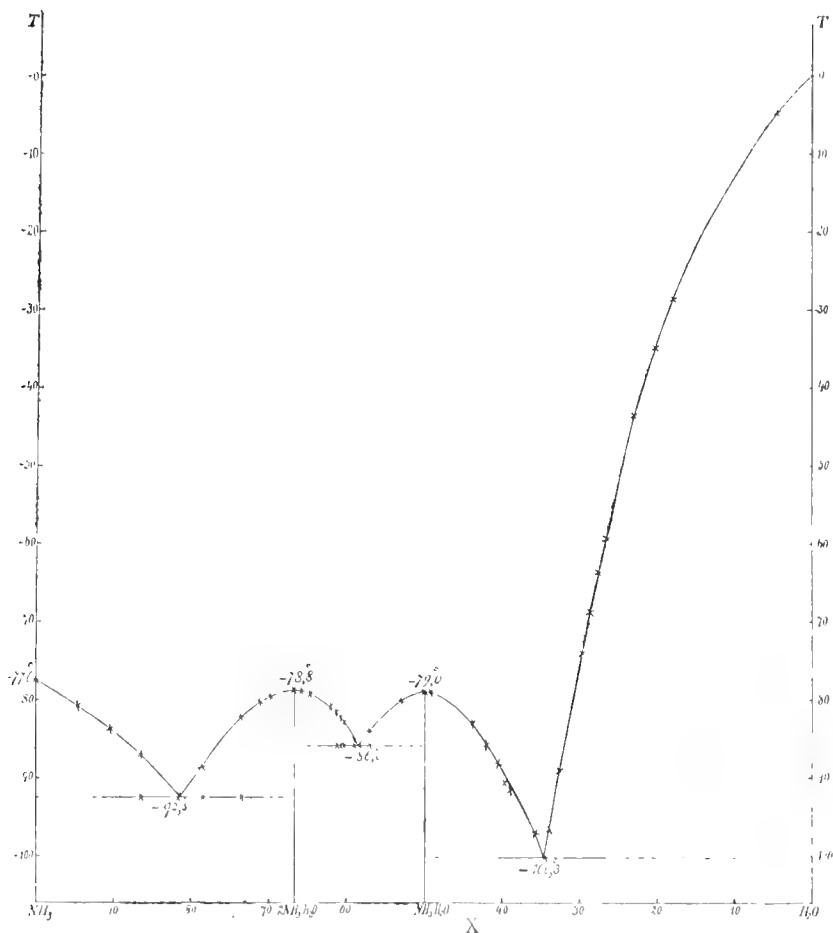

Fig. 1.

As point of solidification RUPERT determines the point at which the crystals brought into the liquid no longer grow or disappear. He measures the temperature accurate down to  $0^\circ.5$  with a verified toluol-thermometer. Below  $-100^\circ$  he uses a thermo-element, tested by comparison with the toluol thermometer and with the boiling point of liquid air. He himself considers the determinations with this thermo-element insufficient, which tallies with our results, as by extrapolation about  $-125^\circ$  may be derived from RUPERT's investigation for the temperature of the eutectic point  $\text{NH}_3\cdot\text{H}_2\text{O} + \text{H}_2\text{O} + \text{L}$ , whereas this point lies certainly  $24^\circ$  higher according to Fig. 1.

Leaving the region of concentration 30—40% out of account, the agreement between RUPERT's results and ours is fairly satisfactory. If we compare the principal points, we get what follows:

Observer	NH <sub>3</sub>	2NH <sub>3</sub> .H <sub>2</sub> O	NH <sub>3</sub> .H <sub>2</sub> O
RUPERT.	— 78.°0	— 79.°0	— 79.°3
SMITS, POSTMA	— 77.°6	— 78.°8	— 79.°0

Observer	Eutecticum	Concentration	Temperature
RUPERT.	NH <sub>3</sub> + 2NH <sub>3</sub> .H <sub>2</sub> O + L	81.2 mol. 0/10 NH <sub>3</sub>	— 94.°0
S. P.	" " "	81.5 " "	— 92.5°
RUPERT.	2NH <sub>3</sub> .H <sub>2</sub> O + NH <sub>3</sub> .H <sub>2</sub> O + L	57.9 " "	— 87.0
S. P.	" " "	58.5 " "	— 85.9°
	NH <sub>3</sub> .H <sub>2</sub> O + H <sub>2</sub> O + L	not determined by RUPERT	
"	" " "	34.7 mol. 0/10 NH <sub>3</sub>	— 100.3°

It is at once apparent from the determination of the melting-point diagram that the two chemical compounds, one with 2 mol. of NH<sub>3</sub> to 1 mol. of H<sub>2</sub>O, and the other with 1 mol. of NH<sub>3</sub> to 1 mol. of H<sub>2</sub>O are already considerably dissociated in liquid state at the temperature of solidification.

#### *Boiling-point lines.*

After certainty had been obtained in the way described here about the existence of two solid compounds between NH<sub>3</sub> and H<sub>2</sub>O, it was of importance to examine whether the existence of these compounds in the liquid state would also follow from the boiling-point lines observed at different pressures. These determinations, which were carried out with an apparatus as was used by Dr. DE LEEUW<sup>1)</sup>, yielded the result that there was no indication to be perceived that could point to the existence of compounds in the liquid. Hence it followed from this that at the observed boiling temperature the dissociation was already too strong, and that the investigation has therefore to be continued at still lower pressures.

As the dynamic method is attended with all kinds of difficulties at low pressure, it was desirable to apply the statistic and not the dynamic method in the continuation of this investigation, and determine the vapour pressure line of different mixtures of definite concentration, from which the boiling-point lines and the *p-x*-lines

<sup>1)</sup> Z.f. phys. Chem. **77**, 284 (1911).

might then be derived. This investigation, in which also the mixtures which had previously been investigated dynamically were verified, yielded the following result.

The following mixtures were examined.

88,0 mol. % NH <sub>3</sub>	54,7 mol. % NH <sub>3</sub>
84,1 " " "	51,5 " " "
77,8 " " "	39,7 " " "
74,6 " " "	35,9 " " "
69,5 " " "	32,7 " " "
66,3 " " "	25,6 " " "
62,7 " " "	

the results of which are expressed in fig. 2.

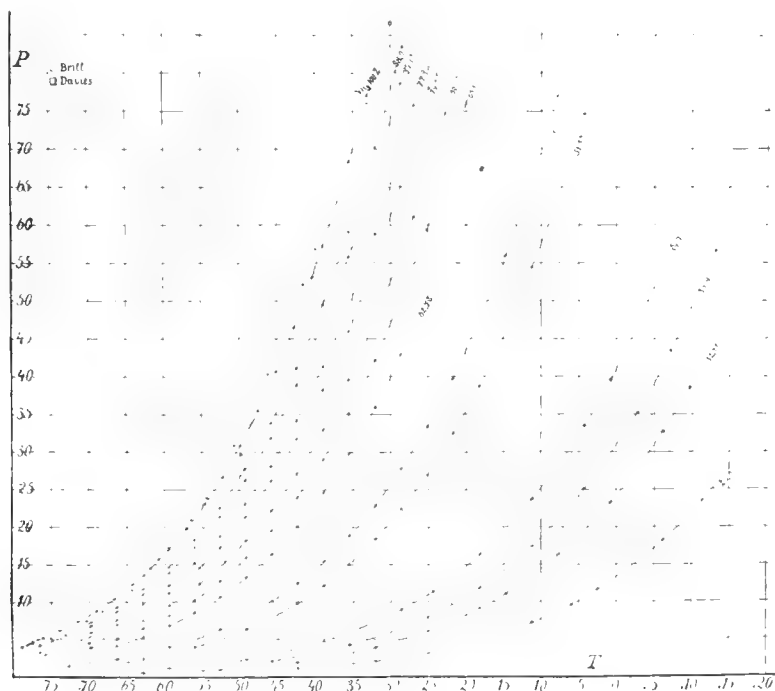

Fig. 2.

These vapour pressure lines enable us to read the corresponding boiling temperature for a definite pressure (see table I), hence to indicate the boiling-point lines, and that with an accuracy down to tenths of degrees, and it is also possible to indicate the vapour tension of different mixtures for a definite temperature (see table II), hence to find the  $(pv)_T$ -lines with an accuracy of  $\pm 0,5$  m.m. Hg.

Fig. 3 contains the boiling-point curves, from which it appears

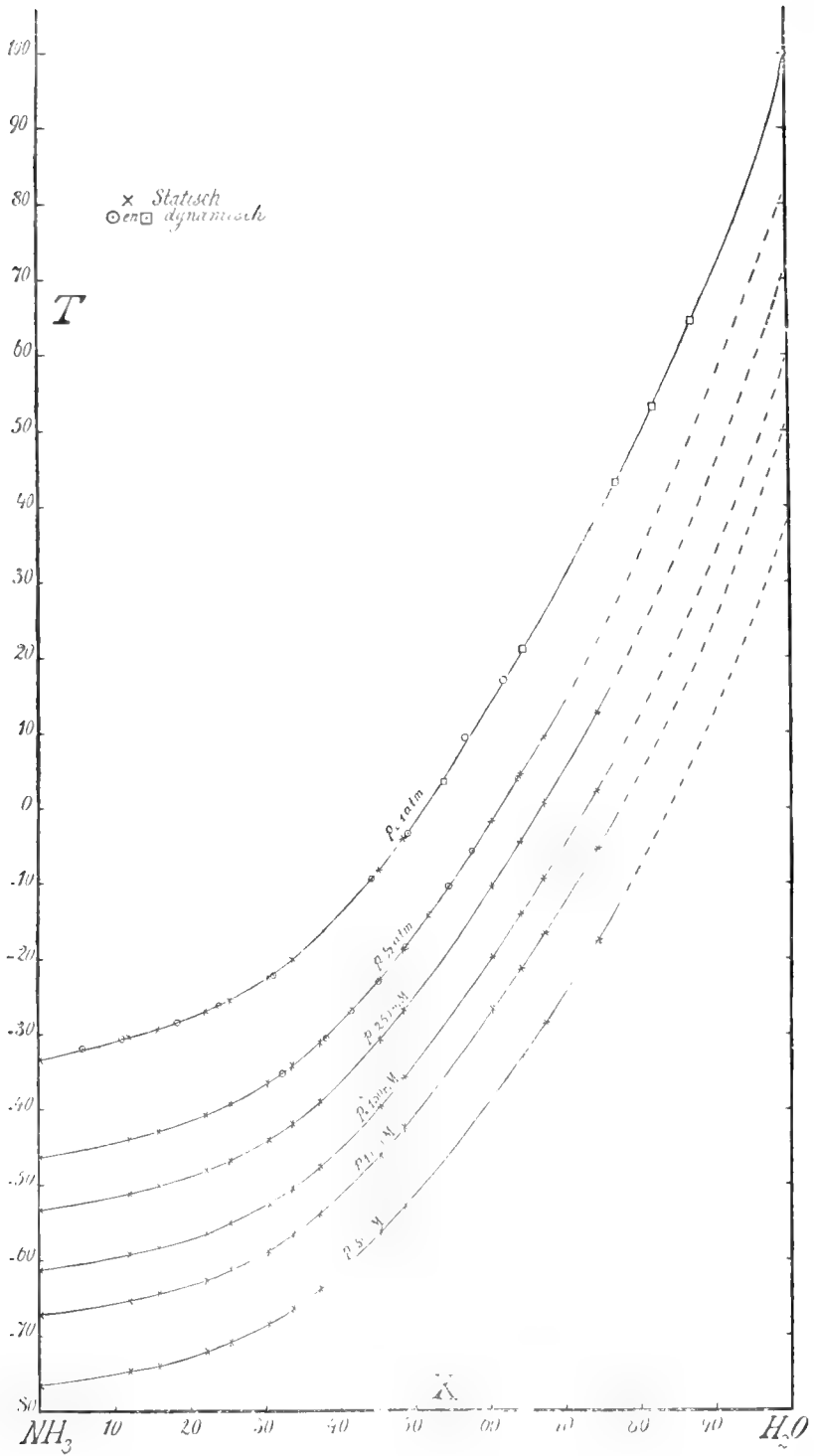

Fig. 3.

T A B L E I.  
*T-X*- or boiling-point lines for different pressures.

mol. % NH <sub>3</sub>	<i>p</i> = 50 mm.	<i>p</i> = 100 mm.	<i>p</i> = 150 mm.	<i>p</i> = 250 mm.	<i>p</i> = 380 mm.	<i>p</i> = 760 mm.
100	— 76.0	— 67.2	— 61.4	— 53.35	— 46.3	— 33.4
88.0	— 74.6	— 65.3	— 59.15	— 51.1	— 43.8	— 30.4
84.1	— 74.1	— 64.35	— 58.3	— 50.1	— 42.8	— 29.3
77.8	— 72.0	— 62.5	— 56.3	— 47.9	— 40.5	— 26.8
74.6	— 70.85	— 61.1	— 54.9	— 46.6	— 39.1	— 25.4
69.5	— 68.6	— 58.7	— 52.4	— 43.8	— 36.3	— 22.3
66.3	— 66.4	— 56.4	— 50.2	— 41.7	— 34.0	— 19.9
62.7	— 63.6	— 53.6	— 47.25	— 38.6	— 30.9	— 8.1
54.7	— 55.95	— 45.95	— 39.3	— 30.5	— 22.6	— 3.9
51.5	— 52.5	— 42.1	— 35.6	— 26.6	— 18.6	—
39.7	— 38.0	— 26.7	— 19.65	— 10.2	— 1.6	—
35.9	— 32.7	— 21.3	— 14.0	— 4.4	+ 4.4	—
32.7	— 28.35	— 16.6	— 9.25	+ 0.65	+ 9.4	—
25.6	— 17.25	— 5.3	+ 2.4	+ 12.75	—	—

T A B L E II.  
*p-X*-lines for different temperatures.

mol. % NH <sub>3</sub>	<i>t</i> = — 70°	<i>t</i> = — 65°	<i>t</i> = — 55°	<i>t</i> = — 45°	<i>t</i> = — 35°	<i>t</i> = — 30°	<i>t</i> = — 25°
	<i>p</i> in cm. Hg.	<i>p</i>	<i>p</i>	<i>p</i>	<i>p</i>	<i>p</i>	<i>p</i>
100	8.25	11.75	22.6	40.95	69.95	—	—
88.0	7.2	10.2	19.6	35.5	60.6	77.4	—
84.1	6.7	9.6	18.5	33.4	57.3	73.6	—
77.8	5.8	8.4	16.2	29.5	50.5	65.0	—
74.6	5.3	7.7	14.9	27.4	47.2	61.0	77.4
69.5	4.55	6.5	12.7	23.3	40.7	52.5	66.8
66.3	3.8	5.5	11.0	20.5	36.0	46.9	59.7
62.7	3.1	4.55	9.2	17.25	30.55	39.9	—
54.7	1.7	2.5	5.4	10.6	19.4	25.7	33.55
51.5	± 1.3	1.95	4.2	8.3	15.5	20.7	27.15
39.7	—	0.85	1.4	3.05	6.1	8.3	11.0
35.9	—	—	± 1.1	2.15	4.35	5.9	7.95
32.7	—	0.4	0.8	1.6	3.15	4.5	6.15
25.6	—	—	—	0.9	1.65	2.3	3.1

that even that corresponding to a pressure of 50 m.m. Hg. does not reveal anything about the existence of compounds in the liquid phase; there is nothing to be detected here of a constriction at the place of the compounds, as was found by Dr. ATEN<sup>1)</sup> in his investiga-

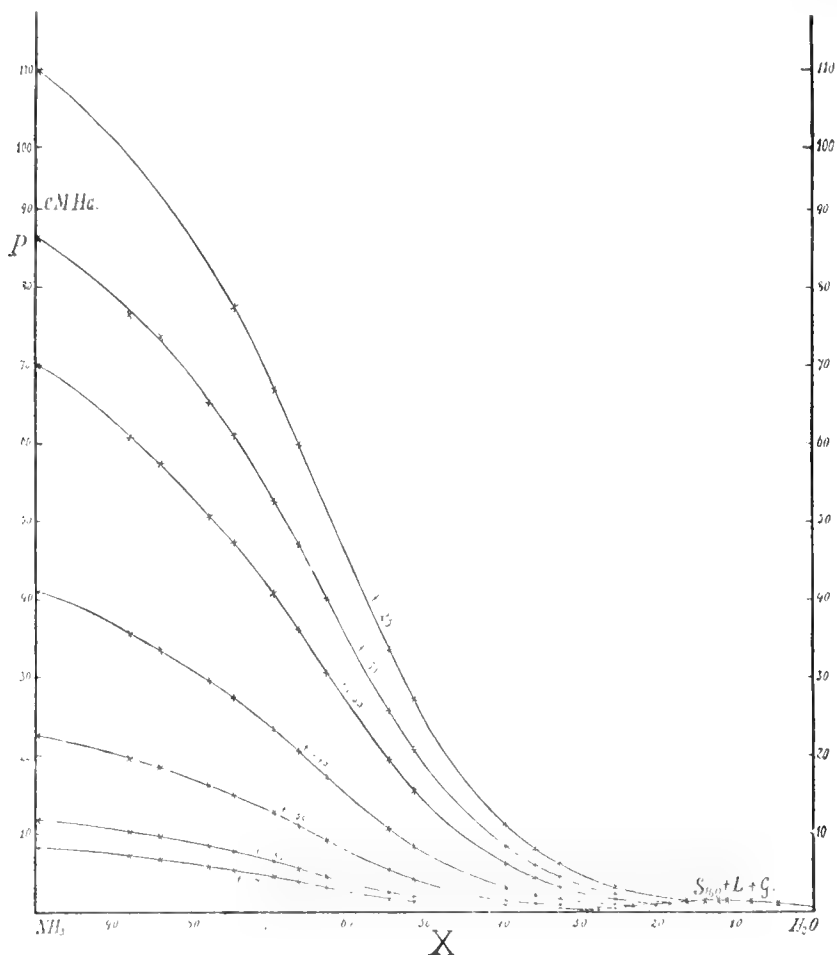

Fig. 4.

tion of the system sulphur-chlorine, and by Dr. DE LEEUW<sup>2)</sup> in the system aldehyde-alcohol.

Still more interesting is the consideration of the liquid lines of the  $(p,T)$ -sections, which are represented in fig. 4 for the temperatures  $-25^{\circ}$ ,  $-30^{\circ}$ ,  $-35^{\circ}$ ,  $-45^{\circ}$ ,  $-55^{\circ}$ ,  $-65^{\circ}$ , and  $-70^{\circ}$ .<sup>3)</sup>

<sup>1)</sup> Z. f. phys. Chem. **54**, 55, (1906).

<sup>2)</sup> loc. cit.

<sup>3)</sup> The vapour phases of the mixtures need not be investigated, as it appeared from a preliminary investigation that they practically consisted only of  $\text{NH}_3$  at the examined temperatures, as was indeed to be expected a priori.



We see that at all the temperatures mentioned here these liquid lines exhibit the type of negative liquid lines<sup>1)</sup>, as was met with by KOHNSTAMM and VAN DALFSEN<sup>2)</sup> for the system ether-chloroform, and by GERLACH<sup>3)</sup> for water and glycerin, while as BAKHUIS ROOZEBOOM remarked, such a line may also be derived from the investigation carried out by SCHREINEMAKERS<sup>4)</sup> for the system acetone-phenol.

Nor do liquid lines of the  $(p,v)_T$ -sections give the least indication of the existence of compounds in the liquid phase, and it is most remarkable that this even applies to the liquid lines corresponding to a temperature of  $-70^\circ$ , so only  $9^\circ$  above the temperature at which the compounds separate out of the liquid; an indubitable proof therefore that the compounds found undergo a dissociation in the liquid, much greater than would have been expected.

To complete the investigation the most important lines of the  $P$ - $T$ -projection of the spacial figure were also determined, the result of which is expressed in fig. 5, in which the three-phase lines of the

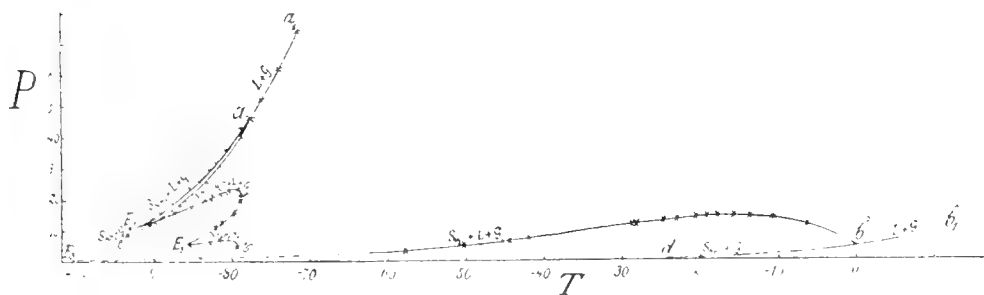

Fig. 5.

two compounds are very apparent. The difference in triple point pressure of the two compounds amounts to  $\pm 17$  m.m. Hg.

Finally also the plaitpoint curve was partially determined; as was to be expected this curve does not present any particularity either.

*Anorg. Chem. Laboratory of the University.*

*Amsterdam, May, 1914.*

<sup>1)</sup> BAKHUIS ROOZEBOOM. *Die Heter. Gleichgew.* II 40 (1904).

<sup>2)</sup> *Verslagen d. Kon. Akad. v. Wet.* 1901, 156.

<sup>3)</sup> *Z. f. anal. Chem.* **24**, 106 (1885).

<sup>4)</sup> *Z. f. phys. Chem.* **39**, 500 (1902).

**Mathematics.** — “On HERMITE’s and ABEL’s polynomia.” By N. G. W. H. BEEGER. (Communicated by Prof. W. KAPTEYN).

(Communicated in the meeting of May 30, 1914).

Prof. KAPTEYN has deduced the following expansion <sup>1)</sup>:

$$\frac{1}{\sqrt{1-\theta^2}} e^{-\frac{x^2 - (\theta x)^2}{1-\theta^2}} = \sum_0^\infty \frac{\theta^n H_n(x) H_n(\alpha)}{2^n \cdot n!} \dots \dots \dots (1)$$

in which  $H_n(x)$  represent the polynomia of HERMITE. Let in this expansion  $\alpha = 0$ , then we find:

$$\frac{1}{\sqrt{1-\theta^2}} e^{-\frac{\theta^2 x^2}{1-\theta^2}} = \sum_0^\infty \frac{\theta^n H_n(x) H_n(0)}{2^n \cdot n!} \dots \dots \dots (2)$$

Now it holds good for the polynomia of HERMITE that:

$$H_{2n+1}(0) = 0 \quad H_{2n}(0) = (-1)^n \frac{(2n)!}{n!} \sqrt{x} \dots \dots (3)$$

On account of which the above relation passes into:

$$\frac{1}{\sqrt{1-\theta^2}} e^{-\frac{\theta^2 x^2}{1-\theta^2}} = \sum_0^\infty (-1)^n \frac{H_{2n}(x)}{2^{2n} \cdot n!} \theta^{2n} \dots \dots \dots (4)$$

For the polynomia  $q_n(x)$  of ABEL we know the expansion:

$$\frac{1}{1-\theta} e^{-\frac{x^2}{1-\theta}} = \sum_0^\infty q_n(x^2) \theta^n \dots \dots \dots (5)$$

If we replace in (4)  $\theta^2$  by  $\theta$  we find:

$$\frac{1}{\sqrt{1-\theta}} e^{-\frac{\theta x^2}{1-\theta}} = \sum_0^\infty (-1)^n \frac{H_{2n}(x)}{2^{2n} \cdot n!} \theta^n$$

If we multiply the first member of this relation by  $\frac{1}{\sqrt{1-\theta}}$  and the second member by  $\sum_0^\infty \frac{(2n)!}{2^{2n} \cdot (n!)^2} \theta^n$ , the first member becomes equal to the first member of (5). By equalizing the coefficient of  $\theta^n$  in the two second members, we find the following relation between the polynomia of ABEL and those of HERMITE:

$$q_n(x^2) = \frac{1}{2^{2n}} \sum_{k=0}^n (-1)^{n-k} \frac{(2k)!}{(k!)^2 (n-k)!} H_{2n-2k}(x) \dots \dots (6)$$

If we multiply both members of (6) by

$$H_{2n-i}(x) e^{-x^2} dx$$

<sup>1)</sup> These Proceedings. Vol. XVI, p. 1198 (22).

and integrate between  $-\infty$  and  $+\infty$ , then we find by application of the well-known integrals:

$$\int_{-\infty}^{+\infty} H_m(x) H_n(x) e^{-x^2} dx = 0 \quad m \neq n$$

$$\int_{-\infty}^{+\infty} H_m^2(x) e^{-x^2} dx = 2^m \cdot m! \sqrt{\pi}$$

$$\int_{-\infty}^{+\infty} q_n(x^2) H_{2n-2i}(x) e^{-x^2} dx = (-1)^i \frac{(2n-2i)!(2i)!}{(i!)^2(n-i)!2^{2i}} \sqrt{\pi} \quad (7)$$

Prof. KAPTEYN deduces the following representation by means of an integral for HERMITE'S polynomials<sup>1)</sup>:

$$H_n(x) = \frac{e^{x^2}}{\sqrt{\pi}} \int_0^{\infty} e^{-\frac{u^2}{4}} u^n \cos\left(xu - \frac{n\pi}{2}\right) du.$$

If we substitute this expression in (6):

$$q_n(x^2) = \frac{e^{x^2}}{2^{2n} \sqrt{\pi}} \int_0^{\infty} e^{-\frac{u^2}{4}} \sum_{k=0}^n (-1)^{n-k} \frac{(2k)!}{(k!)^2(n-k)!} u^{2n-2k} \cos(xu - (n-k)\pi) du$$

or, if we work out the cosine

$$q_n(x^2) = \frac{e^{x^2}}{2^{2n} \sqrt{\pi}} \int_0^{\infty} e^{-\frac{u^2}{4}} \cos xudu \sum_{k=0}^n \frac{(2k)!}{(k!)^2(n-k)!} u^{2(n-k)} \quad (8)$$

Now is

$$(2k)! = \int_0^{\infty} e^{-y} y^{2k} dy$$

consequently

$$\begin{aligned} \sum_0^n \frac{(2k)!}{(k!)^2(n-k)!} u^{2(n-k)} &= \sum_0^n \frac{u^{2(n-k)}}{(k!)^2(n-k)!} \int_0^{\infty} e^{-y} y^{2k} dy = \\ &= u^{2n} \int_0^{\infty} e^{-y} dy \sum_0^n \frac{1}{(k!)^2(n-k)!} \left(\frac{y}{u}\right)^{2k} = \frac{u^{2n}}{n!} \int_0^{\infty} e^{-y} dy \sum_0^n \frac{1}{k!} \binom{n}{k} \left(\frac{y}{u}\right)^{2k} \end{aligned} \quad (9)$$

For ABEL'S polynomials we have:

$$q_n\left(-\frac{y^2}{u^2}\right) = \sum_{k=0}^n \frac{1}{k!} \binom{n}{k} \left(\frac{y}{u}\right)^{2k}$$

1) l. c. p. 1194 (9).

so that we can write for (9)

$$\frac{n^{2n}}{n!} \int_0^x e^{-y} g_n \left( -\frac{y^2}{u^2} \right) du$$

Substituted in (8) we get the double integral

$$g_n(x^2) = \frac{e^{x^2}}{n! \sqrt{\pi}} \int_0^\infty e^{-\frac{u^2}{4}} u^{2n+1} \cos x u du \int_0^\alpha e^{-ut} g_n(-t^2) dt$$

if we introduce  $y = ut$ .

By substitution of  $u = 2y$  it passes into

$$g_n(x^2) = \frac{4e^{x^2}}{n! \sqrt{\pi}} \int_0^\infty e^{-y^2} y^{2n+1} \cos 2xy dy \int_0^\infty e^{-2yt} g_n(-t^2) dt \quad (10)$$

Now we make use of the relation <sup>1)</sup> also deduced by Prof. KAPTEYN

$$\int_0^\infty e^{-t} \frac{t^n}{(1+t)^{n+1}} dt = \int_0^\infty e^{-t} \frac{g_n(t)}{1+t} dt \quad (11)$$

In (10) we substitute  $x = \sqrt{t}$  and then multiply both members by

$$\frac{1}{1+t} e^{-t} dt$$

and integrate between 0 and  $\infty$ , then we get by making use of (11):

$$\int_0^\infty e^{-t} \frac{t^n}{(1+t)^{n+1}} dt = \frac{4}{n! \sqrt{\pi}} \int_0^\infty e^{-y^2} y^{2n+1} dy \int_0^\infty e^{-2yu} g_n(-u^2) du \int_0^\infty \frac{\cos 2y\sqrt{t}}{1+t} dt.$$

According to a well-known integral in the theory of the integral-logarithm, is <sup>2)</sup>

$$\int_0^\infty \frac{\cos 2y\sqrt{t}}{1+t} dt = 2 \int_0^\infty \frac{\cos 2y\sqrt{x}}{1+x^2} dx = -e^{-2y} \operatorname{li}_1(e^{2y}) - e^{2y} \operatorname{li}(e^{-2y})$$

consequently

$$\int_0^\infty e^{-t} \frac{t^n}{(1+t)^{n+1}} dt = - \frac{4}{n! \sqrt{\pi}} \int_0^\infty e^{-y^2} y^{2n+1} \left\{ e^{-2y} \operatorname{li}_1(e^{2y}) + e^{2y} \operatorname{li}(e^{-2y}) \right\} dy \cdot \left. \int_0^\infty e^{-2yu} g_n(-u^2) du \right\} \quad (12)$$

By summation from  $n = 0$  to  $n = \infty$  we find:

<sup>1)</sup> l.c. XV, p. 1250 (14).

<sup>2)</sup> See for instance "Theorie des Integrallogarithmus Dr. NIELSEN page 24.

$$\int_0^x e^{-t} dt = -\frac{4}{\sqrt{\pi}} \int_0^x e^{-y^2} \{e^{-2y} li_1(e^{2y}) + e^{2y} li(e^{-2y})\} dy \int_0^x e^{-2yu} du \sum_0^{\infty} \frac{y^{2n+1}}{n!} q_n(-u^2)$$

Now is <sup>1)</sup>:

$$\sum_0^{\infty} \frac{x^m}{m!} q_m(a) = e^x J_0(2\sqrt{ax})$$

in which  $J_0$  represents the function of BESSEL of order zero. From this it ensues consequently that:

$$1 = -\frac{4}{\sqrt{\pi}} \int_0^{\infty} y \{e^{-2y} li_1(e^{2y}) + e^{2y} li(e^{-2y})\} dy \int_0^{\infty} e^{-2yu} J_0(2iuy) du.$$

As is known,

$$J_0(2iuy) = \sum_{n=0}^{\infty} \frac{u^{2n} y^{2n}}{(n!)^2}$$

so

$$\begin{aligned} \int_0^{\infty} e^{-2uy} J_0(2iuy) du &= \sum_{n=0}^{\infty} \frac{y^{2n}}{(n!)^2} \int_0^{\infty} e^{-2uy} u^{2n} du = \sum_{n=0}^{\infty} \frac{1}{y(n!)^2 2^{2n+1}} \int_0^{\infty} e^{-z} z^{2n} dz = \\ &= \sum_{n=0}^{\infty} \frac{(2n!)}{y(n!)^2 2^{2n+1}}. \end{aligned}$$

Introducing this we have

$$1 = -\frac{4}{\sqrt{\pi}} \int_0^{\infty} [e^{-2y} li_1(e^{2y}) + e^{2y} li(e^{-2y})] dy \cdot \sum_{n=0}^{\infty} \frac{(2n)!}{(n!)^2 2^{2n+1}}$$

or

$$\frac{1}{\sum_{n=0}^{\infty} \binom{2n}{n} \frac{1}{2^{2n+1}}} = -\frac{4}{\sqrt{\pi}} \int_0^{\infty} [e^{-2y} li_1(e^{2y}) + e^{2y} li(e^{-2y})] dy \quad (13)$$

According to an integral used before, is

$$\int_0^{\infty} [e^{-2y} li_1(e^{2y}) + e^{2y} li(e^{-2y})] dy = -2 \int_0^{\infty} t \cos t dt \int_0^{\infty} \frac{dy}{4y^2 + t^2} = -\lim_{y \rightarrow \infty} \int_0^y \cos t \operatorname{arctg} \frac{2y}{t} dt.$$

Formula (13) may also be written as follows:

$$\frac{1}{\sum_{n=0}^{\infty} \binom{2n}{n} \frac{1}{2^{2n+1}}} = \frac{4}{\sqrt{\pi}} \lim_{y \rightarrow \infty} \int_0^y \cos t \operatorname{arctg} \frac{2y}{t} dt \quad (14)$$

By multiplying formula (11) by  $\frac{x^n}{n!}$  and by summation from  $n = 0$  to  $n = \infty$  we find:

<sup>1)</sup> These Proceedings XV, p 1246 (9).

$$\int_0^x \frac{e^{-t}}{1+t} dt \sum_0^{\infty} \frac{x^n}{n!} \left(\frac{t}{1+t}\right)^n = \int_0^x \frac{e^{-t}}{1+t} dt \sum_0^{\infty} \frac{x^n}{n!} \varphi_n(t) = \int_0^{\infty} \frac{e^{-t+x}}{1+t} J_0(2\sqrt{xt})$$

or

$$\int_0^{\infty} \frac{e^{-t^2+(x-1)t}}{1+t} dt = e^x \int_0^{\infty} \frac{e^{-t}}{1+t} J_0(2\sqrt{xt}) dt \dots (15)$$

In order to deduce some more relations from formula (11) we set to work as follows. In Dr. NIJLAND'S dissertation<sup>1)</sup> the following relation is deduced for ABEL'S polynomia:

$$\varphi_n'(x) = - \sum_{k=0}^{n-1} \varphi_k(x).$$

By summation of formula (11) from  $n = 0$  to  $n - 1$ :

$$\int_0^{\infty} e^{-t} \sum_0^{n-1} \frac{t^n}{(1+t)^{n+1}} dt = \int_0^{\infty} \frac{e^{-t}}{1+t} \sum_0^{n-1} \varphi_n(t) dt$$

or

$$\int_0^{\infty} e^{-t} \left\{ \frac{t^n}{(t+1)^n} - 1 \right\} dt = \int_0^{\infty} \frac{e^{-t}}{1+t} \varphi_n'(t) dt$$

or

$$-1 + \int_0^{\infty} e^{-t} \frac{t^n}{(t+1)^n} dt = \int_0^{\infty} \frac{e^{-t}}{1+t} \varphi_n'(t) dt \dots (16)$$

We integrate the second member partially:

$$\begin{aligned} \int_0^{\infty} \frac{e^{-t}}{1+t} \varphi_n'(t) dt &= \left[ \varphi_n(t) \frac{e^{-t}}{1+t} \right]_0^{\infty} + \int_0^{\infty} \frac{(1+t)+1}{(1+t)^2} e^{-t} \varphi_n(t) dt = \\ &= -1 + \int_0^{\infty} \frac{e^{-t}}{1+t} \varphi_n(t) dt + \int_0^{\infty} \frac{e^{-t}}{(1+t)^2} \varphi_n(t) dt. \end{aligned}$$

Formula (16) passes into:

$$\int_0^{\infty} e^{-t} \frac{t^n}{(1+t)^n} dt = \int_0^{\infty} \frac{e^{-t}}{1+t} \varphi_n(t) dt + \int_0^{\infty} \frac{e^{-t}}{(1+t)^2} \varphi_n(t) dt$$

or by application of (11):

<sup>1)</sup> Over een bijzondere soort van geheele functiën. Utrecht. 1896 p. 19.

$$\int_0^\infty e^{-t} \frac{t^n}{(1+t)^n} dt = \int_0^\infty e^{-t} \frac{t^n}{(1+t)^{n+1}} dt + \int_0^\infty \frac{e^{-t}}{(1+t)^2} q_n(t) dt.$$

The first integral of the second member we convey to the first member, and we find:

$$\int_0^\infty e^{-t} \frac{t^{n+1}}{(1+t)^{n+1}} dt = \int_0^\infty \frac{e^{-t}}{(1+t)^2} q_n(t) dt \dots \dots \dots (17)$$

If we apply the same process to this, and again to the result, etc., we find at last after  $m$ -fold appliance:

$$\int_0^\infty e^{-t} \frac{t^{n+m}}{(1+t)^{n+1}} dt = m! \int_0^\infty \frac{e^{-t}}{(1+t)^2} q_n(t) dt \dots \dots \dots (18)$$

We can render this formula still more general by summation from  $n = 0$  to  $n = \infty$  after division by  $(-1)^n m!$ ; we get:

$$\int_0^\infty e^{-2t} \frac{t^n}{(1+t)^{n+1}} dt = \int_0^\infty \frac{e^{-t}}{t+2} q_n(t) dt \dots \dots \dots (19)$$

We apply the process explained above to this again and by summation again after division by  $(-1)^m m!$  etc. we finally find:

$$\int_0^\infty e^{-kt} \frac{t^{n+m}}{(1+t)^{n+1}} dt = m! \int_0^\infty e^{-t} \frac{q_n(t)}{(t+k)^{m+1}} dt \dots \dots \dots (20)$$

in which  $k$  and  $m$  represent positive integers.

Of course a formula analogous to (12) may be deduced from this

$$\int_0^\infty e^{-k^2 u} \frac{u^n}{(1+u)^{n+1}} du = \left( \begin{array}{l} \\ \\ \\ \end{array} \right) (21)$$

$$- \frac{4}{n! \sqrt{\pi}} \int_0^\infty e^{-y^2} y^{2n+1} [e^{-2y k} \text{li}_1(e^{2y^2}) + e^{2y k} \text{li}(e^{-2y^2})] dy \int_0^\infty e^{-2ty} q_n(-t^2) dt.$$

By summation, formula (13) is, however, found again.

The formulae (4) and (5) may also be used in order to express the polynomia  $H_{2n}$  in  $q$ 's. For this purpose we multiply the two members of (5) by

$$\sqrt{1-\theta} = 1 - \frac{1}{2} \theta - \frac{1}{2!} \cdot \frac{1}{2^2} \theta^2 - \frac{1}{3!} \cdot \frac{1 \cdot 3}{2^3} \theta^3 - \frac{1}{4!} \cdot \frac{1 \cdot 3 \cdot 5}{2^4} \theta^4 - \dots$$

By equalizing the coefficient of  $\theta^i$  in the second member of the

equation, thus obtained, to the coefficient of  $O^n$  in the second member of (4) we find:

$$H_{2n}(x) = (-1)^n 2^{2n} \cdot n! \left\{ \varphi_n(x^2) - \frac{1}{2} \varphi_{n-1}(x^2) - \sum_{k=2}^n \frac{1}{k!} \cdot \frac{1 \cdot 3 \cdot 5 \dots (2k-3)}{2^k} \varphi_{n-k}(x^2) \right\} \quad (22)$$

By means of this expression an integral may be deduced.

For if we multiply both members by

$$e^{-x} \varphi_m(x) dx$$

after replacing  $x^2$  by  $x$  and if we then integrate between 0 and  $\infty$ , we find, using the following well-known formulae<sup>1)</sup>:

$$\int_0^\infty e^{-x} \varphi_m(x) \varphi_n(x) dx = 0 \quad m \neq n$$

$$\int_0^\infty e^{-x} \varphi_m^2(x) dx = 1 \quad :$$

$$\int_0^x e^{-x} \varphi_m(x) H_{2n}(\sqrt{x}) dx = (-1)^{n+1} 2^{2n} \cdot n! \frac{1}{(n-m)!} \cdot \frac{1 \cdot 3 \cdot 5 \dots (2n-2m-3)}{2^{n-m}}$$

or after some reduction:

$$\int_0^\infty e^{-x^2} \varphi_m(x^2) H_{2n}(x) x dx = (-1)^{n+1} 2^{n+m-1} \frac{n!}{(n-m)!} 1 \cdot 3 \cdot 5 \dots (2n-2m-3) \quad (23)$$

$$m < n - 1.$$

In the same way we find

$$\int_0^x e^{-x^2} \varphi_n(x^2) H_{2n}(x) x dx = (-1)^n \cdot 2^{2n-1} \cdot n! \dots \quad (24)$$

and

$$\int_0^x e^{-x^2} \varphi_{n-1}(x^2) H_{2n}(x) x dx = (-1)^{n-1} \cdot 2^{2n-2} \cdot n! \dots \quad (25)$$

If we write formula (22) in this form:

$$H_{2n}(x) = (-1)^n 2^{2n} \cdot n! \left\{ \varphi_n(x^2) - \frac{1}{2} \varphi_{n-1}(x^2) - \frac{1}{2\sqrt{x}} \sum_{k=2}^n \frac{\Gamma(k-\frac{1}{2})}{k!} \varphi_{n-k}(x^2) \right\}$$

we know that<sup>2)</sup>

$$\varphi_{n-k}(x^2) = \frac{e^{x^2}}{(n-k)!} \int_0^\infty e^{-2x^2} {}_k J_0(2x\sqrt{a}) da.$$

<sup>1)</sup> Dr. NIJLAND'S Dissertation page 11.

<sup>2)</sup> These Proceedings XV. p. 1247.



This we substitute:

$$H_{2n}(x) = (-1)^n \cdot 2^{2n} \left\{ n! \varphi_n(x^2) - \frac{1}{2} n! \varphi_{n-1}(x^2) - \frac{1}{2\sqrt{\pi}} e^{x^2} \int_0^\infty e^{-z} J_0(2x\sqrt{a}) (2x\sqrt{a}) da \right. \\ \left. - \sum_{k=2}^n \frac{n!}{k!(n-k)!} \Gamma(k-\frac{1}{2}) a^{n-k} \right.$$

We further introduce:

$$\Gamma(k-\frac{1}{2}) = \int_0^\infty e^{-t} t^{k-\frac{3}{2}} dt$$

and

$$\frac{1}{2} n! \varphi_{n-1}(x^2) = \frac{e^{x^2}}{2\sqrt{\pi}} \int_0^\infty e^{-z} J_0(2x\sqrt{a}) da \cdot n a^{n-1} \int_0^\infty e^{-t} t^{-\frac{1}{2}} dt.$$

We find then:

$$H_{2n}(x) = (-1)^n 2^{2n} \left\{ n! \varphi_n(x^2) - \frac{e^{x^2}}{2\sqrt{\pi}} \int_0^\infty e^{-z} J_0(2x\sqrt{a}) da \int_0^\infty e^{-t} t^{-\frac{3}{2}} \sum_{k=1}^n \binom{n}{k} a^{n-k} t^k \right.$$

or after some reduction

$$\left. (-1)^{n-1} \frac{1}{2^{2n}} H_{2n}(x) + n! \varphi_n(x^2) = \frac{e^{x^2}}{2\sqrt{\pi}} \int_0^\infty e^{-z} J_0(2x\sqrt{a}) da \int_0^\infty e^{-t} t^{-\frac{3}{2}} \left\{ (a+t)^n - a^n \right\} dt \right\} \quad (26)$$

For  $x=0$ , the following identities arise from the formulae (6) and (22):

$$2^{2n} = \sum_{k=0}^n \frac{(2k!(2n-2k)!}{k!^2(n-k)!^2} \quad \text{or} \quad \frac{n!^2}{(2n)!} 2^{2n} = \sum_{k=0}^n \binom{n}{k} \binom{2n}{2k} \quad (27)$$

and

$$\frac{(2n)!}{n!} = 2^{2n} \cdot n! \left\{ \frac{1}{2} - \sum_{k=2}^n \frac{1 \cdot 1 \cdot 3 \cdot 5 \dots (2k-3)}{k! \cdot 2^k} \right\}$$

or

$$\frac{1}{n!^2} \frac{1}{2^{2n}} = \frac{1}{2} - \sum_{k=2}^n \frac{1 \cdot 1 \cdot 3 \cdot 5 \dots (2k-3)}{k! \cdot 2^k} \dots \dots \dots (28)$$

**Chemistry.** — “*The metastability of the metals in consequence of allotropy and its significance for Chemistry, Physics, and Technics*”. II. By Prof. ERNST COHEN.

*The specific heat of the metals 1.*

1. In my first paper <sup>1)</sup> on this subject I called attention to the fact that the physical constants of the metals hitherto known, are to be considered as entirely fortuitous values which depend on the previous thermal history of the material used.

In that paper I wrote with regard to the specific heat of the metals: Considering, for instance, the important part which the specific heats of the metals have played in chemistry and physics during the last few years, it is evident that a revision of these constants is wanted.

2. Reviewing the earlier literature dealing with this constant, I found that it contains already a number of data which prove unequivocally that the specific heat of the metals does indeed depend on their previous thermal history.

LE VERRIER published in the year 1892 a paper <sup>2)</sup> “sur la chaleur spécifique des métaux”, in which he describes his measurements with copper, zinc, lead, aluminium, and silver. The calorimetric determinations were carried out between 0° and 1000° by the method of mixtures. The temperature of the metal at the moment at which it was brought into the calorimeter was determined by means of a LE CHATELIER PYROMETER.

3. LE VERRIER stated that the mean specific heat remains as a rule constant till 200–300°, after which it changes abruptly, as PIONCHON <sup>3)</sup> also found in the case of iron, nickel and cobalt.

The variation of the total heat (i. e. the quantity of heat required to raise the temperature of 1 gr. of the substance from 0° to  $t^{\circ}$  C.) with the temperature is consequently to be represented by a curve with breaks and not by a continuous one.

In the neighbourhood of these breaks the condition of the metals is not only a function of the temperature, but also of their previous thermal history.

<sup>1)</sup> These Proc. **16**, 632 (1913).

<sup>2)</sup> C. R. **114**, 907 (1892).

<sup>3)</sup> C. R. **102**, 675, 1454 (1886); **103**, 1122 (1886). In full: Ann. de Chim. et de Phys. (6) **11**, 33 (1887).

As a consequence of the retardations in the structural change (changements d'état) of the metal, a different value of the total heat is found on cooling from that on heating.

If a certain piece of metal is cooled or heated repeatedly, different values for the total heat are found. If we start from a lower temperature and return to it after having overpassed the break in the curve of total heat, a closed and not a single curve is obtained.

4. This result is in complete harmony with the dilatometric and electromotive force measurements carried out by myself in collaboration with MESSRS. HELDERMAN and MOESVELD, on copper, cadmium, zinc and bismuth, measurements which led to the conclusion mentioned above.

5. LE VERRIER'S paper contains some interesting data which we shall now consider in connection with our dilatometric and electromotive force measurements.

The curve representing the variation of the total heat of copper as a function of the temperature, consists of four parts. At 350° an absorption of 2 Cal. occurs; at 550° an absorption of 2 Cal.; while at 750°, 3.5 Cal. are absorbed.

Thus, while our dilatometric measurements proved that there exist more than two modifications of copper, the same fact was noted a long time before by LE VERRIER, using a different method.

The measurements of LE VERRIER which are summarized in table I, have, however, been quite overlooked hitherto.

It may be pointed out here that the transition temperatures which can be deduced from LE VERRIER'S determinations will generally be too high. This is a consequence of the retardation of the molecular changes, which were also observed by him. Fresh experiments with the pure modifications of the different metals will throw light upon this point.

6. From the determinations of LE VERRIER there follows also, that there exists a transition point for lead which has so far been unknown. Experiments in this direction are in progress in my laboratory.

7. The same may be said with regard to silver.

8. Aluminium shows, according to LE VERRIER, an absorption of 10 Cal. at 535°. It may be pointed out that DITTENBERGER (Phys. Techn. Reichsanstalt at Charlottenburg—Berlin) proved ten years

TABLE I.

Temperature.	Mean spec. heat.	Total heat.
<b>Pb.</b>		
0-230°	0.038	$0.038 \times t$
220-250	Almost nil.	Almost constant.
250-300	0.0465	$8.15 + 0.0465 (t-250)$
<b>Zn.</b>		
0-110°	0.096	$0.096 \times t$
100-140 very variable	absorption of 0.8 Cal. in the neighbourhood of 110°	
110-300	0.105	$11.36 + 0.105 (t-110)$
300-400	0.122	$31.4 + 0.122 (t-300)$ increases rapidly above 400° and amounts to 46 Cal. in the neighbourhood of 410° immediately before melting.
<b>Al.</b>		
0-300°	0.22	$0.22 t$
300-530	0.30	$65 + 0.30 (t-300)$
530-560	Te crystallization of the silicium occurs at + 500° and the break lies with Al which contains Si in the neighbourhood of this temperature	
540-600	0.46	Absorption of 10 Cal. in the neighbourhood of 535° $139 + 0.46 (t-530)$ 170 Cal. at ± 600°; increases rapidly and exceeds 200 before melting (620°).
<b>Ag.</b>		
0-260°	0.0565	$0.0565 t$
260-660	0.075	$14.7 + 0.075 (t-260)$
660-900	0.066	$44.7 + 0.066 (t-660)$ 62 Cal. at ± 930, immediately below the melting point.
<b>Cu.</b>		
0-360°	0.104	$0.104 t$
320-380	0.104	Absorption of 2 Cal. at ± 350°
360-580	0.125	$37.2 + 0.125 (t-360)$
560-600	0.125	Absorption of 2 Cal. at ± 580°
580-780	0.09	$37 + 0.09 (t-580)$
740-800	0.09	Absorption of 3.5 Cal. at ± 780°
780-1000	0.118	$92 + 0.118 (t-800)$ 117 Cal. at ± 1020°.

after LE VERRIER that this metal is capable of existing in more than one allotropic modification and he found a transition temperature between 500 and 600°. I hope shortly to report on this point, in connexion also with a question which is important from a technical standpoint i.e. the disintegration of aluminium objects at room temperature, a disease which is the cause of a good many complaints in industrial circles as well as in daily life.

9. That others had never observed the phenomena described by LE VERRIER may be explained by the fact that they had not heated their preparations *repeatedly* to high temperatures, as he did. We have also observed during our dilatometric researches that such a transition point can be overpassed several hundreds of degrees without any effect. If on the contrary the metal is repeatedly cooled and heated the transition is "set going". As the means of overcoming these retardations are now known we are able to avoid them. A systematic research in this direction is now possible and I hope to report shortly on it.

*Utrecht, June 1914.*

VAN 'T HOFF-Laboratory.

**Physics.** — "*Measurements of isotherms of hydrogen at 20° C. and 15°.5 C.*" By Prof. PH. KOHNSTAMM and Dr. K. W. WALSTRA. VAN DER WAALS fund researches N°. 7. (Communicated by Prof. J. D. VAN DER WAALS).

(Communicated in the meeting of April 24, 1914).

§ 1. *Choice of the substance and the temperature.*

With the apparatus described in N°. 5 and 6 of this series we have made measurements of hydrogen isotherms at 20° C. and 15°.5 C. This choice was led by the following considerations. As we already set forth in the beginning of Communication N°. 5, one of the motives of our research was the desire to be able to make an accurate comparison with the results obtained by AMAGAT. Our first intention was to determine anew AMAGAT's air isotherms: then we were, however, checked by peculiar difficulties. Every time, namely, when a measuring tube was filled with air in the way described in the previous Communication, and was then left for

some hours at high pressure, (above 1500 atm.), it appeared to be unfit for accurate measurements after that time. When the apparatus was opened, the mercury appeared to be quite contaminated, the glass tube and the platinum contacts being also covered by a black substance.

Though in view of AMAGAT's experiments it could hardly be supposed that this substance was mercury oxide, formed by the action of the oxygen on the mercury, experiments of various kinds made it impossible to assume another cause. The supposition that at high pressure amalgamation of the platinum took place, proved erroneous, for in the black substance no trace of another metal than mercury could be demonstrated. Also the humidity of the air proved to be entirely without influence. When it finally appeared that neither filling with hydrogen nor with nitrogen yielded any trace, we could not but conclude that we had really to do here with the same phenomenon that KUENEN and ROBSON<sup>1)</sup> and KEESOM<sup>2)</sup> had observed when using closed air-manometers, namely that oxygen and mercury act on each other at pressures of about 100 atm. KEESOM, however, describes a slow action, which only after the lapse of months manifests itself clearly; whereas we could demonstrate the formation of mercury oxide with certainty already after a few hours on account of the so much higher pressures.

How it is that neither in his determination of air-isotherms nor in that of oxygen AMAGAT was troubled by this action, we cannot explain. After we had once ascertained it, the use of oxygen and oxygen mixtures was of course excluded. We therefore resolved to begin with measurements of hydrogen, which is most easily obtained in very pure state. The choice of the temperature of our measurements was directed by the desire to obtain a direct comparison with AMAGAT's measurements on one side, and a supplement to SCHALKWIJK's very accurate measurements at low pressures on the other side.

### § 2. *Filling of the apparatus with pure hydrogen.*

Most of our determinations have been made with hydrogen from the factory "Electro" at Amsterdam, which sells cylinders of compressed electrolytically prepared hydrogen. For the further purification and the filling of the apparatus with purified gas the arrangement was used of which fig. 12 gives a schematic representation. It fits on to the most lefthand part of fig. 6 at *l*.

<sup>1)</sup> Phil. Mag. Jan. 1902, p. 150.

<sup>2)</sup> Diss. p. 50—53. Thesis III.

A horizontal glass tube  $a$  passes on the lefthand side into a vertical tube  $c$  via an emergency reservoir  $b$ . The tube  $c$  can be fastened to the Gaedepump by means of a glass spring and a ground

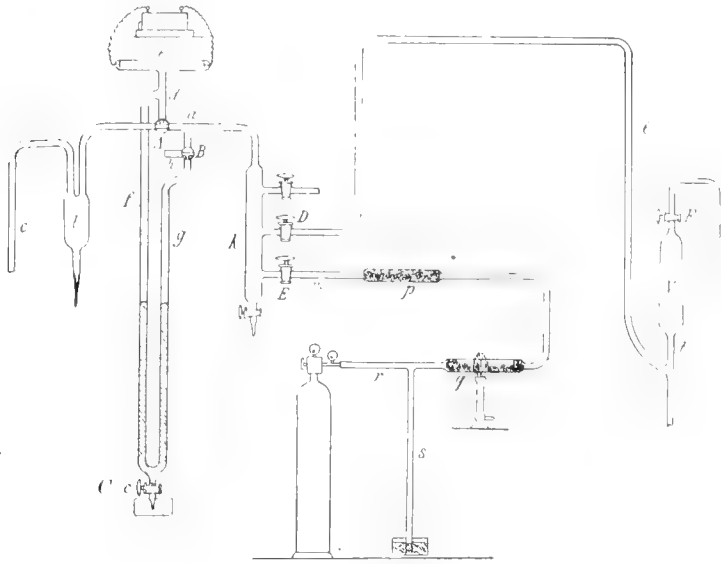

Fig. 12.

joint piece. In the middle of the tube  $a$  is a three-way-cock  $A$ , which gives access to a vertical tube  $d$ . A tube  $e$  is fused on to  $d$ , the former being provided with a cathode and an anode, which are connected with the secondary wire of a Ruhmkorff bobbin. The primary wire is simply connected with the electric light behind an incandescent lamp. The purpose of this tube will be mentioned presently. Attached to  $d$  is a branch tube  $f$ , bent downward, which may be considered as one of the limbs of a siphon barometer. The other leg  $g$  of the barometer is fastened to the righthand part of the tube  $a$ . In this there is another three-way-cock  $B$  with a branch tube  $h$ . To suck the mercury easily into the barometer tubes, resp. to expel it from them, a vertical tube with cock  $C$  is adjusted into the transition from  $f$  to  $g$ . On the tubes  $f$  and  $g$ , which are filled halfway with mercury, millimeter divisions have been etched to a height of 1 m. To make the mercury mirrors visible at a great distance care has been taken that a lamp can be slid up and down behind these tubes, a strip of ground glass between the lamp and the tubes intercepting the heat and making the light more diffuse. To the right of the place where the tube  $g$  opens into  $a$ , the latter is bent downward, and passes into a wider tube  $k$ . This tube is

provided with four branch tubes, which can all be shut off by cocks secured by mercury. For the filling with a single gas the presence of two of these branch tubes is sufficient, namely *l* and *m*, resp. with the cocks *D* and *E*. Tube *l* leads, as appears from the fig., to the mixing vessel, in which the normal volume at 1 atmosphere can be determined. The tube *m* leads to the gas reservoir via the purification apparatus. This gas reservoir is in casu a cylinder of hydrogen as said above. The rubber tube, which is connected with the pressure regulator, is fastened on the other side with solution to a horizontal glass tube *r*. This tube *r* has a vertical side tube *s*,  $\pm 1$  m. long and ending at the bottom into a vessel with mercury. Further *r* is connected by means of a rubber tube to a tube of infusible glass *q*, which is filled with platinum asbestos. The latter tube is connected again by means of a rubber tube to an ordinary drying tube *p*, with phosphorpentoxide, and the latter tube is again in connection by means of rubber with the above mentioned tube *m*. All the closures of rubber to glass are secured with solution.

In order to fill the measuring tube with pure hydrogen, the cocks *E*, *D*, and *F* are opened after the already mentioned operations (Comm. N<sup>o</sup>. 6, p. 828). The position of three-way-cock *A* is such that both sides of *a* are in communication with *d*. The three-way-cock *B* shuts off the tube *g* at the top. Position I.

The air-jet or oil-pump is made to serve in the beginning, the Gaede-pump completing the evacuation. When the air is sufficiently rarefied, the cock *E* is closed, and the empty tubes *m*, *p*, *q*, and *r* are filled with hydrogen from the cylinder. The mercury, which in the tube *s* has risen to barometer height in the meantime, will descend; the mercury difference in the tubes *f* and *g* still indicating the barometric height.<sup>1)</sup> Then the hardglass tube *q* is heated, till the platinum asbestos begins to glow. The cock *E* is slowly opened. And while the gas is flowing into the empty space *k* and further, the hydrogen tube is again opened, so that the pressure in the tubes *m*, *p*, *q*, and *r* always remains  $\pm 1$  atm. This is desirable because in case of too great rarefaction the glowing hardglass tube *q* indents, and soon gives way. The gas that flows through *m* to the different tubes, is almost pure, for the oxygen, for so far as it is present in the electrolytic-factory hydrogen, is quite combined with hydrogen to water through the catalytic action of glowing platinum asbestos,

<sup>1)</sup> On account of an eventually too high pressure the tubes *m*, *p*, *q*, and *r* might burst now, if the open tube *s* with mercury safety valve had not been added.



and the water formed is entirely retained in the phosphorus pentoxide tube  $p$ . When the mercury in  $f'$  and  $g$  is again at the same level, it may be assumed that everything is filled with hydrogen of one atmosphere. Now the cock  $l$  is again closed;  $k$  and the other tubes are again evacuated. An idea about the purity of the gas which was found in the tubes after the first filling, is now given by the discharges in the cathode ray tube  $e$ . As long as traces of oxygen still contaminate the hydrogen (i.e. with air — and the presence of the latter appears at the same time — the only possible contamination) the tube will be filled with red light. When pure hydrogen has filled the tubes, the light will exhibit the well-known rice-colour. An opinion may then be formed at the same time about the degree of rarefaction attained, and also about the closure of different cocks and couplings.

The tubes are then again filled with purified hydrogen, and after another evacuation and filling the purity of the gas in all the tubes may be safely assumed to be sufficient. Then the cock  $D$  is closed, the mercury bulb (see Comm. N<sup>o</sup>. 6 p. 828) is raised, and the pure hydrogen is in the first "pressure stage" (see p. 823). Now for a control the cock  $E$  was always closed once more, and the part of the tubes  $k$ ,  $a$ ,  $g$ ,  $d$ ,  $f'$ , and  $e$  was exhausted, to ascertain the purity of the gas with which we are going to work by means of the colour of the discharge light.

If, what need not yet be done, (p. 830) it is desired first to determine the normal volume of the gas at  $\pm 1$  atm., before it is brought into the first "pressure stage",  $E'$  must be closed before the last filling. The difference in height between the mercury levels in  $l$  and  $t$ , and also the temperature of the thermostat must be determined. The barometric height can be read with the siphon barometer  $f$ ,  $g$ .<sup>1)</sup> But now the tube  $l$  must be in communication with the outer air. This may be effected by turning the cocks  $A$  and  $B$  90° in positive resp. negative direction (Position II). Then the tube  $l$  gets into communication with the outer air via  $k$  and  $h$ . This remains the case with  $g$ . But to prevent the tubes  $d$  and  $f'$  to get communication with the outer air also the cock  $A$  must be turned, but in opposite direction. The determination of the normal volume in  $V$  has, however, as said before, only sense when we wish to convey a quantity of gas quantitatively to the measuring tube, which has not yet been done.

To ascertain whether sufficiently pure hydrogen was obtained in

<sup>1)</sup> By means of a cathetometer and the scalar divisions etched on the tubes.

this way, we made also a series of experiments with distilled hydrogen from the Leyden laboratory. The quantity of admixtures had been estimated at  $\frac{1}{5000}$  at the most by Prof. KAMERLINGH ONNES. We gladly avail ourselves of this opportunity to express our indebtedness to Prof. KAMERLINGH ONNES for his kindness. In the filling with this gas the purification apparatus could safely be omitted; the cylinder was therefore immediately connected with the tube *m*. The results of the measurements with this agreed within the limits of the errors of observation with the results obtained with the gas purified by us in the way described above.

### § 3. *The measurements.*

How through the different "pressure stages" the gas is conveyed to the measuring tube, has already been described above. Also how the temperature is then kept constant. This is seen by the deviation of the galvanometer, inserted into the WHEATSTONE bridge. To get a first idea the pressure at which the galvanometer needle deviates is read on the manometer, and a corresponding number of weights is placed on the rotating pressure gauge, after it has been brought in communication with the tubes. If the number of rotating weights is too great, some are taken off till the galvanometer needle has returned to its original zero position. At last a final condition is reached, in which the putting on of 50 grams on the rotating weights makes the needle deviate, while the needle returns to its position of equilibrium when this weight is removed.

The accuracy with which the pressures are thus measured on the small and the large pressure balance generally amounts to this 25 grams up to 900 atmospheres. When the measurement is made with the small pressure balance, which goes up to 250 kg. per cm<sup>3</sup>. the galvanometer needle may be made to deviate and return by putting on or taking away 10 grams, and even when the contacts are very clean with less. As, however, 25 gr. implies already an accuracy of 1 to 10.000, which is not reached on account of other sources of error, there is no sense in going so far in the determination of the pressure. We only mention the fact as a proof of the very great accuracy of the pressure balance for relative pressure measurements.

When one pressure measurement has thus been made, the pressure is increased. The galvanometer needle, which now would continue to deviate, must again be brought back to zero, because now another resistance of the volume wire is measured.

Thus for every platinum contact in the measuring tube the pressure at the corresponding volume is determined. Then the pressure is diminished, so that two series of observations of the same results must be obtained, but one passed through at increasing, the other at decreasing pressure. The pressure differences at two corresponding observations of two such series rarely amounted to more than 50 grams. It must of course be continually verified whether the temperature differences inside and outside the measuring tube have disappeared. This has taken place when the resistance of the temperature wire (cf. Comm. 6 p. 833) has become constant.

In the measurement of the highest pressures, so when the large "head" of the pressure balance is used, i.e. between 1200—2400 atmospheres, the accuracy of the pressure measurement becomes less, especially on account of the increasing viscosity of the mineral oil used as transmission liquid. Yet the error will certainly remain below  $\frac{1}{2000}$ .

#### § 4. *Determinations between 2 and 200 atms.*

As was already mentioned in Comm. 6 (p. 830) unforeseen difficulties prevented us from determining the normal volume of the quantity used in the apparatus itself. For the determination of the isotherm of 20° C. we could make use for the calculation of the normal volume of SCHALKWIJK's measurements, as will become clear from the discussion of our results. Such data were wanting for 15°.5 C. And in order to be able to carry out all the same an accurate comparison with AMAGAT's measurements, we have executed measurements at lower pressures at that very temperature. In this way a control was obtained whether the equation for low pressures derived from the measurements may be extrapolated.

We shall return to these points when our results are discussed, and first give a description here of these measurements too. As we again wished to use a large quantity of gas, the iron vessel *D* used in the large apparatus was used as a pressure cylinder. We then could fill the piezometer with a quantity of gas of the order of magnitude of 1 liter at 1 atmosphere.

The piezometer originally consists of two pieces. The upper part was as the upper reservoir of our ordinary measuring tubes. At the top at *a* (fig. 13) there are 4 etched lines to be used after the cleaning of the tube. Lower down there is a widening *b*; under this a sealed in platinum wire *c*, and at last an etched scalar division *d*. This tube was connected with a capillary, and bent round. A platinum wire is sealed into the bent part. Here a current can enter, and

leave through the mercury at the wire sealed in higher. When we provide the side-tube with a scale, and fill everything with mercury, and place it in a waterbath, a very accurate gauging is again possible as described in Comm. 5 p. 766. We first gauge the distances of the etched lines, then the volume from these lines to the sealed in wire, and then from there to the etched scalar division, and this division itself.

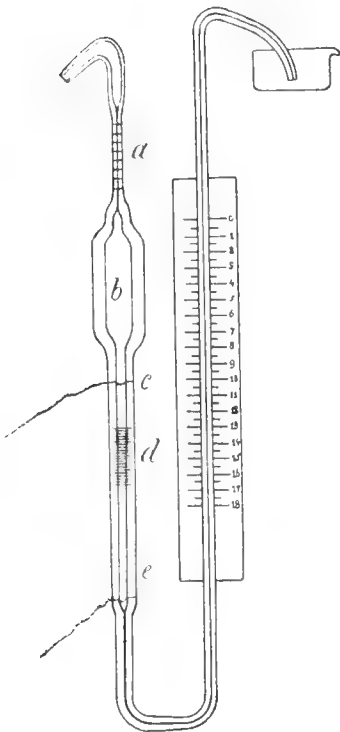

Fig. 13.

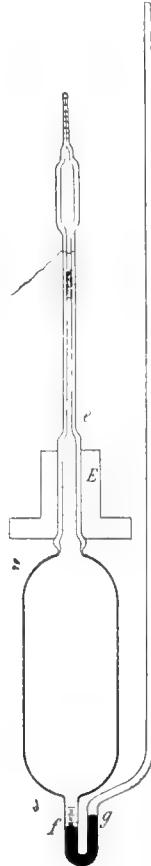

Fig. 14.

The large reservoir, which is to be sealed to this top piece is calibrated after this sealing, by filling with mercury the volume from the scalar division on the top piece to the scalar division at the bottom on the bottom piece.

We now know sufficiently accurately the volume from the etched lines to the sealed in wire, and from here to the scalar division under the large reservoir. The tube is now fused to at the upmost

line, and at the bottom a bent tube is added. The brass flanged tube *E* of the pressure cylinder had been previously cemented at *e*, and after a few drops of mercury have been brought into the large reservoir, the tube is evacuated and filled in a horizontal position. When the tube has been filled with pure hydrogen, it is put erect, and the drops of mercury shut off the gas from the outer air. Then the whole thing is placed in a waterbath of  $15^{\circ}.5$ , while the difference in height of the mercury in the tubes *f*' and *g* is read. As the volume up to the scalar division, and the division itself too, has been gauged, we now know the volume of a definite quantity of hydrogen at about 1 atm. and the desired temperature. In order to determine the pressure accurately, the pressure of the outer air must of course also be determined, for which purpose the siphon barometer is again used (p. 205).

We can further dispense with the side tube, for it only served to protect the mercury at the bottom of the tubes against the water. It is knocked off at *g*, and after the still remaining tube has been entirely filled with mercury, the whole arrangement is put in the pressure cylinder filled with mercury. The pressure cylinder is closed, and connected with the hydrostatic press, which connection is also in communication with the pressure balance. By means of a rubber stopper a glass cylinder provided with a side tube at the bottom and at the top is put round the projecting part, so that water of  $15^{\circ}.5$  from a thermostat keeps the gas at the desired temperature. The current was closed on the iron pressure cylinder; then it passed through the mercury, and when the required height had been reached it passed further through the platinum wire. By means of the pressure balance the pressure at which the platinum wire is reached, hence the pressure at which the gas volume is diminished to the upper part, could be very accurately determined.

### § 5. *Corrections.*

Some corrections should be applied to the experimental results obtained in the above described way. First of all in the gauging the volume is obtained in gr. of mercury of a definite temperature. To reduce these values to the accurate volume in  $\text{cm}^3$ , two reductions must be applied. A reduction should take place to  $\text{cm}^3$ , by dividing the value in gr. of mercury by the specific gravity of mercury at the temperatures of the gauging. The specific gravity of mercury according to the Tables of LANDOLT and BÖRNSTEIN was used for this reduction. Further the compressibility of the glass of

the measuring tube should be taken into account. The gauging takes place at 1 atm.; during the measurement the tube is subjected to a pressure on all sides, in consequence of which the volume decreases. As the correction in question is only a small one, we have thought that for our first calculations it would suffice if we took the compressibility of our glass equal to the value determined by AMAGAT. We have therefore put the factor of compressibility at  $22 \times 10^{-7}$  and assumed this quantity to be constant between 1 and 2500 atms.

Also to the values of the pressure read directly some corrections should be applied. The weights in kg. read on the pressure balance should first be reduced to kg. per  $\text{cm}^2$ , by taking the value of the effective area into account. In anticipation of the comparison of the small pressure balance with an open manometer of sufficient capacity discussed in Comm. N<sup>o</sup>. 5 p. 759, we have assumed that the effective area of the small balance, the piston of which is as accurately as possible ground in at 1  $\text{cm}^2$ , really amounts to 1  $\text{cm}^2$ .

Since we wrote our first communication we have been greatly strengthened in the conviction that we cannot make great errors in this way, by the result of GEORG KLEIN's research<sup>1)</sup>. According to his investigations<sup>2)</sup> the error in consequence of the neglect of the difference between piston and cylinder sections for SCHÄFFER and BUDENBERG's balance amounts to at most 0.1‰, and the deviation of the indicated and the directly measured value of the difference of the two piston sections is 0.4‰ in the case examined by him.

Now the large pressure balance could be compared with the small pressure balance by measuring the same point of the isotherm in the neighbourhood of 250 atms. first with the one, and then with the other. So the measuring tube with the galvanometer in connection with it etc. serves simply as a manoscope, to judge when in the use of the two balances the pressure is exactly equal. It then appeared from some observations carried out in this way that when the section of the small balance is put at  $\approx 1 \text{ cm}^2$ , the section of the small head of the large balance must also be put at 1  $\text{cm}^2$ , within the limits of the errors of observation. As at these pressures the errors of observation are very small as we saw above, and will certainly remain below 0.2‰, this result is a new confirmation of the great accuracy of the SCHÄFFER and BUDENBERG pressure balances, and it gives therefore a new support to the validity of the made supposition.

In the same way a comparison was made between the small and

1) Untersuchung und Kritik von Hochdruckmessern. Berlin 1909.

2) Loc. cit. p. 47.

the large head of the large pressure balance in the neighbourhood of 1200 atms. Instead of the theoretical numerical ratio 4, three measurements gave resp. the values 4,012, 4,015, 4,016, average 4,014. The weights when the large head is used, must therefore be multiplied by this value.

The thus obtained value for the pressure in the head must now still be corrected for the excess of pressure of one atmosphere, and for the hydrostatic pressure difference between the head of the pressure balance and the measuring tube on account of the mercury and oil columns. These liquid columns were roughly measured, in which 1 cm. of mercury more or less need not be considered: nor need the oscillations of the barometer be taken into account.

Finally the thus obtained pressure had to be reduced to atmospheres of 1,0336 kg. per  $\text{cm}^2$ .

In table I.

The column under  $v_g$  indicates the weighed volume in gr. of mercury.

„ „ „  $p_{kg}$  the number of kg. on the pressure balance.

„ „ „  $p_c$  the pressure, corrected for hydrostatic pressure difference in kg. per  $\text{cm}^2$ .

„ „ „  $p$  the corrected pressure in atmospheres.

„ „ „  $\beta$  the ratio of the volume at 1 atm. and at the measured pressure in consequence of the compressibility of the glass.

„ „ „  $\beta v_g$  the product of  $\beta$  and  $v_g$ .

„ „ „  $v$  the corrected volume in  $\text{cm}^3$ .

„ „ „  $p v$  the product of  $p$  and  $v$ .

T A B L E I.

<sup>5</sup>/<sub>6</sub> November 1912.

$t = 20^\circ$ .

$v_g$	$p_{kg}$	$p_c$	$p$	$\beta$	$\beta v_g$	$v$	$p v$
67.1491	195.850	194.750	188.419	0.99959	67.1216	4.95473	933.57
55.0632	245.400	244.300	236.358	0.99948	55.0346	4.06250	960.26
45.4959	306.575	306.175	296.222	0.99935	45.4663	3.35620	994.18
37.3710	390.200	389.800	377.128	0.99917	37.3400	2.75633	1039.49
31.0962	494.550	494.150	478.086	0.99895	31.0636	2.29302	1096.26
27.4110	587.000	586.600	567.531	0.99875	27.3756	2.02087	1146.91
22.7296	769.500	769.100	744.098	0.99836	22.6923	1.67508	1246.42
19.3102	992.625	992.225	959.970	0.99789	19.2695	1.42242	1365.48

T A B L E I. (Continued).

November 21, 1912.

 $t = 20^{\circ}$ .

$v_g$	$\hat{p}_{kg}$	$\hat{p}_c$	$\hat{p}$	$\hat{\beta}$	$\hat{\beta}v_g$	$v$	$\hat{p}v$
90.3267	130.200	129.100	124.903	0.99973	90.3019	6.66580	832.58
87.5019	134.700	133.600	129.257	0.99972	87.4774	6.45734	834.66
85.4277	138.250	137.150	132.692	0.99971	85.4029	6.30420	836.52
43.7526	292.925	292.525	283.016	0.99938	43.7255	3.22769	913.49
34.5011	391.600	391.200	378.483	0.99917	34.4725	2.54466	963.11
25.0070	599.600	599.200	579.721	0.99872	24.9750	1.84358	1068.76

December 11, 1912.

 $t = 20^{\circ}$ .

60.4928	222.500	221.400	214.203	0.99953	60.4644	4.46331	956.05
58.0961	233.000	231.900	224.361	0.99951	58.0676	4.28639	961.70
55.9451	243.350	242.250	234.375	0.99948	55.9160	4.12756	967.40
53.7822	254.700	253.600	245.356	0.99946	53.7532	3.96791	973.55
48.5533	286.400	286.000	276.703	0.99939	48.5237	3.58188	991.07
45.9361	306.000	305.600	295.665	0.99935	45.9062	3.38867	1001.91
42.9934	331.450	331.050	320.288	0.99929	42.9629	3.17140	1015.72
39.4220	368.750	368.350	356.376	0.99922	39.3913	2.90775	1036.25
35.8492	415.575	415.175	401.679	0.99912	35.8177	2.64396	1061.99
22.0889	814.000	813.600	787.152	0.99827	22.0507	1.62772	1281.24

February 10, 1913.

 $t = 20^{\circ}$ .

65.7937	225.050	223.950	216.670	0.99952	65.7621	4.85437	1051.80
34.9813	485.200	484.800	469.040	0.99897	34.9453	2.57956	1209.92
27.9749	660.000	659.600	638.158	0.99860	27.9357	2.06214	1315.97
21.3124	995.000	994.600	952.268	0.99788	21.3470	1.57578	1516.32



## T A B L E I. (Continued).

February 11<sup>12</sup>, 1913. $t = 20^{\circ}$ .

$v_g$	$\hat{p}_{kg}$	$\hat{p}_c$	$\hat{p}$	$\hat{\rho}$	$\hat{\rho}v_g$	$v$	$\hat{p}v$
65.7937	220.200	219.100	211.929	0.99953	65.7628	4.85443	1029.03
34.9813	472.950	472.550	457.188	0.99899	34.9460	2.57962	1179.37
27.9749	641.825	641.425	620.574	0.99863	27.9366	2.06220	1279.75
21.3924	964.100	963.700	932.372	0.99795	21.3486	1.57589	1469.32
14.4836	487.750	1960.3	1896.6	0.99583	14.4232	1.06468	2019.27

February 13, 1913.

 $t = 20^{\circ}$ .

65.7937	196.850	195.750	189.391	0.99958	65.7661	4.85467	919.42
34.9813	416.300	415.900	402.382	0.99911	34.9502	2.57993	1038.14
27.9749	558.800	558.400	540.251	0.99881	27.9416	2.06257	1114.30
14.4836	400.250	1609.1	1556.8	0.99658	14.4341	1.06548	1658.74

April 22<sup>24</sup>, 1913. $t = 20^{\circ}$ .

36.1414	351.450	351.050	339.643	0.99925	10.7858	2.6659	905.45
32.4244	402.700	402.300	389.221	0.99914	13.7748	2.3914	930.79
21.1098	720.400	720.000	696.590	0.99847	17.2937	1.5559	1083.89
17.3297	980.000	979.600	947.755	0.99792	21.0775	1.2765	1209.81
13.8172	361.000	1451.5	1404.3	0.99692	32.3965	1.0168	1427.89
10.8401	587.750	2361.7	2284.9	0.99497	36.1143	0.7962	1819.24

April 22<sup>24</sup>, 1913. $t = 15^{\circ}$ .

36.1414	345.900	345.500	334.272	0.99926	10.7864	2.6659	891.16
32.4244	395.950	395.550	382.691	0.99916	12.0677	2.3914	915.20
21.1098	708.200	707.800	684.791	0.99849	13.7753	1.5559	1065.47
17.3297	964.100	963.700	932.374	0.99795	17.2942	1.2766	1190.26
13.8172	355.750	1430.4	1383.9	0.99695	21.0779	1.0168	1407.15
12.1097	457.000	1836.9	1777.2	0.99609	32.3972	0.8904	1582.42
10.8401	580.250	2331.6	2255.8	0.99504	36.1150	0.7962	1796.07

TABLE I. (*Continued*).

June 4, 1913.

 $t = 20^\circ$ .

$v_g$	$p_{kg}$	$p_c$	$p$	$\beta$	$\beta v_g$	$v$	$p v$
64.3346	141.800	140.700	136.13	0.99970	64.315	4.7476	646.28
59.8154	153.475	152.375	147.42	0.99968	59.796	4.4140	650.71
27.7963	370.500	370.100	358.07	0.99921	27.774	2.0502	734.12
21.2326	524.750	524.350	507.30	0.99888	21.209	1.5656	794.23
16.2658	766.100	765.700	740.81	0.99837	16.239	1.1987	888.01
12.1023	1236.000	1235.600	1195.4	0.99737	12.070	0.89097	1065.07

In conclusion we give the two observations at  $15^\circ.5$  for the determination of the compressibility between 100 atmospheres and atmospheric pressure. The first column gives the pressure in atm., the second the volume in  $\text{cm}^3$ , the third the product  $p v$ .

TABLE II.

November 1913.

 $t = 15^\circ.5$ .

1.0384	484.6	503.19
97.91	5.4474	533.35

December 1913.

 $t = 15^\circ.5$ .

1.0004	536.07	536.28
104.82	5.4474	570.99

*Amsterdam,**Physical Lab. of the University.*

**Physics.** — “*The hydrogen isotherms of 20° C. and of 15°.5 C. between 1 and 2200 atms.*” By Dr. K. W. WALSTRA, VAN DER WAALS’ fund researches N°. 8. (Communicated by Prof. J. D. VAN DER WAALS).

(Communicated in the meeting of May 30, 1914).

$$T = 20^{\circ}.$$

§ 1. *Agreement of the observations below 1000 atms. with SCHALKWIJK’S isotherms.*

For each of the series of observations given in the preceding Communication we have determined an empiric equation of the form:

$$PV = a + bD + cD^2 + dD^3.$$

As only series of observations below 1000 atms. can be represented by this equation with 4 virial coefficients, only these series come into consideration for the present. The obtained observation material above 1000 atms. will have to be considerably extended to enable us to calculate the following virial coefficients with the same certainty.

If of the above equation we wish to determine  $a$ ,  $b$ ,  $c$ , and  $d$ , we get a number of equations equal to the number of observations, and consequently then with 4 unknown quantities. To solve these equations according to the method of least squares is not feasible, as then the normal equations become practically identical, which may already be seen beforehand. We have been able to apply Prof. E. v. D. SANDE BAKHUIZEN’S method successfully, which was also

$T = 20^{\circ}.$ 5/6 November 1912.				$T = 20^{\circ}.$ 21 November 1912.			
$P$	$PV(O)$	$PV(C)$	$(O)-(C)$	$P$	$PV(O)$	$PV(C)$	$(O)-(C)$
959.97	1365.48	1365.48	0.00	579.72	1068.76	1068.76	0.00
744.10	1246.42	1246.43	-0.01	378.48	963.11	963.11	0.00
567.53	1146.91	1146.81	+0.10	283.02	913.49	913.49	0.00
478.09	1096.26	1096.42	-0.16	132.69	836.52	936.49	+0.03
377.13	1039.49	1039.49	0.00	129.26	834.66	834.66	0.00
296.22	994.18	993.95	+0.23	124.90	832.58	832.55	+0.03
236.36	960.26	960.42	-0.16				
188.42	933.57	933.56	+0.01				
$PV = 829.71 + 445.08 D + 353.40 D^2 + 197.28 D^3.$				$PV = 770.50 + 371.45 D + 272.26 D^2 + 192.62 D^3.$			

$T = 20^\circ$ .  $11_{12}$  December 1912.

$P$	$PV(O)$	$PV(C)$	$(O)-(C)$
787.15	1281.24	1281.25	-0.01
401.68	1061.99	1062.00	-0.01
355.38	1036.25	1036.21	0.04
320.29	1015.72	1015.76	-0.04
295.67	1001.91	1001.81	+0.10
276.70	991.07	991.12	-0.05
245.36	973.55	973.51	+0.04
234.38	967.40	967.35	+0.05
224.36	961.70	961.75	-0.05
214.20	956.05	956.11	-0.06

$$PV = 842.61 + 409.64D + 423.18D^2 + 191.36D^3.$$

used at Leyden for the calculation of AMAGAT's values at the time. (See Comm. 71). In how far we have succeeded in determining the empiric equations may appear from the following tables. We have placed there side by side  $P$ ,  $PV(O)$  — observed pressure and pressure  $\times$  volume —, and  $PV(C)$  — calculated with the known volume from the empiric equation;  $(O) - (C)$  the difference between the product  $PV$  following from the observation and that following from the formula.

$T = 20^\circ$ .  $11_{12}$  February 1913.

$P$	$PV(O)$	$PV(C)$	$(O)-(C)$
932.37	1469.32	1469.32	0.00
620.57	1279.75	1279.75	0.00
457.19	1179.37	1179.37	0.00
211.93	1029.03	1209.03	0.00

$$PV = 904.53 + 499.85D + 494.67D^2 + 298.61D^3.$$

$T = 20^\circ$ . 10 February 1913.

$P$	$PV(O)$	$PV(C)$	$(O)-(C)$
962.27	1516.32	1516.32	0.00
638.16	1315.97	1315.97	0.00
469.04	1209.92	1209.92	0.00
216.67	1051.80	1051.80	0.00

$$PV = 923.03 + 508.75D + 552.10D^2 + 296.55D^3.$$

$T = 20^\circ$ .  $22_{24}$  April 1913.

$P$	$PV(O)$	$PV(C)$	$(O)-(C)$
947.76	1209.81	1209.81	0.00
698.53	1086.84	1086.84	0.00
389.22	930.78	930.78	0.00
339.64	905.45	905.45	0.00

$$PV = 732.67 + 358.69D + 257.51D^2 + 101.20D^3.$$

$T = -20^{\circ}$ , 4 June 1913.

$P$	$PV(O)$	$PV(C)$	$(O)-(C)$
740.81	888.01	888.01	+ 0.00
507.30	794.23	794.22	+ 0.01
358.07	734.12	734.12	+ 0.00
147.42	650.71	650.68	+ 0.03
136.13	646.28	646.30	- 0.02

$$PV = 596.07 + 207.24 D + 147.31 D^2 + 34.13 D^3.$$

To find out whether these series of observations are in harmony with each other, they can be brought in correspondence directly. We did so before, and found only a slight deviation between them. Besides it is also possible to try and make all the series of observations agree with SCHALKWIJK's isotherm, and then compare them also inter se. But then there must first be a reason to suppose that it was possible to make these observations agree with SCHALKWIJK's, and this had soon appeared. When in December 1912 only three series of observations had been found, we calculated from that which contained the greatest number of observations (Dec.  $^{11}/_{12}$  1912) an empiric equation from four of the observations, viz. at 787.15, 401.68, 320.29, 276.70 atms.

The other observations of this series appeared to be in good agreement with the found equation:

$$PV = 841.70 + 415.09 D + 414.10 D^2 + 198.16 D^3.$$

Also the two series of observations of Nov. 1912 appeared to be in harmony with this. Then a comparison with SCHALKWIJK's observations was attempted by reduction of the above equation to one with the same virial coefficient:  $\alpha$  as SCHALKWIJK, viz.  $\alpha = 1.07258$ . This reduced equation then becomes:

$$PV = 1.07258 + 0.0,6740 D + 0.0,8569 D^2 + 0.0,6659 D^3.$$

SCHALKWIJK giving:

$$PV = 1.07258 + 0.0,6671 D + 0.0,993 D^2.$$

This equation holds from 8 to 60 atms., ours from 200 to 800 atms., but we are now going to try to extrapolate with respect to the region of the lower pressures in order to compare these extrapolations with SCHALKWIJK's.

The differences are most apparent when the product  $PV$  is deter-

mined from the two equations for different values for  $D$ , and the products are joined in the following tables.  $PV(S)$  is then calculated from SCHALKWIJK's equation with 3 virial coefficients;  $PV(P)$  from our provisional equation.

$D$	$PV(S)$	$PV(P)$	$(P)(S)$	$D$	$PV(S)$	$PV(P)$	$(P)(S)$
1	1.0733	1.0733	0.0000	100	1.1492	1.1486	-0.0006
10	1.0794	1.0794	0.0000	200	1.2457	1.2427	-0.0030
20	1.0863	1.0864	+0.0001	300	1.3621	1.3573	-0.0048
30	1.0935	1.0936	+0.0001	400	1.4983	1.4963	-0.0020
40	1.1009	1.1009	0.0000	500	1.6544	1.6654	+0.0110
50	1.1085	1.1084	-0.0001	600	1.8303	1.8718	+0.0415
60	1.1162	1.1161	-0.0001	700	2.0261	2.1241	+0.0980
70	1.1242	1.1240	-0.0002	800	2.2418	2.4330	+0.1912
80	1.1324	1.1320	-0.0004	900	2.4773	2.8102	+0.3329
90	1.1406	1.1402	-0.0004				

The deviations found in this way from what follows from SCHALKWIJK's equation with the extrapolations from our provisional equation appeared to be surprisingly small. Only at a density 100 or  $P = \pm 115$  atmosphere pressure the difference is greater than 1 per 2000, but this is far outside the region of SCHALKWIJK's observations. At  $D = 200$  or  $P = \pm 250$  atms. the difference becomes 1 per 400. Later on it diminishes again, and takes opposite sign, but  $D = 500$  or  $P = \pm 800$  atms. lies again outside the region of our series of observations.

In connection with the mutual correspondence of the series of observations, the possibility of an agreement with SCHALKWIJK has appeared from this.

In order to be able to compare the 7 series of observations inter se, and judge at the same time about the agreement with SCHALKWIJK, we have reduced the 7 empiric equations in such a way that they give  $PV = 1.3573$  for  $D = 300$ . This is then in agreement with the above table. Then the equations become:

I	$PV = 1.06625 + 0.0_373496 D + 0.0_575009 D^2 + 0.0_{12}69144 D^3$	$\frac{5}{6}$ Nov. 1912.
II	$PV = 1.06917 + 0.0_371540 D + 0.0_572697 D^2 + 0.0_{12}99111 D^3$	21 Nov. 1912.
III	$PV = 1.07375 + 0.0_366523 D + 0.0_587561 D^2 + 0.0_{12}64295 D^3$	$\frac{11}{12}$ Dec. 1912.
IV	$PV = 1.06920 + 0.0_368353 D + 0.0_585981 D^2 + 0.0_{12}62047 D^3$	10 Febr. 1913.
V	$PV = 1.06893 + 0.0_369806 D + 0.0_581640 D^2 + 0.0_{12}68826 D^3$	$\frac{11}{12}$ Febr. 1913.
VI	$PV = 1.05753 + 0.0_374725 D + 0.0_577437 D^2 + 0.0_{12}63400 D^3$	$\frac{22}{24}$ April 1913.
VII	$PV = 1.07341 + 0.0_367205 D + 0.0_586024 D^2 + 0.0_{12}64632 D^3$	4 June 1913.

At 407.19 atms. ( $300 \times 1.3573$ ) the series of observations have now been reduced in agreement with each other.

From these equations we calculate first the product  $PV$  for the densities 100, 200, 300, 400, and 500 for so far as the corresponding pressures lie in the region of observation of the series, and hence agreement may be expected. We then find:

$D$	100	200	300	400	500
I	1.1491	1.2429	1.3573	1.4961	—
II	1.1491	1.2428	1.3573	1.4963	1.6654
III	—	1.2426	1.3573	1.4959	1.6641
IV	—	1.2423	1.3573	1.4963	1.6650
V	—	1.2419	1.3573	1.4967	1.6653
VI	—	—	1.3573	1.4966	1.6644
VII	—	1.2430	1.3573	—	—
Mean	1.1491	1.2427	1.3573	1.4963	1.6648

Besides with the mutual agreement, we are struck here with the agreement of the mean values  $PV$  with those determined provisionally.

We reproduce therefore this part of the table and place the mean values  $PV(M)$  by the side.

$D$	$PV(S)$	$PV(P)$	$PV(M)$
100	1.1492	1.1486	1.1491
200	1.2457	1.2427	1.2427
300	1.3621	1.3573	1.3573
400	1.4983	1.4963	1.4963
500	1.6544	1.6654	1.6648

It remained to draw up an equation which satisfies the last table of the mean values with  $a=1.07258$  in accordance with SCHALKWILK's isotherm. This final equation drawn up for convenience with five virial coefficients, becomes:

$$(F). \quad PV = 1.07258 + 0.0_{\delta}6763D + 0.0_{\delta}88215D^2 + \\ + 0.0_{12}66954D^3 - 0.0_{18}151D^4.$$

This equation not only represents all our observations as well as possible; but the agreement with SCHALKWIJK's results appears to be even better than for the provisional calculation, which is seen from the following table.

$D$	$PV(S)$	$PV(F)$	$(F)-(S)$	$D$	$PV(S)$	$PV(F)$	$(F)-(S)$
1	1.0733	1.0733	0.0000	60	1.1162	1.1163	+0.0001
10	1.0794	1.0794	0.0000	70	1.1242	1.1242	0.0000
20	1.0863	1.0864	+0.0001	80	1.1324	1.1324	0.0000
30	1.0935	1.0936	+0.0001	90	1.1406	1.1406	0.0000
40	1.1009	1.1010	+0.0001	100	1.1492	1.1491	-0.0001
50	1.1085	1.1086	+0.0001				

The final equation may therefore be considered to represent the whole region of the isotherm below 1000 atms. The agreement with SCHALKWIJK is perfect up to  $D=100$ , which corresponds with a pressure of 115 atms. Reversely it appears therefore that we may extrapolate up to  $\pm 120$  atms. from the equation at which SCHALKWIJK arrived from his observations from 8 to 60 atms., viz.

$$PV = 1.07258 + 0.06671D + 0.06993D^2,$$

At  $D=200$  or  $P=250$  atms. the error which would then be made, becomes already 3 per 1000. For greater densities up to  $D=500$  the number of virial coefficients 3 is too small. It must then be 4 at least. It will not do simply to add a 4<sup>th</sup> coefficient to SCHALKWIJK's equation, which appears from the deviations, which (see table) are now positive, now negative.

## § 2. Comparison of the observations at 15°.5 with AMAGAT's.

We have one series of observations with 4 data below 1000 atms. and three above it at our disposal. (See p. 215).

An equation has been calculated from the 4 data below 1000 as a control of the observations at  $\pm 100$  atms. (See preceding communication). To compare our data with those of AMAGAT at 15°.4 we have calculated an empiric equation with 6 virial coefficients from 6 observations. In the seventh observation at 383 atms. we have then a control.



$P$	$PV(O)$	$PV(C)$	$(O)-(C)$
2255.8	1796.07	1796.07	0.00
1777.2	1582.42	1582.42	0.00
1383.9	1407.15	1407.15	0.00
932.37	1190.26	1190.26	0.00
684.79	1065.47	1065.47	0.00
383.29	916.64	916.66	-0.02
334.27	891.16	891.16	0.00

$$PV = 637.965 + 892.46D - 735.72D^2 + 1215.49D^3 - 787.959D^4 + 204.470D^5.$$

With the value of  $PV$  at 700 atms. this equation is then reduced to:

$$PV = 0.92967 + 0.0_218953D - 0.0_522767D^2 + 0.0_{11}79888D^3 - 0.0_{10}10996D^4 + 0.0_{23}60639D^5.$$

The easiest way for the calculation is now to compare the pressures for the same volumes as AMAGAT. We then find:

V	P(Am.)	P(C)	(C)-(Am)
0.002234	700	700	0
0.002046	800	800.5	0.5
0.001895	900	904.7	4.7
0.001778	1000	1005.3	5.3
0.001685	1100	1101.8	1.8
0.001604	1200	1200.7	0.7
0.001533	1300	1301.6	1.6
0.001472	1400	1401.0	1.0
0.001418	1500	1500.9	0.9
0.001370	1600	1601.1	1.1
0.001326	1700	1704.2	4.2
0.001288	1800	1804.2	4.2
0.0012545	1900	1902.6	2.6
0.0012225	2000	2008.0	8.0
0.001194	2100	2113.6	13.6
0.0011685	2200	2220.2	20.2

These deviations and especially the progressive ones above 2000 atms. cannot be explained from the temperature difference of  $0^{\circ}.1$ , among others on account of their irregularity. This would give a pressure difference of no more than 0.6 atm. at 2000 atms. For the rest the deviations are too large and too systematical to be considered as accidental errors of observation. The most obvious explanation, a systematic error in the absolute pressure measurement made by AMAGAT or by us, cannot be accepted either, as it would yield a deviation proportional for large and for small pressures. Probably the same causes come into play, which also prevented agreement between AMAGAT and SCHALKWIJK's observations.

*Amsterdam. Physical Laboratory of the University*

**Hydrostatics.** — “*The different ways of floating of an homogeneous cube.*” By Prof. D. J. KORTEWEG.

(Communicated in the meeting of May 30, 1914).

This problem, whose treatment, however simple it may seem, offers considerable difficulties, was lately brought to a complete solution by Dr. P. BRANDSEN.

If we limit ourselves to the cases in which the specific weight of the cube amounts to less than half of that of the liquid (which is allowed, because the other cases may be derived from it by interchanging the floating and immersed parts) stable floating appears to be possible in four different positions.

In the *first position* four of the edges are vertical. It may be acquired for specific weights, expressed in that of the liquid, smaller than  $\frac{1}{2} - \frac{1}{6}\sqrt{3} = 0,211\dots$ . For those smaller than  $\frac{1}{6} = 0,166\dots$  it is the *only one* possible.

In the *second position* two of the faces are vertical, but the edges belonging to them are sloping. The surface section is consequently a rectangle. This manner of floating is possible between the specific weights 0,211\dots and 0,25.

In the *third position* the space-diagonal of the cube is vertical and the surface section a hexagon. It is possible between the limits  $\frac{1}{6}$  and  $\frac{5}{6}$  of the specific weight. For the limits themselves the cube is lifted or immersed just so far that the surface section, perpendicular to the space-diagonal, has passed into a triangle. Those limiting positions themselves are already unstable; consequently the stability

of this position disappears exactly there where for specific weights  $< \frac{1}{6}$  a hexagonal section becomes impossible on account of ARCHIMEDES' Law.

This third manner of floating was, probably for the first time, referred to in the "Mathematical Gazette" of Dec. 1908, Vol. 4, p. 338, Math. note N<sup>o</sup>. 285, in which note, however, the second one and the case now following was not referred to at all.

In the *fourth position* one of the planes passing through two opposite parallel edges assumes the vertical direction. In this position one of these edges is partially immersed, the other one quite outside the liquid. In consequence of this the surface section is a pentagon for which the intersection of the liquid surface with the plane just mentioned is an axis of symmetry.

Such "pentagonal" floating can only exist, however, between narrow limits of density, viz. between the densities 0,226... and 0,24...

It should be observed that only the first and the second position gradually pass into each other; further that a completely unsymmetrical way of floating, in which neither one of the faces, nor one of the diagonal planes, nor a space-diagonal assumes the vertical position, cannot arise.

One of the greatest difficulties connected with the problem consisted in the formal exclusion of such cases.

It further appears that between definite limits of density, several positions, amounting at most to three, are possible for the same cube, viz.,

Below 0,166... the first position is the only possible.

From 0,166... to 0,211... the first and the third.

From 0,211... to 0,226... the second and the third.

From 0,226... to 0,24... (the limits of pentagonal floating) the second, the third and the fourth.

From 0,24... to 0,25 the second and the third.

Between 0,25 and 0,5 only the third.

Strictly speaking one case in which one of the diagonal planes coincides with the liquid-level and the specific weight therefore amounts to exactly 0,5 ought to have been added to those mentioned above. Dr. BRANDSEN has indeed proved that stability exists in this case. Yet at the slightest alteration of the specific weight the adjacent positions of equilibrium become unstable, e.i. those which arise by

lifting the cube a little or by immersing it in such a way that the diagonal plane mentioned remains parallel with the liquid-level.

A paper by Dr. BRANDSEN in which the results described above are set forth and proved is going to appear in the "Nieuw Archief voor Wiskunde".

**Petrography.** — "*On some rocks of the Island of Taliabu (Sula Islands.)*" By Prof. Dr. A. WICHMANN.

(Communicated in the meeting of May 30, 1914).

After G. E. RUMPHIUS had described, towards the end of the 17th century, some jurassic fossils, originating from the east coast of Taliabu<sup>1)</sup> it was not before the year 1899 that new geological investigations were made again in the island mentioned above. It was R. D. M. VERBEEK who collected some rocks in some places of the north coast on the 4<sup>th</sup> and 5<sup>th</sup> of August and afterwards described them<sup>2)</sup>. In November of the same year G. BOEHM followed his example, and chose as point of departure of his investigations the findingplace mentioned by G. RUMPHIUS, and afterwards continued his work over part of the south coast<sup>3)</sup>. In December 1902, in January and especially during the months of October and November 1904 an extensive part of the southern part of Taliabu was surveyed by J. W. VAN NOUHUYS<sup>4)</sup>. The large collection gathered by him was described by G. BOEHM<sup>5)</sup>, in so far as regards the fossils. In the following lines the communication of an investigation of the rocks may find a place.

1) D'Amboinsche Rariteitkamer. Amsterdam 1705, p.p. 253—255.

2) Voorloopig Verslag over eene geologische reis door het Oostelijk gedeelte van den Indischen Archipel in 1899. Batavia 1900, p.p. 9, 10, 46, 47. — Molukken-Verslag. Jaarboek van het Mijnwezen van Ned. Indië. 37. 1908. Wetensch. ged. Batavia 1908, p.p. 20—21, 107—108, 221—223.

3) Aus den Molukken. Zeitschr. d. D. geol. Ges. 54. 1902. p. 76. — Geologische Mitteilungen aus dem Indo-Australischen Archipel. N. Jahrb. f. Min. Beil. Bd. 27 1906, p.p. 385—395. — Beiträge zur Geologie von Niederländisch-Indien. Palaeontographica. Suppl. IV. Stuttgart. 1904, p.p. 6, 13—14.

4) Maatschappij ter bevordering van het Natuurkundig Onderzoek der Nederlandsche Koloniën. Bulletin No. 48. 1905. — Bijdrage tot de kennis van het eiland Taliaboe der Soela-groep (Moluksche Zee). Tijdschr. K. Nederl. Aardrijksk. Genootsch. (2) 27. Leiden 1910, p.p. 945—976, 1173—1196.

5) Beiträge zur Geologie von Niederländisch-Indien. Palaeontographica. Suppl. IV 1912, p.p. 123—177.

Taliabu is a longitudinal island extending in the direction from East-West between  $124^{\circ}8'$  and  $124^{\circ}41'$  E. and  $1^{\circ}50'$ — $2^{\circ}$  S. Whilst the length amounts to 117 km., the width is no more than  $37\frac{1}{2}$  km. A mountain range of an average height of 1000 to 1200 m. extends over its entire length. The formations of the northern part, hitherto little known, are restricted to old slate-rocks, quartzites, granite-porphry and coral limestone, whilst on the southern part moreover extensive strata are found containing numerous fossils from the Jurassic system those of the Berriasien included <sup>1)</sup>. Among the eruptive rocks occurs especially much granite. Younger formations play here likewise an inferior part, because the coral limestone is found only in the eastern half of the south-coast and no farther than cape Kona [Mantarara] <sup>2)</sup>.

*Granite.* VAN NOUHUYS already called the attention to the fact that the granites of Taliabu have much similarity with the granites described by VERBEEK of the Banggai Islands, which are situated westward from the Sula Islands. They are characterized by the occurrence of dark red orthoclase, greenish dull white plagioclase, white quartz and black biotite <sup>3)</sup>. Rocks in which the orthoclase is of a lighter colour are however not wanting in Taliabu. They are contrary to most granites of the Indian Archipelago, which as a rule are rich in plagioclase, to be regarded as normal biotite-granites, in which a more subordinate place is assigned to oligoclase. It appeared that mikrokline was always absent. The red colour of the orthoclase is caused by a finely distributed reddish brown substance, which disappears however as soon as the feldspar is altered into kaoline. Biotite is indeed always present, but sometimes very scarcely represented. It also occurs that by alteration it has been changed into chlorite, and then, at the same time, rutile-needles appear. Brown iron ore (limonite), in the shape of irregular flakes and accu-

<sup>1)</sup> J. AHLBURG asserts (Versuch einer geologischen Darstellung der Insel Celebes. Geolog. und paleontolog. Abhandl. herausgeg. von J. F. POMPECKI und F. von HUENE. N. F. 12. Jena 1913, page 110), that among others also Lias is found in Taliabu. Most likely he mistakes — he is not so very particular — this island for Misol. Further, he says, with regard to the demarcation strata of the Jurassic and the Cretaceous system, that they "allerdings nach neueren Untersuchungen der Trias angehören". There can neither be question of this, as is clearly proved by G. БОРИН's essay (Palaeontographica. Suppl. IV. 1904, pp. 1—46). Most likely AHLBURG has in this respect mistaken Taliabu for Buru. (Vide: Centralblatt f. Mineralogie 1909, p. 561; 1910, p. 161).

<sup>2)</sup> According to a communication of Mr. VAN NOUHUYS the coral limestone reaches only a height of  $\pm 10$  m.

<sup>3)</sup> Molukken-Verslag, p. 218.

mulations along the fissures is rather widely spread as a product of alteration. Apatite and titanite occur only sporadically.

VAN NOUHUYS has already acquainted us with the finding-places of the granites.<sup>1)</sup> In the western part of the island we must mention the territory of Lekitobi in the first place. The hill westward from the entrance to the lagoon, the hills of the island Kona in the lagoon and likewise Tandjung Merah — the red cape — at the east side are all composed of this rock. The second granite-territory was found on the upper course of the Wai Ila, where it borders upon strongly folded phyllite.

The third region is situated northward from the Wai Taha and extends in the N.E. till beyond the left bank of the Wai Kabuta. A fourth area occurs on the upper course of the Wai Najoo, where it borders the strata of the Jurassic system. South of this river rises moreover a granite-hill on the coast in the neighbourhood of cape Pasturi. The erratics that were found, besides in the rivers mentioned above, also in others namely Wai Miha, Wai Kilo, Wai Ila, Langsa, Wai Tabana and Wai Kasia point to the fact that granite is widely spread over the interior. H. BÜCKING finally mentions a biotite-granite containing hornblende from the Wai Husu<sup>2)</sup>.

The contactmetamorphical formations, which have been caused by the eruption of the granites, deserve attention however in the first place, especially because both old slates and jurassic sediments have been concerned in it.

On the northside of the lagoon Lekitobi an *andalusite-mica-rock* is found as a rock. In the pink compact rock macroscopically only numerous silver-white laminae of muscovite can be detected which, also according to the microscopic examination, form also the chief constituent. Besides the aggregates of these colourless laminae there are also those of irregular grains of quartz.

The elongated prisms of andalusite are already to be recognized by their relief, they are nearly colourless in the thin sections and show no perceptible pleochroism. Rather numerous are the fluid-inclusions which they contain. As an accessory constituent tourmaline is present in the form of little strongly pleochroistical prisms (O = yellow to greenish-brown, E almost colourless). Ore is irregularly scattered in the form of black grains, and occurs moreover as a fine dust

<sup>1)</sup> Bijdrage tot de kennis van het eiland Taliaboe, p. 949, 951, 963, 967, 971, 972, 1174, 1178, 1180, 1184, 1185, 1190, 1191, 1193—1195.

<sup>2)</sup> G. BOEHM. Geologische Mittheilungen aus dem Ind. Australischen Archipel. Neues Jahrbuch für Min. Beil. Bd. 27. 1906 p. 93.

between the muscovite-laminae. As a product of alteration finally brown-iron-ore (limonite) is found.

*Andalusite-mica-schist.* This hard, distinctly schistose, reddish-grey rock, in which the naked eye discerns only silvery muscovite-laminae, was found as a boulder only in the Wai Miha. In the thin sections the rock, of which quartz forms the principal constituent, shows a crystalloblastic structure. Numerous are likewise colourless laminae of muscovite, and besides those of a greenish mica. Andalusite is found in the form of colourless prisms stringed together and in grains, whilst prisms of tourmaline scarcely ever occur. Rutile forms dark-brownish red, very strongly refractory grains and knee-shaped twins.

*Mica-quartzite-schist.* A boulder from the Wai Kabuta, a hard, grey and very fine-grained, distinctly stratified rock. Under the microscope we perceive that quartz, which is usually accompanied by muscovite, is the chief constituent, whilst in strata of a darker colour, but restricted to these, biotite is likewise freely spread. Moreover andalusite occurs in the form of aggregates of prisms, with numerous ore-grains and further occasionally garnet, rutile, titanite and tourmaline.

*Mica-quartzite* occurs among the boulders of the Betino, a left tributary river of the Wai Miha. In this fine-grained, reddish-grey rock numerous muscovite-laminae can be discerned by the naked eye. As appears from fig. 1 the quartz individuals do not exhibit, "Pflasterstructur" under the microscope, but they engage into one another like teeth. Further it must be remarked that finely distributed

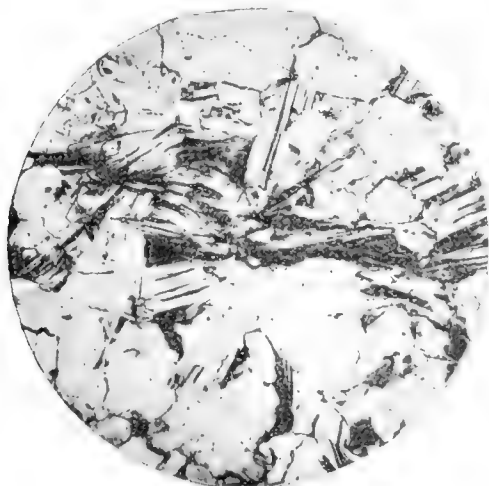

Fig. 1.

ironhydroxide has penetrated between the aggregates of muscovite. Though the rock does not contain andalusite, it is yet likely, that it belongs to the contactmetamorphic formations.

Spotted clay slates such as VERBEEK discovered<sup>1)</sup> in the isle of Labobo (Banggai Isles) were not found among the rocks of Taliabu.

A group of rocks that have likewise been transformed by contact with granite, but belong to the Jurassic system, are of a quite different nature. VAN NOUHUYS indicated already on his map a hornfelsmass in the region of the source of the Wai Najo, whilst for the rest he detected normal Jurassic sediments partly covered with alluvial sediments from the source of the river to its upper course. As appears from a subsequent investigation these hornfelslike masses belong to the caesilicate-rocks.<sup>2)</sup> VAN NOUHUYS collected specimens of these in the Wai Najo and its right tributary, the Baja, and likewise in the Wai Tabana and the Langsa. They are all dense, very hard splintery and usually of a greenish-grey colour which, in some spots, changes into whitish and occasionally into dark grey. Some of those rocks as those of the Langsa consist of parallel strata sharply separated from one another, perceptible to the naked eye, and of a whitish- and blackish-grey colour.

The epidote is a mineral, which, according to the microscopic examination, is never wanting, it is almost always represented by the optically-positive klinozoisite, which is usually colourless but occasionally provided with a light-yellow tint. The always irregularly shaped grains can easily be recognized by their strongly refractory power and their other optical properties. Some parts of the *lime-silicatehornfels* originating from the Wai Najo consist chiefly of aggregates of this mineral, among which is found a colourless groundmass that cannot be nearer defined and often contains infinitesimal parts of dust. In other parts this groundmass forms the chief constituent of the rock, in which klinozoisite occurs then only in the form of isolated grains.

Besides the many and very little grains of klinozoisite in the lime-silicate hornfels found in the river Langsa, prisms of tourmaline and needles of rutile(?) were occasionally met with. According to the microscopic examination the difference between the light and the dark strata is only caused by the fact that the latter are rich in infinitesimal parts of dust.

<sup>1)</sup> Molukken Verslag, p. 219.

<sup>2)</sup> Bijdrage tot de kennis van het eiland Taliaboe, p. 1190, 1193, 1194, map N<sup>o</sup>. XX.



The composition of a calc-silicate-hornfels from the Wai Najo is, according to the analysis of Prof. Dr. M. DITTRICH of Heidelberg, as follows:

$SiO_2$ . . . . .	59,60
$TiO_2$ . . . . .	0,46
$Al_2O_3$ . . . . .	7,90
$Fe_2O_3$ . . . . .	0,64
$Cr_2O_3$ . . . . .	trace
$FeO$ . . . . .	6,02
$MnO$ . . . . .	0,28
$CaO$ . . . . .	15,20
$MgO$ . . . . .	5,35
$K_2O$ . . . . .	0,57
$Na_2O$ . . . . .	1,98
$P_2O_5$ . . . . .	0,22
$CO_2$ . . . . .	0,69
$H_2O$ (under $110^\circ$ ) . . . . .	0,17
$H_2O$ (over $110^\circ$ to $1250^\circ$ ) . . . . .	1,32
	100,40

The specific weight is 3.213. From the analysis it appears that the result of the chemical composition in consequence of the contact-metamorphosis of the Jurassic marls is the disappearance of  $CO_2$ , which, as in other similar rocks, is found only in a very slight quantity. The water was likewise for the greater part evacuated. A modification of the composition with regard to the other constituents cannot be observed. The results of the analyses of the calc-silicate rocks vary greatly, which is not astonishing on account of the great variety of the sediments that gave occasion to their formation.

The fact that the youngest strata of the Jurassic system in Taliabu were interspersed with granite and metamorphosed, is of great importance; its eruption can consequently not have taken place earlier than during the Cretaceous system.

The occurrence of granite of mesozoic age was hitherto only stated or made probable in the Malay peninsula by J. B. SCRIVENOR<sup>1)</sup>, in Sumatra by AUG. TOBLER<sup>2)</sup> and R. D. M. VERBEEK<sup>3)</sup>.

<sup>1)</sup> The Rocks of Pulau Ubin and Pulau Nanas (Singapore). Quart. Journ. Geolog. Soc. **66**. London 1910. p. 429. — The Geologic History of the Malay Peninsula. Quart. Journ. Geolog. Soc. **69**, London 1913, p. 351.

<sup>2)</sup> Voorloopige mededeeling over de geologie van de residentie Djaambi. Jaarboek van het Mijnwezen in Ned. Indië **39**. 1910. Batavia 1912, p. 18—19.

<sup>3)</sup> Koloniaal-Aardrijkskundige Tentoonstelling. Amsterdam 1913. Catalogus, p. 76.

their statements were a short time ago confirmed by W. VOLTZ<sup>1)</sup>. On the contrary J. AHLBURG writes: "Was das Verhalten der Gesteine "[der Tinomboformation] zum Granit betrifft, so ist es immerhin von "Bedeutung, dass wohl nahezu alle echten Granite des Indischen "Archipels, vor allem die Granite von Malakka, Sumatra, "und Bangka, ebenso die grosse Granitplatte von Südwestborneo, "paläozoischen und zwar in den meisten Fällen *nachweislich* <sup>2)</sup> kar- "bonischen Alters sind." <sup>3)</sup>

Mr. AHLBURG is prudent enough not to mention the names of his informants.

*Granite-porphry*. Hitherto this rock has only been found as erratic rock, namely by R. D. M. VERBEEK on the north coast, near Cape Damar <sup>1)</sup>, by G. BOEHM in the Wai Kadai (described by H. BÜCKING <sup>2)</sup>) and by J. W. VAN NOUHUYS in the Wai Ha, a tributary of the Wai Miha. The granite-porphry of the latter finding-place contains a yellowish brown, fine crystalline groundmass, in which numerous grains and dihexaedrons of quartz are inclosed. The light-yellowish crystals of orthoclase — sometimes twins according to the law of Karlsbad — are dull and have caused the formation of scaly muscovite, as appears from the microscopic examination. They are moreover filled up with finely distributed brown iron ore. The much less numerous twinned individuals of plagioclase have caused a similar alteration as the orthoclase. The crystals of quartz are characterized by numerous fluid-inclusions. Sometimes the intrusion of the groundmass is perceived, but glassy inclosures are utterly wanting. Dark constituents were only exceptionally found, and if so, in an entirely decomposed condition. The previous occurrence of biotite however is unmistakable, as the shapes of the laminae are found back in the limonite into which they have changed. The feldspars which form a part of the groundmass as well as the porphyric crystals have caused a transformation into muscovite.

*Quartz-porphry* was collected by G. BOEHM in the Wai Husu and examined by H. BÜCKING. In VAN NOUHUYS's collection are two specimens from the boulders of the Wai Najo. One is characterized

<sup>1)</sup> Oberer Jura in West-Sumatra. Centralbl. f. Min. 1913, p. 757. — Süd-China und Nord-Sumatra. Mitteilungen des Ferd. v. Richthofen-Tages 1913. Berlin 1914, p. 37.

<sup>2)</sup> The italics are mine.

<sup>3)</sup> Versuch einer geologischen Darstellung der Insel Celebes. (Geolog. und paläontologische Abh.dlg. von J. F. POMPECKI und Fr. VON HUENE, N. F. 12. Jena 1913, p. 28).

<sup>4)</sup> Molukken-Verlag, p. 223.

<sup>5)</sup> G. BOEHM. Neues aus dem Indo-Australischen Archipel, p. 391.

by a light brown groundmass, bearing great resemblance to the colour of chocolate, whilst that of the other specimen is yellowish brown. Microscopically the groundmass is like that of the porphyry from the Wai Husu microgranitic. The porphyric crystals of quartz are bluish and attain a diameter of 2—4 mm. The flesh-coloured orthoclase crystals attain a length of about 1 cm. Microscopically they are covered with a fine brown pigment and partly altered into an aggregate of little muscovite-scales. The groundmass is microgranitic and consists of a fine aggregate of quartz and orthoclase.

*Syenite-porphry.* Only one specimen of this rock originating from the Wai Najo is present. With the naked eye only a few dark constituents can be detected in the grey to brownish dense ground-mass showing a somewhat violet tint, with the help of the magnifying glass likewise little rectangular sections of whitish grey feldspar can be discovered. From the microscopic examination it appears that they consist for the greater part of orthoclase, partly however also of plagioclase (oligoclase). The dark constituents are in the first place represented by green hornblende. The pleochroism is  $a =$  yellowish green,  $b =$  dark green,  $c =$  bluish green;  $c > b > a$ ;  $c : a = 12^\circ$ . Besides this biotite occurred frequently, which was however completely transformed into chlorite, whilst grains of ore and epidote were formed. Apatite is found in the shape of little thick prisms. The groundmass is entirely crystalline and is composed of aggregates of particles of feldspar, among which a few little, angular grains of quartz occur.

From the scarcity of porphyric rocks in Taliabu may be deduced that originally they occurred only in the form of dikes.

*Diabase.* This kind of rock is likewise only represented by one specimen from the boulders of the Wai Kabuta. It is dull, greenish-grey and contains a few macroscopically observable dull-white crystals of feldspar. In thin sections the characteristic ophitic structure is to be observed, narrow and broader lath-shaped crystals of plagioclase, between which the xenomorphic augites appear, which have undergone however partly an alteration into epidote. Grains of black ore are freely dispersed. On the fissures of the rock greenish-yellow epidotes have deposited themselves, which are accompanied by quartz.

The oldest sediments found in Taliabu are represented — in so far as it is known — by *phyllites*, which have submitted to a very strong folding, as was already remarked by VAN NOUNNYS at the place mentioned. An extensive region is watered by the Wai Miha, i.e. from its source till it leaves the chasm between the Bápen Kudi and Bono Kedotó, whereupon it reappears again at Nali. In some spots

the rock contains strata and lenses of quartz and occasionally much pyrite<sup>1)</sup>. A second region that has not been thoroughly explored is found, according to the map, at the upper course of Wai Kabuta.

Besides the finding-places mentioned above, VAN NOUHUYS mentions the river Langsa, but he remarks emphatically that the phyllites occur there only in boulders, but nowhere<sup>2)</sup> in the form of rocks. One of the specimens is composed of alternating thin, dark-coloured, almost black strata, and lighter brownish-grey strata more rich in quartz. From the microscopic examination it appears that biotite forms the chief constituent, occasionally accompanied by many grains of ore and fine black particles of dust and only few prisms of tourmaline and grains of titanite. The lighter strata consist chiefly of an aggregate of quartz grains among which are numerous little biotite-laminae. The rock is moreover penetrated in several directions by small veins of quartz, in which yellowish-green, wormshaped aggregates of little pleochroital laminae of chlorite (helminth).

Another phyllite is of a blackish-grey colour, dense and rather hard. In consequence of the decomposition of the rock such parts as are richer in quartz appear at the surface as knots. Microscopically the little biotite-lamellae are irregularly spread over the quartz-mass, and sometimes closely compressed in accumulations. Sometimes a light

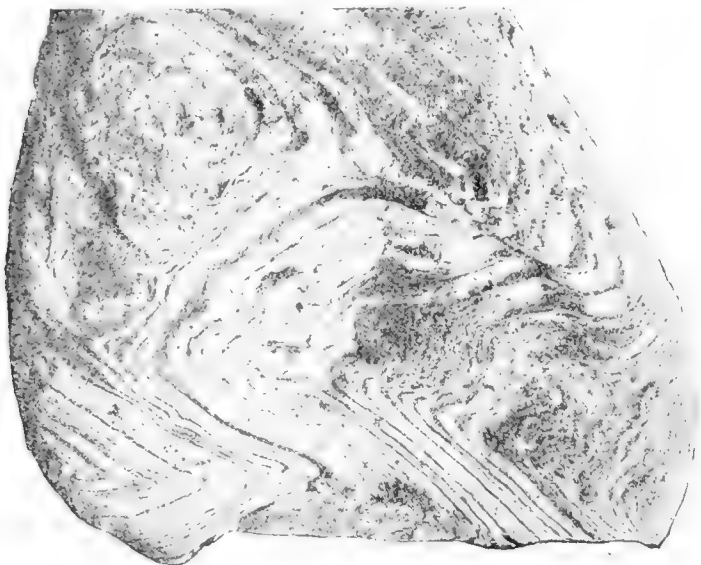

Fig. 2.

1) Bijdrage tot de kennis van het eiland Taliabu, pp. 958, 961, 1174—1176, 1187—1188.

2) Page 1180.

sericitical mica occurs, and further prisms of tourmaline and ilmenite.

The phyllites of the Wai Miha are usually softer than those of the Langsa, and the microscopic examination proves them to be different. Because thin dark, blackish-grey strata alternate with light ones that are rich in quartz, the folding can very distinctly be observed (fig. 2). The former are composed of closely compressed aggregates of light-green sericite, as a consequence of the folding the laminae were likewise bent. Little flakes of brown iron-ore (limonite) are abundantly spread. The lighter strata chiefly consist of aggregates of quartz, containing very few fluid inclusions. Further light greenish mica-lamellae are discerned, floating as it were in the quartzmass that is as clear as water. In other phyllites, besides grains of ore, many particles of carbon are spread and further prisms of tourmaline and needles of rutile.

At the foot of Sangeang, situated on the upper-course of the Wai Miha, occurs a black phyllite containing numerous hexaedrons of pyrite having a diameter of 2 mm., it has great resemblance with the rock collected by R. D. M. VERBEEK on the north coast in the neighbourhood of Cape Damar<sup>1)</sup>. Under the microscope the eye distinguishes light strata containing much quartz, alternating with quite dark ones, which are filled with carbonaceous matter in such a way that even the thin sections remain in some places opaque. It appears that the grains of quartz contain few and small fluid-inclusions. The rock moreover contains light-greenish laminae of sericite, needles of rutile and — along the fissures — particles of limonite.

If the quartz predominates a *phyllitequartzite* is formed.

A similar rock is likewise found as a rock near the Wai Miha and consists chiefly of whitish-grey quartz of a greasy appearance, interwoven with strata of phyllite. At last there is still a *boulder-phyllite* in itself normal and containing small boulders of white quartzite and of siliceous limestone. The rock forms a counterpart of the boulder-clay slate described by E. KALKWOSKY<sup>2)</sup>.

Near the upper course of the Wai Miha was found, besides the rocks described above, a waterworn specimen of *clay slate* which is strongly folded and apparently belongs to the same system of strata as phyllite. Microscopically it behaves as a common roofing-slate, contains as the latter numerous needles of rutile, a few prisms of tourmaline, and black widely distributed carbonaceous matter.

<sup>1)</sup> Molukken-Verlag, p. 223.

<sup>2)</sup> Über Geröllthonschiefer glacialen Ursprungs im Kuhn des Frankenwaldes Zeitschr. d. D. geolog. Ges. 45. 1893, p. 69–86.

VAN NOUTHUYs moreover collected in the bed of the Wai Miha a *phyllite-breccia* consisting of numerous angular, sometimes a little rounded fragments of phyllite having a diameter of at the utmost 3 cm. They are usually strongly altered, and have consequently given occasion to the formation of chloritic minerals. As appears from the microscopic examination the white quartz-cement is composed of some grains of quartz as clear as water, the angles of which engage into one another like teeth.

In the neighbourhood of Cape Pasturi boulders were found of a hard, grey, distinctly stratified *quartzite*, containing moreover a great number of small hexaedrons of pyrite. Under the microscope the eye discovers, beside the grains of quartz which are as clear as water, green lamellae of chlorite, little titanite and a few black grains of ore.

For the present moment it is still impossible to determine the age of the strata of phyllite. It is certain that the folding they have been submitted to, has taken place before the deposit of the Jurassic sediments which show nothing of this nature. Petrographically some fragments are completely identical to some Cambrian rocks in the Ardennes, especially those belonging to the *etage devillo-revinien*. Much nearer to hand is a comparison with similar rocks of the continent of Australia. Whilst there the Cambrian sediments are chiefly represented by limestones, those of the *Praecambrium* contain not only similar rocks as those of Taliabu, but it appears that they are likewise strongly folded all over the continent.

In the strata of the Jurassic system found in Taliabu, a few rocks are found which, also from a petrographical point of view, draw special attention. VAN NOUTHUYs reported already that S. E. from the mouth of the Wai Najo cliffs are found consisting of "iron-hard "dark rock having on the fracture entirely the appearance of con- "glutinated gun-powder. This rock contains belemnites, which are "however as a rule badly conserved, and are often cemented with "the inclosing rock. Moreover the rock behaves entirely like granite, "as it is split into steep perpendicular prisms divided into blocks "by cross-fissures. This rock likewise changes into another of a "lighter colour, in which on the weathering-planes reddish quartz- "grains are found." <sup>1)</sup>

The rock that is meant here, is a chloritic iron-öölite (*chamosite*) dull, of a deep blackish-green colour, and containing numerous small grains, which have indeed great resemblance with gun-powder.

<sup>1)</sup> Bijdrage tot de kennis van het eiland Tahaboe, p. 1195.

As the colour makes us already suspect, in the thin sections under the microscope it is to be observed, that the rock is chiefly composed of fine dirty-green chloritic particles, which have been altered in the same way as those of the Chamoson-valley<sup>1)</sup>. They contain a fine black dustlike matter, further pretty large grains of ore and moreover a few angular splinters of quartz. Some cavities are filled with crystals of calcite.

As to the oölite-formations they distinguish themselves only from the other mass of rock by their structure. In the thin sections they are always of an elliptical or circular shape (diameter 0.08—0.6mm.) and consist of very thin green successive coats. The nucleus usually consists of a stranger body, as a rule of quartz, the grain of which occasionally becomes comparatively large (fig. 3). Though its shape may be ever so irregular the coats of the chamosite are always



Fig. 3.

arranged in such a way that the unevennesses disappear, and the result is in the end a regular oölitic body. There are however likewise fragments of quartz in which every trace of a chamosite-edge is wanting. Exceptionally the fragment of the skeleton of a sponge serves as nucleus of an oölite. In consequence of an alteration the oölitic change into a yellow- to red-brown mass.

Formations of chamosite were also met with in other Jurassic sediments of the Najo-region. As VAN NOUHUYS has already remarked the chamosite-rock changes into another rock of a lighter colour "in which on the weathering-planes reddish quartz-grains are found". The rock meant here, is a rather coarse *sandstone*, the quartz-grains of which have a diameter of 2 mm. The cement is of a greyish-green colour and effervesces strongly by treatment with hydrochloric acid. In thin sections one consequently perceives much calcite, partly in the shape of grains, in which the rhomboedrical cleavage is very obvious, for the greater part however in that of a fine scaly mass forming the real cement. The green chamosite is spread as in the above mentioned rocks, but oölitic are only met with as a great

<sup>1)</sup> C. SCHMIDT. Ueber die Mineralien der Eisenoolithe an der Windgälle im Canton Uri. Zeitschr. f. Krystallographie. XI. 1886, p. 598. — Geologisch-petrographische Mittheilungen. Neues Jahrb. f. Miner. Beil. Bd. 4. 1886, p. 395.

exception. Parts of the skeletons of sponges have also been changed into chamosite in these rocks.

Another sandstone of the same finding-place is more compact and contains much less calcite. Microscopically it appears to consist of angular and rounded quartz-grains, the intervening spaces of which are filled with fragments of sponges, the skeleton parts of which have been altered into chamosite. Oölitic formations are scarce.

In connection with the rocks described above attention must be paid to a *limestone* that was found in the Wai Najo in bank-shaped flakes. The greenish grey fine-grained rock leaves at the solution in hydrochloric acid a green sandy residue which appears to consist of quartz and chamosite, the latter at the same time as petrification-material of numerous skeletons of sponges. In the thin sections of the rock the grains of calcite show rhomboedrical cleavage and form partly also polysynthetic twins. They likewise enclose particles of chamosite. Oölitic formations are not rare, but in this case only the outer zone consists of chamosite, whilst the inner part is still calcite, in which the rhomboedric cleavage-planes of the neighbouring grains of calcite have found their immediate continuation, so that they form with these one individual. The skeletons of the sponges have been metamorphosed into pure green chamosite, whilst the intervening spaces are filled with limpid calcite. Besides the constituents mentioned numerous quartz-grains are present. From the above it appears that the limestone contains the same constituents as the sandstones that contain chamosite, and that there exists only a quantitative difference.

As regards the formation of oölitic, there can be no doubt that they have come into existence in the still soft mass of rock during or after the sedimentation. In my opinion they have originally consisted of carbonate of lime. That chamosite is no original mineral is already proved by the metamorphosed parts of the skeletons of sponges. It remains still unexplained which chemical processes have operated to bring this metamorphosis about. E. R. ZALINSKI has given an excellent summary of the different theories regarding the formation of thuringite and chamosite<sup>1)</sup>, but it appears that none can be regarded as valid.

Finally a few annotations about crystallized minerals of Taliabu may follow:

*Pyrite* occurs — as has already been mentioned — in the shape

<sup>1)</sup> Untersuchungen über Thuringit und Chamosit aus Thüringen und Umgebung. Neues Jahrb. f. Miner. Beil. Bd. 19. 1904, p. 79—82.



of cubic crystals in phyllites and quartzites of the Wai Miha region, whence also pseudomorphoses of limonite originate.

*Quartz* was found in limpid and dull-white crystals, attaining a length of 9 cm., found near Pela, situated between the Wai Miha and the Wai Ha. The shapes are the usual combinations of  $\alpha R$ ,  $R$  and  $-R$ .

*Calcite*. Elegant skalenhedrons  $R3$  were found in a concretion, originating from the river Kempa, a tributary of the river Wai Miha, and likewise in a cavity of a geode with *Macrocephalites*. Small rhombohedrons are present in the cavity of the chamosite-rock in the neighbourhood of the mouth of the Wai Najo.

*Rhodochrosite* occurs in the shape of small rhombohedrons on the walls of the air-chambers of a *Macrocephalites* from the Betino.

*Siderite* was detected in a boulder of quartzite, originating from the upper-course of the Wai Miha, in the shape of yellowish rhombohedrons. Brown rhombohedrons together with calcite were found in the chambers of an Ammonite from the Wai Galo.

*Barite*. All the chambers of *Macrocephalites keeurenis* G. BOEHM are sometimes filled with limpid barite in such a way that the whole mass forms one individual.

**Chemistry.** — “*Studies in the Field of Silicate-Chemistry.*” II.

*On the Lithiumaluminumsilicates whose composition corresponds to that of the Minerals Eucryptite and Spodumene.* By Prof.

F. M. JAEGER and Dr. ANT. SIMEK. (Communicated by Prof. P. VAN ROMBURGH).

(Communicated in the meeting of May 30, 1914).

§ 1. In connection with the study of the ternary system, whose components are: *lithiumoxide*, *alumina* and *silica*, it was necessary for us, to obtain the compounds, whose composition corresponds with that of the minerals *eucryptite* and *spodumene*, in a perfectly pure state, and to investigate their characteristic properties. The third ternary compound, corresponding in its composition with the mineral *petalite*, will be taken in account only afterwards, as for some reasons it is better to deal with it, when the experimental study of the ternary mixtures themselves shall have proceeded some-what further.

The *eucryptite*:  $LiAlSiO_4$  belongs to the series of silicates, whose other members are: *nepheline*, *kaliophilite*, etc. In nature the said compound occurs in the form of microscopical, hexagonal crystals, e. g. in the albite of BRANCHEVILLE (Conn.); albite and eucryptite both take their origin here from spodumene, decomposed by solving agents.

The *spodumene*  $LiAlSi_2O_6$  is a monoclinic lithiumpyroxene. The mineral is found in several places, in the form of colourless or feebly tinged, glassy crystals of prismatic habitus, or in the form of opaque, cryptocrystalline aggregations. The transparent or coloured varieties, which are strongly dichroitic, are used as a beloved precious stone; they are called: *triphane*, *kunzite*, *hiddenite*, etc. Their properties are mentioned further on.

§ 2. As was already pointed out, in a previous paper<sup>1)</sup> on lithiumsiliates, the synthesis of the pure compounds offered severe difficulties, caused by the volatility of the lithiumoxide at higher temperatures. The composition of the mixture is thus altered during the synthesis, and the quantities of all three components must therefore afterwards be corrected, after being accurately determined by long and troublesome analysis. A relatively small loss of the lithiumoxide, is of considerable influence on the meltingpoint and other properties of the investigated compound, because of the very small molecular weight of the oxide. The analysis offered many difficulties: for notwithstanding all care and all arrangements<sup>1)</sup>, it often happens, that some  $Al_2O_3$  is found in the silica, and some  $SiO_2$  in alumina, so that afterwards a controlling determination of these admixtures must be made, which takes a lot of time. The small amount of  $Li_2O$  is furthermore hardly determinable under the colossal excess of  $Na_2O$  in the liquid; therefore, being determined as the difference of 100% with the sum of the percentages for  $SiO_2$  and  $Al_2O_3$ , all mistakes and inaccuracies of those determinations are summed up in the number for  $Li_2O$ , so that the correction of the preparation afterwards, often depending on very slight differences in the amount of  $Li_2O$ , is a hazardous and not very amusing task. So it takes much time to obtain products, which will not differ appreciably in their constants and properties from those to be expected for the true pure compounds, the criterium being given by the perfect identity of the products, prepared in several ways.

### § 3. *Synthesis and Properties of the Pseudo-Eucryptite.*

The materials for this and other syntheses were the same, whose purity was before tested and described; the alumina used was also provided by BAKER and ADAMSON. It was necessary to heat it for a long time in a platinum dish on the blaze, and often to stir the powder with a platinum-wire, to allow the watervapour and the nitrous gases, which the preparation evolved, to escape completely. The

<sup>1)</sup> F. M. JAEGER and H. S. KLOOSTER, these Proceedings p. 900, Febr. (1914).

heating was checked when the weight of the dish remained constant after repeated heatings. Analysis then showed, that an almost pure  $Al_2O_3$  (100%) was present; even no appreciable trace of iron could be demonstrated with the usual reagents.

To point out the change of composition, taking place on heating mixtures of known composition during the melting of the mass, the numbers here following can serve very well: a mixture of 6,23 gram  $Li_2CO_3$ , 8,61 gram  $Al_2O_3$  and 10,16 gram  $SiO_2$ , was melted in a closed platinum crucible in the FLETCHER-furnace at  $1500^\circ C$ . After crystallisation, the mass was finely ground and sieved, melted again, and this process repeated three times. Instead of the expected composition *I*, the composition *II* was found by analysis to be:

	<i>I</i>	<i>II</i>
$SiO_2$	47,7 %	48,6 %
$Al_2O_3$	40,4 %	40,9 %
$Li_2O$	11,9 %	10,5 %

As there was thus 1,5%  $Li_2O$  too little, 0,055 gram  $Al_2O_3$  and 0,718 gram dry  $Li_2CO_3$  were added to 18,92 gram of the resulting product, and this mixture was then heated four times in platinum crucibles, by means of small resistance-furnaces, at  $900^\circ$  or  $1000^\circ C$ ., the mass being finely ground and sieved after every melting. Then the preparation was again heated once at  $1450^\circ C$ . in a resistance-furnace. Analysis gave:

	<i>Observed:</i>	<i>Calculated:</i>
$SiO_2$	47,9 %	47,7 %
$Al_2O_3$	40,1 %	40,4 %
$Li_2O$	12,0 %	11,9 %

The deviation from the exact composition is so slight, that this preparation could safely be used for the study of the properties of the compound.

§ 4. The meltingpoint of this preparation was determined several times by means of a calibrated thermoelement (N<sup>o</sup>. *III*). The mean value of all readings was 14200 M.V.  $\pm$  2 M.V.; as the correction of this element with respect to the standardelement, which was standardized by means of SOSMAN's element *G*, was  $-12$  M.V.; the meltingpoint of the substance, in terms of the *Washington* nitrogasthermometerscale, can be fixed at **1388**° C.

The heat-effect on melting is only small; as a result of that, on cooling down the molten mass, one finds a retardation of its crystallisation up to about 12840 M.V.; then crystallisation takes place while the temperature increases only to  $1306^\circ C$ . The point of

solidification therefore is found  $80^{\circ}$  or  $90^{\circ}$  below the true temperature of equilibrium: solid  $\rightleftharpoons$  liquid, although the velocity of crystallisation can by no means be called very small. From this fact also the discrepancies in the data of different authors are to be explained:  $1330^{\circ}$  C. (DITTLER and BALLÓ),  $1307^{\circ}$  C. (GINSBERG), etc. In this case also, the usual method of cooling appears to give no reliable results.

A remarkable fact is the relatively appreciable *increase* of the volume of the molten mass on crystallisation; it is immediately observable by the deformation of the platinum-crucible. (fig. 1). That

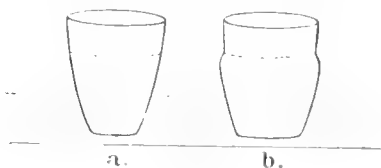

Fig. 1.

Increase of the volume of molten  
Eucriptite on crystallisation.

really this phenomenon is caused in this case by a volume-change like that of water into ice at the freezing-point, and that it need not be explained in the manner mentioned in the case of the spodumene, can be demonstrated by the determination of the specific gravities of the crystallized mass, and of that of the beautiful, colourless "glass", obtained by suddenly chilling the liquid. The expansion seems to be about 3% of the original volume.

§ 5. The crystallized substance, obtained by slowly cooling the liquid, is opaque and greyish white. Microscopical investigation showed it to be a cryptocrystalline aggregation of irregularly shaped, grain-like crystals, which are so small, that even with an 800-times enlargement, they can hardly be seen; they possess a very weak birefringence. Greater pieces seem to be built up between crossed nicols by innumerable lighting points; such aggregations always show an undulatory extinction. In no case crystals with determinable borders were found. As a "mean" refractive-index the value:  $n_D = 1,531 \pm 0,002$  was obtained.

The specific gravity at  $13^{\circ},6$  C. was pycnometrically found to be:  $d_{40} = 2,365$ , and at  $25^{\circ},1$  C:  $d_{40} = 2,362$ ; we used orthochlorotoluene (1.0825 at  $25^{\circ},1$  C.) as immersion-liquid.

As follows clearly from those values for the refraction of light and for the specific gravity, the natural *eucriptite* must be another modification of the compound  $LiAlSiO_4$ ; therefore we will distinguish the artificial silicate by the name: *pseudo-eucriptite*.<sup>1)</sup>

<sup>1)</sup> GINSBERG (Zeits. f. anorg. Chem. **73**. 291 (1911)) describes his preparation in the following manner: completely isotropous, uniaxial negative in convergent polarised light, with a birefringence smaller than that of nepheline. WEYBERG asserts to have obtained an "eucriptite" of rhombic symmetry, by the reaction of  $Li_2SO_4$  on kaoline in solution. Cf. also the experiments of THUGGUT, Zeits. f. anorg. Chemie **2**. 116. (1892).

§ 6. The *glass*, obtained by suddenly chilling the molten mass in mercury or cold water, is colourless, perfectly clear and exceedingly hard. It can be removed from the platinum-crucibles in an easier way than the crystallized mass, which fact is connected with the volume-change in crystallizing.

The refractive index of the glass appeared to be:  $n_D = 1,541$ . We have prepared several glasses of varying chemical composition, all in the vicinity of the composition of the pure compound, with the purpose to measure accurately the refractive indices and the dispersion, in order to get information about the influence of the chemical composition on the optical behaviour of these glasses. They were ground in a flat cylindrical form, and in all directions carefully polished; then they were investigated by means of an ABBE-crystalrefractometer in light of different wave-lengths.

For pure *pseudo-eucryptite-glass* of the composition  $LiAlSiO_4$ , we found:

	Wavelength in $\text{\AA. U.}$	Angle of Total-reflection:	Refractive Index:	$\Delta$ :
Li:	6708	$62^\circ 11'$	1,5450	0,0040
Na:	5893	$61^\circ 54'$	1,5410	0,0056
Tl:	5350	$61^\circ 31'$	1,5354	

In the following are summarized the measurements with the glasses:

II. Compos:  $47,5\% SiO_2$ ;  $40,0\% Al_2O_3$ ;  $12,5\% Li_2O$

III. Compos:  $42,5\% SiO_2$ ;  $38,6\% Al_2O_3$ ;  $18,9\% Li_2O$

IV. Compos:  $48,4\% SiO_2$ ;  $39,3\% Al_2O_3$ ;  $12,3\% Li_2O$

	Wavelength in $\text{\AA. U.}$ :	Angle of Total-reflection:	Refractive Index:	$\Delta$ :
Li	6708	$62^\circ 26'$	1,5484	0,0047
Na	5893	$62^\circ 51\frac{1}{2}'$	1,5437	0,0044
Tl	5350	$61^\circ 47'$	1,5393	

	Wavelength in $\text{\AA. U.}$ :	Angle of Total-reflection:	Refractive Index:	$\Delta$ :
Li	6708	$63^\circ 36'$	1,5647	0,0048
Na	5893	$63^\circ 15'$	1,5599	0,0039
Tl	5350	$62^\circ 58'$	1,5560	

	<i>IV.</i>			
	<i>Wavelength in</i> Å. U.:	<i>Angle of</i> <i>Totalreflection:</i>	<i>Refractive</i> <i>Index:</i>	$\Delta$ :
<i>Li</i>	6708	61°50'	1,5400	0,0046
<i>Na</i>	5893	61°31'	1,5354	0,0053
<i>W</i>	5350	61°9'	1,5301	

It is difficult to deduce a simple relation of chemical composition and optical properties from these data. Generally speaking, an increase of the amount of  $Li_2O$  seems to cause an increase of the refractive power (except in *IV*), while a larger amount of  $SiO_2$  appears just to diminish the refractive index, the exceptional case *IV* could be explained by the superposition of these two causes. This dependence of the quantities of the oxides present, appears to bear some connection with the relatively higher refractive power of the lithiumoxide, and the smaller one of the silica<sup>1)</sup>.

The pseudoeucryptite-glass is, with respect to the opaque, crystallized compound, a typical *metastable* phase: already on heating the glass during a very short time in a BUNSEN-gasburner, the pieces of glass become primarily yellowish, then they become opaque, and finally they appear under the microscope wholly changed into the mentioned cryptocrystalline aggregation of birefringent grains. If heated only for ten minutes at 900° C., they are completely changed, and the same occurs, on heating the finely powdered glass during some time with molten  $LiCl$  or  $LiF$  in a platinum crucible.

The specific gravity of the pure pseudo-eucryptite-glass was determined by means of the method of swimming, in a mixture of bromoform and benzene, at 13° C.; it was found to be:  $d_{40} = 2,429$ . Thus both the refractive index and the density of the glass are somewhat higher than for the crystallized compound.

§ 7. Finally we have compared the artificial product with a natural eucryptite of BRANCHEVILLE (Conn.). The mineral, of which a thin section was prepared, looked as an aggregation of cryptocrystalline, homogeneously extinguishing fields: however, although they had superficially some analogy with the artificial product, they must be considered as composed of much larger crystals, showing apparently the kind of structure, somewhat similar to the so-called "schrift"-granite. Locally it is intermixed with a much more strongly

<sup>1)</sup> F. M. JAEGER and H. S. VAN KLOOSTER, these Proceedings, loco cit. (1914).

birefringent mineral; although the eucryptite is here generated from spodume, with deposition of albite, the properties of the inclusions did not agree with those of the two lastnamed minerals. The specific gravity was pycnometrically determined to be  $d_{40} = 2,667$  at  $25^{\circ}\text{C}$ .; the available data show the composition not to be the proper one, the  $\text{SiO}_2$ -amount being 0,6 % too high and that of the



Fig. 2.



Fig. 3.

$\text{LiO}_2$  about 1 % less than the theoretical value. The fig. 2 and 3 represent two microscopical preparations of the thin section between crossed nicols; in the fig. 3 the preparation is turned over  $30^{\circ}$  with respect to that in fig. 2; — this fact pointing to a trigonal twinning. Also the very peculiar structure of the crystals is shown in fig. 3.

The refractive index was microscopically determined on:  $n_D = 1,545 \pm 0,002$ . A definite meltingpoint could not be fixed by the usual, dynamical method; at about  $1120^{\circ}\text{C}$ . the mineral gradually changes into a viscous mass, which, on cooling, becomes a *glass*. The refractive index of this glass appeared to be:  $n_D = 1,506 \pm 0,001$ ; it is thus evidently lower than that for the glass of *pseudo-eucryptite*. On being heated it is devitrified only slightly; there seems to be no doubt, that the natural mineral and its glass are other than the corresponding phases of the artificial product. As also never any indication of an occurring inversion could be found, it is highly probable that eucryptite and pseudo-eucryptite are in relation of monotropic modifications to each other.

#### § 8. *Synthesis and properties of $\beta$ -Spodumene.*

The compound, whose composition is:  $\text{LiAlSi}_2\text{O}_6$ , was prepared

by us in four different ways, just to get information on the final identity of such preparations:

*a.* By melting together calculated quantities of  $Li_2CO_3$ ,  $Al_2O_3$  and  $SiO_2$ , repeating this manipulation a few times, after thoroughly grinding and sieving the crystallized masses. Analysis and correction were made as usual.

*b.* By starting from pure  $Li_2SiO_3$ ,  $Al_2O_3$  and  $SiO_2$ .

*c.* From  $LiAlSiO_4$  and  $SiO_2$ .

*d.* From  $LiAlO_2$ , the lithiualuminate, and  $SiO_2$ .

The four preparations, thus obtained, were used only for the definitive measurements after it had been proved by repeated analysis and correction, that their composition did correspond, within the limits of error, with that of the formula. All these experiments were made in electrically heated furnaces with oxidizing atmosphere; the preparation of these substances took a long time, because of the volatility of the  $Li_2O$ , and the fact, that only small deviations in the content of  $Li_2O$  showed themselves of appreciable influence on the meltingpoint and properties of the compound.

§ 9. The purest preparation we got, was obtained from synthetic eucryptite by admixture of  $SiO_2$ . Analysis gave the following data:

	I.	II.	Calculated:
$SiO_2$	64,39 %	64,43 %	64,6 %
$Al_2O_3$	27,56 %	27,66 %	27,4 %
$Li_2O$	8,05 %	7,91 %	8,0 %

The mass was kept during a longer time at a high temperature, to allow it to crystallize totally. Then the meltingpoint was determined in the usual way, by means of thermoelement III; we found:

14 353 M. V.

14 341 M. V.

Mean: 14 347 M. V. (without correction),

if the rate of heating was about 65 M.V. pro minute. As the correction for the thermoelement was — 12 M.V. at this temperature, the meltingtemperature is  $1400^\circ C.$ , in terms of the nitrogenthermometer.

As a check the meltingpoint was now again determined by the statical method: very small quantities, wrapped in platinum folium were heated during a considerable time (from half an hour to one full hour) at a certain and accurately constant temperature, and then, after suddenly chilling<sup>1)</sup> in cold mercury, investigated by means of

<sup>1)</sup> F. M. JAEGER, Eine Anleitung zur Ausführung exakter physiko-chemischer Messungen bei höheren Temperaturen. Groningen, 1913, Seite 73, 74.



the microscope. We found that after heating at 14340 M. V. (element III) the whole preparation was again crystalline, although it had the outward appearance of a glassy, half-opaque mass; but on heating at 14360 M. V., all had been changed into a real "glass". The meltingtemperature therefore must be fixed at 14350 M. V. As the correction for the used quenching-system (vid. the determinations of the meltingpoint of natural spodumene of *Madagascar*) was shown to be practically equal to zero, we can conclude from this, that the meltingpoint thus determined is in full agreement with that found by the dynamical method, and can be put at 1401° C. (G Th.). The crystallized product appeared to be identical with the  $\beta$ -modification, later to be described, the refractive index was about:  $n = 1.521$ ; the specific gravity at 25° C:  $d_{40} = 2.411$ .

2. In a similar way the preparation, obtained from lithiumaluminate and  $SiO_2$  was investigated; analysis gave the following data:

	I	II	Calculated:
$SiO_2$	64,80%	64,07%	64,6%
$AlO_3$	27,83%	28,09%	27,4%
$Li_2O$	7,37%	7,84%	8,0%

This preparation therefore evidently can also be considered as a very good one; it contains ca. 0,4%  $Li_2O$  too little, and ca. 0,5%  $Al_2O_3$  too much.

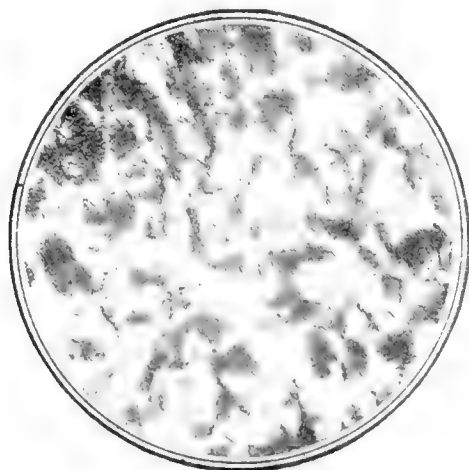

Fig. 4.  
Artificial  $\beta$ -spodumene, obtained from  $LiAlO_2$   
and  $SiO_2$ ; melted and slowly cooled.  
( $\times$  Nicols).

The meltingpoint, determined after the dynamical method (element III), was found:

14463 M. V.

14481 M. V.

Mean 14472 M. V.  $\pm$  10 M. V. (without correction); after correction, the meltingpoint can be fixed at  $1410^\circ \pm 1^\circ$  C. (G.Th.).

After the statical method, the meltingpoint was determined at 14450 M. V., corresponding to  $1410^\circ$  C. The small excess of  $Al_2O_3$  has evidently caused an *increase* of the meltingtemperature, of about  $9^\circ$  C. The crystallized product again was shown to be  $\beta$ -spodumene ( $n = 1,519$ ); a photograph of it, taken between crossed nicols is reproduced in fig. 4.

3. An analogous result was, in both ways, obtained with a preparation, prepared from  $Li_2SiO_3$ ,  $Al_2O_3$  and  $SiO_2$ . Analysis of this product gave the following data:

	I	II	Calculated:
$SiO_2$	64,7 %	64,48 %	64,6 %
$Al_2O_3$	28,4 %	28,5 %	27,4 %
$Li_2O$	6,9 %	7,1 %	8,0 %

The content of  $SiO_2$  is here the right one, but the  $Al_2O_3$  is 1% too high. The meltingpoint determinations gave as a mean value: 14456 M.V. (uncorr.) after the dynamical method, and about: 14450 M.V. after the statical method. The meltingpoint is therefore:  $1409^\circ$  C. (G.Th.).

4. Most deviating from the composition:  $LiAlSi_2O_6$ , was a preparation, obtained from the melting together of  $Li_2CO_3$ ,  $SiO_2$  and  $Al_2O_3$ . Analysis gave the following numbers:

	I	II	Calculated:
$SiO_2$	64,44 %	64,88 %	64,6 %
$Al_2O_3$	27,09 %	27,17 %	27,4 %
$Li_2O$	8,47 %	7,95 %	8,0 %

Evidently it contains about 0,21 %  $Li_2O$  too much.

After the first method the meltingpoint was found at 14552 M.V. (uncorr.), and after the statical method: 14550 M.V. The true meltingpoint can thus be put at:  $1417^\circ$  C. (G.Th.).

§ 10. Although in most cases perfectly colourless products were obtained, which evidently were identical to and independent of the particular manner of preparing them, and which all represented the  $\beta$ -modification, — we succeeded however in several cases in obtaining beautifully crystallized preparations, which locally or also totally were

tinged with a nice, reddish lilac hue; they were in most cases obtained by longer heating, somewhat *below* the meltingtemperature.

The meltingpointdetermination with such an intensively coloured product, prepared from  $LiAlO_2$  and  $SiO_2$  and showing by analysis the following composition :

	I.	II.	Calculated :
$SiO_2$	64,92 %	64,77 %	64,6 %
$Al_2O_3$	28,10 %	27,94 %	27,4 %
$Li_2O$	6,98 %	7,29 %	8,0 %

and thus evidently containing about 0,63 % too much alumina, gave the following results (statical method):

After heating at	14660 M. V. :	all glass.
„ „ „	14640 M. V. :	all glass.
„ „ „	14600 M. V. :	all glass.
„ „ „	14500 M. V. :	all crystallized.
„ „ „	14560 M. V. :	all crystallized.

The meltingpoint is thus situated at 14580 M.V., corresponding with 1420° C. (G.Th.).

Such lilac coloured preparations present in most cases rather larger individuals of the  $\beta$ -modification, which possess a tabular shape with appreciably stronger birefringence than the common cryptocrystalline masses, although the mean refractive index is the same. While commonly this birefringence varies between 0,001 and 0,003, it amounts in these preparations to about 0,007; the principal refractive indices are about: 1,520 and 1,527. In convergent polarized light, at the border of the field an interference-image is partially visible, giving the impression of that of an uniaxial crystal. However on moving the table of the microscope, one can easily observe the curvature and even the hyperbolic form of the dark beams; undoubtedly an optically *biaxial* crystal with a very small axial angle, is present here; while the position of the first bisectrix and the character of the dispersion, point to *monoclinic* symmetry, with a strong tendency to tetragonal forms. This last peculiarity can be deduced, — besides from the apparent uniaxity — from the fact, that rectangular plates are not rare, which possess an extinction under right angles or parallel to a diagonal, and a system of cleavage-directions under 45° with the optical sections. The specific gravity, like the refractive indices, does not differ appreciably from that of the common  $\beta$ -form, and was determined at 25° C.:  $d_p = 2,401 \pm 0,008$ , measured with several preparations. We obtained these same apparently uniaxial plates, also from natural spodumenes by melting and slowly crystallizing; there is no doubt whatever about the fact, that these tabular

crystals are identical with the common  $\beta$ -form, which represents the stable form at the meltingpoint; the plates must be a peculiar kind of crystals of this  $\beta$ -modification.

However we have till now not succeeded in giving a final explanation of the remarkable reddish-lilac colour of many of these preparations. It is quite sure, that it does not depend in any way on the admixture of certain metallic impurities, solved from the crucible-walls; on the contrary it appears to be connected with the macro-crystalline structure of the preparations. The nearer the chemical composition came to the theoretical one, and the slower the crystallisation of the mass takes place, by heating during a long time at a temperature just below the meltingpoint, the more the appearance of the violet tinge seems to be probable.

The *same* colour appears, if spodumene-powder or the pulverized "glass" of it, are brought into liquids of about the same refractive index (e. g. into orthochlorotoluene, with  $n = 1,522$ ); in that case the wellknown phenomenon of the "monochromes" (CHRISTIANSEN) will appear. It is not impossible, that in our case the colour is produced in an analogous way by the presence of the tabular, very thin crystals amidst spodumene-glass, which possesses about the same refractive index (1,519) as the crystal-tables (1,520 till 1,527), or reversely; these tables would be therefore quite invisible in the surrounding medium. It could be understood in this way also, why in the uncoloured mass in some cases locally smaller or larger pink spherulithes are produced, making the impression, as the molten mass were locally inoculated with germs of the violet substance.

By means of the ultra-microscope we were able to show, that the preparation was *not* "optically empty", as a great number of differently coloured lightspots, which do not move however, could be observed; they are manifesting a structure of some particular kind, without it being possible to ascertain of what kind the imbedded particles are.

§ 11. As it follows from these investigations, in connection with the meltingpoint determinations of natural  $\alpha$ -spodumene later to be described, that the chemically pure compound  $LiAlSi_2O_6$  has a meltingpoint considerably lower than the natural spodumene-minerals, — we made a series of investigations to find out, *what* admixtures of the natural spodumenes might cause the mentioned increase of the meltingpoint. Therefore to an artificial product, whose composition was:

$SiO_2$	64,7 %
$Al_2O_3$	27,1 %
$Li_2O$	8,2 %

we added successively in concentrations of 1 mol. percentage, the following chemically pure preparations:

	<i>Observed and reduced Meltingpoints:</i>
1. <i>Jadeite</i> : $NaAlSi_2O_6$ , synthetic.	14415 M.V. = 1382°
2. <i>Leucite</i> : $KAlSi_2O_6$ , synthetic, anhydrous.	14506 M.V. = 1414°
3. <i>Lithiumoxide</i> : $Li_2O$ .	14304 M.V. = 1397°
4. <i>Alumina</i> : $Al_2O_3$ .	14585 M.V. = 1420°
5. <i>Silica</i> : $SiO_2$ (quartz).	14530 M.V. = 1416°
And in concentrations of 2 mol. pere.:	
6. <i>Pseudowollastonite</i> : $CaSiO_3$ , synthetic.	14357 M.V. = 1402°
7. <i>Sillimannite</i> : $Al_2SiO_5$ , synthetic.	14593 M.V. = 1421°

Keeping in mind, that the pure substance melts at 1417° C. (G. Th.), we can deduce from these experiments, that:

a. An excess of  $Li_2O$  lowers the meltingpoint of the compound  $LiAlSi_2O_6$ , while the influence of an excess of  $SiO_2$  is somewhat uncertain, but seems to produce a *slight increase*.

b. That a *lowering* of the meltingpoint is also produced by an excess of synthetic *jadeite*, *leucite* and *pseudowollastonite*, which can be considered as the principal admixtures of the natural *kunzites* and *spodumenes*.

c. That on the contrary, an *increase* of the meltingpoint is produced by an excess of *alumina* and of *alumosilicates*, like e. g. pure *sillimannite*.

In how far these facts, which of course will be studied more in detail, when the ternary system:  $Li_2O—Al_2O_3—SiO_2$  is investigated completely, can be used for the explanation of the phenomena, observed in the case of the natural *spodumenes*, will be shown in the next paper.

Groningen, May 1914.

*Laboratory of Inorganic Chemistry  
of the University.*

**Chemistry.** — “*Studies in the Field of Silicate-Chemistry. III. On the Lithiumaluminiumsilicates, whose composition corresponds to that of the Minerals Eucryptite and Spodumene*”. By Prof. Dr. F. M. JAEGER and Dr. ANT. ŠIMEK. (Continued). (Communicated by Prof. P. VAN ROMBURGH.)

(Communicated in the meeting of May 30, 1914).

§ 12. For the purpose of comparison of the properties of the described artificial product with the mineral itself, we have investigated a number of natural *spodumene*-species in an analogous way.

We obtained a number of very pure *kunzites*, and some good *spodumenes*:

1. An almost colourless, somewhat lilac tinged, strongly dichroïtic *kunzite* from *Rincon* in *California*.

2. A completely transparent, glassy, pale rose tinged *kunzite* from *Schatany-valley* on *Madagascar*.

3. A beautiful, transparent pale greenish yellow *kunzite* from *Minas Gerais* in *Brasil*.

4. A transparent, emerald-green *hiddenite* from *Alexander County* in *North Carolina*, U.S.A., and a pale yellow hiddenite of the same place.

5. A cryptocrystalline, opaque piece of *spodumene* from *Somerö*, in *Finland*.

6. An aggregation of opaque, long prisms of *spodumene* from *Maine*, U. S. A.

All meltingpoints of the finely ground material were determined in exactly the same way and with the same care, as formerly described. The specific gravities were determined by means of a pycnometer, with ortho-chlorotoluene as an immersion-liquid; the specific gravity of this was:  $d_{40} = 1,0841$  at  $25^{\circ},1$  C.

Most of the optical data were obtained by microscopical investigation; the values of the refractive indices are determined at  $16^{\circ}$  or  $17^{\circ}$  C.

#### 1. *Kunzite of Rincon, California.*

Big, very feeble lilac colours, very lustrous and perfectly transparent crystals, evidently with a cleavage parallel to the vertical prism. An analysis of *Davis*, made with the same material, gave the following results:

	<i>Calculated:</i>		<i>Impurities:</i>			
$SiO_2$	: 64,05 %	64,6 %	$CaO$	: 0,8 %	$MnO$	: 0,11 %
$Al_2O_3$	: 27,30 %	27,4 %	$Na_2O$	: 0,3 %	$NiO$	: 0,06 %
$Li_2O$	: 6,88 %	8,0 %	$ZnO$	: 0,44 %	$K_2O$	: 0,06 %
					Total: 0.78 %.	

The crystals show a strong fluorescence under the influence of RÖNTGEN-rays.

The meltingpoint determinations gave, with thermoelement IV, the following results: as a mean value of a greater number of observations, we found:  $14683$  M. V.  $\pm$   $4$  M. V.; as the correction of the thermoelement at this temperature was  $-8$  M.V., the melting-point is thus:  $1428^{\circ}$  C. (G. Th.). It is very sharply localised on the heating-curves.

The specific gravity at  $25,1^{\circ}\text{C}$ . was:  $d_4^0 = 3,204 \pm 0,003$  for the natural, not yet melted compound; after solidification of the molten mass, one obtains, after slowly cooling, a colourless, finely crystallized mass, whose density differs considerably from the original mineral: it is:  $d_4^0 = 2,385$  at  $25^{\circ},1\text{C}$ .

The refractive indices of the molten and solidified substance are considerably different from those of the original mineral. While for the unmelted substance we found respectively:  $n_1 = 1,653 \pm 0,003$ ;  $n_2 = 1,669 \pm 0,003$ ; and  $n_3 = 1,672 \pm 0,003$  <sup>1)</sup>, for the solidified mass we found an extremely feeble birefringence of about 0,001, and a mean refractive index of:  $n_D = 1,518$ . The crystalpieces showed an irregular extinction, evidently by very complicated intergrowth of several individuals.

On rapidly cooling, an isotropous *glass* was obtained, with a refractive index of  $n_D = 1,517 \pm 0,001$ , being about the same as for the crystallized mass. The specific gravity was at  $25^{\circ},2\text{C}$ .:  $d_4^0 = 2,388 \pm 0,003$ . When heated during a longer time at  $1300^{\circ}\text{C}$ ., it becomes crystalline; even at lower temperatures the glass gets soon opaque and like porcelain by devitrification; but glass and crystalline product obtained from it, evidently do not differ in their properties to any appreciable amount.

II. *Kunzite of the Sahatany-valley on Madagascar*. Big, clear and completely transparent crystals; they are dichroitic and tinged with a pale rose hue. Locally the enviroing rock-material is again discernible, as a rusty coloured, finely divided substance. The crystals were carefully cleaned from it; then they were ground and sieved, after which the investigation proceeded in the usual manner.

As a mean value for a greater number of determinations, we found the meltingpoint at:  $14683 \pm 5\text{ M.V.}$ ; as the correction of the thermoelement was  $-8\text{ M.V.}$  at this temperature, we can adopt the value  $14675\text{ M.V.}$  of the E.M.F. of the thermoelement at the meltingpoint, corresponding with:  $1428^{\circ}\text{C}$ . (G. Th.); in this case the meltingpoint is also very sharp.

Evidently this kunzite differs only slightly from the preceding mineral of *Rincon*. With respect to its chemical composition, we have some data, given by LACROIX <sup>2)</sup>, who investigated colourless.

<sup>1)</sup> In a liquid of  $n_D = 1,670$ , composed of methylene-iodide and monobromonaphthaline, the crystalpowder showed a very beautiful reddish-violet colour, just as some of CHRISTIANSEN's "monochromes". The same phenomenon was observed for the glass and the  $\beta$ -modification of artificial spodumene.

<sup>2)</sup> A. LACROIX, *Minéralogie de la France et ses Colonies*, IV, 775, (1910).

greenish-yellow and rose kunzites (triphane) from *Maharitra* on *Madagascar*; the lilac and rose kunzites of *Amposihatra* are imbedded in a kind of kaoline-earth, generated from the spodumene by decaying-processes. The green kunzites possess the greatest values of their refractive indices, however only little differing from the other ones, while the rose tinged crystals have a smaller, the colourless ones yet smaller values for those constants.

We found by means of the immersion-method  $n_1 = 1,658$  and  $n_2 = 1,673$ , which values do not differ appreciably from the mean values:  $n_1 = 1,6588$ ,  $n_2 = 1,6645$  and  $n_3 = 1,6750$ .<sup>1)</sup> For the analysis of the red and greenish crystals, the following data are given in literature; they are reproduced here for comparison with the composition of the Californian kunzite:

<i>rose crystals:</i>	<i>green crystals:</i>
$SiO_2$ : 63,85 <sup>0</sup> / <sub>0</sub> $CaO$ : 0,52 <sup>0</sup> / <sub>0</sub> $MnO$ : trace	$SiO_2$ : 62,21 <sup>0</sup> / <sub>0</sub> $CaO$ : 0,50 <sup>0</sup> / <sub>0</sub> $MnO$ : trace
$Al_2O_3$ : 29,87 <sup>0</sup> / <sub>0</sub> $Na_2O$ : 0,98 <sup>0</sup> / <sub>0</sub> $Fe_2O_3$ : 0,15 <sup>0</sup> / <sub>0</sub>	$Al_2O_3$ : 29,79 <sup>0</sup> / <sub>0</sub> $Na_2O$ : 1,03 <sup>0</sup> / <sub>0</sub> $Fe_2O_3$ : 2,48 <sup>0</sup> / <sub>0</sub>
$Li_2O$ : 3,76 <sup>0</sup> / <sub>0</sub> $MgO$ : 0,13 <sup>0</sup> / <sub>0</sub> $K_2O$ : 0,13 <sup>0</sup> / <sub>0</sub>	$Li_2O$ : 4,02 <sup>0</sup> / <sub>0</sub> $MgO$ : trace $K_2O$ : 0,21 <sup>0</sup> / <sub>0</sub>
Residue : 0,37 <sup>0</sup> / <sub>0</sub> .	Residue : 0,25 <sup>0</sup> / <sub>0</sub> .

From these data results, that the quantity of  $SiO_2$  in the rose crystals is about the same as for the pale rose kunzite of *Rincon*; but the content of  $Al_2O_3$  is much greater in the mineral of *Madagascar*, and thus the  $Li_2O$  appreciably less than in the American kunzite. The sum of those three constituents does not differ very much in all these cases: 97,5 % for the kunzite of *Madagascar*, 98,2 % for that from *Rincon*. The specific gravity of the rose species is about 3,177; — a value, only slightly different from the value, determined by us:  $d_{40} = 3,301 \pm 0,005$ , at 25°,1 C.

The refractive indices of the melted, feebly birefringent product, were found to be  $n_1 = 1,518$  and  $n_2 = 1,520$ ; the birefringence is not greater than 0,002.

At 25°,1 C. the specific gravity of the melted and solidified substance was determined:  $d_{40} = 2,373$ , when the preparation was heated during several hours at a constant temperature, just below the meltingpoint; under the microscope the obtained product then showed the typical aspect of the aggregates of scales, which are always found with the  $\beta$ -spodumene; they have a weak birefringence, and an irregular, often undulatory extinction. When  $\alpha$ -spodumene was *not* melted before, but only kept at a constant temperature below the meltingpoint, the substance appeared to be wholly transformed into the same  $\beta$ -modification, with a specific gravity of:  $d_{40} = 2,376$  at

<sup>1)</sup> DUPARC, WUNDER et SABOT, Mém. de la Soc. physique de Genève, **36**, 402, (1910).



25°,1 C. In both cases the mean refractive index for sodiumlight was:  $n_D = 1,518 \pm 0,001$ . From the molten mass therefore no other phase is deposited than the mentioned  $\beta$ -modification.

The fig. 5, 6, and 7 may give an impression of the manner, in which the transformation of the  $\alpha$ -, into the  $\beta$ -modification gradually occurs. In fig. 5 the original kunzite of *Madagascar* is photographed between crossed nicols, when heated only during 2 hours at 975° C., and showing no trace yet of the  $\beta$ -form; in fig. 7 the same heating, but prolonged to 15 hours, has led to complete transformation of the crystals into the  $\beta$ -form. The fig. 6 represents the crystals, after 8 hours heating at 975° C.; they show a partial transformation, and the gradually occurring differentiation of the originally homogeneous crystals into an aggregation of the felty needles of the  $\beta$ -modification.

### III. Greenish-yellow Kunzite of Minas Gerais, Brasil.

This kunzite appears also in the form of large, very transparent crystals, having a pale greenish or yellowish hue. This colour is caused by a content of  $FeO$ , which in melting the mineral, is converted into:  $Fe_2O_3$ ; thus the solidified mass being always tinged with a reddish-brown colour. The analysis of this mineral <sup>1)</sup> gave the following data :

$SiO_2$ : 63,3—64,3%	$CaO$ : 0,2—0,7 %
$Al_2O_3$ : 27,7—27,9%	$Na_2O$ : 0,6—1,0 %
$Li_2O_3$ : 6,7— 7,4%	$FeO$ : 0,7—1,2 %

This kunzite therefore is also relatively close in composition to that of *Rincon*, approaching in its content of  $Li_2O$  closer to the theoretical value; the sum of the principal constituents is 97,7 %.

The meltingpoint of this mineral was determined five times; the results were, with thermoelement IV :

14643 M.V.  
 14646 M.V.  
 14650 M.V.  
 14639 M.V.  
 14646 M.V.

Mean value: 14645 M.V. ;

after correction: 14637 M.V. (G. Th.)

The meltingpoint, reduced on the nitrogengasthermometer, lies thus at 1425° C., i. e. about 3° C. lower than for the kunzite of *Rincon*.

The specific gravity of the substance before melting, was determined at 25°,1 C. to be:  $d_{40} = 3,262$ ; the data, given in literature for the specific gravity of natural crystals, vary between 3,16 and

<sup>1)</sup> C. HINTZE, Handbuch der Mineralogie.

3,174. The refractive indices of the original substance were:  $n_1 = 1,661$  and  $n_2 = 1,669$ , with apparently a somewhat weaker birefringence as for the already described kunzites.

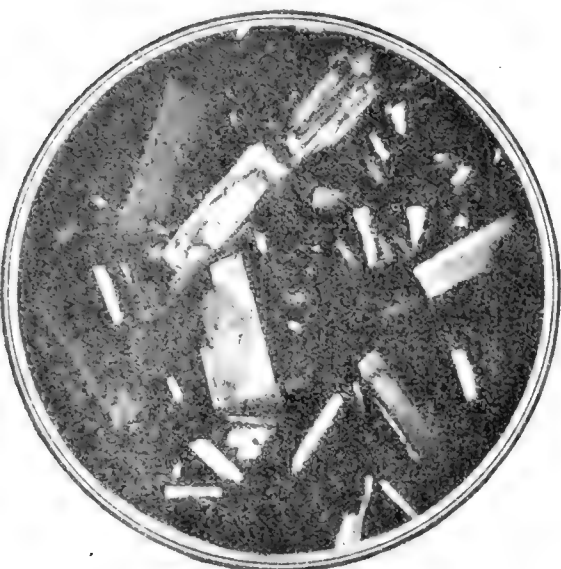

Fig. 5.

Kunzite of *Madagascar*, heated for two hours at  $960^{\circ}\text{C}$ . and not yet perceptibly transformed. ( $\times$  Nicols).



Fig. 6.

Beginning of the transformation of  $\alpha$ -spodumene (*Madagascar*), after being heated during eight hours at  $975^{\circ}\text{C}$ . ( $\times$  Nicols).



Fig. 7.

Kunzite of *Madagascar*, completely transformed into the  $\beta$ -form, after being heated at  $975^{\circ}\text{C}$ . ( $\times$  Nicols).

After being melted however, the reddishbrown, crystalline product had a specific gravity at  $25^{\circ}, 1\text{ C.}$ :  $d_{40} = 2,463$ , while the refractive indices of the feebly birefringent grains were found to be about 1,522 and 1,527. There is no doubt whatever about the fact, that the solidified product is again a modification absolutely different from the original kunzite; moreover it is evidently identical with the already mentioned  $\beta$ -spodumene.

#### IV. *Hiddenite from Alexander County, North Carolina, U.S.A.*

Long, needle-shaped, pale green crystals, and emerald-green crystal-fragments, which are transparent and dichroitic. The specific gravity of this mineral at  $25^{\circ}, 1\text{ C.}$  was found to be:  $d_{40} = 3,295 \pm 0,002$ ; the refractive indices were:  $n_1 = 1,664$  and  $n_2 = 1,674$ . The data for the specific density, given in literature, vary between 3,152 and 3,189. Of a hiddenite from *Alexander City*, with specific weight of:  $d_{40} = 3,177$ , the analysis gave the following results:

$\text{SiO}_2$ : 63,95 %	$\text{FeO}$ : 1,1 %
$\text{Al}_2\text{O}_3$ : 26,58 %	$\text{Na}_2\text{O}$ : 1,54 %
$\text{Li}_2\text{O}$ : 6,82 %	$\text{CaO}$ : no trace.

The sum of the principal constituents is here 97,35 %; the hue of the crystals is caused by the admixture of  $\text{FeO}$ , which is oxydized in melting to  $\text{Fe}_2\text{O}_3$ , giving a brownish-black or chocolate-brown colour to the solidified mass. Another hiddenite of the same locality, but of a paler colour, had: 64,35%  $\text{SiO}_2$ , 28,10%  $\text{Al}_2\text{O}_3$ , and 7,05%  $\text{Li}_2\text{O}$ , — consequently together: 99,5 %; moreover: 0,25%  $\text{FeO}$  and only about 0,3%  $\text{Na}_2\text{O}$ . The differences of the meltingpoints of these two kinds of hiddenite, were about  $1^{\circ}\text{ C.}$  or less. In a series of observations, made with thermoelement IV, the melting-point was found at  $14565\text{ M. V.} \pm 10\text{ M. V.}$ ; after correction, this corresponds to  $1418^{\circ} \pm 1^{\circ}\text{ C.}$  (G.Th.). On cooling down the molten mass, first an undercooling is observed to about  $1255^{\circ}\text{ C.}$ , if the temperature-fall was about  $4^{\circ}$  pro minute; then the temperature rose to  $1262^{\circ}\text{ C.}$  during the solidification of the mass, being  $150^{\circ}\text{ C.}$  lower than the real equilibrium-temperature.

Another time we found an undercooling to  $1208^{\circ}\text{ C.}$ , then solidification at  $1214^{\circ}\text{ C.}$ , — this being  $204^{\circ}\text{ C.}$  lower than the true meltingpoint! Although this point of solidification is lower than that for the pure kunzites, it can have no essential signification whatever, being wholly dependent on the speed of cooling and other accidental circumstances.

V. *Spodumene of Somerö, Finland.*

A white, opaque cryptocrystalline and very hard mass. It was finely ground, and investigated in a manner, quite analogous to that formerly described. The specific gravity at  $25^{\circ},1$  C. was:  $d_{40} = 2,997 \pm 0,050$ ; the refractive indices were about:  $n_1 = 1,658$  and  $n_2 = 1,669$ . With the thermoelement *IV* the meltingpoint was found at  $14649$  M.V.  $\pm 5$  M.V.; being, after correction,  $1425^{\circ}$  C. on the gasthermometer. Because of the inhomogeneity of the material, the meltingpoint is here not so sharply localized on the heatingcurves, as in the cases of the kunzites; on cooling the molten mass, solidification occurs in the neighbourhood of  $1298^{\circ}$  C.

The substance solidified and heated for some hours below its meltingpoint, had a specific gravity at  $25^{\circ},1$  C. of:  $d_{40} = 2,398$ ; the refractive indices were about:  $1,510$  and  $1,518$  for sodiumlight,

just a little smaller than commonly with the  $\beta$ -spodumene. The substance always shows very complicated aggregations of feebly extinguishing scales with undulatory extinction.

If the original substance is not melted, but only heated during a longer time below its meltingpoint, the crystals are converted into the aggregations of the  $\beta$ -spodumene; the specific gravity at  $25^{\circ},1$  C. was now:  $d_{40} = 2,412$  and the refractive indices about:  $1,519$ .

VI. *Spodumene from Maine, U.S.A.; perhaps from Windham.*  
This mineral consists of long, opaque, prismatic crystals, looking



Fig. 13.

Dense  $\alpha$ -Spodumene of Somerö, Finland. ( $\times$  Nicols).

like porcelain, with predominant cleavage. The carefully selected material was finely pulverized, and investigated as described before. The specific gravity at  $25^{\circ},1$  C. was:  $d_{25} = 3,154 \pm 0,002$ ; the refractive indices were about:  $n_1 = 1,656$  and  $n_2 = 1,672$ . A microphotograph of it between crossed nicols is reproduced in the fig. 13.

The meltingpoint was determined several times with the thermo-element III; the following results were obtained:  $14669 \pm 13$  M.V., being after correction:  $1427^{\circ} \pm 1^{\circ}$  C. on the gasthermometer. Also in this case the meltingpoint is not quite so sharp as with the kunzites, just because of the chemical inhomogeneity of the material.

The obtained product had a specific gravity:  $d_{25} = 2,336$  at  $25^{\circ},4$  C.; the weakly birefringent, irregularly extinguishing scales, had refractive indices of about: 1,517 and 1,520; the birefringence is not greater than: 0,003.

In fig. 8 a microphotograph between crossed nicols is given of the dense  $\alpha$ -spodumene of *Maine*; in fig. 9 the same preparation, molten and solidified into the  $\beta$ -form is reproduced in the same way. The strong analogy with the image of fig. 4, representing an artificial  $\beta$ -spodumene, made from  $LiAlO_2$  and  $LiO_2$ , is obvious.

Another preparation was not melted, but only kept at a constant temperature of about  $1200^{\circ}$  C. for some hours. The original  $\alpha$ -form appeared to be totally converted into  $\beta$ -spodumene; the volume of the mass had increased then in such a degree, that the platinum-

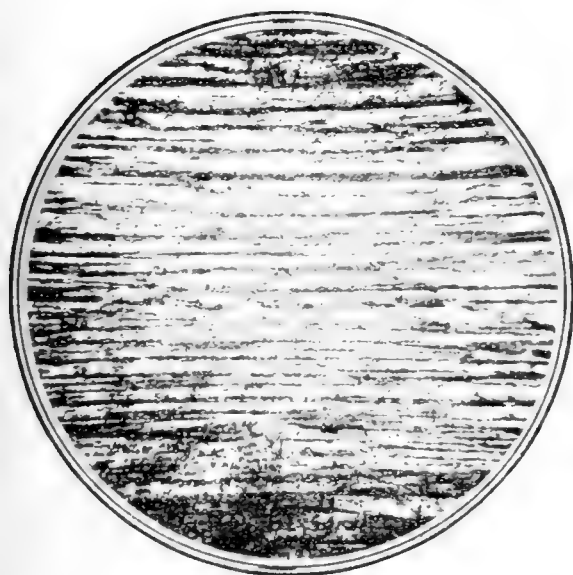

Fig. 8.

Dense  $\alpha$ -Spodumene of Maine, between crossed Nicols.



Fig. 9.

$\beta$ -Spodumene obtained by melting and crystallization of the  $\alpha$ -modification ( $\times$  Nicols).

crucible was wrecked during the process. The substance showed the typical granular structure of the crystal converted into  $\beta$ -spodumene with undulatory extinction and a mean refractive index of: 1,518. The specific weight at  $25^{\circ},7$  C. was determined to be:  $d_{40} = 2,309$ , and to be 2,317 at  $25^{\circ},1$  C.

§ 13. In all these experiments it was observed by us, that the platinumcrucibles, in which the silicate was melted and solidified, showed a strong deformation, which increased every time that the experiment was repeated. As fig. 10 shows very clearly, this observed deformation is of such a kind, that it always appears as a *dilatation*, as if the silicate, like water, solidifies under a volume-expansion. The values obtained for the specific volumes of the crystals and of the *glass*, seem however to make this explanation rather improbable. We have tried by a series of systematic experiments to find out, *when* really this increase of the volume sets in, by measuring the diameter of the crucibles, after their contents had been subjected to different manipulations. In this way, we found, that by far the largest deformation of the crucibles took place, at the transformation of  $\alpha$ -, into  $\beta$ -spodumene, which is accompanied by a volume-increase of about 30% . When the substance is then melted once more, and again solidified, the deformation already present will be increased by the thermal expansion of the mass, and because the liquid substance is

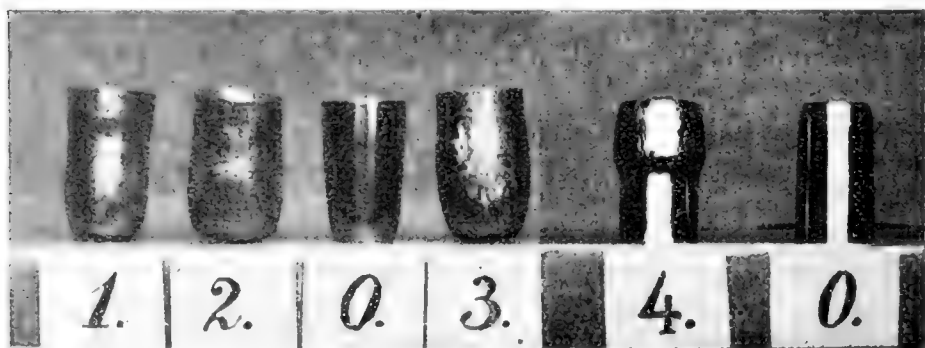

Fig. 10.

Deformation of the platinum crucibles after melting and solidification of the natural Spodumene.

0. Original form of the platinum-crucibles.
1. Pale yellow spodumene of *Minas Geraës, Brasil*.
2. Kunzite of *Sahatany-valley, Madagascar*.
3. Dense Spodumene of *Somerö, Finland*.
4. Kunzite of *Rincon, California*.

enormously viscous, enclosed air-bubbles are hardly squeezed out, but will rather expand in the mass itself, while the surface of the liquid can change its height only with extreme slowness. In repeating successively the melting and solidifying of the substance a number of times, the deformation-effect will be gradually increased to such an extent that, as fig. 10, N<sup>o</sup>. 2 shows clearly, at last the crucible bursts. The gradual lowering of the liquid surface in successive experiments can be seen in those crucibles; in such a manner it often happens, that with a strong deformation of the platinum vessels, when they finally look like inflated balloons, the junction of the thermoelement emerges at last out of the surface of the liquid mass, so that the heat-effects on the heating-curves get gradually worse and will finally disappear totally.

§ 14. To control the found meltingpoints, we have made a series of experiments to determine it once more (with the kunzite of Madagascar) by means of the quenching-method, which is to be described afterwards in connection with our experiments for fixing the temperature of beginning transformation. The quenching-system was first calibrated by means of meltingpoint-determinations, made by this statical method with lithiummetasilicate (1201°) and diopside (1391°); the corrections to be applied to the measured temperatures appeared however to be practically *zero*.

We found in successive experiments :

Kunzite, heated during half an hour at 14600 M.V. and quenched in mercury:	All crystallized
" " " " " " " " 14720 M.V. " " " "	: All glass.
" " " " " " " " 14700 M.V. " " " "	: All glass.
" " " " " " " " 14750 M.V. " " " "	: All glass.
" " " " " " " " 14680 M.V. " " " "	: Glass and crystals.
" " " " " " " " 14660 M.V. " " " "	: All crystallized
" " " " " " " " 14690 M.V. " " " "	: All glass.

Thus, the meltingpoint was found to be 1428° C. (G. Th.), quite in accordance with the direct meltingpointdeterminations after the dynamical method. In these experiments we once obtained a product after longer heating on 14600 M.V., — just somewhat below the meltingpoint, — consisting of somewhat larger individuals. They appeared to be large, homogeneously extinguishing plates, whose birefringence was about 0,007, and with refractive indices of 1,513 and 1,519, like those of the  $\beta$ -spodumene, obtained from artificial spodumene after melting and cooling. In convergent polarized light the same interference-image as in the former case, was observed; there can thus

hardly be any doubt, that the spodumene-modification, which is deposited from the liquid mass, is quite the same as that, which is discerned by us as  $\beta$ -spodumene. There are no reasons to adopt the existence of a third modification, which on cooling should be converted into the  $\beta$ -form, as occasionally has been done.

§ 15. Before describing our experiments with this compound with respect to the study of the transformations into the solid state, the determined values are once more recapitulated in the following table.

From this table (next page) we can see, *that in general the melting-temperatures of the natural kunzites are considerably higher than those for the synthetical products*, and further we can, generally speaking, deduce, *that the meltingpoint of the kunzites are decreasing at the same time with the increase of specific gravity*. (The specific gravities of the two first mentioned kunzites differ too little to give any certain argument for this view). Of the two kinds of dense spodumenes however, the mineral of higher specific density seems to have the higher meltingpoint also, although in this case the meltingpoints are too close together, and are moreover not sufficiently sharp, to give any certain argument for an eventual rational relation between the two mentioned constants.

§ 16. Now we will proceed to the question, in what relation the different modifications of the compound  $LiAlSi_2O_6$  stand with respect to each other. That there are several of these modifications, can already be deduced from the mere fact, *that the product of solidification of the natural spodumenes is quite different from the original substances*.

Our investigations moreover have taught us, that there are really only *two* modifications, which can be discerned as  $\alpha$ - and  $\beta$ -spodumene. Of these two forms the  $\beta$ -modification is undoubtedly the one to be considered as the more stable form at temperatures in the immediate vicinity of the meltingpoint. The question, however, then rises immediately: in what relation are  $\alpha$ - and  $\beta$ -spodumene to each other? Are they *enantiotropic* forms, like e.g. wollastonite and pseudo-wollastonite? Or are they *monotropic* modifications, as e.g. they are observed in some forms of the pentamorphic magnesiummetasilicate?

After numerous experiments in this direction, we have come to the opinion that both forms of spodumene must be considered as *monotropic* ones with respect to each other, and  *$\alpha$ -spodumene, i.e. all kunzites, hiddenites, spodumenes of nature, must be metastable phases of the compound with respect to the  $\beta$ -form at all temperatures below*



## SYNOPSIS OF THE MELTINGPOINTS AND SPECIFIC GRAVITIES OF NATURAL SPODUMENES.

Mineral, and Place of Origin :	Specific gravity $d_4^{25}$ :	Observed E.M.F. of the thermolement : (intern. M.V.)	Corrected E.M.F. : (Gasthermometer- Elements)	Meltingpoints in ° C. on gasthermometer
<i>Kunzite</i> from <i>Rincon</i> , California. (Colourless or pale lilac, transparent)	3.204 ± 0.003	14683	14675	1428°
<i>Kunzite</i> from <i>Sahatany-valley</i> Mada- gascar (pale rose, transparent)	3.201 ± 0.005	14683	14675	1428°
<i>Kunzite</i> from <i>Minas Gerais</i> , Brasil pale greenish-yellow, transparent)	3.262 ± 0.002	14645	14637	1425°
<i>Hiddenite</i> from <i>Alexander County</i> , N. Carolina (emeraldgreen, pale green, transparent)	3.295 ± 0.002	14565	14557	1418°
<i>Dense Spodumene</i> from <i>Somerö</i> , Finland (white, opaque, crypto- crystalline)	2.997 ± 0.050	14662 ± 13	14654 ± 13	1426° ± 1°
<i>Dense Spodumene</i> from <i>Maine</i> . (Colourless, opaque, macrocrystal- line aggregation)	3.154 ± 0.002	14669 ± 13	14661 ± 13	1427° ± 1°

1400° C. Therefore it is neither possible to indicate an "inversion-temperature", below which the  $\alpha$ -form, and above which the  $\beta$ -form would represent the more stable phase: at all temperatures below its meltingpoint, the  $\beta$ -spodumene is the only stable form of the compound  $LiAlSi_2O_6$ . Under what conditions the  $\alpha$ -form was always generated in nature, while it was till now *never* obtained in the laboratory from "dry" molten mixtures, may preliminarily be put aside.

The reason however, that the  $\alpha$ -modification, once produced, has remained so, notwithstanding its metastability with respect to the  $\beta$ -form, is to be ascribed to the *enormous slowness*, with which the transformation  $\alpha \rightarrow \beta$  takes place.

§ 17. To give an idea of this phenomenon, we will describe here a series of experiments, made with the purpose to answer the question, *at what lowest temperature* the transformation  $\alpha \rightarrow \beta$ -form again will occur with a velocity just observable? Preliminary <sup>1)</sup> experiments had taught us that a long and little prominent heat-effect was observed between 900 and 1000° C., if a larger quantity of finely powdered  $\alpha$ -spodumene was gradually heated; and the microscopical investigation also taught us soon, that within the mentioned temperature-interval, a transformation is going on with observable velocity. We therefore made the following series of experiments by means of the already mentioned *statical* method. For it is evident, that just with reactions proceeding so enormously slowly, *this* method can be used with great success, because *it permits us to keep the studied substances at a constant temperature during an arbitrarily long time*; in this way one can be sure that the reaction is thus completely finished, while the sudden chilling of the preparation in cold mercury will fix the momentaneous state of it in a most effective way.

The following data were obtained by observations with the thermo-element IV; because the thermo-element was *not* placed *in* the mass, but beside it, the whole furnace-system needed to be especially calibrated for this series of experiments.

The calibration of the used quenching-system was executed by means of meltingpoint-determinations after the statical method, with substances, whose meltingpoints in terms of the gasthermometer were

<sup>1)</sup> Vide also: G. TAMMANN, Krystallisieren und Schmelzen, p. 114. Spodumene ( $d=3,17$ ) was transformed gradually into a much less dense substance ( $d=2,94$ ), by heating on a *Bunsenburner* during ten hours. The new product was attacked much more rapidly by *HF* than the original substance.

already accurately known before. Only in this way is it possible, to find out, what temperature really corresponds to that, indicated by the thermoelement placed in the furnace. For this purpose we have made use of the meltingpoints of two compounds:  $Li_2SiO_3$  and  $LiBO_2$ ; the  $Li_2SiO_3$  melts at a temperature of 11956 M. V. on our standard-elements, the second at a temperature, corresponding to an E.M.F. of 7822 M.V. <sup>1)</sup>. In this way we observed:

$Li_2SiO_3$ .	State of the chilled system:	$LiBO_2$ .	State of the chilled system:
Heating during a long time at a temperature, at which the E.M.F. of element IV was:		Heating during a long time at a temperature, at which the E.M.F. of element IV was:	
12060 M. V.	All glass.	7800 M. V.	All glass.
12020 "	All glass.	7760 "	All crystals.
11980 "	All glass.	7780 "	Many crystals; a little glass.
11940 "	Much glass, a few crystals	7770 "	All crystals.
11930 "	All crystals	7790 "	All glass.
11950 "	All glass.		

Thus, when the furnace-element indicates 11940 M.V., the meltingpoint of  $Li_2SiO_3$  is reached; the correction of the indicated temperatures at 1201° C. to reduce them the nitrogenthermometer, is therefore + 16 M.V.

The meltingpoint of the  $LiBO_2$  is thus reached, if the furnace-element indicates 7780 M.V.; therefore the correction at 845° C. is: + 42 M.V.

From both these data for 845° C. and for 1201° C., the correction for every intermediate temperature is found by intrapolation; for a temperature of e. g. 965° C., it is + 28 M. V.; etc. It is with this number, that the just mentioned temperature (in M. V.) needs to be augmented, to be reduced to the nitrogenthermometer-scale.

Having in this manner determined the temperature-corrections for the whole quenching-system within the range of temperature from 845° to 1201° C., we have chosen as an object for these experiments

<sup>1)</sup> With the thermoelement IV three series of experiments were made, with heating-rates of 30, 40 and 60 M.V. per half minute. For the lithium-metaborate we found thus successively as mean values: 7786, 7778 and 7781 M.V., — which gives as probable value:  $7782 \pm 4$  M.V. The correction of element IV was + 40 M.V. at this temperature; the true meltingpoint thus being at 7822 M.V. = 845° C. (G. Th.).

the *kunzite* of Madagascar, and we tried to find in the described way the lowest temperature, at which a just discernible transformation of  $\alpha \rightarrow \beta$ -form yet occurred. The reader may be put in mind, that the experiments 1—14 were made with a thermoelement, provided with a very thin protecting tube; in the experiment 14—20, this protecting tube was omitted, which appeared however to make no appreciable difference.

No.	Indication of thermoelement IV at the constant temperature of heating ( $\pm 15$ M. V.)	Uncorrected Temp.	Time during which heating lasted	Result of the Chilling:	
1	6510 M. V.	723°	2 hours	Only $\alpha$ -modif.; no transformation.	
2	6800 "	750	2 "	idem	
3	7380 "	805	2 "	idem	
4	8450 "	901	2 "	idem	
5	9570 "	1000	2 "	All $\beta$ -spodumene.	
6	9500 "	994	2 "	idem	
7	9070 "	957	2 "	No transformation; $\alpha$ -modification.	
8	9220 "	970	2 "	idem	
9	9360 "	982	3 "	Partially transform.; $\alpha$ -, and $\beta$ -form.	
10	9170 "	966	8 "	Probably the same.	
11	9280 "	975	8 "	Partially $\beta$ -spodumene.	
12	9280 "	975	15 "	All $\beta$ -spodumene.	
13	9260 "	973	4 "	Probably partially $\beta$ -form.	
14	9260 "	973	8 "	All $\beta$ -spodumene.	
15	9260 "	973	8 "	All $\beta$ -spodumene.	
16	With unprotected thermoelement	9225 "	970	8 "	For the greater part: $\beta$ -form.
17		9160 "	965	4 "	All $\alpha$ -spodumene.
18		9200 "	968	4 "	Evidently partially $\beta$ -form.
19		9170 "	965.5	4 "	Some $\beta$ -modification, many crystals of $\alpha$ -spodumene.
20		9150 "	964	4 "	No $\beta$ -form; the transformation has not yet begun.

In this case therefore an evident transformation has already taken place at 9170 M. V. (uncorr.), or at 9198 M. V. = 968° C. (G. Th.).

Similar experiments with the kunzite of *Rincon* taught us, that this temperature is situated somewhat higher, at about  $995^{\circ}\text{C}$ .; in all these cases however, only very long continued heating can lead to a complete transformation of the  $\alpha$ -, into the  $\beta$ -form. It is therefore quite evident, that at ordinary temperatures, and even at  $400^{\circ}$  or  $500^{\circ}\text{C}$ ., the transformation-velocity of  $\alpha$ -, into  $\beta$ -form must be practically equal to zero; thus the  $\alpha$ - and  $\beta$ -spodumenes can be in immediate contact with each other, during an undetermined long time, without transformation taking place.

The transition of  $\alpha$ -, into  $\beta$ -form is accompanied by an enormous increase of specific volume: it is augmented from 0.31 to 0.41, being about 33% of the original value. It often occurred that the heated and transformed powder had risen over the borders of the platinum crucibles. In the described quenching-experiments, the transformation could often be stated already, when the used platinum folium had not yet been opened: it seemed to be inflated by the increase of volume of the enclosed preparation. Microscopically it is observed that the larger crystals of the  $\alpha$ -form, in this transformation primarily get innumerable cracks and fissures; afterwards they change into opaque, no longer normally extinguishing aggregations of fine, felty, or even broader needles, whose extinction is *almost* normally orientated on their longer direction; they can be recognized by their weak birefringence, as well as by their low mean refractive index: 1,519. The microphotographs fig. 7 and 9 may give some impression of the aspect of the two modifications between crossed nicols.

§ 18. It may be expected, that the mentioned transformation-velocity will possibly be affected by some catalysers or by some fluxes in such a way, that it will show a discernible value already at considerably lower temperatures.

Indeed we succeeded in proving, that on heating spodumene-glass with molten sodiumtungstate<sup>1)</sup> at temperatures between  $850^{\circ}$  and  $920^{\circ}\text{C}$ ., after 32 hours a partial crystallization has begun, which however was complete only after 65 hours of heating. The crystal-mass had a refractive index of 1,523, and *appeared to be no other thing than  $\beta$ -spodumene*; the determined specific weight was at  $25^{\circ}\text{C}$ .:  $d_{40} = 2,579$ .

<sup>1)</sup> The great difference between the specific gravities of the silicate and the molten tungstate, makes it necessary to use a platinum stirrer, to bring the silicate from the surface into the molten mass again and again. This stirrer was moved by means of a suitable electromotor-driven mechanism.

We then made similar experiments with  $\beta$ -spodumene (of MAINE) in a mixture of 20%  $MoO_3$  and 80% sodiummolybdate at temperatures below 650° C.; on heating during 122 hours on temperatures between 595° and 605° C., we obtained birefringent aggregates of felty needles of the  $\beta$ -modification, with often rectangular borders. The refractive index was 1,527, and while the aggregates of needles did not extinguish in any position between crossed nicols, the rectangular needles often showed a normally orientated extinction. As in the former case, the product had also a pale lilac hue.

Then we made the same experiment with  $\alpha$ -spodumene (of Rincon); it was heated during 88 hours in the same mixtures at 595° to 605° C. The small pieces of the  $\alpha$ -form had got opaque and were converted at their borders or totally into the  $\beta$ -modification; the refractive index was 1,519.

More experiments were made, which all taught us, that from molten magmas, cooled under manifold varied circumstances, never was another thing produced, than either spodumene-“glass”, or  $\beta$ -spodumene; however we did not succeed in getting the  $\alpha$ -form from dry magmas even a single time. As devitrification of spodumene-glass appears also never to give another phase than  $\beta$ -spodumene, — we are of opinion, that it may be considered as sufficiently proved, that the  $\beta$ -modification is the *only* stable modification below the melting point. The spodumenes of nature therefore *certainly cannot* be produced from *dry* magmas; they represent metastable forms of the compound, which are very probably generated from circulating solutions, that is by so-called “hydrothermal” synthesis; the natural forms of the compound only appear to be preserved by the enormously retarding factors, which prohibited the transformation into the more stable  $\beta$ -form. Experiments are going on, with a purpose to produce the  $\alpha$ -modification of the silicate by such hydrothermal synthesis. The results of these experiments will be discussed in a following paper.

§ 19. Finally we can here give some data, concerning the *lithiumaluminat*:  $LiAlO_2$ . This compound was prepared by heating in platinum crucibles the weighed, finely ground and well mixed components, — lithiumcarbonate being taken instead of  $Li_2O$ , — in our resistance furnaces once at 900° C., then at 1200° C. After the resulting mass had been pulverized, the heating was repeated and these manipulations repeated four times. Analysis of the beautifully crystallized, homogeneous mass gave the following numbers:

	Observed:		Calculated:
$Al_2O_3$ :	76,8 %	76,9 %	77,3 %
$Li_2O$ :	23,2 %	23,0 %	22,7 %
			100,0

Although a small excess of  $Li_2O$  was still present, the substance could be considered as practically pure  $LiAlO_2$ , — the more so, as on heating, a certain amount of  $Li_2O$  always volatilizes gradually. A preparation, heated only shortly at  $1600^\circ C.$  contained, as analysis showed us, only 19,34 %  $Li_2O$  and 80,65 %  $Al_2O_3$ ; no further change had occurred than that the crystals of the original preparation *had got much larger dimensions, while preserving their general properties.* At  $1625^\circ C.$  the substance shows no trace of melting, but decomposes partially, by the volatility of the  $Li_2O$ . The platinum is strongly attacked,  $Li_2O_2$  being formed, and thus the aluminate cannot be heated at higher temperatures, without changing its composition. The meltingpoint can thus be hardly determined; the substance must have been changed a long time before already into  $Al_2O_3$ , with perhaps a slight admixture of some lithiumoxide. Even in a "hollow thermoelement", we were not able to melt the substance, notwithstanding it being heated up to  $1625^\circ C.$

Microscopically the aluminate shows large, round-edged, hexagonal or octagonal plates (fig. 12), with a relatively high birefringence

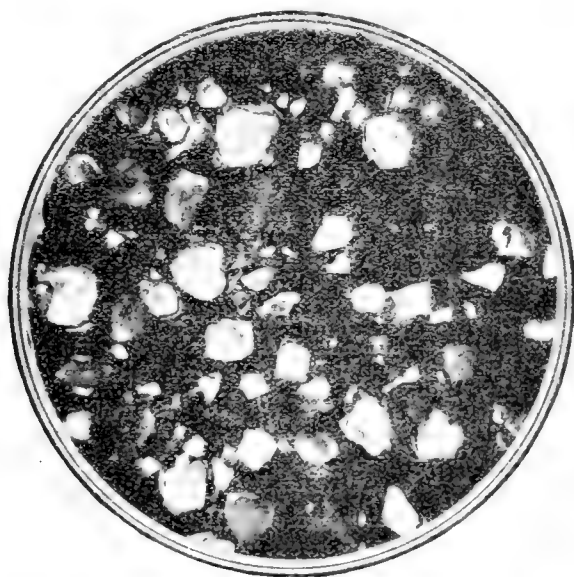

Fig. 12.

Crystals of *Lithiumaluminate*. ( $\times$  Nicols).

and high interference-colours between crossed nicols. The refractive indices were determined to be:  $n_1 = 1,604 \pm 0,001$ ;  $n_2 = 1,615 \pm 0,001$  for sodiumlight; the birefringence was about: 0,012. No axial image could be observed. The specific gravity of the crystals at  $25^{\circ},1$  C. was:  $d_{40} = 2,554$ .

In a following paper we hope to be able to give an account of the formation and the occurrence of the  $\alpha$ -modification of the spodumene in nature, and to review the results so far obtained, also with respect to their geological significance.

*Laboratory for Inorganic Chemistry  
of the University.*

Groningen, May 1914.

**Physiology.** — “*On the survival of isolated mammalian organs with automatic function.*” By Dr. E. LAQUEUR. (Communicated by Prof. H. J. HAMBURGER).

(Communicated in the meeting of April 24, 1914).

When studying the movements of extirpated pieces of gut, I was struck by the following fact: a piece of gut which had contracted for 9 hours in a Tyrode-solution at  $37^{\circ}$ , to which oxygen had been added, and which had been left to itself at room-temperature, began to move again the next morning, after being heated and after a renewed addition of oxygen. However frequently such experiments with pieces of gut — in the way suggested by MAGNUS — have been carried out by various investigators, yet the possibility of keeping the gut alive for so long a period seems to be unknown. Further researches show, however, that the automatic movements of such pieces of gut are of much longer duration than one day and one night. The longest period, as yet observed by me, runs to more than 3 *weeks*. As many as 21 days after the death of the individual the movements of the piece of gut could be observed. This time probably exceeds everything hitherto observed in this respect on mammalian organs working automatically.

We may compare with this, for instance, how long after the death of the individual the heart can be made to contract. The heart is indeed the only automatic organ, as far as I know, on which experiments have been carried out in this direction. KULIABKO, for instance, discovered that when the heart of a rabbit, after being kept for 44 hours after death in an ice-chest, was perfused with LOCKE's solution, contractions again manifested themselves. The heart



sometimes beat for several hours at a stretch; certain parts of the heart are even said to beat on the 3<sup>d</sup>, the 5<sup>th</sup>, and the 7<sup>th</sup> day after death. It is a well-known fact that, when at the obduction air can penetrate into the cavity of the chest, this may give rise to spontaneous contractions of the right atrium — the *ultimum moriens Halleri* or rather *Galenii*. VULPIAN states that he has observed these contractions in the dog for 93½ hours after death. ROUSSEAU maintains that he has seen these movements in an executed woman, 29 hours after death.

The human heart has also been made to contract independently after death. These attempts have never succeeded with adults when the individuals had been dead for more than 11 hours. (H. E. HERING).

This could be done with the heart of a child 20 hours after death and in the case of a monkey as many as 53 hours after death. (KULIABKO, HERING).<sup>1)</sup>

Recently CARREL and INGEBRIGTSEN have stated that some tissues can be kept alive for a long time after the death of the individual; the tissues could even become differentiated under these circumstances. These experiments, however, have been taken partly with very small pieces of hardly differentiated tissues: this applies for instance to the muscle-cells of the embryonic chicken heart, contracting 104 days after the death of the animal. (CARREL). And partly they relate to parts of organs (bone and skin) where it is not so easy to determine whether the cells are living still. To ascertain this the "surviving" tissues must be transplanted on another animal. It must be taken into account, however, that these tissues may have permanently lost their independence. Only with the assistance of the normal tissues of the animal on which they were transplanted, they had regained life.

With regard to the following experiments on the movements of isolated intestines, the investigations of MAGNUS have shown that automatic movements are only met with, when besides the muscle-cell the nervous system of *Auerbach's* plexus has retained its activity. The phenomenon is, therefore, of a complex nature.

Intestines can be kept alive longer than usual ( $\pm$  12 hours) only when the periods of activity are alternated with long periods of rest. This can easily be done, as we know, by lowering the temperature. At body-temperature the isolated gut works itself, *sit venia verbo*, to death, within from 10 to 14 hours.

---

<sup>1)</sup> See the Summaries by O. LANGENDORF in *Ergebnisse der Physiologie* 1903 and 1905.

For various reasons the intestines of smaller animals, mouse, cavia, rabbit, were chiefly experimented upon. The method followed here keeps the intestines longer alive in proportion as they are thinner. In reality this method is a very primitive one. In the intestinal wall there is no longer any circulation and the metabolism is therefore restricted to the diffusion through the whole thickness of the wall. Hitherto I have not succeeded in keeping the gut alive in *tyrode-solution*, a medium particularly fitted for intestine-experiments, for a longer period than 5 days. Pieces of intestine which no longer moved in the solution in which they had been placed immediately after the extirpation, began to move again when the solution was refreshed. This can easily be explained.

The experiments carried out by collaborators of MAGNUS, WEINLAND and NEUKIRCH have taught that when the intestine is placed in a liquid medium, substances are formed which stimulate the intestine. That an accumulation of these stimulating substances, besides the usual decomposition products, and more especially besides the bacterial decomposition products, unavoidable in intestine-experiments, should impair the activity of the intestine in the long run can easily be understood.

If the temperature of the pieces is kept particularly low ( $\pm 3^\circ$ ), then the intestine keeps alive much longer than if the temperature remains but little under the limit at which activity still manifests itself. Pieces of cavia gut in tyrode-solution at  $15^\circ$  were already dead on the 3<sup>rd</sup> or 4<sup>th</sup> day.

If the temperature of the tyrode-solution was  $\pm 3^\circ$ , the gut died only on the 5<sup>th</sup> day.

To keep the gut alive for a longer period a medium is required resembling more than tyrode-solution the normal body-fluids. For this purpose I took *horse-serum*<sup>1)</sup>, the serum of the small animals experimented upon not being obtainable in sufficient quantities.

Since oxygen must bubble through the fluid in which the gut has been placed, a great quantity of froth is formed if serum is taken instead of tyrode-solution. This can be avoided, however, by pouring a thin layer of olive-oil on the serum. It might be assumed as probable that serum would prove a better medium than a salt-solution on the strength of the many experiences obtained with the surviving heart. (WHITE, HOWELL, GREEN, WALDEN, with hearts of warmblooded animals. GUTHRIE and PIKE with hearts of mammals.<sup>1)</sup>)

<sup>1)</sup> Horse-serum can be obtained by the method, described by HAMBURGER and often applied in his laboratory. I take this opportunity of again thanking my colleagues DE HAAN and OUWELEEN for the readiness with which they always provided me with horse serum.

It is true, cases have been mentioned where a frog's heart, which beat no longer in sheep serum and could no longer be stimulated mechanically, was made to contract again by RINGER's solution (WALDEN). Yet the possibility is not excluded that in these cases the strange serum has gradually had a poisonous effect. Therefore I shall also leave it an open question if the time during which the gut keeps alive would not be longer still if, instead of horse-serum, serum of the same animal, if possible of the same individual, were used.

The experiments of INGEBRIGTSEN with tissue-cultures in auto-, homo- and hetero-geneous sera have demonstrated the relative superiority of autogeneous serum to serum of other individuals of the same kind, and of these two sera to heterogeneous ones. INGEBRIGTSEN has not used horse-serum; this seems to be a particularly indifferent medium. Numerous experiments have shown that this serum is a much better medium for the gut than tyrode-solution. The gut of a cavia, for instance, kept in tyrode-solution, was dead after 5 days; when kept in horse-serum another piece of the same gut still moved after 21 days.

The experiments were carried out in the following manner.

The animal, a cavia for instance, is killed by decapitation.

$\pm 20$  c.m. behind the stomach a piece of the small intestine, long  $\pm 40$  c.m. is cut out and divided in Tyrode-solution into 8 pieces long 4—6 c.m., called *a—h*. 4 of these (*a, b, e, f*.) were placed in Tyrode-solution, 4 others (*c, d, g, h*) in horse-serum.

Oxygen is led through the 8 glasses. The pieces *a, e, c, g*, are connected with a writing apparatus to a cymographion (method of MAGNUS)

To *c* and *g* olive-oil is added. The movements of these 4 pieces having been registered at  $\pm 37^\circ$ , they are slowly cooled down. Then the current of oxygen is stopped. The glasses *a, e*, and the reserve-experiments *b, f*, remain at room-temperature ( $\pm 15^\circ$ ), the glasses *c, g* and the reserve-experiments *d, h* are exposed to a temperature of  $\pm 3^\circ$ . The pieces  $aT_{15}$ ,  $eT_2$   $cT_{15}$  and  $gT_2$  remain connected with the writing apparatus or are removed with it.

On the third day after the death of the cavia the pieces *a, e, c*, and *g* are connected with the cymographion whilst oxygen is led through, and are slowly heated to  $40^\circ$ . All the pieces move, but not so much as the first time except  $gS_2$ , the movements of which have become greater. The fluid in all 8 glasses is refreshed after being cooled down and saturated with oxygen as on the first day. On the sixth day all are heated etc. just as on the third day. Piece  $aT_{15}$  moves no longer now, not even after the Tyrode solution has been refreshed. The reserve-piece  $bT_{15}$  does not move either: therefore in Tyrode solution at  $\pm 15^\circ$  the gut dies before the 4th day. The three other pieces  $eT_3$ ,  $cS_{15}$ , and  $gS_3$  still move, the first two less again than last time. On the 6th day everything is heated again etc. Piece  $cT_3$  moves no longer, not even after the Tyrode-solution has been refreshed. Nor does the reserve-piece  $dT_3$  move: hence in Tyrode-solution at  $\pm 3^\circ$

*the gut dies before the 6th day.* Piece  $cS_{15}$  does not move either. On the other hand the reserve-piece  $dS_{15}$  is still in motion. Movements of  $gS_3$  are still greater and have the same frequency as before. The three fluids are renewed etc. On the 8th day only  $eS_3$  moves distinctly: *hence in horse-serum at  $\pm 3^\circ$  death before the 8th day*

On the 10, 13, 15, 17, 20, 22nd day  $gS_3$  moves distinctly, but the movements have become smaller. On the 25th day no movements. The reserve-piece  $hS_3$  got fresh serum for the last time on the 22nd day and is for the first time connected with the cymographion on the 27th day. It does not move; only its tension decreases when heated. *Hence in horse-serum at  $3^\circ$  the intestine dies after the 22nd and before the 25th day.*

*Human gut* can also be kept alive for a comparatively long time <sup>1)</sup>. A piece of colon, obtained after an operation, moved still after 36 hours. And an appendix, kept in horse-serum, described no straight line on the cymographion after as many as 6 days. There were slight but distinct contractions, which ceased when the intestine was cooled down to  $25^\circ$ . Finally I may mention that a human *vas deferens* was still alive in tyrode-solution after 30 hours.

#### *Summary.*

Isolated pieces of mammalian gut can be kept alive during a long time, much longer than the periods found hitherto for other automatic mammalian organs. For this purpose the medium in which the gut has been placed must occasionally be refreshed whilst it is of great importance that the temperature of the solutions should be low.

In Tyrode-solution of  $15^\circ$  the gut dies after 3 days, at  $3^\circ$  after  $\pm 5$  days, in *horse-serum* at  $15^\circ$  after  $\pm 7$  days, at  $3^\circ$  after more than 21 days.

Also pieces of human intestines still showed signs of life after they had lain for 6 days in horse-serum at  $\pm 14^\circ$ .

Groningen, April 1914.

*Physiological Laboratory.*

<sup>1)</sup> I am indebted to Prof. Koch for his kindness of providing me with pieces of human gut.

**Physics.** — “*Isothermals of monatomic substances and their binary mixtures. XVI. New determination of the vapour-pressures of solid argon down to  $-205^{\circ}$ .*” Comm. N<sup>o</sup>. 140a from the Physical Laboratory at Leiden. By C. A. CROMMELIN. (Communicated by Prof. H. KAMERLINGH ONNES).

(Communicated in the meeting of March 28, 1914).

The vapour-pressures of solid argon, which are communicated below, form an extension of and have partly to replace those published on a former occasion.<sup>1)</sup>

The measurements were made in the usual vapour-pressure apparatus for low temperatures.<sup>2)</sup>

The manometer on which the pressures were read was constructed after the model used by G. HOLST for his measurements on ammonia and methyl-chloride to be published shortly: this form of manometer gives perfect security against leakage.

The method of conducting the measurements gives no occasion for special remarks: we refer the reader to the previous paper. It may be mentioned however, that the temperatures were measured with a gold-resistance thermometer, as below  $-200^{\circ}$  gold is preferable to platinum. This thermometer was very carefully compared with the standard-platinum-thermometer  $Pt_{1}$ .

I am indebted to Mr. P. G. CATH assistant in the physical Laboratory for the measurement and calculation of the temperatures and for the comparison of the two resistance-thermometers referred to.

Table I contains the results of the observations and the deviations from the RANKINE-BOSE-formula:

$$\log p_{\text{coex}} = a_{\text{RB}} + b_{\text{RB}} T^{-1} + c_{\text{RB}} T^{-2} + d_{\text{RB}} T^{-3},$$

with the following values for the coefficients

$$\begin{aligned} a_{\text{RB}} &= + 6.6421 & c_{\text{RB}} &= - 0.67743 \times 10^4 \\ b_{\text{RB}} &= - 3.7181 \times 10^3 & d_{\text{RB}} &= + 0.28034 \times 10^6 \end{aligned}$$

<sup>1)</sup> C. A. CROMMELIN, Comm. Leiden. N<sup>o</sup>. 138c. The measurements were repeated because shortly after the publication doubt arose as to the accuracy of the determinations at the lowest temperatures (see note on p. 23 of Comm. N<sup>o</sup>. 138c). The new measurements showed this doubt to be justified, the observation at  $-206^{\circ}.04$  being found altogether wrong and the one at  $-179^{\circ}.62$  not very accurate. The remaining observations of Comm. N<sup>o</sup>. 138c correspond well to those published here. The probable cause of the errors must be air having leaked into the argon at the low pressures: but I cannot explain how it is that this was not noticed during the measurements.

<sup>2)</sup> H. KAMERLINGH ONNES and C. BRAAK, Comm. N<sup>o</sup>. 107a.

TABLE I. *Vapour-pressures of solid argon.*

Date 1913	No.	$\theta$ (Celsius in Kelvin- degrees)	$p_{\text{coex}}$ in atm. int.	$p_{\text{coex}}$ in cms. mercury.	Percentage deviations from	
					RANKINE-BOSE formula.	NERNST formula.
26 Nov.	XXIII	-189.64	0.6554	49.78	+0.20	+1.33
	XXIV	191.31	0.5175	39.30	-0.19	-0.11
	XXVI	195.60	0.2749	20.88	+0.35	-1.33
	XXVII	197.25	0.2153	16.35	+2.16	+0.15
28 Nov.	XXVIII	200.97	0.1113	8.456	-0.94	-2.27
	XXIX	202.21	0.08931	6.783	-0.89	-1.49
	XXX	203.78	0.06740	5.119	-0.04	+0.59
	XXXI	205.32	0.05043	3.830	+0.36	+2.79

and from NERNST's formula (treated simply as an empirical formula)

$$\log p_{\text{coex.}} = \frac{A}{T} + BT + D \log T + C$$

with the coefficients

$$\begin{aligned} A &= -567.49 & C &= +20.851 \\ B &= +0.010899 & D &= -6.9057. \end{aligned}$$

The values of the coefficients in both formulae hold for  $p$  in cms. mercury.

The comparison with the formula which SACKUR has deduced from NERNST's heat-theorem

$$\log p = -\frac{\lambda}{2.3 RT} + \frac{c_p}{R} \log T - \frac{1}{2.3 R} \int_0^T \frac{c}{T} dT + C + \frac{c_p}{2.3 R}$$

is given in table II.

For details as to the manner in which the various values have been calculated the reader is referred to the previous paper. It will be seen that the agreement is satisfactory at the higher temperatures while at the lower temperatures the deviations become very large.

Finally I have calculated the heat of sublimation of solid argon from the simplified CLAPEYRON-CLAUSIUS-formula

$$\lambda_{\text{sol.-vap.}} = \frac{RT^2}{p} \left( \frac{dp}{dT} \right)_{\text{coex.}}$$

TABLE II.

$\theta$	$p(W)$	$p(R)$
-189.64	0.655	0.618
191.31	0.518	0.507
195.60	0.275	0.286
197.25	0.215	0.226
200.97	0.111	0.141
202.21	0.089	0.124
203.78	0.067	0.107
205.32	0.050	0.094

Calculating  $\left(\frac{dp}{dT}\right)_{\text{coex.}}$  from the above RANKINE-BOSE-formula the following values are found for the heat of sublimation expressed in calories per gramme of substance at the various observation temperatures

TABLE III.

*Calculated heat of  
sublimation of argon.*

$\theta$	$\lambda_{\text{sol.}-\text{vap.}}$
-189.64	47.36
191.31	47.16
195.60	46.58
197.25	46.31
200.97	45.59
202.21	45.32
203.78	44.93
205.32	44.51

In concluding I am glad to express my hearty thanks to Professor H. KAMERLINGH ONNES for his continued interest in my work.

**Physics.** *Further experiments with liquid helium. J. The imitation of an AMPÈRE molecular current or a permanent magnet by means of a supra-conductor. (Cont.).* By Prof. H. KAMERLINGH ONNES. Communication N<sup>o</sup>. 140c from the Physical Laboratory at Leiden.

(Communicated in the meeting of May 30, 1914).

§ 5. *The main experiment repeated.* Although the original experiments on the persistence of a current which is started in a closed supra-conductor have established the fact that the diminution of the current with the time is very small (at least if it is assumed that in the phenomena hitherto unknown magnetic properties do not play an important part), still for the magnitude of the change only an upper limit could be fixed. As no change of the current was observed, this upper limit was determined by the uncertainty in the measurement of the current. The only fact established so far was that, if the change had been greater than 10 %<sub>0</sub>, it would have been observed.

In repeating the experiment it was attempted to determine the change itself or otherwise to reduce its upper limit, in so far as the conditions under which the experiment had to be made allowed this. The same supra-conducting lead-coil was used. As before the current was produced in the closed conductor by induction in order that the circuit might be kept free from connections other than of lead fused together<sup>1)</sup>. The current was again measured by compensating the action of the coil on a compass-needle by means of a current in a subsidiary coil. The arrangement was however improved by this coil (of insulated copper wire) being placed in a small vessel with liquid air in a fixed position with respect to the needle. When the compensation was obtained, the experimental coil was turned 180° about a vertical axis and again compensated with the current in the second coil reversed, the magnetic moment of the experimental coil being deduced from the mean of the two observations.

If the diminution of the current can actually be calculated from the residual micro-resistance given in Comm. No. 133, viz.

$$\frac{r_{1^{\circ}.8 \text{ K.}}}{r_{2^{\circ}.6^{\circ} \text{ K.}}} = 0.5 \times 10^{-10}, \text{ or with } r_{290^{\circ} \text{ K.}} = 734 \Omega^2; r_{1^{\circ}.8 \text{ K.}} = 37, \text{ the time}$$

<sup>1)</sup> An attempt is at present being made to manufacture a supra-conducting current-key.

<sup>2)</sup> This value given already in Comm. N<sup>o</sup> 140b is a more accurate value than the one given in Comm. N<sup>o</sup>. 133.



of relaxation, with  $L = 10^7$ , would come to about 270000 seconds or 75 hours. In that case the current would fall by  $4\%$  in three hours. It was hoped that it would be possible with the improved arrangement to establish a diminution of that amount.

The experiment was made with a field of 189 gauss at a temperature of  $1.07$  K. The current amounted to about 0.4 amp. (as before no account was taken of the possibility of magnetisation or of induced circulating currents inside the supraconducting material) and during about  $2\frac{1}{2}$  hours no diminution of the current was observed; it was then necessary to admit a fresh supply of helium into the cryostat: during this operation the temperature rose temporarily to  $4.25$  K. During the next hour the current was found to undergo a gradual diminution and to approach asymptotically a new value of about 0.36 amp. which did not show any further change for  $1\frac{1}{2}$  hours. The observations during the two periods mentioned render it probable, that the change does not attain the value of  $4\%$  in 3 hours as calculated above.

It was considered possible, that the changes of shape of the helium-liquefier and the cryostat during the process of condensation and transfer of the liquid helium, as well as a possible change of zero of the compass-needle which after the magnet has been removed is still near various iron parts of the apparatus, might have had an influence on the values of the current as measured at different moments. Judging by the correspondence of the various readings the accuracy was smaller than had been expected. In again repeating the experiment therefore two compensating coils were used by which compensations on the east and on the west could be effected. They were mounted each in a small vessel with liquid air on a fork-shaped stand and could be rotated about vertical axes in such a manner that the distance of the axes could not change. The same needle served for the compensation on both sides. Guiding pins guaranteed the same position each time of the needle relatively to the compensating coil which was being used. The common support of the two coils was moveable parallel to itself in a horizontal direction on a slide and by means of marks it was possible to place it each time in the same direction and the same position relatively to the vertical axis of the experimental coil. The axes of the three coils were provided with horizontal divided circles moving along fixed pointers. Each measurement consisted of 8 readings in the obvious combinations of 4 positions both with compensation on the left and on the right.

In the experiment with this improved method of reading care was

also taken, that the current did not rise above the value at which no further change had been observed at  $4^{\circ}.25$  K. The current was therefore raised to only 0.22 amp. (approximate value calculated as before from the observed magnetic moment of the coil), so that the supply of a fresh quantity of helium would probably not have the disturbing effect which had been noticed in the previous experiment. The temperature used was  $2^{\circ}$  K. In the beginning again a fall of current was noticed which must however be considered as uncertain, inter alia owing to the possibility of the changes of shape of the apparatus and the change of zero of the needle not having been sufficiently eliminated yet in these observations. In the three hours subsequent to the initial period no further diminution was observed, the last observation even giving a small increase. Still in this experiment the accuracy could not be considered greater than about  $2\%$  of the measured moment and, as it was found impossible to continue the experiment, beyond three hours, again only an upper limit for the change could be established, to be put at about  $\frac{2}{3}\%$  for current and induced magnetisation combined. Taking all the experiments together it may be considered as probable, that the change of the current is less than  $1\%$  per hour which raises the time of relaxation to above 4 days.

§ 6. *Upper limit of the residual micro-resistance according to these experiments.* So far no contradiction has arisen in reasoning on the assumption of the existence of a residual micro-resistance which below the threshold-value of the current again obeys OHM's law. On this view the upper limit of this micro-resistance for lead, which in Comm. N<sup>o</sup>. 133 was placed at  $0.5 \cdot 10^{-10}$  of the ordinary resistance at  $0^{\circ}$ , can now on the basis of the above observations be moved further back to about  $0.3 \cdot 10^{-10}$  or  $0.2 \cdot 10^{-10}$  of the resistance at the ordinary temperature.

§ 7. *Some of the control-experiments repeated.* In the previous paper a few other experiments beside the main experiment were described: some of these have now also been repeated.

Again we did not succeed in conducting the experiment in which the windings are placed parallel to the field, the coil cooled below the vanishing-point while in the field and then the field removed in such a manner, that the compass-needle, when brought near the cryostat after removal of the electro-magnet, did not show any deflection. After the action of a field of 400 gauss at  $4^{\circ}.25$  K. a current of 0.1 amp. was found in the coil. This would give 0.045

amp. with a field of 189 gauss, the same as used with the other experiments, whereas the main experiment at the same temperature and inducing field had given 0.4 amp.

More satisfactory was the experiment in which first a current is produced in the coil — analogous to the currents in resistance-free paths as imagined by WEBER for the explanation of diamagnetism — and then destroyed by the removal of the field: an almost complete compensation was obtained in this case. The experiment was made with a field of 189 gauss. This result is of special importance as it practically disposes of the supposition mentioned in the previous paper as possible, although very improbable, that magnetic properties of the material of the coil might play an important part in the phenomena.

The current in the coil changes with any new magnetic field applied and with any further change in it, or with any change of position relatively to the field. In this respect the influence of the earth-field may be noted. The current in the coil, when placed with its windings at right angles to the meridian, will assume a slightly smaller value in the one position North-South and a somewhat larger value in the opposite position South-North than in the position East-West, which is practically the position in which the experiments were made. In our experiments this action was however too small to be taken into account considering the accuracy which could be attained at the most.

It may be observed that our conductor carrying its current in the absence of an electromotive force, when undergoing the relatively small action of the field of the earth, is analogous to the AMPÈRE molecular currents (in the form of circulating electrons) which play a part in LANGEVIN'S theory of magnetism, when they experience a diamagnetic action on being brought into a field, in accordance with LORENTZ'S theory of the ZEEMAN-effect.

#### § 8. *The experiments repeated with the circuit open.*

So far it has been constantly assumed, that the magnetic properties of the material of the coil play but a secondary part in the phenomena observed, when the experiments were arranged so as to produce a permanent current. This view was based firstly on the difference in the results with the windings parallel and perpendicular to the field during the cooling in the field and secondly on the compensation found on applying and removing the field after the conductor had already been cooled to helium-temperature. Furthermore that the part of the effect which is independent of the circu-

lating current must be ascribed to the lead itself, was to be inferred from the fact, that the current is quenched, as soon as the temperature of the coil rises somewhat above the boiling point of helium and passes the point which, as being the vanishing point for lead, has a special physical meaning for this substance.

In order to obtain further information as to the part of the phenomenon which depends upon the material itself, the experiments were repeated after the lead-wire connecting the ends of the coil had been cut, so that the circuit was no longer closed (apart from possible short-circuits in the coil).

This time the experiments with the exception of one could only be performed at  $4.25^\circ$  K: still there does not seem to be any objection to applying the results for the explanation of the irregularities which had been left unexplained in the main experiments, although these had been mostly carried out at a lower temperature.

In all the experiments a certain residual effect remained, which was reduced to about one tenth when the windings were parallel instead of at right angles to the field and in the latter case was fairly well independent of the field. The amount of this effect corresponded to a moment which was equivalent to a current of 0,05 or 0,06 amp. in the closed circuit. In one of the experiments, the only one in which the temperature was lower than  $4.25^\circ$  K., viz. about  $3^\circ$  K., the moment was estimated to be equivalent to as much as 0,07 amp. The effect with the circuit open is thus very much smaller than in the main experiments. The share born in the effect by the frame of the coil and the lead independently of closing the circuit may therefore be put at less than  $\frac{1}{4}$  of the total effect in the main experiment.

As a check on former experiments the following additional experiments were made with the coil with the lead wire cut.

In the first place at the ordinary temperature after joining up to a ballistic galvanometer the induction was measured arising from putting on or taking off the field with the windings in the position in which they were supposed in the previous experiments to be parallel to the field. The induction was found to be  $\frac{1}{20}$  of the effect in the position at right angles to the field. This observation may contribute to the explanation of the residual effect observed in the experiments in helium in the position with the windings parallel to the field.

In the second place a known current was sent through the coil and its strength measured by the same method as used in determining the moment of the experimental coil in the experiments with the

lead circuit closed. Although the matter requires further elucidation, it would seem to follow from this measurement, that a few of the layers of the coil are short-circuited. After opening the circuit a residual moment remained in the coil as before which was destroyed on raising the temperature slightly above that of the helium-bath.

**Physics.** — “*Further experiments with liquid helium. K. Appearance of beginning paramagnetic saturation.*” By Prof. H. KAMERLINGH ONNES. Communication N<sup>o</sup>. 140*d* from the Physical Laboratory at Leyden.

(Communicated in the meeting of May 30, 1914).

The question, whether paramagnetic substances would show a saturation-effect at high field-strengths, has always been considered a very important one. Although it could hardly be assumed, that the susceptibility would remain independent of the field at higher strengths than were attainable, still so far at the highest fields available it appeared to be the case. LANGEVIN'S theory brought the explanation, why so far all attempts to find paramagnetic saturation-effects had remained unsuccessful. According to this theory the magnetisation appears to be determined by the expression  $\alpha = \frac{\sigma_m H}{RT}$ , where  $\sigma_m$  is the magnetic moment of the molecules per gramme-molecule,  $R$  the gas-constant,  $T$  the absolute temperature and  $H$  the field. As long as  $\alpha$  remains below 0,75, the changes of the susceptibility with the field escape the ordinary method of observation and at the ordinary temperature even a substance as strongly paramagnetic as oxygen gives for  $\alpha$  with a field of 100000 not more than about 0,05. As I pointed out at the 2<sup>nd</sup> International Congress of Refrigeration at Vienna (1910) this theory shows that lowering the temperature is the means by which the observation of paramagnetic saturation might be attained and that helium-temperatures are the most suitable for the purpose. In fact as the absolute temperatures to which one may descend by means of helium are 70 and even 150 times lower than the normal temperature, the result will be equivalent to raising the magnetic field at which the observation is made 70 or 150 fold.

I have lately at last been able<sup>1)</sup> to fulfil my desire to attack by

<sup>1)</sup> Viz. by the acquisition a short time ago of an electromagnet (built according to WEISS'S principle and utilising his friendly advice) the inter Ferrum of which leaves sufficient room at fields of 20000 for experiments with liquid helium.

this method the problem of paramagnetic saturation which is also fundamental to WEISS's theory of ferromagnetism. In the first place it was necessary to have a substance which might be expected to obey CURIE's law, which also follows from LANGEVIN's theory, down to helium-temperatures; in the second place the substance must have a high value of  $\sigma_m$ . Both properties I hoped to find combined in crystallized gadolinium-sulphate, a quantity of which Professor URBAIN some time ago had very kindly put at my disposal.

Earlier investigations in conjunction with PERRIER and OOSTERHUIS had shown, that gadolinium-sulphate follows CURIE's law down to the freezing point of hydrogen and does not show any sign of saturation, which as LANGEVIN's theory shows, if it existed at that temperature, would be ferromagnetic in its nature, as paramagnetic saturation at the value of  $a$  which could be reached would not yet be clearly observable. The number of magnetons calculated according to WEISS is large (38). That gadolinium-sulphate would still obey CURIE's law at helium-temperatures I felt justified to infer from the fact, that it is a "diluted" paramagnetic substance. The gadolinium-atoms, separated as they are e.g. by the water of crystallisation, are at great distances from each other, and this Dr. OOSTERHUIS and I in Comm. N<sup>o</sup>. 139e found a favourable circumstance to CURIE's law being valid down to very low temperatures.

The experiments have given a confirmation of LANGEVIN's theory which is at least qualitatively even now complete. Before an opinion can be formed as to the quantitative agreement various corrections will first have to be investigated. The most important of these which must not be neglected, especially when the validity of CURIE's law is to be tested, is the demagnetising action of the paramagnetisation itself, as the latter attains exceptionally high values. As an instance I may mention that with 0,345 gram of gadolinium-sulphate at 2° K. in a field of 15 kilogauss there was observed an attraction amounting to over 100 grammes. Another circumstance that one should keep in mind is that the object of observation consists of small crystals packed on each other.

The measurements consisted in determining the attraction in a non-homogeneous field, the gadolinium-sulphate in the cryostat being cooled first in liquid hydrogen under normal pressure, next in hydrogen under reduced pressure, next in helium boiling at ordinary pressure and finally in helium under 4 mms, the apparatus and the fields being the same each time.

The measurements at the boiling point of hydrogen (20.<sup>c</sup>3 K.) had the object to obtain the force at a given point for a given

strength of field for controlling the values derived from ballistic calibrations. I hope to return to the details of the measurements and the arrangement of the apparatus afterwards, when an accurate quantitative comparison of the results with LANGEVIN'S theory will have been made. It is as yet impossible to decide, in how far deviations are present which might be attributed to the existence of a small zero-point energy which would manifest itself in the manner in which the saturation changes, as well as in a deviation from CURIE'S law at weak fields. It seems, however, that these deviations are not sufficiently large to disturb the general aspect.

On this occasion I wish to confine myself to communicating the general aspect of the results as laid down in the adjoining graphic representation on which the experimental numbers may also be read with sufficient accuracy. The curves represent the observed attractive force as a function of the square of the field on the axis between the poles. This field was read as a function of the current from a calibration curve.

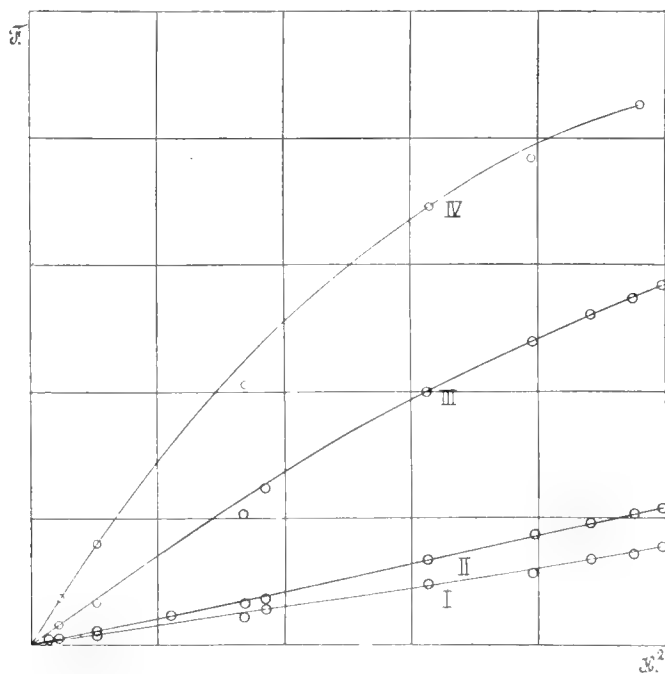

Curve I refers to 20.3 K, curve II to 14.27 K, III to 4.25 K, and IV to 1.9 K. Each division along the horizontal axis corresponds to about 90 kilogauss, along the vertical axis to 25 grammes. The ratio of the force to the square of the field on the axis of the poles per unit of susceptibility was about  $10^{-4}$ , neglecting small changes in the topology of the field.

If the susceptibility does not depend on the field and its topography remains the same, the curves are straight lines. The small deviations from the straight line at 20.°3 K are probably chiefly due to errors in the topography of the field, seeing that according to earlier more accurate determinations we had to await within the limits of the experiments a susceptibility independent of the field and therefore in this graph a straight line. By means of the deviations from the straight line at 20.°3 K the curves for the other temperatures have been provisionally corrected. It will be seen that for a given field these curves are the more strongly curved the lower the temperature to which one descends, in accordance with LANGÉVIN'S theory. Within the limits of accuracy to be expected in connection with the neglect of the various corrections referred to above the tangents of the angles of elevation of the tangents to the curves at the origin appear to be inversely proportional to the temperature as required by CURIE'S law and the deviations of the curves from the tangents as expressed by the ratio between the ordinates of both for a given abscissa are strikingly similar to the deviations of LANGÉVIN'S curve for the magnetisation as a function of the field expressed in the same manner. The nature of paramagnetic magnetisation is very clearly revealed in these measurements at helium-temperatures.

**Mathematics.** — “*On some integral equations.*” By W. KAPTEYN.

1. In a memoir “*Recherches sur les fonctions cylindriques*” (Mém. Soc. Roy. Sc. Liège 3<sup>ème</sup> Série t. VI 1905) we gave the solution of the integral equation

$$f(x) = \int_0^x q(\beta) I_0(x-\beta) d\beta . . . . . (1)$$

in this form

$$q(x) = \frac{df}{dx} + \int_0^x f(\beta) \frac{I_1(x-\beta)}{x-\beta} dx . . . . . (2)$$

where the functions  $I_k$  represent BESSEL'S functions of order  $k$ .

This solution rests upon the relation

$$\int_0^x I_k(\beta) \frac{I_n(x-\beta)}{x-\beta} d\beta = \frac{I_{n+k}(x)}{n} \begin{pmatrix} n = 1 & 2 & 3 & \dots \\ k = 0 & 1 & 2 & \dots \end{pmatrix} . . . (3)$$

from which the following theorem may be deduced.



If

$$F(x) = c_0 I_0(x) + c_1 I_1(x) + c_2 I_2(x) + \dots \dots \dots (4)$$

then

$$\int_0^x F(\beta) \frac{I_n(x-\beta)}{x-\beta} d\beta = c_0 I_n(x) + c_1 I_{n+1}(x) + \dots \dots \dots (5)$$

The object of the present paper is to show that more general integral equations may be solved in the same manner.

2. Let

$$f(x) = \int_0^x g(\beta) I_p(x-\beta) d\beta \dots \dots \dots (6)$$

where  $p$  represents an integer, and let

$$f(x) = c_{p+1} I_{p+1}(x) + c_{p+2} I_{p+2}(x) + \dots \dots \dots$$

$$g(\beta) = b_0 I_0(\beta) + b_1 I_1(\beta) + b_2 I_2(\beta) + \dots \dots \dots$$

then

$$\sum_{p+1}^{\infty} c_n I_n(x) = \sum_0^{\infty} b_n \int_0^x I_n(\beta) I_p(x-\beta) d\beta \dots \dots \dots (7)$$

Therefore the integral equation (6) will be solved if we can determine the coefficients  $b$  in function of the coefficients  $c$ .

We shall first show that

$$u = \int_0^x I_n(\beta) I_p(x-\beta) d\beta$$

can be expressed in a series of BESSEL'S functions.

By differentiating we get

$$\frac{du}{dx} = \int_0^x I_n(\beta) \frac{dI_p(x-\beta)}{dx} d\beta$$

$$\frac{d^2u}{dx^2} = \int_0^x I_n(\beta) \frac{d^2I_p(x-\beta)}{d\beta^2} d\beta.$$

Now

$$\frac{d^2 I_p(x-\beta)}{dx^2} + \frac{1}{x-\beta} \frac{dI_p(x-\beta)}{dx} + \left\{ 1 - \frac{p^2}{(x-\beta)^2} \right\} I_p(x-\beta) = 0$$

or

$$\frac{d^2 I_p(x-\beta)}{dx^2} + I_p(x-\beta) = \frac{p^2}{(x-\beta)^2} I_p(x-\beta) - \frac{1}{x-\beta} \frac{dI_p(x-\beta)}{dx}$$

where the second member may be reduced by means of the relations

$$\frac{p}{x-\beta} I_p(x-\beta) = \frac{1}{2} [I_{p+1}(x-\beta) + I_{p+1}(x-\beta)]$$

$$\frac{d}{dx} I_p(x-\beta) = \frac{1}{2} [I_{p-1}(x-\beta) - I_{p+1}(x-\beta)].$$

Therefore

$$\frac{d^2 I_p(x-\beta)}{dx^2} + I_p(x-\beta) = \frac{p-1}{2} \frac{I_{p-1}(x-\beta)}{x-\beta} + \frac{p+1}{2} \frac{I_{p+1}(x-\beta)}{x-\beta}$$

and

$$\frac{d^2 u}{dx^2} + u = \frac{p-1}{2} \int_0^x I_n(\beta) \frac{I_{p-1}(x-\beta)}{x-\beta} d\beta + \frac{p+1}{2} \int_0^x I_n(\beta) \frac{I_{p+1}(x-\beta)}{x-\beta} d\beta$$

or, according to (3)

$$\frac{d^2 u}{dx^2} + u = \frac{1}{2} [I_{n+p-1}(x) + I_{n+p+1}(x)]$$

$$\frac{d^2 u}{dx^2} + u = (n+p) \frac{I_{n+p}(x)}{x}.$$

This differential equation holds also if  $p = 0$ .

Now the general integral of this equation

$$u = A \sin x + B \cos x + (n+p) \int_0^x \sin(x-\beta) \frac{I_{n+p}(\beta)}{\beta} d\beta$$

gives the required value of  $u$ , when the constants  $A$  and  $B$  are determined by the conditions

$$\begin{aligned} x=0 & \quad u=0 & \quad \frac{du}{dx} &= 0 \\ x=0 & \quad u=0 & \quad \frac{du}{dx} &= 1 \quad (n=p=0). \end{aligned}$$

Thus we obtain generally

$$u = (n+p) \int_0^x \sin(x-\beta) \frac{I_{n+p}(\beta)}{\beta} d\beta$$

and when  $n = p = 0$

$$u = \sin x.$$

Introducing now the known expansions

$$\sin(x-\beta) = 2 [I_1(x-\beta) - I_3(x-\beta) + I_5(x-\beta) - \dots]$$

and

$$\sin x = 2 [I_1(x) - I_3(x) + I_5(x) \dots]$$

we have according to (3)

$$u = 2 [I_{n+\rho+1}(x) - I_{n+\rho+3}(x) + I_{n+\rho+5}(x) - \dots]$$

thus in all cases

$$\int_0^x I_n(\beta) I_\rho(x-\beta) d\beta = 2 [I_{n+\rho+1}(x) - I_{n+\rho+3}(x) + I_{n+\rho+5}(x) - \dots] \quad (8)$$

Applying this result, the equation (7) takes the form

$$\sum_{\rho+1}^{\infty} c_n I_n(x) = 2 \sum_{n=0}^{\infty} b_n [I_{n+\rho+1}(x) - I_{n+\rho+3}(x) + \dots]$$

and comparing the two members we have

$$\begin{aligned} c_{\rho+1} &= 2b_0 \\ c_{\rho+2} &= 2b_1 \\ c_{\rho+3} &= -2b_0 + 2b_2 \\ c_{\rho+4} &= -2b_1 + 2b_3 \\ &\text{etc.} \end{aligned}$$

thus

$$b_0 = \frac{c_{\rho+1}}{2}, \quad b_1 = \frac{c_{\rho+2}}{2}, \quad b_2 = \frac{c_{\rho+1} + c_{\rho+3}}{2}, \quad b_3 = \frac{c_{\rho+2} + c_{\rho+4}}{2}, \dots$$

and

$$g(\beta) = \frac{c_{\rho+1}}{2} I_0(\beta) + \frac{c_{\rho+2}}{2} I_1(\beta) + \frac{c_{\rho+1} + c_{\rho+3}}{2} I_2(\beta) + \frac{c_{\rho+2} + c_{\rho+4}}{2} I_3(\beta) + \dots \quad (9)$$

The solution of the integral equation (1) in the form (2) may be easily deduced from this equation. For putting  $\rho = 0$ , we obtain

$$g(x) = \frac{c_1}{2} I_0(x) + \frac{c_2}{2} I_1(x) + \frac{c_1 + c_3}{2} I_2(x) + \frac{c_2 + c_4}{2} I_3(x) + \dots$$

In this case

$$f'(x) = c_1 I_1(x) + c_2 I_2(x) + c_3 I_3(x) + \dots$$

thus

$$\frac{df}{dx} = \frac{c_1}{2} I_0(x) + \frac{c_2}{2} I_1(x) + \frac{c_3 - c_1}{2} I_2(x) + \frac{c_4 - c_2}{2} I_3(x) + \dots$$

and

$$g(x) - \frac{df}{dx} = c_1 I_2(x) + c_2 I_3(x) + \dots$$

which, according to (5) may be written

$$g(x) - \frac{df}{dx} = \int_0^x f'(\beta) \frac{I_1(x-\beta)}{x-\beta} d\beta.$$

3. We shall next show that the solution (9) may be written in the same manner as the solution (2). It is however convenient to examine first the special cases  $\rho = 1, 2, 3$ .

I.  $p = 1$ .

Let 
$$f(x) = \int_0^x q(\beta) I_1(x - \beta) d\beta$$

then

$$f^{(2)}(x) = 2q(x) - \int_0^x q(\beta) [3I_1(x - \beta) - I_3(x - \beta)] d\beta.$$

Multiplying these equations respectively by 1 and 4, and adding we find

$$\begin{aligned} 2^2 f^{(2)}(x) + 4f(x) - 2q(x) &+ \int_0^x q(\beta) [I_1(x - \beta) + I_3(x - \beta)] d\beta \\ &= 2q(x) + 4 \int_0^x q(\beta) \frac{I_2(x - \beta)}{x - \beta} d\beta \end{aligned}$$

thus

$$2q(x) - [2^2 f^{(2)}(x)] - 4[f(x)] = -4 \int_0^x q(\beta) \frac{I_2(x - \beta)}{x - \beta} d\beta.$$

Now, according to (5)

$$2 \int_0^x q(x) \frac{I_2(x - \beta)}{x - \beta} d\beta = b_0 I_2 + b_1 I_3 + b_2 I_4 + \dots$$

or, with the values of  $b$  from (9)

$$\begin{aligned} &= \frac{1}{2} [c_2 I_2 + c_3 I_3 + c_4 I_4 + \dots] \\ &+ \frac{1}{2} [c_2 I_4 + c_3 I_6 + c_4 I_8 + \dots] \end{aligned}$$

which by means of (5) may be written

$$2 \int_0^x q(x) \frac{I_2(x - \beta)}{x - \beta} d\beta = \frac{1}{2} f(x) + \int_0^x f(\beta) \frac{I_2(x - \beta)}{x - \beta} d\beta.$$

Therefore the solution may be put in this form

$$2q(x) - [2^2 f^{(2)}(x)] - 3[f(x)] = -2 \int_0^x f(\beta) \frac{I_2(x - \beta)}{x - \beta} d\beta \quad (10)$$

II.  $p = 2$ .

Differentiating

$$f(x) = \int_0^x g(\beta) I_2(x-\beta) d\beta$$

we obtain

$$2f^{(1)}(x) = \int_0^x g(\beta) [I_1 - I_3] d\beta$$

$$2^3 f^{(3)}(x) = 2g(x) + \int_0^x g(\beta) [-4I_1 + 3I_3 - I_5] d\beta.$$

Thus

$$2^3 f^{(3)}(x) + 4[2f^{(1)}(x)] = 2g(x) - \int_0^x g(\beta) [I_3 + I_5] d\beta = 2g(x) - 8 \int_0^x g(\beta) \frac{I_4(x-\beta)}{x-\beta} d\beta.$$

where

$$\begin{aligned} & 4 \int_0^x g(\beta) \frac{I_4(x-\beta)}{x-\beta} d\beta = b_0 I_4 + b_1 I_5 + b_2 I_6 + \dots \\ & = \frac{1}{2} [c_3 I_4 + c_4 I_5 + c_5 I_6 + \dots] \\ & + \frac{1}{2} [c_3 I_6 + c_4 I_7 + c_5 I_8 + \dots] \\ & = \frac{1}{2} \int_0^x j(\beta) \frac{I_1(x-\beta)}{x-\beta} d\beta + \frac{3}{2} \int_0^x j(\beta) \frac{I_3(x-\beta)}{x-\beta} d\beta. \end{aligned}$$

This gives the solution

$$2g(x) - [2^3 f^{(3)}(x)] - 4[2f^{(1)}(x)] = \int_0^x j(\beta) \frac{I_1(x-\beta)}{x-\beta} d\beta + 3 \int_0^x j(\beta) \frac{I_3(x-\beta)}{x-\beta} d\beta \quad (11).$$

III.  $p = 3$ .

By differentiating

$$f(x) = \int_0^x g(\beta) I_2(x-\beta) d\beta$$

we obtain

$$2^2 f^{(2)}(x) = \int_0^x g(\beta) [I_1 - 2I_3 + I_5] d\beta$$

$$2^4 j^{(4)}(x) = 2g(x) + \int_0^x g(\beta) [-5I_1 + 6I_3 - 4I_5 + I_7] d\beta.$$

Multiplying these equations respectively by 4, 5, 1 and adding we get

$$\begin{aligned} [2^4 j^{(4)}(x)] + 5[2^2 j^{(2)}(x)] + 4[j(x)] &= 2g(x) + \int_0^x g(\beta) [I_5 + I_7] d\beta = \\ &= 2g(x) + 12 \int_0^x g(\beta) \frac{I_8(x-\beta)}{x-\beta} d\beta \end{aligned}$$

where

$$\begin{aligned} 6 \int_0^x g(\beta) \frac{I_8(x-\beta)}{x-\beta} d\beta &= b_0 I_6 + b_1 I_7 + b_2 I_8 + \dots \\ &= \frac{1}{2} (c_4 I_6 + c_5 I_7 + c_6 I_8 + \dots) \\ &\quad + \frac{1}{2} (c_4 I_8 + c_5 I_9 + c_6 I_{10} + \dots) \\ &= 2 \int_0^x j(\beta) \frac{I_2(x-\beta)}{x-\beta} d\beta + \frac{4}{2} \int_0^x j(\beta) \frac{I_4(x-\beta)}{x-\beta} d\beta \end{aligned}$$

In this case therefore the solution takes the form

$$\begin{aligned} 2g(x) - [2^4 j^{(4)}(x)] - 5 [2^2 j^{(2)}(x)] - 4 [j(x)] &= \\ &= -2 \int_0^x j(\beta) \frac{I_2(x-\beta)}{x-\beta} d\beta - 4 \int_0^x j(\beta) \frac{I_4(x-\beta)}{x-\beta} d\beta . \quad (12) \end{aligned}$$

4. Proceeding now to the general case, we may expect,  $A_i^{(\nu)}$  being constants,

$$\begin{aligned} 2g(x) - A_0^{(\nu)} [2^{\nu+1} j^{(\nu+1)}(x)] - A_1^{(\nu)} [2^{\nu-1} j^{(\nu-1)}(x)] - A_2^{(\nu)} [2^{\nu-3} j^{(\nu-3)}(x)] - \dots = \\ = (-1)^\nu \cdot 4\nu \int_0^x g(\beta) \frac{I_{2\nu}(x-\beta)}{x-\beta} d\beta . \quad (13) \end{aligned}$$

If  $\nu$  be even the last term in the first member is  $-A_{\frac{\nu}{2}}^{(\nu)} [2j^{(1)}(x)]$ ,

and if  $\nu$  be odd it is  $-A_{\frac{\nu+1}{2}}^{(\nu)} [j(x)]$ .

The second member now reduces to

$$2\nu \int_0^x g(x) \frac{I_{2\nu}(x-\beta)}{x-\beta} d\beta = b_0 I_{2\nu} + b_1 I_{2\nu+1} + b_2 I_{2\nu+2} + \dots$$

$$= \frac{1}{2} [c_{p+1}I_{2p} + c_{p+2}I_{2p+1} + c_{p+3}I_{2p+2} + \dots] \\ + \frac{1}{2} [c_{p+1}I_{2p+2} + c_{p+2}I_{2p+3} + c_{p+3}I_{2p+4} + \dots]$$

thus

$$2p \int_0^x q(x) \frac{I_{2p}(x-\beta)}{x-\beta} d\beta = \frac{p-1}{2} \int_0^x f(\beta) \frac{I_{p-1}(x-\beta)}{x-\beta} d\beta + \frac{p+1}{2} \int_0^x f(\beta) \frac{I_{p+1}(x-\beta)}{x-\beta} d\beta \quad (14)$$

Substituting this value in the equation (13) we see that  $q(x)$  may be expressed in differential coefficients of the function  $f(x)$  and two integrals. To determine the law of the coefficients  $A_0^{(p)}, A_1^{(p)}, A_2^{(p)}, A_3^{(p)} \dots$  we put together the values for  $p = 1, 2, \dots, 10$  in the following table:

$p$	$A_0^{(p)}$	$A_1^{(p)}$	$A_2^{(p)}$	$A_3^{(p)}$	$A_4^{(p)}$	$A_5^{(p)}$	$A_6^{(p)}$
1	1	3					
2	1	4					
3	1	5	4				
4	1	6	8				
5	1	7	13	4			
6	1	8	19	12			
7	1	9	26	25	4		
8	1	10	34	44	16		
9	1	11	43	70	41	4	
10	1	12	53	104	85	20	

Examining this table we see that

$$A_1^{(p)} = A_1^{(p-1)} + A_0^{(p-2)}, \\ A_2^{(p)} = A_2^{(p-1)} + A_1^{(p-2)}, \\ A_3^{(p)} = A_3^{(p-1)} + A_2^{(p-2)}, \\ \dots$$

( $p$  even)

$$A_{\frac{p}{2}}^{(p)} = A_{\frac{p}{2}}^{(p-1)} + A_{\frac{p-2}{2}}^{(p-2)} = 4 + A_{\frac{p-2}{2}}^{(p-2)}$$

( $p$  odd)

$$A_{\frac{p+1}{2}}^{(p)} = 4$$

If therefore the coefficients of order  $p - 2$  and  $p - 1$  are known those of order  $p$  may be found. To verify the results we may remark that if

$$\sum A_i^{(p)} = S_p$$

we must find

$$S_p = S_{p-2} + S_{p-1}.$$

The resulting values of these coefficients are as follows

$$\left. \begin{aligned}
 A_0^{(p)} &= 1 & (p=1.2.3\dots) \\
 A_1^{(p)} &= p + 2 & (p = 1.2.3.4. \dots) \\
 A_2^{(p)} &= \frac{1}{2!} (p^2 + p - 4) & (p = 3.4.5\dots) \\
 A_3^{(p)} &= \frac{1}{3!} (p-4) (p^2 + p - 6) & (p=5.6.7\dots) \\
 A_4^{(p)} &= \frac{1}{4!} (p-5) (p-6) (p^2 + p - 8) & (p=7.8.9\dots) \\
 A_5^{(p)} &= \frac{1}{5!} (p-6) (p-7) (p-8) (p^2 + p - 10) & (p=9.10.11\dots) \\
 &\dots & \dots
 \end{aligned} \right\} \cdot (15)$$

where the law of succession is evident. With these values the equations (13) and (14) give the required solution.

4. To generalise the preceding results we will proceed to examine the more general integral equation.

$$f(x) = \int_0^x \varphi(\beta) K(x-\beta) d\beta \dots \dots \dots (16)$$

assuming that the functions  $f(x)$  and  $K(x)$  may be expanded in series of BESSEL'S functions

$$\begin{aligned}
 f(x) &= c_1 I_1(x) + c_2 I_2(x) + c_3 I_3(x) + \dots \\
 K(x) &= a_0 I_0(x) + a_1 I_1(x) + a_2 I_2(x) + \dots
 \end{aligned}$$

which is the case if these functions are finite and continuous from 0 to  $x$ .

If now

$$\varphi(x) = b_0 I_0(x) + b_1 I_1(x) + b_2 I_2(x) + \dots$$

the second member reduces to

$$\begin{aligned}
 &\sum \sum a_p b_q \int_0^x I_q(\beta) I_p(x-\beta) d\beta = \\
 &= 2 \sum \sum a_p b_q [I_{p+q+1}(x) - I_{p+q+3} + I_{p+q+5} - \dots]
 \end{aligned}$$

Thus, comparing the two members, we find

$$\begin{aligned}
 c_1 &= 2a_0 b_0 \\
 c_2 &= 2a_1 b_0 + 2a_0 b_1 \\
 c_3 &= 2(a_2 - a_0) b_0 + 2a_1 b_1 + 2a_0 b_2 \\
 c_4 &= 2(a_3 - a_1) b_0 + 2(a_2 - a_0) b_1 + 2a_1 b_2 + 2a_0 b_3 \\
 &\text{etc.}
 \end{aligned}$$

which give



$$2b_0 = \frac{1}{a_0} c_1$$

$$2b_1 = \frac{1}{a_0^2} \begin{matrix} a_0 & c_1 \\ a_1 & c_2 \end{matrix}$$

$$2b_2 = \frac{1}{a_0^3} \begin{vmatrix} a_0 & 0 & c_1 \\ a_1 & a_0 & c_2 \\ a_2 - a_0 & a_1 & c_3 \end{vmatrix}$$

$$2b_3 = \frac{1}{a_0^4} \begin{vmatrix} a_0 & 0 & 0 & c_1 \\ a_1 & a_0 & 0 & c_2 \\ a_2 - a_0 & a_1 & a_0 & c_3 \\ a_3 - a_1 & a_2 - a_0 & a_1 & c_4 \end{vmatrix}$$

etc.

Therefore  $g(x)$  may be written in this form

$$\begin{aligned} 2g(x) = & \frac{1}{a_0} c_1 I_0 + \frac{1}{a_0^2} \begin{matrix} a_0 & 0 \\ a_1 & c_2 \end{matrix} I_1 + \frac{1}{a_0^3} \begin{matrix} a_0 & 0 & 0 \\ a_1 & a_0 & 0 \\ a_2 - a_0 & a_1 & c_3 \end{matrix} I_2 + \frac{1}{a_0^4} \begin{matrix} a_0 & 0 & 0 & 0 \\ a_1 & a_0 & 0 & 0 \\ a_2 - a_0 & a_1 & a_0 & 0 \\ a_3 - a_1 & a_2 - a_0 & a_1 & c_4 \end{matrix} I_3 + \dots \\ & + \frac{1}{a_0^2} \begin{matrix} a_0 & c_1 \\ a_1 & 0 \end{matrix} I_1 + \frac{1}{a_0^3} \begin{matrix} a_0 & 0 & 0 \\ a_1 & a_0 & c_2 \\ a_2 - a_0 & a_1 & 0 \end{matrix} I_2 + \frac{1}{a_0^4} \begin{matrix} a_0 & 0 & 0 & 0 \\ a_1 & a_0 & 0 & 0 \\ a_2 - a_0 & a_1 & a_0 & c_3 \\ a_3 - a_1 & a_2 - a_0 & a_1 & 0 \end{matrix} I_3 + \dots \\ & + \frac{1}{a_0^2} \begin{matrix} a_0 & 0 & c_1 \\ a_1 & a_0 & 0 \end{matrix} I_2 + \frac{1}{a_0^4} \begin{matrix} a_0 & 0 & 0 & 0 \\ a_1 & a_0 & 0 & c_2 \\ a_2 - a_0 & a_1 & a_0 & 0 \\ a_3 - a_1 & a_2 - a_0 & a_1 & 0 \end{matrix} I_3 + \dots \\ & + \frac{1}{a_0^4} \begin{matrix} a_0 & 0 & 0 & c_1 \\ a_1 & a_0 & 0 & 0 \\ a_2 - a_0 & a_1 & a_0 & 0 \\ a_3 & a_1 & a_2 - a_0 & a_1 & 0 \end{matrix} I_3 + \dots \end{aligned}$$

or

$$\begin{aligned}
 2g(x) &= \frac{1}{a_0} (c_1 I_0 + c_2 I_1 + c_3 I_2 + \dots) \\
 &+ \frac{1}{a_0^2} \begin{vmatrix} a_0 & 1 \\ a_1 & 0 \end{vmatrix} (c_1 I_1 + c_2 I_2 + c_3 I_3 + \dots) \\
 &+ \frac{1}{a_0^3} \begin{vmatrix} a_0 & 0 & 1 \\ a_1 & a_0 & 0 \\ a_2 - a_0 & a_1 & 0 \end{vmatrix} (c_1 I_2 + c_2 I_3 + c_3 I_4 + \dots) \\
 &+ \frac{1}{a_0^4} \begin{vmatrix} a_0 & 0 & 0 & 1 \\ a_1 & a_0 & 0 & 0 \\ a_2 - a_0 & a_1 & a_0 & 0 \\ a_3 - a_1 & a_2 - a_0 & a_1 & 0 \end{vmatrix} (c_1 I_3 + c_2 I_4 + c_3 I_5 + \dots) \\
 &+ \text{etc.}
 \end{aligned}$$

If now

$$j(x) = c_1 I_1 + c_2 I_2 + c_3 I_3 + \dots$$

we have

$$\begin{aligned}
 2 \frac{dj}{dx} &= c_1 I_0 + c_2 I_1 + c_3 I_2 + \dots \\
 &- (c_1 I_2 + c_2 I_3 + c_3 I_4 + \dots)
 \end{aligned}$$

thus, according to (5)

$$c_1 I_0 + c_2 I_1 + c_3 I_2 + \dots = 2 \frac{dj}{dx} + \int_0^x f(\beta) \frac{I_1(x-\beta)}{x-\beta} d\beta$$

and by the same formula

$$c_1 I_n + c_2 I_{n+1} + c_3 I_{n+2} + \dots = (n-1) \int_0^x f(\beta) \frac{I_{n-1}(x-\beta)}{x-\beta} d\beta.$$

Introducing these values we have

$$2g(x) = 2A_0 \frac{dj}{dx} + A_1 j + \int_0^x \frac{f(\beta)}{x-\beta} [(A_0 + A_2) I_1(x-\beta) + 2A_3 I_2 + 3A_4 I_3 + \dots] d\beta$$

where

$$A_0 = \frac{1}{a_0}, \quad A_1 = \frac{1}{a_0^2} \begin{vmatrix} a_0 & 1 \\ a_1 & 0 \end{vmatrix}, \quad A_2 = \frac{1}{a_0^3} \begin{vmatrix} a_0 & 0 & 1 \\ a_1 & a_0 & 0 \\ a_2 - a_0 & a_1 & 0 \end{vmatrix}, \dots \quad (17)$$

Remarking that

$$\frac{n I_n(x-\beta)}{x-\beta} = \frac{1}{2} [I_{n-1}(x-\beta) + I_{n+1}(x-\beta)]$$

this result we may write

$$2g(x) = 2A_0 \frac{df}{dx} + A_1 f + \left. \begin{aligned} & \frac{1}{2} \int_0^x f(\beta) [-A_1 I_1(x-\beta) + A_0 I_2] d\beta + \\ & \left[ \frac{1}{2} \int_0^x f(\beta) \sum_0^{\infty} (A_{p+1} + A_{p+2}) I_p(x-\beta) d\beta \right] \end{aligned} \right\} \dots \quad (18)$$

When the integral equation

$$2I_1(x) = \int_0^x \psi(\beta) K(x-\beta) d\beta$$

is given, we find by (18)

$$\psi(x) = A_0 I_0(x) + A_1 I_1(x) + A_2 I_2(x) + \dots$$

Therefore  $\sum_0^{\infty} (A_p + A_{p+2}) I_p(x)$  be expressed in function of  $\psi$ .

For

$$A_1 I_0(x) + A_2 I_1 + A_3 I_2 + \dots = \frac{2d\psi}{dx} + A_0 I_1 + \int_0^x \psi(\beta) \frac{I_1(x-\beta)}{x-\beta} d\beta$$

and, differentiating again

$$A_2 I_0(x) + A_3 I_1 + A_4 I_2 + \dots = 4 \frac{d^2\psi}{dx^2} + 2\psi + A_1 I_1 - A_0 I_2 - 2 \int_0^x \psi(\beta) \frac{I_2(x-\beta)}{x-\beta} d\beta$$

thus

$$\sum_0^{\infty} (A_p + A_{p+2}) I_p(x) = 4 \frac{d^2\psi}{dx^2} + 3\psi + A_1 I_1 - A_0 I_2 - 2 \int_0^x \psi(\beta) \frac{I_2(x-\beta)}{x-\beta} d\beta.$$

5. We now proceed to give some applications of formula (18).

First let the integral equation be

$$f(x) = \int_0^x g(\beta) I_0(x-\beta) d\beta$$

then

$$a_0 = 1, \quad a_1 = a_2 = \dots = 0$$

hence

$$A_0 = 1, \quad A_1 = 0, \quad A_2 = 1, \quad A_3 = A_4 = \dots = 0$$

thus

$$2g(x) = 2 \frac{df}{dx} + \frac{1}{2} \int_0^x f(\beta) [2I_0(x-\beta) + 2I_2(x-\beta)] d\beta$$

or

$$q(x) = \frac{df}{dx} + \int_0^x f(\beta) \frac{I_1(x-\beta)}{x-\beta} d\beta$$

which agrees with (2).

Considering the integral equation

$$f(x) = \int_0^x q(\beta) I_1(x-\beta) d\beta$$

the formula (18) is not applicable because  $a_0 = 0$ . In this case and assuming  $a_1 \neq 0$ , we have

$$\begin{aligned} 2f(x) &= \frac{1}{a_1} (c_2 I_0 + c_3 I_1 + \dots) \\ &+ \frac{1}{a_1^2} \begin{vmatrix} a_1 & 1 \\ a_2 & 0 \end{vmatrix} (c_2 I_1 + c_3 I_2 + \dots) \\ &+ \frac{1}{a_1^3} \begin{vmatrix} a_1 & 0 & 1 \\ a_2 & a_1 & 0 \\ a_3 - a_1 & a_2 & 0 \end{vmatrix} (c_2 I_2 + c_3 I_3 + \dots) \\ &+ \dots \end{aligned}$$

where

$$c_2 I_2 + c_3 I_3 + \dots = f$$

$$c_2 I_1 + c_3 I_2 + \dots = 2 \frac{df}{dx} + \int_0^x f(\beta) \frac{I_1(x-\beta)}{x-\beta} d\beta$$

$$c_2 I_0 + c_3 I_1 + \dots = 4 \frac{d^2 f}{dx^2} + 2f - 2 \int_0^x f(\beta) \frac{I_2(x-\beta)}{x-\beta} d\beta$$

thus, representing the coefficients by the letters  $B$

$$\begin{aligned} 2f(x) &= B_0 \left[ 4 \frac{d^2 f}{dx^2} + 2f - 2 \int_0^x f(\beta) \frac{I_2(x-\beta)}{x-\beta} d\beta \right] \\ &+ B_1 \left[ 2 \frac{df}{dx} + \int_0^x f(\beta) \frac{I_1(x-\beta)}{x-\beta} d\beta \right] \\ &+ B_2 f \\ &+ B_3 \int_0^x f(\beta) \frac{I_1(x-\beta)}{x-\beta} d\beta \\ &+ \dots \end{aligned}$$

or

$$2g(x) = 4B_0 \frac{d^2 f}{dx^2} + 2B_1 \frac{df}{dx} + (2B_0 + B_2)f - 2B_0 \int_0^x j(\beta) \frac{I_2(x-\beta)}{x-\beta} d\beta + \\ + \int_0^x \frac{j(\beta)}{x-\beta} [(B_1 + B_3)I_1(x-\beta) + 2B_4 I_2 + 3B_5 I_3 + \dots] d\beta.$$

Now putting

$$a_1 = 1 \quad a_2 = a_3 = \dots = 0$$

we have

$$B_0 = 1 \quad B_1 = 0 \quad B_2 = 1 \quad B_3 = B_4 = \dots = 0$$

thus

$$2g(x) = 4 \frac{d^2 f}{dx^2} + 3f - 2 \int_0^x j(\beta) \frac{I_2(x-\beta)}{x-\beta} d\beta$$

which agrees with (10).

Finally let the integral equation to be solved be

$$x = \int_0^x q(\beta) \cos(x-\beta) d\beta$$

In this case

$$a_0 = 1, \quad a_1 = 0, \quad a_2 = 2, \quad a_3 = 0, \quad a_4 = 2, \dots$$

thus

$$A_0 = 1, \quad A_1 = 0, \quad A_2 = 3, \quad A_3 = 0, \quad A_4 = 4, \quad A_5 = 0, \quad A_6 = 4, \dots$$

and, according to (18)

$$2f(x) = 2 + \frac{1}{2} \int_0^x \beta [4I_0(x-\beta) + 8I_2 + 8I_4 + 8I_6 + \dots] d\beta$$

which, by means of the known relation

$$I_0(x) + 2I_2(x) + 2I_4(x) + \dots = 1$$

may be written

$$2g(x) = 2 + 2 \int_0^x \beta d\beta$$

or

$$g(x) = 1 + \frac{x^2}{2}.$$

**Geodesy.** — “*Comparison of the measuring bar used in the base-measurement at Stroe with the Dutch Metre No. 27*”. By H. G. V. D. SANDE BAKHUYZEN, N. WILDEBOER and J. W. DIEPERINK.

In the summer of 1913, the Government-Commission for Triangulation and Levelling measured a base of about 4320 metres, under the direction of Prof. H. J. HEUVELINK, on the high road between Apeldoorn and Amersfoort, near the Railway-station Stroe.

The measurements were made with the base-apparatus of the “Service géographique de l’armée” at Paris, which was lent through the courteous help of the Director of that service to the Government Commission by the French Government.

The measuring bar of this apparatus is an H-shaped invar-bar of four metres length, provided with two very sharp end lines at the extremities, between which three intermediate lines are drawn, which divide the measuring bar into four parts, *a*, *b*, *c* and *d*, each one metre long.

Previous to the base measurement here, this measuring-bar had been compared several times with the mètre international at Breteuil; these comparisons had shown, that the length had undergone some slow changes, as is often the case with invar-bars; it was therefore important to determine the length shortly before and after the base-measurement.

In April 1913 therefore a comparison was made at Breteuil, but as the comparator there had to undergo some repairs, the comparison could not be repeated in the autumn of 1913; it was therefore decided to compare the measuring bar in this country with one of the two Dutch platinum-iridium metres, viz. with No. 27, by means of the comparator which had been supplied by messrs. REPSOLD and Sons in 1867 with the base-apparatus for the triangulation in the East Indies, and which is now mounted in the geodetic buildings in Delft.

From the experience gained in previous measurements we did not consider that sufficient accuracy could be obtained with this comparator, especially on account of the inferior quality of the microscopes; on this account it was decided to order two new micrometer-microscopes from ZEISS (in Jena) which were delivered in the autumn of 1913, so that in December the comparator was ready for the comparison.

We are very much indebted to Prof. HEUVELINK, who arranged everything for the measurements and placed a room in the geodetic buildings, and an instrument-maker at our disposal for some weeks; and further to the “Commission for the preservation of the standards”, who allowed us the use of metre 27.

### 1. *Arrangement of the comparator.*

A complete description of the comparator can be found in Dr. J. A. C. OUDEMANS, "Die Triangulation von Java, erste Abteilung"; we may therefore confine ourselves here to a short account of the arrangement.

A wooden case over four metres long inside, contains a long iron carrier, which can be moved upon rails from one side of the case to the other, at right angles to the length. Upon this carrier the measuring bar and the metre with which it is to be compared, are placed parallel to each other, while the metre with the box in which it is placed can be moved along the carrier in the direction of its length, and can so in turn be placed opposite to each of the four parts *a*, *b*, *c*, and *d* of the measuring rod.

The wooden case is further provided with a strong iron frame to which the micrometer-microscopes are attached at a distance of exactly a metre and which can be moved upon rails, independently of the carrier, above the measuring bar and the metre.

The first thing to do is to place the metre opposite the first part of the measuring bar, parallel to and at the same height as the bar, and to push the carrier upon which they both lie as far as possible sideways across the case, until it touches a pair of correction screws. If everything is properly arranged, the microscope frame upon its rails can then be placed so, that the two microscopes are just above the end lines of the metre, or the part *a* of the measuring bar. If the carrier is then moved to the other side of the case, where it similarly touches two screws, the microscopes will be directed just above the end lines of part *a* or of the metre.

By focussing with the micrometers accurately upon the end lines of the metre and of part *a* in both these positions, it is easy to find the difference in length between them, expressed in micrometer-divisions. By subsequently placing the metre successively opposite to the portions *b*, *c*, and *d* of the measuring bar, and making the same observations, the data are procured, by which the length of the measuring bar can be determined in metres.

In order to be certain that in the successive measurements of portions *a*, *b*, *c*, and *d* the microscopes were each time directed upon the same points of the division lines, small brass plates provided with a point in the middle were fixed on the middle of the bar near the division lines, in this way fixing a line along the middle of the measuring bar. The correction screws at the sides of the case, (against which the carrier moves up in its sideways movements) were so adjusted, that these points came exactly under the fixed

horizontal wires in the two microscopes. As care was taken, that the moveable micrometer wires were parallel to the division lines, an influence of a small deviation of the point upon which the microscopes are directed need not be feared.

2. *Microscopes.* At our request the microscopes were so constructed, that on the objective-side the course of the rays is telecentric; they have a 30-fold magnification, and the illumination of the division lines is not sideways but central, by means of a prism with total reflection, which is placed behind the objective in the tube of the microscope, and occupies half of the field. The light from a small electric lamp falls through an opening in the tube of the microscope upon the dull face of the prism, is then reflected by the prism vertically downwards through the objective, falls upon the reflecting surface of the metre or the measuring bar, and is thus reflected vertically back into the microscope. With an electric lamp of a few candles the illumination was excellent, and the division lines were seen as very fine black lines.

3. *Temperature.* The exact determination of the temperatures of the metre and the measuring bar is a matter of great importance. In order to make the changes of temperature as small as possible we endeavoured, in the first place, to keep the temperature of the room as constant as possible. For this purpose the windows were covered with thick curtains, and the central heating was shut off. As only a small amount of heat was conveyed through the floor and walls, the temperature did not change much, and only rose a little from the presence of the observers, and the burning of a few gas lamps.

All the metal parts of the comparator were shut off from the outside air by wood and other badly conducting material, outside which only the eye-pieces of the microscopes protruded; the measuring bar was moreover entirely enclosed in a thick aluminium case and the metre in a brass box, in which there were only small openings for the reading of the division lines and the thermometers. The protection of the metre from the radiating heat was less effective than that of the measuring rod, so that in half of the measurements, during which the observer was on the side of the comparator nearest to the metre, it was found advisable to cover the outside wall of the comparator with a layer of badly conducting material, which gave a greater constancy of temperature.

For the determination of the temperature of the metre and measuring bar, upon the horizontal faces on which the division lines are drawn a thermometer *A* was laid upon the metre, and on the measur-



ing bar two thermometers  $B$  and  $C$ , the last two about a metre from each extremity. Moreover there were placed in the comparator case a registering thermometer  $D$ , two thermometers  $E$  and  $F$  upon the outside of the aluminium case about above the thermometers  $B$  and  $C$ , and two thermometers  $G$  and  $H$  at the two extremities of the comparator, which were read through glass-covered openings in the end-walls.

On the whole the temperature readings were of such a nature, that there is every reason to believe that the readings of the thermometers  $A$ ,  $B$  and  $C$  may be taken as the temperatures of the metre and the measuring bar.

4. *Programme of the measurements.* It was arranged, that the measurements should be made by the two engineers of the Government Commission for triangulation and levelling, A. WILDEBOER and J. W. DIEPERINK, and a member of the commission, H. G. v. D. SANDE BAKHUYZEN. Each of these made a complete series of measurements. Mr. WILDEBOER and Mr. DIEPERINK arranged everything beforehand, so that (1) metre and measuring bar were parallel to each other and at the same level, (2) the micrometer wires were parallel to the division lines and showed no parallax with regard to the division lines, (3) in the extreme positions of the carrier the division lines of the metre and of the measuring bar appeared in the correct position in the field of the microscopes. In the adjustment of the level of metre and bar, so that no parallax could be detected of the micrometer-wires with respect to the division-lines, the adjustment of one of the observers was always checked by a second or third.

When the carrier had been placed in one of the extreme positions and the microscopes were therefore directed upon the end lines, say of the metre, the observer placed the micrometerwires of the left-hand microscope twice in succession upon the line, then took four readings with the right-hand microscope, and finally two with the left-hand one. In the middle of these eight readings the thermometer on the metre was read. The carrier was now brought into the other extreme position, so that portion  $a$  of the measuring bar came under the microscope. In the same way as for the metre, 8 readings were taken with the microscopes, and readings of the thermometers. The observer then returned to the metre, and in the same way took seven sets of observations in succession, alternately upon the metre and the selected portion of the measuring-bar, each consisting of 8 readings.

A series of observations of this kind, which lasted about a quarter of an hour, we shall henceforth call an observation-series.

Each of the three observers made two of these observation-series in succession.

After these six series, the metre was turned round in its case, so that the mark which first showed on the left hand side now lay on the right hand side; and in the same way as at the beginning of the measurements, the position of the metre with regard to the measuring bar and the microscopes was then properly regulated. As the comparator case had to be opened for this, there was a disturbance in the equilibrium of the temperature. An hour or  $1\frac{1}{2}$  was therefore allowed to pass before fresh measurements were begun. As in the first position, each of the three observers then took two series of observations in this second position.

For the determination of the temperature in the comparator, at the beginning and at the end of the 6 series with the same position of the metre, the thermometers *E*, *F*, *G*, and *H* were read. These readings served only to ascertain, whether disturbances of temperature had occurred in the comparator. In none of the series which were used for the determination of the length of the measuring bar was this the case; there was therefore no further use made of the readings of the thermometers *E*, *F*, *G*, and *H*, any more than of the records of the registering thermometer.

As in the computation of the results the differences of the readings of the right-hand and left-hand microscopes are used, the influence of a personal error of adjustment will disappear from the results, if both end lines, the micrometer wires and the optic images in the two microscopes are exactly alike. This complete equality however does not exist. The lines are, as far as can be seen, all equally fine and faultless, but the distance of the micrometer wires is smaller in the one microscope than in the other, so that the appearance of the line, when it is placed between the two micrometer wires, is different in the two microscopes. In order to eliminate the personal error arising from this, the observations would have to be repeated after exchanging the microscopes, or else with the microscopes in the same position, but the observer standing the second time on the other side of the comparator, so that the microscope which was first on his right hand, is now on his left.

The latter method is simpler than the former, and had the further advantage (over the changing of the microscopes) that the observer, who first stood nearest to the measuring bar, is now nearest to the metre, and an irregular influence of the heat radiated by the observer will thus be also, at least partially, eliminated.

On these grounds the observers, after they had compared each of

the 4 portions of the measuring bar with the metre, while standing on one side of the comparator, repeated the observations standing on the other side.

To distinguish the observation-series from each other, we shall call those which were made while the observers were in their original position with respect to the comparator, *A*, those in which they were on the other side, *B*, the series in which the mark on the metre lay to the right of the observer *r*, that in which it was on the left *l*, while the first of two identical series we shall call 1 and the second 2. For each portion of the measuring bar each observer therefore took 8 series of observations  $Ar_1, Ar_2, Al_1, Al_2, Br_1, Br_2, Bl_1, Bl_2$ . Care was taken, that when the first series was begun with the metre, the second identical series should begin with the measuring bar.

5. *Runs and errors of the micrometer screws.* For the purpose of determining any possible changes in the runs of the micrometer screws, the length of the millimetre divided into 10 marked on the measuring bar near the end lines was measured every day before and after the measurements, with both of the microscopes. From the results it appeared, that the value of the run, which was approximately 200 micromillimetres, did not change perceptibly. As, however, it was not certain, that the millimetres on the measuring bar were of exactly the correct length, the absolute value of the run was afterwards determined by measuring out a distance of 1 centimetre divided into millimetres on a measuring rod of nickel-steel belonging to the Observatory in Leiden, supplied by the Société Genevoise, the errors of division of which had been accurately determined in Breteuil. For all the measurements the same value of the run is assumed, viz. 198.69 micromillimetres for the microscope marked I and 199.82 micromillimetres for the unmarked microscope.

Moreover the periodic errors of the micrometer screws were determined in the observatory at Leiden, by measuring distances equal to a half and a third of a turn. The continuous errors were determined by measuring a larger distance, with portions of the screw situated symmetrically with respect to the zero.

For micrometer I the correction formula of the readings in parts of the divided head, was found to be:  $0.18 \sin(u + 17^\circ)$ ; the influence of the term dependent on the double of the reading was imperceptible.

In the unmarked microscope no periodic errors could be detected by the observations.

The continuous errors were imperceptible in both microscopes.

6. *Reduction of the observations and results obtained.* The micrometer readings are all reduced with the above mentioned values for the run of the screws in micromms and for the periodic errors in micrometer I.

The errors of thermometer 4570 belonging to the Dutch platinum-iridium metres, which was used for the temperature-determinations of metre No. 27, were determined by comparison with two thermometers standardized at Breteuil, and by separate determinations of the freezing point. It appeared, that between  $0^\circ$  and  $30^\circ$  the thermometer is free from errors, except the error of the freezing point, which was  $-0.48^\circ$ . The determinations were made by Mr. H. C. VOLKERS, lecturer at the Technical University at Delft.

For the thermometers 15355 and 15356 belonging to the invar-bar both the errors of division and the correction for the zero are negligible.

In the reduction of the length of the metre and the measuring-bar the following coefficients of expansion were used. For the metre the value communicated by BOSSCHA in his paper: "Relation des expériences qui ont servi à la construction de deux mètres étalons en platine iridié, comparés directement avec le mètre des archives" and which from  $0^\circ$  to  $t^\circ$  gives an expansion for the metre in micromms of:

$$8.4327 t + 0.00401 t^2.$$

For the measuring bar, the determination made at Breteuil was used, which gives for the expansion per metre in micromms;

$$1.6245 t + 0.001065 t^2.$$

After the introduction of these reductions, the three observers obtained the following results for the lengths of the 4 portions of the measuring-bar, each about a metre in length, diminished by the length of N<sup>o</sup>. 27 both at the temperature of zero. These results are the mean of the observations of one series.

Portion 0—1.

	WILDEBOER		DIEPERINK		BAKHUYZEN	
	Position A	Position B	Position A	Position B	Position A	Position B
$l_1$	—29.70	—27.43	—28.65	—27.39	—27.93	—26.40
$l_2$	28.25	27.84	28.28	27.19	28.60	27.13
$r_1$	29.25	28.39	28.85	27.94	29.89	27.96
$r_2$	29.01	28.95	28.89	28.23	29.49	27.91

## Portion 1—2.

	WILDEBOER		DIEPERINK		BAKHUYZEN	
	Position A	Position B	Position A	Position B	Position A	Position B
$l_1$	—99.31	—95.46	—98.59	—96.73	—97.96	—96.10
$l_2$	99.61	95.28	98.64	96.02	97.65	96.22
$r_1$	98.82	95.33	97.95	96.99	97.30	95.69
$r_2$	99.96	95.18	98.50	96.77	97.69	94.94

## Portion 2—3.

	WILDEBOER		DIEPERINK		BAKHUYZEN	
	Position A	Position B	Position A	Position B	Position A	Position B
$l_1$	—122.76	—122.00	—122.70	—123.64	—123.52	—122.95
$l_2$	122.25	122.22	122.26	123.00	122.39	123.03
$r_1$	122.72	121.72	121.18	121.04	122.85	123.35
$r_2$	122.00	121.46	120.75	122.24	121.96	122.83

## Portion 3—4.

	WILDEBOER		DIEPERINK		BAKHUYZEN	
	Position A	Position B	Position A	Position B	Position A	Position B
$l_1$	—144.49	—143.48	—143.28	—143.45	—144.09	—143.22
$l_2$	144.55	143.58	143.96	143.37	143.93	143.28
$r_1$	144.91	144.00	144.09	143.69	145.10	144.57
$r_2$	143.70	144.08	143.98	143.65	144.44	143.48

In order to eliminate the effect of personal errors the means were now formed from the observation-series A and B, those two series being combined in which the metre was in the same absolute position in space, not relatively to the observer, i.e.  $Al_1$  with  $Br_1$ ,  $Al_2$  with  $Br_2$ ,  $Ar_1$  with  $Bl_1$  and  $Ar_2$  with  $Bl_2$ . In this manner the following results were obtained:

	WILDEBOER.			
	Portion 0—1	Portion 1—2	Portion 2—3	Portion 3—4
	—29.04	—97.32	—122.24	—144.20
	28.60	97.39	121.85	144.31
	28.34	97.14	122.36	144.19
	28.42	97.62	122.11	143.64
Mean	28.60	97.37	122.14	144.08

## DIEPERINK.

	Portion 0—1	Portion 1—2	Portion 2—3	Portion 3—4
	—28.29	—97.79	—121.87	—143.48
	28.25	97.70	122.25	143.80
	28.12	97.34	122.41	143.77
	28.04	97.26	121.87	143.67
Mean	28.18	97.52	122.10	143.68

## BAKHUYZEN.

	Portion 0—1	Portion 1—2	Portion 2—3	Portion 3—4
	—27.94	—96.82	—123.43	—144.33
	28.25	96.29	122.61	143.70
	28.14	96.70	122.90	144.16
	28.29	97.45	122.49	143.86
Mean	28.16	96.82	122.86	144.01

If the sum is taken of the lengths of the 4 portions of the measuring-bar, we get for the length of the whole measuring bar at 0°:

Measuring bar = 4 × Metre 27—392 <sup>u</sup> .19	WILDEBOER
„ „ = 4 × Metre 27—391.48	DIEPERINK
„ „ = 4 × Metre 27—391.85	BAKHUYZEN

Mean for the three observers:

$$\text{Measuring bar} = 4 \times \text{Metre } 27\text{—}391^u.84.$$

7. *Mean errors.* The errors in a series of observations are caused by the pointing- and reading errors of the microscopes, the change in the distance of the microscopes, erroneous determinations of temperature and personal errors of observation.

Owing to the excellent optical qualities of the microscopes and the fine sharp end lines, the errors in the reading and pointing of the microscopes are small. From the observations for the determination of the periodic screw-errors we found for the mean reading-error, from the mean of two observers,  $\pm 0^u.32$ : this error leads to a mean error of  $\pm 0^u.17$  in one series of observations.

The influence of other sources of error are difficult to determine separately. We shall therefore try to calculate their combined effect, in different ways, in order to find out, what systematic errors are to be feared, and how the series of observations are to be combined in order to obtain a result in which the effect of the systematic errors will be as far as possible eliminated.

In the first place it was investigated, whether there was a systematic difference in the results of a series of observations according to whether the microscope was pointed 3 times on the metre and 4 times on the measuring-bar, or 4 times on the metre and 3 times on the measuring-bar. For this purpose the mean was first formed of corresponding series in the positions *A* and *B*, in which the number of times that the microscope was pointed on the metre and therefore also on the measuring bar, was the same. According to these averages the mean error of observation in microns was:

WILDEBOER	DIEPERINK	BAKHUYZEN	Mean	
0.371	0.366	0.509	0.420	(I)

After this the average was formed of corresponding series in *A* and *B* in which the number of times pointed on the metre and on the measuring bar was unequal; according to these averages the mean error of observation for a series was:

WILDEBOER	DIEPERINK	BAKHUYZEN	Mean	
0.496	0.330	0.440	0.428	(II)

From the agreement of the two means we may infer that there is no systematic difference in the series with 3 or with 4 pointings on the metre or measuring bar.

It was next investigated, if there was a systematic difference in the results of series in which the metre was in a different position relatively to the observer, i.e. in the results of the series *l* and *r*.

This was done in two ways.

1. The differences were found of the corresponding series in which the observer and the metre were in the same position in which differences the systematic error referred to plays no part. The mean error for a series *m* deduced from this is:

WILDEBOER	DIEPERINK	BAKHUYZEN	Mean	
0.450	0.346	0.492	0.434	(III)

After this the mean was formed of all the corresponding values found with the same position of the observer, in position *l* as well as position *r* of the metre.

The deviations of all these values from their mean, in which the influence of the systematic error is present give the following values for the mean error of a series.

WILDEBOER	DIEPERINK	BAKHUYZEN	Mean	
0.454	0.594	0.636	0.564	(IV)

2. The means were found of an observation-series in position *A* and in a corresponding series in position *B*, in which the metre

was in the reversed position relatively to the observer, i.e.  $r$  and  $l$ . In these averages the systematic error is thus eliminated. In this way the mean error of one series was found to be

WILDEBOER	DIEPERINK	BAKHUYZEN	Mean
0.370	0.296	0.507	0.401 . (V)

If on the other hand a series in position  $A$  was combined with one in  $B$ , in which the metre was in the same position with regard to the observer, so that the systematic error was not eliminated in the mean, the mean error was found to be:

WILDEBOER	DIEPERINK	BAKHUYZEN	Mean
0.424	0.755	0.768	0.666 . (VI)

Both the double sets of mean errors (III) and (IV), and (V) and (VI) show clearly, that there is a systematic difference in the results of the series  $r$  and  $l$ , or with different positions of the metre relatively to the observer. In order to remove the error, therefore, the mean of two corresponding series of observations must always be taken, in which the metre is in different positions with regard to the observer.

We further computed the mean error from all the series of observations for the same portion of the measuring-bar, without regard to the position of the metre or of the observer, in which therefore the influence is present both of the position of the metre and of the observer. First the mean errors were computed for each observer separately. This gave

WILDEBOER	DIEPERINK	BAKHUYZEN	Mean
1.222	0.805	0.955	1.009 , (VII)

Finally the results of the series for the same portion of the measuring bar in all positions of the metre and of the observer for all three observers were averaged, and the mean error determined from the deviations of each of the results, which must therefore contain (1) the influence of the position of the metre (2) the influence of the position of the observer, (3) any other possible influence of the observer. The mean error was then found to be:

$$1.002 \dots \dots \dots \text{(VIII)}$$

The difference of the mean errors (VII) and (IV) shows, that the position of the observer has a marked influence, on the other hand the agreement of the mean errors (VII) and (VIII) shows, that there does not appear to be an influence due to the observer other than that which depends upon the position of the metre and observer.

We may further conclude from the values found, that if the two systematic errors mentioned are eliminated, the mean error of a



series of observations is the mean of the values: 0.420 (I), 0.428 (II), 0.434 (III) and 0.401 (V) therefore:

$$m = \pm 0.421$$

As the measurement of each portion of the measuring bar was obtained for each observer by taking the mean of 8 series of observations, the mean error in the length of each portion measured by one observer is:

$$\pm \frac{0.421}{\sqrt{8}} = \pm 0.149,$$

and as the whole measuring-bar consists of four portions, the mean error in the length of the bar for each observer is

$$\pm 0.149 \sqrt{4} = \pm 0.298.$$

If the value of this mean error is formed by comparing with each other the lengths of the measuring-bar according to each of the three observers, we obtain:

$$\pm 0.355.$$

From the agreement of the last two values we may conclude, that in the results obtained the influence of the observer and of the position of the metre and the measuring-bar is eliminated, and that therefore, beyond the influence of the temperature determination and errors in the coefficient of expansion, the mean error in the length of the whole measuring-bar expressed in the length of metre 27, determined by one observer, is equal to

$$\pm 0.36.$$

and is therefore for the mean of the three observers:

$$\pm \frac{0.36}{\sqrt{3}} = \pm 0.205.$$

**Geodesy.** — *“Comparison of the Dutch platinum-iridium Metre No. 27 with the international Metre M, as derived from the measurements by the Dutch Metre-Commission in 1879 and 1880, and a preliminary determination of the length of the measuring-bar of the French base-apparatus in international Metres.”* By Prof. H. G. VAN DE SANDE BAKHUYZEN.

The main object of the measurements made by the Dutch Metre-Commission (BOSSCHA, OUDEMANS and STAMKART) at Paris in 1879 and 1880 was an accurate comparison of the two Dutch metres 19 and 27 with the Mètre des Archives, the various papers published by BOSSCHA on the subject show, how very well this object was

attained. As we shall have to refer to these papers more than once we shall quote by volume and page from "Bosscha's Verspreide geschriften" (B.'s collected papers) published in three volumes.

The importance of a comparison of the Dutch metres with the International platinum-iridium metre kept in Paris was, however, not lost sight of by the Commission. It was probably by their request, that in the protocol drawn up of the handing over of the two metres by the French Section of the international Metre-Commission to the Dutch delegates BOSSCHA and OUDEMANS it was specially stated: *Cette remise est faite sous la réserve du droit qu'aura le Gouvernement des Pays Bas de faire effectuer les comparaisons entre ces mètres et le prototype du Bureau international des poids et mesures pour la détermination de leurs équations à l'égard de ce mètre.*

However, not only did the Dutch Commission leave open the possibility of obtaining a direct comparison with the international metre later on, but also by making determinations at Paris of the differences between the Dutch metres and metres which are in their turn connected to the International metre, they took care, that the relation between the lengths of our metres and the International metre can be calculated.

Although all the observations which are required for these calculations are fully communicated in BOSSCHA's papers and only very simple calculations are sufficient to obtain the relation in question, the results have not been published either by BOSSCHA himself or as far as I know by anybody else; and as they are needed in order to express the length of our base-line in international metres, I shall here shortly communicate them.

The relation to the International metre is obtained not only through the *mètre des Archives A* (see further down), but also through the two Metres  $I_2$  and 20, both of the second alloy of MATTHEY, of which  $M$  is also made; in addition use is made of the two metres 23 and 27 both of the first alloy (*métal du conservatoire*).

For the reduction of the difference of length of 23 and  $I_2$  the difference of the coefficients of expansion of these two metres is required, and I shall therefore try to derive its most probable value from the results communicated by BOSSCHA.

In the first place we may conclude from BOSSCHA's calculations, that the metres of the second alloy have all got the same coefficient of expansion (Vol. III, p. 74—76). The equality of the coefficients of expansion of the metres 1, 3, 12, and 13 of the first alloy is also demonstrated (Vol. III p. 77). According to FIZEAU's measurements the coefficients of expansion of the metres 19, 27, and 23 of

the first alloy would also have very approximately the same value (Vol. II, p. 314), whereas according to the measurements of the Dutch Commission the difference in expansion of the metres 19 and 23 is too small to be observable. (Vol. II, p. 314, 315). This is not quite in accordance with FIZEAU's results (Vol. II, p. 323) obtained at  $12^\circ$ ,  $42^\circ$ , and  $62^\circ$ , as these give for 19 and 27 somewhat different values. But if the quadratic term is taken into account, the coefficients of expansion at  $40^\circ$ , the mean temperature used by FIZEAU in his measurements, would be according to his formulae  $8^{\circ}.74$  for 19, and  $8^{\circ}.75$  for 27, so that in connection with the equality mentioned above of the expansion of the 4 first-named metres of the "métal du conservatoire" and the equality of the expansion of 19 and 23 found by the Dutch Commission it may be inferred, that all the metres of the first alloy have also the same coefficient of expansion.

The next question is, what the difference is between the coefficients of expansion of the first and second alloy.

According to measurements by BENOIT and GUILLAUME with Metre 6 of the 2<sup>nd</sup> alloy the mean expansion between 0 and  $20^\circ$  per degree and per metre is  $8^{\circ}.617$ ; according to measurements by FIZEAU the mean of the same expansion for metres 19 and 27 of the first alloy is  $8^{\circ}.537$ , i. e. a difference of  $0^{\circ}.08$ . It is necessary, however, to observe, that the two values were obtained by altogether different methods, that of BENOIT and GUILLAUME by ordinary measurements of length at different temperatures, that of FIZEAU by his well-known interference-method.

Against these we have the determinations of the differences in expansion of metre 6 of the 2<sup>nd</sup> and of metres 1, 3, 12, and 13 of the 1<sup>st</sup> alloy (Vol. III p. 77) all from ordinary measurements of length at different temperatures. As the result of these  $0^{\circ}.02$  is obtained as the average of the differences.

Taking into account, that, where the methods of observation differ, systematic errors in the differences are possible, it seems to me probable, that the latter result is the more trustworthy.

In the reduction of the Dutch metre 27 to the International metre the difference in length of metres 23 and 27 also plays a part. For this difference two values have been determined; in 1879 the Dutch Commission found  $27 - 23 = 0^{\circ}.92 \pm 0^{\circ}.031$  (Vol. II, p. 297) and in 1880 the same commission found  $27 - 23 = 0^{\circ}.41 \pm 0^{\circ}.073$  (Vol. II p. 334). Of the latter value no further use has been made by BOSSCHA; it seems to me, however, that it is preferable to use the mean of the two results, taking into account the respective weights. In that case the result is

$$27 - 23 = 0^{\circ}.84.$$

*Reduction by means of  $I_2$ .* From several series of observations at a mean temperature of  $16^{\circ}.44$ , TRESCA found (Vol. III, p. 14)

$$23 = I_2 + 1^{\circ}.24.$$

Adding  $0^{\circ}.02 \times 16.44 = 0^{\circ}.33$  for the reduction to  $0^{\circ}$  the equation becomes

$$23 = I_2 + 1^{\circ}.57,$$

further

$$27 = 23 + 0^{\circ}.84 \text{ (see above)}$$

and

$$I_2 = M + 5^{\circ}.94 \text{ (Vol. III, p. 70),}$$

so that

$$27 = M + 8^{\circ}.35.$$

*Reduction by means of 20.* From three series of measurements one by BOSSCHA and two by TRESCA, follows :

$$23 = 20 + 7^{\circ}.19 \text{ (Vol. III, p. 24),}$$

further

$$27 = 23 + 0^{\circ}.84 \text{ (see above)}$$

and

$$20 = M + 0^{\circ}.96 \text{ (Vol. III, p. 70),}$$

so that

$$27 = M + 8^{\circ}.99.$$

The mean of the two reductions is  $27 = M + 8^{\circ}.67$ .

If the 5 above mentioned different equations containing 4 unknown quantities, are taken as all equally accurate and if they are then solved by the method of least squares, obviously the same value for  $27 - M$  is found, while the mean error of each of the equations is  $\pm 0^{\circ}.32$ , that of  $27 - M = 8^{\circ}.67$  being  $\pm 0^{\circ}.45$ .

A value for  $27 - M$  is also arrived at by using the comparisons with the "Mètre des Archives"  $A$ , viz.

$$27 = A + 6^{\circ}.11 \text{ (Vol. II, p. 323),}$$

$$A = M + 2^{\circ}.63 \text{ (Vol. III, p. 24, 70),}$$

$$\text{Hence } 27 = M + 8^{\circ}.74.$$

This result agrees very closely with the value found above. But, as it is largely based on the comparisons which have also served for calculating the previous result, no particular importance can be attached to the accordance. Considering the value of the mean error  $\pm 0^{\circ}.45$  a direct comparison of 27 and  $M$  would certainly seem to be desirable.

If the length of the measuring bar of the French base-apparatus in terms of metre 27, as given in the previous note, is now expressed in International metres by means of the equation  $27 = M + 8^{\circ}.67$  the result is:

$$L = 4 M - 391^{\circ}.84 + 4 \times 8^{\circ}.67 = 4 M - 357^{\circ}.16.$$

The value of  $L$  had been determined several times before at the "Bureau international des poids et mesures" at Breteuil; on these occasions the following values were obtained, leaving out the somewhat uncertain correction for the "change in the molecular equilibrium".

1903 March	$4 M - 377^{\circ}.6$	Breteuil
1904 June	$- 373 .5$	,,
1907 February	$- 363 .7$	,,
1909 February	$- 356 .8$	,,
1909 December	$- 358 .4$	,,
1910 December	$- 357 .2$	,,
1911 June	$- 355 .3$	,,
1911 Sept.-October	$- 358 .4$	,,
1913 April	$- 348 .7$	,,
1913-14 Dec.-January	$- 357 .2$	Delft.

It appears from these numbers that during the first years up to 1909 the bar increased in length. From that year onwards the length seems to have remained practically unchanged; only in April 1913 a further very marked increase in length shows itself, of which, however, no trace is found in the measurement made by us. In view of this contradiction a new determination at Breteuil of the length of the measuring-bar is desirable; col. LALLEMAND, chief of the geodetic department of the Service géographique de l'armée, and Monsieur BENOIT, Director of the Bureau international des poids et mesures at Breteuil, have both promised to undertake this comparison shortly.

*Postscript.* A few weeks after the meeting of our Academy I received from Monsieur BENOIT a letter in which he communicated the results of an elaborate investigation concerning the length of the bar of the French base apparatus. He and Monsieur MAUDET compared in the Bureau at Breteuil first that bar and three other ones each with the prototype and afterwards the four bars with one another. BENOIT found as final result for the length of the French bar, without correction for the change in the molecular equilibrium:

$$L_0 = 4 M - 348^{\circ}.23,$$

almost exactly the same value as that found in April 1913.

On the average the length determined at Breteuil is therefore  $8^{\circ}.7$  greater than that determined at Delft.

In order to find what may be the causes of that difference I

used the formula by which the length of the bar at zero is derived from the measurements.

During the measurements at Breteuil the temperatures of the bar were, according to BENOIT'S statements, not very different from  $15^{\circ}$ . I have not here at my disposal the data of the exact values of the temperatures during the measurements at Delft, but I know that they presented no great deviations and, if I am not mistaken, the extreme differences from the mean, about  $15^{\circ}$ , were not greater than about two degrees. We can therefore combine the observations at Breteuil, and also those made at Delft each into a mean result, at a mean temperature, and we then obtain the following equation, in which the letters without a dash indicate the values determined at Breteuil, those with a dash the values determined at Delft:

$$L_T = L_0 + \alpha L_0 T = 4l_0 + 4\beta t + S, \quad L'_T = L'_0 + \alpha' L'_0 T' = 4l'_0 + 4\beta' t' + S',$$

$$L_0 - L'_0 = -\alpha L_0 T + \alpha' L'_0 T' + 4(l_0 - l'_0) + 4(\beta t - \beta' t') + S - S'.$$

In these formulae  $L$  is the length of the bar,  $T$  its mean temperature during the measurements,  $\alpha$  the adopted coefficient of expansion of the bar,  $l$  the length of the comparison metre,  $t$  its mean temperature,  $\beta$  the mean expansion of the metre for  $1^{\circ}$ ,  $S$  the difference of the length of the bar and the fourfold of the length of the comparison metre, determined by means of micrometrical measurements with the microscopes;  $T$  and  $\alpha$ , as indices of  $L$  and  $l$  indicate the temperatures to which these lengths have been reduced.

The differences of the temperatures  $T - T' = \Delta T$  and  $t - t' = \Delta t$ , and also the differences in the adopted coefficients of expansion  $\beta - \beta' = \Delta\beta$  are small, and for the value of the coefficient of expansion  $\alpha$  and  $\alpha'$  the same value has been adopted in Breteuil and in Delft; the last of the three equations may therefore be put approximately into the following form:

$$L_0 - L'_0 = \Delta L = -\alpha L \Delta T + 4\Delta l + 4\beta \Delta t + 4t \Delta\beta + S - S'.$$

When  $\Delta T$ ,  $\Delta t$ ,  $\Delta l$ ,  $\Delta\beta$  and  $S - S'$  have their exact values,  $\Delta L$  is zero; the value  $8^{\circ}.7$  for  $\Delta L$  found from the observations is therefore only a function of the errors in those values, and putting on the first side of the formula  $\Delta L = 8^{\circ}.7$  the quantities on the second side represent those errors. We will consider each of the terms separately.

1.  $\alpha L \Delta T$ .  $T$  and  $T'$  have been determined in the same manner by readings of the thermometers laid on the surface of the measuring bar within the thick aluminium case; the temperatures in both comparators were fairly constant, and the value of  $\alpha$  is small;  $\alpha L$  for  $0^{\circ}.1$  is about  $0^{\circ}.7$ . In view of the great value of  $\Delta L$ , we may therefore neglect that term.

2.  $S - S'$ . Taking into account the precision of the metro-metrical measurements and the small influence of the systematic errors in the measurements made at Delft, as appears from the values of the mean errors, that term may also be neglected in trying to explain the great value of  $\Delta L$ .

3.  $\frac{1}{2}\beta\Delta t$ .  $\frac{1}{2}\beta$  is about  $34^\circ$  and  $\Delta t$  is the difference in the errors of the mean temperatures of the metre, determined at Breteuil and at Delft. When we assume, that in the perfectly constructed comparator at Breteuil the error in the mean temperature of the metre was zero, the effect of an error of  $0^\circ,1$  in the mean temperature of the metre at Delft on its length is  $3^\circ,4$ , and in order to get a positive value of  $\Delta L$  the temperature of the thermometer laid on the surface of the metre must be lower than the temperature of the metre itself.

During the measurements the temperature of the metre was slowly rising, it is therefore improbable, that the temperature of the thermometer should be systematically lower than that of the metre, and it is difficult to explain the positive value of  $\Delta L$ , either totally or for the greater part by an error in  $\Delta t$ .

4.  $\frac{1}{2}\Delta l$ . I cannot say, what is the real value of  $\Delta l$ , the error of the difference I adopted between the length of metre N<sup>o</sup>. 27 and the International metre. The mean error of the adopted value of  $\frac{1}{2}\Delta l$  is  $\pm 1^\circ,8$ . It is therefore possible that a part of the  $\Delta L$  may be accounted for by an error in the adopted difference, but it is improbable, that it should explain the whole value,  $8^\circ,7$  of  $\Delta L$ .

5.  $\frac{1}{2}t\Delta\beta$ . We can determine a fairly probable value of that term. According to a telegram from Monsieur BENOIT, the mean expansion for  $1^\circ$  between  $0^\circ$  and  $15^\circ$ , used in the reduction of the measurements of the prototype, made of the second alloy, is  $8^\circ,662$ , the mean expansion per degree between the same limits adopted in my reductions of the length of N<sup>o</sup>. 27 made of the first alloy is  $8^\circ,493$ ; the difference between the two is  $0^\circ,169$ . As a result of direct comparisons, the mean difference of the expansion of the metres of the first and second alloy is  $0^\circ,02$ , as I stated above.

If we assume, that the coefficients of expansion of the metres of the second alloy are really equal and that it is the same with the metres of the first alloy, which assumption after the researches of BOSSCHA is very probable, the error  $\frac{1}{2}t\Delta\beta$  would be equal to  $0,169 - 0,02 = 0^\circ,15$ . As  $t$  is about  $15^\circ$ , the term  $\frac{1}{2}t\Delta\beta$  is  $9^\circ$ , almost equal to the value  $8^\circ,7$  found for  $\Delta L$ .

Although I do not pretend, that the assumptions made in order to explain the difference between the results obtained in Breteuil

and Delft are absolutely certain, still I believe that the probability is not small, that the difference between the assumed and the real coefficients of expansion of the prototype at Breteuil and the metre N<sup>o</sup>. 27, is for the greater part the cause of the value of  $\Delta L$ . It remains absolutely uncertain, what the real coefficients of expansion of the metres are and also whether the coefficient of N<sup>o</sup>. 27, determined after FIZEAU'S method, merits greater or less confidence than that of the prototype deduced, as I believe, from direct measurements at different temperatures. But whatever it may be, it is of great importance, and it is in my opinion the chief result which may be deduced from my discussion, that when a direct comparison of the metre N<sup>o</sup>. 27 and the international metre shall be made, according to the right given to our government, it will not be confined to a comparison at a mean temperature, but that if possible, the absolute coefficient of expansion of our metre, and certainly the difference in expansion of N<sup>o</sup>. 27 and the prototype will also be determined.

*Lenk (Switzerland).*

**Physiology.** — “*On the formation of antibodies after injection of sensitized antigens.*” II. By Dr. L. K. WOLFF. (Communicated by Prof. C. EYKMAN.)

I. As a continuation to my series of experiments given in the first communication, I have examined the immunisation power of a mixture of erythrocytes and specific serum with a surplus of amboceptor.

It is generally stated in literature that this power is very slight or that it does not exist at all; in my two series of experiments I have also found very little or no formation of amboceptor. I shall communicate one of the series.

Horsecorpuscles — specific rabbitserum  $\frac{1}{200}$  strong.

Binding power of 1 c.cm. 5% blood  $\pm 7$  doses.

Mixture of 40 c.cm. serum and 20 c.cm. undiluted blood i. e. 20 doses amboceptor, so a great surplus.

Rabbit 149, 73 and 76 each get 20 c.cm. of the mixture intraperitoneal.

„ 179, 70 and 71 „ „  $6\frac{1}{2}$  „ undiluted blood only „

	Titre	after 1 day	after 7 days	after 12 days
149		$\frac{1}{10}$ weak	$< \frac{1}{10}$	$< \frac{1}{10}$
73		$\frac{1}{50}$	$\frac{1}{50}$ weak	$\frac{1}{50}$ weak
76		$\frac{1}{10}$	$\frac{1}{10}$ weak	$\frac{1}{20}$
179		—	$\frac{1}{20}$	$\frac{1}{20}$
70		—	$\frac{1}{100}$	$\frac{1}{100}$
71		—	$\frac{1}{100}$	$\frac{1}{100}$ weak.



So with the rabbit 149 and 73 we do not find a trace of active immunisation, only of passive; rabbit 76 after 12 days shows a small (active) increase of titre. The controlling rabbits however have distinctly formed amboceptor.

The second experiment with cattle corpuscles had a perfectly analogous course. With these experiments we cannot inject intravenously; the animals which are intravenously injected with such a great quantity of serum and corpuscles die of anaphylaxis.

II. I have now put to myself the question what happens with the sensitized corpuscles after the injection into the rabbit or cavia.

Therefore I have for the time being confined myself to the subcutaneous resp. subconjunctive injection; the intravenous one is very difficult to follow, the progress of the peritoneal one is mostly known; besides the subcutaneous is the only one that is to be considered with regard to man. I expected that in keeping with what happens in the peritoneum, viz. a solution of the sensitized red corpuscles in a short time, the corpuscles would also dissolve in the subcutaneous tissue. I have taken the conjunctiva as the spot where to inject: there the phenomena are to be controlled better than anywhere else, and one can easily cut out little pieces for microscopic examination.

Well then: if we inject foreign corpuscles under the conjunctiva they are generally gone after one, and certainly so after two days.

As they have no movement of their own, we must assume them to be led away along the lymphatics—a leading away by phagocytes in such a short time is not to be assumed. It is however different if sensitized corpuscles are injected; these remain on the spot; they do not dissolve in any quantity worth mentioning, and if one microscopies the place after a longer or shorter space of time (after cutting out, fixing, embedding, and colouring) one will find an important number of leucocytes between the corpuscles.

After 6 to 8 days only the corpuscles have generally disappeared; sometimes however they are still to be seen after 10 to 12 days.

During the first few days one mostly finds polynuclear small leucocytes, later more great mononuclear ones.

Now the question is how to explain this conduct. For this we must examine three things.

1<sup>st</sup>. How is it that the sensitized corpuscles which are injected subconjunctively do not dissolve, while those injected intraperitoneally do.

2<sup>nd</sup>. Why do the sensitized corpuscles remain in the same place, whereas the normal ones are carried away.

3<sup>d</sup>. What happens finally to the sensitized cells; what do the leucocytes do.

Let us first answer the first question.

Here we must ask at once if there is complement in the subcutaneous lymph.

As far as I know H. SCHNEIDER's<sup>1)</sup> researches about this subject are the best; he found that the tissue lymph which is obtained by bringing a piece of cottonwool under the skin, and afterwards pressing it out, contains very little complement indeed. One always finds a little more complement than would really be the case if we had pure tissue lymph; a slight mixing with serum can of course hardly be avoided. It goes without saying that in this way we cannot be certain to get a liquid, agreeing with the tissue lymph; the piece of cottonwool naturally works irritating; an inflammation arises. But the injection of the corpuscles also causes an inflammation, and as such these two processes are equal.

I have also made some complement titrations to the guinea pig and rabbit, of subcutaneous fluids obtained in this way.

For the solution of my haemolytic system I needed:

I. Fresh guinea pig serum	$\frac{1}{100}$ c.cm.
Subcutaneous fluid	$\frac{1}{20}$ c.cm.
II. Fresh guinea pig serum	$\frac{1}{50}$ c.cm.
Subcutaneous fluid	$\frac{1}{50}$ c.cm.
III. Fresh rabbit serum	$\frac{1}{4}$ c.cm.
Subcutaneous fluid	0,6 c.cm. no haemolysis!
Stowing fluid	0,6 c.cm. trace of „

So we can affirm SCHNEIDER's experiments and assume very little or no complement to exist in the subcutaneous cellular tissue; and we need not be astonished about the sensitized corpuscles not dissolving, when being injected subcutaneously.

Now we must answer the second question. The sensitized cells remaining in the same place was supposed to be due to the agglutination which always accompanies the sensitizing. I did not succeed in obtaining an immune serum prepared in the usual way, which did not at the same time agglutinate. As I did not know any method to separate amboceptor and agglutinin when I started my experiments, I took another way to prove that the remaining of the bloodcells was owing to their being agglutinated and not to the sensitizing. I therefore agglutinated the bloodcells in a different way, and now found that clinically and histologically the same was to be seen after injecting these corpuscles as after injecting sensitized (and

<sup>1)</sup> Arch. f. Hygiene 70. p. 40 seq.

at the same time agglutinated) cells. In the first place I used a colloidal solution of  $\text{SiO}_2$  for it.

All the red bloodcells I used (rabbit, guinea pig, horse, cattle, dog) were agglutinated by it, be it in various concentration. Only the  $\text{SiO}_2$  had no effect; it caused neither swelling, nor leucocytosis. It had been prepared by saponifying Siliciumethylether (KARLBÄUM) with greatly diluted hydrochloric acid. Colloidal  $\text{SiO}_2$  prepared in a different way had the same effect. Now one might object against this experiment that the  $\text{SiO}_2$  not only agglutinates the bloodcells, but that it also sensitizes them; for together with guinea pig serum in a great quantity, it can dissolve some kinds of blood. Therefore I took refuge to the vegetable agglutinins which are found in the bean, pea, lentil, and in the seeds of *Datura Stramonium*. In all these cases the result was the same: the bloodcells always remained there; the conjunctiva also showed the wellknown bluish-red change of colour after some days, and histologically the image was always the same. It goes without saying that with all those experiments the sterility was taken into consideration as much as possible.<sup>1)</sup>

In order to make quite sure, however, that only sensitized and agglutinated corpuscles did *not* show the phenomenon, I examined some thirty rabbits out of my collection on haemolysin and agglutinin against sheep-erythrocytes, and I really found some sera which did contain haemolysin, but only little agglutinin. I repeated the experiments with these sera; but the results were not very distinct: there sometimes was a difference, but it was not big enough to draw a certain conclusion from it.

This is because all the sera employed were rather weak (amboceptor  $\frac{1}{50}$ — $\frac{1}{100}$ ) and so a rather big quantity of serum was necessary ( $\pm 3$  cm.) to sensitize the cells. Normal rabbitserum generally containing some agglutinin, we did not succeed in this way in obtaining a suspension of sheep-erythrocytes which are sensitized but little or not agglutinated. Yet I can communicate one experiment which came out rather well:

Serum rabbit 73 titre amboceptor  $\frac{1}{50}$  very little agglutinin.  
 „ „ 147 „ „ nearly  $\frac{1}{100}$  much „

$\frac{1}{2}$  ccm. sheep-erythrocytes is digested with  $\pm 3$  ccm. serum 73. just as  $\frac{1}{2}$  ccm. with  $\pm 3$  ccm. serum 147. The suspensions are centrifuged and the corpuscles are taken up in 1 ccm. salt solution. Erythrocytes 73 are injected on the right, erythrocytes 147 on the

<sup>1)</sup> I did not use ricine because the poisonous qualities of this substance would have injured the image.

left under the conjunctiva of rabbit 172. The serum of this rabbit contains neither amboceptor nor agglutinin in a noticeable quantity against sheep-erythrocytes.

After one day there is a distinct difference. There is very little swelling and redness (+) on the left, but very strong swelling and bluish-red change of colour (+++) on the right. The next day the difference is a little less, but still it is distinct.

Consequently it was desirable to obtain a serum which sensitized strongly (at least  $\frac{1}{1000}$ ), but which agglutinated little or not at all. As there was no question of a chemical separation — all the literature tells us that all suchlike attempts lead to no result whatever — such serum had to be obtained in a different way. In the literature about the heterogenetical antibodies is mentioned that serum of a rabbit which had been in some way prepared in order to get heterogenetical amboceptors against sheep-erythrocytes, would then contain no more agglutinins than are found in normal rabbitserum.

My experiments in this direction have however not yet led to the desired result. One rabbit which was injected with cattle-erythrocytes had a serum with titre  $\frac{1}{200}$  against cattle-corpuscles, and a titre  $\frac{1}{1000}$  against sheep-corpuscles. However it very clearly contained agglutinins against the latter. The same thing appeared with two rabbits which had been injected with horse-kidney extract. The titre against sheep-blood was  $\frac{1}{200}$  of both of them. Both distinctly contained agglutinins, if only little. The sheep-corpuscles treated with this serum remained for some days in the same place, after having been injected under the conjunctiva.

So in this way I could not prove *with certainty* that the agglutinin is the cause of the prepared corpuscles remaining under the conjunctiva.<sup>1</sup>

III. I will now mention some experiments which have been made in connection herewith, but which do not directly bear upon the subject mentioned in the title. I have asked myself whether the same difference as is mentioned above, is also found when non-prepared bloodcells are injected subconjunctively partly with prepared, partly with non-prepared animals, and whether here too the agglutinin was of any importance as to the remaining of the erythrocytes. And this has indeed appeared to be the case.

Rabbits with serum containing amboceptor (and agglutinin) still show a strong swelling under the conjunctiva after one or two days after having been injected with the erythrocytes in question

<sup>1</sup>) Note added during to the correction: Now I had more success with this experiment. The heterogenetical serum which I now used was  $\frac{1}{2000}$  strong.

(in my experiments they were horsecorpuseles), whereas the controlling animals showed hardly any swelling after one, and no swelling at all after two days. In accordance with this the tissue fluid (obtained in the above mentioned way with cottonwool) obtains amboceptor as well as agglutinin, if they are in the serum.

Rabbit 160 immunized against cavia-erythrocytes.

*Serum* agglutination  $\frac{1}{50}$  amboceptor  $\frac{1}{10}$  weak (++)  
*fluid* „ „  $\frac{1}{20}$  „ „  $\frac{1}{10}$  „ (+).

Rabbit 192 immunized against horse-erythrocytes.

*Serum* agglutination  $\frac{1}{10}$  amboceptor  $\frac{1}{20}$   
*fluid* „ „  $\frac{1}{10}$  weak „ „  $\frac{1}{20}$  nearly

Rabbit 147 immunized against cattle-erythrocytes.

*Serum* agglutination  $\frac{1}{5}$  amboceptor  $\frac{1}{50}$   
*fluid* „ „  $\frac{1}{5}$  „ „  $\frac{1}{20}$ .

I have now investigated if it really is the agglutinin which determines the difference.

*Rabbit 116* agglutination strong, amboceptor  $\frac{1}{100}$ .

*Rabbit 148* „ very weak, „ „  $\frac{1}{50}$ .

Both rabbits are subconjunctively injected with  $\frac{1}{2}$  c.cm. washed sheep-erythrocytes.

After one day there is a very strong bluishred swelling with 116, with 148 hardly any swelling; after 2 days still a strong swelling with 116, with 148 nearly all the blood has disappeared.

A stronger proof is given by the rabbits that were injected with horsekidney extract<sup>1)</sup>. Although the titre against sheepcorpuseles was not high here (with both  $\frac{2}{200}$ ) a great difference was stated with the controlling animal (titre also  $\frac{1}{200}$ ).

After one day hardly any blood was to be seen with the first, contrary to the controlling-animal. I think these experiments are of some importance. For in the latest great report about the agglutination known to me, that by PALTAF<sup>2)</sup>, the author says on p. 515: Ob Agglutination auch im Organismus stattfindet erscheint recht zweifelhaft.

At least I believe I have proved the haemagglutination to take place in the subcutaneous tissue. I only want to insert here that

1) These are the same animals as were mentioned above: their serum did contain agglutinin, but much less than the animals immunized in the ordinary way. That here we got no agglutinin effect, and that we did when mixing the serum with the bloodcells in vitro, may be explained by the fact that the agglutinin can pierce with so much more difficulty into the tissue fissures and reach the bloodcells than when a great quantity of serum in vitro is directly added.

2) KOLLE und WASSERMANN, IIe Auflage, II, p. 483—654.

the phenomena mentioned above belong to the department of local anaphylaxis (Phenomenon of ARTHUS). As far as I know they have not been studied as to the immunisation with bloodcells; they have with serum or bacteria. This really is only a question of name however: the essence of local anaphylaxis is still as unknown to us as that of general anaphylaxis.

In any case we can see by the bloodcells that the disintegration of albumen is a very slow one; I do not wish to deny however, that part of the flood of leucocytes is owing to this disintegration. What has been stated somewhere else viz., a primary necrosis of the tissue and after that an infiltration of leucocytes <sup>1)</sup>, I have never observed; I could sometimes also state a toxical influence of the injection out of an oedema of the cornea: but this happened very rarely. Then one should not directly compare the phenomena of subcutaneous injection with those of intracorneal injection (WESSELY, von SZILY); in the latter case the current of fluid is much slower, so that great differences can occur by this. It would however lead us too far if we entered into this more closely.

We must now still treat of the third question: what happens to the sensitized (agglutinated) cells, and what do the leucocytes do in this process? I must first of all mention that I could not find any difference between histological images when injecting sensitized or only agglutinated bloodcells. This, however, is in keeping with other experiments. For, there being a great difference in vitro between the phagocytosis of sensitized (opsonized) and nonsensitized cells, — the former are phagocytated, the latter are not, when brought together with suitable leucocytes — one does not find back this difference in vivo when injecting the cells into the abdomen, previously injected with broth. ACHARD and FOIX <sup>2)</sup> some time ago tried to find the causes of this difference, but in vain. I did not succeed either <sup>3)</sup>. We need not be astonished however, when finding the same conduct in the subcutaneous tissue as in the prepared abdomen.

Are the erythrocytes now phagocytated? Notwithstanding my observing a great many preparations, I did not succeed in getting any certainty whatever about this in my histological sections; to form

<sup>1)</sup> H. FUCHS und MELLER, Z. f. Ophthalmologie. Bd. 87, p. 280.

<sup>2)</sup> ACHARD and FOIX Arch. de Médecine expérimentale et d'anatomie Pathologique, January 1914.

<sup>3)</sup> Prof DE VRIES advised me to add to the mixture (foreign bloodcells, fresh serum (without opsonins) and leucocytes) scrapings of the peritoneum endothelium; with this I had no success either.

an opinion about it is, however, very difficult; leucocytes are always among a great number of red cells and the sections are always thicker than one red or white cell. Anyhow, it seems very probable to me that this must happen. For:

1. the red cells disappear after 6—8 days.
2. in vitro they are easily phagocytated.

3. The subcutaneous cellfluid and the leucocyte extract do not contain an unspecific haemolysin (SCHNEIDER: l. c.; this concerns polynucleous (mikrophages) as well as mononucleous cells (macrophages)).

I have tried after one or two days to cut out the swelling (after injecting the sensitized (agglutinated) cells), and then to spread them out on a coverglass: these preparations too gave bad images; principally by the stickiness of the substance: I did not see a distinct phagocytosis.

I have here always spoken about sensitized cells without wishing to form an opinion about the open question of identity between amboceptors and opsonins and tropins. (NEUFELD<sup>1)</sup> SATSCHENSKO<sup>2)</sup>).

The following experiment will show that there can be amboceptor as well as tropins in the subcutaneous cellular tissue. A piece of cottonwool was entered under the skin of the abdomen of a prepared rabbit (against sheep-erythrocytes) and the fluid was examined after some hours: in vitro it strongly stimulated the phagocytosis of sheep-erythrocytes by rabbit-leucocytes.

As a summary we can draw the following conclusions:

1. When using red corpuscles loaded with amboceptor as antigen one should remove all surplus of serum.
2. Sensitized and agglutinated red corpuscles, when injected subcutaneously, remain in the same place for a long time; non-treated cells are soon led away.
3. This will most probably be the consequence of the agglutination, not of the sensitizing. The same happens to non-specific agglutination — also when it concerns the animal's own cells.
4. With prepared animals possessing agglutinin, the cells injected also remain in the place where they have been injected. So agglutination in vitro also takes place; this is not the case with animals which only possess amboceptors (opsonins) and no agglutinins.
5. The subcutaneous lymph contains very little or no complement, it does contain amboceptor, agglutinin, opsonin (tropin).

The above will show my experiments not yet to be complete. They require to be completed as to the question to what

<sup>1)</sup> Arbeiten aus den Kaiserl. Gesundh. Bd. 25, 27 en 28.

<sup>2)</sup> Arch. Sc. biol. St. Petersburg. XV, blz. 145 1910.

extent the immunizing power of red corpuscles loaded with antibodies is related to that of normal cells as to the tropin- and the agglutinin-content of the serum. We may suppose, also in consequence of the above mentioned experiments, that the content of antibodies of serum and subcutaneous lymph goes parallel and so we shall not investigate this point separately.

IV. After the immunisation with sensitized erythrocytes the one with mixtures of serum and anti-serum comes next. I have not stated the amboceptortitre (to be stated by means of complement fixing) but the precipitincontent. Where the results do not differ much from the experiments with sensitized erythrocytes, I think I can suffice with only stating the precipitin.

*LA* Rabbits, injected intravenously with horseserum, 0,5 c.c.m. per kg. (made inactive).

Rabbit	weight	titre after 3 days	after 5 days	after 7 days	after 12 ds.	after 14 ds.
103	2600	—	—	—	$1/100$	$1/1000$
104	2850	—	—	—	$1/1000$ weak	$1/1000$
105	2850	—	—	—	$1/1000$ "	$1/1000$
106	1650	—	—	—	$1/100$	$1/1000$ weak
107	2100	—	—	—	$1/1000$ weak	$1/1000$

*LB*. Rabbits injected, intravenously with 0,5 c.cm. horseserum (inactive) + 1 c.cm. precip. serum ( $1/1000$ ), after this mixture had stood for 1 hour.

Rabbit	weight	titre aft. 3 days	after 5 days	after 7 days	aft. 12 days	aft. 14 days
108	2150	—	—	$1/10$	$1/100$	$1/100$
109	2150	—	—	$1/10$	$1/1000$	$1/1000$
119	1850	—	—	—	still some } $1/100$	$1/1000$
111	1850	—	—	—	horse serum } $1/1000$	$1/1000$
112	2150	—	—	$1/10$ weak	$1/1000$ weak	$1/1000$

So here we do not see a distinct difference between the *A* and *B* group.

II A. Rabbits, injected intraperitoneally 0,4 ccm. human serum per kg.

Rabbit	Weight	after 5 days	aft. 7 ds.	aft. 10 ds.	aft. 12 ds.	aft. 14 ds.
67	2150	—	—	$1/10$	$1/1000$	$1/10000$
78	2450	—	—	$1/10$	$1/100$	$1/1000$ weak
70	1900	—	—	$1/10$	$1/1000$	$1/10000$
60	2320	—	$1/10$ ?	$1/100$	$1/1000$	$1/10000$
76	1820	—	$1/10$	$1/100$	$1/1000$	$1/10000$

II B. Rabbits injected similarly 0,4 ccm per kg. + 3,6 ccm. antiserum ( $1/1000$  largely). The mixture had stood for 4 hours, a thick precipitate has been formed.



Rabbit	Weight	aft. 5 ds.	aft. 7 ds.	aft. 10 ds.	aft. 12 ds.	aft. 14 ds.
114	2100	—	—	$\frac{1}{100}$	$\frac{1}{1000}$	$\frac{1}{1000}$
113	3200	—	—	—	—	$\frac{1}{10}$
112	2550	—	—	—	—	$\frac{1}{10}$
71	1600	—	—	—	$\frac{1}{1000}$	$\frac{1}{160}$ weak

After 17 days the titre already went back.

Here we can see that, whereas of the series B three rabbits distinctly lag behind, two of them reach as high a titre as the A rabbits. Knowing (UHLENHUTH) that accidental failures in the preparation of precipitinholding sera are not to be avoided, I should not wish to draw any other conclusion from this than that a good formation of precipitins is also possible with mixtures of serum and antiserum.

I have also taken the following series of experiments.

III. Rabbit 140 1 c.cm. horseserum intraperitoneal.

„	116	„	„	„	+ 1 ccm antiserum ( $\frac{1}{1000}$ )
„	142	„	„	„	+ 3 „
„	99	„	„	„	+ 5 „
„	121	„	„	„	+ 7 „
„	8	„	„	„	+ 9 „
„	42	„	„	„	+ 11 „
„	48	„	„	„	+ 13 „

Rabbits	after 8 days
140	—
116	$\frac{1}{100}$ weak.
142	$\frac{1}{1000}$ „
99	$\frac{1}{1000}$
121	$\frac{1}{1000}$
8	$\frac{1}{1000}$
42	$\frac{1}{10000}$
48	—

So here too we find a rather important formation of antiserum with rabbits, which, with the serum, had also got antiserum.

IV. Rabbit 155 50 c.cm. antiserum  $\frac{1}{1000}$  + 2 c.cm. horseserum intraperit.

„	156	30	„	„	+ 2	„	„	„
„	157	10	„	„	+ 2	„	„	„
„	158	0	„	„	+ 2	„	„	„
„	159	15	„	„	+ 0	„	„	„

Rabbit	after 1½ hour	after 1 day	after 3 days	after 5 days	
	contains horse serum	contains horse serum	contains horse serum	contains horse serum	
155	+	+++	++	++	
156	+	++	++	++	
157	?		+?	+?	
158	++	+++	++	++	
159	—	1/10 —	—	—	
	after 7 days.	aft. 10 ds.	aft. 12 ds.	aft. 14 ds.	aft. 17 ds.
	contains horse serum	does not contain any horse-serum			
155	+	1/10	1/100	1/1000 w.	1/100
156	++	1/10	1/100 weak	1/100 w.	1/100
157	—	1/10	1/100	?	1/10 w.
158	++	1/10	1/100	1/100	1/100
159	—	—	—	—	—

Here too we also see some irregularity: (rabbit 157 immunizes somewhat less than the other, but even a mixture of 25 times more antiserum than serum still has immunizing effect.

I did not try if surplus of serum can do any harm when immunizing, for one then gets too great quantities so that it is hard to inject them: 50 ccm. serum is rather much for a rabbit.

These experiments seem to be somewhat contrary to a communication of DÖRR (report about Anaphylaxis, KOLLE UND WASSERM. IIe Aufl.), that the precipitate obtained by mixing serum and antiserum, has no immunizing effect. But this is only a seeming contradiction. For, according to investigations e.g. by WELSH and CHAPMANN<sup>1)</sup> this precipitate only contains traces of parts of the serum and it is almost exclusively formed out of the antiserum.

Thus I have found that of a serum of a rabbit which was immunized against human serum (titre 1/1000) 75 ccm. was necessary to form together with 1 ccm. human serum (together till 150 ccm.) a precipitate, so that in the above mentioned liquid no more human serum could be indicated with my antiserum (1/1000). 1 ccm. being a very small dosis to immunize a rabbit, it is clear that not much can be expected in general from an injection of the precipitate<sup>2)</sup>.

I have now also examined the local effect of serum and antiserum.

<sup>1)</sup> Zeitsch. f. Immunitätsf. 9, p. 517.

<sup>2)</sup> I here give up the question whether there is any human serum at all to be found in the precipitate, or whether it could be again removed by washing.

With this the antiserum and serum were always both inactive, so that we have nothing to do with any possible anaphylatoxin.

If one again injects the mixture in which a precipitate has been formed subconjunctively, one will find a rather strong swelling the next few days, which at a morphological examination again seems to contain polynucleous cells. The controlling animals which had only been injected with serum, were normal again the next day.

If one centrifuges the mixture, the above mentioned liquid is not found to cause a swelling, but the precipitate is. So we have here an analogous conduct as with the corpuscles<sup>1)</sup>.

I have now tried whether specific albumen precipitations did not show the same conduct, and for this I chose the precipitates of horseserum with colloidal  $Fe(OH)_3$  and  $SiO_2$ . Both precipitates gave some swelling and at a morphological investigation polynucleous leucocytosis. This investigation must still be extended.

If one injects a prepared animal with specific serum, one gets the same phenomenon: swelling and leucocytosis. This phenomenon is wellknown. I did not yet succeed in proving here as well that the precipitins hold the serum in its place<sup>2)</sup>, although I do think it likely, considering what goes before. For the time being I do not see a chance of preparing a serum which possesses amboceptor against foreign albumen, but no precipitin.

*Amsterdam.*

*Path. Anat. Laboratory of the University.*

**Chemistry.** — “*The Temperature-coefficients of the free Surface-energy of Liquids at Temperatures from  $-80^\circ$  to  $1650^\circ C.$* ”

**1. Methods and Apparatus.** By Prof. Dr. F. M. JAEGER. (Communicated by Prof. P. VAN ROMBURGH).

§ 1. The purpose of the experiments here described was to endeavour to ascertain the relation between the so-called “molecular surface-energy” of molten salts and the temperature, a relation which has hitherto been studied only in liquids, which possess no electrolytical conductivity.

<sup>1)</sup> The experiments are somewhat analogous to those about the local effect of the anaphylatoxin (FRIEDBERGER), but I always used serum that was made inactive, contrary to the investigators, into the anaphylatoxin.

<sup>2)</sup> That is to say subconjunctively. For the cornea other laws probably prevail; there the serum remains in the same place for rather a long time without there being any precipitins (WESSELY, VON SZILY).

A probable relation founded upon the law of corresponding states, between the value of the temperature-coefficient of the expression:  $\chi \left( \frac{M}{d} \right)^{2.3}$ , and the degree of molecular association of a liquid was first suggested by EÖTVÖS<sup>1)</sup>, and later by RAMSAY and SHIELDS<sup>2)</sup> and a number of others<sup>3)</sup>. These observations appeared to prove, that the values of these coefficients do not differ much from 2,2 Erg per degree C. for "normal" liquids, while for associated ones they are considerably less. In any event some definite knowledge of the dependence of the free surface-energy  $\chi$  upon the temperature will be of high importance for the consideration of all problems, relating to the internal state of liquids.

It can hardly be supposed with any probability, that the law of corresponding states will be found to apply in the case of molten salts, because they are really electrolytes and more or less dissociated. Notwithstanding this, if the investigation should chance to reveal relations in any way analogous to those hitherto supposed to be characteristic of organic liquids, this fact must carefully be considered in estimating the significance of the theoretical speculations mentioned, and especially is this the case, where criteria are sought for judging about the molecular state of liquids in general. In fact, one can better hope to elucidate the influence of chemical constitution on characteristic properties in the case of molten salts, than in the case of the much more complicated organic molecules.

These and other considerations, some years ago (1910) suggested the development<sup>4)</sup> of an experimental method, which should permit the study of the dependence of the molecular surface-energy upon temperature, — even up to temperatures in the vicinity of 1650° C.

<sup>1)</sup> EÖTVÖS, Wied. Ann. **27**. 448. (1886); VAN DER WAALS, Zeits. f. phys. Chem. **13**. 713. (1894). EINSTEIN, Ann. d. Phys. **34**. 165. (1911.)

<sup>2)</sup> RAMSAY and SHIELDS, Zeits. f. phys. Chemie **12**. 433. (1893).

<sup>3)</sup> Vid.: GUYE and collaborators, Journ. de Chim. phys. **5**. 81, 97. (1907); **9**. 505 (1911); etc.; WALDEN and SWINNE, Zeits. f. phys. Chem. **79**, 700. (1912) Bull. Acad. St. Pétersbourg, (1914) 405.

<sup>4)</sup> Preliminary experiments of this kind were begun during my stay at the *Geophysical Laboratory* in *Washington*, (U. S. A.), in the winter 1910–1911, and I wish to express my thanks here once more to my friend Dr. A. L. DAY for his kind assistance and most valuable advice in this matter. Through these preliminary experiments the availability of the method up to 1200° C. was clearly established by me, and it became quite clear, in what directions improvements were necessary. The further development was hindered by the building and equipment of the new Chemical Laboratory of the University of Groningen: not earlier than November 1913 could the first measurements of the present series be made.

With the increase of the temperature of observation, the experimental difficulties of precision-measurements increase very rapidly: measurements, which at room-temperature are of the utmost simplicity, are often very difficult at 400° C., and commonly almost impossible above 1000° C. This fact explains, why it has not been possible until now, to communicate the results obtained, because only an extended experience could prove to us the reliability of the method used and the degree of accuracy obtainable.

§ 2. Of all the methods hitherto described for the determination of surface-tensions, the one most used is the method of measuring the rise of the liquid in capillary tubes. RAMSAY and SHIELDS and most of the investigators who have followed, have used this method. It can however hardly be denied, that the absolute values of  $\gamma$ , obtained by different observers with the same liquids and at the same temperatures, show discrepancies of considerable magnitude. Commonly this lack of agreement is attributed rather to the unequal degree of chemical purity of the materials studied, than to the methods employed. In many of the cases, however the discrepancies were found with liquids, which can be obtained in a state of complete purity without extraordinary trouble; so that one is easily inclined to the belief that the method of measuring the capillary column includes some sources of error which are not yet sufficiently known. Possibly adhesion to the walls of the tubes plays a certain role in it, or perhaps the influence of the angle between liquid and solid material may be not completely negligible, as is ordinarily assumed.

However there is a decisive argument against the use of the method of capillary ascension in the following investigations; the walls of the capillary tubes used, were *always* damaged in a greater or less degree by the action of the molten salts. A microscopical examination of the walls of the tubes readily revealed this fact. The method cannot be employed therefore at temperatures, exceeding 400° C., because the liquids will always be contaminated and the results will be almost valueless. Furthermore, the method assumes, that a rather long column of liquid can be held throughout its full length at a constant and uniform temperature. At high temperatures this condition can scarcely be fulfilled. The study of large platinum resistance-furnaces has shown convincingly, that even in a central furnace-tube of about 26 c.m. length and 4,5 c.m. diameter, with the heating-coil wound inside, the space of really constant temperature is scarcely

longer than 4 or 5 cm.<sup>1)</sup> Therefore it is absolutely essential in every method intended for exact measurement at high temperatures, that the working-space be reduced to dimensions as small as possible. With respect to the measurements of temperature under such conditions, the available methods will permit making them with an accuracy of 0°,1 C.,<sup>2)</sup> which is more than sufficient for the purpose. On the other hand, the necessary measurements of the surface-energy must be made in such a way, that the results will have the same degree of accuracy at the highest temperatures, which they possess at lower temperatures, while at the same time the liquid to be studied must be restricted to a space of one or two cubic centimeters.

§ 3. To fulfill these postulations, there is a method which can be used under certain conditions, which was first projected by M. SIMON, and later developed by CANTOR,<sup>3)</sup> while it was successfully used afterwards for researches at lower temperatures by FEUSTEL.<sup>4)</sup> It appeared to be possible to develop the technical procedure in such a way, that the method could be used, without any appreciable loss of accuracy, up to the highest temperatures, which can be measured with the platinum-platinumrhodium thermoelement.

The principle of the method is the measurement of the maximum pressure  $H$ , prevailing within a very small gas-bubble, which is slowly formed at the circular, knife-edge opening of a capillary tube immersed in the liquid perpendicular to its surface, just at the moment, when the gasbubble is about to burst. The sharp edge of the capillary tube eliminates the influence of the capillary angle. In this way absolute measurements of the surface-energy are possible in Ergs per cm<sup>2</sup>., if the radius  $r$  of the tube, the specific gravity  $d$  of the liquid at the temperature of observation, and the depth of immersion  $i$  of the tube into the liquid, are known. To obtain the true value of  $H$ , the readings of the manometer require to be diminished by the hydrostatic pressure, corresponding to this depth of immersion  $i$ .

The method evidently can only give exact results, if the final state of the gasbubble represents a state of equilibrium, and is thus reached

1) BOTTOMLEY, Journ. of the Chem. Soc. **83**. 1421. (1903); LORENZ and KAUFLE, B. d. d. Chem. Ges. **41**. 3727. (1908); TRAUBE, *ibid.* **24**. 3074. (1891). Vide also: MOTYLEWSKI, Z. f. anorg. Chem. **38**. 410. (1903).

2) F. M. JAEGER, Eine Anleitung zur Ausführung exakter physiko-chemischer Messungen bei höheren Temperaturen. (1913). p. 36, 43.

3) M. SIMON, Ann. de Chim. et Phys. (3). **32**. 5. (1851); CANTOR, Wied. Ann. **47**. 399. (1892).

4) FEUSTEL, Drude's Ann. **16**. 61. (1905); FORCH, *ibid.* **17**. 744. (1905).

passing a series of mere equilibria; that is: the method required to be made practically a *static* one, the final maximum-pressure being independent of the special way, in which the pressure in the growing gas-bubble is gradually augmented.

Thus a *very slow* rise of pressure in the growing gas-bubble is necessary, and only in this way does it appear possible to eliminate the small differences of pressure in the long connecting tubes of the apparatus. For it is well known, that the adjustment of such small pressure-differences takes a considerable time, if the connecting tubes are relatively long.

If the radius of the capillary tube is  $r$  (in cm.), the specific gravity of the liquid  $d$ , and the observed maximum-pressure (in Dynes) is  $H$ , then the surface-energy  $\chi$  (in Erg. pro cm<sup>2</sup>.) is calculated from CANTOR'S expression (*loco cit.*):

$$\chi = \frac{rH}{2} - \frac{1}{3} dr^2 - \frac{1}{2} d^2 r^3.$$

The last two terms of the second member of this equation are usually so small, that they can be neglected in comparison with the experimental errors, as being corrections of the secondary order.

Nevertheless it has become clear, that a special correction requires to be applied to the values calculated in this manner, because of the fact, that in the theoretical deduction of this relation, a simplification is used, which cannot be considered quite legitimate. We will advert to this correction lateron. (*Vid.*: VI; under general remarks).

With this limitation extended experience in the use of the method leads to the conviction, that in the form it is used here, one can obtain reliable and, within narrow limits, reproducible results. It has the advantage, that the surface-layer of the liquid is continually *renewed*, thus the often-observed and troublesome phenomenon of the alteration of this layer, need not be feared. Furthermore one can vary the flowing gas at will with the different liquids, to prevent eventual oxidations or reductions<sup>1)</sup>. With these precautions the results can be considered as accurate at 1650° C. as at ordinary temperatures, if only no abnormally high viscosity is encountered in the liquids; for this will destroy to some extent the reliability of the measurements. The influence of the viscosity will be discussed lateron in more detail.

Of all sources of error to be considered: inaccuracy in the

<sup>1)</sup> As long as the gas is indifferent, i.e. as long as it does not react with the liquid, the results will be quite comparable, because experience teaches, that the differences in the values of  $\chi$ , measured with different gases, are vanishingly small in comparison with the experimental errors.

measurements of  $r$ , of  $d_l$ , of the pressure  $H$ , of the reduction-factor of the observed pressure on the manometer to mercury-pressure, of the measurement of temperature, of the depth  $i$ , etc., — the last mentioned appeared to be the most significant. If all these errors are assumed to be cumulative, the total effect upon the reproducibility of the results, even at  $1650^\circ \text{C}$ . is still within about 1% of the true value of  $\chi$ , and at lower temperatures about 0.6% of that value. With many molten salts, where  $H$  is very great and the viscosity very small, the percentage error appeared to be even less than this, not exceeding 0.4%. For our purpose this degree of accuracy may be considered a very satisfactory one considering the enormous difficulties of measurements at those extreme temperatures. It is also questionable, whether it will be possible to exceed this accuracy at such high temperatures in the near future. And if this could be done, it is very problematical whether much would be gained for the purpose proposed. For experience teaches us, that at those extreme temperatures all compounds are in a state of more or less advanced dissociation, and it can hardly be of any significance to express the surface-energy  $\chi$  of such compounds in tenths of Ergs, when the uncertainty in the values of  $\chi$ , caused by the inevitable admixture of the dissociation-products, will surely be larger than the correction-factors following from this increase in the accuracy of the measurements.

§ 4. In this and the following papers we will successively give an account: (1). Of the experimental arrangements and the manner of procedure, including some instances, illustrating the general adaptability of the method employed in different cases. (2). The results, obtained between  $-80^\circ$  and  $+270^\circ \text{C}$ . in the study of a great number of carboncompounds, in connection with their atomic constitution and the validity of Eötvös' theoretical views. (3). The experiments made to determine the free surface-energy of molten salts, by means of the method here developed. In this connection we will also discuss more in detail the earlier attempts to solve the problem by the method of capillary ascension in glass-tubes. (4). Finally a discussion of the results obtained and a number of considerations of a more general kind will be given, which are suggested by the study and comparison of the data now available.

#### § 5. *Apparatus and Experimental Equipment.*

*a.* In all the measurements pure, dry *nitrogen*, free from oxygen, was used, because even at the highest temperatures this gas appeared



to be quite inert, and to attack neither the compounds studied, nor the thermo-elements. Carbondioxyde can be used as a furnace-atmosphere up to relatively high temperatures, but is often not very suitable to be bubbled through molten salts under these circumstances, because of its character as an anhydrous acid. Furthermore, at the highest temperatures a slight dissociation is always to be feared. At the same time the dry nitrogen permitted us to drive out the air from the glass bulbs at lower temperatures, and completely prevented the oxidation of the organic liquids studied.

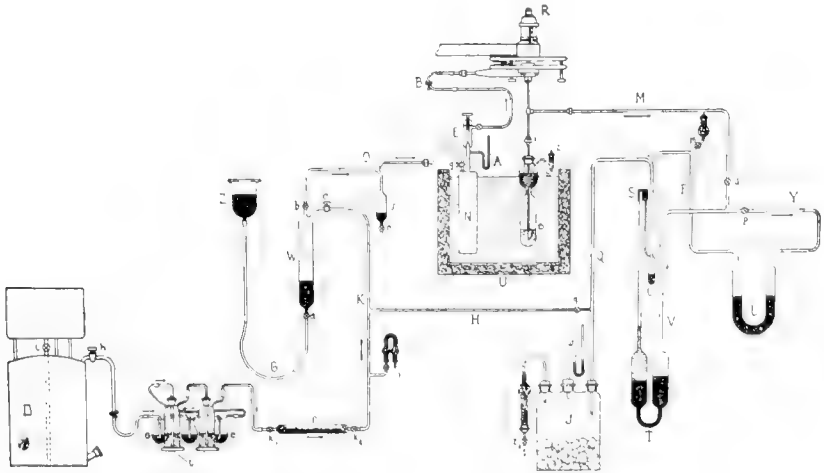

Fig. 1.

The nitrogen employed was prepared from a mixture of pure sodiumnitrite and ammoniumchloride, washed by distilled water, and collected in a gasometer *D* (fig. 1). It was led through a series of wash-bottles *e*, filled with an alkaline solution of pyrogallol, then through others, filled with concentrated sulphuric acid (*f*), and finally through a tube *f'*, containing a large surface of freshly sublimed phosphorous-pentoxide. The dried gas was preserved in a collector *W*, closed with dry mercury. When needed, it was pushed on into a metal reservoir *N* by means of a movable mercury-holder *Z*. Any arbitrarily chosen pressure could be used which was then read on the mercury-manometer *A*. The stopcock *E* carries a micrometer, used in the regulation of the gas-current. In the study of the organic liquids, this reservoir *N* was placed in the oil-thermostat *U*, with the glass-bulbs containing the liquids to be investigated. In this way the nitrogen was pre-heated to the temperature of observation, thus preventing disturbances of temperature in the surface-layer of the

liquid due to the small gas-bubbles emerging from the capillary tube.

The regulation of the velocity of flow of the gas was obtained by means of the stopcock *E* already mentioned, in combination with two accurately adjustable pinch-cocks *B*, which were inserted between the reservoir *N* and the apparatus *R*, carrying the capillary tube and its adjustments. With this arrangement no undesirable cooling of the surface, nor any lack of adjustment of the gas-velocity need be feared as a considerable source of error.

*b.* The apparatus *R* consists of an upright rod *H* (fig. 2*a*), about 1 meter high, and made of brass heavily plated with nickel. It rests on a heavy iron tripod fitted with three levelling screws. The vertical rod can be rotated about its axis by means of two gliding discs *O* at the foot of the pillar; they may be clamped fast when desired. In this way it is possible to bring the horizontal arm, bearing the adjusting arrangements and the movable counter-weight *I* into any desired azimuth, and to fix its position by means of the clamps at *O* and the collar at *H*. With the aid of a handle provided with a vertical rack and pinion, this horizontal arm can be raised to any height and fixed there with proper clamps. This arm can also be moved horizontally, in order to vary its length. Moreover it appeared to be necessary to prevent a slight bending of the pillar *H* under certain circumstances, by means of three steel supports attached to *H* and to the iron tripod<sup>1)</sup>.

Just over *R*, it has at its end a rectangularly bent steel support, to which are attached the spiraltubes *G*, made of gas-tight aluminium-tubes, nearly 3 millimeters wide, and also the similar tubes *U*, which however consist of much wider spirals. The latter form the continuation of the aluminiumtubes *G*, and their ends are firmly fastened to the horizontal beam, which is fixed in the laboratory just above the whole apparatus. The two sets of spiraltubes appeared to be necessary to ensure the desired mobility of the apparatus with regard to the manometer-connecting tubes, and also to render an effective operation of the adjusting devices possible. The great sensitiveness of the manometer makes it necessary, that all the connecting tubes of the instrument, as well as the spirals *G* and *U*, should be wrapped with a thick layer of white flannel or asbestos, in order to avoid the disturbing influence of slight oscillations of temperature.

<sup>1)</sup> In the construction of this apparatus the mechanics D. VONK and A. VAN DER MEULEN, and the amanuensis J. J. FOLKERS, all of Groningen, have aided in a most practical and effective way.

Prof. Dr. F. M. JAEGER. The Temperature-coefficients of the free Surface-energy of Liquids at Temperatures from  $-80^{\circ}$  till  $1650^{\circ}$  C. I. Methods and Apparates.

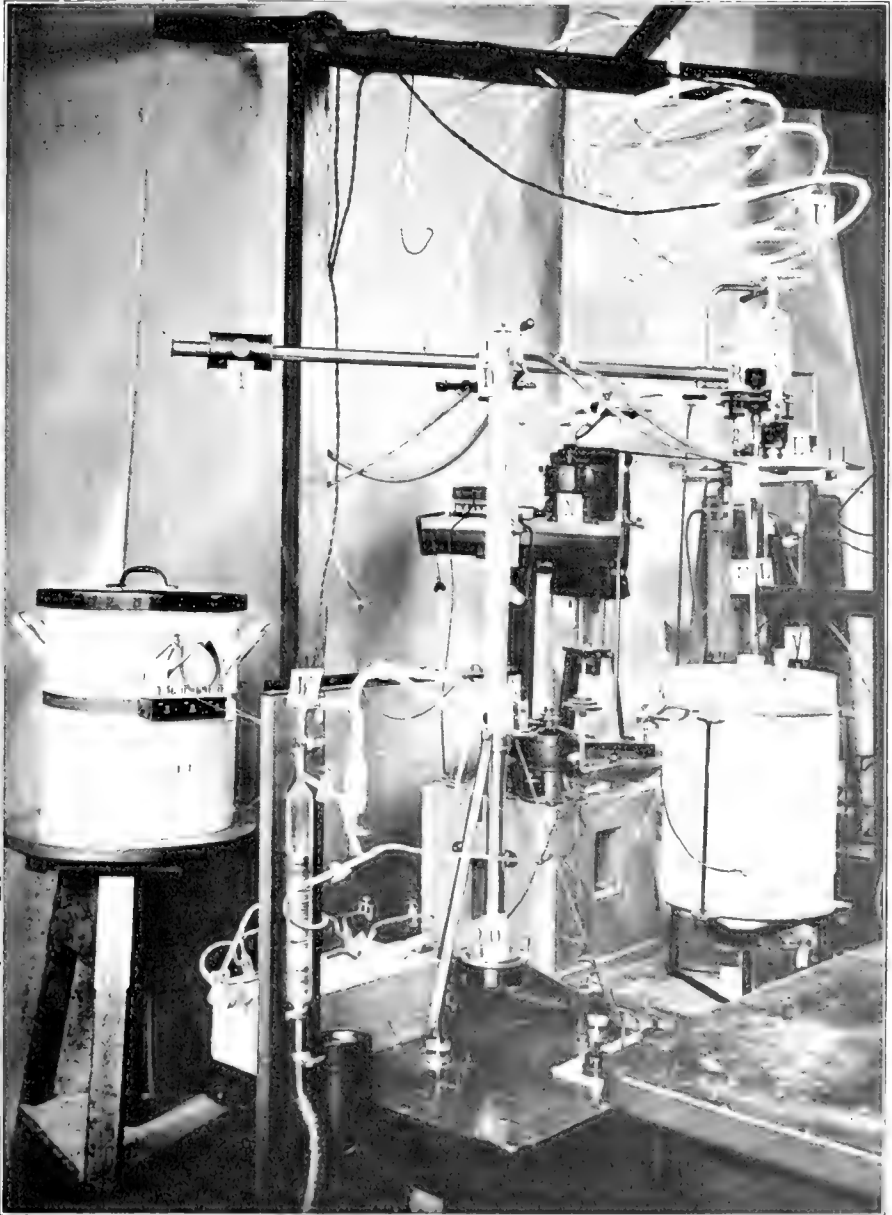

Fig. 2a.



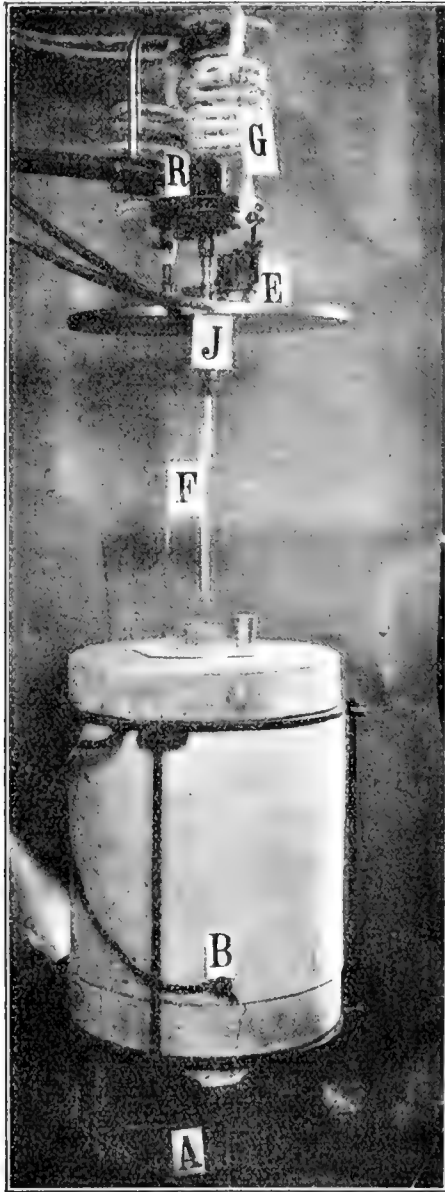

Fig. 2b.

With the protection of the waterscreen *J* it proved possible, to use the manometer even at temperatures of  $1650^{\circ}\text{C}$ ., without any disturbance from the heat-radiation of the furnace. The furnace *B* is a platinum- (or nichrome-) resistance furnace of the usual type <sup>1)</sup>; it has an inside wound heating-coil, and can be heated with a central tube of alundum inside, up to  $1400^{\circ}\text{C}$ ., and without such a

The adjusting device *R* is represented on a somewhat larger scale, in fig. 2*b*; it is fixed in position over a resistance-furnace, and connected with the capillary tube made of the platinum-rhodium-alloy and the thermoelement *E*. In this drawing the rectangular support with the spirals *G* are also plainly discernible, together with the hollow water-screen *J*, in which a current of cold water is continually circulating. This adjusting device consists of two semi-circular parts about 40 c.m. in diameter. One part is permanently attached to the apparatus *R*, the other can be fitted to it by means of pins and short tubes. The latter part has a circular glass-window, where upon the totally reflecting and movable (around a horizontal axis) prism *E* is placed. By means of this prism the behaviour of the liquid in the furnace can be observed and controlled at every moment. At temperatures over  $1000^{\circ}\text{C}$ ., coloured green glasses are inserted in front of the prism.

<sup>1)</sup> F. M. JAEGER, Anleitung u.s.w. (1913). p. 36.

central tube, to about  $1680^{\circ}\text{C}$ . The platinum-crucible is borne upon a movable support of burned magnesite, which can be fixed to the iron support *A* at any elevation.

The construction and arrangement of the part *R* of the adjusting device is elucidated more in detail in fig. 3*a* and 3*b*, *a* giving the

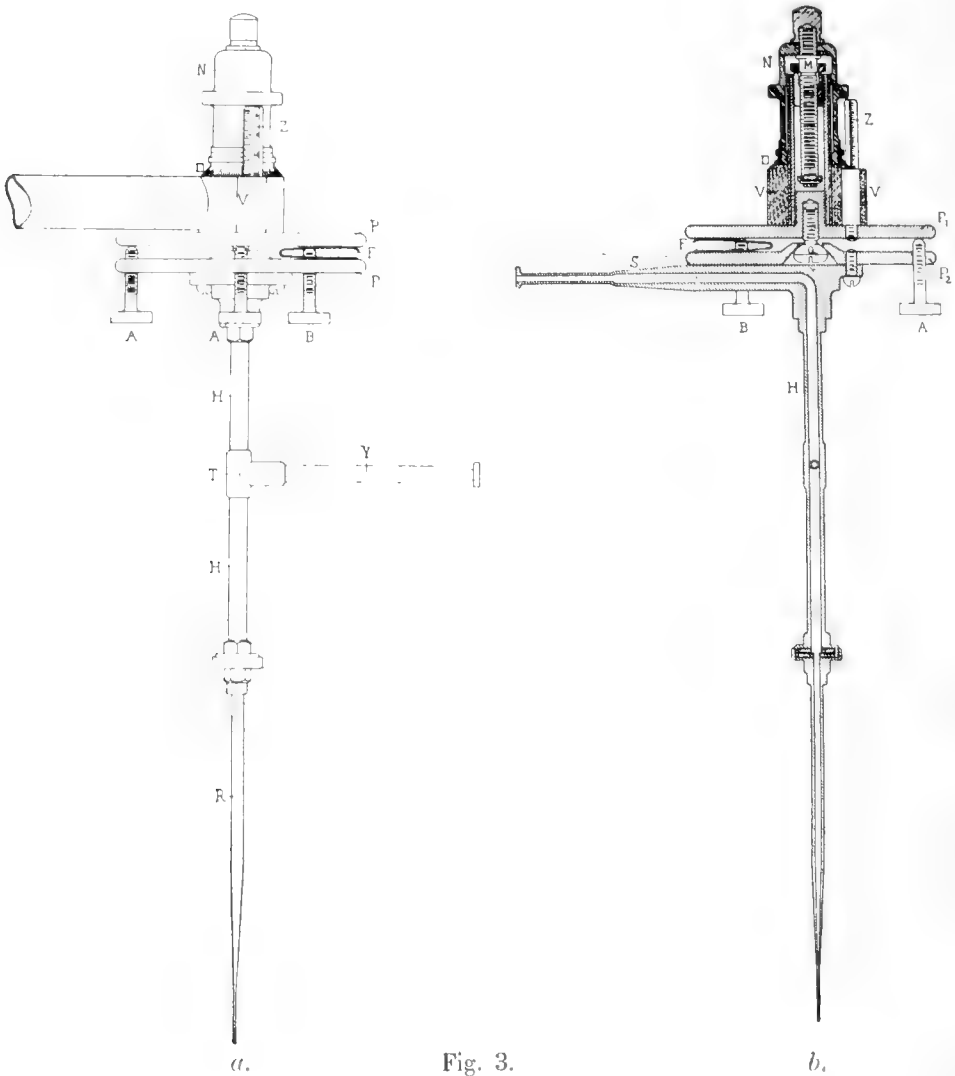

Fig. 3.

external view from one side, *b* a section through it, in a plane, perpendicular to that of fig. 3*a*.

The apparatus consists of two metal discs  $P_1$  and  $P_2$ , of which the disc  $P_2$  with the tube *S* attached to it, can be moved horizontally round the hemi-spherical button *Q*, and by means of the screws  $A_1$  and  $A_2$  can be brought to any inclined position with respect to

$P_1$ . If  $P_2$  is turned in a horizontal direction, the screws  $A_1$  and  $A_2$ , as well as the springs  $E_1$  and  $F_2$ , (fixed at one end only) will glide along the upper disc  $P_1$ , the whole upper part thus remaining in its original position. It appeared to be necessary to use a third screw  $B$  for the adjustment of the capillary tube. It is first completely loosened from  $P_1$ , then after  $P_1$  and  $P_2$  have been brought into the desired relative position, the screw  $B$  is turned so as to touch the disc  $P_1$  slightly: in this way the relative position of the two plates is completely fixed. The tubes  $S$  and  $V$ , (not shown in fig. 3a) are bent rectangularly upwards, and fitted, to the spiral tubes  $G$ . By this arrangement an undesirable motion of the apparatus (during the adjustment of the capillary tube), due to the influence of the stress and weight of the connecting-tubes, could be sufficiently prevented, while the micrometerscrew  $M$  at the same time remained in working condition. This screw  $M$ , fitted with a drum  $N$  and a scale  $D$ , serves to move the discs  $P_1$  and  $P_2$  together through a known vertical distance. The screw has a pitch of 1 mm. exactly, the circumference being divided into one hundred equal parts, it thus permits a vertical motion of 0,01 mm. to be measured at  $D$ . This is more than sufficient, because experience proves, that no adjustment of the capillary tube in contact with the surface of the liquid, can be made with greater accuracy than about 0,1 mm. During this vertical motion the drum  $N$  and the micrometerscrew  $M$  remain in their original positions, because they can only move in a horizontal direction round the fixed part  $V$  of the apparatus. A vertical scale  $Z$ , provided with divisions for about 30 mm., is moved at the same time with the two discs  $P_1$  and  $P_2$ . In this way the number of revolutions of  $N$  can be read directly. Concerning the adjustment of the capillary tube with respect to the surface of the liquid, which can be made either visually, or with the aid of the manometer-readings, the necessary directions will be given below.

§ 6. It was soon found, that the adjustment of the slight differences of pressure in the long connecting-tubes happened so slowly, that considerable errors in the measurements must inevitably occur. For this reason all the capillary tubes, with which the apparatus was originally equipped, were replaced by 5 mm. gas-tight tubes. These tubes were made in part of lead, in part of aluminium <sup>1)</sup> and.

<sup>1)</sup> Also tubes of *cellon*, made by the *Rheinisch-Westphälische Sprengstoffe A.G.* in *Cöln a/Rh.*, and which may be bent in hot water, can be recommended for such purposes. The material is gas-tight and fire-proof; however it is difficult to obtain it from the plant in any desired shape.

where necessary, were wrapped with a thick layer of asbestos. A considerable time had to be spent, to get all connections completely free from leakage; but when this was accomplished the indications of the manometer were so prompt as to be practically instantaneous. After this no errors from this source needed to be feared.

The connection of the tubes occurred in the usual way, as with high-pressure apparatus; these connections appeared to remain gas-tight, even after a longer use.

§ 7. For the measurement of the maximum pressures to be observed, originally a mercury-manometer of the type indicated by SCHEEL and HEUSE<sup>1)</sup> was used. The instrument had been modified in some details; but it appeared not to be suitable for our work, because of the necessity of always reading *two* menisci, which was very troublesome with a pressure varying continually up to the moment, when the maximum was reached.

This instrument therefore, which is very well adapted for static measurements, was only employed for the calibration of the manometer finally constructed. This second instrument was built on the principle of the manometer with two liquids.

In the measurements of organic liquids, it was necessary to avoid any contamination of the connecting-tubes with the vapour of the manometer-liquids, so that only pure *mercury* could be used as one of the liquids in the manometer. For the second liquid we chose normal *octane*. This liquid is very thin, behaves very well in contact with glass-walls, and, if completely dry, appeared not to blacken the mercury-surface, even after long exposure. The vapour-tension at 20° C. is only 10,45 mm., the viscosity at 23° C. is 0,0052 C.G.S., the surface-tension at 25° C. is 21,3 Erg. pro cm<sup>2</sup>., and the expansion-coefficient is 0,00118. After repeated fractional distillation, its boiling-point was found to be 125° C. under 758 mm. pressure, and its specific gravity at 25° C. was:  $d_{40} = 0,6985$ , i. e. about 19,38 times less than that of mercury at the same temperature. This last relation operates in the following way:

Suppose the diameter of the wider tube (fig. 4) to be  $D$ , that of the capillary tube  $d$  and the mercury-meniscus to the right to be  $a$  m.m. higher than to the left. Then the height of the octane-column to the left

<sup>1)</sup> SCHEEL und HEUSE, Ein heizbares Quecksilbermanometer für Drucke bis 100 m.M.; Mitt. aus d. Phys. Techn. Reichs-Anstalt, Zeits. f. Instr. 30. (2). 45. (1910).



side (c) is:  $\frac{a}{\epsilon}$  m.m., if  $\epsilon = \frac{1}{19,38} = 0,0516$ . Suppose  $\Delta p$  to be the increase of pressure (in m.m. mercury), necessary on the right side, to sink the

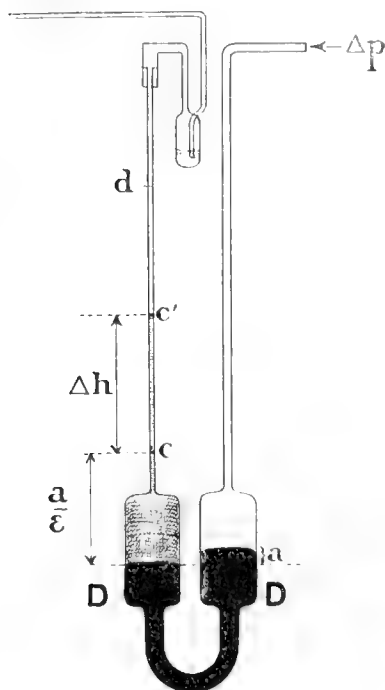

Fig. 4.

$$\frac{\Delta p}{\Delta h} = \frac{2 + \epsilon \left( \frac{D}{d} - 1 \right)}{d} = 2 \frac{d}{D} + \epsilon \left( 1 - \frac{d}{D} \right) = \epsilon \left\{ 2 - \epsilon \right\} \frac{d}{D}$$

or:

$$\Delta p = \left\{ \epsilon + (2 - \epsilon) \frac{d}{D} \right\} \Delta h.$$

The reciprocal of the expression between  $\{ \}$  will be seen to be the "multiplication factor"  $H'$  of the instrument. With small values of  $\epsilon$ ,  $(2 - \epsilon)$  will differ little from 2; therefore it is necessary to reduce  $\frac{d}{D}$  as much as possible and to make  $H'$  as large as possible.

In our instrument these conditions were fulfilled in the following way: preliminary experiment gave  $d = 2,406$  m.m.<sup>2</sup>, and  $D = 1257,36$  m.m.<sup>2</sup>; thus  $\frac{d}{D} = 0,00191$ , and  $H'$  becomes ca. 18. The reproducibility of the same pressure appeared to be possible within a limit of

0.1 m.m. octane, which corresponds to 0.005 m.m. mercury-pressure. The accuracy of the measurements was within the limits 0,05 and 0,1 %; it was greater than necessary in comparison with the magnitude of the systematic errors of the method.

The final form of the manometer, as it was used in all the measurements is shown in fig. 5. This final form resulted from a great number of experiments and numerous changes. The tube *A* is made

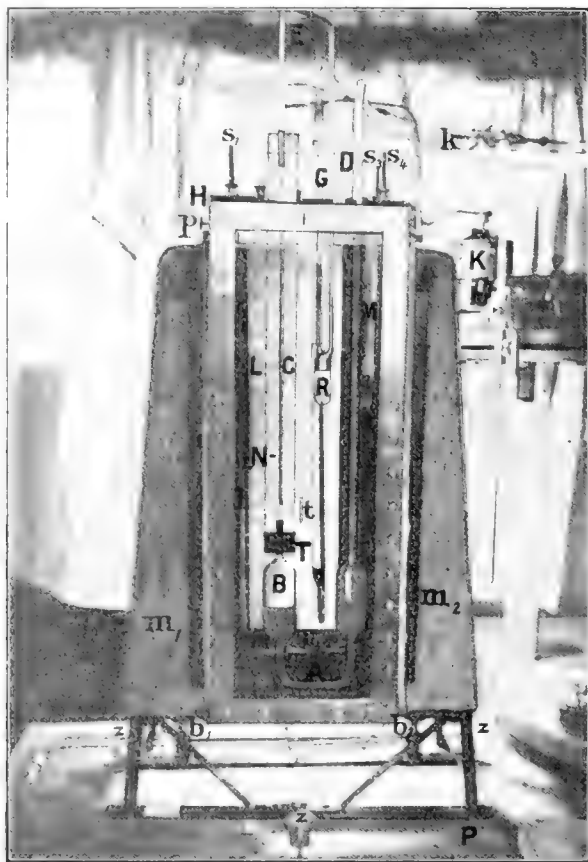

Fig. 5.

from the best quality of hard-glass, and connects two bulbs *B* of ca. 39.9 mm. diameter with a volume of about 130 cubic centimeters; they possess 1,2 mm. wall-thickness. The bulbs must carefully be chosen, and be completely cylindrical throughout their full length. As the height is about 110 mm., it is not easy to find tubes of the desired quality. The capillary tube must have an internal diameter of about 1,7 or 1,8 mm., and a wall-thickness of about 2,5 mm., and must be suitable for precision-measurements and carefully

Prof. Dr. F. M. JAEGER. The Temperature-coefficients of the free Surface-energy of Liquids at Temperatures from  $-80^{\circ}$  till  $1650^{\circ}$  C. I. Methods and Apparates.

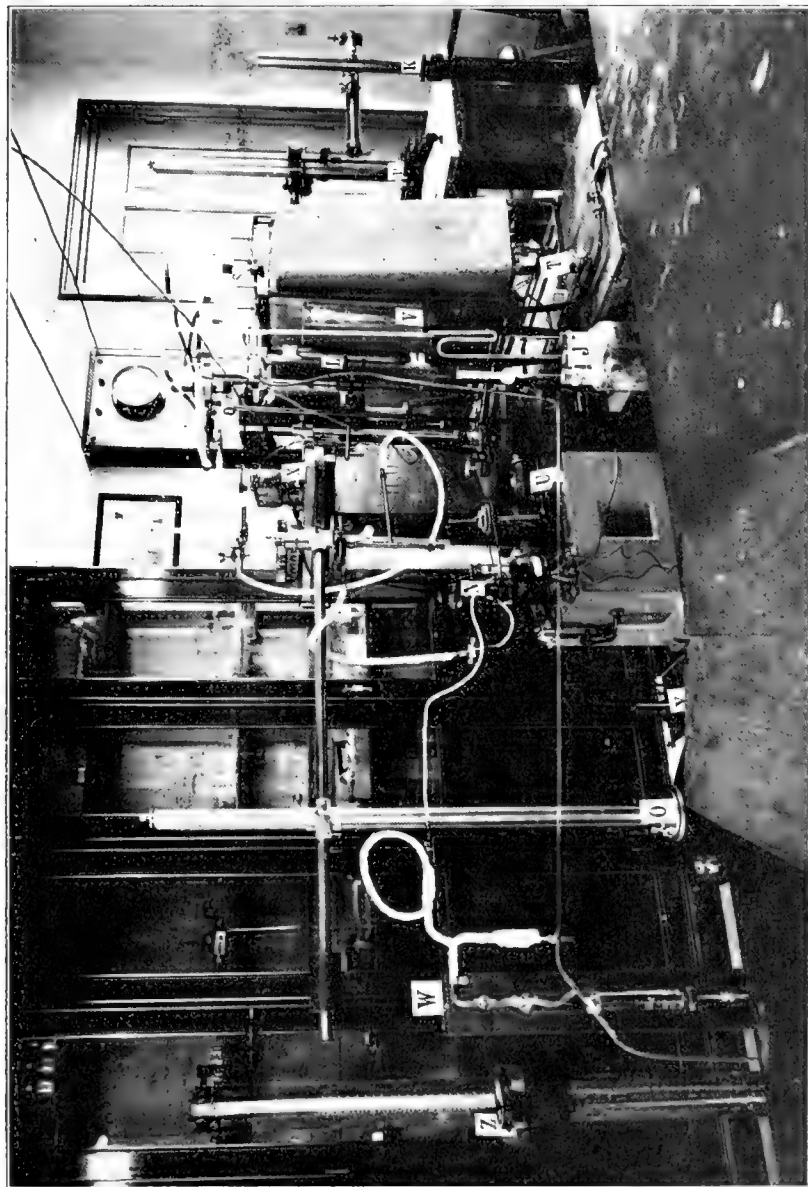

Fig. 6.



calibrated. Its length is about 600 mm. Another tube *D*, of equal length, but about 7 mm. in diameter, serves as a connection to the gasapparatus. The capillary tube *C* bears at its top a silver tube *E*, overlapping the tube *C*; it communicates with *C* by means of a silver capillary tube, and can eventually be easily removed. The tube *C* is widened at its top-end to about 10 mm., and connected with the silvertube in such a manner, that no dust of the room can contaminate the capillary tube *C*, while at the other end it communicates with a small reservoir *R*, partially filled with octane; — this for the purpose of preventing, as far as possible, the evaporation of the liquid in *C*. For this reason *R* is placed in the same thermostat as the manometer-tube. The connection of *R* with the atmosphere (or with the nitrogen) is made by means of an adjustable glass tube *G*, which opens into a very wide connecting tube leading to a large flask with three mouths, which is provided with dry calciumoxide, with a small manometer, a tube with drying materials and with a connection to the nitrogen-holder. In the fig. 1 the octane-reservoir is indicated by *C*, the silver capillary tube by *S*, the three-mouthed bottle by *J*. In the same way the manometer is indicated by *w*, the drying-tube by *z*<sub>2</sub>, and the connecting tubes by *Q* and *H*. The manometer is arranged in a glycerine-thermostat of the type usual in dilatometer-thermostats (KÖHLER), however its construction has been varied in some particulars. The thermostats commonly sold are quite unsuitable for this purpose, because they commonly show leakage or will show it very soon; then they cannot be used for glycerine, which was chosen because of its refractive index and low volatility, because this liquid will dissolve the paste used in setting the glass-windows, within a short time. Two rectangular frames were therefore made of brass, about 3 cm. broad, and soldered to the thermostat. These frames were smoothed as perfectly as possible and possessed an inside furrow about 5 mm. deep and 1 cm. broad, in which a layer of very thin rubber paste, fixed by a solution of rubber (in carbonbisulphide), held the two glasswindows fast. Then a second layer of plastic rubber was applied, and the second brass-frame was uniformly pressed against the former with some forty screws. The thermostat holds 22 kilos of glycerine, but even after long use it shows no leakage. By means of a toluene-regulator *T*, a spiral-stirrer *M* with motor *K*, and a pair of small burners *b*<sub>1</sub> and *b*<sub>2</sub>, the instrument is kept at 25°,1 C. ± 0°,1. *L* is a thermometer, divided in 0°,1 C. The support *E* is suspended from the lid *H* by means of four movable rods *l*. The manometertube can then be brought into a vertical position by means of the screws *s*<sub>1</sub>, *s*<sub>2</sub>, *s*<sub>3</sub> and *s*<sub>4</sub>. Within

the thermostat and just behind the capillary tube  $C$  a glass-scale  $N$  is introduced, which possesses a very accurate division in 0,2 mm., by means of very fine lines (3 microns) made by the Compagnie G n voise. The scale is read with a telescope and ocular-micrometer by the same firm, and at a distance of about 2 Meters; the enlargement is about 25. During the readings the motor  $K$  must be stopped for a moment, because even the slight vibrations are rather annoying. The thermostat is wrapped with felt except for the narrow opening needed for the readings. Behind the manometer a ground glass-plate is applied, which is illuminated by two long, tube-straight-filament incandescent-lamps, each of 50 candle power. Between the lamps and the thermostat, a watertank with glasswindows, is introduced, to prevent heat-radiation into the thermostat. With this mode of lighting the fine divisions and the octane-surface are seen very distinctly, without any observable parallax, against an illuminated background and readings can be made with extreme accuracy, with the aid of the movable cross-hair of the micrometer. However readings of less than 0,1 mm. appeared to be unnecessary, because of the fact, that the mean oscillations in the successive determinations of  $H$ , were about  $\pm 0,05$  mm. octane, the total uncertainty therefore being about 0,1 mm. octane-pressure, or about 0,005 m.m. mercury-pressure.

§ 8. To bring the capillary tube into a vertical position, a mercury-mirror was used: by means of the screws  $A_1$  and  $A_2$  (fig. 3*b*) the position of the capillary tube is altered until its mirrorimage will seem to be in a straight line with the tube; the position of  $P_1$  and  $P_2$  is then fixed by means of the screw  $B$ . The capillary tube itself was originally made from purest, iridiumfree platinum; this however appeared to be too soft, and so an alloy with 10% or 20% of rhodium was used afterwards. It is impossible to get any suitable capillary tubes for this purpose from the shops in trade. Therefore the rough capillary tube with its widened (ca. 6 mm.) upper part, was purveyed by HERAECUS; the lower end was then carefully turned off on the lathe to a conical and sharp edge, which was once more whetted on an oil-stone, if necessary.

With some practice in this way the repairs of the damaged or worn capillary tubes can be accomplished within a relatively short time; and it proved to be possible to obtain a cross section of the tube, which in several directions did not deviate more than about 0,002 m.m. from a pure circular shape, while the rim of the lower end measured no more than 0,01 m.m.

The cross section was determined by means of a horizontal

microscope, provided with a micrometer of the movable-cross-hair type with divided cylinder: the diameters were measured in ten or twelve directions, the squares of these numbers added, the total amount divided by the number of measured diameters, and the square root from this value considered as the true value for  $2r$ . With regard to the measurements to be made at extreme temperatures, and on account of the fact, that a whetting of the capillary tubes appeared to be necessary almost after every set of measurements, no tubes with a radius of less than 0.040 c.m. were used during these investigations.

The platinum-rhodium-tube ends at its upperside in a carefully smoothed, polished brass disc; the tube of the adjustment-apparatus *R* possesses just such a smoothed circular brass-plate. As a washer between the two discs, a very thin ring of mica is used; the capillary tube is screwed against the end of the apparatus *R*, and both tubes are then drawn together by the aid of two steel-keys, till the discs are firmly pressed against each other: in this way an absolutely gas-tight connection is obtained. This closure appears to be a very perfect one, and if it is often controlled, no leakage needs to be feared from this source.

§ 9. The temperature-measurements were made with our calibrated thermo-couples and compensator-equipment, in the way always used in this laboratory<sup>1)</sup>. Originally it was planned to connect the platinum-wire of the thermocouple directly to the end of the platinum-rhodium-tube by means of the oxygen-flame; this tube then being considered as the positive end of the thus obtained thermo-couple. However the perfect isolation of the tube at very high temperatures appeared to be a serious obstacle; so the idea was abandoned, and the usual thermo-couples, provided with isolating MARQUARDT-capillaries, was fixed to the platinum-rhodium-tube by means of fine platinum-wires; at the other end they were connected with the ice-box *Y* (fig. 2*a*). The wires of the element are bare over a distance of about 5 c.m. from the junction; this point lies in the same horizontal plane as the lower end of the capillary tube, thus being in immediate vicinity of its opening. Of course all platinum parts within the furnace (crucibles, coils, etc.) need to be made from iridiumfree platinum, to prevent contamination of the thermo-couples as much as possible.

§ 10. The adjustment of the capillary tube with respect to the

<sup>1)</sup> F. M. JAEGER. Eine Anleitung u. s. w. (1913), vid. p. 16—24.

surface of the investigated liquid, can be made in the following way. The surface of the liquid is strongly illuminated, and now attentively the moment is watched, when the capillary tube, while screwed downwards, will just make contact with its mirror-image, seen in the surface of the liquid. At temperatures above  $500^{\circ}$  C. ordinarily not, and above  $1000^{\circ}$  C. never, a special illumination of the surface is necessary: for the liquid radiates then sufficiently to make the observation of the moment of contact a very accurate one. If the temperature however becomes  $1400^{\circ}$  or higher, it is often no longer possible to discern the end of the capillary tube from the surroundings: in these cases the adjustment must be made by the aid of the manometer, as is further below described in some details.

This visual method involves, even after sufficient practice an uncertainty of about 0.1 mm. in the case of organic liquids, which corresponds to ca. 0,006 to 0,008 mm. of mercury in the determination of the maximum pressure  $H$ . The percentage error of the observation caused thereby, is about from 0,4 to 0,7%; this uncertainty in the adjustment of the capillary tube on the surface of the liquid, really appeared to be the chief source of the errors, as has been said, and is hardly or not to be avoided. However just at higher temperatures this and in the case of molten salts, where  $H$  is very great, the accuracy of the method is only slightly affected by this uncertainty.

The other way of adjustment is this, that the capillary tube is approached quite near to the surface of the liquid; then carefully a flow of nitrogen is applied, and then, while the capillary tube is slowly lowered by means of the micrometer-screw, by observation of the manometer, just the moment is determined in which a sudden rise of pressure, caused by the contact of the tube with the surface of the liquid, is seen. In this way the proposed aim was also often attained; but the uncertainty appeared to be here of the same order of magnitude, as in the case of the visual method. Furthermore it is necessary to ascertain that the small column of liquid, which often remains hanging in the capillary tube, if turned upwards, has no misleading influence on this observation; first this column of liquid needs to be blown out by the aid of a sufficiently strong flow of nitrogen, before the contact with the liquid is made in the way just described.

§ 11. The manometer was originally calibrated by immediate comparison with a mercury-manometer, which was read by means of a cathetometer and a divided scale. The paralaxis appeared to be extremely small; the accurate adjustment of the mercury-surfaces



was highly facilitated, by putting a half transparent and diffusely illuminated screen behind the manometertube, on which screen black lines were drawn under an inclination of about  $25^\circ$  with the horizon in such a way, that their mirror-images in the mercury-surfaces were visible thereupon as a bundle of very fine and easily discernible dark lines. After the application of a certain excessive pressure to both manometers, two observers read *simultaneously* both instruments; the manometers were connected with each other by a short, very wide tube, sufficiently protected against temperature-oscillations. As an example of this calibration, the following series of observations may be reproduced here in detail:

Temperature:	Mercury manometer.		Octane-manometer ( $25^\circ$ C.) Rise of the octane column in m.m.
	Observed pressure:	Pressure at $0^\circ$ C.	
12,°4	7,00	6,99	124,8
12,°6	10,23	10,21	181,8
12,°9	12,45	12,43	220,8
12,°3	9,13	9,11	162,2
12,°6	13,14	13,12	235,3
13,°0	13,78	13,75	245,0
13,°1	12,44	12,42	219,9

A rise of the octane over 1 m.m. is therefore equivalent to an excessive pressure of  $0,0561 \pm 0,0003$  m.m. mercury ( $=74,8 \pm 0,4$  Dynes).

After it was found, that our measurements of the free surface-energy of purest *water*, were in so complete agreement with those of VOLKMANN, BRUNNER, WORLEY, among others, we afterwards repeated this calibration in most cases by the accurate determination of  $\gamma$  for pure water, at three or more temperatures. The factor of enlargement  $F$  of the manometer appeared after all to be only slowly variable: in Octobre 1913 e.g. it was: 17,91 in February 1914: 17,86; in June 1914: 18,10; etc.

§ 12. The molten salts to be studied were in most cases placed into crucibles of iridium-free platinum; for the organic liquids we used vessels of glass of the shape indicated in fig. 7. A cylindrical glass tube  $P$  with rounded bottom possesses a narrower neck at  $A$ ; a wider glass cup  $A$  is fixed round it. A tube  $G$ , closed with a stopper  $K$ , which is firmly fixed round the platinum capillary tube, possesses a collateral tube  $B$ , which ends into a drying tube  $G'$ , which communicates with the free atmosphere at  $Z$ , and which is filled with

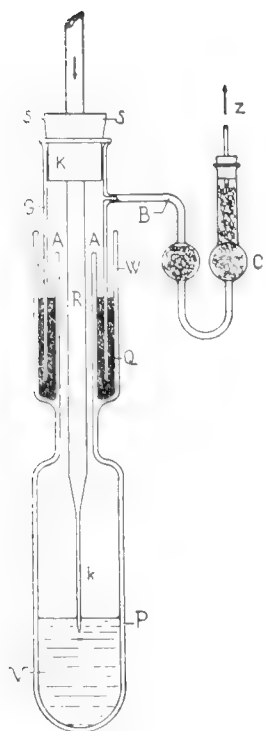

Fig. 7.

apparatus, filled with dry calcium-oxide.

§ 13. All measurements now were made in such a way, that always the zero-point was controlled anew accurately, before and immediately after each reading of the manometer. One needs to ascertain first, that all connecting tubes (fig. 6) are free from leakage, and that a diminution of the speed of gas-flow has *no* influence any longer on the value of the maximum pressure  $H$ . After the highest point of the octane-column is reached the liquid falls suddenly back to a point, which depends upon the speed of gas-flow, and then it begins to rise again slowly; etc. By experience one learns to estimate the reliability of the measurements, by the particular motion of the octane in the manometer; finally the reproducibility of the value of  $H$  needs to be considered as the decisive criterion for answering the question, if the real pressure of equilibrium in the gas-bubble has been measured. Even when the speed of gas-flow is varied within certain limits, this value appears to be reproducible quite exactly. The influence of the variation of the depth of immersion  $i$  on the manometer-readings, can be found by

<sup>1)</sup> For if necessary, the air in the vessel  $P$  can be first substituted by a current of pure nitrogen.

quick line. The vessel  $P$  is cleaned, carefully dried, and if possible several times washed out with the vapours of the boiling liquid  $V$ ; then it is filled again with a fresh quantity of the liquid  $V$ , while a layer of dry mercury is poured into  $W$ . The tube is placed into the oil thermostat, and the capillary tube with the part  $GBC$  fixed to it, is lowered then, till  $G$  makes contact with the surface of the mercury. If  $V$  has reached a constant temperature, the capillary tube is further lowered by screwing it so far downwards, as is necessary to bring it just in contact with the surface of the liquid. This enclosure by means of mercury insures a sufficient freedom of motion, while the liquid at the same time can be shut off from the air <sup>1)</sup>, and the small bubbles of nitrogen, emerging from  $k$ , can freely escape at  $C$  and  $Z_1$ . All communications with the free atmosphere, which are present in the connecting tubes of fig. 1, are provided with drying

repeated lowering of the capillary tube over known distances by means of the micrometer-screw  $N$  (fig. 3a), and by repeating the readings of the manometer in every case.

In all calculations we used the number **1333.2** Dynes as the equivalent of 1 m.m. mercury-pressure at  $0^\circ \text{C}$ .; the surface-energy is expressed in Erg pro c.m.<sup>2</sup>.<sup>1)</sup>

§ 14. As an illustration of the general availability of the method at all temperatures between  $-80^\circ \text{C}$ . and  $+1650^\circ \text{C}$ ., we will give here already some few instances, relating to: *water*, some *colloidal solutions*, some *organic liquids*, and some *molten salts*. The specific weights of the organic liquids were, after a pycnometrical control at  $25^\circ \text{C}$ ., calculated for other temperatures from the thermic expansion-formulae, if they were already sufficiently and accurately known in literature.

In other cases the densities at  $25^\circ$ ,  $50^\circ$ , and  $75^\circ \text{C}$  were pycnometrically determined, and a quadratic relation with three constants was calculated from these observations; this relation was used then afterwards for the determination of the other specific weights. In the case of the molten salts the specific weights must again be determined by means of a method to be described later. To use the numbers for the densities with more than three decimals, has no real significance, because the experimental errors are always of an order so as to make the influence of more decimals of no importance.

#### § 15.

The curve (fig. 8) is evidently *concave* with respect to the temperature-axis; the temperature-coefficient of  $\mu$  is only small, and amounts to from 0,9 to 1,05 Erg. per  $1^\circ \text{C}$ .

Furthermore in this diagram the corresponding curves are reproduced for *a colloidal solution of iron-oxide* and for *a colloidal solution of silicium-dioxide*; from both solutions the electrolytes were eliminated as far as possible by longer continued dialysation.

It appears, that both curves are evidently situated somewhat *above* that for the pure solvent, although the deviations for  $\chi$  from the values for pure water are only very small. The temperature-coefficients are analogous to those for the solvent itself; however in the case of the colloidal iron-oxyde it could be observed, that if such a solution was heated to a higher temperature, and if afterwards the determination of the surface-energy was repeated at the original

<sup>1)</sup> The result is after all the same, as when expressed in "Dynes pro c.m.".

## I.

WATER: $H_2O$ .					
Temperature in $^{\circ}C$ .	Maximum Pressure $H$		Surface- tension $\gamma$ in Erg. pro $cm^2$ .	Specific gravity $d_{40}$	Molecular Surface- energy $\mu$ in Erg. pro $cm^2$ .
	in mm. mer- cury of $0^{\circ}C$ .	in Dynes			
0.4	2.593	3457	75.8	1.000	521.0
2	2.583	3444	75.5	1.000	518.9
16.4	2.498	3330	73.0	0.999	502.1
18.4	2.488	3317	72.7	0.999	500.0
25	2.456	3275	71.7	0.997	493.6
35	2.398	3197	70.0	0.994	483.1
37.8	2.383	3177	69.7	0.993	481.3
55	2.291	3055	66.9	0.986	464.3
74.2	2.178	2904	63.6	0.975	444.8
98.5	2.014	2688	58.9	0.960	415.8
99.9	2.004	2672	58.5	0.959	414.0

Molecular weight: **18.02**.      Radius of the Capillary tube: 0.04385 cm.  
Depth: 0.1 mm.

The value of  $\gamma$  at  $20^{\circ}C$ . is thus **72.6** Erg. pro  $cm^2$ ; it is more probable, than the often accepted value: **75**.<sup>1)</sup> The here mentioned numbers are in full agreement with those of VOLKMANN<sup>2)</sup> (1880), BRUNNER<sup>3)</sup> (1847) and WORLEY<sup>4)</sup> (1914); they differ however considerably from the values published by RAMSAY and SHIELDS<sup>5)</sup>.

lower temperature, for  $\gamma$  a value was found, somewhat different from the formerly observed one with a fresh solution. Thus, although the iron-oxide-solution remains "stable" until relatively higher temperature and in general does not coagulate on heating, it seems however yet to undergo some *irreversible* change, which is manifested by the somewhat changed value of the free surface-energy.

The described method is evidently also adapted for the investigation of *colloidal* solutions of different nature; it is planned to determine these values so highly important for the chemistry of the colloids in the case of a more extended series of colloidal substances.

<sup>1)</sup> FREUNDLICH, Kapillarchemie (1909), p. 28.

<sup>2)</sup> VOLKMANN, Wied. Ann. **11**, 177, (1880); **17**, 353, (1882); **53**, 633, 644, (1894); **56**, 457, (1895); **62**, 507, (1897); **66**, 194, (1898).

<sup>3)</sup> BRUNNER, Pogg. Ann. **70**, 481, (1847).

<sup>4)</sup> WORLEY, Journ. Chem. Soc. **105**, 266, (1914).

<sup>5)</sup> The other points mentioned in the diagram, have the following significance:  $W$  = WEINBERG, Z. f. phys. Chem. **10**, 34, (1892);  $S$  = SIEG, Diss. Berlin, (1887);  $R$  = RAYLEIGH, Phil. Mag. (5), **30**, 386, (1890);  $Ss$  = SENTIS, Ann. de l'Univ. Grenoble, **9**, 1, (1887);  $H$  = PROCTOR HALL, Phil. Mag. (5), **36**, 385, (1893);  $M$  = MAGIE, Wied. Ann. **25**, 421, (1885). These data were obtained by very different methods; they are evidently appreciably deviating from each other.

§ 16. *Aliphatic Derivatives.*

## II.

ETHYLALCOHOL: $C_2H_5.OH.$					
Temperature in ° C.	Maximum Pressure $H$		Surface- tension $\chi$ in Erg. pro cm <sup>2</sup> .	Specific gravity $d_{40}$	Molecular Surface- energy $\mu$ in Erg pro cm <sup>2</sup> .
	in mm. mer- cury of 0° C.	in Dynes			
-79°	1.066	1421.2	30.6	0.886	426.2
-24	0.881	1174.5	25.2	0.820	369.6
0.1	0.825	1086.5	23.3	0.807	345.4
25	0.746	995.7	21.3	0.786	321.4
35	0.724	965.2	20.6	0.777	313.1
55	0.667	889.2	19.1	0.759	294.9
74.5	0.617	822.6	17.6	0.741	276.1

Molecular weight: **46.05**. Radius of the capillary tube: 0.04385 cm.  
Depth: 0.1 mm.

The alcohol was completely anhydrous and was therefore preserved in a bottle with drying-tube. At the boilingpoint (78°4 C.) the value of  $\chi$  is 17.0 Erg. pro cm<sup>2</sup>. The mean temperature-coefficient of  $\mu$  is only: **0.94** Erg.

## III.

ACETIC ACID: $CH_3.COOH.$					
Temperature in ° C.	Maximum Pressure $H$		Surface- tension $\chi$ in Erg. pro cm <sup>2</sup> .	Specific gravity $d_{40}$	Molecular Surface- energy $\mu$ in Erg. pro cm <sup>2</sup> .
	in mm. mer- cury of 0° C.	in Dynes			
26°	0.943	1257.2	27.0	1.046	401.7
34.6	0.914	1218.5	26.1	1.039	390.1
55	0.842	1122.3	24.0	1.022	362.7
70	0.787	1049.3	22.4	1.010	341.2
98.5	0.691	921.3	19.7	0.987	304.7

Molecular weight: **60.03**. Radius of the capillar tube: 0.04385 cm.  
Depth: 0.1 mm.

By repeated freezing and distilling, the liquid was thoroughly purified; its boilingpoint was 118°1 C. The temperature-coefficient is between 26° and 55° C.: **1.3** and preserves that value up to the boiling-point. At the last temperature the value of  $\chi$  is: **17.7** Erg. pro cm<sup>2</sup>.

Specific Surface-energy  $\gamma$   
in Ergs pro c.m<sup>2</sup>.

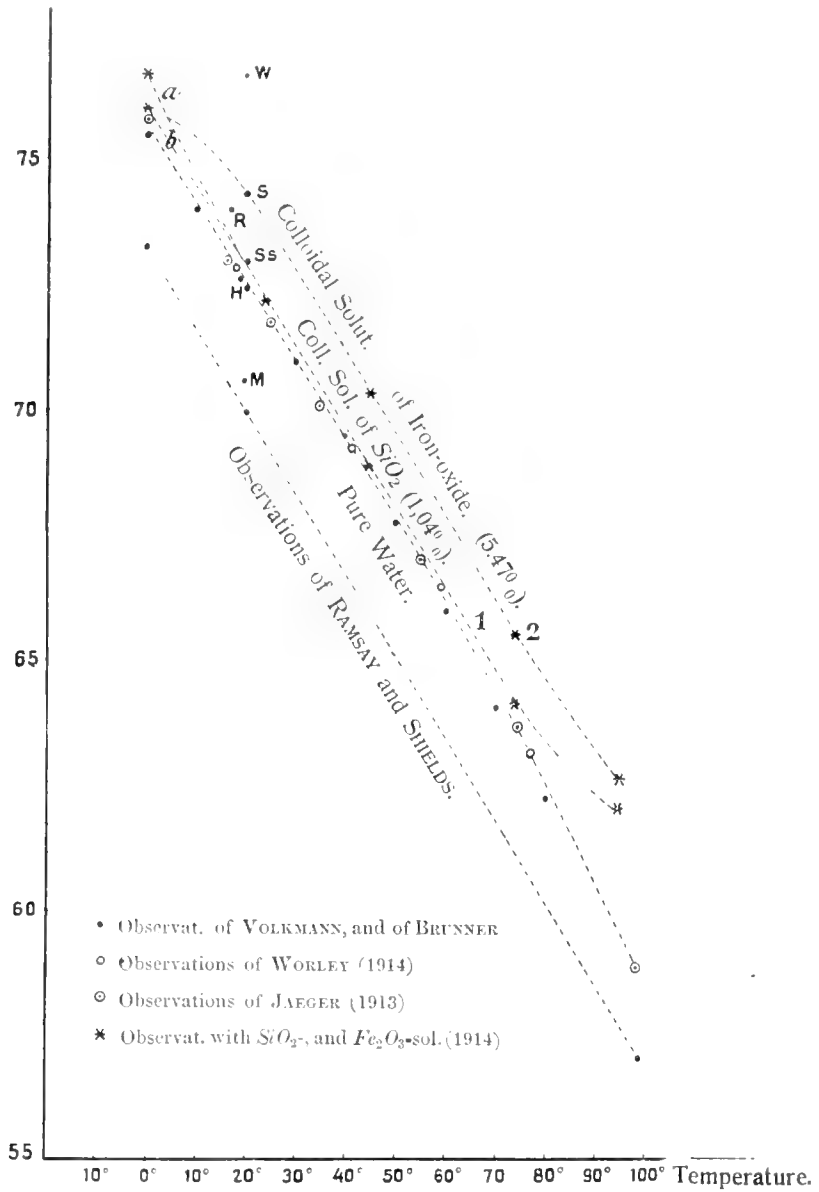

Fig. 8. Surface-tensions of pure water and colloidal solutions at different temperatures.

Although acetic acid doubtless is a gradually dissociating liquid, and in accordance with this manifests only a small temperature coefficient of  $\mu$ , this last remains constant, contrary to the cases, where the curves appear to be concave or convex.

## IV.

DIETHYLMALONATE:  $\text{COO}(\text{C}_2\text{H}_5) \cdot \text{CH}_2 \cdot \text{COO}(\text{C}_2\text{H}_5)$ .

Temperature in $^{\circ}\text{C}$ .	Maximum Pressure $H$		Surface- tension $\chi$ in Erg. pro $\text{cm}^2$ .	Specific gravity $d_{40}$	Molecular Surface- energy $\mu$ in Erg pro $\text{cm}^2$ .
	in mm. mer- cury of $0^{\circ}\text{C}$ .	in Dynes			
-19.9	1.237	1649.2	35.5	1.095	985.3
0.7	1.167	1555.8	33.5	1.075	941.2
8.5	1.142	1523.2	32.9	1.068	928.4
25.2	1.077	1435.9	31.0	1.050	884.8
34.5	1.044	1391.9	30.0	1.041	861.2
50.1	0.994	1325.2	28.5	1.025	826.6
69.2	0.920	1226.8	26.3	1.005	772.9
102	0.804	1071.8	23.0	0.969	692.5
124.5	0.723	963.9	20.6	0.945	630.7
144	0.660	880.2	18.8	0.924	584.3
148.7	0.649	866.4	18.5	0.919	577.1
171	0.571	761.6	16.2	0.896	513.9

Molecular weight: **160.1**. Radius of the capillar tube: 0.04385 cm.  
Depth: 0.1 mm.

The compound boiled constantly at  $197^{\circ}.3\text{C}$ .; at  $-50^{\circ}\text{C}$ . it is solidified. At the boilingpoint the value of  $\chi$  is about: **13.7** Erg pro  $\text{cm}^2$ .; the temperature-coefficient of  $\mu$  has as mean value: **2.52** Erg.

§ 17. *Aromatic Derivatives.*

## V.

BENZENE:  $\text{C}_6\text{H}_6$ .

Temperature in $^{\circ}\text{C}$ .	Maximum Pressure $H$		Surface- tension $\chi$ in Erg. pro $\text{cm}^2$ .	Specific gravity $d_{40}$	Molecular Surface- energy $\mu$ in Erg. pro $\text{cm}^2$ .
	in mm. mer- cury of $0^{\circ}\text{C}$ .	in Dynes			
5.4	1.077	1436.7	30.9	0.895	607.7
9.5	1.055	1406.5	30.2	0.889	596.6
25.1	0.969	1291.9	27.7	0.873	553.8
35	0.920	1226.5	26.3	0.862	530.3
55	0.836	1114.6	23.8	0.841	487.8
74.6	0.757	1009.2	21.6	0.817	451.4

Molecular weight: **78.05**. Radius of the Capillar tube: 0.04385 cm.  
Depth: 0.1 mm.

Although the mean value of the temperature-coefficient of  $\mu$  oscillates round **2.0** Erg., the dependence of  $\mu$  and  $t$  is not a linear one: between  $5^{\circ}$  and  $25^{\circ}$  the coefficient is: **2.65**; between  $25^{\circ}$  and  $55^{\circ}\text{C}$ .: **2.12**; and between  $55^{\circ}$  and  $75^{\circ}$ : **1.95** Erg. At the boilingpoint ( $80.95$ ), the value of  $\chi$  is: **20.7** Erg.

## VI.

ANISOL:  $CH_3 \cdot O \cdot C_6H_5$ .

Temperature in ° C.	Maximum Pressure $H$		Surface- tension $\gamma$ in Erg. pro cm <sup>2</sup> .	Specific gravity $d_{40}$	Molecular Surface- energy $\nu$ in Erg. pro cm <sup>2</sup> .
	in mm. mer- cury of 0° C.	in Dynes			
-21°	1.375	1833.6	39.3	1.029	874.8
0.4	1.306	1741.7	37.3	1.010	840.6
25	1.210	1613.1	34.6	0.987	791.9
45	1.137	1516.5	32.5	0.970	752.5
74.4	1.022	1362.5	29.1	0.942	687.0
90.8	0.962	1282.2	27.4	0.927	653.9
110	0.875	1167.3	24.9	0.907	602.9
134.7	0.765	1020.2	21.7	0.882	535.3
151	0.700	932.9	19.8	0.865	494.8

Molecular weight: **108.6.**Radius of the Capillar tube: 0.04352 cm.  
Depth: 0.1 mm.

The boilingpoint was constant at 151.07 C.; at -50° the substance crystallizes to a beautiful, hard aggregate of crystals. The temperature-coefficient of  $\nu$  increases, just as in the case of water, with increasing temperature: between -21° and 45° C. it is: **1.88**; between 45° and 90° C. it is: ca. **2.14**; between 91° and 151° its mean value is: **2.63**.

## VII.

PHENETOL:  $C_2H_5 \cdot O \cdot C_6H_5$ .

Temperature in ° C.	Maximum Pressure $H$		Surface- tension $\gamma$ in Erg pro cm <sup>2</sup> .	Specific gravity $d_{40}$	Molecular Surface- energy $\nu$ in Erg pro cm <sup>2</sup> .
	in mm. mer- cury of 0° C.	in Dynes			
-21°	1.289	1718.5	36.8	1.006	902.1
0.3	1.213	1617.7	34.6	0.986	859.6
25.2	1.117	1489.0	31.8	0.962	803.1
45	1.037	1383.3	29.5	0.943	755.0
74.3	0.931	1240.8	26.4	0.914	689.9
90.6	0.875	1167.3	24.8	0.899	655.3
110	0.813	1084.6	23.0	0.889	612.3
134.7	0.734	979.0	20.7	0.855	565.6
150.1	0.687	915.9	19.3	0.849	529.8
160.5	0.651	868.6	18.3	0.839	506.3

Molecular weight: **122.1.**Radius of the Capillar tube: 0.04352 cm.  
Depth: 0.1 mm.

The boilingpoint is constant at 168°; the substance solidifies at -50° C. to an aggregate of long, colourless needles. The temperature-coefficient of  $\nu$  can be considered as constant, its mean value being: **2.14** Erg.



## VIII.

ANETHOL:  $CH_3O \cdot C_6H_4 \cdot CH : CH \cdot CH_3(1.4)$ 

Temperature in °C.	Maximum Pressure		Surface- tension $\gamma$ in Erg pro cm <sup>2</sup> .	Specific gravity $d_{40}$	Molecular Surface- energy $\nu$ in Erg pro cm <sup>2</sup> .
	in mm. mer- cury of 0° C.	in Dynes			
*24.7	1.267	1689.2	36.2	0.988	1021.8
*45.5	1.188	1583.8	33.9	0.969	969.1
*75.1	1.078	1438.4	30.7	0.944	893.0
*94.2	1.017	1355.7	28.9	0.927	850.9
115	0.929	1239.0	26.9	0.908	803.0
135.1	0.865	1153.4	25.0	0.890	756.4
160.9	0.787	1049.8	22.7	0.867	698.9
192.8	0.689	919.1	19.8	0.838	623.6
212.7	0.625	833.5	18.0	0.820	575.6
230	0.588	783.9	16.9	0.809	544.9

Molecular weight: **148.1**. Radius of the Capillar tube: 0.04439 cm.;  
in the with \* indicated observations, the  
radius was: 0.04352 cm.  
Depth: 0.1 mm.

The boilingpoint was constant at 230° C.; the meltingpoint is: 21° C.  
Between 25° and 75° C. the temperature-coefficient of  $\nu$  is about: **2.53**;  
later on it becomes fairly constant: **2.25**. At the boilingpoint the value  
of  $\gamma$  is: **1.68** Erg pro cm<sup>2</sup>.

## IX

GUAJACOL:  $CH_3O \cdot C_6H_4 \cdot OH(1,2)$ .

Temperature in °C.	Maximum Pressure $H$		Surface- tension $\gamma$ in Erg. pro cm <sup>2</sup> .	Specific gravity $d_{40}$	Molecular Surface- energy $\nu$ in Erg. pro cm <sup>2</sup> .
	in mm. mer- cury of 0° C.	in Dynes			
26°	1.377	136.4	43.3	1.128	994.0
45.5	1.302	1736.4	40.9	1.109	949.6
66.5	1.224	1632.4	38.4	1.088	902.9
86	1.156	1540.7	36.2	1.078	861.8
106	1.087	1449.1	34.0	1.048	819.7
125	1.024	1365.8	32.0	1.029	780.9
146	0.954	1265.9	29.6	1.008	732.4
166	0.874	1166.0	27.2	0.988	682.1
184	0.803	1070.2	24.9	0.970	632.1
206	0.718	957.7	22.3	0.948	574.8

Molecular weight: **124.06**. Radius of the Capillar tube: 0.04803 cm.  
Depth: 0.1 mm.

The substance boils under 24 mm. pressure at 106° C.; the melting-  
point is 32° C. The temperature-coefficient of  $\nu$  is between 26° and  
46° C.: **2.17**; between 146° and 206° the curve is feebly convex to  
the  $t$  axis and the mean value of the coefficient is therefore about:  
**2.66** Erg.

RESORCINE-MONOMETHYLETHER:  $C_6H_4(OH) \cdot (OCH_3) (1,3)$ .

Temperature in ° C.	Maximum Pressure $H$		Surface- tension $\lambda$ in Erg pro cm <sup>2</sup> .	Specific gravity $d_{40}$	Molecular Surface- energy in $\mu$ Erg pro cm <sup>2</sup> .
	in mm. mercury of ° C.	in Dynes			
-20°	2.622	3495.6	83.1	1.181	1850.1
0	1.636	2181.1	51.6	1.161	1161.9
25.9	1.462	1948.8	46.0	1.136	1051.0
45.9	1.380	1840.5	43.4	1.119	1001.6
66.5	1.318	1757.3	41.4	1.102	965.2
86.5	1.252	1669.7	39.3	1.082	927.5
107	1.196	1594.9	37.5	1.061	896.7
125	1.140	1519.9	35.7	1.044	862.9
146	1.075	1433.2	33.6	1.023	823.2
166	1.009	1345.0	31.5	1.003	782.0
184	0.956	1274.2	29.8	0.986	748.2
206	0.862	1149.4	26.8	0.965	682.6

Molecular weight: **124.06**. Radius of the Capillary tube: 0.04803 cm.  
Depth: 0.1 mm.

Under 25 mm. pressure, the compound has a boilingpoint of 144°C.  
The observations over 180° C. relate to the substance already slightly dissociated, as was seen from the brownish colour of the liquid. At -79° C. it becomes glassy, without indication of crystallisation. At 0° and -20° C. also, the viscosity of the liquid is still enormous.

## XI.

RESORCINE-DIMETHYLETHER:  $C_6H_4(OCH_3)_2 (1,3)$ .

Temperature in ° C.	Maximum Pressure $H$		Surface- tension $\lambda$ in Erg pro cm <sup>2</sup> .	Specific gravity $d_{40}$	Molecular Surface- energy $\mu$ in Erg pro cm <sup>2</sup> .
	in mm. mercury of ° C.	in Dynes			
-22°	1.520	2026.5	44.3	1.104	1107.9
0	1.419	1892.3	41.3	1.084	1045.6
25	1.325	1766.2	38.6	1.064	989.4
45.3	1.250	1667.0	36.4	1.046	944.3
70.5	1.166	1554.4	33.9	1.022	893.2
90.1	1.090	1453.2	31.7	1.004	844.6
116	1.007	1342.7	29.2	0.980	790.6
135.3	0.943	1257.0	27.3	0.963	747.9
*162.1	0.781	1041.0	24.4	0.939	679.8
*189.9	0.700	932.8	21.8	0.914	618.4
*210	0.637	849.5	19.8	0.894	570.0

Molecular weight: **138.08**. Radius of the Capillary tube: 0.04439 cm.;  
in the with \* indicated observations the radius was: 0.04803 cm.  
Depth: 0.1 mm.

The substance has a constant boilingpoint at 214° C.; the liquid can be undercooled to -76° C., and solidifies to a crystal-aggregate, which melts at -52° C. At lower temperatures, as far as to 0° C., the temperature-coefficient of  $\mu$  is rather large: **2.83** Erg; later it is fairly constant, with the value: **2.25** Erg.

## XII.

HYDROCHINON-DIMETHYLETHER:  $C_6H_4(OCH_3)_2$  (1, 4).

Temperatur in ° C.	Maximum Pressure $H$		Surface- tension $\alpha$ in Erg pro cm.	Specific gravity $d_{40}$	Molecular Surface- energy $\mu$ in Erg pro cm <sup>2</sup> .
	in mm. mercury of 0° C.	in Dynes			
66°	1.106	1474.5	34.7	1.036	905.4
86.5	1.031	1374.1	32.3	1.008	858.3
106	0.974	1299.2	30.5	0.990	820.3
126	0.909	1213.8	28.4	0.976	771.1
146	0.843	1124.4	26.4	0.957	726.2
166	0.775	1032.7	24.2	0.938	674.7
184	0.709	945.3	22.1	0.921	623.7
206	0.628	837.0	19.5	0.901	558.4

Molecular weight: **138.08**. Radius of the Capillary tube: 0.04803 cm.  
Depth: 0.1 mm.

The meltingpoint of the substance is at 56° C.; it boils under a pressure of 20 mm., at 109° C. On cooling first a glass is obtained, which gradually crystallizes in fine needles. Between 66° and 106° the temperature-coefficient of  $\mu$  is about: **2.11**; between 106° and 166°, about: **2.46**; and between 166° and 206° C., about: **2.88** Erg. The relating curve is therefore concave to the  $t$ -axis.

§ 18. *Heterocyclic Derivatives.*

## XIII.

PYRIDINE  $C_5H_5N$ .

Temperature in ° C.	Maximum Pressure $H$		Surface- tension $\alpha$ in Erg in cm <sup>2</sup> .	Specific gravity $d_{40}$	Molecular Surface- energy in Erg pro cm <sup>2</sup> .
	in mm. mercury of 0° C.	in Dynes			
-79°	1.698	2263.8	48.9	1.078	827.8
-20.5	1.430	1906.5	41.1	1.018	722.9
0.1	1.329	1771.8	38.1	0.998	679.0
25	1.215	1619.8	34.9	0.975	631.8
35	1.177	1569.2	33.8	0.962	607.3
55	1.099	1465.2	31.5	0.942	583.4
74	1.022	1362.5	29.3	0.923	550.1
92.5	0.960	1279.9	27.5	0.904	523.5

Molecular weight: **75.09**. Radius of the Capillary tube: 0.04385 cm.  
Depth: 0.1 mm.

The pyridine crystallizes readily at -52° C.; thus the measurements at -79° C. relate to a strongly undercooled liquid. The curve, giving the dependence of  $\mu$  and  $t$  is not quite regular. At the boilingpoint (114° 5 C.), the value of  $\alpha$  is: **25.2** Erg pro cm<sup>2</sup>.

## XIV.

 $\alpha$ -PICOLINE:  $C_5H_4(CH_3)N$ .

Temperature in °C.	Maximum Pressure $H$		Surface- tension $\gamma$ in Erg pro cm <sup>2</sup> .	Specific gravity $d_{40}$	Molecular Surface- energy $\mu$ in Erg
	in mm. mercury of 0° C.	in Dynes			
-70°	1.505	2007.1	47.4	1.036	950.8
-20.7	1.246	1661.5	39.2	0.986	812.7
0	1.165	1553.2	36.6	0.965	769.7
25.8	1.074	1432.4	33.7	0.940	721.2
46	0.999	1332.5	31.3	0.920	679.6
66.5	0.928	1236.9	29.0	0.900	638.9
86.5	0.846	1128.5	26.4	0.881	590.0
106	0.787	1049.3	24.6	0.862	557.8
126	0.718	957.7	22.5	0.842	518.2

Molecular weight: **93.07**. Radius of the Capillary tube: 0.04803.  
Depth: 0.1 mm.

The liquid, which is boiling constantly at 133° C., can be under-cooled as far as -74° C.; it solidifies at -64° C. and melts there very rapidly. Between -70° and -21°, the temperature-coefficient is about: **2.83**; afterwards the mean value remains about: **2.02** Erg.

## XV.

CHINOLINE:  $C_6H_4 \cdot N \cdot C_3H_3$ .

Temperature in °C.	Maximum Pressure $H$		Surface- tension $\gamma$ in Erg. pro cm <sup>2</sup> .	Specific gravity $d_{40}$	Molecular Surface- energy $\mu$ in Erg. pro cm <sup>2</sup> .
	in mm. mer- cury of 0° C.	in Dynes			
-21°	1.682	2242.4	49.1	1.124	1160.0
0	1.608	2143.8	47.0	1.108	1121.1
*24.8	1.562	2082.5	44.7	1.089	1078.6
*45.2	1.486	1981.1	42.5	1.073	1035.6
*74.3	1.379	1838.2	39.4	1.051	973.5
*94.7	1.303	1737.1	37.2	1.034	929.1
115	1.210	1613.0	35.2	1.018	888.4
135.2	1.135	1513.8	33.0	1.002	841.7
160	1.047	1395.9	30.4	0.981	786.4
192.5	0.929	1239.0	26.9	0.954	708.9
213	0.855	1139.9	25.7	0.938	658.3
230	0.797	1063.3	23.0	0.924	619.2

Molecular weight: **129.07**. Radius of the Capillary tube: 0.04439 cm.;  
in the with \* indicated observations, the radius was: 0.04352 cm.  
Depth: 0.1 mm.

The boilingpoint was constant at 233° C.; the liquid can be under-cooled as far as -50°, and then crystallizes, melting readily at -25° C. The temperature-coefficient of  $\mu$  increases with the temperature: between -21° and 45° C. it is: **1.92**; between 45° and 115° C.: **2.10**; between 115° and 230°: **2.33** Erg. At the boilingpoint the value of  $\gamma$  is: **22.7** Erg. pro cm<sup>2</sup>.

Molecular Surface-energy, in Erg pro c.m<sup>2</sup>.

Fig. 9.

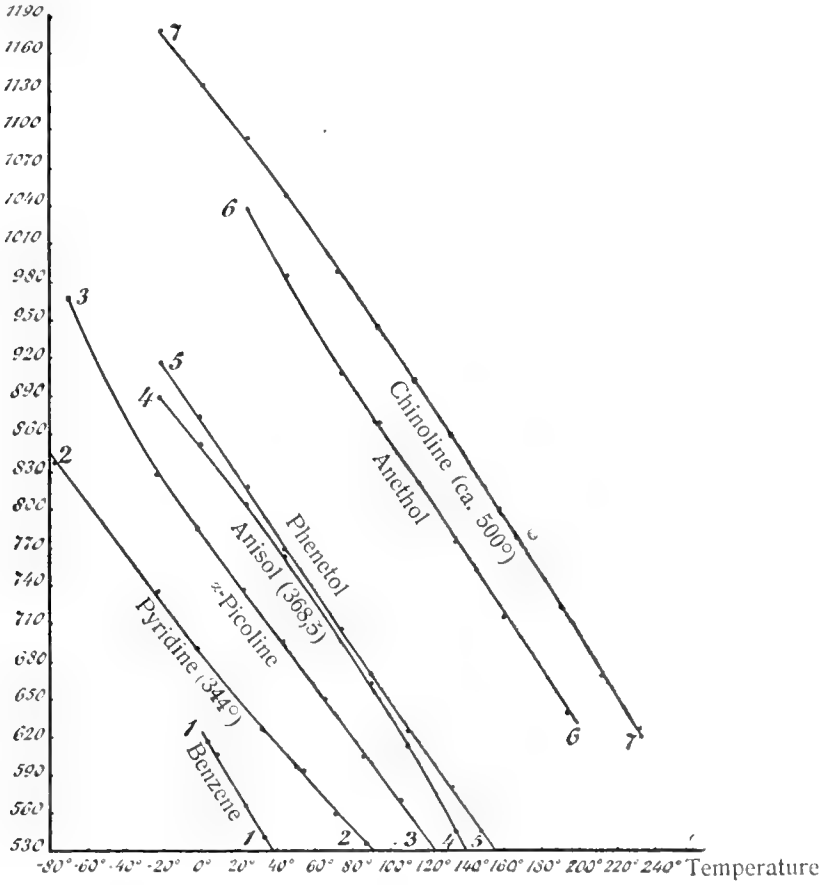

Some of the curves, which relate to these organic liquids, are reproduced here in the usual graphical way (fig. 9); the corresponding critical temperatures of the liquids, so far as they are known, are mentioned and written between ( ) behind the names of the substances investigated.

19. *Salts of the Alkali-Metals.*

## XVI.

POTASSIUMCHLORIDE: <i>KCl</i> .					
Temperature in ° C. (corr. on G. Th.)	Maximum Pressure <i>H</i>		Surface- tension $\chi$ in Erg pro cm <sup>2</sup> .	Specific gravity $d_{40}$	Molecular Surface- energy $\mu$ in Erg pro cm <sup>2</sup> .
	in mm. mer- cury of 0° C.	in Dynes			
799.5	3.015	4019	95.8	1.509	1290.0
827.1	2.957	3942	94.0	1.492	1275.3
861.5	2.873	3830	91.3	1.470	1251.0
885.1	2.819	3758	89.7	1.456	1237.0
908.5	2.768	3690	88.0	1.442	1221.3
941	2.697	3595	85.8	1.421	1202.6
986	2.582	3442	82.2	1.396	1165.8
1029	2.484	3311	79.1	—	—
1054	2.425	3233	77.2	—	—
1087.5	2.361	3147	75.2	—	—
1103.6	2.313	3083	73.7	—	—
1125	2.275	3033	72.5	—	—
1167	2.182	2909	69.6	—	—

Molecular weight: **74.56**. Radius of the Capillary tube: 0.04736 cm. at 15° C. The expansion-coefficient is here 0.0000083.  
Depth: 0.1 mm.

The salt melts sharply at 771° C.; after four hours heating between 900° and 1100°, it solidifies at 769° C. It evaporates rapidly at 980°, at 1160° with great speed. Just as in the case of the other alkali-salts, the vapours are doubtlessly acid, while the solidified mass gives an alkaline reaction, if dissolved in water. The gradual dissociation lowers the value of the maximum pressure more and more, as is seen from repeated experiments after a longer heating 1100° C.

As some illustrations of the changes caused by the commenced dissociation of the salt, the following measurements are given, which were made after a heating at 850° and 1150° C. during full four hours:

At 848° C. the maximum pressure was found to be 2.821 mm. mercury									
" 904 " " " " " " " " " " " " " "								2.720	" "
" 941 " " " " " " " " " " " " " "								2.645	" "
" 956.5 " " " " " " " " " " " " " "								2.615	" "
" 1037 " " " " " " " " " " " " " "								2.455	" "

All values are evidently lower than the previously observed ones, and at the lower temperatures, at which the observations were made after the longest heating of the salt, the decrease is most appreciable.

POTASSIUMBROMIDE: <i>KBr</i> .			
Temperat. in ° C. (corr.)	Maximum Pressure <i>H</i>		Surface- tension $\gamma$ in Erg. pro cm <sup>2</sup> .
	in mm. mercury of 0° C.	in Dynes	
775°	2.702	3602	85.7
798	2.642	3522	83.8
826	2.585	3446	82.0
859	2.504	3338	79.5
886.5	2.450	3266	77.8
920	2.376	3167	75.4

Molecular weight **119.02**.

Radius of the Capillary tube: 0.04728 cm. at 15° C.

Depth: 0.1 mm.

The dissociation and splitting off of hydrogen-bromide and bromine is observed at 825° C. At 940° C. the evaporation and dissociation of the salt have become so rapid, that measurements at higher temperatures seemed to be without any real significance.

## XVIII.

POTASSIUM IODIDE: <i>KJ</i> .			
Temperat. in ° C. (corr. on G. Th.)	Maximum Pressure <i>H</i>		Surface- tension $\gamma$ in Erg pro cm <sup>2</sup> .
	in mm. mercury of 0° C.	in Dynes	
737°	2.372	3162	75.2
764	2.274	3031	72.1
812	2.183	2910	69.2
866	2.106	2807	66.8
873	2.097	2795	66.5

Molecular weight: **165.96**.

Radius of the Capillary tube: 0.04728 cm. at 15° C.

Depth: 0.1—0.2 mm.

The salt melts at ca. 700° C. Already at 750° C. it evaporates rather rapidly, and at 900° C. with dissociation into hydrogen-iodide and iodine. Measurements at higher temperatures can have hardly any significance.

## XIX.

SODIUMCHLORIDE: <i>NaCl</i> .					
Temperature in ° C. (corr. on G. Th.)	Maximum Pressure <i>H</i>		Surface- tension $\gamma$ in Erg. pro cm <sup>2</sup> .	Specific gravity $d_{40}$	Molecular Surface- energy $\mu$ in Erg. pro cm <sup>2</sup> .
	in mm. mer- cury of 0° C.	in Dynes			
802.6	3.580	4772	113.8	1.554	1275.9
810.5	3.572	4762	113.5	1.549	1275.4
820.8	3.552	4735	112.9	1.543	1270.8
832	3.520	4692	111.9	1.537	1262.6
859	3.457	4608	109.9	1.523	1247.7
883.2	3.401	4534	108.2	—	—
907.5	3.345	4459	106.4	—	—
930.6	3.285	4379	104.5	—	—
960.5	3.227	4302	102.7	—	—
995.5	3.132	4175	99.7	—	—
1037	3.047	4062	97.0	—	—
1080	2.951	3934	94.0	—	—
1122.3	2.864	3818	91.3	—	—
1171.8	2.761	3681	88.0	—	—

Molecular weight: **58.46**. Radius of the Capillary tube: 0.01736 cm. at 15° C.  
Depth: 0.1 mm.

The pure salt melts at 801° C. At 1080° it evaporates already rapidly, at 1150° C. very rapidly. The temperature-coefficient of  $\mu$  calculated in the few cases, where values of specific gravity were available, is very small: about **0.57** Erg. The solidified mass gives in water a rather strong alkaline reaction; the vapours of the heated salt have an acid reaction.



## XX.

SODIUMSULPHATE: $Na_2SO_4$ .			
Temperature in ° C. (corr. on G. Th.)	Maximum Pressure $H$		Surface- tension $\gamma$ in Erg pro cm <sup>2</sup> .
	in mm. mer- cury of 0° C.	in Dynes	
900°	6.285	8379	194.8
945	6.247	8328	189.3
990	6.209	8278	188.2
1032	6.149	8197	186.5
1077	6.088	8116	184.7

Molecular weight: **142.07.**

Radius of the Capillary tube: 0.04512 cm.

Depth: 0.1 mm.

The pure salt melts at 884° C. If heated to 1100° C. the solidified mass gives in water a rather strong alkaline reaction, indicating a dissociation. Measurements at higher temperatures than 1100° C. thus seemed to be useless.

## XXI.

SODIUMMOLYBDATE: $Na_2MoO_4$ .			
Temperature in ° C. (corr.)	Maximum Pressure $H$		Surface- tension $\gamma$ in Erg pro cm <sup>2</sup> .
	in mm. mer- cury of 0° C.	in Dynes	
698.5	6.091	8122	214.0
728.5	5.975	7967	210.0
751	5.921	7893	208.1
777	5.828	7770	204.9
818.8	5.757	7675	202.4
858.5	5.657	7542	199.0
903.8	5.552	7401	195.4
948	5.436	7247	191.4
989.5	5.330	7106	187.7
1035	5.224	6966	184.1
1078.5	5.141	6854	181.2
1121.5	5.070	6760	178.8
1171.5	4.998	6654	176.1
1212	4.947	6595	174.6

Molecular weight: **206.**

Radius of the Capillary tube:  
0.05240 cm.

Depth: 0.1 mm.

The compound melts at 687° C. to a  
colourless liquid.

LITHIUMSULPHATE: $Li_2SO_4$ .			
Temperature in ° C. (corr.)	Maximum Pressure $H$		Surface- tension $\gamma$ in Erg pro cm <sup>2</sup> .
	in mm. mercury of 0° C.	in Dynes	
860°	6.361	8481	223.8
873.5	6.342	8455	223.1
897	6.303	8403	221.8
923	6.256	8341	220.2
962.5	6.169	8224	217.4
976.8	6.146	8194	216.4
1001.2	6.099	8132	214.8
1038.5	6.027	8035	212.3
1057	5.987	7982	211.0
1074	5.953	7936	209.8
1089.5	5.923	7897	208.8
1112	5.879	7838	207.3
1156.5	5.791	7720	204.2
1167.5	5.766	7687	203.4
1183.5	5.737	7649	202.4
1192.2	5.718	7624	201.8
1214	5.675	7566	200.3

Molecular weight: **109.94.**  
 Radius of the Capillary tube:  
 0.05240 cm. at 16° C.  
 Depth: 0.1 mm.

The salt was prepared from purest lithium-carbonate and sulfuric acid, carefully dried and heated at 900° C.; it melts at 849° C. After being heated to 1200° C., the substance, shows an alkaline reaction with water. Also here it is of little significance, to pursue the measurements to higher temperatures.

## XXIII.

LITHIUMMETASILICATE: $Li_2SiO_3$ .			
Temperature in ° C. (corr. on G.Th.)	Maximum Pressure $H$		Surface- tension $\gamma$ in Erg pro cm <sup>2</sup> .
	in mm. mercury of 0° C.	in Dynes	
1254°	11.82	15759	374.6
1380	11.29	15052	358.2
1421	11.22	14958	356.2
1479	11.11	14812	352.8
1550	10.97	14626	348.7
1601	10.90	14532	346.6

Molecular weight: **90.01.**  
 Radius of the Capillary tube: 0.04706 cm.  
 Depth: 0.1—0.2 mm.

The analysed metasilicate was perfectly pure. It melts at 1201° C. The temperature-coefficient of  $\mu$  is very small.

§ 20. In the case of POTASSIUMCHLORATE:  $KClO_3$ , the maximum pressure  $H$  was 3,573 mm. mercury at  $413^\circ.5$  C; at  $443^\circ.5$  C. it was: 3,540 mm. The radius of the here used silver-capillary tube being:  $= 0.03460$  cm., the free surface-energy is calculated:

$$\text{At } 413^\circ.5 \text{ C. } \quad \chi = 82,4 \text{ Erg. pro cm}^2.$$

$$\text{At } 443^\circ.5 \text{ C. } \quad \chi = 81,6 \text{ Erg. pro cm}^2.$$

At the last mentioned temperature the salt commenced to decompose already distinctly, while  $O_2$  was split off; at higher temperatures therefore the values of  $\chi$  appeared to *increase* gradually by the generation of  $KClO_4$  and  $KCl$ .

It was not possible therefore to investigate the values of the temperature-coefficients at higher temperatures; in every case however they seem to be rather small.

With SILVERNITRATE:  $AgNO_3$ , the value of  $\chi$  is about 164 Erg. pro.  $cm^2$ . at  $280^\circ$  C; at  $410^\circ$  C. it is about 153.8 Erg. In this case the temperature-coefficient is also in the neighbourhood of 0.6 or 0.9, — this being a rather small value too.

§ 21. It is not my intention, to discuss now already the here mentioned data, nor to add the remarks, which are suggested thereby. It is better to postpone that task, until the complete experimental material now available will be published. The given instances may however prove, that the question: *how to measure the surface-tensions of liquids with great accuracy within a temperature-interval, from  $-80^\circ$  C. to  $1650^\circ$  C.*, may be considered now as completely solved.

Groningen, May 1914.

Laboratory of Inorganic Chemistry  
of the University.

**Chemistry.** — “*The Temperature-coefficients of the free Surface-energy of Liquids, at Temperatures from  $-80^\circ$  to  $1650^\circ$  C*”.

II. *Measurements of Some Aliphatic Derivatives.* By Prof. Dr. F. M. JAEGER and M. J. SMIT. (Communicated by Prof. P. v. ROMBURGH).

§ 1. In what follows the data are reviewed, which were obtained by us in the study of a series of aliphatic derivatives after the method formerly described by one of us<sup>1)</sup>.

With respect to the liquids here used, we can make the following general remarks. No product of commerce, not even the purest ob-

<sup>1)</sup> F. M. JAEGER, These Proceedings (1914).

tainable, can be esteemed suitable for this kind of measurements: the small traces of humidity already, which even the best chemicals always contain, are sufficient to make the results unreliable. Most of the organic liquids of commerce however seem to contain several admixtures, in small quantities or even larger quantities of water. We often obtained a first purification by distilling a small fraction from it, whose boiling point remained constant between  $1^{\circ}$  or  $2^{\circ}$  C. In several cases even this appeared not to be possible: in such case the preparation was dried during some days by means of anhydrous sodiumsulphate; then, if the special character of the substance did not forbid this, it was dried again during a long time by means of freshly sublimed phosphorpentoxide, after which the fractional distillation was tried again. Commonly it appeared to be possible, to separate from it a fraction, whose boiling point remained constant between  $1^{\circ}$  or  $2^{\circ}$  C. With some preparations we succeeded in drying them by means of metallic sodium. After very dry fractions, boiling within a few degrees, had been obtained in this way, they were once more distilled with a small flame only, or on the water-bath, under atmospheric or reduced (12—20 mm.) pressure; in this operation only the fraction, boiling *within an interval of 1 C.*, was used for further treatment. The liquid was then cooled during several hours in a closed vessel, by means of a mixture of salt and ice, or by a bath of solid carbon dioxide and alcohol. If it crystallized, a further purification was often possible by repeated freezing and decanting. Often a very thin layer of a solid substance (eventually of ice) was deposited at the walls of the vessel, the rest remaining liquid and transparent; the liquid portion was poured into a dry, clean vessel then, and the said operation repeated, till no solid layer any more appeared. If however the phenomenon continued to appear, the liquid was treated again at least during a week with fresh phosphorpentoxide, and the freezing repeated again and again. Finally the purified liquid was distilled once more under atmospheric or reduced pressure; only the fraction, boiling *within half a degree* was collected then for the measurements. It is hardly necessary to mention, that hygroscopical liquids were preserved and treated in a suitable manner. The thus obtained liquid was commonly only a very small fraction (10% or 20%) of the original commercial preparation; it must be remarked, that the observed boiling-temperatures often differed appreciably from the data, given in the literature, and in several cases appeared to be *lower* than those; — which perhaps can be explained by the fact, that in the distillations, described in the literature, the liquid was heated *too* rapidly.

In our experiments the speed of distillation often did not exceed about six drops every minute. In some cases, e.g. with *toluene*, it was impossible to distil from the product of commerce a fraction, fulfilling all conditions; in such cases the substance was prepared in some other way, e.g. the mentioned toluene by dry distillation of purified calciumphenylacetate; etc. In the series of compounds described, several were taken from the collection of scientific preparations of this laboratory; from these also only the small, constantly boiling fraction was used for our purpose.

§ 2. Notwithstanding the by no means negligible differences of the boilingpoints observed, the specific gravities of the liquids in most cases differed only slightly or not at all from the data, given in the literature. If this was the case, — and we always controlled this by some pycnometrical determinations at 25° C., — the specific gravities at other temperatures were calculated from the expansion-formulae eventually already determined. If the direct determination of  $d_{40}^{25}$  did not agree with the number, given in literature, or if the expansion-formula was not known accurately enough, three specific gravities, e.g. at 25°, 50°, and 75° C. or at a higher temperature, were determined pycnometrically, and from these determinations an empirical equation of the second degree with respect to  $t$ , was calculated. This is completely sufficient here, because the specific gravities were all abbreviated with three decimals: an account of the densities in more than three decimals, must be esteemed valueless here, with respect to the obtained accuracy of the measurements. With most liquids, the mean decrease of the specific weight for 1° C. does not differ largely from 0,001. For temperatures of — 70° and above 100° C. it was often necessary to extrapolate by the aid of the established empirical formulae: although conscious of the uncertainties, which are always connected with such extrapolations, we are of opinion that we have not introduced here in this way errors of appreciable amount, because for these values such an error could manifest itself only in the third decimal place, and dilatation of the liquids occurs ordinarily in so regular a way, that the probability of heavy errors is thus highly diminished by this circumstance.

Moreover another way was not available at this moment, if not with large sacrifice of time and labour.

§ 3. In the following the obtained results are collected in tables. For the value of 1 mm. mercury at 0° C., 1333,2 Dynes (45°), was calculated, and this value was used in all further calculations; in the tables all numbers for  $\chi$  and  $\mu$  are adjusted by the necessary corrections.

The graphical diagrams relate to the variation of the so-called "molecular" surface-energy  $\mu$  with the temperature; in the same diagram analogous, homologous compounds or such, related by simple substitutions, are put together; this will be of practical use for the comparative considerations later to be given, and allows a rapid review of the behaviour. For the construction of the diagrams, not the numbers of the tables, but those following directly from CANTOR'S formula, are used; therefore the correction, necessary to derive the absolute value of  $\mu$  from these readings by diminution, are indicated on each curve in the diagrams.

#### § 4. Aliphatic Derivatives.

This series of measurements relates to the following aliphatic

Molecular Surface  
Energy in Erg. pro cm<sup>2</sup>.

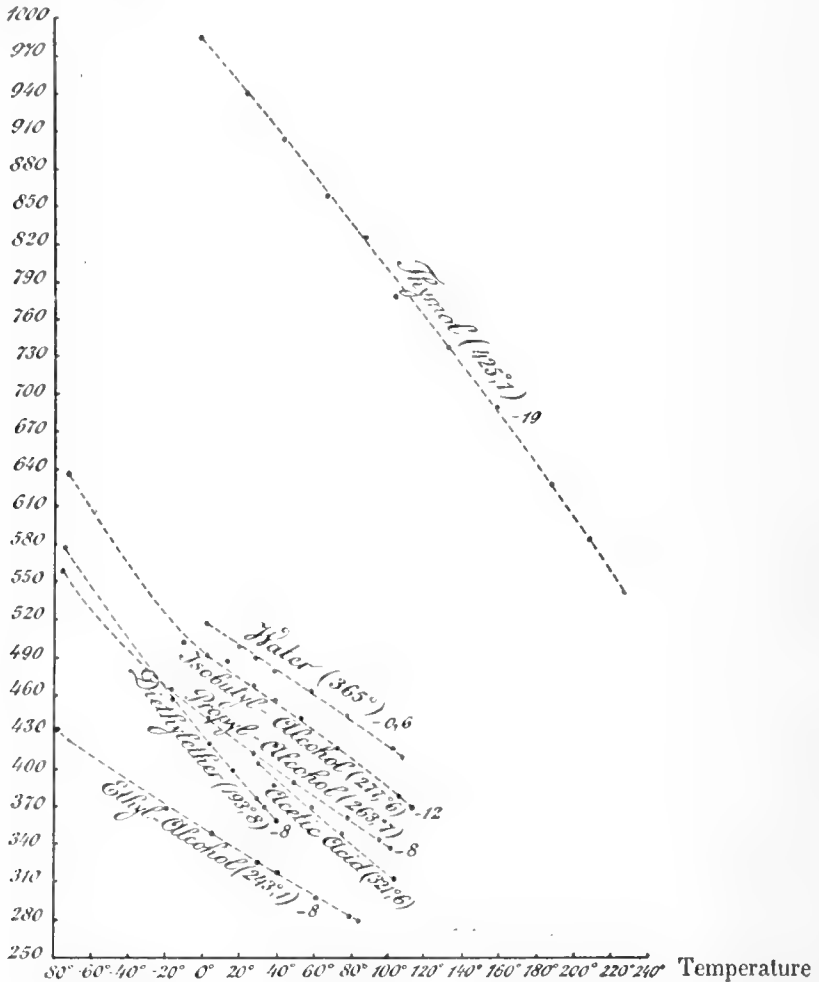

Fig. 1.

substances: *norm. Propylalcohol; Isobutylalcohol; Diethylether; Ethylformiate; Ethylchloroformiate; Ethylacetate, Methyl-, Ethyl-, and*

## I.

<b>norm. Propyl-alcohol: <math>C_3H_7.OH.</math></b>					
Temperature in $^{\circ}C.$	Maximum Pressure $H$		Surface-tension $\gamma$ in Erg. per $cm^2.$	Specific gravity $d_{40}$	Molecular Surface- energy $\mu$ in Erg. pro $cm^2.$
	in mm. mer- cury of $0^{\circ}C.$	in Dynes:			
$-76^{\circ}$	1.170	1559.8	33.4	0.881	557.4
$-21$	0.924	1245.4	26.6	0.837	459.3
0	0.875	1167.3	24.9	0.820	435.9
25.5	0.807	1075.4	22.9	0.800	407.5
45	0.755	1006.4	21.4	0.784	386.0
74.5	0.679	905.3	19.2	0.759	353.9
90.6	0.638	850.2	18.0	0.746	335.6

Molecular weight: **60.06.** Radius of the Capillary tube: 0.04352 cm.  
Depth: : 0.1 mm.

The substance boils at  $96^{\circ}.7$  C. constantly.

## II.

<b>Isobutyl-alcohol: <math>(CH_3)_2CH.CH_2OH.</math></b>					
Temperature in $^{\circ}C.$	Maximum Pressure $H$		Surface tension $\gamma$ in Erg. pro $cm^2.$	Specific gravity $d_{40}$	Molecular Surface- energy $\mu$ in Erg. pro $cm^2.$
	in mm. mer- cury of $0^{\circ}C.$	in Dynes			
$-71.5^{\circ}$	1.149	1531.8	33.0	0.885	631.5
$-12$	0.890	1186.5	25.5	0.828	510.1
0.3	0.853	1137.2	24.4	0.817	492.5
10.4	0.825	1099.9	23.6	0.807	483.9
25.1	0.783	1044.5	22.4	0.794	460.9
35.1	0.756	1008.0	21.6	0.785	447.7
49.7	0.723	963.9	20.6	0.771	432.2
69.6	0.670	893.8	19.1	0.753	407.0
101	0.594	791.9	16.9	0.731	367.4

Molecular weight: **74.08.** Radius of the Capillary tube: 0.04385 cm.  
Depth: 0.1 mm.

The compound boils at  $106^{\circ}.8$  C. constantly; at the boilingpoint  $\gamma$   
has the value: ca. **16.5** Erg. pro  $cm^2.$

*Isobutyl-Isobutyrate; Acetone; Methylpropylketone; Ethyl-Acetyloacetate; Methyl-Methylacetyloacetate; Ethyl-Propylacetyloacetate; Methyl-, Ethyl-,*

## III.

Diethylether: $(C_2H_5)_2O$ .					
Temperature in $^{\circ}C$ .	Maximum Pressure $H$		Surface- tension $\chi$ in Erg. pro $cm^2$ .	Specific gravity $d_{40}$	Molecular Surface- energy $\mu$ in Erg. pro $cm^2$ .
	in mm. mercury of $0^{\circ}C$ .	in Dynes			
$-75^{\circ}$	0.990	1319.9	28.5	0.818	574.7
$-20.5$	0.748	997.2	21.5	0.758	456.2
$0.2$	0.670	893.8	19.2	0.735	415.8
$10.9$	0.628	837.2	17.9	0.723	392.0
$25.3$	0.584	778.6	16.7	0.707	371.2
$29.5$	0.574	766.2	16.4	0.703	365.9

Molecular weight: 74.08. Radius of the Capillary tube: 0.04385 cm.  
Depth: 0.1 mm.

The substance boils at  $34.98^{\circ}C$ . constantly; at the boilingpoint  $\chi$  is:  
15.9 Erg. pro  $cm^2$ .

## IV.

Acetone: $CH_3 \cdot CO \cdot CH_3$ .					
Temperature in $^{\circ}C$ .	Maximum Pressure $H$		Surface- tension $\chi$ in Erg. pro $cm^2$ .	Specific gravity $d_{40}$	Molecular Surface- energy $\mu$ in Erg. pro $cm^2$ .
	in mm. mercury of $0^{\circ}C$ .	in Dynes			
$-73^{\circ}$	1.236	1647.8	35.6	0.917	565.5
$-19.5$	0.971	1295.6	27.9	0.845	468.0
$0.1$	0.886	1181.3	25.4	0.818	435.4
$11.4$	0.838	1117.4	24.0	0.803	416.5
$25.5$	0.786	1047.9	22.5	0.785	396.4
$35$	0.740	985.6	21.1	0.772	375.9
$50.1$	0.695	926.6	19.8	0.757	357.4

Molecular weight: 58.05. Radius of the Capillary tube: 0.04385 cm.  
Depth: 0.1 mm.

The boilingpoint is  $56^{\circ}C$ .; the value of  $\chi$  is there: 19.4 Erg.  
pro  $cm^2$ .



*Propyl-, Butyl-, Isobutyl-, and Amyl-Cyanoacetates; Tri-, and Tetra-chloro-methane; and Isobutylbromide.*

## V.

Methylpropylcetone: $CH_3 \cdot CO \cdot C_3H_7$ .					
Temperature in $^{\circ}C$ .	Maximum Pressure $H$		Surface- tension $\gamma$ in Erg. pro $cm^2$ .	Specific gravity $d_{40}$	Molecular Surface- energy $\mu$ in Erg. pro $cm^2$ .
	in mm. mercury of $0^{\circ}C$ .	in Dynes			
-74.2	1.240	1653.2	35.4	0.936	721.4
-20.5	0.996	1327.9	28.3	0.872	604.6
0.3	0.913	1217.8	26.0	0.852	564.1
25.5	0.831	1107.6	23.6	0.826	522.7
45	0.762	1015.7	21.6	0.806	486.3
74.3	0.672	896.1	19.0	0.777	438.3
90.8	0.613	818.1	17.3	0.761	404.7
99.6	0.589	785.8	16.6	0.753	391.1

Molecular weight: 86.1.      Radius of the Capillary tube: 0.04352 cm.  
Depth: 0.1 mm.

The substance boils at  $101.03^{\circ}C$ . constantly.

## VI.

Ethylformiate: $HCO \cdot O(C_2H_5)$ .					
Temperature in $^{\circ}C$ .	Maximum Pressure $H$		Surface- tension $\gamma$ in Erg. pro $cm^2$ .	Specific gravity $d_{40}$	Molecular Surface- energy $\mu$ in Erg. pro $cm^2$ .
	in mm. mercury of $0^{\circ}C$ .	in Dynes			
* -76.5	1.239	1661.2	37.8	1.032	502.7
* -16.2	0.945	1259.9	28.5	0.958	398.3
* 2.2	0.864	1151.9	26.0	0.938	368.5
24.9	0.802	1069.2	22.9	0.910	331.2
35.2	0.757	1009.6	21.9	0.899	319.3
49.2	0.718	957.2	20.5	0.879	303.4

Molecular weight: 50.05      Radius of the Capillary tube: 0.04408 cm.;  
in the observations, indicated by \*, this  
radius was:  $R = 0.04638$  cm.  
Depth: 0.1 mm.

After carefully drying, this ether boils at  $54.03^{\circ}C$ . constantly; it  
remains a relatively thin liquid as far as  $-79^{\circ}C$ . At the boiling-  
point  $\gamma$  is 19.9 Erg. pro  $cm^2$ .

Molecular Surface-  
Energy in Erg pro cm<sup>2</sup>.

Fig. 2.

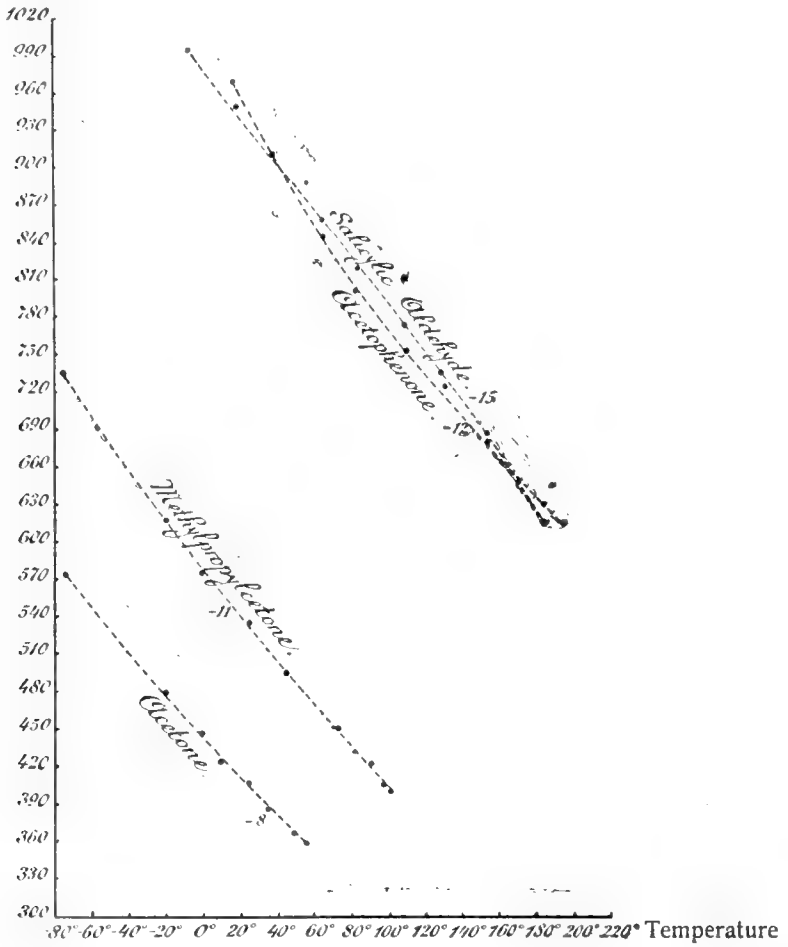

## VII.

Ethylchloroformiate:  $Cl.CO.O(C_2H_5)$ .

Temperature in ° C.	Maximum Pressure $H$		Surface tension $\gamma$ in Erg. pro cm <sup>2</sup> .	Specific gravity $d_{40}$	Molecular Surface energy $\mu$ in Erg. pro cm <sup>2</sup> .
	in mm. mer- cury of 0° C.	in Dynes			
-75.5	1.353	1803.8	42.4	1.278	819.0
-21	1.046	1395.0	32.6	1.186	661.9
0	0.951	1269.2	29.6	1.160	609.9
25	0.847	1129.2	26.2	1.127	550.3
45.3	0.774	1031.8	23.9	1.095	511.7
70.2	0.692	922.6	21.2	1.050	466.8
84.8	0.643	857.8	19.8	1.022	443.9

Molecular weight: **108.49**. Radius of the Capillary tube: 0.04803 cm.  
Depth: 0.1 mm.

The compound boils at 91.95 C. constantly; at this temperature  $\gamma$   
is **19.3** Erg. pro cm<sup>2</sup>.

## VIII.

Ethylacetate:  $CH_3.CO.O(C_2H_5)$ .

Temperature in ° C.	Maximum Pressure $H$		Surface- tension $\gamma$ in Erg. pro cm <sup>2</sup> .	Specific gravity $d_{40}$	Molecular Surface- energy $\mu$ in Erg. pro cm <sup>2</sup> .
	in mm. mer- cury of 0° C.	in Dynes			
-74°	1.274	1698.5	36.6	1.016	716.8
-20	0.994	1325.2	28.4	0.949	582.1
0	0.892	1189.2	25.5	0.924	532.1
25.5	0.780	1039.9	22.2	0.893	473.8
34.7	0.744	992.5	21.2	0.881	456.6
55	0.679	897.2	19.1	0.856	419.3
70	0.623	838.5	17.8	0.829	399.2

Molecular weight: **88.06**. Radius of the Capillary tube: 0.04385 cm.  
Depth: 0.1 mm.

After very carefully drying and repeated distillation, this ether boils  
at 77.91 C. constantly. It remains a thin liquid as far as -80° C. At  
the boilingpoint the value of  $\gamma$  is: **17.2** Erg. pro cm<sup>2</sup>.

## IX.

**Methyl-Isobutyrate:**  $(CH_3)_2 CH . CO . O(CH_3)$ .

Temperature in °C.	Maximum Pressure $H$		Surface- tension $\gamma$ in Erg. pro cm <sup>2</sup> .	Specific gravity $d_{40}$	Molecular Surface- energy $\mu$ in Erg. pro cm <sup>2</sup> .
	in mm. mer- cury of 0° C.	in Dynes			
-73°	1.296	1728.0	37.1	0.995	813.1
-21.5	1.006	1341.9	28.7	0.936	655.1
0.5	0.903	1204.0	25.7	0.911	597.3
25.3	0.805	1073.2	22.8	0.882	541.5
45	0.727	969.7	20.6	0.859	497.9
74.7	0.631	840.9	17.8	0.825	442.0
91.3	0.589	785.8	16.6	0.806	418.6

Molecular weight: **102.08**. Radius of the Capillary tube: 0.04352 cm.  
Depth: 0.1 mm.

The substance boils constantly at 91° 8 C.

## X.

**Ethyl-Isobutyrate:**  $(CH_3)_2 CH . CO . O(C_2H_5)$ .

Temperature in °C.	Maximum Pressure $H$		Surface- tension $\gamma$ in Erg. pro cm <sup>2</sup> .	Specific gravity $d_{40}$	Molecular Surface- energy $\mu$ in Erg. pro cm <sup>2</sup> .
	in mm. mer- cury of 0° C.	in Dynes			
-78.1	1.165	1553.2	33.3	0.976	805.4
-21	0.940	1253.2	26.8	0.913	677.7
0	0.867	1155.9	24.6	0.891	632.3
25.2	0.779	1038.6	22.1	0.859	582.0
45	0.717	955.9	20.3	0.837	544.0
74.3	0.624	831.8	17.6	0.809	482.4
90.8	0.572	762.9	16.1	0.791	448.0
109.5	0.507	675.5	14.2	0.769	412.6

Molecular weight: **116.1**. Radius of the Capillary tube: 0.04352 cm.  
Depth: 0.1 mm.

The substance boils at 110.°2 C. constantly. At -76° C. it is again a thin liquid; it was only slightly turbid, probably by extremely fine crystals.

## XI.

**Isobutyl-Isobutyrate:**  $(CH_3)_2CH \cdot CO \cdot O(CH_2 \cdot (CH \cdot (CH_3)_2))$ .

Temperature in °C.	Maximum Pressure <i>H</i>		Surface- tension $\gamma$ in Erg. pro cm <sup>2</sup> .	Specific gravity $d_{40}$	Molecular Surface- energy $\nu$ in Erg. pro cm <sup>2</sup> .
	in mm. mer- cury of 0° C.	in Dynes			
-76.5	1.182	1576.3	33.8	0.951	960.6
-21.3	0.927	1236.2	26.4	0.896	780.8
0	0.865	1153.5	24.6	0.875	739.2
25.4	0.785	1047.8	22.3	0.850	683.1
45	0.731	974.3	20.7	0.830	644.2
74.7	0.638	850.2	18.0	0.801	573.6
91.1	0.596	795.0	16.8	0.784	543.1
109.2	0.545	726.1	15.3	0.766	502.3
134.5	0.469	625.0	13.1	0.740	440.1

Molecular weight: **144.11**. Radius of the Capillary tube: 0.04352 cm.  
Depth : 0.1 mm.

The compound boils at 147.°2 C. constantly.

## XII.

**Ethyl-Acetyloacetate:**  $CH_3CO \cdot CH_2 \cdot CO \cdot O(C_2H_5)$ .

Temperature in °C.	Maximum Pressure <i>H</i>		Surface- tension $\gamma$ in Erg. pro cm <sup>2</sup> .	Specific gravity $d_{40}$	Molecular Surface- energy $\nu$ in Erg. pro cm <sup>2</sup> .
	in mm. mer- cury of 0° C.	in Dynes			
-20°	1.210	1612.8	36.7	1.070	900.7
1	1.133	1510.5	34.3	1.048	853.5
* 25	1.113	1483.6	32.0	1.023	809.2
* 35.5	1.069	1424.7	30.7	1.013	781.4
* 49.5	1.024	1365.8	29.4	0.999	755.3
71	0.906	1207.4	27.3	0.976	712.3
89	0.841	1121.2	25.3	0.958	668.4
**125	0.774	1031.9	21.7	0.923	587.7
**153	0.675	900.2	18.9	0.896	522.1
**176	0.596	794.9	16.6	0.869	468.0

Molecular weight: **130.08**. Radius of the Capillary tube: 0.04638 cm.;  
in the observations indicated by \*, it was 0.04405 cm.; in those by \*\*: 0.04352 cm.  
Depth: 0.1 mm.

The substance boils at 179.°6 C. constantly.

Molecular Surface-energy in Erg pro cm<sup>2</sup>.

Fig. 3.

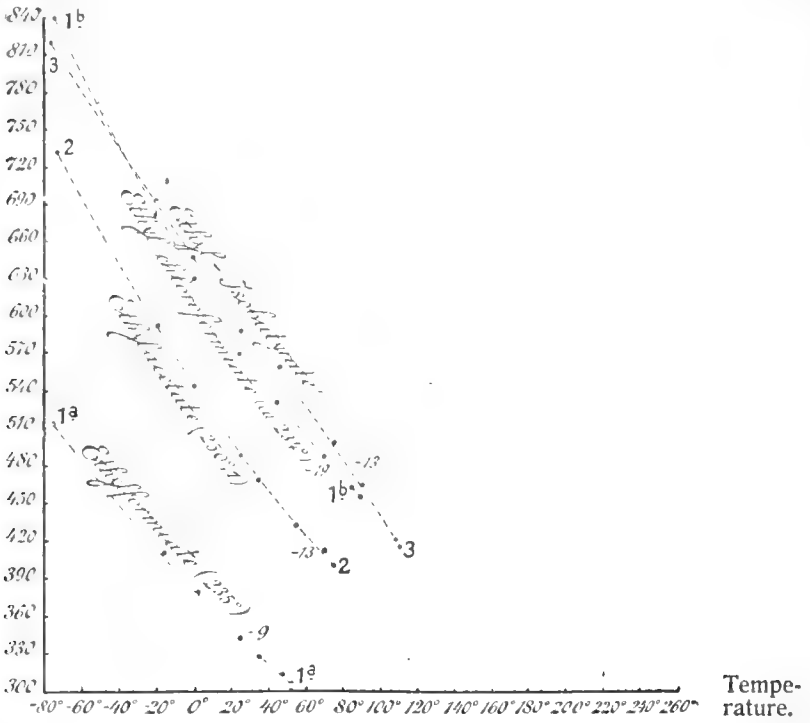

Molecular Surface-energy in Erg pro cm<sup>2</sup>.

Fig. 4.

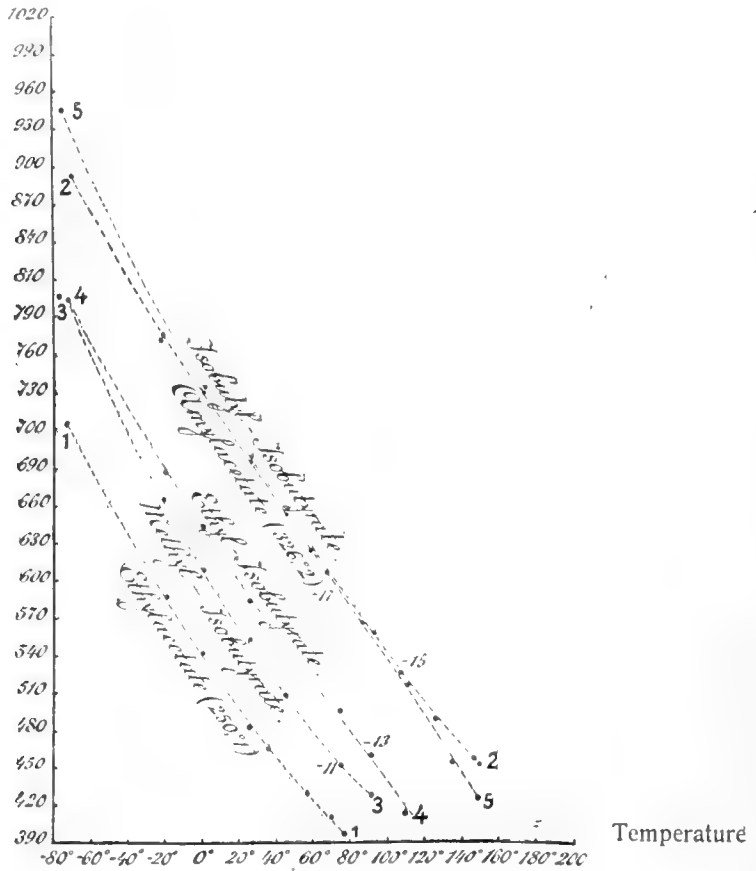

## XIII

**Methyl-Acetylomethylacetate:  $CH_3CO \cdot CH(CH_3) \cdot CO \cdot O(CH_3)$ .**

Temperature in °C.	Maximum Pressure $H$		Surface- tension $\chi$ in Erg. pro cm <sup>2</sup> .	Specific gravity $d_{40}$	Molecular Surface- energy $\mu$ in Erg. pro cm <sup>2</sup> .
	in mm. mer- cury of 0° C.	in Dynes			
-71°	1.477	1969.6	46.5	1.121	1106.2
-21	1.218	1623.8	38.3	1.071	939.3
0	1.137	1515.7	35.7	1.050	887.2
25.3	1.046	1395.0	32.8	1.024	825.9
45.5	0.985	1313.2	30.8	1.003	789.2
70.2	0.901	1201.2	28.1	0.977	732.7
85.2	0.856	1141.2	26.7	0.962	703.4
117	0.768	1024.4	23.9	0.930	644.0
138.2	0.709	945.2	22.0	0.908	602.3
156	0.658	877.2	20.4	0.890	566.0

Molecular weight: **130.08**. Radius of the Capillary tube: 0.04803 cm.  
Depth: 0.1 mm.

Under a pressure of 18 mm., the substance boils at 75.°5 C.; in the  
at -71° C. very viscous liquid, the growing of the gas-bubbles took  
more than 60 seconds. The specific gravity at 25° C. is:  $d_{40} = 1.0247$ ;  
at 50° C.: 0.9991; at 75° C.: 0.9732. At  $t^\circ$  C.:  $d_{40} = 1.0500 - 0.001006t$   
 $- 0.00000024 t^2$ .

## XIV.

**Ethyl-Propylacetyloacetate:  $CH_3CO \cdot CH(C_3H_7)CO \cdot O(C_2H_5)$ .**

Temperature in °C.	Maximum Pressure $H$		Surface- tension $\chi$ in Erg. pro cm <sup>2</sup> .	Specific gravity $d_{40}$	Molecular Surface- energy $\mu$ in Erg. pro cm <sup>2</sup> .
	in mm. mer- cury of 0° C.	in Dynes			
-76.2	1.430	1906.0	43.6	1.082	1280.1
-20	1.142	1522.2	34.8	1.007	1070.2
2.5	1.058	1410.1	32.2	0.978	1011.3
** 25	1.018	1356.6	29.4	0.948	942.7
** 35	0.977	1302.2	28.2	0.934	913.2
** 49	0.929	1238.7	26.8	0.916	879.2
70	0.818	1091.0	24.8	0.889	831.3
90.5	0.763	1017.7	23.1	0.866	786.8
* 125	0.714	951.5	20.2	0.833	706.0
* 143	0.669	891.5	18.9	0.816	669.7
* 152.9	0.641	854.8	18.1	0.806	646.7
* 177	0.576	767.5	16.2	0.785	589.1
* 200.5	0.507	676.4	14.2	0.764	525.8

Molecular weight: **172.13**. Radius of the Capillary tube: 0.04638 cm.;  
in the observations indicated by \*,  $R$   
was 0.04352 cm.; in those indicated by  
\*\*, it was 0.04408 cm. Depth: 0.1 mm.

Under ordinary pressure the boiling point is 223.°6 C. constantly;  
notwithstanding the great viscosity of the liquid at -76° C., it was  
yet possible here to determine the value of  $\chi$  evidently very exactly,  
if the time of grow of the bubbles was sufficiently long (ca. 40 seconds).

Methyl-Cyanoacetate:  $CN.CH_2.CO.O(CH_3)$ .

Temperature in °C.	Maximum Pressure $H$		Surface- tension $\gamma$ in Erg. pro cm <sup>2</sup> .	Specific gravity $d_{40}$	Molecular Surface- energy $\mu$ in Erg pro cm <sup>2</sup> .
	in mm. mercury of 0° C.	in Dynes			
-60	(2.424)	(3231.6)	(74.1)	1.222	(1387.8)
-16	1.443	1923.2	43.9	1.140	861.2
1	1.362	1815.4	41.4	1.122	820.8
** 25.5	1.337	1783.0	38.6	1.096	777.4
50	1.184	1578.3	35.9	1.070	734.6
70.5	1.116	1487.7	33.8	1.039	705.4
90	1.043	1390.8	31.7	1.028	666.2
* 124.5	0.987	1315.8	28.0	0.994	601.8
* 153.1	0.877	1169.2	24.8	0.965	543.7
* 176.5	0.789	1052.4	22.3	0.942	496.8
* 197	0.713	951.3	20.1	0.921	454.6

Molecular weight: 99.05. Radius of the Capillary tube: 0.04638 cm.; in the observations indicated by \*,  $R$  was: 0.04352 cm., in those with \*\*, it was: 0.04408 cm.  
Depth: 0.1 mm.

The carefully dried ether boils constantly at 203° C.; at -76° C. the liquid is extremely viscous and gelatinous; although the time of formation of the gasbubbles was about 100 seconds, the viscosity in this case evidently diminishes the exactitude of the determinations of  $\gamma$ . The specific gravity  $d_{40}$  was at 25° C.: 1.0962; at 50° C.: 1.0698; at 75° C.: 1.0438; at  $t^\circ$ :  $d_{40} = 1.1231 - 0.001086 t + 0.0000004 t^2$ .

## XVI.

Ethyl-Cyanoacetate:  $CN.CH_2.CO.O(C_2H_5)$ .

Temperature in °C.	Maximum Pressure $H$		Surface- tension $\gamma$ in Erg. pro cm <sup>2</sup> .	Specific gravity $d_{40}$	Molecular Surface- energy $\mu$ in Erg. pro cm <sup>2</sup> .
	in mm. mer- cury of 0° C.	in Dynes			
-17°	1.313	1750.8	39.9	1.099	876.1
0	1.245	1660.2	37.8	1.082	838.6
** 25	1.222	1628.8	35.2	1.056	793.7
** 35.5	1.188	1583.5	34.2	1.046	776.1
49	1.083	1444.5	32.8	1.032	751.5
71	1.016	1354.0	30.7	1.009	713.6
90	0.951	1267.8	28.7	0.990	675.6
* 125	0.896	1194.8	25.4	0.955	612.4
* 153	0.803	1070.8	22.7	0.927	558.3
* 176	0.727	969.7	20.5	0.904	512.7
* 201	0.651	868.6	18.3	0.879	466.3

Molecular weight: 113.07. Radius of the Capillary tube: 0.04638 cm.; in the observations indicated by \*,  $R$  was 0.04352 cm.; in those by \*\*, it was: 0.04408 cm.  
Depth: 0.1 mm.

The compound boils at 206° C. constantly; at -76° C. it becomes glassy and crystallizes very slowly on heating. The crystals melt at about -40° C. The specific gravity at 25° C. was: 1.0562; at 50° C.: 1.0307; at 75° C.: 1.0052; at  $t^\circ$ :  $d_{40} = 1.0817 - 0.00102 t$ , in general.



## XVII.

Propyl-Cyanoacetate:  $CN \cdot CH_2 \cdot CO \cdot O(C_3H_7)$ .

Temperature in °C.	Maximum Pressure $H$		Surface- tension $\gamma$ in Erg. pro cm <sup>2</sup> .	Specific gravity $d_{40}$	Molecular Surface- energy $\mu$ in Erg. pro cm <sup>2</sup> .
	in mm. mer- cury of 0° C.	in Dynes			
-16°	1.236	1647.3	37.5	1.058	912.9
0	1.184	1578.3	35.9	1.042	882.9
** 25	1.164	1551.7	33.5	1.021	835.1
** 35	1.130	1506.5	32.5	1.011	815.5
** 51	1.075	1433.8	31.0	0.996	786.0
71	0.961	1280.7	29.1	0.976	747.6
114.5	0.834	1112.5	25.2	0.933	667.1
* 125.5	0.858	1144.4	24.3	0.923	647.9
* 152.5	0.780	1039.9	22.0	0.896	598.3
* 176.1	0.701	934.6	19.7	0.872	546.0
* 201	0.624	831.8	17.5	0.847	494.1

Molecular weight: 127.08. Radius of the Capillary tube: 0.04638 cm.; in the observations, indicated by \*, the radius was: 0.04352 cm.; in those with \*\*, it was: 0.04408 cm. Depth: 0.1 mm.

The substance boils at 216° C. constantly; at -79° it solidifies slowly to a crystal-aggregate, which melts at about -39° C. The density  $d_{40}$  was at 25° C.: 1.0214; at 50° C.: 0.9973; at 75° C.: 0.9717. at  $t^\circ$  C.:  $d_{40} = 1.0424 - 0.000962t + 0.0000012t^2$ .

## XVIII.

Butyl-Cyanoacetate:  $CN \cdot CH_2 \cdot CO \cdot O(C_4H_9)$ .

Temperature in °C.	Maximum Pressure $H$		Surface- tension $\gamma$ in Erg. pro cm <sup>2</sup> .	Specific gravity $d_{40}$	Molecular Surface- energy $\mu$ in Erg. pro cm <sup>2</sup> .
	in mm. mer- cury of 0° C.	in Dynes			
-21.3	1.213	1617.5	35.2	1.041	928.8
0	1.159	1545.2	33.6	1.020	898.7
* 25.2	1.117	1489.0	31.7	0.998	860.3
* 45.2	1.055	1406.2	29.9	0.978	822.5
* 74.5	0.975	1300.6	27.7	0.952	775.8
* 94.1	0.924	1231.6	26.2	0.934	743.2
114.5	0.852	1135.3	24.6	0.915	707.4
135	0.797	1063.3	23.0	0.895	671.2
161.1	0.729	971.9	21.0	0.870	626.3
192.1	0.662	883.1	19.0	0.840	578.4
213.1	0.615	820.0	17.6	0.820	544.5

Molecular weight: 141.1. Radius of the Capillary tube: 0.04439 cm.; in the observations indicated by \* it was: 0.04352 cm. Depth: 0.1 mm.

The ether boils at 230°.5 C. constantly; it can be cooled as far as -80° C., without crystallisation setting in. The specific gravity  $d_{40}$  is at 25° C.: 0.9978; at 50° C.: 0.9749; at 75° C.: 0.9518; at  $t^\circ$  it is:  $d_{40} = 1.0204 - 0.000904t + 0.00000016t^2$ .

## XIX.

**Isobutyl-Cyanoacetate:  $CN \cdot CH_2 \cdot CO \cdot O(CH_2 \cdot CH \cdot (CH_3)_2)$ .**

Temperature in ° C.	Maximum Pressure $H$		Surface- tension $\chi$ in Erg. pro cm <sup>2</sup> .	Specific gravity $d_{40}$	Molecular Surface- energy $\mu$ in Erg. pro cm <sup>2</sup> .
	in mm. mer- cury of 0° C.	in Dynes			
-20.5	1.179	1572.4	34.2	1.033	907.1
0.3	1.122	1495.9	32.5	1.014	872.7
25	1.069	1424.6	30.3	0.990	826.7
* 45	1.013	1351.1	28.7	0.971	793.3
* 74.8	0.934	1245.4	26.4	0.944	743.6
* 94.5	0.879	1174.6	24.9	0.925	710.9
115	0.811	1081.3	23.4	0.905	677.9
135.1	0.757	1009.2	21.8	0.886	640.5
161	0.686	914.6	19.7	0.862	589.5
191.8	0.595	792.9	17.0	0.834	520.0
213	0.541	720.9	15.4	0.815	478.4

Molecular weight: 141.1. Radius of the Capillary tube: 0.04439 cm.;  
in the observations indicated by \*,  $R$  was:  
0.04352 cm.

Depth: 0.1 mm.

The compound boils at 223° C. constantly; it can be undercooled  
as far as -76° C., and crystallizes then slowly into a crystalline  
aggregate, melting at about -26° C. The specific gravity at 25° C.  
was  $d_{40} = 0.9903$ ; at 50° C.: 0.9669; at 75° C.: 0.9441. At  $t^\circ$  it is  
generally:  $d_{40} = 1.0138 - 0.000952 t + 0.00000032 t^2$ .

## XX.

**Amyl-Cyanoacetate:  $CN \cdot CH_2 \cdot CO \cdot O(C_5H_{11})$ .**

Temperature in ° C.	Maximum Pressure $H$		Surface- tension $\chi$ in Erg pro cm <sup>2</sup> .	Specific gravity $d_{40}$	Molecular Surface- energy $\mu$ in Erg pro cm <sup>2</sup> .
	in mm. mercury of 0° C.	in Dynes			
-17.5	1.080	1440.3	32.7	1.017	933.5
1.5	1.029	1371.3	31.1	1.001	897.2
** 25.5	1.028	1370.2	29.5	0.976	865.5
** 35	1.000	1333.2	28.7	0.966	847.9
69	0.880	1172.9	26.5	0.939	797.8
89	0.831	1108.3	25.0	0.920	763.0
* 125	0.807	1075.4	22.7	0.891	707.7
153	0.744	992.6	21.0	0.864	668.3
181	0.689	919.1	19.4	0.843	627.6
201	0.634	845.6	17.8	0.821	586.1

Molecular weight: 155.11. Radius of the Capillary tube: 0.04638 cm.;  
in the observations indicated by \*,  $R$  was  
0.04352 cm.; in those with \*\* it was:  
0.04408 cm.  
Depth: 0.1 mm.

The compound boils at 240° C.; at -76° C. it is a jelly, but does  
not crystallize. The specific gravity at 25° C. was:  $d_{40} = 0.9763$ ;  
at 50° C.: 0.9547; at 75° C.: 0.9327. At  $t^\circ$  it is:  $d_{40} = 1.0019 - 0.090061 t$   
 $+ 0.00000032 t^2$ .

Molecular Surface  
Energy in Erg. pro cm<sup>2</sup>.

Fig. 5.

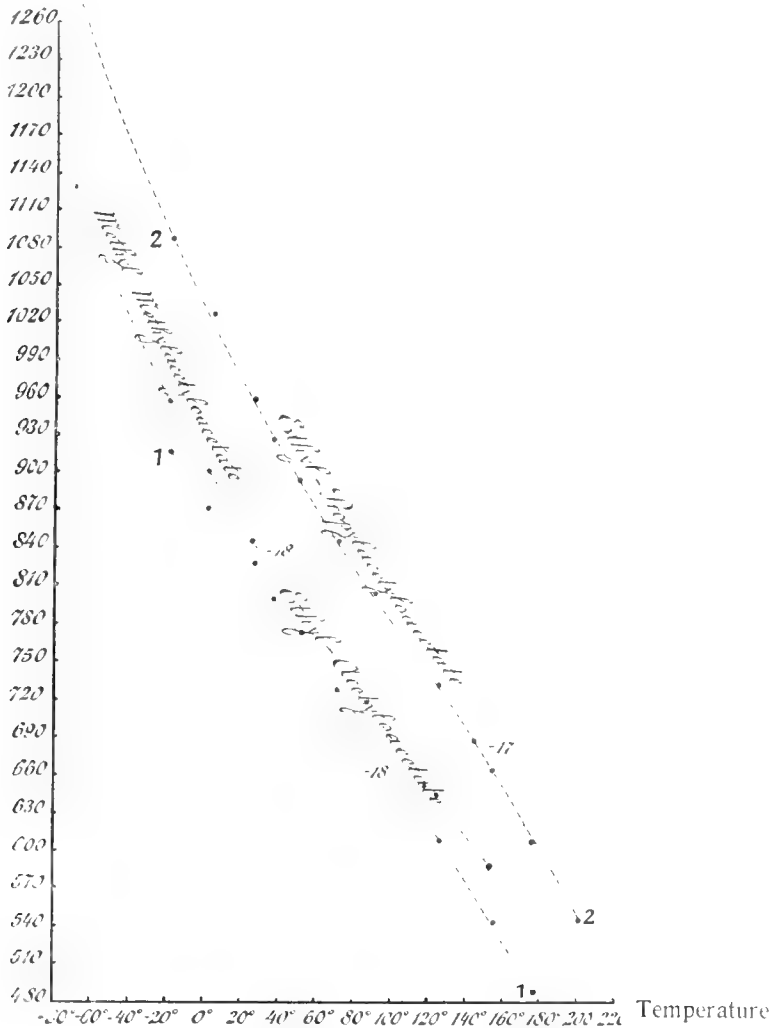

XXI.

Trichloromethane:  $CHCl_3$ .

Temperature in °C	Maximum Pressure $H$		Surface- tension $\gamma$ in Erg. pro cm <sup>2</sup> .	Specific gravity $d_4^0$	Molecular Surface- energy in Erg. pro cm <sup>2</sup> .
	in mm. mercury of 0° C.	in Dynes			
-22	1.142	1523.4	32.5	1.555	587.5
0	1.050	1394.3	29.7	1.519	545.3
25	0.927	1236.0	26.2	1.476	490.4
35	0.881	1174.5	24.8	1.459	467.8
55	0.798	1063.9	22.4	1.425	429.2

Molecular weight: 119.51. Radius of the Capillary tube: 0.04385 cm.  
Depth; 0.1 mm.

The trichloromethane was prepared from purest chloral, carefully dried, at  $-79^\circ$  C. several times frozen, and purified by repeated distillation. It boils constantly at  $61^\circ.2$  C.; at this temperature, the value of  $\gamma$  is: 21,8 Erg. pro cm<sup>2</sup>.

## XXII.

Tetrachloromethane: $CCl_4$ .					
Temperature in $^{\circ}C$ .	Maximum Pressure $H$		Surface- tension $\alpha$ in Erg. pro $cm^2$ .	Specific gravity $d_{40}$	Molecular Surface- energy $\mu$ in Erg. pro $cm^2$ .
	in mm. mer- cury of $0^{\circ}C$ .	in Dynes			
$-18^{\circ}$	1.087	1450.4	30.9	1.659	633.0
0.1	1.005	1340.9	28.5	1.632	590.2
25	0.899	1199.5	25.4	1.585	536.4
35	0.862	1149.4	24.3	1.560	518.6
55	0.793	1058.1	22.3	1.525	483.2

Molecular weight: **153.80**. Radius of the Capillary tube: 0.04385 cm.  
Depth: 0.1 mm.

Under reduced pressure (ca. 90 mm.) it boils at  $26^{\circ}C$ ., and solidifies at  $-60^{\circ}C$ . to a white crystalline mass. Under ordinary pressure, it boils constantly at  $76^{\circ}.4C$ . At this temperature the value of  $\alpha$  is about: **20.2** Erg. pro  $cm^2$ .

Molecular Surface-Energy  
in Erg pro  $cm^2$ .

Fig. 6.

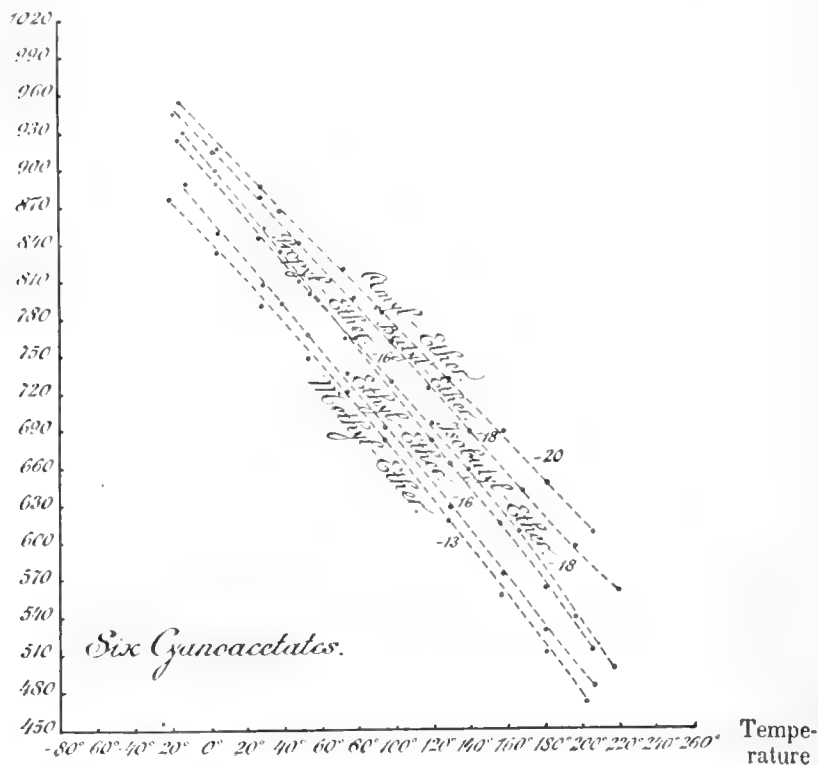

## XXIII.

Isobutylbromide: $(CH_3)_2CH.CH_2Br$ .					
Temperature in $^{\circ}C$ .	Maximum Pressure $H$		Surface- tension $\alpha$ in Erg. pro $cm^2$ .	Specific gravity $d_4^{\circ}$	Molecular Surface- energy $\nu$ in Erg. pro $cm^2$ .
	in mm. mer- cury of $0^{\circ}C$ .	in Dynes			
$-75^{\circ}$	1.227	1636.5	38.4	1.385	821.6
$-19.5$	0.949	1265.9	29.5	1.314	653.7
0	0.874	1166.0	27.1	1.291	607.6
25.4	0.790	1053.5	24.4	1.259	556.3
44.4	0.728	970.2	22.4	1.236	517.1
69.9	0.646	861.9	19.8	1.205	464.8
85.3	0.600	799.5	18.3	1.186	439.2

Molecular weight: **137.07**. Radius of the Capillary tube: 0.04803 cm.  
Depth: 0.1 mm.

The carefully dried compound boils very constantly at  $90.5^{\circ}C$ .; at  
this temperature  $\alpha$  is about **17.9** Erg. pro  $cm^2$ .

Molecular Surface-  
Energy in Erg pro  $cm^2$ .

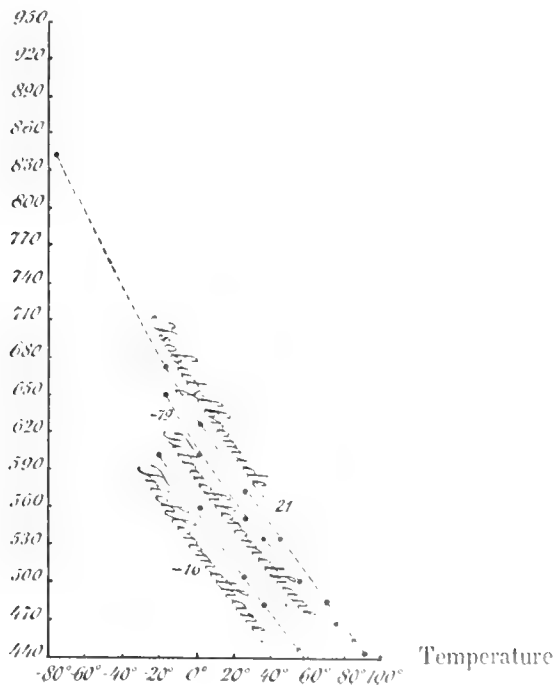

Fig. 7.

§ 5. *Temperature-coefficients of  $\mu$  of the here studied substances.*

<i>norm. Propylalcohol.</i>		
<i>Temperature-interval: <math>\frac{\partial \mu}{\partial t}</math> in Erg.</i>		
between $-76^\circ$ and $-21^\circ$		1,78
$-21^\circ$ „ $+25^\circ$		1,11
$25^\circ$ „ $91^\circ$		1,10

<i>Diethylether.</i>		
between $-75^\circ$ and $-20^\circ$		2,16
$-20^\circ$ „ $0^\circ$		1,94
$0^\circ$ „ $29^\circ$		1,70

<i>Ethylchloroformiate.</i>		
between $-75^\circ$ and $-21^\circ$		2,86
$-21^\circ$ „ $+25^\circ$		2,41
$25^\circ$ „ $70^\circ$		1,82
$70^\circ$ „ $91^\circ$		1,70

<i>Methyl-Isobutyrate.</i>		
between $-73^\circ$ and $-21^\circ,5$		3,0
$-21^\circ$ „ $+25^\circ$		2,4
$25^\circ$ „ $45^\circ$		2,1
$45^\circ$ „ $91^\circ$		1,7

<i>Isobutyl-Isobutyrate.</i>		
between $-76^\circ$ and $-21^\circ$		3,2
$-21^\circ$ „ $+135^\circ$		2,18

<i>Methylpropylcetone.</i>		
between $-74^\circ$ and $0^\circ$		2,13
$0^\circ$ „ $99^\circ$		1,73

<i>Methyl-Methylacetyloacetate.</i>		
between $-71^\circ$ and $-21^\circ$		3,39
$-21^\circ$ „ $0^\circ$		2,47
$0^\circ$ „ $70^\circ$		2,18
$70^\circ$ „ $156^\circ$		1,94

<i>Methyl-Cyanoacetate.</i>		
between $-76^\circ$ and $-16^\circ$	not measurable independently of viscosity.	
$-16^\circ$ „ $+197^\circ$		1,90

<i>Isobutylalcohol.</i>		
<i>Temperature-interval: <math>\frac{\partial \mu}{\partial t}</math> in Erg.</i>		
between $-71^\circ$ and $-12^\circ$		2,3
$-12^\circ$ „ $+101^\circ$		1,1

<i>Ethylformiate.</i>		
between $-76^\circ,5$ and $-16^\circ$		1,72
$-16^\circ$ „ $+25^\circ$		1,62
$25^\circ$ „ $35^\circ$		1,29
$35^\circ$ „ $54^\circ$		1,12

<i>Ethylacetate.</i>		
between $-74^\circ$ and $0^\circ$		2,50
$0^\circ$ „ $25^\circ$		2,37
$25^\circ$ „ $35^\circ$		1,86
$35^\circ$ „ $55^\circ$		1,78
$55^\circ$ „ $77^\circ$		1,30

<i>Ethyl-Isobutyrate.</i>		
between $-78^\circ$ and $+109^\circ$		2,15

<i>Acetone.</i>		
between $-73^\circ$ and $-19^\circ,5$		1,81
$-19^\circ$ „ $+11^\circ$		1,66
$11^\circ$ „ $54^\circ$		1,57

<i>Ethyl-Acetyloacetate.</i>		
between $-20^\circ$ and $+176^\circ$		2,19

<i>Ethyl-Propylacetyloacetate.</i>		
between $-76^\circ$ and $-20^\circ$		3,74
$-20^\circ$ „ $+20^\circ$		2,84
$25^\circ$ „ $70^\circ$		2,36
$70^\circ$ „ $125^\circ$		2,24
$125^\circ$ „ $153^\circ$		2,11

Then an increase: 2,37 to 2,68, occurs as a consequence of beginning dissociation.

<i>Ethyl-Cyanoacetate.</i>		
between $-17^\circ$ and $+201^\circ$		1,88

*Propyl-Cyanoacetate.*

<i>Temperature-interval:</i>	$\frac{\partial \mu}{\partial t}$ in Erg.	
between $-16^{\circ}$ and $+152^{\circ}$		1,88
Then an <i>increase</i> : 2.13, under dissociation and liberation of <i>HCN</i> .		

*Isobutyl-Cyanoacetate.*

between $-20^{\circ}$ and $0^{\circ}$		1,64
$0^{\circ}$ „ $115^{\circ}$		1,70
$115^{\circ}$ „ $213^{\circ}$		2,0
Gradual decomposition, under liberation of <i>HCN</i> .		

*Chloroform.*

between $-22^{\circ}$ and $+55^{\circ}$		2,06
---	--	------

*Isobutylbromide.*

between $-75^{\circ}$ and $-19^{\circ}$		3,0
$-19^{\circ}$ „ $+25^{\circ}$		2,15
$25^{\circ}$ „ $69^{\circ},9$		2,03
$70^{\circ}$ „ $90^{\circ}$		1,91

*Butyl-Cyanoacetate.*

<i>Temperature-interval:</i>	$\frac{\partial \mu}{\partial t}$ in Erg.
between $-21^{\circ}$ and $+213^{\circ}$	1,62

*Amyl-Cyanoacetate.*

between $-17^{\circ}$ and $+1^{\circ}$		2,0
$1^{\circ}$ „ $201^{\circ}$		ca. 1,6

*Carbontetrachloride.*

between $-18^{\circ}$ and $0^{\circ}$		2,6
$0^{\circ}$ „ $25^{\circ}$		1,95
$25^{\circ}$ „ $55^{\circ}$		1,75

Evidently only in some cases the coefficient  $\frac{\partial \mu}{\partial t}$  appears to be really constant; in most cases it *decreases* doubtless with a *rise* of temperature. Where the inverse behaviour was stated, a decomposition of the studied substance always seemed to occur. The value for  $\frac{\partial \mu}{\partial t}$  is in the interval of ordinary temperatures relatively small for *propyl-* and *isobutyl-alcohol* and for the *cetones*; however in these cases it appears to be variable with the temperature in no higher degree than in the cases, where the values of  $\frac{\partial \mu}{\partial t}$  do not differ largely from 2.0 Erg.

Groningen, June 1914.

Laboratory for Inorganic Chemistry  
of the University.

**Chemistry.** — “*The Temperature-coefficients of the free Surface-energy of Liquids, at Temperatures from  $-80^{\circ}$  to  $1650^{\circ}$  C. III. Measurements of some Aromatic Derivatives.*” By Prof. Dr. F. M. JAEGER and M. J. SMIT. (Communicated by Prof. P. v. ROMBURGH).

§ 1. In continuation of our measurements of organic liquids, the data obtained in the study of a series of aromatic compounds, are reviewed here in tables, quite in the same way as in our former communications<sup>1)</sup>. This series of substances includes the following terms:

*Nitrobenzene; ortho-Nitrotoluene; Aniline; Dimethylaniline; ortho-Toluidine; Thymol; Methyl-, Ethyl-, and Benzyl-Benzoates; Salicylic Aldehyde; Acetophenone, and the non-aromatic compound:  $\alpha$ -Campholenic Acid.*

With respect to the determination of the specific gravities and the purification of the studied substances, we can refer to the preceding communication; the diagrams also have the same significance, as indicated there.

§ 2. *Aromatic Derivatives.*

I.

<b>Nitrobenzene: <math>C_6H_5(NO_2)</math>.</b>					
Temperature in $^{\circ}$ C.	Maximum Pressure $H$		Surface- tension $\alpha$ in Erg. pro cm <sup>2</sup> .	Specific gravity $d_{40}$	Molecular Surface- energy $\mu$ in Erg. pro cm <sup>2</sup> .
	in mm. mer- cury of $0^{\circ}$ C.	in Dynes			
5 <sup>o</sup>	1.538	2050.5	44.4	1.215	964.7
26.6	1.473	1965.8	42.5	1.197	932.7
34.9	1.448	1930.5	41.7	1.190	918.7
55.3	1.371	1827.8	39.5	1.171	879.7
70.8	1.314	1751.8	37.8	1.156	849.0
100	1.198	1596.0	34.4	1.125	786.8
110	1.156	1541.6	33.2	1.115	763.9
126	1.089	1459.8	31.4	1.097	730.4
145.5	1.014	1351.9	29.0	1.075	683.7
172.5	0.903	1204.0	25.8	1.042	621.0

Molecular weight: **123.06.** Radius of the Capillary tube: 0.04385 cm.  
Depth: 0.1 mm.

The nitrobenzene was carefully dried, several times frozen, and distilled; it boils at  $209^{\circ}$  C. constantly. At this temperature  $\alpha = 21.2$  Erg. pro cm<sup>2</sup>. At  $0^{\circ}$  C. it solidifies completely. The specific gravity at  $25^{\circ}$  C. is:  $d_{40} = 1.1988$ .

<sup>1)</sup> F. M. JAEGER and M. J. SMIT, Preceding communication, (1914).



## II.

<b>Ortho-Nitrotoluene: <math>CH_3 \cdot C_6H_4 \cdot (NO_2)</math>.</b>					
(1) (2)					
Temperature in ° C.	Maximum Pressure $H$		Surface tension $\alpha$ in Erg. pro cm <sup>2</sup> .	Specific gravity $d_{40}$	Molecular Surface- energy $\nu$ in Erg. pro cm <sup>2</sup> .
	in mm. mer- cury of 0° C.	in Dynes			
0.1	1.505	2006.8	43.3	1.177	1032.8
9.6	1.465	1953.1	42.1	1.170	1008.1
* 25	1.416	1887.5	40.9	1.156	987.3
* 34.8	1.375	1833.1	39.7	1.147	963.3
** 49.3	1.257	1675.8	38.2	1.134	934.0
70	1.252	1669.4	35.8	1.115	885.2
101.6	1.132	1509.8	32.4	1.086	815.4
122.6	1.055	1406.5	30.1	1.067	766.5
144	0.971	1295.4	27.7	1.047	714.3
148.6	0.954	1272.4	27.2	1.044	702.8
170	0.864	1151.9	24.5	1.025	640.8

Molecular weight: **137.1**. Radius of the Capillary tube: 0.04385 cm.;  
in the observations, indicated by \*,  $R$  was 0.04408 cm.; in these with \*\* it was:  
0.04638 cm.  
Depth: 0.1 mm.

The compound boils at 218° C. constantly; the meltingpoint is  
-4° C. At the boilingpoint, the value of  $\alpha$  is about **18.1** Erg. pro cm<sup>2</sup>.

## III.

<b>Aniline: <math>C_6H_5(NH_2)</math>.</b>					
Temperature in ° C.	Maximum Pressure $H$		Surface- tension $\alpha$ in Erg. pro cm <sup>2</sup> .	Specific gravity $d_{40}$	Molecular Surface- energy $\nu$ in Erg. pro cm <sup>2</sup> .
	in mm. mercury of 0° C.	in Dynes			
0°	1.573	2096.5	45.4	1.038	909.3
5.3	1.552	2069.8	44.8	1.032	900.8
26.2	1.473	1963.8	42.5	1.015	864.0
34.7	1.452	1935.8	41.8	1.008	853.7
54.8	1.371	1827.8	39.5	0.990	816.5
70	1.320	1759.8	38.0	0.976	793.0
100	1.190	1586.5	34.2	0.949	727.2
109.5	1.156	1541.6	33.2	0.941	709.9
126	1.089	1459.8	31.4	0.924	679.6
143	1.027	1369.2	29.4	0.907	644.3
148.8	0.998	1331.8	28.6	0.902	629.0
173.7	0.889	1185.8	25.4	0.877	569.2

Molecular weight: **93.04**. Radius of the Capillary tube: 0.04385 cm.  
Depth: 0.1 mm.

The liquid boils at 184° C. constantly. It is colourless, and only at  
higher temperatures it gets somewhat yellowish. At the boilingpoint,  
 $\alpha$  is: **24.3** Erg. pro cm<sup>2</sup>.

**Dimethylaniline;  $C_6H_5 \cdot N(CH_3)_2$ .**

Temperature in ° C.	Maximum Pressure $H$		Surface-tension $\gamma$ in Erg. pro $cm^2$ .	Specific gravity $d_{40}$	Molecular Surface-energy $\mu$ in Erg. pro $cm^2$ .
	in mm. mercury of 0° C.	in Dynes			
26°	1.165	1553.2	36.6	0.951	926.4
45.5	1.087	1449.1	34.1	0.935	873.0
66.5	1.018	1357.5	31.9	0.917	827.3
86.5	0.959	1278.4	30.0	0.900	787.8
106	0.893	1190.8	27.9	0.884	741.5
125.8	0.831	1107.6	25.9	0.867	697.3
146	0.768	1024.4	23.9	0.850	652.0
166	0.709	945.3	22.0	0.832	608.8
184	0.650	866.1	20.1	0.817	563.0

Molecular weight: **121.11**. Radius of the Capillary tube: 0.04803 cm.  
Depth: 0.1 mm.

The liquid boils at 191° C. constantly; it solidifies easily and the crystals melt then at 0°5 C. The value of  $\gamma$  at the boilingpoint is about: **19.3 Erg. per  $cm^2$ .**

Molecular Surface-energy  
in Erg pro  $cm^2$ .

Fig. 1.

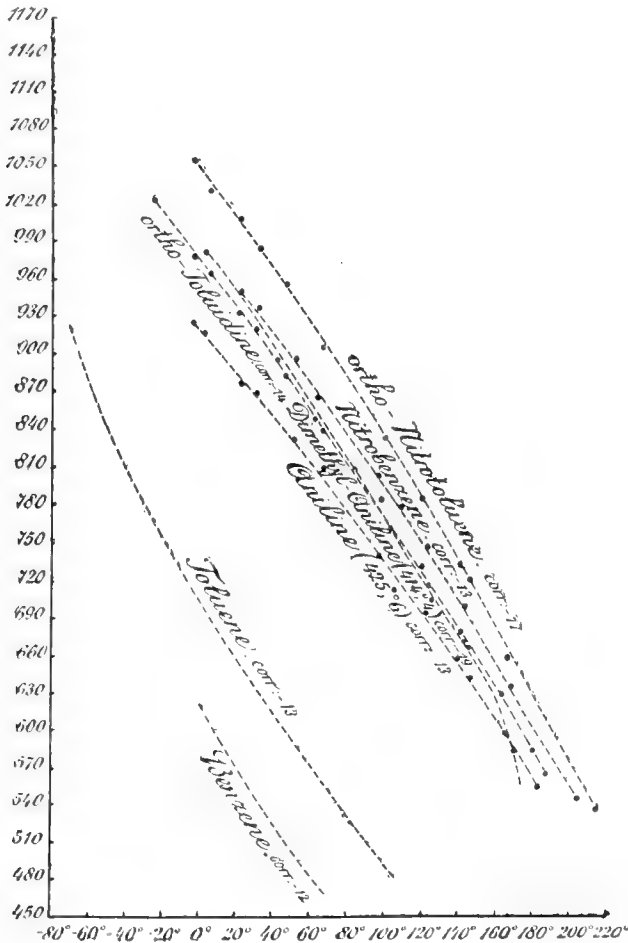

## V.

**Ortho-Toluidine:**  $CH_3 \cdot C_6H_4 \cdot (NH_2)$   
(1) (2)

Temperature in ° C.	Maximum Pressure <i>H</i>		Surface- tension $\gamma$ in Erg. pro cm <sup>2</sup> .	Specific gravity $d_{40}$	Molecular Surface- energy $\mu$ in Erg. pro cm <sup>2</sup> .
	in mm. mer- cury of 0° C.	in Dynes			
-20°	1.573	2098.0	45.4	1.027	1005.8
0.6	1.492	1989.1	43.0	1.013	961.4
9.3	1.465	1953.1	42.2	1.006	947.9
25	1.403	1870.5	40.4	0.992	915.9
34.6	1.375	1833.1	39.6	0.985	902.1
50.1	1.310	1765.8	37.7	0.973	865.8
70.5	1.234	1645.2	35.5	0.957	824.4
101.4	1.133	1510.5	32.5	0.933	767.6
123.2	1.043	1391.0	29.9	0.916	714.9
144	0.957	1277.0	27.4	0.899	663.3
149.5	0.937	1249.8	26.8	0.895	650.8
172	0.831	1108.2	23.7	0.877	583.3

Molecular weight: **107.09**. Radius of the Capillary tube: 0.04385 cm.  
Depth: 0.1 mm.

The ortho-toluidine boils at 197.4 C. constantly. It is perfectly colourless, but above 180° C. it gets gradually reddish brown. At the boilingpoint  $\gamma = 19.9$  Erg pro cm<sup>2</sup>.

## VI.

**Thymol:**  $(CH_3)_2CH \cdot C_6H_3 \cdot OH(CH_3)$ .

Temperature in ° C.	Maximum Pressure <i>H</i>		Surface- tension $\gamma$ in Erg. pro cm <sup>2</sup> .	Specific gravity $d_{40}$	Molecular Surface- energy $\mu$ in Erg. pro cm <sup>2</sup> .
	in mm. mer- cury of 0° C.	in Dynes			
0°	1.176	1567.9	34.2	0.986	975.1
25	1.109	1478.5	32.2	0.968	929.4
45.7	1.054	1405.7	30.6	0.952	893.1
70.7	0.991	1321.9	28.6	0.933	846.0
90.1	0.943	1257.0	27.3	0.920	815.2
115	0.875	1156.6	25.3	0.901	766.0
135.3	0.825	1099.3	23.8	0.887	728.2
* 160	0.703	935.9	21.9	0.867	680.3
* 190.1	0.628	837.0	19.5	0.845	616.2
* 211	0.578	770.3	17.9	0.829	572.9

Molecular weight: **150.11**. Radius of the Capillary tube: 0.04439 cm.;  
in the determinations indicated by \*, *R*  
was: 0.04803 cm.  
Depth: 0.1 mm.

The substance melts at 51.5 C., and boils at 231.75 C. constantly;  
it can be undercooled to a high degree. At the boilingpoint  $\gamma$  is 16.6  
Erg. The specific gravity at 24.74 C. is 0.9639.

## VII.

Methylbenzoate:  $C_6H_5 \cdot CO \cdot O(CH_3)$ .

Temperature in $^{\circ}C$ .	Maximum Pressure $H$		Surface- tension $\gamma$ in Erg. pro $cm^2$ .	Specific gravity $d_{40}$	Molecular Surface- energy $\mu$ in Erg. pro $cm^2$ .
	in mm. mer- cury of $0^{\circ}C$ .	in Dynes			
0 $^{\circ}$	1.405	1873.1	41.0	1.106	1014.1
*25.1	1.306	1741.2	37.3	1.080	937.4
*45	1.222	1629.2	34.8	1.059	886.1
*74.3	1.110	1479.8	31.6	1.028	820.7
*94.5	1.034	1378.7	29.4	1.006	774.6
115.2	0.946	1261.2	27.4	0.984	732.7
135.3	0.875	1166.9	25.3	0.964	684.8
160	0.791	1054.6	22.8	0.937	629.9
192.5	0.686	914.6	19.7	0.902	558.2

Molecular weight: 136.06. Radius of the Capillary tube: 0.04439 cm.;  
in the observations indicated by \*, the  
radius was: 0.04352 cm.  
Depth: 0.1 mm.

The boilingpoint of the compound lies at  $195.2^{\circ}C$ . The liquid can  
be undercooled as far as  $-21^{\circ}C$ .; then it crystallizes, and the crystals  
melt at about  $-15^{\circ}C$ . At the boilingpoint the value of  $\gamma$  is: 19.4 Erg. pro  $cm^2$ .

## VIII.

Ethylbenzoate:  $C_6H_5 \cdot CO \cdot O(C_2H_5)$ .

Temperature in $^{\circ}C$ .	Maximum Pressure $H$		Surface- tension $\gamma$ in Erg. per $cm^2$ .	Specific gravity $d_{40}$	Molecular Surface- energy $\mu$ in Erg. pro $cm^2$ .
	in mm. mer- cury of $0^{\circ}C$ .	in Dynes			
-20.5	1.338	1783.8	39.0	1.081	1045.7
0	1.271	1694.1	37.0	1.066	1001.3
* 25	1.213	1617.6	34.6	1.047	947.7
* 45.1	1.148	1530.4	32.7	1.032	904.3
* 75	1.044	1392.4	29.7	1.009	833.8
* 94.4	0.972	1295.9	27.6	0.995	782.1
114.6	0.892	1189.4	25.8	0.980	738.5
135.4	0.833	1110.6	24.0	0.964	694.6
160.2	0.740	986.7	21.3	0.945	624.7
192.1	0.649	865.0	18.6	0.921	554.9
200	0.628	838.0	18.0	0.914	539.7

Molecular weight: 150.08. Radius of the Capillary tube: 0.04439 cm.;  
in the observations indicated by \* this  
radius was: 0.04352 cm.

The compound boils at  $210.8^{\circ}C$ . It can be undercooled as far as  
 $-79^{\circ}C$ ., and then slowly crystallizes to a white mass, which melts  
at  $-57^{\circ}C$ . At the boilingpoint,  $\gamma$  is 17.4 Erg. pro  $cm^2$ . The great  
viscosity of the liquid at  $-70^{\circ}C$ . makes accurate measurements impossible.

## IX.

Benzylbenzoate: $C_6H_5 \cdot CO \cdot O(CH_2 \cdot C_6H_5)$ .					
Temperature in $^{\circ}C$ .	Maximum Pressure $H$		Surface- tension $\chi$ in Erg. pro $cm^2$ .	Specific gravity $d_{40}$	Molecular Surface- energy $\nu$ in Erg. pro $cm^2$ .
	in mm. mer- cury of $0^{\circ}C$ .	in Dynes			
-21.8	1.622	2162.4	47.4	1.153	1533.2
0	1.548	2063.5	45.2	1.136	1476.6
25	1.456	1941.9	42.5	1.115	1405.7
45	1.384	1851.8	40.5	1.099	1352.5
70.8	1.294	1725.8	37.6	1.078	1271.9
90.8	1.230	1640.0	35.8	1.062	1223.2
106.2	1.179	1572.4	34.3	1.042	1186.9
135.1	1.092	1455.2	31.7	1.027	1107.6
* 159.9	0.949	1265.9	29.8	1.006	1055.6
* 190	0.890	1186.7	27.9	0.982	1004.4
* 211.5	0.849	1132.6	26.6	0.965	968.8

Molecular weight: **212.10**. Radius of the Capillary tube: 0.04439 cm.; in the observations indicated by \*, this radius was: 0.04803 cm.  
Depth: 0.1 mm.

The substance boils constantly at  $308^{\circ}C$ .; it can be undercooled as far as  $-70^{\circ}C$ ., and then crystallizes. The meltingpoint is somewhat higher than  $+12^{\circ}C$ . At the boilingpoint  $\chi$  is **22.6** Erg pro  $cm^2$ . The density at  $25^{\circ}C$ . is:  $d_{40} = 1.1151$ ; at  $50^{\circ}C$ .: 1.0940; at  $75^{\circ}C$ .: 1.0724; at  $t^{\circ}C$ .:  $d_{40} = 1.1357 - 0.000814 t$ .

## X.

Salicylic Aldehyde: $C_6H_5 \cdot COH$ .					
Temperature in $^{\circ}C$ .	Maximum Pressure $H$		Surface- tension $\chi$ in Erg. pro $cm^2$ .	Specific gravity $d_{40}$	Molecular Surface- energy $\nu$ in Erg. pro $cm^2$ .
	in mm. mer- cury of $0^{\circ}C$ .	in Dynes			
0	1.534	2045.5	44.8	1.176	989.4
25	1.443	1923.8	42.1	1.152	942.6
45.5	1.368	1823.8	39.9	1.132	903.9
70.7	1.274	1698.6	37.1	1.108	852.5
90.5	1.205	1606.5	35.0	1.090	813.1
116.2	1.115	1486.8	32.4	1.066	764.0
135.4	1.053	1403.8	30.6	1.052	727.9
* 160	0.896	1195.1	28.1	1.030	677.9
* 190	0.796	1061.9	24.9	1.002	607.2

Molecular weight: **122.05**. Radius of the Capillary tube: 0.04439 cm.; in the with \* indicated observations, this radius was: 0.04803 cm. Depth: 0.1 mm.

The boilingpoint is constant at  $192.5^{\circ}C$ .; the substance soon solidifies, and melts at  $-7^{\circ}C$ . At  $25^{\circ}C$ . the specific gravity is:  $d_{40} = 1.1525$ ; at  $50^{\circ}C$ .: 1.1282; at  $75^{\circ}C$ .: 1.1036. At  $t^{\circ}$  in general:  $d_{40} = 1.1765 - 0.000954 t - 0.00000024 t^2$ . At the boilingpoint, the value of  $\chi$  is: **25.4** Erg. pro  $cm^2$ .

## XI.

Acetophenone:  $CH_3 \cdot CO \cdot C_6H_5$ .

Temperature in ° C.	Maximum Pressure $H$		Surface- tension $\chi$ in Erg. pro cm <sup>2</sup> .	Specific gravity $d_{40}$	Molecular Surface- energy $\mu$ in Erg. pro cm <sup>2</sup> .
	in mm. mer- cury of 0° C.	in Dynes			
24.8.	1.375	1833.6	40.1	1.024	963.5
44.7.	1.277	1703.1	37.2	1.007	903.8
71	1.169	1558.9	34.0	0.984	839.1
90.3.	1.098	1464.2	31.9	0.967	796.3
117	1.017	1356.2	29.5	0.945	747.8
135.3.	0.966	1288.6	28.0	0.929	717.9
* 160	0.824	1099.3	25.8	0.907	672.1
* 189.9.	0.750	999.4	23.4	0.881	621.5
* 200	0.728	970.2	22.7	0.872	607.1

Molecular weight: 120.06. Radius of the Capillary tube: 0.04439 cm.;  
in the observations indicated by \*, the  
radius was: 0.04803 cm.  
Depth: 0.1 mm.

The compound boils constantly at 201.5 C.; and becomes solid at  
-20° C.; it melts at +20° C. At the boilingpoint the value of  $\chi$  is  
22.6 Erg. pro cm<sup>2</sup>. The specific gravity at 25° C. is:  $d_{40} = 1.0236$ ; at  
50° C.: 1.0026.

## XII.

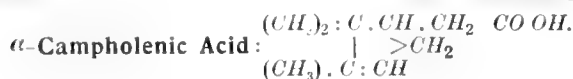

Temperature in ° C.	Maximum Pressure $H$		Surface- tension $\chi$ in Erg. pro cm <sup>2</sup> .	Specific gravity $d_4$	Molecular Surface- energy $\mu$ in Erg. pro cm <sup>2</sup> .
	in mm. mer- cury of 0° C.	in Dynes			
-19.8.	(1.695)	(2259.8)	(53.6)	1.030	(1598.6)
0	1.177	1569.2	37.0	1.016	1114.1
25	1.077	1436.6	33.8	0.999	1029.4
45.4	1.019	1358.5	31.9	0.985	980.9
70	0.953	1270.5	29.8	0.969	926.6
85.3.	0.915	1220.1	28.6	0.960	895.0
117	0.846	1128.5	26.4	0.939	838.7
138.1	0.805	1073.2	25.1	0.925	805.6
156	0.771	1027.9	24.0	0.913	777.5
172	0.728	970.2	22.6	0.902	739.1
191.7	0.664	885.2	20.6	0.889	680.5
212	0.608	810.6	18.8	0.876	627.8

Molecular weight: 168.13. Radius of the Capillary tube: 0.04803 cm.  
Depth: 0.1 mm.

Under a pressure of 12 mm., the compound boils constantly at  
153° C. Below 0° C. the liquid is extremely viscous; although the  
growing of the gas-bubbles lasted about 50 seconds, the measurements  
at -19° C. cannot be considered to be very reliable. The substance  
solidifies at -79° C.; above 160° C. it gets yellow by a slowly proceed-  
ing decomposition.

Molecular Surface-energy  
in Erg pro  $\text{cm}^2$ .

Fig. 2.

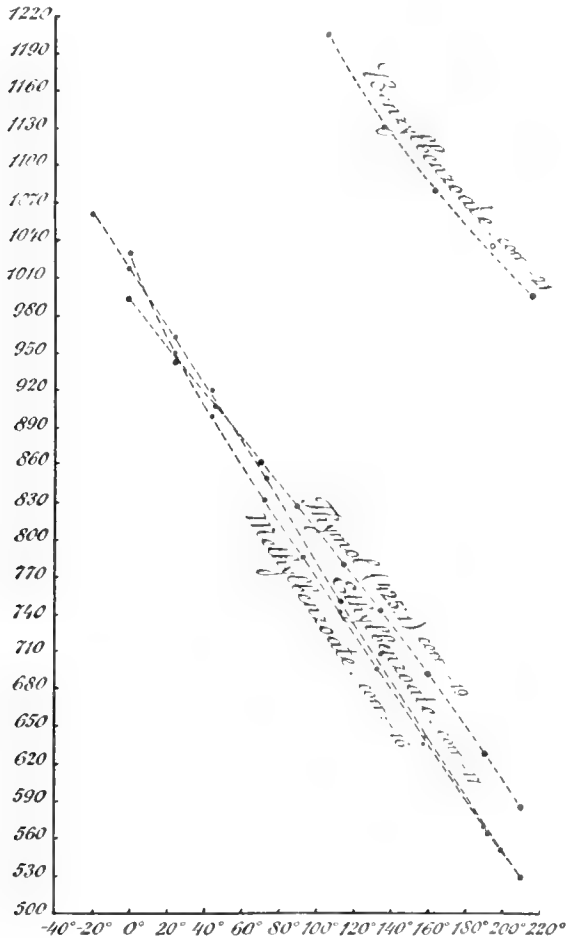

§ 3. Values of the Temperature-coefficients of the molecular Surface-energy  $\mu$ .

<i>Nitrobenzene.</i>			<i>o-Nitrotoluene.</i>		
Temperature-interval:		$\frac{\partial \mu}{\partial t}$ in Erg:	Temperature-interval:		$\frac{\partial \mu}{\partial t}$ in Erg:
between	5° and 35°	1,53	between	0° and 25°	1,81
	35° " 71°	1,93		25° " 49°	2,19
	71° " 110°	2,16		49° " 123°	2,29
	110° " 145°	2,25		123° " 144°	2,42
	145° " 173°	2,31		144° " 170°	2,82
<i>Aniline.</i>			<i>Dimethylaniline.</i>		
between	0° and 35°	1,57	between	26° and 46°	2,72
	35° " 70°	1,73		46° " 184°	2,23
	70° " 174°	2,16			
<i>o-Toluidine.</i>			<i>Thymol.</i>		
between	-20° and +101°	1,98	between	0° and 160°	1,83
	101° " 144°	2,44		160° " 211°	2,09
	144° " 172°	2,85			
Above 160° a gradual decomposition with colouring of the liquid, sets in.					
<i>Methylbenzoate.</i>			<i>Ethylbenzoate.</i>		
between	0° and 25°	3,0	between	-20° and +200°	2,29
	25° " 45°	2,6			
	45° " 192°	2,21			
<i>Benzylbenzoate.</i>			<i>Salicylic Aldehyde.</i>		
between	-22° and +135°	2,70	between	0° and 160°	1,98
	135° " 160°	2,08		160° " 190°	2,19
	160° " 211°	1,66			
<i>Acetophenone.</i>			<i><math>\alpha</math>-Campholenic Acid.</i>		
between	25° and 45°	2,99	between	-19°,8 and 0°	cannot be determined independently of the viscosity
	45° " 71°	2,45		0° " 25°	3,39
	71° " 90°	2,19		25° " 45°	2,42
	90° " 160°	1,76		45° " 85°	2,12
	160° " 200°	1,61		85° " 117°	1,76
				117° " 138°	1,59
				Above 138° (decomposition)	ca. 2,6

Besides some straight lines, there are found here several curves for the dependence of  $\mu$  and  $t$ , showing in contradistinction with the formerly described ones, the shape of that of *water*.

Groningen, June 1914.

Laboratory for Inorganic Chemistry  
of the University.



**Chemistry.** — “*The Temperature-coefficients of the free Surface-energy of Liquids, at Temperatures from  $-80^{\circ}$  to  $1650^{\circ}$  C.:*”

**IV. Measurements of some Aliphatic and Aromatic Ethers.”**

By Prof. F. M. JAEGER and JUL. KAHN. (Communicated by Prof. P. VAN ROMBURGH.)

§ 1. In this communication the results obtained in the measurements of the free surface-energy of a number of ethers, are recorded by us. With respect to the purification-methods and the determination of the specific weights, we can refer to communication II of this series<sup>1)</sup>; also the arrangement of the data and the significance of the diagrams are completely the same as indicated before. This series includes the following aliphatic terms:

*Amylacetate*; *Diethyl-Oxalate*; *Diethylmalonate*; *Diethylbromomalonate*; *Diethyl-Ethylbenzylmalonate*; *Dimethyl* and *Diaethyltartrates*; and the following aromatic substances:

*ortho-Nitroanisol*; *Methyl-, Ethyl-, and Phenyl-Salicylates*; *Methyl-Cinnamylate*.

I.

Amylacetate: $\text{CH}_3 \cdot \text{CO} \cdot \text{O}(\text{C}_5\text{H}_{11})$ .					
Temperature in $^{\circ}\text{C}$ .	Maximum Pressure $H$		Surface- tension $\gamma$ in Erg. pro $\text{cm}^2$ .	Specific gravity $d_{4^{\circ}}$	Molecular Surface- energy $\sigma$ in Erg. pro $\text{cm}^2$ .
	in mm. mer- cury of $0^{\circ}\text{C}$ .	in Dynes			
$-70^{\circ}$	1.099	1465.8	34.6	0.968	907.8
$-21$	0.915	1220.1	28.7	0.918	780.0
0	0.850	1132.6	26.6	0.896	734.9
25.8	0.771	1028.6	24.1	0.869	679.5
46	0.712	949.4	22.2	0.847	636.8
66.5	0.653	870.3	20.3	0.827	591.6
86.5	0.600	799.5	18.6	0.808	550.5
106	0.549	732.9	17.0	0.790	510.8
125	0.506	674.6	15.6	0.774	475.1
146	0.461	614.6	14.2	0.752	440.9

Molecular weight: 130.11. Radius of the Capillary tube: 0.04803 cm.  
Depth: 0.1 mm.

The boilingpoint of the carefully dried compound lies at  $148.04^{\circ}\text{C}$ . ;  
at this temperature  $\gamma$  is 14.0 Erg. pro  $\text{cm}^2$ .

<sup>1)</sup> F. M. JAEGER and M. J. SMIT, These Proc. (1914) p. 365.

## II.

**Diethyl-Oxalate:  $(C_2H_5)_2O \cdot CO \cdot CO \cdot O(C_2H_5)_2$ .**

Temperature in $^{\circ}C$ .	Maximum Pressure $H$		Surface- tension $\gamma$ in Erg. pro cm $^2$ .	Specific gravity $d_4^{20}$	Molecular Surface- energy $\mu$ in Erg. pro cm $^2$ .
	in mm. mer- cury of $0^{\circ}C$	in Dynes			
-20.7	1.177	1569.9	37.0	1.139	941.0
0	1.111	1482.5	34.9	1.110	903.0
26	1.025	1366.5	32.1	1.074	848.8
46	0.952	1278.4	30.0	1.050	805.5
66.7	0.896	1195.1	28.0	1.025	764.0
86.5	0.818	1091.0	25.5	1.001	706.8
106	0.768	1024.4	23.9	0.977	673.3
125	0.717	955.9	22.2	0.954	635.4
145.5	0.650	866.6	20.1	0.930	581.1
166	0.568	757.3	17.6	0.905	521.8
184	0.478	637.3	14.6	0.883	440.0

Molecular weight: **146.08**. Radius of the Capillary tube: 0.04803 cm.  
Depth: 0.1 mm.

The substance boils at  $99.5^{\circ}C$ . constantly, under a pressure of about 12 mm. In solid carbon dioxide and alcohol it soon solidifies, and melts at  $-41.5^{\circ}C$ . Above  $160^{\circ}C$ . the ether seems to decompose slowly.

## III.

**Diethylmalonate:  $(C_2H_5)_2O \cdot CO \cdot CH_2 \cdot CO \cdot O(C_2H_5)_2$ .**

Temperature in $^{\circ}C$ .	Maximum Pressure $H$		Surface- tension $\gamma$ in Erg. pro cm $^2$ .	Specific gravity $d_4^{20}$	Molecular Surface- energy $\mu$ in Erg. pro cm $^2$ .
	in mm. mer- cury of $0^{\circ}C$ .	in Dynes			
-19.9	1.237	1649.2	35.5	1.095	985.3
0.7	1.167	1555.8	33.5	1.075	941.2
8.5	1.142	1523.2	32.9	1.068	928.4
25.2	1.077	1435.9	31.0	1.050	884.8
34.5	1.044	1391.9	30.0	1.041	861.2
50.1	0.994	1325.2	28.5	1.025	826.6
69.2	0.920	1226.8	26.3	1.005	772.9
102	0.804	1071.8	23.0	0.969	692.5
124.5	0.723	963.9	20.6	0.945	630.7
144	0.660	880.2	18.8	0.924	584.3
148.7	0.649	866.4	18.5	0.919	577.1
171	0.571	761.6	16.2	0.896	513.9

Molecular weight: **160.1**. Radius of the Capillary tube: 0.04385 cm.  
Depth: 0.1 mm.

The compound boils constantly at  $197.3^{\circ}C$ .; after crystallisation, it melts at  $-50^{\circ}C$ . At  $25^{\circ}C$ . the specific gravity was 1.0518; at  $50^{\circ}C$ .: 1.0254. At the boilingpoint the value of  $\gamma$  is: **13.7** Erg pro cm $^2$ .

## IV.

**Diethyl-Bromomalonate:**  $(C_2H_5)O \cdot CO \cdot CIBr \cdot CO \cdot O(C_2H_5)$ .

Temperature in ° C.	Maximum Pressure $H$		Surface- tension $\chi$ in Erg. pro cm <sup>2</sup> .	Specific gravity $d_{40}$	Molecular Surface- energy $\mu$ in Erg. pro cm <sup>2</sup> .
	in mm. mer- cury of 0° C.	in Dynes			
-20.7	1.250	1666.5	39.1	1.464	1168.2
0	1.165	1553.2	36.4	1.436	1101.6
26	1.065	1419.9	33.2	1.401	1021.5
45.5	0.999	1332.5	31.1	1.375	968.9
66.6	0.943	1257.6	29.3	1.347	925.4
86.5	0.896	1195.1	27.8	1.320	890.0
106.5	0.853	1136.8	26.4	1.293	856.9
126	0.815	1086.8	25.3	1.266	832.8
146	0.780	1039.9	24.2	1.240	807.7

Molecular weight: **239.09**. Radius of the Capillary tube: 0.04803 cm.;  
Depth: 0.1 mm.

Under reduced pressure (ca. 20 mm.) the substance boils constantly at 121° C.; at -54° C. it becomes a jelly, but does not crystallize. Above 150° C. it begins to be tinged brownish, apparently by beginning deposition. The specific weight at 25° C. is: 1.4022; at 50° C.: 1.3688; at 75° C.: 1.3359; At  $t^\circ$  C.:  $d_{40} = 1.4361 - 0.001356t + 0.0000004t^2$ .

## V.

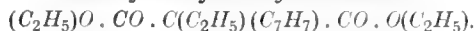
**Diethyl-Ethylbenzylmalonate:**

Temperature in ° C.	Maximum Pressure $H$		Surface- tension $\chi$ in Erg. pro cm <sup>2</sup> .	Specific gravity $d_{40}$	Molecular Surface- energy $\mu$ in Erg. pro cm <sup>2</sup> .
	in mm. mer- cury of 0° C.	in Dynes			
-20.2	(2.174)	(2898.4)	(68.8)	1.086	(2775.0)
0	1.241	1654.5	39.0	1.072	1586.7
26	1.121	1494.9	35.2	1.052	1450.1
45.5	1.050	1399.9	32.9	1.035	1370.2
66.6	0.984	1311.7	30.8	1.016	1298.7
86.7	0.940	1253.4	29.4	1.001	1252.1
106	0.901	1201.2	28.1	0.986	1208.8
126	0.853	1136.8	26.6	0.971	1156.0
146	0.805	1073.2	25.1	0.956	1102.2
166	0.759	1011.9	23.6	0.941	1047.3
184	0.690	920.3	21.4	0.927	959.2
206.5	0.637	849.5	19.7	0.911	893.3

Molecular weight: **278.18**. Radius of the Capillary tube: 0.04803 cm.  
Depth: 0.1 mm.

Under 12 mm. pressure, the substance boils constantly at 189° C.; at -79° C. the liquid becomes a feebly opalescent glass. Already at -20° C. the viscosity is enormous, and at 0° C. again very great. The grow of the gas-bubbles at 0° C. lasted about 40 seconds. The specific gravity at 25° C. is:  $d_{40} = 1.0531$ ; at 50° C.: 1.0322; at 75° C.: 1.0098. At  $t^\circ$  C. in general:  $d_{40} = 1.0725 - 0.000746t - 0.0000012t^2$ .

## VI.

**Dimethyltartrate:  $(CH_3)O.CO.CH(OH)CH(OH).CO.O(CH_3)$ .**

Temperature in °C.	Maximum Pressure <i>H</i>		Surface- tension in Erg. pro cm <sup>2</sup> .	Specific gravity $d_{40}$	Molecular Surface- energy $\mu$ in Erg. pro cm <sup>2</sup> .
	in mm. mer- cury of 0° C.	in Dynes			
45°	1.490	1986.6	43.2	1.306	1144.6
70.7	1.405	1873.1	40.7	1.281	1092.2
90.7	1.340	1786.5	38.8	1.261	1052.2
116.2	1.255	1673.2	36.3	1.235	998.2
135.5	1.200	1599.5	34.7	1.216	964.1
* 159.6	1.046	1395.0	32.7	1.192	920.7
* 190	0.974	1299.2	30.4	1.151	876.1
* 210.3	0.929	1238.5	28.9	1.131	842.7

Molecular weight: **178.08**. Radius of the Capillary tube: 0.04439 cm.; in the observations indicated with \*, it was: 0.04803 cm.  
Depth: 0.1 mm.

The compound boils under 12 mm. pressure, at 180° C. constantly; at -79° C. it becomes a glass, which crystallizes with extreme slowness; the solid substance melts at +48° C. Even at 25° C. the ether is so viscous, that no reliable measurements were possible.

## VII.

**Diethyltartrate:  $(C_2H_5)O.CO.CH(OH).CH(OH).CO.O(C_2H_5)$ .**

Temperature in °C.	Maximum Pressure <i>H</i>		Surface- tension $\chi$ in Erg. pro cm <sup>2</sup> .	Specific gravity $d_{40}$	Molecular Surface- energy $\mu$ in Erg. pro cm <sup>2</sup> .
	in mm. mer- cury of 0° C.	in Dynes			
25°	1.317	1755.5	37.6	1.210	1155.4
45.3	1.241	1654.4	35.4	1.191	1099.3
74.3	1.134	1512.0	32.3	1.164	1018.5
91.1	1.082	1443.0	30.8	1.147	980.8
110.1	1.024	1364.9	29.1	1.129	936.5
134.7	0.948	1263.8	26.9	1.105	878.2
150.1	0.899	1199.4	25.5	1.091	839.6
160.3	0.872	1162.7	24.7	1.081	818.2
192.7	0.765	1019.9	22.0	1.050	743.1
212.7	0.716	955.9	20.2	1.032	690.2

Molecular weight: **206.11**. Radius of the Capillary tube: 0.04352 cm.  
Depth: 0.1 mm.

Under circa 16 mm. pressure, the boilingpoint is 166.5 C. At -79° the liquid becomes glassy, and crystallizes very slowly at -20° C.: only after 5 or 6 hours all has got crystalline. The meltingpoint is 15° C. At 0° and lower temperatures the liquid is too viscous, to make reliable measurements possible.

Molecular Surface-energy  
in Erg pro cm<sup>2</sup>.

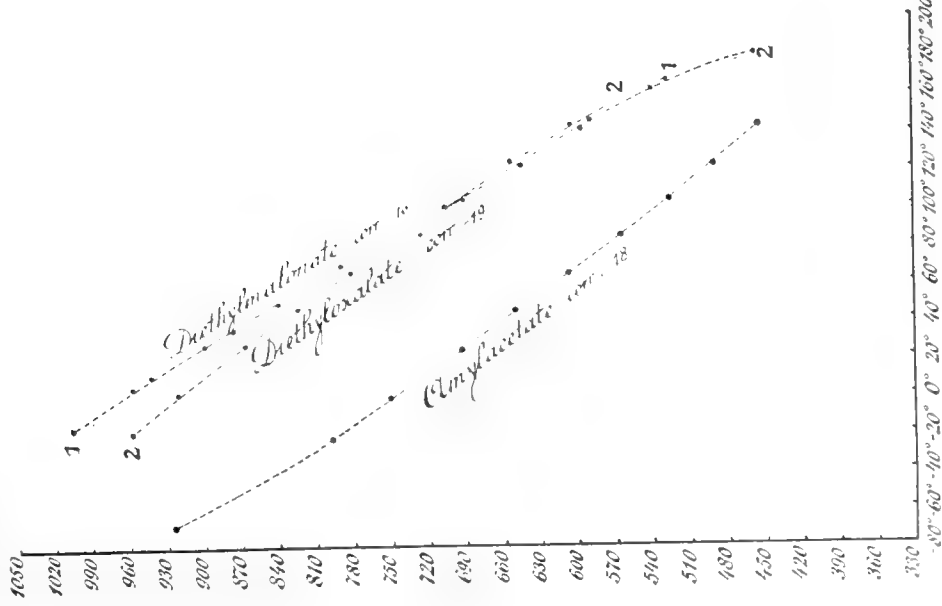

Fig. 1.

Molecular Surface-energy  
in Erg pro cm<sup>2</sup>.

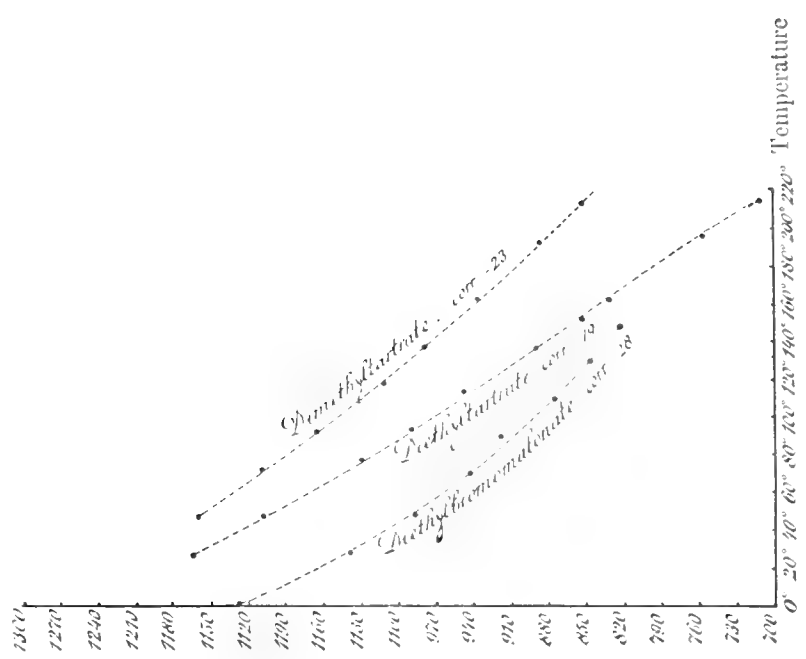

Fig. 2.

## VIII.

**ortho-Nitro-Anisol:  $(CH_3)_O \cdot C_6H_4 \cdot (NO_2)$ .**  
(1) (2)

Temperature in ° C.	Maximum Pressure $H$		Surface- tension $\gamma$ in Erg. pro cm <sup>2</sup> .	Specific gravity $d_4^t$	Molecular Surface- energy $\mu$ in Erg. pro cm <sup>2</sup>
	in mm. mer- cury of 0° C.	in Dynes			
0°	1.613	2150.4	50.8	1.273	1237.6
25.4	1.537	2048.8	48.4	1.247	1195.4
44.9	1.480	1973.8	46.6	1.227	1165.1
70.1	1.390	1853.0	43.7	1.202	1106.1
85.3	1.340	1786.4	42.1	1.187	1074.6
117	1.227	1635.8	38.4	1.156	997.6
138.2	1.160	1546.5	36.3	1.135	947.3
156	1.109	1478.2	34.7	1.118	921.8
172	1.043	1390.8	32.6	1.102	874.4
191.5	0.968	1290.5	30.2	1.083	819.4
212	0.850	1133.0	26.5	1.062	728.8

Molecular weight: **153.07**. Radius of the Capillary tube: 0.04803 cm.  
Depth: 0.1 mm.

The substance boils constantly at 272° C.; at 20° it solidifies, and melts at +10° C. Above 165° C. a slow decomposition begins. The specific weight at 25° C. is:  $d_4^{25} = 1.2472$ ; at 50° C.: 1.2218; at 75° C.: 1.1970; at  $t^\circ$  generally:  $d_4^t = 1.2732 - 0.001052t + 0.00000048t^2$ .

## IX.

**Methylsalicylate:  $C_6H_4(OH) \cdot CO \cdot OCH_3$ .**  
(1) (2)

Temperature in ° C.	Maximum Pressure $H$		Surface- tension $\gamma$ in Erg. pro cm <sup>2</sup> .	Specific gravity $d_4^t$	Molecular Surface- energy $\mu$ in Erg. pro cm <sup>2</sup>
	in mm. mer- cury of 0° C.	in Dynes			
-19.8	1.518	2023.8	44.2	1.220	1102.9
0.3	1.436	1914.8	41.8	1.202	1053.4
* 25	1.372	1829.0	39.1	1.179	998.1
* 45	1.303	1737.2	37.1	1.158	956.4
* 74.7	1.193	1590.1	33.9	1.128	891.7
* 94	1.124	1498.2	31.9	1.110	848.3
114.5	1.031	1374.2	29.8	1.092	801.2
135.2	0.968	1290.5	27.9	1.073	758.4
160.5	0.867	1155.9	24.9	1.050	686.7
192.9	0.760	1013.7	21.8	1.021	612.6
212.2	0.696	928.1	19.8	1.003	562.9

Molecular weight: **152.06**. Radius of the Capillary tube: 0.04439 cm.; in the observations, indicated by \*, it was 0.04352 cm.  
Depth: 0.1 mm.

The substance boils at 217.6° C. constantly; it can be undercooled as far as -50° C., and crystallizes to a solid mass, which melts at -16° C. At the boilingpoint  $\gamma$  is: 19.3 Erg. pro cm<sup>2</sup>. The density at 25° C. is:  $d_4^{25} = 1.1787$ ; at 50° C.: 1.1541; at 75° C.: 1.1285. At  $t^\circ$  C.:  $d_4^t = 1.2023 - 0.000924t - 0.0000008t^2$ .

## X.

**Ethylsalicylate:**  $C_6H_4(OH) \cdot CO \cdot O(C_2H_5)$   
(1) (2)

Temperature in °C.	Maximum Pressure <i>H</i>		Surface- tension $\gamma$ in Erg. pro cm <sup>2</sup> .	Specific gravity $d_{40}$	Molecular Surface- energy $\mu$ in Erg. pro cm <sup>2</sup> .
	in mm. mer- cury of 0° C.	in Dynes			
0°	1.346	1794.5	39.1	1.154	1073.8
* 25	1.275	1700.4	36.3	1.130	1011.0
* 45.1	1.206	1608.5	34.3	1.110	966.7
* 74.1	1.110	1479.8	31.5	1.082	903.0
* 94.3	1.047	1395.9	29.7	1.063	851.6
115.1	0.963	1284.1	27.8	1.043	816.7
135.2	0.906	1207.4	26.1	1.024	776.2
159.8	0.828	1103.8	23.8	1.001	718.6
193	0.723	964.2	20.7	0.980	633.9
212.5	0.669	892.1	19.1	0.962	592.2

Molecular weight: 166.08. Radius of the Capillary tube: 0.0439 cm.  
in the observations, indicated with \* it was:  
0.04352 cm.  
Depth: 0.1 mm

The substance boils at 231.2° C. constantly; at -20° C. it solidifies  
and melts at ca. -10° C. At the boilingpoint  $\gamma$  is 17.6 Erg pro cm<sup>2</sup>.  
The specific weight at 25° C. is: 1.1298; at 50° C.: 1.1053; at 75° C.: 1.0806.  
At  $t^\circ$  it is calculated from:  $d_{40} = 1.1541 - 0.000968 t - 0.00000016 t^2$ .

## XI.

**Phenylsalicylate (Salol):**  $C_6H_4(OH) \cdot CO \cdot O(C_6H_5)$   
(1)

Temperature in °C.	Maximum Pressure <i>H</i>		Surface- tension $\gamma$ in Erg pro cm <sup>2</sup> .	Specific gravity $d_{40}$	Molecular Surface- energy $\mu$ in Erg. pro cm <sup>2</sup> .
	in mm. mer- cury of 0° C.	in Dynes			
-20.1	(2.613)	(3482.8)	(76.5)	1.221	(2396.4)
0	1.571	2095.1	45.7	1.202	1446.7
25	1.485	1980.6	43.2	1.179	1385.2
45	1.419	1892.3	41.2	1.160	1305.1
72	1.335	1779.7	38.7	1.136	1272.0
90.1	1.272	1695.8	36.8	1.120	1221.1
116	1.193	1590.4	34.5	1.098	1160.0
135	1.132	1509.3	32.7	1.078	1130.3
* 160	0.971	1295.0	30.3	1.055	1046.3
* 189.8	0.890	1186.7	27.7	1.026	974.5
* 211.6	0.846	1128.5	26.3	1.006	637.5

Molecular weight: 214.08. Radius of the Capillary tube: 0.04439 cm.;  
in the observations, indicated with \* it was:  
0.04803 cm  
Depth: 0.1 mm.

Under 12 mm. pressure, the salol boils at 173° C.; at -33° C. it  
crystallizes spontaneously, and melts at +42° C. It can be under-  
cooled to a very high degree, and possesses a small velocity of crys-  
tallisation. At 35° C. the specific gravity is: 1.1697; at 50° C.: 1.1553;  
at 75° C.: 1.1330

Some other derivatives of aromatic phenoles: *Anisol*, *Phenetol*, *Anethol*, *Guajacol*, *Resorcine-Mono-*, and *Dimethylethers*; *Hydrochinon-Dimethylether* have been described before by the first of us<sup>1)</sup>. The temperature-coefficients of these compounds are however also reviewed in the present communication, because they were not mentioned in the one referred to. (Vid. also the preceding communications.)

Molecular Surface energy  
in Erg pro cm<sup>2</sup>.

Fig. 3.

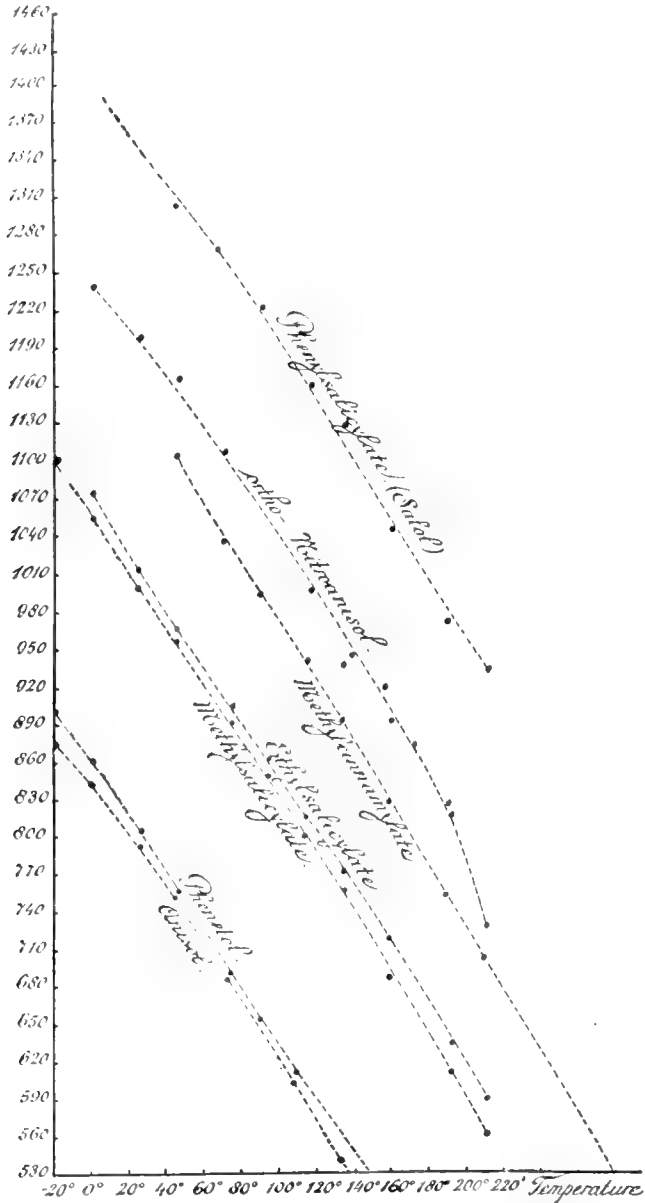

<sup>1)</sup> F. M. JAEGER, These Proc., Comm. I. (1914) p. 354 seq.



**Methyl-Cinnamate:**  $C_6H_5 \cdot CH:CH \cdot CO \cdot O(CH_3)$ .

Temperature in °C.	Maximum Pressure $H$		Surface- tension $\chi$ in Erg. pro cm <sup>2</sup> .	Specific gravity $d_{40}$	Molecular Surface- energy $\nu$ in Erg. pro cm <sup>2</sup> .
	in mm. mer- cury of 0° C.	in Dynes			
45°	1.329	1771.8	38.7	1.062	1105.2
71	1.230	1639.8	35.8	1.038	1038.1
90.6	1.166	1554.5	33.9	1.020	994.5
116.2	1.092	1455.2	31.7	0.997	944.2
135.4	1.024	1365.2	29.7	0.980	894.9
* 159.7	0.868	1157.6	27.1	0.958	829.0
* 190.5	0.777	1035.9	24.2	0.930	755.1
* 210.9	0.712	949.4	22.1	0.911	699.1

Molecular weight: **162.08**. Radius of the Capillary tube: 0.04430 cm.;  
in the observations, indicated by \* it was:  
0.04803 cm.  
Depth: 0.1 mm.

The ether boils at 253.°5 C., and melts at 36.°5 C. At the boiling-  
point  $\chi$  is: **18.6** Erg. pro cm<sup>2</sup>. The specific gravity at 35° C. is:  
 $d_{40} = 1.0700$ ; at 50° C.: 1.0573 at 75° C.: 1.0340.

§ 3. *Values of the Temperature-coefficients of the molecular surface-energy  $\mu$  of the studied compounds.*

*Amylacetate.*

Temperature-interval:	$\frac{\partial \mu}{\partial t}$ in Erg:
between — 70° and — 21°	2,59
— 21° and + 66°	2,14
66° and 106°	2,03
106° and 148°	1,73

*Diethylmalonate.*

between — 20° and + 171°	2,52
--------------------------	------

*Diethyl-Oxalate.*

Temperature-interval:	$\frac{\partial \mu}{\partial t}$ in Erg:
between — 20° and 0°	1,8
0° and 66°	2,02
66° and 106°	2,2
106° and 146°	2,3
146° and 184°	3,6

Above 146° a decomposition seems slowly to set in.

*Diethylbromomalonate.*

between — 21° and 0°	3,20
0° and 26°	3,08
26° and 46°	2,67
46° and 67°	2,04
67° and 86°	1,75
86° and 106°	1,63
106° and 126°	1,35
126° and 146°	1,23

*Diethyl-Ethylbenzylmalonate.*

Temperature-interval:	$\frac{\partial \mu}{\partial t}$ in Erg:
between $-20^{\circ}$ and $0^{\circ}$	cannot be determined independently of the viscosity.
$0^{\circ}$ " $26^{\circ}$	5,2
$26^{\circ}$ " $66^{\circ}$	3,7
$66^{\circ}$ " $106^{\circ}$	2,25
$106^{\circ}$ " $126^{\circ}$	2,6
$126^{\circ}$ " $146^{\circ}$	2,7
$146^{\circ}$ " $166^{\circ}$	2,75
$166^{\circ}$ " $206^{\circ}$	3,85

Above  $166^{\circ}$  a slow decomposition begins to make itself perceptible.

*o-Nitroanisol.*

between $0^{\circ}$ and $45^{\circ}$	1,61
$45^{\circ}$ " $172^{\circ}$	2,29
$172^{\circ}$ " $192^{\circ}$	2,82
$192^{\circ}$ " $212^{\circ}$	4,45

Above  $170^{\circ}$  a gradual decomposition sets in, which proceeds very slowly.

*Ethylsalicylate.*

between $0^{\circ}$ and $212^{\circ}$	2,23
---------------------------------------	------

*Methylcinnamylate.*

between $45^{\circ}$ and $210^{\circ},9$	2,44
--	------

*Phenetol.*

between $-12^{\circ}$ and $0^{\circ}$	2,0
$0^{\circ}$ " $74^{\circ},3$	2,29
$74^{\circ}$ " $160^{\circ}$	2,13

The curve is almost a straight line, with  $\frac{\partial \mu}{\partial t} = 2,14$ .

*Guajacol.*

between $26^{\circ}$ and $146^{\circ}$	2,17
$146^{\circ}$ " $206^{\circ}$	2,66

*Dimethyltartrate.*

Temperature-interval:	$\frac{\partial \mu}{\partial t}$ in Erg:
between $45^{\circ}$ and $117^{\circ}$	2,08
$117^{\circ}$ " $160^{\circ}$	1,77
$160^{\circ}$ " $210^{\circ}$	1,53

*Diethyltartrate.*

between $25^{\circ}$ and $74^{\circ},3$	2,75
$74^{\circ}$ " $213^{\circ}$	2,35

*Methylsalicylate.*

between $-19^{\circ},8$ and $212^{\circ}$	2,30
---	------

*Phenylsalicylate. (Salol).*

between $-20^{\circ}$ and $211^{\circ},6$	2,43
---	------

*Anisol.*

between $-21^{\circ}$ and $+45^{\circ}$	1,88
$45^{\circ}$ " $91^{\circ}$	2,14
$91^{\circ}$ " $151^{\circ}$	2,63

*Anethol.*

between $24^{\circ},7$ and $75^{\circ},1$	2,53
$75^{\circ}$ " $213^{\circ}$	2,25

*Resorcine-Monomethylether.*

between $-20^{\circ}$ and $0^{\circ}$	cannot be determined independently of the viscosity.
$0^{\circ}$ " $26^{\circ}$	4,3
$26^{\circ}$ " $46^{\circ}$	2,45
$46^{\circ}$ " $184^{\circ}$	1,82
$184^{\circ}$ " $206^{\circ}$	2,97

Above  $184^{\circ}$  a decomposition sets in slowly.

*Resorcine-Dimethylether.*

Temperature-interval:	$\frac{\partial \mu}{\partial t}$ in Erg:
between $-22^{\circ}$ and $0^{\circ}$	2,83
$0^{\circ}$ " $210^{\circ}$	2,25

*Hydrochinon-Dimethylether.*

Temperature-interval:	$\frac{\partial \mu}{\partial t}$ in Erg:
between $66^{\circ}$ and $106^{\circ}$	2,11
$106^{\circ}$ " $166^{\circ}$	2,46
$166^{\circ}$ " $206^{\circ}$	2,88

Up to  $166^{\circ}$ , this  $\nu$ - $t$ -curve coincides practically with that of *guajacol* and of *resorcine-dimethylether*.

*Pyridine.*

between $-79^{\circ}$ and $-20^{\circ}$	1,79
$-20^{\circ}$ " $+25^{\circ}$	2,04
$25^{\circ}$ " $92^{\circ}$	1,60

*$\nu$ -Picoline.*

between $-70^{\circ}$ and $-20^{\circ},7$	2,83
$-20^{\circ},7$ " $+126^{\circ}$	2,02

*Chinoline.*

between $-21^{\circ}$ and $+45^{\circ},2$	1,92
$45^{\circ}$ " $115^{\circ}$	2,10
$115^{\circ}$ " $230^{\circ}$	2,33

§ 5. Also for these substances one can state, that a decomposition of the compound causes an extraordinarily rapid decrease of the values for  $\chi$  or  $\mu$  with increasing temperature:  $\frac{\partial \mu}{\partial t}$  becomes much larger in such cases with rising temperature. Furthermore it can be seen from the cases of *salol*, *diethylbenzylmalonate*, *resorcine-monomethylether*, etc., that an extraordinarily great viscosity of the liquid can appreciably diminish the accuracy of the measurements; however the case of *dimethyltartrate* on the contrary proves, that sometimes reliable results can be obtained, even with very high values of the internal friction.

Groningen, June 1914.

Laboratory Inorganic Chemistry  
of the University.

**Chemistry.** — “*The Temperature-coefficients of the free Surface-energy of Liquids, at Temperatures from  $-80^{\circ}$  to  $1650^{\circ}$  C.: V. Measurements of homologous Aromatic Hydrocarbons and some of their Halogenderivatives*”. By Prof. Dr. F. M. JAEGER. (Communicated by Prof. P. VAN ROMBURGH.)

§ 1. In order to answer also the question of an eventual dependence between the chemical constitution of liquids and the values of their free surface-energy and of its temperature-coefficient, in

this communication the results of the measurements are recorded, made with a series of homologous hydrocarbons and some of their halogen-derivatives. With respect to the methods of purification, the determination of the specific gravities, and the significance of the diagrams, we can refer to the previous communications.

This series includes the following terms :

*Benzene; Toluene; para-Xylene; Mesitylene; Pseudocumene; Triphenylmethane; Chlorobenzene; Bromobenzene; meta-Dichlorobenzene; para-Fluorobromobenzene; meta-Fluorotoluene; and para-Chlorotoluene.*

For the purpose of comparison with benzene, also *Cyclohexane* was taken into account here; the data relating to benzene were already published in a former paper<sup>1)</sup>, but are repeated here once more for comparison with the other hydrocarbons. The obtained results are put together in tables, in the ordinary way.

## § 2. Aromatic Hydrocarbons and some Halogenderivatives.

### I.

#### Cyclohexane: $C_6H_{12}$ .

Temperature in ° C.	Maximum Pressure $H$		Surface- tension $\gamma$ in Erg. pro cm <sup>2</sup> .	Specific gravity $d_{40}$	Molecular Surface- energy $\mu$ in Erg. pro cm <sup>2</sup> .
	in mm. mer- cury of 0° C.	in Dynes			
9°	0.830	1106.8	28.3	0.788	636.7
19	0.785	1046.5	26.7	0.778	605.9
24.6	0.755	1007.6	25.7	0.773	585.7
40	0.682	909.2	23.1	0.768	529.2
58	0.601	801.2	20.3	0.744	474.6
70	0.548	730.6	18.4	0.732	434.9
80	0.504	671.6	16.9	0.723	402.7

Molecular weight: 84.1. Radius of the Capillary tube: 0.05240 cm.  
Depth: 0.1 mm.

The liquid boils constantly at 80.<sup>07</sup> C.; at this temperature the value of  $\gamma$  is: 16.7 Erg. pro cm<sup>2</sup>. It solidifies at 10 C.; the crystals melt at +8° C. The specific gravity at 25° C. is. 0.7733; at 35° C.: 0.7645; at 50° C.: 0.7515. At  $t$ ° C.:  $d_{40} = 0.7958 - 0.000913 t + 0.0000053 t^2$ .

<sup>1)</sup> F. M. JAEGER and M. J. SMIT; F. M. JAEGER and J. KAHN; F. M. JAEGER, these Proc., Comm. I, II, IV. (1914).

## II.

<b>Benzene: <math>C_6H_6</math>.</b>					
Temperature in $^{\circ}C$ .	Maximum Pressure <i>H</i>		Surface- tension $\gamma$ in Erg. pro $cm^2$ .	Specific gravity $d_{40}$	Molecular Surface- energy $\mu$ in Erg. pro $cm^2$ .
	in mm. mer- cury of $0^{\circ}C$ .	in Dynes			
5.4	1.077	1436.7	30.9	0.895	607.7
9.5	1.055	1406.5	30.2	0.889	596.6
25.1	0.969	1291.9	27.7	0.873	553.8
35	0.920	1226.5	26.3	0.862	530.3
55	0.836	1114.6	23.8	0.841	487.8
74.6	0.757	1009.2	21.6	0.817	451.4

Molecular weight: **78.05**. Radius of the Capillary tube: 0.04385 cm.  
Depth: 0.1 mm.

The compound was already formerly described <sup>1)</sup>, and is here only mentioned for purpose of comparison. The boilingpoint is  $80.5^{\circ}C$ .; at this temperature  $\gamma$  is: **20.7** Erg. pro  $cm^2$ .

<sup>1)</sup> JAEGER, These Proceedings, Comm. I. (1914).

## III.

<b>Toluene: <math>CH_3 \cdot C_6H_5</math>.</b>					
Temperature in $^{\circ}C$ .	Maximum Pressure <i>H</i>		Surface- tension $\gamma$ in Erg. pro $cm^2$ .	Specific gravity $d_{40}$	Molecular Surface- energy $\mu$ in Erg. pro $cm^2$ .
	in mm. mer- cury of $0^{\circ}C$ .	in Dynes			
$-71^{\circ}$	1.385	1846.5	43.7	0.956	918.1
$-21$	1.090	1453.2	34.3	0.905	747.6
0	1.006	1340.8	31.6	0.884	699.5
26	0.906	1207.6	28.4	0.860	640.3
46	0.831	1107.6	26.0	0.841	595.0
66.6	0.756	1007.7	23.6	0.823	547.9
86.5	0.693	924.4	21.6	0.803	509.7
106	0.637	849.5	19.8	0.783	475.2

Molecular weight: **92.06**. Radius of the Capillary tube: 0.04803 cm.  
Depth: 0.1 mm.

The commercial toluene appeared always to manifest a turbidity of the liquid at  $-22^{\circ}$  and  $-79^{\circ}C$ .; a solid substance in little quantities separated at the walls of the tube. The here used toluene therefore was especially prepared by distillation of sodium phenylacetate; it was dried by means of phosphorpentoxide, and boils at  $109.4^{\circ}C$ . Down to  $-20^{\circ}C$ . it remains perfectly clear; at  $-79^{\circ}C$ . it shows, as e.g. other hydrocarbons (pseudocumene) do, a slight turbidity. At the boilingpoint  $\gamma$  is **19.5** Erg. pro  $cm^2$ .

## IV.

**para-Xylene:**  $(CH_3)_2 \cdot C_6H_4 \cdot (CH_3)_2$   
(1) (4)

Temperature in °C.	Maximum Pressure <i>H</i>		Surface- tension $\gamma$ in Erg. pro cm <sup>2</sup> .	Specific gravity $d_{40}$	Molecular Surface- energy $\mu$ in Erg. pro cm <sup>2</sup> .
	in mm. mer- cury of 0° C.	in Dynes			
25.0°	0.928	1236.7	29.1	0.857	723.3
45.9	0.853	1137.2	26.7	0.839	672.6
66	0.774	1031.9	24.2	0.821	618.5
86.5	0.709	945.2	22.1	0.802	573.7
106	0.648	863.9	20.1	0.784	529.8
126	0.597	794.6	18.5	0.766	495.2

Molecular weight: **106.08**. Radius of the Capillary tube: 0.04803 cm.  
Depth: 0.1 mm.

The substance boils at 136.62 C. and melts at 15° C. At the boiling point  $\gamma$  is about 181 Erg. pro cm<sup>2</sup>. At 20° the density is  $d_{40} = 0.8611$ .

## V.

**Mesitylene:**  $(CH_3)_3 \cdot C_6H_3$ . (1-3-5-).

Temperature in °C.	Maximum Pressure <i>H</i>		Surface- tension $\gamma$ in Erg. pro cm <sup>2</sup> .	Specific gravity $d_{40}$	Molecular Surface- energy $\mu$ in Erg. pro cm <sup>2</sup> .
	in mm. mer- cury of 0° C.	in Dynes			
-20.8°	1.141	1521.1	32.6	0.897	853.2
0	1.061	1415.4	30.3	0.880	803.2
25.5	0.972	1296.0	27.7	0.859	746.2
45.2	0.907	1208.7	25.8	0.843	703.8
74.7	0.807	1075.4	22.9	0.818	637.3
91.3	0.755	1006.4	21.4	0.804	602.5
110	0.700	933.0	19.8	0.788	565.0
134.5	0.631	841.0	17.8	0.768	516.7
150.5	0.585	781.2	16.5	0.754	484.8
160.5	0.562	749.3	15.8	0.741	469.7

Molecular weight: **120.1**. Radius of the Capillary tube: 0.04352 cm.  
Depth: 0.1 mm.

The compound boils at 162.98 C. constantly. At -46° C. it solidifies to an aggregate of long, silky needles.

Pseudocumene:  $(CH_3)_2C_6H_3(1-2-4)$ .

Temperature in °C.	Maximum Pressure $H$		Surface- tension $\alpha$ in Erg. pro cm <sup>2</sup> .	Specific gravity $d_4$	Molecular Surface- energy $\sigma$ in Erg. pro cm <sup>2</sup> .
	in mm. mer- cury of 0° C.	in Dynes			
-21°	1.084	1444.9	34.1	0.910	883.9
0	1.031	1374.1	32.4	0.893	859.5
26	0.953	1270.1	29.9	0.871	798.0
46	0.890	1186.4	27.9	0.855	753.9
66.5	0.828	1103.5	25.9	0.839	708.8
86.5	0.768	1024.4	24.0	0.823	665.2
105	0.725	966.1	22.6	0.807	634.7
125	0.656	874.5	20.4	0.792	580.1
145.9	0.600	799.5	18.6	0.776	536.2
166	0.525	699.6	16.2	0.760	473.5

Molecular weight: 120.1. Radius of the Capillary tube: 0.04803 cm.  
Depth: 0.1 mm.

The substance boils at 168.95 C. constantly. It solidifies at -79° C.;  
the meltingpoint is about -60° C. At the boilingpoint the value of  
 $\alpha$  is 15.8 Erg. pro cm<sup>2</sup>.

Molecular Surface-  
energy in Erg pro cm<sup>2</sup>.

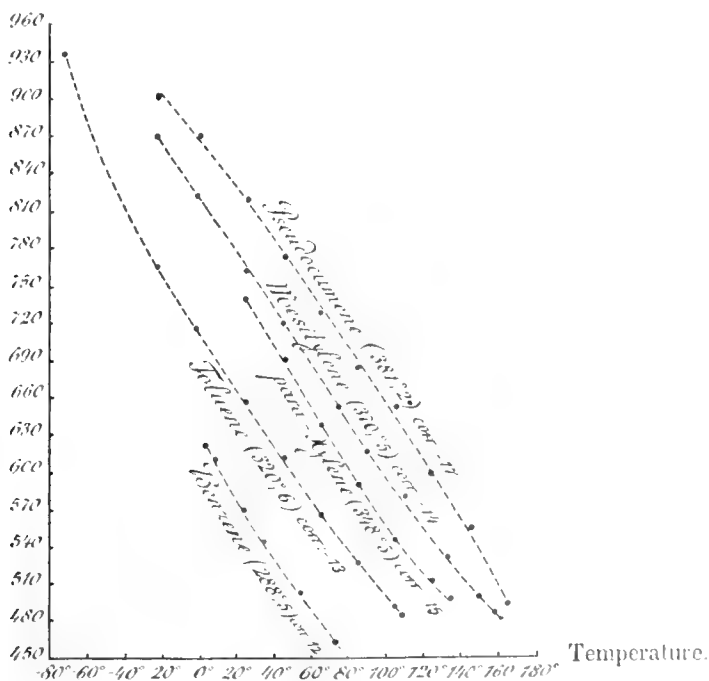

Fig. 1.

Triphenylmethane:  $CH(C_6H_5)_3$ .

Temperature in °C.	Maximum Pressure $H$		Surface- tension $\gamma$ in Erg. pro cm <sup>2</sup> .	Specific gravity $d_{40}$	Molecular Surface- energy $\mu$ in Erg. pro cm <sup>2</sup> .
	in mm. mer- cury of 0° C.	in Dynes			
138.4	1.074	1432.4	33.7	0.984	1330.5
156	1.044	1391.9	32.8	0.971	1302.6
171	0.999	1332.5	31.3	0.959	1257.1
194	0.909	1211.9	28.4	0.942	1154.4
212	0.833	1110.5	26.0	0.928	1067.4

Molecular weight: **244.11**. Radium of the Capillary tube: 0.04803 cm.  
Depth: 0.1 mm.

The meltingpoint of the compound is 92° C.; it is hardly possible to keep it in undercooled condition. Above 165° C. a slow decomposition begins; finally the liquid is coloured brown. The specific gravity  $d_{40}$  is at 95° C.: 1,017; at 100°: 1,013; at 125° C.: 0,994; at 150° C.: 0,975; it was determined by means of the hydrostatic balance. At  $t^\circ d_{40} = 1,013 - 0,00076 (t - 100)$ .

Chlorobenzene:  $C_6H_5 Cl$ .

Temperature in °C.	Maximum Pressure $H$		Surface- tension $\gamma$ in Erg. pro cm <sup>2</sup> .	Specific gravity $d_{40}$	Molecular Surface- energy $\mu$ in Erg. pro cm <sup>2</sup> .
	in mm. mer- cury of 0° C.	in Dynes			
-16°	1.252	1668.8	38.0	1.144	809.6
0	1.184	1578.3	35.9	1.128	772.1
** 25	1.143	1524.5	32.9	1.101	719.1
** 35	1.099	1465.5	31.6	1.090	695.3
50	0.980	1306.6	29.6	1.073	658.1
70.5	0.893	1190.2	26.9	1.051	606.4
90	0.805	1079.0	24.2	1.029	553.3
* 102	0.807	1075.4	22.7	1.016	523.4
* 114.5	0.751	1001.8	21.1	1.003	490.7
* 122	0.717	955.9	20.1	0.995	470.0

Molecular weight: **112.51**. Radius of the Capillary tube: 0.04638 cm.; with the observations, indicated by \*,  $R$  was 0.04352 cm.; with those: \*\*, it was: 0.04408 cm.  
Depth: 0.1 mm.

The compound boils at 131° C. constantly; at -34.5 C. it is completely crystallized.



## IX.

**Bromobenzene:  $C_6H_5Br$ .**

Temperature in ° C.	Maximum Pressure $H$		Surface- tension $\gamma$ in Erg pro cm <sup>2</sup> .	Specific gravity $d_{40}$	Molecular Surface- energy $\nu$ in Erg pro cm <sup>2</sup> .
	in mm. mercury of 0° C.	in Dynes			
-17.5	1.394	1858.6	42.2	1.546	918.4
2.1	1.309	1746.4	39.6	1.519	872.0
*25	1.267	1698.5	36.5	1.488	814.9
*35.6	1.229	1638.5	35.2	1.474	790.8
*49.8	1.172	1562.5	33.5	1.456	758.8
71.5	1.032	1375.6	31.0	1.425	712.3
90.5	0.953	1270.5	28.5	1.399	663.0
**125.5	0.875	1167.3	24.5	1.351	583.3
**153	0.758	1011.0	21.1	1.313	512.0

Molecular weight: **156.96**. Radius of the Capillary tube: 0.04638 cm.; in the observations, indicated by \*  $R$  was: 0.04408; in those by \*\*, it was: 0.04352 cm. Depth: 0.1 mm.

The compound boils constantly at 154° C.

## X.

**meta-Dichlorobenzene:  $C_6H_4Cl_2$  (1-3-).**

Temperature in ° C.	Maximum Pressure $H$		Surface- tension $\gamma$ in Erg pro cm <sup>2</sup> .	Specific gravity $d_{40}$	Molecular Surface- energy $\nu$ in Erg pro cm <sup>2</sup> .
	in mm. mercury of 0° C.	in Dynes			
-22°	1.433	1910.3	41.6	1.332	956.8
0	1.328	1770.6	38.5	1.309	895.9
25	1.230	1640.0	35.6	1.282	840.0
44.9	1.156	1540.9	33.4	1.260	797.9
71	1.061	1414.7	30.6	1.230	722.2
90.7	0.993	1324.6	28.6	1.213	700.2
116.4	0.912	1216.5	26.2	1.185	651.5
136	0.858	1144.4	24.6	1.164	619.0
*160	0.737	982.7	22.8	1.138	582.4

Molecular weight: **146.93**. Radius of the Capillary tube: 0.04439 cm.; in the observation, indicated with \*, the radius was: 0.04803 cm. Depth: 0.1 mm.

The boilingpoint is at 172.5° C. constant; the liquid can be under-cooled to a high degree, but once solidified, it melts at -19° C. At the boilingpoint  $\gamma$  is: 22.2 Erg pro cm<sup>2</sup>. The specific gravity at 25° C. is: 1.2824; at 50° C.: 1.2543; at 75° C.: 1.2253; at  $t$ ° C.: 1.3096 - 0.00107  $t$  - 0.00000072  $t^2$ .

Molecular Surface-  
energy in Erg per c.m<sup>2</sup>.

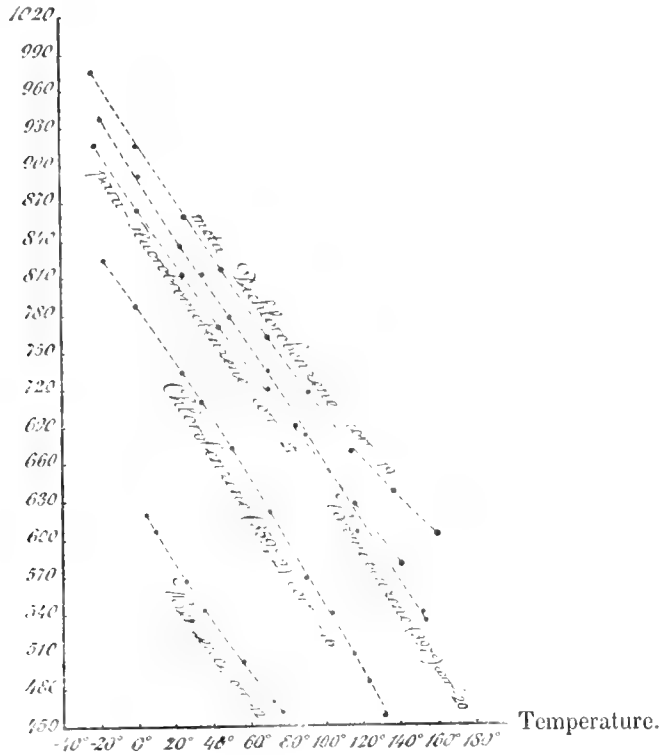

Fig. 2.

XI.

**para-Fluorobromobenzene:  $C_6H_4.F.Br(1.4)$ .**

Temperature in °C.	Maximum Pressure $H$		Surface- tension $\chi$ in Erg. pro cm <sup>2</sup> .	Specific gravity $d_{40}$	Molecular Surface- energy $\nu$ in Erg. pro cm <sup>2</sup> .
	in mm. mer- cury of 0° C.	in Dynes			
-21°	1.281	1707.8	39.8	1.654	890.2
0	1.198	1597.2	37.2	1.626	841.5
25.5	1.106	1474.1	34.3	1.590	787.6
45.3	1.031	1374.1	31.9	1.561	741.6
70	0.953	1270.1	29.4	1.522	695.1
84.7	0.906	1207.6	27.9	1.504	663.8
117	0.810	1079.9	24.8	1.460	602.8
138	0.734	978.6	22.4	1.436	550.5

Molecular weight: 174.95. Radius of the Capillary tube: 0.04803 cm.  
Depth 0.1 mm.

The boilingpoint is constant at 150° C.; the value of  $\chi$  there is:  
21.2 Erg. pro cm<sup>2</sup>. The specific gravity at 25° C. is:  $d_{40} = 1.5908$ ;  
at 50 C.: 1.5538; at 75° C.: 1.5147. At  $t^\circ$  it is:  $d_{40} = 1.6257 - 0.00135$   
 $t - 0.00000168 t^2$ .

**meta-Fluorotoluene:**  $CH_3 \cdot C_6H_4 \cdot F$   
(1) (3)

Temperature in °C.	Maximum Pressure $H$		Surface- tension $\gamma$ in Erg. pro cm <sup>2</sup> .	Specific gravity $d_{40}$	Molecular Surface- energy $\gamma$ in Erg. pro cm <sup>2</sup> .
	in mm. mer- cury of 0° C.	in Dynes			
-71°	1.337	1782.5	42.1	1.097	909.0
-20.5	1.090	1453.3	34.2	1.041	764.7
0	1.006	1340.9	31.5	1.021	713.5
25.4	0.906	1207.9	28.3	0.994	652.6
45.3	0.839	1118.5	26.2	0.973	612.8
70.2	0.760	1021.2	23.8	0.947	566.8
84.9	0.721	961.9	22.4	0.932	539.2

Molecular weight: **110.06**. Radius of the Capillary tube: 0.04803 cm.  
Depth: 0.1 mm.

The boilingpoint of the substance is 114°.5 C.;  $\gamma$  is there: **20.2**  
Erg. pro cm<sup>2</sup>. The density at 25° C. is:  $d_4 = 0.9942$ ; at 50° C.  
0.9680; at 75° C.: 0.9420. At  $t$  it is calculated from:  $d_{40} = 1.0206 -$   
 $-0.00106 t + 0.00000016 t^2$ .

**para-Chlorotoluene:**  $CH_3 \cdot C_6H_4 \cdot Cl$   
(1) (4)

Temperature in °C.	Maximum Pressure $H$		Surface- tension $\gamma$ in Erg. pro cm <sup>2</sup> .	Specific gravity $d_{40}$	Molecular Surface- energy $\gamma$ in Erg. pro cm <sup>2</sup> .
	in mm. mer- cury of 0° C.	in Dynes			
25°	1.137	1515.8	32.9	1.065	795.0
44.7	1.059	1410.2	30.6	1.045	748.8
71	0.959	1279.6	27.7	1.018	689.8
90.2	0.895	1193.2	25.8	0.999	650.6
116.1	0.813	1083.9	23.4	0.973	600.6
135.7	0.760	1013.8	21.8	0.953	567.3
* 160	0.653	870.3	20.2	0.928	535.1

Molecular weight: **126.51**. Radius of the Capillary tube: 0.04439 cm.;  
in the observation, indicated by \*, it was:  
0.04803 cm.  
Depth: 0.1 mm.

The substance boils constantly at 162°.5 C.; it solidifies at -22 C.,  
and melts at +7°.5 C. At the boilingpoint  $\gamma$  is **20.1** Erg. pro cm<sup>2</sup>.

Molecular Surface-energy  
in Erg pro cm<sup>2</sup>.

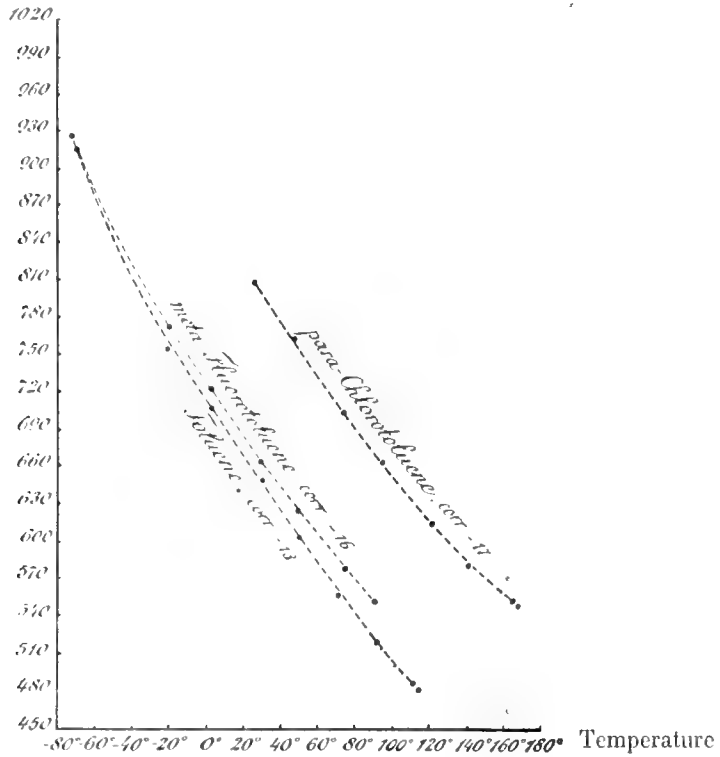

Fig. 3.

§ 3. Values of the Temperature-coefficients of the molecular Surface-energy  $\mu$  of the liquids here studied.

Cyclohexane.		Benzene.	
Temperature-interval:	$\frac{\partial \mu}{\partial t}$ in Erg:	Temperature-interval:	$\frac{\partial \mu}{\partial t}$ in Erg:
between 9° and 80°	3,32	between 5°,4 and 25°,1	2,73
This value is remarkably great; the curve is almost a straight line however.		25     "     55	2,20
		55     "     74,6	1,85
Toluene.		para-Xylene.	
between -71° and -21°	3,40	between 25°,5 and 45°	2,53
-21     "     66,6	2,27	45     "     86	2,43
67     "     86,5	1,90	86     "     106	2,21
86,5     "     109	1,76	106     "     126	1,71

<i>Mesitylene.</i>			<i>Pseudocumene.</i>		
<i>Temperature-interval:</i>	$\frac{\partial \mu}{\partial t}$	<i>in Erg:</i>	<i>Temperature-interval:</i>	$\frac{\partial \mu}{\partial t}$	<i>in Erg:</i>
between $-20^{\circ},8$ and $0^{\circ}$		2,40	between $-21^{\circ}$ and $0^{\circ}$		1,60
0       "       75		2,20	0       "       26		2,00
75       "       110		2,06	26       "       146		2,18
110       "       150		1,97	146       "       166		3,0
<i>Triphenylmethane.</i>			<i>Chlorobenzene.</i>		
between $138^{\circ},4$ and $156^{\circ}$		1,59	between $-16^{\circ}$ and $+25^{\circ}$		2,20
156       "       171		3,03	25       "       50		2,42
171       "       194		4,46	50       "       122		2,60
194       "       212		4,83			
<i>Bromobenzene.</i>			<i>meta-Dichlorobenzene.</i>		
between $-17^{\circ},95$ and $+125^{\circ},5$		2,38	between $-22^{\circ}$ and $0^{\circ}$		2,79
125,5       "       153		2,53	0       "       25		2,23
			25       "       91		2,11
			91       "       117		1,88
			117       "       136		1,64
			136       "       160		1,51
<i>para-Fluorobromobenzene.</i>			<i>meta-Fluorotoluene.</i>		
between $-21^{\circ}$ and $0^{\circ}$		2,41	between $-71^{\circ}$ and $-20^{\circ},5$		2,85
0       "       45		2,09	$-20,5$ "       0		2,49
45       "       117		1,97	0       "       25,4		2,38
117       "       150		2,49	25,4       "       45,3		1,99
			45,3       "       84,9		1,85
<i>para-Chlorotoluene.</i>					
between $25^{\circ}$ and $45^{\circ}$		2,33			
45       "       71		2,23			
71       "       116		1,97			
116       "       160		1,49			

Especially the last mentioned four cases prove once more very strikingly the fact, that  $\frac{\partial \mu}{\partial t}$  cannot be considered as a constant, but that it is itself a function of temperature: in most cases in such a way, that it will decrease with increasing temperature. With *chloro-* and *bromobenzene* however evidently just the reverse happens. In the same way *benzene*, *toluene*, *p-cylene* and *mesitylene* belong to the first group of substances, while the isomeric *pseudocumene* manifests on the contrary an increase of  $\frac{\partial \mu}{\partial t}$  with rising temperature. The deviations of the linear decline are so great and in most cases so systematical, that they can by no means be accounted for by experimental errors; the variability of  $\frac{\partial \mu}{\partial t}$  with the temperature must therefore be considered as an essential fact.

Groningen, June 1914.

Laboratory of Inorganic Chemistry  
of the University.

**Chemistry.** — “*The Temperature-coefficients of the free Surface-energy of Liquids, at Temperatures from  $-80^{\circ}$  to  $1650^{\circ}\text{C}$ : VI. General Remarks*”. By Prof. Dr. F. M. JAEGER. (Communicated by Prof P. ROMBURGH).

§ 1. If we wish to use the results up to now obtained in the study of these more than seventy organic and about ten inorganic liquids, to draw some more general conclusions, the following remarks in this respect may find a place here.

In the first place it is proved once more, that *the free surface-energy of liquids*, — also in the peculiar case of the *electrolytically conducting*, molten salts studied at very high temperatures, — *always decreases with increasing temperature*. This fact, an exception to which also within the temperature-interval hitherto investigated has never been stated, must be esteemed in every respect quite in concordance with the views about the origin of such surface-tensions. It is immediately connected with the other fact, that a *decrease* of the molecular surface-layer must be accompanied by a *heat-evolution*, an *increase* of that layer however with a *heat-absorption*, if the temperature is to remain constant. Furthermore this gradual diminution of  $\chi$  with increasing temperature is in full agreement with the continual levelling of the differences in properties between the liquid phase and its coexistent vapour, when the temperature is gradually rising: at the critical temperature the value of  $\chi$  must have become zero<sup>1)</sup>.

Of more importance for our purposes however are the following results:

1. A *linear* dependence of  $\chi$  and  $t$  appears in general *not* to exist.

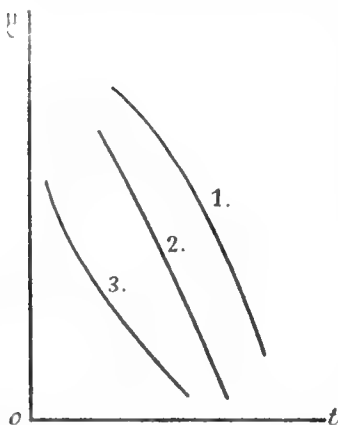

The observations prove the possibility of all the three imaginable principal species of  $\chi$ - $t$ -curves: the type 1, with a concave shape towards the temperature-axis; the type 3 with a shape convex to that axis; and the *rectilinear* type 2. Besides there are found some rare cases of combinations of these three principal types. Characteristic for type N<sup>o</sup>. 1 is, that  $\frac{d\chi}{dt}$  will *increase* with rising temperature, while it *decreases* under those circumstances on the curves of type 3;

<sup>1)</sup> The critical temperatures of the studied liquids, are as far as known, in the diagrams indicated between ( ), behind the names of the different substances.

only in the case N<sup>o</sup>. 2 this quotient remains really constant. It is now of importance to draw attention to the fact, *that in contradiction with the hitherto prevailing views, the presence of type 2 on one side, and of types 1 and 3 on the other side, appears to be in no clear connection with the absolute value of the quotient  $\frac{d\mu}{dt}$ , nor with the absolute values of  $\chi$  or  $\mu$  themselves.*

II. In agreement with the results of previous investigators, it appears to be possible, although only in some arbitrary way, to divide the studied liquids into *two* principal groups, with respect to the value of  $\frac{d\mu}{dt}$ . In the first group A belong all liquids, whose quotients  $\frac{d\mu}{dt}$  really are very near to Eötvös' "constant": 2,27 Erg pro every degree Celsius. However it must be said here, that only a mean value of  $\frac{d\mu}{dt}$  evidently can be considered in these cases, and only over a sparsely extended temperature-interval; for, just as we already mentioned sub I, these liquids will by no means always show a linear dependence of  $\chi$  and  $t$ , corresponding to the type 2, and therefore such a linear dependence may be supposed in most cases only for rather short parts of the curves in question.

To this group A we can bring e. g.: a number of ethers, like *Ethyl-Isobutyrate* (2,15); *Isobutyl-Isobutyrate* (2,18); *Diethyl-Oxalate* (2,26); *Diethylmalonate* (2,52); *Diethyltartrate* (2,35); *Ethyl-Acetyloacetate* (2,19); further: *Chloroform* (2,06); *Dimethylaniline* (2,23); *Phenetol* (2,14); *Anethol* (2,25); *Methylbenzoate* (2,21); *Ethylbenzoate* (2,29); *Methylsalicylate* (2,30); *Ethylsalicylate* (2,23); *Methylcinnamylate* (2,43);  *$\alpha$ -Picoline* (2,02); etc.

With most of these and analogous substances however, we can state a considerable increase of  $\frac{d\mu}{dt}$  at lower temperatures (type 3), and for many of them a value in the vicinity of 2,27 may be accepted only within a very narrow range of temperatures, e. g. between 25° and 80° C.

To the group B all liquids belong, whose quotients  $\frac{d\mu}{dt}$  show values appreciably lower than 2,27 Erg pro 1° C. To this group the following substances can be brought: *Water* (1,04); *Ethylalcohol* (0,94); *Propylalcohol* (1,10); *Isobutylalcohol* (1,10); *Acetone* (1,6); *Acetic Acid* (1,3); *Pyridine* (1,6); etc. However with several of these

liquids the value of  $\frac{d\mu}{dt}$  increases much at the lower temperatures, while to the other side many liquids of group *A*, which e. g. between 25° and 80° C. show rather normal values of  $\frac{\partial\mu}{\partial t}$ , will have abnormally low values for it at the higher temperatures. As far as the not numerous determinations of the specific gravities make a conclusion possible in this respect, to this group *B* can be brought also the molten salts of the alkali-metals: *Sodiumchloride* (0,6), *Potassiumchloride* (0,64); etc. Furthermore the hitherto observed dependence of  $\chi$  and  $t$  for: *Sodiumsulfate*, *Sodiummolybdate*, *Sodiumtungstate*, *Sodiumphosphate*; *Potassiumbromide*, *Potassiumiodide*, *Potassiumphosphate*, *-molybdate*, *-tungstate*; *Lithiumsulfate*, *Lithiummetaborate*, *Lithiummethasilicate*; etc. etc., — seems to prove, that also with these salts the values of  $\frac{\partial\mu}{\partial t}$  will appear to be remarkably small.

§ 2. The prevailable opinion is, that the liquids of the group *B* must differ from those of group *A* in this respect that they would be *associated*, while the liquids of group *A* would be *normal* ones. Regarding those liquids, which show an almost linear dependence of  $\chi$  and  $t$  (type 2), the “association-coefficient”  $x$  is then calculated

from the expression:  $x = \left( \frac{2,2}{\left( \frac{\partial\mu}{\partial t} \right)} \right)^{\frac{3}{2}}$ ; while in the cases, where such

a linear dependence can *not* be supposed, several other formulae are proposed<sup>1)</sup>. After what has been said, however, it can hardly be quite sure, that such a calculation of the degree of association can be thought of as a step in the good direction. For among the substances of group *A* the greater number are of a kind, whose  $\mu$ - $t$ -curves belong to types 1 or 3; type 3 can be thought moreover again to be in so far in agreement with the postulations of the theory, that here at least exists the possibility that the curve will approach to the  $t$ -axis asymptotically in the vicinity of the critical temperature.

If now however the supposition were right, that a decrease of

<sup>1)</sup> After VAN DER WAALS (Z. f. phys. 13. 716. (1894)) e. g., a relation of the form:  $\frac{\partial\chi}{\partial t} = A \left( 1 - \frac{T}{T_{kr}} \right)^B$ , — in which  $B$  at the critical temperature should have the value:  $\frac{3}{2}$ , but in praxi appears to be: about 1,23, — would reproduce in many cases the dependence of  $\chi$  and  $t$  to a rather sufficient degree.



the values for  $\frac{\partial\mu}{\partial t}$  indicated an augmenting degree of association, it would be very difficult to imagine, why the larger number of liquids just show  $\mu$ - $t$ -curves of the type 3: for from the gradual decrease of  $\frac{\partial\mu}{\partial t}$  with increasing temperature in these cases, we must conclude, that the association of the liquid would increase for most liquids with a rise of temperature. But because by far the most dissociations are accompanied by a heat-absorption, the mentioned conclusion could surely be hardly put in concordance with the laws of the mobile equilibrium. With liquids, which will dissociate to a higher degree at higher temperatures, one had to expect on the contrary the progress of type 1: water e.g. is such a liquid, showing a gradual dissociation of complex molecules into simpler ones at increasing temperatures, and the  $\mu$ - $t$ -curve here really possesses<sup>1)</sup> the expected type 1. In the same way we observed some organic liquids (*Diethyl-Oxalate*; *Ethyl-Propylacetyloacetate*; *Propyl-*, and *Isobutyl-Cyanoacetates*; *o-Toluidine*; *Resorcine-Monomethylether*; *Hydrochinondimethylether*;  *$\alpha$ -Campholenic Acid*; etc.), for which a gradual dissociation or decomposition at higher temperatures could be stated, and for those we found also a faster increase of  $\frac{\partial\mu}{\partial t}$  than before, as soon as the temperature of beginning decomposition was surpassed. In opposition therewith is the case of *acetic acid*, where a gradually proceeding depolymerisation with increasing temperature has been quite doubtlessly proved, and where notwithstanding this fact, the value of  $\frac{\partial\mu}{\partial t}$  remains constant within very wide limits of temperature.<sup>2)</sup>

These facts seem after my opinion to make it very dubious, if the increase or decrease of  $\frac{\partial\mu}{\partial t}$  with varying temperature can be esteemed

1) From Eötvös' observations one can deduce already immediately that  $\frac{\partial\mu}{\partial t}$  will increase with rising temperature in the case of *water*: he observes between 3° C. and 40° C. a coefficient: 1,59; between 40° C. and 100° C.: 1,80; between 100° C. and 150° C.: 2,28; and between 150° and 210° C.: 2,27.

2) Also this fact can be already deduced from Eötvös' observations: between 21° and 107° C. he finds for  $\frac{\partial\mu}{\partial t}$ : 1,32; between 107° and 160° C. also: 1,32; between 160° and 230° C.: 1,38.

any longer to be connected directly with the degree of association of liquids?

§ 3. The variations of  $\frac{\partial \mu}{\partial t}$  must in the first instance be dependent on the way, in which the specific heat  $c$  of a liquid, is connected with the magnitude  $S$  of the bordering layer of it. In general we shall have a relation:  $\frac{\partial c}{\partial S} = -T \frac{\partial^2 \chi}{\partial T^2}$ , from which follows, that  $\chi$  can only be a linear function of  $T$  in the case, when  $c$  is independent of  $S$ . From our measurements however we must doubtlessly conclude, that generally  $\frac{\partial^2 \chi}{\partial T^2}$  can not be supposed equal to zero, and, that therefore  $c$  must really be dependent upon  $S$ . This fact proves at the same time, that *the specific heat of the surface-layer must have another value than for the remaining part of the liquid*. The surface-energy therefore cannot be completely of a potential nature, but partially it must be considered as being of kinetic origin. In *what* manner however it will vary with the state of proceeding polymerisation or depolymerisation of the liquid, we cannot tell in advance; and the same is the case *mutatis mutandis* with the dependence of  $\mu$  upon  $t$ .

At the same time it is not superfluous in this connection to fix the attention upon the fact, that it cannot be permitted to make any definitive statement<sup>1)</sup> concerning a high degree of association in the case of molten salts, because the observed values of  $\frac{\partial \mu}{\partial t}$  are very small, and the  $\mu$ - $t$ -curves seem to approach in these cases much better to the rectilinear type 2. For the whole theoretical exposition of EÖTVÖS cannot be applied to cases like the present one, where nobody can know a priori, if the law of corresponding states will be valid. It is just the *question*, if the measurements still to be made will permit us to draw general conclusions upon an analogous connection between the temperature-coefficients of the molecular surface-energy and the degree of association of such electrolytes? Such conclusions could only be esteemed sufficiently justified, if certain analogies in the behaviour of molten salts and of the organic liquids should be found; at this moment we are still far distant from the time, when we shall be able to give any definitive judgment upon this matter.

<sup>1)</sup> Vide e. g. the relating views of WALDEN, Bull. of the Academy of Petrograde loco cit.

§ 4. The rather appreciable differences of our results with respect to the variations of  $\mu$  and  $\chi$  with the temperature, with those of other investigators, who have principally worked after the method of capillary ascensions, have suggested to us to investigate in detail, if perhaps in our way of working certain factors could be present, which may cause systematical errors in any direction?

First it was noted, that besides the particular shape of the mentioned curves, also the *absolute* values of  $\chi$ , determined by us and already by FEUSTEL, were generally somewhat *higher*, than those obtained with the same liquids by other experimenters and by other methods. Of course it is very well possible, that e.g. the lower values published by RAMSAY and SHIELDS, and obtained by them by means of the method of capillary ascension, are caused by the fact, that the moistening of the glass-walls in their capillary tubes has been not so complete, as is supposed in the theory of the phenomenon. In that case the angle of contact  $q$  will play again a role; and because the height of ascension *ceteris paribus* is proportional to the cosinus of the supplementary angle of  $q$ , there could thus really be found a cause, which would make their results appear *smaller*, than those obtained in our work.

But moreover we were able to prove on the other side, that *our* values for  $\chi$ , calculated after CANTOR's theory, must surely appear somewhat higher, than they really are, because in praxi the conditions are not completely fulfilled, on which is based the deduction of the *final* formula between  $H$ ,  $d_t$  and  $r$  in CANTOR's theory.

Let us start with the somewhat more summary deduction of his formula by FEUSTEL<sup>1)</sup>. From this deduction as it is found in the paper of this author, it can be seen, that the formula of CANTOR can have only validity in the special case that the angle  $\theta$ , which the tangent in every point of the sharp edge of the capillary tube drawn in any azimuth to the rotation-surface of the small gasbubble, makes with the horizontal surface of the liquid, — differs only slightly from  $90^\circ$ ; in that case  $\theta = 90^\circ - \varepsilon$ , wherein  $\varepsilon$  has a very small value. Some years ago prof. LORENTZ was so kind as to draw my attention to the fact, that this limiting supposition can be avoided, if one makes a few simple substitutions in the two formulae of FEUSTEL:

$$\frac{2\chi}{r} \cos \theta = r \cdot d_t \cdot \frac{1}{(1 - \cos \theta)^2}$$

and

1) R. FEUSTEL, Ann. d. Phys. loc. cit.

$$H = \frac{r \cdot d_t \cdot \sin \theta}{\cos \theta (1 - \cos \theta)^2} + \frac{r \cdot d_t}{3 \sin \theta} \left( \cos \theta + \frac{2}{1 - \cos \theta} \right),$$

by putting:  $q = \frac{2\chi}{r^2 \cdot d_t}$  and  $p = \frac{H}{r \cdot d_t}$ , where  $r$  is the radius of the capillary tube, and  $\chi$  and  $H$  are the known symbols.

The mentioned formulae can by this substitution be changed into:

$$q = \frac{1}{4 \cos \theta \sin^4 \left( \frac{\theta}{2} \right)} \quad \text{en} \quad p = q \sin \theta + \frac{1}{3} \left\{ \cot \theta + \frac{1}{\sin \theta \sin^2 \left( \frac{\theta}{2} \right)} \right\}.$$

Table of Corresponding Values of  
 $\theta$ ,  $q$  and  $p$

$\theta$	$q$	$p$
0°	$\infty$	$\infty$
10	4399,4	793,94
20	292,60	100,080
30	61,717	30,86
40	23,850	15,33
45	16,458	15,21
50	12,192	12,06
55	9,588	9,995
60	8,000	8,660
65	7,098	7,862
70	6,753	7,546
70 31'43"	6,750	7,542
75	7,033	7,814
80	8,433	9,183
85	13,770	14,479
86	16,567	17,269
87	21,277	21,960
88	30,764	31,448
89	59,35	60,027
89°4	63,44	64,12
90	$\infty$	$\infty$

Now it is possible to calculate for a complete series of values of  $\theta$ , the numbers  $p$  and  $q$ , and to plot them against each other with respect to rectangular coordinate-axes. If  $H$  is measured, and  $r$  and  $d_t$  are known,  $p$  can be calculated for every experiment, and from the diagram the corresponding value of  $q$  (and therefore also of  $\chi$ ) can be immediately found. The following table gives a survey of the corresponding values of  $p$  and  $q$ , for a series of angles  $\theta$  between 0° and 90° C.

From this table it is seen, that  $p$  and  $q$  reach simultaneously a *minimum* for  $\theta = 70^\circ 31' 43''$ , and that CANTOR'S formula is properly only valid without appreciable error for values of  $\varepsilon$  between 0° and

0°55'. The corresponding curve generally deviates only a little from a straight line; however we found that this deviation is yet sufficient, to make a correction necessary for all numbers, calculated from CANTOR'S formula.

§ 5. From a special case we can now see easily, that the calculation of the results in this way and from CANTOR'S formula, will never cause an appreciable change in the general shape of the  $\mu$ - $t$ -curves, and therefore neither in the deduced values of  $\frac{\partial \mu}{\partial t}$ ; the deviation of a linear relation between  $p$  and  $q$  is between  $\theta = 70^{\circ}31'43''$  and  $90^{\circ}$  only so slight, that a somewhat important deformation of the mentioned curves cannot be the result of this difference in computation. However there will be caused a parallellous shift of every curve, which will diminish the absolute values of  $\chi$  and  $\mu$  with a small amount. That this influence is not at all without importance in the cases hitherto investigated, may be proved in the following way. We choose for this purpose two extreme cases of the here studied liquids: *diethylether*, because the observed values of  $H$  are here the smallest, and e.g. a substance as *resorcine-monomethylether*, whose values for  $H$  belong to the rather great ones. The calculation is made as follows:  $H$  in m.m. of mercury (0 C.) is multiplied by the specific weight of mercury, and this number divided by the product  $r \cdot d_t$ , ( $r$  being expressed in mm.). With the obtained value for  $p$ , the corresponding value of  $q$  is found from the table or the diagram; this divided by 2 and multiplied by the product  $r^2 \cdot d_t$ , gives  $\chi$  in mG. pro m.m; the number is reduced to Erg pro  $\text{cm}^2$ . by multiplication with 9,806.

*Diethylether.*

$t^{\circ}$	$p$	$q$	$\chi$ in Erg.	$\chi$ in Erg.	$\mu$ in Erg.	$\mu$ in Erg.
			$\text{cm.}^{-2}$	$\text{cm.}^{-2}$ (CANTOR)	$\text{cm.}^{-2}$	$\text{cm.}^{-2}$ (CANTOR)
—75°	37,53	36,92	28,5	28,9	574,7	582,8
—20°,5	30,60	29,89	21,5	21,9	456,2	464,7
0°	28,28	27,58	19,2	19,6	415,8	424,5
11°	26,93	26,27	17,9	18,4	392,0	402,9
25°	25,61	25,00	16,7	17,1	371,2	380,0
29°,6	25,35	24,70	16,4	16,8	365,9	374,8

The whole  $\chi$ - $t$ -curve is thus parallellously shifted to an amount of —0,4 Erg.

*Resorcine-Monomethylether.*

$t^\circ$	$p$	$q$	$\chi$ in Erg.	$\chi$ in Erg.	$\mu$ in Erg.	$\mu$ in Erg.
			cm. <sup>-2</sup>	cm. <sup>-2</sup> (CANTOR)	cm. <sup>-2</sup>	cm. <sup>-2</sup> (CANTOR)
20°	62,85	62,20	83,1	83,9	1850,1	1867,9
0°	39,89	39,30	51,6	52,4	1161,9	1179,9
46°	34,91	34,30	43,4	44,2	1001,6	1020,1
107°	31,91	31,20	37,5	38,3	896,7	915,8
166°	28,48	27,80	31,5	32,3	782,0	801,8
206°	25,29	24,60	26,8	27,6	682,6	703,0

Here is the  $\chi$ - $t$ -curve shifted totally to an amount of  $-0,8$  Erg.

This is the correction to be applied, and which was already indicated in our first communication<sup>1</sup>); it has been taken into account since in every case in all the tables. It may here be repeated once more, that although the absolute values of the surface-energy really have approached closer by it to the values formerly published, however the shape of the  $\chi$ - $t$ -, or  $\mu$ - $t$ -curves is not altered by it with respect to any particular feature.

§ 6. Another question to be answered with respect to the obtained experimental results, is this, if it may be considered as possible to determine the right values of  $\chi$ , without being embarrassed therein by the influence of the *viscosity* of the studied liquid? For just because the internal friction of liquids always increases rapidly at lower temperatures, and an extreme viscosity of the liquid, — even if the bubbling of the gas is executed with extreme slowness, — will cause, as we have seen, the maximum pressure  $H$  to appear too great from all kinds of disturbing effects, — the influence of this viscosity could perhaps be advanced as a cause of such a deformation of the  $\chi$ - $t$ -curves, that they just would manifest a steeper temperature-gradient at the lower temperatures than at the higher. Therewith an explanation of the curves of type 3 would be given; but it must be here remarked already in advance, that such a cause could hardly be adopted for the presence of the curves of type 1, just because all viscosity-curves have themselves the shape of type 3. However there seem to be many reasons, *not* to attribute too high a value to this explanation of the curvature of the  $\mu$ - $t$ -lines, even not in the case of type 3.

In the first place it must be remarked, that the curvature of the

<sup>1</sup>) F. M. JAEGER these Proc., Comm. I. (1914).

said curves does not run parallel to the variations of the viscosity with temperature. Most strikingly this can be seen in those substances where the curvature is so slight, that the curves can be considered to be *straight* lines: with *ethylbenzoate*, whose viscosity at  $10^{\circ}$  is about six times that of acetone, and in a temperature-interval of  $50^{\circ}$  decreases to two or three times that value, the  $\chi$ - $t$ -curve is a *straight* line; with the *isobutylbromide*, whose  $\chi$ - $t$ -curve between  $0^{\circ}$  and  $85^{\circ}$  can be considered as a *straight* line, the viscosity decreases to less than half its original value (from 0,008 C.G.S. to 0,003 C.G.S.); etc. Neither does the curvature of the  $\chi$ - $t$ -lines seem to be immediately connected with the absolute value of the viscosity: with *acetic acid*, whose viscosity is about three times, with *salicylic aldehyde*, whose viscosity is four times, with *pyridine*, whose viscosity is about twice, with *phenetol*, where it is circa three times as large as that of ethylalcohol, — in all these cases the curvature of the  $\chi$ - $t$ -curves is *less* than for the last mentioned liquid, because they are almost straight lines; and with the *aniline* and *nitrobenzene*, whose viscosity is about eight or ten times as great, as that e.g. of the *ethylformiate*, the  $\chi$ - $t$ -curves are even slightly convex. In many cases the  $\chi$ - $t$ -curves will show a more rapid and steeper curvature at the higher temperatures, where the viscosity becomes smaller; and the part of the  $\chi$ - $t$ -curve between  $-79^{\circ}$  and  $0^{\circ}$  is often almost a straight line. With the *ethylalcohol* the viscosity is about three times as great as in the case of *ethylacetate* or *ethylformiate*, but notwithstanding that, the  $\chi$ - $t$ -curves show in all three cases about the same curvature.

To be sure, we have met during our measurements numerous cases, where very clearly the impossibility was shown, to determine the surface-energy *independently* of the viscosity. But this we observed only, where the viscosity reached such enormous magnitude, that the liquid became *glassy* or *gelatinous*, and did not or hardly move on reversing the vessel. Such cases we found in: *methylcyanoacetate*, *methyl-methylacetyloacetate*, *diethylbromomalonate*, *diethylbenzylethylmalonate*; in undercooled *dimethyl-*, and *diethyltartrate* and  *$\alpha$ -campholenic acid*, and very strikingly with *salol* and *resorcine-monomethyl-*, or *dimethylethers*.

Even in these unfavourable cases we succeeded sometimes in making some good measurements; but in most cases this appears to be impossible, which is shown by the fact, that even with so small a velocity of formation of the gas-bubbles as 50 to more than 200 seconds, it proved to be impossible to find a maximum pressure  $H$ , which really is *independent* of the speed of the nitrogen-flow.

The behaviour of such extremely viscous liquids with respect to the gas-bubbles produced in them, is very variable and often very peculiar: in this case the bubbles are hardly loosened from the capillary tube, in that case one observes a periodic increase and decrease of the gas-pressure, without a bursting of the bubbles occurring; in another case a very large bubble is produced, which suddenly explodes into a great number of very small bubbles; but in no case a maximum pressure can be measured, which is really independent of the speed of the gas-flow, proving that it corresponds to a real state of equilibrium of the gas-bubble. And this last mentioned fact is so characteristic for all our other measurements: *within rather wide limits one can vary the speed of nitrogen-flow, when working with ordinary liquids, without a measurable change in the determined pressure  $H$  being observed.* On the contrary we studied a long series of very thin liquids: e.g. *ethylalcohol, diethylether, ethylformiate, ethylchloroformiate, acetone, methylpropylcetone, chloroform,* etc., cooled to  $-80^{\circ}$  C., which notwithstanding the low temperatures gave very reliable values of  $H$ ; the occasional fact that the temperature is so low, can therefore neither be considered of high importance for the abnormally high values of  $\chi$  and  $\mu$  observed. However it must be said in this connection, that Eötvös' relation can no longer be considered as valid at temperatures, lower than about half the absolute critical temperature of the studied liquids.

In this connection it is not superfluous to remark, that with liquids whose volatility is very great, and which therefore possess at higher temperatures a very considerable vapour-tension, there is often some difficulty in obtaining reliable values for  $H$ , this maximum-pressure being apparently somewhat increased. However the right value can be deduced in such cases by often repeating the adjustment of the capillary tube, until a really reproducible value will be found. The influence of these abnormally high vapour-tensions cannot be of essential significance, if the measurements are controlled accurately and often carefully repeated.

All arguments taken together, we think it really very improbable, that the changes in viscosity of the studied liquids could be argued as the chief cause of the observed curvature of the  $\chi$ - $t$ - or  $\mu$ - $t$ -curves. But in cases of *abnormally great* values of the viscosity, the determination seems doubtlessly no longer possible after this method in any exact way; however with liquids, whose viscosity comes e.g. very near to that of glycerine, or is even somewhat greater, such measurements are already quite reliable if only the formation of the gasbubbles takes place *extremely slowly*: in this way for



instance we found again reliable values with: *diethylmalonate* ( $-20$  and *butyl*-, or *isobutyl-cyanoacetates* ( $-22^{\circ}$ ).

Therefore we think it right to draw the conclusion, *that the non-linear dependence of  $\chi$  on the temperature, must be connected with the very nature of the surface-energy itself, and that it will manifest itself always, as soon the studied temperature-interval is only wide enough.*

We can also mention here the fact, that in the case of molten salts, even at very high temperatures and with very small viscosities of these liquids, we observed just the same three types of  $\chi$ - $t$ -curves: so with *potassiumiodide* the type 3, with *potassium-metaphosphate* the type 1, with many others the rectilinear type 2, — without it being possible to indicate an immediate reason for it. Finally we can draw the attention to the fact, that notwithstanding the fact that these determinations range over a much smaller temperature-interval, some  $\chi$ - $t$ -curves of other experimenters (vide e.g. GUYE and his collaborators) show, on better consideration, also clearly a deviation from the rectilinear type; for *water* this has moreover already been mentioned before.

§ 7. Finally it is here the place to discuss some points connected with the relations between the magnitude of  $\mu$  and the *chemical constituents* of the studied liquids, in so far as we may draw conclusions about it already with respect to the sparing experimental data. Moreover the investigations relating to this subject will be continued in this laboratory in a quite systematical way, because a great number of problems have risen in this respect, which only by collecting a more extended experimental material can be answered by generally acceptable views. The facts hitherto gathered are principally adapted, to bring the values of  $\mu$  in qualitative connection with the *homology* of some analogous compounds, and with the *substitution*-relations between some organic derivatives. This can be executed best by comparison of the  $\mu$ - $t$ -diagrams, which were published in the successive communications.

#### A. Homology.

Of *homologous series* we can mention the following:

- |      |   |      |                                |      |                               |
|------|---|------|--------------------------------|------|-------------------------------|
| 1. { | Ethylalcohol.<br><i>n</i> -Propylalcohol.<br>Isobutylalcohol. | 2. { | Ethylformiate.<br>Ethylacetate | 3. { | Ethylacetate.<br>Amylacetate. |
|------|---|------|--------------------------------|------|-------------------------------|

- |       |                       |       |                           |       |                      |
|-------|-----------------------|-------|---------------------------|-------|----------------------|
| 4. {  | Methylisobutyrate.    | 5. {  | Acetone.                  | 6. {  | Ethylacetyloacetate. |
|       | Ethylisobutyrate.     |       | Methylpropylacetone.      |       | Ethylpropyloacetate. |
|       | Isobutylisobutyrate.  |       |                           |       |                      |
|       | Isobutylcyanoacetate. | 8. {  | Diethylsuccinate.         | 9. {  | Dimethyltartrate.    |
|       | Amylcyanoacetate.     |       | Diethylmalonate.          |       | Diethyltartrate.     |
| 7. {  | Butylcyanoacetate.    |       |                           |       |                      |
|       | Propylcyanoacetate.   |       |                           |       |                      |
|       | Ethylcyanoacetate.    |       |                           |       |                      |
|       | Methylcyanoacetate.   |       |                           |       |                      |
| 10. { | Trichloromethane.     |       | Benzene.                  | 12. { | Nitrobenzene.        |
|       | Tetrachloromethane.   | 11. { | Toluene.                  |       | o-Nitrotoluene.      |
|       |                       |       | p-Xylene.                 | 13. { | Aniline.             |
|       |                       |       | Mesitylene.               |       | o-Toluidine.         |
|       |                       |       | Pseudocumene.             |       |                      |
| 14. { | Anisol.               | 15. { | Resorcinomonomethylether. | 16. { | Methylbenzoate.      |
|       | Phenetol.             |       | Resorcinodimethylether.   |       | Ethylbenzoate.       |
|       |                       |       |                           |       | Benzylbenzoate.      |
|       |                       | 17. { | Methylsalicylate.         | 18. { | Pyridine.            |
|       |                       |       | Ethylsalicylate.          |       | $\alpha$ -Picoline.  |
|       |                       |       | Phenylsalicylate.         |       |                      |

By such a comparison of the results obtained we can now derive the evidently general fact, that the values of the molecular surface energy at the same temperature increase in homologous series, if we come to terms of higher hydrocarbon-radicals. Although quantitative relations do not so strikingly come to the foreground, it seems however to be clear, that the influence of the same increase in this respect, becomes smaller within the series, if the molecular weight of the compound increases; a fact, that must be thought also completely comprehensible. In most cases these rules hold, as the following instances may prove: The value of  $\mu$  is at the same temperature greater for *isobutyl-alcohol*, than for normal *propylalcohol*, and here again greater than with *ethylalcohol*; just so with *ethylacetate* greater than with *ethylformiate*, with *amylacetate* greater than with the corresponding *ethylether*; it is greater for *isobutyl-isobutyrate* than for the *ethylether*, and here again greater than for *methylisobutyrate*; with *ethyl-propylacetyloacetate* greater than for *ethyl-acetyloacetate*. In the series of the six *cyanoacetates*, the value of  $\mu$  is greatest with the *amyl-ether*, and decreases here regularly within the series till the *methyl-ether* is reached, while the temperature-coefficients remain almost the same; the *isobutyl-ether* however has another value for  $\frac{\partial \mu}{\partial t}$ , and values for  $\mu$ , which are only partially greater than for the

*propyl-ether*: in this also a manifestation must be seen of the differences between normal and ramified carbon-chains. In the same way the molecular surface-energy of *diethyltartrate* appears to be greater than of *dimethyltartrate*. In the series of aromatic hydrocarbons, the curves for *pseudocumene* and the isomeric *mesitylene* are situated highest; then follow successively: *p-xylene*, *toluene*, and *benzene*; in the same  $\mu$  is greater for *o-toluidine* than for *aniline*, for *o-nitrotoluene* greater than for *nitrobenzene*; just so for *phenetol* greater than for *anisol*, for *dimethylaniline* greater than for *aniline*, and for  $\alpha$ -*picoline* greater than for *pyridine*. The only exception to this rule hitherto found, is presented by the *resorcine-monomethylether*, which possesses a greater molecular surface-energy than the corresponding *dimethyl-ether*.

The substitution by means of members of the aromatic series has an analogous influence as by those of the aliphatic series, but it is much more intensive: in the series of the *benzoates*, the value of  $\mu$  for the *ethyl-ether* is indeed, greater than for the *methyl-derivative*, but for the corresponding *benzyl-ether* it is excessively much greater; in the same way it is the case with *methyl-*, and *ethylsalicylates* and *salol*, and with *methylpropylketone* on one side, and *acetophenone* on the other.

#### B. Relations of Substitution-derivatives.

The conclusions, which in this respect can be drawn hitherto, can be summed up shortly in the following rules:

1. The substitution of H by halogens is accompanied by an intensive increase of the molecular surface-energy at the same temperatures; the influence increases evidently with augmenting atomic weight of the halogen.

So  $\mu$  for *chlorotoluene* is greater than for *fluorotoluene*<sup>1)</sup>, and here much greater than for *toluene* itself; for *bromobenzene* it is greater than for *chlorobenzene*, and appreciably greater than for *benzene*; with the *m-dichlorobenzene* it is greater than for *fluorobromobenzene*, showing that the specific influence of fluorine seems to be less than the difference between bromine and chlorine. In the same way the value for *diethylbromomalonate* is appreciably greater than for *diethylmalonate*; for *tetrachloromethane* just so greater than for *chloroform*.

2. The substitution of N-atoms for C-atoms, or of that of negative nitrogen containing radicals for a H-atom, is followed by a relatively great increase of the molecular surface-energy at the same temperatures.

<sup>1)</sup> The relatively small differences caused by the structural isomerism of these compounds, is here neglected for the present; generally the *para*-substitution seems to be of the highest, the *meta*-substitution of the smallest influence in this respect. We will discuss this peculiarity afterwards by considering the results of a special set of measurements.

So  $\mu$  is appreciably greater for *o*-nitroanisol, than for anisol; for *o*-nitrotoluene much greater than for toluene; for nitrobenzene much greater than for benzene; for aniline and *o*-toluidine, much greater than for benzene or toluene. Just so for pyridine appreciably greater than for benzene; etc.

3. The substitution of aromatic hydrocarbon-radicals instead of H-atoms makes the values of the molecular surface-energy also considerably greater.

So the values for salol are much greater than for the other salicylates; of benzylbenzoate it is much greater than of both the other benzoates; of acetophenone much greater than of dimethylacetone or methylpropylacetone; of diethyl-benzylmethylmalonate much greater than of diethylmalonate itself; etc.

Only continued investigations in this direction can however, as has already been said, prove with more certainty, if these rules may be considered as general ones. Researches of this kind will be started in this laboratory within a short time.

*Laboratory for Inorganic Chemistry  
of the University.*

Groningen, June 1914.

**Mineralogy.** — “On the real Symmetry of Cordierite and Apophyllite”.

By Prof. H. HAGA and Prof. F. M. JAEGER.

§ 1. In continuation of our investigations<sup>1)</sup> on the symmetry of crystals, which can be discerned as mimetic or pseudosymmetrical, we will give in the following a review of the results obtained in our experiments relating to the cordierite (*iolite*; *dichroite*) and to the apophyllite (*albine*; *ichthyophthalm*). Of both kinds of silicates specimens of different localities were at our disposal, — a fact, which hardly can be over-estimated in the study of RÖNTGEN-patterns, as will be proved below. We will describe in the following pages successively our observations with: a) *Cordierite*; b) *Apophyllite*.

§ 2. a. *Investigations on the true symmetry of Cordierite.*

*Cordierite*, a silicate of the chemical composition:  $H_2(Mg, Fe)_4Al_8Si_{10}O_{37}$ , belongs to those minerals, which like the arragonite, imitate the habitus of hexagonal crystals by means of particular polysynthetical twinformations. In literature it is only mentioned, that it is “rhombic”

<sup>1)</sup> H. HAGA and F. M. JAEGER, these Proceedings, XVI. p. 792. (1914).



cordierite of *Bodenmais*; and a pink cordierite of *Mount Ibity* on *Madagascar*.

*a.* From a magnificent, almost colourless, homogeneous and *single* crystal of cordierite, after its label from *Madagascar*, three plane-

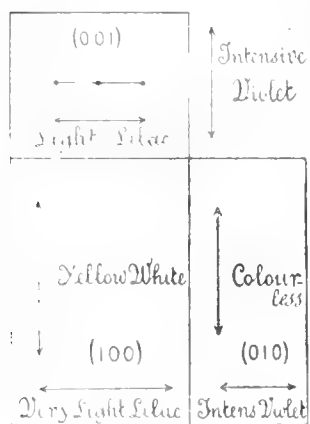

Fig. 2.

parallel plates about 1 or 1,2 mm. thick, were carefully cut, and the following optical properties of them determined (fig. 2); the arrows indicate the direction of the luminous vibrations, for which the mentioned colours were observed in the crystals; obviously thus the absorption-scheme with respect to the crystal-axes is:  $a > b > c$ . The axial plane was parallel to  $\{100\}$ ; the  $c$ -axis was first bisectrix ( $\alpha$ ). The birefringence is about 0,008, and of negative character. Of each of these plates we obtained a RÖNTGEN-pattern, after they had been carefully orientated

in the way formerly described by us.<sup>1)</sup> The distance of the photographic plate and the crystal was 45 mm., while the time of exposure varied between  $1\frac{3}{4}$  and  $2\frac{3}{4}$  hours respectively. In connection with the question of the orientation, attention must be drawn here once more to the fact, that deviations of the theoretically right orientation, even so slight that they cannot be controlled any more by means of optical test, will however always manifest themselves by a slight dissymmetry in the RÖNTGEN-pattern. For instance, the image obtained by radiation through  $\{001\}$  in several experiments, appeared to be always *un*-symmetrical to a more or less degree, while by the optical test in any of these cases *no* appreciable deviation of the optical image and of the right orientation of the first bisectrix could be proved. Thus even the greatest attainable degree of precision in this orientation can never exclude the necessity, to acknowledge certain imperfectibilities of the expected symmetry of the obtained RÖNTGEN-patterns as of only secondary importance in the comparison of these images, and to neglect them presently in drawing conclusions from the photographs. This point must always be considered in all following discussions of the obtained results; without this restriction it simply appears absolutely impossible to draw any valuable conclusion from the results obtained by experiment. At the same occasion we wish further to remark, that the use of a phosphorescent screen (species "Ereseo") behind the photographic plate

<sup>1)</sup> H. HAGA and F. M. JAEGER, these Proc., loc. cit. (1914).

TABLE I: Cordierite.



Fig. 10a.





evidently often causes disturbances in two possible ways: 1<sup>st</sup>. by increasing appreciably the dimensions of the central spot, because of the diffuse light-emission of the screen; which fact may render some of the spots situated in the immediate vicinity of the central part invisible in the reproductions; and 2<sup>nd</sup>. because the impossibility of pressing the phosphorescent screen over its whole surface quite equally against the photographic plate, eventually will cause some differences in the intensities of the black spots, which apparently create an accidental dissymmetry in the obtained photograph. Also both these disturbing effects must be taken into account together with the above given arguments, to explain the inevitable imperfection of the RÖNTGEN-radiograms, thus prepared.

The RÖNTGEN-patterns, which now are reproduced in fig. 3, 4, and 5 of plate I, can teach us the following facts: A somewhat more accurate study of these photographs will immediately show, that the images obtained by radiation through the crystalplates  $\{100\}$  and  $\{010\}$ , possess only a *bilateral* symmetry: the molecular arrangement of the crystal, seen in the two directions perpendicular to these faces, can thus possess only *one single plane of symmetry*, in the first case perpendicular to  $\{100\}$ , in the last one perpendicular to  $\{010\}$  and passing through the *c*-axis; *by both images however it is proved indubitably, that axes of binary symmetry are completely absent.* The image, obtained by radiation through the crystal in a direction perpendicular to  $\{001\}$  however, must be considered doubtlessly to be *symmetrical with respect to a set of two symmetry-planes, perpendicular to each other*; of course the intersection of these two planes, being the *c*-axis, needs to be an *axis of binary symmetry* too. On Table I we have reproduced a RÖNTGENogram of this case, which shows some dissymmetries by a very small error in the normal orientation; the distribution of spots of equal intensity however, etc., suggests the symmetrical nature of this radiogram with respect to the mentioned planes without any doubt. Of this same crystalplate we obtained some more radiograms, which were however not sufficiently intense for reproduction; they were somewhat more symmetrical than the photograph reproduced here, which fact apparently was caused by a somewhat better adjustment of the crystalplate with respect to the RÖNTGEN-tube. But an optical investigation of the crystal-plates in quite the same position as in which they were during the experiment, allowed *no* distinction of the orientation in the several cases: it must therefore be considered a fact of mere chance, if one gets accidentally the right position of the plate, necessary to obtain a pattern, whose symmetry approaches the pure one with more or less perfection;

and furthermore, as we already mentioned, the accidental situation of the phosphorescent screen will play in this question also a more or less important role.

§ 4. The obtained results were so surprising, that we thought it necessary to repeat the experiments of radiation through the plates parallel to  $\{100\}$  and  $\{010\}$ , also with cordierites of other localities.

*b.* From a beautiful, pink cordierite of *Mount Ibity, Madagascar*, which had no geometrically definite boundaries, two plane-parallel plates were cut after  $\{100\}$  and  $\{010\}$  and about 1 m.m. thick. The plate parallel to  $\{010\}$  was distinctly dichroitic: for vibrations in the directions of the axial plane it was lilac-white, for those perpendicular to it intensively pink. On  $\{100\}$  the colour for vibrations perpendicular to the *c*-axis was pink; for those parallel to it, the plate was almost white.

In the same way two such plates were cut from a single, short-prismatic, chalcopyrite-covered cordierite-crystal of *Bodenmais*; it was fixed upon an aggregate of chalcopyrite and sphalerite. The mentioned plates were from 1.0 to 1.1 m.m. thick, and showed no distinct dichroism: the plate parallel to  $\{100\}$  showed hardly any difference of colour for two perpendicular directions; that parallel to  $\{010\}$  was for vibrations parallel to the *c*-axis yellowish-white, for those perpendicular to it however pink coloured.

In a quite analogous way as described before, RÖNTGENograms of these four crystal-plates were obtained. The fig. 6 and 7 give the photographs for the crystal from *Bodenmais*, the figures 8 and 9 those for the crystal of *Mount Ibity*<sup>1)</sup>.

From these RÖNTGEN-patterns it can in the first instance immediately be seen, *that also with these crystal-plates all radiograms are only symmetrical with respect to one single vertical plane, and that in these minerals also binary axes perpendicular to  $\{100\}$  or  $\{010\}$  appear to be absent.* In connection with the results obtained with the other cordierite-plates, it is hardly possible to give any other explanation of this, than *that the absence of both horizontal binary*

<sup>1)</sup> The cordierites of *Ibity* are somewhat richer in  $\text{SiO}_2$ ,  $\text{Al}_2\text{O}_3$ , and  $\text{MgO}$ , than those of *Bodenmais*, but their content of iron-oxides is less; the following analysis may give some idea of this:

*Ibity*: 49.05%  $\text{SiO}_2$ ; 33.08%  $\text{Al}_2\text{O}_3$ ; 11.04%  $\text{MgO}$ ; 5.2%  $\text{FeO} + \text{Fe}_2\text{O}_3$ ; 1.64%  $\text{H}_2\text{O}$ .

*Bodenmais*: 48.58%  $\text{SiO}_2$ ; 31.47%  $\text{Al}_2\text{O}_3$ ; 10.68%  $\text{MgO}$ ; 4.90%  $\text{FeO}$ ; 1.85%  $\text{Fe}_2\text{O}_3$ ; 0.09%  $\text{CaO}$ ; 1.96%  $\text{H}_2\text{O}$ .

Vide also: WULFING and OPPENHEIMER, Sitz. B. Heidelb. Akad. d. Wiss. Abt. A. N<sup>o</sup>. 10. (1914).

*axes and of the horizontal symmetry-plane, is really characteristic of the molecular arrangement of the silicate.* Founding our statement on these experiments, we must therefore draw the conclusion, that cordierite is an *hemimorphic* mineral, belonging to the *rhombic-pyramidal* class (rhombic-hemimorphic class) of the rhombic system, just like *calamine* and *struvite*, etc. The threefold twinning-aggregations of the cordierite must thus be considered to be real pseudo-*hexagonal*, and no pseudo-*trigonal* mimetic forms.

Because all possible space-lattices of the rhombic system, as deduced by BRAVAIS, possess vertical and horizontal planes of symmetry, the molecular arrangement of cordierite can therefore by no means correspond to such a BRAVAIS' space-lattice. However the pseudo-hexagonal symmetry of the mineral, just as its prismatic twinformations, seem to indicate with strong emphasis a structure-unit, which must be considered derived from the rectangular prism with rhombic base, whose angles will differ only slightly (ca. 25') from 60° or 120°. The choice between the possible structures is hardly to be expected: after SCHOENFLIES' theory e.g., there will be no less than 22 arrangements, which correspond to the hemimorphy of the rhombic system. (SCHOENFLIES, *Krystallsysteme und Krystallstruktur*, 1891, S. 433).

§ 5. A second peculiarity of the obtained RÖNTGEN-patterns is this, that notwithstanding their agreement with respect to their general symmetry, yet appreciable differences in the distribution of the black spots show themselves, if analogous crystalplates, but of different localities are compared. Even a superficial comparison of the figures 3, 6, and 8 of plate I to the one side, and of fig. 4, 7, and 9 to the other side, is able to manifest the great differences immediately. Doubtless all analogous images show a number of common spots; but in every radiogram there are moreover new ones, while even homologous spots in the different photographs appear with such different relative intensities, that the total aspect of the figure becomes a quite different one by it.

As these photographs were made all *under precisely the same circumstances*, we must conclude from this, that the symmetry of a species of minerals being evidently always the same, the number and the arrangement of its molecular reticular planes, just as their molecular densities, are however *variable* with the special conditions, which were prevailing during the formation of the crystals. With respect to the *external* form of the crystals, this is a fact which has long been known, and which can moreover readily be explained

by the different influences of the factors accompanying the formation of the crystals. But from our experiments it follows moreover, that the *internal* arrangement also, *the molecular structure itself*, must be considered as being variable with those external factors; thus to the different localities, where minerals are found not only the especial differences in habitus of the crystals must correspond, but also some variations of its internal structure. With respect to the great significance of this conclusion for the question about the constancy of mineral-species in general and about the relations between the external forces during the crystallisationprocess and the internal crystalline structure, — we must remark, that the correctness of our view will be established only satisfactorily by a great number of such experiments, to be made with minerals of very different origin and accurately known chemical composition. For especially of many silicates, and also of cordierite, it is known, that they can be altered under the influence of chemical reagents<sup>1)</sup>; and it is very well explicable, if such differences in internal structure, as we have stated here, were dependent upon such differences in chemical composition, instead of being attributed to the variation of physical factors, which may have had a variation of the external forms as a consequence, however in the case of cordierite, these variations in chemical composition are only small. Only numerous experiments in the direction indicated above, will enable us to decide in the alternative.

§ 6. We have tried to prove the hemimorphy of the cordierite, just as it follows doubtless from the described experiments, by verifying it again by means of the now usual physical methods.

In the first instance we tried<sup>2)</sup> to reach our purpose by the aid of the wellknown *method of corrosion-figures*. The plates of cordierite, having been carefully cleaned by benzene, afterwards by alcohol and ether, were submitted during a short moment to the action of a very dilute solution of hydrofluoric acid; later we made again such experiments by means of gaseous hydrofluoric acid and with dilute potassiumhydrate-solutions. In the last mentioned case, we were unable to get any well-shaped corrosion-figures; in the experiments with hydrofluoric acid however, we always got, even after

<sup>1)</sup> Vide in this respect the paper of WULFING and OPPENHEIMER, just published in: Sitz. B. Heidelb. Akad. d. Wiss., Abt. A. N<sup>o</sup>. 10. (1914), p. 5 and 6; L. OPPENHEIMER, Inaug. Diss. Heidelberg, 1914.

<sup>2)</sup> In these experiments Dr. A. ŠIMEK has willingly given us his esteemed assistance.

the shortest possible action and by means of very dilute solutions of the acid, a great number of corrosion-figures, which appeared to be *elevations*, instead of impressions in by far the most cases. They generally (fig. 10*a, b, c*) did not have any well definable shape, and were moreover quite irregularly distributed over the surface of the crystalplates<sup>1)</sup>, only on {001} we succeeded sometimes in getting some extended rectangular forms, proving the presence of a binary axis and of two perpendicularly intersecting symmetry-planes. The corrosion-figures on {100} and {010}, and also on the prism {110} of the crystals from *Ibity* and *Bodenmais*, proved clearly in every case *the absence of a horizontal plane of symmetry*; they were however furthermore so abnormally shaped, that they could hardly be used for the control of the above deduced symmetry of the crystals. This case proves once more, that the method of corrosion-figures used, eventually can give unreliable results, either by the production of abnormal etching-figures or by a shape of the corrosion-figures, which cannot sufficiently exactly be defined.

A second trial to determine the physical symmetry in this case, was based upon the idea, that because the principal axis *c* was of *polar* nature, it would be possible, that its ends would manifest opposite electrical changes on mechanical deformation or on heating. Although we are strongly convinced of the truth that a negative result can hardly be considered to be a decisive argument in this question, we have nevertheless spent a considerable time in endeavouring to prove the polarity of the *c*-axis by means of KUNDT's method of dust-figures. Although we were able to obtain on this occasion e.g. the alternative red and yellow powdering of the vertical edges of prismatic quartz-crystals in a very satisfactory way, however all our numerous tentatives with plates of cordierite, as well with the pinacoidal as with the prismatic plates, remained without a positive result. In every case, if present, this piezo-, or pyro-electrical polarity of the *c*-axis appears to be only so feeble, that it seems impossible to prove its existence in the described way with any certainty.

It is a quite remarkable fact, which strongly corroborates the value of the new method that even where all crystallographic methods to find the smaller physical symmetry-differences of crystals used up to this date, are failing, the new method however appears to be quite able to elucidate the finer feature of symmetry of such crystals in so complete and persuading a way. Therefore an indubitable place

<sup>1)</sup> In these photographs, the crossed hairs in the field are parallel to the directions of optical extinction of the plates.

needs to be reserved in future to the method of RÖNTGENOGRAMS among all other crystallographical methods. At the same time however it is proved by the results obtained with minerals of different localities, how strictly necessary it properly must be considered, to build up the whole systematical mineralogy starting from this new point of view, and what surprising results are surely to be expected therefrom.

We will now describe here the analogous experiments, made with *apophyllite*.

§ 7. *Investigations relating to the Symmetry of Apophyllite.*

For our investigations of the symmetry of apophyllite, we had material at our disposal from the following localities: *a.* from Paterson (U. S. A.); from *Bergen Hill, Erie Railroad N. J.*; *c.* from *Guamajato, in Mexico*; *d.* from *Berufjord in Iceland*. The apophyllites of American origin we will place opposite to that of *Iceland* as a typical group, because they manifest, as will seen below, some peculiarities in their molecular structure, which are not present in the *Iceland*-mineral, and are substituted in it by other qualities.

*Apophyllite*, a mineral with the chemical composition:

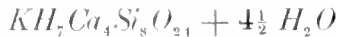

belongs to the important group of the remarkable *zeolithic silicates*; they all contain water, and as was proved for many of them already, their vapour-tension at constant temperature appears to be continually variable with their momentaneous content of water, — a behaviour quite opposite to that of hydrated salts in general. The explanation of this phenomenon is commonly given in this way, — which is confirmed completely moreover by the physical properties of these silicates, — that the water is not combined with the silicate like the water of crystallisation, but that it is present, at least partially, either in solid solution or hold in the silicate-skeleton by absorption.

Apophyllite is a typical representative of an optically anomalous or mimetic crystal: BREWSTER in 1819 already discovered the partition of the crystal-sections in numerous fields, and since that time the pseudo-tetragonal crystals of this mineral have often been the subject of research. For the explanation of this anomalous behaviour, two theories have been started: in 1877 by MALLARD, who supposed the crystals of apophyllite to be polysynthetic twinings of perpendicularly crossed and penetrating monosymmetric lamellae, — the dimensions of the monosymmetric molecular-arrangement differing only slightly from those of a tetragonal structure. The second-view, chiefly defended by C. KLEIN, explains the optical abnormalities as caused by internal

stresses, which in their turn are caused by an isomorphous mixture of optically positive and negative material<sup>1)</sup>. The supposition of the existence of such positive and negative apophyllite-substances which is really confirmed in some cases by direct observation, must serve at the same time for the explanation of the very weak birefringence, and the so-called *leukocyclite*-, and *chromocyclite*-phenomena. We will demonstrate in the following pages, that, — waiving the question, how far the last mentioned phenomena need to be explained by this intergrowth of optically positive and negative substances, — in every case the method of the RÖNTGEN-radiation *decides the alternative between the two views indubitably in favour of MALLARD's hypothesis.*

§ 8. The American apophyllites used were all transparent, pearl-coloured crystals; they have a layer-structure parallel to {001}, to which form also the direction of perfect cleavage is parallel.

*Without exception all these apophyllites are optically biaxial in convergent polarised light, with positive character of the birefringence.* The apparent axial angle is only small, with a dispersion:  $\rho < v$ . By means of a gypsumplate giving the red colour of 1<sup>st</sup> order, one sees, that numerous blue-, and orange-tinged, rectangularly bounded, very small fields are in juxta-, and superposition to each other, as in a mosaic; the crystal makes the impression of consisting of an innumerable quantity of perpendicularly very small lamellae, which evidently are distributed and superposed in very unequal number and in a rather irregular way.

All these preparations give, if the RÖNTGENrays are directed perpendicularly to {001}, the radiograms, which in Table II are reproduced in the figures 1, 2, 3<sup>a</sup> and 4. *Of all these radiograms it is again characteristic, that they possess a single plane of symmetry as unique symmetry-element; it is placed in a vertical situation in all reproduced figures, and corresponds, as was found later, to a direction perpendicular to the axial plane of the optically biaxial individuals.* The direction of this plane of symmetry can always rather easily be fixed on the original negatives by the particular aggregation of spots at the upper side of the image, which has the shape of a double pinnacle between the two very distinct circular garlands of spots there; and also by the fact, that it cuts symmetrically the group of the five very intense black spots, which in fig. 1, 3' and 4 are visible just beneath the centre: in fig. 2 these spots are invisible

<sup>1)</sup> The optical phenomena in basal sections of the optically positive apophyllites are (after Kooke) exactly analogous to those which would be produced in the originally uniaxial crystals, by *stresses*, working parallel to the edges (001):(110).

on the reproduction, by the strong radiation of the phosphorescent screen and the enlargement of the central spot caused by it, but they were distinct on the original photographs.

It is therefore doubtless, that these photographs can be considered to have brought the proof of the fact, that the pseudotetragonal *c*-axis of the apophyllite-crystals, is not even a binary axis; but that at best it can be compared with the vertical axis of a *monosymmetric* molecular arrangement: *the original molecular structure of apophyllite is not of tetragonal, but of monoclinic symmetry.*

We once more emphasize in this connection the existence of the group of five intensive spots, just beneath the centre of the image. Indeed this garland of five spots, which correspond to five molecular planes, seems to be typical for all apophyllites of American origin; it plays evidently in these silicates a preponderant role. As in literature there can be found some data, relating to the fact, that a heating to 270° C. would be able to expel a part of the water and to make the crystal *tetragonal in reality*, — we have studied the effect of such a heating at 270° to 300° C. by means of the heating-apparatus formerly described by us. And now it was found, that all spots disappear, but that the mentioned five intense spots are elongated like the fingers of a hand (fig. 3*b* on plate II). This fact could be explained by the supposition that the original sets of parallel molecular planes, by which the five intensive spots were produced, are changed during the deshydration and heating gradually into the same number of now divergent molecular planes lying in five zones respectively. This would be possible, if the molecular planes, which are situated nearer to the crystal-surface, will lose their watermolecules sooner and more easily than those situated nearer the inner part of the crystal: the expelling of the water takes place namely very slowly and gradually, while the planes are rotating round their zone-axes continually during this deshydration. It is possible, that an analogous, but far more irregular distortion of the positions of the molecular planes will be the cause of a gradually getting vaguer and finally of a disappearing of all other points and spots; if not the other explanation, namely that all these points correspond to the action of the *watermolecules alone*, can be accepted. It will be only possible to give some stronger affirmation of this view, if more zeolitic silicate will be investigated in an analogous way. The fig. 3*b* is made, after the heated crystal being cooled down to the roomtemperature; it appears to be *completely identical* however with the image obtained at 300° C. within the furnace, and it is only reproduced here instead of the other, because the last mentioned



photograph was too pale. The resulting state of the heated apophyllite remains thus absolutely fixed on cooling; after the data given in literature, the water expelled at 260° C. will be only resorbed after about 3600 hours from an atmosphere of water vapour. Anticipating on our experiments with the apophyllite of *Iceland*, we can remark in this connection, that with this mineral, which did *not* show the five mentioned spots, there remained *nothing at all* on the photographic plate, after the crystal was heated, except some feeble action on the places of the most intensive spots of the original image; they only proved, that the transformation by the heating was not yet completely finished. In no case we have therefore succeeded in proving, as before was done with the boracite, that the pseudotetragonal aggregation of monosymmetric material, above a certain temperature can be changed into the really higher symmetrical form: instead of such inversion, a change in the silicate-skeleton is produced, which at least during the short interval of the experiment can be considered to be *irreversible*, and which has nothing or not directly to do with the real transformation into a true tetragonal form.

§ 9. In opposition to these American crystals, the used apophyllite of *Iceland* must be discerned as a most beautiful, glassy, and perfectly clear crystal, which was determined to be a combination of sharp pyramid {111} and basal pinacoid {001}. The angles of the pyramid and of pyramid and basal pinacoid were variable within rather wide limits; they deviated from the angles commonly mentioned in literature by an amount of circa 30' to 1°; yet the reflected images were splendid and quite sharp, this phenomenon too leading to the supposition, that the tetragonal symmetry could only be a mimetic one:

$$\{001\} : \{111\} = 59^{\circ}24' \text{ to } 60^{\circ}13'; \text{ in literature : } 60^{\circ}32'.$$

$$\{111\} : \{\bar{1}\bar{1}1\} = \quad \quad \quad ; \quad \quad \quad \text{,,} \quad \quad : 58^{\circ}56'$$

$$\{111\} : \{\bar{1}11\} = 74^{\circ}38' \text{ to } 75^{\circ}39'; \quad \quad \quad \text{,,} \quad \quad : 75^{\circ} \quad ;$$

“rather oscillating”.

From this crystal two planparallel plates were cut, the one parallel to {001}, the other to {100}.

The plate parallel to {001} between crossed nicols appeared to be *not* completely isotropous, but to possess an extremely weak birefringence, with the principal optical sections orientated perpendicularly to the edges (110) : (001).

By means of a gypsum-lamella, giving the red of 1<sup>st</sup> order, it appeared to be divided into four sections, of which the diametrically

opposed ones were tinged blue, while the other ones were orange. *Every sector is optically biaxial, with positive character; the axial plane is in every sector perpendicularly orientated upon the corresponding edge (110):(001).* The four quadrants were limited in the centre of the basal section by straight borders, corresponding with the edges of the pseudo-tetragonal pyramid; in every sector the direction parallel to the corresponding edge (110):(001) is that of *smaller* optical elasticity.

The plate, which was cut parallel to {100}, showed on very strong enlargement and by the aid of a gypsum-plate with the red of 1<sup>st</sup> order, a very fine lamellar structure: the lamellae are superposed parallel to the faces of the pyramidal, apparently tetragonal limiting forms, while also locally smaller or more extended fields can be discerned, in which the optical orientation appears to be different and in an orientation, evidently perpendicular with respect to each other.

Of these plates the RÖNTGEN-patterns were obtained in the usual way: the fig. 5*a*, plate II represents the image, if the plate parallel to {001} is radiated through; it corresponds to the centre of the basal sections, where the four sections are tangent to each other; fig. 6 was obtained by radiation through one single sector, and fig. 5*b* represents the RÖNTGENogram, corresponding to a radiation through the plate, cut parallel to {100}.

Although fig. 5*a* appears to be approaching to a much higher degree to real tetragonal symmetry, it is easy to recognize in it the perpendicularly crossed partial figures of the photographs fig. 1—4, but without the formerly mentioned intensive five spots near the centre; and fig. 5*b* shows a symmetry with respect to two planes of symmetry, perpendicular to each other, and a binary axis. In fig. 6 it would again be possible to doubt this approach to tetragonal symmetry; however it seems to be present, and the figure allows, e.g. by direct comparison with fig. 4, to prove that in the radiograms of the *Iceland*-apophyllite doubtlessly several elements of the monosymmetric American structures are present. From all these peculiarities it seems that we may conclude, that the image of the apophyllite from *Iceland* approaches only therefore more that of a real tetragonal crystal, because the intergrowth of the monoclinic lamellae is in this case *much finer* and *more regular* than in the American species; and with this doubtlessly the other fact is connected, that the *Iceland*-mineral looks so much clearer and within larger sectors more homogeneous, than the turbid-looking and opaque American apophyllites.

Finally we can here also fix the attention to the fact, that the RÖNTGENOGRAMS of the apophyllites of different localities differ yet in their finer features, although they possess the same general symmetry.

§ 10. In our opinion these investigations have decided without any doubt between the two prevailing theories for the explanation of the optical anomalies of apophyllite, *in favour of* MALLARD'S *hypothesis*: not the tetragonal molecular structure, disturbed later by internal stresses, must be considered as the primary state of the mineral; but this state corresponds to an originally *monoclinic* molecular arrangement, which approaches very closely to a tetragonal one, and which reaches its pseudo-tetragonal character by the crossing and intergrowth of two such monosymmetric structures, by means of polysynthetic lamellar twinning, and a mutual penetration in directions, which make an angle of  $90^\circ$  with each other.

#### POSTSCRIPT.

Finally we will use this opportunity, to add here again a con-

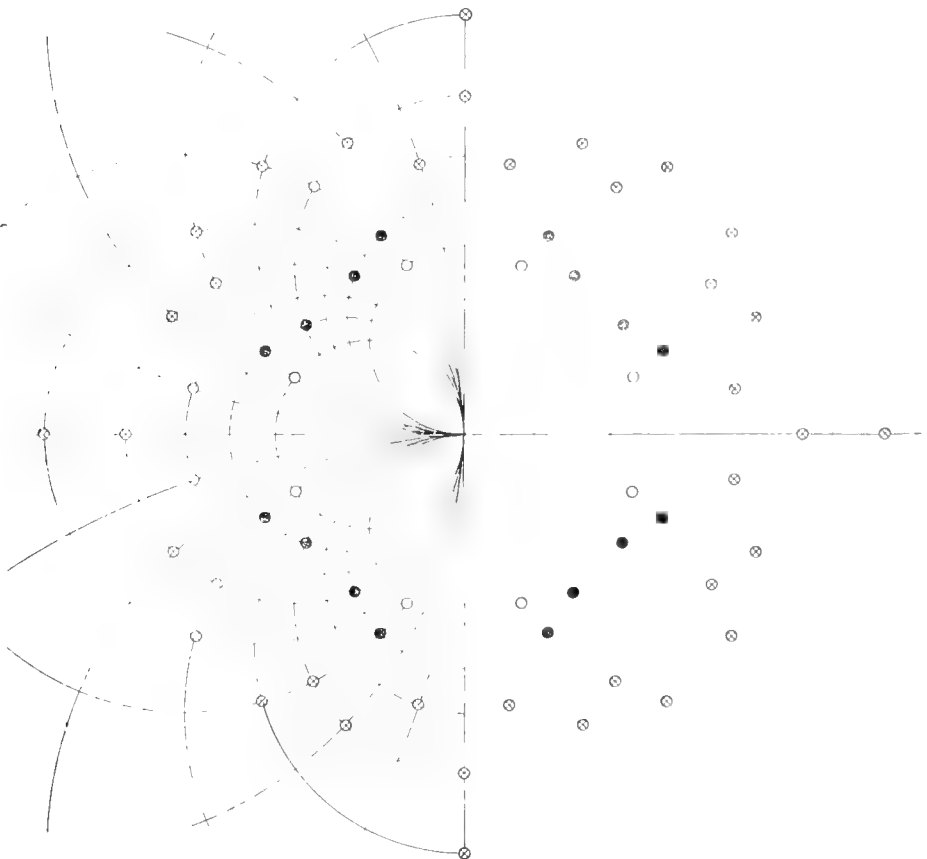

Boracite at  $300^\circ$ . C.

struction-figure, relating to our paper on the symmetry of *boracite*<sup>1)</sup>; this figure will reproduce the changes observed by us with this mineral before and after heating, in a clearer way, than the not very satisfactory photographical reproductions given in that paper. In constructing this stereographical projection, Dr. L. S. ORNSTEIN has given us again his kind assistance, for which we thank him here also once more. The change of the binary axis into the quaternary one, is proved by this figure again in a very striking manner, and it is easy to see, which reticular planes of the molecular structure have disappeared at higher temperature.

At the same time we will correct some errors in the former paper, where on p. 797 the words "right" and "left" need to be interchanged several times, because the photographs are unhappily placed in reversed position, so that on comparison of the text and the figures, there is a confusion of right side, left side, and of horizontal and

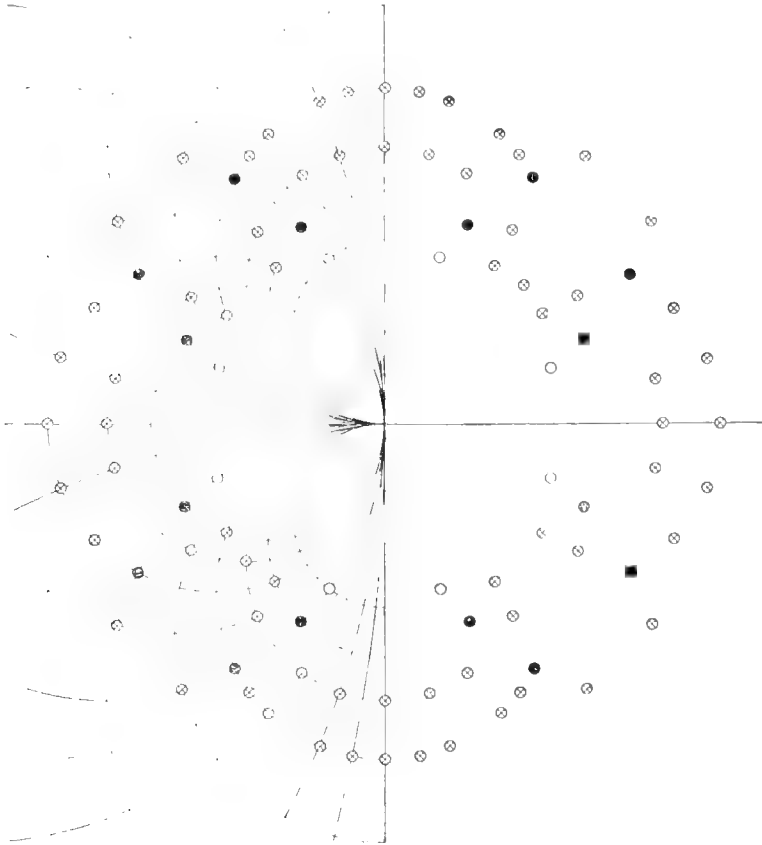

Boracite at room-temperature.

<sup>1)</sup> H. HAGA and F. M. JAEGER, these Proc. loco cit. 798 (1914).

vertical directions. The new figure in this paper has been adjusted in such a position, that it will correspond to the text of p. 797, if only the words vertical and horizontal (line 9 and 10 from beneath) are interchanged on reading.

*Groningen, June 1914.*

*Laboratories for Physics and for Inorganic  
Chemistry of the University.*

**Physics.** — “FRESNEL’S coefficient for light of different colours.”  
(First part). By Prof. P. ZEEMAN.

One of the empirical foundations of the electrodynamics of moving bodies in the domain of optics is FIZEAU’S celebrated experiment on the carrying along of the light waves by the motion of water. Let  $w$  be the velocity of water relative to an observer, then for him the velocity of light propagated in the water would be

$$C_a = \frac{c}{\mu} \pm w$$

if the dynamical laws for the addition of velocities were perfectly general.

In this equation  $\mu$  designs the index of refraction of water,  $c$  the velocity of light in vacuo, and we must take the upper or the lower sign, according as the light goes with or against the stream. FIZEAU demonstrated that not the entire velocity  $w$  but only a fraction of it comes into action. This particular fraction appeared to be approximately equal to  $1 - \frac{1}{\mu^2}$ , FRESNEL’S coefficient. Hence we must write in place of the above given formula:

$$C_a = \frac{c}{\mu} \pm \varepsilon w. \quad \dots \quad (1)$$

where

$$\varepsilon = 1 - \frac{1}{\mu^2}. \quad \dots \quad (2)$$

For water  $\varepsilon$  is equal to seven-sixteenths.

The extremely important role which the formulae (1) and (2) have had in the theory of aberration, in the development of LORENTZ’S electronic theory needs not to be exposed here, and it is hardly necessary to state that equation (1) is now regarded as a simple confirmation of EINSTEIN’S theorem concerning the addition of velocities.

I may be permitted however to point out the smallness of the

second term of formula (1). The velocity which we are able to obtain in a column of water transmitting light is of the order of magnitude of 5 metres per second. We have thus to find a difference of velocity of 5 metres in  $\frac{3 \cdot 10^8}{4/3}$  m., i. e. of one part in fifty millions.

This was done by FIZEAU<sup>1)</sup> in one of the most ingenious experiments of the whole domain of physics. FIZEAU divided a beam of light issuing from a line of light in the focus of an object-glass into two parallel beams. After traversing two parallel tubes these beams pass through a second lens, in the focus of which a silvered mirror is placed. After reflection the rays are returned to the object glass, interchanging their paths. Each ray thus passes through the two tubes. A system of interference fringes is formed in the focus of the first lens. If water is flowing in opposite directions in the two tubes, one of the interfering beams is always travelling with the current and the other against it. When the water is put in motion a shift of the central white band is observed: by reversing the direction of the current the shift is doubled.

The ingenuity of the arrangement lies in the possibility of securing that the two beams traverse identical ways in opposite directions. Every change due for example to a variation of density or of temperature of the moving medium equally influences the two beams and is therefore automatically compensated.

One can be sure that a shift of the system of interference fringes, observed when reversing the direction of the current must be due to a change of the velocity of propagation of the light.

The tubes used by FIZEAU had a length of about 1,5 metres and an internal diameter of 5,3 m.m., whereas the velocity of the water was estimated at 7 metres. With *white light* the shift of the central band of the system of interference fringes observed by reversing the direction of flow was found from 19 rather concordant observations equal to 0,46 of the distance of two fringes; the value calculated with FRESNEL's coefficient is 0,404.

The result is favourable to the theory of FRESNEL. The amount of the shift is less than would correspond to the full velocity of the water and also agrees numerically with a coefficient  $1 - \frac{1}{\mu^2}$ , if the uncertainty of the observations is taken into account.

<sup>1)</sup> H. FIZEAU. Sur les hypothèses relatives à l'éther lumineux et sur une expérience qui paraît démontrer que le mouvement des corps change la vitesse avec laquelle la lumière se propage dans leur intérieur. Ann. de Chim. et de Phys. (3) 57 385. 1859.

FIZEAU'S experiments, though made by a method which is theoretically as simple as it is perfect, left some doubts as to their accuracy, partly by reason of the remarkable conclusions as to relative motion of ether and matter to which they gave rise, and these doubts could only be removed by new experiments.

35 years after FIZEAU'S first communication <sup>1)</sup> to the Académie des Sciences, MICHELSON and MORLEY <sup>2)</sup> repeated the experiment. They intended to remove some difficulties inherent to FIZEAU'S method of observation and also, if possible, to measure accurately the fraction to be applied to the velocity of the water. MICHELSON uses the principle of his interferometer and produces interference fringes of considerable width without reducing at the same time the intensity of the light. The arrangement is further the same as that used by FIZEAU but performed with the considerable means, which American scientists have at their disposal for important scientific questions. The internal diameter of the tubes in the experiment of MICHELSON and MORLEY was 28 m.m. and in a first series the *total* <sup>3)</sup> length of the tubes was 3 metres, in a second series a little more than 6 metres.

From three series of experiments with *white light* MICHELSON found results which if reduced to what they would be if the tube were  $2 \times 5$  metres long and the velocity 1 metre per second, would be as follows:

“Series	$\Delta =$ double displacement
1	0,1858
2	0,1838
3	0,1800”

“The final weighted value of  $\Delta$  for all the observations is  $\Delta = 0,1840$ . From this by substitution in the formula, we get  $\epsilon = 0,434$  with a possible error of  $\pm 0,02$ ”.

For light of the wavelength of the *D*-lines we calculate  $1 - \frac{1}{u^2} = 0,437$ . This agreement between theory and observation is extremely satisfactory.

A new formula for  $\epsilon$  was given by LORENTZ <sup>4)</sup> in 1895 viz.:

<sup>1)</sup> Comptes rendus 33, 349, 1851.

<sup>2)</sup> A. A. MICHELSON and E. W. MORLEY, Influence of motion of the medium on the velocity of light. Am. Journ. of Science (3) 31, 377, 1886.

<sup>3)</sup> *Viz.* the sum of the lengths of the ways in the moving medium, traversed by each of the interfering beams, or approximately twice the length of one of the tubes.

<sup>4)</sup> H. A. LORENTZ Versuch einer Theorie der electrischen und optischen Erscheinungen in bewegten Körpern, p. 101, 1895. See also Theory of Electrons p. 290.

$$\varepsilon = 1 - \frac{1}{\mu^2} - \frac{1}{\mu} \lambda \frac{d\mu}{d\lambda} \dots \dots \dots (3)$$

For the wavelength of the sodium lines this becomes:

$$0.451.$$

We see, therefore, that the value deduced by formula (3) deviates more from the result of the observations than the value given by the simple formula (2).

‘Sollte es gelingen, was zwar schwierig, aber nicht unmöglich scheint, experimentell zwischen den Gleichungen (3) und (2) zu entscheiden, und sollte sich dabei die erstere bewähren, so hätte man gleichsam die DOPPLER'sche Veränderung der Schwingungsdauer für eine künstlich erzeugte Geschwindigkeit beobachtet. Es ist ja nur unter Berücksichtigung dieser Veränderung, dass wir die Gleichung (3) abgeleitet haben’.<sup>1)</sup>

It seemed of some importance to repeat *with light of different colours* FIZEAU's experiment, now that the correspondence between theory and observation had become less brilliant, and in view of the fundamental importance of the experiment for the optics of moving bodies.

From the point of view of the theory of relativity the formula (3) is easily proved, as has been pointed out by LAUE<sup>2)</sup>, neglecting terms of the order  $\frac{v^2}{c^2}$ . Recently, however, again some doubt as to the exactness of LORENTZ's term has been expressed. I may refer here to a remark by MAX B. WEINSTEIN<sup>3)</sup> in a recent publication and to a paper by G. JAUMANN<sup>4)</sup>. The last mentioned physicist gives an expression for the coefficient  $\varepsilon$ , which for water does not differ much, but in other cases deviates very considerably from FRESNEL's coefficient.

The interference fringes were produced by the method of MICHELSON. The method of observation introduced will be described later on. The incident ray *s l a* meets a slightly silvered plate at *a*. Here it divides into a reflected and a transmitted part. The reflected ray follows the path *a b c d e a f*, the transmitted one the path *a e d c b a f*. These rays meeting in the focal plane of *f* have

<sup>1)</sup> LORENTZ. Versuch u. s. w., 102.

<sup>2)</sup> M. LAUE. Die Mitführung des Lichtes durch bewegte Körper nach dem Relativitätsprinzip. Ann. d. Phys. **23**, 989. 1907.

<sup>3)</sup> MAX B. WEINSTEIN. Die Physik der bewegten Materie und die Relativitätstheorie. Leipzig. 1913, see note on p. 227 of his publication.

<sup>4)</sup> G. JAUMANN. Elektromagnetische Theorie. Sitzungsber. d. Kaiserl. Ak. der Wiss. Wien. mathem. naturw. Kl. **117**, 379. 1908, especially p. 459.



pursued identical, not only equivalent, paths, at least this is the case for that part of the system of interference fringes which in white light forms the centre of the central band.

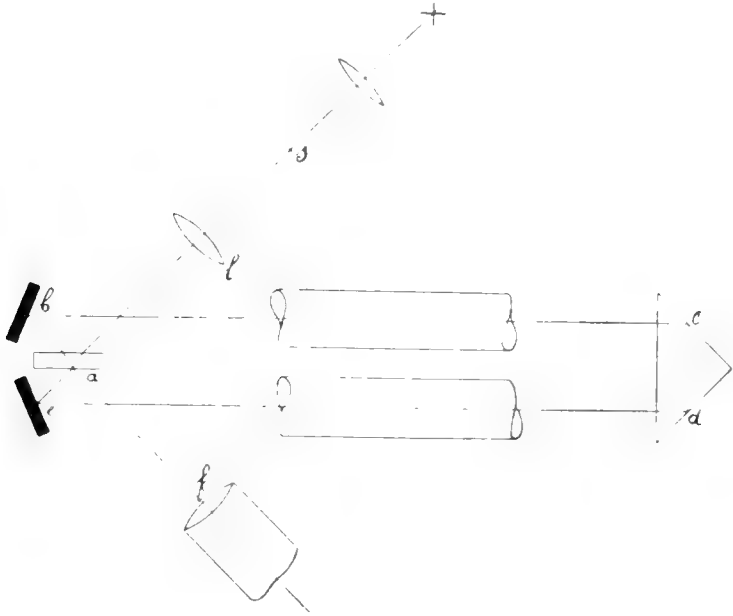

Fig. 1.

In order to verify the formula (3) it is necessary that the light be monochromatic. Further it seems of immense advantage to have a water current which remains constant during a considerable time.

For observations with violet light this even becomes strictly necessary, because visual observations are impossible with the violet mercury line (4358) used. MICHELSON obtained a flow of water by filling a tank, connected with the apparatus; by means of large valves the current was made to flow in either direction through the tubes. "The flow lasted about three minutes, which gave time for a number of observations with the flow in alternating directions". In view of my experiments the municipal authorities of Amsterdam permitted the connection of a pipe of 7.5 cm. internal diameter to the main water conduit. There was no difficulty now photographing the violet system of interference fringes, though the time of exposition with one direction of flow was between 5 and 7 minutes. The pressure of the water proved to be very constant during a series of observations; the maximum velocity in the axis of the tubes, of 40 m.m. internal diameter and of a total length of 6 metres, was about 5.5 metres.

Before recording some details of my experiments, I may be per-

mitted to communicate the general result that for water *there exists a dispersion of FRESNEL's coefficient and that formula (3) and therefore the third term of LORENTZ is essentially correct.*

I wish to record here my thanks to Mr. W. DE GROOT phil. nat. cand. and assistant in the physical laboratory for his assistance during my experiments with the final apparatus.

The difficulties encountered in these experiments were only surmounted after two reconstructions of the apparatus. Great annoyance gave the inconstancy of the interference fringes, when the pressure of the water or the direction of flow were changed. Then not only the width of the interference bands, but the inclination of the fringes were undergoing uncontrollable variations. All these defects were perfectly eliminated by the use of wide tubes and by arranging the end plates in the manner indicated in Fig. 3.

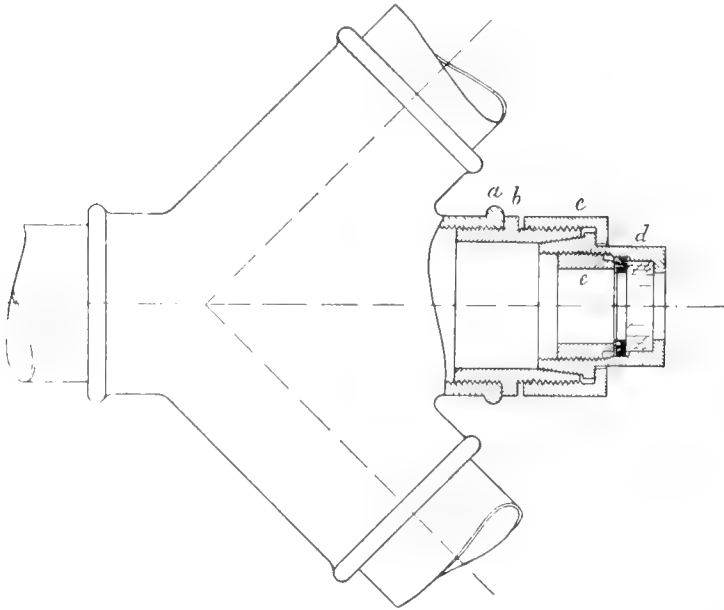

Fig. 3.

I am indebted to Mr. J. VAN DER ZWAAL, instrumentmaker in the laboratory for his carefully carrying out my instructions and designs in the mechanical construction of the apparatus.

In fig. 2A a side aspect, and in Fig. 2B a horizontal projection of the arrangement on a scale of about  $\frac{1}{15}$ <sup>th</sup> is given (see Plate).

The interferometer is at the right side, at the left the rectangular prism is placed.

The mounting of this prism is only sketched and was in reality more stable than might be inferred from the drawing.

Prism and interferometer were mounted on the piers cemented to the large brick pier of the laboratory. The tubes are entirely disconnected from the interferometer and mounted on a large iron I girder; this girder is placed upon piers of freestone cemented to large plates of freestone fixed to the wooden laboratory floors. In this manner the adjustment of the interferometer cannot be disturbed by vibrations proceeding from the tubes. At the right of the horizontal projection the four large valves may be seen, by turning which the current was made to flow in either direction through the tube systems.

The mountings containing the glass plates by which the tubes are closed are not given in the Plate. One of these mountings containing the plane parallel plates of glass is drawn to scale in Fig. 3 at one half of the natural size. The four plates of glass are by HILGER, they are circular of 24 m.m. diameter and 10 m.m. thick; in a second series of observations plates 7 m.m. thick have been used. The accuracy of parallelism of the plates is excellent; they are indeed cut from echelon plates. The general plan adopted for the construction of the plate mountings is this: one can only be sure that no change will occur in the position of the plates during the course of an experiment, if this position is *entirely definite*. In order to attain this the glass plate rests upon the inner, accurately grinded, surface of the brass piece *d*. This piece *d* fits accurately into the conical inner part of a piece *b*, itself rigidly screwed to the tube *a*. Parts *d* and *b* are connected by means of the counter nut *c*. The glassplate is held against *d* by the nut *e*. There is no objection to the presence at the *inside* between *e* and *d* of rings of hard india-rubber and of brass. *(To be continued).*

**Physics.** -- "*A new relation between the critical quantities, and on the unity of all substances in their thermic behaviour.*" (Conclusion). By Dr. J. J. VAN LAAR. (Communicated by Prof. H. A. LORENTZ).

(Communicated in the meeting of April 24, 1914).

By way of supplement we shall add the calculation of three more isotherms *below* the critical temperature, for which (loc. cit.) data are known from the unsaturated vapour region. If the  $\beta$ -values above  $T_k$  were somewhat too high on the whole, now we shall find values which are *much too low*, lower even than  $\beta_0$ , and therefore impossible. These deviating values can only be explained, when with low temperatures and large volumes *association in the vapour* is assumed.

For then, when  $RT$  in the equation of state is made smaller by a factor  $< 1$ , also  $v-b$  will be smaller, hence  $b$  greater. In this way the too small  $b$ -values could therefore be raised to the normal amount. We shall see in the following paragraph that inside the region of coexistence the same phenomenon takes place: the  $b$ -values in the vapour much too small (even large negative), the  $b$ -values in the liquid phase normal and in harmony with the theory.

Something particular takes therefore place for the large volumes: there is either association in the vapour, or the values of the pressure have been measured too small, or the values of the vapour densities too large. We shall presently return to this.

*f.* Isotherm of  $-130^{\circ},38 = 142,71$  absolute. Hence  $m = \underline{0,9473}$ ,  $3,424 m = 3,244$ .

$p$	$d_A$	$\varepsilon$	$n$	$\varepsilon + 5 : n^2$	$n - \beta$	$\beta$
12.773	27.394	0.2661	10.873	0.3084	10.518	0.355
28.878	77.821	0.6016	3.827	0.9430	3.440	0.387
Mean						0.371

Here we should have  $\gamma = 0,727, \beta_{k'} = 0,415, \beta_q = \beta_0 \times 1,475 = 0,421$ . Hence the value of  $\beta_q$  found is too low.

*g.* Isotherm of  $-139^{\circ},62 = 133,47$  abs. Here is  $m = \underline{0,8860}$ ,  $3,424 m = 3,034$ .

$p$	$d_A$	$\varepsilon$	$n$	$\varepsilon + 5 : n^2$	$n - \beta$	$\beta$
11.986	28.122	0.2497	10.591	0.2943	10.308	0.283
14.586	35.573	0.3039	8.373	0.3752	8.085	0.287
Mean						0.285

With  $T = 133,47$  corresponds  $\gamma = 0,719, \beta_{k'} = 0,411, \beta_q = \beta_0 \times 1,457 = 0,416$ . The found value of  $\beta_q$ , viz. 0,285, is far below the theoretical value 0,42.

*h.* Isotherm of  $-149^{\circ},60 = 123,49$  abs. For  $m$  is found  $m = \underline{0,8197}$ , so  $3,424 m = 2,807$ .

$p$	$d_A$	$\varepsilon$	$n$	$\varepsilon + 5 : n^2$	$n - \beta$	$\beta$
11.150	29.183	0.2323	10.206	0.2803	10.014	0.192
12.788	34.646	0.2664	8.597	0.3341	8.401	0.195
Mean						0.194

Here  $\gamma = 0.711$ ,  $\beta_{l'} = 0.406$ ,  $\beta_g = \beta_0 \times 1.439 = 0.411$ ; 0.19 again remains considerably below this.

Combining the found values of  $\beta_g$  in a table and comparing them with the theoretical values, we get the following survey.

$m$	1.95	1.43	1.13	1.04	1.01	0.95	0.89	0.82
$\beta_g$ calc.	0.49	0.46	0.43 <sup>5</sup>	0.43	0.43	0.42	0.42	0.41
$\beta_g$ found	0.55	0.51	0.45	0.43	0.42	0.37?	0.28?	0.19?

As was already remarked above, the great deviation, especially below  $T_k (m < 1)$ , must not be ascribed to the theory, but to the experiment, or to association in the vapour.

For the found values of  $\beta_g$  become, as we shall see, even *negative*, hence impossible, at still lower temperatures — while also  $\beta_{vap.}$  is continually found *smaller* than  $\beta_{liq.}$ , which of course points to something particular in the *vapour*: either association, or inaccurate vapour- or volume determinations, in consequence of a systematic error. (Consult also *g.* of § 18 for a possible explanation.)

**18.** *The region of coexistence.* (Cf. Comm. 131 and These Proc. of Nov. 1913 (Comm. 138)).

For the calculation of  $\beta$  from the given values of the coexisting vapour and liquid densities it is to be regretted that the vapour pressure observations (see also Comm. 115) have not been made at *exactly* the same temperatures as the density observations. This has rendered interpolations necessary, which of course impairs the perfect accuracy of the  $\varepsilon$ , which will make its influence felt chiefly on the  $\beta$ -values which are calculated from the *vapour* densities.

In this connection we should not omit mentioning that the value of  $f'$ , calculated from the first observations of the vapour tensions (Comm. 115), is much too low, viz. 5,712, whereas the much better

value  $f^A > 5,933$  follows from the values given in Comm. 120<sup>a</sup> (see p. 10)<sup>1</sup>).

We had even sufficient reasons (see § 17) to fix the value of  $f^A$  at 6 ( $f^A$  could be still *somewhat* larger then).

RANKINE-BOSE'S interpolation formula (see These Proc. of Nov. 1913, or Comm. 138), namely

$$\log p = a + \frac{b}{T} + \frac{c}{T^2} + \frac{d}{T^3},$$

gives by differentiation:

$$\frac{dp}{p dT} = 2,3 \left( -\frac{b}{T^2} - \frac{2c}{T^3} - \frac{3d}{T^4} \right),$$

hence

$$f = \frac{T dp}{p dT} = 2,3 \left( -b - \frac{2c}{T} - \frac{3d}{T^2} \right) = 2,3 \left[ 634,391 - \frac{61538,18}{T} + \frac{3229392}{T^2} \right].$$

But this formula, which is calculated from all the observations of  $p$  (so also from those below  $-140^\circ,80$ ), and corresponds pretty well with it, gives the value  $f_k = 5,628$ , which is much too low, at  $T_k (150,65)$ , hence still lower than the value  $f_k = 5,712$ , given at the conclusion of Comm. 115, and calculated with  $b = -524,3169$ ,  $c = +11343,28$ ,  $d = 0$ .

In virtue of this I think I have to recommend caution in the use of the values of  $p$ , at least in the neighbourhood of the critical temperature.

We shall now give the following survey of the values found for the densities  $\varrho_1$  and  $\varrho_2$  (Comm. 131), and also the corresponding values of  $p$  (Comm. 115, and These Proc. of Nov. 1913 or Comm. 138).

$-125^\circ.17$	$\varrho_1 = 0.77289$	$\varrho_2 = 0.29534$	$p = 42.457$ (for $-125^\circ.49$ )
$-131^\circ.54$	0.91499	0.19432	35.846 ( $\rightarrow -129^\circ.83$ )
$-135^\circ.51$	0.97385	0.15994	29.264 ( $\rightarrow -134^\circ.72$ )
$-140^\circ.20$	1.03456	0.12552	22.185 ( $\rightarrow -140^\circ.80$ )
$-150^\circ.76$	1.13851	0.06785	13.707 ( $\rightarrow -150^\circ.57$ )
$-161^\circ.23$	1.22414	0.03723	7.4332 ( $\rightarrow -161^\circ.23$ )
$-175^\circ.39$	1.32482	0.01457	— —
$-183^\circ.15$	1.37396	0.00801	1.3369 ( $\rightarrow -183^\circ.01$ )

We have calculated from  $\varrho_1$  and  $\varrho_2$  the values of  $d_1$  and  $d_2$  given in the following tables by means of  $\varrho_k = 0,53078$ .

<sup>1</sup>) Slightly below  $T_k$ , at  $-125^\circ,49$ ,  $f = 2,577 \times 2,3026 = 5,933$  was namely found,

a.  $t = -125^{\circ},17$ , hence  $T = 147,92$ ,  $m = 0,9819$ ,  $3,424m = 3,362$ .  
By means of linear interpolation  $p = 42,944$  has been calculated,  
so  $\varepsilon = 0,8947$ .

$d$	$n$	$\varepsilon + 5d^2$	$n - \beta$	$\beta$
$d_1 = 1.4563$	0.687	11.50	0.292	0.394 (liq.)
$d_2 = 0.5564$	1.797	2.443	1.376	0.421 (vapour)

As theoretically  $\beta$  ranges from 0,42 to 0,29 (see above), both the values found can be correct.

b.  $t = -131^{\circ},54$ ,  $T = 141,55$ . Hence  $m = 0,9396$ ,  $3,424m = 3,217$ . Linear interpolation, giving  $p = 33,545$ ,  $\varepsilon = 0,6989$ , would be too uncertain here, as  $-129^{\circ},8$  differs too much from  $-131^{\circ},5$ .

VAN DER WAALS' formula  $-\log^{10} \varepsilon = f \frac{m}{1-m}$  gives with  $f = 2,444^1$  the value  $\varepsilon = 0,6964$ .

$d$	$n$	$\varepsilon + 5d^2$	$n - \beta$	$\beta$
$d_1 = 1.7238$	0.580	15.55	0.207	0.373 (liq.)
$d_2 = 0.3661$	2.732	1.367	2.354	0.377 (vapour)

As  $\beta$  ranges from 0,42 to 0,29, the  $\beta$ -value in the vapour is too small.

c.  $t = -135^{\circ},51 = 137,58$  abs. Hence  $m = 0,9132$ ,  $3,424m = 3,127$ . A linear interpolation gives  $p = 28,344$ ,  $\varepsilon = 0,5905$ ; VAN DER WAALS' formula with  $f = 2,420$  gives  $\varepsilon = 0,5890$ .

$d$	$n$	$\varepsilon + 5d^2$	$n - \beta$	$\beta$
$d_1 = 1.8348$	0.545	17.42	0.179	0.366 (liq.)
$d_2 = 0.3013$	3.319	1.043	2.998	0.321 (vapour)

<sup>1)</sup> The values of  $f$  have in each case been calculated by me from the vapour-pressure observations.

The  $\beta$ -value in the vapour begins to be smaller here than that in the liquid!

*d.*  $t = -140^{\circ},20 = 132,89$  abs. Hence  $m = 0,8821$ ,  $3,424 m = 3,020$ . For  $p$  we find through linear interpolation  $p = 22,795$ ,  $\varepsilon = 0,4749$ ; from  $-\log^{10} \varepsilon = \text{etc.}$  with  $f' = 2,415$  on the other hand  $\varepsilon = 0,4757$ .

$d$	$n$	$\varepsilon + 5 d^2$	$n - \beta$	$\beta$
$d_1 = 1.9491$	0.513	19.47	0.155	0.358 (liq.)
$d_2 = 0.2365$	4.229	0.7553	3.999	0.230 (v.)

$\beta_v$  should be about 0,42. Besides 0,23 is again  $< 0,36$ .

*e.*  $t = -150^{\circ},76 = 122,33$  abs. Hence  $m = 0,8120$ ,  $3,424 m = 2,780$ . Linear interpolation gives  $p = 13,595$ ,  $\varepsilon = 0,2832$ .

$d$	$n$	$\varepsilon + 5 d^2$	$n - \beta$	$\beta$
$d_1 = 2.1450$	0.466	23.29	0.119	0.347 (liq.)
$d_2 = 0.1278$	7.823	0.3649	7.619	0.204 (v.)

The value of  $\beta_v$  is 0,41; 0,20 remains far below this. We moreover point out that also  $h$  of § 17 at  $t = -149^{\circ},6$  yielded a perfectly harmonious value for the vapour, viz. 0,19. The two series of observations, therefore, cover each other entirely.

*f.*  $t = -161^{\circ},23 = 111,86$  abs. From this  $m = 0,7425$ ,  $3,424 m = 2,542$ . Linear interpolation gives  $p = 7,4332$ ,  $\varepsilon = 0,1549$ .

$d$	$n$	$\varepsilon + 5 d^2$	$n - \beta$	$\beta$
$d_1 = 2.3063$	0.434	26.75	0.095	0.339 (liq.)
$d_2 = 0.07014$	14.257	0.1795	14.167	0.090 (v.)

$\beta_v$  begins to be more and more impossible. We point out that when  $f' - 1$  is taken not  $= 5$ , but e. g.  $= 4,95$ , the value  $\beta_{liq.}$  does not appreciably change: 0,339 then becomes 0,338. But  $\beta_v$  would then become still smaller, viz. 0,07 instead of 0,09<sup>1)</sup>.

1) If  $p = 7,58$  instead of  $= 7,43$ , so  $\varepsilon = 0,158$  instead of  $= 0,155$ , we should also have found 0,34 for the value of  $\beta$  in the vapour, the same value at least as that for the liquid. (Also the assumption  $\rho_2 = 0,0366$  instead of 0,0372 might lead to the desired purpose).



g.  $t = -175^{\circ},39 = 97,70$  abs. Hence  $m = 0,6485$ ,  $3,424 m = 2,221$ . The value of  $\varepsilon$  interpolated from  $-\log^{10} \varepsilon = \text{etc.}$  with  $f' = 2,322$ , gives  $\varepsilon = 0,05518$ .

$d$	$n$	$\varepsilon + 5d^2$	$n - \beta$	$\beta$
$d_1 = 2.4960$	0.401	31.21	0.071	0.329 (liq.)
$d_2 = 0.02745$	36.43	0.05894	37.67	-1.24! (v.)

Can the clue to the singular behaviour of the vapour perhaps be found in this that CROMMELIX has not determined the vapour densities *directly*, but that he has calculated them from the law of BOYLE? With a too small value of  $n$  one naturally gets then a too slight value of  $\beta$  from  $\beta = n - (3,424 m : \varepsilon)$ . Then no association need of course be assumed in the vapour, and the impossible values of  $\beta_r$  below  $T_k$  are at once accounted for. The found values of  $\beta_r$  would then be quite worthless. The question is therefore: where has CROMMELIX begun not to determine the given values of the vapour density directly, but to *calculate* them from the (not yet valid) law of BOYLE? <sup>1)</sup>

h.  $t = -183^{\circ},15 = 89,94$  abs. Here  $m = 0,5970$ ,  $3,424 m = 2,044$ . From  $\log^{10} \varepsilon = \text{etc.}$  we find the value  $\varepsilon = 0,02742$  ( $p = 1,3162$ ) with  $f' = 2,314$ .

$d$	$n$	$\varepsilon + 5d^2$	$n - \beta$	$\beta$
$d_1 = 2.589$	0.386	33.53	0.061	0.325 (liq.)
$d_2 = 0.01509$	66.26	0.02856	71.57	-5.31! (v.)

We point out that the liquid value duly decreases gradually, and is still higher than  $\beta_0 = 0,29$  at  $T = 90$  (absolute). So there is nothing impossible here <sup>2)</sup>.

1) Otherwise  $p = 2,78$  would have to be taken here instead of 2,64, hence  $\varepsilon = 0,058$  instead of 0,055; or else  $q_2$  should be assumed somewhat smaller, in order to find at least the value 0,33 (that of the liquid) for  $\beta_{\text{vapour}}$ .

2) A rise of  $p$  to 1,44 instead of 1,32 ( $\varepsilon$  to 0,030 instead of 0,0274) - or else a diminution of  $q_2$  from 0,0080 to 0,0075 - might reduce  $\beta_r$  to 0,33 here. The first supposition is impossible, for then the value of  $p$  at  $-183^{\circ},15$  would be greater than at  $183^{\circ},01$ , where 1,34 was found. But a diminution of  $q_2$  by 6% in consequence of an erroneous calculation of  $q_2$  (probably from the law of BOYLE) is very well possible.

Summarizing, we get the following survey for the region of coexistence.

$m$	0.98	0.94	0.91	0.88	0.81	0.74	0.65	0.60
$\beta_{liq.}$	0.39	0.37	0.37	0.36	0.35	0.34	0.33	0.325
$\beta_v.$	0.42	0.38	0.32?	0.23?	0.20?	0.09?	-1.24?	-5.3?

At the lowest temperature, viz.  $t = 89,94$  abs.,  $\gamma$  would be about 0,688, and  $\beta_v$  accordingly 0,393,  $\beta_v = \beta_0 \times 1,389 = 0,397$ , so that  $\beta$  ranges from about 0,40 to about 0,29. The liquid value 0,325 at  $n = 0,4$  can be in harmony with this.

In order to examine whether the values of  $\beta_{liq.}$  also agree quantitatively with our theory, we will in the first place indicate for the different values of  $T(m)$  the corresponding values of  $n$  and  $\gamma$  (calculated from  $2\gamma - 1 = 0,038 \sqrt{T}$ ). Besides the value of  $v : v_0 = v : b_0 = n : \beta_0$  is given. ( $\beta_0 = 0,286$ ).

$m$	0.98	0.94	0.91	0.88	0.81	0.74	0.65	0.60	0
$n$	0.687	0.580	0.545	0.513	0.466	0.434	0.401	0.386	0.286
$\gamma$	0.731	0.726	0.723	0.719	0.710	0.702	0.693	0.688	0.5
$v : v_0$	2.40	2.03	1.91	1.79	1.63	1.52	1.40	1.35	1
hence $\beta : \beta_0$	1.33	1.24 <sup>5</sup>	1.21 <sup>5</sup>	1.18	1.14	1.11	1.08	1.07	1
$\left\{ \begin{array}{l} \beta \text{ calc.} \\ \beta \text{ found} \end{array} \right.$	0.381	0.356	0.348	0.338	0.326	0.318	0.309	0.306	0.286
	0.394	0.373	0.366	0.358	0.347	0.39	0.329	0.325	(0.305)

The values  $\beta : \beta_0 = b : b_0$  have been calculated from the tables of § 16, viz. from those for  $\gamma = 0,75$  and  $\gamma = 0,70$ . We have interpolated for the values of  $\gamma$  given in the above table. On an average the found values of  $\beta$  are 6% higher than the values calculated from our formula (30). If  $\beta_0 = 0,30^5$  were taken instead of 0,28<sup>5</sup>, the agreement would have been perfect. In connection with this it is remarkable that the *difference* between  $\beta_{found}$  and  $\beta_{calc.}$  amounts *almost constantly* to 0,018 or 0,019. The *course* of the  $\beta$ -values is therefore perfectly identical with the course calculated from our formula; identity in the *numerical values* may be obtained by simple change of  $\beta_0$  from 0,28<sup>5</sup> to 0,30<sup>5</sup>.

In fact, something is to be said in favour of this. In § 17 we namely calculated the value of  $\beta_0$  from  $2\gamma = b_k : b_0 = \beta_k : \beta_0$ , so that  $\beta_0 = \beta_k : 2\gamma = 0,429 : 1,5$  became  $= 0,286$ . But in this it is assumed that the direction of the straight diameter remains the same down to the absolute zero point — which (as we already observed at the conclusion of § 14 (III p. 1051) *cannot* be the case. On the contrary the coefficient of direction will approach to about 0,5 for all substances at low temperatures. It follows from this that the value of the liquid density at  $T = 0$ , viz.  $\rho_0$ , which is extrapolated from the direction of the so-called straight diameter (*at the critical point*), will always be *too great*, hence  $v_0$  too small, and also  $b_0 = v_0$  too small. Accordingly also the value of  $\beta_0 = b_0 : v_k$  will be found *too small*, when the inadmissible extrapolation is performed.

The *real* value of  $\beta_0$ , occurring in our formula (30) for  $b = f(v)$ , will therefore be always greater than that which occurs in our relations found in I (which are valid *at the critical temperature*). For the calculations of the real  $\beta_0$ , in order to test our formula (30) by the observations, the calculation from  $\beta_0 = \beta_k : 2\gamma_k$  (which is based on this extrapolation) has therefore to be rejected.

The above table need, therefore, give no occasion to conclude to any deviation with respect to the calculated and the found values of  $\beta$ ; the more so as the *course* is perfectly the same, in consequence of the fact that in the relation (30) *not*  $b$ , *but*  $b - b_0$  occurs, so that through simple increase of  $\beta$  to 0,305 the found values of  $b - b_0$ , resp.  $\beta - \beta_0$  will agree perfectly with the values of  $\beta - \beta_0$  calculated from our formula.

*Remark.* We saw that the found values of  $\beta_g$  from the unsaturated gas state (§ 17) were all found *too great* for values of  $m > 1$ ; for values of  $m < 1$  all *too small* i. e. larger or smaller than the values of  $\beta_g$  or  $\beta_k$  calculated from our formulae. Also in the region of coexistence ( $m < 1$ ) we found values for  $\beta_v$  which are all too small, may even negative, hence impossible. Now the too small values may be easily accounted for either by association in the vapour at low temperatures, or through a faulty method of calculation of  $\beta_2$  from the law of BOYLE (see above). But the too large values of  $\beta_g$  at  $m > 1$  *cannot* be accounted for in this way.

It is, however, remarkable, that those too large values of  $\beta_g$  at  $m < 1$ , combined with the *liquid* values at  $m < 1$ , seem to obey the relation

$$\beta = 0,4 \sqrt{m}$$

pretty well, as appears from the table on the next page.

$m =$	1.95	1.43	1.13	1.04	1.01	0.98	0.94	0.91	0.88	0.81	0.74	0.65	0.60
$\sqrt{m} =$	1.40	1.20	1.06	1.02	1.005	0.99	0.97	0.95	0.94	0.90	0.86	0.80	0.775
0.4 $\sqrt{m} =$	0.56	0.48	0.42	0.41	0.40	0.40	0.39	0.38	0.38	0.36	0.34	0.32	0.31
$\beta$ found	0.55	0.51	0.45	0.43	0.42	0.39	0.37	0.37	0.36	0.35	0.34	0.33	0.325

The values on the lefthand side of the dividing line might have a somewhat higher factor, viz. 0.42; those on the righthand side of the line (the liquid values) a somewhat smaller factor, e. g. 0.39.

Yet this relation can hardly satisfy for several reasons. First because the formula  $\beta = 0.4\sqrt{m}$  would yield too large values of  $\beta_g$  for larger values of  $m$ ; it is at least inconceivable that the increase of  $b_g$  with the temperature will continue indefinitely. But secondly the variability with  $v$  would disappear through this consideration, and only dependence on  $T$  would be assumed. It would then be quite indifferent, whether  $b$  was considered at large or at very small volumes. That this, however, is entirely impossible, is at once seen when we bear in mind that only by the assumption  $b = f(v)$  we duly get  $r < 3$ ,  $s > 2/3$ , and  $f' > 4$ ! Only for "ideal" substances, i. e. at the absolute zero point, can  $b$  be independent of the volume.

Other relations could also be derived, among others between the found values of  $\beta$ ,  $n - \beta$ , and  $m$ <sup>1)</sup>, but they may also be due to chance. We shall, therefore, no longer dwell upon them.

### 19. The characteristic function.

It is known that for "ordinary" substances the value of the "characteristic" function  $q$ , i. e.

$$q = \frac{j-1}{j_k-1} \frac{\varepsilon}{d_1 d_2},$$

in which  $j = \frac{m}{\varepsilon} \frac{d\varepsilon_{roc.}}{dm}$  is not constantly = 1 — as would have to be the case, when  $a$  or  $b$  should either not depend on  $T$  or only linearly — but with diminishing  $m$  increases from 1 to about 1.4 at  $m = 0.6$ , with about 1.5 as probable limiting value when  $m$  approaches to 0. See VAN DER WAALS, and also my Paper in These Proc. of 25 April 1912, p. 1099—1101, in which it appeared that  $q = 1 + 6.8(1-m)$  can be put in the neighbourhood of the critical point. (loc. cit. p. 1101).

<sup>1)</sup> When e. g. in the region of coexistence for the different values of  $m$  we write the corresponding values of  $n$  and  $n - \beta$ ,  $\frac{\Delta\beta}{\Delta(n - \beta)}$  appears to be about constant, viz.  $\pm 0.23$ .

For this it is however required that either  $\frac{\partial^2}{\partial m^2} \left( \frac{a}{a_k} \right)_k = 6,8$ , or  $\frac{\partial^2}{\partial m^2} \left( \frac{b}{b_k} \right)_k = -6,5$ . (Cf. These Proc. of 3 Sept. 1913, p. 56 and 57).

It is now certainly interesting to consider how this will be for a substance as Argon, where  $\gamma_k$  is not 0,9, but 0,75.

For the calculation of the values of  $f$  I had to make use of RANKINE—ROSE'S interpolation formula drawn up by CROMMELIN and treated already above (§ 18). This gives, indeed, the much too low value 5,628 instead of 6 for  $f_k$ , but as also the following values of  $f$  will possibly be too small in the same degree, there is a chance that the value of the ratio  $(f - 1) : (f_k - 1)$  will not differ too much from reality. We then find the following table.

$T$	$m$	$\epsilon$	$d_1 d_2$	$\frac{\epsilon}{d_1 d_2}$	$f$	$\frac{f-1}{f_k-1}$	$q$
150.65	1	1	1	1	5.628	1	1
147.92	0.9819	0.8947	0.8103	1.104	5.696	1.015	1.12
141.55	0.9396	0.6964	0.6311	1.104	5.869	1.052	1.16
137.58	0.9132	0.5890	0.5529	1.965	5.987	1.078	1.15
132.89	0.8821	0.4757	0.4609	1.032	6.137	1.110	1.15
122.33	0.8120	0.2832	0.4742	1.033	6.534	1.196	1.24
111.86	0.7425	0.1549	0.1618	0.957	7.047	1.307	1.25
97.70	0.6485	0.0552	0.0685	0.805	8.080	1.530	1.23
89.94	0.5970	0.0274	0.0391	0.702	8.945	1.717	1.21

It is certainly remarkable that it would follow from the found values of  $q$  that here too  $\left( \frac{\partial q}{\partial m} \right)_k$  would be about  $-7$ , just as for ordinary substances as Fluorbenzene e.g. (see above). For  $\left( \frac{\partial q}{\partial m} \right)_k = -\frac{0,120}{0,0181} = -6,63$  (whereas it is  $-6,8$  for  $C_6H_5F$ ). But on this head little can be said with certainty, as we have too few observations in the immediate neighbourhood of  $T_k$  at our disposal.

The limiting value for  $m = 0,6$  is now, however, much lower, namely about 1,23 against 1,41 for ordinary substances. Now for

$C_6H_6F$  the value of  $\gamma_k$  is  $= 0,95$ ; hence  $b_k : b_0 = 2\gamma_k = 1,90$ , and  $(b_g : b_0)_k = 1,90 \times 1,06 = 2,01$ , whereas  $\sqrt{2,01} = 1,42$ . Further for Argon  $\gamma_k = 0,75$ , hence  $b_k : b_0 = 1,50$  and  $(b_g : b_0)_k = 1,49 \times 1,018$  (See II, p. 936)  $= 1,516$ , whereas  $\sqrt{1,516} = 1,231$ .

It follows from this that with great accuracy

$$\varphi_0 = \sqrt{(b_g : b_0)_k} = \sqrt{2\gamma'} \quad . \quad . \quad . \quad . \quad . \quad (41)$$

may be written for the limiting value at low temperature of the characteristic function  $q$ .

It is therefore again only for "ideal" substances ( $b = \text{const.}$ ) that  $\varphi_0 = 1$ , and hence  $q$  continually  $= 1$  from  $T_k$  (then  $= 0$ ) to the absolute zero. But for all the other substances the value of  $q$  will increase from 1 to a limiting value, which will depend on the degree of variability of  $b$ .

As according to (36)  $(b_g - b_0)_k : b_0 = 2\gamma' - 1 = 0,041 \sqrt{T_k}$  (see III § 15), we have also :

$$\varphi_0 = \sqrt{1 + 0,04 \sqrt{T_k}} \quad . \quad . \quad . \quad . \quad . \quad (41a)$$

We shall not enter any further into this subject, leaving it for a possible later discussion.

In conclusion we shall just repeat what we have already remarked in I, p. 820, that the temperature dependence at extremely low temperatures, where the departures from the equipartition law make themselves felt, undergo a modification. But we shall not enter into this any further either, and we only mention that for Argon the departures from the said law fall entirely within the errors of observation even at  $90^\circ$  absolute (the lowest temperature at which observations have been made). Besides, at those *extremely* low temperatures all substances will probably have passed into the *solid* state, and this state is controlled by other laws than the liquid and the gaseous state, for which our considerations exclusively hold.

**20. Conclusion.** Though there are still many questions to be answered, and many difficulties left, we may already conclude in virtue of the foregoing to this:

1. The quantity  $a$  of VAN DER WAALS' equation of state seems within a large range not to depend on the density, so that the molecular attraction can be represented by  $\frac{a}{v^2}$ , both in the gaseous and in the liquid state.<sup>1)</sup>

<sup>1)</sup> Cf. also the conclusions in a paper by TYRER in the just published number of the Zeitschr. f. Ph. Ch. (87, Heft 2) p. 195.

2. Whether the quantity  $a$  is also independent of the temperature, cannot be stated with perfect certainty yet. For as I think I have fully set forth in my Communications of These Proc. of 25 April 1912 (p. 1091—1106) and particularly of 3 Sept. 1913 (44—59), the assumption of a *large* value either of  $\left(\frac{\partial^2 a}{\partial t^2}\right)_k$  or of  $-\left(\frac{\partial^2 b}{\partial t^2}\right)_k$  (see p. 56—57 loc. cit.) is necessary for the explanation of the course of the characteristic function  $q$  (see § 19). And as, according to the above,  $b_g$  is, indeed, variable with the temperature, but probably not so much that  $-\left(\frac{\partial^2 b}{\partial t^2}\right)_k$  gets the required value, besides  $b$  possibly also  $a$  might depend on the temperature. Only a separate investigation can furnish certainty about this.

3. The quantity  $b$  depends both on  $v$  and on  $T$ . The way in which  $b$  depends on  $v$  — which is expressed by a formula of the form (see II p. 931 et seq., III p. 1048, formula (29))

$$\left(\frac{b-b_0}{b_g-b_0}\right)^n = 1 - \left(\frac{x}{x_0}\right)^n,$$

in which  $x = (b-b_0) : (v-v_0)$ , and  $n$  depends on the quantity  $\gamma$ , which is in connection with  $b_g : b_0$  — leads us to suspect that the variability of  $b$  is possibly chiefly a *real* change after all, caused by the action of the pressure  $p + a/v^2$  and of the temperature, in an *analogous* way to that which VAN DER WAALS had in mind when drawing up his “equation of state of the molecule”, with which the above expression shows a close resemblance. [cf. also II p. 930—931 (23 April 1914)]. Particularly also with regard to the temperature dependence, viz. [see III p. 1051—1053, formulae (35) to (36)]

$$\frac{b_g-b_0}{b_0} = 2\gamma' - 1 = 0,04 \sqrt{T},$$

this agreement is remarkable. But whereas VAN DER WAALS' two exponents  $n$  are different, our two exponents are the *same* — and dependent on  $\gamma$ , i. e. on  $T$ , so that  $n$  can vary from  $3^{1/2}$  (for  $\gamma = 1$ ) to  $\infty$  (for  $\gamma = 1/2$ , i. e.  $T = 0$ ), as has been set forth in II, p. 935.

4. It seems to be unnecessary to ascribe the change of  $b$  to “quasi association”. It might namely be assumed that the complex molecules possess another volume than the simple ones, and from this a relation  $b = f(v)$  might be calculated — according to the known thermodynamic relations which indicate the degree of complexity as function of  $v$  and  $T$ .  $RT$  is then however multiplied by another factor which depends on the degree of association.

What VAN DER WAALS has treated in that sense on p. 1076 of

his Paper in These Proc. of 25 Jan. 1913 (published March 13<sup>th</sup>), had then already been treated very fully in a series of four papers, written by me at Clarens 1911—1912 (On the variability of  $b$  etc.; see These Proc. of 26 Oct., 22 Nov. 1911; 24 Jan., 22 Febr. 1912). That a good deal may be attained in this way can sufficiently appear from these Papers. That difficulties present themselves of the same nature as have been advanced by VAN DER WAALS on p. 1076 at the bottom (*loc. cit.*), has also appeared at the end of the 4<sup>th</sup> Paper (p. 716 et seq.).

In any case it is a kind of relief that according to all that proceeds the assumption of quasi association does not seem absolutely necessary. The change namely of  $b$  with  $v$  and  $T$  can very well be explained by other influences.

5. That  $b_g$  gradually decreases with the temperature, so that  $b_g$  would coincide with  $b_0$  at  $T = 0$ , and accordingly the variability of  $b$  would have quite disappeared — in consequence of which we approach more and more to the *ideal* equation of state with constant  $b$ , on approaching the absolute zero — this points to the invalidity of the kinetic assumption, that for *very large* volume (for  $b_g$  only refers to *large* volumes) i. e. in *ideal gas state*,  $b_g$  would be  $= 4b_0$ . For according to the well known kinetic derivation,  $b_i$  would then still be  $= 4b_0$  at the lowest temperatures, whereas it has clearly appeared that  $b_g$  approaches more and more to  $b_0$  at low temperatures. Compare particularly III p. 1051, formula (35) and the subsequent eloquent table.

6. Thus after all it would prove true what I wrote in I p. 809 (These Proc. of 26 March 1914), that namely in  $v-b$  the quantity  $b$  always refers to the real volume of the molecules  $m$  and is not  $= 4m$ , as the kinetic theory would lead us to assume. And in this way the difficulty, which I emphatically pointed out in II, p. 925 (at the bottom)—926, would have naturally vanished.

So it is getting more and more probable that the so-called *quasi* diminution of  $b$  does not exist, and that there remains only *real* diminution, which is represented by a formula of the form (29), as far as the dependence on  $v$  is concerned, and by a formula of the form (36), as far as the dependence on  $T$  is concerned.

Why the earlier kinetic assumption  $b_g = 4m$  is really a fiction, and what circumstance has been overlooked then — this I shall demonstrate in a separate Communication.

It will then have become clear that only  $v-m$ , and not  $v-4m$  determines the thermic pressure — which becomes already probable when the kinetic energy of the moving molecules is thought to be



uniformly absorbed by the surrounding medium (see p. 809 of I, already cited above).

7. Hence at bottom the whole thermic behaviour of a substance does not depend *only* on the two quantities  $a$  and  $b$ , which determine the critical quantities, which in their turn govern the law of the corresponding states — in such a way that all the substances behave correspondingly when they are only considered in equal multiples or sub-divisions of their critical temperature and critical pressure, but also (and the *deviations* from the said law are governed by this) on the *absolute* height of the temperature, at which the substance is considered. According to (36) every substance passes namely through the different types — characterised by the variable ratio  $b_g : b_0$ , from the type of the “ordinary” substances, where  $b_g = b_0$  is about 1,8 ( $\gamma = 0,9$ ) to the type of the “ideal” substances, where  $b_g$  is  $= b_0$  ( $\gamma = 1/2$ ) — when we descend from the ordinary temperatures to the absolute zero point (see the tables in I, p. 819 and III p. 1052).

The *individuality* of the different substances, which they continue to preserve within the region of the Law of the Corresponding States, is therefore entirely determined by the *real* height of the (absolute) temperature.

Hydrogen at  $323^\circ$  absolute ( $T = 10T_k$ ) will e.g. *on the whole* (Law of Corresponding States) exhibit the same behaviour as Helium at  $52^\circ$  absolute ( $T$  also  $= 10T_k$ ) — but  $H_2$  will show a value of about 1,7 for the ratio  $b_g : b_0$  at that higher temperature, while  $He$  at the same “corresponding” temperature shows a value of about 1.2 for that ratio.

For  $v_k : b_k$  we shall find about 2,7 for Hydrogen and Helium at their critical temperature, while  $v_k : b_k = 2,1$  is found for an ordinary substance at its critical temperature. Etc. Etc.

And this may suffice for the present. I hope to come back to some *separate* problems later on, which are still awaiting solution. I may mention: the temperature dependence of  $f'$  (see I, p. 811), the change of direction of the “straight” diameter from  $T_k$  to very low temperatures (III p. 1051), the form of the vapour-pressure equation  $p = f'(T)$ , the dependence of the densities of liquid and vapour on the temperature (in connection with the problem of the direction of the straight diameter); and finally the course of the characteristic function in its dependence on  $T$ .

But the very first point that will be elucidated in a following Paper is the circumstance mentioned under 6 of the conclusions, that  $b_g$  cannot possibly be  $= 4m$ .

*Fontainevent sur Clarens, April 1914.*

**(September 26, 1914.)**



KONINKLIJKE AKADEMIE VAN WETENSCHAPPEN  
TE AMSTERDAM.

PROCEEDINGS OF THE MEETING  
of Saturday September 26, 1914.

VOL. XVII.

*President:* Prof. H. A. LORENTZ.  
*Secretary:* Prof. P. ZEEMAN.

(Translated from: Verslag van de gewone vergadering der Wis- en Natuurkundige  
Afdeling van Zaterdag 26 September 1914, Dl. XXIII).

C O N T E N T S.

- H. DU BOIS: "Modern electromagnets, especially for surgical and metallurgic practice", p. 468.
- A. WICHMANN: "On the Tin of the island of Flores", p. 474.
- M. J. VAN UVEN: "The theory of the combination of observations and the determination of the precision, illustrated by means of vectors." (Communicated by Prof. W. KAPREYS), p. 490.
- H. KAMERLINGH ONNES and G. HOLST: "On the measurement of very low temperatures. XXIV. The hydrogen and helium thermometers of constant volume, down to the freezing-point of hydrogen compared with each other, and with the platinum-resistance thermometer," p. 501.
- II. KAMERLINGH ONNES and G. HOLST: "On the electrical resistance of pure metals etc. IX. The resistance of mercury, tin, cadmium, constantin and manganese down to temperatures, obtainable with liquid hydrogen and with liquid helium at its boiling point," p. 508.
- II. KAMERLINGH ONNES: "Further experiments with liquid helium. L. The persistence of currents without electro-motive force in supra conducting circuits", p. 514.
- II. KAMERLINGH ONNES and K. HOF: "Further experiments with liquid helium N. HALL-effect and the change of resistance in a magnetic field. X. Measurements on cadmium, graphite, gold, silver, bismuth, lead, tin and nickel, at hydrogen- and helium-temperatures." p. 520.
- II. KAMERLINGH ONNES and H. A. KUYPERS: "Measurements on the capillarity of liquid hydrogen," p. 528.
- F. A. H. SCHREINEMAKERS and Miss W. C. DE BAAT: "The system: Copper sulphate, copper chlorid, potassium sulphate, potassium chlorid and water at 30°, p. 533.
- J. BÖESEKEN: "The Catalyse." (Communicated by Prof. A. F. HOLLEMAN), p. 546.
- F. M. JAEGER: "Researches on the Temperature-coefficients of the free Surface-energy of Liquids between  $-80^{\circ}$  to  $1650^{\circ}$  C. VII. The specific surface-energy of the molten Halogénides of the Alkali-metals". p. 555. "Ibid VIII. The Specific Surface-energy of some Salts of the Alkali-metals", (Communicated by Prof. H. HAGA), p. 571.
- G. DE BRUIN: "A crystallized compound of isoprene with sulphur dioxide." (Communicated by Prof. P. VAN ROMBURGH), p. 585.
- J. P. VAN DER STOK: "The treatment of frequencies of directed quantities. p. 586.
- J. J. VAN LAAR: "Some remarks on the values of the critical quantities in case of association." (Communicated by Prof. H. A. LORENTZ), p. 598.
- J. J. VAN LAAR: "On apparent thermodynamic discontinuities, in connection with the value of the quantity  $b$  for infinitely large volume." (Communicated by Prof. H. A. LORENTZ), p. 606.
- II. R. KRUYT: "Current Potentials of Electrolyte solutions." (Communicated by Prof. ERNST COHEN), p. 615.
- II. R. KRUYT: "Electric charge and limit value of Colloids." (Communicated by Prof. ERNST COHEN), p. 623.

**Physics.** — “*Modern electromagnets, especially for surgical and metallurgic practice.*” By H. DU BOIS. (Communication from the BOSSCHA-Laboratory).

(Communicated in the meeting of May 30, 1914).

*Carrying-Magnets.* The lifting-power of the famous steel magnets of LOGEMAN and VAN WETTEREN, has for a long time belonged to the somewhat antiquated subjects. However, traction-electromagnets are now being much more used in different forms, especially for loading and transportation purposes.

In general we may say, that for such magnets with armatures at a very small distance MAXWELL'S well-known law holds; accordingly  $\mathfrak{B}^2/8\pi$  measures the carrying-power per unit cross-section of an almost closed magnetic circuit. Prof. TAYLOR JONES has entirely confirmed this by experiment in the BOSSCHA-Laboratory. The magnetic balance as a measuring instrument is equally based upon this fundamental law. Electro-magnetic brakes on this principle are also being more and more used.

*Field-Magnets* are of more interest for a variety of scientific and practical purposes. In these Proceedings a description was given of semicircular magnets <sup>1)</sup>, one of which, weighing 350 kg., with an interferrum of  $3 \times 0,5$  mm. gave a uniform field of 59 Kilogauss, while using only a few Kilowatts. With a cryomagnetic “immersion-armature” in a liquid gas at low temperature this reduces to 45 Kilogauss. With the heaviest type weighing four times more (1400 kg.) we may cet. par. expect no larger increase than 10%, thus reaching 65 and 50 Kilogauss respectively. Until now these field values have not been superseded, no more than the Haarlem magnets were. For the investigation of several highly interesting problems they are absolutely necessary.

With regard to so small a rise of the field however it requires due consideration whether a further increase of the size of the magnets appears justifiable. For while the weight increases as the third power of the linear dimension, thus becoming quite unwieldy, the field rises logarithmically only, which means a great disadvantage. In fact for a given field we practically obtain only a larger interferrum. However convenient this may be, it is questionable whether it justifies the very high expense which gradually begins to surpass an average laboratory-budget.

<sup>1)</sup> H. DU BOIS, These Proceedings 12 p. 189, 1909; 13 p. 386, 1910.

The results mentioned are partly due to concentration of the Ampère-turns near the air-gap and also to careful calculation and design of all details; the theory of polar armatures<sup>1)</sup> communicated to the Academy, contributed its share to the result.

*Intestinal magnets.* Incidentally the formulae for attractory armatures were also given in the paper referred to. They show, that the attraction of *saturated* ferromagnetic particles is a maximum for cones with a semi-angle of  $39^{\circ}14'$ , and for prisms of  $30^{\circ}$ ; for *non-saturated* ferromagnetic or for *paramagnetic* substances these angles are  $42^{\circ}11'$ , and  $32^{\circ}8'$  respectively. According to the principle of FARADAY and KELVIN the attraction is determined by the gradient of the first [second] power of the intensity  $\mathfrak{H}$  of the field for the first [second] group of substances.

Some time ago Prof. PAYR<sup>2)</sup> proposed a magnetic diagnosis, prophylaxis and cure of peritoneal adhesions and similar deviations. For this purpose a ferromagnetic intestinal filling is introduced either per os or per rectum. Then magnetic force is applied from outside without the necessity of more or less dangerous laparotomy. At the request of this well-known surgeon I was glad to collaborate in the attempt towards a practical solution of this peculiar *attraction*-problem; for a rational treatment of it the above-mentioned armature-theory is absolutely necessary. The existence of an indifferent intermediate zone and the necessity for exciting large attractive forces only beyond this, characterizes this particular question.

The ordinary type has a core of high permeability (of 12 cm. thickness and 40 cm. length). It is somewhat concave at one end and thus fits the average form of the human body. In the paper referred to the formula is given for  $\mathfrak{H}$ ,  $\partial\mathfrak{H}/\partial x$  and  $\partial^2\mathfrak{H}/\partial x^2$  on the  $x$ -axis for the case of a segmental spherical armature and for that of a concave paraboloid of revolution. For the latter case it was shown that a certain distance not before a maximum of the field was reached. In this "neutral" point the gradient is zero and therefore the attraction also vanishes; the latter then increases, reaches a maximum and decreases again gradually. This distribution of the field is favoured by the higher magnetisation at the periphery of the core compared with that of the centre, which makes this case similar to that of hollow cores. In the outset I even used a core with a conical bore in order to allow an eventual radiologic transmission through it; this however proved later on to be practically unnecessary. A central

<sup>1)</sup> H. DU BOIS, These Proceedings 15 p. 330, 1912.

<sup>2)</sup> E. PAYR, Münch. med. Wochenschr. 60 p. 2601, 1913.

filling of the core with a substance of higher permeability might be made to compensate the distribution of the field above described. In our case however this very topography of the field is desired; for it is within the peritoneum only and not in the surrounding layer (the thickness of which individually varies from 2 cm. to 10 cm. and even more) that an attraction may be usefully exerted. Towards its other end the core gradually becomes thicker and the end is formed by a flange in order to decrease the magnetic reluctance; the counter-action of this pole compared with the attraction of the working pole is negligible.

The coils are wound with enamelled copper wire or with oxydized square aluminium wire the thickness of which increases by steps from the working pole towards the other end. This principle is well-known for galvanometers and has also found partial application in my semicircular magnets. The increased efficiency of the "polar windings" must necessarily cause a greater heating effect which may be counter-acted by water circulation.

Until now this precaution proved unnecessary, the more so because too cold iron may cause undesirable vasomotoric reflexes of the patient. The front flange of the coils is conical, in order not to be in the way of the operator's eyes and hands; it may be provided with a corrugated peripheric radiator. The use of alternating currents is not advisable; but a pulsating current may be caused by periodic short-circuiting of the magnet, while a non-inductive resistance remains switched in the circuit. The relaxation-time is a few seconds; by exciting the polar coil only it may be diminished to a few tenths of a second; when pulsations are often to be applied, it is advisable to use a subdivided core.

In order to reduce the weight as much as possible the core ought to be saturated only to  $\frac{3}{4}$  or  $\frac{1}{5}$ . A minimum total weight is obtained for a dimensional ratio<sup>1)</sup> between 3 and 4; then the power required is only little above its minimum value; it amounts at most to 4 K.-watt, for most operations it is considerably less; and considering the short duration of an operation the energy consumed (K.-watt-hours) is but very small. The magnet weighs about 100 kg. and is suspended by a kind of crane above the operation table, in such a way that its 6 degrees of freedom may be disposed of, i. e. a displacement along the vertical and a rotation around it, and the same for two horizontal axes parallel to the body of the patient and normal to it. Below the patient the RÖNTGEN-tube is placed, as

<sup>1)</sup> Calculated from the demagnetizing factors for short cores, as measured by S. P. THOMPSON and E. W. MOSS, Proc. Phys. Soc. Lond. **21**, p. 622, 1909.

far as possible from the magnet, in order to diminish its deviating action on the cathode rays<sup>1)</sup>. In some cases the patient may be treated while standing, which is much simpler.

Deep-seated intestines (7—20 cm. under the skin) are treated without pole-shoes. For those lying nearer the skin, the following pole-shoes are used which may be made of a highly saturated, polished and nicked, substance, such as ferrocobalt.

1. A "drawing-pole" in the form of a truncated cone with a semi-angle of  $40^\circ$ ; the attraction is strongest in the apex of the cone. The contents of the intestines may be first drawn towards a particular spot and then attracted towards the magnet.

2. A prismatic pole with a semi-angle of  $32^\circ$  for the treatment of longer intestinal sections.

3. An unsymmetric hoof-shaped "dragging-pole" for applying force parallel to the peritoneum. Starting from the above-mentioned principle it may be shown that a maximum gradient of  $\mathfrak{H}^2$  is reached when the narrow pole front forms an angle  $\alpha = 65^\circ 54' = \text{tg}^{-1} \sqrt{5}$  with the direction of dragging. For a very long prism on the other hand it ought to be  $\alpha = 60^\circ = \text{tg}^{-1} \sqrt{3}$ . In this way the best adapted shape of the pole-shoe may be determined, also fitting the cylindric core. For special purposes pole-shoes of various shapes may be designed.

The forces used here have often been measured with small iron test-spheres. The force component is

$$F_x = \frac{3}{4\pi} v \mathfrak{H} \frac{\partial \mathfrak{H}}{\partial x} = \frac{r^3}{2} \frac{\partial \mathfrak{H}^2}{\partial x},$$

$v$  denoting the volume,  $r$  the radius, there being no question of saturation. This expression is quite independent of the nature of the substance if only this is not too weakly ferromagnetic. The force, expressed as a multiple of the weight  $G$  of the test-sphere will be greater, the smaller the density of the latter. The value  $F_x/G = 1$  corresponds to the case that at a certain distance under the magnet the sphere is just being prevented from falling down. Considering this, spheres were made of magnetite ( $F_3O_4 =$  ferroferrite = ferr. oxyd. oxydulat. nigrum.) which quite fulfilled my expectations. Best of all proved small spheres of 1 cm. diameter of  $F_3O_4$ -powder mixed with a little mucilage and some light neutral powder; generally

<sup>1)</sup> The RÖNTGEN-tube is moved by the foot of the operator. The deviation of the cathode-current is proportional to its own strength, the value of the field at that place and the sine of the angle between these two directions; these three quantities ought to have low values. An iron-clad RÖNTGEN-tube might prove useful; but sparking constitutes rather a difficulty. In some cases a compensating coil near the cathode rays may be arranged.

these were used as test-spheres. This substance which fulfils all magnetic conditions is also to be recommended from a clinical point of view; it is neither poisonous nor soluble; it does not rust nor causes hydrogen to develop; it is not resorbed and hardly irritates the mucous membrane. It gives good RÖNTGEN-contrasts, even without addition of bismuth carbonate and it is more satisfactory than ferrum reductum pulverisatum; it is the principal ingredient of the emulsions, which are given per os or per anum, the prescriptions of which vary in practice. On this point and on the very satisfactory surgical results I need hardly give full details. The following will suffice <sup>1)</sup>).

The operative conditions were fulfilled and even surpassed. The practice gained with a number of patients led towards a reliable diagnosis of the normal or abnormal mobility of the intestines and of adhesions and their exact place. It was often managed to stretch and to raise them carefully either in the stage of fibrous adherence or in that of lasting mutual connexion. Of course reliable results cannot be obtained until later. The treatment may have a great effect on the position of the intestines or of their special sections; such a locomotion highly influences the peristaltic function; this ought to be especially the case with pulsating magnetic fields of smaller or greater frequency up to about 10 or 20 per second and of different form of pulsation-curve.

The accelerated or retarded displacement of intestinal substance containing ferromagnetic ingredients; the dragging of this into organs, which are too deeply seated to be reached in any other way, especially the appendix, with a view to radiologic diagnosis, the turning and loosening of intestinal slings remain subjects for further research. The principal advantages of this method are its localisation on a special part of the intestines, the precise regulation of the displacement, the easy dosing of the effect by regulating pole distance and current and the simultaneous radiologic examination.

In order to determine the topography of the field for various distances and currents, it was fixed by iron filings, with or without pole-shoes and if necessary it was measured with a standardized test-coil.

Moving along the axis, from the start at the concave pole front a minimum of the field is first met, then a maximum. To these correspond theoretically a transverse maximum and minimum respectively, and also an unstable and a stable zero-point of attraction. This is easily shown with a test-sphere in an axial glass tube, which is seen to remain suspended in that very point. With a plane pole front such singularities do not appear.

<sup>1)</sup> See also E. PAVR, Ber. D. chirurg. Congress, Berlin April 1914.



The attraction of a number of test-spheres or pills was measured under different circumstances with a spring-balance; its maximum was found at a distance of 4—5 cm. and amounts up to 25-fold weight; the greatest “carrying distance” is 22 cm., for test cylinders even more. For a round drawing-pole the maximum was found at 2 or 3 cm. and reaches 50-fold weight; at distances greater than 7 cm. the attraction becomes smaller than that observed without the use of a pole-shoe. The coils were constructed in such a way that their purely electrodynamic attraction, which is determined by the square of the current, contributes considerably to the total force. With a dragging-pole a transverse force is obtained up to 25-fold weight at a distance of 2,5 cm.

Though for our purpose the type described proved amply sufficient, it appears however interesting to study the properties of a similarly enlarged or reduced instrument. If the linear dimensions be  $n$ -fold the weight of the iron varies as  $n^3$ , that of the copper as  $n^3$  (or as  $n^2$ , depending on the mode of winding), the kilowatts consumed as  $n$  (or respectively as  $n^2$ ), the attraction of non-saturated particles at a given distance however nearly as  $n^4$ . This 4<sup>th</sup> power (in fact about the 3,7<sup>th</sup>) is evidently very favourable, especially as compared with the above-mentioned very uneconomical logarithmic progression for field-magnets. We may safely predict that it will be possible to produce any necessary force with magnets which do not yet become unmanageable and the cost of which will hardly prove a serious obstacle in this case, where life and health of the patients may be at stake.

*Extracting magnets.* In this way it ought to be possible to move about ferromagnetic probes brought into the body on purpose or to extract undesirable objects, such as steel bullet shells, broken needles or injection-syringes and various iron or nickel objects, which are daily met with in the surgery of accidents.

Also an effect on other organs, less soft than the intestines may be thought of. It has long been known that all tissues are diamagnetic; FARADAY already showed that this is also the case with blood; the iron atoms in haemoglobine are bound in such a way that no paramagnetism occurs, no more than e.g. for potassium ferrocyanide. PLÜCKER<sup>1)</sup> showed that a magnet repels the red blood globules relatively to the serum. It is moreover also known that the flow of diamagnetic liquids through tubes and their dropping may be con-

---

<sup>1)</sup> A. PLÜCKER, Pogg. Ann. 73 p. 576, 1848.

siderably influenced under special circumstances by very strong fields<sup>1)</sup>.

By putting  $n < 1$  the effect of reducing the dimensions is at once evident; this is interesting with a view to the design of the usual ophthalmic magnets which may also be improved by the above calculations and experiences; the maximum distance in this case is not more than 2.5 cm. A type is now being made of 8.5 cm. diameter of core, serving the double purpose of an intestinal magnet of less strength than the above and at the same time of a very powerful ophthalmic electromagnet.

*Ore separators* have long been applied in metallurgy to separate unmagnetic from ferromagnetic or only paramagnetic powdered ore by the dry or the wet method. These apparatus are variously constructed; the principal magnetic organ is however essential and common to them all and is a more or less finely ribbed polar armature. The best cross-section for a definite mean size of the grains may be determined by means of the theory above-mentioned for a prism semi-angle between  $30^\circ$  and  $32^\circ 8'$ .

**Mineralogy.** — “*On the Tin of the Island of Flores.*” By Prof. Dr. A. WICHMANN.

(Communicated in the meeting of June 27, 1914).

During the last decenniums very contradictory answers were given to the question regarding the occurrence of tin-ore in the Isl and of Flores. The fact that the solution of this question does not only regard the interests of a mining-scientific nature, but is likewise very interesting from a mineralogical and geological point of view may justify the attempt of elucidating this subject.

In the first place we have to bring into remembrance the fact, that in the Sunda Islands the older geological formations gradually disappear if we move in that range of islands in an easterly direction, till — beginning from Bali — only neogenic and pleistocene sediments are found, and at the same time tertiary and post-tertiary eruptive rocks with their tufas begin to play a predominant part. The question rises then: Does Flores make an exception to this rule and do we find in this island remains of ancient granite stocks, accompanied by deposits of tin, or are all the reports regarding the occurrence of this ore only of a legendary nature?

<sup>1)</sup> O. LIEBKNECHT and A. P. WILLS, *Ann. d. Phys.* 1 p. 183, 1900. W. J. DE HAAS and P. DRAPIER, *Ann. d. Phys.* 42 p. 677, 1913.

The first report originates from J. P. FREYSS, who wrote on account of his information received in 1856 in Manggarai (West Flores). "In the mountains of Rokka at Sui Tui <sup>1)</sup> gold is found, whilst "Mount Aspana produces tin <sup>2)</sup>".

In 1866 a resolution was taken by the Governor General L. A. J. W. BARON SLOET VAN DE BEELE "to send a trustworthy functionary "to the isle of Flores in order to investigate if on the south-coast "of this island in the neighbourhood of the village of Rokka tin "is found". It is unknown whether the resolution (of January the 15<sup>th</sup> N<sup>o</sup>. 3) was ever put into execution <sup>3)</sup>.

Five years afterwards J. A. VAN DER CHILS fixed the attention to the fact, "that every year a rather considerable quantity of arm- "and leg-rings made of tin and of a rude construction was exported "from the district of Rokka, situated on the south-coast of the isle "of Flores" <sup>4)</sup>. The Indian Government having been requested to order the controller S. ROOS, established in the isle of Sumba, to make an investigation whether in reality tin occurred in Flores, a resolution was taken to this effect November the 13<sup>th</sup> 1871 N<sup>o</sup>. 3, and the Board of Directors of the Society of Industry and Agriculture received a short time after from the above-mentioned functionary "a few specimens of tin-ore from Masara".

According to the investigation which was entrusted to C. DE GAVERE, the mineral in question was pyrites <sup>5)</sup>. In the mean time the Governor General PIETER MIJER had authorised, by resolution of April the 18<sup>th</sup> 1872 N<sup>o</sup>. 59, the resident of Timor to send an expert to Rokka "that he might convince himself on the spot, in "how far tin-ore is dug up and melted there, and at the same time "to collect some specimens of ore and rocks" <sup>6)</sup>. This investigation had neither any result, for, as was reported, the native chief <sup>7)</sup> this was the expert — "had until now, on account of ill health and

<sup>1)</sup> The place is called Sui (manggaraisch) or Tui (endelmeisch) and is situated on the west-side of the Aiméré bay. There can be no question of the occurrence of gold there, for behind that place rises the extinct vulcano Komba.

<sup>2)</sup> Reizen naar Mangarai en Lombok in 1854—56. Tijdschr. voor Ind. Taal-, Land- en Volkenkunde. **9**. Batavia 1860, p. 507.

<sup>3)</sup> Koloniaal Verslag van 1891, p. 29.

<sup>4)</sup> Tijdschr. voor Nijverheid en Landbouw in Ned. Ind. **16**. Batavia 1871, p. 158—159.

<sup>5)</sup> Tijdschrift voor Nijverheid en Landbouw in Ned. Ind. **17**. Batavia 1872, p. 184. **21**. 1877, p. 40—41.

<sup>6)</sup> As quoted **17**. 1872, p. 385.

<sup>7)</sup> He proved afterwards to be an Arab who had settled in Sumba (Koloniaal Verslag van 1891, p. 22).

“the unfavourable disposition of the population of the island, not yet fulfilled the order given to him.”<sup>1)</sup>

A short time after S. Roos communicated the following information concerning tin. “The people of Rokka often sell on the shore bracelets made of tin, but they do not allow anybody to visit their village . . . The Endehnese admit as rather certain that much tin-ore occurs in the ground of Rokka, but for fear of being murdered they dare not venture into this village; this was likewise the reason why nobody, even for ample payment, would accompany me thither, so that I had to desist from the journey: It is however known to me that proas of Endeh and likewise Chinese of Kupang and persons of other places from time to time come there to trade with the natives i. e. they anchor at Wai Wau or at Aiméré and carry on their trade on the shore with the people of Mangarai and with the inhabitants of the mountains, the latter offering for sale a trifle e. g. a parang or a pair of bracelets made of tin to the merchants. The bracelets are heavy, of rude workmanship, more than a hand broad and are worn above the elbow.”<sup>2)</sup> According to J. G. F. RIEDEL the tin is collected in Liu and Langgi (read Langga) by the natives “in a mysterious manner.”<sup>3)</sup>

Hitherto there had only been question of the supposed occurrence of tin in the district of Rokka, but in 1877 F. C. HEYNE wrote: “according to reliable reports a considerable quantity of tin is found in the territory of the Rajah of Larantuka, somewhere in Flores . . . the tin objects resembling silver gave lately to a traveller whom we met in Flores, the conviction, that the tin there is of an excellent quality.”<sup>4)</sup>

A request made by L. P. DEN DEKKER d.d. Kupang July 1<sup>st</sup> 1882, but not granted, to obtain the permission of prospecting in Flores, the Solor and the Alor Islands fixed again the attention of Government to the tin. The mandate of trying to obtain, if possible, some

<sup>1)</sup> Verslag omtrent het Mijnezen in Ned. Indië voor het jaar 1872. Jaarboek van het Mijnezen in Ned. Indië. Amsterdam 1873. I, p. 327. — Koloniaal Verslag over 1873, p. 260. — Two years afterwards it was reported however that, on account of the distrust of the population, it could not be ascertained whether the territory of Rokka was really rich in tin. (Koloniaal Verslag van 1875, p. 26).

<sup>2)</sup> Iets over Endeh. Tijdschr. voor Ind. T. L. en Vk. 24. Batavia 1877, p. 515.

<sup>3)</sup> The island of Flores or Pulau Bunga [sic.]. Revue coloniale internationale I. Amsterdam 1886, p. 66.

<sup>4)</sup> Het rijk van Larantoeke op het eiland Flores. Studiën op Godsdienstig, Wetenschappelijk en Letterkundig Gebied. 8, No. 6. 's Hertogenbosch 1876, p. 34—35. A. JACOBSEN described tin bracelets of East Flores (Reise in die Inselwelt des Banda-Meerens. Berlin 1896, p. 606—61).

of the tin objects originating from Rokka, given to the resident of Timor and to the magistrate of Larantuka was complied with.<sup>1)</sup>

From the investigation made by H. CRETIER it appeared that a tin bracelet contained lead, whilst a specimen of tin-ore was very ferruginous.<sup>2)</sup>

The examination of some bullets led further to the result that they were not composed of tin, but chiefly of lead and zinc with traces of tin, copper and iron. Should the "strongly ferruginous" ore be identical with the specimen "stroomfinerts van Oost-Flores", mentioned in the catalogue of the Mineralogical Collection of the Office of the Department of Mines at Batavia under N<sup>o</sup>. 3302 and really contain tin, then it is certainly not originating from this territory, where in several places titaniferous iron-ore but no tin is found.

In consequence of the resolution of the Governor General O. VAN REES of August the 5<sup>th</sup> 1887 N<sup>o</sup>. 4 the resident of Timor was authorised to order the magistrate E. F. KLEIAN to go to the district of Rokka, situated on the south-coast of this island, in order to obtain reliable evidence about the occurrence of grounds containing tin-ore in the interior of the isle of Flores.<sup>3)</sup> KLEIAN had supposed that he would reach his aim by choosing as place of issue the village of Nanga Lian in the district of Toa<sup>4)</sup> situated on the north-coast, where he landed the 12<sup>th</sup> of September. The 17<sup>th</sup> he marched to Nbai<sup>5)</sup> (about 8°34' S., 121°10' E.), he was however decidedly refused to go further to Soa and Poma, the supposed finding-places of the tin-ore. An inhabitant of the mountain of the village of Dora told, that at a few days' walk distance in a place called Watam Kadjan, situated between Poma and Soa, specimens of native tin were collected in the ravines, when the rainy season was over, to make bracelets and other ornaments. After having returned to the coast on the 19<sup>th</sup> he continued his journey as far as Rium on the 20<sup>th</sup>. The Rajah here, however, did not know anything about tin, nor was he inclined to procure an interpreter or a guide for the journey to the interior. Without having attained his end KLEIAN returned home again to Kupang.

1) Verslag van het Mijwезen in Ned.-Indië over het jaar 1882—83. Jaarboek van het Mijwезen in Ned.-Ind. 12. 1884. Techn. en administr. ged., p. 376, 301.

2) Bijdragen uit het scheikundig laboratorium van het hoofdbureau van het Mijwезen. Jaarboek van het Mijw. 13. 1884. Wetensch. ged., p. 312.

3) Koloniaal Verslag van 1891, p. 23.

4) He had already paid a visit to this district in 1875. (Een voetreis over het oostelijk deel van Flores. Tijdschr. v. Ind. T. L. en Vk. 34. 1891, p. 530—532.

5) Embai according to J. W. STOUTJESDIJK.

When in 1888 two applications for concession were made, one by A. LANGEN, who had received from a Chinese a specimen of granite and likewise a specimen of tin-ore, said to be originating from "the river Aspana", and a second by R. VAN DEN BROEK<sup>1)</sup> with 4 others, who requested to be allowed to explore 100000 bouws (!), the Governor General C. PIJNAKKER HORDIJK resolved to have an investigation made by an expert into the supposed abundance of tin-ore in Flores. By resolution of the 20<sup>th</sup> Sept. 1889 n<sup>o</sup>. 18 the mining-engineer of the Department of Mines C. J. VAN SCHELLE was appointed leader of the expedition. The expedition left Batavia on the 15<sup>th</sup> Nov., and arrived the 30<sup>th</sup> next at Kupang. After the resident of Timor had ordered the magistrate E. F. KLEIAN to accompany the expedition, they left on the 3<sup>rd</sup> Dec. for Larantuka and afterwards to Ende, where the assistant magistrate F. A. BRUGMAN joined them. On the 10<sup>th</sup> they disembarked at Soa, situated on the westside of the Aiméré Bay, and a reconnoitring-expedition was undertaken in a north-eastern direction as far as the village of Foan, where however none of the inhabitants could be prevailed upon to accompany the expedition to Langga, "which village is said to be situated in the neighbourhood of the "tin-region".

After their return on the 11<sup>th</sup> December they went into bivouac which they left again on the 15<sup>th</sup>. After a 10 hours' march in a north-eastern direction the mountain-ridge of Watu Loko was reached in the neighbourhood of Ekofeto. The next morning, a short time before their departure, they had to sustain an assault in which VAN SCHELLE and KLEIAN were wounded by sword-thrusts. In a forced march the expedition drew back to the Aiméré Bay, which they left in the afternoon of the 17<sup>th</sup> to sail back to Kupang<sup>2)</sup>.

From the information he had obtained VAN SCHELLE came to the conclusion "1<sup>st</sup> that none of the Endelmese, who had visited the "coast-region of Rokka and the neighbouring Mangarai knew anything "of an importation of tin under any form whatsoever. 2<sup>nd</sup> that the "mountaineers of these regions with whom they came into contact "possess tin ornaments, and use likewise tin to make their fishing-

1) This gentleman undertook in 1889 a scientific journey by order of the Kon. Nederl. Aardrijkskundig Genootschap. The results obtained have however never been published.

2) Koloniaal Verslag van 1890, page 21. — Verslag van het Mijnuwezen over het 4e kwartaal 1889, p. 11. — J. C. VAN SCHELLE. Verslag van het onderzoek naar het voorkomen van tinertshoudende gronden op Flores. Extra-Bijvoegsel der Javasche Courant. Batavia 1890, No. 10. — Tijdschr. voor Nederlandsch-Indië 1890. 2, p. 77—79. — TH. POSEWITZ. Die niederländisch-indische Zinnerzexpedition auf Flores. Das Ausland 64. Stuttgart 1891, p. 145—149.

“nets heavier; 3<sup>d</sup> that tin has little value for them and iron and copper is valued higher by them; 4<sup>th</sup> that constantly as finding-place of tin a special spot is indicated, situated northward from Mount Rokka, and the natives possess there considerable quantities of tin”<sup>1</sup>). Further he asserted “that the idea formerly occasionally suggested, that the tin that the people of Rokka possess, should be imported or proceed from solder of petroleum- or other tins must be rejected as utterly unfounded”.

The summary of his considerations was: “As far as the information I obtained reaches, I must admit that the soil to the north of the Mountain of Rokka is very rich in tin-ore. . . . Along a fissure running probably from East to West along the South-coast of Flores, the volcanic products have found a way and partly covered the other formations. The region containing tin-ore is situated at the frontier of the two formations, and we must admit, that the older formation there is strongly impregnated with tin-ore, and that by the desaggregation this comes free at the surface”.

The favourable expectations raised by VAN SCHELLE's report induced the Indian Government to send out a second expedition this time however supported by a strong military power. (Resolution of the 31<sup>st</sup> March 1890)<sup>2</sup>).

On the 11<sup>th</sup> May 1890 a detachment departed from Surabaya and arrived on the 14<sup>th</sup> in the Aiméré Bay, where on the left bank of the Wai Moké (Aiméré River) a bivouac was pitched. On the 8<sup>th</sup> July the well-known Watu Loko was occupied. On the 24<sup>th</sup> and 25<sup>th</sup> under protection of a strong patrol C. J. VAN SCHELLE made from this place in an eastern and north-eastern direction reconnoitring excursions to the supposed tin-region. Instead of grounds containing ore he found however crater-mountains, of which Kopo Lebo and Lebi Segu were ascended. On the 29<sup>h</sup> the patrol reached the top of Wolo Méré, 1650 feet high, and discovered that, as far as could be seen, it was of a volcanic nature.

After this complete failure a last effort was ventured to reach the “tin-region” from the district of Toa situated on the north-coast, where E. F. KLEIAN had taken information in 1887. By resolution of 10<sup>th</sup> Sept. 1890, N<sup>o</sup>. 1 it was stipulated that VAN SCHELLE and

1) In reality more than a dozen places were mentioned.

2) Koloniaal Verslag van 1870, page 22., 1891, p. 23 -29. — Verslag van het Nijnwezen over het 2de kwartaal 1890, p. 16; 3de kw. 1890, p. 12. — P. G. SCHMIDHAMER. De expeditie naar Zuid Flores. Indisch Militair Tijdschrift. 24. Batavia —c Gravenhage 1893, p. 101 -115 157 -213, 289- 307, 315 404, 493 -504, 25. 1894, p. 1 -11.





consequence of a report of ALBERT COLFS<sup>1)</sup> according to which the inhabitants of Potta bring tin to market. That information was not confirmed by him, on the contrary he was told that in the district of Dua to the South of Potta, tin, gold and even diamonds occurred.<sup>2)</sup>

The last investigation took place in the end during the years 1910 and 1911 by J. J. PANNEKOEK VAN RHEDEN. In the second of his papers<sup>3)</sup> mentioned at the foot he says with regard to the occurrence of tin: "According to the reports of WICHMANN and VAN SCHELLE "there was sufficient foundation for the supposition that the tin that "was used by the population of Central Ngada was originating "from ore found in the district itself."<sup>4)</sup> As the presumable finding- "place the region to the North of volcano Inië Rië is indicated. On "the occasion of the expedition in North Ngada in 1890 a slight "quantity of fine cassiterite was collected near Torang. *The investi- "gation I was charged with about the occurrence of tin-ore in these "regions could not yet be brought to an end on account of the un- "favourable political situation."<sup>5)</sup>*

After the above historical explanation we shall now try to answer the question whether there is sufficient ground to admit that tin occurs in Flores. C. J. VAN SCHELLE had answered the question affirmatively and supported his answer by the 3 following hypotheses. 1<sup>st</sup>. nothing is known about the importation of tin objects, 2<sup>nd</sup> the

1) COLFS made a journey through Manggarai in 1880. In the description of his journey not a single word is said about the above communication (Het Journaal van ALBERT COLFS. Batavia 1888, p. 71—72).

2) Verslag van de reis van den Controleur HOEDT naar de noordkust van West-Flores. Tijdschr. voor Ind. T. L. en Vk. 36. 1893, p. 281, 292.

3) Eenige geologische gegevens omtrent het eiland Flores. Jaarboek van het Mijnwezen in Ned. Ind. 39. 1910. Batavia 1912. Verhandl. p. 132—138, pl. X. — Overzicht van de geographische en geologische gegevens verkregen bij de Mijnbouwkundig-geologische verkenning van het eiland Flores in 1910 en 1911. Jaarboek van het Mijnwezen 40. 1911. Batavia 1913. Verhdlg., p. 208—226.

4) This remark is, in so far as regards myself, entirely invented. The only thing ever written by me about this subject runs as follows: "Ebenso schleierhaft (namely, as the origin of the Muti Tanah) ist die Herkunft des Zinns, dem "eine gleiche Entstehung zugeschrieben wird. Es bedarf keiner eingehenden Ausein- "andersetzung, um darzuthun, dass Zinnerz durch brennendes Gras nicht reducirt "werden kann. Man hat auch noch niemals die geringste Spur von Zinnerz auf "Flores gefunden. Die uns zu Gesicht gekommenen Gegenstände aus Zinn hat "WEBER beschrieben. Sie sind sämmtlich bleihaltig." (Tijdschr. K. Nederl. Aardr. Genootsch. (2) 8. 1891, p. 230—231). It is exactly the same with P. G. SCHMIDHAMER's remark concerning the information of the . . . professors WICHMANN and MAX WEBER, (l. c. p. 106).

5) l. c., p. 226.

mountaineers possess tin ornaments, and 3<sup>rd</sup> tin has little value for them and iron and copper is valued much higher by them. Though in general the correctness of these hypotheses will be readily acknowledged, we cannot help remarking that they do not prove anything, for in the possession of the Rokkanese objects of another nature are found, the origin of which is as little known, whilst they can by no possibility be constructed by them. Among these are e.g. the lens-shaped pieces of brass, called by the Endehnese "mas di Rokka" (gold of Rokka), and the dirty-red beads known in the Timor Archipelago by the name of Muti Tanah or Muti Salah. These are made of artfully manufactured glass and certainly not originating from the Malay Archipelago<sup>1)</sup>, but of these the same story is told as of the tin, i.e. that they appear on the surface when the grass is burnt.<sup>2)</sup>

With regard to the "mas di Rokka" A. FRENZEL indicated already that it is an alloy of tin and copper.<sup>3)</sup> When I was in 1888 at Mbawa the mountaineers asked me a gold-piece "with the leaping horse" £ 1 for it. This "gold of Rokka" can no more be originating from Flores, for a nation that stands so low, is not able to manufacture such an alloy.<sup>4)</sup> With respect to the so-called tin objects the same can be asserted. As early as 1884 it was known, that they consist in reality of an alloy of tin and lead, a fact which has not been taken into account, in the first place C. J. VAN SCHELLE did not do so, not even afterwards, when a piece of "tin" obtained during the campaign of 1890 appeared to consist of 59,8% tin and 40,2% lead.<sup>5)</sup> MAX WEBER brought likewise into relief, that the bracelets bought by him in 1888 were composed of these two metals.<sup>6)</sup> The fact communicated by him that the natives of East

1) This subject was treated very elaborately by G. P. ROUFFAER ("Waar kwamen de raadselachtige moetsalah's (aggri kralen) in de Timor-groep oorspronkelijk vandaan?" Bijdr. v. de T. L. en Vk. (6) 6. 's Gravenhage 1899, p. 409—675).

2) J. E. TEYSMANN. Verslag eener botanische reis van Timor... Natuurk. Tijdschrift van Ned. Ind. 34. Batavia 1874, p. 350. — S. Roos. iets over Endeh. Tijdschr. voor Ind. T. L. en Vk. 24. 1877, p. 501.

3) Mineralogisches aus dem Ost Indischen Archipel. Tschermaks Mineralog. Mittheilg., Wien 1877, p. 306.

4) With regard to copper, it is quite certain that at least since the middle of the 18th century it was imported into Flores, J. C. M. RADEMACHER. "Korte beschrijving van het eiland Celebes en de eilanden Flores, Sumbawa, Lombok en Bali." Verhandl. Batav. Genootsch. v. k. en W. 4. Batavia 1786, p. 252.)

5) Koloniaal Verslag van 1891, p. 26.

6) "Mededeelingen over zijne reizen in Indië." Tijdsch. K. Nederl. Aandr. Gen. (2) 7. 1890, p. 457. — Ethnographische Notizen über Flores und Celebes. Intern. Archiv. f. Ethnographie, Suppl. 3. Leiden 1890, p. 15, 16.

Flores opened tins in order to work the solder into bracelets etc, made VAN SCHELLE remark that such an idea, with regard to the Rokkas, "must be rejected as utterly untenable". WEBER on the contrary had positively asserted that this origin of the tin objects of the province of Rokka was unacceptable. The fact that among the constituents of the bracelets in question lead occurs, the import of which was in former times as little known as that of tin, would lead to the conclusion that this metal must likewise be originating from Flores itself.

Leaving out of consideration the fact that lead-ore occurs only sporadically <sup>1)</sup>, nobody will certainly suspect the natives of understanding the art of reducing the metal from it.

A boy of fourteen years who was taken prisoner in 1890 with the object of being able to interrogate him, rightly remarked "he "could not possibly give any information concerning the tin; the tin "that is in their possession, they have as pusaka from their ancestors". <sup>2)</sup> If one should object that objects regarded as pusaka are as a rule higher valued, we may point out that for several years, the gold that is brought by Australian horse-dealers in the shape of sovereigns to Sumba, from where it has found its way to Flores is more to the taste of the natives. During the bad harvests which are by no means rare, they are moreover compelled to part with objects that are dear to them, in order to obtain food.

Consequently we come to the conclusion that the metallic objects in the Rokka territory are not originating from the island itself, but that they were imported in former times. Their origin is as unknown as that of the different metallic objects found with the natives of other islands.

The last question that must be answered is, whether the geological condition of the island is of such a nature, that there is any prospect of being able to detect tin-ore — in whatever form it may be. The following summary may serve for this purpose. In Western Flores, the eastern frontier of which is situated between

---

<sup>1)</sup> Galena was found by J. J. PANNEKOEK VAN RHEDEN in small quantities in the neighbourhood of Lowo Sipi (Endeh) and in the peninsula of Batu Asa (Manggarai). J. P. FREYSS supposed that the same mineral occurs near Rium and near Geliting on the north-coast, which is very unlikely. R. EVERWIJN mentioned lead from Mount "Himendiri in Western-Timor" (Jaarboek van het Mijnw. 1872. I, p. 261). The mountain is really called "Ilimandiri" and situated in Eastern Flores. The piece mentioned is an augite-andesite containing hematite, lead however is not present at all.

<sup>2)</sup> Java-Bode, Tuesday 8 July 1890, N<sup>o</sup>. 154.

120°53' E. on the north- and 120°47' E. on the south-coast, an orographical difference presents itself already between the northern and the southern part. Here very accidented grounds, steep mountains 2646 m. high, and deep valleys and ravines, yonder a more hilly region in which only few mountains reach a height of 1000 m. and more. This northern part is chiefly covered by a formation, to which J. J. PANNEKOEK VAN RHEDEN has given the name of Reo formation, and which consists of limestones — especially coral limestone — resting occasionally on eruptive rocks and sometimes enclosing volcanic products. Here and there they are covered with tuffas<sup>1)</sup>. PANNEKOEK writes regarding the organic remains that are found: “A cursory investigation stated the presence of: Orbitoids, “Corals, fragments of *Spatangus*, *Natica*, *Corithium*, *Conus*, *Lima* (Platystrophia), *Ctenostreon*, *Gervillia*, *Isocardia*, *Teredina*”. A curious mixture indeed. It is to be hoped that this “cursory” examination may soon be followed by a more correct one. From the remark that the strata of the isle of Rindja, “seem to be younger, most “likely tertiary” we must deduce that he supposes the sediments of the Reo formation to be of a mesozoic age, which however cannot be the case. H. ZOLLINGER has already drawn the attention to the similarity of these strata with regard to their petrographic character with those of the south-coast of Java (Besuki, Kediri)<sup>2)</sup>. They have entirely the character of neogenic rocks, as appears already from the occurrence of *Globigerina* limestones<sup>3)</sup>. PANNEKOEK however rightly makes distinction between these and the younger pleistocenic coral limestones, as they are found in the isle of Longos in the neighbourhood of Reo. On the bay of Reo they rest on andesite conglomerate.<sup>4)</sup> A continuation of the Reo formation is most likely still found as far as the Kolitang Bay (Soho Kolitang) 120°77' E. J. F. HOEDT found eastward from the extensive plain a low range

<sup>1)</sup> Overzicht van de geographische en geologische gegevens verkregen bij de Mijnbouwkundig-geologische verkenning van het eiland Flores. Jaarboek van het Mijnwezen in Ned. Indië. 40. 1911. Batavia 1913. Verhandel. p. 217—218.

<sup>2)</sup> Verslag van eene reis naar Bima en Sumbawa . . . . Verhandel. Batav. Gen. v. K. en W. 27. Batavia 1859, p. 14. Remarkable is his annotation according to which at Badjo (meant is perhaps Padja) a day's journey behind Bari a hot spring is found, forming a pond, on which a brownish mass floats, which hardens in the air and can be used for tarring proas.

<sup>3)</sup> J. W. RETGERS describes likewise from Dangkawai 15 kilom. S. W. from Reo, a limestone containing foraminifera. (Jaarboek van het Mijnw. 24. 1895. Wet. ged., p. 135)

<sup>4)</sup> A. WICHMANN. Bericht über eine . . . . Reise nach dem Indischen Archipel. Tijdschr. K. Nederl. Aandr. Gen. (2) 8. 1891. p. 194.

of hills consisting of limestone, and in the plain itself a few isolated hills of limestone <sup>1)</sup>.

Up to the present moment only younger tertiary and post-tertiary eruptive rocks were found in the entire southern half of Western Flores. In the utmost south-western part i. e. in the Madura Bay the Siboga Expedition collected in 1899 rocks that on more exact examination proved to be augite-andesite. According to D. F. VAN BRAAM MORRIS Mount Sosa 1212 m. high farther westward 8°46' S, 129°58' E. must be a still active volcano <sup>2)</sup>. By the volcano called by him Toda (5000 ft.) will most likely be meant Potjo Wai 1740 m. high, the highest mountain of the province of Todo. Potjo Leo 2696 m. high was already called a volcano by J. P. FREYSS <sup>3)</sup> and is still active according to BRAAM MORRIS. J. W. MEERBURG, who marched along its slopes in 1890, does not remark anything in this regard <sup>4)</sup> Potjo Lika (2212 m.) situated in the immediate neighbourhood to W.N.W. is, according to PANNEKOEK's map, volcanic, and the same can most likely be said of Potjo Rea (2006 m.) and Mata Wae (2077 m.) rising at a short distance. J. W. RETGERS has microscopically examined the rocks collected in this region by J. W. MEERBURG. <sup>5)</sup> He mentions pyroxene-andesite from the Wai Renu near Dégé, quartz-augite-andesite of the same place, quartz-hypersthene-andesite and hornblende-hypersthene-andesite from the Wai Lédé near Ruté at the N.E. foot of Potjo Lika, hornblende-hypersthene-andesite from the Wai Soki, between Lidi and Todo, pyroxene-andesite from the Wai Madjo near Todo, hornblende-pyroxene and hornblende-hypersthene-andesite from the Wai Mau, a tributary of the Mésé, 9,4 kilom. N. from Nanga Ramo. Toren Island 780 m. high (8°54' S., 120°15,4' E.) <sup>6)</sup> situated to the south of this place is most likely also of volcanic origin.

According to PANNEKOEK's map the whole region situated between Nango Ramo and the Aiméré Bay, the frontier of Western Flores is of a volcanic nature. It is wellknown, that Mount Komba (926 m.)

1) Verslag van de reis van den controleur HOEDT naar de Noordkust van West-Flores, Tijdschr. v. Ind. T., L. en Vk. 36. Batavia. 1893, p. 292.

2) Nota van toelichting behoorende bij het contract gesloten met het landschap Bima. Tijdschr. v. Ind. T. L. en Vk. 36. 1893, p. 186.

3) Reizen in Manggarai en Lombok. Tijdschr. v. Ind. T. L. en Vk. 9. Batavia 1860, pp. 506-507.

4) Dagboek van den controleur J. W. MEERBURG, gehouden gedurende zijne reis door het binnenland van Manggarai. Tijdschr. v. Ind. T. L. en Vk. 36. 1893, p. 290.

5) Mikroskopisch onderzoek van gesteenten uit Nederl. Oost-Indië. Jaarboek van het Mijnwezen 24. Amsterdam 1895, Wet. ged., p. 135.

6) Also called Pulu Ramo, Nusa Sigo, Gili Enta or Embuanga.

and Mount Lumu (663 m.) rising on the west-side of the mentioned bay over Sosi are extinct volcanoes.

The expedition of 1890 had communicated regarding Central Flores that in the province of Toa, in the river-basin of the Nanga Koli, they had marched exclusively through a volcanic territory. In the upper-river-basin of this river, in the neighbourhood of Soa (about  $8^{\circ}40'$  S.,  $121^{\circ}2'$  E.) — one of the repeatedly mentioned finding-places of tin-ore — PANNEKOEK found at a height of  $\pm 400$  m. a territory of horizontally stratified marls with interjacent light-yellow tufas containing impressions of leaves, molluses, insects and fishes. He supposed these strata to be sediments, deposited in a fresh-water-basin and called it Soa formation <sup>1)</sup>. More eastward, between Mautenda and Dondo on the North-coast another territory is situated which, according to PANNEKOEK's map, is covered by sediments of the Reo formation.

The southern half of Central Flores, on the contrary, contains most of the still active volcanoes of this island. To the East of the Aiméré Bay rises in the first place Inije Rije (Inië Rië) 2494 m. high, more known by the name of Gunung Rokka, which is in a solfataric activity. WILLIAM BLIGH saw it smoking for the first time on the 22<sup>nd</sup> of August <sup>2)</sup> and PANNEKOEK perceived on his visit in 1910 that the solfataras are situated on the east-side of the crater bottom <sup>3)</sup>. The long ridge of the Langga Mountains seems to be, according to PANNEKOEK, a Somma-edge of Mount Rokka. To the East of this mountain rises Watu Sipi 1466 m. and another mountain 1533 m. the name of which is unknown. Both are extinct volcanoes. In the North-east of the Rokka a group of volcanoes is found that are no longer active among others Kopo Lebo, Wolo Meré, about 2000 m. high, Pipodok, Wolo Lega, Lebi Saga, which were discovered during the military expedition of 1890 <sup>4)</sup>.

Inije Lika (Inië Like) 1600 m. high, hitherto entirely unknown, was discovered in 1910 in North Ngada and described by G. P. ROUFFAER <sup>5)</sup>.

<sup>1)</sup> Eenige geologische gegevens omtrent het eiland Flores. Jaarboek van het Mijnwezen 39. 1910. Batavia 1912. Verhdl., p. 135. — Overzicht van de geografische en geologische gegevens . . . van het eiland Flores. Ibid. 40. 1911. Batavia 1913, p. 220—221.

<sup>2)</sup> A Voyage to the South Sea undertaken by Command of His Majesty. London 1792, p. 246. Dr. R. D. M. VERBEEK kindly informs me that this is a mistake. Instead of Mount Rokka has to be put Mount Keo.

<sup>3)</sup> Eenige geologische gegevens. as quoted p. 135—136.

<sup>4)</sup> P. G. SCHMIDHAMER as quoted p. 389, 390, 393 and map.

<sup>5)</sup> De Inije Lika op de hoogvlakte van Ngada. Tijdschr. K. Ned. Aardr. Gen. (2) 27. 1910, p. 1233—1239, vide ikewise J. J. PANNEKOEK VAN RHEDEN, Overzicht van de geografische en geologische gegevens. l. c., p. 219, 223.

The heavy eruption, lasting only five hours, took place in 1905. About Ambu Rombo 2147 m, high, also called Suri Laki, better known by the name of Gunung Keo, we do not know much more than that it has been for more than half a century in a situation of solfataric activity. According to PANNEKOEK<sup>1)</sup> the solfataras are especially situated in the neighbourhood of the northern edge of the top<sup>2)</sup>. As far as it is known only augite-andesite is found as rock on the coast. Ngaru Tangi (1537 m.) rising over the S. W. corner of the Endeh Bay is a volcanic ruin.

In the territory of the Endeh Bay the western part of its north-coast, especially the environs of Nanga Pandan, was examined in 1910 by JOH. ELBERT<sup>3)</sup>. He wrote in his first communication that Central Flores had been "durchquert"<sup>4)</sup> by him and that he had found: graywackes, diabase-tufas, melaphyre-breccias, quartzites, marls, which were perhaps of *palaeozoic age*. In his work published two years afterwards he does not mention these at all, neither are the above-named rocks found back in it, but quite different ones are indicated. Referring to the determinations of M. BELOWSKY and G. RACK he says, that he has found on the Wawu Manu Balu as fundamental rock hypersthene-diorite-porphyrite, over it hornfels, which was succeeded by tufa-rock. On the steep declivities of Woro Weka in the valley of Oto Weka he perceived at the bottom augite-diorite over it hornfels and further quartz-sandstone. He surmised the existence of a contact of the plutonic rocks<sup>5)</sup>. In GEORG RACK's description of the collection gathered by ELBERT (39 specimens in all) however the name of not a single one of the above-mentioned rocks occurs. On the contrary he describes from the river Manu Bala dacite and andesite, from Oto Weka and Langa Weka exclusively andesite!<sup>6)</sup>. According to ELBERT a gray limestone containing numerous Globigerina's and a few Rotalia's occurs near cape Ngaru Kua on the North-coast of the Endeh Bay<sup>7)</sup>.

1) J. J. PANNEKOEK VAN RHEDEN. Eenige geologische gegevens. I. c., p. 136—137. — Overzicht van de geographische en geolog. gegevens . . . I. c., p. 220.

2) A. WICHMANN. Bericht über eine . . . Reise nach dem Indischen Archipel. Tijdschr. K. Nederl. Aardr. Genootsch. (2) 8. 1891, p. 231.

3) B. HAGEN. Bericht über die von Dr. ELBERT geführte Sundaexpedition des Frankfurter Vereins für Geogr. und Stat. Petermanns Mittlg. 56. 1. 1910, p. 308.

4) A somewhat euphemistic expression, if we consider that the direct distance between Nanga Pandan and Geni is only about 10 km.

5) I. c., p. 201.

6) Petrographische Untersuchungen an Ergussgesteinen von Sumbawa und Flores. N. Jahrb. f. Min. Beil. Bd. 34. 1912, p. 73—82.

7) I. c., p. 201.

Also at Liana in the northern part of the province of Endeſ PANNEKOEK found a lime stone rich in Foraminifera, in which moreover fragments of quartz, plagioclase and biotite were detected<sup>1)</sup>. From this it appears that the limestone is younger than the dacite. In the valley of Ndonga, eastward from Ambugaga, I found a boulder of Globigerina-limestone. For the rest effusive rocks with their tufas and loose eruptive materials are prevalent in this region. The southern part of the peninsula of Endeſ is formed by Mount Ija, usually called Gunung Api (635 m.). The material from which it was formed is augite-andesite. For a long time it has been in a solfataric activity.

To the north of this mountain rises Pui or Gunung Medja only 394 m. high, which has retained a regular craterform<sup>2)</sup>. In a northern direction Mount Kengo (514 m.) and Mount Wongo (723 m.) which ELBERT regards as the two cupolas of one encircling mountain, are connected with the peninsula of Endeſ<sup>3)</sup>. Most likely the eruption of a mountain, situated behind Brai, in 1671, which P. J. VETH mentions<sup>4)</sup> relates to Kengo, and not as I supposed formerly to Pui.

To the West of the Ndonga valley rise Geli Bara (1731 m.) and Geli Mutu (1494 m.), the latter of which is in a situation of solfataric activity<sup>5)</sup>. The pyroxene- and labrador-andesites originating from this territory were described by G. RACK<sup>6)</sup>. I found in 1888 in the valley of Ndonga numerous boulders of dacite, labrador-andesite, augite-andesite and on the declivity of the mountain andesite. To the east of volcano Ndonga ELBERT still mentions Nduri, which has a solfatara<sup>7)</sup>. The island of Nusa Endeſ situated in the Endeſ Bay is likewise of a volcanic origin.

In the eastern part of the island of Flores the limestone formations have become very scarce. The little information we have about it is limited to the hillrange in the W.N.W. of Sikka situated in the province of Liu on which, according to H. TEN KATE, the villages of Kiara ( $\pm 275$  m.) and Riipuang ( $\pm 350$  m.) are situated.<sup>8)</sup> The rock collected by him is a Globigerina limestone. In the farthest

<sup>1)</sup> Overzicht van de geogr. en geolog. gegevens I. c., p. 219.

<sup>2)</sup> A. WICHMANN I. c., p. 222.

<sup>3)</sup> I. c., p. 202.

<sup>4)</sup> Het eiland Flores. Tijdschr. voor Nederl.-Indië. 1855. II. p. 157.

<sup>5)</sup> J. J. PANNEKOEK VAN RHEDEN. Eenige geolog. gegevens I. c., p. 157. — J. ELBERT. Die Sunda-Expedition. II. 1912, p. 202.

<sup>6)</sup> I. c., p. 78—82.

<sup>7)</sup> I. c., p. 202.

<sup>8)</sup> Verslag eener reis in de Timorgroep en Polynesië. Tijdschr. K. Nederl. Aandr., Gen. (2) 11. 1894, p. 221.



Northeast occurs then limestone in the vicinity of Tanjung Bunga or Kopondai, the well-known Cape Flores, to which the island owes its name. At a distance of 300 m. eastward from the cape mentioned, G. A. J. VAN DER SANDE discovered a grotto with stalactites. And at last, according to A. J. L. COUVREUR, coral limestone is found to the North of Larantuka from Panté Lela to Panté Beli Beting, especially between the village of Labao and Ili Labao.

The entire remaining part is covered with volcanic material the monotonousness of which is only interrupted by the numerous partly still active volcanoes. In the North westward from Maumeri rises the volcanic ruin of Kiman Buleng (1446 m.). Gunung Dobo or Iliang (900 m.) situated behind Geliting but nearer to the South-coast is on the contrary still active.

Most known, though likewise not sufficiently examined, are the volcanoes situated on the East-coast of Flores. For times immemorial Ilimandiri (1570 m) has not given any sign of activity. The rock of which it is composed is chiefly augite-andesite.<sup>1)</sup> Kabalelo (1075 m.) situated eastward is an old volcanic ruin.<sup>2)</sup> Westward from it Leworoh is situated where on the 16<sup>th</sup> of March 1881 an explosion-crater formed itself.<sup>3)</sup> The largest, highest and most active volcano however in this territory is Lobetobi, consisting of two cones Lakilaki 2170 m. high and Parampuan 2263 m. high.

G. F. TYDEMAN perceived about 37 km. westward from Lobetobi a high volcanic cone; most likely Dara Woër is meant by it.<sup>4)</sup>

As appears from the above, there is in Flores no room for praetertiary sediments and eruptive rocks. Repeatedly however the existence of such like rocks in the form of boulders was hinted at. Near the bay of Bari I found in 1888 quartz-porphry, clay slate and quartzite.<sup>5)</sup> I may now add to this the communication that in the river Reo amphibole-granite and diabase occurs, the hornblende of which has changed into chlorite. More eastward in the territory

1) Een dienstreis benoorden Larantoecka (Oost-Flores). Tijdschr. K. Ned. Aandr. Genootsch. (2) 25. 1908, p. 554.

2) A. [WICHMANN l. c., p. 159. — G. RACK. Beiträge zur Petrographie von Flores. Centralbl. f. Mineral, 1913, p.p. 134—139. — H. MÖHL described from Okka, situated on the south-western extremity of Ilimandiri sanidine-trachite and Hauyn-andesite (N. Jahrb. f. Min. 1874, p.p. 694—697). The determination however was not correct.

3) J. P. VAN DER STOK. Uitbarstingen van vulkanen . . . gedurende het jaar 1881, Nat. Tijdsch. Ned.-Ind. 42. 1882, p. 241.

4) Hydrographic Results of the Siboga Expedition, Siboga Expedition 3. Leiden 1903, p. 56.

5) l. c. 193.

of the mouth of the Nanga Koli A. F. H. HEUSCH collected in 1890 according to PANNEKOEK <sup>1)</sup> quartzite and greywakke(?). On the south-coast at Nanga Mbawa I found granite (read quartz-diorite) and gabbro <sup>2)</sup> and finally in the valley of the river Ndona quartz-diorite. None of these rocks were ever found as rock, they are consequently at least "auf tertiärer Lagerstätte". They are the last remains of rockmasses that got into the conglomerates by washing from which they got afterwards free again.

The oldest formations of Flores belong to the effusive rocks of the character of dacites, labrador-andesites and hornblende-andesites with their tufas, on which those of the limestones of the Reo-formation and those of the tuffas of the Soa formation follow. They were uncovered by subsequent elevation. Afterwards the island was over its entire length the scene of violent volcanic eruptions, from which the only partly known crater mountains proceeded. The material produced by them consists — as far as our knowledge reaches — exclusively of pyroxene-andesites belonging to the Pacific type of rocks. The younger coral limestones occurring only sporadically have only been formed after the formation of the volcanoes.

VON SCHELLE'S postulation that the bottom "to the north of Mount Rokka is very rich in tin-ore" appears to have been not only vain but also very expensive.

**Mathematics.** — "*The theory of the combination of observations and the determination of the precision, illustrated by means of vectors.*" By DR. M. J. VAN UVEN. (Communicated by Prof. W. KAPTEYN)."

(Communicated in the meeting of June 27, 1914).

By L. VON SCHRUTKA <sup>3)</sup> and C. RODRIGUEZ <sup>4)</sup> a method has been given of illustrating geometrically the theory of the combination of observations by the method of least squares, namely by means of vector operations. RODRIGUEZ however chooses in the case of rigorous equations addition another way, whilst VON SCHRUTKA, who consistently

<sup>1)</sup> Overzicht der geographische en geologische gegevens l. c. p. 229.

<sup>2)</sup> l. c. p. 229.

<sup>3)</sup> L. VON SCHRUTKA, Eine vektoranalytische Interpretation der Formeln der Ausgleichsrechnung nach der Methode der kleinsten Quadrate. Archiv der Mathematik und Physik. 3, Reihe, Bd. 21, (1913), p. 293.

<sup>4)</sup> C. RODRIGUEZ, La compensacion de los Errores desde al punto de visto geometrico. Mexico, Soc. Cient. "Antonio Alzate", vol. 33 (1913—1914), p. 57.

opérates with vectors, restricts himself to two variables and one rigorous equation of condition.

It is our purpose not only to extend their method to the case of an arbitrary number ( $N$ ) of variables and an equally arbitrary number ( $r$ ) of conditions, but also to derive the *weight* of the unknown quantities in the same way.

I. There are given  $N$  quantities  $x, y, z, \dots$  which are to be determined from  $n$  (approximate) equations of condition (equations of observation):

$$a_i x + b_i y + c_i z + \dots + m_i = 0 \quad i = 1, \dots, n.$$

These equations have the weights  $g_i$  resp., and so are equivalent to the equations

$$a_i \sqrt{g_i} x + b_i \sqrt{g_i} y + c_i \sqrt{g_i} z + \dots + m_i \sqrt{g_i} = 0 \quad i = 1, \dots, n,$$

each of which has the weight unity.

We now introduce

$$\begin{aligned} \alpha_i &= \frac{a_i \sqrt{g_i}}{\sqrt{[g_i a_i^2]}}, & \beta_i &= \frac{b_i \sqrt{g_i}}{\sqrt{[g_i b_i^2]}}, & \gamma_i &= \frac{c_i \sqrt{g_i}}{\sqrt{[g_i c_i^2]}}, \dots, & \mu_i &= \frac{m_i \sqrt{g_i}}{\sqrt{[g_i m_i^2]}}; \\ A &= x \sqrt{[g_i a_i^2]}, & B &= y \sqrt{[g_i b_i^2]}, & C &= z \sqrt{[g_i c_i^2]}, \dots, & M &= \sqrt{[g_i m_i^2]} \\ A_i &= A \alpha_i = a_i \sqrt{g_i} x, & B_i &= B \beta_i = b_i \sqrt{g_i} y, & C_i &= C \gamma_i = c_i \sqrt{g_i} z, \dots \\ & & & & & & & \dots M_i = M \mu_i = m_i \sqrt{g_i}, \end{aligned}$$

[ ] denoting summation over  $i$  from 1 to  $n$ .

So the equations of observation run in the form

$$A_i + B_i + C_i + \dots + M_i = 0 \quad i = 1, \dots, n$$

We now consider  $A_i, B_i, C_i, \dots, M_i$  as the components of the vectors  $\mathfrak{A}, \mathfrak{B}, \mathfrak{C}, \dots, \mathfrak{M}$ , resolved parallel to the rectangular coordinate axes of an  $n$ -dimensional space. Thus the tensors are  $A, B, C, \dots, M$ ,  $\alpha_i, \beta_i, \gamma_i, \dots, \mu_i$  representing the direction cosines.

The set of  $n$  equations of observation may now be condensed in the single vector-equation

$$\mathfrak{A} + \mathfrak{B} + \mathfrak{C} + \dots + \mathfrak{M} = 0,$$

which expresses, that the vectors  $\mathfrak{A}, \mathfrak{B}, \mathfrak{C}, \dots, \mathfrak{M}$  must form a closed polygon. The coefficients  $a_i, b_i, c_i, \dots$  and the weights  $g_i$  being given, the unit vectors  $\mathfrak{a}, \mathfrak{b}, \mathfrak{c}, \dots$  of the vectors  $\mathfrak{A}, \mathfrak{B}, \mathfrak{C}, \dots$  are determinate. So the vector-equation requires that  $\mathfrak{M}$  may be resolved in the  $N$  directions  $\mathfrak{a}, \mathfrak{b}, \mathfrak{c}, \dots$ , in other words: that  $\mathfrak{M}$  lies in the  $N$ -dimensional space  $R_N$ , determined by the vectors  $\mathfrak{a}, \mathfrak{b}, \mathfrak{c}, \dots$  and called the space of the variables (or unknown quantities).

In consequence of the errors of observation this condition is not fulfilled. The most probable corrected value of  $\mathfrak{M}$  is the projection of  $\mathfrak{M}$  on the space  $R_N$  of the variables.

Denoting the projecting vector by  $\mathfrak{K}$  (tensor  $K$ , direction cosines  $\alpha_i$ , components  $K_i$ ) we have really

$$\mathfrak{A} + \mathfrak{B} + \mathfrak{C} + \dots + \mathfrak{M} = \mathfrak{K}.$$

As  $\mathfrak{K}$  is perpendicular to  $\mathfrak{A}, \mathfrak{B}, \mathfrak{C}, \dots$ , we have

$$(\mathfrak{A}, \mathfrak{K}) = 0, \quad (\mathfrak{B}, \mathfrak{K}) = 0, \quad (\mathfrak{C}, \mathfrak{K}) = 0, \text{ etc}$$

or

$$[\alpha_i K_i] = 0, \quad [\beta_i K_i] = 0, \quad [\gamma_i K_i] = 0, \text{ etc.}$$

or because

$$K_i = A_i + B_i + C_i + \dots + M_i = \alpha_i A + \beta_i B + \gamma_i C + \dots + M_i,$$

$$[\alpha_i^2] A + [\alpha_i \beta_i] B + [\alpha_i \gamma_i] C + \dots + [\alpha_i M_i] = 0,$$

$$[\beta_i \alpha_i] A + [\beta_i^2] B + [\beta_i \gamma_i] C + \dots + [\beta_i M_i] = 0,$$

$$[\gamma_i \alpha_i] A + [\gamma_i \beta_i] B + [\gamma_i^2] C + \dots + [\gamma_i M_i] = 0,$$

. . . . .

By multiplying these equations by  $\sqrt{[g_i a_i^2]}, \sqrt{[g_i b_i^2]}, \sqrt{[g_i c_i^2]}, \dots$  resp., we obtain the "normal equations":

$$[g_i a_i^2] x + [g_i a_i b_i] y + [g_i a_i c_i] z + \dots + [g_i a_i m_i] = 0,$$

$$[g_i b_i a_i] x + [g_i b_i^2] y + [g_i b_i c_i] z + \dots + [g_i b_i m_i] = 0,$$

$$[g_i c_i a_i] x + [g_i c_i b_i] y + [g_i c_i^2] z + \dots + [g_i c_i m_i] = 0,$$

. . . . .

II. After these developments which also are given by VON SCHRUTKA and RODRIGUEZ we proceed to determine the *weights* of the variables.

For this we notice that all the quantities  $M_i$  have the weight 1, and therefore have an equal mean error  $\epsilon$ . From this ensues, that the projection of  $\mathfrak{M}$  in any direction has the same mean error  $\epsilon$ .

We have to investigate the influence on  $\mathfrak{A}$  due to the variation of  $\mathfrak{M}$ , if the other variables  $\mathfrak{B}, \mathfrak{C}, \dots$  do not undergo that influence.

A variation of  $\mathfrak{M}$  which does not displace the foot on  $R_N$  of the projecting vector  $\mathfrak{K}$ , does not act upon any vector  $\mathfrak{A}, \mathfrak{B}, \mathfrak{C}, \dots$ . So we have only to do with a variation of the projection  $\mathfrak{M}'$  of  $\mathfrak{M}$  on  $R_N$ . In order to leave the vectors  $\mathfrak{B}, \mathfrak{C}, \dots$  intact, the foot is to be moved in a direction  $\mathfrak{s}$  perpendicular to  $\mathfrak{B}, \mathfrak{C}, \dots$ , and, because it lies in  $R_N$ , also perpendicular to  $\mathfrak{K}$ .

Denoting by  $\sigma_i$  the direction cosines of  $\mathfrak{s}$ , we may put the equation

$$(\mathfrak{A}, \mathfrak{s}) + (\mathfrak{M}, \mathfrak{s}) = 0,$$

obtained by multiplying the equation of observation scalarly with  $\mathfrak{s}$ , in the form

$$A [\alpha_i \sigma_i] = - M_s$$

$M_s$  designating the projection of  $\mathfrak{M}$  on  $\mathfrak{s}$ .

As  $M_s$  has the mean error  $\epsilon$ , the mean error  $\epsilon_A$  of  $A$  equals

$$\varepsilon_A = \frac{\varepsilon}{[\alpha_i \sigma_i]},$$

whence

$$g_A = [\alpha_i \sigma_i]^2.$$

The vector  $\varepsilon$ , lying in  $R_N$ , may be resolved in the directions  $\alpha, \beta, \gamma, \dots$ . Denoting its components in these directions by  $X, Y, Z, \dots$  we find

$$\varepsilon = X\alpha + Y\beta + Z\gamma + \dots,$$

or

$$\sigma_i = X\alpha_i + Y\beta_i + Z\gamma_i + \dots$$

Now,  $\varepsilon$  being perpendicular to  $\mathfrak{B}, \mathfrak{C}, \dots$ , whence  $[\beta_i \sigma_i] = 0, [\gamma_i \sigma_i] = 0, \dots$ , we have

$$1 = [\sigma_i^2] = X [\alpha_i \sigma_i]$$

or

$$X = \frac{1}{[\alpha_i \sigma_i]}.$$

From the equations

$$[\alpha_i \sigma_i] = \frac{1}{X}, \quad [\beta_i \sigma_i] = 0, \quad [\gamma_i \sigma_i] = 0, \dots$$

which may also be written

$$\begin{aligned} [\alpha_i^2] X + [\alpha_i \beta_i] Y + [\alpha_i \gamma_i] Z + \dots &= \frac{1}{X}, \\ [\beta_i \alpha_i] X + [\beta_i^2] Y + [\beta_i \gamma_i] Z + \dots &= 0, \\ [\gamma_i \alpha_i] X + [\gamma_i \beta_i] Y + [\gamma_i^2] Z + \dots &= 0, \\ \dots & \dots \end{aligned}$$

or

$$\begin{aligned} [\alpha_i^2] X^2 + [\alpha_i \beta_i] XY + [\alpha_i \gamma_i] XZ + \dots - 1 &= 0, \\ [\beta_i \alpha_i] X^2 + [\beta_i^2] XY + [\beta_i \gamma_i] XZ + \dots &= 0, \\ [\gamma_i \alpha_i] X^2 + [\gamma_i \beta_i] XY + [\gamma_i^2] XZ + \dots &= 0, \\ \dots & \dots \end{aligned}$$

the first unknown quantity  $X^2$  takes the value

$$X^2 = \frac{1}{[\alpha_i \sigma_i]^2} = \frac{\varepsilon_A^2}{\varepsilon^2} = \frac{1}{g_A}.$$

The reciprocal value of the weight of  $A$  is therefore found to be the first unknown of the "modified normal equations".

Putting further

$$X = \xi \sqrt{[g_i a_i^2]}, \quad Y = \eta \sqrt{[g_i b_i^2]}, \quad Z = \zeta \sqrt{[g_i c_i^2]}, \dots$$

the modified normal equations pass into

$$\begin{aligned} [g_i a_i^2] \xi^2 + [g_i a_i b_i] \xi \eta + [g_i a_i c_i] \xi \zeta + \dots - 1 &= 0, \\ [g_i b_i a_i] \xi^2 + [g_i b_i^2] \xi \eta + [g_i b_i c_i] \xi \zeta + \dots + 0 &= 0, \\ [g_i c_i a_i] \xi^2 + [g_i c_i b_i] \xi \eta + [g_i c_i^2] \xi \zeta + \dots + 0 &= 0, \\ \dots & \dots \end{aligned}$$

Now, from  $A = x\sqrt{[g_i a_i^2]}$  ensues

$$\varepsilon_A = \varepsilon_x \sqrt{[g_i a_i^2]},$$

hence

$$\frac{1}{g_x} = \frac{\varepsilon_x^2}{\varepsilon^2} = \frac{1}{[g_i a_i^2]} \times \frac{\varepsilon_x^2}{\varepsilon^2} = \frac{X^2}{[g_i a_i^2]} = \xi^2,$$

which is the well-known theorem on the weights of the variables.

Example: 3 equations of observation with 2 variables.

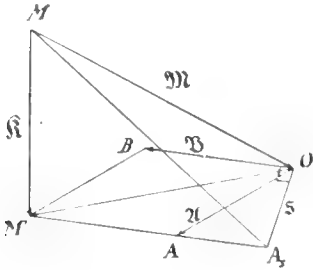

Fig. 1.

The unit-vectors  $\mathfrak{a}$  and  $\mathfrak{b}$  determine a plan  $R_2$ . The extremity  $M$  of  $OM$  is projected on this plane in the point  $M'$ .  $OM'$  is resolved parallel to  $\mathfrak{a}$  and  $\mathfrak{b}$  into the components  $OA = \mathfrak{A}$  and  $OB = \mathfrak{B}$ .

In the plane  $R_2(\mathfrak{A}, \mathfrak{B})$  the vector  $\mathfrak{s}$  is erected perpendicular to  $\mathfrak{B}$ . On this vector  $OM = -\mathfrak{M}$  and  $OA = \mathfrak{A}$  have the same projection  $OA_s = M_s$ . This segment  $M_s$

has the mean error  $\varepsilon$ ; the variable  $x$ , i.e. the segment  $OA$  therefore has the mean error  $\varepsilon_A = \frac{\varepsilon}{\cos \angle OA_s}$ .

III. We now suppose that besides the  $n$  approximate equations of condition (equations of observation)  $r$  rigorous equations of condition are given, viz.:

$$a_{n+j}x + b_{n+j}y + c_{n+j}z + \dots + m_{n+j} = 0 \quad (j=1, \dots, r).$$

For the sake of regularity in the notation, we will also provide these equations with factors  $g_{n+j}$  (which afterwards disappear from the calculation). Thus we really operate with

$$a_{n+j}\sqrt{g_{n+j}}x + b_{n+j}\sqrt{g_{n+j}}y + c_{n+j}\sqrt{g_{n+j}}z + \dots + m_{n+j}\sqrt{g_{n+j}} = 0 \quad (j=1, \dots, r).$$

Agreeing, that  $[i]$  now means a summation over  $i$  from 1 to  $n+r$ , we may, retaining the notation used above, consider  $\mathfrak{A}, \mathfrak{B}, \mathfrak{C}, \dots, \mathfrak{M}$  as vectors in a space of  $n+r$  dimensions.

The vector-equation

$$\mathfrak{A} + \mathfrak{B} + \mathfrak{C} + \dots + \mathfrak{M} = 0$$

is again not fulfilled on account of the errors of observation. The last  $r$  component-equations  $(n+1) \dots (n+r)$  however hold exactly this time.

Putting again

$$\mathfrak{A} + \mathfrak{B} + \mathfrak{C} + \dots + \mathfrak{M} = \mathfrak{X}$$

the  $r$  projections  $K_{n+1}, \dots, K_{n+r}$  of  $\mathfrak{X}$  must be zero, whence

$$x_{n+j} = 0 \quad (j=1, \dots, r).$$

So the vector  $\mathfrak{K}$  is perpendicular to the space  $R_v$  "of condition" determined by the coordinate-axes  $v_{n+j}$  and therefore cannot generally be any longer assumed to be perpendicular to the space  $R_N(\mathfrak{A}, \mathfrak{B}, \mathfrak{C}, \dots)$  of the variables.  $\mathfrak{K}$  lies in the  $n$ -dimensional space  $R'_n$   $x_{n+j} = M_{n+j}$  ( $j=1, \dots, r$ ), which is parallel to the space  $R_n$  "of observation" determined by the axes  $x_h$  ( $h=1, \dots, n$ ).

The parallel-space  $R'_n$  cuts the space  $R_N$  of the variables in a linear space of  $N + n - (n+r) = N - r$  dimensions, which we shall denote by  $\mathfrak{Q}'_{N-r}$ . This latter is parallel to the space  $\mathfrak{Q}_{N-r}$  of intersection of the space  $R_n$  of observation with the space  $R_N$ .

We now project the extremity of  $\mathfrak{M}$  lying in  $R'_n$  in this space on the space  $\mathfrak{Q}'_{N-r}$  of intersection. The projecting vector will now be the "correction-vector"  $\mathfrak{K}$ .

Translating  $\mathfrak{K}$  to the origin into the vector  $OP$ ,  $OP$  will be perpendicular to the space  $\mathfrak{Q}_{N-r}$  common to  $R_N$  and  $R_n$ .

Next we construct the normal space of  $\mathfrak{Q}_{N-r}$  which passes through the origin  $O$ . This space has  $n + r - (N - r) = n + 2r - N$  dimensions. It contains the space  $R_v$  of condition (as normal space of  $R_n$ ), further the line  $OP$ , and also the normal space of  $n + r - N$  dimensions which can be drawn from  $P$  perpendicular to  $R_N$ . This latter space therefore lies together with  $R_v$  in a space of  $n + 2r - N$  dimensions and thus cuts  $R_v$  in a space of  $(n + r - N) + r - (n + 2r - N) = 0$  dimensions, consequently in a point. As for this point  $Q$ , it thus lies both in  $R_v$  and in the normal space drawn from  $P$  perpendicular to  $R_N$ , from which among other things follows, that  $PQ$  makes right angles with each line of  $R_N$ , more particularly with the vectors  $\mathfrak{A}, \mathfrak{B}, \mathfrak{C}, \dots$ . So, projecting  $OP$  and  $OQ$  on  $\mathfrak{A}$ , these projections are equal. The same holds for the projections on  $\mathfrak{B}, \mathfrak{C}, \dots$ .

Representing  $OQ$  by the vector  $\mathfrak{K}'(K', \alpha'_i, K'_i)$ , we have, as  $\mathfrak{K}'$  lies in  $R_v$ ,

$$K'_h = 0 \text{ and } \alpha'_h = 0. \quad (h=1, \dots, n)$$

From

$$(\mathfrak{K}, \mathfrak{A}) = (\mathfrak{K}', \mathfrak{A}), \quad (\mathfrak{K}, \mathfrak{B}) = (\mathfrak{K}', \mathfrak{B}), \quad (\mathfrak{K}, \mathfrak{C}) = (\mathfrak{K}', \mathfrak{C}), \dots$$

follows

$$K[\alpha_i] = K'[\alpha'_i], \quad K[\beta_i] = K'[\beta'_i], \quad K[\gamma_i] = K'[\gamma'_i], \dots$$

As  $\alpha_{n+j} = 0$  for  $j = 1, \dots, r$ , the sum  $[\alpha_i]$  is only to be extended from 1 to  $n$ ; hence  $[\alpha_i] = \sum_1^n \alpha_h \alpha_h = [\alpha_h \alpha_h]'$ ; and since  $\alpha'_h = 0$  for  $h = 1, \dots, n$ , the sum  $[\alpha'_i]$  is to be extended from  $n+1$





move in the space  $S$ , common to the normal space of  $q'_{N-v}$  (of  $n + 2r - N$  dimensions) and the space  $R'_n$  parallel to  $R_n$ . The space  $S$  obviously has  $(n + 2r - N) + n - (n + r) = n + r - N$  dimensions. A component of  $\mathfrak{M}$  in this space has no effect on the vectors  $\mathfrak{A}, \mathfrak{B}, \mathfrak{C}, \dots$ . A component of  $\mathfrak{M}$  will only have any effect on  $\mathfrak{A}, \mathfrak{B}, \mathfrak{C}, \dots$ , when it lies in the normal space  $S'_N$  of  $S$ , which has  $n + r - (n + r - N) = N$  dimensions. By translating this normal space  $S'_N$  to  $O$ , it contains both  $R_v$  and  $q_{N-v}$  (intersection of  $R_N$  and  $R_n$ ).

The variation of  $\mathfrak{M}$  will exclusively influence  $\mathfrak{A}$ , when the component of  $\mathfrak{M}$  undergoing this variation is perpendicular to  $\mathfrak{B}, \mathfrak{C}, \dots$ .

These considerations lead to the result that we want that direction  $\mathfrak{s}$ , which lies in  $S'_N$  and is perpendicular to  $\mathfrak{B}, \mathfrak{C}, \dots$ . The vectors  $\mathfrak{B}, \mathfrak{C}, \dots$  determine together a space of  $N - 1$  dimensions. The vector  $\mathfrak{s}$  must lie in the normal space (of  $n + r - N + 1$  dimensions) of the space  $(\mathfrak{B}, \mathfrak{C}, \dots)$ . This normal space cuts  $S'_N$  in a space of  $(n + r - N + 1) + N - (n + r) = 1$  dimension, hence in a straight line. So there is always one and only one line  $\mathfrak{s}$  fulfilling the imposed conditions.

Since  $\mathfrak{s}$  lies in  $S'_N$ , i. e. in the space joining  $R_v$  with  $q_{N-v}$ , the projection  $\mathfrak{t}$  of  $\mathfrak{s}$  on  $R_n$  will fall into  $q_{N-v}$ .

Now we have for the direction cosines  $\tau_i$  of the projection  $\mathfrak{t}$  of  $\mathfrak{s}$  on  $R_n$ :

$$\tau_h = \frac{\sigma_h}{\sqrt{[\sigma_h^2]}} \quad (h = 1, \dots, n); \quad \tau_{n+j} = 0 \quad (j = 1, \dots, r).$$

As  $\mathfrak{t}$ , being a line of  $q_{N-v}$ , also lies in the space  $R_N$  and therefore may be resolved in the directions  $\mathfrak{A}, \mathfrak{B}, \mathfrak{C}, \dots$ , we have

$$\tau_h = P\alpha_h + Q\beta_h + R\gamma_h + \dots, \quad (h = 1, \dots, n)$$

$$\tau_{n+j} = P\alpha_{n+j} + Q\beta_{n+j} + R\gamma_{n+j} + \dots = 0. \quad (j = 1, \dots, r)$$

Putting

$$P\sqrt{[\sigma_h^2]}' = P', \quad Q\sqrt{[\sigma_h^2]}' = Q', \quad R\sqrt{[\sigma_h^2]}' = R', \dots$$

we obtain:

$$\alpha_h P' + \beta_h Q' + \gamma_h R' + \dots = \sigma_h, \quad (h = 1, \dots, n)$$

$$\alpha_{n+j} P' + \beta_{n+j} Q' + \gamma_{n+j} R' + \dots = 0, \quad (j = 1, \dots, r)$$

and,  $\mathfrak{s}$  being perpendicular to  $\mathfrak{B}, \mathfrak{C}, \dots$ ,

$$[\beta_i \sigma_i] = 0, \quad [\gamma_i \sigma_i] = 0 \dots \quad [\sigma_i^2] = 1.$$

In this way we have collected  $n + v + N$  equations to determine the  $n + v$  unknown quantities  $\sigma_i$  and the  $N$  unknown quantities  $P', Q', R', \dots$ .

$S'_N$  being perpendicular to  $\mathfrak{K}$ ,  $\mathfrak{s}$  is also perpendicular to  $\mathfrak{K}$ . By multiplying the equation

$$\mathfrak{A} + \mathfrak{B} + \mathfrak{C} + \dots + \mathfrak{M} = \mathfrak{S}$$

scalarly by  $\mathfrak{s}$ , it reduces to

$$(\mathfrak{A}, \mathfrak{s}) + (\mathfrak{M}, \mathfrak{s}) = 0$$

or

$$A [\alpha_i \bar{\sigma}_i] = -M_s$$

In order to determine the mean error of  $M_s$ , we remark that of all the lines through  $O$  in  $R_n$   $\mathfrak{t}$  is that which makes the smallest angle with  $\mathfrak{s}$ . The error of  $M_s$  therefore depends for the most part on the error in the components  $M_t$  of  $\mathfrak{M}$  in the direction  $\mathfrak{t}$ . We may consequently write

$$m. e. \text{ of } M_s = m. e. \text{ of } M_t \times \cos(\mathfrak{s}, \mathfrak{t}) = \varepsilon \cos(\mathfrak{s}, \mathfrak{t})$$

or

$$\varepsilon_s = \varepsilon [\bar{\sigma}_i \mathfrak{t}_i] = \varepsilon \left[ \bar{\sigma}_h \cdot \frac{\sigma_h}{\sqrt{[\bar{\sigma}_h^2]'}} \right] = \varepsilon \sqrt{[\bar{\sigma}_h^2]'},$$

hence

$$\varepsilon_A = \frac{\varepsilon_s}{[\alpha_i \bar{\sigma}_i]} = \frac{\sqrt{[\bar{\sigma}_h^2]'}}{[\alpha_i \bar{\sigma}_i]} \varepsilon.$$

Since

$$M_s = M_t [\bar{\sigma}_i \mathfrak{t}_i] = [M_h \mathfrak{t}_h]' \cdot [\bar{\sigma}_i \mathfrak{t}_i] = \left[ M_h \frac{\sigma_h}{\sqrt{[\bar{\sigma}_h^2]'}} \right]' \cdot \sqrt{[\bar{\sigma}_h^2]'} = [M_h \sigma_h]',$$

we have

$$A = - \frac{M_s}{[\alpha_i \bar{\sigma}_i]} = - \left[ \frac{\sigma_h}{[\alpha_i \bar{\sigma}_i]} \cdot M_h \right]'$$

or, putting

$$\begin{aligned} \frac{\sigma_h}{[\alpha_i \bar{\sigma}_i]} &= p_h, \\ A &= - [p_h M_h]', \\ \frac{1}{g_A} &= \frac{\varepsilon_A^2}{\varepsilon^2} = \frac{[\bar{\sigma}_h^2]'}{[\alpha_i \bar{\sigma}_i]^2} = [p_h^2]'. \end{aligned}$$

Introducing

$$X = \frac{P'}{[\alpha_i \bar{\sigma}_i]}, \quad Y = \frac{Q'}{[\alpha_i \bar{\sigma}_i]}, \quad Z = \frac{R'}{[\alpha_i \bar{\sigma}_i]}, \quad \dots; \quad p_{n+j} = \frac{\sigma_{n+j}}{[\alpha_i \bar{\sigma}_i]} \quad (j = 1, \dots, r)$$

we arrive at

$$\begin{aligned} \alpha_h X + \beta_h Y + \gamma_h Z + \dots &= p_h \quad (h = 1, \dots, n) \\ \alpha_{n-j} X + \beta_{n+j} Y + \gamma_{n+j} Z + \dots &= 0 \quad (j = 1, \dots, r) \\ [\alpha_i p_i] &= 1, \quad [\beta_i p_i] = 0, \quad [\gamma_i p_i] = 0, \dots \end{aligned}$$

From these  $n + r + N$  equations we can solve the  $n + r$  unknown quantities  $p_i$  ( $i = 1 \dots n + r$ ) and the  $N$  auxiliary quantities  $X, Y, Z, \dots$

The quantity  $\frac{1}{g_A} = [p_h^2]'$  in question is also found as follows

$$\begin{aligned}
\frac{1}{g_A} &= [p_h^2]' = [p_h(\alpha_n X + \beta_n Y + \gamma_n Z + \dots)]' = X[p_h \alpha_n]' + Y[p_h \beta_n]' + Z[p_h \gamma_n]' + \dots = \\
&= X - X[p_{n+j} \alpha_{n+j}]'' - Y[p_{n+j} \beta_{n+j}]'' - Z[p_{n+j} \gamma_{n+j}]'' \dots \\
&= X - [p_{n+j}(\alpha_{n+j} X + \beta_{n+j} Y + \gamma_{n+j} Z + \dots)]'' \\
&= X.
\end{aligned}$$

Returning to the original variables  $x, y, z, \dots$ , we derive from

$$x = \frac{A}{\sqrt{[g_i a_i^2]}}$$

firstly

$$\varepsilon_x = \frac{\varepsilon_A}{\sqrt{[g_i a_i^2]}}$$

and

$$\frac{1}{g_x} = \frac{\varepsilon_x^2}{\varepsilon^2} = \frac{[p_h^2]'}{[g_i a_i^2]}.$$

Further, putting

$$\begin{aligned}
p_h &= k_h \frac{\sqrt{[g_i a_i^2]}}{\sqrt{g_h}}, & p_{n+j} &= k_{n+j} \frac{\sqrt{[g_i a_i^2]}}{\sqrt{g_{n+j}}} \\
X &= \xi [g_i a_i^2], & Y &= \eta [g_i b_i^2], & Z &= \zeta [g_i c_i^2], \dots
\end{aligned}$$

the  $n + r + N$  equations pass into

$$\begin{aligned}
a_h \xi + b_h \eta + c_h \zeta + \dots &= \frac{k_h}{g_h}, & (h = 1, \dots, n) . \\
a_{n+j} \xi + b_{n+j} \eta + c_{n+j} \zeta + \dots &= 0, & (j = 1, \dots, r) \\
[a_i k_i] &= 1, & [b_i k_i] &= 0, & [c_i k_i] &= 0, \dots
\end{aligned}$$

whence

$$\frac{1}{g_x} = \left[ \frac{k_h^2}{g_h} \right] = g_x.$$

Example: 2 equations of observation with 2 variables and 1 condition. The unit-vectors  $\mathfrak{a}$  and  $\mathfrak{b}$  determine a plane  $R_N (N=2)$ , the plane of the variables. This plane cuts the plane of observation  $R_n (n=2)$  in the line  $\varrho_{N \rightarrow n} (N-r=1)$ , which thus coincides with the line  $\mathfrak{t}$ . The line  $OP$  is drawn in the plane  $R_n$  perpendicular to  $\varrho_{N \rightarrow n} (\mathfrak{t})$ . Through the extremity  $M$  of the vector  $\mathfrak{M}$  a line is drawn parallel to  $OP$ ; this line cuts the plane  $R_N$  of the variables in  $M'$ . The vector  $MM' // PO$  is the correction-vector  $\mathfrak{K}$ .  $OM'$  is resolved in the directions  $\mathfrak{a}$  and  $\mathfrak{b}$  into the components  $OA = \mathfrak{A}$  and  $OB = \mathfrak{B}$ . The lengths of these lines represent the most probable values of the variables  $A$  and  $B$ .

The line  $PQ$  is perpendicular to the plane  $R_N$  and meets the normal  $R_c$  (line of condition), erected in  $O$  on  $R_n$ , in the point  $Q$ . The vector  $OQ$  is called  $\mathfrak{K}'$ .

The space joining  $Q_N$  with  $R$  is here the plane  $S'_N$ . The plane

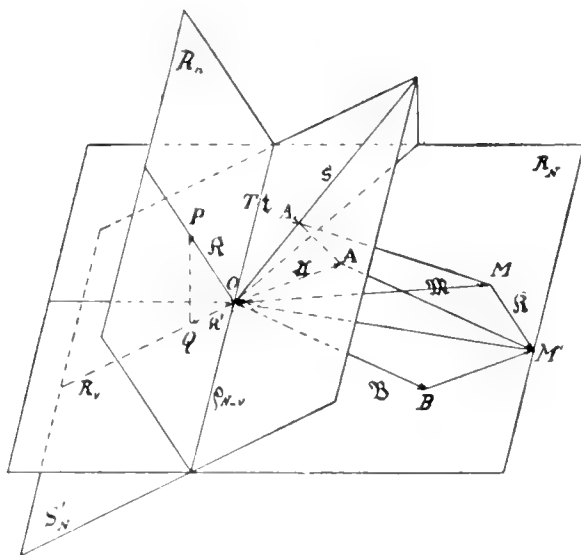

Fig. 2.

erected in  $O$  perpendicular to  $\mathfrak{B}$ , intersects  $S'_N$  in the line  $\mathfrak{g}$ , which therefore is perpendicular to  $\mathfrak{B}$  and  $\mathfrak{R}$ . So  $A$  and  $M$  are projected on  $\mathfrak{g}$  in the same point  $A_s$ .

The normal plane  $AA_sM$  of  $\mathfrak{g}$  cuts  $t$  in a point  $T$ , the distance of which to  $O$  amounts to  $M_t$  (with mean error  $\varepsilon$ ). The mean error  $\varepsilon_s$  of  $A_s$  thus has the value  $\varepsilon_s = \varepsilon \cos(\mathfrak{g}, t)$ , and that of  $A$  the value

$$\varepsilon_A = \frac{\varepsilon_s}{\cos(\mathfrak{g}, a)} = \varepsilon \frac{\cos(\mathfrak{g}, t)}{\cos(\mathfrak{g}, a)}$$

V. The errors (residuals) of  $M_1, M_2, \dots, M_n$  are  $K_1, K_2, \dots, K_n$  resp. The sum of their squares is  $[K_h^2] = K^2$ .

For the case that no equations of condition are given,  $\mathfrak{R}$  must be perpendicular to  $R_N$ . So  $\mathfrak{R}$  may dispose of a space of  $n - N$  dimensions (the normal space of  $R_N$ ). Hence  $\mathfrak{R}$  has  $n - N$  components, all with the same mean value  $\varepsilon$ . Consequently

$$K^2 = (n - N) \times \varepsilon^2$$

hence

$$\varepsilon = \sqrt{\frac{[K_h^2]}{n - N}}$$

In case  $r$  conditions are imposed,  $\mathfrak{R}$  may dispose of the space  $\mathcal{S}$  of  $n + r - N$  dimensions. Consequently  $\mathfrak{R}$  now has  $n + r - N$  components, all with a mean value  $\varepsilon$ . In this case we have therefore

$$\varepsilon = \sqrt{\frac{[K_h^2]'}{n + r - N}}$$

**Physics.** — “*On the measurement of very low temperatures. XXIV. The hydrogen and helium thermometers of constant volume, down to the freezing-point of hydrogen compared with each other, and with the platinum-resistance thermometer.* By Prof. H. KAMERLINGH ONNES and G. HOLST. Communication N<sup>o</sup>. 141*a* from the Physical Laboratory at Leiden.

(Communicated in the meeting of May 30, 1914).

§ 1. *Introduction.* The measurements which this paper deals with bring the investigations undertaken in Leiden for the purpose of establishing the scale of the absolute temperatures as far down as the freezing point of hydrogen, to a conclusion, in so far that a direct comparison has now been made between the helium and hydrogen scales, by measurements with a differential thermometer, which had the object to test the corrections to the absolute scale of temperatures below 0° C., obtained separately for the helium scale (in XIX of this series) and the hydrogen scale (partially given in XVIII of this series<sup>1)</sup>). For the place which the mutual control of these corrections occupies in the more general investigation of the measurement of low temperatures which is being carried out in Leiden, we refer to § 6 Suppl. N<sup>o</sup>. 34*a*. The test could be extended as far as the freezing point of hydrogen, after the compressibility of hydrogen vapour had been determined by KAMERLINGH ONNES and DE HAAS, Comm. N<sup>o</sup>. 127*c*. (June 1912)<sup>2)</sup>. Our comparison of the helium scale with the hydrogen scale<sup>3)</sup> by means of the differential thermometer to which was added a new calibration of the Leiden standard platinum thermometer  $Pt'$  (formerly  $Pt$ ) shows that a very satisfactory agreement has been attained in the temperature determinations.

1) Compare also H. KAMERLINGH ONNES, G. BRAAK and J. CLAY, Comm. N<sup>o</sup>. 101*a*. (Nov. 1907) § 1 under 4*b*.

2) In this Comm. a difference was discussed which existed between the temperature determination with a hydrogen thermometer according to the resistance thermometer  $Pt'$ , which was calibrated by means of it and the temperature determination by extrapolation of the isotherms. According to calculations by Dr. KEESOM, suggested by SACKUR's interesting investigation, this deviation might be connected with the theory of quanta (Comp. Suppl. N<sup>o</sup>. 30 and N<sup>o</sup>. 34*a* § 11).

3) The comparison of the hydrogen and helium thermometers by TRAVERS, SENTER and JAQUEROD, Phil. Trans. A 200 (1903), p. 105, has been discussed in Comm. N<sup>o</sup>. 102. In general their results are in good agreement with our measurements.

§ 2. *Apparatus.* Two identical thermometers of Jena glass 16<sup>III</sup>, such as had been formerly used by H. KAMERLINGH ONNES and C. BRAAK, were connected to one manometer. The arrangement was otherwise exactly the same as that used before. The standardmeter was divided into  $\frac{1}{5}$  m.m. and allowed a direct estimation of  $\frac{1}{50}$  m.m. This gave a considerable saving of time, as it made the use of the measuring eye-piece of the cathetometer unnecessary. The amount of gas in the capillary was measured by an auxiliary capillary of much larger section, as described by CHAPPUIS.

Besides the two thermometer bulbs, the cryostat contained the platinum resistance thermometer  $Pt'_1$  and a large pump, which provided for a good circulation of the liquid.

The hydrogen and the helium were purified by distillation, and were both free from other gases.

§ 3. *Calculations.* The temperature for each of the thermometers forming the differential thermometer was calculated from the formula given in Comm. N<sup>o</sup>. 95*e*, but with a few alterations. The expansion of the glass  $f'(t)$  of the bulb was not calculated from the quadratic formula given there, but taken from a graphic representation in which the curve was drawn through the points experimentally determined and extrapolated by means of the expansion for a different kind of glass as determined by CH. LINDEMANN. The influence of the different temperature function for the expansion of the glass is about  $\frac{1}{1000}^\circ$  at hydrogen temperatures, at all other temperatures it is negligible. Moreover the volume was divided into three parts. *a.* The bulb at the temperature  $t$  of the bath. *b.* The capillary in which the mean density of the gas was determined, by means of the auxiliary capillary: the mean density is proportional to  $\frac{h_0}{h}$ ,  $h^0$  being the pressure in the auxiliary capillary at  $0^\circ$ ,  $h$  the measured pressure. *c.* The steel capillary and the volume about the point, the temperature of which is the same as that of the room.

If we divide all the members of the above mentioned equation by the volume of the bulb it becomes

$$\begin{aligned} \frac{H_t}{1+at} \left[ 1 + f'(t) + \frac{\beta}{V_0} + \frac{V_{cap}}{V_0} (1+at) \frac{h_0}{h} + \frac{V_{dead vol}}{V_0} (1+at) \frac{273}{1+at_k} \right] = \\ = H_0 \left[ 1 + \frac{\beta}{V_0} + \frac{V_{cap}}{V_0} \frac{h_0}{h} + \frac{V_{dead vol}}{V_0} \frac{273}{1+at_k} \right]. \end{aligned}$$

The provisional temperature, which is needed for the calculation of the various corrections, was calculated from the resistance of  $Pt'_1$ .

Even  $\frac{H_t}{H_0}$  gives this temperature with sufficient accuracy. The zero-pressure for the hydrogen thermometer was  $H_0 = 1191$  m.m. <sup>1)</sup>, for the helium thermometer  $H_0 = 1124$  m.m. Circumstances unnecessary to be mentioned here, had prevented these pressures from being made more equal. A new set of determinations in which this will be attended to is planned. The pressure coefficient of hydrogen at the above mentioned pressure was taken at 0.0036628; for helium at 0.0036614, the value derived by KAMERLINGH ONNES <sup>2)</sup> from the isothermals at 0° C. and 100° C. If we calculate with the pressure coefficient 0.0036617 deduced from the isothermals of 20° C. and 100° C. we find, after the introduction of the necessary corrections, almost the same temperature on the absolute scale.

§ 4. *Arrangement for the resistance measurement.* In order to measure and to compare resistance thermometers two identical differential galvanometer circuits were fitted up according to KOHLRAUSCH'S method. Both galvanometers can be read from one place, so that nearly simultaneous measurements can be made. This removes all irregularity in the temperature of the bath in the comparison of resistance thermometers. Two moving coil differential galvanometers from HARTMANN and BRAUN were used. With an additional resistance of  $\pm 1000 \Omega$  in each of the coils these are practically aperiodic in the measurement of resistances less than  $130 \Omega$ , as with all our other thermometers. The sensitivity is sufficient to measure  $\frac{1}{100000} \Omega$  with a current of  $\pm 5$  milliamperes, while the condition of proportionality between deflection and current-strength is very well fulfilled.

Test-measurements have shown, that with this arrangement resistances of about  $100 \Omega$ , such as our thermometers have at ordinary temperature, can be compared to  $\frac{1}{10000}$  without any difficulty. Our

---

<sup>1)</sup> At these pressures even at the melting point of hydrogen no attention need be paid to the thermo-molecular pressure according to KNUDSEN (Comp. Suppl. N<sup>o</sup>. 34 § 7 and a Comm. by H. KAMERLINGH ONNES and S. WEBER which is shortly to be expected, on the determination of the temperatures which can be obtained with liquid helium).

<sup>2)</sup> H. KAMERLINGH ONNES, COMPT. No. 102*b*. The value is here increased by 0.0000001, in consideration of the value 273.09 since assumed for  $T_0$  C. Comp. H. KAMERLINGH ONNES and W. H. KEESOM, Die Zustandsgleichung, Math. Enz. V 10, Suppl. No. 23, Einheiten *c*, and § 82*b*.

experience with moving coil differential galvanometers, for this purpose at any rate is very favourable<sup>1)</sup>.

In the manner described we attained a much greater rapidity of measurement than was possible by the method described in the previous papers of this series, and this in its turn increases the accuracy.

We must also refer to our experience with thermometers in which the wire was sealed to the glass (Comm. N<sup>o</sup>. 95*b* § 1). For temperatures above that of liquid air they are not unsuitable, although even here they are less constant than those with a free thread. After immersion in liquid hydrogen their resistance was found to have increased by about one tenth of an Ohm. Each further immersion in hydrogen carried with it a permanent change of resistance, so that we replaced these thermometers by other ones with free threads wound on porcelain tubes with a double screw thread baked in. After a thermal treatment, consisting in several immersions in liquid hydrogen followed by moderate heating, these became satisfactorily constant.

§ 5. *Results.* In the following table the results of our researches are found. The two first columns contain the hydrogen and helium temperatures calculated from the formula given above. Column 3 and 4 contain the corrected temperatures on the absolute scale deduced from the hydrogen and from the helium thermometer, column 5 contains the resistance of the platinum thermometer *Pt*'.

The agreement is on the whole very satisfactory.

We have already mentioned that with thermometers of the kind described an accuracy of about  $\frac{1}{50}^{\circ}$  might be expected. Our measurements show this to be the case; only in a few points larger deviations occur. These can readily be explained by a small defect which will be avoided when we repeat the experiments, namely that the cryostat which had to be used was not quite symmetrically built. When both auxiliary capillaries worked properly this was not of much consequence. But (except fortunately in the determinations most important for us viz. at the hydrogen-temperatures) the helium capillary got out of order, so that the distribution of the temperature of the stem of the helium thermometer had to be deduced from the observations with the hydrogen capillary. This circumstance has the greatest influence at temperatures at which the methyl chloride and the oxygen evaporated under reduced pressure, and it is exactly there that the greatest deviations occur.

<sup>1)</sup> Compare JAEGER, Zeitschr. f. Instrumentenkunde 1904.



TABLE I.

	$t_{H_2}$	$t_{He}$	$\theta_{H_2}$	$\theta_{He}$	$W_{PtI}$
	0				135.450
1	- 23.96	- 23.94	- 23.96	- 23.94	122.613
2	43.09	43.07	43.09	43.07	112.278
3	61.50	61.49	61.50	61.49	102.280
4	79.57	79.51	79.57	79.51	92.422
5	102.72	102.69	102.70	102.69	79.674
6	113.58	113.55	113.56	113.55	73.629
7	130.46	130.41	130.43	130.41	64.189
8	182.88	182.81	182.82	182.79	34.180
9	186.79	186.70	186.73	186.68	31.904
10	195.24	195.15	195.18	195.13	26.988
11	204.79	204.69	204.71	204.67	21.491
12	212.61	212.52	212.52	212.50	17.097
13	216.25	216.15	216.16	216.13	15.119
14	252.80	252.68	252.66	252.64	1.924
15	256.23	256.10	256.08	256.06	1.601
16	258.56	258.41	258.39	258.37	1.453
17	252.80		252.66		1.925
18	253.78		253.64		1.819
19	255.20		255.05		1.685
20	257.22		257.05		1.531

The readings of  $PtI'$  allow a comparison with the measurements of 1906—1907.

In fig. 1 the deviations from the linear formula  $t = -243 + 243 \frac{W}{W_0}$  are represented for all three calibrations, at temperatures above  $-217^\circ \text{C}$ . The circles refer to the calibration of 1913, the triangles to 1907 and the squares to 1906. For the calculation of temperatures in this field the above formula with the deviation curve belonging to it has been recently used in the Leiden researches.

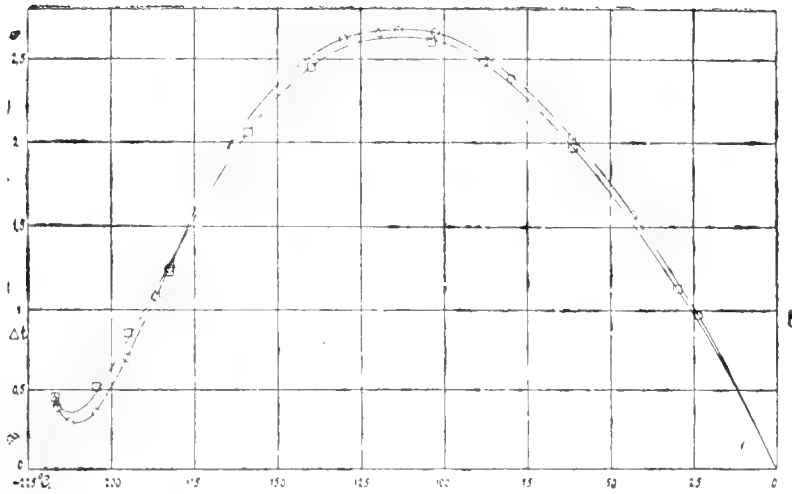

Fig. 1.

The differences between the calibrations of 1913 and 1907 are less than  $\frac{1}{30}$ <sup>th</sup> of a degree throughout. The fact that the differences with the first calibration (1906) are more considerable must undoubtedly be attributed to the mechanical treatment of the wire: after the first calibration the wire broke, and had to be re-wound. It must be ascribed to chance, that the deviations are so small just at the points of the second calibration.

§ 6. *The field of utility of the platinum resistance thermometer at low temperatures. Resistance thermometers for other fields of temperatures.* The curve in fig. 1 shows at once the peculiar behaviour of platinum below  $-200^{\circ}$ . At this temperature a change of direction

in the line which gives the resistance as a function of the temperature is sharply marked. In fig. 2 the deviations from the formula given above in the oxygen field are once more represented (circles) and also those for the thermometers  $P_{ti}$  (squares) and  $P_{tg}$  (triangles), which were also directly compared with the hydrogen-thermometer by Dr. C. DORSMAN and us. It is clear from the curves that we have to deal with a specific peculiarity of platinum, which makes it very unsuitable to be used

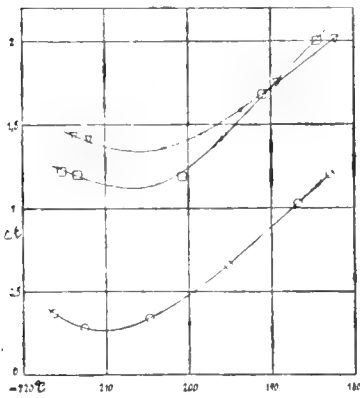

Fig. 2.

as a thermometer in this field, as accurate interpolations are impossible. For this reason in the field of temperatures below  $-200^{\circ}\text{C}$ .

a gold thermometer is preferable to a platinum one, as has already been pointed out by KAMERLINGH ONNES and CLAY <sup>1)</sup>.

At hydrogen temperatures both platinum and gold are no longer approximately linear. Here and at helium temperatures manganine and constantin proved to be nearly linear and fit for resistance thermometers. Concerning these we refer to a future comm. dealing with resistance measurements in particular for the determination of the specific heat of mercury at helium temperatures.

§ 7. *Comparison of our thermometer Pt<sub>I</sub> with other platinum resistance thermometers.* Comparing our measurements with those of F. HENNING <sup>2)</sup> formulae of the form:

$$\Delta R = M(R-1) + N(R-1)^2 \text{ and } \alpha' = \frac{\alpha^2 N}{c} \quad M = \frac{\alpha N}{c}(1-100c) - 1.$$

were used. This was done because there were objections to a direct determination of the temperature coefficient by measuring the resistance of Pt<sub>I</sub> at 0° C. and 100° C. which since the first calibration had never been brought to a temperature above the ordinary. We found

<i>t</i>	$R = \frac{W}{W_0}$ (K.O. and H.)	$R = \frac{W}{W_0}$ (HENNING)	$10^5 \Delta R$	$R-1$
-- 23.96	0.90523	0.90449	74	0.09551
43.09	0.82893	0.82775	118	0.17225
61.50	0.75511	0.75340	171	0.24660
79.57	0.68233	0.67989	237	0.32011
102.72	0.58822	0.58492	330	0.41508
113.58	0.54359	0.54007	352	0.45993
130.46	0.47389	0.46986	403	0.53014
182.88	0.25234	0.24686	548	0.75314
186.79	0.23554	0.22998	556	0.77002

These numbers give:  $M = -0.0078758$

$$N = -0.0007605.$$

And further  $c = -0.30.10^{-5}$

$$100\alpha' = 0.38821$$

From the results it appears that our platinum thermometer, as regards its constants, lies between the platinum thermometers N<sup>o</sup>. 4 and N<sup>o</sup>. 7 used by HENNING in his investigation. This was to be expected, as these thermometers, like ours, were obtained from HERAEUS, N<sup>o</sup>. 1 and Pt<sub>I</sub> being of earlier date. The difference with the values calculated by HENNING is caused by the fact that his calculation was based on our calibration of 1906, which differs from our present one and that of 1907 (Comp. § 5).

<sup>1)</sup> Comm. N<sup>o</sup>. 95. Used also by CROMMELIN, Comm. N<sup>o</sup>. 140a.

<sup>2)</sup> Ann. der Phys. 4te Folge Bd. 40, 1913.

**Physics.** -- "*On the electrical resistance of pure metals etc. IX. The resistance of mercury, tin, cadmium, constantin, and manganin down to temperatures, obtainable with liquid hydrogen and with liquid helium at its boiling point.*" By Prof. H. KAMERLINGH ONNES and G. HOLST. Comm. N°. 142a from the physical Laboratory at Leiden. (Communicated by Prof. H. KAMERLINGH ONNES).

(Communicated in the meeting of June 27, 1914).

§ 1. *The resistance of wires of solid mercury.*

Several mercury resistances were compared with the platinum resistance thermometer  $Pt'$  of the laboratory, first in liquid oxygen,

$T$	$W_{\text{obs.}}$	$W_{\text{calc.}}$	$\Delta W$
< 4.19	supra-conductor		
4.19	0.0560	0.479	0.421
4.27	0.0600	0.489	0.429
4.33	0.0636	0.496	0.432
4.37	0.0656	0.500	0.434
14.57	0.9390	1.667	0.728
15.78	1.069	1.806	0.737
17.89	1.298	2.047	0.749
20.39	1.563	2.333	0.770
80.92	8.086	9.261	1.175
90.13	9.088	10.316	1.228
116.52	12.000	13.337	1.337
122.81	12.694	14.056	1.362
132.72	13.800	15.190	1.390
141.83	14.855	16.233	1.378
154.22	16.354	17.651	1.297
165.80	17.806	18.976	1.170
184.92	20.311	21.164	0.853
218.69	24.716	25.029	0.313
233.53	26.694	26.731	0.037
234.16	26.800	26.800	0.000

then at a number of other temperatures, with the differential-galvanometer according to KOHLRAUSCH'S method.

The result of these determinations was as shown in the table ( $T =$  temperature on the KELVIN scale, with  $T_{0^{\circ}\text{C.}} = 273^{\circ}.09$ )

In the third column are given the values, which would have been obtained, if the resistance diminished linearly from the melting point down to the absolute zero.

$$W_{\text{calc.}} = \frac{T}{T_s} W_s = \frac{T}{234.16} 26.800 = 0.11445 T.$$

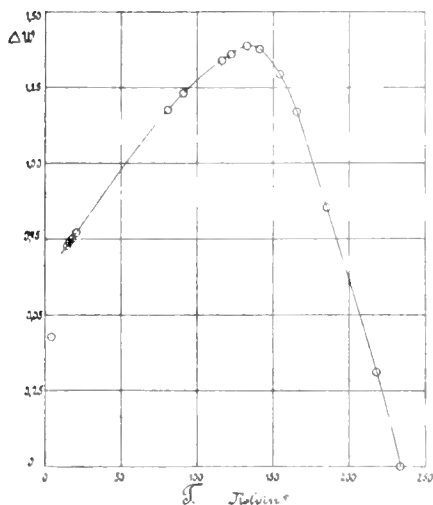

Fig. 1.

Column 4 gives the deviations of the real values of the resistance from those, calculated by means of the linear formula. These deviations are also plotted in the figure. The relation between electrical resistance and temperature seems to be of a very complicated character.

### § 2. Direct determination of the change in resistance at the melting point.

Of two resistances, which were frozen without auxiliary bath, the

change in resistance in melting was determined directly. The first consisted of a narrow capillary filled with mercury, section  $\pm 0.0015$  mm<sup>2</sup>. At  $-49^{\circ}.88$  the resistance was  $25.095 \Omega$ , immediately above the melting point  $115.0 \Omega$ ,

$$\text{the ratio } \frac{w_{\text{liq}}}{w_{\text{sol}}} = 4.66.$$

The second capillary had a section of  $0.43$  mm<sup>2</sup>. With this resistance the ratio  $4.50$  was found.

As a preliminary value of the melting point  $-38^{\circ}.93$  C. was found.<sup>1)</sup>

### § 3. Indirect determination of the change in resistance at the melting point.

During the numerous determinations of mercury resistances in liquid helium (Comm. N<sup>o</sup>. 133), we always measured the resistance at ordinary temperature too. By means of the resistances of solid mercury of

<sup>1)</sup> Our measurements date of 1912. In the meantime was published the paper of F. HENNING Ann. d. Ph. (4) 43 p. 282, 1914 who finds  $-38^{\circ}.89$  C.

§ 1 and of the well-known behaviour of liquid mercury, we calculated in each case the ratio  $\frac{w_{liq}}{w_{sol}}$ .

As in these experiments the mercury resistance was suspended in a vacuum-vessel cooled from the outside, the freezing took place very slowly.

We found:

23 May 1911	4.40
30 „ „	4.63
27 Oct. „	4.41
	4.84
12 Jan. 1912	4.30 $w_{50}$
	5.06 $w_{150}$
17 Febr. „	4.69
	4.19
22 „ „	4.30
14 June „	4.37
	4.90

As probably the highest figure thus obtained comes nearest to the true value of the ratio, we will be not far from the truth, if we assume the number 5 for the mean ratio.

This result has also been found by BALTRUSZAJTIS<sup>1)</sup>, who obtained 4.90 as highest value in his melting-experiments.

It is remarkable, that the ratio of the change with temperature of solid and liquid mercury is also about 5; the increase of resistance per degree remains thus fairly constant in melting.

§ 4. *Some determinations of the change in resistance with the temperature of metals and alloys.*

*a. Object of the experiments.* We made a series of determinations, mainly for orientation, about the change of resistance of different metal wires down to helium-temperatures. The purpose of those determinations was to find a metal or an alloy, which could be used as a resistance thermometer down to the lowest helium temperatures. The results of these measurements are plotted in figure 2. Of special interest is the behaviour of manganin and constantin. While with copper, tin, iron and cadmium no further change of resistance could be established in the region of the lowest temperatures, it appeared, that the resistance of manganin diminished considerably and in a linear way with the temperature, from the lowest oxygen temperatures down to the region of the helium temperatures. So that wires of manganin might be

<sup>1)</sup> A. BALTRUSZAJTIS, Cracovie Bull. Acad. Nov. 1912.

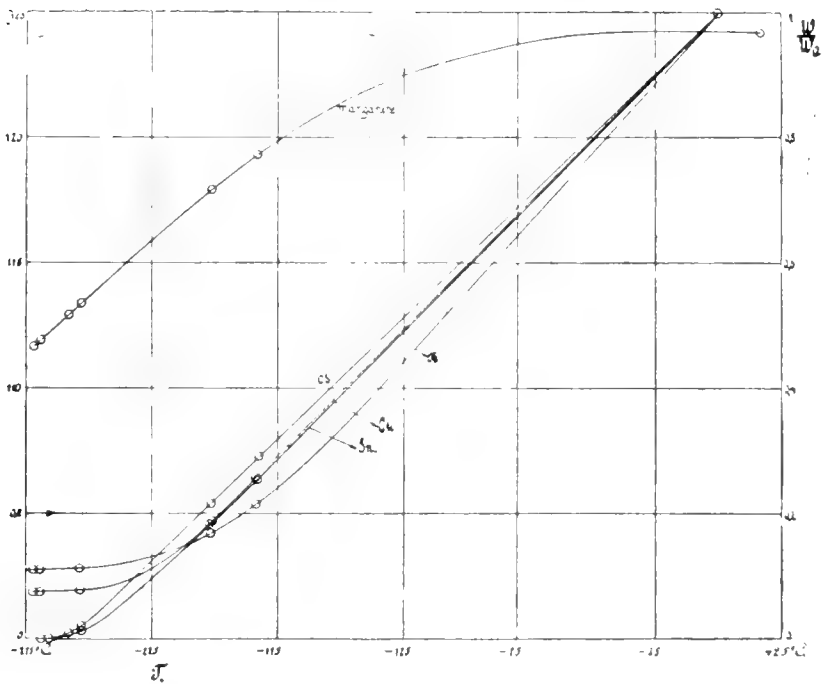

Fig. 2.

used equally well as wires of constantin (the suitability of which was shown on a former occasion), as resistance thermometer in this region of temperatures.

*b. Pure cadmium and pure tin.* Pure cadmium (KAHLBAUM) was cast in a glass tube like mercury. From the tin (KAHLBAUM) a thin wire was cut on the lathe.

$t$	Resistance of tin	$t$	Resistance of cadmium
16.5	$271.10 \cdot 10^{-3} \Omega$	16.6	$76.7 \cdot 10^{-3} \Omega$
-183.2	66.2	-183.2	20.9
-201.4	46.9	-201.2	15.7
-252.9	2.99	-252.9	1.45
-258.3	1.18	-258.3	0.58
-268.9	0.132	-268.9	0.032

*c. Copper and iron.* The copper wire was made of commercial electrolytic copper<sup>1)</sup>. The iron was from Sweden (Kolswa II). It

<sup>1)</sup> W. MEISSNER (Verh. D. Phys. Ges. (16), 262, 1914) used much purer copper. In his determinations the resistance at the boiling point of liquid hydrogen was only 0.26 % of the resistance at 0° C.

had already been used by Dr. B. BECKMAN for measurements concerning the influence of the magnetic field on the resistance.

$t$	$W_{\text{copper}}$	$W_{\text{iron}}$
- 183.7	34.5	3.90
- 201.7	24.7	3.05
- 253.5	10.5	2.04
- 269.5	10.0	2.00
- 272.0	10.0	2.00

The resistance approaches here to a definite limiting value, in the same way as this has already been found for other not quite pure metals (Comm. N<sup>o</sup>. 119).

*d. Constantin and manganin.* The temperature coefficient of constantin which is extremely small even down to oxygen temperatures, increases considerably in the region of the hydrogen temperatures, so that constantin wires are suitable thermometers in this region and especially in the region of helium temperatures.

$T$	$W_{\text{constantin}}$	$T_{\text{calc.}}$	$T - T_{\text{calc.}}$
90.75	145.680		
65.18	144.320		
20.36	138.259	20.36	0.00
18.98 <sup>5</sup>	137.988	19.00	- 0.01
17.33	137.662	17.37	- 0.04
15.83	137.355 <sup>5</sup>	15.83	0.00
14.32	137.050	14.30	0.02

$T_{\text{calc.}}$  are the values calculated by means of a linear formula of the form

$$t = a + br$$

through the points at 20<sup>o</sup>.36 and 15<sup>o</sup>.83. The deviation does not amount to more than 0<sup>o</sup>.04 and shows thus the suitability of constantin wires as thermometers in the hydrogen region, where the platinum-thermometer would require complicated calibrations (comp. Comm. N<sup>o</sup>. 142c).



$\theta$	$W_{\text{manganin}}$
16.5 C	124.20
-183.0	119.35
-201.7	117.90
-253.3	113.42
-258.0	112.91
-269.0	111.92
-271.5	111.71

*e. Gold.* With a view to measurements of specific heats, which will be published before long and to investigate the suitability of the gold-thermometer in the region of oxygen- and hydrogen-temperatures, we determined the resistance of a gold wire at a great number of temperatures in those regions.<sup>1)</sup> The result shows, that in the region of the reduced-oxygen temperatures (mainly below  $-200^{\circ}$  C.) the gold thermometer does not give rise to the difficulties, which make the platinum thermometer nearly worthless in that region (Comm. N<sup>o</sup>. 141*a* § 6 and fig. 2).

$T$	Resistance of gold
14.18 K	0.2910
15.83	0.3037
17.30	0.3190
19.00	0.3412
20.35	0.3621
65.18	2.2901
72.58	2.6763
83.31	3.2312
87.99	3.4710
90.75	3.6110

<sup>1)</sup> Calibrations of other gold wires will be given in the paper by W. H. KEESOM and H. KAMERLINGH ONNES on specific heats Comm. N<sup>o</sup>. 143.

**Physics.** “*Further experiments with liquid helium. I. The persistence of currents without electro-motive force in supra-conducting circuits.*” (Continuation of J). By Prof. H. KAMERLINGH ONNES. Communication N°. 141*b* from the Physical Laboratory at Leiden.

(Communicated in the meeting of June 27, 1914).

§ 9. *The preservation of an electro-kinetic momentum.* All the phenomena that were dealt with in the preceding sections (J) <sup>1)</sup> showing the persistence of the magnetic moment of the coil, without the action of an electro-motive force, agree with what was deduced on the supposition that a current flows through the coil of the value calculated, and which diminishes according to the time of relaxation calculated. At the same time, it was desirable to have a conclusive proof that the magnetic moment of the coil is really caused by a current. We should then be able to prove conversely by the continuation of the moment, that the time of relaxation of the current is very long, and a value, or otherwise an upper limit could be given for the micro-residual-resistance of the conductor in which this current flows.

I got this proof in the following manner.

On either side of the place, where the ends of the windings of the coil are sealed together and close to it, two wires *b, b* (see fig. 2 and 1) were fixed which lead to a ballistic galvanometer. Between these points of attachment the current can be cut through under helium, by pulling up by a thread a bronze loop provided on the inside with a knife edge at *m* (see figs 3 and 1. Figs 1 and 2 give

<sup>1)</sup> Disregarding the existence of threshold-values of current and field and considering that, below these, supra-conductors add up algebraically without appreciable loss the inductional impulses which act on them in the course of time, two points of view may be very simply contrasted in connection with the experiments so far described on the production of currents persisting for a long time.

The first is analogous to that taken up in WEBER's explanation of diamagnetism. In this case we deal with supra-conducting circuits which are currentless outside the magnetic field. By bringing these into a field currents may be obtained which persist as long as the field remains unchanged. But when the field disappears the circuits become again free of current. In this manner a good imitation is obtained of diaphragmatic polarisation. The other point of view may be called the antilogon of that of WEBER. We provide in a magnetic field supra-conducting circuits which are free of current. When these circuits are brought outside the field, they show a current persisting for a long time. Outside the field they imitate permanent magnets. It must, however, not be lost sight of, that this imitation is in so far incomplete, as when the circuits are brought back into the field, they return to the currentless condition.



Fig. 1.



Fig. 2. Fig. 3.

a combined view of the experiments of sections 9 and 11). The thread runs through a tube, the lower part of which is of glass and can be moved by means of a rubber-tubing attachment at the top of the apparatus (fig. 1). The coil was cooled to  $2^{\circ}.4$  K. in a field of 200 gauss by helium evaporating under reduced pressure. The current was again produced through induction by removing the field. When the compass needle with the compensation-coils was arranged, as before, beside the cryostat, a moment corresponding to a current of 0.36 amp. was registered. The observation was continued for an hour, in which the diminution of the current in 45 minutes was within the limits of probable error of the measurement ( $2\%$ ); after this the circuit of the coil was cut through. The needle of the compass fell back to a deviation that corresponded to a current of 0.05 amp. in the coil. The ballistic galvanometer (with a negligible self-induction and with  $2000 \Omega$  in the circuit) showed an electro-kinetic momentum  $Li$  of 300000, from which follows with  $L=10^7$ .

that a current of about 0.3 amp. flowed in the coil. The remaining moment is again the same fraction of the principal effect as was observed previously, it was extinguished as soon as the coil was pulled up above the liquid helium. The experiment proves conclusively, that a current does really flow through the coil.

§ 10. *Further consideration of the momentum produced in the coil, when the circuit is not closed. Persisting FOUCAULT-currents.* In the previous experiments the question arose in how far magnetic properties of the frame of the coil, which developed at the lowest temperatures had an influence, and whether a part of the moment that remained, when the coil, without the ends being connected, was cooled and exposed to the field, was due to windings which were short-circuited. For this purpose first of all a tube of brass, exactly like that used as the frame of the coil, was cooled in the field. It showed no residual magnetism.

To get further light on possible short-circuits in the coil  $P^b_{XII}$ , after it had been shown that cooling in liquid air did not alter

its moment, a new coil of 650 turns was wound, in which the possibility of short-circuiting was excluded by insulation of the windings by piecein and paper. It is true that the magnetic properties of these materials are not known, but from the extinction immediately above the boiling-point of helium of persisting current which was found in the course of the experiments it is almost certain, that the phenomena are entirely due to the lead. It was ascertained that this coil was superconductive, which was a welcome result also for the reason that the wire had been manufactured by compression, and this process gives a much better guarantee of getting the same product again by using the same method, and therefore of obtaining beforehand the certainty of the wires prepared in this way being supra-conducting. In making the experiment with 200 gauss at  $2^{\circ}.4$  K. a residual effect of the same order as with  $Pb_{XII}$  was found, but smaller. The principal current was 0.5 and the residual current 0.020 Amp. It becomes probable, when these figures are compared with those found with  $Pb_{XII}$ , that in the latter there really is some short-circuiting, but there is also apart from the effect due to the short-circuited windings a moment caused by the lead.

It seems as if in the mean time this may be attributed to circular currents in the lead of the wire, which are possible owing to the wire having a certain thickness. We must distinguish in the wire between an inside which is turned towards the axis of the coil, and an outside. In the wire, even when the circuit is opened, a current arises, in which the electricity passes along the whole length of the windings on the outside of the wire (that is not closed in itself), in order to turn round at the one end of the wire and go back along the internal side. With induction in the closed circuit this current is superposed upon the mean electric movement in the circulating current, so that in the wire there is say a stronger current on the outside, and a weaker on the inside. If by means of a galvanic cell a current is sent through the wire, the same phenomenon arises through the action of the field of the current itself. We are here evidently dealing with persisting *FOUCAULT-currents*<sup>1)</sup>.

§ 11. *A supraconducting key.* In the experiments so far described the supra-conducting closing of the conductor tested for supra-conductivity was obtained by melting the two ends together. Now

<sup>1)</sup> Several of the well known experiments by ELIHU THOMSON with alternating currents could also be made with parallel currents and supra-conducting experimental objects.

that these experiments had proved that a current generated in a circuit which is supra-conducting over its whole length, continues without electro-motive force, we could investigate in how far an electric contact interposed in an otherwise supra-conducting circuit, measured by the amount of conductivity of supra-conductors, might be considered as having no resistance. The immediate cause of this investigation was a suggestion made by my colleague KUENEN, whether the current the relaxation period of which was to be studied, might not be obtained in the coil by short-circuiting.

I thought then, that the transitional resistance in a contact to be manipulated under liquid helium could hardly be made small enough for this purpose. The transitional resistance of a stop-contact treated with all due care at ordinary temperature is not likely to be less than  $0,0001 \Omega$ , which is still 100,000 C.G.S. while the micro-resistance of the coil itself is only 37. It has now been found, however, that transitional resistances such as we are considering can become very small at low temperatures. A quite moderate pressure, between two pieces of lead appeared to be sufficient for the purpose. The arrangement is shown in Fig. 2. The small lead plate  $p$ , provided with three small cones directed upwards and connected with the coil through a spirally-wound part of the lead wire which acted as a spring, is attached to a thin rod (partly formed of wood) and was pressed against the block soldered to the glass tube by serewing up the rod, the force being accurately regulated by means of a spring (see top of fig. 1). The tube is provided with a number of side-openings to prevent the very much intensified heat convection (caused by resonance phenomena) which occurs in tubes closed at the top when the bottom is at a very low temperature, and which would lead to excessive evaporation of the helium.

By means of this simple key we were enabled to arrange the following experiment. To each extremity of the windings of the coil two wires were attached (fig. 1 and 2). By means of the one pair  $ac$  a current can be sent through the coil. The other pair  $bb$  can be connected to a ballistic galvanometer. Moreover the two ends are connected to the two parts of the supra-conducting key. With the key and the galvanometer open, a current is sent through the cooled coil, in the neighbourhood of which the compass-needle has been mounted. The coil is then closed in itself, which gives no change in the deviation of the needle. One can then convince oneself as long as one likes, that the side-current, which in ordinary cases is immediately extinguished, remains unaltered in the supra-conductor; the galvanometer connection is then closed, which also brings no change

in the current, and if thereupon the current connection is opened this is accompanied by a throw of the ballistic galvanometer in the circuit of which the current is instantly extinguished and by a return of the needle of the compass into the position which it would also take up, if the current in the closed coil had been generated by a magnetic field equal to that of the current itself. The continuation of the movements in MAXWELL'S mechanism, when it has a superconductor as carrier, is demonstrated by this experiment with equal clearness and simplicity.

§ 12. *Combination of parallel currents into one of greater strength.* In trying to make the same experiments with mercury that we have made with lead, it will be necessary in so far to change the experiment, that one winding will be sufficient. This might be got by freezing mercury in a capillary tube returning in itself with an expansion head (like our other U-shaped mercury resistances). The chief questions then are 1) if with a conductor of as large a section (keeping for the present to the circular form) as would be necessary, with a view to the threshold value of current density, in order to get an action comparable to that with the lead coil, the threshold value of current density — of which as in N<sup>o</sup>. 133 it is assumed that it is determined principally by the current density — does not undergo a considerable diminution in consequence of the larger section, as some considerations in N<sup>o</sup>. 133 would make us fear, and 2) if we can reckon with the microresidual resistance as an ordinary resistance even for such a completely different section as that for which it has been determined. An inducement to try the experiment immediately with a lead ring<sup>1)</sup> was a remark by my colleague EHRENFEST,

1) I am glad to mention here that Mr. J. J. TAUDIN CHABOT of Degerloch (Württemberg) shortly after my paper on the disappearance of resistance in mercury and, as I found afterwards, only acquainted with my result, that the resistance of gold and platinum in an absolutely pure condition would probably disappear altogether at extremely low temperatures, communicated to me a number of suggestions regarding the condition into which metals pass below this temperature and which he would like to be considered as a distinct "fifth" state of aggregation.

Amongst these suggestions was the following: "if a ring (of gold) is brought to the condition of absolutely no resistance (in helium), an impulse (viz. by induction) will be sufficient to produce a permanent current, which will make the ring into a magnetic shell, as long as the temperature of the metal remains below a certain critical value". By critical value was meant — not the vanishing point as discovered afterwards — but the temperature characteristic of each metal at which, according to my earlier views, the resistance of the pure metal would become zero independently of the current-strength. The idea, however, underlying this speculation — which was further developed by supposing the cooled ring to

that the experiment could be made equally well with the windings "parallel" as it had been made with the windings in "series". A calculation (by estimation and further proceeding in the same way as with the coil) about the experiment with a lead ring of an internal radius of 1.2 cm. of a thickness of 0.3 cm. and of a width of 0.35 cm. and assuming that the threshold value found for the thin lead wire would also hold for the thick ring, showed me, that it might succeed very well.

This proved to be the case. The current of 320 amp. that was registered in the ring remained constant for half-an-hour to 1%, hence the current density of 30 was in this experiment not much smaller than it had been in one of the experiments with the coil of lead wire, viz. 49. This may for the present be regarded as a confirmation of the supposition that the threshold value of current strength of a conductor is mainly a threshold value of current density for the material of the conductor.

---

be subjected to a magnetic field which was to be removed afterwards — was also applied in my experiments for the purpose of obtaining persisting currents in supra-conductors, and in the above last experiment actually with a ring as the conducting circuit.

At the time I was so much occupied with the investigation of the peculiar laws of electric conduction in mercury below the vanishing-point and of the degree to which currents might be realised in resistanceless circuits without electromotive force, that I had not yet attacked or was able to fully go into the problems relating to currents to be generated in closed supra-conductors by induction (amongst which problems that of the imitation of diamagnetic polarisation was an obvious one). Still Mr. TARDIN CHABOT's letter was the cause of my coming even then to the conclusion, that in order to be able to obtain persisting currents outside the magnetic field by induction, an artifice based on the peculiarity of supra conductors was required. As such I then found, that the cooling which is to make the conductor supra-conducting is not applied, until the conductor is in the field which is to be used for the induction. Afterwards it was found, that by utilizing the knowledge of the threshold values of current and field circumstances may be realized, in which a permanent current may be obtained outside the field by induction on a circuit which has been made supraconducting by cooling before the field is applied.

**Physics.** — “*Further experiments with liquid helium N. HALL-effect and the change of resistance in a magnetic field. X. Measurements on cadmium, graphite, gold, silver, bismuth, lead, tin and nickel, at hydrogen- and helium-temperatures.* By Prof. H. KAMERLINGH ONNES and K. HOF. (Communication N°. 142b from the Physical Laboratory at Leiden.)

(Communicated in the meeting of June 27, 1914).

§ 1. *Method.* The method was the same as that used in the measurements of this series by H. KAMERLINGH ONNES and BECKMANN (cf. Comm. N°. 129a and others). The notation is also the same as in the previous papers. As regards the HALL-effect, we used both the method in which a galvanometer-deflection caused by the effect is read and the compensation-method, in view of the fact, that the latter, although in general to be preferred, as it allows the elimination of various disturbances, is very troublesome, when small effects have to be measured. The differential-galvanometer used was of the KELVIN-pattern with a volt-sensibility of  $5 \times 10^{-8}$ ; it was iron-shielded and was mounted according to JULIUS. As to the resistance measurements these were partly performed in immediate connection with the determination of the HALL-effect, in which case the resistance of the plate used for this purpose was at the same time measured, partly (by means of the compensation-apparatus) with wires which were wound on thin sheets of mica and could be placed either at right angles to the field or parallel to it, the latter specially with a view to investigating the considerable difference between the transverse and the longitudinal effect, which difference develops specially at helium-temperatures.

§ 2. *Bismuth.* In accordance with frequent practice (e.g. by KAMERLINGH ONNES and BECKMANN) we used this substance in the form of pressed plates. The peculiarities in the resistance observed by STREINTZ with conductors of compressed powder — although occurring also in our plates at higher temperatures — were not observable, when the plates were cooled below 0° C.

The plates which served for our investigation were pressed in a steel mould and heated to about 200° C. in an electric furnace. When made in this way the granular structure was still clearly observable with a magnifying glass. The plate *BiVI* was made without special precautions; with plate *BiVII* the metallic powder



was specially dried before moulding it.  $Bi_{VI}$  gave an abnormally high temperature-coefficient at higher temperatures and even after 36 hours' heating had not yet attained a constant resistance.

The metastable condition which according to Professor E. COHEN is peculiar of most metals as mixtures of different modifications manifested itself also in our experiments. The plates after being heated in the electric furnace to  $60^\circ$  or  $100^\circ$  C. showed some difference as regards resistance and HALL-effect after cooling, with the further peculiarity, that this change took place, although no change in the specific gravity affecting the second decimal place could be established.

The results are contained in tables I and II.

TABLE I.

$Bi_{VI}$				
$H$	$-R$	Resistance	$-R$	Resistance
	$T=289^\circ$ K		$T=20.5$ K	
2400 Gauss	7.71	$2.5 \cdot 10^{-3} \Omega$		$3.7 \cdot 10^{-4}$
2420 "			42.13	
4800 "	6.68		38.95	
7200 "	6.02		35.44	
9650 "	5.37		33.62	
11800 "			29.76	$1.1 \cdot 10^{-3}$
12000 "	4.65	$3.1 \cdot 10^{-3} \Omega$		

TABLE II.

$Bi_{VII}$				
$H$	$-R$	Resistance	$-R$	Resistance
	$T=289^\circ$ K		$T=20.5$ K	
2420 Gauss	10.57	$2.4 \cdot 10^{-3}$	80.03	$3 \cdot 10^{-4}$
4800 "	9.48		78.31	
7200 "	8.11		75.15	
9650 "	7.26		72.51	
12000 "	6.28	$3.2 \cdot 10^{-3}$	70.82	$1.6 \cdot 10^{-3}$

§ 3. *HALL-effect in graphite.* The great change in the properties of graphite through even small admixtures appears clearly from the fact, that with different kinds of graphite the temperature-coefficient of the resistance may even differ in sign.

The material we started from in our experiments was fine graphite-powder, such as is used in electro-plating; the powder was first treated with acids and alkali and carefully dried; the forming of the plate was again carried out in a steel mould. The electrodes which gave some difficulty at first were finally contrived in the following manner: the powder was provisionally moulded to a plate under comparatively low pressure, the stamp was then lifted off and six small pellets of solder were laid on the plate, after which a high pressure was applied. By trial we succeeded finally in obtaining suitable plates of  $\frac{1}{3}$  mm. thickness with six point-electrodes of about  $\frac{1}{2}$  mm. diameter, penetrating through the whole thickness of the plate.

The influence of insufficient drying of the powder was very marked; such plates, as did not come up to standard as regards drying, did not reach their final resistance until the current had gone through for 6 seconds.

The following table contains the results. It may be specially noted that the temperature-coefficient is positive and that the HALL-effect falls strongly from  $20^\circ$  K. to  $14^\circ$  K.

TABLE III.

<i>Graphite.</i>			
<i>H</i>	$290^\circ$ K	$20^\circ.5$ K	$14^\circ.5$ K
	+ <i>R</i> :	+ <i>R</i> :	+ <i>R</i> :
4800 Gauss	0.68	3.4	1.42
6000 "	0.68		
7200 "		3.39	
8400 "	0.68		1.52
9600 "		2.81	
11800 "	0.74	2.22	1.52

§ 4. *The HALL-effect in cadmium.* Two circular rolled-out Cadmium-plates of 1 cm. diameter were experimented on. The results are found in the following table.

TABLE IV.

<i>Cadmium.</i>			
<i>H</i>	290° K	20° .5 K	14° .5 K
	+ <i>R</i> :	+ <i>R</i> :	+ <i>R</i> :
3000 Gauss		13.1.10 <sup>-4</sup>	
3600 "	4.6.10 <sup>-4</sup>		
4800 "		20.2.10 <sup>-4</sup>	22.3.10 <sup>-4</sup>
6000 "	6.3.10 <sup>-4</sup>		
7200 "		20.6.10 <sup>-4</sup>	23.4.10 <sup>-4</sup>
8400 "	5.9.10 <sup>-4</sup>		
9600 "		19.6.10 <sup>-4</sup>	22.3.10 <sup>-4</sup>
11800 "		17.6.10 <sup>-4</sup>	19.1.10 <sup>-4</sup>
12000 "	5.5.10 <sup>-4</sup>		

§ 5. *The HALL-effect at helium-temperatures.* The method was the same as in the previous measurements. To check the results, measurements were made both with the compensation-apparatus and with the differential-galvanometer. Five different plates were experimented upon in the helium-bath. These were chosen so, that they could be regarded as representatives of metals for which the HALL-effect is of a different type. Each set of six wires from the six electrodes of one plate was completely separated from the other sets in the cryostat.

The following plates were investigated.

1. A tin and a lead plate: both metals are supra-conducting at extremely low temperatures. Lead remains supra-conducting up to a considerable threshold-value of current. It may be added that both are diamagnetic: as DE HAAS has shown, the diamagnetic properties are of great importance for the HALL-effect.

At hydrogen-temperatures the HALL-effect is still so small, that it escapes observation. It was found that at 4° .25 K. both with tin and lead the effect can be very well measured, when the field is so high, that ordinary resistance is generated in the metals. As long as the field is low enough for the metal to remain supra-conducting, the HALL-effect, like the ordinary resistance, disappears.

2. A silver plate, as representative of the group of metals for which at the ordinary temperature the HALL-coefficient is of the

TABLE V.

Measurements in Helium.		
<i>H</i>		<i>R</i>
	1. <i>Sn</i> (tin)	
	<i>a.</i> $T = 4^{\circ}25$ K	
11300 Gauss		+ 2.6.10 <sup>-5</sup>
	<i>b.</i> $T = 2^{\circ}8$ K	+ 9.8.10 <sup>-5</sup>
	2. <i>Pb</i> (lead)	
	<i>a.</i> $T = 4^{\circ}25$ K	
300 Gauss		< 6.10 <sup>-5</sup>
1000 "		< 2.10 <sup>-5</sup>
5000 "		+ 0.8.10 <sup>-4</sup>
11300 "		+ 1.8.10 <sup>-4</sup>
	<i>b.</i> $T = 2^{\circ}8$ K	
300 Gauss		< 6.10 <sup>-5</sup>
11300 "		+ 1.3.10 <sup>-4</sup>
	3. <i>Ag</i> (silver)	
	<i>a.</i> $T = 4^{\circ}25$ K	
11300 Gauss		16.10 <sup>-4</sup>
	<i>b.</i> $T = 2^{\circ}8$ K	
11300 "		16.10 <sup>-4</sup>
	4. <i>Ni</i> (nickel)	
	<i>a.</i> $T = 4^{\circ}25$ K	
1300		< 5.10 <sup>-5</sup>
11300		< 1.10 <sup>-5</sup>
	<i>b.</i> $T = 2^{\circ}8$ K	
11300		< 1.10 <sup>-5</sup>
	5. <i>Bi</i>	
	$T = 4^{\circ}25$ K	
1000 Gauss		86.3
5000 "		84.2
11300 "		85.7

order of magnitude  $10^{-4}$ ; silver is diamagnetic and does not become supra-conducting at helium-temperatures.

As appears from the table, it was found that with silver also the HALL-effect increases, when the temperature falls to  $4.25^\circ$  K. At still lower temperature it does not show any further change, no more than the resistance without a field.

3. A bismuth-plate  $Bi_{III}$ , moulded from electrolytic bismuth-powder. Bismuth has a very high HALL-effect at hydrogen-temperatures and the change from  $20^\circ$  K. to  $14^\circ$  K. is still very small. It is the strongest diamagnetic metal.

The table shows that below  $14^\circ$  K. there is not much further change in the HALL-effect. From 71 at  $20^\circ$  K.  $R$  rises only to 85 at  $4.25^\circ$  K.

4. A nickel plate as representative of the ferro-magnetic metals. With nickel at higher temperatures the HALL-effect shows a tendency to saturation owing to the magnetisation of the metal (Comm. No. 129, 130, 132). At hydrogen-temperatures the effect is still easily measurable; at helium-temperatures it disappears, although the resistance of the plate is still considerable. Probably this is connected with the fact, that notwithstanding the already fairly considerable field the magnetisation of the nickel is still very small.

The results are collected in table V. (zie p. 577).

§ 6. *Change of the resistance in the magnetic field.* It was found, that specially at helium-temperatures this change is very considerable, but that at  $20^\circ$  K. also it is still quite well measurable. In general there is a difference between the longitudinal and the transverse effects, which begins to show itself especially clearly at helium-temperatures.

We shall give our results in the form of curves (figs. 1 to 6) on which the numerical values may also be read with sufficient accuracy by using the scale-values indicated in the figures. So far the meas-

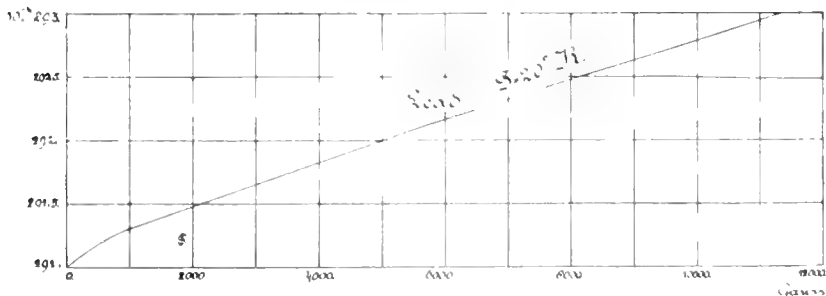

Fig. 1.

urements both at hydrogen- and helium-temperatures have not gone beyond 12000 Gauss. They will afterwards be further extended to higher field-strengths especially at hydrogen-temperatures.

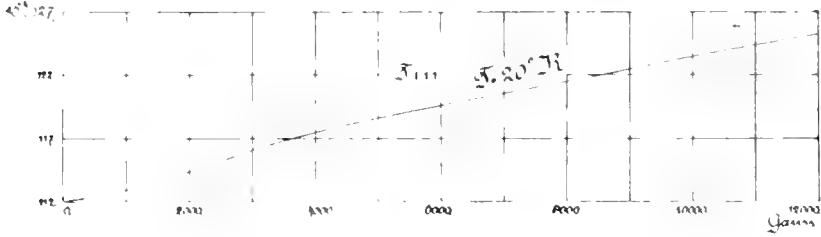

Fig. 2.

Figs. 1 and 2 contain the results for the resistance of lead and tin in a magnetic field. The difference between the longitudinal and

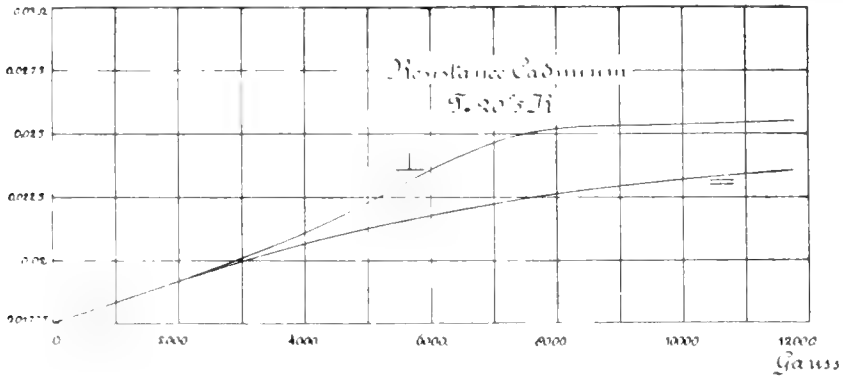

Fig. 3.

transverse effects was not more than the errors of the measurements. The abscissa gives the ratio of the resistance to that at 0° C.

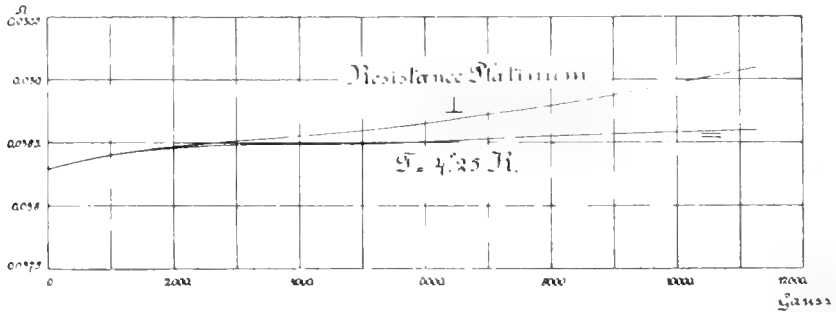

Fig. 4.

Fig. 3 and 4 represent the longitudinal and transverse effects for cadmium and for platinum. The abscissae give directly the resistance in Ohms.

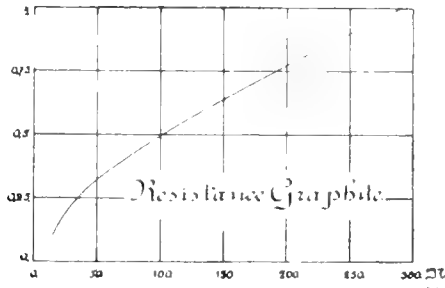

Fig. 5.

Fig. 5 and 6 show the results for graphite, Fig. 5 the dependence of the resistance on the temperature, fig. 6 the dependence on the magnetic field.

We have further made measurements on the resistance of a

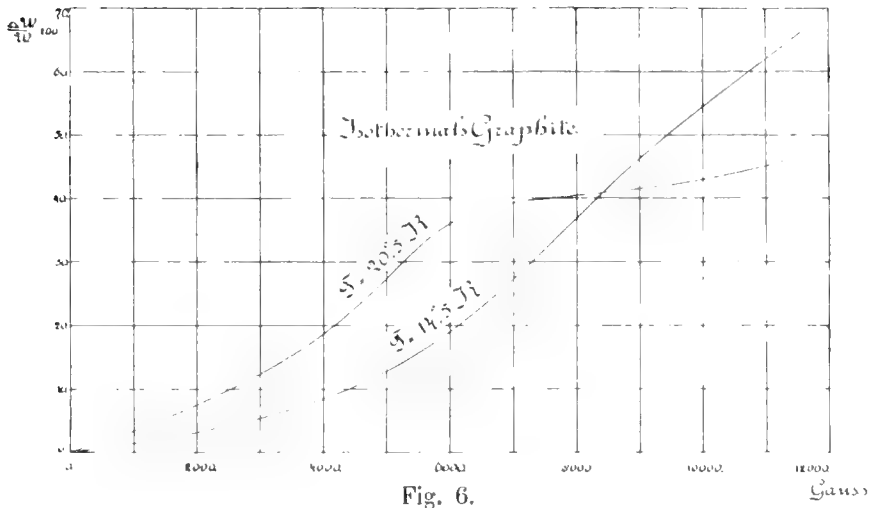

Fig. 6.

plate of not-purified graphite. These are not concluded, however, and will be published later together with measurements on polarisation-phenomena which may possibly show themselves with pressed graphite.

**Physics.** — “*Measurements on the capillarity of liquid hydrogen*”.

By H. KAMERLINGH ONNES and H. A. KUYPERS. (Communication N<sup>o</sup>. 142*d* from the physical laboratory at Leyden).

(Communicated in the meeting of June 27, 1914).

For the determination of the capillary constant of liquid hydrogen in contact with its saturated vapour the method of capillary rise was used. The apparatus are in the main arranged in the manner as used for other liquid gases in Comm. N<sup>o</sup>. 18. On plate I A of Comm.

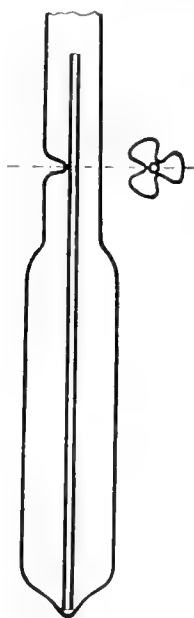

Fig. 1.

N<sup>o</sup>. 107*a* may be seen that part of the apparatus which serves to condense the gas in the wide experimental tube (fig. 1), inside which is the capillary; for this purpose the tube of fig. 1 is sealed in at  $g_2$ .

The radii of the sections of the tubes were found by calibration with mercury as follows:

radius of the capillary	inside $r = 0.3316$ cm
“ “ “ “	outside $r_1 = 0.0801$ cm
“ “ “ surrounding tube	inside $R = 0.554$ cm

*Measurement of the capillary rise.* The reading of the ascension gave some trouble as it had to be made through a number of glass vessels and baths. The rise was measured with a cathetometer; to test the accuracy of the readings they were taken one time on a millimetre scale which had been etched on the capillary and another time directly on the scale of the cathetometer. When it was found, that there was no difference between the heights obtained in the two ways, they were afterwards only measured by means of the scale of the cathetometer, because, when the cryostat was filled with the different liquid gases, the divisions on the capillary were difficult to distinguish owing to the rising gas-bubbles in the liquids.

*Temperature.* The temperature was deduced from the pressure of the vapour in the hydrogen-bath using the vapour-pressure curve (H. KAMERLINGH ONNES and W. H. KEESOM, Comm. N<sup>o</sup>. 137*d*, table on page 41).

*Observations.* The heights measured and the corresponding temperatures of the hydrogen are contained in the following table.



Repeated measurements show, that the accuracy of the reading of the rise may be estimated at 0.002.

TABLE I.

Temperature in KELVIN-degrees	Rise in cms.
20.40	1.616
18.70	1.794
17.99	1.869
16.16	2.064
14.78	2.209

The observed heights ( $h$ ) have to be corrected for the curvature of the surfaces by means of the following formulae: (1) the correction for the meniscus in the narrow tube is  $\frac{r}{3}$ <sup>1)</sup>. (2) the correction for the ring-shaped meniscus is (according to VERSCHAFFELT Comm. N°. 18).

$$h' = \left( h + \frac{r}{3} \right) \frac{\frac{2d}{(R-r_1)^2}}{1 - \frac{2d}{r(R-r_1)^2}}$$

For this correction the height of the ring-shaped meniscus, as the minor axis of the elliptical section with a meridian plane, is required to be known. With the illumination used this height could not be measured accurately. Afterwards for further correction we hope to be able to determine its value by special measurements: in the mean time the section was assumed to be circular with sufficient approximation. The corrected values are given in column 6 of table II.

When the capillary rise is plotted as a function of the temperature — fig. 2 —, a straight line is obtained. The constants determined from this line give the formula

$$H = - 0.1124 T + 40.44.$$

This formula gives  $H = 0$  for  $T_{H=0, \text{extrap.}} = 35.98 \text{ K}$ .

Assuming the critical temperature to be  $T_k = 31.11 \text{ K}$  (mean of

<sup>1)</sup> LAPLACE, Méc. Cél. Tome X, Supp. § 5, Paris 1805.

id. , Oeuvres Tome IV, p. 415, Paris 1845.

ALLAN FERGUSON, Phil. Mag., p. 128, (6) 28, 1914.

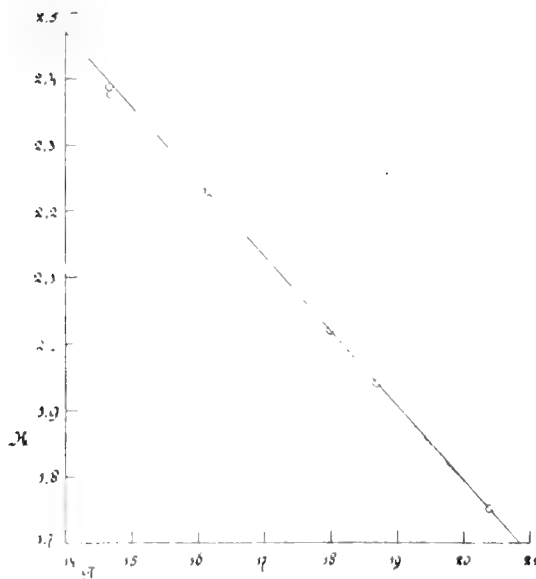

Fig. 2.

DEWAR, OLSZEWSKI and BULLE)<sup>1)</sup> it is seen, that the formula, as was to be expected, does not hold up to the critical temperature and that the curve which gives the dependence of  $H$  on the temperature has its concave side towards the temperature-axis. The difference  $T_{H=0 \text{ extrap.}} - T_k$  for hydrogen amounts to

$$T_{H=0 \text{ extrap.}} - T_k = 3.87.$$

If  $T_{H=0 \text{ extrap.}} - T_k$  is divided by the critical temperature the positive value  $\frac{3.87}{3.21} = 0.125$  is obtained. For methyl-chloride<sup>2)</sup> and ethylether<sup>3)</sup> similar values are obtained<sup>4)</sup>.

*Surface-tension.* From the capillary rise the surface-tension  $\sigma_s$  is found by means of the following formula:

$$H = \frac{2\sigma_s}{(\rho_{\text{liq.}} - \rho_{\text{vap.}})g} \left( \frac{1}{r} - \frac{1}{R-r_1} \right).$$

The densities for liquid hydrogen are taken from the observations by H. KAMERLINGH ONNES and C. A. CROMMELIN (Comm. No. 137a).

<sup>1)</sup> F. BULLE, Physik. Zeitschr. p. 860, XIV, 1913.

<sup>2)</sup> According to measurements by J. VERSCHAFFELT; comp. A. v. ELDIK, Comm. N<sup>o</sup>. 39, p. 14.

<sup>3)</sup> E. C. DE VRIES, Comm. N<sup>o</sup>. 6.

<sup>4)</sup> The corresponding figures (deduced, however, from not-corresponding temperature ranges) are 0.038 and 0.017 respectively.

For the calculation of the vapour-densities use is made of the second virial coefficient, as deduced from the measurements by H. KAMERLINGH ONNES and W. J. DE HAAS (Comm. No. 127c).

TABLE II.

Temp.	$h$	Correction for the meniscus		$H$	$Q_{\text{liq.}}$	$Q_{\text{vap.}}$	$Q_{\text{liq.}} - Q_{\text{vap.}}$	$\psi_{\sigma}$ observ., dyn./cm.	$O-C$
		inside	outside						
20.40°K	1.616	0.011	0.122	1.749	0.0708	0.0013	0.0695	2.12 <sup>6</sup>	-0.01 <sup>1</sup>
20.39 <sup>5</sup>	1.617	11	122	1.750	708	13	695	2.12 <sup>7</sup>	-0.01 <sup>1</sup>
20.39	1.619 <sup>5</sup>	11	122	1.752 <sup>5</sup>	708	13	695	2.13 <sup>0</sup>	-0.00 <sup>9</sup>
18.70	1.794	11	136	1.941	726	08	718	2.43 <sup>8</sup>	-0.00 <sup>5</sup>
17.99	1.869	11	141	2.021	733 <sup>5</sup>	05	728 <sup>5</sup>	2.57 <sup>5</sup>	+0.00 <sup>4</sup>
16.16	2.064	11	156	2.231	751	03	748	2.91 <sup>9</sup>	+0.01 <sup>9</sup>
14.68 <sup>5</sup>	2.199	11	166	2.376	764	02	762	3.16 <sup>7</sup>	+0.00 <sup>4</sup>
14.66	2.209	11	167	2.387	764	02	762	3.18 <sup>2</sup>	+0.01 <sup>5</sup>

With these data the values of  $\psi_{\sigma}$  in table II are calculated. Under  $O-C$  are given the differences between  $\psi_{\sigma}$  obs. and values of  $\psi_{\sigma}$  calculated from VAN DER WAALS' formula

$$\psi_{\sigma} = A(1-t)^B$$

where

$$A = 5.792$$

$$B = 0.9885$$

From the value found for  $B$  it appears, that  $\psi_\tau$  as a function of  $T$  is nearly a straight line.

The constant in EÖTVÖS' formula for hydrogen deviates considerably from the value 2.12, found by RAMSAY and SHIELDS<sup>1)</sup> as the average for a number of normal substances. In Table III the values of  $k_{EÖ}$  for a few of these substances, together with those for some liquid gases, are collected. As observed by KAMERLINGH ONNES and KEESOM (note 381 Suppl. No. 23), normal substances form a series in this respect, on the whole progressing with the critical temperature (although with deviations which may be ascribed to particularities in the law of molecular attraction, e.g. with oxygen).

TABLE III.

Ethylether <sup>2)</sup>	2.1716
Benzene <sup>2)</sup>	2.1043
Argon <sup>3)</sup>	2.020
Nitrogen <sup>3)</sup>	2.002
Carb.monoxide <sup>3)</sup>	1.996
Oxygen <sup>3)</sup>	1.917
Hydrogen	1.464

A calculation of the constant  $k'$  in EINSTEIN'S formula<sup>4)</sup>

$$\left[ \left( \psi_\tau - T \frac{d\psi_\tau}{dT} \right) v_{\text{liq.}}^{\frac{2}{3}} M = k' (\lambda_{M\rho=1} - RT) \right]_{T=20.33}$$

for hydrogen gives

$$7.34 \times 10^{-9}$$

The fact, that hydrogen appears to have a considerably higher value of  $k'$  than that calculated by EINSTEIN for benzene, might, in view of the theory underlying the formula, indicate, that the radius of molecular action is larger for hydrogen molecules than for substances like benzene.

<sup>1)</sup> J. chem. Soc. 63 (1893); ZS. f. physik. Chem. 12 (1893).

<sup>2)</sup> RAMSAY and SHIELDS ZS. f. physik. Chem. 12 (1893), 15 (1894).

<sup>3)</sup> BALY and DONNAN, Journ. chem. soc. 81 (1902).

<sup>4)</sup> A. EINSTEIN, Ann. d. Phys. 4. 34, 1911.

**Chemistry.** — “*The system: copper sulphate, copper chlorid, potassium sulphate, potassium chlorid and water at 30°*”. By Prof. F. A. H. SCHREINEMAKERS and Miss W. C. DE BAAT.

### 1. Introduction.

In previous communications<sup>1)</sup> we have discussed the quaternary systems:

$\text{Cu SO}_4 - \text{Cu Cl}_2 - (\text{NH}_4)_2 \text{SO}_4 - \text{NH}_4 \text{Cl} - \text{water}$   
and  $\text{Cu SO}_4 - \text{Cu Cl}_2 - \text{Na}_2 \text{SO}_4 - \text{Na Cl} - \text{water}$

Now we shall discuss the system



which we have examined at 30°.

As solid substances occur at 30°:

the anhydrous salts:  $\text{K}_2 \text{SO}_4$  and  $\text{KCl}$ ,

the hydrates:  $\text{CuSO}_4 \cdot 5\text{H}_2\text{O}$  and  $\text{CuCl}_2 \cdot 2\text{H}_2\text{O}$ ,

the doublesalts:  $\text{CuSO}_4 \cdot \text{K}_2 \text{SO}_4 \cdot 6\text{H}_2\text{O}$  and  $\text{CuCl}_2 \cdot 2\text{KCl} \cdot 2\text{H}_2\text{O}$ .

Further a peculiar salt exists with the composition:



with or without one molecule  $\text{H}_2\text{O}$ , while sometimes as metastable solid phase a salt with the composition:



has occurred.

In fig. 1 the equilibria occurring at 30° are represented schematic-

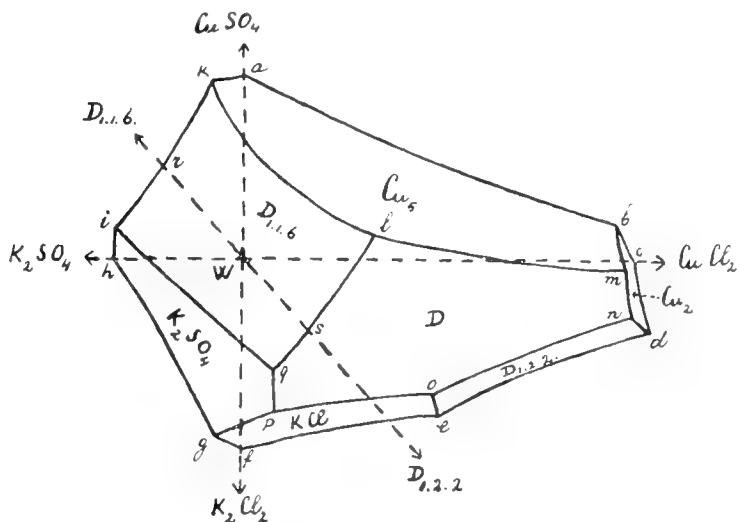

<sup>1)</sup> These Communications 17, 586, (1909), 19 1222 (1911) and Zeitschr. für Phys. Chemie 69, 557, (1909).

ally, the sides of the quadrangle have been omitted, only a part of the diagonals with their point of intersection *W* is drawn. Fig. 1 is not the representation in space of the equilibria, but their projection on the quadrangle. Before discussing the quaternary equilibrium, we will first consider the four ternary equilibria.

## 2. The ternary equilibria.

### *a. The system $K_2SO_4 - KCl - H_2O$ .*

Only  $K_2SO_4$  and  $KCl$  occur as solid phases; in fig. 1 the saturationcurve of  $K_2SO_4$  is represented by *hg* and that of  $KCl$  by *fg*. Consequently point *h* represents the solubility of  $K_2SO_4$ , point *f* the solubility of  $KCl$  in water; point *g* is the solution, saturated with the two salts.

### *b. The system $CuSO_4 - K_2SO_4 - H_2O$ .*

This system was examined already formerly<sup>1)</sup>; as solid phases occur  $K_2SO_4$ ,  $CuSO_4 \cdot 5H_2O$  and the doublesalt  $CuSO_4 \cdot K_2SO_4 \cdot 6H_2O$ . The isotherms of  $30^\circ$  and  $40^\circ$  are determined experimentally; that of  $30^\circ$  is represented schematically in the figure. The saturationcurve of  $K_2SO_4$  has been represented by *hi*, that of  $CuSO_4 \cdot 5H_2O$  by *ak* and that of the doublesalt by *ki*. When we represent this doublesalt in fig. 1 by the point  $D_{1,1,6}$  then the line  $WD_{1,1,6}$  intersects the curve *ik* in a point *v*. The doublesalt is, therefore, soluble in water without decomposition; its solution saturated at  $30^\circ$  is represented by *v*.

The following is still of importance for the investigation of the quaternary system. When we heat an aqueous solution of  $K_2SO_4 + CuSO_4$  above  $50^\circ$ , a light green salt is separated from the solution. MEERBURG found for the composition of this salt:



while BRUNNER<sup>2)</sup>, who examined first this basical salt has found four molecules instead of 3 molecules  $H_2O$ .

### *c. The system $CuSO_4 - CuCl_2 - H_2O$ .*

Also this system was investigated formerly<sup>3)</sup>, as solid substances occur:  $CuSO_4 \cdot 5H_2O$  and  $CuCl_2 \cdot 2H_2O$ . In fig. 1 *ab* represents the saturationcurve of  $CuSO_4 \cdot 5H_2O$  and *cb* that of  $CuCl_2 \cdot 2H_2O$ .

### *d. The system $CuCl_2 - KCl - H_2O$ .*

In this system of which the invariant (P) equilibria were

<sup>1)</sup> P. A. MEERBURG. Gedenkboek J. M. VAN BEMMELEN, 356 (1910).

<sup>2)</sup> BRUNNER. Pogg. Ann. 15 476 (1829).

<sup>3)</sup> F. A. H. SCHREINEMAKERS. These Communications l.c. and Zeitschr. Phys. Chem. 69 557 (1909).

examined formerly<sup>1)</sup> occur as solid phases:  $\text{KCl}$ ,  $\text{CuCl}_2 \cdot 2\text{H}_2\text{O}$ ,  $\text{CuCl}_2 \cdot 2\text{KCl} \cdot 2\text{H}_2\text{O}$  and  $\text{CuCl}_2 \cdot \text{KCl}$ . This last salt, however, occurs only above  $57^\circ$ , so that, at  $30^\circ$ :  $\text{KCl}$ ,  $\text{CuCl}_2 \cdot 2\text{H}_2\text{O}$  and  $\text{CuCl}_2 \cdot 2\text{KCl} \cdot 2\text{H}_2\text{O}$  only occur as solid phases.

The isotherm of  $30^\circ$  is represented schematically in fig. 1;  $fe$  is the saturationcurve of  $\text{KCl}$ ,  $cd$  that of  $\text{CuCl}_2 \cdot 2\text{H}_2\text{O}$  and  $ed$  that of  $\text{CuCl}_2 \cdot 2\text{KCl} \cdot 2\text{H}_2\text{O}$ . When we represent in fig. 1 this doublesalt by  $\text{D}_{1,2,2}$ , then the line  $\text{WD}_{1,2,2}$  does not intersect curve  $ed$ , but curve  $fe$ . This doublesalt is, therefore, at  $30^\circ$  not soluble in water without decomposition, but it is decomposed with separation of  $\text{KCl}$ .

This isotherm of  $30^\circ$  was determined already formerly<sup>2)</sup>; we have also still determined some points.

### 3. The quaternary system.

At first sight we may think that the examined system is built up by five components; as, however, between four of these substances, the reaction:



occurs, this is not the case.

In view of the above-mentioned double-decomposition (1) we shall represent the equilibria with the aid of a quadrilateral pyramid, the base of which is a quadrangle. The four anglepoints of this quadrangle indicate the four substances:  $\text{CuSO}_4$ ,  $\text{CuCl}_2$ ,  $\text{K}_2\text{SO}_4$  and  $\text{K}_2\text{Cl}_2$ , and in this way that the two substances, which are in reaction (1) at the same side of the reaction-sign, are united by a diagonal of the quadrangle. Perpendicular above the point of intersection  $\text{W}$  of the diagonals, is situated the top of the pyramid, which represents the water.

At the examination of this quaternary system we have always remained below the temperature, at which the basical salt

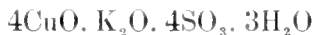

is separated. If this had not been the case, the reaction:



would have occurred. We should then have had to examine a quinary system, in which reactions (1) and (2) occur.

As the quaternary solutions saturated with a solid substance, are represented by a surface in the space, viz. the saturationsurface, we have seven saturationsurfaces. We find their projections in fig. 1:

<sup>1)</sup> W. MEYERHOFFER. Zeitschrift für Phys. Chem. **0** 336 (1889) **5** 97 (1890).

<sup>2)</sup> H. FILIPPO; not yet published.

from this it is apparent that six of these surfaces are side-surfaces and that one is a middle-surface.

<i>a k l m b</i>	is the saturationsurface of the	$\text{Cu SO}_4 \cdot 5\text{H}_2\text{O}$
<i>c b m n d</i>	„ „ „ „ „	$\text{Cu Cl}_2 \cdot 2\text{H}_2\text{O}$
<i>d n o e</i>	„ „ „ „ „	$\text{Cu Cl}_2 \cdot 2\text{KCl} \cdot 2\text{H}_2\text{O}$
<i>e o p q f</i>	„ „ „ „ „	$\text{KCl}$
<i>g p q i h</i>	„ „ „ „ „	$\text{K}_2 \text{SO}_4$
<i>i q l k</i>	„ „ „ „ „	$\text{Cu SO}_4 \cdot \text{K}_2 \text{SO}_4 \cdot 6\text{H}_2\text{O}$
<i>p q l m n o</i>	„ „ „ „ „	$D$

In order to get a better view, in the figure is indicated on each saturationsurface the solid substance, with which the solutions are saturated. For the sake of abbreviation we have called  $\text{Cu SO}_4 \cdot 5\text{H}_2\text{O} = \text{Cu}_5$ ,  $\text{Cu Cl}_2 \cdot 2\text{H}_2\text{O} = \text{Cu}_2$ ,  $\text{Cu Cl}_2 \cdot 2\text{KCl} \cdot 2\text{H}_2\text{O} = \text{D}_{1,2,2}$  and  $\text{Cu SO}_4 \cdot \text{K}_2 \text{SO}_4 \cdot 6\text{H}_2\text{O} = \text{D}_{1,1,6}$ .

The middle-surface *p q l m n o* is the saturationsurface of a salt, which we have represented by *D*. In order to find the composition of this salt we have applied the rest-method, viz. the analysis of the solution and the corresponding rest. From numerous definitions it follows that this salt has the composition :



or  $\text{Cu SO}_4 \cdot \text{K}_2 \text{Cl}_2 \cdot \text{H}_2\text{O} = \text{K}_2 \text{SO}_4 \cdot \text{Cu Cl}_2 \cdot \text{H}_2\text{O} = \text{D}_x$

Some determinations pointed viz. to  $\text{D}_a$ , others to  $\text{D}_x$ , again others to a mixture of  $\text{D}_a$  and  $\text{D}_x$ , so that in the region *p q l m n o* (fig. 1) perhaps the two salts  $\text{D}_a$  and  $\text{D}_x$  occur.

The probability that more than one solid salt occurs in this region, is enhanced by the following observations. In some cases the solid substance was precipitated after shaking (which lasted sometimes a month or longer) within some hours as a greenish powder, in other cases there was formed a greenish or blue-greenish paste, which after days did not yet settle, but stuck to the sides of the shake-bottle. In the first case we could easily remove a large part of the mother-substance by suction, in the latter case this appeared practically impossible. From all this it is apparent that in the saturation-surface (fig. 1) indicated by *D* different salts may occur, two of which have the composition  $\text{D}_a$  and  $\text{D}_x$ .

It follows, however, from the position of the solutions saturated with  $\text{D}_a$  or  $\text{D}_x$  in the region of fig. 1 indicated by *D*, that one of these salts must be metastable with respect to the other, perhaps they are both metastable with respect to a third, which we have however not found in our investigation.



In order to get the solutions of the saturation surface  $D$  saturated with solid salt, we put together the substances in such ratios that the solid substance must be formed in one case from  $\text{Cu SO}_4 \cdot 5\text{H}_2\text{O} + \text{KCl}$ , in the other from  $\text{Cu Cl}_2 \cdot 2\text{H}_2\text{O} + \text{K}_2 \text{SO}_4$ . In both instances now  $D_a$  then  $D_x$  was formed.

In some cases also occurred as solid phase a double salt of the composition:



Later, however, we did not succeed again in getting this salt, but  $D_a$  or  $D_x$  appeared instead. The salt  $D_z$  will therefore, very probably exist in a metastable condition only.

On account of the uncertainty with respect to the substance  $D$ , we will further describe the equilibria as if in the region  $p q l m n o$  occurs only one solid substance  $D$ . When in this region more solid phases may occur in stable condition, then the necessary changes in this region will have to be inserted.

The intersecting lines of the saturation surfaces represent the quaternary solutions, which are saturated with two solid substances, consequently the quaternary saturation lines. The limit-lines of the saturation surfaces on the side-planes of the pyramid form the ternary saturation curves of the four ternary systems, which have already been discussed previously.

The quaternary saturation curves are the following:

$g p$	the saturationline of	$\text{K}_2 \text{SO}_4 + \text{KCl}$
$i q$	„ „ „	$\text{K}_2 \text{SO}_4 + D_{1 \cdot 1 \cdot 6}$
$k l$	„ „ „	$\text{Cu}_6 + D_{1 \cdot 1 \cdot 6}$
$b m$	„ „ „	$\text{Cu}_6 + \text{Cu}_2$
$d n$	the saturationline of	$\text{Cu}_2 + D_{1 \cdot 2 \cdot 2}$
$e o$	„ „ „	$\text{KCl} + D_{1 \cdot 2 \cdot 2}$
$p q$	„ „ „	$\text{K}_2 \text{SO}_4 + D$
$q l$	„ „ „	$D_{1 \cdot 1 \cdot 6} + D$
$l m$	„ „ „	$\text{Cu}_6 + D$
$m n$	„ „ „	$\text{Cu}_2 + D$
$n o$	„ „ „	$D_{1 \cdot 2 \cdot 2} + D$
$o p$	„ „ „	$\text{KCl} + D$

The first six saturation lines are side-curves; each of these has an end on one of the side-planes of the pyramid. The last six saturation lines are middle-curves; each of these has its two ends within the pyramid.

The points of intersection of the saturation-surfaces represent the quaternary solutions, which are saturated with three solid substances consequently the quaternary saturation-points. In each of these points three quaternary saturation-curves come together. In the ternary saturation-points, which we already discussed previously, two ternary and one quaternary saturation-curve come together.

The quaternary saturation-points are the following:

<i>p</i>	saturated with	$K_2SO_4 + KCl + D$
<i>q</i>	„ „	$K_2SO_4 + D_{1,1,6} + D$
<i>l</i>	„ „	$Cu_5 + D_{1,1,6} + D$
<i>m</i>	„ „	$Cu_5 + Cu_2 + D$
<i>n</i>	„ „	$Cu_2 + D_{1,2,2} + D$
<i>o</i>	„ „	$KCl + D_{1,2,2} + D$

As it is easy to see from fig. 1, in presence of solution can exist:

- $K_2SO_4$  by the side of:  $KCl$  or  $D$  or  $D_{1,1,6}$   
but not by the side of:  $Cu_5$  or  $Cu_2$  or  $D_{1,2,2}$
- $KCl$  by the side of:  $K_2SO_4$  or  $D$  or  $D_{1,2,2}$ .  
but not by the side of:  $D_{1,1,6}$  or  $Cu_5$  or  $Cu_2$
- $D_{1,2,2}$  by the side of:  $KCl$  or  $D$  or  $Cu_2$   
but not by the side of:  $K_2SO_4$  or  $D_{1,1,6}$  or  $Cu_5$ .
- $Cu_2$  by the side of:  $Cu_5$  or  $D$  or  $D_{1,2,2}$   
but not by the side of:  $KCl$  or  $K_2SO_4$  or  $D_{1,1,6}$
- $Cu_5$  by the side of:  $Cu_2$  or  $D$  or  $D_{1,1,6}$   
but not by the side of:  $K_2SO_4$  or  $KCl$  or  $D_{1,2,2}$
- $D_{1,1,6}$  by the side of:  $Cu_5$  or  $D$  or  $K_2SO_4$   
but not by the side of:  $KCl$  or  $D_{1,2,2}$  or  $Cu_2$
- $D$  by the side of all other substances.

Different conclusions can be made from the figure. Let us consider the behaviour of the salt  $D$  with respect to water.

When  $D$  is the salt  $D_a$ , it is indicated in the spacial representation by the point of intersection  $W$  of the diagonals (fig. 1). When, however,  $D$  is the salt  $D_x$ , which contains water, it is situated in the spacial representation on the line, which unites the top of the pyramid with the point of intersection of the diagonals. Let us assume that  $D = D_a$  and let us call  $T$  the top of the pyramid, so that point  $T$  represents the water. As the line  $D_aT$  does not intersect the saturation-surface of  $D_a$ ,  $D_a$  is not soluble in water without decomposition. The line  $D_aT$  intersects, however, the saturation-surface  $iklq$  of  $D_{1,1,6}$ , so that the salt  $D_a = CuSO_4 \cdot K_2Cl_2 = K_2SO_4 \cdot CuCl_2$  is decomposed by water, while  $D_{1,1,6} = CuSO_4 \cdot K_2SO_4 \cdot 6H_2O$  is separated. From this we see that we can not wash out the salt

$D_a$  with water to free it from its mother-substance, as this will lead to decomposition.

When we wish to examine accurately what will take place when we bring together  $D_a$  and water, we must consider which spaces of the pyramid are intersected by the line  $D_aT$ . From this amongst others the following is apparent. When we add  $D_a$  to water, then firstly unsaturated solutions arise, which are represented in fig. 1 by the point  $W$ . (In this it is to be considered that fig. 1 is the projection of the spacial representation and that point  $W$  is the projection of the line  $D_aT$ ).

With further addition of  $D_a$  the solution  $W$  arises, which can be saturated with  $D_{1,1,6}$  (this  $D_{1,1,6}$ , however, is not yet present as solid phase) consequently the solution  $W$  of the saturationsurface  $iq/k$ .

With further addition of  $D_a$  now  $D_{1,1,6}$  is separated and the solution traces in fig. 1 the straight line  $Ws$ , this straight line is the projection of a curve situated on the saturationsurface  $iq/k$ . When we add so much  $D_a$  that the solution attains the point  $s$ , then, further addition of  $D_a$  will no more change the solution and there is formed:



When we wish to examine what will take place when we bring together in variable quantities  $K_2SO_4$ ,  $CuCl_2$  and water, then we must intersect the spacial representation by the plane  $K_2SO_4 - CuCl_2 - T$ . When we bring together  $KCl - CuSO_4$  and water in variable quantities we must draw the plane  $K_2Cl_2 - CuSO_4 - T$ .

As the manner, in which these sections with the saturationsurfaces, saturationlines and the different spaces can be obtained, was already discussed previously <sup>1)</sup>, we will not apply this method now.

In tables II and III we find indicated the compositions of several solutions; we have deduced with the aid of the restmethod graphically the solid phases with which these solutions are saturated.

In table II the compositions are expressed in percentages by weight; of the four salts  $CuSO_4$ ,  $CuCl_2$ ,  $K_2SO_4$  and  $K_2Cl_2$ ; only three at the same time are given. This is sufficient also because, if we wish to express the composition also in the fourth salt, it may be done in infinitely many ways with the aid of the reaction-equation



For this the quantities of the substances which take part in the reaction must be expressed in quantities by weight.

<sup>1)</sup> F. A. H. SCHREINEMAKERS, Zeitschr. f. Phys. Chem. 66 699 (1909).

TABLE I.

The ternary system  $K_2SO_4 - KCl - H_2O$  at  $30^\circ$ .

Composition of the solutions							
Point	in proc. by weight			in molproc.			Solid phase.
	$K_2SO_4$	KCl	$H_2O$	$K_2SO_4$	$K_2Cl_2$	$H_2O$	
<i>h</i>	11.5	0	88.5	1.33	0	98.67	$K_2SO_4$
	2.55	17.45	80.0	0.32	2.56	97.12	"
<i>g</i>	1.09	26.20	72.71	0.15	4.16	95.69	$K_2SO_4 + KCl$
<i>f</i>	0	27.22	72.78	0	4.32	95.68	KCl.

TABLE II.

The quaternary system  $CuSO_4 - CuCl_2 - K_2SO_4 - K_2Cl_2 - H_2O$  at  $30^\circ$ .

Composition of the solutions in percents by weight.						
Point	$CuSO_4$	$CuCl_2$	$K_2SO_4$	KCl	$H_2O$	Solid phase.
<i>K</i>	20.60	0	3.61	0	75.79	$Cu_5 + D_{1,1.6}$
Curve <i>kl</i>	14.60	5.23	3.73	0	76.44	"
	10.02	10.74	4.56	0	74.68	"
	1.70	24.48	6.92	0	66.90	"
<i>l</i>	7.43	23.75	0	6.26	62.56	$Cu_5 + D_{1,1.6} + D$
Curve <i>iq</i>	1.63	0	12.01	0	86.36	$K_2SO_4 + D_{1,1.6}$
	1.63	0	9.13	2.98	86.26	"
	1.72	0	6.76	6.01	85.51	"
	0	2.13	5.74	9.84	82.29	"
	0	5.05	3.82	16.02	75.11	"
	2.96	6.07	0	21.86	69.11	"
<i>q</i>	2.97	6.68	0	21.97	68.38	$K_2SO_4 + D_{1,1.6} + D$
Curve <i>gp</i>	0	0	1.09	26.20	72.71	$K_2SO_4 + KCl$
	1.75	4.80	0	25.32	68.13	"
	2.06	6.56		24.68	66.70	$K_2SO_4 + KCl + D$

TABLE II.

The quaternary system:  $\text{Cu SO}_4 - \text{Cu Cl}_2 - \text{K}_2 \text{SO}_4 - \text{K}_2 \text{Cl}_2 - \text{H}_2 \text{O}$  at  $30^\circ$ .

Composition of the solutions in procents by weight.							
Point	$\text{Cu SO}_4$	$\text{Cu Cl}_2$	$\text{K}_2 \text{SO}_4$	K Cl	$\text{H}_2 \text{O}$	Solid phase.	
$p$	2.06	6.56	0	24.68	66.70	$\text{K}_2 \text{SO}_4 + \text{KCl} + \text{D}$	
Curve $pq$	2.34	6.71	0	23.32	67.60	$\text{K}_2 \text{SO}_4 + \text{D}$	
	2.61	6.63	0	22.17	68.59	"	
	$q$	2.97	6.68	0	21.97	68.38	$\text{K}_2 \text{SO}_4 + \text{D}_{1,1.6} + \text{D}$
Curve $ql$	$q$	2.97	6.68	0	21.97	68.38	$\text{K}_2 \text{SO}_4 + \text{D}_{1,1.6} + \text{D}$
		2.94	7.86	0	17.03	68.92	$\text{D}_{1,1.6} + \text{D}$
		3.15	11.00	0	17.31	68.54	"
		4.03	17.37	0	11.81	66.79	"
		4.85	20.30	0	9.44	65.41	"
		7.53	23.31	0	6.63	62.53	"
$l$	7.43	23.75	0	6.26	62.56	$\text{Cu}_5 + \text{D}_{1,1.6} + \text{D}$	
Curve $po$	$p$	2.06	6.56	0	24.68	66.70	$\text{K}_2 \text{SO}_4 + \text{KCl} + \text{D}$
		1.54	9.22	0	23.64	65.60	K Cl + D
		1.34	10.86	0	23.11	64.69	"
		1.30	11.29	0	22.80	64.11	"
		0.80	16.95	0	21.28	60.97	"
		0.75	17.51	0	21.35	60.39	"
		0.72	18.56	0	21.37	59.35	"
$o$	0.56	21.43	0	20.47	57.54	K Cl + D + $\text{D}_{1,2,2}$	
$e$	0	21.62	0	20.86	57.52	K Cl + $\text{D}_{1,2,2}$	
$o$	0.56	21.43	0	20.47	57.54	K Cl + D + $\text{D}_{1,2,2}$	
Curve $on$	$o$	0.56	21.43	0	20.47	57.54	K Cl + D + $\text{D}_{1,2,2}$
		0.59	26.09	0	16.83	56.49	D + $\text{D}_{1,2,2}$
		0.63	29.41	0	15.01	54.95	"
		0.71	32.60	0	13.10	53.59	"
		0.70	37.61	0	10.62	51.07	"
$n$	0.94	42.45	0	7.86	48.75	$\text{Cu} + \text{D} + \text{D}_{1,2,2}$	

TABLE II.

The quaternary system:  $\text{Cu SO}_4 - \text{Cu Cl}_2 - \text{K}_2 \text{SO}_4 - \text{K}_2 \text{Cl}_2 - \text{H}_2\text{O}$  at  $30^\circ$ .

Composition of the solutions in procents by weight.

Point	$\text{Cu SO}_4$	$\text{Cu Cl}_2$	$\text{K}_2 \text{SO}_4$	$\text{K Cl}$	$\text{H}_2\text{O}$	Solid phase.
<i>n</i>	0.94	42.45	0	7.86	48.75	$\text{Cu}_2 + \text{D} + \text{D}_{1.2.2}$
<i>d</i>	0	43.1	0	8.4	48.5	$\text{Cu}_2 + \text{D}_{1.2.2}$
Curve <i>mn</i>	0.94	42.45	0	7.86	48.75	$\text{Cu}_2 + \text{D} + \text{D}_{1.2.2}$
	1.59	42.30	0	5.88	50.23	$\text{Cu}_2 + \text{D}$
	3.46	40.95	0	4.34	51.25	$\text{Cu}_2 + \text{Cu}_5 + \text{D}$
<i>m</i>	3.46	40.95	0	4.34	51.25	$\text{Cu}_2 + \text{Cu}_5 + \text{D}$
<i>b</i>	2.89	42.77	0	0	54.34	$\text{Cu}_2 + \text{Cu}_5$
Curve <i>ml</i>	3.46	40.95	0	4.34	51.25	$\text{Cu}_2 + \text{Cu}_5 + \text{D}$
	4.15	36.69	0	4.79	54.37	$\text{Cu}_5 + \text{D}$
	4.48	34.33	0	5.14	56.05	"
	5.48	29.55	0	5.74	59.23	"
	<i>l</i>	7.43	23.75	0	6.26	62.56
Saturation surface D.	4.90	24.49	0	7.64	62.97	
	2.88	10.71	0	18.57	67.84	
	2.29	10.44	0	20.12	73.15	
	2.15	10.83	0	19.97	67.05	
	2.13	11.38	0	19.60	65.89	
	1.75	11.01	0	21.24	66.00	
	1.31	16.67	0	18.54	63.48	
	1.31	16.57	0	18.68	63.44	
	0.89	23.19	0	16.38	59.54	
	0.85	23.73	0	16.25	59.17	
	0.66	21.80	0	15.92	61.62	
	1.03	27.10	0	13.70	58.17	
	0.77	32.57	0	12.43	54.23	
	2.03	27.75	0	9.93	60.29	
1.47	39.11	0	7.17	52.25		
	6.06	19.84	0	7.75	66.35	Saturation surface $\text{D}_{1.1.6}$

TABLE III.

The quaternary system:  $\text{Cu SO}_4 - \text{Cu Cl}_2 - \text{K}_2 \text{SO}_4 - \text{K}_2 \text{Cl}_2 - \text{H}_2 \text{O}$  at  $30^\circ$ .  
 Ions  $\text{Cu}$ ,  $\text{K}_2$ ,  $\text{SO}_4$  and  $\text{Cl}_2$  and Mol.  $\text{H}_2 \text{O}$  in a quantity of  
 solution which contains 100 Mol. in all.

Point	Cu	K <sub>2</sub>	SO <sub>4</sub>	Cl <sub>2</sub>	H <sub>2</sub> O	Solid phase.
<i>K</i>	2.96	0.48	3.44	0	96.56	$\text{Cu}_5 + \text{D}_{1.1.6}$
Curve <i>Kl</i>	2.97	0.49	2.57	0.89	96.54	"
	3.34	0.61	2.10	1.85	96.05	"
	4.88	1.01	1.28	4.61	94.11	"
<i>l</i>	5.98	1.12	1.25	5.85	92.90	$\text{Cu}_5 + \text{D}_{1.1.6} + \text{D}$
<i>i</i>	0.21	1.41	1.62	0	98.38	$\text{K}_2 \text{SO}_4 + \text{D}_{1.1.6}$
Curve <i>iq</i>	0.21	1.49	1.29	0.41	98.30	"
	0.22	1.64	1.03	0.83	98.14	"
	0.34	2.11	0.70	1.75	97.55	"
	0.86	2.98	0.51	3.33	96.16	"
	1.58	3.62	0.46	4.74	94.80	"
<i>q</i>	1.70	3.68	0.46	4.92	94.62	$\text{K}_2 \text{SO}_4 + \text{D}_{1.1.6} + \text{D}$
Curve <i>gp</i>	0	4.31	0.15	4.16	95.69	$\text{K}_2 \text{SO}_4 + \text{K Cl}$
	1.17	4.25	0.28	5.14	94.58	"
	1.56	4.21	0.33	5.44	94.23	$\text{K}_2 \text{SO}_4 + \text{K Cl} + \text{D}$
<i>p</i>	1.56	4.21	0.33	5.44	94.23	$\text{K}_2 \text{SO}_4 + \text{K Cl} + \text{D}$
Curve <i>pq</i>	1.63	3.94	0.37	5.20	94.43	$\text{K}_2 \text{SO}_4 + \text{D}$
	1.64	3.70	0.41	4.93	94.66	"
	1.70	3.68	0.46	4.92	94.62	$\text{K}_2 \text{SO}_4 + \text{D} + \text{D}_{1.1.6}$
Curve <i>ql</i>	1.70	3.68	0.46	4.92	94.62	$\text{K}_2 \text{SO}_4 + \text{D} + \text{D}_{1.1.6}$
	1.92	3.51	0.46	4.97	94.57	$\text{D}_{1.1.6} + \text{D}$
	2.52	2.89	0.49	4.92	94.59	"
	3.92	2.01	0.64	5.29	94.07	"
	4.68	1.63	0.78	5.53	93.69	"
	5.90	1.19	1.26	5.83	92.91	"
<i>l</i>	5.98	1.12	1.25	5.85	92.90	$\text{Cu}_5 + \text{D}_{1.1.6} + \text{D}$

TABLE III.

The quaternary system:  $\text{Cu SO}_4 - \text{Cu Cl}_2 - \text{K}_2 \text{SO}_4 - \text{K}_2 \text{Cl}_2 - \text{H}_2 \text{O}$  at  $30^\circ$ .Ions  $\text{Cu}$ ,  $\text{K}_2 \text{SO}_4$  and  $\text{Cl}_2$  and Mol.  $\text{H}_2 \text{O}$  in a quantity of solution which contains 100 Mol. in all.

Point	Cu	$\text{K}_2$	$\text{SO}_4$	$\text{Cl}_2$	$\text{H}_2\text{O}$	Solid phase.
<i>p</i>	1.56	4.21	0.33	5.44	94.23	$\text{K}_2 \text{SO}_4 + \text{K Cl} + \text{D}$
	2.02	4.09	0.25	5.85	93.89	$\text{K Cl} + \text{D}$
	2.33	4.04	0.22	6.15	93.63	"
	2.40	3.99	0.21	6.18	93.61	"
	3.58	3.90	0.14	7.34	92.52	"
	3.72	3.95	0.13	7.54	92.33	"
	3.98	4.00	0.12	7.86	92.02	"
<i>o</i>	4.66	3.93	0.10	8.49	91.41	$\text{K Cl} + \text{D} + \text{D}_{1\cdot2\cdot2}$
<i>e</i>	4.58	3.93	0	8.51	91.49	$\text{K Cl} + \text{D}_{1\cdot2\cdot2}$
<i>o</i>	4.66	3.93	0.10	8.49	91.41	$\text{K Cl} + \text{D}_{1\cdot2\cdot2} + \text{D}$
<i>Curve</i> <i>on</i>	4.66	3.93	0.10	8.49	91.41	$\text{K Cl} + \text{D}_{1\cdot2\cdot2} + \text{D}$
	5.74	3.27	0.11	8.90	90.99	$\text{D} + \text{D}_{1\cdot2\cdot2}$
	6.60	2.98	0.12	9.46	90.42	"
	7.46	2.66	0.13	9.99	89.88	"
	8.91	2.23	0.14	11.00	88.86	"
<i>n</i>	10.44	1.71	0.19	11.96	87.85	$\text{Cu}_2 + \text{D}_{1\cdot2\cdot2} + \text{D}$
<i>n</i>	10.44	1.71	0.19	11.96	87.85	$\text{Cu}_2 + \text{D}_{1\cdot2\cdot2} + \text{D}$
<i>d</i>	10.44	1.84	0	12.28	87.72	$\text{Cu}_2 + \text{D}_{1\cdot2\cdot2}$
<i>Curve</i> <i>nm</i> <i>m</i>	10.44	1.71	0.19	11.96	87.85	$\text{Cu}_2 + \text{D}_{1\cdot2\cdot2} + \text{D}$
	10.30	1.25	0.32	11.23	88.45	$\text{Cu}_2 + \text{D}$
	10.19	0.91	0.68	10.42	88.90	$\text{Cu}_2 + \text{Cu}_5 + \text{D}$
<i>m</i>	10.19	0.91	0.68	10.42	88.90	$\text{Cu}_2 + \text{Cu}_5 + \text{D}$
<i>b</i>	10.03	0	0.54	9.49	89.97	$\text{Cu}_2 + \text{Cu}_5$



TABLE III.

The quaternary system:  $\text{Cu SO}_4 - \text{Cu Cl}_2 - \text{K}_2 \text{SO}_4 - \text{K}_2 \text{Cl}_2 - \text{H}_2 \text{O}$  at  $30^\circ$ .  
 Ions  $\text{Cu}$ ,  $\text{K}_2 \text{SO}_4$  and  $\text{Cl}_2$  and Mol.  $\text{H}_2 \text{O}$  in a quantity of  
 solution which contains 100 Mol. in all.

Point	Cu	$\text{K}_2$	$\text{SO}_4$	$\text{Cl}_2$	$\text{H}_2\text{O}$	Solid phase.
<i>m</i>	10.19	0.91	0.68	10.42	88.90	$\text{Cu}_2 + \text{Cu}_5 + \text{D}$
	8.93	0.94	0.78	9.09	90.13	$\text{Cu}_2 + \text{D}$
	8.27	1.01	0.82	8.46	90.72	„
	7.10	1.07	0.96	7.21	91.83	„
<i>l</i>	5.98	1.12	1.25	5.85	92.90	$\text{Cu}_5 + \text{D}_{1.6} + \text{D}$
Saturation surface D	5.67	1.36	0.82	6.21	92.97	
	2.45	3.12	0.45	5.12	94.43	
	2.14	3.15	0.33	4.96	94.71	
	2.38	3.39	0.34	5.43	94.23	
	2.49	3.34	0.34	5.49	94.17	
	2.38	3.65	0.28	5.75	93.97	
	3.50	3.29	0.22	6.57	93.21	
	3.48	3.32	0.22	6.58	93.20	
	4.96	3.06	0.16	7.86	91.98	
	5.09	3.05	0.15	7.99	91.86	
	5.57	2.86	0.11	8.32	91.57	
	5.89	2.60	0.18	7.31	91.51	
	7.39	2.50	0.14	9.75	90.11	
	6.03	1.83	0.35	7.51	92.14	
9.24	1.48	0.28	10.44	89.28		
	4.73	1.33	0.97	5.09	93.94	Saturation surface $\text{D}_{1.6}$ .

In table III the compositions are indicated in the number of ions  $\text{Cu}$ ,  $\text{K}_2$ ,  $\text{SO}_4$  and  $\text{Cl}_2$  and molecules  $\text{H}_2\text{O}$ , which are present in a quantity of solution, which contains in all 100 molecules.

When a solution contains  $a$  ions  $\text{Cu}$ ,  $b$  ions  $\text{K}_2$ ,  $c$  ions  $\text{SO}_4$ ,  $d$  ions  $\text{Cl}_2$  and  $w$  molecules of water, then is consequently

$$a + b = c + d \quad \text{and} \quad w + a + b = w + c + d = 100$$

*Leiden.*

*Anorg. Lab. Chem.*

**Chemistry.** — “*The catalyse*”. By Prof. J. BÖESEKEN. (Communicated by Prof. A. F. HOLLEMAN).

(Communicated in the meeting of June 27, 1914).

1. It appears to me that, a summary having been given from various quarters on catalytic phenomena, the time has arrived to show briefly how the development of my ideas on this subject has advanced and how the insight thus gained has been supported by a deduction of one of my students.

I do this in the first place because in that historical account the gradual elucidation of the phenomena is exposed, but also because I imagine that a point has now been reached where the co-operation of many is necessary in order to assist in completing the edifice of the catalysis.

2. When working at my dissertation (1895—1897), when a large number of fatty-aromatic ketones was prepared according to the reaction of FRIEDEL and CRAFTS, it struck me that when to a cooled mixture of acid chloride and benzene finely powdered aluminium chloride was added, this certainly dissolved rapidly, but that an evolution of hydrogen chloride only took place slowly on warming<sup>1</sup>).

As aluminium chloride did not perceptibly dissolve in benzene, I was then convinced that not the benzene but the acid chloride might be the point of attack of the catalyst.

This question was afterwards taken up by me and solved in so far that the synthesis of the aromatic ketones could be divided into two stages: (a) The catalyst combines with the acid chloride: (b) this compound is attacked by the aromatic hydrocarbon (Rec. **19** 19 (1900) **20** 102 (1901).

Although the course of the reaction was indicated therewith, I was soon aware, however, that the *catalytic action* of aluminium chloride remained in complete obscurity<sup>2</sup>).

In this I was corroborated by the observation that chloroform and benzyl chloride suffered the reaction with benzene still far better and more vigorously, whilst these substances did not combine

<sup>1</sup>) Afterwards I modified the preparation by taking the  $\text{AlCl}_3$  in excess and then adding drop by drop the mixture of acid chloride and benzene, because the reaction then proceeded very regularly. By the research of OLIVIER (Dissertation, Delft 1912) it has been shown that the cause of this favourable result must be attributed to the presence of *free*  $\text{AlCl}_3$  (see later).

<sup>2</sup>) PERRIER who had noticed this reaction course previously (Thèse, Caen 1893) was of opinion that this explained the catalytic action of aluminium chloride.

with aluminium chloride and the quantities of the catalyst necessary for the reaction were much less than in the synthesis of the ketones. (Rec. **22**, 301 (1903)).

When it appeared that nitrobenzyl chloride, which *does* unite with  $\text{AlCl}_3$ , was also attacked much less rapidly than benzyl chloride, and further that the very reactive anisol, which also forms a molecular compound with  $\text{AlCl}_3$ , did not react *at all* with  $\text{CCl}_4$ , whereas benzene did so readily, the facts were such that I ventured the thesis that the formation of compounds between the catalyst and the activated substance had nothing to do with the actual catalytic action (Rec. **23**, 104 (1904)) and that, when the catalyst does not unite with one of the substances present in the reaction, we are dealing with catalytic action in its purest form (Rec. **24**, 10 (1905)).

Thus by means of the inductive method, I came to the conclusion that the formation of a compound with the catalyst did not give an explanation of the catalytic action as such, and that with this the theory of the intermediate products exploded.

2. I have also tried to demonstrate subsequently by means of the deductive method that the formation of a compound of substance and catalyst must necessarily lead to a partial paralysis of the latter (Proc. 1907 p. 613; 1909 p. 418).

Hence, if we wished to arrive at a satisfactory explanation this had to be looked for in what happened before there is any question of a compound between catalyst and substance. When the catalyst draws near to the activated substance a phenomenon ought to take place partaking more of a disruption or a dislocation than of a union (Gedenkboek VAN BEMMELLEN p. 386, Rec. **29**, 87 (1910)).

I have then demonstrated (Proc. 1909 p. 419; also Rec. **32**, 1 (1913); Chem. Weekbl. **7**, 121 (1910); Rec. **29**, 86 (1910)) that a catalyst like  $\text{AlCl}_3$  exerts indeed a dissociating influence on the chlorides which it activates; chloral was resolved into  $\text{CO}$ ,  $\text{HCl}$  and  $\text{C}_2\text{Cl}_4$ ; trimethylacetyl chloride into carbon-monoxide,  $\text{HCl}$ , and isobutene, etc.

But here it transpired also that even now the explanation was not given, because the action had been too violent; instead of the to be expected condensation products with benzene there were obtained in similar cases, either the decomposition products or the condensation products of these molecule residues with benzene. Thus, from  $\text{SO}_2\text{Cl}_2$  and the benzene hydrocarbons were generated relatively very small quantities of sulphones compared to large quantities of sulphinic acid and chlorine derivatives; owing to too great an activity

the catalyst had disrupted the  $\text{SO}_2\text{Cl}_2$  into  $\text{SO}_2$  and  $\text{Cl}_2$ , which were now subsequently influenced catalytically (Rec. **30**, 381 (1911)).

The catalytic action proper can, therefore, be no union, because in that compound the catalyst is paralysed; it also cannot be a dissociation because the substance is then too much attacked, hence, it must be an intermediary influence.

I have called the latter a *dislocation* or *disruption* (Rec **30**, 88 (1911) dating from Sept. 1909) in order to demonstrate that there certainly does exist an influence, but that this should effect neither union or dissociation if it is to be considered as a purely catalytic one. In order to more sharply confirm experimentally this result obtained, the transformation of chloral into metachloral under the influence of diverse catalysts was submitted to a closer investigation.<sup>1)</sup>

This system was chosen because it had been shown that:

1<sup>st</sup> it is an equilibrium between two substances, therefore a very simple case because we are only dealing with the transformation of one substance into another one.

2<sup>nd</sup> this equilibrium is situated in a readily attainable temperature-zone, whereas the properties of monomeride and polymeride differ rather strongly, so that the specific influence of the catalyst may come perceptibly to the fore.

3<sup>rd</sup> That the monomeride itself is a supercharged molecule, so that it was to be expected that the action of the catalyst would be a pronounced one.

In fact it could now be demonstrated that the equilibrium was attained rapidly only then when the activator was present in small quantities and had not perceptibly united with one of the modifications.

If the catalyst (pyridine) was retained (absorbed) in the colloidal polymeride the equilibrium set in, but in the liquid phase of the monomeride the reaction ceased.

If the catalyst combined with one of the components (the monomeride) the equilibrium was shifted in the direction of that component.

If, finally, the action of the activator was stronger still, the splitting products were obtained only.

About the same time, S. C. J. OLIVIER (Diss. Delft 1913, Proc. 1912 and R **33**, 91 (1914) had finished a dynamic research on the action of bromobenzenesulphochloride on some benzene-hydrocarbons under the influence of aluminium chloride.

Whereas the researches had been as yet of a qualitative character it could now also be demonstrated quantitatively that the retention

<sup>1)</sup> R **32**, 112 (1913).

of the catalyst in the sulpho-chloride or in the sulphone caused a partial paralysis, as the reaction proceeded much more rapidly the moment a small quantity of the catalyst in the solution was present in the free state.

Also, could it be deduced sharply from the progress of the reaction (Proc. 1913 p. 1069) that this could be explained satisfactorily only then when the activating action was sought in what happened between benzene on one side and chloride + catalyst on the other side before they had undergone chemical transformation.

Hence, it was proved experimentally also here that the most important stage of the catalysis is that which takes place before the union.

3. If we now consider what can be the significance of the removal of the catalysis to the pre-stage of the reaction, it should be remembered that in view of OSTWALD'S definition a catalyst should be a substance unchanged in quantity and quality after the reaction.

Guided by this definition we may *during the reaction* assume all kinds of material and energetic changes if only the condition is satisfied that the catalyst remains unmodified before the beginning and after the end of the reaction.

If now, however, we look for a further explanation, that is to say, penetrate further into the mechanism of a reaction, we notice that somewhere during the reaction a catalyst can no longer satisfy that definition.

Hence, a catalyst can never remain unchanged during the entire course of the reaction; an ideal catalyst exists no more than an ideal gas or an ideal dilute solution, but for all that we have been able to make excellent use of the notion.

Now, a substance will approach this ideal condition all the more, the smaller the material or energetic displacements will be and it is plain without any further evidence, that similar very small changes will just take place on the approach of the catalyst to the bonds to be activated.

When there the action ceases, we can understand that these shiftings may be so small that they elude observation (so that for instance, apparently a *same* equilibrium is reached under the influence of *diverse* catalysts, which in reality cannot be the case.)

4. If now we want to get a concrete conception of these exceedingly small actions, which in the catalysis are both satisfactory and authoritative, we may consult the modern views on our atomic world.

It is supposed that the atoms consist of (or at least are populated by) electrons and that they hold together by means of force regions between these corpuscles; the catalytic action may then be described as a change of these force regions on the approach of the catalyst. If this is so, we have in the *pure* photocatalysis the simplest catalytic actions and the study of these phenomena will no doubt much deepen our insights.<sup>1)</sup>

On penetrating further into the phenomena in general we are obliged to resolve the substance into steadily decreasing units and the same has happened with the special phenomena called catalytic; here it will just be shown that what takes place in the atoms will be of preponderating importance. But just as we have not been able to find the ideal catalyst among the atoms, we cannot expect to meet it among the electro-magnetic equilibria-perturbations, only the limit of our insight in the catalytic phenomena has advanced a step.

## II.

1. During this mainly inductive development of my ideas my pupil H. J. PRINS had found a synthesis of chloropropane derivatives and I advised him to couple this experimental subject with a survey of the different cases in the reaction of FRIEDEL and CRAFTS.<sup>2)</sup>

With this, however, he did not content himself, but starting from the "Principle of Reciprocity" he has endeavoured to furnish an explanation of the catalytic phenomena in general, with the reaction of FRIEDEL and CRAFTS as a special case.

The result of this is given in his dissertation ("Bijdrage tot de kennis der katalyse", Delft 1912) and supplemented with a few subsequent articles (Journ. f. pr. Chem. N. F. **89**, 425 (1914); Chem. Weekbl. **11**, 474 (1914).

In order to reproduce PRINS's intention in the simplest possible manner, I will quote a few parts of his deduction, taking the liberty to omit the, in my opinion, non-essential matter.

1) The simplest case is the photocatalytic change of a monatomic element.

2) The reaction of FR. and CR. offers us already a great diversity of catalytic reactions, because  $AlCl_3$  can form all kinds of compounds. Only in such cases where it unites neither with the initial products nor with the end product, or attacks this secondarily do we approach a case of pure catalysis.

The number of these cases is very small, the chlorination of benzene is a very appropriate example thereof; here the quantity of the catalyst is minimal indeed (see further)

The axioms which are more particularly applicable to the catalysis are :

“When... the one exerts an influence on the other, this latter... is changed by the first... .

“If in the calculation of one of these the change may be neglected we may speak of a one-sided influencing, which, however, as such... may not be considered one-sidedly (dissertation p. 4—5).

and subsequently :

“If we consider the possible relation of two substances (whether element or compound) three stages are to be distinguished therein”.

“1. The stage of the relative inertness. In this stadium even the catalytic influence is imperceptible, whilst there is no question of a chemical compound.

“2. The catalytic stage<sup>1)</sup> in which occurs also the mutual activation. In this stage the catalytic actions are enacted.

“3. The reaction stage in which appears an intra- or extra-molecular reaction”.

The catalytic stage forms the bridge between the inertness and the chemical compound. In each chemical reaction all three stages are gone through.

By varying the conditions we can, however, cause the influencing to be confined to the second stage”. (Chem. Weekbl. **11**, 475, also Journ. f. pr. Chem. N. F. **89**, 448 (1913).

2. PRINS starts from the general thesis that on interaction, there takes place a change in two conditions, which will be least powerful the moment it begins to reveal itself.

This stage lies, chemically speaking, in the dissociation region where the free energy of the entire system approaches to zero and is called by PRINS the catalytic stage.

In this catalytic stage there is really no question of a catalyst in the sense of OSTWALD; we are dealing with a change of condition:  $A \rightleftharpoons B$  which taken by itself can take place more or less rapidly.

Being in the catalytic stage does not at all imply, in my opinion, that the changes must take place rapidly; this depends on the nature of the change (chemically speaking on the nature of the atoms or atomic groups which in the transformation play a role in the first place).

If, for convenience sake, we call A and B two molecules, one of these molecules, in a reaction in which the other one (with its

<sup>1)</sup> In order to prevent confusion it would be better to speak of the activating stage. (PRINS also points out that the word “activator” expresses his ideas better than catalyst).

specific atomic group) occurs as a component, will be a catalyst in the sense of OSTWALD.



The above symbols represent this explanation from which we gather that the change of the free energy in so far as it concerns the catalyst approaches in the pure catalysis to zero and wherewith we also wish to express that the catalyst is in fact more a change of condition than a substance.

In the positive catalytic action the equilibrium  $A \rightleftharpoons B$  will set in much more rapidly than the reaction  $B \rightarrow C$  or  $A \rightarrow D$  and thus cause or accelerate the same.

Hence an ideal catalyst, according to this deduction and in connexion with OSTWALD'S definition, is a substance which undergoes with one of the to be activated substances (or bonds) such reciprocal action that in the latter system the thermodynamic potential and chemical resistance simultaneously approach to zero.

As it concerns here particularly the bond that is being activated, the other molecule will also be more or less influenced; this we notice immediately when we remember that intramolecular displacements come under the same point of view.

Hence, we will obtain the maximal catalytic action when, with the catalyst (for instance B) we approach as closely as possible the catalytic stage in regard to A as well as D.

The chlorination of benzene again presents us with a suitable meaning example to elucidate the intention of this thesis.

Both chlorine and benzene are in regard to  $AlCl_3$  in the catalytic stage; they are both rendered active without forming a compound.

As soon as we replace benzene by nitrobenzene the action ceases at the ordinary temperature because  $AlCl_3$  forms a solid combination with nitrobenzene so that these two are, in regard to each other, not in the catalytic stage and because  $AlCl_3$  cannot any longer activate the chlorine simultaneously.

At a higher temperature the chlorination starts; we may assume that the system  $AlCl_3 \cdot NO_2 \cdot C_6H_5$  is then again approaching the catalytic stage.

It is, however, self-evident that a case like the chlorination of benzene is rarely met with; as presumably somewhat similar cases I mention: all ionreactions in aqueous solutions; the union of hydrogen and oxygen and the decomposition of hydrogen peroxide



on or in platinum; the transformation: aldehyde  $\rightleftharpoons$  paraldehyde under the influence of sulphuric acid etc.

Much more frequent will be the cases, such as in the chlorination of nitrobenzene, where the catalyst is found, in regard to one of the substances, a good long way over this most favourable stage; in that case it will have united with one of the components to a more or less firm compound.

The sulphone formation from bromosulphone-chloride and benzene under co-operation of  $AlCl_3$  is an illustrative instance hereof:

The  $AlCl_3$  is combined with the sulphone-chloride and is, therefore, in regard to the chloride, already far removed from the catalytic stage, at  $25^\circ$  it is however not completely paralysed, as according to the course of the reaction it is still capable of activating the second molecule (benzene).

The sulphone formed now also unites with  $AlCl_3$  and now it appears also from the course of the reaction that it keeps on activating the benzene, but is, however, no longer capable of influencing the sulfone-chloride, for an excess of the latter exerts no influence on the reaction velocity. (OLIVIER and BÖESEKEN, Proc. 1913 l. c.).

From this case it is shown how complicated this reaction may become when in the reaction mixture different substances are present which paralyse the catalyst more or less, and that only a clear conception of the catalysis enables us to interpret the observations satisfactorily.

Represented symbolically, we thus have here (when we assume that the  $HCl(D)$  does not interfere, which has also been proved by OLIVIER):

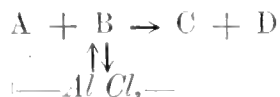

The  $AlCl_3$  united to  $C$  (the sulphone) can no longer reach  $A$  (the sulphonechloride), only the  $AlCl_3$  united to  $A$  itself can still activate the  $S-Cl$  bond, but much less so than free  $AlCl_3$ ; only the benzene ( $B$ ) is still attainable for the  $AlCl_3$ .

I want to observe here that the paralysis starts here, presumably, from the  $SO_2$ -group, because this occurs in the sulphonechloride as well as in the sulphone.

These are just the cases, wherein the catalyst is united with one of the starting products, but is not entirely paralysed thereby, which have originated the theory of the intermediate products.

By removing wilfully from the most favourable catalytic stage

(for instance by lowering the temperature) similar compounds have often been met with and it was imagined that the explanation of the catalytic phenomena had thus been found.

Now, however, it is evident that the explanation is not given by the formation of these compounds, but should be found *before* the formation and that the best catalysts will be those whose dissociation equilibrium extends over as large as possible a region of temperature and pressure, without any compounds being formed.

3. In this manner, ascending by the inductive method from the special case of the reaction of FRIEDEL and CRAFTS (BÖESEKEN) and descending by the deductive method from the general principle of reciprocity (H. J. PRINS), we have come to the conclusion that the catalytic action is situated in the pre-stage of the chemical union.

It is evident that with this result no explanation has been found in the sense that now everything is completely elucidated.

Yet, in my opinion, owing to the sharper definition of the conceptions the whole field is easier to survey (PRINS l.c.) and the special cases are more readily understood, also a fundament has been given on which we can pursue our researches with a greater certainty.

These in view of the further elucidation will have to move in two directions.

1st. It must be ascertained, as has been already done in some cases (l.c.), in how far the change in velocity is connected with the shifting of the catalyst and activated bonds in the dissociation region.

With this may be coupled systematic researches as to the most suitable catalysts for specified reactions, (for instance on metals which are in a rapidly setting in dissociation-equilibrium simultaneously with  $N_2$  and  $H_2$  at a low temperature in view of the ammonia synthesis; or on carbonates which in view of the ketone synthesis from acids according to SABATIER and SENDERENS must, at about  $300^\circ$ , be with those acids in the same favourable conditions).

2nd. Those catalytic actions must be investigated where very small energy shiftings are concerned; to this appertain in the first place the photocatalytic phenomena.

The first series of researches are of a more direct practical result; the second series, on the other hand, are of a more penetrating nature, the object being to attack the catalytic phenomena in their last recess.

*Delft, June 1914.*

**Chemistry.** — “*Researches on the Temperature-coefficients of the free Surface-energy of Liquids between — 80° and 1650° C.:* **VII.** *The specific surface-energy of the molten Halogenides of the Alkali-metals.*” By Prof. Dr. F. M. JAEGER. (Communicated by Prof. HAGA).

§ 1. Notwithstanding the original intention to publish the results of the measurements concerning the temperature-coefficients of the free surface-energy of molten salts at the same time as the determinations of the specific gravities of the investigated salts at different temperatures, and in this way to give completely all data, necessary for the calculation of the temperature-coefficients of their *molecular* surface-energy, — it seemed desirable on account of the present precarious conditions, to resolve already now on the publication of the results hitherto obtained, and relating to the change of the *specific* surface-energies of those salts with the temperature of observation. The present uncertainty about the moment, when the now stopped experiments, necessary for the determination of the specific weights, again may be resumed in future, makes it perhaps desirable to publish already now the available data of the free surface-energy of some forty salts, and to draw the attention on this occasion to some general conclusions, relating to these measurements.

§ 2. In this connection it is perhaps of interest to mention here also some details concerning our original tentatives, to reach the proposed aim by means of the method of capillar ascension-measurements, — notwithstanding the fact, that these experiments finally had to be given up because of reasons already formerly explained<sup>1)</sup>; these details doubtlessly can be of use for later investigations to be made in this direction.

Originally the investigated salt was introduced into wide tubes of heavily fusible *Jena*-glass, provided with rounded bottoms; the tubes were heated in a bath of a molten mixture of potassium-, and sodium-nitrate, either by means of gas, or better by electrical current. The salt-mixture was filled into an iron cylinder, outwardly lined with thick asbestos; its wall was provided with two diametrically opposed, narrow windows, which were closed by glassplates, fastened by means of asbestos-covered iron-frames. Through these planeparallel

<sup>1)</sup> F. M. JAEGER, These Proc. Comm. I. (1914).

windows the desired observations were executed by means of a telescope; the height of ascension in the capillary tubes was read upon a perpendicularly divided scale. The liquid salt in the surrounding bath was continually stirred; an arrangement was made to prevent as much as possible the annoying currents of hot air circulating before the windows.

In all these experiments it was stated very soon, that the investigated salts, when melted in the glass-tubes and on cooling again solidifying therein, made the tubes in most cases crack; or at least they appeared on renewed heating to get soon unsuitable and badly damaged, thus a substitution of the tubes by new ones being necessary after each experiment.

After many attempts, the tubes were arranged finally in the following way, to prevent this effect. *AB* (fig. 1) is a tube of *Jena* heavily

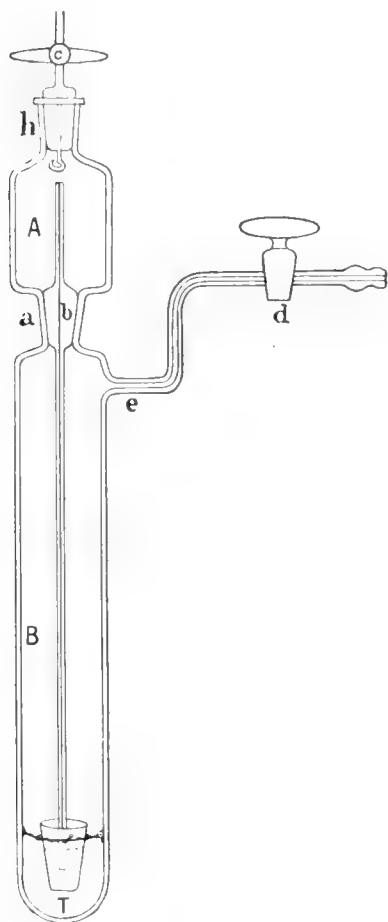

Fig. 1.

fusible glass, which has a conical narrowing at *a*, and a sideways tube *e* with stopcock *d*; the wider tube can be closed at its upper end by means of a stopper *h*, provided with the stopcock *C*. Just above the round bottom of the tube *B*, a small platinum crucible *T* of about 1 cm. volume, hangs between three strong horizontal platinum-wires; they are either melted into the glasswall of the tube, or they can be fixed to a platinum-ring, supported by three elevations in the wall of the tube. If in the last mentioned case the tube *B* at the same time is arranged in such a way, that *e.g.* just below *e* the two parts of it can be put together by means of a ground collar, it will thus be possible eventually to take the platinum-ring easily from the tube, and to restore it again after thoroughly cleaning the different parts of the apparatus. In every case the platinum-crucible *T* needs to be fixed into the tube as centrally as possible. The narrowing at *a* is ground

conically; the piece  $b$  (also conically shaped, ground and enlarged) of the heavily fusible, capillary glass-tube, can just be fixed into it; the capillary tube thus has the form represented in fig. 1, and it is cut to such a length, that it can be easily caught with a pincette from above through the hole  $h$ , while at its other end it reaches just to a little above the bottom of  $T$ , if  $b$  is caught by the collar  $a$ . The enlarged part of  $b$  is provided at its outward side with two very fine, vertical canals, which thus have the function of capillary connections between the spaces  $A$  and  $B$ .

By means of a funnel with a broad and long stem, the crucible  $T$  is now filled with a sufficient quantity of the finely pulverised and dry salt; then  $AB$  is put into the bath, and as soon as the salt in  $T$  is molten, the carefully cleaned capillary tube is lowered *very slowly* into the apparatus, until  $b$  is lying just in the collar  $a$ ; immediately the liquid begins to rise then into the capillary tube. Then both stopcocks  $C$  and  $d$  are closed, after the tube being put in such a position, that the capillary tube will be just vertical; this may be easily controlled by means of a plummet. If now the air is eliminated from  $A$  through  $C$ , it will appear easily to let the liquid rise into the capillary tube, because the settlement of the pressure-differences in  $A$  and  $B$  will occur only very slowly by the narrow canals in  $b$ ; in this way one can try to wet the walls of the tube by the liquid salt, and to eliminate the air-bubbles eventually inclosed. A superfluous rising into the capillary tube can be stopped at any moment by means of the stopcock  $d$ . Reversely, by sucking at  $d$ , it will be possible, if necessary, to introduce air into the molten salt through the capillary tube, or to remove the liquid from it; also it is possible to substitute the air in  $AB$  by a neutral atmosphere, e.g. by nitrogen or another gas, if desired. The experiment being finished, the capillary tube  $b$  is removed first; the salt will afterwards solidify in  $T$ , without causing the cracking of the glass-tube. In such a way several experiments can be made by means of a single apparatus.

§ 3. Although this method of operating can be recommended in such cases as in principle a very suitable one, the experimental difficulties however appeared to be of a rather appreciable magnitude.

One of the chief difficulties was the elimination of the very small air-bubbles from the liquid in the capillary tube, which appeared to be transported into it, whenever the liquid begins to rise into the narrow tube. Notwithstanding all care, this could not be completely prevented, and the column of liquid then appears as if broken into

a great number of pieces. It is extremely difficult, again to eliminate such transported air-bubbles, even in repeating the above mentioned way of rising and falling of the liquid in the capillary tube for a number of times. Almost quite impossible is the elimination of the air, if the wall of the tube moreover is attacked by the molten salt, — this wall becoming more or less rough by it: the air-bubbles will then persist in sticking to the narrow canal.

Moreover the microscopical control of the glass-tubes proved doubtlessly that the walls of it were attacked by the molten salt almost always seriously to a more or less extent; this fact, in connection with the just mentioned difficulties caused by the not removable air-bubbles and the impossibility to determine sufficiently the exact situation of the surface of the liquid in  $T$ , were the chief causes why these tentatives finally had to be stopped. In some cases, e.g. in that of sodiumchromate, we could obtain rather reliable data; but e.g. with lithiumsalts, which will always attack the glass in a high degree, and just so in the case of silvernitrate, only very untrustworthy numbers could be obtained. It appeared moreover to be very difficult, to keep the temperature constant along the full length of the capillary tube; this can soon be controlled by means of a set of very small thermometers, placed within  $B$  at several distances from the bottom.

§ 4. After this experience we thought it adviceable to abandon the said method completely. All numbers here given therefore are collected after the method formerly described by us in detail<sup>1)</sup>; they relate to the purest salts. For the details of these experiments the reader is referred to Comm. I of this series.

#### § 5. *Measurements of molten Alkali-halogenides.*

This series includes the following salts: The *Fluorides* and *Chlorides* of *Lithium*, *Sodium*, *Potassium*, *Rubidium* and *Caesium*, and the *Bromides* and *Iodides* of *Sodium*, *Potassium*, *Rubidium* and *Caesium*. The preparation of the anhydrous bromide and iodide of lithium gave hitherto no good results, because of the hydrolysis caused by heating the crystallized, hydrated salts.

1) F. M. JAEGER, loco cit. 335—348.

## I.

**Lithiumfluoride: *LiF*.**

Temperature in ° C.	Maximum Pressure <i>H</i>		Surface-tension ζ in Erg. pro cm <sup>2</sup> .
	in mm. mer- cury of 0° C.	in Dynes	
868.5	7.098	9463	249.5
897.6	7.021	9360	248.0
944	6.890	9186	242.3
984.6	6.770	9026	238.3
1029.4	6.634	8844	233.5
1065	6.525	8699	229.8
1116.5	6.323	8430	222.7
1155.5	6.170	8226	217.4
1208	5.976	7967	210.6
1270	5.700	7599	201.1

Molecular weight: **25.99**. Radius of the Capillary tube :0.05240  
cm. at 19° C.  
Depth: 0.1 mm.

The salt melts at 840° C.; at 1150° it evaporates already rather rapidly, and above 1270° so fast, as to make measurements useless. The vapours show alkaline reaction.

## II.

**Lithiumchloride: *LiCl*.**

Temperature in ° C.	Maximum Pressure <i>H</i>		Surface-tension ζ in Erg. pro cm <sup>2</sup> .
	in mm. mer- cury of 0° C.	in Dynes	
611°	3.928	5237	137.8
640	3.859	5145	135.4
680	3.786	5047	132.9
734.5	3.668	4890	128.8
775.5	3.580	4773	125.8
813.7	3.504	4672	123.2
860.1	3.410	4546	119.9
914.8	3.300	4400	116.1
967.8	3.199	4265	112.6
1021.9	3.082	4109	108.5
1074.6	2.976	3968	104.8

Molecular weight: **42.45**. Radius of the Capillary tube :0.05240  
cm. at 19° C.  
Depth: 0.1 mm.

The salt melts at 608° C.; at 960° it begins to evaporate readily, and above 1080° so fast, that exact measurements become almost impossible. The sublimed salt has a feeble alkaline reaction.

## III.

Sodiumfluoride : *NaF*.

Temperature in ° C.	Maximum Pressure <i>H</i>		Surface-tension $\gamma$ in Erg. pro cm <sup>2</sup> .
	in mm. mer- cury of 0° C.	in Dynes.	
1010°	5.685	7579	199.5
1052.8	5.570	7426	195.5
1097	5.445	7259	191.2
1146.7	5.290	7053	185.8
1189	5.136	6847	180.5
1234	5.019	6691	176.4
1263.2	4.922	6562	173.1
1313	4.761	6347	167.5
1357.3	4.628	6170	162.9
1405.3	4.480	5973	157.8
1456.4	4.330	5773	152.5
1497	4.220	5626	148.7
1546	4.070	5426	143.5

Molecular weight: 42.0. Radius of the Capillary tube: 0.05223 cm.  
Depth: 0.1 mm.

The salt melts at 990° C. At 1360° C. appreciable vaporisation sets in; at 1450° C. this occurs very rapidly.

## IV.

Sodiumchloride : *NaCl*.

Temperature in ° C.	Maximum Pressure <i>H</i>		Surface-tension $\gamma$ in Erg. pro cm <sup>2</sup> .
	in mm. mer- cury of 0° C.	in Dynes.	
802.6	3.580	4772.9	113.8
810.5	3.572	4762.2	113.5
820.8	3.552	4735.5	112.9
832	3.520	4692.9	111.9
859	3.457	4608.9	109.9
883.2	3.401	4534.3	108.2
907.5	3.345	4459.7	106.4
930.6	3.285	4379.7	104.5
960.5	3.227	4302.3	102.7
995.5	3.132	4175.6	99.7
1037	3.047	4062.3	97.0
1080	2.951	3934.3	94.0
1122.3	2.864	3818.3	91.3
1171.8	2.761	3681.0	88.0

Molecular weight: 58.46. Radius of the Capillary tube: 0.04736 cm.  
at 18° C. Depth: 0.1 mm.

The pure salt melts at 801° C.; at 1080° it begins to evaporate already rapidly, at 1150° C. very rapidly. Between 801° and 859° C. the coefficient of  $\mu$  seems to be about 0.57 Erg., and to increase with rise of temperature. The mass shows in water afterwards a strong alkaline reaction.



## V.

Sodiumbromide: *NaBr*.

Temperature in ° C.	Maximum Pressure <i>H</i>		Surface-tension $\gamma$ in Erg. pro cm <sup>2</sup> .
	in mm. mer- cury of 0° C.	in Dynes	
760.9	3.011	4015	105.8
809.5	2.928	3904	102.9
851.9	2.834	3778	99.6
896.8	2.737	3649	96.2
941.5	2.640	3520	92.9
984.5	2.556	3408	90.0
1029.4	2.449	3265	86.2
1073.5	2.384	3178	84.0
1116	2.302	3069	81.1
1165.7	2.214	2952	78.0

Molecular weight: **102.92**. Radius of the Capillar tube: 0.05240 cm. at 19° C.  
Depth: 0.1 mm.

The salt melts at 768° C.; it begins readily to evaporate at 1000° C., and free bromine can be observed then. The sublimed salt possesses alkaline reaction.

## VI.

Sodium-iodide: *NaI*.

Temperature in ° C.	Maximum Pressure <i>H</i>		Surface-tension $\gamma$ in Erg. pro cm <sup>2</sup> .
	in mm. mer- cury of 0° C.	in Dynes	
705.5	2.438	3250	85.6
746	2.388	3184	83.9
815.5	2.291	3054	80.5
860.7	2.209	2945	77.6

Molecular weight: **149.92**. Radius of the Capillary tube: 0.05240 cm. at 19° C.  
Depth: 0.1 mm.

The salt, which melts at about 660° C, evaporates soon to a high degree, and free iodine is observed. The sublimed salt reacts somewhat alkaline.

## VII.

**Potassiumfluoride: *KF*.**

Temperature in ° C.	Maximum Pressure <i>H</i>		Surface-tension $\gamma$ in Erg. pro cm <sup>2</sup> .
	in mm. mer- cury of 0° C.	in Dynes.	
912.7	4.123	5497	138.4
961.5	4.024	5365	135.2
1015	3.898	5197	131.0
1062	3.790	5053	127.4
1097	3.701	4934	124.5
1146.5	3.564	4752	119.9
1185	3.450	4600	116.1
1234	3.336	4448	112.3
1275	3.225	4300	108.6
1310	3.116	4154	104.9

Molecular weight: **58.1**. Radius of the Capillary tube: 0.05002 cm. at 18° C.  
Depth: 0.1 mm.

The salt melts at 860° C. At 1140° C. it begins to evaporate distinctly, at 1180° C. this goes on already rapidly, while acid vapours are set free.

## VIII.

**Potassiumchloride: *KCl*.**

Temperature in ° C.	Maximum Pressure <i>H</i>		Surface-tension $\gamma$ in Erg. pro cm <sup>2</sup> .
	in mm. mer- cury of 0° C.	in Dynes.	
799.5	3.015	4019	95.8
827.1	2.957	3942	94.0
861.5	2.873	3830	91.3
885.1	2.819	3758	89.7
908.5	2.768	3690	88.0
941	2.697	3595	85.8
986	2.582	3442	82.2
1029	2.484	3311	79.1
1054	2.425	3233	77.2
1087.5	2.361	3147	75.2
1103.6	2.313	3083	73.7
1125	2.275	3033	72.5
1167	2.182	2909	69.6

Molecular weight: **74.56**. Radius of the Capillary tube: 0.04736 cm. at 15° C.  
Depth: 0.1 mm.

The compound solidifies after heating above its meltingpoint during 4 hours, at 768° C. It evaporates at 980° already appreciably, at 1160° very rapidly. The vapours are acid, while the solidified mass shows in water alkaline reaction. The values of the maximum pressure appear to decrease gradually, as a result of continuous heating of the molten mass above 1100° C.

## IX.

**Potassiumbromide: *KBr*.**

Temperature in ° C.	Maximum Pressure <i>H</i>		Surface-tension $\chi$ in Erg. pro cm <sup>2</sup> .
	in mm. mer- cury of 0° C.	in Dynes	
775°	2.702	3602	85.7
798	2.642	3522	83.8
826	2.585	3446	82.0
859	2.504	3338	79.5
886.5	2.450	3266	77.8
920	2.376	3167	75.4

Molecular weight: **119.02**. Radius of the Capillary tube: 0.04728 cm. at 15° C.  
Depth: 0.1 mm.

The salt melts at 734° C. At 825° C. already a decomposition under liberation of hydrobromic acid and bromine is observed; at 940° C. the salt evaporates so rapidly and decomposes to such a degree, that further determinations seem to be useless.

## X.

**Potassium-iodide: *KI*.**

Temperature in ° C.	Maximum Pressure <i>H</i>		Surface-tension $\chi$ in Erg. pro cm <sup>2</sup> .
	in mm. mer- cury of 0° C.	in Dynes	
737°	2.372	3162	75.2
764	2.274	3031	72.1
812	2.183	2910	69.2
866	2.106	2807	66.8
873	2.097	2795	66.5

Molecular weight: **165.96**. Radius of the Capillary tube: 0.04728 cm. at 15° C.  
Depth: 0.1 mm.

The salt melts at 681.05° C. At 750° C. already it begins to evaporate very appreciably, while iodine is set free. For again higher temperatures the determinations can hardly have any essential significance.

## XI.

**Rubidiumfluoride: *RbF*.**

Temperature in ° C.	Maximum Pressure <i>H</i>		Surface-tension $\gamma$ in Erg. pro cm <sup>2</sup> .
	in mm. mer- cury of 0° C.	in Dynes	
802.6	3.630	4839	127.2
847.2	3.461	4614	121.3
886.8	3.327	4436	116.7
936	3.220	4293	113.0
985.6	3.102	4136	108.9
1036.7	2.997	3996	105.2
1085.4	2.910	3879	102.2

Molecular weight: **104.45**. Radius of the Capillary tube: 0.05223 cm. at 19° C.  
Depth: 0.1 mm.

The salt melts at 765° C. At 1000° C. it begins already to evaporate in an appreciable degree.

## XII.

**Rubidiumchloride: *RbCl*.**

Temperature in ° C.	Maximum Pressure <i>H</i>		Surface-tension $\gamma$ in Erg. pro cm <sup>2</sup> .
	in mm. mer- cury of 0° C.	in Dynes	
750	2.732	3642	95.7
769.7	2.689	3585	94.2
828.2	2.540	3386	89.0
880	2.410	3213	84.5
922.7	2.313	3084	81.1
933	2.278	3037	79.9
961.5	2.205	2940	77.3
994	2.130	2840	74.7
1036.6	2.030	2706	71.3
1088.5	1.900	2533	66.7
1150	1.749	2332	61.4

Molecular weight: **120.91**. Radius of the Capillary tube: 0.05223 cm. at 19° C.  
Depth: 0.1 mm.

The salt melts at 720° C.; at 950° C. it begins to sublime already distinctly. Analysis gave: 29.25% *Cl* and 70.75% *Rb*, proving satisfactorily the purity of the salt.

## XIII.

<b>Rubidumbromide: <i>RbBr.</i></b>			
Temperature in ° C.	Maximum Pressure <i>H</i>		Surface-tension $\gamma$ in Erg. pro cm <sup>2</sup> .
	in mm. mer- cury of 0° C.	in Dynes	
729.2	2.504	3338	87.7
779	2.401	3201	84.1
831	2.301	3068	80.7
884.3	2.200	2933	77.2
943.5	2.084	2778	73.1
985.7	2.000	2666	70.2
1041	1.900	2533	66.7
1121	1.724	2298	60.6

Molecular weight: **165.37**. Radius of the Capillary tube: 0.05223 cm. at 19° C.  
Depth: 0.1 mm.

The salt melts at about 685° C.; at 940° C. already it begins to sublime, while bromine and hydrobromic acid distinctly are observed too.

## XIV.

<b>Rubidium-Iodide: <i>RbI.</i></b>			
Temperature in ° C.	Maximum Pressure <i>H</i>		Surface-tension $\gamma$ in Erg. pro cm <sup>2</sup> .
	in mm. mer- cury of 0° C.	in Dynes	
673.4	2.268	3024	79.4
721.8	2.165	2886	75.8
771.5	2.061	2748	72.2
822	1.956	2607	68.5
869	1.857	2476	65.1
918	1.758	2344	61.6
968	1.663	2217	58.3
1016	1.578	2104	55.4

Molecular weight: **212.37**. Radius of the Capillary tube: 0.05223 cm. at 19° C.  
Depth: 0.1 mm.

The salt melts at 642° C. At 900° C. evaporation happens already distinctly; at 1000° C. it is so fast, that the measurements are influenced by it in a most troublesome way, the values of *H* seeming to be increased by the heavy vapours.

## XV.

**Caesiumfluoride: CsF.**

Temperature in ° C.	Maximum Pressure <i>H</i>		Surface-tension $\gamma$ in Erg. pro cm <sup>2</sup> .
	in mm. mer- cury of 0° C.	in Dynes	
722.5	3.116	4154	104.5
768.7	3.011	4014	101.0
825.6	2.872	3829	96.4
877.3	2.748	3664	92.3
929.7	2.624	3498	88.1
985	2.510	3346	84.3
1042	2.418	3224	81.3
1100	2.346	3128	78.9

Molecular weight: **151.81**. Radius of the Capillary tube: 0.05002  
cm. at 18° C.  
Depth: 0.1 mm.

The salt melts at 692° C. At 990° C. it begins to evaporate  
distinctly.

## XVI.

**Caesiumchloride: CsCl.**

Temperature in ° C.	Maximum Pressure <i>H</i>		Surface-tension $\gamma$ in Erg. pro cm <sup>2</sup> .
	in mm. mer- cury of 0° C.	in Dynes	
663.7	2.660	3546	89.2
717	2.560	3413	85.9
771	2.440	3253	81.9
829.6	2.315	3086	77.7
881	2.193	2924	73.7
934.2	2.075	2766	69.7
979	1.975	2633	66.4
1034.7	1.833	2444	61.6
1080	1.673	2230	56.3

Molecular weight: **168.27**. Radius of the Capillary tube: 0.05002  
cm. at 18° C.  
Depth: 0.1 mm.

The salt melts at 632° C. At 925° C. it begins to sublime; at  
1000° C. the evaporation occurs already very rapidly.

## XVII.

<b>Caesiumbromide: CsBr.</b>			
Temperature in ° C.	Maximum Pressure <i>H</i>		Surface-tension $\gamma$ in Erg. pro cm <sup>2</sup> .
	in mm. mer- cury of 0° C.	in Dynes	
657.7	2.439	3252	81.8
693.6	2.351	3134	78.9
752.5	2.231	2974	74.9
807.5	2.132	2842	71.6
858.3	2.040	2720	68.5
915.8	1.950	2600	65.5
970.6	1.865	2486	62.7

Molecular weight: **212.73**. Radius of the Capillary tube: 0.05002 cm. at 18° C.  
Depth: 0.1 mm.

The salt melts at 631° C. At 900° C. it evaporates already very rapidly, making the measurements very difficult.

## XVIII.

<b>Caesium-Iodide: CsI.</b>			
Temperature in ° C.	Maximum Pressure <i>H</i>		Surface-tension $\gamma$ in Erg. pro cm <sup>2</sup> .
	in mm. mer- cury of 0° C.	in Dynes	
653.6	2.178	2904	73.1
713	2.050	2733	68.8
768.2	1.955	2606	65.7
821.4	1.860	2480	62.5
879	1.762	2349	59.2
926	1.684	2245	56.6
980	1.600	2134	53.8
1030	1.520	2026	51.1

Molecular weight: **259.73**. Radius of the Capillary tube: 0.05002 cm. at 18° C.  
Depth: 0.1 mm.

The salt melts at 620° C. It begins to sublime appreciably at 825° C.

§ 6. *The temperature-coefficients of the specific surface-energy of the molten alkali-halogenides.*

During these measurements, it became clear, that the shape of the curves, which illustrated the dependence of  $\chi$  and  $t$ , was in most cases much nearer to that of straight lines, than was the case with most of the hitherto investigated organic liquids. However it must be remarked, that notwithstanding this, also in the case of molten salts, the  $\chi$ - $t$ -curves could evidently belong to every one of the three formerly discerned possible types, while in the case of occurring dissociation a more rapid bending towards the temperature-axis could be stated, just as in the analogous cases formerly studied. Because of the much greater values of the maximum-pressures however in the here studied cases, those deviations from straight lines come much less to the foreground. As a consequence, in thirty cases of the about forty investigated salts, the dependence of  $\chi$  and  $t$  could be expressed with sufficient accuracy by *linear* expressions; for the remaining cases a quadratic expression in  $t$  with three constants appeared to be adapted to this purpose to a really sufficient degree.

If  $t_s$  is the *meltingpoint* of the salt, then  $\chi_t$  above this melting-point, can be calculated from an equation of the form:

$$\chi_t = a - b(t - t_s) + c(t - t_s)^2,$$

in which  $a$  corresponds to the value of  $\chi_t$  at the meltingpoint. In the following table the corresponding values of  $t_s$ ,  $a$ ,  $b$  and  $c$  for every one of the investigated halogenides are resumed:

Formula of the Salt.	$t_s$ in ° C.	$a$	$b$	$c$
<i>LiF</i>	840	255.2	0.126	0
<i>LiCl</i>	608	140.2	0.076	0
<i>NaF</i>	990	201.6	0.106	0
<i>NaCl</i>	801	114.1	0.071	0
<i>NaBr</i>	768	106.5	0.069	0
<i>NaJ</i>	660	88.2	0.053	0
<i>KF</i>	858	143.2	0.087	0
<i>KCl</i>	780	97.4	0.072	0
<i>KBr</i>	734	88.8	0.070	0
<i>KJ</i>	681	78.3	0.064	0
<i>RbF</i>	765	132.0	0.131	0.00012
<i>RbCl</i>	720	98.3	0.086	0
<i>RbBr</i>	685	90.7	0.069	0
<i>RbJ</i>	642	80.3	0.065	0
<i>CsF</i>	692	107.1	0.088	0.00004
<i>CsCl</i>	646	91.3	0.077	0
<i>CsBr</i>	631	83.6	0.063	0
<i>CsJ</i>	620	91.6	0.056	0



Specific Surface-Energy  
in Erg pro cm<sup>2</sup>.

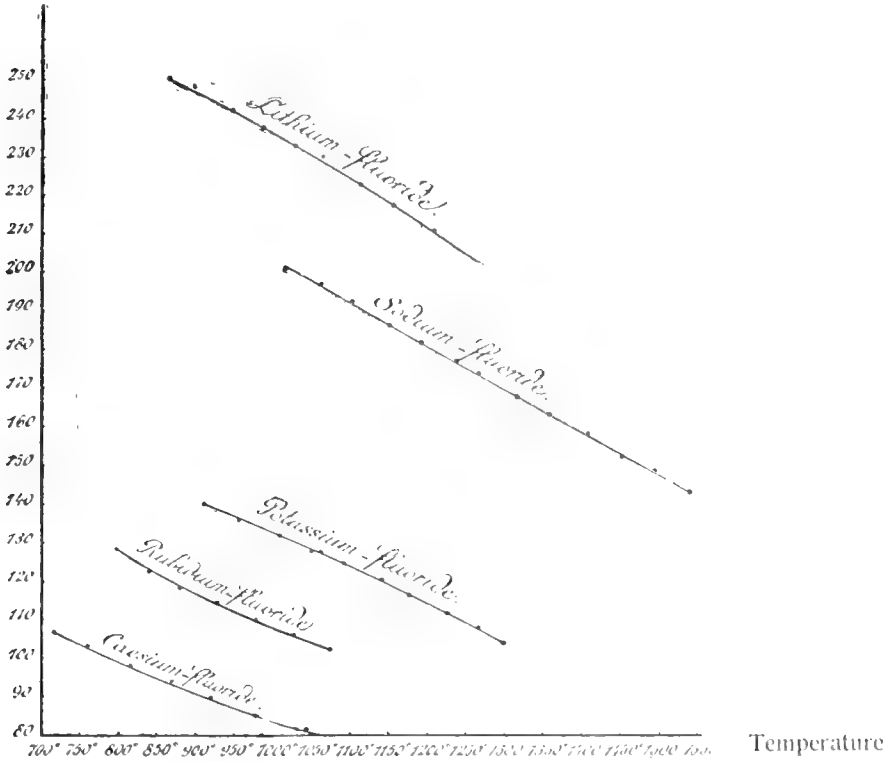

Fig. 2.

Specific Surface-Energy  
in Erg. pro cm<sup>2</sup>.

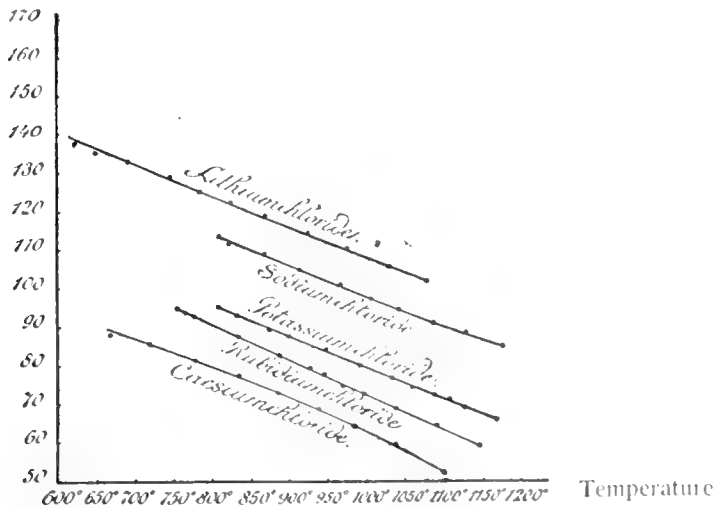

Fig. 3.

Specific Surface-Energy  
in Erg pro cm<sup>2</sup>.

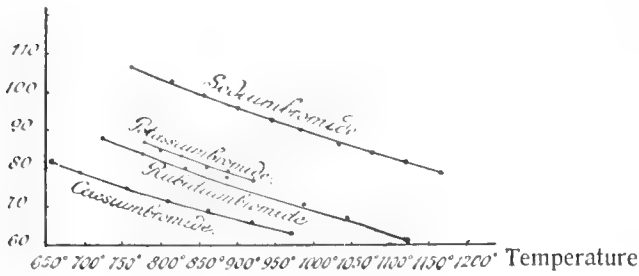

Fig. 4.

Specific Surface-Energy  
in Erg pro cm<sup>2</sup>.

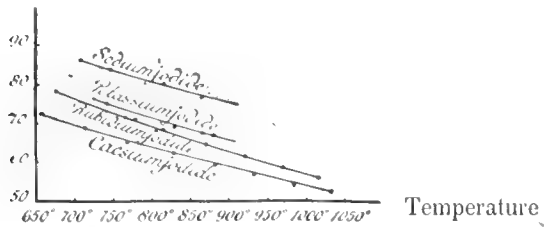

Fig 5.

§ 7. From these data it can be deduced in the first place, that in general the temperature-coefficients of the specific surface-energy  $\chi$  of these salts appear to be *smaller* than for most organic liquids. While in the last mentioned cases these values are oscillating between 0.09 and 0.13, — as the following instances may prove once more:

*Acetic acid*: 0.118.

*Benzene*: 0.136.

*Diethylmalonate*: 0.102

*Anisol*: 0.114.

*Phenetol*: 0.102.

*Anthol*: 0.034.

| *Guajacol*: 0.117.

| *Resorcine-Dimethylether*: 0.105.

| *Hydroquinone Dimethylether*: 0.109.

| *Pyridine*: 0.125.

|  *$\alpha$ -Picoline*: 0.128.

| *Chinoline*: 0.104.

— the values of  $b$  for these salts are situated between 0,05 and 0,09, being thus about of the order of magnitude of the coefficient for e.g. *ethylalcohol*: 0.086. Only in the case of some fluorides some numbers for  $b$  were found, corresponding in some degree with those for organic liquids. (*LiF*: 0,126; *RbF*: 0,131; *NaF*: 0,106). If attention is drawn to the much higher temperatures of observation in the case of molten salts in comparison with those of the organic liquids, it will be hardly permitted to conclude to a principal difference in this respect, in the behaviour of both classes of liquids; on the other side however just with respect to these much higher

temperatures, the enormously high absolute values of  $\gamma$  with these salts, which may occasionally be more than three times that of *water*, must be considered as very remarkable. In connection with the data given above, we can moreover generally conclude:

1. *The temperature-coefficient  $b$  of the specific surface-energy decreases continually in the case of the four halogenides of the same alkali-metal, with increasing atomic weight of the halogen-atom. This rule holds evidently quite accurately in all the cases here considered.*

As to the absolute values of  $\gamma$  of these salts, attention can moreover be drawn to the following general rules:

2. *At the same temperature  $t$ , the values  $\gamma_t$  for the same halogenide of all alkali-metals, will decrease gradually with increasing atomic weight of the alkali-metal.*

3. *At the same temperature  $t$  the values  $\gamma_t$  will gradually decrease in the case of the four halogenides of the same alkali-metal, with increasing atomic weight of the halogen-atom.*

These relations however do not possess a simple *additive* character.

Generally speaking, the *Li*-compounds appear to deviate more from those of the other alkali-metals, than these from each other; the *K*-, *Rb*-, and *Cs*-compounds approach each other more, than each of these elements do the corresponding *Na*-compounds, while in the series of the first mentioned three alcalimetals, the compounds of *K* and *Rb* appear to have the nearest analogies to each other. Probably the liquid lithium-salts may possess a higher degree of molecular complexity, than the salts of the other alkali-metals.

*Groningen, Augustus 1914. Laboratory for Inorganic and Physical Chemistry of the University.*

**Chemistry.** — “*Researches on the Temperature-coefficients of the free Surface-energy of Liquids at Temperatures between — 80° and 1650° C. VIII. The Specific Surface-energy of some Salts of the Alkali-metals.*” By Prof. Dr. F. M. JAEGER. (Communicated by Prof. H. HAGA).

§ 1. As a sequel to the data published in the foregoing communication, which related to the *halogenides* of the alkali-metals, the results of the measurements made with a number of salts of the alkali-metals, which belong to some other series, are communicated in the following pages. These measurements include the following objects:

The *Sulphates of Lithium, Sodium, Potassium, Rubidium and Caesium*; the *Nitrates of Lithium, Sodium, Potassium, Rubidium and Caesium*; the *Metaborates of Lithium, Sodium and Potassium*; and the *Molybdates, Tungstates and Metaphosphates of Sodium and Potassium*.

With the exception of rubidiumsulfate, which evidently contained some potassiumsulfate, all salts were chemically pure; the sulfates, molybdates and tungstates were those commonly used in this laboratory for the calibration of the thermoelements, and just the same was the case with lithiummetaborate. For the method and practice of the measurements etc., we can refer to the foregoing communication.

## § 2.

## I.

<b>Lithiumsulphate: <math>Li_2SO_4</math>.</b>			
Temperature in ° C.	Maximum Pressure $H$		Surface-tension $\gamma$ in Erg. pro $cm^2$ :
	in mm. mer- cury of 0° C.	in Dynes	
860°	6.361	8481	223.8
873.5	6.342	8455	223.1
897	6.303	8403	221.8
923	6.256	8341	220.2
962.5	6.169	8224	217.4
976.8	6.146	8194	216.4
1001.2	6.099	8132	214.8
1038.5	6.027	8035	212.3
1057	5.987	7982	211.0
1074	5.953	7936	209.8
1089.5	5.923	7897	208.8
1112	5.879	7838	207.3
1156.5	5.791	7720	204.2
1167.5	5.766	7687	203.4
1183.5	5.737	7649	202.4
1192.2	5.718	7624	201.8
1214	5.675	7566	200.3

Molecular weight: <b>109.94.</b>	Radius of the Capillary tube 0.05240 cm. at 16° C. Depth: 0.1 mm.
The meltingpoint is 852° C.; the salt appears to be stable up to rather high temperatures.	

## II.

**Sodiumsulphate:  $Na_2SO_4$ .**

Temperature in ° C.	Maximum Pressure $H$		Surface-tension $\gamma$ in Erg. pro $cm^2$ .
	in mm. mer- cury of 0° C.	in Dynes	
900°	6.285	8379	194.8
945	6.247	8329	189.3
990	6.209	8278	188.2
1032	6.149	8198	186.5
1077	6.088	8116	184.7

Molecular weight: **142.07**. Radius of the Capillary tube: 0.04512 cm. at 16° C.  
Depth: 0.1 mm.

The salt melted at 884° C. The molten mass, if brought into water, shows an alkaline reaction, if the temperature of the molten salt has been above 1100° C.

## III.

**Potassiumsulphate:  $K_2SO_4$ .**

Temperature in ° C.	Maximum Pressure $H$		Surface-tension $\gamma$ in Erg. pro $cm^2$ .
	in mm. mer- cury of 0° C.	in Dynes	
1070.2°	4.080	5439	143.7
1103	4.048	5397	142.6
1145	3.989	5318	140.6
1199	3.878	5171	136.7
1247	3.762	5016	132.7
1305.5	3.651	4868	128.8
1347	3.578	4770	126.2
1371.5	3.529	4705	124.6
1400	3.468	4623	122.4
1439.5	3.393	4523	119.8
1462.5	3.344	4458	118.1
1490.4	3.286	4381	116.1
1530.3	3.228	4304	114.1
1586	3.130	4173	110.7
1656	3.020	4026	106.8

Molecular weight: **174.27**. Radius of the Capillary tube: 0.05240 cm. at 19° C.  
Depth: 0.1 mm.

The salt melts at 1074° C., and does not dissociate appreciably up to 1550° C.

## IV.

Rubidiumsulphate:  $Rb_2SO_4$ .

Temperature in ° C.	Maximum Pressure $H$		Surface-tension $\gamma$ in Erg. pro $cm^2$ .
	in mm. mer- cury of 0° C.	in Dynes	
1086°	3.760	5013	132.5
1112	3.681	4907	129.7
1144.7	3.611	4814	127.3
1195	3.520	4693	124.2
1234.5	3.452	4602	121.8
1289	3.368	4490	118.9
1343.8	3.286	4381	116.0
1396.8	3.223	4297	113.8
1414.6	3.200	4267	113.1
1482	3.138	4183	110.9
1545	3.079	4105	108.9

Molecular weight: 266.97. Radius of the Capillary tube: 0.0524 cm. at 18° C.  
Depth: 0.1 mm.

The salt melts at 1055° C. At about 1400° C. it begins to evaporate somewhat faster, and sublimes against the colder parts of the apparatus. It appears to contain some  $K_2SO_4$ ; analysis gave: 37.45%  $SO_4$  and 62.56%  $Rb$ , instead of 36%  $SO_4$  and 64%  $Rb$ .

## V.

Caesiumsulphate:  $Cs_2SO_4$ .

Temperature in ° C.	Maximum Pressure $H$		Surface-tension $\gamma$ in Erg. pro $cm^2$ .
	in mm. mer- cury of 0° C.	in Dynes	
1036°	3.170	4226	111.3
1063	3.080	4106	108.2
1105	2.988	3984	105.0
1165	2.869	3825	100.8
1221	2.764	3685	97.3
1274.5	2.691	3588	94.7
1331.4	2.607	3476	91.7
1372	2.552	3402	89.8
1423	2.482	3309	87.4
1470	2.427	3236	85.5
1530	2.354	3138	83.0

Molecular weight: 361.69. Radius of the Capillary tube: 0.05223 cm. at 18° C.  
Depth: 0.1 mm.

The salt melts at ca. 1015° C. At 1325° C. it begins to evaporate in an appreciable degree; at 1440° C. very rapidly, and at higher temperatures it sublimes in a rather troublesome way.

Specific Surface-Energy  
in Erg. pro cm<sup>2</sup>.

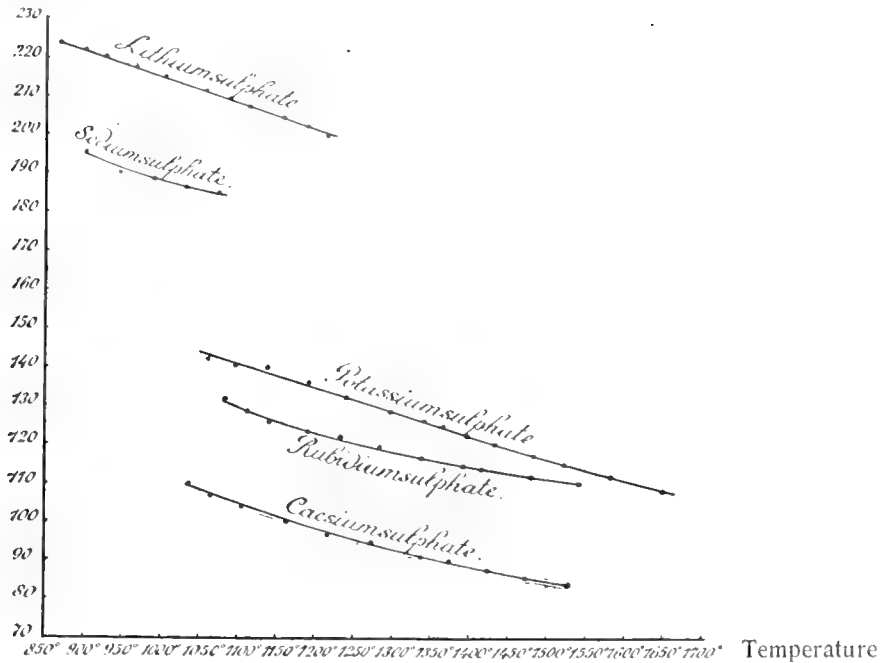

Fig. 1.

VI.

Lithiumnitrate:  $LiNO_3$ .

Temperature in ° C.	Maximum Pressure $H$		Surface-tension $\gamma$ in Erg. pro cm <sup>2</sup> .
	in mm. mer- cury of 0° C.	in Dynes	
358.5	3.334	4445	111.5
403	3.260	4347	109.1
418.2	3.240	4320	108.4
445.3	3.169	4225	106.0
492.5	3.069	4092	102.3
555.3	2.956	3941	99.0
609.4	2.872	3829	96.2

Molecular weight: 68.95.

Radius of the Capillary tube: 0.05002  
cm. at 18° C.  
Depth: 0.1 mm.

The salt melts at 254° C. to a very thin liquid. The values of  $\gamma$  are evidently *smaller* than in the case of the sodium nitrate. At 600° C. already a decomposition, with oxygen and nitrous vapours setting free, can be stated.

## VII.

**Sodiumnitrate:  $\text{NaNO}_3$ .**

Temperature in $^{\circ}$ C.	Maximum Pressure $H$		Surface-tension $\gamma$ in Erg. pro $\text{cm}^2$ .
	in mm. mer- cury of $0^{\circ}$ C.	in Dynes	
321.5	3.580	4773	119.7
355	3.534	4711	118.1
396.5	3.466	4621	115.9
426.5	3.412	4549	114.2
465.7	3.341	4454	111.8
513.1	3.253	4337	108.9
559	3.162	4216	105.9
601.6	3.086	4114	103.4
656.3	2.966	3954	99.4
693	2.889	3852	96.8
738.2	2.793	3723	93.7

Molecular weight: **85.01**. Radius of the Capillary tube: 0.05002 cm.  
at  $18^{\circ}$  C.  
Depth: 0.1 mm.

The salt melts at  $312^{\circ}$  C. At  $700^{\circ}$  C. already it distinctly gives off nitrous vapours and oxygen; the solidified mass gives in water a strong alkaline reaction.

## VIII.

**Potassiumnitrate:  $\text{KNO}_3$ .**

Temperature in $^{\circ}$ C.	Maximum Pressure $H$		Surface-tension $\gamma$ in Erg. pro $\text{cm}^2$ .
	in mm. mer- cury of $0^{\circ}$ C.	in Dynes	
380	3.300	4400	110.4
436	3.168	4223	106.0
480.1	3.073	4097	102.8
534.3	2.942	3923	98.5
578	2.841	3788	95.2
628	2.735	3646	91.6
675.4	2.623	3497	87.9
721.7	2.506	3341	84.0
771.6	2.391	3188	80.2

Molecular weight: **101.11**. Radius of the Capillary tube 0.05002 cm.  
at  $18^{\circ}$  C.  
Depth: 0.1 mm.

The salt melts at  $339^{\circ}$  C. At  $760^{\circ}$  C. already a decomposition, analogous to that observed in the case of the sodiumsalt, can be stated.



## IX.

<b>Rubidiumnitrate: <math>RbNO_3</math>.</b>			
Temperature in ° C.	Maximum Pressure $H$		Surface-tension $\gamma$ in Erg. pro $cm^2$ .
	in mm. mer- cury of 0° C.	in Dynes	
326.5	3.215	4286	107.5
376	3.110	4146	104.0
428	2.982	3976	99.8
480	2.871	3828	96.1
527	2.763	3684	92.5
578	2.653	3537	88.9
625	2.556	3408	85.6
676.2	2.429	3238	81.4
726.2	2.316	3088	77.7

Molecular weight: **147.46**. Radius of the Capillary tube: 0.05002  
cm. at 18° C.  
Depth: 0.1 mm.

The salt melts at 304° C. At 650° C. it begins to decompose,  
setting free oxygen and nitrous vapours.

## X.

<b>Caesiumnitrate: <math>CsNO_3</math>.</b>			
Temperature in ° C.	Maximum Pressure $H$		Surface-tension $\gamma$ in Erg. pro $cm^2$ .
	in mm. mer- cury of 0° C.	in Dynes	
425.5	2.743	3657	91.8
459.7	2.636	3514	88.2
511	2.500	3333	83.7
576.5	2.366	3154	79.2
602	2.277	3036	76.3
686.4	2.162	2882	72.5

Molecular weight: **194.82**. Radius of the Capillary tube: 0.05002  
cm. at 18° C.  
Depth: 0.1 mm.

The salt melts at 414° C.; just as in the case of the solubi-  
lities, also in the situation of the meltingpoints of  $K$ -,  $Rb$ -, and  
 $Cs$ -nitrates an evident irregularity can be stated. At 600° C.  
already the molten salt begins to decompose.

Specific Surface-Energy  
in Erg pro cm<sup>2</sup>.

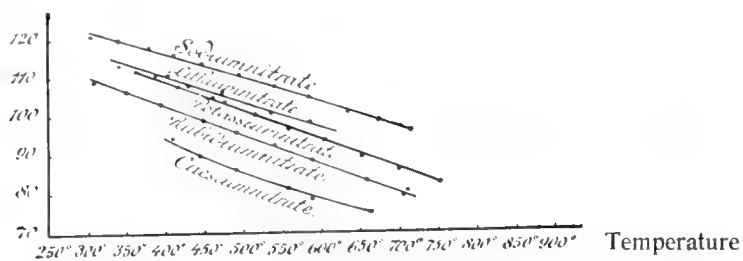

Fig. 2.

XI.

Lithium-Metaborate:  $LiBO_2$ .

Temperature in ° C.	Maximum Pressure $H$		Surface-tension $\gamma$ in Erg. pro cm <sup>2</sup> .
	in mm. mer- cury of 0° C.	in Dynes	
879.2	7.442	9922	261.8
922	7.379	9838	259.7
967.5	7.279	9704	256.2
1011.5	7.190	9586	253.1
1054.5	7.108	9476	250.3
1097.3	7.034	9378	247.7
1149.7	6.912	9215	243.6
1198	6.800	9066	239.7
1249	6.638	8850	234.2
1309.3	6.399	8531	225.8
1355	6.252	8335	220.7
1408	6.022	8029	212.7
1457	5.750	7666	203.1
1520	5.445	7260	192.4

Molecular weight: 49.99.

Radius of the Capillary tube: 0.05240  
cm. at 19° C.

Depth: 0.1 mm.

The salt melts at 845° C. At 1200° C. it begins to evaporate appreciably; the vapours show alkaline reaction ( $Li_2O$ ). At 1300° C. the volatilisation of the  $Li_2O$  occurs already rather rapidly; the  $\gamma$ - $t$ -curve descends by this dissociation far more rapidly, than in the beginning.

## XII.

**Sodiummetaborate:  $NaBO_2$ .**

Temperature in ° C.	Maximum Pressure <i>H</i>		Surface-tension $\gamma$ in Erg. pro cm <sup>2</sup> .
	in mm. mer- cury of 0° C.	in Dynes	
1015.6	5.762	7682	193.7
1051.9	5.599	7465	188.3
1096.5	5.378	7170	180.9
1140	5.190	6919	174.7
1192.2	4.933	6577	166.1
1234	4.700	6266	159.7
1276.5	4.476	5967	150.8
1323.3	4.239	5651	142.9
1372	4.006	5341	135.1
1441	3.740	4986	126.2

Molecular weight: 66.0.      Radius of the Capillary tube: 0.05002  
cm. at 18° C.  
Depth: 0.01 mm.

The salt melts at ca. 965° C. At 1230° C. it begins to evaporate  
distinctly; at 1350° the evaporation goes on rapidly.

## XIII.

**Potassiummetaborate:  $KBO_2$ .**

Temperature in ° C.	Maximum Pressure <i>H</i>		Surface-tension $\gamma$ in Erg. pro cm <sup>2</sup> .
	in mm. mer- cury of 0° C.	in Dynes	
992	3.676	4901	123.5
1036	3.341	4454	112.3
1091	3.062	4083	103.0
1142	2.872	3829	96.6

Molecular weight: 82.1.      Radius of the Capillary tube: 0.05002  
cm. at 18° C.  
Depth: 0.1—0.3 mm.

The salt melts at about 946° C. The measurements were diffi-  
cult by the great volatility and high viscosity of the substance.  
The obtained values cannot be considered therefore as being  
highly accurate.

Specific Surface-Energy  
in Erg pro cm<sup>2</sup>.

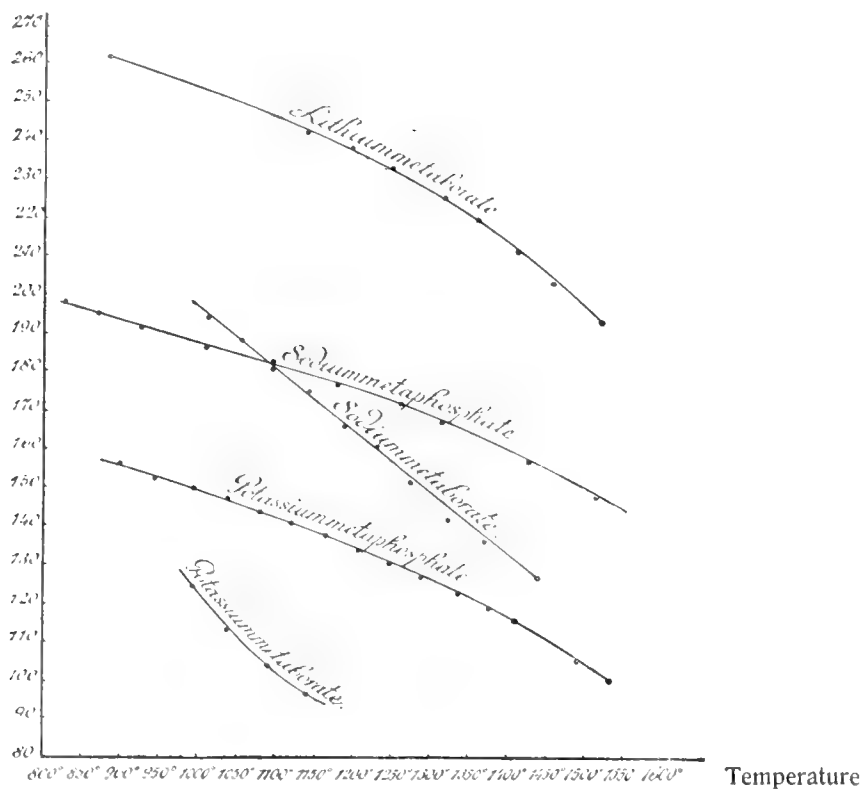

Fig. 3.

XIV.

**Sodiummolybdate:  $Na_2MoO_4$ .**

Temperature in ° C.	Maximum Pressure $H$		Surface-tension $\gamma$ in Erg. pro cm <sup>2</sup> .
	in mm. mer- cury of 0° C.	in Dynes	
698.5	6.091	8122	214.0
728.5	5.975	7967	210.0
751	5.921	7893	208.1
777	5.828	7770	204.9
818.8	5.757	7675	202.4
858.5	5.657	7542	199.0
903.8	5.552	7401	195.4
948	5.436	7247	191.4
989.5	5.330	7106	187.7
1035	5.224	6966	184.1
1078.5	5.141	6854	181.2
1121.5	5.070	6760	178.8
1171.5	4.998	6654	176.1
1212	4.947	6595	174.6

Molecular weight: 206. Radius of the Capillary tube; 0.05240 cm.  
Depth: 0.1 mm.

The salt melts at 687° C. to a colourless liquid.

## XV.

<b>Potassium-Molybdate: <math>K_2MoO_4</math>.</b>			
Temperature in ° C.	Maximum Pressure $H$		Surface-tension $\gamma$ in Erg. pro cm <sup>2</sup> .
	in mm. mer- cury of 0° C.	in Dynes	
930.6	4.310	5746	150.5
977	4.218	5626	147.3
1021	4.158	5543	145.2
1105	4.021	5360	140.7
1143	3.960	5280	138.6
1189.3	3.868	5156	135.5
1273	3.714	4950	130.0
1286	3.676	4900	128.8
1356	3.529	4712	123.6
1438	3.364	4483	118.0
1452.8	3.330	4440	116.9
1522.3	3.205	4273	112.5

Molecular weight: 238.2. Radius of the Capillary tube: 0.05240 cm. at 18° C.  
Depth: 0.1 mm.  
The salt melts at 919° C.; at 1400° C. it begins to decompose very slowly.

## XVI.

<b>Sodiumtungstate: <math>Na_2WO_4</math>.</b>			
Temperature in ° C. (corr. on G. Th.).	Maximum Pressure $H$		Surface-tension $\gamma$ in Erg. pro cm <sup>2</sup> .
	in mm. mer- cury of 0° C.	in Dynes	
710	5.932	7909	203.3
719.5	5.909	7878	202.6
741	5.863	7817	201.0
788	5.778	7703	198.2
834	5.686	7580	195.2
879	5.579	7438	191.5
932	5.517	7355	189.5
985.3	5.364	7151	184.2
1038.5	5.280	7040	181.4
1080.5	5.186	6913	178.3
1133	5.073	6762	174.6
1181.4	5.010	6679	172.4
1231.5	4.880	6506	168.0
1281.8	4.755	6339	163.8
1331.5	4.663	6217	160.6
1390.5	4.494	5991	155.0
1450	4.405	5872	152.0
1516.5	4.265	5686	147.3
1559	4.171	5560	144.0
1595	4.129	5508	142.6

Molecular weight: . Radius of the Capillary tube: 0.05113 cm. at 16° C.  
Depth: 0.1 mm.

The colourless, perfectly anhydrous salt melts at 694° C to a very clear, somewhat viscous liquid, which however at higher temperatures soon becomes much thinner.

Potassiumtungstate:  $K_2WO_4$ .

Temperature in ° C.	Maximum Pressure $H$		Surface-tension $\gamma$ in Erg. pro cm <sup>2</sup> .
	in mm. mer- cury of 0° C.	in Dynes	
925°	4.611	6147	161.0
969	4.410	5879	154.1
1012.5	4.305	5739	150.2
1051.5	4.173	5563	145.9
1097	4.056	5409	141.9
1138.8	3.943	5257	138.0
1183.2	3.832	5109	134.1
1230	3.720	4960	130.3
1284	3.558	4744	124.6
1322.4	3.449	4598	120.9
1366.5	3.379	4505	118.4
1408.5	3.259	4345	114.3
1458.2	3.135	4180	110.0
1489	3.076	4101	107.9
1520.3	3.010	4013	105.6

Molecular weight: 326.2. Radius of the Capillary tube: 0.05201  
cm. at 17° C.  
Depth: 0.1—0.2 mm.

The meltingpoint of the salt is 921° C.; even at 1500° C. the  
compound does not sublime appreciably.

Specific Surface-Energy  
in Erg. pro cm<sup>2</sup>.

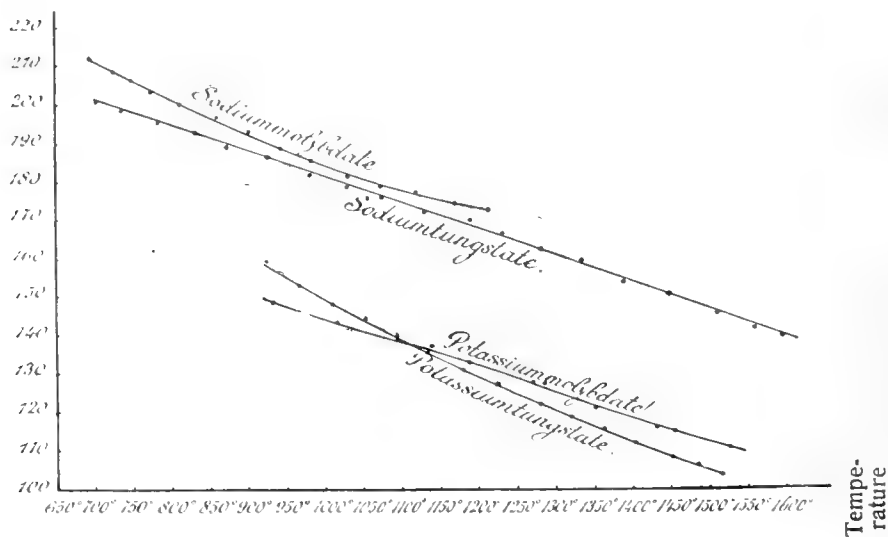

Fig. 4.

## XVIII.

**Sodium-Metaphosphate:  $NaPO_3$ .**

Temperature in ° C.	Maximum Pressure $H$		Surface-tension $\gamma$ in Erg. pro $cm^2$ .
	in mm. mer- cury of 0° C.	in Dynes	
827°	5.730	7639	197.5
871.4	5.648	7538	194.8
927	5.553	7403	191.6
1014	5.406	7202	186.7
1098.5	5.254	7004	181.6
1181	5.109	6811	176.6
1264.5	4.939	6584	170.9
1317	4.814	6418	166.7
1434	4.511	6014	156.2
1516.5	4.254	5671	147.5

Molecular weight: **102.04**. Radius of the Capillary tube: 0.05140 cm. at 15° C.  
Depth: 0.1 mm.

The salt melts at about 620° C. At 1200° C. it begins to evaporate considerably, and sublimes readily at higher temperatures.

## XIX.

**Potassium-Metaphosphate:  $KPO_3$ .**

Temperature in ° C.	Maximum Pressure $H$		Surface-tension $\gamma$ in Erg. pro $cm^2$ .
	in mm. mer- cury of 0° C.	in Dynes	
897°	4.506	6007	155.5
942	4.395	5860	151.8
995.7	4.346	5793	149.0
1036	4.233	5643	146.1
1082	4.137	5515	143.0
1120	4.060	5413	140.3
1167	3.957	5275	136.8
1205.2	3.859	5145	133.5
1250	3.842	5122	130.2
1288	3.650	4866	126.3
1344.5	3.538	4717	122.5
1372	3.422	4562	118.5
1412.5	3.310	4413	114.7
1496.5	3.043	4057	105.5
1536	2.894	3858	100.3

Molecular weight: **118**. Radius of the Capillary tube: 0.05140 cm.  
Depth: 0.1 mm.

The salt melts at about 820° C.; it begins to evaporate readily at 1400° C., and sublimes fast at higher temperatures.

§ 3. *The Temperature-coefficients of the Specific Surface-energy*

In connection with what was said in the foregoing communication about the calculation of  $\chi_t$  at any arbitrary temperature  $t$ , lying above the meltingpoint  $t_s$  of the salt investigated, we only need to resume here the corresponding values of  $t_s$ ,  $a$ ,  $b$ , and  $c$ , for each salt:

Formula of the Salt.	$t_s$ in ° C.	$a$	$b$	$c$	Remarks.
$Li_2SO_4$	852°	224.4	0.067	0	Decomposes above 1320° C.
$Na_2SO_4$	884	196.3	0.140	0.00042	
$K_2SO_4$	1074	144.5	0.066	0	
$Rb_2SO_4$	1055	135.0	0.087	0.00007	
$Cs_2SO_4$	1015	113.1	0.087	0.00006	
$LiNO_3$	254	118.4	0.063	0	
$NaNO_3$	312	120.7	0.063	0	
$KNO_3$	339	112.9	0.075	0	
$RbNO_3$	304	109.4	0.075	0	
$CsNO_3$	414	92.0	0.084	0	
$LiBO_2$	845	264.8	0.082	0	
$NaBO_2$	965	201.6	0.159	0	
$KBO_2$	946	136.6	0.310	0.00053	
$Na_2MoO_4$	687	215.1	0.121	0.00009	
$K_2MoO_4$	919	152.5	0.066	0	
$Na_2WO_4$	694	204.4	0.068	0	
$K_2WO_4$	921	158.2	0.083	0	
$NaPO_3$	620	209.5	0.059	0	
$KPO_3$	820	161.2	0.069	0	Only up to 1275° C.; then the curve bends more rapidly to the tem- perature-axis.

In connection with the general rules, given in § 7 of the foregoing communication, we can make the following remarks with respect to the data given above.

Although in these cases also, the value of  $\chi_t$  at the same temperature  $t$  appears gradually to decrease with increasing atomic weights of the alkali-metals, whose corresponding salts are investigated, we see that in the series of the nitrates, the lithiumsalt represents an exception to this rule, because its  $\chi$ - $t$ -curve lies *under* that of the sodiumnitrate. It is of interest, that just in this series of the alkalinitrates also other deviations of the normal arrangement are found: so with respect to the solubilities and the meltingpoints. About the relative or absolute values of the temperature-coefficient  $b$ , nothing of general application can be put to the fore: evidently no simple relations will be found here, where the structure of the salts is already more complicated than in the case of the halogenides of the alkali-metals.

Groningen, August 1914.

Lab. for Inorg. and Physical  
Chemistry of the University.



**Chemistry.** — “*A crystallized compound of isoprene with sulphur dioxide*”. By Mr. G. DE BRUIN. (Communicated by Prof. P. VAN ROMBURGH).

(Communicated in the meeting of June 27, 1914).

As is known from the patent literature<sup>1)</sup> unsaturated hydrocarbons with conjugated double bonds combine in different circumstances with sulphurous acid. Thus, crude isoprene on shaking with an aqueous solution of that acid yields a compound separating in the form of white flakes.

When I mixed isoprene, prepared according to HARRIES'S method<sup>2)</sup> (from carvene) and which had been purified by fractionation, the fraction from 34° to 38° being collected separately, with an equal volume of liquefied sulphur dioxide and left this mixture in a sealed tube at the temperature of the room, I obtained after one or two days a considerable quantity of a crystallized product. As a rule the mixture soon turns brown, but sometimes it remains colourless.

Beside the crystals is always formed a viscous, white mass which on drying gets hard and brittle. In some experiments no crystals were deposited, but on pouring the contents of these tubes into a small flask it instantly solidified owing to the formation of a large number of crystals.

The crystalline product may be readily recrystallized from ether. By repeating this operation a few times a pure, white product is obtained melting without decomposition at 62°.5. Presence of moisture is not necessary for the formation of the crystals, anyhow exactly the same result was obtained with tubes filled with sulphur dioxide dried over sulphuric acid, and dry isoprene.

The analysis gave the following results:

0.2016 grm. of the substance (burnt in a close tube with lead chromate) gave: 0.3384 grm. CO<sub>2</sub> and 0.1107 grm. H<sub>2</sub>O

0.1612 grm. of the substance gave 0.2814 grm. BaSO<sub>4</sub>

0.1779 " " " " " 0.3156 " "

Found: 45.77 % C. 6.10 % H. I. 23.97 % S. II. 24.35 % S.

Theory for C<sub>6</sub>H<sub>8</sub>SO<sub>2</sub>: 45.46 % C. 6.06 % H. 24.29 % S.

Determination of the molecular weight by means of the lowering of the freezing point in benzene: 0.5491 grm. of substance in 23.806 grms. of benzene gave a lowering of 0°.835. Molecular weight found: 138.

<sup>1)</sup> D. PAT. B. 59862, kl. 120, Gr. 2, 18 Aug. 1910.

<sup>2)</sup> Ann. 383, 228 (1911).

Calculated for  $C_5H_8SO_2$ : 132.

Hence, the crystallized compound is formed from one mol. of isoprene and one mol. of  $SO_2$ .

The substance is soluble in water. The aqueous solution has a neutral reaction.

If a solution of the compound in carbon tetrachloride or ether is shaken with a solution of bromine in the same solvent, the colour of the bromine is not discharged; bromine water, however, is gradually decolourised. With dilute alkaline potassium permanganate a reduction sets in at once.

As to the structure of this compound I do not as yet venture to pronounce an opinion. In connexion with THELE's theory the occurrence of a compound of the formula  $CH_2 - C[CH_3] = CH - CH_2$  would not be improbable.



*Utrecht.*

*Org. Chem. Lab. University.*

**Geophysics.** — “*The treatment of frequencies of directed quantities*”.

By Dr. J. P. VAN DER STOK.

(Communicated in the meeting of June 27, 1914).

1. The frequency-curves of barometric heights, atmospheric temperatures and other meteorological quantities assume different and peculiar forms, which can be considered as climatological characteristics and, as the number of available data increases, it is desirable to subject these curves to such a treatment that these characteristic peculiarities are represented by climatological constants.

If we choose for this purpose the development in series-form, the first question is, what treatment is to be chosen for each special case, in conformity with the distinctive features of the quantities under consideration and the limits between which they are comprised. The purpose of this investigation is to inquire, what form is to be chosen for frequencies of wind-velocities independent of direction, and of direction without regard to velocity. Furthermore, to state in how far the observed series of quantities may be regarded as normal- or standard-values, and the problem may be stated also in this way: what is the best form for frequencies of directed quantities assuming the form of linear quantities, and further, how to integrate the expression

$$\left. \begin{aligned} & \frac{h h'}{\pi} e^{-f(R, \theta)} R dR d\theta \\ f'(R, \theta) &= h^2 [R \sin(\theta - \beta) - a]^2 + h'^2 [R \cos(\theta - \beta) - b]^2 \end{aligned} \right\} \quad (1)$$

i.e. the standard-value of directed quantities, on the one hand with respect to  $\theta$  between the limits  $2\pi$  and zero, on the other hand with respect to  $R$  between the limits  $\infty$  and zero.

Both problems were treated in previous communications<sup>1) 2)</sup>, but it may appear from the following that now a more principal, and therefore more complete, solution can be obtained than seemed possible a few years hence.

2. If we wish to develop a function of one variable in an infinite series of polynomia

$$F(x) = \sum_{n=0}^{n=\infty} A_n U_n \quad .$$

$$U_n = x^n + a_1 x^{n-1} + a_2 x^{n-2} \dots a_n,$$

the quantities  $a$  can be determined so that — as in the FOURIER-series — for the assumed limits,  $\alpha$  and  $\beta$

$$\int U_n U_m dx = 0$$

for all values of  $m$  different from  $n$ .

The constants  $A_n$  are then given by the equation :

$$A_n \int U_n^2 dx = \int F(x) U_n dx.$$

The values of the constants  $a$  are determined by the  $n$  equations :

$$\int U_n dx = 0, \quad \int U_n x dx = 0 \dots \int U_n x^{n-1} dx = 0 \quad \dots \quad (2)$$

every integral being taken between the assumed limits.

By partial integration we have :

1) The treatment of wind-observations. Proc. Sci. Kon. Akad. v. Wet. IX, (684—699).

2) On the Analysis of Frequency-curves according to a general method, Proc. Sci. K. Akad. Wet. X, (799—817).

$$\int_0^x U_n dx = q_1$$

$$\int_0^x U_n x dx = x q_1 - q_2 \quad q_2 = \int_0^x q_1 dx$$

$$\int_0^x U_n x^2 dx = x^2 q_1 - 2x q_2 + q_3 \quad q_3 = \int_0^x q_2 dx, \text{ etc.}$$

By (2) it follows from these equations that the imposed conditions are fulfilled when, in the development

$$\int_0^x U_n x^n dx = x^n q_1 - n x^{n-1} q_2 \dots (-1)^{n-1} n(n-1) \dots 2q_n (-1)^n n! q_{n+1} \quad (3)$$

$q_n$  be given such a value that this function, as also its  $(n-1)$  first differential-quotients, become zero for  $x = \beta$  and  $x = \alpha$  and that then

$$U_n = \frac{d^n q_n}{dx^n} \quad \text{and} \quad \int_{\beta}^{\alpha} U_n^2 dx = (-1)^n n! \int_{\beta}^{\alpha} q_n dx \quad \dots \quad (4)$$

This simple method of determining the terms of the required series was indicated in 1833 by MURPHY as a new method of coming to zonal harmonics; in THOMSON and TAIT'S "Natural Philosophy" it is mentioned in article 782.

The method, however, is by no means restricted to the calculation of zonal harmonics but can easily be generalized and applied to other circumstances than those mentioned above.

Instead of a complete polynomium we can also consider separately even and uneven polynomia; polynomia multiplied by an exponential factor as  $e^{-x^2}$  or  $e^{-x}$  may be used, and instead of  $dx$  we can take  $x dx$  (plane) or  $x^2 dx$  (space) as the element of integration, whereas for  $x$  also quantities of another kind, e.g.  $\sin \alpha$ , may be substituted.

3. If the limits are  $+1$  and  $-1$ , it is rational to put:

$$q_n = C(x^2 - 1)^n \quad U_n = C \frac{d^n}{dx^n} (x^2 - 1)^n$$

$C$  being an arbitrary constant.

Putting

$$C = \frac{n!}{(2n)!}$$

$U_n$  becomes

$$U_n = x^n - \frac{n(n-1)}{2(2n-1)} x^{n-2} + \frac{n(n-1)(n-2)(n-3)}{2 \cdot 4 \cdot (2n-1)(2n-3)} x^{n-4} - \dots \text{ etc.} \quad (5)$$

the well known form (but for a constant factor) of the zonal harmonic function and, according to (4) :

$$\int_{-1}^{+1} U_n^2 dx = \frac{n!n!}{(2n)!} \int_{-1}^{+1} (x^2 - 1)^n dx = \frac{2^{n+1}(n!)^2}{(2n+1)!(2n)!}$$

Putting  $C = \frac{1}{2^n n!}$ , we find, if by  $P_n$  the commonly used form of zonal harmonics is denoted,

$$P_n = \frac{(2n)!}{2^n n! n!} U_n$$

from which

$$\int_{-1}^{+1} P_n^2 dx = \frac{2}{2n+1}.$$

If the limits are  $+\infty$  and  $-\infty$  it is rational to choose for  $q_n$  :

$$q_n = C e^{-x^2} \quad U_n = C \frac{d^n}{dx^n} e^{-x^2}.$$

Putting

$$C = \frac{(-1)^n}{2^n},$$

$U_n$  assumes the form :

$$U_n = U_n' e^{-x^2} = e^{-x^2} \left[ x^n - \frac{n(n-1)}{2^2 \cdot 1!} x^{n-2} + \frac{n(n-1)(n-2)(n-3)}{2^4 \cdot 2!} x^{n-4} - \dots \dots (-1)^{\frac{n-1}{2}} \frac{n!}{2^{n-1} \frac{n-1}{2}!} x \quad (n \text{ uneven}) \right. \\ \left. \dots \dots (-1)^n \frac{n!}{2^n \frac{n}{2}!} \quad (n \text{ even}) \right] \quad (6)$$

or

$$U_n' = \frac{(-1)^n}{2^n} \left( \frac{d}{dx} \right)^n e^{-x^2}$$

and, by (4) :

$$\int_{-\infty}^{+\infty} U_n^2 dx = \frac{n!}{2^n} \int_{-\infty}^{+\infty} e^{-x^2} dx = \frac{n!}{2^n} \sqrt{\pi}.$$

The series (6), proposed by BRUNS <sup>1)</sup> and CHARLIER <sup>2)</sup>, is in mathematics known as HERMITE'S function and might, if applied to analysis of frequencies, be called the  $q_n$  function, as proposed by BRUNS.

It is the most appropriate form for quantities as atmospheric and watertemperatures, barometric heights etc., moving between uncertain limits, and also for wind-observations if generalized for application to functions of two variables.

In either of the cases considered above the terms of even and uneven power are separated automatically because

$$\int_{-1}^{+1} x^{2n+1} dx = 0 \quad \text{and} \quad \int_{-\infty}^{+\infty} x^{2n+1} e^{-x^2} dx = 0.$$

If, however, the limits are 1 and 0 or  $\infty$  and 0, then such a separation does not take place and we must either maintain the complete polynomium or consider both cases separately.

4. Considering the even polynomia separately for the limits 1 and 0, every polynomium  $U_{2n}$  contains only  $n$  constants and the development (5) takes the form :

$$\int_0^x U_{2n} x^{2n} dx = x^{2n} q_1 - 2n x^{2n-2} q_2 + 2^2 n(n-1) x^{2n-4} q_3 - \left. \begin{aligned} & \dots \\ & (-1)^{n-1} 2^{n-1} n(n-1) \dots 2 x^2 q_n - (-1)^n 2^n \cdot n! q_{n+1} \end{aligned} \right\} \quad (7)$$

where

$$q_1 = \int_0^x U_{2n} dx, \quad q_2 = \int_0^x q_1 x dx \dots q_{n+1} = \int_0^x q_n x dx$$

$$\int_0^x U_{2n}^2 dx = (-1)^n 2^n \cdot n! \int_0^x q_n x dx.$$

Putting

$$\Delta = \frac{1}{x} \frac{d}{dx}$$

<sup>1)</sup> Wahrscheinlichkeitsrechnung und Kollektivmasslehre, 1906.

<sup>2)</sup> Researches into the theory of Probability, (Comm. from the Astron. Observ. Lund), 1906.

we find

$$U_{2n} = x \Delta^n q_n \dots \dots \dots (8)$$

whereas for  $q_n$ , as the simplest expression, we must take:

$$q_n = C x^{2n-1} (x^2 - 1)^n.$$

Assigning to  $C$  the value:

$$\frac{1}{(4n-1)(4n-3)\dots(2n+1)}$$

the zonal harmonic function, as given in (5), is again found also for the limits 1 and 0.

In the case of uneven polynomia

$$U_{2n+1} = C \Delta^n x^{2n+1} (x^2 - 1)^n \dots \dots \dots (9)$$

which for

$$C = \frac{1}{(4n+1)(4n-1)\dots(2n+3)}$$

again leads to the expression (5).

Giving  $C$  the value  $\frac{1}{2^n n!}$ , we obtain from (8) as well as from (9)

the zonal harmonic function in the form as commonly used.

No more as for the limits 1 and 0, the development (7) for the limits  $\infty$  and 0 leads to new expressions; we have to put

$$q_n = C x^{2n+1} e^{-x^2}$$

for even as well as for uneven functions, and by the formulæ

$$\left. \begin{aligned} U_{2n} &= \frac{(-1)^n}{(2n+1)2^n} e^{-x^2} \frac{d}{dx} (\Delta - 2)^n x^{2n+1} \\ U_{2n+1} &= \frac{(-1)^n}{2^n} e^{-x^2} (\Delta - 2)^n x^{2n+1} \end{aligned} \right\} \dots (10)$$

we find the same expression as in § 3 for  $q_n$  of formula (6), but by an abridged calculation.

5. The problem, which form of development is the fittest for frequencies of a quantity which assumes the form of a function of one variable, moving between the limits 1 and 0 or  $\infty$  and 0, but, as a matter of fact, must be considered as a function of two variables, is not solved satisfactorily in § 5, at least if we are not satisfied by a merely formal representation.

A graphical representation of such a function is given by the distribution of points in a plane about a given origin, the element of integration is then, not  $dx$ , but  $2\pi R dR$  and the question must be put as follows: to find a polynomium such that

$$\int U_n U_m R dR = 0$$

for all values of  $m$  different from  $n$ .

The development by partial integration then becomes:

$$\left. \int U_{2n} R^{2n+1} dx = R^{2n} \varphi_1 - 2n R^{2n-2} \varphi_2 + 2^2 n (n-1) R^{2n-4} \varphi_3 \right\} \quad (11)$$

$$(-1)^{n-1} 2^{n-1} n (n-1) \dots 2R^2 (-1)^n 2^n \cdot n! \varphi_{n+1}$$

where

$$\varphi_1 = \int U_{2n} R dR, \quad \varphi_2 = \int \varphi_1 R dR \text{ etc.}$$

and

$$\int U_{2n}^2 R dR = (-1)^n n! \int \varphi_n R dR.$$

If the limits are 1 and 0, then we have to put:

$$\varphi_n = CR^{2n} (R^2 - 1)^n$$

so that

$$U_{2n} = C \Delta^n R^{2n} (R^2 - 1)^n.$$

Putting  $C = \frac{1}{2^n}$  we find for the polynomium:

$$U_{2n} = \frac{(2n)!}{n!} R^{2n-n} C_1 \frac{(2n-1)!}{(n-1)!} R^{2n-2} + {}^n C_2 \frac{(2n-2)!}{(n-2)!} R^{2n-4} \dots \text{etc.} \quad (12)$$

where  ${}^n C_p$  denotes the  $p^{\text{th}}$  binomium-coefficient of the  $n^{\text{th}}$  power, further:

$$\int_0^1 U_{2n}^2 R dR = 2^n (2n)! \int_0^1 \varphi_n R dR = (2n)! \int_0^1 R^{2n+1} (R^2 - 1)^n dR = \frac{1}{2} \frac{n!n!}{2n+1}.$$

This new function may be considered as a zonal harmonic generalized for the case of directed quantities and might be applied e.g. to the distribution of hits on a target.

The analogy of (12) with the zonal harmonic function becomes conspicuous if the latter (5), by multiplication by  $\frac{(2n-1)!}{(n-1)!}$ , be given the form:

$$U_n = \frac{(2n-1)!}{(n-1)!} x^n - \frac{C_1}{2} \cdot \frac{(2n-2)!}{(n-2)!} x^{n-2} + \frac{C_2}{2} \cdot \frac{(2n-4)!}{(n-4)!} x^{n-4} - \text{etc.}$$

The expression (12) satisfies the differential equation:

$$R(1-R^2) \frac{d^2 U_{2n}}{dR^2} + (1-3R^2) \frac{dU_{2n}}{dR} + 4n(n+1) R U_{2n} = 0.$$



For uneven polynomiala  $q_n$  has to be given the same value as (9) and then again the common zonal harmonic would result. As, however, the quantities under consideration are essentially positive, uneven functions can be left out of consideration.

If the limits are  $\infty$  and 0, then the same reasoning holds; it is then rational to put:

$$q_n = CR^{2n} e^{-R^2}$$

$$U_{2n} = C \Delta^n R^{2n} e^{-R^2} \quad U'_{2n} = C (\Delta - 2)^n R^{2n}.$$

Putting

$$C = \frac{(-1)^n}{2^n}$$

the polynomial assumes the form:

$$U'_{2n} = R^{2n} - n^2 R^{2n-2} + \frac{n^2(n-1)^2}{2!} R^{2n-4} - \dots (-1)^n n! \quad (13a)$$

and

$$\int_0^\infty U'_{2n} R dR = 2^n \cdot n! \int_0^\infty q_n R dR = \frac{n! n!}{2}.$$

In analogy with (12) the polynomial, by putting

$$C = \frac{(-1)^n}{2^n n!},$$

may be written also:

$$U'_{2n} = \frac{R^{2n}}{n!} - {}^n C_1 \frac{R^{2n-2}}{(n-1)!} + {}^n C_2 \frac{R^{2n-4}}{(n-2)!} \dots (-1)^n \quad (13b)$$

This new function (13) seems to be the proper form of development in the case of directed quantities as wind-velocities, disregarding direction; it satisfies the diff. equations:

$$R \frac{d^2 U'_{2n}}{dR^2} - (2R^2 - 1) \frac{dU'_{2n}}{dR} + 4n R U'_{2n} = 0$$

$$R \frac{d^2 U_{2n}}{dR^2} + (2R^2 + 1) \frac{dU_{2n}}{dR} + 4(n+1) R U_{2n} = 0.$$

In applying this development, a simplification may be obtained by a change of scale-value: writing  $HR$  for  $R$  and putting

$$H^2 = \frac{1}{M^2},$$

the second term with the coefficient  $A_2$  will disappear as

$$U'_2 = (R^2 - 1).$$

Here  $M^2$  denotes the moment of the second order of the given frequency-series.

6. In the same manner as in § 5 in the case of a directed quantity in a plane, the development appropriate for quantities in space may be found, e. g. for distances of stars, disregarding direction.

The element of integration is then  $4\pi R^2 dR$ , and the development (11) holds good if in the left member  $R^{2n+1}$  is written instead of  $R^{2n}$  and, at the same time for  $q_1$

$$q_1 = \int_0^\infty U_{2n} R^2 dR$$

so that

$$U_{2n} = \frac{C}{R} \Delta^n q_n \text{ and } q_n = CR^{2n+1} e^{-R^2}.$$

Putting

$$C = \frac{(-1)^n}{2^n}$$

$U^{2n}$  becomes:

$$U^{2n} = e^{R^2} U_{2n} = R^{2n} - C_1 \frac{2n+1}{2} R^{2n-2} + C_2 \frac{(2n+1)(2n-1)}{2^2} R^{2n-4} \left. \begin{array}{l} \\ \dots (-1)^n \frac{(2n+1)!}{2^{2n} n!} \end{array} \right\} \cdot \quad (14)$$

and

$$\int_0^\infty U^{2n} R^2 dR = (-1)^n \cdot 2^n \cdot n! \int_0^\infty q_n R dR = (-1)^n 2^{n-1} n! n!$$

In applying this development a simplification may be obtained by writing  $HR$  for  $R$  and putting:

$$H^2 = \frac{3}{2M^2},$$

then  $A_2 = 0$ , because

$$U'_2 = R^2 - 3/2.$$

7. Although we may expect *a priori* that the FOURIER-series is the most appropriate form of development for frequencies of directions (disregarding velocity), it seems desirable in connection with the foregoing to show that, following the same method, we, in fact, come to this result.

If

$$U = \sin^{2n} \alpha + a_1 \sin^{2n-2} \alpha + \dots + a_n,$$

then we may distinguish four different types of functions, namely:

$$F_1 = U \quad F_2 = U \sin \alpha \cos \alpha \quad F_3 = U \cos \alpha \quad \text{en} \quad F_4 = U \sin \alpha$$

For  $P_1$  the development holds good:

$$\int U \sin^{2n} \alpha da = q_1 \sin^{2n} \alpha - 2n q_2 \sin^{2n-2} \alpha + \dots$$

$$(-1)^{n-1} \cdot 2^{n-2} \cdot n(n-1) \dots 2 \cdot q_n (-1)^n 2^n n! q_{n+1}$$

where

$$q_1 = \int U da \quad q_2 = \int q_1 \sin \alpha \cos \alpha da \quad \text{etc.}$$

Therefore, putting

$$\Delta = \frac{1}{\sin \alpha \cos \alpha} \frac{d}{d\alpha}$$

$$q_n = C \sin^{2n-1} \alpha \cos^{2n-1} \alpha \quad \text{and} \quad C = \frac{2^n n!}{(2n)!}$$

we find for the limits  $\frac{\pi}{2}$  and  $0$ :

$$F_1 = \frac{2^n \cdot n!}{(2n)!} \sin \alpha \cos \alpha \Delta^n q_n = \cos 2n\alpha.$$

In the same manner:

$$F_2 = \frac{2^n \cdot n!}{(2n-1)!} \Delta^{n-1} \sin^{2n-1} \alpha \cos^{2n-1} \alpha = \sin 2n\alpha$$

$$F_3 = \frac{2^n \cdot n!}{(2n)!} \sin \alpha \Delta^n \sin^{2n-1} \alpha \cos^{2n+1} \alpha = \cos (2n+1)\alpha$$

$$F_4 = \frac{2^n \cdot n!}{(2n)!} \cos \alpha \Delta^n \sin^{2n+1} \alpha \cos^{2n-1} \alpha = \sin (2n+1)\alpha.$$

8. The solution of the second problem, as formulated in § 1, can be simplified by putting  $\theta - \beta = q$  in form. (1), i.e. by counting the angular values not, as usual, from the North-direction, but from  $N\beta E$ ; this has, of course, no influence on the sums of the velocities.

It is, however, unfeasible to apply a similar correction for the components  $a$  and  $b$  of the resulting wind, and the problem to be solved comes to the development in series-form of the expression:

$$\frac{hh'}{\alpha} e^{-h^2(x-a)^2 - h'^2(y-b)^2} \quad \begin{aligned} R \cos \theta &= y \\ R \sin \theta &= x. \end{aligned}$$

It appears from the first of the communications cited in § 1 that, in following the usual method of developing, difficulties are experienced which practically are unsurmountable. In the second communication however, it was shown that the development (6) may be extended to the case of two variables  $x$  and  $y$ , and that such a function can be developed in a series of polynomia of the form:

$$F(x,y)=e^{-x^2-y^2}[A_{0,0}U_0+A_{1,0}U_1+A_{0,1}V_1+A_{2,0}U_2+A_{1,1}U_1V_1+A_{0,2}V_2+et^{\tau}] \tag{15}$$

where  $\Gamma$  represents the same function of  $(y)$  as  $U$  of  $(x)$  in form. (6).

The coefficients  $A$  are then determined by the expression :

$$A_{n,m} = \varepsilon \int_{-\infty}^{\infty} \int_{-\infty}^{\infty} F(x,y) U_n V_m dx dy = \varepsilon S_{n,m}$$

$$\varepsilon^{-1} = \frac{n! m!}{2^{m+n}} \pi \dots \dots \dots \tag{16}$$

Substituting again for  $x$  and  $y$ ,  $R \sin \theta$  and  $R \cos \theta$ , then, by integration with respect to  $\theta$ , all uneven polynomia vanish and, because

$$\int_0^{2\pi} \frac{\sin^{2n} \alpha}{\cos^{2n} \alpha} d\alpha = \frac{(2n)!}{2^{2n} \cdot n! n!},$$

we find

$$\int_0^{2\pi} U_{2n} V_{2m} d\theta = \frac{2\pi}{2^{2(n+m)}} \frac{(2n)!(2m)!}{n! m!} e^{-H^2 R^2} \left[ \frac{(HR)^{2(m+n)}}{(m+n)!} - \dots \right] \tag{17}$$

$$- {}^{m+n}C_1 \frac{(HR)^{2(m+n-1)}}{(m+n-1)!} + {}^{m+n}C_2 \frac{(HR)^{2(m+n-2)}}{(m+n-2)!} - \text{etc.} \left. \right]$$

i.e. the same expression as 13<sup>b</sup>, found in a different way.

As to the determination of the  $A$  coefficients, it is expedient to consider first the case that  $a$  and  $b$  are equal to zero.

It is then easily found that

$$S_{2n,0} = \frac{(2n)!}{2^n \cdot n!} (M^2 H^2 - 1/2)^n = \frac{(2n)!}{2^n \cdot n!} P^n$$

and similarly for the  $V$  function

$$S_{0,2n} = \frac{(2m)!}{2^m \cdot m!} (M'^2 H^2 - 1/2)^n = \frac{(2m)!}{2^m \cdot m!} Q^m$$

$$M^2 = \frac{1}{2h^2} \qquad M'^2 = \frac{1}{2h'^2}.$$

The arbitrary constant  $H$  now can be given such a value that  $P$  or  $Q = 0$ ; putting  $P = 0$ , then  $H = h$ , and in the development only the  $V$  functions remain.

If  $a$  and  $b$  are different from zero, then it appears that (for  $P = 0$ )

$$V \left\{ \begin{aligned} S_2 &= Q + h^2 b^2 \\ S_4 &= 3 Q^2 + 6 h^2 b^2 Q + h^4 b^4 \\ S_6 &= 15 Q^3 + 45 h^2 b^2 Q^2 + 15 h^4 b^4 Q + h^6 b^6 \end{aligned} \right.$$

or, generally :

$$S_{2n, 2m} = h^{2n} a^{2n} \frac{(2m)!}{m! 2^m} \left[ Q^m + {}^m C_1 \frac{h^2 b^2 Q^{m-1}}{1} + \right. \\ \left. + {}^m C_2 \frac{h^4 b^4 Q^{m-2}}{1 \cdot 3} + \dots + \frac{h^{2m} b^{2m}}{1 \cdot 3 \dots (2m-1)} \right] \quad (18)$$

Although, therefore, in this case the  $U$  functions do not altogether vanish, still the form remains the same as in (13<sup>a</sup>) and (13<sup>b</sup>) because, as appears from (17), the polynomial has the same value for all terms where  $n + m$  has the same value so that e.g. the terms with

$$A_{4,0} \quad A_{2,2} \quad \text{and} \quad A_{0,4}$$

can be taken together.

In order to investigate in how far a given collection of wind-observations may be considered as a collection of two independent quantities depending on chance, we have, therefore, in the first place to calculate the constants  $a, b, \beta, h$  and  $h'$  from the set of observations.

In the second place the development (13<sup>b</sup>) has to be applied to the frequency-series of the wind-velocities, thereby taking for  $H$  either  $h$  or  $h'$  so that the term  $U_2$  remains.

A comparison between the  $A$  constants calculated in this way with those determined according to (18) then gives an answer to the question.

9. By writing in (15)  $hR \sin \theta$  and  $hR \cos \theta$  for  $x$  and  $y$ , multiplying by  $RdR$  and integrating with respect to  $R$  between the limits  $\infty$  and zero, we obtain a development representing the frequencies of the directions independent of velocity.

The even terms  $U_{2n}$  and  $V_{2m}$ , or the product  $V_{2n} U_{2m}$  then give rise to a series of terms of the type  $F'_1$  (§ 7) all of which have the factor  $\cos 2na$  in common.

The even terms  $U_{2n+1} V_{2m+1}$ , produced by the product of two uneven terms have  $\sin a \cos a$  as a common factor and give rise to terms with  $\sin 2na$ , according to the functions  $F'_2$  in § 7.

The uneven terms, analogous to  $F'_3$  and  $F'_4$ , assume a simpler form, namely:

$$U_{2n+1} = K \sin a \cos^{2n} a \quad \text{and} \quad V_{2n+1} = K \cos a \sin^{2n} a$$

and therefore give rise to terms with  $\sin (2n+1) a$  and  $\cos (2n+1) a$ , whereas all non-periodic terms vanish, except in the first term with  $A_0$ .

A comparison with the FOURIER-series thus produced and calculated on the base of the five wind-constants with the FOURIER-series as directly deduced from the observations of direction-frequencies, then again gives an answer to the question.

**Physics.** — “Some remarks on the values of the critical quantities in case of association.” By DR. J. J. VAN LAAR. (Communicated by Prof. H. A. LORENTZ).

(Communicated in the meeting of May 30, 1914).

1. Though this subject was treated already very fully by me in a paper in the Arch. TEYLER<sup>1)</sup> in 1908; and use was made afterwards (in 1909) of the contents of this paper in my Treatises on the Solid State<sup>2)</sup> — I wish to make a few remarks induced by a paper by Prof. VAN DER WAALS in These Proceedings of April 1914 (p. 1076 et seq.) which may contribute to the removal of the pretty large difference found by him (p. 1081) for the volume value of  $\text{CH}_2$  for methylalcohol (2.12) and for ethylalcohol (2.76).

VAN DER WAALS makes namely use of values of  $v_k$ ,  $RT_k$  and  $\rho_k$ , of which he states (on p. 1078) that they would be exact by approximation. But it has appeared from the investigation made by me in 1908 that the “linear” dependence of the quantities  $RT_k$  and  $s$  of the association factor  $2:(1 + \beta)$  cannot be assumed even by approximation.

Not only does this hold when (as v. d. W. assumes) the volume of the molecules does not undergo any change on association; when in other words  $\Delta b = -\frac{1}{2}b_2 + b_1 = 0$  — but the deviation in question presents itself to a much greater degree, when  $\Delta b$  is not  $= 0$ , as is certainly the case for water<sup>3)</sup> and the alcohols.

In the cited TEYLER article I started from the equation

$$p = \frac{1 + \beta}{2} \frac{RT}{c - b} - \frac{a}{r^2} \dots \dots \dots (1)$$

in which  $\beta$  represents the degree of dissociation of the double molecules, so that to the original  $\frac{1}{2}$  double molecule are found  $\frac{1}{2}(1 - \beta)$  double molecules and  $\frac{1}{2} \cdot 2\beta = \beta$  single molecules, together  $\frac{1}{2}(1 + \beta)$  molecules.

<sup>1)</sup> Arch. Teyler (2) T. XI, Troisième partie (1908): Théorie générale de l'association de molécules semblables et de la combinaison de molécules différentes. (p. 1—96).

<sup>2)</sup> These Proc. of April 22, June 25, Aug. 31 1909; Nov. 24, 1910; Jan. 26 and June 23, 1911; resp. p. 765, 26, 120, 133, 454, 636 and 84. (See especially the third paper, p. 127—130).

<sup>3)</sup> Already in 1899 I think I showed that the phenomenon of maximum density at 4° C. can be explained in a very simple way by the assumption of a *negative* value of  $\Delta b$ , so that a double molecule would have a larger volume than two single molecules. [Zeitschr. f. physik. Ch. **31** (Jubelband für VAN 'T HOFF)].

The quantity  $a$  appeared to have been left unchanged by the association, viz.  $=a_1$  — the value for the case that all the molecules are single — everything referring to a single<sup>1)</sup> molecular quantity (e.g. 18 Gr. of  $H_2O$ , 46 Gr. of  $C_2H_6O$ , etc.). For we have evidently (the index 2 now refers, in distinction with my TEYLER article to the double molecules, the index 1 to the single molecules):

$$a = \left(\frac{1-\beta}{2}\right)^2 a_2 + 2 \times \frac{1-\beta}{2} \cdot \frac{2\beta}{2} a_{12} + \left(\frac{2\beta}{2}\right)^2 a_1,$$

in which  $a_{12} = 2a_1$  and  $a_2 = 4a_1$ , so that we get:

$$a = (1-\beta)^2 a_1 + 2(1-\beta)\beta a_1 + \beta^2 a_1 = a_1.$$

Further:

$$b = \frac{1-\beta}{2} b_2 + \frac{2\beta}{2} b_1 = b_1 - (1-\beta)(-\frac{1}{2} b_2 + b_1) = b_1 - (1-\beta) \Delta b$$

$$\text{or } = \frac{1}{2} b_2 + \beta(-\frac{1}{2} b_2 + b_1) = \frac{1}{2} b_2 + \beta \Delta b.$$

The equation of state used by VAN DER WAALS (p. 1078) is identical with ours, as VAN DER WAALS starts from  $1-x$  single molecules and  $x$  double molecules, together 1 mol., while we started from  $\beta$  single molecules and  $(1-\beta):2$  double molecules, together  $\frac{1}{2}(1+\beta)$  molecules. Accordingly we left the quantity of substance (viz. a single molecular quantity, e.g. 18 gr. of water etc.) constant, and varied the number of *molecules* on association from 1 to  $\frac{1}{2}(1+\beta)$  — and VAN DER WAALS left the number of molecules constant  $= 1$ , while he increased quantity of the substance from 1 to  $1+x$ .

If this is borne in mind, VAN DER WAALS'S  $v:(1+x)$  now passes into  $v'$  (now just as with us referring to a single molecular quantity of substance), and we get:

$$p = \frac{RT:(1+x)}{v'-b_1} - \frac{a_1}{v'^2},$$

in which therefore  $1:(1+x)$  is identical with our  $(1+\beta):2$ ,  $v'$  with our  $v$ , VAN DER WAALS putting  $\Delta b = 0$ , and therefore identifying  $b$  with  $b_1$ .

2. As  $\beta$ , the degree of dissociation of the double molecules, is a function of  $v$ , the dependence of the quantity  $\beta$  on  $v$  will have to be taken into account in order to find the values of the critical

<sup>1)</sup> In the cited TEYLER article I made everything refer to a *double* molecular quantity, but I think it more practical to continue to make the different quantities refer to a single molecular quantity. Hence all the quantities have now been divided by 2, resp. 4.

quantities in the determination of  $\frac{\partial p}{\partial v} = 0$  and  $\frac{\partial^2 p}{\partial v^2} = 0$ . The calculations relating to this are pretty laborious, and were carried out in a separate chapter (§ 5 p. 25—34) in the cited TEYLER article (cf. also the above cited paper in These Proc. of Aug. 31, 1909, p. 127—130). We refer to this article, and give here only the results of the calculations — again making everything have reference to a single molecular quantity.

For  $v_k$  was found:

$$v_k = 3b_k \times \frac{m^2}{3m^2 - 2n}, \quad \dots \dots \dots (2)$$

in which

$$\left. \begin{aligned} m &= 1 + \frac{1}{2}\beta(1-\beta)(1+q)^2 \\ m &= 1 + \frac{3}{4}\beta(1-\beta)(1+q) + \frac{1}{8}\beta(1-\beta)(1-3\beta^2)(1+q)^2 \end{aligned} \right\}, \quad (3)$$

while

$$q = (1+\beta) \frac{\Delta b}{v-b} \quad \dots \dots \dots (4)$$

(p. 26 and 29 loc. cit.).

When  $\Delta b = 0$  and so also  $q = 0$ , as VAN DER WAALS assumes, even then remains:

$$\left. \begin{aligned} m &= 1 + \frac{1}{2}\beta(1-\beta) = (1+\beta)(1-\frac{1}{2}\beta) \\ m &= 1 + \frac{3}{4}\beta(1-\beta) + \frac{1}{8}\beta(1-\beta)(1-3\beta^2) = (1+\beta)^2(1-\frac{3}{8}\beta + \frac{3}{8}\beta^2) \end{aligned} \right\}, \quad (3^a)$$

through which for  $v_k$ , with

$$3m^2 - 2n = (1+\beta)^2(1-\frac{3}{4}\beta),$$

is found:

$$v_k = 3b_1 \times \frac{(1-\frac{1}{2}\beta)^2}{1-\frac{3}{4}\beta} \quad \dots \dots \dots (2^a)$$

In this the factor 3 must of course be replaced by a smaller one (e.g. 2,1), when  $b$  is a function of  $v$ , and varies between  $b_\infty$  and  $b_0$ , when  $v$  varies from  $\infty$  to  $v_0$ .

With regard to the factor of  $3b_k$  — which according to VAN DER WAALS (referring namely to a single molecular quantity and *not* to a  $1+x$  times larger quantity) would remain constant = 1 (at least by approximation) — we see immediately that this factor can differ pretty considerably from unity. For  $\beta = 0$  (only double molecules) and  $\beta = 1$  (only single molecules) the factor is properly = 1, but for  $\beta = \frac{2}{3}$  it has the *minimum value*  $\frac{8}{9}$ . And this deviation, which already amounts to 11 ‰, is still more pronounced when  $\Delta b$  is *not* = 0, but has e.g. a *negative* value.

For  $RTk$  we have found (p. 31 loc. cit.), again referring to a single molecular quantity:



$$RT_k = \frac{8}{27} \frac{a_1}{b_k} \cdot \frac{2}{1+\beta} \times \frac{n^2(3m^2-2n)}{m^5}, \dots \quad (5)$$

which with  $\Delta b = 0$  passes into

$$RT_k = \frac{8}{27} \frac{a_1}{b_1} \cdot \frac{2}{1+\beta} \times \frac{(1+\beta)(1-\frac{3}{8}\beta + \frac{3}{8}\beta^2)(1-\frac{3}{4}\beta)}{(1-\frac{1}{2}\beta)^5} \dots \quad (5^a)$$

If  $\beta = 1$  (single molecules), then  $RT_k$  duly becomes  $= \frac{8}{27} \frac{a_1}{b_1}$ ,

but for  $\beta = 0$  (double molecules)  $RT_k$  becomes  $= 2 \times \frac{8}{27} \frac{a_1}{b_1}$ .

But it is again immediately seen that  $RT_k$  certainly does not linearly change with  $2:(1+\beta)$ , i.e. with VAN DER WAALS'S  $1+x$ , as the latter assumes on p. 1078 of his treatise.

For the remaining factor is indeed again  $= 1$  for  $\beta = 0$  and  $\beta = 1$ , but it is  $3456 : 3125 = 1,106$  for  $\beta = \frac{1}{3}$ ;  $= 1445 : 1296 = \underline{1,115}$  for  $\beta = \frac{1}{2}$ ; and  $= 1125 : 1024 = 1,099$  for  $\beta = \frac{3}{4}$ . The deviation can therefore again amount to  $\underline{9\%}$ , in comparison with  $11\%$  for  $v_k$ , but in opposite direction. This deviation too is more pronounced, when  $\Delta b$  differs from 0.

With regard to the value of  $p_k$ , at last, we find:

$$p_k = \frac{1}{27} \frac{a}{b_k^2} \times \frac{(3m^2-2n)^2(4n-3m)}{m^5}, \dots \quad (6)$$

passing into

$$p_k = \frac{1}{27} \frac{a}{b_1^2} \times \frac{(1-\frac{3}{4}\beta)^2(1+\beta-3\beta^2+\frac{3}{2}\beta^3)}{(1-\frac{1}{2}\beta)^5}, \dots \quad (6a)$$

when  $\Delta b = 0$ . For

$$4n-3m = (1+\beta)(1+\beta-3\beta^2+\frac{3}{2}\beta^3).$$

The factor of  $\frac{1}{27} \frac{a}{b_1^2}$  duly has the value 1 both for  $\beta = 0$  and  $\beta = 1$ ; but becomes  $= 4617 : 3125 = 1,477$  for  $\beta = \frac{1}{3}$ ;  $= 375 : 243 = \underline{1,543}$  for  $\beta = \frac{1}{2}$ ; and  $= 189 : 128 = 1,476$  for  $\beta = \frac{3}{4}$ .

Accordingly the deviation from unity is very considerable — for  $\beta = \frac{1}{3}$  more than  $\underline{54\%}$ . Hence there is no longer any question of an approximate equality to  $\frac{1}{27} \frac{a}{b_1^2}$ , as VAN DER WAALS supposes he may assume. (p. 1078 l.c.). And this amount can still increase for  $\Delta b \text{ not } = 0$ .

1) If it is taken into account that  $a_1 = \frac{1}{4} a_2$ ,  $b_1 = \frac{1}{2} b_2$ ,  $RT_k$  becomes as it always did  $= \frac{8}{27} \frac{a_2}{b_2}$ , in which  $a_2$  and  $b_2$  now refer to a double molecular quantity.

It is therefore self-evident that when the quantities  $s = RT_k : p_k v_k$  and  $T_k : p_k$  are calculated, which occur in VAN DER WAALS'S considerations, no linear dependence on  $2 : (1 + \beta)$ , resp.  $1 + x$  is to be expected there either.

### 3. Now

$$s = \frac{RT_k}{p_k v_k} = \frac{8}{3} \cdot \frac{2}{1 + \beta} \times \frac{n^2}{m^2 (4n - 3m)} \dots \dots \dots (7)$$

is found for the quantity  $s$ , passing (with  $\Delta b = 0$ ) into

$$s = \frac{8}{3} \frac{2}{1 + \beta} \times \frac{(1 + \beta) (1 - \frac{9}{8} \beta + \frac{3}{8} \beta^2)^2}{(1 - \frac{1}{2} \beta)^2 (1 + \beta - 3\beta^2 + \frac{8}{2} \beta^3)} \dots \dots (7a)$$

For  $\beta = 1$  (all simple molecules)  $s$  becomes  $= s_0 = \frac{8}{3}$  (or  $= 3,77$ , when  $b$  varies with  $v$ ), and for  $\beta = 0$  (all double molecules)  $s$  becomes  $= \frac{8}{3} \times 2$ , hence twice the value. But here too we remain very far from linear dependence.

For  $\beta = \frac{1}{3}$  we find namely for the last factor in (7a) the value  $384 : 475 = 0,808$ ; for  $\beta = \frac{1}{2}$  the value  $280 : 360 = 0,803$ ; and for  $\beta = \frac{2}{3}$  the value  $375 : 448 = 0,837$ . Hence a difference of about  $20\%$  for  $\beta = \frac{1}{3}$ .

On account of the importance of the accurate knowledge of the value of the quantity  $s$  for associating substances, I have calculated the following table.

$\beta$	$\frac{2}{1 + \beta} = 1 + x$	Factor	$\frac{2}{1 + \beta} \times \text{factor} = \frac{s}{s_0}$
0	2	1	2
0.1	1.818	0.903	1.642
0.2	1.667	0.847	1.412
0.3	1.538	0.815	1.253
0.35	1.481	0.805	1.192
0.4	1.429	0.801	1.145
0.5	1.333	0.803	1.071
0.6	1.250	0.820	1.025
0.7	1.176	0.849	0.998
0.8	1.111	0.890	0.989 (min)
.9	1.053	0.945	0.995
1	1	1	1

Instead of a regular linear decrease with  $2:(1+\beta)$ , i.e. with  $1+x$ , values are even seen to appear  $< 1$  in the neighbourhood of  $\beta = 1$  (all the molecules single), with a *minimum* at about  $\beta = 0,8$  (accurately at  $\beta = 0,8015$ ), and a horizontal final direction, i.e.  $\frac{d}{d\beta} \left( \frac{s}{s_0} \right) = 0$ .

On increasing association ( $\beta$  from 1 to 0),  $s$  will therefore first become somewhat smaller than  $s_0$  ( $= 3,77$  for "ordinary" substances), and then (from  $\beta = 0,7$ )  $s:s_0$  will become greater than 1, and increase to 2 for  $\beta = 0$ , when the association to double molecules is perfect.

A straight line for  $s:s_0$  (as VAN DER WAALS thinks) therefore replaced by a line that is pretty considerably curved downward between the values 2 and 1 with a minimum close to 1, so that  $s:s_0$  at first decreases there instead of increasing.

What consequences this behaviour will have with respect to the *degree of association*  $\beta$ , calculated from the value found for  $s$  for *methylalcohol*, viz. 4,52, may appear from what follows.

As  $s:s_0 = 4,52:3,77 = 1,2$ , we should find about  $\beta = 0,67$  or  $x = 0,2$  for  $\beta$ , according to the second column of the above table, when we were led by a supposed linear dependence. But when we also take account of the "factor" by the side of  $2:(1+\beta)$ , we find about  $\beta = 0,35$  or  $x = 0,5$  from the last column for the value for  $\beta$  answering to the ratio  $s:s_0 = 1,2$ .

A difference, in fact, too large to be neglected. Instead of 0,8 single molecules to 0,2 double molecules, as VAN DER WAALS would find with his linear dependence, we find more accurately 0,5 single molecules to 0,5 double ones. The relation  $x:(1-x)$  has become 1 instead of 4.

4. The second quantity which plays a part in the cited paper by VAN DER WAALS, is the quantity  $T_k:p_k$ , which may be put proportional to the molecule size for non-associating substances. We now find for it:

$$\frac{T_k}{p_k} = \frac{8}{R} b_1 \cdot \frac{2}{1+\beta} \times \frac{(1+\beta) (1 - \frac{3}{8}\beta + \frac{3}{8}\beta^2)^2}{(1 - \frac{3}{4}\beta) (1 + \beta - 3\beta^2 + \frac{3}{2}\beta^3)}, \dots \quad (8a)$$

which with  $\Delta b = 0$  passes into

$$\frac{T_k}{p_k} = \frac{8}{R} b_k \cdot \frac{2}{1+\beta} \times \frac{n^2}{(3m^2 - 2n)(4n - 3m)} \dots \dots \quad (8)$$

We shall not discuss the course of this again, but solve from this

the required value of  $\frac{8}{R} b_k$ . By means of (7) and (8) we find easily :

$$(b) = \frac{8}{R} b_k = \left( \frac{T_k : s}{p_k : s_0} \right) \times \frac{3m^2 - 2n}{m^2}, \dots \dots \dots (9)$$

or when  $\Delta b = 0$  :

$$(b) = \frac{8}{R} b_1 = \left( \frac{T_k : s}{p_k : s_0} \right) \times \frac{1 - \frac{3}{4}\beta}{(1 - \frac{1}{2}\beta)^2} \dots \dots \dots (9a)$$

When therefore the value of  $\beta$  has been found from (7) and (7a), it can be substituted in (9) or (9a), and  $\frac{8}{R} b_1$  is known.

According to VAN DER WAALS, (b) would be  $= 6,52 : 1,2 = \underline{5,43}$  for methylalcohol, whereas (for  $\Delta b = 0$ ) the more accurate value with  $\beta = 0,35$  (see above) would amount to  $5,43 \times 1,084 = \underline{5,89}$ .

This value is still larger than that found by VAN DER WAALS, and would yield  $7,55 - 5,89 = 1,66$  for  $\text{CH}_2$ , instead of 2,12. And when  $\Delta b = 0$  is assumed, the accurate value of (b) will be larger than the approximate one for every value of  $\beta$ , because  $1 - \frac{3}{4}$  is always  $> (1 - \frac{1}{2}\beta)^2$ .

It is, however, easy to see that when not (7a) and (9a) are used for the calculation resp. of  $\beta$  and (b), a value  $< 1$ , e. g. 0,88 can very well be found for the factor  $(3m^2 - 2n) : m^2$  in (9), through which 5,43 would diminish to 4,78, so that  $7,55 - 4,78 = 2,77$  would be found for  $\text{CH}_2$ , in good harmony with the value found for ethylalcohol.

Now  $(3m^2 - 2n) : m^2$  becomes  $< 1$ , when

$$3 - \frac{2n}{m^2} > 1 \quad \text{or} \quad m^2 < n.$$

I. e. with a view to (3)

$$[1 + \frac{1}{2}\beta(1-\beta)(1+\varphi)^2]^2 < 1 + \frac{3}{4}\beta(1-\beta)(1+\varphi) + \frac{1}{8}\beta(1-\beta)(1-3\beta^2)(1+\varphi)^3$$

must be, i. e.

$$\beta(1-\beta)(1+\varphi)^2 + \frac{1}{4}\beta^2(1-\beta)^2(1+\varphi)^4 < < \frac{3}{4}\beta(1-\beta)(1+\varphi) + \frac{1}{8}\beta(1-\beta)(1-3\beta^2)(1+\varphi)^3,$$

or

$$(1+\varphi) + \frac{1}{4}\beta(1-\beta)(1+\varphi)^3 < \frac{3}{4} + \frac{1}{8}(1-3\beta^2)(1+\varphi)^2,$$

or also

$$6 - 8(1+\varphi) + (1-3\beta^2)(1+\varphi)^2 - 2\beta(1-\beta)(1+\varphi)^3 > 0.$$

If  $\beta$  were  $= 0$ , then  $\varphi$  would have to be  $< 3 - \sqrt{10}$ , i. e.  $< -0,162$ . If  $\beta$  were  $= \frac{1}{2}$ , then  $\varphi$  ought to be  $<$  about  $-0,25$ . And if  $\beta$  were  $= 1$ , then  $\varphi$  would have to be  $< -3 + \sqrt{7}$ , i. e.

$< -0,354$ . As now according to (4)  $q = (1 + \beta) \Delta b : (v - b)$ , we have also :

$$q = (1 + \beta) \frac{\Delta b}{b} \frac{b}{v - b}.$$

For  $T_k$ , with  $v = 2b$ , the value  $q : (1 + \beta)$  follows from this for  $\Delta b : b$ . For  $\beta$  resp.  $= 0$ ,  $1/2$ , and  $1$  we find therefore resp. the values  $< -0,16$ ,  $< -0,167$  and  $< -0,177$  from this. When accordingly  $\Delta b : b$  becomes smaller than about  $-1/6$ , the value of the factor  $(3m^2 - 2n) : m^2$  can become  $< 1$ . For a value  $0,88$  (see above) it will therefore be necessary that  $-\Delta b : b$  be about 0,2 — a value which in view of the value for  $H_2O$  (which has been found of the same order of magnitude) is not at all impossible for methyl-alcohol either.

At any rate it is seen from the above, that for associating substances ( $b$ ) cannot be put simply proportional to  $(T_k : p_k) : (s : s_0)$ , but that the factor  $(3m^2 - 2n) : m^2$  must be taken into account. Nor may for the calculation of  $\beta$  from  $s : s_0$  simply  $2 : (1 + \beta) = 1 + x$  be written for the latter ratio; another factor  $n^2 : m^2 (4n - 3m)$  must be added to it, which factor amounts to about  $0,8$  (see the above table) in the case  $\Delta b = 0$  between  $\beta = 0,3$  and  $\beta = 0,5$  or  $0,6$ , which differs too much from  $1$  to be neglected.

The error made by VAN DER WAALS is according to § 2 owing to this, that he believed he could assume values for  $RT_k : (1 + x)$  and  $p_k$ , which do not differ (at least differ little) from the corresponding values for non-associating substances.

The calculation (given by me already in the cited TEYLER-article in 1908) teaches something entirely different: for  $p_k$  (with  $\Delta b = 0$ ) e.g. the deviation can amount to more than  $54\%$ .

The finding of a too large value for  $(T_k : p_k) : (s : s_0)$ , viz.  $5,43$  instead of about  $4,8$  points out, that necessarily for  $CH_3OH$  the quantity  $\Delta b : b$  will have a pretty large negative value, namely about  $-0,2$ . If  $\beta$  were about  $1/3$ , then  $b$  would be  $= (1 - \beta)^{1/2} b_2 + \beta b_1 = 1/3 b_2 + 1/3 b_1$ , and from

$$\frac{\Delta b}{b} = \frac{-1/2 b_2 + b_1}{1/3 b_2 + 1/3 b_1} = -0,2$$

would follow  $16 : 13 = 1,23$  for the ratio  $1/2 b_2 : b_1$ , i. e. the double molecules would be about  $1,23$  times as large as two single molecules — which is by no means impossible.

5. On this occasion I will draw attention at the same time that in § 7, p. 40—42 of the cited TEYLER-article also the quantity

$f = \left( \frac{T}{p} \frac{dp}{dT} \right)_k$  for associating substances has been calculated by me.

When the heat of dissociation  $q$  of the double molecules may be put  $= 0$ , we find for  $f'$  (see formula (28) loc. cit.):

$$f = f_0 \times \frac{n}{4n - 3m},$$

or when  $\Delta b = 0$ :

$$f = f_0 \times \frac{(1 - \beta)(1 - \frac{3}{2}\beta + \frac{3}{8}\beta^2)}{1 + \beta - 3\beta^2 + \frac{3}{2}\beta^3},$$

in which the factor of  $f_0$  both for  $\beta = 0$  and for  $\beta = 1$  again assumes the value 1. For  $\beta = \frac{1}{2}$  the value is, however,  $16:19 = 0,84$ , which would make the normal value 7 descend to about 5,9. As  $f'$  for methylalcohol is found  $> 7$ , namely  $\approx$  about 8,6 (cf. KUENEN, Die Zustandsgleichung, p. 142, where the value  $3,75 \times 2,30$  is given), the factor of  $f_0$  would have to be about 1,2 instead of 0,84; i. e.  $\Delta b \neq 0$ , and again *negative* — or also the value of  $q$  (see the full formula in TEYLER, p. 42) would moreover have to be different from 0, and that *positive*.

*Fontaine sur Clarens, May 1, 1914.*

**Physics.** — “On apparent thermodynamic discontinuities, in connection with the value of the quantity  $b$  for infinitely large volume.” By DR. J. J. VAN LAAR. (Communicated by Prof. H. A. LORENTZ).

(Communicated in the meeting of June 27, 1914).

1. One of the principal results of the foregoing series of communications <sup>1)</sup> has been this (cf. particularly II p. 926 and IV p. 464), that the quantity  $b_g$ , i. e. the value of  $b$  for infinitely large volume (hence in the ideal gas state) cannot possibly be  $= 4m$  as the classical kinetic theory gives for it. With decreasing temperature  $b_g$  approaches namely more and more to  $b_0$ . If in the ideal gas state  $b_g$  were  $= 4m$ ,  $b_g$  would have to be  $= 4m$  also at very low temperature (this kinetic result holds namely independent of the temperature), while in the condensed liquid state with cubic arrangement e. g. of the molecules, supposed to be spherical,  $b_0$  would be about  $= 2m'$ , in which  $m'$  is either equal to or smaller than  $m$ , so that then  $b_g$  cannot possibly become  $= b_0$ .

<sup>1)</sup> These Proc. of March 26, April 23, May 29 and Sept. 26, 1914 (to be cited as I–IV).

And yet, everything seems to point to this that actually *all* substances at sufficiently low temperature approach to the type of the mon-atomic substances with exceedingly low critical temperature, at which the quantity  $b$  remains almost unchanged on diminution of the volume from  $\infty$  to  $v_0$ . Instructive are in this respect the tables in I, p. 819 and III p. 1052, and also POINCARÉ'S and KAMERLINGH ONNES'S remarks in the discussion of NERNST'S Report (Conseil SOLVAY German edition, p. 241 at the bottom to 242), where it was pointed out that at very low temperature also the molecular heats of air and hydrogen would probably approach to those of monatomic gases.

The above contradiction is now immediately removed by the assumption that in the rarefied gas state  $b$  is *not*  $= 4m$ , but simply  $= m$  (the real volume of the molecules, at most enlarged by a certain sphere of influence), while also in the condensed liquid state  $b_0$  is  $= m'$ , ( $m' < m$ ) — in such a way that the idea of immediate contact at  $v = v_0$  of the quasi-spherical molecules with small, remaining intermolecular spaces without energy must be replaced by the more rational view of a compact mass of molecules without real interstices, unless they are considered to be the spheres of influence belonging to the molecules, just as for the large volumes. This limiting state might however also be considered as a fictitious state, which may be approached, but which can never be reached entirely. But this is a question which may be left out of consideration here.

The principal thing is that  $b$  always remains  $= m$ , and that on diminution of the volume  $m$ , therefore, only changes in consequence of the increased pressure under which the molecules are then, the less as  $T$  is nearer 0, till at last both at  $v = v_0$  ( $p = \infty$ ) and at  $T = 0$  the molecules will occupy their smallest volume  $b_0 = m'$ , when the atoms or atomic groups inside the molecule have approached each other as closely as possible.

2. Hence we attribute, as VAN DER WAAALS did in his middle period, when he drew up the so-called equation of state of the molecule, the change of  $b$  with  $v$  entirely to a *real* change in consequence of the changed internal pressure<sup>1)</sup> — with rejection of

---

1) For a *real* diminution of the molecule on diminution of  $v$  or lowering of  $T$  speaks also the form of the empirical relation  $b = f(v, T)$  found by us — see II, p. 931—933, and III, p. 1051—1054. How little the later views of VAN DER WAAALS and others — in order to make the original equation of state also applicable to the condensed gas state and the liquid state — chiefly by considering  $b$  as a function of  $v$  and  $T$  (of whatever nature this variability may be) — have yet come

the so-called quasi change, which would be caused by the diminution of the old factor 4 to about 2 in consequence of the partial overlapping of the "distance spheres". We namely assume that the volume available for the calculation of the pressure is immediately found by subtracting the volume of the molecules  $m$  from the total volume  $v$ , always assuming that the kinetic energy of the moving molecules and molecule groups, with the permanent *gradual* interchange of the energy during the collisions, is continuously absorbed by the surrounding medium (see I p. 809, and IV, p. 464 at the bottom), and is finally after subtraction of the internal molecular pressure observed as "external pressure".

It will be asked what part the so-called *association* or *quasi-association* plays in these considerations.

Before answering this question I will first state clearly my opinion about the difference between association and quasi-association, which I hold in connection with the following considerations. We may briefly express this difference in the following way.

*Real* association is quite individual and has a *permanent* character; it quite depends on the chemical nature of the molecules (whether there are e.g. still free valencies or minor valencies present etc.). Water, alcohol, acetic acid are associating substances — ether, benzene, chlorobenzene etc. are *non-associated* substances.

*Quasi-association* on the other hand in consequence of the action of the molecular forces, when two molecules get into each other's neighbourhood, and which gives rise to the formation of temporary "molecule aggregations", is *entirely the same for all substances in corresponding states*, and of *transient*, albeit *stationary* nature.

This last form of association, which has been particularly studied by VAN DER WAALS, is competent to explain why with the ordinary kinetic view (which, when *all* the active factors are taken into consideration, must also lead to the truth) not  $b_0 = 4m$  is found but *less*. The theory which — evading the separate consideration of the moving

under the notice of many, may appear again from an article by A. WOHL in the Z. f. ph. Ch. 87, p. 1—39. This author thinks he can set everything right by an equation of state of the wholly unjustifiable form

$$p = \frac{RT}{v-b} - \frac{a}{v(v-b)} + \frac{c}{v^3},$$

in which  $a$ ,  $b$ , and  $c$  are *constants*. That it is also possible to arrive among others at the accurate values of the critical data by putting  $b$  variable with  $v$  in the ordinary equation of state, does not seem to have occurred to him. Also von JÜPTNER's many articles convey an impression of his not being at all in touch with the new investigations in this department.



molecules, of their collisions and their temporary aggregations — goes straight to its goal by imagining (see above) all the energy absorbed in the surrounding medium, makes it further acceptable that  $4m$  would after all have to become simply  $m$ .

But that the theory of the quasi-association can only be of any use in the rarefied gas state, in conjunction with the theory of the colliding molecules, and that the medium theory can be left aside — though there always remain constants undetermined (viz. the association constants), as we shall immediately see; and that this theory entirely fails for more condensed states — this is immediately to be seen.

For if one would apply the quasi-association theory to liquids, the number of molecules associated to one molecule would theoretically continually increase, so that finally — in the limiting state — the whole liquid mass would have to be considered as one single associated giant molecule, for which the equation of state of the substance would then lose all its significance, as this is based on the joint action of an exceedingly large number of molecules, and not on a single molecule. What for larger volume can therefore be taken as the equation of state of the whole mass of the substance, would now have passed to the equation of state of a single giant molecule. But in this the separate molecules can again be taken as *unities* (*real* association excluded of course) in consequence of the very slight mutual distances (just as for a solid substance), and the equation of state resulting *from this* will have analogous meaning as the original one, which holds for the gas state. Only we shall then have to take into account the continual change of the number of degrees of freedom.

The theory of quasi-association, applied to condensed states, would therefore lead to great contradictions. While the molecules practically behave as *single* ones, the said theory would lead to an infinite complexity in one giant molecule, with abolition of the original equation of state.

While VAN DER WAALS, therefore, thought he could chiefly explain the *deviations* of the liquid state with respect to the ideal equation of state by the association theory, we see that exactly in this state this theory would lead to contradictions. It may only be applied in the rarefied gas state, though just there it is not necessary as an explanation of the deviations from the equation of state meant by VAN DER WAALS, which would make their appearance not before the liquid state, but which as we saw in the foregoing articles can be explained also without the assumption of quasi association. It is indeed necessary, however, as we shall see presently, to explain that then  $4m$  can become  $m$ .

That with respect to the  $b$ -values just liquids behave entirely according to the ordinary theory with  $b = f(v, T)$  — without quasi association being taken into account — has appeared in my recent calculations with respect to *Argon*. In IV p. 458 we saw namely that the liquid values of  $b$  behave entirely according to the relation  $b = f(v)$  derived by me (if namely  $\beta_0 = b_0 : v_k$  is only raised from the value 0,286 obtained by extrapolation to 0,305). That the vapour values of  $b$  exhibit deviations, and even become impossible, is to be ascribed to the way of determination of the vapour volumes at lower temperatures — since it is no longer by direct observation, but by application of the law of BOYLE, which is not yet quite valid then, as I have shown in IV p. 457.

3. Let us now proceed to examine the influence of the quasi association in the very rarefied gas state, by which it will be proved that the kinetic result  $b_j = 4m$  can no longer be maintained.

*Abbreviated derivation.* If in first approximation (this is permissible for great  $v$ ) we put the quantity  $b$  independent of the state of (quasi) association (the quantity  $a$  is always independent of it), the equation of state for great  $v$  is:

$$\underline{p(v-b)} = \underline{(1-1/2x) RT} \quad , \quad . \quad . \quad . \quad . \quad . \quad (1)$$

when a fraction  $x$  of one single molecule associates to double molecules, so that there will be  $1-x$  single and  $1/2 x$  double molecules, together  $1-1/2 x$ . With very large volume the numbers of triple, quadruple etc. molecules can namely be neglected with respect to that of the double molecules.

In this  $x$  is given by an equation of the form (see for a justification of this and of some other assumptions the *Appendix*)

$$\frac{c_1^2}{c_2} = \frac{(1-x)^2}{1/2x(1-1/2x)} = \frac{CT}{p},$$

as the concentration  $c_1$  of the single molecules  $= \sqrt{1-x} : (1-1/2x)$ , and that of the double molecules  $c_2 = 1/2x : (1-1/2x)$ .

In this it is supposed that also the specific heat does not undergo any change in the quasi association, and that moreover the energy change may be put  $= 0$ .

In the ideal gas state we have  $T : p = (v-b) : R(1-1/2x)$ , according to (1), so that we can also write:

$$\frac{(1-x)^2}{1/2x} = \frac{C}{R}(v-b),$$

or also, as  $x$  will always be exceedingly slight with large volume, and  $v$  may be written for  $v-b$ :

$$\underline{v - b'} = \frac{R}{C} \cdot \frac{1}{v} \cdot \dots \dots \dots (2)$$

If we put:

$$p(v - b') = RT,$$

in which  $b'$  is the value of  $b$  which would be found by leaving the quasi association out of account — so the real value therefore in the usual sense —, then by comparison with (1) follows:

$$v - b' = \frac{v - b}{1 - \frac{1}{2}x} = v \left( 1 - \frac{b}{v} \right) (1 + \frac{1}{2}x) = v \left( 1 - \frac{b}{v} + \frac{1}{2}x \right),$$

so

$$v - b' = v - b + v \cdot \frac{1}{2}x,$$

thus

$$\underline{b' = b - v \cdot \frac{1}{2}x} \dots \dots \dots (3)$$

According to (2), however,  $v \cdot \frac{1}{2}x = R : C$ , when  $v$  approaches to  $\infty$  and  $x$  to 0, so that we finally get;

$$\underline{b' = b - \frac{R}{C}}, \dots \dots \dots (4)$$

in which  $b = 4m$  according to the kinetic theory of the perfectly elastic collisions of the molecules, supposed to be spherical. And as  $C$  — the association constant — will always possess a *finite* value, for else there would not be quasi association, we have always:

$$\underline{b' < b}, \quad \text{i. e.} \quad \underline{b' < 4m} \quad (\text{q. e. d.}).$$

At the head of our paper we spoke of “*apparent*” *thermodynamic discontinuities*, and mean by this what follows.

If there were *no* quasi association *at all*, i. e. if the association constant  $C$  were absolutely  $= 0$ , so that there could not exist quasi association at any volume, however small — then  $b' = b = 4m$ . But as soon as there exists quasi association ( $C$  finite), however slight it may be (according to (2)  $= 0$  for  $v = \infty$ ), immediately  $b (= 4m)$  is diminished by the finite quantity  $R : C$ , as  $v \times \frac{1}{2}x = \infty \times 0$  is always finite, so that  $b'$  becomes  $< 4m$ .

There is therefore *discontinuity* — for at an association state  $= 0$  for  $v = \infty$ ,  $b'$  can have the value  $4m$ , and also possess all the values  $< 4m$ . But this is only *apparent*, because the diminution of  $4m$  depends continuously on the value of the dissociation constant  $C$ , which can vary from 0 to any finite value.

Now  $C$  is not known, and this quantity, which depends on the entropy constants, could only be determined by statistical-mechanical way, when we knew *all* the circumstances accurately and could take them into account, which determine the quasi association. In

default of this knowledge we can therefore only say that probably  $C$  will be such that  $b' = 4m - \frac{R}{C}$  will become about  $b' = m_\infty$ , in which  $m_\infty$  represents the volume of the molecules with their immediate sphere of influence (see § 1) — in harmony with the theory of the absorption of energy and transmission through the intermolecular medium (cf. also § 1).

If an analogous image is wanted: the old ballistic theory of the rectilinear motion of the colliding molecules is in the same relation to the modified theory, in which the temporary mutual influencing of the molecules is considered which will take place at every impact, or (what comes to the same thing) to the medium theory — as the consideration of the effect of a ray of light, after it has passed through a narrow aperture without taking the inflection into account, so that only that part of the space behind the aperture would be affected by the light which is in the direction of the ray — is in relation to the complete consideration of the light-effect *with* observance of the diffraction, in which therefore the *whole* space behind the aperture is affected by the light, and of which it is possible to determine the distribution of the intensity.

*Appendix. Complete derivation<sup>1)</sup> of' (4).*

If a fraction  $x_2$  of 1 mol. is temporarily joined to double molecules, a fraction  $x_3$  to triple molecules etc., we have therefore:

$$n_1 = 1 - x_2 - x_3 \dots \text{ single mol. ; } n_2 = \frac{1}{2} x_2 \text{ double mol. ;} \\ n_3 = \frac{1}{3} x_3 \text{ triple mol. ; etc.}$$

If further generally:

$$b = n_1 b_1 + n_2 b_2 + n_3 b_3 + \dots,$$

then

$$b = (1 - x_2 - x_3 - \dots) b_1 + \frac{1}{2} x_2 b_2 + \frac{1}{3} x_3 b_3 + \dots,$$

or

$$b = b_1 - x_2 (b_1 - \frac{1}{2} b_2) - x_3 (b_1 - \frac{1}{3} b_3) - \dots$$

In this  $b_1 - \frac{1}{2} b_2 = \Delta_2 b$  represents the change of  $b$ , always when a half double molecule dissociates to a single molecule;  $b_1 - \frac{1}{3} b_3 = \Delta_3 b$  the change of  $b$ , when one third triple molecule dissociates to a single mol.; etc., so that we can also write:

$$b = b_1 - x_2 \Delta_2 b - x_3 \Delta_3 b - \text{etc.} \quad . . . . (\alpha)$$

That  $a$  does not change in consequence of the association, is known. For three kinds of molecules e.g. holds namely:

<sup>1)</sup> Already derived by me in 1908, but never published.

$$\ddot{a} = n_1^2 a_1 + n_2^2 a_2 + n_3^2 a_3 + 2n_1 n_2 a_{12} + 2n_1 n_3 a_{13} + 2n_2 n_3 a_{23},$$

in which  $a_2 = 4a_1$ ,  $a_3 = 9a_1$ ,  $a_{12} = 2a_1$ ,  $a_{13} = 3a_1$  and  $a_{23} = 6a_1$ , so that we get:

$$a = n_1^2 a_1 + 4n_2^2 a_1 + 9n_3^2 a_1 + 4n_1 n_2 a_1 + 6n_1 n_3 a_1 + 12n_2 n_3 a_1 \\ = (n_1 + 2n_2 + 3n_3)^2 a_1 = a_1,$$

as  $n_1 + 2n_2 + 3n_3 = (1 - x_2 - x_3) + x_2 + x_3 = 1$ .

We may therefore write:

$$\left(p + \frac{a}{v^2}\right)(v - b) = \theta RT, \quad \dots \dots \dots (\beta)$$

in which  $b$  is given by (a), and (see above)

$$\theta = \Sigma n_i = 1 - \frac{1}{2}x_2 - \frac{2}{3}x_3 - \text{etc.} \dots \dots \dots (\gamma)$$

The following equations hold for the dissociation equilibrium of the double, triple etc. molecules resp. (cf. my already frequently cited Teyler paper 1908: *Théorie générale de l'association etc.*, p. 5, and also *These Proc.* of June 23, 1911 (Solid State VII), formula (28)):

$$\left. \begin{aligned} \frac{(1 - x_2 - x_3 - \dots)^2}{\frac{1}{2} x_2 \cdot \theta} &= \frac{C_2 T^{\gamma_2 + 1} e^{-q_2/RT} e^{-(p + a/v^2)2\Delta_2 b : RT}}{p + a/v^2} \\ \frac{(1 - x_2 - x_3 - \dots)^3}{\frac{1}{3} x_3 \cdot \theta^2} &= \frac{C_3 T^{\gamma_3 + 1} e^{-q_3/RT} e^{-(p + a/v^2)3\Delta_3 b : RT}}{(p + a/v^2)^2} \\ \dots \dots \dots \end{aligned} \right\}$$

or taking the equation of state (β) into account:

$$\left. \begin{aligned} \frac{(1 - x_2 - x_3 - \dots)^2}{\frac{1}{2} x_2} &= \frac{C_2}{R} T^{\gamma_2} e^{-q_2/RT} e^{-\theta \cdot 2\Delta_2 b : (v-b) (v-b)} \\ \frac{(1 - x_2 - x_3 - \dots)^3}{\frac{1}{3} x_3} &= \frac{C_3}{R^2} T^{\gamma_3} e^{-q_3/RT} e^{-\theta \cdot 3\Delta_3 b : (v-b) (v-b)^2} \\ \dots \dots \dots \end{aligned} \right\}, \quad \dots \dots \dots (8)$$

in which  $C_1, C_2$ , etc. are the dissociation constants resp. of the double, triple etc. molecules;  $\gamma_2, \gamma_3$ , etc. the changes of the specific heat in the dissociation, divided by  $R$ , viz.  $\gamma_2 = (2k_1 - k_2) : R$ ,  $\gamma_3 = (3k_1 - k_3) : R$ , etc.;  $q_2, q_3$ , etc. the heats of dissociation (energy changes)  $2(e_1)_0 - (e_2)_0$ ,  $3(e_1)_0 - (e_3)_0$ , etc.;  $\Delta_2 b, \Delta_3 b$ , etc. the variations of  $b$  already introduced above, which must now resp. be multiplied by 2, 3, etc., the above equations referring to  $n$ -fold molecular quantities, and not to a single quantity.

The first member contains the relations of the molecular concentrations, viz.

$$\frac{c_1^2}{c_2} = \frac{(n_1 : \Sigma n_1)^2}{n_2 : \Sigma n_1} = \frac{n_1^2}{n_2 \cdot \theta} = \frac{(1 - x_2 - x_3 - \dots)^2}{\sqrt[1]{2} x_2 \cdot \theta}$$

$$\frac{c_1^3}{c_3} = \frac{(n_1 : \Sigma n_1)^3}{n_3 : \Sigma n_1} = \frac{n_1^3}{n_3 \cdot \theta^2} = \frac{(1 - x_2 - x_3 - \dots)^3}{\sqrt[1]{3} x_3 \cdot \theta^2}$$

etc. (for  $\Sigma n_1$  has namely been put  $\theta$ ).

For the dissociation constants  $C_2, C_3$ , etc. holds:

$$\log C_2 = -\gamma_2 + \Delta_2 \eta + (\log R - 1),$$

$$\log C_3 = -\gamma_3 + \Delta_3 \eta + 2(\log R - 1),$$

etc., in which  $\Delta_2 \eta, \Delta_3 \eta$ , etc. represent the variations of the entropy constant, divided by  $R$ , viz.  $\Delta_2 \eta = (2(n_{12})_s - (n_2)_0) : R$ ,  $\Delta_3 \eta = (3(n_{13})_0 - (n_3)_0) : R$ , etc.

If we now put all the quantities  $\gamma$  and  $q = 0$ , which is allowed for quasi association (otherwise we only think the terms referring to it included in the dissociation constants, e. g.,  $C_2 T^{1/2} e^{-q_2/R} = C_2'$ , etc.), then for *large* volumes, where  $x_2, x_3$ , etc. will be *slight*:

$$\left. \begin{aligned} \frac{1}{\sqrt[1]{2} x_2} &= \frac{C_2}{R} e^{-\theta, 2\Delta_2 b : (v-b)(v-b)} \\ \frac{1}{\sqrt[1]{3} x_3} &= \frac{C_3}{R^2} e^{-\theta, 3\Delta_3 b : (v-b)(v-b)^2} \end{aligned} \right\}$$

or as also  $\Delta_2 b : (v-b), \Delta_3 b : (v-b)$ , etc. will be very small for large  $v$ , and  $v$  may be written for  $v - b$ :

$$\sqrt[1]{2} x_2 = \frac{R}{C_2} \frac{1}{v} \quad ; \quad \sqrt[1]{3} x_3 = \frac{R^2}{C_3} \frac{1}{v^2} \quad ; \quad \text{etc., . . . . } (\epsilon)$$

of which the first equation is identical with (2) of § 3.

We further see, what we have already immediately put in our abbreviated derivation, that really for very large volume  $x_3, x_4$ , etc. may be neglected by the side of  $x_2$ , and that therefore the consideration of the *double* molecules suffices with disregard of the numbers of triple and multiple molecules.

If we now again compare the equation (3) with  $(p + a/v)(v - b') = RT$  (the latter therefore without taking quasi association into account), then (see also (a) and (γ)):

$$v - b' = \frac{v - b}{\theta} = \frac{v - b_1 + x_2 \Delta_2 b + x_3 \Delta_3 b + \dots}{1 - \sqrt[1]{2} x_2 - \sqrt[2]{3} x_3 - \dots}$$

hence with neglect of  $x_3$  etc. by the side of  $x_2$ :

$$v - b' = \frac{v - b_1 - x_2 \Delta_2 b}{1 - \sqrt[1]{2} x_2} = v \left( 1 - \frac{b_1}{v} - \frac{\Delta_2 b}{v} + \sqrt[1]{2} x_2 \right),$$

or

$$r - b' = r - b_1 - x_2 \Delta_2 b + v \cdot \frac{1}{2} x_2.$$

In this the infinitesimal quantity  $x_2 \Delta_2 b$  (also when  $\Delta_2 b$  is finite) may be neglected by the side of  $b_1$  and the also finite quantity  $v \cdot \frac{1}{2} x_2$ , and we get:

$$b' = b_1 - v \cdot \frac{1}{2} x_2,$$

identical with (3) of § 3. For  $v \cdot \frac{1}{2} x_2$  the value  $R : C_2$  follows then again from (ε), and the conclusions are further as in the cited paragraph.

*Fontanivent sur Clavens.*

**Chemistry.** — “*Current Potentials of Electrolyte solutions*”. By Dr. H. R. KRUYT. (Communicated by Prof. ERNST COHEN).

(Communicated in the meeting of June 27, 1914).

1. For a proper understanding of the reciprocal action between electrolytes and colloids the knowledge of the capillary-electric phenomena is indispensable<sup>1)</sup>. Researches on the influence of the electrolyte concentration in these phenomena have indeed been carried out of late years; PERRIN<sup>2)</sup> and ELISSAFOFF<sup>3)</sup> studied the electric endosmose of electrolyte solutions, BURTON<sup>4)</sup> determined the influence of electrolytes in various concentrations on the cataphoresis whilst there already exists a vast material on the capillary-electrometer and the dropping electrode<sup>5)</sup>. The recent investigations were, therefore, chiefly concerned with the measurement of the phenomena of motion in consequence of a supplied electric tension; the reverse phenomenon, however, namely the occurrence of an electric tension in consequence of a moving electrolyte solution has been but little studied<sup>6)</sup>. The former investigations on these current potentials (generally, though less accurately, called “Strömungsströme”) are restricted to pure water. True, CHWOLSON<sup>7)</sup> states that electrolyte solutions cannot produce current potentials, but from the quoted treatises of GOURÉ DE VILLEMONTÉE<sup>8)</sup> it appears that the latter only

<sup>1)</sup> For full details of this problem see H. FREUNDLICH, *Kapillarchemie*, Leipzig 1909 in very condensed form H. R. KRUYT, *Aanteekeningen Prov. Utr. Gen.* 3 June 1913 p. 9 and *Chem. Weekbl.* 10, 524 (1915).

<sup>2)</sup> *Journal de Chimie physique* 2, 601 (1904).

<sup>3)</sup> *Z. f. physik. Chem.* 79, 385 (1912).

<sup>4)</sup> *Phil. Mag.* [6] 11, 425; 12, 472 (1905) and 17, 583 (1909).

<sup>5)</sup> Detailed literature statements in CHWOLSON, *Lehrbuch der Physik* IV 1.

<sup>6)</sup> The most important investigations of recent times are those of CAMERON and OETTINGER, *Phil. Mag.* [6] 18, 586 (1909); GRUMBACH, *Ann. de chim. et de phys.* [8] 24, 433 (1911) and RIÉTY, *ibidem* [8] 30, 1 (1913).

<sup>7)</sup> l. c. note 5.

<sup>8)</sup> *Journ. de phys.* [3] 6, 59 (1897).

investigated solutions of  $\text{CuSO}_4$ ,  $\text{ZnSO}_4$  and  $\text{NiSO}_4$  in the concentration of 10 grams per litre. Because current potential and electroendosmose are so to say each other's reflected image <sup>1)</sup>, one may rather expect that the electrolyte concentration will make itself felt in a similar manner in regard to those two phenomena. As ELISSAFOFF (l. c.) found that even exceedingly feeble electrolyte concentrations strongly diminish or suspend the electroendosmotic transport, we can only assume from the negative result of GOURÉ DE VILLEMONTÉE that in the concentrated solutions used by him the potential is already lowered to about zero. RIÉTY'S result <sup>2)</sup> have also confirmed this conclusion.

GRUMBACH <sup>3)</sup>, who investigated the influence of non-electrolytes on the current potential, has not used pure water as comparison liquid but a KCl-solution of the concentration 1 millimol. per litre and in this manner obtained positiv results. In the investigation here described I have made use in many respects of the experimental methods mentioned in GRUMBACH'S paper.

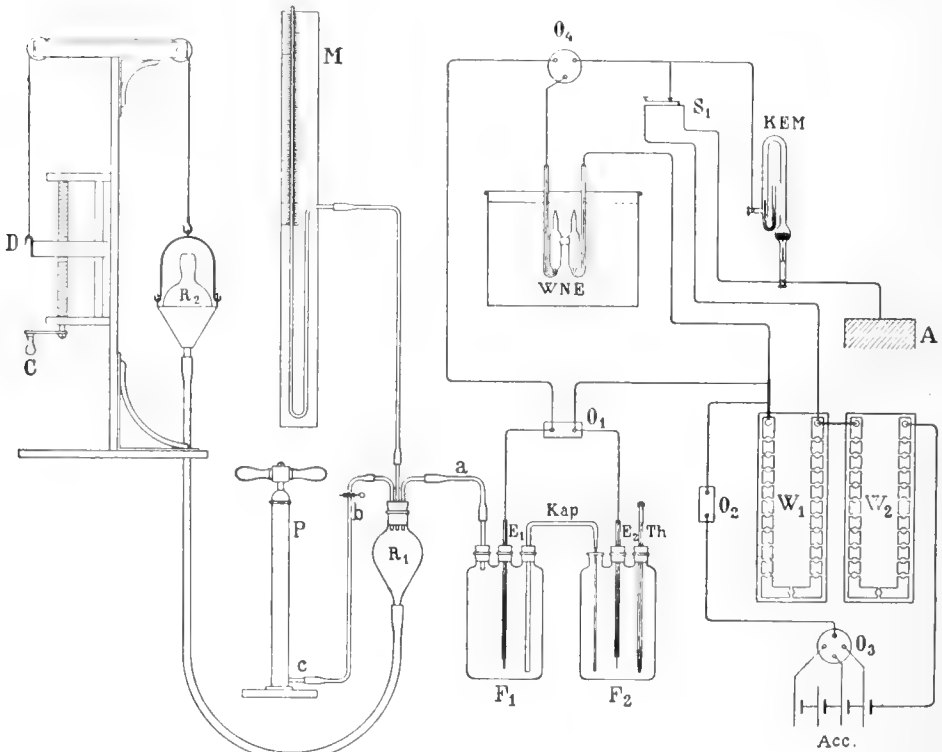

Fig. 1.

<sup>1)</sup> Vgl. SAXÉN, Wied. Ann. 47, 16 (1892).

<sup>2)</sup> l. c.

<sup>3)</sup> l. c.



2. *Apparatus.* In fig. 1 the apparatus used is represented schematically. The liquid serving in the experiment runs from flask  $F_1$  into flask  $F_2$  through a doubly bent glass tube  $Kap$ , which is partly drawn to a capillary. Into the three-necked WOLFF flask  $F_1$ , which is closed by means of rubber stoppers with copper wire ligature, arrives also (1) a tube  $a$  through which air can be pressed and (2) an electrode  $E_1$ . In the other flask  $F_2$  is found an electrode  $E_2$  and a thermometer  $Th$ . The electrodes are Ag-AgCl electrodes. A silver wire is fixed into a glass capillary by means of CAILLETET-wax. The protruding end is electrolytically covered with AgCl according to the indications given by JAHN<sup>1)</sup>.

A constant pressure above the liquid in flask  $F_1$  is obtained as follows: by means of a cycle foot-pump mercury can be pressed from the reservoir  $R_1$  into  $R_2$ ; the pressure thereby generated is read off on the open mercury manometer. As owing to the transferring of the liquid from  $F_1$  to  $F_2$  the pressure would diminish a little during the experiment, it is kept constant by means of the arrangement  $CD$  by turning the handle  $C$ .

The measurement of the potential differences between the electrodes  $E_1$  and  $E_2$  was carried out by the compensation method of POGGENDORFF-DU BOIS REYMOND. A galvanometer could not be used as a zero instrument because the strength of the current passing through the instrument is exceedingly small in consequence of the enormous resistance in the battery  $F_1F_2$ . Hence, a capillary electrometer ( $KEM$  in fig. 1) was used, which was fixed to the object table of an ordinary microscope; the axis of the microscope was, of course, placed horizontally. The readings were made using of an ocular-micrometer, objective  $4c$  (REICHERT) and HUYGENS ocular 1.

The following serves to further explain the figure.  $S_1$  is a key for cutting off the short circuit of the capillary electrometer;  $A$  indicates that this is connected with the earth. As working element are used one or more accumulators  $Acc$  whose tension was determined by comparison with a WESTON standard-cell, which was placed in a thermostat at 25° (WNE). By  $O$  the different current interrupters are indicated; by  $O_1$  the electrodes  $E_1$  and  $E_2$  can be brought into short circuit, which was always done during the time that no observations were made. By  $O_2$  the current of the working cell is twitched in;  $O_3$  annables to introduce at will one, two or four accumulators as a compensation battery.  $O_4$  renders it possible to take up in the circuit either the standard cell or the battery  $F_1F_2$ .

<sup>1)</sup> Zeitschrift f. physik. Chem. **33**, special page 556 (1900).

In order to protect the Ag-AgCl-electrodes from the light, the flasks  $P_1$  and  $P_2$  are externally coated with a film of red gelatin obtained by inserting them in a solution of gelatin to which a little eosine had been added and which had just started to gelatinise. Moreover, they were always protected from direct daylight.

3. *Method and preliminary experiments.* The measurements were made a few minutes after the pressure had set in. A number of measurements at different pressures were always made. When between two measurements the liquid had to be pressed back from flask  $P_2$  to flask  $P_1$  (for which at  $a$  the connection with the pressure arrangement could be broken off and an oil suction pump attached), no measurements were executed at suction pressure.

From GRUMBACH's experiments we notice that the value of the current potentials varies a little during the first days after the construction of a battery  $P_1P_2$ . I repeated one of his observations, also with the object of comparing the results obtained with his and my own apparatus.

Table I contains the results of a series of measurements carried

TABLE I.

$P$ cm mercury	$E$ millivolts	$\frac{E}{P}$	$P$ cm mercury	$E$ millivolts	$\frac{E}{P}$
11 March	$t = 14^\circ$		62.2	253	4.1
61.2	271	4.4	51.2	218	4.3
86.4	367	4.2		average	<b>4.1</b>
54.8	236	4.3	14 March	$t = 16^\circ$	
70.8	315	4.4	82.2	310	3.8
	average	<b>4.3</b>	85.2	323	3.8
12 March	$t = 13^\circ$		72.2	280	3.9
48.2	201	4.2	60.8	236	3.9
57.2	240	4.2		average	<b>3.9</b>
68.1	280	4.1	16 March	$t = 14^\circ$	
	average	<b>4.2</b>	86.2	341	4.0
13 March	$t = 14^\circ$		70.2	284	4.0
85.2	350	4.1	58.8	240	4.1
73.2	302	4.1		average	<b>4.0</b>

out with a solution of the concentration 1 m. Mol.  $KCl$  per Liter. The battery was filled March 11<sup>th</sup>. P indicates the pressure, E the current potentials.

From this we notice that the apparatus acted splendidly. The potential per cm. mercury pressure has each day a constant value, but varies the first two days. On the third day the terminal value is attained.

4. *Measurements.* In this paper a series of measurements is communicated, the object of which was to ascertain the influence of some solutions which differed in the valency of the cation. Therefore solutions of the chlorides of  $K'$ ,  $Ba''$ , and  $Al'''$  were used. As solvent was always used so-called "conductivity water". The very dilute solutions were made by diluting a standard solution. All measures used in this investigation were carefully calibrated or recalibrated.

In order to shorten the time of these tedious measurements they were all executed 20 hours after filling the cell. True, the constant terminal value is then not yet attained, but the difference is comparatively small and the error introduced is the same in all measurements. Moreover, the inaccuracy caused thereby is without influence on the tendency of the conclusions presently to be drawn, in itself a good reason for proceeding to this measure of enormous time saving. Moreover, several sets of flasks were used, in such a manner however that, for instance, all the  $KCl$  solutions were measured in the same set. Finally, the sets were compared mutually in which the solution of 100  $\mu$  Mol. (micromol =  $1/1000$  millimol)  $KCl$  p. L. served as comparison liquid. With both apparatus was found exactly the same value for the potential per unit of pressure.

In the subjoined tables, the concentrations in the first column are given in  $\mu$  mols. p. L.; in the second column is found the current potential  $E$  in millivolts per unit of pressure (cm. of mercury) under which the liquid was forced over. This value is always the mean of two or more measurements whose differences were of the order of those in Table I (generally much less than those).

When in the tables no sign is indicated at the potential value, the condition (as with pure water) is such that the electrode  $E_1$  in fig. 1 is negative. In the  $AlCl_3$  solutions a change of poles took place, hence the potentials following are indicated by +.

The results of the tables II to IV are represented graphically in fig. 2. Fig. 3 also gives the curve for  $AlCl_3$  on a larger scale.

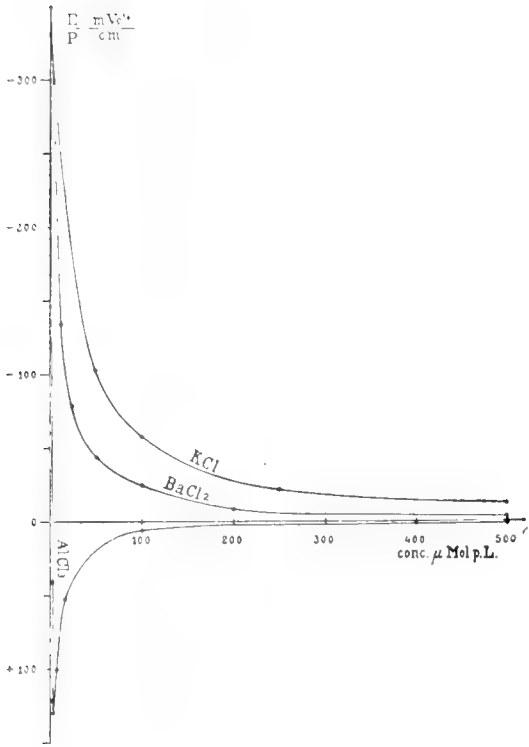

Fig. 2.

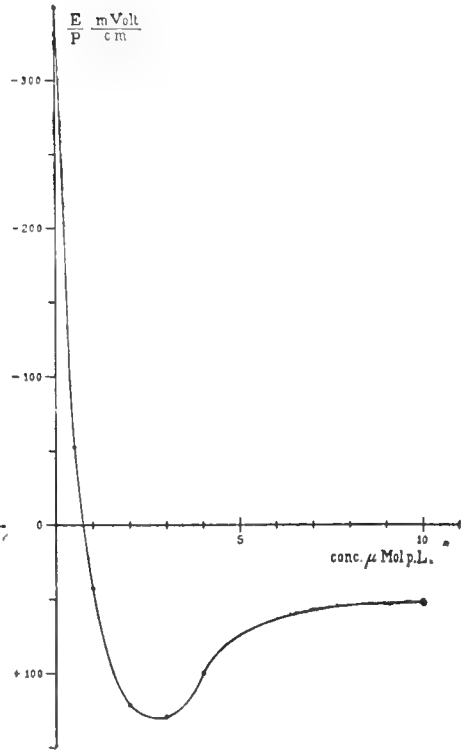

Fig. 3.

TABLE II

## KCl

Conc. in μMol p. L.	$\frac{E}{P}$
0	about 350
50	102
100	57
250	23
500	12
1000	4

TABLE III

BaCl<sub>2</sub>

Conc. in μMol p. L.	$\frac{E}{P}$
10	139
25	79
50	44
100	25
200	9
1000	1
40000	no exchange of poles

TABLE IV

AlCl <sub>3</sub>	
Conc. in $\mu$ Mol p. L	$\frac{E}{P}$
0	about 350
0.5	52
1	+ 42
2	+ 122
3	+ 129
4	+ 100
10	+ 52
100	+ 6
500	+ 1.4

5. On considering these results we notice, of course, first of all the great influence of the valency of the cation; as this gets higher the capillary gets more strongly discharged at an equal concentration. This had also been observed by ELISSAFOFF when measuring the electric endosmose and may be noticed with RIÉTY from his experiments with uni- and bivalent ions. The latter has observed a change of poles only once, namely with copper nitrate and that only at a high concentration<sup>1)</sup>. In the case of AlCl<sub>3</sub> about 0.8  $\mu$  mol. or about 0.1 mg. per liter appears to be sufficient to lower the current potential from about 350 mV. to zero. It seems remarkable that this charge reversal does not take place with BaCl<sub>2</sub> (see Table III) neither with ZnSO<sub>4</sub> or CuSO<sub>4</sub> (RIÉTY) nor with substances with a univalent cation.

Still more striking is the fact that according to ELISSAFOFF, the electro-endosmotic transport requires, in a glass capillary, 100 micromols of Al<sup>+++</sup> to be reduced to 0 without a reversal occurring, whereas the same investigator, although attaining the zero point, with a quartz capillary, at about the same concentration as required in our research [he found 1.6  $\mu$  mol.  $\frac{1}{2}$  Al<sub>2</sub> (SO<sub>4</sub>)<sub>3</sub>] could not even then notice a reversal of the transport direction. This creates the impression that

<sup>1)</sup> The exact concentration cannot be made out from his experiments. In any case, however, it lies above 900  $\mu$  mol p. L.

in that research secondary influences come to the fore; perhaps the powerful electric field in which the measurements are executed is not without influence on the capillary itself. Only the quadrivalent  $\text{Th}^{4+}$ -ion was capable of causing a charge reversal.

The results obtained here are in harmony with the general theoretical points of view. The electric double layer in the capillary, in the case of pure water consists of  $\text{OH}^-$ -ions at the side of the glass wall and  $\text{H}^+$ -ions at the side of the liquid in consequence of the selective ion adsorption of the glass wall which always adsorbs the  $\text{OH}^-$ -ion more strongly. From the electrolyte solutions the cations are absorbed more eagerly than the anions so that the charge gets lowered. If this adsorption for  $\text{KCl}$ ,  $\text{BaCl}_2$  and  $\text{AlCl}_3$  is such that solutions of the same molecular concentration are absorbed about equally, it is conceivable that the three times more active  $\text{Al}^{3+}$ -ion requires a much lesser concentration than the  $\text{K}^+$ -ion in order to attain an equal potential reduction.

If once the capillary is charged reversely the adsorption of the  $\text{Cl}^-$ -ion, which carries a charge now opposite to that of the capillary, seems to predominate. The positive charge now soon attains (at  $3 \mu$  mol.) a maximum value, and then decreases, but only slowly, because the discharging ion is univalent here.

In agreement with the theory are also the results of RIÉTY<sup>1)</sup>, for instance that the salt of a heavy metal has a stronger discharging action than that of a lighter one (Cu and Zn, at least in the small concentrations). A cation of a heavy metal is known to be adsorbed more strongly than that of a light one.<sup>2)</sup>

Moreover, the behaviour in the case of  $\text{CuSO}_4$  and of  $\text{Cu}(\text{NO}_3)_2$  is in agreement with investigations as to the adsorbability of those salts<sup>3)</sup>. The influence of the anions is also observable in RIÉTY's results and appears to have an effect corresponding with that in the case of  $\text{AlCl}_3$  just described.

The question whether the organic cations also behave according to the theoretical expectations is being considered. Several other solutions of electrolytes in water as well as in mixed solvents<sup>4)</sup> will be investigated.

*Utrecht*, June 1914.

VAN 'T HOFF-Laboratory.

1) l. c.

2) MORAWITZ, Koll. Beih. **1**, 301 (1910).

3) FREUNDLICH and SCHUCHT, Z. f. physik. Chem. **85**, 641 (1913).

4) Of these have also already been measured a few series in connexion with the researches of KRUYT and VAN DUIN, Koll. Beih. **5**, 269 (1914).

**Chemistry.** — “*Electric charge and limit value of Colloids*”. By Dr. H. R. KRUYT. (Communicated by Prof. ERNST COHEN).

(Communicated in the meeting of June 27, 1914).

1. The present conception as to the relative stability of the suspensoid system and the way in which it may be suspended has been developed according to the following train of thoughts.

HARDY <sup>1)</sup> and afterwards BURTON <sup>2)</sup> have undoubtedly established the fact that this relative stability falls and stands with the electric charge of the suspended particle. Indeed, the permanently suspended particle that exhibits a vivid BROWN'S motion, has a cataphoretic mobility of the order 2—4  $\mu$  per second and per  $\frac{\text{Volt}}{\text{c.M.}}$ ; if by addition of an electrolyte one diminishes the relative stability, this velocity also decreases and therefore, the electric charge of the particle has evidently decreased also. The “iso-electric” point, where that charge seems to have become zero, coincides with the moment of the smallest stability. Since the research of WHITNEY and OBER <sup>3)</sup> we know moreover, that with the repeal of the stability (the coagulation) is coupled a combination of the coagulating ion with the particles, and by FREUNDLICH'S <sup>4)</sup> researches we arrived at the knowledge that these phenomena are described quantitatively by the equation of the adsorption-isotherm.

From these elements is built up the theory that the particle owes its charge to the selective ion-absorption in its boundary layer and loses it by the selective adsorption of the oppositely charged ion of the coagulating electrolyte. As specific properties of the adsorbent are usually of but very subordinate influence on the order of the characterizing quantities in the adsorption, the action of diverse electrolytes on all capillary-electric phenomena ought to exhibit the same order, which the researches as to the electro-endosmotic phenomena compared with those of the coagulation of colloids have indeed confirmed.

It now occurs to me that the researches on the current potentials, particularly those which have been communicated in the preceding paper, are capable of furnishing us not only with a new proof of that equality of order, but also demonstrate that the influence which

<sup>1)</sup> Z. f. physik. Chem. **33**, 385 (1900).

<sup>2)</sup> Phil. Mag. [6] **11**, 425; **12**, 472 (1906) and **17**, 583 (1909).

<sup>3)</sup> Z. f. physik. Chem. **39**, 630 (1902).

<sup>4)</sup> Zeitschr. f. physik. Chem. **73**, 385 (1910) and **85**, 641 (1913).

electrolytes exert on the charge of a glass capillary is *quantitatively* the same as that exerted on the colloidal particle during the coagulation.

2. As regards the order of the ion-actions, it has been pointed out in the previous paper that the ions discharge more strongly, when their valency is higher and that the heavy metals exert more influence than the light ones of equal valency. It is well-known that the limit values for the coagulation of suspensoids just exhibit the same peculiarities.

3. In order to make a quantitative comparison it should be first observed that the limit values for KCl and BaCl<sub>2</sub> in the same sol. are generally in the proportion of about 60: 1. In contact with either of these solutions the charge of the particle thus gets equally diminished. We may, therefore also expect that the charge of a glass capillary will be lowered by a solution of KCl to the same extent as by the sixty times weaker BaCl<sub>2</sub> solution. Hence, when from the tables in the preceding paper we calculate the charge in concentrations of KCl and BaCl<sub>2</sub> in the said proportion, those should be equal if the idea as to the limit value just revealed is a correct one.

The calculation of the charge is possible according to the theory developed by HELMHOLTZ<sup>1)</sup>. The current potential is sequel to the electric double layer formed at the wall of the capillary and is related to the electric moment  $M$  as follows.

$$E = M \frac{\omega}{\eta} P \dots \dots \dots (1)$$

in which  $\omega$  represents the specific resistance and  $\eta$  the constant of the internal friction whilst  $P$  represents the pressure employed. For comparison purposes we can consider the electric moment of the double layer just as well as the charge  $\epsilon$  per unit of section, as it is in inverse proportion therewith.

We write equation (1):

$$M = \frac{E \eta}{P \omega}$$

If now we indicate the quantities relating to a BaCl<sub>2</sub>- solution with the index  $b$ , those relating to the 60 times more concentrated solution of KCl with the index  $k$ , then on the strength of the above considerations we must get

$$\left(\frac{E}{P}\right)_b \frac{\eta_b}{\omega_b} = \left(\frac{E}{P}\right)_k \frac{\eta_k}{\omega_k}$$

<sup>(1)</sup> Wied. Am. 7, 337 (1879).



As we only have in view very dilute solutions, we may put  $\eta_b = \eta_k$  (namely =  $\eta_{H_2O}$ ). From this follows

$$\frac{\begin{pmatrix} E \\ P \end{pmatrix}_b}{\begin{pmatrix} E \\ P \end{pmatrix}_k} = \frac{\omega_k}{\omega_b} \dots \dots \dots (2)$$

or in words: *the relation of the current potentials of two electrolyte solutions whose concentrations are related as in the limit values of colloids are inversely proportional to the specific resistances of those solutions.*

Meanwhile attention should be called to the fact that by limit values in this connexion we must not understand the concentration  $\gamma$  of the electrolyte added. From this a part is withdrawn by adsorption and hence, to the setting in end-condition appertains a lower concentration, which we will call  $\chi$ . In the experiments as to the current potentials we may probably identify the total concentrations with the equilibrium concentrations as the adsorbing surface (the glass walls) is so small: only in the case of the exceedingly weak  $AlCl_3$  solutions a doubt may arise. But in the colloid systems that difference may not be neglected. These  $\chi$ -values themselves

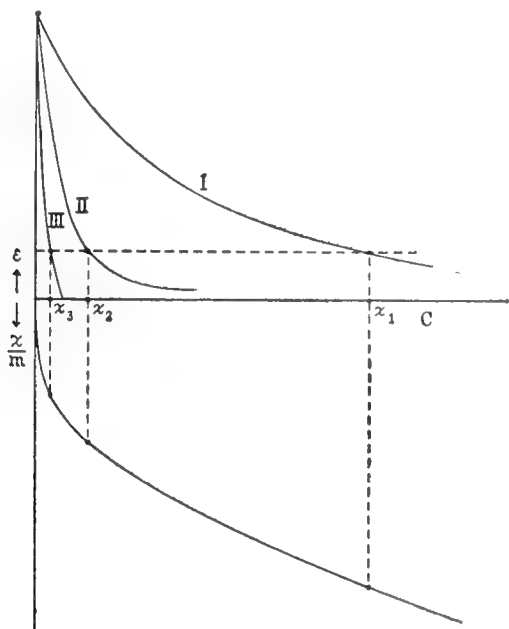

Fig. 1.1)

1) In Fig. 1 on the axis of coordinates should be read  $\frac{\sigma}{m}$  in stead of  $\frac{\chi}{m}$

have been determined only for  $\text{As}_2\text{S}_3$  <sup>1)</sup> and  $\text{HgS}_2$  <sup>2)</sup> and for electrolytes not used here.

The proportions are :

$$\begin{array}{l} \text{With } \text{As}_2\text{S}_3 \quad \chi_{\text{NiCl}_2} : \chi_{\text{UO}_2(\text{NO}_3)_2} = 82 \\ \text{,, } \text{Hg}_2\text{S} \quad \chi_{\text{NiCl}_2} : \chi_{\text{BaBr}_2} = 29. \end{array}$$

The proportion chosen 60 : 1 is, therefore, a rough approximation, but a comparison with  $\gamma$ -values of other sols (*Pt*, *Au* etc.) renders it probable that it represents the average.

The relations between charge, adsorption and limit value are elucidated schematically in the above figure. In the upper half of the figure is drawn the charge  $\epsilon$  of the capillary in dependence on the concentration of the traversing liquid, so that I, II, and III stand for uni-, di- and trivalent cations respectively. In the lower half is given, with the same concentration axis, the correlated adsorption of the electrolyte as a downward directed ordinate. If now  $\chi_1$ ,  $\chi_2$  and  $\chi_3$  indicate the relation of the limit values for uni-, di- and trivalent cations, respectively the correlated downward directed ordinates must show the proportion  $1 : 1\frac{1}{2} : 3$  and the upward directed ones *equal* values.

4. For verification of this relation appeared suitable :

(a) 10  $\mu\text{Mol}$   $\text{BaCl}_2$  — 600  $\mu\text{Mol}$   $\text{KCl}$ .

b) 25  $\mu\text{Mol}$   $\text{BaCl}_2$  — 1500  $\mu\text{Mol}$   $\text{KCl}$ .

It would not do to simply take the specific conductivity powers as being proportional to the concentrations because in the so strongly diluted  $\text{BaCl}_2$  solutions the conductivity power of water could not be neglected. Hence, I have made a direct measurement of the relation of the specific resistances by filling in WHEATSTONE'S bridge a vessel of arbitrary but fixed capacity with the liquids used.

The relation of these resistances was in the pair (a)

$$\frac{\omega_b}{\omega_k} = \frac{4630}{247} = 19$$

and in the pair (b)

$$\frac{\omega_b}{\omega_k} = \frac{2770}{99.9} = 28$$

The values of  $\frac{E}{P}$  are obtained from the research communicated in the preceding paper.

<sup>1)</sup> FREUNDLICH, Zeitschr. f. physik. Chem. **73**, 385 (1910).

<sup>2)</sup> FREUNDLICH en SCHUCHT, ibidem **85**, 641 (1913).

As the relation of the potentials for (a) we obtain  $\frac{1.39}{1.0}$  or **14**; as the relation of the resistances: **19**.

From the combination (b) we obtain for the potentials  $\frac{7.9}{3}$  or **26**, for the resistance **28**.

This agreement undoubtedly tells much in favour of the above mentioned theory. With concentrations somewhat larger than 60 the agreement might be better still.

**5.** The material of RIÉTY<sup>1)</sup> is only once suitable for testing the relation (2).

For so far his measurements have been executed with solutions of salts other than chlorides his measuring electrodes were non-reversible ones and his results are therefore useless for quantitative verification. I have only been able to find one combination of chlorides where concentrations have been measured which are comparable with limit values: they are KCl and HCl. For  $\text{As}_2\text{S}_3$ -sol these limit values have been determined to 50 and 31 mMol p. L. respectively<sup>2)</sup>.

Now from his experiments RIÉTY has calculated the potential at the capillary wall in certain units for 0.01 n. KCl as **3.1**. We can use this figure again for comparison purposes as it is directly proportional to the charge.

In the case of HCl he determined for 0.005 n : 3.39, for 0.010 n : 2.8. For the comparison with 0.01 n HCl we must know the potential at the concentration  $\frac{3.1}{5.0} \times 0.01 = 0.0062$ . This, I have interpolated by assuming that the logarithms of the potentials are directly proportional to those of the concentrations, after I had first convinced myself that this interpolation<sup>3)</sup> formula was quite satisfactory in the longer series stated in RIÉTY's paper. We then find **3.2** which is again a splendid agreement.

**6.** Quantitative comparisons with the trivalent cation are difficult to draw, because the  $\chi$ -values thereof are either not known or uncertain. From the treatises cited on p. 648 we, however, get the impression that the  $\chi$ -values diverge very little from zero, as is also expected from Table IV of the preceding communication, because a complete discharge takes place already at a concentration of 0.8  $\mu$  mol.

**7.** A no less striking parallelism between charge and limit value

<sup>1)</sup> Ann. de chim. et de phys. [8], **30**, 1 (1913).

<sup>2)</sup> FREUNDLICH, Kapillarchemie (Leipzig 1909) Table 81. True, those are  $\gamma$ - and not  $\chi$ -values, but with these univalent ions, this cannot have any serious influence.

<sup>3)</sup> To this formula should only be attached the significance of an interpolation formula.

is furnished by the shape of the curve found for the current potential with  $\text{AlCl}_3$  solutions. This line is absolutely connected with the so-called *irregular series*.

From what is stated in § 3 in connection with Table IV (fig. 3, respectively) of the preceding paper it follows that the concentration at which the battery shows an exchange of poles, is also that of the zero-charge of the capillary, whilst its positive charge goes up to about  $3\mu$  mol. and thence lowers without however reaching zero again. An  $\text{AlCl}_3$  solution will consequently have first a discharging and therefore a coagulating effect on a negative sol.; at higher concentrations it will render it a positive sol and only at a much higher concentration it will again reverse the charge and cause coagulation. But therewith are described exactly the phenomena which, for instance, have been observed by BUXTON and TAEGUE<sup>1)</sup>, when they coagulated mastix with  $\text{AlCl}_3$  and indigo or Pt with  $\text{FeCl}_2$ . The lower non-coalescent, the lower coalescent zone, the upper non- and coalescent zones, they can so to say be read off from the figures of the preceding communication.

One is accustomed to attribute the phenomenon of the irregular series to a special action of the hydrolytically resolved hydroxides of the coagulating ion. In connection with the preceding arises a doubt whether to  $\text{Al}(\text{OH})_3$  ought really to be attributed a preponderating significance. For it does not seem probable that the  $\text{AlCl}_3$  which is present in such a small concentration, can cause a reversal of charge in the capillary. Much more acceptable seems the following idea. A strongly discharging cation unloads the capillary at *such* a small concentration that the small anion-concentration cannot prevent a complete reversal of charge. Of this the anion-concentrations are capable in the case of  $\text{Ba}^+$  and  $\text{K}^+$  because there the charge gets nearer the zero value only at so much larger concentrations.

Hence, the afterzone phenomenon will occur, as soon as the discharge by the cation is already very large at small concentrations and is favoured by a feeble action of the anions. This strongly discharging action of the cation may arise from its higher valency or from its strong adsorbability. The fact that irregular series were observed, for instance, also with strychnine nitrate, new fuchsin, brilliant-green, auramine and silver nitrate<sup>2)</sup> is quite in harmony with this argument. For here we are dealing with strongly adsorbable cations and because they are univalent the equivalent anion

<sup>1)</sup> Z. f. physik. Chem. **57**, 64 (1907).

<sup>2)</sup> FREUNDLICH, l. c.

concentration present is still proportionately three times less than with  $\text{AlCl}_3$ .

A start has already been made with investigations to get a proper insight, particularly in this question of the irregular series.

8. Finally it should be pointed out that the previous considerations also give an explanation of the fact often stated by us that in the case of Al-salts we can determine the limit value much more accurately than with salts of uni- or bivalent metals. Two tubes with  $\text{As}_2\text{S}_3$  sol. which contain Al in concentrations situated 1% above and below the limit value, respectively exhibit after shaking a quite clear and a turbid fluid respectively. In the case of bivalent cations we must, so as to make quite sure, take the difference somewhat larger and very much so for a univalent ion. It is self-evident that the cause lies in the fact that  $\frac{d\varepsilon}{dc}$  ( $\varepsilon$  charge,  $c$  concentration of coalescing ion) for  $\text{Al}^{+++}$  is  $>$  for  $\text{Ba}^{++}$  and this again  $>$  for  $\text{K}^+$ .

*Utrecht*. June 1914.

VAN 'T HOFF-Laboratory.



KONINKLIJKE AKADEMIE VAN WETENSCHAPPEN  
TE AMSTERDAM.

PROCEEDINGS OF THE MEETING  
of Saturday October 31, 1914.

VOL. XVII.

*President:* Prof. H. A. LORENTZ.  
*Secretary:* Prof. P. ZEEMAN.

(Translated from: Verslag van de gewone vergadering der Wis- en Natuurkundige  
Afdeling van Zaterdag 31 October 1914, Dl. XXIII).

C O N T E N T S.

- G. VAN RIJNBEEK: "On the nerve-distribution in the trunk-dermatoma." (Communicated by Prof. C. WINKLER), p. 632.
- ERNST COHEN and W. D. HELDERMAN: "The Allotropy of Cadmium" IV, p. 638.
- ERNST COHEN and W. D. HELDERMAN: "The Allotropy of Zinc." III, p. 641.
- ERNST COHEN and J. C. VAN DEN BOSCH: "The Allotropy of Antimony", I, p. 645.
- A. P. N. FRANCHIMONT and H. J. BACKER: "The Coloration of some derivatives of Picrylmethylamide with alkalies", p. 647.
- A. P. N. FRANCHIMONT and H. J. BACKER: "z-Sulpho-propionic acid and its resolution into optically active isomerides", p. 653.
- Miss H. J. FOLMER: "A new electrometer, specially arranged for radio-active investigations." Part I. (Communicated by Prof. H. HAGA), p. 659.
- A. SMITS: "The metastable continuation of the mixed crystal series of pseudo-components in connection with the phenomenon allotropy". II. (Communicated by Prof. J. D. VAN DER WAALS). p. 672.
- A. SMITS and S. C. BOKHORST: "On the vapour pressure lines of the system phosphorus". II. (Communicated by Prof. J. D. VAN DER WAALS), p. 678.
- A. SMITS and A. H. W. ATEN: "The application of the theory of allotropy to electro-motive equilibria." III. (Communicated by Prof. J. D. VAN DER WAALS), p. 680.
- P. E. C. SCHEFFER: "On gas equilibria, and a test of Prof. VAN DER WAALS Jr.'s formula". I. (Communicated by Prof. J. D. VAN DER WAALS), p. 695.
- W. REINDERS: "Equilibria in the system Pb—S—O; the roasting reaction process". (Communicated by Prof. S. HOOGWERFF), p. 703.

**Physiology.** — “*On the nerve-distribution in the trunk-dermatoma*”.

By Prof. G. VAN RIJNBEEK. (Communicated by Prof. C. WINKLER).

(Communicated in the meeting of September 26, 1914).

We know as a result from the researches on the segmental skin-innervation, made after the method of the so called “remaining aesthesia”, first introduced by SHERRINGTON, that from a definite zone on the skin (the dermatoma or root-area) stimuli may reach the spinal cord along each separate dorsal root of the spinal cord. Such investigations, however, do not teach us anything about the manner in which the sensibility in each of these root-areas is provided for by the peripheral cutaneous nerves. A few experiments made on dogs have enabled me presently to offer the following conclusions concerning exclusively the dermatomata of the trunk.

In a dissertation by O. NÄHRICH<sup>1)</sup>, written under the direction of ELLENBERGER, the nerves providing the skin of the dog are described with elegant accuracy. It is shown therein, that the skin of the

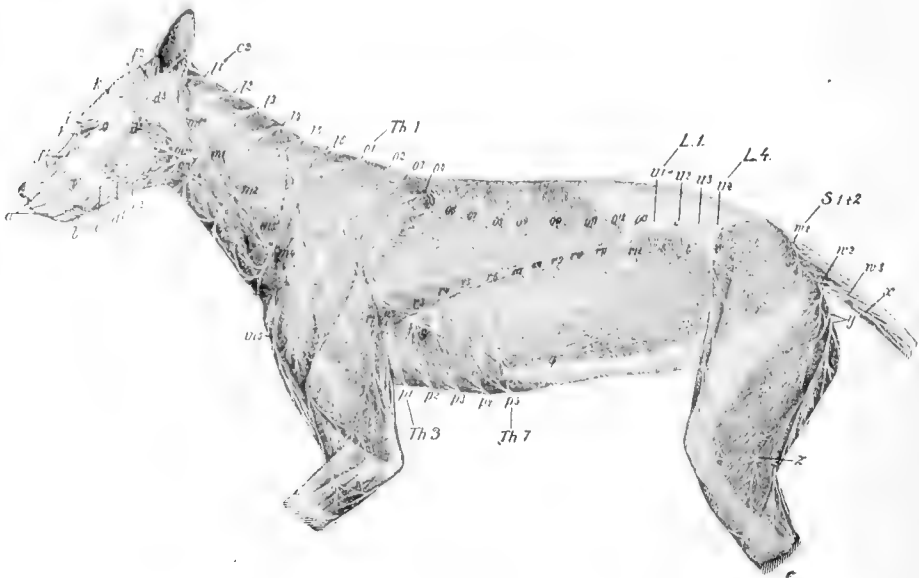

Fig. 1. Cutaneous nerves of the dog, according to NÄHRICH. — O1 = Th. 1, first thoracic nerve, dorsal branch. r1 = first thoracic nerve, lateral branch. r1 = Th. 3, third thoracic nerve, ventral branch, u1 = L. 1, first lumbar nerve, dorsal branch, q = nerve of the large subcutaneous muscle.

<sup>1)</sup> O. NÄHRICH. Die Gefühlsbezirke und die motorischen Punkte des Hundes. Ein Beitrag zur vergl. Anatomie und Physiologie. Inaug. Diss. Zürich 1907.



trunk is innervated by means of the perforating branches of the intercostal and lumbar nerves.

If Th. 3 is taken to be the most cranial and L. 4 to be the most caudal nerve of the trunk, it will be found that from Th. 3 to Th. 7 each nerve-root is sending three perforating branches to the skin: a dorsal, a lateral, and a ventral branch. The dorsal nerve-trunk generally supplies two main branches: a medio-dorsal and a dorso-lateral one. The lateral nerve invariably supplies two branches: a latero-dorsal and a latero-ventral branch. The ventral nerve-trunk usually consists of one main trunk, which may be said to be medio-ventral. From Th. 8 to L. 4 the medio-ventral branches are wanting: their place is taken by the latero-ventral ones.

The different points, where the dorsal, lateral, and ventral nerves enter into the skin, may be interconnected by lines. This having been done, it becomes evident that the dorsal branches, going in a cranial-caudalward direction, perforate the fascia continually at a greater distance from the mid-dorsal line, whilst the lateral trunks on the contrary come forth more dorsalward. A correct insight into the relations of these nerves is offered by Fig. 1. From Fig. 2 it may be seen moreover, that the skin of the trunk can be divided, according to a superficial scheme, into three zones as regards its peripheral nerves: a dorsal, a lateral, and a ventral zone.

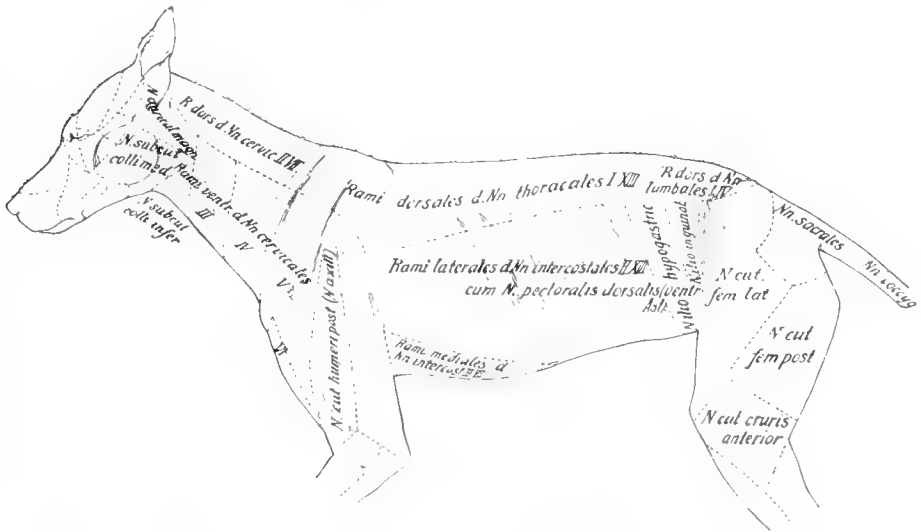

Fig. 2 Extension-zones of the dorsal, lateral, and ventral nerve-branches of the skin of dogs, according to NÄHRICH.

1. The first question I now put to myself was the following: are the perforating dorsal, lateral, and ventral trunks, which belong when

prepared macroscopically, to one intercostal resp. to one lumbar nerve, unisegmental or pluri-segmental nerve-canals. For whilst it is admitted almost generally that the intercostal nerves are unisegmental courses, EISLER<sup>1)</sup> believes he has sufficient grounds for stating that delicate nerve-plexus, situated on the inside of the ribs always connect two intercostal nerves. This being so, an interchange would occur here between nerve-fibres of a different segmental origin. Concerning the nerve-distribution of the root-areas, this question may be formulated as follows: Do the nerve-fibres of each separate dorsal root of the spinal cord reach the skin-area belonging to that root along one single dorsal lateral or ventral perforating nerve-trunk, or along several ones?

In order to solve this question, I made the following experiment. After the afore mentioned method of SHERRINGTON, the dorsal (and ventral) spinal nerve root of a segment on one side of the spinal cord of some dogs was "isolated", usually between three cranial and as many caudal roots, which were cut through extradural. This being done, the isolated root-area, corresponding to the isolated root, was demarcated against the two insensible zones, corresponding to the sectioned roots. Situation, form and extension of the sensible root-area once being well defined, the skin was entirely cleft both in the cranial and in the caudal insensible zone by a slit passing from the mid-dorsal to the mid-ventral line. This of course could be done without narcosis. Immediately after this, a search was made for the perforating skin-nerves, and at least three successive ones of these in cranio-caudal direction, in the dorsal, lateral, and ventral skin-area, were prepared free, as much as possible avoiding any lesion of them. Next to this, by means of the induction-current, these nerves were stimulated to ascertain whether they conducted painstimuli. Invariably the result was, that for each skin-area such was only the case with these branches that belonged to one point of entrance. Irritation of the other branches, even with the strongest induction currents (the bobbin being entirely pushed in), never produced any symptom of pain, if slippings of the current were avoided. This result was wholly confirmed by a contra-experiment. If, after careful determination of the dorsal, lateral and eventually ventral branches, which were conductors of pain-stimuli, these branches were cut through, the sensibility in the isolated root-area proved to be destroyed entirely and irrevocably.

---

<sup>1)</sup> P. EISLER. Ueber die Ursachen der Geflechtbildung an den peripheren Nerven. Verh. d. Anatom. Gesellsch. a. d. 16e Vers. in Halle, 1902. S. 200.

Thus it results that the trunk-skin of the dog forwards its stimuli, destined for a definite segment of the spinal cord, only by means of one set of peripheral skin-nerves. This means that in those nerves only fibres belonging to one posterior root have their course, and that consequently the perforating skin-branches are segmental nerve-canals.

II. A second question, necessarily presenting itself, is the following one: what separate portion within the dermatoma is innervated by either the dorsal or the lateral (ventral) peripheral branches?

To investigate this, the above-mentioned method was partially repeated once more. With dogs, where a nerve-root had been isolated, the peripheral branches entertaining its sensibility were sought for and prepared free. After this the conduction was successively interrupted, either provisorily or lastingly, in one or more of these branches. To obtain a lasting interruption of the conduction, the branch was cut through. For a provisory interruption the branch was enfolded by a piece of cottonwool, drenched in a 5% solution of stovaine. The conduction once interrupted, the root-area was tested to ascertain whether a portion of it had become insensible, and if so the confines of the insensible area found in this manner were determinated.

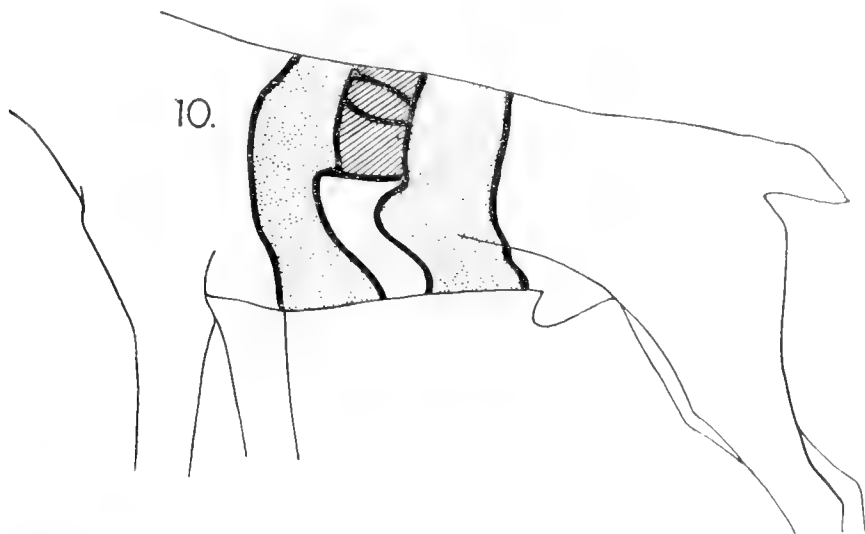

Fig. 3. On a dog a root-area (Th. 10) has been isolated between two insensible zones. After this, three cutaneous branches belonging to the dorsal perforating nerve-trunk, are successively cut through. The dotted portion of the root-area then becomes successively insensible, until finally the whole of its dorsal part has lost sensibility.

*a.* Interruption of the conduction in the joint dorsal cutaneous branches.

After this operation the entire dorsal portion of the isolated dermatoma was found to have lost sensibility. To make the ventral demarcation of the area that has been made insensible in this way rightly understood, I may add the following: For a long time I had been struck by the fact that after a carefully performed root-isolation, the demarcation-lines of the isolated root-areas showed at a definite point a distinct bent. The origin of this bent is, that at some distance from the mid-dorsal line of the body, both the cranial and the caudal demarcation lines of the root-area, change their direction somewhat cranialward. In the cranial demarcationline this bent is always found a little more dorsalward than in the caudal demarcationline. Now it is remarkable, that the ventral limit of the insensible zone, originated by the sectioning of the dorsal nerve-branches, is invariably found to be a straight line, connecting the cranial with the caudal limit just above this bent. This line therefore goes in a cranio-caudal direction. At the same time however it deviates slightly in a dorso-ventral direction. Consequently the latero-ventral nerves supply within the root-area the innervation of a zone extending to a point somewhat above the alleged bent in its demarcation-lines.

*b.* If the conduction is interrupted in the joint latero-ventral branches, the entire ventral portion of the root-area becomes insensible.

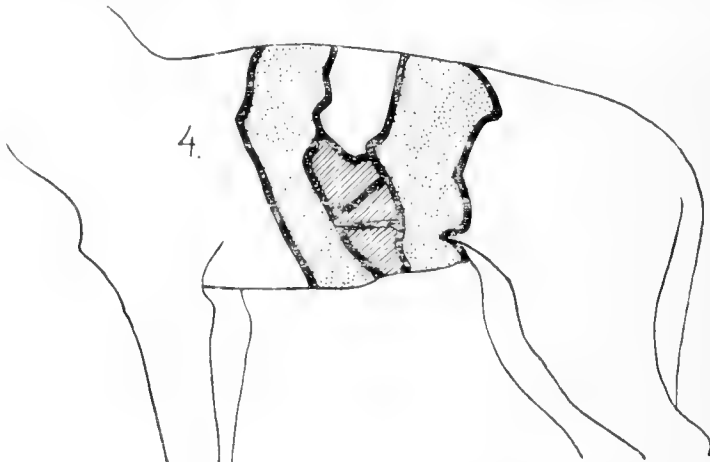

Fig. 4. The same as in Fig. 3, only for branches of the latero-ventral trunk. (The isolated root-area is probably in the main Th. 12. Its closer definition was neglected in the necropsy.)

If we compare the demarcationline found in this way, with that found after interrupting the conduction in the dorsal branches, it becomes evident that the ventral boundary of the dorsal area does

not coincide exactly with the dorsal boundary of the ventral area, but that a reciprocal overlapping occurs, although it be only a slight one. It is shown thereby that the bent, found in the demarcationline of the root-area, is situated exactly at the point where the dorsal and latero-ventral portions of the dermatoma meet. The cranial direction of this bent indicates that the latero-ventral portion must be lying somewhat more cranialward than the dorsal one. This fact has been stated previously by BOLK<sup>1)</sup>, when he found in 1897 a "discrepancy" of the dorsal and ventral dermatoma-areas on the human trunk. In the experimentally defined dermatoma this discrepancy finds its expression in the alleged "bent". Similar conditions have been observed clinically by EICHHORST<sup>2)</sup>, after transversal lesions of the spinal cord in the trunk-area.

c. Interruption of the conduction in separate minor branches of the dorsal and latero-ventral nerves.

The conduction may be interrupted in the separate minor branches of the perforating nerves as well in the dorsal as in the latero-ventral portion of the root-area. When this operation has been performed it becomes evident, as long as only the larger branches were subjected to it, that each of these supplies the innervation of a small zone, extending equally into the cranial and into the caudal boundary of the root-area, and for the rest demarcated by lines going in a cranio-caudal direction. The whole root-area therefore is divided into a series of small areas, lying alongside of one another in dorso-ventral direction. The skin-area of the medio-dorsal branch adjoins the mid-dorsal line, the dorso-lateral branch on the other hand extends over an area, adjacent to the lateral portion of the dermatoma, more ventralward than that of the medio-dorsal branch. A similar ordination is found likewise to exist for all skin-areas corresponding to the various latero-ventral branches.

Whenever very thin branches are cut through, either no insensibility ensues, or else an irregularly insensible spot is found somewhere within the root-area. From the fact that in many cases, after the sectioning of such small branches, no insensibility is found, we may conclude that the areas of extension of the separate branches of the cutaneous nerves must overlap one another to a certain degree. I have not been able however to determine the extension of these overlappings.

<sup>1)</sup> L. BOLK, A few data from the segmental anatomy of the human body. Ned. Tijdschrift v. Geneeskunde. 1897. I p. 982—995, and 1897. II. p. 365—379. (Compare especially p. 365 et seq.).

<sup>2)</sup> H. EICHHORST, Verbreitungsweise der Hautnerven beim Menschen. Zeitschr. f. Klin. Medicin. Bd. XIV. S. 519. Berlin 1888.

III. Finally my attention was given to the nerve of the subcutaneous muscle. NÄHRICH <sup>1)</sup> testifies that by irritation of this nerve, in addition to contraction of the cutaneous muscle, also pain-symptoms are brought forth, whilst after the sectioning of this nerve, the sensibility of the skin had diminished. I have not been able to verify this latter fact. It is not to be doubted moreover that e.g. an isolated root-area, if either the isolated root or the peripheral branches have been cut through, becomes entirely and completely insensible, whilst the nerve of the cutaneous muscle remains intact. It is therefore probable that this nerve does not contribute to the sensibility of the skin. Nevertheless I can confirm the statement of NÄHRICH, that after its having been cut through, irritation of the central end proves painful. It may be that the muscular sensibility plays a part in producing these symptoms of pain.

**Chemistry.** — “*The Allotropy of Cadmium.*” IV. By Prof. ERNST COHEN and W. D. HELDERMAN.

(Communicated in the meeting of September 26, 1914).

*The electromotive behaviour of Cadmium. II.*

1. Up to the present we have only directed attention to the electromotive behaviour of  $\alpha$ - and  $\gamma$ -cadmium; the  $\beta$ -modification has not been mentioned hitherto. It will be treated in the following lines.

2. It may be remembered that a number of cells constructed according to the scheme:

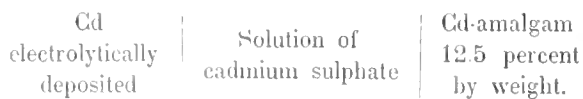

had an E.M.F. of 0.050 Volt at 25°.0, whilst the E.M.F. of others was only 0.047 Volt at the same temperature. (The cells were reproducible within 0.5 millivolt).

3. Now we were struck by the fact that when constructing a large number of these cells we often got cells which had an E.M.F. of 0.048 Volt at 25°.0.

The E.M.F. of cells which originally had an E.M.F. of 0.050 Volt at 25°.0, spontaneously *decreased* till the value 0.048 Volt was reached. After this their E.M.F. remained constant.

4. The conclusion was plain that the cells giving 0.048 Volt might

<sup>1)</sup> L. c. p. 95—96.

contain  $\beta$ -cadmium, those giving 0.047 Volt  $\alpha$ -cadmium, whilst those giving 0.050 Volt have  $\gamma$ -cadmium as a negative electrode.

5. If this were really the case, it would be possible to construct a transition cell by combining a cell with  $\alpha$ -cadmium with one containing  $\beta$ -cadmium; the E.M.F. of this combination would be zero at the transition temperature of the change  $\alpha$ -cadmium  $\rightleftharpoons$   $\beta$ -cadmium.

6. However it is impossible to carry out an exact determination of the transition point in this way, as the E.M.F. of the combination is (at 25°.0) only  $(0.048 - 0.047) = 0.001$  Volt and the reproducibility of each of the cells is only 0.5 millivolt.

7. In order to ascertain if the E.M.F. of the  $\beta$ -cells has a real significance, experiments may be carried out on the following lines:

At temperatures above the transition point of the change  $\alpha$ -cadmium  $\rightleftharpoons$   $\beta$ -cadmium (which we found in the neighbourhood of 60° by dilatometric measurements) the E.M.F. of  $\alpha$ -cells must be higher than that of  $\beta$ -cells. After cooling the cells below the transition point mentioned, the contrary will occur.

8. Our experiments in this direction were carried out in the following way:

We constructed a large number of HULETT cells<sup>1)</sup>; one of these, the E.M.F. of which had been originally 0.050 Volt at 25°.0, had an E.M.F. of 0.047 Volt (at 25°.0) after having been kept for 4 weeks at 47°.5. After this time it remained constant.

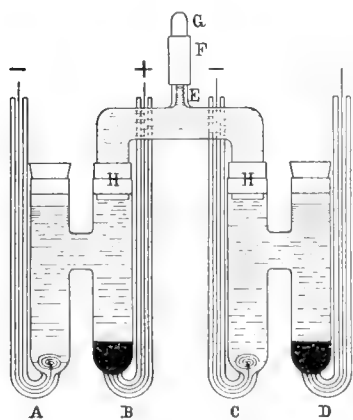

Fig. 1.

will at 25°.0 or 64°.5.

9. We measured the E.M.F. between the cadmium which had been electrolytically deposited on the platinum spirals A and C

We combined this cell (N°. 7) with another one (N°. 22) the E.M.F. of which was 0.048 Volt at 25°.0. The two cells AB (N°. 7) and CD (N°. 22) were connected by a siphon H, which contained *the same* solution of cadmium sulphate as was present in the cells. (Fig. 1).

The lateral tube E of the siphon was closed by a rubber tube F, in which was put a glass rod G. The little apparatus was brought into a thermostat which could be kept at

<sup>1)</sup> Proceedings 17, 122 (1914).

against the *common* amalgam electrode B. (12.5 % by weight). It is absolutely necessary to use a *common* electrode as the cadmium amalgam of 12.5 percent by weight does not form a heterogeneous system at 64°.5; its E.M.F. is then a function of its composition. The use of the *two* amalgam electrodes B and D might give rise to serious mistakes, if there were only small differences in their composition.

The *absolute* E.M.F. of our amalgam electrode against cadmium in A and C does not play any role in our measurements.

10. The determinations of E.M.F. were carried out by the POGENDORFF compensation method. The resistances used, had been checked by the Physikalisch-Technische Reichsanstalt at Charlottenburg—Berlin. The same was the case with the thermometers used. Our two standard elements (WESTON) were put into a thermostat which was kept at 25°.0. We used as a zero instrument a DEPPEZ-D'ARSONVAL galvanometer, which was mounted on a vibration-free suspension (JULIUS). The readings were made by means of a telescope and scale; 0.02 millivolt could easily be measured.

The determinations were continued during several days, until the E.M.F. of the cells had become constant.

Our table I shows the results.

T A B L E I.

Temperature 25°.0.	
E.M.F.	
Cell 7	0.04741 Volt
Cell 22	0.04815 „
Temperature 64°.5	
Cell 7	0.04029 Volt.
Cell 22	0.03979 „

After having brought the cells to 25°.0, we found:

Cell 7	0.04741 Volt.
Cell 22	0.04806 „

The table shows that at 64°.5 there has taken place an inversion of the poles and that the cells regain their original E.M.F. at 25°.0.

A second experiment with two cells (n°. 4 and 8) newly constructed, gave the following results:



TABLE II.

	Temperature 25°.0,
	E.K.
Cell 8	0.04757 Volt
Cell 4	0.04839 „
	Temperature 64°.5.
Cell 8	0.04737 Volt
Cell 4	0.04633 „

After having brought the cells to 25°.0, we found:

Cell 8	0.04776 Volt
Cell 4	0.04789 „

11. From table II it may be seen that we are here at the limit of measurement obtainable in working with cells of so small an E.M.F. the reproducibility of which is 0.5 Millivolt.

12. From the inversion of poles which has been observed, we may conclude that the value 0.048 Volt at 25°.0 really has significance and is to be attributed to the presence of  $\beta$ -cadmium.

13. As to the bearing of the existence of different modifications of cadmium on the E. M. F. of the standard cell of WESTON, we refer to our paper "On the Thermodynamics of standard cells" (sixth communication), published some months ago<sup>1</sup>).

Utrecht, September 1914.

VAN 'T HOFF-Laboratory.

**Chemistry.** — "*The Allotropy of Zinc.*" III. By Prof. ERNST COHEN and W. D. HELDERMAN.

(Communicated in the meeting of September 26, 1914).

1. In our first communication on the allotropy of zinc<sup>2</sup>), we summarized the earlier literature on this subject as follows: as long as half a century ago various investigators tried to solve the problem whether zinc might be capable of existing in different allotropic modifications. As late as 1890 LE CHATELIER proved that this metal does really show a transition point in the neighbourhood of 350°. MÖNKEMEYER found this point at 321°, BENEDICKS at 330° (melting point of pure zinc 419°.4) whilst the measurements of MAX WERNER

<sup>1</sup>) *Chemisch Weekblad* **11**, 740 (1914). This paper will be published before long in the *Zeitschr. f. physik. Chemie.*

<sup>2</sup>) *Proceedings* **16**, 565 (1913).

(who found 300°), published some weeks ago, agree sufficiently with those of LE CHATELIER. We shall discuss in a subsequent paper the differences which exist amongst the results of the investigators mentioned above. Whilst BENEDICKS mentions a second transition point (at 170°), MAX WERNER was unable to find this point. The question as to whether it really exists or not, may be left open for the moment.

2. Since writing the above we became acquainted with the paper of LE VERRIER<sup>1)</sup>, which has been summarized by one of us<sup>2)</sup>. LE VERRIER found that the specific heat of zinc varies greatly between 100 and 140° and that there occurs an absorption of heat within this interval of temperature of 0—8 calories. This result indicates that there exists here a transition point. Mr. G. DE BRUIN is carrying out a systematic investigation in this direction.

3. BENEDICKS and RAGNAR ARPI have recently published<sup>3)</sup> a new investigation of this subject. In his first paper BENEDICKS pointed out that "bezüglich der Frage, ob die für das Zinc. puriss. MERCK (garantiert frei von Eisen und Arsen in Stäben) gefundenen Angaben auch für das absolut reine Metall gelten, bedarf es ebenfalls weiterer Versuche".

That there was no reason to suppose that this sample contained impurities may be concluded from the authors' words: "Jedoch ist es im Hinblick auf die Wichtigkeit der Reinheit dieses Produktes für seine Verwendung für analytische Zwecke sehr wahrscheinlich, dass die Menge von Fremdkörpern zu vernachlässigen ist".

4. However BENEDICKS writes in his most recent paper: "Es ist deshalb hier eine Revision der einschlägigen Verhältnisse vorgenommen worden, die zu ziemlich unerwarteten Ergebnissen geführt hat. Nämlich, dass überhaupt keine Allotropiebeweise für Zink z. Z. vorliegen". He adds: "Abgesehen wird dabei zunächst von derjenigen Andeutung von Allotropie, die neuerdings von E. COHEN und W. D. HELDERMAN durch spez. Gewichtsbestimmungen gefunden wurde". We shall revert to this point later.

5. The method followed by BENEDICKS and ARPI to discover possible transition points was the same as used formerly by BENEDICKS, viz. the determination of the electrical conductivity of the metal at different temperatures.

Whilst he found in his first determinations (working with zinc. puriss. MERCK) transition points at 170° and 330° respectively, he was not able to find them when he used "Zinc KAHLBAUM" which

<sup>1)</sup> C. R. **114**, 907 (1892).

<sup>2)</sup> ERNST COHEN, Proceedings **17**, 200 (1914).

<sup>3)</sup> Zeitschr. f. anorg. Chemie **88**, 237 (1914).

only contained 0,0047% of Cd., 0,0033% of Pb., 0,00045% Fe, Cu).

But working with the same material to which 0.52 per cent by weight of Cd, resp. 0,5 per cent of Pb. or 0,5 per cent of Cd+0,5 per cent of Pb had been added, he found several transition points which grosso modo agreed with those found formerly by BENEDICKS a.o. On account of these results BENEDICKS and ARPI conclude that the transition points found by BENEDICKS in his first investigation are to be attributed to impurities in the metal used and that zinc which is pure does *not* show transition points.

6. In the first place it may be pointed out that the curves which form the basis of the authors' conclusions, are so roughly defined, that it is almost impossible to conclude anything from them. For example, from a consideration of the curve 2 in Fig. 2 (which refers to pure zinc), one might arrive at the conclusion that a break<sup>1)</sup> exists at 150°.

7. However, a more serious objection to the method followed, may be pointed out. Our recent investigations on the allotropy of metals have shown that the changes in these substances take place very slowly even at high temperatures. These retardations can only be removed by special means (inoculating in contact with an electrolyte, repeated changes of temperature etc.). We may call to mind the fact that we were able to heat cadmium 95 degrees above one of its transition points without any changes occurring. It will be necessary to give special attention in future to these phenomena, which play also a role in "thermal analysis" and which may falsify its results.

BENEDICKS and ARPI did not make any provision to eliminate these phenomena. On account of what we know now about these hysteresis phenomena it was to be expected that any transition point, if it really existed, would only be found under favourable circumstances, or by a systematic elimination of the retardations mentioned above.

8. Moreover it may be pointed out that BENEDICKS and ARPI *made the supposition* "dass die betreffenden Metalle nicht genügend rein waren" (viz. the zinc, puriss. MERCK, used by BENEDICKS in his first investigations and by LE CHATELIER among others). We think that the opinion put forward by BENEDICKS in his first paper (see above § 3) "dass die Menge von Fremdkörpern zu vernachlässigen ist", is the just one. As we were told by Messrs. MERCK at Darmstadt their "Zinc. puriss. MERCK (garantiert frei von Eisen und Arsen in Stäben)" contains only small traces of cadmium. We carried out an analysis of this material

<sup>1)</sup> Whether this point really exists or not may be left open for the moment.

following the method described by MYLIUS<sup>1)</sup>). In 100 gr. of this metal we could only detect small traces of cadmium (lead and iron). We think that the explanation of B. and A. which is based on the presence of large amounts of impurities falls to the ground.

9. That it is not the presence of foreign substances which give rise to the strongly marked change of the mechanical properties of zinc at higher temperatures (which fact has been the starting point of BENEDICKS' investigations) is evident from the fact, that this change may also be observed in the purest zinc (Zink "Kahlbaum", comp. § 5). We have been able to confirm this result repeatedly ourselves.

10. Finally some remarks, made in a note by BENEDICKS and ARPI may be considered here.

In the first place they believe, on account of an investigation concerning the quenching velocities of metals, carried out by BENEDICKS<sup>2)</sup>, that "eine besonders grosse Abkühlungsgeschwindigkeit nicht zu erzielen ist" when the method is followed which we used. (1 kilo of zinc was chilled in a mixture of solid carbide dioxide and alcohol). It may be pointed out that the velocity we used has been greatly exaggerated; we got the same results by using water or air of room temperature. We also carried out some experiments with carbon dioxide and alcohol in order to vary the external conditions of our experiments as much as possible. In our researches on the allotropy of copper and cadmium we also used water or air as a cooling medium.

11. Secondly BENEDICKS and ARPI raise the question as to whether there has not taken place an "Auflockerung der Oberfläche" of our preparations when we washed them with dilute hydrochloric acid. By this operation a change of density might have occurred.

They have however overlooked two facts: in the first place the recent investigations of JOHNSTON and ADAMS<sup>3)</sup>, which prove that the density of any substance is *independent* of its state of division. Moreover they have not taken into account the results of our investigations on cadmium<sup>4)</sup>, where the same difficulties would have occurred. The reproducibility and reversibility of the phenomena prove that the disturbances, mentioned by BENEDICKS and ARPI really do not occur.

We hope to report shortly on the real transition points of zinc.  
*Utrecht*, September 1914. VAN 'T HOFF-Laboratory.

<sup>1)</sup> Zeitschr. f. anorg. Chemie **9**, 144 (1895); MYLIUS, *ibid.* **74**, 407 (1912).

<sup>2)</sup> Journ. of the Iron and Steel Institute **77**, 153 (1908).

<sup>3)</sup> Journ. Americ. Chem. Soc. **34**, 563 (1912).

<sup>4)</sup> Proceedings **16**, 485 (1913).

**Chemistry.** — “*The Allotropy of Antimony.*” I. By Prof. ERNST COHEN and J. C. VAN DEN BOSCH.

(Communicated in the meeting of September 26, 1914).

1. The following modifications of this metal were known hitherto:

*a.* The so called *metallic* antimony, a bluish-white solid with metallic lustre. It is very brittle at ordinary temperatures and is said to crystallize in the hexagonal system. Only this modification is found in nature.

*b.* Black antimony. This form has been prepared by STOCK and SIEBERT<sup>1)</sup> in three different ways, the best method being by rapid cooling of the vapour of ordinary metallic antimony. This black modification is converted by heating into metallic antimony. Its colour and density change slowly at 100°; at 400° the conversion occurs instantly. This form *seems* to be metastable at ordinary temperatures.

*c.* Yellow antimony was first prepared by STOCK and GUTTMANN<sup>2)</sup> in the year 1904, by the interaction of antimony hydride (at —90°) with air, oxygen or chlorine. Even at —50° this form is metastable: it is converted by heating into the black modification.

*d.* Explosive Antimony. ERNST COHEN, RINGER, STRENGERS, and COLLINS<sup>3)</sup> proved that the explosion which occurs when this body is pounded, pressed or scraped, is to be attributed to the transformation of an allotropic form called by them  $\beta$ -antimony, into the ordinary modification (metallic antimony;  $\alpha$ -antimony). Hitherto no investigation of the connexion between these different forms has been carried out as it is very difficult to procure sufficiently large quantities of them.

2. The investigations described below deal with the question whether the metal known hitherto as “metallic antimony” is to be considered at ordinary temperatures and pressures as a metastable system, as is the case with the metals we have already investigated. Our experiments will prove that this is really the case.

3. A kilogram of antimony (KAHLBAUM — Berlin) which contained some hundredths of a percent of impurity, was melted and poured into a cylinder of asbestos paper, which was surrounded by a mixture of alcohol and solid carbon dioxide. The chilled metal so obtained was used in all experiments.

4. It was powdered in a mortar. We determined its density at 25°·0 using two pycnometers as described by JOHNSTON and ADAMS<sup>4)</sup>.

<sup>1)</sup> Ber. d. d. chem. Ges. **38**, 3837 (1906).

<sup>2)</sup> Ber. d. d. chem. Ges. **37**, 885 (1904).

<sup>3)</sup> Zeitschr. f. physik. Chemie **47**, 1 (1904); **50**, 292 (1904); **52**, 129 (1905).

<sup>4)</sup> Journ. Am. Chem. Soc. **34**, 563 (1912).

The difference between any two of these determinations never exceeded three units in the third decimal place.

Our thermometers had been compared with a standard of the Phys. Techn. Reichanstalt at Charlottenburg — Berlin.

We used toluene as the liquid in the pycnometer; its density had been determined in four experiments to be  $d \frac{25^{\circ}.0}{4^{\circ}} 0.8603$ .

Two different parts (*A*) and (*E*) of our material gave the values

$$d \frac{25^{\circ}.0}{4^{\circ}} \begin{array}{l} 6.6900 \text{ (A)} \\ 6.6897 \text{ (E)}. \end{array}$$

5. The samples (*A*) and (*E*) were now heated separately during  $4 \times 24$  hours in an aqueous solution of potassium chloride (10 gr. KCl on 100 gr. of water), using a reflux condenser, the boiling point of the solution being  $102^{\circ}.5$ .

The metal was then washed with dilute hydrochloric acid, water, alcohol and ether, and dried *in vacuo* over sulphuric acid.

Its density was now

$$d. \frac{25^{\circ}.0}{4^{\circ}} \begin{array}{l} 6.6744 \text{ (A)} \\ 6.6803 \text{ (E)}; \end{array}$$

Consequently the density has *decreased* by 13 units in the third decimal place.

6. After having heated (*A*) and (*E*) for a second time ( $6 \times 24$  hours) in the boiling solution, we found:

$$d \frac{25^{\circ}.0}{4^{\circ}} \begin{array}{l} 6.6784 \text{ and } 6.6765 \text{ (A)} \\ 6.6789 \text{ and } 6.6778 \text{ (E)}. \end{array}$$

The density had undergone no further change.

7. The experiments described in §§ 4—6 show that the antimony after chilling is present in a form which changes at  $100^{\circ}$  with a measurable velocity.

In order to investigate if there exists here a transition temperature as in the case of the other metals which we have hitherto studied, we carried out some dilatometric measurements, using the electric thermostat which we described formerly.<sup>1)</sup>

8. The material which was put into the dilatometer consisted of small pieces of the metal mixed up with fine powder and a part of the metal from the pycnometers. (500 grams). The paraffin oil used had been heated for some time at  $200^{\circ}$  in contact with finely divided antimony. There was no evolution of gasbubbles.

9. At temperatures below  $119^{\circ}$  there occurred no change of the meniscus at the *first* heating (the bore of the capillary tube was

<sup>1)</sup> Zeitschr. f. physik. Chemie **87**, 409 (1914).

1 mm.), not even when the heating was continued for 48 hours.

On the contrary, the dilatometer having been kept at 15° during a month, the change was:

At 101°.8 in 2 hours, + 74 mm.; i.e. + 37 mm. per hour  
 „ 100.9 „ 1<sup>1</sup>/<sub>3</sub> „ + 20 „ ; „ + 15 „ „ „  
 „ 100.2 „ 12 „ — 89 „ ; „ — 7<sup>1</sup>/<sub>2</sub> „ „ „

From these data one might conclude that there exists a transition point in the neighbourhood of 101° which is in perfect agreement with our density determinations (§ 4—6).

10. Guided by the experience gained in the case of cadmium and copper<sup>1)</sup>, we now carried out some experiments with antimony whose previous thermal history had been changed between wide limits.

After having kept the dilatometer for 50 minutes at 150°, the meniscus fell during a certain time at the constant temperature of 96°.0; after this it became *stationary* and then began to *rise*. From these observations one would conclude that there is a transition point below 96°.0 and that, in consequence of the heating at 150°, the transition temperature had thus been lowered. This experiment proves, that at 96°.0 there are present at the same time more than two modifications.

11. The dilatometer was now kept at 225° for 12 hours. After this there occurred at 94°.6 (at constant temperature) a marked fall in the oil level (569 mm. within 48 hours), while in the experiment described in § 10 there took place a rise of the meniscus at the same temperature.

12. The phenomena described above show that *metallic* antimony, such as we have known it hitherto, is also a metastable system which consists of more than two allotropic forms.

We hope shortly to report on the modifications which play a rôle here.

Utrecht, April 1914.

VAN 'T HOFF-Laboratory.

**Chemistry.** — “*The Coloration of some derivatives of Picrylmethylamide with alkalis*”. By Prof. A. P. N. FRANCHIMONT and H. J. BACKER.

(Communicated in the meeting of September 26, 1914).

In a previous communication (*Rec. trav. chim.* 1913, **32**, 325; *Abstr. Chem. Soc.* 1914, ii, 84) we described the spectrographic investigation of the coloration which picrylalkylnitramines undergo by alkalies. It was shown, that the absorption spectrum of picrylmethylnitramine  $C_6H_2(NO_2)_3NMe(NO_2)$  after addition of alkali gets a certain ana-

<sup>1)</sup> Proceedings **17**, 54, 60 (1914).

logy with that of picrylmethylamide  $C_6H_2(NO_2)_3NHMe$ , and that the latter spectrum is not much changed by alkali.

We then concluded, that the coloration of picrylalkylnitramines with alkalies had a similar cause as the colour of nitranilines (*vid.* FRANCHIMONT, *Rec. trav. chim.* 1910, **29**, 298, 313), which is ascribed by HANTZSCH (*Ber.* 1910, **43**, 1669) to an action between the nitro and amino groups attached to the benzene nucleus. The coloration of the nitramines would thus be produced by nitro groups of the nucleus reacting with the base, the nitro group attached to nitrogen playing only a secondary part.

In order to test this hypothesis, we have now examined several derivatives of picrylmethylamide, compounds of the formula  $Picr. NMe X^1$ ). For  $X$  we have chosen the nitroso group, the organic acyl groups  $COCH_3$ ,  $CO_2Me$ ,  $CO_2Et$  and finally the phenyl group as example of a negative group being no acylgroup. The compounds investigated were thus picrylmethylnitrosamine  $Picr. NMe(NO)$ , picrylmethylacetamide  $Picr. NMe(COCH_3)$ , methylpicrylmethylaminoformiate  $Picr. NMe(CO_2Me)$  and the ethylester  $Picr. NMe(CO_2Et)$ , and picrylphenylmethylamide  $Picr. NMe Ph$ .

In the first place it should be observed that, like the nitrogroup, also the acyl groups  $NO$ ,  $COCH_3$ ,  $CO_2Me$ ,  $CO_2Et$  strongly diminish the colour of the picrylmethylamide. Compared with this deeply yellow coloured amide, the nitramine, nitrosamine, acetyl derivative and both the urethanes are only palish yellow.

These differences are clearly shown by the absorption curves.

Both the absorption bands of picrylmethylamide at  $\frac{1}{\lambda} 2390$  and  $2875$  (see curve 15) disappear wholly; the acyl derivatives give for the concentrations examined, only a continuous absorption in the ultra-violet (curves 3, 5, 8, 10), just as it was found for the nitramine (*Rec. trav. chim.* 1913, **32**, 332).

It must be admitted, that the presence of acyl groups in the aminogroup of picrylmethylamide so strongly diminishes the basic properties of this group, that it loses the power to act with a nitro-group, and thus to produce colour.

If this hypothesis is correct, it must be possible to prevent this reaction also by addition of a strong acid combining with the amine group.

Indeed, picrylmethylamide dissolves perfectly colourless in strong

<sup>1)</sup> In this paper  $Picr.$  means the group 2, 4, 6-trinitrophenyl.



sulphuric acid. The absorption bands disappear wholly from the spectrum, and only a modest continuous absorption in the ultraviolet remains (compare curves 14 and 15). For a concentration of 0.0002 gram-molecules per litre and an absorbing layer of 100 m.m. the beginning of the absorption is repelled by the sulphuric acid from  $\frac{1}{\lambda}$  2150 to 3400. This decoloration of picrylmethylamide by sulphuric acid is just the reverse of the coloration of the nitramine with alkali. In the first case the nitro groups of the nucleus are deprived of the opportunity to combine with a basic group, in the latter case this opportunity is on the contrary given.

The reaction with alkalies seems to be the same for the acyl derivatives now investigated as for the picrylalkylnitramines, the only difference being that they want a little more alkali for the red coloration. Formerly we found (*Rec. trav. chim.* 1913, **32**, 332), that a solution of picrylmethylnitramine containing an excess of alkali gives two bands at  $\frac{1}{\lambda}$  1975 and 2350. At nearly the same places two bands are shown by the alkaline solutions of the acetyl derivative (curve 6) and the urethanes (9 and 11), though one of the bands is only represented by a flat part of the absorption curve.

The anomalous curve given by the nitrosamine with alkali (4) will be discussed separately.

Picrylphenylmethylamide, the last derivative of picrylmethylamide we examined, exists in two forms of the same dark red colour but of different melting points, 108 and 129°. HANTZSCH (*Ber.* 1910, **93**, 1651) calls the two forms homochromic isomerides, whilst BILMANN (*Ber.* 1911, **44**, 827) regards them as polymorphous forms.

As HANTZSCH has already observed, the spectra of the two forms are completely equal (curve 12). It was now found, that the  $\alpha$  and  $\beta$  forms in presence of alkalies also behave in the same way (curve 13), so that the two forms when dissolved seem to be wholly identical. The broad absorption band of the amide at 2350 becomes by addition of alkali a little deeper and is somewhat displaced to larger wavelengths. At the same time it undergoes a division into a flat part at 2070 and a feeble band at 2400. This agrees with the behaviour of the other compounds with bases.

Finally we have examined the coloration of 1,3,5-trinitrobenzene with alkali, since here only the nitrogroups of the nucleus can act with the base.

Whilst trinitrobenzene only absorbs continuously (curve 1), addition

of alkali produces a broad band from 2040 to 2300 (curve 2). Its centre is at about the same place as the centre of the two bands, which show the picrylmethylamide derivatives in presence of alkalies.

In the previous publication (l. c.) we mentioned a remarkable decomposition of the alkaline solution of picrylmethylnitramine. After a day it gave the spectrum of potassium picrate, being hydrolysed in this way:  $\text{Picr. N Me NO}_2 \rightarrow \text{Picr. OH} + \text{Me NH NO}_2$ .

An analogous decomposition takes place, though more slowly, with the acetyl derivative and the two urethanes. In a few days the spectrum of their alkaline solutions is perfectly the same as that shown by potassium picrate (curve 7).

With picrylmethylnitrosamine this decomposition proceeds very quickly, much more rapidly than with the nitramine. During the few minutes required for the spectrographic examination its alkaline solution is already partly decomposed.

The anomalous absorption curve (4) is apparently due to a superposition of the spectrum of the potassium compound of the nitrosamine with that of potassium picrate. From the three bands shown by this curve at  $\frac{1}{\lambda}$  2000, 2400 and 2900 the latter is undoubtedly caused by the presence of potassium picrate, which gives a band at about 2880. In the spectrum of the potassium compound of the nitrosamine there may be expected two bands at about 2000 and 2350, in analogy to the observations made with the other derivatives of picrylmethylamide. The former band is indeed present, whilst the second band, likely with assistance of the flat band shown by potassium picrate at 2500, is transferred to 2400. Two hours after its preparation, the alkaline solution of the nitrosamine was again examined; it then showed the pure spectrum of potassium picrate curve 7.

The results of this investigation may be expressed as follows.

The coloration of picrylmethylnitramine by alkali has the same cause as the coloration of other derivatives of picrylmethylamide by this reagent.

For the nitramine, the acetyl-, carboxymethyl- and carboxyethyl-derivatives, which altogether only have continuous absorption for ultraviolet rays, show two bands at about 2000 and 2350 after addition of alkali. Picrylphenylmethylamide has already of itself an absorption band, which, however, by alkali is divided into two parts at 2070 and 2400.

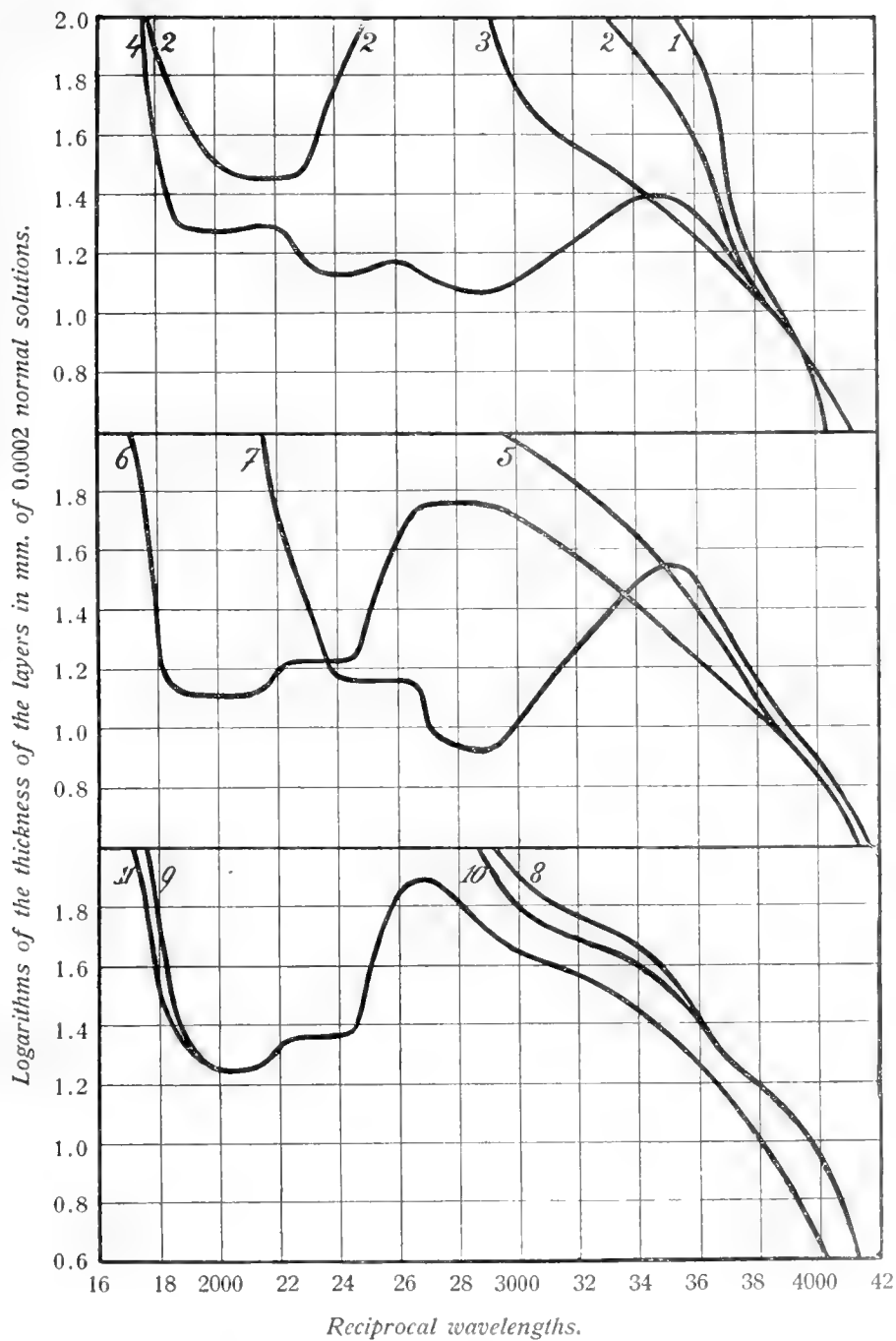

Fig. 1. 1. 1,3,5-Trinitrobenzene. 2. id. + KOH. 3. Picrylmethylnitrosamine. 4. id. + KOH. 5. Picrylmethylacetamide. 6. id. + KOH. 7. Picric acid + KOH. 8. Methyl picrylmethylaminoformiate. 9. id. + KOH. 10. Ethyl picrylmethylaminoformiate. 11. id. + KOH.

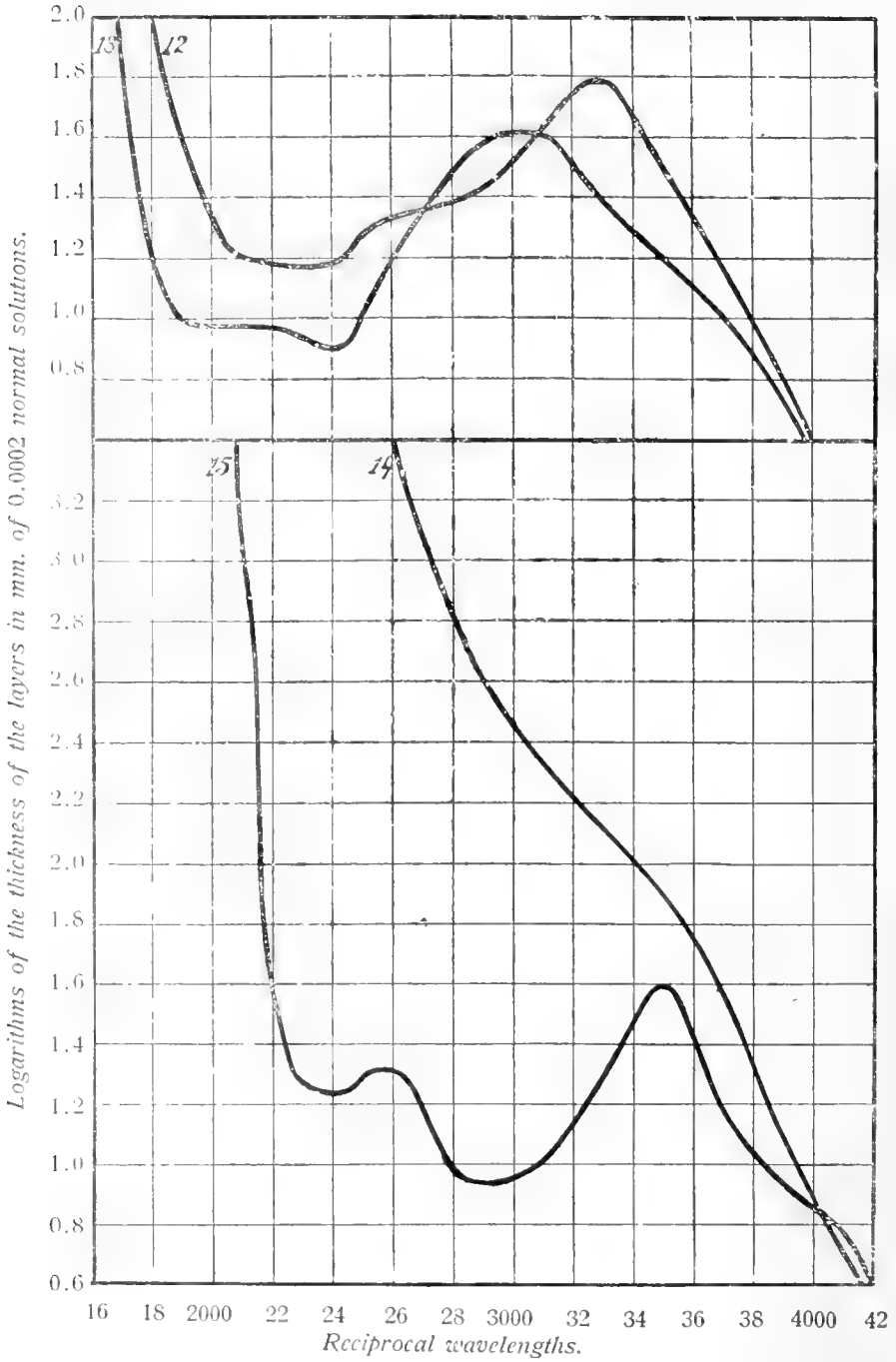

Fig. 11. 12. Picrylphenylmethylamide ( $\alpha$  &  $\beta$ ). 13. id. + KOH. 14. Picrylmethylamide in sulphuric acid. 15. Picrylmethylamide.

The nitrogroup attached to the nitrogen atom of the nitramine is evidently not essential for the reaction.

Further, the spectrum of trinitrobenzene with alkali, though much differing from that of the other alkaline solutions, has yet its absorption in about the same part  $\left(\frac{1}{\lambda} 1800-2500\right)$ .

We may thus conclude, that in all these cases the coloration is produced by a reaction of the base with one or more nitrogroups of the nucleus.

Finally it has been shown, that the presence of a strong acid, as well as the introduction of acyl radicals, completely expels the absorption bands of picrylmethylamide.

**Chemistry.** — *“ $\alpha$ -Sulpho-propionic acid and its resolution into optically active isomerides”*. By Prof. A. P. N. FRANCHIMONT and Dr. H. J. BACKER.

(Communicated in the meeting of September 26, 1914).

Already in 1902 a great number of diverse chemical and biochemical methods were tried by the first of us to separate the  $\alpha$ -sulphopropionic acid  $\text{CH}_3(\text{SO}_3\text{H})\text{CHCO}_2\text{H}$  prepared by him <sup>1)</sup> from propionic anhydride and sulphuric acid, into the two optical isomerides that one might expect according to theory. Not a single one, however, had given the desired result, although sometimes strychnine salts with a different rotating power were obtained, but after their conversion into ammonium salts these always appeared to be inactive.

As SWARTS <sup>2)</sup> had stated that he certainly had obtained from fluorochlorobromoacetic acid strychnine salts with varying rotating power, but had not succeeded in isolating the optically active acids, and as also PONCHER <sup>3)</sup>, who tried to effect a separation of bromochloromethanesulphonic acid by means of cinchonine, only obtained rotating ammonium and barium salts, but no acids, it appeared as if with such simple acids the tendency to form racemic mixtures or compounds was very great and likewise the velocity of conversion. This was provisionally also assumed in the case of  $\alpha$ -sulphopropionic acid (methylsulphoacetic acid) and the experiments were discontinued in consequence.

Still with lactic acid (methylxyacetic acid) PURDIE and WALKER <sup>4)</sup>

<sup>1)</sup> Rec. d. Tr. ch. d. P.B. 7. p. 27 (1888).

<sup>2)</sup> Bull. Ac. Belg. (3) 31. p. 25 (1896).

<sup>3)</sup> Bull. Soc. ch. (3) 27. p. 438 (1903).

<sup>4)</sup> J. ch. Soc. 61. p. 754 (1892).

and with  $\alpha$ -bromopropionic acid (methylbromoacetic acid) RAMBERG <sup>1)</sup> had obtained decided results, but on the other hand, POPE and READ <sup>2)</sup> did not succeed in resolving the chlorosulphoacetic acid. The question now arose whether perhaps the sulphogroup created the difficulty, i. e. causes the rapid racemisation. This became less probable after POPE and READ <sup>3)</sup> had succeeded in splitting the chloriodomethanesulphonic acid and had found that the optically active acids thus obtained were not so readily transformed into the racemic mixture. Hence, the investigation of sulphopropionic acid was at once again taken in hand.

Both chlorosulphoacetic acid and methylsulphoacetic acid ( $\alpha$ -sulphopropionic acid) are dibasic and thus can form acid salts. Moreover, the two groups that cause the acid reaction, have a different composition, the one being a carboxyl- and the other a sulphonyl-group, and of different strength, so that as the sulphonyl is stronger acid, salts will presumably contain the carboxyl-group in the free and the sulphonyl-group in the combined state.

Whereas, previously; chiefly the neutral and mixed metallic salts and the neutral strychnine salt had been experimented with, the acid strychnine salt was now employed and the desired result was obtained at once.

$\alpha$ -Sulphopropionic acid itself was hitherto only known as a viscous syrup, whilst sulphoacetic acid had been obtained in crystals; therefore we have tried also to obtain  $\alpha$ -sulphopropionic acid in a crystallized condition.

A dilute solution of the acid prepared by decomposition of the barium salt with the theoretical quantity of sulphuric acid was concentrated by partial freezing and draining by suction. The strong solution was placed in vacuo first over sulphuric acid and then over  $P_2O_5$ . The viscous residue was kept for a day in an ice safe at about  $0^\circ$ , when gradually large crystals were formed. The acid thus obtained contains one mol. of water and is exceedingly hygroscopic. In order to determine its melting point a little apparatus was constructed, consisting of two tubes communicating with a transverse tube, one of which contained  $P_2O_5$  and the other the  $\alpha$ -sulphopropionic acid. After the apparatus had been evacuated and sealed, it was allowed to stand for a few days. The m. p. of the  $\alpha$ -sulphopropionic acid was then found to be  $100^\circ.5$ , therefore, higher than that of sulphoacetic acid, which is stated to be  $84^\circ-86^\circ$ .

<sup>1)</sup> Ber. d. D. ch. G. 33. p. 3354 (1900).

<sup>2)</sup> J. ch. Soc. 93. p. 795 (1908).

<sup>3)</sup> J. ch. Soc. 105. p. 811 (1914).

An acid strychnine salt was obtained by evaporating an aqueous solution of the acid with the equimolecular quantity of strychnine on a steam-bath until crystallisation set in. The large crystals that had separated were purified by repeated crystallisation from water; their composition then was  $C_3H_6O_3S + C_{21}H_{22}O_2N_2 + H_2O$ . They, however, proved to be not the acid strychnine salt of the inactive (racemic)  $\alpha$ -sulphopropionic acid, but of the dextrorotatory acid. On heating, they are decomposed at about  $250^\circ$  with evolution of gas and formation of a brown liquid.

As in the case of all other compounds described here, the rotating power was determined in aqueous solution with sodium light at  $20^\circ$ . By concentration  $c$  is meant the number of grams of anhydrous active substance per 100 cc. solution. The specific rotation  $[\alpha]$  is likewise calculated on the anhydrous substance. The molecular rotation has, of course, the same value for the anhydrous and the hydrated crystalline substance.

For the acid strychnine salt was found at  $c = 1.938$ ,  $[\alpha]_D^{20} = -14^\circ.6$  and  $[M]_D^{20} = -71^\circ.4$ .

By way of comparing, strychnine hydrochloride was also investigated and at  $c = 1.297$  was found:  $[\alpha] = -30^\circ.2$  and  $[M] = -112^\circ.1$ .

The acid strychnine salt of  $\alpha$ -sulphopropionic acid investigated is, therefore, presumably that of the dextrorotatory acid.

In order to obtain this acid, the acid strychnine salt was first decomposed with the theoretical quantity of barium hydroxide<sup>1)</sup>. After complete separation of the strychnine by extracting the drained off liquid with chloroform, the neutral barium salt was precipitated by addition of alcohol. This salt is *laevorotatory*.

For  $c = 1.764$  was found  $[\alpha] = -4^\circ.96$  and  $[M] = -14^\circ.4$ .

From this salt the active  $\alpha$ -sulphopropionic acid was liberated by

1) This value agrees fairly well with the constant  $[M] = -114^\circ$  found by POPE and READ for a somewhat different concentration. J. Chem. Soc. **105**, p. 820 (1914).

2) The acid strychnine  $\alpha$ -sulphopropionate can be titrated with baryta water and a suitable indicator such as methyl-red which is sensitive to feeble bases. It may also be titrated with litmus or violet-blue. If however, phenolphthalein is used which is but little sensitive to weak bases such as strychnine, the colour does not appear until also the second acid group combined to the strychnine has been neutralised by the inorganic base. As the change in colour is fairly sharp, both with methyl-red and phenolphthalein, the titration forms an interesting application of the theory of indicators. Still more remarkable becomes the experiment, when both indicators are used simultaneously. The methyl-red passes into yellow after addition of a semi-molecule of barium hydroxide, the phenolphthalein then being still colourless; so soon, however, one mol. has been added, the violet colour of the phenolphthalein salt appears, unaffected by the pale yellow colour of the methyl-red.

the theoretical quantity of sulphuric acid and its rotatory power was then determined.

For  $c = 0.645$  was found  $[\alpha] = +31^{\circ}.6$  and  $[M] = +48^{\circ}.7$ .

In another preparation was found for  $c = 1.85$ ,  $[\alpha] = +32^{\circ}.0$  and  $[M] = +49^{\circ}.2$ .

Therefore, it is the *dextrorotatory* acid, whose neutral barium salt is *laevorotatory*.

It was now tried to obtain also this dextrorotatory acid in the solid condition. The solution was, therefore, concentrated in vacuo first over sulphuric acid and then over  $P_2O_5$ . The viscous mass did not crystallize on cooling, but did so slowly after a trace of the racemic compound had been introduced. The crystals are exceedingly hygroscopic, melt between  $81^{\circ}$  and  $82^{\circ}$  and contain one mol. of water.

As the *neutral* barium salt of the *dextro*  $\alpha$ -sulphopropionic acid rotates in the opposite direction of the free acid, it became of importance to investigate also the *acid* salt. For this was found at  $c = 0.776$

$$[\alpha] = +18^{\circ}.0 \text{ and } [M] = +79^{\circ}.8 \text{ or } = 2 \times 39^{\circ}.9^1).$$

The acid potassium salt gave at  $c = 0.516$  the values:

$$[\alpha] = +23^{\circ}.8. [M] = +45^{\circ}.7.$$

The *acid* metallic salts of *dextro*  $\alpha$ -sulphopropionic acid are, therefore, *dextrorotatory* like the acid itself. The racemisation of *dextro*  $\alpha$ -sulphopropionic acid and its salts was also tried.

The aqueous solution, at  $c = 0.645$ , when heated for six hours at  $100^{\circ}$ , suffered no appreciable racemisation, the rotation remaining unchanged.

A solution of the barium salt at  $c = 1.28$  after being heated for eight hours at  $150^{\circ}$  was racemised to the extent of  $80\%$ .

A solution of the potassium salt at  $c = 0.64$ , which also contained  $2\%$  of free potassium hydroxide, was completely racemised after being heated for eight hours at  $180^{\circ}$ . An excess of free base thus seems to accelerate the racemisation<sup>2)</sup>, although also the temperature, the

<sup>1)</sup> As the molecule of the acid barium salt contains two groups of the sulphopropionic acid, it may for the sake of comparison with the other rotations be written more conveniently  $[M] = 2 \times 39^{\circ}.9$ .

<sup>2)</sup> This would agree with the rule given by ROTHE Ber. d. D. ch. G. 46. p. 845. (1914), that active carboxylic acids, the  $\alpha$ -carbon atom of which is asymmetric and carries a hydrogen atom, are readily racemised under the influence of alkalis. He tries to explain this by assuming that, owing to the base, enol formation takes place in the molecule, thus causing the asymmetric carbon atom to disappear temporarily.



concentration and the duration of the reaction may exert an influence.

In the motherliquor, from which the acid strychnine salt of the *dextro*-acid had deposited, there should still be present that of the *laevo*-acid, this being more soluble. On addition of acetone a precipitate was obtained which could be recrystallized from absolute alcohol. Of course, it still contains a trifle of the less soluble salt of the antipode, but yet in one of the preparations it was obtained in a fairly pure condition.

For the rotating power at  $c = 1.658$  was found  $[\alpha] = -27^{\circ}.7$  and  $[M] = -135^{\circ}$ . The concentration does not seem to exert a great influence on the specific rotation, for, at  $c = 8.424$  was found  $[\alpha] = -27^{\circ}.4$  and  $[M] = -134^{\circ}$ .

From this acid strychnine salt of the *l*-acid the neutral ammonium salt was prepared. This gave for  $c = 3.113$  the values  $[\alpha] = +7^{\circ}.9$  and  $[M] = +14^{\circ}.8$ . The neutral ammonium salt of the *l*-acid is therefore, dextrorotatory.

If to a solution of the ammonium salt is slowly added dilute sulphuric acid, the dextrorotation diminishes, becomes zero and then changes to a laevorotation, which finally remains constant, as soon as all the organic acid has been liberated. The rotation for the *l*-acid, at  $c = 2.449$ , amounted to  $[\alpha] = -29^{\circ}.8$  and  $[M] = -45^{\circ}.8$ .

Although we have not prepared the *l*- $\alpha$ -sulphopropionic acid in a pure and solid condition, it appears from the experiments in quite a

	<i>d</i> -acid		<i>l</i> -acid	
	$[\alpha]_D^{20}$	$[M]_D^{20}$	$[\alpha]_D^{20}$	$[M]_D^{20}$
$\alpha$ -sulphopropionic acid $C_3H_6O_5S$	+ 32 <sup>9</sup>	+ 49 <sup>0</sup> .2	- 29 <sup>0</sup> .8	- 45 <sup>0</sup> .8
acid potassium salt $C_3H_5O_5SK$	+ 23.8	+ 45.7		
acid barium salt $(C_3H_5O_5S)_2Ba$	+ 18.0	+ 79.8		
acid strychnine salt $C_3H_6O_5S.C_{21}H_{22}O_2N_2$	- 14.6	= 2 $\times$ 39.9 - 71.4	- 27.7	- 135
neutral ammonium salt $C_3H_4O_5S(NH_4)_2$			+ 7.9	+ 14.8
neutral barium salt $C_3H_4O_5SBa$	- 4.96	- 14.4		

satisfactory manner that a resolution has been effected of the racemic  $\alpha$ -sulphopropionic acid.

The specific and molecular rotations of the compounds investigated are united in the subjoined table. It should, however, be remarked that the values of the *l*-acid and its derivatives are less trustworthy because the acid has not been quite pure.

It deserves notice that the molecular rotation of the  $\alpha$ -sulphopropionic acid ( $49^{\circ}.2$ ) is certainly somewhat stronger than that of the  $\alpha$ -bromopropionic acid<sup>1)</sup> ( $44^{\circ}.4$ ) although the bromine atom (80) differs but little in weight from the sulpho-group (81); still this may perhaps support the view that the weight of the group influences the rotatory power. If for instance, we compare with the rotation of  $\alpha$ -ethylpropionic acid<sup>2)</sup> ( $18^{\circ}.2$ ) we notice that both the rotation and the weight of the group (29) are less.

More interesting seems the fact that the rotation of the neutral metallic salts is much less than, and of an opposite sign to that of the acid metallic salts and the acids themselves, particularly in connexion with what has been stated at the commencement, namely that it concerns here a dibasic acid with two groups of different ionisibility which cause the acid functions.

Although the phenomenon that salts of optically active acids possess a rotatory power contrary to that of the acids themselves was observed previously, for instance with lactic and glyceric acids, the example now found seems a more simple one, because there are not present any groups that can react on each other, and because it may be called highly improbable that in the circumstances stated the carboxyl- and the sulphonyl-group should react on each other. Consequently, the rotation will, probably, be less dependent on concentration, temperature, age of solution etc.

In conclusion, it may be remarked that the laevorotation of the acid strychnine salt of the *l*- $\alpha$ -sulphopropionic acid as compared with that of strychnine hydrochloride, amounts to about as much less as the dextrorotation of the acid metallic salts.

<sup>1)</sup> RAMBERG. Liebig's Ann. 370. p. 234 (1909) gives  $[z] = 29^{\circ}.0$ , whence  $[M] = 44^{\circ}.4$ .

<sup>2)</sup> SCHÜTZ & MARCKWALD. Ber. d. D. ch. G. 29. p. 59 (1896)  $[z] = 17^{\circ}.85$ , hence  $[M] = 18^{\circ}.2$ .

**Physics.** - - "*A new electrometer, specially arranged for radio-active investigations*". Part I. By Miss H. J. FOLMER. (Communicated by Prof. H. HAGA).

(Communicated in the meeting of May 30, 1914).

*Introduction.*

In trying to find an accurate method for measurements of the natural ionisation of air in closed vessels, radio-active radiation of the elements, etc., researches in which very small ionisation currents are to be measured, it seemed to me that the need is felt of an electrometer, which, besides possessing a great sensibility of charge, will also be able to measure very minute currents with *accuracy*.

As to the mentioned conditions, the latter is fulfilled by C. T. R. WILSON's electroscope (the gold-leaf type), which owes this favourable quality to the very simplicity of the system; this namely renders it possible to bring about the ionisation which is to be measured, in the air contained in the apparatus itself, to avoid connecting wires, together with electrostatic and other influences, the disturbance caused by insulators being confined to that of a single one. In my opinion this is the reason that this electroscope is generally preferred for various measurements requiring great accuracy to say a sensitive DOLEZALEK electrometer, which lacks these advantages, notwithstanding the fact of a much greater sensibility of charge of the latter; in consequence of this *sudden* changes in the natural ionisation of air in closed vessels, for instance, the existence of which is accepted by many investigators, cannot manifest themselves clearly when the electroscope is used; moreover measurements of small currents will take much time.

This has led me to construct an electrometer, the principle and the method of working of which I shall discuss in what follows, and which in my opinion can supply the mentioned need. It appeared from the results obtained, that with this apparatus currents can be measured both very accurately and very sensitively; accordingly it seems to me, that for these reasons the apparatus may be very suitable for various radioactive researches requiring the above mentioned qualities, as was also corroborated by experience.

*Description of the principle of the apparatus.*

In the figure a schematic representation of the arrangement is given<sup>1</sup>); the apparatus consists of:

<sup>1</sup>) An accurate description of the apparatus will follow in a 2nd communication.

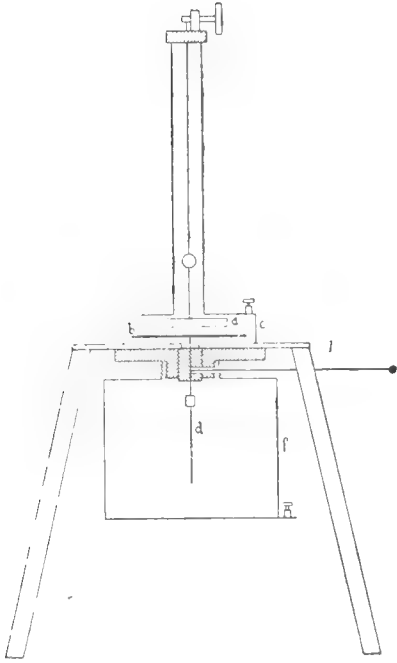

two separate spaces, viz. the measuring space  $c$ : a flat brass cylinder, and the ionisation space  $f$ : a brass cylinder of volume 1 litre; the two cylinders are insulated from each other by ebonite.

In the measuring space is the metal needle  $b$ , supported in the middle by a second metal needle  $d$ , insulated by amber;  $b + d$  together form the conductor, which is charged by the ionisation current.

In  $c$  is also found the very thin aluminium strip  $a$ , which a few mm. above  $b$  is fastened to a thin metal rod with mirror, suspended on a Wollaston wire, which is fastened to a torsion head insulated by means of ebonite.

Through a perforation in the amber and in the ebonite a rod  $l$  can be brought in contact with the needle  $d$ .

In this way  $a$ ,  $b + d$ ,  $c$ , and  $f$ , can therefore be separately brought in a conductive connection with a storage battery or with earth;  $c$  rests on a bottom plate, to which legs are fastened which support the apparatus.

*The charging of the apparatus before use.*

In what follows we shall examine from the course of the lines of force, what state arises in the space  $c$ , and how this takes place, when the system is charged: the lower cylinder  $f$  is of no account as regards this, as it does not belong to the measuring system proper.

The method of charging is founded on this that the two needles  $a$  and  $b$ , which with untwisted position of  $a$  form an angle, let us say of  $30^\circ$ , will *still* have this position with respect to each other, when the system is in the charged state, in which latter case, however, lines of force run between the different conductors.

We begin to charge  $a$  to a constant potential, e. g. to,  $+20$  volts, keeping  $b$  and  $c$  still at potential 0 volt. If for the sake of simplicity we first imagine the state as it would be without the presence of  $b$ , the course of the lines of force would be as follows: lines of force would start from  $a$ , and end upon the bottom, the walls,

and the lid of  $c$ ; in consequence, however, of the unequal distance from  $a$  to those different parts of  $c$ , the potential gradient per unit of length or the electric force, as also the density of the lines of force, or the value of the tensions directed along the lines of force in the space round  $a$  would be of very unequal value; how great, however, the variation in different directions might be, yet there would be complete symmetry in the course of the lines of force with respect to the vertical plane in which the needle itself is situated. The presence of  $b$ , however, disturbs this symmetry in the following way:

1. The lines of force starting from  $a$  in the direction of  $b$  will no longer end on  $c$ , but on  $b$ ; besides, on account of their diminished length, therefore on account of the increased electric force, they become there *denser* than before.

2. There will be inflection of lines of force; some lines of force, viz. those which, when not subjected to the influence of  $b$ , would run beside  $b$  from  $a$  to  $c$ , will pass into lines of force from  $a$  to  $b$  under the influence of  $b$ .

This disturbance caused by  $b$  will give rise to the formation of a resulting electrostatic couple, acting on those halves of the side faces of  $a$ , which are directed to the side of the acute angle between  $a$  and  $b$ , so that consequently  $a$  is deflected to the side of  $b$ , and the angle between  $a$  and  $b$  will become such that the formed torsion couple of the suspension wire will be in equilibrium with the electrostatic directive couple.

In order to make  $a$  return to the untwisted position,  $c$  is charged to a negative potential, which brings about the desired change; for

1. then the density of the lines of force between  $a$  and  $c$  will increase, which causes a slighter variation of lines of force on those halves of the sides of  $a$  which are directed to the side of the acute angle between  $a$  and  $b$ ;

2. some lines of force between  $a$  and  $b$  will deflect and become lines of force between  $a$  and  $c$ .

In case of a sufficient negative potential of  $c$  the above mentioned electrostatic resulting couple will be annihilated through this change. The course of the lines of force has now become more symmetrical (of course not quite), while  $a$  returns to the untwisted position.

In this way e. g. a state of charge is realized for  $a = +20$  V.,  $b = 0$  V.,  $c = -3$  V.

For the sake of simplicity a whole number was taken for the potential of  $c$ , the consequence of which is, that in the final state the needle is only approximately in the untwisted position.

*Measuring method of ionisation currents.*

A quantity of radio-active substance is placed on the bottom of the ionisation cylinder  $f$ ; the system is charged to the state :  $+ 20$  V.,  $0$  V.,  $- 3$  V.;  $f$  is then brought to a potential value, dependent on the strength of current to be measured. While  $a$ ,  $c$ , and  $f$  maintain their potential values,  $b$  is insulated by breaking the contact with  $l$ ; the ions formed, let us say the positive ones, will then charge  $b$  to a constantly increasing potential, with the consequence that the number of lines of force between  $a$  and  $b$  will decrease, and a couple will be formed, which will cause the needles to slowly recede from each other, and that the quicker as the current is the stronger (to return later on to particulars of the motion).

*Consideration.*

It will be seen from the arrangement of the electrometer, how the before mentioned advantages of the WILSON-electroscope are realized in it; in the space  $f$  namely the ionisation current is *directly* carried to the needle  $b + d$ , this needle being perfectly insulated by a single piece of amber. The separation of ionisation space and measuring space has, moreover, this advantage that the measuring system is not contaminated with radio-active impurities, while the ionisation space and the rod  $d$ , which can be removed, as regards the part that lies in  $f$ , can be easily cleaned.

As to the *measuring* system proper, the principle of it differs from that of the quadrant electrometer; it has been thus chosen on purpose that the lines of force formed by the ionisation current contribute as *much* as possible and as *favourably* as possible to the movement of the needle  $a$ .

This is not the case in the quadrant electrometer; there namely the movement is caused by the lines of force which run between the quadrants and the rims of the needle, whereas the vertical lines of force between needle and quadrants do not contribute anything to the moving couple.

In my opinion it would not be possible to modify the quadrant electrometer in such a way that, while maintaining the principle of the quadrants, many lines of force are not retained at the same time which in a measurement either give *no* movement, or will even *counteract* the movement. The latter might be possible, if the flat needle should be replaced by a horizontal wire, in which way a large horizontal surface is, indeed, avoided, but on the other hand the formed lines of force would act on the two sides of the needle, when the latter is rotated. The advantage of the described apparatus

lies in this that the lines of force between  $a$  and  $b$ , which are subjected to a change on ionisation, will mostly arise on *one* side of the *vertical strip*. This removes the last mentioned drawback, a large injurious horizontal surface also being avoided. I think that with this apparatus I have obtained a sensibility of charge, greater than is possible with a DOLEZALEK-electrometer, the same thickness of wire given.

*The realization of a greater sensibility of charge.*

The sensibility of the apparatus appeared to be capable of great variation, the suspension wire being left unaltered, and that by varying the state of charge, whereas, for the rest, the method of charging and measuring remains the same. To make the system more sensitive,  $a$  is not charged to  $+20$  V, but say to  $+32$  V, after which a negative potential value is imparted to  $c$  such that  $a$  has turned back to an almost untwisted position. The potential of  $c$  will also be more strongly negative, of course, for this state than for the state  $(+20.0, -3)$  V; the state of charge will then become e. g.  $(+32.0, -6)$  V.

In order to understand what causes this modification of charge to bring about greater sensibility of charge, we must examine in the apparatus 1. *the variation of the potential sensibility.* 2. *the variation of the value of the capacity;* for these two factors together determine the sensibility of charge.

1. The former is to be found from the curves I, in which examples of some states of charge are given; to investigate the potential

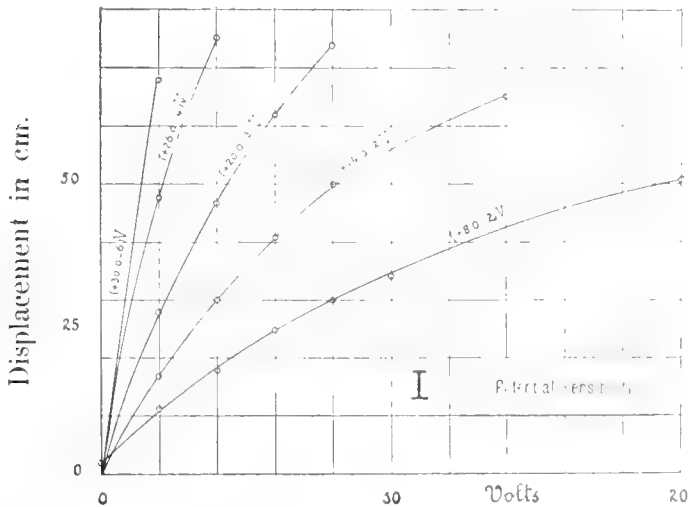

Fig. 1.

sensibility  $b$  was increased every time by 2 Volts in potential for every state separately. The state, as indicated over every curve, always represents the initial state. All the measurements following here were made with a provisional apparatus; the suspension consisted of a WOLLASTON wire  $7\ \mu$  thick, and 97 mm. long. (Scale distance 1.5 m.).

From these curves appears the greater potential sensibility of the system for greater potential difference between  $a$  and  $b$ ; for the state  $(+32.0, -6)$  V e. g. a displacement of almost 700 mm. was found for 2 V potential increase of  $b$ ; for  $(+8.0, -2)$  V it amounted to  $\pm 500$  mm. for 20 Volts. The state  $(+32.0, -6)$  V does not represent the *most sensitive* state that could be obtained.

I think the cause of this greater potential sensibility is the following:

When  $a$  recedes from  $b$  in consequence of a potential increase of  $b$ , which is brought about by increase of charge of  $b$ , the negative induced charge on  $b$  will diminish in consequence of this *motion*, or rather the potential value of  $b$  will be *diminished*; for a positively charged body ( $a$ ) recedes from  $b$ . The greater the potential difference is between  $a$  and  $b$ , the greater will be the potential diminution in question for a definite angle; in other words the potential diminution of  $b$  required for a receding of  $a$  over a definite angle will be the less, i. e. the potential sensibility will be the greater. Besides the said change of the induced charge at the same time increases the angular displacement, which is another reason for greater potential sensibility.

2. It follows from the foregoing, that greater potential sensibility obtained in this way, must be attended by an increasing capacity; for when through a definite addition of charge to  $b$  in a state with greater potential difference between  $a$  and  $b$  a slighter potential increase will set in in consequence of the motion of  $a$ , this will imply a greater capacity of  $b$ . Capacity measurements (method HARMS, Phys. Zs. 1904) give the same result; the capacity in the state  $(+8,0-2)$  V amounted namely to 5,2 e.s. units; that in the state  $(+20,0-3)$  V 6,0 e.s. units. Both values are the mean from a great many determinations.

What is the reason why, in spite of this increase of capacity, the increase of potential sensibility more than counterbalances it, will appear from the application of the following consideration of the capacity.

Though for an electrometer the sensibility of charge is in direct ratio to the potential sensibility, and at the same time in inverse ratio



to the value of the capacity, it does by no means follow from this that the sensibility of charge will be greatest for a capacity as small as possible, and a potential sensibility as great as possible; for the latter quantities are not independent of each other, as appears clearly among others in what was said under 2. therefore I cannot entirely concur with LABORDE's statement, in his: "Methodes de mesure, employées en radioactivité, page 66", where he says: "l'appareil le plus sensible aura une grande sensibilité aux Volts et une faible capacité"; in this statement the above mentioned relation is namely not taken into account.

Thus in consequence of the existing mutual dependence of capacity and potential sensibility it will be possible — and it will be shown here that this really applies to the discussed electrometer — that it will be favourable for the sensibility of charge, to take the capacity not as *slight as possible*, when namely an accompanying increasing potential sensibility more than compensates the disadvantage of this procedure.

That this case presents itself in the described apparatus may be shown by first examining of what the capacity of the apparatus, i.e. of the needle  $b + d$  really consists. This capacity consists of: capacity of the part  $b$ , which refers to arising or vanishing lines of force leading to  $a$  or  $c$ , and capacity of  $d$ .

Now I would distinguish in this capacity between:

*a. useful capacity*, by which I mean capacity which has an influence on the motion of  $a$ ;

*b. injurious capacity* which lacks this influence, and which is really a disadvantage here, because it binds charge of the ionisation current without making it demonstrable. Of the above mentioned capacity only that corresponding to the lines of force between  $a$  and  $b$  is certainly almost entirely useful capacity (see below); the rest is injurious.

And in this lies the cause why the state with greater potential difference between  $a$  and  $b$ , though attended with greater capacity, can yet mean greater sensibility of charge; for this increase of capacity concerns here the capacity of  $b$  with respect to  $a$ ; this is increased, (according to 2) hence the useful capacity of  $b$  is increased; the greater now the ratio of useful to injurious capacity is, the greater the sensibility of charge.

For the rest, as regards the value of the injurious capacity in the apparatus, the following remarks may be made:

1. The injurious capacity of  $d$  with respect to  $f'$  will not be of great influence, since the distance to  $f'$  is great.

2. So far the lines of force starting from the lower *rim* of  $a$ , or from the *back* of  $a$ , ending on  $b$ , were not taken into account; they represent injurious capacity. This influence will make itself slightly felt in the middle of the needle, but will have little effect there on the motion.

3. It is difficult to say anything definite about the value of the injurious capacity of  $b$  with respect to  $c$ .

At any rate it will also appear from what follows, how for *very sensitive* states the total influence of the injurious capacity may almost be disregarded.

In the case of the quadrant-electrometer, on the other hand, the injurious capacity is that of large surfaces with respect to a metal needle lying close by.

Before confirming what has been said above about this increased sensibility of charge for greater potential differences between  $a$  and  $b$  by the communication of some experimental results, a few particulars may be added about the mode of motion of the needle during the current measurement.

*Mode of motion of the needle during the current measurement:*

When the needle  $b$  is charged starting from potential 0 V by means of an ionisation current, when therefore the potential difference between  $a$  and  $b$  decreases,  $a$  will begin to move away from  $b$ ; consequently a motion of the scale division under the crosswire will take place through the reflection of the mirror, which, however, will not be uniform. For the different positions occupied by  $a$  both the potential sensibility and the value of the capacity of  $b$  will be different; for the smaller the angle with  $b$ , the greater is the potential sensibility, as well as the capacity.

The causes are the following: 1. With a smaller angle the distance between  $a$  and  $b$  is smaller and therefore the diminution of the induced charge for a definite change of angle greater.

2) With a smaller angle the potential difference itself is also greater, and this again causes a greater decrease of induced charge for a definite angle.

For both reasons greater potential sensibility, but at the same time greater capacity is to be expected at a smaller angle, but here too for the same reason as for conditions of charge with greater potential difference between  $a$  and  $b$ , the result will be a greater sensibility of charge

In agreement with this the curves I show, how for every state of charge the potential sensibility decreases with greater angle between  $a$  and  $b$ .

Capacity determinations gave the further result that the capacity amounted to 5.75 e. s. units for the state  $(+20,0-3)$  measured from an angular displacement (recession), corresponding to 550 mm. scale displacement, whereas it gave the value 6 e. s. units, when this displacement only extended over 250 mm.

*Measurement of the current.*

With the different above mentioned states of charge ionisation currents were measured, obtained with two different very slight quantities of polonium, which were placed in a dish on the bottom of  $f$ ; the larger quantity is called  $A$ , the smaller  $B$ . The velocity with which the scale moved under the cross wire was determined, and then the intensities of current were derived in absolute measure from this by means of the knowledge of the capacities and potential sensibilities holding for some of the states of charge.

The curves II. represent the result of the measurements for the quantity  $A$ ; it appears from this, that in accordance with expectation the sensibility of charge increases for states with greater potential difference between  $a$  and  $b$ ; at the same time this confirms what

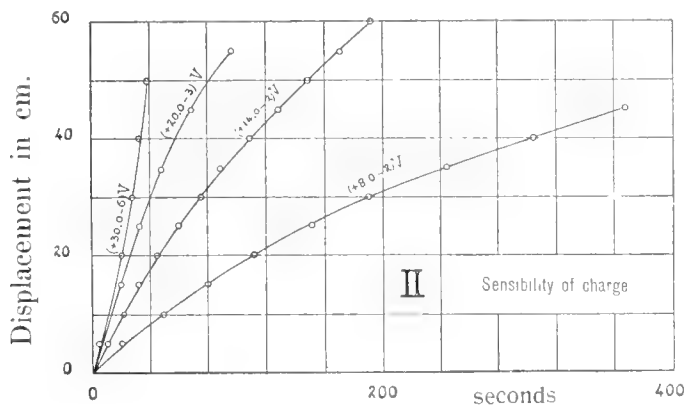

Fig. 2.

was discussed before, that namely the sensibility of charge for one and the same state is greatest, when  $a$  is nearest  $b$ .

From the experiment in itself the ratio of the current intensities of the two quantities of polonium could already be derived, and that even for each state of charge taken by itself. It will namely be equal to the ratio of the times required by  $a$  to pass through the same angle for the quantity  $A$  and for  $B$ . This ratio, which would have to yield the same value for every state of charge, amounted successively to 2.5, 2.7, 2.7, mean 2.6.

According to the above it was now possible at the same time by means of the measured capacities and the known potential sen-

sibilities to determine the currents for  $A$  and  $B$  in ampères, from the formula:  $i_A = \frac{C \times \text{V-increase per sec.}}{9 \times 10^{11}}$ , in which  $C$  represents the capacity of the needle  $b + d$ . As mean values from the values for the 3 most insensitive states we thus obtained:

$$\begin{aligned} i_A &= 1.3 \times 10^{-13} \text{ (quantity } B) \\ i_A &= 3.3 \times 10^{-13} \text{ ( ,, } A) \end{aligned}$$

*Limits of sensitivity of the apparatus.*

Besides being dependent on the state of charge of the system, the sensibility of charge can also be modified by varying the thickness of the suspension wire and the angle between the needles.

It was now of interest to ascertain how far the influence of a change of the state of charge in this respect could extend, how far in other words the apparatus might gain, resp. lose sensibility of charge by a constantly increasing or diminishing potential difference between  $a$  and  $b$ . Experiment showed, that there are limits on either side, at which the apparatus presents a very peculiar character; this will successively be examined for a smallest sensibility, and then for a greatest sensibility.

a. *Limit of smallest sensibility.*

Though for the just mentioned state of charge  $(+8, 0, +2) V$  the phenomena were similar to those for the other states of charge, yet the limit of sensibility appeared to be close in the neighbourhood, viz. at the state:  $(+4, 0, 0) V$ ; this will most clearly appear from the experiment in which the potential sensibility was examined by

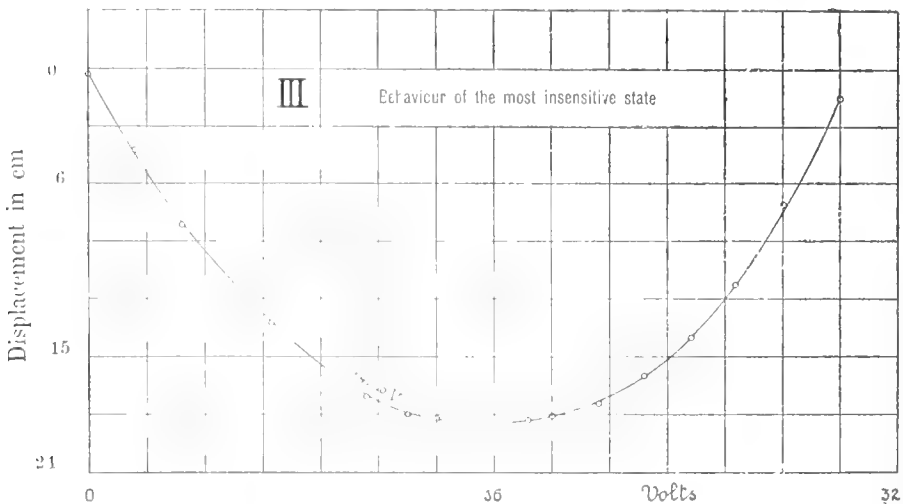

Fig. 3.

the regular increase of the potential value of  $b$ . It appears from curve III how, in contradistinction with the other states,  $a$  first recedes from  $b$ , and then approaches  $b$  again.

The explanation of this deviation from the ordinary phenomena is very obvious; for the potential value of  $a$  being low,  $b$  will soon rise above this value in potential value, and this more and more; hence the diminution in lines of force between  $a$  and  $b$  first continues, till the potential value of  $b$  has risen to  $+4V$ ; then lines of force arise again between  $a$  and  $b$ , whose number increases with the rise of the potential of  $b$ , so that finally the needles will, instead of receding, approach each other.

In accordance with expectation it appeared from the experiment for the current measurement that the needle first receded from  $b$ , stopped, and then approached  $b$ .

This state of charge appeared, therefore, to be unsuitable for the current measurement, of course under for the rest entirely definite circumstances of thickness of wire, height, and angle of the needles.

b. *Limit of greatest sensibility.*

In the following examples of states of charge illustrating this case a certain difference with the foregoing ones may be observed; for the rest this modification was taken voluntarily;  $b$  is here namely in the initial state already at positive potential, while the potential value was lowered during the measurement, in other words in contrast with the preceding cases  $a$  approached to  $b$  through increase of the lines of force between  $a$  and  $b$ .

In the following examples the potential decrease for  $b$  amounts every time to  $2V$ , and it is always stated how much then the deviation is for  $a$ , expressed in mm. of scale displacement.

(1) state (+ 80, + 60, + 60,) V.	(2) state (+ 80, + 40, + 36,) V.
$b$ + 58 V. 82 mm.	$b$ + 38 V. 130 mm.
" + 56 " 85 "	" + 36 " 197 "
" + 54 " 110 "	" + 34 " the needle
" + 52 " 145 "	turns.
" + 50 " 250 "	
(3) state (+ 80, + 30, + 26,) V.	(4) state (+ 80, + 10, + 4,) V.
$b$ + 28 V. 201 mm.	$b$ + 8 V. the needle
" + 26 " the needle	turns.
turns.	
(5) state (+ 120, + 40, + 32) V.	(6) state (+ 120, + 10, + 2) V.
$b$ + 38 V. the needle	$b$ + 8 V. the needle
turns.	turns.

The phenomenon that occurred now was the following: when e.g. in the 3<sup>rd</sup> state  $b$  was charged to  $+26$  V, after having first been brought to  $+28$  V, we did not once more observe a deviation which amounted to somewhat *more* than that for the change of the potential value of  $b$  from  $+30$  V to  $+28$  V (since the sensibility at smaller angle *increases*), but  $a$  passed over so great an angle that the whole scale disappeared from the field, and  $a$  assumed *almost* a position parallel to  $b$ : the needle turned suddenly. In state 4 this phenomenon occurred immediately at the first potential decrease of  $b$  with 2 V, and the same applies to the 5<sup>th</sup> and 6<sup>th</sup> states, whereas in contradistinction with this the first state exhibited stable states throughout the scale for definite potential values of  $b$ . The experiment seemed therefore to point to the existence of an unstable state of equilibrium of  $a$ , which gradually shifted to an increasing angle with  $b$  as the state of charge became more sensitive. To ascertain, whether this displacement was a gradual one, the turning point was approximated as nearly as possible for every state separately; this was done by diminishing  $b$  in potential value not by 2 Volts every time, but only by parts of 1 Volt. The result of this was that, as had been expected, the 2<sup>nd</sup> and 3<sup>rd</sup> states were still realisable throughout the scale, the 4<sup>th</sup>, 5<sup>th</sup>, 6<sup>th</sup> states on the other hand only partially, but again in such a way that the said unstable state of equilibrium, hence the turning point, occurred at a greater angle, as the state of charge was more sensitive.

When after the turning  $a$  had reached its new state of equilibrium, it was not possible to make  $a$  return to its position through a slight potential increase of  $b$ , which, considered in itself, would give rise to a state of charge with a stable equilibrium *outside* the region of turning. This too pointed to the existence of an unstable equilibrium.

The explanation of the existence of such an unstable equilibrium at the point of turning seems to me the following:

In what precedes the change was already discussed of the induced charge on  $b$ , in consequence of an angular displacement of  $a$ ; we saw how this change takes place for a definite angular displacement to a greater degree, the greater the potential difference is between  $a$  and  $b$ , and the smaller the angle is between the needles.

Taking this into consideration we may ask what will take place when e.g. the state  $(+83, +30, +26)$  V is realized, and when the negative charge is continually supplied to  $b$ .

In this the ratio of useful to injurious capacity will namely continually change for the before-mentioned reasons; it will become continually greater; at a definite angle the influence of this injurious

capacity can even fall but vanish. This circumstance can also be expressed thus, that then even a supply of negative charge will no longer make the potential of  $b$  go down, because the approach of  $a$  to  $b$  brought about by this supply just compensates the expected potential decrease.

The angle, for which this consideration holds, will still be found outside the region of turning and may be realized by means of a storage battery.

If more and more negative charge is added at this angle to  $b$ , e.g. through an ionisation current, the potential value of  $b$  will even continually rise in consequence of the preponderating influence of the approach of  $a$  to  $b$ . Finally the state becomes this, and it is then that the turning takes place, that for a further approach of  $a$  to  $b$  a supply of charge to  $b$  is not even required any longer. For the mere induced charge on  $b$  called forth by the approach will be more than sufficient to give rise to an electrostatic couple, which can be in equilibrium with the formed torsion couple.

That, however, in case of such a turning the parallel state is not entirely reached, which was already pointed out, may be accounted for in this way that the lines of force between  $a$  and  $b$  at decreasing angle will also act on the back of  $a$  in appreciable quantity, and this more and more as the angle becomes smaller, so that through this circumstance the electrostatic couple, which tends to make the angle between  $a$  and  $b$  smaller, is counteracted. It will follow from this, that after the turning, the two needles will always *continue* to form a (generally small) angle with each other.

It follows therefore from this explanation of the angle of turning, as was already pointed out on p. 547, that, when the measurement is made in the neighbourhood of this angle, the capacity which must then be taken into account, will chiefly consist of useful capacity, by which the sensitivity of the state is to be explained.

In conclusion a single example of a measurement of air-ionisation and of Rubidium-ionisation.

In these measurements the needle  $a$  was brought to potential zero; the state of charge was: 0 V., — 26 V., — 32 V.

The ionisation space contained only air; volume 1 litre; the number of seconds successively found for the passage through 10 mm. was: 43, 24, 31, 32, 55, 55.

Then a quantity of Rubidium salt was placed in a dish with an area of 50 cm<sup>2</sup>, on the bottom of  $f'$ ; it was found that successively: 9, 10, 10, 11 seconds were required for the passage of 20 mm. In this case  $f'$  was at + 80 V.

*Physical Laboratory of the University at Groningen.*

**Chemistry.** — “*The metastable continuation of the mixed crystal series of pseudo-components in connection with the phenomenon allotropy*”. II. By Prof. A. SMITS. (Communicated by Prof. J. D. VAN DER WAAALS).

(Communicated in the meeting of Sept. 26, 1914).

In the first communication on this subject<sup>1)</sup> different possible continuations of the mixed crystal series in the metastable region have been discussed, in which chiefly the mixed crystal phases coexisting with liquid were considered.

The metastable continuation of the coexistence of two mixed crystal phases was only mentioned in a single case, where namely continuity of the mixed crystal phases in the metastable region was supposed.

It is now, however, the question what can be said of this coexistence for the case that the said continuity does *not* exist. We consider, therefore, one of the figures from 7 to 12 inclusive from the previous communication, and ask what can be predicted about the metastable continuation of the lines *p* and *m*.

On the whole a transgression of the melting temperature without melting setting in, or in other words supersolidification, is considered possible also on slow rise of temperature. The continuity discussed by VAN DER WAAALS between the sublimation line *ab* and the melting

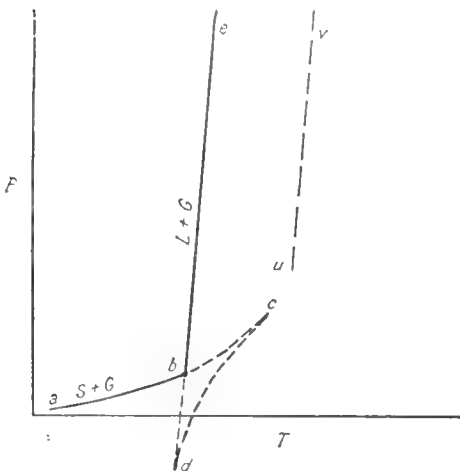

Fig. 1.

point line *bc* of a single substance, see fig. 1, starts from this supposition; we shall, therefore, also here have to take the possibility into account that the melting fails to appear at the eutectic temperature, and that the coexistence continues to exist between the two mixed crystal phases. It is, however, the question whether this possibility is limited. It follows from the continuity between the sublimation line and the melting-point line considered by VAN DER WAAALS that such a limit has been assumed

for the coexistence between solid + vapour and solid + liquid.

<sup>1)</sup> These Proc. XVI p. 1167.



Above the temperature of the higher cusp  $e$ , and below the pressure of the lower cusp  $d$ , the solid substance can no longer exist by the side of the gas resp. liquid.

For our purpose the cusp  $e$  is the most important, for this point expresses that there exists a limit for the coexistence solid + gas, which implies that the orientated condition of the molecules in the solid substance coexisting with its vapour cannot exist any longer at a definite temperature, in consequence of the increasing molecular motion. If this holds for the solid substance in coexistence with vapour, there must also be a limit of existence for the solid substance *without vapour*, and as the contact with the vapour will diminish the stability of the solid state in consequence of the molecular attraction between the molecules in the solid phase and those in the gas phase, we may expect that the limit of existence of the solid substance *without vapour* will lie at a higher temperature. This temperature limit of existence will vary with the pressure, and thus we shall be able to draw a line  $uv$  in the  $PT$ -figure indicating the *limit of existence* of the solid substance.

For a binary system this holds of course, for both the components. When, therefore, we pass from the triple point of the components to the quadruple point, we get something similar. As Dr. SCHEFFER has demonstrated <sup>1)</sup> and as is expressed in Fig. 2, the lines for  $S_A + S_B + G$ ,  $S_A + S_B + L$  merge continuously into each other

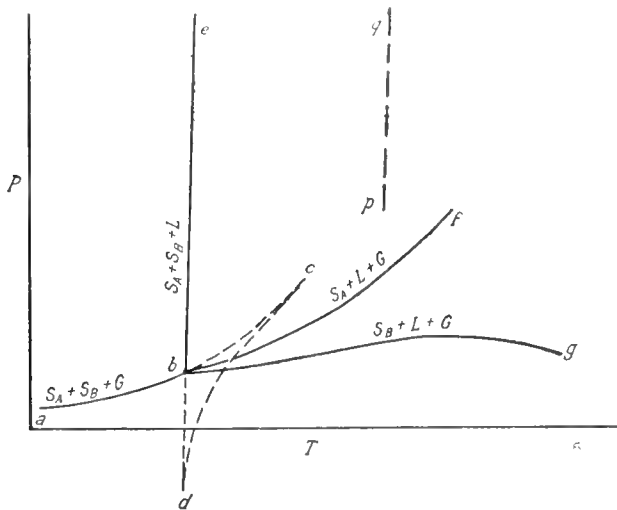

Fig. 2.

also by means of a ridge with two cusps and an unstable inter-

<sup>1)</sup> These Proc. XIII p. 158.

mediate portion, and here a line  $pq$  can be given for the *limit of coexistence* of  $S_A + S_B$ , because either  $S_A$  or  $S_B$  has reached its *limit of coexistence* there, which makes it impossible for the said coexistence to occur any longer.

It follows therefore from this that the lines  $p$  and  $m$  extend metastable to a definite temperature above the eutectic one.

*Transition from monotropy to enantiotropy.*

As is known it often happens that a substance under the vapour pressure presents the phenomenon of monotropy, whereas under higher pressure enantiotropy takes place, as has e.g. been indicated in the  $PT$ -figure 3.

The theory of allotropy again enables us to get a clear insight into the signification of this phenomenon.

Suppose the  $T, X$ -figure 4 to hold for a pressure above the triple

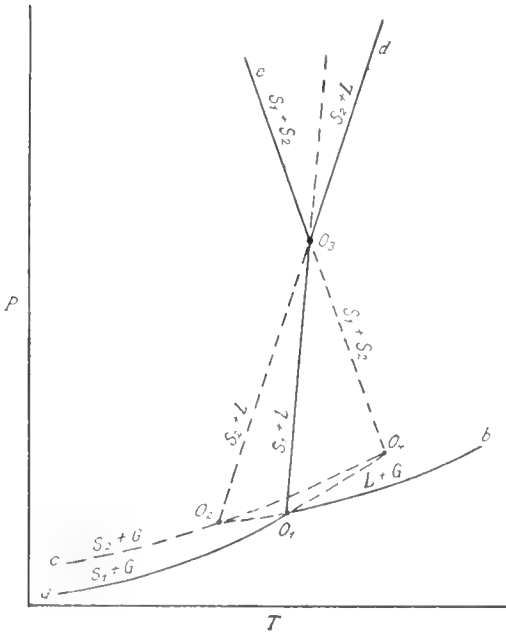

Fig. 3.

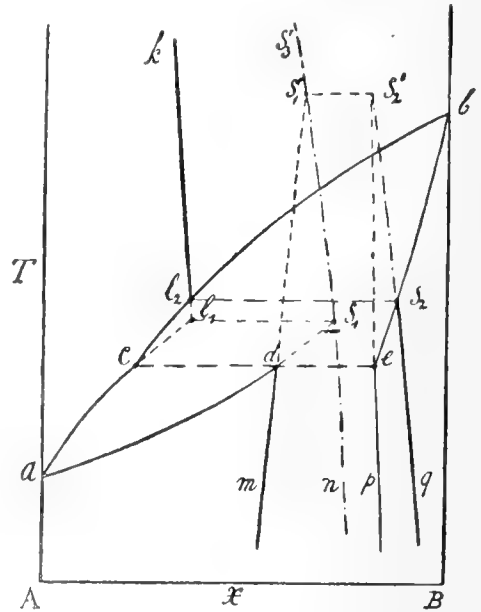

Fig. 4.

point  $O_1$  and below the triple point  $O_3$ , then according to the said theory the conclusion may be drawn from the fact that at higher temperature enantiotropy occurs, that the *situation of the internal equilibrium with respect to the pseudo system is dependent on the*

pressure. For only in this case e.g. the situation of the line for the internal equilibrium in the liquid with respect to the pseudo system will shift with the pressure, and if this displacement is such that the point  $l_2$  moves downward with respect to the pseudo binary  $T, X$ -figure,  $l_2$  will coincide with  $c$ ,  $S_1$  with  $d$  and  $S_2$  with  $e$  at a given pressure, or in other words under this pressure two solid modifications of the unary system will be in equilibrium with each other and with their melt at a definite temperature (triple point temperature).

At this temperature the two modifications have therefore the same melting-point pressure, so that this temperature can also be called a transition temperature under the melting-point pressure.

If we raise the pressure still more, we get a  $T, x$ -figure as given in Fig. 5, from which it appears that whereas the direction of the lines for the internal equilibrium in the solid phase excluded the appearance of a stable point of transition at lower pressure, it must

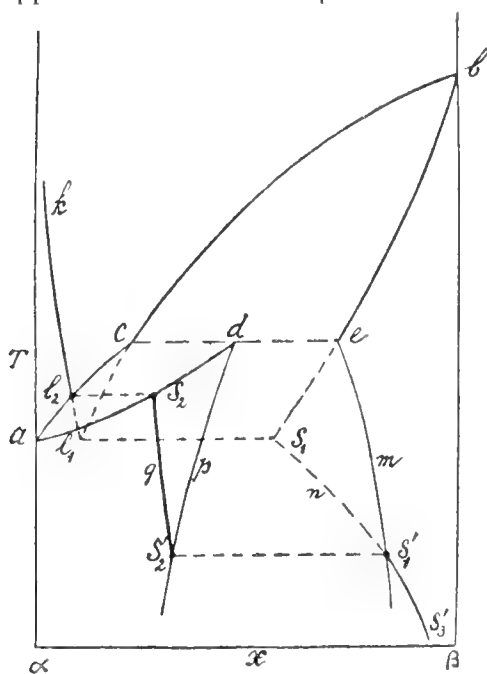

monotropy into enantiotropy can be explained in a simple way by means of the theory of allotropy.

Now the question rises where the transition line  $eo_2$  starts from. A possibility has been given in fig. 3, from which follows that the transition line starts in a metastable point of transition under the vapour pressure  $O_4$ . This is the view to which lead OSTWALD'S<sup>1)</sup> and SCHAUM'S<sup>2)</sup> assumptions on the existence of a metastable point of transition *under vapour pressure*<sup>3)</sup>. Now it is the question whether this is the *only* possibility. It has been pointed out just now that the metastable coexistence is confined between the two mixed crystal series  $md$  and  $pe$  (see Fig. 4), and as the metastable point of transition arises by intersection of the internal equilibrium line of the solid phases with the above mentioned mixed crystal lines, it is clear that it may happen that this intersection does e.g. *not* exist under the vapour pressure.

If in such a case enantiotropy does occur at higher pressure, the transition line will proceed in a metastable way up to that pressure and that temperature at which for the first time an intersection between binary mixed crystal lines and internal equilibrium lines takes place, and there the transition line will then suddenly terminate

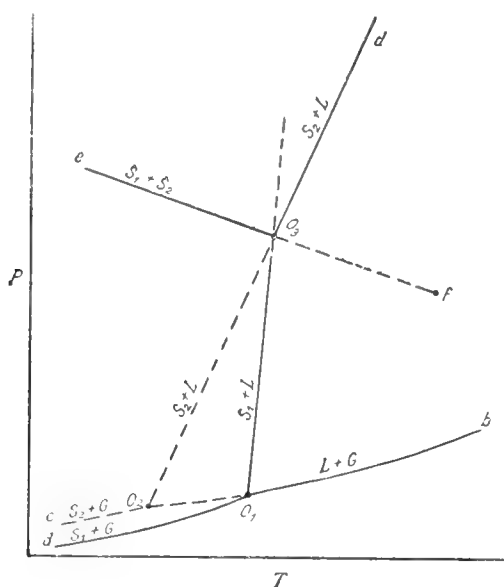

Fig. 6.

in a point that indicates the limit of existence of the coexistence between two solid phases which are in internal equilibrium, as fig. 6 shows.

Now it is clear that the main cause of the transition from monotropy to enantiotropy *can find* its origin exclusively in this that the situation of the pseudo figure varies more greatly with the pressure than that of the unary figure, but in by far the most cases, namely there where the pseudo components are different in molecular

sizes, the situation of the pseudo figure will vary less with the

<sup>1)</sup> Z. f. phys. Chem. 22, 313 (1897).

<sup>2)</sup> Lieb. Ann. 300, 215.

<sup>3)</sup> Cf. also BAKHUIS ROOZEBOOM, "Die Heterogenen Gleichgewichte" I, 187.

pressure than that of the internal equilibrium, and the phenomenon discussed here will have to be attributed to this superposition.

In conclusion it may be pointed out that other particularities may still present themselves, when the internal equilibrium line of the liquid phase *under the vapour pressure* lies so much on one side that there exists no metastable melting point under this pressure. If we now think that this case occurs, and that the internal equilibrium line for the liquid phase under the vapour pressure lies greatly on one side towards the right, and that this line moves towards the left on increase of pressure, we get what follows: The phenomenon

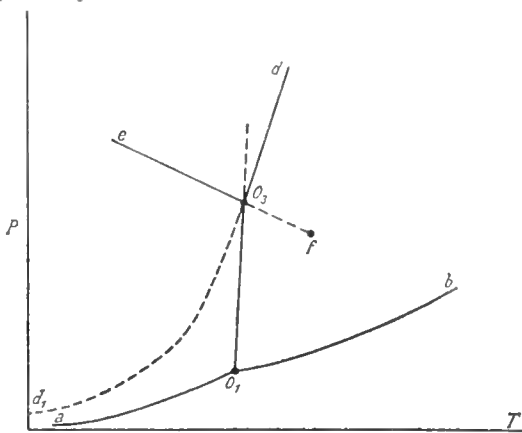

Fig. 7.

of *phase allotropy*<sup>1)</sup> is wanting under the vapour pressure, monotropy *can* however, occur at higher pressure.

The metastable melting-point line will start at the absolute zero e.g. in the case of fig. 10 of the preceding communication<sup>2)</sup>, and run further as represented in fig. 7.

If on the other hand we have to do with the case of fig. 12 of

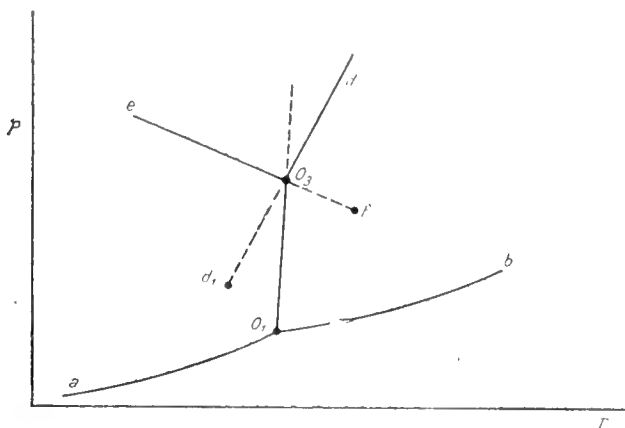

Fig. 8.

<sup>1)</sup> For the occurrence of a substance in two or more similar phases the word *phase allotropy* might be used, while the occurrence of a substance in different kinds of molecules, for which I before introduced the name *homogeneous allotropy*, might be designated by *molecular allotropy*.

<sup>2)</sup> loc. cit.

the preceding communication, a *PT*-figure is possible as fig. 8 shows.

These considerations open our eyes to the possibility that enantiotropy occurs under higher pressure, notwithstanding the phenomenon of monotropy is not found *under the vapour pressure*.

Amsterdam, June 25, 1914.

Anorg. Chem. Laboratory  
of the University.

**Chemistry.** — “On the vapour pressure lines of the system phosphorus.” II. By Prof. A. SMITS and S. C. BOKHORST.  
(Communicated by Prof. J. D. VAN DER WAALS).

(Communicated in the meeting of Sept. 26, 1914).

The continued investigation of the phosphorus purposed to decide with certainty whether the red and the violet phosphorus must be regarded as two different modifications exhibiting the phenomenon of enantiotropy, as seemed to follow from JOLIBOIS'<sup>1)</sup> researches and also from our first investigations.

Confining ourselves to the communication of the result we can state with certainty that the supposed point of transition between red and violet phosphorus does not exist, and that only one solid stable modification of the phosphorus has been found, which is violet in coarser crystalline state, but red in a more finely divided state.

The vapour tensions of different phosphorus preparations approach to amounts which form one continuous vapour pressure line, when the heating is long continued.

An apparent discontinuity may arise under definite circumstances in consequence of too rapid heating. If namely, the preparation at lower temperature contains too much of the more volatile pseudo-component, too high vapour pressures are observed at these lower temperatures, in consequence of the not setting in of the internal equilibrium. In the neighbourhood of 450°, however, the setting in of the internal equilibrium becomes appreciable, and this transformation being attended with a diminution of the vapour pressure, the vapour pressure line will present a course that reminds of a discontinuity. When we worked very slowly and started from states which could only differ little from internal equilibrium states, any discontinuity had, however, disappeared.

At the same time this investigation furnished a fine confirmation

<sup>1)</sup> C. R. **149**, 287 (1909) and **151**, 382 (1910).

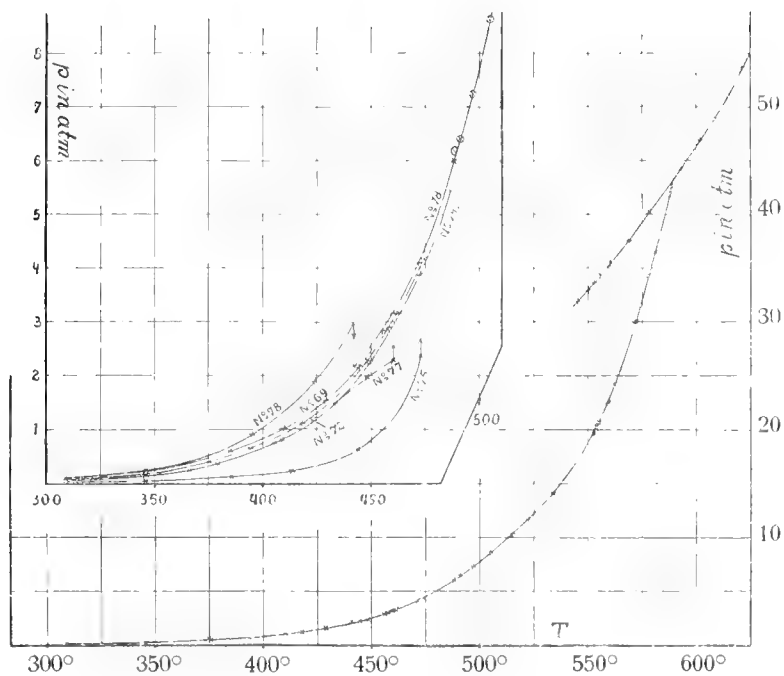

Vapour pressure line red phosphorus determined by means of the glass spring indicator.

Temperature	Vapour pressure in atm.	Temperature	Vapour pressure in atm.	
300°	0.05	480°	5.0	
325	0.1	490	6.25	
350	0.2	500	7.7	
375	0.4	510	9.4	
400	0.7	520	11.2	
410	0.9	530	13.2	
420	1.15	540	15.65	
430	1.55	550	18.75	
440	1.90	560	22.95	
450	2.45	570	28.6	
460	3.15	580	35.6	
470	4.0	589.5	43.1	Triple point

of the theory of allotropy, as it necessarily led to the conclusion that the stable *red* or *violet* modification is really complex, and consists at least of two components, which greatly differ in volatility.

As the denomination *red* phosphorus is universally known, we will also apply this term to the stable modification, though, as was said before, this modification is violet in coarser crystalline state.

The adjoined figure represents the vapour pressure line, as it has been found by us after laborious study, and the table gives the vapour pressures at different temperatures, as they can be read from the vapour pressure line. In a following communication this investigation will be treated more fully.

*Amsterdam, Sept. 25, 1914.*

*Anorg. Chem. Laboratory  
of the University.*

**Chemistry.** — “*The application of the theory of allotropy to electromotive equilibria.*” III. By Prof. A. SMITS and Dr. A. H. W. ATEN. (Communicated by Prof. J. D. VAN DER WAALS).

(Communicated in the meeting of Sept. 26, 1914).

#### *Introduction.*

The application of the theory of allotropy to metals necessarily led to the assumption that every metal that exhibits the phenomenon of phase allotropy, must contain different kinds of ions. As was already mentioned before, these kinds of ions can 1. differ in composition, the electric charge per atom being the same; 2. differ in valence with the same composition, and 3. differ in composition and charge per atom.

On extension of the said theory to the electromotive equilibria it was now demonstrated 1. that the unary electromotive equilibrium finds its place in a  $\Delta r$  figure of a pseudo system, 2. what can be the relation between the unary and the pseudo-binary system, and 3. what phenomena will have to appear when in case of electrolytic solution resp. separation of metals the internal equilibrium is noticeably disturbed. The phenomena of anodic and cathodic polarisation appeared by this in a new light and the passivity of metals revealed itself as a disturbance of the internal equilibrium in the metal surface in the direction of the noblest kind of ions<sup>1)</sup>, which view seemed already to be confirmed by a preliminary investigation<sup>2)</sup>.

Thus we had arrived at the region of the passivity of metals, and

<sup>1)</sup> These Proc. XVI p. 699.

<sup>2)</sup> These Proc. XVII p. 37.



it became desirable to get acquainted with the immensely extensive literature on this phenomenon.

The most important hypotheses that have been proposed as an explanation of this phenomenon, and which have been collected by FREDENHAGEN <sup>1)</sup> in an interesting summary, are the following:

1. The oxide theory of FARADAY, who assumes that passive metals are covered by a coat of oxide <sup>2)</sup>.

2. KRÜGER FINKELSTEIN'S <sup>3)</sup> valence theory which slightly modified is also adopted by MÜLLER <sup>4)</sup>. In this it is assumed that the passivity consists in a change of the proportion between the components of different valence.

3. LE BLANC'S velocity theory <sup>5)</sup>, which supposes the phenomena of passivity to be due to the slight velocity with which the formation of metal ions would take place.

4. The velocity theory of FREDENHAGEN <sup>6)</sup>, MUTHMANN, and FRAUENBERGER <sup>7)</sup>, who start from the supposition that the passivity is caused by the slight reaction velocity between the anodically separated oxygen and the passifiable metal, which causes oxygen charges or solutions of oxygen in metal to originate.

5. The theory of GRAVE <sup>8)</sup>, who assumes a retarded heterogeneous equilibrium metal-electrolyte which is under catalytic influences.

If we now consider the passivity which has arisen by an electrolytic way, it seems to us that too little attention has been paid to the *primary* character of the phenomenon.

First of all we should inquire to what it is owing that in case of anodic polarisation of base metals the potential difference is modified in such a way that the tension of separation for the  $O_2$  is reached, and we should also question why in case of cathodic polarisation of base metals the potential difference changes in such a way that the tension of separation for the  $H_2$  is reached.

<sup>1)</sup> Z. f. phys. Chem. 63, 1 (1908).

<sup>2)</sup> FARADAY has not expressed himself so positively as is generally thought. In a letter to R. TAYLOR FARADAY writes explicitly [Phil Mag X 175. Jan. 21 (1837)]: "I have said (Phil. Mag. IX. 61 1837) that my impression is, that the surface of the metal is oxidized, or else, that the superficial particles of the metal are in such a relation to the oxygen of the electrolyte as to be equivalent to an oxidation, meaning by that not an actual oxidation but a relation..."

<sup>3)</sup> Z. f. phys. Chem. 39, 104, (1902).

<sup>4)</sup> „ „ „ „ 48, 577, (1904). Z. f. Electr. Chem. 11, 755, 823, (1905)

<sup>5)</sup> Chem. News 109, 63 (1914).

<sup>6)</sup> Z. f. phys. chem. 43, 1 (1903).

<sup>7)</sup> Sitzber. K. Bayr. Akad. 34, 201 (1904).

<sup>8)</sup> Z. f. phys. Chem. 77, 513 (1911).

These phenomena being only observed *above a certain current density*, it is clear that we have to do here with a disturbance which makes its appearance when the electric current is passed through with too great velocity.

We have, therefore, to do here with a *question of velocity*, and as an explanation of the primary character of the passivity phenomenon FARADAY'S oxide theory is to be rejected from the beginning.

With regard to GRAVE'S theory we may remark that it seemed very improbable already at a cursory examination. NERNST has namely demonstrated that in the phenomenon of solution equilibrium of saturation always prevails in the boundary layer solid-liquid. In connection with this we may, therefore, expect that this continues to hold for the phenomenon of solution by an electrolytic way. There is no reason at all to make an exception here.

With regard to the second theory it should be observed that the valence hypothesis, on which it is founded, is implied in the conclusions to which the application to metals of the theory of allotropy leads. This theory generally concludes, namely, as was already said before, to the existence of *different kinds of ions in the metal phases* and points out that *one of the possibilities* is this that the metal ions *with the same composition only differ in valence*.

The application of the theory of allotropy to the heterogeneous electrolytic equilibria has further shown that when the metal phase is *complex, apart from the nature of the difference between the ions*, the anodic and cathodic polarisation, and also the passivity of metals can be explained.

Diametrically opposed to this theory are the theories 3, 4 and 5, and it is now clear what will have to be decided. By an experimental way we must try to get an answer to the question as to whether the phenomenon polarisation and passivity resides in the boundary surface between metal and electrolyte, as the theories 3, 4 and 5 suppose, or in the metal surface itself, as the theory of allotropy has rendered probable.

For this purpose the investigation about the complexity is the obvious way. When experiment has proved the complexity, we can try to find out whether it possesses metal ions of different valence.

#### *Experimental part.*

1. To examine whether or no the phenomenon of polarisation and that of passivity resides in the metal surface, it seemed to us the simplest course to attack the metal surface by means of chemical reagents, and to see if it has changed its properties in consequence

of this. If a metal really contains different kinds of ions they will, as was stated before, differ in reactive power; hence an attack may result in a change of the concentration in the metal surface, in the sense of enobling. It is, however, to be seen beforehand that the investigation in this direction will be successful only when the internal equilibrium in the metal surface in contact with the electrolyte is established slowly enough. If this equilibrium is established with very great velocity, no disturbance will of course, take place, even though the ion-kinds differ greatly in reactivity.

It appeared in our previous investigation about polarisation that the metals *Ag*, *Ca*, *Pb* are exceedingly little polarisable, from which we inferred that these metals quickly assume internal equilibrium. Hence the etching of these metals promised little success. Quite in agreement with our anticipations it appeared that the potential difference metal- $\frac{1}{10}$  norm. salt solution was not to be changed for these metals by previous etching.

To examine this the electrode of the metal that was to be investigated, fastened to a platinum thread was etched with acid, and then quickly rinsed with water. Then this electrode was immersed in a  $\frac{1}{10}$  norm. salt solution, and made to rotate, after which the potential with respect to a  $\frac{1}{10}$  N. calomel-electrode was measured as quickly as possible.

When the above mentioned metals according to our anticipations had yielded a negative result, the metals *Co*, *Ni*, *Cr*, and *Fe* were examined with the following result:

Metal	Potential rise through etching	
Co	by HCl	0,108 V
	" H <sub>2</sub> SO <sub>4</sub>	0,109 "
	" HNO <sub>3</sub>	0,107 "
Ni	by HCl	0,04 V
	" HNO <sub>3</sub>	0,10 "
	" Br-water	0,00 "
Cr	by HNO <sub>3</sub>	1,00 V
	" Br-water	0,60 "
Fe	by HNO <sub>3</sub>	above 1,00 V

It follows from this table that these metals about which it was derived from the phenomenon of polarisation that they assume their internal equilibrium much more slowly than *Ag* etc. really become *nobler* when etched with acid, as was expected.

This temporary change of the potential difference in the sense noble must find its origin in a change in the metal surface, and so it is perfectly clear that theories 3, 4, cannot be of any use here.

At the same time they throw a peculiar light on GRAVE's theory. GRAVE thinks that the heterogeneous equilibrium metal-electrolyte can be easily retarded, but that the hydrogen exerts a positively catalytic influence on the heterogeneous equilibrium. According to him iron would become passive by extraction of the dissolved hydrogen, which would take place on anodic polarisation. Now specially in ion-state hydrogen is certainly a catalyst for the transition passive  $\rightarrow$  active, but it is quite unpermissible to derive from this that hydrogen catalyses the heterogeneous equilibrium. It is of importance to state emphatically that according to GRAVE's theory it could by no means be expected that an *enobling* of the metal surface would be brought about when it was etched with HCl or H<sub>2</sub>SO<sub>4</sub>, in which the metal can absorb hydrogen. We have to do here with a phenomenon that cannot be counteracted by the positively catalytic influence of the hydrogen on the internal transformations in the metal surface.

Further we made the following in our opinion very important experiment with iron. An iron electrode forged to a platinum wire was made passive one time through anodic polarisation, another time through immersion in strong nitric acid. Both times the potential of these passive states of the iron electrode immersed in  $\frac{1}{10}$  N.FeSO<sub>4</sub> solution, was measured with respect to  $\frac{1}{10}$  norm. calomel, in which the following appeared.

The potential difference of the passive iron, both after anodic polarisation and after etching with strong HNO<sub>3</sub> at first decreases pretty rapidly, then remains constant for a time, and then descends again rapidly. We now compared the temporarily constant potential difference of the quickly rotating electrode in the two cases, and then found what follows:

Observations	Tension of the constant part of the potential of passive iron
Passivity arisen by anodic polarisation	+0,20 V with respect to $\frac{1}{10}$ Norm. Calomel electrode
Passivity arisen on attack of strong HNO <sub>3</sub>	+0,205 V with respect to $\frac{1}{10}$ Norm. Calomel electrode

From this experiment the important conclusion could, therefore, be drawn that the two passive states are the same.

At the end of this series of experiments we may finally already conclude that from the fact that where anodic enobling was observed, also ore enobling could be demonstrated, follows that the two phenomena must be explained from one and the same point of view, as the theory of allotropy makes possible.

2. As the course followed bade fair to lead to success, we have changed our mode of procedure so that we could expect still greater effects.

Our purpose was now to attack the metals while they were immersed in the salt-solutions, and measure the potential with respect to the calomel-electrodes at the same time.

Very effective in this respect is bromic water, with which in some cases enormous effects were obtained, and a catalytic influence was also discovered of Br-ions for Ni.

### *Nickel.*

The first experiment was made with a screwshaped Ni-electrode, which was kept in rapidly rotatory motion by a motor, and served therefore at the same time as stirrer. The result was as follows.

Ni-electrode in 100 cm<sup>3</sup>  $\frac{1}{10}$  N. Ni(NO<sub>3</sub>)<sub>2</sub>-solution.

Observations	Potential of the Ni-electrode with respect to $\frac{1}{10}$ Norm. Calomel-electrode
Initial value	+ 0,15 V
with one drop of Br-water	+ 0,44 "
" 3 drops   "   "	+ 0,51 "
" 5   "   "   "	+ 0,64 "
" 7   "   "   "	+ 0,67 "
" 3 cm <sup>3</sup> "   "	+ 0,80 "
	Now a pretty abrupt descent of the potential set in. After 4 minutes the potential is constant
	+ 0,42 V
At last 2 drops of pure Br. are added	+ 0,428 "

It follows from this table in the first place that addition of bromic water makes the potential of the nickel rise at first by about 0,65 Volt. Then a maximum is reached, after which a considerable decrease takes place. We further see that when after the potential did not change any more, the bromic concentration was raised to saturation by the addition of three drops of bromine, the potential of the Ni changed only exceedingly little.

This very remarkable result <sup>1)</sup> led us to suspect that the disturbance of the internal equilibrium caused by the action of the bromine, is catalytically influenced by Br<sup>-</sup>-ions which had arisen when the metal was etched. With certain Br<sup>-</sup>-ion-concentration the positive catalytic action of the Br<sup>-</sup>-ions is so great that it can just compensate the disturbing action of the bromine, and the Br<sup>-</sup>-ion-concentration increasing continually, a considerable decrease will then have to set in. If now the bromine concentration is increased considerably, both the disturbing action and the catalytic action is greatly increased, after which the condition *em* become pretty well stationary, and addition of more bromine has little or no influence. To test this supposition the potential of the Ni was first carried up by bromine water, and then KBr was added with the following result :

Ni-electrode in 100 cm<sup>3</sup>  $\frac{1}{10}$  Norm. Ni(NO<sub>3</sub>)<sub>2</sub>-solution.

Observations	Potential of the Ni-electrode with respect to $\frac{1}{10}$ Norm. Calomel-electrode
Initial state	+ 0,07 V
With 5 drops of Br-water	+ 0,52 „
„ 10 „ „ „	+ 0,64 „
„ 2 cm <sup>3</sup> N.KBr solution	+ 0,24 „
„ 2 drops of pure Br	+ 0,35 „

After this a slight decrease takes slowly place.

We see from this that addition of KBr made the potential of Ni really decrease greatly, but then it was necessary in order to get more certainty about the signification of the phenomenon to examine in how far Ni behaved here as a Bromine electrode.

<sup>1)</sup> The same result was obtained with a Ni-electrode glowed in vacuo, from which follows that possibly dissolved hydrogen exerts no influence on the phenomenon.

For this purpose besides a Ni-electrode, also a Pt-electrode covered with Pt-black was placed in the same Ni-nitrate-solution, and then after addition of Br-water the potential of the Ni- and of the Bromine-electrode was determined.

Then the following was found :

Ni and Pt-electrodes immersed in 100 cm<sup>3</sup> N. Ni(NO<sub>3</sub>)<sub>2</sub>-solution.

Observations	Potential of the Ni-electrode with respect to $\frac{1}{10}$ N. Calomel electrode	Potential of the Br-electrode with respect to $\frac{1}{10}$ N. Calomel electrode
Initial value	- 0,33 <sup>1)</sup> V	- 0,03 V
	rise	rise
With 10 drops of Br-water	> 0,60 V	> 0,85 V
" 1 cm <sup>3</sup> " " "	> 0,31 "	> 0,02 "
" 3 " " "	> 0,04 "	> -0,01 "
" 1 " N. KBr-solution	> -0,16 "	> -0,04 "
" 4 " " "	> 0,05 "	> -0,04 "
" 1 " "Na-thiosulphate	> -0,84 "	> -0,79 "
	- 0,43 "	- 0,04 "

Of an unassailable metal which behaves as bromine electrode it may be expected according to the formula :

$$V_{me'.} - V_{so'.} = \Delta = \Delta_0 + 0,058 \log^{10} \frac{\sqrt{C_{Br_2}}}{C_{Br'}}$$

that the addition of the first small quantity of bromine will give rise to a considerable increase of the potential difference, while a subsequent increase of the bromine concentration must exercise a much smaller influence. Our bromine electrode very clearly exhibited this behaviour ; the first 10 drops of brominewater made the potential rise 0,85 Volt, whereas the subsequent addition of 1 cm<sup>3</sup> resp. 3 cm<sup>3</sup> of bromine water no longer practically changed the potential. Increase of the Br'-ion-concentration must lower the potential difference of the bromine electrodes again, and this too was observed. By the addition of 1 cm<sup>3</sup> of N.KBr-solution the potential fell 0,04 Volt. That this lowering is not greater is owing to this that during the action of Bromine on nickel bromine ions had already been formed.

In conclusion we removed all the bromine by addition of Na-

<sup>1)</sup> This negative value must be attributed to the catalytic influence exerted by KBr in the preceding experiment.

thiosulphate, and then the potential fell to  $-0,04$  V., which was about the initial value. If we now compare the behaviour of the Ni-electrode with this behaviour, we notice that the addition of the *first* quantity of bromine has a smaller influence than for the bromine-electrode, and that the addition of more bromine has a much greater influence here than for the bromine-electrode.

While the potential of the bromine electrode *no longer* changes on further addition of Bromine up to  $3$  cm<sup>3</sup>., it increased for the nickel-electrode by an amount of  $0,34$  V., so that the total rise amounted to  $0,95$  V.

And we see further that while the addition of KBr brought about a decrease of only  $0,04$  V. for the bromine-electrode, it came to *four times* the amount, viz. to  $0,16$  V. for the nickel-electrode.

All this suggests that the nickel-electrode does not behave at all as a bromine-electrode in the experiments mentioned here, which is, indeed, not astonishing, as the Br pretty strongly attacks the Ni-electrode.

It is, therefore, clear that we have to do *here* with a very particular behaviour of the metal itself, and that the explanation, as was already surmised, must be this that during the action of bromine on nickel a disturbance of the internal equilibrium takes place in the metal surface, in the nobler sense, and that this disturbance is counteracted by addition of Br-ions, from which follows that bromine ions execute a positively catalytic action. The result is that we have observed here a great disturbance of the internal equilibrium in the metal surface caused by chemical action, which proceeds *continuously*, in the same direction as was found in case of anodic polarisation. The electrolytical solution of metals is, however, very certainly the most efficient means to disturb the internal equilibrium in the metal, and thus in this way an anodic polarisation of  $1,88$  V. was observed for Ni, which after the current had been broken off still amounted to  $0,95$  V., a value which is in fairly good agreement with that found now. The disturbance brought about by Br during the rinsing of the electrode with water being again neutralized, the previous etching experiments with Br had a negative result.

### *Chromium.*

Of all the metals which we have investigated up to now, chromium is nearest akin to Ni.

The following table represents the result obtained when bromine was added to a rotating chromium-electrode immersed in a  $\frac{1}{10}$  N. CrCl<sub>3</sub>-solution.



Cr-electrode in 100 cm<sup>3</sup>  $\frac{1}{10}$  norm. CrCl<sub>3</sub>-solution.

Observations	Potential of the Cr-electrode with respect to $\frac{1}{10}$ norm. Calomelelektrode
Initial state with active chromium <sup>1)</sup>	— 0,26 V
with 3 drops of Br-water	— 0,08 „
	then slowly descends to
	— 0,24 V
with 1 cm <sup>3</sup> of Br-water	+ 0,62 „
	rises in a few minutes to
	+ 0,79 V
with 2 cm <sup>3</sup> of Br-water	+ 0,79 „
with 1 cm <sup>3</sup> of N. KBr solution	+ 0,78 „

Then the preceding experiment was repeated with a solution of Cr(NO<sub>3</sub>)<sub>2</sub> with the following result :

Observations	Potential of the Cr-electrode with respect to $\frac{1}{10}$ Norm. Calomelelektrode
Initial state	— 0,35 V
with 9 drops of Br-water	+ 0,73 „
„ 1 cm <sup>3</sup> of N. KBr-solution	+ 0,74 „

In the first place we see from this that the chromium electrode undergoes an exceedingly strong enobling, in which the metal becomes *passive*, as could be demonstrated. By 1 cm<sup>3</sup>. of bromine water the potential rises more than 1 Volt. Further we see that addition of KBr has no influence on the Cr-potential, which proves both that chromium does *not* behave here as bromine electrode, and that Br<sup>-</sup>-ions do not exert a catalytic influence on the setting in of the metal equilibrium. The metals *Co*, *Al* gave a smaller rise of the potential when attacked by Bromine.

We shall revert to this behaviour later on.

<sup>1)</sup> The commercial chromium is passive, and can as HITTORF states, be activated by heating with strong HCl. Z. f. phys. Chem., **25**, 729 (1898) and **30**, 181 (1889).

## Iron.

The metal iron yielded a remarkable result. The potential of a rotating iron electrode immersed in 100 cm<sup>3</sup>. of  $\frac{1}{10}$  NFeCl<sub>3</sub>, could be affected neither by addition of bromine up to saturation, nor by addition of a solution of N.KBr.

This remarkable result must be explained in the following way. As we shall soon see, iron is strongly attacked by a solution of FeCl<sub>3</sub>, and when acted on in this way iron becomes nobler. Now Br. also attacks iron pretty strongly, and this attack would undoubtedly also lead to an enobling of the iron surface. Evidently, however, the disturbance called forth on attack by Br, is slighter than that caused by FeCl<sub>3</sub>, on account of which the addition of Br could of course have no influence in the just mentioned experiment. What is further most convincingly proved here is this that the iron *absolutely* cannot behave as bromine electrode in consequence of the attack.

This is quite in accordance with what has now been found by us, that namely an enobling of the potential of a metal-electrode caused by addition of bromine, must be attributed to a disturbance of the internal metal equilibrium, at least when the metal is attacked by bromine.

Chlorine acting more strongly on iron than bromine, it was expected that when the former experiment was repeated with chlorine instead of with bromine, a marked rise of the iron potential would be found. As the following table shows, this was actually the case.

Fe-electrode in 100 cm<sup>3</sup> of N.FeCl<sub>3</sub>-solution.

Observations	Potential of the Fe-electrode with respect to $\frac{1}{10}$ Norm. Calomel electrode
Fe in Norm. FeCl <sub>3</sub> -solution	− 0,292 V
In a current of chlorine.	− 0,184 „

We may be sure that the iron which is strongly attacked by chlorine, cannot have behaved here as chlorine electrode, and that this experiment therefore proves that we have succeeded also for iron in disturbing the internal equilibrium in the surface.

Another phenomenon which is in perfect harmony with this view, and which had already been observed by FINKELSTEIN<sup>1)</sup>, is the elec-

1) Z. f. phys. Chem. **39**, 91 (1901).

tromotive behaviour of iron with respect to solutions containing a varying ferro- and ferri-ion content, as appears from the following table.

Fe-electrode in solutions with varying ratio $\frac{\text{ferrosalt}}{\text{ferrisalt}}$	
Observation	Potential of the Fe-electrode with respect to $\frac{1}{10}$ of N. Calomel electrode
Fe-electrode in 1 N. Ferrosulphate	- 0,622 V
" $\frac{1}{2}$ N. Ferro + $\frac{1}{2}$ N. Ferrisalt	- 0,400 "
in 1 N. Ferrisulphate	- 0,292 "

As was said in the introduction, the complexity must first be proved, and then we may try and decide whether the ions differ in valence.

The theory of allotropy already considered the anodic polarisation phenomenon of iron a clear experimental proof, and now the attack experiments have furnished in our opinion the first irrefutable proof.

And now that this stage is reached the electromotive behaviour of iron with respect to solutions with varying ferro- and ferri-ion content appears in a new light.

Now that we namely know that iron must contain different metal

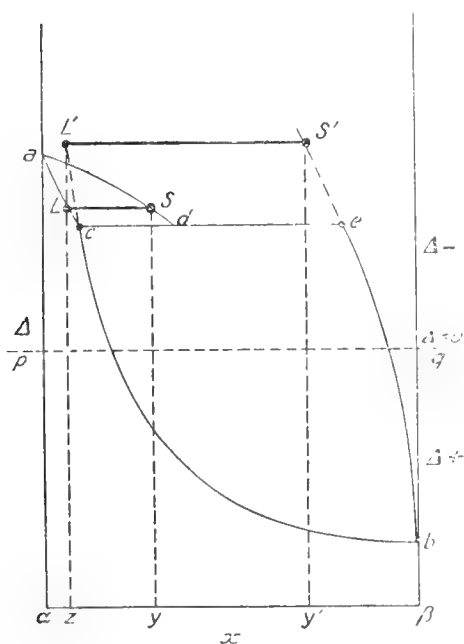

ions, it was natural to try it the observed phenomena may be accounted for from the new point of view on the assumption that iron contains ions of different valence. And really, for so far as we can now survey the region of the observations, this attempt is entirely successful.

If we construct a  $\Delta, x$  figure for the system Fe-electrolyte in the way as was already indicated by one of us, the connection between the pseudo-binary and the unary system drawn in fig. 1 harmonizes well with the experimental facts.

The stable unary electromotive two-phase equilibrium is indicated

by the solution  $L$  and the solid phase  $S$ . This solid phase, therefore, contains very much of the less noble pseudo component  $\alpha$ . The metastable unary electromotive two-phase equilibrium is indicated by the solution  $L'$  and the solid phase  $S'$ .

As was set forth before, on anodic polarisation the metal phase  $S$  will move down along  $Sd$ , hence become nobler, whereas the metal surface will move upward along  $Sa$  on cathodic polarisation, hence become less noble.

The stable unary electromotive equilibrium requires an electrolyte which contains only exceedingly few ferri-ions ( $\beta$ ) by the side of the ferro-ions ( $\alpha$ ). When iron is immersed in a solution of ferri-chloride, the system tends to assume unary electromotive equilibrium, in which we may assume the metal phase to send ferro-ions into solution, whereas ferri-ions are deposited from the solution on the metal.

As follows from the  $\Delta, x$ -figure, a solution containing many ferri-ions could only be in pseudo-electromotive equilibrium with the iron for much less negative potential of the iron. Hence there will be a tendency to make the electrolyte richer in ferro-ions, and the metal in ferri-ions, but until the unary equilibrium concentration has been reached, the iron potential will possess a too small negative value, as was also observed.

It is further to be seen that the negative value of the iron potential will have to increase in a solution of ferro-sulphate, when during the measurement the ferri-ions are precipitated as much as possible.

This follows, indeed, from the following table.

Initial potential of Fe in $1/10$ N. $\text{FeSO}_4$ -solution <sup>1)</sup>					= -0,538 V
Potential	"	idem	"	with a little $\text{NH}_4\text{CNS}$	= -0,578 "
"	"	idem	"	" " " $\text{H}_3\text{PO}_4$	= -0,569 "
"	"	idem	"	" " " $\text{NH}_4$ oxalate	= -0,555 "

The removal of the ferri-ions makes the iron clearly baser.

It is here the place to point out that in the just mentioned etching experiments with chlorine, this substance has only indirectly caused etching. It is namely very well possible that the action of the chlorine has consisted in this that the ferro-ion emitted by the iron is immediately converted into the ferri-ion, in consequence of which the electrolyte remains as far as possible from the concentration of the unary electromotive equilibrium, and that this gives to the electrolyte its maximum etching action with respect to the iron electrode.

<sup>1)</sup> This solution contained traces of ferri salt.

In this case the chlorine would, therefore, indirectly bring about an increase of the disturbance of the internal equilibrium. What is not improbable for iron, may also be true for nickel in the experiment with bromine, when namely the nickel possesses ions of different valence, but this cannot yet be stated with certainty.

Besides this figure accounts for the discontinuous course of the potential, when passive iron immersed in an iron-salt solution, passes into the active form.

Iron which has passed into the passive state by anodic polarisation or by attack with strong  $\text{HNO}_3$ , is greatly enobled superficially, and the potential possesses even a positive value. The concentration of the surface of passive iron, therefore, corresponds to a point on the line  $eb$ , and that below the line  $\Delta = 0$ .

When this passive iron is immersed in a solution of ferro-sulphate, transformations will take place, in consequence of which the unary electromotive equilibrium is approached, and while the potential is falling, the metal surface moves upward along  $be$ , till it has arrived in  $e$ . Here a second metal phase must occur, viz.  $d$ , and as long as the two metal phases occur side by side, the potential of the metal remains constant. The phase  $e$  must be entirely converted to  $d$ , and when this has taken place, the potential descends further, till the unary electromotive equilibrium has been reached, and the metal phase has been superficially transformed into  $S$ .

This is exactly the behaviour that has been observed by many others and also by us. According to our measurements the three-phase equilibrium  $cde$  must lie at  $+0,20$  V. with respect to  $\frac{1}{10}$  N. calomel electrode. The place of the dotted line  $\Delta = 0$  is therefore not correct here; it must be thought between  $LS$  and  $cde$ .

We too found that the transition passive-active is accelerated by  $\text{H}$ -ions, and we are therefore obliged to assume that hydrogen is an accelerator for the internal transformations in the metal, as are also the ions of the halogens. On treatment with strong  $\text{HNO}_3$  and on anodic polarisation the hydrogen is superficially removed, and this greatly promotes the internal transformation, so that the strongly metastable state which we call passive iron, is observed for some time.

Through the diffusion of the hydrogen from within towards the surface the passive iron, no longer subjected to the action of strong  $\text{HNO}_3$  or anodic polarisation, will soon again return to the active form.

Summarizing we come to the following conclusion.

1. FARADAY'S oxide theory, which seemed already sufficiently refuted by others, cannot give an explanation of the *origin* of the

passivity. If a metal is once passive, it can undoubtedly be covered by an oxide coat on anodic polarisation, but the formation of this coat is a secondary phenomenon.

Leaving apart whether on anodic polarisation oxygen charges give rise to a certain rise of the potential, it should be borne in mind that it is exactly the *origin* of these gas charges that is to be explained. Only when the metal during the passage of the current undergoes a rise of the potential and the tension of generation of the  $O_2$  is reached, these gas charges can arise, and so a theory which purposes to explain the phenomenon of passivity; will have to account for this potential rise.

It follows from this that the theories of FREDENHAGEN, MUTHMANN, FRAUENBERGER and others leave the essential part of the passivity phenomenon an open question.

3. Our experiments have proved that the phenomenon of passivity resides in the metal itself, and that though this phenomenon is decidedly a phenomenon of retardation, this retardation is not a retardation of the ion hydratation in the electrolyte, as LE BLANC thinks, but a retardation of the ion transformations in the metal-surface.

4. It is perfectly true, as GRAVE states, that hydrogen accelerates the setting in of the electromotive equilibrium. That the hydrogen would accelerate the setting in of the *heterogeneous* equilibrium metal-electrolyte, is an untenable supposition.

The hydrogen accelerates the establishment of the homogeneous internal equilibrium, but has often appeared to be inadequate to neutralize the disturbance of the equilibrium brought about by etching.

5. With regard to FINKELSTEIN'S (KRÜGER'S) view it might be said to be implied in the new conceptions to which the theory of allotropy has led, but that the said observers, not understanding the deeper signification and the drift of their assumption, were not able to embody their view in a theory.

6. W. J. MÜLLER'S views, which are only distinguished from those of FINKELSTEIN (KRÜGER) by the assumption that the states of different valence formed different phases, are theoretically incorrect, and have therefore not led to any result either.

7. The trustworthy experimental data about passivity mentioned in the literature, just as the new results in this department described here, can all be easily explained by the application of the theory of allotropy to the electromotive equilibria.

*Anorg. Chem. Lab. of the University.*

*Amsterdam, Sept. 25, 1914.*

**Chemistry.** — “*On gas equilibria, and a test of Prof. VAN DER WAALS Jr.’s formula.*” I. By Dr. F. E. C. SCHEFFER. (Communicated by Prof. J. D. VAN DER WAALS).

(Communicated in the meeting of Sept. 26, 1914).

### 1. *Introduction.*

It may be supposed as known that the situation of the equilibrium of a gas reaction at a definite temperature can be calculated, when at that temperature we know the energy of reaction and the variation in entropy free from concentration for molecular conversion according to the chemical equation of reaction. Both quantities are algebraic sums of the energies and entropies of the reacting gases separately, in which the terms referring to substances of different members of the equation of reaction have opposite signs. Energy and entropy of a gas free from concentration are pure functions of the temperature; in the expression for the “equilibrium constant” as function of the temperature the transformation energy and the change in entropy free from concentration at one definite temperature and the temperature coefficients of both occur as constants. The transformation energy of a great number of reactions may be directly derived from BERTHELOT and THOMSEN’s tables; the temperature coefficients are in simple relation with the specific heats, and for this a great number of data are found in the literature; the transformation entropy, however, is generally not determined directly, but from the chemical equilibria by the aid of the above expression.

If one purposes to calculate the chemical equilibria from caloric data, one will have to apply instead of the said mode of calculation of the transformation entropy either direct determinations, or another mode of calculation, in which exclusively quantities of the gases separately are used. The determination of electromotive forces of gas cells might be counted among the direct measurements; for the temperature coefficient of the electromotive force is a measure for the transformation entropy. But this method cannot be applied for a great number of reactions e.g. for dissociations in molecules or atoms of the same kind.

Hence the calculation of chemical equilibria will succeed only when we have a method at our disposal to calculate the entropies of the gases separately or the algebraic sum of the entropies of a gas equilibrium from the constants of the substances.

The thermodynamic entropy of a gas is a quantity, which through its definition is determined except for a constant, and it is therefore

clear that the above mentioned calculations of the entropy of the gases separately have only sense for another definition of entropy. If the entropy is defined as a function of the probability of the condition, it is possible to find a definite value for this entropy; but this value will vary with different meaning of the "probability". Thus the expressions derived by KEESOM<sup>1)</sup>, TETRODE<sup>2)</sup>, and SACKUR<sup>3)</sup> for the entropy of gases present differences which are the consequence of different definitions of probability. These differences only occur in the constant part; if these differences cancelled each other in the algebraic sum, a test by the equilibrium determinations could not give a decision about the correctness of the entropy values. When, however, the algebraic sum of the entropies according to SACKUR and TETRODE are drawn up, it appears that these differences continue to exist also in the algebraic sums, and it must therefore be possible from experimental determinations at least if the accuracy is great enough to get a decision which expression is correct.

While these calculations yield a value for the entropy of the gases separately, Prof. VAN DER WAALS JR. has derived an expression for the "equilibrium constant" of gas reactions, from which the algebraic sum of the entropies can be easily derived; the entropy of the gases separately is again determined here with the exception of a constant. Besides this expression tries to take the variability of the specific heat with the temperature into account<sup>4)</sup>. I intend to test this formula and the above mentioned expressions of SACKUR and TETRODE by a number of data from the chemical literature.

## 2. *The expressions for the entropy of gases.*

For monatomic gases KEESOM, SACKUR, and TETRODE give the value for the entropy free from concentration (eventually after recalculation) successively by the following expressions:

$$H_{v=1} = \frac{3}{2} R \ln T + \frac{3}{2} R \ln R - \frac{5}{2} R \ln N + \frac{3}{2} R \ln m - 3 R \ln h + C_1. \quad (1)$$

in which  $C_1$  represents according to KEESOM  $R \ln \pi + R \left( 4 + \ln \frac{4}{9} \left( \frac{3}{5} \right)^{3/2} \right)$ ,

according to SACKUR  $\frac{3}{2} R \ln 2\pi + \frac{3}{2} R$ , and according to TETRODE

<sup>1)</sup> KEESOM. These Proc. XVI, p. 227, 669, XVII, p. 20.

<sup>2)</sup> TETRODE. Ann. de Phys. (4) 38. 434. 39. 255, (1912).

<sup>3)</sup> SACKUR. Ann. d. Phys. (4) 36. 958, (1911); 40. 67, 87, (1913).

<sup>4)</sup> These Proc. XVI p. 1082.



$\frac{3}{2} R \ln 2\pi + \frac{5}{2} R$ .<sup>1)</sup> This value of  $C_1$  amounts successively to 3,567  $R$ , 4,257  $R$  and 5,257  $R$ .

The values given by SACKUR and TETRODE for di-atomic gases, are:

$$H_{v=1} = \frac{5}{2} R \ln T + \frac{5}{2} R \ln R - \frac{7}{2} R \ln N + \frac{3}{2} R \ln m - \\ - 5 R \ln h + R \ln M + \frac{9}{2} R \ln 2 + \frac{7}{2} R \ln \pi + C_2, \quad \dots \quad (2)$$

in which  $C_2$  according to SACKUR amounts to  $\frac{5}{2} R$ , according to TETRODE to  $\frac{7}{2} R$ .

We get for a tri-atomic gas:

$$H_{v=1} = 3 R \ln T + 3 R \ln R - 4 R \ln N + \frac{3}{2} R \ln m - \\ - 6 R \ln h + \frac{1}{2} R \ln M_1 M_2 M_3 + 6 R \ln 2 + 5 R \ln \pi + C_3, \quad \dots \quad (3)$$

in which  $C_3$  amounts to 3  $R$  according to SACKUR, to 4  $R$  according to TETRODE.

Besides the known values  $N$  and  $h$ , the moments of inertia of the molecules occur therefore in these expressions. For the di-atomic molecules  $M$  is the moment of inertia of the dumbbell shaped molecule with respect to an axis through the centre of gravity, normal to the bar of the dumbbell; for the tri-atomic molecules  $M_1, M_2$  and  $M_3$  are the three chief moments of inertia, which accordingly depend on the relative position of the three atoms in the molecule.

For equilibria in which only mon- or di-atomic molecules participate, the moments of inertia of the di-atomic particles therefore occur, which can be approximately calculated from the different determinations of the mean molecule radius. For a test of the formulae by equilibria of tri-atomic molecules, however, a hypothesis concerning the relative situation of the atoms is indispensable, which is more or less arbitrary, and can make the test less convincing.

### 3. *The equilibrium* $AB \rightleftharpoons A + B$ .

For the simplest gas equilibrium  $AB \rightleftharpoons A + B$ , in which the atoms  $A$  and  $B$  can be of the same or of different kinds, we

<sup>1)</sup> In the expressions of TETRODE l. c. the terms with  $z$  are omitted, which seems justified.

find for the algebraic sum of the entropies free from concentration making use of the expressions of § 2:

$$\begin{aligned} \sum n H_{v=1} &= 2(H_{v=1})_{\text{monat.}} - (H_{v=1})_{\text{diat.}} = \\ &= \frac{1}{2} R \ln T + \frac{1}{2} R \ln R - \frac{3}{2} R \ln N + \frac{3}{2} R \ln \frac{m_A m_B}{m_A + m_B} - R \ln h - \\ &\quad - \frac{3}{2} R \ln 2 - \frac{1}{2} R \ln \pi - R \ln M + C_4, \end{aligned}$$

in which  $C_4$  amounts to  $\frac{1}{2} R$  when SACKUR'S values are used, to  $\frac{3}{2} R$  when TETRODE'S values are used.

SACKUR and TETRODE'S calculations are based on the following assumptions for the specific heats:

$$C_{v \text{ monat.}} = \frac{3}{2} R \quad ; \quad C_{v \text{ diat.}} = \frac{5}{2} R.$$

The value of the transformation energy in its dependence on the temperature is therefore given by:

$$\sum n E = \sum n E_{T=0} + \frac{1}{2} RT.$$

In this expression and the following the molecular values  $n$  of the substances of the second member of the chemical reaction equation are always taken positive, those of the first member negative.

Inserting these values into the expression for  $K_c$ , we find:

$$RT \ln K_c = - \sum n E_{T=0} - \frac{1}{2} RT + T \sum n H_{v=1} - RT,$$

in which  $\sum n H_{v=1}$  is represented by the above derived expressions. We can transform this expression as follows:

$$\ln K_c = - \frac{\sum n E_{T=0}}{RT} + \frac{1}{2} \ln T - \ln M + \ln C_5, \quad \dots \quad (4)$$

in which

$$\ln C_5 = \frac{3}{2} \ln \frac{m_A m_B}{m_A + m_B} - \ln 2Nh + \frac{1}{2} \ln k - \frac{1}{2} \ln 2\pi + C_6; \quad (4a)$$

$C_6$  amounting to  $-1$  according to SACKUR'S expressions, to 0 according to TETRODE.

4. In the fifth communication on the law of partition of energy Prof. VAN DER WAALS JR. derives the following equation for the dissociation equilibrium of a di-atomic molecule:

$$\frac{n_1^2}{n_2} = e^{\frac{\epsilon_1 - \epsilon_0}{\Theta}} \left( \frac{m_A m_B}{m_A + m_B} \right)^{3/2} \frac{1}{M} \frac{1 - e^{-\frac{r h}{\Theta}}}{h} \frac{1}{2} \sqrt{\frac{\Theta}{2\pi}} \quad \dots \quad (5)$$

$\epsilon_1 - \epsilon_0$  here represents the transformation energy at the absolute zero for one particle;  $n_1$  and  $n_2$  represent the number of split and unsplit molecules per volume unity; hence we get:

$$\frac{\epsilon_1 - \epsilon_0}{\Theta} = - \frac{\sum n E_{T=0}}{NkT} = - \frac{\sum n E_{T=0}}{RT} ; K_c = \frac{n_1^2}{n_v} \frac{1}{N} .$$

Equation (5) can, therefore be written in the following form:

$$\ln K_c = - \frac{\sum n E_{T=0}}{RT} + \frac{1}{2} \ln T - \ln M + \ln \left( 1 - e^{-\frac{v h}{kT}} \right) + \ln C_7, \quad (6)$$

in which

$$\ln C_7 = \frac{3}{2} \ln \frac{m_A m_B}{m_A + m_B} - \ln 2 N h + \frac{1}{2} \ln k - \frac{1}{2} \ln 2 \pi . \quad (6a)$$

Equation (6) differs from equation (4) in this that in (6) the term with  $v$  occurs, which takes a vibration of the two atoms in the molecule into account; equation (6a) quite agrees with (4a), if in the latter TETRODE's value is substituted; SACKUR's value yields a unity difference.

### 5. The equilibrium $J_2 \rightleftharpoons 2J$ .

In the chemical literature a series of accurate observations occur of STARCK and BODENSTEIN<sup>1)</sup>; the dissociation constant of iodium is given by them in concentrations, i.e. gram molecules per litre. The equations (4) and (4a), resp. (6) and (6a) yield for their dissociation constant:

$$\ln K_{SB} = - \frac{\sum n E_{T=0}}{RT} + \frac{1}{2} \ln T - \ln M + \left[ \ln \left( 1 - e^{-\frac{v h}{kT}} \right) \right] + \ln C_8, \quad (7)$$

in which  $\log C_8 = \log C_7 + 3$  (according to TETRODE and v. D. WAALS JR.);

$$\log C_8 = \log C_7 + 2,566 \quad (\text{according to SACKUR}).$$

Making use of the values:  $N = 6.85 \cdot 10^{23}$ . (PERRIN),  $h = 1.21 \cdot 10^{-16}$ ,  $h = 5.88 \cdot 10^{-27}$ ,  $m_A = m_B = \frac{127}{6.85 \cdot 10^{23}}$ , we find:

$$\begin{aligned} \log C_8 &= -36.313 \quad (\text{according to TETRODE and VAN DER WAALS JR}) \\ &= -36.747 \quad (\text{according to SACKUR}) \quad . \quad . \quad . \quad . \quad . \quad (7a) \end{aligned}$$

In equation (7) there occur two (resp. three) quantities, which can be calculated from the observations:  $\sum n E_{T=0}$ ,  $M$  (and  $v$ ).

As the term with  $v$  can only have slight influence on the result, we write equation (7) as follows:

$$\begin{aligned} \frac{\sum n E_{T=0}}{2.303 RT} + \log M &= - \log K_{SB} + \frac{1}{2} \log T + \left[ \log \left( 1 - e^{-\frac{v h}{kT}} \right) \right] - \\ &= -36.313 \quad (\text{resp. } -36.747) \quad . \quad . \quad (8) \end{aligned}$$

Let us now assume that  $\lambda$  remains below  $20\mu$ , which seems justified

<sup>1)</sup> Zeitschr. f. Elektrochem. 16, 961 (1910).

in virtue of the observations of the absorption lines and their influence on the specific heats of other gases (see among others BJERRUM); we then find as extremes for the term with  $r$ :

$$\text{zero and } \log \left( 1 - e^{-\frac{3 \cdot 10^{14} \cdot 4.86 \cdot 10^{-11}}{20T}} \right).$$

STARCK and BODENSTEIN's observations now yield the following table for the terms of 8:

TABLE I.

$t(\text{Cels})$	$T$	$K_{S.B.} \cdot 10^3$	$\log K_{S.B.}$	$(\text{term})_{\lambda=20\mu}$	$1/2 \log T$	Second member of 8	
						$\lambda = 0$	$\lambda = 20\mu$
800	1073	0.129	0.111-4	0.693-1	1.515	30.909	- 31.216
900	1173	0.492	0.692-4	0.665-1	1.535	- 31.470	- 31.805
1000	1273	1.58	0.199-3	0.639-1	1.552	- 31.960	- 32.321
1100	1373	4.36	0.639-3	0.615-1	1.569	- 32.383	- 32.768
1200	1473	10.2	0.009-2	0.591-1	1.584	32.738	- 33.147

VAN DER WAALS's equation for  $\lambda = 0$  and TETRODE's entropy expressions yield, therefore, the values of the seventh column of the above table; SACKUR's values always yield 0,4343 less; VAN DER WAALS's equation with  $\lambda = 20\mu$  yields the values of the eighth column.

If we now write equation 8 in the form:

$$\sum_n E_{T=0} + T \log M = TC_p \dots \dots \dots (9)$$

$2,303R$

we find:

TABLE II.

$T$	$(TC_p)_{\lambda=0}$	$\left(\frac{\Delta TC_p}{\Delta T}\right)_{\lambda=0}$	$(TC_p)_S$	$\left(\frac{\Delta TC_p}{\Delta T}\right)_S$	$(TC_p)_{\lambda=20\mu}$	$\left(\frac{\Delta TC_p}{\Delta T}\right)_{\lambda=20\mu}$
1073	- 33166	- 37.5	- 33631	- 37.9	- 33494	- 38.1
1173	- 36915	- 37.7	- 37423	- 38.15	- 37308	38.4
1273	- 40685	- 37.8	- 41238	- 38.2	- 41145	- 38.5
1373	- 44462	- 37.6	- 45058	- 38.0	- 44990	- 38.3
1473	- 48222	mean - 37.6	- 48862	mean - 38.05	- 48824	mean - 38.3

It will be clear that the values of  $\frac{\Delta T C_9}{\Delta T}$  represent the values for  $\log M$  calculated from equation (9). Therefore the value of  $M$  becomes  $10^{-37.6}$  according to TETRODE,  $10^{-38.05}$  according to SACKUR,  $10^{-37.6}$  according to VAN DER WAALS for  $\lambda = 0$ ,  $10^{-33.3}$  for  $\lambda = 20\mu$ .

It is clear from the calculation that the variation of  $\lambda$  from zero to  $20\mu$  does not cause a change in the order of magnitude of  $M$ , that therefore the fact that the frequency is unknown yet renders the rough calculation of  $M$  possible, and that reversely the frequency cannot be calculated but from exceedingly accurate observations. With the measurements available at present this is not yet possible, as appears from table 2.

If the iodine molecule is represented by two spheres, the masses of which are thought concentrated in the centres, and if the distance from the centres is  $d$ , the moment of inertia with respect to an axis through the centre of gravity and normal to the molecule axis is  $2m\left(\frac{d}{2}\right)^2$ . From this follows for the limits of  $d$ :

$$10^{-37.6}, \text{ resp. } 10^{-38.3} = 2 \frac{127}{6.85} \frac{d^2}{10^{23} 4} \text{ or } d = 1.6 \cdot 10^{-8}, \text{ resp. } 7 \cdot 10^{-9} \quad (10)$$

a value which as far as the order of magnitude is concerned is in satisfactory concordance with the diameter calculations according to other methods.

6. SACKUR and TETRODE's entropy expressions which were used in the preceding paragraph are founded on the assumption that the specific heats of the gases are independent of the temperature; the test of these formulae can therefore only be a rough one.<sup>1)</sup> In the expression proposed by VAN DER WAALS, the variability of the specific heats is, however, taken into account.

According to this expression the transformation energy for the iodine dissociation is represented by:

$$\Sigma nE = \Sigma nE_{T=0} + \frac{1}{2} RT - \frac{N\nu h}{e^{kT} - 1} \dots \dots (11)$$

Hence the algebraic sum of the specific heats becomes:

$$\frac{d\Sigma nE}{dT} = \frac{1}{2} R - R \left( \frac{h\nu}{kT} \right)^2 \frac{\frac{h\nu}{e^{kT}}}{\left( \frac{h\nu}{e^{kT} - 1} \right)^2}$$

<sup>1)</sup> A number of calculations of chemical equilibria carried out by the aid of his formula are found in SACKUR, Ann. d. Phys. (4) **40**, 87 (1913).

The specific heat of the two iodine atoms is  $3R$ , that of the iodine molecule therefore

$$\frac{5}{2}R + R \left( \frac{hr}{kT} \right)^2 \frac{h\nu}{e^{kT} - 1} \dots \dots \dots (12)$$

The real specific heat of iodine at  $300^\circ\text{C}$ . is according to STRECKER  $8.53 - 1.985 = 6.545$ . If this expression is substituted for (12), the equation is satisfied for  $\lambda = \text{cir. } 15 \mu$ . If we use this value for equation (8), we get in analogy with tables 1 and 2:

TABLE III.

$t(\text{Cels})$	$(\nu\text{-term})_{\lambda=15\mu}$	Second member of 8 $\lambda=15\mu$	$(TC_9)_{\lambda=15\mu}$	$\left( \frac{\Delta TC_9}{\Delta T} \right)_{\lambda=15\mu}$
800	0.775-1	- 31.134	- 33406	- 38.01
900	0.751-1	- 31.719	- 37207	- 38.25
1000	0.728-1	- 32.232	- 41032	- 38.35
1100	0.705-1	- 32.678	- 44867	- 38.21
1200	0.684-1	- 33.054	- 48688	mean - 38.20

This value yields for the atomic distance:

$$d = 0.82 \cdot 10^{-8} \text{ c.m.}$$

If this value is compared with that for the mean molecule radius, which has been determined in three different ways, it appears that the value for the atomic distance as it is found above, is smaller than the mean molecule radius. We must derive from this that the atom centra in the iodine molecule lie closer together. Remarkable is the agreement of the found  $d$ -value with that of the atom distances, which were calculated by MANDERSLOOT from the width

TABLE IV.

Gas	Radius of Inertia $10^8$
CO	0.566
HCl	0.22
HBr	0.165
J <sub>2</sub>	0.41

of the infra-red bands for three gases <sup>1)</sup>. This agreement appears from the foregoing table, in which the values of the three first mentioned gases are derived from MANDERSLOOT.

I hope soon to come back to the application of the used expressions to some other equilibria.

*Postscript.* During the correction of the proofs a treatise by O. STERN in the *Annalen der Physik* of June came under my notice, in which an expression is derived which shows close resemblance with that of Prof. VAN DER WAALS. Application on the iodine equilibrium can also here lead to a small moment of inertia, which is however considered improbable by STERN.

Amsterdam, Sept. 1914.

*Anorg. Chem. Laboratory  
of the University.*

**Chemistry.** — “*Equilibria in the system Pb—S—O; the roasting reaction process*”. By Prof. W. REINDERS. (Communicated by Prof. S. HOOGWERFF).

(Communicated in the meeting of Sept. 26, 1914).

### *Introduction.*

1. The manufacture of galena into metallic lead is mostly carried out in this manner that the sulphide is first partially roasted and the mass then again strongly heated with unchanged or freshly added lead sulphide out of contact with air. Lead is then formed with evolution of SO<sub>2</sub>.

The reactions that take place in this process known under the name of “Rostreaktionsarbeit” are generally given in the text-books as follows:

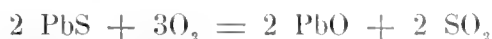
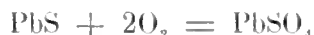

<sup>1)</sup> MANDERSLOOT. Thesis for the Doctorate. Utrecht, 1914.

For a proper insight into this process and to answer the question whether these reactions actually do take place it is necessary to study the equilibria between the different phases that may be formed therein.

After various older researches among which deserve to be mentioned those of H. C. JENKINS and E. H. SMITH <sup>1)</sup>, a systematic research as to these equilibria was carried out some years ago by R. SCHENCK and W. RASSBACH <sup>2)</sup>. They determined the equilibrium pressure of the sulphur dioxide evolved when three of the four phases PbS, PbSO<sub>4</sub>, PbO and Pb are heated together in an evacuated tube at 550° to 900°.

The conclusions which they drew from these measurements as to the nature of the equilibria occurring therein could, however, not be correct in many respects. Their idea has in fact been considerably modified in various subsequent publications thereon <sup>3)</sup>. But even the last concluding articles still contain many contradictions so that it is not plain what equilibria they have actually determined and which phases are stable in the presence of each other.

In the following will, therefore, be discussed (1) the different equilibria imaginable in this system and (2) the results will be communicated of researches which in consequence thereof have been carried out conjointly with Dr. F. GOUDRIAAN.

2. The equilibria between Pb and the compounds PbO, PbS, PbSO<sub>4</sub> and SO<sub>2</sub> may be considered as those in a system of three components, namely Pb, O, and S. The isotherm for the equilibria between the different phases can, then, be indicated by a triangle with these components as apexes. (See fig. 1).

Let us now first suppose that

- a. only the phases Pb, PbS, PbSO<sub>4</sub>, PbO and SO<sub>2</sub> are possible
- b. the gaseous phase is pure SO<sub>2</sub> and the lead phase pure lead.

In the last supposition we therefore neglect the small amount of PbS in the vapour and the solubility of PbS in molten lead; in the first supposition no notice is taken of the basic sulphates which according to the later researches of SCHENCK and RASSBACH <sup>4)</sup> occur as intermediate phases between PbSO<sub>4</sub> and PbO.

<sup>1)</sup> Journ. Chem. Soc. **71**, 666 (1897).

<sup>2)</sup> Ber. d. d. chem. Ges. **40**, 2185 (1907). Metallurgie **4**, 455, (1907).

<sup>3)</sup> Ber. d. d. chem. Ges. **40**, 2947 (1907); **41**, 2917 (1908). R. SCHENCK, Physikalische Chemie der Metalle.

<sup>4)</sup> Ber. d. d. chem. Ges. **41**, 2917, (1908).



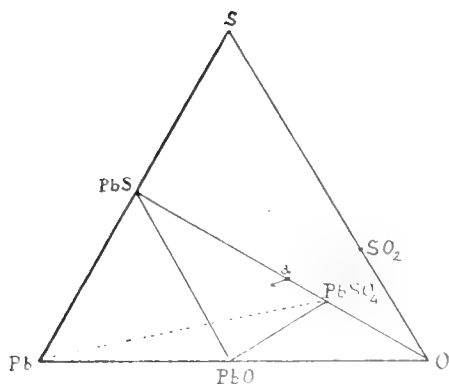
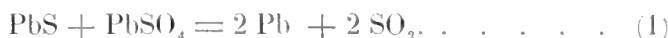

Fig. 1.

The two phases will be capable of existing in the presence of each other and in an unchanged condition at a series of temperatures and pressures.

If on lowering the pressure this falls below a certain limit, one of the two following reactions will take place



or

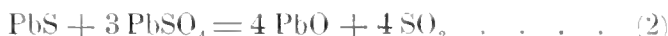

In both cases there are formed in addition to the two existing solid phases two new phases, namely fused Pb and  $\text{SO}_2$ -gas, or solid PbO and  $\text{SO}_2$ -gas. Hence, between these four phases a monovariant equilibrium will set in, which, at a constant temperature, is possible only at one special pressure. This will be  $p_1$  or  $p_2$ .

Only in a very special case, namely with an eventual transition point where the five phases PbS, PbSO<sub>4</sub>, PbO, Pb, and SO<sub>2</sub> might coexist,  $p_1$  and  $p_2$  are equal. As a rule, however, they are not and in consequence only one of the two monovariant equilibria can be stable.

For if  $p_1 > p_2$  the reaction (1), in the presence of the five phases, will take place from the left to the right and the  $\text{SO}_2$  formed act on PbO according to equation (2) in the direction  $\leftarrow$ . Hence, the two reactions together result in the following conversion:



This transformation takes place until one of the phases of the first member of the equation is used up, whilst the other with Pb

We shall see later how the deduced equilibria are being modified when we drop these simplifications.

3. Let us imagine PbS heated at constant temperature between  $600^\circ$  and  $800^\circ$  in an enclosed space wherein a limited quantity of oxygen is forced. PbS is then partly converted into PbSO<sub>4</sub>.

and  $\text{PbSO}_4$  is left.  $\text{PbS}$  and  $\text{PbO}$  are, therefore, not capable of existing side by side of each other.

If, conversely  $p_1 < p_2$  the different reactions take place in the opposite sense and  $\text{Pb}$  and  $\text{PbSO}_4$  recede from each other.

Hence, of the phase pairs  $\text{Pb} + \text{PbSO}_4$  and  $\text{PbS} + \text{PbO}$  only one can be stable, the other forms a metastable equilibrium.

Here we have a case quite similar to that occurring with reciprocal salt pairs where also only one of the two pairs can be stable.

4. Let us now also consider the two other monovariant equilibria which may be assumed to exist with  $\text{SO}_2$ -vapour and which are indicated by the equations



In the case  $p_1 > p_2$ , it follows at once from the incompatibility of the phases  $\text{PbS}$  and  $\text{PbO}$  that the equilibrium (4) can be stable, but not equilibrium (3).

Moreover, we then must have  $p_3 > p_1$  for otherwise after the reaction (1) in the direction  $\rightarrow$  might follow the reaction (3) in the direction  $\leftarrow$  which reactions might jointly cause the conversion (5) in the direction  $\leftarrow$ , which is in conflict with the premiss.

Finally we shall have  $p_4 < p_2$ , for then the stable equilibrium may also be again attained by the reaction (2) in the direction  $\rightarrow$  followed by (4) in the direction  $\leftarrow$ , namely:



Hence, we get this result:

If  $\text{Pb} + \text{PbSO}_4$  forms the *stable* phase pair, then only the monovariant equilibria (1) and (4) are stable and  $p_3 > p_1 > p_2 > p_4$ .

If  $\text{PbO} + \text{PbS}$  form the *stable* phase pair, all the reactions occur in the opposite sense and only the monovariant equilibria (2) and (3) are stable, whereas then  $p_4 > p_2 > p_1 > p_3$ .

5. Starting from the mixture of  $\text{PbS}$  and  $\text{PbSO}_4$  (for instance  $a$  in fig. 1) we will, on withdrawal of  $\text{SO}_2$  travel either through the monovariant equilibria (1) and (4) (region  $\text{PbS}, \text{PbSO}_4, \text{Pb}$  and region  $\text{PbSO}_4, \text{Pb}, \text{PbO}$  of Fig. 1) or the equilibria (2) and (3) (region

PbS, PbSO<sub>4</sub>, PbO and region PbS, PbO, Pb) to finally retain the equilibrium Pb + PbS or Pb + PbO after eliminating the SO<sub>2</sub> as much as possible.

Hence, the reactions (1) and (3), which are generally quoted as taking place in the roasting reaction process cannot possibly indicate *both* stable equilibria.

Of the p-T-lines which SCHENCK and ROSSBACH determined by addition of PbSO<sub>4</sub>, PbS and Pb and of PbS, PbO and Pb one at least must, therefore, indicate an instable equilibrium or an equilibrium between phases other than those which were brought together in the reaction tube.

We will see later that both equilibria are metastable and that the pressure lines recorded by them relate to the equilibrium between other phases.

6. The supposition made in (2) sub *a* is not correct. Between PbSO<sub>4</sub> and PbO there still arrive three basic salts as intermediate phases, namely PbO.PbSO<sub>4</sub>, (PbO)<sub>2</sub>PbSO<sub>4</sub> and (PbO)<sub>3</sub>PbSO<sub>4</sub>. The first of these can be in equilibrium with PbSO<sub>4</sub>.

The four monovariant equilibria mentioned in (3) now become:

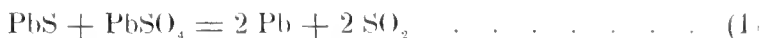

and the alternative found must read:

either Pb + PbSO<sub>4</sub> stable and then  $p_3 > p_1 > p_2 > p_4$  and only (1) and (2) stable,

or PbS + PbO.PbSO<sub>4</sub> stable and then  $p_3 < p_1 < p_2 < p_4$  and only (2) and (3) stable.

### *Experimental.*

(conjointly with Dr. F. GOUDRIAAN).

7. In order to investigate which of these two phase pairs was stable and at the same time to know the SO<sub>2</sub>-pressure of the stable equilibrium, an intimate mixture of PbS and PbSO<sub>4</sub> (6–8 grams) was heated in a porcelain tube connected by means of a ground joint with a manometer and an air-pump.

The lead sulphide was precipitated from a solution of lead acetate with H<sub>2</sub>S and after washing, dried by heating in a current of nitrogen at 200°–300°.

The lead sulphate was precipitated from a solution of lead acetate with sulphuric acid and also dried at 300°.

The mixture was introduced in a porcelain boat. The remaining space in the reaction tube was occupied by a porcelain rod so as to render the gas-volume as small as possible and thus to accelerate the setting in of the equilibrium as much as possible.

The heating took place in an electric furnace. The temperature was measured with a Pt-PtRh thermocell and a galvanometer.

8. Although the reacting substances had been previously dried at  $300^\circ$  there still was evolved, on heating at  $500^\circ$ , in vacuo, a little moisture, which condensed in the colder part of the tubes and was removed by a repeated evacuation and gentle heating.

Subsequently the dissociation pressure was measured at different pressures between  $500^\circ$ — $700^\circ$ .

The equilibrium set in very rapidly so that when the temperature had been raised and more gas began to evolve there could generally not be noticed any change in pressure after 20—30 minutes. Then a further evolution of  $\text{SO}_2$  was caused by a short heating at a somewhat higher temperature and after cooling to the original temperature the course of the absorption of the  $\text{SO}_2$  was recorded. This also took place very rapidly. The equilibrium was thus attained from both sides and yielded figures which differed from each other at most 2 or 3 m.m. Also the same pressure again set in after an evacuation. The equilibrium is, therefore, independent of the total composition, which was confirmed by a change in the proportions of  $\text{PbSO}_4$  and  $\text{PbS}$ .

The results are contained in table I. (Fig. 2 Curve I).

TABLE I.

7 $\text{PbSO}_4$ on 1 $\text{PbS}$		5 $\text{PbSO}_4$ on 1 $\text{PbS}$		3 $\text{PbSO}_4$ on 1 $\text{PbS}$	
$t$	$p$	$t$	$p$	$t$	$p$
582°	26	604	50	590	30
606	56	634	100	620	72
630	94.5	660	185	670	222
655	156	688	346		
680	280				

After the tube had been evacuated a few times and a certain quantity of the dissociation product might thus have been formed,

and as it had been shown that always the old equilibrium again set in, the oven was allowed to cool and the tube was withdrawn.

The reaction product was strongly caked and of a *lighter colour* than the original mixture of PbS and PbSO<sub>4</sub>. Here and there were visible granules with a strong metallic lustre so that at first the suspicion was raised that lead had formed as a reaction product. On closer examination by means of a magnifying glass these granules proved to be very beautifully formed crystals of "galena" which had deposited, besides in the reaction mass, also against the porcelain boat and the extremity of the porcelain rod. The analysis showed this to be perfectly pure PbS, whilst in the reaction product itself not a trace of free lead could be detected.

Hence, no lead has formed so that the reaction product must be *basic lead sulphate*.  $PbS + PbO.PbSO_4$  form the stable phase pair,  $Pb + PbSO_4$  the metastable one.

9. This was confirmed by the following experiment:

An intimate mixture of PbSO<sub>4</sub> and finely divided lead scrapings in the proportion of 10 PbSO<sub>4</sub> to 1 Pb was heated in an evacuated and sealed tube for 3 hours at 600°.

The product obtained gave with hydrochloric acid a very distinct evolution of H<sub>2</sub>S.

A weighed quantity was now heated in a small flask with strong hydrochloric acid and the gas expelled collected in an ammoniacal solution of hydrogen peroxide. This solution was boiled for a while, then acidified, and the resulting H<sub>2</sub>SO<sub>4</sub> precipitated as BaSO<sub>4</sub>.

Five grams of mixture containing originally 0.380 gram of Pb, yielded 0.040 gram of BaSO<sub>4</sub>, equivalent to 0.041 gram of PbS.

According to the equation:



0.142 gram of Pb has been required for this 0.041 gram of PbS.

Although the lead has not yet entirely disappeared, a considerable quantity of the same has been converted into PbS<sup>1)</sup>.

10. The pressures observed almost entirely agree with the values found by SCHENCK and RASSBACH for the mixture of PbS + PbSO<sub>4</sub> + Pb as well as for PbS + PbSO<sub>4</sub> + PbO. They conclude that the pressures

<sup>1)</sup> Afterwards it came to our knowledge that also JENKINS and SMITH (l.c. p. 691) had already made an experiment from which this is shown. They heated a mixture of equal molecular quantities of Pb and PbSO<sub>4</sub> in a porcelain crucible at dull red heat for half an hour; from the residual mass could be expelled with HCl a quantity of H<sub>2</sub>S corresponding with 1.41% of sulphur.

relate to the equilibrium between the first three phases and that the second trio is not stable. From the preceding it follows that both equilibria are metastable and that the pressures recorded relate to the equilibrium  $\text{PbS}, \text{PbSO}_4, \text{PbO} \cdot \text{PbSO}_4, \text{SO}_2$ .

The fact that the lead present exerts so little influence on the equilibrium pressure proves that reaction (4), which should lead to a higher pressure  $p_4$  and the reactions (1) and (3) in the direction — which should lower it either compensate each other or, in comparison with the reaction (2) proceed so slowly that they do not perceptibly alter the pressure. Probably the more finely divided lead is soon converted and the remaining lead, united to larger drops, offers such a small surface of attack that it can react but very slowly.

11. When now from the  $\text{PbS} + \text{PbSO}_4$  so much  $\text{SO}_2$  has been abstracted that all has passed into  $\text{PbS} + \text{PbO} \cdot \text{PbSO}_4$  the equilibrium has become divariant. The residual phases will be capable of existing by the order of each other in a series of pressures  $< p_4$ .

If, however, the pressure falls below a definite limit, a third condensed phase appears. Two phases are concerned here, namely  $\text{Pb}$  and  $(\text{PbO})_2 \cdot \text{PbSO}_4$ .

As noticed in the case  $\text{PbS} + \text{PbSO}_4$ , only one of the two can be in stable equilibrium with  $\text{PbS}$  and  $\text{PbO} \cdot \text{PbSO}_4$ .

This depends on which of the phase pairs  $\text{PbS} + (\text{PbO})_2 \cdot \text{PbSO}_4$  and  $\text{Pb} + \text{PbO} \cdot \text{PbSO}_4$ , which can be converted into each other by double decomposition:

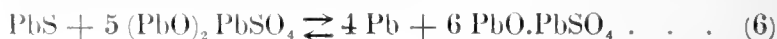

is stable.

12. In order to investigate this an intimate mixture of finely divided lead scrapings and basic lead sulphate in the molecular proportion of 3 : 1 was heated for three hours in an evacuated and sealed tube at  $670^\circ$ — $680^\circ$ .

The  $\text{PbO} \cdot \text{PbSO}_4$  had been prepared by the moist process, according to D. STRÖMHOLM<sup>1)</sup>, by digesting finely powdered  $\text{PbSO}_4$  with a 1—2%  $\text{NH}_3$ -solution. The analysis of the product obtained gave 84.88%  $\text{PbO}$ , theory for  $\text{PbO} \cdot \text{PbSO}_4$  84.79%.

The heating of the mixture  $\text{Pb} + \text{PbO} \cdot \text{PbSO}_4$  yielded apparently a but little changed product. It gave, however, a slight sulphide reaction. Thus it seemed that the mixture selected did not form the

<sup>1)</sup> Zeitschr. f. anorg. Chem. 38, 429 (1904).

stable phase pair. We must, however, consider that the lead phase need not be pure Pb, but may contain dissolved PbS and hence there exists the possibility that the PbS found was present, not as a free phase, but as a solution in the molten Pb.

The amount of PbS was, therefore, determined quantitatively.

From two grams of the mixture were obtained 17,4 mg. of BaSO<sub>4</sub> corresponding with 17,8 mg. of PbS. For the formation of 17,8 mg. of PbS according to reaction (6) are required 70 mg. of Pb. Before the heating 2 grams of the mixture contained 1,082 grams of lead. Hence, there remains 1,022 gram of Pb, which in 100 grams contains

$$\frac{17,8}{1022} \times 100 = 1,77 \text{ grams of PbS.}$$

From the observations of FRIEDRICH and LEROUX<sup>1)</sup> it follows that the lead solution saturated with PbS at 680° contains 2,5% PbS. Hence the PbS will be present in the heated mixture not as a free phase, but as a solution in Pb, and Pb + PbO.PbSO<sub>4</sub> will form the stable phase pair.

13. This conclusion was further confirmed by the dissociation experiments, starting from a mixture of PbS and PbO.PbSO<sub>4</sub>.

These experiments were conducted in a manner similar to that in the case of PbS and PbSO<sub>4</sub>. The SO<sub>2</sub>-evolution started at 680°. The equilibrium set in quite as easily as with PbS + PbSO<sub>4</sub> and could be determined readily from both sides. Also, after removal of larger quantities of SO<sub>2</sub>, the same equilibrium pressure was again always obtained. In order to prevent fusion the mass was not heated above 800°.

The results obtained are united in table II (Fig. 2, Curve II).

TABLE II.

<i>t</i>	<i>p</i>
712	27.5
740	63
750	78
753	87.5
770	123
790	233

<sup>1)</sup> Metallurgie 2, 536 (1905).

These values correspond very well with the pressures found by SCHENCK and RASSBACH with a similar mixture and with a mixture of  $\text{PbS} + \text{PbO}$  which has been heated above  $800^\circ$  and then cooled.

On opening the apparatus it appeared that the reaction product, although not fused, had strongly caked: the porcelain boat was strongly attacked and on the rod a sublimate of very beautiful  $\text{PbS}$ -crystals had again deposited. It was not doubtful that the reaction mass contained *metallic lead*; there could be found large, soft paper-marking and malleable particles. Finally, it was proved by extracting a portion of the reaction product first a few times with ammonium acetate and then with lead acetate. All the  $\text{PbSO}_4$  and  $\text{PbO}$  then dissolves. The residue was treated with fuming  $\text{HNO}_3$ , which converts the  $\text{PbS}$  quantitatively into  $\text{PbSO}_4$ . After expelling the  $\text{HNO}_3$  and filtering off the  $\text{PbSO}_4$ , any  $\text{Pb}$  formed eventually as  $\text{Pb}(\text{NO}_3)_2$  must be present in the filtrate.

The filtrate gave a strong lead reaction. The reaction mass thus contains metallic lead.

Hence  $\text{Pb} + \text{PbO.PbSO}_4$  are the stable phase pair and the pressures measured relate to the reaction:

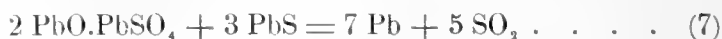

14. From the above it follows that with a sufficient excess of basic lead sulphate the end of reaction (7) will be a mixture of  $\text{PbO.PbSO}_4$  and  $\text{Pb}$ . (In the latter, however, a little  $\text{PbS}$  will still be dissolved).

This equilibrium is divariant and, on a sufficient reduction of pressure, will pass into a monovariant equilibrium.

The third condensed phase occurring therein cannot be a second metallic phase for the solution of  $\text{PbS}$  in  $\text{Pb}$  already present is mixable with pure lead in every proportion.

Hence, it must be the basic sulphate  $(\text{PbO})_2 \cdot \text{PbSO}_4$  which follows the  $\text{PbO.PbSO}_4$  and the reaction occurring is indicated by the following equation:

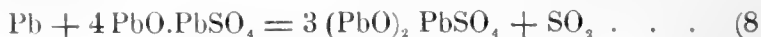

The monovariant equilibrium of this reaction will in turn be followed by still two other monovariant equilibria wherein occur the reactions represented by the equations:

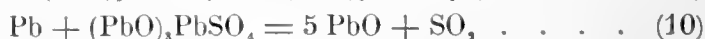

In these reactions *primary formed lead therefore disappears* on behalf of  $\text{PbO}$  until, finally, only  $\text{Pb} + \text{PbO}$  is left.



15. Pressures appertaining to the first monovariant equilibrium were obtained by starting from a mixture of Pb and  $\text{PbO} \cdot \text{PbSO}_4$ .

Not until  $700^\circ$  an evolution of gas was perceptible. The equilibrium sets in with much greater difficulty than in the first two cases; generally two or three hours were required. Probably this is due to the fact that the metal conglomerates and thus offers but a small contact surface with the basic salt. It is also very certain, however, that the greater vapour tension of the  $\text{PbS}$  will have strongly promoted the setting in of the previous equilibria of which  $\text{PbS}$  was one of the active phases. The equilibrium could again be attained from both sides.

The following pressures were measured (Fig. 2 Curve III):

TABLE III.

$t$	$p$
750'	36.5
771	61
789	98

The tube was subsequently evacuated at  $789^\circ$  and the equilibrium pressure again determined. This proved to be unchanged. Even on

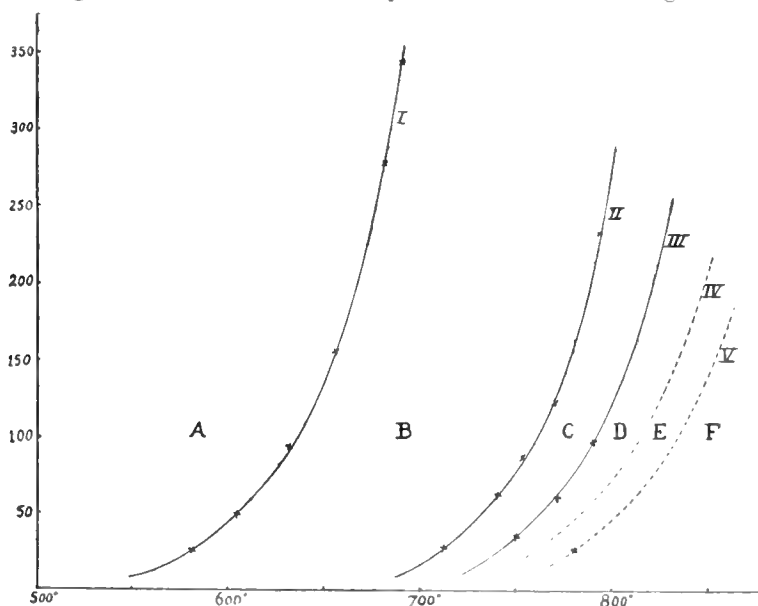

Fig. 2.

evacuating a second time the pressure reverted to its old value. The pressures measured therefore relate to a purely monovariant equilibrium.

16. Without opening the apparatus the experiments were now continued with the same mixture at  $789^\circ$ . The tube was, therefore, evacuated for the third time and then again a few times and each time the equilibrium pressure was again measured. It now appeared that the old pressure no longer set in, but that a lower pressure was attained and the more so when more  $\text{SO}_2$  had been withdrawn. In succession were found 93, 75, 61, 54, 41, 34, and 28 m.m.

This different behaviour can be explained in two ways.

1. The equilibrium is no longer monovariant, but divariant. Instead of three solid phases there are only two, one of which possesses a variable composition. This phase might be a very basic sulphate with a variable content in  $\text{PbO}$ . The fusion diagram  $\text{PbO} - \text{PbSO}_4$  of SCHENCK and RASSBACH gives, however, but little support to this conception.

2. The pressures measured are not true equilibria pressures, but indicate a stationary condition.

For if, on evacuating, the pressure falls below the equilibrium pressure of equilibrium (9) the basic sulfate  $(\text{PbO})_3 \text{PbSO}_4$  can decompose still further and give rise to the formation of  $(\text{PbO})_3 \text{PbSO}_4 \cdot \text{Pb} + \text{PbO} \cdot \text{PbSO}_4$  then strive, according to reaction (8) towards the pressure  $p_8$ ,  $(\text{PbO})_3 \text{PbSO}_4 + \text{SO}_2$  according to reaction (9), however, in the direction  $\leftarrow$  towards  $p_9$ . And when finally both reactions take place with equal velocity, we obtain an apparent equilibrium at a pressure between  $p_8$  and  $p_9$  and dependent on the quantities of the different phases.

It is even possible that  $\text{PbO}$  is also formed and that reaction (10) thus takes place simultaneously.

17. The second assumption was the most probable one. In order to test it more closely a mixture of  $\text{Pb}$  and  $(\text{PbO})_3 \text{PbSO}_4$  was heated in the pressure tube. From this mixture  $\text{PbO}$  only can be formed as the third phase so that only one reaction, that of the monovariant equilibrium (10), should be possible.

$(\text{PbO})_3 \cdot \text{PbSO}_4$  was obtained by fusion of 1  $\text{PbSO}_4$  with more than 3  $\text{PbO}$ . As porcelain is strongly attacked by  $\text{PbO}$ , the mixture was heated in a magnesia boat previously heated and saturated with lead oxide.

The result of the measurement at  $780^\circ$  was  $p = 23$ , after evacuation at the same temperature again 22 m.m., then at  $800^\circ$ , 38 and after evacuation successively 30, 22, 16 m.m. Thus no constant equilibrium is attained.

On opening the pressure tube nearly all appeared to have been

fused and run through the boat although the temperature had not got above  $800^{\circ}$ , whereas the eutecticum of  $\text{PbO}$  and  $(\text{PbO})_3 \cdot \text{PbSO}_4$ , according to SCHENCK and RASSBACH is at  $820^{\circ}$ . Probably the  $\text{MgO}$  is attacked by the  $\text{PbSO}_4$ . The want of a suitable material which is attacked neither by  $\text{PbO}$  nor by  $\text{PbSO}_4$  or  $\text{Pb}$  at this high temperature renders a correct determination of dissociation pressures for reaction (9) and (10) a matter of great difficulty.

If we accept the value of 20 mm. at  $780^{\circ}$  as the correct one for the equilibrium (10), the  $p$ - $T$ -line for this equilibrium would then run as indicated by line V in fig. 2.

The  $p$ - $T$ -line of equilibrium (9) then lies between III and V and is indicated schematically in Fig. 2 by line IV.

18. Although from the preceding it is evident that  $\text{PbS}$  and  $\text{PbO}$  cannot be coexistent, a few experiments were made nevertheless in order to confirm this opinion.

SCHENCK and RASSBACH in all their publications consider the equilibrium  $\text{PbS}$  and  $\text{PbO}$  to be stable although in their dissociation experiments it had already been shown that with such a mixture reproducible pressures were not always obtained, for instance if the temperature had been raised to above  $800^{\circ}$ . They also noticed the formation of sulphate, but assume that this can only be formed at a high temperature and then remains intact on sudden cooling to the dissociation temperatures.

We have now heated an intimate mixture of  $\text{PbO} + \text{PbS}$  for some hours at  $600$ — $700^{\circ}$  in an evacuated and sealed tube.

The reaction product perceptibly contained sulphate. This was estimated quantitatively by boiling a weighed quantity of the product with aqueous sodium hydroxide and then passing  $\text{CO}_2$ . The  $\text{PbSO}_4$  present is then converted into  $\text{PbCO}_3$ . After filtering and acidifying the filtrate the sulphate was precipitated as  $\text{BaSO}_4$ . A check analysis was also made on a portion of the mixture that has not been subjected to heating, under exactly the same conditions of boiling etc.

Mixture of 4 mols. $\text{PbO}$ to 1 mols. $\text{PbS}$ . Temperature $670$ — $680^{\circ}$				
Time of heating	0	$1\frac{1}{2}$	3	6 hours
Gram of $\text{BaSO}_4$ per gram of mixture	0,0498	0,0758	0,1000	0,1121
Additional sulphate formed on heating at $680^{\circ}$				
in gram of $\text{BaSO}_4$ per gram of mixture	—	0,0260	0,0502	0,0623

If the mixture had been converted completely into basic sulphate

according to the equation  $5 \text{ PbO} + \text{PbS} = \text{PbO} \cdot \text{PbSO}_4 + 4 \text{ Pb}$ , 1 gram of the mixture should have yielded 154 mg. of  $\text{BaSO}_4$ . Hence, a large proportion of the  $\text{PbO} + \text{PbS}$  has been converted. <sup>1)</sup>

The pressures which SCHENCK and RASSBACH observed with a mixture of  $\text{Pb} + \text{PbO} + \text{PbS}$  do, therefore, probably not relate to an equilibrium of these three phases with  $\text{SO}_2$ , but to another equilibrium.

By a comparison of their observations with our measurements it appears that on heating at temperatures below  $800^\circ$  this is the equilibrium:  $\text{Pb} + \text{PbO} \cdot \text{PbSO}_4 + (\text{PbO})_2 \text{PbSO}_4$ , and on heating above  $800^\circ$  and then cooling, the equilibrium:  $\text{Pb} + \text{PbS} + \text{PbO} \cdot \text{PbSO}_4$ .

Also below  $800^\circ$  however, this latter equilibrium sets in, which with a sufficient excess of  $\text{PbS}$  is the most stable, as shown from the following experiment:

A mixture of  $\frac{1}{2}$  mols. of  $\text{PbO}$  to 1 mol. of  $\text{PbS}$  was heated in a pressure tube. The evolution of gas started at  $660^\circ$ . After evacuation the following change in pressure was observed at  $750^\circ$ .

time in min.	pressure
0	5
7	14
20	26
34	33
42	35
70	41
100	44
160	53
220	65
280	74
340	81
400	83
460	83

The pressure thus rises rapidly to  $\pm 38$  m.m. and then increases gradually to 83.

The first pressure falls on the  $p$ - $T$ -line of  $\text{Pb} + \text{PbO} \cdot \text{PbSO}_4 + (\text{PbO})_2 \text{PbSO}_4$ , the second on that of  $\text{Pb} + \text{PbS} + \text{PbO} \cdot \text{PbSO}_4$ .

Similarly was found with a fresh mixture on heating at  $790^\circ$  a

<sup>1)</sup> The high result of the sulphate content in the check experiment is very striking, because both the  $\text{PbO}$  and the  $\text{PbS}$  employed were free from sulphate. Evidently the conversion of  $\text{PbS} + \text{PbO}$  into sulphate takes already place at the boiling heat in the aqueous solution, from which it follows that also at the ordinary temperature  $\text{PbS}$  and  $\text{PbO}$  are not stable in each other's presence.

first halt at  $\pm 100$  m.m. and then a slow rise to 236 m.m. Both pressures are again situated on the above cited  $p$ - $T$ -lines.

CONCLUSION.

19. Summarizing it thus appears that on abstraction of  $\text{SO}_2$  from a mixture of  $\text{PbS}$  and  $\text{PbSO}_4$ , the subjoined monovariant equilibria are successively met with, which are indicated in fig. 3 by the regions I, II, III, IV and V.

- $\text{PbS} - \text{PbSO}_4 - \text{PbO} \cdot \text{PbSO}_4 \dots \text{I}$
- $\text{Pb}_a - \text{PbS} - \text{PbO} \cdot \text{PbSO}_4 \dots \text{II}$
- $\text{Pb}_b - \text{PbO} \cdot \text{PbSO}_4 - (\text{PbO})_2 \cdot \text{PbSO}_4 \dots \text{III}$
- $\text{Pb}_c - (\text{PbO})_2 \cdot \text{PbSO}_4 - (\text{PbO})_3 \cdot \text{PbSO}_4 \dots \text{IV}$
- $\text{Pb}_d - (\text{PbO})_3 \cdot \text{PbSO}_4 - \text{PbO} \dots \text{V}$

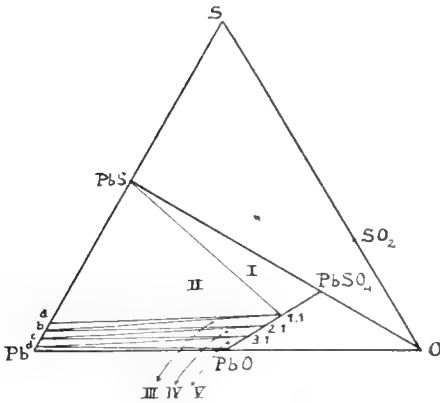

Fig. 3.

Therein region *A* is the existential region of  $\text{PbS} + \text{PbSO}_4$

- ” ” *B* ” ” ” ” ” ”  $\text{PbSO}_4 + \text{PbO} \cdot \text{PbSO}_4$
- ” ” *C* ” ” ” ” ” ”  $\text{PbO} \cdot \text{PbSO}_4 + \text{Pb}$
- ” ” *D* ” ” ” ” ” ”  $(\text{PbO})_2 \text{PbSO}_4 + \text{Pb}$
- ” ” *E* ” ” ” ” ” ”  $(\text{PbO})_3 \text{PbSO}_4 + \text{Pb}$
- ” ” *F* ” ” ” ” ” ”  $\text{PbO} + \text{Pb}$ .

Hence, at the temperatures and pressures of region *F* all the sulphur will have been expelled from the roasting material.

20. By substituting the values found in table 1 first series in the equation  $\log p = -\frac{Q}{4,571 T} + C$  and combining the equations thus obtained in pairs,  $Q_1$  was calculated for the reaction:

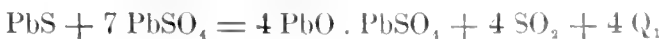

and as mean value was found  $-38390$  cal. Applying the same principle to the  $p-T$ -values of table 2 we found as the mean value for  $Q_2$  in the reaction:

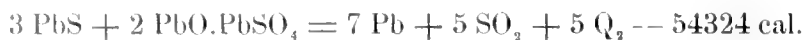

In order to check these figures we eliminate the unknown heat of formation of the basis sulphate from these equations:

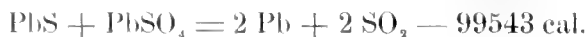

From the molecular heats <sup>1)</sup>

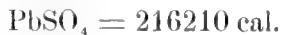

the calculation for the above reaction at  $20^\circ$  gives  $-92470$  cal.  
The agreement is tolerable.

*Delft.*

*Inorg. and phys. chem. Laboratory  
Technical University.*

<sup>1)</sup> LANDOLT. BÖRNSTEIN, Phys. Chem. Tabelle 1912, 870 and 853.

KONINKLIJKE AKADEMIE VAN WETENSCHAPPEN  
TE AMSTERDAM.

PROCEEDINGS OF THE MEETING  
of Saturday November 28, 1914.  
VOL. XVII.

*President:* Prof. H. A. LORENTZ.

*Secretary:* Prof. P. ZEEMAN.

(Translated from: Verslag van de gewone vergadering der Wis- en Natuurkundige  
Afdeling van Zaterdag 28 November 1914, Dl. XXIII).

CONTENTS.

- G. J. ELIAS: "On the structure of the absorption lines  $D_1$  and  $D_2$ ". (Communicated by Prof. H. LORENTZ), p. 720.
- G. J. ELIAS: "On the lowering of the freezing point in consequence of an elastic deformation." (Communicated by Prof. H. A. LORENTZ), p. 732.
- G. J. ELIAS: "The effect of magnetisation of the electrodes on the electromotive force." (Communicated by Prof. H. A. LORENTZ), p. 745.
- II. KAMERLINGH ONNES and G. HOLST: "Further experiments with liquid helium. M. Preliminary determination of the specific heat and of the thermal conductivity of mercury at temperatures obtainable with liquid helium, besides some measurements of thermoelectric forces and resistances for the purpose of these investigations". p. 760.
- F. A. H. SCHREINEMAKERS: "Equilibria in ternary systems" XVII, p. 767.
- F. A. H. SCHREINEMAKERS and Miss W. C. DE BAAT: "On the quaternary system:  $\text{KCl}-\text{CuCl}_2-\text{BaCl}_2-\text{H}_2\text{O}$ ", p. 781.
- I. S. ORNSTEIN: "On the theory of the string galvanometer of EINTHOVEN". (Communicated by Prof. H. A. LORENTZ), p. 784.
- L. S. ORNSTEIN and F. ZERNIKE: "Accidental deviations of density and opalescence at the critical point of a single substance". (Communicated by Prof. H. A. LORENTZ), p. 793.
- A. A. HILMANS VAN DEN BERGH and J. J. DE LA FONTAINE SCHLUTER: "The identification of traces of bilirubin in albuminous fluids" (Communicated by Prof. H. J. HAMBURGER), p. 807. (With one plate).
- M. W. BELJERINGK: "Gummosis in the fruit of the Almond and the Peachalmond as a process of normal life", p. 810.
- ERNST COHEN and W. D. HELDERMAN: "The allotropy of Lead" I. p. 822. (With one plate).
- J. C. KLUYVER: "On an integral formula of STIELTJES", p. 829.
- F. E. C. SCHEFFER: "On unmixing in a binary system for which the three-phase pressure is greater than the sum of the vapour tension; of the two components". (Communicated by Prof. J. D. VAN DER WAALS), p. 834.
- Mrs. T. EHRENFEST-APANASSJEWA: "Contribution to the theory of corresponding states". (Communicated by Prof. H. A. LORENTZ), p. 840.
- A. F. HOLLEMAN: "The nitration of the mixed dihalogen benzenes", p. 846.
- J. BÜSEKEN and W. D. COHEN: "The reduction of aromatic ketones. III. Contribution to the knowledge of the photochemical phenomena" (Communicated by Prof. A. F. HOLLEMAN), p. 849.
- P. EHRENFEST and H. KAMERLINGH ONNES: "Simplified deduction of the formula from the theory of combinations which PLANCK uses as the basis of his radiation-theory, p. 870.

**Physics.** — “*On the structure of the absorption lines  $D_1$  and  $D_2$* ”.

By Dr. G. J. ELIAS. (Communicated by Prof. H. A. LORENTZ).

(Communicated in the meeting of April 24, 1914).

Some time ago Prof. H. A. LORENTZ drew my attention to the results of an investigation by Miss G. v. UBISCH<sup>1</sup>). From phenomena observed by the writer during the investigation of the polarisation state of light emitted by a sodium flame in a magnetic field after it had passed through a tube filled with absorbing sodium vapour, she infers that the wave length for which the absorption of the vapour is a maximum, depends on its temperature, and in such a way too that on rise of temperature a displacement towards the red takes place. The amount of this at  $270^\circ$  would be about  $0.17 \text{ \AA.U.}$  with respect to the emission line. It seemed worth while to ascertain this result by direct observation. During the summer months of last year Dr. W. J. DE HAAS and myself occupied ourselves with this question.

At first we intended to use an échelon-spectroscope for these researches, observe by the aid of this the spectrum of a monochromatic source of light, and then superpose the absorption lines of sodium vapour on this. This vapour was in an iron tube, closed on both ends by plates of selected plate glass, and provided with water cooling; in the middle the tube, which contained there a vessel of metallic sodium, could be heated. Such tubes were used by R. W. WOOD for the investigation of fluorescence of sodium vapour. First a blow-flame served as monochromatic source of light, which was blown by means of air in which a very finely divided solution (mist) of soda was suspended. Afterwards the flame of a Méker-burner was preferred, burning in an atmosphere in which a mist of soda was also suspended. This was reached by placing the flame inside an iron exit tube, at the bottom of which a reservoir was attached, which was in communication with the air, and into which the soda-mist was blown by means of an aspirator. This method appeared very efficient to obtain a sodium flame of constant intensity, which is moreover easy to regulate.

The lines obtained by means of this source of light, were too broad for the investigation with the échelon-spectroscope when the intensity of the light was sufficient for the observation, the self-reversal moreover being very troublesome then. If on the other hand, the light intensity was diminished till the lines were narrow enough, the intensity was again too slight for the observation.

<sup>1</sup>) G. v. UBISCH. Inaug. Diss. Strassburg, 1911. Ann. d. Phys. 35. p. 790; 1911,



We have therefore then tried to see the phenomenon directly by means of the spectrometer, which served for provisional dispersion in the experiments with the échelon spectroscope. We were of opinion that, the dissolving power of the prism system amounting to 60.000, it must be possible to observe in this way a displacement of the above given amount. Nothing was to be detected of this, however. It is true that the at first narrow absorption line (which has originated by self-reversal in the sodium flame) widened considerably on the heating of the Wood tube up to about half the distance of the two  $D$ -lines, but a displacement could not be perceived.

On account of Dr. DE HAAS' return to Berlin we had to stop our joint observations at this point, and I continued the research alone.

First I tried to obtain comparatively narrow emission lines, which should be intensive enough to superpose the absorption lines on them in the investigation with the échelon spectroscope by electric discharges in a heated evacuated Wood tube with sodium. This, however, appeared impossible, the width remained considerable, and the self-reversal troublesome.

Then I took another course, and used an arc lamp as source of light. To obtain monochromatic light I used the above mentioned spectrometer as monochromator, diminishing the widths of the slits so that the issuing light comprised a range of only about 0,5 Å. U., for some observations 0,4 Å. U. In this case the adjacent spectra will overlap only for a small part, as the distance between two successive orders amounts to 0,39 Å. U. The dissolving power of the échelon spectroscope, which consists of 30 plates of 14,45 m.m., amounts to 450.000<sup>1)</sup> for  $D$ -light.

The absorption lines of the arc of light, which are caused by the sodium vapour present in it, appear, observed in this way, to be double. Both for  $D_1$  and for  $D_2$  there are two maxima of absorption, which are somewhat sharper for  $D_1$  than for  $D_2$ , and the distance of which is smaller for  $D_1$  than for  $D_2$ , under for the rest the same circumstances. These distances are, however, variable. The lamp burning normally, the distance generally amounted to 0.053 Å. U. for  $D_1$ , to 0.078 Å. U. for  $D_2$  for a point lying in the middle of the arc, when SIEMENS' S A-carbons were used. It sometimes occurred, however, for a certain pair of carbons that the distance was much smaller, down to half the value; sometimes too that it was much larger, up to almost double the said amount. When new

<sup>1)</sup> The results of the observations made about the components of the mercury lines by the aid of this échelon spectroscope, were in agreement with those of most of the other observers.

carbons are set burning, the distance is also much larger than the normal one, when the arc hisses, the reverse takes place: the lines grow fainter, and the distance grows smaller, in case of very decided hissing they can even become entirely invisible. Also in different places of the arc the distance is different, for the negative carbon the distance is much larger — about twice as large as a rule — than for the positive carbon.

Between the two absorption maxima lies also a region of absorption, which on the whole is of only little greater intensity than the maxima of absorption. Now and then it makes the impression that there are still more feeble maxima of absorption in this region; I have, however, not been able to ascertain this with perfect certainty.

I could artificially modify the aspect of the absorption lines very considerably by blowing a little soda mist into the arc by means of a tube placed parallel to the positive carbon, which lies horizontal; in order not to disturb the equilibrium of the arc the blown in air current had to be only very weak, while the quantity of sodium could be modified by varying the concentration of the sodium solution. It then appeared that always when soda was blown into the arc the distance of the components of the two *D*-lines increased, these becoming vaguer at the same time. The greater the quantity was of the soda that was blown in, the further the components were split up, and the less sharp they became. This splitting up could even reach an amount of about  $0,3 \text{ \AA. U.}$ , in which case they were, however, very vague. The splitting was always perfectly symmetrical with respect to the original double absorption line. The maxima of absorption were — for so far as perceptible — of equal intensity, the sharpness of the two components also seeming pretty well equal. I have not undertaken further quantitative measurements about this, since it would have been impossible to determine the quantity of sodium in the arc, even when the velocity of supply was known; at most this quantity could be very roughly estimated; nor was the phenomenon perfectly constant. Similar phenomena, still less constant, however, were observed when carbons were used which were soaked in a diluted solution of soda.

When the Wood tube is placed in the way of the rays of light so that it follows the spectrometer, which cuts a small portion out of the spectrum, so e.g. between object glass and eye-glass of the reading glass, the absorption lines of the sodium vapour appear also to be double, in which the distance of the components increases as the temperature rises. At the same time, however, distinct phenomena of anomalous dispersion are perceptible, as soon as the heating of

the tube takes place in a somewhat unsymmetrical way. For this reason, and at the same time on account of the large differences of temperature which must necessarily exist in the Wood tube, at which there can be no question of saturate vapour, I did not undertake quantitative measurements.

Finally in order to be able to carry out measurements which should be liable to interpretation, I have generated the sodium vapour in a vertical glass tube, which was first provided with some pieces of sodium, then evacuated down to about 0.001 m.m. of mercury, and sealed to. This tube was uniformly heated all over its length by an electrical way, so that the temperature may be assumed to be the same at all places, and accordingly the sodium vapour to be saturate. In the enclosure there were made two apertures, through which the light fell in horizontal direction. As the glass gradually clouded somewhat at these places, I later on applied side tubes which were also electrically heated, while a wider glass tube was also used. The bore of the tube, with which I carried out my final measurements, amounted to 28 mm. For a reason to be stated later, this tube was placed between object glass and eyeglass of the reading glass. Of course the image suffered by this, but nevertheless it was possible to measure the distances of the components.

The phenomena which I observed in this way were qualitatively in perfect harmony with what I had seen by means of Wood's tube, and during the blowing in of the soda mist into the arc. On rise of temperature the distance of the components increases, while they become less sharp at the same time. Up to almost  $300^{\circ}$  the distance can be very well measured, the results of these measurements have been represented in the curves  $D_1$  and  $D_2$ . At higher temperature the width is too large to be investigated by means of the échelon spectroscope, the phenomenon becoming very vague then, so that the absorption maxima are clearly perceptible on slight magnification only, the light intensity is only little greater than between the absorption maxima than in the maxima themselves. The greatest width measured amounts to about 0,21 Å.U., as is visible from the figure. The resolution is always greater for  $D_2$  than for  $D_1$ ; the curves indicating the course in the two cases run perfectly parallel. On the whole the components of  $D_1$  are somewhat sharper than those of  $D_2$ ; of  $D_1$  the component lying to the side of the red is the stronger and sharper, of  $D_2$ , that which lies to the side of the violet. I think I have been able to observe with pretty great certainty that the two components of  $D_2$  are each double, so that the absorption region would be bounded here by two absorption maxima on either

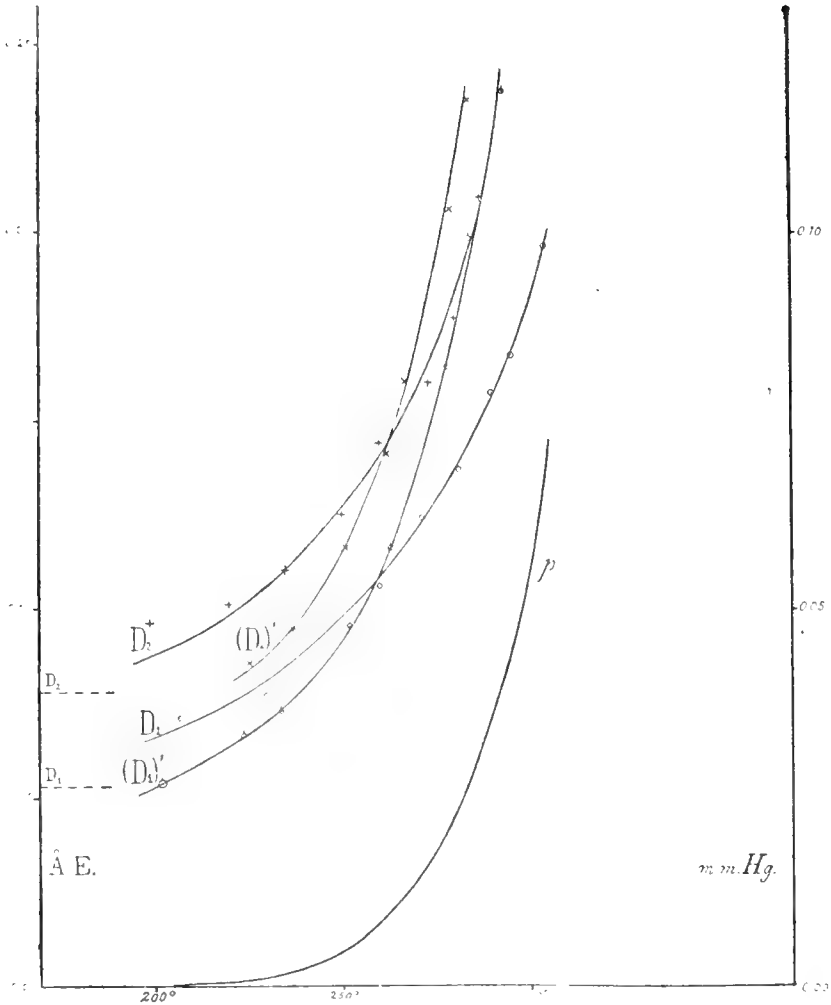

side, which can be distinguished from each other with difficulty. I have not been able to observe anything similar for  $D_1$ , there the absorption maxima seemed single to me. At  $274^\circ$  I found about  $0.035 \text{ \AA.U.}$  for the distance of the two absorption maxima, of which each component of  $D_2$  consists, at  $290^\circ$  about  $0.045 \text{ \AA.U.}$  The distances of the components of  $D_2$  indicated in the figure refer to the extreme components. The region lying between the absorption maxima situated on either side is on the whole of uniform intensity, which, chiefly at the higher temperatures, is but very little greater than that of the absorption maxima. Whether there are still more faint maxima in this region, I have not been able to observe with certainty, though I now and then got the impression that such was, indeed, the case.

In the figure I have also indicated the mean amount of the width of the region of the arc absorption by means of short dotted lines. Further the curve indicated by  $p$  denotes the vapour tension of the sodium vapour for the temperature in question. The scale of the ordinates on the right hand side of the figure refers to this curve. For the determination of this curve I made use of KRÖNER's <sup>1)</sup> research on the vapour tension of alkalimetals; for this it was necessary to extrapolate the values found by KRÖNER, for which purpose I used GRÄTZ's <sup>2)</sup> formula, which is formed from DUPRÉ-HERTZ's <sup>3)</sup> formula based on that of CLAPEYRON by assuming the validity of VAN DER WAALS's law for the vapour instead of that of BOYLE-GAY LUSSAC. GRÄTZ's formula

$$p \cdot e^{-\frac{ap}{T}} = kT^{-m} e^{-\frac{n}{T}}$$

containing four constants, I had to assume four points of the vapour tension curve. I took three points for them, which had been directly determined for sodium by KRÖNER, viz.  $T=693$ ,  $p=2.00$ ;  $T=733$ ,  $p=4.20$ ;  $T=773$ ,  $p=8.64$  (temperatures in absolute scale, pressures in m.m. of mercury). I derived the fourth point, availing myself of RAMSAY and YOUNG's rule, from KRÖNER's determinations for potassium and found for it  $T=589$ ,  $p=0.11$ . I found from this for the constants using BRIGG's logarithms,  $a=28.877$ ,  $\log k=164.88$ ,  $m=48.748$ ,  $n=18143$ . By the aid of these constants I calculated the values of  $p$  given in the figure.

One might be inclined to ascribe the observed phenomena to anomalous dispersion; the observed dark lines would then be no absorption lines proper, but "dispersion lines". If this were actually the case, the light of the considered wave length would only have changed its direction, without having undergone absorption. As to the absorption lines in the light arc, taking the comparatively small value of the anomalous dispersion at the densities in question into consideration, the point of intersection of the rays of light coming from the arc with the plane of the spectrometer slit could never be far distant from the crater image. When this image is moved over the plane of the slit we should therefore have to see light lines in some positions instead of dark ones. As I have never observed anything like this, not when I placed the arc lamp in other positions

<sup>1)</sup> A. KRÖNER. Ann. der Phys. **40**. p. 438. 1913.

<sup>2)</sup> GRÄTZ. Zeitschr. f. Math. u. Phys. **49** p. 289. 1903.

<sup>3)</sup> HERTZ. Wied. Ann. **17**. p. 177. 1882.

DUPRÉ. Théorie mécanique de la chaleur. p. 69. Paris 1869.

either, so that the direction of the issuing beam of light with respect to the light arc was a quite different one, I think I may conclude that the arc lines are not to be attributed to anomalous dispersion.

Nor can for analogous reasons this be the case with the lines which were observed after the light had passed through sodium vapour in a uniformly heated glass tube. Here too light lines would have to be observed at some distance from the dark ones, of which there was however, no question.

On the other hand — as I already remarked just now — when the unsymmetrically heated WOOD tube was used, I saw a sharp light line by the side of the dark region, which latter became blacker then at the same time; in fact besides the absorbed light, also the anomalously dispersed light has vanished from this region.

Everything considered I am therefore of opinion that anomalous dispersion has had no influence on my final results.

I will mention here another phenomenon, which at first made its influence felt in a peculiar way. In my first experiments I had placed the glass tubes in which the sodium vapour was generated, before the entrance slit of the spectrometer, so that the whole beam of white light passed through it. The measurements which I then made of the distances of the components for different tubes, which were distinguished by the thickness of the radiated layer of vapour, were not in harmony; at the same temperature the distance of the components was found larger as the radiated layer was thicker. This peculiar phenomenon must undoubtedly be a consequence of the presence of fluorescence light, which the sodium emits under the influence of the incident white light. According to WOOD'S researches<sup>1)</sup> it is just the two *D*-lines which are very prominent in the fluorescence light. This light will be the stronger as the traversed layer is thicker. In this way it is explicable that the absorption spectrum can be subjected to a modification which will become greater with increasing thickness of layer.

When, however, the distance of the absorption maxima increases in consequence of the superposition of the fluorescence light over the absorption spectrum, which is greatly the case at higher temperatures (see the curves (*D*<sub>1</sub>)' and (*D*<sub>2</sub>)'), it is easy to see that the maximum, resp. the maxima, of the fluorescence light must be situated between the absorption maxima so that the curve representing the intensity of the fluorescence light, exhibits a rise at the place of the absorption maxima, when we move to a point lying halfway

<sup>1)</sup> R. W. WOOD. Phys. Opt. p. 444; 1905.

between the two absorption maxima. If the absorption maxima coincided with maxima of fluorescence, the former would either not shift their places, or they would split up. Hence we arrive at the conclusion that at temperatures above about  $260^{\circ}$  the maxima of absorption do not coincide with maxima of fluorescence, but that the latter maxima, resp. maximum, lie between the maxima of absorption.

I have indicated two curves in the figure for which the influence of the fluorescence light is visible, the curves  $(D_1)'$  and  $(D_2)'$ . They represent the distance of the components of  $D_1$  and  $D_2$  for a radiated thickness of layer of 40 m.m., in which the tube of sodium vapour was placed before the entrance slit of the spectrometer: the distance from the tube to the slit was about 10 cm., the opening of the incident beam being about 1 : 10. Under these circumstances it was also possible to observe the fluorescence light by means of a spectroscope.

If the tube with sodium vapour was placed between object glass and eye glass of the reading glass, the fluorescence can only be brought about by the light that belongs to the narrow spectral range, issuing from the spectrometer, instead of through the undivided white light. It is easy to see that the part of the fluorescence light, which in this case is already very faint, the part that finally reaches the retina, will have to be exceedingly small in comparison with the observed light; the influence of the fluorescence light will, therefore, have to be imperceptible then. I have actually convinced myself that when the tube with vapour is placed between object glass and eye glass of the reading glass the distance of the absorption maxima is independent of the thickness of layer traversed by the rays. For this purpose I compared a tube of 50 m.m. bore with the tube of 28 m.m. used for the measurements; in these two cases the distance of the components was the same at the same temperature.

I think myself justified in drawing the conclusion from all that has been observed that the distance of the absorption maxima of the sodium lines is closely connected with the density of the vapour, and that in this way that the splitting up increases with increasing density. That what has been observed is chiefly an effect of density, and not in the first place a temperature effect, is supported by the fact that the influence of the soda mist blown into the arc is for the greater part the same as that of absorbing sodium vapour of much lower temperature. The temperature at which the absorption in the arc takes place, will namely undoubtedly be much higher than that of the vapour in the glass tube. On the other hand the

phenomenon in the arc is dependent in a high degree on the quantity of soda, the temperature varying very little as long as the equilibrium in the light arc is not disturbed.

In my opinion besides the density also the temperature can have influence, though the latter will be slight. If the arc lines were exclusively dependent on the density of the vapour in the arc, the horizontal dotted lines in the figure would have to cut the curves for  $D_1$  and  $D_3$  in points for which the abscissae are equal. As this seems to be almost the case, the influence of the temperature cannot be very large.

Also with regard to the degree of the absorption — so the value of the absorption index —, there can very well be difference between higher and lower temperatures; I have, however, not examined this. And at last, the absorption lines of low temperature are somewhat sharper than those in the light arc.

Returning to what Miss v. UBISCH derived from her experiments, viz. a displacement of the absorption maxima of sodium vapour on change of temperature, we may question whether this result can be brought into connection with the observations described just now.

In the experiments under consideration the main point was the absorption to which the components of the two magnetically split sodium lines (briefly called ZEEMAN-components) were subjected in the WOOD tube filled with sodium vapour.

The measurements were made of the relative intensities of the differently polarized beams of light both normal to the lines of force of the magnetic field (transversal), and in the direction of the lines of force (longitudinal) (in the transversal observations the beams polarized parallel to and normal to the lines of force, in the longitudinal observations both the circularly polarized ones.) These beams of light were emitted by a sodium flame which was placed between the poles of a magnet; the undispersed sodium light was subjected to absorption in a WOOD tube. This tube was every time heated to a definite temperature, and the temperature being kept constant, the magnetic field was varied till the difference of the intensities of the differently polarized beams of light was a maximum; this measurement took place by rotation of a glass plate, which served as a compensator. For every temperature of the WOOD tube the field was determined, in which the difference of the intensities became a maximum. Miss v. UBISCH makes the supposition that this difference will be a maximum when one ZEEMAN-component coincides with the maximum of absorption, and the other is not absorbed at all. By the aid of this the writer deduces that at  $270^\circ$  the displacement of the



sodium lines would amount to  $0.17 \text{ \AA.U.}$ ; in this case the difference of the intensities was therefore a maximum at a distance of the ZEE-MAN-components or on an average  $0.34 \text{ \AA.U.}$

Now on closer consideration it is clear that the correct interpretation of Miss v. UBISCH's observations would be very intricate, and many more data would have to be available for it. In the first place we should have to know the correct distances and intensities of the ZEE-MAN-components, before they undergo absorption in the WOOD tube; further the accurate course of the curve that denotes the connection between the intensity of the light transmitted in this tube with the wave length, should be known. The absorption maxima of sodium vapour not being sharply defined lines, much will depend on the intensity and sharpness of these maxima; this is the more obvious when it is borne in mind that the real maximum difference of intensity observed by Miss v. UBISCH, constitutes only a few percentages of the whole amount. With so small a difference we should be sooner inclined to assume a difference in absorption to that amount than as the author does, suppose that one ZEE-MAN-component is not weakened at all, the other only a few percentages in the case of a thickness of layer which is at any rate pretty considerable. It is easy to imagine cases in which the absorption maxima are of equal intensity, but difference of intensity of the ZEE-MAN-components is a maximum, when they lie outside the absorption maxima.

Everything considered the amount given by the author can only represent the distance of the absorption maxima as far as the order of magnitude is concerned; accordingly I do not think that the result of my observations (distance of the absorption maxima of about  $0.15 \text{ \AA.U.}$  at  $270^\circ$ ) is in contradiction with that of Miss v. UBISCH.

Besides it is possible that the temperature has not been given perfectly accurately. In this respect a WOOD tube presents more sources of errors than the uniformly heated tube which I used. Moreover the difference need not be very great, taking the very rapid increase of the resolution in the neighbourhood of  $300^\circ$  into consideration.

When seeking an explanation of the observed phenomena now that it has appeared that in the first place there is here question of a density effect, we are naturally led to look for a connection with the widening of spectrum lines in general, and with the explanation which STARK has given for it, which comes to this that this widening

would be the consequence of electrical resolutions of the spectrum lines. It is easy to understand that the greater the density of an (emitting or absorbing) gas, the more frequently it will occur that the vibrating electron systems are in the neighbourhood of electrically charged systems, and will therefore perform their vibrations under the influence of the electric field of these charged systems; hence the spectrum lines brought about by these vibrations will be the more perceptible by the side of those which arise from systems which do not vibrate in an electrical field. In this way we shall be able to obtain a great number of lines, which all being superposed, can make the impression of a broad band. It is very well possible that definite groups of these vibrations can be predominant which will give rise to the appearance of maxima of absorption (resp. emission). If we wanted to give further particulars about this, it would be necessary to enter into an examination of the mechanism of the phenomena <sup>1)</sup>.

As to the order of magnitude of the above described phenomena, it is indeed interesting to compare it with the order of magnitude of the electrical resolutions as STARK has observed them. When we assume that a vibrating system is placed in an electrical field originating from an electrical elementary charge at such a distance as the mean distance of the atoms in saturate sodium vapour of about 280° amounts to, the resolution of the *D*-lines, when taken as an electrical resolution, would at this temperature agree — as far as the order of magnitude is concerned — with the resolutions which STARK found in this part of the spectrum, always on the supposition of a linear course of the electrical resolution with the intensity of the field.

Above 260° the observed resolution increases pretty accurately with the power  $\frac{1}{3}$  of the density, the increase being slower at the lower temperatures; therefore what was observed just now about the order of magnitude of the resolution at 280° cannot possibly be of general validity, as this would require an increase not with the power  $\frac{1}{3}$ , but with the power  $\frac{2}{3}$  of the density.

I also observed the *D*-lines in the solar spectrum, which also exhibited two components each. On the whole the phenomenon was in accordance with what is observed for saturate sodium vapour of about 270°. The distance of the components was about 0.15 Å.U.;

<sup>1)</sup> Even without thinking of electrical resolutions, I pronounced the opinion already before that the "own period" of a vibrating system might vary as it was under the influence of neighbouring systems, and that widenings of spectrum lines might be the consequence of this. Cf. G. J. ELIAS, Diss. Utrecht; p. 146 et seq.

I did not however carry out accurate measurements about this. They further seemed to me slightly less sharp than those which were observed for sodium vapour of low temperature, though this difference was not very conspicuous. If the resolution were really only little dependent on the temperature and possible other factors, we might draw the conclusion from this that the density of the sodium vapour in the chromosphere of the sun is as great as that of saturated sodium vapour of about  $270^\circ$ .

I further made some observations on the emission lines of sodium vapour. For this purpose I used a glass discharge tube which contained some sodium, and which was heated to  $200^\circ$  or  $300^\circ$ .

It then appeared that the emission lines, both  $D_1$  and  $D_2$ , were double, and that the distance of the two light lines increased with increasing temperature. It is not impossible that self-reversal plays a part in this; it was, however, peculiar in this that chiefly for  $D_1$ , the two light lines on either side of the dark core differed in intensity, which would not have to be the case for self-reversal.

With regard to the emission lines  $D_1$  and  $D_2$  MICHELSON<sup>1)</sup> has pronounced the opinion that they would each consist of four components, two intenser ones, and two very faint ones, the distance of the intenser ones amounting to about  $0.15 \text{ \AA.U.}$  FABRY and PÉROT<sup>2)</sup> are, however, of opinion, that reversal phenomena would play the principal part in this.

In conclusion I will still state that already a long time ago I observed for the emission lines of copper when this is in the light arc, resolutions of entirely the same order of magnitude as those which I have now described for the absorption lines  $D_1$  and  $D_2$  of the sodium, also with the aid of the échelon spectroscope. I then observed with a pretty high degree of certainty that these resolutions were greater as the density of the copper in the arc increased. I could not carry out measurements about this, however, as the amount of the resolution was very variable, and besides I had no means to determine the density of the copper in the arc.

*Haarlem, February-April 1914.*

*Physical Laboratory  
of "TEYLER'S Stichting."*

---

<sup>1)</sup> A. A. MICHELSON and E. W. MORLEY. Amer. J. (3) **34**, p. 427; 1887. Phil. Mag. (5) **24** p. 463. 1887.

A. A. MICHELSON. Rep. Brit. Ass. 1892 p. 170. Phil. Mag. (5) **34** p. 280. 1892.

<sup>2)</sup> CH. FABRY and A. PÉROT. C. R. **130** p. 653. 1900.

**Physics.** -- "On the lowering of the freezing point in consequence of an elastic deformation." By Dr. G. J. ELIAS. (Communicated by Prof. H. A. LORENTZ).

(Communicated in the meeting of May 30, 1914).

A number of years ago E. RIECKE<sup>1)</sup> derived from thermodynamic considerations that a solid body subjected to forces which bring about an extension or compression, will in general exhibit a lowering of the freezing point, also at those places of the surface where no deformative forces are directly active.

This case may be extended to that of an arbitrarily deformed body.

1. Let the free energy per unity of mass be  $\psi$ , and the density  $\rho$ , then the total free energy of a certain system will amount to

$$V = \int \rho \cdot \psi \cdot d\tau \dots \dots \dots (1)$$

in which the integration must be extended over all the material elements  $\rho \cdot d\tau$ . Further we make no suppositions at all on the state of the system.

Let us suppose the system to undergo an infinitely small deformation at constant temperature. We can always assume this deformation to consist of the infinitely small dilatations  $x_x, y_y, z_z$ , and the distortions  $y_z, z_x, x_y$ , for which the well-known relations hold:

$$\left. \begin{aligned} x_x &= \frac{\partial \xi}{\partial x} & y_y &= \frac{\partial \eta}{\partial y} & z_z &= \frac{\partial \zeta}{\partial z} \\ z_y = y_z &= \frac{\partial \eta}{\partial z} + \frac{\partial \zeta}{\partial y} & x_z = z_x &= \frac{\partial \zeta}{\partial x} + \frac{\partial \xi}{\partial z} & y_x = x_y &= \frac{\partial \xi}{\partial y} + \frac{\partial \eta}{\partial x} \end{aligned} \right\} \cdot (2)$$

when  $\xi, \eta, \zeta$  denote the infinitely small displacements of the points of the system.

In consequence of this deformation the free energy of the material element  $\rho d\tau$  will increase by the amount

$$\rho d\tau \left( \frac{\partial \psi}{\partial x_x} x_x + \frac{\partial \psi}{\partial y_y} y_y + \frac{\partial \psi}{\partial z_z} z_z + \frac{\partial \psi}{\partial y_z} y_z + \frac{\partial \psi}{\partial z_x} z_x + \frac{\partial \psi}{\partial x_y} x_y \right) \cdot (3)$$

On the other hand work has been done by the external forces. When the components of the joint volume forces which act on the

<sup>1)</sup> E. RIECKE, Wied, Ann. 54 p. 731. 1895.

material element  $\varrho d\tau$  are  $\varrho X d\tau$ ,  $\varrho Y d\tau$ , and  $\varrho Z d\tau$ , and the components of the joint external tensions which act on the surface elements  $d\sigma$  of the surface that bounds the system:  $p_x d\sigma$ ,  $p_y d\sigma$ , and  $p_z d\sigma$ , the total work of the external forces, the displacements being  $\xi$ ,  $\eta$ ,  $\zeta$ , will amount to

$$dA = \int \varrho (X\xi + Y\eta + Z\zeta) d\tau + \int (p_x \xi + p_y \eta + p_z \zeta) d\sigma \quad (4)$$

Now when the temperature is constant

$$d\Psi = dA \dots \dots \dots (5)$$

holds generally as condition of equilibrium.

Hence we derive from (3), (4), and (5):

$$\int \varrho \left( \frac{\partial \Psi}{\partial x_x} x_x + \frac{\partial \Psi}{\partial y_y} y_y + \frac{\partial \Psi}{\partial z_z} z_z + \frac{\partial \Psi}{\partial y_z} y_z + \frac{\partial \Psi}{\partial z_x} z_x + \frac{\partial \Psi}{\partial x_y} x_y \right) = \left\{ \begin{array}{l} (6) \\ = \int \varrho (X\xi + Y\eta + Z\zeta) d\tau + \int (p_x \xi + p_y \eta + p_z \zeta) d\sigma \end{array} \right.$$

Making use of the relations (2) we get from this after partial integration:

$$\left. \begin{aligned} & \int \left[ \xi \left\{ \frac{\partial \Psi}{\partial x_x} \cos(Nx) + \frac{\partial \Psi}{\partial x_y} \cos(Ny) + \frac{\partial \Psi}{\partial x_z} \cos(Nz) \right\} + \right. \\ & + \eta \left\{ \frac{\partial \Psi}{\partial y_x} \cos(Nx) + \frac{\partial \Psi}{\partial y_y} \cos(Ny) + \frac{\partial \Psi}{\partial y_z} \cos(Nz) \right\} + \\ & \left. + \zeta \left\{ \frac{\partial \Psi}{\partial z_x} \cos(Nx) + \frac{\partial \Psi}{\partial z_y} \cos(Ny) + \frac{\partial \Psi}{\partial z_z} \cos(Nz) \right\} \right] \varrho d\sigma - \\ & - \int \left[ \xi \left\{ \frac{\partial \left( \varrho \frac{\partial \Psi}{\partial x_x} \right)}{\partial x} + \frac{\partial \left( \varrho \frac{\partial \Psi}{\partial x_y} \right)}{\partial y} + \frac{\partial \left( \varrho \frac{\partial \Psi}{\partial x_z} \right)}{\partial z} \right\} + \eta \left\{ \frac{\partial \left( \varrho \frac{\partial \Psi}{\partial y_x} \right)}{\partial x} + \right. \right. \\ & \left. \left. + \frac{\partial \left( \varrho \frac{\partial \Psi}{\partial y_y} \right)}{\partial y} + \frac{\partial \left( \varrho \frac{\partial \Psi}{\partial y_z} \right)}{\partial z} \right\} + \zeta \left\{ \frac{\partial \left( \varrho \frac{\partial \Psi}{\partial z_x} \right)}{\partial x} + \frac{\partial \left( \varrho \frac{\partial \Psi}{\partial z_y} \right)}{\partial y} + \right. \right. \\ & \left. \left. + \frac{\partial \left( \varrho \frac{\partial \Psi}{\partial z_z} \right)}{\partial z} \right\} \right] d\tau = \int \varrho (X\xi + Y\eta + Z\zeta) d\tau + \int (p_x \xi + p_y \eta + p_z \zeta) d\sigma \end{aligned} \right\} \quad (7)$$

The quantities  $\xi$ ,  $\eta$ , and  $\zeta$  for the different points of the system being quite independent of each other, we obtain from (7) the relations:

$$\left. \begin{aligned}
 p_x - \rho \left\{ \frac{\partial \psi}{\partial x_x} \cos(Nx) + \frac{\partial \psi}{\partial x_y} \cos(Ny) + \frac{\partial \psi}{\partial x_z} \cos(Nz) \right\} &= 0 \\
 p_y - \rho \left\{ \frac{\partial \psi}{\partial y_x} \cos(Nx) + \frac{\partial \psi}{\partial y_y} \cos(Ny) + \frac{\partial \psi}{\partial y_z} \cos(Nz) \right\} &= 0 \\
 p_z - \rho \left\{ \frac{\partial \psi}{\partial z_x} \cos(Nx) + \frac{\partial \psi}{\partial z_y} \cos(Ny) + \frac{\partial \psi}{\partial z_z} \cos(Nz) \right\} &= 0
 \end{aligned} \right\} \quad (8)$$
  

$$\left. \begin{aligned}
 X + \frac{\partial \left( \rho \frac{\partial \psi}{\partial x_x} \right)}{\partial x} + \frac{\partial \left( \rho \frac{\partial \psi}{\partial x_y} \right)}{\partial y} + \frac{\partial \left( \rho \frac{\partial \psi}{\partial x_z} \right)}{\partial z} &= 0 \\
 Y + \frac{\partial \left( \rho \frac{\partial \psi}{\partial y_x} \right)}{\partial x} + \frac{\partial \left( \rho \frac{\partial \psi}{\partial y_y} \right)}{\partial y} + \frac{\partial \left( \rho \frac{\partial \psi}{\partial y_z} \right)}{\partial z} &= 0 \\
 Z + \frac{\partial \left( \rho \frac{\partial \psi}{\partial z_x} \right)}{\partial x} + \frac{\partial \left( \rho \frac{\partial \psi}{\partial z_y} \right)}{\partial y} + \frac{\partial \left( \rho \frac{\partial \psi}{\partial z_z} \right)}{\partial z} &= 0
 \end{aligned} \right\} \quad (9)$$

If we now introduce the internal tensions  $X_x, Y_y, Z_z, Y_z, Z_x, X_y$ , usual in the theory of elasticity, then hold for the components of these tensions on an element of the surface:

$$\left. \begin{aligned}
 X_N &= X_x \cos(Nx) + X_y \cos(Ny) + X_z \cos(Nz) \\
 Y_N &= Y_x \cos(Nx) + Y_y \cos(Ny) + Y_z \cos(Nz) \\
 Z_N &= Z_x \cos(Nx) + Z_y \cos(Ny) + Z_z \cos(Nz)
 \end{aligned} \right\} \quad (10)$$

Further in case of equilibrium:

$$p_x + X_N = 0 \quad p_y + Y_N = 0 \quad p_z + Z_N = 0 \quad (11)$$

From (8), (10), and (11) follows:

$$\left. \begin{aligned}
 X_x &= -\rho \frac{\partial \psi}{\partial x_x} & Y_y &= -\rho \frac{\partial \psi}{\partial y_y} & Z_z &= -\rho \frac{\partial \psi}{\partial z_z} \\
 Y_z = Z_y &= -\rho \frac{\partial \psi}{\partial y_z} & Z_x = X_z &= -\rho \frac{\partial \psi}{\partial z_x} & X_y = Y_x &= -\rho \frac{\partial \psi}{\partial x_y}
 \end{aligned} \right\} \quad (12)$$

The relations (12) introduced into (9) now yield the equations

$$\left. \begin{aligned}
 X &= \frac{\partial X_x}{\partial x} + \frac{\partial X_y}{\partial y} + \frac{\partial X_z}{\partial z} \\
 Y &= \frac{\partial Y_x}{\partial x} + \frac{\partial Y_y}{\partial y} + \frac{\partial Y_z}{\partial z} \\
 Z &= \frac{\partial Z_x}{\partial x} + \frac{\partial Z_y}{\partial y} + \frac{\partial Z_z}{\partial z}
 \end{aligned} \right\} \quad (13)$$

the known conditions of equilibrium for a deformed system.

2. If we now consider a material element which can be arbitrarily deformed, we can subject its state to an infinitely small variation. With respect to the deformation this variation will be determined by six mutually independent quantities, three dilatations, which determine the change of volume, and three, which determine the change of form. Hence speaking thermodynamically, the variation of state of this element (which need not necessarily be infinitely small, provided it is to be considered as homogeneously deformed) is determined besides by the temperature, by six mutually independent quantities. It now follows from (3) and (12) that for a virtual isothermal variation of state the following equation will hold for the unity of mass

$$\delta\psi = -\frac{1}{\rho}(X_x x_x + Y_y y_y + Z_z z_z + Y_z y_z + Z_x z_x + X_y y_y) \dots \quad (14)$$

If we now start from the unity of volume, and call the free energy of it  $\psi'$ , the following form holds for it

$$\delta\psi' = -(X_x x_x + Y_y y_y + Z_z z_z + Y_z y_z + Z_x z_x + X_y y_y) \dots \quad (15)$$

(In this it should be borne in mind that after the variation the volume will in general be no longer equal to unity).

Now

$$\frac{\partial\psi}{\partial T} = -\eta \dots \dots \dots \quad (16)$$

holds generally for the free energy on change of temperature, when in the expression for the external work with an infinitely small variation no term with  $\delta T$  occurs as factor.

Hence:

$$\delta\psi = -\frac{1}{\rho}(X_x x_x + Y_y y_y + Z_z z_z + Y_z y_z + Z_x z_x + X_y y_y) - \eta \delta T \quad (17)$$

holds for virtual variations of state, in which also the temperature can undergo a change.

When we start from unity of volume, we have

$$\delta\psi' = -(X_x x_x + Y_y y_y + Z_z z_z + Y_z y_z + Z_x z_x + X_y y_y) - \eta' \delta T \quad (18)$$

where  $\eta'$  represents the entropy of the unity of volume.

3. Let us now consider a system consisting of two phases, a liquid and a solid state. We assume the system to be at rest. Let it further as a whole be subjected to the hydrostatic pressure  $p$ , while arbitrary deformative forces can be active on the surface of the solid phase, with the exception of that part that is in contact with the liquid phase; we exclude volume forces. Consequently the same

hydrostatic pressure will prevail everywhere in the liquid. We direct our attention to a part of the system that contains a portion of the boundary plane between the solid and the liquid phase. We assume the surface that bounds the considered part of the system, for so far as it falls inside the solid phase, to be invariable of position, whereas we can subject it to variations of form for so far as it falls inside the liquid phase. On this latter part acts then everywhere the vertically directed hydrostatic pressure  $p$ . We take the part of the solid phase that falls inside the considered part of the system, as homogeneously deformed.

Let the considered part of the system contain  $m_1$  unities of mass of the solid phase,  $m_2$  unities of mass of the liquid phase. The direction of the normal to the boundary plane, which points from the solid towards the liquid phase, may be called  $N$ .

For the part of the system in question are the free energy, the mass, and the volume resp.:

$$\left. \begin{aligned} \psi &= m_1 \psi_1 + m_2 \psi_2 \\ M &= m_1 + m_2 \\ V &= m_1 v_1 + m_2 v_2 \end{aligned} \right\} \dots \dots \dots (19)$$

when  $v_1$  and  $v_2$  represent resp. the volume of the unity of mass of the solid and the liquid phase.

We now subject this part of the system to a virtual change. For this purpose we make a small quantity of one phase pass into the other at constant temperature. This will be attended with a change of the total volume of the considered part of the system. In virtue of the suppositions made above this change of volume can only take place through the change of position of that part of the surface bounding the considered part of the system, which lies in the liquid phase. For the rest the state of the liquid phase will not change. In order to keep also the solid phase in the same state, to leave the quantities determining the deformation unchanged, it will be necessary, to make the tensions of the part of the boundary surface of the considered part of the system lying inside the solid phase undergo infinitesimal variations. Since this part of the boundary surface remains unchanged, no work will be required for this. The only quantity of external work that we have to take into account, will be that which is attended with the change of the part of the boundary surface lying inside the liquid phase.

When  $\delta m_1$  and  $\delta m_2$  represent the changes of the quantities of the two phases, then on account of (19), we shall have:



$$\left. \begin{aligned} \delta\psi &= \psi_1 \delta m_1 + \psi_2 \delta m_2 \\ 0 &= \delta m_1 + \delta m_2 \\ \delta V &= v_1 \delta m_1 + v_2 \delta m_2 \end{aligned} \right\} \dots \dots \dots (20)$$

In connection with the above considerations the work done by external forces amounts to:

$$\delta A = -p\delta V = -p(v_1\delta m_1 + v_2\delta m_2) \dots \dots (21)$$

If we now apply the condition of equilibrium (5), we obtain, making use of (20) and (21),

$$\psi_1 + pr_1 = \psi_2 + pr_2 \dots \dots \dots (22)$$

This equation represents the condition of equilibrium for the two phases in the case considered here.

4. Let us now imagine that the system consisting of the two phases undergoes a real, infinitesimal change. The condition of equilibrium (22) will then retain its validity. It is clear that it will give us then a connection between the differentials of the variables.

As variables determining the state, we choose for the solid phase the dilatations and distortions  $x_x, y_y, z_z, y_z, z_x, x_y$ , besides the temperature  $T$ , for the liquid phase the volume  $v$  and the temperature  $T$ . We ascribe the value zero to the variables  $x_x, y_y, z_z, y_z, z_x$ , and  $x_y$  in the state from which we start (which, however, need not be without tension). In order to be able to distinguish the difference between an eventually ultimately reached final condition (which need not differ infinitely little from the initial condition in mathematical sense) and the initial condition from an actually infinitely small change of condition, we shall represent the latter by  $dx_x, dy_y, dz_z, dy_z, dz_x, dv_y$  instead of by  $x_x, y_y, z_z, y_z, z_x, x_y$ , which we shall use for the final condition that is eventually to be reached. This does not alter the fact that the latter quantities are always treated as if they were infinitely small.

Proceeding in this way we obtain by differentiation from (22):

$$\left. \begin{aligned} \frac{\partial\psi_1}{\partial T} dT + \frac{\partial\psi_1}{\partial x_x} dx_x + \frac{\partial\psi_1}{\partial y_y} dy_y + \frac{\partial\psi_1}{\partial z_z} dz_z + \frac{\partial\psi_1}{\partial y_z} dy_z + \frac{\partial\psi_1}{\partial z_x} dz_x + \\ + \frac{\partial\psi_1}{\partial x_y} dx_y + pdv_1 + v_1 dp = \frac{\partial\psi_2}{\partial T} dT + \frac{\partial\psi_2}{\partial v_2} dv_2 + pdv_2 + v_2 dp \end{aligned} \right\} (23)$$

In this  $\frac{\partial\psi_1}{\partial x_x} dx_x$  denotes the increase of the free energy  $\psi_1$ , when the initial state undergoes a dilatation  $dx_x$  etc., just at this was the case in (3) and the following formulae.

Now according to the theory of elasticity we have:

$$dv_1 = \frac{1}{\rho_1} (dx_x + dy_y + dz_z) \dots \dots \dots (24)$$

while further the well known relations:

$$\frac{\partial \psi_2}{\partial T} = -\eta_2 \quad \frac{\partial \psi_2}{\partial v_2} = -p \dots \dots \dots (25)$$

hold for the liquid phase.

On introduction of (12), (24), and (25) we get from (23).

$$\begin{aligned} (\eta_2 - \eta_1) dT = dp \left( \frac{1}{\rho_2} - \frac{1}{\rho_1} \right) + \frac{1}{\rho_1} \{ & (X_x - p) dx_x + \\ & + (Y_y - p) dy_y + (Z_z - p) dz_z + Y_z dy_z + Z_x dz_x + X_y dx_y \} \end{aligned} \quad (26)$$

We can now put:

$$\eta_2 - \eta_1 = \frac{r}{T} \dots \dots \dots (27)$$

In this we can call the "heat of melting"  $r$ , by which that quantity of heat is to be understood which must be added to convert the unity of mass from the solid to the liquid phase, without the condition of the two phases changing for the rest. We then get:

$$\begin{aligned} dT = \frac{T}{r} \left( \frac{1}{\rho_2} - \frac{1}{\rho_1} \right) dp + \frac{T}{r \cdot \rho_1} \{ & (X_x - p) dx_x + (Y_y - p) dy_y + \\ & + (Z_z - p) dz_z + Y_z dy_z + Z_x dz_x + X_y dx_y \} \end{aligned} \quad (28)$$

When the only deformative force is the hydrostatic pressure, we get the known formula of THOMSON and CLAUSIUS, since then the following equations generally hold:

$$\begin{aligned} X_x - p = 0 \quad Y_y - p = 0 \quad Z_z - p = 0 \quad \{ & \\ Y_z = 0 \quad Z_x = 0 \quad X_y = 0 \quad \} \end{aligned} \dots \dots (29)$$

$$dT = \frac{T}{r} \left( \frac{1}{\rho_2} - \frac{1}{\rho_1} \right) dp \dots \dots \dots (30)$$

If on the other hand  $dp = 0$ , we get:

$$\begin{aligned} dT = \frac{T}{r \cdot \rho_1} \{ & (X_x - p) dx_x + (Y_y - p) dy_y + (Z_z - p) dz_z + \\ & + Y_z dy_z + Z_x dz_x + X_y dx_y \} \end{aligned} \quad (31)$$

Since the form between square brackets, provided with the negative sign, represents the work performed in the deformative forces, with the exception of the pressure  $p$ , a deformation will bring about a lowering of the freezing point, when this work is positive.

5. We shall now assume that the initial state (for which we put  $dx_x, dy_y, dz_z, y_z, z_x, x_y$  equal to zero) is to be considered as without

tension. In this case (31) will also be applicable; we may then, however, replace  $r$  and  $\varrho_1$  by  $r_0$  and  $\varrho_{10}$ , in which  $r_0$  denotes the heat of melting, and  $\varrho_{10}$  the density of the solid phase in the tensionless state; then we have

$$dT = \frac{T}{r_0 \varrho_{10}} [(X_x - p) dx_x + (Y_y - p) dy_y + (Z_z - p) dz_z + \left. \begin{aligned} &+ Y_z dy_z + Z_x dz_x + X_y dx_y \end{aligned} \right\} . \quad (32)$$

If we disregard quantities of the second order, which we are allowed to do when we consider the dilatations and distortions as infinitely small, we can integrate (32), placing  $T$ ,  $r_0$ , and  $\varrho_{10}$  outside the integral sign. We then get for the lowering of the freezing point in the state determined by  $x_x, y_y, z_z, y_z, z_x, x_y$ ,

$$\Delta T = \frac{T}{r_0 \varrho_{10}} \int_0^{x_x \dots y_z \dots} [(X_x - p) dx_x + (Y_y - p) dy_y + (Z_z - p) dz_z + \left. \begin{aligned} &+ Y_z dy_z + Z_x dz_x + X_y dx_y \end{aligned} \right\} \quad (33)$$

The heat of melting in the state determined by  $x_x, y_y, z_z, y_z, z_x, x_y$  will differ from that in the tensionless state by an amount that is of the same order as the dilatations and distortions themselves. For an infinitely small change follows for the change of the free energy from (14):

$$d\psi = -\frac{1}{\varrho} (X_x dx_x + Y_y dy_y + Z_z dz_z + Y_z dy_z + Z_x dz_x + X_y dx_y)$$

Hence the difference in free energy between the deformative and the tensionless state amounts to:

$$\Delta\psi = -\int_0^{x_x \dots y_z \dots} \frac{1}{\varrho} [X_x dx_x + Y_y dy_y + Z_z dz_z + Y_z dy_z + Z_x dz_x + X_y dx_y].$$

For the difference in entropy between these states follows then from (16)

$$\Delta\eta = \frac{\partial}{\partial T} \int_0^{x_x \dots y_z \dots} \frac{1}{\varrho} [X_x dx_x + Y_y dy_y + Z_z dz_z + Y_z dy_z + Z_x dz_x + X_y dx_y].$$

From (27) follows then for the difference in heat of melting:

$$\Delta r = -T \frac{\partial}{\partial T} \int_0^{x_x \dots y_z \dots} \frac{1}{\varrho} [X_x dx_x + Y_y dy_y + Z_z dz_z + Y_z dy_z + Z_x dz_x + X_y dx_y] \quad (34)$$

This will also apply to the case that the initial state is not tensionless; only (34) does not represent then the difference in melting heat between the state  $x_x \dots y_z \dots$  and the tensionless state, but the difference between the state  $x_x \dots y_z \dots$  and the initial state, which is not tensionless in this case.

6. Let us now suppose that forces act on the surface of the solid phase which are exerted by solid bodies which rest on the solid phase, and in consequence of the presence of which the surface of the phase is not in contact with the liquid phase. We can then imagine that a small part of the solid phase that is in contact with the solid bodies which exert forces, is converted to the liquid state, without the solid bodies changing their places. For this case we can again draw up the condition of equilibrium.

We take the boundary plane of the solid phase as  $XY$ -plane, and suppose that the  $Z$ -axis is the normal to this plane which is directed from the solid to the liquid phase. For the total free energy, the mass, and the volume the following relations hold in this case:

$$\left. \begin{aligned} \Psi &= m_1 \psi_1 + m_2 \psi_2 \\ M &= m_1 + m_2 \\ V &= m_1 v_1 + m_2 v_2 \end{aligned} \right\} \dots \dots \dots (35)$$

Let now an infinitely small quantity of the solid phase be converted to the liquid phase, then:

$$\delta \Psi = m_1 \delta \psi_1 + \psi_1 \delta m_1 + m_2 \delta \psi_2 + \psi_2 \delta m_2 \dots \dots (36)$$

During the conversion the volumes  $v_1$  and  $v_2$  will have to change, as the total volume remains constant, as we supposed. The considered change being a virtual change, we may assume that as far as the solid phase is concerned, this change is brought about by variation of  $z_z$  alone. Then we get:

$$\delta \psi_1 = \frac{\partial \psi_1}{\partial z_z} \cdot \delta z_z \dots \dots \dots (37)$$

Further:

$$\delta \psi_2 = \frac{\partial \psi_2}{\partial v_2} \cdot \delta v_2 \dots \dots \dots (38)$$

By introduction of (37) and (38) into (36) we get:

$$\delta \Psi = m_1 \frac{\partial \psi_1}{\partial z_z} \delta z_z + m_2 \frac{\partial \psi_2}{\partial v_2} \delta v_2 + \psi_1 \delta m_1 + \psi_2 \delta m_2 \dots \dots (39)$$

Just as before (see above under 3) the tensions at the surface that bounds the considered part of the system will have to vary now too. We supposed, however, that this surface does not change its



energy per unity of volume taken with the negative sign. Further the coefficients  $\alpha$  must be considered as functions of the temperature. To this most general case, in which the number of coefficients amounts to 21, answers a crystal of the lowest symmetry. This leads, of course, to very intricate calculations.

We prefer, therefore, to consider the simplest case, viz. an isotropous body. For this holds, if we use the prevalent notation<sup>1)</sup>.

$$\left. \begin{aligned} X_x &= -2K[x_x + \theta(x_x + y_y + z_z)] \\ Y_z &= -Ky_z \end{aligned} \right\} \dots \dots (47)$$

from which equations can be derived;

$$\left. \begin{aligned} x_x &= -\frac{1}{2K} \left[ X_x - \frac{\theta}{1+3\theta} (X_x + Y_y + Z_z) \right] \\ Y_z &= -\frac{1}{K} Y_z \end{aligned} \right\} \dots \dots (48)$$

In this the relation:

$$E = 2K \frac{1+3\theta}{1+2\theta} \dots \dots \dots (49)$$

exists between the coefficients  $K$  and  $\theta$  on one side and the elasticity coefficient  $E$  on the other side.

Let us now consider a circular cylinder, the axis of which coincides with the  $Z$ -axis. Let one end be rigidly fastened, while forces resp. couples act on the other. Let the length in the direction of the  $Z$ -axis be  $l$ , and the radius of the cylinder  $R$ . The conditions of this problem may be satisfied by putting

$$X_x = 0 \quad X_y = 0 \quad Y_y = 0 \quad \dots \dots \dots (50)$$

If  $P_x, P_y, P_z$  are the components of the force,  $Q_x, Q_y, Q_z$  the components of the couple acting on the end plane, then for the other tensions hold the expressions:

$$\left. \begin{aligned} Z_z &= \frac{P_z}{\pi R^2} - \frac{4Q_y \cdot x}{\pi R^4} + \frac{4Q_x \cdot y}{\pi R^4} + z \left( \frac{4P_x \cdot x}{\pi R^4} + \frac{4P_y \cdot y}{\pi R^4} \right) \\ X_x &= -\frac{2Q_z \cdot y}{\pi R^4} + \frac{P_x}{2\pi R^4} \frac{(3+8\theta)(R^2-x^2)-\eta^2}{1+3\theta} - \frac{P_y}{\pi R^4} \frac{1+4\theta}{1+3\theta} \cdot xy \\ Y_y &= \frac{2Q_z \cdot x}{\pi R^4} - \frac{P_x}{\pi R^4} \frac{1+4\theta}{1+3\theta} \cdot xy + \frac{P_y}{2\pi R^4} \frac{(3+8\theta)(R^2-y^2)-x^2}{1+3\theta} \end{aligned} \right\} (51)$$

Further:

<sup>1)</sup> Cf. among others G. KIRCHROFF, Vorlesungen über Mechanik.

$$\left. \begin{aligned} Z_z &= -2K \frac{1+3\theta}{1+2\theta} \cdot z_z = -E \cdot z_z \\ X_z &= -K \cdot x_z = -\frac{E}{2} \frac{1+2\theta}{1+3\theta} \cdot x_z \\ Y_z &= -K \cdot y_z = -\frac{E}{2} \frac{1+2\theta}{1+3\theta} \cdot y_z \end{aligned} \right\} \dots \dots (52)$$

We shall now discuss some special cases.

1. Compression resp. extension.

In this only  $P_z \neq 0$  is put, from which follows:

$$Z_z = \frac{P_z}{\pi R^2} \quad X_z = Y_z = 0$$

(in this the liquid pressure  $p$  is neglected).

Then the lowering of the freezing point is

$$\Delta T = -\frac{T}{r_0 Q_0} \int Z_z dz_z$$

Making use of (52) and carrying out the integration, we get:

$$\Delta T = -\frac{T}{r_0 Q_0} \cdot \frac{Z_z^2}{2E}$$

which formula is in perfect concordance with RIECKE's.<sup>1)</sup>

We apply this to ice, which we shall treat as an isotropous substance.

RIECKE assumes 0,7 kg. for the drawing-solidity of ice per mm<sup>2</sup>, and calculates with this 0,017 for  $\Delta T$ . As for most substances the pressing-solidity is considerably greater than the drawing-solidity, this diminution can probably be made larger in the case of compression, so that it can be measured comparatively easily and with suitable apparatus even the just mentioned lowering of the freezing point would also be liable to be measured.

2. Sagging.

In this case we only assume that  $P_y \neq 0$ . When we consider a point for which  $x = R$ ,  $y = 0$ , then it follows from the formulae that:

$$Z_z = 0 \quad X_z = 0 \quad Y_z = \frac{P_y}{\pi R^2} \frac{1+2\theta}{1+3\theta}$$

The lowering of the freezing point of the considered point is:

$$\Delta T = -\frac{T}{r_0 Q_0} \int Y_z dy_z$$

<sup>1)</sup> E. RIECKE, loc. cit. p. 736 form. (20).

Making use of (52) we get after integration :

$$\Delta T = - \frac{T}{r_0 \rho_0} \frac{1+3\theta}{1+2\theta} \frac{Y_z^2}{E}.$$

In order to obtain a limiting value for  $Y_z$ , we make use of the results of an investigation by Hess<sup>1)</sup> on the sagging of ice crystals. He charged a crystal 2.9 cm long, 1.0 cm broad, and 1.2 cm thick at its end with a weight of 5000 grams, without rupture taking place. Let us assume by approximation that an ice cylinder of a diameter of 1 cm could bear the same load. We can then derive a limiting value of  $Y_z$  from (51).

If we introduce this into (52), we find finally, assuming that  $\theta = \frac{1}{2}$ , which is about correct for a great many substances,  $-1.19 \times 10^{-4}$  degree for  $\Delta T$ , which quantity is probably not liable to measurement. That this quantity is so small, is the consequence of the small value of the maximum tangential tensions which ice can bear.

We considered the point on the circumference for which  $x = R$ ,  $y = 0$ . If on the other hand we take the point for which  $x = 0$ ,  $y = R$ , we get the formulae

$$Z_z = \frac{4l}{\pi R^3} \cdot P_y \quad X_z = Y_z = 0.$$

If as before, we again assume that an ice cylinder of a diameter of 1 cm. can bear a load of 5000 grams at its end, we find for  $Z_z$  a value which appears to be greater than the value assumed by RIECKE. If we calculate the lowering of the freezing point by means of this, we find  $\Delta T = -0^\circ.081$ , an amount that can be easily measured.

We see at the same time that the lowering of the freezing point has different values at different points of the surface; a state of equilibrium is therefore impossible. The rod of ice will diminish on the upper surface and on the lower surface, and that much more quickly than on the sides, which will also diminish a little. Further this diminution will increase towards the end where the rod is loaded.

### 3. Torsion.

In this case only  $Q_z \neq 0$ . From the formulae (51) follows then for the point  $x = 0$ ,  $y = R$

$$Z_z = 0 \quad X_z = - \frac{2Q_z}{\pi R^3} \quad Y_z = 0.$$

Taking the small amount of the tangential tensions which ice can

<sup>1)</sup> H. HESS Ann. d. Phys. **8** p. 405. 1902.



bear into consideration, the lowering of the freezing point will again become very small in this case. Since the tangential tension all along the cylinder surface has the same value, equilibrium with the surrounding liquid will now be possible.

*Haarlem, May 1914*

*Physical Laboratory of  
"TEYLER'S Stichting".*

**Physics.** — *"The effect of magnetisation of the electrodes on the electromotive force."* By Dr. G. J. ELIAS. (Communicated by Prof. H. A. LORENTZ).

(Communicated in the meeting of June 27, 1914).

1. The question in how far magnetisation of the electrodes is of influence on the electromotive force in a circuit in which there are electrolytes, has already often been examined, without it being possible to derive a definite answer to this question from the results of these researches. Thus GROSS<sup>1)</sup> found no definite direction of the current in concentrated solutions of ferro salts, while in concentrated solutions of ferri salts the magnetized electrode (both electrodes consisted of iron) became the anode. ANDREWS<sup>2)</sup> arrived at the same result working with strong acids as electrolytes. NICHOLS and FRANKLIN<sup>3)</sup> obtained results which were in concordance with those of GROSS and ANDREWS, in case a pole of a magnetized iron rod came in contact with the electrolyte, which consisted of a solution of chromic acid. In this case the electromotive force greatly increased with the magnetisation, and reached the value of about 68 millivolts in a field of 20000 Gauss. If on the other hand the neutral region of the magnetized rod was in contact with the electrolyte, the sense of the electromotive force was opposite. ROWLAND and BELL<sup>4)</sup> found that the magnetized electrode became cathode when acids that attacked the iron, were used as electrolytes. SQUIER<sup>5)</sup>, who took nitric acid as electrolyte, came to the same result. The maximum electromotive force amounted to 36 millivolts, in a field of 10000

1) TH. GROSS. Sitz. Ber. d. kais. Ak. d. Wiss. **92**. Dec. 1885.

2) ANDREWS. Proc. Roy. Soc. **42** p. 459, 1887; **44** p. 152, 1888.

3) E. L. NICHOLS and W. S. FRANKLIN. Am. Journ. of Science **31** p. 272. 1886; **34** p. 419, 1887; **35** p. 290, 1888.

4) H. A. ROWLAND and L. BELL. Am. Journ. of Science. **36** p. 39, 1888.

5) G. O. SQUIER. Am. Journ. of Science. **45** p. 443, 1893.

Gauss: on further strengthening of the field this amount did not change. Also HURMUCESCU<sup>1)</sup> found the electromotive force in the same sense, when diluted acetic acid or oxalic acid was used as electrolyte. In a field of 7300 Gauss the electromotive force amounted to 14 millivolts. Finally BUCHERER<sup>2)</sup> has occupied himself with this question. His result is in so far entirely negative that he finds no electromotive force which would reach the value of  $10^{-5}$  Volts for neutral solutions of ferro salts in the case of magnetisation of the electrode in a field of 1200 Gauss. He further pronounces the opinion that the electromotive forces found by ROWLAND are caused by mechanical disturbances of the equilibrium ("Erschütterungen"), which would be the consequence of the origin of the magnetic field. Then BUCHERER compares HURMUCESCU's results with what has been theoretically derived by DUHEM<sup>3)</sup>, and concludes that no concordance exists between them. DUHEM arrives at the formula:

$$E = \frac{I^2 \cdot \lambda}{2d \cdot \kappa} \dots \dots \dots (1)$$

in which  $I$  represents the magnetisation of the electrode,  $\lambda$  the electrochemical equivalent of the iron,  $\kappa$  the susceptibility, and  $d$  the density, the electromotive force  $E$  being taken positive, when the magnetized electrode is cathode. When we eliminate  $H_i$ ,  $I$ , and  $\kappa$  by the aid of the relations:

$$B = H_i + 4\pi I \quad B = \mu \cdot H_i \quad I = \kappa \cdot H_i$$

we get instead of (1)

$$E = \frac{B^2 \cdot \lambda}{8\pi d \cdot \mu} \left(1 - \frac{1}{\mu}\right) \dots \dots \dots (2)$$

It has appeared to me that in consequence of an inaccurate expression for the energy of a magnetic field, this value of  $E$  is about  $\mu$  times too small, so that we may write by approximation because  $\mu$  has a large value:

$$E = \frac{B^2 \cdot \lambda}{8\pi \cdot d} \dots \dots \dots (3)$$

which expression, however, only holds when the electrolyte is a neutral iron solution.

When the experiment is arranged in such a way that  $B$  may be put equal to the external intensity of the field  $H$ , we see from (3)

<sup>1)</sup> HURMUCESCU. Eclair. Electr. Nr. 6 and 7, 1895.

<sup>2)</sup> A. H. BUCHERER. Wied. Ann. 58 p. 564, 1896; 59 p. 735, 1896; 61 p. 807, 1897.

<sup>3)</sup> P. DUHEM. Ann. de la Fac. des Sciences de Toulouse, 1888—89. Wied. Ann. Beibl. 13 p. 101, 1889.

that the electromotive force would have to increase with the square of the intensity of the field. On introduction of the values for iron

$$\lambda = 29 \times 10^{-4} \text{ e.m.e.} \quad d = 7.9$$

we get for

$$H = 10000 \text{ Gauss} \quad E = 1.46 \times 10^{-5} \text{ Volt.}$$

In BUCHERER'S experiment the intensity of the field was 1200, if the induction  $B$  had had the same value, the electromotive force would have been  $2.1 \times 10^{-7}$  Volts. As this amount is much less than the smallest value which BUCHERER could measure ( $10^{-5}$  Volts), its negative result cannot be considered in conflict with the theoretical result.

The results of the other investigators, who worked with acids as electrolytes, are not at all in agreement with formula (3), in fact they could hardly be so, as (8) rests on the supposition of a neutral iron solution.

As the case that the electrolyte is a dilute solution of the metal of electrodes, which is assumed to be equal for the two electrodes, is the only one that is liable to exact thermodynamic treatment, I have calculated the value of the potential difference for this case in what follows. Further I have communicated the results of experiments made on this subject.

2. Let us now consider<sup>1)</sup> an arbitrary system in which also electric currents and magnetic fields can be present. As variables in this system we choose the temperature  $T$ , further a number of geometrical quantities  $\alpha_1, \alpha_2, \dots$  and finally the magnetic induction  $\mathfrak{B}$ ; when the last quantity is known everywhere, then, besides the magnetic field, the electrical current is also determined everywhere. The external forces exerted by the system, are the components of force  $A_1, A_2, \dots$  corresponding to the geometrical quantities, besides the external electromotive forces  $\mathfrak{E}_e$ . In order to be justified in leaving JOULE'S heat out of consideration we shall assume that the conductors, for so far as a current passes through them, possess no resistance. We shall further assume that the system loses no energy by electromotive radiation and we exclude currents of displacement.

If the system undergoes an infinitely small virtual variation, we first inquire into the work performed by the system on its surroundings. If the variations of the geometrical quantities are  $d\alpha_1, d\alpha_2, \dots$ , the corresponding work can be expressed by

---

<sup>1)</sup> The train of reasoning on which the general method of treatment followed here is based, was suggested to me by Prof. Dr. H. A. LORENTZ, for which I will express here my heartfelt thanks

$$\delta W_1 = A_1 \delta \alpha_1 + A_2 \delta \alpha_2 + \dots \dots \dots (4)$$

Further the external electromotive forces will perform work per unity of time equal to :

$$-\frac{dW_2}{dt} = \int (\mathfrak{E}_e, \mathfrak{C}) \cdot d\tau$$

in which  $\mathfrak{C}$  denotes the electrical current. The work done by the system amounts, therefore, per unity of time to :

$$\frac{dW_2}{dt} = - \int (\mathfrak{E}_e, \mathfrak{C}) \cdot d\tau.$$

For this we may write :

$$\frac{dW_2}{dt} = - \int (\mathfrak{E} + \mathfrak{E}_e, \mathfrak{C}) \cdot d\tau + \int (\mathfrak{E}, \mathfrak{C}) \cdot d\tau,$$

in which  $\mathfrak{E}$  denotes the electrical force. Now in the conductors

$$\mathfrak{C} = \sigma (\mathfrak{E} + \mathfrak{E}_e).$$

From the supposition that in the conductors  $\sigma$  will be infinitely large, follows that here  $\mathfrak{E} + \mathfrak{E}_e$  must be  $= 0$ , whereas outside the conductors  $\mathfrak{C} = 0$ . Hence the first term in the expression for  $\frac{dW_2}{dt}$  disappears. When we make use of the expression :

$$\mathfrak{C} = c \text{curl } \mathfrak{H}^1)$$

we get after partial integration

$$\frac{dW_2}{dt} = c \int (\mathfrak{H}, \text{curl } \mathfrak{E}) \cdot d\tau + c \int [\mathfrak{H}, \mathfrak{E}]_N \cdot d\sigma.$$

The second term disappears on account of the supposition that no energy leaves the system through radiation. We finally get then by the aid of the relation :

$$-c \text{curl } \mathfrak{E} = \frac{\partial \mathfrak{B}}{\partial t},$$

$$\frac{dW_2}{dt} = - \int \left( \mathfrak{H}, \frac{\partial \mathfrak{B}}{\partial t} \right) \cdot d\tau.$$

If the variation of  $\mathfrak{B}$  in the time  $dt$  is  $\delta \mathfrak{B}$ , we get :

$$\delta W_2 = - \int (\mathfrak{H}, \delta \mathfrak{B}) \cdot d\tau \dots \dots \dots (5)$$

The total work performed by the system now amounts to the sum of (4) and (5),

---

1) Here LORENTZ's system of unities is used.

$$\delta W = A_1 \delta a_1 + A_2 \delta a_2 + \dots - \int (\delta \mathfrak{H}, \delta \mathfrak{B}) d\tau \dots \dots (6)$$

If we now introduce the free energy of the system, the following well known relation holds for it

$$\Psi = E - T \cdot H$$

when  $E$  represents the internal energy,  $H$  the entropy. For an infinitely small variation we get from this:

$$\delta \Psi = \delta E - T \cdot \delta H - H \cdot \delta T.$$

Further

$$T \cdot \delta H = \delta Q = \delta E + \delta W,$$

in which  $\delta Q$  is the quantity of heat added to the system. Making use of (6) we get from this:

$$\delta \Psi = -A_1 \delta a_1 - A_2 \delta a_2 \dots + \int (\delta \mathfrak{H}, \delta \mathfrak{B}) \cdot d\tau - H \cdot \delta T. \dots (7)$$

Let in a certain initial state, in which the variables  $a_1, a_2 \dots$  have the values  $a_{10}, a_{20} \dots$ ,  $\mathfrak{B}$  being  $= 0$ , the system have the free energy  $\Psi_0$ . In the magnetic state, in which  $\mathfrak{B}$  will have a certain value everywhere, and the temperature and another quantity, e.g. the external pressure have remained constant, the geometrical variables will assume other values, which we shall denote by  $a_1, a_2 \dots$ . We can now make this transition take place in two steps. We first give the geometrical variables the values  $a_1, a_2$ ,  $\mathfrak{B}$  remaining  $= 0$ ; hence the free energy will increase by an amount  $\Delta_0 \Psi$ .

Further, while  $a_1, a_2 \dots$  remains unchanged, we can bring the magnetic induction  $\mathfrak{B}$  from zero to the final value; then the free energy will increase by  $\Delta_M \Psi$ . In this way the final state is reached, in which the free energy will be:

$$\Psi = \Psi_0 + \Delta_0 \Psi + \Delta_M \Psi \dots \dots \dots (8)$$

Then according to (7) the following equation will hold:

$$\Delta_M \Psi = \iint (\delta \mathfrak{H}, \delta \mathfrak{B}) \cdot d\tau \dots \dots \dots (9)$$

3. Let us now return to the above discussed case, in which two electrodes of the same metal are placed in the dilute solution of a salt of this metal. The concentration of the solution can be different at different places. We think the circuit closed by means of a wire connecting the two electrodes. Let one electrode be in a magnetic field, in consequence of which it is magnetized. We think the magnetic field excited by an electromagnet, the leads of which possess no resistance.



and anion in the solution, then  $n = \frac{v}{u+v}$  is the quantity which HITTORF has called "Ueberführungszahl" of the cation.

Of a current  $i$  the part  $n \cdot i$  is carried by the cation, the part  $(1-n) \cdot i$  by the anion. So the number of gram equivalents of the cation in the unity of volume will increase per unity of time by:

$$\frac{1}{\epsilon} \operatorname{div} (n \cdot i) = \frac{1}{\epsilon} (i, \nabla n),$$

as  $\operatorname{div} i = 0$  is;  $\epsilon$  represents the charge of a univalent gram ion. In the same way the number of gram equivalents of the anion will increase by the same amount per unity of time, so that the solution will remain neutral. If  $k$  is the valency of the molecule, and  $m$  the molecular weight, the mass of the salt will increase per unity of time by an amount:

$$\frac{m}{k \cdot \epsilon} (i, \nabla n).$$

If the quantity of electricity  $e_1$  passes through the unity of surface, and if  $i_1$  represents the unity vector in the direction  $i$ , the increment is:

$$dr = \frac{m \cdot e_1}{k \cdot \epsilon} (i_1, \nabla n) \cdot \dots \cdot \dots \cdot \dots \cdot \dots \quad (11)$$

In the volume elements which lie on the surface, the increment of the mass of salt will be per unity of surface:

$$dr = \frac{m \cdot e_1}{k \cdot \epsilon} \cdot N_1 \cdot n \cdot \dots \cdot \dots \cdot \dots \cdot \dots \quad (12)$$

when  $N$  is the direction of the normal directed inward. The total quantity of salt inside the solution will now increase by an amount:

$$\int_V dv + \int_S dr = \frac{m}{k \cdot \epsilon} \left[ \int_V e_1 \cdot (i_1, \nabla n) d\tau + \int_S e_1 \cdot (N_1 \cdot n \cdot d\sigma) \right] = 0,$$

when we apply GAUSS'S theorem and make use of the equation  $\operatorname{div} i = 0$ . The quantity of salt, therefore, does not change.

The only change consists in this that the concentration in the different volume elements is modified, and that a quantity of electricity  $e$  dissolved at the anode, has deposited at the cathode.

We shall examine what change the total free energy of the system has undergone in consequence of what has taken place in the electrolyte. Above we found the expression (8) for the free energy, (9) holding for the "magnetic" part of it. We further chose the variation so that the magnetic induction did not undergo any change. In the first place we must now take into account that at

the anode a certain volume of iron has been replaced by the solution, whereas at the cathode the solution has been replaced by iron. The volume of iron  $\frac{1}{d} \cdot \frac{a}{k_0} \cdot \frac{e}{\epsilon}$  will correspond to the quantity of electricity  $e$ , when  $a$  denotes the atomic weight,  $k_0$  the valency of the atom,  $d$  the density of the iron. If we assume that at the anode no magnetic field is present, the substitution of iron solution for iron will not bring about any modification in the magnetic part of the free energy. At the cathode, however, this substitution will give rise to a change in the expression (9), which, when  $\mu_0$  represents the permeability of the iron solution,  $\mu$  that of the iron, amounts to:

$$\delta_1(\Delta_M \Psi) = -\frac{a \cdot e}{d \cdot k_0 \cdot \epsilon} \left[ \int_0^{\bar{B}} \frac{B}{\mu_0} dB - \int_0^{\bar{B}} \frac{B}{\mu} dB \right], \quad \dots \quad (13)$$

when  $B$  means the absolute value of  $\mathfrak{B}$  and  $\bar{B}$  this value at the cathode. When we speak of "at the cathode" or "at the anode", we mean by this that we must take the value of the considered quantity at a plane that is at a very small distance from the cathode resp. anode, this to evade the difficulties which the phenomena taking place in the boundary layer might cause; we shall examine this question more closely further on. On account of the smallness of the considered volume we may assume that the value of  $B$  is the same everywhere inside the volume. If we put  $\mu_0 = 1 + 4\pi \kappa_0$ , in which  $\kappa_0$ , the susceptibility per unity of volume, is to be considered as a small quantity, we get about:

$$\delta_1(\Delta_M \Psi) = -\frac{a \cdot e}{d \cdot k_0 \cdot \epsilon} \left[ \frac{\bar{B}^2}{2} (1 - 4\pi \bar{\kappa}_0) - \int_0^{\bar{B}} \frac{B}{\mu} dB \right], \quad \dots \quad (14)$$

when  $\bar{\kappa}_0$  represents the susceptibility at the cathode. If we assume  $\mu$  to be very great for iron, so that  $\frac{1}{\mu}$  is to be neglected with respect to unity, and if we replace  $\bar{B}$  by  $\bar{H}$ , the absolute value of the intensity of the field in air at the cathode, we get:

$$\delta_1(\Delta_M \Psi) = -\frac{a \cdot e}{d \cdot k_0 \cdot \epsilon} \frac{\bar{H}^2}{2} (1 - 4\pi \bar{\kappa}_0) \quad \dots \quad (15)$$

Instead of (13), using the relation:

$$B \left( 1 - \frac{1}{\mu} \right) = 4\pi I,$$

in which  $I$  is the absolute value of the magnetisation we may further write:



$$\sigma_1 (\Delta_M \Psi) = \frac{4\pi \cdot a \cdot e}{d \cdot k_0 \cdot \epsilon} \int_0^{\bar{B}} (I - I_0) dB. \quad (16)$$

We must further take the changes of concentration in the different elements of the electrolyte into account. If we introduce the concentration  $c$  as the number of grammolecules of the dissolved substance per unity of mass of the solution, this is modified by the passage of the quantity of electricity  $e$ . If the density of the electrolyte is  $\rho$ , then the variation of density, when the volume remains unchanged, will amount to :

$$\delta \rho = \delta v \dots \dots \dots (17)$$

in which  $\delta v$  is given by (11) and (12). By means of this we find easily for the change of concentration :

$$\delta c = \delta v \frac{1 - mc}{m \cdot \rho} \dots \dots \dots (18)$$

Now for dilute solutions very nearly :

$$\kappa_0 = \chi \cdot m \cdot \rho \cdot c \dots \dots \dots (19)$$

holds, in which  $\chi$  is the so-called absolute specific susceptibility per unity of volume, which is considered as independent of  $\rho$ <sup>1)</sup>. We get from this by the aid of (17) and (18) :

$$\delta \kappa_0 = \chi \cdot \delta v.$$

This then gives, as  $\kappa_0$  must be considered as small :

$$\delta \int_0^B \mathfrak{H} \cdot d\mathfrak{H} = - 2\pi B^2 \cdot \chi \cdot \delta v.$$

When we multiply this expression by the volume element  $d\tau$ , then introduce the value of  $\delta v$  from (11) and (12), and integrate with respect to the whole volume of the solution, we get :

$$\delta_2 (\Delta_M \Psi) = - \frac{2\pi \chi \cdot m}{k \cdot \epsilon} \int_V B^2 \cdot e_1 \cdot (i_1, \nabla n) \cdot d\tau - \frac{2\pi \chi \cdot m}{k \cdot \epsilon} \int_S B^2 \cdot e_1 i_{N_1} \cdot n \cdot d\sigma.$$

If we assume  $n$  to be constant, which is permissible, on account of the relative smallness of this term, if we suppose further that at the anode  $B = 0$ , at the cathode in air  $B = \bar{H}$ , we get :

$$\delta_2 (\Delta_M \Psi) = \frac{2\pi m \cdot \chi \cdot e \cdot n}{k \cdot \epsilon} \cdot \bar{H}^2, \dots \dots \dots (20)$$

---

<sup>1)</sup> Relation (19) holds of course only as long as the specific magnetic properties are independent of the concentration.



over the whole volume of the solution, we get:

$$\begin{aligned} \delta \Psi_1 = & \frac{m}{k \cdot \epsilon} \int_V e_1 \cdot (i_1 \cdot \nabla n) \cdot \left[ \psi_0 + \frac{p}{\rho} + \frac{RT}{m} (1 + \log c) - RTc + \frac{\alpha}{m} \right] \cdot d\tau + \\ & + \frac{m}{k \cdot \epsilon} \int_S e_1 \cdot i_{N_1} \cdot n \cdot \left[ \psi_0 + \frac{p}{\rho} + \frac{RT}{m} (1 + \log c) - RTc + \frac{\alpha}{m} \right] \cdot d\sigma. \end{aligned}$$

When we take  $n$  again as constant, we get:

$$\delta \Psi_1 = \frac{m \cdot n}{k} \cdot \frac{e}{\epsilon} \left[ \psi_{01} - \psi_{02} + p \left( \frac{1}{\rho_1} - \frac{1}{\rho_2} \right) + \frac{RT}{m} \log \frac{c_1}{c_2} - RT(c_1 - c_2) \right],$$

when we denote the quantities referring to the anode by the index 1, those referring to the cathode by the index 2.

We may further write:

$$\psi_{02} = \psi_{01} + (c_2 - c_1) \frac{\partial \psi_{01}}{\partial c},$$

or, because

$$\frac{\partial \psi_{01}}{\partial c} = -p,$$

$$\psi_{02} = \psi_{01} + p \left( \frac{1}{\rho_1} - \frac{1}{\rho_2} \right).$$

There remains finally

$$\delta \Psi_1 = \frac{m \cdot n}{k} \cdot \frac{e}{\epsilon} \cdot RT \cdot \left[ \frac{1}{m} \log \frac{c_1}{c_2} - (c_1 - c_2) \right] \cdot \dots \quad (24)$$

From the well known theorem for the free energy:

$$\delta \Psi + \delta W = 0$$

we get with the aid of (10), (16), (20), and (24):

$$\begin{aligned} E = & \left. \frac{4\pi \cdot \lambda}{d} \int_0^B (I - I_0) dB - \frac{2\pi m \cdot \chi \cdot n}{k \cdot \epsilon} \cdot \bar{H}^2 - \right\} \dots \quad (25) \\ & - \frac{m \cdot n}{k \cdot \epsilon} \cdot RT \cdot \left[ \frac{1}{m} \log \frac{c_1}{c_2} - (c_1 - c_2) \right] \end{aligned}$$

in which  $\lambda$  is the electrochemical equivalent of iron.

Hence the potential difference consists of two parts, viz. one part (the first two terms), which depends on the magnetic field, and a second part, which depends on the concentrations at the electrodes. The second term of the first part will increase proportional to the second power of the external intensity of the field, the first term, too, in case of small intensities of the field, where we may replace (16) by (15); at great intensities of the field, however,  $I$  will reach

the value of saturation, so that this term — which far exceeds the other “magnetic” term — will increase only about linearly with the external intensity of the field. The sense of the electromotive force determined by the first term is directed inside the solution from the non-magnetized towards the magnetized electrode. The second part of the expression becomes equal to zero for  $c_1 = c_2$ ; with neglect of the contraction which the solution undergoes on concentration, this expression agrees with the potential difference calculated by HELMHOLTZ<sup>1)</sup>, between two electrodes which are in solutions of different concentrations.

If we assume  $c_1 = c_2$ , and neglect the terms which depend on the susceptibility of the solution, the following form holds for not too great intensities of the field (in which  $\mu$  is still to be considered as very great)

$$E = \frac{\lambda \cdot H^2}{2d} \dots \dots \dots (26)$$

If we use electromagnetic unities, this becomes:

$$E = \frac{\lambda \cdot H^2}{8\pi \cdot d},$$

which agrees with (3).

In order to simplify our considerations we have disregarded the transition layers between iron and electrolyte; in them phenomena will namely take place which cannot be examined in detail. It now remains to prove that in the calculation of the free energy the influence of these transition layers may be neglected. For this purpose it is necessary to assume that the thickness of the transition layers is of the order of magnitude  $l$ , when  $l$  represents so small a quantity that we may assume that inside the thickness  $l$  the liquid is in equilibrium with the electrode. We shall further assume the limits of these transition layers on one side inside the iron, on the other side inside the solution. Let the quantity of electricity  $e$ , which we have passed through the solution, be of the order of magnitude  $\xi$ ; the same thing will be the case with the thickness of the iron layer, which has dissolved at the anode, deposited at the cathode. This iron layer may be infinitely thin with respect to the thickness of the transition layer, and entirely fall within it.

We have already taken into account the change of the “magnetic part” of the free energy, which is the consequence of the displacement of the iron and the dissolved substance. Now we have still to take into account the change of the state of the transition layers, which

<sup>1)</sup> H. HELMHOLTZ. Wied. Ann. 3 p. 201, 1878.

is the consequence of the conveyance of iron and dissolved substance. The quantity of dissolved substance supplied resp. extracted in the transition layers is of the order  $\xi$ , just as the quantity of electricity  $e$ . As the volume of the transition layers is of the order of magnitude  $l$ , the change of state inside these layer will be of the order  $\frac{\xi}{l}$ . Now there was equilibrium in the transition layers before the variation; hence a variation of the free energy per unity of mass of the order of magnitude  $\left(\frac{\xi}{l}\right)^2$  will correspond to a change of state of the order  $\frac{\xi}{l}$  (the external work is zero). The variation of the total free energy of the transition layers will therefore be of the order  $\frac{\xi^2}{l}$ . Thence we see that this variation may be neglected with respect to the other variations of the free energy, which are of the order  $\xi$ .

5. We shall now still examine what will be the equilibrium concentration in the magnetic field, i. e. that concentration which will finally exist after the diffusion has been active between the different volume elements. For this purpose we consider an infinitesimal variation of the total free energy  $\Psi$  of the system. We choose this so that all the parts of the system, with the exception of the solution, remain unvaried; moreover we leave the magnetic induction  $\mathfrak{B}$  unvaried. We can, therefore, restrict ourselves to the variation of  $\Psi_1$ , the free energy of the solution in the magnetic state. For this free energy holds the expression according to (8) and (9):

$$\Psi_1 = \int \left[ \rho \cdot \psi + \int \mathfrak{B} \cdot d\mathfrak{B} \right] d\tau,$$

when we use the expression (23) for  $\psi$ .

As the susceptibility may be considered as small, we may put for it:

$$\Psi_1 = \int \left[ \rho \cdot \psi + \frac{B^2}{2} (1 - 4\pi \kappa_0) \right] d\tau \dots \dots (27)$$

We shall now let the variation consist in a change of the concentration, accompanied with a change of the specific volume; in this we leave the volume of every volume element unvaried, so that the external work is equal to zero. We get the relation between concentration variation and volume variation by eliminating  $d\rho$  from (17) and (18), by which we get:

$$\delta c = \delta Q \cdot \frac{1-mc}{mQ} \dots \dots \dots (28)$$

Now we get from (27), keeping in view that  $B$  remains unchanged:

$$\delta \Psi_1 = \int [Q \cdot \delta \psi + \psi \cdot \delta Q - 2\pi B^2 \delta x_0] d\tau.$$

Making use of (19), (21), and (28) we get from this, when we apply the thesis of the free energy :

$$\int \left[ \frac{p}{Q} + \psi + \frac{1-mc}{m} \frac{\partial \psi}{\partial c} - 2\pi B^2 \cdot \chi \right] \cdot \delta Q \cdot d\tau = 0$$

Further exists the relation :

$$\int Q \cdot d\tau = M,$$

the total mass, from which follows :

$$\int \delta Q \cdot d\tau = 0.$$

The formula

$$\frac{p}{Q} + \psi + \frac{1-mc}{m} \cdot \frac{\partial \psi}{\partial c} - 2\pi B^2 \cdot \chi = const. \dots \dots (29)$$

follows from the two relations as condition of equilibrium for the solution in the magnetic field. For this we may put, just as above in the expressions (22)

$$\psi_0 + \frac{p}{Q} + \frac{RT}{m} (1 + \log c) - RTc + \frac{a}{m} - 2\pi B^2 \cdot \chi = const.,$$

from which follows, because at the anode  $B = 0$ , at the cathode  $B = \bar{H}$ , just as above for (24) :

$$\frac{RT}{m} \log \frac{c_2}{c_1} - RT (c_2 - c_1) = 2\pi \chi \cdot \bar{H}^2 \dots \dots (30)$$

When we introduce this into (25), we get for the potential difference in the state of equilibrium, at which also the solution is in equilibrium

$$E = \frac{4\pi \cdot \lambda}{d} \int_0^{\bar{B}} (I - I_0) dB \dots \dots \dots (31)$$

6. In order to test the obtained result by observation, I made a number of experiments, in the first place with iron. The iron used for this was electrolytic iron, which Prof. FRANZ FISCHER at

1) With neglect of the contraction which the solution undergoes, this result is in accordance with the result derived by VOIGT (Gött. Nachr. Math. phys. Kl. 1910 p. 545).

Charlottenburg kindly procured me. The magnetized electrode consisted of a circular plate, which was of the same size as the pole plane of the electromagnet, and was rigidly fastened to it, a glass plate serving as isolation. The other electrode was outside the field. The concentration of the used solution of ferrosulphate was generally 5%. The results obtained with this may be summarized as follows. On excitation of the magnetic field I always obtained a current in the sense as the theory requires. The extent of the obtained effect differed, however, greatly from the theoretical value; the measured potential differences were, namely, between the strengths of the field 0 and about 20.000 Gauss 10 or 20 times as great as the formula would require. At first the course was about proportional to the second power of the strength of the field, the effect reaching a value of  $6.3 \times 10^{-4}$  Volts at about 16000 Gauss, which did not change on further strengthening of the field. If the used solutions were neutral, the effect remained pretty well constant after excitation of the field. On the other hand for acid solutions (which contained only very little free acid) a diminution and a reversal of the effect soon took place, till a value was reached, about ten times as great as the first effect after the excitation of the field. It is remarkable that ROWLAND and BELL also always found such a reversal, whereas SQUIER found that above a certain strength of field the effect no longer increased, which is in agreement with what I observed. Another phenomenon that I regularly observed was the increase of the resistance of the solution as it was longer in the tube. At last this resistance can reach a value of some hundreds of thousands of ohms.

Besides I made experiments with nickel. The electrodes were of so-called "Rein nickel" from the firm KAHLBAUM; as electrolyte generally a 5% solution of nickel sulphate was used. No effect, however, was observed with certainty, so long as the solution was neutral. Probably there was an effect in the sense required by the theory, but about five times smaller than for iron, which would therefore harmonize better with the theory. It was, however, impossible to obtain certainty in this respect, as the resistance of the solution soon became exceedingly great, even up to more than  $10^6 \Omega$ ; moreover the zero position was very variable, much more so than was the case for iron. It is peculiar that the large resistance only consisted for very small electromotive forces; if on the other hand the latter was a few volts, the resistance became only a few thousands of ohms. For solutions of nickel sulphate greatly acidified with sulphuric acid no other effect was found than in neutral solutions; there was no question of a reversal here.

**Physics.** — “*Further experiments with liquid helium M. Preliminary determination of the specific heat and of the thermal conductivity of mercury at temperatures obtainable with liquid helium, besides some measurements of thermoelectric forces and resistances for the purpose of these investigations*”. By H. KAMERLINGH ONNES and G. HOLST. Communication N<sup>o</sup>. 142c from the Physical Laboratory at Leiden.

(Communicated in the meeting of June 27, 1914).

§ 1. *Introduction.* Measurements of the specific heat and of the thermal conductivity of mercury were considered to be of special importance with a view to the discontinuity, found at 4°·19 K. in the galvanic resistance of this metal. The preliminary results have been already mentioned in Comm. N<sup>o</sup>. 133, for the measurements were carried out as early as June 1912. We wished to repeat the experiments, which we considered only as a first reconnoitring in this region, because our opinion was, that, by some improvements in the experiments, the accuracy of the results could be considerably increased. Special circumstances frustrated this, and now, as there seems to be no prospect of a repetition for the present, we communicate the details of our investigation.

§ 2. *Thermoelectric forces.* The first difficulty in these determinations was the choice of a suitable thermometer. The measurements already performed about the resistance of platinum, gold and mercury did not give much hope, that there would be among the metals a suitable material for resistance thermometers. We have therefore investigated a series of thermoelements. The gold-silver couple, a suitable thermometer at hydrogen temperatures<sup>1)</sup>, showed down to the higher helium temperatures a fairly large thermoelectric power. at the lower helium temperatures, however, the thermoelectric power diminishes rapidly, so that this couple did not satisfy the requirements. Moreover, this couple was not at all free from disturbing electromotive forces, which appeared at places of great fall of temperature in the cryostat. Nearly all other elements were subject to the same fault. But apart from this, none of the combinations was suitable. Notwithstanding, we communicate the results of our determinations, because they show clearly that according to the theoretical investigations of NERNST and KEESOM<sup>2)</sup>, the thermoelectric power of all

<sup>1)</sup> Compare H. KAMERLINGH ONNES and J. CLAY, Comm. N<sup>o</sup>. 107b.

<sup>2)</sup> W. NERNST, Theor. Chem. 7e Aufl. 1913 p. 753. Berl. Sitz. Ber. 11 Dez. 1913 p. 972.

W. H. KEESOM, Leiden. Comm. Suppl. N<sup>o</sup>. 30b (Proceedings May 1913).



couples investigated approaches to zero at helium temperatures. The different wires were measured against copper. After a preliminary research, which included also the determination of the thermo-

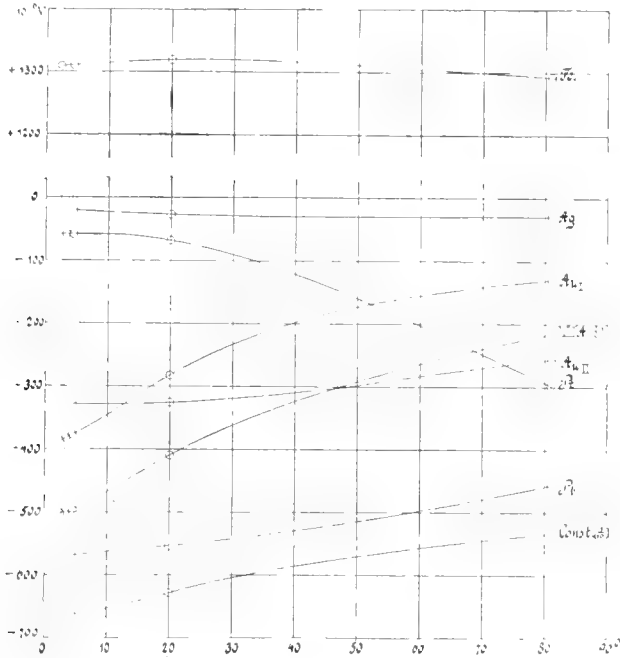

Fig. 1.

electric forces of nickel and of six gold-silver alloys, the following combinations were selected as most promising for investigations in liquid helium.

Thermoelectric forces against copper.

$T$	$Ag$	$Au_1$	$Au_2$	$Pt$	$Pb$	$Fe$	Const.	VIA <sup>1)</sup>
81° K.	-28	-129	-257	-298	-457	+1293	-5320	-432
20°	-28	-282	326	-68	-553	+1319	-6280	-819
4°26	-21	-375	-328	-58	-559	+1309	-6630	-990
3°20	—	-383	—	-59	—	+1309	-6630	-1002
2°26	—	-386	—	—	—	—	—	-1004

<sup>1)</sup>  $Au$  with 0,476 weight %  $Ag$ .

Figure 1 shows their thermoelectric forces against copper, at the absolute temperature  $T$ , given in the first column of the table. The temperature of the second juncture was  $16^{\circ}$  C.

§ 3. *Change of the resistance of alloys with temperature.* As it appeared impossible to find a suitable thermo-couple, our attention was drawn to the change of resistance of constantin, which had already been measured at hydrogen temperatures by KAMERLINGH ONNES and CLAY. This alloy shows here a considerable decrease of resistance at decreasing temperature; it was, therefore, probable that constantin could be suitably used as a resistance thermometer at helium temperatures. Experiments have shown that this was in fact the case. Later measurements (see comm. N<sup>o</sup>. 142a § 4) proved that also manganin, whose resistance begins to diminish at decreasing temperature and which has at oxygen temperatures a considerable smaller resistance than at ordinary temperatures, is fit for temperature measurements in liquid helium.

§ 4. *Specific heat of mercury. a. Experimental arrangements.*

The method, used in the determination of the specific heat, agrees most with the one used by NERNST in his investigations about the specific heat. A little block of solid mercury hung freely in a high vacuum and was heated electrically. The increase of temperature was determined by means of a constantin resistance thermometer. To obtain the little block of mercury the liquid metal (comp. fig. 2 with magnified fig. of details) was poured into the vessel  $C$  through a capillary, provided with a funnel, which could be introduced through  $m$ . First  $C$  was in the same way supplied by means of a funnel with a small quantity of pure pentane, which, at the introduction of the mercury, remains as a thin layer between the glass and the mercury. A little hollow steel cylinder (thickness of the wall  $\frac{1}{20}$  m.m.), which contained the heating wire — a constantin wire, insulated with silk and covered with a thin layer of celluloid to avoid all electrical contact with the mercury — was immersed in the mercury. Round this cylinder a second constantin wire was wrapped, which was to be used as a thermometer. The little cylinder was, by means of silk wires (stiffened by celluloid) fixed to a little glass rod, which could be moved up and down through the tube  $B$ , and which was centred by constrictions in this tube. This glass rod was connected to a silk wire, which could be screwed up and down by turning the handle  $K$ . Now the mercury was frozen by cooling down to the temperature of liquid air. The

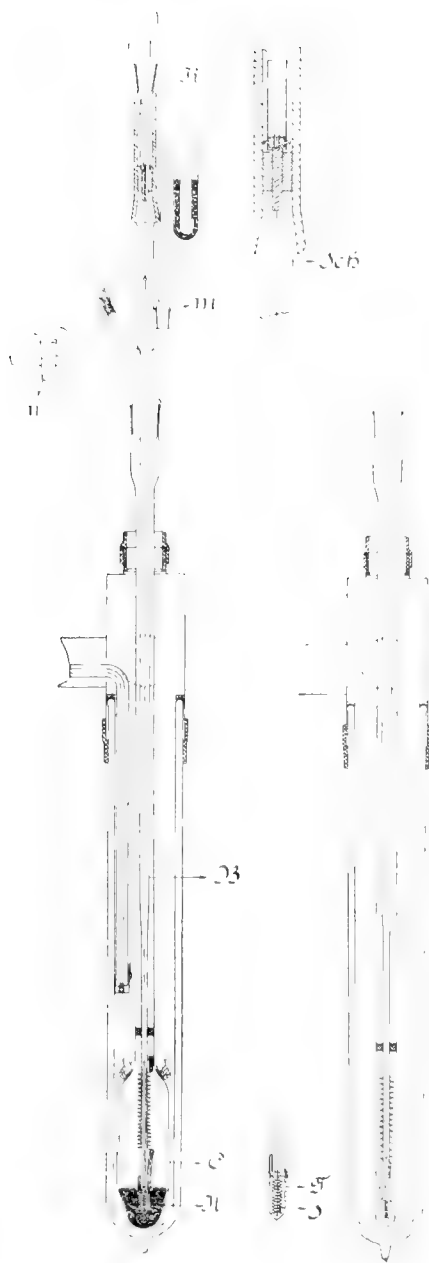

Fig. 2.

Fig. 3.

uncertainty. Nevertheless it seems possible, that the results are accurate to about 10%.

The thermal capacity of the hollow steel cylinder with the thermometer and the heating wires was determined afterwards by a separate experiment, Fig. 3 shows the apparatus used for this purpose.

*b. Results. Measurement at the boiling point of helium.* The quantity of heat supplied to the mercury amounted to 1,10 cal., the increase of

thin layer of pentane, which is spread over the glass, acts as a viscous lubricant at this temperature and prevents the sticking of the mercury to the wall in freezing. After having been frozen, the little block of solid mercury was screwed up by means of the handle *K* and the temperature was increased to about  $-50^{\circ}$  C. Thereupon a high vacuum was established by means of a GAEBDE mercury pump and the pentane was distilled off into a tube, immersed in liquid air. During the experiments the heat insulation of the block appeared to be so good, that the temperature remained many degrees above that of liquid helium, although it was let down against the glass wall. Therefore a little gas had to be admitted in order to cool the block. This manipulation succeeded perfectly, but the gas could not be removed quickly enough in the short time available for the experiments. The loss of heat of the mercury was thus very considerable (decrease of the temperature difference to half of the original value in about 100 seconds) and therefore the correction, to be applied to the increase of temperature while heating, remains the greatest source of

temperature, corrected for the loss of heat during the period of heating, was 2,22 degrees K. whilst the quantity of heat, necessary to heat the little steel cylinder with the thermometers 2,22 degrees, amounted to 0.11 cal. (result of a separate experiment). Control experiments showed that the heating wire (used as a thermometer), and the thermometer wire outside the steel cylinder had the same temperature. The mass of the mercury was 314 grammes, so that 0,00142 cal./degree K. was obtained for the mean specific heat between 4°,26 K. and 6°,48 K.

The relation of GRÜNEISEN <sup>1)</sup>  $\frac{v}{T} - c_p$  would <sup>2)</sup> have given  $c_p = 0.0037$ , for 4°.27 K.

*Measurement at 3°.5 K.* Afterwards the experiment was repeated at the temperature of liquid helium, boiling under a pressure of 6 cm. of mercury; 0.000534 cal./degree K. was found for the mean specific heat between 2°.93 K. and 3°.97 K.

Assuming this mean value of the specific heat, we shall calculate now the value of this quantity for a definite temperature according to DEBIJE's formula, which holds for our very low temperatures

$$c = C \cdot T^3,$$

so that the mean specific heat between two temperatures  $T_1$  and  $T_2$  is

$$c = \frac{C(T_1^4 - T_2^4)}{4(T_1 - T_2)}.$$

We obtain from the two experiments  $C = 0.0000088$  and  $0.0000127$  respectively.

The agreement is not satisfactory; although, taking into account that the absolute temperature occurs in the formula in the 4<sup>th</sup> power, and that therefore small deviations in  $T$  involve very large ones in  $C$ , we may safely conclude from our experiments, that, *with respect to the specific heat, nothing peculiar happens at the point of discontinuity*, and that we may content ourselves with a preliminary mean value  $C = 0.0000110$ , when we assume for the moment that the specific heat does not show any discontinuity at all.

We have then

$$c = CT^3 = 0.0000110 T^3$$

or for a gramme-molecule

$$c = 0.00220 T^3.$$

For the characteristic constant  $\theta$ , introduced by DEBIJE we find

<sup>1)</sup> E. GRÜNEISEN, Verh. d. Deutschen Phys. Ges. 1913 p. 186.

<sup>2)</sup> Compare KAMERLINGH ONNES and HOLST, Leiden Comm. N°. 142a Proceed. June 1914.

with  $c_\infty = 5.96$  and

$$c = 0.00220 T^3 = 77,938 \frac{T^3}{\theta^3} c_\infty = 464 \frac{T^3}{\theta^3}$$

$$\theta = 60.$$

As a matter of fact, the specific heat has been determined here at constant pressure and not at constant volume. In the foregoing calculation, the difference of the specific heats  $c_v$  and  $c_p$ , given by

$$c_v = c_p - A c_p^2 T,$$

has been neglected. Indeed,  $A$  is about  $7,2 \cdot 10^{-5}$  and  $c_p$  and  $T$  are both small.

Using DEBIJE'S formula, we can compare our results with those of POLLITZER<sup>1)</sup> at somewhat higher temperatures. For this purpose we calculate a value of  $\theta$  agreeing as well as possible with POLLITZER'S figures of  $\frac{c}{c_\infty}$ , we find then 110. In fig. 4  $c_v$  is plotted as a function of  $T$  according to DEBIJE; the values, determined experimentally, are indicated by circles.

The accordance at helium temperatures is bad, as could be expected in consequence of the difference between the value of  $\theta$  used in the calculation, and the one deduced from our experiments.

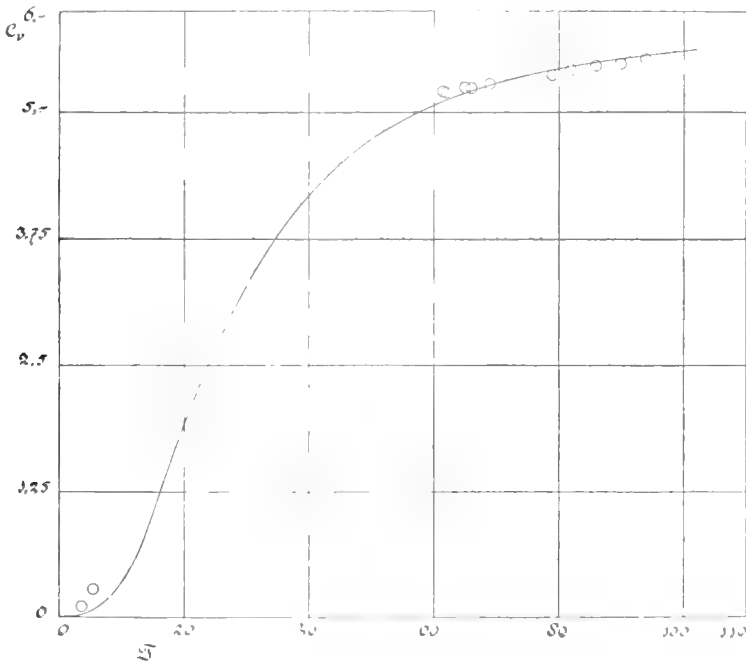

Fig. 4.

<sup>1)</sup> See F. POLLITZER. Zeitschr. f. Elektrochem. 1911. p. 5.

Meanwhile we remark, that in POLLITZER's experiments too a distinct deviation from DEBJE's curve is to be noticed, in the sense of a decrease of  $\theta$  (about 115—162) with decreasing temperature, which would be, according to our experiments, very considerable down to helium temperatures; further that, according to LINDEMANN's formula and by comparison with lead (88),  $\theta = 61$  is to be expected for mercury.

### § 5. *The thermal conductivity.*

The thermal conductivity was determined by means of the apparatus, represented in figure 5. A U-shaped tube, with double walls, and closed at one end, was provided with mercury. The closed branch contained



Fig. 5.

The closed branch contained a constantin wire  $S$ , insulated by means of celluloid, which made contact with the mercury at the free end. This wire was used as a heating wire. The current returned through the mercury itself by means of a wire, in contact with the mercury at the open end of the tube. The fall of temperature was measured with 3 constantin thermometers  $T_1$ ,  $T_2$  and  $T_3$  consisting of wire of  $1/50$  mm. thickness, wrapped around a small glass tube. The experimental arrangement is further explained by the diagrammatic figure. All wires were connected to each other by two wires, insulated by thin layers of celluloid and further running free through the liquid helium.

In consequence of a wrong manipulation during the preparation, the tube had lost a little mercury, so that only the two lower thermometer wires could be used. The heat developed in the heating wire and the difference in temperature thus produced were measured at two different temperatures, the one above and the other one below the point of discontinuity in the electrical resistance. The section of the cylinder of solid mercury amounted to  $0.47 \text{ cm}^2$ , the distance of the thermometers to 5.0 cm.

At the boiling point of helium the supplied energy was 0,633 watt/sec., the difference in temperature produced 0.58; at  $3^\circ.7 \text{ K}$  0,0365 watt sec. and 0,23.

From this we find for the mean thermal conductivity between  $4^\circ.5 \text{ K}$  and  $5^\circ.1 \text{ K}$ .  $k = 0.27 \text{ cal/cm. sec.}$  and between  $3^\circ.7 \text{ K}$  and  $3^\circ.9 \text{ K}$ :  $k = 0.40 \text{ cal/cm. sec.}$

The thing, which immediately strikes us, is that there is here no

distinct discontinuity as was found at  $4^{\circ}.19$  K in the electrical conductivity, although the thermal conductivity becomes much larger, when the temperature decreases. As there do not exist direct determinations for solid mercury, we only can make a rough estimation with the aid of WIEDEMANN and FRANZ's law.

At the melting point, the electrical conductivity of liquid mercury amounts to  $1.10 \cdot 10^4$  cm.  $\Omega^{-1}$  and of solid mercury to about five times as much, thus to  $5.50 \cdot 10^4$  cm $^{-1}$   $\Omega^{-1}$ . From this we find by comparison e.g. with lead about 0.075 for the thermal conductivity. The values here obtained in liquid helium are 3.5 and 5.5 times as large.

**Chemistry.** "*Equilibria in ternary systems*". XVII. By Prof. SCHREINEMAKERS.

(Communicated in the meeting of Oct. 31, 1914).

Now we will consider the case, mentioned sub 3 (XVI), viz: the solid substance is a binary compound of a volatile and a non-volatile component. A similar case occurs for instance in the system  $\text{Na}_2\text{SO}_4 + \text{water} + \text{alcohol}$ , when the solid phase is  $\text{Na}_2\text{SO}_4 \cdot 10 \text{H}_2\text{O}$ , or in the system  $\text{FeCl}_3 + \text{HCl} + \text{H}_2\text{O}$ , when the solid phase is one of the hydrates of ferric chloride, for instance  $\text{Fe}_2\text{Cl}_6 \cdot 12 \text{H}_2\text{O}$ .

For fixing the ideas we shall assume that of the three components  $A$ ,  $B$ , and  $C$  (fig. 1) only  $A$  and  $C$  are volatile, so that all vapours consist either of  $A$  or of  $C$  or of  $A + C$ .

In fig. 1  $CAde$  represents a heterogeneous region  $L-G$ ;  $ed$  is the liquid curve,  $CA$  the corresponding straight vapour-line. The liquid  $d$ , therefore, can be in equilibrium with the vapour  $A$ , the liquid  $e$  with the vapour  $C$  and each liquid of curve  $ed$  with a definite vapour of  $AC$ .

Previously (XVI) we have seen that this heterogeneous region  $L-G$  can arise in different ways on decrease of pressure, viz. either in one of the anglepoints  $A$  and  $C$  or in a point of  $AC$ ; also two heterogeneous regions may occur, the one in  $A$  and the other in  $C$ , which come together on further decrease of pressure somewhere in a point of  $AC$ .

In fig. 1 we may imagine that the region  $L-G$  has arisen in these different ways; curve  $ed$  may of course also turn its convex side towards  $AC$ . Besides this heterogeneous region  $L-G$  we also find, in fig. 1 the saturationcurve under constant pressure of the binary

substance  $F$ , represented by  $pq$  [we leave the curve  $rs$ , drawn in the figure out of consideration for the present].

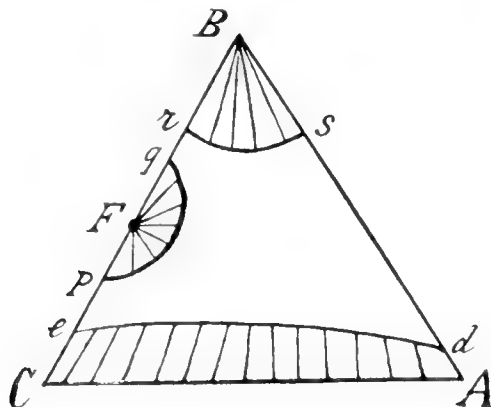

Fig. 1.

In the same way as we have acted in the general case [fig. 11 (1)] or in the peculiar case (XI), we may deduce also now the different diagrams.

$T < T_F$ . At first we take a temperature  $T$  lower than the minimum meltingpoint  $T_F$  of the binary compound  $F$ . Now we find a diagram just as fig. 2 for the saturationcurve under its own vapour-pressure of  $F$  and the corresponding straight vapour-line. In this figure, in which the component-triangle is only partly drawn,  $hgn$  is the saturationcurve under its own vapourpressure; we find the corresponding straight vapour line  $Cg_1$  on side  $CA$ .

When we assume, as is supposed at the deduction of fig. 2, that neither a point of maximum-pressure, nor a point of minimum-pressure occurs, the pressure increases from  $n$  towards  $h$ ; consequently it is lowest in  $n$  and highest in  $h$ , without being, however, a minimum in  $n$  or a maximum in  $h$ . It follows from the deduction that the sides solid-gas and solid-liquid of the threephasetriangles must be situated with respect to one another and to the side  $CB$  just as is drawn in fig. 2.

It is apparent from the figure that the binary liquids  $h$  and  $n$  can be in equilibrium with the unary vapour  $C$  and that the ternary liquids  $a$ ,  $c$  and  $b$  can be in equilibrium with the binary vapours  $a_1$ ,  $c_1$  and  $b_1$ . It is apparent that somewhere between the liquids  $c$  and  $b$  a liquid  $g$  must be situated, the corresponding vapour  $g_1$  of which represents the extreme point of the straight vapour line  $Cg_1$ .

When a liquid follows curve  $hn$ , first from  $h$  towards  $g$  and afterwards from  $g$  towards  $n$ , the corresponding vapour  $g_1$  follows conse-



quently first  $Cg_1$  from  $C$  towards  $g_1$  and afterwards again this same line, but in opposite direction, consequently from  $g_1$  towards  $C$ .

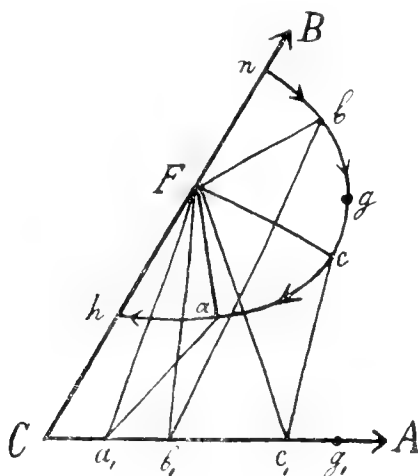

Fig. 2.

Each vapour of this straight vapour line  $Cg_1$  can, therefore, be in equilibrium with two different liquids, the one of branch  $h_f$  and the other of branch  $gn$ .

We may express this also in the following way: when we have an equilibrium  $F + L + G$ , then there exists under another pressure, also an equilibrium  $F + L_1 + G_1$ , in which  $L$  and  $L_1$  have a different composition;  $G$  and  $G_1$ , however, have the same composition.

It is apparent from the deduction of fig. 2 that in curve  $hn$  also a point of maximum pressure can occur. This case is drawn in fig. 3;  $hn$  represents again the saturation curve under its own vapour pressure and  $Cg_1$  represents the corresponding straight vapour line;  $M$  is the point of maximum pressure,  $M_1$  the corresponding vapour. The points  $M_1$ ,  $M$ , and  $F$  must of course be situated on a straight line.

While under the pressure  $P_M$  there occurs only one equilibrium, viz.  $F + L_M + G_{M_1}$ , under each pressure, somewhat lower than  $P_M$  there exist two equilibria, for instance  $F + L_a + G_{a_1}$  and  $F + L_c + G_{c_1}$ ; we can imagine these to be represented by the three phase triangles  $Faa_1$  and  $Fcc_1$ , when we imagine both triangles in the vicinity of the line  $FM_1$ . It follows from the deduction of the diagram that both these triangles turn their sides solid-gas towards one another, consequently also towards the line  $FM_1$ .

Suppose, we want the curves  $ed$  and  $pg$  to move in fig. 1 with respect to one another in such a way that a point of minimum pressure occurs on the saturation curve under its own vapour pressure,

then we see that this is impossible. Yet we can imagine a saturation-curve with a point of maximum- and a point of minimum pressure.

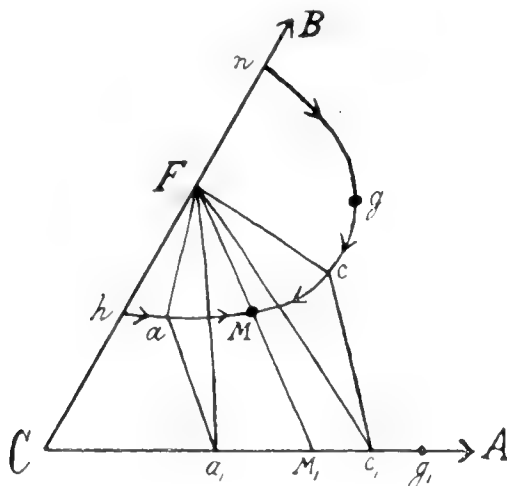

Fig. 3.

When we trace curve  $ln$  starting from  $n$ , we arrive first in the point of maximum- afterwards in the point of minimum pressure. We will refer to this later.

$T_F < T$ . Now we take a temperature  $T$  a little above the minimum meltingpoint  $T_F$  of the solid substance  $B$ . Then we must distinguish two cases, according as the solid substance expands or contracts on melting. We take the first case only.

Then we find a diagram like fig. 4 (XI); herein, however, the same as in figs. 2 and 3, we must imagine that the vapourcurve  $h_1a_1n_1$  is replaced by a straight vapourline  $Cg_1$  on side  $CA$ . We will refer later to the possibility of the occurrence of a point of maximum- and a point of minimum pressure.

We can, however, also get curves of a form as curve  $lm$  and the curves situated inside this in fig. 6 (XI); these curves show as well a point of maximum- as a point of minimum pressure.

When we draw the saturationcurves under their own vapour-pressure for different temperatures, we can distinguish two principal types; we can imagine those to be represented by figs. 5 (XI) and 6 (XI). At temperatures below  $T_F$  these curves are circumphased, above  $T_F$  they are explased. In fig. 5 (XI) they disappear in a point  $H$  on side  $BC$ , in fig. 6 (XI) in a point  $R$  within the triangle. The corresponding straight vapourlines disappear in fig. 5 (XI) at  $T_H$  in the point  $C$ ; in figure 6 (XI) they disappear at  $T_R$  in a point  $R_1$ , the intersecting point of the line  $BR$  with the side  $CA$ .

Now we will consider some points more in detail. In order to get the conditions of equilibrium for the system  $F + L + G$ , when  $F$  is a binary compound of  $B$  and  $C$  and when the vapour consists only of  $A$  and  $C$ , we must equate  $a=0$  and  $y_1=0$ . The conditions (1) (II) pass then into:

$$\left. \begin{aligned} Z - x \frac{\partial Z}{\partial x} - (y - \beta) \frac{\partial Z}{\partial y} &= \xi & \frac{\partial Z}{\partial x} &= \frac{\partial Z_1}{\partial x_1} \\ Z_1 - x_1 \frac{\partial Z_1}{\partial x_1} + \beta \frac{\partial Z}{\partial y} &= \zeta \end{aligned} \right\} \dots \dots (1)$$

Now we put:

$$Z = U + RTx \log x \quad \text{and} \quad Z_1 = U_1 + RTx_1 \log x_1 \dots \dots (2)$$

Hence the conditions (1) pass into:

$$x \frac{\partial U}{\partial x} + (y - \beta) \frac{\partial U}{\partial y} + RTx - U + \xi = 0 \dots \dots (3)$$

$$x_1 \frac{\partial U_1}{\partial x_1} - \beta \frac{\partial U}{\partial y} + RTx_1 - U_1 + \zeta = 0 \dots \dots (4)$$

$$\frac{\partial U}{\partial x} + RT \log x = \frac{\partial U_1}{\partial x_1} + RT \log x_1 \dots \dots (5)$$

When we keep the temperature constant, we may deduce from (3)—(5):

$$[xr + (y - \beta)s + RT] dx + [xs + (y - \beta)t] dy = A dP \dots (6)$$

$$\left[ x_1 r - \beta s + \frac{x_1}{x} RT \right] dx + [x_1 s - \beta t] dy = (A + C) dP \dots (7)$$

$$\left( r + \frac{RT}{x} \right) dx + s dy - \left( r_1 + \frac{RT}{x_1} \right) dx_1 = \left( \frac{\partial V_1}{\partial x_1} - \frac{\partial V}{\partial x} \right) dP \dots (8)$$

Here we must equate of course in  $A$  and  $C$   $a=0$  and  $y_1=0$ . In order to let the pressure be a maximum or a minimum,  $dP$  must be  $=0$ . From (6) and (7) it follows that then must be satisfied:

$$x\beta + x_1(y - \beta) = 0 \dots \dots (9)$$

This means that the point of maximum- or of minimum pressure  $M(x,y)$  and the corresponding vapourpoint  $M_1(x_1,y_1)$  are situated with  $F$  on a straight line (fig. 3).

In order to examine the change of pressure along a saturation-curve under its own vapourpressure in its ends  $h$  and  $n$  (figs. 2 and 3) we equate in (6) and (7)  $x=0$  and  $x_1=0$ . Then we find:

$$[(y - \beta)s + RT] dx + (y - \beta)t dy = \left[ V - v + (\beta - y) \frac{\partial V}{\partial y} \right] dP \dots (10)$$

$$\left[ -\beta s + \frac{x_1}{x} RT \right] dx - \beta t dy = \left[ V_1 - v + \beta \frac{\partial V}{\partial y} \right] dP \dots (11)$$

The ratio  $x_1 : x$  has a definite value herein, as it follows from (5). When we eliminate  $dy$  from (10) and (11), then we find:

$$\left[ \beta + (y - \beta) \frac{x_1}{x} \right] RT dx = [\beta V + (y - \beta) V_1 - yv] dP. \quad (12)$$

The quantities in the coefficient of  $dP$  relate all to the binary equilibrium  $F + L + G$ . When we call  $\Delta V_1$  the change of volume, when between the three phases of this binary equilibrium a reaction takes place, at which the unity of quantity of vapour arises, then is:

$$(y - \beta) \Delta V_1 = \beta V + (y - \beta) V_1 - yv \quad (13)$$

Consequently we may write for (12):

$$dP = \left( \frac{x_1}{x} + \frac{\beta}{y - \beta} \right) \frac{RT}{\Delta V_1} \cdot dx \quad (14)$$

Now we introduce again, as in (XI) the perspective concentrations of the substance  $A$  in liquid and gas; it is evident that the perspective concentration  $S_1$  is equal to the real concentration  $x_1$  of  $A$  in the vapour; we find for the perspective concentration of  $A$  in the liquid:

$$S = \frac{\beta x}{\beta - y} \quad (15)$$

so that we can write for (14):

$$\left( \frac{dP}{dx} \right)_{x=0} = \frac{x_1}{x} \left( 1 - \frac{S}{x_1} \right) \frac{RT}{\Delta V_1} \quad (16)$$

When the vapour contains the three components, then, as we have seen previously (14) (XI) is true; when we replace herein  $S_1$  by  $x_1$ , this passes into (16).

It follows from (16) that the sign of the change of pressure in the ends  $h$  and  $n$  of a saturationcurve under its own vapourpressure, depends on the sign of  $\Delta V_1$ . Now  $\Delta V_1$  is almost always positive for the binary equilibrium  $F + L + G$  and it is only negative between the points  $P$  and  $H$  [fig. 5 (XI) and fig. 6 (XI)]. Consequently  $\Delta V_1$  is positive in the points  $h$  and  $n$  of figs. 2 and 3, also in the point  $h$  of fig. 5 (XI) and 6 (XI);  $\Delta V_1$  is negative in the point  $n$  of the two last figures. Further it follows that the sign of the change of pressure is not determined by the ratio  $x_1 : x$  (the partition of the third substance between gas and liquid) but by the ratio  $S : x_1$  (the perspective partition of the third substance between gas and liquid).

Let us take now a liquid of the saturationcurve under its own vapourpressure in the vicinity of the point  $h$  of fig. 2, for this we imagine triangle  $Faa_1$  in the vicinity of the side  $BC$ . From the position of  $Fa$  and  $Fa_1$  with respect to one another, follows

$S > x_1$ . As  $\Delta V_1$  is positive in  $h$ , it follows from (16) that the pressure must decrease on addition of a third substance. We see that this is in accordance with the direction of the arrow in the vicinity of  $h$ .

In the vicinity of point  $h$  of fig. 3 is  $x_1 > S$  as follows from the position of triangle  $Faa_1$ . As  $\Delta V_1$  is positive, it follows from (16) that the pressure must increase on addition of a third substance. This is in accordance with the direction of the arrow in the vicinity of  $h$ .

In the vicinity of point  $n$  of the figs. 2 and 3  $S$  is negative (we imagine for instance in fig. 2 triangle  $Fbb_1$  in the vicinity of side  $BC$ ); as  $\Delta V_1$  is positive, it follows from (16) that in both figures the pressure must increase, starting from  $n$ .

Consequently we find: in a terminatingpoint of a saturationcurve under its own vapourpressure, situated between  $C$  and  $H$ , the pressure decreases on addition of a third substance, when the threephase-triangle turns its side solid-gas towards  $BC$  (fig. 2) and the pressure increases when the threephasetriangle turns its side solid-liquid towards  $BC$ .

As, therefore, at temperatures lower than  $T_F$  (figs. 2 and 3) the pressure always increases, starting from  $n$ , and increases or decreases starting from  $h$ , we find the following. When we trace curve  $nh$ , the pressure increases continually starting from  $n$  towards  $h$  (fig. 2), or we come starting from  $n$  first in a point of maximumpressure, after which the pressure decreases as far as in  $h$  (fig. 3) or we come, starting from  $n$  first in a point of maximum- and afterwards in a point of minimumpressure, after which the pressure increases up to  $h$ .

As in point  $h$  of fig. 5 (XI) the pressure decreases starting from  $h$ , consequent it is assumed here, that the threephasetriangle turns its [side solid-gas towards  $BC$ . (Cf. fig. 2 and fig. 4 (XI); in this last figure we imagine however curve  $h_1n_1$  on side  $CA$ ). In the point  $h$  of fig. 6 (XI) is assumed that the threephasetriangle turns its side solid-liquid towards  $BC$ .

Let us consider now the terminatingpoint  $n$  of the saturationcurve in fig. 5 (XI) and fig. 6 (XI). As  $n$  is situated between  $F$  and  $H$ ,  $\Delta V_1$  is negative, when the threephasetriangle turns its side solid-gas towards  $BC$ , then is  $S > x_1$  and it follows from (16) that the pressure increases on addition of a third substance. We then have the case of fig. 5 (XI). When, however, the threephasetriangle turns its side solid-liquid towards  $BC$ , then  $S < x_1$  and it follows from (16) that the pressure decreases on addition of a third substance. We then have the case represented in fig. 6 (XI).

When we consider the saturationcurve going through the point  $F$  in fig. 5 (XI) and fig. 6 (XI), then for this point  $y = \beta$ , consequently, according to (15)  $S = \infty$ . From (13) follows also  $\Delta V_1 = \infty$ . Therefore we take (12); from this follows for  $y = \beta$

$$\left(\frac{dP}{dx}\right)_{x=0} = \frac{RT}{V-v} \cdot \dots \dots \dots (17)$$

As fig. 5 (XI) and fig. 6 (XI) are drawn for  $V > v$ , the pressure must increase starting from  $F$  along the saturationcurve going through  $F$ .

As the pressure increases starting from  $F$  along the saturationcurves under their own vapourpressure of fig. 6 (XI) and decreases starting from a point  $n$ , situated in the vicinity of  $H$ , somewhere between  $F$  and  $n$  must consequently be situated a point, starting from which the pressure neither increases nor decreases. This point is, therefore, the point of maximum- or of minimumpressure of a saturationcurve, and is not situated within the componenttriangle, but accidentally it falls on side  $BC$ . It follows from the figure that this point is a point of minimumpressure; we shall call this the point  $m$ .

The limitecurve (viz. the geometrical position of the points of maximum- and minimumpressure) goes consequently through the points  $m$  and  $R$ ; it represents from  $m$  to  $R$  points of minimumpressure; starting from  $R$  further within the triangle, it represents points of maximumpressure. This latter branch can end anywhere between  $H$  and  $C$  on side  $BC$ .

The terminatingpoint of a limitecurve on side  $BC$  can be situated between  $F$  and  $C$ , but cannot be situated between  $F$  and  $B$ . A similar terminatingpoint is viz. a point of maximum- or a point of minimumpressure of the saturationcurve, going through this point. Consequently in this point along this saturationcurve  $dP = 0$ ; from (16) it follows that then must be satisfied:

$$S = x_1 \quad \text{or} \quad \beta x + (y - \beta) x_1 = 0. \quad \dots \dots (18)$$

Herein  $x$  and  $x_1$  are infinitely small; their limit-ratio is determined by (5). As  $x$  and  $x_1$  are both positive, it follows from (18):  $y < \beta$ . The terminatingpoint of a limitecurve must, therefore, be situated between  $F$  and  $C$  (fig. 6) and it cannot be situated between  $F$  and  $B$ . In accordance with this we found above that one of the ends of the limitecurve is situated in fig. 6 (XI) between  $n$  and  $F$ .

Now we must still consider the case mentioned sub 4 (XIV), viz. that the solid substance is one of the components. A similar case

occurs for instance in the systems:  $Z + \text{water} + \text{alcohol}$ , wherein  $Z$  represents an anhydric single, salt, which is not-volatile.

For fixing the ideas we assume that  $B$  is the component, which is not-volatile (fig. 1), so that  $A$  and  $C$  represent the volatile components.

Now we imagine in fig. 1 curve  $pq$  to be omitted, so that the curves  $ed$  and  $rs$  rest only,  $ed$  is the liquidcurve of the region  $L - G$ ,  $rs$  is the saturationcurve under a constant pressure of the substance  $B$ .

We can, in order to obtain the different diagrams, act in the same way as we did before in the general case, or as in communication XIII. For this we consider the movement of the curves  $ed$  and  $rs$  with respect to one another on decrease of pressure.

As we assume that  $B$  is not volatile, these considerations are not true, therefore, for points situated in the vicinity of  $B$ . Equilibria situated in the immediate vicinity of  $B$  have viz. also always the substance  $B$  in their vapour, so that the considerations of communication XIII apply to these.

When we decrease the pressure, the liquidcurve  $ed$  (fig. 1) shifts further into the triangle towards the point  $B$ , so that under a definite pressure the curves  $ed$  and  $rs$  meet one another. Now we distinguish three cases.

1. We assume that the curves  $ed$  and  $rs$  meet one another first in a point on one of the sides of the triangle; when this takes place on side  $BC$ , then consequently the points  $e$  and  $r$  coincide in fig. 1, while the two curves have no other point in common further. On further decrease of  $P$ , this intersecting point shifts within the triangle and it disappears at last on the side  $AB$ , when in fig. 1 the points  $s$  and  $d$  coincide. Curve  $ed$  is situated then inside the sector  $Brs$  and curve  $rs$  inside the region  $CedA$ .

From this follows that the saturationcurve of  $B$  under its own vapourpressure can be represented by curve  $habn$  in fig. 4, in which the arrows indicate the direction, in which the vapourpressure increases. The corresponding vapourcurve is the side  $CA$ ; the liquid  $h$  viz. is in equilibrium with the vapour  $C$ , liquid  $n$  with the vapour  $A$  and with each liquid ( $a$  and  $b$ ) of  $hn$  a definite vapour ( $a_1$  and  $b_1$ ) of  $CA$  is in equilibrium. It follows from the deduction that the threephase-triangles ( $Baa_1$ ,  $Bbb_1$ ) turn their sides solid-gas towards the point  $h$  and their sides solid-liquid towards the point  $n$ .

This fig. 4 is a peculiar case of fig. 2 (XIII); when we suppose viz. that the substance  $B$  does not occur in the vapour, curve  $h_1a_1b_1n_1$  of fig. 2 (XIII) must coincide with the side  $CA$  of the triangle and fig. 4 arises.

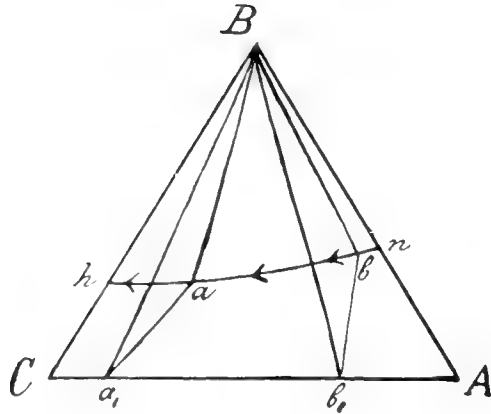

Fig. 4.

2. Now we assume again that the curves  $ed$  and  $rs$  (fig. 1) meet one another first in a point of the side  $BC$ ; this point of intersection shifts then on further decrease of  $P$  into the triangle. Under a definite pressure we want a second point of intersection to be formed by the coincidence of  $d$  and  $s$  (fig. 1). The two points of

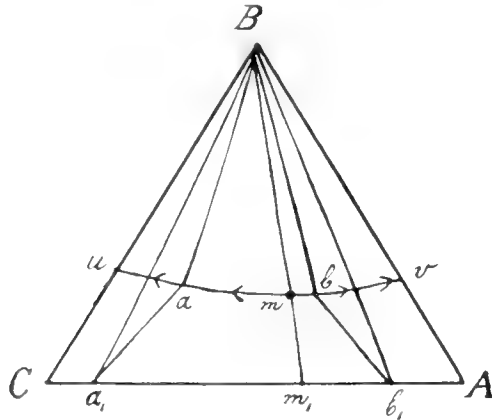

Fig. 5.

intersection approach one another on further decrease of pressure, in order to coincide at last in a point  $m$ . It is evident that  $m$  is a point of minimum pressure of the saturation curve under its own vapour pressure; it is represented in fig. 5 by curve  $uambv$ , the corresponding vapour curve is the side  $CA$ . It is evident that the vapour  $m_1$ , which can be in equilibrium with the liquid  $m$ , is situated on the line  $Bm$ .

3<sup>rd</sup>. We can assume also that the curves  $ed$  and  $rs$  (fig. 1) meet on decrease of pressure first in a point  $M$ , which is situated within the triangle. On further decrease of pressure then two points of



intersection arise; the one disappears on  $BC$  by the coincidence of  $e$  and  $r$ , the other on  $BA$  by the coincidence of  $d$  and  $s$  (fig. 1). It is evident that  $M$  is then the point of maximum-pressure of the saturationcurve of  $B$  under its own vapourpressure, the corresponding vapourpoint  $M_1$  is situated of course on the line  $BM$ .

One can understand the occurring diagram with the aid of fig. 5; herein we have to give an opposite direction to the arrows and we have to replace the points of minimumpressure  $m$  and  $m_1$  by the points of maximumpressure  $M$  and  $M_1$ ; further the triangles  $Baa_1$  and  $Bbb_1$  are to be drawn, in such a way that they turn their sides solid—gas towards the line  $BM$ .

We shall consider some points in another way now. In order to find the conditions of equilibrium for the equilibrium  $B + L + G$ , when the vapour consists of  $A$  and  $C$  only, we equate in the relations (1)–(8)  $\beta = 1$ ; in the general values of  $A$  and  $C$  (II) we put  $\alpha = 0$ ,  $\beta = 1$  and  $\gamma_1 = 0$ . The condition for the occurrence of a point of maximum- or of minimumpressure ( $dP = 0$ ) becomes then:

$$x = (1 - y)x_1 \dots \dots \dots (19)$$

This relation also follows from (9), when we put  $\beta = 1$ . This means: the point of maximum- or of minimumpressure of the saturationcurve of  $B$  under its own vapourpressure and the corresponding vapourpoint are situated with point  $B$  on a straight line (fig. 5).

In order to determine the change of pressure along a saturationcurve under its own vapourpressure in its ends on the sides  $BC$  and  $BA$  (figs. 4 and 5) we put in (16)  $\beta = 1$ . We then find

$$\left(\frac{dP}{dx}\right)_{x=0} = \frac{x_1}{x} \left(1 - \frac{S}{x_1}\right) \frac{RT}{\Delta V_1} \dots \dots \dots (20)$$

In this  $S$  and  $\Delta V_1$  are determined by (13) and (15), when we put herein  $\beta = 1$ . Consequently  $S$  is always positive. When we apply (20) to the figures (4) and (5), then we see that the change of pressure is in accordance with the position of the sides solid-gas and solid-liquid of the threephasetriangles.

Now we have treated the case that either the binary compound  $F$  (figs. 2 and 3) or the component  $B$  (figs. 4 and 5) occurs as solid phase. When  $F$  and  $B$  occur both as solid phases, then the two saturationcurves under their own vapourpressure can either intersect one another or not. We only consider the case, drawn in fig. 6, that the two curves intersect one another in a point; the vapour, being in equilibrium with the liquid  $s$ , is represented by  $s_1$  ( $s_2$  or  $s_3$ ).

A similar case may occur for instance in the system  $\text{Na}_2\text{SO}_4 + \text{water} + \text{alcohol}$ , then curve  $cs$  is the saturationcurve under its own

vapourpressure of  $\text{Na}_2\text{SO}_4 \cdot 10 \text{H}_2\text{O}$  ( $F$ ),  $sa$  the saturationcurve of the anhydric  $\text{Na}_2\text{SO}_4$  ( $B$ ). Then there exists a series of solutions, saturated under their own vapourpressure with  $\text{Na}_2\text{SO}_4 \cdot 10 \text{H}_2\text{O}$  (curve  $cs$ ) and one series saturated with  $\text{Na}_2\text{SO}_4$  (curve  $sa$ ); the equilibrium  $\text{Na}_2\text{SO}_4 \cdot 10 \text{H}_2\text{O} + \text{Na}_2\text{SO}_4 + L_s + G_s$  occurs only under a definite pressure  $P_s$ . The solution  $L_s$  has then a definite composition  $s$  and the vapour, which consists only of water and alcohol has a definite composition  $s_1$ .

In the binary system  $\text{Na}_2\text{SO}_4 + \text{water}$ , the equilibrium  $\text{Na}_2\text{SO}_4 \cdot 10 \text{H}_2\text{O} + \text{Na}_2\text{SO}_4 + \text{vapour}$  exists only under one definite pressure; we shall call this pressure  $P_0$ . In the ternary system  $\text{Na}_2\text{SO}_4 + \text{water} + \text{alcohol}$  the equilibrium  $\text{Na}_2\text{SO}_4 \cdot 10 \text{H}_2\text{O} + \text{Na}_2\text{SO}_4 + L_s + G_s$  exists also only under a definite vapourpressure  $P_s$ . This pressure  $P_s$  is influenced

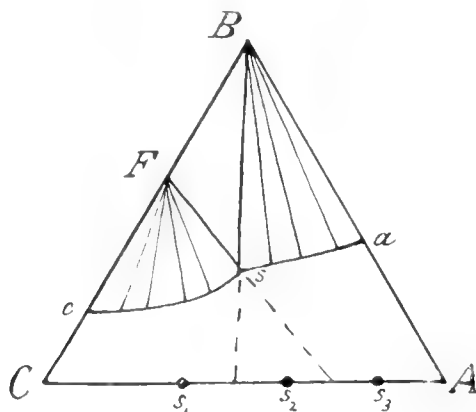

Fig. 6.

by the watervapour and the alcohol-vapour together; now we may show that the partialpressure of the watervapour herein is also equal to  $P_0$  and that the pressure of the alcohol vapour is consequently  $P_s - P_0$ .

In order to show this, we consider the general case that in the system  $A + B + C$  (figs. 1—6) the substances  $A$  and  $C$  are volatile and that a compound  $F$  of  $B$  and  $C$  occurs.

The binary equilibrium  $B + F + G_0$ , wherein the vapour consists of  $C$  only, occurs under a single pressure  $P_0$  only.

The ternary equilibrium  $B + F + G$ , wherein consequently the vapour consists of  $A$  and  $C$ , can occur at a whole series of vapourpressures.

When we represent the  $\xi$  of  $B$  and  $F$  by  $\xi$  and  $\xi_1$ , then the condition of equilibrium is true:

$$\xi_1 - \beta\xi = (1 - \beta) \left( Z_1 - x_1 \frac{\partial Z_1}{\partial x_1} \right) \cdot \cdot \cdot \cdot \quad (21)$$

Hence follows :

$$\left[ v_1 - \beta v - (1 - \beta) \left( V_1 - x_1 \frac{\partial V_1}{\partial x_1} \right) \right] dP + (1 - \beta) x_1 r_1 dx_1 = 0. \quad (22)$$

When we assume that the gas-laws hold for the vapour  $G$ , then :

$$\frac{\partial V_1}{\partial x_1} = 0 \quad \text{and} \quad r_1 = \frac{RT}{x_1(1-x_1)} \quad . \quad . \quad . \quad (23)$$

From (22) now follows :

$$[(1 - \beta) V_1 - v_1 + \beta v] dP = \frac{1 - \beta}{1 - x_1} RT \cdot dx_1 \quad . \quad . \quad . \quad (24)$$

The coefficient of  $dP$  represents the change of volume when 1 Mol.  $F$  is decomposed into  $\beta$  Mol  $B$  +  $(1 - \beta)$  quantities of  $G$ ; this is very nearly  $(1 - \beta) V_1$ . As at the same time  $PV_1 = RT$ , we can write for (24);

$$(1 - x_1) dP = P dx_1 \quad . \quad . \quad . \quad . \quad . \quad (25)$$

From this follows :

$$P = \frac{P_0}{1 - x_1} \quad . \quad . \quad . \quad . \quad . \quad (26)$$

When we call the partial pressures of  $A$  and  $C$  in the vapour  $P_A$  and  $P_C$ , then  $P_A = x_1 P$  and  $P_C = (1 - x_1) P$ ; from (26) now follows :

$$P_A = \frac{x_1}{1 - x_1} P_0 \quad \text{and} \quad P_C = P_0 \quad . \quad . \quad . \quad . \quad (27)$$

This means that in the ternary equilibrium  $B + F + G$  the partial pressure  $P_C$  of the substance  $C$  is equal to the vapourpressure of the binary equilibrium  $B + F + G_0$ .

When we bear in mind now that in a system the pressure and the composition of the vapour do not change, when we add to this system still a liquid, which is in equilibrium with all phases of this system, then follows :

In the ternary equilibria  $B + F + G$  and  $B + F + L_s + G_s$  the partialpressure of the substance  $C$  in the vapour is equal to the vapourpressure of the binary equilibrium  $B + F + G_0$ .

The first equilibrium (viz.  $B + F + G$ ) exists at a whole series of pressures; both the others occur under a definite pressure only.

The binary equilibrium  $\text{Na}_2\text{SO}_4 \cdot 10\text{H}_2\text{O} + \text{Na}_2\text{SO}_4 + \text{watervapour}$  has at  $25^\circ$  a vapourpressure of 18.1 m.m. when we add alcohol, then, when the gas laws hold in the vapour, in the equilibrium  $\text{Na}_2\text{SO}_4 \cdot 10\text{H}_2\text{O} + \text{Na}_2\text{SO}_4 + G$  and  $\text{Na}_2\text{SO}_4 \cdot 10\text{H}_2\text{O} + \text{Na}_2\text{SO}_4 + L + G$  the partialpressure of the watervapour will also be equal to 18.1 m.m.

Now we will put the question, whether we can also deduce some-

thing about the change of pressure starting from  $s$  along the curves  $sa$  and  $sc$  (fig. 6). In communication V we have deduced the following rule. When the equilibrium solid  $+L$  can be converted with increase of volume into solid  $+L' + G'$  (in which  $L'$  differs extremely little from  $L$ ) then of a threephasetriangle solid—liquid—gas the side solid—liquid turns on increase of pressure towards the vapourpoint and it turns away from the vapourpoint on decrease of pressure.

When we assume now that  $s$  (fig. 6) is not situated in the vicinity of  $B$  or  $F$  (the equilibrium  $B + L$  and  $F + L$  converts itself into  $B + L' + G'$  and  $F + L' + G'$  with increase of volume) we can apply the above-mentioned rule. We distinguish now according as the vapour is represented by  $s_1, s_2$  or  $s_3$ , three cases.

1. The vapour is represented by  $s_1$ .

First we consider the threephasetriangle  $Fss_1$ . When the side  $Fs$  turns towards  $c$ , then consequently it turns towards its vapourpoint  $s_1$ ; the vapourpressure increases, therefore, starting from  $s$  along  $sc$  towards  $c$ .

Let us consider now the threephasetriangle  $Bss_1$ . When the side  $Bs$  turns towards  $a$ , it turns, therefore, away from its vapourpoint  $s_1$ ; consequently the vapourpressure decreases starting from  $s$  along  $sa$  towards  $a$ .

Consequently we find that the vapourpressure starting from  $s$  increases along  $sc$  and that it decreases along  $sa$ . It is evident that this is only true for points in the vicinity of  $s$ ; the occurrence at a greater distance of  $s$  of a point of maximumpressure on  $sc$  and a point of minimumpressure on  $sa$ , is viz. not excluded.

2. The vapour is represented by  $s_2$ .

It follows from a consideration of the threephasetriangles  $Fss_2$  and  $Bss_2$  that the vapourpressure starting from  $s$  increases as well along  $sc$  as along  $sa$ .

3. The vapour is represented by  $s_3$ .

It follows from a consideration of threephasetriangles  $Fss_3$  and  $Bss_3$  that the vapourpressure starting from  $s$  decreases along  $sc$  and increases along  $sa$ .

We can obtain the previous results also in the following way. Between the four phases of the equilibrium  $B + F + L_s + \text{vapour}$  ( $s_1, s_2$  or  $s_3$ ) a phasereaction occurs on change of volume. We choose this reaction in such a direction that vapour is formed, we call the change of volume  $\Delta V$ .

The point  $s$  (fig. 6) is a point of the quadruplecurve  $B + F + L + G$ ;  $\Delta V$  is positive for each point of this curve. When, however, a point of maximumtemperature  $H$  occurs on this curve,

then  $\Delta V$  is negative between this point  $H$  and the terminatingpoint of the curve on side  $BC$ . It is apparent from the position of the curves  $sc$  and  $sa$  (fig. 6) that point  $s$  is chosen on that part of the quadruplecurve, where  $\Delta V$  is positive. We distinguish now again the same three cases as above.

1<sup>st</sup>. The vapour is represented by  $s_1$ .

It is apparent from the position of the points  $F, B, s$  and  $s_1$  with respect to one another that the fourphase-reaction:

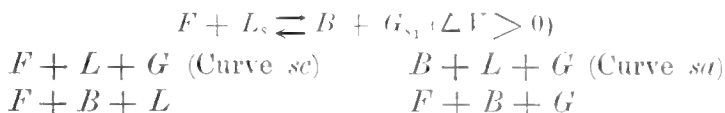

takes place; it proceeds from left to right with increase of volume. Hence it follows that the equilibria written at the right of the vertical line occur under lower pressures, the equilibria at the left occur under higher pressures. In accordance with the above we find, therefore, that starting from  $s$  (fig. 6) the pressure increases along  $sc$  (equilibrium  $F + L + G$ ) and decreases along  $sa$  (equilibrium  $B + L + G$ ).

2<sup>nd</sup> and 3<sup>rd</sup>. Also in these cases we find agreement with the previous considerations.

When a point of maximumtemperature  $H$  occurs on the quadruplecurve  $B + F + L + G$ , then two points of intersection  $s$  occur at temperatures a little below  $T_H$ . When we consider now a point of intersection  $s$  between  $H$  and the terminatingpoint of the quadruplecurve on side  $BC$ , then  $\Delta V$  is negative. This involves that above in 1<sup>st</sup>—3<sup>rd</sup> increase of  $P$  is replaced by decrease of  $P$  and reversally. We find also the same when we consider the threephase-triangles solid-liquid-vapour. *To be continued.*

**Chemistry.** — “*On the quaternary system:  $KCl-CuCl_2-BaCl_2-H_2O$ .*”

By Prof. SCHREINEMAKERS and Miss W. C. DE BAAT.

(Communicated in the meeting of October 31, 1914).

In a previous communication<sup>1)</sup> we have already discussed the equilibria occurring in this system at 40° and at 60°; the results of the analysis on which these considerations are based, we have hitherto not yet communicated. Now we will communicate the results of the analysis; all the points, curves etc. quoted in this communication apply to the two figures of the previous communication (l. c.). We want to draw the attention to the fact that fig. 1 represents the equilibria at 40° and fig. 2 the equilibria at 60°.

<sup>1)</sup> These Communications (1912) 326.

TABLE I.

Composition of the solutions in percentages by weight at 40° (fig. 1. l.c.).

Point	KCl	Ba Cl <sub>2</sub>	Cu Cl <sub>2</sub>	H <sub>2</sub> O	Solid phases
<i>a</i>	0	0	44.67	55.33	Cu Cl <sub>2</sub> · 2 H <sub>2</sub> O
<i>b</i>	0	3.72	42.72	53.56	Ba Cl <sub>2</sub> · 2 H <sub>2</sub> O + CuCl <sub>2</sub> · 2 H <sub>2</sub> O
<i>c</i>	0	28.98	0	71.02	Ba Cl <sub>2</sub> · H <sub>2</sub> O
<i>d</i>	23.98	9.15	0	66.87	Ba Cl <sub>2</sub> · 2 H <sub>2</sub> O + KCl
<i>e</i>	28.63	0	0	71.36	KCl
<i>f</i>	21.53	0	22.85	55.62	KCl + D <sub>1:2:2</sub>
<i>g</i>	9.79	0	43.83	46.38	Cu Cl <sub>2</sub> · 2 H <sub>2</sub> O + D <sub>1:2:2</sub>
Curve <i>bh</i>	0	3.72	42.72	53.56	Ba Cl <sub>2</sub> · 2 H <sub>2</sub> O + Cu Cl <sub>2</sub> · 2 H <sub>2</sub> O
	5.52	3.39	42.35	48.74	"
	9.88	2.99	42.07	45.06	BaCl <sub>2</sub> · 2 H <sub>2</sub> O + CuCl <sub>2</sub> · 2H <sub>2</sub> O + D <sub>1:2:2</sub>
Curve <i>di</i>	23.98	9.15	0	66.87	Ba Cl <sub>2</sub> · 2 H <sub>2</sub> O + KCl
	21.46	8.90	8.44	61.20	"
	20.61	7.63	14.31	57.45	"
	20.61	5.40	20.47	53.52	Ba Cl <sub>2</sub> · 2 H <sub>2</sub> O + KCl + D <sub>1:2:2</sub>
Curve <i>fi</i>	21.53	0	22.85	55.62	KCl + D <sub>1:2:2</sub>
	21.31	2.59	22.06	54.04	"
	20.61	5.40	20.47	53.52	BaCl <sub>2</sub> · 2H <sub>2</sub> O + KCl + D <sub>1:2:2</sub>
Curve <i>gh</i>	9.79	0	43.83	46.38	CuCl <sub>2</sub> · 2H <sub>2</sub> O + D <sub>1:2:2</sub>
	9.94	1.46	43.22	45.38	"
	9.88	2.99	42.07	45.06	CuCl <sub>2</sub> · 2H <sub>2</sub> O + BaCl <sub>2</sub> · 2H <sub>2</sub> O + D <sub>1:2:2</sub>
Curve <i>ih</i>	20.61	5.40	20.47	53.52	BaCl <sub>2</sub> · 2H <sub>2</sub> O + KCl + D <sub>1:2:2</sub>
	16.44	4.72	27.22	51.62	Ba Cl <sub>2</sub> · 2H <sub>2</sub> O + D <sub>1:2:2</sub>
	11.44	3.66	34.65	50.55	"
	9.88	2.99	42.07	45.06	CuCl <sub>2</sub> · 2H <sub>2</sub> O + BaCl <sub>2</sub> · 2H <sub>2</sub> O + D <sub>1:2:2</sub>

TABLE II.

182

Composition of the solutions in percentages by weight at 60° (fig. 2 l.c.).

Point	KCl	BaCl <sub>2</sub>	CuCl <sub>2</sub>	H <sub>2</sub> O	Solid phases
<i>a</i>	0	0	47.42	52.58	CuCl <sub>2</sub> · 2H <sub>2</sub> O
<i>b</i>	0	6.87	43.57	49.56	CuCl <sub>2</sub> · 2H <sub>2</sub> O + BaCl <sub>2</sub> · 2H <sub>2</sub> O
<i>c</i>	0	31.7	0	68.3	BaCl <sub>2</sub> · 2H <sub>2</sub> O
<i>d</i>	23.09	14.83	0	62.08	BaCl <sub>2</sub> · 2H <sub>2</sub> O + KCl
<i>e</i>	31.2	0	0	68.8	KCl
<i>f</i>	26.12	0	26.57	47.31	KCl + D <sub>1-2,2</sub>
<i>g</i>	17.13	0	43.45	39.42	D <sub>1-2,2</sub> + D <sub>1,1</sub>
<i>k</i>	13.67	0	46.40	39.93	CuCl <sub>2</sub> · 2H <sub>2</sub> O + D <sub>1,1</sub>
Curve <i>bl</i>	0	6.87	43.57	49.56	CuCl <sub>2</sub> · 2H <sub>2</sub> O + BaCl <sub>2</sub> · 2H <sub>2</sub> O
	6.32	5.99	43.68	44.01	"
	12.45	4.93	44.69	38.53	CuCl <sub>2</sub> · 2H <sub>2</sub> O + BaCl <sub>2</sub> · 2H <sub>2</sub> O + D <sub>1,1</sub>
Curve <i>di</i>	23.09	14.83	0	62.08	BaCl <sub>2</sub> · 2H <sub>2</sub> O + KCl
	23.15	10.01	12.01	54.83	"
	23.78	5.97	24.61	45.64	BaCl <sub>2</sub> · 2H <sub>2</sub> O + KCl + D <sub>1-2,2</sub>
Curve <i>fi</i>	26.12	0	26.57	47.31	KCl + D <sub>1-2,2</sub>
	24.53	3.32	25.46	46.69	"
	23.78	5.97	24.61	45.64	KCl + BaCl <sub>2</sub> · 2H <sub>2</sub> O + D <sub>1-2,2</sub>
Curve <i>gh</i>	17.13	0	43.45	39.42	D <sub>1-2,2</sub> + D <sub>1,1</sub>
	16.50	2.51	42.20	38.79	"
	15.75	4.75	40.84	38.66	BaCl <sub>2</sub> · 2H <sub>2</sub> O + D <sub>1-2,2</sub> + D <sub>1,1</sub>
Curve <i>kl</i>	13.67	0	46.40	39.93	CuCl <sub>2</sub> · 2H <sub>2</sub> O + D <sub>1,1</sub>
	13.04	2.52	45.24	39.20	"
	12.45	4.93	44.09	38.53	CuCl <sub>2</sub> · 2H <sub>2</sub> O + BaCl <sub>2</sub> · 2H <sub>2</sub> O + D <sub>1,1</sub>
Curve <i>ih</i>	23.78	5.97	24.61	45.64	KCl + BaCl <sub>2</sub> · 2H <sub>2</sub> O + D <sub>1-2,2</sub>
	19.53	5.40	32.37	42.70	BaCl <sub>2</sub> · 2H <sub>2</sub> O + D <sub>1-2,2</sub>
	15.75	4.75	40.84	38.66	BaCl <sub>2</sub> · 2H <sub>2</sub> O + D <sub>1-2,2</sub> + D <sub>1,1</sub>
<i>h</i>	15.75	4.75	40.84	38.66	BaCl <sub>2</sub> · 2H <sub>2</sub> O + D <sub>1-2,2</sub> + D <sub>1,1</sub>
	14.78	4.83	42.13	38.26	BaCl <sub>2</sub> · 2H <sub>2</sub> O + D <sub>1,1</sub>
<i>l</i>	12.45	4.93	44.09	38.53	CuCl <sub>2</sub> · 2H <sub>2</sub> O + BaCl <sub>2</sub> · 2H <sub>2</sub> O + D <sub>1,1</sub>

**Physics.** — “On the theory of the string galvanometer of EINTHOVEN.”

By Dr. L. S. ORNSTEIN. (Communicated by Prof. H. A. LORENTZ.)

(Communicated in the meeting of September 26, 1914).

§ 1. Mr. A. C. CREHORE has developed some considerations in the *Phil. Mag.* of Aug. 1914<sup>1)</sup>, on the motion of the string galvanometer, which cause me to make some remarks on this subject.

For a string, immersed in a magnetic field  $H$ , and carrying a current of the strength  $J$ , the differential equation for the elongation in the motion of the string is

$$\frac{\partial^2 y}{\partial t^2} + \alpha \frac{\partial y}{\partial t} = a^2 \frac{\partial^2 y}{\partial x^2} + \frac{HJ}{\rho} \dots \dots \dots (1)$$

in which  $\alpha$  is the constant damping factor,  $a^2 = \frac{T_1}{\rho}$ ,  $T_1$  is the tension and  $\rho$  is the density. The direction of the stretched string has been chosen as the  $x$ -axis. For  $x=0$  and  $x=l$  the string is fixed, so  $y=0$ . In deducing the equation the ponderomotive force is supposed to be continually parallel to the elongation  $y$ , which is only approximately true, since the force is at every moment perpendicular to the elements of the string (perpendicular to  $J$  and  $H$ ); but if  $y$  may be taken small, then the equation (1) is valid. The approximation causes a parabola to be found for the state of equilibrium with constant  $H$  and  $J$ , instead of the arc of a circle, as it ought to be; however, the parabola is identical with a circle to the degree of approximation used.

Dr. CREHORE now observes, that the equation (1) may be treated after the method of normal coordinates by putting

$$y = \sum q_s \sin \frac{s\pi x}{l} \dots \dots \dots (2)$$

Besides the equation 1, he deduces a set of equations, the “circuit equations”, which give a second relation between  $q_s$  and  $J$  (from (1) there originates in the well-known way an equation for every coordinate  $q_s$ ). The obtained solutions will be independent, when the circuit equation is true, and again their sum is a solution of the problem. However, from the deduction of the circuit equation it cannot well be seen whether this is the case, since not entirely exact energetic considerations underlie this deduction. Now supposing the string to be linked in a circuit with resistance  $R$ , and self-induction  $L$ , the circuit-equation may be easily found by applying MAXWELL’S

<sup>1)</sup> Theory of the String Galvanometer of EINTHOVEN. *Phil. Mag.* Vol. 28, 1914, p. 207.



induction-equation. For in consequence of the motion of the string in the magnetic field the number of lines of force passing through the circuit changes to an amount proportional to

$$\int_0^l \frac{\partial y}{\partial t} dx$$

Expressed in the units used by Dr. CREHORE, the induction-equation now takes the form:

$$E = RJ + L \frac{dJ}{dt} + H \int_0^l \frac{\partial y}{\partial t} dx. \quad \dots \quad (3)$$

where  $E$  is an external electromotive force acting on the circuit.

§ 2. The problem of finding the vibrations governed by the equations (1), (3) and the condition  $y = 0$  for  $x = 0$  and  $x = l$ , can be easily solved. First, let  $E$  be 0, and so the question of free (damped) vibrations may be put. Suppose that

$$y = \varphi e^{i\omega t} \quad J = I e^{i\omega t}$$

where  $\varphi$  is a function of  $x$  and  $I$  is a constant. Then the equations change into

$$\begin{aligned} -\omega^2 \varphi + i\omega x \varphi - a^2 \frac{\partial^2 \varphi}{\partial x^2} &= \frac{HI}{\varrho} \\ 0 &= RI + Li\omega I + iH\omega \int_0^l \varphi dx. \end{aligned}$$

Hence

$$(\omega^2 - i\omega x) \varphi + a^2 \frac{\partial^2 \varphi}{\partial x^2} = \frac{H^2 i\omega}{\varrho(R + Li\omega)} \int_0^l \varphi dx.$$

Putting  $\omega^2 - i\omega x$  in the first member  $n^2$  and  $\frac{H^2 i\omega}{\varrho(R + Li\omega)} = p$  we have

$$n^2 \varphi + a^2 \frac{\partial^2 \varphi}{\partial x^2} = p \int_0^l \varphi dx.$$

This equation may be satisfied by

$$\varphi = A \cos \frac{n}{a} x + B \sin \frac{n}{a} x + C$$

provided that

$$n^2 C = p \left( \frac{a}{n} A \sin \frac{nl}{a} + \frac{a}{n} B \left( 1 - \cos \frac{nl}{a} \right) + Cl \right). \quad (4)$$

whereas, because of the boundary conditions, we must have

$$A + C = 0$$

$$A \cos \frac{nl}{a} + B \sin \frac{nl}{a} + C = 0.$$

This gives for the frequency the transcendental equation

$$n^2 = p \left( -\frac{a}{n} \sin \frac{nl}{a} - \frac{a}{n} \frac{\left( 1 - \cos \frac{nl}{a} \right)^2}{\sin \frac{nl}{a}} + l \right)$$

or

$$n^2 \sin \frac{nl}{a} = p \left( l \sin \frac{nl}{a} - 2 \frac{a}{n} \left( 1 - \cos \frac{nl}{a} \right) \right).$$

From this it appears immediately that we must have

$$\sin \frac{nl}{2a} = 0. \quad \dots \dots \dots (5)$$

or

$$n^2 \cos \frac{nl}{2a} = p \left( l \cos \frac{nl}{2a} - \frac{2a}{n} \sin \frac{nl}{2a} \right) \quad \dots \dots \dots (6)$$

5) can be satisfied by

$$\frac{nl}{2a} = k\pi \quad \dots \dots \dots (7)$$

or, hence

$$\omega^2 - i\omega z = \left( \frac{2k\pi a}{l} \right)^2.$$

As is immediately to be seen, these are the damped vibrations of even order, which the string can perform in the absence of the current. It is evident that the presence of current and field have no influence on the vibrations of even order. If the resistance is infinitely great, the constant  $p$  in the equation (6) is zero. In this case the equations can be satisfied by  $n = 0$ , or  $\omega = 0$ , i. e. the string is at rest; and further by

$$\cos \frac{nl}{2a} = 0.$$

Hence

$$\frac{nl}{2a} = (2k + 1) \frac{\pi}{2} \quad \dots \dots \dots (8)$$

or

$$\omega^2 - i\omega z = \left( \frac{(2k+1)\pi a}{l} \right)^2.$$

The frequencies arrived at are those of odd order, altered by current and field. For large values of  $R$  an approximate value of  $n$  can easily be expressed in the form  $n_\infty + \frac{q}{R}$ . From (6) follows

$$n_s = n_s + \frac{H^2 \omega_s}{\rho R} - \frac{4a^2}{n_s^3 l} i$$

$s$  being an odd number,  $l$  being taken zero, while for  $\omega$  and  $n_s$  their values for  $R = \infty$  must be put. Taking  $z = 0$ , i.e. neglecting the air-damping in comparison with the electrical damping, we find

$$\omega_s = \frac{\pi s a}{l} + \frac{4H^2 il}{R \rho s^3 \pi^2} \dots \dots \dots (9)$$

In the solution, therefore, there is a damping factor of the form

$$e^{-\frac{4H^2 l}{R \rho s^3 \pi^2} t}$$

The influence of the damping is the less, the greater the value of  $s$  is. This is directly evident, for if  $s$  is great, the string vibrates in a great number of parts with opposite motion. The electromotive force generated by those parts therefore is annulled.

In case  $R$  is small, the roots of the equation (6) are those of the transcendental equation

$$l \cos \frac{nl}{2a} - \frac{2a}{n} \sin \frac{nl}{2a} = 0$$

or

$$\frac{2a}{nl} \operatorname{tg} \frac{nl}{2a} = 1 \dots \dots \dots (10)^1$$

The quantity  $\frac{nl}{2a}$  approaches to odd multiples of  $\frac{\pi}{2}$ . For small values of  $R$  an approximate form  $n_0 + aR$  can be easily indicated. Taking again  $L=0$  and  $z=0$ , we find

$$n_s = n_s + \frac{2a R \rho}{l^2 H^2} i.$$

where  $n_s$  is an arbitrary root of (10). In case the resistance is small, all vibrations suffer the same damping.

For  $q$  we find

$$q = \frac{\sin \frac{nl}{2} - \sin \frac{n(l-x)}{a} - \sin \frac{nx}{a}}{\sin \frac{nl}{a}}$$

<sup>1)</sup> Compare for instance RIEMANN-WEBER, Partielle-Differential Gleichungen, II, p. 129.

hence for  $y$

$$y = e^{i\omega t} \frac{\sin \frac{nl}{a} - \sin \frac{n(l-x)}{a} - \sin \frac{nx}{a}}{\sin \frac{nl}{a}} \dots \dots \dots (11)$$

The real and imaginary part of this expression satisfy the equations and the boundary conditions. A sum of solutions for different values of  $\omega$  satisfies the equation. If  $y$  and  $\frac{dy}{dt}$  are given for  $t = 0$ , we can with the aid of the given functions find the solution. The found proper functions are not orthogonal, but by an appropriate linear substitution orthogonal functions can be obtained. If  $y$  is known,  $I$  can be calculated from (3).

§ 3. It is useful to work out the problem. Using the assumption (2) of CREHORE, we obtain for  $q_s$  the following set of equations (taking  $k$  and  $l$  zero):

$$\ddot{q}_s + n_s^2 q_s = \frac{4HI}{s\pi Q} \dots \dots \dots (12)$$

and

$$RJ + \frac{2lH}{\pi} \sum \dot{q}_s = 0 \dots \dots \dots (13)$$

where

$$n_s = \frac{s\pi a}{l}.$$

Here  $s$  is an odd number; for even values the second member of (12) is zero, and the even vibrations are therefore unchanged.

Now putting

$$q_s = \alpha_s e^{i\omega t} \quad , \quad J = I e^{i\omega t},$$

and

$$\alpha_s = \frac{4HI}{s\pi Q} \frac{1}{n_s^2 - \omega^2},$$

we find

$$RI + \frac{2lH^2 i\omega}{\pi} \sum \frac{\alpha_s}{s} = 0.$$

The frequency-equation therefore is

$$R + \frac{8lH^2 i\omega}{Q\pi_2} \sum \frac{1}{s^2 (n_s^2 - \omega^2)} = 0. \dots \dots \dots (6a)$$

This frequency-equation has the same roots as equation (6), which if  $z$  and  $l$  have been taken 0, takes the form

$$\omega \cos \frac{\omega l}{2a} = \frac{iH^2 l}{R\rho} \left( \cos \frac{\omega l}{2a} - \frac{2a}{l\omega} \sin \frac{\omega l}{2a} \right).$$

The identity of these frequency-equations can be easily shown.

Put  $\frac{8lH^2}{R\rho} i = k$ , then (6a) takes the form

$$1 - k \cdot \frac{8}{\pi^2} \sum \frac{1}{s^2} + k \cdot \frac{8}{\pi^2} \sum \frac{n_s^2 \omega}{s^2 (n_s^2 - \omega^2)} = 0$$

The sum of inverse squares of odd numbers is  $\frac{\pi^2}{8}$ . Further,

$n_s^2 = \frac{\pi^2 a^2}{c^2}$ , therefore the first member amounts to

$$1 - \frac{k}{\omega} + 8k \frac{a^2}{l^2 \omega} \sum \frac{1}{n_s^2 - \omega^2} = 0.$$

For  $tg z$  we have

$$tg z = - \sum_1^{\infty} \frac{2z}{z^2 - \left(\frac{s\pi}{2}\right)^2}$$

where  $s$  is again an odd number, therefore we obtain

$$1 - \frac{k}{\omega} + \frac{2a}{\omega^2 l} k tg \frac{\omega l}{2a} = 0 \quad \dots \dots \dots (14)$$

The equation (6) takes the form

$$\omega \cos \frac{\omega l}{2a} \left( 1 - \frac{k}{\omega} + \frac{2a}{l\omega^2} k tg \frac{\omega l}{2a} \right) = 0 \quad \dots \dots \dots (15)$$

The equations (14) and (15) have the same roots, for the vectors  $\omega$  and  $\cos \frac{\omega l}{2a}$  do not contribute roots to (15).

Having found the roots of (14), we can determine  $y$ . Each root yields a FOURIER series. In the case that ( $R = \infty$ ),  $\sin \frac{s\pi x}{e}$  must be combined with one frequency only. For our case we have

$$y = \sum_s \sum_r \frac{A_r}{s(n_s^2 - \omega_r^2)} \cdot e^{i\omega_r t} \sin \frac{s\pi x}{l}$$

$$\sum_s \frac{1}{s} \sin \frac{s\pi x}{l} \sum_R \frac{A_r}{n_s^2 - \omega_r^2} e^{i\omega_r t} \quad \dots \dots \dots (16)$$

The FOURIER series which is the vector of  $A e^{i\omega_r t}$  must be equal to the function which in § 2 appears as the vector of the same exponential. This can be shown by direct development. It is apparent that by a given frequency all the original normal coordinates are

set into motion. For very great and very small values of  $R$ , the constants  $A$  in the expression (16) can easily be determined.

We can also use (9) and (11). Let us write (11) in the form

$$y = e^{i\omega t} \left( 1 - \frac{\cos \left[ \frac{nl}{2a} - \frac{xn}{a} \right]}{\cos \frac{nl}{2a}} \right)$$

and let us introduce the value of  $n$  from (9), we then find

$$y = e^{\frac{n_s i t}{R Q s^2 \pi^2} - \frac{4H^2 l}{R Q s^2 \pi^2} t} \left( 1 - \cos \frac{n_s x}{a} - i \frac{R}{d_s} \sin \frac{n_s x}{a} \right)$$

where  $d_s = \frac{2H^2 l^2}{R Q s^2 \pi^2}$ . Separating the real and imaginary parts, we find

$$y = \sum_s e^{-\frac{4H^2 l}{R Q s^2 \pi^2} t} \left\{ \left( \frac{d_s}{R} \left( 1 - \cos \frac{n_s x}{a} \right) \cos n_s t + \sin \frac{n_s x}{a} \sin n_s t \right) A_s + \left( \frac{d_s}{R} \left( 1 - \cos \frac{n_s x}{a} \right) \sin n_s t - \sin \frac{n_s x}{a} \cos n_s t \right) B_s \right\}$$

For the time  $t = 0$

$$y_0 = \sum_s \left\{ \frac{d_s}{R} \left( 1 - \cos \frac{n_s x}{a} \right) A_s - \sin \frac{n_s x}{a} B_s \right\}$$

and

$$\left( \frac{dy}{dt} \right)_0 = \sum_s n_s \left\{ \sin \frac{n_s x}{a} A_s + \frac{d_s}{R} \left( 1 - \cos \frac{n_s x}{a} \right) B_s + \frac{4H^2 l}{R Q s^2 n_s} B_s \right\}.$$

Putting  $\int_0^l y_0 \sin \frac{s\pi x}{l} dx = a_s$  and  $\int_0^l \left( \frac{dy}{dt} \right)_0 \sin \frac{s\pi x}{l} dx = b_s$  we have

$$b_s = \sum_s \frac{2d_s}{R} A_s - \frac{l}{2} B_s$$

$$a_s = n_s \frac{l}{2} A_s + \frac{2n_s}{R} \sum_s d_s B_s + \frac{4H^2 l}{R Q s^2 n_s} B_s.$$

For  $R = \infty$  we get  $b_s = -\frac{l}{2} B_s$ ,  $a_s = \frac{n_s l}{2} A_s$ . Therefore  $B_s = -\frac{l}{2} b_s$

and  $A_s = \frac{2}{n_s l} a_s$ . Putting

$$A_s = \frac{2}{n_s l} a_s + \frac{a_s}{R}$$

$$B_s = -\frac{2}{l} b_s + \frac{b_s}{R}$$

we have

$$0 = \frac{4}{Rl} \sum \frac{\delta_s a_s}{n_s} - \frac{l}{2} \frac{\beta_s}{R}$$

$$0 = \frac{\alpha_s}{R} - \frac{4}{lR} \sum n_s \delta_s b_s - \frac{8H^2 b_s}{Rl s^2 n_s}.$$

These series are convergent, if the conditions for the ordinary FOURIER series are fulfilled. We can therefore calculate  $\alpha_s$  and  $\beta_s$  with the help of the given formulae.

§ 4. In the case  $E$  is a given function of the time, our equation can also easily be solved.

*a.* First if  $E$  is constant, we have

$$\frac{\partial^2 y}{\partial t^2} + \kappa \frac{\partial y}{\partial t} = a^2 \frac{\partial^2 y}{\partial x^2} + \frac{HJ}{Q}$$

$$E = RJ + H \int_0^l y \, dx.$$

The current  $J$  and  $y$  can be divided into two parts, the one depending on  $t$ , the other not; we indicate those parts by the indices 1 and 2. For the first part we have

$$0 = a^2 \frac{\partial^2 y_1}{\partial x^2} + \frac{HJ_1}{Q}$$

$$E = RJ_1$$

therefore

$$a^2 \frac{\partial^2 y_1}{\partial x^2} = - \frac{EH}{RQ},$$

from which  $y_1$  can be determined if we take into account that  $y_1$  vanishes for  $x=0$  and  $x=l$ . The determining of the second part leads to the problem treated in § 3. The solution can be used in order to fulfill given initial conditions. If an initial value of  $J$  is given, then  $y$  must fulfill at  $t=0$  a condition following from (3).

*b.* Further, we can consider the case  $E = E \cos pt$ .

Putting  $L=0$ , we can try the solution

$$y = q \cos(pt + \beta)$$

$$J = I \cos(pt + \beta)$$

where  $q$  is a function of  $x$ . The first equation gives

$$-p^2 q - a^2 \frac{\partial^2 q}{\partial x^2} = HI.$$

This equation can be solved by

$$q = A \cos \frac{p}{a} x + B \sin \frac{p}{a} x + C$$

or according to the above

$$q = \frac{HI}{p^2} \left( -\cos \frac{p}{a} x - \frac{\left(1 - \cos \frac{pl}{a}\right)}{\sin \frac{pl}{a}} \sin \frac{p}{a} x + 1 \right) \quad (17)$$

Introducing this result into the second equation, we obtain

$$E \cos pt = RI \cos(pt + \beta) + \frac{H^2 I}{Qp} \sin(pt + \beta) \left( -\frac{a}{p} \sin \frac{pl}{a} - \frac{a \left(1 - \cos \frac{pl}{a}\right)^2}{p \sin \frac{pl}{a}} + l \right) \quad (18)$$

Now take

$$\frac{H^2 I}{QpR} \left( -\frac{a}{p} \sin \frac{pl}{a} - \frac{\left(1 - \cos \frac{pl}{a}\right)^2}{\sin \frac{pl}{a}} + l \right) = \tan \alpha$$

then we find

$$E \cos pt = I \sqrt{R^2 + \frac{H^4}{Q^2 p^2} \left( -\frac{a}{p} \sin \frac{pl}{a} - \frac{a \left(1 - \cos \frac{pl}{a}\right)^2}{p \sin \frac{pl}{a}} + l \right)^2} \cos(pt + \beta - \alpha)$$

From this we find for the retardation of phase,  $\beta = \alpha$ ; and for the amplitude of  $I$

$$I = \frac{E}{r}$$

where  $r$  represents the square root in the second member. The current  $I$  being found in this way,  $\gamma$  can be determined from (17).

When  $L$  does not vanish, we can suppose  $\gamma$  and  $I$  to depend on  $e^{ipt}$ ; and finally taking the real part, and following the above method we find the values of  $\gamma$  and  $I$ .

If we express  $\gamma$  by (2), the solution can also easily be found. We then have

$$q_s = \frac{4HI}{s \pi (u^2 - p^2)}$$

Substituting this into the second equation of § 3 (where zero has been replaced by  $E \cos pt$ ) we find



$$E \cos pt = RI \cos (pt + \beta) - \frac{\alpha^2}{p8H^2I} l \sin (pt + \beta) \sum \frac{1}{s^2} \frac{1}{(n_s^2 - p^2)}$$

from which  $I$  can be found. The sum in the second member can be put in a way analogous to that of § 3, into a form identical with (18). Our result does not agree with that of CREHORE (compare p. 214). In our solution the retardation of phase is the same for all vibrations, which is not the case in CREHORE's paper.

It may be observed that in our problem we have to do with a system of an infinite number of variables in which a dissipation-function couples the variables; for eliminating  $J$  from (12) and (13), we obtain

$$\ddot{q}_s + n_s^2 q = - \frac{8H^2}{s\alpha QR} \sum \frac{\dot{q}_s}{s}.$$

The dissipation  $F$  takes the form

$$F = \frac{8H^2}{\alpha^2 QR} \left( \sum \frac{\dot{q}_s}{s} \right)^2.$$

Groningen, Sept. 1914.

**Physics.** — “*Accidental deviations of density and opalescence at the critical point of a single substance.*” By DR. L. S. ORNSTEIN and F. ZERNIKE. (Communicated by Prof. H. A. LORENTZ.)

(Communicated in the meeting of September 26, 1914).

1. The accidental deviations for a single substance as well as for mixtures have been treated by SMOLUCHOWSKI<sup>1)</sup> and EINSTEIN<sup>2)</sup> with the aid of BOLTZMANN's principle; by ORNSTEIN<sup>3)</sup> with the aid of statistical mechanics. It appears as if the considerations used and the results obtained remain valid in the critical point. SMOLUCHOWSKI has applied the formula found for the probability of a deviation to the critical point itself, and has found for the average deviation of density

$$\bar{\delta} = \frac{1.13}{v_r}.$$

He has used this formula to express in terms of the mean density

<sup>1)</sup> M. SMOLUCHOWSKI, *Theorie Cinétique de l'opalescence*. Bull. Crac 1907 p. 1057. Ann. der Phys. Bd. 25, 1908, p. 205. Phil. Mag. 1912. On opalescence of gases in the critical state. W. H. KEESOM, Ann. der Phys. 1911 p. 591.

<sup>2)</sup> A. EINSTEIN. Ann. der Phys. Bd. 33 1910, p. 1276.

<sup>3)</sup> ORNSTEIN, These Proc., 15, p. 54 (1912).

the accidental deviations in a cube, the side of which is equal to the wave-length of the light used in the experiments on opalescence.

Now there is a difficulty with this formula, to which, indeed, lead also the considerations of EINSTEIN as well as statistical mechanics when worked out in an analogous way for the critical point. In all these cases the mutual independence of the elements of volume is presupposed. Now, let there be given for the element of volume  $v$  the mean square of deviation *viz.*  $(n - \bar{n})^2$ . Consider  $p$  equal contiguous elements of volume  $v_1, v_2$ , etc., in which  $n_1, n_2$ , etc. particles are situated,  $\bar{n}_1, \bar{n}_2$  etc. indicating the mean values of these numbers.

Hence in the volume  $V = v_1 + v_2 + \dots$  there are  $N = n_1 + n_2 + \dots$  particles.

For the mean value of  $N$  we have

$$\bar{N} = \bar{n}_1 + \bar{n}_2 + \dots$$

subsequently

$$(\overline{N - \bar{N}})^2 = \{(n_1 - \bar{n}_1) + (n_2 - \bar{n}_2) + \dots\}^2 = p \overline{(n - \bar{n})^2}$$

since, the elements of volume being supposed independent of each other, the means of the double products vanish. So we find for the deviation of density that the product of volume and mean square of deviation must be a constant.

Indeed the above-mentioned formula of probability for the deviations of density is so far inexact, as the terms of higher order appearing in it are at variance with the mutual independence of the elements of volume, which underlies the deduction of the frequency-law. In fact this deduction is only valid for such large elements of volume that these terms are no more of any influence. It is easily seen that this limit, above which the formula is valid, increases indefinitely in approaching the critical point. This explains also mathematically the wrong dependence on  $v$  found for the mean deviation in the critical point itself.

Now one could try to deduce the formula to a farther approximation. However, also the supposition of independence of the elements of volume is inexact in case these are small, and it would thus be impossible to ascertain how far the formula would yet differ from reality. <sup>1)</sup>

<sup>1)</sup> A deduction of the inequalities in which the inexact terms of higher order do not at all appear, is given by ZERNIKE in his thesis, which will shortly appear. As this deduction too uses the independence alluded to, the objection mentioned holds here also.

The remark of EINSTEIN (l.c. p. 1285) that there would be no principal difficulty

2. Now, in order to avoid the difficulties mentioned, it is necessary to take into account the influence of deviations in the one element on the state in another. Let us divide the system into infinitely small elements of volume. A molecule is considered to lie in the element when its centre is situated in it. We consider an element  $dv_0$  in the origin of coordinates. Around this element we imagine the sphere of attraction i.e. the region in which a molecule must lie when it is to have any influence on the state in  $dv_0$ . We determine the numbers of molecules for the elements of the sphere of attraction in giving the deviations  $r_1, r_2$  etc. from the mean number of molecules per unit of volume.

We suppose the mean value of the density  $r_0$ , when  $r_1$  etc. are given, to be a linear function of the deviations  $r_1$  etc., i.e. we put<sup>1)</sup>

$$\bar{r}_0 = C + f_1 r_1 + f_2 r_2 + \dots \quad (1)$$

Taking the mean value of  $r_0$  over all possible values of  $r_1$ , it appears immediately that  $C = 0$ , hence

$$\bar{r}_0 = f_1 r_1 + f_2 r_2 + \dots \quad (2)$$

The coefficients  $f$  denote the coupling of the elements, they only depend on the relative coordinates, i.e. here, on  $x y z$ . That the influence of an element, when the density is given, must be proportional to its size is immediately seen by considering the influence of uniting two elements in (2).

We shall now write the sum (2) as an integral. For the density in the element  $dx dy dz$  we put  $r_{xyz}$ ; further, we can dispose of  $f$  in such a way that  $f(0, 0, 0) = 0$ . Then for (2) we get

$$\bar{r}_0 = \iiint_{-\infty}^{+\infty} r_{xyz} f(x, y, z) dx dy dz \quad \dots \quad (3)$$

The integration may be extended here from  $-\infty$  to  $+\infty$ ,  $f$  being zero outside the sphere of action<sup>2)</sup>.

in extending his deduction to a further approximation, is therefore mistaken. On the contrary, the consideration of higher terms so long as the independence is made use of, will not lead to anything.

<sup>1)</sup> Putting things more generally, we could write a series in  $r_1$  etc. instead of (1). However, for the purpose we have in view, (1) is sufficient.

<sup>2)</sup> The quantity  $r$  can only take the values  $1 - \nu$  and  $\nu$ , hence  $r$  is a discontinuous function of the coordinates. One might be inclined therefore, to continue writing a sum instead of the integral (3) and to solve the problem dealt with in the text with the aid of this sum. In doing so one gets sum-formulae which are wholly analogous to the integrals we used. However, we prefer introducing the integral, as the discontinuous function  $\nu$  has entirely disappeared from formula (6) only the function  $g$  appearing in it, which is continuous when the function  $f$  is

On the contrary, if  $r_0$  is given,  $\bar{r}$  has another value for the surrounding elements, than if  $r_0 = 0$ . Be in the element at  $xyz$

$$\bar{r}_{xyz} = g(x, y, z, r_0 dv_0) \dots \dots \dots (4)$$

and let us try\* to determine the function  $g$ , the function  $f$  being given.

Now take the mean of formula (3), a fixed value  $r_1$  being ascribed to  $r$  in a certain element  $dx_1 dy_1 dz_1$ .

In  $x, y, z$ , according to (4)

$$r_{xyz} = g(x-x_1, y-y_1, z-z_1, r_1 dx_1 dy_1 dz_1) \dots \dots \dots (5)$$

For the first member we therefore get

$$g(x_1, y_1, z_1, r_1 dx_1 dy_1 dz_1)$$

as  $f$  and  $g$  do not depend on the direction of the line joining the elements. In the integral, (5) cannot be applied to the element  $dx_1 dy_1 dz_1$ ; however, this element gives

$$r_1 f(x_1, y_1, z_1) dx_1 dy_1 dz_1$$

Further taking  $g(0, 0, 0)$  zero, as it may arbitrarily be chosen, we get

$$g(x_1, y_1, z_1, r_1 dx_1 dy_1 dz_1) = \iiint_{-\infty}^{+\infty} g(x-x_1, y-y_1, z-z_1, r_1 dx_1 dy_1 dz_1) f(xyz) dx dy dz + r_1 f(x_1, y_1, z_1) dx_1 dy_1 dz_1.$$

This is true for all values of  $r_1 dx_1 dy_1 dz_1$ , hence  $g$  must contain this quantity as a factor, and we obtain

$$g(x_1, y_1, z_1) = \iiint_{-\infty}^{+\infty} g(x-x_1, y-y_1, z-z_1) f(xyz) dx dy dz = f(x_1, y_1, z_1)$$

Now put  $x-x_1 = \xi, y-y_1 = \eta, z-z_1 = \zeta$ , and omit the index, then for  $g$  we get the integral equation

$$g(x, y, z) = \iiint_{-\infty}^{+\infty} f(x+\xi, y+\eta, z+\zeta) g(\xi\eta\zeta) d\xi d\eta d\zeta = f(xyz). \dots (6)$$

For  $g$  we have

$$\bar{v}_{xyz} = g(xyz) v_0 dv_0 \dots \dots \dots (7)$$

from which it appears immediately that

$$\overline{v_{xyz} v_0} = g(xyz) \overline{v_0^2} dv_0 \dots \dots \dots (8)$$

---

continuous. The integral-formulae obtained in this way are easier to deal with mathematically, and besides the integral equation (6) has been solved, this being not so easily found from the analogous sum-formula.

Now let us consider more closely the coefficient of  $g$  in (8).

Let  $a$  molecules be present in the unit of volume, then the mean number of molecules in  $dv$  is equal to  $adv$ . If we take  $dv$  very small, there may be no or one molecule in it. The chance for one molecule is, therefore,  $adv$ ; for none  $1 - adv$ . In the first case  $r = \frac{1}{dv} - a$ , in the latter it is  $-a$ , thus

$$r^2 = \frac{a}{dv} - a^2$$

or

$$r^2 dv = a \dots \dots \dots (9)$$

Introducing this into (8), we find for the two elements  $x_\tau y_\tau z_\tau$  and  $x_\tau y_\tau z_\tau$

$$r_\tau r_\tau = ag(x_\tau - x_\tau, y_\tau - y_\tau, z_\tau - z_\tau) \dots \dots \dots (10)$$

This result can be used to indicate the values of  $(\Delta N - \overline{\Delta N})^2 = \Delta \overline{\Delta N^2}$  for any volume.

We have

$$\Delta N = \int r dv$$

$$\overline{\Delta N^2} = \iint_V \overline{r_\tau^2} dv_\tau + \iint_V \overline{r_\tau r_\tau} dv_\tau dy_\tau dz_\tau dx_\tau dy_\tau dz_\tau$$

from which applying (9) and (10)

$$\Delta \overline{\Delta N^2} = aV + a \iint_V g(x_\tau - x_\tau, y_\tau - y_\tau, z_\tau - z_\tau) dx_\tau dy_\tau dz_\tau dx_\tau dy_\tau dz_\tau.$$

This holds for every size and form of  $V$ . Elaborating it for a cube with side  $l$  the dependence on  $V$  is seen more clearly. Putting  $x_\tau - x_\tau = \xi$ ,  $y_\tau - y_\tau = \eta$ ,  $z_\tau - z_\tau = \zeta$ , and integrating only for  $\xi \eta \zeta$  positive, by which  $1/8$  of the integral in question is found then, we get

$$\overline{\Delta N^2} = \overline{N} + 8a \int_0^l \int_0^l \int_0^l g(\xi \eta \zeta) \int_0^l \int_0^l \int_0^l dx_\tau dy_\tau dz_\tau$$

$$= \overline{N} + 8a \int_0^l \int_0^l \int_0^l (l^3 - l^2 (\xi + \eta + \zeta) + l (\xi \eta + \eta \zeta + \zeta \xi) - \xi \eta \zeta) g d\xi d\eta d\zeta.$$

Hence

$$\frac{\Delta N^2}{N^2} = 1 + \iiint_{-l}^{+l} g(xyz) dx dy dz - 3 \iiint_{-l}^{+l} \frac{|x|}{l} g dx dy dz \\ + 3 \iiint_{-l}^{+l} \frac{x^2}{l^2} g dx dy dz - \iiint_{-l}^{+l} \frac{|x^3|}{l^3} g dx dy dz.$$

Every integral in this formula is always smaller than the preceding one. If  $l$  is large with respect to the distance for which  $g$  has an appreciable value, there remains only the first integral. For any great volume we have

$$\frac{\Delta N^2}{N^2} = 1 + \iiint_{-x}^{+x} g dx dy dz \quad . \quad . \quad . \quad (11)$$

3. In trying to determine the function  $f$  by means of statistical mechanics, we meet with difficulties. Still something may be found about the quantities  $r, r_1$  by applying the statistic-mechanical method to our problem. Indeed statistical mechanics permit to introduce a mutual action of the elements of volume.

We will avail ourselves of a canonical ensemble. We suppose the molecules to be spherical and rigid, and to attract each other for distances which are great with respect to their size. Elements small with respect to the sphere of attraction therefore may still contain a great number of molecules. But now we drop the supposition of the sphere of attraction being homogeneously filled for all systems (or at least for by far the greater part of them)<sup>1)</sup>.

In calculating the number of the various distributions, we must, for the potential energy of attraction, take into account the mutual action of the elements; whereas, in calculating the exclusion of definite configurations of centres, we may neglect the fact that there is some correlation on the borders of the elements. For the dimensions of the elements have been supposed large with respect to the molecular diameter.

The mutual potential energy of the  $r + r_1$  molecules contained in an element  $dv$ , will be represented by

$$= \frac{1}{2} \frac{(r + r_1)^2}{dv} q_{00}$$

in this formula  $r$  represents the number of molecules contained in the volume  $dv$  for the most frequent system. In this system the distribution is homogeneous.

<sup>1)</sup> Cf ORNSTEIN, Toepassing der Statistische mechanica van GIBBS op molekulair-theoretische vraagstukken. Diss. Leiden 1908, p. 43 and p. 110.

Of course, the potential energies will not strictly be the same for different configurations within the elements, but we shall neglect this complication. Further we will represent the mutual potential energy for the two elements  $\sigma$  and  $\varrho$  by

$$-\frac{(\mathbf{r} + \boldsymbol{\tau}_\sigma)(\mathbf{r} + \boldsymbol{\tau}_\varrho) q_{\varrho\sigma}}{dv}$$

all elements of volume being put equal.

For the total potential energy we find, in this way

$$-\frac{1}{2dv} \sum_\sigma (\mathbf{r} + \boldsymbol{\tau}_\sigma) \sum_\varrho (\mathbf{r} + \boldsymbol{\tau}_\varrho) q_{\varrho\sigma}.$$

For the frequency  $\xi$  of a system with the given distribution of molecules we find

$$\xi = C \frac{n!}{(\mathbf{r} + \boldsymbol{\tau}_1)!(\mathbf{r} + \boldsymbol{\tau}_2)! \dots} (\omega_1 dV)^{\nu + \tau_1} \dots (\omega_1 dV)^{\nu + \tau_2} \dots e^{-\frac{1}{2\Theta} dv} \sum_\sigma (\mathbf{r} + \boldsymbol{\tau}_\sigma) \sum_\varrho (\mathbf{r} + \boldsymbol{\tau}_\varrho) q_{\varrho\sigma}.$$

Here  $\omega$  is the function defined in the quoted dissertation on p. 48.

Supposing  $\tau \ll r$  and developing, we get,

$$\begin{aligned} \xi = C \omega^n a^{-n} e^{-\frac{1}{2\Theta} na} \sum_\sigma q_{\varrho\sigma} + \frac{1}{2} \sum \sum \left( -\frac{1}{r} + \frac{1}{r} \frac{d}{du} u^2 \frac{d \log \omega}{du} + \frac{q_{00}}{\Theta dv} \right) \tau_\sigma^2 + \\ + \frac{q_{\varrho\sigma}}{\Theta dv} \tau_\sigma \tau_\varrho + \dots \dots \dots \dots \dots \dots (12) \end{aligned}$$

The number of molecules per unit of volume represented there by  $n$ , has been put  $a$  in this paper. The function  $\omega$  and the faculties are developed in the same way as in the quoted dissertation. The double sum in the exponent gives the forms  $\sum_\sigma r \sum_\varrho \tau_\varrho q_{\varrho\sigma}$  and  $\sum_\sigma \tau_\sigma \sum_\varrho r q_{\varrho\sigma}$ . These forms are identical, as they consist of the same terms differently arranged, further  $\sum q_{\varrho\sigma}$  is the same for all molecules and  $\sum \tau_\sigma = 0$ , consequently both sums vanish.

The constant  $C$  contains the factor  $N e^{\Psi/\Theta}$  along with quantities which do not depend on the volume by summing up (12) over all possible values of  $\tau$  (and taking into account that  $\sum \tau_\sigma = 0$ ) we get  $N$ , the total number of systems in the ensemble. So we find

$$e^{-\frac{\Psi}{\Theta}} = \frac{C'}{\sqrt{\Delta}} \omega^n V^n e^{-\frac{n^2}{2\Theta v} \sum q_{\varrho\sigma}},$$

the quantity  $\Delta$  being the discriminant of the quadratic form in the exponent.

When we write  $\sum_\varrho q_{\varrho\sigma} = \alpha$ , we find for the pressure  $p = -\frac{\partial \Psi}{\partial v}$

$$p = \frac{n}{V} + n \frac{d \log \omega}{dV} - \frac{a}{2\Theta} \frac{n^2}{V^2}$$

$\Delta^{-1/2}$  being very small with respect to the other factors, we may neglect its influence in  $\Phi^1$ ). The equation of state has the same form as VAN DER WAALS' equation. However, the correlation is sensible in the accidental deviation; for it changes the value of  $\tau^2$ ; and  $\tau_z \tau_z$ , which vanish if the correlation is neglected, obtain values deviating from zero.

Denoting by  $\Delta_{zz}$  and by  $\Delta_{zz}$  the minors of the discriminant, we have

$$\tau_z^2 = \frac{\Delta_{zz}}{\Delta} (k-1)$$

$$\tau_z \tau_z = \frac{\Delta_{zz}}{\Delta} (k-1)^2$$

where  $k$  is the number of elements into which the volume is divided.

The condition  $\Delta = 0$  is equivalent to the condition  $\frac{dp}{dr} = 0$ . For if we write down the determinant in some arrangement, and if we add all rows to the first row, we get a determinant of which all terms of the first row have the form

$$-\frac{1}{r} + \frac{1}{r} \frac{d}{da} a^2 \frac{d \log \omega}{da} + \frac{1}{\Theta dr} \sum q_{zz}$$

Strictly speaking, this is not true for some terms at the end of the row, but as we have neglected the action on the borders, we may neglect this fact too. In reality our considerations are only true for an infinitely great volume, where this difficulty disappears, as  $\Delta$  is then an infinite determinant.

Now if

$$-\frac{1}{r} + \frac{1}{r} a^2 \frac{d \log \omega}{da} + \frac{1}{\Theta dr} \sum q_{zz} = 0$$

then  $\Delta = 0$ .

Or if  $\Delta = 0$

$$1 - \frac{d}{da} a^2 \frac{d \log \omega}{da} + \frac{a}{\Theta} a = 0$$

which therefore agrees with  $\frac{dp}{dr} = 0$ .

<sup>1)</sup> Cf. l. c. p. 129.

<sup>2)</sup> Cf. ORNSTEIN, Accidental deviations in mixtures. These Proceedings **15**, p. 54, (1912).



The quantities  $\overline{\tau_z \tau_z}$  etc. here found are related to those mentioned above. And though a statistical deduction of the function  $f$  entering into details may lead to difficulties, yet it is clear that statistical mechanics yield a correlation analogous to that expressed in  $f$ .

If we should wish to continue the deduction of the conditions of the critical point, we should have to use higher powers of  $\tau_z$ , which can be done without difficulty; we then find for the second condition  $\frac{d^2 p}{dv^2} = 0$ .

If we drop the supposition that the sphere of attraction is large, we can use the function  $\mathfrak{D}$ , defined in the quoted dissertation. In order to take into account the correlation, we must suppose the integrals

$$\int e^{-\varepsilon_q/\Theta} dx_1 \dots dz_n \tau_z = \mathfrak{D}(n_z)$$

defining  $\mathfrak{D}$ , to depend on  $n_k$  for the element in question and also on the numbers of molecules in the surrounding elements. Therefore, in general, the numbers of molecules of all elements will appear in  $\mathfrak{D}n_z$ , but the influence of distant elements is so small that  $\frac{\partial \mathfrak{D}n_z}{\partial n_z}$  can be put zero.

By considerations analogous to those used in the quoted dissertation, we can show that  $\mathfrak{D}(n_z)$  has the form

$$V_z^{n_z} (\omega n_z, n_{z'}, n_{z''})^{n_z}$$

in which  $n_{z'} n_{z''}$  denote the densities (molecular), in the elements with which  $V_z$  is in mutual action. The values of all  $n_z$  are equal for the most frequent system.

Now we find for  $\xi$

$$\xi = C V^n (\omega n, n, n, n \dots)^n e^{-P}$$

where  $P$  is a quadratic form in the deviations for the various elements, containing squares as well as double products. The form might be easily indicated, but we will omit it, as it is only our purpose to show how in general the statistic-mechanical considerations, changed in the sense of a correlation of elements of volume, lead to formulae analogous to those given in § 2. Here too the mean square of deviation and the means of double products are represented by quotients of minors of the discriminant of  $P$  and this quantity itself. Here too for  $\frac{dp}{dv} = 0$  the discriminant vanishes.

4. The above considerations can be applied in calculating the critical opalescence. For that purpose we use the simple method indicated by LORENTZ<sup>1)</sup>, which consists in superposing the light-vectors caused by the influence of every individual molecule in a point at great distance.

Consider in the substance through which a beam of light passes, a volume  $V$  great with respect to the wave-length, and take a distant point  $P$ , the direction  $VP$  forming an angle  $q$  with the incident ray.

All molecules lying in one plane perpendicular to the line which bisects the angle  $q$ , will cause equal phase in  $P$ . Take therefore a system of axes with the  $Z$ -axis parallel to this line, then the contribution of one molecule will be

$$\beta \sin \frac{2\pi}{\mu\lambda} (ct + 2z \cos \frac{1}{2} q)$$

where  $\beta$  depends only on the kind of molecules, on  $\lambda$  and on the distance  $VP$ ,  $\mu$  being the index of refraction.

The number of molecules in  $dx dy dz$  amounts to

$$(a + r) dx dy dz.$$

The total light-vector in  $P$  thus becomes

$$\beta \int_V (a + r) \sin \frac{2\pi}{\mu\lambda} (ct + 2z \cos \frac{1}{2} q) dx dy dz,$$

and the intensity

$$\begin{aligned} \beta^2 \frac{c}{\mu\lambda} \int_0^{u_1/c} dt \iint_V (a + r_x) (a + r_z) \sin \frac{2\pi}{\mu\lambda} (ct + 2z_x \cos \frac{1}{2} q) \\ \sin \frac{2\pi}{\mu\lambda} (ct + 2z_z \cos \frac{1}{2} q) \\ dx_x dy_x dz_x dx_z dy_z dz_z. \end{aligned}$$

Integrating with resp. to  $t$ , we get

$$\frac{1}{2} \beta^2 \iint_V \{a^2 + a(r_x + r_z) + r_x r_z\} \cos \left\{ \frac{4\pi}{\mu\lambda} (z_x - z_z) \cos \frac{1}{2} q \right\} dx_x dy_x dz_x dx_z dy_z dz_z.$$

The mean value of this must be calculated. The term with  $r_x + r_z$  vanishes, and that with  $a^2$  yields no contribution proportional to  $V$ . We introduce the value of  $\overline{r_x r_z}$  from formula (10), and for  $\sigma = \tau$  from form. (9). This gives

<sup>1)</sup> H. A. LORENTZ, On the scattering of light by molecules. These Proceedings 13 p. 92 (1910).

$$\frac{1}{2} \beta^2 a V + \frac{1}{2} \beta^2 a \iiint_V g(x_\tau - x_z, y_\tau - y_z, z_\tau - z_z) \cos \frac{4\pi}{\mu\lambda} (z_\tau - z_z) dx_\tau \dots dy_\tau$$

For a great volume one integration over  $V$  can be performed (compare the deduction of formula (11)); further we put  $aV = N$  and for the sake of brevity  $\frac{4\pi}{\mu\lambda} \cos \frac{1}{2} g = C$ , then we get

$$\frac{1}{2} \beta^2 N \left[ 1 + \iiint_x^{+\infty} \cos Cz g(x, y, z) dx dy dz \right] \dots \dots (13)$$

The integral appearing here will be represented by  $G_c$ , that of formula (11) by  $G$ . It will be seen that the deductions criticised in § 1 yield an opalescence proportional to  $r^2$ , a quantity which according to the above is proportional to  $1 + G$ , whereas the opalescence is proportional to  $1 + G_c$ .

With the aid of the integral-equation (6) we can express  $G$  and  $G_c$  in the corresponding integrals of the function  $f$ , which we will indicate by  $F$  and  $F_c$ .

Integrating (6) with resp. to  $xyz$  from  $-\infty$  to  $+\infty$ , we find

$$\begin{aligned} \iiint_{-\infty}^{+\infty} g(xyz) dx dy dz - \iiint_{-\infty}^{+\infty} g(\xi\eta\zeta) d\xi d\eta d\zeta \iiint_{-\infty}^{+\infty} f(x + \xi, y + \eta, z + \zeta) dx dy dz = \\ \iiint_{-\infty}^{+\infty} f(xyz) dx dy dz \end{aligned}$$

or

$$G = \frac{F}{1-F} \dots \dots \dots (14)$$

Multiplying (6) by  $\cos Cz$  and again integrating, we get

$$\begin{aligned} G_c = \iiint_{-\infty}^{+\infty} g(\xi\eta\zeta) d\xi d\eta d\zeta \iiint_{-\infty}^{+\infty} \{ \cos C(z + \xi) \cos C\zeta + \sin C(z + \xi) \sin C\zeta \} \\ f(x + \xi, y + \eta, z + \zeta) dx dy dz = F_c. \end{aligned}$$

The integral with the sines disappears because  $f$  and  $g$  are even functions; we find

$$G_c = \frac{F_c}{1-F_c} \dots \dots \dots (15)$$

In order to apply the results obtained and to test them experimentally, one might try to deduce  $f$  from molecular theory. This would at best be possible under very simplifying suppositions and

even then only an approximation can be obtained. Therefore we will take another way. As remarked in § 1, the exact value of  $v^2$  for *very great volumes* was already known. In our notation we have

$$v^2 V = - \frac{RT}{N} \frac{a^2}{v} \frac{dp}{dv}$$

where  $N$  is the number of AVOGADRO,  $v$  the molecular volume.

According to formula (4) we have

$$v^2 V = a(1 + G) = \frac{a}{1 - F}.$$

Putting these results equal, we get

$$1 - F = - \frac{v^2}{RT} \frac{dp}{dv}.$$

In the critical point  $F = 1$ .<sup>1)</sup>

The formula of opalescence first arrived at by KEESOM and EINSTEIN

1) There appears to exist a closer correspondence between the given statistic-mechanical method and the method using general considerations of probability, than perhaps might be expected. The elements of the discriminant (which is an infinite determinant in the former) agree with the function  $f$  in the latter. The former finds from this the value of  $v^2/v$  as the quotient of a minor with that discriminant, the latter deduces this value from an integral-equation. In the critical point the discriminant vanishes, corresponding to this the FREDHOLM determinant of the integral-equation is likewise zero. That this is the case when  $F = 1$ , appears by more closely studying the equation

$$g(\xi, \eta, \zeta) - \lambda \int g(\xi, \eta, \zeta) f(x + \xi, y + \eta, z + \zeta) d\xi d\eta d\zeta = 0$$

which only permits appropriate solutions if  $\lambda = \frac{1}{F}$ , (i. e. this is the only proper value). For  $F = 1$  this is therefore the case with the equation (6) without second member.

From the formula (15) it will be seen that form. (6) can be solved by a FOURIER integral. Putting

$$\iiint_{-\infty}^{+\infty} \cos mx \cos ny \cos lz f(xyz) dx dy dz = q(m, n, l)$$

we have

$$g(xyz) = \frac{1}{8\pi^3} \iiint_{-\infty}^{+\infty} \frac{q(m, n, l)}{1 - q(m, n, l)} \cos mx \cos ny \cos lz dm dn dl.$$

$$\frac{I_{\text{Op.}}}{I} = \frac{2\pi^2 V RT}{D^2 N} \frac{\mu v \left(\frac{d\mu}{dv}\right)^2}{\frac{dp}{dv}} \lambda^{-4} \sin^2 \psi. \quad \dots \quad (16)$$

in which represent

$D$  distance of observation

$\mu$  index of refraction,

$\psi$  angle of electric force in incident light with direction of observation,

will likewise be found by using in (13) the value found for  $F'$  instead of  $F'_c$ . The exact formula then will result by multiplying by

the factor  $\frac{1 + G_c}{1 + G} = \frac{1 - F'}{1 - F'_c}$ .

Developing the cosine in  $F'$  we find

$$F - F'_c = \frac{C^2}{2} \iiint_{-x}^{+x} z^2 f(xyz) dx dy dz.$$

Representing this integral by  $\varepsilon^2$  and introducing the value of  $C$ , we get

$$F - F'_c = 4\pi^2 (1 + \cos q) \left(\frac{\varepsilon}{\mu\lambda}\right)^2.$$

The formula of opalescence then will be:

$$\frac{I_{\text{Op.}}}{I} = \frac{2\pi^2 V RT}{D^2 N} \frac{\mu v \left(\frac{d\mu}{dv}\right)^2 \lambda^{-4} \sin^2 \psi}{-\frac{dp}{dv} + 4\pi^2 \frac{RT}{v^2} (1 + \cos q) \left(\frac{\varepsilon}{\mu\lambda}\right)^2}. \quad \dots \quad (17)$$

In the critical point itself it therefore is

$$\frac{I_{\text{Op.}}}{I} = \frac{V}{D^2} \frac{v^3 \mu^3 \left(\frac{d\mu}{dv}\right)^2 \sin^2 \psi}{N \varepsilon^2 (1 + \cos q)} \lambda^{-2}. \quad \dots \quad (18)^1$$

The greater exactness of form. (17) as compared with (16) is confirmed by the measurements of one of us (Z.). According to these measurements, which however bear upon a mixture of liquids the

<sup>1</sup>) According to this formula the proportionality of the opalescence to  $\lambda^{-4}$ , which holds for higher temperatures, changes continuously in the immediate neighbourhood of the critical point, into proportionality with  $\lambda^{-2}$ . This *real* "getting whiter" of the opalescence should not be confused with the *apparent* changing of colour which is always observed much farther from the critical point. The latter indeed is only a result of the method of observation, as is clearly proved by the measurements of one of us (cf. ZERNIKE thesis).

reciprocal value of a quantity proportional to the opalescence changes linearly with the difference of temperature  $T - T_k$ , but by extrapolation does not vanish for  $T = T_k$ , but for  $T - T_k = 0,012$ . When therefore for this value of  $T - T_k$  the denominator of (17) is equal to zero, we can find from this, using VAN DER WAALS' equation, an estimation for  $\varepsilon/\lambda$ . The calculation yields:

$$\frac{\varepsilon}{\lambda} = 0,0022 \text{ or } \varepsilon = 1,2 \cdot 10^{-7} \text{ cm.}$$

The quantity  $\varepsilon$  is a measure for the size of the sphere of attraction. For

$$\varepsilon^2 = \frac{1}{3} \iiint_{-\varepsilon}^{+\varepsilon} \rho^2 f(xyz) dx dy dz$$

( $\rho$  distance to origin) whereas in the critical point

$$\iiint_{-\infty}^{+\infty} f(xyz) dx dy dz = 1.$$

If  $f$  were constant within a sphere with radius  $R$ , then  $\varepsilon^2$  would be  $\frac{1}{3} R^2$ , and the above estimation would give

$$R = 2,7 \cdot 10^{-7} \text{ cm.}$$

#### S U M M A R Y.

1. The known formulae of critical opalescence give an infinite value at the critical point. Efforts to escape from this difficulty have furnished formulae for the deviations of density with a dependence upon the volume, at variance with the assumed mutual independence of the elements of volume.

2. In order to obtain formulae applicable in the critical point, it is found necessary to take into account the mutual influence of the elements of volume, it being shown that near the critical point this influence is sensible for distances large in comparison with the radius of the sphere of attraction.

3. Two functions are introduced, one relating to the direct interaction of molecules, the other to the mutual influence of two elements of volume. An integral equation gives the relation between the two functions.

4. Corrected values are found for the mean deviations, and in the formula of opalescence a correction is introduced. The latter depends upon the sphere of attraction which can thus be calculated from observations.

5. Further it is shown that the same results may be arrived at by taking into account the mutual influence of the elements of volume in the deductions of statistical mechanics.

*Groningen, Sept. 1914.*



A. A. HIJMANS VAN DEN BERGH and J. J. DE LA FONTAINE SCHLUITER. „The identification of traces of bilirubin in albuminous fluids.”

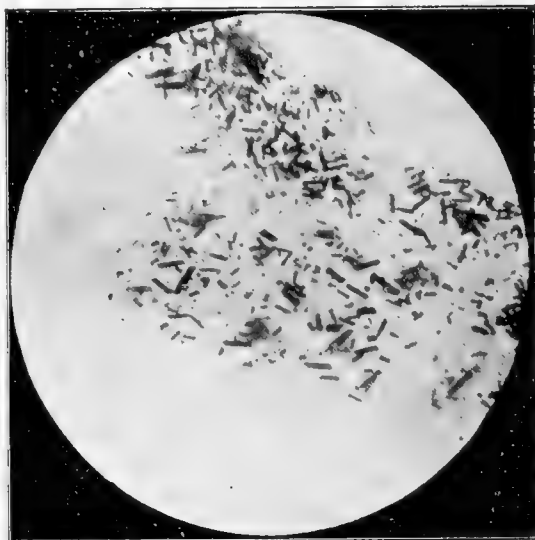

Bilirubin from human bloodserum (Chloroform-method).

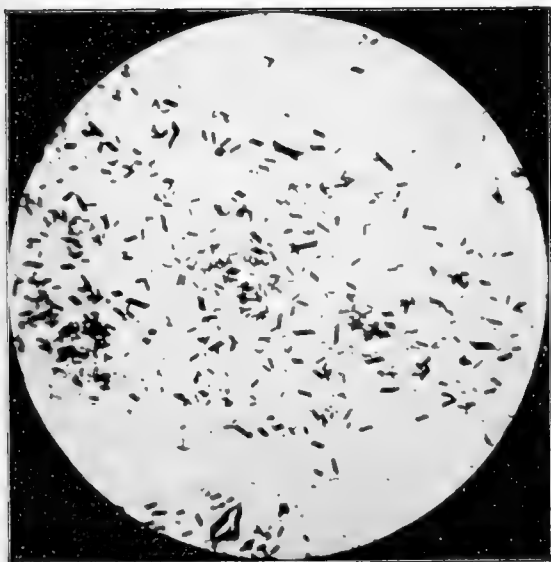

Bilirubin from human ascites fluid  
(Aether-method)



Bilirubin from human ascites fluid  
(Chloroform-method)



**Physiology.** -- "*The identification of traces of bilirubin in albuminous fluids.*" By Prof. A. A. HIJMANS VAN DEN BERGH and J. J. DE LA FONTAINE SCHLUTER. (Communicated by Prof. H. J. HAMBURGER).

Several investigators have tried to demonstrate the presence of slight quantities of bilirubin in albuminous substances, for instance in normal human bloodserum. Most of them did this by adding various oxidizing substances, either directly to the serum or to an alcoholic extract of the latter. The first oxidation-stages of bilirubin having a green or a blue colour, the presence of bilirubin was regarded as established if an addition of these oxidizing substances gave rise to a green or a blue colour (OBERMAJER and POPPER, STEIGER, GILBERT<sup>1)</sup> and others). AUCHÉ<sup>2)</sup> employed a much more reliable method based on the fact that bilirubin, in alkalie solution in the presence of oxide of zinc, is changed, by careful oxidation with iodine, into a substance with a characteristic spectrum. This reaction had already been described by STOKVIS, but AUCHÉ, who mentions STOKVIS' work, owns the merit of having stated accurately the conditions required if the reaction is to take place with absolute certainty, so that it may be used to demonstrate the presence of bilirubin.

Undoubtedly the reaction of STOKVIS-AUCHÉ can be used with success. Only the spectrum-line is very slight in the case of the small amounts of bilirubin dealt with in this treatise: if the presence of bilirubin is to be demonstrated in normal human serum by means of this method, the layer of fluid intended for spectroscopic investigation is to have a thickness of ten centimetres. And even then the result is not always a positive one. For quantitative determinations this method cannot be used.

BIFFI extracted the serum at once with chloroform and carried out his reactions with this<sup>3)</sup>.

The reaction of EHRLICH has supplied us with an excellent means of tracing bilirubin in bloodserum and other albuminous fluids and of determining it quantitatively<sup>4)</sup>. The characteristic difference in colour between an alkaline and an acid medium increases its reliability, whilst the reaction is an extremely sensitive one. It must,

<sup>1)</sup> OBERMAJER u. POPPER. Wiener Klin. Wochenschr. 1908.

STEIGER. Dissert. Zürich 1911.

GILBERT. See for his works the bibliography in: Clinique médicale 1910/1911.

<sup>2)</sup> AUCHÉ. Compt. rend. Acad. d. Sciences 1908.

<sup>3)</sup> BIFFI. Folia Haematolog. 1906 III. 189.

<sup>4)</sup> HIJMANS VAN DEN BERGH and SNAPPER. Deutsch. Arch. f. klin. Med. 1913.

however, be admitted that neither this nor any other colour-reaction enables us to identify the presence of bilirubin with absolute certainty. The possibility of other substances contained in the serum giving the same reaction with the diazo-body may be esteemed less probable, it cannot with absolute certainty be denied.

As far as we know it has hitherto been found impossible to isolate bilirubin from normal human serum, which would have afforded an incontestable proof of its presence. HAMMERSTEN has attempted it<sup>1)</sup>. But though in a great majority of cases he obtained fine bilirubin-crystals from horse-serum, he never succeeded in obtaining them from normal human serum. From the terms used in the latest edition of his Handbook of Physiological Chemistry we gather that this investigator is not quite convinced yet of the presence of bilirubin in normal human serum.

With a view to researches on anhepatic bilirubin-formation we needed a method which would enable us to identify with absolute certainty the presence of small quantities of bilirubin in bloodserum, exsudates and transsudates, if possible by obtaining the pigment in the form of crystals. After some experiments we have succeeded in this, starting from the property of bilirubin — which we have not found mentioned anywhere — of dissolving readily in acetone.

To 10 cm<sup>3</sup>. of bloodserum 20 cm<sup>3</sup>. of pure colourless acetone are added. An albumen precipitate is formed, which is centrifugalized. The fluid at the top, coloured more or less intensely yellow, contains all the bilirubin and only traces of albumen. This liquid is evaporated in vacuo at the ordinary laboratory temperature.

If one has a good vacuum-pump at one's disposal the liquid soon begins to boil; after some minutes the acetone is evaporated. A watery fluid remains in which, besides other serum-substances, all the bilirubin is dissolved. Then the fluid is shaken 2 times or more with aether to remove the fatty bodies as much as possible.

These pass into the aether which is pipetted. The last traces of aether are removed in vacuo. The aether may of course also be removed by means of a separatory. Then a certain amount of chloroform e.g. 2 cm<sup>3</sup>. are added, the fluid is slightly acidified with HCl and shaken. The bilirubin then passes into the chloroform. By centrifugalization the watery fluid can easily be separated from the chloroform. The chloroform is washed thoroughly with water to get rid of all the hydrochloric acid and centrifugalized once more, the water being removed by means of a separatory or by pipetting. Traces of water, however, remain mixed with the chloroform, which sometimes renders

<sup>1)</sup> HAMMARSTEN. Maly's Jahresber. 1878 II. 119.

the fluid slightly troubled. These traces of water are removed by shaking with glowed sulphate of sodium. The latter is removed by filtration. The result is a very pure solution of the yellow pigment in chloroform (solution *A*). It may be easily proved that this yellow pigment is bilirubin.

1. If the chloroform solution is shaken with diluted KOH or NaOH the pigment passes into the latter, while the chloroform loses its colour (solution *B*).

2. If now some acid is added till the fluid reacts distinctly as an acid, then the fluid at the top loses its colour, the pigment passing into the chloroform at the bottom.

3. If to the alkaline solution (see sub 1)  $\text{HNO}_3$  containing some  $\text{HNO}_2$  is added, the result is the well-known colour-play of the reaction of GMELIN.

4. If a slight quantity of a diluted iodine-solution in alcohol (1:100) is carefully poured on to the alkaline solution, a blue ring is formed.

5. If to the alkaline solution first an equal volume of alcohol is added, and then  $\frac{1}{4}$  of the original volume of the diazo-mixture of EHRLICH, a red colour is the result. An addition of a few drops of concentrated HCl changes the red colour into blue.

All these reactions together, prove conclusively that the pigment obtained in the above way is indeed bilirubin.

Crystals of bilirubin can be easily obtained from the pure chloroform-solution (sol. *A*) in the following manner. The latter is poured out into a watch-glass which is covered with another watch-glass and placed in the ice-safe. The chloroform evaporates slowly and on the watch-glass the microscopically visible, pretty, yellow bilirubin-crystals are left. When  $\text{HNO}_3$  containing  $\text{HNO}_2$  is added, these crystals present under the microscope the reaction of GMELIN.

We can also dissolve the yellow crystals again in some solvent (chloroform, dil. NaOH etc.) and carry out the above-mentioned reaction with them.

If one has no good vacuum-pump at one's disposal the method can also be applied with the following modification suggested by Dr. SNAPPER.

10 cm<sup>3</sup> of bloodserum are precipitated with 20 cm<sup>3</sup> of acetone. The albumen-precipitate is centrifugalized. To the pipetted upper-fluid some drops of water are added; then this fluid is washed carefully with aether a few times, to remove the fatty substances as much as possible. These volumes of aether are removed with the pipette every time. Then some drops of ice-vinegar and 1 cm<sup>3</sup>

of aether are added to the fluid. All the bilirubin passes into the mixture of ice-vinegar and aether, which separates entirely from the fluid underneath. If this yellow-coloured aether is pipetted and placed in an ice-safe in a loosely covered watch-glass, we likewise observe that crystals are formed.

The accompanying picture is a micro-photograph of bilirubin crystals which we obtained from the ascites-fluid of a heart-patient, and from normal human serum.

Attempts to produce bilirubin-crystals by the above-mentioned method from the intensely yellow-coloured serum of two icterus-patients, led to a remarkable experience. If namely we placed the chloroform-solution which, as appeared from various reactions, contained much bilirubin, in the ice-safe, for the purpose of a slow evaporation, the yellow colour at a certain moment when, owing to the evaporation of the solvent the concentration had reached a certain value, suddenly passed over into a green one, evidently by a change of the bilirubin into biliverdin. The same phenomenon occurred when we evaporated the chloroform-solution in vacuo. It must be distinctly understood that this occurred only with the solution obtained from the serum of patients suffering from obstructive jaundice. We cannot give an explanation of this phenomenon. Most likely the icterus-serum contains substances promoting the oxidation of bilirubin into biliverdin.

**Botany.** — “*Gummosis in the fruit of the Almond and the Peachalmond as a process of normal life.*” By Prof. M. W. BEIJERINCK.

(Communicated in the meeting of September 26, 1914).

It has hitherto been generally accepted that the formation of gum in the branches of the Amygdalaceae always is a process of pathological nature. I have found that this opinion is erroneous, and that gummosis occurs normally in the fruits of the Almond (*Amygdalus communis*) and the Peachalmond (*Amygdalus amygdalo-persica*) DUHAMEL DUMONCEAU.<sup>1)</sup>

<sup>1)</sup> In some Dutch nurseries the peachalmond is simply called “Almondtree”. The difference is in fact very slight as it consists only in the drying up of the almond fruit before the epicarp opens, and the position of the flowers in pairs, whereas the fruit of the peachalmond remains fleshy even at the dehiscence, and its flowers are mostly single. Between leaves, flowers and branches no constant differences are found.

GRENIER et GODRON (Flore de France T. 1, Pag. 512, 1848) call the peach-

Contrary to what might be expected the phenomenon is the more obvious as the trees are better fed and more vigorous. In specimens on sandy grounds it can only be observed with the microscope.

As gummosis is the effect of a wound stimulus, it is of importance that this process also takes place in the normal development of the healthy plant. The subject is moreover of practical interest. All the chief facts relating to gum formation can almost unchanged be applied to the production of gums in general, of gum resins, and of resins, among which are substances of great medical and technical value. As the study of the influence of parasitism has made it possible to produce gum, and no doubt many of the other substances mentioned, in a more rational way than has been done till now, a short review of the whole subject seems not superfluous.

*Wound stimulus as cause of gummosis. Poisoning, and parasitism also causes of this stimulus.*

Gummosis in the Amygdalaceae is a process of cytolytic, whereby young cells, freshly sprung from cambium or procambium, and sometimes also young parenchyma, are more or less completely dissolved and converted into canals or intercellular spaces, filled with gum. In dissolved parenchymatous tissues usually remains of not wholly disappeared cell walls are found; the gum of the phloem bundles is more homogeneous, but always the microsomes of the dissolved protoplasm are found. The nitrogen of the gum springs from the dissolved protoplasm.

Formerly we proved<sup>1)</sup> that by such different causes as poisoning, parasitism and mechanical wounding gummosis may be experimentally

---

almond *Amygdalus communis* var. *amygdalo-persica*. At present the name *Amygdalus persicoides* (KOCH, SERINGE, ZABEL) is also used, as in the Hortus of the University of Leiden. The opinion that it is a hybrid is not sufficiently founded. When grown from seed the tree seems constant (see MEIJER'S Conversationslexikon, Articles "Mandel" Bd. 11, p. 853 and "Pflirsich" Bd. 13, p. 782, 1896) and identic with the "English almond", of which DARWIN reproduces a stone (Domestication, 2nd Ed., Vol. 1, p. 858, 1875). The fruit is fleshy and bursts open, the kernel is edible, not bitter. At Delft sowing experiments have been going on a long time already, but under unfavourable circumstances. The root cannot resist the winter temperature of the soil, hence, grafting on the plumtree is required.

<sup>1)</sup> M. W. BEIJERINCK et A. RANT. Excitation par traumatisme et parasitisme, et écoulement gommeux chez les Amygdalées. Archives Néerlandaises, Sér. 2, T. II, Pag. 184, 1905. — Centralblatt f. Bakteriologie, 2te Abt., Bd. 15, Pag. 366, 1905. — A. RANT: De Gummosis der Amygdalaceae. Dissertatie Amsterdam, BUSSY, 1906.

provoked in many *Amygdalaceae*, as almond, peachalmond, apricot, peach, plum, cherry, and bird's cherry.

But these three groups of causes may all be considered from one single point of view, by accepting that gummosis is always the effect of a wound stimulus, proceeding from the slowly dying cells, which are found as well in every wound, as at poisoning and parasitism. These dying cells may change into gum themselves, but besides, exert their influence on cambium tissues to distances of some centimeters. This distance-influence is the principal effect of the wound stimulus. But poisoning by sublimate or oxalic acid, introduced under the bark, can as well excite gummosis as an incision or a wound by burning or pricking. Neither the dead cells nor the poison are the active factors here; *the stimulus proceeds from the slowly extinguishing cells, so that gummosis is essentially a necrobiotic process.* Probably the dying cells, after the death of the protoplasm, give off an enzyme or enzyme-like substance, a lysine, fixed during active life, but, which being freed by necrobiosis and absorbed by the young division products of the cambium causes their cytolysis. This reminds of the cytolysines of the animal body, originating when foreign cells are introduced, which liquefy the corresponding cells, for example the haemolysines which dissolve the red blood-cells. Furthermore of the bacteriolysines and of cytase, the enzyme of cellulose.

If the hypothesis of the existence of a "gumlysine" is right, — and I think it is, — this substance must be of a very labile nature, for when bark wounds are infected with gum, quite free from germs of parasites, no more abundant gummosis is observed than at mechanical wounding only. But a difference, however slight, will certainly exist.

#### *Gummosis produced by wound stimulus.*

The influence of this cause is best studied in the following experiment.

A deep wound, penetrating into the cambium of a branch of almond or peach, commonly soon heals completely, but it may be that gum flows from the wound. This is the case when the trees are in sap, thus in February or March at temperatures above 20° C. and below 33° C. The experiment succeeds best with cut branches in the laboratory. When the wounds are made in the open air in that season no gummosis ensues, the temperature then being too low.<sup>1)</sup> In

<sup>1)</sup> If the wounds are infected with *Coryneum*, an extremely copious gum production follows in spring, as the parasite then finds abundant food in the branches. There is, however, no season when wounds, infected with *Coryneum*, do not sooner or later yield gum.

summer the cambium of the still longitudinally growing part of young green branches may be caused to form gum by punctures or incisions, but these wounds heal quickly, except when "kept open" by *Coryneum* or other parasites.

As to thicker branches, wounded in spring, the microscope shows the following.

Around the wound a great number of gum canals are formed in the cambium, about parallel with the axis of the branch, some centimeters long, which become the thinner and shorter as they are more remote from the wound. The canals are separated by the medullary rays, which are with more difficulty converted into gum than the phloem. All the gum canals together form a kind of network, whose meshes are filled by the medullary rays. The whole network has the shape of an ellipse, the "gum ellipse", the wound lies in the lower focus towards the base of the branch. The stimulus extends over the ellipse, evidently farthest in the direction of the branch, less far towards the base and sideways. So it may also be said that the wound stimulus extends farthest opposite to the "descending" current of nutrient matter, following the phloem bundles, or along with the "ascending" water-current, following the wood. Evidently the gum canals are more easily formed in the better fed cells above the wound than in those beneath it, where the nutrition must be worse. This is especially obvious in ringed branches. Wounds in the cambium, directly above the ring produce much more gum than those immediately below.<sup>1)</sup>

Under ordinary circumstances the branches, after simple mechanical wounding, are soon completely healed, and if the cambium at the outside of the gum canals then again begins to produce normal secondary wood, the gum canals may later be found back in the wood itself.<sup>2)</sup> Evidently the healing takes place as soon as the stimulus ceases, and so it is not strange that when it continues by poisons or parasitism the gum production also continues.

---

<sup>1)</sup> The nature of the power, by which the food transmitting, "descending" sap current moves through the phloem bundles, is not known. It is thus not impossible, that if the cause of gummosis is of a material nature, a lysine, moving through the tissues, it is able to run in opposition to the "descending" current. I think, however, that the extension of the stimulus does not go along the phloem but along the xylem bundles and the young wood, with the "ascending" sap.

<sup>2)</sup> I have never seen distinct gum canals in the secondary wood, but according to the descriptions they occur eventually.

*Parasitism as cause of gummosis.  
The connection between wounding and parasitism.*

Wounds in peach branches treated with poisonous substances, such as sublimate, produce gum much longer and more copiously than the like wounds without sublimate. Other poisons have quite the same effect. Now it is clear that the direct influence of parasitism on the organism must be sought in the action of some poisonous substance. Hence it seems certain that what these three causes have in common, namely necrobiose, or the slowly dying of the cells surrounding the dead ones, is the base of gummosis, and that parasitism, where necrobiose lasts as it were endlessly, must be the most powerful instigator of the process.

That this simple view of the question has not yet taken root in science is proved by the most recent treatise on our subject by MIKOSCH,<sup>1)</sup> illustrated with beautiful anatomical figures. After the publication of Dr. A. RANT and myself of 1905, he described the relation of mechanical wounding to gummosis. But he did not think of poisoning experiments, nor has he any belief in the influence of parasitism on gum formation. WIESNER, in his recently published paper on gums in the new edition of his "Rohstoffe des Pflanzenreichs", is also of the same opinion as MIKOSCH.

For my object a short discussion of a few examples of parasitism will suffice.

The little caterpillar *Grapholitha weberiana* makes borings into the bark of plum and apricot, and if the outermost corklayer is removed by shaving it off, the butterfly finds so many fit places for depositing its eggs, that the larvae creep in by hundreds and make new borings from which later the gum flows out. These holes are coated with a layer of slowly dying cells, whence the stimulus extends, which produces the gum canals in the contiguous "cambium". By cambium I simply understand the not yet differentiated division products, "young wood" and young phlooterma. The necrobiotic cells, clothing the continually extending holes in the bark, and the great numbers of new individuals of the caterpillars, make the gum production a chronic process.

To explain the formation of the enormous quantities of gum produced in this way, it seems only necessary to think of mechanical wounding and not of any special excretion from the animal. But it must be noted that the space, where the caterpillar lives during its

<sup>1)</sup> Untersuchungen über die Entstehung des Kirschgummi. Sitzungsber. d. Kais. Akad. d. Wiss. in Wien. Mathem. naturw. Klasse. Bd. 115, Abt. 1. Pag. 912, 1906.



growth, namely a vertical narrow canal in the innerbark, very near to the cambium, could not possibly be imitated artificially.

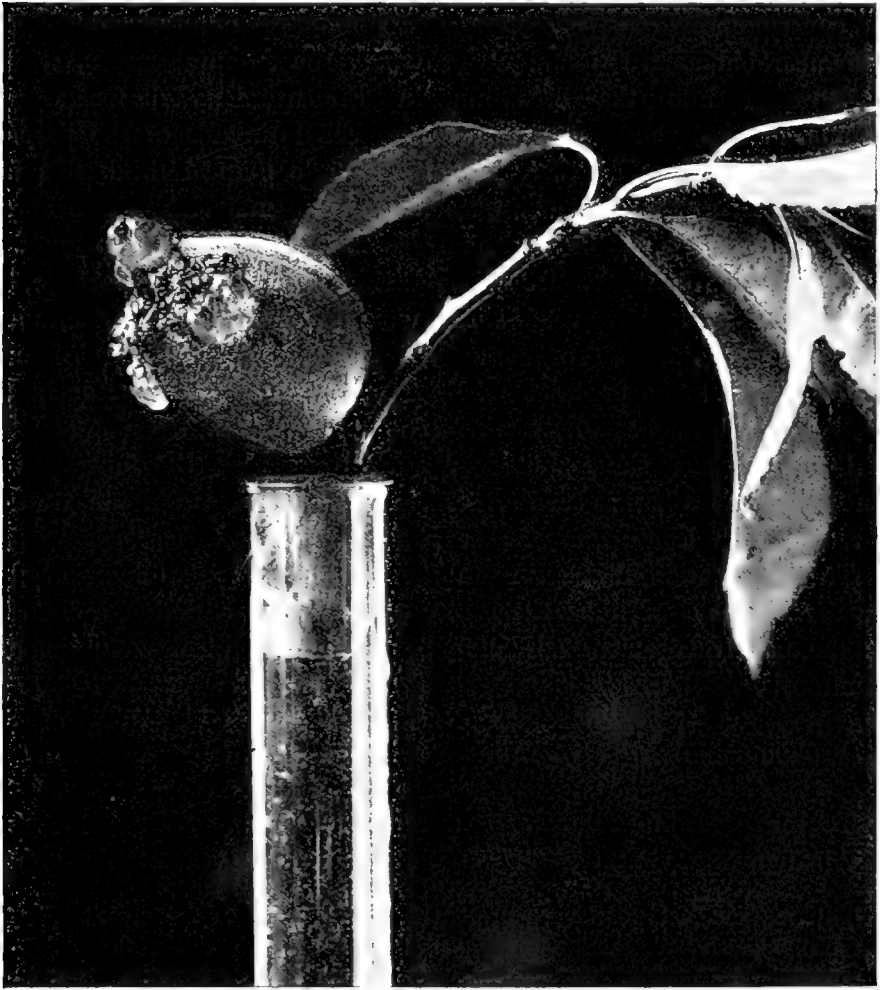

Fig. 1. (Natural size). Gum producing peachalmond in September, whose summit is cut off; the gum from the gum canals is after drying, swollen by moistening with cold water.

Much more common and interesting than the animal parasites are the gum producing Fungi of the *Amygdalaceae*, five of which are found in our country. <sup>1)</sup> The commonest and most vigorous is *Cory-*

<sup>1)</sup> *Coryneum beijerinckii* OUDEMANS, *Cytospora leucostoma* PERSOON, *Monilia cinerea* BONORDEN, *Monilia fructigena* BONORDEN and *Botrytis cinerea* PERSOON (see RANT, l. c. p. 88). German authors also mention bacteria as instigators of gummosis, I never found them.

*ymum bejerinckii* OUDEMANS (*Clasterosporium carpophilum* ADERH.).<sup>1)</sup>

Pure cultures of *Coryneum* in bark wounds of almond, peachalmond, peach, cherry, plum, bird's cherry, sloe, virginian plum, develop with remarkable quickness and soon make the bark die off, evidently in consequence of the secretion of a poison. Around the dead cells the necrobiotic are found from which the stimulus issues, which, penetrating into the cambium in the usual way, forms gum canals in the young wood. Many mycelial threads of the parasite itself are then cytolised and converted into gum. I think this fact remarkable and a strong argument for the material nature of the stimulus.

Undamaged branches are with difficulty infected by the parasite, but it is easy, even by very slight wounds and artificial infection, if only the wounds be numerous, to obtain great quantities of gum. This circumstance explains why nursery men dread wounds in the trunks and branches of stone-fruit trees.

In the green shoots, especially of the peach, the formation of anthocyan is observed in the enfeebled tissue around the wounds infected with *Coryneum* when exposed to sunlight.<sup>2)</sup>

The supposition that secretion products of the parasitic caterpillar or the Fungus could be the direct cause of the stimulus, is contrary to the positively existing relation between mechanical wounding and gummosis.

*Gum canals in the fruitflesh of almond and peachalmond.*

To the preceding facts, long since stated, I wish to add the following. Already in my first paper of 1883 I called attention to the circum-

<sup>1)</sup> BELJERINCK, Onderzoekingen over de besmettelijkheid der gomziekte bij planten. Versl. d. Akad. v. Wetensch. Amsterdam, 1883. — Contagiosité de la maladie de gomme chez les plantes. Archives Néerlandaises, 1<sup>e</sup> Sér., T. 19, Pag. 1, 1886. — C. A. J. A. OUDEMANS, Hedwigia, 1883, N<sup>o</sup>. 8. — SACCARDO, Sylloge Fungorum, Vol. 3, Pag. 774, 1884. — ADERHOLD, Ueber *Clasterosporium carpophilum* (LÉV.) ADERH. und dessen Beziehung zum Gummifluss des Steinobstes. Arbeiten der Biolog. Abt. am Gesundheitsamte zu Berlin. Bd. 2, Pag. 515, 1902. ADERHOLD has experimented with pure cultures of *Coryneum*, which I had made and sent him. He himself has not executed any isolations of gum parasites. His determination as *Clasterosporium amygdalarum* (LÉV.) is thus founded on the imperfect descriptions from the older mycological literature, in which OUDEMANS was no doubt better at home than he. Like LINDAU I reckon *Clasterosporium* to another family than *Coryneum*.

<sup>2)</sup> The apperance of anthocyan in the light is commonly a token of diminished vitality and often a consequence of necrobiose in the adjoining cells. Hence, wounds, poisons and parasitism cause anthocyan production in the most different plants.

stance, that in the fruit-flesh of the peachalmond, and as I may add now, also in that of the almond itself, there is a system of gum canals, precisely corresponding to that of the vascular bundles. Of these the phloem bundles are converted into gum canals by cytolysis, either entirely or with the exception of the outer protophloem; the gum canal (*gp* Fig. 2 and 3) thus, is always immediately contiguous to the woody bundle *xl*.



Fig. 2 (3). Gum canals in the transverse section of the fruit-flesh of a peachalmond; *ha* hairs on epidermis; *hw* dermoidal tissue; *bp* chlorophyll-parenchyma; *xl* xylem bundles; *ph* phloem bundles; *gp* gum canals sprung from phloem bundles.

Fig. 2 and 3 are reproductions from my above mentioned treatises of 1883 and 1886.

The presence of gum in the canals of the fruit is easily shown. In August or September the summit of a peachalmond fruit is cut off and the fruit, or the branch with the fruit, is placed in water. After some moments all over the section droplets of gum are seen evidently issuing from the vascular bundles. As these bundles are distributed through the fruit-flesh, running longitudinally and transversely, and are partly reticulated, the number of droplets is very great and they are of different size. In particular near the stone they are big. If in August the gum is allowed to flow out in cold water it dissolves completely or nearly so. In September the dissolving is no more complete. By drying the gum, its solubility in cold water gets almost lost, but it continues in hot water.

From lateral incisions also much gum flows out. In Fig. 1 the drops are represented after drying, followed by swelling up in cold water.

Although this gum does not only consist of dissolved wall material

but also of cell contents, the microscope can only detect fine granules, evidently corresponding to the microsomes of the protoplasm, which are not dissolved during the cytolysis I could not find back the cell nuclei in the gum, but in the cells of the not yet cytolysed phloem bundles, they are neither perceptible. As under normal circumstances the gum does not flow out, its volume must be about as great as that of the phloem bundles which are cytolysed. It is, however, certain that the capability of the gum to swell up by imbibition is much greater than that of the cell-tissue which gave rise to its formation. It seems thus certain that imbibition with

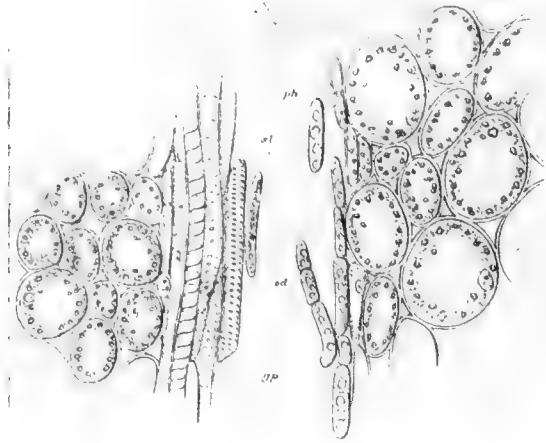

Fig. 3 (360). Gum canal with surrounding; *gp* gum; *xl* xylem bundles, unchanged; *ph* non-dissolved cells of the phloem bundles; *cd* thread-shaped cells in a gum canal, originating from the phloem bundles.

sufficient access of water must lead to a perceptible pressure and also some thickening of the fruit-wall. This must promote the opening of the fruit as well as the remarkable detaching of the stone, although the required mechanical power for these processes must, no doubt, chiefly be the tension of the tissue of the parenchyma of the fruit-wall existing independently of the gummosis. Finally the stone is found quite loose within the fleshy shell, which mostly opens like a bivalvate mollusk, but sometimes shows three or four fractures. The vascular bundles, which pass from the fruit-flesh into the stone, are thereby torn off clear from the stone. At the base the separation seems provided for by an intercepting layer, as at the fall of leaves.

The portion of the phloem bundles within the stone of the peachalmond is never converted into gum; in the almond itself such gum is found in rare cases inside the shell.

*Wound gum in the fruit-wall as a consequence of mechanical stress of the tissue. Gumming almonds.*

In many cases real wound gum is found in the fruits of the almond and the peachalmond, not proceeding from the gum canals but from fractures in the parenchyma of the fruit-flesh. Its origin must undoubtedly be sought in the tension or stress of the tissue, which causes the opening of the fruit. An additional circumstance, however, is required, namely a loss of vital strength, by which the regenerative power of the tissue that coats the fracture is annihilated. The therefrom resulting incapability of regeneration is associated with the ripening of the fruit in a way not yet explained and should rather be attributed to superfluous than to poor nutrition. Parasitism is wholly absent in the production of wound gum from the parenchyma of the fruit.

The fracture is mostly at the side where the two edges of the carpels are grown together and the fruit later opens. Not seldom in this case is wound gum seen to flow spontaneously from the base of the fruit along the short peduncle. In other cases the wound is at the side of the middle nerve of the carpel. Always the edges of the fracture are coated with cells in a condition of necrobiose, which is evident by their quickly colouring brown at the air, which normal living cells do not. These necrobiotic cells and the adjoining tissue produce gum. With the microscope not quite dissolved cell-walls may be found in the gum, showing that the cells were about full-grown when the process began.

In common almonds gum is sometimes found *within the hard shell*,<sup>1)</sup> and eventually part of the kernel itself is then also changed into real wound gum with still recognisable remains of the cell-wall. In such almonds the phloem of the vascular bundles, which run through the stone to the funiculus, is always changed into a gum canal, so that the gum can reach the surface of the young seed.

If we suppose that gummosis originates by the action of a cytolytine, it seems very well possible, that the lysine which has flowed inward together with the "canal gum", is able to attack the developing

<sup>1)</sup> The small quantity of gum found, especially in "hard almonds", at the surface of the shell, proceeds from the gum canals of the fruit-flesh. The sugar layer which covers the shell of the "soft" species is dextrose.

seed and is yet too labile to be demonstrated by infection of bark wounds with gum. Experiments in this direction may perhaps be effected with the peachalmond.

*Wound stimulus as factor of development.*

Formerly I thought that the presence of gum canals in the fruits was accidental and should be explained by parasitism, although I could not find any parasites.

In later years, with better knowledge, I again examined the gum canals in the peachalmond and their surroundings repeatedly. Never did I find a fruit without them, but they were not equally developed in different trees from different gardens. In specimens of sandy grounds they can sometimes only be found with the microscope. Neither microscopically nor by experiments has it been possible to detect gum parasites. This makes it quite certain that in the formation of gum canals parasitism is excluded.<sup>1)</sup>

The great ease wherewith mechanical tension causes wounds in the fruit-flesh of the peachalmond, gives rise to the supposition, that the normal gum canals may be the product of some hidden wound stimulus.

If this supposition is true, we cannot think of wounding in the common sense of the word. When the flowers fall off, a ring-shaped wound forms around the base of the young fruit, but this is a normal process, taking place in an intercepting layer and soon followed by complete healing. In the flowers of peach, plum, apricot, cherry, we observe the same without any formation of gum canals in the fruit-flesh. Moreover, although the peculiar structure of the layer between the woody peduncle and the stone, along which the ripe fruit detaches, reminds of rent tissue, no gum is formed at that spot and the layer also exists in the other stone-fruits, where no gum canals occur.

So long as nothing else has been proved it must therefore be accepted that in the phloem bundles of the fruit of the peachalmond, where cytolysis takes place, the same factor of development is active as that, which gives rise to the pathological gum canals in the cambium of the branches. This leads to the conclusion, that the wound stimulus belongs to the normal factors of development of this fruit, although nothing is seen of external wounds. When considering, that the phloem bundles are built up of extremely thin and soft-walled cells,

<sup>1)</sup> The supposition, sometimes met with in literature that the gum of the Amygdalaceae should consist of bacterial slime is quite erroneous. That parasitic bacteria eventually occur as gum parasites, as is stated by some authors, I do not think impossible, although till now I only found caterpillars and Fungi as active agents,

it is conceivable, that by great tension of the tissue in the surrounding parenchyma, they undergo strain and pressure causing mechanical rupture and necrobiose, centre and prey of the wound stimulus being the phloem bundles themselves.

This conception is in accordance with the fact that the gum canals are broad in the fruits of well-fed trees on rich grounds, which have a hard and solid flesh, wherein stress and strain are certainly very great. Only here and there remains of the protophloem along the gum canals are still to be found in such fruits. But in the softer fruits of sandy soils, along the much narrower gum canals not only the protophloem is still present, but also stripes of the secondary phloem.

Summarising we come to the following conclusions.

Mechanical wounds in growing tissues of *Amygdalaceae* will sometimes heal directly, sometimes after previous gummosis.

The chief tissue, which is transformed into gum is the young secondary wood newly sprung from the cambium and not yet differentiated. By the wound stimulus a network of gum canals is formed around the wound. In thick branches, with a bark wound, this network has an elliptical circumference, the wound being in the lower focus of the ellipse.

If the stimulus is removed by the cure of the wound, the cambium again continues to produce normal secondary wood, so that afterwards the gum canals may be found in the wood itself.

If the stimulus continues the gum formation also becomes lasting.

The stimulus issues from the cells that die slowly by wounding, poisoning or parasitism. Probably a cytolysine flows from these cells into the young wood or the procambium; these bind the lysine and liquefy to gum. Hence, gummosis is caused by necrobiose.

Young medullary rays and phloembundles are with more difficulty converted into gum than the young secondary wood. But in the fruit-flesh of the almond and the peachalmond it is the phloem which changes into gum. The protophloem of the bundles often remains unchanged.

Although gummosis in these fruits belongs to their normal development, a wound stimulus is nevertheless active. This stimulus springs from the strong tension in the parenchyma of the fruit-wall, which gives rise to tearing, necrobiose and gum formation in the delicate tissue of the phloem bundles. Consequently the wound stimulus is here a normal factor of development.

It might also be said that the almond and the peachalmond are pathological species, but thereby nothing would be explained.

**Chemistry.** — “*The allotropy of Lead.*” I. By Prof. ERNST COHEN and W. D. HELDERMAN.

(Communicated in the meeting of Oct. 31, 1914.)

1. Indications concerning the existence of allotropic forms of lead are found not only in the earlier *chemical* literature. Fourteen years ago ERNST COHEN<sup>1)</sup> pointed out in his studies on tin a clause in PLUTARCH'S (50—120 A.D.) *Symposiaca* (VI, 8) in which allusion is made<sup>2)</sup> to the fact that lead is sometimes disintegrated spontaneously at low temperatures.

This clause runs as follows: “No, the craving for food is not caused by the cold, but in the body something takes place similar to that which happens with metals in a very strong winter. There it is seen that cooling not only causes congealing, but also melting, for in strong winters *ἀκόνα μόλιβδον* (pieces of lead) occasionally melt away, consequently something similar may be supposed to take place in the intestinal process, etc. . . .”

Moreover THEOPHRAST (390—286 B.C.) mentions such phenomena in his book *περὶ πηγῶν*: “*καττίτερον γὰρ φασὶ καὶ μόλιβδον ἤδη τακῆραι ἐν τῷ Πόντῳ πάγον καὶ χειμῶνος ὄντος ρεαιζοῦ, χαλκὸν δὲ ῥαγῆραι.*” (It is told that tin and lead melted sometimes in the Pontos when it was very cold in a strong winter, and that copper was disintegrated.

2. SAINTE-CLAIRE DEVILLE<sup>3)</sup> stated that the density of lead is a function of its previous thermal history. He gives the following figures (water at 4° = 1; Temp. ?)

After quick cooling of molten lead 11.363.

„ slow „ „ „ „ „ 11.254.

In a second experiment he found:

Density of lead electrolytically deposited 11.542.

After melting and rapid cooling 11.225.

About the value 11.542 he says:

“Mais telle est la rapidité avec laquelle se carbonate à l'air ce plomb extrêmement divisé, qu'il a fallu le transformer en sulfate pour en déduire ensuite le poids de la matière employée. Cette complication introduit-elle quelque incertitude sur le premier nombre, ou ne doit on pas plutôt l'admettre comme représentant la densité de ce plomb parfaitement cristallisé?”

3. These values as well as others given in earlier literature have to be accepted with reserve as generally no data are given about

<sup>1)</sup> Proceedings of the meeting of Jan. 26, 1901, p. 469. Zeitschr. f. physik. Chemie **36**, 513 (1901).

<sup>2)</sup> PLUTARCHI Chaeronensis varia scripta quae moralia vulgo vocantur. Lipsiae, ex officina Car. Tauchnitii 1820. Tomus IV, 339.

<sup>3)</sup> C. R. **40**, 769 (1855).



(Natural size).

Fig. 1.

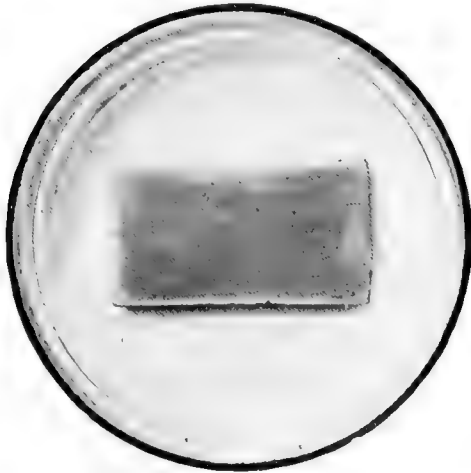

Fig. 2.

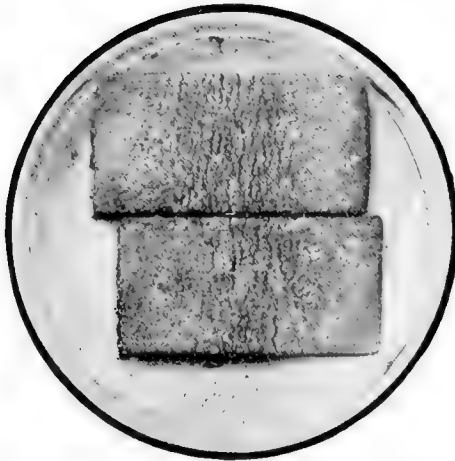

Fig. 3.





the purity of the material experimented on and as there often exists some uncertainty concerning the method whereby the density has been determined.

4. KAHLBAUM, ROTH and SIEDLER<sup>1)</sup> found the density of a pure specimen of lead prepared by distillation in vacuo to be  $d \frac{20^\circ}{4^\circ} 11.341$ .

5. The values given by different authors for the specific heat of lead vary within wide limits, as may be seen from the table given in AREGG's *Handbuch der anorganischen Chemie*.<sup>2)</sup> Moreover it may be called to mind that LE VERRIER<sup>3)</sup> stated, that the specific heat of lead is a function of its previous thermal history.

6. The facts mentioned above as well as the investigations of STOIBA,<sup>4)</sup> and those of OTTO LEHMANN<sup>5)</sup> render a new investigation of the subject very desirable.

7. A year ago we carried out some experiments in this direction. As the results were negative we experimented with other metals, which yielded a more favourable result. Since a fresh investigation on lead has given positive results, as will be proved below, we give here also a short description of our earlier experiments, which taken together with the new experiments furnish a confirmation of the results obtained by us in the case of other metals (bismuth, cadmium, copper, zinc, antimony).

8. Our experiments have been carried out with lead which contained only 0.001 per cent of copper and 0.0006 per cent of iron (Blei-"KAHLBAUM"-Berlin).<sup>6)</sup>

The metal was turned into shavings on a lathe and washed with dilute nitric acid, water, alcohol and ether. After this it was dried in vacuo over sulphuric acid.

9. The density of this material was found to be

$$d \frac{25^\circ}{4^\circ} \quad a. \quad 11.328_6$$

$$b. \quad 11.330_2$$

We put the metal into an aqueous solution of  $PbCl_2$  and kept it for 48 hours at  $100^\circ$ . After washing and drying it, we found:

1) *Zeitschr. f. anorg. Chemie* **29**, 177 (1902).

2) *Bd. 3*, 2te Abteilung, p. 633 (Leipzig 1909).

3) *Comp. ERNST COHEN, Proceedings* **17**, 200 (1914).

4) *Journ. f. prakt. Chemie* **94**, 113 (1865); **96**, 178 (1865).

5) *Zeitschrift f. Kristallographie und Mineralogie* **17**, 274 (1890).

ERNST COHEN and KATSUJI INOUE, *Zeitschr. f. physik. Chemie* **74**, 202 (1910).

6) MYLIUS, *Zeitschr. f. anorg. Chemie* **74**, 407 (1912).

$$d \frac{25^\circ}{4^\circ} \quad c. \quad 11.329_2$$

$$d. \quad 11.328_2$$

Another part of the original material was melted and chilled in a mixture of alcohol and solid carbon dioxide. The determination of the density gave the following result :

$$d \frac{25^\circ}{4^\circ} \quad e. \quad 11.330_2$$

$$f. \quad 11.333_2$$

10. As our determinations had been carried out with an accuracy of 3 or 4 units in the third decimal place, it is evident from the experiments described above that we had not been able to detect any transformation in the lead experimented with.

11. However, some months ago Mr. HANS HELLER at Leipzig was kind enough to call our attention to some phenomena which he described in the letter which follows :

"Gelegentlich eines Vorlesungsversuches, der einen sogenannten "Bleibaum" zur Darstellung bringen sollte, bereitete ich eine Lösung von 400 gr. Bleiazetat in 1000 cc. Wasser unter Zusatz von 100 cc. Salpetersäure (spez. Gew. 1.16), die als Elektrolyt bei der Bleiabseidung diente. Als Elektroden dienten bei dem Versuch Stücke aus reinem Blei. Diese Bleistücke blieben nach der Elektrolyse etwa 3 Wochen in der Lösung stehen. Als ich sie alsdann herausnehmen wollte, bemerkte ich, dass sie ihre weiche, dehnbare Beschaffenheit völlig verloren hatten und eine spröde, bröckelnde Masse geworden waren. Der Gedanke, es hier mit einer stabilen Modifikation zu tun zu haben, erschien mir um so wahrscheinlicher, als das spröde Blei ganz dem grauen Zinn gleicht, beide Metalle zu der gleichen Gruppe des periodischen Systems gehören und Metastabilität unserer Metalle nach Ihren Forschungen nichts Befremdliches mehr ist.

Kurze Zeit darauf brachte mir ein Kollege ein Bleikabel, das an verschiedenen Stellen eine weisse pulvrige Beschaffenheit zeigte von ganz ähnlicher Art, wie ich sie an den vorhergenannten Bleistücken beschrieb. Wir machten darauf den Versuch reine Bleistücke unter konzentrierte Salpetersäure zu bringen und sie mit ein wenig unseres spröden Bleies zu impfen. Der Erfolg blieb nicht aus: nach wenigen Tagen hatten sich beträchtliche Teile der Bleistücke zu der bröckeligen Modifikation verwandelt."

Mr. HELLER kindly invited us to continue these investigations; repeating his experiments with our pure lead we were able to corroborate his statements.

12. The lead was melted, chilled in water and cut into small blocks ( $3,5 \times 2 \times 0,5$  cm.). We put them into glass dishes which were filled up with the solution mentioned by HELLER. The dishes were covered with glass plates. The temperature of the solution was  $15^\circ$ — $20^\circ$ . The addition of some nitric acid has the effect that the surface of the metal remains bright during the experiment.

In this way the electrolyte is in constant contact with the metal and the inoculation which occurs can go on undisturbed.

The photographic reproductions (natural size) which accompany this paper illustrate the development of the phenomenon. Fig. 1 shows a plate of pure lead in its original condition. Fig. 2 represents the plates after having been in contact with the solution for some days; there are to be seen deep cracks, which show that the material has shrunk locally. In consequence of this an increase of the density was to be expected which was proved by means of the pycnometer (comp. § 19). Fig. 3 shows the plates after three weeks in the same conditions: the metal has been disintegrated.

Repeating the experiment with 15 or 20 blocks we got in all cases the same results.

13. We shall prove below that the phenomenon is not a chemical one; the following experiment may give already an indication in this direction. One of the blocks ( $\pm 40$  grams) was put into a calibrated tube which had been filled up with the solution mentioned. This tube stood in a small dish containing the same solution. After three weeks no evolution of gas had occurred, either at room temperature or at higher temperatures.

14. After this the phenomena described above were investigated by means of both the pycnometer and the dilatometer.

#### A. Measurements with the Pycnometer.

15. We exclusively used the instrument (Fig. 4) described by ADAMS and JOHNSTON<sup>1)</sup>, following the indications given by the authors. Moreover we took the precaution of dipping the pycnometer into

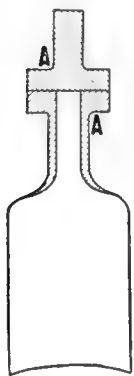

Fig. 4.

water before weighing (empty) and wiping the water off with a dry cloth. If this is omitted a slight error occurs, as the surface of the pycnometer is then not in the same condition as at the subsequent weighings, after it has stood in a (water) thermostat.

All determinations were carried out in duplicate with two pycnometers (C and D) which contained  $\pm 25$  cem.

16. Our investigations on bismuth, cadmium etc. had shown that the pycnometer measurements have to be carried out with special care. The volume changes which accompany the transformation of the

<sup>1)</sup> Journ. Americ. Chem. Soc. **34**, 563 (1912).

different modifications are, it is true, not inconsiderable, but they may be partially compensated in consequence of the simultaneous presence of different forms. In order to detect the remaining volume changes, very accurate determinations of the density must be made. We shall see below that special precautions must also be taken with lead. Evidently it is to be ascribed to such compensations that these phenomena have escaped the attention of earlier authors.

17. We used toluene as a liquid in the pycnometer.

Its density was found to be:

$$d \frac{25^\circ}{4^\circ} 0.86013 \text{ by means of the pycnometer C.}$$

$$0.86013 \quad ,, \quad ,, \quad ,, \quad ,, \quad ,, \quad D.$$

The quantity of lead used for each determination was 40–60 grams. The thermometers (divided into 0.05 degrees) had been checked against a standard of the Phys. Techn. Reichsanstalt at Charlottenburg-Berlin. The weighings were carried out on a BUNGE-balance with telescope. The weights had been checked by the method described by TH. W. RICHARDS<sup>1)</sup>.

18. In the first place we determined (at 25°.0) the density of the lead immediately after its preparation for the experiments. It was melted, chilled in water and filed to powder. It was then treated with a magnet in order to remove traces of iron from the file. We washed the powder with dilute nitric acid, water, alcohol and ether, and dried it in vacuo over sulphuric acid. Its density was now:

$$d \frac{25^\circ}{4^\circ} 11.325_8 \text{ (Pycnometer C).}$$

The metal was then washed and dried again in the same way;  $d \frac{25^\circ}{4^\circ} 11.322_1$  (Pycnometer D). After treating again in this way we found  $d \frac{25^\circ}{4^\circ} 11.324_4$  (Pycnometer D).

19. We brought the metal into the solution of the acetate (temp. 15°). After standing for 3 weeks the material was washed and dried. Its density was now  $d \frac{25^\circ}{4^\circ} 11.340_8$  (Pycnometer C)

$$11.342_4 \text{ (Pycnometer D).}$$

<sup>1)</sup> Zeitschr. f. physik. Chemie **33**, 605 (1900).

The figures show that there has occurred at  $15^\circ$  an *increase* of 17 units in the third decimal place.

20. We put the metal again into the solution which was kept at  $50^\circ$  (in a thermostat) for 120 hours. We found after washing and drying

$$d_{4^\circ}^{25^\circ} 11.313_s \text{ (Pycnometer } C)$$

$$11.312_0 \text{ (Pycnometer } D).$$

The density had *decreased* 28 units in the third decimal place.

21. The experiment was repeated again, this time at  $25^\circ.0$  (in a thermostat) for 144 hours.

$$\text{We found: } d_{4^\circ}^{25^\circ} 11.327_s \text{ (Pycnometer } C)$$

$$11.329_s \text{ (Pycnometer } D).$$

An *increase* of 15 units in the third decimal place had occurred.

22. Our table I contains the results of these determinations:

T A B L E I.

	$d_{4^\circ}^{25^\circ}$
Without any previous treatment	11.324
After treatment at $15^\circ$	11.341
"    "    " $50^\circ$	11.313
"    "    " $25^\circ$	11.328

*B. Measurements with the dilatometer.*

23. This investigation was carried out in the same way as has been described in the case of cadmium<sup>1)</sup>.

Some kilograms of lead were melted in a spoon and poured out into an iron form. The metal cooled in contact with the air. After filing it we treated it with a magnet and put it into the solution of the acetate. Here it remained (at  $15^\circ$ ) for  $15 \times 24$  hours. After this it was washed and dried in the way described above. We used  $\pm 600$  grams in the dilatometer. (Bore of the capillary tube 1 mm.).

<sup>1)</sup> Proceedings 16, 485 (1913); Zeitschr. f. physik. Chemie 87, 409 (1914).

At 50°.8 the *decrease* of the level was 700 mm. (34 hours).

„ 74°.4 „ *rise* „ „ „ „ „ 275 „ (  $2\frac{3}{4}$  „ ).

Whilst the first preparation (§ 20) had shown at 50° a *decrease* of density, we now find an *increase*. From this result we may conclude that there are more than two allotropic forms simultaneously present.

24. Special attention may be paid to a phenomenon which we observed with all our preparations and which stands in close connexion with the fact that lead as it has been known up to the present, forms a metastable system containing simultaneously several allotropic modifications of this metal.

It is generally known that when a bar of any metal which is more electro-negative (resp. electro-positive) than lead is suspended in a solution of a lead salt, the lead is thrown out of solution and a *lead tree* is formed.

We found that the same phenomenon occurred when our pure lead was placed in the solution mentioned above or in a (neutral) solution of lead nitrate (30 grams of nitrate, 70 grams of water). Both at room temperature or at higher temperatures (50°) a lead tree was formed in a few days.

25. We are in the case of lead in specially favourable circumstances for the observation of this phenomenon. The galvanic current which is generated between the stable and metastable modification decomposes the solution. The metal which is electrolytically deposited <sup>1)</sup>, shows in this case a characteristic form (lead tree) so that the phenomenon is very striking <sup>2)</sup>.

26. We hope to report shortly on the different pure modifications of lead and their limits of stability.

*Utrecht*, October 1914.

VAN 'T HOFF-*Laboratory*.

<sup>1)</sup> That the phenomenon is not to be attributed to the presence of iron (0.0006 per cent) or copper (0.001 per cent) is proved by the investigations of OBERBECK [Wied Ann. **31**, 337 (1887)] and by those of KÖNIGSBERGER and MÜLLER [Physik. Zeitschr. **6**, 847 and 849 (1905)].

<sup>2)</sup> We also carried out an experiment with tin: white and grey tin were put in contact in a solution of SnCl<sub>2</sub> (Temp. 15°). After some time a great many beautiful crystals of white tin were deposited by electrolysis upon the white metal. [Comp. ERNST COHEN and E. GOLDSCHMIDT, Zeitschr. für physik. Chemie **50**, 225 (1905)].



**Mathematics.** — “On an integral formula of STIELTJES.” By Prof. J. C. KLUYVER.

(Communicated in the meeting October 31, 1914).

In the Proceedings, and Communications, Physical Section, series 3, 2, 1886, p. 210, STIELTJES treats of definite integrals, referring to the function

$$f(y) = \frac{\sum_{h=1}^{h=a-1} \binom{h}{a} y^h}{1 - y^a} = \sum_{n=1}^{n=\infty} \binom{n}{a} y^n.$$

In this function  $a$  stands for a positive odd integer without quadratic factors, and  $\binom{h}{a}$  represents LEGENDRE'S symbol with the extension given to it by JACOBI.

As poles of the function  $f(y)$  only the points  $y = e^{-\frac{2\pi ik}{a}}$  are to be taken into consideration, and for the residue, belonging to such a pole, one finds

$$-\frac{1}{a} e^{-\frac{2\pi ik}{a}} \sum_{h=1}^{h=a-1} \binom{h}{a} e^{\frac{2\pi i h k}{a}}.$$

From the well-known fundamental equation

$$\sum_{h=1}^{h=a-1} \binom{h}{a} e^{\frac{2\pi i h k}{a}} = i^{\binom{a-1}{2}} \left(\frac{k}{a}\right) \sqrt{a}$$

it follows, that a pole is only to be found in those points  $y = e^{-\frac{2\pi ik}{a}}$ , in which  $k$  is prime to  $a$ . Consequently  $y = 1$  is not a pole of the function, and we have,

$$f(1) = -\frac{1}{a} \sum_{h=1}^{h=a-1} \binom{h}{a} h,$$

from which it follows that  $-af'(1)$  is equal to the sum of the numbers smaller than  $a$ , for which  $\binom{h}{a} = +1$  (residues), diminished with the sum of the numbers smaller than  $a$ , for which  $\binom{h}{a} = -1$  is (non-residues).

In the paper quoted, STIELTJES considers the definite integrals

$$\int_0^{\infty} f(e^{-x}) \sin \frac{atx}{2x} dx \quad \text{and} \quad \int_0^{\infty} f(e^{-x}) \cos \frac{atx}{2x} dx,$$

and he calculates the value of the first integral for the case  $a = 4w + 1$ , the value of the second integral for the case  $a = 4w - 1$ .

In the following I give a shorter deduction for these results.

I suppose that the two positive, otherwise arbitrary numbers  $\beta$  and  $\gamma$  have  $a$  for product, that  $t$  is a positive parameter and now consider the integral

$$I = \int_{-\infty}^{+\infty} f\left(e^{-\frac{2\pi x}{\beta}}\right) e^{2\pi i t x} dx.$$

In order to calculate this integral, it is not necessary, as STIELTJES does, to fall back on an integral formula treated by LEGENDRE and by ABEL. It need only be observed that in the upper half of the complex  $x$ -plane for increasing values of  $|x|$  the modulus of the integrand approaches sufficiently rapidly to zero, to permit us to equate the integral  $I$  to the sum of the residues in this upper half plane, multiplied by  $2\pi i$ .

The poles of the integrand are the poles of  $f\left(e^{-\frac{2\pi x}{\beta}}\right)$ ; that is to say the points  $x = \frac{ki}{\gamma}$  ( $k = 0, 1, 2, \dots$ ), where  $k$  is prime to  $a$ . The residue of such a pole is

$$\frac{1}{2\pi\gamma} e^{-\frac{2\pi kt}{\gamma}} \sum_{h=1}^{h=a-1} \binom{h}{a} e^{-\frac{2\pi i h k}{a}} = \frac{1}{2\pi\gamma} (-i)^{\binom{a-1}{2}} \sqrt{a} \left(\frac{k}{a}\right) e^{-\frac{2\pi kt}{\gamma}},$$

hence

$$I = i \sqrt{\frac{\beta}{\gamma}} (-i)^{\binom{a-1}{2}} \sum_{k=1}^{k=\infty} \left(\frac{k}{a}\right) e^{-\frac{2\pi kt}{\gamma}} = i \sqrt{\frac{\beta}{\gamma}} (-i)^{\binom{a-1}{2}} f\left(e^{-\frac{2\pi t}{\gamma}}\right).$$

We ought to distinguish now between the two cases  $a = 4w + 1$  and  $a = 4w - 1$ .

For  $a = 4w + 1$  we have

$$\binom{h}{a} = + \binom{-h}{a} \text{ and consequently } f\left(e^{-\frac{2\pi x}{\beta}}\right) = -f\left(e^{+\frac{2\pi x}{\beta}}\right),$$

so that it follows from the result found for  $I$ , that

$$\int_0^{\infty} f\left(e^{-\frac{2\pi x}{\beta}}\right) \sin 2\pi t x dx = \frac{1}{2} \sqrt{\frac{\beta}{\gamma}} f\left(e^{-\frac{2\pi t}{\gamma}}\right). \quad (a = 4w + 1) \quad \dots \quad (\text{I})$$

On the other hand for  $a = 4w - 1$

$$\binom{h}{a} = - \binom{-h}{a} \text{ and consequently } f\left(e^{-\frac{2\pi x}{\beta}}\right) = +f\left(e^{+\frac{2\pi x}{\beta}}\right),$$

so that in this case it may be concluded from the integral formula that

$$\int_0^{\alpha} j\left(e^{-\frac{2\pi x}{\beta}}\right) \cos 2\pi t x \, dx = \frac{1}{2} \Gamma\left(\frac{\beta}{\gamma}\right) j\left(e^{-\frac{2\pi t}{\gamma}}\right), \quad (a = 4w - 1) \quad \dots \quad (II)$$

As may be proved the equation (II) remains true if we suppose  $t=0$ , and if the expansion in series

$$j\left(e^{-\frac{2\pi x}{\beta}}\right) = \sum_{m=1}^{m=\infty} \binom{m}{a} e^{-\frac{2\pi m x}{\beta}},$$

is made use of, we get in this exceptional case

$$\sum_{m=1}^{m=\infty} \binom{m}{a} \frac{1}{m} = \frac{\alpha}{\sqrt{a}} j'(1) = -\frac{\alpha}{a\sqrt{a}} \sum_{h=1}^{h=a-1} \binom{h}{a} h. \quad (a = 4w - 1)$$

The results found by STIELTJES have been derived with this, the equations (I) and (II) may now, however, be used, to find other results less known in the theory of numbers.

For real values of  $a$  the function  $j(e^{-\alpha x})$  has the property of approaching rapidly to zero for positive and negative values of  $x$  of increasing modulus. This leads to the conclusion that FOURIER'S general summation-formula

$$\sum_{n=-\infty}^{n=+\infty} F(\xi + n) = \int_{-\infty}^{+\infty} F(y) \, dy + 2 \sum_{n=-\infty}^{n=+\infty} \int_{-1}^{+1} F(y) \cos 2\pi n(y - \xi) \, dy$$

may be applied, if we write

$$F(x) = j\left(e^{-\frac{2\pi x}{\beta}}\right),$$

and if we suppose  $0 < \xi < 1$ .

Distinguishing again the cases  $a = 4w + 1$  and  $a = 4w - 1$ , the value of the integrals in the right-hand member may be determined by means of the equations (I) and (II). It should be taken into consideration in the summations in the left-hand member, that  $j(e^{-\alpha x})$  changes its sign together with  $x$  or not, according as  $a$  is equal to  $4w + 1$  or to  $4w - 1$ .

In this way the two following general equations are derived from the summation formula.

$$\begin{aligned} & j\left(e^{-\frac{2\pi \xi}{\beta}}\right) + \sum_{n=1}^{n=\infty} \left\{ j\left(e^{-\frac{2\pi(n+\xi)}{\beta}}\right) - j\left(e^{-\frac{2\pi(n-\xi)}{\beta}}\right) \right\} = \left\{ \begin{array}{l} \\ \\ \end{array} \right. \quad (III) \\ & = 2 \Gamma\left(\frac{\beta}{\gamma}\right) \sum_{n=1}^{n=\infty} \sin 2\pi n \xi j\left(e^{-\frac{2\pi n}{\gamma}}\right), \quad (a = 4w + 1) \end{aligned}$$

$$\begin{aligned}
 & f\left(e^{-\frac{2\pi\xi}{\beta}}\right) + \sum_{n=1}^{n=\infty} \left\{ f\left(e^{-\frac{2\pi(n+\xi)}{\beta}}\right) + f\left(e^{-\frac{2\pi(n-\xi)}{\beta}}\right) \right\} = \quad \left( \right. \\
 & = \left. \left| \frac{\beta}{\gamma} \right\} f(1) + 2 \sum_{n=1}^{n=\infty} \cos 2\pi n \xi f\left(e^{-\frac{2\pi n}{\gamma}}\right) \right\}, (a=4w-1) \quad \left. \right) \quad (IV)
 \end{aligned}$$

If in both members of these equations the functions  $f$  are expanded into series, the summations indicated are to be executed still further. I shall, however, perform these reductions only for special values of the parameter  $\xi$ , in consequence of which the general results are simplified.

In the equation (III) I substitute therefore  $\xi = \frac{1}{4}$ , at the same time I replace  $\beta$  by  $\frac{\beta}{2}$  and accordingly  $\gamma$  by  $2\gamma$ . I further write

$$e^{-\frac{\pi}{\beta}} = q, \quad e^{-\frac{\pi}{\gamma}} = q'.$$

The numbers  $q$  and  $q'$  are then positive and smaller than 1; they satisfy the relation

$$\log q \times \log q' = \frac{\pi^2}{a},$$

but are for the rest arbitrary.

In this way the equation (III) passes into

$$\sum_{n=0}^{n=\infty} (-1)^n f(q^{2n+1}) = \left| \frac{\beta}{\gamma} \sum_{n=0}^{n=\infty} (-1)^n f(q'^{2n+1}), \right.$$

and if the functions  $f$  are expanded into series, we shall find

$$\left| \log \frac{1}{q} \sum_{m=1}^{m=\infty} \binom{m}{a} \frac{q^m}{1+q^{2m}} = \log \frac{1}{q'} \sum_{m=1}^{m=\infty} \binom{m}{a} \frac{q'^m}{1+q'^{2m}}. (a=4w+1) \right. \quad (V)$$

In the equation (IV) I substitute  $\xi = 0$ . We have then in the first place

$$f(1) + 2 \sum_{n=1}^{n=\infty} f(q^{2n}) = \left| \frac{\beta}{\gamma} \left\{ f(1) + 2 \sum_{n=1}^{n=\infty} f(q'^{2n}) \right\}, \right.$$

and if again use is made of the expansion into series of the functions  $f$  we find

$$\begin{aligned}
 & \left| \log \frac{1}{q} \left\{ f(1) + 2 \sum_{m=1}^{m=\infty} \binom{m}{a} \frac{q^{2m}}{1-q^{2m}} \right\} = \right. \\
 & = \left. \left| \log \frac{1}{q'} \left\{ f(1) + 2 \sum_{m=1}^{m=\infty} \binom{m}{a} \frac{q'^{2m}}{1-q'^{2m}} \right\}. (a=4w-1) \right. \right. \quad (VI)
 \end{aligned}$$

The equations (V) and (VI) completely symmetrical with regard to  $q$  and  $q'$  are again conspicuous for the remarkable properties of

the arithmetical symbol  $\binom{m}{a}$ . For the rest they show some similarity with formulae in the theory of the  $\vartheta$ -functions, and point to a certain connection between the functions  $\vartheta\left(v, \frac{i}{\beta}\right)$  and  $\vartheta\left(v, \frac{i}{\gamma}\right)$ .

So it may be observed, that, from the equation

$$\vartheta_3\left(0, \frac{i}{\beta}\right) \vartheta_4\left(0, \frac{i}{\beta}\right) \frac{\vartheta_3\left(v, \frac{i}{\beta}\right)}{\vartheta_4\left(v, \frac{i}{\beta}\right)} = 1 + 4 \sum_{m=1}^{m=\infty} \frac{q^m}{1+q^{2m}} \cos 2\pi m v$$

in the case  $a = 4w + 1$ , ensues

$$\vartheta_3\left(0, \frac{i}{\beta}\right) \vartheta_4\left(0, \frac{i}{\beta}\right) \sum_{h=1}^{h=a-1} \binom{h}{a} \frac{\vartheta_3\left(\frac{h}{a}, \frac{i}{\beta}\right)}{\vartheta_4\left(\frac{h}{a}, \frac{i}{\beta}\right)} = 4 \sqrt{a} \sum_{m=1}^{m=\infty} \binom{m}{a} \frac{q^m}{1+q^{2m}},$$

and the equation (V) proves that the expression

$$\frac{1}{\sqrt{\beta}} \vartheta_3\left(0, \frac{i}{\beta}\right) \vartheta_4\left(0, \frac{i}{\beta}\right) \sum_{h=1}^{h=a-1} \binom{h}{a} \frac{\vartheta_3\left(\frac{h}{a}, \frac{i}{\beta}\right)}{\vartheta_4\left(\frac{h}{a}, \frac{i}{\beta}\right)} \quad (a = 4w + 1)$$

remains unchanged, if  $\beta$  is replaced by  $\gamma$ .

In a similar way we conclude from

$$\frac{\vartheta_1'\left(v, \frac{i}{\beta}\right)}{\vartheta_1\left(v, \frac{i}{\beta}\right)} = \pi \cot v \pi + 4 \pi \sum_{m=1}^{m=\infty} \frac{q^{2m}}{1-q^{2m}} \sin 2\pi m v$$

for the case  $a = 4w - 1$  to

$$\sum_{h=1}^{h=a-1} \binom{h}{a} \frac{\vartheta_1'\left(\frac{h}{a}, \frac{i}{\beta}\right)}{\vartheta_1\left(\frac{h}{a}, \frac{i}{\beta}\right)} = 2\pi \sqrt{a} \left\{ 2 \sqrt{a} \sum_{h=1}^{h=a-1} \binom{h}{a} \cot \frac{\pi h}{a} + 2 \sum_{m=1}^{m=\infty} \binom{m}{a} \frac{q^{2m}}{1-q^{2m}} \right\}.$$

We can prove now, that

$$\sum_{h=1}^{h=a-1} \binom{h}{a} \cot \frac{\pi h}{a} = 2 \sqrt{a} f(1)$$

consequently it ensues from the equation (VI), that the expression

$$\frac{1}{\sqrt{\beta}} \sum_{h=1}^{h=a-1} \binom{h}{a} \frac{\vartheta_1'\left(\frac{h}{a}, \frac{i}{\beta}\right)}{\vartheta_1\left(\frac{h}{a}, \frac{i}{\beta}\right)} \quad (a = 4w - 1)$$

holds its value, if  $\beta$  is changed into  $\gamma$ .

**Physics.** — “*On unmixing in a binary system for which the three-phase pressure is greater than the sum of the vapour tensions of the two components.*” By Dr. F. E. C. SCHEFFER. (Communicated by Prof. J. D. VAN DER WAALS).

(Communicated in the meeting of Sept. 26, 1914).

1. In my investigation on the system hexane-water the remarkable phenomenon presented itself that the three-phase tension of the two liquid layers by the side of gas appeared to be greater than the sum of the vapour tensions of pure hexane and pure water<sup>1</sup>). When the tensions of the pure substances at a definite temperature are denoted by  $P_1$  and  $P_2$ , the three-phase pressure by  $P$ , then for temperatures which are not too far from the critical end-point

$$P > P_1 + P_2.$$

If we could speak of “partial pressures” for such an equilibrium, this result would be impossible. A proof of this is found in VAN DER WAALS--KOHNSTAMM’s “*Thermodynamik*”, which however is only valid when the gas-laws<sup>2</sup>) hold for the saturate vapours. When the gas-laws do not hold for the gas phases, in other words if the gases possess surface layers, the proof is not valid, and the statement that the three-phase pressure must always be smaller than the sum of the vapour tensions of the components, holds therefore only for rarefied saturate vapours.

In my paper on the system hexane-water I have shown that the contradiction with the second law of thermodynamics, which at first sight may be supposed to exist in the observed phenomenon, is only an apparent one. We might, namely, be inclined to reason as follows: If the three-phase mixture possesses such a high pressure, the pressure exerted by the water and hexane molecules, or at least that of one of them will have to be greater than the pressure of water vapour, resp. hexane vapour over the pure components. If we therefore bring the three-phase mixture by means of a semi-permeable membrane into contact with pure hexane and with pure water under their own vapour pressure, hexane or water will pass through the semi-permeable membranes from the three-phase mixture towards the pure liquid. We should then get splitting up of the three-phase mixture, whereas just on the contrary the so high three-phase pressure sets in of its own accord from pure water and pure hexane. This is in conflict with the second law of thermodynamics.

<sup>1</sup>) These Proc. **16**, 404. (1913).

<sup>2</sup>) *Thermodynamik*. II. S. 476.

I have shown in the cited paper that the conclusion that the three-phase mixture will expel water through a membrane permeable to water, is really correct, and that probably *mutatis mutandis* the opposite thing will apply to hexane. The error in the above reasoning lies therefore only in the very last conclusion. I have pointed out *loc. cit.* that it is, indeed, possible that two liquids, each under its own vapour pressure, mix to a three-phase mixture that possesses the property to get unmixed again into the pure components through semi-permeable membranes; that this is not in contradiction with the second law of thermodynamics, but that on the contrary this phenomenon will be frequently met with in my opinion, also for systems which do not present the special behaviour mentioned at the head of this paper. Thus solutions of gases which are but sparingly soluble in water will certainly expel water, when they are osmotically brought in contact with pure water of the saturate tension. The observed phenomenon is therefore not in conflict with our theoretical considerations.

2. To get an answer to the question whether the system hexane-water presents an exceptional behaviour in the appearance of a three-phase pressure which is greater than the sum of the vapour tensions of the components, I have investigated a number of other systems in the hope of finding the remarkable phenomenon there too. First of all I have chosen the system pentane-water. The pentane which I had at my disposal, was however KAHLBAUM'S "normal pentane", which is no pure normal pentane, but a mixture of normal and isopentane, which can only be separated with great loss of substance and time, as the boiling-points of the two substances lie near room-temperature, and differ only little (slightly more than 8 degrees). This slight difference of boiling-point involves that the pentane mixture behaves pretty well as a pure simple substance: the isothermal pressure ranges for condensation are slight. I have therefore given up the separation of the two pentanes, and compared the vapour tensions of the pentane mixture and of pure water with the three-phase tension of a pentane-water mixture. It is clear that both the pentane mixture and the three-phase mixture must possess a tension dependent on the volume at constant temperature, but also the three-phase tension appeared to be only little dependent on the volume. To execute this comparison of the pressures as exactly as possible I have determined the pressures for final condensation and for about equal volumes of gas and liquids both of the pentane mixture and of the three-phase mixture.

TABLE I.

Pentane mixture.		
Tem- perature.	Pressure (atm.)	
	End- condensation	$V_L = V_G$
151.3	17.65	
151.9		17.8
161.1		20.6
161.45	20.8	
169.95	23.7	
170.1		23.7
180.1		27.6
180.3	27.8	
190.25	32.15	
190.3		32.05
<b>193.3</b>		<b>33.6</b>

TABLE II.

Threephase mixture.		
Tem- perature.	Pressure (atm.)	
	End- condensation	$V_L = V_G$
150.15	22.45	
150.7		22.7
160.6		27.25
160.7	27.35	
166.5		30.3
170.25	32.55	
170.35		32.65
180.3		39.0
180.5	39.25	
<b>187.1</b>		<b>44.1</b>

When the values of pressure and temperature indicated in the above tables are graphically represented, it appears that the line for the end-condensation coincides fairly well with that which holds for equal liquid and vapour volume both for the pentane mixture and for the three-phase mixture; the difference is nearly everywhere smaller than 0.1 atmosphere, and is therefore of about the same value as the errors of observations. When the pressure values are read for definite temperatures from the graphical representation, the values of table 3 are found.

TABLE III.

Temperature	Three-phase pressure	Pentane pressure	Waterpressure	Difference
150	22.4	17.3	4.7	0.4
160	27.0	20.3	6.05	0.65
170	32.4	23.7	7.8	0.9
180	38.8	27.6	9.8	1.4
<b>187.1</b>	<b>44.1</b>	30.7	11.6	1.8



The values for the vapour tension of water have not been derived from earlier observations, but determined by myself to prevent an eventual deviation of the thermometer from vitiating the comparison. All the observations have been carried out with a normal thermometer, and with an Anschützthermometer verified by the boiling point of pure aniline.

We draw the conclusion from the last column of table 3 that the three-phase tension is again greater than the sum of the vapour tensions of the pentane mixture and of pure water. The difference appears again to be greatest at the critical endpoint — in all the tables the critical values are printed in bold type —; with decrease of temperature the difference decreases rapidly, and according to the theory it must reverse its sign at temperatures where the saturate vapours follow the gas laws.

The above described example shows therefore again a case of very high three-phase pressure. Though these experiments would have to be repeated with the pure substances to get perfect certainty about the behaviour of the binary systems, the conclusion that the pentanes and hexane behave analogously with respect to water, seems yet sufficiently certain to me. Also the relative situation of the critical end point with respect to the critical points of the components is the same as for the hexane-water mixtures.

Finally I will still point out that the above only proves that there exists a pentane-water mixture that possesses the repeatedly mentioned remarkable property, and this suffices also for my purpose; other proportions of pentane mixture and water will probably give rise to some change in the three-phase tensions because the pentane mixture is not a simple substance; for the solubilities of the two pentanes in water will probably not be in the same proportion as the quantities of the pentanes in the pentane mixture; the difference in the fifth column can therefore undergo some modification for another ratio of the two "components".

§ 3. The experiments of § 2 confirming my supposition that the abnormal value of the three-phase pressure would be a phenomenon of frequent occurrence, I thought I had a great chance to find the same peculiarity also for other binary systems. I have therefore looked for binary systems of which it was known that for low temperatures the three-phase pressure lies higher than the vapour tensions of the pure components separately and is about equal to the sum. Dr. BÜCHNER drew my attention to the systems carbon tetrachloride-water and benzene-water, which possess three-phase

tensions according to REGNAULT, which deviate little from the sum of the vapour tensions of the pure substances. REGNAULT even asserted that the tension of carbon tetrachloride-water mixtures is somewhat higher than the sum, and thought he had to ascribe this to slight contaminations; GERNEZ has shown later that the three-phase tension is really slightly smaller than the sum of the vapour tensions, which is therefore in harmony with the theory. I have now tried to investigate the two systems at higher pressure; I have, however, not succeeded in doing so with the system carbontetrachloride-water, as the components act on each other at higher temperatures. The investigation is possible for the system benzene-water, and also this system appeared really to furnish an example of the remarkable phenomenon.

Benzene free from thiophene (negative isatine reaction) was distilled from phosphorus pentoxide; the boiling point under normal pressure was 80°.2, and was therefore in perfect concordance with the value given by YOUNG. The vapour tension line of this benzene was determined, and then the three-phase tensions of a benzene-water mixture were measured and compared with the vapour pressure line of water, which was also determined by the aid of the same thermometers. To avoid corrections I have measured the three pressure values

T A B L E IV.

Temperature	Three-phase pressure	Waterpressure	Benzene pressure	Difference
150.0	10.6	4.7	5.9	0
160.0	13.2	6.05	7.1	0.05
170.0	16.4	7.8	8.5	0.
180.0	20.1	9.8	10.2	0.1
190.0	24.6	12.35	12.15	0.1
200.0	29.8	15.3	14.3	0.2
210.0	35.9	18.75	16.7	0.45
220.0	42.9	22.8	19.45	0.65
230.0	50.9	27.5	22.5	0.9
240.1	60.35	33.0	25.95	1.4
250.2	70.65	39.1	29.55	2.0
260.1	82.15	46.1	33.7	2.35
<b>267.8</b>	<b>92.7</b>	calc.(52.4)	calc.(37.35)	2.95
268.2	—	52.6	37.5	—

always at the same temperatures; if a slight error should occur in the absolute value of the given temperatures, this has no influence on the pressure differences. The thermometers which I used in this investigation, have been tested by a resistance thermometer, the resistance of which was determined for boiling water, naphthaline, benzophenon, and sulphur. The obtained results are given in table 4, the pressures are given in atmospheres.

It appears from the last column of table 4 that the difference at  $150^{\circ}$  to  $200^{\circ}$  is only slightly greater than the errors of observation, that the three-phase tension becomes appreciably greater than the sum of the vapour tensions at  $210^{\circ}$ , and that this difference rapidly increases with ascending temperature.

4. When we combine the results of the system hexane-water and those of § 2 and 3, it appears that in the three systems the three-phase tension is always greater than the sum of the vapour tensions of the components in the neighbourhood of the critical endpoint. Moreover these three systems present the same shape of the plaitpointline in the  $T$ - $x$ -projection; the upper critical endpoint always lies lower than the critical points of the two components; the plaitpoint line presents therefore a minimum temperature in the  $T$ - $x$ -projection (homogeneous double plaitpoint). Though in my opinion it is probable that the systems will behave perfectly analogously, a further investigation would have to decide whether for all this homogeneous double plaitpoint lies in the metastable region; I have shown this for the system hexane-water in my cited paper. It is remarkable that in the system ether-water the homogeneous double plaitpoint appears in the immediate neighbourhood of the ether axis or would perhaps lie outside the figure, so that the critical endpoint in contrast with the above discussed systems lies between the critical points of the components. In this system the said peculiarity does not occur. Accordingly I think I have to conclude that the systems which present critical endpoints which lie lower than the critical temperatures of the two components possess three-phase pressures which are higher at high temperatures than the sum of the vapour tensions of the pure substances, whereas the opposite is the case for systems for which the critical endpoint lies between the critical temperatures of the components. Perhaps this conclusion may contribute to account for this remarkable phenomenon.

June 25, 1914.

*Anorg. Chem. Laboratory of the  
University of Amsterdam.*

**Physics.** — “*Contribution to the theory of corresponding states.*”

By Mrs. T. EHRENFEST-AFANASSJEWA, D. Sc. (Communicated by Prof. H. A. LORENTZ).

(Communicated in the meeting of September 26, 1914).

§ 1. MESLIN<sup>1)</sup> has tried to demonstrate that every equation of state which contains the same number of material constants as variables, is to be reduced to a universal shape (i. e. to such a form that no parameters occur any more which vary with the substance), if the variables are replaced by their relations to suitable special values, which may be designated as “corresponding” for different substances.

On closer investigation it appears, however, that the equality of the number of the parameters and that of the variables is neither necessary nor sufficient for the existence of corresponding states.

A method will be given here to decide whether a given equation allows the existence of corresponding states. This method furnishes at the same time the possibility to calculate the eventually corresponding values of the variables for different substances.

§ 2. In the first place we shall define the term “corresponding states” in a somewhat more general form. Let an equation be given between a system of  $n$  variables:  $x_1, x_2, \dots, x_n$  and a number  $m$  of such parameters:  $C_1, C_2, \dots, C_m$  that they can vary with change of definite circumstances (*for example* of the substance).

Let an *arbitrary* system of special values:  $x_1', x_2', \dots, x_n'$  (we shall briefly denote it by  $x_i'$ ) of the variables  $x_i$  be known, which satisfies this equation for definite special values  $C_i'$  of the parameters  $C_i$ .

Let us introduce the following new variables:

$$y_1 = \frac{x_1}{x_1'}, \quad y_2 = \frac{x_2}{x_2'}, \quad \dots \quad y_n = \frac{x_n}{x_n'} \quad \cdot \quad \cdot \quad \cdot \quad (1)$$

All the constants  $S_j$  of the thus transformed equation can be calculated as functions of the former constant coefficients, of the values  $C_i'$  and of the values  $x_i'$ .

When the parameters  $C_i$  assume other special values  $C_i''$ , other systems of special values of the variables will satisfy the original equation.

The case may occur that there is among them such a system of values:

<sup>1)</sup> MESLIN: Sur l'équation de VAN DER WAALS et la démonstration du théorème des états correspondants C.R. 1893, p. 135.

$$x_1'', x_2'', \dots, x_n''$$

that on the substitution of

$$y_i = \frac{x_i}{x_i''} \dots \dots \dots (2)$$

for  $x_i$ , the constants of the transformed equation assume exactly the same numerical values  $S_j$  as in the first case. We call *such values*  $x_1'', x_2'', \dots, x_n''$  *correspondent to the values*  $x_1', x_2', \dots, x_n'$ , and the *state* defined by the values  $x_i''$ , *correspondent to that* defined by the values  $x_i$  (or *corresponding to it*).

The form to which the given equation is reduced in this case by the substitution  $y_i = \frac{x_i}{x_i''}$ , resp.  $y_i = \frac{x_i}{x_i''}$ , will be indicated by the word *universal*.

§ 3. When for the system  $x_i'$  the system  $x_i''$  corresponding to it has been given, the system  $x_{i1}''$  can be easily calculated, which corresponds with every other system  $x_{i1}'$  of  $x_i$  values, which satisfies the equation in the first case, by the aid of the following equations:

$$\frac{x_i'}{x_{i1}'} = \frac{x_i''}{x_{i1}''}$$

Indeed the values  $x_i'$  resp.  $x_i''$  satisfy the original equation, when the parameters  $C_i$  assume in it the values  $C_i'$  resp.  $C_i''$ . When now the substitution

$$y_i = \frac{x_i}{x_{i1}'} \dots \dots \dots (3)$$

has been carried out, the constants  $S_i$  which we have calculated, assume other values, e. g.  $S_{i1}$ , and we must now find the values  $x_{i1}''$ , which keep the quantities  $S_{i1}$  invariant on substitution of  $C_i''$  for  $C_i'$ , when the substitution:

$$y_i = \frac{x_i}{x_{i1}''} \dots \dots \dots (4)$$

is carried out.

The values  $x_i'$ , however, satisfying the given equation,

$$y_{i1}' = \frac{x_i'}{x_{i1}'}$$

satisfy the transformed equation. The constants of the transformed equation do not change, when

$$\frac{x_i''}{x_{i1}''} = \frac{x_i'}{x_{i1}'}$$

is substituted for  $y_{i1}'$ .

The fraction:

$$\frac{x_i''}{x_{i1}''} = \frac{x_i'}{x_{i1}'}$$

belongs therefore to the corresponding values  $x_i''$ , hence  $x_{i1}'$  corresponds to  $x_{i1}''$ .

Hence it is proved that *in the case of a system of values corresponding to a system of solutions, there also exists a system corresponding to every other system of solutions* (when  $C_i'$  have been replaced by  $C_i''$ ).

§ 4. To find a system  $x_i''$ , if the system  $x_i'$  has been given, we take into account every product of powers of the variables:

$$P_i = x_1^{\alpha_{i1}} x_2^{\alpha_{i2}} \dots x_n^{\alpha_{in}} \dots \dots \dots (6)$$

which appears as separate argument in the given equation. We shall therefore write the given equation as follows:

$$\Phi(K_1 P_1, K_2 P_2, \dots K_k P_k; L_1, L_2, \dots L_l) = 0 \dots \dots (7)$$

$K_i$  and  $L_i$  are constants with relation to  $x_i$ ,  $L_i$  are those constants which do not occur as *factor of*  $P_i$ , but *in any other way*. Among the  $K_i$  and  $L_i$  are therefore also included the variable parameters (for their functions).

Let us put that the constants  $K_i, L_i$  in the first, resp. second case have the special values:

$$K_i', L_i', \text{ resp. } K_i'', L_i''$$

(those among them which are independent of  $C_i$ , have the same values in both cases); they are to be considered as *given*. We can write every variable also in the following way:

$$x_i = x_i' \frac{x_i''}{x_i'} = x_i' y_i.$$

If we put them in this form in the equation (7), it assumes the following form:

$$\Phi(Q_1' P_1(y), \dots Q_k' P_k(y); L_1', \dots L_l') = 0 \dots \dots (8)$$

in which

$$Q_i' = K_i' P_i' \dots \dots \dots (9)$$

$$P_i' = x_1^{\alpha_{i1}} x_2^{\alpha_{i2}} \dots x_n^{\alpha_{in}} \dots \dots \dots (10)$$

$$P_i(y) = y_1^{\alpha_{i1}} y_2^{\alpha_{i2}} \dots y_n^{\alpha_{in}} \dots \dots \dots (11)$$

Now it is evidently the question to find such values  $x_i''$  that when  $C_i'$  is replaced by  $C_i''$  and  $x_i'$  by  $x_i''$ , all the constants  $Q_i$  and  $L_i$  — eventually with the exception of one factor, by which all the terms of the equation can be divided — assume the same values.

When we carry out this division — let the factor in question be  $R$  (it can be both one of the  $Q_i$  and one of the  $L_i$ ) in all  $k+l-1$  constants remain, which can have four different forms:

$$Q_j, \frac{Q_j}{R}; L_h, \frac{L_j}{R}.$$

The required  $x_i''$  must now satisfy the following equations:

$$\left. \begin{aligned} Q_f' &= Q_f'' \\ Q_i' &= Q_i'' \\ R' &= R'' \end{aligned} \right\} \dots \dots \dots (12)$$

$$\left. \begin{aligned} L_j' &= L_j'' \\ R' &= R'' \end{aligned} \right\}$$

and besides the following equations must hold:

$$L_h' = L_h'' \dots \dots \dots (13)$$

The number of equations (12), in which  $x_i''$  occurs, is quite independent of the number of  $m$  of the variable parameters  $C_i$ .

When all equations (13) are satisfied, and all those among the equations (12) which do not contain  $x_i''$ , the three following cases can occur.

1. Equations (12) are in conflict with each other (a group of  $s$  of the sought values is defined by more than  $s$  independent equations.
2. They have *one*, or a *finite number* of systems of solutions. (It is required, though not sufficient for this that the number of independent equations in which  $x_i''$  occurs, is equal to  $n$ . Hence  $m$  must not be greater than  $n$ ).

Which of the systems of solutions corresponds with the given system  $x_i'$ , has to be decided by a further investigation in every separate case.

*This is the case in which we have corresponding states.*

3. They have an infinite number of systems of solutions. (It is required for this that  $n$  is greater than the number of the equations that are mutually independent). In this case we may speak of corresponding states for the same conditions (e. g. for the same substance).

§ 5. We shall now examine how MESLIN has come to another conclusion. MESLIN starts from the conviction that all the constants of an equation are independent of the choice of the unities, when every variable in the equation has been divided by a special value of it. This is perfectly correct. It is also true, as we have seen, that every equation can be reduced to a form as meant here.

*It is however not true that those constants that do not change through exchange of the unities, would also have to be univ. sal.*

MESLIN seems to be not quite free from a confusion, which is indeed pretty widely spread: between the change of a number occurring in an equation *through change of unities*, (“formal” change) and its change *through transition to other conditions* (to other specimens of the quantities which are measured by this number) (“material” change).

In connection with this the assertion that in case of an equal number of variables and parameters the latter can always be completely expressed in the former, is to be rejected.

§ 6. We shall illustrate what we have discussed by examples, which though fictitious, are as simple as possible. Their claim to physical signification, can indeed always be vindicated in this way that they are interpreted as equations for the geometric shape of some physical system.

$$1. \quad y = ax^2 + x + b \quad (n = 2, \quad m = 2).$$

a. Introduction of special values of the variables

$$y_0 \frac{y}{y_0} = ax_0^2 \left( \frac{x}{x_0} \right)^2 + x_0 \frac{x}{x_0} + b$$

b. Division by  $(Q_1 = y_0$ :

$$\frac{y}{y_0} = a \frac{x_0^2}{y_0} \left( \frac{x}{x_0} \right)^2 + \frac{x_0}{y_0} \frac{x}{x_0} + \frac{b}{y_0}$$

c. Determination of the numerical values of the special values of the variables satisfying the equation and of the coefficients:

$$x_0 = -\frac{1}{a}, \quad y_0 = b$$

$$\frac{ax_0^2}{y_0} = \frac{1}{ab}$$

$$\frac{x_0}{y_0} = -\frac{1}{ab}$$

$$\frac{b}{y_0} = 1.$$

d. Determination of the system of corresponding values:

$$\left. \begin{array}{l} \frac{a'x_0'^2}{y_0'} = \frac{1}{ab} \\ x_0' = -\frac{1}{ab} \\ \frac{b'}{y_0'} = 1 \end{array} \right\} \begin{array}{l} y_0 = b' \\ x_0' = -\frac{b'}{ab} \\ \frac{a'x_0'^2}{y_0'} = \frac{a'b'}{a^2b^2} = \frac{1}{ab}, \end{array}$$



from which would follow that  $a'b' = ab$ , which would be possible only when we have really but one independent parameter.

It follows, however, from the thesis of § 3 that if for *one* system of solutions there is not to be found a corresponding one, there does not exist one for any other system of solutions.

Hence the given equation cannot be reduced to a universal form.

$$2. \quad y = a^2x^2 + abx + b^2 \quad (n = 2, \quad m = 2)$$

$$a. \quad y_0 \frac{y}{y_0} = a^2x_0^2 \left( \frac{x}{x_0} \right)^2 + abx_0 \frac{x}{x_0} + b^2$$

$$b. \quad \frac{y}{y_0} = \frac{a^2x_0^2}{y_0} \left( \frac{x}{x_0} \right)^2 + \frac{abx_0}{y_0} \frac{x}{x_0} + \frac{b^2}{y_0}$$

$$c. \quad y_0 = -b^2 \quad ; \quad x_0 = \frac{-b}{a}$$

$$\frac{a^2x_0^2}{y_0} = 1 \quad ; \quad ab \frac{x_0}{y_0} = 1 \quad ; \quad \frac{b^2}{y_0} = -1$$

$$d. \quad y_0' = -b^2 \quad ; \quad x_0' = -\frac{b'}{a'}$$

$$3. \quad y = ax^2 + x \quad (n = 2, \quad m = 1)$$

$$a. \quad y_0 \frac{y}{y_0} = ax_0^2 \left( \frac{x}{x_0} \right)^2 + x_0 \frac{x}{x_0}$$

$$b. \quad \frac{y}{y_0} = \frac{ax_0^2}{y_0} \left( \frac{x}{x_0} \right)^2 + \frac{x_0}{y_0} \frac{x}{x_0}$$

$$c. \quad x_0 = \frac{1}{a} \quad ; \quad y_0 = \frac{2}{a}$$

$$\frac{ax_0^2}{y_0} = \frac{1}{2} \quad ; \quad \frac{x_0}{y_0} = \frac{1}{2}$$

$$d. \quad x_0' = \frac{1}{a'} \quad ; \quad y_0' = \frac{2}{a'}$$

$$4^1). \quad pv = A + BT + CT^2 \quad (n = 3, \quad m = 3)$$

$$a. \quad p_0v_0 \frac{p}{p_0} \frac{v}{v_0} = A + BT_0 \frac{T}{T_0} + CT_0^2 \left( \frac{T}{T_0} \right)^2$$

$$d. \quad p_0v_0 = p_0'v_0' \quad ; \quad A = A' \quad ; \quad BT_0 = B'T_0' \quad ; \quad CT_0^2 = C'T_0'^2.$$

As  $\frac{B}{B'}$  is independent of  $\frac{C}{C'} T_0'^2$ , the two last comparisons are contradictory, so that even if  $A = A'$ , we should not have corresponding states.

*Leiden, August 1914.*

<sup>1)</sup> This example fails in the Dutch text.

**Chemistry.** - "*The nitration of the mixed dihalogen benzenes*".

By Prof. A. F. HOLLEMAN.

(Communicated in the meeting of Oct. 31, 1914).

When in benzene are present two substituents and a third is introduced, the substitution velocity caused by the two groups already present is unequal. From the *data* given in the literature it may be deduced that those velocities for the substituents pointing to the p-o-positions decrease in the subjoined order:

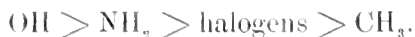

The question now arose how to express those velocities also in figures.

Dr. WIBAUT has done this for chlorine and methyl by determining in what proportion the isomerides are formed in the nitration of o-chlorotoluene. In this compound the positions 4 and 6 are occupied, under the influence of methyl, by a nitro-group, the positions 3 and

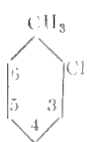

5 under the influence of chlorine. If now we determine the proportion in which the mononitro-chlorotoluenes 4 + 6 are present in regard to the isomerides 3 + 5 in the nitration product, this is then also the proportion of the substitution velocities caused by methyl and chlorine, because they can exert their action in this o-chlorotoluene independently of each other; for the positions which are substituted under the influence of methyl are different from those that are substituted under the influence of chlorine. For this proportion was found  $\text{CH}_3 : \text{Cl} = 1 : 1.475$ .

Dr. VAN DEN AREND had previously determined the proportion in which the nitro-p-chlorotoluenes are formed in the nitration of p-chlorotoluene. If now, with the above mentioned ratio, we calculate the relative quantities, those calculated figures appear to agree approximately with the observed ones.

These researches, carried out in my laboratory, have now been continued, partly by Dr. HEINEKEN, so as to determine also the ratios of the halogens. The method followed previously for the quantitative determination of the isomerides, namely by means of the solidification curves, could, however, not be applied here as the two nitro-p-chlorobromobenzenes give a continuous series of mixed crystals and because it was to be expected, on account of the fact that the properties of the nitrodihalogen benzenes present a strong mutual resemblance, that this would occur in other cases also.

Hence, for the quantitative determination of the isomerides present in the nitration mixtures, we made use of the property that a halogen in nitrohalogen benzenes is taken from the nucleus by Na-methoxide

only then when it is placed in the ortho- or the paraposition in regard to a nitro-group. Of the isomerides

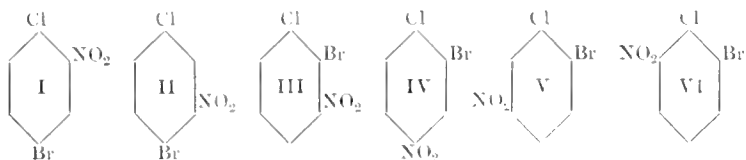

I, IV and VI only chlorine, of II, III and V only bromine will be replaced by  $\text{OCH}_3$ . Hence, if we determine the proportion in which chlorine and bromine are split off from the nitration product of *p*-chlorobromobenzene and from that of *o*-chlorobromobenzene, we get at once the proportion wherein in the first nitration product I and II are present in the second one IV + VI on one side, III + V on the other side. This method has also the considerable advantage that all the isomerides for the construction of the fusion lines now need not be prepared individually and that in the nitration products the various isomerides need not be separated; this latter attempt in particular would, presumably, have failed owing to insuperable obstacles.

The results obtained are as follows:

Nitrationproduct of *p*-chlorobromobenzene contains 45.2% of the

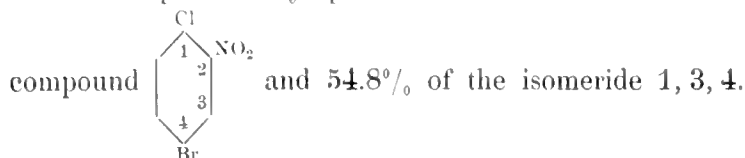

Nitr. product of *o*-chlorobenzene consists of 55.5% of +

and of 44.5% of + ; or in molecular proportion 1 : 0.80.

The substitution velocity caused by chlorine and bromine when present together in the benzene nucleus is therefore as 1 : 0.80. When calculating this proportion from the composition of the nitration product of *p*-chlorobromobenzene it must be remembered that in the nitration of chlorobenzene there is formed 30.1% of the *o*-compound, but in that of the bromobenzene 38.3% of the same. If we call  $x$  the ratio of the velocities caused by chlorine and bromine we have

$$30.1 : 38.3x = 45.2 : 54.8,$$

from which  $x = 0.96$ . Hence, the result is here  $\text{Cl} : \text{Br} = 1 : 0.96$ . The mean result of these two experimental series is therefore:  $\text{Cl} : \text{Br} = 1 : 0.88$ .

The nitration of *p*-chloriodobenzene caused the separation of large quantities of iodine with formation of *p*-chloronitrobenzene. Hence, for my purpose it was unsuitable.

In the nitration of *o*-chloriodobenzene, there was also some separation of iodine, but the formation of *o*-chloronitrobenzene did not amount to more than about 3%. When determining the proportion in which Cl and I were separated from the nitration product by  $\text{NaOCH}_3$  a correction for this must therefore, be applied. For the velocity ratio  $\text{Cl} : \text{I}$  was thus found the mean value of  $1 : 1.84$ .

It now became interesting to also investigate the nitration product of *o*-bromiodobenzene quantitatively as to its components. For, as  $\text{Cl} : \text{Br}$  was found  $= 1 : 0.80$  and  $\text{Cl} : \text{I} = 1 : 1.84$ ,  $\text{Br} : \text{I}$  should be  $= 1 : 2.30$ , if indeed the two halogens present, act quite independently of each other.

Also in this nitration a little separation of iodine took place; the content of *o*-bromonitrobenzene in the nitration product was in this case 4.4%. Applying a correction for this the mean ratio  $\text{Br} : \text{I} = 1 : 1.75$  was found, which rather differs from the calculated figure. If, however, we calculate the percentages of the isomerides with the ratios 1.75 and 2.30 the theoretical value gives 69.7% of the isomerides  $\text{Br}, 1, \text{NO}_2 = 1, 2, 3 + 1, 2, 5$ , and the experimental value 63.6%, which may be considered as a sufficient approximation if we bear in mind the difficulties of these quantitative determinations.

The conclusions from the above are obvious. Since it has appeared that two substituents simultaneously present in ortho- and in parapositions do not sensibly interfere with their respective actions in regard to a third entering group, we shall be able to *calculate* from the figures now found with sufficient probability in what proportion are formed the isomerides of other compounds, for instance in the nitration of *o*- and of *p*-bromotoluene.

The above mentioned order of the substituents towards the decreasing substitution velocity caused by the same now becomes:



Hence, the ratio  $\text{OH} : \text{NH}_2$  and  $\text{NH}_2 : \text{I}$  still remains to be determined. As, however, in the nitration of the iodoanilines great difficulties may be expected, A. F. H. LOBRY DE BRUYN has taken in hand a quantitative research of the nitration of *o*- and *p*-chloroaniline in the above direction. As a preliminary result of his experi-

ments it may be mentioned that the ratio Cl:NH<sub>2</sub> is very large. The above velocity series must, therefore, be resolved into two parts: OH and NH<sub>2</sub> which cause a great substitution velocity and which are presumably of the same order of magnitude; on the other side the halogens and CH<sub>3</sub> with a lesser velocity, also of the same order of magnitude. A more detailed description of the above experiments will be published in the *Recueil*.

Oct. '14.

*Org. Chem. Lab. University Amsterdam.*

**Physics.** — “*The reduction of aromatic ketones. III. Contribution to the knowledge of the photochemical phenomena.*” By Prof. J. BÖESEKEN and Mr. W. D. COHEN. (Communicated by Prof. A. F. HOLLEMAN).

(Communicated in the meeting of October 31, 1914).

I. *The reduction of the aromatic ketones in a perfectly neutral medium.*

In our former communications<sup>1)</sup> we have shown that the reduction of the aromatic ketones does not proceed any further than to pinacone, which is presumably formed from the primary generated half pinacone molecule by rapid polymerisation. The fact that in an alkaline medium hydrol is always obtained, must be attributed to the rapid transformation of the pinacone, under the influence of the hydroxylions, into an equimolecular mixture of hydrol and ketone, the latter of which can be again reduced to pinacone.

This explanation was confirmed by the study of the reduction of ketones by means of aluminium amalgam.

Here is formed a mixture of pinacone and hydrol; the proportion in which these two substances are formed differs from ketone to ketone and now it appeared that the quantities of hydrol ran strictly parallel to the velocities with which the diverse pinacones are converted into a mixture of ketone and hydrol under the influence of sodium ethoxide.

Hence, aluminium amalgam in 80% alcohol may by no means be considered as a neutral reducing agent.

The only *modus operandi* that gives the necessary guarantee that complete neutrality would prevail during and after the reduction is the action of the aromatic ketone on an alcohol under the cooperation of sunlight. The original intention of this part of the research,

<sup>1)</sup> Proc. XVI p. 91 and 962 (1913).

namely the tracing of the progressive change of the reduction, was soon attained by applying this method.

A series of ketones dissolved in a great variety of alcohols and a few other substances, was exposed to sunlight (or to the light of the quartz-lamp); *in all cases where reduction set in, not a trace of hydrol was obtained.*

The ketone was usually quantitatively converted into pinacone; occasionally, namely with benzylalcohol and a prolonged exposure to sunlight a combination of the half pinacone molecule with a group of the benzylalcohol, namely triphenylglycol was obtained as a by-product.<sup>1)</sup>

When to the alcohol some ethoxide was added hydrol was formed, as was to be fully expected.

**Hence, we arrive at the result that in the reduction of aromatic ketones the hydrogen unites exclusively with the oxygen.**

The experiments were carried out as follows:

Quantities of 5 grams of the ketone were dissolved in 50 cc of alcohol rendered carefully anhydrous<sup>2)</sup> and exposed in sealed tubes of common glass to direct sunlight.

The drying of the lower terms was performed by successively boiling with CaO, allowing to remain over metallic calcium at 0°, and distilling; the higher ones were purified by distillation and both were then immediately sealed into the tube together with the ketone. After exposure to the light for some time, during which the course of the reduction could be traced by noticing the deposition of the sparingly soluble pinacone, the tube was opened, the pinacone was filtered off, the filtrate distilled, the residue united with the pinacone and in the distillate the aldehyde or ketone was tested and in some cases determined quantitatively.

The exact details will be published elsewhere by one of us, a few remarks may suffice here.

First of all was investigated the behaviour of benzophenone in regard to methyl, ethyl, *n*-propyl, *sec*-propyl, *iso*-butyl, *n*-heptyl, *sec*-octyl and cetylalcohol. The latter only was not attacked, not

<sup>1)</sup> This had already been noticed by CIAMICIAN and SILBER (B. 36, 1577 (1903)); the formation thereof is moreover a confirmation of our conception that as the first reaction product the half pinacone molecule is formed.

<sup>2)</sup> Water acts in this reaction in a remarkable manner as a powerful negative catalyst; in 80% alcohol no reduction takes place after exposure for months, whereas in absolute alcohol in the same conditions, about two grams of pinacone are formed during ten hours' action of sun-light.

even at higher temperatures; the mixture however, was of a fairly strong yellow colour.

The other alcohols reduced the benzophenone in some sunny spring days, with the exception of methylalcohol which required a much longer time.

The research was then continued with allylalcohol, geraniol, *cyclohexanol*, benzylalcohol, phenylmethylalcohol, benzhydrol and cinna-myralcohol. Of these, the saturated alcohols reduced rapidly and quantitatively; the allylalcohol was attacked more slowly with formation of acetaldehyde (even after two months' exposure to light, the acetaldehyde was unchanged, thus showing that the light alone does not exert a polymerising influence on this mobile substance).

The geraniol was also oxidized very slowly, the cinna-myralcohol remained unaffected (we will refer to this behaviour later).

A few tertiary alcohols were also investigated; it was expected that these would remain unaffected and indeed this was the case with the dimethylethylcarbinol after two months' exposure; during that period, diaethylmethylecarbinol had generated 0,3 gram of pinacone; with methyl-di-n-propylecarbinol the separation of pinacone started after a few days and after two months 0.7 gram had formed.

From this we notice that when the chain becomes longer, the activity of the hydrogen of tertiary alcohols gets enhanced, which enables it, with the cooperation of sun-light, to attack an aromatic ketone; what gets formed from the alcohol has not been investigated by us.

From observations of CIAMICIA and SILBER<sup>1)</sup> it is known that the hydrogen of some hydrocarbons, such as toluene, is already active enough to cause this reduction. We have been able to show that also the hydrogen of the *cyclohexane* is transferred to the ketone, on the other hand, hydrogen itself was not capable of acting.

Besides benzophenone some other ketones — particularly those that were previously subjected by us to the action of aluminium amalgam — were subsequently exposed in alcoholic solution to the light.

Nothing but pinacone was ever obtained, but the phenomena occurring in these photo-reactions induced us to systematically repeat a large part of these purely qualitative observations in such a manner that on using a very simple *modus operandi* a relatively-quantitative result was still obtained.

<sup>1)</sup> B. 43. 1537 (1910).

## II. *The photo-reaction: ketone + hydrogen<sup>1</sup> = pinacone.*

In order to obtain a relatively-quantitative result we could make use of a constant source of light and allow this to act on the different solutions under the same conditions; for this purpose a small 7 cm. quartz-mercury lamp was at our disposal. Yet we have employed this method but rarely, for instance in continuous dark weather, because on account of the unequal distribution of the light, at most two little tubes could be placed in front of the lamp in such a manner that it might be assumed that they existed under equal conditions.

When it had been ascertained by us that the réduction took place quite as well in ordinary white glass as in quartz, from which it appeared that a very large part of the actinic rays was situated in the visible spectrum, the experiments intended for comparison were carried out as follows:

A number of equally wide tubes of the same kind of glass and having walls of approximately the same thickness were filled with the same quantity of solution, and all placed at the same distance in front of a white screen, which was placed close to a large laboratory window.

In this manner it was attained that the quantity of light that fell in the same time on each solution was practically the same, and perfectly comparable results were thus obtained.

It speaks for itself that even then only the figures of a same experimental series were mutually comparable.<sup>1)</sup>

A photo-reaction is distinguished from a reaction in the dark by two points.

It is of a lower and frequently of the 0 order in regard to the substance which is being activated and the temperature coefficient is small.<sup>2)</sup>

As we found that the active light was situated in the visible spectrum and that the alcohols do not absorb visible rays, the ketones are in this reaction the sensitive substances, and so we could expect that the quantities of pinacone would be independent of the

<sup>1)</sup> Also comp. O. GROSS *Z. phys. Ch.* **37**, 168 (1901) and E. GOLDBERG *Z. phys. Ch.* **41**, 1 (1902).

<sup>2)</sup> The first property is due to the activation occurring in the outer layer; from the sensitive substance only a limited number of molecules can be raised by the same quantity of light to the same degree of activity; even at a moderate dilution, the reaction becomes, on this account, independent of the concentration of the sensitive substance and therefore of the 0 order. This applies to slowly progressing reactions where the sensitive substance can be rapidly supplied by diffusion from the dark interior to the light zone.



ketone concentration (in regard to the sensitive substance a reaction of the 0 order).

By selecting the alcohol itself as a solvent the change in concentration thereof could be eliminated. (Table I).

In order to determine the order of the reaction in regard to the alcohol, benzene was chosen as being a general, non-absorbing and non-reducing solvent. (Table Ia) (Chronologically these last experiments were made after the position of the active light in the spectrum had been ascertained; we, however, state them here because they enabled us to give a complete image of the course of the reaction.)

We notice that this reaction is indeed independent of the concentration of the ketone, but not independent, however, of the concentration of the alcohol. As the quantities thereof had been chosen in such a manner that they were amply sufficient even at the slightest concentration, it follows from the figures obtained that the velocity of the pinacone formation is proportional to the concentration of the alcohol.<sup>1)</sup>

Thus we may represent the reaction by the kinetic equation:

$$\frac{d(\text{pinacone})}{dt} = K L. [\text{Alcoh.}]$$

With a constant light-quantity, the velocity of the pinacone formation thus becomes proportional to the alcohol concentration: how many molecules of the ketone act simultaneously cannot be ascertained in this manner. As, however, pinacone and aldehyde are formed and as according to the above equation one molecule of alcohol is attacked simultaneously, the reaction scheme becomes:

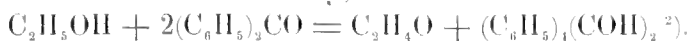

In order to learn the temperature coefficient the ordinary tubes (16 mm. diameter) were enclosed and sealed into a second tube (24 mm. internal diameter): the intervening space was filled with conductivity water and now two of these tubes were exposed to light as described, one of them being kept at 25°—28° and the other at 75°<sub>±</sub>—78°<sup>3)</sup>.

<sup>1)</sup> Here we have assumed that the change in concentration of the alcohol during each of the four experiments was so slight that it could be regarded as being constant; this, of course, is not correct and we really ought to have taken each time a portion from larger apparatus. In that case, however, the experiments would become much more complicated, because the light-quantity did not then remain constant during the experiment. Hence, we have rested content with the above *modus operandi* which is sufficiently accurate for our purpose.

<sup>2)</sup> For a mixture of ketone and benzhydrele we have proved this reaction scheme yet in another manner (see next communication).

<sup>3)</sup> Compare R. LUTHER and F. WEIGERT, Z. phys. Ch. 53, 400 (1905).

T A B L E I.

N <sup>o</sup> .	Concentration of the ketone in 25 cc. alcohol	Quantity of pinacone	Remarks
1st Series			
1	0.1 gr. benzophenone	0.09 gr.	} entirely converted
2	0.25 " "	0.23 "	
3	0.50 " "	0.34 "	
4	0.75 " "	0.36 "	
5	1.— " "	0.36 "	
2nd Series			
1	1 gr. benzophenone	0.47 gr.	
2	2 " "	0.49 "	
3	3 " "	0.49 "	
3rd Series			
1	0.1 gr. o chlorobenzophenone	0.09 gr.	} entirely converted
2	0.25 " "	0.24 "	
3	0.50 " "	0.38 "	
4	0.75 " "	0.39 "	
5	1.— " "	0.39 "	
6	2.— " "	0.38 "	
7	3.— " "	0.39 "	
8	4.— " "	0.41 "	

T A B L E Ia.

N <sup>o</sup> .	Concentration of C <sub>2</sub> H <sub>5</sub> OH in the benzene solution of 2 gr. (C <sub>6</sub> H <sub>5</sub> ) <sub>2</sub> CO per 25 cc.	Quantity of pinacone	Yatios
1	0.2527 gr. or 1 eq.	0.08 gr.	1
2	0.5054 " " 2 "	0.18 "	2.25
3	1.0108 " " 4 "	0.36 "	4.50
4	2.0216 " " 8 "	0.66 "	8.25
5	∞ (pure alcohol)	0.69 "	

More accurate experiments were not considered necessary as we did not care for the absolute value, but only for the order of magnitude of the temperature coefficient.

Adjacent to the jacketed tube was also suspended an ordinary tube to ascertain whether the presence of the jacket had any influence on the pinacone formation.

The subjoined table II gives a survey of some series of experiments.

From these results it follows that the method is sufficiently accurate for our purpose, the ketone reduction is indeed a photo-reaction with a small temperature coefficient; this still falls below the mean stated by PLOTNIKOW<sup>1)</sup> of 1.17 per 10°.

TABLE II. Time of exposure 2—3 days.

N <sup>o</sup> .	Contents of inner tube	t <sup>o</sup>	temp. interval	pinacone	$\frac{K_{t+10}}{K_t}$
1st Series					
1	2 gr. (C <sub>6</sub> H <sub>5</sub> ) <sub>2</sub> CO in 25 cc. alcohol without jacket	25°—28°		0.45 gr.	
2	with jacket	"	} ± 50°	0.76 "	} 1.06
3		75°—78°		1.02 "	
2nd Series					
1	without jacket	25°—28°		0.44 gr.	
2	with jacket	"	} ± 50°	0.70 "	} 1.065
3		75°—78°		0.96 "	
3rd Series					
1	2 gr. (ClC <sub>6</sub> H <sub>4</sub> ) <sub>2</sub> CO in 25cc. alcohol without jacket	25°—28°		0.27 gr.	
2	with jacket	"	} ± 50°	0.35 "	} 1.095
3		75°—78		0.55 "	
4th Series					
1	without jacket	25°—28°		0.24 gr.	
2	with jacket	"	} ± 50°	0.30 "	} 1.10
3		75°—78°		0.50 "	

<sup>1)</sup> JOH. PLOTNIKOW. Photochemische Versuchstechnik, p. 273 (1912).

That the temperature coefficient for *ortho*-chlorobenzophenone is really somewhat higher than for benzophenone seems to us rather probable, but this can only be ascertained by more delicate measurements<sup>1)</sup>.

The independence of the concentration and the very small temperature coefficient now enables us to continue following this very simple method in the quantitative investigation as to the influence of the ketone to be reduced as well as of the reducing alcohol.

#### *Influence of the alcohol.*

The alcohols, as described above, were carefully dried over calcium and, after distillation, poured at once into the tubes containing two grams of ketone. These were then sealed and exposed to the light.

These tubes were suspended at such a distance that they could not interfere with each other.

The subjoined table gives two series of experiments, the first series was exposed for three and the second one for six days; particularly during the first days it was sunny spring weather.

What strikes us here in the first place is the agreement in the action of the alcohols 2—6; the secondary propyl alcohol gets oxidised somewhat more rapidly, the amyl alcohol a little more slowly. In the latter case a strong yellow coloration sets in.

Very much smaller is the velocity of the pinacone formation in the case of methyl and allyl alcohol; as no interfering yellow coloration occurred here and as the conditions were moreover quite equal, this different behaviour must be attributed to the particular position these alcohols occupy.

Although we cannot yet enter here into an explanation of the process, it is obvious that the reduction of benzophenone will proceed all the more readily when in the conversion of alcohol into aldehyde (or ketone) more energy is set free.

The absolute extent of this energy is unknown to us, but still some thermic *data* point to the existence of a parallelism in the

<sup>1)</sup> The remarkably greater reduction velocity in the jacketed as compared with that in an ordinary tube, must be attributed to the larger quantity of light which, owing to refraction in the jacket filled with water, falls on the inner tube. In fact nothing could be noticed of this inner tube when the tube was entirely filled; it looked as if the alcoholic solution has the width of the outer tube. In harmony with this observation, it appears that the ratios of the velocities in the four series namely 76:45, 79:44, 35:27 and 30:24 do not greatly diverge and are about equal to the proportions of the sections of the outer and inner tube 24:16. (Compare LUTHER and WEIGERT l. c. p. 391).

TABLE III.

N <sup>o</sup> . 1st Series	2 gr. benzophenone in 25 cc.	Quantity of pinacone	Remarks
1	methyl alcohol	0.29 gr.	
2	ethyl alcohol	0.84 "	faint yellow coloration
3	<i>n</i> -propyl alcohol	0.85 "	
4	<i>sec.</i> propyl alcohol	0.95 "	
5	<i>n.</i> butyl alcohol	6.84 "	
6	amyl alcohol (Bp. 130 -133°)	0.75 "	strong yellow coloration
7	allyl alcohol	0.25 "	

2 <sup>nd</sup> Series			Ratio 1': 1'' etc.
1'	methyl alcohol	0.49 gr.	1.69
2'	ethyl alcohol	1.46 "	yellow coloration not much increased
3'	<i>n.</i> propyl alcohol	1.49 "	
4'	<i>sec.</i> propyl alcohol	1.60 "	
6'	amyl alcohol (a. ab.)	1.05 "	yellow coloration increased
7'	allyl alcohol	0.42 "	1.68

velocity of the reduction and the extent of the difference of the molecular heat of combustion of alcohol and the correlated aldehyde (or ketone).

The greater this difference the more energy will be represented by the hydrogen atoms playing a rôle in that transformation.

As the heats of evaporation of the alcohols on one side and of the aldehydes on the other side do not sensibly differ and as all we require here are a few figures for comparison, a correction for this may be omitted here. We then find for these differences (according to *data* from the tables of LANDOLT-BÖRNSTEIN-ROTH). (See table IV.)

The heat of combustion of acetaldehyde is not known, neither that of formaldehyde. There is, however, a statement as to meta-formaldehyde: if from this one calculates the molecular combustion as if it were a monomeride, the difference amounts to 47 cal. As, however, this also includes the heat of polymerisation the difference is presumably considerably less than 47 calories.

TABLE IV.

Differences of the heats of combustion of:	methyl alcohol—(meta)formaldehyde	< 47.0 cal.
	ethyl alcohol—aldehyde	47.0 „
	<i>n.</i> propyl alcohol—propionaldehyde	50.0 „
	<i>sec.</i> propyl alcohol—acetone	51.0 „
	amyl alcohol(?)—valeraldehyde	47.0 „

The two series of experiments of table III were started at the same moment, the first was investigated after three and the latter after six days; when the converted quantity of substance is proportional to the quantity of light and no secondary hindrances occur, the proportion of the quantities of pinacone at each of the numbers 1 : 1', 2 : 2' etc. must be the same; these ratios have been inserted in the last column of the second series.

We notice that this ratio is indeed almost constant except in the case of amyl alcohol, where a hindrance in the form of an increasing yellow coloration is distinctly observed.

#### *Influence of the ketone.*

The tubes were filled with solutions of one gram of ketone in 50 cc. of absolute ethyl alcohol. Two series were exposed simultaneously to the action of the light; the first was investigated after three, the second after six days. Some pinacones remain very long in supersaturated solution, hence the alcohol was always distilled off and the residue shaken with 80 % alcohol so as to remove all unconverted ketone.

The subjoined table V gives the results obtained and the ratios of the velocities with those of the benzopinacone formation as unit.

Table VI gives a similar double series; most of the ketones investigated here were not attacked.

Table VII gives a survey of the results obtained in amyl alcohol as solvent and as reducing agent.

1<sup>st</sup>. The velocity of the pinacone formation, according to this survey, is greatly dependent on the nature and on the position of the substituent. As regards the nature, there is only one group (the methyl group on the two para-positions (N<sup>o</sup>. 7)) that appears to accelerate the reduction velocity somewhat, for the rest the substitution causes a decrease in velocity.

This decrease is strongest when the substituting group is a phenyl

TABLE V.

No.	Name of the ketone	Quantities of pinacone				Ratio II/I	Ratio of the Reduction-velocities with that of (C <sub>6</sub> H <sub>5</sub> ) <sub>2</sub> CO as unit
		Series I	Series II	Series I	Series II		
		In grams		In millimols.			
1	benzophenone	0.41	0.85	1.12	2.32	2.05	1.—
2	2 chlorobenzophenone	0.12	0.25	0.28	0.58	2.07	0.25
3	3 chlorobenzophenone	?	±0.10	—	0.23	—	±0.1 (from II)
4	4 chlorobenzophenone	0.32	0.75	0.74	1.73	2.34	0.66
5	4 methoxybenzophenone	0.39	0.80	0.92	1.88	2.04	0.82
6	4 methylbenzophenone	0.41	0.86	1.04	2.18	2.09	0.93
7	4,4' dimethylbenzophenone	0.48	0.95(off)	1.19	—	—	1.06
8	4 bromobenzophenone	0.51	0.98(off)	1.—	—	—	0.90
9 <sup>1)</sup>	4,4' dichlorobenzophenone	?	0.73	—	1.45	—	0.63 (from II)
10	2,2',4,4' tetrachlorobenzoph.	0.22	0.47	0.34	0.72	2.12	0.30
11	2 chloro 4' methyl "	0.27	0.55	0.58	1.18	2.03	0.52
12 <sup>1)</sup>	4 chloro 4' methyl "	0.19	0.70	0.41(?)	1.50	3.66(?)	0.64 (from II)

TABLE VI.

13	benzophenone	0.85	0.98(off)	2.35	—	—	1
14 <sup>1)</sup>	4 phenylbenzophenone	—	—	—	—	—	0
15	phenyl- <i>α</i> -naphthylketone	—	—	—	—	—	0
16	phenyl- <i>β</i> - " "	—	—	—	—	—	0
17	2 methylbenzophenone	—	—	—	—	—	0
18	3 methylbenzophenone	0.80	0.96(off)	2.03	—	—	0.89
19	2,4,2',4' tetramethyl "	—	—	—	—	—	0
20	fluorenone	—	—	—	—	—	0

TABLE VII. Amyl alcohol as solvent.

21	benzophenone	0.75	0.97(off)	2.05	—	—	1
22	2 chlorobenzophenone	0.22	0.33	0.51	0.76	1.49	0.25
23	4 chlorobenzophenone	0.65	0.96	1.49	2.20	1.48	0.72
24	4 methylbenzophenone	0.74	0.96(off)	1.88	—	—	0.91
25	phenyl <i>α</i> -naphthylketone	—	—	—	—	—	0

<sup>1)</sup> These ketones had not entirely passed in solution in the alcohol.

group, because 4-phenylbenzophenone (14) and the two phenyl-naphthylketones (15 and 16) are not reduced.

Halogen atoms and methyl groups *do* diminish the single substitution, but (with one exception) do not prevent the same. Para substitution has the least influence, ortho the greatest; this, however does not apply to the chlorobenzophenones (3), so that we can hardly speak of a universal rule.

The symmetry of the molecule seems to accelerate the velocity.

Whereas the 4-methylbenzophenone has a smaller velocity than the benzophenone (5), the 4,4'-dimethylbenzophenone has a somewhat greater one. The fairly considerable decrease in velocity in the 4-chlorobenzophenone (4) is not continued in the 4,4'-dichlorobenzophenone (9). In connexion with the considerable decrease in the 2-chlorobenzophenone (2) that in the 2,2',4,4'-tetrachlorobenzophenone (10) is unexpectedly high.

A remarkable fact is the slight influence of the methyl group on the meta position (18) in regard to the great one of the chlorine atom (3).

2<sup>nd</sup>. Of more importance is the fact that the alcohol, the reducing agent, is of very secondary significance as regards the ratio of the reduction velocities; this is shown from the comparison of tables V and VII. The ratio of the velocities in ethyl and amyl alcohol is practically the same. We have completed these observations with a few on methyl and propyl alcohol, selecting methyl alcohol because the velocities therein are generally much less, whereas o-chlorobenzophenone with benzophenone were compared as ketones, because the velocities in ethyl (and amyl) alcohol differ strongly.

The subjoined table VIII gives a survey of the results.

TABLE VIII.

	Sol. C <sub>2</sub> H <sub>5</sub> OH, 1 <sup>st</sup> Series		Sol. C <sub>5</sub> H <sub>11</sub> OH, 3 <sup>rd</sup> Series		Sol. CH <sub>4</sub> OH, 4 <sup>th</sup> Series		Sol. nC <sub>3</sub> H <sub>7</sub> OH, 5 <sup>th</sup> Series	
	Quantity in m.mols.	Ratio	Quantity in m.mols.	Ratio	Quantity in m.mols.	Ratio	Quantity in m.mols.	Ratio
Benzophenone	2.32	1.0	2.05	1	1.91	1	2.93	1
2 Chloro „	0.58	0.25	0.51	0.25	0.46	0.24	1.08	0.27
4 „ „	1.73	0.66	1.49	0.72				
4 methyl „	2.18	0.93	1.88	0.91				
phenyl $\alpha$ -naph- thyl ketone	0	0	0	0				



First of all it follows from this constant ratio that the *ketone* is prominent in the photo-reaction, that this passes into a photo-active condition. Further, that the diverse ketones are activated in a perfectly analogous manner in such a way that either a number of molecules (the same for all ketones) become photo-active, which molecules then react with the alcohol with a velocity specific for the ketone; or, a number of molecules specific for each ketone becomes activated which, with a definite velocity which is independent of the ketone, dehydrogenises the alcohol.

A choice from these alternatives can only be made by a further study of the photo-reaction.

*The active light of the ketone reduction.*

The first attempt to ascertain the position of the active light in the spectrum has been made by CLAMCIAN and SILBER<sup>1)</sup>. They investigated, for instance, the reduction of benzophenone and alcohol, employing two photo-filters.

As a red photo-filter was used a cold saturated solution of fluorescein in alcohol (thickness of layer 15 mm.) which extinguishes all light to  $0.510 \mu$ ; by adding gentian-violet the absorption could be raised to  $0.620 \mu$ .

As a blue filter served a  $10\%$  solution of cobalt chloride in alcohol which transmits rays of a wavelength less than  $0,480 \mu$ ; a green band at  $\pm 0,560 \mu$  and a red one at  $\pm 770 \mu$  remain, however, unextinguished. They arrive at the result that all the reactions with which they were engaged, took place under the influence of *blue* light. We have used a larger number of photo-filters and carried out the research in jacketed tubes; the inner tubes were those which were used by us in the other experiments; the intervening space was 15 mm. Above the liquid in the jacket the outer tubes were covered with black lacquer, so that none but filtered light could penetrate into the inner tube.

As photo-filters were selected:

- I. Red: aqueous solution of chrysoidin<sup>2)</sup>.
- II. Green: „ „ „ potassium dichromate + acid green B. extra.<sup>2)</sup>

Blue and violet.

- III.  $10\%$  alcoholic solution of  $\text{CoCl}_2$ .
- IV. Cold saturated aqueous solution of crystal violet 5 B. O.<sup>2)</sup>.
- V. „ „ „ „ „ acid violet 4 B. N.<sup>2)</sup>.
- VI. Solution of iodine in  $\text{CCl}_4$ .

<sup>1)</sup> B. 35, 3593 (1902)

<sup>2)</sup> Colouring matters from the "Gesellschaft f. chem. Ind. Basel".

In agreement with that found by CIAMICIAN and SILBER for the red fluorescein filter we found that the filters I and II which only transmit red (690—598  $\mu\mu$ ) or red and green ( $> 500 \mu\mu$ ) absorbed all actinic rays.

Also V, which besides red rays of about 700  $\mu\mu$  still transmitted blue and violet  $> 433 \mu\mu$ , completely prevented the reduction in the inner tube. On the other hand an important reduction took place with the filters III, IV, and VI which transmitted rays to the extreme, visible violet  $\pm 400 \mu\mu$ .

The series of experiments were conducted in this way that a set of four jacketed tubes with photo-filters were exposed to sun-light for some days in front of the white screen: the results are contained in the subjoined table.

TABLE IX.

N <sup>o</sup> .	Ketone in the inner tube	Photo-filter	Quantity of pinacone in gr.	Remarks
1st Series				
1	2 gr. benzophenone in 25 cc. C <sub>2</sub> H <sub>5</sub> OH	I	0	entirely converted
2	. . . . .	II	0	
3	. . . . .	III	2	
4	. . . . .	IV	0.67	
2nd Series				
5	. . . . .	III	0.85	From the comparison of the figures for III and IV with the controlling tube with conductivity water it appears that there always takes place a partial absorption of the actinic rays; this, however, is relatively small and is probably based on a general absorption, which in a spectroscopic investigation was readily observed.
6	. . . . .	V	0	
7	. . . . .	VI	0.48	
8	. . . . .	{ conductivity water	1.28	
3rd Series				
9	2 gr. o-chlorobenzophenone . .	III	0.33	
10	. . . . .	V	0	
11	. . . . .	VI	0.28	
12	. . . . .	{ conductivity water	0.42	

Now with this method we can only get a very rough determination of the position of the active region, still it appears that the active rays are presumably situated in the violet and have a wavelength smaller than  $\pm 430 \mu\mu$ . In order to see whether in the beginning of the ultraviolet active rays were still present, a small jacketed tube was constructed from quartz, the alcoholic benzophenone solution was put into the inner tube and in the jacket a cold saturated solution of nitrosodimethylaniline<sup>1)</sup> which absorbs all visible violet and blue rays and transmits ultra-violet ones of  $400-280 \mu\mu$ .

Neither in sun-light, nor in front of the quartz lamp did any reduction set in; from this we could conclude that the active rays were not situated in the ultra violet, but in the visible spectrum  $< 430$  and  $> 400 \mu\mu$ .

A fortunate incident now came to our aid when we were engaged in determining the correct position of the active light.

We had noticed that the ketones were converted with comparatively great rapidity into pinacones by means of the HERÄUS quartz-mercury lamp.

The mercury spectrum must thus contain a great quantity of the chemically active rays. This spectrum exhibits a very intensive blue line at  $436-434 \mu\mu$  and two violet ones at  $407,8 \mu\mu$  and  $404,7 \mu\mu$ <sup>2)</sup>.

Photo-filter V completely removes the violet lines and leaves the blue ones unchanged; as this filter in sunlight as well as in front of the quartz lamp prevents all conversion of benzophenone as well as of *o*-chlorobenzophenone, and as we have noticed that the ultra-violet light of the lamp is inactive we may conclude that the active light for the photochemical reduction of the aromatic ketones is situated in the extreme end of the visible violet.

The fact that the nature of the source of light has no principal influence on the reduction process is shown from the subjoined table, in which are given the ratios of the quantities of pinacone that are formed from diverse ketones when exposed either to sun-light or mercury-light.

The exposure to mercury-light was carried out by placing a solution of 0.5 gram of ketone in 15 cc of ethyl alcohol at a distance of 5 cm from and parallel to the quartz lamp and exposing these for 10 hours; hence, the quantity of light was approximately the same for all ketones.

The close agreement of these ratios also renders it probable that

1) Compare PLOTNIKOW etc. p. 19.

2) LEHMANN, Phys. Zeitschr. **11**, 1039 (1910).

TABLE X.

No.	Name of the ketone	Quantity of pinacone on exposure to Hg light		Quantity of pinacone on exposure to sunlight with benz. pinacone as unit
		in grams	in m.mols. with benzopinacone as unit	
1	benzophenone	0.35	1	1
2	2 chlorobenzophenone	0.10	0.23	0.25
3	4 chlorobenzophenone	0.30	0.70	0.66
4	2 methylbenzophenone	0	0	0
5	4 methylbenzophenone	0.34	0.89	0.93
6	phenyl $\beta$ -naphthylketone	0	0	0
7	fluorenone	0	0	0

the active rays are situated for the greater part at 407.8 and 404.7  $\mu\mu$ <sup>1)</sup>.

*The action of light on mixtures of ketones.*

The phenomena observed by us during the exposure to light of ketone mixtures in absolute alcohol divulged a very strong mutual influence.

In order to better understand these observations, the following should precede:

We have noticed that the chemically active light comprises a very limited part of the spectrum, yet, therein are rays of different frequency and intensity.

A. We can now suppose that each of the ketones present wants its own active rays without absorbing rays intended for the other ketone; then — as the pinacone formation is independent of the concentration — there will have formed in the tube with the mixture the sum of the quantities of pinacone that are formed in the separate tubes under the same conditions.

Those quantities within certain limits must also be independent of the proportion of the concentrations of the ketones in the tube containing the mixture.

1) Presumably, the action is in a high degree selective, as a layer of 3 dm 4% benzophenone in absolute alcohol certainly caused a very distinct fading of these *two* mercury lines, whereas nothing could be noticed of a curtailing or fading at the violet side of the arc lamp spectrum through that same liquid layer. We attach, moreover, not much value to this subjective observation, for only an accurate spectrophotometric investigation of the absorption spectra of the ketones can properly determine the connexion between absorption and chemical action.

B. As soon, however, as rays for the one ketone are also consumed by the other one, the quantity of pinacone will be less than the sum in question and, moreover, the proportions of concentrations will no longer be a matter of indifference.

For in the layer where the photo-reaction takes place each molecule of the one ketone requires a part of the light-energy also wanted by the second ketone, so that the hindrance experienced by the latter will become greater when its relative concentration gets less.

C. The extreme case would be that both ketones require just the same rays; we should then obtain a quantity of each of the ketones which in equimolecular concentration is equal to half the quantity that forms in the tube with the separate ketone (always supposing that no other obstacles occur).

The phenomena recorded by us are now best understood from the supposition B: a ketone does require specific rays from its neighbour. Some of the observations approach to A, others to C, some even exceed this extreme case, showing that the action is more complicated than was at first supposed, as will appear from the subjoined tabulated survey.

TABLE XI.

1 <sup>st</sup> Series No.	Solution of 2 gr. of <i>o</i> -chlorobenzophenone and varying quantities of phenyl $\alpha$ -naphthylketone	in 50 cc. alcohol	Quantity pinacone in gr.	Remarks
1	2 gr. <i>o</i> -Cl benzophenone pure		0.84	For one of the ketones of the mixture was selected a substance that did not form pinacone. The case thus became a peculiar one but simple of execution.
2	" +0.1 gr. phenyl $\alpha$ -naphthylketone		0.30	
3	" +0.25 " " "		0.12	
4	" +0.50 " " "		0	
5	" +1.— " " "		0	
2 <sup>nd</sup> Series No.	As above <i>o</i> -Cl benzophenone and varying quantities of <i>o</i> -methylbenzophenone		Quantity pinacone	Remarks
1	2 gr. <i>o</i> -Cl benzophenone pure		0.37	
2	" + 0.1 gr. <i>o</i> -CH <sub>3</sub> benzophenone		0.36	
2	" + 0.25 " "		0.30	As above
4	" + 0.50 " "		0.26	
5	" + 1.— " "		0.15	

We notice that when one of the ketones does not get reduced it exerts a very powerful retarding action on the reduction of the other ketone.

This action, particularly with phenyl- $\alpha$ -naphthylketone is much more important than we should expect even in the extreme case C; besides the elimination of the chemically active rays, the molecules of the naphthylketone must cause an impediment, which may, perhaps be put on a par with the obstruction caused by oxygen in the photo-halogenations.

TABLE XII.

N <sup>o</sup> .	Solutions of various ketones, which are reduced separately in 50 cc. solution.	Quantity of pinacone formed.	Quantity of calculated mixture pinacone.	Halogen content found 0/0.	Halogen content calculated.	Remark	
<b>1st Series</b>							
1	2 gr. benzophenone	1.71	1.71	—	—	The figures given in column 4 and 6 are calculated from the supposition A (v. p.) that the ketones do not exert an impeding action on each other. As to the ratios employed compare Table V. (p. 859).	
2	2 » » + 2 gr. o-Cl benzophenone	2.31	} 2.37	4.16	} 3.8		
3	2 » » + 1 » »	2.18		3.46			
<b>2nd Series</b>							
1	2 gr. benzophenone	1.66	1.66	—	—		
2	2 » » + 2 gr. p Cl benzophenone	2.18	} 2.76	9.19	} 7.2		
3	2 » » + 1 » »	1.69		3.19			
<b>3rd Series</b>							
1	2 gr. benzophenone	0.85	0.85	—	—		
2	2 » » + 2 gr. p Br benzophenone	1.65	} 1.95	23.9	} 19.0		
3	2 » » + 1 » »	1.05		11.4			

From Table XII it appears that, in the case when both ketones are reduced, we have demonstrated a considerably less impediment than in the case that one of them is not reduced. Still, there is always a negative influence, we obtain in all cases a quantity less than the sum of the quantities which we should have obtained in separate tubes; we are always dealing with case B.

In this we notice the smallest mutual hindrance in the mixture of benzophenone and o-chlorobenzophenone, yet we notice plainly that the impediment increases when one of the ketones is present

in large excess (1<sup>st</sup> series N<sup>o</sup>. 3) and that in such a case that present in the smallest amount is the most strongly impeded. Much more pronounced is the hindrance observed with mixtures of benzophenone and p. Cl- or p. Br-benzophenone; the sum of the pinacones remains here far below the calculated quantity. The halogen ketone has as a rule a stronger impeding action than benzophenone, for even in smaller quantities than the molecular ones (N<sup>o</sup>. 2 of the three series) the halogen pinacone in the mixture is predominant. Only with a considerable excess of benzophenone the halogen pinacone is repelled and mostly so in the cases where the greatest hindrance is present (compare N<sup>o</sup>. 3 of the three series).

We thus find in rough traits what we could expect; there occur, however, particularly when one of the ketones is not reduced separately, such great hindrances that they cannot be satisfactorily

TABLE XIII.

N <sup>o</sup> .	Contents inner tube	Contents outer tube	Quantity pinacone		Quantity of pinacone in the inner tube with the blank tube as unit.
			inner tube	jacket	
1 <sup>st</sup> Series					
1	2 gr. benzophenone in 20 cc. abs. alcohol	alcohol (blank-exper.)	0.64	—	1.—
2		p CH <sub>3</sub> benzophenone	0.28	0.66	0.44
3		o Cl benzophenone	0.18	0.19	0.28
4		phenyl- $\alpha$ -naphthylketone	trace	0	trace
2 <sup>nd</sup> Series					
1		alcohol (blank-exper.)	1.05	—	1.—
2		o CH <sub>3</sub> benzophenone	0.50	0	0.48
3		phenyl- $\beta$ -naphthylketone	0.28	0	0.27
4		fluorenone	0	0	0
3 <sup>rd</sup> Series					
1		alcohol (blank-exper.)	0.79	—	1.—
2		p Br benzophenone	0.42	1.18	0.54
3		p Cl benzophenone	0.38	0.83	0.47
4		benzophenone	0.29	0.93	0.37

explained in the above cited manner. There seems to be a connexion here between the extent of the impediment and the non-appearance of the photo-reduction.

Now, in order to eliminate the hindrance which might eventually take place owing to the mixing, the oft-quoted jacketed tubes were filled in such a manner that in the inner tube was always inserted a definite ketone and in the jacket diverse other ketones.

The light then first traversed a  $\pm 2$  mm. thick layer of a ketone then to exert its action on the benzophenone; in this way we could form a better opinion as to the absorption of rays of light by the one ketone (in the jacket) which were needed for the other ketone (in the inner tube).

There exists no doubt that *all* ketones absorb actinic rays intended for the benzophenone; the degree of this absorption is certainly very different and specific.

The ketones which were attacked in the jacket were, during the experiment, reduced in concentration, so that the conditions for the reducing of the benzophenone in the inner tube gradually became more favourable; this causes, however, that we can only consider as fairly comparable the experiments where no reduction takes place in the jacket. Hence, a few ketones have been placed in the jacket in benzene solution whilst in the inner tube was again present a solution of 2 grams of benzophenone in 20 cc. of absolute alcohol; the following result was thus obtained:

TABLE XV.

N <sup>o</sup> .	In the inner tube 2 gr. (C <sub>6</sub> H <sub>5</sub> ) <sub>2</sub> CO in 20 cc. abs. alc.	In the jacket a N 4 benzene solu- tion of	Quantity of pinacone in the inner tube.		Remarks
1		— (blank)	1.34	- 1.0	The benzene solution in the jacket was al- ways coloured pale yellow which colour again faded in the dark.
2		benzophenone	0.45	0.34	
3		o-chloro >	0.53	0.40	
4		p- > >	0.34	0.25	
5		p-methyl >	0.40	0.30	

It appears that several ketones absorb rays of light which effect the benzophenone activation, even when they are dissolved in benzene.

The reversible yellow coloration of this benzene solution, however, tells us to be careful, for the activated ketone can form with benzene



a light-screen, thus causing the absorption effect to be greater than when the ketone had been present in alcoholic solution.

In each case a circumstance occurs owing to which the phenomenon becomes more complicated, so that from these last experiments we may at most draw the conclusion that rays of light are indeed always absorbed by the one ketone, which the other required for the oxidation of alcohols.

The most powerful absorbing ketones appear mostly — but not always — to oxidise the alcohol slowly or not at all, so that we gain the impression that a liberal absorption does take place, but that the possibility of the setting in of a reaction and its velocity does not only depend on the alcohol, but in a great measure on the ketone.

It speaks for itself that the experiments on this almost quite unexplored region can only bear a very provisional character; still we believe we have attained, with very simple means and methods, some results which will prove of importance for the insight into the photochemical reactions.

For the moment, however, we wish to refrain from an attempt to explain the phenomena observed until more accurate spectrophotometric *data* are at our disposal.

#### S U M M A R Y.

- I From aromatic ketones and alcohol are formed, in the light, exclusively pinacones; these latter are, therefore, the products to be first isolated in the reduction. Hydrols are, in the reduction of the aromatic ketones, always formed secondarily (see Proc. XVI 91 and 962) either from the pinacones or from the primarily formed half pinacone molecules.
- II 1. The photo-reduction of the ketone by alcohols was studied by exposing simultaneously to the light a set of tubes of equal dimensions and filled with equal quantities of liquid, thus causing the light-quantity (i. t) for each object of a serial experiment to be equal.
2. The velocity of the pinacone formation appeared to be independent of the concentration of the benzophenone and proportional to the concentration of the alcohol. Hence, it satisfied the equation:

$$\frac{d \text{pinacone}}{dt} = KL \cdot [\text{alcohol}] \text{ and, therefore, the reaction scheme:}$$

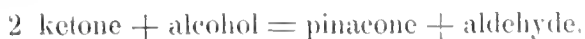

3. The temperature coefficient was small: 1.06—1.11 for 10°.
4. The velocity of the pinacone formation is greatly dependent on the alcohol; for instance, the methyl alcohol and the allyl alcohol were oxidised much more slowly than other primary and secondary alcohols.
5. The velocity of the pinacone formation is greatly dependent on the ketone, the benzophenone is attacked rapidly, most of the ketones as yet examined less rapidly, many not at all.
6. The ratio of these velocities in different alcohols is constant.
7. The active light of the ketone reduction is sure to be situated in the spectrum between 400 and 430  $\mu\mu$  and very probably in, or adjacent to, the rays 404.7 and 407.8 of the mercury quartz lamp.
8. The ratio of the velocities of the pinacone formation in sunlight and in mercury light is the same.
9. When two ketones are present simultaneously one of them absorbs a part of the rays required by the other ketone; this also appears when the light passes through a solution of the one ketone and falls on that of the other.

Particularly in the case of the powerfully absorbing ketones the hindrances are stronger than was to be expected.

*Delft*, October 1914.

**Physics.** — “*Simplified deduction of the formula from the theory of combinations which PLANCK uses as the basis of his radiation-theory.*” By Prof. P. EHRENFEST and Prof. H. KAMERLINGH ONNES.

(Communicated in the meeting of Oct. 31, 1914).

We refer to the expression

$$C_P^N = \frac{(N-1+P)!}{P!(N-1)!} \dots \dots \dots (A)$$

which gives the number of ways in which  $N$  monochromatic resonators  $R_1, R_2, \dots, R_N$  may be distributed over the various degrees of energy, determined by the series of multiples  $0, \epsilon, 2\epsilon, \dots$  of the unit energy  $\epsilon$ , when the resonators together must each time contain the given multiple  $P\epsilon$ . Two methods of distribution will be called identical, and only then, when the first resonator in the one distribution is at the same grade of energy as the same resonator in the second and similarly the second, third,  $\dots$  and the  $N$ th resonator are each at the same energy-grades in the two distributions.

Taking a special example, we shall introduce a symbol for the distribution. Let  $N=4$ , and  $P=7$ . One of the possible distributions



distributions themselves required is thus obtained by dividing (2) by (3) q. e. d. <sup>1)</sup>).

## APPENDIX.

*The contrast between PLANCK's hypothesis of the energy-grades and EINSTEIN's hypothesis of energy-quanta.*

The permutation of the elements  $\varepsilon$  is a purely formal device, just as the permutation of the elements  $\mathbf{O}$  is. More than once the analogous, equally formal device used by PLANCK, viz. distribution of  $P$  energy-elements over  $N$  resonators, has by a misunderstanding been given a physical interpretation, which is absolutely in conflict with PLANCK's radiation-formula and would lead to WIEN's radiation formula.

As a matter of fact PLANCK's energy-elements were in that case almost entirely identified with EINSTEIN's light-quanta and accordingly it was said, that the difference between PLANCK and EINSTEIN consists herein that the latter assumes the existence of mutually independent energy-quanta also in empty space, the former only in the interior of matter, in the resonators. The confusion which underlies this view has been more than once pointed out <sup>2)</sup>. EINSTEIN really considers  $P$  similar quanta, existing *independently of each other*. He discusses for instance the case, that they distribute themselves irreversibly from a space of  $N_1$  cm<sup>3</sup> over a larger space of  $N_2$  cm<sup>3</sup> and he finds using BOLTZMAN's entropy-formula:  $S = k \log W$ , that this produces a gain of entropy <sup>3)</sup>:

$$S - S_0 = k \log \left( \frac{N_2}{N_1} \right)^P \dots \dots \dots (a)$$

<sup>1)</sup> It may be added, that the problem of the distribution of  $N$  resonators over the energy-grades corresponds to the following: On a rod, whose length is a multiple  $P\varepsilon$  of a given length  $\varepsilon$ , notches have been cut at distances  $\varepsilon, 2\varepsilon$ , etc. from one of the ends. At each of the notches, and only there, the rod may be broken, the separate pieces may subsequently be joined together in arbitrary numbers and in arbitrary order, the rods thus obtained not being distinguishable from each other otherwise than by a possible difference in length. The question is, in how many different manners (comp. Appendix) the rod may be divided and the pieces distributed over a given number of boxes, to be distinguished from each other as the 1st 2nd, . . .  $N$ th, when no box may contain more than one rod. If the boxes, which may be thought of as rectangular, are placed side by side in one line, they form together as it were an oblong drawer with  $(N-1)$  partitions, formed of two walls each, (comp. the above symbol in its first form, from which the second form was derived by abstracting from the fact, that each multiple of  $\varepsilon$  forms one whole each time), and these double partitions may be imagined to be mutually exchanged, the boxes themselves remaining where they are. The possibility of this exchange is indicated by the form of the symbol chosen.

As a further example corresponding to the symbol we may take a thread on which between  $P$  beads of the same kind,  $(N-1)$  beads of a different kind are strung, which divide the beads of the first kind in a 1st, 2nd . . .  $N$ th group.

<sup>2)</sup> P. EHRENFEST, Ann. d. Phys. **36**, 91, 1911, G. KRUTKOW, Physik. Zschr. **15**, 133, 363, 1914.

<sup>3)</sup> A. EINSTEIN, Ann. d. Phys. **17**, 132, 1905.

i. e. the same increase as in the analogous irreversible distribution of  $P$  similar, independent gas-molecules, for the number of ways in which  $P$  quanta may be distributed first over  $N_1$ , then over  $N_2$  cells in space, are to each other in the ratio

$$N_1^P : N_2^P \dots \dots \dots (\beta)$$

If with PLANCK the object were to distribute  $P$  mutually independent elements  $\epsilon$  over  $N$  resonators, in passing from  $N_1$  to  $N_2$  resonators the number of possible distributions would in this case also increase in the ratio ( ) and correspondingly the entropy according to equation (z). We know, however, that PLANCK obtains the totally different formula

$$\frac{(N_1 - 1 + P)!}{(N_1 - 1)! P!} : \frac{(N_2 - 1 + P)!}{(N_2 - 1)! P!} \dots \dots \dots (\gamma)$$

(which only coincides approximately with (β) for very large values of  $P$ ) and a corresponding law of dependence of the entropy on  $N$ . This can be simply explained as follows: PLANCK does not deal with really mutually free quanta  $\epsilon$ , the resolution of the multiples of  $\epsilon$  into separate elements  $\epsilon$ , which is essential in his method, and the introduction of these separate elements have to be taken "cum grano salis"; it is simply a formal device entirely analogous to our permutation of the elements  $\epsilon$  or  $\mathbf{O}$ . The real *object which is counted* remains the number of all the different distributions of  $N$  resonators over the energy-grades  $0, \epsilon, 2, \dots$  with a given total energy  $P\epsilon$ . If for instance  $P = 3$ , and  $N = 2$ , EINSTEIN has to distinguish  $2^3 = 8$  ways in which the three (similar) light-quanta  $A, B, C$  can be distributed over the space-cells 1, 2.

	A	B	C
I	1	1	1
II	1	1	2
III	1	2	1
IV	1	2	2
V	2	1	1
VI	2	1	2
VII	2	2	1
VIII	2	2	2

PLANCK on the other hand must count the three cases II, III and V as a single one, for all three express that resonator  $R_1$  is at the grade 2,  $R_2$  at  $\epsilon$ ; similarly he has to reckon the cases IV, VI and VII as one;  $R_1$  has here  $\epsilon$  and  $R_2$   $2\epsilon$ . Adding the two remaining cases I ( $R_1$  contains  $3\epsilon$ ,  $R_2$   $0\epsilon$ ) and II ( $R_1$  has  $0\epsilon$ ,  $R_2$   $3\epsilon$ ) one actually obtains

$$\frac{(N - 1 + P)!}{(N - 1)! P!} = \frac{(2 - 1 + 3)!}{(2 - 1)! 3!} = 4$$

different distributions of the resonators  $R_1, R_2$  over the energy-grades.

We may summarize the above as follows; EINSTEIN's hypothesis leads necessarily to formula (z) for the entropy and thus necessarily to WIEN's radiation-formula, not PLANCK's PLANCK's *formul device* (distribution of  $P$  energy-elements  $\epsilon$  over  $N$  resonators) *cannot be interpreted in the sense of* EINSTEIN's *light-quanta*.





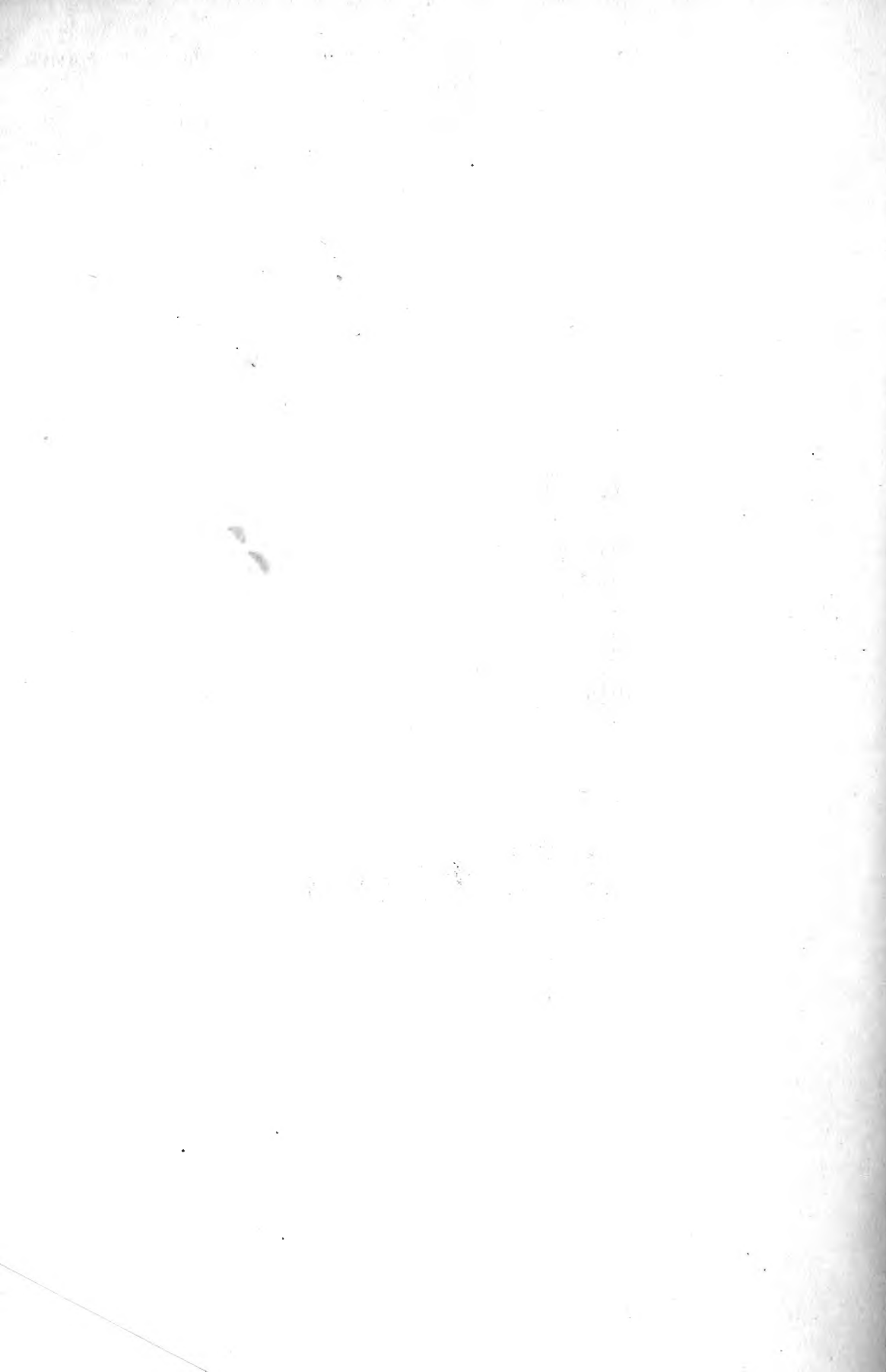



Q  
57  
A48  
v.17  
pt.1  
Physical &  
Applied Sci.  
Serials

Akademie van Wetenschappen,  
Amsterdam. Afdeeling voor  
de Wis- en Natuurkundige  
Wetenschappen  
Proceedings of the Section  
of Sciences

PLEASE DO NOT REMOVE  
CARDS OR SLIPS FROM THIS POCKET

---

UNIVERSITY OF TORONTO LIBRARY

---

**STORAGE**

445

