



LIBRARY OF THE
UNIVERSITY OF ILLINOIS
AT URBANA-CHAMPAIGN

550.5

FI

v. 12

JUN 7 1974



GEOLOGY

this m " re-

(

!

PENNSYLVANIAN INVERTEBRATES
OF THE MAZON CREEK AREA, ILLINOIS

EURYPTERIDA

ERIK N. KJELLESVIG-WAERING

FIELDIANA: GEOLOGY

VOLUME 12, NUMBER 6

Published by

CHICAGO NATURAL HISTORY MUSEUM

SEPTEMBER 17, 1963

GEOLOGY LIBRARY



PENNSYLVANIAN INVERTEBRATES
OF THE MAZON CREEK AREA, ILLINOIS

EURYPTERIDA

ERIK N. KJELLESVIG-WAERING

Research Associate

FIELDIANA: GEOLOGY

VOLUME 12, NUMBER 6

Published by

CHICAGO NATURAL HISTORY MUSEUM

SEPTEMBER 17, 1963

Library of Congress Catalog Card Number: 63-22048

PRINTED IN THE UNITED STATES OF AMERICA
BY CHICAGO NATURAL HISTORY MUSEUM PRESS

Eurypterida

Eurypterids are rarely encountered in the Mazon Creek area, although the number of known specimens has increased gradually since the first report of the holotype of *Adelophthalmus mazonensis* by Meek and Worthen in 1868. In 1948 (p. 17), Kjellesvig-Waering reported on seven more specimens. Up to the present, however, only these eight specimens have been reported in the literature, all of them representing one species, *Adelophthalmus mazonensis* (Meek and Worthen).

The purpose of this notice is to record new morphological and biometric data on twenty-three hitherto unreported specimens of *A. mazonensis* (Meek and Worthen), and to describe two new eurypterids previously unknown in the Mazon Creek fauna. One of these, a very unusual eurypterid of the family Stylonuridae, is described as a new species of the new genus *Mazonipterus*, and the other is represented by fragments of a specimen belonging to *Mycterops*, a peculiar genus previously reported in Pennsylvanian beds of Pennsylvania, Belgium and Holland.

The complete list of Mazon Creek eurypterids is as follows:

Adelophthalmus mazonensis (Meek and Worthen) *Mazonipterus cyclophthalmus*, new gen. and sp.

Mycterops, sp. indet.

Acknowledgments.—I am particularly indebted to Dr. Eugene S. Richardson, Jr., as solely through his co-operation I have been able to locate the specimens of Mazon Creek eurypterids, which are in the hands of private collectors residing principally in the Chicago area. It is mainly through the ceaseless efforts of these avid collectors that the bulk of the Mazon Creek fauna has been revealed to science. I am also indebted to Dr. Willard P. Leutze, who told me about the important specimen PE 6263, which was at that time in the private collection of Mr. Bruce Bell, of Flossmoor, Illinois; Mr. Bell has since presented it to Chicago Natural History Museum. Mr. Jerry Herdina, whose remarkable collection of Mazon Creek eurypterids was kindly lent for description, particularly deserves acknowledgment. Acknowledgments are also due to Messrs. James

Konecny, Michael Moore, and Harry C. Witmer for the loan of their specimens. For the loan of other specimens used in this study I wish to thank the United States National Museum, through Dr. G. Arthur Cooper and Dr. Henry B. Roberts; the Museum of Comparative Zoology, through Dr. Harry B. Whittington and Dr. Donald Baird; the Princeton University Museum, through Dr. B. F. Howell; and the Peabody Museum, through Dr. Carl O. Dunbar. Mr. Matthew Nitecki, of the Walker Museum, University of Chicago, kindly lent the specimen of *Adelophthalmus mansfieldi* (C. E. Hall) shown in figure 51. My wife, Virginia Kjellesvig-Waering, has been of constant and most valued assistance, particularly in photographing the specimen of *Mazonipterus cyclophthalmus*.

Class **Merostomata** Dana, 1852

Subclass **Eurypterida** Burmeister, 1843

Superfamily **Eurypteracea** Burmeister, 1845

Family **Hughmilleriidae** Kjellesvig-Waering, 1951

Genus **Adelophthalmus** Jordan and Meyer, 1854

Adelophthalmus mazonensis (Meek and Worthen)

Figures 44–50

Eurypterus (Anthraconectes) mazonensis Meek and Worthen, 1868, Amer. Jour. Sci., **46**, pp. 19–22; 1868, Geol. Surv. Illinois, **3**, pp. 544–547; Miller, 1877, Am. Palaeoz. Foss., p. 209; J. Hall, 1884, 2nd Geol. Surv. Pennsylvania, Rept. Progr., **PPP**, pp. 24–28, figs. 2, 3; Lesley, 1889, 2nd Geol. Surv. Pennsylvania, Rept. P4, **1** (A–M), pp. 235–236; Woodward, 1907, Geol. Mag., Dec. V, **4**, p. 278; Clarke and Ruedemann, 1912, New York St. Mus., Mem., **14**, pp. 223–226, pl. 26, fig. 1, text figs. 50–51; O'Connell, 1916, Buffalo Soc. Nat. Sci., Bull., **11**, p. 42; Grabau, 1920, Geol. Surv. China, Bull., **2**, p. 65; Diener, 1924, Foss. Cat., I, Animalia, **25**, Eurypterida, p. 20; Pruvost, 1930, Mus. Roy. Hist. Nat. Belg., Mem., **44**, pp. 193–194; Moore, 1936, Geol. Assoc., Proc., **47**, p. 364; Shimer and Shrock, 1944, Index Foss. N. Amer., p. 707, pl. 299, figs. 8, 9.

Eurypterus mazonensis (Meek and Worthen) Miller, 1877, Am. Palaeoz. Foss., p. 217; Woodward, 1888, Geol. Mag., Dec. III, **5**, p. 419; Miller, 1889, N. Amer. Geol. Pal., p. 548; Laurie, 1895, Roy. Soc. Edinburgh, Trans., **37**, p. 520; Weller, 1898, U. S. Geol. Surv., Bull., **153**, p. 269; Clarke, 1909, New York St. Mus., Bull., **133**, p. 37; Pruvost, 1911, Soc. Geol. Nord, Ann., **40**, p. 300; Woodward, 1913, Geol. Mag., Dec. V, **10**, p. 298; Stainier, 1915, Geol. Soc. London, Quart. Jour., **71**, p. 642; Pruvost, 1919, Mém. Carte géol. dét. France, p. 327.

Lepidoderma mazonense (Meek and Worthen) Kjellesvig-Waering, 1948, Illinois St. Mus., Sci. Pap., 2, no. 4, pp. 17-24, pls. 1-5, pl. 6, fig. 1; Størmer, 1955, Treatise Inv. Paleont., P, Arthropoda 2. p. 30, fig. 21 (3b, c).

Adelophthalmus mazonensis (Meek and Worthen) Přibyl, 1953, Česká Akad., Tr., 53, no. 2, p. 7; Caster and Kjellesvig-Waering, 1956, Jour. Paleont., 30, p. 27; Kjellesvig-Waering, 1958, Jour. Paleont., 32, p. 1140; Waterston, 1960, Palaeontology, 3, p. 245.

Adelophthalmus imhofi (Reuss) Van Oyen, 1956, Med. Geol. Sticht., ser. C-IV-3, no. 7, p. 59, text figs. 5, 6, 27.

This rare eurypterid was previously known from the holotype and seven specimens (Kjellesvig-Waering, 1948, p. 17). To this number can be added data from twenty-three specimens. Eighteen of these specimens were collected during ten years of intensive search by Jerry Herdina, of Berwyn, Illinois, and form part of his extensive collection. It includes the largest carapace known (see fig. 44).

Twenty-two of the specimens discussed here are from the spoil heaps of the abandoned strip mines of the Peabody Coal Company in Will and Grundy Counties, Illinois (Richardson, 1956). Several beds of coal have been exploited in these mines, but it is probable that the concretions bearing the famous Mazon Creek fauna (including these eurypterids) are derived from the Francis Creek shale member of the Middle Pennsylvanian (Westphalian C) Carbondale formation overlying Coal 2. The remaining specimen, from the Chiefton strip mine a few miles south of Terre Haute, in Vigo County, Indiana, is slightly younger. Spoil heaps of this mine are at present yielding large numbers of ironstone concretions to the same industrious collectors who have recovered so many fine specimens from the Illinois locality. According to Dr. Charles E. Wier, Head of the Coal Section of the Indiana Geological Survey, the concretion-bearing bed in the Chiefton mine lies above Coal VII, and is thus in the Shelburne formation (also Westphalian C).

The measurements of the holotype given by Clarke and Ruedemann (1912, p. 226) are erroneous as to the width of the carapace, which is given as 53.0 mm. This appears to be a typographical error, as the correct dimension is 43.0 mm. across the base of the carapace.

The new morphological data include the structure of the important ventral shield of the carapace, definite outlines of the spatulate plates of the Type A operculum, and the presence of the alimentary canal. Measurements of all carapaces are recorded for biometric comparisons. In this connection it should be noted that the condition of preservation of the carapace is of great importance



FIG. 44. Carapace of *Adelophthalmus mazonensis* (Meek and Worthen) from the Herdina collection (H-6); $\times 1.3$. This is the largest specimen that has been found.

in biometric studies; therefore the state of preservation is given with each specimen. The dimensions of these carapaces are as follows:

Specimen number	Width at base mm.	Width behind eyes mm.	Length mm.	Ratio	Condition
H-7	11.5	10.3	7.3	6.3:10	C and und.
Vigo Co., Ind.	15.5	13.3	10.0	6.4:10	PC and und.
H-11	16.3	broken	11.2	6.8:10	C and und.
H-16	16.5	broken	11.8	7.1:10	C and und.
H-14	19.4	17.7	14.5	7.4:10	C and und.
PE 6263	19.5	14.5	7.4:10	C and und.
H-15	20.3	17.0	8.3:10	unc. and und.
H-8	20.3	15.0	7.3:10	PC and und.
H-18	20.4	16.8	14.5	7.1:10	PC and und.
H-3	20.8	18.5	15.3	8.8:10	PC and und.
PE 3969	26.8	22.5	16.7	6.3:10	C and und.
PE 5094	23.0	20.3	16.2	8.8:10	PC and und.
H-12	23.8	20.2	16.6	6.9:10	PC and und.
H-2	24.6	20.8	17.3	7.0:10	PC and und.
H-4	26.1	24.0	18.5	7.0:10	C and P dis.
H-10	26.1	24.0	19.0	7.2:10	und.
Witmer	30.0	26.5	19.5	6.5:10	C and und.
H-5	31.8	28.8	24.5	7.7:10	PC and und.
H-13	34.3	25.4	7.4:10	PC and und.
H-1	broken	29.7	25.6		C and und.
H-9	36.8 est.	31.4	27.3 est.	7.4:10	C and und.
H-6	51.0	43.8	37.8	7.4:10	PC and und.

C = compressed dis. = distorted P = partly
 unc. = uncompressed und. = undistorted

The ventral shield (fig. 46) comprises a broad plate, not unlike that of *Hughmilleria*, but without trace of any sutures except a longitudinal one dividing the plate into two halves, longitudinally, along the anterior. This suture is present in *Hughmilleria* (Størmer, 1934, fig. 2). A very narrow, raised, marginal rim surrounds the carapace. A small, deep, triangular indentation occurs at the middle of the anterior of the shield to receive the triangular process at the anterior of the carapace, thereby forming a locking device for the ventral shield.

The ventral shield is ornamented with very fine semi-lunar scales that point away, or radiate, from the position of the mouth (see also fig. 45). It was almost entirely preserved in specimen PE 6263 and partly preserved in specimens H-2 in the Herdina collection and PE 3347.

Specimen PE 5094 (a male, Type A) has the eyes located on the carapace, 4.9 mm. from the anterior margin, 7.7 mm. from the pos-



FIG. 45. Carapace of *Adelophthalmus mazonensis* (Meek and Worthen) from the Herdina collection (H-2), showing the outline of the ventral shield; $\times 2.8$. The scales on the ventral shield point outward (see fig. 46).

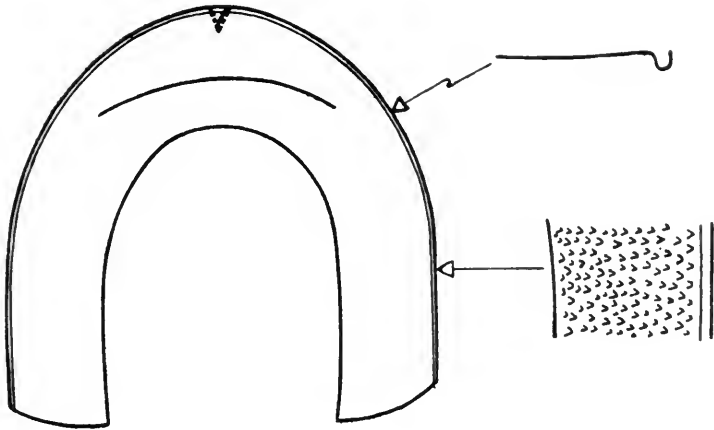

FIG. 46. Schematic drawing of the ventral shield of *Adelophthalmus mazoniensis* (Meek and Worthen) based on specimens H-2, PE 6263 and PE 3347.

terior margin and 3.8 mm. from the lateral margins. They are 2.8 mm. in length, 1.8 mm. in width, 6.7 mm. apart at the front, and 8.6 mm. apart at the back. The ocellar mound is located on the carapace 8.2 mm. from the anterior margin, 6.8 mm. from the posterior margin, and 9.3 mm. from the lateral margin; diameter, 0.8 mm.

Another well-preserved specimen (H-3) has the eyes located on the carapace, 4.2 mm. from the anterior margin, 7.3 mm. from the posterior margin, and 3.7 mm. from the lateral margins. The lateral eyes are 3.7 mm. in length, 2.0 mm. in width, 5.6 mm. apart at the front, and 7.3 mm. apart at the back. The ocellar mound is located on the carapace, 8.5 mm. from the anterior margin, 5.5 mm. from the posterior margin, and 9.0 mm. from the lateral margins. In an uncrushed condition, the ocellar mound is nearly round and measures approximately 1.3 mm. in diameter.

The largest carapace (H-6) has eyes that are 6.8 mm. in length and 4.5 mm. in width.

Although the details of the Type B operculum are known (Kjellesvig-Waering, 1948, p. 23, pl. 1, fig. 6), those of Type A are mainly known from an inconclusive outline given by Meek and Worthen (1868a, pp. 19-22), as the holotype is a dorsal impression and the shape of the operculum could only be surmised by its reflection through the mesosoma. Little can still be added to Meek and Worthen's original interpretation except to reveal that the spatu-



FIG. 47. Well-preserved specimen (male; Type A) of *Adelophthalmus mazonensis* (Meek and Worthen), PE 5094; $\times 1.5$. The underlying mesial appendage was developed to reveal the lateral lobes of the operculum shown on figure 48.

late lobes are large, ear-shaped, and very similar to those of Type B (see fig. 48). This is an important morphological structure, as the operculum of *Adelophthalmus mansfieldi* (C. E. Hall) is quite different with regard to the spatulate lobes. The Type A mesial appendage of *A. mazonensis*, although not clearly preserved, is considerably larger than in *A. mansfieldi*. The operculum of *A. mansfieldi* is given here for comparison (see fig. 51). This is James Hall's hypotype (1884, fig. 4), which remains the only known well-preserved Type A operculum of the genus *Adelophthalmus*.

A very poorly preserved specimen, PE 6174, paradoxically represents the only specimen in which the alimentary canal is preserved. This is preserved from the second tergite to about the ninth, and appears to be thickest in the area occupied by the fourth, fifth, and

sixth tergites (see fig. 50). Ruedemann (1919, p. 92) has previously shown the alimentary canal in *Carcinosoma newlini* (Claypole), and Heubusch (1962, p. 222) has shown it in specimens of *Eurypterus remipes lacustris* Harlan.

FIG. 48. Central part of operculum of specimen PE 5094, *Adelophthalmus mazonensis* (Meek and Worthen). The spatulate lobes of the male are as well developed as those in the female.

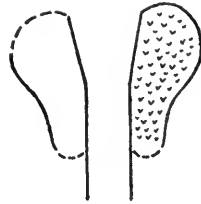

Specimens examined.—The specimens listed as H-1 to H-18 are in the private collection of Jerry Herdina. The specimen listed as “Witmer” is in the private collection of Harry Witmer, of Downers Grove, Illinois; the Vigo County, Indiana, specimen is in the collection of Michael Moore, of Tulsa, Oklahoma; and those listed as PE 3969, PE 5094, and PE 6263 are in the collection of Chicago Natural History Museum. All except the Indiana specimen were collected from the strip mines on the Will-Grundy County line, Illinois. All of the specimens collected by Herdina and the Bell specimen (PE 6263) are from the vicinity of the Santa Fe and the Gulf Mobile and Ohio railway tracks, where they cross the strip mines (see Richardson, 1956, pp. 6, 7). The specimen with the alimentary canal preserved is in the private collection of Francis Tully, of Lockport, Illinois; the copper cast, PE 6174, is in the collection of Chicago Natural History Museum.

Remarks.—The mode of preservation of eurypterids, particularly with reference to biometric studies, is of primary importance. It should be emphasized that the more incompetent the encasing material, the greater the amount of distortion that is found. To illustrate this point, the measurements of two carapaces of *Slimonia acuminata* (Salter) from the Silurian, Ludlow shales of Lesmahago, Scotland, are given (specimens in Princeton University):

Specimen number	Length mm.	Width at base mm.	Width at midsection mm.
1	103.5	96.0	88.0
2	150.0	80.0	77.5

The length/width-at-base ratio of No. 1 is 10.5:10 whereas that of No. 2 is 18.8:10. The latter carapace has been stretched but it



FIG. 49. A particularly well-preserved and only partly compressed specimen of *Adelophtalmus mazonensis* (Meek and Worthen) from the Herdina collection (H-3); $\times 1.8$. The ocellar mound and the short genal spines of the carapace are particularly well preserved.

appears not to be distorted, as there are no breaks on the integument. Both carapaces are of approximately the same size, as attested by the nearly similar dimensions of the lateral eyes. The thin chitin however, is easily distorted when the encasing material is argillaceous. Specimen No. 1 represents the normal dimensions of the carapace of the eurypterid.

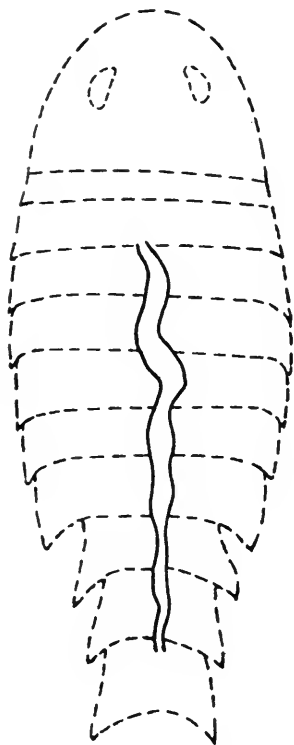

FIG. 50. Schematic drawing of the intestinal tract of *Adelophthalmus mazonensis* (Meek and Worthen) in specimen PE 6174 (copper replica).

For comparison with *Adelophthalmus mazonensis*, the following measurements from specimens of *A. mansfieldi* (C. E. Hall) are offered. The specimens are all from the Darlington black shale of the Middle Pennsylvanian Allegheny formation, collected near Canlton, Beaver County, Pennsylvania. All are preserved in black shale with varying degrees of slight distortion, but overall, the specimens listed here are mainly undistorted, though compressed (all carapaces are complete unless indicated). I have made the following measurements:

Specimen number	Width at base (a) mm.	Width behind eyes (b) mm.	Length (c) mm.	Ratio a : c	Condition
5323/10	9.2	6.2	6.7:10	C
M 848	9.7	8.6	7.7	7.9:10	C
5323/25	11.3	8.3	7.3:10	C and dis.
5323/11	11.8	8.0	6.8:10	C and dis.
M 836	12.0 est.	11.0 est.	8.0 est.	6.7:10	C
M 844	12.5	11.3	7.8	6.2:10	C
M 881	13.0	11.0	7.5	5.8:10	C
M 794	13.0	11.1	9.6	7.4:10	C
5323/9	13.2	10.35	7.8:10	C and und.
M 809	13.4	12.0	11.6	8.6:10	C and dis.
12306 ⁴	13.5	10.0	7.4:10	C and und.
5323/1	14.0 est.	10.0	7.1:10	C
M 828	14.5	11.5	11.5	7.9:10	C
M 840	14.5	13.0 est.	12.4	8.5:10	C and dis.
M 849	15.0	12.5	11.5	7.7:10	C and und.
M 856	15.0	13.0	11.5	7.7:10	C
12296 ²	15.3	9.8	6.4:10	C
2569	15.6	10.5	6.7:10	C
5323/13/29	16.0	11.5	7.2:10	C and P. dis.
12302 ³	16.8	15.4	9.2:10	C and dis.
M 845	17.0	14.8	11.8	6.9:10	C
5323/12	17.0	13.0	7.6:10	C and und.
12298 ⁴	18.2	15.6	12.5	6.9:10	C and dis.
5323/28	18.5	13.8	7.4:10	C and dis.
12296 ⁵	19.3	16.5	13.0	6.7:10	C and und.
5323/23	19.6	12.7	6.5:10	C and dis.
5323/3	19.6	12.7	6.5:10	C
M 863	20.0	16.0	13.5	6.7:10	C and und.
M 839	22.0 est.	19.0 est.	15.5	7.0:10	C and und.
M 843	22.0 est.	17.4	17.6	8.0:10	C and und.
5323	22.0 est.	13.0	5.9:10	C and P. dis.
M 874	23.5 est.	21.7	16.6	7.1:10	C and und.
12296 ⁶	26.0	16.2	6.2:10	C and dis.
M 815	29.5	25.5	23.4	7.9:10	C and und.
5323/27	32.0	28.5	8.9:10	C and dis.
12299 ⁷	43.5	31.0	7.1:10	C

¹ Hypotype (Hall, 1884, pl. 5, fig. 9).⁵ Hypotype (Hall, 1884, pl. 5, fig. 12).² Hypotype (Hall, 1884, pl. 5, fig. 15).⁶ Hypotype (Hall, 1884, pl. 5, fig. 13).³ Hypotype (Hall, 1884, pl. 4, fig. 3).⁷ Hypotype (Hall, 1884, pl. 5, fig. 3).⁴ Holotype (Hall, C. E., 1877, fig.).

Specimens M 794–M 881 are in the Geological Museum, Princeton University; specimens 12296–12306 are in the Walker Museum, University of Chicago; specimens 5323/1–29 are in the Museum of Comparative Zoology; and specimen 2569 is in the Peabody Museum, Yale University.

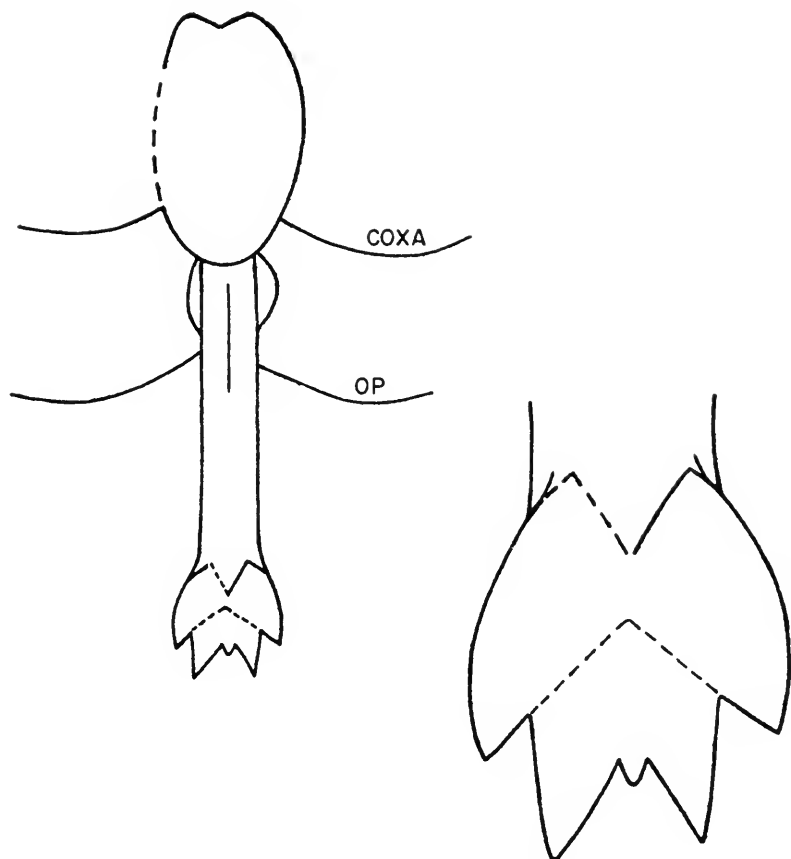

FIG. 51. The only known, well-preserved, and entire male (Type A) mesial appendage of *Adelophthalmus*. This occurs in a specimen of *A. mansfieldi* (C. E. Hall) from the Pennsylvanian, Allegheny group at Cannelton, Darlington township, Beaver County, Pennsylvania; previously figured by James Hall (1884).

In *Adelophthalmus mansfieldi* and *A. mazonensis* the length/width-at-base (of the carapace) ratios and the length/width-behind-eyes ratios show little difference when plotted and when not taking into consideration the important preservational factor. For instance, all of the carapaces of *A. mansfieldi* are preserved in black shale and almost without exception they are completely compressed into one plane. Most of the carapaces of *A. mazonensis*, on the other hand, are only partly compressed and retain, in many cases, considerable relief. Thus *A. mansfieldi* is a much narrower form than *A. mazonensis*, as compressed carapaces of *A. mansfieldi* have nearly

the same dimensions as less compressed carapaces of *A. mazonensis*. This is in keeping with the overall narrow aspect of the entire opisthosoma of *A. mansfieldi*, in contrast to the robust construction of *A. mazonensis*. On the basis of the measurements of the carapaces above, my conclusions differ entirely from those advanced by Van Oyen (1956) in regard to these two species. Other morphological differences as stated on page 92 leave no doubt as to the validity of both species.

An examination of the ratios of both length/width-at-base and length/width-behind-eyes reveals that *A. mansfieldi* progressively becomes more narrow in the carapace with age as compared to *A. mazonensis*, whose ratios remain constant.

Van Oyen (1956, p. 38) states that his conclusions regarding the measurements of the eurypterids from the "Veine D" are based on the measurements of 130 carapaces. Of the length and width-at-base measurements of the carapace it is important to note that fully 107 (almost 86 per cent) of these carapaces should not have been measured, as they represented specimens that were either incomplete or obviously too distorted to permit a reasonable interpretation of the individual variation of the species represented by the prolific "Veine D" eurypterids. Van Oyen, therefore, presents an interpretation of the possible *limits of distortion* of 130 carapaces of the "Veine D" eurypterids rather than a criterion for the identification of the species based on actual individual variation. As a result, his so-called limits of variation lump together (1956, p. 59) nearly all of the North American species of the genus, giving a stratigraphic range from the Middle Pennsylvanian to the Middle Permian for a single species which he identifies as the Bohemian *A. imhofi* (Reuss). Nowhere is a highly specialized form such as an eurypterid known to encompass such a long range. Van Oyen completely disregards obvious morphological differences, as, for example, the under side of well-known forms such as *A. mazonensis* and *A. mansfieldi*, and both are included under *A. imhofi*. In order to reveal the fallacy of the conclusions advocated by Van Oyen, it might be permissible to compare the holotype of *A. imhofi*, which has a telson barely as long as the carapace, with an individual of *A. mansfieldi* of approximately the same size; the latter has a telson at least twice as long as the carapace. The latter also is obviously a much more highly spinous eurypterid, in contrast to the non-spinous character of *A. imhofi*. Nevertheless, Van Oyen groups both as the same species. Morphologically, I know of no two eurypterids that can be so different and

still be of the same genus. On the other hand, Van Oyen (1956, pp. 60, 61) recognizes species and subspecies which easily can be demonstrated to be growth stages ("*E. stylus* Hall") or caused by poor preservation ("*E. derbiensis* Woodward"). Other American species, such as *Adelophthalmus*(?) *potens* (Hall), he also lumps together under the Bohemian *A. imhofi*, although the former probably does not represent the same genus or even the same family as the Bohemian form. Considerable evidence indicates that *A.?* *potens* (Hall) should be referred to the Hibbertopteridae.

Of the "Veine D" eurypterid carapaces figured and measured by Van Oyen (1956) the following are considered sufficiently well-preserved and complete to use for biometric studies:

Specimen number	Width at base mm.	Length mm.	Ratio
A-1	30.0	24.4	8.1:10
A-13	35.8	27.5	7.7:10
A-20	19.0	14.5	7.6:10
A-21	36.0	29.5	8.2:10
A-32	19.2	14.6	7.6:10
A-34	10.5	8.8	8.4:10
A-35	10.6	8.9	8.4:10
A-37	24.4	17.2	7.0:10
A-46	15.6	11.5	7.4:10
A-57	12.4	8.9	7.2:10
A-66	16.6	12.0	7.2:10
A-88	13.0	9.7	7.5:10
A-123	33.0	23.0	7.0:10
A-130	13.7	9.9	7.2:10
A-131	23.4	18.0	7.7:10
A-132 ¹
A-136	26.5	20.0	7.5:10
A-145 ²	34.5 (28.5)	21.5	7.5:10
A-172	7.8	7.2	9.2:10
A-174	13.2	9.0	6.8:10
A-175 ³	36.0	24.7	6.9:10
A-259	20.7	15.5	7.5:10
A-295	9.8	8.1	8.3:10
A-296	11.7	9.5	8.1:10

¹ Not measured although complete and mainly undistorted.

² Erroneously measured by Van Oyen (1956): according to his photograph (fig. 131) and drawing (fig. 125), the correct measurements are 28.5 mm. in width at base and 21.5 mm. in length.

³ Obviously compressed and widened.

It is not the purpose of this paper to evaluate the conclusions reached by Van Oyen except where they concern the interpretation of the eurypterid in question or concern the genus. It has been recognized that many of the species described are much alike, at

least dorsally, and that with more material several may be found to be conspecific, and certainly several must be delegated to sub-specific rank (Kjellesvig-Waering, 1948, p. 5). It should be noted, however, that the eurypterids identified by Van Oyen from the "Veine D" as *A. imhofi* (Reuss) differ as much from the holotype of *A. imhofi* as from *A. mansfieldi*. The species from the "Veine D," in my opinion, is *Adelophthalmus cambieri* (Pruvost).

Superfamily *Stylonuracea* Diener, 1924

Family *Stylonuridae* Diener, 1924

Genus *Mazonipterus*, new genus

Diagnosis.—Stylonuridae of medium size; carapace very elongated, with lateral eyes arcuate and placed anteriorly on the carapace. The greatest width of carapace occurs midway. Palpebral lobe attached to carapace by a narrow bridge on outer-posterior part of lobe. Marginal rim very narrow, simple, not ornamented. Ornamentation smooth. No other parts known.

Occurrence.—Middle Pennsylvanian of Illinois.

Type species.—*Mazonipterus cyclophthalmus* Kjellesvig-Waering.

Remarks.—This is an easily recognizable and very unusual genus. The remarkably long, inflated carapace and the large disc-like, arcuate eyes, well forward of the center of the carapace, recall the Silurian genus *Ctenopterus* Clarke and Ruedemann, 1912, and indeed, may be the Pennsylvanian straggler of that line. We know of no closely related forms between the Middle Silurian and the Middle Pennsylvanian, however, that might give substance to that supposition. The two genera differ in many important structures. *Mazonipterus* has a longer, more inflated carapace; an unornamented marginal rim; highly arcuate eyes, which are covered by disc-like palpebral lobes that join the carapace at the outer posterior part of the eyes; and no surface ornamentation. *Ctenopterus* has a much shorter, converging carapace; an ornamented marginal rim; sub-reniform, lateral eyes located on mounds; and prominent scale-like ornamentation. The Silurian *Stylonurus dolichopteroides* Størmer also bears some resemblance, which, however, might be of more importance when more is known of each. The shape of the carapace, as well as the shape of the lateral eyes, will readily distinguish both.

Mazonipterus is a highly unusual form, not only with regard to morphology but because it is the first definite stylonurid to be found in the upper Carboniferous. Augusta and Přibyl (1951, pp. 2-4,

pl. 1, figs. 1, 2) recorded a leg from the marine Namurian of Czechoslovakia. They named this form *Stylonurus?* (*Ctenopterus?*) *ostravensis* and indicated its possible affinities to *Ctenopterus*. It now might

FIG. 52. Holotype of *Mazonipterus cyclophthalmus*, new sp. Slightly reduced.



be preferable to questionably refer the Czechoslovakian species to *Mazonipterus*. It must be admitted, however, that the incongruous Czechoslovakian form reveals distinct carcinosomatid traits, although very little, if anything, is known of this family after the Silurian. Nevertheless, the morphology of the leg of *M.*(?) *ostravensis* recalls forms such as *Echinognathus* and *Carcinosoma*. The marine occurrence of the Czechoslovakian form is certainly more indicative of the Carcinosomatidae than the Stylonuridae, a family that occupied more brackish-water habitats (see Kjellesvig-Waering, 1961, pp. 793-794).

Mazonipterus cyclophthalmus, new species

Figures 52-54

Holotype.—United States National Museum no. 41169 *a* and *b*.

Diagnosis.—Carapace elongated and campanulate; lateral eyes large, arcuate, with round palpebral lobes and located intramarginally, but forward on the carapace.

Description.—The holotype and only known specimen consists of part and counterpart of a rather well-preserved, nearly complete

carapace, in dorsal aspect in a typical ironstone concretion. The specimen is partly compressed, although there is no appreciable distortion. What appears as a transverse joint-line across the middle



FIG. 53. Counterpart of holotype of *Mazonipterus cyclophthalmus*, new sp., showing outline of ventral shield. Slightly reduced.

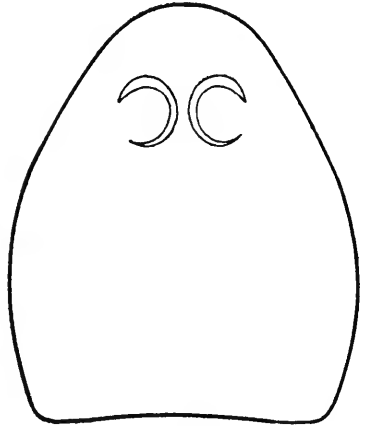

FIG. 54. Schematic drawing of carapace of *Mazonipterus cyclophthalmus*, new sp., restored.

of the carapace is a narrow plant stem that lies on the outside of the carapace. This stem was excavated satisfactorily, and there is no doubt that it represents extraneous material and not the junction of the carapace with a long first tergite, as in the Scottish *Woodwardopterus scabrosus* (Woodward). A similar stem cuts diagonally across the carapace (see fig. 52).

The carapace is very long, surrounded by a very thin, unornamented, marginal rim, and is swollen at approximately midsection. It is therefore campanulate but narrowing toward the genal angles. The large, highly arcuate eyes, with disc-like palpebral lobes, are located on the anterior of the carapace, close together, and intramarginally. There is no trace of any ocelli or ocellar mound and enough of the carapace is present to assure their preservation if they were present. The surface is smooth.

At the anterior of the carapace, the ventral shield is faintly preserved as an impression reflected through the carapace. The holotype previously had been carelessly excavated with a sharp instrument toward the anterior, but part of the doublure can still be discerned. It appears to be strongly cordate (see fig. 52) as in *Limulus* or stylo-nurids such as *Brachyopterus? pentagonalis* (Størmer).

Measurements of holotype.—Prosoma width at base, 42.0 mm. (est.); prosoma width behind eyes, 41.0 mm. (est.); greatest width of prosoma, 49.0 mm. (est.); prosoma length, 65.0 mm. (est.).

FIG. 55. *Mycterops* sp. Portion of characteristic integument; \times 1.8. Specimen PE 6171.

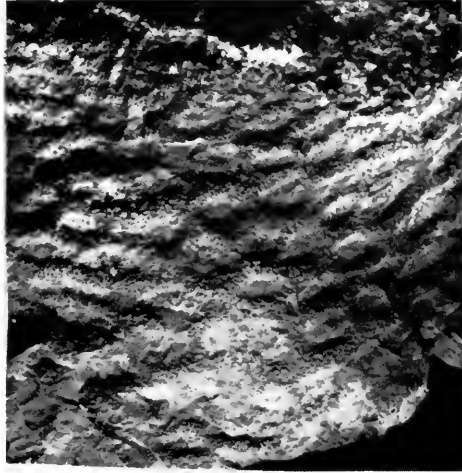

The eyes are located on the carapace: from anterior margin, 12.5 mm.; from posterior margin, 40.0 mm. (est.); from lateral margin, 8.5 mm. The eyes are arcuate, but including the palpebral lobe they are 12.0 mm. in length, 8.5 mm. in width, 3.5 mm. apart at the anterior, and 12.0 mm. in width at the posterior part.

Horizon and locality.—Pennsylvanian, Francis Creek shale, at Mazon Creek, Grundy County, Illinois. No collector or date of collection is given on the labels but apparently from the faded character of the label it was made a considerable time ago.

Family Mycteropidae Cope, 1886

Genus *Mycterops* Cope, 1886

Mycterops, sp. indet.

Figures 55 and 56

Two fragments are recorded here which reveal the presence of this very unusual eurypterid. One, collected by James Konecny, consists of part and counterpart of a medium-sized coxa of the sixth appendage, which measures 42.0 mm. by 34.0 mm. (fig. 56). Another fragment, comprising an undiagnostic, irregular piece of the

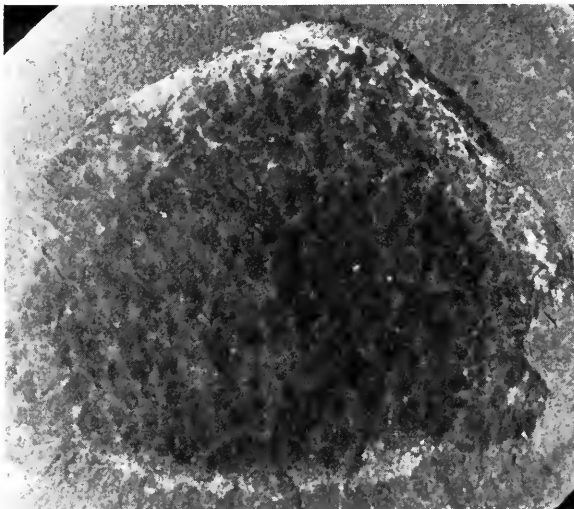

FIG. 56. Coxa of swimming leg of *Mycterops* sp. Specimen in Konecny collection; $\times 2$.

integument, is also recorded (fig. 55). Other than to call attention to the presence of this very unusual eurypterid in the Mazon Creek fauna, little can be discerned from the fragments known. The genus is represented in the Darlington shales of the Allegheny Group in Pennsylvania and is also known in Europe (Kjellesvig-Waering, 1959, p. 251).

Specimens.—The coxa is in the collection of James Konecny of Mokena, Illinois; the fragment of integument is registered as no. PE 6171 in Chicago Natural History Museum. Both are from the strip mines on the Will-Grundy County line.

REFERENCES

- AUGUSTA, J., and PŘIBYL, A.
1951. O Nalezu Zbytku Eurypterida V, Ostravském Karbonu. Česká Spol. Nauk, Věstník, Tř. mat.-přírod., **10**, no. 9, 9 pp., 1 pl.
- CASTER, K. E., and KJELLESVIG-WAERING, E. N.
1956. Some notes on the genus *Dolichopterus* Hall. Jour. Pal., **30**, no. 1, pp. 19-29, 1 fig., pl. 4.
- CLARKE, J. M.
1909. Fifth report of the Director of the Science division. . . . New York State Mus., Bull., **133**, pp. 35-38, pls. 1-2.
- CLARKE, J. M., and RUEDEMANN, R.
1912. The Eurypterida of New York. New York State Mus., Mem., **14**, pp. 1-439, 121 figs., 88 pls.

DIENER, C.

1924. Fossilium Catalogus, I: Animalia. Pars 25: Eurypterida. pp. 1-29. Berlin.

GRABAU, A. W.

1920. A new species of *Eurypterus* from the Permian of China. Bull. Geol. Surv. China, 2, pp. 61-68, pl. 9.

HALL, C. E.

1877. Contributions to Palaeontology from the Museum of the Second Geological Survey. Proc. Amer. Phil. Soc., 16, p. 621.

HALL, JAMES

1884. Eurypteridae from the Lower Productive Coal Measures in Beaver County, and the Lower Carboniferous, Pithole Shale, in Venango County. Second Geol. Surv. Pennsylvania, Rept. Progress PPP, pp. 23-39, 3 text figs., 6 pls.

HEUBUSCH, C. A.

1962. Preservation of the intestine in three specimens of *Eurypterus*. Jour. Pal., 36, pp. 222-224, pl. 39.

KJELLESVIG-WAERING, E. N.

1948. The Mazon Creek eurypterid: A revision of the genus *Lepidoderma*. Illinois State Mus., Sci. Papers, 2, no. 4, 46 pp., 1 text fig., 8 pls.

1958. The genera, species and subspecies of the family Eurypteridae, Burmeister, 1845. Jour. Pal., 32, no. 6, pp. 143-148, 27 text figs.

1959. A taxonomic review of some Late Paleozoic Eurypterida. Jour. Pal., 33, no. 2, pp. 251-256, pl. 38.

1961. The Silurian Eurypterida of the Welsh Borderland. Jour. Pal., 35, no. 4, pp. 789-835, pls. 94-96, 4 text figs.

LAURIE, M.

1895. The anatomy and relations of the Eurypteridae. Trans. Roy. Soc. Edinburgh, 37, pt. 2, no. 24, pp. 509-528, 2 pls.

LESLEY, J. P.

1889. A dictionary of the fossils of Pennsylvania. Second Geol. Surv. Pennsylvania, Rept. P4, 1-3, 1283 pp., figs.

MEEK, F. B., and WORTHEN, A. H.

1868a. Preliminary notice of a scorpion, a *Eurypterus?* and other fossils from the Coal-Measures of Illinois. Amer. Jour. Sci., 2nd ser., 46, no. 136, pp. 19-28.

1868b. Illinois Geol. Surv., Rept., 3, Paleontology, pp. 544-547, 1 fig.

MILLER, S. A.

1877. The American Palaeozoic fossils: A catalogue of the genera and species, etc. 253 pp. Cincinnati, Ohio.

1889, 1892. North American Geology and Paleontology. 664 pp., 1194 figs. (1889). First Appendix, pp. 665-715, figs. 1195-1265 (1892). Cincinnati, Ohio.

MOORE, L. R.

1936. Some eurypterids from the English Coal Measures. Proc. Geol. Assoc., 47, pt. 4, pp. 352-375, 7 figs.

O'CONNELL, M.

1916. The habitat of the Eurypterida. Bull. Buffalo Soc. Nat. Sci., 11, no. 3, 277 pp., 28 figs.

PRIBYL, A.

1953. On the genus *Adelophthalmus* Jordan and Meyer, 1854 (Eurypterida) and its representatives in the Upper Carboniferous of Czechoslovakia. *Ceská Akad., Trf., Rozpravy II*, 53, no. 2, 17 pp., 2 pls.

PRUVOST, P.

1911. Note sur quelques Crustacés (*Prestwichia*, *Belinurus* et *Eurypterus*) du terrain houiller du nord de la France. *Ann. Soc. Geol. Nord*, 40, pp. 295-302, pl. 7.
1919. La faune continentale du terrain houiller du nord de la France. *Mém. La Carte géologique détaillée de la France*, 584 pp., 51 text figs., 24 pls.
1930. La faune continentale du terrain houiller de la Belgique. *Mem. Mus. Roy. Hist. Nat. Belg.*, no. 44. Bruxelles.

RICHARDSON, E. S., JR.

1956. Pennsylvanian invertebrates of the Mazon Creek area, Illinois. *Fieldiana: Geol.*, 12: no. 1, Introduction; no. 2, Insects; no. 3, Marine Fauna; no. 4, Trilobitomorpha, Arthropleurida. 76 pp., 41 figs.

RUEDEMANN, R.

1919. Preservation of alimentary canal in an eurypterid. *Pal. Contr., New York State Mus., Bull.*, 227-228, pp. 92-95, figs. 33-35.

SHIMER, H. W., and SHROCK, R. R.

1944. *Index fossils of North America*. 837 pp., 303 pls. John Wiley and Sons, New York.

STAINIER, X.

1915. On a new eurypterid from the Belgian Coal Measures. *Quart. Jour. Geol. Soc., London*, 71, pp. 639-647, pl. 53.

STØRMER, L.

1934. Merostomata from the Downtonian Sandstone of Ringerike, Norway. *Norske Vidensk.-Akad. i Oslo, I. Matem.-Naturvid. Kl.*, 1933, no. 10, 125 pp., 39 figs., 12 pls.
1955. Treatise on Invertebrate Paleontology, Part P. Arthropoda 2, Chelicerata with sections on Pycnogonida and Palaeoisopus. Eurypterida, pp. P23-P41, figs. 17-30.

VAN OYEN, F. H.

1956. Contribution à la connaissance du genre *Adelophthalmus* Jordan et Meyer, 1854. *Med. Geol. Stichting, Ser. C-IV-3*, no. 7, 98 pp., 156 figs., 24 pls.

WATERLOT, GERARD

1953. Classe des Merostomes; in PIVETEAU, J., *Traité de Paléontologie*, 3, pp. 529-554, figs. 1-58.

WATERSTON, C. D.

1960. The median abdominal appendage of the Silurian eurypterid *Slimonia acuminata* (Salter). *Palaeontology*, 3, no. 3, pp. 245-259, pls. 42, 43.

WELLER, S.

1898. A bibliographic index of North American Carboniferous invertebrates. *Bull. U. S. Geol. Surv.*, 153, 653 pp.

WOODWARD, H.

1888. Note on *Eurypterus* from the Carboniferous. *Geol. Mag.*, Dec. III, 5, no. 9, pp. 419-421, 1 fig.
1907. Two new *Eurypterus* from the Coal Measures of Ilkeston, Derbyshire. *Geol. Mag.*, 4, pp. 277-282, pl. 13.
1913. The position of the Merostomata. *Geol. Mag.*, 10, pp. 293-300, 2 figs.







UNIVERSITY OF ILLINOIS-URBANA

550.5F1 C001
FIELDIANA, GEOLOGY CHGD
12 1956/69



3 0112 026616018