

70
④
75
P51X
BOT

3

5/16
5/12

85

THE PHILIPPINE JOURNAL OF SCIENCE

ALVIN J. COX M. A., PH. D.
GENERAL EDITOR

SECTION C. BOTANY

E. D. MERRILL, M. S.
EDITOR

WITH THE COÖPERATION OF
W. H. BROWN, PH. D.; C. F. BAKER, M. A.; L. M. GUERRERO, PHAR. D.
R. C. MCGREGOR, A. B.

VOLUME XIII
1918

WITH 6 PLATES AND 6 TEXT FIGURES

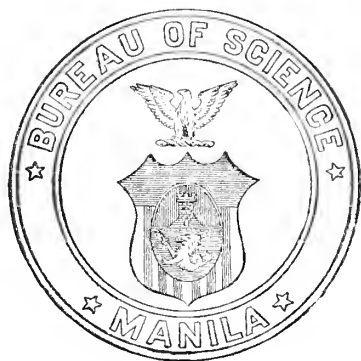

MANILA
BUREAU OF PRINTING
1918

DATES OF ISSUE

- No. 1, pages 1 to 66, February 25, 1918.
No. 2, pages 67 to 122, May 9, 1918.
No. 3, pages 123 to 200, July 16, 1918.
No. 4, pages 201 to 262, September 21, 1918.
No. 5, pages 263 to 334, November 18, 1918.
No. 6, pages 335 to 397, February 25, 1919.

CONTENTS

	Page.
No. 1, January, 1918	
MERRILL, E. D. New or noteworthy Philippine plants, XIII.....	1
No. 2, March, 1918	
MERRILL, E. D. New species of Bornean plants.....	67
No. 3, May, 1918	
MERRILL, E. D. Notes on the flora of Loh Fau Mountain, Kwangtung Province, China	123
FOXWORTHY, F. W. Philippine Dipterocarpaceae, II..... Two plates.	163
No. 4, July, 1918	
BROTHERUS, V. F. Contributions to the bryological flora of the Philippines, V.....	201
BROWN, W. H. The fungi cultivated by termites in the vicinity of Manila and Los Baños..... Two plates.	223
YATES, H. S. Fungi from British North Borneo.....	233
SHAW, W. R. Some microtechnical methods and devices..... Five text figures.	241
No. 5, September, 1918	
MERRILL, E. D. New or noteworthy Philippine plants, XIV.....	263
No. 6, November, 1918	
SWINGLE, W. T. Merrillia, a new rutaceous genus of the tribe Citreae from the Malay Peninsula..... Two plates.	335
BROWN, W. H. The theory of limiting factors..... One text figure.	345
BROWN, W. H., and TRELEASE, S. Alternate shrinkage and elongation of growing stems of <i>Cestrum nocturnum</i>	353
YATES, H. S. Some recently collected Philippine fungi, II.....	361
ERRATA	385
INDEX	387

VOL. XIII, SEC. C, No. 1

JANUARY, 1918

THE PHILIPPINE JOURNAL OF SCIENCE

ALVIN J. COX, M. A., PH. D.
GENERAL EDITOR

SECTION C. BOTANY

E. D. MERRILL, M. S.
EDITOR

WITH THE COÖPERATION OF

W. H. BROWN, PH. D.; C. F. BAKER, M. A.
L. M. GUERRERO, PHAR. D.; R. C. MCGREGOR, A. B.



MANILA
BUREAU OF PRINTING
1918

PHILIPPINE JOURNAL OF SCIENCE

A TEN-YEAR INDEX

CONTENTS AND INDEX OF THE PHILIPPINE JOURNAL OF SCIENCE, VOLUME I (1906) TO VOLUME X (1915)

Order No. 449. Bureau of Science Publication No. 8. Paper, 441 pages.
Price \$2, United States currency, postpaid.

One copy of this index has been sent free of charge to each subscriber that has received Volumes XI and XII of the Journal.

This publication consists of:

The complete contents of the first ten volumes of the Philippine Journal of Science, all sections; giving all authors, titles of articles, and page numbers. The exact date of issue of each number is recorded.

An author index, being an alphabetical list of all the contributors. The titles of all the articles are listed under the names of their respective authors.

A subject index. The subject matter is very fully indexed by catch words from the titles, by geographical localities, and by subjects. All systematic names in zoölogy and botany, as well as the thousands of English and local names, are entered in the index.

STUDIES IN PHILIPPINE DIPTERA, II

By M. BEZZI

Order No. 437. Bureau of Science Publication No. 10. Paper, 59 pages and 1 plate.
Price \$0.50, United States currency, postpaid.

This is the second century of Professor Bezzi's enumeration of Philippine species of flies and includes descriptions of new genera and new species.

PLEASE GIVE ORDER NUMBER

Orders for Bureau of Science publications may be sent to the BUSINESS MANAGER, Philippine Journal of Science, Bureau of Science, Manila, P. I., or to any of the following agents:

AGENTS

THE MACMILLAN COMPANY, 64-66 Fifth Avenue, New York, U. S. A.
WM. WESLEY & SON, 28 Essex Street, Strand, London, W. C., England.
MARTINUS NIJHOFF, Lange Voorhout 9, The Hague, Holland.
KELLY & WALSH, Limited, 32 Raffles Place, Singapore, Straits Settlements.
A. M. & J. FERGUSON, 19 Baillie Street, Colombo, Ceylon.
THACKER, SPINK & Co., P. O. Box 54, Calcutta, India.

THE PHILIPPINE
JOURNAL OF SCIENCE

C. BOTANY

VOL. XIII

JANUARY, 1918

No. 1

NEW OR NOTEWORTHY PHILIPPINE PLANTS, XIII

By E. D. MERRILL¹

(From the Botanical Section of the Biological Laboratory, Bureau of Science, Manila)

The last paper under this title was published in 1915,² the present contribution being essentially similar to the preceding ones of the series. Seventy-two species in thirty-four families are described as new, the groups considered being those that for the most part present comparatively few novelties in current collections. One new genus, *Ilocania*, of the *Cucurbitaceae*, is described. Eight species previously described from extra-Philippine material are for the first time credited to the Archipelago, representatives of these having appeared in our current collections; among these the genus *Zippelia* is new to the Archipelago. A noteworthy species, presenting another striking case of Philippine-Australian distribution is the rare and very characteristic *Ipomoea diversifolia* R. Br., which has definitely been reported only from the small islands in the Gulf of Carpentaria, but which now appears in our collections from north-western Luzon. *Sida longistipula* Merr., described below, a very characteristic and strongly marked species, finds its alliance with a few Australian species rather than with the Asiatic representatives of the genus. *Vitex celebica* Koord. adds another species to the already long list of those known only from the Philippines and Celebes.

¹ Professor of botany, University of the Philippines.

² Merrill, E. D., New or Noteworthy Philippine Plants, XII, *Philip. Journ. Sci.* 10 (1915) Bot. 287-349.

ARACEAE

ALOCASIA Schott

ALOCASIA WENZELII sp. nov. § *Eualocasia*.

Planta magna, glabra; foliis longe petiolatis, usque ad 1 m longis, haud peltatis, oblongo-ovatis vel ovatis, coriaceis, nitidis, laevis, margine cartilagineis, sursum angustatis, apice obtusis ad leviter acuminatis, basi profunde lobatis, lobis oblongis, obtusis, 30 ad 50 cm longis; nervis subtus valde prominentibus, utrinque 8 ad 11, patulis, basilaribus deflexis usque ad apicem loborum attingentibus; inflorescentiis longe pedunculatis, spathis oblongis, acutis, usque ad 12 cm longis et 2.5 cm latis, vetustioribus reflexis, spadiceis circiter 10 cm longis.

A large, coarse, glabrous plant, the caudices in old plants up to 0.7 m high and 15 cm in diameter. Petioles stout, up to 1 m in length, when fresh green and mottled or horizontally striped. Leaf-blades oblong-ovate, up to 1 m in length and 45 cm in width in the widest part, pale-olivaceous when dry, from the tip of the basal lobes to the apex attaining a length of 1 m, coriaceous, somewhat shining, smooth on both surfaces, the margins prominently cartilaginous, entire; basal lobes not spreading, oblong, obtuse, attaining a length of 50 cm, the sinus extending to the insertion of the petiole, usually narrow, acute; apex obtuse to obscurely acuminate, the blade gradually narrowed from base to apex; lateral nerves 8 to 11, very prominent on the lower surface, spreading at nearly right angles except the basal pair which is deflexed and extends quite to the tip of the basal lobes, emitting from one to three prominent veins on the outer side; reticulations obscure. Inflorescences numerous, their peduncles up to 45 cm in length. Tube of the spathe oblong, about 2 cm long, the limb at first boat-shaped, oblong, acute or somewhat apiculate, about 12 cm long and 2.5 cm wide, white, ultimately reflexed and deciduous. Spadix cylindrical, erect, up to 10 cm in length, the basal pistillate portion about 1.5 cm long and less than 1 cm in diameter, the staminate portion 3 to 3.5 cm long, cylindrical, somewhat thicker than the pistillate portion, the appendage acute or acuminate, cylindrical, about equalling the staminate and pistillate portions of the spadix. Staminate and pistillate flowers crowded. Stigmas sessile, subcapitate, scarcely lobed. Apex of the anther-bearing body truncate, crenate, about 2 mm in diameter, anthers apparently 8 to 10. Fruiting spadices ovoid or ellipsoid, when dry about 3 cm long.

LEYTE, Dagami, *Wenzel 97* (type), March 28, 1913, on forested slopes, altitude about 60 meters. BILIRAN, *Bur. Sci. 18929 McGregor*, June 22,

1914, in forests, altitude about 300 meters. SAMAR, Catubig River at Pinipisakan, *Bur. Sci.* 24266 Ramos, March 21, 1916, in forests along the river. MINDANAO, Agusan Subprovince, Amparo, *For. Bur.* 7615 Hutchinson, August 23, 1907, in open forests, altitude about 30 meters. It is known in Leyte as *biga*, the common name for *Alocasia macrorrhiza* Schott, and in Samar as *handuroy*.

A remarkable species belonging in the same group with *Alocasia macrorrhiza* Schott, to which, however, it is not closely allied. It is well characterized by its large, oblong-ovate, coriaceous, very smooth, shining leaves, the basal lobes deflexed, not at all spreading, often attaining a length of one-half the lamina, and its very obscure reticulations.

ALOCASIA MAQUILINGENSIS sp. nov. § *Eualocasia*.

Planta robusta, pedunculis et subtus foliis furfuraceo-hispidulis; foliis late ovatis, usque ad 90 cm longis et 50 cm latis, obtusis vel obscure acuminatis, haud peltatis, lobis latissime ovatis, rotundatis, comparate brevibus, nervis utrinque circiter 10 utrinque, subtus valde prominentibus, patulis, curvatis, basilariibus utrinque pinnati-nervis, leviter deflexis, usque ad apicem loborum attingentibus, reticulis prominentibus; inflorescentiis numerosis, pedunculis usque ad 30 cm longis; spathis circiter 10 cm longis, tubo sub fructu accrescentibus, albis, carnosis, oblongo-ovoidis, usque ad 8 cm longis; spadiciis 8 ad 10 cm longis.

A robust plant, the caudices in old specimens stout, attaining a height of about 0.3 m, perhaps higher. Leaves membranaceous, broadly ovate, up to 90 cm long and 50 cm wide, entire, apex obtuse to obscurely acuminate, base not at all peltate, with two very broad, rounded lobes which are at most 20 cm long, and as wide or wider than long, the sinus rather broad, somewhat rounded, the upper surface, when dry, minutely punctulate-verruculose, the lower uniformly and distinctly furfuraceous-hispidulous on the nerves and reticulations; lateral nerves about 10 on each side of the midrib, prominent on the lower surface, spreading, curved, the basal pair somewhat deflexed and reaching the tip of the lobes, bearing from 3 to 5 pinnately arranged secondary nerves on each side; petioles stout, up to 1.5 m in length, rather densely furfuraceous-pubescent. Inflorescences numerous, up to 30 on each plant, their peduncles pubescent, up to 30 cm in length. Spathes about 10 cm long, the tubular portion 1 to 1.5 cm long, the limb lanceolate or oblong-lanceolate, membranaceous, about 6 cm long, acuminate. Pistillate portion of the spadix about 1 cm long, the flowers crowded; style short, distinct; stigma obscurely lobed. Staminate portion of the spadix about 2 cm long, cylindric, the sterile appendage about 5 cm long. Fruiting spathe ovoid or oblong-ovoid, white, fleshy, up to 8 cm in length, the fruits fleshy, red.

LUZON, Laguna Province, Mount Maquiling, *Baker 868* (type), March 1, 1913, *Bur. Sci. 16926 Serviñas*, November 25, 1912, *Bur. Sci. 6737 Robinson*, April 8, 1909, *Merrill 7153*, September 3, 1910, on forested slopes, altitude 120 to 600 meters.

A species well characterized by its pubescent leaves, petioles, and peduncles, and by its white, fleshy, fruiting spathes.

COMMELINACEAE

ANEILEMA R. Brown

ANEILEMA HUMILE sp. nov. § *Dictyospermum*.

Planta circiter 20 cm alta, erecta, haud ramosa, vaginis et petioles plus minusve hirsutis; foliis paucis, submembranaceis, oblongis ad oblongo-ellipticis, usque ad 10 cm longis, apice tenuiter acuminatis, basi cuneatis; inflorescentiis racemosis, paucifloris, solitariis, e axillis superioribus, circiter 2 cm longis; capsulis ovoideis, glabris, circiter 3 mm longis, 3-ocularibus, 3-valvis, loculis 1-spermis; seminibus osseis, plano-convexis, ellipticis, perspicue rugosis, circiter 2.5 mm longis.

An erect simple plant, or the lower parts of the stem more or less decumbent and geniculate, about 20 cm high, the stems glabrous or very slightly pubescent. Leaves submembranaceous, oblong to oblong-elliptic, 5 to 10 cm long, 1.5 to 3.5 cm wide, subequally narrowed to the slenderly sharp-acuminate apex and to the cuneate base, glabrous, of the same color on both surfaces when dry, scarcely shining, the longitudinal lateral nerves usually three on each side of the midrib, obscure, the petiolar part 3 to 4 mm long, more or less pubescent, the sheaths 1 cm long or less, somewhat inflated, more or less pubescent. Raceme solitary, simple, from the uppermost axil, 2 to 2.5 cm long, few-flowered, glabrous, the base with a narrowly lanceolate, 1 cm long, acuminate bract. Flowers white. Sepals elliptic-obovate, green when fresh, brown when dry, about 3 mm long, concave, somewhat cucullate. Petals very thin, white, oblong-obovate, rounded, about 3.5 mm long, the nerves dark-brown, very prominent. Fertile stamens 3; anthers broadly elliptic-ovate, 1 mm long; staminodes 3. Ovary ovoid, glabrous; style 3 mm long. Capsule ovoid or ovoid-ellipsoid, 3 to 3.5 mm long, 3-valved, 3-celled, the pericarp brittle, shining; seeds solitary in each cell, 2.5 mm long, white, plano-convex, elliptic, prominently rugose.

ALABAT, back of Sangirin, *Merrill 10459*, December 24, 1916, on steep slopes in damp forests, altitude about 80 meters; rare and a few plants observed in only one place.

This very characteristic species is readily distinguished by its inflores-

cence being reduced to a short simple raceme, a character very different from most of the other species in the genus. It is apparently not very closely allied to any previously described form.

LILIACEAE

SMILAX Linnaeus

SMILAX ERECTA sp. nov.

Frutex erectus, glaber, leviter aculeatus, simplex vel parce ramosus, circiter 1 m altus, ecirrhiferus; foliis oblongis, in siccitate brunneis, nitidis, usque ad 20 cm longis, utrinque aequaliter angustatis, apice prominente acuminatis, basi cuneatis, perspicue 3-nerviis; inflorescentiis axillaribus, simpliciter umbellatis, breviter pedunculatis; fructibus ovoideis vel ellipsoideis, circiter 8 mm longis.

An erect shrub about 1 m high, glabrous, simple or at most once dichotomously branched above, without tendrils, the stems terete, pale-brownish, 5 to 6 mm in diameter below and armed with widely scattered, stout, short, straight spines 2 mm in length or less, the upper parts of the stem unarmed. Leaves oblong, subcoriaceous, brown and shining when dry, of nearly the same color on both surfaces, 12 to 20 cm long, 4 to 6 cm wide, equally narrowed to the rather prominently acuminate apex and the acute base, the base prominently 3-nerved, the lateral nerves extending to the tip of the leaf, the reticulations lax, fairly prominent; petioles about 2 cm long, the inflated basal part 1 cm long or less, cucullate. Umbels in the upper axils, solitary, simple, their peduncles 1.5 cm longer less, the pedicels 6 to 10, about 8 mm long. Fruits black when dry, ovoid or ellipsoid, wrinkled, shining, about 8 mm long.

LUZON, Tayabas Province, Mount Binuang, *Bur. Sci.* 28560 (type), 28472 Ramos & Edaña, May, 1917, on forested slopes.

This most characteristic species is readily distinguished by its erect, simple or but once branched stems which are aculeate below; by its prominently 3-nerved leaves; by the entire lack of tendrils; and by its simple umbels.

SMILAX LUCIDA sp. nov.

Frutex scandens, ramis leviter armatis, distincte circiter 9-angulatis, sulcatis; foliis firme chartaceis vel subcoriaceis, oblongo-ovatis ad oblongo-ellipticis, usque ad 16 cm longis, breviter apiculato-acuminatis, basi in foliis minoribus rotundatis, in majoribus distincte cordatis, utrinque nitidis, 5- vel 7-nerviis; umbellis axillaribus, solitariis, pedunculo 2.5 ad 3 cm longo; fructibus globosis, in siccitate subnigris, nitidis, 8 ad 10 mm diametro.

A scandant shrub, the branches and branchlets pale when dry, distinctly about 9-angled, sulcate, sparingly armed with widely scattered, short, straight, rather stout spines that do not exceed 2 mm in length. Leaves firmly chartaceous to subcoriaceous, subolivaceous when dry, prominently shining on both surfaces, oblong-ovate to oblong-elliptic, 8 to 16 cm long, 3.5 to 10 cm wide, all with a stout apiculate-acuminate apex, the smaller ones rounded at the base, the larger ones prominently cordate, 5- or 7-nerved, the inner pair of nerves much stouter than the outer ones, reaching the apex, the reticulations rather lax, prominent; petioles 1 to 2 cm long, the lower part somewhat sheathing, the tendrils attaining a length of about 10 cm. Umbels axillary, solitary, their peduncles 2.5 to 3 cm long, the pedicels in fruit 1.5 to 2 cm long. Fruits globose, numerous, nearly black when dry, somewhat wrinkled, prominently shining, 8 to 10 mm in diameter; seeds usually 3.

LUZON, Tayabas Province, vicinity of Dingalan, on the Pacific coast, *Bur. Sci.* 26611 Ramos & Edaña, August 27, 1916, on dry slopes at medium altitudes.

A species well characterized by its inflorescences being reduced to a simple umbel. In vegetative characters it somewhat resembles *SMILAX ELMERI* nom. nov. (*Smilax reticulata* Elm. Leaf. Philip. Bot. 8 (1815) 2740, non Desv., nec Heer), but *Smilax elmeri* has racemously arranged umbels, and its leaves are acute at the base.

PIPERACEAE

ZIPPELIA Blume

ZIPPELIA BEGONIAEFOLIA Blume in Roem. & Schultes Syst. 7 (1830) 1614, 1651.

Zippelia lappacea Benn. Pl. Jav. Rar. (1838) 76, t. 16.

Piper zippelia C. DC. Prodr. 16³ (1869) 256.

JOLO, Mrs. Clemens 9335, October 15, 1915, in damp forests, altitude about 600 meters.

This monotypic genus is new to the Philippines. Indo-China, Mekong River, Thorel, the Malay Peninsula, Borneo, and Java.

FAGACEAE

QUERCUS Linnaeus

QUERCUS CAGAYANENSIS sp. nov. § *Cyclobalanus*.

Arbor circiter 12 m alta, partibus junioribus densissime ferrugineo-pubescentibus; foliis oblongo-ovatis ad ovato-lanceolatis, integris, coriaceis, usque ad 15 cm longis, basi acutis, apice caudato-acuminatis, supra costa exceptis glabra, nitidis, subtus pallidioribus, ad costa nervisque pubescentibus, nervis utrinque 7 ad 9, subtus prominentibus, curvato-adscendentibus,

haud anastomosantibus, reticulis tenuibus, confertis, obscuris, subparallelis; cupulis obovoideis, pubescentibus, 2 cm diametro, obscure zonulatis, basi contractis, dentibus circiter 1 mm longis, infra distantibus, supra confertis; glans puberulis, 1.5 cm diametro, circiter 1.5 cm longis, subovoideis, apiculatis.

A tree about 12 m high, the younger parts densely ferruginous-pubescent. Branches terete, brownish, glabrous, somewhat lenticellate. Leaves coriaceous, oblong-ovate to ovate-lanceolate, 10 to 15 cm long, 3 to 6 cm wide, entire, base acute, apex slenderly subcaudate-acuminate, the acumen blunt, up to 2 cm in length, the upper surface glabrous except for the pubescent midrib, smooth, shining, pale or brownish-olivaceous when dry, the lower surface paler than the upper, pubescent on the midrib and nerves; lateral nerves 7 to 9 on each side of the midrib, prominent, curved-ascending, not anastomosing, the reticulations slender, close, subparallel, inconspicuous; petioles densely pubescent, 5 to 8 mm long. Infructescences simple, up to 12 cm in length, spike-like, rather stout, lenticellate, when young pubescent, ultimately glabrous, each bearing two or three fruits. Cups obovoid, about 2 cm in diameter, brown-pubescent on both surfaces, rather abruptly contracted below into a stout pseudo-stalk which is 5 to 8 mm long and about 5 mm in diameter, somewhat contracted to the truncate orifice which is 1.5 cm in diameter, the zones obscure, about 10 in all, the lower ones distant and with distant teeth, the upper ones close, the teeth contiguous, the teeth narrow, 1 mm long or less. Glans ovoid from a truncate base, about 1.5 cm long and wide, about two-thirds contained within the cup, puberulent, apiculate.

LUZON, Cagayan Province, Pamplona, *For. Bur. 26973 Velasco*, August 9, 1917, in forests, altitude about 60 meters.

The alliance of this species is not entirely clear, but it is apparently most closely related to *Quercus llanosii* A. DC., from which, however, it is distinguished by numerous characters. It is one of the species that is difficult to place as between the sections *Pasania* and *Cyclobalanus*, but I have placed it in the latter section as the scales have free apices and are not imbricate; the zones are indistinct, distant below, and contiguous above.

QUERCUS MABESAE sp. nov. § *Pasania*.

Arbor circiter 20 m alta, ramulis et subtus foliis minute brunneo-puberulis vel pubescentibus; foliis coriaceis, oblongis, usque ad 14 cm longis, utrinque subaequaliter angustatis, basi acutis, apice tenuiter acuminatis, supra glabris, vel junioribus leviter puberulis, laevis, nitidis, in siccitate brunneis, subtus subconcoloribus vel paullo pallidioribus; nervis utrinque circiter 9, perspicuis, curvatis, obscure anastomosantibus, reticulis sub-

obsoletis; cupulis 2 cm diametro, circiter 1.5 cm altis, truncatis, utrinque dense pubescentibus, zonis circiter 10, contiguas, dentibus numerosis, confertis, 1.5 ad 2 mm longis; glans oblongo-ovoideis, glabris, nitidis, 2.5 cm longis et 1.7 cm diametro.

A tree about 20 m high, the branchlets and lower surface of the leaves minutely brownish puberulent or pubescent. Branches subterete, smooth, subolivaceous. Leaves oblong, coriaceous, 9 to 14 cm long, 3.5 to 6 cm wide, entire, base acute, apex slenderly acuminate, the acumen about 1 cm long, obtuse, the upper surface glabrous, smooth, shining, brownish when dry, or when young slightly puberulent, the lower surface of the same color or slightly paler, brownish-pubescent with very short hairs; lateral nerves about 9 on each side of the midrib, prominent, curved, obscurely anastomosing, the reticulations slender, obscure, often nearly obsolete; petioles castaneous-pubescent, about 5 mm long. Infructescence a simple spike about 10 cm long, the rachis rather stout, pubescent, each bearing but few fruits. Cups cupshaped, 2 cm in diameter, about 1.5 cm high, truncate, densely pubescent with pale-brownish hairs on both surfaces, sessile, the zones about 10, contiguous, the teeth numerous, crowded, oblong, acuminate, 1.5 to 2 cm long. Glans oblong-ovoid, glabrous, shining, brown when dry, 2.5 cm long, 1.7 cm in diameter, apiculate, the lower 7 mm included within the cup.

LUZON, Laguna Province, Mount Maquiling, *For. Bur. 26915 Mabesa*, September 19, 1917, on forested ridges, altitude 300 meters and above, locally known as *ulayan*.

In vegetative characters this species closely resembles *Quercus lipacon* Elm. of Mindanao, but is entirely different in its fruit characters. The cups strongly resemble those of *Quercus jordanae* Laguna, but the present species is not otherwise closely allied to that species.

URTICACEAE

ELATOSTEMA Forster

ELATOSTEMA GRACILIFOLIUM sp. nov.

Herba erecta, 20 ad 40 cm alta, inflorescentiis exceptis glabra, dioica, ramosa, ramis gracilibus, adscendentibus; foliis linearilanceolatis, usque ad 4 cm longis et 6 mm latis, acuminatis, leviter falcatis, inaequilateralibus, utrinque acutis, margine utrinque dentibus 4 ad 6 conspicuis instructis; inflorescentiis ♂ axillaribus, solitariis, sessilibus, bracteis exterioribus orbicularibus, circiter 3 mm diametro, margine perspicue ciliatis, ad apicem perspicue corniculato-apiculatis, interioribus multo mi-

noribus, circiter 2 mm longis, obovatis, ad oblongo-obovatis vel obovato-spatulatis, navicularibus, haud corniculatis; floribus 4-meris.

A slender, erect, branched herb 20 to 40 cm high, glabrous except the inflorescences. Stems greenish when dry, about 3 mm in diameter, the branches slender, ascending, up to 16 cm in length, less than 1 mm in diameter, with numerous cystoliths. Leaves linear-lanceolate, somewhat falcate, subchartaceous, dark-green when dry, 3 to 4 cm long, 3 to 6 mm wide, slenderly acuminate, base acute, somewhat inequilateral, both surfaces with numerous, irregularly arranged cystoliths, margins prominently and sharply toothed above the middle, 4 to 6 teeth on each side; wider side of the leaf with a single ascending nerve leaving the midrib 2 to 3 mm above the base and extending one-fourth to one-third to the apex, the nerves and reticulations otherwise obsolete; petioles 0.5 mm long. Staminate inflorescences axillary, sessile, 3 to 4 mm in diameter, ciliate, the outer two bracts orbicular, 3 mm in diameter, the tip with a 0.5 mm long apiculus, margins prominently glabrous, the inner ones smaller, the innermost about 2 mm long, oblong-obovate to oblong or oblong-spatulate, navicular, hooded, ciliate toward the tips, not corniculate. Staminate flowers 4-merous, their pedicels up to 1.5 mm long, the perianth about 1 mm long, the segments obscurely penicillate.

Luzon, Nueva Ecija Province, Mount Umingan, *Bur. Sci. 26428 Ramos & Edaña*, August 18, 1916, on rocks in forests.

A most characteristic species readily distinguished by its slender branches and very narrow, prominently toothed leaves, which, except for the midrib and single basal nerves, are without evident nerves or reticulations.

ARISTOLOCHIACEAE

ARISTOLOCHIA Linnaeus

ARISTOLOCHIA HUMILIS sp. nov.

Species *A. philippinensis* Warb. affinis. Suffrutex erectus circiter 40 cm altus, simplex vel parce ramosus; foliis membranaeis ad chartaceis, ovatis ad oblongo-obovatis, usque ad 25 cm longis, supra olivaceis, nitidis, glabris, subtus pallidioribus et parce pubescentibus, basi subacutis ad rotundatis, apice acutis, obtusis, vel latissime obtuse acuminatis, nervis utrinque circiter 7, prominentibus, adscendentibus; racemis axillaribus, usque ad 6 cm longis; floribus tenuibus, circiter 3 cm longis; fructibus oblongo-ellipsoideis, circiter 2.5 cm longis, 6-carinatis, apice obtusis, basi acuminato-attenuatis.

An erect undershrub about 40 cm high, simple or sparingly branched, the stems 5 to 10 cm thick, terete, brownish, glabrous, the younger parts sparingly pubescent. Leaves few, 4 to 7 on each plant, ovate to oblong-obovate, membranaceous to chartaceous, 13 to 25 cm long, 6 to 11 cm wide, the upper surface olivaceous, glabrous, shining, the lower paler, sparingly pubescent with very short hairs on the midrib, nerves, and reticulations, the base subacute to rounded, the apex acute, obtuse, or broadly and bluntly acuminate; lateral nerves about 7 on each side of the midrib, prominent, ascending, anastomosing, the reticulations lax, prominent; petioles 2 to 3 cm long, sparingly pubescent, becoming nearly or quite glabrous. Racemes axillary, 4 to 6 cm long, or when young much shorter, many flowered, but only one or two flowers developing at one time, the bracts oblong, somewhat pubescent. Flowers apparently purplish, slender, about 3 cm long, their pedicels 3 to 4 mm in length. Ovary oblong, somewhat keeled, about 3 mm long, the corolla-tube above the ovary slender, cylindric, about 7 mm long, the inflated part ovoid or ellipsoid, base somewhat inequilateral, about 6 mm long, the cylindric tube above the inflated part 5 to 7 mm long, the limb 1-lipped, the lip linear to linear-oblancheolate, about 18 mm long, 3 to 4 mm wide. Anthers 6, the cells contiguous. Capsule brown when dry, glabrous, oblong-ellipsoid, about 2.5 cm long, 6-keeled, the apex obtuse, the base attenuate-acuminate.

LUZON, Tayabas Province, Mount Binuang, *Bur. Sci.* 28480 (type), 28838 Ramos & Edaño, May, 1917; Infanta-Siniloan trail, Ramos s. n., June 14, 1917; Mount Pular, *Bur. Sci.* 19423 Ramos, January 21, 1913, along streams in damp forests at low altitudes.

The alliance of this species is manifestly with *Aristolochia philippinensis* Warb., from which it differs in very numerous characters, notably in its low stature and larger, differently shaped leaves.

MENISPERMACEAE

COCCULUS de Candolle

COCCULUS SARMENTOSUS (Lour.) Diels, var. **STENOPHYLLUS** var. nov.

A typo differt foliis lanceolatis, oblongo-lanceolatis, vel oblancheolatis, basi acutis, 3 ad 5 cm longis, 8 ad 15 mm latis.

LUZON, Ilocos Norte Province, Burgos, *Bur. Sci.* 27231 Ramos, March 4 1917, climbing on trees in forests at low altitudes.

This form differs so radically from the typical form of the species, which is represented by *Bur. Sci.* 27213 Ramos from the same locality, that I believe that it is worthy of at least varietal rank. In this connection *Clemens* 749 from Camp Keithley, Mindanao, cited under *Cocculus sar-*

mentosus (Lour.) Diels and also under *Hypserpa jagori* Diels,³ pertains entirely to *Cocculus* and represents a form distinctly allied to the variety *stenophylla* Merr., but with larger leaves which attain a length to 7.5 cm and a breadth of 2.6 cm.

MAGNOLIACEAE

MICHELIA Linnaeus

MICHELIA PLATYPHYLLA sp. nov.

Arbor glabra; foliis oblongo-ellipticis, chartaceis, usque ad 30 cm longis et 13 cm latis, obtuse acuminatis, basi subacutis, in siccitate pallidis vel subolivaceis, utrinque nitidis, nervis utrinque 18 ad 23, perspicuis; floribus longe pedicellatis, perianthii segmentis circiter 12, oblanceolatis, acuminatis, 2.5 cm longis; antheris circiter 25, 12 mm longis.

A glabrous tree, the branchlets terete, smooth, about 5 mm in diameter, dark-brown, marked with a few conspicuous lenticels and the conspicuous stipular scars, the internodes 2 to 3 cm long. Leaves chartaceous, oblong-elliptic, 23 to 30 cm long, 9 to 13 cm wide, when dry pale or subolivaceous, shining on both surfaces, the base subacute, the apex shortly and obtusely acuminate; lateral nerves 18 to 23 on each side of the midrib, conspicuous on both surfaces as are the rather close, raised reticulations; petioles 2 to 3 cm long; stipules lanceolate, dark-brown and rugose when dry, about 6 mm long, deciduous. Flowers white, axillary, solitary, their pedicels 4 to 5 cm long, with a rather conspicuous bracteole scar above the middle. Buds oblong-ovoid, brown when dry, acute, about 2.5 cm long, the bud-scale splitting down one side, deciduous. Perianth-segments about 12, oblanceolate, acuminate, the outer ones about 2.5 cm long and 1 cm wide, the inner ones smaller and narrower. Stamens about 25, the anthers linear, 12 mm long.

LEYTE, Burauen, Cagañon, *For. Bur. 26866 Tomeldan*, May 21, 1917, in semi-open country (parang) at an altitude of 50 meters, locally known as *hanquilo*.

This species is well characterized by its remarkably large leaves. Its alliance is with the extra-Philippine *Michelia montana* Blume, to which, however, it is not very closely related.

MONIMIACEAE

MATTHAEA Blume

MATTHAEA INTERMEDIA sp. nov.

Frutex circiter 4 m altus inflorescentiis exceptis glaber, ramulis brunneis vel atro-brunneis; foliis subcoriaceis, oblongo-

³ Engl. Pflanzenreich 46 (1910) 211, 232.

ellipticis, usque ad 13 cm longis, integerrimis, breviter acute acuminatis, basi rotundatis et leviter decurrento-acuminatis, in siccitate subolivaceis, subtus pallidioribus; nervis primariis circiter 8, distinctis, supra haud impressis; inflorescentiis axillaribus, pedunculatis, depauperato-cymosis, pubescentibus, 1 ad 2 cm longis; receptaculis ♂ depresso-turbinatis, pubescentibus, circiter 4 mm diametro, tepalis reniformibus, rotundatis, circiter 1.5 mm longis; antheris 3 vel 4, confertis, sessilibus, connectivo haud producto.

A shrub about 4 m high, glabrous except the inflorescence. Branches and branchlets terete, smooth, the former straw-colored, the latter reddish-brown or dark-brown when dry. Leaves subcoriaceous, oblong-elliptic, entire, 8 to 13 cm long, 3 to 6 cm wide, the apex shortly and acutely acuminate, base rounded and somewhat decurrent-acuminate, shining when dry, the upper surface subolivaceous, the lower somewhat paler; primary lateral nerves about 8 on each side of the midrib, spreading, rather prominently arched-anastomosing distant from the margin, not at all impressed on the upper surface and scarcely projecting on the lower surface, the reticulations lax; petioles dark-brown, 1 to 1.5 cm long. Staminate inflorescences axillary, depauperate-cymose, few-flowered, peduncled, 1 to 2 cm long, appressed-pubescent with short, brownish hairs. Receptacles depressed-turbinate, externally sparingly pubescent, about 4 mm in diameter, the bracts oblong, pubescent, 1.5 mm long, the pedicels 5 mm long or less. Tepals subreniform, rounded, about 1.5 mm long, glabrous. Anthers 3 or 4, sessile or subsessile, broadly ovoid or orbicular-ovoid, 1 mm long, the connectives not produced.

LUZON, Tayabas Province, Mount Binuang, *Bur. Sci.* 28614 Ramos & Edaña, May, 1917, in forests, altitude about 1,000 meters.

If the entire leaves be any criterion this species comes near *Matthaea calophylla* Perk. and *M. latifolia* Perk., but it is not otherwise closely allied to these species. It seems to be much more closely allied to *Matthaea sancta* Blume, and in many respects is very similar to the entire-leaved forms of *M. sancta* Blume var. *venulosa* Perk. From this it is easily distinguished by its olivaceous leaves, its dark-brown branchlets, and the lateral nerves rather obscure and not at all impressed on the upper surface of the leaves.

CAPPARIDACEAE

CAPPARIS Linnaeus

CAPPARIS LONGIPES sp. nov.

Frutex scandens, glaber; foliis lanceolatis, membranaceis ad chartaceis, usque ad 11 cm longis, acutissime acuminatis, basi acutis, nervis utrinque circiter 15, distinctis; infructescentiis

axillaribus, tenuibus, parce ramosis, usque ad 20 cm longis; fructibus longe pedicellatis, globosis, circiter 12 mm diametro.

A scandent glabrous shrub, the branches slender, terete, brownish or olivaceous, the ultimate branchlets about 1 mm in diameter, the stipular spines straight, usually about 2 mm long. Leaves lanceolate, membranaceous to chartaceous, green or greenish-olivaceous when dry, somewhat shining, 7 to 11 cm long, 2 to 3 cm wide, narrowed upward to the very slender apex, sharply acute-acuminate, base acute; lateral nerves about 15 on each side of the midrib, slender, distinct on both surfaces, anastomosing, the primary reticulations lax, the ultimate ones close, both distinct; petioles 2 to 3 mm long. Infructescences axillary, very slender, sparingly branched, up to 20 cm in length, each branch bearing a single fruit, its pedicel about 3 cm long. Fruit globose, brown when dry, glabrous, about 12 mm in diameter.

LUZON, Abra Province, Mount Posuey, *Bur. Sci. 26980 Ramos*, February 4, 1917, in forests along streams and on cliffs.

A remarkable species on account of its greatly elongated, axillary, very slender infructescences. Its alliance is with *Capparis loheri* Merr., from which it is distinguished not only by its infructescence but also by its much smaller, entirely glabrous leaves.

CAPPARIS ILOCANA sp. nov.

Frutex glaber, ut videtur scandens, ramis ramulisque teretibus; foliis membranaceis vel chartaceis, oblongo-ellipticis, usque ad 7 cm longis, apice breviter acuteque acuminatis, basi obtusis, nervis utrinque circiter 10, tenuibus, distinctis; inflorescentiis terminalibus, umbellatis, 5- vel 6-floris; floribus longe pedicellatis, pedicellis 2 ad 2.5 cm longis, alabastro globoso, 5 mm diametro.

A glabrous shrub, apparently scandent, the branches slender, terete, brownish-black when dry, the stipular spines very short, straight, about 1 mm long, the branchlets pale-greenish. Leaves pale-greenish when dry, oblong-elliptic, membranaceous to chartaceous, 5 to 7 cm long, 2.5 to 3.5 cm wide, slightly shining, the apex shortly and acutely acuminate, base obtuse; lateral nerves about 10 on each side of the midrib, slender, distinct, anastomosing, the primary reticulations lax, the ultimate ones close, indistinct; petioles 2 to 4 mm long. Inflorescence a simple terminal, few-flowered umbel, the flowers usually 5 or 6, their pedicels 2 to 2.5 cm long. Buds globose, about 5 mm in diameter.

LUZON, Ilocos Norte Province, Burgos, *Bur. Sci. 27120 Ramos*, March 18, 1917, in thickets near the sea.

A species characterized by its terminal, simple, few-flowered umbels

of long-pedicelled flowers. It may be as closely allied to *Capparis sepiaria* Linn. as to any other species, but it is entirely different from the numerous forms of this Linnean species in its vegetative and inflorescence characters.

ROSACEAE

RUBUS Linnaeus

RUBUS EDANOII sp. nov. § *Malachobatus*, *Elongati*.

Frutex scandens, minute aculeatus, ramulis et inflorescentiis pilosis; foliis simplicibus, coriaceis, ovatis ad oblongo-ovatis, usque ad 12 cm longis, acute acuminatis, basi truncato-rotundatis cordatisque, prominente 5- vel 7-nerviis, nervis lateralibus utrinque 5 ad 7, rectis, adscendentibus, in pagina superiore ad costa nervisque pilosis, subtus pilosis et minute leviter aculeatis, margine apiculato-dentatis; inflorescentiis terminalibus, elongatis, circiter 20 cm longis, dense subadpresse pilosis; sepalis oblongo-ovatis ad ovato-lanceolatis, circiter 6 mm longis, petalis brevibus, caducis, oblongo-obovatis, circiter 4 mm longis, basi angustatis, apice prominente dentatis.

A scandent shrub, the branches terete, brown, more or less pilose, and with small, reflexed, scattered aculei 1 mm long or less. Leaves simple, thickly coriaceous, olivaceous, ovate to oblong-ovate, 6 to 12 cm long, 3 to 7 cm wide, shining, apex sharply acuminate, base broadly truncate-rounded and distinctly cordate, prominently 5- or 7-nerved, the nerves straight, the primary ones all ascending, 5 to 7 on each side of the midrib, the primary reticulations subparallel, prominent, the margins acuminate-dentate, the upper surface glabrous or pilose on the midrib and lateral nerves, the lower surface pilose on the midrib and nerves and also with few scattered, minute aculei; petioles pilose, minutely aculeate, 1 to 1.5 cm long; stipules narrowly oblong, free or nearly so, deciduous, about 4 mm long. Panicles terminal, narrow, up to 20 cm long, pilose, the younger parts very densely so, slightly aculeate, the lower branches 3 cm long or less, spreading, widely scattered. Flowers about 1.8 cm in diameter, their pedicels 10 mm long or less. Sepals oblong-ovate to ovate-lanceolate, somewhat acuminate, externally densely pilose with pale appressed hairs, internally densely cinereous-puberulent. Petals thin, glabrous, caducous, narrowly oblong-obovate, about 4 mm long, glabrous, base narrowed, apex prominently toothed. Stamens indefinite. Carpels few, usually 6 or fewer, glabrous or with very few scattered hairs, including the slender styles 2 to 2.5 mm long.

LUZON, Nueva Ecija Province, Mount Umingan, *Bur. Sci.* 26505 Ramos & Edaña, September 6, 1916, in the mossy forest, altitude 300 meters.

A species allied to *Rubus cumingii* O. Kuntze, from which it is distinguished at once, among other characters, by its sharply acuminate leaves. *Rubus cumingii* O. Kuntze is figured by Focke, a photogravure of the type specimen, *Species Ruborum* *Bibl. Bot.* 17 (1910) 59, *fig.* 21.

CONNARACEAE

CONNARUS Linnaeus

CONNARUS SUBFOVEOLATUS sp. nov.

Frutex scandens, ramulis junioribus inflorescentiisque exceptis glaber; foliis trifoliolatis, foliolis ovatis ad subellipticis, usque ad 13 cm longis, in siccitate pallidis, nitidis, utrinque jejunae foveolatis, basi obtusis, apice subabrupte et prominente acuminatis, nervis utrinque 4, adscendentibus, perspicuis; paniculis axillaribus et terminalibus, usque ad 12 cm longis, ferrugineo-pubescentibus; floribus circiter 3 mm longis, petalis in siccitate verrucosis, glabris, perspicue rubro-glandulosis; carpellis solitariis, subglobosis, pubescentibus.

A scandent shrub attaining a length of about 6 m, glabrous except the branchlets and inflorescences, the branches terete, brown, about 4 mm in diameter, lenticellate, the young branchlets sparingly pubescent. Leaves 3-foliolate, the petiole and rachis 6 to 7 cm long. Leaflets firmly chartaceous, ovate to subelliptic, 9 to 13 cm long, 4.5 to 6.5 cm wide, pale and shining when dry, both surfaces manifestly and densely foveolate, the pits shallow, base obtuse, sometimes minutely peltate, the apex rather abruptly and prominently acuminate, the acumen blunt and 8 to 12 mm long; lateral nerves 4 on each side of the midrib, prominent, curved-ascending, anastomosing; petiolules 3 to 5 mm long. Panicles axillary and terminal, up to 12 cm in length, rather lax, densely ferruginous-pubescent with short simple hairs. Flowers brownish-pink, their pedicels 1 to 2 mm long. Sepals oblong, obtuse, pubescent, 2 mm long. Petals narrowly oblong, obtuse, 3 to 3.5 mm long, 0.8 mm wide, verruculose when dry, glabrous, prominently glandular with reddish glands. Carpels solitary, subglobose, pubescent; styles 3 mm long, glabrous.

LUZON, Apayao Subprovince, Ngagan, *Bur. Sci.* 28240 Féria, May 8, 1917, in damp forests.

A species strongly characterized by its trifoliolate leaves and the densely and shallowly foveolate leaflets.

LEGUMINOSAE

ALBIZZIA Durazzini

ALBIZZIA MEGALADENIA sp. nov.

Arbor circiter 8 m alta, subglabra, partibus junioribus leviter pubescentibus; foliis 14 ad 18 cm longis, petiolis et rachibus inter pinnis ultimis glandulis magnis ovoideis instructis; pinnis 6- ad 9-jugatis, 5 ad 7 cm longis; foliolis 20- ad 30-jugatis, oblongis, obtusis, 5 ad 7 mm longis, inaequilateralibus; fructibus anguste oblongis, usque ad 8 cm longis, circiter 1.4 cm latis, obtusis, nitidis, reticulatis; seminibus 15 ad 20, contiguis.

A tree about 8 m high, nearly glabrous. Branches terete, glabrous, dark reddish-brown or nearly black when dry, the branchlets paler in color, also glabrous. Leaves bipinnate, 14 to 18 cm long, 6- to 9-jugate, the petiole at or above the middle with a very prominent, dark-brown, ovoid, projecting, 7 to 9 mm long gland, a similar but smaller one usually present between the ultimate pinnae; pinnae 5 to 7 cm long, the rachis very sparingly pubescent; leaflets oblong, inequilateral, glabrous or nearly so, 20 to 30 pairs on each pinna, 5 to 7 mm long, 1.5 to 2 mm wide, rounded at the apex, the base rounded on the broader side, subacute or obtuse on the narrow side, the nerves indistinct. Pods brownish when dry, shining, somewhat reticulate, narrowly oblong, 7 to 8 cm long, about 1.4 cm wide, rather thin, rounded at the apex, the base acuminate, margins somewhat thickened; seeds 15 to 20, contiguous, subelliptic, compressed, about 4 mm long.

LUZON, Tayabas Province, Umiray, *Bur. Sci.* 29023 Ramos & Edaña, June, 1917, in forests along the Umiray River.

This species in vegetative characters somewhat resembles *Albizzia lebekoides* Benth., but is entirely different in its fruit characters, and in its remarkably large, ovoid, projecting petiolar and rachis glands. The pods, although much smaller, resemble those of *Leucaena glauca* Benth., but are indehiscent and reticulate.

NEPTUNIA Loureiro

NEPTUNIA DEPAUPERATA sp. nov.

Suffrutex prostratus e basi lignosus, usque ad 40 cm longis, ramosis, ramis ramulisque tenuibus, teretibus vel ramulis obscurissime angulosis; foliis 1.5 ad 3 cm longis, 1- ad 4-jugatis; foliolis oblongis, 2 ad 3 cm longis, confertis, crassis, margine leviter ciliatis, obscurissime venosis; capitulis axillaribus, solitariis, pedunculatis; floribus 5-meris, staminibus 5; floribus inferioribus neutris, staminoideis petaloideis, circiter 10 mm lon-

gis, lineari-oblongatis, planis; ovario 6-ovulatis; leguminibus oblongis, planis, 2 cm longis.

A prostrate undershrub from a much thickened woody root, the branches spreading, prostrate, distinctly woody, slender, up to 40 cm in length, branched, the branches and branchlets dark reddish-brown, glabrous; terete, or the ultimate ones very obscurely angular. Leaves 1.5 to 3 cm long, 1- to 4-jugate, the pinnæ 1 cm long or less; leaflets 12 to 16 pairs, sessile, oblong, thick, 2 to 3 mm long, obscurely nerved, base inequilaterally rounded, apex obtuse to minutely apiculate, margins in young leaves sparingly ciliate; stipules inequilateral, slenderly acuminate, ovate, about 3 mm long. Heads axillary, yellow, their peduncles slender, 2 to 3 cm long. Lower flowers neuter. Calyx less than 1 mm long. Petals somewhat oblong-oblongate, 2 mm long, free. Staminodes petaloid, yellow, flat, membranaceous, linear-oblongate, about 1 cm long. Perfect flowers: Calyx 1.5 to 2 mm long, the teeth 5, ovate, obtuse to subacute, 0.5 mm long. Petals 5, free, about 2.5 mm long, oblong-spatulate. Filaments filiform, 4 mm long; anthers oblong-elliptic, 1 mm long, falling very soon after anthesis, tipped with a minute sessile gland. Ovary subsessile, compressed, oblong, inequilateral, glabrous; ovules about 6; style 3 mm long. Pods oblong, thin, brown, about 2 cm long and 5 mm wide, minutely apiculate.

LUZON, Ilocos Norte Province, Burgos, *Bur. Sci.* 27169 Ramos, March 13, 1917, in old dry rice paddies at low altitudes.

This species in many respects resembles *Neptunia triquetra* Benth., which extends from India to Indo-China, but is smaller, with much smaller leaves, and with but five stamens, and very different staminodes. It is distinctly woody, the root being much thickened, the prostrate stems not at all herbaceous. On account of its five stamens its true alliance is with the Australian *Neptunia gracilis* Benth. and *N. monosperma* F. Muell., being more distinctly allied to the former. It is easily distinguished from *Neptunia gracilis* Benth. by its much smaller leaflets.

CROTALARIA Linnaeus

CROTALARIA TRIFOLIASTRUM Willd. Sp. Pl. 3 (1806) 983.

LUZON, Province of Ilocos Norte, Burgos, *Bur. Sci.* 27265 Ramos, March 15, 1917, in open places near streams at low altitudes.

Tropical Asia to northeastern Australia; new to the Philippines.

SPATHOLOBUS Hasskarl

SPATHOLOBUS PHILIPPINENSIS sp. nov.

Frutex scandens inflorescentiis exceptis glaber; foliolis oblongo-ovatis ad ovatis, chartaceis, usque ad 11 cm longis, obtusis, glaberrimis, nervis utrinque circiter 7; leguminibus circiter 11 cm longis et 3 cm latis, in siccitate brunneis, nitidis,

leviter falcatis, utrinque obtusis v.l apice breviter apiculatis, valvis perspicue reticulatis.

A scandent shrub of indefinite length, entirely glabrous except the somewhat ferruginous-pilose inflorescences. Branches and branchlets slender, terete, reddish-brown, smooth. Leaves 3-foliolate, the petioles 2.5 to 6 cm long; leaflets firmly chartaceous, oblong-ovate to ovate, brownish or pale-olivaceous when dry, shining, 7 to 11 cm long, 3 to 6 cm wide, base usually rounded, apex usually obtuse; lateral nerves about 7 on each side of the midrib, distinct, the reticulations evident and rather close on both surfaces. Panicles terminal and in the upper axils, somewhat ferruginous-pilose with subappressed hairs as are the very young calyces. Mature flowers not seen, the panicles before anthesis up to 16 cm in length. Pods glabrous, shining, brownish when dry, thin, in general oblong, somewhat falcate, about 11 cm long and 3 cm wide, base inequilaterally rounded, apex rounded or obtuse, often slightly apiculate, the valves conspicuously reticulate.

LUZON, Laguna Province, Mount Maquiling, *For. Bur. 26841 Mabesa*, July 23, 1917, along trails on rather open slopes, altitude 100 to 200 meters. The same species is represented by *Bur. Sci. 2630 Ramos* and *For. Bur. 466 Ahern's collector*, from Rizal Province, Luzon, both of these specimens being with very young buds.

Spatholobus philippinensis Merr. is entirely different from the few other representatives of the genus known from the Philippines. It is well characterized by being entirely glabrous except for the sparingly pubescent inflorescences. In vegetative characters it is somewhat similar to *Spatholobus harmandii* Gagnep. of Indo-China.

RUTACEAE

EVODIA Forster

EVODIA GLABERRIMA sp. nov.

Frutex glaberrimus, foliis 1- ad 3-foliolatis; foliolis oblongis ad oblongo-lanceolatis, in siccitate nitidis, viridi-olivaceis, utrinque acuminatis, papyraceis, nervis primariis utrinque circiter 16, patulis, anastomosantibus, utrinque perspicue glandulosis; paniculis axillaribus, 3 ad 4 cm longis, paucifloris, floribus circiter 3 mm longis.

An erect, entirely glabrous shrub, the branches and branchlets pale when dry, slender, terete. Leaves opposite, 1- to 3-foliolate on the same branch, the petioles 3 to 5 cm long, the petiolules 1 cm long or less and like the petioles glandular-punctate; leaflets chartaceous, oblong to oblong-lanceolate, greenish-olivaceous and shining when dry, conspicuously glandular-punctate on both sur-

faces, subequally narrowed to the acuminate base and apex, the apical acumen obtuse, stout, about 1 cm long; primary lateral nerves about 16 on each side of the midrib, spreading, distinct, anastomosing, the reticulations distinct. Panicles axillary, solitary, 3 to 4 cm long, peduncled, narrowly pyramidal, few-flowered, the lower branches 1 cm long or less. Young flowers about 3 mm long, the petals 4, oblong, obtuse, glandular. Sepals, ovate, obtuse, 1 mm long. Staminodes 4, about 1 mm long. Ovary glabrous, deeply 4-lobed, the immature carpels brown, about 3.5 mm long.

LUZON, Tayabas Province, Mount Binuang, *Bur. Sci.* 28864 Ramos & Edaña, May 20, 1917, in forests along streams at low altitudes.

The alliance of this species is apparently with *Evodia ternata* (Blanco) Merr., from which it is readily distinguished by its thicker leaflets which vary in number from 1 to 3; its short, few-flowered inflorescences; and in being entirely glabrous in all parts.

TETRACTOMIA Hooker f.

TETRACTOMIA PACHYPHYLLA sp. nov.

Arbor glabra, circiter 15 m alta, ramis crassis, rugosis, cicatricibus perspicuis instructis; foliis crasse coriaceis, obovatis, in siccitate olivaceis vel olivaceo-brunneis, usque ad 11 cm longis, apice latissime rotundatis, basi cuneatis, obscure punctatis, nervis utrinque circiter 8; inflorescentiis usque ad 15 cm longis, longe pedunculatis; floribus circiter 5 mm diametro, petalis latissime ovatis, acutis vel obscure acuminatis, circiter 2.5 mm longis latisque.

A glabrous tree about 15 m high. Branches stout, rugose, about 6 mm in diameter, grayish or grayish-brown, marked with numerous large petiolar scars. Leaves thickly coriaceous, obovate, 6 to 11 cm long, 4 to 7 cm wide, shining, olivaceous or brownish-olivaceous when dry, the lower surface often paler than the upper, the apex very broadly rounded, the base cuneate, the upper surface obscurely pitted, the lower obscurely glandular-punctate; lateral nerves about 8 on each side of the midrib, rather conspicuous, anastomosing, the reticulations lax; petioles 1 to 2 cm long. Inflorescences from the upper axils and sub-terminal, long-peduncled, up to 15 cm long, the branches few, the lower primary ones up to 6 cm in length. Flowers fragrant, yellowish-green, dark-brown when dry, about 5 mm in diameter, somewhat crowded on the ultimate branchlets, shortly pedicelled. Calyx somewhat turbinate, 2.5 to 3 mm in diameter, shallowly toothed. Petals broadly ovate, about 2.5 mm long and wide, acute or somewhat acuminate. Filaments about 3 mm long.

Staminodes 0.5 mm long or less, or sometimes obsolete, the petals then with an evident gland in the median portion.

MINDANAO, Surigao Province (Dinagat Island), *For. Bur.* 26985 Ponce, July 22, 1917, in thin poor soil on semi-open slopes, altitude about 20 meters.

The alliance of this species is manifestly with *Tetractomia tetrandra* (Roxb.) Merr. in Journ. Str. Branch Roy. As. Soc. 76 (1917) 87 (*T. roxburghii* Hook. f.), from which it is distinguished especially by its differently shaped leaves which are broadly rounded at their apices.

POLYGALACEAE

POLYGALA Linnaeus

POLYGALA CARDIOPARPA Kurz in Journ. As. Soc. Beng. 41² (1872) 293; Gagnep. in Lecomte Fl. Gén. Indo-Chine 1 (1899) 253.

NEGROS, near Dumaguete, *Eskridge s. n.*, 1913, with the Visayan name *chicate*.

This species, previously reported only from Burma and Indo-China, is allied to *Polygala triphylla* Ham. The Philippine specimen agrees closely with duplicates of Thorel's Mekong collections cited by Gagnepain as representing Kurz's species.

POLYGALA ELONGATA Klein in Willd. Sp. Pl. 3 (1806) 879.

MINDANAO, Bukidnon Subprovince, Tanculan, *Bur. Sci.* 26016 Fénix, July 12, 1916, in open grasslands: Cotabato District, Makar, *Copeland s. n.*, December, 1911.

This species is reported only from India. The identification of the above specimens has been made entirely from the descriptions; they seem to conform more closely to the form described by Hasskarl as *Polygala eumekes* which Chodat has reduced to *Polygala elongata* Klein as forma *heyneana* (Wall.) Chodat.

HIPPOCRATEACEAE

HIPPOCRATEA Linnaeus

HIPPOCRATEA MEGALOCARPA sp. nov.

Frutex scandens, glaber; foliis coriaceis, integris, ellipticis ad late ellipticis, apice rotundatis vel brevissime abrupte obtuseque acuminatis, nervis utrinque 5 vel 6, distinctis; capsulis oblongo-ellipticis circiter 10 cm longis et 4 cm latis, seminibus 5.

A scandent glabrous shrub, the branches and branchlets terete, brownish. Leaves elliptic to broadly elliptic, entire, coriaceous, rather pale and slightly shining when dry, of the same color on both surfaces, 7 to 13 cm long, 5 to 10 cm wide, apex rounded or very shortly and abruptly blunt-acuminate, base usually rounded; lateral nerves 5 or 6 on each side of the midrib, rather prominent, reticulations lax; petioles stout, 8 to 10 mm long.

Capsules hard, flattened, oblong-elliptic, about 10 cm long and 4 cm wide, apex rounded, base obtuse, subequally narrowed at both ends, the valves pale, somewhat shining, more or less woody. Seeds 5 in each capsule, the seed proper 2 to 2.2 cm long, about 8 mm wide, brown, narrowed upward, compressed, the basal part a prominent, smooth submembranaceous wing attaining a length of 6 cm and a width of 2.7 cm.

LUZON, Laguna Province, Mount Maquiling, *For Bur. 24921 Mabesa*, December 16, 1915, on dry ridges along the Puting Lupa trail, altitude about 177 meters.

A characteristic species distinguishable by its elliptic entire leaves and its unusually large fruits.

HIPPOCRATEA TRICHOPETALA sp. nov.

Frutex scandens, inflorescentiis dense subferrugineo-pubescentibus exceptis glaber; ramis ramulisque teretibus, rubro-brunneis vel atro-brunneis; foliis ellipticis, subcoriaceis, usque ad 10 cm longis, in siccitate utrinque pallidis nitidisque, apice rotundatis, basi acutis, nervis primariis utrinque 6 vel 7, distinctis; cymis axillaribus, pedunculatis, paucifloris, 2 ad 3 cm longis, floribus circiter 9 mm diametro, petalis oblongis, acutis, circiter 4.5 mm longis, extus dense puberulis, intus in $\frac{1}{2}$ superiore parte perspicue pilosis; discus carnosus, circiter 2.5 mm diametro, apice densissime pilosus.

A scandent shrub, glabrous except the inflorescence, the branches and branchlets slender, terete, smooth, dark-brown or reddish-brown. Leaves elliptic, pale and shining on both surfaces when dry, 6 to 10 cm long, 3 to 6 cm wide, apex rounded, base acute, entire; primary nerves 6 or 7 on each side of the midrib, distinct, anastomosing, the reticulations prominent on the lower surface; petioles about 5 mm long. Cymes axillary, few-flowered, peduncled, 2 to 3 cm long, all parts subferruginous-pubescent with short hairs or the peduncles glabrous, dichotomously branched, the branches about 1 cm long. Flowers green, about 9 mm in diameter, the buds ellipsoid, rounded, their pedicels up to 6 mm in length. Calyx about 3 mm in diameter, short, the teeth 5, very short, acute. Petals oblong, outside densely puberulent, inside in the upper one-half and on the margins conspicuously and densely pilose with weak crisped hairs, acute, about 4.5 mm long. Disk fleshy, 2.5 mm in diameter, about 1.5 mm high, glabrous on the sides, the margin densely pilose with crisped hairs. Stamens 3, the filaments very broad, short, the anthers about 1 mm in diameter. Ovary ovoid,

sunk in the disk, glabrous, triangular, 3-celled, the stigma subsessile, minutely 3-lobed. Fruits unknown.

LUZON, Tayabas Province, Umiray, *Bur. Sci. 28958 Ramos & Edaño*, June 2, 1917, in forests along the Umiray River.

This most characteristic species is readily distinguished by its pale, elliptic, rounded leaves and especially by its petals being conspicuously pilose in the upper one-half inside, the hairs about 1 mm long. In its petal characters it is very similar to *Hippocratea cumingii* Laws., which must be typified by the Malacca specimen cited (*Griffith*) to which the description applies; the Philippine specimen, *Cuming 1725* from Samar, is not cited by Lawson in the original description and may or may not represent the same species as the Malacca one.

SALACIA Linnaeus

SALACIA EUPHLEBIA sp. nov.

Frutex scandens, glaber, ramis teretibus, junioribus obscure angulatis; foliis oblongis, coriaceis, olivaceis, nitidis, usque ad 15 cm longis, basi acutis ad subrotundatis, apice acuminatis, margine distanter apiculato-serrulatis; nervis utrinque circiter 9, subtus prominentibus, anastomosantibus, reticulis laxis, distinctis; inflorescentiis axillaribus, solitariis, quam petiolo brevioribus, depauperato-cymosis vel floribus fasciculatis; floribus 5-meris, circiter 3 mm longis, breviter pedicellatis.

A scandent glabrous shrub at least 3 m high, the branches pale-brownish or grayish, terete, or the younger ones obscurely angled, often pruinose. Leaves opposite, coriaceous, oblong, olivaceous, shining, of the same color on both surfaces, 9 to 15 cm long, 3.5 to 5 cm wide, base acute to somewhat rounded, apex distinctly acuminate, margins distantly apiculate-serrulate; lateral nerves about 8 on each side of the midrib, very prominent on the lower surface, spreading, somewhat curved-anastomosing, the primary reticulations distinct; petioles 5 to 8 mm long. Inflorescences axillary, solitary, very few-flowered, depauperate-cymose, the rachis once forked, or simple, very short, supplied with small bracts, or sometimes the inflorescence reduced to a fascicle; when a depauperate cyme but from 1 to 3 flowers produced at one time. Pedicels about 1 mm long. Flowers 5-merous, oblong, about 3 mm long. Calyx-lobes broadly ovate, rounded, about 1 mm long and wide. Petals oblong, rounded, about 2.8 mm long. Disk prominent, cylindric, enclosing the ovary, about 1 mm high. Filaments flattened, 0.8 mm long.

MINDANAO, Surigao Province, Placer, *Wenzel 1867*, July 4, 1916, in forests, altitude about 150 meters, the flowers greenish-yellow.

A species well characterized by its oblong, apiculate-denticulate, prominently nerved leaves, its greatly reduced inflorescences, and short-pedicelled

flowers. Its alliance is apparently with *Salacia subscandens* Elm. of Palawan.

SALACIA WENZELII sp. nov.

Frutex scandens, glaber; foliis oppositis, coriaceis, oblongo-ellipticis ad ellipticis, integris, usque ad 14 cm longis, obtuse acuminatis, basi subrotundatis, nervis utrinque 5 vel 6, subtus prominentibus, curvato-ascendentibus; inflorescentiis breviter pedunculatis, umbellatis vel depauperato umbellato-cymosis; floribus circiter 6.5 mm diametro, calycibus truncatis.

A scandent glabrous shrub, the branches terete. Leaves opposite, coriaceous, oblong-elliptic to elliptic, brownish to olivaceous when dry, somewhat shining, 10 to 14 cm long, 4.5 to 7 cm wide, entire, apex rather prominently but obtusely acuminate, base rounded to subacute; lateral nerves 5 or 6 on each side of the midrib, prominent on the lower surface, curved-ascending, anastomosing, the reticulations fine, rather close, distinct; petioles 1 cm long or less. Inflorescences solitary, axillary, of short peduncled umbels or of depauperate umbellate cymes, the peduncles shorter than the petioles, the flowers green, numerous, crowded, 6 to 7 mm in diameter, their pedicels up to 8 mm in length, grouped in fascicles on the peduncle or its very greatly reduced, short, stout branchlets. Calyx somewhat saucer-shaped, truncate, about 3 mm in diameter, not toothed. Petals 5, oblong-ovate, obtuse, 3.5 to 4 mm long. Stamens 3, about 2 mm long. Ovary and style slightly 3-angled. Disk very prominent.

LEYTE, Tigbao, near Tacloban, *Wenzel 1534*, July 18, 1915, a vine reaching a height of about 4 meters.

Readily distinguished from the other Philippine forms by its densely many-flowered, short-peduncled, umbellate or depauperate cymose-umbellate inflorescences, the peduncles shorter than the petioles, the flowers arranged in fascicles on the peduncle or on its very short stout branchlets, appearing like a true umbel. The very young fruits are ovoid.

SAPINDACEAE

NEPHELIUM Linnaeus

NEPHELIUM SCHNEIDERI sp. nov.

Species *N. mutabile* et *N. intermedio* affinis, differt nervis lateralibus magis numerosis, utrinque circiter 18. Arbor usque ad 9 m alta, partibus junioribus et inflorescentiis exceptis glabra; foliis 25 ad 35 cm longis, foliolis 5 vel 7, oblongis, chartaceis vel subcoriaceis, usque ad 20 cm longis, nitidis, subtus subglaucescentibus, nervis utrinque circiter 18, perspicuis; fructibus globosis, circiter 3 cm diametro, in siccitate castaneis, processibus

subrectis, subtruncatis, compressis, rigidis, sulcatis, circiter 6 mm longis.

A tree about 9 m high, glabrous except the younger parts and the inflorescence. Branches subterete, pale-grayish, often sulcate. Leaves 25 to 35 cm long, glabrous, the leaflets 5 or 7, oblong, chartaceous to subcoriaceous, oblong, 16 to 20 cm long, 5.5 to 8 cm wide, distinctly acuminate, base acute, when dry pale-brownish to pale-olivaceous, shining, the lower surface paler than the upper and usually slightly glaucous; lateral nerves about 18 on each side of the midrib, prominent, the reticulations distinct. Panicles terminal, densely subferruginous-pubescent, the branches few, up to 7 cm in length. Buds rather densely crowded, globose; petals ovate, minute. Fruits globose, pale greenish-yellow when fresh, castaneous when dry, 3 cm in diameter; the spines numerous, spreading, straight or slightly falcate, compressed, striate, subtruncate, about 6 mm long and 1.5 mm wide.

MINDANAO, Zamboanga District, Talisay, *For. Bur. 13775 Foxworthy, DeMesa, & Villamil*, June 18, 1913 (type), in the virgin forest, altitude about 20 meters, locally known as *buli*. The same species is represented by *For. Bur. 24052 Acuña* from Kalambugan, Lanao District, Mindanao, May 17, 1915, with immature flowers.

Its alliance is with *Nephelium mutabile* Blume and *N. intermedium* Radlk., the latter being scarcely distinguishable from the former; from these it is distinguished especially by its much more numerous lateral nerves. The species is dedicated to Mr. E. E. Schneider, wood expert of the Bureau of Forestry, who called my attention to the fact that the wood of this species was entirely different from that of *Nephelium mutabile* Blume as the type specimen was originally identified by me.

OTOPHORA Blume

OTOPHORA CAULIFLORA sp. nov.

Frutex glaber; foliis circiter 40 cm longis, foliolis 5 vel 6, oblongis ad oblongo-ellipticis, usque ad 25 cm longis, nitidis, acuminatis, basi acutis, nervis primariis utrinque circiter 10; stipulis suborbicularis, subcoriaceis, inaequilateralibus, 1 ad 2 cm longis; inflorescentiis paniculatis e ramis vetustioribus, circiter 20 cm longis, anguste pyramidatis, ramis paucis, inferioribus 3 ad 4 cm longis; fructibus carnosus, subglobosis, 3 ad 4 cm diametro, in siccitate brunneis, 2 ad 3 cm diametro.

A glabrous shrub, 1 m high according to the collector, but probably higher. Branches terete, brownish or grayish, lenticellate. Leaves about 40 cm long, the leaflets 5 or 6, chartaceous to subcoriaceous, oblong to oblong-elliptic, or the lower ones subovate, 15 to 25 cm long, 7 to 9 cm wide, base acute, apex

acuminate, pale when dry, of about the same color and shining on both surfaces; primary lateral nerves about 10 on each side of the midrib, prominent, curved, anastomosing, the reticulations prominent on both surfaces; stipules suborbicular, 1 to 2 cm long, similar to the leaves in texture and color, inequilateral, very shortly obtuse-acuminate or obtuse. Panicles from the trunk or larger branches, narrowly pyramidal, about 20 cm long, the branches few, spreading, the lower ones 3 to 4 cm long. Fruits fleshy, white or somewhat pink when fresh and 3 to 4 cm in diameter, when dry subglobose, 2 to 3 cm in diameter, brown, with one or two large, castaneous, shining seeds 1.5 to 2 cm in diameter.

Luzon, Tayabas Province, Mount Binuang, *Bur. Sci.* 28533, 28516 (*type*) Ramos & Edaño, May 8 and 19, 1917, in forests along streams at low altitude.

This species is allied to *Otophora fruticosa* Blume, but is readily distinguished, among other characters, by its very much larger fruits.

RHAMNACEAE

VENTILAGO Gaertner

VENTILAGO BRUNNEA sp. nov.

Frutex scandens, inflorescentiis exceptis glaber; foliis in siccitate brunneis, utrinque concoloribus, nitidis, oblongis, usque ad 20 cm longis, subcoriaceis, basi subacutis ad rotundatis, apice latissime acuminatis et obtusis vel leviter retusis, nervis utrinque circiter 9; inflorescentiis axillaribus terminalibusque, subferrugineo-pubescentibus, simplex vel e basi parce ramosis, usque ad 13 cm longis; floribus numerosis, fasciculatis, breviter pedicellatis, 3 ad 4 mm diametro, petalis obovatis, retusis, circiter 1 mm longis.

A scandent shrub, glabrous except the inflorescence. Branches and branchlets dark-brown, terete, smooth. Leaflets uniformly brown and shining on both surfaces when dry, subcoriaceous or firmly chartaceous, oblong, 12 to 20 cm long, 4 to 6 cm wide, base rounded to subacute, narrowed upward to the very broadly acuminate apex, the acumen rounded or slightly retuse and 3 to 5 mm wide at the tip; primary lateral nerves about 9 on each side of the midrib, prominent, curved, obscurely anastomosing close to the margin, the reticulations dense; petioles brown, 3 mm long or less. Inflorescences axillary and terminal, simple or branched from the base, the branches few, up to 13 cm in length, all parts uniformly pubescent with short, subferruginous or sometimes cinereous hairs. Flowers yellowish-white, numerous,

fascicled along the branches, 3 to 10 in a fascicle, 3 to 4 mm in diameter, their pedicels pubescent, 1 to 1.5 mm long. Calyx dark-brown when dry, externally slightly pubescent, the lobes broadly triangular, acute, 1.5 mm wide at the base, 1.2 mm long. Petals membranaceous, obovate, retuse, 1 mm long. Disk about 2 mm in diameter; styles 2, very short. Fruits unknown, the very young ones when 1 cm long or less very slightly pubescent, apparently soon entirely glabrous.

LUZON, Tayabas Province, Umiray River, *Bur. Sci. 29053 Ramos & Edaño*, June 3, 1917, in forests along the Umiray River at low altitudes.

This species is manifestly allied to *Ventilago dichotoma* (Blanco) Merr., from which it is readily distinguished by its much larger leaves.

VITACEAE

TETRASTIGMA Planchon

TETRASTIGMA CORNICULATUM sp. nov.

Frutex scandens, inflorescentiis et stipulis exceptis glaber; foliis pedatim 5-foliolatis, foliolis chartaceis vel subcoriaceis, ovatis ad oblongo-ovatis, acuminatis, basi subrotundatis, usque ad 9 cm longis grosse serrato-dentatis, nervis utrinque circiter 6; inflorescentiis pedunculatis, subcorymboso-umbellatis, usque ad 5 cm longis, multifloris; sepalis lanceolatis, acuminatis, petalis extus pubescentibus, circiter 4 mm longis, apice prominente acuminato-corniculatis.

A scandent shrub, glabrous except the stipules and the inflorescences, the branches subterete, brown when dry. Leaves pedately 5-foliolate, their petioles up to 10 cm long; stipules inequilateral, oblong-ovate, acute to somewhat acuminate, up to 1 cm long, externally densely ferruginous-puberulent; leaflets ovate to oblong-ovate, subcoriaceous, slightly shining when dry, subolivaceous, 6 to 9 cm long, 4 to 6 cm wide, base usually rounded, often inequilateral, apex rather prominently acuminate, margins rather coarsely serrate-dentate; lateral nerves about 6 on each side of the midrib, slender, distinct; petiolules usually about 1 cm long. Inflorescences in the upper axils, peduncled, umbellate-corymbose, cinereous-puberulent, many flowered. Flowers greenish, umbellately arranged on the ultimate branchlets, their pedicels cinereous-puberulent, 5 to 6 mm long. Sepals 4, lanceolate, pubescent, acuminate, about 1 mm long. Petals oblong-lanceolate, externally rather densely cinereous-puberulent, 4 mm long, prominently acuminate-corniculate, the apical appendage somewhat spreading. Filaments about 2 mm long. Female flowers not seen.

LEYTE, Tigbao, near Tacloban, *Wenzel 1240*, May, 1915, a vine with greenish flowers, reaching a height of about 10 meters.

A species well characterized by its prominently corniculate, pubescent petals, in vegetative characters resembling *Tetrastigma sepulchrei* Merr., but apparently not closely allied to that species.

ELAEOCARPACEAE

ELAEOCARPUS Linnaeus

ELAEOCARPUS BONTOCENSIS sp. nov. § *Dicera*.

Arbor circiter 8 m alta, partibus junioribus inflorescentiisque exceptis glabra; foliis coriaceis, nitidis, elliptico-ovatis, usque ad 7 cm longis, utrinque subaequaliter angustatis, basi acutis, apice breviter obtuseque acuminatis, margine crenato-serrulatis, nervis utrinque circiter 5, axillis glandulosis; racemis leviter pubescentibus, axillaribus, solitariis, 1 ad 2 cm longis, paucifloris; floribus 4- et 5-meris, parvis; petalis margine parvissime ciliatis, apice breviter laceratis; staminibus 20, obtusis, haud ciliatis; ovario 3-locellato, puberulo.

A tree about 8 m high, glabrous except the very young parts and the sparingly pubescent racemes. Branches terete, reddish-brown, rather slender, the tips of the branchlets more or less appressed-pubescent. Leaves elliptic-ovate, coriaceous, rather pale when dry, shining, 4 to 7 cm long, 2 to 4 cm wide, subequally narrowed to the acute base and short, blunt-acuminate apex, margins distinctly crenate-serrate; lateral nerves about 5 on each side of the midrib, rather prominent, their axils glandular, reticulations slender, rather lax; petioles 1 to 1.5 cm long. Racemes axillary, solitary, short, few-flowered, 1 to 2 cm long, sparingly pubescent. Flowers small, 4- and 5-merous, their pedicels about 4 mm long. Sepals oblong-ovate, acute, slightly pubescent, 4 mm long, 2 mm wide. Petals oblong-obovate to obovate, about 3.5 mm long, 2 mm wide, margins and surface inside in the lower part very sparingly ciliate with slender, white hairs, the apical 1 to 1.5 mm cut into 10 to 12 narrow divisions, none of these more than 1 mm in length. Stamens 20, 2 to 2.5 mm long, the filaments short, the anthers narrow, obtuse, scabrid, the cells equal, not awned or ciliate. Disk gray-puberulent. Ovary ovoid, densely gray-puberulent, 3-celled; style puberulent, about 2 mm long.

LUZON, Bontoc Subprovince, Bauco, *Vanoverbergh 3892*, January, 1914, in forests, altitude about 1,700 meters, the flowers pink.

A species well characterized by its very short, few-flowered racemes; 4- and 5-merous, small flowers; its very short petal-segments, very sparingly ciliate petals; and obtuse, not at all awned or ciliate anthers.

ELAEOCARPUS SURIGAENSIS sp. nov. § *Dicera*.

Arbor circiter 20 m alta, inflorescentiis exceptis glaber; foliis oblongis, coriaceis, usque ad 23 cm longis, longe petiolatis, in siccitate brunneo-olivaceis, breviter acuminatis, basi acutis, interdum distincte inaequilateralibus, margin minute distanter cuspidato-denticulatis, nervis utrinque circiter 10, distinctis; racemis axillaribus, usque ad 11 cm longis, laxis, paucifloris, griseo-pubescentibus; floribus 5- vel 6-meris, circiter 7 mm longis, sepalis petalisque extus uniformiter adpresse cinereo-pubescentibus; petalis fimbriatis, staminibus circiter 20, antheris 2.5 ad 3.5 mm longis, muticis; ovario dense pubescente, 3-loculare.

A tree about 20 m high, entirely glabrous except the cinereous-pubescent inflorescence. Branches terete, brownish, rugose, the ultimate ones somewhat thickened, 5 to 10 mm in diameter, the petiolar scars rather prominent. Leaves alternate, oblong, coriaceous, brownish-olivaceous when dry, 17 to 23 cm long, 7.5 to 10 cm wide, subequally narrowed to the shortly acuminate apex and to the acute base, the base sometimes distinctly inequilateral, the margins distantly and obscurely cuspidate-denticulate; lateral nerves about 10 on each side of the midrib, prominent, anastomosing, the reticulations rather close, distinct; petioles 2.5 to 6 cm in length. Racemes axillary, solitary, rather numerous, 9 to 11 cm long, rather lax, few-flowered, all parts uniformly appressed cinereous-pubescent, the pedicels 1 to 1.5 cm long, the subtending bracteoles oblong to lanceolate, 3 to 5 mm long. Flowers 5- and 6-merous, yellow, fragrant, perfect, about 7 mm long. Sepals lanceolate, narrowed upward, acute, about 7 mm long, outside uniformly appressed cinereous-pubescent, inside glabrous in the lower one-half, sparingly pubescent above. Petals equaling the sepals in length, oblong, slightly narrowed below, outside uniformly appressed-pubescent, inside along the median portion and margins densely pubescent, slightly so elsewhere, the upper 2 to 3 mm cut into about 15 slender fimbriae. Stamens about 20, their filaments 1.5 to 2 mm long; anthers narrowly oblong, scabrid, 2.5 to 3.5 mm long, one cell slightly exceeding the other, the tip slightly projecting, not awned. Ovary ovoid, densely pubescent, 3-celled; style pubescent near the base, glabrous above, about 4 mm long.

MINDANAO, Surigao Province, near Mabini, *For. Bur.* 26000 Ponce, May 11, 1916, in level rich soil at the edge of the forest, altitude about 50 meters, locally known as *yagao-yagao*.

In general appearance this species somewhat resembles *Elaeocarpus octopetalus* Merr. and *E. leytensis* Merr. but belongs in a different section

of the genus than either of the above. It does not appear to be closely allied to any previously described Philippine form.

ELAEOCARPUS MONOCERA Cav. Ic. 6 (1801) 1, t. 501.

Elaeocarpus megacarpa Elm. Leaf. Philip. Bot. 7 (1915) 2627.

This species, a very characteristic one, is widely distributed in the Philippines. The type material, on which Cavanilles's description and figure were based was from Los Baños and Jala-jala, Luzon, points on opposite sides of Lake Bay. I can see absolutely no reason for distinguishing *Elaeocarpus megacarpa* Elm. from *E. monocera* Cav. The species is represented by the following specimens:

LUZON, Cagayan Province, Aparri, *For. Bur.* 23687 Bernardo, locally known to the Negritos as *tabian*; *For. Bur.* 17916 Bernardo, locally known to the Ilocanos as *panulauen* (specimen erroneously localized as from Isabela Province on the herbarium label): Rizal Province, *Phil. Pl.* 1051 Merrill: Laguna Province, San Antonio, *Bur. Sci.* 20564 Ramos; Los Baños and Mount Maquiling, *Calycosa* s. n., *For. Bur.* 20484, 22921 Villamil, *For. Bur.* 13150 Curran: Bataan Province, *For. Bur.* 1754, 1804 Borden: Tayabas Province, Merrill 1993: Camarines Province, *For. Bur.* 21142 Miranda, known to the Bicol's as *opong-opong*. SAMAR, Palapag, *Bur. Sci.* 24451 Ramos, known to the Visayans as *upong-upong*. MINDANAO, Agusan Province, Elmer 14059 (type of *Elaeocarpus megacarpa* Elm.).

MALVACEAE

ABELMOSCHUS Medikus

ABELMOSCHUS VANOVERBERGHII sp. nov.

Herba erecta, usque ad 60 cm alta, hispido-hirsuta, leviter ramosa, e basi valde incrassata; foliis palmatim 5- vel 7-lobatis, usque ad 9 cm longis, lobis oblongo-ovatis ad lineari-lanceolatis, grosse serratis; floribus circiter 4 cm longis, flavis, calycibus spathaceis, circiter 2 cm longis, hirsutis, bracteis 10, linearis, circiter 1.5 cm longis, ciliato-hirsutis; capsulis ovoideis vel subellipsoideis, dense hispido-hirsutis, obtusis, circiter 3 cm longis.

An erect, somewhat branched perennial herb from a much thickened underground base, the branches up to 60 cm in length, these, the branchlets, leaves and bracts prominently hispid-hirsute with spreading, stiff, rather pale hairs. Leaves variable, 4 to 9 cm long, palmately 5- or 7-lobed, the lobes oblong ovate and extending half-way to the base to linear-lanceolate and extending nearly to the base, all acute or somewhat acuminate and rather coarsely toothed, scabrid, somewhat hispid-hirsute on both surfaces; petioles 2 to 6 cm long. Flowers yellow, with dark-purple or brown spots at the base of the petals, several on each branch but only one or two opening at one time. Calyx spathaceous, deciduous, about 2 cm long, short appressed-hirsute, grayish when dry, with short narrow lobes at the apex. Corolla about 4 cm long, campanulate. Bracts 10, linear, prominently

hirsute with spreading hairs, about 1.5 cm long. Capsules ovoid to subellipsoid, obtuse, about 3 cm long and 2 cm in diameter, externally densely hirsute with stiff, spreading, pale hairs. Seeds not at all musky.

LUZON, Cagayan Province, *Bolster 122*, July, 1905, *For. Bur. 16499 Bacani*, January, 1909, *Bur. Sci. 7839 Ramos*, April, 1909: Lepanto District, near Cervantes, *Merrill 4480*, November, 1905; Bontoc Subprovince, *Vano-verbergh 879, 1221* (type), October and May, 1911.

This species grows in open grasslands, and is characterized by its thickened, woody, underground base; it is manifestly a perennial plant, differing in this character from *A. moschatus* to which it is evidently allied. It is very closely allied to *Abelmoschus sagittifolius* Kurz, which Hochreutiner has reduced to *A. abelmoschus*, but has smaller flowers which are yellow, not at all pink or red, and differently shaped leaves.

HIBISCUS Linnaeus

HIBISCUS VITIFOLIUS Linn. Sp. Pl. (1753) 696; Mast. in Hook. f. Fl. Brit. Ind. 1 (1874) 338.

LUZON, Union Province, San Fernando, *R. Lete 117, 144*, July and August, 1916, locally known as *mapua*.

Not previously reported from the Philippines; tropical Africa and Asia to tropical Australia.

SIDA Linnaeus

SIDA LONGISTIPULA sp. nov.

Herba annua, prostrata, caulis numerosis, usque ad 20 cm longis, simplex vel rariter ramosis, ciliato-pilosis; foliis oblongis, usque ad 1.8 cm longis, basi cordatis, 3-nerviis, apice obtusis, in $\frac{1}{2}$ vel $\frac{1}{3}$ superiore parte prominente serratis; stipulis linearis vel lineari-spatulatis, circiter 1 cm longis; floribus breviter pedicellatis, axillaribus, plerumque ad apicem ramulorum confertis; calycibus teretibus, haud angulatis vel costatis, 5-lobatis, extus pubescentibus pilosisque, 6 ad 7 mm longis; carpellis 5 ad 8, prominente muricatis, facies interioribus prominente reticulatis, brevissime biaristatis.

An annual herb, the stems numerous, tufted from the apex of the stout perpendicular root, prostrate, spreading, all parts more or less pubescent with sparingly stellate, long, white ciliate-pilose hairs, the stems up to 20 cm in length, simple, rarely branched. Leaves oblong, 1 to 1.8 cm long, 3 to 7 cm wide, long petioled, base cordate, 3-nerved, apex obtuse, in the upper one-half or one-third prominently serrate, the upper surface glabrous, the lower more or less stellate-pilose, the margins sparingly ciliate; petioles up to 1 cm in length, sparingly ciliate-pilose; stipules linear or linear-spatulate, about 1 cm long. Flowers mostly crowded at the apices of the stems, forming a

subcapitate leafy inflorescence, sometimes solitary ones in the lower axils, their pedicels not jointed, 2 to 3 mm long. Calyx 6 to 7 mm long, terete, not ribbed or angled, rather densely cinereous-pubescent and with long, white, ciliate hairs intermixed, the lobes 5, oblong-ovate, acute, 4 to 5 mm long. Corolla-lobes 5 to 6 mm long, oblong-obovate, obtuse, the tube very short. Stamens about 18, the tube about 1.5 mm long. Ovary depressed about 8-celled; styles 8, about 3 mm long; stigmas capitate. Mature carpels 5 to 8, prominently muricate, 3 to 4 mm long, the projections with a minute tuft of hairs at the tips, the inner faces very prominently reticulate, the apex biaristate, the awns 1 mm long or less.

LUZON, Ilocos Norte Province, Bangui and Burgos, *Bur. Sci.* 27445 (type), 27311, 27492 Ramos, February and March, 1917, in dry open places at low altitudes.

The relationship of this strongly marked species is apparently with the Australian *Sida subspicata* F. Muell., but it is not closely allied to that species. It is well characterized by its tufted, simple stems, its long petioled, oblong, 3-nerved, cordate, small leaves which are prominently toothed in the upper part; its long stipules; its crowded flowers which form a dense, subcapitate, leafy inflorescence; and its prominently muricate, short-awned carpels which are strongly reticulate on the inner faces.

DILLENiaceae

SAURAUIA Willdenow

SAURAUIA ALVAREZII sp. nov.

Arbor circiter 6 m alta prominente patule setosis, foliis subcoriaceis, oblongis ad elliptico-oblongis, usque ad 20 cm longis, acutis vel breviter acuminatis, basi obtusis, margine irregulariter spinuloso-serratis, nervis utrinque 10 ad 12, prominentibus, supra olivaceis, subtus pallidis, costa nervisque utrinque setosis; floribus axillaribus, solitariis, longe pedicellatis, pedicellis sub fructu 2 ad 4 cm longis, densissime patule setosis; sepalis 12 ad 14 mm longis, densissime setosis; fructibus 4-locellatis, circiter 12 mm longis, puberulis.

A tree about 6 m high, all parts prominently setose, the setae pale-brownish, rather soft, spreading, thickened below, slenderly acuminate and minutely puberulent. Branches brown, terete, the branchlets very uniformly and densely setose. Leaves alternate, subcoriaceous, oblong to elliptic-oblong, 11 to 20 cm long, 5 to 8 cm wide, the upper surface dark-olivaceous, the lower pale, apex acute to acuminate, base obtuse, margins irregularly spinulose-serrate, midrib on the upper surface spinulose-setose, the epidermis with widely scattered similar hairs, the lower

surface with much more numerous setae; lateral nerves 10 to 12 on each side of the midrib, prominent, curved, anastomosing, the reticulations prominent; petioles densely setose, 1.5 to 2.5 cm long. Flowers axillary, solitary, the pedicels and the sepals externally very densely setose, the pedicels, in fruit, 2 to 4 cm long, often with one or two scars at about the middle. Sepals subcoriaceous, elliptic-ovate to broadly ovate, or the inner ones obovate, 12 to 14 mm long, very densely setose, glabrous inside, the marginal parts of the inner ones thinner, mostly acute. Fruit capsular, about 12 mm long, subellipsoid, 4-celled, externally puberulent, dehiscing in the upper part only.

MINDANAO, Lanao District, Lanao-Cotabato trail, *For. Bur. 25202 Alvarez*, March 21, 1916, in dipterocarp forests, altitude about 1,000 meters, locally known as *carimog*.

A very characteristic species, distinguishable by its long-pedicelled, rather large flowers; its dense indumentum which consists of pale-brownish, spreading, acuminate, rather soft setae, the setae themselves puberulent; and its capsular fruits.

SAURAUIA BICOLOR sp. nov.

Frutex circiter 2 m altus vix setosus, subtus foliis et inflorescentiis densissime cinnamomeo-pubescentibus; foliis chartaceis, oblongis ad oblanceolatis, usque ad 20 cm longis, acuminatis, basi acutis, margine perspicue subglanduloso-denticulatis, supra laevis, glabris, atro-brunneis vel atro-olivaceis, subtus cinnamomeis, nervis utrinque 13 ad 15, perspicuis; inflorescentiis axillaribus, brevibus, paucifloris vel 1-floris, floribus pro ratione magnis, sepalis suborbicularibus, circiter 1 cm diametro, petalis circiter 14 mm longis; ovario dense pubescente, stylis 4, glabris, circiter 8 mm longis, ad basim connatis.

A shrub about 2 m high, the younger branchlets, petioles, inflorescences, and lower surface of the leaves very densely cinnamomeous-pubescent, the indumentum felted. Branches terete, dark reddish-brown, glabrous, the branchlets and petioles with few, widely scattered, appressed, oblong-ovate scales 2 mm long or less. Leaves chartaceous, oblong to oblanceolate, 11 to 20 cm long, 4 to 8 cm wide, narrowed below to the cuneate base, the apex shortly and sharply acuminate, the margins, except at the base, conspicuously denticulate with somewhat spreading, oblong-obtuse, gland-like teeth about 1 mm in length, the upper surface smooth, glabrous, or when young sparingly puberulent, dark-brown or dark-olivaceous, in striking contrast to the densely cinnamomeous-pubescent lower surface where the indumentum is closely felted; lateral nerves 13 to 15 on each side of the

midrib, prominent, curved-ascending, the reticulations slender; petioles 1.5 to 2.5 cm long, the younger ones densely cinnamomeous-pubescent, the older ones glabrous. Inflorescences axillary, few-flowered, sometimes only 1-flowered, shorter than the petioles, the bracts oblong, obtuse, 5 to 6 mm long. Petals about 10 mm in diameter, rounded, suborbicular, outside very densely felted-pubescent. Petals broadly obovate about 14 mm long, retuse. Ovary densely pubescent; styles 4, glabrous, 8 mm long, united for the lower 1.5 mm.

LUZON, Tayabas Province, Mount Binuang, *Bur. Sci.* 28735 Ramos & Edaño, May 12, 1917, on forested ridges.

A most characteristic species, its indumentum similar to *Saurauia mindorensis* Merr., but otherwise not at all closely allied to that species. It is otherwise well characterized by being non-setose, the few scales on the branchlets and petioles being closely appressed.

SAURAUIA GLABRIFOLIA sp. nov.

Frutex circiter 3 m altus, glaber vel ramulis junioribus parvissime furfuraceis; foliis in siccitate viridis, nitidis, subcoriaceis, usque ad 18 cm longis, oblongis ad oblongo-obovatis, acute acuminatis, basi acutis, margine irregulariter glanduloso-serrulatis, nervis utrinque circiter 9, utrinque prominentibus, obscure anastomosantibus, reticulis laxis, obscuris; floribus axillaribus, solitariis vel depauperato-fasciculatis, longe pedicellatis, circiter 13 mm diametro, sepalis margine leviter ciliatis exceptis glabris; ovario glabro; stylis 3, liberis.

A shrub about 3 m high, the younger branchlets usually with few, scattered, closely appressed, rather prominent ovate or orbicular scales less than 1 mm in diameter, otherwise entirely glabrous except the ciliate margins of the sepals. Branches reddish-brown, terete, smooth, the branchlets of the same color, somewhat angular when dry. Leaves alternate, subcoriaceous, greenish when dry, shining, oblong to oblong-obovate, 13 to 18 cm long, 5 to 7 cm wide, the apex prominently and sharply acuminate, the base acute, the margins irregularly glandular-denticulate; lateral nerves about 9 on each side of the midrib, curved, rather prominent on both surfaces, obscurely anastomosing, the reticulations lax, indistinct; petioles 1 to 2 cm long. Flowers white, axillary, solitary or in depauperate fascicles of two or three flowers each, their pedicels slender, up to 1.5 cm in length. Sepals 5, equal, elliptic, rounded, 6 mm long, their margins ciliate, otherwise glabrous. Petals 5, oblong-obovate, about 7 mm long, the apex prominently inequilateral, retuse. Stamens about 20, their anthers about 2 mm long. Ovary globose, glabrous; styles 3, free to the base, about 5 mm long.

MINDANAO, Surigao Province, Placer, *Wenzel 1866*, July 4, 1916, in forests, altitude about 150 meters.

• A strongly marked species, well characterized by its entirely glabrous leaves and slenderly pedicelled flowers. The almost entire absence of indumentum of any type is rather remarkable, as most of the Indo-Malayan species of the genus are prominently pubescent, setose, or ciliate. In the present species the indumentum is reduced to small, widely scattered, closely appressed scales, and these only on the younger parts of the plant.

FLACOURTIACEAE

CASEARIA Linnaeus

CASEARIA EUPHLEBIA sp. nov.

Frutex glaber, ramis ramulisque teretibus; foliis integris, chartaceis vel subcoriaceis, oblongo-ovatis ad oblongo-ellipticis, usque ad 13 cm longis, acuminatis, basi subacutis ad rotundatis, aequilateralibus vel leviter inaequilateralibus, distincte pellucidopunctatis, nervis utrinque circiter 7, subtus valde prominentibus; floribus axillaribus, solitariis, breviter pedicellatis, circiter 4 mm longis, filamentis cum staminoideis adnatis.

A glabrous shrub about 2 m high, the branches pale-grayish, somewhat shining, wrinkled when dry, slender, terete. Leaves greenish-olivaceous and somewhat shining when dry, firmly chartaceous to subcoriaceous, oblong-ovate to oblong-elliptic, 6 to 13 cm long, 3.5 to 6 cm wide, entire, apex distinctly acuminate, base equilateral or somewhat inaequilateral, subacute to rounded, in transmitted light distinctly and minutely pellucid-punctate and with scattered, elongated, larger, translucent dashes; lateral nerves 7 on each side of the midrib, very prominent on the lower surface, curved, anastomosing, the reticulations distinct, rather fine; petioles 3 to 5 mm in length. Flowers solitary, axillary, their pedicels 2 to 2.5 mm long. Sepals somewhat punctulate, elliptic, rounded, about 4 mm long. Stamines oblong, about 1.5 mm long and 0.7 mm wide, obtuse or truncate and slightly pubescent at the apex, the anthers oblong, 0.7 mm in length. Ovary glabrous. Young fruit red, oblong, obtuse, about 1.5 cm long.

LEYTE, Tigbao, near Tacloban, *Wenzel 1503*, June 3, 1915.

A species well characterized by its distinctly pellucid-punctulate, prominently nerved, entire leaves, and its solitary flowers.

CASEARIA CONFERTIFLORA sp. nov.

Frutex circiter 3 m altus, ramulis et floribus et subtus foliis molliter pubescentibus; foliis inaequilateralibus, ovatis ad late oblongo-ovatis, usque ad 11 cm longis, breviter obtuseque acuminatis, margine crenatis, basi late oblique subtruncatis, nervis

utrinque circiter 6; floribus numerosissimis, axillaribus, fasciculatis, dense confertis, breviter pedicellatis, circiter 4 mm longis; filamentis 1.5 ad 2 mm longis, glabris, staminoideis liberis, oblongis, sursum villosis; ovario pubescente.

A species closely allied to *Casearia cinerea* Turcz. and *C. grewiaefolia* Vent., differing especially in its much fewer nerved leaves. A shrub about 3 m high, the branchlets, lower surface of the leaves and the flowers rather densely and softly pubescent. Branches terete, glabrous, reddish-brown when dry, sparingly wrinkled and lenticellate, the branchlets densely subferruginous to cinereous-pubescent. Leaves subcoriaceous, ovate to broadly oblong-ovate, 8 to 11 cm long, 4 to 5.5 cm wide, pale-brownish when dry, apex shortly and obtusely acuminate, margins prominently crenate, base broadly and obliquely truncate, both sides rounded or one side rounded and the other acute, prominently inequilateral, subfalcate, the upper surface glabrous except the sparingly pubescent midrib, the lower surface softly pubescent especially on the midrib and lateral nerves; lateral nerves about 6 on each side of the midrib, prominent, curved-ascending, obscurely anastomosing, the reticulations lax; petioles rather densely pubescent, 3 to 5 mm long. Flowers yellowish, about 4 mm long, very numerous, crowded in subglobose, dense, axillary fascicles, 30 to 50 in a fascicle, their pedicels densely pubescent, 3 to 4 mm long. Perianth-segments 5, elliptic-oblong, densely pubescent, obtuse. Stamens 10; filaments 1.5 to 2 mm long, glabrous; anthers oblong-ovate, 1 mm long; staminodes oblong, obtuse, 1.5 mm long, free, glabrous below, villous in the upper one-half. Ovary ovoid, pubescent; style very short; stigma capitate.

LUZON, Ilocos Norte Province, Bangui, *Bur. Sci.* 27442 Ramos, in dry thickets at low altitudes, locally known to the Ilocanos as *boyboyoc*.

This species is manifestly very closely allied to *Casearia cinerea* Turcz., differing especially in its distinctly fewer nerved leaves and its very numerous, densely crowded flowers.

HOMALIUM Jacquin

HOMALIUM MULTIFLORUM sp. nov. § *Blackwellia*.

Species *H. loheri* affinis, differt foliis minoribus, usque ad 8 cm longis, nervis paucioribus, utrinque circiter 6, bracteis oblongo-ovatis, circiter 2 mm longis.

A tree about 10 m high, the inflorescence prominently ciliate-pubescent with spreading pale or cinereous hairs, otherwise glabrous. Branches terete, reddish-brown, often somewhat glaucous, obscurely lenticellate. Leaves coriaceous or subcoria-

ceous, elliptic, shining, 6 to 8 cm long, 3 to 4.5 cm wide, subequally narrowed to the acute base and to the acute or obscurely acuminate apex, the margins distantly crenate-serrate; lateral nerves about 6 on each side of the midrib, prominent on the lower surface, curved, anastomosing, the reticulations distinct; petioles 5 to 7 mm long. Inflorescences terminal and axillary, the racemes forming large, leafy panicles, the individual racemes or branches mostly simple, up to 12 cm long, all parts more or less pubescent with spreading hairs. Flowers very numerous, 5-merous, about 6 mm in diameter, white, somewhat fascicled along the racemes, their pedicels jointed to the calyx, about 2.5 mm long, the subtending bracts oblong-ovate, acute or acuminate, pubescent, 2 mm long. Calyx-tube narrowly funnel-shaped, 2 mm long. Sepals 5, narrowly oblong, ciliate, 2 mm long, about 0.5 mm wide. Petals 5, narrowly oblong-obovate to somewhat spatulate, ciliate, about 3 mm long. Stamens 1 opposite each petal, the filaments about 2 mm long, sparingly ciliate in the lower one-half. Ovary pubescent; styles 3 or 4, about 1.5 mm long, ciliate.

LUZON, Benguet Subprovince, Pakdal, *For. Bur. 25155 Garcia* (type), March 11, 1916, along small streams at an altitude of 1,500 meters; Trinidad, on limestone formation, *For. Bur. 15933 Bacani*, December 30, 1908, distributed as *H. loheri* Merr.

Very closely allied to *Homalium loheri* Merr., from which it is readily distinguished by its smaller, fewer nerved leaves.

HOMALIUM PLATYPHYLLUM sp. nov. § *Myriantheia*.

Arbor circiter 10 m alta, inflorescentiis exceptis glabra; foliis ellipticis, coriaceis, nitidis, usque ad 20 cm longis et 11 cm latis, integris, apice breviter abrupte obtuseque acuminatis, basi rotundatis, nervis utrinque circiter 9, perspicuis; inflorescentiis dense cinereo-pubescentibus, laxis, multifloris, usque ad 20 cm longis, ramis elongatis; floribus 8-meris, petalis subspatulatis, circiter 3 mm longis, quam sepalis longioribus; staminibus 16.

A tree about 10 m high, glabrous except the rather densely cinereous-pubescent ample inflorescence. Branches terete, brownish. Leaves elliptic, coriaceous, brownish or brownish-olivaceous and shining when dry, about 20 cm long and 11 cm wide, entire, base rounded, apex very shortly and obtusely acuminate; lateral nerves about 9 on each side of the midrib, prominent, reddish-brown on the lower surface when dry, curved-anastomosing, the reticulations slender, distinct; petioles stout, about 1 cm long. Inflorescence ample, paniculate, up to 20 cm in length, the ultimate branches 10 to 15 cm long, all parts

rather densely cinereous-pubescent. Pedicels 1 to 2 mm long. Calyx-tube obconic, about 2 mm long, the lobes 8, linear, about 2 mm long, pubescent. Petals 8, somewhat spatulate, obtuse, cinereous-pubescent, ciliate on the margins, about 3 mm long. Stamens 16, two opposite each petal, their filaments glabrous, about 2 mm long. Ovary and style pubescent, the style-arms 4, about 1 mm long.

LEYTE, Tigbao, near Tacloban, *Wenzel 1525*, July 15, 1915, the flowers green.

A species manifestly allied to *Homalium luzoniense* F.-Vill., but with much larger, entire, and somewhat fewer nerved leaves.

HOMALIUM VILLOSUM sp. nov. § *Myriantheia*.

Arbor circiter 15 m alta subtus foliis et ramulis junioribus et inflorescentiis dense molliter villosis; foliis subcoriaceis, ellipticis, usque ad 8 cm longis, breviter obtuseque acuminatis, basi subacutis, nervis utrinque circiter 6, perspicuis; inflorescentiis axillaribus terminalibusque, paniculatis, ramis elongatis, bracteis elliptico-ovatis, 3 ad 4 mm longis, membranaceis, villosis; floribus 6-meris, petalis sepalisque subaequalibus, villosis, circiter 2 mm longis, oblanceolatis; staminibus 18.

A tree about 15 m high, the branchlets, inflorescence, and lower surface of the leaves densely and softly villous with pale hairs. Branches terete, brownish, glabrous. Leaves elliptic, subcoriaceous, 5 to 8 cm long, 2.5 to 5 cm wide, pale when dry, the upper surface shining, glabrous except the puberulent midrib, apex shortly blunt-acuminate, base acute, margins distantly crenulate, the teeth in young leaves crowned with a tuft of hairs; lateral nerves about 6 on each side of the midrib, prominent, anastomosing, curved; petioles densely villous, 2 to 3 mm long. Panicles terminal and axillary, the branches numerous, elongated, densely many-flowered, up to 10 cm long, the flowers 6-merous, scattered along the rachis, not fascicled, the villous pedicels 2 to 2.5 mm long, the bracts prominently ciliate, elliptic to ovate-elliptic, obtuse, 3 to 4 mm long. Sepals 6, prominently ciliate, oblanceolate, acute or subacute, about 2 mm long. Petals similar to the sepals. Stamens three opposite each petal, their filaments about 1.4 mm long, sparingly ciliate at the base. Ovary villous; styles 5 or 6, about 1 mm long, sparingly ciliate.

SAMAR, near Catbalogan, *For. Bur. 22748 Lasqueti*, August 2, 1914, on forested ridges, altitude about 200 meters, locally known as *batu-batu*.

This specimen was originally determined as *Homalium loheri* Merr., but belongs in a different section of the genus than this species. It falls in the group with *Homalium villarianum* Vid., but is distinguished from

it and from the other Philippine species of the section *Myriantheia* by its indumentum. In its general appearance and its indumentum it resembles *H. barandae* Vid., but the latter belongs in the section *Blackwellia*.

BEGONIACEAE.

BEGONIA Linnaeus

BEGONIA CASTILLOI sp. nov. § *Diploclinium*.

Herba parva, parcissime et longe ciliatis, repens, caulibus usque ad 10 cm longis stipulis multis brunneis oblongo-lanceolatis acuminatis instructis; foliis suborbicularibus, aequilateralibus vel leviter inaequilateralibus, late rotundatis, basi cordatis, 3 ad 5 cm longis, margine integris vel irregulariter denticulatis, ciliatis; inflorescentiis tenuibus, paucifloris, 10 ad 12 cm longis; capsulis circiter 1 cm longis, 1 ad 1.4 cm latis, inaequaliter 3-alatis, suborbicularibus vel apice subtruncatis.

A small herb, the stems up to 10 cm long, creeping, covered with numerous, brown, oblong to lanceolate, slenderly acuminate stipules which are up to 1 cm in length and above usually prominently long-ciliate. Leaves membranaceous, olivaceous-brownish when dry, suborbicular, 3 to 5 cm in diameter, equilateral or somewhat inequilateral, apex broadly rounded, base prominently cordate, the lobes broad, rounded, equal or subequal, 9-nerved, the upper surface glabrous, the lower glabrous or with very few hairs on the nerves, the margins entire or denticulate, sparingly ciliate with long brown hairs; petioles slender, 2.5 to 5 cm long, the younger ones ciliate with long, slender, brown hairs. Inflorescences slender, few-flowered, 10 to 12 cm long, glabrous or nearly so. Capsules unequally 3-winged, about 1 cm long, 1 to 1.5 cm wide, suborbicular, or the upper side of the broad wing truncate, this wing 7 to 9 mm wide, the other two about 2 mm wide.

LUZON, Cagayan Province, Callao, near Peña Blanca, *Bur. Sci.* 22723 *Castillo*, April 23, 1915, on cliffs along the river, altitude about 100 meters.

The general alliance of this species is with *Begonia nigritarum* Steud., to which, however, it is not closely allied. Its distinguishing characters are its small, suborbicular, equilateral or nearly equilateral leaves.

BEGONIA TAYABENSIS sp. nov. § *Diploclinium*.

Herba subglabra, caulibus circiter 1 cm diametro, stipulis deciduis; foliis longe petiolatis, perspicue peltatis, suboblique ovatis ad oblongo-ovatis, usque ad 20 cm longis, basi rotundatis, apice subacutis vel obtusis, margine subintegris, subtus valde reticulatis; inflorescentiis longissime pedunculatis, 25 ad 35 cm longis, dichotomis, laxis, paucifloris; floribus ♂ circiter 2 cm

diametro; capsulis circiter 1 cm longis et 1.8 cm latis, inaequilateraliter 3-alatis.

A subglabrous herb, the stems creeping, reddish-brown when dry, about 1 cm in diameter, glabrous; stipules deciduous, broadly ovate, acuminate, sparingly ferruginous-ciliate, about 1 cm long. Leaves prominently peltate, the petiole inserted 2 to 4 cm from the base of the leaf, membranaceous, somewhat oblique, ovate to oblong-ovate, 15 to 20 cm long, 10 to 12 cm wide, base broadly rounded, apex acute or somewhat obtuse, margins subentire, not at all lobed, with a fringe of scattered, tooth-like, short cilia, both surfaces with widely scattered, short hairs, ultimately glabrous or nearly so; basal nerves radiate, about 9, prominent, the reticulations very prominent on the lower surface; petioles 12 to 15 cm long, glabrous or with very few, widely scattered, short hairs. Inflorescences 25 to 35 cm long, dichotomous, few-flowered, sparingly ciliate with short, pale, spreading, scattered hairs, the flower-bearing part about 10 cm long. Staminate flowers white or slightly pink, about 2 cm in diameter, the sepals elliptic-ovate, rounded. Capsules about 1 cm long and 1.8 cm wide, base rounded, apex subtruncate, one wing very much larger than the other two and about 1 cm in width, the other two 3 to 4 mm wide.

LUZON, Tayabas Province, Umiray River, *Bur. Sci. 29054 Ramos & Edaño*, June 3, 1917, on ledges and steep slopes in forests along the river.

This strongly characterized species is one of the few known representatives of the section *Diploclinium* with peltate leaves. It is readily distinguished from our peltate-leaved species, *Begonia hernandoides* Merr., *B. rufipila* Merr., and *B. ELMERI* Merr. [*B. peltata* Elm. Leaf. Philip. Bot. 7 (1915) 2556, non A. DC., nec Hassk., nec Otto & Dietr.] by being nearly glabrous, the few, widely scattered hairs on the leaves and inflorescences scarcely exceeding 1 mm in length.

BEGONIA APAYAOENSIS sp. nov. § *Petermannia*.

Species *B. brevipes* Merr. similimis, differt floribus fructibusque multo majoribus. Herba erecta, ramosa, usque ad 45 cm alta, perspicue ferrugineo-pubescentibus; foliis inaequilateraliter obovatis, in siccitate brunneis, brevissime petiolatis, usque ad 9 cm longis, acuminatis, basi angustatis, oblique cordatis, margine grosse et irregulariter dentato-lobatis et denticulatis; inflorescentiis terminalibus, 3 ad 5 cm longis, paucifloris; floribus ♀ 5-meris, sepalis late ovatis, obtusis, 13 mm longis; sepalis ♂ 2, ♀ similis; capsulis circiter 2 cm longis et latis, apice truncatis, deorsum angustatis et subacutis, aequaliter 3-alatis.

An erect branched herb about 45 cm high, the lower parts of the stems terete, somewhat decumbent and rooting, dark-brown,

terete, 3 to 4 mm in diameter, ferruginous-hirsute, the younger branchlets rather densely ferruginous-hirsute as are the short petioles and nerves on the lower surface of the leaves. Leaves membranaceous, brown when dry, the lower surface paler than the upper, in general obovate, inequilateral, 7 to 9 cm long, 3.5 to 5.5 cm wide, apex acuminate, base narrowed and obliquely cordate, the wider lobe rounded the other acute, the margins irregularly and coarsely dentate-lobed and denticulate; lateral nerves 4 or 5 on each side of the midrib, prominent; petioles 4 to 10 mm long; stipules membranaceous, 1 cm long or less. Inflorescences terminal, 3 to 5 cm long, few-flowered, the basal flower pistillate, the others staminate, the bracts membranaceous, oblong, acuminate, nearly 1 cm long. Pistillate flowers 5-merous, the sepals broadly ovate, obtuse, about 13 mm long. Staminate flowers white, the sepals 2, similar to those of the pistillate flowers, the stamens numerous, crowded on an elongated axis about 5 mm in length. Capsules equally 3-winged, about 2 cm long and wide, apex truncate, narrowed below to the subacute base, the wings submembranaceous.

LUZON, Apayao Subprovince, Mount Sulu, *Bur. Sci.* 28403 *Fénix*, May 22, 1917, on rocky shaded slopes, altitude about 1,000 meters.

This species resembles *Begonia brevipes* to which it is perhaps most closely allied. It is distinguished especially by its somewhat larger size, denser indumentum, and very much larger flowers and capsules.

BEGONIA BINUANGENSIS sp. nov.

Species *B. wenzelii* Merr. affinis, differt foliis majoribus, usque ad 8 cm longis, petiolis longioribus, capsulis turbinatis, 1.5 cm longis et 2 cm latis. Herba scandens, ramosa, glabra, internodiis 1.5 ad 3.5 cm longis, ramis teretibus, circiter 4 mm diametro; foliis membranaceis, oblongis ad oblongo-lanceolatis, basi rotundatis vel obtusis, apice acuminatis, margine irregulariter serrato-dentatis; sepalis ♂ orbicularibus, circiter 1 cm diametro; capsulis inaequaliter 3-alatis, apice truncatis, deorsum angustatis.

A scandent, glabrous, branched herb, rooting at some of the nodes, the stems and main branches terete, about 4 mm thick, brown, the branchlets more slender, the internodes 1.5 to 3 cm long. Leaves when dry membranaceous, olivaceous, somewhat shining, oblong to oblong-lanceolate, 5 to 8 cm long, 2 to 3 cm wide, somewhat inequilateral, base rounded or obtuse, narrowed above to the acuminate apex, margins irregularly serrate-dentate, the basal nerves 5 or 7, slender, ascending; petioles 1 to 3 cm long. Inflorescences terminal or in the uppermost axils, 3 to 4 cm long, few-flowered. Staminate flowers white, the sepals 2,

orbicular, about 1 cm in diameter. Capsules turbinate, somewhat unequally 3-winged, about 1.5 cm long and 2 cm wide, the apex truncate or subtruncate, narrowed below to the subacute base.

LUZON, Tayabas Province, Mount Binuang, *Bur. Sci. 28813 Ramos & Edaña*, May 11, 1917, climbing on tree trunks in damp forests near the summit of the mountain, altitude apparently about 1,000 meters.

This characteristic species, belonging in the group with *Begonia aequata* A. Gray, is most closely allied to *Begonia wenzelii* Merr., from which it is readily distinguished by its larger, differently shaped, longer petioled leaves and distinctly larger capsules.

BEGONIA CAUDATA sp. nov.

Herba scandens, glabra, usque ad 3 m longa; foliis in siccitate membranaceis, longissime petiolatis, subolivaceis, nitidis, ovatis ad subellipticis vel oblongo-ellipticis, usque ad 20 cm longis, basi inaequilateraliter cordatis, apice tenuiter caudato-acuminatis, margine obscure undulatis et distanter denticulatis; inflorescentiis 40 ad 50 cm longis, axillaribus, longe pedunculatis, dichotomis, laxis; floribus ♂ circiter 25 mm diametro; capsulis 2 cm longis et 3 cm latis, alis valde inaequalibus, 2 circiter 4 mm latis, ala tertia membranacea, circiter 2 cm lata.

A glabrous scandent herb climbing on tree trunks to a height of 3 m, entirely glabrous, the stems 5 to 6 mm in diameter when dry, the internodes 4 to 6 cm long and with numerous roots. Leaves membranaceous, subolivaceous and shining when dry, ovate to subelliptic or oblong-elliptic, 14 to 20 cm long, 8 to 9 cm wide, base somewhat inequilateral, prominently cordate, palmately 7- or 9-nerved, apex rather abruptly and slenderly caudate-acuminate, the acumen 1 to 2 cm long, margins slightly undulate or nearly entire, sometimes with widely scattered, small, obscure teeth, the lateral nerves above the base usually two on each side of the midrib; petioles stout, 10 to 17 cm long. Inflorescences axillary, the peduncles stout, glabrous, up to 40 cm in length, the cymes dichotomous, lax, 15 cm wide or more. Staminate flowers pink, the sepals suborbicular, about 13 mm long, rounded. Capsules about 2 cm long, very unequally 3-winged, one wing membranaceous, about 2 cm wide, the other two about 4 mm wide.

LUZON, Apayao Subprovince, Mount Sulu, *Bur. Sci. 28414 Félix*, May 22, 1917, on rocky slopes in damp forests, altitude apparently above 800 meters.

This most characteristic species is readily recognized by its habit, its long-petioled, subentire, caudate-acuminate leaves, and its very long inflorescences. It apparently belongs in the same group as *Begonia oxysperma* A. DC., but is entirely different from that species in its vegetative

characters, and is equally distinct from the scandent *Begonia megacarpa* Merr.

CORNACEAE

MASTIXIA Blume

MASTIXIA TETRAPETALA sp. nov. § *Tetramastixia*.

Arbor parva, inflorescentiis exceptis glabra; foliis numerosis, confertis, alternis, oblongis ad oblanceolatis, coriaceis, usque ad 8 cm longis, pallide olivaceis, nitidis, apice obtusis ad leviter obtuseque acuminatis, basi cuneatis, nervis utrinque 6 ad 7, distinctis; paniculis terminalibus, circiter 2 cm longis, leviter pubescentibus; floribus 4-meris, circiter 6 mm diametro, petalis late ovatis, subacutis, glabris, 3 mm longis, calycis lobis latis, subacutis, glabris, circiter 1 mm longis.

A small tree 3 to 4 m high *vide* Ramos, glabrous except the very youngest growing parts and the inflorescences. Branches rather stout, brownish, rugose, glabrous, terete, the very young branchlets and young petioles sparingly appressed cinereous-pubescent. Leaves alternate, crowded, sometimes subopposite, coriaceous, oblong to oblanceolate, 5 ad 8 cm long, 2 to 3 cm wide, pale-olivaceous when dry, slightly shining, glabrous, the apex obtuse to shortly and obtusely acuminate, base cuneate, margins often revolute; lateral nerves 6 or 7 on each side of the midrib, distinct, the reticulations obscure; petioles 8 to 14 mm long. Panicles terminal, sparingly appressed-pubescent, about 2 cm long, branched from the base. Flowers 4-merous, rather numerous, greenish-yellow, about 6 mm in diameter. Calyx-tube stout, glabrous or very slightly pubescent, about 2 mm long and thick, the limb somewhat spreading, the teeth 4, broadly triangular, acute, about 1 mm long and wide. Petals suborbicular-ovate, subacute, 3 mm long and wide. Filaments 2.3 mm long; anthers broadly ovoid. Ovary projecting slightly above the calyx-tube, the style stout, angled, about 1 mm long. Bracteoles triangular-ovate, acute, 1 mm long, pubescent.

LUZON, Tayabas Province, Mount Binuang, *Bur. Sci.* 28575 (type), 28628 Ramos & Edaña, May, 1917, in forests near the summit of the mountain, altitude apparently about 1,000 meters.

This species is readily distinguished among the few Philippine forms by its relatively narrow, crowded, alternate, leaves and its 4-merous flowers. It does not appear to be very closely allied to any previously described form. *Bur. Sci.* 29088 Ramos & Edaña, from the same locality, may be referable to this species, but it has subopposite larger leaves and much larger inflorescences; the flowers are very immature. *Mastixia premnoides* (Elm.) Hallier f. (*Vitex premnoides* Elm.), which has 4-merous flowers, is entirely different in its vegetative and floral characters.

MASTIXIA SUBCAUDATA sp. nov. § *Tetramastixia*.

Arbor parva novellis et inflorescentiis exceptis glabra; foliis stricte alternis, chartaceis ad subcoriaceis, oblongo-obovatis, usque ad 6 cm longis, apice perspicue subcaudato-acuminatis, basi cuneatis, nervis utrinque 4 ad 6, tenuibus; inflorescentiis 2 ad 3 cm longis, adpresse cinereo-pubescentibus; floribus 4-meris, circiter 3 mm longis, calycibus haud dentatis, extus glabris vel parvis pubescentibus; petalis glabris.

A small tree, the very youngest parts and the inflorescences appressed cinereous-pubescent, otherwise glabrous. Branches terete, rather pale when dry. Leaves chartaceous to subcoriaceous, oblong-obovate, 5 to 6 cm long, 2 to 2.5 cm wide, the apex prominently subcaudate-acuminate, the acumen blunt and up to 1 cm in length, base cuneate, when dry pale-olivaceous, somewhat shining, the lower surface paler than the upper; lateral nerves 4 to 6 on each-side of the midrib, slender, curved, the reticulations indistinct; petioles 7 to 10 mm long, when young slightly pubescent, becoming glabrous. Panicles terminal, 2 to 3 cm long, appressed cinereous-pubescent with short hairs, branched at or from near the base. Flowers numerous, yellowish, about 3 mm long, 4-merous, the pedicels very short, the bracteoles ovate, acute, pubescent, 1 mm long or less. Calyx about 2 mm long, slightly pubescent, the limb narrow, undulate, somewhat spreading, entire or very obscurely toothed. Petals broadly ovate, obtuse, glabrous, 1.5 mm long. Anthers suborbicular, 1 mm long. Top of the ovary sulcate, the style stout, angled, 0.8 mm long.

LUZÓN, Sorsogon Province, Mount Lalao, *Bur. Sci.* 23353 Ramos, August 23, 1915, on the forested summit of the mountain, altitude not indicated.

The above specimen was originally determined as *Mastixia philippinensis* Wang., a species common and widely distributed in the Philippines. It differs constantly, however, in its 4-merous flowers, and besides has smaller, somewhat differently shaped leaves, entire or subentire calyx-limb, and glabrous petals.

MASTIXIA PREMNOIDES (Elm.) Hallier f. *Beihefte Bot. Centralbl.* 34² (1916) 41.

Vitex premnoides Elm. *Leafl. Philip. Bot.* 8 (1915) 2874.

The type of this species is *Elmer 11644*, from Mount Apo, Mindanao. The species is also represented by the following specimens from the Lanao District, Mindanao, which had been long since written up by me, but not published, as a distinct species of *Mastixia*: *Clemens 683*, in flower, and without number, in fruit, March and February, 1907, *For. Bur.* 25208, 25224 *Alvarez*, March, 1916. The species belongs in the section *Tetramastixia*.

ARALIACEAE

BOERLAGIODENDRON Harms

BOERLAGIODENDRON YATESII sp. nov.

Frutex glaber; foliis palmatim 5- ad 7-foliolatis, foliolis coriaceis, oblongis ad oblongo-ellipticis, 8 ad 18 cm longis, omnibus petiolulatis, acuminatis, basi acutis, margine irregulariter serratis, dentibus mucronatis; inflorescentiis terminalibus, subsessilibus, umbellatis, radiis primariis 5 vel 7, usque ad 3 cm longis, dichotomis vel trichotomis; floribus in capitulis globosis subconferis, 4-meris, capitulis circiter 1 cm diametro.

An erect glabrous shrub, the branches terete, brownish, 8 to 10 mm in diameter. Leaves alternate, palmately 5- to 7-foliolate, their petioles 13 to 20 cm long, the basal crests 2 or 3, coriaceous, glabrous, not at all pectinate; leaflets coriaceous, oblong to oblong-elliptic, 8 to 18 cm long, 4.5 to 7 cm wide, apex rather prominently acuminate, base acute, in the outer leaflets inequilateral, margins very irregularly serrate, the teeth minute to rather coarse or even slightly sinuate, mucronate; lateral nerves 6 to 10 on each side of the midrib, distinct; petiolules 0.5 to 2.5 cm long. Inflorescence terminal, umbellate, subsessile, the primary branches 5 to 7, usually about 3 cm long, these trichotomous or dichotomous, the secondary lateral branches 2 to 2.5 cm long, the central branch very short and bearing a head of sterile flowers. Heads at the tips of the lateral branches globose, about 1 cm in diameter, each composed of from 10 to 15 pedicelled flowers, the pedicels in young fruit 2 to 3 mm long, the subtending bracteoles elliptic-ovate, rounded, about 3 mm long, their margins ciliate. Very young fruits subellipsoid, about 4 mm long, with 4 obscure, rounded angles.

LUZON, Tayabas Province, Mount Cadig, *Bur. Sci. 25418 Yates*, December 12, 1916, in the mossy forest near the summit of the mountain.

A very characteristic species, readily distinguished by its palmately 5- to 7-foliolate leaves, and its comparatively small, coriaceous leaflets. It is perhaps most closely allied to *Boerlagiodendron heterophyllum* Merr.

BOERLAGIODENDRON FENICIS sp. nov.

Frutex circiter 2.5 m altus, inflorescentiis exceptis glaber; foliis circiter 25 cm longis, in ambitu suborbicularibus, 5-lobatis, membranaceis, lobis oblongis, brevissime et abrupte acuminatis, margine distanter denticulatis; petiolis circiter 30 cm longis in dimidio inferiore cristis obliquis pectinatis distantibus instructis; inflorescentiis circiter 6 cm longis, furfuraceis, radiis primariis circiter 15, tenuibus; fructibus sessilibus, ovoideis, 3-sulcatis, 3-angulatis, 3-locellatis, circiter 6 mm longis.

An erect shrub about 2.5 m high, glabrous except the inflorescence, the branches terete, wrinkled, about 1 cm in diameter. Leaves membranaceous or somewhat chartaceous, suborbicular in outline, about 25 cm long, deeply 5-lobed, the base subtruncate, 7-nerved, the lobes oblong, 5.5 to 7 cm wide, extending one-half to two-thirds to the base, the sinuses rounded, the tips shortly and abruptly apiculate, the margins distantly denticulate, not at all lyrate-lobed, both surfaces shining when dry, the upper sub-olivaceous, the lower slightly paler; petioles about 30 cm long, the lower half with prominent, scattered, oblique crests about 2 mm wide, their margins pectinate, the laciniae slender, 1 to 1.5 mm long, the lower crests surrounding the petioles, the upper ones reduced in length. Inflorescences terminal, umbellate, the peduncles about 1.5 cm long, all parts more or less furfuraceous, the primary branches about 15, slender, up to 5 cm in length; each branch bears a pair of ovate, about 3 mm long bracts about 2 cm above the base subtending a short-peduncled sterile head and often an additional long-peduncled fertile one, the sterile heads dense, 4 to 7 mm in diameter, their peduncles 1 cm long or less, the peduncles of the fertile heads 2 to 2.5 cm long and bibracteate at about the middle. Fertile heads in fruit 10 to 12 mm in diameter, the fruits crowded, sessile, ovoid, longitudinally 3-sulcate, 3-angled, 3-celled, about 6 mm long.

LUZON, Apayao Subprovince, Guiniri, *Bur. Sci.* 28186 *Fénix*, May 12, 1917, on rocky slopes near streams.

The alliance of this species is apparently with *Boerlagiodendron luzoniense* Merr., from which it is readily distinguished by its thinner leaves, the lobes denticulate but not at all lyrate-lobed, the numerous scattered crests, 3-celled fruits, and other characters.

BOERLAGIODENDRON TAYABENSE sp. nov. .

Frutex glaber, ramis teretibus, circiter 1 cm crassis; foliis usque ad 28 cm longis, chartaceis, 3-lobatis, basi subtruncatis ad late cordatis, lobis oblongis ad oblongo-obovatis, margine distanter apiculato-serrulatis; petiolis 18 ad 22 cm longis, infra perspicue cristatis, cristulis perspicue pectinatis, laciniis filiformibus, usque ad 1 cm longis; inflorescentiis pedunculatis, confertis, radiis primariis circiter 4 cm longis, parce furfuraceis; capitulis circiter 1 cm diametro.

An erect, apparently simple shrub, glabrous except the inflorescence. Branches wrinkled, terete, about 1 cm in diameter. Leaves 22 to 28 cm long, up to 30 cm in width across the lateral lobes, chartaceous, brownish or olivaceous-brownish when dry, shining, deeply 3-lobed, the base subtruncate to shallowly cordate, 9-nerved, margins distantly apiculate-serrulate, the lateral

lobes somewhat spreading, oblong-ovate, shortly and abruptly acuminate, about 8 cm wide, the central lobe oblong-obovate, about 20 cm long and as wide as the lateral ones, the sinuses rounded, 3 to 4 cm wide at this distance above the base of the lobes; petioles 18 to 22 cm long, the lower part with numerous, spirally arranged crests, the crests prominently pectinate, the laciniae slender, filiform, up to 1 cm in length, similar but smaller crests scattered along the petiole in the lower one-half or two-thirds, the upper crests reduced to few lacinae. Umbels terminal, peduncled, the peduncle about 3 cm long, glabrous. Primary branches of the inflorescence about 15, crowded, about 4 cm long, sparingly furfuraceous, the subtending bracts lanceolate to oblong-lanceolate, about 1.5 cm long. Heads dense, about 1 cm in diameter.

LUZON, Tayabas Province, Mount Bincang, *Bur. Sci.* 28752 Ramos & Edaño, May, 1917, without data.

This species in many respects resembles *Boerlagiodendron pectinatum* Merr., from which it is readily distinguished by its thinner, 3-lobed leaves which are not acute at the base; its longer petioles with the pectinate crests scattered along the lower one-half to two-thirds; its much longer bracts; and larger heads. From the species with 3-lobed leaves it is at once distinguishable by its prominently pectinate crests.

EBENACEAE

DIOSPYROS Linnaeus

DIOSPYROS VELASCOI sp. nov.

Arbor circiter 5 m alta, ramulis foliis junioribus subtus ad costa nervisque calycibus et fructibus pilis longis ferrugineis vestitis; foliis oblongis ad oblongo-ovatis, usque ad 16 cm longis, breviter petiolatis, basi late rotundatis, apice acute acuminatis, nervis utrinque circiter 8, subtus valde prominentibus, anastomosantibus; fructibus axillaribus, solitariis, sessilibus, ovoideis, junioribus circiter 12 mm longis, in siccitate brunneis, nitidis, acutis, pilis longis sparsis vestitis, ut videtur 1-locellatis, monospermis.

A small tree about 5 m high, the young branchlets, younger leaves on the midrib and lateral nerves, petioles, calyces, and young fruits ciliate-pubescent with long ferruginous hairs, the older parts glabrous or nearly so. Older branches terete, smooth, glabrous, sparingly lenticelate, slender. Leaves ovate to oblong-ovate, chartaceous, brittle when dry, brown, shining, the lower surface paler than the upper, 8 to 18 cm long, 2.5 to 7.5 cm wide, base broadly rounded, apex acutely acuminate; lateral nerves

about 8 on each side of the midrib, very prominent on the lower surface, curved-ascending, anastomosing, the reticulations lax; petioles 4 mm long or less. Flowers not seen. Fruits axillary, solitary, sessile, the calyx accrescent, ferruginous-pilose, the lobes 4, ovate-lanceolate, acuminate, about 8 mm long and 5 mm wide. Young fruits ovoid, brown when dry, acute or apiculate, sparingly covered with long, rather weak, brown, subappressed or somewhat spreading hairs, apparently 1-celled and 1-seeded.

LUZON, Province of Cagayan, Patlao, Camalaniugan, *For. Bur. 23278 Velasco*, October 18, 1914, on slopes, altitude about 100 meters.

A species well characterized by its solitary, axillary, sessile, pointed fruits, and especially by the long hairs on the young fruits, calyces, and younger vegetative parts. It is closely allied to *Diospyros eriantha* Champ. of southern China and Formosa, but differs in its larger more numerous nerved leaves which are rounded at the base.

DIOSPYROS TAYABENSIS sp. nov.

Arbor, ramulis junioribus et inflorescentiis dense subferrugineo-pubescentibus; foliis ellipticis ad oblongo-ellipticis, in siccitate brunneis, nitidis, usque ad 16 cm longis, chartaceis ad subcoriaceis, acuminatis, subtus leviter pubescentibus, basi rotundatis vel leviter decurrento-acuminatis, subtus utrinque glandulis 1 ad 3 distinctis instructis, nervis lateralibus utrinque 10 ad 12, perspicuis, arcuato-anastomosantibus; floribus ♂ axillaribus, fasciculatis, circiter 1.5 cm longis, uniformiter dense ferrugineo-pubescentibus, calycis lobis anguste oblongis, 6 mm longis et 2 mm latis; staminibus 10, antheris lineari-lanceolatis, acuminatis, 3 mm longis.

A tree, 20 meters high *vide* Ramos, the branches and branchlets terete, dark-brown, smooth, the former glabrous, the latter uniformly and densely ferruginous-pubescent with short hairs. Leaves elliptic to oblong-elliptic, chartaceous to subcoriaceous, brown and shining when dry, the lower surface a little paler than the upper, 10 to 16 cm long, 4.5 to 7.5 cm wide, the apex with a broad, obtuse, short acumen, the base rounded and usually somewhat decurrent-acuminate, beneath with from 1 to 3, black, rather conspicuous glands on each side of the midrib, the upper surface glabrous, the lower sparingly ferruginous-pubescent especially on the midrib, nerves, and reticulations; lateral nerves 10 to 12 on each side of the midrib, prominent, spreading, somewhat curved, arched-anastomosing, the reticulations lax; petioles rather stout, pubescent, brown, 5 to 8 mm long. Staminate flowers axillary, fascicled, numerous, greenish-white, crowded, about 1.5 cm long, all parts of the inflorescence

uniformly ferruginous-pubescent. Calyx-tube turbinate, about 2 mm long, the lobes 5, narrowly oblong, pubescent, 6 mm long, 2 mm wide. Corolla-tube about 9 mm long, pubescent externally, glabrous within, inflated below, narrowed above, the lobes ovate, obtuse, 5 mm long. Stamens 10, their filaments glabrous, 2 mm long; anthers linear-lanceolate, slenderly acuminate, glabrous, 3 mm long. Rudimentary ovary ferruginous-villous.

LUZON, Tayabas Province, Mount Binuang, *Bur. Sci. 28489 Ramos & Edaño*, May 21, 1917, on forested ridges at low or medium altitudes.

This species greatly resembles *Diospyros pilosanthera* Blanco to which it is apparently most closely allied. It is readily distinguished by its indumentum.

SAPOTACEAE

BASSIA Koenig

BASSIA CAGAYANENSIS sp. nov.

Arbor circiter 15 m alta, floribus exceptis glabra; foliis oblongis ad oblongo-lanceolatis, subcoriaceis, usque ad 20 cm longis, perspicue acuminatis, basi subacutis, interdum leviter inaequilateralibus, nervis utrinque circiter 15, distinctis, reticulis haud perspicuis; petiolis 2.5 ad 4 cm longis; fructibus oblongis, circiter 2.5 cm longis, glabris, sepalis persistentibus, ovatis, circiter 8 mm longis, dense adpresseque pubescentibus.

A tree about 15 m high, glabrous except the flowers and the very tips of the branchlets. Branches grayish-brown, terete. Leaves oblong to oblong-lanceolate, subcoriaceous, pale and shining when dry, 13 to 20 cm long, 4 to 7 cm wide, narrowed upward to the rather prominently acuminate apex, the base subacute and often slightly inequilateral; lateral nerves about 15 on each side of the midrib, distinct, anastomosing, the reticulations not prominent; petioles 2.5 to 4 cm long. Fruits axillary, solitary or fascicled, oblong, olivaceous when dry, about 2.5 cm long and 1 cm thick, tipped by the slender style, their pedicels about 1.5 cm long. Sepals 4, persistent, ovate, coriaceous, appressed-pubescent with pale-brownish hairs, acute or slightly acuminate, about 8 mm long.

LUZON, Cagayan Province, Buyon, *For. Bur. 26883 Bernardo*, January 17, 1917, in dense forests, altitude about 15 meters, the fruits edible; locally known as *gasatan*.

This species is distinguished among the comparatively few Philippine representatives of the genus by its oblong to oblong-lanceolate, acuminate, comparatively long-petioled leaves.

MYRSINACEAE

ARDISIA Swartz

ARDISIA NIGROMACULATA sp. nov. § *Akosmos*.

Frutex glaber, circiter 3 m alta; foliis numerosis, integris, oblongo-ellipticis ad oblongo-obovatis, utrinque maculis numerosis nigris conspicuis instructis, chartaceis vel subcoriaceis, usque ad 8 cm longis, acuminatis, basi acutis, nervis primariis utrinque circiter 10, tenuibus; inflorescentiis axillaribus, bipinnatim paniculatis, multifloris, pedunculatis, foliis subaequantibus; floribus 5-meris, calycis circiter 2.5 mm diametro, glandulosis, lobis ovatis, rotundatis, margine leviter ciliatis, circiter 0.7 mm longis, petalis perspicue sed parce nigro-glandulosis, circiter 3.5 mm longis.

A glabrous shrub about 3 m high, the branches rather stout, brown, 5 to 7 mm in diameter, the petiolar scars large, prominent and rather crowded on the younger parts. Leaves numerous, rather crowded, oblong-elliptic to oblong-obovate, chartaceous to subcoriaceous, pale olivaceous-brown when dry, shining, 5 to 8 cm long, 2.5 to 4 cm wide, subequally narrowed to the acute base and to the acuminate apex, the margins entire, both surfaces with numerous, conspicuous, black or nearly black maculae and minutely glandular-punctate; primary lateral nerves about 10 on each side of the midrib, slender, scarcely more prominent than are the secondary nerves and reticulations; petioles 1 to 1.5 cm long. Inflorescences axillary and from the axils of fallen leaves, bipinnately paniculate, peduncled, about as long as the leaves, the primary branches 2.5 cm long or less. Flowers numerous, racemosely arranged on the primary branches, 5-merous, white, in full anthesis 8 mm in diameter, their pedicels 2 mm long or less, the buds ovoid, acute, the styles not projecting. Calyx 2.5 mm in diameter, the lobes broadly ovate, rounded, margins minutely ciliate, rather prominently glandular. Corolla lobes subelliptic, 3.5 mm long, obtuse, each with from 5 to 11 very prominent, nearly black glands. Anthers oblong-ovate, acute, 2 mm long, the filaments distinct, short, the connective obscurely glandular on the back. Ovary ovoid; style 2 mm long, not projecting beyond the corolla in bud.

LUZON, Tayabas Province, Mount Binuang, *Bur. Sci. 28478 Ramos & Edaño*, May 7, 1917, in the mossy forest, altitude apparently about 1,000 meters. A specimen with immature flowers and somewhat larger, less conspicuously maculate leaves, *Bur. Sci. 28659 Ramos & Edaño*, from the same locality, apparently represents the same species.

This species is manifestly a representative of the section *Akosmos* and is strongly characterized by its conspicuously maculate leaves, in this point simulating some of our species of *Discocalyx*.

ARDISIA RIVULARIS sp. nov. § *Tinus*.

Species *A. boissieri* et *A. salicifoliae* affinis, differt foliis distincte angustioribus. Frutex circiter 2 m altus, glaber; foliis coriaceis, lanceolatis ad oblanceolatis, usque ad 7 cm longis et 10 ad 18 mm latis, utrinque angustatis, acutis, nervis inconspicuis; umbellis 2- ad 7-floris, floribus circiter 1.5 cm diametro, calycis lobis punctatis, margine leviter ciliatis exceptis glabris, antheris haud rugosis, dorso obscure glanduloso.

A glabrous shrub about 2 m high, the branches and branchlets brownish, terete. Leaves numerous, rather crowded, lanceolate to oblanceolate, 5 to 7 cm long, 10 to 18 mm wide, subequally narrowed and acute at both ends, coriaceous, pale-brownish or subolivaceous when dry, shining, of about the same color on both surfaces, obscurely glandular, the midrib prominent, the lateral nerves very slender and obscure; petioles about 5 mm long. Umbels in the upper axils, rather numerous, solitary, 2- to 7-flowered, or sometimes the peduncle bearing but a single flower, the peduncles 1 to 2 cm long, the pedicels usually about 1 cm in length. Flowers pink, about 1.5 cm in diameter when expanded. Calyx glandular, glabrous except the slightly ciliate margins of the lobes, the lobes extending one-half to the base, ovate, rounded, about 1.5 mm long. Corolla-lobes elliptic, acute, glandular, about 7 mm long and 4 mm wide. Anthers 4.5 mm long, not rugose, obscurely glandular on the back, acute or acuminate. Fruits globose, 5 to 6 mm in diameter.

LUZON, Tayabas Province, Umiray, *Bur. Sci.* 29020 (type), 28956 Ramos & Edaña, June 3, 1917, along the Umiray River in forests at low altitudes.

This species, judging from the debris attached to the specimens, and its narrow leaves grows on river banks subject to sudden inundation, having the stenophyllous leaves characteristic of a number of totally unrelated species that grow in similar habitats. Its alliance is manifestly with *Ardisia boissieri* A. DC. and *A. salicifolia* A. DC., but it seems to be sufficiently distinct from both.

LOGANIACEAE

FAGRAEA Thunberg

FRAGRAEA CURRANII sp. nov.

Species *F. auriculatae* Jack affinis, differt nervis lateralibus obsoletis vel subobsoletis. Frutex scandens, glaber; foliis crassissime coriaceis, usque ad 25 cm longis, anguste obovatis ad oblongo-obovatis, rotundatis, basi angustatis, in siccitate utrin-

que densissime verruculoso-rugosis, brunneis vel atro-brunneis, nitidis; floribus magnis, circiter 10 cm longis, subcampanulatis.

A scandent shrub attaining a height of 30 meters according to Curran and a diameter of 18 cm, entirely glabrous. Branches stout, about 1 cm in diameter when dry, wrinkled, olivaceous to blackish-brown, shining. Leaves very thickly coriaceous, brown to black-brown on both surfaces when dry, shining, densely verruculose-rugose, oblong-obovate to narrowly obovate, 12 to 25 cm long, 6 to 8 cm wide, apex rounded, gradually narrowed below the middle to the decurrent-acuminate base, the midrib very prominent, the lateral nerves obsolete or nearly so; petioles stout, 2 to 4 cm long, the thick, inflated, basal portion about 1.5 cm in diameter. Flowers white, two or three at the apex of each branchlet, their pedicels very stout, about 1.5 cm long, black when dry, the subtending bracts oblong, obtuse, thickly coriaceous 1.5 cm long. Calyx ovoid, about 3 cm long, the lobes very thickly coriaceous, subelliptic, rounded, about 2.5 cm long, the bracteoles ovate to oblong-ovate, obtuse, about 1.5 cm long. Corolla somewhat campanulate, the tube up to 5 cm in length, widened above, the lobes very thickly coriaceous, brittle when dry, obovate, rounded, 4 to 5 cm long; anthers thick, about 8 mm long.

LUZON, Laguna Province, Mount Banahao, *For. Bur. 8045 Curran & Merritt*, November 6, 1907 (type), altitude about 100 meters; Mount Maquiling, *For. Bur. 26897 Mabesa*, September 8, 1917, altitude 200 to 300 meters; Cagayan Province, Mount Ababaca, *For. Bur. 17217 Curran*, March, 1909 (sterile). POLILLO, *Bur. Sci. 10430 McGregor*, flowers only.

This species, originally named *Fagraea curranii* in 1908, was not then published, but was placed under *Fagraea auriculata* Jack to which it is closely allied, but it differs from the latter species in a number of characters, notably in the obsolete or subobsolete lateral veins of its leaves.

FAGRAEA MACGREGORII sp. nov.

Ut videtur frutex scandens, *F. longiflorae* Merr. affinis, differt foliis oblongo-obovatis, basi longe decurrentibus, calycibus sub fructu quam fructibus brevioribus, haud accrescentibus.

Apparently a vine, probably pseudo-parasitic, the branches stout. Leaves coriaceous, rather pale when dry, oblong-obovate, up to 70 cm in length and 25 cm in width, acute or slightly acuminate, base gradually narrowed, decurrent along the 6 to 8 cm long petiole; lateral nerves 10 to 12 on each side of the very stout midrib, prominent on the lower surface, reticulations obsolete. Flowers unknown. Fruits crowded at the apices of the branches, about 15 in a rather close, dense head, the subtending bracts ovate, acuminate, about 3 cm long. Fruit, when fresh,

bluish-green, when dry oblong-cylindric, apiculate, about 4 cm long, 1.5 to 2 cm in diameter, somewhat exserted from the calyx, the calyx-lobes ovate, acute, about 1.5 cm long.

LUZON, Ifugao Subprovince, Mount Polis, *Bur. Sci. 17938 McGregor*, February 15, 1913.

A species somewhat resembling and manifestly closely allied to *Fagraea longiflora* Merr., from Mount Banajao, Luzon. It differs, however, in its somewhat exserted fruits and in its vegetative characters, the leaves of the two being entirely different in shape.

APOCYNACEAE

ALYXIA Banks

ALYXIA REVOLUTA sp. nov.

Frutex scandens, glaber, ramis crassis, quadrangulatis; foliis quaternatis, anguste oblongis, crassissime coriaceis, usque ad 18 cm longis, obtusis, basi acutis et plus minusve decurrentibus, margine valde revolutis, supra olivaceis, nitidis, subtus glaucis; nervis lateralibus numerosis, supra obscureis, subtus obsolete; petiolo 3 ad 4 cm longo; infructescentiis axillaribus, solitariis, ramosis, 3 ad 4 cm longis; fructibus ellipsoideis, circiter 1.4 cm longis, apiculatis, vel dispermis et in medio constrictis.

A scandent glabrous shrub, the branches stout, distinctly 4-angled, up to 1 cm in diameter, the ultimate parts 4 to 5 mm in diameter, the internodes 4 to 8 cm long. Leaves 4-nate, very thickly coriaceous, narrowly oblong, 13 to 18 cm long, 3.5 to 5 cm wide, obtuse, base acute and usually somewhat decurrent, the margins very prominently revolute, the midrib very prominent, the upper surface olivaceous, shining, the lower glaucous; lateral nerves numerous, slender, obscure on the upper surface, obsolete on the lower; petioles very stout, 3 to 4 cm long. Cymes axillary, solitary, their peduncles 1 cm long or less, the branches usually 3, short, the bracteoles persistent. Fruits ellipsoid, when fully mature black or dark-purple, the immature ones yellowish-brown when dry, about 1.4 cm long, somewhat wrinkled, stipitate, apiculate, 1-seeded, or sometimes constricted in the middle and 2-seeded.

LUZON, Tayabas Province, Mount Cadig, *Bur. Sci. 25515 Yates*, December 12, 1914, in the mossy forest, altitude at least 800 meters.

A most characteristic species, readily distinguished by its narrowly oblong, very thickly coriaceous, stiff leaves which are glaucous beneath, the nerves here obsolete, but especially by the very strongly revolute margins. Its alliance is with *Alyxia sibuyanensis* Elm.

ALYXIA GLABRA sp. nov.

Frutex scandens, glaber, ramis ramulisque teretibus; foliis quaternatis, oblongo-ellipticis, subcoriaceis, olivaceis, nitidis usque ad 12 cm longis, basi acutis, apice breviter abrupte obtuseque acuminatis, nervis utrinque valde numerosis, tenuibus, confertis; inflorescentiis axillaribus, fasciculatis, brevibus, umbellatis, glabris, umbellis 3- ad 5-floris; floribus circiter 14 mm longis, breviter pedicellatis.

A scandent, entirely glabrous shrub, the branches and branchlets terete, the former pale, the latter dark-brown and about 2 mm in diameter, the internodes 6 to 17 cm long. Leaves quaternate, olivaceous, of the same color on both surfaces and shining when dry, subcoriaceous, oblong-elliptic, 8 to 12 cm long, 3 to 5 cm wide, base acute, apex rather abruptly acuminate, the acumen short, blunt; lateral nerves very slender, not prominent, very numerous, crowded, the primary ones up to 1.5 mm apart; petioles about 1 cm long. Inflorescences axillary, fascicled, umbellate, each umbel 3- to 5-flowered, the peduncles 5 to 6 mm long, the pedicels about 3 mm in length; bracts very broadly ovate, obtuse, 1.5 mm long. Calyx-tube very short, the lobes broadly ovate, obtuse, 2 mm long and wide. Corolla white, the tube cylindrical, about 11 mm long, the lobes broadly elliptic-ovate, obtuse, 3 to 3.5 mm long.

LUZON, Tayabas Province, Infanta-Siniloan trail, *Bur. Sci. 29207 Ramos & Edaña* (type), June 14, 1917, in damp forests; *Umiray, Bur. Sci. 28967 Ramos & Edaña*, June 1, 1917, in forests along the river.

This species resembles *Alyxia monticola* C. B. Rob., the flowers of which are unknown, in many respects but is apparently not very closely allied to it; Robinson's species has the nerves at least twice as far apart as in the present one. The entirely glabrous, simply umbellate inflorescences are characteristic, and at once distinguish *Alyxia glabra* Merr. from *A. monilifera* Vid.

ALYXIA LANCEOLATA sp. nov.

Frutex scandens, partibus junioribus et inflorescentiis parcissime obscureque puberulis exceptis glaber, ramis ramulisque teretibus; foliis quaternatis, lanceolatis, chartaceis ad subcoriaceis, in siccitate pallidis, nitidis, usque ad 7 cm longis, apice perspicue tenuiter et obtuse acuminatis, basi acutis, nervis lateralibus obsoletis vel subobsoletis; inflorescentiis circiter 2 cm longis, unbellatim 3-5-floris; floribus circiter 1 cm longis, corollae tubo 6 ad 7 mm longo.

A scandent shrub, entirely glabrous except the obscurely puberulent younger branchlets, petioles, and inflorescences. Branches

and branchlets terete, the former pale, the latter smooth, reddish-brown, slender, about 1 mm in diameter, the internodes 2.5 to 6 cm long. Leaves quarternate, chartaceous to subcoriaceous, lanceolate, 4 to 7 cm long, 1 to 2 cm wide, narrowed below to the acute base and above to the slenderly but obtusely acuminate apex, the upper surface subolivaceous when dry, shining, the lower much paler, the midrib prominent but the lateral nerves obsolete or subobsolete; petioles 2.5 to 5 mm long. Inflorescences axillary, solitary, peduncled, umbellate, about 2 cm long, each with 3 to 5 pedicelled flowers at the apex of the peduncle, the pedicels 2 to 3 mm long, the bracteoles oblong-ovate, subacute, 1 mm long. Calyx-tube very short, the lobes ovate-lanceolate, acuminate, 2 mm long. Corolla-tube cylindric, 6 to 7 mm long, the lobes oblong-ovate, somewhat acuminate, 3 mm long.

LUZON, Tayabas Province, Infanta-Siniloan trail, *Bur. Sci.* 29209 Ramos & Edaña, June 14, 1917, in damp forests. *Bur. Sci.* 28627 Ramos & Edaña from Mount Binuang, May, 1917, probably represents the same species, but the flowers are very young and the leaves are uniformly dark-brown on both surfaces; the difference in color in the dried specimens is probably due to a difference of method in drying them.

The species is a very characteristic one and is distinguished by its lanceolate, prominently acuminate, practically nerveless leaves and its simple umbellate inflorescences.

ALYXIA LAXIFLORA sp. nov.

Species *A. luzoniensis* affinis, differt inflorescentiis tenuiter pedunculatis, laxis, paucifloris, 3 ad 6 cm longis. Frutex scandens, glaber, ramis teretibus, ramulis tenuibus, obscure angulatis, internodiis elongatis, usque ad 6 cm longis; foliis ternatis, chartaceis, oblongis, ad oblongo-ellipticis, olivaceis vel brunneo-olivaceis, usque ad 6 cm longis, basi acutis, apice late et obtuse subrostrato-acuminatis, nervis utrinque numerosis, tenuibus, obscuris; inflorescentiis axillaribus et terminalibus, laxis, paucifloris, longe pedunculatis, 3 ad 6 cm longis; floribus circiter 1 cm longis.

A scandent glabrous shrub, the stems terete, 3 to 4 mm in diameter, the branchlets dark-brown, smooth, very slender, 1 to 2 mm in diameter, the older ones terete, the younger ones somewhat 3-angled, the internodes 4.5 to 6 cm long. Leaves ternate, chartaceous, olivaceous or dark brownish-olivaceous, of about the same color on both surfaces and shining when dry, oblong to elliptic-oblong, 4 to 6 cm long, 1.5 to 3 cm wide, subequally narrowed to the acute base and to the subrostrate-acuminate apex, the acumen broad, blunt; lateral nerves very slender, obscure, 35 or more on each side of the midrib, the

primary ones no more distinct than are the secondary ones; petioles 3 to 4 mm long. Inflorescences axillary and terminal, lax, few-flowered, 3 to 6 cm long, solitary or fascicled, glabrous, dark-brown when dry, the peduncles 2 to 3 cm long. Flowers (young) greenish-yellow, their pedicels up to 4 mm in length, usually 5 to 7 on each inflorescence, the bracts ovate, obtuse, about 1 mm long. Calyx about 2.5 mm long, glabrous, the lobes oblong-ovate, obtuse, 1 mm long. Corolla-tube about 7 mm long, narrowed below, the buds acuminate, the lobes ovate-lanceolate, about 3 mm long, somewhat acuminate. Anthers about 1 mm long. Ovary ovoid, glabrous.

LUZON, Apayao Subprovince, Mount Sulu, *Bur. Sci. 28371 Fénix*, May 22, 1917, in the mossy forest, apparently above an altitude of 800 meters.

The alliance of this species is manifestly with *Alyxia luzoniensis* Merr., which it closely resembles in most characters except its very lax, long-peduncled, few-flowered inflorescences.

KOPSIA Blume

KOPSIA LAXINERVIA sp. nov.

Frutex circiter 3 m altus, inflorescentiis exceptis glaber; foliis oblongis, membranaceis, usque ad 22 cm longis, subolivaceis, nitidis, basi acutis, apice breviter obtuseque acuminatis; nervis primariis utrinque 10 ad 12, laxis, distantibus, patulis, anastomosantibus, subtus distinctis; fructibus oblongo-ovoideis, circiter 2 cm longis.

An erect shrub, about 3 m high, entirely glabrous except the inflorescences. Branches terete or somewhat compressed, the branchlets sulcate. Leaves membranaceous, olivaceous or pale brownish-olivaceous and shining when dry, the lower surface slightly paler than the upper, oblong, 12 to 22 cm long, 5.5 to 7 cm wide, base acute, apex shortly and broadly blunt-acuminate; lateral nerves 10 to 12 on each side of the midrib, distinct, spreading, anastomosing, lax, the primary reticulations lax, distinct; petioles about 5 mm long. Infructescences terminal, peduncled, 5 to 7 cm long, the younger branchlets and persistent bracts somewhat ferruginous-pubescent. Fruits oblong-ovoid, dark-brown or nearly black when dry, somewhat wrinkled, obtuse, about 2 cm long and 1 cm in diameter.

LUZON, Apayao Subprovince, Guiniri, *Bur. Sci. 28232 Fénix*, May 12, 1917, in thickets near streams.

This species is distinguished from *Kopsia longiflora* Merr., to which it is manifestly allied, by its leaves having much fewer and more laxly arranged nerves than in that species.

CONVOLVULACEAE

ERYCIBE Roxburgh

ERYCIBE SARGENTII sp. nov.

Frutex alte scandens, inflorescentiis plus minusve castaneo-pubescentibus exceptis glaber; foliis coriaceis, oblongis, usque ad 18 cm longis, obtuse acuminatis, basi rotundatis ad acutis, in siccitate utrinque concoloribus, nitidis, uniformiter brunneis vel purpureo-brunneis nervis utrinque 6 ad 8, distantibus, distinctis, anastomosantibus, reticulis laxis; paniculis axillaribus terminalibusque, axillaribus circiter 5 cm longis, terminalibus usque ad 12 cm longis et 5 cm latis, multifloris; sepalis coriaceis, orbicularibus, margine leviter ciliatis; corolla circiter 12 mm longa, lobis obcordatis, circiter 8 mm longis et 12 mm latis.

A scandent shrub apparently of large size, entirely glabrous except the inflorescences. Branches terete, smooth, very pale, the younger branchlets sometimes brown or dark-brown, never angled. Leaves coriaceous, oblong, 10 to 18 cm long, 3 to 8 cm wide, smooth and shining, of the same color on both surfaces, and uniformly brownish or purplish-brown when dry, the apex shortly and obtusely acuminate, the base rounded to acute; lateral nerves 6 to 8 on each side of the midrib, distinct, somewhat curved, anastomosing, the reticulations lax, not prominent; petioles stout, 1 to 2 cm long. Panicles axillary and terminal, when young sparingly pubescent with dark purplish-brown, short hairs, ultimately glabrous, the whole inflorescence uniformly dark-brown when dry, the axillary panicles about 5 cm long, the terminal ones up to 12 cm in length and 5 cm in diameter, rather densely many-flowered. Flowers white or pale-yellowish, fragrant, about 12 mm long, their pedicels 3 to 4 mm long, sparingly pubescent, ultimately glabrous. Sepals orbicular, coriaceous, 3 to 3.5 mm in diameter, margins somewhat ciliate, otherwise glabrous. Exposed parts of the corolla in bud densely purplish-brown pubescent, the central pubescent part in flower ovate-lanceolate, 4 to 5 mm long; corolla tube 4 to 5 mm long; the lobes in anthesis obcordate, about 12 mm wide and 8 mm long. Anthers ovoid-lanceolate, acuminate, 2.5 mm long. Fruits ellipsoid, glabrous, brown when dry, 1.5 to 2 cm long.

LUZON, Cagayan Province, Peñablanca, *Adduru 18*, May 4, 1917; Pangasinan Province, Umingan, *Bur. Sci. 17696 Otanes*, May 6, 1914; Bataan Province, Mount Mariveles, *Williams 593* (type), 798, February and March, 1904; Zambales Province, San Antonio, *Madarang s. n.*, April 29, 1914;

without definite locality, but probably from Zambales Province, *Cuming 1071*.

This characteristic species is apparently allied to *Erycibe laevigata* Wall. The specimens are uniformly brown or purplish-brown when dry, giving the species a distinctly characteristic appearance. The terminal panicles are sometimes supplied with greatly reduced leaves. The species is dedicated to Doctor C. S. Sargent, Director of the Arnold Arboretum, for whom the Adduru collection was made.

IPOMOEA Linnaeus

IPOMOEA DIVERSIFOLIA R. Br. Prodr. (1810) 487; Benth. Fl. Austral. 4 (1867) 416; Bailey Queensland Flora 4 (1901) 1058.

LUZON, Ilocos Norte Province, Bangui, *Bur. Sci. 27589 Ramos*, February 26, 1917, in grasslands at low altitudes.

This identification has been made entirely from the descriptions cited, with which the specimens apparently agree perfectly. The species is known otherwise only from the islands in the Gulf of Carpentaria, Australia. In the Philippine form the ovaries are 3-celled, the flowers about 5 cm long, violet and white according to Ramos, solitary. The leaves closely approximate those of *Ipomoea coptica* (Linn.) Roth (*I. dissecta* Willd.), but the flowers are very much larger than in the latter species.

VERBENACEAE

CALLICARPA Linnaeus

CALLICARPA PLATYPHYLLA sp. nov.

Arbor circiter 8 m alta; foliis subcoriaceis, magnis, usque ad 50 cm longis et 20 cm latis, integris, tenuiter subcaudato-acuminatis, basi acutis, supra glabris, olivaceis, subtus pallidis, nitidis, densissime implexo-puberulis, indumento haud stellato, nervis utrinque circiter 12, cum reticulis valde prominentibus; cymis dichotomis, pedunculatis, circiter 7 cm longis, stellato-tomentosis; calycis truncatis, glabris, 3 cm diametro.

A tree about 8 m high, the branches 1 cm in diameter or less, glabrous, somewhat 4-angled, the branchlets densely puberulent with pale, dirty-brown indumentum. Leaves subcoriaceous; oblong-elliptic to obovate-elliptic, entire, slenderly subcaudate-acuminate, base acute, 35 to 50 cm long, 18 to 20 cm wide, the upper surface glabrous, olivaceous, shining, the lower very densely covered with minute, matted, pale, puberulent hairs, the indumentum not stellate, the whole lower surface pale-brownish, shining, the individual hairs not evident under an ordinary lens; lateral nerves about 12 on each side of the midrib, very prominent on the lower surface as are the subparallel primary reticulations, curved, anastomosing; petioles stout, densely puberulent, angled, 4 to 5 cm long. Cymes axillary, peduncled, rather densely stellate-pubescent with pale hairs, dichotomous, about 7

cm long and 9 cm wide, the bracts linear-lanceolate, 4 to 5 mm long, the bracteoles numerous, similar to the bracts but about 1 mm long. Calyx truncate, cup-shaped, 3 mm in diameter, glabrous or nearly so. Fruits globose, about 3.5 mm in diameter.

LUZON, Cagayan Province, Pamplona, *For. Bur.* 26967 Velasco, August 9, 1917, in forests, altitude about 50 meters.

A most remarkable species, well characterized by its very large, entire, slenderly acuminate leaves which are glabrous above and densely matted-puberulent on the lower surface with a pale-brownish, shining, non-stellate indumentum; glands, if present, are entirely obscured by the indumentum.

VITEX Linnaeus

VITEX CELEBICA Koord. Meded. Lands Plantent. 19 (1898) 560, 645.

MINDANAO, Cotabato District, *For. Bur.* 6543 Hutchinson, March, 1907, *For. Bur.* 15420 Pray, March, 1910; Zamboanga District, Siag River, *For. Bur.* 13383 Foxworthy, DeMesa, & Villamil, May 29, 1912; Butuan Subprovince, Amparo, *For. Bur.* 20746 Rafael & Ponce, October 10, 1913; Davao District, Mount Apo, *Elmer* 11602, September, 1909, distributed as *V. pentaphylla* Merr.

A species previously known only from Celebes, our Philippine material agreeing closely with the description and with Celebes specimens in all essential characters. In Cotabato it is known as *calipapa-aso*, *molave-aso*, *calipapa*, and *calipapa-madam*; and in Zamboanga as *limpapa* and *himulauin*.

SOLANACEAE

SOLANUM Linnaeus

SOLANUM LUZONIENSE sp. nov.

Frutex erectus, ramosus, 0.5 ad 1 m altus, plus minusve pallide stellato-tomentosus, ramis teretibus aculeis sparsis rectis circiter 2 mm longis armatis; foliis membranaceis, oblongis, integris, in siccitate subolivaceis, acuminatis, basi acutis, plerumque obscure inaequilateralibus, nervis utrinque circiter 5, tenuibus, curvatis, anastomosantibus; cymis extra-axillaribus terminalibusque, circiter 3 cm longis, breviter pedunculatis, stellato-tomentosis; floribus extus stellato-tomentosis, circiter 8 mm longis, violaceis; fructibus globosis, glabris, carnis, inermis, coccineis, circiter 6 mm diametro.

An erect, branched, sparingly aculeate, more or less stellate-tomentose shrub or undershrub 0.5 to 1 m high, the branches terete, reddish-brown, sparingly cinereous-stellate-tomentose, with scattered, straight, sharp spines about 2 mm in length, the young branchlets rather densely stellate-tomentose. Leaves alternate, membranaceous, subolivaceous when dry, slightly shining, the lower surface paler than the upper and more pubescent, oblong, entire or obscurely undulate, acuminate, base usually

slightly inequilateral, acute, the upper surface sparingly stellate-pubescent on the midrib and nerves or ultimately glabrous, the lower surface with more numerous stellate hairs, rarely largely confined to the midrib and nerves, more commonly scattered over the entire surface; lateral nerves slender, not prominent, curved, anastomosing, about 5 on each side of midrib; petioles rather densely stellate-tomentose with cinereous hairs, 1 to 2 cm long, unarmed. Cymes extra-axillary and terminal, about 3 cm long, peduncled, rather few-flowered, stellate-tomentose. Flowers violet, about 8 mm long, their pedicels up to 5 mm in length. Calyx somewhat campanulate, sparingly or rather densely stellate-tomentose, about 3 mm long, the lobes oblong-ovate, acute or subobtuse, about 1.5 mm long. Corolla sparingly stellate-tomentose externally, the tube short, the lobes oblong-ovate to ovate-lanceolate, somewhat acuminate, about 6 mm long. Anthers lanceolate, somewhat narrowed upward, obtuse, 4 mm long. Fruit globose, glabrous, smooth, fleshy, red when fresh, about 6 mm in diameter; seeds few, flattened, about 3 mm in diameter.

LUZON, Nueva Ecija Province, Mount Umingan, *Bur. Sci. 26487 Ramos & Edaña*, August 3, 1916, along small streams in open places at low altitudes.

The alliance of this species is apparently with *Solanum retrorsum* Elm., from which, among numerous other characters, it is distinguished by its indumentum and especially by its short, scattered, straight, spreading spines. I refer here also the following specimens: LUZON, Pangasinan Province, Bautista, *Merrill s. n.*, July, 1903; Umingan, *Bur. Sci. 17710 Otones*, April 17, 1914.

Var. **GLABRUM** var. nov.

A typo differt omnibus partibus glabris.

LUZON, Pampanga Province, Calumpit, *Merrill 4237* (type), September, 1905; Tarlac Province, Gerona, *Guerrero s. n.*, April, 1906.

ACANTHACEAE

HEMIGRAPHIS Nees

HEMIGRAPHIS VIRIDIS sp. nov.

Caule herbaceo, erecto, usque ad 50 cm alto, ramis tetragonis vel sulcatis, minute strigosis; foliis subaequalibus, lanceolatis ad anguste lanceolatis, in siccitate viridis, nitidis, usque ad 9 cm longis, margine undulatis, basi obtusis, sursum angustatis et longissime obtuse acuminatis, cystolithis subtus nullis, supra numerosis, magnis, jam oculo nudo distinctis, nervis utrinque circiter 10, subtus strigosis; spicis circiter 3, pedunculatis, 2.5

ad 5 cm longis; bracteis numerosis, imbricatis, in siccitate viridis, ovatis ad ovato-ellipticis, 1 ad 1.5 cm longis, membranaceis, acutis ad obtusis, margine perspicue ciliatis, bracteolis nullis; floribus circiter 13 mm longis, calycis lobis linearis, tenuiter acuminatis, 8 ad 9 mm longis, ciliatis.

An erect, sparingly branched herb attaining a height of 50 cm, branched only in the upper part, the stems terete below, about 2 mm in diameter, dull-greenish, densely covered with short cystoliths, the branches sulcate or 4-angled, appressed-strigose. Leaves of each pair subequal, lanceolate, chartaceous, green on both surfaces, shining and brittle when dry, 6 to 9 cm long, 1 to 2 cm wide, margins somewhat undulate, base abruptly rounded or obtuse, gradually narrowed upward to the slender but obtusely acuminate apex, the upper surface with numerous cystoliths distinctly visible to the naked eye, these wanting on the lower surface but the midrib and lateral nerves here appressed-strigose; lateral nerves about 10 on each side of the midrib, distant, distinct, prominently anastomosing; petioles 2 to 8 mm long. Spikes 3 to 5, peduncled, 2.5 to 5 mm long. Bracts numerous, imbricate, foliaceous, green when dry, ovate to elliptic-ovate, 10 to 15 mm long, 6 to 9 mm wide, shortly stalked, base rounded to subacute, apex acute to obtuse, the margins prominently ciliate with long white hairs; bracteoles none. Flowers white, about 13 mm long. Calyx-lobes free nearly to the base, linear, 8 to 9 mm long, about 1 mm wide, narrowed upward to the slenderly acuminate apex, prominently ciliate, the tip with about three, long, slender, white hairs. Capsules 8 mm long and 2 mm in diameter, slightly narrowed below, sparingly pubescent in the upper part.

LUZON, Ilocos Norte Province, Bangui, *Bur. Sci.* 27587 Ramos, February 27, 1917, in forests at low altitudes, with the Ilocano name *caribuso*.

A species manifestly belonging in the group with *Hemigraphis cumingiana* F.-Vill. and *H. strigosa* F.-Vill., but it is readily distinguished by its vegetative characters.

HEMIGRAPHIS HIRSUTISSIMA sp. nov.

Herba prostrata, e radices sublignosa, ramis adscendentibus, primariis usque ad 30 cm longis, ramis et foliis et bracteis prominente hirsutis; foliis ellipticis ad oblongis, usque ad 3 cm longis, subcoriaceis, rigidis, sordide olivaceis, utrinque acutis vel apice obtusis, supra pustulatis, cystolithis nullis, margine obscurissime irregulariter crenatis vel integris, nervis utrinque 3 vel 4, obscuris; spicis confertis, ovoideis, 1.5 ad 2 cm longis; bracteis oblongis ad oblongo-ellipticis, obtusis vel subacutis, 10 ad 12 mm longis, prominente ciliato-hirsutis; bracteolis filiformibus 3

mm longis, prominente ciliatis, 3 mm longis; floribus 13 mm longis, calycis lobis 5, linearis, ciliatis, tenuiter acuminatis, circiter 6 mm longis.

A prostrate herb from a thickened woody root, the primary branches up to 30 cm long, rooting at the lower nodes, the branchlets and ends of the primary branches erect or ascending, all parts except the corolla prominently hirsute with stiff, pale or pale-yellowish hairs, those on the upper surface of the leaves from thickened bases, the branches terete or very obscurely 4-angled. Leaves of each pair somewhat unequal, elliptic to oblong, subcoriaceous, dull-olivaceous, 1.5 to 3 cm long, 7 to 13 mm wide, acute at both ends or the apex obtuse, margins entire to obscurely and irregularly crenate, both surfaces prominently hirsute, the upper surface pustulate, the cystoliths not evident; lateral nerves 3 or 4 on each side of the midrib, obscure; petioles densely hirsute, 2 to 3 mm long. Spikes sessile or shortly peduncled, dense, ovoid, 1.5 to 2 cm long; bracts imbricate, oblong to oblong-elliptic, obtuse to subacute, prominently hirsute on both surfaces, 10 to 12 mm long; bracteoles filiform, prominently ciliate, 3 mm long. Calyx-tube about 2 mm long, the lobes linear, prominently ciliate, 6 mm long, slenderly acuminate, one slightly longer than the other four. Corolla 13 mm long, externally sparingly pubescent with short hairs.

LUZON, Ilocos Norte Province, Burgos, *Bur. Sci.* 27258 Ramos, March 16, 1917, on rocks along streams, flowers white.

A species well characterized by its comparatively small, rather densely hirsute, obscurely nerved leaves which are pustulate on the upper surface; its dense, ovoid spikes; prominently hirsute bracts; and filiform bracteoles.

HEMIGRAPHIS PAUCIFLORA sp. nov.

Herba erecta, simplex vel parce ramosa, usque ad 30 cm alta, partibus junioribus et foliis et bracteis albido-hirsutis; foliis in paribus subaequalibus, anguste oblongis, membranaceis vel chartaceis, olivaceis, utrinque acutis vel apice obtusis, margine leviter crenatis, usque ad 4.5 cm longis, nervis utrinque circiter 4, obscuris, utrinque hirsutis, pagina superiore cystolithis distinctis inspersis; spicis solitariis, terminalibus, 1 ad 2 cm longis, paucifloris; floribus violaceis, 17 mm longis; bracteis foliaceis, oblongis, hirsutis, 8 ad 14 mm longis, obtusis.

An erect, slender, simple or sparingly branched herb 20 to 30 cm high, rather prominently white-hirsute, the stems below terete, glabrous or slightly scabrid, the younger parts sulcate or somewhat angled, hirsute. Leaves of each pair subequal, narrowly oblong, 3 to 4.5 cm long, 10 to 13 mm wide, olivaceous

or greenish-olivaceous, slightly shining, the lower surface somewhat paler than the upper, the upper surface with distinct cystoliths and scattered, stiff white hairs, the lower surface more prominently hirsute than the upper, acute at both ends, or the apex somewhat obtuse, margins distinctly crenate; lateral nerves about 4 on each side of the midrib, slender, obscure; petioles hirsute, 5 to 8 mm long. Spikes terminal, solitary, 1 to 2 cm long, including the few flowers. Bracts somewhat imbricate, few, foliaceous, hirsute, oblong, obtuse, 8 to 14 mm long, olivaceous; bracteoles filiform, hirsute, about 3 mm long. Calyx tube 2 mm long, the lobes 5, linear-lanceolate, slenderly acuminate, prominently ciliate, one about 6 mm long, the other four 4 mm long. Corolla slightly pubescent externally, 17 mm long.

LUZON, Ilocos Norte Province, Bangui, *Bur. Sci.* 27543 Ramos, March 9, 1917, along streams in forests at low altitudes.

The alliance of this species is manifestly with *Hemigraphis hirsutissima* Merr., from which it differs in its strictly erect stems; longer leaves and petioles; the leaves not pustulate on the upper surface, but with distinct cystoliths; its few-flowered spikes; and distinctly larger flowers.

JUSTICIA Linnaeus

JUSTICIA DISPAR sp. nov. § *Calophanooides*.

Planta ut videtur erecta, suffruticosa, ramosa, subglabra, ramis ramulisque teretibus; foliis in paribus valde inaequalibus, oblongo-ovatis, firmiter chartaceis, acuminatis, basi acutis vel acuminatis, majoribus usque ad 6 cm longis, minoribus 1 ad 2 cm longis, utrinque cystolithis instructis; floribus axillaribus, sessilibus, solitariis vel binis, 1.2 cm longis, bracteis (foliis floralibus) oblongo-spatulatis, 6 mm longis; calycibus segmentis 5, lanceolatis, tenuiter acuminatis, minute adpresse hispidis.

Apparently erect, much branched, suffrutescent or the stems distinctly woody, the branches and branchlets slender, terete, the branches glabrous, the branchlets black when dry, sparsely pubescent, often distinctly zig-zag. Leaves opposite, those of each pair very unequal in size, the larger ones 4 to 6 cm long and 2 to 3 cm wide, the smaller ones 1 to 2 cm long, 1 cm wide or less, acuminate, glabrous, firmly chartaceous, dark-olivaceous when dry, base acute or acuminate, the cystoliths evident on both surfaces; lateral nerves of the larger leaves 4 to 5 on each side of the midrib, slender, their petioles 5 mm long or less. Flowers axillary, solitary or in pairs, white, about 1.2 mm long, each subtended by a bract-like, oblong-spatulate, petiolate, 6 mm long leaf. Calyx-segments 5, lanceolate, slenderly acuminate, 5.5

mm long, about 1.1 mm wide, slightly pubescent. Corolla-tube 5 mm long, lobes 6 mm long, the broader one broadly obovate, 5 mm wide, broadly 3-lobed, the lobes rounded, about 1.2 mm long, the narrower lobe about 1.4 mm wide above, slightly retuse. Stamens 2; anther cells one above the other, about 1 mm long. Ovary oblong, glabrous; style glabrous, 6 mm long. Capsule nearly 1 cm long, glabrous.

LUZON, Nueva Ecija Province, Mount Umingan, *Bur. Sci. 26499 Ramos & Edaño*, September 5, 1916, on dry slopes, altitude about 100 meters.

The alliance of this species appears to be with *Justicia quadrifaria* Wall., from which it is immediately distinguishable by its solitary or paired flowers and its very unequal leaves. Among the Philippine species so far described it is nearest to *Justicia loheri* C. B. Clarke, but that species has linear leaves and differs in numerous other characters.

LEPIDAGATHIS Willdenow

LEPIDAGATHIS MICROPHYLLA sp. nov.

Herba suberecta e radices incrassatis, circiter 20 cm alta, ramis haud 1 mm diametro, teretibus, junioribus 4-angulatis, minutissime cinereo-puberulis; foliis ovatis, haud 1 cm longis, coriaceis, acutis vel leviter acuminatis, integris, subtus puberulis, nervis utrinque 3 vel 4, prominentibus; spicis 1 ad 2 cm longis, falcatis, densis; bracteis imbricatis, lineari-lanceolatis, cinereo-pubescentibus, acuminatis, circiter 7 mm longis, haud lanato-ciliatis ut in *L. cinereae*; floribus 5 mm longis, calycis lobis valde inaequalibus.

A suberect, slender herb about 20 cm high, from somewhat thickened woody roots, the branches terete, less than 1 mm in diameter, minutely puberulent, the younger branches distinctly 4-angled. Leaves ovate, coriaceous, olivaceous, 5 to 9 mm long, 3 to 7 mm wide, entire, acute to slightly acuminate, base rounded or obtuse, the upper surface glabrous or very slightly pubescent, the lower puberulent; lateral nerves 3 or 4 on each side of the midrib, prominent; petioles 1.5 mm long or less. Spikes 1 to 2 cm long, dense, falcate. Bracts linear-lanceolate, acuminate, 7 mm long, 0.8 mm wide, minutely cinereous-pubescent. Upper calyx lobe lanceolate, 6 mm long, 1.2 mm wide, the two lower ones 5.5 mm long and 0.8 mm wide, the two lateral ones 5 mm long and 0.5 mm wide, all pubescent. Corolla reddish, 7 mm long. Anthers 1 mm long. Ovary glabrous.

LUZON, Ilocos Norte Province, Bangui, *Bur. Sci. 27518 Ramos*, March 10, 1917, on dry open hills at low altitudes.

This species somewhat resembles a greatly dwarfed specimen of *Lepidagathis cinerea* Merr., to which it is distantly allied. It is distinguished

by its small size; in being herbaceous; in its ovate, much shorter leaves; and in its narrow, merely pubescent and not lanate-ciliate bracts.

CUCURBITACEAE

TRICHOSANTHES Linnaeus

TRICHOSANTHES BRACTEATA (Lam.) Voigt Hort. Calc. (1845) 58.
Modecca ? bracteata Lam. Encycl. 4 (1798) 410.

LUZON, Ilocos Norte Province, Bangui, *Bur. Sci.* 27415 Ramos, March, 1917; Cavite Province, Alfonso, *Bur. Sci.* 22505 Ramos & Deroy, May, 1915.

The two specimens cited above apparently represent forms of this somewhat polymorphous species, which other than F.-Villar's previously unverified record of *Trichosanthes palmata* Roxb., a synonym, has not been reported from the Philippines. The identification has been made wholly from the published descriptions; both specimens present only male flowers. India and Ceylon to Java, Sumatra, Borneo, and Timor.

ALSOMITRA M. Roemer

ALSOMITRA PUBESCENS sp. nov.

Scandens, omnibus partibus sordide breviter pubescentibus; foliis 3-foliolatis, foliolis ovatis ad elliptico-ovatis, membranaceis, obscure olivaceis, usque ad 14 cm longis, integris, vel lateralibus ad basi lobato-auriculatis; paniculis axillaribus, diffusis, multifloris, usque ad 20 cm longis, floribus ♂ circiter 6 mm diametro.

Scandent, all parts more or less pubescent with short, dirty-brown hairs, those on the stems and branches minutely capitate-glandular. Leaves 3-foliolate, the petioles usually about 3 cm long, the petiolules about 1 cm in length; leaflets ovate to ovate-elliptic, membranaceous, when dry dark-olivaceous, dull, entire, acuminate, base usually acute, 8 to 14 cm long, 4 to 7 cm wide, the terminal one usually larger than the lateral ones, the latter often with a short, oblong lobe on the margin near the base; lateral nerves about 6 on each side of the midrib, distinct, tendrils slender, forked, up to 20 cm in length. Panicles axillary, slender, peduncled, up to 20 cm long, many-flowered, the bracts and bracteoles linear. Staminate flowers rotate, about 6 mm in diameter, their pedicels up to 1 cm in length, slender. Sepals oblong, apiculate, 1.5 mm long, somewhat gibbous at the base, sparingly pubescent. Petals elliptic, rounded or apiculate, minutely pubescent with short scattered hairs, about 3 mm long. Stamens 5, the filaments free, nearly 1 mm long. Pistillate flowers and fruits not seen.

LUZON, Laguna Province, Mount Maquiling, trail to Dampalit Falls, *For. Bur.* 26346 Mabesa (type), January 23, 1917, in thickets, altitude 30 to 50 meters, flowers yellow; *Baker* 4471, January, 1917, "a large vine."

The alliance of this species is manifestly with *Alsomitra integrifoliola* (Cogn.) Hayata, which it rather closely resembles in appearance. It is easily distinguished by its 3-foliolate leaves and its indumentum.

ILOCANIA genus novum

(*Plagiospermeae, Cucumerineae*)

Flores monoici, fasciculati. Masculi: Calycis tubus campanulatus, limbus 5-dentatus, lobi anguste lanceolati, erecti. Corolla campanulata, infra medium 5-lobata, lobi ovati, obtusi. Stamina 3, libera, tubo calycis inserta, filamentis brevis; antherae bilocularis, loculis longitudinaliter triplicatis, connectivo angusto, ultra loculos non producto. Pollen globosum, laeve. Pistillodium nullum. Flores ♀: Corolla maris. Staminodia 3, linearia. Ovarium globosum vel ovoideum, 3-loculare; ovula in loculis 3 vel 4, horizontalia; stylus erectus, trifidus, stigmatibus crassis, furcatis. Fructus globosis vel ovoideis, laevis, baccatis, parvis, indehiscens, circiter 12-spermus. Semina haud compressa, marginata, tumida, corrugata.—Herba scandens, annua, tenuis, glabra; foliis anguste pedato-lobatis, lobis 5 vel 7 linearis ad anguste oblanceolatis, apiculatis, margine obscure denticulatis, chartaceis vel membranaceis; cirrhis bifidis; floribus parvis, flavido-viridis; fructibus parvis, laevis.

ILOCANIA PEDATA sp. nov.

Herba scandens, glabra vel floribus extus parcissime pubescentibus, ramis longitudinaliter sulcatis, tenuibus; foliis in ambitu late ovatis, cordatis, profunde 5- vel 7-lobatis, lobis usque ad 7 cm longis, exterioribus minoribus; petiolo leviter aculeato-denticulato; floribus 5-meris, axillaribus, fasciculatis, breviter pedicellatis, circiter 10 mm longis, campanulatis; fructibus globosis vel ovoideis, circiter 1.5 cm diametro; seminibus circiter 5 mm longis.

A glabrous, monoecious, slender, apparently annual vine, the branches about 1.5 mm in diameter, smooth, sulcate. Leaves broadly ovate in outline, cordate, pedately divided into 5 or 7 narrow lobes which extend almost to the base, the lobes chartaceous or membranaceous, dark-olivaceous, linear to narrowly oblanceolate, 5 to 7 cm long, 2 to 7 mm wide, usually narrowed at both ends, sinuses acute to rounded, tips apiculate-acuminate, margins distantly denticulate, the upper surface, in mature leaves, with numerous, rather prominent, scabrid, minute white spots; petioles usually somewhat aculeate-denticulate, about 3 cm long. Tendrils bifid, slender, at least 10 cm long. Flowers axillary, fascicled, greenish-yellow, campanulate, about 10 mm

long, usually one pistillate and two to four staminate ones in a fascicle, but one or two developing at one time; pedicels 2 to 4 mm long. Staminate flowers: Calyx about 4 mm long, campanulate, the lobes 5, narrowly lanceolate, about 2.5 long. Corolla lobes ovate, obtuse, slightly pubescent, about 6 mm long, 5-nerved. Stamens 3, in mature bud entirely free, the filaments short, the anthers about 3 mm long, sigmoid, 2-celled. Pistillate flowers similar to the staminate ones. Staminodes 3, linear, 2 to 3 mm long. Ovary globose, 3-celled; ovules usually 4 in each cell, horizontal. Style about 2 mm long, the arms 3, about 3 mm long; stigmas stout, dichotomous. Fruit globose or ovoid, baccate, smooth, about 1.5 cm in diameter. Seeds about 12, about 5 mm long, margined, not compressed, prominently swollen at right angles to the margin in the upper one-half, flattened below, rugose.

LUZON, Ilocos Norte Province, Bangui, *Bur. Sci.* 27552 27490 Ramos, February, 1917, borders of clearings at low altitudes, locally known as *parparya*.

This species is readily recognized by its very narrowly lobed leaves, and in its vegetative characters it is radically different from any other form known to me. I cannot place it in any described genus, although, except in its ovule characters, it conforms closely with the American-African genus *Cayaponia* in most respects. However its ovules, while few in number, are horizontal, hence placing it in the *Pleiospermae*. The stamens, entirely free in mature buds, but appearing as if united in dried flowers, are those of the *Cucumerineae*, and it apparently comes in the group with *Sicania* and *Physedra*, yet is very different from both of these genera.

THE PHILIPPINE BUREAU OF SCIENCE

RECENT PUBLICATIONS

AN INTERPRETATION OF RUMPHIUS'S HERBARIUM AMBOINENSE

By E. D. MERRILL

Based on the collections made in Amboina by the late Charles Budd
Robinson

Order No. 450. Bureau of Science Publication No. 9. Paper, 595 pages and 2 maps.
Price \$3, United States currency, postpaid.

The Herbarium Amboinense is a classical work on the Malayan flora and one that is absolutely essential to the systematist to-day. The great importance of the work is due to the fact that later authors have made the Rumphian descriptions and figures the actual "types" of many binomials. As an original source the Herbarium Amboinense stands preëminent among all the early publications on Malayan botany.

Professor Merrill's interpretation of the Herbarium Amboinense discusses the status of each species described by Rumphius and assigns it to a position in the modern system of classification. This publication will be of great service to any one working on Indo-Malayan systematic botany.

A GRAMMAR OF LEPANTO IGOROT AS IT IS SPOKEN AT BAUCO

By MORICE VANOVERBERG

Order No. 438. Vol. V, Part VI, Division of Ethnology Publications. Paper, 102 pages.
Price \$0.75, United States currency, postpaid.

This part completes Volume V of the Division of Ethnology publications and includes the index and the title-page for the volume. A title-page for Volume II is printed with this number.

PLEASE GIVE ORDER NUMBER

Orders for these publications may be sent to the BUSINESS MANAGER, Philippine Journal of Science, Bureau of Science, Manila, P. I., or to any of the following agents:

AGENTS

THE MACMILLAN COMPANY, 64-66 Fifth Avenue, New York, U. S. A.
WM. WESLEY & SON, 28 Essex Street, Strand, London, W. C., England.
MARTINUS NIJHOFF, Lange Voorhout 9, The Hague, Holland.
KELLY & WALSH, Limited, 32 Raffles Place, Singapore, Straits Settlements.
A. M. & J. FERGUSON, 19 Baillie Street, Colombo, Ceylon.
THACKER, SPINK & Co., P. O. Box 54, Calcutta, India.

CONTENTS

	Page.
MERRILL, E. D. New or noteworthy Philippine plants, XIII.....	1

The Philippine Journal of Science is issued in four sections. Each section consists of six numbers a year, is separately paged and indexed, and is a complete publication in itself. Authors receive 100 copies of their papers free.

SUBSCRIPTION RATES TO CURRENT VOLUME	U. S. currency.
Section A (Chemical and Geological Sciences and the Industries)	\$2.00
Section B (Tropical Medicine).....	3.00
Section C (Botany), Elmer D. Merrill, B. S., M. S., Editor.....	2.00
Section D (General Biology, Ethnology, and Anthropology). Section D began with Volume V.....	2.00
Entire Journal (4 sections).....	7.00

PRICES OF BACK NUMBERS AND VOLUMES	
Entire Journal, Volume II, III, or IV (3 sections each); or V (4 sections)	5.00
Entire Journal, beginning with Volume VI (per volume).....	7.00
Single numbers of Volume I.....	.75
Single numbers (except of Volume I).....	.50
Volume I, 1906 (not divided into sections), and supplement, sold only with a complete file of section A, B, or C.....	10.00
Supplement to Volume I (Botany).....	3.50
Volume I (without supplement), sold only with a complete file of section A, B, or C.....	6.50

Publications sent in exchange for the Philippine Journal of Science should be addressed: Library, Bureau of Science, Manila, P. I.

Subscriptions may be sent to the BUSINESS MANAGER, Philippine Journal of Science, Bureau of Science, Manila, P. I., or to any of the agents listed on the inside pages of this cover.

VOL. XIII, SEC. C, No. 2

MARCH, 1918

THE PHILIPPINE JOURNAL OF SCIENCE

ALVIN J. COX, M. A., PH. D.
GENERAL EDITOR

SECTION C. BOTANY

E. D. MERRILL, M. S.
EDITOR

WITH THE COÖPERATION OF

W. H. BROWN, PH. D.; C. F. BAKER, M. A.
L. M. GUERRERO, PHAR. D.; R. C. MCGREGOR, A. B.

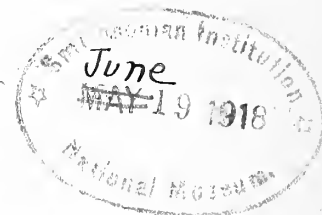

MANILA
BUREAU OF PRINTING
1918

PHILIPPINE JOURNAL OF SCIENCE

A TEN-YEAR INDEX

CONTENTS AND INDEX OF THE PHILIPPINE JOURNAL OF SCIENCE, VOLUME I (1906) TO VOLUME X (1915)

Order No. 449. Bureau of Science Publication No. 8. Paper, 441 pages.
Price \$2, United States currency, postpaid.

One copy of this index has been sent free of charge to each subscriber that has received Volumes XI and XII of the Journal.

This publication consists of:

The complete contents of the first ten volumes of the Philippine Journal of Science, all sections; giving all authors, titles of articles, and page numbers. The exact date of issue of each number is recorded.

An author index, being an alphabetical list of all the contributors. The titles of all the articles are listed under the names of their respective authors.

A subject index. The subject matter is very fully indexed by catch words from the titles, by geographical localities, and by subjects. All systematic names in zoölogy and botany, as well as the thousands of English and local names, are entered in the index.

STUDIES IN PHILIPPINE DIPTERA, II

By M. BEZZI

Order No. 437. Bureau of Science Publication No. 10. Paper, 59 pages and 1 plate.
Price \$0.50, United States currency, postpaid.

This is the second century of Professor Bezzi's enumeration of Philippine species of flies and includes descriptions of new genera and new species.

PLEASE GIVE ORDER NUMBER

Orders for Bureau of Science publications may be sent to the BUSINESS MANAGER, Philippine Journal of Science, Bureau of Science, Manila, P. I., or to any of the following agents:

AGENTS

THE MACMILLAN COMPANY, 64-66 Fifth Avenue, New York, U. S. A.
WM. WESLEY & SON, 28 Essex Street, Strand, London, W. C., England.
MARTINUS NIJHOFF, Lange Voorhout 9, The Hague, Holland.
KELLY & WALSH, Limited, 32 Raffles Place, Singapore, Straits Settlements.
A. M. & J. FERGUSON, 19 Baillie Street, Colombo, Ceylon.
THACKER, SPINK & Co., P. O. Box 54, Calcutta, India.

THE PHILIPPINE
JOURNAL OF SCIENCE

C. BOTANY

VOL. XIII

MARCH, 1918

No. 2

NEW SPECIES OF BORNEAN PLANTS

By E. D. MERRILL¹

(From the Botanical Section of the Biological Laboratory, Bureau of Science, Manila)

In the past two years I have published three papers on the Bornean flora,² the present one being essentially like those already issued. These papers have been the necessary preliminary ones in preparation for the publication of my "Bibliographic Enumeration of Bornean Plants" the manuscript of which is now completed, and which is to be published by the Sarawak Museum. No new species are described in the enumeration, but only those species are included that have been described from or credited to Borneo.

The present paper consists of the descriptions of sixty-one new or presumably new species in the families *Magnoliaceae*, *Connaraceae*, *Leguminosae*, *Rutaceae*, *Meliaceae*, *Euphorbiaceae*, *Sterculiaceae*, *Dilleniaceae*, *Passifloraceae*, *Flacourtiaceae*, *Myrtaceae*, *Araliaceae*, *Clethraceae*, *Myrsinaceae*, *Oleaceae*, *Gentianaceae*, *Asclepiadaceae*, and *Rubiaceae*.

MAGNOLIACEAE

ILLICIAM Linnaeus

ILLICIAM STAPFII sp. nov.

Illicium sp. Stapf in Trans. Linn. Soc. Bot. 4 (1894) 128, cum descr.

To Stapf's diagnosis I add the following data from our recently collected material: Leaves up to 17 cm long and 9 cm

¹ Professor of botany, University of the Philippines.

² Merrill, E. D., Notes on the Flora of Borneo, *Philip. Journ. Sci.* 11 (1916) Bot. 49-100: Contributions to our knowledge of the flora of Borneo, *Journ. Str. Branch Roy. As. Soc.* 76 (1917) 75-117: *Alabastra Borneensis*, *op. cit.* 77 (1917) 189-247.

wide, subopposite or subverticillate. Flowers dull-red. Sepals of fully mature flowers up to 12 mm in length, the petals about as long as but broader than the sepals. Fruiting pedicels up to 8 cm in length, the carpels as many as 11, of which two or three are usually aborted, the individual carpels about 12 mm long, lanceolate, acuminate, spreading.

BRITISH NORTH BORNEO, Mount Kinabalu, Marai Parai Spur, *Mrs. Clemens 10995, 11081, 10949*, November 22 and December 1 and 3, 1915, a shrub or small tree 2 to 6 m high.

The specimens agree with Stapf's diagnosis based on *Haviland 1272* from Kinataki, Mount Kinabalu, and I have no doubt that they represent the same species. Stapf considered that the species was perhaps most closely allied to *Illicium cambodianum* Hance, which Finet & Gagnepain place as a variety of *Illicium griffithii* Hook. f. & Th. My specimens of *Illicium cambodianum* Hance differ remarkably from this Bornean form in their smaller, very obscurely and fewer-nerved leaves.

CONNARACEAE

CONNARUS Linnaeus

CONNARUS AGAMAE sp. nov.

Arbor fide Agama, partibus junioribus minute subferrugineo-pubescentis, ramis ramulisque crassis, teretibus; foliis 3-foliolatis, foliolis subcoriaceis, oblongis ad oblongo-ellipticis, usque ad 23 cm longis, basi rotundatis, apice acuminatis, supra pallidis, nitidis, subtus ad costa nervisque minute puberulis, nervis utrinque 13 ad 15, subtus prominentibus; paniculis axillaribus terminalibusque, sub fructu usque ad 35 cm longis; folliculis inaequilateraliter obovoideis, leviter compressis, crasse carinatis, 5 ad 6 cm longis, apice lateraliter breviter rostratis, basi cuneatis, extus glabris, brunneis, nitidis, oblique striatis, intus densissime simpliciter tomentosus.

A tree fide Agama, the older parts glabrous, the branchlets, inflorescences, and lower surface of the leaflets minutely subferruginous-puberulent. Branches and branchlets terete, stout, the former about 8 mm in diameter, glabrous, brownish, sparingly lenticellate, the latter subferruginous-puberulent. Leaves 3-foliolate, or the uppermost ones 1-foliolate, the petiole and rachis up to 17 cm in length; leaflets oblong to oblong-elliptic, subcoriaceous, 17 to 23 cm long, 7 to 10 cm wide, somewhat acuminate, base rounded, the upper surface pale, shining, glabrous, the lower minutely puberulent especially along the midrib and lateral nerves; lateral nerves 13 to 15 on each side of the midrib, prominent, somewhat curved, anastomosing, the reticulations slender, rather distinct; petiolules stout, rugose, puberulent, or ultimately glabrous. Panicles axillary and terminal, in fruit

up to 35 cm in length, the lower branches often subtended by 1-foliolate leaves, the branches up to 20 cm in length, more or less ferruginous-puberulent, or in age nearly glabrous. Follicles, including the stalk, 5 to 6 cm long, inequilaterally obovoid, somewhat compressed, about 3 cm wide, the sutures rather stoutly keeled, one side nearly straight or but slightly curved, the other very prominently curved, the apex broadly rounded and laterally subrostrate with a stout short beak, narrowed below to the stout, 1 to 1.5 cm long pseudostalk, the pericarp brown, shining, diagonally striate and glabrous externally, almost woody in texture, inside very densely tomentose with somewhat fulvous, simple, shining, short hairs. Aril 2-lobed, the lobes suborbicular, about 8 mm long, the seed very immature.

BRITISH NORTH BORNEO, Tawao, *Agama* 422, July 14, 1917, on ridges, the fruit greenish-red.

This species is strongly characterized by its 3-foliolate leaves, many-nerved, rather large leaflets, and its large, inequilaterally obovoid, laterally beaked follicles, which are densely tomentose within with simple hairs, but glabrous and shining outside. It is probably as closely allied to *Connarus grandis* Jack as to other species.

CONNARUS BORNEENSIS sp. nov.

Frutex scandens, inflorescentiis amplis, minute ferrugineo-pubescentibus; foliis 3- vel 5-foliolatis, foliolis oblongo-ovatis, utrinque glabris, acutis vel leviter acuminatis, basi obtusis ad subrotundatis, in siccitate brunneis, nitidis, subcoriaceis, usque ad 13 cm longis, nervis utrinque 4 vel 5, perspicuis, curvato-adscedentibus; paniculis axillaribus terminalibusque, usque ad 25 cm longis, multifloris; floribus circiter 5 mm longis, sepalis anguste oblongis, obtusis, pubescentibus, petalis oblanceolatis, nigropunctatis, glabris, quam sepalis duplo longioribus; folliculis circiter 3 cm longis, oblique obovoideis, leviter compressis, stipitatis, in siccitate brunneis, nitidis, apice late rotundatis, lateraliter breviter acuteque rostratis, basi cuneatis, junioribus extus parcissime pubescentibus glabrescentibus, intus pilis paucis simplicibus adpressis instructis.

A scandent shrub, glabrous except the minutely pubescent or puberulent inflorescences, the indumentum ferruginous or subferruginous. Branches terete, brownish, sparingly lenticellate, the young branchlets usually slightly pubescent. Leaves 3- or 5-foliolate, about 20 cm long, the rachis and petiole glabrous; leaflets oblong-ovate, subcoriaceous, usually brown when dry, shining, 8 to 13 cm long, 4 to 5 cm wide, apex acute to slightly acuminate, base obtuse to somewhat rounded; lateral nerves 4 or 5 on each side of the midrib, rather prominent, curved-ascend-

ing, anastomosing, the reticulations fine, close, not prominent; petiolules about 5 mm long. Panicles axillary and terminal, up to 25 cm in length, the lower branches up to 20 cm long, more or less ferruginous-puberulent or pubescent, or the indumentum dark-brown, the bracts and bracteoles 1 mm long or less. Flowers about 5 mm long, their pedicels 1 mm long or less. Sepals narrowly oblong, pubescent, obtuse, about 2.6 mm long, sparingly black glandular-punctate. Petals twice as long as the sepals, glabrous, oblanceolate, obtuse, about 1.4 mm wide above, distinctly black glandular-punctate. Longer filaments 5 mm, the shorter ones less than 1 mm in length. Ovary ovoid, pubescent; style about 2 mm long. Follicles obliquely obovoid, slightly compressed, including the stipe about 3 cm long, 1.5 mm wide, the apex broadly rounded, with a short, lateral, acute beak, the base gradually narrowed, cuneate, the stipe about 6 mm long, the pericarp coriaceous, brown and shining when dry, obliquely and finely striate, when young sparingly pubescent outside, soon becoming glabrous, inside sparingly hirsute with widely scattered, appressed, simple hairs.

SARAWAK, Mount Santubong, *Native collector 2361* (type) *Bur. Sci.*, without locality *Native collector 240* *Bur. Sci.*; BRITISH NORTH BORNEO, Sandakan, *Villamil 191*, March 22, 1916.

This species may be distinguished by its glabrous petals, which are twice as long as the sepals; its ample paniculate inflorescences; and its follicles, which are sparingly hirsute inside with widely scattered, appressed, simple hairs.

CONNARUS DENSIFLORUS sp. nov.

Frutex vel arbor, ramulis junioribus et inflorescentiis dense subferrugineo-pubescentis, ramis glabris, verruculoso-lenticellatis; foliis circiter 13 cm longis, 5-foliolatis, foliolis crasse coriaceis, ellipticis, usque ad 8 cm longis, pallide brunneis, nitidis, acuminatis; basi subrotundatis, nervis utrinque 5 vel 6, tenuibus, obscuris; inflorescentiis terminalibus, circiter 20 cm longis, e basi ramosis, ramis valde elongatis; floribus numerosis, in ramulis ultimis dense confertis, circiter 5.5 mm longis, petalis quam sepalis quadruplo longioribus, anguste lanceolatis, utrinque puberulis.

A shrub or tree, possibly scandent, the very young branchlets and the inflorescences rather densely subferruginous-pubescent or puberulent with short, simple hairs. Branches terete, brownish, about 5 mm in diameter, rather prominently verruculose-lenticellate, glabrous. Leaves about 13 cm long, the rachis and petiole 6 to 7 cm long, glabrous. Leaflets thickly coriaceous, subelliptic, pale-brownish when dry, shining, 6 to 8 cm long,

4 to 5 cm wide, apex distinctly acuminate, base subrounded; lateral nerves 5 or 6 on each side of the midrib, slender, indistinct, as are the reticulations, curved, anastomosing; petiolules up to 8 mm in length. Panicles terminal, branched from the base, the branches up to 20 cm in length, densely many-flowered, the flowers crowded on the ultimate branchlets, their pedicels 1 mm long or less, ebracteolate. Sepals pubescent, obtuse, narrowly oblong, about 1.5 mm long. Petals rather densely pale or subfulvous-puberulent on both surfaces, narrowly lanceolate, about 6 mm long and 1.4 mm wide. Longer filaments 5 mm long, the shorter ones 1.2 mm in length. Ovary ovoid, the style 2 mm in length, both densely fulvous-pubescent.

SARAWAK, Retuh, Sadong, *Native collector 2550 Bur. Sci.*

This species is well characterized by its 5-foliolate, entirely glabrous leaves, thickly coriaceous, obscurely nerved leaflets, and densely flowered inflorescences, which are terminal and branched from the base. The leaflets somewhat resemble those of *Connarus pachyphyllus* Merr., but the nerves are obscure, while the inflorescence is entirely different from the infructescence of the latter species.

CONNARUS PACHYPHYLLUS sp. nov.

Arbor, ut videtur glabra, ramis perspicue verruculoso-lenticellatis; foliis 3-foliolatis, foliolis crassissime coriaceis, ellipticis ad oblongo-ellipticis, usque ad 11 cm longis, in siccitate brunneis vel olivaceo-brunneis, nitidis, basi rotundatis vel leviter cordatis, apice latissime et obtuse breviter acuminatis, nervis utrinque circiter 9, haud prominentibus; infructescentiis depauperatocymosis vel paniculatis, lateralibus, folliculis exceptis circiter 2.5 cm longis; folliculis leviter inaequilateralibus, longe stipitatis, leviter compressis, 3.5 ad 4 cm longis, subellipsoideis, apice rotundatis, basi acuminatis, extus irregulariter rugosis, glabris, nitidis, intus glabris.

A tree, *fide* Foxworthy, apparently glabrous throughout (inflorescences not seen). Branches terete, grayish-brown, glabrous, prominently verruculose-lenticellate. Leaves about 20 cm long, 3-foliolate, the petiole and rachis about 8 cm long, brownish, rugose, shining. Leaflets very thickly coriaceous, elliptic to oblong-elliptic, 9 to 11 cm long, 5 to 6 cm wide, base broadly rounded to subcordate, apex shortly and obtusely acuminate, margins recurved, when dry brownish or brownish-olivaceous, prominently shining, the upper surface smooth; lateral nerves about 9 on each side of the midrib, rather distinct but not prominent, anastomosing, the reticulations rather lax; petiolules 6 to 8 mm long, rugose, glabrous. Infructescences lateral, a depauperate cyme or panicle, the rachis and branches 2.5 cm

long or less. Follicles stipitate, up to 4 cm in length, about 2.2 cm wide, somewhat compressed, slightly inequilateral, stipitate, subellipsoid, the apex rounded, laterally and obscurely beaked, base acuminate, the pseudostalk about 1 cm long, the pericarp externally irregularly rugose when dry, brownish, shining, entirely glabrous outside and within. Seeds large, somewhat compressed, 2 to 2.5 cm long, smooth, dark-brown, shining, the aril bilobed, the lobes broadly ovoid, rounded, up to 1.5 cm long, radiately rugose, the margins undulate.

SARAWAK, Lundu, *Foxworthy 35*, May 10, 1908, the fruit yellow when fresh, the seed black, and the aril yellow; local name (Dyak) *bua tumut*.

This species is strongly characterized by its 3-foliolate leaves, its very thickly coriaceous, glabrous leaflets, and its very depauperate lateral inflorescences. It is not closely allied to any other species known to me; the follicles are entirely glabrous without and within.

CONNARUS PLUMOSO-STELLATUS sp. nov.

Frutex ut videtur scandens, ramulis et petiolis et subtus foliis et inflorescentiis densissime ferrugineo-tomentosis, indumento stellato-plumosus; foliis 14 ad 27 cm longis, 5- vel 7-foliolatis, foliolis oblongis, coriaceis, usque ad 11 cm longis, tenuiter acuminatis, basi acutis, nervis utrinque 5 ad 7, perspicuis; paniculis terminalibus axillaribusque, usque ad 30 cm longis; petalis anguste oblanceolatis, utrinque glabris, 6.5 ad 8 mm longis.

A shrub, apparently scandent, the branchlets, petioles, and rachis, lower surface of the leaflets, and the inflorescences very densely ferruginous-pubescent with characteristic stellate-plumose hairs. Branches and branchlets terete, brown. Leaves 14 to 27 cm long, 5- or 7-foliolate; leaflets mostly oblong, coriaceous, 7 to 11 cm long, 2 to 4 cm wide, the upper surface brown, glabrous, shining, the lower densely tomentose, the apex slenderly acuminate, base acute; lateral nerves 5 to 7 on each side of the midrib, rather prominent, curved-ascending, anastomosing, the reticulations rather lax, distinct on the lower surface; petioles densely tomentose, 3 mm long or less. Panicles axillary and terminal, up to 30 cm in length, the primary branches up to 10 cm in length, the bracts and bracteoles linear, curved, about 5 mm long, densely tomentose. Flowers yellow. Sepals linear-oblong, 4 to 5 mm long, densely stellate-pubescent. Petals narrowly oblanceolate, 6.5 to 8 mm long, glandular-punctate, glabrous, obtuse or subacute. Five longer filaments 3 to 4 mm long, the five alternating ones 1 to 2 mm in length. Ovary ovoid, very densely stellate-plumose-pubescent, the hairs up to 1.5 mm in length.

SARAWAK, Matang Road near Kuching, *Native collector 1062, 725* (type), the latter collected May 31, 1901; Samatan, *Foxworthy 157*, in swampy places, May 20, 1908, with the Dyak name *guid malam*.

This species is readily recognizable by its very dense and characteristic, ferruginous, stellate-plumose indumentum. From Blume's entirely inadequate description it might be *Tricholobus ferrugineus* Blume Mus. 1 (1850) 237, which King considers to be the same as *Connarus ferrugineus* Jack, a species entirely different from the present one, but which Schellenberg,³ who has examined Blume's type specimen, states is identical with *Connarus hebephyllus* King. It seems, on the whole, to be closely allied to the Sumatran *Tricholobus fulvus* Blume, and may prove to be identical with Blume's species; however, Blume's specific name is invalid in *Connarus*, so that I have not hesitated in describing the present species under a different specific name.

LEGUMINOSAE

CRUDIA Schreber

CRUDIA RETICULATA sp. nov.

Arbor circiter 7 m alta, glabra, ramulis tenuibus; foliis 2-vel 3-foliolatis, foliolis chartaceis, oblongis, usque ad 23 cm longis, in siccitate pallide brunneis, basi rotundatis ad subacutis, apice tenuiter caudato-acuminatis, nervis lateralibus utrinque circiter 10, supra plus minusve impressis, subtus cum reticulis laxis valde prominulis, arcuato-anastomosantibus; leguminis inaequilateralibus, oblongo-falcatis, usque ad 10 cm longis et 3 cm latis, obtusis, valvis crasse coriaceis, laxe reticulatis.

A tree about 7 m high, entirely glabrous (flowers unknown), the branches and branchlets terete, brownish, the latter slender. Leaves 2- or 3-foliolate, the petiole and rachis 2 to 4 cm long, the latter slightly projecting above the ultimate petiolule; leaflets in general oblong, chartaceous, pale-brownish and shining when dry, 15 to 23 cm long, 5 to 6 cm wide, the apex slenderly caudate-acuminate, the acumen blunt, up to 3.5 cm in length, base rounded to subacute; primary lateral nerves about 10 on each side of the midrib, on the upper surface with the midrib and arcuate marginal nerves somewhat impressed, on the lower surface with the lax reticulations very prominent, arched-anastomosing 5 to 10 mm from the edge of the leaf; petiolules brown, rugose, 5 mm long or less; stipules linear-lanceolate, acuminate, about 7 mm long. Pods oblong, somewhat inequilaterally falcate, obtuse, 8 to 10 cm long, about 3 cm wide, one suture nearly straight, the other curved, the valves glabrous, laxly reticulate, coriaceous, brown and often slightly glaucous when

³ Beitr. Vergleich. Anat. Connar. (1910) 75.

dry; seeds 1 or 2, compressed, brown, 3 to 3.5 cm long, about 2 cm wide.

BRITISH NORTH BORNEO, Sapagaya River, Sandakan District, *Villamil 393*, September, 1917, in level lands, altitude about 10 meters.

This strongly characterized species is well marked by its few, rather large, prominently and laxly reticulate, slenderly caudate-acuminate leaflets; its laxly reticulate valves; and in being entirely glabrous throughout. It differs radically from *Crudia havilandi* Prain, to which it is apparently most closely allied, in its fewer, much larger, more numerous nerved leaflets.

RUTACEAE

MELICOPE Forster

MELICOPE UNIFOLIOLATA sp. nov.

Frutex vel arbor, partibus junioribus inflorescentiisque exceptis glabra; foliis 1-foliolatis, foliolis chartaceis, olivaceis vel brunneis, nitidis, oblongo-ellipticis, usque ad 15 cm longis, acuminatis ad rotundatis, basi cuneatis, nervis primariis utrinque circiter 13, distinctis, anastomosantibus; inflorescentiis axillaribus terminalibusque, paucifloris, pedunculatis, 3 ad 6 cm longis; petalis oblongo-ovatis, 2.5 mm longis, acutis vel leviter acuminatis, parce pubescentibus.

A shrub or tree, glabrous except the tips of the branchlets and the inflorescences. Branches pale when dry, glabrous, compressed. Leaves all 1-foliolate, the leaflets chartaceous, olivaceous or brown when dry, shining on both surfaces, 10 to 15 cm long, 4 to 7 cm wide, mostly oblong-elliptic, the lower surface distinctly glandular-punctulate, the apex broadly acuminate and apiculate to broadly rounded, the base cuneate; primary lateral nerves about 13 on each side of the midrib, distinct, anastomosing, the reticulations irregular, distinct; petioles 1 to 2 cm long. Cymes axillary and terminal, 3 to 6 cm long, few-flowered, sparingly fulvous- to cinereous-pubescent, the primary branches few, 1 cm long or less, each bearing from three to six subumbellately arranged flowers at their apices, the pedicels up to 4 mm in length. Calyx-lobes pubescent, ovate, obtuse, 0.4 mm long or less. Petals sparingly pubescent, oblong-ovate, acute or slightly acuminate, about 2.5 mm long. Ovary glabrous. Stamens 8, the filaments equal.

SARAWAK, *Hose 539, 556* (type), Miri River, January, 1895.

This is one of the few known representatives of the genus with 1-foliolate leaves and is manifestly allied to *Melicope helferi* Hook. f. of the Andaman Islands, from which it is distinguished, among other characters, by its differently shaped, more numerous nerved leaflets and pubescent inflorescences and tips of the young branchlets.

MELIACEAE

DYSOXYLUM Blume

DYSOXYLUM KINABALUENSE sp. nov. § *Eudysoxylum*.

Arbor glabra, circiter 10 m alta; foliis alternis, circiter 40 cm longis, foliolis omnibus alternis, utrinque circiter 4, distantibus, oblongis, chartaceis ad subcoriaceis, usque ad 15 cm longis, in siccitate minute verrucosis, tenuiter acuminatis, basi acutis, plerumque plus minusve inaequilateralibus, nervis utrinque circiter 10; inflorescentiis axillaribus, simplicibus, racemiformibus, circiter 10 cm longis, paucifloris; floribus 4-meris, circiter 6 mm longis, calycis brevibus, subcupulatis, 4-dentatis, petalis extus puberulis, liberis, tubo libero, extus puberulo, ovario minute puberulo.

A glabrous tree about 10 m high, the branches slender, the ultimate branchlets 3 mm in diameter or less. Leaves alternate, about 40 cm long, the leaflets all alternate, distant, about 4 on each side of the rachis, chartaceous to subcoriaceous, oblong, 12 to 15 cm long, 3.5 to 5 cm wide, apex slenderly acuminate, base acute, usually distinctly inequilateral, when dry subolivaceous, or somewhat brownish beneath, slightly shining or dull, minutely but not densely verruculose; lateral nerves rather slender, about 10 on each side of the midrib, curved, obscurely anastomosing, the reticulations nearly obsolete; petiolules 5 to 8 mm long. Inflorescences axillary, solitary, racemiform, about 10 cm long, few-flowered, the rachis castaneous when dry, minutely and obscurely puberulent, the very short, few-flowered branchlets 3 mm long or less. Flowers cream-colored, 4-merous, about 6 mm long, their pedicels very short. Calyx slightly cup-shaped, dark-brown when dry, obscurely puberulent, the teeth 4, short, triangular-ovate, subacute. Petals 4, free, narrowly oblong, 5.5 mm long, slightly puberulent. Staminal-tube cylindric, 5 mm long, shallowly 8-toothed, slightly puberulent externally, glabrous within. Anthers 8. Ovary and style minutely cinereous-puberulent, 4.5 mm long. Disk glabrous, 2 mm long, cylindric, obscurely crenate.

BRITISH NORTH BORNEO, Mount Kinabalu, Gurulau Spur, *Mrs. Clemens 10803*, November 27, 1917, in forests.

The alliance of this species is manifestly with the Philippine *Dysoxylum palawanense* Merr. and *D. panayense* Merr. from both of which it differs in numerous details. It is distinctly closer to the latter than to the former.

Probably referable here is *Clemens 10820*, same locality and date, in fruit. The fruits are bright-orange when fresh, when dry castaneous, glabrous, shining, obovoid, about 4.5 cm long.

WALSURA Roxburgh

WALSURA GLABRA sp. nov.

Arbor glabra, foliis plerumque 3-foliolatis interdum basi foliolis binis depauperatis additis 5-foliolatis, foliolis majoribus oblongo-ellipticis, utrinque acuminatis, chartaceis, nitidis, usque ad 15 cm longis; paniculis usque ad 5 cm longis, paucifloris, floribus 5-meris, sepalis obovatis, imbricatis, liberis, staminibus 10, intus infra antheris barbatis, basi leviter connatis, apice bilacinatis; ovario hirsuto.

A glabrous tree, the branches grayish, terete, somewhat wrinkled. Leaves mostly 3-foliolate, sometimes by the addition of a pair of depauperate basal leaflets 5-foliolate, up to 20 cm long, the larger leaflets in general oblong-elliptic, acuminate and subequally narrowed at both ends, chartaceous, rather pale when dry, shining on both surfaces; lateral nerves about 9 on each side of the midrib, curved, anastomosing, distinct; petiolules 1.5 to 2.5 cm long. Panicles up to 5 cm in length, few-flowered. Flowers pale-yellow, 5-merous. Sepals obovate, rounded, free, imbricate, 1.5 to 2 mm long, so strongly narrowed below as to be almost clawed, glabrous. Petals oblong-elliptic, 4 mm long, glabrous. Stamens 10, united for the lower 0.5 mm, flattened, bearded on the inside below the insertion of the anther, cleft at the apex into two narrowly lanceolate, acuminate, 1 mm long lobes. Ovary densely hirsute; style very short; stigma capitate.

SARAWAK, Siol, *Native collector 2438 Bur. Sci.*, February-June, 1914.

By definition this characteristic species might almost as well be placed in the American-African genus *Trichilia* as in the Indo-Malayan genus *Walsura*, but in the absence of fruits I have placed it in the latter genus. It is well characterized by its usually 3-foliolate but sometimes 5-foliolate leaves, the basal pair of leaflets, when present, being very greatly reduced in size, and in its free, broadly obovate, imbricate, almost clawed sepals.

AGLAIA Loureiro

AGLAIA CLEMENTIS sp. nov. § *Hearnia*.

Arbor, inflorescentiis perspicue stellato-pubescentibus, indumento castaneo; foliis circiter 30 cm longis, alternis, foliolis 9, oblongis ad anguste oblongo-obovatis, subcoriaceis, usque ad 13 cm longis, breviter acuminatis, basi rotundatis ad obtusis, supra pallidis, glabris, subtus brunneis, ad costa nervisque perspicue stellato-lepidotis, nervis utrinque circiter 25, perspicuis, subtus prominulis; paniculis axillaribus foliis subaequantibus vel paullo brevioribus, multifloris, ramis inferioribus usque ad 12 cm longis; floribus racemose dispositis, 5-meris, breviter pedicellatis, calycis extus dense castaneo-stellato-pubescentibus, breviter 5-lobatis,

lobis obtusis; petalis liberis, circiter 1.5 mm longis, tubo turbinate, libero.

A large tree according to Mrs. Clemens, the branchlets and petioles densely and minutely castaneous-lepidote or subfurfuraceous, the ultimate branchlets 4 mm in diameter or less. Leaves alternate, about 30 cm long; leaflets 9, opposite, firmly chartaceous to subcoriaceous, oblong to narrowly oblong-obovate, 8 to 13 cm long, 3.5 to 4.5 cm wide, the upper surface pale when dry, glabrous, the lower brownish with the costa and nerves conspicuously stellate-lepidote, the indumentum castaneous, with scattered hairs on the epidermis, apex shortly acuminate, base rounded to obtuse; lateral nerves about 25 on each side of the midrib, prominent on the lower surface, the reticulations obscure; petiolules densely and minutely castaneous-lepidote, 5 mm long or less. Panicles axillary, usually about as long as the leaves, peduncled, pyramidal, the lower branches up to 12 cm in length, all parts rather densely stellate-pubescent with short, castaneous hairs. Flowers numerous, brownish-yellow, racemously arranged on the ultimate branches, somewhat crowded, their pedicels 1 to 2 mm long. Calyx 2 mm in diameter (spread), stellate-pubescent, shortly 5-lobed, the lobes broadly ovate, obtuse, extending less than one-half to the base. Petals 5, free, glabrous, subelliptic, about 1.5 mm long. Staminal-tube turbinate, free, 0.8 mm high, the margins obscurely crenulate. Anthers 5, inserted on the margin of the tube. Rudimentary ovary minutely pubescent.

BRITISH NORTH BORNEO, Mount Kinabalu, Minitindok Gorge, Mrs. Clemens 10484, November 19, 1915, near the river.

This species is apparently not closely allied to any of the Malayan species of this section previously described, although somewhat resembling some forms of the Philippine *Aglaia harmsiana* Perk. Its true alliance is apparently with *Aglaia elliptica* Blume.

AGLAIA HETEROPHYLLA sp. nov. § *Hearnia*.

Species ut videtur *H. sarawakanae* affinis. Ramulis et inflorescentiis minutissime et dense cupreo-lepidotis; foliis alternis, 12 ad 18 cm longis, foliolis 2 ad 5, chartaceis, oblongo-ovatis ad oblongo-lanceolatis, usque ad 12 cm longis, apice subcaudato-acuminatis, basi acutis, supra glabris, in siccitate griseis, nitidis, costa supra impressa, subtus parcissime lepidotis, nervis lateralibus utrinque 10 ad 12, tenuibus; inflorescentiis paniculatis, axillaribus, 8 ad 12 cm longis, pedunculatis, ramis paucis, patulis, paucifloris; floribus racemose dispositis, laxis, 5-meris, calycis stellato-tomentosis, lobis ovatis, subacutis; petalis liberis, subellipticis, 1.2 mm longis.

A tree, the branches rugose, glabrous, the branchlets densely cupreous-lepidote with minute appressed scales, the ultimate branches about 2 mm in diameter. Leaves alternate, 12 to 18 cm long, the rachis and petioles very minutely subcupreous-lepidote; leaflets 2 to 5, oblong-ovate to oblong-lanceolate, firmly chartaceous, 8 to 12 cm long, 2.5 to 5 cm wide, the upper surface grayish, somewhat shining, glabrous, the lower somewhat brownish, very sparingly lepidote near the midrib and nerves, the base acute, the apex slenderly subcaudate-acuminate; lateral nerves 10 to 12 on each side of the midrib, anastomosing, slender, the midrib impressed on the upper surface, prominent beneath; petiolules 5 mm long or less. Panicles axillary, 8 to 12 cm long, peduncled, lax, few-flowered, the branches spreading, the lower ones up to 6 cm in length. Flowers 5-merous, laxly and racemously arranged on the ultimate branchlets, their pedicels 1 to 1.5 mm long. Calyx 5-lobed, stellate-pubescent, the lobes ovate, subacute, extending two-thirds to the base. Petals 5, free, subelliptic, about 1.2 mm long. Staminal tube turbinate, glabrous, 1 mm long, margins crenulate. Anthers 5, inserted on the margin of the tube.

SARAWAK, Baram District, Mount Treken, *Hose 555*, July, 1895, altitude about 330 meters.

This species is apparently as closely allied to *Aglaia sarawakana* (A. DC.) as to any other described form, but has more numerous, differently shaped, smaller leaflets, while the sepals are distinctly united for the lower one-third. In facies the species resembles the Philippine *Aglaia luzoniensis* (Vid.) Merr. & Rolfe, but is not closely allied to this form, which normally has 1-foliolate leaves.

AGLAIA MOULTONII sp. nov. § *Hearnia*.

Arbor, ramis et foliis glabris, paniculis magnis, minute ferrugineo-stellato-tomentosis; foliis alternis 25 ad 30 cm longis, foliolis circiter 12, oppositis et alternis, lanceolatis, coriaceis usque ad 15 cm longis, in siccitate atro-brunneis vel olivaceo-brunneis, nitidis, apice tenuiter acuminatis, basi obtusis, plerumque distincte inaequilateralibus, nervis utrinque 12 ad 14, subtus distinctis, prominulis, curvatis, vix anastomosantibus; paniculis amplis, quam foliis multo longioribus, axillaribus, usque ad 40 cm longis, pedunculatis, pyramidatis, multifloris; floribus in ramulis ultimis racemose dispositis, confertis, breviter pedicellatis, 5-meris; calycis dense stellato-pubescentibus, breviter 5-lobatis, lobis acutis; petalis liberis; tubo turbinato, vix 0.5 mm longo.

A tree, the branches and leaves entirely glabrous, the inflorescences minutely, and on the younger parts rather densely,

ferruginous-pubescent with short, stellately arranged hairs. Branches smooth, terete, olivaceous-brownish, the ultimate ones 3 mm in diameter. Leaves rather distant, alternate, 25 to 30 cm long; leaflets about 12, alternate and opposite, lanceolate, coriaceous, dark-brown or olivaceous-brown and shining when dry, 11 to 15 cm long, 2.5 to 4 cm wide, apex slenderly acuminate, base obtuse and usually distinctly inequilateral, one side of the lamina extending below the other on the petiolule; lateral nerves 12 to 14 on each side of the midrib, obscure on the upper surface, prominent beneath, curved, scarcely anastomosing, the reticulations distinct or indistinct; petiolules 5 to 9 mm long. Panicles axillary, exceeding the leaves, up to 40 cm in length, shortly peduncled, pyramidal, very many flowered, the lower branches up to 15 cm in length, the older parts nearly glabrous, the younger parts rather densely but minutely stellate-pubescent with ferruginous hairs. Flowers racemose, small, densely arranged on the ultimate branchlets, their pedicels short. Calyx densely stellate-pubescent, 5-lobed, the lobes less than one-half the length of the calyx, acute. Petals 5, free, suborbicular to elliptic-ovate, 1 mm long or less. Staminal tube free, turbinate, 0.5 mm long, crenulate. Anthers 5, attached on the margin of the tube.

SARAWAK, Amproh River, *Native collector 2138 Bur. Sci.*, February-June, 1914.

This species, dedicated to Captain J. C. Moulton, formerly director of the Sarawak Museum, is well characterized in the section *Hearnia* by its glabrous branches and leaves and its very large densely and many flowered panicles. It does not appear to be very closely allied to any previously described species.

AGLAIA MATTHEWSII sp. nov. § *Euaglaia*.

Arbor circiter 5 m alta, ramulis junioribus et inflorescentiis minute ferrugineo-stellato-pubescentibus, ramis teretibus, glabris; foliis omnibus 1-foliolatis, foliolis chartaceis, oblongis, usque ad 15 cm longis, nitidis, apice prominente sed obtuse acuminatis, basi acutis, nervis utrinque circiter 15; paniculis axillaribus, foliis subaequantibus, pauciramosis, ramis patulis, inferioribus usque ad 7 cm longis; floribus subsessilibus vel brevissime pedicellatis, in ramulis ultimis spicatim vel racemose dispositis, interdum subglomeratis, 5-meris; petalis liberis, oblongis ad oblongo-obovatis, circiter 1.8 mm longis.

A tree about 5 m high, the very young branchlets and inflorescences minutely ferruginous-pubescent with short, stellate hairs, otherwise glabrous or nearly so. Branches terete, glabrous, grayish. Leaves all 1-foliolate, the leaflets in general oblong, 10 to 15 cm long, 3 to 5.5 cm wide, subequally narrowed to the

acute base and to the rather prominently but obtusely acuminate apex, the acumen 1.5 cm long or less, pale-olivaceous and shining when dry, glabrous, or the lower surface in young leaves with very few, widely scattered, stellate hairs; midrib projecting on both surfaces; lateral nerves about 15 on each side of the midrib, prominent, curved, obscurely anastomosing, the reticulations close, slender; petioles 1 to 1.5 cm long, jointed at or above the middle, glabrous. Panicles axillary, about as long as the leaves, lax, pyramidal, branched from near the base, the primary branches few, spreading, the lower ones up to 7 cm in length, densely ferruginous-stellate-pubescent with short hairs, the secondary branches when present usually less than 1 cm long, the flowers subsessile or very shortly pedicelled, pale-yellow, 5-merous, subspicately or subracemously arranged, sometimes subglomerate. Calyx-lobes elliptic, rounded, densely and minutely stellate-pubescent, 0.8 mm long. Petals free, glabrous, oblong to oblong-obovate, 1.8 mm long. Staminal-tube obovoid, about 1.2 mm in diameter, contracted to the 0.5 mm orifice, not at all toothed. Stamens 5, included. Ovary minutely pubescent.

BRITISH NORTH BORNEO, Marutai watershed near Tawau, *Villamil 368*, May 28, 1917, on forested slopes at low altitudes.

This species, dedicated to Mr. D. M. Matthews, conservator of forests, British North Borneo, falls in the group of the very few species having unifoliolate leaves, such as *A. luzoniensis* (Vid.) Merr. & Rolfe (*Aglaia monophylla* Perk.) of the Philippines and Celebes, from which *Aglaia unifoliolata* Koord. cannot be distinguished, *A. simplicifolia* Harms of New Guinea (an invalid name), and *Aglaia simplicifolia* (Bedd.) Harms (*Beddomea simplicifolia* Bedd.) of India, from all of which it is distinguished by numerous characters. From the Bornean *Aglaia submonophylla* Miq. it is distinguished by its constantly 1-foliolate leaves, its much longer inflorescences, and by its indumentum not being all lepidote.

EUPHORBIACEAE

CLEISTANTHUS Hooker f.

CLEISTANTHUS OLIGOPHLEBIUS sp. nov. § *Stipulati*.

Species *C. paxii* Jabl. affinis, differt omnibus partibus (floribus et frutibus exceptis) glabra, nervis lateralibus utrinque 3 vel 4, valde obliquis. Frutex vel arbor, ramis ramulisque tenuibus, glabris; foliis oblongis ad oblongo-ovatis, chartaceis vel subcoriaceis, usque ad 9 cm longis, basi acutis ad subrotundatis, apice acuminatis, nervis utrinque 3 vel 4, subtus valde perspicuis, curvato-adscendentibus; fructibus sessilibus, 3-lobatis circiter 12 mm diametro, parcissime adpresse hirsutis glabrescentibus.

A shrub or small tree, glabrous except the flower and fruits. Branches and branchlets slender, terete or subterete, the former

reddish-brown, the latter pale-brownish. Leaves oblong to oblong-ovate, chartaceous to subcoriaceous, rather pale and shining when dry, 7 to 9 cm long, 3 to 3.5 cm wide, base acute to somewhat rounded, apex rather prominently acuminate, the acumen up to 1 cm in length, obtuse; lateral nerves 3 or 4 on each side of the midrib, very prominent on the lower surface, curved-ascending, all or most of them leaving the midrib below its middle, the uppermost pair extending to the apex, the reticulations not prominent; petioles rugose, about 5 mm long; stipules coriaceous, persistent, about 2.5 mm long. Flowers fascicled, axillary, apparently sessile. Fruits sessile, 3-lobed, about 12 mm in diameter, pale-brownish and shining when dry, apparently glabrous or nearly so at full maturity, but the apical portion of those examined appressed-hirsute; styles appressed-hirsute; persistent calyx lobes lanceolate, about 2.5 mm long, appressed-pubescent externally.

BRITISH NORTH BORNEO, Marutai watershed near Tawau, *Villamil 339*, June 4, 1917.

This species is strongly characterized by its few-nerved leaves, the nerves strongly curved-ascending, mostly leaving the midrib in its lower one-half, the upper pair reaching the apex of the leaf. It is most closely allied to *Cleistanthus pavii* Jabl. among the described species of the genus.

MALLOTUS Loureiro

MALLOTUS WOODII sp. nov. § *Axenfeldia*.

Frutex 3 ad 4 m altus, foliis subtus ad costa parcissime ciliatis, inflorescentiis ♀ hirsutis, ceteroquin glabris; foliis alternis, oblongo-ovatis ad oblongo-ellipticis, eglandulosis, usque ad 25 cm longis, subcoriaceis, integris, basi rotundatis, apice tenuiter caudato-acuminatis, penninerviis, nervis utrinque 9 ad 11, subtus prominentibus; inflorescentiis ♀ oppositifoliis, stricte racemosis, paucifloris, circiter 7 cm longis; sepalis lanceolatis, hirsutis, 5 mm longis; ovario dense hirsuto atque pilis capitatis longe stipitatis dense obtecto.

A shrub 3 to 4 m high, glabrous except the sparingly ciliate costa on the lower surface of the leaves and the hirsute inflorescences. Branches terete, pale-olivaceous, smooth, about 3 mm in diameter. Leaves all alternate, oblong-ovate to oblong-elliptic, entire, subcoriaceous, 20 to 25 cm long, 8 to 11 cm wide, base rounded, apex slenderly caudate-acuminate, the acumen about 2 cm long, the upper surface grayish, shining, smooth, eglandular, the lower surface also eglandular, in very young leaves slightly furfuraceous-pilose; lateral nerves 9 to 11 on each side of the midrib, prominent on the lower surface, pinnately ar-

ranged, curved, anastomosing, the primary reticulations very lax, distinct, subparallel; petioles 5 to 6 cm long; stipules lanceolate, acuminate, puberulent, about 7 mm long. Pistillate racemes simple, leaf-opposed, about 7 cm long, few-flowered, rather densely hirsute with stiff, pale-yellowish, more or less deciduous hairs, the pedicels about 1 cm long, the subtending bracteoles ovate, obtuse, 2 mm long or less. Sepals lanceolate, acuminate, hirsute, 5 mm long. Ovary ovoid, densely hirsute and also densely covered with long-stipitate glandular-capitate, hair-like papillae 2 to 2.5 mm in length; styles stout, 8 mm long, densely papillate.

BRITISH NORTH BORNEO, Marutai, near Tawau, *D. D. Wood* 451, June 6, 1917, back of the mangrove swamp.

A strongly characterized species apparently as closely allied to *Mallotus calvus* Pax & K. Hoffm. as to any other species, but with fewer-nerved leaves, few-flowered racemes, much larger pistillate flowers, and hirsute and also densely long-stipitate, glandular-capitate ovaries. The leaf-opposed simple racemes are characteristic.

MALLOTUS AFFINIS sp. nov. § *Axenfeldia*.

Arbor circiter 12 m alta, subtus foliis ad costa nervisque parce ciliato-villosis, inflorescentiis plus minusve tomentosis; foliis omnibus alternis, oblongo-ellipticis ad oblongo-obovatis, subcoriaceis, usque ad 13 cm longis, abrupte acuminatis et minute apiculatis, integerrimis, basi minute biauriculatis et perspicue biglandulosis, subtus dense glandulosis, glandulis immersis; nervis utrinque circiter 10, subtus prominentibus, reticulis primariis prominentibus, parallelis; infructescentiis axillaribus, 6 ad 9 cm longis, simpliciter racemosis; capsulis dicoccis, circiter 1 cm diametro, densissime pallide stellato-tomentosis et dense echinatis.

A tree about 12 m high, the branches terete, brownish-olivaceous, glabrous, smooth, the young branchlets slightly pubescent, the indumentum mostly of short simple hairs with a few stellate ones intermixed. Leaves all alternate, oblong-elliptic to oblong-obovate, entire, 8 to 13 cm long, 3.5 to 5.5 cm wide, rather prominently acuminate, the acumen stout, 1 cm long or less and minutely apiculate, base narrowed, minutely biauriculate and distinctly 2-glandular, the glands impressed on the upper surface, the upper surface grayish, shining, smooth, eglandular, the lower paler, rather densely glandular, the glands immersed; lateral nerves about 10 on each side of the midrib, very prominent on the lower surface, curved, anastomosing, the reticulations prominent, parallel; petioles 3 to 5 cm long, thickened at their apices; stipules acicular, 3 to 5 mm long. Infructescences axillary, simply racemose, 6 to 9 cm long, sparingly pubescent,

the pedicels thickened, densely cinereous-tomentose, 3 to 5 mm long, the bracteoles acicular from a broadened base, about 3 mm long, two or three subtending each pedicel. Fruits about 1 cm in diameter, each composed of two cocci, pale-brownish when dry, globose, densely and minutely tomentose, and densely covered with stiff, slender, glabrous spine-like processes 3 to 5 mm in length.

BRITISH NORTH BORNEO, Marutai watershed at Tawau, *Villamil 370*, May 28, 1917, on damp slopes at low altitudes.

This species is very closely allied to the Philippine *Mallotus auriculatus* Merr., from which it is distinguished by its thicker, entire, rather more numerous nerved leaves, which are rather densely glandular beneath; in having but a single pair of basal glands; and in its densely tomentose cocci, which are much more densely spiny, the spines distinctly longer than in the Philippine form.

MALLOTUS CAUDATUS sp. nov. § *Axenfeldia*.

Frutex circiter 3 m altus, ramulis junioribus et inflorescentiis parce et decidue tomentosus, ramis elenticellatis, ramulis angulato-striatis; foliis oppositis, leviter inaequimagnis, membranaceis vel subchartaceis, oblongis ad late oblongo-oblanceolatis, subolivaceis, nitidis, usque ad 25 cm longis, supra glabris, subtus parce glandulosis, basi obtusis, leviter cordatis, bimaculato-glandulosis, apice tenuiter caudato-acuminatis, nervis utrinque 6 ad 9, subtus valde prominentibus, reticulis laxis; infructescentiis usque ad 13 cm longis, simpliciter racemosis; fructibus junioribus subglobosis, breviter pedicellatis, circiter 1 cm diametro, granuloso-glandulosis, densissime puberulis, molliter echinatis.

A shrub about 3 m high, nearly glabrous (fruits excepted), the younger branchlets and the inflorescences sparingly and deciduously tomentose. Branches terete, pale-brownish, glabrous, not at all lenticellate, the branchlets angular-striate, pale reddish-brown. Leaves opposite, those of each pair slightly unequal in size, membranaceous to subchartaceous, pale-olivaceous, shining, oblong to broadly oblong-oblanceolate, entire, 15 to 25 cm long, 5 to 7 cm wide, the upper surface smooth, glabrous, not at all glandular, the lower with widely scattered, distinct, orange-yellow to brown, granulate glands, the apex slenderly caudate-acuminate, the acumen up to 3 cm in length, the base obtuse, distinctly but minutely cordate, and with two distinct glands on the upper surface; lateral nerves 6 to 9 on each side of the midrib, very prominent on the lower surface, curved-ascending, anastomosing, the primary reticulations lax, subparallel, prominent; petioles 2 to 6 cm long, glabrous. Infructescences sim-

ply racemose, leaf-opposed and in the uppermost axils, up to 13 cm long. Capsules (somewhat immature) subglobose, about 1 cm in diameter, composed of three cocci, outside granulose-glandular, the orange-yellow glands more or less obscured by the very dense, cinereous, stellate-puberulent indumentum, densely and softly echinate, the processes about 3 mm long.

BRITISH NORTH BORNEO Marauti watershed, near Tawau, *Villamil 376*, June 1, 1917, in forests at low altitudes. Locally known as *limpasoh-suluk*.

The alliance of this species is manifestly with the Javan *Mallotus glaberrimus* Muell.-Arg., which has also been reported from Borneo. It differs in its elenticellate branches, caudate-acuminate, entire leaves, which have no marginal glands in the upper part, and fewer lateral nerves.

STERCULIACEAE

TARRIETIA Blume

TARRIETIA BORNEENSIS sp. nov.

Arbor circiter 30 m alta, partibus junioribus exceptis glabra; foliis unifoliolatis, ellipticis ad oblongo-ellipticis, coriaceis, breviter obtuse acuminatis, basi acutis ad subrotundatis, usque ad 14 cm longis, glabris, nitidis, supra dense et minute foveolatis, nervis utrinque circiter 12, distinctis; fructibus glabris, circiter 1.5 cm longis, alae inaequilateraliter oblongo-obovatae, subfalcatae, apice rotundatae, usque ad 7 cm longae et 3 cm latae.

A tree about 30 m high, the trunk about 60 cm in diameter, glabrous except the very young parts. Branches brownish, terete, glabrous, the growing branchlets minutely and densely subferruginous-puberulent-lepidote as are the very young petioles. Leaves simple, elliptic to oblong-elliptic, brown, of about the same color on both surfaces, shining when dry, coriaceous, 9 to 14 cm long, 4 to 6 cm wide, glabrous, the upper surface minutely and densely foveolate, apex shortly and bluntly acuminate, base rounded to acute; lateral nerves about 12 on each side of the midrib, spreading, slightly curved, prominent; petioles 2 to 3 cm long. Peduncles in fruit up to 6 cm long, axillary, solitary, each bearing about three umbellately disposed fruits. Fruits oblong-ovoid, about 1.5 cm long, glabrous, the wings coriaceous, brown, shining, reticulate, glabrous, inequilaterally oblong-obovate, subfalcate, rounded at the apex, up to 7 cm long and 3 cm wide.

BRITISH NORTH BORNEO, near Sandakan, *Villamil 3*, August 14, 1915, on forested slopes, altitude 40 to 70 meters.

This characteristic species is manifestly allied to *Tarrietia simplicifolia* Mast. of the Malay Peninsula, the few known species of the genus with simple leaves being *Tarrietia kunstleri* King and *T. simplicifolia* Mast. of

the Malay Peninsula, and *T. sylvatica* (Vid.) Merr. of the Philippines. It is readily distinguished from *T. simplicifolia* Mast. by its much fewer-nerved leaves, from *T. kunstleri* King by its glabrous fruits, and from *T. sylvatica* Merr. by its leaves not being densely lepidote beneath.

DILLENACEAE

SAURAUIA Willdenow

SAURAUIA ACUMINATA sp. nov.

Frutex circiter 2 m altus, ramis et petiolis et foliis supra ad costa et margine et subtus perspicue tenuiter curvato-patule setosis; foliis chartaceis, oblongis, tenuiter acute acuminatis, basi obtusis ad leviter cordatis, usque ad 28 cm longis, nervis utrinque circiter 20, subtus valde perspicuis; inflorescentiis caulinis, cymosis, fasciculatis, circiter 5 cm longis; floribus numerosis, bracteis linearibus, 5 ad 9 mm longis, setosis; sepalis leviter inaequalibus, 6 ad 7 mm longis, extus setosis, oblongo-ovatis ad oblongo-ellipticis, exterioribus acutis, interioribus obtusis; fructibus ovoideis, glabris; stylis 3, infra connatis.

A shrub about 2 m high, the branches, branchlets, petioles, inflorescences, midrib on the upper surface, margins, and lower surface of the leaves conspicuously setose with slender, curved, spreading setae up to 5 mm in length, most of these parts also pubescent, the setae brownish to purplish-brown when dry, pink to deep-brown when fresh. Leaves chartaceous, oblong, narrowed to both ends, 20 to 28 cm long, 7 to 9 cm wide, apex slenderly and sharply acuminate, base narrowed, obtuse to obscurely cordate, the upper surface grayish, somewhat shining, smooth and glabrous except the setose midrib, the margins setose, the lower surface conspicuously setose on the midrib, nerves, and reticulations, and also somewhat pubescent; lateral nerves about 20 on each side of the midrib, prominent on the lower surface, curved, anastomosing, the reticulations subparallel, distinct; petioles 1.5 to 2 cm long. Cymes cauline, fascicled on densely setose tubercles, about 5 cm long, densely setose and pubescent, rather many-flowered, the bracts linear, setose, 5 to 9 mm long, the pedicels 4 to 7 cm long. Sepals oblong-ovate to oblong-elliptic, 6 to 7 mm long, the outer two acute, densely setose on the back, the inner ones slightly longer, obtuse, setose on the exposed portions, but glabrous on the parts covered by the imbricate outer sepals. Young fruit ovoid, glabrous; styles 3, the arms about 2 mm long, united for the lower 1.5 mm.

BRITISH NORTH BORNEO, Pinayas River, *Villamil 220*, October 2, 1916, in forests along the river, altitude about 15 meters.

This species, like *Saurauia myrmecoidea* Merr., is apparently allied to *Saurauia horrida* Hook. f., from which it is easily distinguished by its midrib being setose on the upper surface and by its cauline fascicled cymes (attachment of the inflorescences not indicated in Hooker's diagnosis, but presumably axillary). The more numerous lateral nerves, glabrous upper surface of the leaves, other than the midrib, and the cauline cymes distinguish it from *S. myrmecoidea* Merr.

SAURAUIA BORNEENSIS sp. nov.

Frutex circiter 2.5 m altus, ramulis junioribus petiolisque densissime cinnamomeo-lanato-tomentosis atque setis paucis curvato-adpressis instructis; foliis late oblongo-oblanceolatis, usque ad 40 cm longis, chartaceis ad subcoriaceis, supra brunneis, laevis, glabris, subtus pallidioribus et plus minusve decidue cinnamomeo-lanatis, apice acutis, deorsum gradatim angustatis, basi obtusis, margine cornuto-serratis, nervis utrinque circiter 20, perspicuis; floribus axillaribus, paucis, fasciculatis, pedicellatis, sepalis leviter inaequalibus, extus leviter pubescentibus; ovario pubescens; stylis 3, liberis.

A shrub about 2.5 m high, the branchlets and petioles densely covered with a cinnamomeous lanate-tomentose indumentum and with few, scattered, curved-appressed setae, the lower surface of the leaves also cinnamomeous-lanate, the indumentum conspicuous along the midrib and nerves, somewhat deciduous. Leaves broadly oblong-oblanceolate, chartaceous to subcoriaceous, 30 to 40 cm long, 8 to 12 cm wide, the upper surface smooth, glabrous, brown, shining, the lower paler, the apex acuminate, gradually narrowed from above the middle to the narrow, obtuse base, the margins serrate; primary lateral nerves about 20 on each side of the midrib, prominent, spreading, curved, anastomosing, the reticulations slender, not prominent, rather lax; petioles 4 to 5 cm long. Flowers white, axillary, fascicled, few, their pedicels pubescent, 1 cm long or less. Sepals pubescent, unequal, mostly rounded or obtuse, two elliptic, 3.5 mm long, three broadly ovate, about 4 mm long. Corolla-lobes oblong-elliptic, somewhat retuse, 4.5 mm long. Ovary globose, somewhat pubescent; styles 3, free, about 3 mm long.

BRITISH NORTH BORNEO, Kalabakan, *Villamil 222*, September 26, 1916, in forests, altitude about 4 meters.

This characteristic species is readily distinguished by its cinnamomeous-lanate indumentum, which on the branchlets and petioles is intermixed with curved-appressed, slender setae; its elongated, broadly oblong-oblanceolate leaves, which are gradually narrowed below the middle to the narrow but obtuse base; and its axillary fascicled flowers. I know of no species that is closely allied to it.

SAURAUIA HETEROSEPALA sp. nov.

Frutex, ramulis junioribus plus minusve adpresse squamulosis; foliis oblongis ad oblongo-obovatis, usque ad 24 cm longis, acuminatis, basi acutis, junioribus subtus ad costa nervisque parcissime adpresse squamulosis, vetustioribus glabris, laevis, nitidis, olivaceis, margine minute incurvato-serrulatis, nervis utrinque 10 ad 13, perspicuis; floribus e axillis defoliatis et caulinis, superioribus solitariis, tenuiter pedunculatis, ebracteolatis, inferioribus depauperato-cymosis, bracteolatis; sepalis glabris, binis exterioribus latissime orbiculato-ovatis, rotundatis, circiter 8 mm longis et latis, interioribus contorto-imbricatis, distincte longioribus; ovario glabro, stylis 3, infra connatis.

A shrub, ultimately glabrous or nearly so, the young branchlets with few, scattered, irregular, ovate to suborbicular, appressed, pale-brownish scales, with similar ones on the midrib and nerves of the younger leaves and on the peduncles, the older leaves glabrous. Leaves oblong to oblong-obovate, 10 to 24 cm long, 4 to 9 cm wide, base acute, apex acuminate, margins minutely incurved-serrate, olivaceous and shining on both surfaces when dry, chartaceous; lateral nerves 10 to 13 on each side of the midrib, prominent, the reticulations slender, close, subparallel; petioles 1 to 2 cm long, sparingly scaly. Flowers in the axils of fallen leaves and from the branches and trunks, the upper ones solitary, ebracteolate, the lower ones in depauperate, few-flowered cymes, the pedicels up to 2.5 cm long. Sepals distinctly unequal, all glabrous, rounded, the outer two broadly orbicular-ovate, about 8 mm long and wide, the inner three twisted-imbricate, about 10 mm long and 9 mm wide. Ovary glabrous; styles united for the lower 3 mm, the arms 3, about 4 mm in length. Bracts on the lower inflorescences oblong-lanceolate to oblanceolate, acute to acuminate, glabrous, 5 to 8 mm long.

BRITISH NORTH BORNEO, Mount Kinabalu, Khota Balud to Kibayo, *Mrs. Clemens 9812*, October 28, 1915, the fruit green.

The alliance of this species is apparently with the Javan *Saurauia leprosa* Korth., from which it is readily distinguished by its inflorescences and floral characters.

SAURAUIA HOSEI sp. nov.

Frutex vel arbor parva; foliis oblongis, usque ad 43 cm longis, chartaceis, olivaceo-brunneis, acuminatis, basi rotundatis, margine spinulosis, nervis utrinque circiter 14, subtus prominentibus, curvatis, anastomosantibus, supra glabris, subtus ad costa et nervis et reticulis parce setosis atque pubescentibus, setis tenui-

bus, patulis vel subpatulis. Inflorescentiis caulinis, fasciculatis, depauperato-cymosis, 2 ad 3 cm longis, pedunculatis, dense hirsutis atque setis numerosis tenuibus patulis instructis; sepalis oblongis ad oblongo-lanceolatis, subacutis, extus setosis, circiter 5 mm longis, interioribus angustioribus; ovario glabro; stylis 3, infra connatis.

A shrub or small tree, the cauline inflorescences, petioles, and midrib, nerves, and reticulations on the lower surface of the leaves subferruginous-hirsute or pubescent and with numerous, slender, usually spreading, setae. Leaves chartaceous, brownish-olivaceous or olivaceous, somewhat shining, the lower surface very slightly paler than the upper, oblong, up to 43 cm long and 15 cm wide, rather slenderly acuminate, base narrowed, rounded, margins spinulose, the slender curved setae terminating the short teeth, the upper surface smooth and glabrous; lateral nerves about 14 on each side of the midrib, prominent beneath, curved, anastomosing, the reticulations distinct; petioles 3 to 3.5 cm long, their slender setae up to 5 mm in length. Cymes fascicled on the trunk, from densely setose tubercles, the individual cymes 2 to 3 cm long, few-flowered, all parts densely subferruginous-setose and hirsute, the pedicels 1 to 1.4 cm long, the bracts few, narrowly lanceolate, densely setose, about 2 mm long. Sepals about 5 mm long, oblong to oblong-lanceolate, acute or subacute, the outer three about 2 mm wide, setose, the inner ones narrower, the innermost glabrous or nearly so. Ovary glabrous. Styles united for the lower 1.5 mm, the arms 3, about 2 mm long.

SARAWAK, Baram District, Mount Trekan, *Hose 552*, July, 1895, altitude about 300 meters.

This species is not closely allied to any previously described Bornean form, and is well characterized by its large leaves, which are glabrous above and setose and pubescent on the midrib, nerves, and reticulations beneath; and by its cauline, fascicled, ferruginous-hirsute and setose cymes.

SAURAUIA KINABALUENSIS sp. nov.

Arbor circiter 10 m alta, partibus junioribus dense setoso-pubescentibus; foliis oblongo-obovatis, membranaceis, usque ad 26 cm longis, breviter acuminatis, basi acutis vel obtusis et distincte inaequilateralibus, utrinque setis sparsis debilis brevibus instructis, margine curvato-serratis, nervis utrinque circiter 12, distinctis; cymis caulinis, fasciculatis, paucifloris, circiter 8 cm longis, breviter setosis, bracteis paucis, lanceolatis ad oblongo-lanceolatis, 4 ad 6 mm longis; floribus circiter 2.5 cm diametro, sepalis inaequalibus, exterioribus crassis, extus leviter brevissime setosis, circiter 10 mm longis, interioribus petaloideis, obovatis,

rotundatis, glabris, 11 ad 12 mm longis. Ovario glabro; stylis 5, infra connatis.

A tree about 10 m high, the young branchlets and very young leaves (when 5 cm long or less) very densely pubescent-setose, the indumentum brownish, none of the setae more than 1 mm long, slender, weak, more or less spreading, sometimes appressed. Leaves membranaceous, olivaceous, shining, oblong-obovate, about 25 cm long, 9 to 11 cm wide, shortly acuminate, base acute or obtuse and distinctly inequilateral, margins incurved-serrate, both surfaces with widely scattered, short, curved, weak, pale, slender setae 1 mm long or less; lateral nerves about 12 on each side of the midrib, prominent, curved, anastomosing. Cymes few-flowered, about 8 cm long, fascicled on tubercles which are scattered along the trunks, the rachis and branches more or less setose or furfuraceous-setose, each cyme bearing 2 or 3 flowers, the pedicels slender, the bracts few, lanceolate to oblong-lanceolate, usually acuminate, toothed, shortly setose. Flowers pink, fragrant, about 2.5 cm in diameter. Sepals unequal, the outer three thicker than the inner ones, orbicular-ovate, about 10 mm long, sparingly short-setose outside, the two inner ones thinner, petaloid, glabrous, obovate, rounded, 11 to 12 mm long. Corolla-lobes deeply and somewhat inequilaterally retuse, about 10 cm long. Ovary glabrous. Styles united for the lower 2 mm, the arms 5, about 5 mm long.

BRITISH NORTH BORNEO, Mount Kinabalu, Minitindok Gorge, *Mrs. Clemens* 10458, November 19, 1915, in forests near the river.

This species is especially characterized by its short weak setae; its fascicled, cauline, depauperate-cymose, 8 cm long, few-flowered inflorescences; and its rather large flowers.

SAURAUIA LONGIPETIOLATA sp. nov.

Frutex, partibus junioribus parce adpresse setosis exceptis glaber. Foliis oblongis ad oblongo-ellipticis, coriaceis, usque ad 30 cm longis, laevis, supra olivaceo-brunneis, subtus pallide brunneis, basi perspicue lateque cordatis, longe petiolatis, margine serrulato-dentatis, nervis utrinque circiter 15, perspicuis; floribus axillaribus, fasciculatis, tenuiter pedicellatis, calycis parce pubescentibus, laevis; fructibus leviter pubescentibus; stylis 3, liberis.

A shrub, glabrous except the younger parts, which are sparingly appressed-setose. Leaves oblong to oblong-elliptic, 20 to 30 cm long, 9 to 12 cm wide, base broadly and prominently cordate, margins mostly dentate, sometimes dentate-serrate, smooth, somewhat shining, the upper surface brownish-olivaceous, the lower surface pale-brownish; lateral nerves about 15 on each side

of the midrib, prominent on the lower surface, spreading, curved, anastomosing, the reticulations distinct; petioles up to 8 cm in length. Flowers axillary, fascicled, their pedicels slender, 8 to 14 mm long, sparingly furfuraceous, each usually with a single, linear-lanceolate, 1 to 2 mm long bracteole. Sepals 5, elliptic, obtuse to subacute, 4 to 4.5 mm long, smooth, sparingly pubescent. Fruit ovoid-globose, about 4 mm long, somewhat pubescent; styles 3, free to the base, 4 mm long; seeds numerous, about 1 mm long, brown, closely reticulate.

BRITISH NORTH BORNEO, Minitindok Gorge, Mount Kinabalu, *Mrs. Clemens 10496*, November 19, 1915, the fruit dull-white.

This species is readily distinguished among its congeners by its long-petioled, glabrous, cordate leaves, its fascicled flowers, three free styles, and somewhat pubescent ovaries and fruits.

SAURAUIA MATTHEWSII sp. nov.

Frutex vel arbor, ramulis plus minusve adpresse squamoso-setosis, squamae lanceolatae; foliis chartaceis, oblongo-lanceolatis ad oblongo-oblancoelatis, tenuiter acuminatis, margine curvato-setosis, deorsum angustatis, basi cuneatis, usque ad 28 cm longis, supra glabris, laevis, nitidis, vel costa parcissime adpresse lanceolato-squamosis, subtus ad costa nervisque leviter hirsutis atque cum reticulis setis subpatulis leviter ciliatis instructis; nervis utrinque 11 ad 13, perspicuis; floribus axillariibus, solitariis vel binis, pedicellatis; sepalis inaequalibus, circiter 7 mm longis, exterioribus extus densissime pallide setosis, setis tenuibus, leviter ciliatis; ovario glabro; stylis 3, alte connatis.

A shrub or small tree, the branchlets more or less appressed-scaly with lanceolate, pale, acuminate, sparingly ciliate, rather stout scales up to 4 mm in length, and also somewhat pubescent. Leaves chartaceous, grayish or somewhat brownish when dry, oblong-lanceolate to oblong-oblancoelate, 23 to 28 cm long, 6 to 8 cm wide, the upper surface smooth, glabrous, or the midrib with few, closely appressed, lanceolate, stiff scales, the lower surface somewhat hirsute on the midrib and lateral nerves, and with numerous, spreading, somewhat curved, 1 to 3 mm long setae on the midrib, nerves, and reticulations, the setae sparingly ciliate, the apex slenderly and sharply caudate-acuminate, below gradually narrowed to the cuneate base, margins ciliate-setose with curved-spreading setae; lateral nerves 11 to 13 on each side of the midrib, prominent on the lower surface, curved-ascending, anastomosing, the reticulations distinct, subparallel; petioles 1 to 1.5 cm long, appressed setose-scaly and pubescent. Flowers axillary, solitary or in pairs, their pedicels 10 to 12 mm

long, very densely setose with slender, somewhat appressed, pale, slenderly acuminate, sparingly ciliate setae up to 2.5 mm in length, the bracts usually two, narrow, 5 mm long or less, densely setose. Sepals about 7 mm long, elliptic to oblong-elliptic, obtuse, the outer ones very densely setose with setae similar to those on the pedicels, the inner ones narrower, setose only on the exposed parts, their margins thin, glabrous. Ovary ovoid, glabrous; style arms 3, about 3 mm long, wholly united for the lower 3 mm.

BRITISH NORTH BORNEO, probably from the Tawau River region, *Villamil 386*, July 13, 1917.

This species is readily recognized by its diverse indumentum, consisting of pubescence, appressed lanceolate scales, and spreading, pale, sparingly ciliate setae; its axillary, solitary or paired flowers; and its very densely setose pedicels and sepals. It is perhaps most closely allied to the Sumatran *Saurauia setigera* Korth. It is named in honor of Mr. D. M. Matthews, conservator of forests, British North Borneo.

SAURAUIA MYRMECOIDEA sp. nov.

Frutex, ramulis et foliis utrinque et inflorescentiis perspicue tenuiter curvato-patule setosis, setis usque ad 5 mm longis; foliis chartaceis, oblongo-ellipticis ad oblongo-obovatis, usque ad 30 cm longis, acuminatis, basi acutis ad obtusis, margine irregulariter dentatis et perspicue curvato-setosis, breviter petiolatis, nervis utrinque 10 ad 15, valde perspicuis; cymis axillaribus, 2 ad 3.5 cm longis, fasciculatis vel subfasciculatis, laxis, bracteis subfiliformibus, 5 ad 9 mm longis, setosis; sepalis ellipticis ad oblongo-ellipticis, 5.5 mm longis, obtusis, extus perspicue setosis; ovario glabro, stylis 3, infra leviter connatis.

A shrub, all parts conspicuously setose with slender, curved, spreading, pale-brownish bristles up to 5 mm in length. Branches setose, the young branchlets densely so. Leaves chartaceous, olivaceous or brownish-olivaceous above, much paler beneath, oblong-elliptic to oblong-obovate, 20 to 30 cm long, 8 to 11 cm wide, acuminate, base acute to obtuse, the margins irregularly dentate, conspicuously setose-ciliate; lateral nerves 10 to 15 on each side of the midrib, impressed on the upper surface, prominent beneath, ascending, curved, anastomosing, the reticulations subparallel, prominent; the upper surface with scattered setae, the lower with similar but more numerous setae confined to the midrib, nerves, and reticulations; petioles densely setose, 1 to 1.5 cm long. Cymes axillary, subfascicled, 2 to 3.5 cm long, prominently setose, rather few-flowered, the bracts subfiliform, setose, 5 to 9 mm long, the pedicels 8 to 10 mm long. Sepals

subequal, elliptic to oblong-elliptic, setose, obtuse, 5.5 mm long. Corolla lobes oblong, about 6 mm long, scarcely retuse. Ovary glabrous; styles 3, about 3 mm long, slightly united below.

SARAWAK, Selungo, Lio-Matu, and Mount Merinjak, *Native collector 2838* (type), 2797, 2579 *Bur. Sci.*, November, 1914, flowers white.

This species is remarkable for its numerous, slender, curved setae, which occur on both surfaces of the leaves, branches, petioles, inflorescences, and calyces, as well as by its subfiliform bracts. It is apparently allied to *Saurauia horrida* Hook. f., which, among other characters, differs in having the leaves glabrous on the upper surface. Two of the three specimens present runways or homes of ants constructed of a black brittle substance and debris, extending along both sides of the midrib on the lower surface of the leaves, whence the specific name.

SAURAUIA OBLANCEOLATA sp. nov.

Frutex erectus, partibus junioribus exceptis glaber; foliis oblanceolatis, chartaceis vel subcoriaceis, usque ad 35 cm longis, basi attenuatis, apice breviter acuminatis, margine calloso-serratis, utrinque glabris, laevis, nervis utrinque circiter 20, perspicuis; floribus axillaribus, fasciculatis, tenuiter pedicellatis; sepalis subaequalibus, ovatis ad elliptico-ovatis, 4.5 ad 5 mm longis, rotundatis, parcissime pubescentibus; fructibus junioribus globosis, leviter pubescentibus; stylis 3, liberis.

An erect shrub, the older parts entirely glabrous, the growing tips of the branchlets sparingly appressed-setose, the very young leaves (when but 1 to 2 cm long) very densely and uniformly appressed-setose on both surfaces. Leaves oblanceolate, chartaceous to subcoriaceous, 20 to 35 cm long, 4 to 8 cm wide, smooth and glabrous on both surfaces, the upper surface dark-brown, the lower pale-brown when dry, shining on both surfaces, gradually narrowed to the attenuate base, the apex somewhat rostrate-acuminate, the margins callose-serrate; lateral nerves about 20 on each side of the midrib, prominent, curved-ascending, anastomosing, the reticulations lax, distinct; petioles about 2 cm long. Flowers axillary, fascicled, their pedicels slender, up to 1.5 cm long, glabrous or slightly pubescent, each with two or three, small, oblong-elliptic, obtuse, 1 to 1.5 mm long bracts below the middle. Sepals subequal, ovate to elliptic-ovate, rounded, 4.5 to 5 mm long, slightly pubescent. Young fruits globose, sparingly pubescent. Styles 3, free, 4 mm long.

BRITISH NORTH BORNEO, Khota Balud to Kibayo, Mount Kinabalu, *Mrs. Clemens 9784*, October 28, 1915, "flowers and fruits white."

This species is well characterized by its oblanceolate, entirely glabrous, elongated leaves, and its fascicled flowers. It does not appear to be especially closely allied to any previously described form.

SAURAUIA PLATYPHYLLA sp. nov.

Frutex, ramulis junioribus dense, patule, tenuiter setosis, setae usque ad 1 cm longae; foliis elliptico-obovatis, coriaceis, usque ad 40 cm longis et 20 cm latis, supra ad costa, subtus ad costa nervisque setis paucis longis patulis tenuibus instructis, apice breviter acuminatis, basi acutis, margine perspicue attenuato-serratis, nervis utrinque circiter 30, patulis, curvatis, utrinque valde prominentibus; floribus caulinis, dense fasciculatis, tenuiter pedicellatis, e tuberculis dense setosis; sepalis subaequalibus, binis exterioribus breviter acuminatis, interioribus rotundatis, obovatis, omnibus glabris; fructibus glabris; stylis 3, liberis.

A shrub, the young branchlets densely covered with spreading, slender, curved, attenuate, pale-brownish setae up to 1 cm in length, with similar scattered setae on the midrib on both surfaces, the nerves beneath, and the petioles. Branches thickened. Leaves elliptic-obovate, coriaceous, up to 40 cm long and 20 cm wide, brownish-olivaceous on the upper surface, paler beneath, the apex shortly acuminate, the base acute, margins conspicuously serrate, the teeth mostly attenuate into slender curved setae; lateral nerves about 30 on each side of the midrib, spreading, curved, arched-anastomosing near the margin, very prominent on both surfaces, the reticulations prominent, subparallel; petioles stout, setose, about 3 cm long. Flowers fascicled, cauline, from densely setose tubercles, usually crowded, their pedicels 2.5 to 3.5 cm long, with short, scattered, curved setae and usually with two or three oblong-lanceolate, glabrous, 2.5 to 4.5 mm long bracts below the middle. Sepals subequal, glabrous, about 7 mm long, the exterior two shortly acuminate, subelliptic, the interior three obovate, rounded. Fruits glabrous, globose; styles 3, free, at least 2 mm in length.

BRITISH NORTH BORNEO, Mount Kinabalu, Kiau, Mrs. Clemens 9999, November 2, 1915, "a small *Saurauia* near streams with green cauline fruits."

This species is remarkable for its unusually large leaves, its slender, spreading, curved, attenuate setae, and its cauline fascicled inflorescences; by these characters it is readily distinguished from its congeners. It does not appear to be closely allied to any previously described form.

SAURAUIA WINKLERI sp. nov.

Frutex vel arbor parva, partibus junioribus exceptis glabris, ramulis teretibus, laevis, atro-brunneis, junioribus squamis paucis adpressis lanceolatis instructis; foliis membranaceis ad chartaceis, oblongis, usque ad 14 cm longis, glabris, in siccitate supra castaneis, subtus pallidis, apice tenuiter acute acuminatis, basi

acutis, margine incurvato-spinuloso-serratis; nervis utrinque circiter 12, distinctis; inflorescentiis axillaribus, cymosis, tenuiter pedunculatis, paucifloris, partibus junioribus leviter pubescentibus; bracteis foliaceis, lanceolatis, acuminatis, ad 12 mm longis; sepalis inaequalibus, extus leviter pubescentibus, rotundatis, exterioribus ellipticis, circiter 5 mm longis, interioribus late ovatis, circiter 5.5 mm longis et 5 mm latis; ovario pubescente; stylis 3, liberis.

A shrub or small tree, nearly glabrous, or the younger parts of the inflorescences sparingly brown-pubescent. Branches and branchlets castaneous when dry, smooth, terete, the latter with few, widely scattered, closely appressed, lanceolate scales. Leaves 6 to 14 cm long, 3 to 4.5 cm wide, membranaceous to chartaceous, in general oblong, subequally narrowed to the acute base and to the slenderly and sharply subcaudate-acuminate apex, entirely glabrous except for the very few, widely scattered, appressed, lanceolate scales on the midrib on both surfaces, the upper surface castaneous when dry, the lower cinereous, the margins spinulose-serrate, the tips of the small teeth incurved; lateral nerves about 12 on each side of the midrib, distinct, brown in contrast to the pale lower surface, anastomosing, the reticulations not prominent; petioles 1.5 to 3 cm long. Inflorescences axillary, solitary, long-peduncled, cymose, few-flowered, the peduncles slender, up to 6 cm in length, glabrous, the young pedicels sparingly pubescent; bracts lanceolate, acuminate, foliaceous, sparingly toothed, equally narrowed at both ends, up to 12 mm long and 3 mm wide; pedicels 10 to 12 mm long. Sepals unequal, externally sparingly pubescent, all rounded, the outer two elliptic, 5 mm long and 3 mm wide, the inner three broadly ovate, 5 to 6 mm long, 5 mm wide. Corolla-tube about 2 mm long, the lobes 6 mm long, retuse. Stamens 20. Ovary ovoid, pubescent; styles 3, free, 4 mm long.

SOUTH-EAST BORNEO, Hayoep, *Winkler 2451*, June 14, 1908.

This species is apparently allied to *Saurauia nigrescens* Korth., but it has smaller leaves, which are slenderly and sharply subcaudate-acuminate; and lanceolate, acuminate, entirely glabrous bracts; while the ovary is distinctly pubescent.

PASSIFLORACEAE

ADENIA Forskal

ADENIA QUADRIFIDA sp. nov. § *Microblepharis*.

Species *A. cordifoliae* (Blume) Engl. similis, differt floribus omnibus 4-meris, foliis chartaceis, utrinque concoloribus, laevis, haud rugosis.

A glabrous scandent plant, the branches slender, pale or brownish when dry, obscurely striate. Leaves ovate to oblong, entire, pale-olivaceous, shining, of about the same color on both surfaces, chartaceous, 4 to 6.5 cm long, 3 to 4.5 cm wide, base broadly rounded and distinctly cordate, beneath with a pair of distinct auricle-like glands, narrowed upward, the apex obtuse to obtusely acuminate and usually minutely apiculate; lateral nerves pinately arranged, 4 or 5 on each side of the midrib, curved, anastomosing, slender but distinct, the reticulations lax; petioles 1 cm long or less. Inflorescences 4 to 7 cm in length, few- to many-flowered, dichotomous, peduncled, the tendrils from the apices of the peduncles between the two primary branches. Flowers yellow, about 1 cm long, their pedicels slender, 1 to 2 cm in length, the bracteoles minute, the perianth narrowly oblong-ovoid, acute at both ends, the sepals 4, oblong-ovate, obtuse, about 1.5 mm long, the petals linear-oblong, 1.5 mm long, thin, inserted at the apex of the perianth-tube. Stamens 4; anthers narrowly oblong, 4 to 4.5 mm long. Fruits red when mature, oblong-ovoid, narrowed at both ends, base and apex acute, 7 to 9 cm long, apparently pendulous, 3-valved, apparently terete, the valves thickly coriaceous, hard and stiff when dry, reddish-brown, smooth and shining. Seeds ellipsoid, compressed, prominently and densely subfoveolate, 8 to 9 mm long.

BRITISH NORTH BORNEO, Mount Kalawat, *Mrs. Clemens 11138*, December 10, 1915 (type); Mount Kinabalu, Kiau, *Mrs. Clemens 10091*, November 27, 1915.

This species much resembles the Javan *Adenia cordifolia* (Blume) Engl. as figured and described by Blume, *Rumphia*, 1 (1835) 167, *t. 49*, from which it is at once distinguished by its 4-merous, not 5-merous flowers.

ADENIA CLEMENTIS sp. nov. § *Microblepharis*.

Frutex scandens, glaber; foliis chartaceis, oblongis, usque ad 10 cm longis, subolivaceis, nitidis, utrinque subaequaliter angustatis, integris, tenuiter acuminatis, basi acutis, perspicue auriculato-glandulosis, nervis utrinque 4, distinctis; inflorescentiis axillaribus, cymosis, pedunculatis, paucifloris, 4 ad 6 cm longis; floribus 5-meris, anguste oblongo-ovoideis, 8 ad 9 mm longis, utrinque subacutis; fructibus ovoideo-ellipsoideis, teretibus, circiter 5 cm longis, apice subrotundatis, basi subacutis vel subrotundatis.

A scandent glabrous shrub, the branches terete, pale or brownish, slightly striate when dry. Leaves oblong, chartaceous, subolivaceous to somewhat pale when dry, of about the same color on both surfaces or somewhat paler beneath, shining, 7 to 10 cm long, 2.5 to 6 cm wide, subequally narrowed to the

acute base and to the slenderly acuminate apex, entire, the acumen acute, 1 to 1.5 cm long, the base with a pair of elongated, auricle-like glands, the margins of the glands recurved; lateral nerves 4 on each side of the midrib, distinct, curved, anastomosing, the reticulations rather close, fine, evident on both surfaces; petioles 1 to 1.5 cm long. Inflorescences axillary, cymose, peduncled, 4 to 6 cm long, few-flowered, dichotomously branched, usually tendriferous. Flowers 5-merous, 8 to 9 mm long, yellowish, narrowly oblong-ovoid, subequally narrowed to the usually acute base and apex. Calyx-lobes 5, three oblong-ovate, 2.5 mm long, 1.5 mm wide, two alternating ones narrowly oblong. Petals 5, thin, oblong, 3 mm long, 1.2 mm wide, inserted at the apex of the perianth-tube. Stamens 5; anthers sessile, narrowly oblong, acuminate, 5 mm long. Fruits ovoid-ellipsoid, yellow, about 5 cm long and 5 cm in diameter, terete, apex usually rounded, base subacute to somewhat rounded, 3-valved, the valves firm, about 3 mm thick, when dry pale and shining.

BRITISH NORTH BORNEO, Kiau, Mrs. Clemens 10166 (type), 10223, November 25, 1917.

The present species is manifestly closely allied to *Adenia longipedunculata* Merr., from which it is especially distinguished by its smaller leaves, and shorter, few-flowered inflorescences.

ADENIA LONGIPEDUNCULATA sp. nov. § *Microblepharis*.

Frutex scandens, glaber, ramis in siccitate flavidis, leviter striatis; foliis chartaceis, ellipticis, integris, usque ad 16 cm longis et 10 cm latis, abrupte acuminatis, basi obtusis vel subacutis, perspicue auriculato-glandulosis, pallidis, utrinque concoloribus, nitidis, nervis utrinque 4, perspicuis, curvatis, tenuiter anastomosantibus; inflorescentiis axillaribus, longe pedunculatis, dichotomis, multifloris, foliis subaequantibus; floribus 5-meris, anguste oblongo-ovoideis, utrinque angustatis, acutis vel obtusis.

A scandent shrub, glabrous throughout, the branches when dry distinctly yellowish, about 5 mm in diameter, slightly striate, terete. Leaves elliptic, chartaceous to firmly chartaceous, pale, of the same color on both surfaces, shining when dry, 14 to 16 cm long, 9 to 10 cm wide, entire, apex abruptly acuminate, the acumen blunt, 1 cm long or less, base obtuse to subacute with a pair of prominent auricle-like glands; lateral nerves 4 on each side of the midrib, projecting on both surfaces, prominent, curved, slenderly anastomosing, the reticulations rather close, distinct; petioles about 3 cm long. Inflorescences axillary, as long as the leaves, rather densely many-flowered, the peduncles up to 13 cm in length, the cymes 5 to 8 cm in diameter, dicto-

tomous. Flowers pale-yellowish, in mature bud narrowly oblong-ovoid, acute or obtuse at both ends, about 8 mm long, 5-merous, their pedicels 5 mm long or less, the bracteoles ovate, acute, about 1 mm long. Calyx-segments oblong-ovate, obtuse, up to 2.5 mm in length. Petals thin, attached at the top of the perianth-tube, oblong, obtuse, 2 to 2.5 mm long. Stamens 5. the anthers sessile, narrowly oblong, acuminate, 6 mm long.

BRITISH NORTH BORNEO, Sandakan, *Agama 437*, August 31, 1917, on the inner edge of swamps along the Sapagaya River at about sea level.

This species is allied to *Adenia acuminata* (Blume) King, from which it is especially distinguished by its more numerous nerved leaves. The leaves are distinctly larger than are those of the Javan *Adenia macrophylla* (Blume) Koord.

FLACOURTIACEAE

RYPAROSA Blume

RYPAROSA OLIGOPHLEBIA sp. nov.

Arbor circiter 5 m alta, subglabra; foliis oblongo-obovatis ad oblongo-oblongatis, usque ad 17 cm longis, chartaceis, breviter et abrupte acuminatis, basi acutis, subtus pallidis, nervis utrinque 2 vel 3, curvato-ascendentibus, subtus prominulis; infructescentiis lateralibus, usque ad 7 cm longis; fructibus ovoideis ad subellipsoideis, circiter 3.5 cm longis, glabris, in siccitate minute verruculosus; seminibus circiter 6.

A tree about 5 m high, nearly glabrous, the very young branchlets sparingly appressed-pubescent, inflorescences and flowers not seen. Branches terete, reddish-brown, glabrous. Leaves chartaceous, oblong-obovate to oblong-oblongate, 10 to 17 cm long, 4 to 6 cm wide, the apex abruptly and rather shortly obtuse-acuminate, base acute, the upper surface more or less olivaceous when dry, the lower pale-grayish; lateral nerves 2 or 3 on each side of the midrib, the nerves curved-ascending, very prominent on the lower surface, obscurely anastomosing, the reticulations rather lax; petioles 1.5 to 2 cm long. Infructescences lateral, up to 7 cm in length, each bearing from 3 to 5 fruits. Fruits ovoid to subellipsoid, brown when dry, glabrous, the pericarp minutely verruculose, irregularly and coarsely wrinkled, about 3.5 cm long, 2.5 to 3 cm wide, apex subacute. Seeds usually 6.

BRITISH NORTH BORNEO, Kalabakan, *Villamil 263*, September 21, 1916, in forested valleys and on gentle slopes, altitude about 30 meters.

This species is strongly characterized by its few-nerved leaves. In its 6-seeded fruits it approaches *Ryparosa kunstleri* King of the Malay Peninsula, but is not otherwise closely allied to that species; most of the species, so far as the fruits are known, have but one- or two-seeded fruits.

MYRTACEAE

EUGENIA Linnaeus

EUGENIA CLEISTOCALYX nom. nov.

Jambosa nitida Korth. in Nederl. Kruidk. Arch. 1 (1847) 202, non

Eugenia nitida Benth., nec Duthie.

Cleistocalyx nitidus Blume Mus. Bot. Lugd.-Bat. 1 (1849) 84, f. 56.

Eugenia nervosa Miq. Fl. Ind. Bat. 1¹ (1855) 442, non Lour.

BRITISH NORTH BORNEO, *Villamil 406*, July 13, 1917, on river banks, local name *alag-alag-sulu*.

The type was from Borneo, and Miquel also credits the species to Sumatra; from Loureiro's description it has nothing to do with *Eugenia nervosa* Lour., where it was placed by Miquel. The species is also the type of Blume's genus *Cleistocalyx*, and it is worthy of note that so far as striking differential characters are concerned, in this case the peculiar, calyptrate, circumscissily deciduous calyx-limb, *Cleistocalyx* is much more sharply differentiated from *Eugenia* than are *Jambosa* and *Syzygium*, and hence has stronger claims to generic recognition than either of these groups.

EUGENIA ALCINAE Merr. in Philip. Journ. Sci. 10 (1915) Bot. 216.

BRITISH NORTH BORNEO, Tawau, *Villamil 371*, May 28, 1917, on the banks of the Sempang Tiga River, at low altitudes; Jesselton, *Yates 71*, October 8, 1917.

Both specimens are an excellent match for the type, which was from northern Palawan.

EUGENIA VILLAMILII sp. nov. § *Syzygium*.

Arbor parva, glabra, ramis ramulisque laevis, pallide-brunneis, teretibus, ramulis circiter 2.5 mm diametro; foliis oppositis, oblongis, chartaceis, utrinque subaequaliter angustatis, usque ad 20 cm longis, supra olivaceis, subtus pallidioribus, utrinque nitidis, epunctatis, apice tenuiter acuminatis, basi acutis, nervis primariis utrinque circiter 20, tenuibus, secundariis reticulisque obscuris, laxis; inflorescentiis terminalibus, circiter 5 cm longis, corymbosis, e basi ramosis, plerumque trichotomis; floribus parvis, alabastro obovoideo-obcuneo, circiter 4 mm longo, in ramulis ultimis subcapitatum dispositis, petalis omnibus connatis, calyptratim deciduis.

A small tree, glabrous throughout, the branches and branchlets terete, slender, smooth, pale-brownish. Leaves opposite, chartaceous, oblong, about 20 cm long, 5 to 6 cm wide, subequally narrowed to the acute base and to the slenderly acuminate apex, the acumen 1 to 1.5 cm long, blunt, both surfaces shining, the upper olivaceous, the lower paler, epunctate; midrib impressed on the upper surface, prominent beneath; primary lateral nerves slender, slightly or scarcely raised on the lower surface, spreading, anastomosing close to the margin with the marginal nerves,

about 20 on each side of the midrib, the secondary nerves and reticulations lax, indistinct; petioles 1 to 1.5 cm long. Inflorescence terminal, corymbose, branched from the base, about 5 cm long, 5 to 6 cm wide across the top, the branches mostly trichotomous, pale-olivaceous, shining, subterete. Flowers numerous, crowded at the tips of the ultimate branchlets, 5 to 7 on each branchlet, sessile, the buds obovoid-obcuneate, about 4 mm long, the calyx terete, brown and slightly rugose when dry, the throat about 2.5 mm in diameter, the limb truncate, produced about 1.8 mm above the ovary. Petals wholly united into a deciduous calyptra about 2.5 mm in diameter. Filaments numerous, 3 to 5 mm long.

BRITISH NORTH BORNEO, Kalabakan watershed, in forests along the Pinajos River, *Villamil 229*, October 3, 1916, altitude about 4 meters.

The striking characters of this species are its oblong, chartaceous, epunctate, slenderly nerved leaves, terete branchlets, and terminal corymbose inflorescences which are branched from the base.

ARALIACEAE

SCHEFFLERA Forster

SCHEFFLERA BIPALMATIFOLIA sp. nov.

Frutex glabra, vel inflorescentiis leviter furfuraceis; foliis longissime petiolatis, bipalmatis, radiis primariis 6 vel 7, petiolis primariis usque ad 18 cm longis, quisque 3- ad 5-foliolatis, foliolis longe petiolulatis, oblongo-ovatis ad oblongo-ellipticis, tenuiter acuminatis, integris, chartaceis, nervis utrinque 8 ad 10; inflorescentiis terminalibus, breviter pedunculatis, ramis confertis, usque ad 30 cm longis; floribus fasciculatis, numerosis, subsessilibus, 5-meris; fructibus subellipsoideis, sulcatis, 4 mm longis, 5-locellatis.

A glabrous shrub, or the inflorescences somewhat furfuraceous. Leaves long-petioled, bipalmately compound, the primary divisions 6 or 7, their partial petioles up to 18 cm in length, each bearing from 3 to 5 palmately arranged leaflets; leaflets chartaceous, greenish-olivaceous, shining, entire, oblong-ovate to oblong-elliptic, 15 to 25 cm long, 7 to 11 cm wide, slenderly acuminate, base rounded to subacute; lateral nerves 8 to 10 on each side of the midrib, prominent; petiolules 2 to 6 cm long. Inflorescences terminal, shortly peduncled, the rachis slightly prolonged, the simple branches crowded, each subtended by a lanceolate, acuminate, somewhat furfuraceous bract up to 2.5 cm long, the individual branches in anthesis up to 30 cm long, longer and glabrous in fruit, the flowers very numerous, crowded

in distinct fascicles along the entire length of the primary branches, subsessile, 6 to 10 in a fascicle. Pedicels very short. Calyx turbinate, truncate, about 1.5 mm long. Petals 5, valvate, triangular-ovate, acute, 1.7 mm long. Stamens 5; filaments 4 mm long. Ovary 5-celled. Fruits elliptic-ovoid, 4 mm long, longitudinally 5-sulcate, 5-celled.

BRITISH NORTH BORNEO, Mount Kinabalu, Kiau, *Mrs. Clemens 10072* (type), 10060, November 2 and 6, 1916, fruits orange-red; growing near streams.

This species is remarkable for its vegetative and inflorescence characters. It is in the group with *Schefflera heterophylla* (Seem.) Harms, of the Malay Peninsula and Java, but the inflorescences of the two species are entirely different.

SCHEFFLERA BORNEENSIS sp. nov.

Frutex, inflorescentiis leviter pubescentibus exceptis glaber; foliis 5-foliolatis, longe petiolatis, foliolis ellipticis ad elliptico-ovatis, chartaceis ad coriaceis, integris, in siccitate pallidis vel brunneis, nitidis, utrinque concoloribus, usque ad 20 cm longis, subabrupte caudato-acuminatis, basi acutis ad rotundatis, nervis utrinque 5 ad 7, subtus perspicuis, curvatis, reticulis utrinque distinctis; inflorescentiis terminalibus, leviter pubescentibus, rhachibus 2 ad 3 cm longis, ramis primariis numerosis, adscendentibus vel patulis, 7 ad 20 cm longis; floribus 5-meris, breviter pedicellatis, umbellis in ramis primariis racemose dispositis, brevissime pedunculatis.

A shrub, glabrous except the inflorescence, which is sparingly pubescent with weak, cinereous, simple hairs. Leaves 5-foliolate, their petioles 10 to 20 cm long, inflated and clasping at the base; leaflets elliptic to elliptic-ovate, chartaceous to coriaceous, entire, pale to brownish and shining when dry, of the same color on both surfaces, 12 to 20 cm long, 6 to 12 cm wide, apex rather abruptly caudate-acuminate, the acumen about 2 cm long, the base acute to rounded; lateral nerves 5 to 7 on each side of the midrib, distant, curved, anastomosing, prominent on the lower surface, the reticulations distinct on both surfaces; petiolules 1.5 to 5 cm long. Inflorescences terminal, the rachis 2 to 3 cm long, often stout, sparingly pubescent, bearing from 6 to 12 spreading to ascending primary branches, each branch subtended by a lanceolate, acuminate, membranaceous bract up to 1.5 cm in length, the branches 8 to 12 cm long, sparingly pubescent. Umbels about 10-flowered, racemosely arranged along the primary branches, their peduncles about 1 mm long, the subtending bracts lanceolate, acuminate, 2 mm long. Pedicels about 2 mm long. Flowers 5-merous. Calyx turbinate.

Petals 5, broadly ovate, acute, 1.5 mm long, valvate. Filaments 3 mm long. Fruit subellipsoid, 5 mm long, deeply 5-sulcate, 5-celled, crowned by the stellately arranged sessile globose stigmas.

SARAWAK, vicinity of Kuching, *Native collector 798* (type), 797, 1875 *Bur. Sci.*, July and August, 1911, Rock Road, near Kuching. Perhaps referable here are also *Native collector 1275, 1717 Bur. Sci.*, but the former is very imperfect, and the latter has longer primary branches of the inflorescence, and distinctly longer peduncled umbels.

The alliance of this species is apparently with *Schefflera gracilis* (Blume) Vig., from which it is easily distinguished by its larger, caudate-acuminate leaflets.

SCHEFFLERA CALYPTRATA sp. nov.

Frutex, inflorescentiis junioribus furfuraceis exceptis glaber; foliis 3-foliolatis, breviter crasseque petiolatis, foliolis coriaceis, rigidis, oblongis, nitidis, laevis, usque ad 22 cm longis, acuminatis, basi obtusis ad subacutis, nervis utrinque 10 ad 12; paniculis terminalibus, ramis paucis, usque ad 14 cm longis; umbellis in ramis primariis racemose dispositis, paucifloris, floribus plerumque 6-meris, breviter pedicellatis, calycis turbinatis vel infundibuliformibus, truncatis, petalis omnibus connatis, calyptratim deciduis.

A shrub, glabrous except the inflorescences, which in anthesis are distinctly furfuraceous. Branches rugose when dry. Leaves 3-foliolate, their petioles stout, 2 cm long or less, the hard, cylindrical, often somewhat curved, sheathing stipules exceeding the petioles. Leaflets thickly coriaceous, rigid, oblong, smooth and shining, 11 to 22 cm long, 5 to 9 cm wide, apex rather abruptly and sharply acuminate, base obtuse to subacute, brownish-olivaceous when dry, the lower surface paler than the upper; lateral nerves 10 to 12 on each side of the midrib, somewhat curved, not prominent, the reticulations obsolete or subobsolete; petiolules stout, about 3.5 cm long. Panicles terminal, furfuraceous, shortly peduncled, branched from near the base, each panicle with but two or three branches, these up to 14 cm in length. Flowers in few-flowered, racemosely disposed umbels, the peduncles opposite, verticillate or alternate, up to 1.5 cm long, 5 to 8 flowers in an umbel, their pedicels glabrous, 4 to 5 mm long, rather stout. Calyx turbinate, truncate, about 2.5 mm long. Petals wholly united into an ovoid, rounded calyptra up to 4 mm in length, which is circumscissily deciduous. Anthers usually 6, oblong, obtuse, 3 mm long. Ovary 6- or 7-celled.

BRITISH NORTH BORNEO, Mount Kinabalu, Kiau, *Mrs. Clemens 10180*, November 1, 1915.

With the specimen is a detached fruiting branch about 30 cm in length,

which is dark-brown and entirely glabrous. The fruits are ovoid-ellipsoid, somewhat sulcate, brown, about 6 mm in diameter, 6- or 7-seeded.

The species is well characterized by its thick, rigid leaflets, which are three in number and with stout petiolules; its unusually stout, short petioles; its elongated rigid stipules; and its petals wholly connate into a deciduous calyptra, the latter character an anomalous one in the genus.

SCHEFFLERA PACHYPHLEBIA sp. nov.

Frutex vel arbor parva, glabra; foliis 6-foliolatis, stipulis coriaceis, oblongis amplexicaulibus, usque ad 2.5 cm longis, ramis saepe incrassatis; foliolis coriaceis, ellipticis, usque ad 10 cm longis, brevissime acuminatis, basi acutis, nitidis, margine revolutis, integris vel versus apicem parvissime serratis, nervis utrinque circiter 6, subtus cum reticulis elevatis valde prominentibus; inflorescentiis terminalibus, umbellis racemose dispositis, pedunculatis; floribus plerumque 5- vel 6-meris; fructibus purpureis, in siccitate atro-brunneis, circiter 6 mm diametro, sulcatis, locellis usque ad 7, seminibus plerumque 4 vel 5.

A shrub or small tree, entirely glabrous, the branchlets often thickened. Leaves 6-foliolate, their petioles about 4 cm long, the stipules oblong, coriaceous, obtuse, up to 2.5 cm long, clasping the stems; leaflets elliptic, coriaceous, usually dark-colored when dry, 7 to 10 cm long, 4 to 5 cm wide, base acute to rounded, apex shortly acuminate, margins revolute, entire or somewhat serrate near the apex, shining when dry, the lower surface sometimes slightly glaucous; petiolules 1.5 to 2 cm long; lateral nerves about 6 on each side of the midrib, very prominent on the lower surface as are the raised primary reticulations. Inflorescence terminal, consisting of from one to several partial inflorescences up to 10 cm in length, these partial inflorescences of racemously disposed umbels. Umbels alternate, opposite, or verticillate, their peduncles 1 to 1.5 cm long, each 6- to 12-flowered, the pedicels about 5 mm long. Flowers mostly 5- or 6-merous. Calyx turbinate, truncate, about 3 mm long. Petals free, valvate, oblong-ovate, acute, 3.5 mm long. Filaments about 4 mm long. Fruit dark-purple when ripe, dark-brown when dry, ovoid, about 6 mm long, sulcate, 5- to 7-celled, usually 5- or 4-seeded.

BRITISH NORTH BORNEO, Mount Kinabalu, Paka Cave, Mrs. Clemens 10592 (type), November 12, 1915, Haslam, August, 1916.

This species is characterized by its prominently nerved, coriaceous, reticulate leaflets, and its greatly produced, coriaceous stipules.

SCHEFFLERA TETRANDRA sp. nov.

Frutex vel arbor parva, inflorescentiis parce stellato-pubescentibus; foliis plerumque 5-foliolatis, foliolis chartaceis ad coriaceis, oblongo-ellipticis ad oblongo-lanceolatis, in siccitate brunneis vel

pallidis, integris, basi acutis, apice tenuiter subcaudato-acuminatis, usque ad 14 cm longis, nervis primariis utrinque circiter 8, quam secundariis vix magis distinctioribus; inflorescentiis terminalibus, rhachibus haud productis, ramis primariis 5 ad 7, adscendentibus, 20 ad 40 cm longis; umbellulis paucifloris, breviter pedunculatis, racemose dispositis; floribus plerumque 4-meris, parvis.

A shrub or a small tree, glabrous except the sparingly stellate-pubescent inflorescences. Leaves palmately 5-foliolate, their petioles 5 to 13 cm long, inflated and clasping at the base; leaflets oblong-elliptic to oblong-lanceolate, chartaceous to coriaceous, entire, pale to brownish when dry, of about the same color on both surfaces, shining, base acute, apex slenderly caudate-acuminate, 8 to 14 cm long, 3 to 4.5 cm wide; primary lateral nerves about 8 on each side of the midrib, distinct but scarcely more prominent than are the secondary nerves, more or less ascending and anastomosing with the extended basal pair of nerves forming a somewhat arched marginal pair extending nearly or quite to the apex, the reticulations distinct on both surfaces. Inflorescences terminal, the rachis not or but very slightly produced, the primary branches 5 to 7, 20 to 40 cm in length, each subtended by an oblong-ovate, acuminate, pale, coriaceous, somewhat pubescent bract 1.5 to 2 cm in length, the younger parts of the inflorescences stellate-pubescent with cinereous hairs, the older parts glabrous or nearly so. Umbels racemously arranged on the primary branches, numerous, 5- to 10-flowered, their peduncles 2 to 10 mm long, or the uppermost ones sometimes sessile, the subtending bracts lanceolate, acuminate, 5 mm long or less. Pedicels usually about 2 mm long. Flowers mostly 4-merous, sometimes 5-merous, the petals about 2 mm long, wholly connate into a deciduous calyptra. Fruits 3 to 4 mm long, 4-, rarely 5-angled and sulcate, 4-, rarely 5-celled.

SARAWAK, near Sandakan, *Native collector* 183, 184, 185, 426, 799, 801, 505, 1763, 2707 *Bur. Sci.*; Lundu, *Foxworthy* 71, May, 1908 (type), with the native name *raka*.

The alliance of this species is apparently with *Schefflera subulata* (Miq.) Vig. but it has distinctly smaller, more numerous leaflets, longer racemes, and usually 4-merous flowers. It is apparently common in Sarawak.

CLETHRACEAE

CLETHRA Linnaeus

CLETHRA PACHYPHYLLA sp. nov.

Arbor parva, ramulis et inflorescentiis dense ferrugineo-villosis; foliis oblongis ad anguste oblongo-obovatis, crasse coriaceis,

usque ad 6 cm longis, acute acuminatis, basi cuneatis, margine irregulariter serrulatis, nervis utrinque 9 ad 12, valde prominentibus, subtus dense ferrugineo-pubescentibus, vetustioribus pallidis et minute puberulis; racemis usque ad 5 cm longis, floribus brevissime pedicellatis, bracteis lineari-lanceolatis, usque ad 8 mm longis.

A small tree, the branchlets and inflorescences densely ferruginous-villous, the branches rugose, brownish, glabrous. Leaves oblong to narrowly oblong-obovate, shortly and sharply acuminate, base cuneate, margins subentire to minutely and irregularly denticulate, thickly coriaceous, 5 to 6 cm long, 1.5 to 2 cm wide, the upper surface dark-brown, glabrous, and somewhat shining when dry, the midrib impressed, the lower surface densely ferruginous-pubescent, with intermixed villous hairs on the midrib and nerves, the older ones pale on the lower surface and minutely puberulent; lateral nerves 9 to 12 on each side of the midrib, very prominent, anastomosing; petioles pubescent, about 1 cm long. Racemes up to 5 cm in length, densely ferruginous-villous, the flowers somewhat crowded, shortly pedicelled, the bracts linear-lanceolate, thick, pubescent, up to 8 mm in length. Sepals oblong-ovate, acute to somewhat acuminate, ferruginous-pubescent, about 4 mm long. Petals (in bud) obovate, glabrous, about 3 mm long.

BRITISH NORTH BORNEO, Mount Kinabalu, Paka Cave to Lobang, *Mrs. Clemens 10692*, November 15, 1915.

The alliance of this species is manifestly with *Clethra luzonica* Merr., which it resembles in many characters. It is distinguished by its fewer-nerved, sharply acuminate, narrower leaves, which are much more pubescent than in the Philippine species, and in its villous branchlets and inflorescences. *Clethra pulgarensis* Elm., of Palawan, has very differently shaped, much broader leaves, which are not sharply acuminate.

CLETHRA CLEMENTIS sp. nov.

Arbor parva, plus minusve stellato-tomentosis; foliis oblongis ad oblongo-lanceolatis, usque ad 11 cm longis, chartaceis, acute acuminatis, basi acutis, margine subintegris ad irregulariter serrulatis, subtus parce stellato-tomentosis, nervis utrinque 10 ad 12, distinctis; paniculis stellato-pubescentibus, ramis 10 ad 20 cm longis; floribus numerosis, petalis obovatis, 3 mm longis, bracteis lineari-lanceolatis, 5 ad 7 mm longis, deciduis; capsulis depresso-globosis, 2.5 ad 3 mm diametro.

A small tree attaining a height of nearly 10 m, or in some habitats a shrub 1.5 to 2 m high, the younger parts stellate-pubescent, the indumentum usually ferruginous and often dense, the older branches glabrous. Leaves oblong to oblong-lanceolate,

chartaceous, 6 to 11 cm long, 1.5 to 3.5 cm wide, subequally narrowed upward to the acutely acuminate apex and below to the acute base, the margins subentire to irregularly serrulate, the upper surface brownish-olivaceous, glabrous or with scattered stellate hairs along the midrib and nerves when young, the lower surface paler, sparingly stellate-pubescent; lateral nerves 10 to 12 on each side of the midrib, distinct; petioles pubescent, 1 cm long or less. Panicles ferruginous- to subcinereous-pubescent, the indumentum dense, short, stellate, the branches often slender, 10 to 20 cm in length, the buds on young branches crowded and subtended by the conspicuous bracts, in anthesis somewhat scattered, their pedicels up to 3 mm in length and persistent after the flower falls, the bracts deciduous, linear-lanceolate, densely pubescent, 5 to 7 mm long. Flowers white or greenish-white, numerous. Sepals ovate to oblong-ovate, 2 to 2.5 mm long, somewhat acuminate, densely pubescent. Petals obovate, glabrous, 3 mm long. Ovary pubescent; style 2 mm long. Fruit depressed-globose, 2.5 to 3 mm in diameter.

BRITISH NORTH BORNEO, Mount Kinabalu, Kibayo to Keung, *Mrs. Clemens 9859, 9826*, October 29, 1915; Mount Kalawat, *Mrs. Clemens 11148* (type), December 10, 1915, common.

It is suspected that this is the form reported from Borneo by Stapf and by Miss Gibbs as *Clethra canescens* Reinw., but it is remarkably distinct from Reinwardt's species as I understand it, and as interpreted by J. J. Smith from Javan and Celebes material; Reinwardt's type was from Celebes, and no satisfactory description of it was published until 1914.⁴ *Koorders 19280* from Celebes unquestionably represents Reinwardt's species, and represents a species from which I am now of the opinion that *Clethra williamsii* C. B. Rob. of Mindanao cannot be distinguished. It has coriaceous leaves, with from 17 to 20 pairs of lateral nerves, while the form above described has at most chartaceous leaves with but 10 to 12 pairs of lateral nerves. *Clethra clementis* Merr. is distinctly more closely allied to the Philippine *C. lancifolia* Turcz., than to *C. canescens* Reinw.

MYRSINACEAE

MAESA Forskal

MAESA SUBCAUDATA sp. nov.

Frutex glaber, ramis ramulisque teretibus, elenticellatis; foliis oblongo-ellipticis ad oblongo-obovatis, usque ad 20 cm longis, membranaceis, basi acutis vel decurrento-acuminatis, apice tenuiter subcaudato-acuminatis, margine perspicue subrepando-dentatis, nervis utrinque 10 ad 12, perspicuis, subtus minutissime subrubiginoso-puncticulatis, obscure reticulatis, lineis ner-

⁴J. J. Smith in Koorders & Valetton Bijdr. Boomsort. Java *Meded. Dept. Lanbouw* 18 (1914) 87.

villiformibus destitutis; racemis axillaribus, solitariis vel binis, usque ad 2.5 cm longis, paucifloris; floribus 5-meris, urceolatis, circiter 4 mm longis, calycis perspicue lineatis, lobis ovatis, obtusis, glabris, integris; petalis $\frac{2}{3}$ connatis, lineatis, lobis circiter 1 mm longis, obtusis ad subacutis.

A glabrous shrub, the branches and branchlets elenticellate, terete, brownish. Leaves oblong-elliptic to oblong-obovate, membranaceous, rather pale when dry, slightly shining, 15 to 20 cm long, 6.5 to 9 cm wide, base acute to decurrent-acuminate, apex slenderly subcaudate-acuminate, the acumen acute, about 1.5 cm long, the margins rather prominently subrepand-dentate, the lower surface very minutely subrubiginous-puncticulate; lateral nerves 10 to 12 on each side of the midrib, prominent, somewhat ascending, the reticulations inconspicuous; petioles about 1.5 cm long. Racemes axillary, simple, solitary or in pairs, up to 2.5 cm long, few-flowered. Flowers 5-merous, about 4 mm long, the pedicels 3 mm long, the bracteoles 2, oblong, less than 1 mm long. Calyx-tube and lobes prominently lineate, the lobes ovate, obtuse, entire, 1.3 to 1.5 mm long. Corolla prominently lineate, the tube about 2 mm long, the lobes broadly ovate, obtuse to subacute, about 1 mm long. Stamens attached at about the middle of the tube, the filaments about as long as the anthers.

BRITISH NORTH BORNEO, *Villamil 234*, June, 1917.

This species is strongly characterized by being entirely glabrous; by its rather large, membranaceous, rather prominently subrepand-dentate, subcaudate-acuminate, rather many-nerved leaves, which are minutely subrubiginous-puncticulate; and its short, few-flowered, simple racemes, the flowers being 5-merous and prominently lineate. It is perhaps as closely allied to *Maesa laevigata* Scheff. as to any other known species.

MAESA CLEMENTIS sp. nov.

Frutex, ramulis junioribus inflorescentiisque parcissime puberulis exceptis glaber, ramis ramulisque in siccitate brunneis, teretibus, parce lenticellatis; foliis oblongo-ovatis ad oblongis, usque ad 11 cm longis, membranaceis ad chartaceis, pallide olivaceis, basi rotundatis ad subacutis, apice distincte acuminatis, nervis utrinque circiter 8, perspicuis, subtus haud puncticulatis, lineis nervilliformibus manifestis auctis, margine distanter subrostrato-vel apiculato-dentatis; inflorescentiis axillaribus, depauperato-paniculatis, petiolo subaequantibus; floribus 5-meris, circiter 3 mm longis, calycis lobis lineatis, ovatis, acuminatis, 1 mm longis, margine minutissime ciliatis; petalis usque ad $\frac{2}{3}$ connatis, lobes lineatis, orbiculari-reniformibus, rotundatis; filamentis quam antheris 3-vel 4-plo longioribus.

A shrub, glabrous except the very slightly puberulent branch-

lets and inflorescences. Branches and branchlets brown when dry, slender, terete, more or less lenticellate, slightly striate. Leaves membranaceous to chartaceous, oblong-ovate to oblong, 7 to 11 cm long, 2.5 to 5 cm wide, pale-olivaceous and shining when dry, the base rounded to acute, the apex distinctly acuminate, the margins distantly dentate with short, stout, blunt, subrostrate or apiculate teeth, the basal parts entire or nearly so; lateral nerves about 8 on each side of the midrib, prominent, curved, scarcely anastomosing, the nerves and their ultimate branches ending in marginal teeth, the reticulations indistinct, the lower surface with numerous, manifest, nerve-like lines; petioles 0.8 to 1.3 cm long. Inflorescences axillary, about as long as the petioles, depauperate-paniculate, rather few-flowered. Flowers white or cream-colored, 5-merous, about 3 mm long, their pedicels 2 mm long, the bracteole subtending the pedicels oblong, acuminate, less than 1 mm long, the two prophyllae subtending the flower similar to the bracteoles but slightly smaller. Calyx distinctly lineate, the lobes ovate, acuminate, about 1 mm long, their margins very minutely ciliate. Petals connate for about two-thirds their length, the tube not lineate, the lobes subreniform-ovate, rounded, lineate, about 0.8 mm long and 1.5 mm wide. Filaments attached near the base of the tube, three to four times as long as the anthers.

BRITISH NORTH BORNEO, Mount Kinabalu, Minitindok and Lobang Gorges, and Kiau, *Mrs. Clemens 10494* (type), *10102, 10462*, November 19 and 29, 1915.

The alliance of this species is with *Maesa montana* A. DC., from which it differs notably in its differently shaped, shortly acuminate leaves, and numerous other characters.

MAESA CONFERTA sp. nov.

Species ut videtur *M. japonicae* affinis. Frutex glaberrimus, ramis nitidis, griseis vel brunneis; foliis submembranaceis vel chartaceis, oblongo-ovatis ad oblongo-lanceolatis, usque ad 17 cm longis, nitidis, epuncticulatis, basi subacutis, apice tenuiter acuminatis, margine distanter apiculato-dentatis vel subintegris, nervis utrinque 5 vel 6, curvato-adscedentibus, perspicuis, anastomosantibus; infructescentiis axillaribus, quam petiolis brevioribus, fructibus valde confertis, ovoideis, circiter 5 mm longis, perspicue longitudinaliter striato-lineatis; calycis lobis 5, ovatis, obtusis ad subacutis, lineatis, glabris, integris, circiter 1.5 mm longis.

An entirely glabrous shrub, the branches terete, grayish to brownish, shining, elenticellate. Leaves submembranaceous to chartaceous, pale-olivaceous and shining when dry, not puncticu-

late, oblong-ovate to oblong-lanceolate, 12 to 17 cm long, 4 to 6.5 cm wide, base subacute, the apex slenderly acuminate, the acumen subacute, up to 2 cm in length, the margins very distantly apiculate-dentate, the teeth always short, sometimes obsolete and the margins entire or nearly so; lateral nerves 5 or 6 on each side of the midrib, rather prominent, curved-ascending, anastomosing, the reticulations lax, indistinct; petioles about 1 cm long. Infructescences axillary, shorter than the petioles, of solitary or paired, simple racemes, the rachis 5 mm long or less. Fruits ovoid, brown, about 5 mm long, prominently striate-lineate, their pedicels 2 mm long or less, the bracteoles minute, 0.4 mm long or less. Persistent calyx-teeth 5, ovate, obtuse to subacute, entire, glabrous, prominently lineate, 1.5 mm long. Seeds numerous, sharply angled, quadrangular, about 1 mm in diameter.

BRITISH NORTH BORNEO, Mount Kinabalu, Kiau, *Mrs. Clemens 9969* (type), *9968*, November 29, 1917, "fruit greenish-brown, pale-striped."

While the flowers of this species are unknown, I feel rather confident that its alliance is with *Maesa japonica* (Thunb.) Moritz, which it resembles in its vegetative characters and especially in its fruits. It is well characterized by its very short infructescences, which are distinctly shorter than the petioles, and its crowded fruits.

ARDISIA Swartz

ARDISIA MOULTONII sp. nov. § *Tinopsis*.

Frutex vel arbor, ramis griseis, teretibus, glabris, ramulis junioribus et inflorescentiis dense brunneo- vel castaneo-furfuraceis; foliis oblongis, coriaceis, nitidis, epunctatis, integris, usque ad 20 cm longis, basi acutis, apice acuminatis, nervis primariis utrinque circiter 35, distinctis vel indistinctis; inflorescentiis terminalibus, usque ad 12 cm longis, tripinnatim paniculatis, floribus in ramulis ultimis subumbellatim dispositis, confertis, breviter et crasse pedicellatis, calycis tubo obconico, 3 ad 4 mm longo, lobis late ovatis, valde imbricatis, acutis vel acuminatis, circiter 6 mm longis, coriaceis, obscure punctatis, margine ciliatis.

A shrub or tree, glabrous except the distinctly and rather densely brownish- to castaneous-lepidote branchlets and inflorescences, the leaves often minutely lepidote. Branches terete, grayish. Leaves alternate, oblong, coriaceous, somewhat shining, brownish-olivaceous, of about the same color on both surfaces, epunctate, 12 to 20 cm long, 2.5 to 7 cm wide, subequally narrowed to the acute base and the somewhat acuminate apex, entire, the midrib somewhat impressed on the upper surface, very prominent on the lower surface; lateral nerves about 25

on each side of the midrib, distinct or indistinct, sometimes obscure, spreading, curved, anastomosing, the reticulations usually very obscure; petioles about 1 cm long. Inflorescences terminal, tripinnately paniculate, up to 12 cm in length, the branches racemosely arranged, alternate, the lower ones subtended by reduced leaves and up to 5 cm in length, the flowers umbellately arranged at the tips of the ultimate branchlets, crowded, 5 to 7 in an umbel, subsessile or pedicellate, the pedicels stout, up to 4 mm in length, the subtending bracteoles lanceolate, 3 to 5 mm in length, the bracts similar but larger. Calyx-tube obconic, 3 to 4 mm long, the lobes broadly ovate to suborbicular-ovate, acute to somewhat acuminate, undulate, coriaceous, obscurely punctate, the margins somewhat ciliate, about 6 mm long, very prominently imbricate, the outer basal part often distinctly rounded-auricled. Petals ovate, subcoriaceous, about 6 mm long, somewhat acuminate, scarcely punctate. Anthers acuminate, 3 mm long. Ovary glabrous; style 4 to 5 mm long, included in bud.

SARAWAK, Siol, and other localities, *Native collector 156, 372, 673 (type), 1631, 2350 Bur. Sci.*, the type collected June 1, 1911.

The alliance of this species is apparently with *Ardisia lanceolata* Roxb. and *A. nitidula* Mez. It is well characterized by its crowded, umbellately arranged, subsessile to shortly pedicelled flowers; its distinctly elongated calyx-tube; and its prominently imbricate sepals. It is dedicated to Captain J. C. Moulton, formerly director of the SARAWAK Museum, under whose supervision extensive botanical collections were made for the Bureau of Science.

ARDISIA SARAWAKENSIS sp. nov. § *Tinopsis*.

Arbor 6 ad 7 m alta, glabra; foliis alternis, coriaceis, oblongis, circiter 20 cm longis, in siccitate purpureo-brunneis, nitidis, minute undulatis, apice obtusis, basi acutis, utrinque perspicue punctatis, nervis primariis utrinque circiter 25, patulis, anastomosantibus, subtus prominulis, reticulis laxis; paniculis terminalibus, pedunculatis, circiter 10 cm longis, pyramidatis, bipinnatim paniculatis, floribus in ramulis primariis subumbellatim dispositis; sepalis elliptico-ovatis, acutis vel obtusis, perspicue glandulosis, margine leviter ciliatis, circiter 3 mm longis, imbricatis; petalis ovato-lanceolatis, acuminatis, 6 mm longis, supra parce punctatis, infra densissime puncticulatis.

A tree, 6 to 7 m high, entirely glabrous. Branches terete, purplish-brown, rugose. Leaves alternate, oblong, coriaceous, purplish-brown when dry, shining, about 20 cm long, 4 to 5.5 cm wide, entire, subequally narrowed to the obtuse apex and the acute base, both surfaces conspicuously punctate-glandular,

the glands distinctly visible to the naked eye; primary lateral nerves about 25 on each side of the midrib, spreading, anastomosing, distinct on the lower surface, the reticulations lax; petioles stout, about 5 mm long. Panicles terminal, pyramidal, peduncled, about 10 cm long, bipinnate, the flowers subumbellately arranged at the tips of the primary branches, the branches alternate, the lower ones 3 cm long or less. Flowers pink, 6 to 12 in each umbel, their pedicels 7 to 9 mm long. Sepals elliptic-ovate, acute or obtuse, about 3 mm long, prominently glandular, margins sparingly ciliate, distinctly imbricate in the basal parts, nearly free. Petals ovate-lanceolate, acuminate, about 6 mm long and 3 mm wide, the upper part with few, scattered, large glands, the median portion of the lower half densely punctate-glandular with small glands. Anthers oblong-lanceolate, acuminate, about 4 mm long, the connectives not glandular. Ovary ovoid, glabrous; style 4.5 mm long, not exerted in bud.

SARAWAK, Mount Poe, *Foxworthy 201*, May 24, 1908, altitude about 1,300 meters.

This species falls in the group with *Ardisia lanceolata* Roxb., but is not closely allied to that species. It is well characterized by its purplish-brown, oblong, obscurely undulate, prominently punctate, short-petioled, obtuse leaves.

ARDISIA PYGMAEA sp. nov. § *Bladhia*.

Suffrutex usque ad 20 cm altus, glaber, caulibus simplicibus, erectis vel infra decumbens; foliis confertis, obovatis ad oblongo-obovatis, integris, usque ad 13 cm longis, chartaceis ad subcoriaceis, apice rotundatis, basi acutis vel subacutis, breviter petiolatis, nervis utrinque 12 ad 15, distinctis; inflorescentiis in axillis superioribus, usque ad 8 cm longis, simpliciter racemosis; calycis lobis ovatis, acuminatis, perspicue glandulosis, margine ciliatis, circiter 1.5 mm longis; fructibus globosis, glabris, circiter 6 mm diametro.

A dwarfed, erect, simple undershrub about 20 cm high, the stems erect or decumbent below, woody, up to 5 mm in diameter, dark-brown. Leaves crowded toward the apices of the stems, olivaceous, chartaceous to subcoriaceous, obovate to oblong-obovate, 8 to 13 cm long, 4 to 5.5 cm wide, glabrous, epunctate or with but few glands, apex broadly rounded, narrowed below to the acute or subacute base, the margins entire; lateral nerves 12 to 15 on each side of the midrib, distinct; petioles 4 to 7 mm long. Racemes simple, erect, up to 8 cm long, in the upper axils, glabrous. Pedicels 3 to 4 mm long, recurved, the subtending bracteoles ovate to oblong-ovate, prominently glandular, up

to 2.5 mm in length. Calyx about 5 mm in diameter, the lobes ovate, acuminate, about 1.5 mm long, prominently glandular, margins ciliate. Fruits globose, glabrous, about 6 mm in diameter, the styles slender, 3 to 4 mm long.

SARAWAK, *Native collector* 672, 424, 1448, 1178 (type) *Bur. Sci.*, one of the specimens from Matang Road, July 25, 1911, the others not localized.

This very characteristic species is somewhat anomalous in the section *Bladhia* in its racemose inflorescences, entire leaves, and in being glabrous throughout. It does not appear to be closely allied to any previously described species of the genus.

ARDISIA LUCIDA sp. nov. § *Pimelandra*.

Arbor circiter 8 m alta, novellis minutissime ferrugineo-tomentosis exceptis glabra; foliis oblongis, chartaceis, nitidis, usque ad 13 cm longis, alternis, supra subolivaceis, subtus pallide brunneis, utrinque subaequaliter angustatis, acuminatis, integris, epunctatis, nervis utrinque circiter 14, curvatis, anastomosantibus, supra plerumque impressis, subtus prominulis; inflorescentiis axillaribus, circiter 2 cm longis, bipinnatim paniculatis, e basi ramosis, floribus umbellatim dispositis; calycis lobis oblongis, acutis, 1.2 mm longis, leviter furfuraceis, margine minute ciliatis, eglandulosis.

A tree about 8 m high, glabrous except the minutely ferruginous-tomentose growing tips of the branchlets. Branches terete, brownish, smooth. Leaves alternate, chartaceous, shining on both surfaces, the upper surface subolivaceous, the lower pale-brownish, epunctate, oblong, 9 to 13 cm long, 2.5 to 5 cm wide, subequally narrowed to the acute or somewhat acuminate base and the distinctly acuminate apex; primary lateral nerves about 14 on each side of the midrib, usually impressed on the upper surface, prominent on the lower surface, curved, anastomosing, the reticulations close, not prominent; petioles 9 to 13 mm long. Panicles bipinnate, branched from the base, axillary, about 2 cm long, solitary, lax, few-flowered, the flowers umbellately disposed, the pedicels, in fruit, about 5 mm long. Calyx slightly furfuraceous, about 4 mm in diameter, the lobes oblong, acute, about 1.2 mm long, eglandular, margins slightly ciliate. Fruits globose, glabrous, about 5 mm in diameter.

BRITISH NORTH BORNEO, Mount Kinabalu, Lobang and Minitindok Gorges, *Mrs. Clemens* 10435 (type), 10331, November 15 and 19, 1915.

This species, a characteristic one of the section *Pimelandra*, falls in the group with, and is most closely allied to, *Ardisia brachybotrys* Lauterb. & K. Schum. of New Guinea, from which it may be distinguished by its differently shaped, smaller leaves, its eglandular sepals, and its smooth, not tuberculate fruits.

ARDISIA DOLICHOSEPALA sp. nov. § *Crispardisia*.

Frutex glaber, vel ramulis et inflorescentiis parcissime pubescens; foliis alternis, oblong ad oblongo-lanceolatis, membranaceis, olivaceis, nitidis, usque ad 21 cm longis, utrinque subaequaliter angustatis, acuminatis, nigro-punctatis, margine irregulariter crenatis, nervis utrinque circiter 15, tenuibus; inflorescentiis subsessilibus vel pedunculatis, paucifloris, umbellatis; floribus 5-, rariter 6-meris, circiter 8 mm longis, sepalis membranaceis, lanceolatis, obtusis, 7 ad 8 mm longis, perspicue punctatis; petalis perspicue punctatis, oblongo-ovatis, sepalis aequilongis.

A glabrous shrub or the very young branchlets and inflorescences very slightly pubescent. Branches terete, brownish, rugose. Leaves alternate, membranaceous, olivaceous, shining, oblong to oblong-lanceolate, 12 to 21 cm long, 3 to 4.5 cm wide, subequally narrowed to the acute base and the blunt-acuminate apex, the margins irregularly crenate, conspicuously black-punctate; lateral nerves about 15 on each side of the midrib, slender, anastomosing, the reticulations very lax, indistinct; petioles 1 to 1.5 cm long. Umbels simple, in the upper axils, subsessile or pedunculate, the peduncles up to 3 cm in length, the pedicels about 1 cm long, ten or fewer flowers in each umbel. Flowers pink, about 8 mm long, the bracteoles oblong, glandular, up to 3 mm in length. Sepals membranaceous, lanceolate, obtuse, conspicuously glandular-punctate, 7 to 8 mm long, 1.6 to 2 mm wide, nearly glabrous, the margins sometimes with a few short hairs. Petals as long as the sepals, oblong-ovate, acuminate, conspicuously glandular-punctate, about 4 mm wide. Anthers oblong-ovate, subobtuse, 4 mm long, the connectives glandular. Ovary ovoid, glabrous; style slender, 7 mm long. Fruits red, brown when dry, subglobose, about 6 mm in diameter.

BRITISH NORTH BORNEO, Mount Kinabalu, Gurulau Spur, Minitindok Gorge, and Kiau, *Mrs. Clemens 10819* (type), *10486*, s. n., November 17 and 27, 1915.

The alliance of this species is with *Ardisia petocalyx* Scheff., from which it is distinguished by its vegetative and inflorescence characters. The flowers are occasionally 6-merous, but normally 5-merous. The sinuses of the crenulations bear the characteristic glands of the subgenus, the leaf-margin otherwise bearing a rather close row of black glands similar to those that are scattered over other parts of the leaf.

ARDISIA OBSCURINERVIA sp. nov. § *Tinus*.

Arbor, partibus junioribus minute furfuraceo-lepidotis exceptis glabra; foliis alternis, coriaceis, oblongis, usque ad 17 cm longis, in siccitate olivaceo-brunneis, opacis vel leviter nitidis, utrinque subaequaliter angustatis, basi acutis, apice leviter obtuse

acuminatis, epunctatis, nervis lateralibus valde obscuris, interdum obsolete; inflorescentiis e axillis foliis reductis, paniculam foliaceam formans; floribus umbellatim dispositis; sepalis orbiculari-ovatis, 3 mm longis, imbricatis, obscure glandulosis vel eglandulosis, margine ciliatis; petalis elliptico-ovatis, 4 ad 5 mm longis, obtusis, epunctatis.

A tree, glabrous except the minutely furfuraceous-lepidote younger parts, the indumentum subferruginous, deciduous. Branches terete, grayish, glabrous. Leaves alternate, coriaceous, oblong, 12 to 17 cm long, 4 to 4.5 cm wide, those subtending the inflorescences greatly reduced and 3 to 5 cm in length, subequally narrowed to the acute base and the blunt-acuminate apex, brownish-olivaceous and dull or slightly shining when dry, of the same color on both surfaces, entire, epunctate, the midrib impressed on the upper surface, prominent beneath, the lateral nerves very slender, obscure, sometimes obsolete; petioles stout, rugose, pale, about 8 mm long. Inflorescences from the axils of reduced leaves toward the apices of the branches, forming a somewhat leafy panicle, all lateral, the individual inflorescences bipinnate, the flowers umbellately arranged at the tips of the branches, 5 to 7 flowers in a panicle, their pedicels 5 mm long or less, subtended by oblong bracteoles, the primary branches 1 cm long or less, subtended by oblong-lanceolate bracts up to 8 mm in length. Sepals 3 mm long, imbricate, orbicular-ovate, rounded, obscurely glandular, margins ciliate. Petals elliptic-ovate, 4 to 5 mm long, 3 mm wide, obtuse, glabrous, epunctate. Ovary depressed-globose, glabrous; style 5 mm long, included. Anthers oblong-ovate, acuminate, 3 mm long, the connectives not or very obscurely glandular.

SARAWAK, Lundu, *Foxworthy 34*, May 10, 1908, with the local name *gimá*.

The alliance of this species is apparently with *Ardisia pendula* Mez, from which it is distinguished, among numerous other characters, by its shorter petioles, epunctate leaves, erect or spreading, not pendulous inflorescences, and smaller flowers.

ARDISIA LANCIFOLIA sp. nov. § *Acrardisia*.

Frutex, ramulis junioribus dense cupreo-lepidotis, foliis subter parce sed distincte lepidotis; foliis lanceolatis ad oblongo-lanceolatis, chartaceis, olivaceis, nitidis, usque ad 11 cm longis, integris, basi acutis, apice tenuiter acuminatis, epunctatis vel punctis paucis instructis, nervis utrinque circiter 10, tenuibus, anastomosantibus; inflorescentiis terminalibus, paucifloris, 2 ad 3 cm longis, floribus subumbellatim dispositis; calycis lobis oblongo-ovatis, obtusis, perspicue parce punctatis, margine ciliatis, cir-

citer 1 mm longis; petalis oblongo-ovatis, 3.5 mm longis, acuminatis, epunctatis vel cum glandulis 1 vel 2 instructis.

A shrub, the young branchlets and the inflorescences rather densely cupreous-lepidote, the leaves distinctly but sparingly lepidote on the lower surface. Branches terete, glabrous, brownish, slender. Leaves alternate, chartaceous, usually olivaceous when dry, shining, lanceolate to oblong-lanceolate, 5.5 to 11 cm long, 1.5 to 2.5 cm wide, entire, the base acute, apex slenderly but bluntly acuminate, eglandular or with few glands, the lower surface with scattered, brown or cupreous, minute scales; lateral nerves about 10 on each side of the midrib, slender, distinct, anastomosing; petioles 5 to 10 mm long. Inflorescence terminal, paniculate, few-flowered, more or less cupreous-lepidote, the flowers subumbellately arranged on the ultimate branchlets, usually but two or three to a branchlet, their pedicels 5 to 7 mm long. Calyx 3 mm in diameter, the lobes oblong-ovate, obtuse, ciliate on the margins, each lobe with 2 to 5 conspicuous glands. Petals oblong-ovate, acuminate, 3.5 mm long, eglandular or with one or two glands. Anthers oblong-lanceolate, acuminate, 2.5 mm long, the connectives slightly glandular. Ovary glabrous; style 2 to 2.5 mm long.

BRITISH NORTH BORNEO, Mount Kinabalu, Kemberanga and Gurulau Spur, *Mrs. Clemens 10518* (type), *10827*, November 15 and 27, 1915.

This is allied to both *Ardisia kinabaluensis* Merr. and *A. lepidotula* Merr., differing from the former conspicuously in its fewer-nerved leaves, and from the latter in its distinct nerves, widely scattered lepidote scales on the lower surface of the leaves, and other characters.

ARDISIA KINABALUENSIS sp. nov. § *Acrardisia*.

Frutex, partibus junioribus minute cupreo-lepidulotis; foliis alternis, olivaceis vel brunneo-olivaceis, nitidis, oblongis ad oblongo-ellipticis, usque ad 9 cm longis, obtuse acuminatis, basi acutis, utrinque punctis multis instructis, nervis utrinque circiter 18, tenuibus, distinctis; inflorescentiis terminalibus, circiter 4 cm longis, bipinnatim paniculatis, paucifloris, floribus in ramulis ultimis umbellatim dispositis; floribus circiter 1 cm diametro, calycis lobis oblongo-ovatis, obtusis, circiter 1 mm longis, parce punctatis, margine minute ciliatis; petalis 5 mm longis, oblongo-ovatis, acuminatis, parce glanduloso-punctatis.

A shrub, the very young parts distinctly but minutely cupreous-lepidote, the older parts entirely glabrous. Branches terete, brownish or reddish-brown, glabrous. Leaves alternate, subcoriaceous, olivaceous to brownish, shining, oblong to oblong-elliptic, 5 to 9 cm long, 2 to 4 cm wide, base acute, apex blunt-acuminate, margins entire, both surfaces with numerous, black

or dark-colored glands, these often visible to the naked eye; lateral nerves about 18 on each side of the midrib, slender, distinct on both surfaces; petioles 2 to 3 mm long. Panicles bipinnate, terminal, few-flowered, about 4 cm long, the flowers umbellately arranged at the tips of the ultimate branchlets, their pedicels up to 7 mm in length. Flowers (spread) about 1 cm in diameter. Calyx about 3 mm in diameter, the lobes oblong-ovate, obtuse, sparingly glandular, 1 mm long, their margins minutely ciliate. Petals 5 mm long, oblong-ovate, acuminate, sparingly glandular-punctate. Anthers oblong-lanceolate, acuminate, 3 mm long, the connectives not glandular. Ovary glabrous; style 3.5 mm long, not exerted in bud.

BRITISH NORTH BORNEO, Mount Kinabalu, Kemberanga, and Paka Cave to Low's Peak, ascending to an altitude of 3,350 meters, *Mrs. Clemens 10517* (type), 10663, 10663a, November 12 to 15, 1915, *Haslam*, August, 1916.

This species is manifestly allied to the Philippine *Ardisia scabrada* Mez, from which it is distinguished, among other characters, by its thicker leaves, and obtuse, distinctly ciliate sepals.

ARDISIA LEPIDOTULA sp. nov. § *Acrardisia*.

Frutex circiter 1.5 m altus, ramulis et inflorescentiis et subtus foliis junioribus dense ferrugineo- ad cupreo-lepidotulis; foliis oblongis, petiolatis, chartaceis ad subcoriaceis, integris, usque ad 8 cm longis, brunneis vel olivaceis, basi acutis, apice distincte sed obtuse acuminatis, utrinque minutissime punctulatis, nervis primariis utrinque circiter 12, tenuibus, indistinctis, interdum subobsoletis; inflorescentiis terminalibus, 2 ad 4 cm longis, paucifloris, tripinnatim paniculatis, floribus parvis, in ramulis ultimis umbellatim dispositis; sepalis oblongo-ovatis, obtusis, circiter 1 mm longis, glandulosis, margine leviter ciliatis; petalis parce glandulosis, circiter 3 mm longis.

A shrub about 1.5 m high, the young branchlets, lower surface of the younger leaves, and the inflorescences densely and minutely ferruginous- to cupreous-lepidulote, the very old leaves glabrous or nearly so. Branches terete, grayish-brown, rugose, glabrous. Leaves alternate, chartaceous to subcoriaceous, oblong, 4 to 8 cm long, 1.5 to 2.5 cm wide, entire, brownish or olivaceous and more or less shining when dry, base acute, apex distinctly but bluntly acuminate, the midrib usually impressed on the upper surface, prominent on the lower surface, both surfaces very minutely and obscurely punctulate; primary lateral nerves about 12 on each side of the midrib, very slender, usually obscure, often nearly obsolete; petioles about 5 mm long, ultimately glabrous, when young densely cupreous-lepidote. Panicles termi-

nal, 2 to 4 cm long, bipinnately paniculate, few-flowered, densely cupreous-lepidote, the primary branches few, 1 cm long or less, the flowers umbellately arranged on the ultimate branchlets, their pedicels 3 mm long or less. Sepals oblong, obtuse, about 1 mm long, not at all imbricate, margins minutely ciliate, glandular-punctate. Petals glabrous, oblong-ovate, subacute, sparingly glandular, about 3 mm long. Styles not at all exerted.

SARAWAK, Mount Poe, *Foxworthy* 375, 386 (type), June 3, 1908, near the summit, altitude about 1,700 meters; Mount Santubong, *Native collector* 2227 *Bur. Sci.*

In the group of comparatively few species to which this form pertains, it is well characterized by its small inflorescences but more especially by its ferruginous to cupreous lepidote indumentum.

ARDISIA HOSEI sp. nov. § *Acrardisia*.

Arbor glabra, ramis ramulisque teretibus; foliis oblongis ad oblongo-lanceolatis, chartaceis, olivaceis, usque ad 20 cm longis, acuminatis, basi acutis, utrinque perspicue glandulosis, nervis primariis utrinque 15 ad 18, tenuibus; inflorescentiis terminalibus, pedunculatis, 10 ad 12 cm longis, bipinnatim paniculatis, paucifloris; floribus magnis, apertis circiter 2.5 cm diametro, racemose dispositis, pedicellis 1 ad 1.3 cm longis; sepalis sub anthesin apertis, haud imbricatis, oblongo-obovatis ad obovato-ellipticis, obtusis, glabris, perspicue nigro-punctatis, in alabastro valde imbricato; petalis circiter 1.2 mm longis, obtusis, glanduloso-punctatis, oblongo-ellipticis.

A glabrous tree, the branches and branchlets terete, reddish-brown, sparingly glandular-punctate. Leaves alternate, chartaceous, olivaceous, slightly shining, oblong to oblong-lanceolate, 13 to 20 cm long, 4 to 5 cm wide, base acute, apex somewhat acuminate, the acumen blunt, both surfaces conspicuously and rather densely glandular-punctate, the glands all alike in size, margins entire; primary lateral nerves 15 to 18 on each side of the midrib, slender, sometimes scarcely more prominent than are the secondary nerves; petioles 1 to 1.8 cm long. Panicles terminal, bipinnate, few-flowered, peduncled, 10 to 12 cm long, the flowers racemosely arranged on the ultimate branches, the pedicels 1 to 1.3 cm long. Flowers unusually large for the genus, when spread about 2.5 cm in diameter. Sepals in bud strongly imbricate, in anthesis spreading, not at all imbricate, oblong-obovate to elliptic-obovate, entirely glabrous, conspicuously black-glandular, rounded or obtuse. Corolla-lobes nearly free, about 12 mm long, 5 mm wide, obtuse, glandular, oblong-elliptic. Fila-

ments about 3 mm long; anthers oblong-lanceolate, subcaudate-acuminate, 5 to 6 mm long, the connectives sparingly glandular.

SARAWAK, Baram District, Marudi, *Hose 585*, April, 1905.

This species is well characterized by its unusually large flowers, in the characters of these differing entirely from *Ardisia polyactis* Mez, to which it is apparently most closely allied; in vegetative characters it closely approximates Mez's species.

OLEACEAE

LINOCIERA Swartz

LINOCIERA MACROBOTRYS sp. nov.

Frutex glaber, ramulis laevis, teretibus, rubro-brunneis; foliis coriaceis, oblongis, subolivaceis, utrinque subconcoloribus, nitidis, usque ad 6 cm longis, subtus minute puncticulatis, utrinque acutis vel apice obscure acuminatis, nervis utrinque circiter 6, tenuibus, obscuris, interdum obsolete vel subobsolete, subtus leviter impressis, reticulis obsolete; inflorescentiis usque ad 15 cm longis, amplis, multifloris, laxis, ramis inferioribus usque ad 9 cm longis quadripinnatim paniculatis; floribus tenuiter pedicellatis, 4-meris, circiter 4 mm longis, petalis basi leviter connatis, oblongis, obtusis.

A shrub 2 m high *vide* Foxworthy, entirely glabrous in all parts, the branches terete, smooth, reddish-brown, sometimes slightly glaucous. Leaves coriaceous, oblong, 5 to 6 cm long, 2 to 2.5 cm wide, subequally narrowed to the acute base and apex, or the apex slightly acuminate, margins usually recurved, entire, when dry subolivaceous to brownish-olivaceous, of about the same color and shining on both surfaces, the lower surface minutely punctulate, the midrib impressed on the upper surface, somewhat prominent on the lower surface; lateral nerves very slender, obscure, sometimes obsolete or nearly so, about 6 on each side of the midrib, not anastomosing, the reticulations obsolete, often very slightly impressed on the lower surface; petioles about 5 mm long. Panicles terminal and lateral, ample, 4-pinnately paniculate, up to 15 cm in length, branched from near the base, the lower branches up to 9 cm in length, lax, many-flowered, the bracts deciduous, about 3 mm long, the rachis and branches reddish-brown when dry. Flowers yellowish, brown when dry, 4-merous, about 2 mm long, their pedicels 2 to 3 mm in length. Calyx-teeth triangular-ovate, acute, 0.5 mm long. Petals somewhat united, oblong, obtuse. Anthers 1.2 mm long, the connectives very broad.

SARAWAK, Mount Poe, *Foxworthy 369* (type), 290, June 3, 1908 in forests on the upper slopes of the mountain, altitude 1,500 to 1,700 meters, with the Dyak name *barungian batu*.

The striking characters of this species are its small, coriaceous, very obscurely nerved, non-reticulate leaves, and its unusually large panicles. It does not seem to be closely allied to any other described Malayan species.

LINOCIERA OLIGANTHA sp. nov.

Arbor glabra, vel bracteolis calycibusque parcissime pubescentibus, ramis ramulisque pallidis, teretibus; foliis oblongis, chartaceis ad subcoriaceis, usque ad 15 cm longis, in siccitate laevis, pallidis, nitidis, apice acuminatis, basi acutis, nervis utrinque circiter 8, tenuibus, supra saepe obsoletis vel subobsoletis, subtus leviter prominulis, reticulis obsoletis vel subobsoletis; inflorescentiis axillaribus, spiciformibus, solitariis vel binis, usque ad 1.5 cm longis, paucifloris; floribus circiter 5.5 mm longis, 4-meris, petalis involutis.

A tree, glabrous throughout or the bracteoles and calyces very obscurely pubescent. Branches and branchlets terete, slender, smooth, pale. Leaves opposite, oblong, chartaceous to subcoriaceous, eglandular, smooth, pale, and shining when dry, 10 to 15 cm long, 3.5 to 5 cm wide, subequally narrowed to the acute base and to the prominently but blunt-acuminate apex, the midrib impressed on the upper surface, somewhat prominent on the lower surface; lateral nerves about 8 on each side of the midrib, slender, not prominent, often obsolete or subobsolete on the upper surface, slightly projecting on the lower surface, obscurely anastomosing, the reticulations lax, indistinct, often obsolete or nearly so; petioles pale, stout, 4 mm long or less. Inflorescences spike-like, simple, axillary, solitary or in pairs, few-flowered, 5 to 15 mm long, all parts except the pale bracteoles dark-brown when dry, the bracteoles ovate, 1.2 mm long, usually slightly pubescent. Flowers opposite, subsessile, 5 to 5.5 mm long, 4-merous. Calyx-lobes broadly ovate, rounded, 0.4 mm long, often obscurely pubescent. Petals 4.5 mm long, slightly united at the base, oblong, involute, obtuse, glabrous. Filaments very short; anthers elliptic, about 1 mm long. Ovary glabrous.

BRITISH NORTH BORNEO, *Villamil 385* (type), June, 1917. I am also disposed to refer to this species *Hose 554* from Mount Trekan, Baram District, Sarawak, July, 1895, which closely resembles the type, differing in its even shorter inflorescences and more distinctly nerved leaves.

The alliance of this species is manifestly with *Linociera montana* (Blume) DC. of Java, from which it is distinguished, among other characters, by its slender lateral nerves being distinctly raised on the lower surface of the leaves.

LINOCIERA VERRUCULOSA sp. nov.

Arbor circiter 10 m alta, ramulis et inflorescentiis plus minusve subferrugineo-pubescentibus; foliis subcoriaceis, oblongis, usque ad 24 cm longis, breviter et abrupte subapiculato-acuminatis, basi acutis, in siccitate brunneis, nitidis, laevis, eglandulosis; nervis lateralibus utrinque 10 ad 12, supra impressis, subtus prominulis, anastomosantibus, reticulis laxissimis; paniculis lateralibus, 6 ad 8 cm longis, pubescentibus, bi- vel tripinnatis, floribus in ramulis subspicatum dispositis, 4-meris, calycis ovoideis, 1.2 mm longis; fructibus ellipsoideis, in siccitate atro-brunneis, junioribus circiter 1.3 cm longis, perspicue verrucosis.

A tree about 10 m high, the branchlets and inflorescences more or less ferruginous- or subferruginous-pubescent. Branches grayish, smooth, terete, the branchlets pale-brownish. Leaves oblong, subcoriaceous, 20 to 24 cm long, 7 to 8 cm wide, brown and shining when dry, somewhat paler on the lower surface than the upper, smooth, eglandular, the base acute, the apex abruptly and broadly subapiculate, the midrib and nerves impressed on the upper surface, prominent on the lower surface, the nerves 10 to 12 on each side of the midrib, prominent, anastomosing, the reticulations very lax; petioles 1 to 1.2 cm long. Panicles lateral, 6 to 8 cm long, peduncled or branched from near the base, bi- or tripinnate, the flowers subspicately crowded on the ultimate branchlets, 4-merous, subsessile or very shortly pedicelled, the bracts pubescent, 1.5 mm long or less. Calyx ovoid, about 1.2 mm long, the lobes ovate, obtuse, pubescent, 0.8 mm long. Corolla not seen. Fruits (immature) when dry blackish-brown, ellipsoid, about 1.3 cm long, very prominently verrucose, their pedicels about 2 mm long, much thicker than long.

BRITISH NORTH BORNEO, in forests along the Kalabakan River, *Villamil 224*, September 26, 1916, altitude about 3 meters.

This species is strikingly characterized by its prominently verrucose fruits, all other species of the genus known to me having smooth fruits. In vegetative characters it closely resembles *Linociera callophylla* (Blume) Knobl., as I have interpreted the latter from the short and imperfect description, and is also similar to "IV, A, 120" in cultivation in the Botanic Garden at Buitenzorg, Java, from Sumatra; the latter bears an unpublished name of Scheffer's, and Boldingh⁵ has erroneously referred it to *Chionanthus ramiflora* Roxb., with which it has little in common. It is suspected that this specimen will prove to be the same as *Linociera callophylla* Knobl.

⁵ Cat. Herb. Hort. Bogor. (1914) 152.

GENTIANACEAE

GENTIANA Linnaeus

GENTIANA CLEMENTIS sp. nov.

Species *G. atkinsonii* Burkill valde affinis, differt foliis paullo minoribus, floribus paullo brevioribus, corollae lobis haud reticulatis, acutis.

A caespitose, perennial, glabrous plant 10 cm high or less, from stout, elongated, perpendicular roots, the basal leaves rosulate, the flowering branches up to 6 cm in length, spreading or ascending, several from each plant, leafless or with but one pair of leaves in addition to those subtending the flowers. Basal leaves 3 to 5 cm long, 4 to 6 mm wide, coriaceous, shining, sessile, lanceolate, acuminate, the midrib prominent, those on the flowering branches similar to the cauline ones but smaller. Flowers pale-purplish, sessile or subsessile, 2 to 4 at the apex of each branch, subtended by a whorl of 2 to 4 bract-like leaves. Calyx-tube 6 to 8 mm long, narrowed below, the teeth lanceolate, acuminate, 3 to 4 mm long. Corolla about 2.3 cm long, the lobes oblong-ovate, acute, 5 mm long, the tube narrowed below, plicate, the alternating small lobes triangular-acute, about 1 mm long. Stamens about as long as the corolla-tube; style recurved, 3 mm long.

BRITISH NORTH BORNEO, Mount Kinabalu, Paka Cave to Low's Peak and Paka Cave to Lobang, Mrs. Clemens 10703 (type), 10650, November 13 and 15, 1915, in wet ground, associated with *Potentilla*, altitude 2,400 to 4,000 meters.

This is the third representative of the genus to be found in Borneo, the other two being known only from Mount Kinabalu, and both of them represented in Mrs. Clemens's collection. It is a distinct Asiatic type and is very closely allied to *Gentiana atkinsonii* Burkill, a species known only from Loh Fau Mountain, Kwangtung Province, China, of which I have a topotype (Merrill 10326). It so strongly resembles Burkill's species that had the specimens described above been collected on Loh Fau Mountain it is very probable that botanists generally would have referred them to *Gentiana atkinsonii* Burkill as a somewhat reduced form. The Kinabalu specimens differ from Burkill's specimens in the small size of the plants, the shorter flowering branches, smaller leaves, and somewhat smaller flowers.

ASCLEPIADACEAE

CEROPEGIA Linnaeus

CEROPEGIA BORNEENSIS sp. nov.

Herba scandens, glabra, ramulis teretibus; foliis membranaceis, oblongis ad oblongo-ovatis, usque ad 10 cm longis, acutis vel acute-acuminatis, basi rotundatis vel subtruncatis, nervis utrin-

que 4 vel 5, distantibus; cymis axillaribus, tenuiter pedunculatis, paucifloris; floribus 5 ad 7 cm longis, curvatis, corollae tubo infra leviter inflato deinde constricto, lobis lanceolatis, acuminatis, circiter 2 cm longis, supra cohaerentibus.

A scandent, rather slender, herbaceous plant, the stems terete, twining. Leaves opposite, membranaceous, generally oblong, sometimes oblong-ovate, rather pale and shining when dry, the apex acute to acutely acuminate, base rounded to subtruncate, the lateral nerves 4 or 5 on each side of the midrib, curved, distant, rather distinct; petioles 1.5 to 2.5 cm long. Cymes axillary, few-flowered, their peduncles 5 to 7 cm long. Flowers 5 to 7 cm long, white or yellowish-white and purplish, the pedicels 2 to 3 cm in length. Sepals narrowly lanceolate, acuminate, glabrous, 3 mm long. Corolla-tube pubescent within, somewhat inflated at the base, then constricted, somewhat curved, again inflated above the constriction, the lobes lanceolate, acuminate, about 2 cm long, cohering by their apices. Follicles slender, terete, about 25 cm long, curved.

BRITISH NORTH BORNEO, Khota Balud to Kibayo, trail to Mount Kinabalu, Mrs. Clemens 9810 (type), Topping 1490, October 28, 1915, in thickets along the trail.

The genus *Ceropegia* is poorly represented in Malaya, this being the first one to be reported from Borneo. The flowers are much larger than are those of the Philippine *Ceropegia cumingiana* Decne. or of the Javan *C. curviflora* Hassk.

RUBIACEAE

XANTHOPHYTUM Blume

XANTHOPHYTUM INVOLUCRATUM sp. nov.

Frutex erectus, foliis junioribus subtus dense adpresse subferrugineo-pilosus; foliis chartaceis vel submembranaceis, oblongis ad oblongo-oblancoelatis, usque ad 18 cm longis, utrinque acuminatis, longe petiolatis, nervis utrinque circiter 15, perspicuis; stipulis latissime ovatis, acuminatis, usque ad 1.8 cm longis; inflorescentiis subcapitatis, axillaribus, pedunculatis, bracteis bracteolisque magnis numerosis involucriformibus instructis.

An erect shrub, the younger leaves densely appressed pilose beneath, the indumentum subferruginous, shining, the sparse indumentum on the older parts ferruginous to castaneous, the branches and branchlets somewhat 4-angled. Leaves chartaceous to submembranaceous, oblong to oblanceolate, 13 to 18 cm long, 3.5 to 6 cm wide, subequally narrowed to the acuminate base and apex, olivaceous, the upper surface smooth, glabrous, the lower somewhat pubescent on the midrib, nerves, and reticula-

tions; lateral nerves about 15 on each side of the midrib, distinct, dark-brown in contrast to the paler surface; petioles 3 to 6 cm long; stipules very broadly ovate, subpersistent, up to 1.8 cm long and 1.4 cm wide, striate. Inflorescences axillary, solitary, peduncled, subcapitate, in fruit up to 1.5 cm in diameter without the bracts, the peduncles about 1.5 cm long; bracts subtending the heads ovate, up to 15 mm long and 10 mm wide, somewhat pubescent, the bracteoles in general elliptic, up to 5 mm long and 2.5 mm wide. Fruits subglobose, about 3 mm in diameter, somewhat ferruginous- or castaneous-hirsute, their pedicels up to 3 mm in length.

SARAWAK, Sadong, Mount Merinjak, *Native collector 2591 Bur. Sci.*, February-June, 1914.

This species, not radically different from *Xanthophytum fruticosum* Blume in vegetative characters, is well characterized by its large stipules and its peduncled, solitary, subcapitate, involucrate inflorescences.

THE PHILIPPINE BUREAU OF SCIENCE

RECENT PUBLICATIONS

AN INTERPRETATION OF RUMPHIUS'S HERBARIUM AMBOINENSE

By E. D. MERRILL

Based on the collections made in Amboina by the late Charles Budd
Robinson

Order No. 450. Bureau of Science Publication No. 9. Paper, 595 pages and 2 maps.
Price \$3, United States currency, postpaid.

The Herbarium Amboinense is a classical work on the Malayan flora and one that is absolutely essential to the systematist to-day. The great importance of the work is due to the fact that later authors have made the Rumphian descriptions and figures the actual "types" of many binomials. As an original source the Herbarium Amboinense stands preëminent among all the early publications on Malayan botany.

Professor Merrill's interpretation of the Herbarium Amboinense discusses the status of each species described by Rumphius and assigns it to a position in the modern system of classification. This publication will be of great service to any one working on Indo-Malayan systematic botany.

A GRAMMAR OF LEPANTO IGOROT AS IT IS SPOKEN AT BAUCO

By MORICE VANOVERBERG

Order No. 438. Vol. V, Part VI, Division of Ethnology Publications. Paper, 102 pages.
Price \$0.75, United States currency, postpaid.

This part completes Volume V of the Division of Ethnology publications and includes the index and the title-page for the volume. A title-page for Volume II is printed with this number.

PLEASE GIVE ORDER NUMBER

Orders for these publications may be sent to the BUSINESS MANAGER, Philippine Journal of Science, Bureau of Science, Manila, P. I., or to any of the following agents:

AGENTS

THE MACMILLAN COMPANY, 64-66 Fifth Avenue, New York, U. S. A.

WM. WESLEY & SON, 28 Essex Street, Strand, London, W. C., England.

MARTINUS NIJHOFF, Lange Voorhout 9, The Hague, Holland.

KELLY & WALSH, Limited, 32 Raffles Place, Singapore, Straits Settlements.

A. M. & J. FERGUSON, 19 Baillie Street, Colombo, Ceylon.

THACKER, SPINK & Co., P. O. Box 54, Calcutta, India.

CONTENTS

	Page.
MERRILL, E. D. New species of Bornean plants.....	67

The Philippine Journal of Science is issued in four sections. Each section consists of six numbers a year, is separately paged and indexed, and is a complete publication in itself. Authors receive 100 copies of their papers free.

	U. S. currency.
SUBSCRIPTION RATES TO CURRENT VOLUME	
Section A (Chemical and Geological Sciences and the Industries)	\$2.00
Section B (Tropical Medicine).....	3.00
Section C (Botany), Elmer D. Merrill, B. S., M. S., Editor.....	2.00
Section D (General Biology, Ethnology, and Anthropology). Section D began with Volume V.....	2.00
Entire Journal (4 sections).....	7.00

PRICES OF BACK NUMBERS AND VOLUMES	
Entire Journal, Volume II, III, or IV (3 sections each); or V (4 sections)	5.00
Entire Journal, beginning with Volume VI (per volume).....	7.00
Single numbers of Volume I.....	.75
Single numbers (except of Volume I).....	.50
Volume I, 1906 (not divided into sections), and supplement, sold only with a complete file of section A, B, or C.....	10.00
Supplement to Volume I (Botany).....	3.50
Volume I (without supplement), sold only with a complete file of section A, B, or C.....	6.50

Publications sent in exchange for the Philippine Journal of Science should be addressed: Library, Bureau of Science, Manila, P. I.

Subscriptions may be sent to the BUSINESS MANAGER, Philippine Journal of Science, Bureau of Science, Manila, P. I., or to any of the agents listed on the inside pages of this cover.

VOL. XIII, SEC. C, No. 3

MAY, 1918

THE PHILIPPINE JOURNAL OF SCIENCE

ALVIN J. COX, M. A., PH. D.
GENERAL EDITOR

SECTION C. BOTANY

E. D. MERRILL, M. S.
EDITOR

WITH THE COÖPERATION OF

W. H. BROWN, PH. D.; C. F. BAKER, M. A.
L. M. GUERRERO, PHAR. D.; R. C. MCGREGOR, A. B.

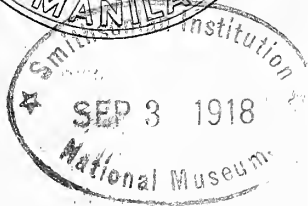

MANILA
BUREAU OF PRINTING
1918

PHILIPPINE JOURNAL OF SCIENCE

A TEN-YEAR INDEX

CONTENTS AND INDEX OF THE PHILIPPINE JOURNAL OF SCIENCE, VOLUME I (1906) TO VOLUME X (1915)

Order No. 449. Bureau of Science Publication No. 8. Paper, 441 pages.
Price \$2, United States currency, postpaid.

One copy of this index has been sent free of charge to each subscriber that has received Volumes XI and XII of the Journal.

This publication consists of:

The complete contents of the first ten volumes of the Philippine Journal of Science, all sections; giving all authors, titles of articles, and page numbers. The exact date of issue of each number is recorded.

An author index, being an alphabetical list of all the contributors. The titles of all the articles are listed under the names of their respective authors.

A subject index. The subject matter is very fully indexed by catch words from the titles, by geographical localities, and by subjects. All systematic names in zoölogy and botany, as well as the thousands of English and local names, are entered in the index.

STUDIES IN PHILIPPINE DIPTERA, II

By M. BEZZI

Order No. 437. Bureau of Science Publication No. 10. Paper, 59 pages and 1 plate.
Price \$0.50, United States currency, postpaid.

This is the second century of Professor Bezzi's enumeration of Philippine species of flies and includes descriptions of new genera and new species.

PLEASE GIVE ORDER NUMBER

Orders for Bureau of Science publications may be sent to the BUSINESS MANAGER, Philippine Journal of Science, Bureau of Science, Manila, P. I., or to any of the following agents:

AGENTS

THE MACMILLAN COMPANY, 64-66 Fifth Avenue, New York, U. S. A.
WM. WESLEY & SON, 28 Essex Street, Strand, London, W. C., England.
MARTINUS NIJHOFF, Lange Voorhout 9, The Hague, Holland.
KELLY & WALSH, Limited, 32 Raffles Place, Singapore, Straits Settlements.
A. M. & J. FERGUSON, 19 Baillie Street, Colombo, Ceylon.
THACKER, SPINK & Co., P. O. Box 54, Calcutta, India.



THE PHILIPPINE
JOURNAL OF SCIENCE

C. BOTANY

VOL. XIII

MAY, 1918

No. 3

NOTES ON THE FLORA OF LOH FAU MOUNTAIN, KWANGTUNG
PROVINCE, CHINA

By E. D. MERRILL¹

*(From the Botanical Section of the Biological Laboratory, Bureau of Science,
Manila)*

In 1916 I spent the period from October 13 to November 9 in prosecuting field work in botany in Kwangtung Province, working chiefly in the immediate vicinity of Canton, with a few days' trip to Loh Fau Mountain (Lofaushan). The trip was made possible through the interest of Doctor Walter T. Swingle, of the United States Department of Agriculture, and one of its objects was to encourage the authorities at the Canton Christian College to undertake the formation of a local herbarium and to initiate some work in a botanical exploration of Kwangtung Province in connection with the course in agriculture that was being developed in that institution. The idea of developing botanical work in the Canton Christian College was encouraged for the reason that through such work we could reasonably expect to secure in the future not only botanical material from the less-explored parts of Kwangtung Province, but also seeds and living plants of valuable economic species.

Mr. G. Weidman Groff, of the Canton Christian College, was deeply interested in the project but, on account of his pending departure for the United States on leave, the matter of developing the work devolved on Mr. C. O. Levine, who had recently accepted an appointment in the college. With such information as I could impart to Mr. Levine in the short time that I was in Canton as a basis for the work, he took up the project with great enthusiasm, and as one result has had collected and sub-

¹ Professor of botany, University of the Philippines.

mitted to me for identification more than 1,800 numbers of plants in slightly more than one year. The local herbarium established as a result of my visit is rapidly expanding and bids fair to prove a most valuable adjunct to the work of the college.

Through the continued interest of Doctor Swingle it was possible for me to repeat the trip in 1917, utilizing for the purpose my annual leave, as I had done in 1916. As a result of the two trips I have been able to spend the periods from October 13 to November 9, and from August 9 to August 27 in prosecuting field work in botany in Kwangtung Province. The work has resulted not only in the accumulation of considerable collections of botanical material, but the collections have yielded representatives of about seventy-five species not previously recorded from Kwangtung Province, including about thirty that are presumably new to science.

In a previous paper² based on collections made by me in 1916 I recorded about twenty-three species as new to the Kwangtung flora, describing six as new. The present paper is in the nature of a continuation of the first one, but is based chiefly on the collections made by me on Loh Fau Mountain (Lofaushan), August 9 to 27, 1917, supplemented by material secured by Mr. Levine in the same locality and collected at the same time, and includes some material secured by Mr. Levine at other localities in Kwangtung Province.

Loh Fau Mountain was selected as the base for field work not only because it is one of the highest mountains in Kwangtung Province, and because a botanical exploration of the region promised to yield considerable of interest, but also because of the fact that various American and European residents of Canton had established there a summer camp. By utilizing the facilities provided by this camp, the matter of prosecuting field work was greatly simplified. Moreover, the location of the camp at an altitude of approximately 1,000 meters rendered it possible for us to explore the more interesting floristic regions, which are located chiefly in the deep forested ravines at higher altitudes, with a minimum loss of time and effort. Most of our field work was prosecuted on the upper parts of the mountain, but trips were made to the base at So Liu Koon and at Wa Shau T'oi, as in the vicinity of the monasteries at these two places considerable low-altitude forested areas still exist. In the period from August 9, the date of our arrival at the camp, to August

² Merrill, E. D., Notes on the flora of Kwangtung Province, China, *Philip. Journ. Sci.* 12 (1917) *Bot.* 99-116.

28, the date of our departure on the return trip to Canton, I made a collection aggregating 544 numbers, independent of the extensive collections made by Mr. Levine in the same period.

Among the results of eighteen days' actual field work has been the accrediting of representatives of the following genera to the Kwangtung flora, none of them having previously been recorded from that Province: *Coniogramme*, *Hypolepis*, *Botrychium*, *Polytoca*, *Agrostis*, *Herminium*, *Skimmia*, *Tristylidium*, *Epilobium*, and *Brandisia*; the list may be increased by the addition of *Alnus*, of which sterile specimens, not in condition for further identification, were secured. A total of fifty-three species is here recorded from Kwangtung Province for the first time, including twenty-four that I have described as new.

The results secured indicate, as might be expected, that although about 2,575 different species of *Pteridophyta* and *Spermatophyta* are now known from Kwangtung Province, extensive additions to the known flora are to be expected as the result of intensive field work in any of the lesser known areas, especially in the mountainous regions. Loh Fau Mountain is indicated by Messrs. Dunn and Tutcher³ as one of the areas that is botanically explored, yet the short period that I was able to utilize in field work there in 1917, and the few days spent there in the previous year, have yielded material on which a relatively large number of species have been recorded as additions to the known flora of the province. A glance at the map accompanying their publication will at once reveal the fact that the greater part of Kwangtung Province has scarcely been visited, much less explored, by any botanist or collector. The work carried on by Mr. Levine so far, chiefly at low altitudes in the immediate vicinity of Canton, and in a region well-known botanically, continues to yield additions to the known flora. While it is true that continued field work in Kwangtung Province will yield material that will to a large degree duplicate collections already made, still such collections are necessary to give us an adequate conception of the characters of the flora, the range of the species, their relative abundance, their range of variation, their native names, and their economic uses. Southern China may justly be classed with those parts of the world that are very inadequately explored, and it will take intensive work over a period of many years before we are in a position properly to judge the extent of its flora. At the present time we can hardly state that more than a good start has been made in this direction. It is scarcely

³ Fl. Kwangtung and Hongkong, *Kew Bull. Add. Series* 10 (1912) 1-370.

to be expected that the Chinese themselves have the necessary interest and training to accomplish much in working up the botany of China, and for the present, at least, such work as is done must of necessity be largely accomplished by the foreign residents. The local resident who has an interest in the study of the natural sciences is as a rule infinitely better located to secure productive results than is the casual visitor or explorer who has but a limited amount of time to devote to field work; here as in other subtropical and tropical countries field work must be carried on in all months of the year, and in this respect the local resident always has the advantage of position. It is greatly to be desired that the botanical work on the flora of Kwangtung be continued and that botanical exploration be extended to the more remote and inaccessible parts of the province.

POLYPODIACEAE

ATHYRIUM Roth

ATHYRIUM WICHURAE (Mett.) comb. nov.

Asplenium wichurae Mett. in Ann. Mus. Bot. Lugd.-Bat. 2 (1866) 237.

Diplazium wichurae Diels in Engl. & Prantl Nat. Pflanzenfam. 1⁴ (1899) 226.

Kwangtung Province, Loh Fau Mountain (Lofaushan), Merrill 10988, Levine 1481, August 16, 1917, on damp shaded banks in deep ravines, altitude 1,000 to 1,100 meters.

This species, previously known from Japan, China, and Formosa, has not before been reported from Kwangtung Province. Except in its creeping rhizomes it closely resembles *Athyrium bulbiferum* (Brack.) (*Diplazium bulbiferum* Brack.; *Athyrium pinnatum* Copel., non *Allantodia pinnata* Blanco). I follow Copeland in treating *Diplazium* as congeneric with *Athyrium*, as in examining a large series of specimens it becomes evident that the two genera cannot be retained as distinct on account of the very numerous intermediate forms; it is sufficiently difficult always to distinguish between *Athyrium* and *Asplenium*, yet the number of intergrades between the latter are few in comparison with those between *Athyrium* and *Diplazium*.

The synonymy of the following Formosan species is here adjusted:

ATHYRIUM TENUISSIMUM (Hayata) comb. nov.

Nephrolepis tenuissima Hayata Ic. Pl. Form. 4 (1914) 202, f. 137.

Athyrium obtusifolium Rosenst. in Hedwigia 56 (1915) 335.

FORMOSA, Arisan, Ito 66, October, 1910, Faurie 364, May, 1914 (cotype of *Athyrium obtusifolium* Rosenst.).

This species is manifestly an *Athyrium* with dryopteroid sori and is closely allied to *Athyrium macrocarpum* (Blume) Milde. The species as described by Hayata (*Nephrolepis tenuissima* Hayata) is identical with *Athyrium obtusifolium* Rosenst., but Hayata's name being the older is here

adopted under its proper genus; Hayata's type was also from Arisan. It may be mentioned here that *Lycopodium fauriei* Rosenst. (1915) is identical with *Lycopodium tereticaule* Hayata (1914).

CONIOGRAMME Fée

CONIOGRAMME FRAXINEA (Don) Diels in Engl. & Prantl Nat. Pflanzenfam. 1' (1899) 262.

Kwangtung Province, Loh Fau Mountain (Lofaushan), *Merrill 10866*, *Levine 1485*, August 25, 1917, in thickets, slopes of damp shaded ravines, altitude about 1,000 meters; abundant locally.

Japan to Madagascar, tropical Australia, and Polynesia; not previously recorded from Kwangtung Province.

HYPOLEPIS Bernhardt

HYPOLEPIS PUNCTATA (Thunb.) Mett. in Kuhn Fil. Afr. (1868) 120.

Kwangtung Province, Loh Fau Mountain (Lofaushan), *Levine 1466*, August 15, 1917, scattered in damp forested ravines, altitude about 1,000 meters.

This widely distributed species does not appear to be recorded from Kwangtung Province; it is placed by C. Christensen in the genus *Dryopteris*, as *D. punctata* (Thunb.) C. Chr.

LOXOGRAMME Presl

LOXOGRAMME FAURIEI Copel. in Philip. Journ. Sci. 11 (1916) Bot. 45, t. 1, f. 5.

Kwangtung Province, Loh Fau Mountain (Lofaushan), *Merrill 10341*, *10740*, October 28, 1916, August 18, 1917, on wet cliffs and boulders in damp shaded ravines, altitude 1,000 to 1,050 meters.

This form is probably included by Dunn & Tutchter in *Gymnogramme lanceolata* Hook.=*Loxogramme lanceolata* (Sw.) Presl, a species of the Mascarene Islands and one that does not extend to China. For the Indo-Malayan form commonly identified as *Loxogramme lanceolata*, Copeland has proposed the name *Loxogramme malayana* Copel. The Kwangtung specimens have distinctly long-stipitate fronds and certainly represent the Formosan species described by Copeland as *Loxogramme fauriei*, and are not referable to *Loxogramme malayana* Copel.

Loxogramme linearis Copel. in Philip. Journ. Sci. 11 (1916) Bot. 45, t. 2, f. 8 is identical with *Loxogramme remote-frondigerum* Hayata Ic. Pl. Formos. 5 (1915) 323 (*Polypodium remote-frondigerum* Hayata l. c. f. 135, A-B) and should be reduced to the latter.

PLAGIOGYRIA Mettenius

PLAGIOGYRIA CHRISTII Copel. in Philip. Journ. Sci. 1 (1906) Suppl. 153.

Kwangtung Province, Loh Fau Mountain (Lofaushan), *Merrill 10669*, August 17, 1917, in damp shaded ravines along small streams, altitude about 1,100 meters; rare.

The specimen is an excellent match for the type of Copeland's species, the pinnae being rather more distant than in the Philippine specimens.

Previously known only from the mountains of Mindoro and Mindanao in the Philippines.

PLAGIOGYRIA ADNATA (Blume) Bedd. Ferns Brit. Ind. (1865) t. 51.

Kwangtung Province, Loh Fau Mountain (Lofaushan), *Merrill 11114*, August 12, 1917, in damp shaded ravines, altitude about 1,000 meters.

The specimens have distinctly 4-angled stipes and conform well with Malayan and Philippine specimens of this species. From Copeland's description it cannot be the same as *Plagiogyria tenuifolia* Copel. (*Lomaria matthewii* Christ), the only representative of the genus previously reported from Kwangtung Province.

POLYPODIUM Linnaeus

POLYPODIUM OLIGOLEPIDUM Baker in Gard. Chron. II 14 (1880) 494;
Takeda in Notes Bot. Gard. Edinb. 8 (1915) 276, cum descr.!

Polypodium kawakami Hayata in Bot. Mag. Tokyo 23 (1909) 77, Ic. Pl. Formos. 5 (1915) 318, f. 130.

Polypodium arisanense Rosenst. in Hedwigia 56 (1915) 347.

Kwangtung Province, Loh Fau Mountain (Lofaushan), *Merrill 10221*, *10684*, *Levine 1486*, October, 1916, and August, 1917, on ledges and boulders in damp shaded ravines, altitude 900 to 1,050 meters.

This form was included by Dunn and Tutcher in *Polypodium lineare* Thunb., and has been indicated by Christ as a variety of Thunberg's species; it is certainly distinct from *Polypodium lineare* Thunb. The Kwangtung specimens agree perfectly with the original description of Hayata's species, with his additional data and figure, and with Formosan specimens from Arisan, *Kawakami!*, *Shimada & Ito 19!*, *Faurie 472!*, the latter a cotype of *Polypodium arisanense* Rosenst.

POLYPODIUM HANCOCKII Baker in Journ. Bot. 23 (1885) 106.

Kwangtung Province, Loh Fau Mountain (Lofaushan), *Merrill 10956*, August 24, 1917, on forested slopes of damp ravines, altitude about 1,000 meters; very rare, but three specimens seen.

This species has previously been reported only from Formosa, the Kwangtung specimens agreeing with the description and with Formosan material. I do not agree with Takeda's disposition of the species, who places it as a synonym of *Polypodium pteropus* Blume.

PTERIS Linnaeus

PTERIS FAURIEI Hieron. in Hedwigia 55 (1914) 345.

Kwangtung Province, Loh Fau Mountain (Lofaushan), *Merrill 10158*, *10664*, October, 1916, and August, 1917, on talus slopes in damp ravines, altitude 900 to 1,050 meters; Teng Woo Mountain, *Levine & Groff 50*, November 18, 1916.

This species is one of the numerous ones segregated by Hieronymus from the collective *Pteris quadriaurita* Retz., and was probably included by Dunn & Tutcher in *Pteris biaurita* Linn., from which it is very distinct. Hieronymus based his species on material from Formosa, Oshima, and Amoy.

OPHIOGLOSSACEAE

BOTRYCHIUM Swartz

BOTRYCHIUM TERNATUM (Thunb.) Sw. in Schrad. Journ. 1800'
(1801) 111.

Kwangtung Province, Loh Fau Mountain (Lofaushan) *Merrill 11018*, August 16, 1917, in meadows in front of the ruined monastery at Put Wan Tsz, altitude about 1,100 meters; very rare.

Japan to the Himalayan region; no representative of the genus has been previously reported from Kwangtung Province.

GRAMINEAE

ANDROPOGON Linnaeus

ANDROPOGON FRAGILIS R. Br. Prodr. (1810) 202.

Kwangtung Province, White Cloud Mountain, near Canton, *Levine 1145*, August 30, 1917.

This is the typical form of the species and conforms entirely with Banks and Solander's specimen, on which the species was based, a fragment of which has been kindly communicated to me by Mr. J. H. Maiden, director of the Botanic Garden, Sydney.

Var. **SINENSIS** Rendle in Journ. Linn. Soc. Bot. 36 (1904) 372.

Kwangtung Province, White Cloud Mountain, near Canton, *Levine 1140*, August 28, 1917.

This form, which I at first considered to represent a distinct species, approximates the type in all characters except in the sessile spikelet being densely villous on the back in the lower one-half, the first glume of the empty spikelet being glabrous in the type. The Philippine material referred to *Andropogon fragilis* R. Br., with the exception of a single specimen, and New Guinea material collected by *King*, differs from the type not only in its smaller spikelets but also in having the rachis-joints and pedicels of the sterile spikelets entirely glabrous, and will have to be distinguished at least as a variety.

POLYTOCA R. Brown

POLYTOCA HETEROCLITA (Roxb.) Merr. in Philip. Journ. Sci. 10
(1915) Bot. 288.

Coix heteroclita Roxb. Fl. Ind. ed. 2, 3 (1832) 572.

Polytoca bracteata R. Br. in Benn. Pl. Jav. Rar. (1838) 20, t. 5.

Kwangtung Province, Wa Shau T'oi, at the base of Loh Fau Mountain (Lofaushan), *Merrill 10887*, *Levine 1571*, August 20, 1917, on open grassy slopes, altitude about 140 meters.

India to Burma, Tonkin, Java, and Mindanao; no representative of the genus has hitherto been reported from China.

PASPALUM Linnaeus

PASPALUM LONGIFOLIUM Roxb. Fl. Ind. 1 (1820) 283.

Kwangtung Province, Wa Shau T'oi, at the base of Loh Fau Mountain (Lofaushan), *Merrill 10792*, August 20, 1917, on open grassy slopes, altitude about 150 meters.

This form has usually four spikes, with the spikelets in several rows on each partial inflorescence. It is unquestionably referable to Roxburgh's species as currently interpreted. India to Malaya, but not previously reported from China.

OPLISMENUS Beauvois

OPLISMENUS UNDULATIFOLIUS (Ard.) Beauv. Agrost. (1812) 54.

Kwangtung Province, Loh Fau Mountain (Lofaushan), *Merrill 10841*, August 24, 1917, on ledges along streams in deep ravines, altitude about 900 meters.

This species, which extends from southern Europe to Japan southward to tropical Africa and Australia, has not previously been reported from southern China.

GARNOTIA Brongniart

GARNOTIA STRICTA Brongn. Bot. Duperry's Voy. (1829) 133, t. 21.

Kwangtung Province, Loh Fau Mountain (Lofaushan), *Merrill 10313, 11080*, October, 1916, and August, 1917, on ledges in torrent beds, altitude about 1,000 meters.

The specimens come well within the range of variation of this widely distributed species as interpreted by Hooker f. *Fl. Brit. Ind. 7 (1897) 243*. It has not previously been reported from China.

GARNOTIA BARBULATA (Nees) comb. nov.

Miquelia barbulata Nees in *Nov. Act. Acad. Nat. Cur. 19 (1843) Suppl. 1:178*.

Garnotia patula Munro ex Benth. *Fl. Hongk. (1861) 416*.

Berghausia patula Munro in *Proc. Amer. Acad. 4 (1860) 262*.

Kwangtung Province, Teng Woo Mountain, *Levine & Groff 68*, November 18, 1916.

This species, for which the oldest specific name is here adopted, is known only from southern China.

GARNOTIA CILIATA sp. nov.

Herba annua, 25 ad 40 cm alta, vaginis et foliis et spiculis perspicue longe molliter ciliatis; culmis erectis e basi decumbentis, 1 ad 1.5 mm diametro, glabris, nodis leviter ciliato-barbatis; foliis flaccidis, anguste lanceolatis, usque ad 11 cm longis et 9 mm latis, planis, acuminatis, utrinque parce sed molliter et perspicue ciliatis; inflorescentiis usque ad 13 cm longis, ramis strictis (junioribus), inferioribus usque ad 6 cm longis; spiculis lanceolatis, acuminatis, glumis vacuis aequalibus, anguste lanceolatis, tenuiter acuminatis, 3-nerviis, parce ciliatis, gluma fertilis obscurissime 1-nervia, 5 mm longa, apice tenuiter aristata.

An erect, simple, annual grass, 25 to 40 cm high, the culms decumbent at the base and sometimes rooting at the lower nodes, gregarious but scarcely caespitose, the culms glabrous, 1 to 1.5 mm in diameter, the nodes sparingly bearded with few, long,

soft hairs. Leaves flaccid, plane, narrowly lanceolate, 8 to 11 cm long, 5 to 8 mm wide, acuminate, conspicuously ciliate on both surfaces with scattered, soft, spreading, 2 to 3 mm long hairs usually from papillate bases; sheaths with hairs similar to those on the leaves, longer than the internodes, the upper ones somewhat inflated; ligules less than 0.5 mm long, densely and minutely ciliate. Panicles up to 13 cm in length, when young more or less inclosed in the uppermost sheath, the branches strict, ascending, the lower ones up to 6 cm in length. Spikelets narrowly lanceolate, about 6 mm long, usually one sessile and one pedicelled at each node, the rachis and branchlets angular, scabrid. Empty glumes two, narrowly lanceolate, acuminate, 6 mm long and about 1 mm wide, 3-nerved, very slenderly acuminate, sparingly ciliate with long, soft hairs. Flowering glume hyaline, lanceolate, 5 mm long, very faintly 1-nerved, slightly cleft at the apex, the awn slender, straight when wet, sometimes slightly bent when dry, up to 1 cm in length.

Kwangtung Province, Loh Fau Mountain (Lofaushan), *Merrill 10701*, August 25, 1917, on thin earth over boulders along streams, altitude 900 to 1,000 meters.

This species is somewhat allied to *Garnotia stricta* Brongn. but is readily distinguished by its prominently ciliate leaves, sheaths, and more sparingly ciliate empty glumes, the hairs being very slender, white or pale, spreading, 2 to 3 mm in length, and usually from papillate bases. It occurs only in a very special habitat, on thin soil associated with mosses covering large boulders and ledges which are not subject to overflow in times of flood. It must be a short-lived plant, as on August 25, 1917, it was conspicuous on boulders at our camp site, the plants a few days previous to this date presenting no inflorescences; in October, 1916, the old dried remains of the same species was observed in the same locality, but no specimens were then prepared as the spikelets had all fallen and the plants were all withered and dry.

AGROSTIS Linnaeus

AGROSTIS ELMERI Merr. in Govt. Lab. Publ. (Philip.) 29 (1905) 7.

Kwangtung Province, Loh Fau Mountain (Lofaushan), *Merrill 10924*, August 16, 1917, in the wet sandy bottoms of drained pools, altitude about 1,000 meters; a few plants observed in a single restricted area.

The genus is new to Kwangtung Province, and I can see no reason for considering the specimen cited above as representing other than a rather slender form of *Agrostis elmeri* Merr., a species previously known only from the higher mountains of the Philippines. The spikelets are distinctly jointed below the empty glumes, but Mr. Hitchcock, of the United States Department of Agriculture, calls my attention to the fact that this character is not uncommon in *Agrostis*, occurring even in the common *Agrostis alba* Linn. The spikelets of this form are but about one-half as large as are those of *Agrostis hugoniana* Rendle, to which *Agrostis elmeri* Merr. is apparently allied.

CYPERACEAE

KYLLINGA Rottboell

KYLLINGA ODORATA Vahl, var. **CYLINDRICA** (Nees) Kükenth. ex Mer. in Journ. Str. Branch Roy. As. Soc. 76 (1917) 80.

Kwangtung Province, Loh Fau Mountain (Lofaushan), *Merrill 10655*, *Levine 1395*, August 16 and 25, 1917, scattered on open grassy slopes, altitude 1,100 meters.

This form, which is widely distributed in the tropics of the Old World, has previously been reported from China only from Yunnan Province.

ELEOCHARIS R. Brown

ELEOCHARIS TETRAQUETRA Nees in Wight Contrib. (1834) 113.

Kwangtung Province, Loh Fau Mountain (Lofaushan), at Wa Shau T'oi, *Merrill 10809*, *Levine 1410*, August 20, 1917, among grasses in swampy places, altitude about 150 meters.

This species, which extends from India to Japan southward to tropical Australia, has been reported from several parts of China, but not previously from Kwangtung Province.

FIMBRISTYLIS Vahl

FIMBRISTYLIS HOOKERIANA Boeck. in Linnaea 37 (1871) 22; Clarke in Hook. f. Fl. Brit. Ind. 6 (1893) 641.

Kwangtung Province, Loh Fau Mountain (Lofaushan), *Merrill 10750*, August 12, 1917, on thin soil over boulders and ledges on open slopes, altitude about 1,100 meters. The same species is represented by *Levine 1202*, from Chat Sing Kong, Honam Island, near Canton.

India and Cochinchina (*Pierre!*); not previously reported from China.

FIMBRISTYLIS ANNUA (All.) R. & S. Syst. 2 (1817) 95, var. **TOMENTOSA** (Vahl) Kükenthal in herb.

Honam Island, on the grounds of the Canton Christian College, *Levine 1185*, July 25, 1917.

This pubescent form of *Fimbristylis annua* R. & S. (*F. diphylla* Vahl) agrees with Philippine material determined by Kükenthal as the above variety.

CAREX Linnaeus

CAREX BAMBUSETORUM sp. nov. § *Mitratae*, *Eumitratae*.

Species *C. rhynchachaenio* affinis, differt scapis longioribus, utriculis minoribus, glabris, acheniis multo minoribus, 2 mm longis.

Rather densely tufted, the base clothed with the filiform remnants of old sheaths. Leaves plane, scabrid, numerous, 20 to 30 cm long, 3 to 4.5 mm wide, pale, shining, tapering upward to the long and slenderly acuminate apex. Scapes slender, about 13 cm long, each bearing about three pistillate spikelets and a terminal staminate one, the bracts slender, 12 to 22 mm long, sheathing in the lower 4 to 9 mm. Pistillate spikelets 1 to 1.4 cm long, lax, 3 to 4 mm in diameter, their pedicels slender, at

least 1 cm long, the glumes ovate-lanceolate to lanceolate, slenderly acuminate by the excurrent midrib, pale, 2 to 3 mm long. Utricles about 3 mm long, prominently ribbed, glabrous or nearly so, somewhat flask-shaped, prominently beaked. Achenes 3-angled, 2 mm long, rather prominently beaked, narrowed below and above, the beak thick, cylindric, truncate, about 0.3 mm long.

Kwangtung Province, Loh Fau Mountain (Lofaushan), *Merrill 10985*, August 12, 1917, on dry banks in ravines, in dense bamboo thickets, altitude about 1,000 meters; very rare.

I was at first disposed to refer this to *Carex rhynchachaenium* Clarke, of Luzon, which it closely resembles and to which it is closely allied. It differs constantly from our full series of Philippine specimens in the characters indicated in the diagnosis and is, I believe, specifically distinct.

CAREX DONIANA Spreng. Syst. 3 (1826) 825.

Kwangtung Province, Loh Fau Mountain (Lofaushan), *Merrill 10971*, *Levine 1494*, August 13, 1917, in swampy places in the shade of coarse grasses and sedges, altitude about 1,050 meters; rare.

Although the spikelets are at most 1.5 cm long, I believe that this form is referable to Sprengel's species, which extends from India to Japan. Kükenthal does not recognize this form as specifically distinct, but treats it as a variety of *Carex japonica* Thunb.

CAREX TEINOGYNA Boott Illustr. Carex 1 (1858) 60, t. 158; Kükenth. in Engl. Pflanzenreich 38 (1909) 602, f. 102 F-H.

Kwangtung Province, Loh Fau Mountain (Lofaushan), *Merrill 10178*, October 28, 1916, on moss-covered boulders in shaded stream beds in ravines, locally very abundant, altitude about 1,100 meters.

The specimen cited above was referred by me to the allied *Carex brunnea* Thunb., but Mr. Tutcher has called my attention to the fact that it is not the same as Thunberg's species and suggested its identity with Boott's species. I have not seen the original description, but the specimen conforms with Kükenthal's description and figure, and with Khasia specimens collected by C. B. Clarke. The species occurs in India, with a variety in Japan, but has not previously been reported from China. The plants were very abundant and conspicuous in October, 1916, but none were in evidence as late as August 27 the following year; they probably develop very rapidly after the close of the rainy season.

ARACEAE

AGLAONEMA Schott

AGLAONEMA MODESTUM Schott ex Engl. in DC. Monog. Phan. 2 (1879) 442, Pflanzenreich 64 (1915) 29, f. 13, Arac. Exsic. no. 74, 258.

Aglanema acutispathum N. E. Br. in Gard. Chron. 24 (1885) 39.

Kwangtung Province, near Canton, *Levine 1167*, May 1, 1917.

The specimen is of considerable interest from the standpoint of the history of this species. It agrees perfectly with the descriptions and figures of Schott's species. The type (*Gaudichaud*) was supposed to have been collected in Luzon, but although the regions that Gaudichaud visited in the Archipelago are now all thoroughly well known botanically, this species

has never been detected; the probabilities are very great that Gaudichaud's specimen came from Macao, where he also botanized, and not from the Philippines. Doctor Gagnepain informs me that he was unable to locate Gaudichaud's specimen in the Paris herbarium. It is to be noted that in the original description of the species Engler states "patria ignota." The type of *Aglaonema acutispathum* N. E. Br. was a specimen purchased in Hongkong by Dr. Knaggs, and was thought to have come from the vicinity of Canton; however, Brown⁴¹ states that there is another specimen in the Kew Herbarium labelled as having been brought from Shanghai by Dr. Knaggs; he also states that it was cultivated in southern China, the basis of this being *Hance 11459*. At any rate, the species must now definitely be credited to Kwangtung Province, at least as a cultivated plant, and excluded from the Philippine list.

DIOSCOREACEAE

DIOSCOREA Linnaeus

DIOSCOREA PENTAPHYLLA Linn. Sp. Pl. (1753) 1032.

Kwangtung Province, Loh Fau Mountain (Lofaushan), at Wa Shau T'oi, *Merrill 10886*, August 20, 1917, in thickets, altitude about 160 meters; a sterile specimen; White Cloud Mountain, near Canton, *Levine 1687*, September, 1917.

This species is widely distributed in tropical Asia and Malaya but has not previously been reported from Kwangtung Province.

LILIACEAE

PELIOSANTHES Andrews

PELIOSANTHES STENOPHYLLA sp. nov.

Foliis numerosissimis, anguste lanceolatis, usque ad 27 cm longis, 5 ad 10 mm latis, utrinque attenuatis, nervis 7 vel 9, nervulis transversalibus obsoletis; inflorescentiis usque ad 15 cm longis, floribus cernuis, pallide purpureis, circiter 7 mm longis, pedicellis binis vel trinis, 10 ad 12 mm longis, articulatis; bracteis scariosis, lanceolatis, acuminatis, inferioribus usque ad 2 cm longis, superioribus minoribus.

Rootstock 5 mm in diameter or less, woody, covered with the scarious basal portions of old leaves. Leaves numerous, up to 30 or more on each plant, narrowly lanceolate to linear-lanceolate, chartaceous, attenuate at both ends, the blades 13 to 27 cm long, 5 to 10 mm wide, acuminate, sometimes slightly falcate, the longitudinal veins 7 or 9, the transverse veinlets obsolete, the very young leaves with broad, pale, scarious, deciduous margins, these scarious margins more or less persistent on the lower parts of the petioles and imbricately surrounding the short stem, the petioles up to 7 cm in length. Scapes solitary, erect, rather many-flowered, up to 15 cm in length, the flowers

⁴¹ Journ. Linn. Soc. Bot. 36 (1903) 185.

pale-purple, nodding, somewhat campanulate, fascicled, usually two or three from the axil of each bract, their pedicels slender, 10 to 12 mm long, jointed in the middle, the bracts scarious, lanceolate, acuminate, the lower ones up to 2 cm in length, the upper ones gradually shorter. Perianth-segments lanceolate, acuminate, about 6 mm long, 2 to 2.5 mm wide. Anthers about 3 mm long, subsessile. Ovules 2 in each cell.

Kwangtung Province, Loh Fau Mountain (Lofaushan), *Merrill 10757* (type), *Levine 1613*, August 16, 1917, widely scattered in damp shaded ravines, altitude 900 to 1,000 meters.

This species is well characterized by its very numerous and unusually narrow leaves, differing from all of the described species in the latter character. It is entirely different from the only other species known from Kwangtung Province, *Peliosanthes macrostegia* Hance, the type of which was also from Loh Fau Mountain.

ORCHIDACEAE

HERMINIUM Linnaeus

HERMINIUM ANGUSTIFOLIUM (Lindl.) Benth. ex Hook. f. Fl. Brit. Ind. 6 (1890) 129.

Kwangtung Province, Loh Fau Mountain (Lofaushan), *Merrill 11121*, *Levine 1479*, August 15, 1917, widely scattered on open grassy slopes, altitude 100 to 1,150 meters.

This genus has not previously been reported from Kwangtung Province. The species extends from India to China and Formosa, the Philippines, Java, and Timor.

PIPERACEAE

PEPEROMIA Ruiz & Pavon

PEPEROMIA REFLEXA A. Dietr. Sp. Pl. 1 (1831) 180, forma **CAPENSIS** Miq. Syst. Pip. (1843) 169.

Kwangtung Province, Loh Fau Mountain (Lofaushan), *Merrill 10846*, August 24, 1917, on ledges among mosses in damp ravines, altitude about 900 meters.

Peperomia reflexa A. Dietr. has previously been reported from China, but not from Kwangtung Province; it is widely distributed in the tropics of the Old World.

MORACEAE

FICUS Linnaeus

FICUS RECTINERVIA sp. nov. § *Eusyce*.

Frutex ut videtur parvus, ramulis junioribus hirsutis, ramis ramulisque cicatricibus multis notatis, internodiis brevissimis; foliis brevissime petiolatis, subcoriaceis, lanceolatis ad lineari-lanceolatis, usque ad 10 cm longis, glabris, laevis, nitidis, integris, apice tenuiter acuminatis, basi obtusis et minute cordatis, margine revolutis, nervis utrinque circiter 20, patulis, rectis, dis-

tinctis; receptaculis ovoideis ad leviter obovoideis, glabris, usque ad 15 mm longis, tenuiter pedunculatis.

An erect shrub, apparently of small size, glabrous except the distinctly hirsute branchlets. Branches and branchlets dark reddish-brown, rugose, marked with numerous, rather densely arranged, petiolar scars, the internodes very short. Leaves lanceolate to linear-lanceolate, subcoriaceous, smooth, shining, olivaceous, brownish or somewhat greenish when dry, the lower surface paler than the upper and distinctly punctulate, the apex slenderly acuminate, base obtuse and distinctly although minutely cordate, the margins recurved; lateral nerves spreading at nearly right angles from the midrib, about 20 on each side, straight, distinct, anastomosing directly with the somewhat arched, longitudinal, submarginal nerves; petioles pubescent, 2 to 3 mm long; stipules lanceolate, acuminate, up to 4 mm in length. Receptacles few, axillary, ovoid to somewhat obovoid, about 15 mm long, somewhat narrowed below into a short pseudostalk above the bracts, glabrous, the peduncles up to 12 mm in length, sparingly pubescent, the three bracts at the apex of the peduncle broadly triangular-ovate, acute, about 1 mm long. Staminate flowers numerous but only in the upper part of the receptacle, their pedicels 1 to 3 mm in length, the perianth-segments 3, lanceolate, acuminate, brown, about 1 mm long. Stamens 2, rarely 3, the anthers as long as the perianth-segments. Gall flowers very numerous, their perianth-segments lanceolate, acuminate, brown, 2 mm long. Ovary ovoid to obovoid, 1.2 mm in diameter; style very short. Fertile female flowers not seen.

Kwangtung Province, Loh Fau Mountain (Lofaushan), *Levine 331*, February 18, 1916, with no further data.

The alliance of this species is manifestly with *Ficus pyriformis* Hook. & Arn., and *F. stenophylla* Hemsl., being much closer to the latter than to the former. It may be distinguished from Hemsley's species by its larger, longer-peduncled receptacles, and its very differently nerved leaves, which are distinctly but minutely cordate at the base; the distinct lateral nerves are much more numerous than in *Ficus stenophylla* Hemsl. and leave the midrib at nearly right angles.

URTICACEAE

PILEA Lindley

PILEA SWINGLEI sp. nov.

Planta dioica, erecta, simplex vel parce ramosa, glabra, circiter 20 cm alta; foliis in paribus leviter inaequalibus, membranaceis, ovatis, usque ad 4 cm longis, basi rotundatis, 3-nerviis, apice acutis vel leviter acuminatis, margine grosse serratis, dentibus

utrinque circiter 6, utrinque cystolithis linearibus irregulariter dispositis instructis; inflorescentiis ♀ axillaribus, tenuibus, petiolo subaequantibus, floribus in capitulis paucis distantibus 2 ad 5 mm diametro dispositis.

An erect, simple or sparingly branched, succulent, glabrous, dioecious herb about 20 cm high, the stipules, if any, caducous. Stems weak when dry, slender. Leaves opposite, those of each pair slightly unequal, ovate, membranaceous, greenish-olivaceous, shining, 2.5 to 4 cm long, 1.5 to 2.5 cm wide, base rounded, 3-nerved, apex acute or somewhat acuminate, margins coarsely serrate, about 6 prominent teeth on each side, the lateral nerves reaching to about the upper three-fourths of the leaf, both surfaces with numerous, linear, irregularly disposed cystoliths; petioles slender, 1 to 2.5 cm long, that of the smaller leaf shorter than the one of the larger leaf in each pair. Pistillate inflorescences axillary, slender, about as long as the petioles, each bearing one or two, rarely three, heads of flowers and fruits 2 to 5 mm in diameter, the flowers not at all scorpid in arrangement. Pedicels about 1 mm long. Large perianth segment about 1 mm long, the other two minute. Achene subelliptic, compressed, subacute, about 0.8 mm long.

Kwangtung Province, Loh Fau Mountain (Lofaushan), *Merrill 11036* (type), *10771*, *Levine 1806*, at the bases of very wet cliffs in damp shaded ravines, and under overhanging boulders on open slopes, altitude 900 to 1,100 meters, August 12 to 17, 1917.

This species somewhat resembles some forms of *Pilea pumila* A. Gray, but differs totally from that species in its entirely different, non-scorpid inflorescences. The capitate arrangement of the flowers is characteristic.

LAURACEAE

NEOLITSEA Merrill

NEOLITSEA PULCHELLA (Meissn.) comb. nov.

Litsea pulchella Meissn. in DC. Prodr. 15¹ (1864) 224.

Kwangtung Province, Loh Fau Mountain (Lofaushan), *Merrill 10239*, in flower, October 23, 1916, *Merrill 10840*, *Levine 1319*, in fruit, August 23, 1917, in damp forested ravines, altitude about 1,000 meters.

The type of Meissner's species was from Hongkong, and from his description it is evident that he saw no staminate flowers. In our material the fertile stamens are six in number, and accordingly the species is transferred to *Neolitsea*.

NEOLITSEA SUBCAUDATA sp. nov.

Arbor circiter 5 m alta, glabra; foliis alternis, chartaceis ad subcoriaceis, oblongis ad lanceolatis, nitidis, apice tenuiter subcaudato-acuminatis, basi acutis, 3-nervis, utrinque nec profunde

sed dense subfoveolatis, usque ad 9 cm longis, subtus pallidis vel glaucescentibus; fructibus axillaribus, fasciculatis, pedicellatis, subellipsoideis, circiter 8 mm longis.

A tree about 5 m high, entirely glabrous except the imbricate axillary bud-scales (flowers not seen). Branches and branchlets terete, slender, brownish to nearly black when dry. Leaves alternate, not at all pseudo-verticillate, chartaceous to subcoriaceous, oblong to lanceolate, 5.5 to 9 cm long, 1.5 to 3.5 cm wide, pale to olivaceous when dry, shining, the lower surface usually glaucous, both surfaces densely and shallowly subfoveolate, the base acute, prominently 3-nerved, not at all 3-plinerved, the lateral nerves extending nearly to the tip, the apex slenderly subcaudate-acuminate, the acumen 1 to 1.5 cm long; petioles 1 cm long or less. Flowers not seen. Fruits axillary, fascicled, numerous, their pedicels somewhat thickened upward, up to 1 cm in length, the immature fruits subellipsoid, about 8 mm long.

Kwangtung Province, Loh Fau Mountain (Lofaushan), *Merrill 11016* (type), *Levine 1351*, widely scattered in damp forested ravines, altitude 800 to 1,100 meters.

This species is well characterized by its alternate, shallowly and densely foveolate, 3-nerved (not 3-plinerved), subcaudate-acuminate leaves, which are glaucous on the lower surface. In aspect it somewhat resembles *Neolitsea pulchella* Merr. but is distinguished by being entirely glabrous (except the pubescent bud-scales), in its 3-nerved, not 3-plinerved, subcaudate-acuminate leaves, and in their strictly alternate, not pseudo-verticillate, arrangement.

NEOLITSEA ? LEVINEI sp. nov.

Arbor circiter 6 m alta, ramulis et petiolis dense brunneo-pubescentibus; foliis verticillatis, coriaceis, oblongo-lanceolatis ad oblongo-oblancoelatis, usque ad 20 cm longis, nitidis, basi acutis, perspicue 3-plinerviis, nervis primariis supra basin utrinque 1, prominentibus, apice perspicue acuminatis, supra laevis, nitidis, subtus albido-glaucoscentibus; fructibus e axillis defoliatis, racemose dispositis, ellipsoideis, circiter 1.5 cm longis.

A tree about 6 m high, glabrous or nearly so except for the densely brown-pubescent branchlets and petioles, the branches and branchlets terete. Leaves verticillately crowded at the tips of the branchlets, 4 or 5 in a whorl, coriaceous, oblong-lanceolate to oblong-oblancoelate, 15 to 20 cm long, 4.5 to 7 cm wide, base acute, prominently 3-plinerved, the lateral nerves leaving the midrib about 1 cm above the base, arched-anastomosing with the other pair of lateral nerves in the upper three-fourths of the leaf, the only other pair of lateral nerves leaving the midrib in the upper two-thirds to three-fourths, the reticulations lax,

subparallel, prominent, the apex prominently acuminate, the upper surface smooth, glabrous, shining, pale-greenish to brownish-olivaceous, the lower white-glaucous in contrast to the brown midrib, nerves, and reticulations; petioles about 1.5 cm long. Infructescences lateral, 4 cm long or less, sparingly pubescent, the rachis rugose, 1 to 1.5 cm long, the fruits racemosely disposed, their pedicels somewhat thickened, about 1 cm long. Fruits ellipsoid, somewhat rugose, about 1.5 cm long.

Kwangtung Province, Loh Fau Mountain (Lofaushan), *Merrill 11071* (type), *Levine 1332*, August 24, 1917, in damp forested ravines, altitude 800 to 1,000 meters.

I am by no means certain that this species belongs in the genus *Neolitsea*, a point that can definitely be determined only when flowers are available. It approaches *Neolitsea* in the verticillate arrangement of its leaves and in their being prominently 3-plinerved, but this character is found in other allied genera that are distinguished otherwise only by certain floral characters. The leaves are unusually large for *Neolitsea*, and the species may ultimately be found to belong in *Lindera* or in *Actinodaphne*.

ROSACEAE

RUBUS Linnaeus

RUBUS BUERGERI Miq. *Ann. Mus. Bot. Lugd.-Bat.* 3 (1867) 86; Focke in *Bibl. Bot.* 7 (1910) 114, f. 53.

Kwangtung Province, Loh Fau Mountain (Lofaushan), *Merrill s. n.* August, 1917, on open grassy slopes about boulders, altitude about 900 meters.

This species is widely distributed in Japan, and is reported from Yunnan by Focke. The Loh Fau specimen agrees closely with the description, with Focke's figure, and with authentically named Japanese material.

RUBUS FIMBRIIFERUS Focke in *Bibl. Bot.* 7 (1910) 80.

Kwangtung Province, Teng Woo Mountain, *Levine & Groff 143*, November 18, 1916.

The type of this species was a specimen from the Hongkong Herbarium collected on the West River, Kwangtung Province. It is not included by Dunn & Tutchter in their Flora of Kwangtung and Hongkong, and agrees with none of the species admitted by them.

LEGUMINOSAE

MILLETTIA Wight & Arnott

MILLETTIA DUNNII sp. nov.

Frutex suberectus, ramis elongatis, arcuatis, inflorescentiis et subtus foliis exceptis glaber; ramis brunneis, teretibus, perspicue lenticellatis; foliis usque ad 35 cm longis, foliolis 11 ad 15, chartaceis, estipellatis, oblongis, usque ad 12 cm longis, breviter acuminatis, basi acutis ad obtusis, supra glabris, olivaceis vel olivaceo-brunneis, nitidis, subtus pallidioribus, pubescentibus, nervis

utrinque circiter 12, perspicuis; inflorescentiis racemosis, sub fructu foliis subaequantibus; leguminis crassis, ovoideis (1-spermis) vel oblongis (2-spermis), glabris, acuminatis, 3 ad 6 cm longis, circiter 2.5 cm latis, valvis in vivo subcarnosis, in siccitate crasse coriaceis, dense et perspicue lenticellato-verruculosis.

A suberect shrub with elongated, arcuate branches up to 4 m in length, apparently ultimately scandent, glabrous except the inflorescences and the leaves. Branches terete, brownish, lenticellate, glabrous. Leaves up to 35 cm in length, the petiole and rachis glabrous, reddish-brown or dark-brown. Leaflets estipellate, oblong, chartaceous, 8 to 12 cm long, 3 to 4.5 cm wide, apex shortly acuminate, base acute to obtuse, the upper surface glabrous, shining, olivaceous or brownish-olivaceous, the lower surface paler, rather densely pubescent with short, cinereous hairs; lateral nerves about 12 on each side of the midrib, impressed on the upper surface, prominent beneath, curved, obscurely anastomosing; petiolules dark-brown, rugose, 5 mm long or less; stipels none. Racemes in fruit about as long as the leaves, sparingly pubescent, lenticellate. Pods somewhat fleshy when fresh, ovoid to oblong in outline (ovoid when 1-seeded, oblong when 2-seeded), 3 to 6 cm long, about 2.5 cm wide, acuminate, base rounded, when fresh nearly as thick as wide, when dry distinctly compressed, the valves when dry thickly coriaceous and very prominently and densely verrucose-lenticellate, glabrous, tardily dehiscent. Seeds (somewhat immature) about 1.5 cm in diameter.

Kwangtung Province, Loh Fau Mountain (Lofaushan), in thickets near So Liu Koon, altitude about 200 meters, *Merrill 10861* (type), *Levine 1371*, August 13, 1917, locally known as *ue tang tsai*.

I was at first disposed to refer these specimens to *Millettia oosperma* Dunn, to which the species is perhaps most closely allied, but they differ radically from Dunn's species in their more numerous leaflets (never 2-jugate), and shorter, glabrous pods. The species is dedicated to Mr. S. T. Dunn, late director of the Hongkong Botanic Garden and author of a recent revision of the genus *Millettia*.

ALBIZZIA Durazzini

ALBIZZIA CORNICULATA (Lour.) comb. nov.

Mimosa corniculata Lour. Fl. Cochinch. (1790) 651.

Albizzia milletii Benth. in Hook. Lond. Journ. Bot. 3 (1846) 89.

Caesalpinia lebbekkoides DC. Prodr. 2 (1825) 483.

Kwangtung Province, Loh Fau Mountain at Wa Shau T'oi, *Merrill 11004*; vicinity of Canton, *Levine 774, 1158, 1578*.

Loureiro's type was from the vicinity of Canton, and his description applies unmistakably to the form commonly known as *Albizzia milletii*

Benth., for which *Mimosa corniculata* Lour. supplies the oldest valid specific name. The corniculate pulvinus subtending the petioles, from which Loureiro took his specific name, is very characteristic of the species.

GLEDITSCHIA Scopoli

GLEDITSCHIA FERA (Lour.) comb. nov.

Mimosa fera Lour. Fl. Cochinch. (1790) 652.

Kwangtung Province, Honam Island, near Canton, *Levine 1289, 1852*, September and November, 1917, with the Cantonese name *tai yip ying*.

These specimens, one of which I provisionally referred to *Gleditschia australis* Hemsl., and the other to *G. macracantha* Desf., are both in fruit, and both manifestly represent the same species. They agree closely with Loureiro's description, and I have no doubt that they present his species; however he gives the Chinese name as *tsáo kiě*. The pods are about 20 cm long and 3 to 3.5 cm wide, straight or slightly curved, agreeing in length with Loureiro's description, but being about twice as long as are those of *G. australis* Hemsl. I suspect that it is the Kwangtung form that has been referred to *Gleditschia macracantha* Desf., but Desfontaine's description is so very short and imperfect that it is impossible to determine from it alone what the true characters of his species are. Hemsley states that *G. macracantha* Desf. has nearly quadrate flat seeds; the specimens cited above have the seeds of *Gleditschia australis* Hemsl. The Cochinchina form placed here by Loureiro may be the one referred by Gagnepain to *G. australis* Hemsl.

RUTACEAE

SKIMMIA Thunberg

SKIMMIA JAPONICA Thunb. Nov. Gen. (1781-1801) 58.

Kwangtung Province, Loh Fau Mountain (Lofaushan), *Merrill 11056, Levine 1361*, August 11, 1917, in thickets, damp ravines, altitude about 1,100 meters.

This species extends from Japan to India southward to Formosa and northern Luzon, occurring at high altitudes in the south. The genus is new to Kwangtung Province.

FAGARA Linnaeus

FAGARA CHINENSIS sp. nov.

Frutex scandens, inflorescentiis axillaribus leviter pubescentibus exceptis glaber, ramulis ramulisque inermis, rhachis canaliculato-angulatis, subtus spinis paucis, recurvis armatis; foliis circiter 15 cm longis, foliolis 7, oppositis vel suboppositis, lanceolatis ad ovato-lanceolatis, coriaceis, tenuiter sed obtuse acuminatis, basi acutis, integris, usque ad 7 cm longis, nervis primariis utrinque 7 ad 9, distinctis; paniculis axillaribus, anguste pyramidatis, circiter 4 cm longis; fructibus sessilibus, rugosis, subellipsoideis, circiter 5.5 mm longis, apice leviter oblique rostratis.

A scandent shrub, attaining a length of at least 5 m, glabrous except the sparingly pubescent inflorescences. Branches and

branchlets terete, unarmed, the former grayish, rugose, the latter smooth, nearly black. Leaves alternate, about 15 cm long, the rachis canaliculate, somewhat angled, armed on the lower side with few, scattered, rather stout, recurved, 1 to 1.5 mm long spines. Leaflets 7, coriaceous, lanceolate to ovate-lanceolate, entire, opposite or subopposite, 3.5 to 7 cm long, 1.2 to 2.6 cm wide, shining, olivaceous-brownish when dry, the glands not prominent, narrowed below to the acute and sometimes slightly inequilateral base, and above to the slenderly but obtusely acuminate apex; lateral nerves 7 to 9 on each side of the midrib, distinct on the lower surface, anastomosing, the reticulations lax; petiolules 2.5 to 4 mm long. Panicles axillary, narrowly pyramidal, about 4 cm long, sparingly pubescent, the primary branches about 5 mm long. Cocci subelliptic, brown and rugose when dry, about 5.5 mm long, keeled but scarcely compressed, obliquely beaked at the apex, 1-seeded, sessile, but one or two developing from each ovary.

Kwangtung Province, Loh Fau Mountain (Lofaushan), *Merrill 10660*, August 13, 1917, in thickets near Paak Wan Moon, altitude about 900 meters.

This species is apparently represented by *Cavalerie 950* from Kouy-tchéou, which has been identified with *Zanthoxylum oxyphyllum* Edgw., but to which species I do not consider that it can possibly be referred. It is well characterized by its few leaflets, which are entire and slenderly acuminate; its unarmed branches and branchlets; and its short, axillary, very narrow panicles.

POLYGALACEAE

EPIRIXANTHES Blume

EPIRIXANTHES APHYLLA (Griff.) comb. nov.

Salomonina aphylla Griff. in Proc. Linn. Soc. 1 (1844) 221, Trans. Linn. Soc. 14 (1845) 112.

Kwangtung Province, Loh Fau Mountain (Lofaushan), at So Liu Koon, *Merrill 10898*, August 13, 1917, in damp forests along trails, altitude about 180 meters.

I have transferred this species to *Epirixanthes* Blume, as I consider this group to be generically distinct from *Salomonina*.

EUPHORBIACEAE.

BRIDELIA Loureiro

BRIDELIA MONOICA (Lour.) comb. nov.

Clutia monoica Lour. Fl. Cochinch. (1790) 638.

Cleistanthus monoicus Muell.-Arg. in DC. Prodr. 15² (1866) 508; Jabl. in Engl. Pflanzenreich 65 (1915) 53.

Bridelia loureiri Hook. & Arn. Bot. Beechy's Voy. (1841) 211.

Kaluhabunghos monoecus O. Kuntze Rev. Gen. Pl. 2 (1891) 607.

Bridelia tomentosa Blume Bijdr. (1825) 597; Jabl. in Engl. Pflanzenreich 65 (1915) 58, cum syn.

Kwangtung Province, Canton and vicinity, Merrill 9859, Levine 429, 1232, Levine & Groff 88.

This species is common in thickets in the vicinity of Canton. Jablonszky places *Cleistanthus monoicus* (Lour.) Muell.-Arg. among the *species omnino dubiae*, but there is no doubt in my mind as to the correctness of the present interpretation. Loureiro's type was from Canton, and his description in all essentials, except for the description of the fruit, applies word for word to this common species. The only differences are in his description of the leaves as glabrous (they are glabrous above and sparingly pubescent beneath) and in characterizing the fruit as a 3-celled, 1-seeded capsule; the fruit is a small drupe. This discrepancy is explained by the certainty that Loureiro saw no fruits, but made the description of them conform to the generic description of *Clutia* as quoted by him. *Bridelia monoica* (Lour.) Merr. is the only species known from southern China that conforms at all to Loureiro's description. No *Cleistanthus* is known from China.

AQUIFOLIACEAE

ILEX Linnaeus

ILEX TUTCHERI sp. nov. § *Aquifolium*, *Sideroxyloides*.

Frutex 2 ad 4 m altus, glaberrimus; foliis obovatis ad oblongo-obovatis, crassissime coriaceis, usque ad 5.5 cm longis, apice rotundatis, interdum retusis, margine integris, revolutis, basi cuneatis, costa supra impressa, subtus prominula, nervis lateralibus obsolete, supra olivaceis vel brunneo-olivaceis, nitidis, subtus brunneis, minutissime et densissime punctulatis; fructibus axillaribus, fasciculatis, tenuiter pedicellatis, globosis vel subglobosis, estriatis, 4 ad 5 mm diametro, 6- vel 7-locellatis, calycis lobis 6, rotundatis.

An entirely glabrous shrub, 2 to 4 m high, the branches terete, dark-grayish, somewhat rugose, the branchlets reddish-brown, somewhat angled. Leaves rather densely crowded, obovate to oblong-obovate, thickly coriaceous, 2.5 to 5.5 cm long, 1.2 to 2.5 cm wide, apex rounded, sometimes slightly retuse, base cuneate, margins entire, recurved, the upper surface olivaceous or brownish-olivaceous, shining, the lower surface brownish, densely and very minutely punctulate, the midrib impressed on the upper surface, prominent on the lower surface, the lateral nerves and reticulations obsolete; petioles 2 to 8 mm long. Fruits numerous, axillary and in the axils of fallen leaves, usually about 3 in a fascicle, globose or subglobose, when fresh fleshy, purplish, smooth, when dry dark-brown, smooth or slightly rugose, not

striate, the apex prominently papillate, 4 to 5 mm in diameter, 6- or 7-celled. Persistent calyx coriaceous, 3.5 to 4 mm in diameter, the lobes 6, broadly rounded, short; pedicels 6 to 10 mm long.

Kwangtung Province, Loh Fau Mountain (Lofaushan), *Merrill 10377* (type), 10244, October 28, 1916, on open exposed slopes and in damp forested ravines, altitude 900 to 1,000 meters.

The above-cited specimens were originally determined by me, from the description, as representing *Ilex memecylifolia* Champ., but Mr. W. J. Tutcher, director of the Botanic Garden, Hongkong, to whom the species is dedicated, has called my attention to the fact that the present form differs radically from Champion's species in its vegetative characters and especially in its 6-merous calyces with short, rounded lobes. Its alliance is apparently with *Ilex championii* Loesen. and *I. memecylifolia* Champ., but it is abundantly distinct from both.

ILEX LOHFAUENSIS sp. nov.

Species *I. hanceanae* affinis, differt foliis multo minoribus, apice semper perspicue retusis, nervis lateralibus subobsoletis, floribus omnibus fasciculatis vel solitariis.

A shrub, 3 to 4 m high, the branchlets distinctly cinereous-pubescent with soft, short, spreading hairs. Branches brownish, terete, smooth, glabrous. Leaves numerous, oblong-obovate, brown and shining when dry, 1 to 2 cm long, 5 to 9 mm wide, apex obtuse and prominently retuse, base cuneate to decurrent-acuminate, margins entire, the midrib somewhat prominent on the upper surface and often slightly pubescent, distinctly prominent on the lower surface, glabrous; lateral nerves very slender, 5 to 8 on each side of the midrib, always obscure, often obsolete or nearly so; petioles 1 to 2 mm long, puberulent. Flowers axillary, solitary or fascicled but never more than two or three in an axil, white, 4-merous, about 4 mm in diameter, their pedicels pubescent, 2 mm long or less. Calyx about 2 mm in diameter, shallowly 4-lobed, the lobes broadly rounded, pubescent. Petals united into a distinct tube, the lobes broadly ovate, obtuse to rounded, spreading, about 1.6 mm long. Filaments 0.5 mm long, the anthers about as long as the filaments. Ovary ovoid. Young fruit ovoid, glabrous, smooth, about 2.5 mm in diameter.

Kwangtung Province, Loh Fau Mountain (Lofaushan), *Merrill 10678* (type), August 16, 1917, *Levine 1455*, from the same plant, in thickets, damp shaded ravines, altitude about 1,000 meters.

I was at first disposed to refer these specimens to *Ilex hanceana* Maxim., but as they differ so constantly in their smaller and always prominently retuse leaves, I believe that they represent a distinct but allied species. The species is certainly distinct from the Philippine *Ilex fletcheri* Merr., which Loesener thinks is a synonym of *Ilex hanceana* Maxim.

VITACEAE

CISSUS Linnaeus

CISSUS ASSAMICA (Laws.) Craib in Kew Bull. (1911) 30; Gagnep. Not. Syst. 1 (1911) 353.

Vitis assamica Laws. in Hook. f. Fl. Brit. Ind. 1 (1875) 648.

Kwangtung Province, Loh Fau Mountain (Lofaushan), *Merrill 10682*, *Levine 1465*, August 17, 1917, in thickets, damp ravines, altitude about 900 meters.

This species extends from India (Assam and Sikkim) to Siam, but has not previously been reported from China. It is very similar to *Cissus adnata* Roxb., but is easily distinguished, among other characters, by its more or less appressed hairs being attached by the middle, not by the base. The Chinese specimens cited above have distinctly pubescent inflorescences, but the leaves are practically glabrous, except for a few scattered hairs on the lower surface; the disk and ovary are entirely glabrous. By the key given by Dunn & Tutcher this falls under *Vitis repens* Wight & Arn. and has perhaps been included by these authors under Lamarck's species; it is, however, abundantly distinct from *Cissus repens* Lam.

COLUMELLA Loureiro

COLUMELLA TENUIFOLIA (Heyne) Merr. in Philip. Journ. Sci. 11 (1916) Bot. 134.

Cissus tenuifolia Heyne in Wall. Cat. (1831) no. 6022; Planch. in DC. Monog. Phan. 5 (1887) 563.

Cayratia tenuifolia Gagnep. in Not. Syst. 1 (1911) 348.

Macao, *Callery 93!* Kwangtung Province, *Levine 1000*, originally identified by me as *Columella japonica*. Formosa, Arisan, *Faurie 512*, June, 1914.

This has been included in *Cissus japonica* Willd., but is certainly specifically distinct. India to southern China and the Philippines.

COLUMELLA JAPONICA (Thunb.) comb. nov.

Vitis japonica Thunb. Fl. Jap. (1784) 104.

Cissus japonica Willd. Sp. Pl. 1 (1797) 659.

Cayratia japonica Gagnep. in Not. Syst. 1 (1911) 349.

Kwangtung Province, Loh Fau Mountain, *Merrill 11119*, *Levine 1355*, August, 1917, in thickets, altitude about 1,000 meters.

Japan to Indo-China; the Philippine specimen referred by Gagnepain to this species I consider to represent *Columella corniculata* (Benth.) Merr.

PARTHENOCISSUS Planchon

It has been conclusively shown that *Psedera* Neck. Elem. 1 (1790) 158, and *Quinaria* Rafin. Medic. Fl. 2 (1830) 122, are synonyms of *Parthenocissus* Planch. in DC. Monog. Phan. 5 (1889) 447, and that following strictly the rules of priority *Psedera* Neck. is the oldest generic name for this group. *Quinaria* of Rafinesque is preoccupied by the different *Quinaria* Lour. Fl. Cochinch. (1790) 272; Loureiro's name, however, is a synonym of *Clausena*. However, as *Parthenocissus* Planch. is the retained name adopted by the

last International Botanical Congress,⁵ Planchon's generic designation should be the one to be retained. Gagnepain⁶ has clearly shown that *Landukia* Planch. is not generically distinct from *Parthenocissus*. *Landukia* Planch. has page priority over *Parthenocissus* Planch., and hence has claims to recognition as the valid generic name, for the group under discussion, among those botanists who accept the generic lists of *nomina conservanda* adopted by the last two International Botanical Congresses. That *Landukia* should be included in the next list of *nomina rejicenda* is evident, and I prefer to make no new combinations under this generic name at the present time. The proper specific name for a common Chinese species, however, needs adjustment, as there is no reason whatever for discarding Blume's very descriptive name for the plant now known as *Parthenocissus landuk* Gagnep. *Ampelopsis heterophylla* Sieb. & Zucc. was published many years after Blume's binomial, and of course does not invalidate Blume's specific name.

PARTHENOCISSUS HETEROPHYLLA (Blume) Merr. in Philip. Journ. Sci. 11 (1916) Bot. 129.

Ampelopsis heterophylla Blume Bijdr. (1825) 194.

Cissus landuk Hassk. in Flora 25 (1842) Beibl. 2:39.

Vitis landuk Miq. Ann. Mus. Bot. Lugd.-Bat. 1 (1863) 90.

Landukia landuk Planch. in DC. Monog. Phan. 5 (1887) 447.

Parthenocissus landuk Gagnep. in Bull. Soc. Hist. Nat. Autun 24 (1911) 15, et in Sargent Pl. Wils. 1 (1911) 102.

Kwangtung Province, near Canton, *Levine* 1271, August, 1917; Loh Fau Mountain, *Merrill* 10715, August, 1917; Chekiang Province, *Meyer* 1613. Hainan, *Hongkong Herbarium* 413. Probably referable here is *Merrill* 11132 from plants cultivated on a compound wall at Sheklung, Kwangtung Province, which differs from other specimens cited in having 3- and 5-foliolate leaves.

STERCULIACEAE

PTEROSPERMUM Schreber

PTEROSPERMUM LEVINEI sp. nov.

Arbor circiter 13 m alta partibus junioribus et subtus foliis dense subferrugineo- ad subalbido-tomentosis. Ramis teretibus, glabris, tenuibus; foliis oblongis, chartaceis, leviter inaequilateralibus, integris, 8 ad 14 cm longis, 4 ad 5.5 cm latis, supra brunneo-olivaceis, nitidis, glabris, acuminatis, basi leviter oblique truncatis vel subcordatis, subtus densissime tomentosis, nervis utrinque circiter 8, distinctis; petiolis circiter 8 mm longis; stipulis ovatis ad oblongo-ovatis, integris, inaequilateralibus, acutis ad acuminatis, utrinque minute albido-tomentosis, circiter 5 mm longis, deciduis; fructibus ellipsoideis ad oblongo-ellipsoideis, teretibus, 4.5 ad 5 cm longis, brunneis, apice minute et breviter acuminatis, basi stipitatis, stipite circiter 8 mm longo

⁵ Act. III^{me} Congr. Internat. Bot. Brux. 1 (1910) 114.

⁶ Bull. Soc. Hist. Nat. Autun 24 (1911) 10.

et 5 mm diametro, extus dense et minutissime ferrugineo-stellato-tomentosis.

Kwangtung Province, Sum Sun, Nam Hoi, at the base of a hill, *Levine 1173*, September 7, 1917.

The alliance of this species is manifestly with *Pterospermum jackianum* Wall., to which I first referred the specimen. It differs from Penang material representing Wallich's species, and from the descriptions in a number of details, notably in its entirely different stipules.

The only species reported from China proper are the entirely different *Pterospermum proteus* Burkill and *P. heterophyllum* Hance; *Pterospermum formosanum* Mats., judging from the single sterile specimen I have seen, must be very closely allied to or identical with the Philippine *P. niveum* Vid.

DILLENACEAE

TETRACERA Linnaeus

TETRACERA LEVINEI sp. nov.

Frutex scandens, subglaber; foliis oblongis, rigidis, laevis vel sublaevis, usque ad 13 cm longis, in siccitate pallidis, nitidis, basi acutis, apice acutis, obtusis, vel obscurissime acuminatis, nervis utrinque circiter 15, perspicuis; paniculis axillaribus terminalibusque, usque ad 12 cm longis; fructibus circiter 7 mm longis, glabris, 1-spermis, sepalis utrinque glabris.

A scandent shrub, subglabrous, the inflorescences somewhat appressed-strigose. Branches brownish, somewhat wrinkled, smooth or minutely scabrid. Leaves subcoriaceous, rigid, brittle, oblong, pale and shining when dry, smooth or nearly so, 11 to 13 cm long, 4 to 5 cm wide, base acute, apex acute, somewhat obtuse, or even slightly acuminate, the margins minutely denticulate in the upper one-half; lateral nerves about 15 on each side of the midrib, prominent. Panicles terminal and in the upper axils, up to 12 cm in length. Fruits 1-seeded, ovoid, glabrous, shining, somewhat apiculate, about 7 mm long, the aril orange-yellow. Sepals glabrous on both surfaces.

Kwangtung Province, White Cloud Mountain, near Canton, *Levine 1794*, near small streams, October 22, 1917.

This species is manifestly allied to *Tetracera scandens* (Linn.) Merr. (*T. sarmentosa* Vahl), which is common in Kwangtung Province, from which it differs in its smooth or nearly smooth, not scabrid leaves, and more numerous lateral nerves. The synonyms *Leontoglossum scabrum* Hance, *Actaea aspera* Lour., *Trachytella actaea* DC., and *Calligonum asperum* Lour., based on Kwangtung and Cochinchina specimens, appear to be correctly referred to *Tetracera sarmentosa* Vahl=*T. scandens* (Linn.) Merr. The latter species is represented by *Hongkong Herbarium 1415*, from Hongkong, and *Merrill 10724* and *Levine 1418* from the base of Loh Fau Mountain, Kwangtung Province.

THEACEAE

TRISTYLIUM Turczaninow

TRISTYLIUM OCHNACEUM (DC.) comb. nov.

Cleyra ochracea DC. in Mém. Soc. Phys. Genève. 1 (1822) 412, Prodr. 1 (1824) 524.

Eurya ochracea Szysz. in Engl. & Prantl Nat. Pflanzenfam. 3^e (1893) 189.

Kwangtung Province, Loh Fau Mountain (Lofaushan) *Merrill 10243*, 10686, October, 1916, August, 1917, *Levine 1453*, August, 1917, on exposed open slopes, altitude about 1,000 meters.

This species extends from Japan to Formosa and the central Himalayan region, but has not previously been reported from Kwangtung Province. My number 10243 was originally referred, with doubt, to *Adinandra millettii* Benth., but Mr. Tutcher has called my attention to the fact that the specimen is properly referable to *Cleyra ochracea* DC.; all the specimens are in fruit and agree very closely with authentic Japanese material received from the Leiden Herbarium.

This species has been confused by some authors with the entirely different *Ternstroemia japonica* Thunb. Szyszylowicz has reduced *Cleyra* DC. (non Thunb.) to *Eurya* Thunb., which does not appear to me to be the proper disposition of it; I consider it to be more closely allied to *Adinandra* Jack. *Cleyra* DC., non Thunb., nec Adans., is invalid, and I propose to adopt *Tristylum* Turcz. as the proper valid generic name for this group.

TERNSTROEMIA Mutis

TERNSTROEMIA KWANGTUNGENSIS sp. nov.

Arbor 4 ad 5 m alta, glabra, ramis ramulisque crassis, rugosis; foliis crassime coriaceis, late ellipticis ad elliptico-ovatis, usque ad 9 cm longis, breviter obtuseque acuminatis, basi decurrento-acuminatis, in siccitate supra atro-brunneis, nitidis, subtus brunneis, opacis, nervis utrinque circiter 7, indistinctis, petiolis crassis, 1.5 ad 2.3 cm longis; fructibus depresso-globosis, circiter 1.3 cm diametro (immaturis), sepalis persistentibus, coriaceis, elliptico-ovatis, circiter 8 mm longis.

A tree, 4 to 5 m high, entirely glabrous. Branches and branchlets thickened, rugose, brownish or somewhat reddish-brown, 5 to 7 mm in diameter, the petiolar scars rather prominent. Leaves thickly coriaceous, broadly elliptic to elliptic-ovate, 7 to 9 cm long, 4 to 5 cm wide, the apex shortly and obtusely acuminate, base decurrent-acuminate, the upper surface blackish-brown when dry, prominently shining, the lower surface brown, dull; lateral nerves about 7 on each side of the midrib, slender, indistinct; petioles stout, black when dry, 1.5 to 2.3 cm long. Fruits axillary, solitary, depressed-globose, about 1.3 cm in diameter (immature), dark-brown when dry, the pedicels stout, 1 cm long or less. Persistent sepals coriaceous, elliptic-ovate, about 8 mm long, rounded, scarcely fimbriate.

Kwangtung Province, Loh Fau Mountain (Lofaushan), *Merrill 11013*, August 29, 1917, in damp forested gorges, altitude about 1,000 meters.

This species is closely allied to *Ternstroemia japonica* Thunb., from which it is distinguished by its larger, broader, differently shaped leaves, its distinctly longer petioles, shorter pedicels, and depressed-globose fruits. It is clearly not the same as *Cleyra fragrans* Champ. and *C. dubia* Champ., which were described from Hongkong material, and which are apparently properly reduced as synonyms of *Ternstroemia japonica* Thunb.

THEA Linnaeus

THEA FURFURACEA sp. nov.

Arbor parva, bracteis et fructibus exceptis glabra; foliis oblongis, coriaceis, usque ad 12 cm longis, utrinque subaequaliter angustatis, basi acutis, apice acuminatis, margine glanduloso-denticulatis, in siccitate subolivaceis vel viridi-olivaceis, nitidis, subtus pallidioribus, glandulosis, breviter petiolatis, nervis utrinque 8 ad 10, supra impressis, subtus perspicuis, anastomosantibus; fructibus terminalibus, globosis vel depresso-globosis, breviter et crasse pedicellatis, circiter 1 cm diametro (immaturis), extus densissime furfuraceis atque pilis paucis deciduis instructis.

A small tree, usually about 3 m high, entirely glabrous except the bracts and fruits (flowers not seen). Branches terete, smooth, pale-brownish, the branchlets occasionally somewhat compressed. Leaves oblong, coriaceous, 7 to 12 cm long, 2.5 to 4 cm wide, subequally narrowed to the acute base and to the rather slenderly but blunt-acuminate apex, the margins glandular-denticulate throughout, the upper surface pale-olivaceous or greenish-olivaceous when dry, shining, the lower surface paler, glandular, shining; lateral nerves 8 to 10 on each side of the midrib, somewhat impressed on the upper surface, rather prominent on the lower surface, anastomosing, the lax reticulations distinct; petioles about 3 mm long, brown. Fruits terminal, globose or depressed-globose, about 1 cm in diameter (immature), externally densely covered with pale-brownish, furfuraceous, appressed scales and with few, somewhat tufted, deciduous, pale hairs, 3-celled, with three seeds in each cell; pedicels short, stout, 4 mm long or less, densely covered with the persistent, imbricate bases of the bracts, the outer bracts broadly ovate to somewhat reniform, obtuse to subacute, somewhat pubescent on the margins and in the median part of the back, the innermost up to 1 cm in length and somewhat cucullate.

Kwangtung Province, Loh Fau Mountain (Lofaushan), *Merrill 10681* (type), *Levine 1516*, August 17, 1917, in damp forested gorges, altitude about 1,000 meters.

This species is well characterized by its densely furfuraceous fruits.

SCHIMA Reinwardt

SCHIMA CONFERTIFLORA sp. nov.

Arbor (vel interdum frutex, 1 ad 3 m altus) usque ad 10 m alta, novellis floribusque exceptis glabra; foliis coriaceis, in siccitate brunneis ad brunneo-olivaceis, oblongo-ovatis ad oblongo-ellipticis, usque ad 9 cm longis, breviter obtuseque acuminatis, basi acutis, margine distincte crenato-serratis, nervis utrinque 8 ad 10, tenuibus; floribus numerosis, axillaribus et ad apicem ramulorum dense subracemoso-confertis, breviter pedunculatis; sepalis orbicularibus, extus glabris, margine perspicue ciliatis; fructibus depresso-globosis, circiter 1.2 cm diametro, breviter crasseque pedunculatis.

A tree attaining a height of 10 m, or when growing on exposed slopes a shrub 1 to 3 m high, glabrous except the flowers and the growing tips of the branchlets. Branches dark-brown, rugose, rather stout, terete, the terminal bud-scales densely appressed-pubescent with pale shining hairs. Leaves numerous, crowded, thickly coriaceous, oblong-ovate to oblong-elliptic, 4.5 to 9 cm long, 2 to 3.3 cm wide, base acute, apex shortly and obtusely acuminate, margins distinctly crenate-serrate, when dry brown to brownish-olivaceous, shining; lateral nerves slender, not prominent, 8 to 10 on each side of the midrib, anastomosing, the reticulations indistinct; petioles 1 to 1.5 cm long. Flowers numerous, white, in the uppermost axils and racemously crowded at the tips of the branchlets, about 3 cm in diameter, their pedicels glabrous, about 1 cm long, stout, brown when dry. Sepals suborbicular, rounded, coriaceous, about 5 mm in diameter, glabrous externally, internally densely appressed-pubescent, the margins densely and prominently ciliate with pale hairs. Petals obovate, glabrous except the sparingly ciliate margins. Ovary ovoid, densely pubescent at the base, glabrous above; style stout, about 7 mm long. Fruit globose or depressed-globose, woody, about 1.2 cm in diameter, brown when dry, sparingly appressed-pubescent, ultimately glabrous, at first splitting into two or three valves, ultimately into five, the persistent sepals very coriaceous, glabrous, the pedicels stout, about 1 cm long, the mature fruits in the axils of fallen leaves; seeds somewhat reniform, rounded at both ends, about 7 mm long and 4.5 mm wide, somewhat rugose.

Kwangtung Province, Loh Fau Mountain (Lofaushan), *Merrill 10690* (type), August 16, 1917, on open exposed ridges, altitude 950 meters, *Merrill 11052*, August 11, 1917, in damp forested ravines, altitude about 900 meters, *Merrill 10156* and *Levine 601, 1513*, October 28, 1916, August 10, 1917, in fruit, and in flower, on open slopes, altitude about 900 meters.

This form differs so radically from the typical Malayan *Schima noronhae* Reinw., and from the Chinese and Formosan form that has been referred to Reinwardt's species, that I am constrained to consider it a distinct species. From typical Javan *Schima noronhae* Reinw. it is readily distinguished by its smaller leaves, which are not slenderly acuminate; crowded, shortly pedicelled flowers; smaller fruits; and numerous other characters. From the Chinese form that has been referred to Reinwardt's species, but which I consider should be retained as a distinct species under the name *Schima superba* Garden. & Champ., it differs in its smaller leaves which are not slenderly and sharply acuminate; distinctly smaller fruits; and shorter-peduncled, more numerous, densely crowded flowers.

OENOTHERACEAE

EPILOBIUM Linnaeus

EPILOBIUM PHILIPPINENSE C. B. Rob. in Philip. Journ. Sci. 5 (1910) Bot. 369.

Kwangtung Province, Loh Fau Mountain (Lofaushan), *Merrill 10658*, *Levine 1467*, August 16, 1917, on rubbish of fallen walls at the ruined monastery Put Wan T'sz, altitude about 1,100 meters.

The genus is new to Kwangtung Province. The specimens are more robust than the Philippine form, with somewhat shorter fruits and slightly smaller seeds, but in other characters closely approximates Robinson's type. It is very probable that as species are interpreted in this genus by Haussknecht and by Lévillé, these authors would consider the Chinese form specifically distinct from the Philippine one; it is not improbable that this Chinese form has already been described under some other specific names, but as distinctions are drawn by Lévillé it is practically impossible to gain a clear conception of many of his species from the descriptions alone, the same being true also of many of Haussknecht's species.

MELASTOMATACEAE

BLASTUS Loureiro

BLASTUS PAUCIFLORUS (Benth.) comb. nov.

Allomorphia pauciflora Benth. in Hook. Lond. Journ. Bot. 1 (1842) 485; Hemsl. in Journ. Linn. Soc. Bot. 23 (1887) 301; Cogn. in DC. Monog. Phan. 7 (1891) 465; Dunn & Tutcher in Kew Bull. Add. Series 10 (1912) 107 (Fl. Hongk. Kwangtung).

Oxyspora ? pauciflora Benth. Fl. Hongk. (1861) 116.

Blastus hindsii Hance in Journ. Linn. Soc. Bot. 13 (1873) 103.

Hongkong, Victoria Peak, comm. *W. J. Tutcher*: Kwangtung Province, Loh Fau Mountain (Lofaushan), *Merrill 10743*, *Levine 1462*, about ledges in thickets, in damp ravines, altitude about 950 meters, August 16, 1917.

An examination of the flowers of this species shows that it belongs in the genus *Blastus*, and it is accordingly so placed. *Blastus cochinchinensis* Lour. is distinguished, among other characters, by its short, axillary inflorescences. Lévillé has described several species of *Blastus* with terminal inflorescences, some of which, judging from his wholly inadequate diagnoses, must be very close to the present species.

ARALIACEAE

DENDROPANAX Decaisne & Planchon

DENDROPANAX ACUMINATISSIMUM sp. nov.

Frutex glaber, 3 ad 4 m altus; foliis lanceolatis ad anguste lanceolatis, usque ad 11 cm longis, tenuiter caudato-acuminatis, basi acutis, integris, nervis utrinque 10 ad 12, tenuibus, indistinctis, anastomosantibus; umbellis terminalibus, solitariis vel trinis, breviter pedunculatis, subpaucifloris; floribus 5-meris, circiter 5.5 mm longis.

A slender, erect, glabrous shrub, 3 to 4 m high; the branches and branchlets terete, somewhat brownish, the latter smooth. Leaves scattered, lanceolate to narrowly lanceolate, firmly chartaceous to subcoriaceous, rather pale-olivaceous when dry, 7 to 11 cm long, 1 to 2 cm wide, entire, base acute, narrowed above into the slenderly caudate-acuminate apex; lateral nerves 10 to 13 on each side of the midrib, slender, spreading-ascending, anastomosing, indistinct; petioles 1 to 3.5 cm long. Umbels terminal, solitary or in threes, about 2 cm in diameter in anthesis, their peduncles 5 to 10 mm long, 10- to 15-flowered, the bracteoles linear, 2 to 8 mm long, deciduous, the pedicels about 6 mm long. Calyx green, cup-shaped, about 3 mm long, its margin 5-denticulate. Petals 5, white, ovate to oblong-ovate, 2.5 mm long. Filaments about 2 mm long. Ovary 5-celled; style stout, furrowed, somewhat narrowed upward, about 1.3 mm long.

Kwangtung Province, Loh Fau Mountain (Lofaushan), *Merrill 10817* (type), *Levine 1315*, August 24, 1917, from the same plant.

This species occurs on steep forested slopes of damp ravines, altitude 800 to 1,000 meters, and is very rare, as only a few specimens were observed in several weeks' work on Loh Fau Mountain. It is well characterized by its very narrow, lanceolate, slenderly acuminate leaves which are not at all 3-nerved or 3-plinerved at the base. *Dendropanax japonicum* Seem. is abundant on open slopes on Loh Fau Mountain, while what I take to be *D. proteum* Benth. also occurs in similar habitats.

ERICACEAE

VACCINIUM Linnaeus

VACCINIUM HANCOCKIAE sp. nov.

Frutex 2 ad 3 m altus, glaber; foliis coriaceis, oblongo-ovatis ad oblongo-lanceolatis, in siccitate brunneo-olivaceis, nitidis, usque ad 5 cm longis, acuminatis, basi acutis, margine cartilagineis, distanter serrulatis, nervis utrinque circiter 5, tenuibus, anastomosantibus; racemis in axillis superioribus, circiter 2 cm longis, bracteolis oblongo-ovatis, circiter 1 mm longis; floribus subcylindraceis, circiter 7 mm longis, sursum leviter angustatis; calycis

lobis lanceolatis, tenuiter acuminatis, subpatulis, circiter 1.5 mm longis.

A shrub 2 to 3 m high, entirely glabrous except the top of the ovary, the filaments, and the inside of the corollas. Branches terete, reddish-brown to grayish-brown, crowded, the internodes short. Leaves numerous, coriaceous, oblong-ovate to oblong-lanceolate, 2 to 5 cm long, 8 to 16 mm wide, brownish-olivaceous when dry, not glandular, shining, the lower surface slightly paler than the upper, narrowed below to the acute base and above to the rather slenderly acuminate apex, the margins cartilaginous, distantly serrulate; lateral nerves about 5 on each side of the midrib, slender, distinct on the lower surface, curved-ascending, anastomosing, the reticulations distinct; petioles about 3 mm long. Racemes in the uppermost axils, about 2 cm long, 6- to 10-flowered, the pedicels spreading or recurved, about 3 mm long, the minute bracteoles oblong-ovate, acuminate, about 1 mm long. Calyx-tube turbinate, black or somewhat glaucous when dry, the lobes lanceolate, slenderly acuminate, about 1.5 mm long, somewhat spreading. Corolla white, glabrous externally, slightly pubescent inside, subcylindric, slightly narrowed above, about 6 mm long and 2 mm in diameter, the lobes subovate, obtuse, 0.8 mm long, recurved. Top of the ovary hirsute. Stamens 10; filaments thickened and villous below, filiform and glabrous above, about 3.5 mm long; anthers slender, narrow, 2 to 2.8 mm long, the spurs 1.2 to 2 mm long. Style glabrous, rather stout, 6 mm long.

Kwangtung Province, Loh Fau Mountain (Lofaushan), *Merrill 10705*, (type), *Levine 1355*, August 25, 1917, on open grassy slopes 600 to 900 meters, rare.

This species somewhat resembles *Vaccinium carlesii* Dunn, but is entirely different in its floral characters. It is the third species of the genus to be found in Kwangtung Province, the other two, *Vaccinium bracteatum* Thunb. and *V. iteophyllum* Hance, being common on Loh Fau Mountain. It is dedicated to Miss A. Hancock, of the New Zealand Presbyterian Mission at Canton, in commemoration of her interest in the flora of Kwangtung Province, and in appreciation of her coolness in extricating herself, Mr. Levine, and the author in a serious encounter with Chinese robbers on Loh Fau Mountain on August 22, 1917.

RHODODENDRON Linnaeus

RHODODENDRON LEVINEI sp. nov.

Arbor 3 ad 4 m alta, ramulis et petiolis et foliis junioribus pilis longis tenuibus ferrugineis ornatis; foliis subcoriaceis, oblongo-ellipticis ad ellipticis, usque ad 10 cm longis, apice late rotundatis, interdum brevissime apiculatis, basi acutis ad rotundatis, margine revolutis, supra brunneo-olivaceis, subtus brun-

neis vel glaucescentibus, eleganter glanduloso-lepidotis, nervis utrinque circiter 8, distinctis; fructibus circiter 1.8 cm longis, oblongo-ovoideis, brunneis, glandulosis; sepalis persistentibus, subovatis, circiter 1.2 cm longis.

A tree 3 to 4 m high, the young branchlets, petioles, and young leaves prominently ciliate with long, spreading, brown or ferruginous, slender hairs 3 to 5 mm in length. Branches terete, smooth, reddish-brown, glabrous. Leaves crowded at the apices of the branchlets, subcoriaceous, oblong-elliptic to elliptic, 5 to 10 cm long, 3 to 5 cm wide, the apex broadly rounded, sometimes shortly apiculate, the base acute or subacute, the younger ones with scattered, slender, elongated hairs on both surfaces and on the margins, the older ones glabrous or nearly so, the upper surface shining, brownish-olivaceous when dry, the reticulations impressed, the lower surface of about the same color as the upper or glaucous, with numerous, scattered, brown, shining lepidote glands; primary lateral nerves about 8 on each side of the midrib, slender, distinct, anastomosing; petioles 1 to 1.5 cm long. Flowers not seen. Fruits umbellately arranged at the tips of the branchlets, usually 3 to 5 on each branchlet, their pedicels about 2 cm in length, glabrous or nearly so, the capsules brown when dry, glandular, oblong-ovoid, about 1.8 cm long and 1 cm in diameter, the subpersistent style at least 2.5 cm long; sepals persistent, subovate, obtuse, about 1.2 cm long, reticulate, glandular, glabrous, chartaceous.

Kwangtung Province, Loh Fau Mountain (Lofaushan), *Merrill 10952* (type), *Levine 1330*, from the same plant, August 24, 1917, in a deep forested ravine in the "Perfect Pool gorge" growing out over a small stream, altitude about 950 meters.

This species must be exceedingly rare, as only a single plant was observed during our exploration of the numerous gorges on the upper slopes of Loh Fau Mountain. It is strikingly characterized by its indumentum; its subelliptic leaves which are broadly rounded at the apices and prominently lepidote-glandular beneath; and its persistent, reticulate sepals. It is dedicated to Mr. C. O. Levine, of the Canton Christian College.

CLETHRACEAE

CLETHRA Linnaeus

CLETHRA FABRI Hance in Journ Bot. 21 (1883) 130.

Clethra canescens Hemsl. in Journ. Linn. Soc. Bot. 26 (1881) 33;
Dunn & Tutcher in Kew Bull. Add. Series 10 (1912) 155, non Reinw.

Kwangtung Province, Loh Fau Mountain (Lofaushan), *Merrill 10742*, August 21, 1917, about boulders on open grassy slopes, altitude about 1,100 meters, rare.

The type of *Clethra fabri* Hance was from Loh Fau Mountain. Hance's

species was reduced by Hemsley to the Malayan *Clethra canescens* Reinw., the type of which was from Celebes. Comparison of the Chinese material with a Celebes specimen, presumably representing Reinwardt's species, shows that the two are unmistakably distinct. The Chinese form is also specifically distinct from the Philippine *Clethra lancifolia* Turcz., erroneously placed by Hemsley as a synonym of *Clethra canescens* Reinw. *Clethra fabri* Hance can readily be distinguished *C. canescens* Reinw. by its much fewer-nerved leaves, and from *C. lancifolia* Turcz. by its distinctly larger flowers.

VERBENACEAE

CALLICARPA Linnaeus

CALLICARPA OLIGANTHA sp. nov.

Frutex 2 ad 3 m altus, subglaber, ramulis junioribus parcissime et decidue stellato-pubescentibus; foliis brevissime petiolatis, anguste lanceolatis, usque ad 12 cm longis et 1.5 cm latis, chartaceis, utrinque subaequaliter angustatis, acuminatis, basi cuneatis, margine in $\frac{3}{4}$ superiore parte distincte serrulatis, supra glabris, subtus glandulosis, glabris, vel junioribus parcissime stellato-pubescentibus, nervis utrinque 7 ad 9, curvato-adscendentibus, tenuibus; cymis axillaribus depauperatis, 2- vel 3-floris, brevissime pedunculatis, pedicellis glabris, circiter 4 mm longis; fructibus globosis, 3 ad 3.5 mm diametro, glabris, calycis persistentibus, glabris, truncatis.

A slender shrub, 2 to 3 m high, in age glabrous or nearly so, the young branchlets sparingly stellate-pubescent. Branches slender, terete, smooth, glabrous, grayish. Leaves narrowly lanceolate, chartaceous, 6 to 12 cm long, 0.8 to 1.5 cm wide, narrowed at both ends, the upper surface glabrous, smooth, eglandular, brownish-olivaceous, shining, the lower surface slightly paler, distinctly pitted-glandular, glabrous, or when young sparingly stellate-pubescent near the midrib, the base cuneate, the apex rather slenderly but bluntly acuminate, the margins in the upper two-thirds distinctly serrulate; lateral nerves 7 to 9 on each side of the midrib, slender, curved-ascending, anastomosing, the reticulations slender, not prominent; petioles 2 mm long or less. Cymes axillary, few, subsessile or shortly peduncled, depauperate, 2- or 3-flowered, the peduncles 2 mm long or less, the pedicels not exceeding 4 mm in length, glabrous. Fruits globose or subglobose, dark-brown when dry, 3 to 3.5 mm in diameter, glabrous, the persistent calyx truncate, glabrous.

Kwangtung Province, Loh Fau Mountain (Lofaushan), Merrill 11060, August 23, 1917, in thickets along small streams, altitude about 900 meters; rare, but a single plant seen.

The alliance of this species is manifestly with the form commonly

known as *Callicarpa purpurea* Juss., but which should be known as *C. dichotoma* (Lour.) Raeusch. It differs in its relatively much narrower leaves, and depauperate, subsessile, very few-flowered cymes.

CALLICARPA DICHOTOMA (Lour.) Raeusch. *Nomencl. ed. 3* (1817) 37.

Porphyra dichotoma Lour. *Fl. Cochinch.* (1790) 70.

Callicarpa purpurea Juss. in *Ann. Mus. Paris* 7 (1806) 69.

Kwangtung Province, Teng Woo Mountain *Levine 743*, *Levine & Groff 114*, November, 1916 and June, 1917.

The type of *Porphyra dichotoma* Lour. was from the vicinity of Canton, and the specimens cited above agree perfectly with the original description and are practically topotypes. There is no valid reason for displacing Loureiro's specific name by the more recent *Callicarpa purpurea* Juss.

CALLICARPA LONGILOBA nom. nov.

Callicarpa tomentosa Hook. & Arn. *Bot. Beechey's Voy.* (1841) 205;

Benth. *Fl. Hongk.* (1861) 269; Forbes & Hemsl. in *Journ. Linn.*

Soc. Bot. 26 (1890) 255; Dunn & Tutchter *Fl. Kwangtung & Hong-*

kong (1912) 202; ? Willd. *Enum. Hort. Berol.* (1809) 158; ?

Schauer in *DC. Prodr.* 11 (1857) 647, non Murr.

This strongly characterized species is readily distinguished by its slender, elongated calyx-teeth; and, there being no tenable name for it, I propose to call it *Callicarpa longiloba*. *Callicarpa tomentosa* Willd. was based on a specimen the origin of which was unknown, and it may not be the same as *Callicarpa tomentosa* as interpreted by modern authors; there is little in the description that would indicate that Willdenow's species is the same as the Chinese form commonly referred to *Callicarpa tomentosa* Willd. Whatever the status of the form Willdenow originally described, the name is invalidated by *Callicarpa tomentosa* (Linn.) Murr. (1798) based on *Tomex tomentosa* Linn. (1753), it being the valid name of the Indian species commonly known as *Callicarpa lanata* Linn. Specimens examined are as follows: Kwangtung Province, Loh Fau Mountain (Lo-faushan) *Merrill 10312, 10677, Levine 1517*; Formosa, *Kanehira*.

GESNERACEAE

DIDYMOCARPUS Wallich

DIDYMOCARPUS SWINGLEI sp. nov.

Herba acaulescens; foliis omnibus radicalibus, succulentis, fragilis, in siccitate membranaceis, olivaceis, utrinque parce pubescentibus, oblongo-obovatis, usque ad 15 cm longis, apice rotundatis, basi decurrento-acuminatis, saepe inaequalateralibus, margine undulato-dentatis, nervis utrinque 5 vel 6; scapis pendulis, usque ad 20 cm longis, pubescentibus, plerumque trichotome ramosis, pedicellis 4 ad 8 cm longis, bracteis parvis, oblongis, circiter 4 mm longis; calycis lobis lanceolatis, pubescentibus, liberis, 7 mm longis; corolla campanulata, 3 ad 3.5 cm longa, purpureo-azurea; capsulis circiter 2 cm longis, pubescentibus.

An acaulescent succulent herb, the leaves all radical, subrosulate, when fresh thick, fleshy, brittle, when dry membranaceous, olivaceous, in general oblong-obovate, apex rounded, base decurrent-acuminate and usually distinctly inequilateral, both surfaces rather sparingly pubescent with short hairs, the margins somewhat undulate-dentate; lateral nerves 5 or 6 on each side of the midrib, rather distinct; petioles up to 4 cm in length. Scapes several, usually trichotomously branched, slender, each several-flowered, distinctly pubescent, pendulous, up to 20 cm in length; bracts small, oblong, pubescent, about 4 mm long; pedicels slender, rather densely pubescent, 4 to 8 cm long. Flowers campanulate, blue-purple, 3 to 3.5 cm long. Calyx-lobes lanceolate, free to the base, pubescent, about 7 mm long. Corolla-tube terete, not gibbous, gradually widened upward, 3 to 3.5 cm long, the limb somewhat bilabiate, the five lobes all subequal, rounded. Stamens 2 only; filaments glabrous; anthers about 3.5 mm wide and 1.5 mm long, united. Ovary and style pubescent; stigma liguliform, entire, about 2 mm long, oblique, as persistent on immature fruits often slightly reflexed. Capsules linear-lanceolate, pubescent, about 2 cm long.

Kwangtung Province, Loh Fau Mountain (Lofaushan), *Merrill 10692* (type), *Levine 1538*, August 16, 1917, gregarious on very damp cliffs in deep, shaded ravines; altitude about 1,000 meters.

This species is apparently confined to its peculiar habitat, and was observed in but a few restricted places, although where found it was gregarious and abundant. It grows on perpendicular cliffs, and its inflorescences are pendulous; when occurring in mass and in full anthesis, it is strikingly ornamental. It does not conform with the descriptions of any of the known Chinese species of *Chirita* or *Didymocarpus*, and might with almost equal propriety be placed in *Chirita* as in *Didymocarpus*. I have placed it in the latter genus as the liguliform stigma is not at all lobed.

SCROPHULARIACEAE

BRANDISIA Hooker f. & Thomson

BRANDISIA SWINGLEI sp. nov.

Suffrutex erectus, circiter 1 m altus, ramulis et subtus foliis et floribusque dense cinereo-pubescentibus, indumento stellato; foliis oppositis, oblongo-ovatis, membranaceis, usque ad 8 cm longis, acutis vel leviter acuminatis, basi rotundatis, margine denticulatis vel subintegris, supra in siccitate nigrescentibus, subglabris, subtus pallidis; floribus axillaribus, solitariis vel binis, pedicellatis, circiter 2.3 cm longis, flavidis.

A suffrutescent erect plant, about 1 m high, the younger parts

and lower surface of the leaves densely and softly stellate-pubescent with pale-gray indumentum, the hairs elongated, somewhat matted, rather woolly, the older branches terete, smooth, glabrous. Leaves opposite, membranaceous, oblong-ovate, 4.5 to 8 cm long, 2 to 4 cm wide, base rounded, apex acute to rather slenderly acuminate, margins usually denticulate, sometimes nearly entire, the upper surface blackish when dry, shining, ultimately glabrous, the lower pale-grayish; lateral nerves about 5 on each side of the midrib, anastomosing, conspicuous; petioles about 5 mm long. Flowers yellow, axillary, solitary or in pairs, their pedicels 5 to 7 mm long, the filiform bracteoles nearly as long as the pedicels. Calyx about 13 mm long, externally densely and softly gray-tomentose, inside densely appressed-hirsute, the lobes 5, oblong-lanceolate, acuminate, 5 mm long. Corolla yellow, externally cinereous-tomentose, about 23 mm long, the two lobes of the upper lip oblong-obovate, about 9 mm long, the three of the lower lip suborbicular, about 6 mm long. Anthers suborbicular, 2.5 mm in diameter, their margins very prominently bearded, cohering. Ovary densely tomentose. Capsule oblong-ovoid, somewhat cinereous-tomentose, about 1 cm long, 2-celled, first loculicidally dehiscent into two valves, ultimately splitting again through the placentae into four valves. Seeds numerous, thin, compressed, linear-oblong, often slightly falcate, about 4 mm long, 1 mm wide, the testa expanded into a thin wing surrounding the very narrow seed proper.

Kwangtung Province, Loh Fau Mountain (Lofaushan), *Merrill 10851*, August 22, 1917, in thickets along small streams, altitude about 950 meters; very rare, a single plant observed.

This species is allied to *Brandisia hancei* Hook. f., of which no description has ever been published. My conception of Hooker's species is gained from an examination of Yunnan material, *Henry 9013*, *Delavay 1934*, *4626*. In these specimens the leaves are smaller than in *B. swinglei* Merr., much thicker, often cordate at the base, while the dense indumentum is ferruginous, and its stellate character is very evident; the calyx is broader, and its lobes are very different in shape in the Yunnan material. The genus is new to Kwangtung Province, the known forms now being *Brandisia discolor* Hook. f. & Th., *B. hancei* Hook. f., *B. racemosa* Hemsl., *B. souliei* Bonati, *B. laetevirens* Rehder, and *B. glabrescens* Rehder.

LINDERNIA Allioni

LINDERNIA PYXIDARIA All. Misc. Taur. 3 (1755) 178.

Vandellia pyxidaria Maxim. in Bull. Acad. Pétersb. 20 (1875) 449.

Kwangtung Province, Sheklung, *Merrill 11130*, August 28, 1917, on muddy river banks.

Not previously reported from Kwangtung Province: Central Europe to Japan, southward to Malaya and Polynesia.

RUBIACEAE

MYCETIA Blume

MYCETIA CORIACEA (Dunn) comb. nov.

Adenosacme coriacea Dunn in Kew Bull. Add. Series 10 (1912) 130
(Fl. Hongkong & Kwangtung).

Kwangtung Province, Loh Fau Mountain (Lofaushan), Merrill 10386, 10867, Levine 597, 1490, November, 1916 and August, 1917, a characteristic undershrub along small streams, in thickets, altitude 900 to 1,100 meters. The specimens agree with Dunn's authentic material in the Hongkong Herbarium, but I have adopted the generic designation *Mycetia* in place of *Adenosacme*, as the former is the older name.

HEDYOTIS Linnaeus

HEDYOTIS ACUMINATISSIMA sp. nov.

Herba erecta, glabra, ramosa, usque ad 75 cm alta, basi sublig-nosa, caulis infra teretibus, supra cum ramis 4-angulatis; foliis lanceolatis, chartaceis, scaberulis, usque ad 7 cm longis, basi acutis vel decurrento-acuminatis, apice tenuiter acuminatis, nervis utrinque 3, adscendentibus, perspicuis, supra impressis, subtus prominulis; stipulis ovatis, circiter 2 mm longis, denticulatis, apice plerumque 3-laciniatis; cymis axillaribus terminalibusque, circiter 4 cm longis, laxis; floribus albidis, corollae laciniis lanceolatis, recurvatis, 5 mm longis, intus villosis, tubo circiter 1.8 mm longo.

An erect, branched, glabrous herb attaining a height of 75 cm, the lower part of the stem terete, 3 to 4 mm in diameter, the internodes 4 to 7 cm long, unbranched in the lower 20 to 40 cm, the upper parts of the stem and the branches rather sharply 4-angled, the branches 20 to 30 cm in length. Leaves opposite, lanceolate, chartaceous, somewhat scaberulous, greenish or yellowish-green when dry, 4 to 7 cm long, 1 to 1.5 cm wide, the base acute or decurrent-acuminate, the apex slenderly and sharply acuminate; lateral nerves 3 on each side of the midrib, ascending, impressed on the upper surface, prominent beneath, anastomosing, the reticulations few, lax; petioles about 5 mm long; stipules ovate, about 2 mm long, their margins denticulate, the apex usually cleft into three lacinae. Cymes terminal and axillary, about 4 cm long, rather lax, few-flowered, the bracteoles lanceolate, 1 to 1.5 mm long, the pedicels 2 to 4 mm in length. Calyx-tube terete, ovoid, about 2 mm long, the lobes oblong-ovate, acute, 1 mm long. Corolla white, the tube about 1.8 mm long, the lobes 4, lanceolate, recurved, densely villous inside, about 5 mm long. Style 8 mm long.

Kwangtung Province, Loh Fau Mountain (Lofaushan), *Merrill 10763* (type), 10826, August 12 and 17, 1917, on wet grassy slopes and in damp forested ravines, altitude 1,000 to 1,100 meters, rare.

This species is well characterized by its habit, its older and somewhat woody stems being terete, the younger parts and branches being rather sharply 4-angled; its lanceolate, slenderly acuminate, slightly scaberulous, few-nerved leaves; and its rather lax cymes, the corolla lobes being about three times as long as the corolla-tube. This species is probably as closely allied to *Hedyotis acutangula* Champ. as to any other; but it is abundantly distinct from Champion's species, which is by far the commonest representative of the genus found on Loh Fau Mountain.

MORINDA Linnaeus

MORINDA PARVIFOLIA Bartl. in DC. Prodr. 4 (1830) 449; Merr. in Philip. Journ. Sci. 3 (1908) Bot. 438.

Kwangtung Province, Canton and vicinity, *Levine 782, 961, 1675*: Hongkong, *Mrs. Clemens 4270, Curran*: Formosa, *Kawakami 1624*.

This form has been included in the rather polymorphous *Morinda umbellata* Linn., but I consider it to be specifically distinct. The specimens cited closely match Bartling's type, a fragment of which is before me, as well as Cuming's material on which *Morinda cumingiana* Vid. (*Lucinaea cumingiana* Vid.) was based. The species is otherwise known only from northern Luzon and the Batan and Babuyan Islands.

TARENNA Gaertner

TARENNA ATTENUATA (Voigt) Hutch. in Sargent Pl. Wils. 3 (1916) 411.

Stylocoryne attenuata Voigt Hort. Suburb. Calcut. (1845) 377.

Webera attenuata Hook. f. Fl. Brit. Ind. 3 (1880) 104; Dunn & Tutchter Fl. Kwangtung & Hongkong (1912) 130.

Stylocoryne webera Benth. Fl. Hongk. (1861) 156, non A. Rich.

Kwangtung Province, Loh Fau Mountain (Lofaushan), *Merrill s. n.*, August 20, 1917, on forested slopes in ravines, altitude about 1,000 meters.

The specimen agrees closely with the descriptions and with *Hongkong Herbarium 1715*, from Hongkong, and *Henry 89* from Formosa. The generic name *Webera* is untenable under all rules of botanical nomenclature, hence the adoption of the generic designation *Tarenna*.

TARENNA MOLLISSIMA (Hook. & Arn.) comb. nov.

Webera mollissima Benth. ex Hance in Journ. Linn. Soc. Bot. 13 (1873) 105; Dunn & Tutchter Fl. Kwangtung & Hongkong (1912) 130.

Stylocoryne mollissima Walp. Repert. 2 (1843) 517; Benth. in Kew Journ. Bot. 4 (1852) 195, Fl. Hongk. (1861) 156.

Cupia mollissima Hook. & Arn. Bot. Beechy's Voy. (1841) 192. Kwangtung Province, *Mell 52*.

UNCARIA Schreber

UNCARIA RHYNCHOPHYLLA (Miq.) Jackson in Index Kewensis (1895) 1145; Haviland in Journ. Linn. Soc. Bot. 33 (1897) 89.

Nauclea rynchophylla Miq. Ann. Mus. Bot. Lugd.-Bat. 3 (1867) 108. Kwangtung Province, Loh Fau Mountain (Lofaushan), *Merrill 10331*,

Levine 1324, August 24, 1917, from the same plant; in forested ravines, altitude about 1,000 meters, a single plant seen.

This species was originally described from sterile Japanese material, and as a *Nauclea*, not as an *Uncaria*; the first publication of the binomial *Uncaria rhynchophylla* seems to be that in *Index Kewensis*. The specimens cited above agree closely with Japanese material, *Wichura 1280*, with *Dunn 2794* from Fokien Province, China; with the original description; and with the more ample one given by Haviland. The species has not previously been reported from China.

COMPOSITAE

CARPESIUM Linnaeus

CARPESIUM CERNUUM Linn. Sp. Pl. (1753) 859.

Kwangtung Province, White Cloud Mountain, near Canton, *Levine 1782*, October, 1917; Swatow, *Dalziel*, October 1899.

The specimens are by no means typical of the Linnean species, and a critical revision of the genus may show that they are referable to some other species. *Carpesium cernuum* Linn. extends from Europe to Japan and northeastern Australia; it occurs on the mountains of northern Luzon, but has not been reported from the Malay Archipelago. The species is new to Kwangtung Province.

PHILIPPINE DIPTEROCARPACEAE, II

By F. W. FOXWORTHY
(From the Bureau of Forestry)

TWO PLATES

Six years ago I published a synopsis of the Philippine species of this group.¹ At that time we recognized seven genera and forty-eight species as occurring in the Archipelago; we now recognize nine genera and seventy species. Since then two other articles have been issued dealing with some of the Philippine representatives of this group. One of these was by Mr. A. D. E. Elmer,² who described two new species of *Hopea* and two of *Vatica*; the other was my own paper on the Dipterocarpaceae of the Agusan region, based on collections made by Mr. Elmer;³ in that paper I described five species as new and recorded notes on five other species. In the present paper an attempt is made to bring our present knowledge of the group into classified form. All of the keys have had to be rewritten.

COMMON NAMES OF DIPTEROCARPS

The ten or twelve well-known types of Philippine dipterocarp woods are supplied by about seventy different species. A particular wood in nearly every case is furnished by a group of species. Most of the species are sufficiently well known to have common names, but the same tree often has different names in different localities; this has caused a great deal of confusion. In the interests of accuracy and uniformity it has seemed advisable to make a list of the known names and to make an effort to standardize them. In doing this, there has first been made a list of the commercial woods by their names in their principal markets. Following this there is a list of the species known to produce each wood; and, finally, there is an alphabetical list of all the known common names with the species to which they are affixed.

¹ Philip. Journ. Sci. 6 (1911) Bot. 231-288.

² Leaflet. Philip. Bot. 4 (1912) 1471-1474.

³ Leaflet. Philip. Bot. 6 (1913) 1949-1958.

The commercial woods, in their order of apparent abundance, are:

- | | |
|----------------------------------|------------------------------------|
| 1. Apitong. | 7. Mangasinoro, including kalunti. |
| 2. Red lauan. | 8. Palosapis, or mayapis. |
| 3. White lauan, including almon. | 9. Mangachapuy, or dalingdingan. |
| 4. Tanguile. | 10. Narig. |
| 5. Guijo. | |
| 6. Yacal. | |

APITONG

This is the wood furnished by any and all species of *Dipterocarpus*. That from *Dipterocarpus grandiflorus* Blanco seems to have been the one first recorded under this name. Commercially, it seems to be impossible to distinguish among the different species, when one is handling logs or converted timber. The species furnishing the wood apitong are the following of the genus *Dipterocarpus*:

- | | |
|------------------------------------|--------------------------------|
| <i>Dipterocarpus pilosus</i> Roxb. | <i>D. obconicus</i> Foxw. |
| <i>D. affinis</i> Brandis. | <i>D. cuneatus</i> Foxw. |
| <i>D. trinervis</i> Blume. | <i>D. warburgii</i> Brandis. |
| <i>D. gracilis</i> Blume. | <i>D. speciosus</i> Brandis. |
| <i>D. hasseltii</i> Blume. | <i>D. basilanicus</i> Foxw. |
| <i>D. vernicifluus</i> Blanco. | <i>D. grandiflorus</i> Blanco. |
| <i>D. subalpinus</i> Foxw. | <i>D. philippinensis</i> Foxw. |
| <i>D. caudatus</i> Foxw. | <i>D. orbicularis</i> Foxw. |
| <i>D. perturbinatus</i> Foxw. | |

Apitong is the most abundant wood in the Philippine Islands, apparently making up about 20 per cent of the volume of our commercial forests.

RED LAUAN

This is the name applied to the wood of a number of closely related species of *Shorea*, which have rather soft, reddish, usually rather coarse-grained wood. There are differences in color and grain among the different forms of red lauan. It is not so uniform in quality as apitong. Collectively, the different red lauans are more abundant than apitong, constituting about 21 per cent by volume of our forests. A very good red lauan, which has been exported to a considerable extent, is that furnished by *Shorea negrosensis* Foxw. Other species that furnish woods known as red lauan are: *Shorea warburgii* Gilg, *S. squamata* (Turcz.) Dyer, *S. rugosa* Heim, *S. plagata* Foxw., and possibly *Parashorea plicata* Brandis.

WHITE LAUAN

This name is applied to those lauans whose wood is not distinctly red. It includes a considerable range in color from white through yellow and gray to pink. The best-known white lauan is furnished by *Pentacme contorta* (Vid.) Merr. & Rolfe. *Pentacme mindanensis* Foxw. furnishes the same grade of wood.

ALMON

This is a white lauan, whose wood is very light in weight, coarse-grained, and of a light pink color. It is furnished by *Shorea eximia* (Miq.) Scheff. The wood of bagtican, *Parashorea plicata* Brandis, is slightly harder than the last. It is usually classed as a white lauan. Mangasinoro and kalunti are sometime classed as white lauans; they are here treated separately, however. Several other species of *Shorea*, which have pale yellow wood, are classed as white lauans or mangasinoro, according as their vessels are scattered or arranged in a reticulate pattern. Some of these are: *Shorea malaanonan* (Blanco) Blume, *S. polita* Vid., and *S. pallida* Foxw.

Collectively, the white lauans rank third in order of abundance of all the Philippine woods. They constitute about 17 per cent of the volume of our forests.

TANGUILE

This wood is harder and finer-grained than red lauan, which it very much resembles. It is furnished by *Shorea polysperma* (Blanco) Merr. and, probably also, by *S. warburgii* Gilg. A closely related form which usually passes for tanguile is tiaong, *S. teysmanniana* Dyer. It is usually lighter colored and straighter-grained than *S. polysperma*, but the difference is exceedingly slight. Tanguile is the fourth most abundant Philippine wood. It makes up about 7 per cent of the volume of the forests.

GUIJO

This wood is furnished by *Shorea guiso* (Blanco) Blume and by one or more undetermined species of *Shorea*. It is our fifth most abundant wood and makes up about 5 per cent of the volume of the forest.

YACAL

This name was first recorded for the wood of *Hopea plagata* (Blanco) Vid. The woods of other species of this and other genera, which seem to be identical in structure and durability,

are not distinguished from that of *Hopea plagata* and, like it, are known by the name of yacal. The name yacal is properly applied to any wood of this grade or to the tree that produces such wood. Species producing yacal are the following:

<i>Hopea plagata</i> (Blanco.) Vid.	<i>Shorea balangeran</i> (Korth.)
<i>H. foxworthyi</i> Elmer.	Dyer.
<i>H. odorata</i> Roxb.	<i>S. ciliata</i> King.
<i>H. malibato</i> Foxw.	<i>S. astylosa</i> Foxw.
<i>Balanocarpus cagayanensis</i>	<i>S. malibato</i> Foxw.
Foxw.	<i>S. faleiferoides</i> Foxw.
<i>B. brachyptera</i> Foxw.	<i>S. scrobiculata</i> Burck.
<i>Isoptera borneensis</i> Scheff.	

It is thought that several other species belong here; but their identification is still in doubt. Yacal is the most valued of any of our dipterocarps. It is the sixth Philippine wood in order of abundance, making up about 3 per cent by volume of our forests.

MANGASINORO

This is a pale yellow, rather coarse-grained lauan, with the vessels arranged in a reticulate pattern. It is evident that the wood is the product of several species, whose identity is not understood. Kalunti is a rather poor grade of mangasinoro and is the product of *Shorea mindanensis* Foxw. Mangasinoro is the seventh in order of abundance of the Philippine woods and makes up something more than 2.5 per cent of the volume of the forest.

PALOSAPIS, OR MAYAPIS

This is furnished by the different species of the genus *Anisoptera*. They are: *Anisoptera thurifera* (Blanco) Bl., *A. curtisii* Dyer, *A. brunnea* Foxw., *A. mindanensis* Foxw., and another species, which has not yet been described.

Palosapis seems to rank about tenth in order of abundance among Philippine woods and to make up about 1.5 per cent of the volume of the forests.

MANGACHAPUY, OR DALINGDINGAN

This is a wood lighter in weight and color and rather softer than yacal. It is sometimes quite difficult to determine whether a wood is a yacal or a dalingdingan. Usually the harder and finer-grained forms of dalingdingan are furnished by species that attain a rather small diameter. So far as known, all of our dalingdingans are furnished by species of *Hopea*. Some of these species are:

<i>Hopea acuminata</i> Merr.	<i>H. philippinensis</i> Dyer.
<i>H. basilanica</i> Foxw.	<i>H. glutinosa</i> Elmer.
<i>H. mindanensis</i> Foxw.	<i>H. maquilangensis</i> Foxw.
<i>H. pierrei</i> Hance.	

This wood is thought to be about the twelfth in order of abundance among Philippine woods and to make up usually about 1 per cent of the volume of the forest.

NARIG

This is the name applied to all members of the genus *Vatica*. These are:

<i>Vatica mangachapoi</i> Blanco.	<i>V. sorsogonensis</i> Foxw.
<i>V. blancoana</i> Elmer.	<i>V. spp.</i> , including several un-
<i>V. obtusifolia</i> Elmer.	identified species.
<i>V. mindanensis</i> Foxw.	

The members of this group are less gregarious in habit than are the other members of the family. They are usually scattered through the forest and make up less than 0.5 per cent of the total volume.

Local names of Philippine Dipterocarps.

Local name.	Dialect, province, or island.	Latin name.	Trade name.
Abuhungan	Bicol	<i>Shorea polysperma</i>	Tanguile.
Adumoy	do	do	Do.
Afu	Cagayan	<i>Anisoptera brunnea</i>	Palosapis.
Agan-an	Bicol	<i>Dipterocarpus vernicifluus</i>	Apitong.
Alam	Mangyan	<i>Shorea squamata</i>	Red lauan.
Almon	Visayan	<i>Shorea eximia</i>	White lauan.
Almon	do	<i>Parashorea plicata</i>	Do.
Amaraun (?)	Bicol	<i>Dipterocarpus affinis</i>	Apitong.
Anahaun	Bicol, Tagalo	<i>Dipterocarpus gracilis</i>	Do.
Do	Bicol	<i>Dipterocarpus grandiflorus</i>	Do.
Do	do	<i>Dipterocarpus orbicularis</i>	Do.
Do	do	<i>Dipterocarpus pilosus</i>	Do.
Anas	Ilocano	<i>Pentacme contorta</i>	White lauan.
Aniga	Benguet	<i>Vatica mangachapoi</i>	Narig.
Aningat	Pangasinan	do	Do.
Antam	Negrito	<i>Shorea guiso</i>	Guijo.
Apitong	Visayan (Capiz)	<i>Anisoptera thurifera</i>	Palosapis.
Do	Sibuyan	do	Do.
Do	Tagalo, Bicol	<i>Dipterocarpus caudatus</i>	Apitong.
Do	Tagalo	<i>Dipterocarpus gracilis</i>	Do.
Do	do	<i>Dipterocarpus grandiflorus</i>	Do.
Do	do	<i>Dipterocarpus perturbanatus</i>	Do.
Do	Tagalo, Visayan	<i>Dipterocarpus pilosus</i>	Do.
Do	Visayan	<i>Dipterocarpus speciosus</i>	Do.
Do	do	<i>Dipterocarpus trinervis</i>	Do.
Do	Tagalo	<i>Dipterocarpus vernicifluus</i>	Do.
Apitong blanco	Chabocano	<i>Vatica mangachapoi</i>	Narig.
Apitong colorado	Visayan	<i>Dipterocarpus subalpinus</i>	Apitong.
Apnit	Ilocano	<i>Anisoptera thurifera</i>	Palosapis.
Do	Southern Luzon	<i>Parashorea plicata</i>	White lauan.
Do	Cagayan Ilocano	<i>Pentacme contorta</i>	Do.
Do	Ilocano	<i>Shorea malaanonan</i>	Do.

Local names of Philippine Dipterocarps—Continued.

Local name.	Dialect, province, or island.	Latin name.	Trade name.
Apnit	Tagalo	<i>Shorea squamata</i>	Red lauan.
Araka	Ilocano	<i>Shorea polysperma</i>	Tanguile.
Aromoy	do	<i>Shorea guiso</i>	Guijo.
Asep	do	<i>Vatica mangachapoi</i>	Narig.
As-asin	do	do	Do.
Bagansusu	Visayan, Moro	do	Do.
Bagobahong	Visayan (Samar)	<i>Anisoptera thurifera</i>	Palosapis.
Bagtican	Visayan	<i>Parashorea plicata</i>	White lauan.
Balabak	Ibanag	<i>Shorea squamata</i>	Red lauan.
Balac	Negrito Cagayan	<i>Pentacme contorta</i>	White lauan.
Bacnitan	Tagalo	<i>Shorea polysperma</i>	Tanguile.
Balacbac	Negrito	<i>Pentacme contorta</i>	White lauan.
Balacbacan	Visayan	<i>Shorea polysperma</i>	Tanguile.
Balagayan	Mangyan	do	Do.
Balagbag	Cagayan	<i>Pentacme contorta</i>	White lauan.
Balao	Visayan (Negros)	<i>Anisoptera curtisii</i>	Palosapis.
Do	Visayan (Samar)	<i>Anisoptera mindanensis</i>	Do.
Do	Moro, Manobo	<i>Dipterocarpus affinis</i>	Apitong.
Do	Tagalo, Manobo	<i>Dipterocarpus grandiflorus</i>	Do.
Do	Visayan	<i>Dipterocarpus subalpinus</i>	Do.
Do	Manobo	<i>Dipterocarpus pilosus</i>	Do.
Do	Chabocano	<i>Dipterocarpus vernicifluus</i>	Do.
Balimbokbok	Zambales	<i>Vatica mangachapoi</i>	Narig.
Baliuisiuis	Pangasinan	<i>Shorea malaanonan</i>	White lauan.
Balsian	Kalinga	<i>Shorea polysperma</i>	Tanguile.
Bananis	Moro	<i>Vatica mangachapoi</i>	Narig.
Baniacao	Cagayan	<i>Hopea acuminata</i>	Dalingdangan.
Banic	do	<i>Vatica mangachapoi</i>	Narig.
Banit	do	do	Do.
Banutan	Gadang	<i>Hopea plagata</i>	Yacal.
Barosingsing	Ilocano	<i>Hopea acuminata</i>	Dalingdangan.
Bayocan	Tagalo	<i>Pentacme contorta</i>	White lauan.
Bayucan	do	<i>Parashorea plicata</i>	Do.
Do	do	<i>Shorea squamata</i>	Red lauan.
Bayu	Manobo	<i>Dipterocarpus affinis</i>	Apitong.
Betic	Ilocano	<i>Hopea plagata</i>	Yacal.
Do	Tagalo	<i>Shorea teysmanniana</i>	Tanguile.
Betik	do	<i>Shorea guiso</i>	Guijo.
Binalioan	do	<i>Parashorea plicata</i>	White lauan.
Binaliuwan	do	do	Do.
Boñgonan	Visayan (Samar)	<i>Vatica mangachapoi</i>	Narig.
Bula	Tagalo	<i>Shorea eximia</i>	Almon.
Bunnó	Manobo	<i>Shorea balangeran</i>	Yacal.
Caliaan	do	<i>Shorea squamata</i>	Red lauan.
Calian	Moro	do	Do.
Do	Manobo	<i>Shorea negrosensis</i>	Do.
Camuyao	Cagayan	<i>Dipterocarpus affinis</i>	Apitong.
Do	do	<i>Dipterocarpus warburgii</i>	Do.
Do	do	<i>Dipterocarpus pilosus</i>	Do.
Do	do	<i>Dipterocarpus vernicifluus</i>	Do.
Canacan	Negrito	<i>Shorea pallida</i>	White lauan.
Careg	Tagalo	<i>Vatica mangachapoi</i>	Narig.

Local names of Philippine Dipterocarps—Continued.

Local name.	Dialect, province, or island.	Latin name.	Trade name.
Caribu	Kalinga	<i>Shorea guiso</i>	Guijo.
Cariocan	Tagalo	<i>Vatica mangachapoi</i>	Narig.
Cullisiau	do	<i>Hopea philippinensis</i>	Dalingdingan.
Chapuy	Visayan	<i>Shorea negrosensis</i>	Red lauan.
Daa	Visayan (Bohol)	<i>Shorea squamata</i>	Do.
Dala	Negrito	<i>Hopea pierrei</i>	Dalingdingan.
Dagam	Bicol	<i>Vatica mangachapoi</i>	Narig.
Dagang	Tagalo	<i>Anisoptera curtisii</i>	Palosapis.
Do	Tagalo, Bicol	<i>Anisoptera thurifera</i>	Do.
Dagang na puti	Tagalo	do	Do.
Dagum	do	do	Do.
Dalingdingan	do	<i>Hopea acuminata</i>	Dalingdingan.
Do	Basilan	<i>Hopea basilanica</i>	Do.
Do	Tagalo	<i>Hopea glutinosa</i>	Do.
Do	do	<i>Hopea pierrei</i>	Do.
Dalingdingan isak	do	do	Do.
Dakulan	Bicol	<i>Shorea eximia</i>	Almon.
Damalalian	Cagayan	<i>Dipterocarpus grandiflorus</i>	Apitong.
Damilan	Kalinga	<i>Shorea squamata</i>	Red lauan.
Damilang	Cagayan	<i>Shorea negrosensis</i>	Do.
Do	Ibanag	<i>Shorea polysperma</i>	Tanguile.
Dangi	Rizal	<i>Vatica mangachapoi</i>	Narig.
Dangue	Tagalo	do	Do.
Danglog	Visayan	<i>Pentacme contorta</i>	White lauan.
Danlig	Tagalo	<i>Parashorea plicata</i>	Do.
Do	Visayan, Tagalo	<i>Pentacme contorta</i>	Do.
Do	Tagalo	<i>Shorea malaanonan</i>	Do.
Do	Laguna	<i>Shorea pallida</i>	Do.
Do	Tayabas	<i>Shorea squamata</i>	Do.
Danlig mayapis	Tagalo	<i>Shorea eximia</i>	Almon.
Danlig	Rizal	<i>Shorea polita</i>	White lauan.
Danlig tabac	Tagalo	<i>Shorea squamata</i>	Red lauan.
Danlig	Visayan (Capiz)	<i>Dipterocarpus grandiflorus</i>	Apitong.
Do	Manobo	<i>Pentacme contorta</i>	White lauan.
Duco	Negrito	<i>Dipterocarpus grandiflorus</i>	Apitong.
Ducu	Cagayan	<i>Dipterocarpus vernicifluus</i>	Do.
Dungon	Manobo	<i>Shorea balangeran</i>	Yacal.
Duyong	Ilocano	<i>Anisoptera thurifera</i>	Palosapis.
Do	Tagalo	<i>Shorea guiso</i>	Guijo.
Guijo	do	do	Do.
Guijo-bitic	do	do	Do.
Galunti	Moro	<i>Shorea squamata</i>	Red lauan.
Guijo amarillo	do	<i>Shorea malibato</i>	Yacal.
Guiso	Tagalo	<i>Shorea guiso</i>	Guijo.
Guisoc	Visayan	<i>Hopea philippinensis</i>	Dalingdingan.
Do	Bicol, Visayan, Moro	<i>Hopea plagata</i>	Yacal.
Do	Manobo	<i>Shorea astylosa</i>	Do.
Do	Bicol	<i>Shorea balangeran</i>	Do.
Do	Visayan, Moro, Manobo.	<i>Shorea guiso</i>	Guijo.
Guisoc amarillo	Bicol	<i>Shorea balangeran</i>	Yacal.
Guisoc bayasuason	do	do	Do.

Local names of Philippine Dipterocarps—Continued.

Local name.	Dialect, province, or island.	Latin name.	Trade name.
Guisoc guisoc	Visayan	<i>Hopca philippinensis</i>	Dalingdingan.
Do	Bicol	<i>Shorea balangeran</i>	Yacal.
Guisoc-madlao	Visayan	do	Do.
Do	do	<i>Vatica</i> sp.	Narig.
Guisoc-niga-madlao	do	<i>Hopea ovalifolia</i>	Yacal.
Guisoc-niga-salngan	do	<i>Hopca philippinensis</i>	Dalingdingan.
Guisoc-pula	Bicol	<i>Shorea polysperma</i>	Tanguile.
Guisoc-tacpang	Chabocano	<i>Isoptera borneensis</i>	Yacal.
Guyong		<i>Anisoptera thurifera</i>	Palosapis.
Gyam	Tawi Tawi	<i>Hopea</i> sp.	Yacal.
Hagachac	Sibuyan	<i>Dipterocarpus grandiflorus</i>	Apitong.
Do	Tagalo	<i>Dipterocarpus affinis</i>	Do.
Do	Bicol, Visayan	<i>Dipterocarpus pilosus</i>	Do.
Hapnit	Bicol	<i>Parashorea plicata</i>	White lauan.
Do	do	<i>Shorea polysperma</i>	Tanguile.
Hil-lagasi	Visayan	do	Do.
Hinpagkaytan	Visayan (Samar)	<i>Dipterocarpus grandiflorus</i>	Apitong.
Isak	Tagalo	<i>Hopea glutinosa</i>	Dalingdingan.
Jacas	Visayan	<i>Hopea plagata</i>	Yacal.
Kalinigin	Ilocano	<i>Vatica mangachapoi</i>	Narig.
Kalia-an	Manobo	<i>Shorea squamata</i>	Red lauan.
Kalunti	Chabocano	<i>Shorea mindanensis</i>	Kalunti.
Kalunti colorado	do	do	Do.
Kalliot	Ilocano	<i>Hopea acuminata</i>	Dalingdingan.
Kamuyao	Cagayan	<i>Dipterocarpus vernicifluus</i>	Apitong.
Do	do	<i>Dipterocarpus grandiflorus</i>	Do.
Karig	Chabocano	<i>Vatica mangachapoi</i>	Narig.
Labang	Ilocano	do	Do.
Lalian	Tagalo	<i>Dipterocarpus vernicifluus</i>	Apitong.
Lamilan	Negrito	do	Do.
Lanutan	Pangasinan	<i>Vatica mangachapoi</i>	Narig.
Lauan	Rizal	<i>Anisoptera thurifera</i>	Palosapis.
Do	Nueva Ecija	<i>Dipterocarpus vernicifluus</i>	Apitong.
Do	Tagalo	<i>Parashorea plicata</i>	White lauan.
Do	do	<i>Pentacme contorta</i>	Do.
Do	Visayan	<i>Shorea rugosa</i>	Red lauan.
Laua-an	Tagalo	<i>Parashorea plicata</i>	White lauan.
Lauan	do	<i>Shorea malaanonan</i>	Do.
Do	do	<i>Shorea squamata</i>	Red lauan.
Lauan-anil	Zambales	<i>Shorea polita</i>	White lauan.
Lauan-barik	Visayan	<i>Parashorea plicata</i>	Do.
Lauan-colorado	do	<i>Shorea negrosensis</i>	Red lauan.
Lauan-danlog	do	<i>Parashorea plicata</i>	White lauan.
Do	do	<i>Pentacme contorta</i>	Do.
Lauan-magsino	Leyte	<i>Shorea squamata</i>	Red lauan.
Lauan-mapula	do	do	Do.
Lauan-pula	Tagalo	do	Do.
Lauan-puti	Ilocano	<i>Shorea malaanonan</i>	White lauan.
Do	Tagalo	<i>Pentacme contorta</i>	Do.
Do	do	<i>Parashorea plicata</i>	Do.
Letis	Visayan	<i>Anisoptera thurifera</i>	Palosapis.

Local names of Philippine Dipterocarps—Continued.

Local name.	Dialect, province, or island.	Latin name.	Trade name.
Lipus	Visayan, Manobo	<i>Dipterocarpus vernicifluus</i>	Apitong.
Liput	Manobo	<i>Dipterocarpus affinis</i>	Do.
Litis	Visayan (Capiz)	<i>Dipterocarpus grandiflorus</i>	Do.
Lito	Cagayan	<i>Hopea pierrei</i>	Dalingdingan.
Litoc	Negrilo	<i>Shorea malaanonan</i>	White lauan.
Do	do	<i>Shorea polita</i>	Do.
Lisican	Tagalo	<i>Vatica mangachapoi</i>	Narig.
Lutub	Moro	do	Do.
Magaboung	Manobo	<i>Shorea negrosensis</i>	Red lauan.
Magasusu	Moro	<i>Hopea mindanensis</i>	Dalingdingan.
Mago-orang	Bicol	<i>Shorea polysperma</i>	Tanguile.
Magasano	Manobo	<i>Shorea squamata</i>	Red lauan.
Malaanonan	Tagalo	<i>Pentacme contorta</i>	White lauan.
Malaanonang	do	<i>Parashorea plicata</i>	Do.
Do	do	<i>Shorea malaanonan</i>	Do.
Do	do	<i>Shorea polita</i>	Do.
Do	do	<i>Shorea pallida</i>	Do.
Malaanonang na pula.	do	<i>Parashorea plicata</i>	Do.
Mala-cacao	do	<i>Shorea squamata</i>	Red lauan.
Malabalabang	Cagayan	do	Do.
Malacayan	Moro	<i>Pentacme contorta</i>	White lauan.
Do	Chabocano	<i>Shorea eximia</i>	Almon.
Malacayan blanco	do	<i>Pentacme mindanensis</i>	White lauan.
Malakayan	Moro	<i>Shorea squamata</i>	Red lauan.
Malaguiso	Tagalo	<i>Shorea teysmanniana</i>	Tanguile.
Do	do	<i>Shorea polysperma</i>	Do.
Malagangao	do	<i>Anisoptera curtisii</i>	Palosapis.
Do	Manobo	<i>Shorea negrosensis</i>	Red lauan.
Malapaho	Tagalo	<i>Anisoptera curtisii</i>	Palosapis.
Do	do	<i>Dipterocarpus grandiflorus</i>	Apitong.
Do	do	<i>Dipterocarpus vernicifluus</i>	Do.
Malagmat	do	<i>Shorea polysperma</i>	Tanguile.
Malasinoro	Samar	<i>Shorea squamata</i>	Red lauan.
Do	Bicol	<i>Shorea negrosensis</i>	Do.
Do	do	<i>Shorea eximia</i>	Almon.
Do	do	<i>Pentacme contorta</i>	White lauan.
Malatagum	do	<i>Hopea pierrei</i>	Dalingdingan.
Malebato	Manobo	<i>Hopea philippinensis</i>	Do.
Malibato	do	<i>Shorea balangeran</i>	Yacal.
Malium	Mangyan	<i>Hopea plogota</i>	Do.
Matulug	Visayan (Negros)	<i>Vatica mindanensis</i>	Narig.
Manaog	Cebu	<i>Shorea polysperma</i>	Tanguile.
Manapayog	Visayan	do	Do.
Manapo	Tagalo	<i>Anisoptera curtisii</i>	Palosapis.
Mangachapuy	do	<i>Hopea maquilangensis</i>	Dalingdingan.
Do	Visayan	<i>Shorea eximia</i>	Almon.
Do	do	<i>Shorea negrosensis</i>	Red lauan.
Do	Chabocano	<i>Hopea foxworthyi</i>	Yacal.
Do	Tagalo	<i>Hopea acuminata</i>	Dalingdingan.
Do	Tagalo, Visayan	<i>Hopea pierrei</i>	Do.

Local names of Philippine Dipterocarps—Continued.

Local name.	Dialect, province, or island.	Latin name.	Trade name
Mangasinoro	Manobo	<i>Shorea negrosensis</i>	Red lauan.
Do	Chabocano	<i>Shorea mindanensis</i>	Mangasinoro.
Do	Tagalo	<i>Shorea polita</i>	White lauan.
Do	Bicol	<i>Shorea eximia</i>	Almon.
Do	Masbate	<i>Parashorea plicata</i>	White lauan.
Do	Tagalo	<i>Shorea malaanonan</i>	Do.
Mangatsapuy	Visayan	<i>Hopea glutinosa</i>	Dalingdingan.
Manili	Bicol	<i>Shorea polysperma</i>	Tanguile.
Manolococo	Tagalo	<i>Shorea eximia</i>	Almon.
Maquitarem	Bicol	<i>Hopea pierrei</i>	Dalingdingan.
Do	Tagalo, Bicol	<i>Hopea philippinensis</i>	Do.
Mayapis	Tagalo	<i>Parashorea plicata</i>	White lauan.
Do	do	<i>Anisoptera thurifera</i>	Palosapis.
Do	do	<i>Dipterocarpus grandiflorus</i>	Apitong.
Do	do	<i>Vatica mangachapoi</i>	Narig.
Do	do	<i>Shorea squamata</i>	Red lauan.
Do	do	<i>Shorea polysperma</i>	Tanguile.
Mantolalina	Zamboanga	<i>Dipterocarpus vernicifluus</i>	Apitong.
Menapo	Dumagat	<i>Anisoptera curtisii</i>	Palosapis.
Molato	Visayan (Bohol)	<i>Hopea plagata</i>	Yacal.
Narec	Cagayan	<i>Balanocarpus cagayanensis</i>	Do.
Narig	Tagalo	<i>Vatica spp.</i>	Narig.
Oghayan	Samar	<i>Shorea squamata</i>	Red lauan.
Pagacsan	Bicol	<i>Hopea philippinensis</i>	Dalingdingan.
Pagsahingin	Tagalo	<i>Dipterocarpus hasseltii</i>	Apitong.
Do	do	<i>Dipterocarpus vernicifluus</i>	Do.
Do	do	<i>Dipterocarpus grandiflorus</i>	Do.
Paihapy	do	<i>Anisoptera thurifera</i>	Palosapis.
Paina	Bicol	<i>Hopea philippinensis</i>	Dalingdingan.
Palanopang	Tagalo	<i>Dipterocarpus vernicifluus</i>	Apitong.
Palosapis	Pangasinan, Tagalo	<i>Anisoptera thurifera</i>	Palosapis.
Do	Bicol, Pangasinan	<i>Anisoptera curtisii</i>	Do.
Pamalalian	Cagayan	<i>Dipterocarpus grandiflorus</i>	Apitong.
Do	do	<i>Dipterocarpus vernicifluus</i>	Do.
Pamantuling	Pangasinan, Ilocano	<i>Dipterocarpus grandiflorus</i>	Do.
Do	Pangasinan	<i>Dipterocarpus vernicifluus</i>	Do.
Pamarnisen	Ilocano	<i>Dipterocarpus grandiflorus</i>	Do.
Pamasugan	Bicol	<i>Shorea polysperma</i>	Tanguile.
Pamayadasan	Ilocano	<i>Shorea balangeran</i>	Yacal.
Pamayawasan	Bicol, Pangasinan	do	Do.
Panalsalan	Bicol	<i>Dipterocarpus speciosus</i>	Apitong.
Panao	Tagalo	<i>Dipterocarpus vernicifluus</i>	Do.
Do	do	<i>Dipterocarpus hasseltii</i>	Do.
Do	do	<i>Dipterocarpus grandiflorus</i>	Do.
Panungsognan	Bicol	<i>Shorea polysperma</i>	Tanguile.
Paralsalan	do	<i>Dipterocarpus cuneatus</i>	Apitong.
Pata	Pangasinan	<i>Shorea polysperma</i>	Tanguile.
Patsahingin	Tagalo	<i>Dipterocarpus perturbanatus</i>	Apitong.
Do	do	<i>Dipterocarpus vernicifluus</i>	Do.
Pisac	Cagayan	<i>Hopea pierrei</i>	Dalingdingan.
Pisec	Ilocano	<i>Shorea guiso</i>	Guijo.
Payena	Tagalo	<i>Hopea plagata</i>	Yacal.

Local names of Philippine Dipterocarps—Continued.

Local name.	Dialect, province, or island.	Latin name.	Trade name.
Pongo	Visayan	<i>Hopea philippinensis</i>	Dalingdingan.
Pura	Bicol	<i>Shorea squamata</i>	Red lauan.
Putiyan	Pangasinan	<i>Vatica mangachapoi</i>	Narig.
Salabas abad	Mangyan	<i>Hopea pierrei</i>	Dalingdingan.
Salnigen	Ilocano	<i>Vatica mangachapoi</i>	Narig.
Salongsalangan	Manobo	do	Do.
Sandana	Tagalo	<i>Pentacme contorta</i>	White lauan.
Quebra hacha	Chabocano	<i>Hopea plagata</i>	Yacal.
Quela	Visayan	<i>Shorea negrosensis</i>	Red lauan.
Saplig	Manobo	do	Do.
Saplungan	Tagalo	<i>Hopea plagata</i>	Yacal.
Sarai	Ilocano	<i>Shorea guiso</i>	Guijo.
Saray	Cagayan	<i>Shorea pallida</i>	White lauan.
Do	do	<i>Shorea guiso</i>	Guijo.
Do	do	<i>Shorea scrobiculata</i>	Yacal.
Salungan	Leyte	<i>Vatica mangachapoi</i>	Narig.
Siacal	Tagalo	<i>Hopea odorata</i>	Yacal.
Siggay	Cagayan	<i>Hopea plagata</i>	Do.
Siyao	Visayan	<i>Hopea acuminata</i>	Dalingdingan.
Do	Samar	<i>Anisoptera brunnea</i>	Palosapis.
Do	do	<i>Anisoptera mindanensis</i>	Do.
Do	Visayan (Samar)	<i>Hopea pierrei</i>	Dalingdingan.
Subiang	Visayan	<i>Hopea philippinensis</i>	Do.
Sugcao	Visayan (Samar)	<i>Hopea pierrei</i>	Do.
Tabak	Tagalo, Bicol	<i>Shorea squamata</i>	Red lauan.
Tabiguion	Visayan (Samar)	<i>Shorea polysperma</i>	Tanguile.
Tacuban	Bicol	<i>Parashorea plicata</i>	White lauan.
Taculao	Ilocano	<i>Pentacme contorta</i>	Do.
Taggay	do	<i>Hopea plagata</i>	Yacal.
Takuban	Bicol	<i>Shorea eximia</i>	Almon.
Tamoc	Cagayan	<i>Shorea warburgii</i>	Tanguile.
Taming-taming-dinda.	Moro	<i>Hopea philippinensis</i>	Dalingdingan.
Tamparassa	Marinao	<i>Shorea eximia</i>	Almon.
Tampassuk	Moro	<i>Vatica mangachapoi</i>	Narig.
Tanguile	Tagalo	<i>Shorea polysperma</i>	Tanguile.
Tanie	Cagayan	<i>Shorea teysmanniana</i>	Do.
Tapurao	Bicol, Visayan	<i>Vatica mangachapoi</i>	Narig.
Tiaong	Tagalo	<i>Shorea teysmanniana</i>	Tanguile.
Tiaong puti	do	<i>Shorea pallida</i>	White lauan.
Tenġag	Manobo	<i>Shorea squamata</i>	Red lauan.
Tiranlay	Pangasinan	<i>Vatica mangachapoi</i>	Narig.
Tomotogani	Tagalo	<i>Shorea polysperma</i>	Tanguile.
Tuguai	Bicol	do	Do.
Ubanan	Manobo	<i>Shorea negrosensis</i>	Red lauan.
Do	do	<i>Shorea squamata</i>	Do.
Ugahayan	Visayan (Samar)	<i>Shorea eximia</i>	Almon.
Do	do	<i>Shorea squamata</i>	Red lauan.
Yacal	Tagalo	<i>Hopea plagata</i>	Yacal.
Do	Chabocano	<i>Shorea astylosa</i>	Do.
Do	Tagalo, Bicol	<i>Shorea balangeran</i>	Do.

Local names of Philippine Dipterocarps—Continued.

Local name.	Dialect, province, or island.	Latin name.	Trade name.
Do	Tagalo	<i>Hopea acuminata</i>	Dalingdingan.
Do	Basilan	<i>Hopea basilanica</i>	Yacal.
Do	Chabocano	<i>Hopea foxworthyi</i>	Do.
Do	Moro, Tagalo	<i>Shorea ciliata</i>	Do.
Do	Tagalo	<i>Shorea scrobiculata</i>	Do.
Do	Chabocano	<i>Hopea ovalifolia</i>	Do.
Yacal blanco	do	<i>Shorea balangeran</i>	Do.
Do	Tagalo	<i>Vatica mangachapoi</i>	Narig.
Yamban	Zambales	<i>Shorea guiso</i>	Guijo.
Do	Pangasinan	<i>Shorea balangeran</i>	Yacal.
Yamban a balabaga	Ilocano	do	Do.
Yamban puti	do	do	Do.
Yamban matabia	Zambales	<i>Shorea falciferoides</i>	Do.
Yamban molato	Ilocano	<i>Shorea balangeran</i>	Do.

The local names here given have been taken from collectors' notes, as found with herbarium specimens. In spite of the extensive field work that has been done during the past fifteen years, a number of forms that are locally of some importance remain but little understood botanically.

The most important of these is mangasinoro, which is a widely distributed lauan. It seems to be produced by more than one species of *Shorea*, but we lack flowering and fruiting material sufficient for its identification. Kalliot and yamban seem to be of importance locally, but are not well understood. They seem to include guijos, dalingdingans, and yacals and are found in Zambales, Pangasinan and La Union Provinces, Luzon. A considerable amount of additional collecting is needed to straighten out these names.

A certain amount of confusion is caused by the duplication of names in different regions. Thus mayapis, which seems to have been the best-known name for *Anisoptera thurifera* in Bulacan, Pampanga, Zambales Provinces and in parts of Rizal and Bataan Provinces, is the name applied to *Shorea squamata* in the rain forest of northern Laguna Province and in a part of Tayabas Province. The two species are very distinct in appearance, structure, uses, and habitat.

Anisoptera thurifera is also known through a part of its range as palosapis, and the largest part of the wood to reach the Manila market during the past six years has come in under this name.

Key to the Philippine genera of Dipterocarpaceae.

- a*¹. Lobes of fruiting calyx usually shorter than fruit and not extending beyond it.
- b*¹. Calyx-lobes round and recurved; stamens 30 to 60..... 7. *Isoptera*.
- b*². Calyx-lobes not as above; stamens 10 or 15..... 8. *Balanocarpus*.
- a*². Lobes of fruiting calyx longer than fruit.
- b*¹. Calyx-tube enclosing fruit; two lobes expanding into long wings.
- c*¹. Stipules large, amplexicaul, calyx-tube free; stamens 8; style filiform 1. *Dipterocarpus*.
- c*². Stipules small, deciduous, fruit connate with calyx-tube stamens 20 to 35; style short..... 2. *Anisoptera*.
- b*². Calyx-tube not enclosing fruit.
- c*¹. Fruit with five long wings..... 6. *Parashorea*.
- c*². Fruit with three long wings.
- d*¹. Anthers with five pointed appendages..... 4. *Pentaeme*.
- d*². Anthers with less than five appendages..... 5. *Shorea*.
- c*³. Fruit with two long wings.
- d*¹. Calyx imbricate in bud..... 3. *Hopea*.
- d*². Calyx valvate in bud..... 9. *Vatica*.

1. DIPTEROCARPUS Gaertner f.

The members of this genus are rather uniform in habit but occupy a tolerably wide range of habitats. Some forms, as *Dipterocarpus grandiflorus* Blanco, are often found on rather exposed forested ridges; while others, such as *D. pilosus* Roxb., are characteristically found in moist lowland forests. The wood is very uniform in structure and is known in the market as apitong. It is the most abundant Philippine timber, making up about 17 per cent by volume of our forests.

Since the publication of my previous paper we have found representatives of all of the sections of the genus, as arranged by Dyer, except the section *Plicati*, which has not yet been found in the Islands.

At the present time about seventy-five species are known in the genus, seventeen of which are known from the Philippines. Six of the Philippine species are known from outside the Archipelago. These are *Dipterocarpus pilosus* Roxb., known from Burma, the Andamans, Sumatra, and Bangka; *D. trinervis* Blume, from Java; *D. gracilis* Blume, from Java; *D. hasseltii* Blume, from Malacca, Sumatra, and Java; *D. grandiflorus* Blanco, from the Malay Peninsula, Bangka, and Borneo; and *D. orbicularis* Foxw., from British North Borneo.

Key to the Philippine species of Dipterocarpus.

- a*¹. Fruit not angled, usually globose (§ *Sphaerales* Dyer).
- b*¹. Leaves small (10 to 13 cm long, 2 to 3.5 cm broad), narrow, long-caudate-acuminate 8. *D. caudatus*.
- b*². Leaves larger, not long-caudate-acuminate.
- c*¹. Fruit less than 2 cm in diameter.

4. *DIPTEROCARPUS GRACILIS* Blume. *Anahaun, apitong* (Tag.).

LUZON, Camarines Province. MINDORO. This species is not known from any other locality in the Philippines.

5. *DIPTEROCARPUS HASSELTII* Blume. *Panao, pagsahingan* (Tag.).

LUZON, Nueva Ecija and Laguna Provinces. NEGROS. MINDANAO, Zamboanga.

6. *DIPTEROCARPUS VERNICIFLUUS* Blanco. *Panao, apitong, pagsahingan* (Tag.), *kamuyao* (Cag.), *malpaho* (Pol.).

LUZON: Cagayan, Isabela, Ilocos Norte, Ilocos Sur, Pangasinan, Nueva Ecija, Bulacan, Pampanga, Zambales, Bataan, Rizal, Laguna, Tayabas, Camarines, Albay. POLILLO. MARINDUQUE. MINDORO. LEYTE. PALAWAN. MINDANAO: Agusan (?), Surigao, Davao, Cotabato, Zamboanga.

7. *DIPTEROCARPUS SUBALPINUS* Foxw. in Leaf. Phil. Bot. 6 (1913) 1950. *Balaou* (Agusan).

MINDANAO, Zamboanga, *For. Bur. 23837, 22007 Villamil, For. Bur. 22761 Nave*; Agusan Province. BILIRAN, *Bur. Sci. 18487 McGregor*.

This species differs from *Dipterocarpus vernicifluus* in its more glabrous leaves and buds and generally smaller leaves, and from *D. hasseltii* in the smaller leaves and fruit and greater number of secondary veins. The three short wings of the fruit are also shorter than the similar wings in *D. hasseltii* and are not expanded nor reflexed as is the case in that species.

8. *DIPTEROCARPUS CAUDATUS* sp. nov. *Apitong* (Tag. and Bicol).

Arbor magna. Folia longe caudato-acuminata, 9 ad 13 cm longa, 2.5 cm lata, glabra; nervis secundariis circa 10; petiolo 1.1 ad 1.5 cm longo. Fructus globosus.

This form is distinct by its small-sized, long-caudate-acuminate leaves, which are glabrous, elliptic, cuneate at base, 9 to 13 cm long, 2.5 to 5 cm wide; the long-caudate acumen about 1.5 cm long; secondary veins are about 10 pairs; petiole 1.1 to 1.5 cm long; stipules linear, ferruginous-pilose.

LUZON, Camarines Province, *For. Bur. 21193 Alvarez*, March 28, 1914 (type); Albay Province, *For. Bur. 10607, 10610 Curran*, 1908.

Very old and very young fruits picked up under the tree show this to belong to the section *Sphaerales*, and the leaves are sufficiently distinct to warrant its description as a new species.

9. *DIPTEROCARPUS PERTURBINATUS* sp. nov.

Arbor magna. Folia elliptica, glabra, coriacea, a basi cuneata vel rotundata, 6.5 ad 11 cm longa, 4 ad 6.5 cm. lata; petiolo 2.5 ad 3.5 cm longo. Fructus turbinatus, 2.5 ad 3.5 cm diametro. Calycis segmentis 2 majoribus oblongis, 11 ad 13 cm longis, 3 cm latis.

A large tree, with glabrous leaves and twigs and turbinate fruits. Leaves coriaceous, elliptic, acute or slightly acuminate at the apex, cuneate or rounded at the base, margins crenate, 6.5 to 11 cm long, 4 to 6.5 cm wide; petiole 2.5 to 3.5 cm long; secondary veins about 10 pairs. Fruit 2.5 to 3.5 cm in diameter,

distinctly turbinate. Wings 11 to 13 cm long, 3 cm wide, with three principal longitudinal veins and numerous irregularly branched lateral veins. The short wings are very inconspicuous enlargements of the rim of the calyx-tube.

LUZON, Tayabas Province, Pagbilao, *For. Bur.* 23841 *F. Manuel*, August 6, 1914 (type). Said to be known locally as *apitong*.

This plant was represented by fragmentary material collected by Mr. H. M. Curran in Sorsogon Province, Luzon, in 1909. It was mentioned by me in 1911,⁴ but it was not until 1914 that enough material was obtained for a full diagnosis.

The following are referred here: LUZON, Laguna Province, *For. Bur.* 8864, 10074, 19251 *Curran*; Tayabas Province, *For. Bur.* s. n., *For. Bur.* 3223 *Hagger*, *For. Bur.* 6045 *Kobbe*, *For. Bur.* 12500 *Rosenbluth*; Albay Province, *Cuming* 881; Sorsogon Province, *For. Bur.* 10564 *Curran*. This species seems to be fairly common in dense forests on low ridges in some parts of Tayabas Province.

10. **DIPTEROCARPUS OBCONICUS** Foxw. in *Leaf. Phil. Bot.* 6 (1913) 1951.

The leaf-form, venation, and hairiness of buds correspond very closely to those of *Dipterocarpus gracilis* Blume, as figured in *Fl. Javae*, t. 5. It is characterized by its fruit which has an obconical base.

MINDANAO, Agusan Province, Cabadbaran, *Elmer* 13498, August, 1912 (type), at 230 meters elevation.

11. **DIPTEROCARPUS CUNEATUS** sp. nov.

Arbor magna, *D. obconico* similis sed glabra, petiolo longiore et calycis segmentis longioribus.

Closely related to *D. obconicus* Foxw., but differing from that species by being glabrous, by having more slender and longer petioles, and by the narrower and longer fruit-wings. A large tree. Leaves elliptic, glabrous, 6 to 12 cm long, 2.9 to 7 cm wide, abruptly acuminate at apex, cuneate at base, margin crenulate and slightly inrolled, glabrous throughout. Secondary veins 10 to 14 pairs. Petioles 16 to 32 mm long, slender. Buds glabrous, elongate. Fruit obconic 22 to 23 mm long, 16 to 18 mm in diameter. Long wings oblanceolate, 11 to 13 cm long, 2 to 2.5 cm wide. Three principal longitudinal veins and numerous oblique and transverse veins.

LUZON, Camarines Province, Mount Sanot, *For. Bur.* 21469 *Alvarez*, May 24, 1914 (type). Common name, *panalsalan*.

12. **DIPTEROCARPUS WARBURGII** Brandis; Foxworthy in *Leaf. Phil. Bot.* 6 (1913) 1952. *Balaou* (Manobo).

MINDANAO, Agusan and Davao. LUZON, Cagayan Province.

13. **DIPTEROCARPUS SPECIOSUS** Brandis.

This species is sufficiently variable in its fruit to permit of its being

⁴ *Phil. Journ. Sci.* 6 (1911) *Bot.* 247, t. 39.

considered as sometimes in the section *Angulati* and sometimes in the section *Alati*.

LUZON: Tayabas, Camarines, and Albay Provinces. NEGROS. BASILAN.

14. *DIPTEROCARPUS BASILANICUS* sp. nov.

Arbor magna. Folia chartacea, elliptica, apice acuminatis, basi cuneatis, nervis secundariis utrinque 13, tertiariis plurimis, parallelis et reticulatis, obscuris, 6 ad 11 cm longa, 2 ad 5.5 cm lata, margine undulatis, subtus pubescentibus. Floribus ignotis. Fructus 5-angulatis, 15 ad 18 mm longis, aliis late linearibus, oblongus e basi 3-nervis, 7 ad 9 cm longis, 14 ad 21 mm latis.

A tree 40 m tall and 50 cm in diameter. Leaves and twigs finer than in most Philippine species. Leaves chartaceous, elliptic, with acuminate apex and cuneate base. Under side of leaves and young twigs pubescent. Terminal buds clothed with long pilose, silky hairs. Secondary nerves about 13. Leaves 6 to 11 cm long and 2 to 5.5 cm wide. Fruit 5-angled, 15 to 18 mm long and of about the same diameter. Angles of fruit more or less distinctly developed into wings, but thick and hard.

BASILAN, Mount Basilan, at 500 to 600 meters elevation, *For. Bur.* 18895 *Miranda*, August 27, 1912 (type), *For. Bur.* 18896 *Miranda*, *Bur. Sci.* 16128 *Reillo*, August, 1912.

The wood is said to be harder than that of ordinary apitong and is used for general construction.

This species suggests a form referred to by King in *Journ. As. Soc. Beng.* 62² (1893) 99: "A Perak species (Herb. Scortechini mixed with No. 1478) represented by fruits something like those of *D. fagineus* Vesque, but with the calyx-tube winged, not angled." It is evident that the relationship here must be very close, but identity is doubtful. This species is our only representative of the § *Angulati*. It seems noteworthy in that section in that the angles are developed until they resemble wings. It is most closely related to *Dipterocarpus fagineus* Vesque, of the Malay Peninsula and Borneo, but differs from that species in having slightly smaller fruits, which are more sharply angled and with more scantily developed venation in the fruit wings.

15. *DIPTEROCARPUS GRANDIFLORUS* Blanco. *Apitong*.

LUZON: Cagayan, Isabela, Ilocos Sur, Abra, Benguet, Pangasinan, Nueva Ecija, Zambales, Bataan, Bulacan, Rizal, Laguna, Tayabas, Camarines, Albay. MINDORO. SIBUYAN. PANAY, Capiz. NEGROS. SAMAR. BILIRAN. PALAWAN. MINDANAO: Agusan, Misamis.

16. *DIPTEROCARPUS PHILIPPINENSIS* sp. nov.

Arbor magna. Fructus alatus *D. marginato* Korth. similis sed minoribus.

A large tree 30 m tall and 75 cm in diameter. Fruit winged, leaves of seedlings similar to those of *D. vernicifluus* Blanco. Mature leaf (picked up under the tree) ovate-lanceolate, acute,

base truncate, margin entire, 19 cm long, 11 to 12 cm wide, secondary nerves 18 pairs; tertiary nerves parallel and reticulate, with stellate hairs; petiole 5 cm long. Young shoots and seedling leaves ferruginous-hairy exceedingly like the same parts in *D. vernicifluus*. Fruit much the size and shape of that of *D. marginatus*, but more constricted at the top and with ridges produced into membranaceous wings, as in *D. grandiflorus* Blanco. Fruit 3 to 3.5 cm long and 2 to 2.5 cm in diameter, the two long wings 15 to 17 cm long and 25 to 28 mm wide.

LUZON, Bataan Province, Mount Mariveles, *For. Bur. 12395 Curran & Merritt*, August 1908 (type.) The type consists of three mature fruits, two young seedlings and one adult leaf, picked up under the parent tree. There has been but the one collection. As always, where the material is picked up under the tree, there is question of the accuracy of the diagnosis. However, the collectors were very careful and it has seemed desirable to give this collection a name. In 1911⁵ I published a note concerning this apparently distinct form.

17. **DIPTEROCARPUS ORBICULARIS** sp. nov.

Arbor magna. Foliis suborbicularis vel obovatis, 9 ad 22 cm longis, 6 ad 11 cm latis, acuminatis, basi cuneatis vel rotundatis; nervis secundariis 9 ad 12; nervis tertiariis parallelis vel reticulatis; pagina superiore glabra, inferiore pilosa. Fructus alatus, alae membranaceae.

A large tree with brownish tomentum on twigs, petioles and underside of leaves. Leaves mostly suborbicular, some obovate, 9 to 12 cm long, 6 to 11 cm wide, with crenulate margins; apex shortly and very bluntly acuminate; base rounded or cuneate. Secondary nerves 9 to 12 pairs; tertiary veins parallel and reticulate. Petioles 2.5 to 3.5 cm long. Twigs, buds, petioles, and margins of leaves densely clothed with long pilose hairs. Upper side of leaf glabrous, except for a few scattered hairs along the veins. Lower surface very thickly covered with large stellate hairs, many of which are set on the tertiary veins. The secondary veins and midvein are clothed, for the most part, with pilose hairs. The secondary veins unite near the margin with a fine intramarginal vein, which is very much the same size as the tertiary veins and united with them. Fruit (immature) with membranous wings as in *D. grandiflorus* Blanco.

LUZON, Camarines Province, *For. Bur. 21719 Peñas, Soriano and Abellanosa*, April 26, 1914 (type).

This form differs from all other known species of the genus by the orbicular or nearly orbicular leaves.

There are found in the collections also the following sheets, which were

⁵ Philip. Journ. Sci. 6 (1911) Bot. 253, t. 38.

placed provisionally under *Dipterocarpus speciosus* Brandis: *For. Bur.* 10711 Curran, 1908 (with old fruit), *For. Bur.* 22646 Alvarez, 1911, *For. Bur.* 21737 Peñas, Soriano & Abellanosa, 1914, *For. Bur.* 21216 Alvarez, 1914. All of these specimens were collected in Camarines Province and all were sterile, except Curran's specimen, which had fruit picked up under the tree. These all have leaves very much larger and with a larger number of secondary veins than those of the type. They may well represent another species; but, for the present, it seems well to place them under this.

Villamil 44, collected in the southeastern part of British North Borneo in 1915, seems to belong with the form just mentioned.

2. ANISOPTERA Korthals

Key to the Philippine species of *Anisoptera*

- a*¹. Leaves brown, hairy beneath..... 1. *A. brunnea*.
*a*². Leaves yellow beneath.
*b*¹. Leaves always distinctly gold-yellow beneath..... 2. *A. curtisii*.
*b*². Only the young leaves golden-yellow beneath, mature leaves green beneath 3. *A. sp.*
*a*³. Leaves green beneath.
*b*¹. Flowers white, 1 cm in diameter, in spreading erect panicles.. 5. *A. mindanensis*.
*b*². Flowers yellow, less than 1 cm in diameter, crowded in drooping panicles 4. *A. thurifera*.

1. ANISOPTERA BRUNNEA Foxw. *Afu*.

LUZON: Cagayan, Ilocos Norte. SAMAR.

2. ANISOPTERA CURTISII Dyer. *Dagang*.

LUZON: Pangasinan, Nueva Ecija, Laguna, Tayabas, Camarines. POLILLO. NEGROS.

3. ANISOPTERA sp.

This is the form which is apparently intermediate between *Anisoptera thurifera* and *A. curtisii*. It is known only from Bataan Province, Luzon.

4. ANISOPTERA THURIFERA (Blanco) Blume.

LUZON: Cagayan, Ilocos Norte, Ilocos Sur, Abra, Nueva Viscaya, Pangasinan, Nueva Ecija, Zambales, Bataan, Bulacan, Rizal, Laguna, Camarines, Albay. TICAPO. MINDORO. MASBATE. SIBUYAN. SAMAR. NEGROS. PANAY: Iloilo, Capiz. MINDANAO: Zamboanga.

The commonest names for this species are *mayapis*, *palosapis*, and *lauan*.

5. ANISOPTERA MINDANENSIS sp. nov.

Arbor magna. Folia elliptica vel oblonga, chartacea, glabra; lamina 11.5 ad 14.5 cm longa, 5.7 ad 7 cm lata, nervis secundariis utrinque 16; petiolo 18 ad 20 mm longo. Flores 1.5 cm diametro. Calycis segmenta valvata, lanceolata, pubescentia. Petala oblonga vel obovata, 10 mm longa, 6 mm lata. Stamina 25 ad 30, filamentis 0.3 mm longis, antheris 0.3 ad 0.6 mm, arista 2 ad 2.5

mm longa. Stylopodio vix constricto, 3.5 mm longo. Stylis 0.4 mm longis.

A large tree. Leaves glabrous or nearly so, chartaceous, oblong-elliptic, 11.5 to 14.5 cm long, 5.7 to 7 cm wide; secondary veins about 20 pairs, in the lower half of the leaf with a number of short intermediate veins; tertiary veins very prominent, reticulate. Secondary veins anastomosing near the margin, which is entire and slightly inrolled. Petiole 18 to 20 mm long. Flower clusters paniculate, apparently terminal and erect. Flowers white. Small branches of inflorescence stellate-pubescent. Pedicels 1 to 2 mm long, slender. Flowers spreading, about 1.5 cm in diameter. Calyx segments valvate, lanceolate, acute, pubescent on both surfaces, 3 mm long and 2 mm wide at the base. Petals oblong or obovate, 10 mm long, 6 mm wide. Stamens 25 to 30, filaments short, connective with very long appendage, 4 to 5 times as long as anther cells. Filaments about 0.3 mm long, anther cells 0.3 to 0.6 mm long, connective 2 to 2.5 mm long. Inner pair of anther cells much smaller than the outer. Stylopodium very large, almost cylindric, somewhat constricted just above the base and tapering at the top, about 3.5 mm long and 1.5 mm in diameter, deeply ridged, crowned by three short, slender styles, each about 0.4 mm long. Stylopodium pubescent for its whole length, very distinct in appearance from that of other species examined.

MINDANAO, Zamboanga, *For. Bur. 21899 Villamil*, May 19, 1914 (type). *For. Bur. 9371* and *9135 Whitford & Hutchinson*, also collected in Zamboanga Province, belong here, as does *For. Bur. 23833 Villamil*, collected in the same neighborhood as the type in May 1914. *For. Bur. 25937 Cortes*, from Samar, June, 1916, seems also to belong here.

3. HOPEA Roxburgh

This genus shows a very large percentage of endemism. Of the sixty-five species known in the genus, thirteen are found in the Philippines. Of these but three *Hopea ovalifolia* Boerl., West Borneo, *H. pierrei* Hance, and *H. odorata* Roxb., are known outside the Archipelago.

Key to the Philippine species of Hopea.

*a*¹. Secondary veins few and prominent.

*b*¹. Leaves narrowly oblong, unilaterally unsymmetrical.

*c*¹. Leaves 10 to 15 cm long, 2.2 to 7 cm wide; calyx-wings less than 8 cm long.

*d*¹. Stipules long, semipersistent; calyx-wings 6 to 7.5 cm long.

3. *H. philippinensis*.

*d*². Stipules short; calyx-wings 3.5 to 4.3 cm long. 1. *H. basilanica*.

*c*². Leaves larger; calyx-wings 8 cm or more in length.

2. *H. mindanensis*.

- b*². Leaves not narrowly oblong.
- c*¹. Leaves broad, elliptic-oval..... 7. *H. ovalifolia*.
- c*². Leaves lanceolate to ovate lanceolate.
- d*¹. Leaves 3 to 6 cm long, with few (5 to 7) pairs of secondary veins 6. *H. sp. (gyam)*.
- d*². Leaves larger and with a greater number of veins.
- e*¹. Leaves long acuminate, without domatia.
- f*¹. Calyx-wings more than 3 cm long..... 9. *H. maquilingsensis*.
- f*². Calyx-wings less than 3 cm long..... 8. *H. acuminata*.
- e*². Leaves not long acuminate, domatia prominent.
- f*¹. Fruit 5 to 6 mm in diameter; wings oblanceolate.
4. *H. plagata*.
- f*². Fruit up to 9 cm in diameter; wings broader, sometimes almost oblong 5. *H. odorata*.
- a*¹. Secondary veins not distant; leaves coriaceous, glabrous, with numerous indistinct and almost parallel secondary veins.
- b*¹. Leaves 8 to 12 cm long; calyx-wings 4.5 to 5 cm long.. 13. *H. malibato*.
- b*². Leaves and fruit smaller.
- c*¹. Fruit more than 1 cm long..... 12. *H. glutinosa*.
- c*². Fruit less than 1 cm long.
- d*¹. Fruit reddish-brown; leaves with domatia.....10. *H. pierrei*.
- d*². Fruit greenish, leaves without domatia..... 11. *H. foxworthyi*.

1. HOPEA BASILANICA Foxw.

BASILAN.

2. HOPEA MINDANENSIS Foxw.

MINDANAO, Zamboanga.

3. HOPEA PHILIPPINENSIS Dyer.

LUZON: Laguna, Tayabas, Camarines, Albay. NEGROS. SAMAR. LEYTE. BILIRAN. MINDANAO: Agusan, Lanao, Zamboanga.

4. HOPEA PLAGATA (Blanco) Vidal.

LUZON: Cagayan, Ilocos Norte, Nueva Vizcaya, Nueva Ecija, Pangasinan, Tarlac, Zambales, Bataan, Bulacan, Tayabas, Camarines, Sorsogon. MINDORO. TABLAS. BOHOL. BASILAN. MINDANAO: Cotabato, Zamboanga.

5. HOPEA ODORATA Roxb.

For. Bur. 25889, 26133, Borromeo and Alhambra, both collected in Bataan Province, Luzon, in July, 1916, seem to represent this species. The material is in fruit, which looks very much like the figure given by Korthals, *Verh. Nat. Gesch. Bot.* (1839-42) 75, and also much like the fruit figured in Roxburg's *Pl. Coromandel* 3 (1819) 7, t. 210. Vidal, in his *Atlas* (1883) t. 15, f. A 1-5, figures a form under the name of *H. odorata*. The leaves and flowers are said to have come from San Miguel de Mayumo, Bulacan Province, Luzon. The form figured seems to be *H. plagata*, in everything except the fruit, which is copied from Korthals' figure. *Hopea odorata* occurs in Burma, Siam, Cochinchina, the Andamans, and Borneo.

6. HOPEA sp. (Gyam).

TAWITAWI.

7. HOPEA OVALIFOLIA Boerl.

MINDANAO: Zamboanga, Agusan. LUZON, Camarines. SAMAR.

8. HOPEA ACUMINATA Merr.

LUZON: Cagayan, Ilocos Norte, Nueva Vizcaya, La Union, Pangasinan,

Tarlac, Nueva Ecija, Bulacan, Laguna, Tayabas, Camarines, Albay, Sorsogon. MINDORO. LEYTE. MINDANAO: Misamis, Davao.

9. *HOPEA MAQUILINGENSIS* sp. nov.

Arbor, *H. acuminatae* similis sed fructibus majoribus.

A medium-sized or large tree. Leaves chartaceous, lanceolate-acuminate, glabrous above, except for occasional hairs on the midrib, paler and pubescent beneath, domatia in the axils of the lower veins, 5.5 to 9.5 cm long, 2 to 3.6 cm wide, rounded or subcuneate and slightly inequilateral at the base, secondary veins 8 to 10 pairs. Petiole 6 to 9 mm long. Young twigs slender, dark brown. Fruit conical, about 4 mm high and about 3 mm in diameter, surmounted by the 0.5 mm long style. Calyx-lobes densely gray-pubescent, the two long ones up to 5 cm long and 1 cm wide, oblanceolate, pale green, with slight pubescence, principal longitudinal nerves about 7, transverse veins irregular and rather indistinct. Flowers in unilateral racemes and these in much branched panicles. Racemes 3 cm long or less, panicles 8 cm long or less. Stamens 10. Anthers about 0.4 mm long, appendage very slender, as long as the anther. Filament short and thick, 0.5 mm long, 0.3 mm wide. Ovary cylindrical, 0.7 mm in diameter, 0.8 to 0.9 mm high, gray-pubescent. Style pubescent, slender, dark brown, 0.3 mm long. Stylopodium none.

LUZON, Laguna Province, Mount Maquiling, *For. Bur. s. n. Cañacosa*, August 1914 (type) *For. Bur. 21988* and *22969 Cañacosa*.

This form is a smaller tree than *Hopea acuminata* and has a thinner, lighter, less deeply furrowed bark; the leaves are rather more pubescent on the underside, and the fruit is much larger.

10. *HOPEA PIERREI* Hance.

LUZON: Cagayan, Pangasinan, Nueva Ecija, Zambales, Laguna, Tayabas, Camarines, Albay, Sorsogon. POLILLO. MINDORO. NEGROS. SAMAR. MINDANAO, Lanao.

11. *HOPEA FOXWORTHYI* Elmer in Leaflet. Phil. Bot. 4 (1912) 1469.

SIBUYAN. MINDANAO, Zamboanga.

This species differs from *Hopea pierrei* by its smaller leaves without domatia and its pale-greenish fruits.

12. *HOPEA GLUTINOSA* Elmer in Leaflet. Phil. Bot. 4 (1912) 1470.

SIBUYAN. LUZON, Laguna. PANAY, Capiz.

This is most closely related to *Hopea pierrei*, from which it differs by its larger, glutinous fruits.

13. *HOPEA MALIBATO* Foxw. in Leaflet. Phil. Bot. 6 (1913) 1953.

MINDANAO, Agusan.

This is most closely related to *Hopea beccariana* Burck, from which it differs in the greater size of the leaves and the fruits and in the greater number of veins on the larger fruit wings. It differs from *Hopea pierrei*

Hance in the greater size of the leaves and the fruits and in the evident resinous coating of the upper part of the fruit.

4. PENTACME A. de Candolle

Key to the Philippine species of Pentacme.

- α^1 . Leaves lanceolate, more than 15 cm long..... 1. *P. mindanensis*.
 α^2 . Leaves less than 15 cm long, ovate or oblong.
 β^1 . Leaves glabrous on both sides..... 2. *P. contorta*.
 β^2 . Leaves tomentose on under side..... 3. *P. sp.* (from Tayabas).

1. PENTACME MINDANENSIS sp. nov.

Arbor magna. Foliis et fructibus *P. contortae* similis sed majoribus.

A large tree with oblong-lanceolate glabrous leaves, which are bluntly acuminate, with rounded bases, 19 to 29 cm long, 8 to 10 cm wide; secondary nerves 8 to 12 pairs. Petioles 2.5 to 4 cm long. Flower clusters paniculate, terminal. Individual flowers on slightly obconical pedicels 1 to 2 mm long. Branches of the inflorescence stellate-pubescent. Pedicels and outside of calyx-lobes grayish pubescent. Inside of the calyx puberulous. Sepals imbricate, broadly elliptic, concave, 6 mm long, 5 to 6 mm wide, with a fringe of coarser pubescence along the edge, and very faint longitudinal vein-like markings. Corolla spreading, about 1.5 cm in diameter. Petals grayish pubescent on the outside, yellow or brownish within, spreading after surpassing the sepals, obovate-elliptic, sometimes slightly retuse at the apex, narrowed to the base, 12 to 13 mm long, 4.5 to 6 mm wide, with about 15 longitudinal veins. Stamens fifteen, 8 mm long. Filament thick, 3.5 mm long 0.6 mm wide. Anther cells narrowly oblong, mucronate at apex, each anther with five mucronate appendages. Anther 4.5 mm long 0.8 mm wide. Appendages short, 0.5 to 1.0 mm long; anther-cells tapering to the apex. Ovary depressed-hemispheric, densely pubescent, 1.8 mm high, 2 mm in diameter, tapering abruptly into the long, cylindrical, pubescent, faintly ridged style, which is 6.6 mm long and 0.3 mm in diameter, slightly hollowed at apex.

The fruit is pubescent, 3 cm long, 13 to 14 mm in diameter. The long wings are 7 to 8 cm long, 15 to 27 mm wide; the short wings 2.5 to 3 cm long, 6 to 7 mm wide; longitudinal veins 12 to 14, transverse veins numerous, distinct, oblique.

MINDANAO, Zamboanga Province, *For. Bur. 21893 Villamil*, May 25, 1914 (type).

Other collections referred to this species are: *For. Bur. 13737, 13792 Foxworthy, De Mesa & Villamil*, Zamboanga, June 19, 1912; *Mrs. Clemens 247*, Lanao, Mindanao, February, 1905; *For. Bur. 24327 Cortez & Fernandez*,

For. Bur. 23831 Villamil, Naganaga, Zamboanga, Mindanao, May, 1914, in flower; *For. Bur.* 25193, 25210 Alvarez, Lanao, Mindanao; *For. Bur.* 4813 Hutchinson, Basilan, July, 1906 (in fruit); *For. Bur.* 22757 Nave, Olutanga Island, June, 1914, with immature fruit.

The flowers of this species are very much like those of *Pentacme contorta*, but are rather larger and have the ovary distinctly pubescent. It grows in much the same situations as *P. contorta*, and produces the same kind of wood. It is known in southern Mindanao as *malaccayan blanco*. The large leaves and the rather large fruit are the characters by which the species is most readily recognized.

2. PENTACME CONTORTA (Vid.) Merr. & Rolfe.

LUZON: Cagayan, Isabela, Ilocos Norte, Ilocos Sur, Abra, Bontoc, Benguet, Nueva Vizcaya, Nueva Ecija, Pangasinan, Zambales, Bataan, Bulacan, Rizal, Laguna, Tayabas, Camarines, Albay, Sorsogon. POLILLO. MARINDUQUE. MINDORO. MASBATE. SIBUYAN. SAMAR. NEGROS. BASILAN. MINDANAO: Agusan, Davao, Cotabato, Lanao, Zamboanga.

3. PENTACME sp.

This is a very little known form, of which sterile material was once collected in Tayabas. It is not certain that it should go in this genus and will remain in doubt till more complete material is collected.

5. SHOREA Roxb.

Of about one hundred species in this genus, twenty-one are known from the Philippines. These include several of our most important woods. Most red lauan and mangasinoro, all tanguile and guijo, and some kinds of yacals and white lauans are produced by species of *Shorea*.

Collectively, the members of this genus produce at least 35 per cent by volume of the stand of our commercial forests. There is considerable variation in leaf, bark, and wood characters. Some of the species have been collected only in flower, others in fruit, and yet others only with sterile material. This has made it difficult to be sure of the specific identification in a number of instances and has made it very difficult to prepare a key to the Philippine species. In a number of cases, it has not been practicable to refer collections to any particular species, and most of these cases have been left out of consideration in preparing the key. I have found it necessary to use wood characters for the main divisions of the key, in default of sufficiently sharp leaf differences.

Key to the Philippine species of *Shorea*.

- a¹. Wood very hard and heavy, dark-yellowish, or yellowish-brown.
 The yacals.
- b¹. Leaves the same color on both surfaces..... 18. *S. scrobiculata*.
- b². Leaves lighter colored beneath.
- c¹. Leaves cuneate or subcuneate at base.
- d¹. Secondary nerves 8 or 9 pairs..... 2. *S. ciliata*.
- d². Secondary nerves about 14 pairs..... 4. *S. malibato*.
- c². Leaves rounded at base.
- d¹. Style very short or wanting..... 3. *S. astylosa*.
- d². Style distinct.
- e¹. Leaves ovate-oblong 16 cm long, 7 cm wide.. 1. *S. balangeran*.
- e². Leaves oblong to oblong-lanceolate 8.5 to 12 cm long, 3 to 6 cm wide 5. *S. falciferoides*.

- a¹. Wood white to reddish, not very hard.
- b¹. Leaves distinctly lighter-colored beneath.
 - c¹. Leaves retuse at apex, coriaceous, almost glabrous beneath; wood soft, light-colored and coarse-grained.
 - d¹. Leaves 6 to 9 cm long, 2.5 to 4 cm wide..... 7. *S. polita*.
 - d². Leaves 6 to 12 cm long, 4 to 6.5 cm wide..... 6. *S. malaanonan*.
 - c². Leaves acute at apex, chartaceous, with grayish pubescence of stellate hairs beneath, wood hard, fine-grained, red.
 - 11. *S. sp.* (pubescent guijo).
- b². Leaves usually the same color on both surfaces.
 - c¹. Stipules small and early deciduous.
 - d¹. Domatia usually conspicuous..... 20. *S. plagata*.
 - d². Domatia not conspicuous.
 - e¹. Leaf-bases usually cuneate; wood hard and pale red.
 - 10. *S. guiso*.
 - e². Leaf-bases usually rounded or cordate.
 - f¹. Leaves coriaceous, glabrous or with scanty pubescence of simple hairs.
 - g¹. Leaves lanceolate 15. *S. polysperma*.
 - g². Leaves broadly elliptic..... 16. *S. warburgii*.
 - g³. Leaves broadly ovate..... 21. *S. mindanensis*.
 - f². Leaves chartaceous with pubescence of stellate hairs beneath.
 - 8. *S. philippinensis*.
 - c². Stipules of some size, sometimes persistent, at least on young shoots.
 - d¹. Stipules broadly ovoid, acute or obtuse, thickly covered with stellate hairs.
 - e¹. Leaves large, copper-colored when dry..... 12. *S. squamata*.
 - e². Leaves small, pallid when dry..... 9. *S. pallida*.
 - d². Stipules lanceolate acuminate.
 - e¹. Leaves lanceolate-acuminate, narrow, not prominently stellate-pubescent beneath; buds scurfy..... 17. *S. teysmanniana*.
 - e². Leaves elliptic or oblong, acuminate, prominently stellate-pubescent beneath.
 - f¹. Tertiary veins thickly beset with stellate hairs; wood pale red.
 - g¹. Twigs scurfy 13. *S. rugosa*.
 - g². Twigs not scurfy..... 14. *S. eximia*.
 - f². Tertiary veins not so thickly covered with stellate hairs; wood bright red..... 19. *S. negrosensis*.

1. SHOREA BALANGERAN (Korth.) Dyer.

Our material credited to this species resembles very closely that shown in Korthals' original figure [Verh. Nat. Gesch. Bot. (1848) t. 7] in leaf and flower characters, except that there are more than fifteen stamens, in some cases about thirty, and the appendage to the connective is ciliate. The style is also shorter than that shown in the figure. I have not seen the type of *Shorea balangeran* and thus do not feel that it is desirable to describe our form as a new species. Much of our material is sterile. The fruit has not yet been collected.

LUZON: Pangasinan, Zambales, Tayabas, Camarines, Albay. LEYTE. SAMAR. MINDANAO: Agusan, Davao, Zamboanga.

2. *SHOREA CILIATA* King.

This species has previously been reported only from Penang. It is represented by *For. Bur.* 22788 *Tabat*, collected in flower April 20, 1914, at Pinagcamaligan, Tayabas Province, Luzon, growing in lowland forest. It is known by the local name *yacal*. It matches very closely the description of the species in the flowers and leaves. The fruit has not yet been collected in the Philippines. It is represented also by *Bur. Sci.* 13575 *McGregor*, in flower, collected on Biliran Island, May 24, 1914.

This is a large tree with smooth brownish bark and yellowish inner bark, which is very resinous. The leaves are coriaceous, glabrous above, lighter colored, sometimes almost glaucous, and slightly pubescent beneath, elliptic-lanceolate, acuminate at apex, cuneate at base, 6.5 to 9 cm long, 2.4 to 3.4 cm wide; petiole brownish, sometimes pubescent, 12 to 15 mm long; secondary veins 8 or 9 pairs, tertiary veins parallel and reticulate. Flowers yellowish, with sweet odor.

3. *SHOREA ASTYLOSA* sp. nov.

Arbor excelsa. Folia ovata, acuminata, basi rotundata, glabra; nervis secundariis utrinque 8 ad 12. S. balangeran similis sed foliis brevioribus et staminibus ciliatis.

A very large tree, 25 to 30 m tall and 1 m or more in diameter. Wood very hard, dark brownish-yellow, resinous. Leaves ovate, entire, margins slightly inrolled, rounded at base, acuminate at apex, glabrous on upper surface and only slightly puberulent beneath, lighter-colored beneath, coriaceous, shining, 6.5 to 9 cm long, 3.5 to 4.5 cm wide; petioles dark-colored, slender, 1 to 2 cm long. Twigs very dark, almost black. Secondary veins 8 to 12 pairs, tertiary veins fine, parallel and reticulate, almost as distinct above as below. Flowers pale to rusty yellow with a sweet odor. Inflorescence axillary, paniculate, less than 5 cm long. Branches of inflorescence, calyx and outside of corolla grayish pubescent. Sepals broadly ovate, grayish pubescent on the outside, smoother within, concave, imbricate, 1.5 mm long and wide. Petals oblong-lanceolate, rusty yellow, 8 mm long, 2 mm wide, rounded at apex, more or less twisted, convolute in bud, concave, grayish pubescent on the outside and faintly puberulous within. Stamens 20 to 30, less than 1 mm long, filaments short, anther cells elliptic-oblong, about 0.2 mm long, appendix to connective ciliate about 0.3 mm long. Ovary pyramidal or conical, grayish pubescent, 1.5 mm tall and about 1 mm in diameter at the base, bluntly rounded at the apex. Style practically absent or very short. Fruit unknown.

MINDANAO, Zamboanga Province, *For. Bur.* 13271 *Foxworthy, De Mesa, & Villamil*, May 8, 1912, collected on a bluff overlooking a swamp at the edge of Dumanquilas Bay (type). Local name, *yacal*.

This species differs from *Shorea balangeran* by the shorter and relatively broader leaves, with a smaller number of secondary veins; the smaller size

of the flowers; and the almost or complete absence of a style. It differs from *S. ciliata* in the broader leaves, which are rounded at the base; and in the petals, ovary and style. It is further represented by the following specimens:

MINDANAO, Zamboanga Province, *For. Bur.* 23836, 23835, 21992, 21999 Villamil, May, 1914, *For. Bur.* 13287 Foxworthy, De Mesa, & Villamil, May, 1912; Agusan Province, *For. Bur.* 24438 Miras, Soriano, & Mariano; LUZON, Camarines Province, *For. Bur.* 21432, 21460 Alvarez, May, 1914.

4. *SHOREA MALIBATO* Foxw. in *Leafl. Phil. Bot.* 6 (1913) 1955.

This is represented by the original collection from Agusan Province, Mindanao. The leaves resemble those of *Shorea ciliata*, but the fruit is smaller and the long calyx-lobes have more numerous longitudinal nerves. *For. Bur.* 22786 Miranda, collected in Zamboanga Province, Mindanao, August 17, 1914, under the name of *guijo amarillo*, has fruit which seems to be intermediate between that of *Shorea malibato* and *S. ciliata*. The fruit is slightly larger than that of *S. ciliata* and the wings are those of *S. malibato*.

5. *SHOREA FALCIFEROIDES* sp. nov. *Yamban matibia* (Zambales).

Arbor magna. Foliis et fructibus *S. falciferae* similis sed foliis majoribus et fructibus minoribus.

A large tree with oblong to oblong-lanceolate, coriaceous leaves which are glabrous or nearly so and dark green above, distinctly lighter and finely pubescent beneath, 8.5 to 12 cm long, 3 to 6 cm wide, rather abruptly blunt acuminate at apex, rounded at base; secondary veins 12 to 14 pairs, occasionally with domatia in the axils of some of the lower veins, tertiary veins not conspicuous; petiole 15 to 20 mm long, grayish pubescent, as are also the twigs and the branches of the flower clusters. Stipules small, deciduous. Fruit conical gray pubescent, tapering into the hairy persistent style, 7 to 8 mm in diameter and 7 to 10 mm tall. The three long calyx-lobes 4 to 5 cm long, 10 to 12 mm wide, grayish pubescent, oblanceolate, with 8 to 10 principal longitudinal veins and numerous irregular cross-veins, the short wings 2.5 to 3 cm long, 2 to 3 mm wide, oblanceolate, with about the same number of longitudinal veins as the larger wings. Flowers unknown.

LUZON, Zambales Province, Masinloc, *For. Bur.* 25664 Mayor, June 8, 1916 (type).

This form resembles *Shorea falcifera* Dyer but has larger and differently shaped leaves, with a greater number of veins and smaller fruits. The wood is said to be of very good quality and to be used for structural work.

6. *SHOREA MALAANONAN* (Blanco) Blume in *Mus. Lugd. Bat.* 2 (1852) 34; Foxw. in *Phil. Journ. Sci.* 6 (1911) Bot. 270.

Mocanera malaanonan Blanco, *Fl. Filip.* (1837) 858.

Dipterocarpus malaanonan Blanco, *Fl. Filip.* ed. 2 (1845) 312.

This species is still but little known. Blanco's description is not a close one and the material referred to this species presents considerable variation. Other species that have been considered as belonging here are *Parashorea*

plicata and *Shorea polita*. The principal reason for considering the first as a possibility is that it has the underside of the leaves whitish and is sometimes known by the common name of *malaanonan*. Both of these conditions are met by the other two species. Blanco's description refers to three long calyx lobes in the fruit, which would certainly indicate *Shorea* rather than *Parashorea*. The description also mentions three stigmas, which is not the case in *Parashorea plicata*. It is often known as *lauan* or *malaanonan*. The common names reported for it from different provinces are: *Litoc* (Cagayan); *apnit* (Ilocos Sur); *lauan* or *lauan puti* (Nueva Ecija, Zambales, and Tayabas); *malaanonang* (Rizal); *baluisuis* (Pang.). Much of our material is sterile and some of the material referred here is very doubtfully identified.

Shorea polita Vid. I now believe to be a distinct species, differing from *S. malaanonan* by the smaller leaves. The fruit of the two forms is very similar.

LUZON: Cagayan, Ilocos Sur, Pangasinan, Nueva Ecija, Zambales, Rizal, Tayabas.

7. *SHOREA POLITA* Vidal Sinopsis, Atlas (1883) 15, t. 15, f. d.

In my former paper I placed this, mistakenly, with *S. malaanonan*, from which it seems to be distinct. It is known by the following local names: *Litoc* (Cagayan); *lauan* (Zambales); *malaanonang* (Rizal); *dantiñ* (Rizal); and *mangasinoro* (Tayabas).

LUZON: Cagayan, Zambales, Rizal, Tayabas.

8. *SHOREA PHILIPPINENSIS* Brandis.

We are no nearer to understanding this species than we were six years since.

LUZON: Bulacan, Bataan, Tayabas. TICAQ. LEYTE.

9. *SHOREA PALLIDA* sp. nov.

Arbor, ramuli pilis stellatis tecti. Folia coriacea elliptica, brevissime acuminata, basi rotundata vel subcordata, petiolis et subtus foliis pilis stellatis obtectis, nervis secundariis utrinque 12 ad 15, tertiariis conspicuis. Fructus ovoideus, alae 3 oblongo-spatulatae, 7 cm longae, 16 mm latae.

A large tree 30 m high and 75 cm in diameter. Wood white to brownish, soft, wood parenchyma lines and lines of resin-canals inconspicuous or wanting. Vessels arranged in more or less regular patterns. Wood resembling that of *Pentacme* in appearance. Leaves elliptic, coriaceous, pallid above and beneath when dry, the very young leaves being darker in color, bluntly acuminate at apex, rounded or subcordate at base, 5 to 9 cm long, 3 to 5 cm wide. Secondary nerves 12 to 15 pairs, tertiary nerves distinct. Petioles short, 8 to 9 mm long, pubescent.

Stipular-bracts enclosing the bud triangular-ovate, rather large and semipersistent, with several longitudinal nerves; stipules leaving a distinct scar on falling. Twigs dark colored, pubescent, with short internodes. Fruit ovoid, about 1 cm long and about the same diameter, enclosed by the bases of the calyx lobes; three

wings longer than the rest, oblong-spatulate, 7 cm long, 16 mm wide, with 10 to 12 longitudinal veins and numerous reticulate cross veins; the shorter wings 4 to 6 cm long and 5 to 6 mm wide, with only 5 or 6 long nerves. Fruit green when fresh, reddish brown when dry.

LUZON, Cagayan Province, on river bank at Missionis near the coast, *For. Bur.* 17158 Curran, March, 1909 (type). Common name *saray*. Other collections: *For. Bur.* 17652 Curran, Laguna, February, 1910 (sterile); *For. Bur.* s. n. Curran, Cagayan, February, 1912 (fallen fruit picked up from the ground); *For. Bur.* 12996 Bernardo, Cagayan, July, 1911 (in fruit); *For. Bur.* 7084 Klemme, Cagayan, May, 1907.

This form was noted in a previous article.*

10. *SHOREA GUISO* (Blanco) Blume.

LUZON: Cagayan, Isabela, Bontoc, Ilocos Norte, Ilocos Sur, Abra, Union, Nueva Vizcaya, Nueva Ecija, Pangasinan, Tarlac, Zambales, Bataan, Pampanga, Bulacan, Rizal, Laguna, Batangas, Tayabas, Camarines, Albay, Sorsogon. MARINDUQUE. TICAQ. MINDORO. MASBATE. SAMAR. LEYTE. NEGROS. PANAY, Capiz. MINDANAO: Agusan, Misamis, Davao, Cotabato, Zamboanga.

11. *SHOREA* sp. (pubescent guijo).

LUZON: Bataan, Zambales, Pampanga, Laguna.

12. *SHOREA SQUAMATA* (Turcz.) Dyer.

LUZON: Cagayan, Isabela, Ilocos Norte, Nueva Ecija, Bulacan, Rizal, Laguna, Tayabas, Camarines, Albay, Sorsogon. POLILLO. MARINDUQUE. MINDORO. SAMAR. LEYTE. BOHOL. BILIRAN. BASILAN. MINDANAO: Surigao, Agusan, Misamis, Davao, Lanao, Zamboanga.

13. *SHOREA RUGOSA* Heim.

MINDANAO, Zamboanga, *For. Bur.* 13293 Foxworthy, De Mesa & Villamil, in fruit, May 17, 1912.

This was previously known only from Borneo. It resembles *Shorea eximia* but differs by the scurfy twigs and the smaller, stellate-pubescent fruits. The wood is a red lauan.

14. *SHORA EXIMIA* (Miq.) Scheffer.

LUZON: Tayabas, Camarines, Albay, Sorsogon. SAMAR. NEGROS. BASILAN. MINDANAO, Agusan, Lanao, Zamboanga.

15. *SHOREA POLYSPERMA* (Blanco) Merr.

LUZON: Cagayan, Isabela, Ilocos Norte, Pangasinan, Nueva Ecija, Bulacan, Zambales, Bataan, Laguna, Tayabas, Camarines, Albay, Sorsogon. MARINDUQUE. SAMAR. LEYTE. CEBU. MINDORO. NEGROS. PANAY, Capiz. BILIRAN. BASILAN. MINDANAO: Surigao, Cotabato.

This species seems to be very variable in fruit characters.

16. *SHOREA WARBURGII* Gilg.

This may be not distinct from *Shorea polysperma*, but I am not sure of it. It seems to have broader leaves than that species. Our material is sterile and is from Cagayan Province, Luzon, and from Samar.

* Philip. Journ. Bot. 6 (1911) Bot. 272.

17. *SHOREA TEYSMANNIANA* Dyer.

LUZON: Cagayan, Ilocos Norte, Nueva Ecija, Bulacan, Laguna, Tayabas, Camarines, Sorsogon. POLILLO. MINDANAO: Agusan.

This species has not yet been found in flower or fruit.

18. *SHOREA SCROBICULATA* Burck.

LUZON, Tayabas Province, *For. Bur.* 22712, July 30, 1914. This differs from the type of *Shorea scrobiculata* in having generally smaller leaves and fruits and in the longer and more slender wings to the fruits. Its general appearance is so like the species, however, that it is thought best to place it with *S. scrobiculata*, for the present. Credited with being a yacal. This species has, till now, been known only from Borneo.

19. *SHOREA NEGROSENSIS* Foxw.

LUZON: Cagayan, Isabela, Laguna, Tayabas, Albay, Sorsogon. NEGROS. MINDANAO: Surigao, Agusan.

20. *SHOREA PLAGATA* sp. nov. § *Anthoshorea*.

Arbor magna, 40 m alta, 90 cm diametro. Cortex nigro, crasso, squamuloso. Folia coriacea, ovato-lanceolata vel elliptica; lamina 6 ad 12 cm longa, 3 ad 5.5 cm lata; petiolo 12 ad 15 mm longo, nigro. Nervis secundariis 9 ad 12, plerumque 10. Stipulae parvae, fugaceae. Paniculae terminales. Flores ignota. Fructus ovoideus, sericeus, 12 ad 15 mm longus, 11 mm diametro. Ovarium, conoideum sericeum. Stylopodium 0. Stylus conicus, sericeus. Alae 5, 3 majora 7 cm longa, 12 ad 16 mm lata; nerviis longitudinalis 7 ad 10, reticulatis.

A very large tree with thick black, furrowed or scaly bark. Heartwood dark red, moderately hard and light. A fine grade of red lauan but harder and heavier than is usually the case with that wood. It has some resemblance to guiyo and is locally known by that name. It grows with other Dipterocarps in tall forest. The fruit, when fresh, showed a distinct reddish tinge in the wings, the nut being covered with a pale silky pubescence. The fruit is eaten by the forest animals very quickly after its fall.

MINDANAO, Zamboanga District, Port Banga, *For. Bur.* 13758, *Foxworthy, De Mesa & Villamil*, June 17, 1912 (type). This species was first collected by *Whitford & Hutchinson*, *For. Bur.* 9174, 9493, in the same neighborhood, in December and January, 1907 and 1908. More recent collections have been (all of them from the same part of the Zamboanga Peninsula): *For. Bur.* 14210, *Foxworthy, De Mesa & Villamil*, June, 1912 (with the name *malacayan colorado*); *For. Bur.* 20266, *Stadtmiller & Ferraris*, January, 1913.

The specific name "plagata" is given because of the resemblance of the leaves to those of *Hopea plagata*. It is allied to *Shorea selanica* Blume and apparently also is rather closely related to *Shorea warburgii* Gilg.

21. *SHOREA MINDANENSIS* sp. nov. § *Anthoshorea*.

Arbor magna. Folia late ovata, elliptica vel oblonga, 6.5 ad

10.5 cm longa, 4.3 ad 6.5 cm lata, glabra, apice retusa, abrupte acuminata, basi rotundata vel subcuneata. Nervis secundariis circa 14, tertiariis parallelis et reticulatis, non conspicuis. Petiolo 2 ad 2.5 cm longo. Stamina connectivi appendice quam loculis antherae 2-3-plo longiore. Filamenta brevis. Stylopodio nullo. Ovario depresso conico. Stylo longo. Fructus viridis; alae longiores, circa 5 cm longae et 1 cm latae, breviores circa 2 cm longae, fructus circiter 1 cm longus.

A large tree, 35 to 50 m tall and 50 to 150 cm in diameter. Bark thick, dark, and furrowed longitudinally. Leaves broadly elliptic to oblong, usually retuse at the apex, sometimes shortly and very bluntly acuminate. Base rounded or subcuneate, 6.5 to 10.5 cm long, 4.3 to 6.5 cm broad, glabrous on both surfaces. Secondary nerves about 14 pairs, tertiary veins parallel and reticulate, not very prominent. Petioles 2 to 2.5 cm long. Flowers (picked up on ground under the tree) with appendix to connective 2 to 3 times as long as anther cells. Filaments short, less than half the length of anther. No stylopodium. Ovary flatly conical. Style long and slender. Stigma 3-lobed. Ovary and lower part of style pubescent. Fruit green when fresh; the three long wings about 5 cm long and up to 1 cm wide, the two short wings about 2 cm long. Fruit about 1 cm long.

BASILAN, *For. Bur. 13769 Foxworthy, De Mesa & Villamil, April 27, 1912* (type).

The flowers were picked up from the ground. They had evidently been borne a week or two earlier. It is locally known as *kalunti* and is one of the very common timber trees in Basilan and southern Mindanao.

Other collections of this species are: *For. Bur. 13768 Foxworthy, De Mesa & Villamil, Basilan, April 27, 1912*; *For. Bur. 13902, Zamboanga, same collectors, June, 1912*; *For. Bur. 9076, 9130 Whitford & Hutchinson, Zamboanga, Dec. 1907, also 9372, same place, Jan. 1908*; *For. Bur. 13294 Foxworthy, De Mesa & Villamil, Zamboanga, May 17, 1912*. This was known as *kalunti colorado* and is possibly a distinct species. *For. Bur. 13289 Foxworthy, De Mesa & Villamil, opposite Olutanga Island, May 16, 1912, is possibly a distinct species. It was collected under the name of mangasinoro.*

Fruit described from immature material. Base green, wings maroon color. Fruits borne in a panicle. Two small and three long wings, enclosing the fruit very closely. The large wings 3.5 to 7 cm long and 7 to 11 cm wide, with about 10 nerves. Short wings 1.8 to 2 cm long and 2 to 3 mm wide. Very abundant fruiting, but much the largest part of the seeds drop before maturing.

6. PARASHOREA Kurz

Key to the Philippine species of Parashorea.

- a*¹. Fruit less than 1 cm in diameter..... 1. *P. plicata*.
*a*². Fruit 2 cm in diameter..... 2. *P. warburgii*.

1. **PARASHOREA PLICATA** Brandis.

LUZON: Nueva Ecija, Bulacan, Rizal, Laguna, Tayabas, Camarines, Albay, Sorsogon. POLILLO. CATANDUANES. MASBATE. SAMAR. LEYTE. CEBU. NEGROS. PANAY, Capiz. BILIRAN. MINDANAO: Surigao, Agusan, Davao, Zamboanga.

This is one of the most abundant and widely distributed species in the regions of even rainfall.

2. **PARASHOREA WARBURGII** Brandis in Journ. Linn. Soc. Bot. 31 (1895) 10, Foxw. in Leaf. Phil. Bot. 6 (1913) 1954.

MINDANAO: Davao and Agusan.

7. **ISOPTERA** Scheffer1. **ISOPTERA BORNEENSIS** Scheffer. Plate I.

This species was collected in fruit May 26, 1914, by Ranger *Oliveros*, in the Zamboanga Peninsula, Mindanao, *For. Bur.* 23829 and 23839. It was also collected, in the same locality, two months later by Rangers *Acuña* and *Belen*, *For. Bur.* 22683. This is the first time that this genus has been reported from the Philippines. The specimens seem to match very well material collected in Borneo. The species is also known from the Malay Peninsula and Bangka.

8. **BALANOCARPUS** Beddome

This genus is distinct by reason of its calyx-lobes, which are pointed and shorter than the fruit. The trees of this genus are of large size and have very hard wood, which is a fine grade of yacal. Sixteen species are known, mainly in the Malay Peninsula and Borneo.

Key to the Philippine species of Balanocarpus.

- α^1 . Calyx-wings only about one-half as long as the fruit; leaves narrowly oblong 1. *B. cagayanensis*.
 α^2 . Calyx-wings nearly as long as fruit; leaves lanceolate. 2. *B. brachyptera*.

1. **BALANOCARPUS CAGAYANENSIS** sp. nov. Plate II.

Arbor magna. Foliis chartaceis, oblongis, acuminatis, basi cuneatis, rotundatis admodum leviter inaequalateralibus, 7 ad 13 cm longis, 2 ad 4 cm latis. Nervis secundariis 10 ad 12, tertiariis approximatis, parallelis. Calycis segmentis quam fructibus duplo brevioribus.

A large tree. Leaves oblong, acuminate, faintly cuneate, slightly rounded, or slightly inequilateral at the base, 7 to 13 cm long, 2 to 4 cm wide, margin slightly inrolled. Secondary nerves 10 to 12 pairs, with occasional intermediate short veins. Tertiary veins approximate, mostly parallel. Domatia in axils of secondary veins. Glabrous above and almost glabrous beneath, occasional scattered hairs. Flower clusters not distinctly unilateral, black or dark gray. Petals yellowish-brown in dried material, about twice as long as sepals. Petals pale-sericeous on the outside, glabrous within. Stamens with filaments expanded

at the base, attached to base of petals and, more or less, to each other, forming at least an indication of a monadelphous condition. Anthers almost round and equal. Connective prolonged into a tapering awn, distinctly longer than the anther. Gynoecium hour-glass shaped, the ovary subspherical, the stylopodium as long as the ovary and almost columnar. The stylopodium abruptly narrowed into the style, which is rather less than half as long. The stigma is shallowly notched. Fruit 1 to 1.3 cm long and about 1 cm in diameter, roughly conical, apiculate. Calyx-wings of about equal length and less than two-thirds the height of the fruit. The wood is said to be more durable than that of Molave (*Vitex* spp.).

LUZON, Cagayan Province, near Claveria, *For. Bur.* 19987 Bernardo, August, 1913 (type). It is also represented by the following specimens: *For. Bur.* 20453 Bernardo, in flower, May 30, 1913; *For. Bur.* 17774, 17775, 17776 Curran, and *For. Bur.* 20454. All of these are from the same part of the province as the type. The local name is *narec*.

The stylopodium resembles that of *Hopea helferi* Brandis, *Journ. Linn. Soc. Bot.* 31 (1895) p. 62, t. 2, f. 2, but is relatively longer. The stamens are like those of *H. helferi* (l. c. fig. 1) and like those figured for *H. javanica* Burck, *Ann. Jard. Bot. Buitenz.* 2 (1887) 235, t. 29, f. 7.

Some sterile material in the herbarium representing collections in some other provinces may belong here, but the identifications are very doubtful.

2. BALANOCARPUS BRACHYPTERA sp. nov.

Arbor. Folia chartacea, elliptica, oblonga vel ovato-lanceolata, breviter acuminata, basi rotundata vel subcuneata, margine crenulata, glabra, 5.8 ad 7.3 cm longa, 2.7 ad 3.8 cm lata; nervis secundariis 10 ad 12, tertiariis inconspicue reticulatis; petiolo 3 ad 5 mm longo. Fructus ovoideus, circiter 1 cm longus.

A medium sized tree. Leaves chartaceous, elliptic or oblong to ovate-lanceolate, apex blunt-acuminate, base rounded or subcuneate, margin crenulate, glabrous except along the principal veins, where there is a sparse pubescence, mainly of grayish pilose hairs, with hairy domatia in the axils of veins on under side of leaf, 5.8 to 7.3 cm long, 2.7 to 3.8 cm wide. Secondary veins 10 to 12 pairs, tertiary veins rather indistinct, mainly reticulate; petioles 3 to 5 mm long. Flowers unknown. Fruits ovoid, about 1 cm long and 9 mm in diameter, borne in short axillary panicles. Calyx-lobes triangular-ovate, imbricate, rather closely surrounding the fruit, and a little shorter than the fruit. Margins of the sepals frequently brownish and scarious, in one immature fruit, very slightly reflexed. Fruit conical, faintly pubescent, with thin pericarp, the short style projecting through a small circular depression at the apex. Style glabrous, about 0.5 mm. long.

MINDANAO, Zamboanga Province, Naganaga, *For. Bur. 21895 Villamil*, May 18, 1914 (type). Also *For. Bur. 23832*.

9. VATICA Linnaeus

Key to the Philippine species of *Vatica*.

- a*¹. Leaves obtusely rounded at both ends..... 2. *V. obtusifolia*.
*a*². Leaves acute or acuminate at apex.
*b*¹. Stigma distinctly lobed, not glandular..... 1. *V. mangachapoi*.
*b*². Stigma capitate and glandular.
*c*¹. Style gray-tomentose 5. *V. sorsogonensis*.
*c*². Style glabrous.
*d*¹. Secondary veins about 7 pairs..... 3. *V. blancoana*.
*d*². Secondary veins 11 to 14 pairs..... 4. *V. mindanensis*.

1. VATICA MANGACHAPOI Blanco.

BABUYAN ISANDS. LUZON: Cagayan, Benguet, Ilocos Norte, Ilocos Sur, Union, Pangasinan, Nueva Ecija, Zambales, Bataan, Rizal, Laguna, Tayabas, Camarines, Albay. SAMAR. LEYTE. PANAY. MINDANAO: Agusan, Davao, Cotabato, Lanao, Olutanga, Zamboanga. BASILAN.

This species is quite variable in texture and in the arrangement of its leaves. There is also a considerable variation in the amount of pubescence on the twigs and inflorescences.

2. VATICA OBTUSIFOLIA Elmer in Leaf. Phil. Bot. 4 (1912) 1471.

Known only from Palawan.

3. VATICA BLANCOANA Elmer in Leaf. Phil. Bot. 4 (1912) 1473.

Known only from Palawan.

4. VATICA MINDANENSIS Foxw. in Leaf. Phil. Bot. 6 (1913) 1957.

MINDANAO, Agusan. LEYTE. NEGROS.

Some of the forms credited here have fruits larger than those in the type.

5. VATICA SORSOGONENSIS sp. nov.

Arbor magna. Folia chartacea, glabra, 5 ad 10 cm longa, 2.3 ad 8 cm lata, acuminata, ad basin rotundata vel cuneata; nervis secundariis 11 ad 13; petiolo 14 ad 20 mm. longo, ferrugino-pubescente. Floribus paniculatis, axillaribus, 1.5 cm diametro. Fructibus ovoideus, tomentosus, 4 ad 5 mm longus, aliis oblanceolatis vel oblongis, 3.5 ad 4.5 cm longis, 9 ad 10 mm latis, pubescentibus.

A tree, 12 m high and 60 cm in diam. Leaves chartaceous, glabrous, except along the veins, dark green above, much lighter beneath, 5 to 10 cm long, 2.3 to 8 cm wide, acuminate, rounded or cuneate at the base, secondary veins 11 to 13 pairs; tertiary veins reticulate, more distinct on lower side of leaf; petiole 14 to 20 mm long, ferruginous-pubescent, as are also the twigs, buds, the branches of the inflorescence and the lower part of the midrib of the leaf. Inflorescence paniculate, axillary, 2 to 4 cm long, near the ends of the branches. Flowers about 1.5 cm in

diameter. Sepals thick, coriaceous, 2.5 to 3 mm long, 1.3 mm wide, almost triangular, densely gray-tomentose. Petals broadly oblong, densely tomentose without and within, about 10 mm long and 6 mm wide, with indications of 7 or 8 principal longitudinal veins; the petals become irregularly distorted in drying and are hard to straighten out. Stamens 15, arranged in groups, 1.5 mm long, 0.4 mm in diameter, filaments thick and broad at the base, tapering to about 0.3 mm in diameter below the attachment of the anthers; total length of filament about 0.8 mm; anthers ellipsoid, the inner pair smaller than the outer, 0.2–0.3 mm long, connective blunt-conical, projecting beyond the anthers for about 0.1 to 0.15 mm. Ovary rather hemispheric, about 1.7 mm high and 2 mm in diameter, densely grayish tomentose, with indication of division into 3 lobes. Style tapering, cylindric, about 2 mm long, densely grayish tomentose, about 0.4 mm in diameter at the base and 0.2 mm at apex. Stigma apparently capitate and glandular. Ovary 2-celled. Fruit gray-tomentose, ovoid 4 to 5 mm tall, sometimes with the persistent style, often somewhat resinous. The two long wings oblanceolate or oblong, 3.5 to 4.5 cm long, 9 to 10 mm wide, with five principal distinct longitudinal nerves and numerous less distinct reticulate cross veins. Wings pubescent throughout. Short wings lanceolate, about 1 cm long and 1 mm wide, with pubescence so dense as to obscure the longitudinal nerves.

LUZON, Sorsogon Province, Irosin, 16840 *Elmer*, August, 1916, (type). Field note: "Medium-sized tree in woodlands along streams at 1,000 feet facing the Pacific. Trunk terete, somewhat crooked, 2 feet thick, 40 feet high, mainly branched toward the top; wood whitish on the outside, moderately hard; bark thick, smoothish and chalky white blotched, ochroleucous otherwise; main branches divaricate, not long but repeatedly branched; leaves chartaceous, conduplicate, descending, slightly paler green beneath, points recurved, fruit wings pale yellowish green, turning dull purple, the nut ovoid, green or yellowish green."

This is most nearly related to *Vatica lowii* King, from which it differs by the smaller size of the fruit, the fewer veins to the leaf, and the much larger size of the flowers.

Several other species of this genus seem to be represented in our collections by sterile material. Their identification will have to wait until more complete material is collected.

[Vol. XIII, No. 1, including pages 1 to 66, was issued February 25, 1918, and No. 2, including pages 67 to 122, was issued May 9, 1918.]



ILLUSTRATIONS

[Drawings by J. K. Santos.]

PLATE I. *Isoptera borneensis* Burck.

- a*, habit sketch of a fruiting branch, reduced about one-half.
- b*, a fruit, natural size.

II. *Balanocarpus cagayanensis* Foxw.

- a*, habit sketch of a flowering branch, reduced about one-half.
- b*, a flower, $\times 3$.
- c*, stamens, $\times 20$.
- d*, a fruit, natural size.
- e*, portion of the lower surface of a leaf, showing details of the reticulations and the domatia, $\times 1.5$.



PLATE I. *Isoptera borneensis* Burck.

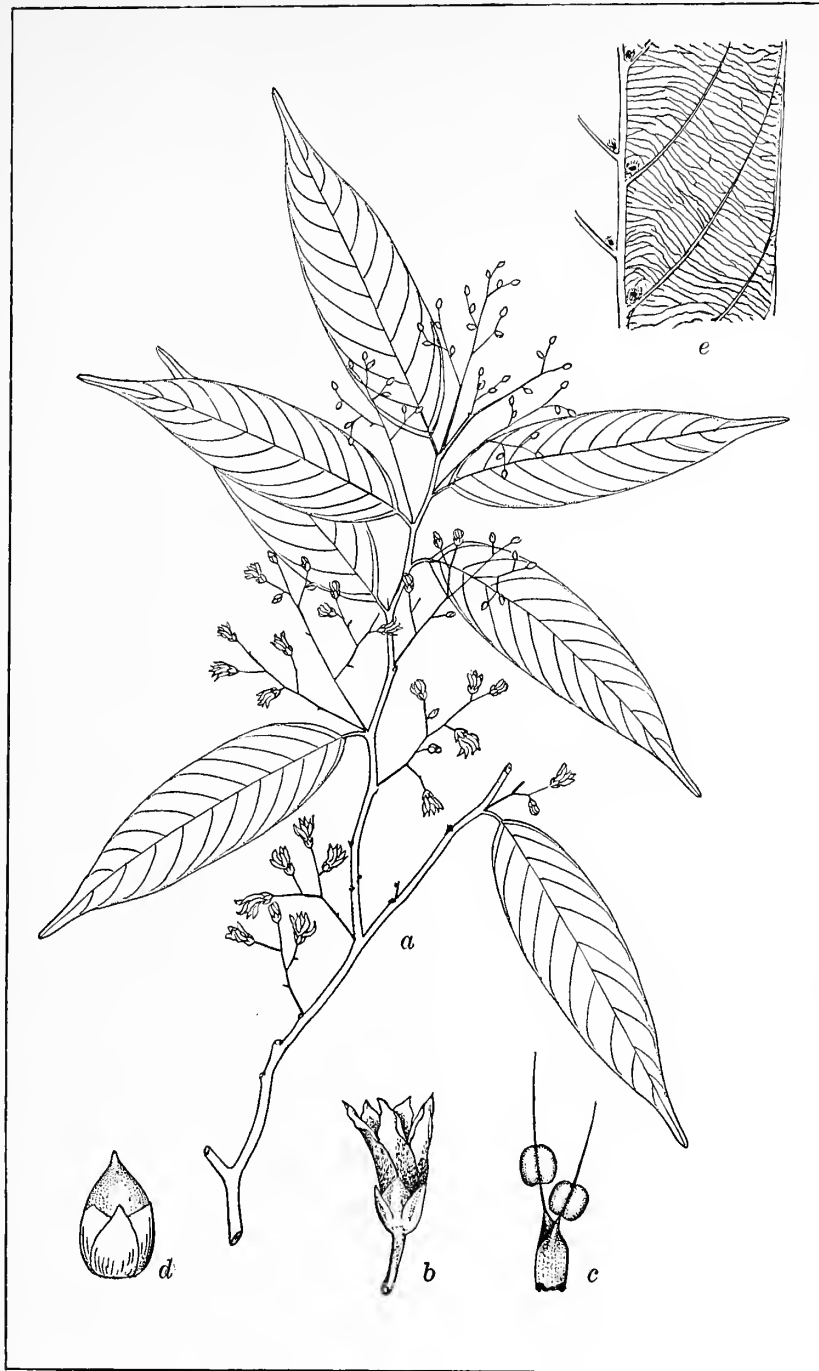

PLATE II. *Balanocarpus cagayanensis* Foxw.



THE PHILIPPINE BUREAU OF SCIENCE

RECENT PUBLICATIONS

AN INTERPRETATION OF RUMPHIUS'S HERBARIUM AMBOINENSE

By E. D. MERRILL

Based on the collections made in Amboina by the late Charles Budd
Robinson

Order No. 450. Bureau of Science Publication No. 9. Paper, 595 pages and 2 maps.
Price \$3, United States currency, postpaid.

The Herbarium Amboinense is a classical work on the Malayan flora and one that is absolutely essential to the systematist to-day. The great importance of the work is due to the fact that later authors have made the Rumphian descriptions and figures the actual "types" of many binomials. As an original source the Herbarium Amboinense stands preëminent among all the early publications on Malayan botany.

Professor Merrill's interpretation of the Herbarium Amboinense discusses the status of each species described by Rumphius and assigns it to a position in the modern system of classification. This publication will be of great service to any one working on Indo-Malayan systematic botany.

A GRAMMAR OF LEPANTO IGOROT AS IT IS SPOKEN AT BAUCO

By MORICE VANOVERBERG

Order No. 438. Vol. V, Part VI, Division of Ethnology Publications. Paper, 102 pages.
Price \$0.75, United States currency, postpaid.

This part completes Volume V of the Division of Ethnology publications and includes the index and the title-page for the volume. A title-page for Volume II is printed with this number.

PLEASE GIVE ORDER NUMBER

Orders for these publications may be sent to the BUSINESS MANAGER, Philippine Journal of Science, Bureau of Science, Manila, P. I., or to any of the following agents:

AGENTS

THE MACMILLAN COMPANY, 64-66 Fifth Avenue, New York, U. S. A.

WM. WESLEY & SON, 28 Essex Street, Strand, London, W. C., England.

MARTINUS NIJHOFF, Lange Voorhout 9, The Hague, Holland.

KELLY & WALSH, Limited, 32 Raffles Place, Singapore, Straits Settlements.

A. M. & J. FERGUSON, 19 Baillie Street, Colombo, Ceylon.

THACKER, SPINK & Co., P. O. Box 54, Calcutta, India.

CONTENTS

	Page.
MERRILL, E. D. Notes on the flora of Loh Fau Mountain, Kwangtung Province, China.....	123
FOXWORTHY, F. W. Philippine Dipterocarpaceæ, II.....	163

The Philippine Journal of Science is issued in four sections. Each section consists of six numbers a year, is separately paged and indexed, and is a complete publication in itself. Authors receive 100 copies of their papers free.

	U. S. currency.
SUBSCRIPTION RATES TO CURRENT VOLUME	
Section A (Chemical and Geological Sciences and the Industries).....	\$2.00
Section B (Tropical Medicine).....	3.00
Section C (Botany), Elmer D. Merrill, B. S., M. S., Editor.....	2.00
Section D (General Biology, Ethnology, and Anthropology). Section D began with Volume V.....	2.00
Entire Journal (4 sections).....	7.00

PRICES OF BACK NUMBERS AND VOLUMES	
Entire Journal, Volume II, III, or IV (3 sections each); or V (4 sections).....	5.00
Entire Journal, beginning with Volume VI (per volume).....	7.00
Single numbers of Volume I.....	.75
Single numbers (except of Volume I).....	.50
Volume I, 1906 (not divided into sections), and supplement, sold only with a complete file of section A, B, or C.....	10.00
Supplement to Volume I (Botany).....	3.50
Volume I (without supplement), sold only with a complete file of section A, B, or C.....	6.50

Publications sent in exchange for the Philippine Journal of Science should be addressed: Library, Bureau of Science, Manila, P. I.

Subscriptions may be sent to the BUSINESS MANAGER, Philippine Journal of Science, Bureau of Science, Manila, P. I., or to any of the agents listed on the inside pages of this cover.

VOL. XIII, SEC. C, No. 4

JULY, 1918

THE PHILIPPINE JOURNAL OF SCIENCE

ALVIN J. COX, M. A., PH. D.
GENERAL EDITOR

SECTION C. BOTANY

E. D. MERRILL, M. S.
EDITOR

WITH THE COÖPERATION OF

W. H. BROWN, PH. D.; C. F. BAKER, M. A.
L. M. GUERRERO, PHAR. D.; R. C. MCGREGOR, A. B.



MANILA
BUREAU OF PRINTING
1918

PHILIPPINE JOURNAL OF SCIENCE

A TEN-YEAR INDEX

CONTENTS AND INDEX OF THE PHILIPPINE JOURNAL OF SCIENCE, VOLUME I (1906) TO VOLUME X (1915)

Order No. 449. Bureau of Science Publication No. 8. Paper, 441 pages.
Price \$2, United States currency, postpaid.

One copy of this index has been sent free of charge to each subscriber that has received Volumes XI and XII of the Journal.

This publication consists of:

The complete contents of the first ten volumes of the Philippine Journal of Science, all sections; giving all authors, titles of articles, and page numbers. The exact date of issue of each number is recorded.

An author index, being an alphabetical list of all the contributors. The titles of all the articles are listed under the names of their respective authors.

A subject index. The subject matter is very fully indexed by catch words from the titles, by geographical localities, and by subjects. All systematic names in zoölogy and botany, as well as the thousands of English and local names, are entered in the index.

STUDIES IN PHILIPPINE DIPTERA, II

By M. BEZZI

Order No. 437. Bureau of Science Publication No. 10. Paper, 59 pages and 1 plate.
Price \$0.50, United States currency, postpaid.

This is the second century of Professor Bezzi's enumeration of Philippine species of flies and includes descriptions of new genera and new species.

PLEASE GIVE ORDER NUMBER

Orders for Bureau of Science publications may be sent to the BUSINESS MANAGER, Philippine Journal of Science, Bureau of Science, Manila, P. I., or to any of the following agents:

AGENTS

THE MACMILLAN COMPANY, 64-66 Fifth Avenue, New York, U. S. A.
WM. WESLEY & SON, 28 Essex Street, Strand, London, W. C., England.
MARTINUS NIJHOFF, Lange Voorhout 9, The Hague, Holland.
KELLY & WALSH, Limited, 32 Raffles Place, Singapore, Straits Settlements.
A. M. & J. FERGUSON, 19 Baillie Street, Colombo, Ceylon.
THACKER, SPINK & Co., P. O. Box 54, Calcutta, India.

THE PHILIPPINE JOURNAL OF SCIENCE

C. BOTANY

VOL. XIII

JULY, 1918

No. 4

CONTRIBUTIONS TO THE BRYOLOGICAL FLORA OF THE PHILIPPINES, V

By V. F. BROTHERUS
(Helsingfors, Finland)

The first manuscript of this paper was lost through the sinking of the steamer that carried it. As I unfortunately had retained no copy of it, I was obliged to rewrite the entire paper, which explains the delay in the preparation and publication of it.

In the present paper the geographic distribution is not indicated for those species which were included in the former parts.¹

DICRANACEAE

TREMATODON Michaux

TREMATODON PAUCIFOLIUS C. Müll.

LUZON, Batangas Province, Taal Volcano, on bluffs near the lake, altitude 4 meters, *Merrill 10610*.

TREMATODON DREPANELLUS Besch.

LUZON, Benguet Subprovince, Baguio and vicinity, *Merrill 7869, 7879, 14051*; Ifugao Subprovince, *Bur. Sci. 20048, 20047 McGregor*.

TREMATODON CAPILLIPES C. Müll.

LUZON, Cagayan Province, Abulug River, *Weber 1588*.

Area: Philippines.

CAMPYLOPODIUM (C. Müll.) Bescherelle

CAMPYLOPODIUM EUPHOROCLADUM (C. Müll.) Besch.

LUZON, Abra Province, Mount Posuey, *Bur. Sci. 27094 Ramos*.

¹ Brotherus, V. F., Contributions to the Bryological flora of the Philippines, I, *Öfversigt Finska Vetensk.-Soc. Förhandl.* 47³⁴ (1905) 1-12; II, *Philip. Journ. Sci.* 3 (1908) Bot. 11-30; III, *op. cit.* 5 (1910) Bot. 137-162; IV, *op. cit.* 8 (1913) Bot. 65-98.



DICRANOLOMA Renault

DICRANOLOMA MONOCARPUM Broth. sp. nov.

Dioicum; robustulum, caespitosum, caespitibus laxis, lutescenti-viridibus, nitidis; *caulis* usque ad 7 cm longus, adscendens vel erectus, ubique ferrugineo-tomentosus, densiuscule foliosus, simplex; *folia* patula, comalia plerumque subsecunda, canaliculato-concava, haud plicata, e basi ovata sensim lanceolato-subulata, usque ad 8 mm longa et c. 0.6 mm lata, ultra medium anguste limbata, superne dense et argute serrata, nervo tenui superne dorso argute serrato, cellulis elongatis, incrassatis, lumine angustissimo, alaribus numerosis, fusco-aureis; *seta* solitaria, usque ad 2 cm alta, tenuissima, straminea; *theca* indistincte strumifera, anguste cylindrica, arcuatula, fusca. Caetera ignota.

LUZON, Camarines Province, Mount Isarog, *Bur. Sci.* 22114 Ramos.

Species *D. assimili* (Hamp.) Par. affinis, sed foliis angustioribus sporogoniisque solitariis dignoscenda.

DICRANOLOMA TENUIRETE Broth. sp. nov.

Dioicum; gracilescens, caespitosum, caespitibus densis, pallide lutescenti-viridibus, nitidis; *caulis* usque ad 4 cm longus, adscendens, ubique ferrugineo-tomentosus, dense foliosus, simplex vel furcatus; *folia* falcata, canaliculato-concava, sicca plicatula, e basi ovata sensim lanceolato-subulata, usque ad 7 mm longa et c. 0.75 mm lata, ultra medium anguste limbata, superne argute serrata, nervo tenui, superne dorso argute serrato, cellulis breviter linearibus, haud incrassatis, alaribus numerosis, fusco-aureis. Caetera ignota.

LUZON, Abra Province, Mount Posuey, *Bur. Sci.* 27090 Ramos.

Species e minoribus, cum *D. ramosii* Broth. comparanda, sed foliis falcatis nec non cellulis haud incrassatis dignoscenda.

CAMPYLOPUS Bridel

CAMPYLOPUS ERICOIDES (Griff.) Jaeg.

LUZON, Laguna Province, Mount Maquiling, *Bur. Sci.* 17075 Robinson.

Area: Nepal, Khasia, Ceylon, Luzon.

CAMPYLOPUS HEMITRIUS (C. Müll.) Jaeg.

LUZON, Laguna Province, Mount Banahao, *Bur. Sci.* 9839 Robinson.

Area: Luzon.

CAMPYLOPUS ERICOIDES (Griff.) Jaeg.

LUZON, Laguna Province, Mount Maquiling, *Bur. Sci.* 17075 Robinson.

Area: India and Luzon.

PILOPOGON Bridel

PILOPOGON BLUMEI (Doz. et Molk.) Broth.

LUZON, Lepanto Subprovince, Malaya Mountains, *Bona* 147; Camiguin de Mindanao, *Bur. Sci.* 14898 Ramos.

PILOPOGON SUBEXASPERATUS (C. Müll.) Broth.

LUZON, Bontoc Subproince, *Vanoverbergh 1309*: Ifugao Subprovince, Mount Polis, *Bur. Sci. 20315* *McGregor*: Nueva Vizcaya Province, *Bur. Sci. 20220* *McGregor*.

LEUCOBRYACEAE**LEUCOBRYUM** Hampe**LEUCOBRYUM SANCTUM** Hamp.

LUZON, Laguna Province, San Antonio, *Bur. Sci. 20620, 20626* *Ramos*; Mount Maquiling, *Bur. Sci. 20356* *Villamil*; Paete, *Bur. Sci. 10059* *Ramos*: SAMAR, *Bur. Sci. 17621* *Ramos*.

LEUCOBRYUM SCALARE C. Müll.

LUZON, Laguna Province, *Bur. Sci. 23277* *McGregor*; Mount Maquiling, *Baker 2590*.

Area: Singapore, Java, Sumbawa and Luzon.

Var. **TJIBODENSIS** Fleisch.

CAMIGUIN DE MINDANAO, *Bur. Sci. 14887* *Ramos* (f. *robusta*). PALAWAN Mount Capoas, *Merrill 9096* (f. *robusta*).

Area: Java.

LEUCOBRYUM BOWRINGII Mitt.

LUZON, Laguna Province, Mount Maquiling, on trees, altitude 750 meters, *Bur. Sci. 17055* *Robinson*.

LEUCOBRYUM SERICEUM Broth.

LUZON, Tayabas Province, Guinayangan, *Bur. Sci. 20920* *Escritor*.

OCTOBLEPHARUM Hedwig**OCTOBLEPHARUM ALBIDUM** (L.) Hedw.

LUZON, Nueva Vizcaya Province, *Bur. Sci. 20221* *McGregor*. PANAY, Iloilo Province, Larena, on dead trees, alt. 750 meters, *Bur. Sci. 18220* *Robinson*.

SCHISTOMITRIUM Dozy et Molkenboer**SCHISTOMITRIUM APICULATUM** Doz. et Molk.

LUZON, Pangasinan Province, Umingan, *Bur. Sci. 18356* *Otanés*. MINDANAO, Zamboanga Province, *Merrill 8362*.

SCHISTOMITRIUM COPELANDII Broth.

BASILAN, *Bur. Sci. 16269* *Reillo*.

SCHISTOMITRIUM ROBUSTUM Doz. et Molk.

BASILAN, *Bur. Sci. 16271* *Reillo*.

LEUCOPHANES Bridel**LEUCOPHANES CANDIDUM** (Hornsch.) Lindb.

LUZON, Rizal Province, *Bur. Sci. 19316* *Reillo*: Sorsogon Province, *Bur. Sci. 23745* *Ramos*. SAMAR, *Bur. Sci. 17622* *Ramos*. BASILAN, *Bur. Sci. 16274* *Reillo*.

FISSIDENTACEAE**FISSIDENS** Hedwig**FISSIDENS BRAUNII** (C. Müll.) Doz. et Molk.

LUZON, Laguna Province, Mount Maquiling, *Bur. Sci. 17013* *Robinson*.

Area: Java and Luzon.

FISSIDENS (AMBLYOTHALLIA) ROBINSONII Broth. sp. nov.

Dioicus; robustiusculus, caespitosus, caespitibus laxiusculis, pallide viridibus, opacis; *caulis* usque ad 6 mm longus, cum foliis c. 3 mm latus, infima basi fusco-radiculosus, dense foliosus, simplex; *folia* c. 15-juga, sicca homomalla, comalia circinato-incurva, humida erecto-patentia, stricta, elongate linearia, lanceolato-acuminata, mucronata, integerrima, elimbata, lamina vera paulum ultra medium folii producta, lamina dorsali ad basin nervi enata ibidemque rotundata, nervo crassiusculo, pallido, brevissima excedente, cellulis minutissimis, rotundato-hexagonis, pellucidis, laevissimis. Caetera ignota.

PANAY, Iloilo Province, Salug River, altitude 340 meters, *Bur. Sci.* 18105 Robinson. MINDANAO, Surigao Province, Agusan Valley, *For. Bur.* 7607 Hutchinson.

Species follis elongate linearibus, lanceolato-acuminatis, cellulis pellucidis, laevissimis dignoscenda.

FISSIDENS NAGASAKINUS Besch. var. **LUZONENSIS** Broth. var. nov.

Folia superne minus angustata, nerve crassiore.

LUZON, Benguet Subprovince, *Merrill* 7851.

FISSIDENS NOBILIS Griff.

LUZON, Abra Province, Mount Posuey, *Bur. Sci.* 2708 Ramos: Benguet Subprovince, Baguio, *Baker* 3843.

CALYMPERACEAE**SYRRHOPODON** Schwaegrichen**SYRRHOPODON ALBOVAGINATUS** Schwaegr.

LUZON, Laguna Province, San Antonio, *Bur. Sci.* 16670 Ramos. BILIRAN, *Bur. Sci.* 18464 McGregor.

SYRRHOPODON MÜLLERI (Doz. et Molk.) Lac.

LUZON, Laguna Province, *Bur. Sci.* 23272 McGregor. MINDANAO, Lake Lanao, Camp Keithley, *Mrs. Clemens*.

SYRRHOPODON SUBULATUS Lac.

MINDANAO, Lake Lanao, Camp Keithley, *Mrs. Clemens*.
Area: Sumatra, Celebes, Borneo and New Guinea.

CALYMPERES Swartz**CALYMPERES SERRATUM** A. Br.

LUZON, Laguna Province, Mount Maquiling, on trees, altitude 640 meters, *Bur. Sci.* 17121 Robinson.

Area: Ceylon, Sumatra, Java, Borneo, Labuan, Celebes, Hongkong and Samoa.

CALYMPERES ORIENTALE Mitt.

BILIRAN, *Bur. Sci.* 18459 McGregor.

POTTIACEAE

BARBULA Hedwig

BARBULA ORIENTALIS (Willd.) Broth.

LUZON, Laguna Province, Los Baños, on stone walls and on earth, altitude 10 meters, *Bur. Sci. 17138, 17140 Robinson*; Manila, *Bur. Sci. 18274 Robinson*: Rizal Province, Tanay, *Bur. Sci. 11882 Robinson & Ramos*. PANAY, Iloilo Province, Suague River, on walls, altitude 100 meters, *Bur. Sci. 18146 Robinson*.

BARBULA CONSANGUINEA (Thwait. et Mitt.) Jaeg.

LUZON, Rizal Province, Bosoboso, *Bur. Sci. 1166 Ramos*: Pangasinan Province, Umingan, *Bur. Sci. 18357 Otones*: Ilocos Province, Bangui, on damp banks, *Bur. Sci. 27778 Ramos*.

Area: Ceylon, Singapore, Java and Luzon.

BARBULA INFLEXA (Dub.) C. Müll.

LUZON, Batangas Province, Taal Volcano, on very wet walls in ravines, altitude 80 meters, *Merrill 10608*. PANAY, Iloilo Province, Tigom River on rocks, altitude 150 meters, *Bur. Sci. 18052 Robinson*.

Area: Ceylon and Java.

HYOPHILA Bridel

HYOPHILA FLAVIPES Broth.

PANAY, Iloilo Province, Tigom River, on rocks, altitude 150 meters, *Bur. Sci. 18055 Robinson*. LUZON, Ifugao Subprovince, *Bur. Sci. 20041 McGregor*.

GYMNOSTOMIELLA Fleischer

GYMNOSTOMIELLA VERNICOSA (Hamp.) Fleisch.

LUZON, Laguna Province, Los Baños, on stone walls, altitude 10 meters, *Bur. Sci. 17139 Robinson*. PANAY, Iloilo Province, Tigom River, on rocks, altitude 150 meters, *Bur. Sci. 18051 Robinson*.

Area: Nepal, Burma, Java and Amboina.

GYMNOSTOMIELLA LONGINERVIS Broth. sp. nov.

Dioica; tenella, caespitosa, caespitibus densis, mollibus, late extensis, laete viridibus; *caulis* erectus, gracillimus, usque ad 8 mm longus, hic illic radiculis longis fuscis instructus, laxiuscule foliosus, simplex vel innovando ramosus; *folia* sicca contracta, humida patentia, comalia in rosulam congesta, e basi spatulata ovalia vel obovata, rotundato-obtusa, usque ad 0.76 mm longa et 0.30 mm lata, integerrima, nervo lutescente, infra summum apicem folii evanido, cellulis ovali-hexagonis, 0.015-0.020 mm longis, teneris, pellucidis, verrucosis, marginalibus minoribus, transverse dispositis, basilaribus rectangularibus, laevibus. Caetera ignota.

PANAY, Iloilo Province, Tigom River, on rocks, altitude 150 meters, *Bur. Sci. 18053 Robinson*.

Species a praecedente statura robustiore nec non foliorum forma et nervo multo longiore dignoscenda.

MERCEYOPSIS Brotherus et Dixon

MERCEYOPSIS MINUTA (Broth.) var. SUBMINUTA (Broth.) Broth. et
Dix.

NEGROS, Mount Canlaon, *For. Bur. 17384 Curran.*

ORTHOTRICHACEAE

ANOECTANGIUM (Hedw.) Bryol. eur.

ANOECTANGIUM SUBALARUM Broth.

LUZON, Benguet Subprovince, Mount Pulog, *Bur. Sci. 16400 Curran, Merritt, Zchokke.*

MACROMITRIUM Bridel

MACROMITRIUM GONIORRHYNCHUM (Doz. et Molk.) Mitt.

LUZON, Pangasinan Province, Umingan, *Bur. Sci. 18358 Otones: Rizal Province, Bur. Sci. 18321 Reillo.* PANAY, Iloilo Province, *Bur. Sci. 18217 Robinson.*

MACROMITRIUM ANGUSTIFOLIUM Bryol. jav.

LUZON, Bontoc Subprovince, *Vanoverbergh 398.*

MACROMITRIUM MERRILLII Broth.

LUZON, Tayabas Province, Mauban, on trees near sea, *Bur. Sci. 19396 Ramos: Rizal Province, Bur. Sci. 21343 Ramos.* PALAWAN, Taytay, *Merrill 8991.*

MACROMITRIUM SUBULIGERUM Bryol. jav.

LUZON, Laguna Province, San Antonio, *Bur. Sci. 14923, 16671 Ramos: Tayabas Province, Mount Pular, on trees, Bur. Sci. 19393 Ramos.* PANAY, Iloilo Province, Atimonan River, *Bur. Sci. 18167 Ramos.*

MACROMITRIUM SEMIPELLUCIDUM Doz et Molk.

LUZON, Laguna Province, San Antonio, on trees, *Bur. Sci. 20613 Ramos.* PANAY, Iloilo Province, Ulian River, on trees, altitude 400 meters, *Bur. Sci. 18260 Robinson.*

FUNARIACEAE

FUNARIA Schreber

FUNARIA CALVESCENS Schwaegr.

LUZON, Nueva Vizcaya Province, *Bur. Sci. 20228 McGregor.*

FUNARIA LUZONENSIS Broth.

LUZON, Bontoc Subprovince, *Vanoverbergh 745.*

BRYACEAE

WEBERA Hedwig

WEBERA SCABRIDENS (Mitt.) Jaeg.

LUZON, Benguet Subprovince, Baguio and vicinity, *Bur. Sci. 14095 Robinson.*

PSEUDOPHILIA Williams

PSEUDOPHILIA BULBIFERA Williams.

LUZON, Nueva Vizcaya Province, *Bur. Sci. 20231 McGregor.*
Area: Luzon.

PSEUDOPOHLIA MERRILLII Broth. sp. nov.

Dioica; gracilescens, caespitosa, caespitibus laxis, fusciscentibus, nitidiusculis; caulis 5-7 mm longus, infima basi fusco-radiculosus, dense foliosus, innovando ramosus, in axillis superioribus propagula turgide obovata, foliolis 4-5 ornata gerentia; *folia* sicca adpressa, humida erecto-patentia, comalia saepe homomalla, decurrentia, infima minora, dein sensim majora, elongate lanceolata, anguste acuminata, usque ad 2 mm longa et 0.35 mm lata, marginibus erectis vel anguste recurvis, apice serrulatis, nervo rufescente, continuo vel infra summum apicem folii evanido, cellulis elongatis, angustis; *seta* c. 2.5 cm alta, tenuis, lutescens; *theca* nutans, cum collo angusto sporangii fere longitudinis pyriformis, fusca; *peristomium* destructum.

NEGROS, Canlaon Volcano, *Merrill 6817*.

Species distinctissima, a praecedente foliorum forma nec non theca nutante, pyriformi longe diversa.

ANOMOBRYUM Schimper

ANOMOBRYUM GEMMIGERUM Broth.

LUZON, Bontoc Subprovince, *Vanoverbergh 727*.

BRACHYMENIUM Schwaegrichen

BRACHYMENIUM NEPALENSE Hook.

LUZON, Bontoc Subprovince, on trees, altitude 1,700 meters, *Vanoverbergh 2233*; Benguet Subprovince, Pauai, *Baker 1334*. CAMIGUIN DE MINDANAO, *Bur. Sci. 14899 Ramos*.

BRYUM (Dill.) Schimper

BRYUM COMPRESSIDENS C. Müll.

LUZON, Bontoc Subprovince, Bauco, *Vanoverbergh 93, 1770*; Batangas Province, Taal Volcano, on banks in very damp ravine on the outer slope of the cone, altitude 70 meters, *Merrill 10609*.

BRYUM CORONATUM Schwaegr.

LUZON, Bulacan Province, Angat, *Bur. Sci. 21860 Ramos*. DUMARAN, *Bur. Sci. 21643 Escritor*. PALAWAN, Taytay, *Merrill 8993*.

BRYUM AMBIGUUM Dub.

PANAY, Iloilo Province, *Bur. Sci. 18203 Robinson*.

BRYUM RAMOSUM (Hook.) Mitt.

LUZON, Benguet Subprovince, Pauai, *Baker 1324*.

RHODOBRYUM (Schimp.) Hampe

RHODOBRYUM GIGANTEUM (Hook.) Hamp.

LUZON, Bontoc Subprovince, Bauco, altitude 1,700 meters, *Vanoverbergh 1734*; Ifugao Subprovince, Mount Polis, *Bur. Sci. 20319 McGregor*.

MNIACEAE

ORTHOMNIUM Wilson

ORTHOMNIUM LOHERI Broth.

LUZON, Benguet Subprovince, Pauai, *Baker 1341*; Mount Pulog, *Merrill 6399*.

MNIUM (Dill.) Linnaeus

MNIUM SUCCULENTUM Mitt.

LUZON, Bontoc Subprovince, Bauco, near brooks, altitude 1,250 meters, *Vanoverbergh 1775*.

RHIZOGONIACEAE

HYMENODON Hooker f. et Wilson

HYMENODON SERICEUS (Doz. et Molk.) C. Müll.

LUZON, Laguna Province, summit of Mount Maquiling, *Baker 2753, 2755*, *Bur. Sci. 17027 Robinson*.

RHIZOGONIUM Bridel

RHIZOGONIUM SPINIFORME (L.) Bruch.

LUZON, Laguna Province, Mount Maquiling, on trees, altitude 670 to 1,000 meters, *Bur. Sci. 17015, 17047, 17038 Robinson, Baker: Rizal Province, Mount Canumay, Bur. Sci. 13796 Ramos: Abra Province, Mount Posuey, on dead tree, Bur. Sci. 27088 Ramos: Bataan Province, Bur. Sci. 22041 Medina: Nueva Vizcaya Province, vicinity of Dupax, Bur. Sci. 14341 McGregor. CAMIGUIN DE MINDANAO, Bur. Sci. 14892 Ramos. PANAY, Iloilo Province, Bur. Sci. 18206 Robinson.*

SPIRIDENTACEAE

SPIRIDENS Nees

SPIRIDENS REINWARDTII Nees.

BILIRAN, *Bur. Sci. 18455 McGregor*. LEYTE, Dagami, *Bur. Sci. 15396 Ramos*. CAMIGUIN DE MINDANAO, *Bur. Sci. 14904 Ramos*. JOLO, *Mrs. Clemens 9400*.

SPIRIDENS LONGIFOLIUS Lindb.

LUZON, Benguet Subprovince, Pauai, *Mrs. Clemens 9319, Baker 1330*: Ifugao Subprovince, Mount Polis, *Bur. Sci. 20329 McGregor*.

BARTRAMIACEAE

PHILONOTIS Bridel

PHILONOTIS GRIFFITHIANA (Wills.) Mitt.

CAMIGUIN DE MINDANAO, *Bur. Sci. 14891 Ramos*.

PHILONOTIS REVOLUTA Bryol. jav.

LUZON, Bontoc Subprovince, Bauco, *Vanoverbergh 1059, 1750, 1768*: Ifugao Subprovince, Mount Polis, *Bur. Sci. 20320, 20325 McGregor*.

PHILONOTIS SECUNDA (Doz. et Molk.) Bryol. jav.

LUZON, Ifugao Subprovince, *Bur. Sci. 20040 McGregor*: Nueva Vizcaya Province, *Bur. Sci. 20219 McGregor*. PANAY, Iloilo Province, Larena, on walls, altitude 820 meters, *Bur. Sci. 18204 Robinson*.

PHILONOTIS MOLLIS (Doz. et Molk.) Bryol. jav.

LUZON, Laguna Province, Los Baños, altitude 10 meters, *Bur. Sci. 17141*
Robinson: Rizal Province, Bosoboso, *Bur. Sci. 16962* Ramos.

PHILONOTIS TURNERIANA (Schwaegr.) Mitt.

LUZON, Benguet Subprovince, Mount Tonglon, on banks, altitude about
 1,900 meters, *Merrill 7868*: Laguna Province, summit of Mount Maquiling,
Baker 2748.

Area: Nepal, Sikkim, Khasia, Java, Japan, Hawaii.

PHILONOTIS FALCATA (Hook.) Mitt.

LUZON, Benguet Subprovince, Pauai, *Mrs. Clemens 9320*.

Area: Himalaya, Tibet, Nilghiri, China, Japan.

BREUTELIA Schimper**BREUTELIA ARUNDINIFOLIA** (Dub.) Broth.

LUZON, Benguet Subprovince, Pauai, *Mrs. Clemens 9315*.

NECKERACEAE

ENDOTRICHELLA C. Müller**ENDOTRICHELLA ELEGANS** (Doz. et Molk.) Fleisch.

BILIRAN, *Bur. Sci. 18472* McGregor. BASILAN, *Bur. Sci. 16273* Reillo.
 PANAY, Iloilo Province, Larena, on dead wood, altitude 750 meters, *Robin-*
son. LUZON, Ifugao Subprovince, Mount Polis, *Bur. Sci. 20321* McGregor:
 Benguet Subprovince, Pauai, *Baker 1332*. PALAWAN, Cabinbin River, *We-*
ber 1568.

ENDOTRICHELLA PERPLICATA Broth.

LUZON, Rizal Province, *Bur. Sci. 19318* Reillo: Ifugao Subprovince, *Bur.*
Sci. 20324 McGregor.

ENDOTRICHELLA ELMERI Broth.

SAMAR, *Bur. Sci. 17656* Ramos.

GAROVAGLIA Endlicher**GAROVAGLIA BAKERI** Broth. sp. nov.

Robustiuscula, rigidissima, laete viridis, hic illic rufescens,
 nitida, *caules secundarii* numerosi, adscendentes, superne ar-
 cuati, usque ad 10 cm longi, densissime foliosi, subteretes, sim-
 plices, obtusi; *folia* sicca imbricata, undulata basi plicata humida
 suberecta, concava, ovato-oblonga, raptim in acumen lanceolato-
 subulatum attenuata, superne minute, in acumen argute serrata,
 enervia, cellulis incrassatis, lumine lineari-elliptico, inferioribus
 sensim longioribus et angustioribus, alaribus sat numerosis
 ovalibus vel subquadratis, omnibus laevissimis; *bractee peri-*
chaetii convolutatae, superne latiores, rotundatae, brevissime
 cuspidatae, integrae vel subintegrae. Caetera ignota.

LUZON, Laguna Province, Mount Banahao, *Baker 2324*.

Species *G. undulatae* Ren. et Card. affinis, sed statura minore, rigiditate
 foliorumque forma optime diversa.

GAROVAGLIA PERUNDULATA Broth. sp. nov.

Gracilis, rigida, laete viridis, nitida; *caules secundarii* nemosi, arcuato-adscendentes, usque ad 6 cm longi, densissime foliosi, complanati, simplices, obtusi; *folia* sicca imbricata, undulata, humida concava, breviter oblonga, raptim in acumen lanceolato-subulatum attenuati, acumine plus minusve serrulato, enervia, cellulis haud incrassatis, rhomboideis, basin versus sensim longioribus et angustioribus, alaribus numerosis, subquadratis, aureis, omnibus laevissimis. Caetera ignota.

LUZON, Ifugao Subprovince, Mount Polis, *Bur. Sci. 19917* McGregor.

Species distinctissima, praecedenti affinis, sed statura gracili foliisque cellulis leptodermibus facillime dignoscenda.

GAROVAGLIA PLICATA (Nees) Endl. var. **GRACILESCENS** Broth. var. nov.

Gracilescens; *caules secundarii* usque ad 11 cm longi, laxius foliosi; *folia* lateralia arcuato-patentia.

LUZON, Nueva Vizcaya Province, *Bur. Sci. 20224* McGregor.

FLORIBUNDARIA C. Müller**FLORIBUNDARIA FLORIBUNDA** (Doz. et Molk.) Fleisch.

PALAWAN, Cabinbin River, on boulders, *Weber 1566*.

PAPILLARIA (C. Müll.) C. Müller**PAPILLARIA FUSCESCENS** (Hook.) Jaeg.

LUZON, Abra Province, Mount Posuey, on trees, *Bur. Sci. 27093* Ramos.

AËROBRYOPSIS Fleischer**AËROBRYOPSIS LANOSA** (Mitt.) Broth.

PANAY, Iloilo Province, Larena, on *Ficus*, altitude 820 meters, *Bur. Sci. 18207* Robinson. MINDANAO, Butuan Subprovince, *Weber 1321*.

BARBELLA (C. Müll.) Fleischer**BARBELLA PENDULA** (Sull.) Fleisch.

LUZON, Benguet Subprovince, Pauai, *Mrs. Clemens 9318*: Ifugao Subprovince, Mount Polis, *Bur. Sci. 20312* McGregor.

BARBELLA (EUBARBELLA) CLEMENSIAE Broth. sp. nov.

Gracilescens, mollis, aureo-flava sericeo-nitens; *caules secundarii* longissimi, penduli, flexuosi, laxe foliosi, remote subpinnatim ramosi, ramis patulis, usque ad 2 cm vel paulum ultra longis, flexuosis, laxe foliosis, complanatis, plerumque plus minusve distincte attenuatis, simplicibus vel parce ramulosis; *folia caulina* adpressa, ovato-lanceolata, in subulam piliformem sensim attenuata, ubique minute denticulata, nervo tenui, ultra medium folii evanido, cellulis anguste linearibus, papilla minutissima plerisque medio instructis, basilaribus infimis multo latiori-

bus, alaribus sat numerosis oblongis, rufescentibus; *folia ramea* patula, magis concava, brevius acuminata. Caetera ignota.

LUZON, Benguet Subprovince, Pauai, *Mrs. Clemens 9317*.

Species habitu *B. bombycinae* (Ren. et Card.) Fleisch. valde similis, sed foliorum forma dignoscenda.

BARBELLA ENERVIS (Mitt.) Fleisch.

LUZON, Benguet Subprovince, Pauai, *Baker 1329*.

METEORIUM (Doz. et Molk.) Fleischer

METEORIUM MIQUELIANUM (C. Müll.) Fleisch.

LUZON, Pampanga Province, Mount Arayat, *Bur. Sci. 22450 Ramos*: Ifugao Subprovince, Mount Polis, *Bur. Sci. 20303 McGregor*. PANAY, Iloilo Province, Ulian River, on trees, altitude 400 meters, *Bur. Sci. 18257 Robinson*.

METEORIUM HELMINTHOCLADUM (C. Müll.) Fleisch.

LUZON, Ifugao Subprovince, Mount Polis, *Bur. Sci. 19937 McGregor*: Benguet Subprovince, Pauai, *Baker 1325*.

METEORIOPSIS Fleischer

METEORIOPSIS RECLINATA (C. Müll.) Fleisch.

LUZON, Bontoc Subprovince, Bauco, altitude 1,250 meters, *Vanoverbergh 1743*: Nueva Vizcaya Province, *Bur. Sci. 20223 McGregor*: Ifugao Subprovince, Mount Polis, *Bur. Sci. 20306 McGregor*: Rizal Province, *Bur. Sci. 19322 Reillo*.

f. **PILIFER** Fleisch.

LUZON, Nueva Vizcaya Province, vicinity of Dupax, *Bur. Sci. 14345 McGregor*.

TRACHYPODOPSIS Fleischer

TRACHYPODOPSIS CRISPATULA (Hook.) Fleisch.

LUZON, Abra Province, Mount Posuey, *Bur. Sci. 27097 Ramos*: Ifugao Subprovince, Mount Polis, *Bur. Sci. 19926 McGregor*.

CALYPTOTHECIUM Mitten

CALYPTOTHECIUM TUMIDUM (Mitt.) Fleisch.

BILIRAN, *Bur. Sci. 18454, 18456 McGregor*.

NECKEROPSIS Reichardt

NECKEROPSIS LEPINEANA (Mont.) Fleisch.

BILIRAN, *Bur. Sci. 18462 McGregor*. PANAY, Iloilo Province, *Bur. Sci. 18178 Robinson*. LUZON, Laguna Province, Mount Maquiling, *Bur. Sci. 17122 Robinson*; Nueva Vizcaya Province, vicinity of Dupax, *Bur. Sci. 14351 McGregor*.

NECKEROPSIS GRACILENTA (Bryol. jav.) Fleisch.

PANAY, Iloilo Province, *Bur. Sci. 18240 Robinson*.

NECKEROPSIS CRINITA (Griff.) Fleisch.

MINDANAO, Butuan Subprovince, *Weber 1290*.

HIMANTHOCLADIUM (Mitt.) Fleischer

HIMANTHOCLADIUM LORIFORME (Bryol. jav.) Fleisch.

BASILAN, *Bur. Sci.* 16278 Reillo. BILIRAN, *Bur. Sci.* 18470, 18465 McGregor. LUZON, Rizal Province, *Bur. Sci.* 19317 Reillo.

HOMALIODENDRON Fleischer

HOMALIODENDRON FLABELLATUM (Dicks.) Fleisch.

LUZON, Rizal Province, *Bur. Sci.* 19326 Reillo. BILIRAN, *Bur. Sci.* 18471 McGregor.

HOMALIODENDRON SCALPELLIFOLIUM (Mitt.) Fleisch.

LUZON, Benguet Subprovince, Baguio, *Baker* 3852.

THAMNIUM Schimper

THAMNIUM ELLIPTICUM (Bryol. jav.) Kindb.

LUZON, Laguna Province, Mount Maquiling, *Bur. Sci.* 17215 Robinson.

ENTODONTACEAE

ENTODON C. Müller

ENTODON LONGIDENS Broth.

LUZON, Ifugao Subprovince, *Bur. Sci.* 20045 McGregor: Nueva Vizcaya Province, *Bur. Sci.* 20229 McGregor.

ENTODON RUBICUNDUS (Wils.) Jaeg.

LUZON, Bontoc Subprovince, *Vanoverbergh* 1319.

Area: Himalaya, Khasia, Bhotan, and the Andaman Islands.

ERYTHRODONTIUM Hampe

ERYTHRODONTIUM SQUARRULOSUM (Mont.) Par.

LUZON, Pangasinan Province, Umingan, *Bur. Sci.* 18359 Otones.

TRACHYPHYLLUM Gepp

TRACHYPHYLLUM INFLEXUM (Harv.) Gepp.

LUZON, Pangasinan Province, San Quintin, *Bur. Sci.* 5661, 5577 Otones; Umingan, *Bur. Sci.* 18360 Otones.

Area: Central India, Nepal, Sikkim, Ava and Pegu.

HOOKERIAACEAE

CALLICOSTELLA (C. Müll.) Mitten

CALLICOSTELLA PAPILLATA (Mont.) Mitt.

LUZON, Laguna Province, Mount Maquiling, *Bur. Sci.* 17195, 17196, 17205, 17204 Robinson; Los Baños, *Bur. Sci.* 14148 Robinson: Rizal Province, Mount Canumay, *Bur. Sci.* 13798 Ramos. BILIRAN, *Bur. Sci.* 18466 McGregor.

DISTICHOPHYLLUM Dozy et Molkenboer

DISTICHOPHYLLUM NIGRICAULE Mitt.

LUZON, Laguna Province, Mount Maquiling, *Bur. Sci.* 17082 Robinson.
Area: Java.

LESKEODON Brotherus

LESKEODON PHILIPPINENSIS Broth. sp. nov.

Synoicus; robustus, caespitosus, caespitibus densis, mollibus, pallide viridibus, subopacis; *caulis* usque ad 2.5 cm longus, plus minusve alte fusco-radiculosus, dense et complanate foliosus, cum foliis c. 5 mm latus, simplex, obtusus; *folia lateral*ia patula, e basi brevissime spathulata oblonga, breviter acuminata, in subulam piliformem attenuata, lamina c. 3 mm longa et c. 1.3 mm lata, limbata, integerrima, nervo tenui, in subulam usque ad 0.8 mm longam continuo, cellulis superioribus rotundato-hexagonis. 0.025-0.030 mm, marginem versus multo minoribus, basilaribus oblongo-hexagonis, marginalibus limbum inferne triseriatum, superne angustiore, hyalinum efformantibus; *seta* c. 2 mm alta, rubra, summo apice mamillis grossis scabra; *theca* erecta, minuta, ovalis, pallide fuscidula; *exostomii* dentes pallidi, lanceolato-subulati, c. 0.5 mm longi, dense lamellati, papilloso; *processus* dentium longitudinis, lineari-lanceolati, papilloso; *spori* 0.010-0.015 mm, laeves; *operculum* e basi convexo-conica breviter rostratum; *calyptra* operculum tantum obtegens, glabra, basi pilis longis densisque instructa.

BILIRAN, *Bur. Sci.* 18468 *McGregor*.

Species pulcherrima, cum *L. acuminato* (Bryol. jav.) Fleisch. comparanda, sed foliorum forma cellulisque laxioribus dignoscenda.

CHAETOMITRIUM Dozy et Molkenboer

CHAETOMITRIUM PHILIPPINENSE (Mont.) Bryol. eur.

PANAY, Iloilo Province, Atimonan River, on tree, altitude 300 m, *Bur. Sci.* 18164 *Robinson*.

CHAETOMITRIUM PAPILLIFOLIUM Bryol. jav.

LUZON, Nueva Vizcaya Province, vicinity of Dupax, *Bur. Sci.* 14343 *McGregor*.

CHAETOMITRIUM ORTHORRHYNCHUM (Doz. et Molk.) Bryol. jav.

BASILAN, Cumalarang, *Bur. Sci.* 16267 *Reillo*.

ERIOPIUS (Brid.) C. Müller

ERIOPIUS FLACCIDUS Broth. sp. nov.

Dioicus; gracilescens, caespitosus, caespitibus laxis, sordide viridibus, vernicosus; *caulis* usque ad 6 cm longus, plus minusve alte fusco-radiculosus, laxe et complanate foliosus, plerumque attenuatus, simplex vel divisus; *folia* sicca contracta, facillime emollita, flaccida, lateralia patula, asymmetrica, e basi brevissime spathulata late oblonga, obtusa, mucronata, c. 5 mm longa et c. 2 mm lata, supra medium argute serrata, nervis binis, uno

crasso, brevi, altero saepe nullo, cellulis superioribus c. 0.060 mm longis et c. 0.030 mm latis, basin versus sensim longioribus, marginalibus elongatis, angustis, limbum triseriatum, lutescentem efformantibus; folia dorsalia et ventralia multo minora, late ovalia; bracteae perichaetii late ovalis, vaginantes, raptim in acumen subulatum attenuatae; seta c. 8 mm alta, pallida, ubique setosa, ciliis superne usque ad 0.125 mm longis, basin versus brevioribus; *theca* horizontalis, minuta, ovalis, atrofusca. Caetera ignota.

LUZON, Laguna Province, Mount Banahao, *Merrill 7523*.

Species *E. ramoso* Fleisch. affinis, sed foliis flaccidis nec non seta ciliis duplo brevioribus instructa optime diversa.

LESKEACEAE

PSEUDOLESKEOPSIS Brotherus

PSEUDOLESKEOPSIS DECURVATA (Mitt.) Broth.

LUZON, Nueva Vizcaya Province, vicinity of Dupax, *Bur. Sci. 14346 McGregor*.

PSEUDOLESKEOPSIS ACUTISSIMA Broth. sp. nov.

Species praecedenti habitu simillima, sed foliis late ovatis, acutissimis, plerumque cellula hyalina terminatis dignoscenda.

LUZON, Rizal Province, San Isidro, on wet rock by streams, *Bur. Sci. 5172 Foxworthy*.

PELEKIUM Mitten

PELEKIUM VELATUM Mitt.

LUZON, Laguna Province, Mount Maquiling, *Bur. Sci. 17201, 17230 Robinson*; Los Baños, *Baker 698, 2399*. PANAY, Iloilo Province, Tigom River, on dead wood, altitude 160 meters, *Bur. Sci. 18049 Robinson*.

THUIDIUM Bryol. eur.

THUIDIUM TAMARISCELLUM (C. Müll.) Bryol. jav.

LUZON, Benguet Subprovince, *Bur. Sci. 12939 Fénix*; Bontoc Subprovince, *Vanoverbergh 396*.

Area: Nilghiri, Tonkin, Sumatra and Luzon.

THUIDIUM TRACHYPODUM (Mitt.) Bryol. jav.

LUZON, Laguna Province, Mount Maquiling, *Bur. Sci. 17212 Robinson*. PANAY, Iloilo Province, *Bur. Sci. 18130 Robinson*.

THUIDIUM MEYENIANUM (Hamp.) Bryol. jav.

LUZON, Ifugao Subprovince, *Bur. Sci. 20044 McGregor*.

THUIDIUM BIFARIUM Bryol. jav.

PANAY, Iloilo Province, Atimonan River, on rocks, altitude 475 meters, *Bur. Sci. 18158 Robinson*; Salug River, on sandstone, altitude 340 meters, *Bur. Sci. 18099, 18101, 18104, 18107 Robinson*.

Area: Java and Sumatra.

THUIDIUM CYMBIFOLIUM (Doz. et Molk.) Bryol. jav.

LUZON, Ifugao Subprovince, Mount Polis, *Bur. Sci. 20314 McGregor*: Rizal Province, *Bur. Sci. 19325 Reillo*: Nueva Vizcaya Province, vicinity of Dupax, *Bur. Sci. 14350 McGregor*. PALAWAN, Cabinbin River, on rocks along streams, *Weber 1569*.

THUIDIUM PLUMULOSUM (Doz. et Molk.) Bryol. jav.

SAMAR, *Bur. Sci. 17620 Ramos*. CAMIGUIN DE MINDANAO, *Bur. Sci. 14895 Ramos*. LUZON, Laguna Province, Los Baños, on rocks, *Baker 760, 702, 2382*.

THUIDIUM CASUARINUM (C. Müll.) Jaeg.

LUZON, Rizal Province, Mount Canumay, *Bur. Sci. 13799 Ramos*.

HYPNACEAE

CAMPYLIUM (Sull.) Bryhn.

CAMPYLIUM GLAUCOCARPUM (Reinw.) Broth.

LUZON, Bontoc Subprovince, Bauco, *Vanoverbergh 2871*: Benguet Subprovince, Pauai, *Baker 1331*: Ifugao Subprovince Mount Polis, *Bur. Sci. 19922, 20301, 20307, 20310 McGregor*: Abra Province, Mount Posuey, *Bur. Sci. 27098 Ramos*.

CTENIDIUM (Schimp.) Mitten

CTENIDIUM FORSTENII (Bryol. jav.) Broth.

LUZON, Bontoc Subprovince, *Vanoverbergh 1275*.
Area: Celebes.

LEPTOHYMENIUM Schwaegrichen

LEPTOHYMENIUM TENUE (Hook.) Schwaegr.

LUZON, Benguet Subprovince, Pauai, *Mrs. Clemens 9316*.

MACROTHAMNIUM Fleischer

MACROTHAMNIUM MACROCARPUM (Reinw. et Hornsch.) Fleisch.

LUZON, Laguna Province, Mount Banahao, *Baker 827*.

ELMERIOBRYUM Brotherus

ELMERIOBRYUM PHILIPPINENSE Broth.

LUZON, Benguet Subprovince, Pauai, *Baker 1340*: Ifugao Subprovince, Mount Polis, *Bur. Sci. 20309 McGregor*.

ECTROPOTHECIUM Mitten

ECTROPOTHECIUM MONUMENTORUM (Dub.) Jaeg.

LUZON, Panay Iloilo Province, Salug River, on rocks, altitude 280 meters, *Bur. Sci. 18090, 18103, 18218 Robinson*.

ECTROPOTHECIUM ASSIMILE Broth.

PANAY, Iloilo Province, Tigom River, on rocks, altitude 150 meters, *Bur. Sci. 18048, 18054 Robinson*; Salug River, on trees, altitude 500 meters, *Bur. Sci. 18128, 18143 Robinson*.

ECTROPOTHECIUM MICROPYXIS Broth.

LUZON, Laguna Province, Mount Maquiling near Los Baños, *Baker 2611*: Ifugao Subprovince, Mount Polis, *Bur. Sci. 19921 McGregor*. MINDANAO, Butuan Subprovince, *Weber 1310*.

ECTROPOTHECIUM LUZONIAE (C. Müll.) Brcth.

LUZON, Ifugao Subprovince, Mount Polis, *Bur. Sci.* 19923, 19935, 20308, 20311 *McGregor*.

ECTROPOTHECIUM FERRUGINEUM (C. Müll.) Jaeg.

LUZON, Laguna Province, Mount Maquiling, on trees, and on rocks, altitude 600 to 750 meters, *Bur. Sci.* 17011, 17017, 17030, 17046, 17049 17058 *Robinson*.

Area: Luzon.

ECTROPOTHECIUM SUBINTORQUATUM Broth.

LUZON, Ifugao Subprovince, Mount Polis, *Bur. Sci.* 19920, 20307 *McGregor*: Laguna Province, Mount Maquiling, on trees, altitude 850 meters, *Bur. Sci.* 17066 *Robinson*.

ECTROPOTHECIUM ELEGANTI-PINNATUM (C. Müll.) Jaeg.

PANAY, Iloilo Province, near Camp Larena, altitude 800 meters, *Bur. Sci.* 18195 and Larena, on *Ficus*, altitude 850 meters, *Bur. Sci.* 18209 *Robinson*. PALAWAN, Cabinbin River, on decaying logs, *Weber* 1564. LUZON, Laguna Province, Mount Banahao, *Bur. Sci.* 9862 *Robinson*.

ECTROPOTHECIUM ELMERI Broth.

LUZON, Ifugao Subprovince, Mount Polis, *Bur. Sci.* 19924 *McGregor*.

ECTROPOTHECIUM CALLICHOIDES (C. Müll.) Jaeg.

LUZON, Laguna Province, Mount Maquiling, on wood, living and dead, altitude 780 meters, *Bur. Sci.* 17101 *Robinson*.

ECTROPOTHECIUM BRACHYPHYLLUM Broth. sp. nov.

Dioicum; robustum, caespitosum, caespitibus densis, rigidis, pallide lutescenti-viridibus, nitidis; *caulis* elongatus, densiuscule foliosus, irregulariter vel remote foliosus, ramis patulis, inaequalibus, valde complanatis, simplicibus, raro longioribus, parce ramulosis; *folia* falcata, e basi oblonga breviter lanceolato-acuminata, apice serrulata, nervis, binis, brevibus vel obsolete, cellulis angustissime linearibus, alaribus vix ullis, omnibus laevissimis; *bractee perichaetii* longius acuminatae, superne serrulatae. Caetera ignota.

LUZON, Bontoc Subprovince, *Vanoverbergh* 1272: Benguet Subprovince, Mount Tonglon, on boulders in forest, altitude about 2,000 meters, *Merrill* 7838.

Species *E. buitenzorgii* (Bél.) Jaeg. valde affinis.

ECTROPOTHECIUM ICHNOTOCLADUM (C. Müll.) Jaeg.

LUZON, Benguet Subprovince, Lutab to Kabayan, *Bur. Sci.* 8738 *McGregor*.

Area: Sikkim, Sumatra, Java, Borneo, Celebes, and Amboina.

ECTROPOTHECIUM CYPEROIDES (Hook.) Jaeg.

LUZON, Tayabas Province, Guinayangan, *Bur. Sci.* 20919 *Escritor*: Cagayan Province, Abulug River, *Weber* 1589: Laguna Province, Los Baños, *Baker* 2381, 2384, 2378. MINDANAO, Bukidnon Subprovince, *Weber* 1505.

TRISMEGISTIA (C. Müll.) Brotherus

TRISMEGISTIA LANCIFOLIA (Harv.) Broth.

LUZON, Laguna Province, San Antonio, on trees, *Bur. Sci.* 16669 Ramos.
MINDANAO, Misamis Province, *For. Bur.* 17950 Miranda. BASILAN, *Bur. Sci.* 16266 Reillo.

TRISMEGISTIA RIGIDA (Hornsch. et Reinw.) Broth.

LUZON, Laguna Province, Mount Maquiling, *For. Bur.* 20854 Villamil;
Mount Banahao, *Baker* 2326. CAMIGUIN DE MINDANAO, *Bur. Sci.* 14900 Ramos.

ISOPTERYGIUM Mitten

ISOPTERYGIUM ALBESCENS (Schwaegr.) Jaeg.

LUZON, Laguna Province, Mount Banahao, *Baker*.

ISOPTERYGIUM MINUTIRAMEUM (C. Müll.) Jaeg.

LUZON, Laguna Province, Mount Maquiling, on stones, altitude 700 meters, *Bur. Sci.* 17023 Robinson, and on dead wood, *Bur. Sci.* 17029 Robinson.

Area: Java, Banca and Borneo.

ISOPTERYGIUM TAXIRAMEUM (Mitt.) Jaeg.

PANAY, Iloilo Province, *Bur. Sci.* 18154 Robinson; Tinayoc, on earth, altitude 210 meters, *Bur. Sci.* 18035 Robinson, and Tigom River, on trees, altitude 170 meters, *Bur. Sci.* 18050 Robinson.

Area: Himalaya, Khasia, Ceylon, Sumatra, Formosa, Assam and Japan.

VESICULARIA (C. Müll.) C. Müller

VESICULARIA RETICULATA (Doz. et Molk.) Broth.

LUZON, Laguna Province, Mount Maquiling, *Baker* 2586.

VESICULARIA CAMPYLOTHECIUM (Broth.) Broth.

LUZON, Laguna Province, Mount Maquiling, *Baker* 2586; Rizal Province, Antipolo, *Bur. Sci.* 20996 Ramos.

VESICULARIA MEYENIANA (Hamp.) Broth.

LUZON, Laguna Province, Mount Maquiling, *Bur. Sci.* 17203 Robinson.
PANAY, Iloilo Province, Suague River, on rocks, altitude 225 meters, *Bur. Sci.* 18151 Robinson. BILIRAN, *Bur. Sci.* 18467 McGregor.

VESICULARIA SUCCOSA (Mitt.) Broth.

LUZON, Nueva Vizcaya Province, vicinity of Dupax, *Bur. Sci.* 14340 McGregor.

Area: Nepal and Sikkim.

VESICULARIA FILICUSPES Broth.

LUZON, Laguna Province, Mount Banahao, *Baker* 2333. CAMIGUIN DE MINDANAO, *Bur. Sci.* 14889 Ramos.

TAXITHELIUM Spruce

TAXITHELIUM INSTRATUM (Brid.) Broth.

LUZON, Laguna Province, Mount Maquiling, *Bur. Sci.* 17928 Brown.
PANAY, Iloilo Province, *Bur. Sci.* 18145 Robinson.

TAXITHELIUM NEPALENSE (Schwaegr.) Broth.

LUZON, Rizal Province, *Bur. Sci.* 21344, 21342 Ramos: Laguna Province,

Los Baños, on stones in creek, *Baker 42*: Batangas Province, *Bur. Sci. 22412 Ramos*. PANAY, Iloilo Province, Santa Barbara, on *Mangifera indica*, altitude 25 meters, *Bur. Sci. 18145 Robinson*.

TAXITHELIUM (POLYSTIGMA, APTERA) BAKERI Broth. sp. nov.

Antoicum; tenellum, caespitosum, caespitibus densis, depressis, cortici adnatis, laete viridibus, aetate lutescentibus, opacis; *caulis* elongatus, repens, dense et regulariter pinnatim ramosus, ramis patulis, vix ultra 3 mm longis, valde complanatis, dense foliosis, cum foliis vix ultra 1 mm latis, simplicibus, obtusis; *folia* lateralia patula, concaviuscula, ovato-lanceolata, subintegra, enervia, cellulis anguste linearibus, dense seriatim papillois, marginalibus brevioribus et latioribus, laevissimis, alaribus vix diversis. Caetera ignota.

LUZON, Laguna Province, Los Baños, *Baker 2379, 2400*.

Species *T. Kaermebachii* (Broth.) Broth. valde affinis, sed foliis longius acuminatis dignoscenda.

TAXITHELIUM (POLYSTIGMA) ROBINSONII Broth. sp. nov.

Antoicum; tenellum, caespitosum, caespitibus densis, mollibus, late extensis, lutescenti-viridibus, sericeo-nitidis; *caulis* elongatus, repens, per totam longitudinem fusco-radiculosus, dense ramosus, ramis adscendentibus, vix ultra 5 mm longis, densiuscule foliosis, complanatis, simplicibus, obtusis; *folia* patentia concaviuscula e basi contracta ovato-lanceolata, breviter subulato-acuminata, superne argute serrata, enervia, cellulis angustissimis, superioribus indistincte et tenerrime seriatim papillois, alaribus vesiculosis paucissimis; *bracteae perichaetii* internae e basi vaginante subsensim longe subulatae, superne argute serratae; *seta* usque ad 2.5 cm alta, tenuissima, rubra, laevissima; *theca* inclinata, minuta, asymmetrica, sicca sub ore constricta, fusca. Caetera ignota.

LUZON, Laguna Province, Mount Banahao, *Bur. Sci. 9820, 9864 Robinson*.

Species *T. benguetiae* Broth. affinis, sed foliis superne argute serratis, cellulis indistincte seriatim papillois nec non seta multo longiore optime diversa.

TAXITHELIUM PERCAPILLIPES Broth.

LUZON, Tayabas Province, Mount Pular, *Bur. Sci. 19431 Ramos*.

TAXITHELIUM LINDBERGII (Bryol. jav.) Ren. et Card.

LUZON, Laguna Province, Mount Maquiling, on trees, altitude 650-700 meters, *Bur. Sci. 17031, 17100 Robinson*: Camarines Province, Mount Cawayan, *Bur. Sci. 22166 Ramos*.

TAXITHELIUM ALARE Broth.

LUZON, Laguna Province, Mount Maquiling, on trees, altitude 900 me-

ters, *Bur. Sci.* 17077 *Robinson*: Ifugao Subprovince, Mount Polis, *Bur. Sci.* 19919 *McGregor*. CAMIGUIN DE MINDANAO, *Bur. Sci.* 14894 *Ramos*.

TAXITHELIUM BENGUETIAE Broth.

LUZON, Nueva Vizcaya Province, *Bur. Sci.* 20226 *McGregor*.

TAXITHELIUM (LIMNOBIELLA) MERRILLII Broth. sp. nov.

Antoicum; robustiusculum, caespitosum, caespitibus densis, sordide fusco-viridibus, opacis; *caulis* elongatus, repens, laxe foliosus, inferne parce, superne densius pinnatim ramosus, ramis patulis, vix ultra 5 mm longis, densiuscule foliosis, complanatis, cum foliis usque ad 1.9 mm latis, simplicibus, attenuatulis vel obtusis; *folia* ramea lateralia patula, concava, e basi contracta ovalia, obtusiuscula, plerumque apiculata, apice minutissime serrulata, nervis binis, brevissimis, plerumque obsolete, cellulis linearibus, superioribus indistincte et tenerrime seriatim papillois, alaribus paucis vesiculosis, supra alaribus paucis subquadratis; *seta* c. 1.5 cm alta, tenuis, rubra. Caetera ignota.

PALAWAN, Taytay, *Merrill* 8992.

TAXITHELIUM PAPILLATUM (Harv.) Broth.

LUZON, Cagayan Province, *Bur. Sci.* 14585 *Ramos*. BILIRAN, *Bur. Sci.* 18460, 18469 *McGregor*.

LEUCOMIACEAE

LEUCOMIUM Mitten

LEUCOMIUM ANEURODICTYON (C. Müll.) Jaeg.

LUZON, Laguna Province, Mount Maquiling, *Bur. Sci.* 17212 *Robinson*.
Area: Sumatra, Java, Borneo and Amboina.

SEMATOPHYLLACEAE

MEIOTHECIUM Mitten

MEIOTHECIUM MICROCARPUM (Harv.) Mitt.

LUZON, Nueva Vizcaya Province, vicinity of Dupax, *Bur. Sci.* 14347 *McGregor*.

MEIOTHECIUM JAGORI (C. Müll.) Broth.

CAMIGUIN DE MINDANAO, *Bur. Sci.* 14897 *Ramos*.

MEIOTHECIUM OBTUSUM Broth. sp. nov.

Antoicum; robustiusculum, pallide fuscescenti-viride, nitidum; *caulis* elongatus repens, per totam longitudinem hic illic fusco-radiculosus, dense foliosus, plus minusve dense pinnatim ramosus, ramis teretibus, simplicibus, c. 1-2 cm longis vel longioribus, parce ramulosis; *folia* sicca imbricata, suberecta, concava, laevia, elongate oblonga, breviter acuminata, apice recurvo, obtuso, marginibus late recurvis, integerrimis, enervia, cellulis valde incrassatis, lumine angustissimo, alaribus oblongis, vesiculosis, omnibus laevissimis; *seta* c. 5 mm alta, tenuissima, rubra,

superne mamillis humillimis, latis instructa; *theca* horizontalis, minuta, oblonga, fusca. Caetera ignota.

LUZON, Laguna Province, summit of Mount Maquiling, *Baker 2762*.

Species *M. fornicato* (Card.) Broth. valde affinis, sed foliis angustioribus, acumine angustiore dignoscenda.

RHAPHIDOSTEGIUM (Bryol. eur.) de Notaris

RHAPHIDOSTEGIUM SAPROXYLOPHILUM (C. Müll.) Jaeg.

LUZON, Laguna Province, San Antonio, on bamboo, *Bur. Sci. 16673 Ramos*; Rizal Province, *Bur. Sci. 21341 Ramos*.

RHAPHIDOSTEGIUM (APTYCHUS) LUZONENSE Broth. sp. nov.

Rhaphidostegium tristiculum Broth. in Philip. Journ. Sci. 8 (1913) Bot. 93 nec (Mitt.) Jaeg.

Antoicum; robustum, caespitosum, caespitibus densis, lutescentibus, sericeo-nitidis; *caulis* elongatus, repens, per totam longitudinem fusco-radiculosus, dense foliosus, dense pinnatim ramosus, ramis arcuato-ascendingibus, simplicibus, obtusis; *folia* homomalla, concava, oblongo-elliptica, lanceolato-acuminata, marginibus late recurvis, integerrimis vel apice remote et minutissime serrulatis, enervia, cellulis elongatis, angustis, haud incrassatis, pellucidis, basilaribus infimis brevioribus, aureis, alaribus vesiculaeformibus, supraalaribus laxe subquadratis, aureis, omnibus laevissimis; *bractee perichaetii* internae erectae, vaginantes, subsensim lanceolato-acuminatae, integrae; *seta* c. 1 cm alta, tenuissima, rubra, laevissima; *theca* subhorizontalis, e collo breviusculo ovalis vel oblonga, minuta, sicca deoperculata sub ore constricta, fusca; *operculum* longe rostratum.

LUZON, Benguet Subprovince, *Sanchez 6, 11, For. Bur. 15639 Curran*; Baguio and vicinity, *Bur. Sci. 14053 Robinson*.

Species *Rh. subhumili* (C. Müll.) Jaeg. et *Rh. phaeniceo* (C. Müll.) Jaeg. affinis sed statura multo robustiore oculo nudo jam dignoscenda, a *Rh. tristiculo* (Mitt.) Jaeg., quocum olium confusi, cellulis angustioribus, pellucidis diversa.

TRICHOSTELEUM (Mitt.) Jaeger

TRICHOSTELEUM HAMATUM (Doz. et Molk.) Jaeg.

LUZON, Laguna Province, Mount Maquiling, altitude 660 to 1,000 meters, *Bur. Sci. 17009, 17028, 17070, 17150, 17106 Robinson*; Mount Banahao, *Baker 2325*.

Var. **SEMIMAMILLOSUM** (C. Müll.) Par.

LUZON, Laguna Province, Mount Maquiling, on trees, altitude 700 meters, *Bur. Sci. 17021 Robinson*; Abra Province, Mount Posuey, *Bur. Sci. 27096 Ramos*.

TRICHOSTELEUM (PAPILLIDIUM) BASILANENSE Broth. sp. nov.

Antoicum: tenellum, caespitosum, caespitibus densis, depressis, lutescenti-fuscescentibus, nitidiusculis; *caulis* elongatus,

repens, per totam longitudinem fusco-radiculosus, dense pinna-
tim ramosus, ramis dense foliosis, complanatis, brevibus, simpli-
cibus vel longioribus parce ramulosis; *folia* patentia, concava,
e basi contracta elongate et anguste elliptico-oblonga, in acumen
subloriforme, plerumque semitortum sensim attenuata, margini-
bus late recurvis, inferne minute, superne argute serratis, ener-
via, cellulis anguste ellipticis, superioribus papilla media incon-
spicua instructis, alaribus magnis, oblongis, vesiculosus, hyalinis
vel luteis; *bractea* *perichaetii* internae e basi vaginante raptim
longe subulatae, superne argute serratae; *seta* usque ad 8 mm
alta, tenuissima, rubra, apice scaberula; *theca* suberecta, minu-
tissima, ovalis, atropurpurea; *operculum* e basi conica oblique
subulatum.

BASILAN, Cumalarang, *Bur. Sci.* 16268 Reillo.

Species *Tr. Boschii* (Doz. et Molk.) affinis, sed foliorum forma setaque
brevis jam dignoscenda.

SEMATOPHYLLUM (Mitt.) Jaeger

SEMATOPHYLLUM SUBULATUM (Hamp.) Jaeg.

LUZON, Laguna Province, Mount Maquiling, altitude 700 to 1,100 meters,
Bur. Sci. 17024, 17053, 17065, 17117, 17160, 17163 Robinson.

SEMATOPHYLLUM ALTOPUNGENS (C. Müll.) Jaeg.

LUZON, Laguna Province, Mount Maquiling, *Bur. Sci.* 17315 Robinson &
Brown.

SEMATOPHYLLUM HYALINUM (Reinw.) Jaeg.

LUZON, Laguna Province, Mount Maquiling, altitude 900 to 1,000 me-
ters, *Bur. Sci.* 17054, 17076, 17084 Robinson: Pampanga Province, Mount
Arayat, *Bur. Sci.* 22449 Ramos. CAMIGUIN DE MINDANAO, *Bur. Sci.* 14903
Ramos.

SEMATOPHYLLUM HERMAPHRODITUM (C. Müll.) Besch.

LUZON, Laguna Province, Mount Maquiling, altitude 1,000 meters, *Bur.*
Sci. 17098, 17116, 17319 Robinson: Sorsogon Province, *Bur. Sci.* 23746
p.p. Ramos. CAMIGUIN DE MINDANAO, *Bur. Sci.* 14901 Ramos.

SEMATOPHYLLUM (CHAETOMITRIELLA) LUZONENSE Broth. sp. nov.

Dioicum; robustiusculum, caespitosum, caespitibus densis, viri-
dibus vel lutescenti-viridibus, nitidis; *caulis* repens, dense ramo-
sus, ramis usque ad 4 cm longis, dense ramulosis, ramis et
ramulis dense foliosis, complanatulis, cuspidatis; *folia* patentia,
cochleariformi-concava, ovato-ovalia, in acumen elongatum, pili-
forme contracta, marginibus erectis, integerrimis, enervia, cellu-
lis incrassatis, conflatis, lumine angustissime lineari, flexuosulo,
basilaribus infimis abbreviatis, aureis, alaribus quaternis, oblon-
go-vesiculosus, fusco-aureis, omnibus laevissimis; *bractea* *peri-
chaetii* erectae, foliis conformes, sed minores, acumine serrato,
cellulis basilaribus laxioribus; *seta* 1.5 cm vel paulum ultra alta,

tenuissima, rubra, summo apice mamillis latis, humillimis obiecta; *theca* horizontalis, cylindrica, collo tuberculoso, atropurpurea; *operculum* e basi convexa longissime subulatum.

LUZON, Laguna Province, Mount Maquiling, on base of buttress-roots of living tree, altitude 600 meters, *Bur. Sci. 17010 Robinson*.

Species *S. pilifero* Broth. affinis, sed stratura duplo minore, foliorum forma nec non seta multo brevior optime diversa.

BRACHYTHECIACEAE

RHYNCHOSTEGIUM Bryol. eur.

RHYNCHOSTEGIUM VAGANS (Harv.) Jaeg.

LUZON, Ifugao Subprovince, Mount Polis, *Bur. Sci. 19932 McGregor*.

Area: Nepal, Sikkim, Java, Ceram and Ternate.

HYPNODENDRACEAE

HYPNODENDRON (C. Müll.) Lindberg

HYPNODENDRON FORMOSICUM Card

LUZON, Laguna Province, Mount Maquiling, on trees, altitude 750 to 1,000 meters, *Bur. Sci. 17094 Robinson*.

MNIODENDRON Lindberg

MNIODENDRON DIVARICATUM (Reinw. et Hornsch.) Lindb.

LUZON, Ifugao Subprovince, Mount Polis, *Bur. Sci. 20328 McGregor*.
MINDANAO, Butuan Subprovince, *Weber 1304*.

MNIODENDRON FUSCOMUCRONATUM (C. Müll.) Broth.

LUZON, Bataan Province, *Bur. Sci. 22042 Medina*. BILIRAN, *Bur. Sci. 18458 McGregor*.

RHACOPIACEAE

RHACOPILUM Beauvois

RHACOPILUM SPECTABILE Reinw. et Hornsch.

LUZON, Benguet Subprovince, Pauai, *Baker 1326*: Ifugao Subprovince, Mount Polis, *Bur. Sci. 19929 McGregor*: Nueva Vizcaya Province, vicinity of Dupax, *Bur. Sci. 14349 McGregor*. BILIRAN, *Bur. Sci. 18457 McGregor*. CAMIGUIN DE MINDANAO, *Bur. Sci. 14888 Ramos*. PANAY, Iloilo Province, near Camp Larena, altitude 800 meters, *Robinson*.

POLYTRICHACEAE

POGONATUM Beauvois

POGONATUM ALBOMARGINATUM (C. Müll.) Jaeg.

LUZON, Abra Province, Mount Posuey, *Bur. Sci. 27087 Ramos*.

POGONATUM MICROSTOMUM R. Br.

LUZON, Benguet Subprovince, Pauai, *Baker 1338*.

POGONATUM SPURIO-CIRRATUM Broth.

LUZON, Laguna Province, Mount Banahao, *Merrill 7532, Bur. Sci. 19594 Ramos*: Benguet Subprovince, *Merrill 7831*.

THE FUNGI CULTIVATED BY TERMITES IN THE VICINITY
OF MANILA AND LOS BAÑOS

By WILLIAM H. BROWN

(From the College of Liberal Arts, University of the Philippines, and from
the Bureau of Science, Manila)

TWO PLATES

It is well known that certain species of termites use their excreta for building combs upon which grow fungi that serve as food for the young and for the queen. Petch¹ has given a very extensive account of the fungi of the termite nests of Ceylon and, more recently, has written a general review of the literature on termite fungi. In the latter publication² he has shown that the same fungi occur on termite combs in very widely separated geographical regions.

Certain termites, which are very common in the vicinity of Manila, build nests that in many ways are similar to those described by Petch. These nests are of two types. One consists of a mound of earth which may be a meter or more in height and frequently in addition has cavities underground. The other is entirely underground. Within the nest are a large number of cavities connected by passages. In the center of the mounds (Plate III, fig. 1) there is usually a hard portion which contains the queen chamber and smaller cavities and passages connected with it. Outside of this region the cavities are larger and usually contain combs. Plate III, fig. 2, represents a section of the outer portion of a large nest.

The combs (Plate IV, fig. 1) are composed of small balls closely packed together and appear to be built from the excrement of the termites. In this, they agree with Petch's description. Their composition is quite different from the substratum of the "fungus gardens" of the *Attii* which according to Belt³ are usually composed of fragments of leaves but also of flowers

¹ Petch, T., The fungi of certain Termite nests, *Ann. Bot. Gard. Peradeniya* 3 (1906) 185-270, f. 3.

² Petch, T., Termite Fungi: A résumé, *Ann. Bot. Gard. Peradeniya* 5 (1913) 303-341.

³ Belt, Thomas, *The Naturalist in Nicaragua* (1874), ed. 2 (1888).

and fruit. Tanner⁴ reports that the ants work these fragments with their mouth parts and then place them in position.

The termite combs, from Manila and Los Baños, (Plate III, fig. 2, and Plate IV, fig. 1) lie loosely on the floor of the larger cavities or chambers of the nest. They are brown, either flat or convexo-concave, about 2 centimeters thick and from a few to many centimeters in diameter. The passages in the combs are either rounded or elongated and run from the top to the bottom of the comb. They are frequently simple or a few may be connected together.

In the following discussion, the different fungi found on the termite combs in the vicinity of Manila and Los Baños, will be treated separately.

THE "CONIDIAL" SPHERE (AEGERITA DUTHEI BERK.)

The termite combs in the vicinity of Manila and Los Baños are impregnated with fungus hyphae and their surfaces are thickly dotted with rounded fungoid bodies on short stalks (Plate IV, fig. 1). These appear to be entirely similar to those described from Ceylon by Petch and are probably eaten by the termites, as what seem to be spores from these can be found inside the young termites.

Holtermann,⁵ who studied the termites of India and Malaya, described these white, stalked, spherical bodies which occurred on the mycelium of the termite combs. Holtermann and Doflein⁶ both found that these were eaten by the termites. Doflein suggests that these bodies form the food of all the larvae and the sexual individuals, while at a certain stage the soldiers and workers adopt another kind of food. The geographic distribution of these spheres is summarized by Petch⁷ as follows:

Holtermann regarded these spheres as identical in all the nests he examined, whether in Ceylon, Java, Singapore, or Borneo. It is, I think, clear from the description and figures of the Madagascar species that the latter is identical with that found in Ceylon; and from Berkeley's figures the Ceylon species is certainly the same as that found in India. Furthermore, Trägårdh's description and figures of the fungus on the combs of *T. vulgaris* in the Sudan agree well with the Ceylon species. I have not been able to find any reference, in the literature at my disposal, to

⁴ Tanner, J. E., *Oecodema cephalotes*, the parasol or leaf-cutting ant, *Trinidad Field Nat. Club* 1 (1892) 68-69.

⁵ Holtermann, C., *Botanische Untersuchungen* (1899) 411-420.

⁶ Doflein, F., *Die Pilzkulturen der Termiten*, *Verhandl. Deutsch. Zool. Gesellschaft* (1905) 140-149.

⁷ Petch, T., *Termite fungi: A résumé*, *Ann. Bot. Gard. Peradeniya* 5 (1913) 303-341.

any similar fungus in termite nests in Australia or America, but in all the countries in which the fungus on the termite comb has been carefully examined the species is the same, as far as can be determined from a conidial form only.

In discussing the connection of these spheres with higher fungi occurring on termite combs Petch⁸ says:

It has been the aim of all mycologists who have studied the subject to establish a connection between the conidial fungus, (*Aegerita Duthei*) and one of the other termite fungi, but so far all these attempts have proved fruitless.

THE XYLARIA

When the combs from the vicinity of Manila or Los Baños were removed from the nests and placed in covered battery jars, a sterile form of what appeared to be a *Xylaria* always grew from them. These growths had a white core surrounded by a dense black layer which was tomentose with white to black hyphae. Branched specimens were rare except in cases where the developing fungus had come in contact with a solid object. The growths showed two very distinct types between which there were all degrees of intergradation. The largest (Plate IV, fig. 3) had a rudimentary stalk above which there was an oval shaped portion which usually tapered into a long whiplike extremity. The two largest specimens of this type were respectively 2.5 and 1 cm in diameter in the widest portion and 52 and 99 cm in length. The other extreme type (Plate IV, fig. 2) was a threadlike form averaging about 2 mm in diameter and 30 cm in length. The longest was 3 mm in its greatest diameter and 152 cm in length. Others were less than 1 cm long. The production of these two types seemed to be influenced by the age of the combs, the smaller type appearing in general on the oldest combs. The smallest specimens of the smaller type were produced under very dry conditions. A variety of these sterile forms is shown in Plate IV, fig. 3 while Plate IV, fig. 2 represents a cone bearing a large number of the smaller type.

The *Xylaria*-like growths do not seem to come from the conidial spheres on the combs as after the combs are removed from the nests the spheres turn brown and disappear in a few days. On the second day after the combs are placed in the battery jars they become covered by a very sparse growth of white mycelium, which comes out from the substance of the comb and not from the spherical bodies. On the third day

⁸ Petch, T., op. cit.

feathery columns of white hyphae grow up, apparently, from the mycelium in the interior of the comb. As these columns increase in length the central portions become denser and in seven to ten days the separate columns have metamorphosed into the *Xylaria*-like structures. The outermost hyphae remain as a tomentose covering while the tips, especially in the larger type, are frequently composed of a mass of loose white hyphae. The sparse growth of hyphae which covered the comb undergoes a similar change and comes to have the appearance of a loose black net.

In two cases combs were placed in earth in brick flower pots, the combs being covered by a layer of earth about 2 cm deep. In the first case the pot was left uncovered. The structures produced were of the larger type and curled around the soil without appearing at the surface. In the other case the pot was placed under a battery jar. The *Xylaria*-like structures produced were mostly of an intermediate type but there were a few threadlike forms about 10 cm in length which were covered by a loose layer of conidiophores. The conidiophores grew out perpendicular to the axis of the fruit body and terminated in club-shaped four-lobed heads on which numerous rows of spores were borne. The entire head formed a somewhat flattened spherical structure. The spores were catenulate and from 4 to 5 μ in diameter. These spores are similar to the conidiospores ascribed to *Xylaria furcata* Fr.⁹ Similar conidiophores were also produced on some sclerotia grown on agar. These sclerotia were obtained by taking a few hyphae from a developing sterile form and transferring them to agar in test tubes. In a few days these produced other sterile sclerotia from 6 to 10 cm in length and from 3 to 7 mm in diameter. By transferring hyphae from these to fresh tubes, before the sclerotia had turned black, other sclerotia were again produced. This process was repeated six times without any apparent diminution in the vigor of the growth. As some of these sclerotia dried out they became covered by a loose layer of conidiophores similar to those previously described. The entire structure of these fertile forms agrees quite well with the description which Petch gives of the *Xylarias* grown by him in pots except that his stromata were smaller, never being more than 1 cm in length.

In one jar simple conidiophores were produced on sclerotia grown on combs. These formed a dense covering around the

⁹ Petch, T., Termite fungi: A résumé, *Ann. Bot. Gard. Peradeniya* 5 (1913) 303-341.

apical part of the fruit bodies. The spores were oval and about 3 by 2 μ . Petch reports simple conidia with spores from 4 to 6 by 2 μ from *Xylaria nigripes*.

The development and general appearance of the sterile *Xylaria*-like structures is very similar to Petch's description. The forms grown by him under bell jars showed a much greater tendency to branch than did the form under discussion; and were in general smaller, the longest mentioned by him having a length of only 14 cm. Petch, however, describes other forms which grew out of a deserted nest from combs 40 to 50 cm below the surface. These must have had a length comparable to that of those grown in Manila. The larger of the Manila types is, moreover, paralleled to some extent by sclerotia which he found in the same nest. These are described as black, irregular or fig-shaped, up to 8 cm in length and 3 cm in breadth. The lower left-hand figure in Plate IV, fig. 3 agrees very well with this description.

Petch¹⁰ in writing of the *Xylarias* on termite combs says:

To simplify matters, we may for the present adopt von Höhnel's view, that there are two species of *Xylaria* present.

Petch, however, apparently thinks that there is only one species as in discussing the number of species or termite combs, he says:

Apparently there are two, but there are several facts which make it probable that these are forms of one species.

If there is only one species present, this is *Xylaria nigripes* Klotzsch. The ascigerous forms of *Xylaria nigripes* occurs at Los Baños on deserted termite nests, so that, although no connection has been traced between the *Xylaria* grown on termite cones and the ascigerous form of *Xylaria nigripes*, it is probable that this species is represented among the sterile forms. *Xylaria furcata* is a dichotomously branched species. The only dichotomously branched specimen in my cultures was an abortive one grown at Los Baños. This never turned black and did not develop further than the loose feathery stage. On the other hand, the catenulate spores, mentioned above, are similar to those ascribed to *Xylaria furcata*. The absence of branched specimens and the presence of these spores would seem to be another point of evidence indicating that *Xylaria furcata* is simply a form of *Xylaria nigripes*.

¹⁰ Petch, T., op. cit.

Petch¹¹ gives the following discussion of the distribution of *Xylaria nigripes*:

Summing up, we find that *Sclerotium stipitatum* has been found in termite nests in India, Ceylon, Java, and Africa; *Xylaria nigripes* occurs in the same situation in Ceylon, Java, Madagascar, and probably Brazil; and *Xylaria furcata* in Ceylon and Java. *X. nigripes* has been recorded from other countries also, without any reference to its connection with termite nests. But in all such cases it is said to grow on the ground, not on wood. In Ceylon neither *X. nigripes* nor *X. furcata* are found except growing from termite nests.

The writer has not observed any *Xylaria*-like structures in termite nests, but Blanco¹² describes, under the name *Sclerotium subterraneum*, some sclerotia which came from a termite nest and which, judging by his description, had an appearance very similar to the larger form above considered. According to Petch¹³ similar structures are found in India, Ceylon, Java, and Africa. Blanco's name is older than *Sclerotium stipitatum* Berk. and Curr.

The general appearance of the substance of the black network which grew over the combs in the vicinity of Manila and Los Baños, was very similar to the stromata of the *Xylaria*, while the structure of the individual cells of the two seemed to be identical. On some of these threadlike growths there appeared small, white, spherical sclerotia which in superficial appearance resembled very closely the spherical bodies on the combs. These sclerotia contained only one kind of conidia-like cells, but these, though smaller, have the same appearance as the conidia in the spherical bodies on the cones in the nests while the hyphae on which the two are borne appear to be entirely similar except for size. When these sclerotia were examined under a microscope they appeared to arise from the cells of the black threads and no other fungus hyphae were apparent. The hyphae of the sclerotia, moreover, had an appearance which except for size seemed to be identical with the hyphae which formed the stromata of the *Xylarias*. The presence of these sclerotia would suggest the possibility that the "conidial" spheres on the combs might grow from the hyphae of the *Xylaria*.

Petch observed small spherical sclerotia in his cultures. These, however, contained no conidia but in two cases produced *Xylaria* stromata.

¹¹ Petch, T., op. cit.

¹² Blanco, M., Fl. Filip. ed. 2 (1845) 584.

¹³ Petch, T., op. cit.

THE AGARIC

Petch¹⁴ describes in considerable detail the agaric, *Collybia albuminosa* (Berk.) Petch, which grows from the actual combs in the termite nests. He¹⁵ makes the following statements concerning its habitat:

The agaric arises from the nest while it is still inhabited by the termites. It seldom appears on the actual termite hill, but usually among the grass round the base. At Peradeniya it is more frequently found growing from subterranean nests which have not yet attained the hill stage, and whose presence is indicated by a few small chimneys only.

Its geographic distribution is summarized by Petch¹⁶ as follows:

The occurrence of agarics in or around termite nests has been recorded from Ceylon, India, Singapore, Java, Borneo, and Brazil. The species in question is usually regarded as edible, and for that reason it has frequently been included in collections of tropical agarics; it is, for example, due to that fact that we have the records relating to termite nests in India. The names under which the agaric has been described differ in different countries, and even from the same country it has had several names bestowed upon it, but from a comparison of the descriptions, and the type specimens in some cases, it is quite certain that the species which develops from termite nests is the same in all the countries in which it has been found up to the present.

Although this fungus is very common on termite nests, it has not been grown from the combs removed from the nests.

The agaric occurs in two forms, identical so far as pilei are concerned, but differing in the character of the stalk. In one form the stalk is almost uniform in diameter throughout. In the other the lower part of the stalk is about two millimeters in diameter, but as it ascends to the soil it expands up to 1-2 centimeters in diameter.

While in Los Baños, my attention was called by Doctor E. B. Copeland to an agaric which appeared to be growing from the ground but which he had traced to termite combs in subterranean nests. This fungus showed two forms which Doctor Copeland has identified as the two forms of the agaric described by Petch from Ceylon. At Los Baños, as in Ceylon, this fungus appears to grow only from termite nests, and to be always connected with the combs.

¹⁴ Petch, T., The fungi of certain termite nests, *Ann. Bot. Gard. Peradeniya* 3 (1906) 185-270, fig. 3.

¹⁵ Petch, T., Termite fungi: A résumé, *Ann. Bot. Gard. Peradeniya* 5 (1913) 303-341.

¹⁶ Petch, T., op. cit.

ILLUSTRATIONS

PLATE III

- FIG. 1. Vertical section through the center of a termite nest. The white strip of paper in the left of the picture is 50 centimeters in length. In the center of the nest is seen a compact structure with numerous passageways. This structure contains the queen cavity.
2. Vertical section through the peripheral part of a termite nest. The cones are seen very plainly in the cavities.

PLATE IV

- FIG. 1. A small termite cone slightly reduced. The fungus bodies appear as white spots. That the cone is composed of a large number of round structures can be seen from the picture. These structures are the balls of termite excreta.
2. A termite cone producing a large number of small *Xylaria*-like structures.
3. A variety of *Xylaria*-like structures produced by termite cones. The scale represents 20 centimeters divided into centimeters.

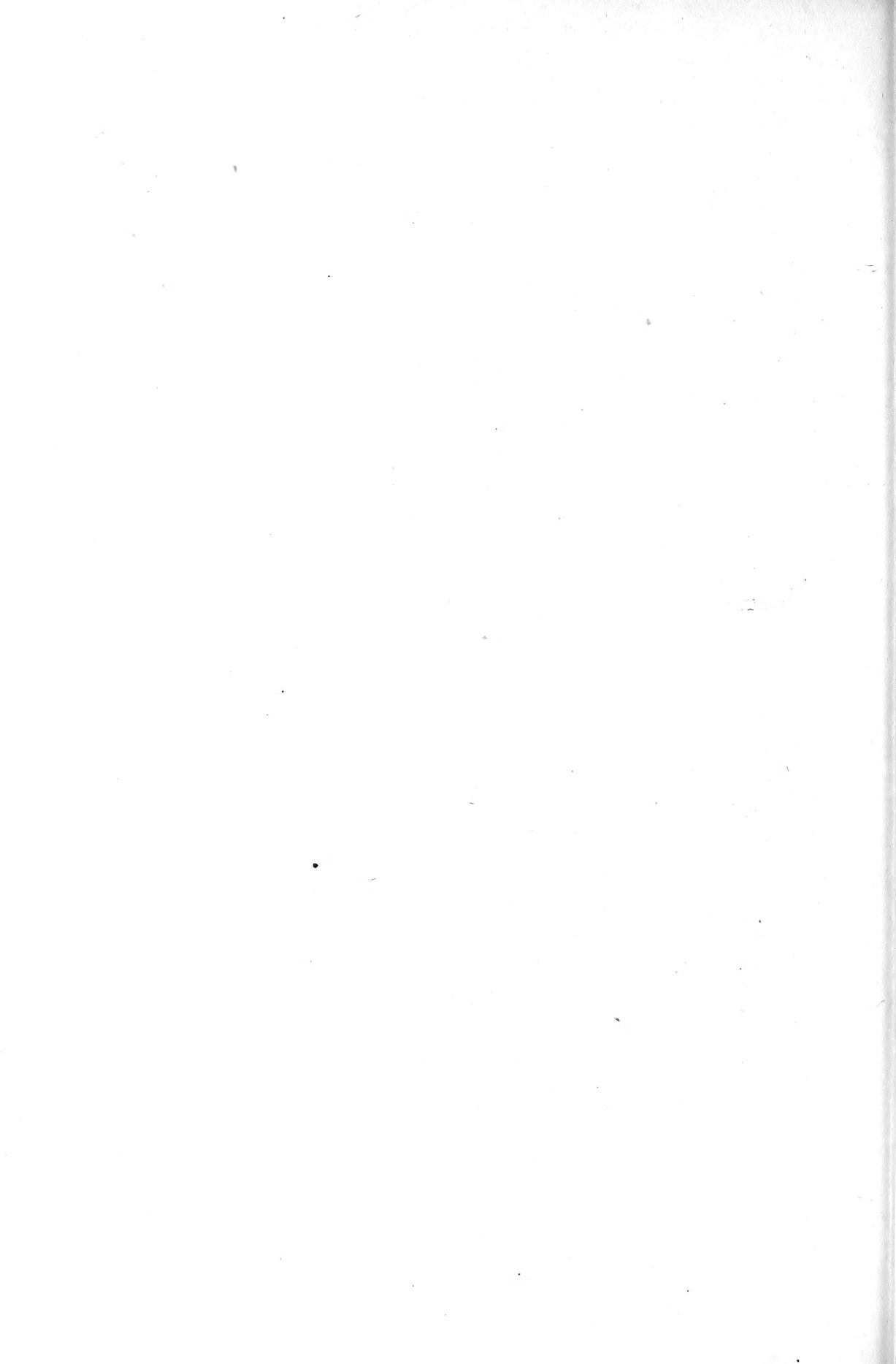

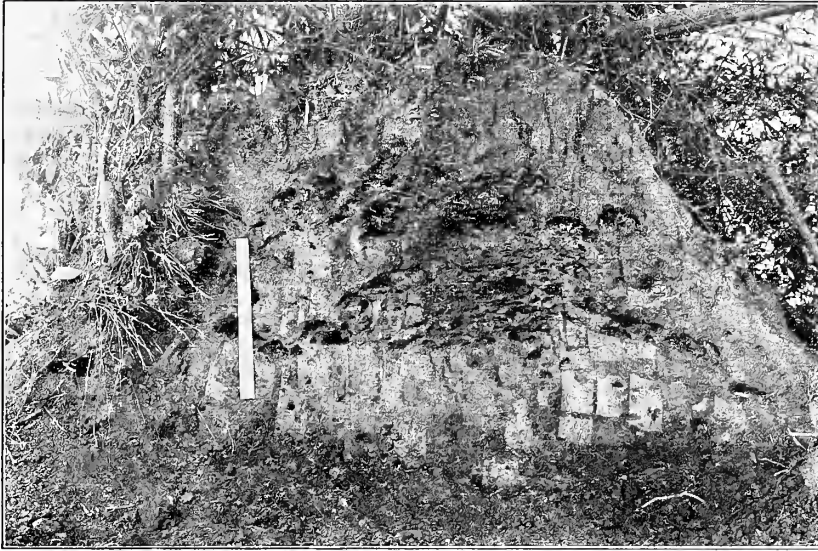

Fig. 1. Vertical section through the center of a termite nest.



Fig. 2. Vertical section through the peripheral part of a termite nest.

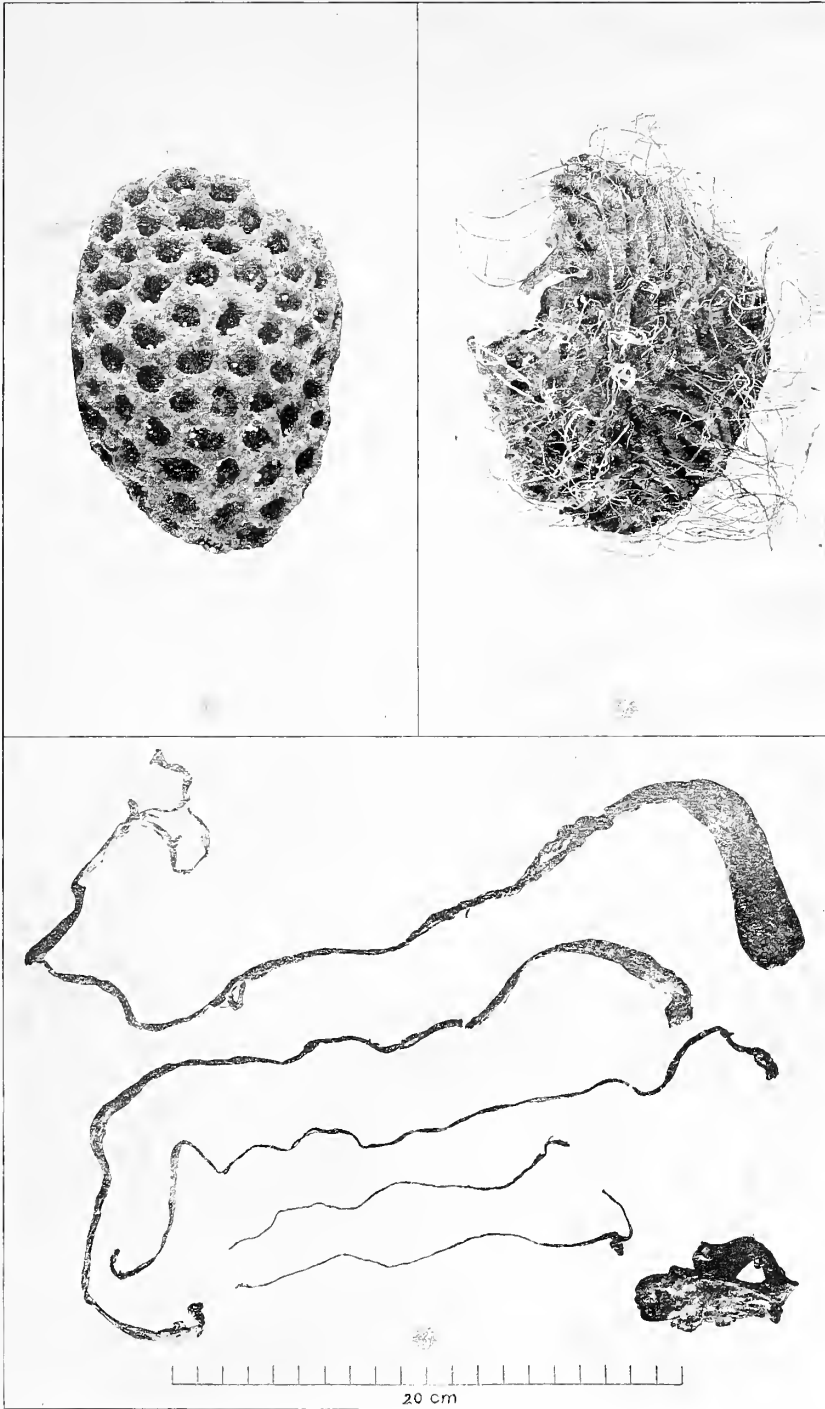

Fig. 1. A small termite cone slightly reduced. 2. A termite cone producing a large number of small Xylaria-like structures. 3. A variety of Xylaria-like structures produced by termite cone.

FUNGI FROM BRITISH NORTH BORNEO

By HARRY S. YATES

(From the Botanical Section of the Biological Laboratory, Bureau of Science, Manila)

The fungus flora of Borneo is at present but little known. In 1844 Léveillé¹ cited two species of *Exidia*, one of which is described as new, collected in Borneo by Korthals. Berkeley² gives a list of thirty-four fungi collected in Borneo; of these one is described as new. Nineteen are referred to the genus *Polyporus* and of the remainder all but three belong either to the *Polyporaceae* or *Agaricaceae*. In 1898 Masee³ cited nine species of fungi from the east coast of British North Borneo, one of which is described as new. Three species belong to the *Agaricaceae* and the remainder are *Polyporaceae*. Hennings⁴ describes a species of *Omphalia* from western Borneo near Bengkajang. Bresadola⁵ gives the results of a study of a collection of fungi made by Winkler in 1908 in southeast Borneo. In this paper he cites twenty-one species all appertaining to the higher fungi, three of which are described as new. In 1912 Sydow⁶ described five new species of lower fungi all collected in southeast Borneo by Winkler.

By far the most important paper dealing with Borneo fungi is that of Cesati⁷ in which the fungi collected by Beccari during his travels in Borneo are listed and the new forms described. Unfortunately this publication is not available in Manila, but by a search through Saccardo's *Sylloge Fungorum* what is believed to be a fairly complete list of the fungi known from Borneo has been compiled. The total number of fungi reported from Borneo previous to the present paper is two hundred ninety-six; of these about thirty are *Agaricaceae*, eighty-three *Polyporaceae*, sixteen *Thelephoraceae*, three *Clavariaceae*, and one *Hydnaceae*, making a total of one hundred thirty-two to be referred to the higher fungi. Of the remainder, forty-three species belong to the *Xylariaceae* and about thirteen to the

¹ Ann. Sci. Nat. Bot. III 2 (1844) 167-221.

² Hooker Journ. Bot. Kew Miscel. 4 (1852) 161-164.

³ Kew Bulletin (1898) 119-120.

⁴ Hedwigia 32 (1893) 63, t. 7, f. 3.

⁵ Ann. Myc. 9 (1911) 549-553.

⁶ Ann. Myc. 10 (1912) 77-85.

⁷ Atti Accad. Sci. Napoli 8 (1878) 1-28, t. 1-4

Hypocreaceae. A few species each of *Phallaceae*, *Lycoperdaceae*, *Nidulariaceae*, *Sphaeriaceae*, and *Pezizaceae* are reported. Other groups are represented in the list by only one or two species. Four *Laboulbeniaceae* have been reported from the island. Up to the present time only one species of *Meliola* had been recorded from Borneo.

In examining the data in reference to the number of fungi reported from Borneo it is to be noted that most of the species belong to groups in which the plants are relatively large and conspicuous. Comparatively few representatives of the smaller leaf parasites appear in the list. In listing the fungi reported from Borneo, I have made no attempt to adjust the synonymy and so the actual number of distinct forms is probably considerably less than the figures as given above would indicate. The extent of our knowledge of Bornean fungi appears to be at least no greater than that possessed of Philippine fungi previous to 1906 when Ricker's⁸ compilation showed less than two hundred species to be known from the Archipelago. While no exact data is available at the present time, it is probable that the known Philippine fungi number between 2,000 and 2,500 species. In fact it seems likely that our knowledge of Bornean fungi at the present time is comparatively less than was our knowledge of the Philippine forms in 1906, since in 1906 a proportionately far larger number of inconspicuous forms of Philippine fungi were known than is the case regarding the smaller forms in Borneo.

The present paper gives the results of a study of a small collection of fungi secured by the writer during a recent visit to British North Borneo. The fungi were collected incidental to other work and were mostly secured in the lowlands along the coast as no time was available for excursions into the forests of the interior. As is to be expected a large proportion of the specimens secured are referable to well known and widely distributed species. Five apparently new species are described and a number previously unknown from Borneo are recorded.

CENANGIACEAE

TRYBLIDIELLA Saccardo

TRYBLIDIELLA MINDANAENSIS P. Henn. in Philip. Journ. Sci. 3 (1908) Bot. 53.

BRITISH NORTH BORNEO, Membakut, Yates 116, October 9, 1917, on dead branches of *Hevea brasiliensis*; Tenom, Yates 87, October, 1917, on the same host.

⁸ Philip. Journ. Sci. 1 (1906) Suppl. 277-294.

This is one of the commonest species of the lower fungi in the Philippines and apparently is also abundant in Borneo. It is a saprophyte and occurs in all sorts of dead wood. It has also been collected in the Philippines on dead branches of *Hevea brasiliensis*.

PERISPORIACEAE

MELIOLA Fries

MELIOLA PTEROCARPIAE sp. nov.

Maculis epiphyllis, subpelliculosis, atris, orbicularibus vel suborbicularibus, 2 ad 6 mm diametro, vel confluentibus et magnam partem folium occupante, mycelio tenuissimo, ex hyphis parce ramosis brunneis 6 ad 8 μ crassis composito; ramis plerumque oppositis; hyphopodiis capitatis numerosis, alternantibus, cellula superiore ovata, 11 ad 13 X 19 ad 12 μ , cellula inferiore 5 μ longa; hyphopodiis mucronatis paucissimis, ampulliformibus, usque ad 18 μ longis; setis mycelicis validis, rectis, erectis, atris, opacis, simplicibus, acutis, 200 μ longis, 10 ad 12 μ crassis; peritheceis numerosis, globosis, atris, opacis, 125 ad 140 μ diametro; ascis ovatis, bisporis, mox diffluentibus; sporidiis cylindraceutis, utrinque late rotundatis, 4-septatis, ad septa constrictis, brunneis, 38 ad 40 X 12 ad 15 μ .

BRITISH NORTH BORNEO, Tenom, Yates 102, October 17, 1917, on leaves of *Pterocarpus indicus*.

Parasitized by *Spegazzinia* and associated with *Phaeodothiopsis pterocarpae* Yates.

MELIOLA OTOPHORAE sp. nov.

Maculas epiphyllas, atras, orbiculares vel suborbiculares, 2 ad 5 mm diametro; mycelio abundante, ex hyphis rectis vel tortuosis brunneis 7 ad 8 μ crassis composito; ramosis, ramis plerumque alternantibus; hyphopodiis capitatis numerosis, cellula superiore oblonga vel subinde lobata, 10 ad 12 μ longa, 6 ad 10 μ lata, cellula inferiore 5 ad 6 μ longa; hyphopodiis mucronatis paucissimis, ampulliformibus, usque ad 15 μ longis, setis mycelicis erectis, rectis, obscure brunneis, 350 ad 450 μ longis, 7 ad 8 μ crassis, acutis; peritheceis numerosis, globosis, atris, opacis, 150 ad 200 μ diametro; ascis ovoideis, 30 ad 35 X 18 ad 20 μ , bisporis; sporidiis 4-septatis, ad septa constrictis, cylindraceutis, utrinque obtusis, brunneis, 30 ad 32 μ longis, 8 ad 12 μ latis.

BRITISH NORTH BORNEO, Sapong, Yates 107, October 16, 1917, on the leaves of *Otophora fructicosa*.

MELIOLA JASMINICOLA P. Henn. in Hedwigia 34 (1895) 11.

BRITISH NORTH BORNEO, Bangawan, Yates 94, October 10, 1917, on *Jasminium sambac*.

Hennings' description of material from Tonkin states that the perithecia are 240 to 300 μ in diameter, in the Bornean material they are about 150 μ in diameter; the spores are given as 30 to 36 \times 10 to 15 μ and in our specimens they are 40 to 45 \times 15 to 18 μ . I have referred this material to *Meliola jasminicola* because comparison with material in the herbarium of the Bureau of Science (Merrill 7469) of a *Meliola* on *Jasminium sambac* determined by Sydow as *M. jasminicola* shows the same variation as do the Bornean specimens.

MELIOLA MANGIFERA Earle in Bull. New York Bot. Gard. 9 (1904) 307.

BRITISH NORTH BORNEO, Membakut, Yates 111, October 9, 1917, on leaves of *Mangifera indica*.

Our specimens differ in certain details from the description, but in general seem to agree closely enough to be placed here. In our material the spots are mostly on the upper surface of the leaves but occur also upon the lower surface. The setae are comparatively few and all of one sort; they are 500 to 700 μ long and the tips are acute. The species was originally described from Jamaica and has also been collected in the Philippines, Porto Rico, and India.

CAPNODIACEAE

AITHALODERMA Sydow

AITHALODERMA CLAVATISPORUM Syd. in Ann. Myc. 11 (1913) 257, f. 3.

BRITISH NORTH BORNEO, Sandakan, Yates 83, October 26, 1917, on leaves of *Acrostichum aureum*; Yates 83a, on *Mallotus polyanthus*.

This species was first described on *Voacanga globosa* from the Philippines and has since been collected on *Psidium guajava*, *Ixora coccinea*, *Antidesma bunius* and *Sandoricum indicum*. The Borneo specimens appear to be referable here though the mycelium is much less dense than in the Philippine material. The entire upper leaf surface is covered by a black coating which is readily removed as a pellicle.

CAPNODIUM Montagne

CAPNODIUM sp.

Mycelium crustaceous, widely effused and entirely covering the upper surface of the leaf, black; hyphae brown, septate, branched, articulations varying, but mostly 5 to 10 μ long, constricted at the septa, 5 to 8 μ in diameter, lighter brown filamentous hyphae are also present; pycnidia cylindrical, enlarged at the base, 500 to 700 μ long; perithecia numerous, 100 μ in diameter; no ascospores found.

BRITISH NORTH BORNEO, Membakut, Yates 99, October 9, 1917, on leaves of *Annona*.

Patouillard, in Bull. Soc. Myc. Fr. 20 (1904) 135, has described a species of *Capnodium* (*C. anonae* Pat.) on *Annona squamosa* from Polynesia, but it appears to differ very considerably from our species. *Capnodium anonae* has been reported on leaves of *Ficus* and *Agave* from India by Sydow and Butler in Ann. Myc. 9 (1911) 384.

HYPOCREACEAE

MEGALONECTRIA Spegazzini

MEGALONECTRIA PSEUDOTRICHIA (Schw.) Speg. in Anal. Soc. Cienc. Argent. 12 (1881) 217.

Sphaerostilbe pseudotrichia B. & Br. in Journ. Linn. Soc. Bot. 14 (1875) 114.

Nectria pseudotrichia B. & C. in Journ. Acad. Phila. II 2 (1835) 289.

Sphaeria pseudotrichia Schw. in Berk. & Curt. Journ. Acad. Phila. II 2 (1853) 289 (as synonym).

BRITISH NORTH BORNEO, Tenom, Yates 86, October 16, 1917, on dead branches of *Hevea brasiliensis*.

This is very abundant on dead branches lying on the ground and is often associated with *Diplodia cacaoicola*.

HYPOCREA Fries

HYPOCREA BORNEENSIS sp. nov.

Stromatibus gregariis, sessilibus, convexo-pulvinatis, 3 ad 6 mm diametro, extus brunneis, intus pallide brunneis; peritheceis globosis, immersis, ostiolis punctiformibus, brevis, ascis cylindraceutis, aparaphysatis, 70 ad 80 X 5 ad 6 μ , 8-sporis (simulate 16-sporis); sporidiis monostichis e duabus cellulis aequalibus compositis, mox decedentibus, cellulis singulis globosis, hyalinis, 4 ad 5 μ diametro.

BRITISH NORTH BORNEO, Membakut, Yates 100, October 9, 1917, on decaying log of *Hevea brasiliensis*.

PHYLLACHORACEAE

PHAEODOTHIOPSIS Theissen et Sydow

PHAEODOTHIOPSIS PTEROCARPI sp. nov.

Stromatibus epiphyllis, numerosis ca. 0.5 ad 1.5 mm diametro, dispersis, carbonaceis, hemisphaerico-pulvinatis, laevibus, atris, in maculis fuscidulis, 2 ad 3 mm diametro dispositis; oculis ca. 6 ad 12, 80 ad 120 μ diametro, globosis; ascis cylindraceutis, 50 ad 60 μ longis, 10 μ latis, 8-sporis, paraphysatis; sporidiis distichis, oblongis, utrinque rotundatis, brunneis, ad basim 1-septatis, constrictis, cellula superiore 10 X 12.5 μ , inferiore 3 ad 4 μ longa et 3 μ lata.

BRITISH NORTH BORNEO, Tenom, Yates 104, October 17, 1917, on leaves of *Pterocarpus indicus*.

This species is very abundant on the leaves of *Pterocarpus*, associated with *Meliola pterocarpi* Yates. The 2-celled brown spores readily distinguish it from the other *Phyllachoraceae* reported upon this host. Conidia are borne on the younger stromata. They are subglobose or somewhat irregular in shape, brown and about 10 to 12 μ diam.

TRABUTIA Saccardo et Roumeguère

TRABUTIA VERNICOSA Theiss. et Syd. in Ann. Myc. 13 (1915) 353.

BRITISH NORTH BORNEO, Bangawan, Yates 92, October 10, 1917, on leaves of *Ficus* sp.

This specimen is apparently to be referred to this species which has previously been collected only in Mindoro, Philippines. It appears to be very abundant on *Ficus* in Borneo.

MYCOSPHAERELLACEAE

MYCOSPHAERELLA Johanson

MYCOSPHAERELLA ALOCASIAE Syd. in Philip. Journ. Sci. 8 (1913) Bot. 195.

BRITISH NORTH BORNEO, Tenom, Yates 84, October 16, 1917, on leaves of *Alocasia macrorrhiza*.

Unfortunately the specimens are rather immature and the spores are not fully developed, but otherwise the material agrees well with *Mycosphaerella alocasiae* which is very common on *Alocasia* and related plants.

VALSACEAE

EUTYPA Tulasne

EUTYPA BAMBUSINA Penz et Sacc. in Malpighia 11 (1897) 501; Ic. Fung. Java (1904) t. 23, f. 1.

BRITISH NORTH BORNEO, Papar, Yates 110, October 14, 1917, on dead bamboo.

This was first described from Java, and is one of the most abundant species in the Philippines. It appears to occur only upon dead bamboo.

XYLARIACEAE

DALDINIA de Notaris et Cesati

DALDINIA CONCENTRICA (Bolt.) Ces. et De Not. in Comm. Critt. Ital. 1 (1863) 198.

Sphaeria concentrica Bolt. Hist. Fung. Halifax 3 (1791) 180 t. 1.

BRITISH NORTH BORNEO, Membakut, Yates 69, October 9, 1917, on dead log of *Hevea brasiliensis*.

A cosmopolitan species very common on many kinds of dead wood in the Philippines and one of the few species collected by me that has previously been reported from Borneo.

KRETZSCHMARIA Fries

KRETZSCHMARIA ? PECHUELII P. Henn. in Engl. Bot. Jahrb. 14 (1891) 365, t. 6, f. 10.

BRITISH NORTH BORNEO, Tenom, Yates 103, October 17, on a dead and half decayed log of *Hevea brasiliensis*.

Kretzschmaria pechuelii was described by Hennings from material collected on dead stumps in Africa. In our material the fungus is about 15 millimeters high, the sterile portion branching, the branches contiguous

and the more or less spherical fertile portions at the end of each branch also contiguous and forming a crust. Our material appears to be somewhat larger and more robust than the form described by Hennings. The asci were not seen but the spores agree very well with Hennings' description. This may be a distinct species but in the absence of material of *K. pechuelii* for comparison I have referred it to that species.

USTULINA Tulasne

USTULINA ZONATA (Lév.) Sacc. in Syll. Fung. 1 (1882) 352.

Sphaeria zonata Lév. in Ann. Sci. Nat. III 3 (1845) 48.

BRITISH NORTH BORNEO, Membakut, Yates 112, October 9, 1917, on the base of trunks of living *Hevea brasiliensis*.

This fungus was first described from material obtained on a palm in Java. It causes a serious disease of tea in Ceylon and is now known to cause a rather important disease of *Hevea brasiliensis* in Malaya. It has also been reported on *Hevea brasiliensis* and a number of other hosts in Ceylon.

THELEPHORACEAE

CORTICIUM Persoon

CORTICIUM SALMONICOLOR B. et Br. in Journ. Linn. Soc. Bot. 14 (1875) 71.

Necator decretus Mass. in Kew Bull. (1898) 119.

Corticium javanicum Zimmerman in Centralbl. Bakter. 7 (1901) 103.

Corticium zimmermanni Sacc. et Syd. Syll. Fung. 16 (1902) 117 (Nomen); Syll. Fung. 17 (1905) 169.

BRITISH NORTH BORNEO, Membakut, Yates 114, October 9, 1917, on living branches of *Hevea brasiliensis*; Yates 115, on branches of *Annona*.

This fungus was first described from Ceylon material about 1875 and apparently did not attract attention again until about 1897 when it appeared on coffee in Malaya. Specimens sent to Kew were described by Masee as a new genus and species of *fungi imperfecti* which he named *Necator decretus* Masee. In 1901 Zimmermann reported the fungus on coffee, tea, *Bixa orellana* and *Erythroxylon coca* in Java and connected *Necator decretus* Masee with the perfect stage which he described as *Corticium javanicum* Zimm. It was first reported from Borneo by Ridley in 1904 on *Hevea* sent from Sandakan. It is now known to occur practically throughout the tropical regions of the orient and a recent report indicates its presence in Porto Rico. It causes a very serious disease of rubber in Malaya and Borneo and of tea in Ceylon. In the Philippines it causes a rather serious disease of *Citrus*.

POLYPORACEAE

DAEDALEA Persoon

DAEDALEA IMPONENS Ces. in Atti Accad. Sci. Napoli 8 (1878) 7.

Funalia philippinensis Murr. in Bull. Torrey Bot. Club. 34 (1907) 469.

BRITISH NORTH BORNEO, Tenom, Yates 105, October 17, 1917, on dead partly decayed logs.

While the specimens differ in some respects from Cesati's description, as given in the Sylloge Fungorum, they agree fairly well with specimens

in the Bureau of Science herbarium so named by Bresadola. When fresh the margin of the pileus was lavender in color, soon fading however to brown.

SPHAERIOIDACEAE

PHYLLOSTICTA Persoon

PHYLLOSTICTA HEVEAE Zimm. in Bull. Inst. Bot. Buitenz. 10 (1901) 21.

BRITISH NORTH BORNEO, Membakut, *Yates 113*, October 9, 1917, on leaves of *Hevea brasiliensis*.

This specimen is referred here though it differs in some respects from Zimmerman's description. The spores are about 8 x 3.5 to 4 μ and the ends are obtuse.

PHYLLOSTICTA MELOCHIAE sp. nov.

Maculis amphigenis, orbicularibus, 2 ad 4 mm diametro; albescentibus, linea fusco-purpurea cinctis; pycnidiis epiphyllis sparsis, immersis, minutissimis, atris, 45 ad 60 μ diametro, poro vix conspicuo, contextu subopaco, irregulariter parenchymatico; sporulis paucis, subglobosis, hyalinis, 5 ad 6 X 4 ad 4.5 μ diametro, intus granulosis.

BRITISH NORTH BORNEO, Tenom, *Yates 109*, October 16, 1917, on *Melochia* leaves.

The spots are small and irregularly scattered over the leaf. The affected tissue finally drops out leaving holes in the leaf.

DEMATIACEAE

CERCOSPORA Fresenius

CERCOSPORA MANGIFERAE Koord. Bot. Unters. Java Pilz. (1907) 236, f. 47.

BRITISH NORTH BORNEO, Bangawan, *Yates 93*, October 10, 1917, on leaves of *Mangifera indica*.

This species was first described from Java and is a common fungus on this host in the Philippines. The leaf spot produced by the fungus apparently causes very little injury to the tree.

SOME MICROTECHNICAL METHODS AND DEVICES

By WALTER R. SHAW

(From the Department of Botany, University of the Philippines, Manila)

FIVE TEXT FIGURES

CONTENTS

1. Ocular micrometers used as stage micrometers.
2. The square-ruled micrometer used as a position indicator.
3. The square-ruled micrometer for drawing to scale.
4. Capillary glass rods for cover-glass supports.
5. Autographic records on micrographic negatives.
6. A method of recording magnification on micrographic negatives.
7. Concentration of glycerin hastened by the vacuum pump.
8. A method for making sealed glycerin mounts.
9. The Osterhout mounting method adapted to *Volvocaceae*.
10. A plankton net for larger organisms.
11. Washing devices for small objects.
12. Methods of estimating the number of cells in spheroidal surfaces.

During several years of teaching botany and pharmacognosy, and collecting and preparing material for a study of the *Volvocaceae* of the vicinity of Manila, it has been found expedient to employ modifications of the methods laid down in the various laboratory handbooks. For the most part these modifications, made to meet requirements of the work in hand and local conditions, have originated in suggestions obtained during many years from many sources which it would now be difficult, if not impossible, to trace. The methods and devices here presented have served useful purposes for the writer and his students in the past and are here published that they may be available for others in the future.

OCULAR MICROMETERS USED AS STAGE MICROMETERS

In an instruction laboratory in which each compound microscope is furnished with a linear and a square-ruled micrometer disk, each of these scales may be used as a stage micrometer for determining the value of the intervals of the other used as an ocular micrometer. The disk to serve as the stage micrometer is easily affixed to a clean slide with a capillary film of water. By this means I am enabled to give simultaneously to all the students of a class exercises in the determination of the micrometer scale values without the expense of supplying a stage micrometer for each student.

THE SQUARE-RULED MICROMETER USED AS A POSITION INDICATOR

For the purpose of referring to specific parts of the microscope field in the discussion of objects in view under the compound microscope, the square-ruled ocular micrometer scale is in some ways superior to the field pointer. When so using the scale I assign numbers to the transverse rows of squares and letters to the vertical rows so that each small square in the scale may be specifically indicated by a number with a letter. The Zeiss scales that I use are not marked with numbers. If the scales were to be so marked I would prefer that the transverse rows be numbered and the vertical rows lettered. The obvious advantage of using this accessory instead of a field pointer is that many different parts of the field can be indicated without readjustment of the apparatus.

THE SQUARE-RULED MICROMETER FOR DRAWING TO SCALE

For use in drawing to scale from the compound microscope all students in my classes in botany and pharmacognosy since 1911 have been supplied with square-ruled ocular micrometers. I have found it convenient to use for the drawing a thin¹ semi-transparent paper of suitable texture, and to place under it a paper scale ruled into squares corresponding to those of the ocular scale. Using a Zeiss No. 3 huygenian micrometer ocular containing a micrometer disk with a 5 mm square ruled at 0.5 mm intervals each way and a paper scale 90 mm square ruled at 9 mm intervals, magnifications of 120 and 500 diameters are obtained with the Zeiss achromatic objectives A and D, respectively. As paper scales for any desired magnification can be easily provided, this method affords unrestricted choice within a greater range of available magnifications than can be had with a camera lucida. The dimming of the microscope image and the complication of light adjustments attendant on the use of the Abbe camera lucida are avoided by the use of the square micrometer as an aid in drawing. And the expense of equipment and deterioration is comparatively insignificant.

CAPILLARY GLASS RODS FOR COVER-GLASS SUPPORTS

In making Venetian-turpentine mounts of delicate objects as variable in size as the *Volvocaceae* it is desirable to have cover-glass supports of greater range of thickness than is afforded

¹The use of a translucent drawing table illuminated from below, with the square-ruled scale on thin paper or on the glass of the table, would make it possible to use thicker drawing paper.

by the use of fragments of cover glasses. Pieces of capillary glass rods serve this purpose well. Ordinary glass rods are heated to softness in a flame and drawn out to suitable thinness. As they then taper more or less it is well to pass the drawn rods through the jaws of a cover-glass tester, of the type manufactured by Zeiss, and break them at points corresponding to the limitations selected for a series of grades according to size. I keep the graded pieces of rod in marked watch glasses or vials and break them into short lengths for use. Four short pieces are distributed on the slide in the Venetian turpentine before the cover is added. A light clip is used to make the cover settle down on the rods. One advantage of using rods instead of bits of cover-glass is that the rods, being approximately cylindrical, may have their thickness determined, at any time after being mounted, by the use of the ocular micrometer.

AUTOGRAPHIC RECORDS ON MICROGRAPHIC NEGATIVES

These may be made by a device so simple that it seems probable that it has already been employed. I have used it for numbering negatives, but it is suitable for any autographic record, which it may be desirable to make on a micrographic or other photographic plate in the laboratory, and might be adapted to service with a plate camera in the field. The data are written with black drawing ink on a piece or pieces of transparent celluloid. Kodoid plates furnished the celluloid used by me. For serial numbers the labels were prepared in advance. After all adjustments have been made preliminary to insertion of the plateholder, the celluloid label is attached by bits of adhesive tape to the metallic diaphragm close to the focal plane of the camera, in a part of the field selected for the purpose. Its location may be verified by making another inspection of the image on the ground glass before inserting the plate holder for the exposure.

A METHOD OF RECORDING MAGNIFICATION ON MICROGRAPHIC NEGATIVES

It is a simple matter to photograph the image of a slide-micrometer scale on a negative beside the image of any microscopic object so that the scale and object appear side by side on the photographic positive and any reproduction. The advantage of this method of indicating the scale of magnification over that in which the scale is drawn on the finished print is obvious.

For this purpose one side of the circular camera field is blocked out by a screen attached to the metallic diaphragm,

which in every good micrographic camera is close to the ground glass and plate. The necessary adjustments are made to bring the image of the object near the shadow of the screen, and the exposure is made. Then the plate holder is removed; a second screen is fixed to the diaphragm to block out the remainder of the field, its edge just touching the first screen, after which the first one is removed. The micrometer slide is then substituted for the object slide on the stage of the microscope and adjusted to throw its image on the unexposed portion of the plate. A second exposure of the plate is then made of the same duration as the first.

Pieces of black paper with straight edges serve for screens and are easily fixed in place by pieces of adhesive tape. Sheets of black metal would do as well or better, and clips might be provided for holding them in place. Or a pair of diaphragms with complementary openings might be employed in place of the single diaphragm with its circular opening. However, the use of adjustable screens has the advantage of permitting variation of the position of the scale to suit the size of the object image.

To facilitate the adjustment of the micrometer slide there may be gummed to its upper side two strips of black paper; one across the slide to block off all the space beyond one end of the scale, and the other lengthwise to block off as much of the scale lines as is superfluous, leaving exposed only a short portion of each of the lines which mark the smaller divisions. The slide thus blocked may be very quickly brought into position on the microscope stage and afterward brought into focus.

CONCENTRATION OF GLYCERIN HASTENED BY THE VACUUM PUMP

In his most admirable presentation of the glycerin and Venetian-turpentine methods of making microscopical preparations, Chamberlain² directs that the material, properly prepared, be put in 10 per cent glycerin (1 part glycerin and 9 parts water) and the water allowed "to evaporate gradually in a place as free from dust as possible." He specifically states that:

It is not necessary to use an exsiccator. Merely put the glycerin into shallow dishes, and leave it exposed to the air, but protected from dust. If the material is in Petri dishes or other dishes with a large surface, 3 or 4 days will be sufficient. This process should not be hastened by warming.

² Chamberlain, Chas. J., *Methods in Plant Histology*, 3d revised edition, Chicago (1915) 93 and 98.

Working with *Volvocaceae* and other algae at Manila, I have not found the above specified procedure satisfactory. It was sometimes successful, but often the evaporation of the water from the glycerin was so slow that fungus mycelia developed to the ruination of the specimens which were exposed to the air in shallow dishes, but protected from dust. And, usually, glycerin which has been concentrated becomes greatly diluted by absorption of atmospheric moisture on extended exposure to the air. I have secured satisfactory evaporation of the water from the glycerin for small quantities of material by the use of the desiccator, and for larger quantities by the use of the vacuum pump. But to provide for the suppression of fungous growth during early stages of evaporation, and on holidays when the vacuum pump, located in the power house, is not in operation, thymol was added to the dilute glycerin. The glycerin solution was prepared by dissolving 0.9 gm of thymol in 9 cc of 95 per cent alcohol, adding the solution to 900 cc of distilled water and shaking, and finally adding 100 cc of glycerin and shaking again. While the thymol prevents fungous growth, it cannot be relied on to serve indefinitely in open dishes, for it seems to escape in the course of time. And pieces of thymol, to be of service, would need to be fastened below the surface of the liquid. In using the desiccator for the evaporation, it is preferable to have the material in vials with narrow mouths, or if it be in wide shallow dishes, to keep the dishes nearly covered to insure that the evaporation and concentration be not too rapid.

For concentrating glycerin containing from 2.5 to 25 cc of *Volvocaceae* wide-mouthed bottles of 250 cc capacity are used. Each bottle is provided with a rubber stopper with two holes. In one hole is placed a bent glass exit tube which does not extend below the stopper. In the other hole is placed a glass tube of which the lower end is drawn to capillary fineness. It is broken off until, by trial, a suitable nozzle is obtained. It does not extend below the bottom of the stopper. The upper end is filled with a plug of cotton just dense enough to serve as a dust arrestor. The specimens in dilute glycerin are placed in the bottle, which is filled with the solution up to the shoulder. The stopper with its tubes is inserted in the bottle, and the outlet tube is connected with the vacuum apparatus. In the system used the pressure varies, but averages about one-fifth of an atmosphere. When the vacuum cock is open the air jet from the capillary nozzle should produce a depression in the

surface of the liquid without undue stirring or agitation. Several days are required for concentration of the glycerin. Too rapid concentration causes shrinkage of the specimens. Passing the air admitted to the bottle through calcium chloride tubes and a sulphuric acid gas drier does not materially accelerate the evaporation.

When smaller quantities than 2.5 cc of material are to be treated, the specimens in dilute glycerin are placed in a cylindrical vial about 23 mm wide and 80 mm deep, which is filled to a depth of about 70 mm. This vial is then placed in the larger bottle so as to stand under the air jet. When used in this way the larger bottles are provided with a floor of paraffin, which is melted and then cooled while the bottle stands on a level support, to give it a flat, level surface.

The use of an aspirator or aspirator pump for providing the air blast is yet to be tried.

A METHOD FOR MAKING SEALED GLYCERIN MOUNTS

Sealing mounts in concentrated or dilute glycerin presents a difficulty that does not occur in the use of aqueous media, which on evaporation leave the cover and slide surfaces dry; namely, the impossibility of securing contact of the cementing medium with glass surfaces which have become coated with a film of the nonvolatile glycerin. And, further, owing to its hygroscopic property, the glycerin takes up atmospheric moisture through the least crevice, expanding, and exuding in damp weather, and evaporates, contracting, and drawing air under the cover, until, after the seasonal changes of several years, slides defectively sealed are likely to become completely dry. This difficulty can be obviated by using a cement which is readily freed from a glycerin coat and providing contact of the cement with the glass surfaces before the glycerin is applied.

I have made mounts of the larger *Volvocaceae*, which require considerable space between slide and cover, and these are in good condition after three years. The cement used is an alcoholic solution of shellac. It is applied with a brush. The method will now be described in detail.

Orange flake shellac is prepared by covering it with 95 per cent alcohol and allowing it to stand for several days. If the resulting solution be too thin it is allowed to evaporate partially; if too thick more alcohol is added. A camel's hair brush for applying the shellac is inserted in a perforated rubber stopper of a bottle of 95 per cent alcohol, in which it is kept when not in use.

A clean slide is placed on a self-centering turntable, with care that if it be slightly curved it shall rest on its ends and not on its middle. With the table rotating slowly a ring of shellac is applied to the slide. This ring is made of such width that there are several millimeters of ring both within and without the area of the circular cover glass to be used. The slide is placed in a desiccator for the shellac to harden, after which additional rings are added in the same manner until the ring has been built up to the required thickness. Then, the ring being dried to a suitable consistency, the slide is placed on the turntable, rotated, preferably by means of a motor, and the inner edge of the ring is trimmed away with a sharp instrument. This leaves the inner side of the ring nearly perpendicular, doing away with the sloping beach on which specimens would be liable to get stranded and be crushed by the cover glass. It is preferable that the thickest part of the ring be at or near its inner edge, and therefore well within the periphery of the cover. A clean, circular cover glass is then laid on the ring and, if the consistency of the ring be just right, a slight pressure on its center with a clean needle will cause it to stick sufficiently to permit the application of a thin ring of shellac to the cover. This ring is made with its inner diameter the same as that of the slide ring and extends just to the outer edge of the cover. The cover is then removed from the slide and placed in a desiccator for the shellac to harden.

The specimens in glycerin are placed on the slide with sufficient liquid to fill the space within the ring. The cover is placed on the liquid with its ring lowermost and pressed gently upon the slide ring. For continued pressure cylindrical metal weights, a little smaller than the cover, are used. Superfluous glycerin is removed from the upper surface of the slide ring with the moistened end of a strip of filter paper. Then the slide is placed on the turntable and shellac is applied so as to occupy all space between the two shellac rings. Finally the slide is again placed in a desiccator for hardening the shellac.

Failures will be indicated, after a time, according to the condition of the atmosphere to which the mounts are exposed. In moist atmosphere there will be exudation of the liquid, and in dry atmosphere bubbles will appear and grow.

It is not desirable to use glass supports for regulating the thickness of the chamber of these mounts unless such supports are sealed in place, for they are very liable to get loose and damage delicate specimens if the slides are not kept constantly in a horizontal position.

The advantage of the foregoing procedure is that it provides ample contact of the cementing medium with both cover and slide and affords ample support for the cover against such pressure as it may be necessary to employ for occasional cleaning of the upper surface of the cover. Further, it provides for the exclusion of specimens from beneath that part of the cover glass which may be overlapped by the sealing ring. And the sealing ring may be kept entirely below the level of the upper side of the cover in case it is desired to employ close-working objectives for the marginal regions of the mount.

THE OSTERHOUT MOUNTING METHOD ADAPTED TO VOLVOACEAE

A rapid method of mounting in aqueous media which was devised by Osterhout³ is rendered more suitable for the larger *Volvocaceae* by the use of glass rodlets for cover-glass supports. It has been employed successfully for mounting stained specimens in nearly concentrated glycerin. I will describe the method as modified for my special purpose.

For each mount a larger cover glass, 18 mm square, and a smaller one, 11 mm square, are used. A pair of covers 22 and 15 mm square would give the same margin. It is advantageous to provide a special slide for the preliminary manipulations. This

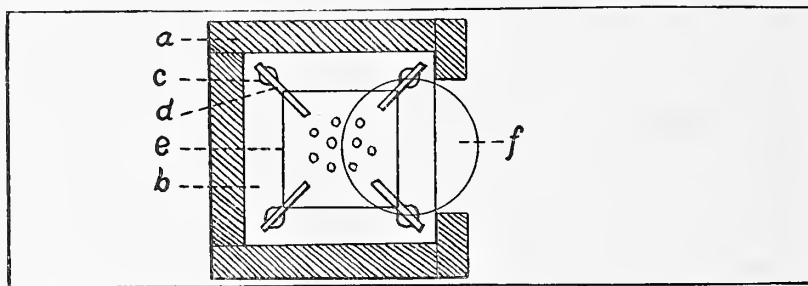

FIG. 1. Special slide with preparation ready for transfer to permanent slide. Glass or paper guides cemented in place, *a*; larger cover, *b*; balsam droplets, *c*; glass rodlets, *d*; smaller cover placed over the ruled square on the slide, *e*; depression in slide for forceps, *f*; material, the nine round bodies. Somewhat enlarged.

may consist of a slide with a small hollow-ground depression, to which are affixed glass or paper guides for holding the larger cover glass in position concentrically over a ruled square of the size of the smaller cover, the guides and ruled square being so placed that the hollow in the slide admits the tip of a forceps point under the margin of the larger cover glass. This ar-

³ Osterhout, W. J. V., Contributions to cytological technique, *Univ. California Publ. Bot.* 2 (1904) 73-90.

rangement is shown in fig. 1. The larger cover is placed on this holder slide and a small drop of Canada balsam is placed on it near each corner. A glass rodlet of the required size is placed on each droplet so as to project into the area of the smaller cover, and pressed into contact with the cover. The balsam is allowed to thicken or harden. Specimens in approximately the proper quantity of glycerin are placed on the center of the larger cover glass and covered with the smaller cover. Excess of glycerin is removed by use of a capillary pipette or a piece of slightly moistened filter paper, with care not to moisten the margin of the larger cover or the upper surface of the smaller cover. A deficiency of glycerin is supplied from a capillary pipette. The smaller cover should rest firmly on the glass rodlets. The covers are then picked up with a pair of forceps, inverted, and placed, smaller cover lowermost, on a plain slide

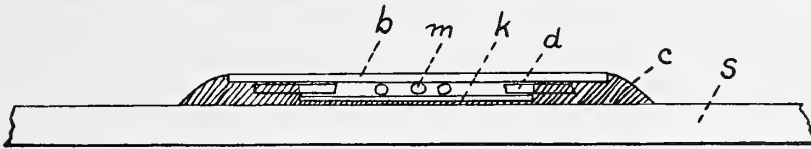

FIG. 2. Sectional view of permanent mount. Slide, *s*; larger cover, *b*; smaller cover, *k*; glass rodlets, *d*; balsam, *c*; material, *m*. About $2\frac{1}{2}$ times natural size.

on which there has been placed, just previously, a drop of very thin balsam dissolved in xylene. As much balsam is added and allowed to run under the larger cover as is necessary to fill the marginal space. The arrangement is then as shown in fig. 2.

Osterhout cautions that—

The balsam should be quite fluid so that the weight of the preparation will force it out from beneath the lower cover glass, since it will not do to press down on it for this purpose on account of the danger of forcing the water out from between the covers. Neither will it do to heat to any great extent, since this may cause bubbles. The preparation is now set aside to dry and treated like any balsam preparation.

A PLANKTON NET FOR LARGER ORGANISMS

After using several unsatisfactory means of collecting *Volvocaceae* I devised a plankton net which combines a number of advantages. The receptacle of this net is a sedimentation tube of 15 cc capacity with the bottom cut off and stopped with a cork. The bottom of the tube is removed by filing a nick near the closed end of the tube and pressing the tube firmly down on the end of a stick which fits inside the bottom. The cut end of the tube is then softened by heating in a flame and flared, by rotation on the conical tip of an arc lamp carbon, for the reception of the cork.

The net itself, of batiste or pearline lawn of suitable fineness, is conical in form, with the lower end open and just large enough to hold the upper end of the glass receptacle in the last centimeter of its length. The upper circumference of the net is sewed to a muslin band about 8 cm wide. The ends of this band overlap, but are united only by the lower and upper edges, leaving a placket gap for changing the glass receptacle when breakage occurs after the net is completed. The upper edge of the muslin band is hemmed to a metal ring, either plain or mounted with solder on the smaller end of a tapering ferrule. The plain rings are provided with strings for attachment to a pole. The mouth of the net is closed with a piece of bobbinet sewed to the muslin band near the ring for the purpose of excluding large objects. With this net it is easy to strain the organisms of certain dimensions from large volumes of water and wash them down into the receptacle where they may be inspected with a pocket lens.

In place of specially prepared sedimentation tubes, homeopathic vials have been used by cutting off the bottoms and smoothing and flaring the cut ends to fit the net. Nets with small rings or rectangular frames have been made to fit in metal pocket boxes such as those in which some brands of candy and tobacco are sold. The nets require to be dried before being stowed in these boxes.

Experience has shown that, in the tropics at least, the delicate fabrics, such as batiste, are liable to injury by gnawing insects unless well protected. One new net stood for several weeks against a wall and when used for the first time was found to have been eaten in several places. After repair with patches fixed in place with a mixture of beeswax and resin, the net was used, dried, and placed in a desk drawer. When required for use again it was found to have a fresh lot of insect holes. The nets in metal boxes are constantly ready for use.

WASHING DEVICES FOR SMALL OBJECTS

For washing chrom-acetic fixing solutions from quantities of *Volvocaceae*, amounting to several cubic centimeters in some cases, by a flow of distilled water, which neither compacts the mass of organisms nor washes any of them away, I have used several devices. The more satisfactory of these will now be described.

A simpler form consists of a calcium chloride U tube with two side tubes, fitted with a cork or rubber diaphragm holding a filter-paper floor, and a bent glass tube connected by a short

rubber tube with one of the side tubes, as shown in fig. 3. A perforated cork fitted over the same side tube serves as means of hanging the apparatus on a rack. Water is supplied from an aspirator bottle on a shelf and controlled by a screw compressor clamp on a rubber supply tube having a glass nozzle. The U tube has an inside diameter of about 18 mm and a capacity below the side tubes of about 58 cc, and in one arm between the side tube and the filter floor holds about 15 cc. The diaphragm is a piece of cork or rubber stopper about 7 to 10 mm high with the smaller end slightly smaller and the larger end slightly larger than the bore of the U tube, perforated with

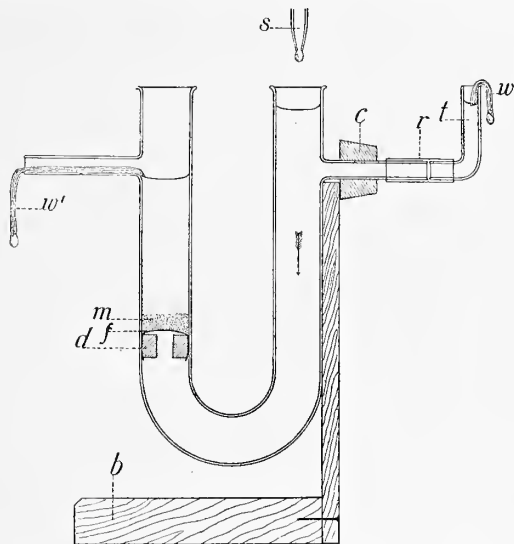

FIG. 3. Smaller washing apparatus made from a calcium chlorid tube. Diaphragm of cork or rubber, *d*; filter paper, *f*; material, *m*; filter paper wicks, *w*, and *w'*; glass tube, *t*; rubber connection, *r*; cork hanger, *c*; supply of water, *s*; base of stand, *b*. $\times \frac{1}{3}$.

a hole about one-third the diameter of the stopper. A piece of dry filter paper is placed over one mouth of the U tube and pressed into the tube with the larger side of the diaphragm, the margin of the paper being crimped and bunched. The diaphragm and paper are then withdrawn and the paper trimmed to leave a suitable margin, after which the diaphragm with its paper cover is inserted into the mouth of the tube, smaller side first, and pressed down almost to the bend of the U tube with the blunt end of a cork borer of larger diameter than the perforation of the diaphragm. The bent tube has its longer arm about equal in length to the distance from the mouth of the U tube to the side tube, is connected with the side tube of the open arm of the U tube, the inlet arm, and serves as a

means of regulating the maximum pressure of the water under the filter floor. The assembled apparatus in use is represented by fig. 3.

In use the bend of the U tube is first filled with distilled water to a level somewhat above the filter floor. Then, with the inlet mouth and side tube closed, the tube is inverted with the filter side lowermost, and shaken if necessary, to release all air bubbles from below the filter. It is returned to the upright position and hung on a suitable support.

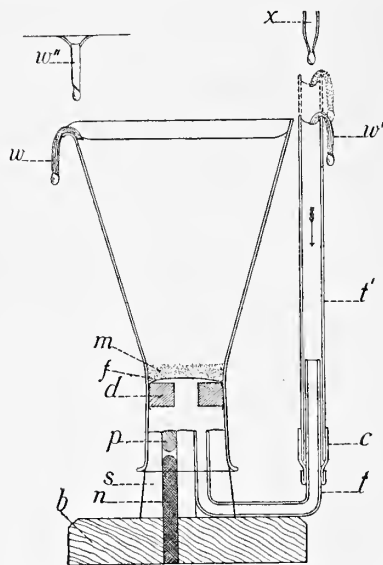

FIG. 4. Larger washing apparatus made from a flask. Diaphragm of cork or rubber, *d*; filter paper, *f*; material, *m*; plug, *p*; supporting rod, *n*; rubber stopper with two holes, *s*; glass tubes, *t* and *t'*; rubber connection, *c*; base, *b*; filter paper wicks, *w* and *w'*; supply of water, *x*; wick in front view of lip, *w''* $\times \frac{3}{4}$.

Next, the open side is filled with water up to the level of the outlet, and the liquid containing the specimens is quickly poured into the other side, the object being to prevent any fixing fluid from passing through the filter. In practice it is preferable to decant superfluous fixing fluid and dilute before pouring into the washing apparatus. After the specimens have been allowed to settle, a narrow wick of several layers of filter paper, pointed at the outer end, is inserted in the outlet tube to insure a steady outflow. The bent tube on the side tube of the inlet arm is provided with a similar wick and adjusted to provide for the maximum limit of pressure. Washing water is allowed to drop into the inlet mouth of the U tube.

A form of this apparatus having a larger capacity is made by using an Erlenmeyer flask from which the bottom has been cut with a diamond, the edges smoothed by heating over a flame, and a spout, like that of a beaker, shaped in the larger end as shown in fig. 4. The flasks used have a nearly cylindrical neck about 4 cm long and 33 mm inside diameter, and it is preferable that this inside diameter be smallest near the union of the neck with the conical body of the flask. A ring diaphragm to fit tightly in the neck is cut from a cork or rubber stopper. The aperture in the diaphragm should be large enough to permit the exit of bubbles which may form between the dia-

phragm and the filter floor. The rubber diaphragms are about 10 mm thick and those of cork about 9. The mouth of the flask is provided with a two-hole rubber stopper, which fits tightly when about half of the stopper is within the neck. A channel is cut on the larger end from one hole to the margin. A glass tube of a size to fit snugly in the stopper hole is bent at right angles in two places so that one arm shall reach through the stopper from the channel to the smaller end of the stopper, and the other end shall extend upward in a vertical direction beyond the margin of the flask and a little higher than the filter floor. A straight piece of glass tubing, large enough to slip over the bent tube and long enough to reach from the bend of the small tube to the level of the flask spout, is provided on one end with a short piece of soft rubber tubing. If necessary, about 7 mm of this rubber tubing is turned back over itself to make it fit snugly over the bent tube. The inner end of the other hole in the stopper is plugged with a piece of tightly fitting glass rod or with beeswax-resin cement. A piece of wood to serve as a base for the apparatus is fitted with an upward projecting metal rod of a size to fit snugly in the stopper perforation and to reach almost up to the plug. The arrangement and use of this apparatus are shown in fig. 4.

To prepare the apparatus for use a piece of filter paper is placed over the mouth of the flask and pressed into the neck with the diaphragm, which is introduced larger side first. When the smaller side is flush with the mouth the paper is trimmed, and then the diaphragm is pressed, with a loosely fitting cork, so far into the neck as to be well beyond the reach of the stopper. Holding the flask mouth upward under a flowing stream of water, the neck is filled from filter floor to brim with care to exclude bubbles, the stopper is inserted with its bent tube in place, and the apparatus immediately inverted and placed in position on its base. Water is added to the level of the free arm of the bent tube. The larger tube with its rubber connection is slipped over the bent tube and filled with water, and immediately the specimens in fixing fluid, preferably previously diluted, are poured into the space above the filter floor. The specimens are allowed to settle, a filter paper wick is placed in the spout to insure steady outflow, and inflow of water into the tube is provided. The height of the inflow tube is adjusted to fix the maximum limit of pressure and rate of flow. Washing can be hastened by occasionally siphoning off the liquid from above the specimens, provided the filter paper will withstand the increased pressure.

Obviously these devices can be adjusted and used for washing with a flow of water in the opposite direction. For some classes of objects a large cylindrical vessel would serve the purpose as well as a conical one. The special advantage of the conical form is that it provides for the smaller, more slowly settling individuals among the specimens. Though prepared especially for washing *Volvox*, the larger, conical, washing apparatus was successfully used for washing 4 cc of pollen of *Cycas circinalis*.

METHODS OF ESTIMATING THE NUMBER OF CELLS IN SPHERICAL SURFACES

For estimating the number of cells present in *Volvox coenobia* various methods have been employed. Those used by the earlier workers have been critically discussed by Klein.⁴

Leeuwenhoek counted the cells around the periphery of the spheroid and calculated the total number present from the count.

Ehrenberg based his calculations on the same count, but, as Klein points out, his formula for the calculation was erroneous and gave numbers too large by more than half. Furthermore, his peripheral counts were, naturally enough, too large because of failure to limit the count to cells lying within an optical section no thicker than the average intercellular distance. The proper formula and coefficient for this method have been recently stated by Janet and are given below.

Cohn⁵ counted the number of cells present in a measured area of the spheroidal surface (100 microns square) and calculated therefrom the total number, deriving the area of the spheroid from the radius. A special variety of this method was used by the present writer, and is stated in detail below.

Drude counted the cells in one-eighth of the spheroidal surface by means of a cross-hair ocular.

Klein described the method which he found expeditious for making numerous estimates. Using a camera lucida, he drew the periphery of the coenobium and within it a group of cells not extending so far from the center as to give any considerable error due to foreshortening of the intercellular distances by projection. In this group of cells, drawn as points, he selected 4 to 6 as nearly as possible in a straight line. He then determined how many times the length of this line was contained in the periphery.

⁴ Klein, L., Morphologische und biologische Studien ueber die Gattung *Volvox*. *Pringsheim's Jahrb. für wiss. Bot.* 20 (1889) 145-146.

⁵ Cohn, F., Die Entwicklungsgeschichte der Gattung *Volvox*, *Festschrift* (1875) 15.

This measurement of the periphery was reduced to terms of average intercellular distance by multiplying it by the number of intercellular distances in the selected row. From this measurement of the periphery $= 2\pi r$ he calculated r and then $4\pi r^2$. He thus obtained the area of the spheroidal surface in terms of the average area occupied by a single cell assuming the latter area to be equal to the square of the intercellular distance.

Janet⁶ has recently applied to the above method the assumption, more in accord with fact, that each cell occupies a hexagonal area. Taking e the average intercellular distance, and d the mean diameter of the sphere, he gives the formula⁷ for the total number, N , of cells as:

$$N = 3.627 \left(\frac{d}{e}\right)^2.$$

He also gives the formula for the calculation of the number of cells, N , from the number, n , of cells counted in the great circle which forms the visible contour of the median optical section. Based on the assumption that each cell occupies a hexagonal area of the spherical surface, the formula⁸ is:

$$N = 0.367 n^2.$$

⁶ Janet, C., *Le Volvox*. Ducourtieux et Gout, Limoges (1912), 28.

⁷ This formula may be derived from those for the area of the surface of a sphere in which A is the area, r the radius, and d the diameter:

$$A = 4\pi r^2 = \pi d^2.$$

Since the area of a hexagon having a diameter of unity is equal to the sine of 60° , which is 0.86603, the number, N , of hexagons of unity diameter in the spherical surface is:

$$N = \frac{A}{0.86603} = \frac{\pi d^2}{0.86603} = \frac{\pi}{0.86603} d^2 = 3.627 d^2.$$

The coefficient in this formula is, then, π divided by the sine of 60° ; and d over e is the diameter of the sphere in terms of the average diameter of the area occupied by a single cell.

⁸ This formula may be derived from that for obtaining the area of the surface of a sphere from the circumference of a great circle. A being that area, and c the circumference:

$$A = \pi \left(\frac{c}{\pi}\right)^2 = \pi \frac{c^2}{\pi^2} = \frac{c^2}{\pi} = \frac{1}{\pi} c^2.$$

Taking account of the fact that the area of a hexagon having a diameter of unity is 0.86603, the formula for the number, N , is:

$$N = \frac{A}{0.86603} = \frac{\frac{1}{\pi} c^2}{0.86603} = \frac{1}{0.86603 \pi} c^2 = 0.367 c^2.$$

The coefficient in this formula is, then, the reciprocal of π divided by the sine of 60° ; and n is the circumference of a great circle in terms of the average diameter of the area occupied by a single cell.

I have used a procedure which is an adaptation of that used by Cohn for estimating the number of cells in the coenobia. With a Zeiss acromatic objective D and a net-ruled ocular-micrometer adjusted so that each small square measured 18 microns on a side, an area of the object was selected which occupied 25 of the small squares, preferably 5 by 5. When shadows of daughter coenobia or other objects interfered with the use of a square area, groups of small squares in various arrangements were taken. When a good view of so large an area could not be obtained, a smaller area was used and the number counted multiplied by the factor required to give the number of cells in 25 small squares. Areas were taken as nearly central as possible, to keep down the error arising from projection of the spherical surface into the image plane. In cases where the intercellular distance decreased from anterior to posterior pole, either an equatorial area was used, or, in cases of polar presentations, a count was made around each pole and the average of the two counts taken. The count represented, then, the average number of cells in an area 90 by 90 microns square, equal to 8,100 square microns. The counts were made by inspection when convenient, otherwise by making a camera drawing of the boundaries of the area and the outlines of the included cells. Cells on the boundary were included when their larger parts lay within the boundary. The diameter of the coenobium was measured with an eyepiece micrometer, or with a camera lucida measuring scale prepared by making a camera lucida drawing of a stage micrometer. The latter is usually the more convenient way.

To use these data let d be the mean diameter of the coenobium in microns, a the area of the count in square microns, and n the number of cells counted. Then the formula for the number of cells, N , will be ;

$$N = \frac{d^2 n}{a}$$

Using the same area for all counts, or reducing all counts to correspond to that area, the formula put in the form :

$$N = \frac{n}{a} d^2.$$

may be reduced, for the area 8,100 square microns, to :

$$N = \frac{n}{2578} d^2.$$

The slide rule was found most satisfactory for making the calculations. It is operated as follows: find n on scale A; bring c , the constant⁹ 2578, on scale B opposite n ; set the hair line of the runner at d on scale C; the number, N , is thereby marked by the hair line on scale A. The position of the decimal

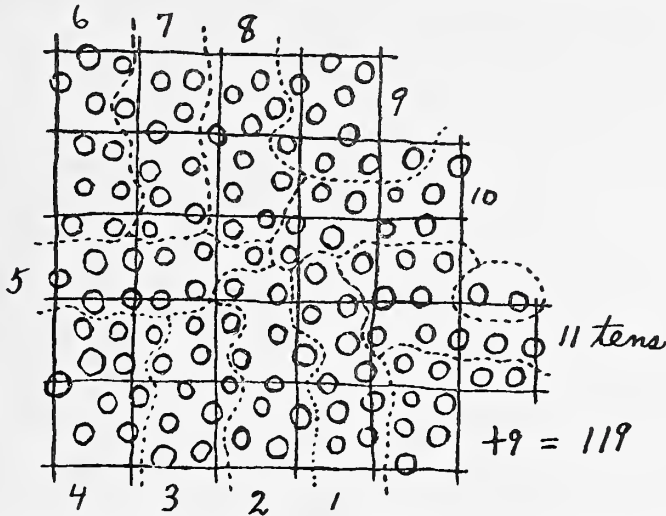

FIG. 5. A sketch of cells of a coenobium included within an area of 8,100 sq. μ indicated by the portion of the square-ruled ocular micrometer sketched at the same time. In practice the grouping lines, here drawn dotted, are drawn in red ink. The upper right square was not used because of some interfering object, the appended square at the right being substituted for it.

point in the number may be quickly found by reference to a previously prepared table of counts and diameters corresponding to cell numbers 1,000 and 10,000. Such a table may be easily made from slide rule readings.

The foregoing may be illustrated by the following example: A spheroidal coenobium is found to have transverse and polar diameters of 610 and 635 μ respectively measured from center to

⁹ For convenience in operating the slide rule I have marked this constant in two places on the slide rule which I use. To accomplish this in the best way, set the 8.1 mark on scale B under the π mark on scale A. Then make a mark on the B scale under the 1 mark of scale A. Then set the 81 mark on scale B under the π mark on scale A, and make another mark on scale B under the 1 mark on scale A. I cut these marks in the celluloid with a suitable sharp knife and fill them with red paint. This instrumental constant, dependent on the area selected for the counting of cells, is not to be confused with the constants c and c^1 which are marked on the C scale of some slide rules to indicate the square roots respectively, of four and forty times the reciprocal of π .

center of cells at the ends of the diameters. We take 618 as an approximate mean diameter. Then we sketch, as in fig. 5, the selected area of the surface of the coenobium showing the cells and the micrometer lines. The cells counted are 119. We now place our constant mark on the slide rule under the 1.19 place on the scale A, bring the hair line of the runner over the 6.18 place on the scale C, and read under the hair line on scale A the number sought, which is about 17.7. A glance at our prepared table shows that for a count of 120 cells and diameters between 463 and 1,035 μ the range of cell numbers is from 10,000 to 50,000. Consequently our number must be 17,700.

A modification of the above procedure was devised for the purpose of more closely approximating the number sought, and for simplifying the operation of the slide rule. The former purpose was attained by using a circular area instead of a square for the count, thereby eliminating the cells at the corners, these being more crowded in the microscope field because projected into the image plane from more sloping parts of the spherical surface. The area selected was, necessarily, smaller than the square, and for simplification of the slide-rule operation the area taken was 3141 square microns, for which area the constant, $c, = a$ divided by $\pi = 1,000$. The circle was drawn by taking the radius 31.6 microns as measured on the drawing paper under the camera lucida from the image of a stage micrometer. For use with semitransparent drawing paper the circle was drawn with India ink on a white card, and for use with opaque paper the circle was carefully cut out of a card. This was done to avoid errors which might arise from disadjustment of a pair of compasses. The circles were drawn on paper and within them the cells were sketched for counting. The counting was made easier in all cases by subdividing the area sketched, with red ink, into areolae containing ten cells each.

This method was first applied to checking over sketches and notes previously made by use of the square areas, and it served to disclose several clerical errors as well as errors which arose from projection.

An error which increases with decrease in the diameter of the coenobia is that which occurs if the diameter of the coenobia be measured from surface to surface of the spheroids. On this account, especially when working with small coenobia, the diameters were measured from center to center of cells on opposite sides of the coenobium, thus basing the reckoning on the spheroid in which the centers of the cells lie.

For cases in which very small areas suffice for the count a circle of 314 square microns was used, the radius being 10 microns, and the corresponding constant, k , is 100. This served for counts of cells of daughter coenobia within the parents.

For very large coenobia with widely separated cells the area taken for count was 31,416 square microns, the radius being 100 microns, and the constant, K , 10,000.

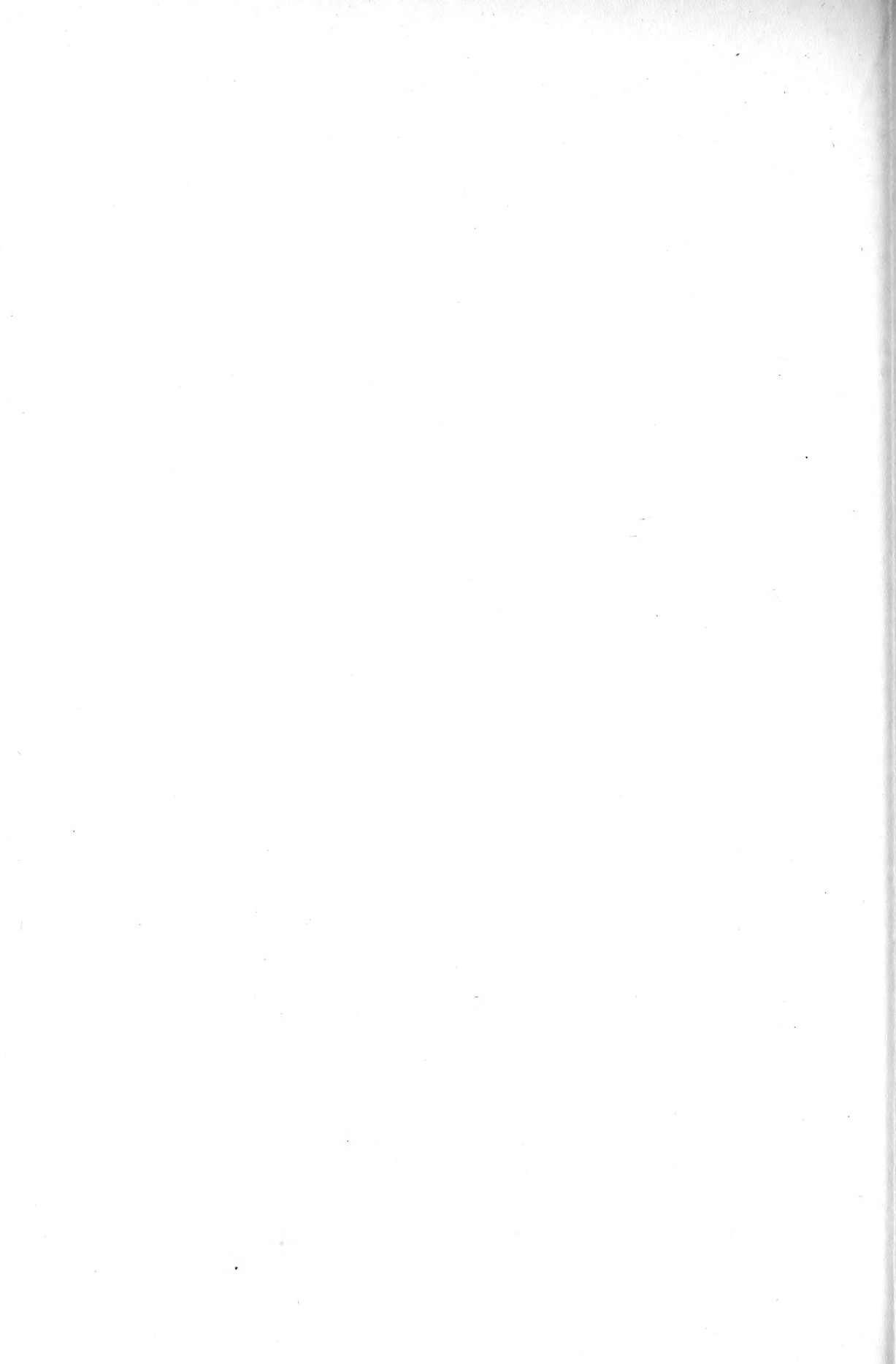

ILLUSTRATIONS

TEXT FIGURES

- FIG. 1.** Special slide with preparation ready to transfer to permanent slide. Glass or paper guides cemented in place, *a*; larger cover, *b*; balsam droplets, *c*; glass rodlets, *d*; smaller cover placed over the ruled square on the slide, *e*; depression in slide for forceps, *f*; material, the nine round bodies. Somewhat enlarged.
2. Sectional view of permanent mount. Slide, *s*; larger cover, *b*; smaller cover, *k*; glass rodlets, *d*; balsam, *c*; material, *m*. About $2\frac{1}{2}$ times natural size.
3. Smaller washing apparatus made from a calcium chloride tube. Diaphragm of cork or rubber, *d*; filter paper, *f*; material, *m*; filter paper wicks, *w* and *w'*; glass tube, *t*; rubber connection, *r*; cork hanger, *c*; supply of water, *s*; base of stand, *b*. $\times \frac{1}{3}$.
4. Larger washing apparatus made from a flask. Diaphragm of cork or rubber, *d*; filter paper, *f*; material, *m*; plug, *p*; supporting rod, *n*; rubber stopper with two holes, *s*; glass tubes, *t* and *t'*; rubber connection, *c*; base, *b*; filter paper wicks, *w* and *w'*; supply of water, *x*; wick in front view of lip, *w''*. $\times \frac{1}{3}$.
5. A sketch of cells of a coenobium included within an area of 8,100 sq. μ indicated by the portion of the square-ruled ocular micrometer sketched at the same time. In practice the grouping lines, here drawn dotted, are drawn in red ink. The upper right square was not used because of some interfering object, the appended square at the right being substituted for it.

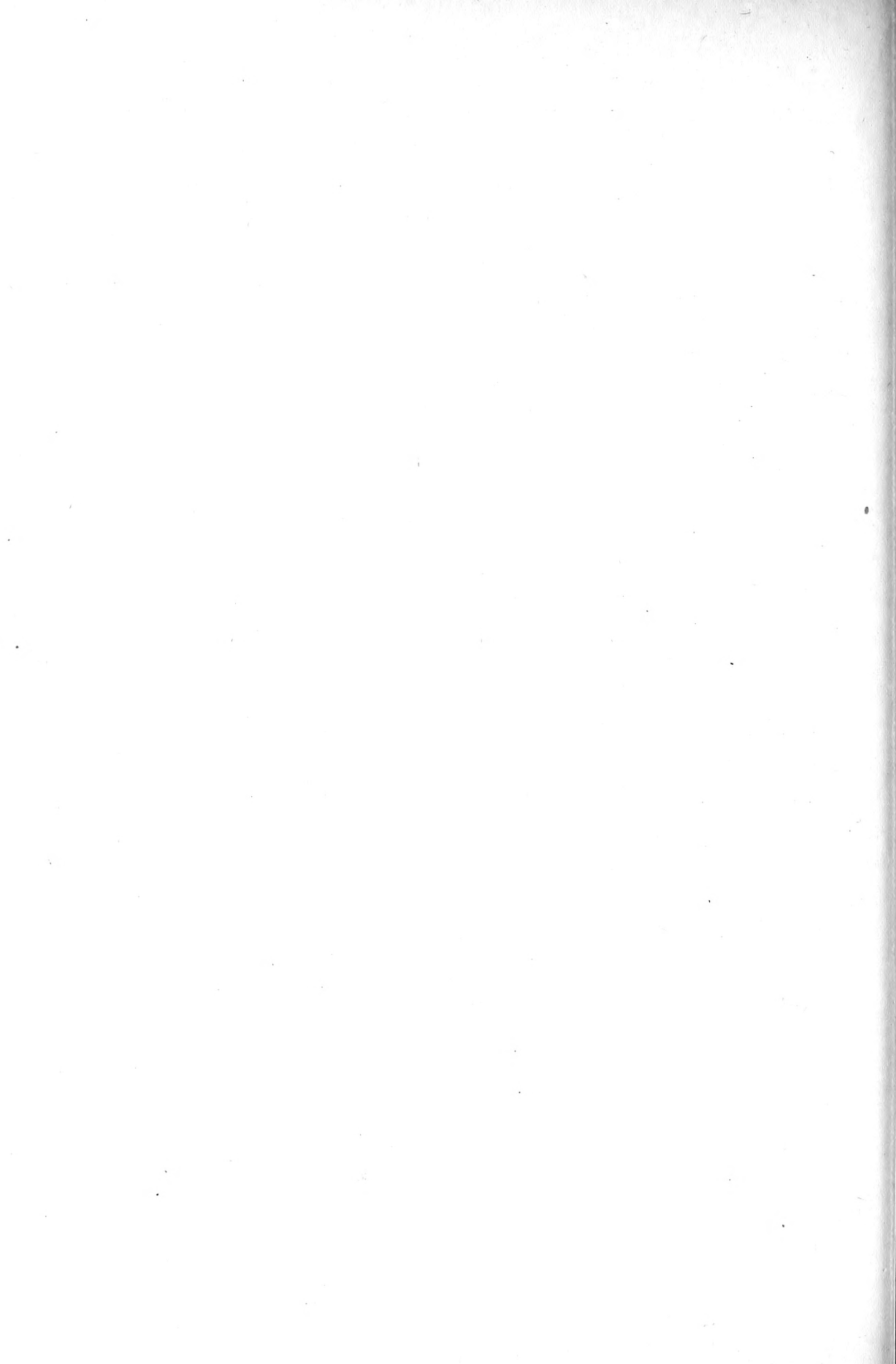

THE PHILIPPINE BUREAU OF SCIENCE

RECENT PUBLICATIONS

AN INTERPRETATION OF RUMPHIUS'S HERBARIUM AMBOINENSE

By E. D. MERRILL

Based on the collections made in Amboina by the late Charles Budd
Robinson

Order No. 450. Bureau of Science Publication No. 9. Paper, 595 pages and 2 maps.
Price \$3, United States currency, postpaid.

The Herbarium Amboinense is a classical work on the Malayan flora and one that is absolutely essential to the systematist to-day. The great importance of the work is due to the fact that later authors have made the Rumphian descriptions and figures the actual "types" of many binomials. As an original source the Herbarium Amboinense stands preëminent among all the early publications on Malayan botany.

Professor Merrill's interpretation of the Herbarium Amboinense discusses the status of each species described by Rumphius and assigns it to a position in the modern system of classification. This publication will be of great service to any one working on Indo-Malayan systematic botany.

A GRAMMAR OF LEPANTO IGOROT AS IT IS SPOKEN AT BAUCO

By MORICE VANOVERBERG

Order No. 438. Vol. V, Part VI, Division of Ethnology Publications. Paper, 102 pages.
Price \$0.75, United States currency, postpaid.

This part completes Volume V of the Division of Ethnology publications and includes the index and the title-page for the volume. A title-page for Volume II is printed with this number.

PLEASE GIVE ORDER NUMBER

Orders for these publications may be sent to the BUSINESS MANAGER, Philippine Journal of Science, Bureau of Science, Manila, P. I., or to any of the following agents:

AGENTS

THE MACMILLAN COMPANY, 64-66 Fifth Avenue, New York, U. S. A.
WM. WESLEY & SON, 28 Essex Street, Strand, London, W. C., England.
MARTINUS NIJHOFF, Lange Voorhout 9, The Hague, Holland.
KELLY & WALSH, Limited, 32 Raffles Place, Singapore, Straits Settlements.
A. M. & J. FERGUSON, 19 Baillie Street, Colombo, Ceylon.
THACKER, SPINK & Co., P. O. Box 54, Calcutta, India.

CONTENTS

	Page.
BROTHERUS, V. F. Contributions to the bryological flora of the Philippines, V.....	201
BROWN, W. H. The fungi cultivated by termites in the vicinity of Manila and Los Baños.....	223
YATES, H. S. Fungi from British North Borneo.....	233
SHAW, W. R. Some microtechnical methods and devices.....	241

The Philippine Journal of Science is issued in four sections. Each section consists of six numbers a year, is separately paged and indexed, and is a complete publication in itself. Authors receive 100 copies of their papers free.

SUBSCRIPTION RATES TO CURRENT VOLUME	U. S. currency.
Section A' (Chemical and Geological Sciences and the Industries)	\$2.00
Section B (Tropical Medicine).....	3.00
Section C (Botany), Elmer D. Merrill, B. S., M. S., Editor.....	2.00
Section D (General Biology, Ethnology, and Anthropology). Section D began with Volume V.....	2.00
Entire Journal (4 sections).....	7.00

PRICES OF BACK NUMBERS AND VOLUMES	
Entire Journal, Volume II, III, or IV (3 sections each); or V (4 sections)	5.00
Entire Journal, beginning with Volume VI (per volume).....	7.00
Single numbers of Volume I.....	.75
Single numbers (except of Volume I).....	.50
Volume I, 1906 (not divided into sections), and supplement, sold only with a complete file of section A, B, or C.....	10.00
Supplement to Volume I (Botany).....	3.50
Volume I (without supplement), sold only with a complete file of section A, B, or C.....	6.50

Publications sent in exchange for the Philippine Journal of Science should be addressed: Library, Bureau of Science, Manila, P. I.

Subscriptions may be sent to the BUSINESS MANAGER, Philippine Journal of Science, Bureau of Science, Manila, P. I., or to any of the agents listed on the inside pages of this cover.

VOL. XIII, SEC. C, No. 5

SEPTEMBER, 1918

THE PHILIPPINE JOURNAL OF SCIENCE

ALVIN J. COX, M. A., PH. D.
GENERAL EDITOR

SECTION C. BOTANY

E. D. MERRILL, M. S.
EDITOR

WITH THE COÖPERATION OF

W. H. BROWN, PH. D.; C. F. BAKER, M. A.
L. M. GUERRERO, PHAR. D.; R. C. MCGREGOR, A. B.



MANILA
BUREAU OF PRINTING
1918



PHILIPPINE JOURNAL OF SCIENCE

A TEN-YEAR INDEX

CONTENTS AND INDEX OF THE PHILIPPINE JOURNAL OF SCIENCE, VOLUME I (1906) TO VOLUME X (1915)

Order No. 449. Bureau of Science Publication No. 8. Paper, 441 pages.
Price \$2, United States currency, postpaid.

One copy of this index has been sent free of charge to each subscriber that has received Volumes XI and XII of the Journal.

This publication consists of:

The complete contents of the first ten volumes of the Philippine Journal of Science, all sections; giving all authors, titles of articles, and page numbers. The exact date of issue of each number is recorded.

An author index, being an alphabetical list of all the contributors. The titles of all the articles are listed under the names of their respective authors.

A subject index. The subject matter is very fully indexed by catch words from the titles, by geographical localities, and by subjects. All systematic names in zoology and botany, as well as the thousands of English and local names, are entered in the index.

STUDIES IN PHILIPPINE DIPTERA, II

By M. BEZZI

Order No. 437. Bureau of Science Publication No. 10. Paper, 59 pages and 1 plate.
Price \$0.50, United States currency, postpaid.

This is the second century of Professor Bezzi's enumeration of Philippine species of flies and includes descriptions of new genera and new species.

PLEASE GIVE ORDER NUMBER

Orders for Bureau of Science publications may be sent to the BUSINESS MANAGER, Philippine Journal of Science, Bureau of Science, Manila, P. I., or to any of the following agents:

AGENTS

THE MACMILLAN COMPANY, 64-66 Fifth Avenue, New York, U. S. A.
WM. WESLEY & SON, 28 Essex Street, Strand, London, W. C., England.
MARTINUS NIJHOFF, Lange Voorhout 9, The Hague, Holland.
KELLY & WALSH, Limited, 32 Raffles Place, Singapore, Straits Settlements.
A. M. & J. FERGUSON, 19 Baillie Street, Colombo, Ceylon.
THACKER, SPINK & Co., P. O. Box 54, Calcutta, India.

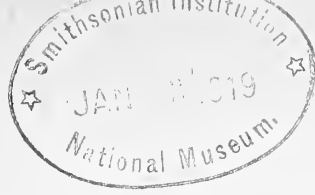

THE PHILIPPINE
JOURNAL OF SCIENCE

C. BOTANY

VOL. XIII

SEPTEMBER, 1918

No. 5

NEW OR NOTEWORTHY PHILIPPINE PLANTS, XIV

By E. D. MERRILL¹

(From the Botanical Section of the Biological Laboratory, Bureau of Science, Manila, P. I.)

The last number of this series was published early in the present year.² The present paper contains the descriptions of one new genus of the *Araliaceae* and of eighty-four new species distributed in twenty-six families. In addition to these proposed new species a few forms previously described from extra-Philippine material are for the first time credited to the Archipelago, and a few changes in nomenclature are proposed. The present paper is, therefore, essentially similar to the preceding ones of the series.

PANDANACEAE

PANDANUS Linnaeus

PANDANUS SUBACAULIS sp. nov. § *Keura*.

Frutex humile, subacaule; foliis circiter 70 cm longis et 5 cm latis, acutis vel breviter lobatis, lobis usque ad 1.5 cm longis; pedunculis terminalibus; syncarpiis solitariis, globosis, circiter 8 cm diametro; drupis numerosis, circiter 3 cm longis, 5- vel 6-locellatis, apice sulcatis; stigmatibus 2 ad 3 mm diametro, leviter obliquis in centro valde depresso.

A low shrub, practically acaulescent, the trunk, entirely covered by the imbricate leaf-bases, 20 cm in length or less. Leaves numerous, about 70 cm long and 5 cm wide, the margins armed with numerous, antrorse, conspicuous teeth about 2 mm in length, with similar ones on the midrib beneath and along the two

¹ Professor of botany, University of the Philippines.

² Philip. Journ. Sci. 13 (1918) Bot. 1-66.

lateral nerves on the upper surface toward the apex, the apex acute in very young leaves, in mature ones cleft into two short lobes, the lobes oblong-ovate, acute or acuminate, up to 1.5 cm long, their margins toothed. Syncarps solitary, terminal, globose, about 8 cm in diameter, the peduncles about 10 cm long, apparently pendulous. Drupes numerous, crowded, about 3 cm long, 1 to 2 cm wide, narrowed below, 5- or 6-celled, angular, the apical part cleft between the loculi, the individual terminal parts of the loculi 5 to 10 mm long, angular, narrowed upward; stigmas somewhat oblique, 2 to 3 mm in diameter, prominently depressed in the center.

CATANDUANES, on forested slopes along the Santo Domingo River, *Bur. Sci.* 30489 Ramos, December 5, 1917.

A species well characterized by being nearly acaulescent, in habit closely approximating *Pandanus brachypodus* Martelli, but with solitary syncarps and entirely different drupes.

PANDANUS PHILIPPINENSIS sp. nov. § *Keura*.

Arbor circiter 10 m alta; foliis usque ad 2.2 m longis, circiter 9 cm latis, sursum angustatis, acuminatis; syncarpiis circiter 6, spicatum dispositis, confertis, subglobose ad subellipsoideis, circiter 11 cm longis; drupis numerosis, confertis, circiter 3.5 cm longis, plerumque circiter 1.5 cm diametro, angulatis, 5- ad 8-locellatis, partibus $\frac{1}{4}$ superioribus liberis, subpyramidatis, extremitate truncatis, circiter 1 cm diametro, loculorum apices pyramidales, 5 ad 7 mm longis, sulcis distinctis separati; stigmatibus obliquis.

A tree about 10 m high. Leaves coriaceous, about 2.2 m long and 9 cm wide, the margins toothed throughout, the midrib on the lower surface with scattered teeth in the upper part of the leaf, the lateral veins here distinct, one on each side of the midrib, unarmed. Syncarps usually 6, arranged in a dense spike, subglobose to subellipsoid. Drupes numerous, crowded, about 3.5 cm long, mostly about 1.5 cm in diameter, 5- to 8-celled, angular, narrowed below, the upper one-fourth free, narrowed upward, the apex truncate and about 1 cm in diameter, the apices of the loculi pyramidal, 5 to 7 mm long, the sulci between them distinct, narrow; stigmas oblique, about 1.5 mm in diameter.

LUZON, Nueva Vizcaya Province, Campote, *Bur. Sci.* 11289 McGregor, March, 1912, on forested hillsides.

This species is well characterized by its crowded, spicately arranged syncarps, and the narrowly pyramidal free apices of the loculi of the drupes. In vegetative characters it is suggestive of *Pandanus exaltatus* Blanco, but is totally different from that species in its numerous syncarps, and in the details of the individual drupes.

PANDANUS OCCULTUS sp. nov. § *Keura*.

Caulis prostratis, parce ramosis, usque ad 3 m longis; foliis usque ad 2.2 m longis, circiter 4 cm latis, superne leviter angustatis, acuminatis; syncarpiis solitariis, erectis, breviter pedunculatis, ellipsoideis, circiter 20 cm longis; drupis numerosis, 4 ad 4.5 cm longis, deorsum gradatim angustatis, 1.5 ad 2.5 cm latis, superne haud angustatis, apice truncatis; loculis circiter 5, apices pentagonis, 5 ad 8 mm diametro, angulatis, leviter pyramidatis, sulcis distinctis separatis; stigmatibus obliquis.

Trunk prostrate, sparingly branched, 3 to 4 cm in diameter, up to 3 m in length, the tips ascending about 0.5 m. Leaves very numerous, greatly elongated, coriaceous, about 2.2 m long and 4 cm wide, gradually narrowed upward, acuminate, the margins rather coarsely toothed especially in the lower part, the teeth less conspicuous and usually appressed above the middle, the midrib beneath with few, small, scattered teeth in the upper part of the leaf, and the two lateral nerves on the upper surface with corresponding teeth. Syncarps solitary, erect, short-peduncled, very dark-green when fresh, ellipsoid, hidden in the terminal crown of leaves and nearly covered with the numerous, imbricate, dead bracts, its length about 20 cm, its diameter about 11 cm. Drupes numerous, densely crowded, 4 to 4.5 cm long, 1.5 to 2.5 cm wide, the apex broad, truncate, gradually narrowed below, compressed or angular, usually 5-celled, the tips of the loculi 5-angled, 5 to 8 mm in diameter, somewhat pyramidal, distinctly separated by narrow and not very deep sulci, the stigmas solitary, oblique, pointed.

PALAWAN, Taytay, Merrill 9361, May 7, 1913, in level forests, dry at this season but swampy in the rainy season, slightly above sea level.

This species is prominently characterized by its habit, being prostrate with ascending branches; its greatly elongated leaves; and its solitary, erect, ellipsoid syncarps, which are hidden in the terminal crown of leaves and nearly covered with the dead bracts. The plants were common in one restricted area, and were very familiar to me for several weeks before I discovered that a few of them were fruiting.

PANDANUS ACLADUS sp. nov. § *Vinsonia*.

Arbor 5 ad 6 m alta, simplex; foliis usque ad 2 m longis et 10 cm latis, crasse coriaceis, supra gradatim angustatis; infructescentiis pendulis, syncarpiis circiter 9, oblongo-ellipsoideis vel oblongo-ovoideis, circiter 18 cm longis et 10 cm latis; drupis numerosis, obovoideis, angulatis, 3.5 ad 5 cm longis, 2 ad 2.5 cm diametro, 9- ad 15-locellatis, apice truncatis et leviter sulcatis, stigmatibus vix obliquis, 1 ad 1.5 mm diametro.

A tree 5 to 6 m high, unbranched. Leaves up to 2 m in

length, about 10 cm wide, thickly coriaceous, the marginal teeth below coarse, spreading, above finer and ascending, the midrib on the lower surface in the upper part with small antrorse teeth. Infructescences terminal, pendulous, the rachis 2 to 3 cm in diameter, the heads about 9, oblong-ellipsoid or oblong-ovoid, about 18 cm long and 10 cm in diameter. Drupes numerous, obovoid, angular, 3.5 to 5 cm long, 2 to 2.5 cm wide, 9- to 15-celled, the apical parts with rounded shoulders, the tip truncate and 1 to 1.5 cm in diameter, shallowly sulcate between the tips of the loculi, the latter irregularly conical, 2 mm long or less and at most 4 mm in diameter at their bases. Stigmas scarcely oblique, rounded or reniform, 1 to 1.5 mm in diameter, usually depressed in the center.

CATANDUANES, *Bur. Sci.* 30462 Ramos, December 10, 1917, in damp forests.

This species is remarkable for its habit, being tall and unbranched, and for its pendulous spikelike racemes of numerous syncarps. It belongs in the same group as *Pandanus radicans* Blanco and *P. botryoides* Martelli, from both of which it is readily distinguished by its more numerous syncarps, larger drupes, and much more numerous stigmas and loculi.

PANDANUS BILIRANENSIS sp. nov. § *Vinsonia*.

Arbor circiter 7 m alta; foliis circiter 2.5 m longis et 6 cm latis, acuminatis; syncarpiis solitariis, globosis, ut videtur circiter 20 cm diametro; drupis numerosis, circiter 7 cm longis, plerumque circiter 3 cm diametro, 5- vel 6-locellatis, 5- vel 6-angulatis, in $\frac{3}{4}$ inferiore parte angustatis, apice subpyramidatis, late rostratis, extremitate 5 ad 8 mm diametro, planis vel leviter concavis; stigmatibus 5 vel 6, planis, confluentibus.

A tree about 7 m high. Leaves about 2.5 cm long and 6 cm wide, coriaceous, narrowed upward to the acuminate apex, the margins toothed throughout, the teeth much more prominent in the lower 50 cm than above, the midrib near the tip minutely toothed on the lower surface. Syncarps solitary, globose, apparently pendulous, and about 20 cm in diameter. Drupes large, numerous, about 7 cm long, mostly about 3 cm in diameter, 5- or 6-angled, 5- or 6-celled, narrowed below from the upper three-fourths, the upper one-fourth subpyramidal, broadly rostrate, the tip plane or slightly concave, 5 to 8 mm in diameter, the stigmas 5 or 6, confluent, plane, quite covering the tip of the syncarp.

BILIRAN, *Bur. Sci.* 18895 McGregor, June 20, 1914, in forests, altitude about 300 meters.

In the form and aspect of the drupes, except in their broadly rostrate apices and plane, confluent stigmas covering the truncate tips, this species is suggestive of *Pandanus dubius* Spreng., but it does not belong in the

section *Hombronia*. It does not appear to be closely allied to any previously described species.

FREYCINETIA Gaudichaud

FREYCINETIA ACUTIFOLIA sp. nov. § *Oligostigma*.

Foliis subcoriaceis, anguste oblongis, usque ad 35 cm longis et 6.5 cm latis, apice acutis vel obscure acuminatis, basi plus minusve angustatis; syncarpiis 6, anguste cylindraceutis, 8 ad 11 cm longis, circiter 1.5 cm diametro; fructibus superne angustatis, partibus superioribus perspicue 4- vel 5-angulatis et sulcatis; stigmatibus 2, rariter 3.

Scandent, the branches about 12 mm in diameter. Leaves narrowly oblong, 30 to 35 cm long, 4.5 to 6.5 cm wide, above rather abruptly narrowed to the acute or slightly acuminate tip, the base narrowed, the clasping part 2 to 2.5 cm wide, margins below conspicuously toothed, in the median parts smooth or with scattered small teeth, toward the apex again toothed, the midrib beneath with small scattered teeth. Syncarps 6, cylindric, 8 to 11 cm long, about 1.5 cm in diameter, the peduncles 5 to 6 cm long, very scabrous above, below nearly smooth except along the edges. Fruits numerous, the upper one-half or more entirely free, narrowed upward, conspicuously 4- or 5-angled and sulcate, the truncate tip about 1 mm in diameter; stigmas 2, rarely 3.

CATANDUANES, back of Calolbong, *Bur. Sci. 30319 Ramos*, December 10, 1917, in forests along small streams at low altitudes.

This characteristic species is manifestly allied to *Freycinetia oblongifolia* Merr., from which it is at once distinguished by its longer leaves, longer and narrower syncarps, and much narrower fruits.

FREYCINETIA PLATYPHYLLA sp. nov. § *Oligostigma*.

Foliis chartaceis, oblongis ad oblongo-ellipticis, usque ad 20 cm longis et 8 cm latis, perspicue tessellatis, abrupte et brevissime acuminatis, deorsum valde angustatis, margine, basi et acumine exceptis, laevis; syncarpiis 4, cylindraceutis, junioribus circiter 1.5 cm longis et 6 mm diametro; stigmatibus 2.

Scandent, the branches about 5 mm in diameter. Leaves thinly chartaceous, oblong to oblong-elliptic, 15 to 20 cm long, 5.5 to 8 cm wide, pale-olivaceous, prominently tessellate, nerves about 20 on each side of the midrib, slender, distinct, the apex abruptly and shortly acuminate, the acumen 7 mm long or less, finely toothed, margins otherwise unarmed except at the very base, the blade conspicuously narrowed below and but about 1 cm wide where it sheathes the stem. Very young syncarps 4, cylindric, about 1.5 cm long and 6 mm in diameter, their pedicels densely spinulose; bracts red, membranaceous, oblong, acute or somewhat acuminate, up to 6 cm in length. Stigmas 2.

SAMAR, Catubig River at Pinpisakan, *Bur. Sci.* 24349 Ramos, March 21, 1916, in forests near the river.

A species most closely allied to *Freycinetia oblongifolia* Merr., but strongly characterized by its unusually broad, thinly chartaceous, prominently tessellate leaves.

FREYCINETIA BOTULIFORMIS sp. nov. § *Pleio stigma*.

Foliis circiter 70 cm longis et 3.5 cm latis, sensim angustatis, tenuiter et longe acuminatis, basi haud angustatis, auriculis 2 ad 3 cm longis, omnino adnatis, laminae marginibus dentibus brevibus praeditis, in parte media laevibus; syncarpiis 3, ut videtur carnosus, siccitate cylindraceutis, botuliformibus, 17 ad 20 cm longis, 2.5 cm latis; fructibus confertis, alte connatis, numerosissimis, circiter 3 mm diametro, apice subplanis vel paullo elevatis, haud angulatis; stigmatibus 7 vel 8.

Scandent, the branches stout, 1 to 1.5 cm in diameter. Leaves about 70 cm long and 3.5 cm wide, gradually narrowed upward to the slenderly acuminate apex, the base not narrowed, the basal auricles adnate throughout, narrow, 2 to 3 cm long, toothed toward their apices, the margins below membranaceous, deciduous; leaf margins below toothed, in the median part entire, and near the tip finely toothed, the midrib beneath with small teeth in the lower part, glabrous above. Syncarps 3, cylindrical, dense, 17 to 20 cm long and 2.5 cm in diameter when dry, their peduncles smooth, stout, about 3 cm long from a 5 to 6 cm long common peduncle. Fruits very numerous, connate nearly to their apices, about 3 mm in diameter, apparently fleshy, the free apices nearly plane or slightly elevated, not at all angular, the stigmatic portion elliptic, about 2 mm long; stigmas 7 or 8.

LUZON, Sorsogon Province, Mount Lalao, *Bur. Sci.* 23363 Ramos, September, 1915, in damp forests.

This species is well characterized by its elongated leaves and its sausage-shaped, elongated syncarps, the individual fruits being united except at the very tips, the free portion being slightly elevated and not at all angular. In its elongated syncarps it differs radically from the species to which it is allied, such as *F. scabripes* Warb., *F. batanensis* Martelli, and *F. banahaensis* Elm.

FREYCINETIA BULUSANENSIS sp. nov. § *Pleio stigma*.

Species *F. williamsii* affinis, differt foliis longioribus et angustioribus, longissime et tenuissime attenuatis, pro ratio subferociter serratis.

Scandent, slender, branched, the branches brownish, about 3 mm in diameter, the internodes 3 to 8 mm long. Leaves rather stiff, 20 to 29 cm long, 5 mm wide, very gradually narrowed upward to the long and slender acuminate apex, the margins and midrib on the lower surface toothed throughout, the teeth

toward the base rather conspicuous. Syncarps 3, globose, 2.5 cm in diameter, their peduncles glabrous, 1.5 cm long. Fruits numerous, flask-shaped, about 9 mm long, narrowed upward, the upper part somewhat angular. Stigmas 4 or 5.

LUZON, Sorsogon Province, Mount Bulusan, *Bur. Sci.* 23686 Ramos, September, 1915.

A species manifestly allied to *Freycinetia williamsii* Merr., but distinguished by the characters indicated in the diagnosis. In the typical form of *Freycinetia williamsii* the leaves are not at all toothed.

FREYCINETIA APAYAOENSIS sp. nov. § *Pleio stigma*.

Foliis numerosis, anguste ensiformibus, usque ad 70 cm longis et 1.5 cm latis, superne sensim longe attenuato-acuminatis, vix tessellatis, coriaceis, auriculis apice liberis; syncarpiis 4, cylindraceis, 6 ad 8 cm longis, circiter 2 cm diametro, pedicellis scabris; fructibus numerosis, liberis, superne subpyramidatis, 4- ad 6-angulatis et sulcatis, sursum angustatis, apice circiter 1 mm diametro; stigmatibus 4 ad 6.

Scandent, attaining a length of 12 m, the stems, when dry, about 1 cm in diameter. Leaves numerous, narrowly ensiform, 60 to 70 cm long, about 1.5 cm wide, coriaceous, scarcely tessellate, gradually narrowed upward to the very slenderly acuminate apex, somewhat narrowed below, the base above the sheathing parts about 1 cm wide, margins below sharply toothed, in the median parts unarmed or sometimes with a few scattered teeth, the long slender tip finely toothed on the margins and midrib, the latter usually unarmed in the lower part of the leaf; auricle chartaceous, rather brittle, adnate to the leaf-margin except at the tip, here 3 to 4 mm wide, subtruncate to somewhat ovate and toothed on the upper side. Syncarps 4, cylindric, 6 to 8 cm long, about 2 cm in diameter, their pedicels scabrous, about 3 cm long. Fruits numerous, free, the upper parts subpyramidal, narrowed upward, conspicuously 4- to 6-angled and sulcate, the tip about 1 mm in diameter; stigmas 4 to 6.

LUZON, Apayao Subprovince, Ngagan, *Bur. Sci.* 28034 *Fénix*, May 9, 1917, in forests.

This species belongs in the group with *Freycinetia scabripes* Warb. and *F. atocensis* Martelli, but among other characters is readily distinguished from both by its conspicuously 4- to 6-angled and sulcate fruits which are narrowly pyramidal above.

MARANTACEAE

PHACELOPHRYNIUM K. Schumann

PHACELOPHRYNIUM CYLINDRICUM sp. nov.

Foliis longe petiolatis, chartaceis, oblongo-ellipticis, acuminatis, usque ad 30 cm longis; inflorescentiis pedunculatis, spicis

3, cylindræis, sessilibus, 4 ad 6 cm longis, circiter 8 mm diametro; bracteis numerosis, imbricatis, dense spiralter dispositis, circiter 1 cm longis, acutis vel leviter acuminatis, sursum plus minusve villosis, bracteis florentes bicarinatis, circiter 8 mm longis; floribus circiter 9 mm longis.

An herb, about 1 m high, tufted, the petioles nearly 1 m long, the leaves chartaceous, oblong-elliptic, acuminate, 25 to 30 cm long, 9 to 11 cm wide. Inflorescences from the sheaths 10 to 12 cm below the base of the leaf, each composed of three, dense, cylindric spikes fascicled at the tip of the common 3 to 4 cm long peduncle, the individual spikes 4 to 6 cm long, about 8 mm in diameter, composed of numerous, imbricate, spirally arranged bracts; bracts about 1 cm long and 5 mm wide, oblong-elliptic, acute or somewhat acuminate, more or less villous above, green, each subtending an inner (floral) bract, which in turn encloses two bracteoles and two flowers, this floral bract about 8 mm long, flattened on the back, the margins inflexed, the keels conspicuously 2-keeled or 2-winged; bracteoles membranaceous, oblong, 5 mm long. Flowers white, about 9 mm long. Ovary densely villous. Sepals oblong-lanceolate, acuminate, about 7 mm long, rather densely 7-nerved, slightly villous toward the tip. Corolla-tube about 4 mm long, the lobes oblong, obtuse, 5 to 6 mm long, 2 to 2.5 mm wide. Staminode one only, oblong-elliptic, rounded, 3 mm long. Cucullate stamen obovate, 3 mm long, callus one 4 mm long, 2 mm wide, plane, somewhat inequilateral, fertile one narrowly oblong, 2 mm long, 1 mm wide.

CATANDUANES, Mount Mariguison, *Bur. Sci. 30503 Ramos*, November 23, 1917, in damp forests.

This species is strikingly characterized by its 3-partite, peduncled inflorescences springing from the sheaths, the individual spikes dense, cylindric, sessile, composed of numerous, imbricate, spirally arranged bracts. It is anomalous in *Phacelophrynium* in its spirally arranged bracts; each of which, however, subtends an inner floral bract, which in turn contains two flowers. In its floral characters it conforms to the genus.

URTICACEAE

LAPORTEA Gaudichaud

LAPORTEA PENDULA sp. nov.

Frutex, inflorescentiis et foliis exceptis glaber; foliis longe petiolatis, oblongo-ovatis, usque ad 35 cm longis, basi rotundatis, apice acuminatis, supra glabris, subtus pallidioribus et plus minusve hirsutis, nervis utrinque circiter 10, perspicuis; inflorescentiis laxis, axillaribus, pendulis, longissime pedunculatis, usque ad 75 cm longis, partibus junioribus et receptaculis pilis

numerosis urentibus instructis; floribus flabellatim dispositis, receptaculis concavis, accrescentibus, usque ad 9 mm diametro.

A shrub, glabrous except the lower surface of the leaves and the inflorescences. Branches thickened, rugose, the ultimate ones about 1 cm thick when dry. Leaves chartaceous, brittle, oblong-ovate, 30 to 35 cm long, about 13 cm wide, base rounded, the apex acuminate, the upper surface olivaceous, rather dull, densely punctulate, glabrous, the lower surface somewhat paler than the upper and more or less hirsute with rather numerous, scattered, short, stinging hairs; lateral nerves about 10 on each side of the midrib, prominent on the lower surface, the reticulations lax, prominent; petioles 8 to 10 cm long; stipules oblong-ovate, chartaceous to subcoriaceous, densely punctulate, 2.5 to 3 cm long. Inflorescences axillary, lax, pendulous, long-peduncled, up to 75 cm in length, the younger parts and the receptacles rather densely covered with short stinging hairs. Receptacles obovoid to somewhat reniform, blue when fresh, accrescent and attaining a diameter of 9 mm, concave, the pistillate flowers borne in a single row along the margin, inflexed, about 10 in each receptacle. Achenes about 4.5 mm long, tipped with the reflexed, 2 mm long, lanceolate, acuminate style.

CATANDUANES, Mount Mariguison, *Bur. Sci. 30229 Ramos*, along small streams in damp forests, altitude about 200 meters, November 21, 1917.

This striking species is well characterized by its greatly elongated, pendulous, lax inflorescences which attain a length of 75 cm. In this character it differs from all other species of the genus known to me.

ELATOSTEMA Forster

ELATOSTEMA CATANDUANENSE sp. nov.

Herba, infra prostrata, ramis paucis, erectis vel adscendentibus, usque ad 20 cm longis, tenuibus, brevissime adpresse hirsutis; foliis oblongo-lanceolatis ad oblongo-oblancheolatis, leviter falcatis, usque ad 2 cm longis, acuminatis, basi valde inaequalateralibus, auriculatis, dentibus utrinque 2 vel 3, perspicuis; receptaculis axillaribus, omnibus sessilibus, bracteis exterioribus chartaceis, latissime obovatis, truncatis vel leviter retusis, circiter 4 mm longis, leviter corniculatis, interioribus obovatis et valde retusis ad lineari-lanceolatis et ciliatis, perianthii segmentis 4.

A sparingly branched, slender herb, prostrate below, the branches ascending or erect, up to 20 cm in length, appressed-hirsute with short, appressed hairs. Leaves chartaceous, olivaceous-brown when dry, dull or slightly shining, without cystoliths, narrowly oblong-lanceolate to narrowly oblong-oblancheolate, 1.5

to 2 cm long, 3 to 5 mm wide, somewhat falcate, acuminate, the base very inequilateral, one side with a rounded auricle, the other acute, the margins with 2 or 3 very conspicuous teeth on each side in the upper one-half, entire below, both surfaces minutely punctulate, the lower paler than the upper and appressed-hirsute with short hairs on the midrib beneath; lateral nerves 4 or 5 on each side of the midrib, distinct on the lower surface, anastomosing, the reticulations rather lax; stipules lanceolate, falcate, acuminate, often irregularly cleft near the apex, membranaceous, 4 to 8 mm long. Receptacles all axillary, solitary, sessile, mostly pistillate, occasionally a staminate one on the same plant with the pistillate ones. Outer bracts very broadly obovate, about 4 mm wide and long, much thicker than the inner ones, brown, truncate, slightly corniculate, glabrous; the next inner ones thinner, obovate, prominently retuse; the innermost ones linear-lanceolate, ciliate. Staminate perianth segments 4, 2 mm long, two slightly corniculate; anthers 4. Pistillate segments 4, 0.5 mm long, oblong, obtuse. Achene 0.8 mm long.

CATANDUANES, Santo Domingo River, on stones along small streams in forests at low altitudes, *Bur. Sci.* 30555 Ramos, December 5, 1917.

This is perhaps as near *Elatostema gracilifolium* Merr. as any other species, but is radically different from it in habit; its shorter, fewer-toothed leaves which have no cystoliths; and in the details of its inflorescences.

FAGACEAE

QUERCUS Linnaeus

QUERCUS RIZALENSIS sp. nov. § *Cyclobalanus*.

Arbor parva, cupulis exceptis glabra, ramulis atro-brunneis vel nigrescentibus; foliis coriaceis, integris, ellipticis ad elliptico-ovatis, usque ad 6 cm longis, utrinque acuminatis, subtus pallidis vel glaucescentibus, nervis utrinque circiter 6, tenuibus, distinctis; fructibus paucis, in spicis brevibus dispositis; cupulis circiter 1.3 cm diametro, cinereo-puberulis, lamellis 5 ad 7, denticulatis; glans conico-ovoideis, glabris vel junioribus leviter pubescentibus, circiter 1.4 cm longis et latis.

A small tree, glabrous except the cups (inflorescences not seen), the branches terete, dark-colored, the branchlets dark blackish-brown, glabrous. Leaves numerous, elliptic to elliptic-ovate, coriaceous, 4.5 to 6 cm long, 2 to 3 cm wide, subequally narrowed to the acuminate base and to the acuminate apex, the apical acumen narrow, hardly caudate, and less than 1 cm long, the upper surface smooth, pale to brownish-olivaceous, the lower pale or somewhat glaucous; lateral nerves about 6 on each side of the midrib, slender, distinct, very obscurely anastomosing

close to the margin, the reticulations slender, obscure; petioles 3 to 5 mm long. Spikes short, mostly less than 2 cm long, glabrous, each with few fruits. Cups shallow, cinereous-puberulent, about 1.3 cm in diameter, the lamellae 5 to 7, the lower ones distant, the upper close, denticulate. Glans conical-ovoid, brown, glabrous, shining, apiculate, about 1.4 cm long and wide, the younger ones more or less pubescent.

LUZON, Rizal Province, Mount Lumutan, *Bur. Sci. 29587 Ramos & Edaño*, in the summit forests, altitude apparently about 1,000 meters. The same species is also represented by *Bur. Sci. 9445 Robinson* from a similar altitude on Mount Binuang, Tayabas Province, Luzon.

The alliance of this species is manifestly with *Quercus philippinensis* A. DC., from which it is distinguished by its smaller, not caudate-acuminate leaves and smaller fruits. Its fruits are much smaller than are those of *Quercus minahassae* Koord., another allied species.

LORANTHACEAE

LORANTHUS Linnaeus

LORANTHUS CONFERTIFLORUS sp. nov. § *Heteranthus*.

Frutex parasiticus inflorescentiis exceptis glaber; ramis 4-angulatis, ramulis acutissime tetragonis, internodiis elongatis; foliis oppositis, coriaceis, olivaceis, nitidis, oblongis ad late oblongo-lanceolatis, acuminatis, basi rotundatis, usque ad 13 cm longis, nervis utrinque circiter 9, vix prominentibus; inflorescentiis axillaribus, solitariis, usque ad 3 cm longis; floribus 6-meris, cylindraceutis, omnibus sessilibus, in triadibus subsessilibus vel breviter pedunculatis dispositis, secundis, rhachibus dense puberulis.

A parasitic shrub, glabrous except the densely puberulent rachis and bracts of the inflorescences. Branches stout, brownish, distinctly 4-angled, the older ones becoming nearly terete, the angles represented by raised lines, the younger branchlets very sharply 4-angled, the internodes 3 to 9 cm long. Leaves opposite, coriaceous, olivaceous and of the same color on both surfaces, shining when dry, oblong to broadly oblong-lanceolate, 8 to 13 cm long, 3 to 5 cm wide, narrowed upward to the rather prominently acuminate apex, base rounded; lateral nerves not prominent, distant, irregular, about 9 on each side of the midrib, the reticulations lax, obscure; petioles about 1 cm long. Inflorescences axillary, solitary, about 3 cm long, the flowers all secund, very densely arranged along one side of the densely puberulent rachis, all sessile in triads, the triads racemosely arranged on very short peduncles. Flowers red, 6-merous, about 23 mm long, the buds very slightly enlarged at the base and again above

the very slight constriction, cylindrical, the bracts 3, forming a small involucre at the apex of the short peduncle, one bract subtending each flower, ovate, obtuse to subacute, about 3 mm long, densely puberulent. Calyx subcylindrical, oblong, about 3 mm long, the limb slightly pubescent, somewhat spreading, irregularly lobed. Petals free to the base, or the basal margins slightly cohering, the petals linear, about 20 mm long, the reflexed part above the insertion of the anthers narrowly oblong, 3 to 3.5 mm long, slightly puberulent on the back. Anthers linear, continuous, 2 to 2.5 mm long.

LEYTE, Tigbao, near Tacloban, *Wenzel 1249*, May 25, 1915, a parasitic shrub about 2 m high.

A very characteristic species readily recognized by its elongated internodes, prominently 4-angled stems and branchlets, and its very dense, solitary inflorescences, the flowers all secund, all sessile in triads, the triads with very short peduncles racemously arranged along the densely puberulent rachis.

LORANTHUS CRASSILIMBUS sp. nov. § *Heteranthus*.

Frutex parasiticus, glaber, ramis ramulisque teretibus, crassis, internodiis brevibus; foliis oppositis, petiolatis, crasse coriaceis, oblongis, usque ad 13 cm longis, obtusis, basi acutis, nervis reticulisque obsoletis; inflorescentiis axillaribus, solitariis, circiter 3 cm longis; floribus circiter 2.8 mm longis, 6-meris, solitariis vel in diadibus vel triadibus racemose dispositis; petalis liberis.

A parasitic glabrous shrub, the branches and branchlets terete, stout, brown when dry, the latter smooth, about 5 mm in diameter, the internodes 1.5 to 3 cm long. Leaves opposite, very thickly coriaceous, oblong, 12 to 13 cm long, 4.5 to 5 cm wide, the upper surface greenish-olivaceous when dry, the lower brown, smooth, slightly shining, apex obtuse, base acute or somewhat decurrent-acuminate, midrib very prominent, the lateral nerves and reticulations obsolete, or the former faintly visible on the upper surface; petioles stout, 1.5 to 2 cm long. Inflorescences axillary, solitary, the rachis about 3 cm long, the flowers racemously arranged, more or less secund, solitary, in pairs, or in triads, their peduncles about 4 mm long, the flowers subtended by a whorl of ovate, acuminate, coriaceous, 4 mm long bracts. Calyx cylindrical, about 4 mm long, slightly contracted below the thin limb, the limb about 1 mm long, irregularly lacerate-toothed. Petals 6, linear, free, the unopened flowers somewhat angular, not inflated, the petals about 24 mm long and 2 mm wide below, narrowed upward, the reflexed part above the insertion of the stamen narrowly oblong, acute or somewhat acuminate, 6 mm long.

Anthers linear-oblong, 3 mm long, subsessile. Bracteoles subtending the calyces ovate, acuminate, about 2 mm long.

LUZON, Nueva Ecija Province, Mount Umingan, *Bur. Sci.* 26409 Ramos & Edaña, August 15, 1916, on trees in forests, altitude about 300 meters, the flowers red and yellow.

This very characteristic species is readily distinguishable by its very thickly coriaceous leaves, the veins and reticulations obsolete, or the former faintly visible on the upper surface. It does not appear to be closely allied to any previously described Philippine form.

LORANTHUS EDANOII sp. nov. § *Heteranthus*.

Frutex parasiticus, glaber, ramis ramulisque teretibus, internodiis elongatis; foliis oppositis, sessilibus, crasse coriaceis, oblongo-ovatis, usque ad 16 cm longis, apice obtusis vel obtuse acuminatis, basi obtusis, in siccitate minute verruculosus, brunneo-olivaceis, nervis primariis utrinque circiter 5, subobscuris, curvato-adscendentibus, secundariis obsolete; inflorescentiis axillaribus et secus internodiis seriatim dispositis, breviter pedunculatis, 6-floris; floribus omnibus sessilibus, 5-meris, cylindraceis, circiter 16 mm longis, petalis liberis.

A parasitic glabrous shrub, or the inflorescences very obscurely ferruginous-puberulent. Branches and branchlets terete, dark-brown, smooth, or the older branches lenticellate, the internodes 7 to 11 cm in length. Leaves opposite, sessile, thickly coriaceous, dull, brownish-olivaceous, of the same color on both surfaces and minutely verruculose when dry, often slightly inequilateral, oblong-ovate, 11 to 16 cm long, 5.5 to 6 cm long, apex obtuse to obscurely blunt-acuminate, base obtuse; lateral nerves about 5 on each side of the midrib, curved-ascending, not prominent, evanescent or obscurely anastomosing, the secondary nerves and reticulations obsolete. Inflorescences axillary and seriatly arranged along one side of the internodes, all peduncled and 6-flowered. Peduncles about 5 mm long. Flowers red, 5-merous, all sessile, and each subtended by a reniform-ovate, rounded bracteole, about 2 mm long and 2.5 mm wide. Calyx cylindric, slightly curved, 3.5 mm long, the limb truncate, produced about 1 mm. Petals 5, linear, free, about 13 mm long, 1 mm wide, glabrous, the portion above the insertion of the stamen thickened, narrowly oblong-obovate, obtuse, 3 mm long. Anthers oblong, continuous with the filament, 1.2 mm long, the filament as long as the anther.

LUZON, Nueva Ecija Province, Mount Umingan, *Bur. Sci.* 26241 Ramos & Edaña, August 8, 1916, on trees at low altitudes.

A very characteristic species, in vegetative characters approaching *Loranthus cuernosensis* Elm. and *L. seriatius* Merr. It is readily dis-

tinguished by its peduncled, 6-flowered inflorescences, which are in the axils and also seriatly arranged along one side of the internodes.

LORANTHUS SAMARENSIS sp. nov. § *Heteranthus*.

Frutex parasiticus, glaber, ramulis teretibus; foliis oppositis, sessilibus, ovatis, usque ad 18 cm longis, crasse coriaceis, in siccitate brunneis, utrinque minute verruculosus, apice obtuse acuminatis, basi rotundatis vel leviter cordatis, nervis utrinque 5 vel 6, arcuato-anastomosantibus, subdistinctis; inflorescentiis secundum internodiis plus minusve confertis, fasciculis 4-floris, sessilibus vel brevissime pedunculatis; floribus teretibus, circiter 2.4 cm longis, 5-meris, petalis liberis.

A parasitic glabrous shrub, the branches and branchlets terete, reddish-brown, smooth. Leaves opposite, sessile, thickly coriaceous, brown when dry, of the same color on both surfaces, minutely verruculose, ovate, 9 to 18 cm long, 7 to 11 cm wide, often slightly inequilateral, apex obtusely acuminate, base rounded, sometimes slightly cordate; lateral nerves 5 or 6 on each side of the midrib, rather distinct, stout, curved, anastomosing, the secondary ones and the reticulations obsolete. Flowers terete, cylindrical, 5-merous, all sessile, about 2.4 cm long, in 4-flowered fascicles, the fascicles sessile or on very short peduncles (peduncles 2 mm long or less), densely crowded along one side of the internodes, each flower subtended by a broad, rounded bracteole 1.5 to 2 mm in length. Calyx cylindrical, somewhat thickened upward, about 4 mm long, the limb produced about 1 mm, truncate, minutely ciliate. Petals 5, linear, free, 2 cm long, about 2 mm wide, the part above the insertion of the stamen about 7 mm long, thickened, acute. Anthers oblong, 3 mm long, continuous with the 2 mm long filament.

SAMAR, Catubig River, *Bur. Sci.* 24265 Ramos, February 7, 1916.

A species manifestly allied to *Loranthus cuernosensis* Elm. and to *L. edanoi* Merr., differing from the former in its flowers being densely crowded in 4-flowered sessile or shortly peduncled fascicles on the internodes, not axillary, and from the latter in its leaves being rounded or somewhat cordate at the base; its 4-flowered, not 6-flowered fascicles; the peduncles, when present, much shorter; and its longer flowers.

LORANTHUS PACHYCLADUS sp. nov. § *Dendrophthoë*.

Frutex parasiticus, glaber, ramis ut videtur plus minusve carnosus, in siccitate teretibus, laevis, nitidis, brunneo-olivaceis, circiter 1 cm diametro; foliis ternatis vel subternatis, oblongis ad oblongo-ellipticis, coriaceis, usque ad 10 cm longis, nitidis, supra olivaceis, subtus pallidis, apice obtusis, basi cuneatis, nervis utrinque circiter 6, valde obscuris vel subobsoletis; inflorescentiis axillaribus terminalibusque, circiter 10 cm longis, pedunculatis,

umbellatis, ramis primariis 4 vel 5, 1 ad 1.5 cm longis; floribus in ramulis primariis in triadibus dispositis, lateralibus breviter pedicellatis, 6-meris, teretibus, infra leviter inflatis, circiter 5 cm longis, segmentis crassis, linearis, tubo circiter 6 mm longo.

A parasitic glabrous shrub, the branches stout, apparently fleshy when fresh, terete, smooth, shining, brownish-olivaceous when dry, about 1 cm in diameter, the branchlets longitudinally striate. Leaves ternate or subternate, oblong to oblong-elliptic, coriaceous, 8 to 10 cm long, 3 to 4 cm wide, shining, smooth, the upper surface somewhat olivaceous, the lower paler, apex obtuse, base cuneate; lateral nerves about 6 on each side of the midrib, slender, obscure, often obsolete or nearly so; petioles 2 to 2.5 cm long. Inflorescences terminal and in the uppermost axils, peduncled, umbellate, the peduncles about 3 cm long, the primary branches 4 or 5, 1 to 1.5 cm long, each bearing at its apex a triad consisting of one central sessile flower and two lateral short-pedicelled ones, each subtended by a broadly ovate, obtuse, 2.5 mm long bract, the lateral pedicels 4 to 5 mm long. Flowers greenish-yellow, 6-merous, about 5 mm long. Calyx cylindric, 6 mm long, the limb truncate, produced about 1.5 mm. Corolla inflated in the lower 1 cm, terete, the lobes 6, united for the lower 6 to 7 mm, the free parts abruptly narrowed, linear, thickened, the reflexed part above the insertion of the filament about 10 mm long and 2 mm wide, thickened, prominently bicarinate inside by the extended margins, obtuse, slightly widened upward, linear. Filaments 4 to 5 mm long, the anthers continuous, linear, 7 to 8 mm long.

LUZON, Ilocos Norte Province, Burgos, *Bur. Sci.* 27323 Ramos, March 10, 1917, on trees in forests at low and medium altitudes.

A remarkable species, well characterized by its rather long-peduncled, lax, umbellate inflorescences, the primary rays few in number, each bearing a single terminal triad of one sessile and two shortly pedicelled, 6-merous flowers, which are about 5 cm in length. It belongs in the group that Van Tieghem characterized as *Stemmatophyllum*, but is not at all closely allied to the other species belonging here, such as *Loranthus haenkeanus* Presl, *L. curranii* Merr., etc.

LORANTHUS AMPLIFOLIUS sp. nov. § *Lepeostegeres*.

Frutex parasiticus, glaber, ramis teretibus, ramulis leviter compressis; foliis oppositis, ovatis ad late ovatis, usque ad 16 cm longis, coriaceis, obtusis, basi late acutis vel subtruncatis, nervis utrinque 8 ad 10; capitulis axillaribus, sessilibus, 15- ad 20-floris, bracteis coriaceis, exterioribus reniformibus, circiter 1 cm longis et 2 cm latis, interioribus obovatis, bracteolis lineari-oblongis vel oblongis; floribus sessilibus, 6-meris, circiter 21 mm longis.

A parasitic glabrous shrub, the branches terete, the branchlets somewhat compressed, dull-brownish, smooth, the internodes 5 to 10 cm long. Leaves opposite, coriaceous, dull-brownish when dry, ovate to broadly ovate, 11 to 16 cm long, 8 to 13 cm wide, obtuse, base broadly acute to subtruncate; lateral nerves 8 to 10 on each side of the midrib, distinct, the secondary ones and the reticulations obsolete or nearly so; petioles stout, about 1 cm long. Heads axillary, 15- to 20-flowered, the bracts coriaceous, the outer ones reniform, 1 cm long and 2 cm wide, the inner ones obovate, the bracteoles linear-oblong to oblong, somewhat keeled, about 11 mm long, obtuse. Calyx 4 mm long, cylindric, the limb inflated, membranaceous, produced about 1.5 mm. Corolla-tube inflated below, the lobes six, united for the lower 5 mm, the free portions 2 mm wide below, narrowed upward, the reflexed part above the insertion of the stamens oblong, obtuse, 5 mm long. Anthers linear, acuminate, sessile, 4 mm long.

SAMAR, Catbalogan, *Bur. Sci. 17448 Ramos*, April 22, 1914, on trees in damp forests at low altitudes, the inflorescence reddish, but the corollas green and yellow.

A species readily distinguished among all the Philippine representatives of the section *Lepeostegeres* by its very broad leaves.

LORANTHUS OVATIBRACTEUS sp. nov. § *Macrosolen*.

Frutex parasiticus, glaber, ramulis ramulisque teretibus; foliis oppositis, breviter petiolatis, oblongo-ovatis, coriaceis, usque ad 15 cm longis, obtusis, basi acutis vel leviter decurrento-acuminatis, in siccitate supra brunneo-olivaceis, subtus pallidis, nervis utrinque 6 ad 8, obscuris; capitulis axillaribus 12- ad 15-floris, sessilibus, bracteis ovatis, leviter carinatis, circiter 13 mm longis, bracteolis ellipticis ad oblongo-ellipticis, carinatis, 7 ad 11 mm longis; floribus in triadibus sessilibus dispositis, 6-meris, circiter 21 mm longis.

A parasitic, glabrous shrub, the branches and branchlets terete, the former pale- the latter dark-brown, smooth, the internodes 2 to 5 cm long. Leaves opposite, oblong-ovate, coriaceous, shining, 12 to 15 cm long, 5.5 to 7.5 cm wide, narrowed upward to the obtuse apex and below to the acute or somewhat decurrent-acuminate base, the upper surface dark brownish-olivaceous, the lower surface pale-brownish; lateral nerves 6 to 8 on each side of the midrib, slender, very obscure, often evanescent, the secondary nerves and reticulations obsolete; petioles 5 to 8 mm long. Heads axillary, sessile, 12- to 15-flowered, the outer four bracts ovate, coriaceous, acute, more or less keeled, about 13 mm long, the bracteoles subtending the triads elliptic to oblong-

elliptic, keeled, 7 to 11 mm long, 3.5 to 6 mm wide. Flowers 6-merous, red, sessile, each triad subtended by a bracteole. Calyx cylindric, somewhat thickened upward, 3 mm long, the limb produced about 1 mm, somewhat spreading, thin, more or less crenate-lacerate. Corolla in bud about 18 mm long, cylindric, somewhat enlarged in the median portion, the lobes wholly united for the lower 5 mm, the free parts 1.5 mm wide below, narrowed upward, the part above the insertion of the anther linear, reflexed, 3.5 mm long, acute. Anther linear, subsessile, 2.5 mm long.

SAMAR, Caminiwan on the Catubig River, *Bur. Sci.* 24135 Ramos, February 8, 1916, at low altitudes.

A species of the section *Macrosolen* not very closely allied to the others of this group known from the Philippines. The elliptic to oblong-elliptic, carinate bracteoles, one bracteole subtending each triad of sessile flowers, are characteristic.

LORANTHUS SPRAGUEI nom. nov.

Loranthus pubiflorus Merr. in Philip. Journ. Sci. 7 (1912) Bot. 263, non Sprague.

Mr. T. A. Sprague of the Royal Gardens, Kew, England, has kindly called my attention to the fact that *Loranthus pubiflorus* Merr. is a name pre-occupied by the African *L. pubiflorus* Sprague, the latter published a few months before the Philippine one, and I accordingly propose the above new name for the Philippine form described by me.

LORANTHUS PALAWANENSIS nom. nov.

Loranthus fragilis Merr. in Philip. Journ. Sci. 9 (1914) Bot. 278, non Sprague.

Loranthus fragilis Sprague was published in 1910 for an African species, and accordingly the Philippine form described by me in 1914 under the same specific name is here called *Loranthus palawanensis* Merr.

ELYTRANTHE Blume

ELYTRANTHE ACUÑAE sp. nov.

Frutex parasiticus, glaber, ramis ramulisque teretibus; foliis oppositis, coriaceis, in siccitate pallide brunneo-olivaceis, nitidis, ovatis ad oblongo-ovatis, usque ad 18 cm longis, acuminatis, basi rotundatis, nervis utrinque circiter 8, distantibus, subtus subprominentibus; racemis axillaribus, brevibus, paucifloris, bracteolis usque ad $\frac{1}{2}$ connatis; floribus 6-meris, curvatis, circiter 5 cm longis.

A parasitic glabrous shrub, the branches and branchlets pale-brownish, terete, smooth, the internodes 3.5 to 11 cm long. Leaves opposite, coriaceous, ovate to oblong-ovate, about 18 cm long, 8 to 9 cm wide, apex prominently acuminate, base rounded, when dry pale-brownish-olivaceous, shining; lateral nerves about

8 on each side of the midrib, rather prominent on the lower surface, curved, obscurely or scarcely anastomosing, the secondary ones and reticulations obsolete; petioles 3 to 5 mm long. Racemes axillary, solitary, the peduncle and axis 1.5 cm long or less. Flowers 6-merous, about 5 mm long, curved, red, their pedicels 2 to 3 mm long; bracts elliptic-ovate, 3.5 mm long; bracteoles united to the middle, about 2 mm long and 3 mm wide, the lobes triangular, acute. Calyx 4 mm long, somewhat urceolate, the limb produced about 1 mm. Corolla-tube about 3 cm long, somewhat enlarged upward, the lobes about 12 mm long, spatulate, much narrowed below, then broadened for a short distance, the limb 2.8 mm wide in the middle. Anthers linear, 2.3 mm long, continuous with the 8 mm long filament.

MINDANAO, Lanao District, Titunod, *For. Bur. 23386 Acuña*, December 12, 1914, in forests along Libas Creek at low altitudes.

This species is readily recognized among the few Philippine species of *Elytranthe* by its large leaves and long flowers. It is not closely allied to any previously described form from the Philippines, but seems to be allied to the extra-Philippine *Elytranthe formosa* G. Don.

ARISTOLOCHIACEAE

ARISTOLOCHIA Linnaeus

ARISTOLOCHIA FOVEOLATA sp. nov.

Frutex scandens; foliis subcoriaceis, ovato-lanceolatis, usque ad 12 cm longis, nitidis, sursum gradatim angustatis, apice acutis vel acuminatis, basi profunde cordatis, lobis rotundatis, subtus dense foveolato-reticulatis et minutissime puberulis; fructibus axillaribus, solitariis, cylindraceutis ad anguste obovatois, circiter 3.5 cm longis.

A scandent shrub, glabrous except for the minutely puberulent lower surfaces of the leaves. Branches nearly black when dry, the older ones very prominently lenticellate. Leaves subcoriaceous, rather pale when dry, shining, ovate-lanceolate, about 12 cm long, 4 to 5 cm wide across the base, gradually narrowed upward to the acute or acuminate apex, the base deeply cordate, the sinus narrow, rounded, the lobes broadly rounded and often overlapping, the upper surface distinctly reticulate, the lower densely foveolate-reticulate; basal nerves 7 or 9, the inner pair nearly reaching the apex, the lower one or two pairs extending into the basal lobes; petioles 3.5 to 4 cm long. Capsules cylindrical to narrowly obovoid, glabrous, dark-colored when dry, axillary, solitary, pendulous, about 3.5 cm long, 1.5 cm in diameter, the apex rounded, base attenuate.

CATANDUANES, in forests along small streams back of Calolbong, *Bur. Sci.* 30370 Ramos, December 9, 1917.

This species is well characterized by its subcoriaceous leaves, which are densely foveolate and minutely puberulent on the lower surface and deeply cordate at the base, the sinuses being narrow and the broad rounded lobes usually overlapping. It belongs in the same general group as *Aristolochia tagala* Cham., but is not closely allied to that species or to any other known to me.

MYRISTICACEAE

MYRISTICA Linnaeus

MYRISTICA MINDORENSIS sp. nov.

Species *M. cumingiae* Warb. valde affinis, differt foliis minoribus, usque ad 13 cm longis, 4 cm latis, nervis lateralibus paucioribus, circiter 7 utrinque, floribus paullo majoribus.

A tree about 14 m high, glabrous except the inflorescence and the terminal buds. Branches reddish-brown, terete, rugose when dry, the lenticels few. Leaves oblong-lanceolate, firmly membranaceous or subcoriaceous, brown and somewhat shining when dry and of about the same color on both surfaces, 7 to 13 cm long, 2 to 4 cm wide, widest at about the middle, about equally narrowed at both ends, the base acute, the apex acuminate; nerves 7 on each side of the midrib, curved-ascending, prominent beneath, obscurely anastomosing, the reticulations subobsolete; petioles 1 to 1.4 cm long, rather slender. Staminate inflorescence axillary, the flowers fasciculate on short, stout, solitary, unbranched, or sometimes shortly forked, axillary, pubescent tubercles, 3 to 4 mm long and nearly as thick, each bearing from two to five flowers; pedicels about 2.5 mm long, pubescent, with a large, broad, 3 mm wide, and about 2 mm long, bracteole immediately below the flower. Staminate flowers oblong-ovoid, 5 to 6 mm long, 3-merous, pubescent outside, the lobes oblong-ovate, about 2.5 mm long, obtuse or acute. Anthers about 10, entirely united into a cylindric column about 3 mm long, 1 mm in diameter, the stipe about as thick as the anther-column, 1 mm long. Pistillate flowers and fruits unknown.

MINDORO, Cauayan, *For. Bur.* 3698 Merritt, March, 1906.

A species manifestly closely allied to *Myristica cumingii* Warb. but with quite different vegetative characters.

MYRISTICA DISCOLOR sp. nov.

Species *M. simiarum* A. DC. affinis, differt foliis subtus pallidis, floribus ♂ duplo majoribus, circiter 7 mm longis.

A tree, glabrous except the inflorescence. Branches terete, wrinkled, brownish when dry, slender, the branchlets nearly

black. Leaves oblong, chartaceous to thinly coriaceous, 10 to 15 cm long, 3.5 to 6 cm wide, the apex acute or somewhat blunt-acuminate, the base slightly decurrent-acuminate, the upper surface dark-colored when dry, slightly shining, minutely pustulate, the lower surface pale, glaucescent or sometimes nearly white, slightly pustulate, sometimes minutely and sparingly pubescent with very short scattered hairs; lateral nerves about 10 on each side of the midrib, slender, prominent on the lower surface, dark-colored in contrast to the pale lower surface of the leaf, looped-anastomosing, the reticulations lax; petioles 2 cm long. Staminate inflorescence axillary, solitary, 2 to 2.5 cm long, the rachis glabrous or nearly so, bearing 3 or 4, stout, short, cylindric, thickened branches, these branches about 1 cm long, 2 mm thick, more or less ferruginous-pubescent, covered with the prominent scars of fallen pedicels, flower-bearing only at the apex. Male flowers 7 mm long, about 2.3 mm in diameter, their pedicels 2 mm long, with an ovate, pubescent, black-punctate, 1 mm long bracteole at the apex. Calyx externally appressed-ferruginous-pubescent, the buds cylindric, the lobes 3, ovate, thick, subacute or obtuse, somewhat recurved in anthesis, 3 mm long, the tube and lobes minutely black-punctate. United anthers cylindric, 3 to 3.5 mm long, their united filaments 1.5 to 2 mm long, slightly appressed-hirsute. Female flowers and fruits unknown.

LUZON, Laguna Province, Mount Maquiling, *For. Bur.* 13155 Curran, November or December, 1911, altitude not stated.

A very characteristic species manifestly allied to *Myristica simiarum* A. DC., the type of which was also from Laguna Province (Calauan). It is well characterized by its 3- or 4-branched staminate inflorescences, the branches thickened, cylindric, and covered with pedicel-scars, and its characteristic leaves, which are dark-colored above and very pale beneath. The minutely pustulate leaves and the black-punctate flowers are also characteristic. Its staminate flowers are twice as large as are those of its closest ally, *Myristica simiarum* A. DC.

MYRISTICA NITIDA sp. nov.

Arbor, inflorescentiis fructibusque exceptis glabra; foliis lanceolatis vel oblongo-lanceolatis, usque ad 18 cm longis, apice longe acute acuminatis, basi acutis, supra valde nitidis subtus paullo pallidioribus nitidisque; nervis lateralibus circiter 10 utrinque; fructibus oblongis vel ellipsoideis, circiter 6 cm longis, minute brunneo-tomentosis.

A tree, glabrous except the fruit and apparently the inflorescence, the latter not seen. Branches terete, wrinkled when dry, dark-colored or brownish, the branchlets light-brown. Leaves lanceolate or oblong-lanceolate, chartaceous to thinly coriaceous,

10 to 18 cm long, 2.5 to 5 cm wide, narrowed above to the slenderly acuminate apex and below to the acute base, the upper surface very strongly shining, brownish or pale-olivaceous, the lower surface somewhat paler, usually brownish, shining but less so than the upper surface; lateral nerves about 10 on each side of the midrib, rather slender, faintly anastomosing, not much more prominent than are the alternating secondary nerves, the reticulations lax, obscure; petioles rather slender, 1 to 1.5 cm long. Inflorescence and flowers unknown. Fruits axillary, solitary, oblong to ellipsoid, about 6 cm long, mature ones 3 cm thick and equally rounded at both ends, immature ones somewhat narrower, sometimes inequilateral; pericarp brittle, densely covered with a very short, pale-brown indumentum which rubs off at maturity.

Luzon, Nueva Ecija Province, *For. Bur. 22199 Alvarez*, December, 1910.

Possibly as closely allied to *Myristica cumingii* Warb. as to any other species, but very different from that form. It is well characterized by its very strongly shining, entirely glabrous, and slenderly acuminate leaves.

MYRISTICA PALAWANENSIS sp. nov.

Arbor parva, usque ad 8 m alta; foliis coriaceis, oblongis ad oblongo-ellipticis, usque ad 40 cm longis, obtusis vel breviter obtuse acuminatis, basi acutis vel rotundatis, nervis utrinque circiter 24, supra glabris, subtus dense ferrugineo- vel pallide ferrugineo-pubescentibus; inflorescentiis ♂ brevibus, densissime ferrugineo-pubescentibus, circiter 4 cm longis, bracteis lineari-lanceolatis, circiter 2 cm longis, bracteolis nullis; floribus ♂ circiter 5 mm longis; fructibus ellipsoideis vel ellipsoideo-ovoideis, 3 cm longis, extus dense ferrugineo-pubescentibus.

A small tree 5 to 8 m high, the branchlets, inflorescence, and lower surfaces of the leaves uniformly and densely ferruginous-pubescent with persistent hairs, the leaves, in age, often pale on the lower surface. Branches terete, glabrous, rugose when dry. Leaves oblong to oblong-elliptic, coriaceous, 25 to 40 cm long, 8 to 19 cm wide, obtuse or the apex shortly, broadly, and obtusely acuminate, the base acute to rounded, the upper surface olivaceous, glabrous, somewhat shining when dry, the lower surface densely ferruginous- or pale ferruginous-pubescent; lateral nerves about 24 on each side of the midrib, very prominent, reticulations obscured by the indumentum on the lower surface, faint on the upper surface; petioles stout, 2 to 3 cm long, when young pubescent, becoming glabrous. Male inflorescence in the uppermost axils, forming a subterminal densely ferruginous, sparingly branched inflorescence about 4 cm long. Flowers brown, densely crowded, racemosely disposed, the primary branches (racemes) subtended by very thick, coriaceous,

pubescent, linear-lanceolate, 2 cm long bracts, the bracteoles absent. Flowers 5 to 6 mm long, their lobes broadly ovate, obtuse, 3 mm long, the pedicels about 3 mm long. Anthers 3 mm long. Fruit ellipsoid to ovoid-ellipsoid, 3 cm long, nearly 2 cm in diameter, the pericarp somewhat wrinkled when dry, densely and uniformly ferruginous-pubescent with very short hairs, crustaceous, 2 mm thick or less.

PALAWAN, Taytay, *Merrill 9253* (type), *9353*, May, 1913; Dawara, *For. Bur. 7437 Manalo*, March, 1907, in forests at low altitudes.

A species manifestly closely allied to *Myristica guateriifolia* A. DC. and to *M. cookii* Warb., differing from the former in its larger leaves, more numerous nerves, and smaller fruits; and from the latter in its paler indumentum, and smaller and fewer-nerved leaves.

GYMNACRANTHERA Warburg

GYMNACRANTHERA MACROBOTRYS sp. nov.

Arbor circiter 30 m alta, inflorescentiis exceptis glabra; foliis oblongis vel anguste oblongo-ellipticis, acuminatis, basi acutis, usque ad 20 cm longis, nervis utrinque 12 ad 15, distinctis; paniculis axillaribus, adpresse ferrugineo-pubescentibus, circiter 8 cm longis; floribus ♂ 4 ad 4.5 mm longis, lobis 3 ad 5; antheris circiter 9, lanceolatis, 2 mm longis.

A tree about 30 m high, glabrous except the inflorescence, the branches terete, grayish to reddish-brown, lenticellate, the terminal buds lanceolate, ferruginous-pubescent. Leaves oblong to narrowly oblong-elliptic, firmly chartaceous, 15 to 20 cm long, 4.5 to 7 cm wide, subequally narrowed at both ends, the apex acuminate, base acute, the upper surface smooth and shining, the lower paler, slightly glaucous; lateral nerves 12 to 15 on each side of the midrib, distinct, the reticulations rather lax, very fine, not at all prominent; petioles about 1 cm long. Panicles axillary, solitary, 6 to 9 cm long, appressed-ferruginous-pubescent, branched from the base, the branches rather distant, the lower ones 2.5 to 4 cm long, many flowered. Male flowers 4 to 4.5 mm long, externally appressed-ferruginous-pubescent, ebracteolate, internally shortly pubescent, the perianth 3- to 5-lobed, the lobes ovate, acute or obtuse, about 2 mm long. Stamens about 9, lanceolate, acuminate, about 2 mm long, on the stout, 0.3 mm long filament.

LEYTE, near Dagami, *Phil. Pl. 1171 Ramos*, August 9, 1912, in forests.

A species well characterized by its large staminate flowers, these being larger than in any previously known species of the genus. In this character *Gymnacranthera macrobotrys* is allied to *G. murtoni* Warb., of the Malay Peninsula and Borneo, but otherwise does not seem to be closely allied. From the common *Gymnacranthera paniculata* Warb. of the

Philippines it differs, among other characters, in its decidedly larger, broader, more numerous nerved leaves.

HORSFIELDIA Willdenow

HORSFIELDIA CONFERTIFLORA sp. nov.

Arbor circiter 25 m alta, inflorescentiis exceptis glabra; ramis ramulisque teretibus, lenticellatis; foliis chartaceis vel subcoriaceis, oblongis, usque ad 25 cm longis, breviter acuminatis, nervis utrinque circiter 18, subtus perspicuis; inflorescentiis ♂ e axillis defoliatis, paniculatis, usque ad 13 cm longis, plus minusve ferrugineo-pubescentibus; floribus pedicellatis, 3-, rariter 4-meris, circiter 1.7 mm diametro, in ramulis ultimis dense confertis.

A tree reaching a height of about 25 m, glabrous except the inflorescence. Branches terete, stout, brownish and striate when dry, lenticellate, the branchlets also terete, glabrous. Leaves firmly chartaceous or subcoriaceous, oblong, 17 to 25 cm long, 4.5 to 8 cm wide, slightly shining and usually more or less brownish when dry, the apex shortly acuminate, the base acute or obtuse; nerves about 18 on each side of the midrib, prominent beneath, anastomosing, the reticulations obsolete or nearly so, very lax; petioles about 1 cm long. Staminate inflorescence from the axils of fallen leaves, paniculate, pyramidal, 10 to 13 cm long, the lower branches spreading, often 5 cm long, the upper few gradually shorter, the rachis, branches and especially the ultimate branchlets more or less ferruginous-pubescent, the flowers densely crowded on the ultimate branchlets, their pedicels less than 1 mm long. Buds globose, less than 2 mm in diameter. Mature flowers 1.5 to 1.8 mm long, 3-, rarely 4-merous, the lobes broadly ovate, acute, about 1 mm long, quite glabrous. Stamens about 14, the anthers entirely united into a sessile, globose or depressed-globose mass about 1 mm in diameter. Immature fruits oblong, about 2 mm long, glabrous.

LUZON, Bataan Province, Lamao River, *For. Bur.* 2487 Borden, January, 1905 (sterile), *For. Bur.* 7509 Curran, September, 1907: Rizal Province, Bosoboso, *For. Bur.* 3183 Ahern's collector, July, 1905 (type): Tayabas Province, Mount Banahao, *For. Bur.* 8049 Curran & Merritt, November, 1907.

I am disposed to place this species in the section *Pyrrhosa*, allied to *H. kingii*, *H. amygdalina*, and *H. glabra*. It strongly resembles, however, *H. irya* and allied species, but the anthers seem to be entirely united, and the flowers are never 2-merous. This is the form previously identified by me as *Horsfieldia ardisiifolia* Warb.,³ the determination having been made

³ Philip. Journ. Sci. 1 (1906) Suppl. 55.

from a single sterile specimen. It is not at all closely allied to that species, although resembling it in vegetative characters.

HORSFIELDIA MEGACARPA sp. nov.

Arbor alta, glabra (floribus ignotis); foliis crasse coriaceis, circiter 18 cm longis, oblongis, obscure et obtuse acuminatis, basi subacutis ad subrotundatis, supra verruculosus, in siccitate nitidis, fragilis, nervis utrinque circiter 18, subtus valde perspicuis; infructescentiis brevibus, crassis, circiter 4 cm longis; fructibus globosis, vel globoso-ellipsoideis, circiter 4 cm diametro, pericarpio crassissimo.

A tall tree, quite glabrous (inflorescence and flowers not seen), or the very young growing parts ferruginous-puberulent. Branches stout, brown, terete, lenticellate. Leaves oblong, thickly coriaceous, brittle when dry, about 18 cm long, 7 to 8 cm wide, apparently recurved or falcate, obscurely blunt-acuminate, base subacute to subrounded, when dry brown on both surfaces, the upper surface strongly shining, distinctly verruculose with minute scattered projections; lateral nerves about 18 on each side of the midrib, prominent, anastomosing, the reticulations lax, faint, obscure; petioles stout, about 1 cm long. Inflorescence and flowers unknown. Infructescence from the branches below the leaves, short, stout, simple, about 4 cm long, each bearing 3 or 4 fruits. Immature fruits globose to ellipsoid-globose, about 4 cm in diameter, the line of dehiscence evident, the pericarp brittle, very thick (about 1 cm).

LUZON, Laguna Province, Dahican River, *Bur. Sci.* 16527 Ramos, September 18, 1912, in forests.

A strongly marked species, characterized by its short infructescence and especially by its unusually large, globose fruits, which have a very thick (1 cm) brittle pericarp.

HORSFIELDIA OBLONGATA sp. nov.

Arbor alta, glabra; foliis chartaceis, oblongis ad anguste oblongo-obovatis, usque ad 20 cm longis, acuminatis, basi acutis, in siccitate brunneis vel olivaceo-brunneis, nitidis, nervis utrinque 9 ad 13; infructescentiis e axillis defoliatis, usque ad 20 cm longis; fructibus oblongo-ovoideis vel anguste oblongo-ovoideis, 4 cm longis, deorsum 2 cm diametro, sursum angustatis, apice obtusis.

A tall tree, apparently entirely glabrous (flowers not seen). Branches terete, brown, much wrinkled when dry, the branchlets slender. Leaves oblong to narrowly oblong-obovate, 11 to 20 cm long, 4 to 6 cm wide, chartaceous or submembranaceous, the apex acuminate, base acute, when dry brown or brown-olivaceous, shining, lower surface very slightly paler than the

upper; lateral nerves 9 to 11 on each side of the midrib, rather distant, distinct, curved upward, faintly anastomosing, the reticulations lax, slender, not prominent; petioles 1 to 1.5 cm long. Infructescence from the axils of fallen leaves on the branches below the leaves, slender, sparingly branched, up to 20 cm long. Fruits few, oblong-ovoid or narrowly oblong-ovoid, 4 cm long, 2 cm in diameter in the lower part, narrowed upward to the blunt apex, the base somewhat rounded and produced slightly as a short stout pseudostalk. Pericarp thickly coriaceous, about 1.5 mm thick when dry, the lines of dehiscence evident. Aril not at all lacinate.

LUZON, Tayabas Province, Mount Pular, *Phil. Pl. 1393 Ramos*, Jan. 17, 1913, in forests.

A species in vegetative characters somewhat resembling *Horsfieldia merrillii* Warb., well characterized, however, by its peculiarly shaped, oblong-ovoid fruits which are gradually narrowed upward to the blunt apex.

KNEMA Loureiro

KNEMA PARVIFOLIA sp. nov.

Arbor circiter 15 m alta, partibus junioribus inflorescentiisque ferrugineo-puberulis; foliis chartaceis, oblongis, elliptico-oblongis vel oblongo-lanceolatis, supra nitidis, subtus pallidioribus, acuminatis, basi acutis, 5 ad 10 cm longis, nervis utrinque 9 ad 13, subtus perspicuis; floribus ♂ parvis, vix 3 mm longis, paucis, e tuberculis axillaribus vel e axillis defoliatis, disco stamineo glabro, margine antheris 8 vel 9 breviter stipitatis coronato.

A tree about 15 m high, the trunk reaching a diameter of 35 cm. Branches dark-brown, terete, striate when dry, somewhat shining, glabrous, the slender branchlets minutely and densely ferruginous-puberulent as are the petioles and inflorescences. Leaves chartaceous, oblong, elliptic-oblong, or oblong-lanceolate, entire, 5 to 10 cm long, 1.8 to 2.8 cm wide, the upper surface shining, glabrous, the lower pale when dry, dull, with scattered, small, brown, sublepidote, glandular dots, especially on the midrib and nerves, the base acute, the apex acuminate, acumen rather short, blunt; primary nerves 9 to 13 on each side of the midrib, prominent beneath, anastomosing, the secondary nerves and reticulations rather close, fine; petioles 6 to 9 mm long. Staminate flowers on short, pubescent, rather stout tubercles, these tubercles about 4 mm long, marked with scars of fallen pedicels, each bearing from 2 to 5 long-pedicelled flowers, the tubercles solitary in the axils of leaves or of fallen leaves; pedicels slender, rusty-puberulent, 8 to 10 mm long, with

a small, deciduous, oblong, obtuse, 1 mm long bracteole at the upper one-fourth or one-third. Staminate flowers small, not exceeding 3 mm in length, the buds ferruginous-puberulent outside, glabrous within, subglobose or somewhat 3-angled, 3-, rarely 4-merous, the calyx-segments thick, ovate, 3 mm long or less, acute. Staminal-disk stipitate, glabrous, the stipe less than 1 mm long, bearing on the margins of the disk 8 or 9, radiately disposed, 0.5 mm long anthers. Pistillate flowers and fruits unknown.

LUZON, Albay Province, Manito, *For. Bur. 10573 Curran*, June, 1908, on forested ridges, altitude about 30 meters.

A species apparently not closely allied to the other Philippine representatives of the genus, well characterized by its unusually small staminate flowers and by its small leaves.

KNEMA ALVAREZII sp. nov.

Arbor 12 ad 15 m alta, partibus junioribus fructibusque densissime ferrugineo-tomentosis; foliis lanceolatis vel oblongo-lanceolatis, 8 ad 12 cm longis, coriaceis, acuminatis, basi acutis vel obtusis, supra glabris, nitidis, subtus pallidis, nervis utrinque 12 ad 15; floribus ♂ axillaribus, parvis, 3-meris, extus densissime ferrugineo-tomentosis, disco stamineo glabro, breviter stipitato, staminibus 6; fructibus junioribus ellipsoideis, 1.5 ad 2 cm longis, dense ferrugineo-tomentosis.

A tree 12 to 15 m high, the young branchlets and leaves very densely ferruginous-tomentose as are the buds and young fruits. Branches grayish-brown, striate, glabrous. Leaves lanceolate to oblong-lanceolate, coriaceous, 8 to 12 cm long, 2 to 3 cm wide, entire, rather slenderly acuminate, base acute or obtuse, the upper surface glabrous, shining, the lower surface pale, puberulent, ultimately becoming nearly glabrous; petioles when young ferruginous-tomentose, later puberulent, 8 to 15 mm long; nerves 12 to 15 on each side of the midrib, prominent, anastomosing, the reticulations not prominent. Male flowers on short, axillary, solitary tubercles, the whole inflorescence ferruginous-tomentose, 1 cm long or less. Pedicels short. Flowers crowded, in bud globose or ovoid, the perianth-segments 3, ovate, about 3 mm long, the bracteoles ovate, deciduous, 2 mm long. Staminal-disk shortly stipitate, glabrous, bearing on the margins 6 radiately spreading anthers about 0.5 mm long. Fruit (immature) ellipsoid, 1.5 to 2 cm long, densely ferruginous-tomentose.

LUZON, Nueva Ecija Province, Mount Macasandal, *For. Bur. 22395, 22397 Alvarez*, February 10, 1911, in forests, altitude about 850 meters.

A species manifestly allied to *Knema heterophylla* Warb., differing in its smaller, fewer-nerved, apparently always entire leaves, the younger

parts and fruits densely ferruginous-tomentose. From *Knema parviflora* Merr. it is distinguished by its different indumentum, short-pedicelled male flowers, and fewer anthers.

MELIACEAE

AGLAIA Loureiro

AGLAIA RIZALENSIS sp. nov. § *Hearnia*.

Species *A. luzoniensis* affinis differt foliolis lanceolatis ad oblongo-lanceolatis, usque ad 10 cm longis et 2.5 cm latis. Arbor parva, novellis et inflorescentiis dense cupreo-lepidotis; foliis 1-foliolatis, foliolis subcoriaceis, rigidis, acuminatis, subtus par-cissime lepidotis, nervis utrinque 10 ad 12, tenuibus; paniculis axillaribus, brevibus, paucifloris, 2 ad 4 cm longis; floribus parvis, 5-meris, racemose dispositis, petalis liberis, extus par-cissime lepidotis.

A small tree, about 4 m high, the younger parts and the inflorescences densely cupreous-lepidote. Branches terete, grayish-brown, somewhat wrinkled, glabrous, the branchlets densely lepidote as are the very young leaves. Leaves simple, alternate, the petiole 1 to 1.5 cm long, more or less lepidote, the leaflet lanceolate to oblong-lanceolate, subcoriaceous, olivaceous when dry, dull or slightly shining, 6 to 10 cm long, 1.5 to 2.5 cm wide, subequally narrowed to the acute base and the acuminate apex, the upper surface glabrous, the lower sparingly lepidote especially along the midrib; lateral nerves slender, 10 to 12 on each side of the midrib, indistinct, obsolete or nearly so on the upper surface, the reticulations obsolete. Panicles axillary, few-flowered, 2 to 4 cm long, densely cupreous-lepidote, usually branched from the base, the lower branches 1.5 cm long or less; flowers yellowish, racemously arranged on the branches, their pedicels 1 to 2.5 mm long. Calyx densely lepidote, the teeth 5, short, acute to obtuse. Petals 5, orbicular, 1 to 1.2 mm in diameter, externally slightly lepidote. Staminal tube free, broad, about 1 mm high. Anthers 5, inserted at the apex of the tube just within the rim. Ovary pubescent.

LUZON, Rizal Province, Mount Lumutan, *Bur. Sci. 29640 Ramos & Edaña*, April 22, 1917.

This species is manifestly allied to *Aglaiia luzoniensis* (Vid.) Merr. & Rolfe, one of the few species of the genus with unifoliolate leaves. It is readily distinguished by its much narrower, differently shaped leaves. It is distinguished from *Aglaiia brevipetiolata* Merr. by its much longer petioles and differently shaped leaves. I now have before me a cotype of the Celebesian *Aglaiia unifoliolata* Koord., and am able to confirm its identity with the Philippine *Aglaiia monophylla* Perk.; both are identical with *Beddomea luzoniensis* Vid., the basis of *Aglaiia luzoniensis* Merr. &

Rolfe. This very characteristic species is common and widely distributed in the Philippines and, like numerous other strongly marked and characteristic types, is otherwise known only from Celebes and New Guinea.

AGLAIA PYRIFORMIS sp. nov. § *Hearnia*.

Arbor parva, partibus junioribus dense cupreo-lepidotis; foliis alternis, circiter 20 cm longis, foliolis 7, oblongis, coriaceis, usque ad 10 cm longis, acutis vel brevissime acuminatis, basi acutis ad obtusis, subaequilateralibus, utrinque minute punctulatis, subtus ad costa et nervis cupreo-lepidotis, nervis lateralibus utrinque 8 vel 9, perspicuis, curvatis, evanescentibus vel obscure anastomosantibus, reticulis obsoletis; paniculis axillaribus, usque ad 18 cm longis, angustis; floribus 5-meris, racemose dispositis, circiter 3 mm diametro; fructibus anguste obovoideis, usque ad 2.5 cm longis, extus dense minuteque cupreo-lepidotis.

A tree about 5 m high, the younger branches, petioles, petiolules, midrib and lateral nerves on the lower surface of the leaflets, panicles, and fruits densely cupreous-lepidote. Leaves alternate, about 20 cm long; leaflets 7, oblong, coriaceous, minutely punctulate on both surfaces, rather pale when dry, shining, 5 to 10 cm long, 2.5 to 4 cm wide, subequally narrowed to the acute or obscurely acuminate apex and to the acute or somewhat obtuse base, the midrib very prominent on the lower surface; lateral nerves 8 or 9 pairs, prominent, curved, evanescent or obscurely anastomosing, the reticulations obsolete; petiolules 1 cm long or less. Panicles axillary, up to 20 cm long, narrow, the lower branches 3 cm long or less, the flowers racemously arranged on the ultimate branchlets, rather few. Flowers pink, 5-merous, their pedicels stout, 2 mm long or less. Calyx 2 mm long, ovoid, the lobes lepidote, obtuse, coriaceous. Petals 5, free, about 2 mm long, oblong-elliptic, rounded. Staminal-tube turbinate, free, 1 mm long, about 1.5 mm in diameter, truncate. Anthers 5 or 6, inserted on the edge of the tube, inflexed, 0.8 mm long. Fruits narrowly obovoid, dark-brown when dry, rounded, gradually narrowed below, up to 2.5 cm long, externally very densely and minutely cupreous-lepidote.

LUZON, Tayabas Province, Mount Dingalan, *Bur. Sci.* 26604 Ramos & Edaña, September 9, 1916, in forests, altitude about 300 meters.

A most characteristic species, distinguishable by its indumentum; its coriaceous punctulate leaflets; the prominent evanescent nerves; the obsolete reticulations; and its dark-brown, pyriform fruits.

AGLAIA PUNCTICULATA sp. nov. § *Hearnia*.

Frutex circiter 2 m altus, partibus junioribus foliolis subtus ad costa nervis et paniculis dense cupreo-lepidotis; foliis circiter

30 cm longis, foliis longe petiolatis, oblongis, usque ad 13 cm longis, coriaceis, utrinque punctulatis, breviter acute acuminatis, basi acutis ad obtusis, nervis utrinque circiter 10, curvatis, perspicuis, evanescentibus, reticulis obsolete; paniculis axillaribus, circiter 20 cm longis, anguste pyramidatis; floribus numerosis, graciliter pedicellatis, racemose dispositis, 5-meris, 1.5 mm diametro.

A shrub, said by the collector to be about 2 m high, the younger branches, petioles, petiolules, costa and nerves on the lower surface, and inflorescences densely cupreous-lepidote. Leaves alternate, about 30 cm long; leaflets 7, oblong, rather pale when dry, coriaceous, both surfaces minutely punctulate, 10 to 13 cm long, 2.5 to 5.5 cm wide, apex shortly acuminate, base acute to obtuse; lateral nerves 10 on each side of the midrib, prominent, curved, evanescent, the reticulations obsolete; petiolules 2 to 2.5 cm long. Panicles axillary, narrowly pyramidal, about 20 cm long, the lower branches up to 7 cm in length. Flowers numerous, 5-merous, racemosely disposed on the ultimate branchlets, 1.5 mm in diameter, their pedicels about 2 mm long, slender. Sepals orbicular-obovate, 1 mm in diameter, rounded, stellate-lepidote. Petals 5, free, 1.5 mm long, rounded. Staminal-tube turbinate, 1 mm in diameter, truncate, 0.6 mm long. Anthers 5, 0.6 mm long, inserted on the edge of the tube.

LUZON, Nueva Ecija Province, Mount Umingan, *Bur. Sci.* 26306 Ramos & Edaña, August 21, 1916, in forests, altitude about 400 meters, locally known as *amponayan*.

This species in its indumentum, its oblong, coriaceous, punctulate leaves, and its evanescent nerves, the reticulations obsolete, strongly resembles *Aglaiia pyriformis* Merr., and is manifestly allied to it. It differs from *Aglaiia pyriformis* in its larger leaves; larger leaflets, which have much longer petiolules; its longer panicle branches; and especially in its more numerous, much smaller, slenderly pedicelled flowers.

AGLAIA ROBINSONII sp. nov. § *Hearnia*?

Frutex 3 ad 4 m altus, partibus junioribus petiolis infructescentiis et fructibus densissime cupreo-stellato-tomentosis; foliis alternis, 12 ad 25 cm longis, foliis 7 ad 10, oppositis vel alternis, lanceolatis, chartaceis vel subcoriaceis, usque ad 7 cm longis, acuminatis, basi acutis, leviter inaequilateralibus, subtus ad costa densissime cupreo-tomentosis, ceteroquin glabra, nervis utrinque 7 ad 10, tenuibus, curvatis, anastomosantibus; infructescentiis axillaribus, brevibus, 1 ad 2 cm longis; fructibus ellipsoideis, 1.5 cm longis, densissime cupreo-tomentosis.

A shrub 3 to 4 m high, the branchlets, petioles, petiolules, midribs on the lower surface of the leaflets, very short infructes-

cences and fruits densely and uniformly stellate-tomentose with short, more or less spreading, cupreous hairs. Leaves alternate, 12 to 25 cm long; leaflets 7 to 10, alternate or opposite, lanceolate, subolivaceous or brownish-olivaceous when dry, somewhat shining, 4 to 7 cm long, 1 to 2 cm wide, subequally narrowed to the acute, somewhat inequilateral base and to the acuminate apex, chartaceous or subcoriaceous, glabrous except the midrib on the lower surface; lateral nerves 7 to 10 on each side of the midrib, slender, curved, anastomosing; petiolules 2 to 3 mm long, densely pubescent. Infructescences axillary, solitary, all parts densely cupreous-pubescent, the rather stout rachis 1 to 1.5 cm long, the infructescence reduced to a simple raceme. Fruits ellipsoid, 1.5 cm long, few, very densely cupreous-pubescent.

LUZON, Tayabas Province, Infanta, Mount Binuang, *Bur. Sci.* 9433 *Robinson*, August 28, 1909, in mossy forests, altitude 900 meters, *Bur. Sci.* 28634 *Ramos & Edaña*, May, 1917; Mount Dingalan, *Bur. Sci.* 26562 *Ramos & Edaña* (type), August 25, 1916, locally known to the Balugos as *ma-raampiit*.

A species well characterized by its lanceolate, small leaflets, its dense cupreous indumentum, and especially by its very short infructescences, which, including the ellipsoid fruits, scarcely exceed 2 cm in length.

AGLAIA TAYABENSIS sp. nov. § *Hearnia*.

Species *A. harmsianae* affinis differt foliis multo majoribus, usque ad 29 cm longis et 11 cm latis. Arbor, partibus junioribus et inflorescentiis dense subcastaneo-stellato-tomentosis; foliis usque ad 65 cm longis, alternis, foliis 7, oblongo-ellipticis, chartaceis, breviter acuminatis, basi obtusis ad subcordatis, utrinque ad costa stellato-tomentosis, nervis utrinque 15 ad 20; paniculis axillaribus, pyramidatis, pedunculatis, folia subaequantibus; floribus 5-meris, parvis, calycis extus stellato-tomentosis.

A tree about 8 m high, the young branchlets, petioles, inflorescences, and midrib on both surfaces of the leaflets densely subcastaneous-stellate-tomentose. Branches terete, brown, about 7 mm in diameter, tomentose. Leaves alternate, about 65 cm long. Leaflets 7, the lateral ones opposite, oblong-elliptic, chartaceous, brownish-olivaceous when dry, 25 to 29 cm long, 9.5 to 11 cm wide, the upper surface glabrous except for the stellate-tomentose midrib, the lower stellate-tomentose on the midrib and to a less degree on the lateral nerves, the base obtuse to rounded or subcordate, the apex shortly and abruptly acuminate; lateral nerves 15 to 20 on each side of the midrib, distinct, anastomosing, the reticulations lax, indistinct;

petiolules stout, densely stellate-tomentose. Panicles axillary, about as long as the leaves, densely stellate-tomentose, the indumentum subcastaneous, peduncled, the branches few, scattered, spreading, the lower ones up to 16 cm in length. Flowers rather densely crowded on the ultimate branchlets, 5-merous, in bud about 1 mm in diameter, the calyx externally stellate-tomentose, the lobes 1 mm long or less.

LUZON, Tayabas Province, Mount Tulaog, *Bur. Sci. 29133 Ramos & Edaño*, May 24, 1917, in forests near streams.

The alliance of this species is unmistakably with *Aglaia harmsiana* Perk., from which it differs chiefly in its very much larger leaflets.

AGLAIA GRANDIFOLIOLA sp. nov. § *Euaglaia*.

Arbor parva, partibus junioribus et inflorescentiis dense et pallide lepidotis, costa subtus parcissime lepidotis; foliis alternis, circiter 60 cm longis, foliolis circiter 5, oblongo-ellipticis, membranaceis, nitidis, acuminatis, usque ad 30 cm longis; paniculis axillaribus, paucifloris, 5 ad 6 cm longis; floribus magnis, 5-meris, circiter 5 mm longis; antheris 8, oblongis, 2 mm longis.

A small tree, 7 m high *vide* Ramos, the younger parts densely lepidote, the scales appressed, pale, small. Branches terete, brownish, smooth, about 5 mm in diameter, ultimately glabrous. Leaves alternate, about 60 cm long, the petioles and rachis rather densely pale-lepidote, the midrib on the lower surface of the leaflets sparingly lepidote. Leaflets about 5, membranaceous, brownish-olivaceous when dry, shining, oblong-elliptic, 20 to 30 cm long, 8 to 10 cm wide, base rounded to acute, that of the lateral ones inequilateral, apex slenderly acuminate; lateral nerves about 10 on each side of the midrib, prominent, curved, distant, anastomosing, the reticulations lax, indistinct. Panicles axillary, few-flowered, 5 to 6 cm long, densely pale-lepidote, the branches few, the lower ones 1.5 cm long or less, spreading. Flowers yellow, distinctly large for the genus, about 5 mm long, their pedicels short, stout, densely lepidote. Calyx about 3 mm long and wide, the lobes broadly ovate, obtuse, about 1.5 mm long, externally lepidote. Petals 5, free, obovate, glabrous, 5 to 5.5 mm long, apex rounded, base narrowed. Staminal-tube obovoid, 4 mm long, the anthers 8, oblong, 2 mm long, included.

LUZON, Tayabas Province, Umiray River, *Bur. Sci. 23981 Ramos & Edaño*, June 3, 1917, in forests along the river.

A strongly marked species, well characterized by its few, unusually large leaflets, which are entirely glabrous except for the sparingly lepidote midrib; its very short, few-flowered panicles; and its unusually large flowers.

AGLAIA LANCILIMBA sp. nov. § *Euaglaia*.

Arbor circiter 10 m alta, ramulis inflorescentiisque densissime cupreo-lepidotis; foliis circiter 25 cm longis, rhachibus petiolulisque dense cupreo-lepidotis; foliolis 11 ad 17, lanceolatis, acuminatis, usque ad 9 cm longis, in siccitate pallidis, nitidis, supra minutissime puncticulatis, in costa utrinque perspicue cupreo-lepidotis, nervis utrinque 10 ad 14, tenuibus, obscuris, reticulis obsolete; paniculis folia subaequantibus, anguste pyramidatis, multifloris; floribus 5-meris, racemose dispositis, 2.5 ad 3 mm longis.

A tree about 10 m high, the branches and branchlets, inflorescences, petioles, rachises, and petiolules, and the midrib on both surfaces of the leaflets conspicuously and densely cupreous-lepidote. Ultimate branches terete, cupreous, nearly smooth, about 6 mm in diameter. Leaves numerous, crowded near the apices of the branchlets, about 25 cm long, the rachis, petioles and petiolules densely and conspicuously cupreous-lepidote; leaflets 11 to 17, lanceolate, chartaceous, pale when dry, somewhat shining, apex slenderly acuminate, base somewhat inequilateral, acute, 7 to 9 cm long, 1.2 to 2 cm wide, the upper surface minutely puncticulate-pitted, the lower paler than the upper, conspicuously cupreous-lepidote on and along the midrib on both surfaces, with few, widely scattered scales on the epidermis; lateral nerves 10 to 14 on each side of the midrib, very slender, obscure, not anastomosing, the reticulations obsolete; petiolules 6 to 9 mm long. Panicles in the uppermost axils, narrowly pyramidal, nearly as long as the leaves, peduncled, all parts densely cupreous-lepidote, the lower branches up to 12 cm in length, the upper shorter. Flowers 5-merous, racemosely disposed on the ultimate branchlets, their pedicels 1.5 to 2.5 mm long. Sepals 5, suborbicular, densely cupreous-lepidote, about 1 mm in diameter. Petals 5, free, glabrous, about 3 mm long, oblong-elliptic to oblong-obovate, rounded, concave. Staminal-tube oblong-obovoid, 2.2 mm long, slightly crenate. Anthers 5 or 6, oblong, 1 mm long, inserted at about the middle of the tube, included.

LUZON, Camarines Province, Paracale, *For. Bur. 26509 De Mesa & Magistrado*, August 2, 1916, on low hills, altitude about 20 meters, locally known as *ibaiba*.

This very characteristic species is well marked by its dense, cupreous, lepidote indumentum and its narrow, pale leaves. It somewhat resembles *Aglai lanceolata* Merr. and *A. curranii* Merr., being most closely allied to the former. It is distinguished from both by its much larger flowers.

AGLAIA MIRANDAE sp. nov. § *Euaglaia*.

Species *A. stenophyllae* Merr. affinis, differt foliis multo brevioribus latioribusque, usque ad 12 cm longis et 4 cm latis, breviter obtuseque acuminatis, nervis minus numerosis, 10 ad 12 utrinque, inflorescentiis dense multifloris, e basi ramosis.

A small tree about 7 m high, the branchlets, petioles, inflorescences, and some other parts of the plant rather densely ferruginous-pubescent with short stellate hairs. Branches grayish, rather slender, ultimately glabrous. Leaves alternate, about 30 cm long, the petiole and rachis ferruginous-stellate-pubescent; leaflets alternate, or the uppermost ones opposite, usually 9, subchartaceous, oblong to somewhat oblong-obovate, 6 to 12 cm long, 2.5 to 4 cm wide, pale and shining when dry, the apex obscurely blunt-acuminate, the base acute to rounded, often more or less inequilateral; nerves 10 to 12 on each side of the midrib, slender, not anastomosing, the reticulations nearly obsolete, the midrib on the lower surface ferruginous-stellate-pubescent as are the 2 mm long petiolules. Panicles axillary, 2 to 5 cm long, pyramidal, branched from the base, densely many-flowered, the flowers yellowish, racemously arranged on the ultimate branchlets, 5-merous, their pedicels about 1 mm long. Calyx stellate-pubescent, the lobes ovate, obtuse, 0.5 mm long. Petals 5, free, glabrous, elliptic, rounded, about 1 mm long. Staminal-tube depressed-globose, glabrous, free, truncate, about 0.6 mm long, the anthers 5, included.

BASILAN, near Sangal, *For. Bur. 18970 Miranda*, October 1, 1912, in forests, altitude about 100 meters.

A species manifestly allied to *Aglaia stenophylla* Merr. of Samar, differing radically however in its very differently shaped, fewer-nerved leaflets. In its very abbreviated panicles it strongly resembles that species, but here differs in the panicles being very densely many-flowered and branched from the base.

AGLAIA MYRIANTHA sp. nov. § *Euaglaia*.

Arbor parva, partibus junioribus, petiolis, petiolulis et inflorescentiis dense pallide stellato-tomentosis; foliis alternis, circiter 45 cm longis, foliolis circiter 15, lanceolatis ad oblongo-lanceolatis, tenuiter acuminatis, basi valde inaequilateralibus, usque ad 11 cm long, in siccitate pallidis, nitidis, nervis utrinque circiter 12, tenuibus, distinctis; paniculis axillaribus, folia subaequantibus, pedunculatis, multifloris; floribus numerosis, sessilibus, in ramulis ultimis glomeratim dispositis, 5-meris, sepalis extus stellato-tomentosis, circiter 1 mm longis.

A small tree, the younger parts, petioles, rachis, petiolules, midrib on the lower surface of the leaflets, and the ample inflorescences densely and uniformly stellate-tomentose with short, pale-brownish or grayish-brown hairs. Branches thickened, the ultimate ones at least 8 mm in diameter. Leaves crowded toward the apices of the branchlets, about 45 cm long; leaflets opposite and alternate, pale-brownish when dry, slightly shining, of the same color on both surfaces, subcoriaceous, lanceolate to oblong-lanceolate, 8 to 11 cm long, 2.5 to 3 cm wide, slenderly acuminate, base strongly inequilateral, acute, or acute on one side and somewhat rounded on the other, the lowermost ones shorter than the others; the midrib beneath, and sometimes also on the upper surface, stellate-tomentose; lateral nerves slender, somewhat curved, obscurely anastomosing, about 12 on each side of the midrib, the reticulations obscure; petiolules 5 to 8 mm long. Panicles axillary, as long as the leaves, peduncled, the lower branches up to 20 cm long, the branchlets densely flowered, the flowers somewhat glomerate on the spike-like ultimate branchlets. Flowers 5-merous, minute, very numerous, the sepals ovate, pubescent, about 1 mm long. Petals 5, free, when young orbicular-ovate, about 1 mm in diameter.

LUZON, Tayabas Province, Mount Dingalan, *Bur. Sci.* 26593 Ramos & Edaña, August 27, 1913, in forests, altitude about 160 meters, locally known as *sarorongan*.

A species not closely allied to any other known to me, well characterized by its long leaves and panicles, narrow, pale, very inequilateral leaflets, and very numerous, sessile glomerate flowers on the spike-like ultimate branchlets.

AGLAIA ELAEAGNOIDEA (Juss.) Benth. *Fl. Austral.* 1 (1863) 383; *C. DC. Monog. Phan.* 1 (1878) 611.

PALAWAN, *For. Bur.* 3323 Curran, March, 1906, from flat forests back of the beach, *Phil. Pl.* 1275 Merrill, *Bur. Sci.* 21535 Escritor. JOLO, *For. Bur.* 22524 Klemme, August, 1912, in level open forests near the sea. BASILAN *For. Bur.* 13260 Foxworthy, DeMesa, & Villamil, June, 1912 (sterile), along the seashore, *Bur. Sci.* 16089 Reillo, *For. Bur.* 18853 Miranda, August, 1912, back of the mangrove. MALAMAUI, *Bur. Sci.* 16376 Reillo, *For. Bur.* 18880 Miranda. SIBUTU, *For. Bur.* 20818 Ferraris & Stadtmiller. BALABAC, *Weber s. n.*

The specimens are rather characteristic, and appear to be decidedly uniform in essential characters; they agree closely with specimens from the Malay Archipelago and from Queensland. Its habitat is apparently characteristic.

The species is new to the Philippines, although I have previously described a variety from the Batanes Islands. I am now of the opinion that this northern form is specifically distinct, and herewith raise it to specific rank.

AGLAIA PALLENS (Merr.) comb. nov.

*Aglai*a *elaeanoidea* Benth. var. *pallens* Merr. in Philip. Journ. Sci. 3 (1908) Bot. 413.

BATANES ISLANDS, Batan, *Bur. Sci.* 3831 *Fénix*, June, 1907; *For. Bur.* 19365 *Agudo*, May, 1909, locally known as *alui*. BABUYAN ISLANDS, Camiguin, *Bur. Sci.* 4122 *Fénix*, July, 1907.

This species differs from *Aglai*a *elaeanoidea* Benth. especially in its much smaller leaves.

CHISOCHETON Blume**CHISOCHETON (DASYCOLEUM) PARVIFOLIOLUS** sp. nov.

Arbor parva, inflorescentiis exceptis glabra; foliis usque ad 25 cm longis, foliolis usque ad 14, oppositis, coriaceis, oblongis, usque ad 10 cm longis, obtuse acuminatis, in siccitate pallidis, nervis utrinque 10 ad 12, subtus valde perspicuis, subpatulis; infructescentiis axillaribus, longe pedunculatis, folia subaequantibus, puberulis; fructibus globosis vel depresso-globosis, 1.5 ad 2 cm diametro, pericarpio puberulo.

A small tree, glabrous except the more or less cinereous-puberulent inflorescence and younger parts. Branches terete, rather stout, the ultimate ones 5 to 7 mm in diameter, wrinkled when dry, grayish. Leaves alternate, up to 25 cm in length, the leaflets usually about 7 pairs, opposite, coriaceous, oblong, pale when dry, 7 to 10 cm long, 2.5 to 3.5 cm wide, somewhat inequilateral, apex obtusely acuminate, base distinctly inequilateral, rounded on both sides; lateral nerves 10 to 12 on each side of the midrib, spreading, very prominent; petiolules 2 to 3 mm long. Infructescences axillary, long-peduncled, about as long as the leaves, narrowly pyramidal, fruit bearing only in the upper one-third, the primary branches at most 3 cm long, spreading. Fruits globose or depressed-globose, pale-brownish when dry, 1.5 to 2 cm in diameter, puberulent, smooth, indehiscent, usually containing two seeds.

LUZON, Ilocos Sur Province, Tineg, Lagayan, *For. Bur.* 25467 *Paraiso*, March 20, 1915, on slopes, altitude about 300 meters, locally known as *palatangan*.

A species closely allied to *Chisocheton philippinus* Harms., from which it is distinguished by its much smaller, very prominently nerved leaflets.

DYSOXYLUM Blume**DYSOXYLUM HEXANDRUM** sp. nov. § *Eudissoxylum*.

Arbor, inflorescentiis exceptis glabra; foliis alternis, 30 ad 80 cm longis, foliolis alternis vel superioribus suboppositis, chartaceis, olivaceis, in siccitate utrinque minutissime verrucosis, oblongis ad oblongo-ovatis vel oblongo-ellipticis, plerumque cir-

citer 20 cm longis, acuminatis, nervis utrinque 9 ad 12, perspicuis; inflorescentiis axillaribus, depauperato-paniculatis, 12 ad 20 cm longis, ramis paucis; floribus 4-meris, circiter 1 cm longis, petalis extus pubescentibus, liberis; antheris 6; ovario pubescente.

A tree, at least 6 m high, probably higher, glabrous except the inflorescences. Branches grayish to brownish, the ultimate ones 5 to 10 mm in diameter. Leaves alternate, distant, 30 to 80 cm long; leaflets alternate, or the upper ones subopposite, chartaceous, olivaceous and rather dull when dry, both surfaces minutely verruculose, oblong to oblong-ovate or oblong-elliptic, 15 to 30 cm long (mostly about 20 cm), 6 to 11 cm wide; lateral nerves 9 to 12 on each side of the midrib, prominent, somewhat curved, obscurely anastomosing, the reticulations nearly obsolete. Panicles axillary, cinereous-pubescent, sparingly branched, 12 to 20 cm long, the lower branches 6 cm long or less. Flowers white, 4-merous, their pedicels 2 to 4 mm long. Calyx somewhat pubescent, 3 mm in diameter, shallow, somewhat 4-angled, obscurely 4-toothed. Petals 4, narrowly oblong, obtuse, pubescent externally, 10 mm long, 2.5 to 2.8 mm wide, free. Staminal-tube cylindric, glabrous on both surfaces, 9 mm long, crenulate. Anthers 6, about 1 mm long, included, inserted near the top of the tube. Disk cylindric, glabrous, crenulate, 3 to 3.5 mm long. Ovary ovoid, pubescent; style pubescent, about 7 mm long. Fruit obovoid, reddish-yellow, brown when dry, rather hard, 6 to 7 cm long, 5 to 6 cm in diameter.

CATANDUANES, *Bur. Sci.* 30214 (type), 30272 Ramos, November, 1917, in forests. SAMAR, Catubig River, *Bur. Sci.* 24392 Ramos, February, 1916, with the Visayan name *dalaganan*.

This species greatly resembles *Dysoxylum platyphyllum* Merr. in its vegetative and inflorescence characters, but is readily distinguished by its petals being pubescent outside and glabrous within; its entirely glabrous staminal tube; its six anthers; and its minutely and uniformly verruculose leaflets.

DYSOXYLUM ILOCANUM sp. nov. § *Eudysoxylum*.

Arbor parva, ramulis et foliis et inflorescentiis plus minusve griseo-puberulis vel pubescentibus; foliis alternis, circiter 25 cm longis, foliolis 6 vel 8, oppositis, oblongo-ellipticis vel subellipticis, usque ad 10 cm longis, subcoriaceis, in siccitate pallidis, basi rotundatis, leviter inaequilateralibus, apice obtusis ad obscure acuminatis, nervis lateralibus utrinque circiter 14, subtus valde perspicuis; inflorescentiis axillaribus, solitariis, 5 ad 7 cm longis, racemosis vel depauperato-paniculatis; floribus 4-meris, circiter 7 mm longis, petalis liberis, ovario pubescente.

A small tree, rather prominently grayish-puberulent or pubes-

cent. Branches terete, the ultimate ones about 5 mm in diameter, pale-brownish, pubescent, the branchlets very densely and uniformly grayish-pubescent with short hairs, a similar indumentum on the petioles, petiolules, and inflorescences. Leaves alternate, about 25 cm long, the leaflets opposite, 3 or 4 pairs, pale when dry, oblong-elliptic to subelliptic, subcoriaceous, mostly 8 to 10 cm long and 4 to 5.5 cm wide, base somewhat inequilateral, rounded, apex obtuse to obscurely acuminate, the upper surface glabrous except for the pubescent midrib, the midrib and lateral nerves on the lower surface sparingly pilose with spreading hairs; lateral nerves somewhat impressed on the upper surface, very prominent on the lower surface, about 14 on each side of the midrib, slightly curved, obscurely anastomosing, the reticulations subobsolete. Inflorescences axillary, solitary, pubescent, 5 to 7 cm long, simple, racemose or the nodes somewhat projecting and forming a very depauperate, raceme-like panicle. Flowers about 7 mm long, 4-merous, somewhat crowded at the nodes, their pedicels about 1 mm long. Calyx-lobes ovate, acute to obtuse, about 1.5 mm long, free nearly to the base, slightly pubescent. Petals 4, oblong, obtuse, free, 7 mm long, 3 mm wide, externally very obscurely pubescent. Staminal-tube cylindric, 6 mm long, glabrous, free, obscurely crenate; anthers 8, 1 mm long, included. Disk cup-shaped, 2 mm long and wide, margins slightly undulate, glabrous outside, somewhat pubescent inside. Ovary pubescent; style pubescent in the lower one-half, glabrous above, including the ovary about 6 mm long.

LUZON, Ilocos Norte Province, Dilumut, Pasaquin, *For. Bur.* 25091 *Paraiso*, February 18, 1916, on slopes, altitude about 300 meters, locally known as *aducag*.

A characteristic species belonging in the group with *Dysoxylum vrieseanum* C. DC. It is most closely allied to *Dysoxylum wenzelii* Merr., of Leyte, but is readily distinguishable by its more numerous nerved leaves and different indumentum.

DYSOXYLUM PANAYENSE sp. nov. § *Eudysoxylum*.

Arbor circiter 13 m alta, ramulis junioribus et inflorescentiis dense minuteque cupreo-puberulis; foliis alternis, usque ad 45 cm longis, petiolis et costa et petiolulis in siccitate purpureo-brunneis; foliolis alternis vel suboppositis, circiter 8, oblongis, subcoriaceis, in siccitate olivaceis, fragilis, utrinque dense verruculosus, usque ad 14 cm longis, base inaequilateralibus, decurrento-acuminatis, apice tenuiter subcaudato-acuminatis, nervis utrinque circiter 12; inflorescentiis axillaribus, spiciformis, usque ad 18 cm longis; floribus fasciculatis, 4-meris, breviter

pedicellatis, circiter 7 mm longis, petalis extus puberulis, liberis; disco cylindrico, crenato, glabro; ovario pubescente, 3-loculare.

A tree about 13 m high, glabrous except the minutely but densely cupreous-puberulent branchlets, younger parts, and inflorescences. Branches pale-brownish, about 8 mm in diameter. Leaves alternate, up to 45 cm in length, the petioles, rachis, petiolules, and midribs of the leaflets purplish-brown when dry; leaflets about 8, alternate or subopposite, oblong, subcoriaceous, brittle when dry, olivaceous, both surfaces densely and minutely verruculose, 10 to 14 cm long, 4 to 5 cm wide, base prominently inequilateral, decurrent-acuminate, apex rather slenderly subcaudate-acuminate; lateral nerves about 12 on each side of the midrib, distinct, slightly curved, not anastomosing, the reticulations obsolete. Inflorescences axillary, solitary, up to 18 cm long, spikelike, the rachis brownish-purple when dry. Flowers 4-merous, white, about 7 mm long, somewhat crowded on the very slightly produced nodes, their pedicels stout, 1 to 1.5 mm long. Calyx slightly pubescent, broadly and shallowly 4-toothed, about 2 mm in diameter. Petals oblong, free, 7 mm long, 2 mm wide, externally puberulent. Staminal-tube cylindric, free, glabrous, crenate, 6 mm long; anthers 8, about 0.9 mm long. Disk cylindric, crenate, glabrous, 2 mm long. Ovary narrowly ovoid, pubescent, 3-celled; style about 5 mm long.

PANAY, Capiz Province, *For. Bur.* 23951 *Hirro*, February 13, 1915, in dipterocarp forests near streams at an altitude of about 400 meters, locally known as *balic*.

A species manifestly closely allied to *Dysoxylum palawanense* Merr., which it greatly resembles. It is readily distinguished, however, by its brownish-purple branchlets, petioles, petiolules, midribs, and inflorescences, its somewhat caudate-acuminate leaflets, and its cylindric, crenate disk.

VAVAEA Bentham

This genus, long considered to be a typical Polynesian one, is apparently as well or even better represented in the Malayan region than in Polynesia. At least one species is widely distributed in the Malay Archipelago, represented by numerous collections, as yet unidentified, in the Buitenzorg herbarium. In Java is also found *Vavaea bantamensis* (Koord. & Val.) Koord. & Merr., originally described, from fruiting specimens, as a species of *Vitex*, while at least eight species are represented in our Philippine collections. The previously described species are *Vavaea amicorum* Benth., *V. harveyi* Seem., and *V. megaphylla* C. H. Wright, of Fiji and the Friendly Islands; *V. papuana* F. M. Bailey, of New Guinea; *V. chalmersii* C. DC., of New Guinea; *V. pauciflora* Volk., of the Caroline Islands; *V. bantamensis* Koord. & Merr., of Java; and *V. surigaoensis* Elm. and *V. ardisioides* Elm., of Mindanao. At least in the Philippines, the species do not appear to be sharply defined, as in some cases specimens are found presenting intermediate characters between rather distinct types.

VAVAEA AMICORUM Benth. in Hook. Lond. Journ. Bot. 2 (1843) 212;
A. Gray Bot. Wilkes U. S. Explor. Exped. (1854) 44, t. 16, f. B.

LUZON, Zambales Province, *For. Bur.* 6503 Aguilar, Hallier s. n.: Nueva Ecija Province, *For. Bur.* 22354 Alvarez, *Bur. Sci.* 12316 Foxworthy: Batangas Province, *For. Bur.* 7680 Merritt & Curran. MINDORO, *For. Bur.* 9811 Merritt. NEGROS, *For. Bur.* 22892 Vergara & Cardona. SAMAR, *For. Bur.* 22688 Oro, *Bur. Sci.* 17574 Ramos. BASILAN, *Bur. Sci.* 16312 Reillo, *For. Bur.* 9524 Hutchinson. JOLO, *For. Bur.* 22532 Klemme. PALAWAN, Elmer 12970, as *Vavaea harveyi* Seem.

My conception of *Vavaea amicorum* Benth. is based on the descriptions and Gray's figure cited above. The Philippine specimens, some of which have been referred to *Vavaea harveyi* Seem., appear to me to agree much better with the characters of Bentham's species than with Seemann's.

VAVAEA SURIGAOENSIS Elm. Leaf. Philip. Bot. 8 (1915) 2768.

In addition to the two specimens cited by Mr. Elmer in the original description, I refer here the following:

LUZON, Tayabas Province, *Bur. Sci.* 20846 Escritor, *Bur. Sci.* 13208 Foxworthy & Ramos, *Bur. Sci.* 19414, 19470 Ramos. SAMAR, *Bur. Sci.* 17482 Ramos. MINDANAO, Surigao Province, Placer, Ahern 405.

The species is very closely allied to both *Vavaea harveyi* Seem. and *V. amicorum* Benth. and is by no means always easy to distinguish from the latter as interpreted above.

VAVAEA ARDISIODES Elm. Leaf. Philip. Bot. 8 (1915) 2767.

This is very similar to *Vavaea amicorum* Benth., but with much smaller leaves.

VAVAEA RETUSA sp. nov.

Arbor circiter 15 m alta, partibus junioribus et inflorescentiis exceptis glabra; foliis obovatis, perspicue retusis, basi angustatis, acutis, usque ad 12 cm longis, nervis utrinque 8 ad 10, rectis, distinctis; inflorescentiis axillaribus, solitariis, pedunculatis, circiter 4 cm longis, fructibus parcissime pilosis.

A tree about 15 m high. Branches terete, brownish or grayish, wrinkled when dry, glabrous, the branchlets rather prominently pubescent with subappressed olivaceous-brownish hairs, a similar indumentum on the petioles and inflorescence. Leaves chartaceous, obovate, pale when dry, shining, glabrous, or the midrib sparingly pubescent, 6 to 12 cm long, 5 to 7.5 cm wide, base broadly rounded and prominently retuse, gradually narrowed from about the upper one-third to the acute base; lateral nerves 8 to 10 on each side of the midrib, straight, slightly ascending, distinct; petioles about 8 mm long. Cymes axillary, solitary, in fruit about 4 cm long, pubescent, each bearing few fruits, the branches few, short. Persistent calyx pubescent externally, the teeth broad, acute. Fruits subglobose, purplish when fresh, brownish when dry, about 8 mm in diameter, externally very sparingly pubescent.

NEGROS, Malabunhao, near San Carlos, *For. Bur. 23402 Contreras*, July 15, 1914, in rocky soil in the hills, altitude about 200 meters, locally known as *saguibunon*.

This species is characterized especially by its strongly obovate, broadly rounded, and very prominently retuse leaves. It is manifestly very closely allied to *Vavaea amicorum* Benth. and *V. harveyi* Seem.

VAVAEA PILOSA sp. nov.

Arbor parva, partibus junioribus et inflorescentiis et foliis praesertim subtus ad costa nervisque perspicue subferrugineo ciliato-pilosis; foliis firme chartaceis, in siccitate pallidis, obovatis ad oblong-obovatis, usque ad 20 cm longis, apice acutis, breviter acuminatis, vel subrotundatis, basi angustatis, cuneatis, nervis utrinque circiter 15, curvatis, perspicuis; inflorescentiis dense pubescentibus, axillaribus, numerosis, longe pedunculatis, circiter 10 cm longis; floribus 8 ad 10 mm longis, petalis puberulis, filamentis dense pilosis.

A small tree, apparently deciduous, the inflorescences usually appearing with the young leaves, the younger parts, inflorescences, and the leaves beneath prominently ciliate-pilose with spreading subferruginous hairs. Branches terete, brownish, glabrous, the branchlets marked with prominent petiolar scars, densely pubescent. Leaves crowded at the apices of the branchlets, obovate to oblong-obovate, 11 to 20 cm long, 5 to 9 cm wide, firmly chartaceous, pale when dry, shining, the apex acute, somewhat acuminate, or sometimes rounded or obtuse, base gradually narrowed, cuneate, the midrib on the upper surface rather densely pubescent, otherwise glabrous, or the nerves with few scattered hairs, the lower surface rather softly and densely pubescent with spreading hairs especially on the midrib and lateral nerves; lateral nerves about 15 on each side of the midrib, prominent, somewhat curved, anastomosing; petioles densely pubescent, 1 to 1.5 cm long. Cymes numerous, solitary, in the upper axils, about 10 cm long, densely pubescent, long-peduncled, the flower-bearing portion usually less than 3 cm long, the branches few, somewhat spreading, the inflorescences rarely exceeding 5 cm in diameter. Flowers white or yellowish-white, 4- and 5-merous. Calyx densely pubescent, about 4 mm long, the lobes 4 or 5, acute, 1 to 2 mm long. Petals 4 or 5, oblong, obtuse, puberulent externally, 8 to 10 mm long. Staminal-tube 1.5 to 2 mm long, glabrous externally; stamens 10 or 12, alternate ones slightly shorter than the others, the free parts of the filaments densely pubescent, about 2 mm long; anthers ovoid, about 0.5 mm long. Ovary ovoid, pubescent, 3-, sometimes 4-celled; style rather stout, about 4 mm long. Fruit subovoid,

brownish when dry, about 8 mm long, externally very slightly pubescent.

LUZON, Rizal Province, Bosoboso, Montalban, and Tanay, *For. Bur.* 3094 (type), 3391 *Ahern's collector*, Merrill 2652, 2329, *Bur. Sci.* 2135 Ramos, *Loher* 6172: Bulacan Province, Angat, *Bur. Sci.* 22302 Ramos. Apparently referable here are *Phil. Pl.* 1589 Ramos, from Camarines Province; Merrill 9647, from Benguet Subprovince; *For. Bur.* 20189 Aguilar, from Tayabas Province; and *For. Bur.* 14872 Darling, from Nueva Vizcaya Province, Luzon.

A species not strikingly different from *Vavaca amicorum* Benth., distinguished, however, by its prominent indumentum, which is composed of subferruginous, spreading, ciliate-pilose hairs.

VAVAEA HETEROPHYLLA sp. nov.

Arbor circiter 12 m alta, partibus junioribus et inflorescentiis exceptis glabra; foliis confertis, majoribus obovatis, usque ad 15 cm longis, apice latissime rotundatis, nervis utrinque circiter 8, minoribus oblongis ad obovatis, 2 ad 6 cm longis, omnibus breviter petiolatis; inflorescentiis in axillis superioribus, longe pedunculatis, cymosis, circiter 10 cm longis; petalis 1 cm longis; filamentis plerumque 12, intus densissime villosis, tubo glabro, 2 mm longo.

A tree about 12 m high, the younger parts and inflorescences more or less pubescent. Branches reddish-brown, rugose, 6 to 8 mm in diameter, glabrous, the branchlets somewhat cinereous-pubescent. Leaves crowded at the apices of the branchlets, very diverse in size, the larger ones broadly obovate, 8 to 15 cm long with about 8 pairs of primary nerves, apex broadly rounded, gradually narrowed below to the acute or subacute base, the smaller ones oblong to obovate, 2 to 6 cm long, all chartaceous, pale to brownish when dry, glabrous or the younger ones somewhat pubescent along the midrib on both surfaces, the lower surface somewhat punctulate; petioles pubescent, 4 mm long or less. Cymes in the uppermost axils, long-peduncled, 9 to 11 cm long, more or less pubescent, many-flowered, each cyme about 4 cm in diameter. Flowers pinkish-white, fragrant. Calyx pubescent, about 4 mm in diameter, usually 5-angled or toothed. Petals 5, oblong, puberulent, about 10 mm long, 3 to 4 mm wide. Staminal-tube glabrous, about 2 mm high, the filaments usually 12, 2.5 to 3 mm long, the alternate ones slightly shorter than the others, densely villous inside. Ovary and style pubescent, the latter 5 to 5.5 mm long; stigma capitate.

LUZON, Camarines Province, Paracale, Casalongan, *For. Bur.* 27062 *Magistrado*, May 12, 1917, on forested slopes, altitude about 20 meters, with the local name *pinganpingan*.

This species is well characterized by its short-petioled, chartaceous

leaves, which are truncately rounded at the apex and which vary exceedingly in size and somewhat in shape. It is apparently most closely allied to *Vavaea pachyphylla* Merr., but its leaves are entirely different in texture and have much shorter petioles than is the case with the latter species.

VAVAEA PACHYPHYLLA sp. nov.

Frutex vel arbor parva, ramis incrassatis, partibus junioribus et inflorescentiis plus minusve adpresse fulvo-pubescentibus; foliis crasse coriaceis, obovatis, usque ad 13 cm longis, apice latissime rotundatis, basi acutis, nitidis, nervis utrinque 7 vel 8, perspicuis, subtus ad costa nervisque pubescentibus; cymis sub fructu longe pedunculatis, parvis, 2.5 ad 3.5 cm diametro, fructibus glabris, ovoideis, circiter 1 cm longis.

A shrub or small tree (2 to 3 m high *vide* Ramos), the branches stout, brown, about 1 cm in diameter, the branchlets 5 to 7 mm in diameter, or sometimes as thick as the branches, often marked with numerous petiolar scars, glabrous except the growing tip which is rather densely pubescent with pale-fulvous appressed hairs. Leaves thickly coriaceous, rather pale when dry, obovate to broadly obovate, 9 to 13 cm long, 6 to 9 cm wide, shining, the apex broadly rounded, the base narrowed, acute, the upper surface smooth, glabrous except for the pubescent midrib, the lower surface distinctly reticulate, the veinlets raised, appressed-pubescent on the midrib and lateral nerves; nerves 7 or 8 on each side of the midrib, very prominent, curved, anastomosing; petioles stout, pubescent, 1 to 1.5 cm long. Fruiting peduncles axillary, solitary, 8 to 10 cm long, sparingly pubescent, the cymes 2.5 to 3.5 cm long and wide, the bracts subtending the primary branches oblong, pubescent, up to 1 cm in length. Primary branches few, stout, somewhat pubescent. Fruits ovoid, glabrous, about 1 cm long, the persistent calyx appressed-pubescent with pale-fulvous hairs.

LUZON, Tayabas Province, Mount Binuang, *Bur. Sci.* 28816 Ramos & Edaña, May 11, 1917, in the mossy forest, altitude apparently about 1,000 meters. I refer here without hesitation *Bur. Sci.* 28757 Ramos & Edaña, from the same locality, a specimen with juvenile, yet thickly coriaceous, leaves 5 to 6 cm in length, and rather densely pubescent inflorescences with very young flowers.

The species is a most characteristic one and is readily distinguishable by its very thickly coriaceous, obovate leaves which are broadly rounded at their apices.

BURSERACEAE

CANARIUM Linnaeus

CANARIUM MICROPHYLLUM sp. nov. § *Choriandra*.

Arbor parva, plus minusve puberulis vel pubescentibus; foliis usque ad 17 cm longis, foliolis circiter 11, parvis, oblongo-ovatis,

chartaceis, integris, usque ad 5 cm longis, apice tenuiter subcaudato-acuminatis, basi acutis, inaequilateralibus, nervis utrinque circiter 8, perspicuis; inflorescentiis ♂ axillaribus, circiter 6 cm longis, racemosis, floribus ad nodis fasciculatis; calycis parce cinereo-pubescentibus, 3 mm longis, 3-lobatis; staminibus 6, liberis; disco villosa.

A small tree, 5 m high *vide* Ramos, the branchlets, inflorescences, and parts of the leaves puberulent, the tips of the branchlets also rather densely villous. Branches glabrous, terete, brownish, the ultimate ones 3 to 4 mm in diameter. Leaves alternate, about 17 cm long, the rachis and petiole puberulent as are the midribs on both surfaces and nerves beneath; leaflets usually 11, oblong-ovate, chartaceous, brownish-olivaceous, shining, 4 to 5 cm long, 1.5 to 2 cm wide, inequilateral, entire, the apex slenderly subcaudate-acuminate, the acumen blunt, base acute; primary nerves about 8 on each side of the midrib, prominent, curved, anastomosing; petiolules 3 to 5 mm long; stipules none. Inflorescences in the uppermost axils, about 6 cm long, slender, somewhat pubescent, the flowers fascicled at the nodes in the upper part, their pedicels 1 to 1.5 mm long, pubescent. Calyx about 5 mm long, the lobes 3, broadly ovate, obtuse, slightly pubescent. Stamens 6, inserted outside of the villous disk, free.

CATANDUANES, *Bur. Sci.* 30351 Ramos, December 10, 1917, in forests back of Calolbong at low altitudes.

This species is well characterized by its unusually small, entire, slenderly subcaudate-acuminate leaflets, these being distinctly smaller than are those of any other described Philippine species. It is closely allied to *Canarium euryphyllum* Perk., differing in its indumentum and in its smaller leaves; *Canarium euryphyllum* Perk. is entirely glabrous.

SANTIRIA Blume

SANTIRIA ELLIPTIFOLIA sp. nov.

Arbor glabra, circiter 20 m alta; foliis alternis, usque ad 35 cm longis, foliolis 9 ad 13, subcoriaceis, ellipticis ad oblongo-ellipticis, olivaceis, nitidis, usque ad 16 cm longis, apice obtusis ad latissime et breviter acuminatis, basi rotundatis vel truncatis, saepe plus minusve inaequilateralibus, nervis utrinque circiter 11, patulis, curvatis, distinctis; paniculis axillaribus, solitariis, circiter 20 cm longis, e basi ramosis, amplis, multifloris; floribus parvis, petalis ovatis, circiter 2.8 mm longis.

A glabrous tree about 20 m high, the ultimate branches terete, brownish, lenticellate, about 8 mm in diameter. Leaves alternate, up to 35 cm in length, the rachis dark reddish-brown; leaflets 9 to 11, opposite, subcoriaceous, elliptic to oblong-elliptic, entire, 9 to 16 cm long, 4.5 to 7 cm wide, olivaceous when dry,

shining, the apex obtuse to broadly and shortly acuminate, base rounded to truncate, often inequilateral; primary nerves about 11 on each side of the midrib, slender but distinct, spreading, curved, anastomosing, the reticulations distinct on the lower surface; petiolules 2 to 2.5 cm long. Panicles axillary, solitary, branched at or from near the base, up to 20 cm long, the primary branches up to 10 cm in length. Flowers numerous, greenish-yellow, fragrant, the buds obovoid. Calyx with three very short rounded teeth. Petals ovate, about 2.8 mm long and 2 mm wide. Stamens 6, their filaments about 1 mm long, inserted outside of the conspicuous disk which is about 1.5 mm in diameter and 6-angled.

LUZON, Camarines Province, Paracale, *For. Bur. 27097 Alambra*, March 22, 1918, in dipterocarp forests, altitude about 50 meters.

Among the Philippine species this form is well characterized by its elliptic to oblong-elliptic leaflets and its ample inflorescences.

CELASTRACEAE

MICROTROPIS Wallich

MICROTROPIS PHILIPPINENSIS sp. nov.

Frutex glaber, ramis teretibus, ramulis leviter compressis et obscure sulcatis ad distincte 4-angulatis; foliis chartaceis, oblongo-ellipticis, usque ad 11 cm longis, in siccitate pallidis, nitidis, utrinque subaequaliter angustatis, acuminatis, nervis primariis utrinque 6 ad 8, distantibus, arcuato-anastomosantibus; cymis axillaribus, ut videtur paucifloris, breviter pedunculatis; fructibus oblongo-ovoideis, circiter 1.5 cm longis, acuminatis, sepalis 5, persistentibus reniformibus, 2.5 ad 3 mm latis.

A glabrous shrub, the branches terete, the branchlets somewhat compressed and obscurely sulcate to distinctly 4-angled, reddish-brown. Leaves opposite, chartaceous, pale when dry, shining, in general oblong-elliptic, acuminate and subequally narrowed at both ends, 8 to 11 cm long, 3 to 5 cm wide; primary lateral nerves 6 to 8 on each side of the midrib, distant, lax, rather distinct on the lower surface, arched-anastomosing, the reticulations lax; petioles 8 to 10 mm long. Cymes axillary, few-flowered, shortly peduncled, usually dichotomously branched, the two primary branches each bearing a single fruit, the peduncles 5 cm long or less, the branches somewhat shorter than the peduncles. Persistent sepals 5, reniform, rounded or retuse, about 2 mm long, 2.5 to 3 mm wide. Fruits reddish-yellow when fresh, when dry dark reddish-brown, oblong-ovoid, prominently acuminate, about 1.5 cm long, 5 to 8 mm in diameter.

CATANDUANES, Mount Mariguison, *Bur. Sci. 30580 Ramos*, November 30, 1917, on forested slopes.

This is the third species of the genus to be found in the Philippines, and is most closely allied to *Microtropis platyphylla* Merr., from which it is distinguished by its smaller, differently shaped, and fewer-nerved leaves; and by its short-peduncled, few-flowered cymes.

VITACEAE

LEEA Linnaeus

LEEA PAPILLOSA sp. nov.

Frutex circiter 2 m altus, ramis et petiolis et rhachibus et inflorescentiis perspicue firmiter papillois, papillis rigidis, simplicibus vel furcatis, usque ad 2 mm longis; foliis tripinnatis, usque ad 60 cm longis, foliolis chartaceis ad subcoriaceis, oblongis, usque ad 18 cm longis, subabrupte caudato-acuminatis, margine perspicue serratis; infructescentiis amplis, laxis, diffusis, usque ad 25 cm longis, pedunculatis; fructibus globosis, glabris, in siccitate nigris, plus minusve rugosis, circiter 8 mm diametro, calycis lobis 5, subpersistentibus.

A shrub about 2 m high, the branches, branchlets, petioles, rachises and secondary rachises of the leaves, and the inflorescences conspicuously papillate, the papillae numerous, stiff, rigid, simple or forked, up to 2 mm long, all these parts dark-brown when dry, the ultimate branches about 5 mm in diameter. Leaves tripinnate, up to 60 cm long, the primary pinnae few, usually 4 or 5, the lower ones up to 35 cm in length. Leaflets in general oblong, firmly chartaceous to subcoriaceous, 9 to 18 cm long, 4 to 6 cm wide, glabrous except the midrib beneath, which is usually supplied with scattered tufts of short hairs and with small papillae, rather pale-olivaceous, shining, the apex rather abruptly caudate-acuminate, the acumen slender, blunt, 1.5 to 2 cm long, the base usually rounded; lateral nerves 8 to 12 on each side of the midrib, prominent, anastomosing, the reticulations prominent. Infructescences diffuse, lax, up to 25 cm in length, their peduncles about 5 cm long, all parts papillate with processes similar to those on the petioles and branches. Fruits globose, glabrous, black and somewhat rugose when dry, about 8 mm in diameter, the subpersistent calyx-lobes 5.

CATANDUANES, *Bur. Sci. 20338 Ramos*, December 8, 1917, along small streams in forests back of Calolbong at low altitudes.

This species is remarkable for the numerous, short, simple or forked, stiff, rigid papillae or papilla-like protuberances on the branches, branchlets, leaves, and inflorescences, in this particular character differing from all other described species of the genus known to me.

STERCULIACEAE

FIRMIANA Marsigli

FIRMIANA SIMPLEX (Linn.) W. F. Wight in U. S. Dept. Agr. Bur. Pl. Ind. Bull. 142 (1909) 67.

Hibiscus simplex Linn. Sp. Pl. ed. 2 (1763) 977.

Sterculia platanifolia Linn. f. Suppl. (1781) 423.

LUZON, Pangasinan Province, Mount San Isidro, Labrador, *Bur. Sci.* 29858 *Fénix*, November 6, 1917, in forests, altitude about 400 meters, locally known as *bitnong*.

The specimen is in flower and presents immature leaves, which are glabrous and considerably smaller than are those on our Chinese material. The tree is manifestly deciduous, the new leaves appearing with the flowers. I can see no reason, in the absence of more complete material, and especially mature leaves and fruits, for distinguishing this Philippine form from this well-known Chinese and Japanese species. In floral characters it conforms very closely with material from southern China.

DILLENiaceae

SAURAUIA Willdenow

SAURAUIA OLIGOPHLEBIA sp. nov.

Frutex, ramulis, petiolis, et pedicellis dense adpresso paleaceis; foliis chartaceis, oblongis, usque ad 8 cm longis, supra brunneo-olivaceis, nitidis, ad costa nervisque breviter adpresso setosis, subtus pallidioribus, apice breviter acuminatis, basi acutis ad obtusis, margine denticulato-setosis, nervis utrinque 5 vel 6; floribus axillaribus, solitariis, breviter pedicellatis, ebracteatis, circiter 2 cm diametro, sepalis ovato-ellipticis, exterioribus acutis, dense subpatule setosis, interioribus subpetaloideis, obtusis; ovario glabro; stylis 3, liberis.

A shrub about 1 m high, the branchlets, petioles, and pedicels rather densely appressed-paleaceous with oblong, obtuse to acuminate, 0.5 to 1.2 mm long, thick scales, with similar ones on the midrib and nerves on both surfaces of the leaves. Leaves oblong, chartaceous, 5 to 8 cm long, 2 to 3.5 cm wide, the upper surface brownish-olivaceous, shining, the lower paler, here also with scales on the reticulations, the apex shortly acuminate, base acute to obtuse, margins denticulate-setose; lateral nerves 5 or 6 on each side of the midrib, prominent, the reticulations distinct; petioles 0.5 to 1 cm long. Flowers axillary, solitary, white, ebracteate, about 2 cm in diameter, their pedicels 5 to 8 mm long. Sepals ovate-elliptic, about 8 mm long, the outer two densely setose on the back, acute, the inner three more or less petaloid, thinner, rounded, setose only on the exposed parts, the setae somewhat spreading, thick, lanceolate, acuminate, up to

3 mm in length. Petals irregularly retuse. Stamens 20. Ovary globose, glabrous; styles 3, free, about 4 mm long.

CATANDUANES, *Bur. Sci. 30323 Ramos*, December 10, 1917, in forests back of Calolbong.

This species apparently belongs in the group with *Saurauia oligantha* Merr. and *S. sparsiflora* Elm., differing from both in numerous characters, notably in its much larger flowers and densely setose sepals.

THEACEAE

TERNSTROEMIA Mutis

TERNSTROEMIA MEGACARPA sp. nov.

Arbor glabra, circiter 12 m alta; foliis crasse coriaceis, in siccitate brunneis, oblongo-ellipticis ad obovato-oblongis, usque ad 30 cm longis et 11 cm latis, apice breviter obtuseque acuminatis, basi cuneatis, nervis utrinque circiter 15, sat distinctis; floribus axillaribus, longe pedicellatis, pedicellis 4 ad 10 cm longis; fructibus ovoideis, circiter 6 cm longis; seminibus oblongis, utrinque obtusis, circiter 3 cm longis.

A glabrous tree about 12 m high. Branches terete, grayish-brown, wrinkled when dry. Leaves thickly coriaceous, brown when dry, slightly shining, oblong-elliptic to obovate-oblong, 16 to 30 cm long, 7 to 11 cm wide, apex broadly and shortly blunt-acuminate, base narrowed, cuneate, the lower surface somewhat verruculose, not black-punctulate or glandular; lateral nerves about 15 on each side of the midrib, rather distinct; petioles stout, about 2 cm long. Flowers axillary, dioecious, solitary, long-pedicelled, the pedicels rather stout, 4 to 10 cm long. Calyx lobes orbicular, thickly coriaceous, about 1 cm in diameter. Stamens indefinite, crowded, the anthers about 1.5 cm long. Fruit ovoid or ellipsoid-ovoid, about 6 cm long and 4 cm in diameter, brown when dry, the pericarp brittle-coriaceous, glabrous. Seeds oblong, rounded at both ends, crimson when fresh, about 3 cm long.

MINDANAO, Lanao District, Camp Keithley, *Mrs. Clemens s. n.* (type) and 959, collected in March, June, July, and September, 1907.

This species is distinguished from *Ternstroemia philippinensis* Merr. by its larger, more prominently nerved leaves which are not black-glandular or punctulate on the lower surface, and its long-peduncled flowers and fruits. Its alliance with the extra-Philippine species appears to be with *Ternstroemia penangiana* Choisy, to which it is not closely allied, and *T. robinsonii* Merr., of Amboina.

EURYA Thunberg

EURYA PACHYPHYLLA sp. nov.

Arbor parva, 4 ad 5 m alta, glabra; foliis coriaceis, ellipticis ad oblongo-ellipticis, brunneo-olivaceis, nitidis, usque ad 5 cm

longis, nervis cum venularum reti utrinque distinctis, basi acutis, apice breviter acuminatis, acuminis retusis; petiolo 4 ad 5 mm longo; floribus axillaribus, solitariis vel binis, breviter pedicellatis, sepalis omnino glabris; stylis 3, paene liberis.

A small glabrous tree 4 to 5 m high, the branches and branchlets terete, smooth, reddish-brown, the ultimate branchlets slender, 1 mm in diameter or less, the internodes mostly about 1 cm long. Leaves coriaceous, elliptic to oblong-elliptic, 4 to 5 cm long, 2 to 3 cm wide, subequally narrowed to the acute base and to the shortly acuminate apex, the apex retuse, margins minutely crenulate-serrulate, the nerves and reticulations distinct on both surfaces, the primary lateral nerves 7 to 9 on each side of the midrib, scarcely more prominent than are the secondary nerves and primary reticulations, freely anastomosing; petioles 4 to 5 mm long. Flowers axillary, solitary or in pairs, their pedicels 2 mm long or less. Sepals glabrous, orbicular to subreniform, retuse, the outer ones about 2 mm, the inner 3 mm in diameter. Fruits globose, 5 mm in diameter; styles 3, nearly free, about 1 mm long.

LUZON, Tayabas Province, Mount Dingalan, *Bur. Sci.* 26525 Ramos & Edaño (type), September 10, 1916, in forests, altitude about 200 meters: Camarines Province, Mount Calinigan, *For. Bur.* 21699 Miranda, April 24, 1914, in forests, altitude about 700 meters.

A species in the general alliance with *Eurya japonica* Thunb., but distinguished by many characters, notably in its thicker, prominently and rather densely reticulate leaves. Among the Philippine species it is most closely allied to *Eurya coriacea* Merr., from which it is distinguished by its shorter petioles and much smaller, entirely glabrous sepals.

EURYA PACHYRHACHIS sp. nov.

Arbor parva, circiter 5 m alta, glabra, ramis et ramulis crassis, internodiis brevibus, circiter 5 mm longis; foliis crasse coriaceis, ellipticis ad ovato-ellipticis, olivaceis vel brunneo-olivaceis, nitidis, usque ad 6 cm longis, aequilateralibus, basi obtusis, apice breviter acuminatis, acuminis retusis, margine minute crenulato-serrulatis, nervis utrinque 7 ad 9, tenuibus, distinctis, anastomosantibus; petiolo 3 ad 5 mm longo; inflorescentiis axillaribus et e axillis defoliatis, rhachibus crassis, 2 ad 4 mm longis, cicatris multis instructis, ad apice 1- vel 2-floris; floribus brevissime pedicellatis, sepalis margine minute ciliatis; stylis 3, usque ad $\frac{1}{2}$ connatis.

A small tree, about 5 m high, entirely glabrous except the minutely ciliate margins of the sepals. Branches and branchlets dark-gray, rather stout, the ultimate branchlets 2 to 3 mm in diameter, the internodes short, usually 5 mm long or less.

Leaves thickly coriaceous, elliptic to ovate-elliptic, 3.5 to 6 cm long, 2.3 to 3 cm wide, shining, olivaceous or brownish-olivaceous, base obtuse to rounded, apex shortly acuminate, the acumen retuse, margins minutely crenulate-serrulate; lateral nerves 7 to 9 on each side of the midrib, slender, distinct, anastomosing, the reticulations distinct; petioles 3 to 5 mm long. Racemes axillary, and in the axils of fallen leaves, solitary, the rachis stout, 2 to 4 mm long, marked with numerous scars of fallen pedicels, each bearing at one time one or two flowers at the apex, sessile or the pedicels 1 to 1.5 mm long. Sepals orbicular to reniform, the inner ones up to 2 mm long and 3.5 mm wide, their margins ciliate. Ovary ovoid, glabrous; styles 3, about 2 mm long, united for one-half their length.

LUZON, Tayabas Province, Mount Dingalan, *Bur. Sci.* 26579 Ramos & Edaña, September 9, 1916, in forests, altitude about 200 meters.

A species resembling *Eurya coriacea* Merr., but with shorter petioles and an entirely different inflorescence. The short, stout, scarred rachis of the axillary racemes is characteristic.

DIPTEROCARPACEAE

VATICA Linnaeus

VATICA PACHYPHYLLA sp. nov.

Arbor circiter 20 m alta; foliis crasse coriaceis, ellipticis ad oblongo-ellipticis, glabris, olivaceis, nitidis, usque ad 14 cm longis et 8 cm latis, apice acuminatis, basi subacutis ad rotundatis, nervis primariis utrinque circiter 12, subtus prominulis; paniculis terminalibus, anguste pyramidatis, usque ad 18 cm longis, densissime stellato-furfuraceis, indumento luteo; floribus numerosis; petalis oblongis, circiter 11 mm longis; antheris 15; ovario glabro; stylis circiter 0.7 mm longis, glabris, stigmatibus obscurissime 3-lobato.

A tree about 20 m high, glabrous except the younger parts. Branches terete, brownish, wrinkled when dry, about 5 mm in diameter, glabrous or nearly so, the branchlets densely ferruginous-furfuraceous. Leaves thickly coriaceous, elliptic to oblong-elliptic, 11 to 14 cm long, 5 to 8 cm wide, the apex rather prominently acuminate, base acute to rounded, when dry olivaceous, shining, the very young ones more or less stellate-puberulent, the indumentum caducous, the leaves soon entirely glabrous; lateral nerves about 12 on each side of the midrib, prominent, curved, the reticulations not conspicuous; petioles 1.5 to 2 cm long, when young densely and minutely furfuraceous, in age glabrous or nearly so. Panicles terminal, pyramidal, up to 18 cm in length, the lower branches up to 9 cm in length, all parts

densely stellate-furfuraceous, the indumentum usually lemon-yellow, on the younger parts shading to pale-gray. Flowers numerous. Sepals oblong, obtuse, about 4 mm long and 1 to 1.5 mm wide, densely pale-gray puberulent. Petals narrowly oblong, about 11 mm long, 3 mm wide, densely puberulent. Stamens 15, the anthers less than 1 mm long. Ovary subglobose, glabrous; style 0.7 mm long or less, glabrous; stigma subcapitate, very obscurely 3-lobed.

LUZON, Camarines Province, Paracale, Cabcabin, *For. Bur.* 27102 *Alambra*, March 12, 1918, in dipterocarp forests of the yacal-lauan type, altitude about 40 meters, with the local name *hagachac na itim*.

This species is well characterized by its elliptic, thickly coriaceous leaves, from which it is readily distinguished from the other Philippine forms of the genus. The ferruginous indumentum of the young branchlets and the lemon-yellow to pale-gray indumentum of the inflorescences are characteristic.

THYMELAEACEAE

WIKSTROEMIA Endlicher

WIKSTROEMIA FENICIS sp. nov.

Frutex circiter 2 m altus, inflorescentiis parcissime pubescentibus exceptis glaber; foliis lanceolatis ad ovato-lanceolatis, chartaceis, usque ad 13 cm longis, olivaceis, utrinque nitidis, sursum angustatis, acuminatis, basi rotundatis ad subacutis, nervis primariis utrinque circiter 12, distinctis; inflorescentiis terminalibus; floribus sessilibus, confertis, 1 cm longis. Species *W. meyenianae* affinis, differt foliis crassioribus, nervis distinctioribus et magis numerosis, et floribus brevioribus.

A shrub about 2 m high, entirely glabrous except the very sparingly pubescent inflorescences. Branches terete, pale-brownish, the branchlets slender, brown or somewhat reddish-brown. Leaves chartaceous, olivaceous, shining, lanceolate to ovate-lanceolate, 10 to 13 cm long, 3 to 4.5 cm wide, gradually narrowed upward to the acuminate apex, base rounded to subacute; primary lateral nerves about 12 on each side of the midrib, distinct, raised on the lower surface, anastomosing, the reticulations distinct; petioles about 3 mm long. Inflorescences terminal, the racemes forming a somewhat leafy panicle, the leaves associated with the inflorescence greatly reduced, 2 to 3 cm long. Individual racemes 2 to 3 cm long, each bearing 7 to 10 sessile flowers crowded at the tip of the rachis. Flowers pale-green, 1 cm long, externally very slightly pubescent with widely scattered, short, appressed hairs, the perianth-lobes 4, elliptic, rounded, 2 mm long. Stamens 8, in two series. Ovary oblong-ovoid, sparingly pubescent at the tip; style 0.3 mm long.

LUZON, Pangasinan Province, Mount San Isidro, Labrador, *Bur. Sci.* 29843 *Fénix*, November 10, 1917, in damp forests, altitude about 400 meters.

This species resembles *Wikstroemia meyeniana* Warb. and is manifestly allied to it. It differs notably in its thicker, more-prominently and numerously nerved leaves and especially in its shorter flowers.

WIKSTROEMIA BRACHYANTHA sp. nov.

Frutex circiter 2 m altus, ramulis junioribus parce pubescentibus exceptis glaber; foliis lanceolatis ad oblongo-lanceolatis, usque ad 12 cm longis, chartaceis, in siccitate plerumque brunneis, nitidis, basi acutis, apice tenuiter acuminatis, nervis primariis utrinque 12 ad 15, distinctis, juxta marginem anastomosantibus; racemis terminalibus et in axillis superioribus, brevibus, paucifloris; floribus breviter pedicellatis, extus parcissime pubescentibus, circiter 6.5 mm longis.

A shrub about 2 m high, glabrous except the sparingly appressed-pubescent younger branchlets, the branches and branchlets terete, dark-brown to reddish-brown when dry. Leaves rather firmly chartaceous, usually brown or brownish when dry or the upper surface olivaceous-brownish, shining, the lower distinctly paler than the upper, lanceolate to oblong-lanceolate, rather distinctly variable even on the same branchlet, 8 to 12 cm long, 1.5 to 4 cm wide, the base acute, the apex slenderly acuminate; primary lateral nerves 12 to 15 on each side of the midrib, rather distinct and somewhat projecting on the lower surface, somewhat ascending, anastomosing close to the margin with the rather distinct marginal veins, the secondary veins often about as prominent as the primary ones; petioles about 3 mm long. Racemes terminal, or sometimes also in the upper axils, solitary, simple, the axis and peduncle 5 mm long or less, the former with rather numerous scars of fallen pedicels, each inflorescence presenting but 5 or 6 flowers at one time. Flowers green, about 6.5 mm long, externally very slightly pubescent, the lobes 4, subreniform, about 1 mm long and 1.5 mm wide, their pedicels 1 to 1.5 mm long. Stamens 8. Ovary elongated, villous at the tip. Glands 2, narrowly oblong, about 1 mm long. Fruit red, ellipsoid to somewhat obovoid, up to 1 cm long.

CATANDUANES, *Bur. Sci.* 30392 *Ramos* (type), December 2, 1917, in damp forests near streams at low altitudes. LUZON, Tayabas Province, Mount Cadig, *Bur. Sci.* 25449 *Yates*, December, 1916; Mount Pular, *Bur. Sci.* 19438 *Ramos*, January, 1913.

This species is well characterized by its relatively thick leaves, which are distinctly variable in shape, but prevailingly lanceolate; its distinct marginal veins; short inflorescences; and unusually short flowers. It is perhaps as closely allied to *Wikstroemia fenicis* Merr. as to any other species but has entirely different inflorescences and smaller flowers.

BEGONIACEAE

BEGONIA Linnaeus

BEGONIA EDANOII sp. nov. § *Diploclinium*.

Species *B. aquatae* affinis, differt capsulis multo majoribus, apice truncatis, basi late rotundatis, usque ad 1.8 cm longis et 1.5 cm latis; petiolo circiter 5 mm longo.

A slender, scandent, glabrous plant growing on tree trunks. Leaves inequilateral, oblong-ovate, membranaceous, olivaceous, and shining when dry, 4 to 5 cm long, 1.5 to 2 cm wide, base rounded or obtuse, not at all cordate, apex acuminate, somewhat falcate, margins rather coarsely and irregularly toothed; petioles about 5 mm long. Capsules axillary, usually in pairs, equally 3-winged, truncate at the apex, scarcely narrowed below, the base broadly rounded; up to 1.7 cm long and 1.5 cm wide; pedicels slender, about 1.5 cm long.

LUZON, Rizal Province, Mount Susong Dalaga, *Bur. Sci.* 29374 Ramos & Edaña, August 8, 1917, in damp forests.

This species belongs in the characteristic group of *Begonia aequata* A. Gray, the type of which was from Mount Maquiling, the other closely allied forms being *Begonia wenzelii* Merr., *B. lagunensis* Elm., and *B. elegans* Elm. It differs from *Begonia aequata* in its very much larger capsules, and from *B. lagunensis* Elm., to which it is also closely allied, in its very short petioles, and somewhat smaller, distinctly differently shaped capsules, which are not gradually narrowed below but which are abruptly rounded at the base.

MELASTOMATACEAE

MEMECYLON Linnaeus

MEMECYLON ELLIPTIFOLIUM sp. nov. § *Eumemecylon*.

Arbor circiter 12 m alta, glabra, ramulis teretibus; foliis ellipticis, sessilibus, coriaceis, usque ad 14 cm longis, utrinque rotundatis vel apice latissime et breviter acuminatis, nervis primariis tenuibus, indistinctis vel interdum subobsoletis, marginalibus nullis; inflorescentiis axillaribus, brevibus, 1 ad 1.5 cm longis, breviter pedunculatis; floribus confertis, calycis infundibuliformibus, 5 mm diametro.

A tree about 12 m high, glabrous throughout. Branches terete, smooth, grayish, the branchlets brownish, terete, about 2 mm in diameter. Leaves opposite, sessile, elliptic, thickly coriaceous, yellowish to yellowish-green or brown when dry, shining, brittle, 9 to 14 cm long, 5 to 6.5 cm wide, subequally rounded at both ends or the apex very broadly and shortly acuminate; primary lateral nerves about 20 on each side of the midrib, slender, indistinct, sometimes obsolete or nearly so, with

no marginal veins. Inflorescences axillary, solitary or fascicled, 1 to 1.5 cm long, cymose, their peduncles 4 mm long or less. Flowers white, crowded, comparatively large, the funnel-shaped calyces about 5 mm in diameter, the pedicels usually about 3 mm long.

LUZON, Camarines Province, Paracale, Calaburnay, *For. Bur.* 27060 *Magistrado*, July 24, 1917, on slopes, altitude about 100 meters, with the local name *calasgas*.

This species greatly resembles *Memecylon sessilifolium* Merr., but differs radically in its terete, not prominently 4-angled branches and branchlets. Its much more numerous lateral nerves, shorter, dense inflorescences, and its leaves not narrowed upward distinguish it from *Memecylon pachyphyllum* Merr. to which it is probably most closely allied.

EVERETTIA Merrill

EVERETTIA OCTODONTA sp. nov.

Species *E. pulcherrimae* similis, differt foliis laevis, glabris, calycibus 8-dentatis. Arbor, partibus junioribus plus minusve castaneo-pubescentibus exceptis glabra; foliis subcoriaceis, rigidis, in siccitate viridis, anguste oblongis, longe petiolatis, usque ad 13 cm longis, nervis primariis utrinque 20 ad 25, patulis, distinctis, haud prominulis, utrinque acutis vel apice leviter acuminatis; fructibus turbinatis, circiter 2 cm diametro, calycis dentibus 8, oblongis ad oblongo-ovatis, acuminatis, usque ad 8 mm longis.

A tree about 6 m high, entirely glabrous except the more or less castaneous-pubescent very young parts. Branches terete, glabrous, with few large lenticels. Leaves numerous, subcoriaceous, rigid, brittle, narrowly oblong, 10 to 13 cm long, 2.5 to 4 cm wide, subequally narrowed to the acute base and apex, or the apex somewhat acuminate, greenish or yellowish-green and very minutely verruculose when dry, the nerves not at all impressed or projecting; primary lateral nerves 20 to 25 on each side of the midrib, slender, spreading, anastomosing close to the margin with the slender, nearly straight marginal nerve, distinct, not projecting; petioles 3 to 4 cm long. Infructescence terminal, peduncled, the fruits few, turbinate, about 2 cm in diameter, base truncate-rounded, the tube scarcely constricted, the persistent teeth 8, coriaceous, oblong to oblong-ovate, acuminate, often somewhat recurved, up to 8 mm in length.

CATANDUANES, in forests at low altitudes along the Santo Domingo River, *Bur. Sci.* 30556 *Ramos*, December 3, 1917.

While in general appearance this species resembles *Everettia pulcherrima* Merr., the only other known species of the genus, it differs radically in that the nerves are not at all impressed or raised, while the calyx is prominently 8-toothed.

ARALIACEAE

ACANTHOPHORA genus novum

Calycis margo 5- vel 6-dentatus. Petala 5 vel 6, imbricata, acuta vel obtusa, basi lata affixa. Stamina 5 vel 6; filamenta filiformia; antherae ovoidae, in alabastro inflexae. Discus convexus. Ovarium 5- vel 6-loculare; styli 5 vel 6, erecti, a basi distincti; stigmata terminalia, parva. Fructus ovoideus, in siccitate obtuse 5- vel 6-angulatus.—Frutex alte scandens aculeis parvis armatus. Folia ampla, alterna, tripinnata. Umbellulae paniculatae. Pedicelli sub flore articulati. Flores hermaphroditi.

ACANTHOPHORA SCANDENS sp. nov.

Frutex scandens, ramis et paniculis et foliis ad petiolo rhachibusque primariis et secundariis et ad costa subtus spinis numerosis parvis recurvatis armatis; foliis amplis, tripinnatis, usque ad 1.5 m longis; foliolis numerosis, ovatis ad ovato-lanceolatis, acuminatis, submembranaceis, 7 ad 14 cm longis, basi rotundatis vel subcordatis, margine spinuloso-dentatis; paniculis terminalibus, amplis, usque ad 1 m longis; umbellulis numerosis, circiter 20-floris, pedunculatis; floribus 5- vel 6-meris, petalis imbricatis.

A scandent, sparingly branched, aculeate vine, sprawling over thickets, the stems about 2.5 cm in diameter, these, the petioles, primary and secondary leaf-rachises, petiolules, midribs of the leaflets beneath, and the inflorescences armed with short, stout, sharp, scattered but numerous, recurved spines, otherwise entirely glabrous. Leaves alternate, 1 to 1.5 cm long, triangular in outline, at least tripinnate, the lower primary pinnae long, the upper ones gradually shorter; petioles stout, aculeate, the lower 6 to 8 cm split on the upper side and with 1 cm wide wings (stipules) which surround the stem at the base, the lower ultimate divisions of the leaf odd-pinnate, the upper ones trifoliate. Leaflets ovate to elliptic-ovate or ovate-lanceolate, submembranaceous, 7 to 14 cm long, 3 to 5 cm wide, the apex strongly acuminate, the base broad, rounded or subcordate, the margins rather finely spinulose-denticulate, glabrous and somewhat shining, the midrib beneath and more rarely also on the upper surface with few, scattered, recurved spines; nerves 5 to 7 on each side of the midrib, rather prominent, anastomosing; petiolules 3 to 10 mm long. Panicles terminal, ample, pinnately compound, up to about 1 m in length, the branches alternate, opposite, or somewhat whorled, the primary ones up to 40 cm in length. Umbels numerous, racemously arranged on the ultimate branchlets, each about 20-flowered, their peduncles 1 to

4 cm long, the subtending bracts lanceolate, acuminate, less than 1 cm long; pedicels slender, about 1 cm long, the bracteoles lanceolate, acuminate, 2 to 3 mm long. Calyx jointed with the pedicels, about 3 mm long, the teeth 5 or 6, short, acute. Petals 5 or 6, narrowly ovate, obtuse or acute, 1-nerved, attached by a broad base, the margins overlapping, about 3 mm long, the base about 1.5 mm wide. Stamens 5 or 6; filaments 4 mm long; anthers inflexed in bud, about 1 mm long. Ovary 5- or 6-celled; styles 5 or 6, erect, free or very slightly connate at the base, 0.5 to 0.7 mm long. Fruit ellipsoid or ovoid, 5- or 6-ridged, 5- or 6-celled, about 5 mm long, crowned by the radiately spreading styles.

MINDANAO, Lake Lanao, Camp Keithley, *Mrs. Clemens 752* (type), September–October, 1906, and again, without number, a year later: Davao District, Todaya, Mount Apo, *Elmer 11605*, September, 1909, known to the Bagobos as *simbar*. CATANDUANES, *Bur. Sci. 30211 Ramos*, November, 1917. LUZON, Laguna Province, San Antonio, *Bur. Sci. 23833 Ramos*, October, 1915.

Preliminary work was done on this peculiar species in 1906, and again in 1908, but on account of the rather fragmentary material then available it was impossible to determine the exact nature of the entire leaves and the inflorescences. Mr. Elmer later collected the same form on Mount Apo, and kindly submitted his copious material and notes for my examination, which have enabled me to complete my description regarding some details of the plant. Mr. Elmer's field note is as follows:

"Sprawling amongst thickets of dense growth in fertile moist soil of an open slope at 3250 feet. Stem terete, 1 inch thick, covered with thin brownish bark and provided with sharp spines, very sparingly branched, the upper leaf-bearing portion green but quite as thick as the parts below. Leaves alternate, one foot apart more or less, horizontally spreading or descending, all the stalks greenish-brown, provided with recurved hooks, especially along the lower side. Petiole a foot long or longer. Sheath 3 inches long, fully one-half inch deep, adnate to the upper portion of the peduncle and clasping the stem, smooth, turning brownish. Leaves proper 3 to 5 feet long, triangular in outline. Leaflets horizontally recurved, submembranaceous, the upper surface somewhat shining. Inflorescence spreading similar to the leaves but much shorter and terminating the stem; *simbar*."

The genus is well characterized by its habit, its very large decompose leaves, its ample terminal inflorescence, and its 5- or 6-merous flowers, the petals being imbricate, not valvate. It seems to me to be most closely allied to *Aralia*, although in habit, and more especially in its recurved spines, it recalls *Acanthopanax*; in *Acanthopanax*, however, the petals are valvate.

I strongly suspect that this form is identical with the Celebes material referred by Koorders⁴ to *Aralia ferox* Miq. I saw Koorders's specimens in the Buitenzorg Herbarium in January, 1914, but had no opportunity of

⁴ Meded. Lands Plantent. 19 (1899) 488; Syst. Verzeich. 2^o (1914) 99.

studying them critically or comparing them with Philippine material. Koorders states that the Celebes plant is a climber, attaining a height of 10 meters; the Javan *Aralia ferox* Miq. is an erect shrub. Thus we have another characteristic species added to the already long list of Philippine-Celebes forms, the list of genera and species having this special and restricted distribution being increased as collections from the two regions are studied and compared. It is now thoroughly established that the Celebes and Moluccan floras are distinctly more closely allied to the flora of the Philippines than is that of any other region, indicating clearly that land connections undoubtedly existed in previous geologic times between the Philippines and the islands to the south and southeast.

The species affords an excellent illustration of one marked line of distribution of species within the Philippines, and that is the extension of the Mindanao flora to the north, through Leyte, Samar, and along the eastern parts of Luzon. This distribution is probably limited by certain climatic conditions, chiefly the seasonal distribution of the rainfall throughout the year. Many parts of Mindanao have no sharply defined dry season, and the geographic distribution of the species characteristic of such regions to the north is limited to those regions having a similar seasonal distribution of the rainfall, such as Samar, Leyte, Catanduanes, and the eastern parts of Luzon generally. The San Antonio region in Luzon is a region that is continually wet, due to its proximity to the east coast range of mountains.

BOERLAGIODENDRON Harms

BOERLAGIODENDRON CATANDUANENSE sp. nov.

Frutex circiter 1 m altus, inflorescentiis exceptis glaber; foliis longe petiolatis, palmatim 7-foliolatis, foliolis longe petiolulatis, usque ad 20 cm longis, grosse lyrato-lobatis, utrinque acuminatis; inflorescentiis parcissime furfuraceis, radiis primariis circiter 10, dichotomis; floribus capitatis, sessilibus, 4-meris; fructibus ovoideis, 4-sulcatis vel 4-angulatis, 7 mm longis.

A shrub about 1 m high, entirely glabrous except the sparingly furfuraceous inflorescences. Ultimate branches pale-grayish, about 1 cm in diameter. Leaves palmately 7-foliolate, leaflets olivaceous, shining, 15 to 20 cm long, chartaceous to subcoriaceous, in general lanceolate, coarsely and irregularly lyrate-lobed, the lobes few, the larger ones broadly ovate to oblong-ovate, 2 to 3 cm long, apex and base acuminate, the apex slenderly so; petiolules mostly 3 to 4 cm long; petioles about 25 cm long, the basal crests few, short, coriaceous, recurved, not at all pectinate. Inflorescences sparingly furfuraceous, the primary branches about 10, these about 2 cm in length, each bearing two branches as long as the primary ones, these subtended by broadly ovate bracts 5 mm in length or less, the secondary branches with a pair of similar but smaller bracts at about their middle; each primary branch bears between the two secondary ones a sessile or shortly peduncled group of sterile

flowers, the flowers few-pedicelled. Flowers capitate, sessile, 4-merous, about 15 at the end of each secondary branch. Fruits ovoid, about 7 mm long, 4-celled, 4-sulcate or 4-angled, sessile.

CATANDUANES, *Bur. Sci. 30438 Ramos*, November 18, 1917, on forested slopes, altitude about 350 meters.

The alliance of this species is with *Boerlagiodendron yatesii* Merr., of Luzon, and *B. heterophyllum* Merr., of Mindanao. It is well characterized by its compound leaves and differs from *B. yatesii* in its lyrate-lobed, longer, petiolulate leaflets; and from *B. heterophyllum* in its smaller, long-petiolulate leaflets and in the basal crests of the petioles not being at all pectinate.

SCHEFFLERA Forster

SCHEFFLERA CATANDUANENSIS sp. nov. § *Cephaloschefflera*.

Frutex epiphyticus, glaber; foliis 9- ad 12-foliolatis, foliolis coriaceis, oblongis ad oblongo-obovatis, integris, usque ad 12 cm longis, nitidis, apice abrupte subcaudato-acuminatis, basi obtusis ad acutis, nervis primariis utrinque circiter 15, tenuibus; inflorescentiis glabris, ramis 20 ad 25 cm longis, crassis; capitulis racemose dispositis, breviter pedunculatis, ovoideis ad depressoglobosis, 1.5 ad 2 cm diametro; fructibus junioribus plerumque 6- vel 7-locellatis.

A shrub or tree, entirely glabrous. Ultimate branches up to 1 cm in diameter. Leaves 9- to 12-foliolate, their petioles 16 to 18 cm long, inflated and clasping at the base, the petiolules 2 to 3.5 cm long; leaflets coriaceous, dark-olivaceous and shining on the upper surface, the lower surface somewhat paler, oblong to oblong-obovate, entire, 8 to 12 cm long, 4 to 5.5 cm wide, the apex rather abruptly subcaudate-acuminate, the acumen 1 cm long or less, the base obtuse to acute; primary lateral nerves about 15 on each side of the midrib, slender, scarcely more prominent than are the secondary ones. Inflorescences reduced to one or few raceme-like branches 20 to 25 cm in length, each bearing from 8 to 10 dense heads in the upper one-half, the rachis and peduncle stout, 5 to 7 mm in diameter, the peduncles of the heads stout, 5 mm long or less. Heads dense, ovoid to depressed-globose, 1.5 to 2 cm in diameter, dark-brown when dry, composed of very many connate carpels, the apical part of each individual fruit conical or subconical; young fruits mostly 6- or 7-celled.

CATANDUANES, Mount Mariguison, *Bur. Sci. 20341 Ramos*, November 26, 1917, epiphytic in dense damp forests, altitude about 400 meters.

This species is most closely allied to *Schefflera ovoidea* Merr., of Mindanao, from which it is readily distinguished by its much smaller leaflets, smaller heads, and fewer-celled fruits.

SCHEFFLERA ELLIPTIFOLIOLA sp. nov. § *Euschefflera*.

Frutex epiphyticus, inflorescentiis plus minusve pallide pubescentibus; foliis longe petiolatis, 9- ad 11-foliolatis, foliolis chartaceis ad subcoriaceis, ellipticis ad obovato-ellipticis, usque ad 13 cm longis, breviter abrupteque acuminatis, basi rotundatis, nervis utrinque circiter 12, tenuibus, utrinque distinctis. Paniculis amplis, multifloris, rhachibus productis, ramis primariis 15 ad 20, racemose dispositis, usque ad 20 cm longis; floribus 5-meris, umbellatis, umbellis in ramis primariis racemose dispositis; fructibus subellipsoideis, 3 ad 4 mm longis, 5-sulcatis, 5-locellatis.

An epiphytic shrub, glabrous except the more or less pale-pubescent inflorescences. Leaves 9- to 11-foliolate, their petioles 13 to 16 cm long, inflated and clasping at the base, the petiolules 3 to 5.5 cm long; leaflets elliptic to obovate-elliptic, chartaceous to subcoriaceous, entire, pale and shining when dry, 7 to 13 cm long, 4.5 to 7 cm wide, the apex shortly and abruptly acuminate, base rounded; primary lateral nerves about 12 on each side of the midrib, slender, distinct on both surfaces. Panicles terminal, ample, peduncled, the peduncle 4 to 10 cm long, with few to many bracts resembling the inflated petiolar bases, the rachis produced, in large panicles attaining a length of 20 cm, the younger parts more or less pale-pubescent, the indumentum deciduous on the older parts; primary branches racemosely disposed, 15 to 20 on each panicle, up to 20 cm in length. Flowers umbellate, the umbels racemosely disposed on the primary branches, the peduncles 5 to 8 mm long. Flowers 5-merous, small, 8 to 12 in each umbel, their pedicels, just after anthesis, 2 to 4 mm in length. Fruit subellipsoid, 3 to 4 mm long, 5-sulcate, 5-celled.

CATANDUANES, Mount Mariguidon, *Bur. Sci.* 30511 (type), 30210 Ramos, November, 1917, epiphytic, in damp forests.

This species is especially well characterized by its ample inflorescences, the rachis being greatly prolonged, and the numerous primary racemosely disposed branches; and by the umbels being racemosely disposed on the primary branches.

SCHEFFLERA MYRIANTHELLA sp. nov. § *Euschefflera*.

Frutex epiphyticus, inflorescentiis distincte furfuraceis exceptis glaber; foliis 6- ad 8-foliolatis, foliolis obovatis, integris, usque ad 12 cm longis, breviter acuminatis, nitidis, nervis utrinque circiter 12, tenuibus; paniculis terminalibus, pedunculatis, amplis, quadripinnatim-paniculatis, rhachibus valde elongatis, ramis primariis racemose dispositis, usque ad 23 cm longis, ramis secundariis numerosis, 2.5 ad 3.5 cm longis; floribus sub-

capitato-umbellatis, umbellulis breviter pedunculatis, paucifloris, in ramis secundariis racemose dispositis; floribus 5-meris, brevissime pedicellatis vel subsessilibus, petalis 1.8 mm longis.

An epiphytic shrub, glabrous except the inflorescence. Leaves 6- to 8-foliolate, their petioles 6 to 8 cm long, inflated and clasping at the base, the petiolules 2.5 to 5 cm long; leaflets obovate, subcoriaceous, rather pale and prominently shining when dry, 7 to 12 cm long, 5 to 6 cm wide, entire, the apex rather abruptly and shortly acuminate, base acute; primary lateral nerves about 12 on each side of the midrib, slender, distinct. Panicles terminal, quadripinnate, peduncled, pale-furfuraceous, the indumentum more or less deciduous on the older parts, the peduncles up to 6 cm in length, the rachis and peduncle at least 20 cm in length; primary branches up to 23 cm long, numerous, racemously arranged, each subtended by an ovate to oblong-ovate, acuminate, 5 to 8 mm long bract; secondary branches numerous, slender, 2.5 to 3.5 cm long, racemously disposed on the primary ones; flowers small, 5-merous, capitate-umbellate, the umbels 5- to 8-flowered, numerous, shortly peduncled, racemously arranged, their peduncles about 2 mm long. Petals about 1.8 mm long. Flowers 5-merous, subsessile or the pedicels up to 0.5 mm in length.

LUZON, Laguna Province, San Antonio, *Bur. Sci. 23824 Ramos*, October 19, 1915, on trees in damp forests.

This species is well characterized by its ample, many-flowered, quadripinnately paniculate inflorescence; the elongated primary branches which are racemously arranged on the produced rachis; the numerous, short, slender, racemously arranged secondary branches; and the capitate-umbellate, few-flowered, racemously arranged, short-peduncled umbels.

MYRSINACEAE

MAESA Forskal

MAESA BRUNNEA sp. nov. § *Eumaesa*.

Frutex glaber; foliis chartaceis ad subcoriaceis, late ovatis ad oblongo-ovatis, usque ad 14 cm longis, apice breviter acuminatis, basi subtruncato-rotundatis ad subacutis, margine undulatis et distanter calloso-crenatis, utrinque lineis nervilliformibus praeditis, supra subolivaceis, subtus brunneis, nervis primariis utrinque 5 vel 6, conspicuis, reticulis obsoletis vel subobsoletis; infructescentiis axillaribus, depauperato-paniculatis, usque ad 4 cm longis; fructibus elliptico-ovoideis, circiter 5 mm longis, sepalis latissime ovatis, obtusis, obscurissime punctatis, margine minutissime ciliatis.

A glabrous shrub, the branches dark-brown, terete, lenticel-

late. Leaves broadly ovate to oblong-ovate, chartaceous to subcoriaceous, dull or slightly shining when dry, the upper surface subolivaceous, the lower brown, both surfaces supplied with slender, obscure, irregular, longitudinal, nerve-like lines, 9 to 14 cm long, 5 to 9 cm wide, the apex shortly and obtusely acuminate, base subtruncate-rounded to subacute, margins coarsely undulate, each undulation tipped with a thickened crenate callosity; lateral nerves 5 or 6 on each side of the midrib, prominent, curved, very obscurely anastomosing, the reticulations obsolete or nearly so; petioles 1.5 to 3 cm long. Infructescences axillary, solitary, depauperate-paniculate, 3 to 4 cm long, the branches few, spreading, 3 cm long or less. Fruits ellipsoid-ovoid, about 5 mm long, their pedicels about 3 mm long. Calyx-teeth broadly ovate, obtuse, about 1 mm long and 1.5 mm wide, very obscurely punctulate, not lineate, the margins very minutely and obscurely ciliate.

CATANDUANES, Mount Mariguidon, *Bur. Sci.* 30500 (type), 30308 Ramos, November and December, 1917, in forests.

This species manifestly belongs in the group with *Maesa denticulata* Mez, from which species it is distinguished by its thicker, larger leaves which are prominently undulate, brown beneath when dry, and by its obsolete or nearly obsolete reticulations. *Maesa platyphylla* Elm. is distinguished by its more numerous nerved, nearly entire leaves, while *M. megaphylla* Merr. has much larger, more numerous nerved, entire leaves and very much longer inflorescences.

EBENACEAE

DIOSPYROS Linnaeus

DIOSPYROS STREPTOSEPALA sp. nov.

Arbor parva, foliis subtus ad costa, ramulis, petiolis, et fructibus parce longissime ciliatis; foliis oblongo-ovatis ad ovato lanceolatis, usque ad 17 cm longis, basi late rotundatis, plerumque leviter cordatis, sursum angustatis, acuminatis, supra glabris, brunneo-olivaceis, subtus pallidis, nervis utrinque circiter 8, tenuibus, distinctis, reticulis laxis; fructibus ovoideis, circiter 2 cm longis, pericarpio fragile, extus perspicue longissime ciliato; seminibus 2, ovato-ellipticis, plano-convexis, circiter 1 cm longis, albumine aequabile; sepalis 4, persistentibus, circiter 1 cm longis, longe filiformiter caudatis.

A small tree, 5 m high *vide* Ramos, the leaves beneath especially near the midrib, the branchlets, and the petioles with few, widely scattered, slender, spreading, about 3 mm long hairs, these more numerous on the fruits. Branches dark-brown or nearly black, terete, glabrous, the branchlets slender. Leaves chartaceous, oblong-ovate to ovate-lanceolate, 9 to 17 cm long,

2.5 to 5 cm wide, the base broadly rounded and usually slightly cordate, narrowed upward to the rather slenderly acuminate apex, the upper surface brownish-olivaceous, somewhat shining, glabrous, the lower much paler; primary lateral nerves about 8 on each side of the midrib, slender, distinct, laxly anastomosing, the reticulations lax, distinct; petioles 5 mm long or less. Fruits solitary, in the uppermost axils, their pedicels long-ciliate, about 5 mm long, the mature fruits ovoid, apex rounded or obtuse, about 2 cm long, the pericarp thin, fragile when dry, dark-brown, with many, long, slender, ciliate hairs similar to those on the vegetative parts. Seeds 2, ovate-elliptic, plano-convex, about 1 cm long, distinctly narrowed upward, obtuse or apiculate, smooth, castaneous and shining when dry, the albumen uniform. Persistent sepals 4, up to 1 cm long, ciliate, long filiform-caudate from a somewhat broadened base.

CATANDUANES, Mount Mariguidon, *Bur. Sci.* 30481 Ramos, November 25, 1917, in forests near the summit of the mountain, altitude apparently about 400 meters.

This species is strongly characterized by its indumentum of scattered, elongated, very slender hairs and especially by its very slender filiform-caudate, elongated sepals. It is not at all closely allied to any other species known to me.

SAPOTACEAE

BASSIA Koenig

BASSIA OBLONGIFOLIA sp. nov.

Arbor circiter 18 m alta, subtus foliis dense adpresseque puberulis; foliis coriaceis, oblongis, usque ad 20 cm longis, breviter obtuse acuminatis, basi acutis vel subacutis, in siccitate supra pallidis, nitidis, subtus subcupreis, nervis utrinque 22 ad 27, tenuibus, distinctis, patulis, leviter curvatis; floribus fasciculatis, in axillis defoliatis, pedicellis sursum incrassatis, 2 ad 2.5 cm longis; sepalis extus adpresse-pubescentibus, late ovatis, leviter acuminatis, circiter 7 mm longis, fructibus junioribus glabris.

A tree about 18 m high, the branches terete, glabrous, rugose, the branchlets up to 6 mm in diameter, somewhat pubescent. Leaves oblong, coriaceous, 15 to 20 cm long, 4.5 to 7 cm wide, the upper surface glabrous, pale and shining when dry, the lower subcupreous and rather densely appressed-puberulent, the apex shortly blunt-acuminate, base acute, the midrib impressed on the upper surface, very prominent on the lower surface; lateral nerves slender, distinct, spreading, slightly curved, parallel, 22 to 27 on each side of the midrib, anastomosing close to the edge of the leaf, the reticulations not prominent; petioles

3.5 to 5 cm long, when young slightly pubescent, soon becoming glabrous. Flowers fascicled in the axils of fallen leaves, their pedicels thickened upward, 2 to 2.5 cm long, appressed pubescent. Sepals 4, broadly ovate, somewhat acuminate, coriaceous, about 7 mm long and wide, pubescent externally. Very young fruits ovoid, glabrous; styles up to 1.7 cm long.

LUZON, Camarines Province, Paracale, Cabcabin, *For. Bur.* 27101 *Alambra*, March 12, 1918, in dipterocarp forests, altitude about 40 meters, with the local name *calacalachuhe*.

This species is well characterized by its oblong leaves with numerous, slender but distinct, parallel primary nerves, by which characters it is readily distinguished from the other known Philippine representatives of the genus.

BASSIA MIRANDAE sp. nov.

Species *B. coriaceae* affinis differt foliis majoribus, usque ad 23 cm longis et 8.5 cm latis, sepalis duplo majoribus.

A tree about 18 m high, glabrous. Branches pale-brownish, somewhat rugose, the ultimate ones about 8 mm in diameter, the branchlets glabrous, smooth, somewhat sulcate. Leaves oblong-obovate, coriaceous, 16 to 23 cm long, 5.5 to 8.5 cm wide, glabrous, shining, rather pale when dry, the apex obtuse to rounded or somewhat acuminate, narrowed below to the acute base; primary nerves about 12 on each side of the midrib, curved, somewhat ascending, distinct, anastomosing, 1 to 2 cm apart, the reticulations lax; petioles 2 to 2.5 cm long. Fruits apparently few, in the axils of fallen leaves, their pedicels about 2.5 cm long, glabrous. Sepals 4, coriaceous, glabrous, broadly ovate, rounded, about 5 mm long, the outer two up to 8 mm in width. Fruit (immature) ovoid-ellipsoid, apiculate, 3 cm long, glabrous, very coarsely wrinkled when dry.

MINDANAO, Zamboanga District, *For. Bur.* 24161 *Miranda*, July 6, 1915, on forested ridges, Mount Kaladis, altitude about 100 meters.

This species is closely allied to *Bassia coriacea* Merr., of Luzon, which it greatly resembles. It is distinguished by its much larger leaves and sepals.

OLEACEAE

LINOCIERA Swartz

LINOCIERA REMOTINERVIA sp. nov.

Arbor glabra; foliis crassissime coriaceis, in siccitate pallidis, usque ad 15 cm longis, anguste oblongo-obovatis, apice plerumque rotundatis, basi acuminatis, margine recurvatis; nervis primariis utrinque circiter 5, distantibus, tenuibus, laxissime arcuato-anastomosantibus, reticulis obsoletis vel subobsoletis; in-

fructescentiis axillaribus, circiter 3 cm longis; fructibus ellipsoideis, circiter 1.4 cm longis.

A glabrous tree about 12 m high, the branchlets smooth, pale. Leaves very thickly coriaceous, narrowly oblong-obovate, 12 to 15 cm long, 3.5 to 5.5 cm wide, pale, of about the same color on both surfaces, smooth and shining when dry, the apex usually rounded, sometimes retuse, or at times shortly acuminate, base acuminate, margins recurved; midrib very prominent on the lower surface; lateral nerves about 5 on each side of the midrib, slender, distant, forked and laxly arched-anastomosing distant from the margin, the reticulations obsolete or nearly so; petioles 1.5 to 2 cm long. Infructescences axillary, about 3 cm long, peduncled, the fruits few, ellipsoid, olivaceous when dry, smooth, about 1.4 cm long.

LUZON, Pangasinan Province, Mount San Isidro, Labrador, *Bur. Sci.* 29933 *Fénix*, on open grassy slopes near the edge of the forest, altitude about 300 meters.

This species is well characterized by its very thickly coriaceous leaves and its few, distant, obscure, laxly arched-anastomosing nerves, the reticulations obsolete or nearly so.

CORNACEAE

MASTIXIA Blume

MASTIXIA PACHYPHYLLA sp. nov. § *Tetramastixia*.

Arbor glabra (floribus ignotis); foliis stricte oppositis, crasse coriaceis, oblongis ad oblongo-ellipticis vel anguste obovato-ellipticis, usque ad 14 cm longis, apice plerumque rotundatis, basi acutis, margine recurvatis, nervis utrinque 9 ad 11, distinctis; infructescentiis terminalibus, breviter pedunculatis, 6 ad 10 cm longis; fructibus ovoideis ad ellipsoideis, 2 ad 3 cm longis, sepalis 4, persistentibus, parvis.

A tree 6 to 8 m high, glabrous (flowers unknown). Leaves strictly opposite, thickly coriaceous, oblong to oblong-elliptic or narrowly obovate-elliptic, the apex usually rounded, the base acute, margins recurved, the upper surface smooth, greenish-olivaceous, shining, the lower paler; lateral nerves 9 to 11 on each side of the midrib; petioles stout, about 1.5 cm long. Infructescences 6 to 10 cm long, glabrous, somewhat peduncled, branched, the bracteoles ovate, acute, about 1.5 mm long. Fruits ovoid to ellipsoid, pale-brownish and smooth when dry, 2 to 3 cm long, the persistent calyx-lobes 4, small, indistinct.

CATANDUANES, Santo Domingo River, *Bur. Sci.* 30399 (type), 30413 *Ramos*, December 5, 1917, on forested slopes below an altitude of 100 meters.

This species of the section *Tetramastixia* is distinguished among the few Philippine forms by its relatively large and thickly coriaceous leaves. It is probably most closely allied to *Mastixia tetrapetala* Merr., but has much larger, more numerous nerved leaves than that species, which, moreover, are strictly alternate. It is less closely allied to *M. premnoides* (Elm.) Hallier f., of Mindanao.

GESNERIACEAE

CYRTANDRA R. Brown

CYRTANDRA ALVAREZII sp. nov.

Frutex, novellis densissime ferrugineo-lanosis; foliis oppositis, late oblanceolatis, usque ad 38 cm longis, breviter petiolatis, apice acutis vel obscure acuminatis, basi longe angustatis, margine irregulariter dentatis, supra olivaceis, glabris, subtus subdense ferrugineo-villosis, nervis utrinque circiter 18, curvato-ascendentibus, distinctis; fructibus numerosis, oblongo-ellipsoideis, glabris, circiter 1.5 cm longis, utrinque angustatis, brunneis, umbellatis, umbellis distincte pedunculatis.

A shrub, the branchlets and young leaves very densely lanate with shining, appressed, ferruginous hairs, the ultimate branches 5 to 8 mm in diameter. Leaves opposite, subcoriaceous, apparently in equal pairs, broadly oblong-oblanceolate, up to 38 cm long and 12 cm wide, apex acute or obscurely acuminate, gradually narrowed from the middle or upper two-thirds to the base, margins irregularly dentate, or serrate-dentate, the teeth usually tipped with tufts of hairs, the upper surface in maturity entirely glabrous, olivaceous, dull, the lower rather densely ferruginous-villous; lateral nerves about 18 on each side of the midrib, distinct, ascending, curved, the reticulations lax; petioles stout, 1 cm long or less. Infructescence axillary, solitary, umbellate, its peduncle stout, about 1 cm long, each bearing from 10 to 20 fruits, the individual fruits oblong-ellipsoid, about 1.5 cm long, brown, glabrous, narrowed at both ends, their pedicels slender, about 1 cm in length. The inflorescence is apparently subtended by a large bract or by bracts.

MINDANAO, Lanao District, Lanao-Cotabato trail, *For. Bur. 25214 Alvarez*, March 21, 1916, in dipterocarp forests, altitude about 1,000 meters.

A most characteristic species, distinguishable by its indumentum, its large, broadly oblong-oblanceolate leaves, and its umbellate fruits.

CYRTANDRA CASTANEA sp. nov. § *Dissimiles*.

Frutex circiter 1 m altus, partibus junioribus subtus foliis ad costa et nervis calycibusque dense castaneo-villosis; foliis alternis vel oppositis et dissimilis, subcoriaceous, oblongo-oblanceolatis, usque ad 15 cm longis, tenuiter acutissime acuminatis,

basi acutis, margine irregulariter undulato-serratis, nervis utrinque 6 vel 7, subtus valde perspicuis; floribus axillaribus, solitariis, breviter pedicellatis, circiter 4 cm longis, bracteis lineari-lanceolatis ad oblongo-lanceolatis, 6 ad 11 mm longis.

A shrub about 1 m high, apparently sparingly branched, the indumentum of characteristic, castaneous, subappressed, villous hairs. Branches terete, glabrous, pale-brownish, the young branchlets densely castaneous-villous. Leaves alternate or the upper ones opposite and dissimilar, oblong-oblongate, subcoriaceous, 5 to 15 cm long, 1.8 to 4 cm wide, slenderly and acutely acuminate, base acute, margins irregularly sinuate-serrate, the upper surface dark-olivaceous, glabrous, the lower brownish-olivaceous, paler than the upper, the midrib, lateral nerves, and reticulations dark-brown, castaneous-villous, contrasting with the paler epidermis; petioles castaneous-villous, 0.7 to 1 cm long. Flowers axillary, solitary, about 4 cm long, their pedicels about 6 mm long, the subtending bracts linear-lanceolate to oblong-lanceolate, castaneous-villous like the calyx, 6 to 11 mm long. Calyx 1.5 cm long, the tube 7 mm long, narrow, the lobes usually 3 or 4, lanceolate, slenderly long-acuminate, as long as the tube, externally characteristically castaneous-villous. Corolla white when fresh, 4 cm long, densely ferruginous-villous. Disk about 2 mm long, glabrous, irregularly lobed. Ovary and style about 2 cm long, ferruginous- or castaneous-villous, the immature fruits lanceolate, 2.5 cm long, appressed castaneous-villous.

LUZON, Tayabas Province, Mount Dalindingan, *Bur. Sci.* 26606 Ramos & Edaña, August 25, 1916, on forested slopes, altitude about 120 meters.

This species in many characters resembles *Cyrtandra incisa* C. B. Clarke and *C. multifolia* Merr. and manifestly belongs in the same section with both. The upper leaves are opposite and dissimilar, the lower ones alternate. It is readily distinguished by its characteristic castaneous indumentum.

CYRTANDRA MULTIFOLIA sp. nov. *Dissimiles*.

Frutex ramosus, circiter 1 m altus, partibus junioribus ferrugineo-pilosus; foliis numerosis, oppositis, dissimilis, oblongo-lanceolatis, usque ad 9 cm longis, subcoriaceis, tenuiter acuminatis, basi acutis, margine distanter leviter undulato-serrulatis, nervis utrinque 7 vel 8; floribus axillaribus, solitariis vel binis, pedicellatis, circiter 4.5 cm longis, calycibus tubo 1 cm longo, laciniis 1 cm longis, caudato-acuminatis.

An erect much-branched shrub about 1 m high, the younger parts more or less densely covered with long, soft, weak, ferruginous hairs. Branches terete, brownish, glabrous, somewhat striate when dry, the internodes 1 to 2 cm long, the young

branchlets ferruginous-villous. Leaves opposite, numerous, oblong-lanceolate, those of each pair dissimilar in size, one usually about one-half as large as the other, subcoriaceous, 5 to 9 cm long, 1 to 2.5 cm wide, slenderly subcaudate-acuminate, base acute, margins distantly undulate-serrulate, the upper surface dark-olivaceous when dry, glabrous, the lower paler, brown, ferruginous-villous on the midrib and lateral nerves; lateral nerves 7 or 8 on each side of the midrib, prominent on the lower surface, the reticulations obsolete or nearly so; petioles ferruginous-villous, 5 to 8 mm long. Flowers axillary, solitary or in pairs, pink to white, about 4.5 cm long, their pedicels 1 to 1.5 cm long, sparingly villous, each subtended by a pair of leaflike bracts 0.7 to 2 cm long. Calyx 2 cm long, ferruginous-villous, the tube about 1 cm long, somewhat inflated, the lobes slenderly lanceolate, caudate-acuminate, about as long as the tube. Corolla 4.5 cm long, ferruginous-villous. Disk about 1.8 mm high. Ovary densely ferruginous-villous, including the style about 3 cm long.

LUZON, Nueva Ecija Province, Mount Umingan, *Bur. Sci. 26459 Ramos & Edaña*, August 12, 1916, on forested slopes at an altitude between 300 and 400 meters.

The alliance of this species is manifestly with *Cyrtandra incisa* C. B. Clarke, from which it is distinguished by its much smaller, but slightly toothed leaves and its larger flowers.

CYRTANDRA MICROPHYLLA sp. nov.

Frutex circiter 1 m altus, ramosus, ramulis et petiolis et inflorescentiis leviter castaneo-ciliato-setosis, pilis adpressis; foliis oppositis, numerosis, oblongis ad late oblongo-oblancoatis, usque ad 5 cm longis, firme chartaceis, acuminatis, basi acutis, undulato-serratis, glabris, in siccitate supra nigro-brunneis, subtus brunneis, nervis utrinque 4 vel 5, subtus prominentibus; inflorescentiis axillaribus, solitariis, tenuibus, usque ad 4 cm longis, umbellatim 1- ad 3-floris; calycis tubo 2 mm longo, dentibus lineari-lanceolatis, 4 mm longis.

A much-branched shrub about 1 m high, the branchlets, petioles, and inflorescences with scattered, appressed, rather stiff, castaneous, ciliate-setose hairs, otherwise glabrous. Branches terete, grayish-brown, the branchlets slender. Leaves very numerous, opposite, firmly chartaceous, oblong to broadly oblong-oblancoate, those of each pair more or less unequal in size, 2.5 to 5 cm long, 0.8 to 1.5 cm wide, acuminate, base acute, margins distantly undulate-serrate, the upper surface blackish-brown when dry, the lower much paler, brownish; lateral nerves 4 or 5 on each side of the midrib, rather prominent on the lower sur-

face, dark-brown in contrast with the paler epidermis; petioles 5 to 8 mm long. Inflorescences axillary, solitary, very slender, 2 to 4 cm long, umbellately 1- to 3-flowered, the pedicels about 3 mm long; bracts linear-spatulate, about 6 mm long. Calyx glabrous, the tube cup-shaped, about 2 mm long, the lobes 5, linear-lanceolate, about 4 mm long. Ovary ovoid, glabrous; style 6 mm long. Corolla not seen.

LUZON, Nueva Ecija Province, Mount Umingan, *Bur. Sci.* 26250 Ramos & Edaña, August 12, 1916, on forested slopes at an altitude between 300 and 400 meters.

The alliance of this species is manifestly with *Cyrtandra tenuipes* Merr., from which it differs especially in its relatively narrower leaves and in its calyx-tube being but about one-half as long as the slender calyx-lobes.

CYRTANDRA LONGIPES sp. nov.

Frutex scandens, plus minusve ferrugineo-villosis; foliis longissime petiolatis, in foliis majoribus petiolis usque ad 14 cm longis, oblongis, chartaceis, laevis, usque ad 20 cm longis et 9 cm latis, apice breviter et obtuse acuminatis, basi leviter inaequilateralibus, subacutis, margine superne undulato-crenatis, nervis utrinque circiter 8, curvatis, subtus prominulis, reticulis subobsoletis; inflorescentiis axillaribus, floribus in ramulis junioribus fasciculatis, in ramis vetustioribus in inflorescentiis ramosis elongatis usque ad 9 cm longis dispositis; floribus circiter 2 cm longis, calycis inflatis, 1.2 ad 1.4 cm longis, glabris, 5-lobatis, lobis oblongo-lanceolatis, acuminatis, circiter 6 mm longis.

A scandent shrub, the stems about 1 cm in diameter, usually root-bearing on one side, pale-brownish, terete, rather conspicuously ferruginous-villous, the indumentum more or less deciduous, the internodes about 10 cm long. Younger parts of the slender branchlets rather densely ferruginous-villous, the inflorescences slightly so. Leaves oblong, rather firmly chartaceous, 10 to 20 cm long, 4 to 9 cm wide, glabrous or nearly so, smooth, brittle when dry, the upper surface olivaceous, the lower pale, shining, the apex broadly and shortly blunt-acuminate, the base slightly inequilateral, subacute, the margins above undulate-crenate; petioles of the larger leaves 12 to 14 cm in length, glabrous or nearly so; lateral nerves about 8 on each side of the midrib, prominent on the lower surface, curved, with very few, widely scattered, slender, secondary veins, some of which scarcely anastomose. Inflorescences axillary, on the branchlets the flowers fascicled, on the stems arranged in branched inflorescences up to 9 cm in length; bracts narrowly oblong, acuminate, up to 1 cm in length; pedicels slender, 2 to 2.5 cm long. Flowers about

2 cm in length, glabrous or nearly so. Calyx somewhat inflated, 1.2 to 1.4 cm long, 5-lobed, the lobes oblong-lanceolate, acuminate, about 6 mm long.

CATANDUANES, *Bur. Sci. 30353 Ramos*, December 10, 1917, climbing on tree trunks in forests at low altitudes, near Calolbong.

This species, among numerous other distinctive characters, can readily be recognized by its very greatly elongated petioles.

CYRTANDRA TENUIPES nom. nov.

Cyrtandra longipedunculata Merr. in Philip. Journ. Sci. 10 (1915) Bot. 77, non Rechinger, 1908.

A new name is necessary for the Luzon form I described in 1915, as the specific name had already been utilized by Rechinger in 1908 for a Samoan species.

ASCLEPIADACEAE

DISCHIDIA R. Brown

DISCHIDIA LANCIFOLIA sp. nov.

Species *D. merrillii* affinis, differt foliis lanceolatis, usque ad 8 cm longis et 1 cm latis, tenuiter acuminatis, in siccitate utrinque rugosis sed haud reticulatis.

A slender glabrous vine, the branches terete, grayish, about 1 mm in diameter. Leaves lanceolate, apparently fleshy when fresh, when dry coriaceous, pale-greenish, somewhat shining, wrinkled on both surfaces but not reticulate, the lateral nerves obsolete, 5 to 8 cm long, 8 to 10 mm wide, narrowed below to the acute or somewhat obtuse base and above to the slenderly acuminate apex; petioles about 5 mm long. Peduncles axillary, solitary, 1 cm long or less, few-flowered, the flowers subumbellately arranged at the apex of the peduncle, reddish, about 7 mm long, their pedicels 2 to 3 mm in length. Corolla-tube somewhat inflated below, narrowed above, at the most 3 mm wide when flattened. Follicles slender, linear-lanceolate, acuminate, about 3 mm long and 3 mm in diameter.

CATANDUANES, back of Calolbong, *Bur. Sci. 30374 Ramos*, December 10, 1917, on tree trunks in damp forests at low altitudes.

A species well characterized by its lanceolate leaves, manifestly allied to *Dischidia merrillii* Schltr., but at once distinguished by the characters indicated in the diagnosis.

HOYA R. Brown.

HOYA PENTAPHLEBIA sp. nov. § *Euhoya*.

Species *H. fischerianae* Warb. affinis, differt foliis late ovatis ad ellipticis. Ramis teretibus; foliis crasse coriaceis, 8 ad 16 cm longis, 6 ad 9 cm latis, pallidis, nitidis, distincte acuminatis, basi rotundatis, perspicue 5-nerviis, nervis interioribus apicem

attingentibus, reticulis laxis, distinctis; petiolo crasso, 2 ad 5 cm longo; pedunculis 2 ad 5 cm longis, partibus superioribus incrassatis, 3 ad 4 mm diametro; floribus numerosis, flavidis, 7 ad 8 mm diametro, petalis intus papillois, rhomboideis, leviter acuminatis; coronae lobis patulis, oblongo-ovatis, acutis, subplanis, 2 mm longis.

A scandent plant entirely glabrous except the papillose corolla lobes. Branches terete, brownish or grayish, smooth, up to 5 mm in diameter, sometimes with roots along one side of the internodes, the internodes up to 12 cm in length. Leaves thickly coriaceous, pale and shining when dry, broadly ovate to elliptic, 8 to 16 cm long, 6 to 9 cm wide, the apex broadly and rather prominently acuminate, base rounded, prominently 5-nerved, the interior pair of nerves reaching the apex, the reticulations very lax, distinct on both surfaces, the margins somewhat recurved; petioles stout, 2 to 5 cm long. Umbels axillary, solitary or fascicled many-flowered, about 4 cm in diameter, the peduncles 2 to 5 cm long, the thickened upper part of the rachis cylindrical, 3 to 4 mm in diameter, marked with numerous scars, this rachis on older inflorescences up to 4 cm in length. Flowers yellowish, 7 to 8 mm in diameter, rotate, the buds prominently 5-angled, 4 mm in diameter. Sepals membranaceous, oblong-ovate, somewhat acuminate, 1.5 mm long. Corolla distinctly papillate within, the lobes rhomboid, somewhat acuminate, about 4 mm long and 3 mm wide. Staminal-column about 4 mm in diameter, the lobes spreading, oblong-ovate, acute, the upper surface nearly flat or slightly concave, the external apex not recurved, the internal one elevated, acute, short. Follicles about 12 cm long.

SAMAR, Cauayan Valley, *Bur. Sci. 17411 Ramos* (type), March 9, 1914, in damp forests. BILIRAN, *Bur. Sci. 18831 McGregor*, June 28, 1914.

The alliance of this species is manifestly with *Hoya fischeriana* Warb., to which it conforms closely in its floral characters. It is distinguished by its very differently shaped leaves.

HOYA PUBICALYX sp. nov. § *Euhoya*.

Frutex scandens, inflorescentiis exceptis glaber, ramis subteretibus, circiter 3 mm diametro; foliis carnosis, in siccitate coriaceis, oblongis ad oblongo-obovatis, usque ad 14 cm longis, pallidis, nitidis, basi obtusis, apice acuminatis, in siccitate verruculosus, pinnatinerviis, nervis utrinque circiter 6, utrinque valde obscuris; pedicellis tenuibus, leviter pubescentibus, circiter 3.5 cm longis; floribus rotatis, in siccitate brunneis, circiter 1.8 cm diametro, sepalis oblongis, subacutis, extus leviter pubescentibus,

4 mm longis; corollae lobis late triangularibus, acuminatis, circiter 6 mm longis, alte connatis, indus dense papillosis, apice leviter reflexis; coronae lobis coriaceis, oblongo-ovatis, 5 mm longis, acuminatis vel acutis, patentibus, apice leviter retusis, subplanis.

A scandent shrub, entirely glabrous except the inflorescence, the branches subterete, rather pale when dry, about 3 mm in diameter, the internodes up to 20 cm in length. Leaves opposite, fleshy, when dry coriaceous, pale and shining on both surfaces and more or less wrinkled, oblong to oblong-obovate, 10 to 14 cm long, 3 to 5 cm wide, base obtuse, apex distinctly acuminate; lateral nerves pinnately arranged, indistinct, about 6 on each side of the midrib, ascending, scarcely more evident than are the lax, indistinct reticulations; petioles about 1 cm long. Umbels many-flowered, 8 to 9 cm in diameter, the thickened rachis about 4 mm in diameter above, the pedicels spreading, slender, about 3.5 cm long, sparingly appressed-pubescent. Flowers fragrant, about 1.8 cm in diameter, brown when dry. Calyx-segments oblong-ovate to ovate-lanceolate, acute or subacute, externally somewhat pubescent, about 4 mm long. Corolla-lobes broadly triangular, about 6 mm long and wide, spreading, rotate, externally glabrous, internally densely papillose, the acuminate apex somewhat recurved. Corona 10 to 12 mm in diameter, stellate, the lobes spreading, coriaceous, brown, shining, oblong-ovate to ovate-lanceolate, acuminate, about 5 mm long, the external tip slightly retuse, the internal one ascending, the upper surface plano-convex and somewhat keeled in the median portion.

LUZON, Tayabas Province, Mauban, *Bur. Sci. 19484 Ramos & Edaña*, January 24, 1913, on trees along streams in damp forests.

The alliance of this species is with *Hoya luzonica* Schltr., from which it is readily distinguished by its larger flowers, its pubescent pedicels and sepals, and its differently shaped, longer, acuminate, and slightly retuse corona-segments.

CUCURBITACEAE

TRICHOSANTHES Linnaeus

TRICHOSANTHES ELLIPSOIDEA sp. nov. § *Eutrichosanthes*.

Herbacea, scandens, glaberrima, caulis tenuibus. Foliis chartaceis, oblongo-ovatis, usque ad 14 cm longis, integris vel obscure repandis, apice acuminatis, basi profunde cordatis, supra albido-punctatis, subtus verruculosis, nervis reticulisque perspicuis; floribus ♀ axillaribus, solitariis, pedicellatis, ebracteolatis, tubo 6 ad 7 cm longo; calycis lobis lanceolatis, acuminatis, 6 ad 7 mm longis; petalis puberulis, obovatis, circiter 3 cm longis,

$\frac{1}{2}$ fimbriatis; fructibus junioribus ellipsoideis, seminibus compressis, oblongo-lanceolatis, circiter 1.3 cm longis.

A scandent, glabrous, slender, herbaceous plant, the branches terete, slightly sulcate. Leaves chartaceous, oblong-ovate, 11 to 14 cm long, about 7 cm wide, olivaceous, shining, the upper surface somewhat scabrid by the whitish-punctate dots, the lower verruculose, the apex rather slenderly acuminate, base deeply cordate, the sinus narrow, the basal lobes somewhat angular or repand, the margins otherwise entire or very obscurely undulate, the nerves and reticulations prominent; petioles about 3.5 cm long; tendrils up to at least 15 cm in length, glabrous. Pistillate flowers solitary, axillary, ebracteate, their pedicels 1.5 to 3 cm long, the tube slender, cylindric, including the ovarian part 6 to 7 cm long. Sepals lanceolate, acuminate, 6 to 7 mm long. Petals obovate, puberulent, about 3 cm long, white, split to the middle or beyond into numerous very slender fimbriae. Immature fruits ellipsoid, about 5 cm long, deeply wrinkled when dry, glabrous, castaneous when dry. Seeds oblong-lanceolate, compressed, about 1.3 cm long.

CATANDUANES, *Bur. Sci.* 30364 Ramos, November 27, 1917, border of forests near abacá (Manila hemp) plantations, slopes of Mount Mari-guidon.

This species is well characterized by its oblong-ovate, deeply cordate leaves, which are entire or slightly undulate, not at all lobed, and its ellipsoid fruits.

[Vol. XIII, Sec. C, No. 3, including pages 123 to 200, was issued July 16, 1918; and No. 4, including pages 201 to 262, was issued September 21, 1918.]

THE PHILIPPINE BUREAU OF SCIENCE

RECENT PUBLICATIONS

AN INTERPRETATION OF RUMPHIUS'S HERBARIUM AMBOINENSE

By E. D. MERRILL

Based on the collections made in Amboina by the late Charles Budd
Robinson

Order No. 450. Bureau of Science Publication No. 9. Paper, 595 pages and 2 maps.
Price \$3, United States currency, postpaid.

The Herbarium Amboinense is a classical work on the Malayan flora and one that is absolutely essential to the systematist to-day. The great importance of the work is due to the fact that later authors have made the Rumphian descriptions and figures the actual "types" of many binomials. As an original source the Herbarium Amboinense stands preëminent among all the early publications on Malayan botany.

Professor Merrill's interpretation of the Herbarium Amboinense discusses the status of each species described by Rumphius and assigns it to a position in the modern system of classification. This publication will be of great service to any one working on Indo-Malayan systematic botany.

A GRAMMAR OF LEPANTO IGOROT AS IT IS SPOKEN AT BAUCO

By MORICE VANOVERBERG

Order No. 438. Vol. V, Part VI, Division of Ethnology Publications. Paper, 102 pages.
Price \$0.75, United States currency, postpaid.

This part completes Volume V of the Division of Ethnology publications and includes the index and the title-page for the volume. A title-page for Volume II is printed with this number.

PLEASE GIVE ORDER NUMBER

Orders for these publications may be sent to the BUSINESS MANAGER, Philippine Journal of Science, Bureau of Science, Manila, P. I., or to any of the following agents:

AGENTS

THE MACMILLAN COMPANY, 64-66 Fifth Avenue, New York, U. S. A.
WM. WESLEY & SON, 28 Essex Street, Strand, London, W. C., England.
MARTINUS NIJHOFF, Lange Voorhout 9, The Hague, Holland.
KELLY & WALSH, Limited, 32 Raffles Place, Singapore, Straits Settlements.
A. M. & J. FERGUSON, 19 Baillie Street, Colombo, Ceylon.
THACKER, SPINK & Co., P. O. Box 54, Calcutta, India.

CONTENTS

	Page.
MERRILL, E. D. New or noteworthy Philippine plants, XIV.....	263

The Philippine Journal of Science is issued in four sections. Each section consists of six numbers a year, is separately paged and indexed, and is a complete publication in itself. Authors receive 100 copies of their papers free.

SUBSCRIPTION RATES TO CURRENT VOLUME	U. S. currency.
Section A (Chemical and Geological Sciences and the Industries)	\$2.00
Section B (Tropical Medicine).....	3.00
Section C (Botany), Elmer D. Merrill, B. S., M. S., Editor.....	2.00
Section D (General Biology, Ethnology, and Anthropology). Section D began with Volume V.....	2.00
Entire Journal (4 sections).....	7.00

PRICES OF BACK NUMBERS AND VOLUMES	
Entire Journal, Volume II, III, or IV (3 sections each); or V (4 sections)	5.00
Entire Journal, beginning with Volume VI (per volume).....	7.00
Single numbers of Volume I.....	.75
Single numbers (except of Volume I).....	.50
Volume I, 1906 (not divided into sections), and supplement, sold only with a complete file of section A, B, or C.....	10.00
Supplement to Volume I (Botany).....	3.50
Volume I (without supplement), sold only with a complete file of section A, B, or C.....	6.50

Publications sent in exchange for the Philippine Journal of Science should be addressed: Library, Bureau of Science, Manila, P. I.

Subscriptions may be sent to the BUSINESS MANAGER, Philippine Journal of Science, Bureau of Science, Manila, P. I., or to any of the agents listed on the inside pages of this cover.

VOL. XIII, SEC. C, No 6

NOVEMBER, 1918

THE PHILIPPINE JOURNAL OF SCIENCE

ALVIN J. COX, M. A., PH. D.
GENERAL EDITOR

SECTION C. BOTANY

E. D. MERRILL, M. S.
EDITOR

WITH THE COÖPERATION OF

W. H. BROWN, PH. D.; C. F. BAKER, M. A.
L. M. GUERRERO, PHAR. D.; R. C. MCGREGOR, A. B.



MANILA
BUREAU OF PRINTING
1918

PHILIPPINE JOURNAL OF SCIENCE

A TEN-YEAR INDEX

CONTENTS AND INDEX OF THE PHILIPPINE JOURNAL OF SCIENCE, VOLUME I (1906) TO VOLUME X (1915)

Order No. 449. Bureau of Science Publication No. 8. Paper, 441 pages.
Price \$2, United States currency, postpaid.

One copy of this index has been sent free of charge to each subscriber that has received Volumes XI and XII of the Journal.

This publication consists of:

The complete contents of the first ten volumes of the Philippine Journal of Science, all sections; giving all authors, titles of articles, and page numbers. The exact date of issue of each number is recorded.

An author index, being an alphabetical list of all the contributors. The titles of all the articles are listed under the names of their respective authors.

A subject index. The subject matter is very fully indexed by catch words from the titles, by geographical localities, and by subjects. All systematic names in zoölogy and botany, as well as the thousands of English and local names, are entered in the index.

STUDIES IN PHILIPPINE DIPTERA, II

By M. BEZZI

Order No. 437. Bureau of Science Publication No. 10. Paper, 59 pages and 1 plate.
Price \$0.50, United States currency, postpaid.

This is the second century of Professor Bezzi's enumeration of Philippine species of flies and includes descriptions of new genera and new species.

PLEASE GIVE ORDER NUMBER

Orders for Bureau of Science publications may be sent to the BUSINESS MANAGER, Philippine Journal of Science, Bureau of Science, Manila, P. I., or to any of the following agents:

AGENTS

THE MACMILLAN COMPANY, 64-66 Fifth Avenue, New York, U. S. A.
WM. WESLEY & SON, 28 Essex Street, Strand, London, W. C., England.
MARTINUS NIJHOFF, Lange Voorhout 9, The Hague, Holland.
KELLY & WALSH, Limited, 32 Raffles Place, Singapore, Straits Settlements.
A. M. & J. FERGUSON, 19 Baillie Street, Colombo, Ceylon.
THACKER, SPINK & Co., P. O. Box 54, Calcutta, India.

THE PHILIPPINE
JOURNAL OF SCIENCE

C. BOTANY

VOL. XIII

NOVEMBER, 1918

No. 6

MERRILLIA, A NEW RUTACEOUS GENUS OF THE TRIBE
CITREAE FROM THE MALAY PENINSULA

By WALTER T. SWINGLE

TWO PLATES

In the tropical regions of the Eastern hemisphere there occurs a small but very well-marked group of citrous plants having large fruits with a woody or leathery pericarp, and five or more locules with numerous seeds embedded in a transparent glutinous jelly. These so-called hard-shelled citrous fruits comprise at present six genera and nine species, and range from the Philippines west to Liberia in western Africa, and from India and Indo-China to Java and other Malayan Islands. *Aegle*¹ with one species occurs in India and Indo-China, *Balsamocitrus*² with three species in tropical Africa, *Aeglopsis* with one species in West Africa, *Feronia* with one species in India and Indo-China, *Feroniella*³ with two species in Indo-China and Java, and *Chaetospermum*⁴ with one species in the Philippine Islands. These six genera constitute a natural group inside the tribe *Citreae*. This group I propose to recognize as a subtribe *Balsamocitrinae*,

¹ These genera and species I have described in popular form in L. H. Bailey's Standard Cyclopaedia of Horticulture. New York (1914-1917).

² Swingle, Walter T., Le genre *Balsamocitrus* et un nouveau genre voisin, *Aeglopsis*, *Bull. Soc. Bot. France* 58 (mém. 8d) (1911) 225-245, t. 1-5. Reprinted in Chevalier, Aug., *Novitates florae africanae*, fasc. 4: 225-245, t. 1-5.

³ Swingle, Walter T., *Feroniella*, genre nouveau de la tribu des *Citreae*, fondée sur le *F. oblata*, espèce nouvelle de l'Indo-Chine, *Bull. Soc. Bot. France* 59 (1912) 774-783, t. 18.

⁴ Swingle, Walter T., *Chaetospermum*, a new genus of hard-shelled citrous fruits, *Journ. Washington Acad. Sci.* 3 (1913) 99-102.

typified of course by *Balsamocitrus*. The genera of the *Balsamocitrinae* are very different from each other and have many distinct characters of taxonomic importance. In other words they seem like the widely scattered survivors of a once larger group.

Subtribe BALSAMOCITRINAE Swingle

The genera of this subtribe fall into three divisions or supergenera: (1) *Aegle*, *Balsamocitrus*, and *Aeglopsis*, with very hard-shelled fruits having many locules and trifoliolate or rarely unifoliolate leaves; (2) *Feronia* and *Feroniella*, with very hard-shelled fruits with five locules coalescing into a single cavity, and pinnate leaves; (3) *Chaetospermum*, with a leathery rinded 8- to 10-celled fruit and trifoliolate leaves.

Recently a new member of the *Balsamocitrinae* has come to light in the Malay Peninsula. It is apparently most closely related to *Chaetospermum* but differs widely from it as will be seen from the account given below.

During the winter of 1917-18 Professor C. F. Baker sent to me at Washington a fine specimen of the fruit of *Murraya caloxyylon* Ridl.,⁵ from a tree growing in the botanic gardens at Singapore. It was at once apparent that this fruit did not belong to a plant of the genus *Murraya* (*Chalcas*) but appertained instead to the group mentioned above. As I did not have a flowering specimen, I hesitated to publish on this plant because it had so many aberrant characters that it seemed possible the flower might show unexpected characters.

Upon reaching Manila in July, 1918, I was agreeably surprised to find that Professor E. D. Merrill, acting director of the Bureau of Science, had secured from Mr. I. H. Burkill, director of the Singapore Botanic Gardens, a beautiful flowering specimen collected in March, 1918, and also fresh fruits from the same tree. One of these fruits had been kept in the refrigerator and was still fresh enough to be studied.

In the meantime Professor C. F. Baker, dean of the College of Agriculture of the University of the Philippines, had brought seeds from Singapore and planted them in the college nurseries at Los Baños, Laguna Province, Luzon. These seedlings enabled me to observe the germination characters.

Thanks to all this material, as well as my notes on the type material of the species (*H. C. Robinson 5548*) which, through the courtesy of Mr. E. G. Baker, I was able to study in the British

⁵ Ridley, H. N., New or rare Malayan plants, Series IV, *Journ. Straits Branch. Roy. As. Soc.* 50 (1908) 111-114.

Museum, at South Kensington, in 1911, I now feel able to discuss this remarkable species, in many ways unique among the plants closely related to *Citrus*. In the first place all the known members of the tribe *Citreae* have either unifoliolate leaves or else pinnate leaves *with strictly opposite leaflets*. The other genera of the subfamily *Citratae*, such as *Chalcas* (*Murraya*), *Clausena*, *Glycosmis*, and *Micromelum*, have pinnate leaves with alternately arranged leaflets but never with a winged rachis. Up to now a single leaf, even if immature, would serve to distinguish any of these genera from the true *Citreae*. The Singapore plant has pinnate leaves with alternate leaflets and a narrowly but clearly winged rachis. All the pinnate-leaved members of the subfamily *Citratae* have a clearly marked petiole below the first pair of leaflets. The flowering specimen of *Murraya caloxylon*, collected in the Singapore Botanic Gardens in March, 1918, shows sessile or subsessile leaves, the lowest leaflets being very small, nearly opposite, and attached near to or at the very base of the rachis. The fruits are even more remarkable, being like *Chaetospermum* in having a leathery rind, but differing widely in the irregularly lacunose pericarp and in having the walls of the locules solid. The seeds at first glance seem to be hairy like those of *Chaetospermum* and *Aegle*, but closer examination of what appear to be hairs shows that they are thin, elongated, somewhat fimbriate paleae. The seeds also show an ariloid ridge at one edge, unlike the seeds of the other members of this subtribe.

Many other characters of less importance serve to mark off this plant as perhaps the most remarkably aberrant of the citrous fruits.

I take pleasure in naming this remarkable new genus in honor of Professor E. D. Merrill, who has done so much valuable work on the flora of the Philippines, the Malayan region, and southern China.

MERRILLIA genus novum

(*Rutaceae*, *Citratae*, *Balsamocitrinae*)

Genus *Chaetospermo* (Roem.) Swingle ut videtur affinis perspicue differt ovario 5- vel 6-loculare, pericarpio irregulariter lacunoso, seminibus dense paleaceis, paleae elongatae, membranaceae, leviter laciniatae, foliis sessilibus, pinnatis, rhachibus anguste alatis, foliolis alternis.

Arbor inermis. Folia pinnata, sessilis vel subsessilis, rhachibus anguste alatis; foliola alterna, inferioribus parvis, sursum gradatim majores, terminalibus majoribus; petiolulo brevissimo.

Inflorescentia axillaris, 2-1-floris. Floris ♂, majusculi, 5-meri. Calyx 5-partitus, parvus, lobis triangulari-ovatis. Petala 5, deorsum angustatis. Stamina 10, libera, inaequalia. Ovarium 5-rariter 6-loculare, stipitatum, in stylum elongatum attenuatum, stigmatibus capitato; ovula in loculis 8 ad 10. Bacca subglobosa, magna, pericarpio crassissime coriaceo, irregulariter radiatim-lacunoso, septis cartilagineis, loculis muco repletis, semina numerosa (in quoque loculo ca. 8 ad 10), lenticularis, testa dense paleaceis, paleae leviter fimbriatae, membranaceae, elongatae, hilo carinato, subariloides. Germinatione cotyledones subterraneae, foliis primariis simplicibus, oppositis, late ovato-lanceolatis.

The type species of this genus is *Murraya caloxylon* Ridl., a tree native to the Malay Peninsula. It is known from southern Siam and Upper Perak, and is in cultivation in the Singapore Botanic Gardens.

Specimens examined: *H. C. Robinson 5548*, Upper Perak, Kenering, at 500 feet elevation (British Museum, London); *I. H. Burkill*, March, 1918, from a tree cultivated in the Singapore Botanic Gardens, the specimen with flowers and fruits.

Only one species is known, the *katinga* of the Malay Peninsula and Siam.

MERRILLIA CALOXYLON (Ridley) Swingle comb. nov. Plates V and VI.

Murraya caloxylon Ridley in Journ. Straits Branch Roy. As. Soc. 50 (1908) 113.

The original description is as follows:

Murraya caloxylon, n. sp.

A tree of considerable size the branches covered with a pale flaky bark. Leaves 8 inches or more long with 13 leaflets, rachis flattened and winged narrow, leaflets 3-3½ inches long or less by 1½ inch wide, alternate oblanceolate obtusely acuminate with a triangular base, minutely petiolate inequilateral thin bright deep green. Flowers pale yellowish green several together in small panicles, in the upper axils of a branch, about an inch long. Sepals connate ovate acute ¼₁₀ inch long. Petals and stamens not seen. Ovary stalked, hairy, style rather stout hairy, stigma capitate. Fruit oblong rounded at both ends, 4 inches long and three inches in diameter, the pericarp dotted and warty greenish eventually becoming yellow, half an inch thick, lemon yellow inside, full of long resin cells narrowed at the mouth and dilated below, cells 5, with rather thick tough walls, pulp of transparent flattened sticky fibers olive green in colour and tasteless. Seeds numerous about 5 in a section ovate flattened half an inch long ½ inch thick, olive grey.

Southern Siam: Patani (Penney); Upper Perak: Kenering at 500 feet elevation (Robinson 5548).

This tree known as the *Katinga* is famous in the Malay peninsula for its beautiful wood. This handsome wood is of light yellow color,

ornamented with dark brown streaks and strains, fairly hard in texture and taking a good polish. Mr. F. Penney obtained a considerable quantity of the wood from Siamese territory North of Province Wellesley, from which he had made furniture, boxes, etc., which was very highly valued on account of its beauty. He obtained also leaves and fruit of the tree. For the flowers I am indebted to Mr. H. C. Robinson, who met with it in Upper Perak.

It differs from other species of the genus in the greater size of the leaves, the conspicuously stalked ovary, and the remarkable fruit which resembles a citron. The rind has a bitter terpiney flavour, and the comparatively scanty pulp is quite tasteless. The fruit is so entirely different from that of any other species of the genus that the plant might almost be separated generically.

In the introduction to the fourth series of *New or Rare Malayan Plants*⁶ the following paragraph occurs:

The well known furniture wood Katinga from the Siamese borders has long been prized and I obtained leaves and a fruit some years ago from Mr. F. G. Penney, who had a fine collection of furniture made from its wood. A number of young plants were raised in the Botanic Gardens, and I lately obtained specimens shewing parts of the flower from Mr. H. C. Robinson. It proves to be a *Murraya* allied to the well known Kamuning wood, so much valued for the handles and sheaths of Krises.

As Ridley did not have good flowering specimens or fresh fruits the original description should be supplemented in some particulars and emended in others. The following notes were made from the flowering specimen and fruit collected in March, 1918, from the tree cultivated in the Singapore Botanic Gardens.

The leaves of fruiting twigs are sessile, pinnate, with 6 to 8 alternate leaflets. The petiole is very short or wanting, the rachis 10 to 15 cm long, narrowly winged, the wing increasing in width gradually up to the point of attachment of the leaflets, then suddenly diminishing. The leaflets are very unequal in size and shape, the basal ones—sometimes a pair nearly opposite—being very small, 5 to 10 mm in diameter, and very broad, often suborbicular. The lateral leaflets increase rapidly in size up to the penultimate, and at the same time become narrower and more pointed, becoming also somewhat inequilateral. The penultimate leaflet is 70 to 80 by 20 to 30 mm, rhomboid-lanceolate, subacuminate at the apex but with the very tip bluntly rounded; the base is cuneate. The terminal leaflet is like the penultimate in shape but symmetrical, 80 to 100 by 30 to 35 mm. The margins of the leaflets are wavy, sometimes slightly serrate. The very young leaves, like the young twigs, are minutely pubescent, but the older leaflets become nearly glabrous. The

⁶ Ridley, H. N., *op. cit.*, p. 111.

oil dots are small but very numerous. Inflorescences 1- or 2-flowered, axillary, pedicels slender with a few minute bracts. The flower buds are very large, 35 to 45 by 10 to 12 mm, greenish-white. The petals are 35 to 40 by 5 to 10 mm, bluntly pointed at the apex and narrowed gradually to the base. Stamens 10, unequal, filaments long, slender, free. Pistil 20 to 25 mm long, slightly hairy, with a clavate ovary narrowing abruptly into the cylindric style 12 to 15 mm long, which ends in a capitate stigma. Ovary 5- or 6-celled, narrowing gradually toward the base. Fresh fruits subglobose, when dry often slightly oval, 70 to 80 mm in diameter, nearly smooth, gray-green with a leathery pericarp 10 to 12 mm thick with irregular branched lacunae filled with a resinous gum; loculae 5 or 6, with cartilaginous solid walls 3 to 4 mm thick, the locules filled with a transparent jellylike gum surrounding the seeds. Seeds 8 to 10 in a locule, lenticular, 9 to 10 by 7 to 8 by 3.5 to 4 mm, gray-green in color, abundantly provided with very thin, elongated, hairlike, slightly fimbriate paleae 6 to 10 mm long, 0.25 to 2 mm wide. Near the hilum on the angle of the seed is a light yellowish-gray ariloid ridge 5 to 7 mm long and 1 to 2 mm high; because of the numerous hairlike fimbriate paleae the seeds almost completely fill the space, the interstices alone being filled with transparent jellylike gum. In the fresh fruits the paleae of the seeds being embedded in the transparent gum are very inconspicuous, but become increasingly conspicuous as the fruit dries.

On germination the cotyledons remain buried, the first pair of foliage leaves are opposite, entire, broadly lanceolate, the next few foliage leaves are pinnate with more and more leaflets. The leaflets often have sharply serrate margins.

The specimens studied at Manila, collected in March, 1918, as well as the fruits sent to Washington and the seeds planted at Los Baños, all come from a tree in the Singapore Botanic Gardens. It is probable that it was grown from seeds taken from the fruit sent to the former director, H. N. Ridley, "some years" before 1908, collected by F. G. Penney in southern Siam, especially as Ridley states in his original description of the species that he then had seedlings in the botanic garden. If planted, say in 1904, the tree would have been old enough to bear fruit in 1917 when Professor Baker collected fruits.

POSSIBLE ECONOMIC USES OF THE KATINGA

If the katinga proves to be rather closely related to *Chaetospermum* it is not improbable that, like *Chaetospermum glutin-*

nosum (Blanco) Swingle, it may be used as a stock upon which to graft the commonly cultivated species of *Citrus*. Mr. Ridley has called attention to the beauty of the wood of the katinga and Mr. F. G. Penney secured enough of this wood in southern Siam to make a much-admired set of furniture. The flowers are very large and it is possible that this species would be worthy of cultivation as an ornamental plant. At any rate it deserves a place in every tropical and subtropical botanic garden and arboretum.

ILLUSTRATIONS

[The drawings of the fruit and seeds are from a nearly dry fruit preserved for some months in a refrigerator. Drawings by J. K. Santos.]

PLATE V. *Merrillia caloxylon* (Ridley) Swingle.

A flowering branch from specimens taken from a tree growing in the Singapore Botanic Gardens, showing young and mature leaves and mature buds, one opening. Natural size.

VI. *Merrillia caloxylon* (Ridley) Swingle.

a, a mature bud, natural size, drawn from the large bud shown in Plate V soaked in water and partly opened.

b, pistil, $\times 2$.

c, cross section of the ovary, $\times 20$.

d, a seed, natural size.

e, a seed deprived of its paleae, showing the ariloid ridge at the hilum.

f, cross section of a seed, $\times 2$.

g, longitudinal section of a seed, $\times 2$.

h, paleae from the seed, $\times 4$.

i, cross section of a partly dry ripe fruit, natural size.

j, tangential section of a part of the pericarp, $\times 5$, showing the lacunae.



PLATE V. MERRILLIA CALOXYLON (RIDLEY) SWINGLE.

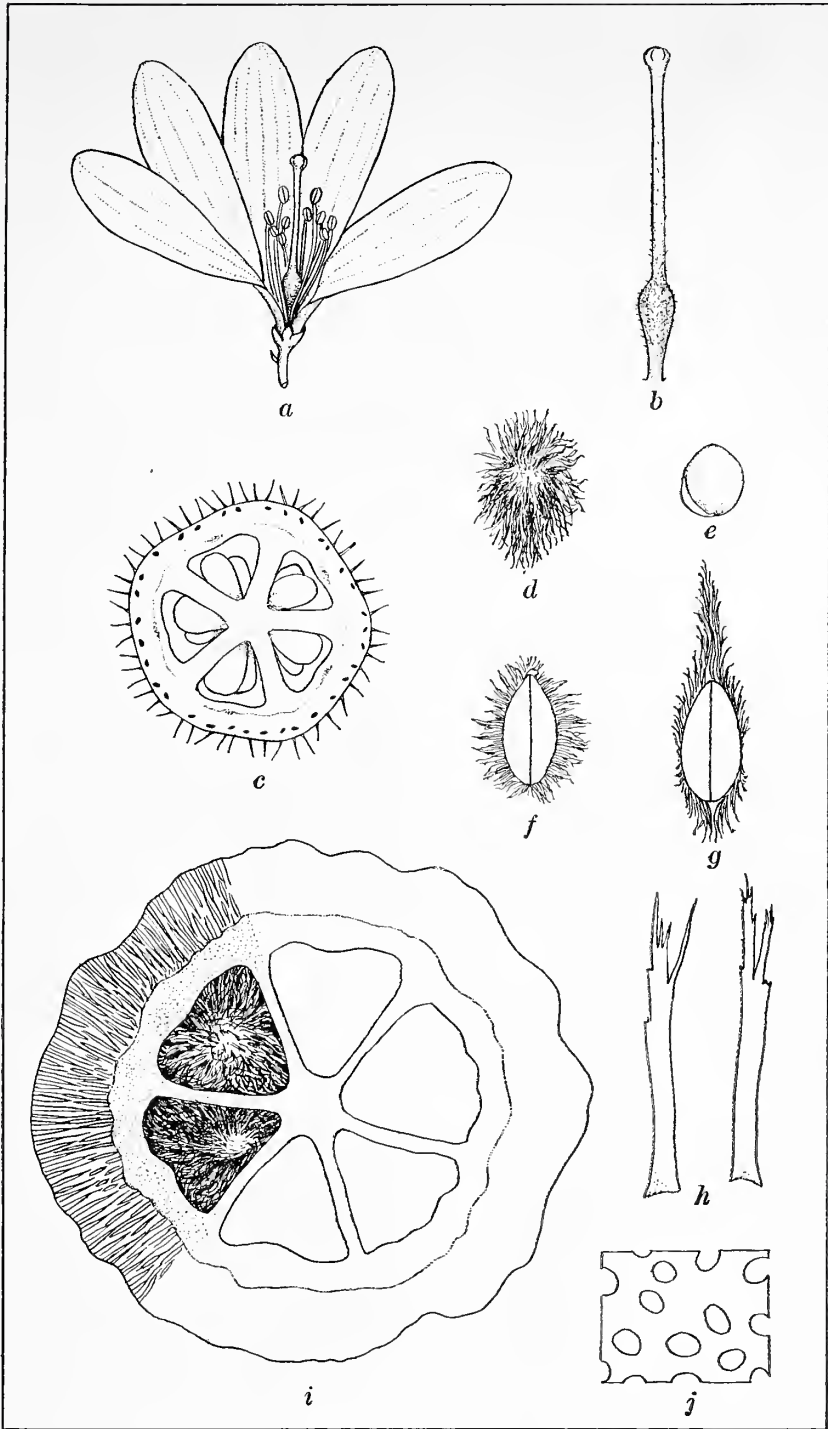

PLATE VI. MERRILLIA CALOXYLON (RIDLEY) SWINGLE.

THE THEORY OF LIMITING FACTORS

By WILLIAM H. BROWN

(From the College of Liberal Arts, University of the Philippines, and the Bureau of Science, Manila, P. I.)

ONE TEXT FIGURE

Since the appearance in 1905 of Blackman's¹ paper on limiting factors, this subject has received considerable attention. In his paper Blackman postulates as an axiom: *When the process is conditioned as to its rapidity by a number of separate factors, the rate of the process is limited by the pace of the 'slowest' factor.*

While such a theory might work in some cases, it may be said that it is a theory only, and that it has not been proven to be generally applicable to physiological processes. Blackman's best evidence appears to have been deduced from Matthei's work on photosynthesis.² However, Brown and Heise³ have shown that the conclusions reached by Matthei were due to misinterpretation. An examination of their paper would seem to show that this work cannot be used in proof of Blackman's theory. In reviewing Brown and Heise's paper Crocker⁴ made a mistake in saying that they misquoted Kanitz's formula, an error which he himself has since corrected.

The idea of limiting factors as developed by Blackman has not been clearly understood by all writers on the subject, so it may be well to examine its meaning. According to Blackman's development of this theory, there would appear to be a limiting factor for a physiological process under all conditions. An increase in the intensity of any other factor (unless, perhaps, the increase were so great as to be harmful) would be without effect, as the rate of the process is limited by the limiting factor.

¹ Blackman, F. F., Optima and limiting factors, *Ann. Bot.* 19 (1905) 281-295.

² Matthei, G. L. C., Experimental researches of temperature on carbon dioxide assimilation, *Phil. Trans. Roy. Soc. London* B97 (1905) 47-105.

³ Brown, W. H., and Heise, G. W., The application of photochemical temperature coefficients to carbon dioxide assimilation, *Philipp. Journ. Sci.* 12 (1917) Bot. 1-25.

⁴ Crocker, Wm., Photosynthesis, *Bot. Gaz.* 65 (1918) 568-569.

If there were two limiting factors, then the intensity of both would have to be increased to augment the rate of the process, as increasing only one would still leave the other as a limiting factor. It would follow from this that it could not be possible under any condition to increase the intensity of either of two factors independently and get an increase in the rate of a process in both cases; for, if either were limiting, an increase in the intensity of the other would be without effect. On the other hand, if neither factor were limiting, then some other would be, and an increase in the intensity of either or both of the two factors that are not limiting would be entirely without effect. This point of view is clearly shown in Blackman's discussion in the paper cited above, and also in a paper on assimilation in submerged water plants.⁵

In the latter paper Blackman and Smith determine the relation of variations in the concentration of carbon dioxide to photosynthesis; also of two different temperatures and two light intensities to photosynthesis. They presented these results in the form of a diagram on page 402, in which the ordinates represent the assimilation. Separate curves were drawn representing the relation to assimilation of the carbon-dioxide supply, the temperature, and the illumination. Concerning these curves they write as follows:

* * * We can by inspection tell exactly what minimum of CO₂, temperature, and light will be required for any one of the values of assimilation on the ordinates by following the horizontal line right across the diagram and noting where it intersects the three curves respectively.

Reciprocally, given any hypothetical combination of different magnitudes of the three factors, we have only to note in the diagram the values of assimilation corresponding to each of them, and we can foretell that the value of assimilation actually attained in that combination will be *the lowest of the three values*.

Now, according to this last quotation, if temperature were the limiting factor, an increase in carbon-dioxide supply or illumination would appear to have no effect. Blackman and Smith's paper was supposed to demonstrate the action of the theory of limiting factors as proposed by Blackman.⁶ It may, therefore, be interesting to examine some of the results.

The first section of the paper deals with the relation of the

⁵ Blackman, F. F., and Smith, A. M., Experimental researches on vegetable assimilation and respiration. IX.—On assimilation in submerged water-plants, and its relation to the concentration of carbon dioxide and other factors, *Proc. Roy. Soc. London* B83 (1910-1911) 389-412.

⁶ Blackman, F. F., and Smith, A. M., op. cit.

carbon-dioxide supply to assimilation. The largest number of experiments were performed with *Elodea* and the next largest with a bryophyte, *Fontinalis*. There were also three experiments with *Ceratophyllum* and one with *Potamogeton*.

In these experiments light was measured in arbitrary units. The experiments with *Elodea* were conducted with varying amounts of carbon dioxide, varying temperatures, and light intensity of either 5.7 or 8.1 units. In plotting the curve for *Elodea*, Blackman and Smith do not indicate either the temperature or the light intensity for any of these experiments. For this reason the results are plotted in fig. 1 of the present paper. In this figure the ordinates represent assimilation and

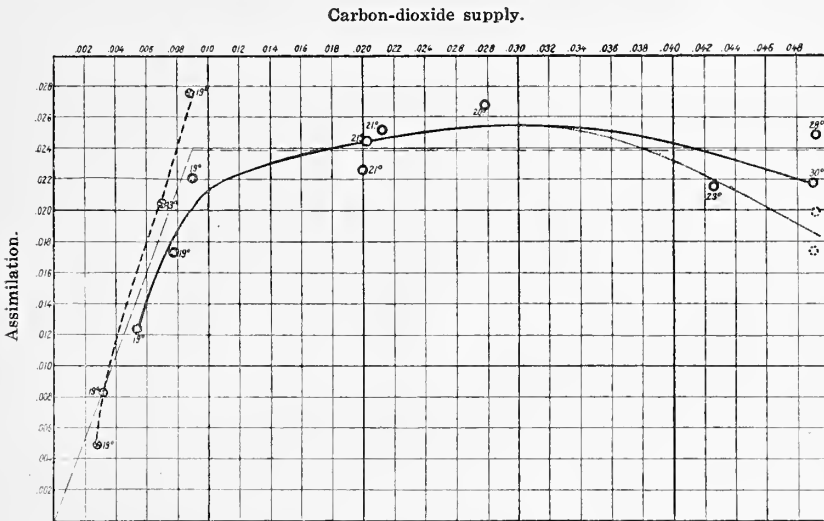

FIG. 1. Relation of assimilation to supply of carbon-dioxide. Data from Blackman and Smith.

the abscissae the supply of carbon dioxide in terms of grams of carbon dioxide in 100 cc of water. The experiments performed with 8.1 units of light are represented by crosses, and those with 5.7 units by continuous circles. The temperature at which these experiments were performed is written by the point representing the result. The position of Blackman and Smith's curve, as nearly as could be determined, is represented by a line of long dashes. According to Blackman and Smith, this curve for photosynthesis rises with increasing concentrations until it reaches a certain point, after which there is no further rise, as some other factor (which in this case seems to be light) has become limiting. This interpretation is illustrated

very clearly by the form of the curve. It would seem, however, that it would be more instructive to draw separate curves for the experiments with different light intensities. Following this idea a solid line has been drawn to represent the experiments performed with 5.7 units of light, and a line of short dashes to represent those with 8.1 units. On examining these two curves it will be seen that the curve for 8.1 units of light is considerably higher than that for 5.7 units, a result which is not surprising. The curve for 8.1 units does not appear to reach an optimum with the supply of carbon dioxide employed with this light. The curve for 5.7 units at first rises rapidly with increasing concentrations of carbon dioxide, then more slowly until it reaches what appears to be an optimum, after which it falls. An examination of the two experiments with the highest concentrations shows that they were performed at temperatures of 28° and 30°, whereas those with the lower concentrations were carried out with a temperature of 19°. According to the work of Van Amstel,⁷ a rise of temperature from 24° to 34° increases the rate of assimilation of *Elodea* by 26 per cent. Now, in view of this, it seems possible that these last two experiments showed a rate of assimilation at least 20 per cent higher than they would have shown had they been performed at a temperature of 19°. If we apply to them a correction of 20 per cent, then the points representing them would take the positions indicated by the broken circles. The curve drawn to pass between these points is shown as a dotted line and indicates, even more clearly than the solid line, that there is an optimum concentration of carbon dioxide. Either the curve represented by the solid line, or this curve as modified by the dotted line, would seem to represent the experiments more accurately than Blackman and Smith's curve, and both fail to show the operation of any limiting factor. Moreover, since the curve for light intensity of 5.7 units rises with increasing concentration of carbon dioxide up to a certain point, and the curve for light intensity of 8.1 lies above it, it would seem that an increase in either the light intensity or the carbon dioxide would bring about an increased rate of assimilation. This is, of course, exactly the opposite of Blackman's theory, according to which it would be impossible to increase the intensity of either one of two factors and in either case get an increase in the rate of the process.

⁷ Van Amstel, J. E., On the influence of temperature on the CO₂-assimilation of *Helodea canadensis*, *Rec. Trav. Bot. Néerl.* 13 (1916) 1-29.

An examination of Blackman and Smith's curve for *Fontinalis* shows that it might just as well have been drawn to indicate an optimum as to demonstrate the operation of a limiting factor.

If the theory of limiting factors as expounded by Blackman held rigidly for all physiological processes, we would expect it to be a well-known and generally applied law in physical chemistry dealing with such things as pressure, temperature, and concentrations. Such, however, is not the case, as two very simple examples will illustrate:

First, we may take the case of the solution of carbon dioxide in water. If carbon dioxide is in an atmosphere in the proportion of 1 per cent and under a pressure of one atmosphere, it will go into solution at a given rate. If now we independently increase either the concentration of carbon dioxide to 2 per cent or the pressure to two atmospheres, the rate at which the carbon dioxide will be dissolved will increase. Clearly in this case there is no single limiting factor.

Another example is afforded by the action of hydrochloric acid on calcium carbonate. We will suppose that a 10 per cent solution of hydrochloric acid is acting on a given amount of calcium carbonate at a temperature of 15°. If now we increase independently the concentration of the acid to 15 per cent, or the temperature to 20°, the rate of the reaction will be increased. In this case also there is clearly no single limiting factor.

If the rates of such simple chemical processes as those just mentioned do not show the operation of a limiting factor, it is hardly to be expected that physiological processes in general would do so. It might be mentioned that, if Blackman's theory did hold, we would expect to find instances frequently reported. But such does not seem to be the case. That one factor should have much more influence than another under certain conditions is entirely reasonable and, in fact, such is known to be the case; but this does not prove that changes in other factors are without effect.

Crocker⁸ in a review mentions quite a number of reasons why the theory of limiting factors cannot be regarded as generally applicable to physiological processes. He says:

Hooker⁹ gives an interesting discussion on the application of the law of the minimum, or limiting factors, to biological problems. He is perhaps fortunate, in so far as rigid application of the law is concerned, in drawing

⁸ Crocker, W., Law of the minimum, *Bot. Gaz.* 65 (1918) 287-288.

⁹ Hooker, D. H., Liebig's law of the minimum in relation to general biological problems, *Science* N. S. 46: 197-204, 1917.

his early illustrations from simple chemical and physical processes, for it is rapidly becoming a question whether the law applies to plant activities as generally as or with anything like the rigidity assumed by some workers. The fact of vicarious conditions, or stimuli, renders the conception of limiting factors less definite. In some light requiring seeds, for instance, several things can be substituted for light, as salts, higher temperatures, acids, etc. To speak of the lack of sufficient light as a limiting factor to germination helps little. What should be learned is, what internal condition, or inhibitor, may any one of these factors act upon to initiate growth? The conception of an external condition as a limiting factor frequently leads physiologists to fail to examine the internal mechanism upon which that and other factors play to bring about a given result. The reviewer feels that the law of the minimum should be applied to biological problems with due realization of its limitations.

Examples might be easily multiplied. Shive,¹⁰ working with three salt solutions found that, for a given set of external conditions and a given total concentration, there was a certain set of salt proportions that gave the best growth. For another total concentration, however, all the other conditions remaining as before, quite another set of salt proportions was most favorable for growth. It is difficult to see how the theory of limiting factors could be applied to such a case. Brown,¹¹ working with *Elodea* in tap water, found that either an increase in the carbon-dioxide supply or the addition of nutritive salts produced an increased rate of growth.

The law of the minimum seems to be applicable within limits when dealing with quantities of reacting chemicals which produce a given substance; but the law of the minimum, or the theory of limiting factors, certainly does not appear to apply generally to physiological processes, or even to chemical phenomena with regard to combinations of such factors as temperature, pressure, and concentrations.

¹⁰ Shive, J. W., A study of physiological balance in nutrient media, *Physiological Researches* 1 (1913-1916) 327-397.

¹¹ Brown, W. H., The relation of the substratum to the growth of *Elodea*, *Philip. Journ. Sci.* 8 (1913) *Bot.* 1-20.

ILLUSTRATION

TEXT FIGURE

FIG. 1. Chart, showing the relation of assimilation to supply of carbon dioxide. Data from Blackman and Smith.

158742—2

351

ALTERNATE SHRINKAGE AND ELONGATION OF GROWING
STEMS OF *CESTRUM NOCTURNUM**

By WILLIAM H. BROWN and SAM F. TRELEASE

(From the Bureau of Science, Manila, P. I., and the University of the
Philippines)

A number of rapidly growing plants in Manila wilt during every comparatively dry sunny day. Conspicuous among these are two vines, *Ipomoea nil* and *Thunbergia grandiflora*, and a large shrub with pendent branches, *Cestrum nocturnum*. That these plants lose more water during the day than they absorb would seem to be self-evident from the fact that they wilt. Livingston and Brown¹ have shown that the leaves of mesophytic plants growing in Arizona contain considerably less water during the day than at night. Shreve² has shown that this applies not only to leaves but also to stems of *Parkinsonia microphylla*. The size of plant parts is apparently affected by this decrease in water content. Thoday³ found that the leaves of many plants shrink during the day, so that they decrease in area two or three per cent, or in some cases as much as six per cent. Kraus⁴ has shown that tree trunks may shrink in diameter during the day, while Darwin⁵ has found the same thing to be true of the fruits of *Cucurbita*, and Smith⁶ of the fruits of *Artocarpus*.

¹ Livingston, B. E., and Brown, W. H., Relation of the daily march of transpiration to variations in the water content of foliage leaves, *Bot. Gaz.* 53 (1912) 309-330.

² Shreve, E. B., The daily march of transpiration in a desert perennial, *Carnegie Inst. Washington Publ. No.* 194 (1914).

³ Thoday, D., Experimental researches on vegetable assimilation and respiration. V. A critical examination of Sachs' method for using increase of dry weight as a measure of carbon dioxide assimilation in leaves, *Proc. Roy. Soc. London B*, 82 (1909) 1-55.

⁴ Kraus, G., Physiologisches aus den Tropen, *Ann. Jard. Bot. Buitenzorg* 11 (1895) 196.

⁵ Darwin, F., On the growth of the fruit of *Cucurbita*, *Ann. Bot.* 7 (1893) 459.

⁶ Smith, A. M., On the application of the theory of limiting factors to measurements and observations of growth in Ceylon, *Ann. Roy. Bot. Gard. Peradeniya* 3 (1906) 303.

These facts led us to undertake an experiment to determine what changes occur in the length of stems of *Cestrum nocturnum* during the day and the night. The young shoots of this plant appear to respond very quickly by curvature to changes in their water content. When fully turgid at night the stems bend upward slightly. Early in the day they become less stiff and assume a straight position. This on dry days is followed by a downward bending until they hang down in a markedly wilted condition. Later in the day, when they are no longer exposed to direct sunlight, they straighten and either late in the afternoon or early at night again become slightly bent upward. These various changes in curvature may probably be taken to indicate the presence of different amounts of water in the shoots.

The two plants used in the experiment were in a yard in Manila and were between two houses; owing to their position the time of exposure to direct sunlight was different for the two. In order to measure the changes in the length of a shoot, an ink line was placed as near as could conveniently be done to the growing apex, and another farther back, in a region where elongation had apparently ceased. The distance between these two lines was then measured at intervals during the day and night.

On one plant four shoots were selected for such measurement. A Livingston white spherical atmometer was placed near these four shoots, in such position that its exposure to direct sunlight was practically the same as was that of the four shoots. A thermometer was placed in the shade near the shoots and read at the same time that the measurements were made. Measurements were begun at 12.30 in the afternoon, April 29, 1918, and continued until 8.00 in the evening, the following day. The results of these measurements, together with observations on environmental conditions and on the appearance of the shoots, are given in Table I. The evaporation, reduced to Livingston's standard, is given in cubic centimeters per hour. The period covered by the evaporation reading for any particular hour begins at the time of the preceding measurement.

When the first measurements of length were made all of the shoots were in the shade, and they continued so until dark. At 8.00 in the morning of the following day they were exposed to direct sunlight, and continued to be so exposed until after 11.00 in the morning, when the sky became overcast with clouds. During the afternoon the sun again shone brightly, but by this time the plants were in the shade of a building. At 12.30 in the after-

TABLE I.—Measurements of shoots of plant 1 of *Cestrum nocturnum* at various hours during the day and night.

Time.	Temperature.	Evaporation per hour.	Illumination.	Measurements of shoots.				Condition of shoots.
				Shoot 1.	Shoot 2.	Shoot 3.	Shoot 4.	
<i>p. m.</i>		<i>cc.</i>		<i>cm.</i>	<i>cm.</i>	<i>cm.</i>	<i>cm.</i>	
12.30		1.32	Shade	9.40	7.60	12.50	7.60	Much wilted.
1.30		1.38	do	9.50	7.65	12.60	7.65	Do.
2.30		1.20	do	9.50	7.65	12.60	7.65	Less wilted.
4.00		0.84	do	9.50	7.65	12.65	7.70	Slightly wilted.
6.00	27	0.90	Dusk	9.55	7.75	12.70	7.75	Straight.
8.30	26	0.30	Dark	9.75	7.85	12.85	7.80	Curved upward.
<i>a. m.</i>								
7.00	25	0.18		10.25	8.25	13.30	8.25	Do.
8.00	28	0.58	Sun	10.20	8.25	13.30	8.30	Slightly curved downward.
9.00	29	1.34	do	10.10	8.10	13.15	8.20	Very visibly wilted.
10.00	31	1.63	do	10.00	8.10	13.05	8.15	Much wilted.
11.00	29	1.63	do	10.00	8.10	13.10	8.15	Do.
12 noon	30	1.44	Diffused light	10.05	8.15	13.10	8.20	Do.
<i>p. m.</i>								
1.00	33	2.30	Shade	10.05	8.15	13.15	8.20	Less wilted.
2.00	33	2.40	do	10.10	8.15	13.20	8.20	Slightly wilted.
3.00	32	2.11	do	10.10	8.20	13.20	8.25	Do.
4.00	32	2.21	do	10.10	8.20	13.25	8.25	Very slightly wilted.
5.00	30	2.21	do	10.10	8.25	13.25	8.25	Do.
6.00	27	1.34	Dusk	10.15	8.25	13.25	8.30	Straight.
8.00	27	0.72	Dark	10.20	8.25	13.30	8.30	Curved upward.

noon, when the first measurement was made, the shoots were very much wilted, as they were also at the time of the second measurement. Following this they became less wilted and were straight by 6 o'clock, and at 8.30 in the evening they were curved upward. This whole period was one during which the shoots were apparently recovering from wilting, and in doing so they showed an elongation amounting in the different cases to between 2 and 3.5 millimeters. At 8.30 in the evening the shoots were curved upward and apparently had completely recovered from wilting. Between this hour and 7 o'clock in the morning, when still turned upward and apparently very turgid, they showed an elongation varying in the different cases between 4 and 5 millimeters. By 8 o'clock, after having been exposed for a short time to the sun, one of them had decreased in length 0.5 millimeter and another had elongated 0.5 millimeter, while the other two had shown no change. The shoots at this time were curved downward slightly. By 9 o'clock all of them were visibly wilted, and all had shortened either 1 or 1.5 millimeters. At 10 o'clock they were very much wilted, and all except one

had decreased still further in length. Between 11 o'clock and noon, when they were exposed to diffused light, three of them elongated 0.5 millimeter, while the other one remained stationary. This latter, however, had elongated 0.5 millimeter during the preceding hour. After this all of the shoots were in the shade and there was a gradual elongation until 8 o'clock in the evening, when all of the stems were again curved upward. From the table it will be seen that, as they increased in length, they gradually became less wilted. However, at 8 o'clock in the evening, when all of the shoots were apparently turgid and curved upward, the length was in every case exactly the same as at 8 o'clock in the morning, which would indicate that they made absolutely no growth during the intervening period. This result would, of course, be expected from the wilted condition of the shoots which was noticeable throughout the day. The elongation during the first afternoon, as the shoots became more turgid, was very probably also due simply to their regaining the length they had possessed in the morning. If the evaporating power of air is compared with the measurements of the shoots and the condition of the plants, as shown in their respective columns, it will be seen that the period of greatest decrease in length and greatest degree of wilting did not coincide with the time when the evaporating power of air was greatest; but that, when the evaporating power of air was greatest, the plants were elongating and recovering from wilting. Had measurements of evaporation been made with a radio-atmometer instead of with a white atmometer, the records would in all probability have shown greater coincidence between the period of greatest evaporation and that of greatest wilting. From the figures in Table I it would appear that the action of sunlight on the leaves had a greater effect in producing wilting than had the evaporating power of the air, as measured by the white atmometer. That the plants did not grow during the day but made a fairly rapid growth at night would seem to be related to the amount of water contained in them. When the wilting of the plants indicated that they were giving off more water than they were absorbing, they made no growth.

Two shoots on the second plant were selected for measurement. The results for these are presented in Table II in the same form as are those in Table I. The evaporation given in this table was measured by the atmometer placed near the first plant and, as the atmometer was not illuminated in the same manner as the second plant, it could not be expected to

TABLE II.—Measurements of shoots of plant 2 of *Cestrum nocturnum* at various hours of the day and night.

Time.	Temperature.	Evaporation per hour.	Illumination.	Measurements.		Condition of shoots.
				Shoot 1.	Shoot 2.	
<i>p. m.</i>		<i>cc.</i>		<i>cm.</i>	<i>cm.</i>	
1.30		1.38	Sun	4.05	4.55	Much wilted.
2.30		1.20	Partial shade	4.05	4.60	Very slightly wilted.
4.00		0.84	Shade	4.10	4.60	Straight.
6.00	27	0.90	Dusk	4.20	4.70	Curved upward.
<i>a. m.</i>						
7.00	25	0.24	Shade	4.60	5.00	Do.
8.00	28	0.58	do	4.60	5.05	Do.
9.00	29	1.34	Sun	4.60	5.00	Slightly curved downward.
10.00	31	1.63	do	4.55	5.00	Evidently wilted.
11.00	29	1.63	Diffused light	4.60	5.05	Straight.
12 noon	30	1.44	Sun	4.60	5.00	Slightly wilted.
<i>p. m.</i>						
1.00	33	2.30	do	4.55	5.00	Much wilted.
2.00	33	2.40	Partial shade	4.60	4.95	Slightly wilted.
3.00	32	2.11	Shade	4.60	5.00	Straight.
4.00	32	2.21	do	4.60	5.00	Do.
5.00	30	2.21	do	4.60	5.05	Curved upward.
6.00	27	1.34	Dusk	4.65	5.05	Do.
8.00	27	0.72	Dark	4.70	5.05	Do.

give an accurate measurement of evaporation near the latter. The shoots on the second plant were not so vigorous in appearance as those on the first and showed slower rates of growth; wilting was, moreover, less prolonged. The shoots on the second plant were first measured at 1.30 p. m., April 29, and measurements were continued until 8 p. m. on the following day. At the time of the first measurement they were exposed to direct sun and were very much wilted. An hour later they were in partial shade and were only slightly wilted. At 4 p. m. they were in the shade and were straight, and at 6 p. m. they were apparently very turgid and curved upward. This whole period, therefore, may be considered as one during which the plants were recovering from a wilted condition, and during it both shoots elongated 1.5 millimeters. At 7 o'clock in the morning the following day they were still curved upward; one had increased in length 4 millimeters and the other 3. At 8 o'clock they were still in the shade and still curved upward. One showed no change in length, while the other had increased 0.5 millimeter. At 9 o'clock they were exposed to the direct sun. By 10 o'clock, while still in the sun, they were evidently wilted,

and both had decreased in length 0.5 millimeter. During the next hour they were exposed to diffused light, and both increased in length 0.5 millimeter. At the end of this hour they were both straight. During the next two hours they were exposed to direct sunlight, became much wilted, and decreased in length 0.5 millimeter. At 2 o'clock they were in partial shade and were slightly wilted; one had increased in length 0.5 millimeter, while the other had decreased the same amount. From 2 o'clock until dark they were in the shade. By 3 o'clock they had become straight. By 5 o'clock they were curved upward and had regained their longest previous length, having exactly the same length as at 8 o'clock in the morning. During the following three hours both shoots were curved upward and apparently turgid; one increased in length 1 millimeter, while the other remained stationary.

It will be noticed that these shoots, like the previous ones, made no growth on the second day between 8 o'clock in the morning and dusk, but during the elongation in the afternoon regained only the length they had had in the morning. The elongation which took place between 1.30 and 6 in the afternoon of the preceding day was accompanied by a recovery from wilting and was probably also a return to a previous early morning length.

The response of the shoots of the second plant to direct sunlight was very striking. During the first period of sun they decreased in length, while one hour of diffused light was sufficient to restore their original length. Later in the day, while again exposed to the sun, they again decreased in length.

It is interesting to note in this connection that MacDougal⁷ has found that *Opuntia discata* might shorten during the night as the result of increased acidity and heightened transpiration, as is shown in the following quotation:

A number of mature joints of this succulent were placed in bearing with precision auxographs of a type devised by the author in 1902, in which both expansions and contractions, magnified 20 to 50 times, are recorded. The changes of size of a mature joint, such as those indicated in March 1913, consist mainly of swelling by increased absorption of water made possible by disintegration of acids in the sap. This does not proceed at an even rate, but is most rapid in the first half of the day, being greatest from 11 a. m. until 2 p. m. During the remainder of the day this action would fall off and actual shortening might occur at night as a result of increased acidity and heightened transpiration. These reversible changes in form also take place in young joints, and accompany

⁷ MacDougal, D. T., Carnegie Inst. Wash. Year Book 14 (1915) 71.

growth, running parallel to its course and being determined in greater part by identical causes.

That the water balance is actually decreased at night and increased by day has been found by Mrs. E. B. Shreve,⁸ who says of a cylindropuntia:

"It was found, under conditions of average transpiration, such as occur in the greenhouse in summer, that the water intake at night is less than the outgo, while during the day the intake is greater than or at least equal to the outgo An examination of the water-content of stems from plants in the open and from the greenhouse showed that the highest water-content is at 5 p. m. after the close of a bright day, and the lowest just before daylight the next morning, with an intermediate amount at noon."

In the case of *Cestrum* the shortening during the day would appear to be very evidently connected with excessive transpiration.

That excessive transpiration may check growth or cause actual shrinkage has been demonstrated by Lloyd⁹ in *Eriogonum*. Concerning his experiments he says:

The daily march of growth is as follows: During the early daylight hours until about 8 there is usually a slight rise in growth-rate. After that hour the rate falls to a low value, or, much more frequently, there ensues an actual shrinkage. This is the period during which the loss of water by transpiration is rapidly increasing, reaching its maximum at about noon. Coincidentally with the checking of transpiration, the growth-rates rapidly increase in value, the maximum rate being attained by 1 or 2 p. m., and thereafter maintained, with fluctuations, until 6 p. m., when the rates fall to the night values. The afternoon rates are great enough to more than make up for the negative behavior of the morning, except, as above stated, under unusual conditions.

* * * it was found possible experimentally to alter the rates both positively and negatively quite independently of the constancy, increase, or decrease of illumination, even when this has been increased with respect to the growing part by insolation from three directions. There seems, indeed, to be no maximum insolation normally occurring in the field at this locality which can cause any cessation or inhibition of growth when conditions obtain which insure water-supply to the growing part. Thus, when a cessation of growth is apparent, it may be checked, and high rates instituted, by the removal of leaves (which divert the water-supply), by increasing the vapor-tension in the vicinity of the growing part, * * *.

The present results on *Cestrum* indicate that a retardation or inhibition of growth during the day may be due to other conditions than the direct action of light. In this they agree with Lloyd's results and tend to support MacDougal's earlier conclusions:¹⁰

⁸ Carnegie Inst. Wash. Year Book 13 (1914) 98, 99.

⁹ Carnegie Inst. Wash. Year Book 15 (1916) 58.

¹⁰ MacDougal, D. T., Influence of light and darkness on growth and development, *Mem. N. Y. Bot. Garden* 2 (1903) 307.

The failure of a large proportion of the forms examined to make an accelerated or exaggerated growth when freed from the influence of light, even when provided with an adequate food supply, shows that light has no invariable or universal relation to increase in length, or thickness, or to the multiplication or increase in volume of separate cells.

Cestrum nocturnum is one of the most rapidly growing of all cultivated plants in Manila; it branches profusely and in a very short time grows into a large shrub. It seems to grow very much better when fully exposed to the sun than it does in the shade. It is interesting to note that this plant is so apparently adversely affected by the very conditions that seem to be necessary for its rapid growth. However, while it is not elongating, it may be accumulating food to be used in elongation at night, and it is doubtful whether or not the apparently adverse effect of high transpiration during the day has any considerable influence on the total rate of growth of the plant for a day and night period.

The shortening of the shoot during the day is apparently a very similar process to the decrease in the diameter of fruits and stems, the decrease in area of leaves, and the lessened water-content of leaves. It thus appears that perhaps all aerial parts of mesophytic plants may decrease in size as the result of excessive water loss.

SUMMARY

Shoots of *Cestrum nocturnum* wilt regularly on every comparatively dry day during the time they are exposed to direct sunlight. During such days they may decrease in length; and late in the afternoon or early at night, when they again become turgid, return to their original length. At night they elongate rapidly, while during most of the day they may show no elongation except insofar as, in the late afternoon, they return to their original length. Absence of growth and actual shrinkage during the day are apparently connected with excessive transpiration, which causes the plants to lose more water than they absorb.

SOME RECENTLY COLLECTED PHILIPPINE FUNGI, II¹

By HARRY S. YATES

(From the Botanical Section of the Biological Laboratory, Bureau of
Science, Manila)

MUCORACEAE

RHIZOPUS Ehrenberg

RHIZOPUS ARTOCARPI (B. & Br.) Rac. in Paras. Alg. Pilze Javas 1
(1900) 11.

Mucor artocarp B. & Br. in Journ. Linn. Soc. Bot. 14 (1875) 137.

LUZON, Nueva Ecija Province, Muñoz, *Bur. Sci.* 30625 Arce, March,
1918, on inflorescences of *Artocarpus integrifolia* L. f.

This interesting fungus was first described from Ceylon material on
inflorescences of *Artocarpus*. In 1900 Raciborski reported it on the same
host in Java. An account of a physiological study of this fungus by
Sartory and Sydow made from Philippine material collected by Prof. C.
F. Baker appeared in *Ann. Myc.* 11 (1913) 421.

PERONOSPORACEAE

PLASMOPARA Schroeter

PLASMOPARA CUBENSIS (B. & C.) Humphrey in Mass. Agric. Exp.
Station Rept. (1890) 210, t. 2, f. 11-14.

Peronospora cubensis B. & C. in Journ. Linn. Soc. Bot. 10 (1869) 363.

LUZON, Manila, *Bur. Sci.* 30627 Day, March 27, 1918, on leaves of
Cucumis sativus.

PHYTOPHTHORA De Bary

PHYTOPHTHORA INFESTANS (Mont.) De Bary in Journ. Bot. 14
(1876) 106; Journ. Roy. Agric. Soc. 12 (1876) 239-269.

Botrytis infestans Mont. in Mém. de l'Inst. (1845) 313.

LUZON, Lepanto Subprovince, *Bur. Sci.* 25208 Yates, April, 1916:
Benguet Subprovince, Pauai, *Bur. Sci.* 25197 Yates, March 18, 1916, on
leaves of *Solanum tuberosum*.

BULGARIACEAE

BULGARIASTRUM Sydow

BULGARIASTRUM CAESPITOSUM Syd. in Philip. Journ. Sci. 8 (1913)
Bot. 497.

LUZON, Ilocos Norte Province, Burgos, *Bur. Sci.* 27799 Ramos, March
18, 1917, on leaves of *Capparis sepiaria*.

¹The first paper of this series was published in *Philip. Journ. Sci.* 12
(1917) Bot. 361-380.

CENANGIACEAE

TRYBLIDIELLA Saccardo

TRYBLIDIELLA MINDANAENSIS P. Henn. in Hedwigia 47 (1908) 261.

BASILAN, Isabela, *Bur. Sci.* 25884 Yates, November, 1917, on dead branches of *Hevea brasiliensis*.

PERISPORIACEAE

DIMERIUM Theissen

DIMERIUM TAYABENSE sp. nov.

Mycelio ex hyphis tenuibus ramosis subhyalinis ca. 2 μ crassis composito; peritheciis globosis vel ovoideis, 45–55 μ diam., astomatis, membranaceis, obscure brunneis, pseudoparenchymaticis, setis paucis (6–12), brunneis, septatis, ca. 20 μ longis; ascis numerosis, subclavatis, octosporis, 40 x 12 μ ; sporidiis distichis, brunneis, ovoideo-oblongis, 1-septatis, constrictis, loculo superiore latiore, 10–12 x 2 μ .

LUZON, Tayabas Province, Mount Binuang, *Bur. Sci.* 28890 Ramos & Edaño, May 13, 1917, parasitic on the mycelium of *Meliola* and *Asterina* on the upper leaf surface of *Momordica* sp.

Dimerium tayabensis appears to be growing on both the *Meliola* and *Asterina momordicae* Yates. The spots formed by the combination of the three fungi are black, crustaceous and about 2–3 mm diameter. The *Meliola* is an apparently undescribed species with brown 4-septate spores, 40–45 x 12–15 μ , and with a rather coarse irregularly branching mycelium of 9–10 μ broad hyphae. The capitate hyphopodia are mostly alternate, and the end cell is ovate or irregular, 12–15 μ in diameter. No setae were seen.

MELIOLA Fries

MELIOLA BARRINGTONIAE Yates in Philip. Journ. Sci. 12 (1917) Bot. 363.

LUZON, Rizal Province, Antipolo, *Bur. Sci.* 29572 Ramos & Edaño, July, 1917, on leaves of *Barringtonia* sp.

The material appears to be rather young and the perithecia are smaller than in the type, the largest attaining a diameter of only 140 μ .

MELIOLA BATAANENSIS Syd. in Ann. Myc. 12 (1914) 551.

LUZON, Tayabas Province, *Bur. Sci.* 26741 Ramos, October, 1916, on leaves of *Millettia*.

The present specimen is probably best referred to this species, though it differs in several respects from the type. The setae are much longer (500–700 μ) and occasionally forked, and the perithecia average somewhat larger. The material appears to be more mature and more fully developed than the type.

MELIOLA CALLICARPAE Syd. in Ann. Myc. 10 (1912) 80.

LUZON, Ilocos Norte Province, Burgos, *Bur. Sci.* 27794 Ramos, March 10, 1917, on leaves of *Callicarpa* sp.

MELIOLA CLERODENDRICOLOA P. Henn. in *Hedwigia* 37 (1898) 288.

LUZON, Rizal Province, *Bur. Sci.* 26754 Ramos, October to November, 1916, on leaves of *Clerodendron* sp.

MELIOLA DESMODI Karst. & Roum. in *Rev. Myc.* 12 (1890) 77.

LUZON, Rizal Province, *Bur. Sci.* 25890 Yates, January, 1917, on leaves of *Desmodium*: Cavite Province, Talisay ridge, *Merrill* 11202, January 21, 1917, on leaves of *Desmodium*.

MELIOLA DIPLOCHAETA Syd. in *Leaf. Philip. Bot.* 5 (1912) 1536.

LUZON, Apayao Subprovince, *Bur. Sci.* 28333 *Fénix*, May 9, 1917, on leaves of *Talauma villariana*.

The specimen agrees very well with the type which was collected in Palawan. This is apparently a rather abundant species on this host but seldom producing perithecia.

MELIOLA FAGRAEAE Syd. in *Ann. Myc.* 12 (1914) 549.

LUZON, Rizal Province, Mount Lumutan, *Bur. Sci.* 29811 Ramos & Edaña, September 3, 1917, on leaves of *Fagraea*.

In these specimens the perithecia are much larger than in the type, sometimes attaining a diameter of more than 220 μ . Like the type, this material is densely overgrown by *Helminthosporium*.

MELIOLA GYMNOSPORIAE Syd. in *Ann. Myc.* 10 (1912) 79.

LUZON, Manila and vicinity, *Bur. Sci.* 30617 Yates, February, 1918, on leaves of *Gymnospora spinosa*.

MELIOLA HAMATA Syd. in *Ann. Myc.* 12 (1914) 548.

LUZON, Rizal Province, *Bur. Sci.* 25894 Yates, January 21, 1917, on leaves of *Buchanania arborescens*.

MELIOLA LITSEAE Yates in *Philip. Journ. Sci.* 12 (1917) Bot. 366.

LUZON, Manila and vicinity, *Bur. Sci.* 25845 Yates, March, 1916, on leaves of *Litsea glutinosa*.

MELIOLA MANGIFERAE Earle in *Bull. New York Bot. Gard.* 3 (1904) 307.

LUZON, Rizal Province, Antipolo, *Bur. Sci.* 22698 Ramos, June 10, 1915, on leaves of *Mangifera indica*.

MELIOLA MICROMERA Syd. in *Ann. Myc.* 12 (1914) 552.

LUZON, Rizal Province, *Bur. Sci.* 25895 Yates, January 21, 1917, on leaves of *Gmelina philippensis*.

MELIOLA MITRAGYNES Syd. in *Philip. Journ. Sci.* 8 (1913) Bot. 478.

LUZON, Manila and vicinity, *Bur. Sci.* 25900 Yates, February, 1917, on leaves of *Mitragyne rotundifolia*.

MELIOLA RAMOSI Syd. in *Ann. Myc.* 12 (1914) 552.

LUZON, Tayabas Province, Umiray, *Bur. Sci.* 29079 Ramos & Edaña, June 2, 1917, on leaves of *Homonoia riparia*.

MELIOLA TAMARINDI Syd. in *Ann. Myc.* 10 (1912) 79.

LUZON, Rizal Province, *Bur. Sci.* 25896 Yates, January 19, 1917, on leaves of *Tamarindus indica*.

MELIOLA AMOORAE sp. nov.

Maculas epiphyllas, atras, subpelliculosas, irregulares et magnam partem folium occupantes; mycelio abundante, ex hyphis laevis brunneis radiantibus 7–8 μ crassis formato; ramis oppositis; hyphopodiis capitatis numerosissimis, oppositis, cellula superiore ovata, 9–10 μ longa, 6 μ lata, cellula inferiore 4–5 μ longa; hyphopodiis mucronatis ampulliformibus, irregularibus, usque ad 15 μ longis; setis paucis, rectis, erectis, opacis, acutis, 450–600 μ longis, ad basim 10 μ latis; peritheciis numerosis, globosis, atris, subopacis, 120–130 μ diametro; ascis ovatis, 40 x 20 μ , 4-sporis; sporidiis subcylindraceutis, utrinque late rotundatis, 4-septatis, ad septa leviter constrictis, brunneis, 30 x 12–15 μ .

LUZON, Tayabas Province, Mount Binuang, *Bur. Sci.* 28908 Ramos & Edaño, May 20, 1917, on leaves of *Amoora* sp.

MELIOLA APAYAOENSIS sp. nov.

Amphigena, plerumque epiphylla, plagulas atras, velutinas, orbiculares, 3–8 mm diam.; mycelio ex hyphis radiantibus brunneis septatis 6–7 μ latis composito, articulis 25–35 μ longis; hyphopodiis capitatis numerosis, alternantibus, vel unilaterilibus, bicellularibus, cellula superiore ovata vel lobata 15–18 μ diam., cellula inferiore 6–10 μ longa; hyphopodiis mucronatis non visis; setis mycelicis numerosissimis, erectis, rectis vel leviter curvatis, atris, opacis, versus apicem brunneis, acutis, 200–280 μ longis, 10–12 μ crassis; peritheciis paucis, globosis, tuberculatis, atris, opacis, 175–200 μ diam.; ascis bisporis, 50–60 x 20–30 μ ; sporidiis 4-septatis, ad septa leviter constrictis, subcylindraceutis, utrinque rotundatis, brunneis 50–58 μ longis, 13–16 μ latis.

LUZON, Apayao Subprovince, *Bur. Sci.* 28331 Fenix, May 7, 1917, on leaves of *Macaranga tanarius*.

This species is distinguished by the very numerous short mycelial setae; the alternate capitate hyphopodia; and the large spores tapering slightly from the middle toward the ends. In this species the spores sometimes germinate while still within the perithecia. Two such spores were observed with germ tubes about 40 μ in length.

MELIOLA BANAHAENSIS sp. nov.

Hypophylla, plagulas orbiculares 3–8 mm diam. velutinas atras formans; mycelio ex hyphis densissime intertextis ramosis castaneo-brunneis 7–8 μ crassis formato; hyphopodiis capitatis alternantibus, cellula superiore ovata 12–15 μ diam., cellula inferiore brevi, 6–8 μ longa; hyphopodiis mucronatis paucis, irregularibus, ampulliformibus, usque ad 20 μ longis; setis my-

celicis numerosissimis, rectis, erectis, ad basim geniculatis, tota longitudine opacis, 300–350 μ longis, 8–10 μ latis; ad apicem acutis vel bi-trifurcatis, dentibus 5–8 μ longis; peritheciis numerosis, 200–250 μ diam., atris, opacis; ascis 65–75 x 30 μ , bisporis; sporidiis cylindraceutis, utrinque late rotundatis, 4-septatis, ad septa constrictis, brunneis, 50–55 x 19–21 μ .

LUZON, Laguna Province, Mount Banahao, *Bur. Sci.* 28011 *Ocampo*, May 8, 1917, on leaves of *Dysoxylum*?

MELIOLA BANGUIENSIS sp. nov.

Amphigena, plerumque epiphylla, plus minus effusa, plagulas subarachnoideas, orbiculares, 0.3–2.0 cm diam., vel confluentes; mycelio modice evoluto, ex hyphis ramosis brunneis 7–8 μ diam. composito; hyphopodiis capitatis alternantibus, numerosis, cellula superiore ovata, 10–18 μ longa, 10–12 μ lata, cellula inferiore 5 μ longa; hyphopodiis mucronatis plerumque oppositis, ampulliformibus, 18–22 μ longis, setis mycelicis numerosis, 350–650 μ longis, 10–12 μ crassis, circa perithecia oriundis, erectis, rectis, simplicibus, atris, opacis, apicis acutis; peritheciis numerosis, globosis, in sicco collapsis, 125–175 μ diam., tuberculatis; ascis ovatis, 6–8-sporis, 40 x 18 μ , evanescentibus, sporidiis oblongis, 4-septatis, ad septa leviter constrictis, brunneis, 36–40 μ longis, 11–14 μ latis.

LUZON, Ilocos Norte Province, Bangui, *Bur. Sci.* 27696 *Ramos*, February–March, 1917, on leaves of one of the *Menispermaceae*.

MELIOLA BAUHINIAE sp. nov.

Hypophylla, plagulas atras, velutinas, orbiculares, 3–6 mm diam.; mycelio ex hyphis intertextis ramosis anastomosantibus castaneo-brunneis 4–5 μ crassis formato; hyphopodiis capitatis numerosis, alternantibus, vel unilateralibus, cellula superiore subglobosa, 12–13 μ diam., cellula inferiore 5–8 μ longa; hyphopodiis mucronatis paucis, usque ad 20–25 μ longis; setis mycelicis numerosissimis, rectis, erectis, simplicibus, ad apicem subacutis, atris, tota longitudine opacis, 200–250 μ longis, 8 μ crassis; peritheciis sparsis, 170–200 μ diam., globosis, tuberculatis, atris, opacis, astomatis; ascis bisporis, ellipsoideis, 40–45 x 20–25 μ ; sporidiis cylindraceutis, 4-septatis, ad septa constrictis, utrinque late rotundatis, brunneis, 40 μ longis, 12–15 μ latis.

LUZON, Ilocos Norte Province, *Bur. Sci.* 27801 *Ramos*, February to March, 1917, on leaves of *Bauhinia* sp.

MELIOLA BOERLAGIODENDRIAE sp. nov.

Maculas amphigenas, atras, primo orbiculares, 5–10 mm diam., deinde confluentes et magnam partem folium occupantes;

mycelio abundante, ex hyphis obscure brunneis et subopacis 7-8 μ diam. composito; hyphopodiis capitatis numerosis, alternantibus, unilateralibus vel irregularibus, cellula superiore subglobosa, 12-14 μ diam., cellula inferiore 4-5 μ longa; hyphopodiis mucronatis paucis, usque ad 16 μ longis; setis numerosissimis, erectis, dichotome furcatis, opacis, atris, ad basim 8 μ latis; peritheciis paucis, globosis, atris, opacis, tuberculatis, 150-200 μ diam.; ascis non visis; sporidiis 4-septatis, ad septa constrictis, subcylindratis, utrinque rotundatis; obscure brunneis, 40-50 x 12-15 μ .

LUZON, Tayabas Province, Mount Binuang, *Bur. Sci. 28911 Ramos & Edaña*, May 9, 1917, on leaves of *Boerlagiodendron* sp.

This species of *Meliola* is well characterized by the dichotomously forked setae. The setae are about 100-150 μ long to the first fork. The prongs are usually 50-75 μ long and then again forked with prongs 10-20 μ in length.

MELIOLA CAVITENSIS sp. nov.

Epiphylla, plagulas orbiculares vel irregulares, 2 ad 6 mm diam. tenues formans; mycelio ex hyphis longis, rectis vel flexuosis 6-7 μ crassis septatis brunneis ramosis composito; articulis 20-25 μ longis; hyphopodiis capitatis numerosis, plerumque alternantibus, cellula superiore subglobosa vel ovata, 12 μ diam., cellula inferiore 5-6 μ longa; hyphopodiis mucronatis numerosis, oppositis vel alternantibus, ampulliformibus, usque ad 25 μ longis; setis mycelicis paucis, rectis vel curvatis, septatis, obscure brunneis, obtusis, 300-400 μ longis, 8-10 μ latis; peritheciis numerosis, globosis, obscure brunneis, subopacis, 85-100 μ diam.; ascis clavatis, 35 μ longis, 8-10 μ latis, circiter 6-8-sporis; sporidiis cylindratis, utrinque rotundatis, 4-septatis, ad septa constrictis, brunneis 30-35 μ longis, 10-12 μ latis.

LUZON, Cavite Province, Talisay ridge, *Merrill 10634*, January 21, 1917, on leaves of *Coleus*.

Most of the spores are immature and the dimensions of the asci given above are of those containing immature spores.

MELIOLA CELTICOLA sp. nov.

Amphigena, maculas atras, pelliculosas, orbiculares, 2-4 mm diam., vel confluentes; mycelio ex hyphis dense intertextis brunneis 7-8 μ crassis ramosis et anastomosantibus composito; hyphopodiis capitatis numerosis, alternantibus, cellula superiore angulata vel irregulares, 20-25 μ diam., cellula inferiore 10 μ longa, 4-5 μ lata; hyphopodiis mucronatis numerosis, plerumque alternantibus, ampulliformibus, 20-30 μ longis; setis mycelicis paucis, atris, opacis, ad apicem uncinatis, acutis, rarius obtusis

250–350 μ longis, 6 μ crassis, peritheciis numerosis, globulosis, atris, verrucosis, 150–225 μ diam.; ascis bisporis, evanescentibus; sporidiis cylindraceutis, castaneo-brunneis, 4-septatis, ad septa constrictis, utrinque late rotundatis, 45–50 μ longis, 17–19 μ latis.

LUZON, Ilocos Norte Province, Bangui, *Bur. Sci.* 27746 Ramos, February 25, 1917, on leaves of *Celtis philippensis*.

This species appears to be closely related to *Meliola celtidiae* but differs from that species in the size and character of the spots and in the rather short hooked setae.

MELIOLA CELTIDIAE sp. nov.

Hypophylla, atra, velutina, maculas orbiculares, 1–2 cm diam.; mycelio ex hyphis brunneis septatis tortuosis anastomosantibus radiantibus 10–12 μ crassis composito; hyphopodiis capitatis numerosis, alternantibus, cellula superiore globosa, 15–18 μ diam. vel lobata et 12–20 μ longa, 10–25 μ lata; hyphopodiis mucronatis numerosis, irregularibus, ampulliformibus, usque ad 20–30 μ longis; setis rectis, erectis, ad basim geniculatis, 800–1200 μ longis, 20–25 μ crassis, atris, opacis, obtusis; peritheciis numerosis, atris, opacis, tuberculatis, globosis vel applanatis, 175–225 μ diam.; ascis evanescentibus; sporidiis obscure fuscis, oblongis, utrinque rotundatis, 4-septatis, ad septa constrictis, 50–55 μ longis, 15–20 μ latis.

SAMAR, Catubig River, *Bur. Sci.* 24616 Ramos, February–March, 1916, on leaves of *Celtis luzonensis*.

The long perithecial setae together with the tortuous mycelium and the large, lobed, capitate hyphopodia are characteristic of this species. It differs from *Meliola celticola* in the character and size of the colonies and in the long straight setae.

MELIOLA CURVATA sp. nov.

Epiphylla, maculas atras, minutissimas, 0.5–2 mm diam., orbiculares formans vel confluentes; mycelio ex hyphis ramosis brunneis anastomosantibus septatis 7–8 μ crassis composito; hyphopodiis capitatis numerosis, plerumque alternantibus, cellula superiore globulosa, 10–12 μ diam., inferiore 3–5 μ longa; hyphopodiis mucronatis paucis, ampulliformibus, usque ad 20 μ longis; setis peritheciis ca. 4–5 ad basim quaque perithecium, primitus subhyalinis apicis spiraliter curvatis dein erectis vel leviter curvatis, ad basim geniculatis, atris, 100–130 μ longis, 10 μ latis, apice acutis, simplicibus; peritheciis globulis, atris, opacis, tuberculatis, 120–180 μ diam.; ascis ovatis, 4-sporis, 50–60 μ longis, 30 μ latis; sporidiis cylindraceutis, utrinque late rotundatis, ad septa vix constrictis, brunneis, 40–45 μ longis, 15–20 μ latis.

SAMAR, Catubig River, *Bur. Sci.* 24642 Ramos, February, March, 1916, on leaves of an unknown host.

The young hyaline setae with spirally curved or distorted tips are characteristic. The specific name is derived from this character.

MELIOLA DERRIDIS sp. nov.

Epiphylla, plagulas atras, orbiculares 3–5 mm diam., vel confluentes et subinde totam folii superficiem obtegentes formans; mycelio radiante, ex hyphis fuscis anastomosantibus 6–7 μ crassis composito; ramis plerumque oppositis; hyphopodiis capitatis numerosis, alternantibus, cellula superiore rotundata 10–12 μ diam., cellula inferiore 5 μ longa; hyphopodiis mucronatis numerosis, oppositis, ampulliformibus, usque ad 20–25 μ longis; setis mycelicis numerosis, erectis, rectis vel curvatis, 300–400 μ longis, 7–8 μ latis, castaneo-brunneis, subopacis, apicis obtusis; peritheciis paucis, globosis, atris, 125–150 μ diam.; ascis non visis; sporidiis 4-septatis, oblongis, utrinque rotundatis, obscure fuscis, 30–35 μ longis, 11–13 μ latis, ad septa constrictis.

LUZON, Ilocos Norte Province, Burgos, *Bur. Sci.* 27788 Ramos, February–May, 1917, on leaves of *Derris*.

MELIOLA EXOCARPIAE sp. nov.

Amphigena, plagulas orbiculares, 2–8 mm diam., atras formans; mycelio abundante, ex hyphis castaneis tortuosis anastomosantibus 6–8 μ diam. composito; hyphopodiis capitatis numerosis, alternantibus, cellula superiore globosa vel subglobosa et 18–22 μ diam., cellula inferiore 10–18 μ longa, 10–12 μ lata, hyphopodiis mucronatis rarissimis, irregularibus, ampulliformibus, usque ad 22–24 μ longis; setis mycelicis numerosis, rectis, erectis, atris, opacis, vel ad apicem brunneis, apicis obtusis, 200–250 μ longis, 10–12 μ latis; peritheciis paucis, globosis, verrucosis, atris, opacis, 140–160 μ diam.; ascis non visis, sporidiis cylindraceis, utrinque late rotundatis, 4-septatis, ad septa constrictis, brunneis, 50–55 μ longis, 15–20 μ latis.

LUZON, Ilocos Norte Province, *Bur. Sci.* 27846 Ramos, March 1, 1917, on leaves of *Exocarpus latifolius*.

This species is distinguished by the large capitate hyphopodia and the comparatively short, stout, mycelial setae.

MELIOLA FICIUM sp. nov.

Epiphylla, maculas atras, suborbiculares, 4–8 mm diametro vel aggregatis, subpelliculosis; mycelio ex hyphis intertextis radiantibus ramosis castaneo-brunneis 6–7 μ crassis formato; hyphopodiis capitatis numerosis, alternantibus, cylindraceis, cellula superiore ovata vel subglobosa, 10–12 μ diam.; cellula inferiore 4–5 μ longa; hyphopodiis mucronatis rarissimis, irregularibus, am-

pulliformibus, usque ad 20 μ longis; setis peritheciis erectis, rectis vel leviter curvatis, atris, opacis, 500–600 μ longis, 15 μ latis, ad apicem acutis; peritheciis numerosis, globosis, tuberculatis, atris, opacis, 200–225 μ diam.; ascis bisporis, ellipsoideis, 45–50 x 15–30 μ ; sporidiis oblongis, 4-septatis, ad septa constrictis, brunneis, utrinque rotundatis, 45–50 μ longis, 15–18 μ latis.

LUZON, Laguna Province, Mount Banahao, *Bur. Sci.* 28002 Ocampo, May 8, 1917, on leaves of *Ficus* sp.

MELIOLA GARCINIAE sp. nov.

Maculas plerumque epiphyllas, irregulares, 5–10 mm diam. vel confluentes, atras, crustaceas; mycelio ex hyphis castaneis 8–10 μ crassis formato; ramis plerumque oppositis; hyphopodiis capitatis numerosis, plerumque alternantibus, cellula superiore subglobosa vel ovata, 12–14 x 11–12 μ , cellula inferiore 8–10 μ longa; hyphopodiis mucronatis numerosis, alternantibus vel oppositis, ampulliformibus, usque ad 25–30 μ longis; setis mycelicis numerosis, rectis, erectis, 11–13 μ crassis, 700–1000 μ longis, atris, opacis, acutis vel obtusis; peritheciis paucis, globosis, atris, opacis 200–300 μ diam., ascis non visis; sporidiis castaneis, cylindraceutis, utrinque rotundatis, 4-septatis, ad septa vix constrictis, 50–55 μ longis 18–20 μ latis.

LUZON, Ilocos Norte Province, Burgos, *Bur. Sci.* 27795 Ramos, March 14, 1917, on leaves of *Garcinia* sp.

The specimen is heavily parasitized by a species of *Helminthosporium* as well as by other fungi which are not determinable.

MELIOLA HOPEAE sp. nov.

Hypophylla, maculas atras, 1–2 cm diam., orbiculares formans; mycelio laxo radiante ex hyphis brunneis 5–7 μ latis septatis composito; ramis oppositis vel alternantibus; hyphopodiis capitatis numerosis, plerumque alternantibus, cellula superiore ovoidea, 10 μ diam., cellula inferiore 5 μ longa; hyphopodiis mucronatis numerosis, plerumque irregularibus, ampulliformibus, usque ad 15–25 μ longis; setis peritheciis et mycelicis circa 6 ad basim quaque perithecium, erectis, basi geniculatis 300–400 μ longis, 8 μ latis, septatis, apicis simplicibus, obtusis; peritheciis rotundatis, applanatis, atris, opacis, tuberculatis, 100–140 μ diam.; ascis evanescentibus 2–4-sporis; sporidiis oblongis, utrinque late rotundatis, 4-septatis, ad septa non constrictis, brunneis, 35–38 μ longis, 12–14 μ latis.

LUZON, Tayabas Province, Mount Cadig, *Bur. Sci.* 25774 Yates, December, 1916, on leaves of *Hopea* sp.

MELIOLA ROUREAE sp. nov.

Epiphylla, plagulas atras, orbiculares, 3–5 mm diam., vel confluentes, mycelio ex hyphis ramosis anastomosantibus obscure brunneis, 8–9 μ crassis composito; hyphopodiis capitatis numerosis, alternantibus vel unilateralibus, cellula superiore ovata, 12–15 x 10–12 μ , cellula inferiore 10–12 μ longa, hyphopodiis mucronatis numerosis, plerumque oppositis, ampulliformibus, usque ad 22–30 μ longis; setis peritheciis erectis, rectis, ad basim curvatis, 450–600 μ longis, 8–10 μ crassis, inferne atris, opacis, superne brunneis, obtusis; peritheciis numerosis, 100–125 μ diam.; globosis, verrucosis, atris, opacis; ascis non visis; sporidiis oblongo-cylindratis, 4-septatis, ad septa constrictis, utrinque rotundatis, castaneis, 40–45 μ longis, 16–19 μ latis.

LUZON, Ilocos Norte Province, Bangui, *Bur. Sci.* 27724 Ramos, February to March, 1917, on leaves of *Rourea erecta*.

MELIOLA TRACHELOSPERMAE sp. nov.

Maculas hypophyllas, atras, subpelliculosas, orbiculares, 2–5 mm diam., vel confluentes; mycelio abundante ex hyphis brunneis 7–9 μ crassis formato, ramis oppositis; hyphopodiis capitatis numerosissimis, alternantibus, cellula superiore ovata, 13–16 x 10 μ , cellula inferiore 5–10 μ longa; hyphopodiis mucronatis numerosis, plerumque alternantibus, usque ad 18 μ longis; setis mycelicis paucis, rectis, erectis, acutis, atris, opacis, 300–400 μ longis, ad basim 8 μ crassis; peritheciis globosis, atris, opacis 180–200 μ diam.; sporidiis 4-septatis, elongatis, utrinque late rotundatis, ad septa constrictis, brunneis, 35–40 x 16–20 μ .

LUZON, Rizal Province, Mount Lumutan, *Bur. Sci.* 29813 Ramos & Edaña, September 3, 1917, on leaves of *Trachelospermum*.

The specimen is heavily overgrown by *Spegazzinia* and other parasites.

MELIOLA UMIRAYENSIS sp. nov.

Maculas plerumque epiphyllas, atras, suborbiculares et 4–10 mm diam., vel confluentes et magna partem folium occupantes; mycelio abundante, ex hyphis brunneis 6–8 μ crassis composito; hyphopodiis capitatis numerosis, alternantibus, cellula superiore subglobosa vel lobata, 14–18 μ diam., cellula inferiore 12–16 μ longa, 5–6 μ lata; hyphopodiis mucronatis non visis; setis nullis; peritheciis paucis, 100–150 μ diam., atris, opacis; ascis bisporis 50 x 20 μ ; sporidiis 3-septatis, ad septa constrictis, elongatis, utrinque late rotundatis, laeve brunneis, 40–45 μ longis, 12–14 μ latis.

LUZON, Tayabas Province, Umiray, *Bur. Sci.* 29081 Ramos & Edaña, June 2, 1917, on leaves of *Ficus*.

This *Meliola* is badly infested with a species of *Helminthosporium* and

it is possible that the numerous erect conidiophores of the latter may have caused the setae to be overlooked. *Meliola umirayensis* however is well characterized by the 3-septate spores which are rather broader at one end than at the other. The spores are also lighter in color than in most *Meliolas*.

MELIOLA WRIGHTIAE sp. nov.

Amphigena, plerumque epiphylla et totam folium superficiem plus minus continua aterrima obducens; maculas orbiculares 3–6 mm diam.; mycelio ex hyphis densissime intertextis brunneis septatis anastomosantibus composito; ramis alternantibus vel oppositis; hyphopodiis capitatis numerosis, plerumque alternantibus, subglobosis vel ovatis, 12 μ longis, 10–12 μ latis, cellula inferiore ca. 6 μ longa, hyphopodiis mucronatis paucis, irregularibus vel oppositis, ampulliformibus, usque ad 18 μ longis; setis mycelicis numerosis, erectis, rectis vel leviter curvatis, 200–225 μ longis, 6–8 μ latis, saepe ad basim geniculatis, obtusis, obscure brunneis vel versus apicem dilutioribus et fuscis; peritheciis numerosis, globosis, 120–150 μ diam., atris, opacis, tuberculatis, in sicco collapsis; ascis ovatis, 30 μ longis, 20 μ latis; bisporis, mox evanescentibus; sporidiis cylindratis, utrinque late rotundatis, fuscis, 4-septatis, ad septa leviter constrictis, 28–35 μ longis, 12–16 μ latis.

LUZON, Rizal Province, *Bur. Sci. 26757 Ramos* (type), November 28, 1916, on leaves of *Wrightia laniti*: Batangas Province, Taal Volcano, *Merrill 10618*, January 20, 1917, on the same host.

MELIOLINA Sydow

MELIOLINA PULCHERRIMA Syd. in *Ann. Myc.* 12 (1914) 553.

Meliola pulcherrima Syd. in *Ann. Myc.* 11 (1913) 254, f. 1.

LUZON, Tayabas Province, Mount Binuang, *Bur. Sci. 28893 Ramos & Edaño*, May 11, 1917, on leaves of *Eugenia*.

PARODIELLA Spegazzini

PARODIELLA GRAMMODES (Kze.) Cooke *Australian Fungi* (1892) 301.

Sphaeria grammodes Kunze in Weig. Exs.

Dothidea grammodes Berk. in *Journ. Linn. Soc. Bot.* 10 (1869) 390.

Dothidea perisporioides B. & C. in *Grevillea* 4 (1878) 103.

Dothidella perisporioides Sacc. in *Syll. Fung.* 2 (1883) 634.

Parodiella perisporioides Speg. in *Anal. Soc. Cient. Arg.* (1880) 178.

LUZON, Bulacan Province, Angat, *Bur. Sci. 21808 Ramos*, September 4, 1913, on leaves of *Desmodium triflorum*.

MICROTHYRIACEAE

ASTERINA Lévillé

ASTERINA BREYNIAE Yates in *Philipp. Journ. Sci.* 12 (1917) Bot. 370.

LUZON, Ilocos Norte Province, Burgos, *Bur. Sci. 27798 Ramos*, March 1, 1917, on leaves of *Breynia*.

In this specimen the fungus occurs on both surfaces of the leaves. An *Asterina* (?) having perithecia and spores almost double the size of those of *A. breyniae* is also present.

ASTERINA CAPPARIDIS Syd. et Butl. in Ann. Myc. 9 (1911) 390.

LUZON, Ilocos Norte Province, Burgos, *Bur. Sci.* 27839 Ramos, March 18, 1917; Bangui, *Bur. Sci.* 27713 Ramos, March 10, 1917; both on leaves of *Capparis* sp.

ASTERINA DECIPIENS Syd. in Leaf. Philip. Bot. 5 (1912) 1540.

LUZON, Rizal Province, *Bur. Sci.* 21896 Ramos, August 18, 1913; Bontoc Subprovince, *Bur. Sci.* 25247 Yates, April 14, 1916, on leaves of *Champerea manillana*.

ASTERINA ELMERI Syd. in Leaf. Philip. Bot. 4 (1911) 1156.

LUZON, Bontoc Subprovince, *Bur. Sci.* 25248 Yates, April 14, 1916; Ilocos Norte Province, Bangui, *Bur. Sci.* 27754, 27767 Ramos, February 28 and February 21, 1917; Burgos, *Bur. Sci.* 27816, 27803 Ramos, March 14 and March 3, 1917; all on leaves of *Champerea manillana*.

ASTERINA LAXIUSCULA Syd. in Philip. Journ. Sci. 8 (1913) Bot. 276.

LUZON, Ilocos Norte Province, Bangui, *Bur. Sci.* 27758 Ramos, February 28 and February 21, 1917; Burgos, *Bur. Sci.* 27816, 27803 Ramos, March Yates, November 5, 1917, on leaves of *Sideroxylon ferrugineum*.

ASTERINA BANGUIENSIS sp. nov.

Epiphylla, plagulas plus minus effusas, 0.5–2 cm longas et latas formans, vel orbiculares et 3–6 mm diam., vel confluentes et magnam partem folium occupantes; mycelio ex hyphis ramosis valde anastomosantibus obscure brunneis 5–6.5 μ crassis composito; articulis 15–22 μ longis; hyphopodiis numerosis, cylindraceis 10–12 μ longis, 5 μ latis; peritheciis numerosis, dense dispositis, rotundatis, 120–160 μ diam., late et plane convexis, opacis, contextu et hyphis 2–4.5 μ crassis composito, ambitu mox magis fimbriatis; ascis ovatis, octosporis, aparaphysatis, 45–50 μ longis, 18–22 μ latis; sporidiis ovato-oblongis, ad medio septatis et constrictis, utrinque rotundatis, brunneis, laevis, 20–22 μ longis, 8–10 μ latis.

LUZON, Ilocos Norte Province, Bangui, *Bur. Sci.* 27714 Ramos, February 26, 1917, on leaves of *Glycosmis*.

ASTERINA CANTHII sp. nov.

Amphigena, maculas crustaceas, atras, irregulares, 5–6 mm diam.; mycelio abundante, ad superficiem foliorum adpressis, ex hyphis anastomosantibus obscure brunneis 6–8 μ crassis formato; ramis oppositis vel alternantibus; hyphopodiis numerosissimis, oppositis, unicellularibus, oblongo-cylindraceis, apicis rotundatis, 4–5 x 5 μ ; peritheciis rotundatis, atris, opacis, ambitu fimbriatis, 90–175 μ diam.; contextu subparenchymaticis, irregu-

lariter dehiscentibus; ascis oblongo-cylindraceutis, 30–40 x 8–10 μ , paraphysatis, octosporis, sporidiis ad medio 1-septatis et constrictis, brunneis, utrinque subacutis, 10–12 μ longis, 3–3.5 μ latis.

LUZON, Ilocos Norte Province, Burgos, *Bur. Sci.* 27826 Ramos, March 2, 1917, on leaves of *Canthium*.

ASTERINA FAGARAE sp. nov.

Epiphylla, plagulas orbiculares vel irregulares, 4–6 mm diam., ex hyphis brunneis ramosis anastomosantibus 4–6 μ crassis composito; hyphopodiis numerosis, ramis simillimis, alternantibus vel irregularibus, 10–15 μ longis, 4–5 μ latis; peritheciis opacis, rotundatis, applanatis, 170–220 μ diam., stellatim dehiscentibus, contextu ex hyphis radiantibus obscure-brunneis 5–7 μ crassis composito; ascis ovatis, 50–55 x 35–40 μ , octosporis, paraphysatis; sporidiis conglobatis, oblongis, utrinque late rotundatis, ad medio 1-septatis et constrictis, brunneis, laevis, 22–25 μ longis, 11–13 μ latis.

LUZON, Rizal Province, *Bur. Sci.* 26762 Ramos, October–November, 1916, on leaves of *Fagara avicennae* sp.

ASTERINA JASMINICOLA sp. nov.

Peritheciis amphigeniis hinc inde maculiformiter aggregatis vel saepe per totum folium plus minusve aequae distributis, maculis 2–6 mm diam.; mycelio ex hyphis brunneis 4–5 μ diam. tortuosis composito; hyphopodiis numerosis bicellularibus, irregulariter distributis nunquam oppositis; cellula superiore irregulariter angulatis et lobatis, 8–10 μ diam., inferiore 5.5–6.5 μ longa, 4–4.5 μ lata; peritheciis numerosis, globosis, atris, opacis, irregulariter dehiscentibus; ascis globosis, 22–26 μ diam., octosporis, paraphysatis; sporidiis ad medio 1-septatis, brunneis, verrucosis, ellipsoideo-oblongis, utrinque rotundatis, 17–19 x 8–10 μ .

LUZON, Ilocos Norte Province, Burgos, *Bur. Sci.* 27797 Ramos, March 1, 1917, on leaves of *Jasminum*.

ASTERINA LITSEAE sp. nov.

Amphigena, plerumque epiphylla, plagulas irregulares, plus minus totum folium obtegeta; mycelio effuso, laxo ex hyphis obscure fuscis 3.5–4.5 μ latis anastomosantibus radiantibus formato; ramis irregularibus; hyphopodiis numerosis, unicellularibus, 7–8 μ longis, 3–5 μ latis, irregulariter dispositis; peritheciis numerosissimis, gregariis, rotundatis, 100–140 μ diam., stellatim dehiscentibus, convexis, contextu ex hyphis brunneis 2–3 μ latis, ambitu hyphis brevibus radiantibus fimbriatis; ascis

paraphysatis, ovoideo-globosis, 28–32 μ longis, 18–24 μ latis, octosporis; sporidiis ellipsoidiis, utrinque rotundatis, ad medio 1-septatis et constrictis, brunneis, laevis, 15–17 μ longis, 8–9 μ latis.

LUZON, Ilocos Norte Province, Burgos, *Bur. Sci.* 27842 Ramos, February to March, 1917, on leaves of *Litsea* sp.

ASTERINA MOMORDICAE sp. nov.

Epiphylla, maculas 2–4 mm latas, atras efficiens; mycelio ex hyphis remote septatis fuscis 5–6 μ crassis composito; hyphopodiis numerosis, irregularibus, unicellularibus, 8–12 μ longis, lobatis; peritheciis rotundatis, 80–90 μ diam., stellatim dehiscen- centibus, contextu ex hyphis rectis brunneis radiatis 2.5–3 μ latis composito; ascis subglobosis, 35–40 x 22–24 μ , octosporis, paraphysatis; sporidiis oblongis, utrinque rotundatis, ad medio 1-septatis et constrictis, brunneis, laevis, 19–21 μ longis, 9–11 μ latis; cellula superiore latiore.

LUZON, Tayabas Province, Mount Binuang, *Bur. Sci.* 28890 Ramos & Edaña, May 13, 1917, on leaves of *Momordica* sp.

Asterina momordicae is parasitized by *Dimerium tayabensis* Yates and is associated with an undetermined species of *Meliola*.

ASTERINA NEOLITSEAE sp. nov.

Epiphylla, plagulas suborbiculares, 4–10 mm diam. vel confluentes, atras; mycelio ex hyphis brunneis septatis 5–7 μ crassis longe articulatis (30 μ) anastomosantibus formato; hyphopodiis numerosis, alternantibus, bicellularibus; cellula superiore lobata, 15 μ lata; cellula inferiore 4–5 μ longa, peritheciis numerosis, rotundatis, 150–170 μ diam., applanatis, obscure brunneis, opacis, contextu ex hyphis 3–4 μ latis radiantibus composito, articulis 6–7 μ longis, ambitu fimbriatis; ascis ellipsoideis, octosporis, 60 x 25–30 μ , aparaphysatis; sporidiis oblongis, ellipsoideis, utrinque rotundatis, constrictis, fuscis, verruculosi, 44–46 x 14–15 μ .

LUZON, Abra Province, *Bur. Sci.* 27083 Ramos, February, 1917; Mount Posuey, *Bur. Sci.* 27076 Ramos, February, 1917, on leaves of *Neolitsea*.

ASTERINA PIPERIS sp. nov.

Mycelio epiphylo, parce evoluta, tenue, laxo, effuso, ex hyphis brunneis 4 μ crassis formato; hyphopodiis alternantibus vel irregularibus, 2-cellularibus, cellula superiore irregulariter lobata, 6–8 μ longa, 4–5 μ lata, cellula inferiore, 4–5 μ longa; peritheciis numerosis, applanatis, rotundatis, brunneis, stellatim dehiscen- tibus, 115–130 μ diam., contextu ex hyphis fuscis 2–3 μ crassis composito, ambitu parum fimbriatis; ascis globosis vel subglo- bosis, aparaphysatis, 25 x 20 μ , octosporis; sporidiis conglobatis,

oblongis, utrinque late rotundatis, ad medio 1-septatis et constrictis, fuscis, laevibus, 15–18 μ longis, 7–8 μ latis.

LUZON, Ilocos Norte Province, Bangui, *Bur. Sci.* 27739 Ramos, February 20, 1917, on leaves of *Piper* sp.

ASTERINA RAMOSII sp. nov.

Hypophylla, maculas suborbiculares, atro-griseas, 4–10 mm diam.; mycelio effuso, laxo, ex hyphis brunneis septatis ramosis 4–5 μ crassis composito; hyphopodiis paucis, alternantibus vel irregularibus, cylindraceis, globosis vel lobatis, 6–8 μ longis, 5 μ latis; peritheciis numerosis, rotundatis, 80–120 μ diam., subopacis, stellatim dehiscentibus, radiatim contextis, contextu ex hyphis, 4–5 μ latis composito; ascis ovatis, 18–20 μ longis, 15–17 μ latis, octosporis, paraphysatis; sporidiis conglobatis, oblongis, subinde late rotundatis, ad medio 1-septatis, ad septa constrictis, laevis, 14–16 μ longis, 6–8 μ latis.

SAMAR, Catubig River, *Bur. Sci.* 24643 Ramos, February 20, 1916, on leaves of *Dillenia* sp.

ASTERINA ZIZYPHIAE sp. nov.

Amphigena, plagulas effusas, 2–5 mm diam., saepe confluentes et totum folium plus minus occupans; mycelio ex hyphis brunneis anastomosantibus 6 μ crassis remote septatis (articulos 20–25 μ longis) ramosis composito; hyphopodiis irregularibus, unicellularibus, globosis, 10 μ diam.; peritheciis paucis, rotundatis, 120–170 μ diam., brunneis, ambitu non fimbriatis, contextu radiatim ex hyphis brunneis leviter flexuosis 2–4 μ crassis composito; ascis octosporis, ovato-globosis, 40 x 30 μ , paraphysatis; sporidiis (immaturis) oblongo-ellipsoideis, utrinque rotundatis, ad medio 1-septatis, constrictis, laevis, hyalinis, 15 x 10 μ .

LUZON, Tayabas Province, Mount Tulaog, *Bur. Sci.* 29156 Ramos & Edaña, May 25, 1917, on leaves of *Zizyphus*.

Unfortunately all the spores on this material appear to be immature. However, the species is well characterized by the small globose hyphopodia.

This *Asterina* is associated with, or parasitized by, a fungus having a delicate hyaline mycelium and 4-celled spores; the two middle cells are brown and much larger than the end cells which are hyaline. The spores are slightly curved and about 30 x 12–14 μ .

ASTERINELLA Theissen

ASTERINELLA CALAMI Syd. in Philip. Journ. Sci. 9 (1914) Bot. 182.

LUZON, Rizal Province, Mount Susong Dalaga, *Bur. Sci.* 29435 Ramos & Edaña, August 4, 1917, on leaves of *Calamus*.

This has previously been collected on Palawan Island. It is a very characteristic species with strongly nodulose radiating mycelium. The asci are 8-spored, 70–75 μ long, 45 μ broad.

ASTERINELLA LUZONENSIS Syd. in Philip. Journ. Sci. 8 (1913) Bot. 491.

SAMAR, Catubig River, *Bur. Sci.* 24724 Ramos, February 26, 1916, on leaves of *Shorea*.

MORENOELLA Spegazzini

MORENOELLA ANISOCARPA Syd. in Ann. Myc. 12 (1914) 559.

LUZON, Tayabas Province, Mount Cadig, *Bur. Sci.* 25818 Yates, December 11, 1916, on leaves of *Hopea plagata*.

HYPOCREACEAE

HYPOCRELLA Saccardo

HYPOCRELLA SCHIZOSTACHYII P. Henn. in Hedwigia 47 (1908) 253.

SAMAR, Catubig River, *Bur. Sci.* 24923 Ramos, February 18, 1916, on culms of *Schizostachyum*.

USTILAGINOIDEA Brefeld

USTILAGINOIDEA VIRENS (Cke.) Tak. in Bot. Mag. Tokyo 10 (1896) 19, t. 2, f. 1-8.

Ustilago virens Cooke in Grev. 7 (1878) 15.

Tilletia oryzae Pat. in Bull. Soc. Myc. Fr. 13 (1897) 124, t. 10, f. 2.

Ustilaginoidea oryzae Bref. Untersuch. 12 (1895) 194, t. 21, f. 22-29.

LUZON, Manila and vicinity, *Bur. Sci.* 30623 Yates, February 20, 1918, on ovaries of *Oryza sativa*.

POLYSTOMELLACEAE

ACTINODOTHIS Sydow

ACTINODOTHIS PIPERIS Syd. in Philip. Journ. Sci. 9 (1914) Bot. 175.

LUZON, Ilocos Norte Province, Bangui, *Bur. Sci.* 27718, 27751 Ramos, February 25 and February 24, 1917, on leaves of *Piper* sp.; Cavite Province, Talisay ridge, Merrill 11196, January 21, 1917, on leaves of *Piper retrofractum*.

INOCYCLUS Theissen et Sydow

INOCYCLUS PSYCHOTRIAE Syd. in Ann. Myc. 13 (1915) 211.

Hysterostomella psychotriae Syd. in Philip. Journ. Sci. 8 (1913) Bot. 275.

LUZON, Rizal Province, Antipolo, *Bur. Sci.* 21874 Ramos, August 19, 1913, on leaves of *Psychotria luconiensis*.

PHYLLACHORACEAE

CATACAUMA Theissen et Sydow

CATACAUMA ASPIDIUM (Berk.) Theiss. & Syd. in Ann. Myc. 13 (1915)

380, forma **FICI FULVAE** (Koord.) Theiss. & Syd. in Ann. Myc. 13 (1915) 381.

Phyllachora fici-fulvae Koord. in Verh. Akad. Wet. Amsterdam 2 (1907) 183.

LUZON, Benguet Subprovince, *Bur. Sci.* 25194 Yates, March 19, 1916, on leaves of *Ficus validicaudata*; Bontoc Subprovince, Barlig, *Bur. Sci.* 25223, 25224 Yates, March 5, 1916, on leaves of *Ficus* sp.

ENDODOTHELLA Theissen et Sydow

ENDODOTHELLA ALBIZZIAE Syd. in Ann. Myc. 13 (1915) 590.

Dothidella albizziae Syd. in Philip. Journ. Sci. 8 (1913) Bot. 280.

LUZON, Tayabas Province, *Bur. Sci.* 26744 Ramos, October, 1916, on living leaves of *Bauhinia*.

This species was first described from material on the leaves of *Albizzia marginata*. The present collection agrees well with the type. In this material the stromata occur on both surfaces of the leaves and the asci are somewhat longer and the spores slightly larger than in the type.

PHYLLACHORA Nitschke

PHYLLACHORA LUZONENSIS P. Henn. in Hedwigia 47 (1908) 255.

LUZON, Rizal Province, *Bur. Sci.* 25892 Yates, January 19, 1917, on leaves of *Millettia* sp.

PHYLLACHORA PONGAMIAE (B. & Br.) Petch in Ann. Roy. Bot. Gard. Peradeniya 5 (1912) 291.

Rhytisma pongamiae B. & Br. in Journ. Linn. Soc. Bot. 14 (1875) 131.

Cryptomyces pongamiae Sacc. in Syll. Fung. 8 (1889) 708.

Phyllachora pongamiae P. Henn. in Hedwigia 47 (1908) 255.

LUZON, Ilocos Norte Province, Bangui, *Bur. Sci.* 27723 Ramos, February 21, 1917, on leaves of *Pongamia* sp.

PHYLLACHORA SORGHI v. Höhn. in Sitzb. Kais. Akad. Wiss. Wien 118 (1909) 844.

LUZON, Ilocos Norte Province, Burgos, *Bur. Sci.* 27783 Ramos, March 14, 1917, on leaves of *Andropogon halepensis* var.

MYCOSPHAERELLACEAE

MYCOSPHAERELLA Johanson

MYCOSPHAERELLA ARISTOLOCHIAE Syd. in Ann. Myc. 12 (1914) 555.

LUZON, Cavite Province, Talisay ridge, *Merrill* 11199, on leaves of *Aristolochia tagala*.

MYCOSPHAERELLA OCULATA Syd. in Ann. Myc. 11 (1913) 403.

LUZON, Rizal Province, *Bur. Sci.* 25891 Yates, January 21, 1917, on leaves of *Premna odorata*: Cavite Province, Talisay ridge, *Merrill* 11198, January 21, 1917, on leaves of *Premna odorata*.

GUIGNARDIA Viala et Ravaz

GUIGNARDIA CREBERRIMA Syd. in Philip. Journ. Sci. 8 (1913) Bot. 482.

LUZON, Manila and vicinity, *Bur. Sci.* 25897 Yates, February, 1917, on leaves of *Capparis horrida*.

PLEOSPORACEAE

PHYSALOSPORA Niessl

PHYSALOSPORA EMBELIAE sp. nov.

Maculis amphigenis, orbicularibus, 0.6–1.4 cm diam., perithe-

ciis immersis, epiphyllis, in maculis concentricis dispositis, globulosis, 250–300 μ diam., epidermide elevata tectis et ostiolo papilliformi atro tantum prominulo; ascis cylindraceis 100 x 6–8 μ , basi in pedicellum attenuatis, 8-sporis; paraphysibus filiformibus; sporidiis monostichis, ellipsoideis, utrinque late rotundatis, hyalinis, 10 x 5 μ .

BASILAN, *Bur. Sci.* 25873 Yates, November 5, 1917, on leaves of *Embelia* sp.

The spots on the lower surface are very light yellow in color; on the upper surface the leaf tissue is light yellow but the numerous brown perithecia make the spots at a little distance appear brown with a narrow surrounding ring of yellow. The perithecia in each spot are arranged in more or less concentric circles.

VALSACEAE

EUTYPELLA Nitschke

EUTYPELLA HEVEAE sp. nov.

Stromatibus sparsis, ramos aequaliter densiusculeque obtegentibus, 0.5–0.75 mm diam., per corticem erumpentibus; ostioliis per peridermium arcte adhaerens erumpentibus, nigris; peritheciis in quoque acervulo 4–8, globulosis, 300–350 μ diam.; collis elongatis (200–250 μ longis); ostioliis crassis, plerumque 4-sulcatis; ascis oblongo-clavatis, longe pedicellatis, parte sporiferis 30–35 μ longis, 5 μ latis, octosporis; sporidiis distichis vel congestis, allantoideis, leviter curvulis, lutescentibus, 7–8 x 2–2.5 μ .

BASILAN, Isabela, *Bur. Sci.* 25879, 25885 Yates (type), November 11, 1917, on dead branches of *Hevea brasiliensis*.

XYLARIACEAE

DALDINIA De Notaris et Cesati

DALDINIA CONCENTRICA (Bolt.) Ces. et De Not. in *Comm. Critt. Ital.* 1 (1863) 198.

LUZON, Kalinga Subprovince, *Bur. Sci.* 25312 Yates, March, 1916, on dead logs.

TILLETIACEAE

ENTYLOMA de Bary

ENTYLOMA ORYZAE Syd. in *Ann. Myc.* 12 (1914) 197.

LUZON, Bulacan Province, Angat, *Bur. Sci.* 21849 Ramos, September, 1913, on the leaves of *Oryza sativa*.

PUCCINIACEAE

AECIDIUM Persoon

AECIDIUM KARNBACHII P. Henn. in *Engl. Bot. Jahrb.* 15 (1892) Beibl. 33: 5.

LUZON, Cavite Province, Talisay ridge, *Merrill* 11201, January 21, 1917, on leaves of *Lepistemon flavescens*.

AECIDIUM RHYTISMOIDEUM B. & Br. in Journ. Linn. Soc. Bot. 14 (1875) 95.

LUZON, Tayabas Province, Basiad, *Bur. Sci.* 25721, 25725 Yates, December, 1916, on leaves of *Diospyros discolor*: Rizal Province, *Bur. Sci.* 25893 Yates, January 20, 1917, on leaves of *Diospyros discolor*.

HEMILEIA Berkeley et Broome

HEMILEIA CANTHII B. & Br. in Journ. Linn. Soc. Bot. 14 (1875) 93.

LUZON, Cavite Province, *Merrill* 11200, January 21, 1917, on leaves of *Plectronia* (*Canthium*) *peduncularis*.

HEMILEIA VASTATRIX B. & Br. in Gard. Chron. (1869) 1157.

LUZON, Bontoc Subprovince, *Bur. Sci.* 25221 Yates, April–May, 1916, *Vanoverbergh* 3704, August, 1913: Benguet Subprovince, *Bur. Sci.* 25187 Yates, March–May, 1916: Lepanto Subprovince, *Bur. Sci.* 25206 Yates, April, 1916. MINDANAO, Bukidnon Subprovince, *Bur. Sci.* 15796 *Fenix*; all on leaves of *Coffea arabica*.

PUCCINIA Persoon

PUCCINIA CITRATA Syd. in Ann. Myc. 10 (1912) 78.

LUZON, Cavite Province, Talisay ridge, *Merrill* 11197, January 21, 1917, on leaves of *Andropogon citratus*.

PUCCINIA HETEROSPORA Berk. et Curt. in Journ. Linn. Soc. Bot. 10 (1869) 356.

LUZON, Manila and vicinity, *Bur. Sci.* 25381 Yates, August, 1916, on leaves of *Sida javensis*.

PUCCINIA THWAITESII B. & Br. in Journ. Linn. Soc. Bot. 14 (1875) 91.

LUZON, Bulacan Province, Angat, *Bur. Sci.* 21842 *Ramos*, September, 1913: Bataan Province, Lamao, *Bur. Sci.* 16844 *W. R. Shaw*, October, 1907: Bontoc Subprovince, *Bur. Sci.* 3805 *Vanoverbergh*, September–November, 1913: Kalinga Subprovince, *Bur. Sci.* 25327 Yates, March, 1916: Ilocos Norte Province, Bangui, *Bur. Sci.* 27711 *Ramos*, February 25, 1917; all on leaves of *Justicia gendarussa*.

SPHAEROPHRAGMIUM P. Magnus

SPHAEROPHRAGMIUM LUZONICUM sp. nov.

Soris uredosporiferis hypophyllis, minutis, 0.5–1.0 mm diam., epidermide fissa cinctis, brunneis, uredosporis ovatis vel pyriformis, minutissime verruculosis, flavo-brunneis, 18–25 x 13–16 μ , episporio ca. 1.0 μ crasso, poris germinationis unibus instructis; teleutosporis in soris uredosporiferis, 30–40 x 27–33 μ , globosis vel ellipsoideis, ex cellulis 4–8 compositis, castaneo-brunneis, tota superficie appendiculis brunneis usque ad 8–10 μ longis, basi leviter dilatatis et ad apicem stellatim furcatis, dentibus 2.5–3 μ longis; cellulis singulis 14–16 μ diam.; pedicello persistente, hyalino vel ad apicem leviter brunneo, usque ad 50–70 μ longo, 6–7 μ lato.

LUZON, Rizal Province, *Bur. Sci.* 25838 Yates, January 22, 1917, on leaves of *Albizia procera*.

This species appears to be very closely related to *Sphaerophragmium acaciae* (Cooke) P. Magn. The teleutospores are very few in number but they appear to be always borne in the same sorus with the uredospores.

TRIPHRAGMIUM Link

TRIPHRAGMIUM THWAITESII Berk. et Br. in Journ. Linn. Soc. Bot. 14 (1875) 92; Sydow, Monog. Ured. 3 (1912) 180.

LUZON, Ifugao Subprovince, *Bur. Sci.* 25202 Yates, April 12, 1916, on leaves of *Schefflera* sp.

The spores are produced mostly on the lower leaf surface but also occasionally on the upper surface. The leaf tissue is killed and becomes yellow over a spot 1 to 3 cm in diameter, or sometimes the entire leaf is killed. The spores are 3-celled, 25 to 35 μ in diameter and about 35 μ long. Each cell bears four spines; one at each outer angle. The spines are 5 to 8 μ long and dichotomously forked at the tip with prongs 2 to 3 μ long. The position and size of the spines are very uniform. The general appearance of the spots is somewhat similar to those produced on *Justicia gendarussa* by *Puccinia thwaitesii* Berk.

SPHAERIOIDACEAE

DOTHIOPSIS Karsten

DOTHIOPSIS ? PHILIPPINENSIS sp. nov.

Epiphylla, stromata atra carbonacea, gregariis, sub epidermide immersis, unilocularibus; pycnidiis applanatis, ca. 300 μ diam., 50 ad 100 μ altis, muralis ca. 30 μ crassis; sporidiis ovoidiis vel globosis, 22–27 μ longis, 18–20 μ latis, uniguttulatis; basidiis non visis.

LUZON, Tarlac Province, San Clemente, *For. Bur.* 24965A Villanueva, January, 1916, on leaves of *Mastixia philippinensis*.

This specimen is provisionally referred to *Dothiopsis* as it seems to agree best with the description of that genus. It is possibly the conidial stage of some dothideaceous fungus.

HENDERSONIA Berkeley

HENDERSONIA CELASTRI sp. nov.

Pycnidiis in maculis orbicularibus vel suborbicularibus collectis; maculis pallidis, margine brunneis, 3–12 mm diam.; ostioliis epiphyllis; pycnidiis ovoideo-depressis, 150–200 μ diam., pertusis; sporidiis subfusiformibus, vertice rotundatis, basi leviter angustato-acutatis, plerumque triseptatis, ad septa non constrictis, brunneis 10–14 μ longis, 2.5–3.5 μ latis.

LUZON, Batangas Province, Taal Volcano, *Merrill* 10613, January 20, 1917, on leaves of *Celastrus paniculata*.

PAZSCHKEELLA Sydow

PAZSCHKEELLA PHILIPPINENSIS sp. nov.

Stromatibus epiphyllis, numerosis, gregariis vel confluentibus, atris, subglobosis, 200 μ diametro vel confluentibus et maculis

1-3 mm diam. formans; peritheciis in stromatibus immersis, globosis, 100-150 μ diam.; sporulis numerosis, oblongis, utrinque rotundatis, 1-septatis, non guttulatis, ad septa non constrictis, hyalinis vel subhyalinis 15-17 x 3.5-4.5 μ ; loculis inaequalis, 5-7 μ longis et 10 μ longis; basidiis non visis.

LUZON, Ilocos Norte Province, Bangui, *Bur. Sci.* 27721 Ramos, February 23, 1913, on leaves of *Dunbaria* sp.

The present species appears to be best referable to Sydow's genus *Pazschkeella* described from Brazilian material in Bull. Herb. Boiss. II 1 (1901) 83. The Philippine specimen differs in several respects from the original description and a comparison with Sydow's type might show that our plant should be better described as the type of a new genus.

PHYLLOSTICTA Persoon

PHYLLOSTICTA GELONIAE sp. nov.

Maculis amplis, primus marginalis, subinde fere totum folium occupantibus, pallide ochraceis, margine brunneis, epiphyllis, gregariis, primo epidermide tectis, dein erumpentibus, atris, 65 ad 85 μ diam.; sporulis fusiformis, utrinque attenuatis, continuis, hyalinis, 10-12 x 2.5-3.5 μ .

ALABAT, *Merrill 10538*, December 25, 1916, on leaves of *Gelonium*.

The spots appear at first on the margins of the leaf near the apex and advance inward, killing the tissue, until a large part of the leaf is affected.

PHYLLOSTICTA GRAFFIANA Sacc. in *Ann. Myc.* 11 (1913) 316.

LUZON, Manila and vicinity, *Bur. Sci.* 30622 Yates, February 20, 1918, on leaves of *Dioscorea esculenta*.

PHYLLOSTICTA MIURAE K. Miyake in *Journ. Coll. Agric. Tokyo* 2 (1910) 253.

LUZON, Laguna Province, *Bur. Sci.* 29258 Arce, August, 1917, on leaves of *Oryza sativa*.

PLACOSPHAERIA Saccardo

PLACOSPHAERIA TIGLII P. Henn. in *Hedwigia* 47 (1908) 263.

LUZON, Bontoc Subprovince, Barlig, *Bur. Sci.* 25259 Yates, April 7, 1916, on leaves of *Croton tiglium*.

PYCNOTHYRIACEAE

LASIOTHYRIUM Sydow

LASIOTHYRIUM CYCLOSCHIZON Syd. in *Philip. Journ. Sci.* 8 (1913) Bot. 504, f. 7.

LUZON, Rizal Province, Pasay, *Bur. Sci.* 29831 Ramos, September 20, 1917, on leaves of *Aegiceras corniculatum*.

MONILIACEAE

PIRICULARIA Saccardo

PIRICULARIA ORYZAE Cavr. in *Atti Instit. Bot. Pavia* 4 (1897) 79.

LUZON, Rizal Province, Cainta, *Bur. Sci.* 29832 Reyes, September 4, 1917, on leaves of *Oryza sativa*.

The collector reports that this fungus is particularly abundant on a variety of rice known as "awa" or "maca-awa." Where the rice is growing under very moist conditions it may cause the loss of a large part of the crop. This disease of rice has also been reported from Japan.

DEMATIACEAE

CERCOSPORA Fries

CERCOSPORA GLIRICIDIAE Syd. in Philip. Journ. Sci. 8 (1913) Bot. 283.

LUZON, Manila and vicinity, *Bur. Sci. 30621* Yates, February 20, 1918, on leaves of *Gliricidia sepium*.

CONIOSPORIUM Link

CONIOSPORIUM ORYZINUM Sacc. in Nuov. Giorn. Bot. Ital. 23 (1916) 213.

LUZON, Manila and vicinity, *Bur. Sci. 30624* Yates, February 20, 1918, on leaves and glumes of *Oryza sativa*.

This organism was described by Saccardo from Philippine specimens said to be on dead and partly decayed leaves of rice. The present collection occurred on dying and dead leaves and glumes and appeared to be the cause of the injury. If it should prove to be the primary cause of the disease, and be widely distributed, it may cause a very appreciable reduction in the yield of rice in the Philippines.

HADRONEMA Sydow

HADRONEMA ORBICULARE Syd. in Ann. Myc. 7 (1909) 172.

LUZON, Camarines Province, Mount Isarog, *Bur. Sci. 22125* Ramos, November 29, 1913, on leaves of *Quercus* sp.

HELMINTHOSPORIUM Link

HELMINTHOSPORIUM FICUUM sp. nov.

Mycelio abundante, ex hyphis subhyalinis, 2–3.5 μ crassis composito; conidiophoris numerosis, erectis, obscure brunneis (castaneis), septatis, 350–450 μ longis, 8–10 μ crassis, deinde ad apicem torulosis; conidiis ad basim truncatis, plerumque 4-septatis, 44–50 μ longis, 6–9 μ latis, brunneis, ad septa non constrictis.

LUZON, Tayabas Province, Mount Binuang, *Bur. Sci. 28897* Ramos & Edaña, May 15, 1917, on sterile mycelium of *Meliola* on leaves of *Ficus caudatifolia*.

The conidiophores are often aggregated into tufts and then approach *Arthobotryum* sp.

HELMINTHOSPORIUM LEUCOSYKEAE sp. nov.

Mycelio ex hyphis brunneis septatis 5–5.5 μ crassis formato; conidiophoris numerosis, erectis, brunneis, septatis, 300 μ longis, 7–8 μ crassis, conidiis ad basim truncatis, 3-septatis, ad septa non constrictis, apicem rostratis, 30 x 8 μ .

LUZON, Tayabas Province, Umiray, *Bur. Sci. 29084* Ramos & Edaña,

June 2, 1917, on a *Meliola* on the lower surface of the leaves of *Leucosyke capitellata*.

The *Meliola* on which this grows appears to be an undescribed species having perithecia 150 to 200 μ diam., and brown 4-septate spores 45–50 μ long by 18–20 μ wide. The conidiophores of the *Helminthosporium* are not at all torulose. The two end cells of the spores are hyaline and the apex is prolonged into a beak 7–8 μ long.

HELMINTHOSPORIUM FLAGELLATUM sp. nov.

Mycelio abundante, ex hyphis subhyalinis 2.5–4 μ crassis formato; conidiophoris numerosis, erectis, obscure brunneis, septatis 200–300 μ longis, 10 μ crassis, prope apicem (50–75 μ) torulosis; conidiis ad basim truncatis, 3–4 septatis, 40–50 μ longis, 10–12 μ latis, brunneis, ad septa non constrictis.

LUZON, Rizal Province, Mount Lumutan, *Bur. Sci. 29804 Ramos & Edaña*, July 2, 1917, on the sterile mycelium of a *Meliola* on the lower surface of leaves of *Ardisia disticha*.

The mycelium of this species of *Helminthosporium* is almost hyaline, though certain filaments have a distinctly yellow tinge. The spores are mostly either 3- or 4-septate, the terminal cells being much lighter in color than the others. The apex is often prolonged into a hyaline beak or flagellum 20–30 μ long and 3 μ in diameter; measurements of spores as given do not include this beak.

HELMINTHOSPORIUM RAVENELII Curt. in *Am. Journ. Sci. Arts* II 6 (1848) 352.

LUZON, Benguet Subprovince, Trinidad, *Bur. Sci. 25151 Yates*, March 16, 1916; Bontoc Subprovince, Bontoc, *Bur. Sci. 25230 Yates*, April 17, 1916, both on inflorescences of *Sporobolus elongatus*. SAMAR, Catubig River, *Bur. Sci. 24635 Ramos*, February–March, 1916, on the inflorescence of *Panicum auritum*.

SPIRALOTRICHUM genus novum

Hyphis sterilis erectis, spiraliter tortuosis, simplicibus, in caespitulis aggregatis; conidiis acrogenis, globosis, brunneis; basidiis erectis, brevibus.

SPIRALOTRICHUM PIPERIS sp. nov.

Caespitulis hypophyllis, minutis, punctiformibus, 0.25–0.5 mm diam.; hyphis sterilis spiraliter tortuosis, 50–90 μ longis, 5–7 μ latis, brunneis, non ramosis; basidiis brevioribus, simplicibus; conidiis globosis, castaneo-brunneis, papillatis, 3.5–4.0 μ diam.

LUZON, Tayabas Province, Basiad, *Bur. Sci. 25663 Yates*, December 19, 1916, on living leaves of *Piper* sp.: Ilocos Norte Province, Bangui, *Bur. Sci. 27725 Ramos*, March 6, 1917, on living leaves of *Piper* sp.

This fungus appears to be an active parasite on the leaves of pepper.

A large part of the leaf tissue is killed and becomes light gray in color. The spots of dead tissue are more or less circular in outline or confluent with narrow black margins. The fungus appears on the areas of dead tissue before the entire leaf is killed.

TUBERCULARIACEAE

HYMENOPSIS Saccardo

HYMENOPSIS CUDRANIAE Mass. in Kew Bull. (1899) 167.

LUZON, Ilocos Norte Province, Bangui, *Bur. Sci.* 27733 Ramos, February 20, 1917, on leaves of *Cudrania javanica*.

ERRATA

Page 175, line 8 from the top, *for* stamens 8 *read* stamens ∞ .

Page 183, line 14 from the top, *for* 9 cm. *read* 9 mm.

Page 193, line 7 from the bottom, *for* 11 cm *read* 11 mm.

Page 196, lines 7 and 15 from the bottom, *for* 8 cm *read* 3.8 cm.

INDEX

[New generic and specific names and new combinations are in **black-faced type**: synonyms and names of species incidentally mentioned in the text are in *italics*.]

A

- Abelmoschus *sagittifolius* Kurz, 30.
vanoverberghii Merr., 29.
- Acanthaceae, 59.
- Acanthophora *scandens* Merr., 316.
- Actaea *aspera* Lour., 147.
- Actinodothis *piperis* Syd., 376.
- Adenia *acuminata* (Blume) King, 97:
clementis Merr., 95.
cordifolia (Blume) Engl., 95.
longipedunculata Merr., 96.
macrophylla (Blume) Koord., 97.
quadrifida Merr., 94.
- Adenosacme *coriacea* Dunn, 159.
- Adinandra *millettii* Benth., 148.
- Aecidium *karnbachii* P. Henn., 378.
rhytismoideum B. & Br., 379.
- Aegle, 335.
- Aeglopsis, 335.
- Aerobryopsis *lanosa* (Mitt.) Broth., 210.
- Aglaiia *brevipetiolata* Merr., 289.
clementis Merr., 76.
curranii Merr., 294.
elaeanoidea (Juss.) Benth., 296.
elaeanoidea Benth. var. *pallens* Merr., 297.
elliptica Blume, 77.
grandifoliola Merr., 293.
harmsiana Perk., 77, 293.
heterophylla Merr., 77.
lanceolata Merr., 294.
lancilimba Merr., 294.
luzoniensis (Vid.) Merr. & Rolfe, 78, 289.
matthewsii Merr., 79.
mirandae Merr., 295.
monophylla Perk., 80, 289.
moultonii Merr., 78.
myriantha Merr., 295.
pallens Merr., 297.
puncticulata Merr., 290.
pyriformis Merr., 290, 291.
rizalensis Merr., 289.
robinsonii Merr., 291.
sarawakana (A. DC.) Merr., 78.
simplicifolia Harms, 80.
stenophylla Merr., 295.
submonophylla Miq., 80.
tayabensis Merr., 292.
unifoliolata Koord., 80, 289.
- Aglanema *acutispathum* N. E. Br., 133.
modestum Schott, 133.
- Agrostis *alba* Linn., 131.
elmeri Merr., 131.
hugoniana Rendle, 131.
- Aithaloderma *clavatisporum* Syd., 236.
- Albizzia *corniculata* (Lour.) Merr., 140.
lebbeckoides Benth., 16.
megaladenia Merr., 16.
millettii Benth., 140.
- Allantodia *pinnata* Blanco, 126.
- Allomorpha *pauciflora* Benth., 151.
- Alocasia *macrorrhiza* Schott, 3.
maquilingensis Merr., 3.
wenzelii Merr., 2.
- Alsomitra *integrifoliola* (Cogn.) Hayata, 65.
pubescens Merr., 64.
- Alyxia *glabra* Merr., 53.
lanceolata Merr., 53.
laxiflora Merr., 54.
luzoniensis Merr., 55.
monilifera Vid., 53.
monticola C. B. Rob., 53.
revoluta Merr., 52.
sibuyanensis Elm., 52.
- Ampelopsis *heterophylla* Blume, 146.
heterophylla Sieb. & Succ., 146.
- Andropogon *fragilis* R. Br., 129.
fragilis R. Br., var. *sinensis* Rendle, 129.
- Aneilema *humile* Merr., 4.
- Anisoptera *brunnea* Foxw., 181.
curtisii Dyer, 181.
mindanensis Foxw., 181.
thurifera (Blanco) Blume, 181.
- Anoetangium *subalarum* Broth., 206.
- Anomobryum *gemmigerum* Broth., 207.
- Apocynaceae, 52.
- Aquifoliaceae, 143.
- Araceae, 2, 133.
- Araliaceae, 44, 99, 152, 316.
- Aralia *ferox* Miq., 317.
- Ardisia *boissieri* A. DC., 50.
brachybotrys Lauterb. & K. Schum., 111.
dolichosepala Merr., 112.
hosei Merr., 116.
kinabaluensis Merr., 114.
lanceolata Roxb., 109.
lancifolia Merr., 113.
lepidotula Merr., 115.
lucida Merr., 111.
moultonii Merr., 108.
nigromaculata Merr., 49.
nitidula Mez, 109.

- Ardisia obscurinervia* Merr., 112.
pendula Mez, 113.
petocalyx Scheff., 112.
polyactis Mez, 117.
pygmaea Merr., 110.
rivularis Merr., 50.
salicifolia A. DC., 50.
sarawakensis Merr., 109.
scabrida Mez, 115.
- Aristolochiaceae, 9, 280.
- Aristolochia foveolata* Merr., 280.
humilis Merr., 9.
philippinensis Warb., 10.
tagata Cham., 281.
- Artocarpus*, 353.
- Asclepiadaceae, 120, 330.
- Asplenium wichurae* Mett., 126.
- Asterina banguiensis* Yates, 372.
breyntiae Yates, 371.
canthii Yates, 372.
capparidis Syd., 372.
decipiens Syd., 372.
elmeri Syd., 372.
fagarae Yates, 373.
jasminicola Yates, 373.
laxiuscula Syd., 372.
litseae Yates, 373.
momordicae Yates, 374.
neolitseae Yates, 374.
piperis Yates, 374.
ramosii Yates, 375.
zizyphiae Yates, 375.
- Asterinella calami* Syd., 375.
luzonensis Syd., 376.
- Athyrium bulbiferum* (Brack.) Merr., 126.
macrocarpum (Blume) Milde, 126.
obtusifolium Rosenst., 126.
pinnatum Copel., 126.
tenuissimum (Hayata) Merr., 126.
wichurae (Mett.) Merr., 126.
- B**
- Balanocarpus brachyptera* Foxw., 195.
cagayanensis Foxw., 194.
- Balsamocitrinae*, 335.
Balsamocitrus, 335.
- Barbella clemensiae* Broth., 210.
consanguinea (Thwait. et Mitt.)
 Jaeg., 205.
enervis (Mitt.) Fleisch., 211.
inflexa (Dub.) C. Müll., 205.
orientalis (Willd.) Broth., 205.
pendula (Sull.) Fleisch., 210.
- Bartramiaceae, 208.
- Bassia cagayanensis* Merr., 48.
coriaca Merr., 324.
mirandae Merr., 324.
oblongifolia Merr., 323.
- Beddomea luzonensis* Vid., 289.
simplicifolia Bedd., 80.
- Begoniaceae, 38, 314.
- Begonia aequata* A. Gray, 41, 314.
apayaensis Merr., 39.
binuangensis Merr., 40.
castilloi Merr., 38.
caudata Merr., 41.
- Begonia edanoi* Merr., 314.
elegans Elm., 314.
elmeri Merr., 39.
hernandioides Merr., 39.
lagunensis Elm., 314.
megacarpa Merr., 42.
nigritarum Steud., 38.
oxysperma A. DC., 41.
pellata Elm., 39.
rujipila Merr., 39.
tayabensis Merr., 38.
wenzelii Merr., 41, 314.
- Berghausia patula* Munro, 130.
- Blastus cochinchinensis* Lour., 151.
hindsii Hance, 151.
pauciflorus Merr., 151.
- Boerlagiodendron catanduanense* Merr., 318.
fenicis Merr., 44.
heterophyllum Merr., 44, 319.
luzonicense Merr., 45.
pectinatum Merr., 46.
tayabense Merr., 45.
yatesii Merr., 44, 319.
- Botrychium ternatum* (Thunb.) Sw., 129.
- Botrytis infestans* Mont., 361.
- Brachymenium nepalense* Hook., 207.
- Brachytheciaceae, 222.
- Brandisia discolor* Hook. f. & Th., 158.
glabrescens Rehder, 158.
hancei Hook. f., 158.
laetevirens Rehder, 158.
racemosa Hemsl., 158.
souliei Bonati, 158.
swinglei Merr., 157.
- Breutelia arundinifolia* (Dub.) Broth., 209.
- Bridelia loureiri* Hook. & Arn., 142.
monica (Lour.) Merr., 142.
- Bryaceae, 206.
- Bryum ambiguum* Dub., 207.
compressidens C. Müll., 207.
coronatum Schwaegr., 207.
ramosum (Hook.) Mitt., 207.
- Bulgariaceae, 361.
- Bulgariastrum caespitosum* Syd., 361.
- Burseraceae, 304.
- C**
- Caesalpinia lebbkoides* DC., 140.
- Callicarpa dichotoma* (Lour.) Raeusch., 156.
lanata Linn., 156.
longiloba Merr., 156.
oligantha Merr., 155.
platyphylla Merr., 57.
purpurea Juss., 156.
tomentosa Hook. & Arn., 156.
tomentosa Murr., 156.
tomentosa Willd., 156.
- Callicostella papillata* (Mont.) Mitt., 212.
- Calligonum asperum* Lour., 147.
- Calympereaceae, 204.
- Calymperes orientale* Mitt., 204.
serratum A. Br., 204.
- Calyptothecium tumidum* (Mitt.) Fleisch., 211.
- Campyllum glaucocarpum* (Reinw.) Broth.,
 215.
- Campylopodium euphorocladum* (C. Müll.)
 Besch., 201.

- Campylopus ericoides* (Griff.) Jaeg., 202.
 hemitrius (C. Müll.) Jaeg., 202.
Canarium euryphyllum Perk., 305.
 microphyllum Merr., 304.
 Capnodiaceae, 236.
 Cappariaceae, 12.
Capparis ilocana Merr., 13.
 loheri Merr., 13.
 longipes Merr., 12.
 sepiaria Linn., 14.
Carex bambusetorum Merr., 132.
 brunnea Thunb., 133.
 doniana Spreng., 133.
 japonica Thunb., 133.
 rhynchochaenium Clarke, 133.
 teinogyna Boott, 133.
Carpesium cernuum Linn., 161.
Casearia cinerea Turcz., 35.
 confertiflora Merr., 34.
 euphlebia Merr., 34.
 grewiaefolia Vent., 35.
Catacauma aspidium (Berk.) Theiss. & Syd., 376.
Cayratia japonica Gagnep., 145.
 tenuifolia Gagnep., 145.
 Celastraceae, 306.
 Cenangiaceae, 234, 362.
Ceratophyllum, 347.
Cercospora gliricidiae Syd., 382.
 mangiferae Koord., 240.
Ceropegia borneensis Merr., 120.
 cumingiana Decne., 121.
 curvisflora Hassk., 121.
Cestrum nocturnum, 353.
Chaetomitrium orthorrhynchum (Doz. et Molk.)
 Bryol. jav., 213.
 papillifolium Bryol. jav., 213.
 philippinense (Mont.) Bryol.
 jav., 213.
Chaetospermum glutinosum (Blanco) Swingle,
 340.
Chalcas, 336.
Chionanthus ramiflora Roxb., 119.
Chisocheton parvifolius Merr., 297.
 philippinus Harms, 297.
Cissus assamica Craib., 145.
 japonica Willd., 145.
 landuk Hassk., 146.
 tenuifolia Heyne, 145.
Clausena, 337.
Cleistanthus monoicus Muell.-Arg., 142.
 oligophlebius Merr., 80.
 paxii Jabl., 81.
Cleistocalyx nitidus Blume, 98.
 Clethraceae, 103, 154.
Clethra canescens Hemsl., 154.
 canescens Reinw., 105.
 clementis Merr., 104.
 fabri Hance, 154.
 lancifolia Turcz., 105, 155.
 luzonica Merr., 104.
 pachyphylla Merr., 103.
 pulgarensis Elm., 104.
 williamsii C. B. Rob., 105.
Cleyra dubia Champ., 149.
 fragrans Champ., 149.
 ochracea DC., 148.
Clusia monoica Lour., 142.
Cocculus sarmentosus (Lour.) Diels, var.
 stenophyllus Merr., 10.
Coix heteroclita Roxb., 129.
Collybia albuminosa (Berk.) Petch, 229.
Columella japonica Merr., 145.
 tenuifolia Merr., 145.
 Commelinaceae, 4.
 Compositae, 161.
Coniogramme fraxinea (Don) Diels, 127.
Coniosporium oryzinum Sacc., 382.
 Connaraceae, 15, 68.
Connarus agamae Merr., 68.
 borneensis Merr., 69.
 densiflorus Merr., 70.
 ferrugineus Jack, 73.
 grandis Jack, 69.
 hebephyllus King, 73.
 pachyphyllus Merr., 71.
 plumoso-stellatus Merr., 72.
 subfoveolatus Merr., 15.
 Convolvulaceae, 56.
 Cornaceae, 42, 325.
Corticium javanicum Zimmerman, 239.
 salmonicolor B. et Br., 239.
 zimmermanni Sacc. et Syd., 239.
Crotalaria trifoliolatum Willd., 17.
Crudia havilandii Prain, 74.
 reticulata Merr., 73.
Cryptomyces pongamiae Sacc., 377.
Ctenidium forstenii (Bryol. jav.) Broth., 215.
 Cucurbitaceae, 64, 332.
Cucurbita, 353.
Cupia mollissima Hook. & Arn., 160.
 Cyperaceae, 132.
Cyrtandra alvarezii Merr., 326.
 castanea Merr., 326.
 incisa C. B. Clarke, 327.
 longipedunculata Merr., 330.
 longipes Merr., 329.
 microphylla Merr., 328.
 multifolia Merr., 327.
 tenuipes Merr., 329, 330.
 D
Daedalea imponens Ces., 239.
Daldinia concentrica (Bolt.) Ces. et De Not.,
 238, 378.
 Dematiaceae, 240, 382.
Dendropanax acuminatissimum Merr., 152.
 japonicum Seem., 152.
 proteum Benth., 152.
 Dicteranaceae, 201.
Dicranoloma monocarpum Broth., 202.
 tenuirete Broth., 202.
Didymocarpus swinglei Merr., 156.
 Dilleniaceae, 31, 85, 147, 308.
Dimerium tayabense Yates, 362.
 Dioscoreaceae, 134.
Dioscorea pentaphylla Linn., 134.
Diospyros eriantha Champ., 47.
 pilosanthera Blanco, 68.

- Diospyros *streptosepala* Merr., 322.
tayabensis Merr., 47.
velascoi Merr., 46.
- Diplazium bulbiferum* Brack., 126.
wichuriae Diels, 126.
- Diplodia cacaoicola* 237.
- Dipterocarpaceae, 163, 311.
- Dipterocarpus *affinis* Brandis, 176.
basilanicus Foxw., 179.
caudatus Foxw., 177.
cuneatus Foxw., 178.
fagineus Vesque, 179.
gracilis Blume, 177, 178.
grandiflorus Blanco, 179.
hasseltii Blume, 177.
malaanonan Blanco, 189.
obconicus Foxw., 178.
orbicularis Foxw., 180.
perturbinatus Foxw., 177.
philippinensis Foxw., 179.
pilosus Roxb., 176.
speciosus Brandis, 178.
subalpinus Foxw., 177.
trinervis Blume, 176.
verniciifluus Blanco, 177, 179.
warburgii Brandis, 178.
- Dischidia *lanceifolia* Merr., 330
merrillii Schltr., 330.
- Distichophyllum *nigricale* Mitt., 212.
- Dothidea grammodes* Berk., 371.
perisporioides B. & C., 371.
- Dothidella albizziae* Syd., 377.
perisporioides Sacc., 371.
- Dothiopsis philippinensis* Yates, 380.
- Dryopteris punctata* (Thunb.) C. Chr., 127.
- Dysoxylum *hexandrum* Merr., 297.
ilocanum Merr., 298.
kinabaluense Merr., 75.
palawanense Merr., 75, 300.
panayense Merr., 75, 299.
platyphyllum Merr., 298.
vriescanum C. DC., 299.
wenzelii Merr., 299.
- E
- Ebenaceae, 46, 322.
- Ectropothecium *assimile* Broth., 215.
brachyphyllum Broth., 216.
buitenzorgii (Bél.) Jaeg., 216.
callichroides (C. Müll.) Jaeg., 216.
cyperoides (Hook.) Jaeg., 216.
eleganti-pinnatum (C. Müll.) Jaeg., 216.
elmeri Broth., 216.
ferrugineum (C. Müll.) Jaeg., 216.
ichnotocladum (C. Müll.) Jaeg., 216.
luzoniae (C. Müll.) Broth., 216.
micropyxis Broth., 215.
monumentorum (Dub.) Jaeg., 215.
subintorquatum Broth., 216.
- Elaeocarpaceae, 27.
- Elaeocarpus *bontocensis* Merr., 27.
leytensis Merr., 28.
megacarpa Elm., 29.
monocera Cav., 29.
octopetalus Merr., 28.
surigaensis Merr., 28.
- Elatostema *catanduanense* Merr., 271.
gracilifolium Merr., 8, 272.
- Eleocharis *tetraquetra* Nees, 132.
- Elmeriobryum *philippinense* Broth., 215.
- Elodea*, 347.
- Elytranthe *acuñae* Merr., 279.
formosa G. Don, 280.
- Endodothella *albizziae* Syd., 377.
- Endotrichella *elegans* (Doz. et Molk.) Fleisch., 209.
eimeri Broth., 209.
perplicata Broth., 209.
- Entodontaceae, 212.
- Entodon *longidens* Broth., 212.
rubicundus (Wils.) Jaeg., 212.
- Entyloma *oryzae* Syd., 378.
- Epilobium *philippinense* C. B. Rob., 151.
- Epirixanthes *aphylla* (Griff.) Merr., 142.
- Ericaceae, 152.
- Eriogonum*, 359.
- Eriopus *flaccidus* Broth., 213.
- Erycibe *laevigata* Wall., 57.
sargentii Merr., 56.
- Erythrodontium *squarulosum* (Mont.) Par., 212.
- Eugenia *alcinae* Merr., 98.
cleistocalyx Merr., 98.
nervosa Miq., 98.
villamilii Merr., 98.
- Euphorbiaceae, 80, 142.
- Eurya *coriacea* Merr., 310.
japonica Thunb., 310.
ochracea Szysz., 148.
pachyphylla Merr., 309.
pachyrhachis Merr., 310.
- Eutypa *bambusina* Penz et Sacc., 238.
- Eutypella *heveae* Yates, 378.
- Everettia *octodonta* Merr., 315.
pulcherrima Merr., 315.
- Evodia *glaberrima* Merr., 18.
ternata Merr., 19.
- F
- Fagaceae, 6, 272.
- Fagara *chinensis* Merr., 141.
- Fagraea *auriculata* Jack, 51.
curranii Merr., 50.
longiflora Merr., 52.
macgregorii Merr., 51.
- Feronia*, 335.
Feroniella, 335.
- Ficus *pyriformis* Hook. & Arn., 136.
rectinervia Merr., 135.
stenophylla Hemsl., 136.
- Fimbristylis *annua* (All.) R. & S., 132.
diphylla Vahl, 132.
hookeriana Boeck., 132.
- Firmiana *simplex* (Linn.) W. F. Wight, 308.
- Fissidentaceae, 203.
- Fissidens *braunii* (C. Müll.) Doz. et Molk., 203.

- Fissidens nagasakinus Besch. var. luzonensis Broth., 204.
nobilis Griff., 204.
robinsonii Broth., 204.
- Flacourtiaceae, 34, 97.
- Floribundaria floribunda (Doz. et Molck.) Fleisch., 210.
- Fontinalis, 347.
- Freycinetia acutifolia Merr., 267.
apayaensis Merr., 269.
atocensis Martelli, 269.
banahaensis Elm., 268.
batanensis Mart., 268.
botuliformis Merr., 268.
bulusanensis Merr., 268.
oblongifolia Merr., 267.
platyphylla Merr., 267.
scabripes Warb., 268.
williamsii Merr., 269.
- Funalia philippinensis Murr., 239.
- Funariaceae, 206.
- Funaria clavescens Schwaegr., 206.
luzonensis Broth., 206.
- G**
- Garnotia barbulate (Nees) Merr., 130.
ciliata Merr., 130.
patula Munro, 130.
stricta Brongn., 130, 131.
- Garovaglia bakeri Broth., 209.
perundulata Broth., 210.
plicata (Nees) Endl. var. gracilescens Broth., 210.
- Gentianaceae, 120.
- Gentiana atkinsonii Burkill, 120.
clementis Merr., 120.
- Gesneriaceae, 156, 326.
- Gleditschia australia Hemsl., 141.
fera (Lour.) Merr., 141.
macracantha Desf., 141.
- Glycosmis, 337.
- Gramineae, 129.
- Guignardia creberrima Syd., 377.
- Gymnacranthera macrobotrys Merr., 284.
murtoni Warb., 284.
paniculata Warb., 284.
- Gymnogramme lanceolata Hook., 127.
- Gymnostomiella longinervis Broth., 205.
vernica (Hamp.) Fleisch., 205.
- H**
- Hadronema orbiculare Syd., 382.
- Hedyotis acuminatissima Merr., 159.
acutangula Champ., 160.
- Helminthosporium ficuum Yates, 382.
flagellatum Yates, 383.
leucosykeae Yates, 382.
ravenelii Curt., 383.
- Hemigraphis cumingiana F.-Vill., 60.
hirsutissima Merr., 60, 62.
pauciflora Merr., 61.
strigosa F.-Vill., 60.
viridis Merr., 59.
- Hemileia canthii B. & Br., 379.
vastatrix B. & Br., 379.
- Hendersonia celastri Yates, 380.
- Herminium angustifolium (Lindl.) Benth., 135.
- Hecca brasiliensis Muell., 234.
- Hibiscus simplex Linn., 308.
vitifolius Linn., 30.
- Himanthocladium loriforme Fleisch., 212.
- Hippocrateaceae, 20.
- Hippocratea cumingii Laws., 22.
megalocarpa Merr., 20.
trichopetala Merr., 21.
- Homaliodendron flabellatum (Dicks.) Fleisch., 212.
scalpellifolium (Mitt.) Fleisch., 212.
- Homalium barandae Vid., 38.
loheri Merr., 37.
luzoniense F.-Vill., 37.
multiflorum Merr., 35.
platyphyllum Merr., 36.
villarlanum Vid., 37.
villosum Merr., 37.
- Hookeriaceae, 212.
- Hopea acuminata Merr., 183.
basilana Foxw., 183.
beccariana Burck, 184.
foxworthyi Elm., 184.
glutinosa Elm., 184.
malibato Foxw., 184.
maquilingensis Foxw., 184.
mindanensis Foxw., 183.
ovalifolia Boerl., 183.
philippinensis Dyer, 183.
pierrei Hance, 184.
plagata (Blanco) Vidal, 183.
- Horsfieldia ardisiifolia Warb., 285.
confertiflora Merr., 285.
megacarpa Merr., 286.
merrillii Warb., 287.
oblongata Merr., 286.
- Hoya fischeriana Warb., 331.
luzonica Schltr., 332.
pentaplebia Merr., 330.
pubicalyx Merr., 331.
- Hymenodon sericeus (Doz. et Molck.) C. Müll., 208.
- Hymenopsis cudraniae Mass., 384.
- Hyophila flavipes Broth., 205.
- Hypnaceae, 215.
- Hypnodendraceae, 222.
- Hypnodendron formosicum Card., 222.
- Hypocreaeae, 237, 376.
- Hypocrea borneensis Yates, 237.
- Hypocrella schizostachyii P. Henn., 376.
- Hypolepis punctata (Thunb.) Mett., 127.
- Hypserpa jagori Diels, 11.
- Hysterostomella psychotriae Syd., 376.
- I**
- Ilex fletcheri Merr., 144.
hanceana Maxim., 144.
lohfaensis Merr., 144.
memecylifolia Champ., 144.
tutcheri Merr., 143.

- Illicium cambodianum* Hance, 68.
stapfii Merr., 67.
Ilocania pedata Merr., 65.
Inocyclus psychotriac Syd., 376.
Ipomoea coptica (Linn.) Roth, 57.
dissecta Willd., 57.
diversifolia R. Br., 57.
nil, 353.
Isoptera borneensis Scheff., 194.
Isopterygium albescens (Schwaegr.) Jaeg., 217.
minutirameum (C. Müll.) Jaeg., 217.
taxirameum (Mitt.) Jaeg., 217.
- J**
- Jambosa nitida* Korth., 98.
Justicia dispar Merr., 62.
loheri C. B. Clarke, 63.
quadrifaria Wall., 63.
- K**
- Kalchaburunghos monoecus* O. Kuntze, 143.
Knema alvarezii Merr., 288.
heterophylla Warb., 288.
parvifolia Merr., 287.
Kopsia lacinervia Merr., 55.
longiflora Merr., 55.
Kretzschmaria pechuelii P. Henn., 238.
Kyllinga odorata Vahl var. *cylindrica* (Nees) Kükenth., 132.
- L**
- Londukia landuk* Planch., 146.
Laportea pendula Merr., 270.
Lasiothyrium cycloschizon Syd., 381.
 Lauraceae, 137.
Leea papillosa Merr., 307.
 Leguminosae, 16, 73, 139.
Leontoglossum scabrum Hance, 147.
Lepidagathis cinerea Merr., 63.
microphylla Merr., 63.
Leptohyemium tenue (Hook.) Schwaegr., 215.
 Leskeaceae, 214.
Leskeodon philippinensis Broth., 213.
 Leucobryaceae, 203.
Leucobryum bowringii Mitt., 203.
sanctum Hamp., 203.
scalare C. Müll., 203.
scalare C. Müll. var. *tjibodensis* Fleisch., 203.
sericeum Broth., 203.
 Leucomiaceae, 219.
Leucomium aneurodictyon (C. Müll.) Jaeg., 219.
Leucophanes candidum (Hornsch.) Lindb., 203.
 Liliaceae, 5, 134.
Lindernia pyxidaria All., 158.
Linociera calophylla (Blume) Knobl., 119.
macrobotrys Merr., 117.
montana (Blume) DC., 118.
oligantha Merr., 118.
remotinervia Merr., 324.
verruculosa Merr., 119.
Litsea pulchella Meisn., 137.
 Loganiaceae, 50.
- Lomaria matthewii* Christ, 128.
 Loranthaceae, 273.
Loranthus amplifolius Merr., 277.
confertiflorus Merr., 273.
cuernosensis Elm., 275.
crassilimbus Merr., 274.
curranii Merr., 277.
edanoi Merr., 275.
fragilis Merr., 279.
fragilis Sprague, 279.
haenkeanus Presl, 277.
ovatibracteus Merr., 278.
pachycladus Merr., 276.
palawanensis Merr., 279.
pubiflorus Merr., 279.
pubiflorus Sprague, 279.
samarensis Merr., 276.
seriatus Merr., 275.
spraguei Merr., 279.
Loxogramme fauriei Copel., 127.
lanceolata (Sw.) Presl, 127.
linearis Copel., 127.
malayana Copel., 127.
remote-frondigerum Hayata, 127.
Lucinaea cumingiana Vid., 160.
Lycopodium fauriei Rosenst., 127.
tereticaule Hayata, 127.
- M**
- Macromitrium angustifolium* Bryol. jav., 206.
goniorrhynchum (Doz. et Molk.) Mitt., 206.
merrillii Broth., 206.
scimpellucidum Doz. et Molk. 206.
subuligerum Bryol., 206.
Macrothamnium macrocarpum (Reinw. et Hornsch.) Fleisch., 215.
Maesa brunnea Merr., 321.
clementis Merr., 106.
conferta Merr., 107.
denticulata Mez., 322.
japonica (Thunb.) Moritzi, 108.
laevigata Scheff., 106.
megaphylla Merr., 322.
montana A. DC., 107.
platyphylla Elm., 322.
subcaudata Merr., 105.
 Magnoliaceae, 11, 67.
Mallotus affinis Merr., 82.
auriculatus Merr., 83.
calvus Pax & K. Hoffm., 82.
caudatus Merr., 83.
glaberrimus Muell.-Arg., 84.
woodii Merr., 81.
 Malvaceae, 29.
 Marantaceae, 269.
Mastixia pachyphylla Merr., 325.
philippinensis Wang., 43.
premnoides (Elm.) Hallier f., 43, 326.
subcaudata Merr., 43.
tetrapetala Merr., 42, 326.
Matthaea calophylla Perk., 12.
intermedia Merr., 11.
latifolia Perk., 12.

- Matthaea sancta* Blume, 12.
sancta Blume var. *venulosa* Perk., 12.
Megalonectria pseudotrichia (Schw.) Speg., 237.
Meiothecium jagori (C. Müll.) Broth., 219.
microcarpum (Harv.) Mitt., 219.
obtusum Broth., 219.
Melastomataceae, 151, 314.
Meliaceae, 75, 289.
Melicope helferi Hook. f., 74.
unifoliolata Merr., 74.
Meliola amoorae Yates, 364.
apayaensis Yates, 364.
banahaensis Yates, 364.
banguiensis Yates, 365.
barringtoniae Yates, 362.
bataanensis Syd., 362.
bauhiniae Yates, 365.
boerlagiodendriae Yates, 365.
callicarpae Syd., 362.
cavitensis Yates, 366.
celticola Yates, 366.
celtidiae Yates, 367.
clerodendricola P. Henn., 363.
curvata Yates, 367.
derridis Yates, 368.
desmodi Karst. & Roum., 363.
diplochaeta Syd., 363.
exocarpiae Yates, 368.
fagraeae Syd., 363.
ficium Yates, 368.
garcinia Yates, 369.
gymnosporiae Syd., 363.
hamata Syd., 363.
hopeae Yates, 369.
jasminicola P. Henn., 235.
litseae Yates, 363.
mangiferae Earle, 236, 363.
micromera Syd., 363.
mitragynes Syd., 363.
otophorae Yates, 235.
pterotheciae Yates, 235.
pulcherrima Syd., 371.
ramosi Syd., 363.
roureae Yates, 370.
tamarindi Syd., 363.
trachelospermae Yates, 370.
umirayensis Yates, 370.
wrightiae Yates, 371.
Meliolina pulcherrima Syd., 371.
Memecylon elliptifolium Merr., 314.
pachyphyllum Merr., 315.
sessilifolium Merr., 315.
Menispermaceae, 10.
Merceyopsis minuta (Broth.) var. *subminuta* (Broth.) Broth. et Dix, 206.
Merrillia caloxylon Swingle, 338.
Meteoriopsis reclinata (C. Müll.) Fleisch., 211.
Meteorium helminthocladum (C. Müll.) Fleisch., 211.
miquelianum (C. Müll.) Fleisch., 211.
Michelia montana Blume, 11.
platyphylla Merr., 11.
Microthyriaceae, 371.
Microtropis philippinensis Merr., 306.
platyphylla Merr., 307.
Millettia dunnii Merr., 139.
oosperma Dunn, 140.
Mimosa corniculata Lour., 140.
fera Lour., 141.
Miquelia barbulate Nees, 130.
Mniaceae, 208.
Mniodendron divaricatum (Reinw. et Hornsch.) Lindb., 222.
fuscomucronatum (C. Müll.) Broth., 222.
Mnium succulentum Mitt., 208.
Mocanera malaanonan Blanco, 189.
Moniliaceae, 381.
Monimiaceae, 11.
Moraceae, 135.
Morenoella anisocarpa Syd., 376.
Morinda cumingiana Vid., 160.
parvifolia Bartl., 160.
umbellata Linn., 160.
Mucoraceae, 361.
Mucor artocarp B. & Br., 361.
Murraya caloxylon Ridl., 336, 338.
Mycetia coriacea Merr., 159.
Mycosphaerellaceae, 238, 377.
Mycosphaerella alocasiae Syd., 238.
aristolochiae Syd., 377.
oculata Syd., 377.
Myristicaceae, 281.
Myristica cookii Warb., 284.
cumingii Warb., 281.
discolor Merr., 281.
gutterifolia A. DC., 284.
mindorensis Merr., 281.
nitida Merr., 282.
palawanensis Merr., 283.
simiarum A. DC., 282.
Myrsinaceae, 49, 105, 321.
Myrtaceae, 98.
N
Nauclea rhynchophylla Miq., 160.
Necator decretus Mass., 239.
Neckeraceae, 209.
Neckeropsis crinita (Griff.) Fleisch., 211.
gracilentata (Bryol. jav.) Fleisch., 211.
lepineana (Mont.) Fleisch., 211.
Nectria pseudotrichia B. & C., 237.
Neolitsea levinei Merr., 138.
pulchella (Meissn.) Merr., 137.
subcaudata Merr., 137.
Nephelium intermedium Radlk., 24.
mutabile Blume, 24.
schneideri Merr., 23.
Nephrolepis tenuissima Hayata, 126.
Neptunia depauperata Merr., 16.
gracilis Benth., 17.
monosperma F. Muell., 17.
triquetra Benth., 17.
O
Octoblepharum albidum (L.) Hedw., 208.
Oenotheraceae, 151.
Oleaceae, 117, 324.
Ophioglossaceae, 129.
Oplismenus undulatifolius (Ard.) Beauv., 130.

- Opuntia discata*, 358.
 Orchidaceae, 135.
 Orthomnium loheri Broth., 208.
 Orthotrichaceae, 206.
 Otophora cauliflora Merr., 24.
 fruticosa Blume, 25.
Oxyspora pauciflora Benth., 151.
- P**
- Pandanaceae, 263.
 Pandanus akladus Merr., 265.
 biliranensis Merr., 266.
 botryoides Mart., 266.
 brachypodus Mart., 264.
 dubius Spreng., 266.
 exaltatus Blanco, 264.
 occultus Merr., 265.
 philippinensis Merr., 264.
 radicans Blanco, 266.
 subcaulis Merr., 263.
 Papillaria fuscescens (Hook.) Jaeg., 210.
 Parashorea plicata Brandis, 194.
 warburgii Brandis, 194.
Parkinsonia microphylla, 353.
 Parodiella grammodes (Kze.) Cooke, 371.
 perisporioides Speng., 371.
 Parthenocissus heterophylla (Blume) Merr.,
 146.
 landuk Gagnep., 146.
 Paspalum longifolium Roxb., 129.
 Passifloraceae, 94.
 Pazzscheella philippinensis Yates, 380.
 Pelekium velatum Mitt., 214.
 Peliosanthes macrostegia Hance, 135.
 stenophylla Merr., 134.
 Pentacme contorta (Vid.) Merr. & Rolfe, 186.
 mindanensis Foxw., 185.
 Peperomia reflexa A. Dietr., 135.
 Perisporiaceae, 235, 362.
 Peronosporaceae, 361.
Peronospora cubensis B. & C., 361.
 Phacelophrynum cylindricum Merr., 269.
 Phaeodotiopsis pterocarpi Yates, 237.
 Philonotis falcata (Hook.) Mitt., 209.
 griffithiana (Wills.) Mitt., 208.
 mollis (Doz. et Molk.) Bryol., 209.
 revoluta Bryol., 208.
 secunda (Doz. et Molk.) Bryol., 208.
 turneriana (Schwaegr.) Mitt., 209.
 Phyllachoraceae, 237, 376.
 Phyllachora *fici-fulvae* Koord., 376.
 luzonensis P. Henn., 377.
 pongamiae P. Henn., 377.
 pongamiae (B. & Br.) Petch,
 377.
 sorghii v. Höhn., 377.
 Phyllosticta *geloniae* Yates, 381.
 graffiana Sacc., 381.
 heveae Zimm., 240.
 melochiae Yates, 240.
 miurae K. Miyake, 381.
 Phyalospora embeliae Yates, 377.
 Phytophthora infestans (Mont.) De Bary, 361.
 Pilea *pumila* A. Gray, 137.
 swinglei Merr., 136.
 Pilopogon blumei (Doz. et Molk.) Broth., 202.
 Pilopogon subexasperatus (C. Müll.) Broth.,
 203.
 Piperaceae, 6, 135.
Piper zippelia C. DC., 6.
 Piricularia oryzae Cavr., 381.
 Placosphaeria tigllii P. Henn., 381.
 Plagiogyria adnata (Blume) Bedd., 128.
 christii Copel., 127.
 tenuifolia Copel., 128.
 Plasmopara cubensis (B. & C.) Humphrey,
 361.
 Pleosporaceae, 377.
 Pogonatum albomarginatum (C. Müll.) Jaeg.,
 222.
 microstomum R. Br., 222.
 spurio-cirratum Broth., 222.
 Polygalaceae, 20, 142.
 Polygala cardiocarpa Kurz, 20.
 elongata Klein, 20.
 eumekes Hassk., 20.
 triphylla Ham., 20.
 Polypodiaceae, 126.
 Polypodium *arisanense* Rosenst., 128.
 hancockii Baker, 128.
 kawakanii Hayata, 128.
 lineare Thunb., 128.
 oligolepidum Baker, 128.
 pteropus Blume, 128.
 remote-frondigerum Hayata, 127.
 Polyporaceae, 239.
 Polystomellaceae, 376.
 Polytoca *bracteata* R. Br., 129.
 heteroclita (Roxb.) Merr., 129.
 Polytrophicaceae, 222.
Porphyra dichotoma Lour., 156.
Potamogeton, 347.
 Pottiaceae, 205.
Psedera Neck., 145.
 Pseudoleskeopsis *acutissima* Broth., 214.
 decurvata (Mitt.) Broth.,
 214.
 Pseudophlia bulbifera Williams, 206.
 merrillii Broth., 207.
 Pteris *biaurita* Linn., 128.
 fauriei Hieron., 128.
 quadriaurita Retz., 128.
 Pterospermum *formosamum* Mats., 147.
 heterophyllum Hance, 147.
 jackianum Wall., 147.
 levinei Merr., 146.
 niveum Vid., 147.
 proteus Burkill, 147.
 Pucciniaceae, 378.
 Puccinia citrata Syd., 379.
 heterospora Berk. et Curt., 379.
 thwaitesii B. & Br., 379.
 Pyrenothyriaceae, 381.
- Q**
- Quercus *cagayanensis* Merr., 6.
 jordanae Laguna, 8.
 llanosii A. DC., 7.
 mabesae Merr., 7.
 minahassae Koord., 273.
 philippinensis A. DC., 273.
 rizalensis Merr., 272.
Quinaria Raf., 145.

R

- Rhacopilaceae, 222.
 Rhacopilum spectabile Reinw. et Hornsch., 222.
 Rhamnaceae, 25.
 Rhaphidostegium luzonense Broth., 220.
 saproxylophilum (C. Müll.)
 Jaeg., 220.
 Rhizogoniaceae, 208.
 Rhizogonium spiniforme (L.) Bruch, 208.
 Rhizopus artocarpus (B. & Br.) Rac., 361.
 Rhodobryum giganteum (Hook.) Hamp., 207.
 Rhododendron levinei Merr., 153.
 Rhyrachostegium vagans (Harv.) Jaeg., 222.
 Rhytisma pongamiae B. & Br., 377.
 Rosaceae, 14, 139.
 Rubiaceae, 121, 159.
 Rubus buergeri Miq., 139.
 cumingii O. Kuntze, 15.
 edanonii Merr., 14.
 fimbriiferus Focke, 139.
 Rutaceae, 18, 74, 141, 335.
 Ryparosa kunstleri King, 97.
 oligophlebia Merr., 97.
- S
- Salacia euphlebia Merr., 22.
 subscandens Elm., 23.
 wenzelii Merr., 23.
 Salomonina aphylla Griff., 142.
 Santiria elliptifolia Merr., 305.
 Sapindaceae, 23.
 Sapotaceae, 48, 323.
 Saurauia acuminata Merr., 85.
 alvarezii Merr., 31.
 bicolor Merr., 32.
 borneensis Merr., 86.
 glabrifolia Merr., 33.
 heterosepala Merr., 87.
 horruda Hook. f., 86.
 hosei Merr., 87.
 kinabaluensis Merr., 88.
 leprosa Korth., 87.
 longipetiolata Merr., 89.
 matthewsii Merr., 90.
 mindorensis Merr., 33.
 myrmecoidea Merr., 91.
 nigrescens Korth., 94.
 oblanceolata Merr., 92.
 oligantha Merr., 309.
 oligophlebia Merr., 308.
 platyphylla Merr., 93.
 setigera Korth., 91.
 sparsiflora Elm., 309.
 winkleri Merr., 93.
 Schefflera bipalmatifolia Merr., 99.
 borneensis Merr., 100.
 calyptrata Merr., 101.
 catanduanensis Merr., 319.
 elliptifoliola Merr., 320.
 gracilis (Blume) Vig., 101.
 heterophylla (Seem.) Harms, 100.
 myrianthella Merr., 320.
 ovoidea Merr., 319.
 pachyphlebia Merr., 102.
 subulata (Miq.) Vig., 103.
 tetrandra Merr., 102.

- Schima confertiflora Merr., 150.
 noronhae Reinw., 151.
 superba Garden. & Champ., 151.
 Schistomitrium apiculatum Doz. et Molk, 203.
 copelandii Broth., 203.
 robustum Doz. et Molk, 203.
 Sclerotium stipitatum Berk. & Curr., 228.
 Scrophulariaceae, 157.
 Sematophyllaceae, 219.
 Sematophyllum altopungens (C. Müll.) Jaeg.,
 221.
 hermaphroditum (C. Müll.)
 Besch., 221.
 hyalinum (Reinw.) Jaeg., 221.
 luzonense Broth., 221.
 subulatum (Hamp.) Jaeg.,
 221.
 Shorea astylosa Foxw., 188.
 balangeran (Korth.) Dyer, 187.
 ciliata King, 188.
 eximia (Miq.) Scheff., 191.
 falciferoides Foxw., 189.
 guiso (Blanco) Blume, 191.
 malaanonan (Blanco) Blume, 189.
 malibato Foxw., 189.
 mindanensis Foxw., 192.
 negrosensis Foxw., 192.
 pallida Foxw., 190.
 philippinensis Brandis, 190.
 plagata Foxw., 192.
 polita Vid., 190.
 polysperma (Blanco) Merr., 191.
 rugosa Heim, 191.
 serobiculata Burck, 192.
 squamata (Turcz.) Dyer, 191.
 teysmanniana Dyer, 192.
 warburgii Gilg, 191.
 Sida longistipula Merr., 30.
 subspicata F. Muell., 31.
 Skimmia japonica Thunb., 141.
 Smilax elmeri Merr., 6.
 erecta Merr., 5.
 lucida Merr., 5.
 reticulata Elm., 6.
 Solanaceae, 58.
 Solanum luzoniense Merr., 58.
 luzoniense var. glabrum Merr., 59.
 retrosum Elm., 59.
 Spatholobus harmandii Gagnep., 18.
 philippinensis Merr., 17.
 Sphaeroidaceae, 240, 380.
 Sphaeria concentrica Bolt., 238.
 grammodes Kunze, 371.
 pseudotrichia Schw., 237.
 zonata Lév., 239.
 Sphaerophragmium luzonicum Yates, 379.
 Sphaerostilbe pseudotrichia B. & Br., 237.
 Spiralostrichum piperis Yates, 383.
 Spiridentaceae, 208.
 Spiridens longifolius Lindb., 208.
 reinwardtii Nees, 208.
 Sterculiaceae, 84, 146, 308.
 Sterculia platanifolia Linn., 308.
 Stylocoryne attenuata Voigt, 160.
 mollissima Walp., 160.
 wcberea Benth., 160.

- Syrrhophodon *albovaginatus* Schwaegr., 204.
mülleri (Doz. et Molck.) Lac., 204.
subulatus Lac., 204.
- T**
- Tarenna *attenuata* (Voigt) Hutch., 160.
mollissima Merr., 160.
- Tarrietia *borneensis* Merr., 84.
kunstleri King, 84.
simplicifolia Mast., 84.
sylvatica (Vid.) Merr., 85.
- Taxithelium *alare* Broth., 218.
bakeri Broth., 218.
henguetiae Broth., 219.
instratum (Brid.) Broth., 217.
lindbergii (Bryol. jav.) Ren. et Card., 218.
merrillii Broth., 219.
nepalense (Schwaegr.) Broth., 217.
papillatum (Harv.) Broth., 219.
percapillipes Broth., 218.
robinsonii Broth., 218.
- Ternstroemia *japonica* Thunb., 148.
kwangtungensis Merr., 148.
megacarpa Merr., 309.
penangiana Choisy, 309.
philippinensis Merr., 309.
robinsonii Merr., 309.
- Tetracera *levinei* Merr., 147.
sarmentosa Vahl, 147.
scandens Merr., 147.
- Tetractomia *pachyphylla* Merr., 19.
tetrandra Merr., 20.
- Tetrastigma *corniculatum* Merr., 26.
sepulchrei Merr., 27.
- Thamnum *ellipticum* (Bryol. jav.) Kindb., 212.
- Theaceae, 148, 309.
- Thea *furfuracea* Merr., 149.
- Theleporaceae, 239.
- Thuidium *bifarium* Bryol., 214.
casuarinum (C. Müll.) Jaeg., 215.
cymbifolium (Doz. et Molck.) Bryol., 215.
meyenianum (Hamp.) Bryol., 214.
plumulosum (Doz. et Molck.) Bryol., 215.
tamariscellum (C. Müll.) Bryol., 214.
trachypodium (Mitt.) Bryol., 214.
- Thunbergia grandiflora*, 353.
- Thymelaeaceae, 312.
- Tilletiaceae, 378.
- Tilletia oryzae* Pat., 376.
- Tomex tomentosa* Linn., 156.
- Trabutia *vernica* Theiss. et Syd., 238.
- Trachyphyllum *inflexum* (Harv.) Gepp., 212.
- Trachypodopsis *crispatula* (Hook.) Fleisch., 211.
- Trachytella actaea* DC., 147.
- Trematodon *capillipes* C. Müll., 201.
drepanellus Besch., 201.
paucifolius C. Müll., 201.
- Tricholobus ferrugineus* Blume, 73.
fulvus Blume, 73.
- Trichosanthes *bracteata* (Lam.) Voigt, 64.
ellipsoidea Merr., 332.
palmata Roxb., 64.
- Trichosteleum *basilanense* Broth., 220.
hamatum (Doz. et Molck.) Jaeg., 220.
hamatum var. *semimamillosum* (C. Müll.) Par., 220.
- Triphragmium *thwaitesii* Berk. et Br., 380.
- Trismegistia *lanceifolia* (Harv.) Broth., 217.
rigida (Hornsch. et Reinw.) Broth., 217.
- Tristylidium *ochraceum* Merr., 148.
- Tryblidiella *mindanaensis* P. Henn., 234, 362.
- Tuberculariaceae, 384.
- U**
- Uncaria *rhynchophylla* (Miq.) Jackson, 160.
- Urticaceae, 8, 136, 270.
- Ustilaginoidea *oryzae* Bref., 376.
virens (Cke.) Tak., 376.
- Ustilago virens* Cooke, 376.
- Ustulina *zonata* (Lév.) Sacc., 239.
- V**
- Vaccinium *bracteatum* Thunb., 153.
carlesii Dunn, 153.
hancockiae Merr., 152.
iteophyllum Hance, 153.
- Valsaceae, 238, 378.
- Vandellia pyxidaria* Maxim., 158.
- Vatica *blancoana* Elm., 196.
mangachapoi Blanco, 196.
mindanensis Foxw., 196.
obtusifolia Elm., 196.
pachyphylla Merr., 311.
sorsogonensis Foxw., 196.
- Vavaea amicorum* Benth., 300.
ardisoides Elm., 301.
bantamensis (Koord. & Val.) Koord. & Merr., 300.
chalmersii C. DC., 300.
harveyi Seem., 300.
heterophylla Merr., 303.
megaphylla C. H. Wright, 300.
pachyphylla Merr., 304.
papuana F. M. Bailey, 300.
pauciflora Volk., 300.
pilosa Merr., 302.
retusa Merr., 301.
surigaensis Elm., 301.
- Ventilago *brunnea* Merr., 25.
dichotoma (Blanco) Merr., 26.
- Verbenaceae, 57, 155.
- Vesicularia *campylothecium* (Broth.) Broth., 217.
filicuspis Broth., 217.
meyeniana (Hamp.) Broth., 217.
reticulata (Doz. et Molck.) Broth., 217.
succosa (Mitt.) Broth., 217.
- Vitaceae, 26, 145, 307.
- Vitex *celebica* Koord., 58.
pentaphylla Merr., 58.
premnoides Elm., 43.

Vitis assamica Laws., 145.
japonica Thunb., 145.
landuk Miq., 146.

W

Walsura glabra Merr., 76.
Webera attenuata Hook. f., 160.
mollissima Benth., 160.
scabridens (Mitt.) Jaeg., 206.
Wikstroemia brachyantha Merr., 313.
fenicis Merr., 312, 313.
meyeniana Warb., 313.

X

Xanthophytum fruticosum Blume, 122.
involucratum Merr., 121.
 Xylariaceae, 238, 378.
Xylaria furcata Fr., 226.
nigripes Klotzsch., 227.

Z

Zanthoxylum oxyphyllum Edgw., 142.
Zippelia begoniaefolia Blume, 6.
tappacea Benn., 6.



THE PHILIPPINE BUREAU OF SCIENCE

RECENT PUBLICATIONS

AN INTERPRETATION OF RUMPHIUS'S HERBARIUM AMBOINENSE

By E. D. MERRILL

Based on the collections made in Amboina by the late Charles Budd
Robinson

Order No. 450. Bureau of Science Publication No. 9. Paper, 595 pages and 2 maps.
Price \$3, United States currency, postpaid.

The Herbarium Amboinense is a classical work on the Malayan flora and one that is absolutely essential to the systematist to-day. The great importance of the work is due to the fact that later authors have made the Rumphian descriptions and figures the actual "types" of many binomials. As an original source the Herbarium Amboinense stands preëminent among all the early publications on Malayan botany.

Professor Merrill's interpretation of the Herbarium Amboinense discusses the status of each species described by Rumphius and assigns it to a position in the modern system of classification. This publication will be of great service to any one working on Indo-Malayan systematic botany.

A GRAMMAR OF LEPANTO IGOROT AS IT IS SPOKEN AT BAUCO

By MORICE VANOVERBERG

Order No. 438. Vol. V, Part VI, Division of Ethnology Publications. Paper, 102 pages.
Price \$0.75, United States currency, postpaid.

This part completes Volume V of the Division of Ethnology publications and includes the index and the title-page for the volume. A title-page for Volume II is printed with this number.

PLEASE GIVE ORDER NUMBER

Orders for these publications may be sent to the BUSINESS MANAGER, Philippine Journal of Science, Bureau of Science, Manila, P. I., or to any of the following agents:

AGENTS

THE MACMILLAN COMPANY, 64-66 Fifth Avenue, New York, U. S. A.
WM. WESLEY & SON, 28 Essex Street, Strand, London, W. C., England.
MARTINUS NIJHOFF, Lange Voorhout 9, The Hague, Holland.
KELLY & WALSH, Limited, 32 Raffles Place, Singapore, Straits Settlements.
A. M. & J. FERGUSON, 19 Baillie Street, Colombo, Ceylon.
THACKER, SPINK & Co., P. O. Box 54, Calcutta, India.

CONTENTS

	Page.
SWINGLE, WALTER T. <i>Merrillia</i> , a new genus of the tribe Citreae from the Malay Peninsula.....	335
BROWN, WILLIAM H. The theory of limiting factors.....	345
BROWN, WILLIAM H., and TRELEASE, SAM F. Alternate shrinkage and elongation of growing stems of <i>Cestrum noc-</i> <i>turnum</i>	353
YATES, HARRY S. Some recently collected Philippine fungi, II..	361
ERRATA	385
INDEX	387

The Philippine Journal of Science is issued in four sections. Each section consists of six numbers a year, is separately paged and indexed, and is a complete publication in itself. Authors receive 100 copies of their papers free.

SUBSCRIPTION RATES TO CURRENT VOLUME	U. S. currency.
Section A (Chemical and Geological Sciences and the Indus- tries)	\$2.00
Section B (Tropical Medicine).....	3.00
Section C (Botany), Elmer D. Merrill, B. S., M. S., Editor.....	2.00
Section D (General Biology, Ethnology, and Anthropology). Section D began with Volume V.....	2.00
Entire Journal (4 sections).....	7.00

PRICES OF BACK NUMBERS AND VOLUMES	
Entire Journal, Volume II, III, or IV (3 sections each); or V (4 sections)	5.00
Entire Journal, beginning with Volume VI (per volume).....	7.00
Single numbers of Volume I.....	.75
Single numbers (except of Volume I).....	.50
Volume I, 1906 (not divided into sections), and supplement, sold only with a complete file of section A, B, or C.....	10.00
Supplement to Volume I (Botany).....	3.50
Volume I (without supplement), sold only with a complete file of section A, B, or C.....	6.50

Publications sent in exchange for the Philippine Journal of Science should be addressed: Library, Bureau of Science, Manila, P. I.

Subscriptions may be sent to the BUSINESS MANAGER, Philippine Journal of Science, Bureau of Science, Manila, P. I., or to any of the agents listed on the inside pages of this cover.

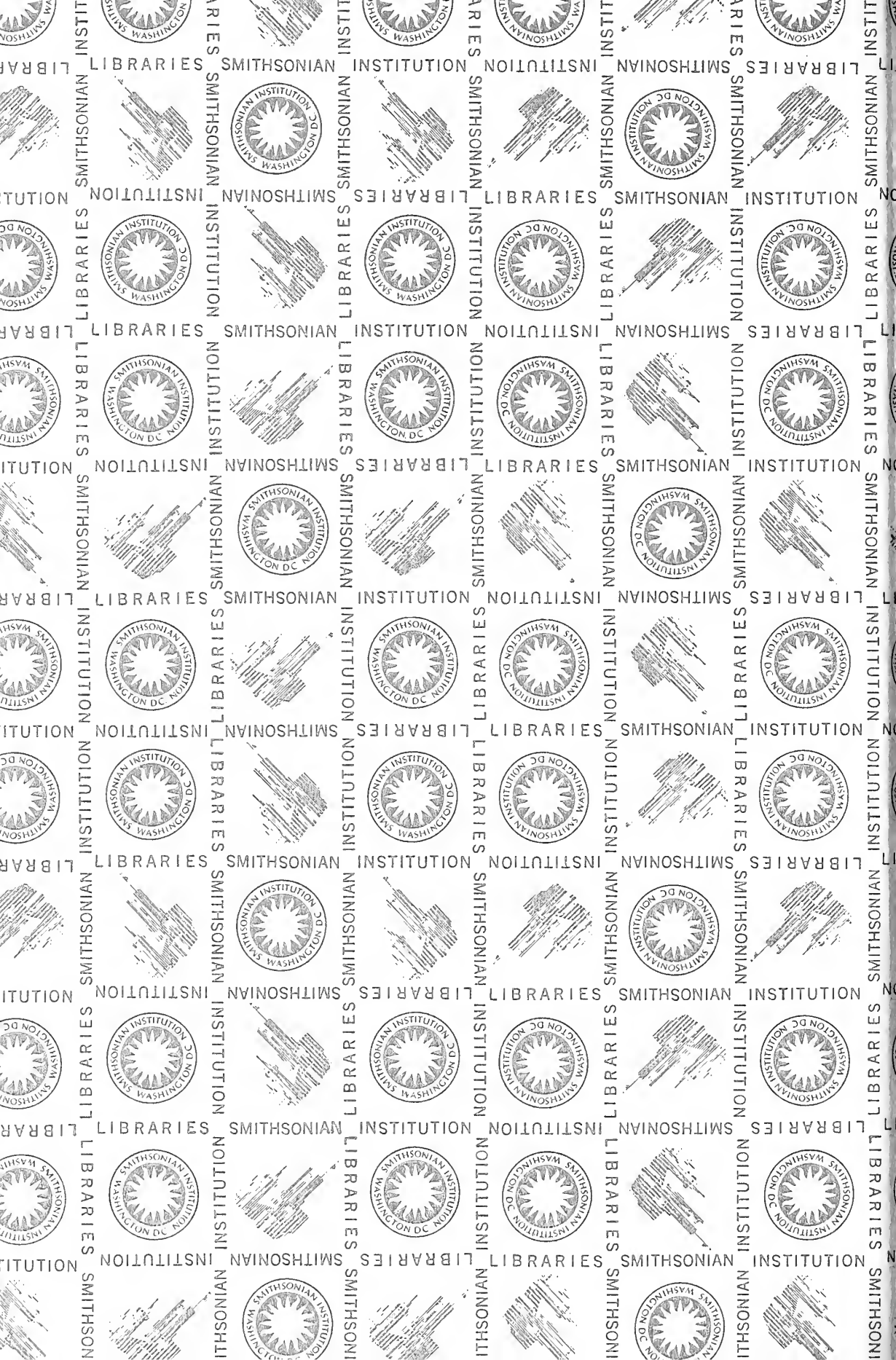

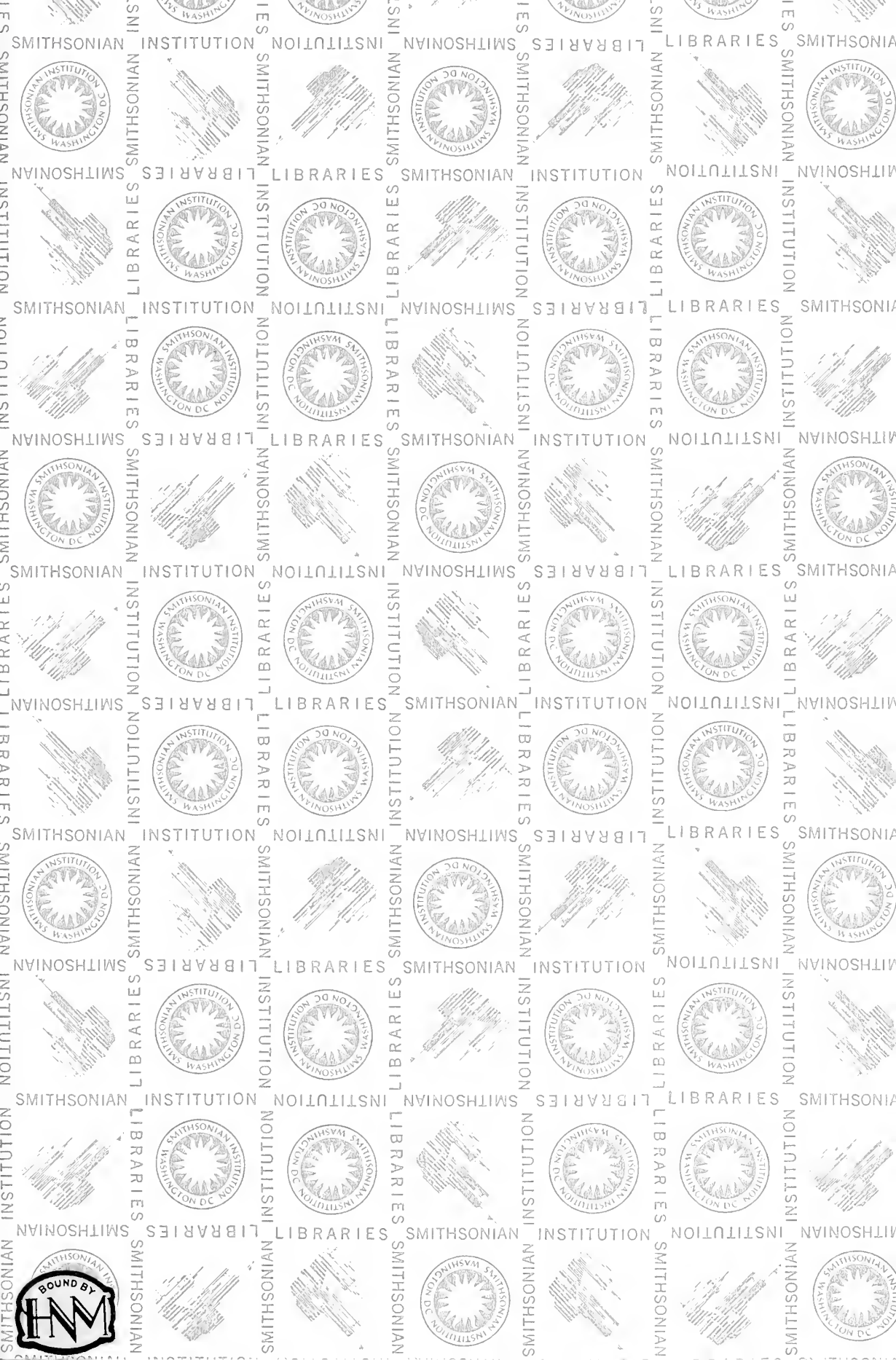

SMITHSONIAN INSTITUTION LIBRARIES



3 9088 01497 9892