





THE PHILIPPINE
JOURNAL OF SCIENCE

VOLUME 18 —

JANUARY TO JUNE, 1921
WITH 27 PLATES AND 41 TEXT FIGURES



MANILA
BUREAU OF PRINTING
1921

EDITORIAL BOARD

ELMER D. MERRILL, M.S., *Editor*

R. C. MCGREGOR, A.B., *Associate Editor*

ALBERT H. WELLS, A.B.; GRANVILLE A. PERKINS, PH.D.; A. P. WEST, PH.D.
T. DAR JUAN, A.B., PHAR.D.; F. AGCAOILI, A.B.; A. S. ARGUELLES, B.S.

ALBERT E. W. KING

Chemistry

WARREN D. SMITH, PH.D.; ROY E. DICKERSON, PH.D.

Geology

H. W. WADE, M.D.; OTTO SCHÖBL, M.D.

F. G. HAUGHWOUT; STANTON YOUNGBERG, D.V.M.

Experimental Medicine

LIBORO GOMEZ, M.D., PH.D.; F. CALDERON, B.A., L.M.

VICENTE DE JESUS, M.D.

Clinical Medicine

W. H. BROWN, PH.D.; C. F. BAKER, M.A.; ATHERTON LEE, M.S.

O. A. REINKING, B.S.A., M.S.; L. M. GUERRERO, PHAR.D.

Botany

ALBERT C. HERRE, PH.D.; C. F. BAKER, M.A.; S. F. LIGHT, M.A.

C. S. BANKS, M.A.; L. D. WHARTON, M.A.; W. SCHULTZE

Zoölogy

H. O. BEYER, M.A.; OTTO JOHNS SCHEERER, M.A.

Anthropology

ANNA B. BANYEA, *Copy Editor*

CONTENTS

No. 1, January, 1921

[Issued May 23, 1921.]

	Page.
DICKERSON, ROY E. A fauna of the Vigo group: its bearing on the evolution of marine molluscan faunas..... Two plates.	1
LIGHT, S. F. Further notes on Philippine scyphomedusan jellyfishes.. Four text figures.	25
MERRILL, ELMER D. New Philippine Moraceae.....	49
FLEUTIAUX, ED. Deux genres nouveaux de Coléoptères (Melasidæ)....	71
FLEUTIAUX, ED. Deux espèces nouvelles de Coléoptères (Elateridæ)..	73
MCGREGOR, RICHARD C. New or noteworthy Philippine birds, III.... Four plates.	75
LEE, H. ATHERTON. The relation of stocks to mottled leaf of citrus trees Three plates.	85
NAKAYAMA, SHONOSUKE. An enumeration of the Japanese Apherlininæ, with descriptions of two new species..... One plate.	97
REVIEWS	103

No. 2, February, 1921

[Issued May 28, 1921.]

KING, ALBERT E. W. Physical properties of Philippine concrete and concrete aggregates	105
---	-----

No. 3, March, 1921.

[Issued June 10, 1921.]

SMITH, WARREN D. Tropical geology and engineering.....	221
LIGHT, S. F. Notes on Philippine termites, I.....	243
UICHANCO, LEOPOLDO B. New records and species of Psyllidæ from the Philippine Islands, with descriptions of some preadult stages and habits Five plates.	259
MERRILL, ELMER D. New Philippine Myrtaceae.....	289
ROHWER, S. A. Descriptions of New Philippine wasps of the subfamily Pseninæ	309

No. 4, April, 1921

[Issued July 5, 1921.]

	Page.
PERKINS, GRANVILLE A. The structure of the electron.....	325
PERKINS, GRANVILLE A. Absolute units and the relativity principle..	341
FISHER, W. S. New Coleoptera from the Philippine Islands. Family Buprestidæ, tribe Agrilini.....	349
HAUGHWOUT, FRANK G. A case of human coccidiosis detected in the Philippine Islands, with remarks on the development and vitality of the cysts of <i>Isospora hominis</i> (Rivolta).....	449
Four plates and one text figure.	

No. 5, May, 1921

[Issued July 14, 1921.]

VALENCIA, F. V. Mechanical tests of some commercial Philippine timbers	485
One plate and nineteen text figures.	
MCGREGOR, RICHARD C. Birds of Antique Province, Panay, Philip- pine Islands	537
Two plates.	
KIEFFER, J. J. Chironomides des Philippines et de Formose.....	557
SACCARDO, P. A. Fungi Sinensis aliquot a cl. Prof. Otto A. Rein- king collecti et communicati.....	595
KARNY, H. H. Katydid (Tettigonioidea) of the Philippine Islands, collected by C. F. Baker.....	607

No. 6, June, 1921

[Issued September 15, 1921.]

WEST, AUGUSTUS P., and MONTES, ZOILA. The composition, solubility, and oxidation of lumbang oil.....	619
Three plates.	
MORRISON, HAROLD. Some nondiaspine Coccidæ from the Malay Peninsula, with descriptions of apparently new species.....	637
One plate and thirteen text figures.	
FUNKHOUSER, W. D. New genera and species of Philippine Mem- bracidæ	679
One plate.	
ROHWER, S. A. Some Philippine wasps of the family Chrysididæ....	691
PESCHET, R. Description d'un Canthydrus (Coleoptera Dytiscidæ) nouveau, des Iles Philippines.....	693
NAÑAGAS, JUAN C. Position and size of the kidneys among Filipinos..	695
Three text figures.	
GARCIA, ARTURO, and SOLLOZA, JUAN. Length and position of the vermiform appendix in Filipinos.....	707
One text figure.	
SPAETH, FRANK. Philippine and Bornean species of Hoplionota (Coleoptera)	721
REVIEWS	733
INDEX	735

VOL. 18, No. 1

JANUARY, 1921

THE PHILIPPINE JOURNAL OF SCIENCE

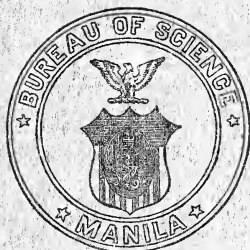

MANILA
BUREAU OF PRINTING
1921

THE PHILIPPINE JOURNAL OF SCIENCE

Published by the Bureau of Science of the Government of the Philippine Islands

ELMER D. MERRILL, M.S., *Editor*

R. C. MCGREGOR, A.B., *Associate Editor*

ALBERT H. WELLS, A.B.; GRANVILLE A. PERKINS, PH.D.; A. P. WEST, PH.D.
T. DAR JUAN, A.B., PHAR.D.; F. AGCAOILI, A.B.; A. S. ARGUELLES, B.S.;
ALBERT E. W. KING

Chemistry

WARREN D. SMITH, PH.D.; ROY E. DICKERSON, PH.D.

Geology

H. W. WADE, M.D.; OTTO SCHÜBL, M.D.
F. G. HAUGHWOUT; STANTON YOUNGBERG, D.V.M.

Experimental Medicine

LIBORIO GOMEZ, M.D., PH.D.; F. CALDERON, B.A., L.M.
VICENTE DE JESUS, M.D.

Clinical Medicine

W. H. BROWN, PH.D.; C. F. BAKER, M.A.; ATHERTON LEE, M.S.
O. A. REINKING, B.S.A., M.S.; L. M. GUERRERO, PHAR.D.

Botany

ALBERT C. HERRE, PH.D.; C. F. BAKER, M.A.; S. F. LIGHT, M.A.;
C. S. BANKS, M.A.; L. D. WHARTON, M.A.; W. SCHULTZE

Zoology

H. O. BEYER, M.A.; OTTO JOHNS SCHEERER, M.A.

Anthropology

ANNA B. BANYEA, *Copy Editor*

Manuscript intended for publication and books for review should be sent to the editor. One hundred separates of papers published in the Journal are furnished to authors without charge. Additional copies may be had at authors' expense.

Publications sent in exchange for the Philippine Journal of Science should be addressed; Library, Bureau of Science, Manila, P. I.

The Journal is issued twelve times a year. The subscription price is 5 dollars, United States currency, per year. Single numbers, 50 cents each.

Subscriptions may be sent to the BUSINESS MANAGER, Philippine Journal of Science, Bureau of Science, Manila, P. I., or to any of the agents listed on the third page of this cover.

THE PHILIPPINE JOURNAL OF SCIENCE

VOL. 18

JANUARY, 1921

No. 1

A FAUNA OF THE VIGO GROUP: ITS BEARING ON THE EVOLUTION OF MARINE MOLLUSCAN FAUNAS

By ROY E. DICKERSON

*Honorary Curator, Department of Paleontology, California Academy of
Science, Golden Gate Park, San Francisco, California*

TWO PLATES

A comparison of the rate of evolution of a marine invertebrate fauna in the Tropics with that of faunas of the temperate zones brings out some interesting results. During the past year, 1919-1920, the writer has had the opportunity and rare good fortune to collect some excellently preserved fossils from the Vigo group of the Philippine Islands, incidental to some economic investigations in which he was engaged. After several years spent in study of the faunal Tertiary problems of the Pacific Coast of North America, the writer naturally had acquired a point of view of the worker in temperate climes to a certain extent. However, many interesting problems in the Eocene of California, Oregon, and Washington suggested that marine Eocene molluscan faunas did not evolve as rapidly as those of the Miocene and Pliocene and that the same "yard stick" in the Tertiary geological time scale could not be applied. Many problems of the Eocene are directly connected with the rate of evolution of a tropical fauna and as the Eocene faunas of California, Oregon, and Washington are essentially tropical or subtropical, the writer was glad to devote spare time to the study of a tropical fauna.

Does the Lyell percentage system apply to tropical invertebrate faunas? In answering this question one must bear in mind that this scale is really an expression of the time rate of



evolution of Tertiary molluscan faunas based upon the study of the Tertiary of Europe. Briefly, this scale as now generally applied is:

Period.	Per cent.
Eocene	0
Oligocene	3
Miocene	25
Pliocene	60
Pleistocene	90

Practically all the Eocene molluscan genera exist to-day in the Recent faunas of the tropical and temperate zones. Great was our surprise to find that our collections from the upper Vigo shales and the Canguinsa formation, regarded by Pratt and Smith¹ as being of lower Miocene and Oligocene age, yielded a molluscan fauna containing 75 per cent Recent species. The results of these preliminary studies indicate that a negative answer must be given to the rhetorical question stated above. An essential modification of the Lyell percentage scale seems necessary to the writer for the proper interpretation of the Tertiary faunas of the Tropics. If this hypothesis is true then evidently marine molluscan faunal changes take place with far less rapidity in the Tropics than in the temperate zones. Now this conclusion is apparently in direct contradiction to the fact that the Recent molluscan fauna of the Philippines is specifically far more numerous than a Recent fauna from a temperate region. Hidalgo² reports from 4,300 to 4,500 land, terrestrial, fluvial, and marine testaceous mollusca, and of these fully two-thirds are marine. This anomaly will be considered after the presentation of the data.

Prof. K. Martin³ recognized in a general way that the percentage system of Deshayes (and Lyell) did not strictly apply in Java, and that climatic variation was a prime cause of the differences.

BRIEF STATEMENT OF GEOLOGIC HISTORY

The fauna upon which this paper is based was collected from the southern half of the Bondoc Peninsula from strata referred by Pratt and Smith to the Canguinsa formation and Vigo

¹ Pratt, W. E., and Smith, W. D., The geology and petroleum resources of the southern part of Bondoc Peninsula, *Philip. Journ. Sci.* § A 8 (1913) 312.

² Hidalgo, J. G., *Catálogo de los Moluscos Testáceos de las Islas Filipinas,oló y Marianas.* Madrid (1904-1905) 389.

³ Martin, K., *Die Tertiarschichten auf Java, Die Lagerunas verhaelt-nisse.* Leiden (1880) 22-24.

group. In order that the reader may appreciate the significance of this assemblage of mollusca, a brief resumé of the geologic history of that region is necessary. The southern half of the Bondoc Peninsula consists almost entirely of marine sedimentary rocks which have been highly folded and faulted. The oldest rocks here recognized consist of shales and sandstones from 3,000 to 4,000 feet in thickness, the Vigo group and its uppermost member, the Canguinsa formation. The strata as exposed in the vicinity of Vigo River are steeply dipping, black, organic shales, subordinate sandstones, and minor lignitic strata which are unconformably overlain by the Malumbang formation.⁴

The Malumbang formation consisting of coralline limestone and associated marls varies in thickness from small residuals to 1,000 feet. From what is known of the rate of growth of reef corals, this formation must represent a long time interval. In a few places in the Bondoc Peninsula—notably in the vicinity of San Andres—marine terraces truncate the Malumbang strata. These terraces are in places thickly mantled with coralline limestone of Pleistocene age. Some of the limestone four miles east of Mulanay, at an elevation of 500 feet, may represent high Pleistocene terraces, as terraces at this height occur in Leyte, and at much greater elevations in Cebu where the same geologic horizons are also found. These horizons exhibit the same essential conditions in northwestern Leyte and are beautifully exemplified in the vicinity of Toledo, Cebu, as well. The Vigo group in all probability occurs in the region north of Fort Pikit in Mindanao, so that we are not dealing with local conditions but with general ones which existed over the site of these islands. The conditions of deposition during Malumbang and Pleistocene time resembled those existing to-day in the vicinity of the Bondoc Peninsula, and essentially the same mollusca occur in the coral reef facies of all three. The deposition during Vigo time was in marked contrast with these later times, in that the contributing land masses consisted largely of diorites, schists, and serpentines or peridotites from which they were probably derived. At times the material contained in the Vigo sandstones is very coarse, and conglomerates occur locally in the Bondoc Peninsula and on a great scale in northwestern Leyte, east of the Barrio of Tababunga, where they in part closely resemble

⁴The writer's view concerning the stratigraphy of the region under discussion differs in this regard from that of Pratt and Smith, but a full exposition of this important point can not be given here.

characteristic desert fanglomerates. Such materials could not have been transported great distances and it is probable that a land mass or land masses lay to the east of the site of the Bondoc Peninsula and northwestern Leyte. In other words, the sediments of the Vigo group were deposited in the moderately deep waters of an inland sea with high mountainous islands to the east. The total time represented since the beginning of the Vigo is evidently long, and on these grounds as well as faunal the Vigo group appears to be as old as the Miocene, and the Malumbang probably represents at least a portion of the Pliocene. The time represented by the unconformity between these horizons was sufficiently long to reduce many of the mountains formed at the close of Vigo time to nearly base level before the region was again gradually lowered to receive its great load of Malumbang coralline limestone and associated marls in the clear, warm, shallow water of a tropical Pliocene sea. Likewise the orogenic movements which ended Malumbang time were fairly long continued, and the erosion interval which preceded the formation of Pleistocene terraces was not a brief one. The age of the Vigo group will be discussed at length after its fauna is considered.

FAUNA

The fauna upon which this paper is based was obtained from the Bahay River vicinity (2x, 3x, 4x, 5x); the cañon of Dumalog Creek (9x); and from Sapa Tubigbinukot, the northern extension of the Amoguis, Amougis, Agipot, or Pagsangahan River⁵ (11x), from strata which are all unmistakably members of the Vigo group and unconformably below the Malumbang formation.

The following notes upon the collection localities and their fossils are given in detail, as there are but few places in these islands where good collections are obtained from localities with satisfactory stratigraphy.

The fauna noted in the following list was obtained from locality 2x, Philippine Islands, Luzon, Tayabas Province, Bondoc Peninsula, west shore of Ragay Gulf, 600 meters upstream from Bureau of Lands Bench Mark No. 1 (Bahay Oil Well No. 1), on the northeast bank of Bahay River in a 50-foot cliff of yellow sandstone and bluish clayey sandstone disturbed by minor faulting. Coll., Roy E. Dickerson.

The Malumbang limestone is found in the hill 100 yards to

⁵ Different local names for the same stream.

the northeast and from the general relations in the field it is clearly unconformable upon the underlying Canguinsa formation.

Species from locality 2x.

<i>Actaeon reticulatus</i> K. Martin.	<i>Nassa quadrasii</i> Hidalgo; living.
<i>Architectonica pictum</i> (Philippi); living.	<i>Nassa thersites leptospira</i> Bruguiere; living.
<i>Bullaria ampullaria</i> (Linnæus).	<i>Natica albumen</i> Lamarck; living.
<i>Cancellaria crenifera</i> Sowerby; living.	<i>Natica?</i>
<i>Cerithium jenkinsi</i> K. Martin.	<i>Natica spadicea</i> Reeve; living.
<i>Cerithium monilliferum</i> Kiener; living.	<i>Natica mamilla</i> Lamarck; living.
<i>Cerithium herklotsi</i> K. Martin.	<i>Nerita funiculata</i> Reeve; living.
<i>Comus ornatissimus</i> K. Martin.	<i>Nyctilochus.</i>
<i>Comus</i> sp. nov.?	<i>Olivella.</i>
<i>Comus lividus</i> Hwass; living.	<i>Ranella subgranosa</i> Beck; living.
<i>Comus</i> sp.	<i>Ranella.</i>
<i>Cyclonassa elegans</i> Kiener.	<i>Ranella tuberculata</i> Broderip; living.
<i>Drillia.</i>	<i>Strombus canarium</i> (Linnæus); living.
<i>Haminea.</i>	<i>Strombus swainsoni</i> Reeve; living.
<i>Mangelia.</i>	<i>Terebra.</i>
<i>Mitra javana</i> K. Martin.	<i>Terebra bicincta</i> K. Martin.
<i>Mitra</i> cf. <i>jenkinsi</i> K. Martin.	<i>Terebra javana</i> K. Martin.
<i>Mitra junghuhnii</i> K. Martin.	<i>Turris (Surcula) flavidula</i> Lamarck; living.
<i>Nassa crenulata</i> (Bruguiere); living.	<i>Turris garnonsi</i> Reeve; living.
<i>Nassa dispar</i> Adams; living.	<i>Turris deshayesi</i> (Doumet); living.
<i>Nassa gemmulata</i> (Lamarck); living.	<i>Turris carinata woodwardi</i> K. Martin; living.
<i>Nassa globosa minor</i> Quoy; living.	
<i>Nassa thersites immersa</i> Carpenter; living.	

PELECYPODA

<i>Arca cornea</i> Reeve; living.	<i>Pinna</i> sp.
<i>Cardium</i> sp.	<i>Placuna placenta</i> Linnæus; living.
<i>Cardium donaciformis</i> Cuming.	<i>Psammobia</i> cf. <i>lessoni</i> Blainville.
<i>Chione chlorotica</i> Philippi; living.	<i>Solen</i> sp.
<i>Corbula socialis</i> K. Martin.	<i>Tellina.</i>
<i>Corbula scaphoides</i> Hinds.	<i>Dentalium.</i>
<i>Ostrea</i> sp.	Coral.
<i>Pecten</i> sp.	Coral.
<i>Pecten (Pleuronectia) pleuronecta</i> Linnæus; living.	Echinoid.

The predominance of littoral species and the character of the strata indicate that these forms lived in the shallow inshore waters of an inland sea.

The following species were collected from locality 3x, Philippine Islands, Luzon, Tayabas Province, Bondoc Peninsula, west

shore of Ragay Gulf, Bahay River, upstream 800 meters from Bureau of Lands Bench Mark No. 1 (Bahay Oil Co. Well No. 1), on southwest bank of stream in a stiff dark gray shale. August 25, 1919. Colls., Roy E. Dickerson and Mark Fuken.

Species from locality 3x.

- Actaeon reticulatus* K. Martin.
Architectonica pictum (Philippi); living.
Cancellaria elegans Sowerby; living.
Cerithidea (*Pyrasus*) cf. *sulcatus* Bruguiere; living.
Cerithium herklotsi K. Martin.
Cerithium bandongensis K. Martin.
Cerithium jonkeri K. Martin.
Cerithium moniliferum Kiener; living.
Cerithium jenkinsi K. Martin.
Cerithium sp. nov.
Columbella bandongensis K. Martin.
Conus sp. nov.?
Conus sp.
Conus ornatissimus K. Martin.
Cypraea cf. *tigris* Linnæus; living.
Distortio clathrata Lamarck; living.
Melania asperata Linnæus; living.
Melania cf. *asperata inquinata* Quadras; living.
Mitra junghuhni K. Martin.
Mitra javana K. Martin.
Murex endivia Lamarck; living.
Nassa thersites leptospira (Bruguiere); living.
Nassa thersites immersa Carpenter; living.
- Nassa quadrasi* Hidalgo; living.
Nassa globosa minor Quoy; living.
Nassa crenulata (Bruguiere); living.
Nassa canaliculata Lamarck; living.
Nassa dispar Adams; living.
Natica mamilla Lamarck; living.
Natica lacernula d'Orbigny; living.
Olivella.
Phos roseatus Hinds.
Ranella tuberculata Broderip; living.
Rostellaria fusus Linnæus; living.
Rostellaria crispata Kiener; living.
Strombus canarium (Linnæus); living.
Strombus sp. a.
Strombus sp. b.
Telescopium telescopium Linnæus; living.
Terebra.
Triton pfeifferianum Reeve; living.
Trivia smithi K. Martin.
Turris garronsi Reeve; living.
Turris (*Surcula*) *flavidula* (Lamarck); living.
Turris deshayesi Doumet; living.
Turris carinata woodwardi K. Martin; living.
Turris coronifer (K. Martin).
Voluta cf. *innexa* Reeve.

PELECYPODA

- Arca ferruginea* Reeve; living.
Arca granosa Linnæus; living.
Arca cornea Reeve; living.
Barbatia fusca (Bruguiere); living.
Chione chlorotica Philippi; living.
Corbula socialis K. Martin.
Corbula scaphoides Hinds.
Dosinia cf. *lenticularis*; living.
- Paphia textrix* Deshayes; living.
Placuna placenta Linnæus; living.
Psammodia sp.; living.
Ostrea.
Spisula sp.
Tellina sp.
Vermetus sp.
 Coral.
 Coral.

This fauna flourished in slightly deeper, or at least quieter, water as one specimen of the fragile *Placuna placenta* with both valves splendidly preserved shows that the specimen was not within strong wave action. The preservation of the other species is remarkably fine. The strata at this locality are nearly vertical, a good dip and strike being obtainable in the middle of the stream.

The following species were obtained from locality 4x, Philippine Islands, Luzon, Tayabas Province, Bondoc Peninsula, west side of Ragay Gulf, Bahay River; 320 meters east of the mouth of Apad Creek in road cut 60 feet above the river in yellow sandstone, about 50 feet stratigraphically above the brackish water fauna in the lignitic strata of locality 5. Colls., Roy E. Dickerson and Mark Fuken.

Species from locality 4x.

<i>Architectonica pictum</i> (Philippi); living.	<i>Nassa costellifera</i> A. Adams; living.
<i>Cerithidea</i> cf. <i>ornata</i> Hinds; living.	<i>Nassa crenulata</i> (Bruguere); living.
<i>Cerithium bandongensis</i> K. Martin.	<i>Natica spadicea</i> Reeve; living. <i>Phos roseatus</i> Hinds; living.
<i>Columbella bandongensis</i> K. Martin.	<i>Ranella tuberculata</i> Broderip; living.
<i>Conus ornatissimus</i> K. Martin.	<i>Ricinula spectrum</i> Reeve; living.
<i>Cypraea</i> sp.	<i>Rostellaria fusus</i> Linnæus; living.
<i>Delphinula?</i>	<i>Rostellaria crispata</i> Kiener; living.
<i>Delphinula reeviana</i> Hinds.	<i>Strombus</i> sp. a.
<i>Eburna ambulacrum</i> Sowerby; living.	<i>Terebra javana</i> K. Martin.
<i>Marginella.</i>	<i>Terebra bicincta</i> K. Martin.
<i>Melania asperata</i> Linnæus.	<i>Trochus</i> sp.
<i>Mitra bucciniformis</i> K. Martin.	<i>Turris marmorata</i> (Lamarck); living.
<i>Mitra junghuhni</i> K. Martin.	<i>Turris</i> (<i>Surcula</i>) <i>flavidula</i> La- marck; living.
<i>Mitra javana</i> K. Martin.	

PELECYPODA

<i>Arca ferruginea</i> Reeve; living.	<i>Pecten</i> cf. <i>cristularis</i> Adams and Reeve; living.
<i>Corbula socialis</i> K. Martin.	<i>Pecten</i> cf. <i>radula</i> Linnæus; living.
<i>Chione chlorotica</i> Philippi; living.	<i>Pecten</i> (<i>Pleuronectia</i>) <i>pleuronecta</i> Linnæus; living.
<i>Glycimeris viteus</i> (Lamarck); living.	<i>Placuna placenta</i> Linnæus; living.
<i>Pecten</i> cf. <i>pseudolima</i> Sowerby; living.	<i>Solecurtus quoyi</i> Deshayes; living.
	<i>Spondylus</i> sp.

Locality 5x, Philippine Islands, Luzon, Tayabas Province, Bondoc Peninsula, west side of Ragay Gulf, Bahay River; 300 meters east of the mouth of Apad Creek in lignitic gray sandstone which was deposited in brackish water. Coll., Roy E. Dickerson. This yielded the species listed below.

Species from locality 5x.

GASTROPODA

<i>Cassidaria.</i>	<i>Strombus</i> (?) sp.
<i>Cerithium jenkinsi</i> K. Martin.	<i>Telescopium telescopium</i> Linnæus;
<i>Cerithium</i> sp. nov.	living.
<i>Conus laroisii</i> Kiener; living.	

PELECYPODA

<i>Arca tenebrica</i> Reeve; living.	<i>Ostrea</i> sp.
<i>Chione</i> (?) sp.	Amber and petrified wood.

This fauna was made up largely of *Cerithium jenkinsi* K. Martin, *Cerithium* sp. nov., and *Ostrea* sp. The other forms are represented by only one or two species which were probably carried across the sand bar by small crabs that sidled over the sands of the Vigo Sea. The abundance of carbonaceous material and the occurrence of amber and petrified wood also indicate that conditions of deposition here differed from those in the previously described localities.

Locality 9x, Philippine Islands, Luzon, Tayabas Province, Bondoc Peninsula, on Dumalog Creek; about 5 miles northwest of San Narciso, three-quarters of a mile downstream from the Mulanay-San Narciso Trail in uppermost Vigo just conformably below Canguinsa sandstone in black shale. October 17, 1919. Colls., Roy E. Dickerson and Mark Fuken.

Species from locality 9x.

<i>Arca</i> cf. <i>coelata</i> Reeve; living.	<i>Dosinia cretacea</i> Philippi; living.
<i>Arca ferruginea</i> Reeve; living.	<i>Mitra bucciniformis</i> K. Martin.
<i>Buccinum simplex</i> K. Martin.	<i>Nassa crenulata</i> (Bruguieri);
<i>Clementia hyalina</i> Philippi = <i>C.</i>	living.
<i>papyracea</i> ; living.	<i>Strombus</i> (?) <i>fusus</i> K. Martin
<i>Conus striatellus</i> Jenkins.	(probably <i>Clavella</i>).
<i>Conus hardi</i> K. Martin.	<i>Tellina</i> sp.

This fauna, though meager, is not distinct in any way from faunas listed above. As Pratt and Smith⁶ point out, there is no evidence of any notable stratigraphic break here, and the stream in its meanderings so exposes the strata that exact observations are possible. Their tentative evidence of an unconformity between the Canguinsa and the Vigo in Cambagaco Ridge near Vigo River is interpreted by the writer as a result of faulting.

Locality 11x, Philippine Islands, Luzon, Tayabas Province, Bondoc Peninsula, on west bank of Sapa Tubiginukot 400 yards upstream from Sapa Yaknas; in soft, yellow sandstone of Canguinsa age. October 31, 1919. Coll., Roy E. Dickerson. The strata at this point dip west about 20° while the overlying Malumbang, a few hundred feet west, has a gentle dip of 2° to 3°. At other places in this vicinity a notable unconformity separates these two formations. The fauna listed below is especially noteworthy as being composed of 85.90 per cent living species. Here again the stratigraphy is very satisfactory.

Species from locality 11x.

<i>Architectonica pictum</i> (Philippi); living.	<i>Nassa crenulata</i> (Bruguiere); living.
<i>Cancellaria elegans</i> Sowerby; living.	<i>Nassa reussi</i> K. Martin? (may = <i>N. costellifera</i> Adams).
<i>Cerithidea</i> near <i>dohrni</i> , but detail differs.	<i>Natica spadicea</i> Reeve; living.
<i>Cypraea</i> sp.	<i>Natica cumingiana</i> Recluz; living.
<i>Ficus reticulata</i> (Lamarck); living.	<i>Ranella tuberculata</i> Broderip; living.
<i>Harpa articularis</i> Lamarck; living.	<i>Strombus swainsoni</i> Reeve; living.
<i>Nassa thersites</i> (Bruguiere); living.	<i>Terebra bicincta</i> K. Martin.
	<i>Turris marmorata</i> (Lamarck); living.

PELECYPODA

<i>Cardita antiquata</i> Linnæus; living.	<i>Glycimeris angulatus</i> (Lamarck); living.
<i>Cardium attenuatum</i> Sowerby; living.	<i>Ostrea</i> .
<i>Cardium unicolor</i> Sowerby; living.	<i>Pecten pseudolima</i> Sowerby; living.
<i>Clementia hyalina</i> Philippi = <i>C.</i> <i>papyracea</i> ; living.	<i>Spisula</i> sp.
<i>Glycimeris viteus</i> (Lamarck); living.	<i>Vermetus javanus</i> ? K. Martin.

⁶ Pratt, W. E., and Smith, W. D., Philip. Journ. Sci. § A 8 (1913) 317.

For comparison and summary purposes the fossils from these various localities have been combined in one list, as follows:

Partial list of species from the *Vigo* group.

	2x.	3x.	4x.	5x.	9x.	11x.	L.
<i>Architectonica pictum</i> (Philippi)	×	×	×			×	×
<i>Actaeon reticulatus</i> K. Martin	×	×					
<i>Buccinum simplex</i> K. Martin					×		
<i>Bullaria ampulla</i> (Linnæus)	×						×
<i>Cancellaria crenifera</i> Sowerby	×						×
<i>Cancellaria elegans</i> Sowerby		×				×	×
<i>Cassidaria</i>				×			
<i>Cerithium jenkinsi</i> K. Martin	×	×		×			
<i>Cerithium herklotsi</i> K. Martin	×	×					
<i>Cerithium moniliferum</i> Kiener	×	×					×
<i>Cerithium bandongensis</i> K. Martin			×				
<i>Cerithium</i> sp. nov.		×		×			
<i>Cerithium jonkeri</i> K. Martin		×					
<i>Cerithidea</i> cf. <i>ornata</i> Hinds		×					×
<i>Cerithidea</i> (<i>Pyrasus</i>) cf. <i>sulcatus</i> Bruguiere			×				×
<i>Cerithidea</i> near <i>dohrni</i> ?						×	
<i>Conus ornatus</i> K. Martin	×	×	×				
<i>Conus</i> sp. nov.?	×	×					
<i>Conus</i> sp.	×	×					
<i>Conus lividus</i> Hwass	×						×
<i>Conus lorosis</i> Kiener				×			×
<i>Conus hardi</i> K. Martin					×		
<i>Conus striatellus</i> Jenkins					×		
<i>Columbella bandongensis</i> K. Martin		×	×				
<i>Cyclonassa elegans</i> Kiener	×						×
<i>Cypraea</i> cf. <i>tigris</i> Linnæus		×					×
<i>Cypraea</i> sp.			×			×	
<i>Drillia</i> sp.	×						
<i>Delphinula</i> ?			×				
<i>Delphinula reeviana</i> Hinds			×				×
<i>Distortio clathrata</i> Lamarck		×					×
<i>Eburna ambulaerum</i> Sowerby			×				×
<i>Ficus reticulata</i> (Lamarck)						×	×
<i>Haminea</i>	×						
<i>Harpa articularis</i> Lamarck						×	×
<i>Mitra javana</i> K. Martin	×	×	×				
<i>Mitra</i> cf. <i>jenkinsi</i> K. Martin	×						
<i>Mitra junghuhni</i> K. Martin	×	×	×				
<i>Mitra bucciniiformis</i> K. Martin			×		×		
<i>Mangelia</i>	×						
<i>Murex endivia</i> Lamarck		×					×
<i>Marginella</i>			×				
<i>Melania asperata</i> Linnæus		×	×				×
<i>Melania asperata inquinata</i> Quadras		×					×
<i>Nassa crenulata</i> (Bruguiere)	×	×	×		×	×	
<i>Nassa dispar</i> Adams	×	×					×
<i>Nassa gemmulata</i> (Lamarck)	×						×
<i>Nassa globosa minor</i> Quoy	×	×					×
<i>Nassa thersites immersa</i> Carpenter	×	×					×
<i>Nassa thersites leptospira</i> (Bruguiere)	×	×				×	×

Partial list of species from the Vigo group—Continued.

	2x.	3x.	4x.	5x.	9x.	11x.	L.
<i>Nassa quadrasi</i> HidaIgo	×	×					×
<i>Nassa canaliculata</i> Lamarck		×					×
<i>Nassa costellifera</i> A. Adams			×				×
<i>Nassa reussi</i> K. Martin (may = <i>N. costellifera</i>)						×	×
<i>Natica albumen</i> Lamarck	×	×					×
<i>Natica?</i>	×	×					
<i>Natica spadicea</i> Reeve	×		×			×	×
<i>Natica mamilla</i> Lamarck	×	×					×
<i>Natica lacernula</i> d'Orbigny		×					×
<i>Natica eumingiana</i> Recluz						×	×
<i>Nerita funiculata</i> Reeve	×						×
<i>Olivella</i>	×	×					
<i>Phos roseatus</i> Hinds		×	×				×
<i>Ranella</i>	×						
<i>Ranella subgranosa</i> Beck	×						×
<i>Ranella tuberculata</i> Broderip	×	×	×			×	×
<i>Ricinula spectrum</i> Reeve			×				×
<i>Rostellaria fusus</i> Linnæus		×	×				×
<i>Rostellaria crispata</i> Kiener	×	×	×				×
<i>Strombus canarium</i> (Linnæus)	×	×					×
<i>Strombus</i> , sp. a.		×	×				
<i>Strombus</i> , sp. b.		×					
<i>Strombus swainsoni</i> Reeve	×					×	×
<i>Strombus</i> (?) <i>fuscus</i> K. Martin					×		
<i>Strombus</i> (?) sp.				×			
<i>Turris</i> (<i>Sureula</i>) <i>flavidula</i> Lamarck	×	×	×				×
<i>Turris garnonsi</i> Reeve	×	×					×
<i>Turris deshayesi</i> (Doumet)	×	×					×
<i>Turris carinata</i> woodwardi K. Martin	×	×					×
<i>Turris coronifer</i> (K. Martin)		×					
<i>Turris marmorata</i> (Lamarck)						×	×
<i>Terebra bicincta</i> K. Martin	×		×			×	
<i>Terebra javana</i> K. Martin	×		×				
<i>Terebra</i>	×	×					
<i>Triton pfeifferianum</i> Reeve		×					×
<i>Trochus</i>			×				
<i>Telescopium telescopium</i> Linnæus		×		×			×
<i>Trivia smithi</i> K. Martin		×					
<i>Voluta</i> cf. <i>inneza</i> Reeve		×					
PELECYPODA.							
<i>Arca cornea</i> Reeve	×	×					×
<i>Arca ferruginea</i> Reeve		×	×		×		×
<i>Arca granosa</i> Linnæus		×					×
<i>Arca</i> cf. <i>coelata</i> Reeve					×		×
<i>Arca tenebrica</i> Reeve				×			×
<i>Barbatia fusca</i> (Bruguere)		×					×
<i>Cardium</i>	×						
<i>Cardium attenuatum</i> Sowerby						×	×
<i>Cardium donaciformis</i> Cuming	×						×
<i>Cardium unicolor</i> Sowerby						×	×
<i>Cardita antiquata</i> Linnæus						×	×
<i>Chione chlorotica</i> Philippi	×	×	×				×
<i>Chione?</i>				×			

Partial list of species from the Vigo group—Continued.

	2x.	3x.	4x.	5x.	9x.	11x.	L.
PELECYPODA—continued.							
<i>Corbula scaphoides</i> Hinds	×	×	-----	-----	-----	-----	×
<i>Corbula socialis</i> K. Martin	×	×	×	-----	-----	-----	-----
<i>Clementia hyalina</i> Philippi— <i>C. papyracea</i>	-----	-----	-----	-----	×	×	-----
<i>Dosinia cf. lenticularis</i>	-----	×	-----	-----	-----	-----	×
<i>Dosinia erectacea</i> Philippi	-----	-----	-----	-----	×	-----	×
<i>Glycimeris viteus</i> (Lamarck)	-----	-----	×	-----	-----	×	×
<i>Glycimeris angulatus</i> (Lamarck)	-----	-----	-----	-----	-----	×	×
<i>Ostrea</i>	×	×	-----	×	-----	×	-----
<i>Faphia textrix</i> Deshayes	-----	×	-----	-----	-----	-----	×
<i>Pecten (Pleuronectia) pleuronecta</i> Linnæus	×	-----	×	-----	-----	-----	×
<i>Pecten cf. radula</i> Linnæus	-----	-----	×	-----	-----	-----	×
<i>Pecten cf. pseudotima</i> Sowerby	-----	-----	×	-----	-----	-----	×
<i>Pecten pseudotima</i> Sowerby	-----	-----	-----	-----	-----	×	×
<i>Pecten cf. cristularis</i> Adams and Reeve	-----	-----	×	-----	-----	-----	×
<i>Placuna placenta</i> Linnæus	×	×	×	-----	-----	-----	×
<i>Psammobia cf. lessoni</i> Blainville	×	-----	-----	-----	-----	-----	-----
<i>Psammobia</i> sp	-----	×	-----	-----	-----	-----	-----
<i>Pinna</i> sp	×	-----	-----	-----	-----	-----	-----
<i>Solen</i> sp	×	-----	-----	-----	-----	-----	-----
<i>Spisula</i> sp	-----	×	-----	-----	-----	×	-----
<i>Solecirtus quoyi</i> Deshayes	-----	-----	×	-----	-----	-----	×
<i>Spondylus</i> sp	-----	-----	×	-----	-----	-----	-----
<i>Tellina</i> sp	×	-----	-----	-----	×	-----	-----
<i>Tellina</i> sp	-----	×	-----	-----	-----	-----	-----
<i>Vermetus javanus?</i> K. Martin	-----	-----	-----	-----	-----	×	-----
<i>Vermetus</i> sp. nov.	-----	×	-----	-----	-----	-----	-----

AGE OF THE VIGO GROUP

In the above list there are 98 forms that are specifically determined and of these 74, or 75.5 per cent, are living species, an astonishing number when the geologic history of the region yielding these forms is considered. In addition, the extinct forms are practically all common to the upper Miocene of Java, according to K. Martin.⁷

Cerithium jenkinsi is from Martin's locality Z; *Cerithium herklotsi* and *Cerithium bandongensis*, from his locality O; *Conus hardi* and *Conus striatellus*, locality O; *Columbella bandongensis*, locality O; *Mitra junghuhni* and *Mitra javana*, locality O; *Mitra jenkinsi*, locality K; *Mitra bucciniformis*, locality R; *Turris coronifer*, locality O; *Terebra javana* and *Terebra bicinta*, locality K; *Vicarya callosa*, localities O and P; and *Vermetus javanus*, localities I and P. According to Martin, most of these forms are characteristic of the upper Miocene of Java.

⁷ Martin, K., Tertiarschichten auf Java. Leiden (1880) 44–51.

In a very excellent paper, entitled "Concerning Tertiary Fossils in the Philippines," Prof. Karl Martin listed a series of faunas from the Cagayan Valley of northern Luzon which apparently belong to this same horizon. Concerning these faunas he gives the following discussion:

Now, in reviewing Semper's collection, I was at once struck with *Vicarya callosa* Jenkins, which is known from Java and is described in detail below; and this induced me to make a closer comparison between the fossils of the Philippines and those of the Indian Archipelago, whereby it at once became apparent that a whole series of species, especially of the Javanese Tertiary is common to both regions. Thus far, indeed, I have been unable to make a complete study of Semper's collection, and for the time being it has little further interest, because statements as to stratigraphical position are entirely lacking and the equivalent deposits of neighboring regions are still very insufficiently known. After completion of my monograph on the fossils of Java, however, I hope to undertake a more thorough study of the Philippine fossils, and to supplement this preliminary communication.

Martin lists the following from Luzon:

1. *Minanga*; right bank of the *Catalangan*.

<i>Fusus verbeeki</i> Mart. M; P.	<i>Ranella raninoides</i> Mart. M.
<i>Tritonidea ventriosa</i> Mart. M.	<i>Rostellaria javana</i> Mart. M.
<i>Murex brevispina</i> Lam. M (?); P; L.	<i>Natica mamilla</i> Lam. M; L.
<i>Murex pinnatus</i> Wood. M; L.	<i>Cardita decipiens</i> Mart. P.
	<i>Venus squamosa</i> Lam. P; L.

2. *Minanga*; right bank of the *Ilaeroen*.

<i>Terebra jenkinsi</i> Mart. M.	<i>Ranella gyrina</i> Linn. L.
<i>Terebra bandongensis</i> Mart. M.	<i>Rostellaria javana</i> Mart. M.
<i>Fusus verbeeki</i> Mart. M; P.	<i>Vicarya callosa</i> Jenk. M.
<i>Murex grooti</i> Jenk. M.	<i>Cardita decipiens</i> Mart. P.

3. Right bank of the *Ilaeroen*; 4 miles above *Minanga*.

<i>Fusus verbeeki</i> Mart. M; P.	<i>Ranella raninoides</i> Mart. M.
<i>Murex brevispina</i> Lam. M (?) P; L.	<i>Rostellaria javana</i> Mart. M.
	<i>Natica mamilla</i> Lam. M; L.

4. Left bank of the *Ilaeroen*; 1.5 miles above *Goroen*.

<i>Murex djarianensis</i> Mart. M.	<i>Ranella spinosa</i> Lam. M; L.
<i>Murex brevispina</i> Lam. M (?); P; L.	<i>Potamides jenkinsi</i> Mart. P.
<i>Murex microphyllus</i> Lam. M; L.	<i>Natica mamilla</i> Lam. M; L.
<i>Murex grooti</i> Jenk. M.	<i>Cardita decipiens</i> Mart. P.

5. Left bank of the *Ilaeroen*; 4 miles above *Goroen*.

<i>Conus sinensis</i> Sow. P; L.	<i>Fusus verbeeki</i> Mart. M; P.
<i>Conus palabuanensis</i> Mart. J.	<i>Ranella gyrina</i> Linn. L.

6. Foothills in front of Aringay.

Conus lotoisii Kien. M; P; L. *Nassa verbeeki* Mart. P.
Pleurotoma gendinganensis Mart. *Natica mamilla* Lam. M; L.
P.

7. Hills close to Aringay.

Pleurotoma carinata. P; L.

8. *Dicamui* Brook.

Vicarya callosa Jenk. M.

9. *Satput*.

Cypraea smithi Mart. M.

Rostellaria javana Mart. M.

The appended initials indicate the occurrence of the species in the Tertiary of other parts of the Indian Archipelago, as well as among the fauna of the present day. Thus E denotes Eocene; M, Miocene; P, Pliocene; J, later Tertiary in general; Q, Quaternary; L, living species.

The fossils in Martin's list come from nine different localities and the largest number of species from any one locality is ten. According to Martin, the strata in the vicinity of Minanga belong essentially to the same horizon, and he says:

Judging from these facts, the strata of Minanga are to be classed with the upper Miocene bed which exists in Java in the locality denoted by Junghuhn by O and at Selatajan on the Tjilongan.

As was indicated above, many of the fossils from the Bondoc Peninsula are common to this locality O in Java, and the equivalence of the Upper Vigo beds with these Javan beds is evident. Upon the basis of Martin's work, the age of the Vigo beds is upper Miocene.

Martin lists the distinctive foraminifera, *Cycloclypeus communis* Martin from his (and Junghuhn's) localities K, L, O, and P.; *Orbitoides gigantea* Martin is from locality L; and *O. radiata* Martin is from locality K. These localities all represent about the same horizon in Java and it is important to note these forms here, as they are regarded as excellent horizon determiners.

Dr. W. D. Smith,⁸ on the strength of the occurrence of *Cycloclypeus communis* K. Martin and *Lepidocyclina richthofeni* Smith, refers the Canguinsa sandstone to the middle or lower Miocene. His exact statement is as follows:

* * * The limestone from Mount Morabi * * * contains *Cycloclypeus communis* K. Martin, which represents the middle Miocene, and large lepidocyclinas some of which are 45 millimeters in diameter and 5

⁸ Pratt, W. E., and Smith, W. D., Philip. Journ. Sci. § A 8 (1913) 330.

millimeters broad in the thickened central portion. *Lepidocyclus richt-hofeni* Smith was identified among these. This species has been referred by Douvillé to the lower Miocene.

No definite age determinations can be made from the fossils in the Canguinsa sandstone proper. The fossils in the included limestone, however, are well known and have been used in correlation by various authorities. From their presence it is concluded that the Canguinsa sandstone should be placed in the middle Miocene, extending, perhaps into the lower Miocene.

In a recent publication, Prof. H. Yabe⁹ gives a full discussion of correlation of these equivalent beds in Cebu, and Smith's and Douvillé's correlation tables are quoted. It is noteworthy that the beds under discussion are classified by Douvillé as Aquitanian. All who have studied the large foraminifera from the Philippine Islands agree that one of the characteristic genera is *Lepidocyclus*. Cushman¹⁰ in a recent paper makes the following significant statement:

Because in general *Orbitoides* with some modification to be noted in a future paper, is Cretaceous, *Orthophragmina* Eocene and *Lepidocyclus* Oligocene, much importance is attached to these organisms in the investigation of problems of geologic correlation.

From another point of view the age of the beds in question might depend upon the age determination of the overlying Malumbang formation. Concerning the age of this formation, Pratt and Smith¹¹ state the case as follows:

The most conclusive evidence as to the age of the Malumbang series is found in the Lower limestone, which, on the basis of the fossil *Lithothamnion ramosissimum* Reuss * * * may be assigned to the Miocene. The upper beds in the series are apparently as young as the upper Miocene or the Pliocene. The formation is similar to the "étage marneux" which Verbeek assigns to the middle stage of the upper Tertiary for Java.

Concerning the range of this species, Prof. H. Yabe¹² notes the following:

This reef building organism is very often cited from the limestone of the Oligocene and Miocene ages of the Indo-Pacific region, its occurrence being known from Japan, the Philippines, Borneo, Timor, Amboina, New Guinea and adjacent islands, New Hebrides, Victoria, the Christmas Is. etc.

⁹ Yabe, H., Notes on a *Lepidocyclus* limestone from Cebu, Science Reports (Geology), Tohoku Imperial Univ. No. 2, II 5 (1919) 40.

¹⁰ Cushman, J. A., Orbitoid Foraminifera of the genus *Orthophragmina* from Georgia and Florida, Prof. Paper 108 United States Geologic Survey, (1918) 115.

¹¹ Pratt, W. E., and Smith, W. D., Philip. Journ. Sci. § A 8 (1913) 327.

¹² Yabe H., Notes on a *Carpenteria*-limestone from British North Borneo. Science Reports of the Tohoku Imperial Univ. (Geology) No. 1, II 5 (1918) 14.

In Japan it is found not only in *Lepidocyclina* and *Miogysina*-limestone and similar and equivalent beds of Formosa, Botel-tobakee, the Riukiu Islands and the Ogasawara-Jima, but also in the *Lepidocyclina* and *Miogysina*-limestones of the provinces of Sagami and Kae, 2, the Lithothamnion-limestones of Oyami-Yama and Megami-yami near Sagau, Province of Lotomi; and 3, the Lithothamnion-limestone intercalated in an oil-bearing Tertiary complex of Echigo, 4, the Lithothamnion-limestone of Shiroiwa, Makatsuka-mura, Otsu-gou, Province of Natigo.

It is evident from these references that this form has considerable range in the Miocene and probably the Pliocene.

From all the evidence Canguinsa and Upper Vigo beds may be assigned to some stage of the Miocene, and the evidence of *Lepidocyclina* indicates a still greater age, the Oligocene.

IMPORTANCE OF GUIDE FOSSILS

Good guide fossils are far more difficult to select in connection with tropical Tertiary faunas of the Philippines than in connection with the California Tertiary, owing to the great predominance of Recent mollusca. As will be seen from a study of the fauna cited above, most of the forms which are extinct were originally described from a correlative horizon in Java. Of these, the writer is inclined to think that *Cerithium jenkinsi*, *C. herklotsi*, *C. bandongensis*, *Mitra javana*, *M. jenkinsi*, *M. jung-huhni*, *M. bucciniformis*, *Turris coronifer*, *Terebra bicincta*, *Terebra javana*, *Vicarya callosa*, and *Vermetus javanus* will probably prove reliable guides among the mollusca. All of these species are representatives of highly organized genera and their extinction during the post-Miocene time was probably due to their inability to obtain life conditions suited to their highly specialized needs.

Corals, echinoderms, and the more highly organized foraminifera will probably prove to be even better horizon determiners, but their comparative infrequency in strata of the Philippines will at times preclude their use. The writer has not yet attempted to identify the corals and the echinoderms in the collections made, but their value will no doubt prove to be great. It seems that their evolution may have been greatly retarded, but much study will be required in this connection. For stratigraphic work in the Tropics, large and complete collections are necessary to obtain results of any value as, even with the best data available, geologic and paleontologic history is read with much difficulty. Much comparative material, both Recent and fossil, should be accumulated, as subspecific differences will be

recognized only through comparative studies. These subspecific differences are exceedingly important for minute separation and discrimination of strata deposited under tropical conditions.

FACTORS PROMOTING EVOLUTION OF PELECYPODS AND GASTROPODS

The changes in conditions of environment of marine pelecypods and gastropods—salinity, temperature, depth of water, character of bottom, food, oceanic currents—determine the existence of individuals, and in all probability species also. Many marine forms are very delicately adjusted to their environment, and even slight changes may cause their extinction in certain localities. Of these conditions, change in temperature is probably the most important. The annual temperature range of waters in the Tropics is far less than similar ranges in the temperate zones. Likewise, variations in salinity are probably less, as this is a secondary factor dependent in large part upon temperature. The influence of oceanic currents is intimately connected with temperature and salinity. Depth of water and the character of the bottom may be altered by changes in the volume of sediments brought into the ocean from the neighboring land and by epeirogenic (continent-building) movements which have caused a restriction or enlargement of a continental shelf. Epeirogenic movements vitally affect food conditions of pelecypods and gastropods; for, if the continental shelf is greatly reduced by uplift, the feeding areas are thus reduced, and if the competition among gastropods and pelecypods is too great, a species may rapidly become extinct. All of these changes are probably far less under tropical conditions than under temperate or arctic conditions.

COMPARISON OF LIFE CONDITIONS DURING VIGO-MIOCENE TIME WITH THOSE OF RECENT TIME

The close relationship between the Vigo-Miocene fauna of the Philippines and the Recent fauna of these same waters indicates that changes in living conditions since the beginning of Miocene time have been but slight. Apparently change in temperature has not had notable influence. It can be shown by general geologic evidence that an archipelagic condition existed during Miocene, Pliocene, and Pleistocene times. Salinity during the last half of the Tertiary and Recent has probably altered but little, and this only locally. Oceanic currents, and changes in character of ocean bottom were probably different during Vigo-Miocene time than during Malumbang-Pleistocene or Recent time, as is

evidenced by the absence of reef-building corals from the Vigo and by the argillaceous and sandy character of the sediments of this group. A study of Vigo sedimentation indicates that an extensive land area stretched from north to south near the outer border of the continental shelf of the Philippines, unbroken by straits like the San Bernardino of the present. Diorites, schists, serpentines, and associated metamorphic and igneous rocks composed this land mass and the mud-laden, westerly flowing streams deposited their loads in the Philippine inland sea of Miocene age. Judging from the coarse agglomeratic character of the basal Vigo beds in Leyte, high-grade torrential streams descended to a semi-arid lowland from a high mountainous terrane to the east. The absence of many reef-building corals from the Vigo fauna is probably due to the presence of muddy waters and the lack of strong currents because, judging from the presence of many tropical species, the waters were quite warm enough for coralline growth. From the character of both the sediments and the fauna, the waters of the Vigo sea were not too deep for the existence of reef-building corals. During Malumbang time marine life conditions were very similar to those prevailing in the Philippines to-day, but the continental shelf was apparently wider and the islands were much smaller, since coralline limestone covered more extensive areas during the Pliocene than now. During the Pleistocene the islands were outlined about as at present, but many local changes took place during this time. Cebu, for example, was probably greatly restricted during the Pleistocene as well as during the Pliocene, and it was probably represented by several small islets then. Recent and Pleistocene faulting on a great scale seems largely to have controlled the physiography of that island. The northwestern peninsula of Leyte, 40 miles east, has not only a clear-cut record in its terraced sides, registering a series of uplifts, but an equally clear record of Recent or Pleistocene submergence on its west side. This last event is evidenced by a series of beautiful small bays, drowned valleys of small westward-flowing antecedent streams. Such local movements did not seem to affect the species very materially on the whole. It is quite possible that some forms had to seek other quarters, but with such a great variety of neighborhood from which to choose, every clam could find its proper mud flat and each snail its own dugout.

The possible tendency of a species to have within itself the power to evolve into a higher form, or a form still better suited

to its environment, is not apparently present in the case of the tropical pelecypods and gastropods, and the slow changes of fauna are apparently produced by slight changes in temperature, depth, salinity, and food. In other words, the "wonderful stability of protoplasm" seems to be exhibited in these marine tropical invertebrates, except when environmental changes impress alterations upon this vital life substance.

CROWDING OF SPECIES AND THE RECENT FAUNA OF THE PHILIPPINES

A seeming objection to the main thesis of this paper is found in connection with the great abundance of species in the marine waters surrounding the Philippine Islands. As was mentioned above, climatic zones were by no means as sharply differentiated during the early portion of the Tertiary as during the later. Practically all Recent tropical genera were initiated in the Eocene, and many of the species representing these genera had during this period an exceedingly wide geographic range, particularly as respects latitude. During this time tropical species flourished in high latitudes. To use a simple comparison, the tropical life "accordion" was extended to its greatest limit. The exact nature of the change which caused a separation of remarkable distinctness between the Oligocene and the Eocene faunas of the Pacific Coast of North America is not fully understood. It seems probable, however, that the time represented by unconformity between Oligocene and Eocene was long. The distribution of land masses on the earth was profoundly affected, and it seems quite probable that the climate during this ep-Eocene time was decidedly cooler than in the Eocene or the Oligocene which followed. It seems quite probable that the life "accordion" was compressed, and that many species which ranged far to the north in Eocene time were compelled to seek the more genial climates of the tropic seas. When the faunas during the Oligocene again had a chance to expand into higher latitudes, they encountered new conditions of environment and were nearly all specifically changed. The Oligocene faunas of Oregon, Washington, and California are distinctly set off from the Miocene, and similar changes may have taken place during ep-Miocene time. Again, many of the species succeeded in making a strategic retreat. Even more pronounced were the "accordion"-like changes during the Pliocene and the Pleistocene.

As was pointed out above, archipelagic conditions prevailed in the Philippines during the Tertiary, although the record for the Eocene is missing, or extremely meager. An archipelago

located in the Tropics offers a great variety of habitat and a new species entering such a region could on this account find suitable conditions for existence.

From Miocene to Recent in the Tropics molluscan faunas have changed but little, and but slight specific alterations have occurred. Since a tropical or subtropical climate prevailed over California, Oregon, and Washington during upper Eocene time the great geographic and stratigraphic ranges of certain species of Tejon (upper Eocene) age are due to nearly uniform conditions of temperature and other factors mentioned. The great stratigraphic range of many Tejon-Eocene species is probably due to uniformity in climate during long periods of time, and slight faunal changes have greater significance in the upper Eocene than corresponding changes in the Miocene, Pliocene, and Pleistocene time; these variations probably required a much longer time for their production as well. Uniformity in oceanic temperature enabled many species to range far to the north, and in fact far west of California to the Eocene of Japan where *Perissolax blakei*, *Pholadomya nasuta*, or their near relatives occurred.¹³

Eocene time then must not be measured by the same faunal "yardstick" as Pliocene and Miocene time, but a much finer scale is required. It is the writer's opinion, based upon the above consideration, that Eocene time is far longer than any of the other divisions of the Tertiary.

SUMMARY

The tentative conclusion of the writer is that in the study of Tertiary faunas of the Tropics a different percentage scale must be used. For the later Tertiary, Miocene, Pliocene, and Pleistocene the percentages which apply in the temperate regions to the Pliocene are roughly adaptable to the Miocene; similarly, the percentages which apply in the temperate regions to the Pleistocene are apparently those of the Pliocene of the Tropics. This apparent lack of faunal differentiation during the Tertiary in the Tropics is due to uniformity of temperature, salinity, food, and other life essentials. From another viewpoint the rate of evolution of gastropods and pelecypods in the Tropics during the Tertiary was far less than during this same time in the more rigorous environs of the temperate zones. The tropical or subtropical faunas of the Pacific Coast of North America exhibit but slight differences compared to the faunas of Miocene and

¹³ Yokoyama, M., Some Tertiary fossils from the Miiki coal fields, Journ. Coll. Sci. Imperial Univ. of Tokyo, 27 (1911).

Pliocene age of this same region, and the writer ascribes this to the uniformity of life conditions which prevailed during Eocene time. The amount of faunal change must not be used as a measure of time in the whole of the Tertiary, but in measuring the tropic and subtropic faunas differently marked scales are necessary for the Eocene and the Oligocene than for the Miocene, the Pliocene, and the Pleistocene. It is particularly noteworthy that the Japanese paleontologists are now searching for comparisons with the Pacific Coast of North America and Australia rather than with Europe. In other words, many problems of the tropical Orient will be solved only when conditions on both sides of the Pacific become better known.

ILLUSTRATIONS

PLATE 1

Relief map of the Philippine Islands.

PLATE 2

Relief map of Bondoc Peninsula, showing fossil localities cited.



PLATE 1. THE PHILIPPINE ISLANDS.

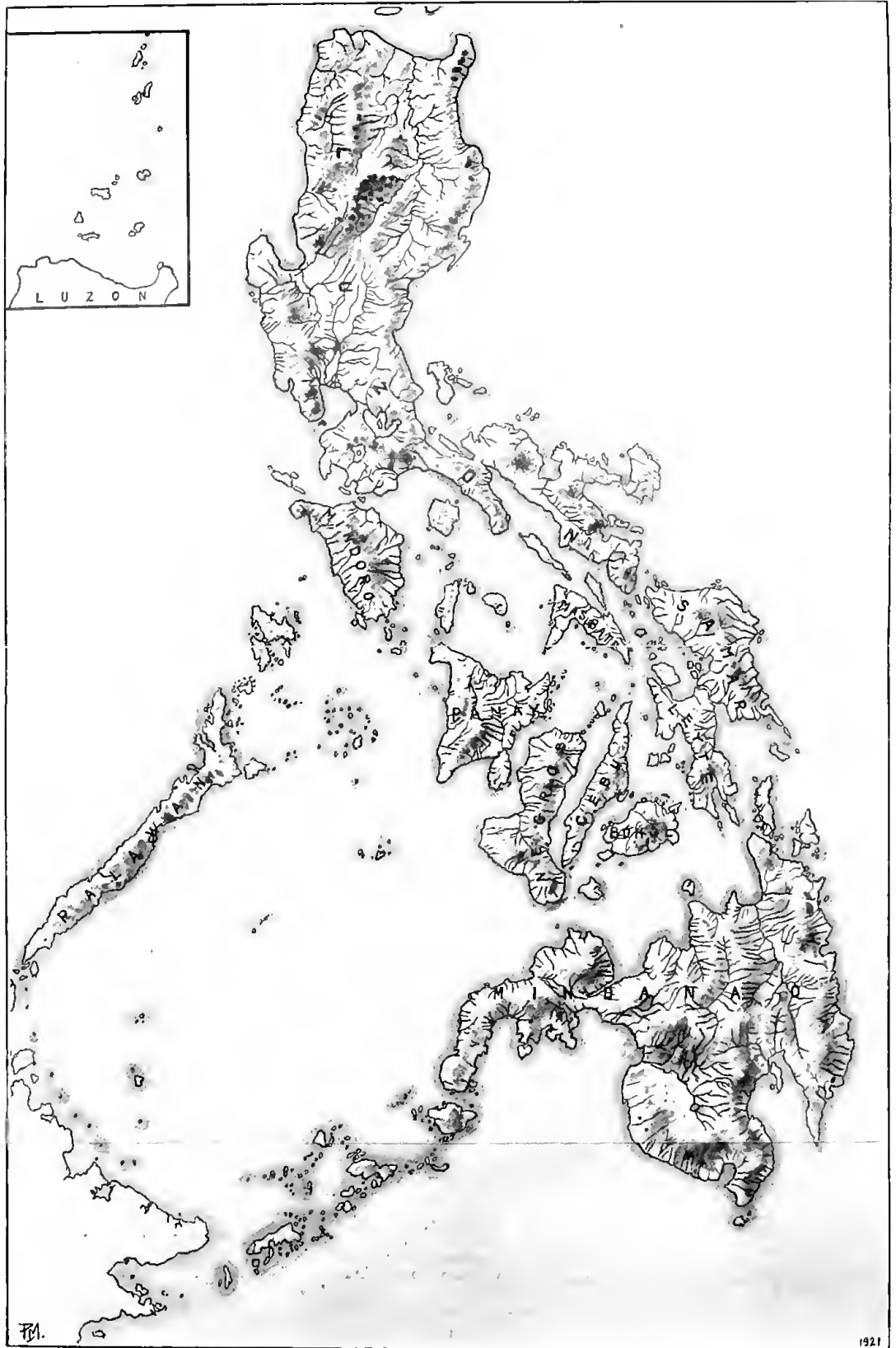

PLATE 1. THE PHILIPPINE ISLANDS.



PLATE 2. BODOC PENINSULA, LUZON, P. I.

FURTHER NOTES ON PHILIPPINE SCYPHOMEDUSAN JELLYFISHES

By S. F. LIGHT

Professor of Zoölogy, College of Liberal Arts, University of the Philippines

FOUR TEXT FIGURES

This paper has for its purpose the publication of miscellaneous new data concerning the scyphomedusan fauna of the Philippine Islands and includes the descriptions of two new genera and one new species. Since my former paper on Philippine Scyphomedusæ (1914), Mayer has published (1915) an article on the "Medusæ of the Philippines and Torres Straits." The Philippine material for that paper, as well as that for his descriptions of Philippine forms in "Medusæ of the World" (1910), came from the collections in Philippine waters of the United States Fish Commission Steamer *Albatross*. Mayer found thirty-one species and varieties from the Philippines in the *Albatross* collection. The forms reported in my paper (1914) from the collection of the University of the Philippines added seven to this number, and the new species described in the present paper makes a total of thirty-nine species and varieties of scyphomedusan jellyfishes known from Philippine waters.

This is a surprisingly large number when the smaller numbers found in other better-known regions and the incompleteness of the collections here are taken into consideration. Mayer (1915, p. 160) says:

It is evident that the region of the Philippines is very rich in scyphomedusæ, for off the far better-known Atlantic coast of the United States there are but 25 species of scyphomedusæ and only 4 of these are Rhizostomæ, while among the 38 species taken by the *Albatross*, and by Light, in the region of the Philippines, 22 are Rhizostomæ. Among these 38 species 15 were new to science.

The new form described in this paper is a rhizostomid and brings the number of Philippine species belonging to that order to twenty-four and the number of species named from Philippine materials to sixteen. Of these sixteen species and varieties, all but one (*Discomedusa philippina* Mayer, 1915) are Rhizostomæ. It would seem, therefore, that the Philippines have

not only a rich but a very characteristic rhizostomid fauna. There is no doubt in my mind that more systematic collections with the proper facilities will increase very considerably not only the total of species but the number of new species from the Archipelago.

The list of species and varieties known from the Philippines, with notes on distribution, follows. Names and dates in parentheses refer to the recorders and the dates of publication.

Order CARYBDEIDÆ

1. *Carybdea rastonii* Haacke.
Luzon and Mindoro (Mayer, 1910 and 1915).
2. *Carybdea alata* var. *grandis* Agassiz and Mayer.
Manila Bay (Mayer, 1915).
Carybdea alata var. *moseri* Mayer is probably an immature form of *C. alata* var. *grandis* as is *C. philippina* Semper, 1860 (Semper, 1860).
3. *Chiropsalmus quadrigatus* Haeckel.
Common except in inclosed bays such as Manila Bay (Mayer, 1910 and 1915; Light, 1914).

Order CORONATÆ

4. *Periphylla hyacinthina* Steenstrup.
Common pelagic form in deeper waters (Mayer 1910, 1915).
5. *Linuche unguiculata* (Schwartz) var. *aquila* Mayer.
Mactan, Cebu (Mayer, 1910 and 1915).
6. *Atolla bairdii* Fewkes forma *wyvillei* Haeckel.
Common pelagic form in deeper waters (Mayer, 1910 and 1915).
7. *Atolla bairdii* Fewkes forma *gigantea* Maas.
(Mayer, 1915).
8. *Atolla bairdii* Fewkes forma *valdiviæ* Vanhöffen.
Sogod Bay (Mayer, 1910 and 1915).

Order SEMÆOSTOMÆ

9. *Pelagia panopyra* Péron and Lesueur. (Mayer, 1915).
Pelagia panopyra var. *placenta* (Haeckel) (Mayer, 1910).
Common pelagic form in deeper waters (Mayer, 1910 and 1915).
10. *Chrysaora melanaster* Brandt.
San Miguel Bay (Mayer, 1915).
11. *Dactylometra africana* Vanhöffen.
Off Corregidor Light, Manila Bay (Mayer, 1915).
12. *Dactylometra quinquecirrha* L. Agassiz.
Chrysaora stage very common in Manila Bay (Light, 1914).
13. *Sanderia malayensis* Götte.
Common pelagic form in deeper waters (Mayer, 1910 and 1915).
14. *Discomedusa philippina* Mayer.
Catingan Bay (Mayer, 1910 and 1915).
15. *Aurellia aurita* Lamarck.
(Mayer, 1915).

16. *Aurellia labiata* Chamisso and Eysenhardt.
Masbate (Mayer, 1910); Jolo (Mayer, 1915); Manila Bay (Light, 1914).

Order RHIZOSTOMÆ

17. *Cassiopea polypoides* Keller var. *culionensis* Light.
Culion Island (Light, 1914).
18. *Cassiopea medusa* Light.
Culion Island (Light, 1914).
19. *Cassiopea ornata* Haeckel.
Simaluc Islands, Subic Bay, and Catbalogan, Samar (Mayer, 1910).
This species is reported from the above localities by Mayer (1910, p. 648), but in his synopsis of described forms of *Cassiopea* (1910, p. 638) he does not give this distribution, and in his list of Philippine Scyphomedusæ (1915, p. 159) he gives only *C. andromeda* var. *baduensis* Mayer. He gives no record of this medusa from the Philippines, however, and its characters are not those of the Philippine forms placed under *C. ornata*; hence I believe the Philippine form to be *C. ornata* as above, and not *C. andromeda* var. *baduensis*.
20. *Cephea cephea* (Forskål) Mayer.
Mariveles (Light, 1914).
21. *Cephea cephea* var. *cœrulea* (Vanhöffen) Mayer.
Legaspi (Mayer, 1915).
22. *Cephea octostyla* (Forskål) Mayer.
Jolo (Mayer, 1910 and 1915).
23. *Anomalorhiza shawi* gen. et sp. nov.
Manila Bay (Light, this paper).
24. *Cotylorhizoïdes* (*Cotylorhiza* Mayer, 1915) *pacificus* (Mayer) gen. nov.
Manila Bay (Mayer, 1915; Light, this paper).
25. *Catostylus purpurus* Mayer.
Very common in Manila Bay (Mayer, 1910 and 1915; Light, 1914).
26. *Catostylus mosaicus* (Quoy and Gaimard) L. Agassiz.
Malampaya Sound, Palawan (Mayer, 1915).
27. *Acromitus maculosus* Light.
Taytay, Palawan (Light, 1914).
28. *Lychnorhiza bartschi* Mayer.
Jolo (Mayer, 1910 and 1915).
29. *Mastigias papua* (Lesson) L. Agassiz.
Luzon: Pagopas Bay (Mayer, 1910 and 1915); Manila Bay (Light, this paper)—Mindoro: Port Galera (Light, 1914)—Palawan: Taytay (Light, 1914)—Cebu: off Cebu (Mayer, 1915); Candamon Island between Cebu and Bohol (Mayer, 1915).
30. *Mastigias ocellata* (Modeer) Haeckel.
(Mayer, 1910 and 1915).
31. *Phyllorhiza luzoni* Mayer.
Luzon: Varadero Bay (Mayer, 1915).
32. *Versura maasi* Mayer.
Bohol: Montacao Island (Mayer, 1910 and 1915).
33. *Lobonema smithii* Mayer.
Manila Bay (Mayer, 1910).
34. *Lobonema mayeri* Light.
Taytay, Palawan and Manila Bay (Light, 1914 and this paper).

35. *Lobonemoides gracilis* Light.
Taytay, Palawan (Light, 1914).
36. *Thysanostoma thysanura* Haeckel.
Mindanao—Mindoro; Singaan Island—Luzon; Atuluyan Bay (Mayer, 1910 and 1915); Manila Bay (Light, this paper).
37. *Lorifera lorifera* var. *pacifica* (Schultze) Mayer.
Port Palapog, Luzon (Mayer, 1915).
38. *Lorifera flagellata* (Haeckel) Mayer.
Albatross Station D5226 (Mayer, 1910).
39. *Rhopilema visayana* Light.
Taytay, Palawan (Light, 1914).

Since 1914 it has not been possible to make any extensive or systematic collection of Philippine Scyphomedusæ. Thanks, however, to the interest of Prof. W. R. Shaw, of the department of botany, University of the Philippines, and to occasional collections which I have been able to make in Manila Bay, a number of new facts as to distribution, structure, and classification have accumulated and with the finding by Professor Shaw of a specimen in good condition which represents a new genus and species (see *Anomalorhiza shawi* below) it seemed appropriate to bring our knowledge of Philippine Scyphomedusæ to date.

As in my paper of 1914, I follow closely the system of classification and generic diagnosis given by Mayer in his "Medusæ of the World" and followed by him in his "Medusæ of the Philippines and Torres Straits."

As all the material here referred to has been collected from Manila Bay, a list of the species of Scyphomedusæ known from that locality follows, with notes on numbers, collector, etc.:

1. *Carybdea alata* var. *grandis* Agassiz and Mayer.
Two specimens collected by the *Albatross* at Station 5361, February 9, 1909, Manila Bay. Reported by Mayer (1915).
2. *Dactylometra africana* Vanhöffen.
Five specimens collected by the *Albatross* at Station D5461, June 14, 1909, at a depth of 12 fathoms, about 7.2 miles off Corregidor Light, Manila. Reported by Mayer (1915).
3. *Dactylometra quinquecirrha* L. Agassiz.
The *Chrysaora* stage is very common at Pasay beach, at Cavite, and probably at other points on Manila Bay. Reported by Light (1914).
4. *Aurellia labiata* Chamisso and Eysenhardt.
Found rarely and in small numbers at Pasay beach. Reported by Light (1914).
5. *Cephea cephea* (Forskål) Mayer.
Reported by Light (1914) from a single specimen from Mariveles.
6. *Anomalorhiza shawi* gen. et sp. nov.
Reported here for the first time from a specimen collected by Professor Shaw, in whose honor it is named because of the interest he has always shown in the collection and classification of the jellyfishes of

Pasay beach. One mutilated specimen was collected by Gregorio Ylarde some years ago. A magnificent specimen was collected from the bay by Mr. Hilario A. Roxas, of the department of zoölogy, December 19, 1920, near Parañaque, with the assistance of Paulino Aguilar.

7. *Cotylorhizoides* (gen. nov.) *pacificus* (Mayer) 1915.

Cotylorhiza pacifica MAYER, Pub. Carnegie Inst. Washington 212 (1915) 185-187.

Reported by Mayer from a single mutilated specimen collected by the *Albatross* at the launch landing, Manila Bay. Common in Manila Bay at irregular intervals. Specimens collected by Shaw and myself at Pasay beach, May, 1918, and at other times.

8. *Catostylus purpurus* Mayer.

The commonest jellyfish of Manila Bay and its tidal creeks (esteros). Reported by Mayer (1910 and 1915) and Light (1914).

9. *Mastigias papua* L. Agassiz.

An occasional visitor to Manila Bay. Reported from the bay for the first time in this paper.

10. *Lobonema mayeri* Light.

Very common during the summer months. Perhaps to be considered the same as the next species. Reported by Light (1914).

11. *Lobonema smithii* Mayer.

Reported by Mayer (1910) from a single mutilated specimen. Perhaps the same as the preceding species.

12. *Thysanostoma thysanura* Haeckel.

Reported here for the first time from Manila Bay from two perfect specimens collected by Doctor Shaw at Pasay beach, one in the summer of 1919 and the other in July, 1920.

In the following pages I shall consider these species in order placing them systematically and giving such notes concerning habits, morphology, classification, etc., as have accumulated since my paper of 1914. No attempt is made to give complete synonymies. References are to the original descriptions, change to present form of name, and to reports from Manila Bay.

Order CARYBDEIDÆ Gegenbauer, 1856

Genus CARYBDEA Péron and Lesueur, 1809

Carybdea alata var. *grandis* Agassiz and Mayer.

Charybdea grandis A. AGASSIZ and MAYER, Mem. Mus. Comp. Zool. Harvard College 26 (1902) 153, pl. 6, figs. 26-31.

Carybdea alata var. *grandis* MAYER, Medusae of the World 3 (1910) 511, fig. 329; Pub. Carnegie Inst. Washington 212 (1915) 171.

Mayer (1915) reports two specimens of this variety collected by the *Albatross*, at Station 5361, Manila Bay, February 9, 1909, in 12 fathoms. This is the only record of this form and I have never encountered it. It is the only record of any species of the family Carybdeidæ from Manila Bay and their presence was

probably due to chance currents as they are typically found along more exposed shores.

Order SEMÆOSTOMÆ L. Agassiz, 1862

Family PELAGIDÆ Gegenbauer, 1856

Genus DACTYLOMETRA L. Agassiz, 1862

Dactylometra africana Vanhöffen, 1902.

Dactylometra africana VANHÖFFEN, Wissen. Ergeb. deutsch. Tiefsee Expedition, Dampfer Valdivia, Bd. 3, Lfg. 1 (1902) 40, taf. 4, fig. 20; MAYER, Pub. Carnegie Inst. Washington 212 (1915) 180.

"Lappets and tentacles red. Red radial streaks over exumbrella. * * * Distinguished by its lappets being deeply pigmented near the margin on the exumbrella side." (Mayer, 1915.)

I have seen no specimen of this species, which Mayer reported (1915) from five specimens captured by the *Albatross* in Manila Bay in 12 fathoms, 7.2 miles off Corregidor Light, *Albatross* station D5461.

It is worthy of note that these specimens were in the *Chrysaora* stage; that is, with twenty-four sense organs and thirty-two tentacles, as are practically all of the specimens of *Dactylometra quinquecirrha* so common in Manila Bay. It is possible that these specimens and those studied by me and identified as *D. quinquecirrha* belong to the same species; either *D. africana*, although the distinguishing pigment is entirely lacking in the many specimens I have examined from Manila Bay, or *D. quinquecirrha*. Or it may be that the two forms are simply variants of the same variable species. Whatever their systematic position no other specimens of this type have been reported from Manila Bay, and it is probable that they are very rare visitors there.

Dactylometra quinquecirrha (Desor, 1848) L. Agassiz, 1862.

Pelagia quinquecirrha E. DESOR, Proc. Boston Soc. Nat. Hist. 3 (1848) p. 76.

Dactylometra quinquecirrha L. AGASSIZ, Cont. Nat. Hist. U. S. 4 (1862) 125, 166; MAYER, Medusae of the World 3 (1910) 585, pl. 62-64a, figs. 371, 372; LIGHT, Philip. Journ. Sci. § D 9 (1914) 198.

While the species belonging to the genus *Dactylometra* are characterized by the presence of 5×8 tentacles and 6×8 lappets, the medusæ pass through a *Chrysaora* stage in which they have the 3×8 tentacles and 4×8 marginal lappets characteristic of the genus *Chrysaora* Péron and Lesueur. Indeed it seems probable that some, if not all, of the forms referred to the genus

Chrysaora are immature or stunted forms of species of *Dactylometra*.

I have seen many specimens of this *Dactylometra*, the small white jellyfish which is extremely common in the bay at certain seasons of the year, particularly from June to November, but none of them have exhibited the 40 tentacles of the mature *Dactylometra*. One large specimen, collected by Doctor Shaw in June, 1920, shows the marginal lappets near the sense organ in each octant weakly divided, making the 6×8 marginal lappets characteristic of *Dactylometra* and confirming my diagnosis of this form as a species of *Dactylometra*.

This is the dangerous jellyfish of Manila Bay. Its sting is at all times most unpleasant and often extremely dangerous. Among the symptoms caused by its sting are excruciating pains across the back; general pains spreading from the region of the sting; in some cases a paralysis, also spreading from the region of the sting, in others intense cramps and, in severe cases, a watery discharge from the throat accompanied by a dry hacking cough and strong mental depression, which is so strong at times as to cause a desire to commit suicide. A friend visiting in Cavite tells me that this form is very numerous there at the present time (June, 1920), and is the cause of numerous very severe stings. In the case of a bather who dived head foremost into a medusa and was severely stung about the head the pain was so intense and mental symptoms were so serious, I am told, as to require the administration of morphine on several occasions. This all goes to prove my contention¹ that the cases of poisoning reported by Old (1908) were due to this *Dactylometra* rather than to *Lobonema* as Doctor Smith believed (Mayer, 1910), particularly since the symptoms reported in cases of poisoning by *Dactylometra* agree with those reported by Old.

Family ULMARIDÆ Haeckel, 1880, sensu Mayer, 1910

Subfamily AURELINÆ L. Agassiz, 1862

Genus AURELLIA Péron and Lesueur, 1809

Aurellia labiata Chamisso and Eysenhardt, 1820.

Aurellia labiata CHAMISSE and EYSENHARDT, Nova Acta Phys. Med. Leop. Car. 10 (1820) 358, pl. 28 figs. 1 A. B.; MAYER, Medusae of the World 3 (1910) 628, fig. 398; LIGHT, Philip. Journ. Sci. § D 9 (1914) 200; MAYER, Pub. Carnegie Inst. Washington 212 (1915) 182.

¹ Philip. Journ. Sci. § B 9 (1914) 295.

No specimen of this species has been recorded from Manila Bay since my former paper (1914).

Order RHIZOSTOMÆ Cuvier, 1799

Rhizostomata dichotoma Vanhoffen, 1888

Genus CEPHEA Péron and Lesueur, 1809

Cephea cephea (Forskål, 1775) sensu Mayer, 1910.

Medusa cephea FORSKÅL, *Descrip. Anim. Itin. Orient.* (1775) 108, No. 22, Icon., tab. 30 (non tabl. 29).

Cephea cephea MAYER, *Medusae of the World* 3 (1910) 654, 655; LIGHT, *Philip. Journ. Sci.* § D 9 (1914) 206; MAYER, *Pub. Carnegie Inst. Washington* 212 (1915) 185.

This species has not been recorded from Manila Bay since 1914. It is probably only a chance visitor to Manila Bay.

Genus ANOMALORHIZA novum

Generic diagnosis.—*Rhizostomata dichotoma*, the bifurcation of whose mouth arms is confined to a small distal region. A terminal, club-shaped appendage containing a continuation of the mouth-arm canal is found arising from the inner surface of each mouth arm at the point of bifurcation. Small, very slender, threadlike filaments are scattered among the mouth arms. The 8 sense organs have small exumbrellar sensory pits, and distinct

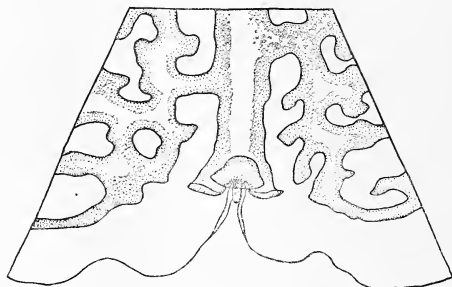

FIG. 1. A sense organ of *Anomalorhiza shawi* gen. et sp. nov. as seen from the subumbrellar side showing the subumbrellar shelf. $\times 6$.

subumbrellar shelves (see fig. 1). A distinct ring canal anastomosing externally with a canal system extending to the margin and internally with 16 radial canals, the 8 rhopalar canals extending to the sense organ, the 8 interocular canals not being

distinguishable beyond the ring canal, the centripetal system consisting of one blind canal between each two radial canals (see fig. 2). Subgenital ostia wide and narrow, much wider than the base of the mouth-arm pillar. Subgenital porticus unitary.

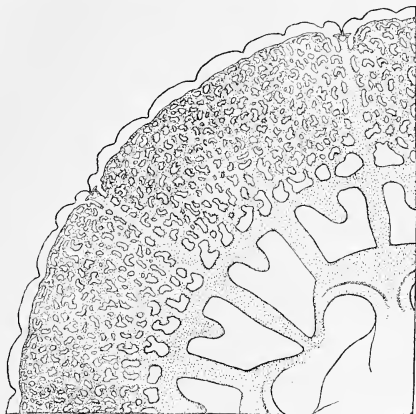

FIG. 2. A quadrant of *Anomalorhiza shawi* gen. et. sp. nov. in subumbrellar view, showing canal system, subgenital ostium, etc. $\times 1$.

Type species, *Anomalorhiza shawi* sp. nov.

This new genus differs strikingly from the other genera of *Rhizostomata dichotoma* in the unusual branching of the mouth arms, which are dichotomously branched only near the tip, the entire outer surface of the arm being quite bare; in the presence of a very large, distinct ring canal; in that the interocular canals are but 8 in number; and in the absence of any externally visible musculature. It is most nearly related to *Cotylorhizoides* (see diagnosis below) in that they both have terminal clubs on the mouth arms, large subgenital ostia, and small exumbrellar sensory pits, but differs from *Cotylorhizoides* in the points mentioned above and also more strikingly in the thinness and fragility of the bell as contrasted to the stiff massive bell of that form.

Anomalorhiza shawi sp. nov. Figs. 1 to 3.

The bell, which in the entirely relaxed, preserved specimen is nearly flat and measures about 150 millimeters in diameter, is

thickest between the ring canal and the base of the mouth-arm pillars (about 20 millimeters in thickness) while the area beyond the ring canal is very thin and tapers gradually to the extremely thin lappets. In a magnificent specimen, obtained since the illustrations were completed and after this paper was in proof, the bell in life was observed to approach a hemisphere and to have a minimum diameter of about 400 millimeters. The whole organism was very soft and pliable and when extended in death measured 600 millimeters or more in diameter.

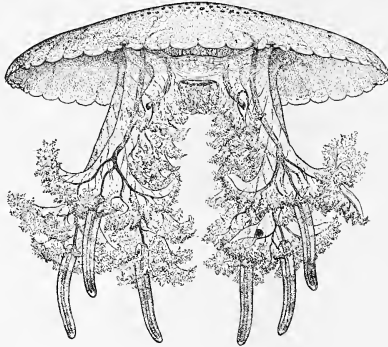

FIG. 3. *Anomalorhiza shawi* gen. et sp. nov. $\times 0.5$. Two mouth arms have been cut away in front. (The specimen was very much relaxed and in life the bell is much deeper.)

The entire exumbrella with the exception of the grooves between the marginal lappets is thickly set with low, flat, wartlike projections colored a velvety brown. These warts increase in size from the margin, where they average a few millimeters in diameter and are most irregular in shape and deep in color, to the region of the exumbrella internal to the ring canal, where they reach a diameter of 20 millimeters or, where elongated, a length of 30 millimeters, and are more lightly colored and more elevated. This color fades out in preserved specimens but the warts remain conspicuous. These thickset brown spots give the only color to the bell, which is transparent white, the canals being slightly opaque white and the gonads, which protrude widely from the subgenital ostia of the adult, are opaque white in young specimens and a beautiful pale violet shading into pale pink in the adult.

The 8 rhopalia are small but distinct and have a porcelain-white color in life. There is a very small exumbrellar sensory pit and a distinct subumbrellar shelf. (See fig. 1.)

The marginal lappets are very thin and fragile and quite transparent, the canal system not extending into them. There are 6 velar lappets in each octant, the 2 lying next the ocular lappets being smaller than the other 4. The lappets present only a slight convexity and in large specimens are hardly to be made out distally. They are separated on the exumbrellar surface, however, by distinct, broad and deep grooves which are marked by the absence of the warts and the brown color of the remainder of the exumbrella. In the largest specimen there appear, in the center of many of these grooves, small rudimentary lappets marked by a slight distal projection and a very small area of brown color.

The mouth-arm disk which is 4-sided has a width of 45 millimeters in the figured specimen. Each mouth-arm pillar (two united mouth arms) has a diameter of 20 millimeters where it joins the mouth-arm disk, and a minimum diameter of 10 millimeters between the subgenital ostia which have a width of about 30 millimeters, or 3 times that of the pillars which separate them. The subgenital porticus is unitary.

The mouth arms, which in the figured specimen are about 70 millimeters long, exclusive of the terminal clubs, are very narrow externally and flat in the radial plane, the fleshy, unbranched portion being 20 millimeters broad and only 7 millimeters thick. The outer surface is bare for about 50 millimeters after which the arm is dichotomously branched once and each branch twice dichotomously divided again. The inner surface of each branch and of each arm is also alternately branched. The mouths surrounded by tiny tentacles are scattered rather sparsely on the inner and lower surfaces of the minor branches. Scattered between the mouths and most numerous near the center of the disk are very small, slender, delicate filaments, and projecting from the tip of each arm, giving it an appearance quite different from more typical *Rhizostomata dichotoma*, is a terminal club having a length of about 35 millimeters. This club, which has a surface color of light diffuse brown, is covered with low nematocyst-bearing warts and contains a continuation of the main canal of the arm at least half the diameter of the club and showing, like all the canals of the mouth arms, the clear purple color which gives this medusa a most beautiful and distinctive appearance.

In the large specimen referred to above, the mouth-arm disk is approximately 150 millimeters in diameter, the subgenital ostia have a maximum aperture of about 180 millimeters, and the mouth-arm pillars show a minimum diameter (at the center of the subgenital ostia) of about 65 millimeters. The mouth arms are about 340 millimeters long, the undivided portion being about 280 millimeters long. The fleshy, unbranched portion is about 60 millimeters broad and 17 millimeters thick. The mouth-arm club is distinctly pedunculated, more than 150 millimeters in length (all are imperfect) and about 12 millimeters in diameter. The proximal half of its central canal is a mottled brownish purple, the distal half of the purple color characteristic of the mouth-arm canals of the species.

The canal system consists of 16 broad, radial canals: 8 ocular canals which run to the margin and bifurcate at the base of the sense organ (see fig. 1), and 8 interocular. The interocular canals end at the ring canal, which is very broad and distinct and is connected externally to the canal network of the margin by several small branches in each octant (7 in the specimen figured), and gives off internally between each 2 radial canals (that is, 2 in each octant) a single, broad and very short, blind diverticulum. The interocular canals are considerably larger than the ocular canals which are narrowed proximally.

The muscles are poorly developed, not being visible externally.

I have named this strikingly beautiful medusa after Prof. W. R. Shaw, of the department of botany, University of the Philippines, who collected the first perfect specimen (figured here) and whose untiring interest in collecting specimens from Pasay beach is responsible for much of the data in this paper. While this paper was with the printer, Mr. Hilario A. Roxas, assistant in the department of zoölogy, collected the splendid specimen referred to above.

Genus COTYLORHIZOIDES novum

Generic diagnosis.—*Rhizostomata dichotoma* with 8 simple bifurcated mouth arms, the terminal branches of which branch pinnately. Subgenital porticus unitary, 8 marginal sense organs with or without ocelli and exumbrellar sensory pits, 8 large rhopalal canals and many small, anastomosing, interocular canals. No radial muscles. Strong circular muscles interrupted in the 8 principal radii. Circular canal small or absent. Bell high and dome-shaped, without a central dome-shaped region as in *Cotylorhiza*.

Type species, *Cotylorhiza pacifica* Mayer.

Cotylorhizoides pacificus (Mayer) emend.

Cotylorhiza pacifica MAYER, Pub. Carnegie Inst. Washington 212 (1915) 185.

Bell deeply dome-shaped, reaching a diameter of 300 millimeters and a depth nearly as great. Exumbrella covered with a mosaic of faint diffuse brown due to large numbers of minute brown spots, apparently clumps of Zoöchlorellæ (unicellular symbiotic algæ). In formalin specimens this color fades out entirely, and in alcohol specimens it remains as a mosaic of frosty white. A band extending from the inner ends of the velar clefts to about the middle of the velar lappets is a dull blue in some living specimens, due to the blue color of the canal network of that area. The exumbrella is more or less regularly marked by porcelain-white spots which have a characteristic appearance, due to their being pear-shaped with the swollen portion submerged; only the smaller end appears on the surface, where it simulates the opening of a gland, being transparent in the center. This transparent spot which simulates the opening is surrounded by a porcelain-white area, this by a transparent area, this by an area of diffuse brown, and this finally by an opaque white zone. These spots are about 5 to 10 millimeters apart on the surface, have a surface diameter of about 1 millimeter, and are from 2 to 4 millimeters in diameter at their widest point, which is usually internal. Toward the periphery these spots become more irregular, often larger, and sometimes more numerous. The exumbrella is also covered with minute cone-shaped papillæ.

Each of the 8 sense organs shows a single, large, brown ocellus which fades out in formalin. Above each sense organ is a small, but deep, exumbrellar sensory pit.

The rhopalar canals are large and distinct; the numerous interocular canals which anastomose freely with each other and with the ocular canals are much smaller than the ocular canals. The ring canal, while small, can be demonstrated by injection or dissection.

There are no radial muscles. The strong circular muscles extend to the bases of the mouth-arm pillars and are interrupted in the rhopalar areas, completely so internal to the ring canal and nearly so external to it.

The subgenital ostia are about one and a half times as wide as the mouth-arm pillars and have a convex lower border. In a specimen, 200 millimeters in diameter, the mouth-arm disk had a diameter of 110 millimeters; the perradial mouth-arm pillars were 40 millimeters across, and the subgenital ostia, 60.

The floor of the stomach is reinforced by four perradial thickenings corresponding to the walls separating the subgenital portici in forms such as *Cotylorhiza*.

Besides the numerous, small, pedunculated, knobbed appendages, the mouth arms bear large, rather stiff clubs which break off on lifting the medusæ from the water. The club at the distal end of each mouth arm is very long and of a solid consistency. Proximally it is transparent and spindle-shaped, narrowing distally before it expands to form a three-sided, dart-shaped region, which is frosted white proximally and grayish green distally and contains very powerful nematocysts, able to pierce the skin of the palm of the hand. They evidently contain no poison, however, as they cause no itching or burning sensation. These clubs contain anastomosing canals like those of *Mastigias*.

The mouth arms are short, fleshy, and thick and show window-like openings in the lateral membranes like those of Mayer's *Cotylorhiza pacifica* (placed here in *Cotylorhizoides*) and *Lobonema*. The mouth arms of a specimen measuring 200 millimeters in diameter (in preservation) were 80 millimeters in length, the upper arm being 20 millimeters long.

This very large and striking medusa is common in Manila Bay at apparently irregular intervals. The specimens upon which this description is based were collected by Doctor Shaw in May of 1918. I found them common among the more numerous *Lobonemæ* at that time. They appear to be very sluggish, their sting is negligible, and, having no long, flexible, nematocyst-armed appendages (like the tentacles of *Chiropsalmus*, the tentacles and oral lobes of *Dactylometra*, and the filaments of *Lobonema*) and being very conspicuous, they are seldom, if ever, a source of annoyance to fishermen or bathers.

Mayer's description of *Cotylorhiza pacifica* was made from a single mutilated specimen. While the forms here placed in that species differ from the description of *C. pacifica* in certain points, most strikingly in the presence of exumbrellar sensory pits and ring canal, I am inclined to attribute these differences to the poor condition of Mayer's specimen. A reexamination of the type in the light of our present knowledge would probably show it to be in agreement with the above description. If not, the form described here must be considered as a new species, for which I propose the name *Cotylorhizoides punctatus* because of the striking porcelain-white spots which characterize this form.

I was at first inclined to consider this a new species until a reexamination of the type of *C. pacifica* showed otherwise; but

this leads to a very unpleasant situation exemplified by the two species of *Lobonema*, which will be discussed later.

The present description from living material has added many points not discernible in fixed material, such as the presence of an ocellus in the sense organ which fades out in formalin material, the remarkable coloration of the exumbrella, and the presence of the long, characteristic mouth-arm clubs which break off when the medusa is taken from the water.

Mayer (1915, p. 187), speaking of *Cotylorhiza pacifica*, says:

It differs from *Cotylorhiza tuberculata* in having no radial-muscles, and in the circular muscles being interrupted in the 8 principal radii. The sub-genital ostia and arm-disk are larger and the appendages of the mouth-arms smaller and fewer than in *C. tuberculata*. Moreover, the peculiar window-like openings in its mouth-arm membranes at once distinguish this species.

These distinctions are indeed of such a nature that if one felt so inclined a new genus could be established to receive this medusa. I believe, however, that its relationships will be more clearly indicated by placing it in the genus *Cotylorhiza*, within which it forms a well-marked species.

In view of the additional differences here brought out such as the presence of an exumbrellar sensory pit, an ocellus, a ring canal and the large, distinctive, mouth-arm clubs, it becomes necessary to erect a new genus to receive this very characteristic species which, while it resembles *Cotylorhiza* in certain points, differs from it very widely in many important characters. This resemblance I have indicated in the name *Cotylorhizoides*.

IMMATURE FORM OF COTYLORHIZOIDES PACIFICUS (FIG. 4)

A small medusa measuring in the specimens seen from 20 to 30 millimeters in diameter is present in small numbers in Manila Bay at irregular intervals. In its superficial appearance it resembles *Mastigias papua*, having the same brownish color of the bell and a terminal club on each mouth arm predominantly purple in color.

More careful examination shows it to agree in generic characters with *Cotylorhizoides*, and to differ from *Cotylorhiza pacifica* only in characters which might well be due to immaturity. The points in which it differs are the lack of the white spots which characterize the adult *Cotylorhiza pacifica* and the absence of the pedunculated clubs on the mouth arms.

The number and arrangement of the marginal lappets are those characteristic of *Cotylorhiza pacifica*; that is, in each octant, a pointed ocular lappet, two single velar lappets, two double velar lappets, two single velar lappets, and a single ocular

lappet, making ten in all if the individuals of the double lappets are counted.

The sense organ appears large and shows a distinct brown ocellus which does not fade in formalin as does that of the adult. The small but deep exumbrellar pit agrees with that of the adult *Cotylorhiza pacifica*.

The terminal mouth-arm clubs of the immature form are nearly as long as the mouth arms; these clubs are purple, except at the somewhat swollen, three-sided distal region, where they are frosty white.

That these are immature forms is shown by the absence of well-developed gonads, the small size, the large size of the sense organs and ocular lappets in proportion to the size of the velar lappets, and the fact that at the inner base of each mouth-arm pillar there is often found a portion of the original central mouth as yet unclosed.

SYSTEMATIC POSITION OF ANOMALORHIZA AND COTYLORHIZOIDES

The two new genera of *Rhizostomata dichotoma* here described but emphasize, as Mayer has already pointed out, that we are not dealing with a sharply defined group. He states (1910, p. 663):

There is no sharp line of demarkation between the *Rhizostomata dichotoma* with mouth-arms V-like in cross-section and the *Rhizostomata triptera* wherein the arms are Y-shaped in cross-section.

He points out that further means of differentiation are the strong radial and weak circular muscles and the absence of the ring canal in *Rhizostomata dichotoma*. In *Cotylorhizoides*, however, there are very strong circular muscles, no visible radial muscles, and a ring canal. The only characters left to place it among the *Rhizostomata dichotoma* are the division of the mouth arms and the arrangement of the mouths upon the mouth arms. A glance at fig. 4, which is a very true representation of the appearance of an immature specimen of this species, will show how strikingly it simulates the appearance of the *Rhizostomata triptera*, particularly *Mastigias* with which it is very apt to be confused.

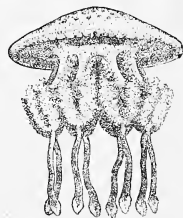

FIG. 4. Immature individual of *Cotylorhizoides pacifous* (Mayer). $\times 1$.

Indeed, a study of this species seems to show a much greater affinity to *Mastigias* with its club-shaped appendages terminating the mouth arms, its numerous anastomosing interradial canals, its large subgenital ostia, its ring

canal, and its circular muscles than to *Cotylorhiza* and the other genera of the *Rhizostomata dichotoma*.

Much more so is this true in the case of *Anomalorhiza*. Here even the branching of the mouth arms is difficult to homologize with the other *Rhizostomata dichotoma*, since they branch dichotomously only near the tip, and the axial canal is continued downward into the terminal club. Here also there are no other characters to place it with this group. On the other hand, however, it is equally hard to place it among the *Rhizostomata triptera* on the basis of its mouth arms. Indeed, it is because of this anomalous condition of the arms that I have given it the generic name *Anomalorhiza*.

Rhizostomata triptera Vanhöffen, sensu Maas, 1903

Genus *CATOSTYLUS* L. Agassiz, 1862

Catostylus purpurus Mayer.

Catostylus purpurus MAYER, Medusae of the World 3 (1910) 671, fig. 412; LIGHT, Philip. Journ. Sci. § D 9 (1914) 207; MAYER, Pub. Carnegie Inst. Washington 212 (1915) 187.

This is the commonest jellyfish of Manila Bay. Its bell, varying in color from deep brown to black through purple, is to be seen at practically all seasons of the year dotting the shallower waters of the bay and its tidal streams and creeks (esteros).

In a former note² I spoke of this medusa as not being capable of administering a sting of any severity. Statements on the part of bathers that the sting was severe when the mouth arms of the medusæ came into firm contact with the body led me to experiment on myself. I rubbed the mouth arms of a large specimen across the back of my wrist. There was no immediate severe stinging sensation as is the case with *Lobonema*, but it was more intense and of longer duration. I quote from my notes: "The area soon became very red and hot with a pronounced stinging and burning sensation. This was relieved somewhat by application of ammonia but much more so by powdered sodium bicarbonate. The relief was only temporary and numerous applications were necessary. Although the burning sensation passed away after a few hours the area was still sore some twelve hours later. About three hours after the sting the bones and joints began to ache as in dengue fever, and this was accompanied by a dull but persistent ache over the kidneys and a dull headache. After taking 10 grains of aspirin the symptoms were much alleviated."

² Philip. Journ. Sci. § B 3 (1908) 329.

One interesting thing noted about this medusa was its ability to free its nematocysts or its poison on being handled or moved about by the waves. This is particularly noticeable when specimens are lifted from the water and returned. Persons standing in the water within a radius of five feet experience a most unpleasant, but merely temporary, burning and itching sensation on those parts of the body at the surface even though covered with a bathing suit. I am told that when these forms are numerous bathing becomes unpleasant along the exposed water front, due to the release of this poison or the nematocysts by the medusæ which are beaten about in the surf.

IMMATURE FORMS

This species evidently completes its life cycle in the bay since very small forms are abundant at times. Several collected by Doctor Shaw in June, 1920, show interesting stages in development. The smallest of these is 7 millimeters in diameter. The central mouth is just closing, being closed at the center with the four corners still open. Three of the four corners of the mouth have begun to bifurcate forecasting the 8-armed condition of the adult. Along each side of the gutterlike furrows which represent the open portion of the mouth is a single row of tentacles.

The centripetal vessels are represented by but a single short, blind canal between each two radial canals and unconnected with either radial canal. In this stage *Catostylus* which in the adult condition has its centripetal vessels communicating with all 16 radial canals, and *Acromitus* which in the adult form has its centripetal vessels joining only with the 8 rhopalar, would probably be indistinguishable. However, in a specimen 13 millimeters in diameter, the centripetal vessels join the 8 adradial canals, while in *Acromitus* they join the 8 rhopalar canals and not the adradials. In specimens of 20 millimeters or more in diameter the centripetals anastomose with all the radial canals, as in the adult.

Genus MASTIGIAS L. Agassiz, 1862

Mastigias papua (Lesson) L. Agassiz.

Cephea papua LESSON, Voyage de la Coquille, Zooph. (1829) 122, pl. 11, figs. 2, 3.

Mastigias papua L. AGASSIZ, Cont. Nat. Hist. U. S. 4 (1862) 152; MAYER, Medusæ of the World 3 (1910) 678, fig. 415; LIGHT, Philip. Journ. Sci. § D 9 (1914) 209; MAYER, Pub. Carnegie Inst. Washington 212 (1915) 193.

This ubiquitous medusa of oriental waters is here reported from Manila Bay for the first time where it appears to be present

at frequent intervals but in small numbers. Two specimens collected by Doctor Shaw at Pasay beach in June, 1918, agreed with my description (1914).

Genus **LOBONEMA** Mayer, 1910

Lobonema mayeri Light.

Lobonema mayeri LIGHT, Philip. Journ. Sci. § D 9 (1914) 217, figs. 7-9.

This specific name was given in 1914 to a medusa common in Malampaya Sound, Palawan, in May, 1913, which differed in several important points from *L. smithii* as described by Mayer from Manila Bay in 1910. These differences combined with the different habitat seemed to make it certain that the two were distinctly different regional species, although I had not had the opportunity of examining specimens of *Lobonema* from Manila Bay.

On examining *Lobonema* from Manila Bay in 1918 I was greatly surprised to find that it agreed in all important details with my description of *L. mayeri* rather than with Mayer's *L. smithii* as I had expected.

The question at once arises, Are these the same species or separate ones? Unfortunately, this question cannot be answered until after a careful reëxamination of the type and comparison with specimens of *Lobonema mayeri*, and perhaps not definitely then.

I am inclined to believe, however, that the characters which seemed to mark *Lobonema smithii* as distinctly different from *L. mayeri* were due to a great extent to the condition of the material from which the diagnosis was made. Mayer's description was based on a "quadrant" of a perfect specimen, and two imperfect specimens. The chief outstanding difference between the two species was that *L. smithii* had but 8 sense organs while *L. mayeri* has from 12 to 16, usually about 14. This may be accounted for by Mayer's "quadrant" having been less than one-fourth of the entire medusa and also by its having been that part of the bell in which the sense organs were least numerous, for the distribution of sense organs is often unsymmetrical. In a number of specimens I have seen two sense organs nearly side by side, giving the appearance of having arisen by fission. This difference in the number of sense organs could not be due to the immaturity of Mayer's specimens since several specimens less than half as large as his showed 14 sense organs. While, therefore, I believe that *Lobonema smithii* and *L. mayeri* are probably the same species, or at most varieties, I have no scientific

basis for reducing *L. mayeri* and we must await a reëxamination of the type to settle this unpleasant tangle. It was to avoid another such situation that I refrained from giving a new specific name to our common Manila Bay *Cotylorhizoides*.

Lobonema mayeri is one of the commonest jellyfishes of Manila Bay, being present at intervals from May to September of every year, and perhaps at other times. It is the largest, most striking, and most beautiful jellyfish of the bay.

Its colors vary between wide limits. Some specimens are uniform opaque white; others show increasing amounts of pink and purple in gonads and mouth arms. The Manila Bay specimens never seem to reach the brilliance of color characteristic of those of Malampaya Sound. Several specimens were noted, however, in which the peripheral canal system was picked out in deep purplish blue.

The very thin stomach floor protrudes from the subgenital ostia in life. The tentacle-like lappets are entirely noncontractile. The bell is somewhat less than a hemisphere in relaxation, and considerably more than a hemisphere in contraction. The lappets undergo continuous beating movements due to the alternate contraction and relaxation of the bell. At complete relaxation they lie extended backward over the upper part of the mouth arms. On contraction of the bell they are drawn forward and inward, and on relaxation are thrown outward and finally come to rest extended backward as before.

The little Carangid fishes are always present in great numbers in and around these medusæ apparently suffering no harm from the heavily armed mouth-arm appendages. The mouth arms (in the region of the mouths, and mouth-arm filaments) are able to administer a most unpleasant but not serious sting. It raises a welt, white at first, later becoming red, which disappears in a short time, a few hours at the most. The arm clubs, which are rather large, are invisible in the water.

Lobonema smithii Mayer, 1910.

Lobonema smithii MAYER, Medusae of the World 3 (1910) 688, figs. 417, 418; Pub. Carnegie Inst. Washington 212 (1915) 196.

As stated above, this species was based on material from Manila Bay collected by the *Albatross*. Since then no specimens agreeing with Mayer's description have been found and it seems probable, for reasons given above, that there is a single species of *Lobonema*, *L. smithii*, the diagnosis of which would therefore be changed to admit the forms described by me under the name *L. mayeri*.

Rhizostomata lorifera Vanhöffen, 1888

Genus **THYSANOSTOMA** L. Agassiz, 1862**Thysanostoma thysanura** Haeckel.

Thysanostoma thysanura HAECKEL, System der Medusen (1880) 625, taf. 39, figs. 1-9. MAYER, Medusae of the World 3 (1910) 692, fig. 420; Pub. Carnegie Inst. Washington 212 (1915) 197.

This medusa is known from Manila Bay from two perfect specimens collected by Dr. Shaw, one in the summer of 1919, and the other in July of 1920. They agree closely with Mayer's description in "Medusae of the World."

ILLUSTRATIONS

[Drawings by M. Ligaya.]

TEXT FIGURES

- FIG. 1. A sense organ of *Anomalorhiza shawi* gen. et sp. nov., as seen from the subumbrellar side showing the subumbrellar shelf. $\times 6$.
2. A quadrant of *Anomalorhiza shawi* gen. et sp. nov. in subumbrellar view, showing canal system, subgenital ostium, etc. $\times 1$.
3. *Anomalorhiza shawi* gen. et sp. nov. $\times 0.5$. Two mouth arms have been cut away in front. (The specimen was very much relaxed and the bell is much deeper in life.)
4. Immature individual of *Cotylorhizoides pacificus* (Mayer). Natural size.



NEW PHILIPPINE MORACEAE

By ELMER D. MERRILL

Director and Botanist, Bureau of Science, Manila

The present paper consists chiefly of the descriptions of twenty-two presumably new species of Moraceae, although notes on a few previously described forms are included. Of the new species two belong in the genus *Artocarpus*, one in *Conocephalus*, one in *Cudrania*, and the remainder in the genus *Ficus*. *Artocarpus superba* Becc., previously known only from Borneo, is here recorded from Mindanao and Basilan, while the genus *Gymnartocarpus* is first credited to the Archipelago by the transfer to it of *Artocarpus woodii* Merr. *Ficus crininervia* Miq. is recorded for the first time from the Archipelago.

ARTOCARPUS Forster

ARTOCARPUS ACUMINATISSIMA sp. nov.

Arbor circiter 10 m alta, plus minusve hirsuta; foliis oblongis, chartaceis, integris vel sursum minute denticulatis, usque ad 35 cm longis, basi leviter cordatis, apice longissime tenuiter caudato-acuminatis, nervis utrinque circiter 20, subtus perspicuis; receptaculis laevis, ovoideis, saltem 3.5 cm diametro, anthocarpiis planis, indistinctis, seminibus subglobosis, circiter 1 cm diametro.

A tree, about 10 m high, the branchlets, petioles, and lower surfaces of the leaves distinctly hirsute with short, spreading, more or less scattered hairs. Branches dark-brown, glabrous, the ultimate ones 4 mm in diameter or less. Leaves oblong, equilateral, chartaceous, 30 to 35 cm long, 9 to 12 cm wide, entire, or distantly and minutely denticulate in the upper part, base rounded distinctly but slightly cordate, apex very long caudate-acuminate, the acumen up to 4 cm long, acute, the upper surface brown and shining when dry, glabrous except the more or less pubescent midrib; petioles about 1 cm long. Receptacles axillary, solitary, ovoid, at least 3.5 cm in diameter, the peduncles 6 to 7 cm long. Anthocarps numerous, but few maturing seeds, their tips plane, indistinct, less than 1 mm in diameter, forming a smooth fruit. Seeds subglobose, about 1 cm in diameter.

LUZON, Tayabas Province, Hinobaan, *For. Bur. 22777 DeMesa & Rosario*, September 28, 1913, in dense forests, altitude 240 meters, locally known as *cubi*.

A very characteristic species at once distinguished from all other Philippine forms by its vegetative characters and its ample, entire or but obscurely denticulate, long caudate-acuminate, equilateral leaves, which are cordate at the base and hirsute on the lower surface.

ARTOCARPUS PINNATISECTA sp. nov.

Arbor alta, ramulis stipulisque exceptis glabra; foliis circiter 50 cm longis, pinnatisectis, coriaceis, segmentis lanceolatis, acuminatis, circiter 20 cm longis; inflorescentiis ♂ cylindraceis, axillaribus, solitariis, circiter 10 cm longis, 3 cm diametro; stipulis coriaceis, 20 ad 26 cm longis, extus dense ciliato-villosis; fructibus cylindraceis.

A tall tree, glabrous except the younger parts and the stipules, the ultimate branchlets terete, very stout, 1.5 to 3 cm in diameter, dark reddish-brown, marked with prominent petiolar and stipular scars, ciliate-bearded below the petioles and stipules, otherwise glabrous. Leaves oblong to oblong-ovate in outline, about 50 cm long, nearly glabrous, coriaceous, pinnately divided into about 15 segments, the sinuses narrow, extending nearly or quite to the midrib, the segments lanceolate, entire, sharply acuminate, straight or somewhat falcate, ascending, about 20 cm long, 1.5 to 3 cm wide, the midrib and nerves somewhat pubescent; petioles very stout, 10 to 12 cm long; stipules lanceolate, coriaceous, 20 to 26 cm long, acuminate, inside brown and glabrous, outside rather densely ciliate-villous with long, rather soft, shining, brownish or grayish hairs. Staminate inflorescence axillary, solitary, cylindric, about 10 cm long, 3 cm in diameter, rounded at both ends, the peduncles stout, 3 to 4 cm long, glabrous or somewhat ciliate-villous. Immature fruits cylindric, about 15 cm long, 4 cm in diameter, the tips of the anthocarps ovoid, about 2 mm long and 1.5 mm wide, blunt, densely verruculose.

LUZON, Tayabas Province, Mount Cadig, *Bur. Sci. 20789 Escritor* (type), March 9, 1913; Camarines Province, Paracale, *Bur. Sci. 33536 Ramos & Edaña*. MINDANAO, Davao Subprovince, *For. Bur. 27751 Cruz*.

A very striking species in the group with *Artocarpus communis* Forst., characterized by its long, ciliate-villous stipules and especially by its pinnately divided leaves, the numerous, narrow, lanceolate segments, and the equally narrow sinuses which extend quite or nearly to the midrib.

ARTOCARPUS SUPERBA Becc. Nelle Foreste di Borneo (1902) 625.

MINDANAO, Zamboanga Subprovince, mountains back of Zamboanga, *Merrill 8280*, December 6, 1911, in forests, altitude about 400 meters; Port Banga, *For. Bur. 9164 Whitford & Hutchinson*.
BASILAN, *For. Bur. 3989 Hutchinson*.

A very interesting addition to the rather meager list of species known only from the Philippines and Borneo. Although the Mindanao specimens are sterile, there appears to be no doubt as to the identity of the Bornean and Philippine plants. So far as the material goes, it agrees with Beccari's description, and with specimens from Sarawak in the herbarium of the Bureau of Science, *Foxworthy 344*. The local name is given as *pikpikuag* (Sulu).

CONOCEPHALUS Blume

CONOCEPHALUS MOLLIS sp. nov.

Frutex scandens subtus foliis molliter pubescens; foliis oblongis, integris, late oblongis, usque ad 27 cm longis, basi rotundatis, apice acutis vel acuminatis, nervis utrinque circiter 15, subtus dense pubescens, supra cystolithis numerosissimis instructis; inflorescentiis ♂ diffusis, dichotomis, usque ad 27 cm latis, capitulis numerosis, 4- ad 6-floris.

A scandent shrub, the ultimate branches about 1.5 cm in diameter, the young branchlets, inflorescences, and especially the lower surfaces of the leaves softly pubescent. Leaves chartaceous, broadly oblong, about 27 cm long, 16 cm wide, entire, base rounded, apex acute to acuminate, dull, of the same color, and greenish-olivaceous on both surfaces when dry, the lower surface softly and densely pubescent, the upper surface uniformly and densely covered with cystoliths, the cystoliths scattered and radiate; lateral nerves about 15 on each side of the midrib, prominent; petioles about 8 cm long. Male inflorescences axillary, solitary, diffuse, repeatedly dichotomous, in anthesis up to 27 cm wide, short-peduncled, pubescent with scattered hairs, the very young ones with numerous, concave, imbricate, pubescent bracts about 1 cm in diameter. Male flowers numerous, all sessile, borne on the ultimate branchlets, usually a solitary sessile flower at the ultimate fork, with two lateral, peduncled heads of from 4 to 6 flowers each. Perianth about 1.7 mm long, 4-toothed or lobed. Stamens 4, about 2 mm long, the anthers erect in bud.

SAMAR, Ambalete, *Bur. Sci. 17582 Ramos*, April 7, 1914, in damp forests, the flowers white.

A very characteristic species, at once distinguished by its leaves being softly and densely pubescent on the lower surface,

the upper surface being densely and uniformly covered with radiate and scattered cystoliths; its very diffuse, repeatedly dichotomous male inflorescences; and the peculiar disposition of the flowers, a solitary sessile one at each ultimate fork, the others in small few-flowered heads.

CUDRANIA Trécul

CUDRANIA GRANDIFOLIA sp. nov.

Frutex scandens, glaber, vel ramulis junioribus leviter adpresse pubescens; foliis chartaceis vel subcoriaceis, ellipticis, usque ad 15 cm longis, breviter acuminatis, basi acutis ad rotundatis, nervis utrinque 6 ad 8, perspicuis; fructibus globosis, dissimiliter puberulis, in siccitate 1 ad 2 cm diametro.

A scandent glabrous shrub, or the younger branchlets sparingly appressed-pubescent. Branches terete, in the specimens examined unarmed, pale-brownish, shining, minutely lenticellate. Leaves chartaceous to subcoriaceous, elliptic, olivaceous, somewhat shining, the larger ones up to 15 cm long and 8 cm wide, the lower surface paler than the upper, apex rather prominently acuminate, the acumen often short, abrupt, base acute to rounded; lateral nerves 6 to 8 on each side of the midrib, prominent, curved-ascending, anastomosing, the reticulations distinct; petioles 1.5 to 2 cm long. Fruits globose, axillary, solitary or in pairs, when dry 1 to 2 cm in diameter, their peduncles 5 mm long or less, grayish-brown when dry, densely and uniformly puberulent.

MINDANAO, Surigao Province, Placer, Wenzel 1883, July 11, 1916, in forests, altitude about 150 meters.

A species manifestly allied to *Cudrania javanensis* Tréc., from which it is distinguished by its much larger leaves.

GYMNARTOCARPUS Boerlage

GYMNARTOCARPUS WOODII (Merr.) comb. nov.

Artocarpus woodii Merr. in Philip. Journ. Sci. 3 (1908) Bot. 221; Elm. Leaflet. Philip. Bot. 2 (1909) 623.

This species is manifestly referable to the genus *Gymnartocarpus*, in which it is here placed, and is very closely allied to the Javan *G. venenosa* (Zoll.) Boerl., the type of the genus.¹ In fact, a critical examination of a large series of Javan and Philippine specimens may show that the two species are identical. I have

¹ Ic. Bogor. 1 (1897) 73, t. 25, 26.

not only the descriptions and figures of *Gymnartocarpus venenosa* (Zoll.) Boerl., but also botanical specimens with immature capitula and with portions of a mature fruit, from specimens cultivated in the Botanical Garden at Buitenzorg. The Philippine material seems to differ constantly in its longer-peduncled capitula, its sharply acuminate leaves, not acuminate and retuse as in the Javan specimens. *Gymnartocarpus woodii* is represented by the following material:

LUZON, without definite locality, *Loher 6946*: Cagayan Province, *For. Bur. 6650 Klemme*: Zambales Province, *For. Bur. 6080 Aguilar*; *For. Bur. 6331 Curran*: Bataan Province, *For. Bur. 12942 Alvarez*, *For. Bur. 17584, 17599 Curran*: Laguna Province, *For. Bur. 11993, 15382 Tamesis*, *Bur. Sci. 12392 McGregor*, *For. Bur. 11652 Whitford*: Camarines Province, *Ahern 41, 281*. MINDORO, Mount Halcon, *Merrill 5557*, *For. Bur. 8763, 8783 Merritt*. LEYTE, *Bur. Sci. 15184 Ramos*. BUCAS, *Merrill 5259* (type).

The species is known in Laguna as *anubing-cagyos* and *anubing-na-nangca*; in Bataan as *malananca* and *sulipa*; in Zambales as *pongi*; and in Cagayan as *buratu*. There is no record that the sap is at all poisonous.

FICUS Linnaeus

FICUS ELLIPTIFOLIA sp. nov. § *Urostigma*.

Arbor circiter 15 m alta, ramulis receptaculisque exceptis glabra; foliis ellipticis, coriaceis, utrinque rotundatis, usque ad 12 cm longis, petiolatis, nervis utrinque circiter 7, subtus perspicuis; receptaculis axillaribus, sessilibus, solitariis, ebracteatis, ellipsoideis, 3.5 ad 4 cm longis, extus perspicue adpresse setoso-hirsutis.

A tree, nearly glabrous, the branches terete, wrinkled when dry, pale reddish-brown, glabrous, the branchlets more or less appressed-hirsute with stiff brownish hairs. Leaves alternate, elliptic, coriaceous, rather pale when dry, 9 to 12 cm long, 4.5 to 6 cm wide, entire, usually subequally rounded at both ends, or the base somewhat narrowed, the apex sometimes merely blunt; lateral nerves about 7 on each side of the midrib, prominent on the lower surface, looped-anastomosing, the ultimate reticulations rather dense; petioles 1.5 to 2.5 cm long. Receptacles axillary, solitary, sessile, ellipsoid, 3.5 to 4 cm long, about 2 cm in diameter, coarsely wrinkled when dry, umbilicus prominent at the apex, base somewhat narrowed, outside with appressed, brownish-yellow, shining, stiff, long, bristle-like hairs, the bracts none or very early deciduous.

MINDANAO, Zamboanga Subprovince, *Copeland s. n.*, *For. Bur.* 9309 *Whitford & Hutchinson* (type), January, 1908, in forests, altitude 30 meters.

A species manifestly closely allied to *Ficus cucurbitina* King of Borneo and Celebes, but with somewhat smaller fruits and very differently shaped leaves. A specimen from Mount Maquiling with smaller and bracteate fruits may prove to be the same species (*Villamil s. n.*).

FICUS HALLIERI sp. nov. § *Urostigma*.

Arbor alta, receptaculis exceptis glabra; foliis coriaceis, oblongis ad oblongo-ellipticis, laevis, usque ad 18 cm longis, acuminatis, integris, basi acutis vel subacutis, nervis utrinque circiter 12, subtus perspicuis; receptaculis axillaribus, solitariis vel binis, longe pedunculatis, globosis, extus plus minusve ferrugineo-hirsutis, circiter 3 cm diametro, basi 3-bracteatis, bracteis triangulari-ovatis, acutis, circiter 4 mm longis.

A tall tree, glabrous except the receptacles. Branches terete, pale or brownish when dry, much wrinkled, 3 to 6 mm in diameter. Leaves alternate, smooth, coriaceous, dark-brownish when dry, 13 to 18 cm long, 4 to 8 cm wide, oblong to oblong-elliptic, entire, rather prominently acuminate, base acute or subacute, obscurely 3-plinerved, the lateral nerves about 12 on each side of the midrib, prominent on the lower surface, spreading, anastomosing; petioles 2.5 to 3.5 cm long. Receptacles axillary, solitary or in pairs, globose, about 3 cm in diameter, brown, outside somewhat ferruginous-hirsute, the pubescence more or less deciduous; peduncles about 4 cm long, prominently ferruginous-pubescent, bearing at the apex three, pubescent, triangular-ovate, acute, about 4 mm-long bracts.

MINDANAO, Zamboanga Subprovince, San Ramon, *Hallier s. n.*, February, 1904; Surigao Province, *Bur. Sci.* 34357 *Ramos & Pascasio*.

This species has already been considered twice by Mr. Elmer² but not described, or at least only partly described. He refers to *Ficus hallieri* his No. 10142 from Negros, which I have not seen, and No. 11080 from Mindanao, which is probably identical with the type, although in our material the receptacles of the latter number are apparently quite glabrous. The species is manifestly in the *F. chrysolepis* group, but is readily recognizable by its globose, long-peduncled, more or less ferruginous-pubescent receptacles.

² Leaf. Philip. Bot. 2 (1909) 536; 4 (1911) 1243.

FIGUS BALETE sp. nov. § *Urostigma*.

Arbor glabra, usque ad 15 m alta; foliis alternis, crasse coriaceis, ellipticis ad oblongis vel obovato-oblongis, integris, apice breviter late obtuseque acuminatis, basi acutis ad rotundatis, petiolatis, nervis primariis utrinque circiter 12 quam secundariis vix magis distinctioribus; receptaculis axillaribus, solitariis, pedunculatis, oblongo-ovoideis ad ellipsoideis, glabris, circiter 1.5 cm longis, bracteis 3, perspicuis, late ovatis, obtusis, patulis, circiter 6 mm longis.

A glabrous tree, starting as an epiphyte and soon strangling its host, reaching a height of about 15 m, the branches terete, yellowish-brown, wrinkled, the ultimate ones about 5 mm in diameter, marked with scars of fallen petioles and stipules. Leaves alternate, thickly coriaceous, 7 to 13 cm long, 3 to 6 cm wide, elliptic to oblong-elliptic or oblong-obovate, brownish or olivaceous when dry, somewhat shining, entire, the apex shortly, broadly, and obtusely acuminate, the base acute to rounded, somewhat 3-plinerved; primary lateral nerves about 12 on each side of the midrib, rather prominent but scarcely more distinct than are the secondary nerves, the reticulations distinct, all anastomosing in a submarginal nerve; petioles 1.5 to 2.5 cm long; stipules lanceolate, acuminate, coriaceous, brown, 2.5 cm long. Receptacles axillary, solitary, glabrous, red when mature, but little wrinkled, hard, oblong-ovoid to ellipsoid, rounded at the apex, 1.5 to 1.8 cm long, 1 to 1.3 cm in diameter, the base with three, broadly ovate, obtuse, coriaceous, persistent, spreading, brown, glabrous bracts about 6 mm long, the peduncles about 8 mm long.

LUZON, Zambales Province, *Merrill 2931*, May, 1903, *Hallier s. n.*: Rizal Province, Antipolo, *Merrill 1732*, March, 1903, *Bur. Sci. 22246 Ramos*: Laguna Province, Mount Maquiling, *For. Bur. 26449 Catalan*, *For. Bur. 20124 Forestry School*, March, 1913, *Elmer 18266*: Tayabas Province, Guinayangan, *Merrill 2033 (type)*, 2041, April, 1903, *Bur. Sci. 20869 Escritor*, March, 1913, *Bur. Sci. 26878 Edaño*: Camarines Province, *Ahern 193*, 23. MINDORO, *For. Bur. 8535 Merritt*, January, 1908. PANAY, *Copeland 131*, January, 1904, *Bur. Sci. 31516 Ramos & Edaño*.

A species, widely distributed in the northern Philippines at low altitudes, well characterized by its medium-sized, short-peduncled receptacles which have three prominent, spreading bracts at the base. It is commonly known as *balete*, but this native name is applied to many other species of the section *Urostigma*.

FICUS LAMAOENSIS sp. nov. § *Urostigma*.

Arbor alta, glabra; foliis coriaceis, oblongis ad oblongo-ellipticis, petiolatis, laevis, usque ad 18 cm longis, late breviter obtuseque acuminatis, basi subacutis ad rotundatis, nervis utrinque circiter 9, distinctis; receptaculis globosis, sessilibus, circiter 1 cm diametro, basi 3-bracteatis.

A tall tree, quite glabrous, reaching a height of at least 25 m, the branches terete, grayish or reddish-brown when dry, wrinkled, 4 to 5 mm in diameter. Leaves alternate, oblong to oblong-elliptic, coriaceous, 12 to 18 cm long, 5 to 7 cm wide, entire, apex shortly, broadly, and obtusely acuminate, base subacute to rounded; lateral nerves about 9 on each side of the midrib, prominent on the lower surface, anastomosing, the reticulations distinct; petioles 2.5 to 3 cm long. Receptacles axillary, solitary, sessile, globose, orange-yellow when mature, about 1 cm in diameter, the basal bracts three, broadly ovate, about 3 mm long.

LUZON, Bataan Province, Lamao River, *For. Bur. 2483* (type), 2369 Borden, January, 1905, *For. Bur. 2316 Meyer*, December, 1904, on forested ridges, altitude about 200 meters.

A species in the group with *Ficus benjamina* Linn., but with larger leaves and receptacles and strongly differentiated nerves, the primary ones being distant and much more prominent than are the reticulations.

FICUS BRUNNEA sp. nov. § *Synoecia*.

Frutex glaber 2 ad 3 m altus; foliis chartaceis vel subcoriaceis, in siccitate brunneis, lanceolatis ad oblongo-lanceolatis, usque ad 13 cm longis et 2.5 cm latis, integris, utrinque subaequaliter angustatis, apice acuminatis, basi acutis, nervis utrinque 9 ad 16; receptaculis axillaribus, globosis, laevis, breviter pedicellatis, circiter 1 cm diametro.

A glabrous shrub, 2 to 3 m high, the branches terete, pale brownish-gray, slender, smooth. Leaves alternate, lanceolate to oblong-lanceolate, 5 to 13 cm long, 1 to 2.5 cm wide, subequally narrowed to the acute base and to the acuminate apex, entire, smooth, glabrous, brownish and of about the same color on both surfaces and slightly shining when dry, chartaceous to subcoriaceous; lateral nerves 9 to 16 on each side of the midrib, distant, spreading, not very prominent, anastomosing, the reticulations obscure; petioles 5 to 12 cm long; stipules lanceolate or linear-lanceolate, acuminate, about 1 cm long. Receptacles axillary, solitary, globose, smooth, about 1 cm in diameter, the

peduncles about 3 mm long, stout, thickened upward, and with three broadly ovate-subreniform bracts at the apex about 1.2 mm in length. Male flowers only near the orifice; stamens 1, the anthers 0.8 mm long. Gall flowers numerous, sessile to pedicelled, the ovaries ellipsoid, 1.2 to 1.5 mm long when mature.

SAMAR, Yabong, *Phil. Pl. 1605 Ramos*, April, 1914, on forested slopes; Catubig River, *Bur. Sci. 24338 Ramos*, March, 1916.

A species characterized by its brownish, rather narrow leaves which are subequally and gradually narrowed at both ends. It remotely resembles *Ficus philippinensis* Miq., but is entirely distinct from that species.

FICUS APPENDICULATA sp. nov. § *Covellia*.

Arbor usque ad 10 m alta, glabra; foliis alternis, chartaceis, ellipticis ad oblongo-obovatis, 10 ad 20 cm longis, basi rotundatis ad acutis admodum plus minusve inaequalateralibus, apice acuminatis, nervis utrinque 8 ad 10, conspicuis; inflorescentiis caulinis, e tuberculis magnis usque ad 3 cm diametro, vel ramosis, ramis paucis vel numerosis, crassis, usque ad 4 cm longis, cicatricibus magnis instructis; receptaculis numerosis, obovoideis ad depresso-globosis, in siccitate usque ad 2.5 cm diametro, pedunculatis, partibus superioribus bracteis 3 perspicuis, distantibus triangulariter dispositis instructis.

A tree, up to 10 m high, glabrous or nearly so throughout. Leaves alternate, chartaceous, elliptic to oblong or somewhat oblong-obovate, usually brownish when dry, 10 to 20 cm long, 4 to 10 cm wide, the base broadly rounded to acute, sometimes more or less inequilateral, the apex rather distinctly acuminate, the margins entire to undulate or obscurely and irregularly toothed; lateral nerves 8 to 10 on each side of the midrib, conspicuous; petioles 1.5 to 3 cm long; stipules lanceolate, acuminate, deciduous, about 1.5 cm long. Inflorescences cauline and on the larger branches, the receptacles numerous, green, borne on very large, stout tubercles up to 3 cm in diameter or the inflorescences composed of few to many, very stout branches up to 4 cm in length, these marked with numerous large conspicuous scars of fallen peduncles. Receptacles numerous, obovoid to depressed-globose, when young somewhat pubescent, glabrous at maturity, brown, conspicuously rugose when dry and up to 2.5 cm in diameter, when fresh green and apparently about 4 cm in diameter, the apical portion with a conspicuous triangular area varying from 1 to 2 cm in diameter and marked by the coriaceous, somewhat spreading, broadly triangular bractlike appendages

at the corners of the triangle, these appendages quite distinct from the areolar bracts; peduncles up to 2.5 cm long, each supplied at the apex with 3 triangular-ovate, acute bracts about 3 mm long. Fertile female flowers only in one set of receptacles, numerous, their pedicels up to 2 mm long; ovary obovoid, inequilateral, about 1.5 mm long; style about as long as the ovary. Male flowers only near the orifice in certain receptacles, about 2.5 mm long, their perianth segments obovate to oblong-obovate, about 1.5 mm in length.

SAMAR, Catubig River, *Sablaya 1* (type), *Bur. Sci. 24429 Ramos*, February and March, 1916. MINDANAO, Surigao Province, *Bur. Sci. 34465 Ramos & Pascasio*, April 29, 1919, in damp forests at low altitudes, known to the Visayans of Samar as *tuyokay na digtoy* and as *tubog*.

A species of the section *Covellia* well characterized by its large, cauline tubercles or the very stout, short, prominently scarred branches of the infructescence and especially by bractlike appendages on the upper part of the receptacles, these forming a conspicuous triangular area surrounding but distinct from the apical areola.

FICUS MIRABILIS sp. nov. § *Covellia*.

Arbor parva, partibus junioribus plus minusve ciliato-hirsutis; foliis alternis, obovatis, usque ad 18 cm longis, scabris, brevissime acuminatis, basi angustatis, obtusis; inflorescentiis in ramis specialibus, simplicibus, e trunco oriundis, usque ad 3.3 m longis; receptaculis paucis, solitariis, depresso-globosis, 1.5 ad 2 cm diametro, sessilibus, extus perspicue brunneo-ciliato-setosis.

A small tree, the younger parts more or less ciliate-hirsute with stiff, dark-brown, long, straight hairs. Branches terete, more or less ciliate-hirsute, the younger parts rather densely so. Leaves alternate, obovate, 15 to 18 cm long, 7 to 9 cm wide, scabrid on both surfaces, slightly hirsute, becoming nearly glabrous, shortly and sharply acuminate, margins subentire or entire, base narrowed, obtuse, the lower surface punctulate, paler than the upper; lateral nerves about 6 on each side of the midrib, prominent on the lower surface; petioles 1 to 1.5 cm long, brown-ciliate; stipules oblong, 1.5 cm long, chartaceous. Inflorescence from the trunk, simple, greatly elongated, either pendulous or spreading on the ground from the base of the tree, emitting rootlets, the whole inflorescence up to 3.3 m long, brown, terete, 5 mm in diameter, the younger parts with scattered, stiff,

brown hairs and with numerous, chartaceous, ovate, obtuse, brown-setose bracts 1 cm long or less. Receptacles few and only near the end of the inflorescence, depressed-globose, sessile, 1.5 to 2 cm in diameter, covered with brown, stiff, shining, elongated hairs.

LUZON, Laguna Province, San Antonio, *Bur. Sci.* 20395 Ramos, February, 1913 (type): Camarines Province, Paracale, *Bur. Sci.* 33490 Ramos & Edaña, December, 1918: Bontoc Subprovince, *Vanoverbergh* 3970, 1354.

A species to be compared with *Ficus geocarpa* Teysm., remarkable for its elongated, unbranched, specialized infructescences which spread on the ground from the base of the trunks. In vegetative characters it is very distinct from Teysmann's species as figured by King.

FICUS CONFERTIFOLIA sp. nov. § *Eusyce*.

Frutex erectus, circiter 3 m altus, glaberrimus, multiramis; foliis confertis, coriaceis, oblongis ad oblongo-ovatis, integris, usque ad 3.5 cm longis, in siccitate pallidis, acutis vel leviter acuminatis, basi acutis, triplinerviis, nervis utrinque 4 ad 6, subtus brunneo-puncticulatis; receptaculis axillaribus, pedunculatis, ovoideis, circiter 6 mm diametro; floribus ♂ diandris.

An erect, entirely glabrous, much-branched shrub about 3 m high, the branches and branchlets stiff, terete, reddish-brown, the bark somewhat papery, the ultimate branchlets somewhat fastigate. Leaves numerous, crowded on the ultimate branchlets, oblong to oblong-ovate, coriaceous, brittle, 2 to 3.5 cm long, 1 to 1.7 cm wide, entire, brown when dry, slightly shining, apex acute or slightly acuminate, base acute, distinctly 3-plinerved, the primary lateral nerves above the basal pair 4 to 6, slender, spreading, anastomosing, the lower surface brown-punctulate; petioles 3 to 5 mm long. Receptacles axillary, solitary, ovoid, smooth, brown when dry, about 6 mm in diameter, their peduncles up to 9 mm in length, 3-bracteate at the apex, the bracts small, ovate. Staminate and gall flowers in the same receptacle, both numerous. Staminate flowers pedicellate, the pedicels up to 1.2 mm long, with a conspicuous, ovate, acuminate, 1 mm-long bracteole; perianth segments usually 3, brown, ovate, acuminate, 1 to 1.2 mm long; stamens two, the anthers about 1 mm long. Gall flowers: perianth segments lanceolate, acuminate, somewhat curved, 1.3 mm long, brown; ovary somewhat obovoid, 1.2 mm long; style slender, sublateral.

LUZON, Nueva Ecija Province, Mount Umingan, *Bur. Sci.* 26307 Ramos & Edaña, August 22, 1916, in the mossy forest, altitude apparently about 1,000 meters.

This very characteristic species is manifestly allied to *Ficus formosana* Maxim., from which it is distinguished by its numerous, subfastigiâte branchlets, and much smaller, coriaceous, fewer-nerved leaves.

FICUS SAMARENSIS sp. nov. § *Eusyce*.

Frutex scandens, partibus junioribus et subtus foliis ad costa nervisque et petiolis ferrugineo-villosis; foliis ovatis ad oblongo-ovatis, coriaceis, usque ad 15 cm longis, tenuiter acuminatis, basi rotundatis, integris, in siccitate brunneis, supra glabris; receptaculis globosis, sessilibus, 6 ad 8 mm diametro, extus parcissime pubescentibus vel glabris.

A scandent shrub, the younger parts, petioles, and leaves on the midrib and lateral nerves beneath more or less subappressed ferruginous-villous. Branches brown, terete, glabrous. Leaves alternate, ovate to oblong-ovate, coriaceous, 8 to 15 cm long, 4 to 6 cm wide, brown when dry, the upper surface glabrous, somewhat shining, the lower surface ferruginous-villous on the midrib and lateral nerves, with much shorter hairs on the reticulations, the apex rather slenderly and sharply acuminate, base rounded; lateral nerves about 6 on each side of the midrib, very prominent on the lower surface, anastomosing; petioles 7 to 14 mm long. Receptacles axillary, somewhat fascicled, sessile, globose or subglobose, 6 to 8 mm in diameter, brown when dry, glabrous or with very few short hairs, each subtended by three, broadly ovate, brown, 1.5 to 2 mm-long bracts. Fertile female flowers numerous, the ovaries oblong-elliptic, about 1.2 mm long; styles terminal, up to 1 mm in length, ovary and style pale in contrast to the brown segments which are oblong and about 1.5 mm in length.

SAMAR, Yabong, *Phil. Pl.* 1606 Ramos (type), March 18, 1914, in damp forests. The collector notes that the fruits also grow on the main stems of the plant. CATANDUANES, *Bur. Sci.* 30290 Ramos.

A species very closely allied to *Ficus lanata* Blume, but with somewhat larger leaves which are not uniformly and densely villous beneath, and sessile, not peduncled fruits. Among the Philippine species it is very close to *Ficus propinqua* Merr., but is less villous and has smaller fruits; from *Ficus ramosii*

Merr., it is entirely different in its indumentum, although in other characters quite similar to this species.

FIGUS AHERNII sp. nov. § *Eusyce*.

Frutex scandens, *F. obtusae* Hassk. affine; foliis ovatis ad elliptico-ovatis, usque ad 10 cm longis, apice obtusis vel rotundatis, basi cordatis, margine integris, supra scabris, subtus pubescentibus, nervis utrinque 4 vel 5; receptaculis axillaribus, solitariis, globosis, pedunculatis, circiter 1.5 cm diametro, glabris vel subglabris, bracteis circiter 2 mm longis.

A scandent shrub, the younger parts more or less densely pubescent; branches terete, dark-colored when dry, glabrous, striate, the branchlets densely ferruginous-pubescent; leaves alternate, ovate to elliptic-ovate, coriaceous, entire, 7 to 10 cm long, 4 to 8 cm wide, the apex broadly rounded or obtuse, base distinctly cordate, sometimes merely subtruncate, the upper surface rather pale, scabrid, the lower somewhat similar in color but rather densely pubescent; lateral nerves 4 or 5 on each side of the midrib, prominent; petioles densely brown-pubescent, 1 to 2.5 cm long. Receptacles axillary, solitary, peduncled, globose, glabrous or nearly so, about 1.5 cm in diameter, containing only fertile female flowers so far as examined, the peduncles about 1 cm long, pubescent, bearing at their apices three small, ovate, 2 mm-long bracts.

LUZON, Rizal Province, Bosoboso, *For. Bur. 3104 Ahern's collector*, May, 1908 (type): Sorsogon Province, *Elmer 17022, 14406*. BILIRAN, *Bur. Sci. 18639 McGregor*. SAMAR, *Bur. Sci. 17512, 17568 Ramos*.

This species is manifestly very closely allied to the Malayan *Ficus obtusa* Hassk. It differs from our Javan material (*Koorders 38836*) in its receptacles being glabrous or nearly so, not densely ferruginous-pubescent, and in its much smaller bracts and longer peduncles. It is named in honor of Major G. P. Ahern, formerly Director of the Bureau of Forestry.

FIGUS OBTUSA Hassk. *Cat. Hort. Bogor.* (1844) 75; King in *Ann. Bot. Gard. Calcutta* 1 (1888) 130, *t. 163*.

LUZON, Laguna Province, Mount Maquiling, *For. Bur. 26749 Mabesa, For. Bur. 20212 Villamil*, February, 1917, and May, 1913. In forests, ascending to 400 meters.

A species widely distributed in the Malay Peninsula and Archipelago, but not previously recorded from the Philippines. The specimens agree with the description and with our Javan material representing it. *Ficus ahernii* Merr., is closely allied.

FIGUS EDAÑOI sp. nov. § *Eusyce*.

Frutex suberectus, ramulis junioribus leviter pubescens, cortex tenuiter papyraceis, deciduis; foliis subcoriaceis, oblongis, 5 ad 9 cm longis, obtusis, basi obtusis et plerumque leviter cordatis vel auriculatis, nervis utrinque 6 ad 8, perspicuis, brunneo-glandulosus vel punctatis; receptaculis solitariis, pedunculatis, ovoideis, glabris, circiter 8 mm longis, pedunculo 10 ad 12 mm longo, bracteis apicalibus 3, triangulari-ovatis, acuminatis, 1.5 mm longis.

An erect or spreading shrub, the young branchlets and pedicels somewhat pubescent, otherwise glabrous, the branches and branchlets terete, the bark thin, papery, the outer layers loose, soon becoming detached in thin flakes. Leaves subcoriaceous, oblong, 5 to 9 cm long, 2 to 3.5 cm wide, rather pale when dry, the apex obtuse, base obtuse and usually slightly cordate or auriculate, the margins entire or obscurely undulate, both surfaces smooth, the nerves 6 to 8 on each side of the midrib, brown in contrast to the pale lower surface, conspicuous, anastomosing, the reticulations distinct, under a lens distinctly brown-glandular or punctate; petioles 5 to 8 mm long; stipules deciduous, linear-lanceolate, slenderly acuminate up to 12 mm long. Receptacles axillary, solitary, ovoid, glabrous, about 8 mm long, brown when dry, their peduncles 10 to 12 mm in length, somewhat pubescent, supplied at the apex with three, triangular-ovate, acuminate, slightly pubescent bracts, about 1.5 mm long.

LUZON, Tayabas Province, near Mount Tulaog, *Bur. Sci.* 29130 Ramos & Edaño, May 23, 1917, spreading on rocks near the sea.

The alliance of this species is apparently with *Ficus mearnsii* Merr., from which it differs notably in its entirely differently shaped leaves.

FIGUS HAGGERI sp. nov. § *Eusyce*.

Arbor circiter 20 m alta, glabra vel foliis minute scaberulis; foliis ovatis ad late elliptico-ovatis, leviter inaequilateralibus, usque ad 20 cm longis, integris breviter acuminatis, basi leviter oblique cordatis, nervis utrinque circiter 8; receptaculis axillaribus et e axillis defoliatis, solitariis vel binis, pedunculatis, globosis, circiter 1 cm diametro, glabris vel minute scaberulis, basi 3-bracteatis.

A tree, about 20 m high, quite glabrous, or the branchlets and leaves minutely scaberulous. Branches rather slender, terete, reddish-brown. Leaves alternate, ovate to broadly elliptic-ovate, 18 to 20 cm long, 9 to 12 cm wide, entire, apex somewhat acumin-

ate, base somewhat inequilateral and distinctly obliquely cordate, margins entire, when dry both surfaces pale, the upper somewhat shining; lateral nerves about 8 on each side of the midrib, prominent on the lower surface, the reticulations distinct; petioles 1.5 to 2 cm long. Receptacles axillary and in the axils of fallen leaves, solitary and in pairs, globose, pale when dry, glabrous or minutely scabrid, about 1 cm in diameter, the peduncles 6 to 8 mm long bearing three small bracts near the apex; fertile female flowers only observed.

LUZON, Tayabas Province, Guinayangan, *Merrill 2009*, collected by E. Hagger, March 28, 1903, in flat forests along Danlagan River, locally known as *opli*: Laguna Province, Mount Maquiling, *For. Bur. 26036 Mabesa*. LEYTE, *Wenzel 1230*.

A species best recognized by its broad, slightly obliquely cordate leaves which are nearly glabrous or only minutely scabrid. Its alliances are not clear to me.

FICUS SARGENTII sp. nov. § *Sycidium*.

Arbor 6 ad 7 m alta, ramulis et petiolis et foliis utrinque perspicue hispidis; foliis alternis, subcoriaceis, oblongo-ellipticis, 25 ad 30 cm longis, acuminatis, basi late rotundatis, leviter cordatis, distincte inaequilateralibus, nervis utrinque circiter 8, perspicuis; inflorescentiis caulinis, receptaculis e tuberculis parvis vel in ramis crassis confertis dispositis, ramis usque ad 3 cm longis, et 5 ad 11 mm diametro, cicatricibus magnis instructis; receptaculis obovoideis, hispidis, 1 ad 1.4 cm diametro, pedunculo usque ad 12 mm longo.

A tree 6 to 7 m high, the branchlets, petioles and leaves on both surfaces conspicuously hispid. Leaves alternate, subcoriaceous, oblong-elliptic, 25 to 30 cm long, about 15 cm wide, harsh, brittle, the apex somewhat acuminate, base broad, rounded, shallowly cordate, distinctly inequilateral, the margins entire or obscurely toothed; lateral nerves about 8 on each side of the midrib; petioles 2 to 2.5 cm long. Inflorescences cauline, the receptacles from small and unbranched tubercles about 1 cm long or from more or less coarsely branched infructescences up to 3 cm long, the branches short, crowded, very stout, 5 to 10 mm in diameter. Receptacles yellow, obovoid, hispid, 1 to 1.4 cm in diameter, their peduncles up to 12 mm long with 1 or more bracts at the base. Fertile female flowers only observed, these numerous, their ovaries oblong-obovoid, 1 mm long; style about as long as the ovary; subtending bracteoles numerous, oblong-obovate to spatulate, about 2 mm long.

SAMAR, Catubig River, *Sablaya 10*, March 13, 1916, in damp forests at low altitudes; collected for the Arnold Arboretum.

This species is well characterized by its ample, harsh, inequilateral, alternate leaves and its cauline inflorescences. It distinctly resembles *Ficus heteropoda* Miq., from which I am of the opinion that *F. decussata* Warb. and *F. anomala* Merr. are not to be distinguished; the present species is easily distinguished from Miquel's by its alternate leaves which are further different in shape and have much shorter petioles.

FICUS SPARSIFOLIA sp. nov. § *Sycidium*.

Frutex erectus, ramis ramulisque teretibus, tenuibus, glabris; foliis alternis, utrinque scaberulis, lanceolatis ad oblongo-lanceolatis, firmiter chartaceis, usque ad 9 cm longis, perspicue acuminatis, integris, vel obscure undulatis vel interdum basi unilateraliter hastatis, basi plerumque acutis, inaequilateralibus, nervis utrinque circiter 7 perspicuis, anastomosantibus; receptaculis in axillis superioribus minute bibracteatis, solitariis, ovoideis, minutissime scaberulis, circiter 1.5 cm longis, pedunculatis, osteoli bracteolis perspicuis, lanceolatis, acuminatis, erectis, 2.5 ad 3 mm longis, ciliato-hispidis; perigonii laciniis pallidis, glabris, lanceolatis, acuminatis, 2.5 ad 3.5 mm longis.

An erect, branched shrub, 1 m high or more, the branches and branchlets slender, terete, grayish or reddish-brown, glabrous, smooth. Leaves alternate, firmly chartaceous, pale-olivaceous, shining, scaberulous on both surfaces, lanceolate to oblong-lanceolate, 5 to 9 m long, 1 to 1.5 cm wide, prominently and slenderly acuminate, often caudate-acuminate, base usually slightly inequilateral and acute, sometimes prominently hastate on one side and acute on the other, the margins entire or obscurely undulate; lateral nerves about 7 on each side of the midrib, prominent, curved, anastomosing, irregular, the primary reticulations distinct; petioles slender, minutely scabrid, about 5 mm long. Receptacles in the uppermost axils, solitary, ovoid, green, about 1.5 cm in diameter, minutely scabrid, the ostiole surrounded by numerous, erect, lanceolate, acuminate, 2.5 to 3 mm-long, ciliate-hispid bracteoles; peduncles slender, minutely scabrid, about 8 mm long, with two or three small, scattered bracts. Staminate flowers few and only near the ostiole, monandrous, the perianth segments 4, membranaceous, pale, lanceolate, acuminate, 2 to 2.5 mm long, glabrous; anthers 1 mm long. Gall flowers numerous, pedicellate, the pedicels 1.2 mm long, sparingly hispid;

perianth segments 4, pale, membranaceous, lanceolate, acuminate, glabrous, 2.5 to 3.5 mm long. Ovary ovoid-ellipsoid, 1.5 mm in diameter; style lateral, brown, 0.7 mm long.

LUZON, Nueva Ecija Province, Mount Umingan, *Bur. Sci.* 26492 Ramos & Edaña, August 3, 1916, in thickets along small streams at low altitudes.

This characteristic species in many respects resembles *Ficus cumingii* Miq., but is distinguished by its smaller, fewer-nerved, alternate leaves and its very conspicuous erect bracteoles about the ostiole. From *Ficus blepharostoma* Warb. it is distinguished by its very differently shaped, much smaller leaves.

FICUS LINEARIS sp. nov. § *Sycidium*.

Frutex circiter 1 m altus, glaber; foliis linearis vel lineari-lanceolatis, usque ad 10 cm longis et 1 cm latis, rectis vel leviter falcatis, tenuiter acuminatis, laevis, nervis obscuris; receptaculis axillaribus, pedicellatis, depresso-globosis, circiter 1 cm diametro, plus minusve angulatis, extus lenticellatis.

A shrub, about 1 m high, entirely glabrous. Branches terete, reddish-brown, smooth, very slightly wrinkled when dry. Leaves alternate, chartaceous or subcoriaceous, linear or linear-lanceolate, 5 to 10 cm long, 0.5 to 1 cm wide, straight or somewhat falcate, entire, smooth, shining, the apex slenderly acuminate, the base acute or cuneate, subequally narrowed at both ends, lower surface punctulate; lateral nerves obscure, 10 to 15 on each side of the midrib, obscurely anastomosing, the reticulations obsolete or nearly so; petioles 3 to 5 mm long; stipules lanceolate, acuminate, brown up to 1.5 cm long, deciduous. Receptacles axillary, solitary or in pairs, peduncled, depressed-globose, longitudinally ridged or angled, lenticellate, about 1 cm in diameter, glabrous, the peduncles up to 6 mm in length. Fertile female flowers numerous, sessile or pedicelled, the pedicels up to 1 mm in length; ovary obovoid, 1 to 1.2 mm long; segments very greatly reduced; styles 1 to 1.2 mm long, lateral, sparingly hirsute. Gall and male flowers not seen.

SAMAR, along streams, *Bur. Sci.* 17433 Ramos, April 22, 1914.

A species well characterized by its very narrow, linear or linear-lanceolate leaves. It is manifestly in the same group with *Ficus leucantatoma* Poir., *F. hawaii* Blanco, etc., and has the same type of angled or ridged fruits as those species; it is, however, remarkably distinct in its vegetative characters.

FICUS FENICIS sp. nov.

Frutex rigidus, scandens, ramis laevis, ramulis hispidis; foliis alternis, plerumque oblongo-ovatis, coriaceis, rigidis, utrinque perspicue scabridis, integris, 2.5 ad 7 cm longis, obtusis, basi late rotundatis vel leviter cordatis, admodum leviter inaequilateralibus, nervis utrinque 7, distinctis, patulis; receptaculis axillaribus, solitariis, subglobosis, hispido-hirsutus, breviter pedunculatis, 5 ad 6 mm diametro.

A rigid, more or less climbing, much-branched shrub, growing over rocks and cliffs, the branches pale, terete, smooth, the branchlets hispid with short spreading hairs. Leaves alternate, mostly oblong-ovate, coriaceous, rigid, conspicuously scabrid on both surfaces, pale green when dry, entire, 2.5 to 7 cm long, 1.5 to 3.5 cm wide, apex acute to obtuse, the base broad, rounded, or somewhat cordate, often slightly inequilateral; lateral nerves about 7 on each side of the midrib, distinct, spreading, anastomosing, the reticulations rather conspicuous; petioles 3 to 5 mm long, densely hirsute or scabrid when young; stipules 3 to 4 mm long. Receptacles (immature) axillary, solitary, subglobose, 5 to 6 mm in diameter, hispid-hirsute, their peduncles about 2 mm long, subtended by 2 or 3 membranaceous, broadly ovate bracts.

MINDANAO, Bukidnon Province, near Tankulan, *Bur. Sci.* 26097 *Fénix*, July 13, 1916, scandent over rocks on open hillsides.

In habit and general appearance this species strikingly resembles *Ficus tinctoria* Forst., from which it is at once distinguishable by its conspicuously scabrid leaves, those of Forster's species being very smooth.

FICUS MULTISTIPULARIS sp. nov.

Frutex erectus, partibus junioribus leviter adpresse hirsutis; foliis confertis, chartaceis ad subcoriaceis, oblongo-obovatis, integris, usque ad 28 cm longis, apice abrupte et perspicue acuminatis, deorsum angustatis, basi obtusis, saepe inaequilateralibus, glabris, laevis, nervis utrinque 4 ad 6, adscendentibus, perspicuis; stipulis numerosis, persistentibus, oblongo-ovatis, acuminatis, 2 ad 2.5 cm longis, extus adpresse pubescentibus; receptaculis breviter pedicellatis, axillaribus, solitariis, circiter 12 mm longis, ellipsoideo-ovoideis parce hirsutis.

An erect shrub, about 2 m high *fide* Ramos, the younger parts sparingly hirsute, the backs of the conspicuous persistent stipules densely so. Branches terete, brown, glabrous, about 8 mm in diameter. Leaves opposite, crowded at the apices of the branchlets, firmly chartaceous to subcoriaceous, when dry pale-brownish

above and brown beneath, smooth, glabrous, or the midrib and nerves beneath with a very few appressed hairs, oblong-obovate, often narrowly so, 17 to 28 cm long, 5 to 9 cm wide, entire, the apex abruptly but conspicuously acuminate, the acumen about 1 cm long, blunt, narrowed from the upper three-fourths to the obtuse base, the base 1 to 1.5 cm wide, often inequilateral, sometimes rounded-obtuse on one side and acute on the other; lateral nerves 4 to 6 on each side of the midrib, prominent, ascending, the reticulations distinct, rather close, punctate on the lower surface; petioles 1.5 to 3 cm long, glabrous; stipules numerous, conspicuous, oblong-ovate, persistent, densely appressed-pubescent on the back, narrowed upward, acuminate, 2 to 2.5 cm long. Receptacles axillary, solitary, slightly hirsute, usually distinctly ridged when fresh, brown when dry, ellipsoid-ovoid, about 12 mm long; peduncles up to 4 mm in length, the apical bracts elliptic-ovate, rounded, thick, 3 to 4 mm long. Ostiole conspicuous, up to 6 mm in diameter, the scales reniform, prominent. Fertile female flowers numerous, the ovaries about 1 mm long, the styles 1.5 mm in length. Perianth none.

CATANDUANES, *Bur. Sci. 30270 Ramos* (type), December 9, 1917, in forests along small streams back of Calolbong, at low altitudes. SAMAR, Catubig River, *Bur. Sci. 24412 Ramos*, March, 1916.

This species is well characterized by its leaves and by its conspicuous persistent stipules. I know of no species to which it is closely allied.

FIGUS BINUANGENSIS sp. nov.

Arbor circiter 8 m alta, ramulis et petiolis hirsutis, subtus foliis ad costa nervisque plus minusve pubescens; foliis oppositis, membranaceis, oblongo-obovatis, integris, circiter 25 cm longis, acuminatis, nervis utrinque circiter 8, perspicuis; inflorescentiis caulinis, receptaculis in ramis specialibus patulis ramosis circiter 8 cm longis dispositis, ramulis incrassatis, cicatricibus bracteisque multis instructis; receptaculis obovoideis, 1.5 ad 2 cm diametro, leviter hirsutis, pedunculatis, pedunculo 1.5 ad 2.5 cm longo.

A tree, about 8 m high, the branchlets and petioles rather densely hirsute with short hairs, the leaves more or less pubescent beneath on the midrib, nerves, and reticulations, the infructescence cauline. Leaves opposite, equal, membranaceous, oblong-obovate, entire, about 25 cm long and 12 cm wide, the apex rather abruptly acuminate, the acumen about 1 cm in length,

somewhat narrowed below to the rounded base, the upper surface brown, smooth, glabrous, the lower surface paler, the midrib, nerves and reticulations brown in contrast to the paler epidermis; lateral nerves about 8 on each side of the midrib, prominent, curved-ascending, the reticulations distinct; petioles about 2.5 cm long. Receptacles numerous, reddish, somewhat obovoid, rugose when dry and 1 to 2 cm in diameter, probably larger when fresh, sparingly hirsute, borne on specialized thickened branches, cauline; infructescences about 8 cm in length, these infructescences spreading, branched from the base, the ultimate branches about 5 mm in diameter marked with numerous scars of fallen pedicels and toward their apices supplied with numerous, broadly ovate, more or less persistent, coriaceous bracts up to 4 mm in length; peduncles 1.5 to 2.5 cm long, sparingly hirsute, 3-bracteate at the apex, the bracts oblong-ovate, obtuse, about 3.5 mm long. Receptacles containing fertile female flowers only, these very numerous, their pedicels up to 2.5 mm long. Ovary obliquely ovoid to somewhat obovoid, 1.5 mm long; style about as long as the ovary; perianth none or very rudimentary.

LUZON, Tayabas Province, Mount Binuang, *Bur. Sci.* 28831 Ramos & Edaña, May 13, 1917, in forests at low altitudes.

It is suspected from the vegetative characters of this species that it belongs in the same section with *Ficus paucinervis* Merr. although it has the infructescence of species belonging in the section *Covellia*.

FICUS FISKEI Elm. Leaf. Philip. Bot. 1 (1906) 195.

This apparently distinct species is of wide distribution in the Philippines, and is represented by the following specimens: LUZON, Ilocos Norte Province, *Bur. Sci.* 33042 Ramos: Rizal Province, *Loher* 4917, *Bur. Sci.* 5207, 4643, 1119, 13745 Ramos: Laguna Province, *Bur. Sci.* 6052 Robinson: without definite locality, *Vidal* 3802, 3816: Tayabas Province, *Bur. Sci.* 19551 Ramos: Sorsogon Province, *For. Bur.* 10547 Curran, *Bur. Sci.* 23401 Ramos, *Elmer* 7304. POLILLO, *Bur. Sci.* 6929 Robinson. LEYTE, *Elmer* 7185, 7324 (type number). SAMAR, *Bur. Sci.* 17445, 24503 Ramos. CEBU, *Bur. Sci.* 1708 McGregor. SAMAR, *Piper* 353, 370. MINDANAO, Butuan Subprovince, *Piper* 296: Agusan Subprovince, *Elmer* 13315.

Var. **CEBUENSIS** var. nov.

A typo differt foliis profunde sinuato-lobatis, receptaculis spinuloso-hispidulis, fasciculatis, in axillis defoliatis, pedunculis longioribus.

CEBU, Guadalupe, in thickets along roadsides, *Bur. Sci.* 11086 Ramos, March, 1912. LUZON, Sorsogon Province, *Elmer* 16425.

In aspect somewhat different from typical *Ficus fiskei*, but apparently not specifically distinct from that species. The leaves are rougher and harsher, somewhat more prominently veined, but differ from those of the species chiefly in being deeply sinuate-lobed. The receptacles are clustered in the axils of fallen leaves, are distinctly spinulous-hispid, and are longer than in typical *Ficus fiskei* Elm.

Var. *LAEVIFOLIA* var. nov.

A typo differt foliis laevis, haud scabridis.

SIARGAO, *Bur. Sci.* 35030, 34967 Ramos & Pascasio, June 1, 1919.

FIGUS CRININERVIA Miq. Fl. Ind. Bat. Suppl. (1861) 175, 432; King in Ann. Bot. Gard. Calcutta 1 (1888) 138, t. 173.

BASILAN, *Bur. Sci.* 13425 Reillo, August, 1912.

The species is new to the Philippines, its range, according to King, being from Assam through the Malay Peninsula and Archipelago to New Guinea. The Philippine specimen differs from the species as figured and described by King in having some of the receptacles fascicled rather than in pairs. In all essential characters, however, it seems to be quite the same as Miquel's species.

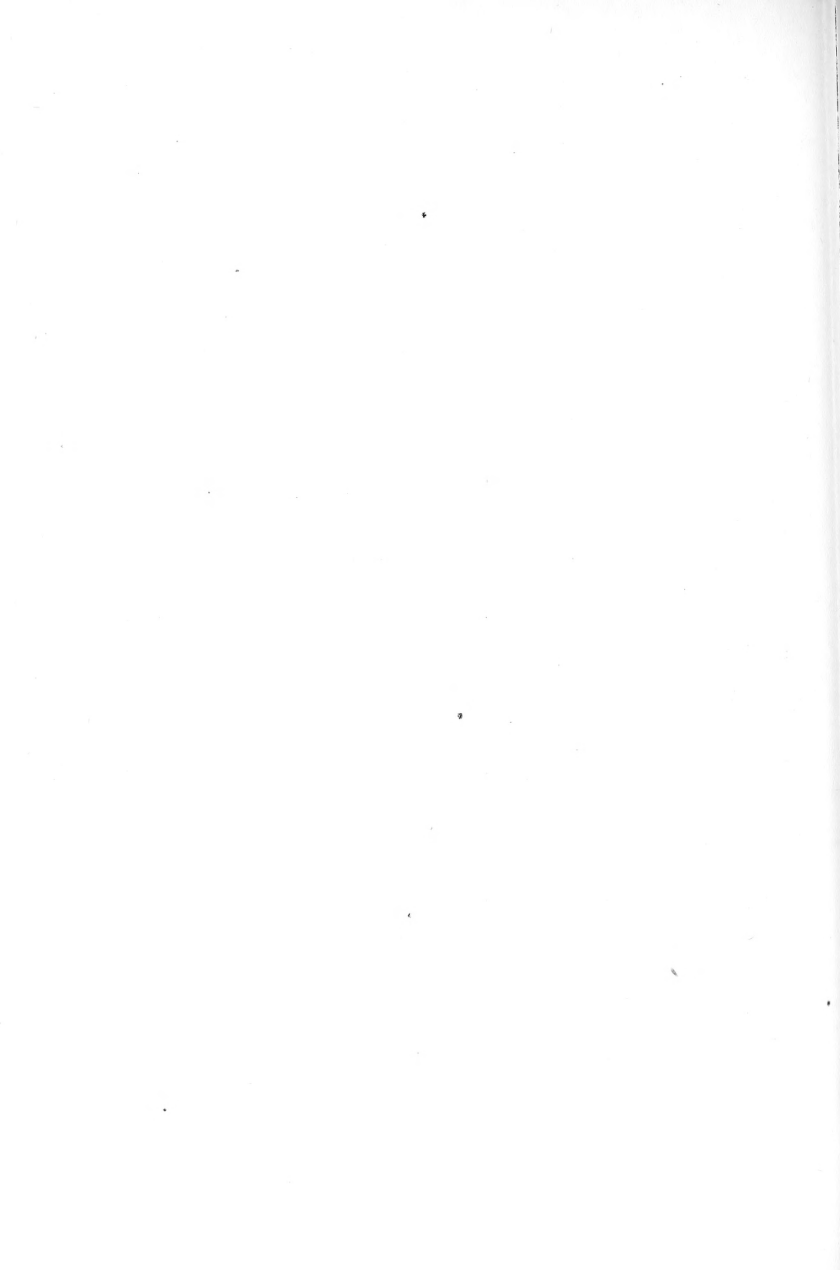

DEUX GENRES NOUVEAUX DE COLÉOPTÈRES
(MELASIDÆ)

Par ED. FLEUTIAUX

Nogent-sur-Marne, France

Genus **BOTHRION** novum

Allongé, subcylindrique. Tête convexe; épistome rétréci à la base. Antennes pectinées à partir du 3^e article. Pronotum arrondi en avant, déprimé à la base. Ecusson convexe. Elytres subparallèles, rétrécis dans le dernier quart, arrondis au sommet, rugueux et striés. Sillons antennaires marginaux, profonds, lisses, nettement limités en dedans par un rebord; bord postérieur des propleures plus court que l'interne; prosternum avec une cavité ronde et profonde à rebords nettement limités, au milieu, en avant et contre les hanches antérieures; saillie prosternale subparallèle, tronquée au sommet. Episternes métathoraciques parallèles, plus étroits que les épipleures des élytres. Hanches postérieures rétrécies en dehors, bord postérieur sinué, bord externe plus large que les épisternes. Dernier segment abdominal arrondi. Pattes grêles; 4^e article des tarsi échancré en dessus pour recevoir de 5^e et dilaté en dessous.

Vient se placer près du genre *Euryaulacus* Bonvouloir; forme générale plus étroite et plus parallèle; élytres moins courts, moins atténués; antennes longuement pectinées.

Bothrion bakeri sp. nov.

Brun-noir avec la base des élytres jaunâtre; pubescence jaune plus apparente à la base du pronotum et des élytres. Tête convexe, à ponctuation ombiliquée très serrée. Épistome aussi large à la base que l'espace compris entre le fond de son échancrure latérale et l'oeil. Antennes noirâtres, dépassant à peine la base du pronotum; 1^{er} article épais, atteignant la moitié de l'oeil; 2^e très petit; 3^e prolongé latéralement en un rameau deux fois plus long que lui; 4^e à 10^e plus courts, longuement pectinés; dernier mince et très allongé. Pronotum un peu plus long que large, peu convexe, à ponctuation ombiliquée très serrée. Elytres rugueux, ponctués-striés. Dessous de même couleur. Propectus à ponctuation large et ombiliquée. Métasternum et abdomen à ponctuation serrée mais moins nette. Pattes jaunes; fémurs

noirâtres; 4^e article des tarsi excavé en dessus et dilaté en dessous.

Longeur, 4 millimètres.

Iles Philippines, Mindanao, Kolambagan (*Baker*).

Genus **ARHAGUS** novum

Court, épais, cylindrique. Tête convexe avec une fossette entre les yeux; épistome rétréci à la base. Antennes longuement pectinées à partir du 3^e article; 1^{er} plus épais que les autres, atteignant le bord externe de l'oeil; 2^e très court; suivants plus longs. Pronotum aussi long que large, arrondi en avant, sinué latéralement, très convexe, relevé en arrière en bosse sillonnée au milieu, sinué à la base, très rugueusement ponctué; angles postérieurs aigus et dirigés en arrière; carène marginale en bord antérieur brusquement recourbée en arrière au niveau supérieur de l'oeil pour former le tronçon d'une deuxième carène latérale; carène latérale presque entière, interrompue tout près du bord antérieur. Ecusson plan, rétréci en arrière et tronqué. Elytres rétrécis en arrière dans la seconde moitié, arrondis à l'extrémité, densément ponctué, sillonnés de stries peu profondes. Propectus fortement ponctué, sans aucun trace de dépressions antennaires; saillie prosternale graduellement rétrécie. Epipleures des élytres largement arrondis. Episternes métathoraciques étroits, élargis postérieurement. Métasternum et abdomen finement et densément ponctué. Hanches postérieures élargies en dehors. Abdomen convexe; dernier arceau lisse au milieu, rugueux sur les bords, subtronqué au sommet. Pattes grêles: 4^e article des tarsi lamellé.

Voisin de *Adelothyreus* Chevrolat; en diffère pour sa forme épaisse, son pronotum très convexe, l'absence totale de dépressions antennaires.

Arhagus bakeri sp. nov.

Noir mat; pubescence jaune apparente seulement à la base des élytres. Tête densément ponctué. Épistome aussi large à la base que l'espace compris entre le fond de son échancrure et l'oeil. Antennes noires avec le 2^e article ferrugineux, n'atteignant pas la moitié du corps. Pronotum assez fortement, très densément et rugueusement ponctué. Ecusson finement ponctué. Elytres finement et densément ponctué, légèrement striés. Dessous noir, pubescence jaune très fine et très courte. Fémurs noirs; tibiai ferrugineux, jaune clair vers le bout; tarsi jaunes.

Longeur, 8 millimètres.

Borneo, Sandakan (*Baker*).

DEUX ESPÈCES NOUVELLES DE COLEOPTÈRES
(ELATERIDÆ)

Par ED. FLEUTIAUX

Nogent-sur-Marne, France

Melanoxanthus illustris sp. nov.

Allongé, assez large, convexe; pubescence peu apparente. Tête noire, jaune en avant, densément ponctuée. Labre noir. Antennes noires. Pronotum jaune avec quatre points ronds noirs, peu rétréci en avant, arrondi près des angles antérieurs, convexe, déprimé à la base, densément ponctué; angles postérieurs aigus, non divergents, carénés. Ecusson noir, rétréci en arrière, perpendiculaire, convexe et ponctué. Elytres jaunes, avec la suture, les bords latéraux et l'extrémité noirs; la bordure externe est élargie à la base et forme au tiers postérieur une tache arrondie intérieurement s'étendant jusqu'au cinquième interstrie; un peu plus étroits que le pronotum, subparallèles, obliquement tronqués à l'extrémité, convexes, légèrement et peu densément ponctués, ponctués-striés. Dessous jaune avec le dernier segment abdominal noir, finement ponctué. Sutures prosternales parallèles. Hanches postérieures peu rétrécies en dehors. Pattes jaunes.

Très jolie espèce remarquable pour les quatre points ronds qui ornent le pronotum et le dessin des élytres. Voisin de *M. quadripunctatus* Candeze, appartient au groupe *M. melanurus* Candeze—*M. bimaculatus* Fleutiaux.

Longeur, 9.5 millimètres.

Iles Philippines, Mindanao, Davao (*Baker*).

Melanoxanthus insignis sp. nov.

Allongé, convexe, atténué en arrière; pubescence fine. Tête jaune avec un tache noire arrondie en arrière, convexe et densément ponctuée. Antennes noires, minces et courtes. Pronotum convexe, plus long que large, parallèle en arrière, arrondi en avant, jaune avec quatre bandes longitudinales noires n'atteignant pas la base, ponctuation serrée, plus forte en arrière; angles postérieurs dirigés en arrière, fortement carénés. Ecusson

triangulaire, convexe. Elytres atténués graduellement dès la base, échancrés au sommet, noirs avec chacun une bande jaune subsutural s'arrêtant au de là de la moitié, et un bande transversale au dessous ne touchant pas les bords latéraux ni la suture, finement rugueux, ponctués-striés. Dessous jaune, métasternum et dernier segment abdominal noirs, ponctuation fine. Sutures prosternales parallèles. Hanches postérieures peu rétrécies en dehors. Dernier arceau ventral arrondi au sommet. Pattes jaunes; tarsi noirs.

Voisin de *M. quadrilineatus* Schwarz; les bandes noires latérales du pronotum n'atteignant pas la base, pas de tache noire sur les propleures, pas de tache jaune à l'extrémité des élytres.

Longeur, 12 millimètres.

Iles Philippines, Mindanao, Davao (*Baker*).

NEW OR NOTEWORTHY PHILIPPINE BIRDS, III

By RICHARD C. MCGREGOR

Ornithologist, Bureau of Science, Manila

FOUR PLATES

Canutus rogersi Mathews.

Tringa canutus SHARPE, Cat. Birds. Brit. Mus. 24 (1896) 593 (part.).

Canutus canutus rogersi MATHEWS, Birds of Australia 3^a (1913) 270; RIDGWAY, Bull. U. S. Nat. Mus. 50^a (1919) 238 (in synonymy).

Two sandpipers collected at Obando, Bulacan Province, Luzon, in 1910 were doubtfully identified as *Tringa canutus* as they are smaller in all measurements than the Asiatic knot. Dr. C. W. Richmond, of the United States National Museum, has kindly examined these two specimens and has labeled them *Canutus canutus rogersi*. The lower parts of No. 7378 are mottled with ochraceous buff and the upper parts retain a few scattered, worn, black feathers of the summer plumage. This specimen measured 250 millimeters in length in the flesh. The other specimen, which was collected a day earlier, is in complete, fresh, winter plumage.

Measurements of knots.

CANUTUS ROGERSI.

No.	Sex.	Locality.	Date.	Wing.	Tail.	Culmen.	Tarsus.	Middle toe with claw.
				<i>mm.</i>	<i>mm.</i>	<i>mm.</i>	<i>mm.</i>	<i>mm.</i>
7376	♂	Obando, Bulacan, Luzon...	Nov. 15, 1910	160	65	33	29	26
7378	♀do	Nov. 16, 1910	165	61	31	29	27

CANUTUS TENUIROSTRIS.

12985	(?)	Cavite, Luzon	Nov. 13, 1909	174	67	41	35	28
7377	♀ ?	Obando, Bulacan, Luzon...	Nov. 15, 1910	179	70	43	34	28
13328	♀do	Nov. 25, 1916	175	68	42	33	28

Canutus tenuirostris (Horsfield).

Tringa crassirostris TEMMINCK and SCHLEGEL, Fauna Japonica (1847) 107; SHARPE, Cat. Birds Brit. Mus. 24 (1896) 600 (part.); MCGREGOR, Man. Philip. Birds (1909) 141 (Mindanao? and Negros). *Anteliotringa tenuirostris* MATHEWS, Birds of Australia 3^a (1913) 277 (*Totanus tenuirostris* Horsfield).

Canutus tenuirostris RIDGWAY, Bull. U. S. Nat. Mus. 50^s (1919) 231.

The Asiatic knot was collected in Negros by Moseley and by Bourns and Worcester, and Mearns had at least one Philippine specimen, probably from Mindanao. I am now able to record three specimens that were collected in Luzon. The one from Cavite was collected by Dr. H. C. Curl, who recorded its length as 270 millimeters. No. 7377 was 275 millimeters in length in the flesh. Other measurements of the three specimens are given in the table under the preceding species and need not be repeated here.

Mathews has attached the generic name *Anteliotringa* to this species, but I do not think it is necessary to separate it generically from the smaller knots.

+ *Muscicapula calayensis* sp. nov.

Muscicapula luzoniensis MCGREGOR, Bull. Philip. Mus. 4 (1904) 32 (part referring to Calayan).

Type.—No. 3405, adult male, Bureau of Science collection; Calayan Island, Babuyan, P. I.; October 1, 1903; R. C. McGregor and A. Celestino, collectors. Length, in the flesh, 127 millimeters; wing, 63; tail, 49; tarsus, 18; exposed culmen, 12. Bill black; iris dark; legs white with a slight blue wash; nails light brown.

Specific characters.—Similar to *Muscicapula luzoniensis* Grant, but chin, throat, breast, and sides darker—dark ochraceous-buff to dark antimony yellow instead of chamois yellow; wing and bill slightly longer.

Remarks.—I recorded this specimen as *M. luzoniensis*, but its darker underparts and slightly greater size are sufficient grounds for its separation.

Gerygone simplex Cabanis. Plates 1 and 2.

The muscicapine genus *Gerygone* includes about twenty-five species of small, somewhat aberrant flycatchers. Several species are found in Australia, while others inhabit various parts of the Sunda Islands, Papua, Borneo, Sumatra, and the Malay Peninsula. *Gerygone simplex*, which appears to be confined to the Philippine Islands, has been recorded from Mindoro, Luzon, and

two of the small islands near Luzon. Mearns has described *Gerygone rhizophoræ* from Mindanao, but there seems to be no record of the genus from Samar, Negros, and the other islands. My experience with *Gerygone simplex* indicates that it prefers mangroves and open, second-growth bamboo.

Mr. E. H. Taylor recently found this flycatcher nesting in the vicinity of Alabang, Laguna Province, Luzon. The nests were in second-growth shrubs and bushes.

One nest was about 2 meters from the ground in a spiny shrub, *Capparis horrida* Linnæus (Plate 1). It is composed of plant fibers and covered with cobwebs. It is suspended near the end of a small twig, and its general appearance suggests the nest of some sunbird or bushtit. This nest is about 30 centimeters long and 5 centimeters broad. At the middle of one side there is a circular opening about 2.5 centimeters in diameter which is nearly concealed by an overhanging roof. This roof projects about 4 centimeters from the side of the nest. The two eggs were slightly incubated and measure 15.8 by 12 and 16.6 by 12.2 millimeters, respectively. The ground color is very pale pinkish buff. Near the larger end of the egg is a definite ring formed of spots of mahogany red to Hay's russet. There are a few spots scattered over the rest of the egg.

Another nest collected on the same date, June 4, 1920, was about 3.5 meters from the ground in a large-leaved shrub, *Semecarpus cuneiformis* Blanco (Plate 2). This nest is only 20 centimeters long, and the roof over the entrance does not hide the opening so well as in the other nest. The two eggs of this set contained such large embryos that they could not be blown. These eggs are slenderer than those of the other set; the markings are more scattered and scarcely form a zone. The measurements in millimeters are 18.5 by 12.2 and 18.1 by 12.

Several species of the genus *Gerygone* are resident in Australia, and the nests and habits are described by North.¹ The picture of the nest of *Gerygone fusca* (Gould), on page 197 of North's work, resembles somewhat the longer nest of *Gerygone simplex*, but the Australian species elaborates the roof into "a narrow bottle-neck like entrance." Another nest of *Gerygone fusca*, figured by North,² resembles closely the long nest of *G. simplex*. The various Australian gerygones lay two or three eggs in a set.

¹Nests and Eggs of Birds found breeding in Australia and Tasmania, Special Catal. Australian Mus. 1¹ (1904) 192-203.

²Op. cit. 3² (1911) 22.

Rhipidura nigritorquis Vigors. Plate 3.

Rhipidura nigritorquis Vigors, GRANT and WHITEHEAD, Ibis (1898) 236; OATES and REID, Cat. Birds' Eggs Brit. Mus. 3 (1903) 277, pl. 8, fig. 19.

Grant and Whitehead describe two sets of eggs of the black and white fantail that were collected by J. B. Steere in Marinduque early in May. Although this is one of the commonest Philippine species, Whitehead does not seem to have collected eggs of it himself. Oates and Reid record the two sets collected by Steere, one egg from Cebu (*Koch*), and one egg from Luzon (*Schadenberg*). The nest is described by Grant and Whitehead as being cup-shaped, composed of tightly woven fiber and wide grass bound together with cobwebs, and neatly lined with fine grasses and black fiber.

On June 4, 1920, Mr. E. H. Taylor collected a nest and three eggs of this species near Alabang, Laguna Province, Luzon. The nest was saddled on a small, nearly horizontal fork of a shrub; it is smooth, regular in shape, and compactly made of small twigs, rootlets, and other vegetable materials (Plate 3). The outside of the nest is smooth, and the materials are closely matted. The outside diameter of the nest is about 65 millimeters; outside depth, 50; inside depth, 35.

The eggs are very light brown and are marked with small spots and blotches of snuff brown, Saccardo's umber, and sepia, which form a poorly defined zone just above the greatest diameter and are scattered evenly toward the ends of the eggs. The eggs measure, in millimeters, 19.3 by 13.9, 19 by 13.9, and 19 by 14.1.

Xeocephus rufus (Gray).

In Sharpe's³ key to the genera of the Muscicapidæ *Xeocephus* falls under "k" Tail graduated, the two centre feathers not exceeding the next one by as much as the length of the culmen." This is true of most specimens of *Xeocephus* that I have collected; it is also true of nonbreeding and immature examples of *Terpsiphone*. In some males of *Xeocephus rufus* the central rectrices greatly exceed the others. Therefore *Terpsiphone* and *Xeocephus* cannot be separated by Sharpe's key, and I do not know on what characters they can be distinguished. I have seen no specimen of *X. cinnamomeus* with long rectrices, but it would be strange if they were not developed in the breeding male.

For the blue *Xeocephus*, of Palawan, I propose—

³ Cat. Bds. Brit. Mus. 4 (1879) 116.

Subgenus *NEOXEOCEPHUS* novum

Subgeneric characters.—Similar to *Xeocephus*, but crest full and long, the feathers loose and hairlike; eye wattle (if present) very narrow; tail strongly graduated, but central pair of rectrices not known to be greatly lengthened. The type and only species is *Zeocephus cyanescens* Sharpe.

Xeocephus cyanescens Sharpe.

This species is confined to Palawan and the Calamianes; the distribution, together with the entirely different coloration, would suggest the generic or subgeneric separation of the species from *Xeocephus*. Whether or not the adult male of this species has streamerlike central rectrices seems to be unknown. I have examined seven males collected in January, February, July, and December, and find the rectrices moderately graduated in all of them. There is no suggestion of the central pair being streamerlike.

The predominant color of *Xeocephus cyanescens* is blue. The immature plumage differs considerably from that of the adult. A male collected in Palawan on July 1, 1910, shows that in the young the wings and upper parts are brown, while the blue of the throat, breast, and abdomen is very pale. The back and wings are tawny to ochraceous tawny; primaries dark brown; upper tail coverts and rectrices russet; head, chin, and throat covered with short pin feathers that do not indicate any color; breast and sides deep Dutch blue, fading to white on abdomen; under tail coverts white, washed with clay color. The remiges are much worn except the eighth and ninth primaries which are fresh blue feathers of the adult plumage; a few of the primary and secondary coverts are also of the new blue plumage.

I propose a subgeneric name for this blue flycatcher to call attention to its difference from typical *Xeocephus*, but my opinion is that both *Callaeops* and *Xeocephus* should be considered as no more than subgenera of *Terpsiphone*.

Terpsiphone periophthalmica (Grant). Plate 4.

Callaeops periophthalmica GRANT, Bull. Brit. Orn. Club 4 (1895) 18; Ibis VII 1 (1895) 253 (not "275"); WHITEHEAD, Ibis VII 5 (1899) 108; SHARPE, Hand-List 3 (1901) 263; MCGREGOR and WORCESTER, Hand-list Philip. Bds. (1906) 74 (not "94"); MCGREGOR, Man. Philip. Bds. (1910) 464; HARTERT, Novit. Zool. 23 (1916) 335, pl. 1; RICHMOND, Auk 34 (1917) 215.

Callaeops periophthalmica DUBOIS, Synop. Av. 1⁴ (1900) 288.

Terpsiphone nigra MCGREGOR, Philip. Journ. Sci. § A 2 (1907) 340, pls. 1-3; Man. Philip. Bds. (1910) 466.

The publication of a colored plate illustrating the type of *Callaeops periopthalmica* and Richmond's comment on this species, as well as a letter from Dr. C. W. Richmond with regard to the species, have led me to reëxamine the specimens of "Terpsiphone nigra" in the Bureau of Science collection.

The type of *C. periopthalmica* was purchased by John Whitehead from Brolio Barboza, a Filipino taxidermist, with whom I was well acquainted. The collector assured me that the specimen was killed with a blow gun near Malabon, a small town a few kilometers from Manila. Like many other taxidermists this man kept no record of his specimens and so was unable to furnish me any other information about this bird. Who really killed the bird is doubtful and is of no consequence, but I think it probable that the bird was really collected near Manila. In the vicinity of Malabon the vegetation is entirely unsuited to such birds as the long-tailed flycatchers. Therefore, I think there can be no doubt that the type of "Callaeops" was a wind-driven individual far from its normal habitat. Unfortunately we do not know the date on which this specimen was collected.

In May, 1907, through the courtesy of Gen. Leonard Wood, in company with the late Col. E. A. Mearns, I was able to visit Batan Island, one of the most northern islands of the Philippine Archipelago. On that island I was delighted to find a long-tailed, black and white flycatcher of which we collected a good series. This I described as *Terpsiphone nigra*, but I noted that some of the specimens agreed with the description of *Callaeops periopthalmica*. The type of the latter species has passed to the Tring Museum, and Hartert has published some comment on the species and a colored plate of the type. Richmond has published some further notes on the species.

Hartert's colored plate shows a bluish black bird with the abdomen and the tips of the inferior tail coverts white. Twelve graduated rectrices are shown, the middle pair being the narrowest; the greatest differences in length are between the first and the second pairs and between the fifth and the sixth pairs.

That "Terpsiphone nigra" breeds before it attains the full black plumage is indicated by specimen 6440 in which one of the central rectrices is considerably lengthened and the other is nearly as short as the next pair; the latter feathers are not conspicuously longer than the third pair (Plate 4, fig. 1). This specimen is a male collected June 5, and is marked "breeding male." The abdomen is extensively whitish, and the inferior tail coverts are entirely cinnamon. The head and neck are

black, but the mantle and rump are about walnut brown. I have stated that "The short-tailed black males of this flycatcher agree with the description of *Callaeops periopthalmica*," but I find that the two short-tailed black males in the collection, on which I based this statement, are imperfect, the long, streamer-like rectrices having been shot away. However, if the long rectrices are molted in the nonbreeding season, the adults will closely resemble Hartert's plate.

La Touche,⁴ writing on *Terpsiphone incii* (Gould) in China, says:

In spring most of the males have the long central rectrices, and breed in the red plumage as well as in the white. The latter plumage, which is that of the old males at least two years old, is without doubt moulted at the end of the summer before the autumn migration begins.

With reference to the same species I take the liberty of quoting from a letter written by Mr. La Touche at Mengtshz, Yunnan, China, on November 3, 1920, as follows:

During the period 1882-1919, when I paid much attention to China birds, I never once obtained or saw a male in white plumage on the autumn migration. Hence my remark. Now, in this place, I have this autumn obtained three white males, all with short tails. In this province at least, *T. incii* retains the white plumage after the summer but has dropped the long central rectrices just as is the case with the Indian birds.

The type of *Terpsiphone nigra*, which appears to be the most adult male collected by me, has a little white on the middle of the abdomen, but none on the tips of the inferior tail coverts (Plate 4, fig. 2). The bases of these coverts are white and the inner edges are light clay brown. This is the only specimen with the inferior tail coverts nearly all black. Each of seven other long-tailed males has more white on the abdomen than the type, and the coverts are white or clay brown; but in none are the coverts black with clear white tips as shown in the colored plate of *Callaeops periopthalmica*.

In some specimens of *Terpsiphone nigra*, the axillars and inferior wing coverts are more or less white, and in others these feathers are entirely black. In none is the white so conspicuous as in *T. princeps*. It should be noted that in the adult, breeding male the two central rectrices are not the only ones lengthened, for the next two pairs are much longer than in immature birds. It seems probable that the type of *Callaeops periopthalmica* is an adult male in nonbreeding plumage. This supposition

⁴ Ibis XI 2 (1920) 666.

is sustained by the condition of a male specimen of *Terpsiphone princeps* (Temm.), collected at "Hiuga-Kiushū," Japan, on August 5, 1894. In this specimen the rectrices are graduated, with the central pair slightly narrowed; the greatest differences in length are as shown in Hartert's plate of *Callaeops*.

For the present I am satisfied to let *Terpsiphone nigra* stand as a synonym of *Callaeops periopthalmica*, but I do not feel sure that a long-tailed black flycatcher will not be discovered in Luzon. *Callaeops* is no more than a subgenus of *Terpsiphone*.

The distribution of the species is: **Batan Island, Batanes, resident; accidental near Manila, Luzon, P. I.**

ILLUSTRATIONS

PLATE 1

A nest of *Gerygone simplex* Cabanis, from Alabang, Luzon, P. I.

PLATE 2

A nest of *Gerygone simplex* Cabanis, from Alabang, Luzon, P. I.

PLATE 3

A nest of *Rhipidura nigritorquis* Vigors, from Alabang, Luzon, P. I.

PLATE 4

- FIG. 1. *Terpsiphone periopthalmica* (Grant). A breeding male in immature plumage, with one of the middle rectrices lengthened. No. 6440.
2. *Terpsiphone periopthalmica* (Grant). An adult breeding male, with well-developed rectrices. No. 6395, type of *Terpsiphone nigra* McGregor.
3. *Terpsiphone periopthalmica* (Grant). A female in adult plumage. No. 6495.

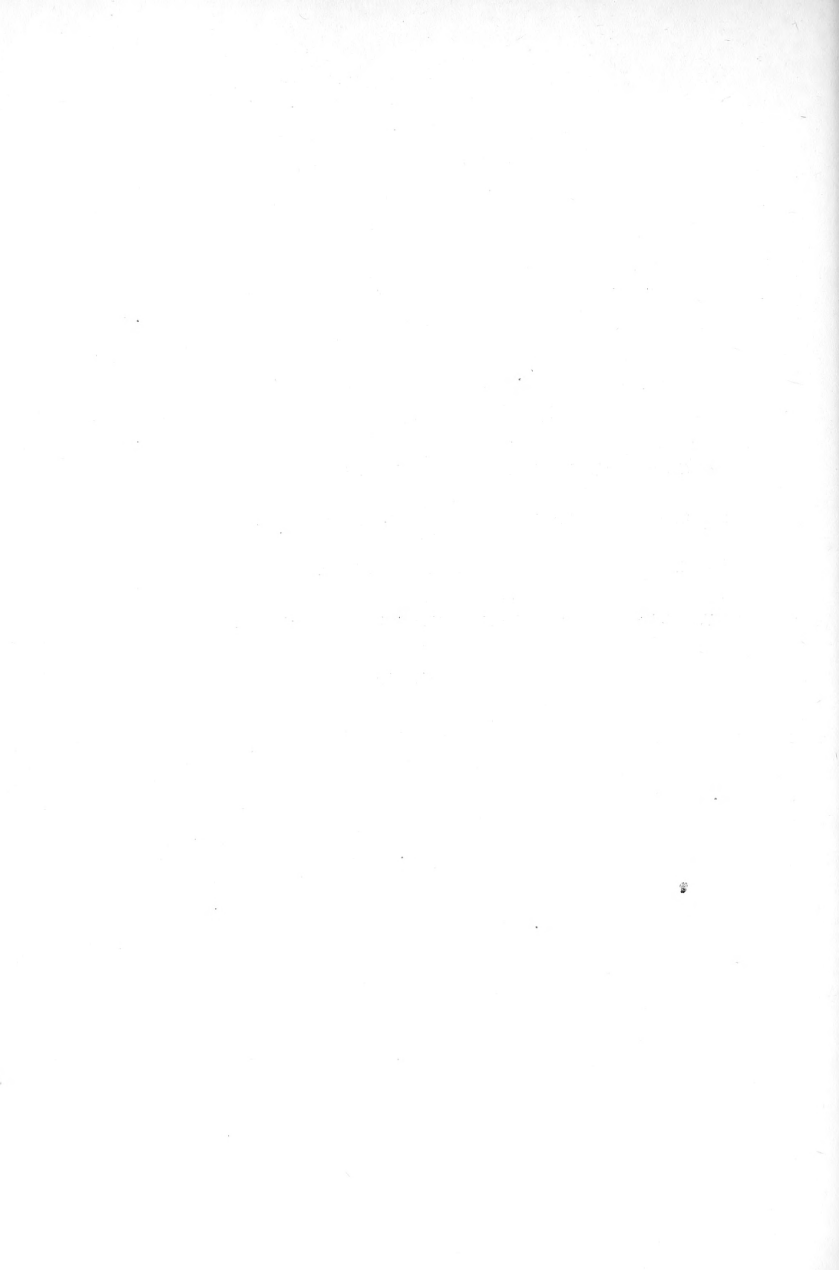



PLATE 1. A NEST OF GERYGONE SIMPLEX CABANIS.



PLATE 2. A NEST OF GERYGONE SIMPLEX CABANIS.



PLATE 3. A NEST OF RHIPIDURA NIGRITORQUIS VIGORS.

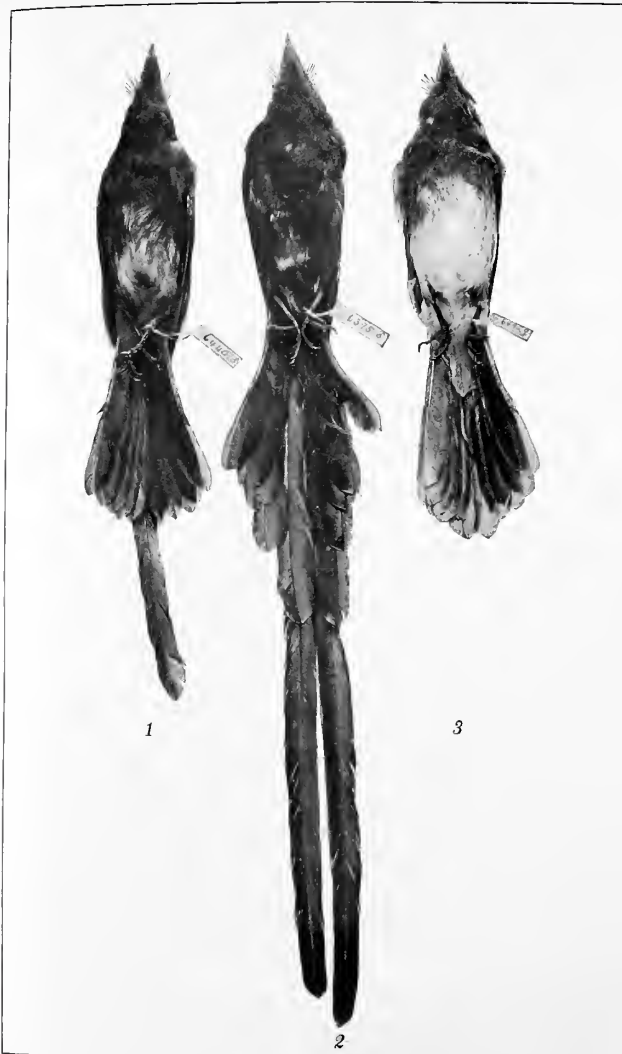

PLATE 4. TERPSIPHONE PERIOPHTHALMICA (GRANT).

THE RELATION OF STOCKS TO MOTTLED LEAF OF CITRUS TREES¹

By H. ATHERTON LEE

*Pathologist, Office of Fruit Disease Investigations, United States
Department of Agriculture*

THREE PLATES

INTRODUCTION

Mottled leaf of citrus trees has become increasingly important within the last few years in the citrus-growing regions of the United States and has been the subject of much discussion among growers, physiologists, and pathologists. The present paper submits definite data concerning the relation of stocks to mottled leaf which may contribute slightly to our knowledge of the disease. The data also make possible a suggestion for its future control.

BRIEF HISTORY OF THE DISEASE

A number of hypotheses have been advanced to explain the cause of this disease, based usually on substantial investigations in some one area where trees were badly affected. Thus Hilgard,² in 1906, advanced the theory of an excess of lime as a cause of mottled leaf in the Porterville region in California. His conclusions were based upon his observations of the occurrence of the disease in areas where lime was considerably in excess. Another theory, somewhat in opposition to that of an excess of lime, was advanced by Snowden,³ and depended on an improper relationship of calcium to magnesium in the soil, it being ex-

¹ The writer is greatly indebted and herein expresses gratitude to Mr. S. Apostol, chief of the Division of Plant Industry of the Philippine Bureau of Agriculture, for the use of the citrus orchards at Lamao. The use of the orchards, as well as living accommodations at Lamao, were made available through the efforts of Mr. Apostol; without this unusual opportunity the work would have been impossible.

² Hilgard, E. W., Marly subsoils and chlorosis or yellowing of citrus trees, Univ. Calif. Agr. Exp. Sta. Circular 27 (1906).

³ Snowden, R. R., The magnesia lime trouble in citrus orchards, California Cultivator (1910) 124.

plained that the proportion of magnesium to calcium was too great in areas where mottled leaf was found. This explanation was apparently not so well supported by evidence as was Hilgard's.

It was shown by Thomas⁴ that, in a large number of cases, nematodes were to be found upon the roots of trees with mottled leaf. These observations by Thomas were taken in representative districts of California. The conclusion that nematodes were a direct cause of mottled leaf was abandoned, however, by the subsequent finding of mottled leaf trees, upon the roots of which no nematodes could be found.

Smith and Smith⁵ found mottled leaf to be associated with poorly drained soils, and with soils of a poor physical texture. Mottled leaf was also recorded by them as accompanying excesses of manure or as occurring on trees situated near stables or corrals where there was an excess of organic matter. They concluded that mottled leaf was a result of an irregular supply of food and moisture. Kellerman and Wright,⁶ in 1914, claimed to have correlated the occurrence of mottled leaf with soils in which there was an excess of nitrate nitrogen. They stated that the turning under of straw and other substances high in cellulose increased the amount of mottled leaf; the explanation apparently advanced was that the cellulose-dissolving bacteria, which increased when straw was turned under, used up at the same time large amounts of nitrate nitrogen. They claimed to have induced mottling, artificially, by introducing into the soil straw and other substances high in cellulose, and suggested the turning under of green cover crops as a means of preventing mottled leaf. Lipman,⁷ in 1915, advanced an interesting theory in explanation of the cause of mottled leaf; his conclusion was that the disease was caused by a lack of nitrogen in an available form, and was based upon field observations and pot experiments. He suggested that, although the total nitrogen content of the soil might be high, such nitrogen was not necessarily in an available form,

⁴ Thomas, E. C., A preliminary report of a nematode observed on citrus roots and its possible relation with the mottled appearance of citrus, Calif. Agr. Exp. Sta. Circular 85 (1913).

⁵ Smith, R. E., and Smith, E. H., California plant diseases, Calif. Agr. Exp. Sta. Bull. 213 (1911) 1137-1159.

⁶ Kellerman, K. F., and Wright, R. C., Relation of bacterial transformations of soil nitrogen to nutrition of citrous plants, Journ. Agr. Res. 2 (1914) 101.

⁷ Lipman, Chas. B., A suggestion of a new phase of the problem of physiological diseases of plants, *Phytopathology* 5 (1915) 111.

and that the soil flora of that locality possibly was not able to convert the nitrogen into an available form.

Briggs, Jensen, and McLane,⁸ in 1916, found that mottled leaf in citrus was correlated in a large number of cases with a low humus content.

McBeth⁹ showed, in 1917, that mottled leaves generally have a higher nitrogen content and a higher moisture content than normal leaves. He concluded from his work that an irregular food and moisture supply was a cause of mottled leaf, and corroborated the view advanced by Smith and Smith. Briggs, Jensen, and McLane,¹⁰ in 1917, showed control of mottled leaf in a number of cases by the use of mulches, combined with basin irrigation, which carried organic material into the soil and also maintained the temperature of the soil more uniformly. They concluded that lack of humus is a cause of mottled leaf. The use of the mulched basin system of irrigation has not been accepted generally by growers, however, because this practice possesses several disadvantages.

Jensen,¹¹ in 1917, showed that very badly mottled leaves of orange and lemon contained higher percentages of iron, calcium, magnesium, and phosphoric acid than did healthy leaves. He also observed, in general, an increase in the percentage of these elements in the leaf stems and midribs, indicating difficulty in their transfer to the mesophyll tissues in the later stages of mottling. This apparently is not advanced as a cause but as a contribution to the general understanding of the disease.

Floyd,¹² in 1917, found mottled leaf in Florida to be correlated with the use of excessive amounts of ground limestone. He was able to induce the mottled leaf symptoms by adding ground limestone to the soil of potted plants. The writer has seen the mottled leaf in Florida which Floyd describes; apparently the yellowing between the veins, the stunting of the leaves, and the

⁸ Briggs, L. J., Jensen, C. A., and McLane, J. W., Mottle-leaf of citrus trees in relation to soil conditions, *Journ. Agr. Res.* 6 (1916) 721-759.

⁹ McBeth, I. G., Relation of the transformation and distribution of soil nitrogen to the nutrition of citrus plants, in *Journ. Agr. Res.* 9 (1917) 183.

¹⁰ Briggs, L. J., Jensen, C. A., and McLane, J. W., The mulched basin system of irrigated citrus culture and its bearing on the control of mottle-leaf, U. S. Dept. Agr. Bull. 499, professional paper (1917).

¹¹ Jensen, C. A., Citrus leaves at various stages of mottling. In *Journ. Agr. Res.* 9 (1917).

¹² Floyd, B. F., Some cases of injury to citrus trees apparently induced by ground limestone, *Florida Agr. Exp. Sta. Bull.* 137 (1917).

thickness and the greater toughness of the leaves differ in no way from the symptoms known in California as mottled leaf.

According to this brief review, a number of causes have been ascribed to mottled leaf, all of them being advanced after a careful study of the disease which sometimes extended over a considerable period of time. It would seem reasonable to conclude from this review of past studies that the complex of symptoms known as mottled leaf may be induced by several different types of injury, any one of which may cause the same reaction of the plant. That is, several types of injury to citrus trees may produce the same ultimate reaction and symptoms.

OBSERVATIONS ON MOTTLED LEAF AT LAMAO, PHILIPPINE ISLANDS

The Philippine Bureau of Agriculture maintains a horticultural station and plant propagation garden at Lamao, in Bataan Province near Manila. At this experiment station there are three orchards which contain a number of American and Japanese citrus varieties, and very extensive nurseries for the propagation of these varieties. These extensive collections and introductions are the work of Mr. P. J. Wester, of the Philippine Bureau of Agriculture. The writer is greatly indebted to Mr. Wester for assistance in identifying varieties at Lamao, and for numerous kindnesses in many other ways, and herein he expresses his deep appreciation to him.

The orchard trees and nursery trees at Lamao are planted upon stocks of different species; the stocks represented are the pummelo (*Citrus maxima*), the cabuyao (*Citrus hystrix*), the sour orange (*Citrus aurantium*), the sweet orange (*Citrus sinensis*), the calamondin (*Citrus mitis*), and the mandarin orange (*Citrus nobilis*).

It was noticed that a considerable amount of mottled leaf was present in the nurseries, and that there was also mottled leaf in the mature orchards, although to a less extent. The type of mottling was entirely the same as that seen in California, the leaves yellowing slightly between the veins in the less-affected cases, while in the more severe cases the leaves became yellow to include all of the leaf-blade tissue with the exception of the main veins and midrib, which remained green. The affected leaves were stunted in size, thickened, and more leathery than were the normal leaves. It gradually became evident that there was a correlation between the occurrence of mottled leaf and the species used for a stock. A determination was made for each

tree of the occurrence of mottled leaf, the variety and species on which the disease showed, and the species of the stock. A summary of these observations is presented in the following tables:

TABLE 1.—Number of trees affected with mottled leaf upon pummelo stocks.*

Pummelo stocks budded with—	Total trees.	Trees affected with mottled leaf.	
		Number.	Per cent.
Calamondin	3	0	0.00
Lime	28	2	7.14
Pummelo.....	175	27	15.42
Pummelo stocks unbudded.....	86	14	16.27
Lemon.....	99	53	53.53
Mandarin orange.....	348	259	74.42
Cabuyao.....	4	3	75.00
Grapefruit.....	127	98	77.16
Sweet orange.....	223	191	85.65
Tangelo.....	50	48	96.00

* The term pummelo is used here to indicate the East Indian form of *Citrus maxima*; in the West Indies the term shaddock is used for the same type of fruit. The tangelo is a hybrid between the tangerine and the grapefruit.

TABLE 2.—Number of trees affected with mottled leaf upon cabuyao stocks.

Cabuyao stock budded with—	Total trees.	Trees affected with mottled leaf.	
		Number.	Per cent.
Calamondin	2	0	0.00
Cabuyao	2	0	0.00
Sour orange.....	2	0	0.00
Lemon.....	1	0	0.00
Pummelo.....	1	0	0.00
Sweet orange.....	19	5	26.31
Tangelo.....	11	7	63.65
Mandarin orange.....	3	2	66.66

TABLE 3.—Number of trees affected with mottled leaf on sour orange stocks.

Sour orange stock budded with—	Total trees.	Trees affected with mottled leaf.	
		Number.	Per cent.
Pummelo.....	18	1	5.55
Grapefruit.....	8	1	12.5
Lemon.....	7	1	14.28
Mandarin orange.....	34	8	23.52
Sweet orange.....	28	12	42.85

TABLE 4.—Number of trees affected with mottled leaf on calamondin stocks.

Calamondin stock budded with—	Total trees.	Trees affected with mottled leaf.	
		Number.	Per cent.
Calamondin	6	0	0.00
Cabuyao	2	0	0.00
Sour orange	3	0	0.00
Lime	2	0	0.00
Grapefruit	22	2	9.09
Mandarin orange	113	11	9.78
Lemon	24	3	12.50
Sweet orange	93	12	12.90
Pummelo	11	2	18.18
Tangelo	22	4	18.18

TABLE 5.—Number of citrus trees affected with mottled leaf on mandarin orange stocks.

Mandarin orange stock budded with—	Total trees.	Trees affected with mottled leaf.	
		Number.	Per cent.
Cabuyao	14	0	0.00
Sour orange	10	0	0.00
Stock unbudded	84	0	0.00
Lime	8	0	0.00
Pummelo	68	0	0.00
Grapefruit	10	0	0.00
Mandarin orange	138	2	1.44
Sweet orange	70	3	4.28
Lemon	63	17	26.98

Previous work on this subject has offered little opportunity for a comparison between the various citrus species as to their susceptibility to mottled leaf; the above tables will indicate such comparative susceptibility in a general way. Although it will be impossible to arrange the species in the order of susceptibility (from these tables at least), still it can be said that the calamondin and the lime exhibit the mottled leaf symptoms but slightly; and that the tangelo, sweet orange, and mandarin orange varieties are most commonly affected by mottled leaf.

The relationship of the stocks to mottled leaf is indicated in the foregoing tables by comparison of the figures in the various tables for a given species; as, for instance, the sweet orange, which is recorded in all of the tables. Thus, the sweet orange on pummelo stock developed 191 cases of mottled leaf of a total of 223 trees so propagated, or 85.65 per cent of positive cases. Sweet orange propagated upon cabuyao stock developed 5 cases of mottled leaf from a total of 19 trees budded on cabuyao, or 26.31 per cent. Sweet orange on sour orange stock developed

12 cases out of 28 trees, or 42.85 per cent. Sweet orange on calamondin stock developed 12 cases out of 93 trees, or 12.90 per cent, and of 70 trees propagated on mandarin orange stock only 3, or 4.28 per cent, developed mottled leaf.

Similar comparison with reference to other species shows high percentages of mottled leaf on pummelo stocks, lower ones on cabuyao and sour orange stocks, and but small percentages on calamondin and mandarin orange stocks. A table has been prepared, combining all the species upon a given stock, and is given here as it presents a more comprehensive summary of the relationship of stocks to mottled leaf.

TABLE 6.—*Summary of the influence of various citrus species as stocks upon the susceptibility of citrus trees to mottled leaf.*

Stock.	Total trees.	Trees affected with mottled leaf.	
		Number.	Per cent.
Pummelo.....	1145	695	60.80
Cabuyao.....	41	14	34.14
Sour orange.....	95	23	24.21
Calamondin.....	298	34	11.4
Mandarin orange.....	465	22	4.78

The differences between the stocks were even more impressive in the nursery rows than they seem when summarized in tables. Moreover, the effect of mottled leaf on the growth of the trees was very striking. Trees of the Valencia orange or Oneco mandarin, for instance, made a very substantial growth on mandarin orange stock. The same varieties, of the same age, on pummelo stocks of the same age in adjoining rows, were much smaller at the time of the observation and lacked the vigorous appearance of the trees on the other stocks. The photographs, Plates 2 and 3, show the comparative growth of trees upon pummelo and mandarin stocks.

The effects of the pummelo stock in inducing mottled leaf were very noticeable. A row of trees budded upon this stock would be badly mottled and stunted; a tree would then occur on which the scion had not grown and the stock had developed in its place. Such a tree of the unbudded stock would be perfectly normal, with no trace of mottled leaf, and much greater in size than the budded trees upon the pummelo stock. Very commonly, also, a pummelo scion upon pummelo stock would develop entirely free of the disease and make a normal growth. This and the observation that the mandarin and other species mottled badly on pummelo, while the pummelo itself on pummelo seldom if

ever exhibited the symptoms, led to the conclusion at first that this species was in some way incompatible to the sweet orange and mandarin orange species. That is, it was thought that possibly the mandarin orange and sweet orange species were not closely enough related to the pummelo to bud well. However, this theory was abandoned since the converse, pummelo budded on mandarin orange in near-by rows under identical conditions, did not result in mottled leaf but made perfectly normal growth.

The correlation of the pummelo stocks to mottled leaf presented in this paper is not advanced as a cause of the disease but as a factor conducive to mottled leaf if the conditions are favorable. That is to say, it is believed that trees upon pummelo stocks mottle only when the other contributing factors are present, while if such factors are absent the trees will remain perfectly normal. The use of pummelo stock therefore is conducive to mottled leaf only when the original contributing cause or causes are present. Trees upon mandarin orange stock, however, have but little mottled leaf, even in the presence of one of the series of contributing causes.

A plausible assumption for the different reactions of the different species on various stocks would seem to be the comparative resistance and susceptibility of such stocks. Thus it would seem that the mandarin orange and the calamondin as stocks are resistant to the peculiar environmental conditions at Lamao which are conducive to mottled leaf; the pummelo as a stock would seem to be extremely sensitive. No analysis as to the reasons for such resistance and susceptibility is possible from the data at present available. However, the practical application is immediately apparent; that is, it would seem possible in such regions where the soils have been shown to be favorable to mottled leaf to minimize injury from this disease by the use of the proper stocks.

THE SOIL AT LAMAO

Soil conditions have been so closely connected with mottled leaf in previous literature that such a brief description as is possible is presented here for the use of others interested in this disease. The soil at Lamao is fairly uniform in physical texture throughout all the citrus orchards. It is probably of alluvial origin and may be classed as a sandy loam; this sandy loam extends to a depth of from 2.5 to 3 meters before gravel is reached. The drainage throughout the orchards is very good and water never stands upon the surface of the soil. During the dry season it is possible that irrigation is sometimes irregular.

To the unaided eye there is no evidence of any considerable amount of decaying organic matter in the soil. The nurseries and orchards are given very much the same treatment that orchards in the United States would receive. In the dry season they are clean cultivated and a good dust mulch is maintained. In the wet season a small crop of weeds grows up which is plowed under at the close of the rains.

THE USE OF STOCKS IN CONNECTION WITH MOTTLED LEAF

From a commercial viewpoint the data presented here would indicate that the use of pummelo varieties of *Citrus maxima* under certain conditions is to be avoided. In the Philippines under the same conditions, where mottled leaf occurred severely upon pummelo stock, trees upon mandarin orange and calamondin stocks were affected but slightly, or not at all. It is suggested, therefore, that in areas where mottled leaf prevails the promising types of mandarin orange and calamondin, if given a trial as stocks, might give good results. The mandarin orange is used as a stock almost exclusively in the Swatow region in China, and is found to give very satisfactory results. It should be understood definitely that the mandarin orange or calamondin stocks are not recommended here for orchard practice until they have been thoroughly tried out experimentally under the local conditions in which it is intended to utilize them. They are suggested here only as promising for such a trial.

SUMMARY

1. The history of the disease has shown that a number of careful investigations at different times and in different places have pointed to different factors as causing mottled leaf. It would seem possible that the symptoms of mottled leaf accompany several different types of malnutrition, and are not necessarily the result of excess or lack of any one substance in the soil.

2. In the Philippines it was observed that trees upon pummelo stock were badly affected with mottled leaf. Trees upon mandarin orange and calamondin stocks under the same conditions did not mottle. The relationship of stocks to mottled leaf in this case is not advanced as a cause of the disease, but it would seem that certain stocks are conducive to mottled leaf when the causal factors are present. The calamondin and mandarin orange when used as stocks apparently enable the tree to avoid the disease, even though the causal factors are present.

3. In localities where mottled leaf prevails, trees upon a mandarin orange or calamondin stock would possibly offer a solution in preventing the disease.

ILLUSTRATIONS

PLATE 1

Leaves of sweet orange variety (*Citrus sinensis*) typically affected by mottled leaf.

PLATE 2

Left, tree of mandarin orange variety on mandarin orange stock; right, two trees of same mandarin orange variety on pummelo stock showing the stunting of growth due to mottled leaf. All three trees are of the same age and were taken from adjacent rows.

PLATE 3

- FIG. 1. Trees of Valencia orange. The middle tree is budded on mandarin orange stock; the two other trees are budded on pummelo stock and show the stunting effects of mottled leaf. All three trees are of the same age and were taken from adjacent nursery rows.
2. Trees of a mandarin orange variety. The middle tree is budded on mandarin orange stock; the two other trees are budded on pummelo stock and show the stunting effects of mottled leaf. All three trees are of the same age and were taken from adjacent nursery rows.



PLATE 1. LEAVES OF SWEET ORANGE VARIETY (*CITRUS SINENSIS*) TYPICALLY AFFECTED BY MOTTLLED LEAF.



Left, tree of mandarin orange variety on mandarin orange stock; right, two trees of same mandarin orange variety on pummelo stock showing the stunting of growth due to mottled leaf. All three trees are of the same age and were taken from adjacent rows.

PLATE 2.

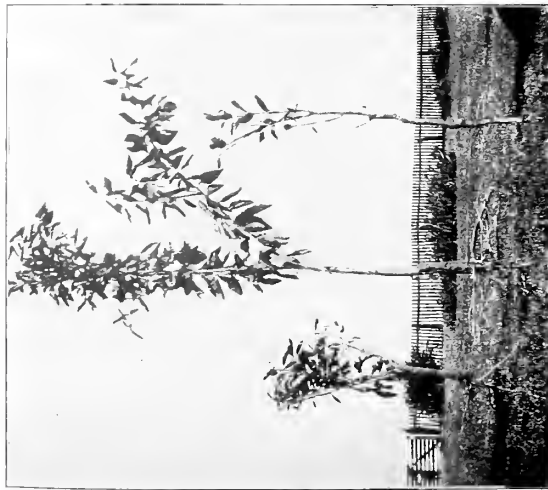

Fig. 1. Trees of Valencia orange.

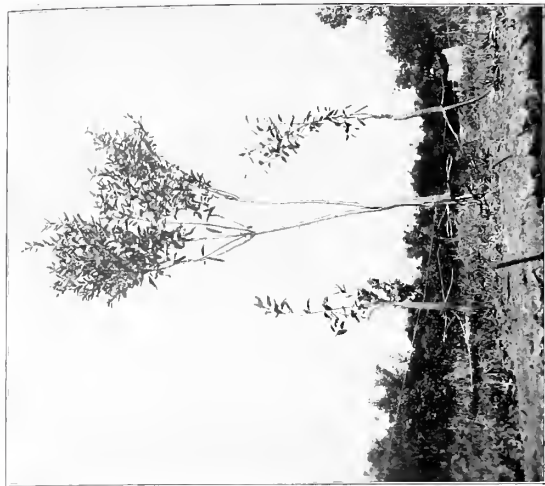

Fig. 2. Trees of a mandarin orange variety.

PLATE 3.

AN ENUMERATION OF THE JAPANESE APHELININÆ,
WITH DESCRIPTIONS OF TWO NEW SPECIES

By SHONOSUKE NAKAYAMA

*Of the Imperial Plant Quarantine Station of the Department of
Agriculture and Commerce of Japan*

ONE PLATE

The present paper enumerates the twelve known species of Japanese Aphelininæ, described by Howard, Ashmead, Fitch, Girault, and Silvestri, and two new species, which are described herein, making fourteen species recorded from Japan in this subfamily of the Chalcididæ. These minute, coccid parasites represent eight genera.

I am greatly indebted to Dr. L. O. Howard, chief of the Bureau of Entomology, of the United States Department of Agriculture, for help in the preparation of this paper.

Subfamily APHELININÆ Howard

Tribe APHELININI Ashmead

Genus ABLERUS Howard

Ablerus perspicuosus Girault.

Ann. Ent. Soc. Am. 9 (1916) 292.

Host.—*Aulacaspis pentagona* Targ.

Habitat.—Tokio, Japan.

Genus APHELINUS Dalman

Aphelinus fuscipennis Howard.

HOWARD, Revision of the Aphelininæ of North America, Tech. Ser.
Div. Ent., U. S. Dept. Agr. 1 (1895) 27; KUWANA, The Coccidæ
of Japan 1 (1911) 21.

Host.—*Aspidiotus perniciosus* Comst.; *Chionaspis* sp.

Habitat.—Tokio, Niigata-ken, Japan.

Aphelinus japonicus Ashmead.

Journ. N. Y. Ent. Soc. 12 (1904) 161, 162.

Habitat.—Atami, Japan.

Aphelinus mytilaspidis Le Baron.

Revision of the Aphelininæ of North America, Tech. Ser. Div. Ent.,
U. S. Dept. Agr. 1 (1895) 25, 26.

Host.—*Hemichionaspis aspidistræ* Sign.

Habitat.—Tokio, Shizuoka-ken, Japan.

Genus AZOTUS Howard

Azotus capensis Howard.

New genera and species of Aphelininæ, with a revised table of
genera, Tech. Ser. Bur. Ent., U. S. Dept. Agr. 12⁴ (1907) 75, 76,
fig. 15; The Coccidæ of Japan 1 (1911) 20.

Host.—*Aulacaspis pentagona* Targ.

Habitat.—Tokio, Japan.

Azotus chionaspidis Howard.

Proc. Ent. Soc. Wash. 16 (1914) 85.

Hosts.—*Chionaspis difficilis* Ckll.; *Aulacaspis pentagona* Targ.

Habitat.—Tokio, Niigata-ken, Kanagawa-ken, Japan.

Genus COCCOPHAGUS Westwood

Coccophagus lecanii Fitch.

Revision of the Aphelininæ of North America, Tech. Ser. Div. Ent.,
U. S. Dept. Agr. 1 (1895) 33, 34.

Hosts.—*Ceroplastes rubens* Mask.; *Phenacoccus pergandei*
Ckll.; *Pulvinaria citricola* Kuw.

Coccophagus yoshidæ sp. nov. Plate 1, fig. 1.

Female.—Length, 1.72 millimeters; wing expanse, 2.85;
greatest width of forewing, 0.54. Antennæ as long as the
thorax; segment 1 of funicle longer than segment 2 or 3; club
segments subequal in length and each as long as segment 3 of
funicle; thorax as long as the abdomen, but slightly widened
toward the posterior margin; general color black; anterior and
intermediate tibiæ light-colored, posterior dark-colored; eyes
clear but hairy; body rather hairy; wings dusky with short
cilia; marginal fringe very short, even wanting along basal
three-fourths of caudal margin of forewing; tibial spur of middle
leg nearly as long as basal tarsal segment.

This species was reared by Mr. Kashichi Yoshida, of the
Shizuoka-ken Agricultural Experiment Station, in the vicinity
of Shizuoka, from *Coccus hesperidum* Linn., in May, 1918. The
specific name is given in honor of the collector of this species.

The male is unknown.

Host.—*Coccus hesperidum* Linn.

Habitat.—Shizuoka-ken, Japan.

Genus *PERISSOPTERUS* Howard

Perissopterus mexicanus Howard.

Revision of the Aphelininæ of North America, Tech. Ser. Div. Ent.,
U. S. Dept. Agr. 1 (1895) 22, 23, fig. 5b; The Coccidæ of Japan,
1 (1911) 20.

Host.—*Aulacaspis pentagona* Targ.

Habitat.—Tokio, Japan.

Genus *PROSPALTELLA* Howard

Prospaltella aurantii Howard.

Revision of the Aphelininæ of North America, Tech. Ser. Div. Ent.,
U. S. Dept. Agr. 1 (1895) 41, 42, fig. 13; The Coccidæ of Japan
1 (1911) 21.

Host.—*Aspidiotus perniciosus* Comst.

Habitat.—Tokio, Shizuoka-ken, Japan.

Prospaltella berleseii Howard.

On the parasites of *Diaspis pentagona*, Ent. News 17 (1906) 292,
fig. [published October, 1906]; Redia 3 (1905) [published No-
vember 30, 1906] 391, fig.

Host.—*Aulacaspis pentagona* Targ.

Habitat.—Tokio, Japan.

Prospaltella niigatæ sp. nov. Plate 1, fig. 2.

Female.—Length, 0.69 millimeters; expanse, 1.53; greatest width of forewing, 0.19. Thorax broader than abdomen; length about same; pedicel as long as segment 3 of funicle which is longer and broader than segment 1 or 2; segment 2 of funicle longer than segment 1; club segments 1 and 2 subequal in length; terminal segment pointed at apex; thorax, width greater than length; general color brownish yellow; antennæ and legs light yellow; ocelli red; eyes black; abdomen black, broad anteriorly with narrow, dark bands between the segments; meso-scutellar parapsides also black; wings hyaline; veins pale yellow; forewings not so densely covered with cilia as in *Prospaltella berleseii*; marginal fringe long.

I reared this species from *Aulacaspis pentagona* Targ., infesting specimens of the mulberry tree that were brought from Tookamachi, Niigata-ken, in September, 1918, in the hope that

some parasites might be reared. Toward the end of September and in the early part of October, 1918, minute, active chalcids were bred from the scale, which differ from *Prospaltella berlesei* Howard. Specimens of the latter species were received from Prof. Antonio Berlese some time ago. This new parasite, which I name *Prospaltella niigatae*, has long, expanded forewings, and remarkably broad thorax. Segment 2 of funicle of this new species is longer than segment 1; in *Prospaltella berlesei* segment 1 is the longer.

The male is unknown.

Host.—*Aulacaspis pentagona* Targ.

Habitat.—Tookamachi, Niigata-ken, Japan.

Tribe PTEROPTRICINI Ashmead

Genus ARCHENOMUS Howard

Archenomus orientalis Silvestri.¹

Host.—*Aulacaspis pentagona* Targ.

Habitat.—Tokio, Japan.

Genus CASCA Howard

Casca chinensis Howard.

New genera and species of Aphelininae, with a revised table of genera, Tech. Ser. Bur. Ent., U. S. Dept. Agr. 12⁴ (1907) 83, fig. 20.

Host.—*Chionaspis difficilis* Ckll.

Habitat.—Tokio, Japan.

¹ Professor Silvestri reports that he has described this species, but I am unable to locate his literature.

ILLUSTRATIONS

[Drawings by the author.]

PLATE 1

- FIG. 1. *Coccophagus yoshidæ* sp. nov., female; greatly enlarged.
2. *Prospaltella niigatæ* sp. nov., female; greatly enlarged.

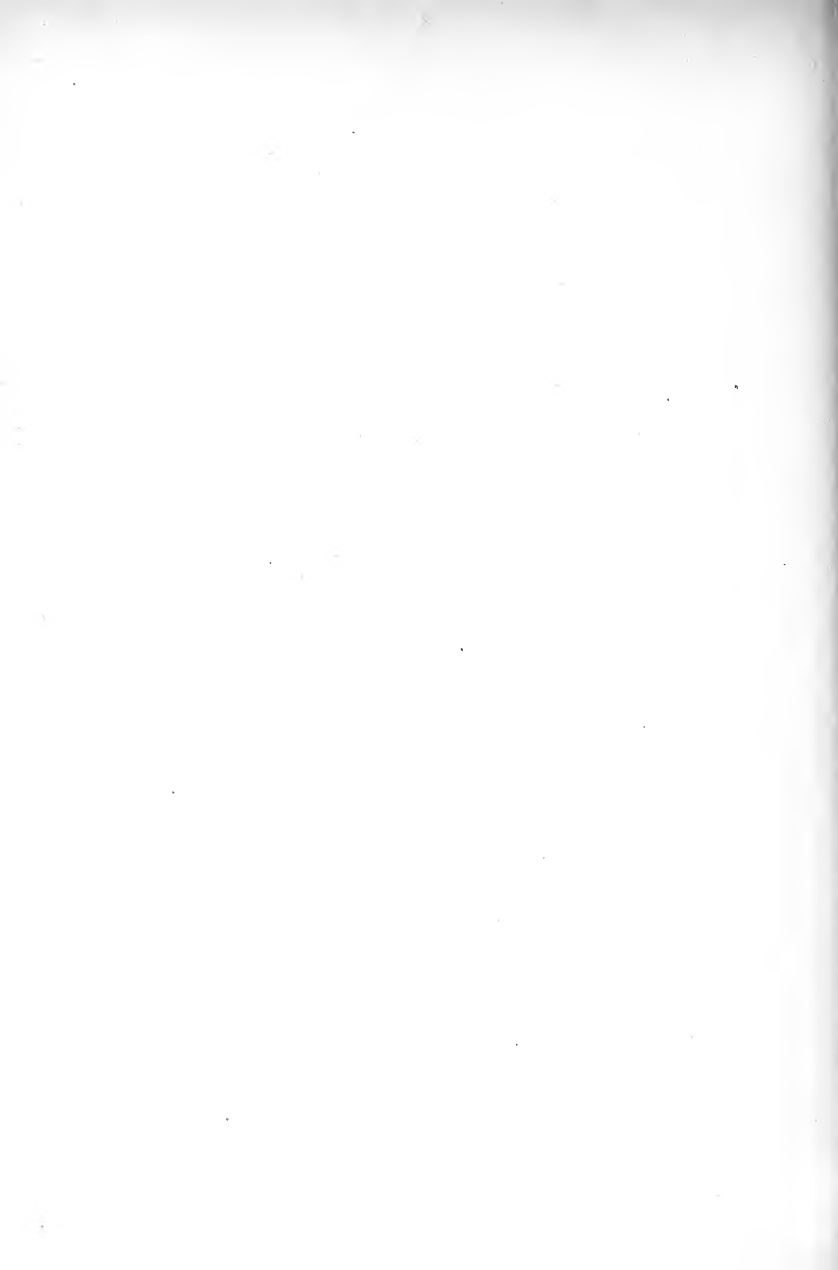

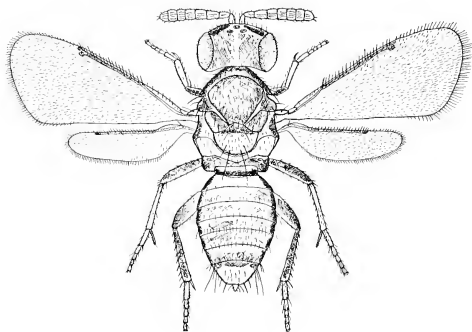

1

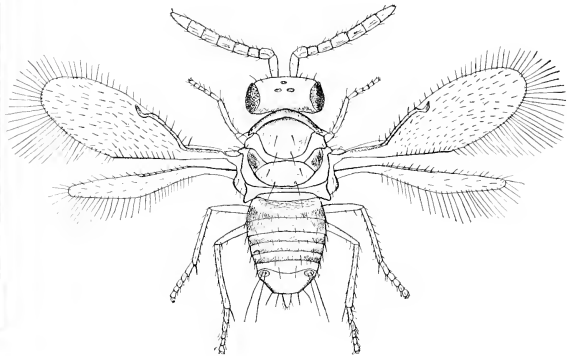

2

Fig. 1. *Coccophagus yoshida* sp. nov.

2. *Prospaltella niigata* sp. nov.

REVIEWS

Les maitres de la pensée scientifique | collection de mémoires publiés par les soins de M. Solovine | Traité | de | La lumière | par | Christian Huyghens | Paris | Gauthier-Villars et Cie, Éditeurs | Libraires du Bureau des Longitudes, de L'École Polytechnique | Quai des Grands-Augustins, 55 | 1920 | Paper, pp. i-x + 1-155.

Cours | De Chimie | A L'usage | Des Etudiants P. C. N. et S. P. C. N. | par | R. de Forcrand | [three lines of titles] | Deuxième édition | Tome 1 | Généralités. Chimie minérale | Paris | Gauthier-Villars et Cie, Éditeurs | Libraires du Bureau des Longitudes, de L'École Polytechnique | 55, Quai des Grands-Augustins, 55 | 1918 | Paper, pp. i-viii + 1-437.

Cours | De Chimie | A L'usage | Des Etudiants P. C. N. et S. P. C. N. | par | R. de Forcrand | [three lines of titles] | Deuxième édition | Tome II | Chimie organique Chimie analytique | Applications numériques | Paris | Gauthier-Villars et Cie, Éditeurs | Libraires du Bureau des Longitudes, de L'École Polytechnique | 55, Quai des Grands-Augustins, 55 | 1919 | Paper, pp. 1-527.

Mesures pratiques | en | Radioactivité | par | W. Makower [three lines of titles] | et | H. Geiger [two lines of titles] | Traduit de L'anglais | par | E. Philippi | Licencié és sciences | Paris | Gauthier-Villars et Cie, Éditeurs | Libraires du Bureau des Longitudes, de L'École Polytechnique | 55, Quai des Grands-Augustins, 55 | 1919 | Paper, pp. i-vii + 1-181 including index.

Troité | de | L'immunité | dans les | Maladies infectieuses | par | le Dr Jules Bordet [two lines of titles] | Masson et Cie, Éditeurs | Libraires de L'Académie de Médecine | 120, Boulevard Saint-Germain, Paris | 1920 | Paper, pp. i-viii + 1-720. Price, 40 f. net.

Manual | of | Psychiatry | edited by | Aaron J. Rosanoff, M. D. [three lines of titles] | Fifth edition. Revised and enlarged | New York | John Wiley & Sons, Inc. | London | Chapman & Hall, Limited | 1920 | Cloth, pp. i-xv + 1-684 including index. Price, \$4.

La Réaction | de Bordet-Wassermann | pour le | sérodiagnostic de la syphilis | étude théorique et pratique—methodes recommandées | interprétation des résultats | par | A.-D. Ronchese [two lines of titles] | Préface par M. le Professeur Fernand Widal | Masson & Cie, Éditeurs | Libraires de L'Académie de Médecine | 120, Boulevard Saint-Germain, Paris | Paper, pp. i-xvi + 1-211. Price, 10 f. net.

Clinique des voies urinaires | de la Faculté de Médecine de Paris | Physiologie | Normale et Pathologique | des reins | par | L. Ambard
[three lines of titles] | Deuxième édition | entièrement remaniée |
Masson et Cie, éditeurs | Libraires de L'Académie de Médecine | 120,
Boulevard Saint-Germain, Paris-VI° | 1920 | Paper, pp. 1-368.
Price, 18 f. net.

THE PHILIPPINE BUREAU OF SCIENCE

RECENT PUBLICATIONS

AN INTERPRETATION OF RUMPHIUS'S HERBARIUM AMBOINENSE

By E. D. MERRILL

Based on the collections made in Amboina by the late Charles Budd Robinson

Order No. 450. Bureau of Science Publication No. 9. Paper, 595 pages and 2 maps.

Price, \$3 United States currency, postpaid.

SPECIES BLANCOANAE: A CRITICAL REVISION OF THE PHILIPPINE SPECIES OF PLANTS DESCRIBED BY BLANCO AND BY LLANOS

By E. D. MERRILL

Order No. 461. Bureau of Science Publication No. 12. Paper, 423 pages and 1 map.

Price, \$2.25 United States currency, postpaid.

PHILIPPINE WATER SUPPLIES

By George W. Heise and A. S. Behrman

Order No. 466. Bureau of Science Publication No. 11. Paper, 218 pages, 19 plates, and 4 text figures.

Price, \$1.75 United States currency, postpaid.

VEGETATION OF PHILIPPINE MOUNTAINS

The relation between the environment and physical types at different altitudes

By WILLIAM H. BROWN

Order No. 473. Bureau of Science Publication No. 13. Paper, 434 pages, 41 plates, 30 text figures.

Price, \$2.50 United States currency, postpaid.

PLEASE GIVE ORDER NUMBER

Orders for these publications may be sent to the Business Manager, Philippine Journal of Science, Bureau of Science, Manila, P. I., or to any of the following agents:

AGENTS

THE MACMILLAN COMPANY, 64-66 Fifth Avenue, New York, U. S. A.
WM. WESLEY & SON, 28 Essex Street, Strand, London, W. C., England.
MARTINUS NIJHOFF, Lange Voorhout 9, The Hague, Holland.
KELLY & WALSH, Limited, 32 Raffles Place, Singapore, Straits Settlements.
THACKER, SPINK & CO., P. O. Box 54, Calcutta, India.
THE MARUZEN CO., Limited, 11-16 Nihonbashi, Tori-Sauchoime, Tokyo, Japan.

CONTENTS

	Page
DICKERSON, ROY E. A fauna of the Vigo group: its bearing on the evolution of marine molluscan faunas..	1
LIGHT, S. F. Further notes on Philippine scyphomedusan jellyfishes	25
MERRILL, ELMER D. New Philippine Moraceae.....	49
FLEUTIAUX, ED. Deux genres nouveaux de Coléoptères (Melasidæ)	71
FLEUTIAUX, ED. Deux espèces nouvelles de Coléoptères (Elateridæ)	73
MCGREGOR, RICHARD C. New or noteworthy Philippine birds, III.....	75
LEE, H. ATHERTON. The relation of stocks to mottled leaf of citrus trees.....	85
NAKAYAMA, SHONOSUKE. An enumeration of the Japanese Aphelininæ, with descriptions of two new species	97
REVIEWS	103

The Philippine Journal of Science is issued twelve times a year. The sections were discontinued with the completion of Volume XIII (1918).

Yearly subscription, beginning with Volume XIV, 5 dollars United States currency. Single numbers, 50 cents each.

Publications sent in exchange for the Philippine Journal of Science should be addressed: Library, Bureau of Science, Manila, P. I.

Subscriptions may be sent to the BUSINESS MANAGER, Philippine Journal of Science, Bureau of Science, Manila, P. I., or to any of the agents listed on the third page of this cover.

VOL. 18, No. 2

FEBRUARY, 1921

THE PHILIPPINE JOURNAL OF SCIENCE



MANILA
BUREAU OF PRINTING
1921

176688

THE PHILIPPINE JOURNAL OF SCIENCE

Published by the Bureau of Science of the Government of the Philippine Islands

ELMER D. MERRILL, M.S., *Editor*

R. C. MCGREGOR, A.B., *Associate Editor*

ALBERT H. WELLS, A.B.; GRANVILLE A. PERKINS, PH.D.; A. P. WEST, PH.D.
T. DAR JUAN, A.B., PHAR.D.; F. AGGAILI, A.B.; A. S. ARGÜELLES, B.S.
ALBERT E. W. KING

Chemistry

WARREN D. SMITH, PH.D.; ROY E. DICKERSON, PH.D.

Geology

H. W. WADE, M.D.; OTTO SCHÖBL, M.D.
F. G. HAUGHWOUT; STANTON YOUNGBERG, D.V.M.

Experimental Medicine

LIBORIO GOMEZ, M.D., PH.D.; F. CALDERON, B.A., L.M.
VICENTE DE JESUS, M.D.

Clinical Medicine

W. H. BROWN, PH.D.; C. F. BAKER, M.A.; ATHERTON LEE, M.S.
O. A. REINKING, B.S.A., M.S.; L. M. GUERRERO, PHAR.D.

Botany

ALBERT C. HERRE, PH.D.; C. F. BAKER, M.A.; S. F. LIGHT, M.A.
C. S. BANKS, M.A.; L. D. WHARTON, M.A.; W. SCHULTZE

Zoölogy

H. O. BEYER, M.A.; OTTO JOHNS SCHEERER, M.A.

Anthropology

ANNA B. BANYEA, *Copy Editor*

Manuscript intended for publication and books for review should be sent to the editor. One hundred separates of papers published in the Journal are furnished to authors without charge. Additional copies may be had at authors' expense.

Publications sent in exchange for the Philippine Journal of Science should be addressed: Library, Bureau of Science, Manila, P. I.

The Journal is issued twelve times a year. The subscription price is 5 dollars, United States currency, per year. Single numbers, 50 cents each.

Subscriptions may be sent to the BUSINESS MANAGER, Philippine Journal of Science, Bureau of Science, Manila, P. I., or to any of the agents listed on the third page of this cover.

THE PHILIPPINE JOURNAL OF SCIENCE

VOL. 18

FEBRUARY, 1921

No. 2

PHYSICAL PROPERTIES OF PHILIPPINE CONCRETE AND CONCRETE AGGREGATES¹

By ALBERT E. W. KING

Of the Bureau of Science, Manila

Among other activities, during the past ten years, the materials testing laboratory of the Bureau of Science has been conducting tests on concrete made for the Government in different parts of the Archipelago. Not only has this laboratory tested specimens of concrete that have been cast on the building site under typical field conditions, but it has sometimes made preliminary laboratory tests of the same aggregates so that a comparison of the strength of concrete made in the field with that of concrete mixed under carefully controlled laboratory conditions is possible. However, it should be mentioned that the Government has lately erected numerous concrete structures throughout the Islands without making a previous laboratory examination of the aggregates, and even without casting test specimens during the process of construction, so that the results recorded in this paper, unfortunately, are fragmentary. Then again, some of the data obtained by this laboratory were so lacunose that their inclusion here is not warranted. For instance, the Bureau of Science materials testing laboratory has occasionally received concrete test pieces without marks of identification as to age, quality of the mixture, aggregates and cement used, or the structure represented. As it is, I have included tests of concrete made of aggregates whose precise origin is unknown. Sufficient data, however, are given in these instances to sanction publication. Nearly all of the test specimens made in the field were sent to the Bureau of Science by

¹ Received for publication June 19, 1920.

the district engineers directly in charge of Bureau of Public Works building projects throughout the Philippines. A few of the field test specimens represent concrete that has entered into the construction of some of Manila's modern business edifices, such as the Manila Hotel, the Masonic Temple, and the Chaco Building. An interesting series of results was secured from test specimens cast in the field during the construction of the United States Army pier in Manila.² These results are especially noteworthy in that they show that the careful selection of aggregates, a close supervision of all mixing operations, including the proportioning of the cement, sand, water, gravel, and crushed stone, together with conscientious inspection of the process of putting the concrete in place, so as to compel sufficient spading and tamping of the mix, will under field conditions yield a concrete that is as strong as concrete made from the same materials in the laboratory.

The number of tests recorded totals 1,677. In Table 1 is shown the number of concrete specimens, classified according to provinces that submitted aggregates or test pieces. This table will give some idea of the amount of constructional activity carried on by the Government, throughout the Philippines, during the past decade.

Preliminary to the erection of concrete structures built under the supervision of the Bureau of Public Works, it has been customary to send to the Bureau of Science, for testing, samples of sand and gravel occurring as near as possible to the building site, and at the time thought by the engineer to be the best available material for the work contemplated. The samples of aggregates arrived at the materials testing laboratory packed in gunny sacks, cartons, wooden boxes, kerosene cans, and cement barrels, and ranged in quantity from barely sufficient to make six briquettes and one or two 6-inch cubes, to a barrelful (about 3.8 cubic feet) each of sand and gravel or crushed stone. In general it may be said that the samples were too small, and whether they were truly representative of the deposits or not is problematical. In several instances, tests

²For these specimens I am indebted to Mr. George H. Bevin, C. E., general superintendent of construction, Quartermaster Department, United States Army, who turned over to the Bureau of Science one hundred seventy-two 6-inch concrete cubes that were taken from batches used in making the piles, braces, and floor of the Quartermaster's pier. Fourteen cubes were tested and the cubes remaining are being preserved for long-time tests, a portion under the eaves of the laboratory roof, and the other portion in a steel cage submerged in the salt water beneath the pier.

of aggregates had to be postponed because the material sent was insufficient, thus entailing a delay of several weeks; sometimes the samples never came, and construction proceeded without a preliminary test of the aggregates. Such conditions are regrettable. The purpose of conducting tests on concrete aggregates is to eliminate, at the minimum of expense, unsuitable materials. Unfortunately it has not always been possible to carry out the recommendations of this laboratory; and there are instances on record where fine aggregates, entirely unfitted for concrete construction, have been used, often with disastrous results.

TABLE 1.—*Number of concrete specimens, classified according to provinces submitting aggregates or test pieces.*

Province.	Specimens tested.
Leyte	256
Manila and vicinity	242
Bulacan	229
Iloilo	156
Cebu	88
Samar	78
Cavite	73
Occidental Negros	68
Laguna	52
Albay	49
Capiz	47
Pangasinan	32
Bohol	27
Tarlac	26
Cotabato	22
Marinduque	20
Ilocos Norte	18
Ilocos Sur	18
Antique	18
Rizal	16
Sorsogon	16
Isabela	16
Oriental Negros	14
Batangas	13
Tayabas	13
Surigao	12
Zambales	12
Bataan	11
Misamis	10
Nueva Ecija	8
Zamboanga	8
Pampanga	4
Palawan	3
Jolo	2
Total	1,677

Upon arrival at the laboratory, the samples of sand and gravel were first thinly spread on a concrete platform and then rapidly dried by exposure to the heat of the sun, which at sea level in a tropical country is great. When dry, the aggregates were ready for testing. Complete sand tests in this laboratory comprise the determination of percentage of voids, apparent specific gravity, granulometric analysis, comparison of tensile and compressive strengths of 1 : 3 mortar with those of 1 : 3 Ottawa sand mortar, and approximate mineralogical composition; but sometimes not all of these tests were performed. Examinations were conducted in conformity with requests made by the Bureau of Public Works and, as Table 2 shows, are not complete. Ten years' testing of sands for concrete work has shown that very little practical value has been derived in the Philippines from knowledge of percentage of voids, apparent specific gravity, and mineralogical composition data, and that for ordinary routine examinations these tests might very well be omitted, since they tell us nothing regarding the compressive strength of the mortar or mortars yielded by the sand. The compressive strength of mortar is, after all, of paramount importance to the designing engineer; with the exception of granulometric analysis, all other tests play a very inconspicuous rôle in determining the suitability of a sand as a concrete aggregate. The size of the grain and the gradation of grain sizes, more than any other factors determine the compressive strength obtainable from a sand when mixed with Portland cement; so that the granulometric analysis of a sand, in nearly all instances, forms a valuable, practical criterion of the compressive strength.

What has just been said with respect to sand may also be applied to gravel and crushed stone, which constitute the coarsest components of concrete. Specific gravity, percentage of voids, granulometric analysis, and mineralogical composition data are of secondary importance. Table 3 gives the granulometric analyses of some Philippine gravels.

The most important test of gravel in ordinary routine investigation consists in actually making a series of concrete mixtures with this coarse aggregate and then ascertaining the compressive strength of the resultant test specimens. The proportions usually designated by the Bureau of Public Works are the standard 1 : 2 : 4, 1 : 2.5 : 5, and 1 : 3 : 6 mixtures; occasionally requests for other mixtures are received.

LABORATORY TESTS OF AGGREGATES USED IN CONCRETE

Percentage of voids.—A graduated cylinder about 7 centimeters in diameter with a capacity of 500 cubic centimeters was used in determining the voids in the sand. A small quantity of the dried sand was placed in the cylinder and compacted by striking the cylinder lightly on a cloth pad. About twenty blows were given and successive additions of sand compacted until the cylinder was filled to the 500 cubic centimeter mark. It is important to compact all sands to the same mark in order to secure reliable results. The difference between the weight of the cylinder containing the sand and that of the empty cylinder gave the weight of the 500 cubic centimeters of dry compacted sand. Knowing the specific gravity of the sand, the actual volume occupied by the sand grains may be easily calculated by substituting the proper values in the formula:

$$\text{Volume} = \frac{\text{Mass}}{\text{Specific gravity}}$$

If the true volume of the sand particles be now subtracted from the apparent volume as measured in the graduated cylinder, the difference will represent the void space in 500 cubic centimeters of sand. The void space divided by 500 and multiplied by 100 will give the percentage of voids.

The method used for determining the percentage of voids in the coarse aggregate (gravel) is analogous to that employed in connection with the sands and screenings. On account of the larger size of the grain a more spacious and less fragile container was used for weighing a compacted volume of the aggregate. A wooden box with inside lineal dimensions of 15 centimeters was filled with gravel, which was compacted by subjecting it to gentle percussion. The difference between the filled box and the empty box gave the mass of the compacted aggregate contained within a space of 3,375 cubic centimeters. Knowing the mass and the specific gravity of the gravel, it is an easy matter to calculate the true volume of the constituent pebbles by means of the formula already mentioned. The true volume of the gravel subtracted from the apparent volume (3,375 cubic centimeters) gives the void space, and this in turn divided by the apparent volume and multiplied by 100 gives the percentage of void space.

18	CAPIZ.									
18										
19										
20										
21										
	CAVITE.									
22										
23										
24										
	CEBU.									
25										
26										
27										
28										
	COTABATO.									
29										
30										
	ILOCOS NORTE.									
31										
	ILOCOS SUR.									
32										
	ILOILO.									
33										
34										
35										
36										
	JOLO.									
37										
	LAGUNA.									
38										
39										
40										

* United States Army crushed quartz sand used in making briquettes.

TABLE 2.—Physical tests of Philippine sands—Continued.

Tracing No.	Province or origin of sand.	Percentage by weight of sand passing through sieve No.—						Specific gravity.	Voids. P, et.	Tensile strength in pounds per square inch of 1.3 mortar briquettes.								
		10.	20.	30.	40.	50.	80.			100.	200.	Ottawa sand. 7 days.	28 days.	Sand submitted for test. 7 days.	28 days.			
	LEYTE.																	
41	Tigbauo River.....	79	38	10	5	3	1	2.74	36									
42	Tabontabon.....	87	74	63	57	62	23	15	2.72					327	436	231	340	
	MANILA.																	
43	Mariquina River.....	66	27	10	6	3	0.2		2.68	31				240	285	290	347	
44	Beach.....	98	96	95	88	73	17	9	5	2.73	45			223	283	97	150	
45	Pasig River.....	95	76	33	24	9	2	1										
	MISAMIS.																	
46	Cagayan River.....	98	87	49	35	20	5	2	1	2.63	42							
47	Do.....	99	91	55	36	14	5	3	1	2.71	44							
48	Do.....	44	10	6	4	3	1	0	2.70	33				335	458	394	589	
49	Mouth of Cagayan River.....	98	78	40	23	9	2	0	2.79	38								
50	Beach at mouth of Cagayan River.....	98	77	50	35	20	5	2	2.63	42								
	OCCIDENTAL NEGROS.																	
51	Binalbagan River.....	97	82	46	26	10	2	1	2.65	40				227	278	190	263	
	ORIENTAL NEGROS.																	
52	Bais River.....	81	53	26	19	12	2	1	2.61	40				316	402	197	312	
	PALAWAN.																	
53	Beach at Coron.....	87	66	48	35	23	5	3	1	2.56	40			265	335	216	309	
	FAMPANGA.																	
54	Back of Camp Stotsenberg.....	88	68	46	34	25	12	7						169	219	131	164	

55	Not given	81	56	35	23	15	6	4	2	2.75	36	237	319	340	465
56	Limestone screenings crushed and graded at the Bureau of Science.	45	28	23	18	15	9	5	2	2.58	40	237	319	408	490
57	Mariquina River	85	74	36	33	17	2	1			39	367	351	336	428
	RIZAL.														
	SAMAR.														
58	Beach	100	95	73	55	11	0.2			2.58	42	231	355	140	226
59	Do	100	100	99	97	96	85	82		2.59	45	231	355	40	181
60	Do	92	42	1	0.5							309	340	328	397
61	Surigao River	97	96	83	65	23	7	3	1	2.63	42	259	363	150	226
62	Wharf site	98	85	53	34	13	3	2	1	2.69	41	314	366	217	299
63	Santiago River	59	26	15	8	5	2	1		2.71	37	257	354	290	382
64	Pit 1, Sariaya-Muntig River	77	46	28	17	11	4	3	2	2.67	32	280	375	308	417
65	Anunang River														
66	Mouth of Anunang River														
67	Sitio of Galagala, 3.5 kilometers from bridge site	97	68	34	25	12	2	1		2.79	32	263	309	255	380
68	Mouth of Lucan River, 400 meters from bridge site	98	75	47	38	20	3	0.5		2.67	34	263	309	357	430
69	Lavis River, 1 kilometer from bridge site	88	65	25	16	7	1	0.5		2.75	32	299	380	290	436
70	Mouth of Yamot River, 2 kilometers from bridge site	99	96	49	23	6	2			2.72	33	322	366	216	274
71	Beach south of Kiling	99	84	50	31	8	2			2.84	37				
72	Kauayan-Kiling River	83	45	15	10	5	2	0.5		2.63	36				
	ZAMBOANGA.														
73	Beach	86	60	41	30	15	5	1		2.66	29	273	334	243	358
74	River	88	63	38	23	10	3	2	2	2.61	46	270	334	209	296

^a United States Army crushed quartz sand used in making briquettes.

TABLE 2.—Physical tests of Philippine sands—Continued.

Tracing No.	Province or origin of sand.	Compressive strength in pounds per square inch of 1:3 mortar cylinders.						Date of test.	Remarks.
		Ottawa sand.		Sand submitted for test.					
		7 days.	28 days.	7 days.	7 days.	28 days.	28 days.		
	ALBAY.								
1	Unknown.....	1,864	2,610	1,460	2,010	2,010	Jan. 7, 1915	Basaltic and andesitic sand proposed for use on bridges and culverts on Guinobatan-Jovellar Road.	
2	Quinale River.....	1,611	2,472	1,375	2,000	2,000	Jan. 25, 1915	Intended for use on Bridge No. 8.1, Guinobatan-Jovellar Road.	
3	Guinobatan River.....	1,942	2,490	1,287	2,400	2,400	Feb., 1915	Intended for use on Quinale Bridge.	
4	Unknown.....	1,925	2,737	1,550	2,537	2,537	July, 1915		
	BOHOL.								
5	Beach at Duero.....	2,012	3,045	1,148	1,919	1,919	Feb., 1918	Very clean sand, composed of smooth, rounded, granitic grains, 50 per cent; quartz, 5 per cent; and shell fragments, hornblende, and mica, 5 per cent.	
6	Beach sand.....	1,092	2,109	408	580	580	Oct., 1917	Very fine, clean beach sand, containing about 90 per cent of rounded quartz grains.	
7	Do.....	1,092	2,109	651	1,204	1,204	do	Fine beach sand, composed of 90 per cent of rounded shell and coral fragments.	
	BULACAN.								
8	Pullian River.....						Oct., 1915	Sand contains quartz and a high percentage of basalt.	
9	Bocue River.....						do	Coarse river sand, containing quartz, basalt, and some magnetite.	
10	Santo Niño River.....						do	Fine sand, derived from igneous rocks, and contains quartz, basalt, magnetite, and shell fragments.	
11	Not known.....						Jan. 17, 1912	Used in Santo Niño Bridge and in making concrete cubes at Bureau of Science.	
12	Maasin.....						Dec. 29, 1912	Composed of quartz, fragments of andesite, ilmenite, hematite, and magnetite.	

13	San Miguel	1,474	2,385	1,130	2,310	Apr. 23, 1913	Used in Bolo River Bridge.
14	Santa Maria River					Nov. 22, 1917	Medium coarse sand, derived from vesicular basalt and used in constructing Santa Maria Bridge.
	BATAAN.						
15	Mariveles Beach, No. 0					Nov. 27, 1909	In connection with proposed barrack building at Mariveles Quarantine Station, but rejected on account of extreme fineness; mortar tests very low.
16	Mariveles Beach, No. 1					Jan., 1916	Clean calcareous sand, composed of about 72 per cent shell débris; said to have good granulometric composition. Proposed for barrack building at Mariveles Quarantine Station.
17	Mariveles Beach, No. 2					do	Composed of about 70 per cent shell débris.
	CAPIZ.						
18	Junction of Lauan and Capiz Rivers	2,955			1,375	do	Fine sand, containing quartz, magnetite, olivine, basalt, and shell fragments. Soft grains of weathered rock present; proposed for constructing Libas Bridge.
19	Jaro River, Jaro, Iloilo	3,231			2,597	do	Proposed for use on Balucuan and Libas Bridges, in Dao and Capiz, respectively.
20	Panay River, Dao	2,824			2,723	do	Fairly coarse, graded sand for use in Balucuan Bridge.
21	Bar at junction of Lauan and Capiz Rivers					Dec., 1915	Contains quartz, hornblende tuff, basalt, and shell fragments; used in constructing Ivisan School, Ivisan.
	CAVITE.						
22	Rio Grande	783	1,878	1,584	2,804	Dec. 20, 1916	Coarse sand, composed of soft fragments of volcanic rock; no quartz grains present.
23	Imus River	783	1,878	1,534	1,968	do	Coarse sand, containing no quartz grains; appreciable quantities of light, porous, scoriolike pebbles present.
24	Rio Grande	657	1,824	602	1,113	Dec., 1916	Composed mostly of ferro-magnesian minerals; very little quartz present.
	CERU.						
25	Mananga River					Sept. 30, 1912	Composed of hornblende, olivine, and small quantities of quartz, sand proposed for Cebu Quarantine Station.
26	Davao River						
27	Unknown						
28	Stream bed, kilometer 115.8 on Bari-I-South Road.					May 8, 1913	

TABLE 2.—Physical tests of Philippine sands—Continued.

Tracing No.	Province or origin of sand.	Compressive strength in pounds per square inch of 1.3 mortar cylinders.				Date of test.	Remarks.
		Ottawa sand.			Sand submitted for test.		
		7 days.	28 days.	7 days.			
29	COTABATO. Linaac Beach, Cotabato.....	3,201	4,637	2,559	4,327	Nov. 26, 1915	Used in constructing Cotabato Hospital; consists principally of quartz, with ferro-magnesian minerals and shell fragments.
30	Do.....	1,091	1,393	1,056	1,519	May, 1917	Contains about 50 per cent quartz; used in constructing Cotabato River wall drain pipe, Cotabato Hospital.
31	ILOCOS NORTE. Laong.....						Composed principally of quartz, with fragments of magnetite and andesite; used for replacing the destroyed spillway of Gilbert Bridge.
32	ILOCOS SUR. Unknown.....					Mar. 17, 1915	Quartz sand used in the construction of Singson Waterworks.
33	ILOILO. Unknown.....						Proposed for constructing Molo Bridge, but rejected.
34	Unknown, No. 2.....					Do.	Do.
35	Unknown, No. 3.....					Jan. 16, 1911	Used in constructing Molo Bridge.
36	La Paz.....					June 18, 1911	Grains hard and clean.
37	JOLO. Jolo Beach.....	1,279	2,030	774	988	April 8, 1914	Derived from coral and shells.
38	LAGUNA. Barrio of Bayog, Los Baños.....						
39	Barrio of Mayondon, Los Baños.....						
40	Fagsanjan.....	842	1,246	919	1,416	Dec., 1918	Clean, coarse, angular basalt sand, containing practically no quartz; used in constructing the Fagsanjan Waterworks.

	LEYTE.											
41	Tigbao River	3,315	5,004	3,946	3,946	Dec., 1915.	Proposed for constructing Tacloban Port Works.					
42	Tabontabon	3,612	2,881	3,684	do	Used in constructing Tabontabon School.						
	MANILA.											
43	Mariguina River	795	1,360	1,585	Aug. 10, 1915	Used in constructing Masonic Temple, Manila.						
44	Beach				July, 1917.	Used by cadastral survey, Bureau of Lands, for making monuments, but discontinued on account of unsatisfactory results.						
45	Pasig River											
	MISAMIS.											
46	Cagayan River				March, 1916.	Proposed for constructing Cagayan Wharf.						
47	Do				do	Do.						
48	Do	1,508	2,827	2,808	Sept., 1916	Clean, very coarse sand, composed principally of hard, rounded, basaltic pebbles; very little quartz present; proposed for Cagayan Central School.						
49	Mouth of Cagayan River				April, 1916	Contains appreciable quantities of magnetite and olivine, and very little quartz; proposed for Macabalan Wharf.						
50	Beach at mouth of Cagayan River				Mar. 6, 1916.	Rock pebble sand, containing small quantities of quartz; proposed for constructing Cagayan Wharf.						
51	Binalbagan River	1,300	1,688	1,077	Oct., 1916.	Proposed for constructing Binalbagan Bridge, Isabela.						
	OCCIDENTAL NEGROS.											
52	Bais River	1,704	2,425	779	Mar., 1916	Contains considerable coralline limestone grains; proposed for Bais River Bridge.						
	PALAWAN.											
53	Beach at Coron	1,618	2,618	854	Mar., 1917	Angular, iron-stained quartz sand, proposed for construction of Coron Wharf.						
	PAMPANGA.											
54	Back of Camp Slotsenberg											

TABLE 2.—Physical tests of Philippine sands—Continued.

Tracing No.	Province or origin of sand.	Compressive strength in pounds per square inch of 1.3 mortar cylinders.						Date of test.	Remarks.
		Ottawa sand.		Sand submitted for test.					
		7 days.	28 days.	7 days.	28 days.	7 days.	28 days.		
55	Not given	1,624	2,463	1,896	2,042		July, 1917	Diorite pebble sand containing less than 1 per cent quartz; shell fragments and magnetite grains present; proposed for constructing Lingayen Provincial Building.	
56	Limestone screenings crushed and graded at the Bureau of Science.	1,624	2,463	2,186	2,913		do	Pangasinan limestone, crushed and graded (100 per cent through 0.25-inch mesh opening) at Bureau of Science to yield a mortar of high strength. Proposed for Provincial Building, Lingayen.	
57	Mariquina River	2,030	2,654	1,662	2,164		Feb., 1916	Used in constructing Angono Bridge, Binangonan, Rizal.	
58	Beach	1,252	1,983	829	935		1914	Fine beach sand, containing much shell debris.	
59	Do	1,262	1,983	241	829		do	Very fine beach sand, containing much calcareous matter.	
60	Do	1,973	2,990	1,833	2,948		Nov. 24, 1914	In connection with construction of Ilo, Sorsogon, and Bachow Bridges.	
61	Surigao River	1,116	1,966	598	894		Nov., 1915	Quartz sand with a small percentage of limestone. Proposed for constructing Bilang-bilang Wharf, Surigao.	
62	Wharf site	1,143	2,073	876	1,634		Oct., 1915	Quartz sand with admixture of basalt and andesite grains. Proposed for constructing Bilang-bilang Wharf.	

63	TARLAC. Santiago River	783	1,878	2,485	2,995	Nov., 1916	Contains less than 5 per cent of quartz; composed principally of clear, glassy grains of plagioclase feldspar. Proposed for use in constructing bridge 5.5, Capas-Concepcion Road.
64	TAYABAS. Pit 1, Sariaya-Muntig River	2,005	2,323	2,196	3,685	Nov., 1917	Angular pebble sand containing no quartz and derived principally from basalt. Proposed for constructing bridge No. 23.6, Lucena-Tiaong Road over Quiapo River.
65	ZAMBALES. Anunang River	2,303	2,312	1,964	2,069	Mar. 20, 1916	Proposed for constructing Anunang River Bridge, Cabangan, Zambales.
66	Mouth of Anunang River	2,303	2,312	1,689	2,351		
67	Site of Galagala, 3.5 kilometers from bridge site.	1,176	1,679	923	1,234	Sept., 1916	Very clean, hard-grained sand, proposed for constructing Candelaria School, Candelaria, Zambales.
68	Mouth of Lucan River, 400 meters from bridge site.	1,176	1,679	1,279	2,115	do	Very clean sand; proposed for constructing Lucapon Bridge, Alhambra, Zambales.
69	Lauis River, 1 kilometer from bridge site.	1,593	2,679	1,700	3,127	July, 1916	Proposed for Yamot Bridge.
70	Mouth of Yamot River, 2 kilometers from bridge site.	1,693	2,679	1,325	1,959	do	Do.
71	Beach south of Kiling					Jan., 1916	Composed of quartz grains; proposed for bridges, Iba-Subic Road.
72	Kauyan-Kiling River		2,918		2,870	do	Proposed for bridges, Iba-Subic Road.
73	ZAMBOANGA. Beach	912	1,450	738	1,298	Feb., 1918	Very clean sand, containing about 20 per cent coral and shell fragments; 4 per cent milky quartz; and 76 per cent rock pebbles; proposed for Zamboanga Normal School.
74	River	912	1,450	317	661	do	Fairly clean sand containing less than 5 per cent quartz, and principally composed of volcanic and metamorphic rock pebbles, about 10 per cent of which are in an advanced state of decomposition.

TABLE 3.—*Granulometric analyses of Philippine gravels.*

Province or origin of gravel.	Percentage by weight of gravel passing through circular opening having a diameter of—						Date of test.	Remarks.
	2.25 inches.	1.50 inches.	1 inch.	0.57 inch.	0.45 inch.	0.30 inch.		
Unknown		66	46	23	6	1	Jan. 7, 1915.	Vesicular andesite, proposed for bridges and culverts on Guinobatan-Jovellar Road.
ALBAY.								
Mariveles beach, No. 2	99		71	30	10			Specific gravity, 2.66; voids, 46 per cent; gravel soft and highly weathered.
Mariveles beach, No. 3		100	98	93	79	60		Contains 38 per cent sand; specific gravity, 2.47; voids, 46 per cent.
Mariveles beach, No. 4	80	38	32	6				Three per cent retained on 8-inch circular opening; only the portion passing 1.5-inch circular opening used in concrete.
Sisiman crushed andesite from Mariveles, No. 5.	83	16	3					Ninety-eight per cent passed through 8-inch circular opening; only the portion passing 1.5-inch circular opening used for concrete; specific gravity 2.62; rock hard and tough.
BULACAN.								
Pullian River	100	83	41	18	0.2	0.0	Oct., 1915	Altered basalt; impregnated with pyrites.
Bocane River	100	77	50	31	26	0.4	do.	Altered basalt.
Quiagna River		100	77	51	22	8		One per cent through 0.20-inch circular opening.
Bocane River		100	97	80	42	15		Do.
San Miguel		100	96	89	67	43	May, 1913	Contains 3 per cent sand; proposed for Bolo River Bridge.
Do.		100	86	57	36	13	do.	Proposed for Bolo River Bridge.
Sibul		100	71	57	37	22		Contains 11 per cent sand; proposed for Bolo River Bridge.
Santa Maria River		83	63	27	5	1		Soft, highly weathered gravel, derived from volcanic rock; used in Santa Maria Bridge.

CAVITE.													
Imus River.....	100	90	78	64	46								Sand content approximately 27 per cent; gravel contains basalt, andesite tuff, and shell fragments; specific gravity, 2.35; voids, 37.3 per cent; for use in constructing Aguinaldo School, Kawit.
Rio Grande.....	79	64	40	24	11								Contains about 10 per cent of sand; clean, hard gravel; specific gravity, 2.44; voids, 35.4 per cent.
Imus River.....	100	73	63	51	42								Composed largely of vesicular basalt; specific gravity, 2.10; voids, 45.9 per cent; contains about 30 per cent sand.
Rio Grande.....	75	68	45	30	20								Contains about 10 per cent sand; specific gravity, 2.60; voids, 39 per cent; soft gravel.
Do.....	100	87	70	46	34								Contains volcanic ejecta, basalt, and scoria; contains about 25 per cent sand; specific gravity, 2.40; voids 25.4 per cent.
CEBU.													
Mananga River.....	100	86	55	15	3								Specific gravity, 2.63.
Unknown.....	100	76	22	1	0.5								Composed of andesite pebbles, specific gravity, 2.64; voids, 42 per cent. Proposed for Cebu Quarantine Station.
ILOCOS NORTE.													
Laogay.....	100	93	65	18	9								Andesite pebbles; used in the reconstruction of the destroyed spillway of Gilbert Bridge.
ILOCOS SUR.													
Unknown.....	100	80	45	10	2								Used in constructing Singson Waterworks, Vigan.
JOLO.													
Jolo beach.....	100	96	85	50	20								Composed of coral fragments, and contains 17 per cent sand; specific gravity, 2.33; voids, 56.3 per cent.
LAGUNA.													
Crushed rock from upper ledge of quarry at Los Baños.	100	23	6	3	2								Hard, durable basalt.
MANILA.													
Mariquina River.....	100	68	56	30	8								
MISAMIS.													
Beach.....	100	100	33	3	0								Proposed for Cagayan Wharf.
Cagayan River.....	100	96	59	63	40								Proposed for Cagayan Wharf; contains about 25 per cent sand.
Do.....	100	83	20	0									Proposed for Cagayan Central School.

TABLE 3.—*Granulometric analyses of Philippine gravels*—Continued.

Province or origin of gravel.	Percentage by weight of gravel passing through circular opening having a diameter of—					Date of test.	Remarks.	
	2.25 inches.	1.50 inches.	1 inch.	0.67 inch.	0.45 inch.			0.30 inch.
ORIENTAL NEGROS.								
Bals River.....	100	59	48	27	8	2	Mar., 1916.....	Soft gravel, proposed for constructing Bais River Bridge.
PAMPANGA.								
Crushed run surface rock from Camp Stotsenberg.	100	100	38	23	11	7	-----	Soft, hornblende andesite.
Crushed float rock from Banaban River.	100	100	21	7	1	-----	-----	Hard basalt, having pronounced cleavage planes.
PANGASINAN.								
Unknown.....	100	91	87	69	29	5	-----	Proposed for Provincial Building, Lingayen; composed principally of diorite.
RIZAL.								
Anġono River.....	83	83	56	45	29	17	-----	Contains about 5 per cent sand; proposed for constructing Anġono Bridge, Binangonan, Rizal.
ZAMBALES.								
Beach gravel from Galagala, 3.5 kilometers from bridge site.	100	94	18	-----	-----	-----	Sept., 1916.....	Hard, clean gravel, containing appreciable quantities of quartz pebbles. Proposed for Candalaria School.
Lauis River, 4 kilometers from bridge site.	81	64	7	0.3	-----	-----	June, 1916.....	Coarse, clean, hard gravel; proposed for Yamot Bridge.
Cabangan River.....	100	49	3	0.4	-----	-----	Jan., 1916.....	Composed of hard, volcanic, metamorphic rock; proposed for bridges on Iba-Subic Road.

Specific gravity.—Sixty-four grams of the dried sand were introduced into a Le Chatelier flask filled to the zero mark with 95 per cent alcohol. The rise of the meniscus on the graduated neck represents the volume displaced by the grains of sand. Dividing the mass of the sample used by the displacement in cubic centimeters indicated on the neck of the flask quickly and accurately gives the specific gravity of the sand.

For determining the specific gravity of the coarse aggregate about 1,000 grams of the dried gravel were accurately weighed, and then allowed to rest under water for twenty-four hours in order to fill the pores. After the aggregate was saturated with water, it was quickly dried with a cloth, then with a blotter, and the displacement of the gravel noted in a large graduated cylinder containing a measured quantity of water. The specific gravity was calculated from the well-known formula:

$$\text{Specific gravity} = \frac{\text{Mass}}{\text{Volume}}$$

Granulometric analysis.—In determining the granulometric analysis of sand, 200 grams of a representative sample were successively shaken on a series of sieves ranging from 10 to 200 meshes to the linear inch and the residue on each sieve was weighed. The sieves are 8 inches in diameter and fitted with double-crimped, brass, wire cloth having square mesh openings. In Table 4 are recorded the actual mesh and wire sizes, obtained by examining the sieves under a microscope fitted with an ocular micrometer. The granulometric results obtained during the period 1908 to 1914 were secured by hand sieving; results after 1914 were gotten by using an electrically driven sieving apparatus commercially known as The Per Se Testing Sieve Agitator manufactured by Howard and Morse, of Brooklyn, New York.

TABLE 4.—*Mesh, space, and wire sizes of sieves used in performing granulometric analyses of Philippine sands.*

Meshes per linear inch.	Width of clear opening from one wire to another.		Diameter of wire.	
	in.	mm.	in.	mm.
10	0.0734	1.87	0.0266	0.675
20	0.0323	0.820	0.0177	0.450
30	0.0203	0.517	0.0130	0.330
40	0.0144	0.365	0.0106	0.270
50	0.0111	0.283	0.0089	0.225
80	0.0066	0.168	0.0059	0.150
100	0.0053	0.134	0.0047	0.120
200	0.0026	0.067	0.0024	0.060

For the granulometric test of gravel and crushed stone, a set of sieves was used having circular openings ranging in diameter from 2.25 inches down to 0.30 inch, namely 2.25, 1.50, 1.00, 0.67, 0.45, and 0.30. Instead of wire cloth, these sieves consisted of sheet iron punched with round holes, which was soldered to a circular frame 12 inches in diameter and 3 inches deep.

A 2,000-gram sample of the dry gravel was placed on the sieve with the largest opening and shaken by hand until no more of the material passed through. The material coming through this screen was placed on the sieve next smaller in hole opening and the sieving performed as before, and the process continued with the other sieves in the series. The portions of aggregate remaining on each of the screens were weighed and recorded.

Tensile and compressive strength tests.—The sands and screenings were tested for tensile strength in the proportions by weight of one part cement to three parts sand. Three-gang standard briquette molds were used for molding the test specimens. The briquettes were made in accordance with the directions prescribed in the United States Government specification for Portland cement.³

Specimens for compression were made in the proportions by weight of one part cement to three parts sand, but in several instances the smallness of the sample precluded such a test. The compression specimens were cylindrical, with a diameter of 3.568 inches and a height of 7.136 inches. The cylinder-shaped molds used in forming these test pieces are constructed of cast iron and are split vertically into halves for facility in removing the specimens. During the molding operation, the two halves of the mold are held together by a cast-iron ring that encircles the body of the mold with a taper fit. The diameter was made 3.568 inches so that the area of the bearing faces would be exactly 10 square inches, as this greatly facilitates the calculation of the strength per square inch. The height was made twice the least lateral diameter in order to secure the correct shearing angle during rupture. For the purpose of comparison briquettes and cylinders were molded of mortar composed of one part cement and three parts standard Ottawa sand, by weight. Both the tension and the compression test mortar specimens, unless otherwise noted, were stored for the first twenty-four hours in a moist-air cabinet; at the end of this period the test pieces were removed from the molds and stored up to the time of rupture in fresh running water maintained at an average temperature of 28° C.

³ United States Government Specification for Portland Cement, Circular Bur. Standards 33 (May 1, 1912, and January 18, 1917).

In Table 5 are recorded typical results of physical tests of eight brands of Portland cement that have been used in concrete construction in the Philippine Islands. These tests were made in the materials testing laboratory of the Bureau of Science in accordance with the United States Government specification for Portland cement.⁴ The requirements of the older specification were in force in the Philippine Islands until May 24, 1918, and are abstracted here for convenience in studying the results given in Table 5.

2. In the finished cement, the following limits shall not be exceeded:

	Per cent.
Loss on ignition for 15 minutes.....	4.00
Insoluble residue	1.00
Sulphuric anhydride (SO ₃).....	1.75
Magnesia (MgO)	4.00

SPECIFIC GRAVITY

3. The specific gravity of the cement shall be not less than 3.10. Should the cement as received fall below this requirement, a second test may be made upon a sample heated for 30 minutes at a very dull red heat.

FINESS

4. Ninety-two per cent of the cement, by weight, shall pass through the No. 100 sieve, and 75 per cent shall pass through the No. 200 sieve.

SOUNDNESS

5. Pats of neat cement prepared and treated as hereinafter prescribed shall remain firm and hard and show no sign of distortion, checking, cracking, or disintegrating. If the cement fails to meet the prescribed steaming test, the cement may be rejected or the steaming test repeated after seven or more days at the option of the engineer.

TIME OF SETTING

6. The cement shall not acquire its initial set in less than 45 minutes and must have acquired its final set within 10 hours.

TENSILE STRENGTH

7. Briquettes made of neat cement, after being kept in moist air for 24 hours and the rest of the time in water, shall develop tensile strength per square inch as follows:

	Pounds.
After 7 days	500
After 28 days	600

8. Briquettes made up of 1 part cement and 3 parts of standard Ottawa sand, by weight, shall develop tensile strength per square inch as follows:

	Pounds.
After 7 days	200
After 28 days	275

⁴ United States Government Specification for Portland Cement, Circular Bur. Standards 33 (May 1, 1912, and January 18, 1917).

The foregoing specification has been superseded by that published in the third edition of Circular 33, issued January 18, 1917. The latter United States Government specification for the testing of Portland cement has been in force in the Philippine Islands since May 24, 1918, and is effective at the present time. For the purpose of comparison, the new requirements are here given.

CHEMICAL LIMITS

2. The following limits shall not be exceeded:

	Per cent.
Loss on ignition	4.00
Insoluble residue	0.85
Sulphuric anhydride (SO ₃).....	2.00
Magnesia (MgO)	5.00

SPECIFIC GRAVITY

3. The specific gravity of cement shall be not less than 3.10 (3.07 for White Portland cement). Should the test of cement as received fall below this requirement, a second test may be made upon an ignited sample. The specific-gravity test will not be made unless specifically ordered.

FINENESS

4. The residue on a standard No. 200 sieve shall not exceed 22 per cent by weight.

SOUNDNESS

5. A pat of neat cement shall remain firm and hard, and show no signs of distortion, cracking, checking, or disintegration in the steam test for soundness.

TIME OF SETTING

6. The cement shall not develop initial set in less than 45 minutes when the Vicat needle is used or 60 minutes when the Gillmore needle is used. Final set shall be attained within 10 hours.

TENSILE STRENGTH

7. The average tensile strength, in pounds per square inch of not less than three standard mortar briquettes composed of one part cement and three parts standard sand, by weight, shall be equal to or higher than the following:

Age at test.	Storage of briquettes.	Tensile strength, pounds per square inch.
<i>Days.</i>		
7	1 day in moist air, 6 days in water	200
28	1 day in moist air, 27 days in water	300

TABLE 5.—Typical results of physical tests conducted upon Portland cements used in the Philippines.

Tracing No.	Brand.	Manufactured In—	Tested.	Fineness, percentage through—		Specific gravity.	Soundness.		Setting time.		Tensile strength, pounds per square inch.				Remarks.
				300 mesh.	100 mesh.		5 hours in steam.	28 days in water.	Initial.	Final.	Neat.		1:3 Ottawa mortar.		
1	Asano	Japan	Nov. 10, 1916	10	86	3.11	O. K.	h.	h.	m.	597	648	252	362	All results within specifications.
2	Do	do	Apr. 22, 1918	100	81	3.11	O. K.	4	12	6	25	597	648	252	
3	Alsen	Germany	Sept. 12, 1912	100	82	3.08	O. K.	1	56	4	26	a456	e197	d308	
4	Do	do	July 3, 1911	20	77	3.08	O. K.	1	38	4	41	b501	f617	e294	
5	Caballo	China	Oct. 8, 1917	20	78	3.11	O. K.	3	36	5	13	594	636	289	
6	Do	do	Mar. 2, 1918	100	82	3.11	O. K.	3	13	6	29	1547	k606	236	
7	Culebra	Japan	Dec. 15, 1915	20	80	3.11	O. K.	5	08	7	52	609	737	277	
8	Do	do	Oct. 23, 1919	37	71	3.12	O. K.	3	34	6	40	m179	n261	369	
9	Green Island	China	Mar. 11, 1911	60	78	3.10	O. K.	1	26	3	38	598	p659	276	
10	Do	do	Apr. 18, 1911	10	77	3.12	O. K.	3	02	5	33	654	q236	r297	
11	Haiphong	Indo-China	Feb. 25, 1916	12	84	3.09	O. K.	4	12	7	41	565	654	337	
12	Do	do	June 17, 1910	35	83	3.09	O. K.	1	51	5	04	s111	t619	u250	
13	Onoda	Japan	Jan. 18, 1916	25	89	3.14	O. K.	4	29	7	45	555	659	283	
14	Do	do	Jan. 25, 1916	25	88	3.14	O. K.	5	35	7	25	554	w650	260	
15	Rizal	Philippine Is.	Oct. 4, 1916	10	80	3.12	O. K.	3	34	5	34	566	631	297	
16	Do	do	May 15, 1916	40	79	3.14	(*) O. K.	2	30	4	39	y547	z644	aa160	

a 92 samples failed.
 b 97 samples failed.
 c 53 samples failed.
 d 36 samples failed.
 e 36 samples failed.
 f 1 sample failed.
 g 78 samples failed.
 h 10 samples failed.
 i 18 samples failed.
 j 30 samples failed.
 k 36 samples failed.
 l 36 samples failed.
 m 28 samples failed.
 n 30 samples failed.
 o 2 samples failed.
 p 1 sample failed.
 q 2 samples failed.
 r 3 samples failed.
 s 13 samples failed.
 t 13 samples failed.
 u 7 samples failed.
 v 9 samples failed.
 w 2 samples failed.
 x 27 samples unsound.
 y 4 samples failed.
 z 2 samples failed.
 aa 25 samples failed.
 bb 33 samples failed.

In this laboratory it is customary to test one barrel of cement in every ten. Each sample of cement received by the Bureau of Science, so far as the Government is concerned at least, therefore represents ten barrels of cement. Only one sample in every ten is tested for fineness, one in every five for time of setting and for specific gravity, but every sample is tested for soundness and tensile strength. An incomplete chemical analysis is also made of every lot of cement received by the laboratory, a single composite sample being taken for this purpose. Table 6 gives the loss on ignition, insoluble residue, sulphuric anhydride, and magnesia of some cements used in the Philippine Islands.

TABLE 6.—*Incomplete chemical analyses of Portland cement used in the Philippine Islands.*

Brand.	Loss on ignition.	Insoluble residue.	Sulphuric anhydride.	Magnesia.
	<i>Per cent.</i>	<i>Per cent.</i>	<i>Per cent.</i>	<i>Per cent.</i>
Asano	1.63	0.55	1.30	1.35
Caballo	2.10	0.25	1.17	2.12
Culebra	1.90	0.35	1.16	1.96
Green Island	1.85	0.44	1.25	1.95
Onada	1.46	0.41	1.50	1.79
Rizal	2.73	0.53	1.62	1.54

In Table 7 are recorded the number of samples of Portland cement tested at the materials testing laboratory since the inception of such work in 1907 at the Bureau of Science. Previous to that year the testing of Portland cement was scattered throughout the various government entities using it.

Mineralogical composition.—Some of the sands were examined under the magnifying glass for the purpose of making a rough approximation to their mineralogical composition. In order

TABLE 7.—*Number of samples of Portland cement tested at the Bureau of Science.*

Year.	Samples.	Year.	Samples.
1907	24	1914	6,817
1908	1,200	1915	6,716
1909	* 2,788	1916	15,790
1910	* 3,293	1917	5,687
1911	* 3,724	1918	4,999
1912	8,476	1919	6,888
1913	9,535		

* Figures include a small unknown number of soil, fertilizer, and sand samples.

to determine the mineralogical nature of the grains it was generally necessary to free them from adhering dust, dirt, or clay by washing with water. Representative pieces of the coarse aggregates (gravels and stone) were fractured by rapping them sharply with a geological hammer, and the clean broken surface was examined macroscopically.

TECHNIC OF CONCRETE TESTS

Method of mixing and molding.—All proportions used in this paper to indicate concrete mixtures are by volume. For proportioning the mixtures the weight of a cubic foot of cement was assumed to be 90 pounds. Both the sand and the gravel were measured dry, and compacted in the measuring boxes by gentle percussion. After having found the weight of a unit volume of the compacted aggregate it was more convenient to proportion the mix by using the weight of a unit volume of the materials. The aggregates required for a mixture were weighed instead of actually measured by volume, and the loss in time and the tediousness of compacting them were thus avoided. Likewise, it was more convenient and more accurate to weigh the cement for the various tests and then to calculate the volume, than actually to measure by volume the cement required. The sand and cement were then intimately mixed with a shovel on a concrete slab, after which the gravel was added and the whole thoroughly mixed in the dry state. In these laboratory tests the batches never weighed more than 30 kilograms, so that it was a comparatively easy matter to secure a homogeneous mixture. A crater was next made in the middle of the heap and water amounting to from 7 to 10 per cent (depending upon the granular sizes of the sand and gravel) of the total weight of the dry batch was added; fine aggregates always required more water than coarse ones. The consistency sought in these tests may be described as "quaking;" such a mixture is a fairly stiff one, which upon slight tamping yields water on the surface. The mass does not flow readily and has to be spaded and rammed vigorously to produce specimens free from honeycombing. The test pieces were made by tamping the concrete into the molds in layers about 1 inch thick; the mold was also subjected to a vibratory motion by rapping the outside with a wooden block. When the mold was full, the top surface of the specimen was smoothly finished with a trowel. Most of the laboratory specimens were 6-inch cubes; some concretes made of small-sized gravels were cast in the cylindrical molds already described under mortar tests. At the end of twenty-four hours the speci-

mens were taken out of the molds and stored either in the laboratory air or in the moist-air closet until the time of rupture.

With a few exceptions, the test specimens sent to the materials testing laboratory of the Bureau of Science were hand-mixed. From personal observation of the activities of concrete-mixing gangs in various parts of the Archipelago I am in a position to account for the exceptionally low and erratic results obtained from specimens made on the building site. Laboratory tests of many of the aggregates gave high and uniform results; however, the proportioning of the same aggregates and cement in the field in the Philippine Islands is, in general, a haphazard operation that results in an arbitrary mixture which bears little relationship to the concrete prescribed by the designer. In some instances both the cement and the aggregates are measured loosely, with the result that instead of using from 90 to 100 pounds to the cubic foot as packed in the barrel, the cement is used in volumes that weigh anywhere from 50 to 70 pounds to the cubic foot. By using this method one barrel of cement is made to go a long way, but the resultant concrete is very friable and gives extraordinarily low compressive strength. In other instances I have seen the sand and gravel measured in wheelbarrows—a certain number of loads of each to one barrel of cement—with the result that the actual ratio of cement to sand to gravel was unknown.

Irregularities also occur in the operation of mixing that cast light on the discordant results secured from a lot of specimens made from the same batch of concrete. The usual method employed in making concrete by hand in the Philippines is to mix the sand and cement dry until it is fairly homogeneous; in general this means that a barrel of cement is dumped on the sand and the pile shoveled through once to form a cone. Sometimes the cone thus formed is shoveled through once more. The workmen now form a crater in the center of the cone while a man plays an ordinary garden hose or pours pails of water into the depression thus formed. The amount of water added is determined by the mixers, who continue to call for water until the mortar has lost all of its stiffness and plasticity, and the shovel can be passed through the mass with a minimum amount of labor. No attempt is made to measure the water; it is used in such superabundance largely for the purpose of reducing to a minimum the work of mixing and placing. The mortar thus drenched with water is soupy, and more than once I have seen it flow over the edge of the wooden mixing

board. The mortar is now distributed on the gravel layer which has been spread on the mixing board to a depth that may range from 6 to 12 inches. Two or four men with shovels, stationed in pairs and facing each other, now proceed to mix the superimposed blanket of mortar with the underlying layer of gravel in such a manner that the mortar is incorporated with only that portion of gravel lying directly underneath it so that the mass as a whole is not thoroughly intermingled, but is mixed sectionwise. In other words the two-layered mound of mortar and gravel is shoveled directly into buckets or wheelbarrows used for conveying the concrete to the structure, after each shovelful has been subjected to an average of four turns. During this last mixing operation a man stands by with a hose or with pails of water to do the bidding of the men engaged in the mixing operation, who call for water as long as the mass offers decided resistance to the passage of the shovel on account of plasticity. They aim to get as wet a mix as possible in order to reduce their work to a minimum and to facilitate the placing of the concrete in the structure. The result is a soupy, non-uniform concrete, subject to segregation while being conveyed to its final resting place and while being placed. On account of the excessive amount of water added the concrete so mixed will have a low compressive strength, as tests have already shown.

The concrete specimens cast in the field lacked the careful workmanship shown by the cylinders and cubes molded in the laboratory. In some few cases the honeycombed texture of the concrete test pieces made on the building site showed evidence of lack of tamping and spading. Their chief fault, however, was the irregular manner in which the cylinder ends had been finished so that it was necessary to embed them in plaster of Paris before they could be subjected to the compression test. Careless packing accounted for injuries sustained by some test pieces during transport from the building site to the laboratory, as a result of which no tests were possible.

Data on the storage of concrete specimens fabricated in the field show considerable variation. On account of the distance between the building site and the laboratory and the irregularities of interisland communication, it was not always possible to receive the specimens in time to break them at the end of twenty-eight days. Results obtained from such belated test pieces lose some of their comparative value; but they have been included in this paper in order to convey some idea of the quality of

the concrete used in the particular structure concerned. Field specimens, referred to as stored in moist air, may be considered as having been sprinkled with water or as having been kept under moist sacking or buried in the ground.

METHOD OF TESTING

To insure uniform distribution of the load on the specimens made in the field it was found necessary to embed in plaster of Paris the rough ends bearing on the testing machine. The test pieces made in the laboratory were so smoothly finished that capping with plaster was unnecessary; but a piece of cardboard was interposed between the bearing surfaces and the table and crosshead of the machine.

In embedding the ends of a specimen, plaster was thinly spread on a piece of cardboard resting upon a surface plate and one end of the test piece pressed in by hand so that plaster oozed out on all sides. After the plaster had set, the specimen was turned upside down and the other end forced into a thin layer spread on a piece of cardboard resting on a spherical bearing block. This time the specimen was pressed into the plaster by the testing machine, care being taken not to exceed an average pressure of 30 pounds per square inch. After resting for at least twelve hours, the specimens were centered on a spherical bearing block that rests on the weighing table of the testing machine, and the test pieces together with the upper section of the spherical block were slowly rotated to insure uniform bearing, while the crosshead was brought down upon the specimen. The load was applied uniformly at the rate of about 0.5 millimeter per minute. After rupture, the specimen was removed from the machine, and the fragments examined to determine the nature of the failure. If only the mortar had failed, the test was reported as a "mortar failure;" whereas, if considerable gravel or stone had been sheared or fractured in addition, the specimen was reported as a "gravel and mortar failure."

DISCUSSION OF RESULTS

In Table 8 are recorded data obtained in testing 1,677 specimens of concrete. Most of these results were gotten from test pieces made in the field throughout the Archipelago; the rest were from specimens made in the materials testing laboratory of the Bureau of Science of aggregates sent by district engineers in charge of provincial building projects.

ALBAY

Examination of the data on compressive strength of concrete specimens listed under Albay, in Table 8, shows that the field

tests are fair. When classified into series and averaged the results are consistent in that the mixtures poorest in cement average weakest, and those richest in cement average strongest. Disregarding the slight differences in age of the various field specimens, it will be seen that the 1 : 3 : 6 mixtures average 607 pounds per square inch; the 1 : 2 : 5 mixtures, 923; and the 1 : 2 : 4 mixtures, 1,068. The corresponding results obtained from laboratory-made specimens average about twice as high; thus the results given by the 1 : 2 : 4 concrete made at the Bureau of Science average 2,578 pounds per square inch, and a single laboratory-made specimen of 1 : 3 : 6 concrete has a compressive strength of 1,046 pounds per square inch; these results are 2.5 and 1.7 times as great as the respective average field results. Table 2 gives the tests of four sands from Albay, all of which are satisfactory and compare favorably with those of Ottawa sand. In fact, Quinale River sand mortar gives a higher compressive strength at the end of 28 days than does standard Ottawa sand mortar.

ANTIQUÉ

The results obtained from concrete specimens made in Antique are interesting examples of extreme aberrancy and are somewhat puzzling, considering the lack of information on the aggregates used. No tests have been made of Antique sands or gravels, and even the origin of the aggregates which were used in making the 1 : 2 : 4 mixtures that gave the extraordinarily low average compressive strengths of 233 and 281 pounds per square inch is not known. The specimens cast of similar concrete and used in constructing Ipil Bridge, though younger, gave the good average strength value of 1,334 pounds per square inch. The results are clearly freakish and indicative of careless field procedure. A preliminary laboratory test of available aggregates for the purpose of choosing the most suitable sand and gravel, coupled with careful field work, would have obviated such irregular results.

BATAAN

The compressive strengths of concrete recorded under Bataan were all obtained from specimens made in the materials testing laboratory of the Bureau of Science. The results are only fair. Specimens made of 1 : 2 : 4 concrete and aged 28 days average only 1,723 pounds per square inch, and 1 : 3 : 6 test pieces of the same age average 889. These low compressive strength values are entirely due to the very fine beach sands used. Table

TABLE 8.—Compressive strength of Portland cement concrete made in various parts of the Philippine Islands.

Tracing No.	Structure in which concrete was used.	Concrete specimens cast.	Source of aggregate.		Test specimens preserved in—			When tested.
			Sand.	Gravel.	Moist air.	Water.	Air.	
1	None	Dec. 10, 1914		Gravel.				Days.
2	Do.	do			1	1	27	28
3	Not known.		Limestone screenings, Mauroaro Quarry.	Crushed limestone, Mauroaro Quarry.	1	1	27	28
4	Do.	Dec. 24, 1914	Big Cabranan River	Broken limestone bowlders from Km. 14, Guinobatan-Jovellar Road				28
5	Do.	do	Half limestone screenings, half sand from Big Cabranan River.					31
6	Do.	do	Limestone screenings.	do				31
7	Do.	do	Guinobatan	do				31
8	Do.	Mar. 10, 1915	Sand from Cabranan River.	Limestone from Cabranan River.				36
9	Do.	do	do	do				36
10	None	Jan. 25, 1915	Quinala River	Crushed limestone from Mauroaro Quarry.	1	1	27	28
11	Arch, Bridge 8, I, Guinobatan-Jovellar Road.	Apr. 15, 1915						42
12	None	Jan. 27, 1915	Limestone screenings.	Crushed limestone from Mauroaro Quarry.				
13	Do.	do	do	do				
14	Guinobatan-Jovellar bridges, Camalig		Cabranan River	Cabranan River				28
15	Quinala-Lihon Bridge 134, Polangui	Sept. 13, 1915	Polangui River	Quinala River	8	11	14	28
16	Manita School, Manita	Sept. 24, 1915	Manita Beach	Manita Beach	13	13	15	28
17	Bridge 42. 1, Polangui	June 6, 1915	Polangui River (fine)	Polangui River (soft)	15	129	129	144

18	Do.....	June 25, 1915	Guinobatan.....				28
19	Not used in any structure.....	Feb. 6, 1915	do.....	Mauraro Quarry.....			32
20	Do.....	do.....	do.....	do.....			32
21	Do.....	do.....	do.....	do.....			32
ANTIQUE.							
22	Bunŕol Bridge, Culasi.....	Apr. 30, 1915					37
23	Do.....	May 11, 1915					60
24	Do.....	Jan. 21, 1916	Beach near Bunŕol River	Beach.....	7	2	29
25	Ipil Bridge, Barboza.....	July 21, 1916	Beach.....	do.....	7	7	21
BATAAN.							
26	None.....	Oct. 30, 1909	Mariveles Beach sand, No. 0.....	Mariveles Beach gravel, No. 2.....	7		21
27	Do.....	do.....	do.....	do.....	7		21
28	Do.....	do.....	Mariveles Beach sand, No. 2.....	Mariveles Beach gravel, No. 4.....	7		21
29	Do.....	do.....	Mariveles Beach sand, No. 1.....	Sisiman crushed ande- site, No. 5.....	7		21
30	Do.....	do.....	do.....	do.....	7		21
31	Do.....	do.....	Mariveles Beach, No. 2.....	do.....	7		21
32	Do.....	do.....	do.....	do.....	7		21
33	Do.....	do.....	Mariveles Beach, No. 1.....	Mariveles Beach gravel, No. 3.....	7		21
34	Do.....	Oct. 16, 1911	Bataan Beach.....	Coral fingers from Ba- taan Beach.....	7		21
35	Do.....	do.....	do.....	Reef coral from Bataan	7		21
BATANGAS.							
36	Obispo Bridge, Obispo.....	June 13, 1910					57
37	Do.....	do.....					57
38	Munting-Tubig Bridge.....	do.....					57
39	Do.....	do.....					57
40	Matayunoc Bridge.....	Oct. 9, 1915			5	13	28

TABLE 8.—Compressive strength of Portland cement concrete made in various parts of the Philippine Islands—Continued.

Tracing No.	Structure in which concrete was used.	Concrete specimens cast.	Source of aggregate.		Test specimens preserved in—			When tested.
			Sand.	Gravel.	Moist air.	Water.		
						Days.	Days.	
	BOHOL.							
41	Abatan Bridge, Cortes, floor system	Feb. 16, 1910			11	12	23	Days.
42	Abatan Bridge, pier foundation	Feb. 18, 1910			9	12	21	Days.
43	Abatan Bridge	Apr. 24, 1910			22	14	36	Days.
44	Abatan Bridge, panels 1 and 2 numbered from south	June 20, 1910			21	14	35	Days.
45	Abatan Bridge, panels 3 and 4	June 21, 1910			20	14	34	Days.
46	Abatan Bridge, panels 5 and 6	June 22, 1910						Days.
47	Abatan Bridge, north span	July 5, 1910						Days.
48	Do.	July 6, 1910						Days.
49	Do.	July 7, 1910						Days.
50	Do.	July 12, 1910						Days.
51	Calape-Tubigon bridges and culverts	May, 1910						Days.
52	Do.	do						Days.
53	Do.	do						Days.
54	Inayagan Bridge, Calape-Tubigon Road	do						Days.
55	Do.	do						Days.
56	Do.	do						Days.
	BULACAN.							
57	Bigaa River Bridge	June 18, 1910						Days.
58	None	do						Days.
59	Do.	Dec. 20, 1911		Bocane River	7	21	28	Days.
60	Do.	do		Quingua River	7	21	28	Days.
61	Do.	do		Bocane River	7	21	28	Days.
62	Santo Niño Bridge	do		Quingua River	7	21	28	Days.
63	Do.	do		do				Days.

64	Do	Feb. 10, 1912	Maasin	Maasin	7		36
65	None	Dec. 29, 1912	Ottawa	Maasin	7	22	29
66	Do	do	Ottawa	do	7	22	29
67	Do	do	Maasin	Bahug	7	22	29
68	Do	do	Ottawa	do	7	22	29
69	Do	May 1, 1913	San Miguel	San Miguel	7	21	28
70	Do	do	do	do	7	21	28
71	Do	do	do	Sibul	7	21	28
72	Do	do	do	do	7	21	28
73	Malolos Market, footings	Aug. 1, 1915	Pullian River	Pullian River	7	21	28
74	Do	July 30, 1915	do	do			29
75	Malolos Market, columns	Aug. 7, 1915	do	do			28
76	Do	do	do	do			28
77	Do	do	do	do			28
78	Do	do	do	do			28
79	Do	do	do	do			28
80	Do	Aug. 18-20, 1915	do	do	1	13	28
81	Do	do	do	do	1	13	90
82	Do	do	do	do	1	13	14
83	Do	do	do	do	1	13	28
84	Do	do	do	do	1	13	90
85	Do	do	do	do	1	13	28
86	Do	do	do	do	1	13	14
87	Do	do	do	do	1	13	28
88	Do	do	do	do	1	13	90
89	Do	do	do	do	1	13	14
90	Do	Aug. 16, 1915	do	do	1	13	28
91	Do	do	do	do	1	13	28
92	Do	do	do	do	1	13	14
93	Do	do	do	do	1	13	28
94	Do	Aug. 13, 1915	do	do	1	13	28
95	Do	do	do	do	1	13	14
96	Do	do	do	do			28
		Aug. 18, 1915	do	do			28
			do	do			28
			do	do			181

TABLE 8.—Compressive strength of Portland cement concrete made in various parts of the Philippine Islands—Continued.

Tracing No.	Structure in which concrete was used.	Concrete specimens cast.	Source of aggregate.		Test specimens pre-served in—			When tested.	
			Sand.	Gravel.	Moist air.	Water.	Air.		
					Days.	Days.	Days.	Days.	
97	BULACAN—continued. Malolos Market, columns	Aug. 19, 1915	do	do	1	13	14	181	
98		Do	Aug. 20, 1915	do	do	1	13	14	
99		Pullian Market	Sept. 1, 1915	do	do	1	13	14	
100		Do	do	do	do	1	13	14	
101		Do	do	do	do	1	13	14	
102		Do	Sept. 2, 1915	do	do	1	13	14	
103		Do	Sept. 1, 1915	do	do	1	13	14	
104		Do	Aug. 30, 1915	do	do	1	15	11	
105		Do	Sept. 1, 1915	do	do	1	13	14	
106		Bagbag Bridge, Calumpit	Nov. 7, 1916	do	do	1	1	25	
107		Do	do	do	do	1	1	25	
108		Do	do	do	do	1	1	25	
109	Do	do	Pullian River	do	1	15	12		
110	Do	do	do	do	1	15	12		
111	Do	do	do	do	1	13	14		
112	None	Nov. 23, 1917	Santa Maria River	Santa Maria River	28				
113	CAPIZ. Capiz Bridge, south and north arch rings	Dec. 11, 1909	Ivisan River	Ivisan River, soft.				67	
114		Do	do	do				69	
115		Do	Dec. 13, 1909	do	do				70
116		Ivisan School	Dec. 14, 1909	do	do				27
117	Do	Aug. 31, 1915	Ivisan River, very fine and dirty.	Ivisan Bay, large and not graded.				27	
118	Do	Oct. 15, 1915	Panay River	do	1	13	13	27	
119	Do	do	do	Santa Barbara	1	13	18	32	
			do	do	1	13	18	32	

120	Pilar School	Aug. 27, 1915	Pilar Beach (very fine)	Sibala River, large, not graded.	1	13	14	26	
121	Do.	do	do	do	1	13	14	23	
122	Do.	Oct. 23, 1915	Arangul River	Sibala River.	1	13	14	28	
123	Do.	do	do	do	1	13	14	28	
124	Lubas Bridge, Capiz	Jan. 16, 1917	Panay River	Santa Barbara, Iloilo	1	13	16	30	
125	Do.	do	do	do	1	13	16	30	
126	Balucuan Bridge, Dao, skew arch	Jan. 15, 1916	Panay River at Dao	do	1	13	15	29	
127	Do.	do	do	do	1	13	15	29	
128	Do.	Jan. 17, 1916	do	do	1	13	15	29	
129	Do.	do	do	do	1	13	15	29	
130	Capiz water tank	Oct. 2, 1916	Passi River, Iloilo	do	1	13	19	33	
131	Do.	Oct. 3, 1916	do	do	1	13	18	32	
132	Do.	Oct. 4, 1916	do	do	1	13	17	31	
133	Do.	Oct. 5, 1916	do	do	1	13	16	30	
134	Do.	Nov. 3, 1916	do	do	1	13	20	34	
135	Do.	Nov. 4, 1916	do	do	1	13	18	32	
136	Bridges, Mianay Road, Ivisan, Capiz.	Oct. 26, 1916	Km. 12, Ivisan, Mianay River.	Km. 12, Ivisan, Mianay River.	1	13	28	42	
137	Do.	do	do	do	1	13	28	42	
CAVITE.									
138	Tabon Bridge, southwest corner and south abutment.	Dec. 20, 1910	Pasig River	Pasig River				44	
139	Tabon Bridge, center, south abutment	Dec. 21, 1910	do	do				43	
140	Tabon Bridge, southeast side, south abutment	Dec. 22, 1910	do	do				42	
141	Tabon Bridge, center, north abutment.	Dec. 31, 1910	do	do				33	
142	Tabon Bridge, spandrel wall	Jan. 2, 1911	do	do				31	
143	Do.	do	do	do				46	
144	Tabon Bridge, south side ring; north and south abutments.	Jan. 11, 1911	do	do				37	
145	Tabon Bridge, spandrel wall	Jan. 12, 1911	do	do				36	
146	Tabon Bridge, balustrade, east side.	Jan. 15, 1911	do	do				33	
147	Tabon Bridge, balustrade, west side	Jan. 19, 1911	do	do				29	
148	Canacao Bridge, piles	Nov. 12, 1915	Mariguina River, coarse, dirty.	Mariguina River	2	13	17	32	

TABLE 8.—Compressive strength of Portland cement concrete made in various parts of the Philippine Islands—Continued.

Tracing No.	Structure in which concrete was used.	Concrete specimens cast.	Source of aggregate.		Test specimens prepared in—		When tested.
			Sand.	Gravel.	Moist air.	Water.	
					Days.	Days.	Days.
149	Cafacao Bridge, continued.	Jan. 26, 1916	do	do	2	13	28
150	Do	Feb. 9, 1916	do	do	1	14	31
151	Cafacao Bridge	Feb. 11, 1916	do	do	1	14	29
152	Do	Feb. 14, 1916	do	do	1	14	28
153	Cafacao Bridge, retaining walls	Mar. 2, 1916	do	do	2	13	28
154	Do	Mar. 4, 1916	Mariquina River, sand washed.	do	2	13	28
155	Do	Mar. 8, 1916	Mariquina River, washed very clean.	Mariquina River, washed very clean.	2	13	28
156	Do	Mar. 9, 1916	Mariquina River, sand very dirty.	Mariquina River, gravel very dirty.	2	13	28
157	San Juan culvert 25.3, Noveleta	Oct. 23, 1915	Mariquina River	Mariquina River	2	13	29
158	None	Nov. 1, 1916	Rio Grande	Rio Grande	1	27	28
159	Calero Bridge, Noveleta-Cavite Road	Oct. 18, 1916	do	do	2	13	28
160	Do	Oct. 20, 1916	do	do	2	13	28
161	Do	Oct. 23, 1916	do	do	2	13	28
162	Calero Bridge, Noveleta-Cavite Road, piles	Nov. 18, 1916	do	do	13	11	28
163	Culverts, Noveleta-Cavite Road	Nov. 17, 1916	do	do	13	15	28
164	Do	Nov. 18, 1916	do	do	13	16	28
165	None	May, 1916	Imus River	Imus River	23	16	28
166	Do	Nov., 1916	do	do	1	27	28
167	Do	do	Rio Grande	Rio Grande	1	27	28
168	Naga River Bridge.	Sept. 7, 1909					28
169	Do.	do					28

170	Naga River Bridge, floor	Nov. 16, 1909							30
171	Carcar Bridge, south arch ring	Sept. 12, 1909					14	47	61
172	Carcar Bridge, spandrel wall	Sept. 24, 1909					14	36	49
173	Do	Oct. 6, 1909					14	23	37
174	Do	Oct. 8, 1909					14	21	35
175	None	Mar. 23, 1910	Cebu	crushed iron-stained quartz.		7	21	21	28
176	Do	May 13, 1910	Danao River			7	23	23	30
177	Do	do	Mananga River			7	21	21	28
178	Do	do	Danao River			7	21	21	28
179	Do	May 21, 1910	Mananga River			7	21	21	28
180	Osmeña Waterworks, dam	May 22, 1911	Cebu	crushed quartz.					29
181	Do	June 23, 1911		3 parts crushed stone, 1 part fine gravel.					36
182	Do	July 29, 1911	Cebu	crushed stone.					28
183	Do	Aug. 8, 1911	do	do					31
184	Do	Aug. 18, 1911	do	do					28
185	Magallanes Bridge, west abutment	Oct. 15, 1911							31
186	Magallanes Bridge, arch rings	Nov. 5, 1911							30
187	None	Sept. 2, 1912	Mananga River			7	21	21	28
188	Do	do	do	do		7	21	21	28
189	Do	Jan. 20, 1913				7	21	21	28
190	Do	do				7	21	21	28
191	Do	May 10, 1913	Stream bed, kilometer 115.8 Barili-South Road.			7	21	21	28
192	Sibonga Bridge	Nov. 28, 1915	Sibonga Beach			15	11	11	26
193	Do	do	do			15	11	11	26
194	Do	Jan. 4, 1916	do	do		10	17	17	27
195	Do	Jan. 10, 1916	do	do		10	18	18	28
196	Cebu Wharf extension	Sept. 2, 1917	Talisay River, course	Danao quarry, crushed rock. ^f					297
197	Do	Sept. 3, 1917	do	do					296
198	Do	Sept. 26, 1917	do	do					92
199	Do	Sept. 27, 1917	do	do					91

^f Danao rock from quarry is a siliceous limestone; coefficient of wear, 3.36; specific gravity, 2.69; rock is proposed for metalling Cebu streets.

TABLE 8.—Compressive strength of Portland cement concrete made in various parts of the Philippine Islands—Continued.

Tracing No.	Structure in which concrete was used.	Concrete specimens cast.	Source of aggregate.		Test specimens prepared from—			When tested.
			Sand.	Gravel.	Moist air.	Water.	Air.	
COTABATO.								
200	Parang Waterworks, 30 cm. conduit.....	May 1, 1916	Nituan River.....	Nituan River.....	1	13	40	54
201	Parang Waterworks, intake and ram base.....do.....do.....do.....	1	13	40	54
202	Parang Waterworks.....	May 26, 1916do.....do.....	1	13	19	33
203	Parang Waterworks, tank.....	June 5, 1916do.....do.....do.....do.....do.....	77
204	Do.....	July 7, 1916do.....do.....do.....do.....do.....	55
205	Parang Waterworks, pipe.....	July 10, 1916do.....do.....	1	13	38	52
206	Cotabato Light House, accumulator.....	July 26, 1916	Manila.....	Manila.....	1	13	22	36
207	Cotabato Public Hospital, Cotabato.....	Aug. 18, 1916	Linaac Beach, fine.....	Dimapatoy River, soft.....	1	13	42	56
208	Do.....	Sept. 22, 1916do.....do.....do.....do.....do.....	43
209	Do.....	Dec. 15, 1916do.....	Dimapatoy River, soft limestone.....	1	13	35	49
210	Cotabato River wall, Cotabato, drain pipe.....	Dec. 4, 1916do.....do.....	1	13	46	60
ILOCOS NORTE.								
211	Spillway piles, Gilbert Bridge, Laoag.....	July 28, 1915	Laoag River.....	Laoag River.....	1	27	23	34
212	None.....	Oct., 1915do.....do.....do.....do.....do.....	30
213	Spillway piles, Gilbert Bridge.....	Oct. 11, 1915do.....do.....	1	13	16	30
214	Badoe School, Badoe.....	Dec. 23, 1915	Badoe Beach.....	Badoe Beach.....	1	13	15	29
215	Do.....	Dec. 27, 1915do.....do.....	1	13	17	31
216	Do.....	Mar. 22, 1916do.....do.....	1	13	19	33
217	Do.....	Mar. 23, 1916do.....do.....	1	13	19	33
ILOCOS SUB.								
218	Bridge piles.....	Oct. 12, 1912do.....do.....do.....do.....do.....	33
219	Do.....do.....do.....do.....do.....do.....do.....	33
220	Cabugao Bridge.....	Nov. 27, 1912do.....do.....do.....do.....do.....	37
221	Singson Waterworks.....	Mar. 23, 1915do.....do.....do.....do.....do.....	31

222	Vigan Central School, piers	Aug. 28, 1915	Vigan River	Vigan River	1	13	14	28
223	Vigan Central School	Sept. 22, 1915	Govantes River	Govantes River	1	13	43	57
ILOILO.								
224	None	Dec. 12, 1910	Sand No. 1	Bridge Site	15		13	28
225	Do	Dec. 13, 1910	do	Crushed siliceous limestone	15		13	28
226	Do	do	Sand No. 2	do	15		13	28
227	Do	do	Sand No. 3	do	15		13	28
228	Molo Bridge	Jan. 9, 1911	Beach Sand No. 3	Santa Barbara			13	25
229	Do	do	do	do			25	25
230	Do	do	do	do			25	25
231	Do	do	do	do			25	25
232	Do	Jan. 6, 1911	do	do			29	29
233	Do	do	do	do			29	29
234	Do	do	do	do			29	29
235	Do	do	do	do			29	29
236	Do	Jan. 17, 1911	do	do			37	37
237	Do	Jan. 18, 1911	do	do			36	36
238	Do	Jan. 20, 1911	do	do			34	34
239	Do	Jan. 23, 1911	do	do			59	59
240	Do	Jan. 24, 1911	do	do			58	58
241	Do	Jan. 31, 1911	do	do			51	51
242	Do	Feb. 4, 1911	do	do			47	47
243	Do	Feb. 8, 1911	do	do			43	43
244	Molo Bridge, pier 1	Feb. 11, 1911	Molo Bridge	Santa Barbara pit			44	44
245	Do	Feb. 14, 1911	do	do			43	43
246	Molo Bridge	Feb. 16, 1911	do	do			39	39
247	Do	do	do	do			39	39
248	Do	do	do	do			39	39
249	Do	do	do	do			39	39
250	Molo Bridge, pier 2	Mar. 7, 1911	do	do			41	41
251	Do	do	do	do			41	41
252	Do	Mar. 8, 1911	do	do			40	40
253	Do	Mar. 9, 1911	do	do			39	39
254	Do	Mar. 14, 1911	do	do			34	34

TABLE 8.—Compressive strength of Portland cement concrete made in various parts of the Philippine Islands—Continued.

Tracing No.	Structure in which concrete was used.	Concrete specimens cast.	Source of aggregate.		Test specimens prepared in—		When tested.
			Sand.	Gravel.	Moist air.	Water.	
ILOILO—continued.							
255	Molo Bridge, pier 2	Mar. 17, 1911	.do	.do	Days	Days	31
256	Do.	Mar. 20, 1911	.do	.do	Days	Days	28
257	Molo Bridge	Mar. 31, 1911	.do	.do	Days	Days	41
258	Molo Bridge, pier 6	May 12, 1911	.do	.do	Days	Days	40
259	Do.	May 13, 1911	.do	.do	Days	Days	39
260	Molo Bridge, abutment A	May 17, 1911	.do	.do	Days	Days	35
261	Do.	May 24, 1911	.do	.do	Days	Days	28
262	Do.	.do	.do	.do	Days	Days	28
263	Do.	May 25, 1911	.do	.do	Days	Days	27
264	Do.	May 30, 1911	.do	.do	Days	Days	53
266	Do.	June 5, 1911	.do	.do	Days	Days	47
266	Molo Bridge	June 7, 1911	.do	.do	Days	Days	46
267	Do.	June 8, 1911	.do	.do	Days	Days	44
268	Do.	June 9, 1911	.do	.do	Days	Days	43
269	Do.	June 17, 1911	.do	.do	Days	Days	35
270	Do.	.do	.do	.do	Days	Days	35
271	None	June 18, 1911	La Paz, Iloilo.	Santa Barbara pit	7	24	31
272	Do.	.do	do	Oton	7	24	31
273	Molo Bridge, slab 2	July 6, 1911				60	59
274	Do.	July 7, 1911				59	59
275	Do.	July 8, 1911				58	58
276	Do.	July 10, 1911				57	57
277	Do.	July 15, 1911				49	49
278	Do.	July 14, 1911				50	50
279	Do.	July 18, 1911				49	49
280	Do.	July 19, 1911				48	48

281	Molo Bridgedo											45	
282	Do.	July 20, 1911											44	
283	Do.	Aug. 1, 1911											35	
284	Do.	Aug. 3, 1911											32	
285	Do.	Aug. 4, 1911											31	
286	Do.	Aug. 5, 1911											30	
287	Do.	Aug. 7, 1911											38	
288	Do.	Aug. 16, 1911											30	
289	Do.	Aug. 17, 1911											37	
290	Do.	Aug. 24, 1911											30	
291	Do.	Aug. 25, 1911											29	
292	Do.	Aug. 26, 1911											41	
293	Do.	Aug. 28, 1911											39	
294	Do.	Aug. 29, 1911											38	
295	Do.	Aug. 31, 1911											40	
296	Molo Bridge, span 7	Sept. 13, 1911											36	
297	Do.	Sept. 15, 1911											38	
298	Molo Bridge, span 4	Sept. 27, 1911											34	
299	Do.	Sept. 29, 1911											32	
300	Do.	Sept. 30, 1911											31	
ISABELA.														
301	Echague School, piers	Jan. 31, 1916				Cagayan River				1			13	32
302	Echague School, girders	Feb. 11, 1916				do				1			13	33
303	Echague School, footings	Feb. 12, 1916				do				1			19	39
304	Cabagan Farm School, footings	Jan. 27, 1917				do				1			13	74
305	Cabagan Farm School, piers	Feb. 5, 1917				Cabagan River				1			13	65
306	Cabagan Farm School, girders	Feb. 12, 1917				do				1			13	57
307	Caayan Presidencia	May 10, 1916				do				1			13	31
308	Do.	Sept. 23, 1916				Malabulig River				1			6	21
						do				1			28	28
309	None	Apr. 8, 1914				Bench coral and shell débris.				1			27	28
310	Do.do				do				1			27	28

TABLE 8.—Compressive strength of Portland cement concrete made in various parts of the Philippine Islands—Continued.

Tracing No.	Structure in which concrete was used.	Concrete specimens cast.	Source of aggregate.		Test specimens prepared in—			When tested.
			Sand.	Gravel.	Moist air.	Water.	Air.	
311	None		Los Baños, basalt screenings.	Gravel.	Days. 15	Days. 14	Days. 29	
312	Do	Oct. 25, 1910	Mogondon sand	do	15	14	29	
313	Do	do	Half basalt screenings, half Mogondon sand.	do	15	13	28	
314	Do	do	do	do	15	13	28	
315	Do	do	Mogondon sand	Los Baños, basalt from lower ledge.	15	15	30	
316	Do	do	do	do	15	15	30	
317	Do	do	Bayog	do	15	15	30	
318	Do	do	do	do	15	15	30	
319	San Juan Bridge, Calamba	Dec. 10, 1910	do	do			30	
320	Do	do	do	do			30	
321	San Juan Bridge, abutments	Apr. 1, 1911	do	do			39	
322	San Juan Bridge	Apr. 21, 1911	do	do			29	
323	San Juan Bridge; footing, abutment	Apr. 23, 1911	do	do			28	
324	Do	Apr. 25, 1911	do	do			32	
325	San Juan Bridge, pier 3	Apr. 21, 1911	do	do			36	
326	Do	Apr. 18, 1911	do	do			39	
327	Do	Apr. 26, 1911	do	do			31	
328	San Juan Bridge	May 1, 1911	do	do			40	
329	Do	May 3, 1911	do	do			38	
330	Do	May 2, 1911	do	do			39	
331	San Juan Bridge, footing, abutment A	May 4, 1911	do	do			23	
332	San Juan Bridge, main arch rings	do	do	do			37	
333	San Juan Bridge; footing, abutment A	May 5, 1911	do	do			22	

389	Do	Aug. 20, 1915	do	do	do	1	13	33	47
390	Do	Aug. 23, 1915	do	do	do	1	13	25	39
391	Do	Aug. 30, 1915	do	do	do	1	13	22	36
392	Do	Oct. 5, 1915	Hilongos River	do	do	1	14	16	31
393	Do	Oct. 7, 1915	do	do	do	1	14	16	31
394	Dumog Bridge, Bato	Sept. 20, 1915	Beach, fine	do	do	1	13	33	47
395	Do	Sept. 21, 1915	do	do	do	1	13	33	47
396	Do	Oct. 5, 1915	Hilongos River	do	do	4	10	14	28
397	Albuera School, Ormoc	Sept. 20, 1915	Beach	do	do	4	10	14	28
398	Do	do	do	do	do	4	10	14	28
399	Do	Nov. 30, 1915	do	do	do	1	13	19	33
400	Tanauan School, Tanauan	Sept. 30, 1915	Beach, fine	do	Tigbaeo River, soft	1	13	16	29
401	Do	do	do	do	do	1	13	16	29
402	Do	Mar. 9, 1916	do	do	Malaguibay	1	13	14	28
403	Do	Mar. 9, 1916	Beach	do	Malaguibay	1	13	14	28
404	Do	do	do	do	do	1	13	14	28
405	Do	Mar. 31, 1916	Beach, very fine	do	do	1	14	13	28
406	Do	Apr. 5, 1916	do	do	do	1	14	13	28
407	Babay School, Babay	do	do	do	Beach	4	10	14	28
408	Do	May 13, 1916	do	do	do	1	14	41	55
409	Do	Mar. 25, 1916	do	do	do	1	14	22	37
410	Tabango School, San Isidro	May 23, 1916	Tabango Beach	do	do	1	14	13	28
411	Do	Aug. 23, 1916	do	do	Tabango Beach	1	14	13	28
412	Maasin Bridge, Maasin	June 3, 1916	Canturing Beach, fine	do	Canturing River	4	10	21	35
413	Costa bridges and culverts, Inopacan	June 4, 1916	Inopacan Beach	do	Inopacan Beach	4	14	16	34
414	Do	June 6, 1916	do	do	do	4	10	18	32
415	Tacloban Port Works	July 20, 1916	Tigbaeo River	do	Tigbaeo River	1	13	27	41
416	Do	July 24, 1916	do	do	do	1	13	23	37
417	Tacloban Port Works, column	Aug. 21, 1916	Tigbaeo River, very fine	do	do	1	13	33	47
418	Do	Aug. 25, 1916	do	do	do	1	13	29	43
419	Do	Sept. 1, 1916	Tigbaeo River	do	do	1	26	3	29
420	Do	Oct. 5, 1916	do	do	do	1	13	14	28
421	Tacloban Port Works	Oct. 7, 1916	do	do	do	1	25	7	33
422	Do	Nov. 4, 1916	Tigbaeo River, very fine	do	do	1	13	14	28

TABLE 8.—Compressive strength of Portland cement concrete made in various parts of the Philippine Islands—Continued.

Tracing No.	Structure in which concrete was used.	Concrete specimens cast.	Source of aggregate.		Test specimens prepared in—			When tested.
			Sand.	Gravel.	Moist air.	Water.	Air.	
					Days.	Days.	Days.	Days.
					1	13	14	28
423	Tacloban Port Works		do	do	1	13	17	31
424	Do.	June 30, 1917	Beach, very fine	do	1	13	19	33
425	Do.	June 23, 1917	do	do	1	13	22	37
426	Do.	Sept. 25, 1917	do	do	1	14	23	38
427	Academic Building, Tacloban Trade School	June 23, 1917	Mangronbaugon River	do	1	14	16	31
428	Do.	July 14, 1917	do	do	1	14	20	35
429	Do.	Aug. 21, 1917	do	do	1	14	16	31
430	Do.	Aug. 25, 1917	do	do	1	14	24	39
431	Provincial Building, Tacloban	Dec. 1, 1917	Beach, fine	do	1	14	38	48
432	Do.	Apr. 4, 1918	do	do	1	14	28	28
433	Dulag Market	Mar. 12, 1918	Dulag Beach	Dulag Beach				
434	Abuyog Administration Building, Abuyog	do	Abuyog Beach	Abuyog Beach				
					25	25	71	96
435	None	May 21, 1909	Pasig River	Pasig River	25	25	71	96
436	Do.	do	Orani River	Pasig River	25	25	71	96
437	Do.	do	Pasig River	do	25	25	70	90
438	Do.	May 27, 1909	do	do	20	20	31	28
439	Philippine Medical School, second wall and stairs	Feb. 4, 1910						
440	Philippine Medical School; roof, floor, east wing	Feb. 14, 1910						
441	Manila Hotel	Sept. 15, 1910						
442	Do.	Sept. 16, 1910						
443	Do.	Sept. 17, 1910						
444	Do.	Sept. 18, 1910						
445	Do.	Oct. 26, 1910						
446	Do.	Oct. 23, 1910						
					27	27	84	61
					27	27	83	60
					27	27	82	59
					27	27	31	58
					7	7	31	38
					7	7	29	36

447	Do.....	Oct. 30, 1910				7		27	34
448	Do.....	Nov. 29, 1910			Crushed stone from city quarry.			34	41
449	Do.....	Dec. 1, 1910			Gravel.....	7		32	39
450	Do.....	Jan. 25, 1911				7		33	40
451	Do.....	Feb. 2, 1911				7		25	32
452	Fernandez Building.....	June 12, 1914							28
453	Warehouse, Calle Roman Soler.....	May 25, 1914							38
454	Warehouse, Calle Azarraga.....	June 15, 1914							28
455	Mariano Uy Chaco Building, walls.....do							28
456	Do.....	Aug. 25, 1914							37
457	Mariano Uy Chaco Building.....	June 15, 1914							28
458	Roxas Building, columns.....	June 10, 1914							33
459	Hogar Filipino Building.....	Feb. 1915							28
460	Family Hotel, corner of Herran and Dakota.....	April 16, 1915							28
461	Do.....	April 14, 1915							49
462	Masonic Temple.....	April 15, 1915							48
463	Do.....	April 22, 1915							41
464	Do.....	July 2, 1915			Pasig River.....	7		21	28
465	Do.....do		do	7		21	28
466	Do.....	July, 1915		do			13	28
467	Do.....	Aug. 10, 1915			Pasig River, fine gravel.....	2	13	13	28
468	None.....do			Pasig River, coarse gravel.....	2	13	13	28
469	Do.....do		do				28
470	Masonic Temple.....	July 15, 1915						7	21
471	Do.....	July 20, 1915			Mariquina River.....			7	21
472	Do.....	July 21, 1915		do			7	21
473	Do.....	July 24, 1915		do			7	21
474	Masonic Temple.....	July 28, 1915			Mariquina River.....			7	21
475	Do.....	Aug. 4, 1915			Pasig River.....	1	19	16	36
476	Do.....do		do			1	16
477	Columbia Club Addition.....	July 1, 1915		do				28
478	Do.....do		do				28

506	None	July 20, 1915	do	do	1	19	8	28
506	Philippine School of Arts and Trades, roof	Dec. 8, 1915	Pasig River	Pasig River	1	13	20	34
507	Philippine School of Arts and Trades, girders	Nov. 24, 1915	do	do	1	13	33	37
508	Philippine School of Arts and Trades	Jan. 22, 1916	Mariquina River	Mariquina River	1	20	31	52
509	San Jose Building, Calle Rosario	Sept. 3, 1915	Pasig River	Pasig River	1	13	14	28
510	Postigo Building, second floor wall	Dec. 15, 1915	do	do	1	19	8	28
511	Postigo Building, first floor slab	Dec. 24, 1915	do	do	1	14	13	28
512	Do	Jan. 22, 1916	Mariquina River	Mariquina River	1	13	14	28
513	Engineering Laboratory, University of P. I., foundation and footings	Dec. 15, 1915	do	do	1	13	15	29
514	Engineering Laboratory, University of P. I., walls above floor	Dec. 29, 1915	do	do	1	13	13	27
515	Engineering Laboratory, University of P. I.	Jan. 22, 1916	Mariquina River	Mariquina River	1	13	13	27
516	Spanish Casino	Apr. 13, 1916	Pasig River	Pasig River	3	96	99	69
517	Jones Bridge, caissons	July 7, 1917	Mariquina River	Mariquina River	15	54	69	28
518	Do	Aug. 2, 1917	do	do	15	13	28	28
519	Do	Aug. 8, 1917	do	do	28	28	28	28
520	Do	Sept. 3, 1917	do	do	28	28	28	28
521	U. S. Army Quartermaster Pier 1, concrete from piles	Oct. 12, 1914	Sisiman screenings	Sisiman crushed stone	1 240	812	1,052	
522	Do	do	do	do	1 231	1 784	36	1,051
523	Do	Oct. 15, 1914	do	do	1 240	809	1,049	
524	Do	Do	do	do	1 228	1 784	36	1,048
525	Do	Oct. 17, 1914	do	do	1 240	807	1,047	
526	Do	do	do	do	1 228	1 784	36	1,046
527	Do	Oct. 19, 1914	do	do	1 240	805	1,045	
528	Do	do	do	do	1 224	1 784	36	1,044
529	Do	Oct. 22, 1914	do	do	1 240	802	1,042	
530	Do	do	do	do	1 221	1 784	36	1,041
531	Do	Nov. 24, 1913	do	Pasig River	1 180	1 784	409	1,373
532	Do	do	do	Sisiman crushed stone	1 180	1,193	1,373	
533	Do	do	do	do	1 180	1 784	409	1,373
534	Do	do	do	do	1 180	1,193	1,373	

↓ Specimens submerged in salt water of Manila Bay under Pier 1.

↑ Specimens covered with damp sackings.

TABLE 8.—Compressive strength of Portland cement concrete made in various parts of the Philippine Islands—Continued.

Tracing No.	Structure in which concrete was used.	Concrete specimens cast.	Source of aggregate.			Test specimens prepared in—			When tested.
			Sand.	Gravel.	Moist air.	Water.	Air.	Days.	
MARINDUQUE.									
535	Tignton Bridge 16.1. Gasan	Aug. 9, 1915	Tignton River	Beach				28	
536	Do	Sept. 28, 1915	do	do	1	13	17	31	
537	Do	Dec. 10, 1915	do	do	1	13	19	33	
538	Do	Dec. 17, 1915	do	do	1	13	15	29	
MISAMIS.									
539	Gusa Central School, footings	Dec. 8, 1910	Beach	Beach				30	
540	Gusa Central School, walls	do	do	do				30	
541	Gusa Central School, girders	do	do	do				30	
542	Cagayan Municipal Market, columns	Jan. 26, 1911	do	do				34	
543	None	June 9, 1914	Sea, unwashed	Sea, unwashed				28	
544	Do	do	Sea, sand washed with fresh water.	Sea, gravel washed with fresh water.				23	
545	Do	do	do	do				28	
546	Cagayan Central School	do	Cagayan River	do				28	
MISCELLANEOUS TESTS.									
547	None	Feb. 26, 1910	Paing River	Crushed Sisimanandesite	9		21	30	
548	Do	do	do	do	9		21	30	
549	Do	Aug. 27, 1910	do	Crushed rock from ledge adjoining U. S. Engineer's Quarries on mainland opposite Carabao Island. ^k	15		13	28	
550	Do	do	do	do				28	
551	Do	Oct. 29, 1910	do	do	15		13	48	

552	Do.....	Oct. 31, 1910					46
553	Do.....	Nov. 2, 1910					44
554	Do.....	Nov. 8, 1910					38
555	Do.....	Nov. 18, 1910					28
OCCIDENTAL NEGROES.							
556	Bridge 0.40, Pontevedra, La Carlota Road	Apr. 4, 1916	Marayo River	San Enrique			85
557	Bridge 0.40, Pontevedra, La Carlota Road; slab 1	Apr. 23, 1916	Candaguig River	Candaguig River			40
558	Bridge 0.40, Pontevedra, La Carlota Road; slab 5	May 5, 1916	do	do			33
559	Bridge 0.40, Pontevedra, La Carlota Road; slab 7 and abutment 2	May 7, 1916	do	do			31
560	Binalbagan Bridge, Hinigaran	July 1, 1916	Bagacay River	Bagacay River			28
561	Do.....	June 22, 1916	do	do			37
562	Do.....	Aug. 23, 1916	do	do			34
563	Do.....	Aug. 17, 1916	do	do			30
564	Do.....	Dec. 5, 1916	do	do			41
565	Do.....	Dec. 12, 1916	do	do			63
566	Binalbagan Bridge, Hinigaran; abutments 1 and 2	Dec. 23, 1916	do	do		14	16
567	Binalbagan Bridge, Hinigaran	Jan. 1, 1917	do	do		14	18
568	Do.....	Feb. 16, 1917	do	do		14	33
569	Binalbagan Bridge, Hinigaran; abutments 1 and 2	Feb. 26, 1917	do	do		14	23
570	Bridge 36.5, Bago; abutment 2	Mar. 8, 1917	Maragandang River	Maragandang River		1	13
571	Bridge 36.5, Bago; abutment 1	Apr. 16, 1917	do	do		1	13
572	Do.....	Apr. 23, 1917	do	do		1	13
573	Presidencia, Bago; foundation and wall	June 24, 1917	Bago River	Bago River		1	14
574	Presidencia, Bago; first floor	Aug. 26, 1917	do	do		1	30
575	Presidencia, Bago; second floor	June 27, 1917	do	do		1	14
576	Bridge 42.0, Pontevedra	Sept. 8, 1917	Candaguig River	Candaguig River		1	13
577	Do.....	Oct. 1, 1917	do	do		1	28
578	Bridge 42.0, Pontevedra; second north abutment	Nov. 20, 1917	do	do		1	24
579	Sumag Bridge, Bacolod; abutment	Oct. 1, 1917	Sumag Beach	Sumag Beach			36
580	Sumag Bridge, Bacolod; first pile cap	Oct. 3, 1917	do	do			67
581	Sumag Bridge, Bacolod; second pile cap	Oct. 13, 1917	do	do			65
582	Sumag Bridge, first girder span	Oct. 17, 1917	do	do			55
							42

* Used in fortifications at Carabao and El Fraile.

TABLE 8.—Compressive strength of Portland cement concrete made in various parts of the Philippine Islands—Continued.

Tracing No.	Structure in which concrete was used.	Concrete specimens cast.	Source of aggregate.		Test specimens preserved in—			When tested.
			Sand.	Gravel.	Moist air.	Water.	Air.	
					Days.	Days.	Days.	Days.
OCCIDENTAL NEGROS—continued.								
583	Sumag Bridge.....	Nov. 2, 1917	Sumag Beach.....	Masungay River.....	1	13	24	38
584	Sumag Bridge, gutter.....	Nov. 8, 1917	do.....	do.....	1	13	18	32
585	Do.....	Nov. 10, 1917	do.....	do.....	1	13	16	30
586	Sumag Bridge, fifth girder span.....	Nov. 15, 1917	do.....	do.....	1	13	51	65
587	Sumag Bridge, abutment.....	Nov. 16, 1917	do.....	do.....	1	13	50	64
588	Sumag Bridge, slab.....	Nov. 22, 1917	do.....	do.....	1	13	44	58
589	Sumag Bridge, wing wall.....	Dec. 2, 1917	do.....	do.....	1	13	34	48
ORIENTAL NEGROS.								
590	None.....	June 22, 1910	Amblan River.....	Amblan River.....	15	13	---	28
591	Do.....	do.....	Tanbay River.....	Tanbay River.....	15	13	---	28
592	Do.....	do.....	Amblan River.....	Amblan River.....	15	13	---	28
593	Do.....	do.....	Tanbay River.....	Tanbay River.....	15	13	---	28
594	Amblan River Bridge, abutment B.....	June 22, 1911	do.....	do.....	---	---	---	44
595	Amblan River Bridge, abutment A.....	June 23, 1911	do.....	do.....	---	---	---	43
596	Amblan River Bridge, bridge seat abutment A.....	June 23, 1911	do.....	do.....	---	---	---	37
597	Amblan River Bridge, pier 4.....	July 5, 1911	do.....	do.....	---	---	---	31
598	Bais Bridge.....	Feb. 22, 1916	Bais River.....	Bais River.....	1	13	29	43
599	Do.....	Feb. 23, 1916	do.....	do.....	1	13	28	42
NUEVA ECUA.								
600	Guimba Market, Guimba.....	Jan. 7, 1916	Binutuan River, dirty sand.....	Binutuan River, soft.....	1	13	14	28
601	Do.....	do.....	do.....	do.....	1	13	14	28
602	Do.....	do.....	do.....	Balinguay River.....	1	13	14	28
603	Do.....	do.....	do.....	do.....	1	13	14	28

604	None		Mar. 6, 1917	Coron Beach	1	27	28
PALAWAN.							
PAMPANGA.							
605	None		Oct. 22, 1910	Crusher-run surface rock	15	13	28
606	Do		do	do	15	13	28
607	Do		do	Back of troop stables	15	16	31
608	Do		do	Banban River	15	16	31
PANGASINAN.							
609	Bayanos Bridge		May 9, 1909				33
610	Do		May 11, 1909				31
611	Do		June 19, 1909				31
612	Do		June 21, 1909				29
613	Do		Aug. 2, 1909				30
614	Do		Aug. 6, 1909				26
615	Pantal Bridge, piles		Oct. 16, 1909				26
616	Pantal Bridge, east abutment		Dec. 16, 1909				28
617	Calmay Bridge, piles		Feb. 8, 1910				27
618	Do		Mar. 23, 1910				28
RIZAL.							
619	Angono Bridge, Binangonan.		Feb. 4, 1916	Pasig River			28
620	Do		Feb. 7, 1916	do			28
621	Do		Mar. 23, 1916	Marikina River			43
622	Do		Mar. 31, 1916	do			40
623	Angono Bridge, Binangonan; arch ring		May 18, 1916	do			39
624	Do		May 19, 1916	do			38
625	San Juan Presidencia, San Juan del Monte		Apr. 25, 1916	do			28
626	Bilibiran Bridge, Binangonan pier		May 9, 1916	do			31
627	Bilibiran Bridge, Taytay pier		May 11, 1916	do			30
SARAJ.							
628	Bridge 0.7, Calbayog North and South Roads, slabs and girder spans 1 and 2.		May 29 to July 9, 1914				69
629	Bridge 0.7, Calbayog North and South Roads, pile cap, abutment 1.		do				85

TABLE 8.—Compressive strength of Portland cement concrete made in various parts of the Philippine Islands—Continued.

Tracing No.	Structure in which concrete was used.	Concrete specimens cast.	Source of aggregate.		Test specimens pre-served in—			When tested.
			Sand.	Gravel.	Moist air.	Water.	Air.	
					Days.	Days.	Days.	Days.
630	SAMAR—continued. Bridge 0.7, Calbayog North and South Roads, pile cap and internal bents 1 and 2.	July 9, 1914						76
631	Do.....	do						80
632	Bridge 0.7, Calbayog North and South Roads, pile abutment 2, internal bent 4.	do						66
633	Do.....	do						62
634	Bridge 0.7, Calbayog North and South Roads, slabs and girders, span 3.	do						50
635	Bridge 4.3, Calbayog North and South Roads, pile cap, abutment 1, bent 1.	do						47
636	Bridge 19.4, Calbayog North and South Roads, piles.....	do						89
637	Do.....	do						78
638	Bridge 19.4, Calbayog North and South Roads, pile cap, abutment 2, Ilo Bridge.	Oct. 30, 1914						39
639	Bridge 19.4, Calbayog North and South Roads, Ilo Bridge.	Nov. 24, 1914						28
640	Bridge 19.4, Calbayog North and South Roads, Ilo Bridge, slabs 1, 2, and 3.	Mar. 5, 1915						91
641	Bridge 8.9, Calbayog North and South Roads, North abutment, Arapison Bridge.	Oct. 30, 1914						27
642	Bridge 8.9, piles, Arapison Bridge.	Dec. 16, 1914						28
643	Bridge 8.9, slab and girders, Arapison Bridge.	Mar. 5, 1914						79
644	Bridge 9.6, Sorsogon Bridge.....	Mar. 24, 1914						76
645	Bridge 9.6, piles, Sorsogon Bridge.	Nov. 24, 1914						28
		Dec. 16, 1914						28

646	Bridge 3-6, slab girder-1, Sorsogon Bridge.	Mar. 5, 1915				91
647	Bridge 3-6, slab girders 1 and 2, Sorsogon Bridge.	do				90
648	Bridge 3-6, Calbayog North and South Roads, slab girders 1 and 2.	do				66
649	Do	do				65
650	Do	do				66
651	Do	do				66
652	Do	do				65
653	Do	do				65
654	Do	do				65
655	Bridge 20-1, 11-meter piles	Mar. 24, 1915				74
656	Bridge 8-1, Gumabatan-Jovellar Road, arch.	Apr. 15, 1915				42
657	Culvert, Cathalogan North Road	Nov. 15, 1915				31
658	Do	Nov. 12, 1915				17
659	Culvert, Cathalogan South Road	Apr. 4, 1916				34
660	Do	do	Antiao River	Tagdaranao Beach	1	13
661	Cara Bridge, Calbayog	Apr. 14, 1916	do	do	1	13
662	Do	Apr. 16, 1916	do	do	1	13
663	High School, Cathalogan	Sept. 13, 1916	Tagdaranao Island	Tagdaranao Island	1	13
664	Do	Sept. 20, 1916	do	do	1	13
665	Do	Nov. 2, 1916	do	do	1	13
666	Do	Nov. 2, 1916	Taranguan Beach	Marasatubig	1	13
667	Do	Nov. 3, 1916	do	do	1	13
668	School, Basey	Jan. 23, 1918	do	do	1	13
669	Do	do	do	do	1	13
670	Market booths, Calbayog Market	Apr. 29, 1918	Tacloban Beach, fine	Osmeria Beach.	1	13
671	Do	May 2, 1918	do	do	1	13
			Ipaog Beach	Liburan Beach	1	13
			do	do	1	13
			Salog River	Salog River	1	13
672	Sorsogon Court House and Jail	Oct. 24, 1915	do	do	1	13
673	Do	Oct. 27, 1915	do	do	1	13
674	Do	Nov. 6, 1915	do	do	1	13
675	Do	Dec. 14, 1915	do	do	1	13
676	Do	Dec. 17, 1915	do	do	1	13
677	Do	Dec. 27, 1915	do	do	1	13
					1	15
						23
						37
						20
						34
						29
						29
						33
						31
						44
						51

SORSOGON.

TABLE 8.—Compressive strength of Portland cement concrete made in various parts of the Philippine Islands—Continued.

Tracing No.	Structure in which concrete was used.	Concrete specimens cast.	Source of aggregate.		Test specimens preserved in—			When tested.
			Sand.	Gravel.	Moist air.	Water.	Air.	
					Days.	Days.	Days.	Days.
SORSOGON—continued.								
678	Sorsogon Court House and jail	Nov. 9, 1915	Salog River	Salog River	1	13	16	30
679	Do.	Nov. 15, 1915	do	do	1	13	19	33
SURIGAO.								
680	Bilang-Bilang Wharf	Dec. 7, 1916	Beach, near wharf	Barrio of Ipi	1		28	29
681	Do.	Dec. 14, 1915	do	do				37
682	Do.	Dec. 24, 1915	do	do				21
683	Do.	Dec. 27, 1915	do	do				35
684	Do.	Jan. 8, 1916	do	do				28
685	Do.	Jan. 12, 1916	do	do				28
TAYABAS.								
686	Bridge 14, Pagbilao, Aimanon Road	Sept. 20, 1909						28
687	Do.	do						28
688	Trade School, Aimanon	Oct. 6, 1910	Beach	Aimanon				18
689	Do.	Dec. 15, 1910	do	do				58
690	Do.	do	do	do				58
691	Do.	do	do	do				58
692	Do.	do	do	do				58
693	Repairs on Dumaca Bridge, Lucena	July 30, 1916	Dumaca River	Dumaca River				29
694	Do.	Aug. 1, 1916	do	do				28
695	Do.	do	do	do				28
TARLAC.								
696	San Antonio Bridge, piles	May 8, 1913						26
697	Do.							31

698	Divisoria Bridge, piles	July 18, 1913						50	
699	Unfruit Bridge, slabs	Dec. 5, 1913						49	
700	Do.	do						49	
701	Do.	Nov. 22, 1913						62	
	ZAMBALES.								
702	Yamot Bridge, abutment 1	Oct. 7, 1916						28	
703	Yamot Bridge, intermediate span 1	Oct. 11, 1916						28	
704	Yamot Bridge, intermediate span 2	Oct. 16, 1916						28	
705	Yamot Bridge, end span	Oct. 17, 1916						28	
706	Candelaria Bridge	Oct. 16, 1916				Luis River		43	
707	Do.	Oct. 19, 1916				do		40	
708	Do.	Oct. 31, 1916				do		28	
	ZAMBOANGA.								
709	Zamboanga Waterworks	Jan. 3, 1916				Tumaga River	2	12	
710	Do.	Jan. 4, 1916				do	2	18	
711	Do.	Jan. 5, 1916				do	2	19	
712	Do.	Jan. 6, 1916				do	2	19	

TABLE 8.—Compressive strength of Portland cement concrete made in various parts of the Philippine Islands—Continued.

Tracing No.	Structure in which concrete was used.	Eccentrically sized or specimens broken.	Proportions by volume of cement, sand and gravel.	Compressive strength of concrete, in pounds per square inch.		Remarks.
				First crack stress.	Ultimate stress.	
ALBAY.						
1	None	a 1	1:2:4	1,977	2,210	Aggregates tested and concrete made at the Bureau of Science.
2	Do	a 1	1:3:6	947	1,046	Do.
3	Not known	a 3	1:2:4	1,053	1,119	Stone failed in every case; all cubes show numerous voids, some 1 inch in diameter. Limestone rock very porous and highly weathered. Cubes made by engineer in province.
4	Do	a 3	1:3:6	354	507	All mortar failures; cubes honeycombed with air pockets. The faces of the cubes were finished with a neat cement plaster coat $\frac{1}{8}$ to $\frac{1}{4}$ inch thick. The crushed limestone markedly weathered and coated with residual clay; test cubes made by engineer in province.
5	Do	a 3	1:3:5	388	614	Do.
6	Do	a 3	1:3:6	370	526	Do.
7	Do	a 3	1:3:6	504	624	Do.
8	Do	a 3	1:2:4	735	773	Gravel abraded in all test specimens. Aggregates intended for use in construction of abutments of Big Cabarran River Bridge; test cubes made by engineer in province.
9	Do	a 3	1:2:5	784	823	Do.
10	None	a 1	1:2:4	-----	2,945	Stone and mortar failures; concrete made at the Bureau of Science.
11	Arch, Bridge 8.1, Guinobatan-Jovellar Road	a 3	1:2:4	-----	894	Stone and mortar failures; honeycombed with air pockets; limestone highly weathered and porous; test cubes made by engineer in province in connection with construction of Guinobatan-Jovellar Road.
12	None	a 2	1:2:4	1,229	1,236	

13	Do.....	a	1:2:4	820	885	Do.
14	Guinobatan-Jovellar Bridges, Camalig.....	*2	1:1:3 ³ / ₄	-----	b 1,152	Mortar failures.
15	Quinale-Libon Bridge 234, Polangue.....	*2	1:3:6	724	973	Gravel soft.
16	Manila School, Manila.....	*2	1:2:1.5	-----	b 507	Mortar failures.
17	Bridge 42.1, Polangui.....	*1	1:1.5:2.4	-----	1,946	Special test specimen cut from full-sized pile. Block faced on bearing; ends and embedded in plaster; area of bearing surface, 45 square inches.
18	Do.....	*3	1:1.5:2.4	740	b 785	Mortar and gravel failures.
19	Not used in any structure.....	*3	1:2:1.5	1,391	1,440	All stone and mortar failures. These concrete cubes represent experimental mixtures made on the building site in connection with the construction of Guinobatan-Jovellar Bridges.
20	Do.....	*3	1:2:4	1,200	1,311	Do.
21	Do.....	*3	1:2:1.4 ¹ / ₂	1,820	1,442	Do.
ANTIQUÉ.						
22	Bunfioi Bridge, Culasi.....	*3	1:2:4	191	b 233	Mortar failures; Happong cement used.
23	Do.....	*3	1:2:4	207	b 281	Do.
24	Do.....	*6	1:2:4	813	b 1,233	Do.
25	Ipil Bridge, Barbaza.....	*6	1:2:4	1,070	b 1,334	Do.
26	None.....	*2	1:2:4	562	1,201	Mortar and gravel failures; experimental concrete mixtures made in the Bureau of Science; aggregates proposed for Mariveles Quarantine Station Barracks.
27	Do.....	*1	1:3:6	222	800	Do.
28	Do.....	*1	1:2:5	968	1,337	Do.
29	Do.....	*1	1:2:4	550	1,540	Mortar failures; experimental concrete mixtures made in the Bureau of Science; aggregates proposed for Mariveles Quarantine Station Barracks.
30	Do.....	*1	1:3:6	423	963	Do.
31	Do.....	*1	1:2:4	1,825	2,105	Do.
32	Do.....	*1	1:3:6	685	964	Do.
33	Do.....	*1	1:2:6	463	710	Do.

b Hand mixed.

a Test specimens are 6-inch cubes.

TABLE 8.—Compressive strength of Portland cement concrete made in various parts of the Philippine Islands—Continued.

Tracing No.	Structure in which concrete was used.	Result-averaged specimens broken.	Proportions by volume of cement, sand, and gravel.	Compressive strength of concrete, in pounds per square inch.		Remarks.
				First-mate crack stress.	Ultimate gravel stress.	
34	None	*1	1:2:4	1,722	1,926	Experimental concrete mixtures made in the Bureau of Science, of aggregates submitted by East Bataan Coal Mining Co.
35	Do	*1	1:2:4	1,402	1,842	
BATAAN—continued.						
36	Obispo Bridge, Obispo	*3	1:2:4	544	1,115	Mortar failures.
37	Do	*3	1:3:6	433	1,097	
38	Munting-Tubig Bridge	*3	1:2:4	766	1,227	Do.
39	Do	*2	1:3:6	317	958	Do.
40	Matayuanoc Bridge	*2	1:2:4	450	487	Do.
BOHOL						
41	Abatan Bridge, Cortes floor system	*3	1:2:4	318	688	Very soft, highly weathered gravel, covered with green algae (<i>Protococcus</i>). Considerable quantities of soft coral rock present in gravel; mortar and gravel failures; cubes well made.
42	Abatan Bridge, pier foundation	*3	1:2:4	394	738	
43	Abatan Bridge	*2	1:2:4	595	962	Do.
44	Abatan Bridge, panels 1 and 2 numbered from south	*2	1:2:4	460	848	Mortar and gravel failures; gravel is composed of coral.
45	Abatan Bridge, panels 2 and 4	*2	1:2:4	382	746	
46	Abatan Bridge, panels 5 and 6	*2	1:2:4	310	717	Do.
47	Abatan Bridge, north span	*3	1:2:4	511	1,093	Mortar and gravel failures; excessive mortar in cubes. Aggregate is composed of soft, yellow coral; Green Island cement used.
48	Do	*1	1:2:4	342	686	
49	Do	*1	1:2:4	261	602	Do.

50	Do.	1:2:4	283	668	Do.
51	Calape-Tubigon Bridge and culverts.	1:2:4	224	755	Mortar and gravel failures; concrete very dirty; coarse aggregate is coral.
52	Do.	1:2:1:5	509	843	Do.
53	Do.	1:3:6	129	294	Do.
54	Inayagan Bridge, Calape-Tubigon Road	1:2:4	245	815	Mortar and gravel failures; gravel very soft.
55	Do.	1:2:1:5	306	949	
56	Do.	1:3:6	658	719	
BULACAN.					
57	Bigaa River Bridge	1:2:4	135	606	Mortar failures; concrete from floor.
	Do.	1:2:1:5	156	495	
58	None	1:2:4	2,364	2,478	Experimental mixture made in the Bureau of Science of aggregates proposed for construction of Santo Niño Bridge.
59	Do.	1:2:4	2,444	2,654	Do.
60	Do.	1:3:6	1,028	1,097	Do.
61	Do.	1:3:6	1,167	1,268	Do.
62	Santo Niño Bridge	1:2:4	1,097	1,574	
63	Do.	1:3:6	395	623	
64	Do.	1:3:6	830	1,142	
65	None	1:2:4	1,963	2,039	Experimental mixtures made in the Bureau of Science.
66	Do.	1:2:4	1,764	2,778	Do.
67	Do.	1:2:4	2,055	2,282	Do.
68	Do.	1:2:4	1,555	2,507	Do.
69	Do.	1:2:4	1,576	1,557	Experimental mixtures made in the Bureau of Science of aggregates proposed for Bolo River Bridge.
70	Do.	1:3:6	670	757	Do.
71	Do.	1:2:4	1,611	1,099	Do.
72	Do.	1:3:6	722	833	Do.
73	Malolos Market, Footings.	1:3:6	574	594	Mortar failures.
74	Do.	1:3:6	742	788	Do.

^a Test specimens are 6-inch cubes.

TABLE 8.—Compressive strength of Portland cement concrete made in various parts of the Philippine Islands—Continued.

Tracing No.	Structure in which concrete was used.	Result averaged or specimens broken.	Proportion of volume of cement, sand, and gravel.	Compressive strength of concrete, in pounds per square inch.		Remarks.
				First crack stress.	Ultimate crack stress.	
	BULACAN—continued.					
75	Malolos Market, columns.....	a3	1:2:5	437	437	Mortar failures.
76	Do.....	a3	1:2:5	800	800	Do.
77	Do.....	a3	1:2:5	479	479	Do.
78	Do.....	a3	1:2:4	773	773	Do.
79	Do.....	a3	1:2:1:4	823	823	Do.
80	Do.....	a5	1:1:1:4	659	659	Do.
81	Do.....	a5	1:1:1:4	1,012	1,012	Do.
82	Do.....	a5	1:2:4	726	726	Do.
83	Do.....	a5	1:2:4	1,103	1,103	Do.
84	Do.....	a5	1:2:4	b 667	b 667	Do.
85	Do.....	a5	1:2:4	b 1,097	b 1,097	Do.
86	Do.....	a5	1:2:5	b 624	b 624	Do.
87	Do.....	a5	1:2:5	b 1,018	b 1,018	Do.
88	Do.....	a5	1:2:5	b 621	b 621	Do.
89	Do.....	a5	1:2:5	b 988	b 988	Do.
90	Do.....	a3	1:1:1:4	b 857	b 857	Do.
91	Do.....	a3	1:2:4	b 594	b 594	Do.
92	Do.....	a6	1:2:4	b 391	b 391	Do.
93	Do.....	a6	1:2:4	605	605	Do.
94	Do.....	a 12	1:2:5	865	865	Do.
95	Do.....	a6	1:1:1:4	833	833	Do.
96	Do.....	a5	1:1:1:4	2,900	2,900	Do.
97	Do.....	a9	1:2:5	1,765	1,765	Do.

98	Do.....	a 10	1:2:4	2, 327	3, 117	
99	Pullian Market.....	a 8	1:2:4	b 797	b 797	Caballoon cement and fresh well water used.
100	Do.....	a 9	1:2:4	b 1,663	b 1,663	Do.
101	Do.....	a 9	1:2:5 ^a	b 510	b 510	Do.
102	Do.....	a 9	1:2:5	b 835	b 835	Mortar failures; aggregates and cement measured by the barrel.
103	Do.....	a 9	1:2:5	b 799	b 799	Do.
104	Do.....	a 6	1:2:5	b 783	b 783	Do.
105	Do.....	a 9	1:2:5	b 739	b 739	Do.
106	Bagbag Bridge, Calumpit.....	e 2	1:2:4	658	b 1,466	Mortar failure; Asano cement used.
107	Do.....	e 2	1:3:6	346	b 557	Do.
108	Do.....	c 2	1:2:5	394	b 551	Do.
109	Do.....	c 1	1:2:4	798	b 1,180	Mortar failures; Rizal cement used.
110	Do.....	c 1	1:2:5	514	b 626	Do.
111	Do.....	c 1	1:3:6	371	448	Do.
112	None.....	d 3	1:2:4	-----	1, 328	Mortar failures; experimental concrete mixture made at the Bureau of Science of aggregates proposed for Santa Maria Bridge.
CAPIZ.						
113	Capiz Bridge, south and north arch rings.....	a 2	1:2:4	765	1, 310	Gravel and mortar failures.
114	Do.....	a 1	1:2:4	767	1, 719	Do.
115	Do.....	a 1	1:2:4	944	1, 782	Do.
116	Ivisan School.....	a 1	1:3:6	b 97	b 97	Onada cement used.
117	Do.....	a 2	1:2:4	b 266	b 266	Do.
118	Do.....	a 2	1:2:4	b 619	b 619	Do.
119	Do.....	a 2	1:3:6	b 836	b 836	Do.
120	Pilar School.....	a 2	1:2:4	178	b 254	
121	Do.....	a 2	1:3:6	170	b 243	
122	Do.....	a 2	1:2:4	-----	b 629	Mortar failures.
123	Do.....	a 2	1:3:6	-----	b 424	Do.
124	Litas Bridge, Capiz.....	a 2	1:3:6	337	b 417	Mortar failures; Haiiphong cement used.
125	Do.....	a 2	1:2:4	578	b 867	Do.
126	Bahucuan Bridge, Dao, skew arch.....	a 2	1:2:4	890	b 1,434	Do.
127	Do.....	a 2	1:3:6	563	b 1,023	Do.

^a Test specimens are 6-inch cubes.

^b Hand mixed.

^c Test specimens are cylinders 8 inches in diameter and 16 inches high.

^d Test specimens are cylinders 3.568 inches in diameter and 7.136 inches high.

TABLE 8.—Compressive strength of Portland cement concrete made in various parts of the Philippine Islands—Continued.

Tracing No.	Structure in which concrete was used.	Results by averaging specimens broken.	Proportions by volume of cement, sand and gravel.	Compressive strength, in pounds per square inch.		Remarks.
				First-crack stress.	Ultimate stress.	
CAPIZ—continued.						
128	Baluacan Bridge, Dao, skew arch	a 2	12:4	887	b 1,578	Mortar failures, Haiphong cement used.
129	Do	a 2	13:6	499	b 810	Do.
130	Capiz water tank	e 2	12:4	633	b 1,228	Mortar failures; Rizal cement used.
131	Do	e 2	12:4	890	b 1,467	Do.
132	Do	e 2	13:4½	570	b 764	Do.
133	Do	e 2	12:6	461	b 686	Do.
134	Do	e 2	11:2:4	1,069	a 1,571	Do.
135	Do	e 2	11:2:4	929	a 1,143	Do.
136	Bridges, Mianny Road, Ivisan, Capiz	e 2	12:4	554	b 643	Mortar failures; barrels of cement received in poor condition April, 1916, hoops, staves, and heads broken; cement exposed to air, but well stored. Rizal cement used.
137	Do	e 2	13:6	357	b 425	Do.
CAVITE.						
138	Tabon Bridge, southwest corner and south abutment	a 1	13:1:7	56	199	Mortar failures; no gravel sheared during test; specimens poorly made.
139	Tabon Bridge, center, south abutment	a 1	13:1:7	92	276	Do.
140	Tabon Bridge, southeast side, south abutment	a 1	13:1:7	144	396	Do.
141	Tabon Bridge, center, north abutment	a 2	13:1:7	234	384	Do.
142	Tabon Bridge, spandrel wall	a 1	13:6	299	633	Do.
143	Do	a 1	13:6	532	853	Mortar failures.
144	Tabon Bridge, south side ring; north and south abutments.	a 4	12:4	365	579	Do.
145	Tabon Bridge, spandrel wall	a 2	13:6	143	356	Do.

146	Taon Bridge, balustrade, east side.....	a 1	1:2:4	298	447	Do.
147	Taon Bridge, balustrade, west side.....	a 1	1:2:4	483	942	Do.
148	Canacao Bridge, piles.....	a 4	1:2:4	-----	b 488	Water from brackish well near beach used for mixing concrete; Onoda cement used.
149	Canacao Bridge, slabs 1 and 2.....	4	1:1:1 ¹ / ₄	1,674	e 2,203	Mortar and gravel failures; brackish water and Green Island cement used.
150	Do.....	4	1:2:4	1,107	a 1,846	Do.
151	Canacao Bridge.....	4	1:2:4	1,387	a 1,763	Do.
152	Do.....	4	1:2:4	1,444	a 1,996	Do.
153	Canacao Bridge, retaining walls.....	a 3	1:1:1 ¹ / ₄	423	b 609	Dirty salt water used in mixing concrete; cylinders stored in salt water 13 days. Rizal cement used.
154	Do.....	a 3	1:1:1 ¹ / ₄	1,225	b 1,304	Test specimens stored in salt water 13 days. Fresh water and Rizal cement used.
155	Do.....	a 3	1:2:4	866	b 1,161	Do.
156	Do.....	a 3	1:2:4	887	b 934	Test specimens stored in salt water 13 days; dirty salt water and Rizal cement used.
157	San Juan culvert No. 25.3, Noveleta.....	e 2	1:1.7:2.3	-----	b 764	Green Island cement used.
158	None.....	a 5	1:1:3	1,037	a 2,384	Caballo cement used. Experimental mixture made at the Bureau of Science of aggregates proposed for Calero Bridge.
159	Calero Bridge, Noveleta-Cavite Road.....	a 1	1:2:1 ¹ / ₂	510	b 723	Caballo cement used. To every 36 parts by volume of mixing water (artesian) was added 1 part of Truss-con water-proofing paste; mortar failures.
160	Do.....	a 1	1:1.7:4.3	402	b 521	Do.
161	Do.....	e 2	1:1.7:4.3	477	b 739	Do.
162	Calero Bridge, Noveleta-Cavite Road, piles.....	e 2	1:2:4	637	b 1,161	Water from artesian well used for mixing concrete.
163	Culverts, Noveleta-Cavite Road.....	e 2	1:2:4	413	b 550	Asano cement and artesian water used.
164	Do.....	e 2	1:2:1 ¹ / ₂	363	b 441	Do.
165	None.....	a 3	1:2:4	881	b 1,558	Experimental mixture made at the Bureau of Science of aggregates proposed for Argunhako School.
166	Do.....	a 3	1:1:3	785	b 1,037	
167	Do.....	a 3	1:2:4	1,134	b 2,913	

^a Test specimens are 6-inch cubes.

^b Hand mixed.

^c Test specimens are cylinders 8 inches in diameter and 16 inches high.

^d Test specimens are cylinders 8.688 inches in diameter and 7.136 inches high.

^e Machine mixed.

TABLE 8.—Compressive strength of Portland cement concrete made in various parts of the Philippine Islands—Continued.

Tracing No.	Structure in which concrete was used.	Result specimens broken.	Proportions by volume of cement, sand, and gravel.	Compressive strength of concrete, in pounds per square inch.		Remarks.
				First failure stress.	Ultimate stress.	
	CEBU.					
168	Naga River Bridge.....	*1	1:2:4	272	527	Mortar very friable and easily broken with the fingers.
169	Do.....	*1	1:2:1:5	135	271	Do.
170	Naga River Bridge, floor.....	*6	1:2:4	385	563	Mortar and gravel failures; gravel fine and very soft.
171	Carcar Bridge, south arch ring.....	*5	1:2:4	1,239	1,557	Mortar and gravel failures; some pieces of gravel 3 inches in diameter.
172	Carcar Bridge, spandrel wall.....	*5	1:2:1:5	360	978	Mortar and gravel failures; gravel soft.
173	Do.....	*2	1:2:1:5	536	786	Mortar and gravel failures; gravel soft; concrete contains dirt and shells.
174	Do.....	*3	1:2:1:5	545	1,236	Mortar and gravel failures.
175	None.....	*2	1:2:4	2,318	2,427	Mortar failures; crushed rock very hard; experimental mixtures made at Bureau of Science of aggregates proposed for dam of Cebu Gravity Water Supply, Osmeña Waterworks.
176	Do.....	*2	1:3:6	427	624	Do.
177	Do.....	*2	1:3:6	771	1,093	Do.
178	Do.....	*2	1:2:4	900	1,429	Mortar and gravel failures; experimental mixtures made at Bureau of Science of aggregates proposed for dam of Cebu Gravity Water Supply, Osmeña Waterworks.
179	Do.....	*2	1:2:4	1,471	1,816	Do.
180	Osmeña Waterworks dam.....	*1	1:2:4	1,014	1,639	Mortar and gravel failures.
181	Do.....	*1	1:2:4	1,389	1,800	Do.
182	Do.....	*1	1:2:4	1,361	1,719	Do.
183	Do.....	*1	1:2:4	1,555	1,884	Do.
184	Do.....	*1	1:2:4	2,944	3,155	Do.

186	Magallanes Bridge, west abutment	a 4	1,336	1,646	2,183	
186	Magallanes Bridge, arch rings	a 12	1,224	1,954	2,659	Experimental mixtures made at the Bureau of Science of aggregates submitted by the Bureau of Navigation.
187	None	a 3	1,224	1,259	b 2,546	Do.
188	Do	a 3	1,336	1,180	b 1,380	Mortar failures; gravel not sheared; experimental mixtures made at the Bureau of Science of aggregates proposed for Cebu Quarantine Station.
189	Do	a 2	1,224	1,327	b 1,960	Do.
190	Do	a 2	1,225	1,555	b 1,823	Experimental mixtures made at the Bureau of Science of aggregates proposed for Barfil Road bridges.
191	Do	a 1	1,224	1,969	b 2,126	Mortar and gravel failures; Asano cement and muddy water from Sibonga River used.
192	Sibonga Bridge	a 3	1,224	1,030	b 1,899	Mortar failure; muddy Sibonga River water used.
193	Do	a 3	1,336	795	b 1,002	Do.
194	Do	a 1	1,336		b 503	Mortar and gravel failures.
195	Do	a 4	1,224	1,339	2,274	Do.
196	Cebu Wharf extension	a 3	1,336	1,274	a 1,634	Mortar and gravel failures; Caballo cement used.
197	Do	a 3	1,215		a 1,954	Do.
198	Do	a 3	1,224		a 1,382	Do.
199	Do	a 3	1,224		a 1,820	Do.
COTABATO.						
200	Parang Waterworks, 30 cm conduit.	a 2	1,224	813	974	Mortar failures.
201	Parang Waterworks, intake and ram base	a 2	1,336	670	940	Do.
202	Parang Waterworks	a 2	1,113	719	951	Do.
203	Parang Waterworks, tank	a 2	1,224	1,237	1,446	Do.
204	Do	a 2	1,224	964	1,269	Mortar and gravel failures.
205	Parang Waterworks, pipe	a 2	1,113	666	1,025	Mortar failures.
206	Cotabato Lighthouse, accumulator	a 2	1,224	619	1,085	Mortar failures; muddy, salty water from Cotabato River used in mixing concrete.
207	Cotabato Public Hospital, Cotabato.	a 2	1,336	175	373	Mortar failures; concrete hand-mixed with Cotabato River water.
208	Do	a 2	1,336	556	599	Mortar failures; concrete hand-mixed with spring water.

^a Test specimens are 6-inch cubes.

^b Hand mixed.

^c Test specimens are cylinders 8 inches in diameter and 16 inches high.

^d Machine mixed.

TABLE 8.—Compressive strength of Portland cement concrete made in various parts of the Philippine Islands—Continued.

Tracing No.	Structure in which concrete was used.	Result averaged or specimens broken.	Proportions by volume of cement, sand and gravel.	Compressive strength by strength of concrete, in pounds per square inch.		Remarks.
				First-trial stress.	Ultimate stress.	
COTABATO—continued.						
209	Cotabato Public Hospital, Cotabato.	e 2	1:3:6	1,822	2,119	Mortar and gravel failures; concrete hand-mixed with spring water.
210	Cotabato River wall, Cotabato drain pipe.	e 2	1:2:4	1,446	1,517	Mortar failures; concrete hand-mixed with muddy Cotabato River water.
ILOCOS NORTE.						
211	Spillway piles, Gilbert Bridge, Laang.	a 3	1:2:4	2,889	b 3,111	Experimental cubes made at Bureau of Science of aggregates used in piles of spillway, Gilbert Bridge.
212	None	45	1:2:4	1,289	b 1,905	Mortar and gravel failures.
213	Spillway, Gilbert Bridge.	a 2	1:2:4	-----	b 714	Catalo cement and clear stagnant water from Balaybabuy canal used.
214	Badoc School, Badoc.	e 2	1:2:4	-----	b 763	Do.
215	Do.	e 2	1:2:1:5	-----	b 434	Do.
216	Do.	e 2	1:2:4	1,042	b 1,288	Do.
217	Do.	e 2	1:2:1:5	711	b 887	Do.
ILOCOS SUR.						
218	Bridge piles	a 3	1:2:4	620	1,384	Mortar failures; sand very fine.
219	Do.	a 3	1:3:6	264	689	Do.
220	Cabugao Bridge	a 6	1:2:4	415	777	Do.
221	Singson Waterworks.	a 2	1:1:1:3	532	548	Mortar failures; failed by splitting in a plane at right angles to bearing surfaces.
222	Vigan Central school, piers	a 2	1:2:1:5	-----	b 816	Mortar failures; Emerald cement used.
223	Vigan Central School	a 2	1:2:4	-----	b 617	Do.
224	None	a 1	1:2:4	1,042	1,411	Mortar failures; no stone sheared during test; experimental mixtures made at the Bureau of Science of aggregates proposed for the construction of Molo Bridge.

225	Do.....	a 2	1:2:4	2, 088	2, 301	Do.
226	Do.....	a 2	1:2:4	1, 896	2, 031	Do.
227	Do.....	a 2	1:2:4	2, 347	2, 529	Do.
228	Molo Bridge.....	a 3	1:2:1:5	796	1, 209	Sand and gravel unscreened; soft water used in mixing concrete; Green Island cement employed.
229	Do.....	a 3	1:2:1:5	767	838	Unscreened gravel and screened sand used; salt water and Green Island cement employed.
230	Do.....	a 3	1:2:1:5	859	1, 397	Screened gravel and unscreened sand used; salt water and Green Island cement employed.
231	Do.....	a 3	1:2:1:5	673	1, 066	Screened sand and gravel used; salt water and Green Island cement employed.
232	Do.....	a 3	1:3:6	754	1, 208	Sand and gravel not screened; fresh water and Green Island cement used.
233	Do.....	a 3	1:3:6	658	843	Gravel unscreened; sand screened; fresh water and Green Island cement used.
234	Do.....	a 3	1:3:6	876	1, 135	Gravel screened; sand unscreened; fresh water and Green Island cement used.
235	Do.....	a 2	1:3:6	920	1, 202	Gravel and sand screened; fresh water and Green Island cement used.
236	Do.....	a 3	1:2:1:5	1, 220	1, 955	Mortar and gravel failures.
237	Do.....	a 2	1:2:1:5	1, 124	1, 858	Do.
238	Do.....	a 4	1:2:1:5	1, 690	1, 891	Do.
239	Do.....	a 2	1:3:6	1, 139	1, 611	Mortar failures.
240	Do.....	a 2	1:3:6	708	1, 490	Do.
241	Do.....	a 2	1:3:6	638	965	Do.
242	Do.....	a 3	1:3:6	572	850	Mortar failures; Green Island cement used.
243	Do.....	a 1	1:2:1:5	888	1, 228	Do.
244	Molo Bridge, pier 1.....	a 1	1:3:6	872	1, 286	Salt water used in mixing concrete; Green Island cement used.
245	Do.....	a 1	1:3:6	811	969	Do.
246	Molo Bridge.....	a 2	1:2:4	553	975	Sand and gravel not screened; salt water used; Green Island cement used.

^a Test specimens are 6-inch cubes.

^b Hand mixed.

^c Test specimens are cylinders 8 inches in diameter and 16 inches high.

^d Test specimens are cylinders 8.568 inches in diameter and 7.136 inches high.

TABLE 8.—Compressive strength of Portland cement concrete made in various parts of the Philippine Islands—Continued.

Trial No.	Structure in which concrete was used.	Result of average specimens and broken.	Proportion of cement, sand, and gravel.	Compressive strength of concrete, in pounds per square inch.		Remarks.
				First crack stress.	Ultimate crack stress.	
247	Molo Bridge	a 2	1:2:4	396	700	Sand screened; gravel unscreened; salt water and Green Island cement used.
248	Do	a 2	1:2:4	507	781	Sand unscreened; gravel screened; salt water and Green Island cement used.
249	Do	a 2	1:2:4	912	1,089	Sand and gravel screened; salt water and Green Island cement used.
250	Molo Bridge, pier 2	a 3	1:2:1.5	965	1,769	Mortar failures; Green Island cement used.
251	Do	a 1	1:3:6	972	1,382	Do.
252	Do	a 3	1:2:1.5	1,182	1,769	Do.
253	Do	a 3	1:2:1.5	1,104	1,746	Do.
254	Do	a 1	1:3:6	1,230	1,583	Do.
255	Do	a 2	1:3:6	481	874	Do.
256	Do	a 1	1:3:6	403	1,213	Do.
257	Molo Bridge	a 8	1:2:1.5	1,622	1,954	
258	Molo Bridge, pier 6	a 4	1:2:1.5	876	1,597	
259	Do	a 2	1:2:1.5	827	1,363	
260	Molo Bridge, abutment A	a 2	1:3:6	782	1,178	
261	Do	a 1	1:3:6	158	786	
262	Do	a 1	1:2:1.5	1,065	1,178	
263	Do	a 1	1:2:1.5	380	897	
264	Do	a 1	1:3:6	772	979	
265	Do	a 1	1:3:6	778	1,100	
266	Molo Bridge	a 4	1:2:1.5	872	1,232	
267	Do	a 4	1:2:1.5	906	1,429	

268	Molo Bridge								
269	Do	a 1	1:2½:5	597	1,090				
270	Do	a 2	1:3:6	840	1,194				
271	Do	a 1	1:2½:5	764	1,090				
271	None	a 1	1:2:4	2,667	2,715				
272	Do	a 1	1:2:4	2,278	2,352				
273	Molo Bridge, slab 2	a 1	1:2:4	1,167	1,310				
274	Do	a 1	1:2:4	1,417	1,561				
275	Do	a 1	1:2:4	988	1,257				
276	Do	a 1	1:2:4	1,097	1,262				
277	Do	a 1	1:2:4	1,656	1,894				
278	Do	a 1	1:2:4	980	1,200				
279	Do	a 1	1:2:4	888	1,207				
280	Do	a 1	1:2:4	1,022	1,300				
281	Molo Bridge	a 1	1:2½:5	1,041	1,263				
282	Do	a 5	1:2½:5	852	1,289				
283	Do	a 1	1:3:6	478	688				
284	Do	a 2	1:2:4	1,094	1,331				
285	Do	a 2	1:2:4	920	1,048				
286	Do	a 2	1:2:4	1,000	1,227				
287	Do	a 2	1:2:4	1,076	1,421				
288	Do	a 2	1:2:4	883	1,158				
289	Do	a 2	1:2:4	1,326	1,422				
290	Do	a 2	1:2:4	1,083	1,345				
291	Do	a 2	1:2:4	819	1,175				
292	Do	a 1	1:2:4	944	1,247				
293	Do	a 2	1:2:4	1,275	1,406				
294	Do	a 2	1:2:4	1,199	1,428				
295	Do	a 1	1:2:4	1,000	1,244				
296	Molo Bridge, span 7	a 2	1:2:4	1,118	1,473				
297	Do	a 2	1:2:4	1,021	1,285				

* Test specimens are 6-inch cubes.

Mortar failures; experimental mixtures made in the Bureau of Science of aggregates proposed for the construction of Iloilo Prison.

Do.

TABLE 8.—Compressive strength of Portland cement concrete made in various parts of the Philippine Islands—Continued.

Tracing No.	Structure in which concrete was used.	Result of strength test on aged specimens or specimens broken.	Proportions by volume of cement, sand and gravel.	Compressive strength of concrete, in pounds per square inch.		Remarks.
				First crack stress.	Ultimate stress.	
ILOILO—continued.						
286	Molo Bridge, span 4	a2	1:2:4	1,611	1,614	
289	Do	a1	1:2:4	1,076	1,234	
300	Do	a4	1:2:4	1,645	1,700	
ISABELA.						
301	Echagne School, piers	c2	1:2:5		b896	Mortar failures, clear lake water used in mixing concrete.
302	Echagne School, girders	c2	1:2:4	789	b885	Do.
303	Echagne School, footings	c2	1:2:5		b888	Do.
304	Cabagan Farm School, footings	c2	1:2:5	491	b683	Mortar failures; well water and Asano cement used.
305	Cabagan Farm School, piers	c2	1:2:5	583	b1,173	Do.
306	Cabagan Farm School, girders	a2	1:2:4	827	b1,172	Do.
307	Cauayan Presidencia	a2	1:2:4	919	b1,277	Mortar failures; water from Malabulig Creek and Asano cement used.
308	Do	c2	1:2:5	412	b811	Do.
JOLO.						
309	None	a1	1:2:4	1,217	1,217	Experimental mixture made in the Bureau of Science of aggregates sent from Jolo.
310	Do	a1	1:3:6	577	577	Do.
LAGUNA.						
311	None	a1	1:2:4	1,278	2,880	Crushed basalt from upper ledge and basalt screenings used; experimental mixtures made at the Bureau of Science of aggregates submitted for test by U. S. A. Quartermaster.

312	Do.....	a 1	1224	1,347	1,638	Crushed basalt from upper ledge and sand from barrio of Mogondon used; experimental mixtures made at the Bureau of Science of aggregates submitted for test by U. S. A. Quartermaster.
313	Do.....	a 1	1224	1,936	2,310	Fine aggregate composed of equal parts by volume of screenings and Mogondon sand; experimental mixtures made at the Bureau of Science of aggregates submitted for test by U. S. A. Quartermaster.
314	Do.....	a 1	1236	1,556	2,214	Do.
315	Do.....	a 2	1224	1,225	1,638	Do.
316	Do.....	a 2	1236	431	825	Crushed basalt from lower ledge and Mogondon sand used; mortar failures; experimental mixtures made at the Bureau of Science of aggregates submitted for test by U. S. A. Quartermaster.
317	Do.....	a 2	1224	1,470	2,012	Do.
318	Do.....	a 2	1236	871	1,210	Do.
319	San Juan Bridge, Calamba.....	a 3	1224	1,158	1,841	Mortar failures:
320	Do.....	a 8	1236	969	1,215	Do.
321	San Juan Bridge, abutments.....	a 1	1231:7	119	440	
322	San Juan Bridge.....	a 1	1224	1,000	1,217	
323	San Juan Bridge, footing, abutment.....	a 1	1224	611	1,273	
324	Do.....	a 1	1231:5	1,222	1,584	
325	San Juan Bridge, pier 3.....	a 2	1236	769	1,220	
326	Do.....	a 1	1236	889	1,105	
327	Do.....	a 1	1231:5	875	1,857	
328	San Juan Bridge.....	a 1	1224	441	1,167	
329	Do.....	a 2	1224	378	1,309	
330	Do.....	a 2	1224	535	1,138	
331	San Juan Bridge, footing, abutment A.....	a 1	1231:5	389	1,209	
332	San Juan Bridge, main arch rings.....	a 2	1224	674	1,289	
333	San Juan Bridge, footing, abutment A.....	a 2	1231:5	1,185	1,434	
334	San Juan Bridge, main arch rings.....	a 2	1224	750	1,367	
335	Do.....	a 2	1224	740	1,200	
336	Do.....	a 2	1224	292	553	

^a Test specimens are 6-inch cubes.

^b Hand mixed.

^c Test specimens are cylinders 8 inches in diameter and 16 inches high.

TABLE 8.—Compressive strength of Portland cement concrete made in various parts of the Philippine Islands—Continued.

Tracing No.	Structure in which concrete was used.	Result of specimens averaged or specimen broken.	Proportions by volume of cement, sand, and gravel.	Compressive strength of concrete, in pounds per square inch.		Remarks
				First crack stress.	Ultimate stress.	
LAGUNA—continued.						
337	San Juan Bridge, main arch rings	a 2	1:2:4	670	1,556	
338	Do.	a 2	1:2:4	395	950	
339	Pagsanjan water tank	c 1	1:2:4	-----	b 200	Mortar failures; artesian water and Asano cement used.
340	Do.	c 1	1:2:4	-----	b 795	Do.
341	Do.	c 1	1:2:4	-----	b 578	Do.
342	Do.	a 3	1:2:4	1,573	2,137	Experimental mixtures made at the Bureau of Science of aggregates used in constructing Barugo School, Barugo.
LEYTE.						
343	Guinaron Bridge	c 1	1:2:4	1,585	1,910	
344	Barugo School, Barugo	a 3	1:3:6	198	b 130	Caballo cement used.
345	None	d 4	1:2:5	1,637	1,989	Mortar and gravel failures; experimental mixtures made at the Bureau of Science of aggregates used in constructing Barugo School.
346	Do.	d 3	1:1.3:4.3	1,697	1,894	Do.
347	Do.	d 4	1:2.5:5	945	1,220	Do.
348	Do.	d 3	1:1.8:5.8	1,601	1,969	Do.
349	Barugo School, Barugo	a 3	1:3:6	234	b 251	Mortar failures; fresh well water used.
350	Do.	a 2	1:2:4	457	b 582	Do.
351	Do.	a 2	1:3:6	391	b 917	Do.
352	Do.	a 2	1:2:4	657	b 672	Do.
353	Do.	a 3	1:2:4	-----	763	Caballo cement and fresh well water used.
354	Do.	a 3	1:2:5	-----	882	Do.
355	Do.	a 3	1:2:5	-----	673	Do.
356	Tabontabon School, Dagami	a 3	1:2:4	120	b 177	Caballo cement used.

357	Do.....	a 3	1:3:6	b 606	Do.	
358	Do.....	a 3	1:3:6	b 154	Mortar very friable and porous.	
359	Do.....	c 3	1:2:4	b 1,244	Mortar and gravel failures; Caballo cement and fresh well water used.	
360	Mainit Bridge, Alangdang, Leyte.....	a 3	1:2:1.5	b 1,971	Water from Mainit River and Green Island cement used.	
361	Do.....	a 2	1:2:4	c 530	Water from Mainit River and Green Island cement used; mortar failures.	
362	Do.....	a 2	1:2:1.5	e 727	Do.	
363	Do.....	a 5	1:3:6	e 586	Do.	
364	Do.....	a 3	1:2:1.5	b 825	Mainit River water and Asano cement used; mortar failures.	
365	Do.....	a 3	1:12:3.6	b 621	Do.	
366	Do.....	a 5	1:12:3.6	b 843	Mainit River water and Asano cement used; mortar and gravel failures.	
367	Do.....	a 2	1:3:6	e 500	Mainit River water and Culobra cement used; mortar and gravel failures.	
368	Do.....	a 2	1:12:2:1.5	e 738	Do.	
369	Do.....	a 2	1:12:3:6	e 571	Do.	
370	Do.....	a 2	1:12:3:6	e 761	Do.	
371	Ormoc Market, Ormoc.....	a 3	1:2:4	b 281	Mortar failures; Caballo cement used.	
372	Do.....	a 3	1:3:6	b 118	Do.	
373	Ormoc Market.....	a 8	1:2:4	b 1,057	Caballo cement and fresh well water used.	
374	Do.....	a 3	1:2:3:6	b 1,974	Caballo cement and fresh well water used; mortar and gravel failures.	
375	Do.....	a 3	1:2:2:4	1,198	2,627	Caballo cement and Hilongos River water used; mortar failures.
376	Naval School, Leyte.....	a 2	1:2:4	1,123	1,123	Caballo cement and fresh well water used; mortar failures.
377	Do.....	a 3	1:2:4	2,363	3,884	Caballo cement and fresh well water used; mortar and gravel failures.
378	Do.....	a 3	1:2:4	1,261	3,053	Do.

^a Test specimens are 6-inch cubes.

^b Hand mixed.

^c Test specimens are cylinders 8 inches in diameter and 16 inches high.

^d Test specimens are cylinders 3.668 inches in diameter and 7.136 inches high.

^e Machine mixed.

^f Four-inch cube.

TABLE 8.—Compressive strength of Portland cement concrete made in various parts of the Philippine Islands—Continued.

Tracing No.	Structure in which concrete was used.	Results of averaged specimens and broken.	Proportion of cement, sand, gravel.	Compressive strength of concrete, in pounds per square inch.		Remarks.
				First crack stress.	Ultimate stress.	
LEYTE—continued.						
379	Hilongos Market.....	a 3	1:2:4	379	b 409	Caballo cement and Hilongos River water used; mortar failures.
380	Do.....	a 3	1:3:6	b 295	b 295	Do.
381	Do.....	a 3	1:2:4	772	b 818	Caballo cement and well water used; mortar and gravel failures.
382	Do.....	a 3	1:3:6	b 601	Do.
383	Do.....	a 2	1:2:4	b 1,030	Do.
384	Hilongos Market (Floor).....	a 3	1:1.5:2.4	1,461	b 3,383	Do.
385	Do.....	a 3	1:1.5:3:6	942	b 1,719	Caballo cement and fresh well water used; mortar failures.
386	Punong Bridge, Bato.....	a 6	1:2:4	926	b 944	Caballo cement and river water used; mortar failures.
387	Do.....	a 2	1:2:4	b 1,361	Caballo cement used; mortar failures.
388	Taghaligue Bridge, Matalom.....	a 3	1:3:6	b 905	Do.
389	Do.....	a 3	1:3:6	b 1,273	Do.
390	Do.....	a 2	1:2:4	340	b 367	Do.
391	Do.....	a 3	1:3:4:7	488	b 513	Do.
392	Do.....	a 2	1:2:4	b 1,321	Caballo cement and fresh well water used; mortar and gravel failures.
393	Do.....	a 3	1:2:4	b 1,153	Caballo cement and well water used; mortar and gravel failures.
394	Dumog Bridge, Bato.....	a 3	1:2:4	1,276	b 1,321	Caballo cement used; mortar and gravel failures.
395	Do.....	a 3	1:2:4	1,475	b 1,616	Do.
396	Do.....	a 2	1:2:4	b 1,261	Do.
397	Albavera School, Ormoc.....	a 2	1:3:6	b 921	Caballo cement and fresh well water used; mortar failures.
398	Do.....	a 2	1:2:4	b 749	Do.
399	Do.....	a 2	1:2:4:5	1,815	b 2,581	Caballo cement and fresh well water used.
400	Tanauan School, Tanauan.....	a 2	1:2:4	450	Caballo cement and fresh well water used; mortar failures.

401	Do.....	a 2	1336	431	Do.
402	Do.....	e 1	1,15:2:5	768	Do.
403	Do.....	e 1	1,15:2:4	686	Asano cement and fresh well water used; mortar failures.
404	Do.....	e 1	1,15:2:5	572	Do.
405	Do.....	e 2	1:2:4	277	Asano cement and fresh well water used; mortar and gravel failures.
406	Do.....	e 2	1:2:5	743	Do.
407	Babay School, Babay.....	a 2	1:2:4	772	Caballo cement and fresh well water used; mortar and gravel failures.
408	Do.....	a 3	1:2:4	1,890	Caballo cement and fresh well water used.
409	Do.....	a 3	1:2:4	1,887	Do.
410	Ta bango School, San Isidro.....	a 3	1:2:4	1,019	Caballo cement and fresh well water used; mortar failures.
411	Do.....	a 3	1:2:4	874	Asano cement and fresh well water used.
412	Maasin Bridge, Maasin.....	e 3	1:2:2:4	446	Asano cement and fresh well water used; mortar failures.
413	Costa bridges and culverts, Inopacan.....	e 2	1:15:3:6	768	Do.
414	Do.....	e 2	1:15:3:6	512	Do.
415	Taclaban Port Works.....	e 3	1:2:4	1,011	Asano cement and fresh well water used; mortar and gravel failures.
416	Do.....	e 3	1:2:1:5	464	Do.
417	Taclaban Port Works, column.....	e 2	1:2:2:4	535	Asano cement and fresh well water used; mortar failures.
418	Do.....	e 2	1:2:2:4	711	Do.
419	Do.....	e 3	1:2:2:4	1,276	Do.
420	Do.....	e 3	1:2:2:1:5	408	Asano cement and fresh well water used; mortar failures.
421	Taclaban Port Works.....	e 3	1:2:1:6	462	Do.
422	Do.....	e 3	1:2:1:5	347	Do.
423	Do.....	e 3	1:2:6	421	Do.
424	Do.....	e 3	1:2:2:4	940	Do.
425	Do.....	e 3	1:2:2:1:5	677	Do.
426	Do.....	e 3	1:2:2:4	635	Do.

^a Test specimens are 6-inch cubes.

^b Hand mixed.

^c Test specimens are cylinders 8 inches in diameter and 16 inches high.

TABLE 8.—Compressive strength of Portland cement concrete made in various parts of the Philippine Islands—Continued.

Tracing No.	Structure in which concrete was used.	Result of test—specimens aged or broken.	Proportions by volume of cement, sand and gravel.	Compressive strength of concrete, in pounds per square inch.		Remarks.
				First crack stress.	Ultimate stress.	
LEYTE—continued.						
427	Academic Building, Tacloban Trade School	c 3	1:2:5	b 600		Rizal cement and fresh well water used.
428	Do	c 3	1:2:4	507	b 1,125	Rizal cement and fresh well water used; mortar failures.
429	Do	c 3	1:2:2:5	362	b 490	Do.
430	Do	c 3	1:2:2:4	574	b 832	Rizal cement and fresh well water used; mortar and gravel failures.
431	Provincial Building, Tacloban	c 3	1:2:2:4	1,641	b 1,736	Do.
432	Do	c 3	1:2:2:4		e 2,210	Caballo cement and fresh well water used; mortar and gravel failures.
433	Dulang Market	c 3	1:2:4	751	b 919	Do.
434	Abuyog Administration Building, Abuyog	c 3	1:2:4	730	b 931	Caballo cement and well water used; mortar failures.
435	None	a 2	1:1.85:5	1,259	1,960	Alsen cement used; gravel screened on 4-mesh sieve (0.202-mesh opening) to remove sand; sand passed 100% through 4-mesh sieve. Mortar and gravel failures; experimental mixtures at the Bureau of Science.
436	Do	a 2	1:2.16:5	1,351	1,878	Do.
437	Do	a 1	1:2:5	1,178	2,210	Do.
438	Do	a 3	1:2.16:5	912	1,542	Do.
439	Philippine Medical School, second wall and stairs	a 4	1:2:5	565	e 806	
440	Philippine Medical School, roof, floor, east wing	a 4	1:2:4	526	e 1,048	
441	Manila Hotel	a 1	1:2:4	773	1,919	Gravel washed but not screened; sand used as delivered.
442	Do	a 2	1:2:4	815	872	Do.
443	Do	a 2	1:2:4	1,082	1,264	Gravel screened but not washed; sand used as delivered.

444	Do	a 2	1:2:4	500	919	Do.
445	Do	a 2	1:2:4	718	981	Mortar failures. Very fine sand.
446	Do	a 2	1:2:4	648	1,045	Do.
447	Do	a 2	1:2:4	488	885	Do.
448	Do	a 5	1:2:4	937	1,616	
449	Do	a 1	1:2:4	830	1,496	
450	Do	a 1	1:2:4	644	1,218	
451	Do	a 1	1:2:4	264	697	
452	Fernandez Building	a 1	1:2:1:5	536	573	
453	Warehouse, Calle Roman Soler	a 1	1:2:1:5	200	448	
454	Warehouse, Calle Azencraga	a 1	1:2:1:5	278	518	
455	Mariano Uy Chaco Building, walls	a 2	1:2:1:5	558	743	
456	Do	a 2	1:2:1	687	785	
457	Mariano Uy Chaco Building	b 2	1:2:1:5	776	1,140	
458	Roxas Building, columns	a 1	1:2:4	568	718	
459	Hogar Filipino Building	b 2	1:2:1:5	565	667	
460	Family Hotel, corner of Herran and Dakota	b 4	1:2:1:5	228	253	
461	Do	b 2	1:2:1:5	441	563	
462	Masonic Temple	b 2	1:1:1:1:1		534	Mortar failures.
463	Do	b 2	1:1:1:1:1		300	Do.
464	Do	b 2	1:1:1:1:1		577	Do.
465	Do	b 2	1:1:1:5		563	
466	Do	b 3	1:1:1:5		e 611	
467	Do	b 3	1:1:1:5		e 484	
468	None	a 2	1:2:4		b 2, 784	Experimental mixtures made at the Bureau of Science of aggregate used in Masonic Temple; Green Island cement used.
469	Do	a 2	1:2:4		b 2, 956	Do.
470	Masonic Temple	a 2	1:1:1:1:1		370	Green Island cement used.
471	Do	a 2	1:1:1:1:1		673	Do.

a Test specimens are 6-inch cubes.

b H and H specimens.

c Test specimens are cylinders 8 inches in diameter and 16 inches high.

d Test specimens are cylinders 3.568 inches in diameter and 7.136 inches high.

e Machine mixed.

b Test specimens are cylinders 6 inches in diameter and 6 inches high.

TABLE 8.—Compressive strength of Portland cement concrete made in various parts of the Philippine Islands—Continued.

Tracing No.	Structure in which concrete was used.	Result and age of specimens or specimens broken.	Proportions by volume of cement and gravel.	Compressive strength by concrete, in pounds per square inch.		Remarks.
				First-crack stress.	Ultimate stress.	
MANILA—continued.						
472	Masonic Temple.....	a 2	1:1½:4½	-----	254	Green Island cement used.
473	Do.....	a 2	1:1½:4½	-----	673	Do.
474	Do.....	a 2	1:1½:4½	-----	254	Do.
475	Do.....	b 3	1:1½:3½	-----	1,199	Do.
476	Do.....	b 3	1:1½:4	-----	821	Do.
477	Columbia Club Addition.....	b 2	1:2:4	-----	393	Dragon cement used.
478	Do.....	b 2	1:2:5	-----	360	Do.
479	Do.....	b 3	1:2:4	-----	652	Do.
480	Do.....	b 3	1:1:3½	-----	622	Do.
481	None.....	43	1:2:4	-----	2,652	Experimental mixtures made at the Bureau of Science of aggregates used in construction of bulkheads between piers 3 and 5; Green Island cement used.
482	Bulkhead between piers 3 and 5.....	c 3	1:3:6	-----	e 434	Green Island cement used.
483	Do.....	c 3	1:2:4	-----	e 1,304	Mortar failures.
484	Do.....	c 3	1:2:5	-----	e 991	Mortar and gravel failures.
485	Do.....	e 2	1:2:4	1,258	e 1,568	Green Island cement used; mortar and gravel failures.
486	Do.....	e 2	1:2:4	820	e 1,290	Do.
487	Do.....	e 2	1:2:4	-----	e 986	Do.
488	Do.....	e 2	1:2:4	1,706	e 1,820	Rizal cement used.
489	Do.....	e 2	1:2:4	-----	e 1,591	Do.
490	Do.....	e 2	1:2:4	1,288	e 2,668	Rizal cement used; mortar and gravel failures.
491	Do.....	e 2	1:2:4	1,633	e 1,980	Do.
492	Bulkhead between piers 3 and 5, floor section 7.....	e 2	1:2:4	757	e 1,343	Rizal cement used; mortar-failures.
493	Do.....	e 2	1:2:4	904	e 1,375	Do.

494	Bulkhead between piers 3 and 5, floor section 8	e2	1:2:4	1, 050	e 1, 147	Do.
495	Bulkhead between piers 3 and 5	e2	1:2:5	1, 102	e 1, 246	Do.
496	Do	e1	1:2:5	1, 120	e 1, 356	Do.
497	Do	e2	1:3:6	1, 122	e 1, 288	Do.
498	Do	e2	1:3:6	856	e 929	Do.
499	Do	e4	1:3:6	742	e 924	Do.
500	Bulkhead between piers 3 and 5, floor section 9	e4	1:2:4	727	e 1, 288	Rizal cement used.
501	Bulkhead between piers 3 and 5, beam 2	e2	1:2:4	458	e 729	Do.
502	Bulkhead between piers 3 and 5, beam 13	e4	1:3:6	316	e 393	Do.
503	Bulkhead between piers 3 and 5	e2	1:2:5	575	762	
504	Do	e2	1:2:5	848	1, 020	
505	None	b5	1:1:3 $\frac{1}{2}$	b 1, 394	b 727	Concrete made in the field; Green Island cement used.
506	Philippine School of Arts and Trades, roof	e2	1:2:4	b 727	b 727	Calebra cement used.
507	Philippine School of Arts and Trades, girders	e2	1:2:4	b 1, 061	b 748	Onada cement used; mortar failures.
508	Philippine School of Arts and Trades	e2	1:2:4			Green Island cement used.
509	San Jose Building, Calle Rosario	b4	1:2:4	1, 289	b2, 026	Rizal cement used; mortar failures.
510	Postigo Building, second floor wall	e2	1:2:4		b 672	Do.
511	Postigo Building, first floor slab	e2	1:3:6		b 484	Do.
512	Do	e2	1:2:4	629	b 814	Asano cement; mortar failures.
513	Engineering Laboratory, University of P. I., foundation and footings	e2	1:2:5		b 751	Rizal cement used.
514	Engineering Laboratory, University of P. I., walls above floor	e2	1:2:4		b 926	Rizal cement used; mortar and gravel failures.
515	Engineering Laboratory, University of P. I.	e2	1:2:4	876	b 1, 251	Onada cement used.
516	Spanish Casino	b6	1:2:5	435	b 874	Rizal cement used.
517	Jones Bridge, caisson	e6	1:3:7		e 731	Cabalbo cement used; mortar failures.
518	Do	e6	1:2:4	697	e 771	Do.
519	Do	e6	1:2:4		e 1, 097	Do.
520	Do	e6	1:3:7		e 933	Do.

a Test specimens are 6-inch cubes.

b Hand mixed.

c Test specimens are cylinders 8 inches in diameter and 16 inches high.

d Test specimens are cylinders 3.568 inches in diameter and 7.136 inches high.

e Machine mixed.

f Test specimens are cylinders 6 inches in diameter and 6 inches high.

TABLE 8.—Compressive strength of Portland cement concrete made in various parts of the Philippine Islands—Continued.

Tracing No.	Structure in which concrete was used.	Result averaged of specimens broken.	Proportions by volume of cement, sand, and gravel.	Compressive strength of concrete, in pounds per square inch.		Remarks.
				First crack stress.	Ultimate stress.	
MANILA—continued.						
621	U. S. Army Quartermaster pier 1, concrete from piles	a 1	1:2:4	2,760	b 3,874	Asano cement used; mortar and stone failure.
622	Do.	a 1	1:2:4	2,431	b 3,246	Do.
623	Do.	a 1	1:2:4	3,338	e 3,853	Do.
624	Do.	a 1	1:2:4	1,191	e 3,949	Do.
625	Do.	a 1	1:2:4	1,708	b 4,968	Do.
626	Do.	a 1	1:2:4	1,873	b 4,002	Do.
627	Do.	a 1	1:2:4	2,722	e 4,560	Do.
628	Do.	a 1	1:2:4	1,871	e 3,628	Do.
629	Do.	a 1	1:2:4	2,126	e 4,669	Do.
630	Do.	a 1	1:2:4	-----	e 4,080	Do.
631	Do.	a 1	1:2:4	1,568	b 1,941	Alsen cement used; mortar and gravel failure.
632	Do.	a 1	1:2:4	1,616	b 4,225	Alsen cement used; mortar and stone failure.
633	Do.	a 1	1:2:4	2,248	b 2,773	Do.
634	Do.	a 1	1:2:4	4,020	b 4,905	Do.
MARINDUQUE.						
635	Tignon Bridge 16, 1, Gasan	a 6	1:2:4	-----	b 181	Alsen cement used; mortar clearly deficient in cement.
636	Do.	a 8	1:2:4	-----	b 251	Alsen cement used; mortar clearly deficient in cement; well water used.
637	Do.	a 3	1:2:4	359	b 1,014	Rizal cement and river water used; mortar and gravel failures.
638	Do.	a 3	1:2:4	-----	b 327	Rizal cement and river water used; mortar failures.
MISAMIS.						
639	Gusa Central School, footings	a 1	1:2:1.5	469	848	Hennmoor cement used.
640	Gusa Central School, walls	a 1	1:2:1.4	246	945	Do.

541	Guan Central School, girders	a 1	1:2:4	-----	922	Do.	
542	Cagayan Municipal Market, columns	a 2	1:2:4	854	2, 039	Mortar failures.	
543	None	a 1	1:2:4	612	b 1, 868	Cubes cast in Cagayan de Misamis by district engineer; Caballo cement and salt water used.	
544	Do	a 1	1:2:4	556	b 1, 276	Do.	
545	Do	a 1	1:2:4	167	b 1, 563	Caballo cement and fresh water used.	
546	Cagayan Central School	a 1	1:2:1.5	370	b 548	Caballo cement used; mortar failures.	
MISCELLANEOUS TESTS.							
547	None	a 2	1:2:4	2, 271	2, 779	Experimental mixtures made at the Bureau of Science of aggregates submitted by the U. S. Engineer's office for fortification construction; Atlas cement used; mortar and gravel failures.	
548	Do	a 1	1:1:1.3	2, 038	3, 107	Do.	
549	Do	a 2	1:2:4	2, 142	2, 606	Do.	
550	Do	a 2	1:3:6	1, 621	1, 767	Do.	
551	Do	a 2	1:2:4	607	829	Submitted by the Constructing Quartermaster, Fort Mills; Hai-phong cement used.	
552	Do	a 1	1:2:4	777	972	Do.	
553	Do	a 1	1:2:4	389	921	Do.	
554	Do	a 1	1:2:4	-----	1, 177	Do.	
555	Do	a 1	1:2:4	300	1, 031	Do.	
OCCIDENTAL NEGROS.							
556	Bridge 0. 40, Pontevedra, La Carlota Road	e 1	1:2:4	482	b 760	Hai-phong cement and fresh well water used; mortar failure.	
557	Bridge 0. 40, Pontevedra, La Carlota Road; slab 1	e 1	1:2:1	-----	b 408	Do.	
558	Bridge 0. 40, Pontevedra, La Carlota Road; slab 5	e 1	1:2:4	-----	b 677	Do.	
559	Bridge 0. 40, Pontevedra, La Carlota Road; slab 7 and abutment 2.	e 4	1:2:4	-----	b 640	Do.	
560	Banabagan Bridge, Hinigaran	e 2	1:2:4	444	b 644	Asano cement and river water used; mortar failures.	
561	Do	e 2	1:3:6	340	b 413	Do.	
562	Do	e 2	1:2:1.5	329	b 431	Do.	
563	Do	e 2	1:2:1.5	510	b 583	Do.	
564	Do	e 2	1:2:1.5	350	b 560	Do.	

a Test specimens are 6-inch cubes.

b Hand mixed.

c Test specimens are cylinders 8 inches in diameter and 16 inches high.

e Machine mixed.

TABLE 8.—Compressive strength of Portland cement concrete made in various parts of the Philippine Islands—Continued.

Tracing No.	Structure in which concrete was used.	Result after aged specimens broken.	Proportions by volume of cement, sand and gravel.	Compressive strength of concrete, in pounds per square inch.		Remarks.
				First crack stress.	Ultimate stress.	
OCCIDENTAL NEGROS—continued.						
565	Binalbagan Bridge, Hinigaran	e 2	1:2½:5	684	b 533	Asapo cement and river water used; mortar failures.
566	Binalbagan Bridge, Hinigaran; abutments 1 and 2	e 2	1:2½:5	416	e 552	Do.
567	Binalbagan Bridge, Hinigaran	e 2	1:2½:5	543	e 651	Do.
568	Do.	e 2	1:2½:5	440	e 532	Do.
569	Binalbagan Bridge, Hinigaran; abutments 1 and 2	e 2	1:2½:5	472	e 570	Do.
570	Bridge 36.5, Bago; abutment 2	e 2	1:3:6	673	b 884	
571	Bridge 36.5, Bago; abutment 1	e 2	1:2½:5	690	b 788	
572	Do.	e 2	1:2½:5	733	b 839	
573	Presidencia, Bago; foundation and wall	e 2	1:2½:5	435	b 681	Caballo cement and artesian water used; mortar failures.
574	Presidencia, Bago; first floor	e 2	1:3:6	342	b 467	Do.
575	Presidencia, Bago; second floor	e 2	1:2:4	---	b 1,316	Do.
576	Bridge 42.0, Pontevedra	e 3	1:3:6	774	b 976	Green Island cement and river water used; mortar failures.
577	Do.	e 3	1:3:6	717	b 794	Do.
578	Bridge 42.0, Pontevedra, second north abutment	e 2	1:3:6	---	b 799	Do.
579	Sumag Bridge, Bacolod; abutment	e 2	1:2:4	1,380	b 1,532	Rizal cement and well water used; mortar failures.
580	Sumag Bridge, Bacolod; first pile cap	e 2	1:2:4	808	b 1,030	Do.
581	Sumag Bridge, Bacolod; second pile cap	e 2	1:2:4	614	b 851	Do.
582	Sumag Bridge, first girder span	e 2	1:2:4	948	b 1,063	Do.
583	Sumag Bridge	e 2	1:2:4	---	b 1,047	Do.
584	Sumag Bridge, gutter	e 2	1:2:4	---	b 756	Do.
585	Do.	e 2	1:2:4	663	b 686	Do.
586	Sumag Bridge, fifth girder span	e 2	1:2:4	1,018	b 1,114	Rizal cement and well water used; mortar and gravel failures.
587	Sumag Bridge, abutment	e 2	1:2:4	1,234	b 1,441	Do.

588	Sumag Bridge, slab	b ² 922	Rizal cement and well water used; mortar failures.
589	Sumag Bridge, wing wall	b ¹ 1,290	Rizal cement and well water used; mortar and gravel failures.
ORIENTAL NEGROS.						
590	None
591	Do	1:24	1,838	2,224	Experimental mixtures made at the Bureau of Science of aggregates proposed for Amblan River Bridge; Green Island cement used; mortar failures.
592	Do	1:24	1,815	2,282	Do.
593	Do	1:3:6	966	1,262	Do.
594	Amblan River Bridge, abutment B	1:3:6	500	1,190	Do.
595	Amblan River Bridge, abutment A	1:3:6	778	1,280	Do.
596	Amblan River Bridge, bridge seat abutment A	1:2:1:5	389	850	Do.
597	Amblan River Bridge, pier 4	1:3:6	486	705	Do.
598	Bais Bridge	1:2:4	1,273	b ¹ 1,964	Rizal cement and Bais River water used; mortar failures.
599	Do	1:3:6	867	b ¹ 1,187	Do.
NUEVA ECJA.						
600	Guimba Market, Guimba	1:2:4	b ² 288	Rizal cement and well water used; mortar failures.
601	Do	1:3:6	b ² 246	Do.
602	Do	1:2:4	409	b ² 455	Do.
603	Do	1:2:4	636	b ² 772	Do.
PALAWAN.						
604	None	1:2:4	1,866	2,448	Experimental mixture made in Bureau of Science of aggregates coming from Coron, and proposed for Coron wharf; mortar and gravel failures.
PAMPANGA.						
605	None	1:2:4	1,472	2,004	Mortar and gravel failures; experimental mixtures made at the Bureau of Science of aggregates proposed for construction at Camp Stotsenberg.
606	Do	1:2:4	1,222	1,421	Do.
607	Do	1:2:4	1,830	2,171	Do.
608	Do	1:2:4	1,667	2,104	Do.

^a Test specimens are 6-inch cubes.

^b Hand mixed.

^c Test specimens are cylinders 8 inches in diameter and 16 inches high.

^e Machine mixed.

TABLE 8.—Comparative strength of Portland cement concrete made in various parts of the Philippine Islands—Continued.

Tracing No.	Structure in which concrete was used.	Result averaged specimens broken.	Proportion of cement, sand, and gravel.	Compressive strength by specimens per square inch.		Remarks.
				First crack stress.	Ultimate stress.	
PANGASINAN.						
609	Bayasos Bridge	a 3	1:2½:5	562	730	
610	Do	a 3	1:2:4	1,422	1,546	Mortar failures.
611	Do	a 3	1:2½:5	724	1,568	
612	Do	a 3	1:2:4	1,403	1,898	Do.
613	Do	a 3	1:2:4	658	1,778	Do.
614	Do	a 3	1:2½:5	947	1,717	Do.
615	Pantal Bridge, piles	a 4	1:2:4	1,291	1,500	Do.
616	Pantal Bridge, east abutment	a 4	1:3:6	683	864	Do.
617	Calmay Bridge, piles	a 4	1:2:4	1,444	1,710	
618	Do	a 2	1:2:4	1,078	1,384	
RIZAL.						
619	Angono Bridge, Binangonan	e 2	1:2:4	490	b 558	Rizal cement and river water used; mortar failures.
620	Do	e 2	1:3:6	-----	b 397	Do.
621	Do	e 1	1:3:6	756	e 857	Do.
622	Do	e 1	1:3:6	616	e 696	Do.
623	Angono Bridge, Binangonan; arch ring	e 2	1:2:4	927	e 1,521	Do.
624	Do	e 2	1:2:4	681	e 1,131	Do.
625	San Juan presidencia, San Juan del Monte	e 2	1:2½:5	514	b 654	Do.
626	Bilibiran Bridge, Binangonan pier	e 2	1:3:6	666	b 997	Do.
627	Bilibiran Bridge, Taytay pier	e 2	1:3:6	787	b 1,091	Do.
SAMAR.						
628	Bridge 0.7, Calbayog North and South Roads, slabs and girder spans 1 and 2.	a 1	1:2:4	1,792	1,903	

629	Bridge 0.7, Calbayog North and South Roads, pile cap, abutment 1.	*1	1:2:4	1,495	1,634
630	Bridge 0.7, Calbayog North and South Roads, pile cap and internal bents 1 and 2.	*1	1:2:4	654	1,277
631	Do.....	*1	1:2:4	-----	1,485
632	Bridge 0.7, Calbayog North and South Roads, pile abutment 2, internal bent 4.	*1	1:2:4	423	800
633	Do.....	*1	1:2:4	2,000	2,241
634	Bridge 0.7, Calbayog North and South Roads, slabs and girders, span 3.	*1	1:2:4	634	763
635	Bridge 4.3, Calbayog North and South Roads, pile cap, abutment 1, bent 1.	*1	1:2:4	428	549
636	Bridge 19.4, Calbayog North and South Roads, piles.....	*1	1:2:4	518	1,063
637	Do.....	*1	1:2:4	-----	975
638	Bridge 19.4, Calbayog North and South Roads, pile cap, abutment 2, Ilo Bridge.	*1	1:2:4	525	688
639	Bridge 19.4, Calbayog North and South Roads, Ilo Bridge.	*2	1:2:4	515	879
640	Bridge 19.4, Calbayog North and South Roads, Ilo Bridge, slabs 1, 2, and 3.	*1	1:2:4	-----	698
641	Bridge 8.9, Calbayog North and South Roads, North abutment, Arapison Bridge.	*1	1:2:4	-----	380
642	Bridge 8.9, piles, Arapison Bridge.....	*2	1:2:4	1,125	1,655
643	Bridge 8.9, slabs and girders, Arapison Bridge.....	*3	1:2:4	434	479
644	Bridge 9.6, Sorsogon Bridge.....	*1	1:2:4	-----	368
645	Bridge 9.6, piles, Sorsogon Bridge.....	*1	1:2:4	-----	460
646	Bridge 9.6, slab girder 1, Sorsogon Bridge.....	*1	1:2:4	500	1,422
647	Bridge 9.6, slab girders 1 and 2, Sorsogon Bridge.....	*3	1:2:4	-----	698
				578	603

^a Test specimens are 6-inch cubes.

^b Hand mixed.

^c Test specimens are cylinders 8 inches in diameter and 16 inches high.

• Machine mixed.

Mortar failure.

Mortar failures.

Mortar failure.

Do.

Mortar failures.

Do.

Mortar failure.

Do.

Do.

Do.

Do.

Do.

Do.

TABLE 8.—Comparative strength of Portland cement concrete made in various parts of the Philippine Islands—Continued.

Tracing No.	Structure in which concrete was used.	Result averaged or specimens broken.	Proportion of cement, sand, and gravel.	Compressive strength of concrete, in pounds per square inch.		Remarks.
				First-mate crack stress.	Ultimate stress.	
648	SAMAR—continued. Bridge 9.6, Calbayog North and South Roads, slab girders 1 and 2.	a 1	1:2:4	1,442	1,581	20 per cent water used in mixing; mortar failure.
649	Do.....	a 1	1:2:4	678	834	22.5 per cent water used in mixing; mortar failure.
650	Do.....	a 1	1:2:4	1,072	1,122	25 per cent water used in mixing; mortar failure.
651	Do.....	a 6	1:2:4	1,190	1,219	27.5 per cent water used in mixing; mortar failure.
652	Do.....	a 1	1:2:4	997	997	30 per cent water used in mixing; mortar failure.
653	Do.....	a 1	1:2:4	-----	1,252	32.5 per cent water used in mixing; mortar failure.
654	Do.....	a 1	1:2:4	-----	1,028	35 per cent water used in mixing; mortar failure.
655	Bridge 20.1, 11-meter piles	a 4	1:2:4	-----	739	Mortar failures.
656	Bridge 8.1, Guinobatan-Jovellar Road, arch	a 3	1:2:4	-----	886	-----
657	Culvert, Catbalogan North Road	c 2	1:2:4	-----	b 1,058	Fresh well water and Onada cement used; mortar failures.
658	Do.....	c 2	1:3:6	-----	b 645	Do.
659	Culvert, Catbalogan South Road	e 2	1:2:4	727	b 831	Fresh well water and Caballo cement used; mortar failures.
660	Do.....	e 2	1:3:6	672	b 806	Do.
661	Carra Bridge, Calbayog	e 2	1:2:4	-----	b 1,307	Do.
662	Do.....	e 2	1:3:6	631	b 964	Do.
663	High School, Catbalogan	e 2	1:2:4	506	b 703	Fresh well water and Asano cement used; mortar failures.
664	Do.....	e 2	1:3:6	419	b 496	Do.
665	Do.....	e 2	1:2:4	783	b 1,242	Caballo cement and well water used.
666	Do.....	e 2	1:3:6	-----	b 833	Do.
667	Do.....	e 4	1:2:4	1,585	b 2,168	Do.
668	School, Basey	e 2	1:2:4	-----	b 462	Do.
669	Do.....	e 2	1:3:6	-----	b 388	Do.

670	Market booths, Calbayog Market				b 2, 080	Do.
671	Do.	* 2 1:2:4 * 2 1:3:6			b 739	Do.
SORSOCON.						
672	Sorsocon Court House and Jail	* 2 1:2:4			b 961	Onada cement and fresh, clear well water used; both cubes failed by splitting at right angles to bearing surfaces; mortar and gravel failures.
673	Do.	* 2 1:2:4			b 837	Do.
674	Do.	* 2 1:2:4			b 681	Onada cement and well water used.
675	Do.	* 2 1:2:4			b 554	Do.
676	Do.	* 2 1:2:4			b 1, 016	Do.
677	Do.	* 2 1:2:4			b 981	Do.
678	Do.	* 2 1:2:4			b 432	Asano cement and well water used.
679	Do.	* 2 1:2:4			b 582	Do.
SURIGAO.						
680	Bilang-Bilang Wharf	* 2 1:2:4			b 633	Asano cement and surface well water used; mortar failures.
681	Do.	* 2 1:2:4			b 528	Do.
682	Do.	* 2 1:2:4			b 642	Do.
683	Do.	* 2 1:2:4			b 416	Do.
684	Do.	* 2 1:2:4			b 564	Do.
685	Do.	* 2 1:2:4			b 570	Do.
TAYABAS.						
686	Bridge 14, Pagblao, Atimunan Road	1 1 1:2:4	331	619		Mortar and gravel failures; the gravel is very soft and the concrete contains considerable quantities of shell debris.
687	Do.	1 1 1:2½:5	438	612		Do.
688	Trade School, Atimunan	m 1 1:3:6	200	230		Mortar failure; concrete contains much clay.
689	Do.	a 1	169	329		

^a Test specimens are 6-inch cubes.

^b Hand mixed.

^c Test specimens are cylinders 8 inches in diameter and 16 inches high.

^d Test specimens are 4-inch cubes.

^e Test specimen is a prism 3½ by 3½ by 5½ inches.

TABLE 8.—Comparative strength of Portland cement concrete made in various parts of the Philippine Islands—Continued.

Tracing No.	Structure in which concrete was used.	Results averaged or specimens broken.	Proportions by volume of cement, sand, and gravel.	Compressive strength of concrete, in pounds per square inch.		Remarks.
				First-crack stress.	Ultimate stress.	
TAYABAS—Continued.						
650	Trade School, Atimonan	a 1	1:2:4	1,000	1,530	
651	Do.	a 1	1:2:4	281	561	
652	Do.	a 1	1:2:4	400	825	
653	Repairs on Dumaca Bridge, Lucena.	e 2	1:3:6	333	b 423	Ritzal cement and brackish water used; mortar failures.
654	Do.	e 2	1:3:6	339	b 759	Do.
655	Do.	e 2	1:3:6	339	b 533	Do.
TARLAC.						
656	San Antonio Bridge, piles	a 5	1:2:4	1,460	2,462	
657	Do.	a 6	1:2:4	637	1,045	
658	Divisoria Bridge, piles	a 6	1:2:4	1,275	1,575	
659	Ungait Bridge, slabs	a 3	1:2:4	708	1,025	
700	Do.	a 3	1:2:4	620	887	
701	Do.	a 3	1:2:4	528	1,212	
ZAMBALES.						
702	Yamot Bridge, abutment 1.	e 2	1:2:4	384	459	Mortar failures.
703	Yamot Bridge, intermediate span 1.	e 2	1:2:4	311	544	Do.
704	Yamot Bridge, intermediate span 2.	e 2	1:2:4	200	390	Do.
705	Yamot Bridge, end span	e 2	1:2:4	533	1,067	Do.
706	Candelaria Bridge.	e 1	1:2:4	571	b 846	Caballo cement and Yamot River water used; mortar failure.
707	Do.	e 1	1:2:4	733	b 1,356	Do.
708	Do.	e 2	1:2:4	563	b 852	Onada cement and Yamot River water used; mortar failures.

ZAMBOANGA.					
709	Zamboanga Waterworks	c 2	1:2:4	b 792	Hapboeng cement and clear water from Santa Maria canal used; mortar failures.
710	Do	c 2	do	b 843	Do.
711	Do	c 2	do	b 827	Caballo cement and clear water from Santa Maria canal used; mortar failures.
712	Do	c 2	do	b 760	Do.

^a Test specimens are 6-inch cubes.

^b Hand mixed.

^c Test specimens are cylinders 8 inches in diameter and 16 inches high.

2 gives test data on three Bataan sands, all of which are too fine for high-grade concrete work.

BATANGAS

Tests of concretes coming from Batangas Province are anomalous. The two series of results obtained from 6-inch cubes made of concrete used in Obispo Bridge have practically the same values, 1,115 and 1,097 pounds per square inch, respectively, though the mixtures are apparently differently proportioned, the specimens being marked 1 : 2 : 4 and 1 : 3 : 6, respectively. It is impossible to explain these irregular results, on account of the scanty data available. This laboratory has made no test of Batangas sand or gravel. It is not improbable, however, that these two series of specimens were made from the same batch of concrete, and were subsequently marked as shown in Table 8. Considering the age of the specimens in the first four series (57 days), these concretes must be classed as poor. The two tests of concrete from Matayuanoc Bridge indicate a very inferior product.

BOHOL

Disregarding the small differences in age of the concrete specimens made in Bohol, the compressive strengths average 777, 843, and 507 pounds per square inch for the 1 : 2 : 4, 1 : 2.5 : 5, and 1 : 3 : 6 mixtures, respectively. The 1 : 2.5 : 5 mixtures average stronger than the richer 1 : 2 : 4. No information was sent to this laboratory concerning the source and kind of aggregate used in these specimens, but the débris remaining at the conclusion of the compression tests showed that the sand and gravel were of poor quality; the gravel was very soft, and some of it was covered with green algæ which prevented good bonding. The sand was fine and dirty. All of these tests were made during 1910. Since that time the Bureau of Science has received no concrete specimens from Bohol. Three sands tested during 1917 and 1918 gave poor results; the grains are fine and soft and contain much shell and coral débris. Mortars made from these inferior sands range in tensile strength from 28 to 63 per cent of that of Ottawa sand mortar. It is clear that Bohol concrete aggregates are of inferior quality and unfit for high-grade concrete construction.

BULACAN

As a whole, concrete aggregates from Bulacan are better than the average, and they have given excellent results in the laboratory, though the field tests are too low. Pulilan and Bocaue

River sands particularly, as Table 2 shows, are coarse and have a desirable granulometric composition. The sand used in the construction of Santo Niño Bridge, although rather fine, nevertheless gave an excellent result in the 1 : 2 : 4 field specimens, which averaged 1,574 pounds per square inch. However, field specimens, particularly the 1 : 2 : 4 mixtures, show lower compressive strengths than the corresponding concrete specimens made in the laboratory. The results of laboratory-made 1 : 2 : 4 concrete average 2,158 pounds per square inch, and the corresponding field-made specimens average only 895. The difference in strength of field and laboratory 1 : 3 : 6 concrete is not so great; specimens of this mixture made at the Bureau of Science average 988 pounds per square inch, and those made on the building site, 692. No 1 : 2.5 : 5 or 1 : 2 : 5 mixtures were made in the laboratory; those fabricated in the field average 557 and 702 pounds per square inch, respectively. In general concrete from Bulacan is fair in strength, and in one case the results are very good. With the aggregates available, better field results should have been obtained in the case of the 1 : 2 : 4 mixtures. It is reassuring to note that all of the long-time tests (90 and 181 days) show substantial increases over the 28-day tests.

CAPIZ

Two distinctly different series of results for each of the two groups of 1 : 2 : 4 and 1 : 3 : 6 concrete specimens are characteristic of the tests from Capiz. The 1 : 2 : 4 specimens from Ivisan and Pilar Schools and from Libas Bridge average 527 pounds per square inch, which is about one-third of what concrete of this proportion should test at 28 days. These low results are due to the use of fine, dirty sands from Ivisan and Panay Rivers and from Pilar beach. The 1 : 3 : 6 mixtures involving these sands also give low strengths and average 349 pounds per square inch. The lowest result recorded in this paper was obtained from a concrete specimen coming from Ivisan School, and has a value of only 97 pounds per square inch. Preliminary tests and the exercise of judgment could have prevented the use of these sands for concrete work. In sharp contrast to these low compressive strengths are those obtained from specimens cast of concrete used in the construction of Balucuan Bridge and the Capiz water tank. The 1 : 2 : 4 results from these structures are close together and average 1,427 pounds per square inch. The compressive strength of the 1 : 3 : 6 specimens from Balucuan Bridge average 917 pounds

per square inch, which is practically three times as high as the strength of the other 1 : 3 : 6 mixtures from Capiz Province. Table 2 shows that the sand used in the construction of Balucuan Bridge is coarse, and yields a mortar nearly as strong as that made of standard Ottawa sand. The high compressive strengths of the concretes just cited are due largely to the coarse, clean sands used.

CAVITE

Compressive strengths of concrete specimens from Cavite show a wide degree of variation. Tests of 1 : 2 : 4 cubes from Tabon Bridge average 656 pounds per square inch, which is poor for this class of concrete. The first lot of specimens from Cañacao Bridge made of hand-mixed concrete shows still lower strengths and averages 488 pounds. These results were apparently alarming, for the next lot of specimens sent to the Bureau of Science show great improvement, having been made from machine-mixed concrete; they give the excellent average of 1,868 pounds per square inch. Toward the end of the construction, machine mixing was abandoned and the specimens were again made from hand-mixed concrete, the compressive strength of which is only 1,048 pounds per square inch. The same aggregates were used throughout, so that machine mixing at first glance seems to account for the high strength. Caution must be used in drawing this conclusion, however, because details of proportioning are lacking, and it is not improbable that on account of the crude methods of measuring aggregates in the field, more cement was used in one case than in the other. Concretes mixed in the materials testing laboratory of the Bureau of Science give higher average results than do field-mixed specimens. The 1 : 2 : 4 laboratory mixtures average 2,251 pounds per square inch. Field specimens proportioned 1 : 3 : 6, aged between 31 and 36 days, average 495 pounds per square inch, which incidentally is higher than the lowest result already discussed in the 1 : 2 : 4 series. The mixture 1 : 1.5 : 4.5 was used rather freely in constructing Cañacao Bridge, and the results obtained from these test specimens show extraordinary variation. The highest average result in this series is 2,203 pounds per square inch, and was obtained from machine-mixed concrete; the lowest, 609 pounds per square inch, was given by specimens made from hand-mixed concrete. The entire group of results obtained from 1 : 1.5 : 4.5 concrete specimens gives the good average of 1,319 pounds per square inch. Careful

work would certainly have resulted in more uniform results. Table 2 shows that two of the three sands submitted from Cavite are excellent, and the other is good. Suitable aggregates for concrete work are available in Cavite Province, so that with proper supervision high-testing concrete ought to be the rule.

CEBU

With the exception of the results obtained from Naga River Bridge specimens, the compressive strengths of Cebu concretes are excellent. Excluding the low Naga River Bridge results, and averaging the remaining field compressive strengths obtained from 1 : 2 : 4 concrete specimens having ages between 26 and 28 days, a mean is obtained of 2,091 pounds per square inch, which exceeds by 37 pounds the average compressive strength of the 1 : 2 : 4 concrete specimens made at the Bureau of Science. The field-made 1 : 3 : 6 specimens average considerably higher than laboratory-made test pieces; these results are 1,229 and 1,032 pounds per square inch, respectively. However, the extraordinarily high average result of 2,183 pounds per square inch, gotten from the four 1 : 3 : 6 field specimens representing concrete that was used in the west abutment of Magallanes Bridge, October 15, 1911, should be viewed with suspicion. The probability that the specimens were mislabeled (1 : 3 : 6 for 1 : 2 : 4), or that there was an accidental increase in the quantity of cement used, should not be excluded. By ignoring this doubtful high result, the average of the remaining 1 : 3 : 6 specimens aged 26 to 27 days is reduced to 753 pounds per square inch, which compares favorably with the average of 1,032 pounds obtained from the laboratory-made specimens.

It is interesting to note the great divergency in the compressive strengths of two lots of specimens coming from Sibonga Bridge. Both series of results were obtained from 1 : 3 : 6 concrete of practically the same age and made of the same aggregate, yet one average result is twice that of the other; the compressive strengths are 1,002 and 503 pounds per square inch, respectively. Such discrepancies are not uncommon in the data published in this paper and detract not a little from the reliance that can be placed on these tests. As Table 2 shows, tests of sands from Cebu are fragmentary; no compression tests of mortars were made, but the tensile strength of 1 : 3 mixture shows that Mananga River sand is an excellent concrete aggregate, whereas the other three are of only fair quality.

COTABATO

All of the concrete specimens coming from Cotabato were tested at ages ranging from 33 to 77 days, the majority being over 50 days old. Cotabato is located south of Manila a distance of several days by steamer, and transportation service between the two points is not always regular, so that considerable time is required for specimens to reach Manila. Delay during transit explains the age of the test pieces. Taking into consideration the time that elapsed between the date of manufacture and the date of rupture of these specimens, it will be seen that concrete from Cotabato ranges from poor to fair. The two 1 : 3 : 6 specimens made August 18, 1916, from concrete used in the construction of Cotabato Public Hospital, average 373 pounds per square inch, which is pretty low. Linaac sand used in these cubes is fine-grained, as Table 2 shows, and one would expect a low-testing mortar; but two series of laboratory tests made at two different times, separated by an interval of two years, show that the 1 : 3 mortar is in both cases of practically the same strength as is standard Ottawa sand mortar. The unsatisfactory results obtained from this concrete are therefore not due to poor aggregate but are very likely due to incorrect proportioning of ingredients.

ILOCOS NORTE

Compressive strength results given by concrete specimens coming from Ilocos Norte are so extremely erratic and inconsistent that careless field work is clearly evident. The strength of the 1 : 2 : 4 test pieces made of concrete used in repair work on Gilbert Bridge show a startling variation. The minimum value is 714 pounds per square inch and the maximum 3,111. Concrete used in Badoc School possesses more or less the same variability. The 1 : 2.5 : 5 results vary from 434 to 887 pounds per square inch. Results like these are of little value. By the exercise of due supervision during the proportioning and casting of concrete such freakish results can be obviated.

ILOCOS SUR

The few tests made of concrete cast in Ilocos Sur are characteristically irregular. Mixtures proportioned 1 : 2 : 4 and aged 33 to 37 days gave average ultimate compressive strengths ranging between 777 and 1,384 pounds per square inch, and two test specimens from Vigan Central School, at the age of 57 days, failed at even lower strengths, the average being 617 pounds per square inch. Specimens made of the rich 1 : 1.5 : 3

mixture used in the Singson Waterworks gave anomalous results, the average compressive strength being lower than that shown by either of the leaner mixtures (1 : 2 : 4 and 1 : 3 : 6). Since no preliminary laboratory tests were made of the aggregates employed in Ilocos Sur concretes, it is impossible to hazard an explanation of these abnormalities.

ILOILO

All of the one hundred fifty-six tests of concrete listed under Iloilo in Table 8 were obtained from specimens made in connection with the construction of Molo Bridge. Nine of these results were gotten from laboratory-made test pieces, and the remainder from field-cast specimens molded during the period January 9 to September 30, 1911, so that ample data are available on this structure. More than ordinary care was apparently observed in the erection of this bridge. Before beginning the fabrication of concrete, the district engineer sent samples of several aggregates to the materials testing laboratory during November, 1910, for preliminary examination, and mixing of concrete was begun in January, 1911, of aggregates that had given the best laboratory results. These steps are shown in Table 8 under Iloilo. In general all of the field tests show very good results; they are fairly high and uniform. The 1 : 2 : 4 specimens ranging in age between 28 and 34 days average 1,344 pounds, whereas the corresponding laboratory-made test pieces, having an age that varies between 28 and 31 days, average 2,223 pounds per square inch. However, this catena of results taken as a whole is not free from puzzling anomalies. For instance, as stated before, the 1 : 2 : 4 specimens aged between 28 and 34 days give a mean compressive strength of 1,344 pounds per square inch, while the group of 1 : 2 : 4 results from specimens next in age, varying between 36 and 41 days, actually show a decrease in compressive strength and average 1,184 pounds per square inch. The remaining results in this 1 : 2 : 4 series average 1,275 pounds per square inch for those having ages between 48 and 50 days, and 1,348 for those aged 57 to 60 days; the last result is practically the same as that given by the youngest specimens. The same irregularity is found in the results obtained from the 1 : 2.5 : 5 and the 1 : 3 : 6 specimens. The former series gives averages of 1,098 pounds per square inch at 25 to 28 days, 1,657 pounds at 34 to 40 days, and 1,408 pounds at 41 to 45 days; the latter series shows 1,068 pounds per square inch at 28 to 35 days, 1,076 pounds at 41 to 51 days,

and 1,556 pounds at 58 to 59 days. It is interesting to note that there is practically no difference in the average compressive strength of the youngest specimens in the 1 : 2.5 : 5 and the 1 : 3 : 6 series, these showing 1,098 and 1,068 pounds per square inch, respectively. With increasing age both give higher results than the richer 1 : 2 : 4 series of corresponding ages. Briquettes made of the four Iloilo sands in the proportion of one part cement to three parts sand all give good tensile strengths. Table 2 shows that the 1 : 3 Iloilo sand mortars at 28 days are, respectively, 79, 91, 95, and 105 per cent as strong as the corresponding Ottawa sand mortars.

ISABELA

Compressive strengths of concrete specimens from Isabela are low. The results given by test pieces coming from Echague School are consistent in that the 1 : 2 : 4 specimens are the strongest, and the 1 : 2.5 : 5 the weakest, the 1 : 2 : 5 coming between. On the other hand there is very little difference between the average strengths of 1 : 2 : 4 and 1 : 2 : 5 specimens coming from Cabagan Farm School which are aged 71 and 79 days, respectively. No laboratory mixture of concrete made of Isabela aggregates was tested, nor has this laboratory ever received either sand or gravel from this province for test.

JOLO

Only two tests, both of laboratory-made mixtures, were made of concrete composed of Jolo aggregates. No field specimens from this province have ever been tested at the Bureau of Science. Both results, as Table 8 shows, are low and unsatisfactory, due largely to the fine, soft, coralline beach sand. These and similar aggregates, which occur abundantly in the Philippines, should under no circumstances be used in concrete work.

LAGUNA

Results obtained from Laguna field-made test specimens, proportioned 1 : 3 : 6 and having ages ranging between 30 and 39 days, show a higher average compressive strength than do those proportioned 1 : 2 : 4 and aged 28 to 33 days; the respective figures are 1,180 and 1,075 pounds per square inch. Field-made 1 : 2 : 4 test pieces aged 35 to 40 days average 1,266 pounds per square inch and are therefore not much better than the younger, 1 : 3 : 6 specimens. Disregarding possible errors, these results show that the 1 : 2 : 4 mixture is uneconomical, since the leaner mixture gives practically the same mean strength at a lower cost per cubic meter. The 1 : 2.5 : 5 field

specimens gave an average result of 1,521 pounds per square inch, which is higher than either of the average results obtained from the 1 : 2 : 4 or the 1 : 3 : 6 specimens made in the field. Average results obtained from laboratory-made specimens are in each case higher than the corresponding mean values given by test pieces made on the building site; 1 : 2 : 4 results average 2,103 pounds per square inch, and 1 : 3 : 6 results average 1,483. Most of the test pieces coming from Laguna were made of concrete used in the construction of San Juan Bridge; no information was sent to this laboratory regarding the source of the aggregate employed in this structure. The 1 : 3 : 6 and the 1 : 2.5 : 5 mixtures gave excellent results, whereas the 1 : 2 : 4 mixture gave only fair values. Laboratory tests made of Pagsanjan sand gave excellent results, but the concrete made in the field with it (for the construction of the Pagsanjan water tank) in one instance gave the very poor strength of 200 pounds per square inch. Careless manipulation apparently accounts for this extremely low result.

LEYTE

Compressive strengths of concrete used in the building of Leyte structures are strikingly incongruous, low, and aberrant. Results obtained from 1 : 2 : 4 specimens aged 28 to 31 days vary between the wide limits of 177 and 1,556 pounds per square inch. The extremely low average of 177 was obtained from three specimens made August 2, 1915, of concrete used in constructing Tabontabon School, at Dagami, Leyte. Since the Tabontabon River sand used in this concrete is of excellent quality, as Table 2 shows, the ridiculously low compressive strength is probably due either to faulty manipulation during mixing and casting, or to incorrect proportioning of cement, or to both causes. There are several other low values in this series of 1 : 2 : 4 mixtures; the three specimens from Ormoc Market, cast August 19, 1915, gave compressive strengths that average 261 pounds per square inch, and those from concrete cast September 30, 1915, and used in Tanauan School average 450. A grand average of the mean values given by the 1 : 2 : 4 specimens having ages between 28 and 31 days gives 907 pounds per square inch as compared with 1,989 pounds obtained from 1 : 2 : 4 specimens made at the Bureau of Science August 4, 1915, of fine beach sand and Baluguhay River gravel. Field-made 1 : 2 : 4 test pieces aged between 35 and 41 days average 1,874 pounds per square inch, and those aged between 47 and 55 days average 1,809, thus showing appreciable increase in

strength with advancing age. Cognizance by those in charge of construction was apparently taken of the poor results given by the 1 : 2 : 4 mixture, and an effort was made to increase the ultimate compressive strength of the concrete by increasing the quantity of cement some 15 per cent. The average result obtained from the 1.2 : 2 : 4 specimens at 29 to 31 days is 1,512 pounds per square inch, and that of older specimens in this series, aged 35 to 48 days, is anomalously lower, being 1,225 pounds per square inch. Mixtures proportioned 1.15 : 2 : 4 and aged 29 to 34 days gave better results, showing a mean value of 1,841 pounds per square inch. Increase in the quantity of cement gave higher results at the end of 28 to 31 days than did the 1 : 2 : 4 mixture; but at later periods the results given by richer mixtures are practically the same as, or less than, those obtained from the leaner mixtures. Comparatively few tests were made of 1 : 2 : 5 and 1 : 2.5 : 5 mixtures. Results obtained from test pieces made of 1 : 2 : 5 concrete aged 29 to 35 days average 821 pounds per square inch, and those given by 1 : 2.5 : 5 specimens aged 28 to 33 days average 1,296, which is much higher than the results given by 1 : 2 : 4 specimens of similar ages. Increasing the percentage of cement in this series to yield the mixtures 1.12 : 2.5 : 5 and 1.2 : 2.5 : 5 gives such anomalous results as to lead one seriously to question the methods of proportioning employed. Increased cement content should increase the compressive strength of the concrete, but the results actually obtained are lower. The 1.2 : 2.5 : 5 specimens aged 28 to 33 days average 810 pounds per square inch, and the 1.12 : 2.5 : 5 test pieces aged 28 to 35 days average 666.

A consideration of the values secured from the 1 : 3 : 6 specimens discloses some of the lowest compressive strengths recorded in this paper, the lowest result, 97 pounds per square inch, being obtained from 1 : 3 : 6 concrete made in Capiz. Concrete from Barugo School averages 130 and 251 pounds per square inch; that from Tabontabon School, 154 pounds; three specimens from Ormoc Market, 118 pounds; and some test specimens made of concrete used in Hilongos Market gave a mean compressive strength of 295 pounds. These results are rather disquieting; if the concrete in the test specimens is representative of that actually used in the respective structures, failures may be expected. The grand average of 444 pounds per square inch is obtained from the values given by the 1 : 3 : 6 specimens aged 27 to 31 days; with aging there is a substantial increase of strength, specimens of this mixture aged 37 to 47 days showing an average of 926 pounds per square inch. An increase in cement con-

tent gave, with one exception, much higher results; at 28 to 32 days the 1.12 : 3 : 6 specimens averaged 979 pounds per square inch, and the 1.2 : 3 : 6 test pieces at 77 days, 1,974. In general the poor results given by concrete made in Leyte are due to the fine-grained sands. The unconfomable and inconsistent nature of the compressive strength values is very likely due to faulty proportioning of cement and aggregates.

MANILA AND VICINITY

Most of the concrete specimens made in Manila were marked 1 : 2 : 4; and these, like specimens coming from other provinces, gave widely variant compressive strengths. Test pieces aged 25 to 34 days gave minimum and maximum values of 393 and 2,093 pounds per square inch, respectively, and a mean compressive strength of 1,016 pounds per square inch; the latter value is fair. Aging increases the strength very little; in fact, the average compressive strength given by test pieces aged 52 to 61 days is 1,222 pounds per square inch, which is practically the same as the mean value of 1,292 pounds obtained from specimens aged 36 to 49 days. Laboratory-made 1 : 2 : 4 specimens gave concordant results that average 2,797 pounds per square inch, which is more than twice the average value given by the corresponding series of field-made test pieces.

The fourteen results obtained from specimens made of concrete used in the construction of the United States Quartermaster Pier are particularly noteworthy. This concrete is in a class by itself; it is exceptionally resistant, compact, and stonelike, and on rupture shows no cleavage planes along the surfaces where mortar and stone meet. The five cubes aged 1,042 to 1,052 days kept in air under the materials testing laboratory eaves gave an average compressive strength of 4,393 pounds per square inch. The other five specimens in this series, aged 1,041 to 1,051 days and stored in a steel cage totally submerged under the pier in Manila Bay for a period of 784 days, show marked decrease in average compressive strength; the compressive strength of salt-water specimens averages 3,781 pounds per square inch. Four other specimens, representing concrete from this structure, were ruptured; these were older, and had an age of 1,373 days. There is a well-defined difference between the compressive strength of the specimens submerged in Manila Bay for 784 days and those kept in air, the average being 2,357 and 4,565 pounds per square inch, respectively. The relatively low value of 1,941 pounds per square inch of one of the salt-water specimens is due to the use of soft Pasig sand and gravel, which possess neither the hardness

nor the favorable clean and rough bonding surface characteristic of freshly crushed Sisiman stone and screenings. In both of these series of tests, the weakening effect of salt-water immersion is unmistakably evident. Seventy-seven cubes made of concrete employed in the United States Army Quartermaster Pier are still submerged in Manila Bay, and eighty-eight specimens are being kept in air under the eaves of the materials testing laboratory for long-time tests. Data on these test pieces will be published as soon as possible.

Some other mixtures used in Manila and tested at the Bureau of Science are the 1:2.5:5, the 1:3:6, and the 1:1.5:4.5. The last proportion was used largely in constructing the Masonic Temple, and the results obtained from field-made test specimens are very poor. The compressive strength of test pieces made of 1:1.5:4.5 concrete and aged 28 days averages as low as 254 pounds per square inch and never exceeds 673, the grand average being 446. With the material available much better results should have been obtained. Older test pieces in this series show practically no gain in strength, the grand average obtained from specimens aged 36 to 49 days being only 483 pounds per square inch. Both of the leaner mixtures 1:2.5:5 and 1:3:6 gave better average results than did the 1:1.5:4.5 mixtures. At ages ranging from 28 to 34 days the 1:2.5:5 mixtures gave an average compressive strength of 729 pounds per square inch, which at 38 to 41 days is augmented to 1,005. The 1:3:6 results average 739 pounds per square inch at 28 to 36 days; this strength is practically the same as that given by the 1:2.5:5 specimens. One cannot help but be impressed here, as in other instances, with the sameness in the average compressive strength given by specimens made of concrete that is apparently differently proportioned. For all practical purposes there is no difference between the average strengths of the 1:2.5:5 and 1:3:6 concretes; and richer mixtures, made of the same aggregate and the same cement, which should show higher strengths, on the contrary, give abnormally lower values. These irregular results seem to point to a faulty method of measuring the cement, so that many of the mixtures tested are deficient in this material. Practically all of the sand used in Manila for concrete work comes from the Pasig and Mariquina River beds. Pasig River sand is fine and is composed of very soft grains of rock in advanced stages of decomposition. It contains little if any quartz and is often contaminated with considerable shell débris. It is a poor concrete aggregate and

should be used with caution. Mariquina River sand is much coarser than that from Pasig River and yields strong mortar of appreciably higher strengths than those given by standard Ottawa sand, as Table 2 shows. Sand from Mariquina River contains practically no quartz and has been derived from the weathering and erosion of andesitic and basaltic rocks. The grains are fairly soft, but excellent results have been obtained from laboratory-made concretes containing this sand, and if due care be exercised there is no reason why Mariquina sand should not give very good results in the field.

Concrete tests, made in connection with the fortification of El Fraile and Carabao Islands at the mouth of Manila Bay, show that laboratory-made specimens are much stronger than those coming from Fort Mills, and those made of 1:2:4 concrete at an age of 28 to 30 days have a mean compressive strength of 2,693 pounds per square inch. Older field specimens made of 1:2:4 concrete, and aged 28 to 38 days, have a mean compressive strength of 1,104 pounds per square inch. Still older cubes made in the field show less strength than this; those 44 to 48 days old average only 907 pounds per square inch. A comparison of the compressive strengths of concrete specimens coming from Fort Mills with those of the provincial test pieces that gave the best results shows the marked superiority of the latter. With the materials available, much better results should have been obtained from the field mixtures here recorded.

MARINDUQUE

With one exception, all results obtained from concrete specimens coming from Marinduque are very poor. Six cubes made on August 19, 1915, of 1 : 2 : 4 concrete used in constructing Tiguion Bridge, at Gasan, are the only specimens tested. The average value shown is 443 pounds per square inch; the minimum, 181; and the maximum, 1,014—results that are certainly extraordinarily erratic. Examination of the spalls and fragments remaining after testing these cubes showed not only that a fine beach sand was used, but also that there was unmistakable deficiency of cement, so that in reality the concrete contained less cement than that required for a 1 : 2 : 4 mixture. Insufficiency of cement is therefore the chief cause for this very low average value of 443 pounds per square inch, which is just about one-fourth of what a good 1 : 2 : 4 concrete should test at 28 days. Varying percentages of cement probably account for the freakish results, no two of which are alike, though nominally

obtained from 1 : 2 : 4 mixtures composed of the same kind of aggregates. More careful proportioning of cement and aggregates would undoubtedly have given more uniform results.

MISAMIS

Good results were obtained from 1 : 2 : 4 concrete specimens coming from Misamis, the average being 1,534 pounds per square inch for specimens aged 28 to 34 days; the minimum value of 922 pounds per square inch in this series is less than half of the maximum value, 2,039 pounds. The three 1 : 2.5 : 5 test pieces gave low results, which average 698 pounds per square inch. The compressive strength values show that care was taken in proportioning and that concrete materials of good quality are available in this province. One sample of sand from Cagayan River must be classed as excellent. It yielded an extraordinarily resistant 1 : 3 mortar, unsurpassed in compressive strength by any other mortar recorded in this paper. The average ultimate compressive strength, at 28 days, of specimens made with the use of this sand is 5,508 pounds per square inch, which is nearly twice that of specimens made of Ottawa sand. The high strength of this mortar is primarily due to the very coarse and graded granulometric composition of the sand combined with hardness and cleanness of the grains. This sand is composed principally of rounded basaltic pebbles and contains very little quartz.

NUEVA ECIJA

Values obtained from concrete specimens coming from Nueva Ecija are poor, particularly those made of Binutuan River aggregate, which is soft, dirty, and fine-grained. The 1 : 2 : 4 test pieces made of this aggregate gave the extraordinarily low result of 288 pounds per square inch, which is very close to the mean compressive strength of 246 pounds per square inch given by the 1 : 3 : 6 specimens at 28 days, so that it is not improbable that the same mixture was used in casting all four of these specimens. The results were so bad that the district engineer was ordered to use a different aggregate. The 1 : 2 : 4 specimens made of Guimba River sand and Baliuag River gravel gave higher compressive strengths; but these values also are unsatisfactory, and, moreover, they are markedly variant. The average given by these four cubes is 614 pounds per square inch. Preliminary laboratory tests of available Nueva Ecija sands would certainly have given valuable information, which would have resulted in the elimination of the unsuitable materials that were unfortunately used in actual construction.

OCCIDENTAL NEGROS

Results obtained from concrete specimens coming from Occidental Negros and marked 1 : 2 : 4, 1 : 2.5 : 5, and 1 : 3 : 6 are so much alike that one is almost forced to conclude that the entire series of test pieces was made from mixtures of more or less the same proportions. Specimens made of 1 : 2 : 4 concrete and aged 28 to 33 days gave an average compressive strength of 681 pounds per square inch; 1 : 2.5 : 5 specimens aged 30 to 34 days average 601 pounds; and the 1 : 3 : 6 test pieces ranging in age from 27 to 42 days average 722 pounds per square inch. With one exception, increasing age brought about increasing compressive strength in the series of test pieces made of 1 : 2 : 4 concrete; those aged 38 to 42 days average 859 pounds per square inch, those aged 48 to 55 days average 1,044, and those aged 64 to 67 days average 1,279. The oldest specimens in this series however, those 85 and 93 days old, respectively, show less strength, and give the mean value of 1,038 pounds per square inch. Test pieces made of 1 : 2.5 : 5 concrete aged 37 to 41 days average 554 pounds per square inch, whereas those aged 56 to 63 days average 836 pounds per square inch. Values obtained from the 1 : 2 : 4 specimens are low and indicate a very poor grade of concrete. Fair strengths were given by the other mixtures. Only one sand coming from Occidental Negros was tested, and the results obtained are very satisfactory, though from field data it seems that this sand was never used in actual construction.

ORIENTAL NEGROS

Results shown by field specimens from Oriental Negros are good, though most of them were obtained from cubes considerably older than those made in the laboratory, so that comparison of the two is unsatisfactory. Laboratory-made concrete proportioned 1 : 2 : 4 at 28 days gives an average compressive strength of 2,253 pounds per square inch. Only two field-made test pieces made of 1 : 2 : 4 were tested, and these at an age of 43 days average 1,964 pounds per square inch. The values given by the field specimens made of 1 : 3 : 6 concrete compare favorably with those obtained from laboratory-made cubes. The latter at 28 days average 1,128 pounds per square inch, and a single test piece of the former at 31 days gives 705 pounds. At ages ranging between 42 and 44 days, field specimens of 1 : 3 : 6 concrete give a mean compressive strength of 1,202 pounds per square inch. Only one sand from Oriental Negros

was tested in the laboratory and the average compressive strength at 28 days given by the 1 : 3 mortar specimens is very good, being 91 per cent of that given by test pieces made of standard Ottawa sand mortar.

PALAWAN

No concrete test specimens have been received from Palawan Province, and only three laboratory-made specimens were tested; these were made of Coron beach sand and gravel. Although the average compressive strength of the 1 : 3 mortar cylinders made of Coron beach sand is less than half of that shown by the 1 : 3 Ottawa sand test pieces, the compressive strength (2,443 pounds per square inch) of the 1 : 2 : 4 concrete made of the sand and gravel from Coron beach, used in connection with the construction of the Coron wharf, is very good. Inspection of the results in Table 2 obtained in testing Coron beach sands shows that whereas the average compressive strength of the 1 : 3 mortar specimens is 92 per cent of that given by the Ottawa sand test pieces, the tensile strength of the 1 : 3 Coron sand briquettes is only 44 per cent of that given by Ottawa sand briquettes, the age in all cases being 28 days. These results show that the time-honored tensile-strength test of Portland cement mortars is not always a true guide as to what may be expected from the same mortar when subjected to compression.

PAMPANGA

All results recorded under Pampanga in Table 8 were obtained from specimens made at the Bureau of Science of aggregates proposed for buildings at Camp Stotsenberg. All of the mixtures are 1 : 2 : 4 and give a mean compressive strength of 1,925 pounds per square inch, which is a little better than fair. Table 2 shows that the sand coming from Camp Stotsenberg is fine, and 1 : 3 mortar made therefrom gives only 75 per cent of the tensile strength of the 1 : 3 mortar briquettes made from standard Army sand composed of crushed quartz.

PANGASINAN

Very good results were obtained from concrete test specimens coming from Pangasinan. The values given by the 1 : 2 : 4 mixtures are uniform and average 1,628 pounds per square inch; those of cubes made of 1 : 2.5 : 5 concrete are erratic and average 1,238 pounds per square inch. The marked variability of strength in this series from a minimum of 730 to a maximum of 1,717 pounds per square inch is probably due to difference

in aggregate, though the difference between 1,268 and 730 pounds per square inch for specimens made from the same materials is more puzzling. As in other instances, the data here given lack certain value that they would have, had the district engineer included the source of the aggregate used in the concrete.

RIZAL

Compressive strength values given by concrete specimens from Rizal Province are variable; this variability, however, is almost entirely due to the different aggregates used. Specimens made of 1 : 3 : 6 concrete having ages between 28 and 31 days vary from 397 to 1,091 pounds per square inch, and average 825. The low values were obtained from test pieces containing Pasig River sand, and the high ones from specimens containing Mariquina River sand. The same difference is noted in the compressive strength obtained from the 1 : 2 : 4 specimens, though here an appreciable difference in age may have exerted some influence on the strength; the concrete specimens containing the soft, fine-grained Pasig River sand average 558 pounds per square inch at 28 days, and those containing the Mariquina River sand average 1,326 pounds, at 38 to 39 days. The use of Pasig River sand was abandoned in the last stages of the construction of Angono Bridge, because of the low results shown by the concrete containing this sand, and Mariquina sand was substituted with better results.

SAMAR

Most of the test specimens coming from Samar Province were marked 1 : 2 : 4, the rest being labeled 1 : 3 : 6 mixtures. By averaging the values given by the latter specimens, a compressive strength of 696 pounds per square inch is obtained; the age of these 1 : 3 : 6 test pieces varies from 28 to 34 days. Two low results, 496 and 388 pounds per square inch, characterize this series; the highest figure, 964 pounds, is good for this class of concrete. The specimens made of 1 : 2 : 4 concrete and aged 27 to 31 days gave extremely rambling results, varying from 330 to 2,168 pounds per square inch; this series shows an average compressive strength¹ of 957 pounds per square inch. The striking irregularity in compressive strengths obtained from the 1 : 2 : 4 specimens made October 30 and December 16, 1914, from concrete used in the construction of Arapison Bridge is very likely due to carelessness; a variation of from 330 to 1,655 pounds per square inch could hardly be explained otherwise. It will be noted that most of the 1 : 2 : 4 specimens were con-

siderably older than 28 days at the time of the test. These irregularities in age, as in most of the other cases, were caused by delays in shipping the specimens to the testing laboratory in Manila. On account of transportation difficulties it is not always possible to send specimens from unfavorably located districts promptly and have them in Manila in time for the 28-day test.

The 1 : 2 : 4 specimens aged 62 to 69 days average 1,298 pounds per square inch, and those aged from 74 to 91 days, only 913. These results are poor and are less than the value that a good grade of 1 : 2 : 4 concrete should give at 28 days. Some of the poor results obtained from Samar concrete are undoubtedly due to the use of the very fine beach sands characteristic of that province. Of the three sands tested two gave very unfavorable results, as Table 2 shows, and they should not be used as concrete aggregates. The compressive strength of the 1 : 3 mortar specimens in both of these instances is less than half that given by the corresponding Ottawa sand mortar test pieces. The third sand, which also came from the beach and which was tested November 24, 1914, although it gives excellent mortar strength values, shows a deficiency of fine grains and, therefore, makes a porous, permeable mortar that would allow the ingress of disintegrating substances.

SORSOGON

Although all of the specimens coming from Sorsogon were made of Salog River aggregate, and all, with the exception of those cast on November 9 and 15, 1915, were made of the same brand of cement, the compressive strengths show marked variation, the highest value being more than twice that of the lowest. The maximum and minimum are 961 and 432 pounds per square inch, respectively, and the average for 1 : 2 : 4 specimens aged 29 to 33 days is 668 pounds per square inch. The mean compressive strength is low and indicates a poor grade of concrete. Older specimens however show improvement in strength; the four test pieces aged 51 to 58 days average 974 pounds per square inch.

SURIGAO

Test pieces coming from Surigao were all made from 1 : 2 : 4 concrete used in the construction of Bilang-bilang wharf. The results are all poor. Specimens aged 21 to 29 days are fairly uniform in strength and average 602 pounds per square inch. The results given by the oldest, aged 35 to 37 days, are anomalous in that the older specimens are weaker than the younger

ones. Unquestionably, poor sand accounts largely for the unsatisfactory concrete strengths. Table 2 shows that the two Surigao sands tested are fine-grained, particularly the one coming from Surigao River. Specimens made of 1 : 3 Surigao River sand at 28 days give a compressive strength that is 46 per cent of that given by the corresponding Ottawa sand mortar test pieces. Sand from the wharf site gives a better value—74 per cent of that of the standard specimens. The latter sand was apparently used on the job, but the results are only one-third of what a good concrete should give.

TARLAC

Comparison of results obtained from concrete made in Tarlac is not very satisfactory on account of the appreciable differences in age of the test specimens. Some results are excellent, whereas others are only fair, and still others are incongruous. The great disagreement that exists between the average compressive strengths of 1 : 2 : 4 specimens made of concrete used in the piles of San Antonio Bridge is puzzling and is very likely due to carelessness in the manipulation of materials. Specimens cast May 8, 1913, and aged 25 days give the excellent average of 2,462 pounds per square inch, whereas another series of six specimens (date of manufacture not given) averages only 1,045 pounds per square inch at 31 days. It is likely that the proportioning of materials varied in these two cases and that a difference in cement content probably accounts for the difference in strength. Tarlac Province has an excellent building sand, which is commonly called Tarlac sand, and which on account of its light color makes it a suitable material for ornamental concrete. As Table 2 shows, the average compressive strength of 1 : 3 mortar specimens at 28 days is 1.6 times that given by the test pieces made of Ottawa sand. Tarlac sand is coarse and well graded, and contains very little quartz, the principal constituent being a clear, glassy, plagioclase feldspar. The Tarlac sand deposit is located along the Manila-Dagupan Railroad, and the sand has been transported by rail to Manila in fairly large quantities, for use in special work conducted by the Bureau of Science and the Bureau of Public Works.

TAYABAS

In general, tests of concrete made in Tayabas give unsatisfactory results. The compressive strength of the only 1 : 2 : 4 specimen is low and practically the same as that of the single 1 : 2.5 : 5 test piece coming from the same job. No information

is available with respect to the proportions used in the 58-day specimens made of concrete employed in the construction of the Atimonan Trade School. These particular test pieces give an extraordinary variation in compressive strength; the minimum and maximum values are 329 and 1,530 pounds, respectively. Concrete from Dumaca Bridge proportioned 1 : 3 : 6 gives fair values which average 573 pounds per square inch for specimens aged 28 or 29 days. Only one Tayabas sand was tested. It came from pit No. 1, Sariaya-Muntig River, and as Table 2 shows 1 : 3 mortar made therefrom gives excellent tensile and compressive strengths, which are appreciably higher than the corresponding ones obtained from Ottawa sand mortar test specimens.

ZAMBALES

Compressive strengths of concretes coming from Zambales Province are characterized by low, erratic averages. The specimens made of 1 : 2 : 4 concrete aged 28 days and used in the construction of Yamot Bridge give strengths that vary from 390 to 1,067 pounds per square inch. Test specimens made from 1 : 2 : 4 concrete employed in Candelaria Bridge give slightly better results than the 28-day cylinders averaging 822 pounds per square inch, and the 40 to 43-day cylinders averaging 1,101. The sands available for concrete construction in Zambales are very good as a whole, and some are excellent. All of them are clean and composed of hard grains, but the granulometric analysis in most cases shows a preponderance of fine grains. Nevertheless, the compressive strength of some of the 1 : 3 mortar specimens exceeds that shown by the corresponding Ottawa sand mortar cylinders. Test specimens made of sand from Luis River give an average compressive strength at 28 days of 3,120 pounds per square inch, which is about 1.2 times that shown by Ottawa sand mortar test pieces. This sand apparently was used in the construction of Yamot Bridge, but the field tests of concrete containing it are far from satisfactory. Taking into consideration the good qualities possessed by Zambales sands in general, high-testing concrete ought to be the rule.

ZAMBOANGA

All of the test specimens coming from Zamboanga were made of the 1 : 2 : 4 concrete used in the construction of the Zamboanga Waterworks. The compressive strengths are fair. They are also uniform, which indicates a uniform method of measuring the cement and aggregates. The minimum and maximum re-

sults are 760 and 927 pounds per square inch, respectively, and the mean of the entire series is 831 pounds per square inch. These specimens range in age from 33 to 36 days. Two Zamboanga sands were tested at the Bureau of Science. Both are coarse, but they show strikingly different mortar-strength values. The beach sand composed of fairly hard grains yields a 1 : 3 mortar which at 28 days gives an ultimate compressive strength that is 90 per cent of that shown by the Ottawa sand test specimens. The river sand, containing soft grains in an advanced state of decomposition, gives a 1 : 3 mortar that is weak and at 28 days is only 46 per cent as strong as Ottawa sand mortar.

GENERAL DISCUSSION

Attention has already been called to the extraordinary variation in ultimate compressive strength of field concrete specimens made of the same materials, nominally proportioned alike, and differing only in being mixed and cast on different dates. Differences amounting to several hundred per cent characterize the results obtained from specimens from nearly all the provinces. With uniform materials, carefully proportioned and thoroughly mixed, such variation would be much reduced. Exceedingly crude methods of proportioning probably account for the extreme variations noted.

Considerable variation also exists in the compressive strengths obtained from specimens made from a single batch of concrete, as well as from specimens made of the same materials, proportioned alike, and made from various batches of concrete mixed on the same day. It will be noticed that most of the ultimate compressive strength values appearing in Table 8 are averages of two or more results obtained by rupturing two or more test specimens. It is the difference between results that have been so averaged that is being discussed at present. One would expect more or less close agreement of results obtained from specimens made from the same batch of concrete. However, the variation from the mean compressive strength in a given series in the field specimens is sometimes abnormally high, and in one case actually amounts to 135 per cent. Such extreme variation from a mean value in a series indicates either improper mixing or careless proportioning of materials; slovenly procedure during the molding of the test piece may also be a contributing cause. Any one, or two, or all three of these factors could cause erratic results. In Table 9 are recorded the maximum and minimum compressive strength values of concrete specimens in

TABLE 9.—Maximum and minimum unit compressive-strength values of concrete specimens in typical series of tests.
FIELD-MADE SPECIMENS.

Tracing No.	Structure in which concrete was used.	Concrete specimens cast.	Source of aggregate.		Test specimens preserved in—			Age when tested.	Results averaged or specimens broken.	Proportions by volume of cement, sand, and gravel.	Compressive strength of concrete, in pounds per square inch; ultimate stress.			P. ct.
			Sand.	Gravel.	Moist air.	Water.	Air.				Minimum value of series.	Maximum value of series.	Mean value of series.	
1	Bridge 8.1, Guinobatan-Lovellar Road, Albay.	Apr. 15, 1915			Days.	Days.	Days.	42	b3	1:2:4	778	1,125	894	26
2	Burígel Bridge, Antique.	Jan. 21, 1916	Beach near Burígel River.		7	2	29	38	b6	1:2:4	1,083	1,454	1,238	17
3	Obispo Bridge, Batangas.	June 13, 1910			11			57	b3	1:3:5	977	1,259	1,097	15
4	Abatan Bridge, Bohol.	Feb. 16, 1910					12	23	b3	1:2:4	566	784	668	15
5	Malolos Market, Bulacan, footings	Aug. 1, 1915	Pullian River.					29	b6	1:3:6	440	682	594	26
6	Cañacao Bridge, Cavite, retaining walls.	Mar. 2, 1916	Mariquina River.	Mariquina River.	2	13	13	28	e3	1:1:1½	400	875	609	44
7	Do.	Mar. 8, 1916	do.	do.	2	13	13	28	e3	1:2:4	870	1,708	1,161	47
8	Naga River Bridge, Cebu.	Nov. 16, 1909						30	b6	1:2:4	313	778	583	46
9	Magallanes Bridge, Cebu.	Nov. 5, 1911						30	b12	1:2:4	2,191	3,205	2,659	21
10	Bridge piles, Ilocos Sur.	Oct. 12, 1912						33	b3	1:2:4	1,073	1,620	1,384	22
11	San Juan Bridge, Laguna.	Dec. 10, 1910	Beach, fine	Ormoc River.				30	b3	1:2:4	1,781	1,917	1,841	4
12	Ormoc Market, Leyte.	Sept. 13, 1915	Pasig River.	Pasig River.	1	14	13	29	b8	1:2:4	794	1,639	1,057	55
13	Masonic Temple, Manila.	July 1915						28	e8	1:1:1½	305	617	484	37
14	Do.	Aug. 4, 1915	do.	do.	1	19	16	36	e3	1:1:1½	1,142	1,298	1,199	8

typical series of tests, together with the maximum variation from the mean compressive strength. It is apparent that the grand mean value of 34 per cent obtained by averaging the individual maximum variations from the mean compressive strength of the field-made specimens is excessively high and could have been reduced considerably by more accurate and careful field work.

The maximum variation from the mean compressive strength of laboratory-made specimens is between 3 and 20 per cent and the grand mean variation is only 9 per cent, which is about one-fourth of that shown by the average results obtained from field-made specimens. By making smaller batches and giving greater attention to detail, the results from test specimens made in the laboratory will usually be more concordant. However, with due care, equally uniform results can be obtained from specimens made in the field.

Insufficient mixing that yields a nonuniform concrete; variation in the percentage of water; inaccuracies in proportioning cement, sand, and gravel; mistakes in marking test specimens; variation in storage conditions of the concrete test pieces—are all contributing factors to the erratic results already noted. However, there is still another factor which considerably affects the strength of concrete test specimens; namely, the manner in which the concrete is placed in the mold. It is certain that not a little of the variation in results is due to the different methods of molding the specimens comprised in a single series. Some of the specimens were made without tamping or spading and, of course, were honeycombed with air blebs. Others were tamped and consequently showed a compact texture. A uniform method of molding is conducive to uniform ultimate compressive strength but naturally cannot overcome the other disturbing factors which are the chief cause of irregular results. The more uniform the materials, the more carefully they are mixed; and the more uniformly and carefully the concrete is placed in the mold, the more uniform will be the ultimate compressive strengths given by the test specimens.

SUMMARY AND CONCLUSIONS

Ultimate compressive strength tests have been conducted on 1,677 concrete specimens more or less representative of concrete made in the Philippines during the decade from 1908 to 1918.

Laboratory-made concrete specimens proportioned 1 : 2 : 4 and aged 28 to 31 days give an average ultimate compressive strength

of 2,245 pounds per square inch, and field-made concrete test pieces marked 1 : 2 : 4 and aged 25 to 42 days give an average ultimate compressive strength of only 980 pounds per square inch. The lowest compressive strength, 177 pounds per square inch, given by 1 : 2 : 4 concrete was obtained from three specimens coming from Leyte.

Field specimens made of 1 : 2.5 : 5 concrete and aged 26 to 36 days average 944 pounds per square inch which, for all practical purposes, is the same as the mean compressive strength of concrete which is supposedly much richer. No 1:2.5:5 concrete mixture was made in the laboratory.

Test pieces made in the field of 1 : 3 : 6 concrete and aged 27 to 42 days give a mean ultimate compressive strength of 705 pounds per square inch, which compares favorably with the average results of 1,104 pounds per square inch given by the laboratory-made 1 : 3 : 6 concrete test pieces. The lowest compressive strength of 1 : 3 : 6 concrete recorded is 97 pounds per square inch and is given by a specimen coming from Capiz.

The differences between the average ultimate compressive strength of the 1 : 2 : 4, 1 : 2.5 : 5, and the 1 : 3 : 6 series of test specimens, respectively, are very slight and there are good reasons for suspecting that the procedure in proportioning the component cement, sand, and gravel was in the majority of the cases grossly inaccurate.

Aging beyond 28 days in most instances exercised an inconsiderable influence on the strength of the concrete specimens tested. Little if any increase in compressive strength accompanies increase in age of the greater part of the older concrete test pieces. In several cases an average decrease in compressive strength is characteristic of old test specimens.

Most of the low average ultimate compressive strengths may be traced to the use of fine sands, some may be attributed to faulty proportioning of cement, and in a few cases incomplete mixing of the batch accounts for low and erratic results. Careless molding of the test specimens in a few instances has been the cause of poor strength. Too much water and faulty storage of concrete undoubtedly have contributed not a little to the poor quality generally characteristic of field-made concrete in the Philippines, but in the absence of reliable data, it is impossible to estimate the influence exercised by these two factors.

Sands unsuitable for concrete work have been used throughout the Philippines and without subjecting them to a preliminary laboratory test. It was only after considerable actual con-

struction had taken place and samples of concrete had been tested, that the pooriness of the sands was recognized. Usually a change in aggregate was then made. Such a procedure is to be deplored, and it often entails loss of time and money. A thorough laboratory examination of concrete aggregates is always a helpful guide to the engineer in selecting his material, and it is hoped that copious reliable data on Philippine concrete aggregates may be collected in the future.

Compressive strength results obtained from series of field specimens made from the same materials on the same day, and from the same batch of concrete, and averaged to give the values recorded in Table 8, generally show considerable variation. Laboratory-made specimens composed of the same materials, and molded from the same batch of concrete, are in much better agreement, and show only one-fourth of the average maximum variation from the mean that field-made specimens show.

THE PHILIPPINE BUREAU OF SCIENCE

RECENT PUBLICATIONS

AN INTERPRETATION OF RUMPHIUS'S HERBARIUM AMBOINENSE

By E. D. MERRILL

Based on the collections made in Amboina by the late Charles Budd Robinson

Order No. 450. Bureau of Science Publication No. 9. Paper, 595 pages and 2 maps.

Price, \$3 United States currency, postpaid.

SPECIES BLANCOANAE: A CRITICAL REVISION OF THE PHILIPPINE SPECIES OF PLANTS DESCRIBED BY BLANCO AND BY LLANOS

By E. D. MERRILL

Order No. 461. Bureau of Science Publication No. 12. Paper, 423 pages and 1 map.

Price, \$2.25 United States currency, postpaid.

PHILIPPINE WATER SUPPLIES

By George W. Heise and A. S. Behrman

Order No. 460. Bureau of Science Publication No. 11. Paper, 218 pages, 19 plates, and 4 text figures.

Price, \$1.75 United States currency, postpaid.

VEGETATION OF PHILIPPINE MOUNTAINS

The relation between the environment and physical types at different altitudes

By WILLIAM H. BROWN

Order No. 473. Bureau of Science Publication No. 13. Paper, 434 pages, 41 plates, 30 text figures.

Price, \$2.50 United States currency, postpaid.

PLEASE GIVE ORDER NUMBER

Orders for these publications may be sent to the Business Manager, Philippine Journal of Science, Bureau of Science, Manila, P. I., or to any of the following agents:

AGENTS

THE MACMILLAN COMPANY, 64-66 Fifth Avenue, New York, U. S. A.
WM. WESLEY & SON, 28 Essex Street, Strand, London, W. C., England.
MARTINUS NIJHOFF, Lange Voorhout 9, The Hague, Holland.
KELLY & WALSH, Limited, 32 Raffles Place, Singapore, Straits Settlements.
THACKER, SPINK & CO., P. O. Box 54, Calcutta, India.
THE MARUZEN CO., Limited, 11-16 Nihonbashi, Tori-Sanchome, Tokyo, Japan.

CONTENTS

	Page.
KING, ALBERT E. W. Physical properties of Philippine concrete and concrete aggregates.....	105

The Philippine Journal of Science is issued twelve times a year. The sections were discontinued with the completion of Volume XIII (1918).

Yearly subscription, beginning with Volume XIV, 5 dollars United States currency. Single numbers, 50 cents each.

Publications sent in exchange for the Philippine Journal of Science should be addressed: Library, Bureau of Science, Manila, P. I.

Subscriptions may be sent to the BUSINESS MANAGER, Philippine Journal of Science, Bureau of Science, Manila, P. I., or to any of the agents listed on the third page of this cover.

Entered at the post office at Manila, P. I., as second-class matter.

VOL. 18, No. 3

MARCH, 1921

THE PHILIPPINE JOURNAL OF SCIENCE

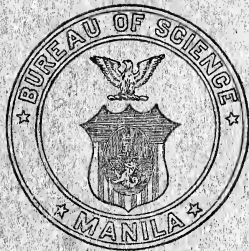

MANILA
BUREAU OF PRINTING
1921

THE PHILIPPINE JOURNAL OF SCIENCE

Published by the Bureau of Science of the Government of the Philippine Islands

ELMER D. MERRILL, M.S., *Editor*

R. C. MCGREGOR, A.B., *Associate Editor*

ALBERT H. WELLS, A.B.; GRANVILLE A. PERKINS, PH.D.; A. P. WEST, PH.D.
T. DAR JUAN, A.B., PHAR.D.; F. AGCAOILI, A.B.; A. S. ARGUELLES, B.S.
ALBERT E. W. KING

Chemistry

WARREN D. SMITH, PH.D.; ROY E. DICKERSON, PH.D.

Geology

H. W. WADE, M.D.; OTTO SCHÖBL, M.D.
F. G. HAUGHWOUT; STANTON YOUNGBERG, D.V.M.

Experimental Medicine

LIBORIO GOMEZ, M.D., PH.D.; F. CALDERON, B.A., L.M.
VICENTE DE JESUS, M.D.

Clinical Medicine

W. H. BROWN, PH.D.; C. F. BAKER, M.A.; ATHERTON LEE, M.S.
O. A. REINKING, B.S.A., M.S.; L. M. GUERRERO, PHAR.D.

Botany

ALBERT C. HERRE, PH.D.; C. F. BAKER, M.A.; S. F. LIGHT, M.A.
C. S. BANKS, M.A.; L. D. WHARTON, M.A.; W. SCHULTZE

Zoology

H. O. BEYER, M.A.; OTTO JOHNS SCHEERER, M.A.

Anthropology

ANNA B. BANYEA, *Copy Editor*

Manuscript intended for publication and books for review should be sent to the editor. One hundred separates of papers published in the Journal are furnished to authors without charge. Additional copies may be had at authors' expense.

Publications sent in exchange for the Philippine Journal of Science should be addressed: Library, Bureau of Science, Manila, P. I.

The Journal is issued twelve times a year. The subscription price is 5 dollars, United States currency, per year. Single numbers, 50 cents each.

Subscriptions may be sent to the BUSINESS MANAGER, Philippine Journal of Science, Bureau of Science, Manila, P. I., or to any of the agents listed on the third page of this cover.

THE PHILIPPINE JOURNAL OF SCIENCE

VOL. 18

MARCH, 1921

No. 3

TROPICAL GEOLOGY AND ENGINEERING ¹

By WARREN D. SMITH

*Professor of Geology, University of Oregon, and Acting
Chief, Division of Mines, Bureau of Science, Manila*

CONTENTS

INTRODUCTION.

GEOLOGICAL AGENTS.

- Diastrophism.
- Vulcanism.
- Gradation.
- The work of organisms.
- Corals.

STRUCTURE.

- Faults.
- Joints.
- Folds.

SPECIAL PROBLEMS.

- Road building and maintenance.
- Artesian water.
- Dams and reservoirs.
- Coal mining.
- Geodesy.
- Physiographic influence upon economic development.
- Seismology.

SUMMARY.

INTRODUCTION

The purpose of the present paper is to discuss, first, the general geologic processes as they are found at work in the Tropics, contrasting their effects with the same processes in the temperate regions of the earth; and second, to cite some examples showing their practical bearing upon the engineering problems that arise in those regions.

From many years of contact with engineers and their problems, particularly in the case of tropical countries, the writer knows that often all too little attention is paid by the engineer to the fundamental considerations upon which geology alone

¹Several years ago the writer published some notes in the Mining and Scientific Press of California. The present article is a completely rewritten, revised, and considerably enlarged discussion along the same lines.



is capable of throwing light. This is due frequently to a deficiency in and lack of breadth of training. How is it to be overcome? It is hardly to be expected that the engineer-student will be able to include more geology in his already crowded courses. That, however, is not necessary, for all that is desired is that he realize his limitations and the importance of the bearing of geology upon his work and the need for expert advice. Some engineers in the Philippines with whom the writer has had the pleasure of working showed that they appreciated this fully. Others did not, and as a consequence they have left monuments to their lack of insight.

Previous to our experience in the Philippines, Cuba, and Panama, Americans had had no extensive contact with the Tropics and consequently many of our engineering data were found untrustworthy when applied to wholly new and unusual conditions. An especially good example may be cited in the location of our highways and railroads. In the United States we run a railroad line up one cañon, over the pass, and down the other side by way of another cañon. This has been tried in the Philippines, notably in the Benguet Road; the result is that this road may have to be abandoned because of excessive cost of maintenance. In the Tropics, during high water, there is room for but one thing in a valley and that is the stream which occupies it; such a feat of engineering as that which has made the Royal Gorge and the Denver & Rio Grande Railroad famous is absolutely out of the question in the Tropics.

There is one cardinal rule to be laid down at the outset, namely, take nothing for granted; investigate each problem separately. Handbooks and set formulæ are worse than useless; they are dangerous.

GEOLOGICAL AGENTS

The three most important geological agents are diastrophism, vulcanism, and gradation. The last has four important contributing factors to be considered; namely, *a*, weathering; *b*, transportation; *c*, corrasion; and *d*, corrosion.

Diastrophism.—The first of these, diastrophism, denotes the up-and-down movements in the outer shell of the earth. Such movements are negligible apparently in the older and more stable parts of the earth, but even there they occasionally manifest themselves as earthquakes. In the newer parts of the earth, and particularly along continental borders, they are of considerable magnitude and importance. As it happens, many of these places are in the Tropics. This is true of both Panama

and the Philippines. Once before, and perhaps twice, the barrier of the Isthmus of Panama, which has cost so much in life, labor, and money to cut through, has been opened so that the waters of the Atlantic and the Pacific intermingled, and it is not at all impossible that future diastrophism will render all our labor useless. However, these movements are so slow as to be almost negligible in any one generation. Only the geodesist finds that he has to readjust some of his calculations. We see the results in many parts of the world of such movements, but as yet we do not know much about them. Our data are not sufficient. Two facts are established, however; namely, that such movements as have taken place in the Philippines have been great during the late geological periods, amounting to as much as 1,800 meters, and that they have been differential. There has been within the Recent period a marked tilting of the Philippine block toward the Pacific Ocean. This will explain to the engineer why we have comparatively shallow river mouths on the west side of the Archipelago, and deep, drowned ones on the eastern side. It should be stated that in some parts of the Archipelago, notably Cebu, the reverse is the case, which further substantiates the statement,

Vulcanism.—As the Philippine Archipelago is a part of the so-called "Circle of Fire" that girds the Pacific Ocean, we naturally expect vulcanism to be of such magnitude that engineers would be continually anxious. Nevertheless, except for those regions in the immediate vicinity of active volcanoes, little damage has ever been recorded from this cause. The most-marked effects were those noted in 1911 resulting from the explosive eruption of Taal Volcano, situated about 45 kilometers due south of Manila. Had there been a large city (the size of Kingston, Jamaica, for example) situated on the shores of Lake Bombon, tremendously greater loss of life and damage might have occurred. The town of Taal, a few kilometers distant, suffered to the extent that an old church made of volcanic tuff was badly disfigured and a triangular section of land, crossed by one of the Government's new highways, dropped about a meter, allowing the tide to come inland for perhaps four-fifths of a kilometer. The length of damaged road amounted to about 3 kilometers. These effects were due directly to earthquakes and indirectly to the volcano. Although four hundred ninety-eight distinct shocks were recorded in Manila at the time of the eruption, practically no damage there was noted. The claims of a certain American

firm dealing in a patent type of concrete construction, that none of its buildings had suffered any damage at the time, were strictly correct, for no buildings in Manila were damaged!

Another instance in which vulcanism did play an important part was that in which a section of road in Albay Province, Luzon, was obliterated for a distance of 3 to 5 kilometers by a fall of bombs and a deluge of mud and ashes from Mayon Volcano in 1915. As volcanic activity in the Recent period in the Philippines has been entirely of the explosive type in which no lava outpourings occurred comparable to those from the Hawaiian volcanoes, the damage resulting to public works would be of very different character and also less serious.

Gradation.—This is the sum total of the wearing-down process, in many respects the dominant type of geological work. If we analyze this process we find that the following agents are contributory: *a*, weathering; *b*, transportation; *c*, corrosion; *d*, corrasion. I would, however, make "corrosion" a subheading under weathering, there being two factors involved; namely, a mechanical deformation and a chemical change, either of which may precede the other. Once weathering, or to use a very crude term defining it in part only, "slacking," has taken place, transportation comes in and does its work; and then "corrasion," or mechanical wear, becomes operative, but not until there is movement.

Of course, these factors are operative in all countries and under nearly all conditions, but gradation proceeds at a maximum rate in the Tropics. Two reasons are given for this; namely, rainfall and temperature or, in a word, climate.

In the Philippines we have a mean annual rainfall of well over 2,540 millimeters (100 inches), with sometimes exceptional and almost unprecedented precipitation, notably 1,168.1 millimeters (46 inches) in twenty-four hours on July 29, 1911, at the Baguio Observatory. This is, as far as we know, the world's record for a single rainfall. The reported rainfall of 23,387 millimeters (905 inches) a year at Cherraponji, in Assam, has lately been questioned. However, a precipitation of over 15,240 millimeters (600 inches) has been recorded on Mount Waialeale, Kauai Island, H. T. At such times the streams leave their banks and spread out over the country in sheets of water. Needless to say, the amount of material then transported is almost unbelievable. Furthermore, we have another factor to consider, and that is velocity. Often this is not taken into consideration. When we stop to consider that doubling the velocity of a stream means

increasing its transportation power sixty-four times, we realize what a power we are trying to combat. We shall return to this topic.

Once the tropical downpour of warm rain has stripped off the soil, weathering can and does strike deeper into the core of rocks beneath, and however far we go underground in mine workings we find the rocks exhibiting incipient decomposition. The writer knows this to be true from the examination of a great many thin sections of wall-rock from the deepest mines in the Archipelago. Undoubtedly the presence of organic acids, resulting from the decay of the rank tropical vegetation, hastens this decomposition. Of course, we have little or no frost, except in the highest mountains, but we do have wide ranges in temperature during the twenty-four hours and this adds to the disintegrating forces at work. Therefore, all things considered, we have reason to think that gradation, which includes degradation, is the most potent of the geologic processes at work in the Tropics.

This excessive weathering in tropical regions, where andesite and basaltic lavas are to be found, has resulted in places in the accumulation of a formation, of considerable thickness, known as laterite. This is an aluminous soil, or heavy clay, also rich in iron. When the iron exceeds 35 per cent it can be used as an ore. Vast deposits of laterite are known in India and Cuba, and some years ago an American engineer discovered a commercial deposit of this in northeastern Mindanao, in the Philippines. A study of this deposit shows that it is a product of weathering and concentration.

The work of organisms.—Nothing has been said as yet about the destructive work of plants and animals in the tropical regions, as the writer has made little personal study of the subject. There is no question but that they play no inconsiderable part in the processes of weathering and on occasion have to be reckoned with in engineering operations. We have but to call attention to Branner's ² observations on the geologic work of ants in Brazil to remind the reader of the importance of these insects. Not only do their numerous mounds, in some cases exceeding 5 meters in height, considerably alter the topography, but they seriously undermine the subsoil so as to endanger structures. They promote weathering by opening the formations to the atmosphere and to gases. The writer has seen many ant hills in

² Branner, J. C., Bull. Geol. Soc. Am. 21 (1910) 449-496.

the Philippines, but none commensurate with those in Brazil, described by Branner.

The writer's attention has just been called to the very interesting investigations of Oshima³ on Formosan termites wherein he states that *Coptotermes formosanus* secretes a milky, acidulous fluid which dissolves the lime in the mortar of brick buildings. In order to protect the buildings he advises the construction of a concrete basement floor which shall have as few seams as possible.

It also appears from such studies as have been made that certain termites occupy in the Tropics a place analogous to that filled by the common earthworms in temperate regions.

An instance of the work of winds and plants in combination may be of interest. In the recent destructive typhoon which struck Manila with such force (September 1, 1920), a great many of the fine acacia trees, which are the principal shade trees of the city, were uprooted and many sections of cement sidewalk were badly damaged as a result. These trees have widely ramifying and very shallow roots, with no tap root; consequently, with their wide-spreading tops, they became easy victims of the storm.

Corals.—The rôle that corals and coral reefs play in matters of engineering and the economic development of a country cannot be overlooked. We have already alluded to the connection between coral formations and water supply. Coral limestone is a very important source of construction material. In certain other ways coral formations are of great importance. For instance, the fringing reefs protect the shore from storm waves; also, they afford a firm foundation for future land when covered with earth, either naturally or artificially. Most of the coastal plain tracts in the Archipelago have a coral foundation which is much more stable than is mere alluvium.

STRUCTURE

Much has been written in the textbooks about structure, and most engineers are probably cognizant of the importance of this branch of geology, but as yet little has got into the literature concerning this subject in tropical regions. Naturally an engineering feat of the magnitude and importance of the Panama Canal would necessitate a most careful regard for anything which might have an effect upon both the task of construction and the

³ Oshima, M., Formosan Termites, Philip. Journ. Sci. 15 (1919) 319.

permanence of the canal. It is not the writer's intention to allude to any of the work of the Canal Commission geologist⁴ further than to advise any engineer who is working, or expecting to work, in tropical regions to give this important work considerable study.

In the Philippines we have the same sort of structures found in many parts of the world with the difference that here some of the structures are not only of recent origin but are still in the making. Where dynamic forces are at work the engineer cannot afford to be off his guard or ignorant of how they are to be recognized. The builders of the Los Angeles (California) aqueduct have very wisely studied and provided against the possible breaks which might interrupt that system, having been forewarned and forearmed by a geological study of the region, a region traversed by long parallel faults in the strata.

Faults.—In the Philippines there are many faults, some large, some small, which every mining man knows about. Does the civil engineer know about them? Can he recognize them? Are they old ones where movement has long since ceased or are they fresh and is movement likely to recur, and how will that movement be manifested? Which part will move up and which down? Is the fault normal or thrust? It makes a great deal of difference which. It can be readily seen that when it comes to railroad tunnels and water mains this becomes a serious matter. Cebu Island, for example, is apparently broken by a number of faults of considerable size, and it is the belief of some geologists that the straits between Cebu and Negros Islands are due to a down-faulted block of rock strata. Therefore, the construction of engineering works of any size on that island should be preceded by careful geologic investigations. As yet the writer knows of no engineering projects in the Islands seriously affected by faults.

During a recent geological examination of the area in the vicinity of the Montalban reservoir, Dr. R. E. Dickerson suggested to the writer the possibility of a large fault traversing it. If further detailed study of the region should reveal such a break, it would be of the utmost importance to the citizens of Manila to know it. Possibly, this could not be worked out in less than several weeks, but whatever the length of time necessary, it would be justifiable.

⁴ MacDonald, Donald F., Bull. U. S. Bur. Mines 86 (1915).

All faults in the Philippines which the writer has seen are, with a few minor exceptions, of the normal type. Thrust faulting may be present.

Joints.—One of the commonest features of rock formations is jointing. The cleats in coal may be considered as jointing on a small scale. Any quarry man is of course familiar with the great, regular, smooth-walled cracks which traverse various formations for long distances and more or less in definite systems. These are both an advantage and a source of trouble. Farther on the writer calls attention to the part these play in the building of the Benguet road.

Folds.—The importance of folds in the strata, such as the syncline (basin) or monocline in the case of artesian water and the anticline (arch) in the accumulation of oil, is well known to most people nowadays; but has it occurred to many people that the ease of excavation, or the control of water, causing flooding, etc., are dependent upon the attitude of the formations? In the Philippines we have the rock strata in all conceivable attitudes, each locality presenting different conditions which must be studied locally. Of course, in this respect the Philippines and the Tropics in general do not differ from many other parts of the world. However, owing to excessive vegetation and weathering these important structural facts are often concealed even from the trained eye of the geologist.

SPECIAL PROBLEMS

Road building and maintenance.—In parts of the Tropics, and particularly in the monsoon region of southeast Asia, the seasons are sharply defined, one of practically no rain and one during which it rains in torrents. If we recall the rule that the carrying power of a stream varies as the sixth power of its velocity, we know at once we cannot take any chances with a tropical torrent. In regions of high relief we have four things to consider, and we cannot neglect any one of them. They are: Declivity or head, sudden increase of volume due to configuration of the valleys, the angle of slope of valley walls, and material and structure of the valley walls.

The writer has seen instances where the highway was placed in a valley at such a point that the road was continually menaced by the stream just below it and by the sliding of material from the slopes above. The stream is dangerous because of two things: First, because of the sapping of the water itself; and

second, because, when the velocity is doubled, it can carry particles of rock sixty-four times as large as before, and in time of freshets boulders weighing tons are carried along, each one acting as a battering ram. No retaining wall can be expected to withstand this terrific bombardment, nor does it do so.

Again, the composition of the country rock, its structure, texture, and the state of weathering are of vital importance; and, if this weathered material slides into the cañon below, a temporary and very dangerous dam results. When the dam breaks, as it soon must with the impounding of the torrent behind it, all is swept before it. We have a remarkable example of this in the now famous Benguet Road on Luzon Island. Buéd River is a small stream, little more than a creek in the dry season; it flows from 1,524 meters (5,000 feet) elevation to the sea. The valley walls are V-shaped, the average slope being probably as high as 35° or even 40°. The country rock is a badly decomposed andesite, for the most part with some tuff deposits, much jointed and with innumerable small faults, all loosened by many earthquakes. Here we have ideal conditions of instability, which were perfectly apparent to geologists; yet, so far as the writer knows, no geologist was consulted by the engineers until it was too late. The inevitable happened. First, slides continued until the slopes reached the angle of repose; then dams followed, impounding the water to a great depth; next, the dams broke and search parties were out looking for the road, buried under twenty meters of débris. Now, after many years and the expenditure of much money, a new road has been constructed by way of the old Naguilian trail. We have had to go back to the ridges, following the example of the Spaniards. Of course, if we had cared to, we might have taken a lesson from the native trails, the majority of which follow ridges.

In the matter of engineering technic involved in the construction of these roads, the writer would venture to lay emphasis on the necessity for drainage; keep the foundation of your road drained. The excellence and easy maintenance of the Hawaiian roads is due largely to the very porous subsoil and, consequently, perfect drainage. You may say that this is nothing new, that every engineer knows that; but the application of drainage in America, where the rainfall is merely a light summer shower as compared with the tropical downpour, is a different problem. As to how it should be drained, that is a matter not within the writer's province as a geologist.

Maintenance on a road constructed of poor materials is one thing, while that on a road wherein a wise selection of metal has been the rule is an entirely different thing. In this a geologist with his microscope is a necessity. Petrography, once looked upon as a mere academic study, is now indispensable to the scientific road builder. There is a pathology of rock just as there is a pathology of animal tissue. The microscope will reveal at once, and at little expense, whether or not the minerals composing the rock are sound, whether there is incipient decomposition, or a far-gone state of decay. It will show also the texture or fabric of the rock. If the rock has an ophitic texture, that is, the minerals interlaced to make up a sort of mat, then we may look for toughness. Why one rock splinters and another does not is at once made clear.

At one time the writer collected rock specimens from a number of places along one of the principal Philippine highways, and among the samples was one that yielded a briquet which when placed in the Page cementation machine did not break under two thousands blows, whereas an ordinary basalt briquet yielded at the twenty-second blow. A thin section of the fresh rock was made and examination showed that there was a small amount of secondary calcite in the rock, an alteration product of the lime-bearing silicates; it was this that furnished the excellent binding qualities. The rock was a diorite just beginning to decompose without having gone so far as to reveal this condition to the naked eye. This rock, with its holocrystalline texture and just the right amount of calcite, would make a most excellent road metal because it has two essential qualities, namely, toughness and high cementation quality. Of course, the objection of high cost will be raised at once; but no matter how the finances stand, there is never any excuse for putting worthless and unsuitable rock on a road. The proper way is to let the geologist recommend one or more kinds of material, and then the engineer may consider which he can afford to use. Many state highway departments now follow this method, and formerly the engineers of the Philippine Government always submitted their road and building materials to the Bureau of Science for the proper tests. Of late years this has not been done, and the results are beginning to appear.

Still another important factor to be considered in connection with the cementation quality of the road metal is that of the wind. During a typhoon, a storm which is much like the Gulf hurricane, the velocity of the wind is as high as 165 kilometers

(103 miles) an hour and the roads are swept literally by a natural cyclone blower and all loose material is removed as effectually as if a vacuum cleaner had gone over them. So we must consider not only the work of the deluge of rain but the combined effect of water and driving wind. Road maintenance from these and other causes is a very serious problem, in the Philippines at least, and any criticism of our highways should be tempered by a consideration of the difficulties we have to overcome.

Two chief sources of trouble in concrete mixtures in the Philippines are found; first, the fineness and generally poor quality of the sand, and second, lack of strength of the crushed rock. Both Reibling and King, of the Bureau of Science, have repeatedly called attention to these weaknesses in local concrete, as revealed by their long series of actual tests made on thousands of samples. The ultimate cause for this condition of things is found in the mineralogy and geology of the raw materials employed. Not only is the mineral composition of the sand commonly used here unsatisfactory, but also the extremely weathered condition of the materials is a matter of menace. Now it is agreed that the practical tests are of prime importance in the proving of such materials, but the examination of the sand and of thin sections of the rock is also of very great value. Such examination will reveal the cause for the failure; and, of course, this is really the most important thing of all, if we want to avoid future trouble of this kind.

The so-called "sand" oftenest used here is sand only by courtesy. The microscope reveals little or no quartz, the feldspar present is often in a far-gone condition of decay, and the predominant minerals are often dark-colored hornblendes, pyroxene, olivines, etc. To one accustomed to the clear, white, sharp Ottawa sand used in standard tests, the local sand appears more like dirt.

Reverting to the subject of landslides, a thorough acquaintance with tropical conditions will reveal at once the futility of attempting to control slides like those of the Culebra cut at Panama. Retaining walls, drainage, etc., are all makeshifts. The only practical and final solution of the problem is to increase the sliding until the walls are brought to the angle of repose where they will no longer slide. According to MacDonald, geologist of the Canal Commission, the most important types of slides were structural breaks and deformations and for this type of slide there was only one remedy that had utilitarian value

under the conditions involved, and that was applied. It consisted in making the slopes less steep by removing material from their upper parts until the balanced pressure at the foot of the slope became less than the crushing or deforming strength of the rock. In other words, the slopes were brought down to the angle of repose.

This was recently well illustrated at Eugene, Oregon, where both the formation (weathered basalt) and the rainfall simulate tropical conditions. A hillside of this material, becoming saturated with rain water, started to slice off, slide, and flow under a large lumber mill at the bottom of the slope, bulging the latter upward, completely throwing it out of alignment and even threatening the structure. The simple expedient of sluicing at the foot of the slide solved the difficulty and the material of the hill was brought to such an angle that it no longer moved.

Artesian water.—In view of the fact that a great many people have a hazy notion of what an artesian well is, the term is here defined. An artesian well is a type of well first bored, as far as we know, in Artois, France, and when the word artesian is correctly employed we mean a deep well from which water flows above the mouth under more or less pressure. This pressure is due to the peculiar geological conditions obtaining in the locality. Ordinary, shallow, dug wells are not artesian.

The principles governing the concentration and movement of ground water are now well understood; but, at the risk of repetition, the writer will make a few general statements.

Although we do not see it, the sea of underground water is almost as extensive as, and in some ways more important than, the ocean. All the rocks, varying in degree of saturation, contain water down to limiting depth. Some of this water is found in the large trunk channels, joints, and faults, but a great deal of it is in the form of hygroscopic water; that is, water held in the pores of the rock by capillary attraction.

An English geologist, H. B. Woodward, makes the statement that the quantity of water held in the chalk of England by capillary attraction is tremendous. One square mile of dry upper chalk, one yard in thickness, contains ordinarily nearly 3,500,000 gallons of water, and when saturated holds 200,000,000 gallons. Recent experimental work by Van A. Mills⁵ indicates that, in saturated strata, capillarity retards fluid movements, so that water so held might not flow readily.

⁵ Econ. Geol. 15 (1920) 420.

Some rocks, like the dense volcanic flows and quartzites, contain practically no water. Other rocks, like the limestone formations, have subterranean rivers passing through them, but the sandstones and chalks are the most important in this respect. A true sandstone consists of grains of quartz compacted together. The more nearly spherical these grains are, the more continuous are the openings, ignoring for the moment the cementing material which in some cases may completely close the voids. In such an arrangement of spherical grains there is always one continuous passage through the mass. Along these passages the water travels. Some sandstones have as high as 35 per cent of pore space.

The loose volcanic tuff formations of the Philippines are also great water-carrying formations. This water is generally circulating slowly in the small openings, but when the water reaches a fissure, naturally the circulation is rapid.

As the deep-seated igneous rocks are usually dense and have but little pore space, and as the fractures in these rocks have no regularity, it can be seen at once that they are poor formations in which to seek water. Water may be traveling along a fissure in such formations, and the well digger may perchance strike this fissure, but usually the chances are slim. There is no excuse for locating a well in such a formation, unless this is the only kind of rock in the region. A limestone formation is also poor, as a rule; for, while it is cavernous and contains underground streams, it is a piece of pure luck when one of these is struck. Pratt,⁶ a former colleague in the Philippine geological work, found that where coral limestone was interbedded with clay layers a fairly good supply of water was available. Very often, however, shallow wells in limestone areas located near the sea would yield salt water or be dry in about half the cases. The best conditions are found in the sandstone, volcanic tuffs, and beds of unconsolidated ash.

Having found the formation, we must next consider some features in the structure of the region. The ideal condition is where the sediments form a syncline (basin), with the water-bearing stratum outcropping at a higher point than the site of the well and where there is an impervious layer of clay or shale just above the water-bearing stratum. The effect of a fault on the water circulation would be to divert the flow to springs at the outcrop, but the effect of an igneous intrusion would be

⁶ Pratt, W. E., *Philip. Journ. Sci.* 10 § A (1915) 236.

to block the water circulation. All of these conditions must be considered, if possible, previous to the digging of the well.

It is incredible that even at this late day water should be sought with a divining rod, yet a few years ago an attempt was made to find artesian water with a divining rod in the city of Zamboanga, Mindanao. Water was not found, and an examination of the geology of the country showed that very little chance existed of a supply being tapped within a reasonable depth in the location desired. In spite of some apparently successful instances of the use of the divining rod, the employment of this device may be classed with other pseudo-scientific operations, such as palmistry and astrology.

Probably the Bureau of Public Works has paid more regard to the geology of the country than any other engineering organization in the Philippines; and, so far as its wells have been dug in the Manila central plain, good results have been obtained. But the writer wishes to emphasize this fact; that, in spite of all the practical experience of a well driller, there are many more things to be taken into consideration than simply those that pertain to digging the well.

Some years ago at Olongapo, Luzon, a well was drilled on the Naval Reservation; the writer, when visiting the place, examined the cuttings in the drill and found the material to be diorite, which is the basal formation of the island and contains very little water, having no regular continuous water-passages. The well digger drilled here for twenty-two months. No water was found, and in the end he lost all his tools in the hole. As the driller was paid by the foot, he, of course, did not have to pay the bill.

In parts of the Hawaiian Islands water has been found by sinking through the overlying formation, largely consisting of lava, to the ash beds that lie buried below. The water here is ponded in this loose formation by the coral reefs bordering many parts of the Islands. The same conditions, no doubt, could be found in other tropical countries.

At the present time geologists are engaged in the Hawaiian Islands in attempting to locate high level sources of water to be brought down for irrigation purposes. Some success has been met with by bringing water through tunnels from the rainy sides of the various islands to the drier sides. It should be pointed out here that if the geologist is expected to predict the finding of water in such regions with any degree of certainty unfair advantage is being taken of him. The conditions in predominantly lava formations are too uncertain to permit of

the more nearly exact work possible in the stratified rocks. The geologist can do many things, but he is not gifted with second sight.

Dams and reservoirs.—The geological conditions affording the best sites for dams and reservoirs have also been discussed by several writers. With reference to this phase of the subject, the writer wishes to state that a geological examination of a district and several years of stream gauging are not only desirable but imperative in the Tropics. Many examples of how these works should not be located could be cited, but two or three will suffice. The city reservoir at Montalban, Luzon, was located in a limestone gorge. The limestone is full of caverns and the reservoir failed to hold water until it was lined, bottom and sides, with cement. If the dam had been placed at the upper end of the gorge the reservoir would have had a natural clay bottom.

The destruction some years ago of the Tarlac (Luzon) dam probably could not have been foreseen, but if a few more data concerning annual precipitation and stream discharge had been secured the trouble might have been averted. Agno River when under full head is a terrible engine of destruction. Another dam was built in the hills back of Cebu, making use of an apparently substantial formation for abutments and spillway. Drilling was recommended by the geologist who examined it; but no, that would be too expensive. The abutments held in a terrific storm that ensued; but the spillway, which was too small, forced the water to eat its way down through a decomposed formation which had a hard shell on the outside, so that the dam was rendered useless. The writer, from his observations in the Philippines, should be inclined to say *never* when it can be avoided build a reservoir in the Tropics. If water is needed, use diversion weirs in the streams or artesian wells.

Coal mining.—The writer had not intended to touch on any phase of the application of geology to mining engineering in this article for the reason that the connection between the two is so generally recognized. There is one particular phenomenon that has given more or less trouble to those who would work coal seams in the Far Eastern Tropics. It has been the writer's experience throughout some years of examination of coal prospects and mines in the Tropics that the persistence of a given seam of coal is always a matter of conjecture. The seams are either interrupted by small faults or they thin, or "peter out," just when you are counting on a good working thickness.

We have great rainfall over most of Malaysia to-day. There is every reason to suppose that this has been the case throughout most of the Tertiary period, which is the age of the tropical Malaysian coal. These great deluging downpours of rain mean coarse sedimentation and frequent interruptions to the quiet accumulation of vegetal matter from which we are to hope for a future coal deposit. We do find that the character of the underlying and overlying beds in the neighborhood of these uncertain coal beds is very variable; coarse and fine strata alternate with, in many places, no great thickness to any one stratum. So the advice to the engineer or geologist who is sent out to examine a coal deposit in any part of the Tropics is this: Examine carefully the nature of the inclosing strata, the character of the grains, their size and arrangement, and take nothing for granted; put down test pits or drill holes fairly closely spaced and, better still, drive on the coal. The reader who would care for more detailed discussion of this topic will find an admirable paper on the subject by Pratt.⁷

Geodesy.—Over fifty years ago there appeared in the Transactions of the Royal Society⁸ several articles by the Bishop of Calcutta, a mathematician and physicist of no mean repute, relating to the perplexities then confronting the surveyors in control of the great Trigonometric Survey of India. This, one of the greatest of surveys, has recently been completed. The problem that confronted them was how to account and allow for a very noticeable and very important discrepancy between the trigonometrically located stations and those ascertained by astronomical determinations.

It was expected that the great mass of the Himalayas would deflect the plumb bob toward them, but another factor entered into the problem which at first was not understood, namely, density. There was for some reason a deflection of less amount of the negative sign which could not be accounted for; it was finally accounted for by assuming a deficiency of gravity beneath the mountain mass and a greater gravity beneath the sunken area to the south. The whole question is intimately bound up with the theory of isostasy, which is too complex a subject for review in this paper.

In 1906 Hayford⁹ wrote a paper, in which the whole question is reviewed and the theory of isostasy clearly substantiated.

⁷ Pratt, W. E., Philip. Journ. Sci. § A 10 (1915) 289.

⁸ Phil. Trans. Roy. Soc. London (1853).

⁹ Hayford, John T., Proc. Washington Acad. Sci. 8 (May, 1906) 25-40.

In the course of the coast survey of the Philippine Islands, also, considerable discrepancies were frequently noted between the trigonometrical and the astronomical location of stations, in some places amounting to 30 or 40 seconds of arc; such a difference might mean a matter of one-fourth mile or more on the surface of the earth. How to adjust this has been a matter of some difficulty. The great piles of volcanic rock constituting the Zambales Mountains suffice to explain the discrepancies at some of the stations on the west coast of Luzon. Near Olongapo, it was found that the plumb bob was deflected to the west instead of to the east, though the main mass of the Zambales Mountains lies to the east. An examination made by the writer several years ago on the Cinco Picos Range, which lies to the west of Olongapo, revealed the fact that these mountains are made up of one of the densest rocks known, periodotite. This rock has a density of over 3, whereas the main mass of the rock in the Zambales Range to the east has a density of only about 2.5. Therefore, apparently, this discrepancy is explained by our knowledge of the geological features of the two regions.

The work of Hayford has shown so clearly the importance of the data of geodesy in the solution of problems of geophysics that geologists interested in these broader and fundamental problems, such as that of isostasy, cannot afford to ignore them. On the other hand, from the example cited, the dependence is clearly seen to be mutual. The writer is planning to carry a small gravity instrument into the interior of Luzon on some of his expeditions within the coming year, as we have no data of this kind from the interior.

Physiographic influence upon economic development.—Under this topic it is proposed to cite several examples of how a knowledge of the geologic and physiographic conditions would be of direct practical value in other matters, aside from its more obvious applications to mining, and so forth, already given. The relation to engineering here is only indirect.

Cebu Island, one of the Visayan group of the islands of the Philippine Archipelago, is long, narrow, and mountainous. It has an interrupted narrow strip of coastal plain on which practically the entire population of the island (the most populous in the Archipelago) may be found. The people are comparatively poor and live largely on and by the sea. There is at present, owing to conditions produced by the war, a partial refutation of this statement. There is little productive "hin-

terland," or back country. The interior is high, rugged, and sparsely inhabited.

Near the sea, in places within a few meters of it, runs a first-class macadamized highway and, parallel with this man-made highway and the sea (the cheapest highway of all), a railroad has been built which has a spur running up to the Danao-Compostela coal field. Except the freight to and from the mines there is very little to haul over this railroad. Had it not been for the Government guarantee of 4 per cent, this venture would have been a great loss to the investors. A railroad cannot, except under unusual conditions, compete with transportation by sea, and it must have productive back country to feed it.

Although Magellan discovered the Philippine Archipelago by first landing at Cebu and although a large and prosperous city is there to-day, the physiographic advantages of the position of Manila are so superior that it has been able far to outstrip its southern rival, notwithstanding the fact that Manila as a Spanish city was not founded till nearly a half century later. Cebu is a distributing point and has to draw upon neighboring islands. In Manila we have a remarkable juxtaposition of sea, excellent harbor, river, mountain, and plain (affording a productive hinterland) which has led to the development of what is fast becoming the most important city of the Orient.

Seismology.—Earthquakes are not confined to the Tropics. Nevertheless, many regions of great seismic disturbances are either within the Tropics or not many degrees removed. There may or may not be any direct connection between these facts. It also happens that many of the geologically newer parts of the earth are within this zone. In view of the great engineering works built at Panama, in the Hawaiian Islands, in the Philippines, and elsewhere it is of prime importance to understand the principles controlling earthquake phenomena. The damage done at San Francisco by the slip along the San Andreas rift, the catastrophes of Messina and Avazzano, and the lesser disturbances that have occurred in the Philippines from time to time should force us to pull our heads out of the sand and look facts squarely in the face. Real estate boosters as a rule do not readily fall in with this idea.

For the benefit of the possible lay reader a few elementary facts are here repeated. Earthquakes are due to three causes; namely, rockfall, vulcanism, and slips along fault planes. These

are called tectonic. Those of the last group are most numerous and most destructive. The San Francisco earthquake of 1906 was of this class.

In an investigation conducted for many years by Father Saderra Masó, of the Philippine Weather Bureau, and the writer, we found that of the great number of earthquakes that occurred in the Philippines from 1599 to 1909 only a comparatively small number could be traced to volcanoes; that of the twenty-five seismic districts in the Islands only five are near or include active or dormant volcanoes; and that two regions of greatest seismicity have no volcanoes at all.

Recently some very interesting and important conclusions concerning the connection between seismic phenomena and rainfall have been put forward by M. G. Zeil,¹⁰ formerly topographer and geologist of the Government of French Indo-China and now of the Carte Geologique of France. This investigator asserts that seismicity in various parts of the world increases with rainfall. He mentions only one notable exception, the Valley of the Amazon, where, although the rainfall is heavy, seismicity is feeble. He cites, especially, the example of Agusan Valley in the Philippines to which Saderra Masó and the writer called attention some years ago, though not connecting the fact with the rainfall of the region.

It appears that the rapid loading and unloading of a given piece of terrain by a heavy rainfall which is discharged quickly into the lowlands or the sea, effecting considerable erosion, is the prime factor in many of the sudden adjustments in the outer shell of the lithosphere. In a heavily forested region like the Amazon the run-off of the streams is slow and consequently erosion is comparatively slight.

The rainfall would have still another effect, that of lubrication, thus causing slipping of one formation, or of the beds of the same formation, over one another.

M. Zeil in a letter to the writer has pointed out that in Annam, in those places where the natives have cut away the forests, the number and frequency of earthquakes have increased. Here is a splendid example of the need for coöperative investigations on the part of the engineer, the forester, the seismologist, and the geologist.

This particular subject is one to which we have as yet devoted little attention in the Philippines, but we shall in the future

¹⁰ Zeil, M. G., Acad. des Sci., Seance de 12 juillet (1920) 117-119.

attempt to follow up these most interesting suggestions of M. Zeil.

There are three things we must do in order to cope with earthquakes. The most obvious thing is in the line of engineering. We must build structures so tied together that the parts will not fly into fragments, and the material must be elastic. The safest and cheapest type of construction is the native house of bamboo wherein rattan takes the place of nails. Sand-lime brick securely tied to a steel frame, and reinforced concrete, are the most suitable for large buildings. Volcanic tuff (locally quarried as Guadalupe stone) is one of the best cheap materials I have yet seen. The walls and many of the older public buildings of Manila are constructed of this stone.

Aside from the class of building material to be used, is the all-important question of the nature of the ground on which large structures may safely be erected. The investigations of the California Earthquake Commission revealed very conclusively the dangers from "made ground" in regions subject to earthquakes. Nevertheless, in spite of their findings, of which any up-to-date engineer ought to have knowledge, we see right here in Manila large five- and six-storied structures (it is true they are of reinforced concrete) being erected on made ground or on river alluvium which is none too stable. Buildings of the skyscraper type, such as the Luneta Hotel, are nothing less than a defiance of good engineering sense. Piles and test borings have not yet been able to bottom on the Luneta. In fact, practically the whole of Manila is located on loose sand saturated with water. Indeed it is impossible to bury the dead below ground in most sections of Manila because of this fact. In such material large structures are subject to settling and they do settle. Furthermore, since seismic waves travel with the greatest acceleration and amplitude in loose formations, the displacement due to earthquake motions will be greatest on ground of this kind. Three or four stories ought to be the limit of height for buildings in Manila. The writer is glad to say that the city engineer of Manila (a Filipino) has tried to have an ordinance passed limiting buildings to five stories. This is certainly the absolute limit of safety in this country.

The geologists of countries subject to seismic disturbances must be instructed and must be afforded ample opportunity, in connection with their economic work, to map the geological details, such as formations, contacts, joints, faults, etc., in order that we may have data from which to draw conclusions of

importance. The work of the Italian geologists in Calabria and Sicily in this particular field of investigation has given us a fine example of what to do and how to do it.

Finally, as volcanic eruptions and tectonic earthquakes may both be connected with deep-seated phenomena in the earth magma, it behooves us to proceed vigorously and continuously with detailed volcanological studies along the lines laid down by Perrett, of the Vesuvius Observatory; Omori, of Japan; and Jagger, of the Volcano Observatory of Kilauea, Hawaii. If we do this we shall have a collection of data which in time will enable us to cope with these dreaded phenomena as we now do with the typhoon.

SUMMARY

1. The geological agents at work in tropical regions are the same as those found operating in temperate parts of the earth, with the difference that they are often greatly accelerated in the former.

2. In the Philippines structural conditions are of prime importance in engineering. Both major and minor faulting occur here which as yet have not caused trouble save in mining operations.

3. Both road location and maintenance in tropical countries like the Philippines are much more difficult than in the United States and Europe.

4. Dams and reservoirs should be avoided when possible in countries like the Philippines.

5. The instability of the Philippine geological structure is established.

6. Weathering of the rocks in tropical regions is notable. The so-called laterite, in some places of considerable economic importance, is a product of weathering. It is characteristic of many tropical countries.

7. The geologic work of organisms is great in the Tropics, though but little studied.

8. The work of tropical rain and running water is not appreciated as it should be.

9. Handbooks and formulæ prepared by engineers acquainted only with conditions in temperate regions are worse than useless in the Tropics. They are positively dangerous.

10. Engineers as a whole should, if possible, give more attention to the study of modern geology which is no longer merely a descriptive subject but is becoming more and more a close relative of engineering.

NOTES ON PHILIPPINE TERMITES, I

By S. F. LIGHT

Professor of Zoölogy, University of the Philippines

The social insects known as termites, "white ants" or, in Philippine dialects, as *anay*, constitute a distinct order, the Isoptera. They are most nearly related to the Orthoptera and Neuroptera and, within the former order, to the Blattidæ, or cockroaches. They are, therefore, among the more primitive of insects, as regards structure and life history, which but makes the more impressive the high development of social instincts and habits and the striking polymorphism and division of labor which characterize the group. In structure and development they are far removed from the true ants, of the order Hymenoptera, and as has been often pointed out the only reasons for the name "white ants" are that they form large colonies with a highly developed division of labor and specialization of castes, build mounds or nests, and display a complex social system—all suggestive of conditions among the true ants.

The termites present splendid opportunities for the study of social habits and instincts and are at the same time of very great economic importance because of the enormous damage caused by their attacks on wooden structures and even living trees and shrubs. Hence any work on termites—systematic, morphological, ecological, or faunistic—is of practical value and may have a direct, present-day bearing on human welfare.

The literature dealing with termites is very extensive. The works of outstanding importance are those of Smeathman (1781), Hagen (1855–1860, who gives a complete summary of all earlier work), Grassi and Sandias (1893), Froggatt (1895–1897), Sjöstedt (1896–1914), Wasmann (1896 to the present time), Haviland (1898), Silvestri (1901 to the present time), Banks (1901 to the present time but particularly his "A Revision of the Nearctic Termites," 1920), Heath (1903 and 1907), Desneux (1904–1907), Holmgren (1906 to the present time), Escherich (1908 and 1912), Bugnion (1910–1915), Oshima (1910 to the present time), Andrews (1911), Snyder (1912 to the present time), Fuller (1912 and 1915), Hill (1915

to the present time), Hozawa (1915), Thompson (1916 to the present time), and others.

In spite of the many and extensive studies which have been made on termites, the ecological field is barely touched, and much remains to be done along systematic and economic lines. This is particularly true in the Tropics, where termite life reaches its climax, and most strikingly is it the case in the Philippine Archipelago, where systematic study has been only begun and little has been done along biological lines.

Led but recently into this fascinating field of study through an investigation of the protozoan parasites which are found in the intestines of the more primitive genera, I regret that my study of the termites was not begun many years ago. They furnish an ideal combination of theoretical and practical interest. The strangeness of form and the variety in shape of the different species, particularly of their soldiers, the high development of caste and division of labor, the fascinatingly interesting glimpses of a complex social development based on instinct, the ever-present problem of lessening or preventing their inroads on wooden structures—all combine to make this one of the most compelling and profitable fields of insect study. This is particularly true in a region where the termites are all around one, where there is hardly a house but shows signs of their ravages, where any dead limb or stump, or piece of waste wood, or the very chair on which you sit may harbor a colony, perhaps of a species as yet unknown to science, at least interesting in all the details of its complex life and as yet practically unstudied.

The Philippine termite fauna is apparently very rich. This might be expected when we consider the large number of islands, the great variety of habitat, and the luxuriance of plant life.

In this set of Notes on Philippine Termites, I plan to work over the systematic field until all but the rarest species are thoroughly known. Ultimately, I hope to monograph our Philippine termites with full descriptions, illustrations, and keys. Such economic and biologic data as accumulate from time to time will also be published, and when the systematic work is on a firm basis I hope to publish the results of more extensive economic and ecologic investigations.

CLASSIFICATION

The classification of termites is in a superficially unsatisfactory condition due to various causes. This condition has resulted mainly from failure to follow more or less widely

accepted rules of nomenclature, from failure to investigate generic types and designate them in the case of new genera, and from lack of clear definitions of generic and subgeneric groups, as well as from the inherent difficulties involved in systematic work in a group where polymorphism occurs and where it is often necessary to establish species and even genera without all the variants, the adult or the soldiers being unknown in many cases. Conservatism on the part of the older workers in the group and a dislike to make radical changes in well-established generic names is easily understood and to be expected, and it may be said before going any further that the system of classification due mainly to Holmgren, and in part to Silvestri, Wasmann, Froggatt, and others seems to present a very natural arrangement of the families and genera of termites. Banks,¹ however, in a recent monograph on Nearctic termites, not only has presented a new grouping of the genera but has made radical changes in generic names based on a study of type species. *Odontotermes* and *Microcerotermes*, for example, become synonyms and are replaced, respectively, by the older generic names *Termes* and *Eutermes*, at present applied to other and very large groups.

Such a condition places the beginner in the field in a most unfortunate position. He recognizes on the one hand, the splendid results of the older workers and sympathizes with their very natural sentiments with regard to names of long standing, which are recognized by practically all termitologists; but, on the other hand, he sees the need and the great importance of definite rules of nomenclature. Therefore, he stands, as it were, at the parting of the ways, hesitant as to the path he shall follow, lacking that confidence which can only come from a mature knowledge of the field and, hence, feeling a natural temerity at the idea of attempting to change long-established usage but, on the other hand, lacking that sentiment for the older names so natural to one to whom the work of years has endeared them and, especially if a younger man, he finds himself facing a most unpleasant dilemma.

If further researches show that Banks's contentions as to generic types are justified, it seems inevitable that the changes in generic names which he proposes must in part at least be adopted. Not being able to verify them myself, however, I shall

¹ Banks, Nathan, A Revision of the Nearctic Termites, Bull. U. S. Nat. Mus. 108 (1920).

retain the older names until a more mature knowledge of the group or further researches on the part of other workers or consensus of opinion makes necessary the radical changes in generic names involved.

Several of the larger genera, *Calotermes*, *Termes*, and *Eutermes*, contain quite distinct subgroups which it has been customary to consider as subgenera, the result being cumbersome tripartite names. The recent tendency has been toward considering these groups as genera whenever possible, a tendency which makes for simplicity and greater ease in classification.

With regard to families, the divisions of Holmgren seem to fulfill the requirements of a natural classification but the names Protermitidæ, Mesotermidæ, and Metatermitidæ, not being based on type genera, must ultimately be replaced, preferably by Kalatermitidæ, Rhinotermidæ, and Termitidæ, respectively.

With regard to the use of adult characters or those of soldiers for classification, I agree with Banks to the extent that I believe the divisions between larger groups and the ultimate classification of the group as a whole should be based on the characters of the adult as being phylogenetically the typical form; but for practical purposes and for preliminary classification the characters of the soldiers are available and will be used by me, as indeed they are by him and all other systematic workers on termites. Were we to wait for the collection of the adults of the different species, we should be halted indefinitely in our study of Philippine forms, for the imago is unknown for nearly two-thirds of the species so far reported from the Philippines. Indeed, after some little collecting experience I am compelled to wonder at the almost marvelous success of Haviland in obtaining queens and winged adults under somewhat similar conditions.

Hagen,² in his very complete survey of the literature dealing with termites, mentions three very early descriptions of Philippine termites. I give them here because of their local historical interest rather than for their scientific value.

The first of these, and probably the first mention in literature of Philippine termites, is by Nieremberg³ in 1635 and consists of a description of an "ant" from the Philippines under the name of *sulum*, which Hagen believes to be a termite.

The second of these early notices of Philippine termites is

² Hagen, *Linnea Ent.* 9-12 (1855-1860).

³ Nieremberg, *Histor. nat.* 1635, fol. lib. 13, cap. 13, p. 28." Hagen, *Linnea Ent.* 10 (1855) 19.

found among descriptions of animals, etc., in a History of Mexico by Hernandez, published in 1651.⁴ Here again the animal concerned is given the name *sulum* and is believed by Hagen to be the same termite.

The third and last of these early descriptions of Philippine animals believed by Hagen to refer to termites is found in an article, describing various Philippine animals, written by the Jesuit Father Camel (Camelli) and communicated by Petiver⁵ in 1709 to the Royal Philosophical Society of London.

According to Hagen, who quotes extensively, Camelli gives descriptions of fourteen species of "ants" from the Philippines, of which Hagen believes that five possibly apply to termites. The first of these he believes to be the same as the *sulum* of Nieremberg and of Hernandez and gives it the name *bondoc* which means in Philippine dialects "mountain" or "hill" and is never used to mean ant or termite. It seems probable that Father Camelli misunderstood his informants and substituted the name of the habitat for that of the animal. The description he gives seems to suggest a termite, particularly with regard to the size of the queen or, as he puts it, the king and the form of the nest. The animals, however, are spoken of as being black. Hagen believed this to be a description of *Termes carbonarius*, which is darker than most termites. Unfortunately for this surmise, *T. carbonarius* has not been recorded from the Philippines. While this does not by any means prove that the species does not exist here, it suggests that *T. carbonarius* is not among our common forms, and consequently it is rather improbable that specimens of this species were found among the first known termites.

But for their habitat ("cushions and pillows!"), which has never been noted for a termite, the second of these descriptions might well apply to one of the smaller wood-attacking species, such as those of the genus *Coptotermes* or *Microcerotermes*, since he describes the insects as small, white, and about the size of a louse. To these he gives the name *cuyutil*, which I have not been able to place in any Philippine dialect, and speaks of the insects as living in cushions and pillows where they make their nests of clay. The word *cuitib* is used in Tagalog for

⁴"Hernandez, animalium etc. Mexican. historia Romae. fol. 1651, im angehängten liber unicus etc., p. 76." Hagen, Linnea Ent. 10 (1855) 29.

⁵"De variis animalibus Philippinensibus ex Mss. Geo. Jos. Camelli communicavit Petiver. Philos. Transact. 1709, vol. 26, No. 318." Hagen, Linnea Ent. 12 (1858) 247.

a very small red ant and it is barely possible that this has been distorted into *cuyutil*.

The next two descriptions seem to apply to some lac-forming insects rather than to termites, since they are called *lac-ha* and are spoken of as forming a gumlike mass; and, aside from their living in trees, there is nothing in the descriptions which would seem to place them as termites.

The last of the descriptions, and the only one which is undoubtedly that of a termite, refers to the terrible destructiveness of the insect to wooden structures, clothes, books, etc., and here for the first time we find recorded the name *anai* or *anay* almost universally applied to termites in Philippine dialects. It is, however, quite impossible to determine from the description which termite is here referred to, and one is led to believe that much of hearsay is mixed with a modicum of fact.

In the systematic portion of his monograph Hagen records only a single termite species, *Termes dives* Hagen,⁶ from the Philippines. His species was based on adult material from the Philippines and Java and has been shown by Holmgren⁷ to belong to the genus *Odontotermes*, and the soldiers described by Hagen to belong to *Termes gilvus*. It has not as yet been identified with any of our known forms.

The soldiers, larvæ, etc., collected in the Philippines by Heer and placed by Hagen under *Termes* are placed by Holmgren⁷ under the common Malayan *Macrotermes* species, *Termes gilvus*. This would seem to be Oshima's *T. (M.) copelandi* and it seems probable that the latter name must be considered a synonym of the first. Further study of a wide range of material will be necessary to clear up this point.

The next species to be reported from the Philippines was *Termes distans* Haviland, reported by him in 1898⁸ from the Sulu Islands.

Since Haviland's paper the only systematic work on Philippine termites has been done by Oshima, who has published descriptions in four different papers.⁹

The only biological work on Philippine termites consists of a paper by Uichanco (1919)¹⁰ on the biology of the common mound-

⁶ Hagen, *Linnea Ent.* 12 (1858) 139-142.

⁷ Holmgren, *Kungl. Sv. Vet. Akademiens Handlingar* 50, 2 (1913) 131.

⁸ Haviland, *Journ. Linn. Soc. London* 26 (1898) 401, 402.

⁹ Oshima, *Annot. Zool. Jap.* 8 (1914) 553-585; *Philip. Journ. Sci.* § D 9 (1916) 351; 12 (1917) 217-225; 17 (1920) 489-512.

¹⁰ Uichanco, *Philip. Journ. Sci.* 15 (1919) 59-65.

building form, probably *Termes* (*Macrotermes*) *copelandi* Oshima or *philippinensis* Oshima, and a paper by Brown (1918)¹¹ on the fungi cultivated by the mound-building termites identified by Oshima¹² as *Termes* (*Macrotermes*) *philippinensis* Oshima.

To date there have been reported from the Philippine Islands thirty-three species of termites; thirty by Oshima and one each by Hagen, Haviland, and Holmgren. Oshima's first Philippine material was collected by Prof. C. F. Baker, dean of the College of Agriculture, University of the Philippines, at Los Baños, where the College is located. That for his last three papers was collected by Mr. R. C. McGregor, associate editor of the Philippine Journal of Science, at present acting director of the Bureau of Science. Mr. McGregor has shown the greatest interest in my work as also in the previous termite work. He has been an invaluable aid both by personal collecting and by helping me to make collections as well as by his unflagging interest and enthusiasm. I wish to take this opportunity of expressing my appreciation for what he has done and, I feel certain, will continue to do to aid in the study of our termite fauna.

A list of the species reported from the Philippines forms a part of this paper. I do not feel ready to give the species the names which recent changes in the knowledge of generic types and diagnoses and a fuller comparative knowledge of our termite fauna may well require. I have therefore given them the scientific names under which they were reported from the Islands. The names and date or dates in parentheses refer to the reporter and date when reported.

Following each species the following data are given: 1, original locality; 2, distribution within the Archipelago and collectors; 3, distribution outside the Archipelago; 4, habitat notes; 5, imago, whether known or unknown.

Mr. Baker's material and that of Mr. McGregor, with the exception of one collection from Panay, was all collected within a radius of 65 kilometers of Manila. Therefore, collections having been made in but two islands, and in very limited regions of each, the distribution data will have but little faunistic value. It is hoped, however, that our future collecting may be sufficiently thorough to allow for the ultimate drawing of conclu-

¹¹ Brown, Philip. Journ. Sci. § C 13 (1918) 223-231.

¹² Oshima, Philip. Journ. Sci. 17 (1920) 489-512.

sions as to species range, faunal affinities, migration routes, etc.; the present data are given here merely to form a starting point for future studies on distribution.

TERMITES REPORTED FROM THE PHILIPPINES

Caloterms (*Neoterms*) *malatensis* Oshima, 1917. (Oshima, 1917, 1920.)

Original locality: Manila.

Philippine distribution: Luzon, Manila (*McGregor*).

No foreign distribution known.

"From a decayed limb of a small tree (*Samanea saman* Merrill)."

Imago known.

Caloterms (*Neoterms*) *lagunaensis* Oshima, 1920.

Original and only known locality: Luzon, Laguna Province, Paete (*McGregor*).

Imago unknown.

Coptotermes flavicephalus Oshima, 1914. (Oshima, 1914, 1916.)

Original and only known locality: Luzon, Laguna Province, Los Baños (*Baker*).

Imago unknown.

Coptotermes formosanus Shiraki, 1909. (Oshima, 1920.)

Original locality: Formosa.

Philippine distribution: Manila (*McGregor*).

Foreign distribution: Formosa, China Coast, and Japan.

"Formosa's most destructive termite."

Imago known from Formosa and Japan but not from the Philippines.

Coptotermes travians (Haviland, 1898). (Oshima, 1920.)

Original localities: Singapore and Sarawak.

Philippine distribution: Luzon, Manila (*McGregor*); Panay, Antique Province, Culasi (*McGregor*).

Foreign distribution: Malay Peninsula and Borneo.

"Making covered tunnels on telephone posts." "Attacking house posts, floors, clothing, and papers."

Imago known but not from the Philippines.

Rhinotermes (*Schedorhinotermes*) *bidentatus* Oshima, 1920.

Original and only known locality: Panay, Antique Province, Culasi (*McGregor*).

"Living in a decaying log in the forest."

Imago unknown.

Rhinotermes (*Schedorhinotermes*) *longirostris* (Brauer, 1865). (Oshima, 1916.)

Original locality: Nicobar Islands.

Philippine distribution: Luzon, Laguna Province, Paete and Sarai near Paete (*McGregor*).

Foreign distribution: Celebes and Nicobar Islands.

"Found in tunnels in a much decayed log."

Imago unknown from the Philippines.

- Rhinotermes* (*Schedorhinotermes*) *tarakensis* Oshima, 1914. (Oshima, 1920.)
 Original locality: Tarakan, Dutch Borneo.
 Philippine distribution: Luzon, Laguna Province, near Paete (*McGregor*).
 Foreign distribution: Borneo.
 Living "under a hard, round, black nest."
 Imago unknown.
- Termitogetonella* *tibiaoensis* Oshima, 1920.
 Original and only known locality: Panay, Antique Province, Tibiao (*McGregor*).
 "Living in an old log."
 Imago known.
- Termes* (*Termes*) *copelandi* Oshima, 1914. (Oshima, 1914, 1916, 1920.)
Termes (*Macrotermes*) *copelandi* Oshima, 1920.
 Original locality: Los Baños.
 Philippine distribution: Luzon, Laguna Province, Los Baños (*Baker*);
 Manila (*McGregor*); Rizal Province (*McGregor*); Palawan (*Schultze*);
 Panay, Capiz Province, Ibaday (*McGregor*).
 No foreign distribution known as such but if, as seems probable, this
 is *Termes gilvus*, it is widespread throughout the East Indies.
 "Forms broad low clay mounds." "Makes earthen runways over trees
 and shrubs eating their bark." One of the commonest mound-building
 termites, if not the only common mound-building species.
 Imago unreported as such.
 Common throughout East Indies.
- Termes* *dives* Hagen, 1858.
 Original locality: Manila (*Baron von Huegel, Heer, Chamisso*).
 Philippine distribution not known.
 Foreign distribution: Common throughout East Indies.
 Imago known.
- Termes gilvus* Hagen, 1858. (Holmgren, 1913.)
 Probably the same as *T. copelandi* Oshima.
- Termes* (*Macrotermes*) *luzonensis* Oshima, 1914. (Oshima, 1914, 1916, 1920.)
 Original locality: Los Baños.
 Philippine distribution: Luzon, Laguna Province (*Baker*); Rizal Province
 (*McGregor*).
 No foreign distribution known.
 "Builds large earth mounds and makes tunnels on *Artocarpus*." Prob-
 ably a form of *T. copelandi* or *T. gilvus*.
 Imago (queen) known but not described.
- Termes* (*Macrotermes*) *manilanus* Oshima, 1914. (Oshima, 1914, 1916, 1920.)
 Original locality: Manila.
 Philippine distribution: Luzon, Manila (*C. S. Banks*); Laguna Province
 (*McGregor*); Panay, Antique Province, Culasi (*McGregor*).
 No foreign distribution known.
 Known only from winged imago.

- Termes (Macrotermes) philippinensis* Oshima, 1914. (Oshima, 1914, 1916, 1917, 1920.)
Original locality: Los Baños, Laguna Province.
Philippine distribution: Luzon, Laguna Province (*Baker*); Manila (*McGregor*); Bulacan Province (*McGregor*); Panay, Antique Province, Culasi (*McGregor*).
No foreign distribution known.
"Builds large earth mounds. Makes tunnels on *Artocarpus*."
Imago known.
Common throughout East Indies.
- Odontotermes medioidentatus* Oshima, 1920.
Original and only known locality: Paete, Laguna Province (*McGregor*).
Imago unknown.
- Eutermes (Hospitalitermes) hospitalis* (Haviland, 1898). (Oshima, 1920.)
Original locality: Sarawak, Borneo.
Philippine distribution: Luzon, Rizal Province, San Francisco del Monte (*McGregor*).
Foreign distribution: Malay Archipelago, Borneo.
"Day foragers."
Imago known from Borneo but not from the Philippines.
- Eutermes (Hospitalitermes) luzonensis* Oshima, 1917. (*E. [H.] hospitalis* of Oshima, 1916.) (Oshima, 1917, 1920.)
Original locality: Sarai, near Paete, Laguna Province.
Philippine distribution: Luzon, Laguna Province (*McGregor*); Rizal Province (*McGregor*).
No foreign distribution.
"Day foragers."
Imago not known.
- Eutermes (Hospitalitermes) saraiensis* Oshima, 1916.
Only known locality: Sarai, near Paete, Laguna Province (*McGregor*).
Imago unknown.
- Eutermes (Ceylonitermes) mcgregori* Oshima, 1916. (Oshima, 1916, 1920.)
Original locality: Sarai, near Paete, Laguna Province.
Philippine distribution: Luzon, Laguna Province (*McGregor*); Panay, Antique Province (*McGregor*).
No foreign distribution known.
"In decayed wood."
Imago known.
- Eutermes (Eutermes) balintauacensis* Oshima, 1917. (Oshima, 1917, 1920.)
Original locality: Balintauac, near Manila, Rizal Province.
Philippine distribution: Luzon, Laguna Province (*McGregor*); Rizal Province (*McGregor*).
No foreign distribution known.
"Covered tunnels on *Caesalpinia sappan* Linn."
Imago unknown.

Eutermes (Eutermes) castaneus Oshima, 1920.

Original locality: Sarai, near Paete, Laguna Province.

Philippine distribution: Luzon, Laguna Province (*McGregor*); Panay, Antique Province (*McGregor*).

No foreign distribution known.

Imago unknown.

Eutermes (Eutermes) gracilis Oshima, 1916. (Oshima, 1916, 1920.)

Original locality: Sarai, near Paete, Laguna Province.

Philippine distribution: Luzon, Laguna Province (*McGregor*).

No foreign distribution known.

Imago unknown.

Eutermes (Eutermes) las-piñasensis Oshima, 1920.

Original locality: Sarai, near Paete, Laguna Province.

Philippine distribution: Luzon, Laguna Province (*McGregor*); Manila (*McGregor*); Rizal Province (*McGregor*); Bulacan Province (*McGregor*).

No foreign distribution known.

"Makes wide covered tunnels over *Pithecolobium* and *Barringtonia* which it attacks."

Imago unknown.

Eutermes (Eutermes) manilensis Oshima, 1916.

Original and only known locality: Manila (*C. S. Banks*).

Imago unknown.

Eutermes minutus Oshima. (Oshima, 1917.)

Reported from Las Piñas, Rizal Province (*McGregor*).

"Inside an old log."

Eutermes (Grallatotermes) luzonicus Oshima, 1914. (Oshima, 1914, 1916, 1920.)

Original locality: Los Baños, Laguna Province.

Philippine distribution: Luzon, Laguna Province (*Baker*); Manila (*McGregor*); Rizal Province (*McGregor*); Panay, Antique Province (*McGregor*); Capiz Province (*McGregor*).

No foreign distribution known.

"Attacks *Pithecolobium*, *Spondias*, bamboo, cocos, and wooden parts of houses." Our commonest *Eutermes* species.

Imago unknown.

Eutermes (Grallatotermes) panayensis Oshima, 1920.

Original and only known locality: Culasi, Antique Province, Panay (*McGregor*).

"From tunnels on large tree."

Imago unknown.

Eutermes (Trinervitermes) menadoensis Oshima, 1914. (Oshima, 1920.)

Original locality: Menado, Celebes.

Philippine distribution: Luzon, Rizal Province (*McGregor*); Laguna Province (*McGregor*).

Foreign distribution: Borneo and Celebes.

"Attacks *Ficus* and *Barringtonia*, making covered tunnels from nests on ground."

Imago unknown.

Eutermes (*Rotunditermes*) *culasiensis* Oshima, 1920.

Original and only known locality: Culasi, Antique Province, Panay (*McGregor*).

"In bark of decayed log."

Imago unknown.

Microcerotermes los-bañosensis Oshima, 1914. (Oshima, 1914, 1916, 1917, 1920.)

Original locality: Los Baños, Laguna Province (*Baker*).

Philippine distribution: Luzon, Laguna Province (*Baker*, *McGregor*); Manila (*McGregor*); Bulacan Province (*McGregor*); Panay, Antique Province and Batbatan Island (*McGregor*); Romblon (*McGregor*).

No outside distribution known.

"One of our commonest Philippine termites. Makes hard nests at base of bamboo, cocos, *Pithecolobium*, etc., and builds tunnels over them. Occasionally attacks houses and furniture."

Imago known.

Termes distans Haviland, 1898.

Original localities: Sulu Islands and Celebes.

Philippine distribution: Sulu Islands (*Haviland*).

Foreign distribution: Celebes.

Imago known.

Capritermes paetensis Oshima, 1920.

Original and only known locality: Paete, Laguna Province, Luzon (*McGregor*).

"In damp ground under vegetable waste."

Imago unknown.

These thirty-three species of termites, recorded from the Philippines, belong to nine genera. One genus, *Termitogetonella* Oshima, 1920, is known from the Philippines only.

No less than twenty-three of these thirty-three species were named from Philippine material and are known from that region only. Which of these are truly endemic cannot be determined until we have a much more thorough knowledge of the species on the Asiatic mainland, and the East Indies. That some of them will later be found to be present in nearby regions seems most probable. That some few of them will be found to be synonymous with species already described from Borneo, Singapore, Java, Japan, Formosa, etc., seems probable, particularly in the case of species belonging to the genera *Coptotermes*, *Macrotermes*, and *Eutermes*. Such cases will probably be comparatively rare, however, due to the fact that Professor Oshima had the peculiar advantage of studying his first Phil-

ippine material in connection with numerous species from the Malay Archipelago and adjacent regions. Oshima is also an authority on Formosan and Japanese termites and hence we should expect little overlapping of specific diagnoses with that region.

Judging from the fact that most termite species have a comparatively limited range, we should expect collections made from the central area of the Archipelago to yield a high percentage of endemic species. That not only the percentage of new species but the actual number of such species is high indicates that the Islands have a remarkably rich termite fauna.

The species are distributed as follows:

Luzon	27
Laguna Province	21
Manila and Rizal Province *	16
Bulacan Province	3
Panay	12
Antique Province	11
Capiz Province	2
Batbatan Island	1
Romblon	1
Palawan	1
Sulu Islands	1

* The city of Manila belongs naturally with Rizal Province and will be so considered in questions of distribution.

The numbers for the different provinces and islands are not, of course, an index of the number of termite species to be found in them, but are merely an indication of the amount of collecting done. The figures are given in order to form a starting point for further investigation. Nineteen species are so far known from Luzon only, four from Panay only, and one from the Sulu Islands only. Eight species are reported from both Panay and Luzon; one from Panay, Romblon, and Luzon (*Microcerotermes losbañosensis* Oshima); and one from Palawan, Panay, and Luzon (*Termes (Macrotermes) copelandi* Oshima). These would seem to be our commonest and most-widespread species, but further study may show them to be polyspecific groups. The former is a nest-building form, and the latter builds large, low, clay or earthen mounds. It is possible that the former will be found to consist of a number of closely related species, as Haviland suggests of the corresponding Borneo and Malay Archipelago forms. Furthermore, the *Macrotermes* groups will require very extensive and intensive study before we can diagnose the species with certainty.

Of the thirty-three species of Philippine termites nine, and possibly one more,¹³ have been reported from other regions. Of these but one, *Coptotermes formosanus* Oshima, is found in Formosa and Japan, and the other eight are from the East Indies and the Malay Archipelago. Six of these eight are found in Borneo and two in Celebes, showing the expected relationship of our fauna to that of those regions. Of these *Coptotermes travians* Haviland seems to have the greatest range, being reported from Ceylon and intermediate regions. Further study, however, may show our species to be distinct from that of Haviland.

The data as to interrelations of termite faunæ are so fragmentary at present as to make it impossible to speak with any surety, but we may confidently expect that further study will show our fauna to have a close relation, through Palawan and the Sulu Islands, with that of Borneo and the Malay Peninsula, and through the Babuyanes and Batanes with that of Formosa and Japan.

It will be seen that twenty-seven of the known species have been recorded from Luzon and that twenty of these were described by Oshima as new to science. The Luzon collections have been made in a very limited area within 65 kilometers of Manila, mainly in Laguna and Rizal Provinces (with the latter of which Manila should be included from the point of view of distribution), with some few from near the Rizal-Bulacan boundary. It might be expected that collections from so limited a region yielding so many new species would have exhausted the readily available new forms. On the contrary, however, collections made by Mr. McGregor and myself on four half-day trips over the same ground—that is, to Alabang, Antipolo, Balintauac, and Montalban, respectively—all type localities for many of Oshima's species—together with a few collections in and about Manila made by Mr. McGregor, myself, and some of my students show about thirty different species. Seventeen or more of these appear to be new to the Philippines and most, if not all, of these new to science. There is every reason to believe, therefore, that complete collections from the many islands of the Archipelago ranging from the Batanes in the north, which should give us an interesting intergradation with the Formosan fauna, to the Sulu Islands in the south, whose termite fauna should furnish interesting relationships with that of Borneo, Celebes, and the Malay

¹³ *Eutermes minutus* Oshima, Philip. Journ. Sci. § D 12 (1917) 225. I have been unable to locate the description of this species, which is mentioned in the above paper without references or subgenus.

Peninsula, should show the Philippine Archipelago to have one of the richest termite faunas of the world and one of the most interesting for the study of variation, distribution, and faunistic relations and their bearing on the problem of evolution.

Of the thirty-three species of termites known from the Islands the adult is known for only twelve. Mr. McGregor, who collected much of Oshima's material and who is at present aiding me in my collections, concurs with me in a feeling of admiration for the success of Haviland in procuring the adult forms of so many of the species which he describes. While we hope ultimately to achieve a similar success, it is rather discouraging to seek through a nest, piece by piece, only to find thousands of eggs and immature forms but no sign of adults. This has happened so many times with the forms which have nasute soldiers that we have come to the conclusion that the queen and king must be located in some subterranean chamber from which the eggs are transported to more exposed regions to pass through their development stages.

This is but one example of the many gaps to be filled before our knowledge of Philippine termites is at all complete. Aside from its systematic interest, every one of the many Philippine species presents a fascinating problem, almost untouched, in ecology, social habits, and morphology, and several of them present economic problems of great importance. Any extensive work along such lines must, however, await a fuller knowledge of the systematic position of our termite species.

The next of this series of notes will present descriptions of several new species belonging to genera or subgenera not here tofore reported from the Philippines.

NEW RECORDS AND SPECIES OF PSYLLIDÆ FROM THE
PHILIPPINE ISLANDS, WITH DESCRIPTIONS OF
SOME PREADULT STAGES AND HABITS ¹

By LEOPOLDO B. UICHANCO

*Of the College of Agriculture, University of the Philippines,
Los Baños, P. I.*

FIVE PLATES

The present paper is based largely on the materials I collected while working with Philippine plant galls from Mount Maquiling and the neighboring plains. Prof. Charles S. Banks and the students in economic entomology at the College of Agriculture, University of the Philippines, also contributed a number of specimens.

I have made an effort to follow throughout my paper the classification which has been so carefully worked out during the past seven or eight years by Prof. D. L. Crawford, now of the College of Hawaii, Honolulu, to whom our knowledge of this interesting family of insects is largely due. The terminology adopted for designating the various morphological parts used in classification is that discussed in Crawford's monograph (Crawford '14).

The galls of five of the insects treated in the present work have been described in an earlier paper (Uichanco '19). The character of these galls differs with the causative insect, and ranges from a simple convolution or depression in leaf lamina to very highly specialized and extraordinarily complex, well-defined formations. There are also species which are not gall-makers.

The study of the immature stages of these insects has been practically neglected, although it seems to be a most promising field from both the biologic and the taxonomic points of view. The habits of the nymphs, especially as to formation or non-formation of galls and the general characters of galls formed, are apparently uniformly similar for certain groups. Likewise, a number of distinctive taxonomic characters, such as

¹ Contributions from the Bussey Institution for Research in Applied Biology, Harvard University, No. 172.

the genal cones of the Triozinæ, early become apparent in the immature forms. A thorough study of these preadult stages may result in a more reliable establishment of the true systematic position of some anomalous genera, or be of help in distinguishing certain apparently closely related groups which hitherto have been difficult to separate. In the present paper descriptions of a few of the nymphal instars and their habits are included, and it is hoped that further collecting and field observations may lead to the accumulation of sufficient material for a more adequate treatise on this phase of the subject.

Subfamily LIVIINÆ Löw

Tribe APHALARINI (Löw)

Genus **HAPLAPHALARA** novum

Head very slightly declivous; vertex less than one-half as wide as long, flat; genæ roundly swollen ventrad to antennal tubercles; frons visible as a short sclerite-bearing anterior ocellus; eyes subglobose, prominent; anterior ocellus visible only from cephalic aspect of head; posterior ocelli not elevated; clypeus large; antennæ slender, not much longer than width of head. Thorax scarcely arched, slightly thicker than abdomen; pronotum nearly half as long as vertex, not depressed below level of latter, terminating laterad almost at level of eyes in a knoblike process; mesopræscutum about three times as long as pronotum; legs moderately long and slender; eight distal spines on hind tibiæ; meracanthi over twice as long as thickness at base; forewings subelliptical, rounded at apex, more or less maculated, subequal in length to body, nearly twice as long as wide; pterostigma large, open proximad. Abdomen slightly shorter than thorax.

Male.—Anal valve slightly longer than genital forceps, both without process. Genital segment roundly produced ventrad below level of adjacent proximal sternite.

Female.—Anal valve about as long as the rest of abdomen; ventral valve shorter than dorsal; both without process.

Type of the genus, *Haplaphalara dahli* (Rübsaamen).

The genus is very closely allied to *Aphalara* Förster, as recharacterized by Crawford ('14:24), resembling the latter in many characters. The following characters, however, distinguish it from *Aphalara*: Longer mesopræscutum in proportion to pronotum; absence of spines on basal tarsi of hind legs; presence of pterostigma; and absence of posterior lobe on male anal valve. The last two characters, according to Crawford,

are always present in *Aphalara*. The present genus is also distinguishable from *Aphalaroida* Crawford ('14:38) as follows: Vertex flattened and longer in proportion to width than in the latter; antennæ longer. The characters it has in common with *Aphalaroida* are as follows: Genæ somewhat roundly swollen ventrad; short frons; slight arching of thorax; lateral termination of pronotum in a knoblike swelling; thickened, semiopaque wings, with pterostigma; absence of process on male anal valve.

Haplaphalara dahli (Rübsaamen). Plate 2, fig. 16; Plate 3, fig. 23; Plate 4, fig. 41; Plate 5, fig. 51.

Aphalara dahli RÜBSAAMEN '05: 23.

Type locality.—BISMARCK ARCHIPELAGO, Coast of Rabakaul, February 27, 1897 (*Dahl*).

Male.—Length of body, 1.2 to 1.36 millimeters; width of head, 0.52 to 0.55; length of antennæ, 0.72 to 0.78; length of forewings, 1.28 to 1.3, width, 0.54 to 0.56. Brownish yellow. More or less thickly mottled with very dark brown as follows: Vertex; antennal segments I and II; distal segment of labium; thoracic nota and pleurites; hind coxæ; and abdominal tergites. Uniformly dark brown: Eyes; genital segment; genital forceps; anal valve; frons; genæ; clypeus; apical segment and distal half of subapical antennal segment; distal spines of hind tibiæ; and ungues. Pale stramineous: Sternum; trochanters; femora; tibiæ; tarsi; abdominal sternites, with exceptions noted above; and antennal segments, except as otherwise indicated above and except distal portions of IV, V, and VII, which are pale brown. Ocelli light brownish red. A uniformly dark brown, subtriangular spot occupying apical fourth of forewings; another lighter brown, broadly and irregularly linear, transverse band at middle portion; and a third subbasal, broadly linear, somewhat transverse, brown band; veins irregularly spotted with dark brown. Body and appendages finely reticulate, sparsely covered with moderately long hairs.

Head slightly narrower than thorax, very slightly declivous, dorsal surface subconfluent with pronotum. Vertex flat, about one and two-thirds times as wide as long, nearly truncate at cephalic margin, slightly rounded down in front; a shallow depression bordering anterior ocellus; caudal margin concave. Frons about one and two-thirds times as wide as anterior ocellus, visible from latter to base of clypeus; length subequal to width. Clypeus (cephalic aspect) subhemispher-

ical, with base located at about two-thirds the distance from dorsal to ventral surfaces of head. Genæ broadly swollen ventrad but not produced into genal cones. Eyes elongately subhemispherical, about two-thirds as thick as distance from margin of eye to median suture of vertex. Anterior ocellus flatly subhemispherical, subequal in diameter to antennal segment III, located mediad on anterior surface of head. Posterior ocelli subhemispherical, somewhat smaller than anterior, located near apices of angles formed by caudal and lateral margins of vertex. Antennæ about one and five-eighths times as long as width of head including eyes; segments I and II subequal in diameter, about one and two-thirds times diameter of III; the rest of the segments subequal in diameter to III; two slender apical setæ, subequal in length to apical segment, to which they are attached.

Thorax not strongly arched, about one and one-eighth times as long as wide; thickness about seven-ninths of length. Pronotum and mesopræscutum somewhat deflected cephalad but not depressed below level of adjoining sclerites; surfaces subconfluent. Pronotum about seven times as wide as long, terminating laterad slightly below level of eyes in a knoblike swelling. Mesopræscutum about two and three-fifths times as long as pronotum, about two and seven-tenths times as wide as long, irregularly subelliptical, more strongly arcuate at caudal than at cephalic margin, somewhat acutely produced laterad. Mesoscutum about one and three-tenths times as long as mesopræscutum, about two and two-fifths times as wide as long, irregularly subreniform; a short, spinelike projection from each lateral margin. Mesoscutellum about half as long as mesoscutum, about half as long as distance between points of attachment of axillary cords, truncate at cephalic margin, with a depressed, anteriorly directed projection which is confluent with surface of mesoscutum. Forewings subelliptical, slightly narrowed basad, rounded at apex; R and M + Cu subequal in length; pterostigma open proximad, slightly longer than first marginal cell; Rs, M, Cu₁ and anal margin of wing subparallel and subequidistant; first marginal cell elongate, about three times as large as second. Legs moderately long, femora about two and a half times as thick as tibiæ; eight moderately long, dark brown, distal spines on hind tibiæ; meracanthi about two and one-fourth times as long as thick, slightly deflected apicad.

Abdomen about one and one-seventh times as long as thorax, about one and one-eighth times as long as thick, about as thick

as wide. Genital segment roundly produced ventrad below level of adjacent proximal sternite. Anal valve about one-fourth as long as total length of abdomen, about twice as long as thick, rounded subapicad, and produced apicad into a short, slender, subconical projection. Genital forceps about four-fifths as long as anal valve, narrowly attenuate apicad. Anal valve, genital forceps and genital segment more thickly hairy than the rest of abdomen.

Female.—Anal valve about half the total length of abdomen, about as long as thickness at base, subacute distad, slightly flexed dorsad at apex. Ventral valve about two-thirds as long as anal, about twice as long as thickness at base, subconical, very acutely pointed distad.

Redescribed from six males and six females.

LUZON, Laguna, College of Agriculture, Los Baños, at an altitude of about 70 meters, January, 1919. College of Agriculture accession No. 18413.

The insect lives on *Thespesia populnea* (L.) Sal. (Malvaceæ), causing irregular depressions and wrinkles in the leaf lamina. Evidence of the work and of the presence of the preadult stages is noted throughout the year in the locality cited, but the adults seem to appear only in certain months.

The occurrence of this species or of any other representative of the subfamily Liviinæ has never been recorded from the Philippines before.

Rübsaamen ('05) reports the insect as producing galls on *Thespesia macrophylla* Blume in Bismarck Archipelago.

Subfamily PAUROPSYLLINÆ Crawford

Genus PAUROPSYLLA Rübsaamen

Pauropsylla udei Rübsaamen ('99: 262). Plate 1, fig. 1; Plate 2, fig. 13; Plate 3, fig. 18; Plate 4, fig. 33; Plate 5, fig. 44.

Male.—Length of body, 1.76 millimeters; width of head, 0.61; length of forewings, 2.08, width, 1.23. Dark yellowish brown. Light brownish yellow as follows: Ventral half of antennal tubercles; antennal segments I, II, III, IV, and basal three-fourths of V; clypeus; coxæ; meracanthi; trochanters; femora; tibiæ, except distal spines, which are dark yellowish brown; first tarsal segments; lateral borders of mesopræscutum and mesoscutum; ventral third of mesothoracic episternum; medial half of third abdominal tergite and cephalic margin of fourth. Eyes and ocelli reddish brown. Body and appendages finely

reticulated; more conspicuously so on vertex and nota; sparsely beset with moderately long hairs.

Head subequal in width to thorax, not strongly deflected. Vertex about four times as broad as long, slightly concave at occipital margin. Frons, a narrow sclerite bounding anterior ocellus, subtriangular along anterior and posterior borders of latter. Clypeus (cephalic view) irregularly subpyriform, subconically raised on each side ectodistad, about one and one-third times as long as wide. Eyes subhemispherical, about three-fourths as thick as distance from lateral margin to median suture of vertex. Diameter of anterior ocellus about three times that of antennal segment III. Posterior ocelli slightly smaller than anterior, somewhat prominently elevated. Antennæ about one and one-third times as long as width of head including eyes; segments I and II short and thick, subequal to each other in length and diameter; III one and one-third times as long and about one-third as thick as II; the rest of the segments distad subequal in diameter to III.

Thorax about one and one-third times as long as wide, one and one-eighth times as long as thick, slightly arched. Prothorax very short, depressed below, and almost hidden by cephalic emargination of mesopræscutum. Mesopræscutum irregularly subhemispherical, about as long as wide. Mesoscutum broadly crescent-shaped with concave margin directed cephalad, about one and a half times as wide as mesopræscutum, about twice as wide as long. Mesoscutellum about half as wide as mesoscutum, about three-fifths as long as wide, slightly deflected caudad; two shallow, broadly concave indentations at cephalic margin. Forewings obovate; apex broadly rounded: $M+Cu$ about one-fifteenth as long as $R+M+Cu$; first marginal cell about three times as large as second; a black, rather inconspicuous spot at anal margin between branches of cubitus; one between branches of cubitus and media; and a third between branches of media. Legs long and slender; hind leg about one and one-third times as long as fore or middle leg; unguis broadly curved.

Abdomen about four-fifths as long as head and thorax combined; slightly narrower than thorax. Genital forceps subequal in length to anal valve, elongately subovoid, about twice as long as wide. Anal valve irregularly subcylindrical, about two and a half times as long as wide. Genital forceps and anal valve more thickly beset with hairs than adjoining segments.

Female.—Genitalia about one-third total length of abdomen. Dorsal and ventral valves subequal in length and basal diameter, acutely pointed distad.

Nymphs (apparently full-grown living specimens).—Length of body, 2.25 millimeters; width of head, including eyes, 0.70; width of thorax, including wing pads, 1.6; length of forewing pads, 0.8, width, 0.4; length of abdomen, 1.3, width, 1.2. Dark orange yellow. Light yellow as follows: Antennæ, wing pads, and legs. Eyes dark brick-red. A slightly raised, median, dorsal ridge visible from middle of pronotum to caudal end of abdomen. Body and appendages smooth and shiny, free from waxy coating, sparsely beset with short hairs.

Head about three and a half times as wide as long, subequal in width to prothorax. Vertex rounded cephalad. Eyes moderately large, subhemispherical; caudal portion recessive into pronotum. Antennæ subequal in length to width of vertex, slender, slightly tapering toward apex.

Thorax not arched, about one and a half times as long as wide, subquadrangular at dorsum. Forewing pads about one and one-third times as long as thorax, semitranslucent, subangularly pointed ectodistad at apex. Legs stout and moderately long, sparsely pubescent; division between tibiæ and tarsal segments indistinct; unguis broadly curved.

Abdomen subcircular from dorsal aspect, very obtusely rounded caudad, shorter but wider than thorax, sparsely pubescent.

LUZON, Laguna, Los Baños Falls, near Los Baños, at an altitude of about 50 meters, January, 1917; Mount Maquiling, at altitudes of 70 to 150 meters, August, 1917. College of Agriculture accession No. 18310 (*Uichanco*).

Numerous specimens of this insect were bred from leaf galls on *Ficus variegata* Blume (Moraceæ). For descriptions of the gall, see Rübsaamen '99: 261, and Uichanco '19: 546, Pl. 6, figs. 2, 4, and 5; pl. 13, fig. 1. The causative insect was tentatively reported in the latter paper as *Pauropsylla montana* sp. nov. (MS); but a further study of the specimens before me shows that their characters are those of *P. udei* Rübsaamen. The nymphs of the present collection differ from the one figured by Rübsaamen ('99: 266, text fig. 13) in that the abdomen of the former is shorter in proportion to the body.

Rübsaamen evidently made an error in reporting the host plant as a species of Rubiaceæ. The shape of the leaf in his text figure 7, page 261, and the position, relative size, and form of the

galls, in this and in his Plate 1, figures 6 and 7, together with his descriptive notes, are apparently identical with the work of this insect as I found it on *Ficus variegata*.

Crawford ('15: 258, pl. 1, fig. F) described the insect as *P. bakeri* sp. nov., and in a later paper (Crawford '19: 145) reported its identity with Rübsaamen's species, by which the former is preoccupied.

Pauropsylla triopectera Crawford ('13: 296). Plate 1, fig. 5; Plate 2, fig. 14; Plate 3, fig. 19; Plate 4, fig. 34; Plate 5, fig. 45.

Male.—Length of body, 1.7 millimeters; width of head, 0.64; length of antennæ, 0.96; length of forewings, 2.72, width, 1.49. Dark reddish brown. Brownish yellow as follows: Antennal segments I, II, and III, and basal fourth of IV, VI, and VII; ocelli; legs, except distal spines of femora and tibiæ and distal third of ungues, which are dark brown; genital segment; genital forceps; and anal valve. Body smooth and shiny, sparsely and briefly pubescent, more densely so at mesopræscutum, mesoscutum, mesoscutellum, femora, tibiæ, tarsi, genital segment, genital forceps, and anal valve.

Head subequal in width to thorax, not deflected. Vertex about three and one-third times as wide as long, deeply concave. Frons about four and a half times as long as wide, visible as a narrow sclerite from anterior ocellus to base of clypeus. Eyes subhemispherical, about three-fourths as thick as distance from lateral margin to median suture of vertex. Anterior ocellus subhemispherical, subequal in size to posterior. Posterior ocelli prominently elevated. Antennæ about one and a half times as long as width of head including eyes; segment I slightly thicker than II; I and II subequal in length; II about three times as thick as III; III and the rest of the segments distad subequal in diameter.

Thorax robust; length slightly shorter than thickness and about three-fourths of width. Prothorax short and completely hidden from above by cephalic portion of mesopræscutum. Mesopræscutum subpentagonal, about three-fourths as long as wide, broadly rounded down cephalad; cephalic margin describing an angle of about 90°; an abruptly subconical projection on each lateral area. Mesoscutum subreniform; concave margin directed cephalad; about two and two-fifths times as wide as long, about five-sixths as long as præscutum; a lateral, somewhat anteriorly divergent, abruptly subconical projection

on each side. Mesoscutellum about three-fourths as long as mesoscutum, about one and two-thirds times as wide as long, somewhat deflected caudad, roundly emarginate mesocephalad at cephalic margin, abruptly produced subconically ectad at anterolateral angles. Mesosternum slightly produced ventrocephalad. Wings asymmetrically obovate, hyaline; apex somewhat angular along direction of second marginal cell; pterostigma and cubital petiole wanting; first marginal cell about twice as large as second; a small, elongately subtriangular area covered with coarse brown dots between branches of cubitus, one between branches of cubitus and media, and a third between branches of media. Hind legs slightly shorter than body; fore and middle legs somewhat shorter than hind; unguis broadly curved.

Abdomen subequal in length to thorax, somewhat strongly deflected caudad, about one and a half times as long as wide, about as thick as wide. Anal valve about three-sixteenths as long as the whole of abdomen, about twice as long as diameter at base, truncately subconical, slightly constricted subdistad. Genital forceps subequal in length to anal valve, about one and a half times as long as diameter at base, vaguely retort-shaped with diameter of neck about half that of larger portion.

Female.—Dorsal and ventral valves subconcolorous with the rest of abdomen, more densely pubescent than latter. Dorsal valve narrowly subconical, acutely produced apicad, more densely pubescent than ventral, about as long as the rest of abdomen, about three and one-third times as long as diameter at base. Ventral valve slightly shorter than dorsal, about twice as long as diameter at base.

Newly emerged adults.—Bluish green. Eyes dark brown. Greenish yellow as follows: Antennal segments I and II; mesopleura and metapleura; mesosternites and metasternites; legs; and, in male, genital forceps and anal valve.

Nymph (apparently full-grown).—Length of body, 2.12 millimeters; width of head, 0.67; length of antennæ, 0.48; length of forewing pads, 0.8, width, 0.35; length of abdomen, 0.96, width, 0.9. Bluish green, lighter on head. Eyes brick red. Body and appendages covered with a white waxy coating, very sparsely beset with moderately long hairs.

Head slightly narrower than thorax, about two and a half times as wide as long, broadly rounded cephalad. Eyes subhemispherical, with caudal portions touching thorax, about three-eighths as thick as width of head. Antennæ about

three-fourths as long as width of head; segment I slightly thicker than II; II about one and one-third times as thick as III.

Thorax not arched, about one and one-fifth times as long as wide. Forewing pads about three times as long as wide, broadly rounded apicad. Hind legs about half as long as body; fore and middle legs about five-sevenths as long as hind; subdistal third of femora in all legs slightly curved entad; unguis about one and one-fourth times as long as diameter of tibiæ, strongly curved subapicad.

Abdomen about one and two-fifths times as long as thorax, about as long as wide, irregularly subcircular from dorsal aspect, slightly narrowing down caudad; caudal margin truncate, without process.

Younger nymphal instars.—Distinguishable from full-grown nymphs by their smaller size, brighter red eyes, and, in very early instars, absence of wax coating.

LUZON, Laguna, College of Agriculture, Los Baños, at an altitude of about 42 meters, January and March, 1917. Accession No. 18309, College of Agriculture collection (*Uichanco*).

This species passes its preadult stages in the very common leaf galls on *Ficus ulmifolia* Lam. (Moraceæ). For a description of the gall and some field observations on the adult insect, see Uichanco ('19: 545, pl. 6, fig. 1; pl. 12, figs. 1, 5, and 6). The gall is apparently similar to the work of an Indian species of Psyllidæ on *Ficus glomerata* Roxb., as figured by H. M. Lefroy ('09: pl. 80, fig. 6).

Pauprosylla tuberculata Crawford ('12: 430). Plate 1, fig. 3; Plate 2, fig. 12; Plate 4, fig. 35; Plate 5, fig. 46.

Male.—Length of body, 0.9 to 1 millimeter; width of head, 0.53 to 0.64; length of antennæ, 0.35 to 0.4; length of forewings, 1.12 to 1.36, width, 0.53 to 0.6. Very dark reddish brown. A large, subtriangular, depressed, reddish orange area on metapleura. Yellowish brown as follows: Fore and middle legs; hind tibiæ and tarsi; antennæ, except distal segments, which are dark reddish brown; mesopræscutum; and distal third of anal valve. A broadly subtriangular, longitudinal, median, light reddish brown band, and a concolorous, broadly sublinear area on cephalic half of lateral margin, on mesoscutum; also on cephalic margin of mesoscutellum and median third of abdominal tergites III and IV. Body and appendages sparsely and briefly pubescent.

Head slightly wider than thorax, strongly deflected. Vertex about one and a half times as wide as long, deeply concave at occipital margin, strongly rounded down in front; a shallow, longitudinal fovea cephalad to antennal tubercle. Eyes sub-hemispherical, somewhat thicker dorsad than ventrad, about as thick as distance from lateral margin to median suture of vertex. Genæ somewhat swollen ventrad to antennal tubercles. Posterior ocelli subequal in diameter to anterior, slightly elevated. Antennæ a little more than half width of head, slender from segment III distad; distal segment slightly incrassate; apical setæ very slender, about half the total length of antennæ. Clypeus large and subglobose.

Thorax robust, strongly arched, about one and one-fifth times as wide as long, about one and two-fifths times as thick as wide. Pronotum about one-seventh as thick as vertex, about six times as wide as long, deflected cephalad, greater part of lateral portion concealed by eyes. Mesopræscutum about four times as long as pronotum, about two and seven-tenths times as wide as long. Mesoscutum subequal in length to mesopræscutum, about four-sevenths as long as wide. Mesoscutellum about half as long as mesoscutum, abruptly produced at anterolateral angles. Hind legs excluding coxæ about one and one-ninth times as long as body; basal tarsi with two clawlike spines distad; unguis light brown, short, broadly curved; meracanthi moderately long, about one and two-thirds times as long as diameter at base. Fore and middle legs excluding coxæ subequal in length, about one-third as long as corresponding parts of hind legs. Forewing about one and two-fifths times as long as body, narrowly obovate, about twice as long as wide, about twice as wide subdistad as subproximad, broadly rounded at apex; R one and a half times as long as M + Cu; R + M + Cu subequal in length to R; pterostigma wanting; $M_1 +_2$ and Rs subangularly bent with corresponding vertices coalescent; first marginal cell about one-twentieth as large as second.

Abdomen about seven-tenths as long as thorax, about one and two-fifths times as thick as long, about as long as wide; third abdominal tergite greatly produced dorsad; fourth much more so. Anal valve about one-seventh as long as abdomen, about two and four-fifths times as long as thick, slightly thicker basad, truncate apicad. Genital forceps about two-thirds as long as anal valve, thicker basad, somewhat sloping distad, subacute

at apex. Anal valve and genital forceps more thickly pubescent than the rest of body.

Female.—Dorsal and ventral valves acute apicad, abruptly subconical, more densely pubescent than the rest of body. Dorsal valve about three-elevenths as long as abdomen, about one and a half times as long as thickness at base, somewhat elevated at border of anus. Ventral valve about two-thirds as long as dorsal, about as long as wide, abruptly produced apicad.

Newly emerged female.—Bright yellow. Eyes grayish white. Last apical antennal segment black. Abdomen and legs subcolorous, lighter yellow than thorax. A white, transverse band on two or three proximal abdominal tergites.

Nymph (age unknown; balsam mounts).—Length of body, 1.15 millimeters; width of head, including eyes, 0.44; length of antennæ 0.4; length of forewing pads, 0.43, width, 0.22; length of abdomen, 0.56, width, 0.53. Body and appendages sparsely covered with moderately long hairs.

Head subequal in width to thorax; about one and five-sixths times as wide as long, obtusely subangular at anterior margin. Eyes subhemispherical, about one-fifth as thick as total width of head. Antennæ subequal in length to width of head, acutely pointed distad.

Thorax about as long as wide, about as wide as thick. Hind legs about one-third as long as body; femora slightly arcuate entad; unguis strongly curved. Fore and middle legs subequal in length, slightly shorter than hind, in other respects similar to hind legs. Forewing pads about twice as long as wide, about one and one-sixth times as long as thorax, roundly sloping ectodistad at base; apex subparallel to basal slope; intermediate portion subequal in width throughout.

Abdomen about as long as wide, subcircular from dorsal aspect; caudal margin rounded, without process.

LUZON, Laguna, College of Agriculture, Los Baños, at an altitude of about 50 meters. Five males and five females on pins; seven nymphs on slide; reared from leaf galls on *Alstonia scholaris* R. Br. (Apocynaceæ), May, 1917. College of Agriculture accession No. 18322 (*Uichanco*).

This species is apparently of wide distribution in the Orient. The gall caused by the insect has been described from Bismarck Archipelago by Rübsaamen ('05: 7); by Leeuwen-Reijnvaan from Java ('10: 38) and from Celebes ('16: 24); and by Uichanco from the Philippines ('19: 544, pl. 5, figs. 1 and 2; pl. 12, figs.

2 and 3). The adult (apparently female), nymph, and work, as they occurred in India, have been beautifully figured in colors by H. M. Lefroy ('09: 742, pl. 80, figs. 2-5), and the insect and its host plant casually mentioned in the text, but he evidently did not recognize it then as a new species. The first taxonomic description of this species was published by Crawford ('12) from six females bred on "pumpkin" and on *Alstonia scholaris*. The adult male and the nymphs are described for the first time in the present paper.

Genus LEPTYNOPTERA Crawford

Leptynoptera sulfurea Crawford ('19: 147). Plate 1, figs. 5 and 6.

Type locality.—MOLUCCAS, Amboina (*Muir*).

Leptynoptera sulfurea rubrocincta var. nov. Plate 1, fig. 4; Plate 3, fig. 20; Plate 4, fig. 38; Plate 5, fig. 48.

Male.—Length of body, 1.44 to 1.52 millimeters; width of head, 0.45 to 0.48; length of antennæ, 0.72; length of forewings, 2.05 to 2.16, width, 0.9 to 0.96. Light greenish yellow. Light brown as follows: Eyes; antennal segments I and II, and basal half of VIII; fore and middle femora; tibiæ and tarsi in all legs; an irregular, narrowly sublinear band near and parallel to caudal margin of hind coxæ; median third of abdominal sternites III and IV. Very dark reddish brown: Distal half of antennal segments IV, VI (except a proximal greenish yellow portion), distal half of VIII, and the whole of IX; the greater portion of anal valve ventrad; a broad, sublinear marking on each side of genital segment from dorsal margin to apex of its caudoventral projection; apices and distal spines of hind tibiæ; and meracanthi. Ocelli brownish yellow. Four longitudinal, narrowly sublinear, white, waxy bands on vertex from caudal margin to level of anterior ocellus and bordering foveæ; another transversely on pronotum; another linear waxy band on median area and one on each side inclosing an irregularly elliptical, sublateral area of mesopræscutum; five longitudinal waxy bands on mesoscutum, the middle one being subconfluent with the corresponding band of mesopræscutum. A subovate, bright red area bounded cephalad by a dark brown line on laterocaudal area of abdominal tergites IV to VII; a bright red, narrow, transverse band bounded cephalad by a dark brown line adjoining caudal margin of IV; a small, subcircular red spot on laterocephalic angle of abdominal sternite III. An elongately subrhomboid brown spot, intersecting a median, elongate, white band, running from

C+Sc entad and occupying about half of cell formed by C+Sc, R+M+Cu, and R; a dark brown, diffuse spot on anal vein near distal end of clavus, another near primary fork of R+M+Cu; a brown, subtriangular spot adjoining anal margin between branches of media and another between branch of media and cubitus. Body and appendages sparsely covered with rather long hairs.

Head slightly narrower than thorax, not deflected. Vertex nearly as long as wide, very slightly concave at caudal margin; cephalic margin somewhat produced laterad into a prominent, abrupt protuberance near base of antennal tubercle; lateral margins slightly raised above level of eyes; one rather deep, narrowly subelliptical, longitudinal fovea on each side of vertex between median suture and lateral margin. Genæ slightly swollen, abruptly produced cephalad beyond margin of vertex. Frons visible ventrad to anterior ocellus as an elongate sclerite, about three and a half times as long as wide, slightly narrower dorsad, rounded at dorsal end. Clypeus about one and two-thirds times as wide as frons, about one and one-fifth times as long as wide, about twice wider distad than proximad. Eyes subhemispherical, slightly thicker than distance from lateral margin to median suture of vertex. Anterior ocellus subhemispherical, not prominent. Posterior ocelli subequal in size to anterior, slightly elevated. Antennæ about one and three-fifths times as long as width of head including eyes; segments I and II subequal in thickness, three times as thick as III, both segments with ventral portions of apex produced.

Thorax robust, not strongly arched, about as thick as long, about six-sevenths as wide as thick. Pronotum short, about one-ninth as long as vertex, about fourteen times as wide as long. Mesopræscutum about six times as long as pronotum, about one and a half times as wide as long, deflected cephalad at an angle of about 45°. Mesoscutum subequal in length to mesopræscutum, about three times as wide as long. Mesoscutellum about half as long as mesoscutum, almost truncate at cephalic margin. Forewings hyaline, costal margin subparallel to anal; apex almost truncate, rounded toward costal margin, somewhat angular toward anal; pterostigma wanting; radial sector broadly arcuate; cubital petiole wanting; cubitus not forked. Hind wings about one-fifth as long as fore, cleft from apex to near base, giving wings a biramous appearance, dark brown along costal margin and base. Hind legs excluding coxæ about five-sixths as long as body, five abrupt, rather stout spines

entad on apices of tibiæ; meracanthi short, about one and one-third times as long as thickness at base; ungues broadly curved. Fore and middle legs shorter than hind.

Abdomen about one and two-sevenths times as long as thorax, about one and four-fifths times as long as thick; thickness subequal to width. Genitalia about half as long as total length of abdomen; genital segment produced caudoventrad beyond genital forceps at an angle of 30° to 40° from median line of body; distance from apex of elongation to base of segment about three times width. Anal valve about one-sixth total length of abdomen, about one and one-third times as long as wide, somewhat attenuate and rounded apicad, abruptly petiolate basad. Genital forceps subequal in length to anal valve, about three times as long as wide, slightly thicker proximad than distad, nearly truncate at apex. Anal valve and genital forceps more densely hairy than the rest of body.

Female.—Abdomen subequal in length to thorax. Genitalia about half total length of abdomen. Dorsal valve about one and one-seventh times as long as ventral, about two and a half times as long as thickness at base, about half as thick at distal half as at basal, rounded at apex. Ventral valve about six times as long as thickness at base, acute apicad. Dorsal and ventral valves more thickly hairy than the rest of body.

Described from eleven males and nine females.

Cotypes.—No. 18348, College of Agriculture, University of the Philippines.

LUZON, Manila, Government Laboratories accession No. 5160, February 17, 1906, one male, one female, and one imperfect specimen with broken genitalia (*Banks*); Manila, Bureau of Science accession No. 14771, November 16, 1911, two specimens (*Banks*), on *Calophyllum inophyllum* L. (Guttiferæ); Laguna, Los Baños, College of Agriculture accession No. 18348, March 11, 1918, eleven males and nine females (*Uichanco*), on the same plant. The gall has been previously described (*Uichanco* '19: 544, pl. 13, fig. 4).

The present variety differs from the species, as originally described by Crawford, as follows: Longer vertex in proportion to width, presence of waxy bands on vertex and notum; slightly longer antennæ; absence of basal spur on hind tibiæ; longitudinal bifurcation of hind wings; red spots on the abdomen (not evident in one female of the series); and additional brown spots on forewings. The type of the species is unfortunately a single, partly mutilated example, and the differences noted

herein may have been due to the difficulty in working with an imperfect specimen. When more is known about the Moluccan insect, the present variety may finally have to be merged with the species. As the case now stands, however, there appear to be sufficient differences from Crawford's description to justify the tentative placing of the Philippine material before me in a separate variety.

In erecting the genus, Crawford ('19:147) made some remarks regarding its being an anomalous one on account of its possessing some of the characters of both Pauropsyllinæ and Triozinæ. Supplementary to the characters he enumerated may be mentioned the caudally produced genital segment, which in combination with the reduced hind wings and other peculiarities point to a close affinity with certain members of Triozinæ, particularly *Trioza diptera* Crawford ('19:191, pl. 3, figs. 6 and 7).

Genus PAUROCEPHALA Crawford

Paurocephala kleinhofæ sp. nov. Plate 1, fig. 2; Plate 3, fig. 21; Plate 4, fig. 37; Plate 5, fig. 47.

Male.—Length of body, 0.88 to 0.96 millimeters; width of head, 0.46 to 0.48; length of antennæ, 0.26 to 0.31; length of forewings, 1.04, width, 0.48 to 0.52. Brownish yellow. Dark brown as follows: Apical and distal half of subapical segments of antennæ; eyes; median suture of vertex; junction of radial, medial, and cubital branches with marginal veins of forewings; a spot on anal vein midway between proximal and distal ends of clavus; pleura and coxæ (unevenly so); anterior, posterior, and lateral margins of abdominal tergites and lateral three-sevenths on each side of abdominal sternites, except genital segment, anal valve, and genital forceps. Light stramineous: A narrow, sublinear band bordering each side of median suture of vertex; laterocephalic tubercle of pronotum; a narrowly subtriangular, median spot from caudal to near cephalic margin of pronotum and another at mesopræscutum; posterior margin of latter; four faintly visible, longitudinal, narrowly linear markings on median third, and a diffusely subcircular area adjoining laterocephalic margin of mesoscutum; lateral third on each side of mesoscutellum near bases of axillary cords; median prominences of pseudometanotum and fourth to seventh abdominal

tergites; hind tibiæ and distal portions of hind femora (more darkly so). Body and appendages very sparsely and briefly pubescent.

Head subequal in width to thorax, somewhat deflected. Vertex about one and four-fifths times as wide as long, concave at caudal margin between posterior ocelli, broadly arcuate at cephalic margin, rounded down in front, somewhat depressed arcuately from lateral margins ventrad. Genæ slightly swollen ventrad to antennal tubercles. Eyes subglobular, about five-sixths as thick as distance from lateral margin to median suture of vertex. Clypeus subglobose, about one and a half times as thick as anterior ocellus. Anterior ocellus subhemispherical, not prominently set. Posterior ocelli subellipsoid, slightly smaller than anterior, somewhat prominently elevated due to up-curved edges of vertex. Antennæ about five-eighths as long as width of head including eyes; diameter of segments I and II subequal and about one and one-third times that of III; the rest of the segments subequal in diameter to III; two apical setæ, subequal in length to each other, and about three times as long as distal segment.

Thorax robust; not strongly arched, about eight-ninths as long as thick; width subequal to length. Pronotum about three-fourths as long as vertex, about four and a half times as wide as long; a prominent, subhemispherical tubercle on laterocephalic margin. Mesopræscutum about one and a half times as long as pronotum, about twice as wide as long, subangular laterad, abruptly deflected at lateral and caudal margins. Mesoscutum about one and two-fifths times as long as mesopræscutum, nearly twice as wide as long, broadly rounded down toward margins. Mesoscutellum about one-third as long as mesoscutum and about the same proportion to distance between points of attachment of axillary cords; anterolateral angles produced into abruptly subconical, somewhat divergent projections. Pseudometanotum produced caudad into a prominent, erect, subconical projection. Wings hyaline, irregularly obovate, broadly rounded at apex; R very slightly shorter than M+Cu; pterostigma slightly smaller than first marginal cell, subelliptical, with an inner, equally subelliptical area bounded by suture; first marginal cell subelliptical, about two and one-third times as long as wide and about twice area of second;

second marginal cell subtriangular. Hind legs longer than fore or middle; unguis broadly curved; meracanthi about three times as long as thick, of uniform thickness, rounded at apex.

Abdomen about one and one-third times as long as thick; width subequal to thickness; fourth, fifth, and sixth tergites with a prominent, erect, abruptly subconical, median tubercle; seventh with a longer and caudally directed projection at caudal margin. Anal valve about one-fourth total length of abdomen, about three times as long as thick, subcylindrical, somewhat flattened out at apex. Genital forceps about two-thirds as long as anal valve, about two and a half times as long as diameter at base, subconical.

Female.—Genitalia deflected at an angle of about 120° , anal valve about half the total length of abdomen, about twice as long as thickness at base, subconical, very acute at tip. Ventral valve about four-fifths as long as anal, about one and three-fourths times as long as diameter at base, very acutely pointed at apex, broadly curved subapically dorsad. Anal and ventral valves beset midway with irregular whorls of somewhat long, caudally divergent, bristlelike hairs.

Described from five males and nine females.

Cotypes.—No. 18415, in College of Agriculture, University of the Philippines.

LUZON, Laguna, College of Agriculture, east of "temporary building," Los Baños, at an altitude of about 50 meters, December, 1918. Accession No. 18415, College of Agriculture collection (*Uichanco*).

Nymphs and adults feed on leaves of *Kleinhofia hospita* L. (Sterculiaceæ), causing shallow, subhemispherical depressions in the leaf lamina. The insect produces no waxy secretion in any of its stages.

Paurocephala psyloptera Crawford ('13: 294).

Type locality.—LUZON, Laguna, Los Baños (*Baker*), on *Ficus ulmifolia* Lam. (Moraceæ).

Paurocephala psyloptera maculipennis var. nov. Plate 1, fig. 6; Plate 2, fig. 17; Plate 3, fig. 22; Plate 4, fig. 36; Plate 5, fig. 50.

Male.—Length of body, 1.5 millimeters; width of head, 0.65; length of forewings, 1.76, width, 0.8. Very dark fuscous. Light stramineous as follows: Ocelli; antennal segments I to III and basal half of IV; hind coxæ and trochanters; prothoracic femora and tibiæ. Brownish yellow: Mesothoracic and

metathoracic femora and tibiæ. Eyes light reddish brown. Body finely and irregularly reticulated. Body and appendages very sparsely and briefly pubescent.

Head subequal in width to thorax, slightly deflected. Vertex about four times as broad as long, conspicuously concave dorsad; caudal half hidden mediad from above by prothorax. Ocelli small, somewhat less in diameter than antennal segment III; anterior subequal in diameter to posterior. Eyes subglobose, subequal in thickness to distance from lateral margin to median suture of vertex. Antennæ about one and two-thirds times as long as width of head including eyes; diameter of segment I slightly greater than II; II about one and two-thirds times III; the rest of the segments distad subequal in diameter to III. Clypeus large and subglobose.

Thorax robust, slightly longer than wide, about as wide as thick. Length of pronotum about one-fifth that of mesopræscutum; the former deflected and partly hidden laterad beneath latter. Mesopræscutum irregularly pentagonal, about half as long as wide, produced on each side into an abrupt, caudolaterally diverging spine. Mesoscutum subequal in length to mesopræscutum; about one and one-third times as wide as long, irregularly subcircular. Mesoscutellum less than half as wide as mesoscutum, concave at cephalic margin. Metascutum with an erect, subconical epiphysis dorsad. Wing hyaline, irregularly obovate, broadly rounded at apex, slightly more than twice as long as wide. Pterostigma about one-third area of first marginal cell, brown. Hind legs slightly longer than body, about one and one-third times as long as middle legs; entire length of hind tibiæ sparsely armed with moderately long spines. Fore and middle legs subequal in length; ungues broadly curved.

Abdomen subequal in length to thorax; length about twice width, and one and one-sixth times thickness. Fifth tergite elevated dorsocaudad above level of sixth. Genital segment, together with anal valve and genital forceps, nearly one-fourth total length of abdomen, strigose. Genital forceps subellipsoidal, slightly shorter than anal valve and subequal in diameter to latter. Anal valve elongately subellipsoidal.

Female.—Genitalia about two-fifths total length of abdomen, deflected at an angle of 80° to 120° from longitudinal axis of body, very sparsely pubescent. Dorsal valve subequal in diameter to ventral; length of former about one and one-fourth times that of latter; both acutely subconical. Ventral valve broadly curved subapically dorsad.

Described from fourteen males and eight females.

Cotypes.—No. 18178, in College of Agriculture, University of the Philippines.

The present variety is distinguished from the species principally by its strongly deflected head, brown pterostigma, and darker brown abdomen, which is concolorous with notum.

Nymphs (living specimens).—Very light whitish yellow. Black as follows: Apical and subapical antennal segments; distal portions of the rest of antennal segments proximad. Eyes red. Tibiæ and tarsi reddish white. Body and appendages sparsely covered with long hairs and an irregular thin coating of wax. A slender, fluffy, waxy filament, usually longer than body, joined to each side of subapical abdominal tergite.

The species, likewise, has been reported to produce similar waxy secretions (Crawford '15:260), and it is said to be attended by ants.

Nymph (apparently full-grown; mounted in balsam).—Length of body, 1.84 millimeters; width of head, including eyes, 0.6; length of forewing pads, 0.64, width, 0.2; length of abdomen, 1.04, width, 0.59; length of larger caudolateral wax glands, 0.2, thickness, 0.09. Light yellow. Eyes red. Brown as follows: Ungues; terminal and subterminal antennal segments. Body and appendages very sparsely covered with moderately long hairs.

Head slightly narrower than thorax, obtuse at cephalic margin. Vertex about one and one-fourth times as long as wide. Eyes subhemispherical, about four-sevenths as thick as width of vertex. Two small, irregularly diffuse areas situated meso-caudad from eyes and concolorous with latter, presumably representing posterior ocelli. Antennæ about twice as long as width of head including eyes; basal two segments shorter and thicker than the rest, as in adult.

Thorax about one and one-eighth times as long as wide, subuniform in width throughout. Hind legs about one and one-fifth times as long as middle; fore and middle legs subequal in length; ungues curved apicad.

Abdomen about one and six-sevenths times as long as thorax; width about half the length; uniform in width from thorax to beginning of caudolateral wax glands; obtusely angular caudad, terminating in a small, subcylindrical, caudal segment, about twice as wide as long and about two-sevenths as wide as larger portion of abdomen; two short, bristlelike hairs on each side of caudal segment ectodistad. Larger pair of subreniform wax

glands about twice as long as wide, nearly one-sixth as long as total length of abdomen, apparently situated on each side of fifth abdominal segment. A smaller pair, immediately caudad to and adjoining larger pair, about three-fifths as long as latter, nearly three times as long as wide, subuniform in width throughout.

LUZON, Laguna, Los Baños, at an altitude of about 50 meters, February 2, 1918, College of Agriculture accession No. 18178 (*Uichanco*). On nether surface of fully expanded young leaves of *Ficus nota* Merrill (Moraceæ).

The insects are mostly confined to an area along the midrib, and their presence is accompanied by a deposition of a white, fluffy coating of wax on the infested area of the leaf. The leaf margins are often more or less curved inferiorly.

Subfamily CARSIDARINÆ Crawford

Genus **TYORIA** Walker

Tyoria indica Crawford ('19:159). Plate 1, fig. 7; Plate 3, figs. 24 and 25; Plate 4, fig. 39; Plate 5, fig. 49.

Male.—Length of body, 2.24 to 2.72 millimeters; width of head, 0.6; length of forewings, 3.2 to 3.6, width, 1.12 to 1.28. General color light clay yellow, with conspicuous, longitudinal, reddish orange streaks marking borders of foveæ on vertex and terga; distal portions of antennal segments IV to VIII, inclusive, and the whole of IX and X, dark brown. Body and appendages very sparsely and briefly pubescent.

Head slightly narrower than thorax, not deflected. Vertex somewhat broader than long, with one longitudinal fovea on each side between median suture and lateral margin. Frons visible as a narrow, elongate, subtriangular sclerite bordering anterior ocellus, subequal in width to diameter of anterior ocellus. Anterior ocellus large, reddish brown, prominent. Posterior ocelli subequal in diameter to anterior, less prominent. Eyes dull yellowish brown, subhemispherical; diameter about three-fourths length of vertex. Genæ produced cephalad into moderately large antennal sockets. Antennæ about three-fourths as long as body without wings; segments I and II subequal in length, about one-fifth as long as III; diameter of I about one and one-fourth times that of II; of II, about one and one-fourth times that of III; IV to X, inclusive, subequal in diameter to III.

Thorax not strongly arched; about two and a half times as long as wide. Pronotum two-thirds as long as vertex; with

eight ridges, conspicuous but less prominent than those bordering foveæ at vertex, arranged as follows: One bordering each lateral margin of pronotum; another parallel to and very near each of former; the last two pairs almost aligned with ridges at vertex. Three much less prominent ridges on mesopraescutum, equidistant from each other and from the lateral margins of latter. Five obsolete, longitudinal, subequidistant ridges on mesoscutum. Legs concolorous with body; hind legs slightly longer than thorax; first and second pairs slightly shorter than third. Characteristic basal spur on hind tibia concolorous with the rest of leg. Hind tibiæ and tarsi of all legs equipped with dark brown, distal spines. Wings hyaline. Forewings about three times as long as broad; subacute at apex; R+M+Cu, cubital petiole, and media in almost one continuous straight line; R+M+Cu and cubital petiole subequal in length; area of first marginal cell about half that of second; a dark brownish tinge on terminal portions of veins; pterostigma wanting; a dark brown, acutely triangular spot between branches of media, and another between branches of media and cubitus.

Abdomen subequal in length to head and thorax combined, gradually tapering caudad. Longer pair of genital forceps about two and three-fifths times as long as anal valve, the forceps consisting of two parts: (1) a suberect, slender pair, curved cephalad near apex, about four times as long as diameter at base, abruptly pointed apicad; and (2) a shorter pair, about half as long as, and situated cephalad and parallel to, former, about four times as long as diameter at base, slightly curved cephalad, subacute apicad. Anal valve without process, about one and a half times as long as wide, somewhat constricted basad; the rest of uniform thickness. Penis drawn subhorizontally cephalad beyond anal valve to about seventh abdominal tergite; length from dorsal surface of genital segment to apex of penis about three and one-third times that of anal valve.

Female.—Dorsal and ventral valves subequal in length; both acute and tapering, forming with the genital segment a very slender, subconical projection which is slightly shorter than eighth abdominal segment. Eighth abdominal sternite beset caudad with numerous long, bristlelike hairs.

LUZON, Manila, Bureau of Government Laboratories accession No. 9931, February 11, 1909, two males and eight females on pins and two males on slides (*Banks*). MINDANAO, Kolambugan, Bureau of Science accession No. 18567, June, 1914 (*Banks*).

The specimens before me appear to differ from Crawford's original description in certain minor color characters only.

Subfamily PSYLLINÆ Puton

Genus **EPIPSYLLA** Kuwayama

Epipsylla forcipata Crawford ('17: 167). Plate 2, fig. 8; Plate 3, figs. 26 and 28; Plate 5, fig. 54.

One slightly damaged female specimen, apparently belonging to this species, collected in Manila on May 8, 1910 (*Banks*), No. 18568, Bureau of Science collection. This specimen appears to differ slightly from Crawford's type as follows: Pterostigma opaque; another proximal opaque area contiguous to pterostigma and bordering costal margin of wing. However, in as much as the specimen before me is imperfect and I have no means of deciding whether or not this is an abnormality, I deem it inadvisable to place this insect in another variety.

Genus **PSYLLA** Geoffroy

Psylla similæ Crawford ('12: 246). Plate 2, fig. 10; Plate 3, fig. 29; Plate 4, fig. 42; Plate 5, fig. 52.

One male, two females, and a fourth specimen with broken abdomen, collected at Los Baños, Laguna, Luzon, at an altitude of about 50 meters, accession No. 18516, College of Agriculture collection, March 8, 1915 (*Banks*); from the same locality, accession No. 18517, College of Agriculture collection, February 17, 1917 (*A. Goco*). This species was formerly known only from Simla, West Himalayas, at an altitude of about 2,100 meters.

Subfamily TRIOZINÆ Puton

Genus **MEGATRIOZA** Crawford

Megatrioza banksi sp. nov. Plate 2, fig. 15; Plate 3, fig. 32; Plate 4, fig. 43; Plate 5, fig. 53.

Male.—Length of body, 3.44 millimeters; width of head, 0.64; length of antennæ, 1.4; length of forewings, 5.36, width, 1.36. General color dark yellowish brown; ventral surface of body, legs, and antennal segments III to VII lighter brown; antennal segments I and II, longitudinal ectal halves of genal cones, and ocelli red, unicolorous; vertex and notum pale yellowish brown, with lateral margins of dorsal sclerites dark brown; two dark brown, sublinear, rather broad, subparallel, longitudinal stripes extending from lateral fourth on each side of mesoscutellum to

cephalic margin of pronotum; a dark brown, very broadly linear spot bounding median suture of vertex, occupying about one-third total area of latter, and continuous thence through longitudinal ental half of genal cones. Body and appendages sparsely beset with rather long hairs; genal cones densely hirsute.

Head scarcely narrower than thorax, very slightly deflected. Vertex about one and a half times as broad as long, slightly and broadly concave mediad, broadly cleft at caudal margin. Ocelli large, subequal to each other in diameter; anterior more prominent than posterior. Eyes subhemispherical, slightly thicker than distance from lateral margin to median suture of vertex, dark brown. Genal cones porrect, long, slender, subconical, rounded apicad, noncoalescent, more densely hirsute ventrad than dorsad, about three times as long as diameter at base, slightly shorter than vertex. Antennæ about twice as long as width of head; segments III to IX slender.

Thorax robust, less than twice as long as wide, slightly arched. Pronotum about one-third as long as vertex; pronotum and cephalic two-thirds of mesopræscutum with a broadly suppressed, longitudinal, median carina which terminates cephalad in a short, horizontal, subtriangular emargination. Mesopræscutum and mesoscutum with a pair of abruptly subconical projections at lateral margins. Hind legs about twice as long as thorax; hind femora and tibiæ relatively thick; the latter somewhat hirsute, equipped with moderately large, subconical, divergent spurs basad and subdistad, and four black spines and a number of bristlelike hairs apicad; ungues broadly curved. Forewings about four times as long as wide, hyaline and membranous, with a faint brownish tinge, subacute at apex; cubital petiole and pterostigma wanting; Rs about half the length of M, the two veins subparallel; first marginal cell about one and a half times as large as second; a large, elongately subtriangular, dark reddish brown mark along anal vein between Cu_2 and base of wings; a very small, much less conspicuous, subtriangular, light brown spot between branches of cubitus, another between branches of cubitus and media, and a third between branches of media, near apex.

Abdomen subequal in length to thorax; about twice as long as wide. Genital forceps slightly longer than anal valve, both subconical, rounded apicad.

Female.—Anal and ventral valves about one-third total length of abdomen, the former slightly longer than the latter, subequal to each other in diameter, both subacute apicad, slightly

hairy; hairs on anal valve somewhat longer than those on ventral.

Described from one male and one female.

Type and allotype.—No. 18569, in Bureau of Science collection.

MINDANAO, Kolambugan, Bureau of Science accession No. 18569, June, 1914 (*Banks*). Food plant not recorded.

This species appears to be closely related to *M. armata* Crawford ('15:264), but is distinguishable from the latter as follows: Presence of large, reddish brown spot along anal vein of forewings subbasal; genal cones slightly shorter than vertex; antennæ shorter in comparison with width of head; and pronotum much shorter than vertex.

Megatrioza pallida sp. nov. Plate 2, figs. 9 and 11; Plate 3, figs. 27, 30, and 31; Plate 4, fig. 40; Plate 5, fig. 55.

Male.—Length of body, 1.76 millimeters; width of head, 0.48; length of antennæ, 0.6; length of forewings, 2.88 to 3.04, width, 0.96. Light yellowish brown. Dark brown as follows: Two irregularly linear markings running longitudinally cephalocaudad from caudal margin of mesoscutum, near cephalic angles of mesoscutellum, to cephalic margin of mesopræscutum; marginal areas of pronotum, cephalic marginal area of mesopræscutum, and submarginal areas of abdominal tergites and sternites I to V; an irregularly diffuse spot marking each of the two foveæ at vertex; apices of genal cones; distal portions of antennal segments IV and VI, proximal and distal portions of VII, the whole of VIII, except a very small, faintly yellow, basal portion, and the whole of IX and X. Apex of genital forceps and ungues brownish black. Distal tarsal segments in all legs yellowish brown. Body and appendages very sparsely and briefly pubescent.

Head slightly narrower than thorax, somewhat declivous. Vertex about one and a half times as broad as long, cephalic emargination describing an angle of about 120°; a rather deep, angular fovea on each side extending from caudal margin to proximity of base of antennal tubercles and located midway between median suture and lateral margin of vertex. Ocelli subconcolorous with vertex: anterior ocellus moderately large, fairly prominent; posterior ocelli somewhat smaller than anterior, a large portion basad hidden beneath cuticular surface. Eyes large and prominent, dark yellowish brown, subhemispherical, about as thick as distance from lateral margin to median suture of vertex. Genal cones small, about one-fourth

as long as vertex, subporrect, slightly curved dorsad at apices. Length of antennæ about one and one-fifth times width of head; diameter of segment I about one and one-third times that of II; of II, about one and two-thirds times that of III; the rest of the segments distad subequal in diameter to III.

Thorax robust, slightly arched, about one and one-third times as long as broad. Pronotum about one-seventh as long as mesopræscutum, slightly deflected but confluent with surface of latter. Mesopræscutum about one and one-sixth times as long as wide; cephalic margin broadly angular, caudal broadly curved. Mesoscutum remotely crescent-shaped, about twice as wide as long. Cephalic margin of mesoscutellum about one-third width of mesoscutum. Wings large, hyaline, membranous, with a faint yellowish tinge, about three times as long as wide, subacute at apex; wing veins subconcolorous with body; cubital petiole and pterostigma wanting; Rs slightly shorter than M; the two veins running subparallel to each other; first marginal cell about two and a half times as large as second; a small, inconspicuous, acutely subtriangular, marginal spot, consisting of minute dark brown dots, between branches of media, another between branches of media and cubitus, and a third between branches of cubitus. Hind legs about one and one-third times as long as thorax; hind tibiæ equipped with a short basal spur and three distal, broadly curved spines. Middle legs subequal in length to thorax, slightly longer than forelegs; unguis broadly curved.

Abdomen subequal in length to thorax, about twice as long as broad. Anal valve slender, subconical, about twice as long as diameter at base, broadly curved caudad near apex. Genital forceps slightly shorter than, and subequal in basal diameter to, anal valve, less acutely pointed distad than latter, curved caudad near apex. Genital segment, genital forceps, and anal valve beset with much longer hairs than the rest of body.

Female.—Dorsal valve about two-fifths total length of abdomen, about one and two-fifths times as long as diameter at base, subconical. Ventral valve slightly shorter than dorsal, about three times as long as diameter at base; apical half about three-fifths as thick as basal. Dorsal and ventral valves more thickly beset with longer hairs than the rest of body.

Cotypes.—No. 18174, in College of Agriculture, University of the Philippines.

Nymph (earlier instar).—Length of body, 1.44 millimeters; width of head, 0.5; length of antennæ, 0.26; width of thorax, including wing pads, 1.2; length of forewing pads, 0.84, width,

0.36; length of abdomen, 0.61, width, 1. Ventral surface of body somewhat convex, dorsal almost plane. Cephalic margin of head, costal margin and apex of forewing pads, and abdomen fringed with numerous subcylindrical hairs. Hairs slightly attenuate apicad, about seven times as long as thick, semitranslucent. Basal tubercle of hair about one and one-fourth times as thick as hair, about one and a half times as long as wide; insertion of hair visible through distal third of tubercle. Surfaces of body and of wing pads less thickly covered with hairs; hairs of the same description as above.

Head about one and four-sevenths times as wide as long; cephalic margin broadly rounded, with a deep, narrow, median cleft. Eyes subhemispherical; caudal fourth partly hidden laterad by thorax; about one-sixth as thick as total width of head. Antennæ about half as long as width of head including eyes, somewhat thicker basad, slightly attenuate at apical third; a moderately long hair on apical segment distad; another subdistad.

Length of thorax apparently subequal to width.² Forewing pads about three times as long as wide, subacute apicad, rounded ectoproximad; intermediate portion uniform in width throughout. Hind legs about two-thirds as long as body; fore and middle legs slightly shorter than hind; ungues sharply bent over at apical third.³

Abdomen subequal in length to thorax, about two-thirds as long as wide, subhemidiscoidal; anal segments without process.

LUZON, Laguna, Los Baños, at an altitude of about 50 meters, January, 1918. College of Agriculture accession No. 18174 (*Uichanco*). Reared from leaf galls on *Mallotus philippensis* (Lam.) Muell.-Arg. (Euphorbiacæ). For a description of the gall, see Uichanco '19: 546, pl. 5, fig. 3; pl. 13, figs. 2 and 3.

² The lateral margins of the thorax are very much obscured by the wing-pads and are almost indistinguishable in the mounted specimens.

³ No living specimens were available at the time of writing, and on this account color notes, presence or absence of waxy coating, and such other characters as can be studied only from fresh material are not reported here. The present description is based on balsam mounts and some fragmentary field notes.

LITERATURE CITED

CRAWFORD, D. L.

- '12. Indian Psyllidæ. *Records Indian Mus.* 7 (1912) 419-435, pls. 33-35.
- '13. New genera and species of Psyllidæ from the Philippine Islands. *Philip. Journ. Sci.* § D 8 (1913) 293-299, pl. 1.
- '14. A monograph of the jumping plant lice, or Psyllidæ, of the New World. *Bull. U. S. Nat. Mus.* 85 (1914) 1-169, pls. 1-30.
- '15. Ceylonese and Philippine Psyllidæ (Homoptera). *Philip. Journ. Sci.* § D 10 (1915) 257-267, pl. 1.
- '17. Philippine and Asiatic Psyllidæ. *Philip. Journ. Sci.* § D 12 (1917) 163-174, pl. 1.
- '19. The jumping plant lice of the Palæotropics and the South Pacific Islands. *Philip. Journ. Sci.* 15 (1919) 139-205, pls. 1, 2.

LEEUWEN-REIJNVAAN, W. AND J. DOCTERS VAN

- '10. Einige Gallen aus Java, III. *Marcellia* 9 (1910) 37-61.
- '16. Niederländisch ost-indische Gallen. *Bull. Jard. Bot. Buitenzorg* II 21 (1916) 24.

LEFROY, H. MAXWELL.

- '09. *Indian Insect Life.* Calcutta and Simla (1909) 1-786.

RÜBSAAMEN, E. H.

- '99. Mittheilungen über neue und bekannte Gallen aus Europa, Asien, Afrika und Amerika. *Ent. Nachrichten* 25 (1899) 225-282, pls. 1, 2.
- '05. Beiträge zur Kenntnis aussereuropäischer Zoocecidien. I. Gallen von Bismarck Archipel. *Marcellia* 4 (1905) 5-25.

UICHANCO, L. B.

- '19. A biological and systematic study of Philippine plant galls. *Philip. Journ. Sci.* 14 (1919) 527-550, pls. 1-15.

ILLUSTRATIONS

[Unless otherwise specified, all illustrations of adult parts are based on the male.]

PLATE 1

- FIG. 1. *Pauropsylla udei* Rübсаamen, forewings, female, $\times 29.5$.
2. *Paurocephala kleinhofia* sp. nov., forewings, $\times 29.5$.
3. *Pauropsylla tuberculata* Crawford, forewings, $\times 29.5$.
4. *Leptynoptera sulfurea rubrocincta* var. nov., forewings, $\times 29.5$.
5. *Pauropsylla triozyptera* Crawford, forewings, $\times 29.5$.
6. *Paurocephala psyloptera maculipennis* var. nov., forewings, $\times 29.5$.
7. *Tyoria indica* Crawford, forewings, $\times 29.5$.

PLATE 2

- FIG. 8. *Epipsylla forcipata* Crawford, forewings, $\times 26.2$.
9. *Megatrioza pallida* sp. nov., forewings, $\times 26.2$.
10. *Psylla similæ* Crawford, forewings, $\times 26.2$.
11. *Megatrioza pallida*, outlines of forewing pads, nymphs, $\times 56.4$.
12. *Pauropsylla tuberculata*, outlines of forewing pads, nymphs, $\times 56.4$.
13. *Pauropsylla udei*, outlines of forewing pads, nymphs, $\times 56.4$.
14. *Pauropsylla triozyptera*, outlines of forewing pads, nymphs, $\times 56.4$.
15. *Megatrioza banksi*, sp. nov., forewings, $\times 26.2$.
16. *Haplaphalara dahli* (Rübсаamen) gen. nov., forewings, $\times 26.2$.
17. *Paurocephala psyloptera maculipennis*, outlines of forewing pads, nymphs, $\times 56.4$.

PLATE 3

- FIG. 18. *Pauropsylla udei*, head, anterior aspect, $\times 50.8$.
19. *Pauropsylla triozyptera*, head, anterior aspect, $\times 50.8$.
20. *Leptynoptera sulfurea rubrocincta*, head, lateral aspect, $\times 50.8$.
21. *Paurocephala kleinhofia*, head, anterior aspect, $\times 50.8$.
22. *Paurocephala psyloptera maculipennis*, head, anterior aspect, $\times 50.8$.
23. *Haplaphalara dahli*, head, dorsal aspect, $\times 50.8$.
24. *Tyoria indica*, head, female; anterior aspect, $\times 50.8$.
25. *Tyoria indica*, head, dorsal aspect, $\times 50.8$.
26. *Epipsylla forcipata*, head, dorsal aspect, $\times 50.8$.
27. *Megatrioza pallida*, antenna, nymph, $\times 224$.
28. *Epipsylla forcipata*, head, female; lateral aspect, $\times 50.8$.
29. *Psylla similæ*, head, anterior aspect, $\times 50.8$.
30. *Megatrioza pallida*, head, anterior aspect, $\times 50.8$.
31. *Megatrioza pallida*, hair on forewing pads, nymph, $\times 448$.
32. *Megatrioza banksi*, head, dorsal aspect, $\times 50.8$.

PLATE 4

- FIG. 33. *Pauropsylla udei*, male genitalia, \times 63.5.
34. *Pauropsylla triozyoptera*, male genitalia, \times 63.5.
35. *Pauropsylla tuberculata*, male genitalia, \times 63.5.
36. *Paurocephala psyloptera maculipennis*, male genitalia, \times 63.5.
37. *Paurocephala kleinhofiae*, male genitalia, \times 63.5.
38. *Leptynoptera sulfurea rubrocincta*, male genitalia, \times 63.5.
39. *Tyoria indica*, male genitalia, drawn from balsam mounts, \times 63.5.
40. *Megatrioza pallida*, male genitalia, \times 63.5.
41. *Haplaphalara dahli*, male genitalia, \times 63.5.
42. *Psylla simlæ*, male genitalia, \times 63.5.
43. *Megatrioza banksi*, male genitalia, \times 63.5.

PLATE 5

- FIG. 44. *Pauropsylla udei*, female genitalia, \times 50.8.
45. *Pauropsylla triozyoptera*, female genitalia, \times 50.8.
46. *Pauropsylla tuberculata*, female genitalia, \times 50.8.
47. *Paurocephala kleinhofiae*, female genitalia, \times 50.8.
48. *Leptynoptera sulfurea rubrocincta*, female genitalia, \times 50.8.
49. *Tyoria indica*, female genitalia, \times 50.8.
50. *Paurocephala psyloptera maculipennis*, female genitalia, \times 50.8.
51. *Haplaphalara dahli*, female genitalia, \times 50.8.
52. *Psylla simlæ*, female genitalia, \times 50.8.
53. *Megatrioza banksi*, female genitalia, \times 50.8.
54. *Epipsylla forcipata*, female genitalia, \times 50.8.
55. *Megatrioza pallida*, female genitalia, \times 50.8.

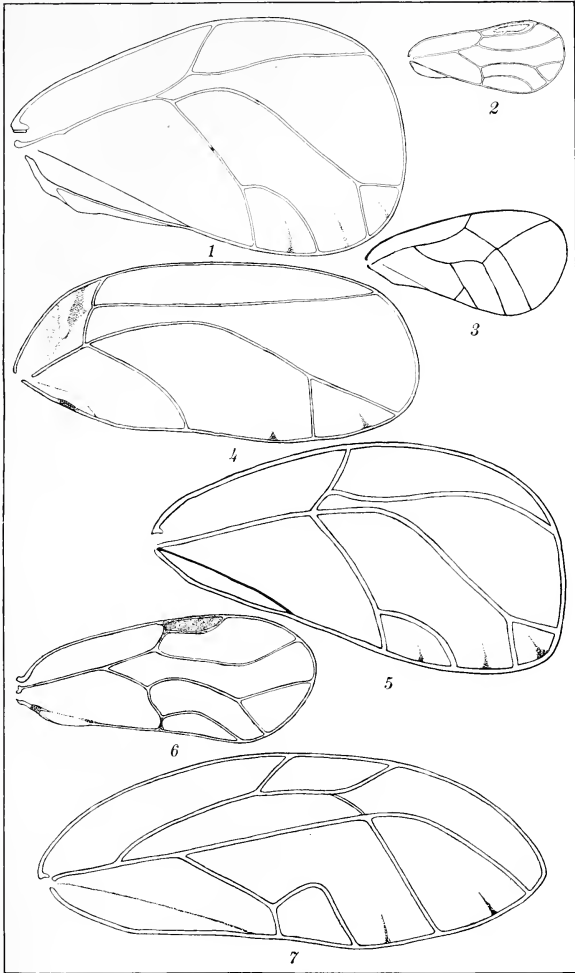

PLATE 1. PHILIPPINE PSYLLIDÆ.

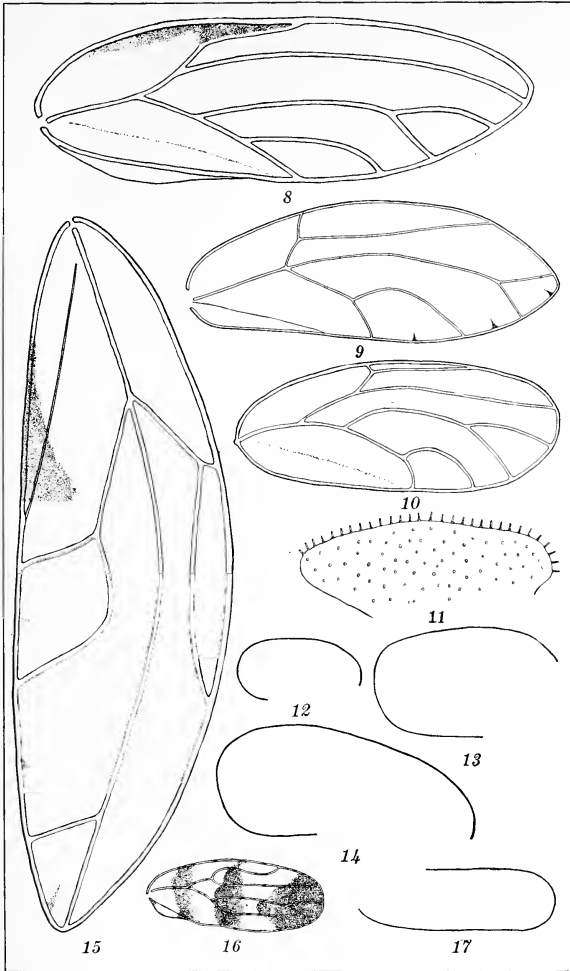

PLATE 2. PHILIPPINE PSYLLIDÆ.

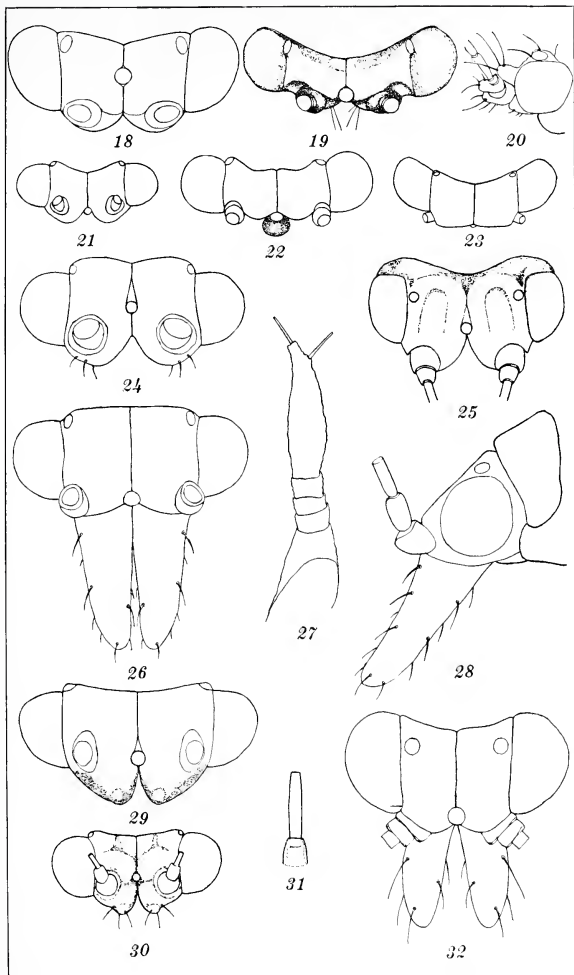

PLATE 3. PHILIPPINE PSYLLIDÆ.

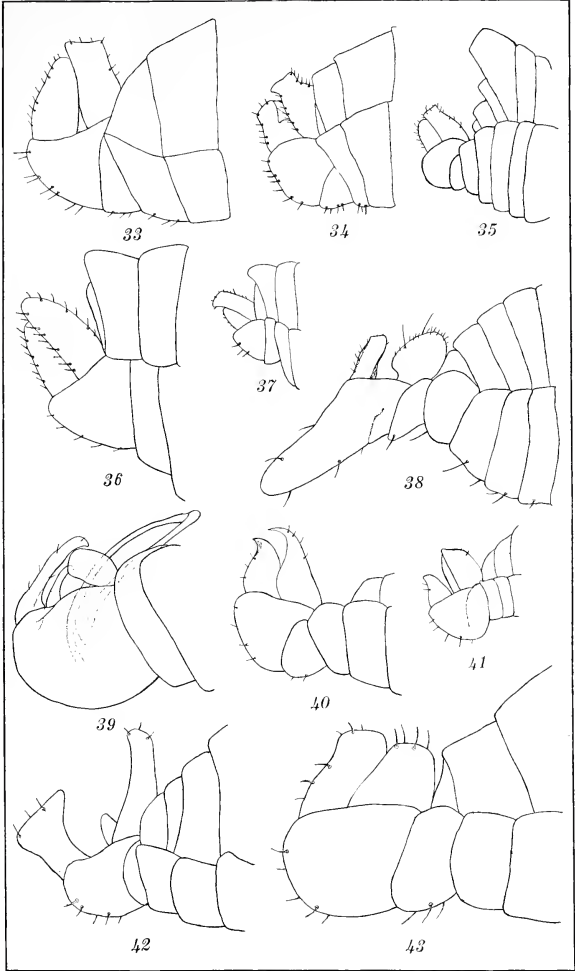

PLATE 4. PHILIPPINE PSYLLIDÆ.

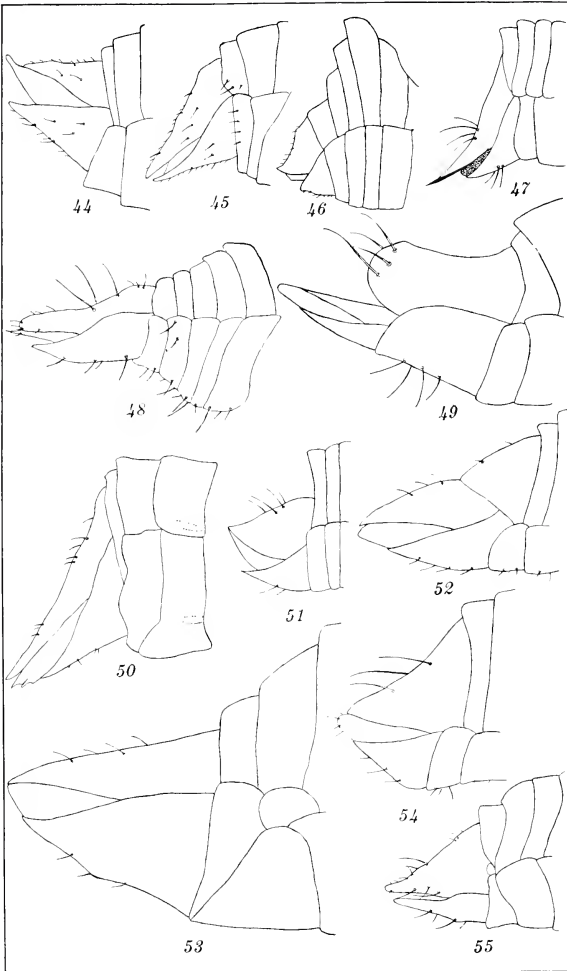

PLATE 5. PHILIPPINE PSYLLIDÆ.

NEW PHILIPPINE MYRTACEAE

By ELMER D. MERRILL

Director and Botanist, Bureau of Science, Manila

The present paper consists of the descriptions of twenty-three presumably new species; one *Decaspermum*, the remainder in the genus *Eugenia*.

DECASPERMUM Forster

DECASPERMUM MICROPHYLLUM sp. nov.

Frutex, ramulis adpresse pubescens; foliis numerosis, parvis, confertis, 8 ad 15 mm longis, ellipticis, obtusis vel acutis; floribus axillaribus, solitariis, 8 mm diameter, 2-bracteolatis. bracteolis linearis, 3 mm longis; calycis dense adpresse albido-pubescentis, lobis lanceolatis, acuminatis, 2 mm longis.

A shrub, the branches glabrous, the branchlets appressed-pubescent with white hairs. Leaves numerous, crowded, coriaceous, shining, elliptic, 8 to 15 mm long, 5 to 8 mm wide, base and apex acute or rounded, the upper surface glabrous, minutely pitted; the lower surface punctate-glandular, sparingly pubescent when young, in age glabrous; petioles very short. Flowers axillary, about 8 mm in diameter, their pedicels appressed-pubescent, up to 5 mm long, 2-bracteolate at the apex, the bracteoles linear, pubescent, about 3 mm long. Calyx-tube ovoid, about 2 mm in diameter, densely appressed-pubescent with white hairs, the lobes lanceolate, acuminate, pubescent, about 2 mm long. Petals obovate, about 4 mm long, their margins slightly ciliate; when fresh white, when dry pinkish. Stamens indefinite, the filaments about 4 mm long. Ovary 5-celled, each cell 2-ovuled.

MINDANAO, Surigao Province, *Bur. Sci. 34715 Ramos & Pascasio*, June 15, 1919, in thickets along streams at low altitudes at the iron deposit along the northeast coast.

This remarkably distinct species is well characterized by its very small leaves and does not appear to be closely allied to any previously described form.

EUGENIA Linnaeus

EUGENIA SARGENTII sp. nov. § *Eueugenia*.

Arbor 5 ad 12 m alta, partibus junioribus floribusque albidotomentosis; ramis ramulisque tenuibus, teretibus; foliis oppositis, oblongo-ellipticis ad oblongo-obovatis, usque ad 9 cm longis, in siccitate brunneis vel subolivaceis, nitidis, glandulosis, basi acutis, apice brevissime obtuseque acuminatis, nervis utrinque 8 and 10, tenuibus; floribus sessilibus, glomeratis, axillaribus et terminalibus, circiter 1 cm diametro, calycis et bracteis albidotomentosis.

A tree, 5 to 12 m high, glabrous except the younger parts and the inflorescences. Branches and branchlets slender, brown, terete, the very young branchlets and leaves rather densely white-tomentose, soon becoming glabrous. Leaves oblong-elliptic to elliptic-obovate, coriaceous or subcoriaceous, brownish or somewhat olivaceous when dry, the lower surface somewhat paler than the upper and more or less glandular with scattered glands, shining, 5 to 9 cm long, 2 to 4 cm wide, base acute, apex very shortly and obtusely acuminate, the margins often slightly recurved; primary lateral nerves 8 to 10 on each side of the midrib, slender, indistinct, anastomosing; petioles 5 to 10 mm long. Flowers white, axillary and terminal, glomerate, sessile, about 1 cm in diameter, 4-merous, the subtending bracts oblong, obtuse, white-tomentose, somewhat navicular, about 3 mm long. Calyx-tube broad, pubescent, about 4 mm in diameter, shallow, the lobes reniform to orbicular-ovate, pubescent, glandular, rounded, about 3 mm wide, 2.5 to 3 mm long. Petals glabrous, elliptic-obovate, rounded, about 5 mm long and 4 mm wide, glandular. Stamens very numerous, the filaments 3 to 4 mm long, the staminal disk much thickened, about 3.5 mm in diameter. Fruits ovoid, fleshy, peduncled, about 1.5 cm long, black or brown when dry, nearly glabrous, when young pubescent, the peduncles 8 mm long or less.

LUZON, Cagayan Province, Peñablanca, *Adduru 169* (type), 170, June 5, 1917, with the Ibanag names *tulisayan* and *tumaluhu*, on forested slopes at low altitudes: Zambales Province, *For. Bur. 5917 Curran*, January, 1907: Pampanga Province, Mount Arayat, *For. Bur. 17734 Curran*, March, 1910: Ilocos Norte Province, Mount Piao, *For. Bur. 13987 Merritt & Darling*, November, 1908, sterile: Rizal Province, Oriud, *Loher 5985*, February, 1906, sterile, leaves smaller than in the type. TICA0, *For. Bur. 1024 Clark*, May 30, 1914, with the Visayan name *pandaraga*.

In the section *Eueugenia* this species is well characterized among the Philippine forms by its sessile, glomerate flowers. The wood is fine-grained and hard, as in other species of the genus. The species is dedicated to Dr. C. S. Sargent, director of the Arnold Arboretum.

EUGENIA ELLIPTIFOLIA sp. nov. § *Jambosa*.

Arbor glabra, ramis ramulisque teretibus; foliis oppositis, coriaceis, nitidis, ellipticis, breviter petiolatis, usque ad 11 cm longis, apice late rotundatis, basi acutis, subtus punctatis, nervis primariis utrinque circiter 10, distinctis, anastomosantibus, reticulis vix perspicuis; inflorescentiis terminalibus axillaribusque, pedunculatis, 2- vel 3-floris; floribus breviter pedicellatis, bibracteolatis, calycis tubo infundibuliforme, circiter 8 mm longo, lobis distinctis, reniformibus.

A glabrous tree, the branches rather stout, the branchlets pale-brownish, smooth, terete, the ultimate ones about 3 mm in diameter. Leaves opposite, coriaceous, pale-olivaceous, shining, elliptic, 9 to 11 cm long, 5.5 to 7 cm wide, base acute, apex broadly rounded, smooth, the lower surface rather obscurely punctate; primary lateral nerves about 10 on each side of the midrib, distinct, somewhat curved, anastomosing directly with the subequally distinct, straight or slightly arcuate marginal nerves 2 to 3 mm from the edge of the leaf, the reticulations not prominent; petioles stout, 5 mm long or less. Inflorescences terminal and axillary, 2 to 5 cm long, peduncled, 2- or 3-flowered, or sometimes the terminal inflorescences branched from the base, the branches 1-flowered. Calyx-tube funnel-shaped, terete, smooth, blackish-brown when dry, shining, about 8 mm long and wide, the lobes 4, reniform, the pedicels 5 mm long or less.

CATANDUANES, *Bur. Sci.* 30518, Ramos (type), November, 1917, in primary forests at medium altitudes.

This species is probably as closely allied to *Eugenia calubcob* C. B. Rob. as to any other described form; it is well characterized by its elliptic leaves which are rounded at the apex and acute at the base.

EUGENIA ILOCANA sp. nov. § *Jambosa*.

Arbor circiter 18 m alta, glabra, ramis ramulisque teretibus vel ramulis leviter compressis; foliis oppositis, brevissime petiolatis, oblongis, apice obtusis ad rotundatis, basi obtusis, in siccitate pallidis, nitidis, crasse coriaceis, usque ad 7.5 cm longis, obscure parvissime punctulatis, nervis primariis utrinque cir-

citer 15, tenuibus, adscendentibus; inflorescentiis terminalibus, paniculatis, usque ad 12 cm longis, pedunculatis vel e basi ramosis, plerumque trichotomis; floribus 5-meris, circiter 3 cm longis, in ramulis ultimis subfasciculatis, sessilibus vel brevissime pedicellatis, calycibus truncatis, obconicis.

A glabrous tree, about 18 m high, the branches and branchlets grayish-brown, terete, or the branchlets somewhat compressed. Leaves opposite, subsessile or very shortly petiolate, thickly coriaceous, oblong or narrowly oblong-elliptic, 5 to 7.5 cm long, 1.5 to 2.7 cm wide, apex obtuse to rounded, base obtuse, margins somewhat cartilaginous, pale and shining when dry, both surfaces usually sparingly and obscurely punctulate, the glands sometimes evident only near the midrib and margins; lateral nerves about 15 on each side of the midrib, slender, not prominent, ascending, anastomosing close to the margin, the secondary ones nearly as distinct. Panicles terminal, up to 12 cm long, peduncled or branched from the base, mostly trichotomously branched, the branches and branchlets wrinkled and somewhat angular when dry, the flowers sessile or subsessile, three to five at the tip of each ultimate branchlet, the bracteoles obsolete or minute and very early deciduous. Flowers white, 5-merous, about 3 cm long in anthesis. Calyx about 14 mm long, 8 mm in diameter at the throat, terete, narrowed below, truncate or with about 5 very broad, short, obscure, irregular lobes. Petals 5, free, suborbicular, 5 to 6 mm in diameter. Stamens indefinite, their filaments 8 to 14 mm long.

LUZON, Ilocos Norte Province, Bangui, *Bur. Sci.* 27420
Ramos, March 13, 1917, at low altitudes.

A very characteristic species not closely resembling any other form known to me. It is well characterized by its thickly coriaceous, oblong to narrowly oblong-elliptic, pale, subsessile leaves with obtuse to rounded tips and obtuse bases, and, among those species with truncate calyx-tubes, its relatively large, 5-merous flowers.

EUGENIA PANAYENSIS sp. nov. § *Jambosa*.

Arbor glabra, *Eugenia speciosissimae* affinis, differt floribus brevissime pedicellatis, albis, nervis lateralibus paucioribus. Ramis ramulisque teretibus. Foliis coriaceis, oblongis ad oblongo-ovatis, sessilibus vel brevissime petiolatis, acuminatis, basi perspicue cordatis, nervis utrinque 8 vel 9, subtus valde perspicuis; floribus terminalibus et lateralibus, solitariis, brevissime pedicellatis, 4 ad 5 cm diametro.

An entirely glabrous tree, 4 to 5 m high, the branches and branchlets terete, the latter about 2 mm in diameter, grayish or somewhat reddish-brown. Leaves coriaceous, oblong to oblong-ovate, sessile or very shortly petioled, 8 to 11 cm long, 3 to 6.5 cm wide, acuminate, base rounded and conspicuously cordate, the upper surface olivaceous, slightly shining, the nerves slightly impressed, the lower surface paler than the upper; lateral nerves 8 or 9 on each side of the midrib, very prominent, distant, spreading, curved-anastomosing with the equally prominent, slightly arched, marginal nerves about 5 mm from the edge of the leaf, the reticulations lax, distinct; petioles none or very stout and up to 4 mm in length. Flowers white, solitary, 4 to 5 cm in diameter, terminal and lateral, erect, short-pedicelled. Calyx turbinate, about 1.7 cm in diameter, narrowed below, the pedicels jointed, 5 mm long or less, the lobes broadly reniform. Petals reniform, about 12 mm wide, stamens very numerous. Fruits globose, urceolate, about 2.5 cm long, 2 cm in diameter, crowned by the persistent calyx rim and lobes.

PANAY, Antique Province, Culasi, *Bur. Sci.* 32470 *McGregor* (type), and two specimens without number, May 24, 1918, in the mossy forest, altitude 1,000 meters.

This species is manifestly allied to *Eugenia speciosissima* C. B. Rob., of northern Luzon, from which it is distinguished by its very shortly pedicelled white flowers and fewer lateral nerves.

EUGENIA PEÑASII sp. nov. § *Jambosa*.

Arbor glabra, ramis ramulisque teretibus; foliis subcoriaceis, oblongo-ellipticis ad oblongo-obovatis, usque ad 10 cm longis, apice breviter obtuseque acuminatis, basi acuminatis, in siccitate olivaceis, supra perspicue nitidis, subtus paullo pallidioribus et distincte punctato-glandulosis, nervis primariis utrinque circiter 15, tenuibus, quam secundariis reticulisque vix magis distinctioribus; inflorescentiis axillaribus terminalibusque, circiter 6 cm longis, racemoso-paniculatis; floribus numerosis, confertis, plerumque in triadibus dispositis, sessilibus vel subsessilibus, calycis tubo circiter 12 mm longo, cylindrico, 6 mm diametro, deorsum angustato; petalis calyptratim connatis.

A glabrous tree, about 18 m high, the branches and branchlets terete, brownish, the latter 3 to 4 mm in diameter. Leaves opposite, subcoriaceous, prominently shining, oblong-elliptic to oblong-obovate, 6 to 10 cm long, 3 to 5 cm wide, the apex shortly and obtusely acuminate, base decurrent-acuminate, olivaceous

when dry, the lower surface somewhat paler than the upper and distinctly glandular-punctulate; primary lateral nerves about 15 on each side of the midrib, slender, scarcely more prominent than are the secondary ones and the reticulations, anastomosing with the slender marginal nerves about 1 mm from the edge of the leaf; petioles 1.5 to 2 cm long. Panicles solitary in the uppermost axils and fascicled at the tips of the branchlets, about 6 cm long, subracemose, the flowers white, sessile or subsessile in triads at the tips of the ultimate branchlets, forming a rather dense corymblike inflorescence. Calyx-tube cylindrical, pale when dry, about 12 mm long and 6 mm in diameter, gradually narrowed to the base, the lobes 4, shallow, about 4 mm wide and 1.5 mm long. Calyptra about 6 mm in diameter, the petals separable with difficulty, the outer ones broadly ovate, the inner obovate. Stamens indefinite; filaments 9 to 15 mm long. Style about 15 mm long.

BABUYAN ISLANDS, Calayan, *For. Bur.* 26703 Peñas, May 20, 1917, on forested slopes of Mount Nagboyoonon, altitude about 300 meters.

In vegetative characters and general appearance, this species closely approximates *Eugenia wenzelii* Merr., but is totally different in its floral structure, although the calyx-tubes are similar in both. It is distinguished at once by its 4, broad, short calyx-teeth and by its very much longer filaments.

EUGENIA SANTOSII sp. nov. § *Jambosa*.

Arbor glaberrima usque ad 18 m alta, ramis ramulisque teretibus, griseis; foliis crasse coriaceis, ovatis ad oblongo-ovatis, usque ad 8 cm longis, in siccitate utrinque pallidis, nitidis, subtus obscure glandulosis, margine perspicue revolutis, apice tenuiter caudato-acuminatis, basi longe decurrento-acuminatis, nervis utrinque tenuibus, distinctis, circiter 15; inflorescentiis terminalibus axillaribusque, pedunculatis, corymbosis, usque ad 6 cm longis, ramis ramulisque crassis, angulatis vel compressis, ramulis ultimis brevissimis, saepissime, flores 3 sessiles gerentibus; calycis tubo circiter 6 mm longo, apice circiter 4.5 mm diametro, deorsum angustato, obscurissime 4-lobato, vetustioribus plus minusve eroso; petalis liberis, circiter 3 mm diametro.

An entirely glabrous tree, 15 to 18 m high, the branches and branchlets terete, grayish or sometimes slightly brownish, nearly smooth. Leaves thickly coriaceous, pale and shining on both surfaces when dry, ovate to oblong-ovate, 6 to 8 cm long,

2.5 to 4 cm wide, the apex long and slenderly caudate-acuminate, the acumen usually curved, base long decurrent-acuminate, the margins prominently revolute, the lower surface obscurely glandular; lateral nerves about 15 on each side of the midrib, slender but rather distinct, anastomosing directly with the marginal vein about 2 mm from the edge of the leaf; petioles 1 to 1.5 cm long. Inflorescences terminal and in the upper axils, peduncled, corymbose, the rachis and branches angled or compressed, stout, the ultimate branchlets 5 mm long or less, each bearing usually three sessile flowers, the bracteoles inconspicuous. Flowers white. Calyces about 6 mm long, narrowed below, sometimes forming a short pseudostalk, the limb about 4.5 mm in diameter, very obscurely 4-lobed, in age more or less irregularly erose. Petals free, orbicular, about 3 mm in diameter, deciduous, strongly imbricate in bud. Stamens numerous, their filaments up to 7 mm in length. Fruit purple, ellipsoid or ovoid, about 6 mm long (immature).

LUZON, Benguet Subprovince, Pauai, *Bur. Sci.* 31844 Santos, June 1, 1918, on slopes, altitude about 2,200 meters, with the Igorot name *bultic*.

This species is manifestly closely allied to *Eugenia robinsoniana* Elm., but among other characters is readily distinguished by its thicker leaves, which are uniformly pale and not at all brownish-purple when dry; its much stouter, angled or compressed inflorescence branches; and its strongly revolute leaf-margins.

EUGENIA SARCOCARPA sp. nov. § *Jambosa*.

Arbor glabra, ramulis circiter 5 mm diametro, distincte 4-angulatis; foliis brevissime petiolatis, oblongo-ellipticis; coriaceis, 16 ad 22 cm longis, basi leviter inaequilateralibus, rotundatis vel leviter cordatis, apice acutis vel breviter acuminatis, nervis utrinque 20 ad 25, valde perspicuis; floribus ad nodis infra foliis fasciculatis, brevissime pedicellatis, calycis tubulate infundibuliformibus circiter 6 mm longis et 7 mm latis, 4-lobatis; fructibus ovoideis carnosis, in siccitate griseis et circiter 2.5 cm diametro.

A glabrous tree, about 8 m high, the branches terete, grayish, the ultimate branchlets about 5 mm in diameter, distinctly 4-angled. Leaves opposite, coriaceous, oblong-elliptic, 16 to 22 cm long, 7 to 10 cm wide, somewhat narrowed below to the usually slightly inequilateral, rounded, or often somewhat cordate base, the apex acute or shortly acuminate, the upper sur-

face castaneous, shining, the lower paler, obscurely glandular-punctate; lateral nerves 20 to 25 on each side of the midrib, prominent, anastomosing with the equally distinct marginal nerves about 5 mm from the edge of the leaf, the reticulations not prominent; petiole very stout, 4 mm long or less. Flowers fasciated at the nodes below the branches, the calyx-tube broadly funnel-shaped, wrinkled when dry, about 6 mm long, the throat about 7 mm wide, shallowly 4-lobed, the lobes spreading, 2 mm long or less. Fruits rather large, ovoid, fleshy, when dry grayish and about 2.5 cm in diameter, crowned by the persistent calyx-tube and lobes.

LEYTE, Tacloban, *Wenzel 1484*, April 5, 1915, in forests, probably at low or medium altitudes near Tigbao.

This characteristic species does not appear to be closely allied to any previously described form. It is readily distinguishable by its vegetative characters; its 4-angled branchlets; and its shortly pedicelled flowers being fasciated at the nodes below the leaves.

EUGENIA SESSILILIMBA sp. nov. § *Jambosa*.

Arbor parva, glabra, ramis teretibus, ramulis acute 4-angulatis, internodiis sursum incrassatis, 3 ad 5 mm diametro; foliis sessilibus vel brevissime petiolatis, crassissime, coriaceis, oblongis, 8 ad 12 cm longis, basi late rotundatis, cordatis, apice acutis vel acuminate; nervis utrinque 18 ad 20, patulis, perspicuis; floribus terminalibus, solitariis, tenuiter pedicellatis, 5 cm diametro.

A glabrous tree, about 6 m high, the older branches terete, the younger ones and the branchlets very sharply 4-angled, the ultimate internodes thickened upward and 3 to 5 mm in diameter. Leaves sessile or subsessile, opposite, very thickly coriaceous, oblong, 8 to 12 cm long, 2 to 4 cm wide, base broadly rounded and distinctly cordate, narrowed upward to the acute or somewhat acuminate apex, the margins often prominently revolute; midrib somewhat impressed on the upper surface, very stout and prominent on the lower surface; lateral nerves spreading at right angles, 18 to 20 on each side of the midrib, prominent, straight, anastomosing with the equally prominent marginal nerve about 3 mm from the edge of the leaf. Flowers terminal, solitary, white, about 5 cm in diameter, the calyx-tube obconic, about 1 cm long; lobes broadly ovate, rounded, about 7 mm long and wide; pedicels slender, jointed, with the base of the calyx-tube about 2.5 cm long.

LUZON, Ilocos Norte Province, Mount Palimlim, *Bur. Sci.* 33342 Ramos, August 20, 1918, on forested slopes, altitude about 950 meters.

In foliage characters this species closely resembles *Eugenia speciosissima* C. B. Rob., from which it is easily distinguished by its sharply 4-angled branchlets and its terminal flowers.

EUGENIA SURIGAENSIS sp. nov. § *Jambosa*.

Frutex glaber, ramis ramulisque teretibus; foliis coriaceis, oblongis ad oblongo-lanceolatis, basi late acutis ad rotundatis, sursum angustatis et leviter acuminatis, haud punctatis, nervis utrinque circiter 10, perspicuis; petiolo 2 ad 4 mm longo; floribus e ramis defoliatis, solitariis, vel pedunculis 3-floris, calycis tubo turbinato, circiter 1.5 cm longo et usque ad 2 cm diametro.

A glabrous shrub, the branches terete, grayish, rather rough, the branchlets pale brown, smooth, the ultimate ones 2 mm in diameter or less. Leaves coriaceous, oblong to oblong-lanceolate, the base broadly acute to rounded, narrowed upward to the somewhat acuminate apex, brownish or olivaceous when dry, the lower surface paler than the upper and scarcely punctate; lateral nerves about 10 on each side of the midrib, prominent, anastomosing, the reticulations lax; petioles very stout, 2 to 4 mm long. Flowers white, from the branches below the leaves, solitary or 3-flowered peduncles, the peduncles 1.5 to 2.5 cm long, the pedicels about 1.5 cm long. Calyx-tube turbinate, brown when dry, about 1.5 cm long, 1.5 to 2 cm in diameter, shallowly 4-lobed. Petals suborbicular, 1.5 mm in diameter. Fruit cup-shaped, 2.5 cm long and wide.

MINDANAO, Surigao Province, *Bur. Sci.* 34686 Ramos & Pascasio, June 14, 1919, along streams at low altitudes at the iron deposit on the northeast coast.

The alliance of this species is manifestly with *Eugenia megalantha* C. B. Rob. of Palawan, from which it differs in its fewer-nerved leaves which are not glandular-punctate and beneath, and in its shorter, very stout petioles. In *Eugenia megalantha* the leaves are subequally narrowed to both ends, but in the present species they are wider below the middle and are gradually narrowed upward.

EUGENIA TULA sp. nov. § *Jambosa*.

Arbor glabra, ramulis teretibus; foliis subcoriaceis, oblongo-ellipticis ad elliptico-obovatis, utrinque concoloribus, 8 ad 11 cm

longis, basi cuneatis, apice distincte acuminatis, nitidis, minutissime nigro-punctatis, nervis utrinque circiter 7, tenuibus; inflorescentiis terminalibus axillaribusque, e basi ramosis, circiter 4 cm longis; floribus circiter 1.5 cm diametro, calycibus infundibuliformibus, 6 mm longis, 4-lobatis. Petalis suborbicularibus, 5 mm diametro, perspicue punctatis.

A glabrous tree, about 10 m high, the branches and branchlets rather slender, terete, grayish. Leaves opposite or the lower ones subalternate, subcoriaceous, oblong-elliptic to elliptic-ovate, rather grayish and of about the same color on both surfaces when dry, 8 to 11 cm long, 3 to 5 cm wide, the base cuneate, the apex distinctly acuminate, shining, the upper surface minutely pitted, the lower surface distinctly glandular with minute black or nearly black glands; lateral nerves about 7 on each side of the midrib, slender, not very prominent, arched-anastomosing, the reticulations nearly obsolete; petioles about 3 mm long. Inflorescences terminal and in the upper axils branched from the base, about 4 cm long, the lower branches usually spreading, each branch bearing 3 to 5 flowers, the ultimate branchlets 3 mm long or less. Flowers white, about 1.5 cm in diameter. Calyx funnel-shaped, 6 mm long and wide, the lobes 4, somewhat reniform, 3 to 3.5 mm long, the lower 2 mm of the calyx-tube forming a short pseudostalk. Petals suborbicular, 5 mm in diameter, densely punctate.

MINDANAO, Davao Province, Santa Cruz, *For. Bur. 27540 De Mesa*, April 29, 1919. In rich soil at low altitudes with the local Tagakaolo name *tula*.

This species is probably as closely allied to *Eugenia bordenii* Merr. as to any other described form and may be readily recognized by its minutely black-punctulate glandular leaves.

EUGENIA XIPHOPHYLLA sp. nov. § *Jambosa*.

Arbor glabra, circiter 4 m alta, ramis ramulisque perspicue et acute 4-angulatis; foliis oppositis, lineari-lanceolatis, coriaceis, in siccitate pallidis, nitidis, usque ad 40 cm longis et 3 cm latis, utrinque subaequaliter angustatis, basi attenuatis, nervis numerosis, saltem 40 utrinque, prominentibus; inflorescentiis terminalibus, longi pedicellatis, usque ad 15 cm longis, 3-floris; floribus junioribus circiter 1.5 cm longis, alabastro obovoideo.

A glabrous tree, about 12 m high, the branches and branchlets pale, smooth, sharply 4-angled, the sides concave, more or less thickened at the nodes, 5 to 8 mm in diameter. Leaves opposite,

coriaceous, linear-lanceolate, up to 40 cm in length, 2 to 3 cm wide, pale and shining when dry, subequally narrowed at both ends, base attenuate, apex apparently acuminate, margins recurved; lateral nerves at least 40 on each side of the midrib, impressed on the upper surface, prominent beneath, somewhat spreading, slightly curved, anastomosing with the distinct submarginal nerve, reticulations obsolete on the upper surface, prominent on the lower; petioles stout, reddish-brown, rugose, about 5 mm long. Inflorescence terminal, slender, 3-flowered, long-peduncled, the inflorescences solitary or in pairs, about 15 cm long, the peduncles 10 to 12 cm long. Buds obovoid, about 1.5 cm long, rounded, narrowed below, dark-brown when dry.

MINDANAO, Lanao District, Libas, *For. Bur. 24060 Acuña*, May 29, 1916, locally known as *malasugui*.

A most striking species on account of its 4-angled stems; its very long, narrow, coriaceous leaves; and its slender, elongated, terminal, 3-flowered inflorescences. It is allied to *Eugenia ramosii* C. B. Rob., from which it is distinguished by its narrower leaves and longer peduncles.

EUGENIA ATTENUATIFOLIA sp. nov. § *Syzygium*.

Arbor glabra, circiter 10 m alta, ramis ramulisque brunneis, teretibus, vel ramulis obscure 4-angulatis; foliis coriaceis, in siccitate pallidis, nitidis, subtus punctatis, glandulis jam oculo nudo distinctis, ovato-lanceolatis, usque ad 9 cm longis, basi acutis, apice tenuiter caudato-acuminatis, nervis primariis utrinque circiter 8, tenuibus, subtus, distinctis; infructescentiis terminalibus, corymbosis, 6 ad 9 cm longis, e basi ramosis, ramulis sulcatis vel angulatis; fructibus globosis ad obovoideis, usque ad 8 mm diametro, sessilibus vel breviter pedicellatis.

A glabrous tree, about 10 m high, the branches brown or reddish-brown, striate, terete, the cortex somewhat stringy, the branchlets of the same color, smooth, usually somewhat 4-angled. Leaves opposite, coriaceous, ovate-lanceolate, pale and shining when dry, 6 to 9 cm long, 2.3 to 3 cm wide, base acute or somewhat acuminate, apex slenderly caudate-acuminate, the acumen acute, up to 2 cm in length, the lower surface distinctly punctate, the glands distinctly visible to the naked eye; primary lateral nerves about 8 on each side of the midrib, slender but distinct on the lower surface, the reticulations not prominent, anastomosing directly with the nearly straight or slightly arcuate marginal nerves 2 to 3 mm from the edge of the leaf;

petioles 5 to 8 mm long. Infructescences terminal, corymbose, branched from the base, 6 to 9 cm long, up to 7 cm wide across the nearly flat top, the branches and branchlets usually 4-angled or at least sulcate. Fruit obovoid to globose, brown when dry, smooth, up to 8 mm in diameter, sessile or jointed on very short pedicels which are in turn jointed to the usually short branchlets, usually but one or at most two on each ultimate branchlet.

CATANDUANES, Mount Mariguidon, *Bur. Sci.* 30314 Ramos, November 26, 1917, in forests near the summit of the mountain.

This species is well characterized by its prominently punctate, slenderly caudate-acuminate leaves. It belongs in the group with *Eugenia mindorensis* C. B. Rob., but differs from that species in numerous other points than those just indicated.

EUGENIA CONSANGUINEA sp. nov. § *Syzygium*.

Species *E. brittonianae* C. B. Rob. affinis, differt foliis majoribus, usque ad 12 cm longis, nervis lateralibus magis numerosis, utrinque circiter 15, floribus paullo minoribus et omnibus breviter pedicellatis.

A tree, about 8 m high, entirely glabrous, the branches and branchlets terete, brown, smooth. Leaves oblong to oblong-lanceolate, coriaceous, not punctate, 8 to 12 cm long, 2.5 to 4 cm wide, apex prominently acuminate, the acumen obtuse, base acute, the upper surface dark-brown when dry, slightly shining, the lower pale-brown; primary lateral nerves about 15 on each side of the midrib, very prominent on the lower surface, irregular, nearly straight, anastomosing with the almost equally prominent and slightly arcuate marginal nerves 2 to 3 mm from the edge of the leaf, the reticulations lax, indistinct; petioles 2 to 5 mm long. Panicles terminal, usually shortly peduncled, about 6 cm long, 6 to 8 cm wide, the lower branches up to 4.5 cm in length, the branches, branchlets, and pedicels terete or nearly so, the pedicels stout, 2 mm long or less. Flowers white, all shortly pedicelled, in triads on the ultimate branchlets. Calyx-tube turbinate, dark-brown when dry, about 4 mm long, nearly smooth, terete, narrowed below, the apex with four, very short, obscure, broad, rounded lobes. Petals united into a calyptra about 3 mm in diameter. Fruits globose, about 12 mm in diameter, smooth, dark-brown when dry, crowned by the short calyx-tube.

LUZON, Abra Province, Mount Posuey, *Bur. Sci.* 26995 (type), 26984 Ramos, February, 1917, on forested slopes and along small streams in forests at medium altitudes.

The alliance of this species is manifestly with *Eugenia brittoniana* C. B. Rob. to which it is indeed closely related. It differs in its larger, more-numerously nerved leaves, and in all of its flowers being pedicelled.

EUGENIA DIFFUSA sp. nov. § *Syzygium*.

Arbor glabra, circiter 15 m alta, ramis et ramulis teretibus, tenuibus; foliis oblongo-lanceolatis ad oblongo-obovatis, usque ad 6 cm longis, subcoriaceis, apice breviter obtuse acuminatis, basi acutis, supra subolivaceis, subtus pallidioribus, obscurissime glandulosis, nervis primariis supra obsoletis, subtus obscuris, tenuibus, densis; inflorescentiis terminalibus et in axillis superioribus, diffusis, circiter 10 cm longis, ramis ramulisque elongatis; floribus 4-meris, sessilibus, in triadibus dispositis; calycibus turbinatis, 5 mm longis; petalis calyptratis.

A glabrous tree about 15 m high, the branches and branchlets slender, terete, brown, the ultimate ones about 1.5 mm in diameter. Leaves opposite, subcoriaceous, oblong-lanceolate to oblong-obovate, 4 to 6 cm long, 1.5 to 2.3 cm wide, the apex broadly and obtusely acuminate, base acute, the upper surface subolivaceous, smooth, slightly shining, the lower paler, obscurely glandular, the midrib prominent on both surfaces; lateral nerves very slender, obscure on the lower surface, entirely obsolete on the upper surface, densely arranged, the primary ones scarcely more distinct than are the secondary ones; petioles 1 to 2 mm long. Panicles terminal and in the upper axils, about 10 cm long, lax, diffuse, the primary branches racemously arranged, 2 to 3 cm long, the secondary ones bearing a terminal triad of sessile white flowers, the bracteoles none or very minute and caducous. Calyx-tube about 5 mm long, turbinate, pale when dry, terete, gradually narrowed below, the tip 3 to 3.5 mm wide, with four, broad, short, rounded lobes about 1.5 mm wide and 0.5 mm long. Petals wholly united into a calyptra about 3 mm in diameter. Filaments indefinite, slender, 3 to 8 mm long.

LUZON, Ilocos Norte Province, Burgos, *Bur. Sci.* 27155 Ramos, March 14, 1917, in dry forests at low altitudes.

This strongly marked species falls in the group with *Eugenia perpallida* Merr. and *E. parva* Merr., but is at once distinguished from both in its diffuse panicles and much larger flowers.

EUGENIA NEEI sp. nov. § *Syzygium*.

Arbor glabra, circiter 15 m alta, ramis ramulisque teretibus; foliis subcoriaceis, oblongis ad oblongo-ellipticis, usque ad 10 cm

longis, haud punctatis, apice distincte acuminatis, basi acutis vel decurrento-acuminatis, in siccitate subolivaceis, nitidis, nervis primariis utrinque circiter 20, tenuibus, distinctis, quam secundariis vix magis distinctioribus, circiter margine anastomosantibus; paniculis axillaribus, laxis, circiter 6 cm longis; floribus plerumque in triadibus dispositis, sessilibus, cylindraceis, circiter 7 mm longis, anguste clavatis, truncatis, deorsum angustatis petalis in calyptram unitis.

A glabrous tree about 15 m high, the branches and branchlets slender, terete, grayish or brownish, the former about 2 mm in diameter. Leaves opposite, subcoriaceous, oblong to oblong-elliptic, 7 to 10 cm long, 2 to 4 cm wide, subequally narrowed to the distinctly acuminate apex and the acute or decurrent-acuminate base, not punctate, the upper surface subolivaceous, shining, the lower paler; primary lateral nerves about 20 on each side of the midrib, slender but distinct on both surfaces and scarcely more prominent than are the secondary ones and the reticulations, nearly straight, somewhat ascending, anastomosing with the slender marginal vein about 1 mm from the edge of the leaf; petioles 1 to 1.5 cm long. Panicles axillary, lax, rather few-flowered, about 6 cm long, peduncled or branched from or near the base, the branches spreading or ascending, the lower ones about 3 cm long. Flowers mostly in triads at the tips of the ultimate branchlets, sometimes five on a branchlet, all sessile, ebracteolate, cylindric, the calyces about 7 mm long, brown when dry, gradually narrowed in the lower two-thirds, about 1.8 mm in diameter above, truncate. Petals united into a deciduous calyptra about 1.5 mm in diameter.

LUZON, Ilocos Norte Province, Burgos, *Bur. Sci.* 27156 Ramos, March 5, 1917, in dry forests at low altitudes.

This species, dedicated to Luis Née, one of the botanists of the Malaspina Expedition, belongs in the group with *Eugenia clavellata* Merr., but is entirely different in its vegetative characters as well as in its inflorescences and in its calyx-tubes not being abruptly enlarged at the tip.

EUGENIA RIZALENSIS sp. nov. § *Syzygium*.

Frutex vel arbor glabra, ramis ramulisque teretibus, ramulis ultimis tenuibus, circiter 1 mm diametro; foliis elliptico-ovatis, in siccitate pallidis, nitidis, subtus punctatis, chartaceis, usque ad 4 cm longis, basi acutis, apice obtuse acuminatis, nervis primariis utrinque circiter 12, tenuibus; infructescentiis axillari-

bus terminalibusque, brevissimis, paucifloris; fructibus ampulliformibus, circiter 8 mm longis, in siccitate atris vel atro-brunneis, basi acutis, breviter pedicellatis.

A glabrous shrub or small tree, the branches and branchlets terete, brownish to grayish, the latter very slender, about 1 mm in diameter. Leaves numerous, in general elliptic-ovate, 2 to 4 cm long, 1 to 2 mm wide, subequally narrowed to the acute base and to the obtusely acuminate apex, chartaceous, pale, of the same color on both surfaces and shining when dry, the lower surface punctate; primary lateral nerves about 12, slender, scarcely more distinct than are the secondary nerves and reticulations, anastomosing with the equally distinct marginal nerve about 1 mm from the edge of the leaf; petioles 2 to 3 mm long. Inflorescences terminal and axillary, excluding the fruits 5 mm long or less, depauperate-cymose. Fruits apparently dark-purple when fresh, when dry ampulliform, about 8 mm long, black or very dark-brown, 3 to 4 mm in diameter in the middle, narrowed to the acute base, smooth or slightly wrinkled, again narrowed above the middle, the apex truncate.

LUZON, Rizal Province, Mount Susong Dalaga, *Bur. Sci.* 29280 Ramos & Edaña, August 2, 1917, on the forested upper ridges.

This species is well characterized by its small leaves; its very slender branchlets; its very short, cymose, terminal and axillary inflorescences, and its ampulliform fruits. It belongs in the group with *Eugenia claviflora* Roxb.

EUGENIA SIDEROCOLA sp. nov. § *Syzygium*.

Frutex vel arbor parva, glabra, ramulis 4-angulatis, tenuibus; foliis coriaceis, anguste oblongis ad oblongo-ellipticis, obtusis vel rotundatis, basi cuneatis, 2 ad 4 cm longis, 8 ad 14 mm latis, haud punctatis, nervis lateralibus obsolete; inflorescentiis terminalibus, pedunculatis, usque ad 4 cm longis, multifloris, ramulis ultimis dichotomis vel trichotomis, floribus sessilibus, calycis 2 ad 2.5 mm longis.

A glabrous shrub or small tree, up to 4 m high, the branches grayish brown, terete, the branchlets somewhat 4-angled, slender. Leaves coriaceous, narrowly oblong to oblong-elliptic, the apex obtuse or rounded, base cuneate, 2 to 4 cm long, 8 to 14 mm wide, the lower surface scarcely punctate, the lateral nerves and reticulations obsolete; petioles 1 to 2.5 mm long. Inflorescences terminal and in the uppermost axils, peduncled, 2.5 to 4 cm long, many-flowered, the ultimate branchlets dichotomous

or trichotomous. Flowers sessile, the calyx shallowly toothed, wrinkled when dry, reddish brown, 2 to 2.5 mm long, the petals suborbicular, 2 mm in diameter, more or less calyptrate.

MINDANAO, Surigao Province, *Bur. Sci.* 34521 (type), 34722 Ramos & Pascasio, June 14, 1919, on ridges and along streams at the iron deposit on the northeast coast, extending from low altitudes to at least 650 meters.

This species is well characterized by its small, coriaceous, nerveless leaves and, although in some respects suggestive of *Eugenia cagayanensis* Merr., it differs radically from the latter in its inflorescences and flowers, and is not closely allied to it.

EUGENIA BERNARDOI sp. nov.

Arbor glabra, circiter 5 m alta, ramis ramulisque teretibus; foliis oppositis, ovatis ad lanceolatis, basi latissime rotundatis et perspicue cordatis, brevissime petiolatis vel subsessilibus, sursum angustatis, tenuiter acuminatis, usque ad 13 cm longis, coriaceis, nitidis, in siccitate olivaceis, epunctatis, nervis primariis utrinque circiter 15, haud prominulis; infructescentiis terminalibus, sessilibus vel breviter pedunculatis, cymosis, rhachibus et ramis circiter 3 cm longis; fructibus ovoideis, in siccitate pallidis, circiter 2.5 cm longis.

A small glabrous tree, about 5 m high, the branches and branchlets slender, terete, about 2 mm in diameter, smooth, reddish-brown, the younger parts often with somewhat shredded cortex. Leaves coriaceous, epunctate, ovate to lanceolate, opposite, very shortly petioled or subsessile, 9 to 13 cm long, 2.5 to 5.5 cm wide across the base which is broadly rounded and rather prominently cordate, gradually narrowed upward from near the base to the slenderly acuminate apex, when dry olivaceous, shining; lateral nerves slender, not prominent, rather irregular, about 15 on each side of the midrib, anastomosing with the subequally prominent continuous marginal nerve about 1.5 mm from the edge of the leaf; petioles 2 mm long or less. Infructescence terminal, cymose, excluding the rather large fruits about 3 cm long, sessile or shortly peduncled. Fruits pink when fresh, when dry pale, ovoid, about 2.5 cm long, the pericarp thin, coarsely wrinkled, the persistent calyx lobes 4, subreniform, about 3 mm wide.

LUZON, Cagayan Province, Aparri, *For. Bur.* 27074 Bernardo, October 16, 1917, in dense forests, altitude about 15 meters, with the local name *maramaatan*.

This very characteristic species probably belongs in the group with *Eugenia zeylanica* Wight. It is conspicuously characterized by its nearly sessile, broadly rounded, and distinctly cordate leaves, which are gradually narrowed upward from near the base to the slenderly acuminate apex, the leaves varying in outline from ovate to lanceolate. It is totally different from all the other known Philippine species of this very large genus.

EUGENIA CAPIZENSIS sp. nov.

Arbor glabra, circiter 10 m alta, ramulis teretibus, circiter 3 mm diametro; foliis subcoriaceis, nitidis, vix punctatis, oblongis, 18 ad 34 cm longis, basi rotundatis et leviter cordatis, apice acutis vel leviter acuminatis, nervis utrinque circiter 25, valde perspicuis; petiolo circiter 5 mm longo; infructescentiis longipedunculatis partibus floriferis 5 ad 6 cm longis, ramis inferioribus usque ad 3 cm longis; calycis urceolatis, 1 ad 1.5 cm longis, circiter 7 mm diametro, truncatis, limbo valde producto.

A tree about 10 m high, the branches terete, the ultimate ones somewhat compressed, grayish or reddish brown, about 3 mm in diameter. Leaves subcoriaceous, shining, scarcely punctate, oblong, 18 to 34 cm long, 7.5 to 11 cm wide, the base rounded and slightly cordate, the apex acute to somewhat acuminate; lateral nerves about 25 on each side of the midrib, prominent, straight, anastomosing with the equally prominent marginal nerves 4 to 6 mm from the edge of the leaf. Petioles stout, about 5 mm long. Infructescences long-peduncled, the peduncles up to 18 cm in length, the flower-bearing portions 5 to 6 cm long and wide, the lower branches up to 3 cm in length. Calyx after anthesis urceolate, 1 to 1.5 cm long, about 7 mm in diameter, truncate, the limb extended 5 to 7 mm above the ovary.

PANAY, Capiz Province, Mount Salibongbong, Bur. Sci. 35584 Martelino & Edaño, June 22, 1919, on forested slopes, altitude about 500 meters.

The alliance of this species is apparently with *Eugenia urdanetensis* Elm. and *E. caudatifolia* Merr. It differs from the former in its much larger leaves and flowers and its elongated peduncles, and from the latter in its less-acuminate, fewer-nerved leaves and apparently larger flowers.

EUGENIA CARDIOPHYLLA sp. nov.

Arbor parva, glabra, ramis ramisque teretibus, crassis, circiter 5 mm diametro. Foliis oppositis, crasse coriaceis, brevis-

sime petiolatis, ovatis ad late ovatis usque ad 14 cm longis, basi latissime rotundatis et leviter cordatis apice breviter acuminatis, in siccitate pallidis, utrinque concoloribus, nitidis, eglandulosis; nervis primariis utrinque circiter 15, distinctis, cum lateralibus conjunctis; inflorescentiis terminalibus, corymboso-paniculatis, 5 ad 8 cm longis, sessilibus, basi ramosis, ramis ramulisque crassis, brevibus; fructibus sessilibus, ad apices ramulorum confertis, leviter urceolatis, junioribus circiter 7 mm longis.

A glabrous tree, about 4 m high, the branches and branchlets terete, rather stout, about 5 mm in diameter, brownish, nearly smooth when dry. Leaves ovate to broadly ovate, thickly coriaceous, eglandular, 10 to 14 cm long, 6 to 9 cm wide, rather pale, shining and of the same color on both surfaces when dry, the base very broadly rounded and slightly cordate, apex shortly acuminate; lateral nerves about 15 on each side of the midrib, about equally distinct on both surfaces, nearly straight, spreading, anastomosing with the equally distinct marginal nerves 3 to 5 mm from the edge of the leaf, the reticulations very obscure; petioles stout, reddish-brown, 2 mm long or less. Inflorescences terminal, stout, 5 to 8 cm long, sessile, branched from the base, corymboso-paniculate, the branches stout, the primary ones 2.5 to 3.5 cm long, brown, rugose, about 4 mm in diameter, the ultimate branchlets usually in threes, about 1 cm long, stout, compressed, the flowers all sessile and crowded at the tips of the branchlets, three to nine on each branchlet. Young fruits somewhat urceolate, cylindric, slightly wrinkled when dry, about 7 mm long, crowned by the four short calyx-lobes.

MINDANAO, Bukidnon Subprovince, Malantog, *For Bur.* 26534 Rola, April 17, 1917, in the margins of forests, altitude about 600 meters.

This species does not appear to be very closely allied to any previously described Philippine form. It is well characterized by its thickly coriaceous, subsessile, heart-shaped leaves, and its stout, terminal inflorescences, the sessile flowers being crowded on the ultimate branchlets.

EUGENIA MARTELINOLII sp. nov.

Arbor parva, glabra, ramulis teretibus, 2 ad 3 mm diametro; foliis sessilibus, coriaceis, supra nitidissimis, oblongis ad oblongo-ellipticis, subtus minute punctatis, 6 ad 10 cm longis, apice obtusis vel late acuminatis, basi late rotundatis et distincte cordatis,

nervis utrinque circiter 18, tenuibus; infructescentiis terminalibus, basi ramosis, 3 ad 4.5 cm longis, floribus sessilibus, calycis urceolatis, circiter 1.5 cm longis, limbo producto 5 ad 8 mm longo, leviter 4-lobato.

A small glabrous tree, the branches and branchlets terete, the latter 2 to 3 mm in diameter. Leaves sessile, oblong to oblong-elliptic, coriaceous, the upper surface strongly shining, the lower surface rather dull and minutely punctate, 6 to 10 cm long, 3 to 5 cm wide, the apex obtuse or broadly and obtusely acuminate, the base broadly rounded and distinctly cordate; lateral nerves slender, about 18 on each side of the midrib, straight, anastomosing with the equally distinct marginal nerves 1 to 2 mm from the edge of the leaf. Infructescences terminal, branched from the base, 3 to 4.5 cm long, the branches rather stout, 4-angled, flowers sessile, the calyx after anthesis urceolate, about 1.5 cm long, the throat about 8 mm in diameter, the limb produced 5 to 8 mm, shallowly 4-lobed.

PANAY, Capiz Province, Mount Salibongbong, *Bur. Sci.* 35630 *Martelino & Edaña*, June 19, 1919, in forests at the summit of the mountain, altitude about 650 meters.

A species well characterized by its terete branchlets; its sessile, cordate, strongly shining leaves; its terminal inflorescences; and its elongated calyx-tubes. The rim of the calyx-tube is extended above the ovary for a distance of from 5 to 8 mm. This species does not appear to be closely allied to any previously described form, although in some respects an alliance with *Eugenia ilocana* Merr. is indicated.

EUGENIA PASCASIOII sp. nov.

Frutex glaber, ramulis tenuibus, teretibus; foliis coriaceis, oblongis ad oblongo-lanceolatis, 12 ad 16 cm longis, basi acutis, apice caudato-acuminatis, nitidis, haud punctatis, nervis utrinque circiter 15, indistinctis, reticulis obscuris vel obsoletis; inflorescentiis terminalibus, breviter pedunculatis, 4 cm longis, ramulis brevibus, ad nodis valde constrictis, calycis tubo oblongo, 7 ad 8 mm longo, 3.5 mm diametro, subtruncato.

A glabrous shrub, the branchlets rather slender, terete. Leaves coriaceous, oblong to oblong-lanceolate, 12 to 16 cm long, 3 to 4.5 cm wide, the base acute, the apex slenderly caudate-acuminate, the upper surface dark olivaceous, shining, the lower paler, not glandular-punctate; lateral nerves slender, indistinct,

about 15 on each side of the midrib, anastomosing with the equally indistinct marginal nerves 2 to 3 mm from the edge of the leaf, the reticulations obscure or obsolete; petioles 7 to 10 mm long. Inflorescences terminal, shortly peduncled, about 4 cm long, the few branches and the branchlets greatly constricted at the nodes, 4 to 8 mm in length, the pedicels very short. Calyx-tube oblong, brown when dry, 7 to 8 mm long, about 3.5 mm in diameter, truncate or obscurely toothed, narrowed below to the blunt base.

BUCAS GRANDE, *Bur. Sci.* 35057 Ramos & Pascasio, June 11, 1919, in dry forests at low altitudes.

The alliance of this characteristic species is not entirely clear although in some respects it is suggestive of *Eugenia dura* Merr.: it is, however, very distinct from that species.

DESCRIPTIONS OF NEW PHILIPPINE WASPS OF THE SUBFAMILY PSEININÆ

By S. A. ROHWER

Forest Insects, Bureau of Entomology, Washington, D. C.

The present paper is based on material in the collection of the United States National Museum, and on that forwarded to the author by C. F. Baker from Los Baños, Philippine Islands. The types of all the new species and most of the specimens are in the National Museum.

Genus *DIODONTUS* Curtis

The scope of the genus *Diodontus* is here enlarged to include species which belong to the group *Psenulus* Kohl and new species which differ in both thoracic and venational characters from typical members of the genus. Many of the species from the Philippine Islands differ from typical members of the genus in having the first recurrent interstitial with or antefurcal to the first intercubitus. One of the new species, *Diodontus scutatus*, differs from all other members of the genus known to the author, in having the parapsidal furrows strong and complete. At first sight these two groups seem to be worthy of generic rank, but there is some variation in the position occupied by the first recurrent, and in some species the parapsidal furrows are present anteriorly. For this reason, and because it seems likely that more collecting, in this and other tropical regions, will reveal still other specific aggregates showing diversity in structure, it has been deemed advisable to enlarge, rather than restrict, the generic, concept. By this, however, the author does not wish to be understood that he would imply that the Philippine species are closely allied to the Nearctic species. It is his belief that future investigations will demonstrate the desirability of naming, at least as subgenera, such specific groups.¹

¹ For a discussion of the genotype of *Diodontus* see Proc. U. S. Nat. Mus. 49 (1915) 243.

Key to the Philippine species of *Diodontus* Curtis.

1. Abdomen black or with reddish spots only on second tergite..... 2.
Abdomen reddish except sometimes the petiole..... 4.
2. Scutellum yellow; no tubercles on frons near the top of the eyes;
four anterior femora yellow..... *D. xanthognathus* (Rohwer).
Scutellum black; a prominent tubercle on frons near the top of the
eyes; four anterior femora black except the apices..... 3.
3. Posterior surface of propodeum rugulose; pronotum and metanotum
marked with yellow..... *D. tuberculifrons* sp. nov.
Posterior surface of propodeum coarsely reticulate; pronotum and
metanotum black..... *D. maurus* sp. nov.
4. Parapsidal furrows strong, extending to scutellum; petiole black.
D. scutatus sp. nov.
Parapsidal furrows weak, wanting posteriorly..... 5.
5. Thorax except tubercles black..... 6.
Thorax largely yellow..... 7.
6. Petiole concolorous with gaster; area outside lateral ocelli depressed.
D. philippinensis sp. nov.
Petiole black; area around ocelli not depressed... *D. basilanensis* sp. nov.
7. Frons, near the top of the eye, with a low tubercle; scutum with large
punctures..... *D. bakeri* sp. nov.
Frons without tubercles; scutum practically impunctate..... 8.
8. Face with a transverse ridge just below antennæ; large species.
D. ajax sp. nov.
Face without a transverse ridge..... 9.
9. Apical margin of clypeus slightly produced and emarginate so as to
appear bidentate; scutum mostly yellow; first recurrent and first
intercubitus interstitial..... *D. luzonensis* sp. nov.
Apical margin of clypeus truncate, not bidentate; scutum largely black;
first recurrent interstitial..... 10.
10. Frons shining, with a few aciculations; first recurrent in the first cu-
bital; flagellum much thickened apically..... *D. luteopictus* sp. nov.
Frons subopaque, coriaceous; first recurrent in the second cubital;
flagellum not much thickened apically..... *D. multipictus* sp. nov.

*A. Parapsidal furrows complete to scutellum.**Diodontus scutatus* sp. nov.

In the complete parapsidal furrows and the venation of the anterior wings, this species differs from the typical members of this genus.

Female.—Length, 7 millimeters. Clypeus flat, shining, sparsely punctured basally, the apical margin straight, with three small median teeth and a small lateral tooth; face opaque, finely granular; a median, free-edged, truncate process above the middle of the face connecting with the lower margin of the very prominent ventral portion of the frontal carina; frons, vertex, and posterior orbits smooth, shining; no tubercles on the frons; a broad, shallow U-shaped depression partially surrounding the ocellar area; ocelli in an equilateral

triangle; the postocellar line subequal to the ocellocular line; scape of normal length, the outer margin slightly curved; flagellum subclavate, the first joint one-sixth longer than the second; thorax smooth, shining; pronotum rounded, not carinate, the lateral angles rounded; parapsidal furrows strong, complete to scutellum, parallel for most of their length; propodeal enclosure nearly transverse, with many rugæ; posterior surface of the propodeum with a strong median sulcus of uniform width; sides and dorsal aspect of propodeum separated by a curved, finely crenulate furrow; abdomen smooth, shining; postpetiole not sharply defined; petiole cylindrical; strongly curved basally, extending slightly beyond the middle of the posterior femur; posterior femur slightly produced at the base beneath; posterior tibia sharply thickening apically, at the base with a number of short close spines; longer calcarium of the posterior tibia strongly curved, subequal in length to the posterior basitarsus; first and third cubital cells each receiving a recurrent vein, the first near the apex, the second at the basal third; second cubital cell trapezoidal in outline; third intercubitus oblique; venation of hind wings normal. Head black; mandibles, except apices and palpi, yellow; scape yellow; flagellum ferruginous, the apical joints piceous; thorax yellow; pronotum anteriorly, a median spot on the scutum, inclosure and median sulcus of propodeum, mesepimeron, a line beneath wings, and a small spot at apex of propodeum black; legs yellow, the posterior femora and tibiæ ferruginous; abdomen, except the black petiole, red. Wings hyaline, iridescent; venation yellowish. Face, clypeus, sides of frons, and posterior orbits with silvery pubescence, thorax with sparse gray hair.

Male.—Length, 7 millimeters. Clypeus slightly convex, the apical margin rounded with two minute median teeth; facial prominence broader than in female, extending the width of the face; posterior orbits very narrow, broader below; scape short, straight; flagellum moniliform; posterior surface of propodeum obliquely rugulose, the median sulcus feebly foveolate; posterior femur and tibia normal. Black; mandibles except apices, palpi, scape, posterior margin of pronotum, tubercles, tegulæ, anterior margin of the scutum and a projection posteriorly above wings, a median quadrate posterior spot on the scutum, prepectus, spot below wings, scutellum, metanotum, propodeum except a transverse basal and apical spot and median sulcus yellow; flagellum piceous, the basal segments ferruginous beneath.

Except where mentioned the male agrees with the female.

Type locality.—Los Baños, Laguna, Luzon. Described from one female type and one male allotype from Los Baños and from a female paratype from Mount Maquiling. All received from C. F. Baker.

Type.—Catalogue No. 22838, United States National Museum.

A single male from Puerto Princesa, Palawan, received from C. F. Baker after the above was written, differs from the allotype in lacking some of the yellow markings. It is labeled as variety A and is not considered as part of the type material. The color of this specimen is as follows: Black; mandibles, except apices, scape, dorsal margin of pronotum, tubercles, tegulae, a spot above and one below, scutellum, metanotum, two small, elongate spots on posterior surface of propodeum yellow; flagellum piceous, yellow below; legs yellow, bases of four anterior femora brownish, hind legs below trochanters brownish; abdomen reddish, petiole and postpetiole black; wings hyaline, venation pale brown.

B. Parapsidal furrows wanting, or at most only present anteriorly.

1. *Second and third cubital cells each receiving a recurrent, or the first recurrent interstitial with the first intercubitus.*

a. *Abdomen and most of body black.*

Diodontus xanthognathus (Rohwer).

Males and females of this species were taken at Los Baños and on Mount Maquiling, Luzon, and at Puerto Princesa, Palawan; a male was taken at Dapitan, Mindanao. All received from C. F. Baker.

Female.—Length, 6 millimeters. Facial carina almost obsolete; median teeth of clypeus more distinct than in male; antennae subclavate, the third joint slightly longer than the fourth; posterior surface of propodeum smooth shining, median sulcus poorly defined; pygidial area not defined; posterior tarsi piceous; second tergite with two reddish spots which vary in size. Otherwise agrees well with male.

There is some variation in the color of the four anterior femora, as in two males they are piceous to near the apex.

b. *Abdomen reddish, thorax yellow marked with black.*

Diodontus bakeri sp. nov.

This species may be separated from *Psenulus interstitialis* Cameron by the triangular, not transverse, inclosed area on the propodeum, and by the different clypeus.

Female.—Length, 9 millimeters. Clypeus flat, closely, finely punctured, the apical margin with two triangular median teeth; face sculptured like the clypeus, without a transverse carina; frontal carina complete from anterior ocellus, very prominent between the antennæ; frons, vertex, and posterior orbits shining; on the frons near the top of the eye margin is an elongate tubercle, the dorsal margin of which is tangent to a line touching the lower margin of anterior ocellus; postocellar line one-fourth shorter than the ocellular line; scape nearly straight; flagellum thickening apically, the third joint distinctly longer than the second; anterior margin of the pronotum feebly carinate, the lateral angles rounded; mesoscutum with sparse, rather large punctures; parapsidal furrows weak, about one-third the length of the scutum; scutellum and metanotum impunctate; mesopleura and sides of propodeum anteriorly shining, impunctate; inclosed area of propodeum broadly triangular, with strong longitudinal carinæ, defined posteriorly by a smooth area; posterior surface and sides of propodeum posteriorly finely transversely striate-reticulate, the posterior surface with a median sulcus; abdomen smooth, shining; postpetiole rather sharply defined anteriorly; petiole cylindrical, curved, as long as posterior leg to apical third of femur; pygidial area not defined; venation typical except that the first recurrent is interstitial with the first intercubitus; second cubital cell trapezoidal in outline; third intercubitus sharply angulate above the middle. Head black; mandibles, except apices, yellow; scape and pedicellum yellow, flagellum piceous, ferruginous beneath; thorax yellow; pronotum anteriorly, three spots on the scutum (the median one the largest), mesosternum medially, spot on mesepisternum, posterior margin of mesepisternum, mesepimeron, metapleura, inclosed area and median sulcus of propodeum black; legs yellow, posterior trochanters, bases of posterior femora and posterior tarsi piceous; abdomen reddish. Wings hyaline, iridescent; venation dark brown. Face, clypeus, and thorax with sparse golden pubescence.

Type locality.—Mount Maquiling, Laguna, Luzon. Described from one female from Mount Maquiling (type) and one female from Los Baños, Luzon. Collected by C. F. Baker, for whom the species is named.

Type.—Catalogue No. 22839, United States National Museum.

Diodontus luzonensis sp. nov.

This species closely resembles *Diodontus bakeri* but may be easily differentiated from that species by the impunctate scutum

and the absence of tubercles on frons near the top of inner eye margin.

Female.—Length, 8 millimeters. Clypeus gently convex, the surface finely punctured; apical margin with two obscure median teeth; face sculptured like the clypeus, without a transverse carina; a strong, blunt, ridgelike tubercle between bases of antennæ; frontal carina weak but complete; frons, vertex, and posterior orbits smooth, shining; postocellar line slightly shorter than ocellocular line; scape gently curved; antennæ subclavate; third joint one-third longer than fourth; pronotum subcarinate anteriorly, the lateral angles rounded; mesoscutum, scutellum, metanotum, and mesepisternum smooth, shining; parapsidal furrows weak, about one-third the length of scutum; inclosed area of propodeum broadly triangular, longitudinally rugose; posterior surface and sides of propodeum finely obliquely rugulose; posterior surface with a median sulcus; abdomen smooth, shining; postpetiole nodose; petiole curved, cylindrical, and as long as the posterior legs to near apices of femur; pygidial area obsolete; venation typical, except for the interstitial first recurrent and first intercubitus; second cubital cell trapezoidal; third intercubitus strongly angulate above middle. Head black; mandibles, except apices, and palpi yellow; scape and pedicellum yellow, flagellum piceous, ferruginous beneath; thorax yellow; a median spot on scutum, a small spot before tubercle, a spot below each tegula, mesepimeron, a spot before, inclosed area of propodeum and sulcus of posterior surface black; legs yellow, the posterior pair red below trochanters; abdomen red. Wings hyaline, iridescent; venation dark brown. Face, clypeus, inner margins of eyes to vertex and posterior orbits with dense, silvery or slightly yellowish pubescence; thorax with sparse, gray hair.

In the paratype there is a small black spot on the side of the mesoscutum.

Type locality.—Los Baños, Laguna, Luzon. Described from two females forwarded by C. F. Baker.

Type.—Catalogue No. 22840, United States National Museum.

Diodontus multipictus sp. nov.

Allied to *Diodontus luteopictus*, but can be distinguished by the characters used in the preceding key.

Female.—Length, 8.5 millimeters. Clypeus flat, the apical margin narrowly depressed and truncate; face without a transverse carina; frontal carina strong, especially prominent

below; frons and vertex coriaceous with a tendency to rugulosity just above the antennæ; occiput smooth; lateral ocelli in distinct pits; postocellar line distinctly shorter than the ocellular line; antennæ rather short, scarcely thickening apically, the third joint distinctly longer than the fourth; anterior dorsal margin of pronotum carinate, not dentate laterally; scutum polished, with well-separated punctures, parapsidal furrows not indicated; scutellum and metanotum with only setigerous punctures; base of propodeum with a triangularly shaped, depressed area which is crossed by about twelve rugæ; the median sulcus distinct, deep; posterior surface of the propodeum coriaceous; mesepisternum polished, with only setigerous punctures, sutures not foveolate; petiole cylindrical, curved, almost as long as hind trochanter and femur; longer calcarium of hind tibia shorter than hind basitarsus; first recurrent received by the second cubital near the base; second recurrent received well within the third cubital cell. Black, with abundant yellow marks; flagellum testaceous; mandibles, scape, pronotum dorsally, tubercles, tegulæ, large spot on mesepisternum, spot below hind wings, scutum except three broad lines, scutellum, metanotum, propodeum except basal depressed area and median line yellow; legs yellow, hind femora, tibiæ, and tarsi testaceous; petiole yellow at base, black apically; gaster reddish; body sparsely clothed with silvery hair; wings clear hyaline; venation testaceous.

Type locality.—Mount Banahao, Luzon. Described from one female received from C. F. Baker.

Type.—Catalogue No. 22841, United States National Museum.

2. *First and third cubital cells each receiving a recurrent vein.*

c. *Body almost entirely black.*

Diodontus tuberculifrons sp. nov.

Female.—Length, 8.5 millimeters. Clypeus flat, with separate, distinct punctures, the apical margin straight, with two median teeth; face sculptured like the clypeus; facial protuberance nearly as wide as face, rounded laterally and emarginate medially where the strong frontal carina joins it; frontal carina from anterior ocellus to between bases of antennæ weak; frons, vertex, and posterior orbits smooth, shining, very sparsely punctured; intraocellar area strongly raised, punctures distinct; ocelli in an equilateral triangle, postocellar line subequal with the ocellular line; on the frons opposite the top of the eye is an elongate convex tubercle; scape rather short, the outer

margin slightly curved; flagellum stout, subclavate, the first joint slightly longer than the second; pronotum carinate anteriorly, rounded laterally; mesoscutum shining, with sparse, poorly defined punctures which are smaller and denser anteriorly; parapsidal furrows weak, indicated for about half the length of the scutum; scutellum and metanotum with separate distinct punctures; mesopleura, metapleura, and sides of propodeum anteriorly, smooth, shining; episternauli poorly defined; inclosed area of propodeum broadly triangular, with a few rugæ, the median ones more prominent; posterior surface of propodeum transversely rugulose, the sides posteriorly finely reticulate; legs robust; longer calcarium of posterior tibia nearly as long as hind basitarsus; abdomen smooth, shining; petiole cylindrical, curved, about the same length as the hind femur; pygidial area defined by carinæ, very long and narrow, the carinæ nearly parallel; first and third cubital cells each receiving a recurrent vein; second cubital cell narrower above because of the oblique first intercubitus; venation of hind wings normal. Black; mandibles except apices, palpi, scape, flagellum beneath except apices, pronotum posteriorly, tubercles, tegulæ, two spots on scutum posteriorly, metanotum, four anterior legs below apical third of femora, posterior femora beneath apically, posterior tibiæ except a black median band and posterior basitarsi yellow; face and clypeus with silvery pubescence; vertex and thorax with sparse hair. Wings hyaline, iridescent; venation black.

The paratypes indicate that the line on the metanotum may be interrupted.

Type locality.—Los Baños, Laguna, Luzon. Described from two females (one type) from Los Baños, and from one female from Mount Banahao. All specimens received from C. F. Baker.

Type.—Catalogue No. 22842, United States National Museum.

Diodontus maurus sp. nov.

This species is allied to *Diodontus tuberculifrons* Rohwer, but besides the characters given in the preceding key it may be distinguished from that species by the black hind legs.

Male.—Length, 7 millimeters. Clypeus convex medially, the apical margin with two obtuse teeth, which are separated by a U-shaped emargination; clypeus and face with distinct, separate punctures; frontal carina weak dorsally, very prominent between bases of antennæ to the transverse facial carina; transverse facial carina nearly complete to eye margins where it joins a raised

line which follows the eye margins; frons and vertex shining and sparsely punctured; on the frons near the top of the eye is an elongate, shining tubercle; intraocellar area and behind a narrow curved depressed line; postocellar line slightly longer than the ocellocular line; antennæ submoniliform, the third joint slightly longer than the fourth; anterior dorsal margin of the pronotum carinate and feebly dentate laterally; scutum shining, with well-separated, distinct punctures; parapsidal furrows present anteriorly; scutellum and metanotum punctured like the scutum; propodeum coarsely reticulate, the median impressed line of uniform width; mesopleura shining, almost impunctate, the sutures feebly foveolate; longer calcarium of the posterior tibia shorter than the hind basitarsus; petiole cylindrical, fully as long as hind trochanter and femur; abdomen shining; first recurrent joining first cubital well before the apex. Black; mandibles except apices, spot on tubercles, scape beneath, and four anterior tibiæ and tarsi yellow; rather sparsely clothed with silvery hair; wings hyaline, iridescent; venation black.

Type locality.—Mount Maquiling, Laguna, Luzon. Described from one male received from C. F. Baker.

Type.—Catalogue No. 22843, United States National Museum.

d. Abdomen reddish, thorax black without yellow markings.

Diodontus philippinensis sp. nov.

Judging from the description this species resembles *Psen rufoventris* Cameron, but may be separated from that species by the different sculpture on the front, different propodeum, and shorter petiole.

Female.—Length, 8 millimeters. Clypeus convex, the apical margin truncate, the surface irregularly punctured; face finely punctured; a strong carina, between the bases of antennæ, extends ventrally until it unites with the complete transverse facial carina, and dorsally to the anterior ocellus (not so prominent above the antennæ); frons, vertex, and posterior orbits smooth, shining; between ocelli and eye an elongate raised area: postocellar line slightly shorter than the ocellocular line; antennæ slightly thickening apically, scape curved, the third joint slightly longer than the fourth; pronotum carinate anteriorly, anterior lateral angles sharp; mesoscutum with sparse, small punctures; parapsidal furrows weak, extending about half the length of the scutum; mesepisternum smooth, shining; scutellum sculptured like the scutum; inclosed area on propodeum broadly triangular, sharply defined posteriorly by a carina and with longitudinal rugæ; sides and posterior surface reticulate, posterior surface

with a median carina; postpetiole not nodose; petiole cylindrical, as long as the posterior leg to apex of femur; abdomen smooth, shining; pygidial area obsolete; first recurrent received near apex of first cubital cell; second cubital cell narrowed above; second recurrent received in the third cubital cell at a little greater distance from the second transverse cubitus than the first recurrent is from the first transverse cubitus; venation of hind wings typical. Black; mandibles except apices, first three segments of flagellum, tegulae, tubercles yellow; legs and abdomen reddish; flagellum piceous, yellowish beneath; face, clypeus, and thorax (more sparsely) clothed with silvery pubescence. Wings hyaline, iridescent; venation brown.

Type locality.—Los Baños, Laguna, Luzon. Described from two females (one type) forwarded by C. F. Baker. A paratype from Lamao, Bataan, Luzon, also from C. V. Piper.

Type.—Catalogue No. 22844, United States National Museum.

In the position of the first recurrent this species is not typical of the genus *Diodontus*.

Diodontus basilanensis sp. nov.

Allied to *Diodontus philippinensis*, but can be readily separated by the characters given in the preceding key.

Female.—Length, 8 millimeters. Clypeus convex, the apical margin with a depressed area medially which is nearly truncate; frontal carina strong, terminating ventrally in a transverse ridge; seen from in front this ridge is slightly produced, and then emarginate, medially; antennae long, slender, but slightly thicker apically, the third joint about one-fifth longer than the fourth; frons flat; no depression around the ocelli; postocellar line only a little longer than ocellular line; anterior dorsal margin of pronotum with a distinct carina, not dentate laterally; scutum shining, with only setigerous punctures, parapsidal furrows present on anterior half; scutellum shining, almost without sculpture; metanotum with dense hair; base of propodeum with a depressed area which is crossed by about twelve rugae; rest of propodeum, except polished areas at the sides basally, reticulate-coriaceous, the reticulations more pronounced posteriorly; mesepisternum smooth, with setigerous punctures, the sulci not foveolate; four anterior femora rather robust; longer calcarium of hind tibia subequal in length to the hind basitarsus; petiole cylindrical, strongly curved, its length about equal to that of the hind femur; first recurrent slightly before the first intercubitus; second recurrent joining the third cubital at a distance

half the length of the second intercubitus from its base. Black; mandibles, scape, flagellum beneath, tegulæ, tubercles, and legs beyond coxæ testaceous; gaster reddish; head and thorax with long silvery hair which is especially dense on the propodeum; wings hyaline, iridescent; venation testaceous.

Type locality.—Basilan. One female from C. F. Baker.

Type.—Catalogue No. 22845, United States National Museum.

e. Abdomen reddish, thorax black with yellow markings.

Diodontus luteopictus sp. nov.

Of the described oriental species this species seems to be more closely allied to *Psen pulcherrimus* Bingham, but the color, sculpture, and venation are decidedly different from that species.

Female.—Length, 9.5 millimeters. Clypeus very slightly convex, shining, sparsely punctured, the apical margin rounded; face more closely punctured than the clypeus; a strong median carina, between the bases of the antennæ, ends well above the middle of the face, as a short transverse carina, and extends dorsally to the anterior ocellus; frons, vertex, and posterior orbits smooth and shining; intraocellar area raised; ocelli in an equilateral triangle, the anterior ocellus the largest; postocellar line subequal to the ocellocular line; scape short, straight; flagellum subclavate, first joint one-fourth longer than second, the second and third subequal; pronotum carinate anteriorly, rounded laterally; scutum with sparse, poorly defined punctures; parapsidal furrows weak, indicated on the anterior fourth; scutellum, metanotum, mesosternum, mesopleura, metapleura, and sides of propodeum anteriorly smooth, shining, impunctate; inclosed area of the propodeum broadly triangular, prolonged as a sulcus to the apex of the segment, the basal portion with a few prominent rugæ; posterior surface and sides of propodeum posteriorly transversely rugulose; abdomen smooth, shining; postpetiole not sharply defined; petiole cylindrical, slightly longer than the posterior legs to apices of femora; pygidial area not defined; first and third cubital cells each receiving a recurrent vein; second cubital cell nearly quadrate; third intercubitus strongly curved; venation of the hind wings normal. Black; mandibles except apices, palpi, scape, pedicellum, flagellum beneath, pronotum posteriorly, tubercles, tegulæ, a line above, two spots below, two spots on scutum (broader behind), scutellum, postscutellum, spot beneath each posterior wing, posterior surface of propodeum except a median line, legs except the posterior femora above and beneath, and the posterior tarsi

yellow; abdomen ferruginous, except petiole and spots on the third and fourth tergites and sternites which are piceous. Wings hyaline, iridescent; venation pale brown. Face, clypeus, frons, and thorax (sparsely) with yellowish pubescence.

Type locality.—Luzon. Described from two females from C. F. Baker. The type from Mount Maquiling, the paratype from Mount Limay.

Type.—Catalogue No. 22849, United States National Museum.

The venation of the anterior wings is not typical of this genus.

Diodontus ajax sp. nov.

The large size and transverse ridge across the face will readily distinguish this species from its allies.

Female.—Length, 12 millimeters. Labrum broadly arcuately emarginate apically and with a fringe of hair; clypeus convex, with separate, distinct punctures, the apical margin with two small teeth; frontal carina prominent and sharp, terminating ventrally in a transverse ridge which does not quite reach the eye margin; frons and vertex shining, with small sparse punctures; no tubercles on frons; ocelli in a low triangle; the post-ocellar line subequal with the ocellocular line; flagellum only slightly thickened apically, the first joint somewhat longer than the second; pronotum sharply carinate anteriorly but not toothed; scutum shining, with small, well-separated punctures, parapsidal furrows present anteriorly; scutum in front of scutellum strongly foveolate; scutellum and metanotum smooth, impunctate; mesopleura smooth, polished, the posterior aspect finely aciculate, dorsal aspect with a transverse area which has twelve longitudinal carinæ; median sulcus of posterior surface strong and of uniform width; legs rather hairy; longer spur of hind tibia as long as the basitarsus, strongly angled basad of middle; petiole cylindrical, without carinæ, nearly as long as hind trochanter and femur; abdomen polished; first recurrent before the first intercubitus by a distance as great as the second abscissa of radius, the second recurrent the same distance beyond the second intercubitus; third intercubitus forming a right angle with the cubitus for a short distance only, then strongly curving inward to the radius so that the third cubital is one-fourth longer on the cubitus. Head black; a yellow spot on mandibles; antennæ black, scape, pedicellum, and most of flagellum beneath yellowish; thorax black with the following yellow marks: Top of pronotum, tegulæ, scutum except a large median and a small lateral spot, scutellum, metanotum, two large

spots on posterior and lateral surfaces of propodeum, top of mesepisternum; legs yellow, posterior femora and tibiæ above black; hind tarsi brownish; abdomen reddish, base of petiole yellow, its apex blackish; wings hyaline, iridescent; venation dark brown.

Type locality.—Mount Maquiling, Laguna, Luzon. Described from one female received from C. F. Baker.

Type.—Catalogue No. 22847, United States National Museum.

Genus FSEN Latreille

The three Philippine species of *Pseninæ*, which have the nervellus reclivate and postfurcal, belong to the subgenus *Mimesa* Schuckard and may be distinguished by the following synopsis:

1. Propodeal enclosure with a deep, narrow median sulcus; legs blow coxæ rufous..... *P. politiventris* sp. nov.
- Propodeal enclosure without a distinct median sulcus..... 2.
2. Face and clypeus with silvery pubescence; legs and abdomen black.
..... *P. melanosoma* sp. nov.
- Face and clypeus with golden pubescence; anterior legs below coxæ, and posterior legs in part yellowish ferruginous; abdomen with ferruginous spots..... *P. aureohirta* sp. nov.

Psen (*Mimesa*) *politiventris* sp. nov.

Besides the characters used in the above synopsis, this species can be readily distinguished from the other Philippine species by the highly polished abdomen.

Female.—Length, 8.5 millimeters. Apical margin of clypeus broadly produced, the sides of the produced portion rounded, medially, with a broad V-shaped emargination; face with rather close, small punctures; a faint carina between bases of antennæ; frons and vertex smooth, shining, though medially the frons is punctate-striate; ocelli in a low triangle, the postocellar line subequal with the ocellocular line; antennæ rather long, thickened apically, the third joint much longer than the fourth; pronotum short, the anterior dorsal margin carinate, not prominent laterally; scutum subglabrous, with small, separate, distinct punctures; parapsidal furrows slightly indicated anteriorly; scutellum polished, with rather large, distinct, well-separated punctures; metanotum impunctate; propodeal inclosure concave, U-shaped in outline, with a narrow median sulcus and about twelve oblique rugæ; posterior surface of the propodeum reticulate; the median sulcus foveolate; mesepisternum shining, practically without sculpture; episternum distinct; sides of propodeum shining, with small well-separated punctures; petiole cylindrical, as long as hind leg to apex of femur; gaster

polished; pygidium sharply defined, two and one-half times as long as basal width, granular; second recurrent interstitial with the second intercubitus. Black; legs below coxæ rufous (tarsi somewhat infuscated); wings smoky, venation black; face with dense, slightly golden, pubescence; thorax with sparse silvery pubescence.

Type locality.—Baguio, Benguet, Luzon. Described from a single female received from C. F. Baker under his No. 7993.

Type.—Catalogue No. 22881, United States National Museum.

Psen (Mimesa) melanosoma sp. nov.

Male.—Length, 9 millimeters. Clypeus convex, with close small punctures, the apical margin slightly rounded and with two rounded median teeth; face sculptured with transverse carina; frontal carina complete from anterior ocellus to between bases of antennæ where it is more prominent; frons with distinct, small, close punctures; vertex (more broadly laterally) and posterior orbits shining; ocelli in a low triangle; the postocellar and ocellular lines subequal; scape rather short, the outer margin nearly straight; flagellum rather long, slightly thickening apically, first joint one-third longer than second, the fifth and sixth joints irregularly rounded beneath; pronotum feebly carinate anteriorly, rounded laterally; parapsidal furrows completely wanting; scutum shining, with close, well-defined punctures; scutellum convex, more sparsely punctured than the scutum; mesopleura and metapleura shining, impunctate; episternauli complete; inclosed area of propodeum broadly triangular in outline, closely rugose, medially with a diamond-shaped area; sides and posterior surface of propodeum coarsely reticulate, the posterior surface with a median carina; legs slender; abdomen shining impunctate; petiole cylindrical, as long as posterior leg to apex of femur; last tergite with sparse punctures; second cubital cell large, trapezoidal in outline, third transverse cubitus strongly bent at middle. Black; anterior legs below femora piceous; clypeus, face, frons below middle, and pronotum dorsally with appressed silvery pubescence; thorax with sparse silvery pubescence except on the scutum where it is blackish. Wings hyaline, iridescent; venation black.

Type locality.—Mount Maquiling, Laguna, Luzon. Described from two males (one type) received from C. F. Baker.

Type.—Catalogue No. 22882, United States National Museum.

Psen (Mimesa) aureohirta sp. nov.

Female.—Length, 8 millimeters. Clypeus convex medially,

surface granular, apical margin truncate with a broad, shallow emargination; face closely punctured, without a transverse carina; frontal carina complete from anterior ocellus to between bases of antennæ and of uniform strength; along the inner margin of eye to level of anterior ocellus is a rounded raised area; vertex and posterior orbits shining; nearly impunctate; intraocellar area convex; ocelli in a little less than an equilateral triangle; postocellar line slightly shorter than the ocellular line; scape short, the outer margin curved; flagellum long, subclavate apically; the first joint but little shorter than the second and third; pronotum carinate anteriorly, rounded laterally, the anterior surface granular; scutum with distinct, rather close punctures; parapsidal furrows obsolete; scutellum slightly convex, more sparsely punctured than the scutum; mesopleura and metapleura shining, impunctate; episternauli distinct; inclosed area of propodeum with many strong rugæ, a triangular median area which connects with the carina of the posterior surface; sides and posterior surface of propodeum feebly, widely reticulate; legs rather stout; abdomen shining; petiole cylindrical, curved, as long as posterior leg to middle of femur; pygidial area broad, rounded apically, with large punctures; second cubital cell nearly rectangular; third transverse cubitus strongly bent near middle; second transverse cubitus and second recurrent interstitial. Black; mandibles, scape, flagellum beneath, trochanters, femora beneath basally, tibiæ basally and basitarsi of posterior legs, apical margin of first and two spots on second tergites ferruginous; face, clypeus, posterior orbits, and anterior surface of pronotum dorsally (both latter areas more sparsely) with appressed golden pubescence; thorax with sparse golden pubescence. Wings yellowish hyaline; venation dark brown.

Male.—Length, 7 millimeters; length of antennæ, 4 millimeters. Flagellum joints 5 to 9, inclusive, apically spinose beneath; apical margins of tergites 3 and 4 each with four long, curved spines; pygidial area obsolete; wings hyaline. Agrees otherwise with female.

Paratype indicates that the second recurrent may be received at base of third cubital cell.

Type locality.—Mount Maquiling, Laguna, Luzon. Described from two females (one type) and one male (allotype) from Mount Maquiling, and one male paratype from Los Baños. All from C. F. Baker.

Type.—Catalogue No. 22883, United States National Museum.

THE PHILIPPINE BUREAU OF SCIENCE

RECENT PUBLICATIONS

AN INTERPRETATION OF RUMPHIUS'S HERBARIUM AMBOINENSE

By E. D. MERRILL

Based on the collections made in Amboina by the late Charles Budd
Robinson

Order No. 450. Bureau of Science Publication No. 9. Paper, 595 pages
and 2 maps.

Price, \$3 United States currency, postpaid.

SPECIES BLANCOANAE: A CRITICAL REVISION OF THE PHILIPPINE SPECIES OF PLANTS DESCRIBED BY BLANCO AND BY LLANOS

By E. D. MERRILL

Order No. 461. Bureau of Science Publication No. 12. Paper, 423 pages
and 1 map.

Price, \$2.25 United States currency, postpaid.

PHILIPPINE WATER SUPPLIES

By George W. Heise and A. S. Behrman

Order No. 460. Bureau of Science Publication No. 11. Paper, 218 pages,
19 plates, and 4 text figures.

Price, \$1.75 United States currency, postpaid.

VEGETATION OF PHILIPPINE MOUNTAINS

The relation between the environment and physical types
at different altitudes

By WILLIAM H. BROWN

Order No. 473. Bureau of Science Publication No. 13. Paper, 434 pages,
41 plates, 30 text figures.

Price, \$2.50 United States currency, postpaid.

PLEASE GIVE ORDER NUMBER

Orders for these publications may be sent to the Business Manager, Philippine Journal
of Science, Bureau of Science, Manila, P. I., or to any of the following agents:

AGENTS

THE MACMILLAN COMPANY, 64-66 Fifth Avenue, New York, U. S. A.
WM. WESLEY & SON, 28 Essex Street, Strand, London, W. C., England.
MARTINUS NIJHOFF, Lange Voorhout 9, The Hague, Holland.
KELLY & WALSH, Limited, 32 Raffles Place, Singapore, Straits Settlements.
THACKER, SPINK & CO., P. O. Box 54, Calcutta, India.
THE MARUZEN CO., Limited, 11-16 Nihonbashi, Tori-Sasabome, Tokyo, Japan.

CONTENTS

	Page
SMITH, WARREN D. Tropical geology and engineering	221
LIGHT, S. F. Notes on Philippine termites, I.....	243
UICHANCO, LEOPOLDO B. New records and species of Psyllidæ from the Philippine Islands, with descriptions of some preadult stages and habits.....	259
MERRILL, ELMER D. New Philippine Myrtaceæ.....	289
ROHWER, S. A. Descriptions of New Philippine wasps of the subfamily Pseninæ	309

The Philippine Journal of Science is issued twelve times a year. The sections were discontinued with the completion of Volume XIII (1918).

Yearly subscription, beginning with Volume XIV, 5 dollars United States currency. Single numbers, 50 cents each.

Publications sent in exchange for the Philippine Journal of Science should be addressed: Library, Bureau of Science, Manila, P. I.

Subscriptions may be sent to the BUSINESS MANAGER, Philippine Journal of Science, Bureau of Science, Manila, P. I., or to any of the agents listed on the third page of this cover.

Entered at the post office at Manila, P. I., as second-class matter.

VOL. 18, No. 4

APRIL, 1921

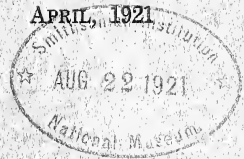

THE PHILIPPINE JOURNAL OF SCIENCE



MANILA
BUREAU OF PRINTING
1921

177676

THE PHILIPPINE JOURNAL OF SCIENCE

Published by the Bureau of Science of the Government of the Philippine Islands

ELMER D. MERRILL, M.S., *Editor*

R. C. MCGREGOR, A.B., *Associate Editor*

ALBERT H. WELLS, A.B.; GRANVILLE A. PERKINS, PH.D.; A. P. WEST, PH.D.
T. DAR JUAN, A.B., PHAR.D.; F. AGCAOILI, A.B.; A. S. ARGUELLES, B.S.

ALBERT E. W. KING

Chemistry

WARREN D. SMITH, PH.D.; ROY E. DICKERSON, PH.D.

Geology

H. W. WADE, M.D.; OTTO SCHÖBL, M.D.
F. G. HAUGHWOUT; STANTON YOUNGBERG, D.V.M.

Experimental Medicine

LIBORIO GOMEZ, M.D., PH.D.; F. CALDERON, B.A., L.M.

VICENTE DE JESUS, M.D.

Clinical Medicine

W. H. BROWN, PH.D.; C. F. BAKER, M.A.; ATHERTON LEE, M.S.
O. A. REINKING, B.S.A., M.S.; L. M. GUERRERO, PHAR.D.

Botany

ALBERT C. HERRE, PH.D.; C. F. BAKER, M.A.; S. F. LIGHT, M.A.
C. S. BANKS, M.A.; L. D. WHARTON, M.A.; W. SCHULTZE

Zoölogy

H. O. BEYER, M.A.; OTTO JOHNS SCHEERER, M.A.

Anthropology

ANNA B. BANYEA, *Copy Editor*

Manuscript intended for publication and books for review should be sent to the editor. One hundred separates of papers published in the Journal are furnished to authors without charge. Additional copies may be had at authors' expense.

Publications sent in exchange for the Philippine Journal of Science should be addressed: Library, Bureau of Science, Manila, P. I.

The Journal is issued twelve times a year. The subscription price is 5 dollars, United States currency, per year. Single numbers, 50 cents each.

Subscriptions may be sent to the BUSINESS MANAGER, Philippine Journal of Science, Bureau of Science, Manila, P. I., or to any of the agents listed on the third page of this cover.



THE PHILIPPINE JOURNAL OF SCIENCE

VOL. 18

APRIL, 1921

No. 4

THE STRUCTURE OF THE ELECTRON¹

By GRANVILLE A. PERKINS

Of the Bureau of Science, Manila

The general advances during the last twenty years in scientific knowledge concerning the properties of matter have been connected intimately with the unit of negative electricity, called the electron. Although the unitary nature of electricity was strongly suspected by Faraday, and others since his time, on the basis of electrochemical evidence, the conclusive demonstration of this is of comparatively recent date. The discovery² that cathode rays act as if they consist of negatively charged matter moving with about one-tenth the speed of light and show a nearly constant ratio of charge to mass, as would be expected of a stream of negative units, was soon followed by the development of methods³ by which these particles have been caught in cloud drops of water and of oil. In this manner not only has the discrete nature of negative electricity been proved, but the elementary charge has been exactly measured⁴ and found to be 4.774×10^{-10} of the customary electrostatic units.

¹ Rearranged from an address before the Freer Club, Manila. Received for publication April 15, 1921.

² Thompson, J. J., *Phil. Mag.* V 44 (1897) 298; Wiechert, E., *Verhandl. der Physik.-Ökon. Gesellsch. zu Königsberg*, i. Pr. (1897).

³ Wilson, C. T. R., *Proc. Roy. Soc. March 19, 1896*; *Phil. Trans. Roy. Soc. A* 192 (1899) 403; Thompson, J. J., *Phil. Mag.* V 46 (1898) 528; Wilson, H. A., *Phil. Mag.* VI 5 (1903) 429; Millikan, R. A., *Phil. Mag.* VI 19 (1910) 209.

⁴ Millikan, R. A., *Science* 45 (1917) 327.

THE MASS OF AN ELECTRON

According to the accepted electromagnetic theory any charged body has a certain mass (resistance to change of state of motion), which is due to nothing but the electric charge and depends upon its spacial distribution. The more concentrated a charge is, the greater is the mass due to it. For a given charge at a definite concentration the corresponding mass practically follows Newton's assumption of constant mass for any velocity up to and including those of cathode rays; that is, about one-tenth of the velocity of light. The idea that all the mass of ordinary matter is of this electromagnetic character was somewhat revolutionary when proposed by Larmor,⁵ but the assumption of mass of any other kind, at least in the case of electrons, has been since shown to be entirely superfluous.

The mass of the electron has been found to be 9.01×10^{-28} grams⁶ for all of the ordinary velocities at which it has been measured. According to experiments with the very rapid electrons given off by radium, which have been studied at velocities from three-tenths to eight-tenths of that of light, the apparent mass does not stay constant at this figure, but increases inversely with $\sqrt{c^2-v^2}$ (in which c is the velocity of light and v that of the electron⁶). Thus at one-tenth of the velocity of light the apparent mass of an electron is 9.1×10^{-28} ; at three-tenths, 9.5×10^{-28} ; at five-tenths, 10.4×10^{-28} ; and at eight-tenths, 15.0×10^{-28} grams. As the experiments referred to measure the mass by forces transverse to the direction of motion, this is called the transverse mass. The longitudinal mass has been measured indirectly by optical experiments designed to show the absolute velocity of the earth through the ether. The explanation of the failure of such experiments to show any such absolute motion implies that the apparent longitudinal mass of an electron varies inversely with $(c^2-v^2)^{\frac{3}{2}}$.

ELECTRON MODELS WHICH HAVE BEEN PROPOSED

It would be logical to suppose that, since we find actual negative charges to be made up of units, we could consider these units, that is, electrons, not as "charged bodies," but as indivisible elements of negative charge. In the sense that the total

⁵ Larmor, *Phil. Trans. Roy. Soc.* 186 (1895) 697.

⁶ Bucherer, A., *Ann. d. Phys.* 28 (1908) 513; 29 (1909) 1063; Wolz, R., *Ann. d. Phys.* 30 (1909) 273; Schaefer, C., *Phys. Zeit* 14 (1913) 1117.

mass of an electron is electric, this is true. But mass is not a constant property of electric charge; it depends on the distribution of the charge. Therefore we must consider that an electron has a certain *distribution of charge within it*. Evidently the conception of negative charge must be applied to portions of the electron. It has been customary to assume that an electron at rest has spherical symmetry, and that the charge resides only on the surface, as it does on charged conductors of observable size. The mass of such an electron is accounted for by the accepted electromagnetic laws, if its radius is about 1.8×10^{-13} centimeters. The mass of a spherical electron would vary with its velocity, but not according to the law experimentally verified (see above). Lorentz⁷ has shown that it is only necessary to modify the spherical electron by a contraction in the direction of the motion so that the dimensions in this direction become $\sqrt{1 - \frac{v^2}{c^2}}$: 1 as compared to the dimensions of the electron at rest. This is certainly only a special case of a quite general principle, and may be looked upon as the consequence of the imperfections of our ideas of space⁸ or, perhaps, of our measurements of mass, rather than an actual contraction of the electron.

The Lorentz elastic shell electron is a satisfactory model for electrons, such as the β -rays, which have been separated from positive charges, but not for the electrons in the nucleus or those which surround the nucleus of an atom. Such electrons either are not of the shape suggested by Lorentz, or do not follow the classical electromagnetic laws. The fact that there are strong magnetic fields in atoms cannot be explained by Lorentz electrons rotating in orbits, because there is no accompanying emission of light. Now a continuous circular current would give a magnetic field without radiation. On this basis Parson⁹ has developed his theory of a "magneton," or ring electron, whose diameter is about 3×10^{-9} centimeters, and which rotates with about the velocity of light.

Compton¹⁰ has found that the scattering of X-rays is much greater than could be explained by the Lorentz electron, and

⁷ Lorentz, H. A., Konink. Akad. Wetensch. Amsterdam, Versl. 12 (1904) 986; Theory of Electrons, 217.

⁸ Minkowski, H., Raum und Zeit, Phys. Zeit. 10 (1909) 104; cf. Cunningham, E., Relativity and the Electron Theory. London, Longmans, Green & Co. (1915).

⁹ Parson, A. L., Smithsonian Misc. Coll. 65 (1915-16) No. 11.

¹⁰ Compton, A. H., Phys. Rev. 14 (1919) 20, 247.

concludes that electrons in atoms are rings about 4×10^{-10} centimeters in diameter.

Although the conception of a ring electron obviously extends somewhat the applicability of the known electromagnetic laws to forces within atoms and molecules, no one has ever proposed a quantitative explanation of the characteristic behavior of an accelerated electron on this basis.

THE CHEMICAL PROBLEM OF TO-DAY

The ultimate and fundamental problem of chemistry is to express in some intelligible and quantitative manner the interaction of atoms at short distances. Since modern physical research tells us that atomic forces are only the aggregate of electronic forces, it seems that the problem may be simplified, and we need only find the manner in which electrons and positive electric units act at short distances, including the interaction of like and unlike units.

The laws of action of like and unlike charges at relatively long distances were the subject of much investigational work in the nineteenth century, and were shown by Maxwell¹¹ and others to be expressible in a few simple equations now known as the classical electromagnetic theory. This theory has been thoroughly verified for all distances between those of molecular dimensions and very large ones; but it is not a complete expression of the observed facts concerning electricity. To explain experimental evidence not provided for by the classical theory we have two alternatives:

1. To consider that the classical theory is valid even for infinitesimal distances but that there is some *additional influence* quite external to the facts covered by this theory.
2. To discard the classical theory and invent new laws which will explain the experimental evidence.

In the problem of atomic forces the most obvious fact not explained by the classical theory is the *existence* of the electron. The theory says that negative charge, unless bound or confined in some way, has a powerful expansive action due to the repulsion of every infinitesimal part of it for every other part. The fact is that we find finite particles of negative charge which show no tendency to expand. Adopting method 1 we

¹¹ Maxwell, J. C., *Electricity and Magnetism*, ed. 3. Oxford, Clarendon Press (1904); cf. also Hertz, H., *Electric Waves*. London, Macmillan and Co. (1900).

would say that the classical theory applies even within the electron, and that even infinitesimal subdivisions of an electron may be treated mathematically as charged elements. This view necessitates the additional assumption of a binding force or influence which keeps the charge within an electron from expanding indefinitely. In explaining the mass of an electron this method was long ago tentatively accepted, principally because a very simple assumption concerning the binding influence gives a Lorentz electron (see above) which explains exactly the observed mass of β -ray particles. Nevertheless many physicists seem to prefer to use method 2, and say that an electron is an indivisible unit whose mass is the same as it would be if it were constructed as suggested by method 1. This is probably because they prefer to think of an unchangeable unit of charge¹² rather than a mysterious binding influence. This is very satisfactory, if the properties of β -rays are the only facts to be considered, because the necessary modification of the classical theory is in this case very simple and reasonable. It is perfectly evident, however,¹³ that the exact form of the necessary modification of the classical theory was only arrived at by first considering the problem according to method 1.

As we pass from a consideration of the β -rays to the problem of electrons in the atom, we find that the Lorentz electron fails entirely to explain the experimental data. Some of the difficulties have already been mentioned, and have led to the conception of a ring electron. The problem, however, which has attracted most attention in this field for the past ten years is a certain mysterious discontinuity in the action of electrons in the atom.

It is surprising that nearly all physicists have attacked this problem by method 2 instead of testing thoroughly method 1, which has given perfectly satisfactory results in explaining the properties of β -rays. Besides the fact that the newly invented discontinuous force laws and "parcels of energy" are directly contrary to the empirical principle of continuity of dynamical effects and represent the law of variation with the inverse square of the distance as more of a "statistical" coin-

¹² The Lorentz electron is unchangeable as viewed from the standpoint of the relativity principle.

¹³ Lorentz, H. A., *Konink. Akad. Wetensch. Amsterdam, Versl.* 12 (1904) 986; *Theory of Electrons*, 217.

vidence than a fundamental principle,¹⁴ we have very good evidence that the classical theory is valid for distances much smaller than the radius of an atom. It has been experimentally verified for positive nuclei (containing both positive units and electrons) at distances¹⁵ of about 3×10^{-12} centimeters.

It is the purpose of this paper to point out the value of the theories of atomic structure which are based on method 1, and to suggest further possible lines of advance along this road. The best empirical expression of the mysterious discontinuity referred to has been given by Planck, whose quantum theory will now be briefly reviewed.

PLANCK'S QUANTUM THEORY

Planck's theory, proposed in 1901,¹⁶ has been recently presented by him as follows:¹⁷ Water waves on an inclosed area are reflected from shore to shore with a constant subdivision into shorter waves. If the wind originally causing them ceases, they become converted into smaller and smaller waves until finally all the energy has gone into the form of molecular motion, that is, heat. The classical theory would lead us to expect that similarly confined and reflected light or heat waves would also be converted into very short waves. To continue, in Planck's own words:

But of such a phenomenon no trace can be discovered in Nature. The conversion sooner or later attains a perfectly definite and assignable limit, and after that, the radiation-conditions remain stable in every respect.

In order to reconcile this fact with the Classical Theory the most varied experiments have already been made, but the result has always been that the contradiction went too deep into the roots of the Theory to leave them unhurt. So again nothing remains but to re-examine the foundations of the Theory. And again we must admit that the principles of Thermodynamics have shown themselves to be unshakable. For the only method so far found to promise a complete solution of the riddle depends directly upon the two laws of Thermodynamics; though it combines with them

¹⁴ Einstein's law of gravitation is sometimes considered as an instance of how a complicated dynamical effect may superficially appear simple. The whole tendency of the relativity theory, however, is to show that observed slightly complicated laws are converted into simple ones by four-dimensional mathematical treatment. No suggestion which could explain a discontinuous dynamical effect is found in the development of the relativity theory.

¹⁵ Geiger, H., and Marsden, E., *Phil. Mag.* 25 (1913) 604.

¹⁶ Planck, Max, *Ann. d. Physik.* 4 (1901) 553.

¹⁷ New paths of physical knowledge, *Phil. Mag.* 28 (1914) 66.

a new and peculiar hypothesis, which, if we utilize the two illustrations above mentioned, can be expressed somewhat as follows:

In the case of the Water waves, the disintegration of the energy of motion is limited by the fact that the atoms hold the energy together, in a way, each atom representing a certain finite material Quantum which can only move as a whole. In the same sort of way certain processes must be at work in the case of light and heat rays, although they are quite of an immaterial nature, which shall hold together the energy of radiation in definite Quanta, and shall unite it the more strongly the shorter the waves and the quicker therefore the frequency of the oscillations.

In what way we are to conceive the nature of quanta of a purely dynamical nature, we cannot yet say for certain. Possibly such quanta might be accounted for if each source of radiation can only emit energy when that energy attains at least a certain minimum value; just as a rubber pipe, into which air is gradually compressed, bursts and scatters its contents only when the elastic energy in it attains a certain quantity.

In any case, the hypothesis of Quanta has led to the idea that there are changes in Nature which do not occur continuously but in an explosive manner. I need hardly remind you that this view has become much more conceivable since the discovery and investigation of Radio-Active Phenomena. Besides, all difficulties connected with detailed explanation are at present overshadowed by the circumstance that the Quantum Hypothesis has yielded results which are in closer agreement with radiation-measurements than are all previous theories.

Planck then emphasizes the fact that the classical theory would lead us to be certain of a fairly constant specific heat for a given solid, even at low temperatures. His theory not only explains why the specific heat becomes almost zero at low temperatures but enables the exact calculation of the specific heats of many substances from their compressibilities.

Planck's hypothesis is that vibrational energy is somehow divided into quanta, the size of which is determined by the frequency of vibration. If ϵ represents a quantum of energy, and ν the frequency,

$$\epsilon = h\nu.$$

h is a universal constant, and has been determined fairly accurately¹⁸ as 6.545×10^{-27} erg-seconds. It is evident that ϵ is not a unit of energy in the sense that the electron is a unit of charge, because it is h , not ϵ , that is constant. Therefore, the hypothesis has in all probability no connection with the innate nature of energy. Nor does it necessarily apply to vibration in general, because it is only in vibrations of high frequency that ϵ is large enough to be appreciable. The only such vibrations

¹⁸ Millikan, R. A., *Science* 45 (1917) 327.

known are ether waves (infra-red and all shorter waves), electronic vibrations, and atomic vibrations. The questions of whether a vibrating system emits or absorbs energy in quanta and, if so, by what mechanism, have remained for twenty years without a definite answer, but the value of Planck's equation as representing some connection between frequency and the transfer of energy has become established by its signal success in the varied fields of radiation laws, specific heats, spectral series, ionization potentials, and atomic structure.

We have, then, an empirical equation which is at present mysterious, but presumably has an intelligible physical basis in one of three entities, or in some relation between these: the ether, the electron, or the positive unit. These three are so intimately connected in nature that no one has been able so far to point out just where the discontinuity lies.

Theories have been advanced that a wave front of light (or other ether wave) is discontinuous, and only follows the classical equations approximately.¹⁹ It is generally admitted, however, that there is no incompatibility between Planck's equation and the classical theory of the propagation of waves in free ether.

Jeans,²⁰ after a mathematical analysis of the situation, says that "we are called upon to revolutionize views which have long been regarded as well-established on the nature or meaning of electricity, ether, or radiation." He cannot show just what view must be revolutionized, however. One of his assumptions has to do with the structure of the electron, which one may perhaps be excused from regarding as well-established.

The favorite method of attempting to explain Planck's equation seems to be in assuming "discontinuous force laws" at small distances, or that "tubes of force" are definite actual realities instead of convenient conceptions.²¹ It is impossible to say that any of these views is incorrect or absurd; but better results, both in arithmetical calculation and physical intelligibility, seem to have been arrived at by those physicists who have modified the classical theory as little as possible. Among these Bohr²² has achieved the most marked success in construct-

¹⁹ Einstein, A., *Ann. d. Physik.* 17 (1905) 132; Thompson, J. J., *Proc. Camb. Phil. Soc.* 14 (1906-8) 417.

²⁰ Jeans, J. H., *Phil. Mag.* 27 (1914) 22.

²¹ Thompson, J. J., *Phil. Mag.* 30 (1917); 37 (1919) 419; 39 (1920) 679-90; Langmuir, I., *Journ. Am. Chem. Soc.* 41 (1919) 932, and many others.

²² Bohr, N., *Phil. Mag.* 26 (1913) 1, 476, 857.

ing an arithmetically correct hydrogen atom, and Parson²³ and Webster²⁴ in suggesting a possible physical basis for the supposed discrepancies between radiation and the classical theory. Lewis²⁵ and Langmuir²⁶ have succeeded in establishing the gross structure of the atom by a judicious combination of physical and chemical data.

THE REAL PROBLEM

A man looking through a telescope may fail to see what is in his hand. Therefore, it is necessary to state a problem before we can work at it intelligently. Some persons enjoy delving into the *effects* which an object produces, and others, into the *construction* of the object. Now each of these points of view is necessary for the advancement of science. Either without the other is absolutely helpless. We know nothing of objects except from their effects, and on the other hand the most profound mathematician could never disregard *structure* entirely and write an equation representing the summation of the *effects* of the universe upon his consciousness at any instant.²⁷

Although it is impossible to prove on a basis of *pure* logic that we can obtain a true conception of any object in the universe it is equally impossible to prove that we cannot. *Common-sense* logic not only tells us that we can, but has justified its stand by the present development of science, which would have been absolutely impossible without it.

Now common sense must always be open to correction, but it has always divided objective realities into two classes, which may be called independent and dependent. A rifle bullet, for example, exists independently of its kinetic energy, but common-sense logic tells us that kinetic energy is a *property* which the bullet may or may not possess. We can say that the bullet has kinetic energy, or momentum, or entropy, or a property defined as energy divided by entropy, or a property defined as acceleration multiplied by radius, and so on ad infinitum, but it is still the same bullet. There is no possibility of denying that certain

²³ Parson, A. L., *Smithsonian Miscellaneous Collections* 65 (1915-6) No. 11.

²⁴ Webster, D. L., *Proc. Am. Acad.* 50 (1915) 131; *Phys. Rev.* 13 (1919) 305.

²⁵ Lewis, G. N., *Journ. Am. Chem. Soc.* 38 (1916) 762.

²⁶ Langmuir, I., *Journ. Am. Chem. Soc.* 41 (1919) 868, 1543; 42 (1920) 274.

²⁷ Except for those times when Σ effect = 0.

of these conceptions are very valuable, and certain relations between them, such as the law of conservation of energy (especially if we are particular always to define energy in such a manner that this law will not be violated), are fundamentally necessary to science. The fact, however, that one could in a single day define as many as a thousand such conceptions hitherto unused, and could spend a lifetime in developing new equations expressing the relations between these quantities, even if they all applied only to a single rifle bullet considered as a rigid body, should prevent us from setting up any such conception or any such relation as a "graven image to bow down and worship it."

Presumably none of our ideas are absolutely correct, but common-sense reasoning tells us that some, like Euclid's and Maxwell's laws, are intimately connected with the real structure of the universe; while others, like the statement that the entropy of a system always tends to a maximum, or $\epsilon = h\nu$, bear distinct trademarks of human manufacture. I think Minkowski has conclusively demonstrated the value of considering that our concept of space is only a partial view of a more fundamental four-dimensional construction of the universe. I may add that it does not follow that time is not an entity independent of this four-dimensional construction. For we can measure time in absolute units (see following paper) wherever we may be situated in this four-dimensional construction, from which fact I can form no other conclusion but that time, if correctly defined, is independent of the four-dimensional construction. However this may be, the four-dimensional construction has not shaken our faith that Maxwell's and Euclid's laws represent close approximations to the fundamental construction of the universe, but rather has increased our reason for belief that these laws, in the extended four-dimensional forms (which, for the purposes of the present paper, are equivalent to the three-dimensional forms with the Lorentz transformation), are very fundamental. Therefore, it seems to me the height of folly so to concentrate our attention on one of the laws of the second class mentioned that we fail to apply to our problems the known laws which are of a much more fundamental nature.

Common-sense logic (which of course is always subject to correction) tells us that a light wave is the motion of something caused by the motion of something else. If we find a peculiar relation between light waves, it is natural to refer it to the properties of one of these things. It has been for some

time quite evident that the formula, $\epsilon = h\nu$, and the structure of the atom have some intimate relation with each other. It seems to me that the only reason that physicists have not long ago discovered the exact nature of this relation is that they tried to explain one single property of a complex object, the atom, before seriously considering how it is put together. The structure of the atom was a difficult problem before the discovery of electrons, and even yet is not a solved problem; but the nature of the most successful hypotheses on this subject, and some considerations which will be discussed later in this paper, make it seem very probable that the solution could have been entirely deduced from the classical electromagnetic theory and the experimental evidence available twenty years ago. In speaking of the classical theory I refer to the experimentally verified simple laws which were developed in the nineteenth century concerning the properties of electricity. The difficulty was not due to lack of evidence or lack of theory; it was caused by the introduction of entirely gratuitous assumptions concerning the spacial distribution of electricity in an electron.

It was well known in 1900²⁸ that an atom could not be explained on the basis of point nuclei and the electromagnetic theory. Now why anyone should wish to explain an atom on this basis is a mystery, because a point nucleus is impossible according to the electromagnetic theory. In spite of the fact that the electromagnetic theory was amply justified in every detail by years of experimental work, for some reason it has not been this theory, but the fixed idea of a point nucleus, upheld by absolutely no experimental evidence, that has dominated practically all attempts to solve the problem of the atom in the last twenty years. Sometimes the idea of the point nucleus has been discarded, but generally with a corresponding disregard for the electromagnetic theory.

Now I am far from claiming that the classical theory is infallible, even in its present four-dimensional form, but I can see no objection to using it as a working hypothesis until there is some reason to doubt its validity. The fact that such arbitrary and apparently impossible assumptions as infinite velocity, point nuclei, or Lorentz electrons are incompatible with it appears to me to be in no way a reflection on the validity of the classical theory.

²⁸ Larmor, J., *Aether and Matter*. Cambridge University Press (1900).

The real problem of physics for the past twenty years has not been to show how matter is nothing but a form of energy, or that the entropy of the universe is constantly increasing, or to explain $\epsilon = h\nu$, but to explain how positive and negative units of electricity combine to form atoms. It is very easy to obtain a possible partial solution of this problem if one states it clearly as follows:

1. Given that atoms contain positive and negative units of electricity, and so far as we know nothing else.
2. Given the classical electromagnetic equations as a working hypothesis to be applied to the interpretation of experimental data.
3. To find an explanation for the stability and definiteness of atoms.

A MECHANICAL CONCEPTION OF THE POSITIVE AND NEGATIVE UNITS

For the purposes of the argument here presented no particular mechanical concept of the electron is necessary, but if we use the term "ether" in the sense defined by Cunningham²⁹ and "space" in the sense used by Einstein,³⁰ we can obtain a mechanical concept which is fairly accurate. A positive unit is thus a small cavity in space, from which ether is continually proceeding, presumably from some sphere beyond the confines of our knowledge. The flow of ether is constant and its tension is constant, presumably due to a kind of resistance which it meets in passing through the surface of the cavity. The only way of conceiving of the effect due to this tension is to consider space projected down to two dimensions. It then becomes like a rubber band being pulled through a sheet of paper, which causes a local distortion of the sheet. The attraction which two distortions in the same direction would naturally have (cf. the paper analogy) for one another is comparable to Einstein's expression for gravitation.

According to this view an electron is a larger cavity through which ether escapes from our space, having accomplished its purpose, so far as we are concerned, of tending to bring positive and negative units together.

²⁹ Cunningham, E., *Relativity and the Electron Theory*. London, Longmans, Green & Co. (1915), 92.

³⁰ Einstein, A., *Ann. d. Phys.* 354 (1916) 769.

AN EXPLANATION FOR THE STABILITY AND DEFINITENESS
OF ATOMS

Whatever be the ultimate nature of electrons, they are bodies having apparently constant electric charge and probably constant mass (if mass is defined properly from a relativity standpoint), but no evidence has ever been found that they have constant shape under different conditions. So far as I know the Lorentz electron, which is a rigid sphere from a relativity standpoint, satisfactorily represents electrons which are in uniform motion or in uniform acceleration; but it is not satisfactory for any case of an electron in nonuniform acceleration, such as, for instance, any electron in an atom. Some, at least, of the electrons in atoms are known to have magnetic effects, and the facts of radio-activity teach us that even nuclei contain electrons in extremely rapid rotation. These properties are not accompanied by that steady loss of energy by radiation which the classical theory tells us that Lorentz electrons in orbits would give. The classical theory tells us that to produce such results electricity must be in a form of motion which does not cause its distribution in space to vary. It is not necessary to point out the reasons why a rotating disk, or hollow sphere, or other shapes of circular symmetry would not give effects corresponding to experimental data. Whether they do or do not, a thin circular ring, rotating about its center, would undoubtedly give magnetic effects without radiation.

Now I am far from assuming that an electron is a ring. But I object to the assumption of an electron of any shape which is perfectly rigid (as the Lorentz electron is from a relativity standpoint). We cannot assume that an electron has any absolutely unchangeable shape without involving a contradiction of that principle of common-sense logic which says that a physical cause and its effect cannot exist in different places at the same time. If we do not assume an absolutely unchangeable shape we must assume some force or influence which holds the electric charge together. Making the least assumption possible, namely, that there is such a force, but that we do not know anything about its magnitude, we find that any electron in any nonuniformly accelerating field will be distorted in a manner similar to the tide producing distortion of the earth, which is familiar to all of us. Since we have made no assumption as to the strength of the forces which

resist distortion in an electron we find that, whatever the shape of the electron at rest, tidal streamers²¹ may be formed when it approaches close to a positive nucleus. It is reasonable to suppose that two streamers may become united, probably by the very close approach of both to the nucleus. We certainly have* no reason to assume, as has been assumed, that the influence confining an electron is so strong that a ring cannot thus be formed.

Whether formed in this manner or in some other, it is quite evident that a ring, or some similar shape, exists. We also know that electrons in atoms are in quite definite stable positions or orbits, of which there are two types, those inside the nucleus and those outside the nucleus. Now it may easily be shown that a ring of electricity, rotating about a positive nucleus, will in general be a variable ellipse, unless there is a definite stabilizing force. The instability may be expressed in this way, that a displacement, relative to the ring, of the nucleus in the plane of the ring (of course really the ring moves more than the nucleus) causes a wave of longitudinal and transverse distortion to proceed along the circumference of the ring with a velocity the same as that of the rotation. We may assume that this wave does not produce instability because it is checked by the unchangeable shape of the ring, but the spectral evidence of a thousand or more different definite states indicates that it is checked by a vibrational wave from the same source traveling in the opposite direction around the ring and with the natural velocity of vibrational propagation in that ring. The stable states for such vibrations are those in which the circumference of the ring contains one, two, three, four, etc., complete wave lengths of vibrations, so that standing waves can be set up. Any disturbing influence up to a certain limit may accordingly be supposed to increase the energy of the standing waves, without interfering with the definite character of the state of motion. The most stable states are those in which there is a single standing wave. Of these there are two types to be expected, because the velocities of longitudinal and transverse vibration in rings are different. I suppose that the transverse vibrations determine the stable state inside the nucleus, and the longitudinal vibrations the state outside of the nucleus.

²¹ Cf. Chamberlain, T. C., *Carnegie Inst. of Washington Year Book 3* (1904) 195.

According to this view a hydrogen molecule looks somewhat like this ⊙⊙ , and a helium nucleus the same only something like a thousand times smaller with two extra positive units stably bound because of the high local concentration of negative charge.

So much for pure deduction from the classical theory toward explaining the stability and definiteness of atoms. This could have been done twenty years ago³² except for the fixed idea of a point electron. In fact the discovery of radio-activity might have been predicted if the electromagnetic theory had been logically applied to the atomic problem in the nineteenth century.

Having found a working hypothesis for the most fundamental part of our problem, namely, for the existence of the atom, we are in a position to return to the spectral lines of the elements, in which there are volumes of information as to the velocities, dimensions, magnetic flux, and internal properties of electrons in atoms. These volumes are somewhat complicated, and a detailed consideration of radiation will be deferred to a later paper. It seems, however, that each spectral series has a limiting frequency, which has an effect on all the lines of the series and often on one line in each of many other series as well. This leads us to infer that each limiting frequency is the frequency of rotation of an electron, upon which other frequencies may be superposed, perhaps by the formation of a vortex ring tangent to the main ring (like a large doughnut on a bicycle tire, if we could put it on).

Whatever the exact explanation of radiation we know from Moseley's³³ work that each atom has a K-series of a very fundamental character, the limiting frequency of which varies approximately with the square of the atomic number. Only one such series is known which is uninfluenced by the presence of more than one electron, namely, the Lyman (K) series of hydrogen. Bohr has shown,³⁴ however, beyond reasonable

³² The writer need hardly point out that if the physicists of the nineteenth century were incapable of such a deduction, he himself was infinitely less capable of originally arriving at this result by a process of direct reasoning. The direct method of attack was apparent to him only after several years of mental permutations and commutations of the ideas of a score of physicists, notably the idea of constant angular momentum due to Bohr, who in turn derived it from Planck's quantum theory.

³³ Cf. Millikan, R. A., *Science* 45 (1917) 323.

³⁴ Bohr, N., *Nature* 92 (1913) 231.

doubt, that the fundamental K-frequency for helium with only one electron is exactly 4.0016 times that for hydrogen. Such a close approximation to a very simple relation leads us to infer that the actual laws governing the process are very simple.

Any explanation of the stability of electronic orbits, when applied to the frequencies of the K-series, naturally takes the form of Bohr's "constancy of angular momentum," or something equivalent to it. If mvr is a constant for this series, the natural explanation seems to be that the velocity of propagation of waves in the electron ring varies inversely with its radius. The K-series electrons, and probably all stable electrons in atoms may be considered to contain single standing waves, but Bohr's "outer orbits" of hydrogen, and similar partially stable electronic conditions would seem to be determined by the presence of two, three, four, etc., standing waves in the ring.

In conclusion I wish to propose the *vibrating electron ring* as a working hypothesis for the stability and definiteness of atoms which is entirely consistent with the classical electromagnetic laws.

SUMMARY

1. The general methods of attack on the problems of the structure and properties of electrons have been briefly reviewed.
2. It has been pointed out that an interpretation of the outstanding experimental observations in terms of the classical electromagnetic theory leads to the hypothesis of a ring electron vibrating internally in standing waves.

ABSOLUTE UNITS AND THE RELATIVITY PRINCIPLE

By GRANVILE A. PERKINS¹

Of the Bureau of Science, Manila

The Relativity Principle, announced by Einstein in 1905,² to the effect that if we have any absolute uniform velocity through space we cannot possibly determine it or even detect its existence by the measurement of any known physical quantities, is inconsistent with the nineteenth century ideas of a stationary ether. It is even considered to be incompatible with our intuitions regarding time and space. In spite of these facts, it is generally conceded that the Relativity Principle is a logical conclusion from a mass of experimental evidence. It is further unquestionable that Minkowski,³ and others following him, have been able to give a more complete mathematical form to the known physical laws by the use of four-dimensional coördinates instead of the usual three-dimensional space which corresponds to our intuitive ideas.

The Relativity Principle has firm foundations, but certain applications which the "relativists" have made of it have not been universally accepted. They claim that "*the phrase 'simultaneous events at different points' has no meaning until the velocity of those points is stated.*"⁴ This would not be so serious in itself, but they proceed to deduce from this alleged fact that we cannot possibly have any absolute units of length, time, or mass, and devise complicated "clock" and "light-signal" systems for defining various units of "times." Crehore⁵ and others have pointed out the absurdity of such ideas, and the present paper

¹ From an address before the Freer Club, Manila. Received for publication April 15, 1921.

² Einstein, A., Ann. d. Physik. 322 (1905) 891.

³ Minkowski, H., Raum und Zeit, Phys. Zeit. 10 (1909) 104; cf. Cunningham, E., Relativity and the Electron Theory, London, Longmans, Green & Co. (1915); cf. also Einstein A., Ann. d. Physik. 354 (1917) 769.

⁴ Cunningham, E., op. cit., 29; cf. also Eddington, A. S., in the relativity symposium in Nature 106 (1921) 781-813. This interesting collection of articles came to the writer's attention after the present paper went to press.

⁵ Crehore, A. C., The Mystery of Matter and Energy. New York, Van Nostrand Co. (1917) 51.

is a somewhat detailed extension of the "non-relativists'" arguments upon this subject.

The fundamental fallacy of the relativists seems to be due to the fact that the Relativity Principle happened to be discovered by certain experiments on the velocity of light. Now the Relativity Principle states that it is impossible to detect by the measurement of *any* physical quantity our absolute motion through space. Therefore, *all* physical quantities are *apparently* unaffected by our absolute motion through space. If a single exception to this rule should ever be found, the Relativity Principle would lose forever its physical significance.

From the standpoint of present-day knowledge there is absolutely no reason to consider that the velocity of light is in any way more dependent upon an electromagnetic medium (the ether) than are any of the physical quantities usually considered the properties of matter, with the possible exception of gravitation. It is universally conceded that part, if not all, of the mass of matter is electromagnetic in origin and behavior, and that part, if not all, of the forces of chemical union, cohesion, and elasticity are of this same nature. Certainly the apparent mass of a rapidly moving electron varies enormously with its speed through the electromagnetic medium, if we measure it when the electron is moving relative to us; and, if the force between two electric charges were not subject to the same variation, we would not teach in our schools that magnetism is the effect of electricity in motion. The Relativity Principle states that all of these quantities, though apparently variable if we do not move along with the object in question, are apparently constant, as far as the motion of the object is concerned, if we do move along with it.

Our problem, therefore, is as follows:

It being given that the following quantities are not affected by the motion of the earth through space.

1. The apparent velocity of light in our vicinity, from whatever source;
2. The apparent mass of an electron in our vicinity, from whatever source;
3. The apparent mass of a positive nucleus;
4. The apparent charge of an electron;
5. The apparent density of water (under definite pressure and temperature);

6. The apparent hardness of the diamond;
7. The apparent compressibility of sulphur dioxide (under definite pressure and temperature);
8. One thousand and one apparent physical quantities that we can measure;

To find:

1. Absolute units of length, time, and mass such that, if we should send our experimental data on the density of water to a scientist on a planet of Sirius, he could interpret the results *without any reference to his velocity relative to us*.

2. A criterion of *absolute* simultaneity at two different points which shall not involve the velocity of those points.

Now if Bucherer's experiment on the mass of an electron had preceded the Michaelson-Morley experiment on the velocity of light, I suppose the principle of relativity would have been deduced from the constancy of the Mass of an Electron, as it certainly could have been, because if the mass really varies with the absolute motion through space we would get very different results for one electron going along with the absolute motion of the earth and another going against this absolute motion.

Similarly if some brilliant physicist had discovered that the compressibility of sulphur dioxide was remarkably constant, whether taken in the direction of the earth's absolute motion or across it, the principle of relativity might have been founded on the constant Compressibility of Sulphur Dioxide.

As it happened, however, the relativity principle was discovered by means of experiments on the Velocity of Light, so the relativists set up the constancy of the velocity of light as a "graven image," and commanded the rest of the world to come with them into the mud of "ambiguity," "clocks," and "light-signals," and worship it.

It seems to me that there is only one conclusion that we can arrive at from the data that have just been stated.² It may be wrong, of course, and some other conclusion may be right; but wrong or right, the other conclusion was obtained from some other sources than the experimental data. The conclusion that corresponds to the data is that every item given represents a *natural constant* which is *absolutely* independent of uniform motion through space. Whether we draw this conclusion or not, we can solve the problem, as stated.

If an umpire were required to measure a baseball, he would hardly attempt the feat while the ball was speeding toward him from the pitcher's hand. He would first get it in his hand, at rest, as far as he is concerned, and then measure it. A scientist has an advantage over the umpire, in that he can measure the properties of things which are in motion relative to him; but if he does so, and if they are moving very fast, he must apply a correction to his results which is known as the Lorentz transformation.

Now if a scientist wishes to define his units in an *absolute* manner he naturally measures something which is at rest relative to him, so that he can be sure of his results.

There are certain quantities which involve motion, and are therefore inconsistent with relative rest, but he has a wide range for the practical constancy of these quantities, which becomes a theoretical constancy in the limiting case. The conditions for the measurement of the velocity of light do not bother him, because our premise states that this value, if measured in his vicinity, is apparently a constant. He must still be cautious, however, and measure only light in his immediate vicinity. If he tries to measure the velocity of light on some body that is moving relative to him he still must correct his measurements.

The relativists claim that a unit of length, time, or mass is meaningless except for a "frame having a certain velocity." Does that mean that my measurement of the density of water to-day is meaningless to-morrow when my "frame of reference" is different? "Oh, no," they say, "the *numerical* value of the measurement will still be good, but both the density and the size of your units will have changed without your knowledge. You cannot compare to-day's units or to-day's actual density with to-morrow's units or to-morrow's actual density without a knowledge of your velocity to-day relative to your velocity to-morrow."

This statement is fallacious. There are many ways in which we can define our units of length, time, and mass, in terms of absolute units which are not affected by the velocity of "frame." Without saying anything about the *absolute* mass of an electron, we have given, from the Relativity Principle itself, that the *apparent* mass of an electron, properly measured, is a constant not affected by change of "frame." We have given the same as to the apparent charge of an electron and the apparent velocity of light.

Let us define a gram as this apparent mass of an electron multiplied by $\frac{10^{28}}{9.01}$. The manner specified for measuring the mass of the electron (that is, that the electron shall be at rest relative to the observer), does not specify any *particular* "frame" for the observer and electron. The apparent mass so determined is constant according to the Relativity Principle itself. The pure number $\frac{10^{28}}{9.01}$ can hardly be expected to vary with the "frame," so we have an *absolute* definition of the gram, in the sense that every quantity in it is independent of the "frame."

An absolute unit of length may be similarly obtained from the known properties of a system of two electrons at rest relative to the observer. If they are at rest at an apparent distance L_1 , which we need not measure in any units, after a short apparent time the apparent distance between them will be increased by a length L_2 . During the same time any light wave in the neighborhood will have apparently moved a distance which we will call L_3 . Now we know that as we choose the interval of apparent time shorter and shorter, the apparent length $\frac{L_1^2 \cdot T^2}{L_3^2}$ approaches a constant value absolutely independent of our "frame" in space, provided only that there is no relative motion between us and the electrons. We may now define a centimeter as a length which contains $\frac{9.01 \times (2.9986)^2 \times 10^{12}}{(4.774)^2}$ of these absolute length units.⁶

The second may now be defined as the apparent time required for light to travel 2.9986×10^{10} centimeters. Now these units are all apparent quantities, but they are also absolute,

⁶ The above numerical relation of the centimeter to this absolute unit is arrived at as follows:

$$\text{acceleration of each electron} = \frac{e^2}{m L_1^2}$$

$$\text{velocity of each} = \frac{e^2 T}{m L_1^2}$$

$$T = 0 \int^{\infty} \frac{L_2}{T} = \frac{e^2 T}{m L_1^2}$$

$$L_3 = c T$$

$$T = 0 \int^{\infty} \frac{c L_2}{L_3} = \frac{e^2 L_3}{m L_1^2 c}$$

$$T = 0 \int^{\infty} \frac{L_1^2 L_2}{L_3^2} = \frac{e^2}{m c^2}$$

in the sense that they are entirely independent of the "frame of reference" of the quantity to be measured. The only specification is the manner in which quantities shall be measured when using these units.

The question remains as to whether units thus defined would be intelligible to an observer on a planet of Sirius if, he did not know his relative velocity, and without the use of "light-signals." Certainly, when we have the comets under better control we can write the definition in Inter-stellar Esperanto and mail it to him. I see no reason why his electrons should not have the same apparent properties as ours. If they do not it would be necessary for him to remove some of the "Earth" electrons from the letter we send and measure their apparent properties. The Principle of Relativity tells us that these would not have changed in changing the "frame of reference."

With units independent of "frame" the problem of simultaneity is simple. It is generally admitted that a position-time coincidence is a simultaneity. But after this coincidence, time keeps "flowing on," as Newton said, for each particle in the same absolute units. Therefore any two particles which ever have been together have absolute simultaneity, measured by the number of seconds which have elapsed since their coincidence. Similarly these particles may impart their absolute simultaneity to other particles by coincidences with them, and therefore any two bodies possess absolute simultaneity if any connection between them has ever been established by coincidences. To suppose that they really do not possess this property unless they have been so connected is to assume that the smallest particle may have an enormous effect on the largest star.

I would not dwell so minutely on this subject but for the pernicious and widespread effect that the "light-signals" doctrine has had and is still having. I hope I have been able to show that it is in no sense a true representation of the Principle of Relativity. There is no necessity for allowing our intuitions to prejudice us against the Relativity Principle. On the other hand there is no excuse for allowing the Relativity Principle to prejudice us against the very valuable concept that there are certain fundamental quantities in the Universe which we can measure with our somewhat imperfect ideas of length, mass, and time.

SUMMARY

1. It is pointed out that the velocity of light is only one of many physical quantities, equally electromagnetic in nature, which are apparently not affected by the motion of the earth through space.

2. In view of this fact it is a fallacy to assume any one of these quantities to be a Universal Constant and to deduce from this assumption that the others are not real constants but only apparent constants.

3. Whatever view we take of the situation we can define our units of length, time, and mass in such a way as to make them independent of the velocity through space of the system considered, and it follows that absolute simultaneity is definable.

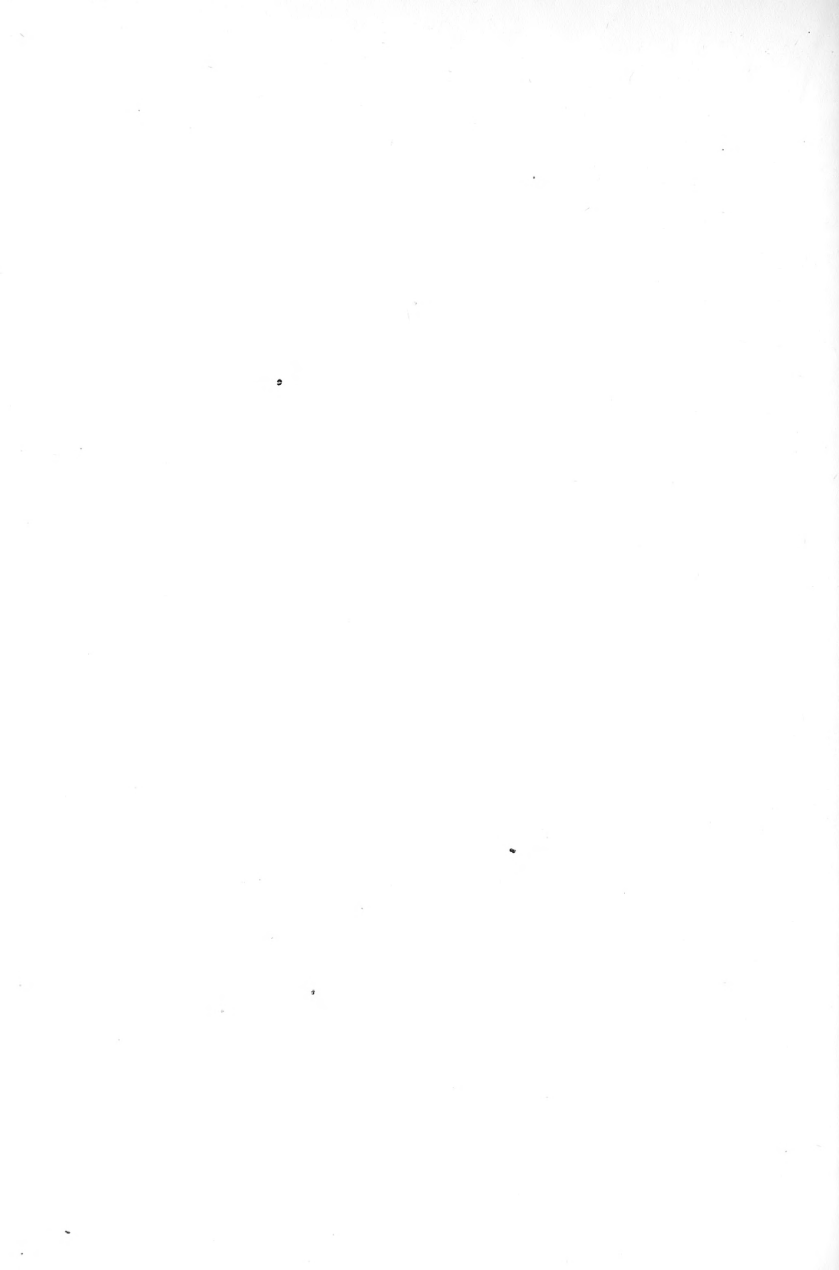

NEW COLEOPTERA FROM THE PHILIPPINE ISLANDS

FAMILY BUPRESTIDÆ, TRIBE AGRILINI

By W. S. FISHER

Of the Bureau of Entomology, United States Department of Agriculture

This paper is based on part of a collection of Buprestidæ received from Prof. Charles Fuller Baker, College of Agriculture, University of the Philippines, Los Baños, P. I., together with the material in the collection of the United States National Museum, Washington, D. C.

Material from the Malaysian region was not well represented in the Museum collection, and most of the species mentioned in the present paper have been collected by Professor Baker on various islands of the Philippine Archipelago. The collection is especially rich in the smaller species of the family, and as these minute forms are seldom taken by the average collector, they are usually not very well known. It is, therefore, necessary to describe a number of these as new. The present paper is confined to the tribe Agrilini, which includes nearly all of the smaller Buprestidæ and is the largest tribe of the family, including over one-third of all the described species.

Very little has been written on the habits of this tribe from the Philippines; one species, *Agrilus occipitalis* Esch., has been reported as injuring branches of lemon and orange trees, and other species will be found of great economic importance just as soon as their habits are known.

Through the kindness of Professor Baker, all the types of the new species here described have been placed in the United States National Museum.

I take the opportunity of thanking Professor Baker for having given me the privilege of studying the material of this family from that interesting region.

The keys given in the present paper do not include all the described species from the region, but are only based on the material received from Professor Baker, together with the specimens in the Museum collection. It has been impossible to include these other species, as many of the characters used in the keys are not mentioned in the descriptions by the various authors.

Tribe AGRILINI Castelnau and Gory

Key to the genera.¹

1. Median coxæ not more widely separated from each other than the anterior ones; anterior margin of posterior coxæ strongly concave; tarsi more or less elongate..... 2.
- Median coxæ more widely separated from each other than the anterior ones; anterior margin of posterior coxæ feebly concave; tarsi very short..... 12.
2. Eyes large, touching pronotum..... 3.
- Eyes small, placed a certain distance from pronotum.
Cylindromorphus Kies.
3. Antennæ free in repose..... 4.
- Antennæ inserted in a prosternal groove in repose. Neosambus gen. nov.
4. First joint of posterior tarsi short, rarely as long as the following two joints united..... 5.
- First joint of posterior tarsi as long as or longer than the following two joints united..... Agrilus Steph.
5. Antennæ serrate, beginning at the fourth joint..... 6.
- Antennæ serrate, beginning at the fifth or sixth joint..... 9.
6. Lateral margin of pronotum smooth..... Melibæus Deyr.
- Lateral margin of pronotum crenulate..... 7.
7. Prosternal lobe short, more or less lobed on sides..... 8.
- Without prosternal lobe..... Coræabus Cast. and Gory.
8. Pronotum with disk convex and smooth..... Cisseicoraebus Kerrem.
- Pronotum with disk uneven and indented..... Amorphosoma Cast.
9. Femora normal..... 10.
- Femora robust, dentate on the inner side..... Sambus Deyr.
10. Tibiæ dilated for insertion of tarsi in repose.... Cryptodactylus Deyr.
- Tibiæ not dilated for insertion of tarsi..... 11.
11. Tibiæ arcuate, leaving a space between them and the femora.
Toxoscelus Deyr.
- Tibiæ straight..... Neotoxoscelus gen. nov.
12. Tibiæ free in repose..... 13.
- Tibiæ received in a deep groove in repose..... 14.
13. Base of pronotum truncate; eyes parallel..... Paratrachys Saund.
- Base of pronotum sinuate; eyes oblique..... Trachys Fabr.
14. Epistoma wide; antennal cavities far apart..... Anthaxomorphus Deyr.
- Epistoma narrow; antennal cavities close together..... 15.
15. Antennæ with joints 8 to 11 forming a distinct club.
Aphanistelus Latr.
- Antennæ normally dentate, not forming a distinct club.. Endelus Deyr.

Genus CYLINDROMORPHUS Kiesenwetter

Cylindromorphus orientalis Kerremans.

This species is represented in the United States National Museum collection by three specimens; two labeled "Acc. No.

¹ *Melibæus aeneifrons* Deyr., *M. bakeri* Kerrem., and *Cisseicoraebus grandis* Kerrem. have been described from the Philippines, but I have been unable to examine any of these species.

986, Bur. Agr. P. I., collected by C. R. Jones" and "Acc. No. 1667 Bur. Agr. P. I., collected by C. R. Jones," all specimens without any definite locality. The Bureau of Agriculture reports that the locality for these numbers is Lamao, Bataan Province, Luzon.

These specimens agree with the original description with the exception that they are of a uniform bronzy color.

Genus *NEOSAMBUS* novum

Form of *Sambus*. Head strongly convex; cheeks unarmed; antennal cavities rather large, oblique, widely separated and situated a little distance from the inner margin of the eyes. Antennæ short, serrate from the fifth joint; joints one and two robust, the second shorter; third and fourth more slender and about subequal in length; following joints strongly serrate on the inner margin. Eyes large, oval, distinctly more remote on occiput than at base. Pronotum wider than long, disk uneven, without lateral carina; lateral margin feebly crenulate. Scutellum visible. Elytra convex, without distinct basal depressions; sides sinuate and expanded behind middle. Prosternum with two large lobes in front, concealing the sides of the mouth; deeply grooved along sides for insertion of antennæ in repose. Intercostal process elevated and abruptly bent downward at apex. Pygidium broadly projecting behind tips of elytra, strongly, longitudinally carinate at middle, the carina angular and strongly elevated. Metasternum deeply emarginate in front. Middle coxæ not more widely separated than the anterior ones. Posterior coxæ deeply concave behind, nearly straight in front, with the lateral margin strongly dilated posteriorly. Femora moderately flat, arcuately narrowed toward apex, the inner margin with a few very strong teeth. Tibiæ very feebly arcuate and subcylindrical, the posterior one ciliate on the posterior margin. Tarsi very short, first joint about equal in length to the second; claws bifid at base, the lower portion touching that of the opposite side.

Genotype, *Neosambus cupricollis* sp. nov.

This genus superficially resembles *Sambus* Deyr., but can be easily separated from that genus by having the sides of the prosternum deeply grooved for the reception of the antennæ in repose. In structure it is rather closely allied to the genus *Kamosia* Kerrem., from Africa, but the cheeks are unarmed while in that genus they are armed with a sharp tooth. In *Neosambus* the antennæ are serrate from the fifth joint, while in *Kamosia* the serration begins at the fourth joint.

Key to the species.

1. Above pubescent; elytra with transverse pubescent bands. N. ornatus sp. nov.
 Above glabrous..... 2.
 2. Head feebly, longitudinally grooved..... N. cupricollis sp. nov.
 Head without longitudinal groove..... 3.
 3. Elytra strongly expanded behind middle and of a bottle-green color. N. viridipennis sp. nov.
 Elytra feebly expanded behind middle and of a reddish violaceous color. N. glabrus sp. nov.

Neosambus cupricollis sp. nov.

Elongate, robust and strongly convex, shining; head and pronotum bright cupreous, becoming brassy on front of head; elytra and beneath bright greenish blue, glabrous.

Head with the front wide, strongly convex, feebly gibbose on the vertex, with a feeble, median, longitudinal groove on vertex and occiput, becoming obsolete on middle of front; surface strongly strigose, the strigæ transverse on the front and becoming concentric on the gibbosities; intervals with large, shallow punctures; epistoma transverse, anterior margin broadly but not deeply, arcuately emarginate, the angles extending beneath the antennal cavities; clypeal suture transverse, elevated. Pronotum one-half wider than long, widest at about the middle, slightly narrower in front than behind; sides feebly margined and crenulate, strongly arcuate from apex to basal sixth, then nearly straight to the posterior angles, which are nearly rectangular; anterior margin deeply emarginate, with a large, broadly rounded lobe at middle, the angles acute; base strongly bisinuate with a large median lobe, which is truncate in front of scutellum; disk strongly gibbose behind the middle; surface with a broad, irregular depression along the lateral margin, extending from apical sixth to base, coarsely, transversely rugose, except on the gibbosities, where the rugæ are more or less concentric, intervals smooth, with elongate punctures connected posteriorly to the rugæ. Scutellum triangular, very acute posteriorly; surface smooth. Elytra as wide as pronotum at base, strongly convex; humeral angles obtusely angulate; sides strongly sinuate at posterior coxæ, broadly expanded just behind the middle, then arcuately narrowed to tips, which are separately, broadly rounded and finely dentate; surface very coarsely, transversely rugose, becoming much smoother toward apex, intervals with coarse, elongate punctures behind the rugæ. Abdomen rather convex, glabrous, rather densely marked with distinct crenulate lines; prosternum coarsely scabrous and

sparsely pubescent; intercoxal process nearly parallel to behind coxæ, then abruptly narrowed to apex, which is acute; tarsi and claws black; tarsal lamellæ brownish.

Length, 6.1 millimeters; width, 2.25.

Described from a single specimen from Davao, Mindanao (*C. F. Baker*).

Neosambus ornatus sp. nov.

Elongate, subparallel, moderately convex, uniformly piceous, with a feeble greenish tinge on elytra; head with the front cupreous; elytra ornamented with transverse pubescent bands.

Head with the front wide, convex, not gibbose on vertex, with a vague median longitudinal groove, extending from occiput to the clypeal suture, which is transversely truncate; surface very sparsely, coarsely punctate, and sparsely pubescent; epistoma transverse, anterior margin broadly, but not deeply, arcuately emarginate, the angles extending beneath the antennal cavities. Pronotum three-fourths wider than long, widest at about the middle, base and apex about equal in width; sides feebly crenulate and evenly, arcuately rounded; anterior margin moderately emarginate, with a broadly rounded lobe at middle, the angles acute; base bisinuate, with a broadly rounded lobe in front of scutellum, the angles obtusely rounded; disk rather evenly convex, with a broad, inconspicuous depression posteriorly along the lateral margin; surface sparsely, coarsely punctate and feebly strigose, sparsely clothed with long, white and brown, recumbent pubescence. Scutellum transversely triangular; surface smooth. Elytra as wide as pronotum at base, strongly convex; humeral angles strongly angulate; sides sinuate at posterior coxæ, broadly expanded behind middle, then arcuately narrowed to tips, which are separately, broadly rounded; surface strongly, transversely rugose and rather densely punctate, the punctures and rugæ becoming finer toward apex, sparsely clothed with black and silvery white pubescence, the white pubescence forming designs on each elytron as follows: A broad oblique band extending from humerus to suture at basal fourth, a wide transverse band just behind the middle, and a narrower transverse band near apex. Abdomen rather convex, sparsely punctate and rather densely clothed with long white pubescence; last segment feebly emarginate at apex; prosternum coarsely scabrous and sparsely pubescent; intercoxal process parallel-sided to behind coxæ, then abruptly narrowed to apex, which is acute; tarsi and claws black; tarsal lamellæ yellowish.

Length, 4 millimeters; width, 1.5.

Described from a unique specimen from Iligan, Mindanao (*Baker*).

Neosambus viridipennis sp. nov.

Elongate, rather robust, attenuate posteriorly, strongly convex; head and pronotum bright brassy green; elytra bright bottle green; beneath piceous, shining and glabrous.

Head with the front narrower than in the other species of this genus, strongly convex, not gibbose on vertex, and without median longitudinal groove; sides concave, with the front feebly expanded on occiput, more strongly expanded at anterior margin; surface coarsely, densely strigose, the strigæ transverse on the front, becoming concentric on vertex, intervals with large shallow punctures; epistoma transverse, anterior margin broadly, but not deeply, arcuately emarginate, the angles extending beneath the antennal cavities; clypeal suture transverse, elevated. Pronotum one-half wider than long, widest at about the middle, slightly narrower in front than behind; sides feebly margined and crenulate, strongly, arcuately rounded from apex to middle, then nearly parallel to posterior angles, which are nearly rectangular; anterior margin arcuately emarginate, with a feeble median lobe, the angles acute; base bisinuate, with a large median lobe, which is truncate in front of the scutellum; disk broadly gibbose on the anterior median part; surface with a broad, deep, irregular depression along lateral margin, reaching from apical angles to the base, and a broad, transverse, concave depression along the posterior margin, rather finely, sparsely rugose, the intervals nearly smooth, with a few small punctures connected to the rugæ posteriorly. Scutellum triangular, very acute posteriorly; surface finely strigose. Elytra as wide as pronotum at base, strongly convex; humeral angles obtusely rounded; sides strongly sinuate at posterior coxæ, broadly expanded behind middle, then rather obliquely narrowed to tips, which are separately, broadly rounded, and feebly dentate; surface rather coarsely, transversely rugose, becoming smooth posteriorly, intervals sparsely, coarsely punctate. Abdomen rather convex, glabrous, shining, sparsely and indistinctly marked with crenulate lines; last segment broadly emarginate at apex; prosternum finely, densely scabrous; intercoxal process parallel-sided to behind coxæ, then abruptly narrowed to the apex, which is rather acute, sparsely clothed with long pubescence; tarsi and claws black; tarsal lamellæ yellowish.

Length, 4.25 millimeters; width, 1.4.

Described from a single specimen from Puerto Princesa, Palawan (*Baker*).

Neosambus glabrus sp. nov.

Elongate, rather robust, attenuate posteriorly, strongly convex, glabrous; head green; pronotum dull green, with a violaceous tinge; elytra dark reddish violaceous; beneath aëneous.

Head with the front wide, strongly convex, not gibbose on vertex, without median longitudinal groove; surface rather coarsely, densely punctate and vaguely strigose, feebly pubescent on the front; epistoma about as long as wide, anterior margin broadly, but not deeply, arcuately emarginate, the angles wide and extending beneath antennal cavities; clypeal suture not distinct. Pronotum nearly two times as wide as long, widest at about the middle, narrower in front than behind; sides feebly margined and crenulate, strongly arcuate from apex to basal sixth, then nearly straight to posterior angles, which are nearly rectangular; anterior margin deeply emarginate, with a large, broadly rounded lobe at middle, the angles acute; base strongly bisinuate, with a large median lobe, which is truncate in front of the scutellum; disk strongly gibbose at middle; surface with a broad irregular depression along the lateral margin, which is more deeply depressed just back of the anterior margin, coarsely, transversely rugose, the rugæ becoming somewhat concentric on the elevated part. Scutellum triangular, very acute posteriorly; surface vaguely strigose. Elytra about equal in width to pronotum at base, strongly convex; humeral angles obtusely angulate; sides sinuate at posterior coxæ, feebly expanded just back of the middle, then strongly, arcuately narrowed to tips, which are separately broadly rounded and feebly dentate; surface very strongly, transversely rugose, the rugæ becoming finer and denser toward apex, intervals with large elongate punctures, connected to the rugæ posteriorly. Abdomen rather convex, glabrous, rather densely marked with distinct crenulate lines; prosternum densely scabrous; intercoxal process parallel to behind coxæ, then abruptly narrowed to apex, which is rather obtuse, rather densely clothed with long white pubescence at middle; tarsi and claws black; tarsal lamellæ brownish.

Length, 4.25 millimeters; width, 1.6.

Described from a single specimen from Mount Banahao, Luzon (*Baker*).

Genus *AGRILUS* StephensKey to the species.²

1. Elytra spinose at tip..... 2.
Elytra not spinose at tip, sometimes strongly dentate..... 12.
2. Elytra unispinose at tip..... 3.
Elytra bispinose at tip..... 4.
3. Tip of elytron acuminate, spine at middle of apex..... 8.
Tip of elytron emarginate, spine on outer angle, sometimes with a very minute spine at sutural angle..... 6.
4. Pygidium with projecting carina at tip..... 5.
Pygidium without projecting carina at tip..... *A. quadriplagiatus* sp. nov.
5. Elytra with pubescent spaces..... *A. sexsignatus* sp. nov.
Elytra without pubescent spaces..... *A. benguetensis* sp. nov.
6. Claws cleft in such a manner that the lower portion is turned inward, nearly or quite touching that of the opposite side..... 7.
Claws simply cleft, the lower portion not inverted..... *A. ornatus* Deyr.
7. Above bright blue..... *A. piperi* sp. nov.
Above green or bronzy green..... *A. luzonicus* Kerrem.
8. Pygidium with projecting carina at tip..... 9.
Pygidium without projecting carina at tip..... 10.
9. Elytra with transverse dark band at apical third; male without tubercle at middle of first abdominal segment. *A. nigrocinctus* Saund.
Elytra with a small dark area at apical third along suture, not reaching lateral margin; male with two small tubercles at middle of first abdominal segment..... *A. inquinatus* Saund.
10. Elytra with pubescent spaces..... *A. subspinosus* sp. nov.
Elytra without pubescent spaces..... 11.
11. Prothoracic carina short, very arcuate; elytral spines unequal; color blue..... *A. banahaensis* sp. nov.
Prothoracic carina long, nearly straight; elytral spines equal; color bronzy green..... *A. maquilingensis* sp. nov.
12. Claws cleft in such a manner that the lower portion is turned inward, nearly or quite touching that of the opposite side..... 13.
Claws simply cleft, the lower portion not inverted..... 21.
13. Hind angles of pronotum carinate..... 14.
Hind angles of pronotum not carinate..... 17.
14. Hind tarsi half as long as the tibiae; form elongate.... *A. occipitalis* Esch.
Hind tarsi not half as long as tibiae; form short..... 15.
15. Intercostal process elevated along sides..... *A. albocinctus* sp. nov.
Intercostal process not elevated along sides..... 16.
16. Color above blue to greenish blue..... *A. subpubescens* sp. nov.
Head and pronotum green; elytra brown..... *A. zamboangensis* sp. nov.

² The following species of *Agrilus* have been reported from the Philippines but have not been seen by me: *Agrilus abdominalis* Saund., *A. acutus* Thunb., *A. aegnicollis* Esch., *A. atomus* Kerrem., *A. balnearis* Kerrem., *A. discicollis* Deyr., *A. fontanus* Kerrem., *A. pilicauda* Saund., *A. rubifrons* Deyr., *A. semperi* Saund., *A. striaticollis* Kerrem., *A. vilis* Saund., and *A. oreophilus* Fisher (*monticola* Kerrem.).

17. Elytra with pubescent spaces..... 18.
 Elytra without pubescent spaces..... 20.
18. Pubescence on elytra forming an inconspicuous vitta.
A. inconstans sp. nov.
 Pubescence on elytra forming spots..... 19.
19. Color blue; tips of elytron broadly rounded and dentate.
A. rotundipennis sp. nov.
 Color green, shading to cupreous violaceous at tips of elytra, which
 are narrowly rounded and strongly dentate..... *A. bakeri* Kerrem.
20. Color above bluish green..... *A. subviridis* sp. nov.
 Color above cupreous to bronzy (rubbed specimens).
A. inconstans sp. nov.
21. Hind angles of pronotum carinate..... 24.
 Hind angles of pronotum not carinate..... 22.
22. Intercostal process gradually narrowing; tip acute..... 23.
 Intercostal process expanded behind coxæ; tip broad and emarginate.
A. semipubesceus sp. nov.
23. Prosternal lobe arcuately emarginate in front; male with a sharp tooth
 at middle of first abdominal segment..... *A. subvittatus* sp. nov.
 Prosternal lobe broadly rounded in front; male without tooth at middle
 of first abdominal segment..... *A. fulvovittatus* sp. nov.
24. Pygidium with projecting carina at tip..... *A. innotatus* sp. nov.
 Pygidium without projecting carina at tip..... 25.
25. Intercostal process parallel between and behind coxæ..... 26.
 Intercostal process expanded behind the coxæ..... 30.
26. Head with front deeply impressed..... *A. aguinaldoi* sp. nov.
 Head with the front flat or convex; vertex more or less grooved.... 27.
27. Elytra with distinct pubescent spaces..... 28.
 Elytra without distinct pubescent spaces..... 29.
28. Prosternal lobe broadly rounded; first joint of hind tarsi one-fifth as
 long as tibiæ; intercoxal process squarely truncate at apex with
 acute tooth at middle..... *A. palawanensis* sp. nov.
 Prosternal lobe arcuately emarginate; first joint of hind tarsi one-
 third as long as tibiæ; intercoxal process arcuately rounded at apex.
A. bisignatus sp. nov.
29. Pronotum regularly convex..... *A. tayabensis* sp. nov.
 Pronotum with the convexity limited posteriorly by a transverse depres-
 sion along basal margin..... *A. dapitanensis* sp. nov.
30. Elytra longitudinally carinate behind humeri..... 34.
 Elytra not longitudinally carinate behind humeri..... 31.
31. Elytra with transverse dark band at apical third.
A. philippinensis sp. nov.
 Elytra without transverse dark band at apical third..... 32.
32. Tip of intercoxal process wide and biemarginate, with the angles very
 acute..... 33.
 Tip of intercoxal process attenuate, with the angles obtuse.
A. attenuatus sp. nov.
33. Last ventral segment rounded at tip; male with intercoxal process
 longitudinally carinate at middle..... *A. manilensis* sp. nov.
 Last ventral segment emarginate at tip; intercoxal process not carinate
 in the male..... *A. butuanensis* sp. nov.

34. Elytra with transverse dark band..... 35.
 Elytra without transverse dark band..... 37.
35. Transverse dark band at middle of elytra; last ventral segment rounded at tip..... *A. inermis* sp. nov.
 Transverse dark band at apical third; last ventral segment emarginate at tip..... 36.
36. Elytra with basal two-thirds and apical fourth uniformly clothed with white pubescence..... *A. minutus* sp. nov.
 Elytra with apical fourth and transverse band just behind middle clothed with white pubescence..... *A. pulcher* Deyr.
37. Tip of intercoxal process wide and biemarginate, with the angles very acute..... 38.
 Tip of intercoxal process attenuate, with the angles obtuse..... 41.
38. Eyes converging posteriorly..... 39.
 Eyes not converging posteriorly..... 40.
39. Form robust; carina on elytra short; elytral pubescence very coarse.
A. butuanensis sp. nov.
 Form more slender; carina on elytra long; elytral pubescence fine.
A. immaoulatus sp. nov.
40. Elytra cupreous, with two indistinct white spots along suture near apex; form robust..... *A. malinaoensis* sp. nov.
 Elytra greenish bronze; form more slender..... *A. iliganensis* sp. nov.
41. Eyes converging toward clypeus; hind tibiae flattened and angulate on outer margin near apex..... *A. davaoensis* sp. nov.
 Eyes not converging, sides parallel; hind tibiae not angulate on outer margin..... *A. mindanaoensis* sp. nov.

Agrilus oreophilus nom. nov.

In 1906 Kerremans³ described a species of *Agrilus* from New Guinea under the name *monticola*, and in 1914 he described a species of the same genus from Mount Maquiling, Luzon, Philippine Islands, under the same name.⁴ For the species from Luzon I propose the new name *oreophilus*.

Agrilus quadriplagiatus sp. nov.

Female.—Form moderately elongate, robust, front of head cupreous, sides of pronotum and beneath bright aëneous with a strong cupreous reflection; occiput, prosternum, legs, disks of pronotum, and base of elytra dull dark green with a slight purplish tinge, the elytra becoming dark violaceous posteriorly and ornamented with pubescent spaces.

Antennæ shining black, reaching to middle of pronotum, serrate from the fourth joint. Head with the front rather flat, the sides gradually narrowed from vertex to clypeus, broadly and rather feebly, longitudinally impressed from occiput to clypeus;

³ Deutsche ent. Zeitschr. (1906) 416.

⁴ Philip. Journ. Sci. § D 9 (1914) 85.

surface densely, transversely strigose and clothed with a few inconspicuous white hairs, the hairs becoming finer, darker, and almost invisible posteriorly. Clypeus wider than long, with the front margin broadly, arcuately emarginate. Pronotum nearly twice as wide as long, slightly narrowed at base; sides feebly arcuate from apex to base; lateral margin nearly straight when viewed laterally; hind angles rectangular, with a sharply defined, very short, arcuate carina, which does not extend beyond basal fourth; disk convex, with a vague transverse impression behind anterior margin and a similar but deeper one at middle, a deep, oblique, lateral depression joining the transverse median impression; surface coarsely, closely, and irregularly, transversely strigose, the intervals between the strigæ punctate and clothed with short, erect, inconspicuous hairs. Scutellum with a double transverse carina. Elytra rather strongly sinuate behind the humeri, scarcely dilated behind the middle, then obliquely narrowed to apices, these extending into a long acute spine, which is on a line with the middle of the elytron, the outer edge of the elytron before the spine rather strongly serrulate, the inner edge concave, with a few, small, sharp teeth near the suture; sides of the abdomen exposed above; disk rather convex, without distinct costæ, the sutural edge slightly elevated at apical third; humeri prominent, not carinate; basal depression moderately deep; surface shining, finely and densely imbricate, becoming smoother and simply punctate toward apex, sparsely clothed with short, inconspicuous, recumbent hairs, which do not conceal the surface sculpture, each elytron with two round white pubescent spots, one at the middle and the other at the apical third. Body beneath bright aëneous with a feeble cupreous reflection, prosternum and legs dull dark green with a brassy tinge, the former densely, rather coarsely rugose, and sparsely, finely pubescent; prosternal lobe broadly, arcuately emarginate; intercoxal process broad, parallel, and acute at tip; propleura coarsely rugose, not pubescent; metasternum coarsely strigose. Abdomen nearly smooth, feebly, transversely strigose, finely punctate along the edge of the strigæ, third segment with a densely pubescent transverse spot at side; first ventral segment convex, neither impressed nor pubescent; last ventral obtusely rounded at tip; vertical portion of the segments, except the second, densely pubescent; pygidium coarsely punctate, not at all carinate. Hind tarsi five-sevenths as long as the tibiæ, first joint longer than the four following joints united; tibiæ not

mucronate; claws divaricate, rather strongly cleft, the lower portion not inverted.

Length, 11 millimeters; width, 3.75.

Described from a single female from Davao, Mindanao (*Baker*).

Agrilus sexsignatus sp. nov.

Form elongate, parallel, front of head and margin of pronotum green, occiput of head, pronotum except margin, and elytra black, sides of pronotum and each elytron with three yellow pubescent spots, the first filling the basal depression, the second at middle near suture, and the third at the apical third and closer to suture than the middle one.

Antennæ black, with the basal joints slightly bronzy, reaching to middle of pronotum, serrate from the fourth joint; front flat, slightly narrowed toward clypeus; occiput very feebly impressed, the line extending to the middle of the front; surface closely, coarsely punctate, becoming slightly, longitudinally strigose on the occiput, clothed with a few golden yellow hairs on anterior half, becoming denser behind the clypeus. Clypeus wider than long, with the front margin nearly truncate. Pronotum one-third wider than long, distinctly narrower at base than apex, sides slightly sinuate, lateral margin strongly sinuate when viewed laterally, hind angles rectangular, without any trace of carina, disk moderately convex, a moderately deep impression behind the front angles, which is entirely lateral, and a faint antescutellar depression; surface rather finely and densely, transversely strigose-punctate, a broad band of golden pubescence along the lateral margin, the hind angles, however, not pubescent. Scutellum strongly, transversely carinate. Elytra slightly sinuate behind the humeri, with a feeble postmedian dilatation, then gradually narrowed to apices, sides of abdomen exposed above; apices extending into a long acute spine, which is on a line with the middle of the elytron, the outer edge of the elytra before the spine rather strongly serrulate, the inner edge of spine feebly serrulate; disk slightly flattened, with distinct costæ, the sutural edge slightly elevated at apical third, humeri moderate, not carinate; basal depressions well marked; surface subopaque, strongly and densely, imbricately granulate, sparsely clothed with short, inconspicuous, recumbent hairs, which do not conceal the surface sculpture, and ornamented as above. Body beneath with a slight aëneous tinge; prosternum densely, roughly scabrous, and sparsely, finely pubescent; prosternal lobe broadly

rounded, and feebly, broadly, arcuately emarginate at middle; intercoxal process broad, distinctly broadened behind the coxæ, apex broad and biemarginate; propleura densely punctate and sparsely pubescent; metasternum finely rugose. Abdomen rather finely strigose, becoming more coarsely so at the middle of first segment, third segment with a dense golden pubescent spot at sides; first segment convex, not impressed nor distinctly pubescent, with a series of sharp sawlike teeth along the posterior margin on the median line, the teeth feebly elevated and pointing backward; last ventral obtusely rounded and feebly emarginate at tip, vertical portions of the first and third segments covered with dense golden pubescence; pygidium punctate, rather strongly carinate, the carina projecting and truncate at tip. Hind tarsi about one-half as long as the tibiæ, first joint about equal in length to the four following joints united; front and middle tibiæ feebly mucronate at tip; claws divaricate, strongly cleft, the lower portions incurved, those of the anterior and middle tarsi less incurved than the posterior ones, so that the points are quite distant.

Length, 6.25 to 8 millimeters; width, 1.75 to 2.

Described from two specimens, probably males. The type is from Imugan, Nueva Vizcaya Province, Luzon (*Baker*); a paratype is from Puerto Princesa, Palawan (*Baker*).

Agrilus benguetensis sp. nov.

Female.—Form elongate, subcylindrical; head shining, dark olivaceous; pronotum reddish cupreous; elytra dull olivaceous, becoming violaceous posteriorly.

(Antennæ broken off.) Head with the front slightly concave; sides arcuately expanded at vertex, then slightly narrowed toward occiput and clypeus; broadly, longitudinally impressed from occiput to clypeus, the impression becoming deep on the occiput, and with a broad transverse impression in front of clypeus; surface strongly, transversely strigose, intervals sparsely and coarsely punctured, clothed with numerous short white hairs behind the clypeus. Clypeus wider than long, with the front margin broadly, arcuately emarginate. Pronotum two-thirds wider than long, slightly narrowed at base, sides slightly arcuate, lateral margin slightly sinuous when viewed laterally, hind angles rectangular, with sharply defined, slightly arcuate carina, the carina extending to lateral margin near middle, disk moderately convex, a deep, oblique, lateral depression and a broad and rather deep concavity in front of scutellum; surface coarsely,

closely, and irregularly, transversely strigose, the intervals between the ridges punctate and clothed with short, erect, inconspicuous hairs. Scutellum transversely carinate, the carina broadly interrupted at middle. Elytra slightly sinuate behind the humeri, with a feeble postmedian dilatation, then strongly narrowed to apices, sides of abdomen exposed; apices extending into a long acute spine, which is on a line with the middle of the elytron, outer edge of the elytron before the spine scarcely serrulate, inner edge of spine concave, with a few small sharp teeth near the end of suture; disk moderately convex, without distinct costæ, the sutural edge feebly elevated near the apex; humeri moderate, not carinate; basal depressions well marked; surface subopaque, finely and densely, imbricately granulate, rather densely clothed with short, inconspicuous, recumbent hairs, which do not conceal the surface sculpture. Body beneath aëneous, with a cupreous tinge toward the lateral margins; prosternum roughly scabrous and sparsely, finely pubescent; prosternal lobe broadly rounded, feebly arcuately and broadly emarginate at middle; intercoxal process broad, the sides parallel, very abruptly narrowed at apex, which is rather obtuse; propleura slightly strigose and very little pubescent; metasternum coarsely punctate-strigose, the sides densely punctate and rather densely pubescent. Abdomen rather sparsely, coarsely punctate and somewhat strigose along the median line, with very finely and densely punctured areas, midway between the sides and middle, sparsely pubescent; first ventral segment convex, not impressed nor pubescent; last ventral obtusely rounded at tip; vertical portions of the segments not conspicuously pubescent, the first rather strongly granulate, pygidium punctate, carinate, the carina projecting and truncate at tip. Hind tarsi four-sevenths as long as the tibiæ, first joint longer than the four following joints united; tibiæ not mucronate; claws divaricate, cleft at the middle, the lower portion not inverted.

Length, 10.5 millimeters; width, 2.6.

Described from a single female from Baguio, Benguet, Luzon (*Baker*).

Agrilus piperi sp. nov.

Male.—Form short, rather robust, entirely bright blue, with a wide transverse band of sparsely placed, silvery white, recumbent hairs at tip of elytra.

Antennæ short, not quite reaching to middle of pronotum, serrate from the fourth joint. Head with the front concave, sides

arcuately expanded at vertex, then slightly narrowed posteriorly and more strongly toward clypeus; rather deeply and broadly, longitudinally impressed from occiput to clypeus; surface with coarsely placed sinuate striæ and nearly glabrous. Clypeus slightly wider than long, with the front margin broadly, arcuately emarginate. Pronotum one-half wider than long, slightly narrower at base than apex, sides strongly arcuate in front, slightly sinuate behind middle, lateral margin feebly sinuate, hind angles rectangular, with a sharply defined, sinuous carina, the carina rather distant from posterior margin, extending to near lateral margin a little beyond middle, disk moderately convex, with a deep, oblique, lateral depression, and a feeble one in front of scutellum; surface finely and widely striate, the striæ transverse at middle, oblique at sides, intervals broad and shining, the depression sparsely punctate. Scutellum feebly, transversely carinate. Elytra slightly sinuate behind the humeri, broadened behind the middle, nearly entirely concealing the abdomen from above, then obliquely narrowed to apices, these conjointly, broadly, arcuately emarginate, with a short sharp spine at outer angles and a very minute one at sutural angles, the outer edge of the elytra moderately serrulate at apex; disk slightly flattened, without distinct costæ, the sutural edge elevated behind the middle, humeri not prominent nor carinate, basal depressions not very deep; surface shining, densely and coarsely, imbricately granulate, slightly strigose at sides, sparsely clothed with short, inconspicuous, recumbent hairs, which do not conceal the surface sculpture and ornamented as above. Body beneath same color as above; prosternum densely, roughly scabrous, and sparsely, finely pubescent; prosternal lobe broadly, arcuately rounded, feebly truncate in front; intercoxal process feebly broadened behind coxæ, apex truncate, with an acute tooth at middle; propleura scabrous, slightly strigose, and feebly pubescent; metasternum moderately strigose. Abdomen sparsely punctate and transversely strigose, the strigæ coarse at the base, becoming finer toward apex, sparsely clothed with distinct white hairs, third and fourth segments with a more densely pubescent spot at the sides; first ventral segment convex, not impressed nor distinctly pubescent; last ventral obtusely rounded at tip; vertical portions of the first, third, and fourth segments with rather dense pubescent areas; pygidium indistinctly punctate, with a feeble median carina, which is not projecting at apex. Hind tarsi not quite half as long as the tibiæ, first joint about equal in length to the four following joints united; front and middle tibiæ feebly

arcuate, hind tibiae straight, not mucronate at tip; claws similar on all the tarsi, deeply cleft, the lower portion strongly incurved and touching that of the opposite side.

Length, 8.5 millimeters; width, 1.9.

Described from a single male specimen in the United States National Museum collection, labeled "Lamao, Luzon, P. I., iii-vi, 1911, C. V. Piper collector."

Agrilus ornatus Deyrolle.

Specimens of this species were examined from the following localities: Butuan, Mindanao (*Baker 8356*); Puerto Princesa, Palawan (*Baker 8355*).

This species is variable in size; specimens measure from 5.25 to 7.5 millimeters in length, but otherwise are identical.

Agrilus luzonicus Kerremans.

This species seems to be rather common and to have a wide distribution, as specimens were examined from the following localities: Mount Maquiling, Luzon (*Baker 8316, 8314, 8315, 8317*); Los Baños, Luzon (*Baker*); Tacloban, Leyte (*Baker*); Davao, Mindanao (*Baker*).

The specimens are uniform in size but vary in color from greenish blue to bright brassy green.

Agrilus nigrocinctus Saunders.

Specimens of this species were examined from the following localities: One male from Davao, Mindanao (*Baker 8368*) and a female from Baguio, Benguet Province, Luzon (*Baker*).

Agrilus inquinatus Saunders.

Material of this species was examined from the following localities in Mindanao: One male and one female from Davao (*Baker 8324, 8361*); two females from Zamboanga (*Baker 8321*); a male from Butuan (*Baker*).

Agrilus subspinosus sp. nov.

Male.—Form elongate, rather slender, head and sides of pronotum aëneous, disk of pronotum dark olive green, with a purplish tinge; elytra aëneous, becoming purpureous toward apex; each elytron ornate with an inconspicuous wide band of short white pubescence, reaching from the basal depressions along suture to just beyond the middle, then obliquely backward toward lateral margin, but not quite reaching it.

Antennæ aëneous, becoming black toward tip, reaching to basal third of pronotum, serrate from the fourth joint. Head with the front convex, sides slightly narrowed toward clypeus, broadly and rather deeply impressed on vertex, less deeply on occiput; surface finely rugose, with the intervals sparsely punctate and very finely granulate, with a row of white hairs along lateral margin and a few sparsely placed ones behind clypeus. Clypeus slightly wider than long, with the front margin truncate. Pronotum one-third wider than long, slightly narrowed at base; sides nearly straight anteriorly, slightly arcuate behind middle and narrowly explanate; lateral margin strongly sinuate when viewed laterally; behind angles rectangular, with a well-defined arcuate carina, the carina extending to lateral margin near middle; disk convex, with a broad lateral depression and the median line with two vague depressions, the posterior the larger; surface finely, densely, irregularly strigose, the intervals between the ridges densely and coarsely punctate, each puncture with a short, erect, inconspicuous hair. Scutellum transversely carinate. Elytra distinctly sinuate behind the humeri, with a very feeble postmedian dilatation, then strongly narrowed to apices; sides of abdomen exposed above; each elytron emarginate at tip, the sutural angle produced into a long acute spine which is feebly serrate on the inner side, the lateral margin feebly serrate and extending into a very minute spine; disk rather flat, without distinct costæ, the sutural edge rather strongly elevated at apical third; humeri moderately prominent, not carinate; basal depressions moderately deep; surface shining, coarsely punctate-granulate, becoming smoother and feebly imbricate near apex, sparsely clothed with short, inconspicuous hairs and ornamented as above. Body beneath aëneous; prosternum densely and very finely punctate along the middle, clothed with fine, suberect, silky pubescence, sides coarsely punctate and scabrous; prosternal lobe broad, deeply and arcuately emarginate at middle; intercoxal process broad, sides feebly broadened behind coxæ, apex truncate and biemarginate; propleura coarsely punctate and slightly strigose, sparsely pubescent; metasternum roughly scabrous, somewhat strigose and pubescent. Abdomen densely punctate at sides, especially near base, more sparsely along median line; first ventral segment slightly depressed at middle, second with a narrow longitudinal smooth line extending to middle; last ventral broadly concave, with a feeble longitudinal

carina extending from apex to about the middle, obtusely rounded at tip; vertical portions without conspicuous pubescent areas; pygidium finely punctate, subacute at apex, the carina well marked but not projecting. Hind tarsi two-thirds as long as the tibiæ, first joint just about equal in length to the four following joints united; anterior and middle tibiæ with a distinct mucro at the inner apex, posterior tibiæ simple; claws similar on all the tarsi, divaricate, broadly toothed, the lower portion not incurved.

Length, 7.25 millimeters; width, 1.8.

Female.—Differs from the male as follows: Head darker in color; prosternum densely and roughly scabrous over entire surface, without distinct pubescence; first ventral segment convex, uniformly punctate and pubescent; last ventral convex, without longitudinal carina, obtusely rounded at apex; tibiæ not mucronate.

Described from two specimens. The type is a male from Davao, Mindanao (*Baker*); the allotype is a female from Mount Maquiling, Luzon (*Baker*).

Agrilus banahaensis sp. nov.

Male.—Form elongate, subcylindrical, front of head æneous, occiput of head and pronotum cyaneous, elytra dark blue, becoming violaceous posteriorly.

Antennæ æneous, reaching a little beyond the middle of pronotum, serrate from the fourth joint. Head with the front flat, the sides nearly parallel; occiput rather deeply and broadly impressed, with a feeble broad impression on the front; surface strongly, transversely strigose, the intervals sparsely punctate, finely granulate and very sparsely clothed with a few inconspicuous hairs. Clypeus wider than long, with the front margin truncate. Pronotum one-third wider than long, slightly narrower at base than apex; sides slightly sinuate, lateral margin strongly sinuous when viewed laterally; hind angles rectangular, with a sharply defined, arcuate carina, the carina ending abruptly near lateral margin at basal third, disk moderately convex, a moderately deep, oblique, lateral depression and a vague anterior and posterior depression on the median line; surface finely, densely, and irregularly strigose, the intervals between the strigæ densely and coarsely punctate, each puncture with a short, erect, inconspicuous hair. Scutellum transversely carinate. Elytra with a slight posthumeral sinuation, behind

which there is a slight dilatation, then strongly narrowed to apices, which are bispinose, the inner spine long, acute, and on a line with the middle of the elytron, lateral margin smooth, extending into a sharp spine which is shorter than the inner one; sides of abdomen exposed above; disk slightly flattened, without distinct costæ, the sutural edge strongly elevated behind the middle; humeri prominent, with a very minute carina at base; basal depressions moderately deep; surface shining, rather finely and densely, imbricately granulate, smoother near apex, rather densely clothed with short, semierect hairs, which do not conceal the surface sculpture. Body beneath plumbeous, with the legs of a more greenish color; prosternum densely, roughly scabrous and sparsely, finely pubescent; prosternal lobe broadly rounded and deeply, arcuately emarginate in front; intercoxal process broad, sides parallel to behind coxæ, then abruptly narrowed to apex, which is acute; propleura finely punctate and sparsely pubescent; metasternum at sides densely and rather coarsely punctate, smooth along the middle and rather densely pubescent. Abdomen finely punctate at middle, more densely at sides, sparsely clothed with distinct white hairs; first ventral segment feebly flattened and slightly more densely punctured and pubescent; last ventral obtusely rounded at apex; vertical portions of the segments not conspicuously pubescent; pygidium finely punctate, pubescent at apex, the carina well marked, but not projecting. Hind tarsi nearly half as long as the tibiæ, first joint about equal in length to the four following joints united; front tibiæ feebly arcuate; middle and posterior tibiæ straight, not mucronate at tip; claws similar on all the tarsi, divaricate, broadly toothed at base, the lower portion not incurved.

Length, 8 millimeters, width, 2.1.

Described from a single male specimen from Mount Banahao, Luzon (*Baker*).

Agrius maquilingsis sp. nov.

Female.—Form elongate, rather slender; entirely aëneous.

Antennæ aëneous, reaching a little beyond the middle of pronotum, serrate from the fourth joint. Head with the front rather convex and slightly gibbose at the sides on vertex; sides nearly parallel, abruptly and deeply impressed on the vertex, becoming less distinct on the occiput; surface finely rugose, with the intervals sparsely punctate and finely, densely granulate, the rugæ becoming more distinct and longitudinal on the occiput, sparsely

clothed with a few long yellow hairs behind the clypeus. Clypeus wider than long, with the front margin nearly truncate. Pronotum one-third wider than long, distinctly narrower at base than apex; sides nearly straight in front, sinuate posteriorly; lateral margin very nearly straight when viewed laterally; hind angles rectangular, with a well-defined, slightly arcuate carina, the carina extending to lateral margin near middle; disk strongly convex, with a feeble lateral depression and another similar one in front of scutellum; surface coarsely, closely, transversely strigose, the intervals between the strigæ finely and sparsely punctate. Scutellum transversely carinate. Elytra strongly sinuate behind the humeri, with the postmedian dilatation nearly entirely concealing the sides of abdomen from above, strongly narrowed to the apices; each elytron rather feebly, arcuately emarginate at tip, the angles produced into short spines, which are equal in length, outer edge of elytron near apex smooth; disk rather flat, without distinct costæ, sutural edge gradually elevated from the basal fourth, becoming quite distinct behind the middle; humeri rather prominent, not carinate; basal depressions rather feeble; surface subopaque, finely, densely granulate-scabrous, and sparsely clothed with short, white, recumbent hairs, which do not conceal the surface sculpture. Body beneath aëneous, more shining than above; prosternum densely, roughly scabrous, without pubescence; prosternal lobe acutely and rather deeply emarginate at middle; intercoxal process broad, sides nearly parallel, abruptly narrowed to apex, which is acute; propleura coarsely punctate, slightly strigose, not pubescent; metasternum closely punctate and strongly reticulate, without conspicuous pubescence. Abdomen finely and rather closely punctate, distinctly strigose at base, with fine punctures along the edge of the strigæ, nearly glabrous; first ventral segment convex, not impressed nor pubescent; last ventral feebly truncate at apex, with few feeble asperities posteriorly; vertical portions not conspicuously pubescent; pygidium punctate, subacute at apex, the carina well marked, but not projecting at tip. Hind tarsi a little more than half as long as tibiæ, first joint distinctly longer than the four following joints united; all tibiæ nearly straight, not mucronate at tip; claws similar on all the tarsi, divaricate, broadly toothed at base, the lower portion not incurved.

Length, 6 millimeters; width, 1.8.

Described from a unique female from Mount Maquiling, Luzon (Baker).

Agrilus occipitalis Eschscholtz.

This seems to be the commonest species of the genus in the Philippines, and all the specimens examined are quite uniform in size and coloration. Material has been examined from the following localities in Mindanao: Davao (*Baker 8358, 8359*); Zamboanga (*Baker 8347*); Dapitan (*Baker 8301*); Butuan (*Baker 8302*). Specimens from Luzon are from Malinao (*Baker 8304*) and Mount Maquiling (*Baker*). Material in the United States National Museum collection without definite locality is labeled "Bur. Agri., P. I., Acc. Nos. 183, 242, 252, 1484, 2269 collected by B. Arce and C. R. Jones." The Bureau of Agriculture reports localities and collectors for these numbers as follows: Manila (*Arce 183, 1484, Jones 252*); Santo Tomas, Batangas Province, Luzon (*Jones 242*); Diklom, Bukidnon, Mindanao (*John T. Zimmer 2269*).

Agrilus albocinctus sp. nov.

Form short, rather robust, front of head and beneath aëneous, posterior part of head, pronotum, and elytra greenish blue, with a strong violaceous tinge.

Antennæ dark, with the basal joints aëneous, reaching to basal fourth of pronotum, and serrate from the fourth joint. Head with the front strongly convex, sides strongly expanded at vertex, then narrowed both posteriorly and toward clypeus, broadly and feebly impressed on vertex and occiput; surface nearly smooth, shining, with a few indistinct punctures and clothed with a row of sparsely placed, short white hairs along the lateral margin. Clypeus with the front margin truncate, slightly wider than long. Pronotum two-thirds wider than long, not narrower at base than apex, sides nearly straight, slightly sinuate near hind angles, lateral margin nearly straight; hind angles rectangular, with a feebly defined straight carina, the carina extending to near lateral margin at middle; disk convex, with a wide, oblique, lateral depression extending along the basal fourth; surface finely and rather distantly striate, the intervals smooth and shining. Scutellum transversely carinate. Elytra slightly sinuate behind the humeri, slightly broadened behind middle, nearly entirely concealing the sides of the abdomen from above, then strongly, obliquely narrowed to the apices, which are separately rounded and rather strongly serrulate; disk convex, without distinct costæ, sutural edge feebly elevated near apex; humeri moderate, without carina; basal depressions rather feeble but more distinct than in *A. subpubescens*; surface shining,

coarsely, imbricately granulate, becoming smoother near apex, sparsely clothed with short inconspicuous hairs and each elytron with a transverse band of white pubescence at the apical third and a similar band at tip. Body beneath dark aëneous; prosternum sparsely and coarsely rugose, finely granulate between the rugæ and sparsely pubescent; prosternal lobe broad, very broadly rounded and fully truncate in front; intercoxal process broad, sides parallel, with the edge strongly, abruptly elevated along the coxæ, abruptly narrowed at tip; propleura punctate, feebly reticulate and sparsely pubescent; metasternum strongly, transversely strigose, with fine punctures along the edge of the strigæ, sparsely pubescent. Abdomen sparsely and coarsely strigose at base, becoming more densely, finely strigose and punctate at the sides, sparsely pubescent; first ventral segment convex, not impressed nor conspicuously pubescent; last ventral broadly and feebly, transversely concave, the apex acutely, but not deeply emarginate at middle; vertical portions not conspicuously pubescent; pygidium punctate and carinate at middle, the carina not projecting at apex. Hind tarsi very short, one-fourth as long as the tibiæ, first joint slightly longer than the second; all of the tibiæ nearly straight, without a distinct mucro; hind femora not as robust as in *A. subpubescens*; claws similar on all tarsi, strongly cleft, the lower portions incurved, but with the points distant.

Length, 5 millimeters; width, 1.7.

Described from three specimens, which are probably all males. The type is from Davao, Mindanao (*Baker 8313*). One paratype from the same locality and another from Zamboanga, Mindanao (*Baker*).

This species is closely allied to *A. subpubescens* but can be easily distinguished from that species by the white pubescent band on the elytra, the broadly rounded prosternal lobe, and by having the sides of the intercoxal process abruptly elevated along the coxæ.

Agrilus subpubescens sp. nov.

Form short, rather robust, color entirely greenish blue, some examples with a purplish tinge on the elytra.

Antennæ cupreous, with the basal joints more or less aëneous, reaching to basal third of pronotum, serrate from the fourth joint. Head with the front nearly flat, widest at clypeus, then gradually narrowed posteriorly; vertex and occiput slightly impressed; surface strongly rugose, the rugæ becoming less distinct

anteriorly, intervals sparsely, coarsely punctate, with a patch of white pubescence along lateral margin behind clypeus. Clypeus slightly wider than long, front margin truncate, with a sharp tooth at each anterior angle. Pronotum twice as wide as long, not narrower at base than apex; sides strongly arcuate in front, obliquely narrowed behind; lateral margin straight; hind angles rectangular, without trace of a carina; disk moderately convex, without lateral or median depressions; surface coarsely, closely, transversely strigose, the intervals between the strigæ sparsely and finely punctate. Scutellum wide, transversely carinate. Elytra with a slight posthumeral sinuation, behind which there is a slight dilatation, then strongly, obliquely narrowed to the apices, which are conjointly rounded and feebly serrulate, sides of abdomen exposed above; disk convex, without distinct costæ, the sutural edge elevated at apical third; humeri moderately prominent, not carinate; basal depressions almost obliterated; surface shining, coarsely and closely, imbricately granulate, coarser near the base, sparsely clothed with short, inconspicuous, recumbent hairs which do not conceal the surface sculpture. Body beneath usually more greenish than above; prosternum coarsely and densely scabrous, opaque and sparsely pubescent; prosternal lobe broad, deeply and rather acutely emarginate at middle; intercoxal process broad, sides parallel, abruptly narrowed at apex; propleura coarsely punctate, slightly strigose and sparsely pubescent; metasternum strigose and with fine punctures along the edge of the strigæ. Abdomen sparsely and finely punctate, becoming feebly strigose at side, sparsely pubescent; first ventral segment convex, not impressed nor conspicuously pubescent; last ventral truncate and feebly emarginate at apex; vertical portions not conspicuously pubescent; pygidium punctate, feebly carinate, the carina not projecting at apex. Hind tarsi very short, one-fourth as long as the tibiæ, first joint about equal in length to the two following joints united; anterior tibiæ feebly arcuate, the middle and posterior tibiæ simple, not mucronate; posterior femora very robust, resembling species of the chrysomelid genus *Altica*; claws similar on all tarsi, strongly cleft, the lower portion incurved, but with the tips quite distant.

Length, 5.5 millimeters; width, 1.9.

Described from four specimens, probably all males. The type is from Davao, Mindanao (*Baker 8366*). Paratypes are from Davao and Zamboanga, Mindanao; and from Malinao, Tayabas Province, Luzon; all specimens collected by C. F. Baker.

Agrilus zamboangensis sp. nov.

Male.—Form very short, rather robust, head and pronotum bright brassy green, elytra dark brown, with a distinct metallic luster.

Antennæ aëneous, reaching to basal fourth of pronotum, serrate from the fourth joint. Head with the front convex, sides nearly parallel to vertex, then slightly narrowed posteriorly; occiput slightly, longitudinally impressed; surface strongly rugose on vertex and occiput, with two smooth areas on the front, intervals strongly and rather densely punctate, with patches of long white pubescence along lateral margin and behind clypeus. Clypeus slightly wider than long, with the front margin truncate and with a sharp tooth at each anterior angle. Pronotum two-thirds wider than long, not narrower at base than apex; sides feebly arcuate in front, slightly sinuate posteriorly; lateral margin nearly straight; hind angles rectangular, with an indistinct, short, straight carina; disk convex, without lateral or median depressions; surface coarsely, closely, transversely strigose, the intervals between the ridges sparsely and finely punctate. Scutellum wide, transversely carinate. Elytra with a feeble posthumeral sinuation, scarcely dilated behind middle, then broadly, arcuately narrowed to apices, which are separately, acutely rounded and feebly serrulate; sides of abdomen entirely concealed from above; disk convex, without distinct costæ, sutural edge scarcely elevated; humeri moderately prominent, not carinate; basal depressions rather feeble; surface shining, coarsely imbricate, slightly rugose at sides and sparsely clothed with distinct, short, yellowish, recumbent hairs. Body beneath piceous, with a greenish tinge; prosternum roughly scabrous, sparsely pubescent; prosternal lobe broad, broadly, arcuately emarginate at middle, intercoxal process wide, sides parallel to behind coxæ, then abruptly narrowed to apex, which is rather obtuse; propleura coarsely, densely punctate and feebly reticulate, very sparsely pubescent; metasternum strigose and closely punctate. Abdomen finely strigose, with fine punctures along the edge of the strigæ, the strigæ coarser at base than at sides, sparsely pubescent; first ventral segment convex, not impressed nor conspicuously pubescent; last ventral truncate and feebly emarginate at apex; pygidium punctate, with a feeble median carina, which does not project at tip. (Hind tarsi broken off.) Anterior tibiæ with an extremely feeble mucro at the tip; middle and posterior tibiæ simple; claws on front and

middle tarsi similar, strongly cleft, the lower portion feebly incurved but with the tips distant.

Length, 4 millimeters; width, 1.5.

Described from a single male from Zamboanga, Mindanao (*Baker*).

Agrilus inconstans sp. nov.

Male.—Form rather elongate and moderately robust, varying in color from bronzy to cupreous, except head, which is dull green.

Antennæ greenish, reaching to middle of pronotum, serrate from the fourth joint. Head with front convex, the sides slightly, arcuately emarginate between vertex and clypeus; occiput with scarcely any trace of longitudinal impression; surface densely, rather coarsely punctate and finely granulate, becoming rugose on the occiput; clothed with very short white hairs, becoming denser and longer toward clypeus. Clypeus wider than long, with the front margin broadly, arcuately emarginate. Pronotum one-half wider than long, distinctly narrowed at base; sides feebly arcuate, lateral margin straight; hind angles rectangular, without distinct carina; disk convex, without lateral or median depressions; surface coarsely, closely, transversely strigose, the intervals between the ridges finely and sparsely punctate. Scutellum transversely carinate. Elytra rather strongly sinuate behind the humeri, with a very feeble postmedian broadening, then strongly, obliquely narrowed to apices, which are separately rounded and finely serrulate; sides of abdomen widely exposed above; disk convex, without distinct costæ; sutural edge slightly elevated near apex; humeri moderate, not carinate; basal depressions moderately deep; surface subopaque, closely and rather finely, imbricately granulate, coarser near the base, sparsely clothed with short, white, recumbent hairs, in some specimens forming a broad inconspicuous vitta along the suture. Body beneath aëneous; prosternum densely and strongly scabrous, sparsely clothed with long silky pubescence; prosternal lobe broadly, arcuately rounded in front; intercoxal process not very broad, gradually narrowed from in front of coxæ to apex, which is rather acute; propleura finely punctate and feebly strigose, sparsely pubescent and farinaceous, metasternum at sides strongly strigose and densely punctate, rather densely pubescent and more or less farinaceous. Abdomen rather coarsely and densely punctate, becoming strigose on the sides of the first two

segments, rather densely clothed with short, recumbent, white pubescence; first ventral segment convex, the middle with a longitudinal series of long, semierect, silken hairs; last ventral feebly concave, with a series of longer hairs and distinct asperities posteriorly, feebly, arcuately emarginate at apex; vertical portions except the first and second densely clothed with white pubescence; pygidium punctate, with a median carina, which is not projecting at apex. Hind tarsi not quite one-half as long as the tibiæ, first joint about as long as the second and third joints united; anterior tibiæ feebly arcuate, with a very feeble mucro at tip; middle and posterior tibiæ simple; claws similar on all tarsi, strongly cleft, the lower portion incurved, with the point not quite touching that of the opposite side.

Length, 5.75 millimeters; width, 1.75.

Female.—Differs from the male in having the front of head cupreous, slightly less pubescent; first ventral segment without distinct, long, semierect hairs, and by having all the tibiæ simple.

Described from six specimens, one male and five females. The type, which is a male, is from Davao, Mindanao (*Baker 8325*); allotype from the same locality (*Baker 8365*). Paratypes: One female from same locality as type; one female from Baguio, Benguet Province, Luzon; one female from Puerto Princesa, Palawan; and a female from Mount Maquiling, Luzon, all collected by C. F. Baker.

The female from Luzon has the front of head more convex and strongly, transversely rugose, becoming concentrically rugose on the vertex, and the front margin of prosternal lobe more squarely truncate than in the type.

Agrilus rotundipennis sp. nov.

Male.—Form elongate, subcylindrical, color uniformly dark blue, with a slight greenish tinge, each elytron with the tip and a round spot near suture at apical third of short white pubescence.

Antennæ brassy, reaching to middle of pronotum, serrate from the fourth joint. Head with the front nearly flat, sides slightly narrowed toward clypeus; vertex broadly and rather deeply impressed, the impression becoming nearly obliterated near clypeus; surface sparsely and rather coarsely punctate, becoming concentrically rugose on vertex, intervals smooth and shining, nearly glabrous. Clypeus slightly wider than long, with the front margin broadly, arcuately emarginate. Pronotum nearly one-half wider than long, not narrower at base than apex; sides feebly arcuate in front, slightly sinuate behind the middle,

lateral margin strongly sinuate when viewed laterally; hind angles rectangular, without trace of carina; disk convex, the median line with a moderately deep anterior and posterior depression, and a deep oblique depression at side connecting with the posterior depression at middle; surface finely and rather distantly, irregularly striate, the intervals smooth and shining. Scutellum transversely carinate. Elytra feebly sinuate behind humeri, scarcely dilated behind the middle, then strongly narrowed to apices, which are separately, very broadly rounded and strongly serrulate; sides of abdomen widely exposed above; disk feebly flattened, without costæ, sutural edge elevated behind the middle; humeri moderately prominent, not carinate; basal depressions rather deep; surface shining, coarsely rugose and rather densely punctate, the rugæ becoming finer toward apex, sparsely clothed with short, inconspicuous hairs and ornamented as above. Body beneath similar to that above; prosternum sparsely rugose and coarsely punctate, sparsely pubescent; prosternal lobe broad, truncate in front; intercoxal process broad, sides parallel to behind coxæ, then abruptly narrowed to apex, which is rather acute; propleura finely reticulate and sparsely pubescent; metasternum coarsely punctate-strigose, along the middle much smoother, the sides rather densely pubescent. Abdomen sparsely strigose, with fine punctures along the edge of the strigæ, nearly glabrous; first ventral segment convex, not impressed nor pubescent; last ventral obtusely rounded at apex; vertical portion of first segment densely pubescent on the posterior half; pygidium without projecting carina at apex. Hind tarsi about one-third as long as tibiæ, first joint equal in length to the four following joints united; anterior tibiæ feebly mucronate, the middle and posterior ones simple; claws similar on all tarsi, strongly cleft, the lower portion feebly incurved, but with tips quite distant.

Length, 8 millimeters; width, 2.5.

Described from a male specimen in the United States National Museum collection labeled "Acc. No. 1666, Bur. Agri., P. I., collected by C. R. Jones," without any definite locality given. The Bureau of Agriculture reports that this specimen was collected at Lamao, Bataan Province, Luzon.

This species is closely allied to *A. monticola* Kerrem.⁵ I have not seen any specimens of Kerremans's species, but in the description he states that the hind angles of the pronotum are carinate, while in *A. rotundipennis* there is no trace of a carina.

⁵ *Agrilus monticola* Kerrem. || = *Agrilus oreophilus* Fisher.

Agrilus bakeri Kerremans.

This species is represented in the collection by a single specimen from Baguio, Benguet Province, Luzon (*Baker*).

Agrilus subviridis sp. nov.

Male.—Form a little shorter and more robust than *A. rotundipennis*, of a uniform bluish green color, front of head green, becoming bluish on vertex and occiput.

Antennæ slightly cupreous, reaching just a little beyond front angles of pronotum, serrate from the fourth joint. Head with the front nearly flat, the sides strongly narrowed from vertex to clypeus; vertex broadly but not very deeply impressed, the impression becoming less distinct toward clypeus; surface sparsely and finely punctured, becoming finely, concentrically rugose on vertex, intervals smooth and shining, glabrous. Clypeus triangular, scarcely wider than long, with front margin broadly, arcuately emarginate. Pronotum nearly one-half wider than long, slightly narrower at base than apex, sides feebly arcuate, lateral margin slightly sinuous when viewed laterally, hind angles rectangular, without trace of carina; disk convex, a rather deep, oblique depression at the side nearly reaching median line, which is feebly, transversely impressed in front of scutellum; surface coarsely, closely, and irregularly strigose, intervals between strigæ sparsely and rather finely punctate. Scutellum transversely carinate. Elytra slightly sinuate behind humeri, a little dilated behind the middle, then strongly, obliquely narrowed to the apices which are separately, broadly rounded and strongly serrulate, sides of the abdomen feebly exposed above; disk slightly flattened without distinct costæ, sutural edge strongly elevated from middle to apex; humeri moderately prominent, not carinate; basal depressions large and moderately deep; surface rather shining, coarsely, transversely rugose, becoming smoother and feebly imbricate near apex, intervals sparsely punctate and glabrous. Body beneath aëneous; prosternum densely, coarsely rugose and sparsely clothed along median line with long, semierect, white pubescence; prosternal lobe broadly truncate in front; intercoxal process broad, sides parallel to behind coxæ, then narrowed to apex, which is acute; propleura coarsely and rather densely punctate, vaguely strigose, and feebly pubescent; metasternum densely and roughly, rugosely punctate, rather densely pubescent. Abdomen strongly, transversely strigose, with fine punctures along the edge of the strigæ, sparsely pubescent; first ventral segment

convex, not impressed nor conspicuously pubescent; last segment broadly concave, very densely, finely punctate, and densely clothed with long silky pubescence, apex broadly rounded; vertical portions of segments glabrous; pygidium without projecting carina. Hind tarsi not quite one-half as long as tibiae; first joint nearly as long as the four following joints united; anterior tibiae feebly arcuate, with a slight mucro at the inner apex, middle and posterior tibiae simple; claws similar on all tarsi, strongly cleft, the lower portion incurved, with the point not quite touching that of the opposite side.

Length, 7 millimeters; width, 2.25.

Described from two specimens. The type from Davao, Mindanao (*Baker 8300*); a paratype from Mount Maquiling, Luzon (*Baker*).

Agrilus semipubesceus sp. nov.

Form elongate, subcylindrical, color uniformly olivaceous.

Antennae piceous, with the basal joints greenish, reaching to the middle of pronotum, serrate from the fourth joint. Head with the front nearly flat, sides nearly parallel from clypeus to vertex, then strongly narrowed posteriorly; vertex broadly, but not deeply, longitudinally impressed, the impression reaching to the middle of the front; surface densely and coarsely punctate, becoming slightly rugose on occiput, and nearly glabrous. Clypeus wider than long, with the front margin truncate. Pronotum one-third wider than long, slightly narrower at base than apex; sides feebly arcuate in front, sinuate behind the middle; lateral margin nearly straight when viewed laterally; hind angles rectangular, without a carina; disk convex, without a distinct lateral depression, on the median line two feeble depressions, the posterior the larger; surface coarsely, closely, transversely strigose, the intervals sparsely and finely punctate. Scutellum wide, strongly, transversely carinate. Elytra with a slight post-humeral sinuation, behind which is a slight dilation, then strongly narrowed to apices, which are separately, rather broadly rounded and strongly serrulate, sides of abdomen visible from above; disk rather convex, feebly, broadly concave along suture, without distinct costae, sutural edge elevated behind the middle, humeri moderately developed, not carinate; basal depressions moderately deep; surface feebly shining, coarsely and densely, imbricately granulate, but smoother toward apex, rather densely clothed with short, semierect white hairs, which form a wide inconspicuous band along the suture. Body beneath

olivaceous, slightly darker than above; prosternum densely and coarsely scabrous; sparsely pubescent; prosternal lobe broadly but feebly emarginate; intercoxal process strongly expanded behind the coxæ, the apex broad, biemarginate, with a sharp tooth at middle; propleura with reticulate sculpture and sparsely pubescent; metasternum rather coarsely imbricate and feebly pubescent. Abdomen finely strigose-punctate, the strigæ coarser at base and along sides of first and second segments, sparsely pubescent; first ventral segment convex, not impressed nor pubescent; last ventral feebly concave, truncate and feebly emarginate at apex; vertical portions not conspicuously pubescent; pygidium punctate, carina along the middle, the carina not projecting at apex. Hind tarsi about one-half as long as tibiæ, first joint as long as the four following joints united; tibiæ simple, claws divaricate, broadly toothed at base.

Length, 6.5 millimeters; width, 1.75.

Described from a unique specimen which is probably a male, collected at Butuan, Mindanao (*Baker*).

Agrilus subvittatus sp. nov.

Male.—Form more robust than in *A. fulvovittatus*, color slightly more cupreous than in that species and with the vitta less distinct.

Antennæ piceous, reaching a little beyond middle of pronotum, serrate from the fourth joint. Head with the front nearly flat, sides roundly expanded at middle, then gradually narrowed posteriorly and toward clypeus; vertex slightly, longitudinally impressed; with a broad shallow impression behind the clypeus, which is slightly elevated; surface transversely rugose on front, becoming longitudinally rugose on vertex and occiput, intervals sparsely and coarsely punctate, with a few short white hairs behind clypeus. Clypeus wider than long, the front margin deeply, arcuately emarginate. Pronotum fully one-half wider than long, slightly narrower at base; sides slightly arcuate; lateral margin nearly straight when viewed laterally; hind angles rectangular, without trace of carina in either sex; disk moderately convex, the median line with a feeble, transverse, anterior and posterior depression and a shallow oblique depression at the side extending to the posterior median one; surface coarsely, closely, transversely strigose, the intervals between the ridges sparsely and finely punctate, from each puncture arises a short, inconspicuous hair. Scutellum wide, strongly, transversely carinate. Elytra sinuate behind humeri, scarcely dilated

behind the middle, then strongly narrowed to apices, which are separately, rather broadly rounded and strongly serrulate; sides of abdomen visible from above; disk rather convex, without distinct costæ; humeri moderately prominent, not carinate; basal depressions moderately deep; surface rather shining, strongly and densely, imbricately granulate, the granulation coarser than in *A. fulvovittatus*, becoming finer posteriorly, sparsely clothed with short, fine, semierect hairs and ornamented as above. Body beneath dark æneous; prosternum coarsely and densely rugose, sparsely pubescent, without conspicuous pubescence at middle; prosternal lobe broadly rounded, with an acute emargination at middle; intercoxal process rather narrow, sides parallel to behind coxæ, then gradually narrowed to apex, which is acute; propleura rather densely punctate and pubescent; metasternum coarsely strigose-punctate and rather densely pubescent. Abdomen rather densely strigose-punctate, the strigæ becoming coarser at base and sides of first and second segments, sparsely clothed with rather long white pubescence; first ventral segment convex, with a distinct sharp tooth at middle posteriorly; last ventral feebly concave, apex acutely rounded, with a series of distinct asperities along the margin; vertical portions of segments not conspicuously pubescent; pygidium without projecting carina at apex. Hind tarsi not quite one-half as long as the tibiæ, first joint about equal in length to the four following joints united; anterior and middle tibiæ mucronate at the inner apical angles, posterior tibiæ simple; claws similar on all the tarsi, cleft near apex, forming a short, acute tooth; the lower portion is very feebly incurved in some specimens.

Length, 6.75 to 7.50 millimeters; width, 2 to 2.4.

Female.—Differs from the male in having the front of the head cupreous, pubescence shorter, only the anterior tibiæ with an extremely feeble mucro at tip, and without a tooth on the median part of the first abdominal segment.

Described from one male and three females. The type is from Davao, Mindanao (*Baker*). Three female paratypes; two from Zamboanga, Mindanao (*Baker 8346*), and one from Butuan, Mindanao (*Baker 8299*).

Agrilus fulvovittatus sp. nov.

Male.—Form elongate, rather slender, head and pronotum brassy green, elytra green with a purplish tinge, each elytron with a narrow vitta of golden pubescence reaching from the basal depression to apex.

Antennæ brassy, reaching to apical fourth of pronotum, serrate from the fourth joint. Head with the front convex, the sides roundly expanded at vertex, then slightly narrowed posteriorly and toward clypeus; vertex and occiput very feebly, longitudinally impressed; surface finely scabrous, becoming longitudinally rugose on occiput, intervals finely, densely granulate, nearly glabrous. Clypeus wider than long, with the front margin deeply, arcuately emarginate. Pronotum one-half wider than long, strongly narrowed at base; sides moderately arcuate in front, sinuate behind the middle; lateral margin nearly straight when viewed laterally; hind angles rectangular without any trace of a carina in either sex; disk moderately convex without depressions, either at middle or sides; surface coarsely, closely, transversely strigose, the intervals between the ridges sparsely and finely punctate. Scutellum strongly, transversely carinate. Elytra sinuate behind the humeri, scarcely dilated behind the middle, then strongly narrowed to apices, which are separately, acutely rounded and strongly serrulate; sides of abdomen exposed above; disk with a distinct costa extending from humeri to apex, the interval between this and the suture feebly concave; sutural edge slightly elevated from middle to apex; humeri not well developed, not carinate; basal depressions rather feeble; surface subopaque, finely and densely, imbricately granulate, smoother at apex, and ornamented as above. Body beneath brassy green; prosternum densely granulate, with a broad band of densely placed, suberect, white hairs along the middle; prosternal lobe broadly rounded and vaguely emarginate at middle; intercoxal process not very wide, gradually narrowed to behind coxæ, then abruptly narrowed to apex, which is acute; propleura moderately, closely punctate and sparsely pubescent; metasternum densely, imbricately granulate, sparsely and finely pubescent. Abdomen finely strigose-punctate, becoming granulate at sides of first segment, finely pubescent; first ventral segment convex, not impressed nor conspicuously pubescent; last ventral obtusely rounded at apex; vertical portions of the segments rather densely pubescent; pygidium without a projecting carina at apex. Hind tarsi one-half as long as the tibiæ, first joint equal in length to the two following joints united; anterior tibiæ feebly arcuate, with a slight mucro at the inner apical angle; middle and posterior tibiæ simple; claws dissimilar, anterior ones almost truly bifid, cleft near apex, middle ones less so, and the posterior ones cleft near middle, forming a rather broad tooth, the lower portion not incurved.

Length, 5.25 to 6.75 millimeters; width, 1.3 to 1.8.

Described from five specimens, probably all males. The type is from Mount Maquiling, Luzon. Paratypes from Davao (*Baker 8323*), Iligan, and Butuan, Mindanao; all specimens collected by C. F. Baker.

Agrilus innotatus sp. nov.

Female.—Form elongate, slender, color uniformly plumbeous, with a slight purplish and greenish tinge, except the front of head which is cupreous.

Antennæ black, with the basal joints slightly greenish, reaching to the base of pronotum, serrate from the fourth joint. Head with the front convex, the sides gradually narrowed from clypeus to occiput; vertex very slightly impressed; surface very finely rugose, the rugæ becoming more longitudinal and distinct on the occiput, intervals very finely granulate, with a few moderately long white hairs along the eyes and in front of clypeus. Clypeus slightly wider than long, with the front margin broadly, arcuately emarginate. Pronotum nearly one-half wider than long, distinctly narrower at base than apex; sides very feebly arcuate and narrowly explanate; lateral margin strongly sinuate; anterior part of disk strongly convex, with a deep, broad, lateral depression extending along the base; hind angles rectangular, with a sharply defined, slightly arcuate carina, the carina reaching the lateral margin near the middle; surface rather finely and irregularly strigose, the intervals between the strigæ wide and rather densely punctate, becoming more densely punctate near posterior angles. Scutellum transversely carinate. Elytra narrowed from the base, with a very feeble post-median dilatation, then strongly, obliquely narrowed to the apices, which are separately, obtusely rounded, and rather strongly serrulate, the teeth well separated, sides of the abdomen exposed; disk slightly flattened along suture, without distinct costæ, sutural edge elevated behind the middle, humeri moderate, not carinate; basal impressions moderately deep; surface subopaque, closely and rather finely, imbricately granulate, rather densely clothed with distinct, short, whitish, recumbent hairs, although not dense enough to obscure the surface sculpture. Body beneath piceous with a greenish metallic luster; prosternum coarsely and sparsely scabrous, very feebly pubescent; prosternal lobe broadly, arcuately rounded in front; intercoxal process rather narrow, sides parallel, abruptly narrowed to apex, which is obtuse; propleura finely punctate, sparsely pubes-

cent; metasternum rather finely punctate and sparsely pubescent. Abdomen rather finely strigose-punctate, more coarsely at the base, moderately pubescent; first ventral segment convex, not impressed nor more pubescent than rest of body; last ventral subtruncate at apex; vertical portions of segments sparsely pubescent; pygidium rather strongly carinate, the carina projecting and truncate at tip. Hind tarsi a little more than one-half as long as tibiæ; first joint fully as long as the four following joints united; tibiæ simple; claws divaricate, broadly toothed at base.

Length, 5.25 millimeters; width, 1.5.

Described from a unique female from Davao, Mindanao (*Baker*).

Agrilus aguinaldoi sp. nov.

Male.—Form elongate, parallel, head greenish blue, pronotum and base of elytra blue, with a strong violaceous tinge, balance of elytra purplish brown, becoming violaceous toward apex.

Antennæ piceous, with a metallic luster, reaching to middle of pronotum, serrate from the fourth joint. Head with the front strongly convex, the sides gradually narrowed from occiput to clypeus; widely and very deeply, longitudinally impressed from occiput to clypeus, with the impression suddenly expanded at the middle of the front; surface coarsely and rather densely punctured, becoming concentrically rugose on the occiput, intervals smooth, sparsely clothed with long white hairs on the anterior half, the hairs becoming finer and darker posteriorly. Clypeus nearly square, narrower at base, front margin truncate with an obtuse tooth at each anterior angle. Pronotum quadrate, nearly as long as wide, slightly narrower at base than apex, sides rather strongly arcuate from apex to base; lateral margin very strongly sinuate when viewed laterally; hind angles rectangular, carina not well defined and reaching the lateral margin at basal third; disk strongly convex, with a very deep, round, lateral depression, the median line with a feeble impression in front of middle and a broad, deeper one in front of scutellum; surface coarsely, closely, and irregularly strigose, the intervals between the strigæ deep and densely, coarsely punctate, from each puncture arises a short, erect, inconspicuous hair. Scutellum strongly, transversely carinate, the carina bisinuate. Elytra strongly sinuate behind the humeri, with a strong postmedian dilatation, entirely concealing the sides of the abdomen from above, from the postmedian dilatation the sides are broadly,

arcuately narrowed to the apices, which are separately, broadly rounded and very strongly serrulate; disk slightly concave along the suture without distinct costæ, sutural edge rather strongly elevated from apical third to apex; humeri strongly developed, not carinate; basal depressions very deep, with the humeri well developed; surface subopaque, coarsely rugose, sparsely and rather strongly punctate, becoming somewhat smoother toward apex, rather densely clothed with moderately long, inconspicuous pubescence, except along the suture where the hairs are lighter and form an inconspicuous elongate vitta. Body beneath greenish blue; prosternum very coarsely and densely scabrous, sparsely clothed with semierect white pubescence; prosternal lobe rather narrow, truncate and vaguely emarginate in front; intercoxal process rather wide, sides parallel to behind coxæ, then gradually narrowed to apex, which is acute; propleura coarsely punctate, slightly strigose, and sparsely pubescent; metasternum very coarsely punctate-strigose, sparsely pubescent. Abdomen coarsely punctate-strigose, the sculpture becoming rapidly finer toward apex and sparsely pubescent; first ventral segment convex, not impressed nor pubescent; last ventral broadly rounded at apex; pygidium coarsely, sparsely punctate, with a well-defined median carina, which is not projecting at apex. Hind tarsi a little more than one-half as long as the tibiæ, first joint as long as the four following joints united; anterior and middle tibiæ with a slight mucro at the inner apex, the posterior ones simple, with the outer margin flattened and strongly sinuate; claws divaricate, cleft close to the apex.

Length, 11 millimeters; width, 2.6.

Described from a unique male from Malinao, Tayabas Province, Luzon (*Baker*).

Agrilus palawanensis sp. nov.

Female.—Form a little shorter than *A. bisignatus*, color and markings similar to that species with the exception of an additional postscutellar pubescent area.

Antennæ cupreous, reaching a little beyond middle of pronotum, serrate from the fourth joint. Head with the front flat, wider than in *A. bisignatus*, the sides nearly parallel; vertex slightly, longitudinally impressed; surface rather finely scabrous, becoming strongly, longitudinally rugose on occiput, sparsely and evenly clothed with long, recumbent white hairs. Clypeus fully twice as wide as long, with the front margin broadly, arcuately emarginate. Pronotum nearly twice as wide

as long, slightly narrower at base than apex; sides arcuate from apex to base; lateral margin nearly straight when viewed laterally; hind angles rectangular, with a well-defined sinuate carina, the carina reaching the lateral margin near the apical angles; disk convex, with a feeble, oblique lateral concavity, without median depressions; surface rather finely and irregularly strigose, near sides and posterior angles simply punctate, the intervals between the rugæ densely and rather coarsely punctate, sparsely clothed with short, recumbent white hairs. Scutellum wide, strongly, transversely carinate. Elytra scarcely sinuate behind the humeri, without distinct postmedian dilatation, strongly, obliquely narrowed to apices, which are separately, rather broadly rounded and strongly serrulate; sides of abdomen broadly exposed above, disk feebly flattened, becoming rather deeply concave along suture behind the middle, with distinct costæ, sutural edge strongly elevated from apical third to tips, humeri moderate, not carinate; basal depressions moderately deep, surface shining, finely and very densely, imbricately granulate and rather densely clothed with short, distinct, white and yellow, recumbent hairs and ornamented as above. Body beneath aëneous, with a cupreous tinge; prosternum coarsely and densely scabrous, sparsely pubescent; prosternal lobe broadly rounded in front; intercoxal process rather narrow, sides parallel; squarely truncate at apex, with an acute tooth at middle; propleura densely, finely punctate and sparsely pubescent; metasternum at sides densely punctate. Abdomen finely, densely punctate-strigose, and moderately clothed with very short white pubescence; first ventral segment convex, not impressed nor conspicuously pubescent; last segment broadly concave and subtruncate at apex; vertical portions of the segments sparsely and evenly pubescent; pygidium without projecting carina. Hind tarsi one-half as long as tibiæ, first joint about equal in length to the two following joints united; tibiæ straight; claws divaricate, cleft at middle, forming an acute tooth, the lower portion not incurved.

Length, 6.5 millimeters; width, 2.

Described from a unique female from Puerto Princesa, Palawan (*Baker*).

This species superficially resembles *A. bisignatus*, but can be distinguished from that species by the following characters: Form much shorter, tips of the elytron more rounded, prosternal lobe broadly rounded, and by having the intercoxal process

squarely truncate at apex with an acute tooth at middle, while in *A. bisignatus* it is arcuately rounded at apex.

Agrilus bisignatus sp. nov.

Female.—Form elongate, rather robust, color uniform cupreous, each elytron with a small spot of pale yellowish pubescence near suture at apical third.

Antennæ brassy, with the other joints piceous, reaching a little beyond middle of pronotum, serrate from the fourth joint. Head with the front flat, sides nearly parallel; vertex very slightly impressed; surface strongly scabrous, strongly, longitudinally rugose on occiput, nearly glabrous. Clypeus about twice as wide as long, with the front margin broadly, arcuately emarginate. Pronotum one-half wider than long, narrower at base than apex; sides nearly straight to about basal third, then gradually narrowed to posterior angles; lateral margin strongly sinuate; hind angles rectangular, with a sharply defined sinuate carina, the carina reaching nearly to the apical angles; disk moderately convex, a moderately deep, oblique, lateral depression and on the median line two broad feeble depressions, the posterior one larger; surface rather finely, closely, and irregularly strigose, the depressions coarsely and densely punctate, feebly pubescent at sides and on median line. Scutellum wide, strongly, transversely carinate, the carina feebly sinuate. Elytra narrowed from the base, with a very feeble postmedian dilatation, then strongly, obliquely narrowed to the apices, which are separately, arcuately rounded and very strongly serrulate, sides of abdomen visible from above; disk feebly flattened, without distinct costa, sutural edge strongly elevated from the middle to apex; humeri moderately developed, not carinate; basal depressions rather deep; surface shining, finely and very densely, imbricately granulate, sparsely clothed with short, rather distinct, yellowish, recumbent hairs, and ornamented as above. Body beneath aëneous; prosternum coarsely and densely scabrous, sparsely pubescent; prosternal lobe broadly rounded in front, with a rather acute emargination at middle; intercoxal process rather broad, sides parallel to behind coxæ, then arcuately rounded to apex, which is obtuse; propleura coarsely punctate, slightly strigose, feebly pubescent; metasternum densely punctate-strigose and sparsely pubescent. Abdomen coarsely punctate-strigose at base, more densely and finely at sides and toward apex; first ventral convex, not impressed nor conspicuously pubescent; last segment rather acutely rounded and feebly

emarginate at apex, with a few sparsely placed asperities along the apical margin; vertical portions of the segments evenly pubescent; pygidium without projecting carina. Hind tarsi about one-half as long as the tibiæ, first joint fully as long as the four following joints united; anterior tibiæ feebly arcuate, the middle and posterior ones straight; claws divaricate, cleft at middle, forming an acute tooth, the lower portion not incurved.

Length, 7.5 millimeters; width, 2.25.

Described from a single female from Butuan, Mindanao (*Baker*).

Agrilus tayabensis sp. nov.

Male.—Form elongate, slender; color olivaceous bronze, with the head dark green.

Antennæ brassy, with the outer six or seven joints cupreous, densely and finely granulate, reaching to basal third of pronotum, serrate from the fourth joint. Head with the front slightly convex, the sides nearly parallel to vertex, then slightly narrowed posteriorly; vertex slightly, longitudinally impressed; surface coarsely and very densely punctate, more rugose on the occiput and densely clothed in front of clypeus with long white pubescence. Clypeus slightly wider than long, with the front margin truncate. Pronotum nearly one-half wider than long, strongly narrowed toward the base, slightly arcuate in front, sinuate behind the middle; lateral sides nearly straight when viewed laterally; hind angles rectangular, with a sharply defined, strongly arcuate carina, the carina reaching lateral margin at the middle; disk moderately convex, with a broad, vague, lateral concavity and a faint antescutellar depression; surface rather finely, closely, transversely strigose, the intervals finely punctate. Scutellum strongly, transversely carinate. Elytra feebly sinuate behind the humeri, with scarcely any postmedian dilatation, then obliquely narrowed to the apices, which are separately, obtusely rounded and rather finely serrulate, sides of abdomen broadly exposed above; disk flattened, without distinct costæ, sutural edge feebly elevated near apex, humeri moderate, not carinate; basal depressions rather deep; surface shining, finely and densely, imbricately granulate, sparsely clothed with short, yellow, recumbent hairs, forming a broad inconspicuous vitta along the suture. Body beneath olivaceous bronze; prosternum sparsely granulate anteriorly, between the coxæ rugose, nearly glabrous; prosternal lobe broadly rounded, with a small acute emargination at middle; inter-

coxal process rather narrow, sides parallel to behind coxæ, then abruptly narrowed to apex, which is acute; propleura coarsely, sparsely punctate; metasternum at middle with a narrow, elongate, smooth area, sides finely, densely punctate and feebly pubescent. Abdomen transversely, finely strigose, with fine punctures along the edge of the strigæ, smoother toward apex, vaguely pubescent; first ventral segment with a short, transverse, inconspicuous elevation at middle along posterior margin; last segment feebly concave, with a series of asperities at middle near apex, the tip obtusely rounded; vertical portions of the segments sparsely punctate and glabrous; pygidium coarsely, sparsely punctate, with a median carina, but not projecting at apex. Hind tarsi about three-fourths as long as tibiæ, first joint fully as long as the four following joints united; anterior and middle tibiæ mucronate at apex, posterior one simple; claws divaricate, cleft close to apex, forming a sharp tooth, the lower portion not incurved.

Length, 5.2 millimeters; width, 1.9.

Female.—Differs from the male in having the front of head cupreous, less coarsely punctate, more finely granulate, and not so conspicuously pubescent in front of scutellum; basal half of elytra distinctly, transversely strigose; prosternal lobe broadly rounded; intercoxal process with the sides feebly elevated; abdomen less densely punctate, the first ventral segment simple, last segment convex, acute at apex, with a series of long asperities at the tip; tibiæ simple; and by having the claws broadly toothed at middle.

Described from two specimens. The type is a male from Malinao, Tayabas Province, Luzon (*Baker*); the allotype is from Baguio, Benguet Province, Luzon (*Baker*).

Agrilus dapitanensis sp. nov.

Female.—Form small, very slender; color piceous, head and legs greenish.

Antennæ slightly brassy, reaching to basal third of pronotum, serrate from the fourth joint. Head with the front convex, the sides gradually narrowed from occiput to clypeus; vertex slightly, longitudinally impressed; surface sparsely and very finely punctured, the intervals dull, finely and densely granulate, sparsely clothed with long pale yellow hairs in front of clypeus. Clypeus narrow, triangular, with the front margin truncate. Pronotum one-third wider than long, narrower at base than apex, sides strongly arcuate in front, sinuate behind middle,

rather broadly explanate; lateral margin feebly sinuate when viewed from the side; hind angles rectangular, with a sharply defined, strongly angulate carina, the carina reaching lateral margin near apical third; disk strongly convex anteriorly, with a broad, rather deep, oblique, lateral depression extending along the base, the depression slightly deeper in front of scutellum; surface comparatively smooth, with a few indistinct strigæ and sparsely clothed with inconspicuous recumbent hairs. Scutellum transversely carinate. Elytra gradually narrowed to middle, with a feeble postmedian dilatation, then obliquely narrowed to apices, which are separately, obtusely rounded and finely serrulate, sides of abdomen nearly concealed from above; disk convex, with distinct costæ; sutural edge feebly elevated near apex, with a sharply elevated carina extending from humeri to middle, basal depressions almost obliterated; surface opaque, finely and densely, imbricately granulate, sparsely clothed with rather long recumbent pubescence. Body beneath piceous; prosternum densely scabrous, not pubescent; prosternal lobe broadly rounded in front; intercoxal process narrow, sides parallel to behind coxæ, then obtusely rounded; propleura finely reticulate; metasternum finely strigose. Abdomen sparsely punctate-strigose; first ventral segment convex, not impressed or pubescent; last segment obtusely rounded at apex; pygidium without projecting carina. Hind tarsi about one-half as long as the tibiæ, the first joint equal in length to the four following joints united; tibiæ simple; claws of anterior tarsi cleft at apex; (middle claws broken off); posterior claws cleft near base forming a short, acute tooth.

Length, 3.3 millimeters; width, 1.

Described from a single female from Dapitan, Mindanao (*Baker*).

Agrilus philippinensis sp. nov.

Male.—Form elongate, rather slender, color olivaceous bronze, head dull green, each elytron with a transverse dark band at apical third.

Antennæ brassy, reaching to basal third of pronotum, serrate from the fourth joint. Head with the front slightly convex, the sides nearly parallel, slightly arcuate at middle of front; vertex very slightly, longitudinally impressed; surface sparsely and rather finely punctate, becoming slightly rugose on the occiput, intervals dull, finely and very densely granulate, sparsely clothed with long white hairs along the eyes and in front of

clypeus. Clypeus slightly wider than long, with the front margin nearly truncate. Pronotum nearly one-half wider than long, distinctly narrower at base than apex; sides strongly arcuate anteriorly, sinuate behind middle; lateral margin very nearly straight; hind angles sharply rectangular, with a sharply defined strongly arcuate carina, the carina reaching the lateral margin at the middle; disk convex, the median line with a vague anterior and posterior depression and with a vague, narrow, oblique, lateral depression; surface rather coarsely, closely, transversely strigose, the intervals rather densely and coarsely punctate. Scutellum not very wide, sharply, transversely carinate. Elytra gradually narrowed to middle, with a feeble postmedian dilatation, then strongly, obliquely narrowed to apices, which are separately, rather acutely rounded and finely serrulate, sides of abdomen visible from above; disk slightly concave along the suture, the concavity slightly wider at middle, without distinct costæ; sutural edge feebly elevated behind middle; humeri feeble, not carinate; basal depression rather feeble; surface shining, finely and densely, imbricately granulate, rather densely clothed with distinct, short, whitish, recumbent hairs, except for a denuded transverse dark band at the apical third. Body beneath olivaceous bronze; prosternum densely and rather finely scabrous, feebly pubescent; prosternal lobe broadly rounded, with a deep semicircular emargination at the middle, angles of the emargination very acute; intercoxal process broad, sides expanded behind coxæ, apex truncate, with a sharp tooth at the middle and the lateral angles very acute and incurved; propleura coarsely punctate, slightly strigose, and feebly pubescent; metasternum densely and finely rugose. Abdomen finely, densely punctate-strigose, vaguely pubescent; first ventral segment convex, not impressed nor conspicuously pubescent; last segment subtruncate and feebly emarginate at apex; vertical portions of the segments glabrous; pygidium punctate, median carina well marked, but not projecting. Hind tarsi three-fourths as long as tibiæ, the first joint fully as long as the four following joints united; anterior and middle tibiæ mucronate at the inner apex, the posterior simple; claws of anterior and middle tarsi cleft at apex, the hind claws broadly toothed.

Length, 5 to 6.25 millimeters; width, 1.3 to 1.75.

Female.—Differs from the male in having the front of head cupreous, more densely punctate and transversely rugose, prosternal lobe less deeply emarginate, tibiæ simple, and the claws on all feet cleft at middle forming a broad tooth.

Described from three males and three females. The type is a male from Davao, Mindanao (*Baker 8364*); allotype from the same locality (*Baker 8362*). One male paratype (*Baker 8363*), two females and one male paratype without numbers, all from the type locality and collected by Baker. There is also a male from Mount Maquiling, Luzon (*Baker*).

The specimen from Mount Maquiling has the carina at posterior angles of pronotum longer, reaching to near the apical angles and strongly angulate at the middle, the median depression a little deeper, the rugæ broader, the intervals broad and not as coarsely punctate, sparsely clothed with short, inconspicuous, white hairs, which are a little more conspicuous on the median line; sides of elytra rather strongly sinuate behind humeri, basal depression deep, surface smoother and the prosternal lobe less deeply emarginate than in the type.

Agrilus attenuatus sp. nov.

Male.—Form small, elongate, and rather slender, color olivaceous bronze, head green, disk of pronotum slightly purpureous.

Antennæ brassy, with the outer joints cupreous, reaching nearly to posterior angles of pronotum, serrate from the fourth joint. Head with the front slightly convex, slightly narrower in front than behind, the sides slightly, arcuately emarginate from vertex to clypeus; vertex slightly, longitudinally impressed; surface dull, finely and very densely granulate, with a few sparsely placed indistinct punctures intermixed, becoming less granulate and finely rugose in front of clypeus and on occiput, sparsely clothed along eyes and in front of clypeus with long white hairs. Clypeus slightly wider than long, with the front margin nearly truncate. Pronotum one-fourth wider than long, distinctly narrower at base than apex, sides strongly arcuate; lateral margin feebly sinuate when viewed laterally; hind angles sharply rectangular, with a sharply defined arcuate carina, the carina reaching lateral margin near the apical angles; disk convex, median line with an indistinct anterior and posterior depression, without distinct lateral depressions; surface finely and transversely strigose, the intervals broad, feebly granulate, sparsely and feebly punctate. Scutellum not very wide, sharply, transversely carinate. Elytra slightly sinuate behind the humeri, a little broadened behind the middle, then obliquely narrowed to the apices, which are separately, obtusely rounded and finely serrulate; sides of abdomen slightly exposed; disk feebly flattened, without distinct costæ; sutural

edge elevated behind the middle; humeri feeble, not carinate; basal depressions moderately deep; surface feebly shining, finely and densely, imbricately granulate, becoming rugose at the sides, rather densely clothed with distinct, short, semierect whitish pubescence, the pubescence becoming indistinct along the lateral margin. Body beneath aëneous, more shining than above; prosternum finely, rugosely punctate, feebly pubescent; prosternal lobe rather acutely, but not deeply, emarginate at middle; intercostal process rather narrow, sides feebly broadened behind coxæ, then abruptly narrowed to apex, which is acute; propleura with reticulate sculpture; metasternum coarsely punctate-strigose at sides, smoother at the middle, with a short, feeble, elongate carina on the median line. Abdomen at base less coarsely punctate-strigose than side of metasternum, much smoother toward apex, vaguely pubescent; first ventral segment convex, not impressed or more pubescent than rest of surface; last segment obtusely rounded at apex; vertical portions of the segments not pubescent; pygidium coarsely punctate, carinate along median line, carina not projecting. Hind tarsi nearly as long as the tibiæ, the first joint equal in length to the four following joints united; anterior and middle tibiæ arcuate, with a mucro at the inner apex, the posterior simple; claws of anterior and middle tarsi cleft near apex, posterior claws cleft at middle forming a broad tooth.

Length, 4.5 millimeters; width, .11.

Female.—Differs from the male in having the front of head cupreous, prosternal lobe subtruncate at middle in front, prosternum slightly smoother, metasternum without median carina, tibiæ simple, and the claws on all the feet cleft at the middle forming a broad tooth.

Described from three males and one female. The type, which is a male, is from Eutuan, Mindanao (*Baker 8308*); allotype from the same locality without any number. Also two males, one from Dapitan, Mindanao, and the other from Baguio, Benguet Province, Luzon (*Baker*).

The specimen from Baguio is not quite typical and differs from the type as follows: Pronotum entirely olivaceous bronze, wider and more rectangular, base and apex nearly equal in width, sides nearly straight, the two median depressions more distinct and the strigæ coarser and closer; elytra smoother and not quite so densely pubescent; prosternal lobe more deeply emarginate at middle; metasternum without tooth on median line, and the claws more broadly toothed.

Agrilus manilensis sp. nov.

Male.—Form small, elongate, and rather slender, color olivaceous bronze, head and legs green.

Antennæ brassy, with the outer joints cupreous, reaching nearly to the posterior angles of pronotum, serrate from the fourth joint. Head with the front narrow and slightly convex, the sides strongly narrowed from occiput to clypeus; vertex and occiput broadly, longitudinally impressed, causing the sides to become slightly gibbose; surface dull, finely and very densely granulate, with a few sparsely placed indistinct punctures, finely, longitudinally rugose on occiput and densely clothed along eyes and behind clypeus with long yellowish pubescence, the pubescent areas not granulate but finely punctate; clypeus small, slightly wider than long, front margin nearly truncate. Pronotum one-half wider than long, slightly narrower at base than apex; sides slightly arcuate from apex to base; lateral margin nearly straight when viewed laterally; hind angles rectangular, with a well-defined, slightly arcuate carina, the carina reaching lateral margin at about the apical third; disk convex, with a moderately deep median depression divided into two parts, without distinct lateral depression; surface rather finely, transversely strigose, the intervals broad, sparsely and finely punctate, from each puncture arises a short inconspicuous hair. Scutellum not very wide, sharply, transversely carinate. Elytra feebly narrowed to middle, behind which is a slight dilatation, then obliquely narrowed to apices, which are obtusely rounded and indistinctly serrulate; sides of abdomen visible from above; disk flattened, without distinct costæ, sutural edge elevated from apical third; humeri feeble, not carinate; basal depressions moderately deep and extending obliquely from behind the humeri to the suture; surface shining, rather finely and densely, imbricately granulate, smoother near apex, and rather densely clothed with distinct, short, yellowish, recumbent pubescence, but not concealing the surface sculpture. Body beneath piceous, with greenish metallic luster; prosternum finely rugose and feebly pubescent, with a longitudinal carina along middle extending into a blunt tooth between coxæ; prosternal lobe broadly rounded and subtruncate at middle; intercoxal process broad, sides strongly expanded behind coxæ, then abruptly narrowed to apex, which is obtuse; propleura with reticulate sculpture and feebly pubescent; metasternum finely punctate, strigose at the sides, the middle with a distinct, blunt, elongate tooth. Abdomen coarsely punctate and feebly strigose near base, smoother poste-

riorly, vaguely pubescent; first ventral segment convex, not impressed nor conspicuously pubescent; last ventral subtruncate at apex; vertical portions of the segments feebly pubescent; pygidium coarsely punctate, median catina well marked, but not projecting at apex. Hind tarsi three-fourths as long as tibiæ, the first joint fully as long as the four following joints united; anterior and middle tibiæ with a slight mucro at the inner apex, the posterior tibiæ simple; claws of anterior and middle tarsi cleft at apex, posterior claws cleft at middle, forming a rather broad tooth.

Length, 4.25 millimeters; width, 1.25.

Female.—Differs from the male by having the front of head cupreous, prosternum and metasternum without a tooth on median line, tibiæ simple, and the claws on all the feet cleft at the middle forming a broad tooth.

The type is a male from Mount Maquiling, Luzon (*Baker*). The paratypes are a male and two females in the United States National Museum collection labeled "Acc. No. 990, Bur. Agri. P. I., collected by C. R. Jones" and a male from Mount Banahao, Luzon (*Baker 8310*). There is also a male from Butuan, Mindanao (*Baker 8309*) and another male from Basilan Island (*Baker*), which are not quite typical, but are placed with the species for the present. The Bureau of Agriculture reports that No. 990 was collected at Lamao, Bataan Province, Luzon.

The male from Basilan differs from the type in being more cupreous, with the front of head less densely granulate and more shining, and with the disk of pronotum violaceous and more strongly strigose. The specimen from Mindanao has the prothoracic carina a little longer, the surface of the pronotum more strongly strigose, the elytra strongly rugose at sides, and the prosternal lobe feebly emarginate in front.

Agrilus butuanensis sp. nov.

Male.—Form short, rather robust, head green, pronotum piceous, with a strong æneous tinge, elytra piceous, with a metallic tinge.

Antennæ cupreous, with the basal joints brassy, not quite reaching to middle of pronotum, serrate from the fourth joint. Head with the front wide, rather strongly convex, sides nearly parallel; vertex and occiput broadly and rather deeply impressed; surface shining and strongly rugose, intervals sparsely punctate, sparsely clothed with rather long, semierect, pale yellow hairs over entire surface. Clypeus slightly wider than

long, with the front margin slightly arcuate. Pronotum one-half wider than long, wider at base than apex; sides nearly straight, lateral margin strongly sinuate when viewed laterally; hind angles rectangular, with a sharply defined, arcuate carina, the carina extending to lateral margin at apical third; disk convex, with a vague, broadly transverse depression in front of scutellum; surface very finely and irregularly strigose, near sides more densely strigose-punctate, intervals rather densely and finely punctate, from each puncture arises a short, semierect, inconspicuous hair. Scutellum wide, strongly, transversely bicarinate. Elytra nearly parallel to just behind the middle, then strongly, obliquely narrowed to apices, which are conjointly rounded without serrulation, sides of abdomen entirely concealed from above; disk rather convex, slightly flattened posteriorly along suture, without distinct costæ, sutural margin feebly elevated near apex, humeral carina very short; basal depressions rather feeble; surface shining, coarsely and densely, imbricately granulate, rather densely clothed with distinct, short, whitish, semierect pubescence. Body beneath piceous, with a strong æneous tinge; prosternum coarsely rugose and feebly pubescent; prosternal lobe broadly rounded, and vaguely emarginate at middle; intercoxal process abruptly expanded behind coxæ, apex broad and biemarginate, with the median tooth more advanced in front than the sides; propleura coarsely, sparsely punctate, slightly strigose and vaguely pubescent; metasternum at sides coarsely punctate-strigose. Abdomen not as coarsely punctate-strigose as metasternum, becoming smoother posteriorly; first ventral segment convex, not impressed or more pubescent than the rest of abdomen; last segment feebly concave, deeply and acutely emarginate at apex; pygidium without projecting carina. Hind tarsi about one-half as long as the tibiæ, the first joint equal in length to the four following joints united; anterior and middle tibiæ distinctly mucronate at the inner apex, the posterior simple; claws divaricate, cleft close to apex on all the feet.

Length, 4.7 millimeters; width, 1.6.

Female.—Very similar to the male but differs in having the front of head bright cupreous, all the tibiæ simple, claws on all the feet cleft at middle forming a short, acute tooth, and by having the posterior tarsi shorter than in the male, not being one-half as long as the tibiæ.

Described from three males and one female. The type is a male from Butuan, Mindanao (*Baker 8307*). Allotype from the

same locality (*Baker 8306*). One male paratype from the type locality without any number and another male from Davao, Mindanao (*Baker 8320*).

Agrilus inermis sp. nov.

Form small, elongate, and slender, head and pronotum brassy green, elytra piceous, with a strong metallic luster, covered with short white hairs, except a broad transverse band at the middle.

Antennæ brassy green, reaching to the basal third of pronotum, serrate from the fourth joint. Head with the front slightly convex, sides slightly narrowed from vertex to clypeus; vertex and occiput broadly and rather deeply impressed; surface very finely and densely granulate, becoming less granulose and more coarsely punctate on occiput; in front of clypeus and along the eyes densely clothed with long pale yellow hairs. Clypeus nearly square, with the front margin nearly truncate. Pronotum quadrate, nearly as long as wide, base and apex equal in width; sides nearly straight; narrowly explanate; lateral margin feebly sinuate when viewed laterally; hind angles rectangular, with a sharply defined, abruptly angulate carina, the carina joining lateral margin just in front of middle; disk convex, with a vague median depression divided into two portions, and an indistinct depression at the sides; surface rather finely but coarsely and irregularly strigose, near the posterior angles more densely strigose-punctate, intervals sparsely and finely punctate, and very sparsely clothed with inconspicuous hairs. Scutellum not very wide, strongly, transversely carinate. Elytra slightly narrowed from the base, with a very feeble postmedian broadening, then more obliquely narrowed to the apices, which are subtruncate and without distinct serrulation, sides of abdomen exposed above; disk flattened, with an elongate concave space along suture at the middle, without distinct costæ; sutural margin elevated from about the apical third, with a sharply elevated carina extending from the humeri to the basal third, on a line with the prothoracic carina; basal depressions moderately deep and extending obliquely behind the scutellum to the suture; surface rather shining, finely granulate-punctate, sparsely clothed with distinct short whitish pubescence, except for a broad transverse denuded band at the middle. Body beneath piceous, with a strong brassy tinge; prosternum sparsely punctate and feebly scabrous; prosternal lobe obtusely angulate in front, with a very minute tooth along margin on each side

of median line; intercoxal process abruptly expanded behind the coxæ, then arcuately emarginate to the apex, which is acute and distinctly more advanced in front than the sides; propleura coarsely punctate and strigose; metasternum at sides strongly punctate-strigose. Abdomen not quite as coarsely punctate-strigose as the metasternum, the strigæ finer and more sparsely placed toward apex, nearly glabrous; first ventral segment convex, not impressed or pubescent; last segment subtruncate at apex; vertical portions of the segments vaguely punctate and nearly glabrous, except the first, which is rather densely pubescent; pygidium feebly carinate along median line, the carina not projecting. Hind tarsi two-thirds as long as tibiæ; first joint as long as the four following joints united; anterior and middle tibiæ arcuate, with a slight mucro at the inner apex, the posterior simple; claws on all the tarsi cleft near the apex.

Length, 4 millimeters; width, 1.1.

Described from a unique specimen, which is probably a male, from Puerto Princesa, Palawan (*Baker 8311*).

Agrilus minutus sp. nov.

Male.—Form very small and slender, head green, pronotum cupreous, with a purple tinge, elytra brassy green, with a broad, transverse purplish band at apical third.

Antennæ slightly æneous, reaching to basal third of pronotum, serrate from the fourth joint. Head with the front rather narrow, slightly convex, sides nearly parallel, slightly, arcuately emarginate from vertex to clypeus; occiput slightly, longitudinally impressed; surface dull, finely and densely granulate, becoming finely rugose on the occiput, with a few sparsely placed punctures on the front and sparsely clothed behind the clypeus with short, pale yellow pubescence. Clypeus narrow, with the front margin truncate. Pronotum nearly one-half wider than long, narrower at base than apex, sides arcuate from apex to base; lateral margin very nearly straight; hind angles rectangular, with a sharply defined sinuate carina, the carina joining the lateral margin near the apical angles; disk convex, the median line with an indistinct anterior and posterior depression, a feeble, oblique depression at the side; surface finely and irregularly strigose, densely punctate at sides and posterior angles, intervals between the strigæ sparsely and rather coarsely punctate. Scutellum sharply, transversely carinate. Elytra slightly narrowed from the base with a very feeble

postmedian broadening, then more obliquely narrowed to the apices, which are separately, obtusely rounded, not distinctly serrulate, sides of abdomen nearly concealed from above; disk feebly flattened, without distinct costæ; sutural margin elevated at the apical third; with a sharply elevated carina extending from the humeri to near the middle on a line with the prothoracic carina, basal depressions moderately deep; surface rather shining, finely and densely, imbricately granulate, becoming nearly smooth on the dark transverse area, sparsely clothed with distinct, short, whitish, semierect hairs, except for a broad transverse denuded band at the apical third. Body beneath æneous; prosternum sparsely, finely punctate and feebly scabrous; prosternal lobe broadly rounded in front; intercoxal process expanded behind coxæ, then obliquely narrowed to the apex, which is obtuse; propleura finely, reticulately punctate and vaguely pubescent; metasternum at side rather finely punctate-strigose. Abdomen more finely punctate-rugose than the metasternum; first ventral segment convex, not impressed or conspicuously pubescent; last segment very deeply and acutely emarginate at the apex; vertical portions of the segments finely punctate and nearly glabrous; pygidium without projecting carina at apex. Hind tarsi missing; tibiæ not mucronate. (Claws missing in all the feet.)

Length, 3.25 millimeters; width, 1.

Described from a single male specimen from Puerto Princesa, Palawan (*Baker*).

Agrilus pulcher Deyrolle.

This species is represented in the collection by a male specimen from Davao, Mindanao (*Baker*).

Agrilus immaculatus sp. nov.

Female.—Form small, elongate, and rather slender, olivaceous bronze.

Antennæ æneous, serrate from the fourth joint (broken off at ninth joint). Head with the front rather wide, strongly convex, sides nearly parallel; vertex and occiput slightly, longitudinally impressed, the impression extending from occiput to near clypeus, and becoming nearly obliterated anteriorly except for a small round depression at middle of front; surface finely, densely granulate and sparsely punctate on the front, becoming finely, densely punctate on the anterior pubescent area and finely rugose on the vertex and occiput, densely clothed

behind the clypeus with short, erect, white hairs. Clypeus a little wider than long, with the front margin slightly, arcuately emarginate. Pronotum a little more than one-half wider than long, base and apex nearly equal in width, sides slightly arcuate; lateral margin feebly sinuate; hind angles rectangular, with a well-defined, sinuate carina, the carina close to lateral margin and joining it near the apical angles; disk convex, a moderately deep impression behind the front angles, and on the median line two depressions, the antescutellar one much deeper and larger than the anterior one, which is nearly obsolete; surface rather finely and irregularly strigose, the intervals between the ridges rather densely and finely punctate. Scutellum rather wide, sharply, transversely bicarinate. Elytra slightly sinuate behind the humeri, with a feeble postmedian dilatation, then obliquely narrowed to the apices, which are conjointly, obtusely rounded without serrulation, sides of abdomen narrowly visible from above; disk feebly flattened, slightly concave posteriorly along suture, without distinct costæ, sutural edge elevated behind the middle, with a sharply elevated carina extending from humeri to the basal third and on a line with the prothoracic carina; basal depressions deep; surface subopaque, finely and densely, imbricately granulate, rather densely clothed with distinct, short, whitish, recumbent pubescence. Body beneath æneous, more shining than above; prosternum finely, densely scabrous, and very vaguely pubescent; prosternal lobe broadly rounded in front; intercoxal process gradually, obliquely expanded to behind coxæ, then abruptly narrowed to the apex, which is rather obtuse; propleura coarsely and densely, reticulately punctate; metasternum rather strongly, densely punctate-strigose and feebly pubescent. Abdomen more sparsely punctate-strigose than metasternum, the strigæ becoming finer posteriorly; first ventral segment convex; not impressed or more pubescent than rest of surface; last segment very obtusely rounded at apex; vertical portions of segments evenly and very vaguely pubescent; pygidium without projecting carina. Hind tarsi about one-half as long as the tibiæ, the first joint about equal in length to the four following joints united; tibiæ simple; claws on all the feet cleft at middle forming a rather long, acute tooth.

Length, 4.3 millimeters; width, 1.25.

Described from a unique female from Mount Maquiling, Luzon (*Baker*).

Agrilus malinaoensis sp. nov.

Female.—Form short and robust, color dark coppery, with a slight purplish tinge; each elytron with an indistinct, white, pubescent spot along suture near apex.

Antennæ piceous, not quite reaching to middle of pronotum, serrate from the fourth joint. Head with the front rather narrow, moderately convex, the sides strongly narrowed from clypeus to occiput; a feeble impression extending from occiput to near clypeus; surface strongly rugose, intervals very finely granulate, sparsely and rather coarsely punctate, rather densely clothed behind the clypeus with very short white hairs. Clypeus elevated, wider than long, with the front margin broadly and rather deeply, arcuately emarginate. Pronotum a little more than one-half as wide as long, base and apex about equal in width; sides feebly arcuate; lateral margin nearly straight; hind angles rectangular, with a sharply defined, strongly sinuate carina, the carina extending to lateral margin near apical angles; disk convex, with three depressions, a broadly oval one in front of scutellum and a less distinct basal one on each side along inner side of lateral carina; surface rather finely, transversely strigose, the intervals sparsely and finely punctate, with a few short, semierect, inconspicuous hairs. Scutellum not very wide, strongly, transversely carinate. Elytra with a slight posthumeral situation, behind which there is a slight dilatation, then strongly, obliquely narrowed to apices, which are conjointly, obtusely rounded and very finely serrulate, sides of abdomen exposed above; disk slightly flattened, narrowly concave along suture at apical third, without distinct costæ, sutural margin elevated from apical third, humeral carinæ very short, slightly sinuate posteriorly; basal depressions moderately deep; surface opaque, finely and densely, imbricately granulate, sparsely clothed with short, inconspicuous, recumbent hairs, each elytron with an indistinct, white pubescent spot along the suture near apex. Body beneath aëneous, more shining than above; prosternum coarsely, densely scabrous and sparsely pubescent; prosternal lobe wide, broadly subtruncate in front; intercoxal process very abruptly expanded behind the coxæ, the apex wide and deeply biemarginate; propleura finely punctate, slightly strigose, without pubescence; metasternum coarsely punctate-strigose, with a smooth elongate space at middle. Abdomen densely, transversely strigose, with fine punctures along the edge of the strigæ, and rather densely clothed with

short white hairs; first ventral segment convex, not impressed nor more conspicuously pubescent than rest of surface; last segment rather widely, but not deeply, arcuately emarginate at apex; vertical portions of the segments rather densely punctate and sparsely pubescent; pygidium finely, densely punctate, with a well-defined median carina, which does not project at the apex. Hind tarsi about one-third as long as the tibiae; the first joint about as long as the two following joints united; anterior and middle tibiae straight, with a mucro at the apex, posterior tibiae feebly arcuate; femora abruptly narrowed near the apex; claws on all the feet cleft at middle forming a rather broad tooth, which is not incurved.

Length, 5.25 millimeters; width, 1.7.

Described from two females from Malinao, Tayabas Province, Luzon (*Baker*).

Agrilus iliganensis sp. nov.

Male.—Form short, not quite as robust as *A. butuanensis*, olivaceous bronze.

Antennae brassy green, reaching to middle of pronotum, serrate from the fourth joint. Head with the front narrow and slightly convex, the sides strongly narrowed from clypeus to occiput, without a distinct median impression; surface densely and coarsely rugose, intervals sparsely, coarsely punctate and rather densely clothed behind the clypeus with long white hairs. Clypeus a little wider than long, with the front margin broadly and rather deeply, arcuately emarginate. Pronotum a little more than one-half wider than long, base and apex nearly equal in width; sides feebly arcuate; lateral margin very nearly straight; hind angles rectangular, with a well-defined, strongly angulate carina, the carina reaching lateral margin near the apical angles; disk convex, with a broad and rather deep median depression, extending from base nearly to apex, and a less distinct basal depression on each side along the inner margin of the lateral carina; surface finely, rather closely and irregularly strigose, the intervals finely granulate, rather densely, coarsely punctate and sparsely clothed with short, semierect, inconspicuous hairs. Scutellum not very wide, sharply, transversely carinate. Elytra nearly parallel to just behind the middle, then arcuately narrowed to apices, which are conjointly, broadly rounded without serrulation, sides of abdomen narrowly exposed above; disk somewhat flattened and concave along the suture, more narrowly and deeply concave posteriorly, without distinct costae, sutural

edge elevated behind the middle, humeral carina short, indistinct posteriorly; basal depressions moderately deep; surface subopaque, finely and densely, imbricately granulate, rather densely clothed with short, white, inconspicuous hairs. Body beneath more shining and greenish than above; prosternum finely, densely scabrous, sparsely clothed along middle with long suberect pubescence; prosternal lobe wide, broadly subtruncate in front; intercoxal process very abruptly expanded behind the coxæ, the apex wide and deeply biemarginate; propleura finely, sparsely punctate and slightly strigose; metasternum densely and coarsely punctate-strigose. Abdomen less densely punctate-strigose than metasternum, the strigæ becoming finer posteriorly, coarsely pubescent; first ventral segment convex, not impressed or conspicuously pubescent; last segment feebly emarginate at apex; vertical portion of the segments evenly, sparsely pubescent; pygidium finely punctate, carinate along the median line, the carina not projecting at apex. Hind tarsi about one-half as long as the tibiæ, the first joint about as long as the two following joints united, anterior tibiæ with a feeble mucro at the tip, the middle and posterior simple; femora feebly, abruptly narrowed near apex; claws of anterior and middle tarsi cleft near apex, posterior claws cleft near middle forming a rather long, acute tooth, which is not incurved.

Length, 4 millimeters; width, 1.75.

Female.—Very similar to the male, but differs from it by having the front of head more coppery, antennæ a little shorter, prosternum not quite as pubescent at middle, tibiæ simple, and the claws on all the tarsi cleft at middle, forming a long, acute tooth.

The type, which is a male, is from Davao, Mindanao (*Baker 8360*); allotype from Iligan, Mindanao (*Baker 8305*). Other specimens without numbers collected by Baker are as follows: Another male from the type locality, a male from Zamboanga, Mindanao; a male from Mount Banahao, Luzon; and a female from Puerto Princesa, Palawan. The last specimen is provisionally referred to this species.

In some of the specimens the front margin of the clypeus is nearly truncate. The specimen from Palawan is not quite typical and may represent another species, but for the present it is placed with this species. It has the front of the head nearly smooth and very densely clothed with long yellowish pubescence behind the clypeus, the pronotum less depressed on the median line, and the claws a little more sharply cleft.

Agrilus davaoensis sp. nov.

Male.—Form elongate, rather slender, olivaceous bronze varying to cupro-aëneous.

Antennæ greenish black, nearly attaining the hind angles of pronotum, serrate from the fourth joint. Head with the front rather narrow and slightly convex, the sides parallel from occiput to middle of front, then strongly narrowed to clypeus; occiput moderately impressed, the impression extending to middle of the front; surface coarsely, transversely rugose, intervals sparsely and coarsely punctate, nearly glabrous. Clypeus strongly elevated, slightly wider than long, with the front margin broadly, arcuately emarginate. Pronotum one-half wider than long, slightly narrower at base than apex; sides rather strongly arcuate from apex to base; lateral margin feebly sinuate when viewed laterally; hind angles rectangular, with a sharply defined sinuate carina, the carina joining the lateral margin a little in front of middle; disk convex, a feeble, oblique depression extending from lateral margin to base along inner side of lateral carina, and on the median line two depressions, the antescutellar one the larger; surface rather coarsely, closely, transversely strigose, the intervals between the strigæ sparsely and finely punctate. Scutellum sharply, transversely carinate. Elytra slightly sinuate behind the humeri, a little broadened behind the middle, then obliquely narrowed to apices, which are separately and rather acutely rounded, without serrulation, sides of abdomen exposed; disk rather convex, without distinct costæ, sutural margin elevated, from the middle, with a sharply elevated carina extending from the humeri to near the middle, on a line with the prothoracic carina; basal depressions deep; surface shining, densely, closely, imbricately granulate, and rather densely clothed with distinct short, whitish, semierect pubescence. Body beneath piceous, with a strong brassy metallic luster; prosternum coarsely, densely scarbrous and vaguely pubescent; prosternal lobe wide, broadly subtruncate in front; intercoxal process broad, sides gradually widened behind the coxæ, then abruptly narrowed to apex, which is obtuse; propleura densely, coarsely punctate and moderately strigose; metasternum densely, coarsely punctate-strigose and rather densely pubescent. Abdomen sparsely and rather finely punctate-strigose, the strigæ becoming finer posteriorly, very sparsely clothed with short pubescence; first ventral segment convex, not impressed nor conspicuously pubescent; last segment feebly emarginate at apex; vertical portions of segments vaguely

pubescent; pygidium finely punctate and feebly carinate along the median line, the carina not projecting. Hind tarsi about one-half as long as the tibiae; the first joint about as long as the four following joints united; anterior and middle tibiae slightly mucronate at the inner apex, posterior tibiae simple; claws on all the tarsi cleft near apex, the lower portions not incurved.

Length, 5.25 millimeters; width, 1.5.

Female.—Differs from the male in having the head and pronotum coppery, tibiae simple, and the claws on all the tarsi cleft near middle, forming a rather broad tooth.

Described from three males and one female. The type is a male from Davao, Mindanao (*Baker 8369*); the allotype and two male paratypes are from the same locality without a number.

Agrilus mindanaoensis sp. nov.

Male.—Form small, elongate, and rather slender, color olivaceous bronze varying to cupro-aëneous.

Antennae varying from aëneous to cupreous, nearly attaining hind angles of pronotum, serrate from the fourth joint. Head with the front rather convex, the sides nearly parallel, slightly, arcuately emarginate from vertex to clypeus; vertex rather deeply and broadly impressed, the impressed line not extending to the middle of the front; surface finely, densely granulate with a few rather large punctures intermixed, somewhat rugose on the occiput, and a wide transverse band along front margin smooth, densely, finely punctate, and densely clothed with short white to pale yellow hairs, the pubescence extending along margin of eyes. Clypeus slightly wider than long, with the front margin nearly truncate. Pronotum quadrate, nearly as long as wide, base and apex equal in width, sides nearly straight, narrowly explanate; lateral margin very nearly straight; hind angles rectangular, with a sharply defined, strongly arcuate carina, the carina joining the lateral margin a little in front of middle; disk convex, a moderately deep oblique depression extending from lateral margin to base along inner side of lateral carina, and a vague median depression extending from base nearly to apex, slightly interrupted at middle; surface rather finely and irregularly strigose, the intervals between the ridges sparsely and finely punctate. Scutellum not very wide, transversely carinate. Elytra sinuate behind the humeri; scarcely dilated behind the middle, then obliquely narrowed to apices, which are conjointly, obtusely rounded, without serrulation; sides of abdomen visible from above; disk feebly flattened,

without distinct costæ, sutural margin feebly elevated behind the middle, with a sharply elevated carina extending from the humeri to the basal third; basal depressions moderately deep; surface subopaque, finely and densely, imbricately granulate, sparsely clothed with distinct, short whitish hairs. Body beneath æneous, more shining than above; prosternum finely and rather sparsely scabrous, nearly glabrous; prosternal lobe vaguely emarginate; intercoxal process with the sides slightly expanded behind the coxæ, then narrowed to apex, which is rather acute, surface feebly concave, with the sides slightly elevated; propleura sparsely and rather coarsely punctate; metasternum at sides coarsely and sparsely punctate-strigose, much smoother along the middle. Abdomen coarsely punctate-strigose on first segment, becoming rapidly finer toward apex; first ventral segment convex, with a very vague elevation at middle, not conspicuously pubescent, last segment broadly subtruncate; vertical portions of the segments feebly punctate and nearly glabrous; pygidium feebly carinate along the median line, the carina not projecting. Hind tarsi nearly two-thirds as long as the tibiæ, the first joint as long as the four following joints united; anterior and middle tibiæ feebly arcuate, mucronate at the inner apex, posterior tibiæ simple; claws on anterior and middle tarsi cleft near apex, posterior claws cleft at middle, forming a rather broad tooth, which is not incurved.

Length, 4 to 4.75 millimeters; width, 1 to 1.3.

Female.—Differs from the male in having the front of head plumbeous, smoother and scarcely pubescent, tibiæ simple, and by having the claws on all the feet cleft near the middle.

Described from five males and five females. The type, allotype, and one male and one female paratype from Davao, Mindanao (*Baker*). One male and one female from Butuan, Mindanao (*Baker 8312*); two males and one female from Iligan, Mindanao (*Baker 8303*); and one female from Puerto Princesa, Palawan (*Baker*).

This seems to be a rather variable species. In some of the specimens the vertex is slightly gibbose on each side of the median impression, tips of elytra separately rounded and feebly serrulate, the prosternal lobe scarcely emarginate in front, the intercoxal process flat, and some have a more coppery tinge than others. The male specimens from Iligan have the pronotum of a dark plumbeous color, with a greenish tinge along the base, more finely strigose and without distinct median depression, the elytra feebly concave along suture and with the apices

separately, rather acutely rounded and feebly serrulate. The female from Puerto Princesa differs from the allotype in having the front of head wider and not quite as strongly impressed on vertex.

Genus **CORAEBUS** Castlenau and Gory

*Key to the species.**

1. Pronotum with lateral carina..... 2.
Pronotum without lateral carina..... 3.
2. Elytra with transverse pubescent bands..... *C. azureus* sp. nov.
Elytra without transverse pubescent bands..... *C. melibaefiformis* Saund.
3. Elytra rounded at apex..... *C. piperi* sp. nov.
Elytra deeply emarginate at apex..... 4.
4. Elytra with large triangular cupreous band bordered with violet; color green..... *C. bajulus* Deyr.
Elytra with transverse band of white pubescence at apical third; color green or blue..... *C. spinosus* Cast. and Gory.

Coraebus azureus sp. nov.

Short, moderately convex, brilliant blue, elytra with transverse bands of white pubescence; beneath greenish blue, legs coppery, with a greenish reflection.

Head produced in front beyond the eyes, widely and deeply channeled, sparsely punctate-reticulate and sparsely clothed with short white curved hairs, which are hardly visible on the occiput, except from the side. Pronotum much wider than long, narrower in front than behind; disk convex and regularly rounded, with the sides narrowly depressed in front, and more widely at the posterior angles, the depression extending along base to near the middle; lateral margin regularly arcuate and finely crenulate; anterior margin strongly, arcuately emarginate, with the median lobe strongly angulate at middle; base strongly bisinuate, with a broadly rounded median lobe in front of scutellum, the posterior angles broadly rounded; surface strongly punctate and irregularly rugose, sparsely clothed with inconspicuous black hairs, becoming cinereous toward lateral margin; lateral carina short and strongly arcuate. Scutellum cordate, transversely rugose. Elytra about equal in width to pronotum, slightly convex, with a deep depression along base, a similar one along lateral margin behind humerus, and a broad, shallow one

*The following species of this genus reported from the Philippines have not been seen by me: *Coraebus cisseoides* Saund., *C. caelestis* Saund., *C. hastanus* Cast. and Gory, *C. pullatus* Saund., and *C. transversus* Kerrem.

along suture near apex; sides nearly parallel to apical third, then arcuately attenuate to tips, which are conjointly, broadly rounded; lateral margin finely crenulate anteriorly, becoming strongly dentate toward apex; surface strongly imbricate, becoming scabrous toward apex, sparsely clothed with short, black, curved hairs, which are scarcely visible, except when viewed from the side, and also marked with broader cinereous hairs arranged as follows: Each elytron with three small spots at middle forming a triangle, a distinct transverse band at apical fourth, and a small spot near apex. Beneath coarsely imbricate, and sparsely clothed with short, recumbent, cinereous hairs.

Length, 7.5 millimeters; width, 3.

Described from one specimen from Baguio, Benguet, Luzon (*Baker*).

This species is closely allied to *C. melibaeiformis* Saund., but differs from that species by being more elongate and having the elytra marked with transverse bands of cinereous pubescence.

Coraeus melibaeiformis Saunders.

One specimen in the United States National Museum collection labeled "Lamao, Luzon, P. I., III-VI, 1911, C. V. Piper, collector."

Coraeus bajulus Deyrolle.

Two specimens in the United States National Museum collection labeled "Negros Island, P. I., May 1911, C. V. Piper, collector."

Coraeus spinosus Castelnau and Gory.

One specimen from Davao, Mindanao (*Baker 8319*), and another specimen from Dapitan, Mindanao (*Baker 11976*).

Coraeus piperi sp. nov.

Large, robust, moderately convex, resembling the genus *Cisseis*, olive green, head, side of pronotum, and spots on elytra of a very dense ochraceous pubescence; beneath aëneous, densely clothed with ochraceous pubescence.

Head with the front and vertex deeply, broadly grooved, copery, and coarsely punctate, with the concavity filled with long, recumbent, ochraceous pubescence; occiput green, coarsely, deeply punctate, and sparsely clothed with inconspicuous long black hairs; antennæ coppery, reaching to apical third of pronotum. Pronotum wider than long, narrower in front than behind; sides regularly arcuate, with the lateral margin finely crenulate, and

the posterior angles obtusely angulate; anterior margin deeply, arcuately emarginate, with the median lobe broadly rounded, the anterior angles acute; base deeply bisinuate, with the broadly rounded median lobe truncate in front of scutellum; disk strongly convex and regularly rounded, with the sides widely depressed and densely clothed with long, recumbent, ochraceous hairs; rest of surface coarsely, deeply punctate, from each puncture arises a long, recumbent, black hair, which is scarcely visible, except from the side; lateral carina absent. Scutellum cordate, impunctate. Elytra about equal in width to pronotum, slightly convex, with a deep triangular depression along base near humerus, and another shallow elongate one along suture, extending from apical fourth to the apex; sides strongly sinuate in front of middle, strongly expanded at apical third, then attenuate to the tips, which are conjointly, broadly rounded; lateral margin finely crenulate to about the middle, then strongly dentate to apex; surface scabrous-punctate, becoming smoother along suture on basal half, and with the pubescent areas finely, densely punctate, sparsely clothed with short black curved hairs, which are scarcely visible, except when viewed from the side, and also marked with patches of densely placed, recumbent, ochraceous pubescence arranged as follows: Each elytron with a triangular basal area, filling the basal depression and continuing on a line with the pubescence on side of pronotum, a round spot on middle of disk at basal third, two similar ones along lateral margin, one at about the middle and the other midway between it and the apex, another round spot along suture at apical third, and an oblong spot near apex, reaching from lateral margin obliquely forward to near the suture, but not quite reaching it. Abdomen beneath coarsely, densely punctate, with the sides densely clothed with long, recumbent, ochraceous pubescence. Legs of a darker bronze color than the abdomen; tarsi shining black.

Length, 10 millimeters; width, 4.

One specimen in the United States National Museum collection labeled "Lamao, Luzon, P. I., III-VI, 1911, C. V. Piper, collector." The species is named for the collector.

This species is allied to *C. cissooides* Saund., but differs from that species by having the triangular basal depression of elytron densely clothed with ochraceous pubescence and by having six distinct pubescent spots on each elytron, instead of five, as in *cissooides*.

Genus *AMORPHOSOMA* Castelnau*Amorphosoma marmoreus* Deyrolle.

I have determined two specimens as of this species; one from Mount Banahao, Luzon (*Baker 8353*), and the other one from Butuan, Mindanao (*Baker 8352*).

These two specimens differ slightly in a number of ways, but the markings are identical and they are probably only sexes of the same species. Deyrolle gives this species as having a wide distribution in the Malaysian islands, but the specimens before me do not quite agree with his description in regard to the elytral tips. In his figures⁷ he shows this species as having the elytral tips strongly spinose at the sutural angles, but in his description he gives the following:

L'extrémité qui est tronquée, denticulée et fortement épineuse à peu de distance de la suture, cette forte épine disparaissant chez certains exemplaires de taille médiocre.

The specimen from Butuan measures 11 millimeters in length, with the tips of the elytron slightly rounded at the angles and the margin evenly, strongly dentate, the lamellælike scales on elytra quite prominent and with six gibbosities on the pronotum; while the specimen from Mount Banahao measures only 8.5 millimeters in length, the dentations on tips of elytron are larger and more separated, the lamellælike scales on elytra are not very prominent, and with eight gibbosities on the pronotum, two of which are not very prominent.

Genus *SAMBUS* Deyrolle*Key to the species.*⁸

- | | |
|---|-------------------------------|
| 1. Head with vertex distinctly gibbose..... | <i>S. gibbosus</i> sp. nov. |
| Head with vertex not distinctly gibbose..... | 2. |
| 2. Surface of elytra bicolored..... | 3. |
| Surface of elytra unicolored..... | 4. |
| 3. Elytra with a reddish purple spot along lateral margin. | |
| | <i>S. bakeri</i> sp. nov. |
| Elytra with irregular black and green designs..... | <i>S. parallelus</i> sp. nov. |
| 4. Elytra bronzy..... | 5. |
| Elytra blue or black..... | 6. |
| 5. Pubescence on elytra uniform, not forming distinct designs. | |
| | <i>S. confusus</i> sp. nov. |
| Pubescence on elytra forming distinct designs, especially on apical part. | |
| | <i>S. ornatus</i> sp. nov. |

⁷ Ann. Soc. Ent. Belg. 8 (1864) pl. 4, fig. 14.

⁸ *Sambus auricolor*, described by Saunders from Luzon, has not been seen by me.

6. Elytra blue..... *S. fasciatus* sp. nov.
 Elytra black..... 7.
 7. Pronotum and elytra uniformly colored..... 8.
 Pronotum coppery; elytra black..... 9.
 8. Pubescence on elytra forming a transverse row of four ring-shaped spots
 at the apical fourth..... *S. luzonicus* sp. nov.
 Pubescence on elytra forming a transverse zigzag band at apical third,
 behind which is a solid transverse band..... *S. nigricans* sp. nov.
 9. Pubescence above consisting of white hairs..... *S. aeneicollis* sp. nov.
 Pubescence above consisting of yellow hairs or with white and yellow
 hairs intermixed..... *S. lugubris* Saund.

Sambus gibbosus sp. nov.

Small, rather elongate, head and pronotum bright reddish purple, the former with the front bright green, the latter with a faint greenish tinge along the lateral margin; elytra coppery bronze and marked with irregular designs of white and pale yellow pubescence, the transverse zigzag band at apical fourth very distinct; beneath bronzy green and clothed with short white pubescence.

Head broadly grooved for its entire length, strongly gibbose on vertex, slightly rugose and densely, finely granulate, rather evenly clothed with long white pubescence, the hairs becoming finer and sparser on occiput; antennæ green, reaching to middle of pronotum; clypeal suture distinct; epistoma very narrow between antennæ. Pronotum much wider than long, narrower in front than behind; sides flattened and regularly arcuate, with the lateral margin crenulate; anterior margin bisinuate, with the median lobe broadly rounded; base bisinuate, with a large median lobe in front of scutellum; lateral carina nearly straight and perpendicular to base, reaching from posterior angles to a little beyond the middle; disk strongly convex anteriorly; surface coarsely punctate, concentrically rugose, and sparsely clothed with inconspicuous dark hairs on disk, the sides more densely clothed with long white hairs. Scutellum large, triangular, cupreous, and finely, transversely carinate. Elytra narrower at base than middle of pronotum, rather convex; sides strongly sinuate at posterior coxæ, expanded at apical third, then strongly attenuate to tips, which are conjointly, broadly rounded and finely dentate; surface strongly imbricate, becoming less distinct posteriorly, and clothed with pubescence which is arranged as follows: Each elytron with a small round patch of silvery white hairs at basal third near suture, but separated from it, a similar patch of pale yellow hairs behind these at the middle, a very distinct transverse zigzag band of similar white hairs at apical

fourth, behind which is a short transverse row of recumbent white hairs near suture, balance of surface sparsely clothed with fine inconspicuous yellow hairs, becoming darker and slenderer toward apex. Abdomen strongly punctate and finely rugose.

Length, 4 millimeters; width, 1.5.

Described from a unique specimen from Butuan, Mindanao (*Baker*).

This species differs from all the other species examined by its head being strongly gibbose on the vertex and the epistoma very narrow between the eyes, which are nearly contiguous.

Sambus bakeri sp. nov.

Rather robust, uniformly cupreous, except head which is brilliant reddish purple; each elytron with a large, oblong, lateral spot of a beautiful reddish purple color; beneath cupreous, with a slight purplish reflection, sparsely clothed with short white hairs.

Head deeply grooved, the groove becoming less distinct on the front, slightly, transversely rugose, sparsely, finely punctate and clothed with pale yellow pubescence, becoming denser and longer on the occiput; antennæ coppery, reaching to middle of pronotum; clypeal suture distinct; epistoma wide, transverse between antennæ. Pronotum much wider than long, distinctly narrower in front than behind; sides flattened and regularly arcuate, with the lateral margin crenulate; anterior margin bisinuate, with the median lobe broadly rounded; base strongly bisinuate, with the median lobe rather abruptly rounded in front of scutellum; lateral carina slightly arcuate, reaching perpendicularly from the posterior angles to apical fourth; disk convex anteriorly, broadly concave posteriorly, with a rather deep depression inside of lateral carina reaching from base to median part; surface strongly punctate and concentrically rugose, densely clothed with long, yellowish, recumbent pubescence. Scutellum large, triangular; surface finely reticulate. Elytra narrower at base than middle of pronotum, rather convex; sides nearly parallel to middle, strongly expanded at posterior third, then arcuately attenuate to tips, which are conjointly, broadly rounded and finely dentate; surface finely imbricate, with a shallow depression extending obliquely from base to suture at basal fourth, and another near suture at apical fifth; a semioblong spot of brilliant reddish purple along lateral margin of each elytron, extending from humeral angle to apical third and internally to the median part and clothed with inconspicuous, fine black hairs, rest of surface of a uniformly bright coppery color and densely clothed with

semierect pale yellow hairs, which are broader than those on the reddish parts. Abdomen finely punctate and rugose.

Length, 5.25 millimeters; width, 2.

Described from two specimens. The type is from Mount Maquiling, Luzon (*Baker*); paratype from Butuan, Mindanao (*Baker*).

In the specimen from Mindanao the pubescence on the elytra is white instead of pale yellow, but otherwise the two specimens are identical.

Sambus parallelus sp. nov.

Slender, nearly parallel, head and pronotum brassy green, the former with the front of a brighter green; surface of elytra black and brassy green, forming distinct designs; beneath black, with bronzy tinge, nearly glabrous.

Head deeply grooved its entire length, strongly, transversely rugose, and sparsely clothed with long white pubescence, becoming finer and slightly yellow on the occiput; antennæ coppery, reaching to basal third of pronotum; clypeal suture indistinct; epistoma wide, transverse between antennæ. Pronotum much wider than long, about as wide in front as behind; sides flattened and arcuate, slightly sinuate posteriorly, with the lateral margin crenulate; anterior margin bisinuate, with a broadly rounded median lobe; base strongly bisinuate, with a large median lobe, truncate in front of scutellum; lateral carina strongly arcuate, reaching perpendicularly from posterior angles to middle; disk convex, limited at basal third by a widely rounded transverse depression, becoming deeper near lateral carina; surface concentrically rugose on the disk and very densely punctate on the inside of the lateral carina, sparsely clothed with yellowish hairs, becoming white in front of scutellum. Scutellum violaceous black, large and triangular; surface finely reticulate. Elytra a little narrower at base than middle of pronotum, rather convex, with a wide depression along suture at apical fifth; sides strongly sinuate at posterior coxæ, expanded at apical third, then arcuately attenuate to the tips, which are conjointly, broadly rounded and rather strongly dentate; surface strongly imbricate, indistinctly clothed with minute black hairs and distinctly marked with brassy green areas, these brassy areas clothed with white and yellow pubescence as follows: Each elytron with a narrow irregular band along base and suture, reaching to the apical third and connected to a similar band along the lateral margin by three irregular and broken transverse bands on the

basal half, at the apical fourth the transverse band from lateral margin to median part, then bent abruptly forward to suture at apical third, and the entire apical fifth except for an inclosed oblong dark area. Beneath nearly smooth, except median part of first two abdominal segments, which are longitudinally grooved, densely, finely punctate, and clothed with a row of dense erect hairs.

Length, 4 millimeters; width, 1.25.

Described from a single specimen from Mount Maquilang, Luzon (*Baker*).

Sambus confusus sp. nov.

Small, rather slender, entirely bright aëneous above, except front of head, which is bright green, becoming slightly bronzy on the occiput, rather evenly clothed with short, pale yellow, recumbent hairs, but not forming distinct designs; beneath bright brassy green, clothed with silvery white pubescence.

Head flat in front, rather deeply grooved on vertex and occiput, slightly rugose, finely, densely granulate and evenly clothed with moderately long white pubescence; antennæ greenish, reaching to middle of pronotum; clypeal suture distinct; epistoma wide, transverse between the antennæ. Pronotum much wider than long, a little narrower behind than in front; sides slightly flattened and regularly arcuate, with the lateral margin crenulate; anterior margin slightly bisinuate, the median lobe nearly straight and the anterior angles advanced forward and acute; base bisinuate, with a broadly rounded median lobe in front of scutellum; lateral carina slightly arcuate, nearly parallel with the lateral margin and reaching from base near posterior angle to the apical fourth; disk convex, with a rather deep depression on inside of lateral carina, reaching from base to median part; surface slightly rugose, densely punctate and densely clothed with short, yellow, recumbent hairs. Scutellum large, triangular; surface finely reticulate. Elytra at base about equal in width to pronotum, rather convex, without any distinct depressions; sides nearly parallel to middle, slightly expanded at apical third, then arcuately attenuate to tips, which are separately rounded and finely dentate; surface finely rugose and rather densely clothed with short, pale yellow, recumbent pubescence, forming very indistinct transverse zigzag bands near apex. Abdomen sparsely, finely punctate.

Length, 4 millimeters; width, 1.25.

Described from a single specimen from Baguio, Benguet Province, Luzon (*Baker 8330*).

Sambus ornatus sp. nov.

Rather robust, head and pronotum brilliant green in the male, coppery in the female; pronotum bronzy; elytra bronzy and marked with irregular patches of white or pale yellow hairs, these pubescent areas becoming transverse near apical part; beneath bronzy, clothed with short white pubescence.

Head with front slightly rounded, slightly grooved on vertex and occiput, densely punctate, finely, densely granulate and sparsely clothed with short white pubescence in male, yellow in female; antennæ green in male, bronzy in female, reaching to middle of pronotum; clypeal suture distinct; epistoma wide, transverse between the antennæ. Pronotum much wider than long, slightly narrower in front than behind; sides slightly flattened and regularly arcuate, with the lateral margin crenulate; anterior margin bisinuate, with the median lobe broadly rounded; base bisinuate, with the median lobe broadly rounded in front of scutellum; lateral carina arcuate, reaching from posterior angle to apical fourth; disk convex anteriorly, with a rather deep depression on the inside of the lateral carina, reaching from base to median part; surface densely punctate, finely rugose and sparsely clothed with very fine white pubescence in the male, pale yellow in the female. Scutellum large, triangular, dark bronzy; surface finely reticulate. Elytra at base about equal in width to pronotum at middle, rather convex, with a slight depression along lateral margin behind the humerus; sides parallel to middle, expanded at apical third, then arcuately attenuate to the tips, which are separately rounded and finely dentate; surface finely imbricate and rather densely clothed with broad white hairs in the male—pale yellow in the female—which are interrupted by dark areas sparsely clothed with inconspicuous dark hairs as follows: An oblong spot along lateral margin behind the humeri, a diamond-shaped spot behind the scutellum, inclosing a spot of white hairs, a broad transverse band a little behind the middle, with two longitudinal areas extending anteriorly on the median part of each elytron and obliquely backward along suture for a short distance, a crescent-shaped spot on the median part of each elytron at apical fourth, and another oblong spot near apex, reaching from lateral margin

obliquely to near the suture. Abdomen rather densely punctate.

Length, 4.5 millimeters; width, 1.6.

Described from two specimens. The type is from Iligan, Mindanao (*Baker 8329*); paratype from the same locality as the type, without a number.

Sambus fasciatus sp. nov.

Robust, form of the genus *Coræbus*, entirely blue above, elytra marked with transverse bands of silvery white pubescence; beneath greenish blue and rather densely clothed with silvery white pubescence.

Head rather deeply grooved, the groove becoming less distinct on the front, densely punctate on front and vertex, slightly rugose on occiput, rather densely clothed with long white pubescence, becoming nearly obsolete on occiput; antennæ reaching to apical third of pronotum, basal joints green, following joints black, with a slight coppery reflection; clypeal suture distinct; epistoma wide, transverse between the antennæ. Pronotum much wider than long, slightly narrower in front than behind; sides scarcely flattened, regularly arcuate, with lateral margin crenulate and posterior angles broadly rounded; anterior margin deeply, arcuately emarginate, with a slight median lobe and the anterior angles acute; base strongly bisinuate, with a broad median lobe in front of scutellum; lateral carina sinuate and reaching from base to apical fourth; disk rather evenly convex; surface rather densely punctate and concentrically rugose, sparsely clothed with short white hairs, becoming denser toward lateral margin. Scutellum large, triangular, aëneous; surface finely reticulate. Elytra at base about equal in width to pronotum at middle, slightly convex, with the basal depressions shallow and an oblong depression along lateral margin behind the humeri; sides nearly parallel to apical third, then strongly attenuate to tips, which are separately rounded and finely dentate; surface finely imbricate, becoming finely rugose and punctate toward apex, sparsely clothed with short black hairs and marked with a series of short white hairs as follows: An indistinct, broken, transverse band at middle, with a few scattered hairs on basal half, a distinct, wide, transverse band at apical fourth, which is emarginate anteriorly, and with a few scattered hairs at apex. Abdominal segments very densely punctate posteriorly.

Length, 7 millimeters; width, 2.75.

Described from a single specimen from Malinao, Tayabas Province, Luzon (*Baker*).

***Sambus luzonicus* sp. nov.**

Short, nearly parallel, head bright cupreous, pronotum black, with a distinct violaceous reflection; elytra black, basal half irregularly marked with white pubescence, and a transverse band of four rings of white pubescence at apical fourth; beneath shining black, sparsely clothed with very short white pubescence.

Head flat in front, rather deeply grooved on the vertex and occiput, surface strongly, transversely rugose, with a few very short white hairs along the anterior margin; antennæ short, reaching to apical third of pronotum, basal joints coppery, following joints shining black; clypeal suture distinct; epistoma wide, transverse between the antennæ. Pronotum much wider than long, about as wide in front as behind; sides flattened and regularly arcuate, with the lateral margin crenulate; anterior margin bisinuate, with the median lobe broadly rounded; base bisinuate, with a broad median lobe in front of scutellum; lateral carina slightly arcuate, reaching from posterior angles perpendicularly to the middle; disk convex, limited behind at the basal fourth by a widely rounded, transverse depression; surface concentrically rugose on disk and sparsely clothed with recumbent white hairs. Scutellum large, triangular, green; surface finely reticulate. Elytra narrower at base than middle of pronotum, convex, with an oblong depression along lateral margin behind humeri; sides nearly parallel to middle, expanded at apical third, then strongly attenuate to the tips, which are conjointly rounded and finely dentate; surface finely imbricate, sparsely clothed with very short, inconspicuous, brown hairs and irregularly variegated on basal half with broader white hairs, a transverse row of four rings of white pubescence at apical fourth and a few scattered hairs of the same color at apex. Abdomen very finely punctate.

Length, 3.25 millimeters; width, 1.2.

Described from a unique specimen from Mount Banahao, Luzon (*Baker 8331*).

***Sambus nigricans* sp. nov.**

Rather robust, entirely black, elytra marked with irregular patches and transverse bands of silvery white pubescence; beneath black, clothed with short white pubescence.

Head rounded in front, deeply grooved on vertex and occiput, with a broadly rounded depression on front, moderately punctate, very densely granulate, and sparsely clothed with short

white pubescence; antennæ black, reaching to apical fourth of pronotum; clypeal suture not distinct at middle; epistoma wide, transverse between the antennæ. Pronotum much wider than long, slightly narrower in front than behind; sides scarcely flattened, regularly arcuate, with the lateral margin crenulate; anterior margin bisinuate, with the median lobe broadly rounded; base bisinuate, with the median lobe broadly rounded in front of scutellum; lateral carina slightly arcuate, reaching perpendicularly from posterior angle to apical third; disk regularly convex, limited at basal third by a broadly rounded transverse depression, the depression becoming deeper near lateral carina; surface moderately punctate and rather densely clothed with short white hairs. Scutellum large, triangular; surface finely reticulate. Elytral base about equal in width to pronotum at middle, rather convex, with shallow basal depressions, and an oblong depression along lateral margin behind humeri; sides parallel to middle, expanded at apical third, then arcuately attenuate to tips, which are separately rounded and finely dentate; surface finely imbricate at base, becoming finely punctate toward apex, sparsely clothed with inconspicuous hairs of the same color as the surface, and also by a series of broader white hairs, forming designs as follows: On the basal half an irregular longitudinal band on median part and another along suture, these somewhat broken up and connected at basal fourth, a transverse zigzag band at apical fourth connected along suture and lateral margin to a straight transverse band at apical fifth. Abdomen finely punctate and sparsely rugose.

Length, 5 millimeters; width, 1.9.

Described from a single specimen from Malinao, Tayabas Province, Luzon (*Baker*).

Sambus aeneicollis sp. nov.

Rather robust, parallel to apical third; head and pronotum of a bright coppery bronze; elytra black and marked with transverse zigzag bands of silvery white pubescence; beneath black, clothed with short white pubescence.

Head broadly grooved, the groove becoming deeper on vertex and occiput, slightly gibbose on occiput and vertex, finely, densely granulate and sparsely clothed with rather short white and yellow hairs intermixed; antennæ bronzy, short, reaching to apical third of pronotum; clypeal suture distinct; epistoma wide, transverse between the antennæ. Pronotum much wider than long, about as wide in front as behind; sides flattened and

regularly arcuate, with the lateral margin crenulate and the posterior angles broadly rounded; anterior margin slightly bisinuate, without a distinct median lobe; base strongly bisinuate, with a broadly rounded median lobe in front of scutellum; lateral carina strongly arcuate, slightly sinuate anteriorly and reaching from base to near the anterior angles; disk strongly convex anteriorly and limited at the basal fourth by a broadly rounded, transverse depression; surface rather densely punctate and concentrically rugose, sparsely clothed with fine, short, white hairs. Scutellum dark bronzy, large, triangular; surface finely, transversely carinate. Elytra narrower at base than middle of pronotum, rather convex, with shallow basal depressions and a similar depression along suture near apex; sides parallel to apical third, then arcuately attenuate to tips, which are broadly, conjointly rounded and finely dentate; surface finely imbricate, rather densely clothed with short, inconspicuous, dark hairs of the same color as the surface, and marked with broader white hairs as follows: An indistinct elongate series along suture behind scutellum, a double transverse zigzag row near middle, and a similar, more distinct double row at apical fourth. Abdomen rather densely punctate and finely crenulate.

Length, 4 millimeters; width, 1.6.

Described from a single specimen from Mount Maquiling, Luzon (*Baker 8326*).

Sambus lugubris Saunders.

This species is represented by one specimen from Mount Maquiling, Luzon (*Baker 8327*); one from Baguio, Benguet Province, Luzon (*Baker*); one from Dapitan, Mindanao (*Baker 8328*); three from Davao, Mindanao (*Baker*); and a specimen in the United States National Museum collection labeled "Acc. No. 1130, Bur. Agri., P. I., collected by C. R. Jones," without any definite locality. The Bureau of Agriculture gives Lamao, Bataan Province, Luzon, as the locality for the last specimen.

This species is slightly variable in the coloration of the pubescence. In some specimens the transverse bands are composed of yellow and white hairs intermixed, while in others the pubescence is entirely pale yellow, with all forms of intergrades, but the markings seem to be quite constant on all of the specimens. The males have the entire head bright green and the pronotum of a more bronzy color, while in the females the head and pronotum are of a bright reddish copper color.

Genus **CRYPTODACTYLUS** Deyrolle

Cryptodaetylus philippinensis Saunders.

One specimen which I take to be this species was received from Davao, Mindanao (*Baker 8354*).

Genus **TOXOSCELUS** Deyrolle

Toxoscelus rugicollis Saunders.

One specimen from Kobe, Japan, received from Prof. C. F. Baker.

This species was described from central Luzon, and so far the genus has not been reported from Japan. The specimen agrees with the original description in every way with the exception that it is of a dark bronzy color, without any purplish tinge.

Genus **NEOTOXOSCELUS** novum

Form of *Toxoscelus*. Head convex, with a median longitudinal groove interrupted at middle of front, feebly gibbose on vertex; epistoma very narrow and separated from front of head by a deep, sinuate groove; cheeks unarmed; antennal cavities large, oblique, nearly contiguous, and situated a little distance from the inner margin of the eyes. Antennæ short, serrate from the fifth joint; joints one and two robust, the second shorter; third and fourth more slender and about subequal in length; the following joints abruptly and strongly serrate on the inner margin. Eyes large, oval, slightly oblique and more feebly remote behind vertex. Pronotum wider than long, disk convex, with distinct lateral carina; lateral margin smooth. Scutellum visible. Elytra rather flat on the disk; sides sinuate and expanded behind the middle. Prosternum rather flat, with a well-developed frontal lobe, sides not grooved for insertion of antennæ in repose. Mesosternum divided, the lateral branches very short and arcuate between the anterior and median coxæ. Metasternum emarginate in front. Middle coxæ not more widely separated than the anterior ones. Posterior coxæ concave behind, with the lateral margin strongly dilated anteriorly. Femora moderately flat. Tibiæ straight and subcylindrical, the posterior ones ciliate on the posterior margin. Tarsi very short, the first joint not much longer than the second; claws appendiculate at the base.

Genotype, *Neotoxoscelus bakeri* sp. nov.

This genus resembles *Toxoscelus* Deyr. very closely and, superficially, would be placed in that genus. It is, however, easily

separated from *Toxoscelus* in having the pronotum more even and convex, the femora not toothed on the inner side, and by the tibiæ being straight, while in that genus they are very arcuate, leaving a space between them and the femora when closed. From *Metasambus* Kerrem., to which it is also allied, it can be separated by the lateral edge of the pronotum being smooth and not crenulate as in that genus.

Nectoxoscelus bakeri sp. nov.

Elongate, subparallel, feebly convex; above rather shining, dark brown, with a strong violaceous tinge, pubescence on elytra forming irregular designs; beneath piceous, with a strong purplish bronze tinge.

Head cupreous, with the front feebly convex, broadly excavated on vertex and occiput, causing the sides to be feebly gibbose; surface sparsely punctate and vaguely strigose, the intervals finely granulate, glabrous; epistoma broadly emarginate in front; eyes not quite as remote as in *N. luzonicus*. Pronotum one-half wider than long, widest at basal third, slightly wider in front than behind; sides feebly, arcuately rounded to basal third, then suddenly, arcuately narrowed to posterior angles, which are very broadly rounded; anterior margin rather deeply emarginate, with a broadly rounded median lobe, the anterior angles acute; base deeply bisinuate, with a large, broadly rounded lobe in front of scutellum; lateral carina long, sinuous and strongly elevated, distant from the margin and reaching from the apical fifth to the base; surface concave between lateral carina and margin, with a broad, transverse depression along basal third, becoming deeper toward lateral carina, sparsely punctate and feebly strigose, the intervals becoming densely granulate toward lateral margin, sparsely clothed with long, brown and white, recumbent pubescence. Scutellum broadly triangular, surface finely strigose. Elytra at base slightly narrower than widest part of pronotum, slightly flattened on disk, with the basal depressions shallow and a vaguely transverse depression at apical fourth; humeral angles obtusely rounded; sides strongly sinuate at posterior coxæ, broadly expanded just behind middle, then gradually narrowed to tips, which are very broadly, conjointly rounded and finely dentate; surface densely, coarsely punctate and vaguely rugose, sparsely clothed with long brown and white pubescence, the white pubescence forming designs as follows: Each elytron with an elongate series along suture behind scutellum, a large

oblong ring on basal third, a narrow, transverse, zigzag band just behind the middle, and a similar band in the transverse depressed area at apical fourth. Abdomen strongly convex, nearly glabrous, vaguely marked with fine crenulate lines, becoming more distinct on basal segment; prosternum coarsely but not very densely scabrous; prosternal lobe very broad, feebly, arcuately emarginate in front, the margin not elevated, anterior angles rounded; intercoxal process nearly parallel sided to behind coxæ, then arcuately emarginate to apex, which is long and acute; tarsi and claws black; tarsal lamellæ yellowish.

Length, 6.25 millimeters; width, 2.25.

Described from two specimens. The type from Davao, Mindanao (*Baker 8367*); a paratype from the same locality as the type, without any number, is considerably smaller, measuring only 4.5 millimeters in length and 1.5 millimeters in width, and is slightly more cupreous than the type.

Neotoxoscelus luzonicus sp. nov.

Elongate, subparallel, feebly convex; above shining black, with a feeble bluish reflection, pubescence on elytra forming distinct irregular designs; beneath black, shining.

Head with the front strongly convex, broadly excavated on the vertex and occiput, causing the sides to be feebly gibbose; surface finely strigose, the strigæ transverse on the front and becoming concentric on the gibbosities, very sparsely pubescent; epistoma obtusely angulate in front. Pronotum one-half wider than long, widest just behind middle, apex and base about equal in width; sides broadly, arcuately rounded to just behind middle, then abruptly, obliquely narrowed to posterior angles, which are broadly rounded; anterior margin deeply emarginate, with a large, broadly rounded, median lobe, the anterior angles acute; base strongly bisinuate with a broadly rounded lobe in front of scutellum; lateral carina short, arcuate and strongly elevated, distant from the margin and reaching from the apical fourth to just behind the middle; surface concave between lateral carina and margin, and feebly, transversely depressed along basal third, densely, coarsely rugose and sparsely punctate, the punctures becoming coarser along lateral margin, where the surface is feebly reticulate, sparsely clothed with rather long, black pubescence. Scutellum broadly triangular, surface finely strigose-granulate. Elytra at base distinctly narrower than widest part of pronotum, feebly flattened on disk, basal depressions shallow; humeral angles obtusely rounded; sides

nearly parallel to just behind the middle, where they are strongly, broadly expanded, then gradually narrowed to tips, which are conjointly rounded, but not as broadly as in *N. bakeri*, and feebly dentate; surface densely, rather finely punctate, and feebly rugose at base, sparsely clothed with long black and white pubescence, the white pubescence forming designs as follows: Each elytron with an oblong circle at middle, connected posteriorly to a transverse, irregular series, and a narrow transverse zigzag band at apical fifth. Abdomen strongly convex, nearly glabrous, vaguely marked with fine crenulate lines; prosternum densely, roughly scabrous; prosternal lobe widely, arcuately emarginate in front, with the margin elevated; intercoxal process gradually narrowed behind coxæ, the apex rather acute; tarsi and claws black; tarsal lamellæ dark brown.

Length, 6 millimeters; width, 2.1.

Described from one specimen from Los Baños, Luzon (*Baker*).

This species is closely allied to *N. bakeri*, but differs from it in the coloration and arrangement of the white pubescent spaces on the elytra, tips of the elytron not as broadly rounded, and by the very short lateral carina on pronotum.

Genus **PARATRACHYS** Saunders

Paratrachys pilifrons Kerremans.

This genus has not been reported from the Philippines before, but one specimen which I take for Kerremans' *pilifrons* was received from Baguio, Benguet, Luzon (*Baker 8345*).

This species was originally described from Sumatra.

Genus **TRACHYS** Fabricius

*Key to the species.**

- | | |
|--|-----------------------------------|
| 1. Elytra with longitudinal carina along lateral margin..... | 2. |
| Elytra without longitudinal carina along lateral margin..... | 7. |
| 2. Epistoma narrow between antennæ, not transverse..... | 3. |
| Epistoma wide between the antennæ, transverse..... | 4. |
| 3. Surface above glabrous..... | <i>T. glabra</i> sp. nov. |
| Surface above pubescent..... | <i>T. palawana</i> Kerrem. |
| 4. Head with deep pit above base of antennæ..... | 5. |
| Head without deep pit above base of antennæ..... | <i>T. metallica</i> sp. nov. |
| 5. Surface above unicolored..... | <i>T. philippinensis</i> sp. nov. |
| Surface above bicolored..... | 6. |

* The following species of *Trachys* reported from the Philippines have not been seen by me: *Trachys bakeri* Kerrem., *T. cornuta* Kerrem., *T. dubia* Saund., *T. formosana* Kerrem., *T. fraterna* Kerrem., *T. luzonica* Kerrem., and *T. rufescens* Kerrem.

6. Sides of pronotum widely flattened; dense yellow pubescence of elytra extending along suture and forming two oblong fascia near apex.
T. cuneiformis sp. nov.
 Sides of pronotum not distinctly flattened; dense yellow pubescence of elytra confined to apical fourth but not forming distinct fascia.
T. mindanaoensis sp. nov.
7. Intercoxal process wider than long, apex truncate.... *T. picta* sp. nov.
 Intercoxal process longer than wide, apex rounded..... 8.
8. Epistoma narrow between antennæ, not transverse..... 9.
 Epistoma wide between antennæ, transverse..... 10.
9. Form cuneiform; surface unicolored; tarsal joints and lamellæ yellow.
T. piceiventris sp. nov.
 Form ovate; surface bicolored; tarsal joints black, lamellæ paler.
T. cupripyga Deyr.
10. Epistoma arcuately emarginate in front..... 11.
 Epistoma rectangularly emarginate in front..... 14.
11. Surface above glabrous..... *T. cyanipennis* sp. nov.
 Surface above pubescent..... 12.
12. Color above blue..... *T. princeps* Saund.
 Color above dark bronze..... 13.
13. Broadly ovate; elytra with a distinct U-shaped design.
T. lunata sp. nov.
 Narrowly ovate; elytra without a distinct U-shaped design.
T. marmorata sp. nov.
14. Form rather robust; tarsal joints black; pubescence of elytra consisting of white and yellow hairs intermixed..... *T. ovata* sp. nov.
 Form more slender; tarsal joints yellow; pubescence of elytra consisting of white and dark brown hairs intermixed.
T. viridula Kerrem.

Trachys glabra sp. nov.

Ovate, slightly convex, rounded posteriorly, uniformly black above and beneath, glabrous.

Head narrow, with the front slightly concave between the eyes, with a feeble, median, longitudinal groove, becoming broader anteriorly; surface with a small puncture near base of antennæ, granulose and sparsely marked with small circles containing a minute puncture at middle; eyes rather strongly margined on the inner side; epistoma very narrow, not transverse, longitudinally grooved, the anterior margin not distinctly emarginate; clypeal suture not visible; antennæ nearly contiguous. Pronotum short, two and one-half times as wide as long, much narrower in front than behind; surface rather densely marked with distinct circles, intervals between the circles smooth, except along lateral margin, where they are finely granulose; anterior margin deeply, arcuately emarginate, the angles acute and extending forward on a line with the front of head; sides broadly flattened, strongly arcuate to middle, then obliquely widened to

the posterior angles, which are rather acute; base nearly truncate to the median lobe, which is broadly rounded in front of the scutellum. Scutellum small, triangular. Elytra a little wider than pronotum at base; sides slightly flattened, strongly arcuate to basal fourth, then arcuately attenuate to the tips, which are conjointly, broadly rounded; humeri not prominent; surface with a distinct, arcuate, lateral carina reaching from humerus to apical margin, with rows of fine punctures, the sutural row widely arcuate behind the scutellum, forming a moderately wide smooth area, and with a rather deep, elongate depression along lateral margin behind the humeri. Beneath flattened; abdomen very finely granulate and with densely placed, elongate, circular marks; prosternum distinctly divided into two parts, the anterior part slightly bent downward, the front margin truncate but not distinctly elevated; intercoxal process flat, transverse, sides nearly parallel to posterior angles, which are rounded, apex truncate; mesosternum with the anterior margin truncate; tarsi and claws black; tarsal lamellæ pale.

Length, 2 millimeters; width, 1.35.

One specimen from Davao, Mindanao (*Baker*).

Trachys palawana Kerremans.

Two specimens of this species received from Puerto Princesa, Palawan (one is *Baker* 8342, the other without a number).

Trachys metallica sp. nov.

Elongate, slightly convex, very much enlarged anteriorly; above dark bronze, shining pubescent; beneath shining black.

Head with the front slightly concave between the eyes, median longitudinal groove indistinct; surface nearly smooth, indistinctly marked with small circles, and very sparsely clothed with fine, yellow, recumbent hairs; epistoma wide, not elevated; clypeal suture not distinct; anterior margin of epistoma broadly, arcuately emarginate, the anterior angles acute and projecting beneath base of antennæ, which are widely separated; eyes with the inner side strongly margined. Pronotum short, nearly three and one-half times as wide as long, much narrower in front than behind; surface with a small oblong depression near each posterior angle, densely marked with distinct circles, having a distinct puncture in the middle, and sparsely clothed with fine, yellow, recumbent pubescence; anterior margin rather deeply, arcuately emarginate, front angles acute; sides obliquely arcuate; base slightly bisinuate, the median lobe broadly angulate

and slightly emarginate in front of the scutellum. Scutellum rather large, triangular. Elytra a little wider than pronotum at base, slightly sinuate near posterior coxæ, then strongly attenuate to the tips, which are conjointly, broadly rounded; humeri not prominent; surface with a distinct straight lateral carina, reaching from posterior part of humerus to near the apical margin, finely punctate and slightly rugose, with a shallow broad depression along base and a deeper one along lateral margin behind the humerus, very sparsely clothed with short, yellow, recumbent hairs, becoming a little denser along lateral margin, and forming three inconspicuous, transverse bands which are interrupted at the suture; the first at about the middle, the second at apical third, and the last one at the apex. Beneath convex; abdomen densely marked with semicircular lines, in the middle of which is a small puncture; intervals very finely granulate, with a few extremely short white hairs; prosternum distinctly divided into two parts, the anterior part bent downward, with the front margin truncate and slightly elevated; intercoxal process transverse, flat, distinctly narrower in front than behind, apex truncate, the angles rounded; mesosternum with the anterior margin truncate; tarsi and claws black.

Length, 3.25 millimeters; width, 2.

One specimen from Zamboanga, Mindanao (*Baker*).

Trachys philippinensis sp. nov.

Elongate, convex, enlarged anteriorly; above of a bright bronzy color, pubescent; beneath black, with a slight metallic reflection.

Head with the front rather deeply concave between the eyes, median longitudinal groove not distinctly marked; surface nearly smooth, punctuation indistinct except under a high-power lens, with a deep puncture near base of antennæ and a widely angulated median depression in front of clypeal suture, sparsely clothed with short, light yellow, recumbent hairs; eyes rather strongly margined on the inner side; epistoma wide, elevated, finely, transversely strigose, anterior margin truncate, the angles acute and extending beneath base of antennæ, which are rather widely separated; clypeal suture distinct, subtruncate. Pronotum short, a little more than three times as wide as long, narrower in front than behind; surface rather densely marked with inconspicuous circles, becoming smoother on the disk, sparsely clothed with short, light yellow, recumbent pubescence; anterior margin deeply, arcuately emarginate, the angles acute;

sides obliquely arcuate; base bisinuate, with a broadly rounded median lobe in front of the scutellum. Scutellum small, triangular. Elytra as wide as pronotum at base, obliquely sinuate to posterior coxæ, then strongly attenuate to near tips, which are conjointly, broadly rounded; humeri not prominent; surface with an arcuate lateral carina, reaching from near the humerus to just in front of the apical margin, finely punctate and rather strongly rugose, with a shallow depression along the base and a similar one along lateral margin behind the humerus, rather sparsely clothed with pale and golden yellow pubescence, the pale hairs forming three inconspicuous, transverse, somewhat irregular designs as follows: The first near middle, the second at apical third, and the third one near the apex. Beneath convex; abdomen densely marked with semicircular lines, in the middle of which is a small puncture, intervals distinctly granulose and with a few indistinct white hairs; prosternum divided into two parts, the anterior part flat, with the front margin distinctly margined and a transverse costa near and parallel to it; intercoxal process transverse, flat, narrower in front than behind, sides margined, apex truncate, with the angles rounded; mesosternum with the anterior margin truncate; tarsi and claws black; tarsal lamellæ dark brown.

Length, 3 millimeters; width, 1.75.

One specimen from Mount Maquiling, Luzon (*Baker 8338*).

Trachys cuneiformis sp. nov.

Cuneiform, slightly convex, very much enlarged anteriorly, head, pronotum, suture, and posterior third of elytra bronzy, anterior two-thirds of elytra, except suture, dark blue, with a violaceous reflection, pubescent; beneath black, with a metallic reflection.

Head with the front deeply concave between the eyes, median longitudinal groove slightly marked from occiput to near middle; surface with a deep, round puncture in front of suture near base of antennæ, sparsely marked with indistinct circles, from which arises a short, yellow, recumbent hair, the circles denser on the occiput and near frontal suture; eyes very strongly margined on the inner side; epistoma wide, finely, transversely strigose, anterior margin truncate, the anterior angles acute and extending around base of antennæ, which are widely separated; clypeal suture distinct, truncate. Pronotum short, three times as wide as long, much narrower in front than behind; surface densely marked with distinct circles, becoming less distinct on

the elevated part of disk, sparsely clothed with moderately long, whitish and golden yellow, recumbent pubescence; sides flattened, becoming more broadly so posteriorly, and extending along posterior margin, forming a broadly triangular elevation on the anterior median part, and with a small puncture near the posterior angles; anterior margin deeply, arcuately emarginate, with the angles acute; sides strongly, obliquely arcuate; base bisinuate, with a large, round, median lobe, slightly truncate in front of the scutellum. Scutellum rather large, broadly triangular. Elytra as wide as pronotum at base, slightly sinuate near posterior coxæ, strongly attenuate to the tips, which are conjointly, broadly rounded; humeri rather prominent; surface with a distinct arcuate carina, reaching from humeral angles to apical margin, finely, rather densely punctate and moderately rugose, with a deep linear depression along base and a deeply concave depression between the lateral carina and lateral margin, reaching from humeral angle to a little beyond the posterior coxæ, sparsely clothed on the violaceous parts with short, dark, recumbent pubescence, the pubescence more yellow on the cupreous part along suture, and becoming much denser and more golden yellow on the entire apical third, which is margined anteriorly by a transverse zigzag series of white hairs, the apical part with a small, inconspicuous, round, median spot on each elytron, composed of darker pubescence. Beneath rather convex; abdomen densely marked with circles, in the middle of which is a small puncture; intervals finely granulose, with a few, inconspicuous, white hairs. Prosternum distinctly divided into two parts, the anterior portion bent downward, with the front margin broadly arcuate and feebly margined; intercoxal process transverse, flat, much narrower in front than behind, apex truncate, with the angles rounded; mesosternum with the anterior margin truncate; tarsi and claws black; tarsal lamellæ brownish.

Length, 3 millimeters; width, 1.75.

Described from two specimens. The type from Davao, Mindanao (*Baker 8339*); paratype from the same locality without a number.

Trachys mindanaensis sp. nov.

Elongate, slightly convex, attenuate posteriorly; head and pronotum of a dark bronze color; elytra dark violaceous blue, becoming slightly bronzy posteriorly, pubescent; beneath black, with a metallic reflection.

Head with the front slightly concave between the eyes, with a median longitudinal groove reaching from apex to middle; surface rather densely marked with small circles, from the center of which arises a very fine, light yellow, recumbent hair, and with a deep oblong puncture in front of suture near base of antennæ; eyes slightly margined on the inner side; epistoma wide, slightly elevated, finely, transversely strigose, anterior margin truncate, the angles acute and protruding around base of antennæ, which are widely separated; clypeal suture distinct, subtruncate. Pronotum short, three times as wide as long, much narrower in front than behind; surface with rather densely placed circular marks, becoming less dense on the disk, sparsely clothed with fine, light yellow, recumbent hairs; anterior margin deeply, arcuately emarginate, the angles rather acute; sides strongly, obliquely arcuate to the posterior angles, which are acute; base bisinuate, with a broadly rounded median lobe in front of scutellum. Scutellum small, triangular. Elytra as wide as pronotum at base, slightly sinuate near posterior coxæ, then obliquely arcuate to near tips, which are conjointly rounded; humeri not prominent; surface with a distinct lateral carina, reaching from the humeri to near the apex, rather densely, finely punctate, broadly depressed along base near humeri and with a more elongate depression along lateral margin just behind humeri, sparsely clothed on the anterior violaceous part with short, reddish brown, recumbent hairs, becoming much denser and more golden yellow on the apical third. Beneath convex, abdomen densely marked with semicircular lines, the middle of each with a fine puncture; intervals finely granulate, with a few, inconspicuous, white hairs; prosternum divided into two parts, the anterior part slightly bent downward, with the front margin truncate and distinctly margined; intercoxal process transverse, flat, narrower in front than behind, apex truncate, with the angles slightly rounded; mesosternum with the anterior margin truncate; tarsi and claws black.

Length, 3 millimeters; width, 1.8.

Described from two specimens. The type from Iligan, Mindanao (*Baker 8340*); a paratype from Davao, Mindanao (*Baker*).

Trachys picta sp. nov.

Oblong-ovate, convex, slightly enlarged anteriorly, rounded posteriorly; above bronzy black, pubescent; beneath black, with a metallic reflection.

Head with the front slightly concave between the eyes, with a median longitudinal groove reaching from apex to middle; surface with a deep puncture near base of antennæ, rather densely marked with small circles, from the center of which arises a short, yellow, recumbent hair and with a small median smooth area; eyes with the inner side strongly margined; epistoma wide, elevated, anterior margin widely, arcuately emarginate, the angles acute and extending under base of antennæ, which are widely separated; clypeal suture distinct. Pronotum short, about four times as wide as long, narrower in front than behind; surface densely marked with circles, similar to that of the head, densely clothed with white, yellow, and reddish brown recumbent pubescence intermixed; anterior margin deeply, arcuately emarginate, with the angles acute; sides oblique and slightly arcuate; base bisinuate, with a broadly rounded median lobe in front of scutellum. Scutellum small, triangular. Elytra as wide as pronotum at base, gradually attenuate to the posterior third, then arcuate to the tips, which are conjointly, broadly rounded; humeri not very prominent; surface without lateral carina, densely punctate and rather strongly rugose, broadly depressed along base near humeri, and densely clothed with short white, yellow, and dark brown recumbent pubescence, forming irregular designs, the designs becoming more transversely zigzag toward the apex, with a distinctly marked inverted W, composed of white pubescence just in front of apex. Beneath convex; abdomen coarsely and densely marked with semicircular lines, in the middle of which is a small puncture, finely granulate and sparsely clothed with distinct whitish recumbent hairs; prosternum distinctly divided into two parts, the anterior part bent downward, with the front margin broadly arcuate and distinctly margined; intercoxal process transverse, flat, narrower in front than behind, sides distinctly margined and slightly arcuate to the posterior angles, which are rounded, apex truncate; mesosternum with the anterior margin truncate; tarsi and claws black.

Length, 4 millimeters; width, 2.4.

One specimen from Dapitan, Mindanao (*Baker*).

Trachys piceiventris sp. nov.

Elongate, convex, slightly enlarged anteriorly, feebly rounded posteriorly; uniform piceous above, with a slight bronzy reflection, pubescent; beneath piceous.

Head with the front deeply concave between the eyes, without

median longitudinal groove; surface smooth and rather densely clothed with long, golden, recumbent pubescence; eyes strongly margined on the inner side; epistoma narrow, not transverse, slightly elevated, anterior margin deeply, arcuately emarginate, the anterior angles not well defined; antennæ narrowly separated; clypeal suture distinct and strongly angulate. Pronotum short, three times as wide as long, slightly narrower in front than behind; surface densely marked with distinct circles, from the center of which arises a rather erect pale yellow hair; anterior margin rather deeply, arcuately emarginate, the angles rather obtuse; sides slightly, obliquely arcuate, base bisinuate, with a broadly rounded median lobe in front of scutellum. Scutellum very small, triangular. Elytra a little wider than pronotum at base, slightly sinuate to posterior coxæ, then obliquely arcuate to the tips, which are conjointly rounded, humeri not prominent; surface without lateral carina, finely and rather densely punctate, with a wide, shallow depression along base and a similar one along lateral margin behind humerus, the entire anterior two-thirds rather densely clothed with short, very fine, semierect, piceous hairs, with the exception of a few scattered pale yellow hairs near scutellum, the entire apical third densely clothed with pale yellow recumbent hairs, this space with the anterior margin angulate, and with a round dark spot on the middle of each elytron at the apical fourth. Beneath convex; abdomen rather densely but not distinctly marked with semi-circular lines and finely granulate, sparsely clothed with minute white hairs; prosternum not distinctly divided into two parts, anterior margin truncate and distinctly margined; intercoxal process elongate, flat, sides feebly, arcuately concave, apex slightly expanded and broadly rounded; mesosternum with the anterior margin deeply, arcuately emarginate; tarsi and lamellæ yellow; claws black.

Length, 2.75 millimeters; width, 1.5.

One specimen from Puerto Princesa, Palawan (*Baker*).

Trachys cupripyga Deyrolle.

One specimen which I take for this species was received from Puerto Princesa, Palawan (*Baker 8344*).

Trachys cyanipennis sp. nov.

Elongate, strongly convex, rounded posteriorly, head and pronotum bronzy black; elytra bright cyaneous, glabrous; beneath black, rather shining.

Head with the front broadly concave between the eyes, without distinct median groove; surface with a deep puncture near base of antennæ and indistinctly marked with small circles, glabrous; eyes rather strongly margined on the inner side; epistoma wide, flat, anterior margin very deeply, arcuately emarginate, anterior angles rather broad; antennæ widely separated; clypeal suture not distinct. Pronotum strongly convex, short, two and one-half times as wide as long, slightly narrower in front than behind; surface nearly smooth, rather densely marked with nearly obsolete circles, similar to those of the head; anterior margin arcuately emarginate, the angles rather obtuse; sides slightly flattened, arcuate to the middle, then obliquely widened to the posterior angles, which are nearly rectangular; base bisinuate, with a broadly rounded median lobe in front of the scutellum. Scutellum very small, triangular. Elytra strongly convex, without any conspicuous depressions, slightly wider than pronotum at base, parallel to near middle, then strongly, arcuately attenuate to the tips, which are conjointly, narrowly rounded; humeri not prominent; surface without lateral carina, densely, irregularly, and coarsely punctate. Beneath convex; abdomen rather densely marked with semicircular lines and very finely granulate, glabrous; prosternum divided into parts, anterior margin truncate, sharply margined; intercoxal process elevated, elongate, wider behind than in front, sides slightly margined, apex rounded; mesosternum with the anterior margin deeply, arcuately emarginate; tarsi and claws black.

Length, 2.9 millimeters; width, 1.7.

One specimen from Tacloban, Leyte (*Baker 8343*).

Trachys lunata sp. nov.

Ovate, moderately convex, rounded posteriorly; above of a dark bronzy color, pubescent; beneath black, shining.

Head with the front slightly concave between the eyes, with a distinct, median, longitudinal groove reaching from apex to middle; surface smooth, with a small round puncture near base of antennæ, rather densely marked with indistinct circles, and sparsely clothed with reddish yellow, recumbent pubescence; eyes slightly margined on the inner side; epistoma wide, smooth, and not elevated, anterior margin rather deeply, arcuately emarginate, angles rather broad; antennæ widely separated; clypeal suture not visible. Pronotum short, three times as

wide as long, much narrower in front than behind; surface densely marked with circles, becoming less distinct on the anterior part of the disk, rather densely clothed with short, white and golden yellow, recumbent hairs intermixed, giving it a variegated appearance; anterior margin slightly, arcuately emarginate, the angles obtuse; sides finely crenulate and slightly, obliquely arcuate; base strongly bisinuate, with a widely angulated median lobe in front of the scutellum. Scutellum very small, triangular. Elytra a little wider than pronotum at base, slightly sinuate near the posterior coxæ, then strongly arcuate to the tips, which are conjointly, widely rounded and slightly gibbose; humeri not prominent; surface without lateral carina, finely, densely punctate and rather strongly rugose, with a wide, shallow depression along base and a similar one along lateral margin near the posterior coxæ, uniformly, densely clothed with short, white and reddish yellow, recumbent pubescence, except a large U-shaped design on the disk, composed of very slender, dense, black hairs, the design reaching from the base to the apical third. Beneath convex; abdomen densely reticulate and finely granulate, sparsely clothed with inconspicuous white hairs; prosternum not distinctly divided into two parts, anterior margin truncate and distinctly margined; intercoxal process elongate, flat, nearly parallel, sides distinctly margined, apex broadly rounded; mesosternum with the anterior margin arcuately emarginate; tarsi and lamellæ yellow; claws black.

Length, 4 millimeters; width, 2.25.

One specimen from Davao, Mindanao (*Baker 8341*).

Trachys princeps Saunders.

This beautiful species is represented in the United States National Museum collection by two specimens; one labeled "Acc. No. 1710 Bur. Agri., P. I., collected by C. R. Jones," without any definite locality, and the other one labeled "Lamao, Luzon, P. I., III-VI, 11, C. V. Piper, collector." The Bureau of Agriculture gives Lamao as the locality for the specimen collected by Jones.

Trachys marmorata sp. nov.

Oblong-ovate, slightly convex, rounded posteriorly, head of a bright bronzy color, pronotum and elytra piceous, the former with bronzy reflections, pubescent; beneath shining black, with metallic reflections.

Head with the front rather deeply concave between the eyes, without distinct median longitudinal groove, but with a rather deep, wide, median depression, reaching from middle to clypeal suture; surface with a deep, round puncture in front of suture near base of antennæ, very finely punctate, and densely clothed with long, golden yellow, recumbent pubescence; eyes rather strongly margined on the inner side; epistoma wide, slightly elevated, finely, transversely strigose, anterior margin very deeply, arcuately emarginate, the angles rather broad; antennæ widely separated; clypeal suture not very distinct, broadly arcuate. Pronotum short, nearly three and one-half times as wide as long, narrower in front than behind; surface densely marked with circles, becoming less distinct on disk, clothed with white and dark reddish brown, recumbent hairs, arranged in distinct, irregular series over the entire surface, the darker hairs becoming inconspicuous on the dark areas; anterior margin slightly, arcuately emarginate, anterior angles obtuse; sides slightly flattened, finely crenulate and feebly, obliquely arcuaté; base bisinuate, with a broadly rounded median lobe in front of the scutellum. Scutellum very small, triangular. Elytra a little wider than pronotum at base, strongly attenuate to near the tips, which are conjointly rounded and slightly gibbose; humeri not prominent, longitudinally carinate in front; surface without lateral carina, densely, finely punctate, with a wide, shallow depression along base and a somewhat deeper one along the lateral margin below the humerus, rather densely clothed with long, very slender, black hairs, intermixed with broader, silvery white, recumbent ones, the white hairs forming irregular designs on the anterior half and a double transverse zigzag row at the apical third. Beneath rather convex; abdomen densely reticulate and very finely granulate, with a few white recumbent hairs; prosternum not divided, anterior margin truncate and slightly elevated; intercoxal process elongate, flat, elevated, narrower in front than behind, sides distinctly margined, apex dilated and broadly rounded; mesosternum with the anterior margin arcuately emarginate; tarsi reddish brown, with the lamellæ paler; claws black.

Length, 3.65 millimeters; width, 2.

Described from one specimen in the United States National Museum collection, collected in Mindanao, May, 1914 (C. V. Piper).

Trachys ovata sp. nov.

Ovate, moderately convex, rounded posteriorly; head and pronotum dark bronzy; beneath black; elytra piceous with bronzy reflection.

Head with the front rather deeply concave between the eyes, with an indistinct median longitudinal groove reaching from apex to clypeal suture; surface with a small round puncture near base of antennæ, rather densely marked with indistinct circles and clothed with short, white and yellow, recumbent hairs intermixed; eyes rather strongly margined on the inner side; epistoma wide, flat, finely, transversely strigose, anterior margin rectangularly emarginate, the angles rather broad; antennæ rather widely separated; clypeal suture indistinct. Pronotum short, three times as wide as long, slightly narrower in front than behind; surface densely marked with indistinct circles, and clothed with short, white and golden yellow, recumbent hairs intermixed; anterior margin slightly, arcuately emarginate, the angles obtuse; sides finely crenulate, oblique and slightly arcuate; base bisinuate, with a broadly rounded median lobe in front of scutellum. Scutellum small, triangular. Elytra a little wider than pronotum at base, slightly sinuate to posterior coxæ, then strongly, arcuately attenuate to tips, which are conjointly rounded; humeri moderately prominent; surface without lateral carina, very finely and densely punctate, with a broad, shallow depression at base and a deeper one along lateral margin behind the humerus, rather densely clothed with short, silvery white and golden yellow, recumbent pubescence, the white hairs forming irregular designs on the basal half, and two distinct zigzag lines, the first just behind the middle and the other one at the apical fourth. Beneath rather convex, abdomen marked with semicircular lines and very finely granulate, sparsely clothed with short, recumbent, white hairs; prosternum not distinctly divided into two parts, anterior margin truncate and margined; intercoxal process elongate, wider behind than in front, sides slightly margined, apex rounded; mesosternum with the anterior margin arcuately emarginate; tarsi and claws black; tarsal lamellæ paler.

Length, 2.5 millimeters; width, 1.5.

Described from three specimens in the United States National Museum collection labeled "Acc. No. 996, Bur. Agri., P. I., collected by C. R. Jones," without a definite locality. The Bureau of Agri-

culture gives Lamao, Bataan Province, Luzon, as the locality for this number.

This species is closely allied to *T. viridula* Kerrem., but can be at once distinguished from that species by the tarsal joints being black instead of yellow; the pubescence on elytra consisting of white and yellow hairs, while in *viridula* they are white and dark brown, and also by being a little more robust.

Trachys viridula Kerremans.

This species is represented in the United States National Museum collection by three specimens labeled "Acc. No. 996, Bur. Agri., P. I., collected by C. R. Jones," without a definite locality. The Bureau of Agriculture gives Lamao, Bataan Province, Luzon, as the locality for this number. Another specimen from Mount Maquiling, Luzon (*Baker*), does not differ from the ones in the collection.

Genus ANTHAXOMORPHUS Deyrolle

Anthaxomorphus philippinensis sp. nov.

Oblong, rather convex, dark brown, with slight coppery reflection, head, sides of pronotum and elytra greenish bronze, shining; beneath black.

Head widely grooved between the eyes, the groove becoming more widely flattened in front of epistoma; front divided into two parts, which are round on the vertex, finely granulate, and finely, irregularly rugose; antennal cavities large; epistoma broadly triangular, anterior margin broadly, arcuately concave, with the angles very acute. Pronotum very transverse, more than twice as wide as long; front narrower than base; sides finely crenulate, arcuately rounded from base to just behind the middle, then more rapidly narrowed to front angles, which are obtuse; anterior margin sinuate, with a widely rounded median lobe; base strongly bisinuate, with a very large, widely rounded lobe in front of scutellum; surface rather evenly convex, with a slight depression along the base on each side of the median lobe, very finely punctate and transversely rugose over entire surface. Scutellum small, broadly triangular. Elytra equal in width to widest part of pronotum; humeral angles broadly rounded; sides finely dentate, strongly sinuate near middle, then broadly rounded to the tips, which are conjointly rounded; humeri not prominent, back of which is a rather deep depression along the anterior margin of elytra, extending obliquely toward the tips, the depression becoming nearly obsolete behind middle,

but having the rugæ a little finer; very finely punctate and irregularly rugose over entire surface. Beneath shining black, sparsely, finely punctate, each abdominal segment with two large punctures along anterior margin; prosternum broadly rounded at apex, the median part rather densely covered with short, acute tubercles; legs, tarsi, and tarsal claws black; tarsal lamellæ light brown.

Length, 3.5 millimeters; width, 2.

The type is from Malinao, Tayabas Province, Luzon (*Baker*). A specimen from Dapitan, Mindanao (*Baker*), differs from the type in being darker in color, head bluish on anterior half, becoming greenish toward vertex, a little more elongated in form, and by being slightly smaller, measuring 3.35 millimeters in length and 1.75 millimeters in width.

Genus APHANISTICUS Latreille

*Key to the species.*¹⁰

1. Elytra with longitudinal costæ..... 2.
Elytra without longitudinal costæ..... 3.
2. Prothorax broadly cordate; elytral intervals not distinctly, transversely costate; scutellum visible..... *A. costipennis* sp. nov.
Prothorax transverse, sides evenly arcuate; elytral intervals on anterior part of disk transversely costate; scutellum invisible.
A. bakeri sp. nov.
3. Head deeply excavated between the eyes..... 4.
Head feebly excavated between the eyes..... 5.
4. Pronotum distinctly, transversely grooved at middle.. *A. excavatus* sp. nov.
Pronotum not transversely grooved at middle..... *A. piceipennis* sp. nov.
5. Pronotum with a deep fovea near posterior angles..... 6.
Pronotum without a deep fovea near posterior angles..... 7.
6. Head rounded in front..... *A. mindanaoensis* sp. nov.
Head narrowly, deeply emarginate in front..... *A. foveicollis* sp. nov.
7. Form slender; prothorax widest in front of middle.
A. unicolor sp. nov.
Form robust; prothorax widest at middle..... *A. trachyformis* sp. nov.

Aphanisticus costipennis sp. nov.

Elongate, depressed, uniformly black, shining.

Head elongate, slightly narrower posteriorly, much narrower than the prothorax; front rather widely and very deeply excavated between the eyes, the lateral sides of excavation subparallel; eyes with the inner side abruptly margined and placed at the extreme lateral part of the excavation; surface finely,

¹⁰ I have been unable to examine specimens of either *A. bodongi* Kerrem. or *A. nigroaeneus* Kerrem., both of which are reported from the Philippines.

densely granulate, with a few large punctures intermixed on the vertex. Pronotum broadly cordate, much wider than long; sides very finely crenulate, broadly, arcuately rounded posteriorly to the middle, then obliquely narrowing to posterior angles, which are obtuse; anterior margin broadly, arcuately emarginate; base bisinuate, with a rounded median lobe, somewhat elevated, in front of the scutellum; disk convex, the convexity formed by two abrupt transverse elevations, the anterior one consisting of two semicircular swellings joined together at the middle, with the tips pointing backward, the posterior elevation consisting of a broadly triangular swelling, joined anteriorly to the front elevation on the median line and posteriorly to the median lobe in front of scutellum; surface finely, densely granulate, the granulation becoming somewhat finer on the elevations. Elytra distinctly wider than prothorax at base; humeral angles obtusely angulate; sides strongly sinuate behind the humeri to near the middle, then obliquely narrowed to the tips, which are separately, broadly rounded and very finely dentate; on the middle of each elytron a distinct sinuate median costa reaching from base to near apex, then following the outline of elytral tip and joining the suture, which is strongly elevated on the posterior half, an indistinct subsutural costa, subequally distant between the median costa and suture, becoming obsolete just behind the middle, and another indistinct costa parallel to the anterior margin, beginning just back of the lateral depression and joining the median costa near the apex; humeri with a distinct oblique costa, limited posteriorly by a rather deep depression reaching from the median costa to the anterior margin; intervals strongly, densely granulate, with a few indistinct, irregular, transverse rugæ between the costæ. Beneath shining black, surface of abdomen marked with large oblong circles; anterior margin of prosternum sinuate; tarsi and claws black; tarsal lamellæ yellow.

Length, 4 millimeters; width, 1.25.

One specimen from Malinao, Tayabas Province, Luzon (*Baker*).

Aphanisticus bakeri sp. nov.

Elongate, subconvex, uniformly shining black.

Head elongate, slightly wider posteriorly, distinctly narrower than the prothorax; front rather widely and deeply excavated between the eyes, lateral sides of excavation more obliquely concave than in *costipennis*, subparallel; eyes with the inner side

abruptly margined and placed at the extreme lateral part of the excavation; surface finely, densely granulate, with a few large punctures intermixed on the vertex. Pronotum transverse, much wider than long; sides very finely crenulate, broadly, evenly arcuate, widest at middle; anterior margin sinuate, with a large median lobe, the anterior angles rather acute; base bisinuate, with a large, acutely triangular lobe at middle; disk convex, the convexity formed by two abrupt, transverse elevations, separated by a very deep transverse groove, which extends around the ends of the posterior elevation, then extending along the base toward median lobe, the anterior elevation placed at middle of pronotum and abruptly truncate posteriorly, the posterior one not quite as long, with the top evenly rounded; along the anterior margin on the median lobe are two abruptly elevated teeth, pointing backward; surface finely, densely granulate, the granulation becoming somewhat finer on the elevations. Scutellum invisible. Elytra wider than prothorax at base; humeral angles obtusely angulate; sides strongly sinuate behind the humeri and rather abruptly expanded just behind middle, then strongly, obliquely narrowed to tips, which are separately rounded and finely dentate; median costa strongly elevated from base to apex, subsutural costa slightly nearer the median costa than the suture, strongly elevated, becoming suddenly obsolete at middle of elytron, an indistinct costa parallel to the lateral margin, beginning at the inflated portion, meeting the median costa at apex and extending around the tips of elytron and joining the suture, which is strongly elevated for its entire length; humeri strongly gibbous, with a distinct lateral costa, limited posteriorly by a very deep depression, reaching from median costa to internal margin and posteriorly to the inflated lateral part of the elytron; intervals very finely and densely granulate, with numerous transverse rugæ between the costæ on the anterior half of the elytron, the rugæ as well marked as the costæ. Beneath shining black, surface of abdomen marked with large oblong circles; anterior margin of prosternum truncate; tarsi and claws black; tarsal lamellæ yellow.

Length, 3.25 millimeters; width, 1.

One specimen from Davao, Mindanao (*Baker 8333*).

Aphanisticus excavatus sp. nov.

Elongate, rather convex, head and prothorax dark bronzy, elytra black, shining.

Head elongate, slightly wider posteriorly, much narrower than the prothorax; front rather widely and very deeply excavated between the eyes, the lateral sides of the excavation parallel; eyes with the inner side sharply margined, but not as abruptly as in *costipennis*, placed at the extreme lateral part of the excavation; surface very finely granulate, shining, with a few large, round punctures intermixed, especially in the excavation between the eyes. Pronotum somewhat broadly cordate, much wider than long; sides indistinctly crenulate, broadly, arcuately rounded posteriorly to a little behind the middle, then obliquely narrowing to the posterior angles, which are obtuse; anterior margin broadly, arcuately emarginate; base bisinuate, with a widely rounded median lobe in front of scutellum; disk rather abruptly convex, with the sides widely flattened, the convexity with a shallow groove just back of the middle and another angulate, somewhat deeper groove, along the anterior margin; surface finely, densely granulate. Scutellum very small, triangular. Elytra a little wider than prothorax at base; humeral angles strongly angulate; sides slightly sinuate behind the humeri, strongly, obliquely narrowed from middle to the tips, which are separately rounded; humeri not prominent, limited posteriorly by a depression along the lateral edge, causing the side margin to be slightly flattened along the anterior third; suture gradually elevated on the posterior fourth; surface without costæ, very finely granulate and transversely rugose, with indistinct rows of very narrow, long punctures. Beneath shining black, slightly bronzy on prosternum, which has the anterior margin arcuately emarginate, surface of abdomen marked with numerous oblong circles; tarsi and claws black; tarsal lamellæ yellow.

Length, 3.5 millimeters; width, 1.1.

One specimen from Mount Maquiling, Luzon (*Baker*).

Aphanisticus piceipennis sp. nov.

Elongate, somewhat depressed, uniformly piceous, with a bronzy reflection on head and prothorax, shining.

Head elongate, slightly wider posteriorly, much narrower than prothorax; front rather widely and deeply excavated between the eyes, the lateral sides of the excavation parallel; eyes with the inner side rather sharply margined as in *excavatus*, and placed at the extreme lateral part of the excavation; surface very finely granulate, moderately shining, with a few large, round punctures intermixed. Pronotum transverse, much wider than long; sides indistinctly crenulate, broadly, arcuately rounded to a little be-

hind the middle, then rather obliquely narrowed to posterior angles, which are obtuse; anterior margin broadly, arcuately emarginate; base bisinuate, with a rather abruptly rounded lobe at the middle; disk moderately convex, the convexity limited in front by a deep, transverse, angulate groove along the anterior margin, and behind by another, somewhat shallower groove along the posterior margin, limited on each side by a rather deep, broad depression; on each side an indistinct groove, perpendicular to the base; surface finely, densely granulate. Scutellum very small, triangular. Elytra a little wider than prothorax at base; humeral angles strongly angulate; sides slightly sinuate behind the humeri, strongly, obliquely narrowed from near the middle to the tips, which are separately rounded and very finely dentate; humeri not prominent, limited posteriorly by a depression along the lateral edge, causing the margin to become slightly flattened along the anterior third; suture slightly elevated near the apex; surface without costæ, very finely granulate, with indistinct rows of very narrow, elongate punctures and indistinctly rugose. Beneath black, shining; abdomen marked with numerous oblong circles over entire surface; anterior margin of prosternum broadly, arcuately emarginate; tarsi and claws black, tarsal lamellæ yellow.

Length, 2.9 millimeters; width, 1.

The type is from Mount Maquiling, Luzon (*Baker*); a paratype from Mount Banahao, Luzon (*Baker*). A specimen from Davao, Mindanao (*Baker*), is not quite typical of the species, the sides of the pronotum are more flattened and bronzy green, the transverse anterior groove on pronotum not quite as deep, and the disk with an obsolete transverse groove at the middle; otherwise it resembles the type and is best placed with this species for the present.

This species is closely allied to *A. bodongi* Kerrem., but from the description given for that species, the anterior margin of the prosternum is truncate, while in *piceipennis* it is broadly, arcuately emarginate. In *piceipennis* the elytra are not depressed along the suture and the measurements of this species are less than those given for *bodongi*.

Aphanisticus mindanaoensis sp. nov.

Oblong-ovate, rather convex, uniformly shining black, with a slight bronzy reflection on sides of pronotum.

Head very short, much narrower than prothorax; sides and front arcuately rounded, forming a half circle; front slightly,

broadly excavated between the eyes, these not sharply margined on the inner side nor placed forward on a projecting front; surface shining, very finely and densely granulate, with a few, large, round punctures intermixed. Pronotum transverse, much wider than long; sides rather broadly arcuate, widest at about the middle, then slightly, obliquely narrowed to posterior angles, which are obtuse; anterior margin broadly, arcuately emarginate, the anterior angles acute; base bisinuate, with a widely rounded median lobe in front of scutellum; disk rather evenly convex, sides slightly flattened, with a broad, rather deep depression near each of the posterior angles; surface finely, densely granulate, with a few large punctures intermixed. Scutellum very small, transversely triangular. Elytra about as wide as prothorax at base; humeral angles strongly angulate; sides slightly sinuate behind the humeri, strongly, obliquely narrowed from middle to the tips, which are separately rounded and finely dentate; humeri not prominent, just behind these a deep depression, causing the lateral margin to become slightly flattened along the anterior third; suture broadly elevated along posterior fourth; surface without costæ, finely, densely granulate and obsoletely rugose, with a few distinct punctures behind the scutellum. Beneath shining black, surface of abdomen marked with a few indistinct circles along the sides, becoming obsolete at the middle; anterior margin of prosternum broadly, arcuately emarginate; tarsi and claws black; tarsal lamellæ brownish.

Length, 3 millimeters; width, 1.25.

One specimen from Davao, Mindanao (*Baker*).

Aphanisticus foveicollis sp. nov.

Oblong-ovate, rather convex, dark bronzy, lateral margins of prothorax greenish bronze, shining.

Head very short, much narrower than prothorax; sides and front arcuately rounded, forming a half circle; front only slightly excavated between the eyes, the extreme front with a very small, abrupt, rather deep notch; eyes not sharply margined on the inner side nor placed forward on a projecting front as in *costipennis*; surface very finely, densely granulate, shining, with a few, large, round, indistinct punctures intermixed. Pronotum transverse, much wider than long; sides broadly, evenly arcuate, widest at middle; anterior margin broadly, arcuately emarginate, the angles rather acute; base bisinuate, with a widely rounded

median lobe in front of scutellum; disk rather suddenly convex, with the sides slightly flattened, the convexity with an indistinct groove posteriorly, and a broad, rather deep depression near each of the posterior angles; surface finely, densely granulate, with a few large punctures intermixed. Scutellum very small, transversely triangular. Elytra about as wide as prothorax at base; humeral angles strongly angulate; sides slightly sinuate behind the humeri, strongly, obliquely narrowed from near middle to the tips, which are separately rounded and finely dentate; humeri not prominent, just behind these a deep depression along the lateral edge, causing the margin to become slightly flattened along the anterior third; suture broadly elevated near apex; surface without costæ, finely, densely granulate and obsoletely rugose, with a few large punctures forming indistinct rows on the disk. Beneath shining black, surface of abdomen without distinct circular marks; anterior margin of prosternum broadly, arcuately emarginate; tarsi and claws black; tarsal lamellæ brownish.

Length, 2.75 millimeters; width, 1.25.

One specimen from Puerto Princesa, Palawan (*Baker*).

Aphanisticus unicolor sp. nov.

Elongate, rather convex, uniformly shining black.

Head very short, much narrower than prothorax; sides and front arcuately rounded, forming a half circle; front not distinctly excavated between the eyes, these not sharply margined on the inner side nor placed forward on a projecting front as in *costipennis*; surface very finely, densely granulate, with a few large, round, indistinct punctures intermixed. Pronotum transverse, much wider than long; sides broadly, evenly arcuate, widest at middle; anterior margin broadly, arcuately emarginate, the anterior angles acute; base bisinuate, with a large, rounded, median lobe in front of scutellum; disk moderately, evenly convex, with the sides slightly flattened; surface finely, densely granulate, with a few large punctures intermixed. Scutellum very small, triangular. Elytra a little wider than prothorax at base; humeral angles sharply angulate; sides strongly sinuate near middle, then obliquely narrowed to the tips, which are separately rounded and finely dentate; humeri not prominent, just behind these a deep depression, causing the lateral margin to become slightly flattened along the anterior third; suture broadly

elevated on the posterior fourth; surface without costæ, finely, densely granulate and obsolete, transversely rugose, with indistinct rows of very narrow, long punctures. Beneath shining black; anterior margin of prosternum broadly, arcuately emarginate; surface of abdomen marked with numerous, rather distinct, oblong circles; tarsi and claws black; tarsal lamellæ yellow.

Length, 3 millimeters; width, 1.1.

Two specimens from Imugan, Nueva Vizcaya Province, Luzon (*Baker 8334, 8337*).

Aphanisticus trachyformis sp. nov.

Oblong-ovate, convex, uniformly bright bronzy black, shining.

Head very short, much narrower than prothorax; sides rather obliquely rounded; front slightly, broadly excavated between the eyes, these not sharply margined on the inner side nor placed forward on a projecting front; surface shining, very finely, densely granulate, with a few large round punctures intermixed. Pronotum transverse, much wider than long; sides broadly arcuate, widest behind middle, then more strongly narrowed anteriorly; anterior margin broadly, arcuately emarginate, the angles rather obtuse; base bisinuate, with a large, widely rounded, median lobe in front of scutellum; disk evenly convex, sides slightly flattened; surface finely, densely granulate, with a few large punctures intermixed, the punctuation becoming denser along the lateral margin. Scutellum very small, transversely triangular. Elytra about as wide as prothorax at base; humeral angles strongly angulate; sides slightly sinuate behind humeri, arcuately narrowed from the middle to the tips, which are separately, broadly rounded; humeri not prominent, just behind these a depression along the lateral edge, causing the lateral margin to become slightly flattened along the anterior third; suture elevated near apex; surface without costæ, very finely granulate and indistinctly rugose, with a few large punctures intermixed, becoming obsolete toward apex. Beneath shining black; abdomen marked with numerous slightly oblong circles over entire surface; anterior margin of prosternum slightly arcuate; tarsi and claws black; tarsal lamellæ brown.

Length, 3.25 millimeters; width, 1.5.

The type is from Tacloban, Leyte (*Baker 8335*). Another specimen from Dapitan, Mindanao (*Baker*), differs from the type in being darker, without the bronzy reflections.

Genus **ENDELUS** Deyrolle*Key to the species.*¹¹

1. Form robust; head much narrower than pronotum.
 - *E. violaceipennis* sp. nov.
 - Form elongate; head nearly as wide as pronotum..... 2.
2. Pronotum broadly cordate..... 3.
 - Pronotum transverse, sides arcuately rounded..... 4
3. Black with violaceous reflections..... *E. palawanensis* sp. nov.
 - Uniformly bronzy..... *E. bakeri* Kerrem.
4. Elytra bicolored..... *E. lunatus* sp. nov.
 - Elytra unicolored..... 5.
5. Form elongate, agriliform; pronotum not twice as wide as long.
 - *E. agriliformis* sp. nov.
 - Form more robust; pronotum twice as wide as long.
 - *E. aeneipennis* sp. nov.

Endelus violaceipennis sp. nov.

Broadly ovate, attenuate posteriorly, subconvex; head and pronotum bluish black, the latter with the anterior angles reddish, shining; elytra bright violaceous; beneath bronzy green.

Head elongate, slightly wider posteriorly, very much narrower than prothorax; front narrowly, abruptly, and deeply excavated between the eyes, lateral sides of excavation nearly parallel, median line distinctly marked from vertex to middle, becoming obsolete in front of epistoma; eyes prominent and strongly angulate, with the inner side strongly margined, placed at the extreme lateral part of the excavation; surface very finely granulate, with a few larger punctures intermixed and of a cupreous color on the anterior part, deeply impressed in front of epistoma, which is elevated, narrowly and deeply emarginate, and with the lateral parts extending along the inner side of the eyes; sides very much constricted below the antennæ, which are nearly contiguous. Pronotum transverse, about twice as wide as long, widest a little behind the middle, front distinctly narrower than base; sides rather strongly angulate at the posterior third, strongly rounded anteriorly, obliquely narrowed posteriorly to the hind angles, which are obtusely rounded; anterior margin with a large, widely rounded, median lobe, with the angles rather obtuse; base bisinuate, with a large median lobe, truncate in front of the scutellum; disk widely, transversely elevated anteriorly; sides broadly flattened, basal third with a widely rounded, transverse concavity; surface nearly smooth, with a few, indistinct, sparsely placed punctures. Scutellum

¹¹ *Endelus cornutus*, described by Kerremans from Luzon, has not been seen by me.

rather large, triangular, black, anterior margin truncate. Elytra a little wider than pronotum, humeral angles widely rounded; sides slightly sinuate and nearly parallel to just behind the middle, then abruptly, obliquely narrowed to the tips, which are conjointly, widely rounded and finely dentate; humeri prominent; surface nearly smooth, shining, with a few, sparsely placed, inconspicuous punctures, also with numerous, irregular elevations forming depressions as follows: A deep elongate depression at the base, another irregular one along the lateral margin reaching from the humeri to just behind the middle, causing the lateral margin to be distinctly flattened, an irregularly rounded depression on middle of disk, and a triangular one along suture near apex, which is broadly gibbous. Beneath the sides of abdomen marked with irregular lines, becoming less distinct and crenulate on the median part; prosternum coarsely punctate; posterior coxæ with a distinct tooth at the middle of the posterior margin.

Length, 5.25 millimeters; width, 2.75.

One specimen from Davao, Mindanao (*Baker*).

This species is allied to *Endelus difformis* Deyr., but differs from that species in the coloration.

Endelus palawanensis sp. nov.

Elongate, attenuate posteriorly, subconvex, uniformly black, with a violaceous reflection, shining; beneath black.

Head large, distinctly wider anteriorly, slightly narrower than the prothorax, widely and deeply excavated between the eyes, a distinct median groove reaching from clypeal suture to occiput and dividing the head into two lobes; eyes prominent, strongly angulate, with the inner side slightly margined, and placed at the extreme lateral part of the projecting part; surface very finely granulate, with a few larger punctures intermixed; median line with a deep puncture at the middle and a similar one in front of epistoma, which is strongly elevated and narrowly constricted between the antennæ. Pronotum broadly cordate, twice as wide as long, widest at anterior fourth; sides finely crenulate, arcuately rounded anteriorly to near the middle, then strongly, obliquely narrowed to the posterior angles, which are obtuse; anterior margin slightly lobed at middle, the angles rather acute and protruding; base bisinuate, with a large median lobe truncate in front of scutellum; disk rather convex, with the sides somewhat flattened, the convexity formed by a transverse elevation joined on the median line to a common anterior eleva-

tion along the frontal margin; surface nearly smooth, with a few, indistinct, round, shallow punctures. Scutellum rather large, triangular, truncate in front. Elytra distinctly wider than pronotum at base; humeral angles obtusely rounded; sides nearly parallel to the posterior third, then obliquely narrowing to the tips, which are widely and separately rounded and rather strongly dentate; humeri rather prominent; surface slightly rugose, with a few, rather large, inconspicuous punctures; each elytron with numerous irregular elevations, forming shallow depressions as follows: Three irregular-shaped ones along the lateral margin, a deeper transverse one along base, and three irregular round ones along the suture, the one near the tip being more elongate. Beneath marked with a network of indistinct crenulate lines.

Length, 3.75 millimeters; width, 1.5.

One specimen from Puerto Princesa, Palawan (*Baker 8336*).

This species is allied to *Endelus bakeri* Kerrem., but differs from it in coloration and in having the elytra not so distinctly punctured.

Endelus bakeri Kerremans.

Two specimens which I take to be this species are from Los Baños, Luzon (*Baker 8322*).

Endelus lunatus sp. nov.

Elongate, attenuate posteriorly, rather convex; head and pronotum bright greenish bronze; elytra violaceous with green spots; beneath black with a bronzy reflection.

Head short, slightly narrower than prothorax, widely concave between the eyes; median line not distinctly impressed, except at the middle; eyes prominent, strongly angulated, inner margin slightly margined, placed at the anterior lateral part, which is scarcely projecting; surface smooth, shining, with rather large circular marks becoming more numerous on the vertex, two deep, semicircular depressions in front of epistoma, which is elevated and strongly narrowed between antennæ. Pronotum transverse, two and one-half times as wide as long, widest at middle; sides feebly crenulate, evenly, arcuately rounded; anterior margin slightly lobed at middle, the angles acute and protruding; base bisinuate, with a large median lobe truncate in front of scutellum; disk broadly, transversely elevated anteriorly, the sides flattened, with a wide transverse concavity along the posterior margin; surface nearly smooth, indistinctly marked with circles, becoming crenulate on the anterior part. Scutellum green,

rather large, triangular, truncate in front. Elytra about as wide as pronotum; humeral angles rather obtusely angulate; sides slightly sinuate near hind femora, slightly narrowed from base to posterior third, then more abruptly narrowed to tips, which are conjointly, widely rounded and finely dentate; humeri rather prominent; surface with a rather deep transverse depression along base and another elongate one along lateral margin behind humeri, also with rather large, sparsely placed punctures, except on the green spots, where the surface becomes very finely granulate, with a few larger punctures intermixed; the arrangement of the green spots is as follows: Each elytron with a round spot on the humerus, a smaller one along the side of scutellum, a transverse crescent-shaped spot just behind the middle, with the tips pointing forward, but not reaching suture nor lateral margin, a large round spot at the posterior fourth, and a less distinct one at the apex. Beneath very finely granulate and marked with a network of crenulate lines.

Length, 3.25 millimeters; width, 1.4.

One specimen from Cuernos Mountains, Negros (*Baker*).

This species is allied to *Endelus scintillans* Deyr., but differs from that species in the arrangement of the spots on the elytra.

Endelus agriliformis sp. nov.

Elongate, very slender, agriliform, attenuate posteriorly, head and pronotum coppery bronze; elytra dark reddish bronze with a slight violaceous reflection; beneath bronzy.

Head short, nearly as wide as the prothorax, widely concave between the eyes; median line slightly impressed from vertex to middle and ending abruptly in a small deep pit; eyes prominent, slightly angulate but not distinctly margined on the inner side, placed at the anterior lateral part, which is not projecting; surface finely, densely granulate, with a few large punctures intermixed, two deep oblong depressions below the antennal cavities; front strongly constricted between the antennæ, which are nearly contiguous; epistoma triangular, anterior margin slightly arcuate. Pronotum transverse, one and two-thirds times as wide as long, sides arcuate, a little wider in front than behind, widest at about the basal third; anterior margin nearly straight, the angles obtuse; base bisinuate, with a large median lobe, truncate in front of scutellum; disk moderately convex, with a wide transverse concavity along the posterior margin, becoming more deeply impressed near the lateral angles, and a similar transverse depression at the middle; surface finely

granulate and reticulate. Scutellum rather large, triangular. Elytra about as wide as the pronotum; humeral angles obtusely rounded; sides strongly sinuate at the posterior coxæ, then rather strongly expanded and gradually attenuate to the tips, which are separately rounded and finely serrate; humeri rather prominent; surface with a broad deep depression at base, strongly, transversely rugose and sparsely punctate. Beneath very finely reticulate and distinctly crenulate.

Length, 4.75 millimeters; width, 1.25.

One specimen from Davao, Mindanao (*Baker*).

This species resembles a very slender *Agrius*.

Endelus aeneipennis sp. nov.

Elongate, moderately robust, slightly attenuate posteriorly, rather convex; head and pronotum bright greenish bronze; elytra aëneous; beneath bronzy.

Head short, slightly narrower than prothorax, widely concave between the eyes; median line not distinctly impressed, except for a shallow pit at middle; eyes prominent, not strongly angulate, inner side slightly margined, placed at the anterior lateral part, which is not projecting; surface distinctly, densely granulate and indistinctly marked with fine crenulate lines, with two deep depressions behind the antennal cavities; front strongly narrowed between the antennæ; epistoma triangular, anterior margin slightly arcuate. Pronotum transverse, twice as wide as long, widest at about the middle; sides evenly, arcuately rounded; anterior margin broadly lobed at middle, the angles rather obtuse; base bisinuate, with a large, abruptly rounded, median lobe in front of scutellum; disk moderately convex, with a wide, transverse concavity along the posterior margin and a median transverse depression, widely interrupted at middle; surface finely, densely reticulate, with numerous distinct crenulate lines. Scutellum rather large, triangular. Elytra about as wide as pronotum; humeral angles obtusely angulate; sides nearly parallel to apical third, then slightly attenuate to the tips, which are separately, broadly rounded and finely serrate; humeri not prominent: surface with a shallow basal depression and a similar depression along the lateral margin behind the humeri, strongly rugose and rather densely punctate. Beneath marked with a network of indistinct crenulate lines.

Length, 4.5 millimeters; width, 1.5.

One specimen from Malinao, Tayabas Province, Luzon (*Baker*).

A CASE OF HUMAN COCCIDIOSIS DETECTED IN THE
PHILIPPINE ISLANDS, WITH REMARKS ON THE
DEVELOPMENT AND VITALITY OF THE CYSTS
OF ISOSPORAS HOMINIS (RIVOLTA)

By FRANK G. HAUGHWOUT

Protozoölogist, Bureau of Science

FOUR PLATES AND ONE TEXT FIGURE

When Woodcock, in an appendix to a paper by Ledingham and Penfold, published in 1915(18) announced the discovery of sporozoan cysts in the stools of soldiers invalidated home from Gallipoli, he reopened the entire subject of coccidiosis in man. Knowledge bearing on this subject was, at that time, on a very uncertain basis, and the general belief was that the coccidia of man were identical with those found in the rabbit and in the cat. Woodcock was not successful in his attempt to obtain development of the cysts and, therefore, could give only a very incomplete account of what he had found.

However, confirmation came very quickly from Low and from Wenyon(17) and within a year or two a number of cases of infections with *Eimeria* and *Isospora* were detected by workers in the war zones. Published figures of the cysts made it quite apparent that the species concerned were not the familiar parasites of the rabbit and the cat. Circumstances connected with these findings indicated that the focus of infection lay in the eastern Mediterranean area, and subsequent observations have, in a large measure, confirmed this. On the basis of these reports I published a short paper in 1918(9) calling attention to the problem that seemed to be arising. At that time I raised a question as to the specificity of the parasites found in man, and also ventured the prediction that under war conditions, coccidial infections in man were likely to crop up at any time or place.

Since the publication of that paper Dobell, in his admirable monograph on the coccidia of man,(3) has stabilized the situation as regards the identity of the organisms involved and has completely analyzed the literature. Moreover, later reports have shown that *Isospora hominis* (Rivolta, 1878) emend. Dobell,

1919, has nearly circumnavigated the earth, proceeding east and west from the eastern Mediterranean area and arriving at Bombay and possibly Saigon in an easterly journey from the region of Gallipoli and, in a westerly direction at Manila, probably by way of France and the United States. It is this last case that will be reported in this paper.

This case was presented by an American, a chemist by profession, 32 years old and a resident of Georgetown, Illinois. He spent the years 1915-1916 as a member of the technical staff of the Bureau of Science, Manila, and then returned to the United States, almost immediately proceeding to Trenton, Ontario. He lived there for about a year, and, so far as he had knowledge, was not in contact with any person who had returned from the war zones, or who had ever been in the eastern Mediterranean region or in Egypt. At Trenton, his meals were prepared by a Chinese cook.

During the years 1918 to 1920, he occupied a position at the Government smokeless-powder plant at Nitro, West Virginia, a war settlement situated about 24 kilometers from Charleston. During that time he made one or two short trips to New York. The sanitary conditions at the powder plant he describes as excellent. He bought food supplies from the Government stores. He purchased green vegetables from local produce dealers, but knew nothing of the sanitary conditions at the farms or the antecedents of the farm hands. He employed no servants and all the meals were cooked by members of the family.

The personnel of the powder plant included laborers from many parts of Europe, and, he thinks, men from the eastern Mediterranean area. He also came in contact with men returned from the war zones in France, but never messed with them.

The patient sailed from San Francisco for the Philippines on November 19, 1920. He went ashore in Japan, but ate only one meal ashore. This was a dinner at a tea house in Kobe. None of the others who were at this meal were in Manila at the time the case came to my attention, so their stools could not be studied. He arrived in Manila on December 19.

Inquiry into the previous medical history of the patient failed to reveal anything of note except an attack of typhoid fever in 1910. This was the only intestinal trouble from which he ever had suffered. His bowels always had been regular, and he had suffered neither from constipation nor from diarrhœa. His wife

had an attack of dysentery in Manila in 1916 and has experienced some bowel trouble since her return to the United States. I was led to believe that her dysentery was of the amoebic type.

Late in January of this year, the patient went to Mindanao, and into the Cotabato country. He went on a hard field trip about February 5, 1921, for which he was not physically prepared. He had three days of hard marching in the hot sun and, as a result, returned to headquarters completely exhausted. He did not take proper care of himself and sustained a chill. A period of constipation set in, and he sought relief with compound cathartic pills. These acted promptly, and he began to pass frequent watery stools which, however, were not accompanied by tenesmus. He saw neither blood, pus, nor mucus in the stools. This diarrhoea continued intermittently for several days.

Feeling rather sick, the patient returned to Manila. The trip consumed eleven days on the boat, during which time he had little if any appetite and ate very lightly. He had, however, accumulated something of an appetite on his arrival in Manila on February 26, and that night he visited a restaurant and ate a heavy meal consisting of beefsteak, potatoes, celery, and a variety of other things. He repeated this the following night.

The diarrhoea recurred on the morning of February 28, and continued all the following day. The movements were very frequent and watery in character. On the afternoon of March 1, he came to the Bureau of Science where his stool was examined by a member of the staff. The microscopist subsequently stated to me that the stool contained numerous small amoebæ, but no blood. These amoebæ were not identified. The patient then began to treat himself with Alcresta ipecac tablets.

On March 3 I returned from an out-of-town trip and the case was referred to me. I saw the patient the following day, at which time he informed me that the watery movements had increased in number and were inconveniently frequent. He said that he had suffered no real abdominal pain or tenesmus, but that there was considerable abdominal discomfort of a rather vague character due, he thought, to gas. His abdomen was not tender to palpation. His stool was dark in color and diarrhoeal in character, but bore absolutely no evidence of dysentery. No amoebæ were found at this or any subsequent examination, and there was no evidence of blood or tissue elements of any kind. One undeveloped oöcyst of *Isoospora hominis* was

discovered in the first preparation, but no other animal parasites were ever found. He had a light Blastocystis infection.

I questioned the patient and learned that he was taking the equivalent of 90 grains of ipecac daily. This led me to suspect that much of his trouble was due to the ipecac. I therefore told him to discontinue taking the drug, for I saw no indication for continuing it, and within twenty-four hours his fæces had become formed.

The patient did not report to me again until March 12, at which time he passed a hard, formed, rather dry stool. Microscopically, the stool contained rather numerous cysts of *Isoospora*, Blastocystis, and a few Charcot-Leyden crystals of the short form. Parenthetically it might be mentioned that Noc,⁽¹²⁾ who has recently reported a case of infection with this parasite, which I shall discuss later, found in the stools of his patient some crystals in the form of elongated lozenges (*losange allonge*) which he believes were fatty-acid crystals. These, I am inclined to believe, may have been Charcot-Leyden crystals. As a check, one of the cysts was measured and was found to be 26.6 μ in length by 14.9 μ in breadth.

On March 15 the patient came to me again and passed a light, yellowish brown, soft-formed stool at the laboratory. The cysts were much more numerous than before. The following day the patient passed another stool at the laboratory. This consisted of two distinct portions—an apparently normal, formed, brown mass and a greenish brown, bile-stained and very soft portion passed after it. Cysts were very numerous.

On this day (March 16) the patient looked ill and anxious. On my instruction he had been eating carefully and avoiding all food that would have a tendency to lay stress on his intestinal tract. He seemed to suffer no actual pain, but he complained of a dull, dragging sensation in the abdomen and slight nausea at times.

He was no better when he next visited the laboratory on March 21. The stool passed that morning was light yellow and again consisted of two portions—a solid portion and one, passed after it, that was very soft to watery, verging on diarrhœa. It, also, contained numerous oöcysts of *Isoospora*. Microscopically, I found numerous strands of mucus containing epithelial cell débris, but no blood nor pus. The stool certainly was not dysenteric in character, but it showed unmistakable evidence of a morbid process somewhere in the intestinal tract. I carefully

studied the epithelial cells in the hope of finding intracellular stages of the coccidium, but without success. Several slides were fixed and stained, but later examination of these was likewise barren of results.

The patient complained greatly of fatigue and lassitude. He reported that he was particularly uncomfortable at night and that he obtained relief by pressing the pillow against his abdomen. He was very restless at night and dreamed a great deal. On arising in the morning he felt completely worn out. On this particular morning he had felt somewhat better and had read the newspaper comfortably before going down to breakfast. At the table, however, he lost his appetite and ate only some papaya, prunes, and shredded wheat biscuit—not much of any of them. He said that he experienced something approaching an appetite for about one out of every three meals. This condition continued until I lost sight of the case, although the patient showed improvement in other ways. He had, in the meantime, lost 15 pounds in weight since the onset of the trouble. His temperature showed no tendency to rise except about half a degree Fahrenheit for a day or two following his return to Manila. The flatulence which troubled him before had disappeared to a large extent, but he still suffered from the dull sensation of uneasiness and discomfort in the abdomen, although there was no actual pain. The nausea had disappeared, but his appetite had not returned. Normally, he stated, he was “an enthusiastic eater.” At times his tongue was coated, and he was much annoyed at night by a bad taste in his mouth which made it necessary for him to arise, brush his teeth, and gargle with antiseptic solution.

The next examination of the patient's stool was made on March 30. On that day his stool presented the same general characters as the two preceding specimens. The first portion was dark yellow in color and fully formed; the second was lighter yellow and very soft. No cysts were discovered in the careful examination of ten fresh preparations selected from both portions of the stool. Concentration by the method of Cropper and Row of about 2 grams of the stool, made up of samples selected at random from both portions of the specimen, likewise failed to disclose any cysts.

The patient still complained of a slight degree of abdominal discomfort and of anorexia. On the whole, however, he seemed

to feel better, and his color and general appearance showed improvement. He had gained no weight.

I saw the patient for the last time on the night of April 10, at which time he furnished me another stool specimen. This was a seemingly normal, formed stool, light yellow in color. Examination of it on the following morning showed that he still retained his infection, for a few cysts in the sporoblast stage were found on examination of the first preparation.

The following day the patient sailed for the United States. His condition had improved, and he stated that he felt much better. I referred him to Prof. Charles A. Kofoid, of the University of California, in order that the state of his infection might be determined on his arrival in California.

To summarize the clinical side of the case:

It seems likely that the patient contracted his infection in the United States. The population of the camp at Nitro was such that it is not improbable that it may have numbered infected persons hailing either from the eastern Mediterranean zone or from the trenches in France. That is to say, the patient's contacts in other places were much more unlikely to have been infected with *Isospora*. Moreover, during a residence of seven years in the Philippine Islands, I have studied thousands of stools of healthy persons and of persons suffering from intestinal disorders, who have hailed from nearly all portions of the Islands; and, until I ran across this case, I never encountered a case of human coccidiosis, notwithstanding I have had the possibility in mind ever since the first cases were reported abroad in 1915 and 1916.

Apparently the onset of the trouble came about February 9. This would not necessarily mean that the patient must have contracted his infection only a short time previously. It is not improbable that some digestive disturbance may have occurred at this time, that was quite separate from the coccidial infection. With a light initial infection it is conceivable that a fairly long period might elapse before involvement of the intestinal mucosa became extensive. It is to be doubted if every merozoite discharged at schizogony finds its host cell. On the contrary, a large proportion of them, particularly those formed in cells which do not lie deep in the crypts, must be caught in the flow of the intestinal contents and swept on to perish for lack of suitable food. This is probably just what happens in the early stages of the infection, and it is only later that the organisms work up into the crypts where they are more or less secure.

That the patient had an infection with some species of amoeba would appear evident from the findings in the Bureau of Science; but the species was not determined, and they never reappeared in the stool after the day they were discovered. The patient, it is true, had taken heavy doses of ipecac; but his stool, at no time while he was under my observation, showed any of the elements characteristic of dysentery of any type.

The clinical symptoms seemed to be fairly constant, and they abated with the subsidence of the infection. The stools at times were watery, but always feculent and contained no pathologic elements aside from shed epithelial cells occurring in groups of five or even more cells, which despite their surroundings looked remarkably healthy—more as if they had been mechanically detached from their bases than as if they had been subjected to an inflammatory process. There was neither pain, griping, nor tenesmus, though, of course, there is no reason why the patient should experience tenesmus when one reflects on the anatomical site of the lesion. There was, however, a constant, dull feeling of discomfort in the abdomen, sometimes accompanied by flatulence, that the patient found very hard to define, but which, nevertheless, was perfectly real. The patient also suffered from fatigue and lassitude, restlessness at night, and occasional nausea. At times, particularly at night, he had a bad taste in the mouth and his tongue usually was foul, notwithstanding his bowels moved every day. Anorexia was a prominent and persistent symptom. The patient, like Noc's recently reported case,⁽¹²⁾ also lost weight.

The general impression seems to be that these infections are extremely transitory, and at least one writer has placed three weeks as about the limit of their duration. I think there is no doubt that there are at least exceptions to that rule, if it is a rule. The infection persists long enough for the patient to journey from Mesopotamia to Bombay or from Germany to Senegal, or from France to America and lastly from the eastern United States to Manila, a journey of five weeks. This, added to the time the last-named patient was under observation, comprehends a period of more than four months, and *he was still infected when he parted from me*, which rather effectually disposes of the theory that these infections are "purely transitory." During that time the patient's stool yielded but one negative examination, and I have little doubt that, if I had spent more time on it, I should have found some cysts.

DETECTION OF ISOSPORA INFECTIONS

Having had the opportunity to study the cysts of *Isospora hominis* it is hard for me to escape the conclusion that many infections with this organism have been overlooked and that the infection is probably more common than present reports would indicate. It is also a fact, to which some significance may be attached, that the present geographical distribution of *I. hominis* corresponds rather closely to the geographical distribution of protozoologists experienced in coprology. That point, however, will be discussed later.

The difficulties in diagnosis are several. The oöcysts are exceedingly transparent and the protoplasm is often so widely separated from their inner aspects that the cysts are practically invisible under the powers ordinarily employed by experienced microscopists in searching preparations of fæces. Then, the oval to rounded contour of the zygotes and sporoblasts and their greenish coloration render it extremely difficult to avoid mistaking them for some of the small plant forms so common in fæces. After one has studied these cysts for a while, under high as well as low powers, it becomes somewhat easier to pick them up under the low dry objective; but one has to have the experience first. However, the recognition of these cysts in any stage of development affords no real difficulty to any person who has had previous experience with the coccidia. It is the tyro, who has not studied the coccidia, who is likely to miss the cases.

Two points should be carried in mind by those searching for these cysts. Preparations should be exceedingly thin and well diluted with water—even thinner than the preparations usually made for the detection of intestinal protozoa and the ova of parasitic worms. The light should be well regulated—that is to say, carefully cut down, but not too much. Under these conditions the outline of the oöcyst may be visible even at the lowest magnifications ordinarily employed in work with fæces; that is, 100 diameters. India ink, diluted about one-half with water, and Donaldson's iodine-eosin mixture I have found useful in picking up cysts, for their clear, oval shape in these fluids sharply differentiates them from other objects in the preparation. The ink and the iodine-eosin mixtures should not be used when it is desired to make camera lucida drawings or measurements of the cysts, for I find the fluid flows over the rounded ends of the cysts and obscures their outlines. The cysts come down nicely on concentration by the method of Cropper and

Row and are much easier to pick up than in the usual slide emulsion.

So far as I can learn from this case, there are no criteria other than the finding of the cysts that will enable a sure microscopical diagnosis of intestinal coccidiosis. The stool affords no constant characters other than the cysts, so far as I have seen, that will render it possible to make a presumptive or tentative diagnosis, as is possible in the case of the dysenteries. If active symptoms should appear before cyst formation begins, there would appear to be nothing to do except to wait until the cysts begin to appear in the fæces, as they will in due time. Porter⁽¹³⁾ in writing on this subject says, however, "The infective oöcysts and sometimes epithelial cells containing trophozoites or schizonts are found in fæces and serve for diagnosis." I cannot agree that the finding of infected cells in the fæces is sufficiently constant to be of much aid in microscopic diagnosis. At least that was not my experience with this case.

In these infections the destruction of tissue by the parasite is limited to the epithelial cells of the intestine and it is not a necrotic process. It is conceivable that in extensive infections secondary bacterial invasion might occur and its products make their appearance in the stools, but such stools could scarcely be expected to be in any way characteristic of coccidiosis. It seems to me safe to say that in the general run of cases, pus and blood will not appear in stools. This, notwithstanding Noc has reported finding blood in the stool of his Dakur case. Mucus may be present and Noc, and Porter, as well as I have seen desquamated epithelial cells. Noc was fortunate enough to find one containing what would appear to have been a trophozoite of *Isospora*. I saw these epithelial cells on one occasion only; but, although I searched carefully, I found no intracellular parasites.

Some day, some one may succeed in making recognizable stained preparations of coccidial cysts, but for the present I should advise the amateur not to waste his time trying to stain them, for he will not succeed by the usual methods. Indeed he may even have trouble in fixing them. Such observations as have been made on the cysts of the coccidia have been made on fresh material, and we have no real knowledge of the cytology of the organisms in this stage of their life cycle.

Another thing that will trouble the inexperienced is the rather large number of unfertilized and otherwise abnormal cysts that will be found on study of a case. For this reason I have thought

it desirable to figure a number of these cysts (Plate 3, figs. 1 to 12). The oöcysts also show considerable variation in outline, from those that are virtually oval to those that resemble a bottle or elongated flask—a shape that is more or less characteristic of the species. This variation is shown in the plates that accompany this article.

The oöcyst, itself, is a delicate, transparent, double-contoured affair with a perfectly smooth surface. Some writers have described a delicate membrane lying within the cysts and a structure at the constricted end that has been interpreted as the micropyle. I have not been able to convince myself of the presence of either of these in the cysts I have studied; but I have been compelled to make my studies at this time with achromatic objectives, and it may be that my failure to demonstrate them has been due to lack of proper optical equipment. Noc(12) suggests that the bottle-neck appearance of the cysts may be due to the pressure of the elongated sporocysts as they rotate within the oöcyst. I think this interpretation is incorrect, for one frequently finds undeveloped cysts which show the constriction at one end (vide the plate accompanying Dobell's article).⁽³⁾

I regret I cannot give adequate treatment of the dimensions of these cysts at the present time. Recently, the cross hair on my filar micrometer became broken, and such measurements as I have made have been made with an ordinary ocular micrometer and a stage micrometer in whose accuracy I have not great confidence. I am giving measurements of nine oöcysts selected at random, and they are shown in Table 1.

TABLE 1.—Measurements of nine oöcysts of *Isospora hominis*.

Length.	Breadth.
μ	μ
33.2	13.6
36.4	13.6
39.0	14.5
35.8	15.8
39.1	12.7
37.3	18.2
38.2	19.1
39.1	19.4
40.0	17.6

*
These measurements were made with a Ramsden micrometer ocular at a magnification of about 715 diameters.

Nearly all of the measurements shown in Table 1 will be seen to exceed the dimensions reported by other workers. Dobell⁽³⁾

says the cysts measure from $25\ \mu$ to $33\ \mu$ in length and that they have a breadth at the widest part of ca. $12.5\ \mu$ to $16\ \mu$. That is to say, the width of the cysts is approximately half their length. However, as he has pointed out and as my illustrations show, the relative dimensions are not constant, although the long and slender forms predominate over those that are short and plump.

In freshly passed stools the zygotes are practically undeveloped, and may show very little shrinkage away from the walls of the oöcyst. However, one not infrequently picks up cysts that have undergone sporoblast formation, but that is the limit of development in the freshly passed stool. The cell body is coarsely granular, has a distinct greenish tint and, under suitable illumination, the mass shines like a gem. The resemblance to certain plant forms found in the fæces is rather striking at first, but one soon becomes able to pick them out from the general collection of plant and animal forms.

SPOROBLAST FORMATION

The preliminary stages of spore formation appear to take place rather early, and may be seen in some cysts within two hours after the stool is passed. Meanwhile the protoplasmic mass changes considerably in shape and shrinks away from the cyst wall rather rapidly, finally forming a practically spherical mass in the center of the cyst. A clear area often appears in this mass, toward the center, as if the granular inclusions had been forced away from the center (Plate 1, fig. 1). This may or may not mark the site of the nucleus. Frequently, however, two or more of these clear areas form in the cell (Plate 1, figs. 2 and 3), and I am inclined to suspect that the appearance may be connected with cytolysis, which becomes fairly active in the cell at this stage of development. The spherical form assumed, the cell appears to lose much of its passive nature. It undergoes almost constant change of form. These changes are slow, very much in the nature of the movements of leucocytes, or some of the very sluggish amœbæ, but they can be followed, nevertheless. The protoplasm is in a condition of constant though slow cyclosis in which the granules are circulated round about through the cell. On the outer aspect, from time to time, appear clear, hyaline processes, devoid of inclusions, that superficially resemble pseudopodia (Plate 1, fig. 4). These may also appear in the early sporoblast stages as is suggested by Wenyon's figure (fig. 2, p. 625).⁽¹⁶⁾ These form slowly and appear to develop more by the retraction of the endoplasmic granules from

the periphery and a metabolic change of form, than by the actual extrusion of the protoplasmic mass, as is the case in pseudopodia formation.

I was able to follow the process of sporoblast formation in one cyst (Plate 1, figs. 5 to 10; Plate 2, fig. 1). The process of plasmogamy, from the time of the appearance of the first signs of cleavage of the zygote, was forty minutes. Of course, there is no way of estimating the time of the entire process, for it is impossible to tell whether division of the nucleus occurs soon after zygosis or is deferred until just before division of the cell body occurs.

The cyst in question was first seen by me at 10.40 a. m. The temperature of the laboratory at that time was 28° C., and it did not appreciably vary from that during the process. The material was mounted in physiological salt solution and sealed with vaseline. The zygote, at that time, showed a distinct equatorial constriction (Plate 1, fig. 5). The cyst was sketched rapidly under the camera lucida. At 10.55 the cleft had become quite sharp (Plate 1, fig. 6). At this time the cell showed great protoplasmic activity. The outline of the cell was constantly changing and cyclosis was very marked.

At 11.03 the outline of the dividing cell had lost its irregularity and was becoming rounded (Plate 1, fig. 7). The cleft had distinctly deepened. The outer aspect of the cell was still more sharply defined and the cleft much deeper at 11.08

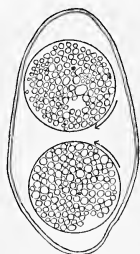

FIG. 1. Oscillation of sporoblasts following cell division in *Isoospora hominis* (Rivolta).

(Plate 1, fig. 8), and at 11.17 the daughter cells were connected by a very slender strand only (Plate 1, fig. 9). At this stage, the posterior cell (lowermost in the figure) showed a slight transverse elongation, and at the same time a distinct movement of the two cells was observed. This was a slight to-and-fro rotation, as if the two cells were geared (text fig. 1); and when separation had become complete, at 11.19, at which time the cells moved apart, this movement became more pronounced, and it continued until after 4 o'clock in the afternoon.

At 11.30 o'clock, eleven minutes after separation of the cells had taken place, the cells were widely separated (Plate 1, fig. 10). The ectoplasmic layer began to show a tendency to stiffen, although it was still sufficiently plastic to allow for slight changes of external form. The general spherical shape was main-

tained until 12.40 o'clock, when the sporoblasts were seen to have elongated (Plate 2, fig. 1) and there was a distinct separation of the protoplasm from the membranous capsule that had formed externally, while the granular cell contents showed a tendency to clump toward the center of the cells. Beyond changes in the positions of the sporoblasts, nothing further was observed during the day; a defect in the mounting resulted in the loss of the cyst during the night.

This clumping of the granules and differentiation of the protoplasm observed in this particular cyst is not the invariable appearance. More frequently, it would seem, sporoblasts retain their spherical form for a while in the sporocyst state, and the distribution of granules through the cells remains fairly uniform, as is seen in Plate 2, fig. 2, which was drawn from another specimen. Moreover, development of the sporocysts is not necessarily synchronous, as will be seen by another cyst (Plate 2, fig. 3).

The next steps in sporozoite formation would seem to consist in the elongation of the sporocysts which often, although not invariably, become tilted at an angle to the long axis of the oöcyst (Plate 2, fig. 11); the gradual condensation of the protoplasm into a more-compact mass; and the concentration of the so-called sporocystic residuum toward the center of the sporocysts.

Unfortunately, I have been unable to find material that will yield information as to the further steps in sporozoite formation. Indeed, the process of sporogony could scarcely be worked out completely in the study of material obtained from a limited number of stool examinations. The only cyst I found that seemed to show a definite step (Plate 2, fig. 4) had been in the ice box at 10° C. for forty-eight hours. It was rather difficult to focus down through the mass of granules and distinguish the details at the lower focal levels; but the protoplasm had apparently expelled the nutritional granules, undergone concentration, and assumed a crescentic form preparatory to the first sporozoite division. That was the only cyst I have so far encountered that showed definite evidence of any stage between the sporocyst and the completely developed tetrazoic spores (Plate 2, figs. 5 to 12; Plate 3, fig. 10).

The cyst shown in Plate 3, fig. 6, is in all probability a cyst that had undergone partial sporozoite development through the first sporozoite division in one sporocyst, but had failed of further development through some untoward external condition,

or possibly because of insufficient store of food supply. It was taken from the stool passed on March 16, that had been in the ice box at 10° C. for forty-eight hours and had then been sealed on a slide in physiological salt solution. Another cyst (Plate 3, fig. 8), also abnormal, was found in the same preparation.

As I have said, most of the cysts found in freshly passed faeces are in early zygote stages, but sporoblast stages are not infrequently found. However, I have seen no later stages in the fresh material. In his monograph, Dobell⁽³⁾ says: "Development of the spores takes place outside the host and requires several days for its completion." This is more or less in harmony with the behavior of cysts of other species of *Isospora*, and probably is the general rule with this species; but it is not by any means invariable, as I have found on studying this case. Certain factors may intervene to yield cysts in the infective stage at a much earlier period. The bacteriological and general chemical and physical conditions, as oxygen supply, in the faecal mass probably play an important part, as may also a state of constipation which delays the passage of the cysts. For instance: The stool passed at 8.45 a. m., on March 16, consisted of two distinct portions—a normal, formed, brown mass and another portion, passed after it, that was greenish brown and soft in consistence. It was immediately examined, and both portions were found to contain oöcysts in an early stage of development.

The stool was examined again the following day at 4.30 p. m., approximately thirty-two hours after its passage. The temperature during this time had varied between 28° C. and 30° C. The formed portion of the stool contained undeveloped zygotes, sporoblasts, sporocysts, and a number of fully developed cysts and some that were degenerated (Plate 2, fig. 7). The softer portion of the stool yielded no fully developed cysts. A few cysts were seen that had gone as far as sporoblast development, but there were many cysts that clearly were undergoing degenerative changes.

Of course, this is only an isolated case, but it does show that under certain conditions the cysts may become infective in considerably under two days, a fact that must be taken into consideration in the epidemiology of the disease. The preservation of the cysts in the formed portion of the stool was excellent. A specimen of the material was examined on April 2, after it had rested in a bottle on the laboratory shelf since it was passed, and was found to contain numerous, fully developed and healthy-looking cysts.

The stool passed on March 15, which was light yellowish brown and soft-formed—much softer than the other—was examined on April 1, after it had rested under similar conditions. It contained a number of healthy-appearing cysts in full development, but with shrunken oöcysts, and also large numbers of cysts in various stages of development up to full development, which had undergone marked degeneration in addition to the wrinkling of the oöcyst. Contraction or wrinkling of the oöcyst does not, however, necessarily mean that the cyst is not infective, as I shall try to show later. Death of the protoplasm is probably quickly followed by its disintegration, even under the double protection afforded by the oöcyst and the sporocyst.

The proportion of cysts discharged from the intestinal mucosa that fail to develop for one reason or another, is probably rather large, and I am at present trying to determine that approximately, but it will take the consideration of many cases to give any definite idea. It would seem to me to be a much larger proportion than is the case with the cysts of *Entamoeba histolytica*. From time to time, one encounters cases of infection with the latter organism in which the greater number of the cysts examined are in the mono- or binucleate stage. As Dobell⁽⁴⁾ has pointed out (p. 48), and as my own experience corroborates, these cysts undergo no further development after they have left the intestine. I am inclined to believe that they hail from nests of amœbæ located in the tissues lying rather low down in the intestine, whence the journey to the outer world is too short to give them time for full development. These cases are relatively uncommon, and it is likely that such cysts are incapable of infecting a new host.

So far as my observations have led me, I am inclined to believe that there are three general causes underlying the failure of these cysts of *Isospora* to develop: (1) failure of the macrogamete to be fertilized by a microgamete, (2) failure of the macrogamete to store sufficient energy in the form of food reserve to carry it through the rather dynamic processes of division and differentiation which, from the behavior of the zygote during the earlier stages of sporogony, would seem to call for the expenditure of not a little energy, and (3) a variety of untoward environmental conditions.

Four undeveloped and more or less degenerate cysts are shown (Plate 3, figs. 1, 3, 4, and 11). Fig. 1 shows a cyst, the protoplasm of which, it is true, is somewhat vacuolated, but perhaps not unduly so, although I have not sufficient knowledge of the

normal protoplasmic appearance of these cysts to judge well. This cyst would appear to have failed of fertilization, for it was three days old when examined. What has happened to two of the other cysts (Plate 3, figs. 3 and 4) is a little hard to say, for they are badly degenerated. The cyst shown in fig. 3 has apparently suffered from osmotic changes, and the protoplasm presents a picture frequently seen in dying protozoa. The cyst shown in fig. 11 probably failed of fertilization. Its appearance recalled, somewhat, the appearance of the contents of an unfertilized *Ascaris* ovum. Five of the other cysts (Plate 3, figs. 5 to 9) clearly owed their destruction to causes other than failure to secure fertilization, for they had progressed considerably toward complete development. Indeed, it is not unlikely that the cyst shown in fig. 7 actually attained full development and went to pieces later. The cyst shown in fig. 5 had been in the ice box for forty-eight hours and had then been sealed in 10 per cent potassium bichromate solution for twenty-four hours. The cyst in fig. 6 had received similar treatment, except that it had been sealed in physiological salt solution. The cyst in fig. 7 had been in the ice box for one week and had then been allowed to develop overnight in the laboratory. The preparation in which it was found contained numerous fully developed and perfectly healthy cysts as well as a few others that had degenerated. Figs. 8 and 9 were also ice-box specimens that for some reason had gone wrong after sporoblast and sporocyst formation, respectively. The cyst in fig. 9 might still have been capable of further development, notwithstanding the extrusion of the endoplasmic granules. The occurrence of the clump of granules lying at one side of the center of the cyst measuring about 3.6μ in diameter, I am inclined to regard as fortuitous and not to be interpreted as an oöcystic residuum.

The cyst shown in Plate 3, fig. 2, was one of the largest I encountered in the study. Unfortunately it was lost before I could measure it. It looked startlingly like a developing cyst of *Eimeria*. I had managed to draw the outlines under the camera lucida, when I was called to the telephone. When I returned, evaporation had swept it away and I was unable to find it again.

In only one instance did I find a sporocyst that had become separated from its oöcyst (Plate 3, fig. 12). Dobell quotes Wenyon and O'Connor as reporting the occasional occurrence of oöcysts of *Isospora hominis* containing a single sporocyst with eight sporozoites. I encountered no such forms. Dobell has seen them occasionally in *Isospora bigemina*.

The structure of the fully developed cyst shows considerable variation as regards the shape and size of the oöcysts, the character and amount of sporocystic residuum present, and the arrangement of the sporozoites. I gather from reading Noc's paper, that he is under the impression that the oöcysts increase in size as they reach full development. At the present time I am inclined to doubt if this is really so, but the whole matter of the dimensions of these cysts is a subject I am purposely not taking up in this paper, and I shall defer further consideration of it until I have had the opportunity to go over the measurements I have already made and the measurements of some preserved material. It has occurred to me that there may be races within these species, characterized by the size of their cysts. The difficulty lies in making accurate calculations of the size of cysts that assume such irregular outlines.

It will be seen, by viewing the figures of some of the fully developed cysts (Plate 2, figs. 5 to 11, Plate 3, fig. 10), that the sporocystic residuum shows considerable variation in character and amount. In some cysts (Plate 2, figs. 6, 7, 8, and 10) it is fairly rich and normal-appearing, while in others (Plate 2, figs. 5, 9, and 11) it is formed largely of fine, dark granules and is scant in amount. In others (Plate 3, fig. 10; Plate 2, fig. 12), it appears in the form of dull, hyaline-looking bodies. Both these cysts had been subjected to dessication for one week. These are appearances that are not restricted to this species, but may be seen in other species of coccidia.

DEVELOPMENT OF THE CYSTS AT 10° C

A study of the development of the cysts at a constant temperature of 10° C. was rather interesting. One of the stools studied thus was that of March 21, a portion of which was placed in the ice box a few minutes after it was passed. Twenty-four hours later a sample was taken from the ice box, but none of the cysts had passed beyond the early zygote stage. On the morning of March 23, numerous, well-advanced sporoblasts were seen, also some zygotes, apparently in good condition. There were very few degenerating cysts. Oöcysts containing sporocysts were found on the morning of March 24. The sample taken from the ice box on that day was laid aside on the laboratory table overnight (temperature, 30° to 32° C.). When it was examined the next morning (temperature,

31.5° C.), several cysts containing fully developed sporozoites were found (Plate 2, fig. 8).

Examination of the ice-box material every day until April 3 yielded no cysts beyond the sporocyst stage, while many in the late zygote and sporoblast stages were found each day. Each specimen was left on the table overnight and, each morning after, fully developed cysts were found. On the morning of April 3, just two weeks after the experiment was started, fully developed cysts (containing sporozoites) were found in the faeces immediately after it was removed from the ice box.

In other words, the lowered temperature, as was to be expected, retarded the development of the cysts considerably, but they "picked up" rapidly on being carried into a warmer atmosphere and, after the third day, were capable of completing their development overnight in the higher temperature. The cold also undoubtedly favors the cysts in that it retards the fermentative changes in the faeces that are inimical to the cysts. This would seem to indicate that the temperature in the fall and spring months, and possibly into the early and late winter in temperate climates, will tend to favor the dissemination of the infection. It is not by any means certain that the meteorology of the Tropics will afford favorable conditions for the spread of coccidial infections.

EFFECTS OF TROPICAL SUN ON THE CYSTS

The resistance of coccidial cysts to desiccation and the action of chemicals is well known, but it occurred to me that it would be interesting to try the effects of the tropical sun on them. For that purpose the following rather crude experiment was undertaken:

The material used was part of the stool passed on March 16, which had been in the ice box forty-eight hours. At the time the experiment was started, none of the cysts had passed beyond the sporoblast stage. A quantity of faeces was emulsified in physiological salt solution and spread out in a very thin layer on the middle of each of a number of slides. The area covered was square and about equal to the area of an ordinary square cover slip. The slides were quickly examined under the microscope to make certain that they contained cysts and were then placed at the window in the direct rays of the forenoon sun, which is very hot in Manila at this time of the year. The slides were allowed to remain there for about two hours, at the end of which time they were distinctly hot,

and the material on them was literally baked "bone dry." They were then placed in Petri dishes for protection and allowed to remain in the same position, still exposed to the morning sun. This was on March 18.

The slides remained thus exposed to the hot sun for about three hours each forenoon, until March 25. On that day, another set of Petri dishes was prepared with wet filter paper in the bottom of each, forming a set of moist chambers. The dried slides were transferred to these, being supported on match sticks and inverted so the water of condensation from the filter paper would collect on the faecal film. One or two of the slides were mounted in water and examined under the microscope. Many badly wrinkled oöcysts were found, but the contents had a healthy, greenish tint. All were in early stages of development.

On the following day (March 26) the slides were examined in water mounts, but no changes were noted. On March 27 one fully developed cyst (Plate 3, fig. 10), not visibly deformed, and bearing every evidence of good health save for the unusual character of the sporocystic residuum, was found. This cyst was firmly embedded at one edge in a mass of faecal débris, but it could be clearly studied. Many cysts found were dead and degenerated, but many zygote, sporoblast, and sporocyst stages, with badly wrinkled oöcysts but with apparently healthy interiors, were also found.

The last examination of the slides was made on the afternoon of March 29. It was found that there was a tendency for the wrinkled oöcysts to smooth out. Some of the fully developed cysts that appeared to be in good condition, showed a close contraction of the oöcyst around the sporocysts (Plate 2, fig. 12). The similarity in appearance of the sporocystic residuum to that of the cyst just mentioned should be noted. Numbers of apparently healthy cysts in intermediate stages of development also were found, as well as many, before observed, that clearly were dead.

The experiment, rough as it was, showed that complete desiccation of the faeces and daily exposure for at least three hours to the tropical sun over a period of a week will not prevent the full development of at least a portion of the cysts in a stool, as soon as a condition of moisture is restored. How long it would take the cysts to develop without the subsequent interposition of moisture, I cannot say, but I believe they would develop in the course of time.

Of course, infection experiments, only, would prove that the fully developed cysts I observed were actually living and capable of infecting a new host; but the sporozoites bore every evidence from their color and general appearance of being alive.

A series of experiments designed to establish the resistance of the cysts to various chemical agents was also undertaken, but the results so far secured are not altogether satisfactory. For that reason a report on them will be deferred to a later paper. I am inclined to suspect, however, that the cysts of *Isospora hominis* are not so resistant as those of *I. bigemina*.

EPIDEMIOLOGICAL CONSIDERATIONS

The epidemiology of human coccidiosis offers the subject of a rather interesting study. It is a study, however, that is fraught with not a little difficulty to the microscopist who is unfamiliar with the sporozoa. It is true that the present geographical distribution of the coccidia of man rather closely coincides with the geographical distribution of experienced protozoologists, but there is the not less-striking fact that a large proportion of the cases so far reported can be more or less directly traced to one source—the eastern Mediterranean area, Mesopotamia, or the Balkans. In fact, out of the cases shown on the map accompanying this paper only four, Noc's Saigon case (the identity of the parasite here is not established), the two cases found by Miss Porter in Johannesburg, and Snijders' Sumatra case, appear to be untraceable. Moreover, while there have been changes in personnel in the different laboratories where large numbers of stools are examined, protozoologists have been pretty well scattered about the world for years. War conditions will account for the discoveries of the early cases, but they do not account for the later detections.

Dobell⁽³⁾ has thoroughly reviewed the situation up to 1919, so it is unnecessary to repeat the statistics he has given and the illuminating comment he has made. The principal findings are plotted on the map. Dobell⁽⁵⁾ also has disposed of two fictitious cases of human coccidiosis, so they need not be considered here.¹ For the purpose of tracing the case reported in this paper, however, it is necessary to recall that Brumpt has stated that the French armies were infected with *Eimeria* to the extent of 0.2 to 0.33 per cent. Nothing, however, is said about *Isospora*

¹ I refer to the cases reported by Huetter and by Lockhart Mummery and Gabriel.

infections; but I think we may safely assume that, if the French troops were infected with *Eimeria*, they were infected with *Isoospora* as well, especially as *Isoospora* infections so far reported seem to outnumber the *Eimeria* infections.

Porter,⁽¹³⁾ in 1917, discovered two cases of infection with "*Isoospora bigemina* var. *hominis*" in Johannesburg. One of these infections was in a Hottentot, and the other in a Dutch South African who had never been out of the country. No data are given that will aid in tracing these cases. Noc,⁽¹²⁾ meanwhile, in 1916, had picked up a case of *Isoospora* infection in a European at Saigon. The case was lost to study after the first examination of the fæces, and Noc has ventured the supposition that the man had been eating rabbits' livers that were infected with *Isoospora bigemina*. As he gives no description of the cysts he found, it is impossible to pass judgment on this. No information was obtained as to the previous travels of the man.

Noc, fortunately, was able to secure more detailed information concerning the travels of the man whose case he recently reported from Senegal.⁽¹²⁾ His description leaves no room for doubt that the infection was with *Isoospora hominis*. The man had been at St. Mihiel, and had been a prisoner of war in German camps in Westphalia, Wurttemberg, and Hanover, where the sanitary conditions were very bad. The patient had every opportunity to pick up his infection at any of these four places, and it seems to be perfectly reasonable to assume that the ultimate source of the infection was the eastern Mediterranean area.

Snijders⁽¹⁴⁾ reported his case almost coincidentally with Noc, while Dobell⁽⁵⁾ has confirmed his findings and has given the name *Eimeria snijdersi* to the parasite, thus bringing the total number of species of coccidia known to be parasitic in man up to five.²

Snijders' case was presented by a man at Medan on the east coast of Sumatra, who had lived in the Tropics for ten years. He gave a history of amœbic dysentery extending back for five years. The infection seems to have been especially intractable, for it had failed to yield either to emetine or to emetine bismu-

² For the present, at least, I think we must accept Dobell's judgment regarding Gubler's coccidium of the human liver. Dobell has left the naming of this organism to some investigator who, in the future, may run across and study it. He merely designates it as "an undetermined species of *Eimeria* (?)."

thous iodide. The cysts of this coccidium appeared only once in the stools of the patient, but on that occasion they were exceedingly numerous. Snijders has given a good description of them; and Dobell,⁽⁵⁾ who studied some of his material, has shown that the species is entirely distinct from *Eimeria oxyspora*, to which it bears a superficial resemblance in that it forms whetstone-shaped spores. There the resemblance ceases.

This case, of course, must be looked upon as an isolated one. The parasite bears no real resemblance, beyond its generic characters, to any of the other Eimeridæ that have been reported as occurring in man, and there is nothing in the history of the man's travels that would lead us to believe that he contracted the infection outside of Sumatra. Snijders observed no intestinal symptoms that could be attributed to the coccidia.

One more report requires special reference at this time, because it carries the infection farther east and helps to establish the banding of the globe by *Isospora hominis*. That is the report of Cragg,⁽¹⁾ who in 1918 recorded four cases of *Isospora* infection in men returned from Mesopotamia. Reference to these cases will be made later.

If we are to regard the five species of coccidia³ now credited with being parasitic in man as specific parasites of man, and evidence to the contrary is lacking, we must expect to find many more infections; for every one of the cases reported must, of course, have been derived from an infection in some other man. It is rather trite to say that these strains must have been carried on for long periods of time, and there is little reason to believe that they are about to perish abruptly at this time.

It is barely possible that the dissemination of human coccidial infections is partially governed by environmental conditions of a peculiar nature, but the distribution already has reached points in the Tropics as well as in temperate regions. However, very little has been learned as to how much dissemination occurs at any points outside of the eastern Mediterranean area. Dobell,⁽⁶⁾ in his recent report on autochthonous infections with intestinal protozoa among inhabitants of Britain, says:

I would particularly emphasize the fact that no infections with intestinal coccidia or with *Balantidium* appear to have been reported in British residents who have never been abroad. As regards the former, it may be noted that there is one British case of supposed coccidiosis of the liver (Silcock, 1890); but this is still somewhat doubtful.

³ I refer to *Eimeria wenyoni*, *E. oxyspora*, *E. snijdersi*, *E. (?) sp.* and *Isospora hominis*.

This would seem to me not to be particularly surprising, if we regard the invasion of Britain by the coccidia of man as having taken place under war conditions and during that period. The only way in which it seems to me possible to establish if conditions in Britain are favorable to the dissemination of coccidial infections in man would be to trace the cases among returned soldiers that have been observed and round up their contacts both before and after their infections were discovered. To be sure, this might be difficult. It would seem to me to be a highly desirable and rather interesting thing to do this at all points where *Eimeria* and *Isospora* have been reported.

The reports of Kofoid and his coworkers indicate strongly that coccidial infections have reached the United States from the eastern Mediterranean country, probably by way of France; and there is reason to believe that dissemination has taken place, as witness the four autochthonous infections reported by him. Of course, there remains the possibility that the infection has been mildly endemic in the United States for a long time, and unless we can get detailed data regarding the antecedents of the four cases he reports in home-service troops, which would dispose of that idea, we must continue to carry it in mind.

Kofoid's findings were made in the course of the study of the stools of between 2,000 and 3,000 overseas and home-service troops at Debarkation Hospital No. 3, New York, in 1919. In his first paper⁽¹⁰⁾ Kofoid states that the overseas troops had seen service in Flanders, Chateau Thierry, the Argonne, and Toal, while some of them had been in France but had never seen service at the front. These troops served in 584 regiments and had been recruited from every state in the Union. Only a small proportion of them had served on the Mexican border. The home-service contingent was largely composed of cooks, bakers, and food handlers from the point of debarkation—principally from the medical department. The names of 27 per cent of these were suggestive of Russian, Polish, Italian, or Spanish nationality. Seven of them were negroes from Florida. In his first paper, Kofoid records the findings in his table, making no allusion to them in the text. He found and recorded, under the name *Isospora*, six infections in overseas troops and four in home-service troops.

In the second paper,⁽¹¹⁾ which apparently represents a continuation of the previous work, and which is reported more fully in the transactions of the American Gastro-enterological Asso-

ciation for 1919,⁴ seven cases in overseas and four in home-service troops are recorded in the accompanying table under the term Sporozoa. I am assuming that the second paper represents an extension of the work reported in the first and therefore have considered that Kofoid and his coworkers found eleven cases in all, four of which are under suspicion as being autochthonous.

I think we may safely assume that the case reported by me was autochthonous in the United States, because there was small chance of its having been picked up in Japan en route to the Philippines, and I doubt exceedingly the presence of human coccidial infections in the Philippine Islands prior to this case. In the United States there is a very suggestive history of contact at the munitions works in Nitro, although the method by which infection might have been brought about is not so clear. At the front the conditions for the dissemination of intestinal parasites were rather favorable, and that, coupled with the thorough system of stool examinations carried out by the allied armies, explains the comparatively large number of cases that were discovered during the course of the war.

Taking all these things into consideration and adding the interest in and knowledge concerning these parasites that is certain to follow recent work on them, I think we may expect to hear of other cases in the United States as well as elsewhere.

Turning back to the Manila case, we find a state of affairs that is not without promise of future developments. When this patient stopped at Cotabato in the course of his trip, he lived at the local hotel. The sanitation there he reports as very bad, the water closet being located next to the kitchen. At Parang and Reina Regente, which he also visited, the sanitary conditions were somewhat better. The method of disposal of excreta at these places is what is known as the "can system." By this method, the faeces are passed into large gasolene cans to await the convenience of the attendant delegated to look after them. In well-regulated households the cans are kept covered and are emptied rather frequently, and thus secured against invasion by flies, cockroaches, and other itinerant scavengers; but not all households are well regulated, so that the system sometimes breaks down and becomes a serious factor in the dissemination of intestinal infections. The methods of disposing of the contents of the cans is not always what it should be.

⁴I have not, so far, seen this paper.

It was in the Bual district, however, where the excreta disposal conditions were the worst. In this section of country, where there are any closet facilities whatever, the system is what is colloquially spoken of as the "pig system." The "pig system" is widely employed throughout the Tropics as a labor-saving institution under the mistaken notion that the pig altruistically protects mankind against the spread of intestinal diseases. Incidentally, his activities are supposed to result in economy of municipal funds. I have accumulated sufficient evidence during my stay in the Philippine Islands to convince myself that in his rôle as a sanitarian and public benefactor the domestic pig is a dismal failure, and that, while he brings about a superficial appearance of cleanliness, he really makes a bad matter worse by distributing a more or less localized filth broadcast within a settlement. The back doors of latrines are left open for his convenience, he avails himself of the facilities thus afforded him, and then sallies forth upon the highway and among the children of the village, in their mud-pie industry, fulfilling his errand of dissemination. In the course of time he has distributed his consignment of human parasites, shipped at the latrine, and may even have added a few of his own in the form of *Balantidium coli*.

From such observations as I have been able to make, I believe that the ova and cysts of the general run of intestinal parasites of man pass unchanged through the alimentary tract of the pig and emerge quite as potential for harm as if they never had made the journey. Therefore, it seems to me not at all unlikely that in this country, where the parasitic index already is high, we may expect, in the course of time, to encounter new cases of infection with *Isospora*.

There are several means by which the cysts of *Isospora* in an infective stage may be transmitted in a country such as this. Direct transmission through the medium of the soiled hands of a food handler is not altogether impossible for I have shown (p. 462) that, under certain conditions, cysts may reach full development within thirty-two hours after the passage of the stool containing them. I have known food handlers who refrained from washing their hands over even longer periods than this. Flies, pigs, and probably cockroaches must be accepted as likely vectors, and there is the old bogey of green vegetables fertilized with human excreta. In fact, the methods of transmission are much the same as in the case of the other intestinal Protozoa. Peculiar factors involved are the longevity and

higher resistance of the cysts and the fact that a longer period of exogenous development is required before the cysts of *Isospora* become infective. With *Eimeria* this period is greatly reduced, for the cysts of species of this genus may be passed almost fully if not completely developed. Other protozoan cysts are usually fully developed when they leave the intestine and are more vulnerable to unfavorable environmental conditions.

The self-limiting nature of intestinal coccidiosis precludes the occurrence of coccidia carriers. This, of course, presupposes the avoidance of reinfections of the original host, that may operate to bring about the more or less constant discharge of cysts over periods beyond the duration of a primary infection.

It will be a matter of interest, moreover, to watch the developments in the United States, for it is my belief that other cases will occur there and add to the new problems that the home-coming soldier has brought with him. In this connection I am minded to repeat certain remarks I made in the course of a paper published in 1917:(8)

The importance of the protozoa as the causative factors in many grave diseases is thoroughly recognized today by every alert practitioner, particularly those whose labors carry them into tropical or semitropical zones. There is likewise a gradual awakening to the fact that many parasitic protozoa do not restrict their activities to those localities, but, on the contrary, are exceedingly ubiquitous. With the opening up of new trade routes and the broadening and development of commerce to the Far East, South America and Africa, and as a result of conditions which are developing with the progress of the European war, they are gradually establishing themselves in cooler climes. The malarial parasite has long been known too well in North America, and there is a growing realization that endemic dysentery is not by any means a rare malady in the same territory. The medical schools of the United States will have to cope with this situation before long, and they can meet it only by extending their curriculums so as to meet the protozoological needs, not only of the men who will have to deal with conditions at home, but also of the rapidly increasing number of medical men who are answering the call to the tropics.

PATHOGENICITY

Before going into the question of pathogenicity and the problem of the treatment of coccidial infections in man, it may be well, for the benefit of those who have not had the opportunity to study these organisms, briefly to review the coccidial life cycle. In all essential points, the life cycles of species of the genera *Eimeria* and *Isospora* coincide with that worked out by Schaudinn for *Eimeria* (*Coccidium*) *schubergi*, parasitic in the gut of *Lithobius forficatus*. The parasite enters the alimentary tract of the host in encysted form. In *Eimeria* these cysts (oöcysts), on full development, contain four dizoic spores;

in *Isoospora* there are two tetrazoic spores, there being eight sporozoites formed in each case. In the intestine the vermiform sporozoites emerge from their containing cysts and invade the epithelial cells of the mucosa of the small intestine. In some instances the epithelium of the bile ducts is invaded, but this seems not to be the case with species of *Isoospora*, which seem to restrict their activities to the intestine. They are obligatory epithelial-cell parasites. Within the host cell the sporozoites develop into trophozoites, which grow at the expense of the protoplasm of the host cell. When the food supply has become exhausted, and the trophozoite has attained full growth, the nucleus undergoes multiple division (schizogony) and with plastogamy a number of daughter cells, or merozoites, are formed.⁵ These escape from the host cell and enter the bowel lumen to seek new host cells. Those that are successful, in their turn develop into trophozoites which also undergo schizogony. This asexual cycle is repeated a variable number of times, depending upon the vitality of the race,⁶ and finally changes take place leading to a sexual process (sporogony), which is initiated by a process of fertilization involving the union of sexually differentiated gametes. This is followed by the encystation of the zygote, which then passes out of the fæces and completes its development in the outer world. It so comes to pass that in the course of events the entire race, in time, undergoes sporogony and the host becomes purged of his infection. In this respect, the infection may be said to be self-limited, and if the host can withstand the initial onslaught, his chances for recovery are good. No immunity is conferred, however. In a large proportion of cases the host seems to undergo no marked discomfort, while in others, as in the case of the karyozoic parasite *Cycloospora caryolytica* of the ground mole, the symptoms may be very acute and rapidly progress to a fatal termination. In other cases, the infection may drag along for a long period of time, the host constantly discharging cysts. In such cases, however, it is necessary to rule out reinfection with a new crop of parasites.

⁵ Porter says fifteen to twenty merozoites are produced from one schizont in the *Isoospora* of man. I presume she bases this statement on the infection experiments of Fantham with kittens, the report of which I regret to say I have not seen.

⁶ Some authors maintain that "virulent" infections leading to extensive destruction of tissue bring about a condition which stimulates the development of sporogony and thereby relieves the situation.

There is some diversity of opinion regarding the pathogenicity of *Isoospora hominis*. Fantham,(7) in a paper which I regret is not accessible to me, has claimed success in infecting kittens with *Isoospora hominis*, and to have produced a condition in the intestines "resembling that seen in the human intestine examined post mortem." In a footnote (p. 186) Dobell(3) comments: "This, however, has never been described, so far as I am aware; and the statement can hardly be accepted without some concrete evidence to support it."

Animal experiments, with this exception, that have so far been attempted with this parasite have uniformly failed, attempts having been made with kittens, a mouse, and two young puppies. Noc(12) also fed the cysts to a white rat, but up to the time he wrote his paper he had secured no evidence that infection had taken place.

Practically all writers agree that the parasite has a certain potentiality for harm, but one great objection to many of the observations made lies in the fact that the patients were suffering from dysentery or some other intestinal ailment that would tend to obscure any existing coccidial symptoms. In one case studied by Wenyon(17) in which there were a concomitant infection with *Entamoeba coli* and dysenteric symptoms, no cause for the dysentery could be found and Wenyon remarks that "It may have been that the dysenteric symptoms of this case were due to the coccidium, for no pathogenic bacteria had been isolated from the fæces;" which, however, does not necessarily follow, as one may gather from the conservatism of the statement. Dobell(2) states his conclusions (p. 68) as follows:

No evidence is brought forward to show that either of the Coccidia found (*Isoospora* or *Eimeria*) is pathogenic. As both of these are tissue-parasites, which probably invade the cells of the small intestine, it is possible that they may give rise to pathological conditions. At present there is no indication that this is so. It may be added that many animals appear to suffer no inconvenience from immense infection with coccidia; and it is quite possible therefore that the forms occurring in man are of no practical importance.

The watery diarrhoea reported in three of Cragg's Mesopotamia-Bombay cases looks interesting, but the cases are too clouded by dysenteric complications to admit of much stress being laid upon them. It is greatly to be regretted that the opportunity afforded for a study of the intracellular stages of

the parasites in Cragg's two cases that went to autopsy was not realized.

I am strongly of the belief that the symptoms exhibited by my patient were due to his coccidiosis. Beyond an infection with *Blastocystis* he carried no parasites except the *Isoospora*, and much of the time his diet was under strict regulation. Noc's patient complained of pain in the right iliac region, and he exhibited hepatic enlargement and persistent diarrhoea. Noc reports the presence of no other intestinal parasite, although the high eosinophile count (6.5 per cent) looks suspicious.

The gross and microscopical lesions accompanying infections with *Isoospora hominis* must remain a matter for speculation until some case goes to autopsy. Porter(13) says the epithelium of the ileum is often most heavily infected and that the jejunum is also invaded. This postpones the settlement of the whole question of pathogenicity. Cases so far reported have been in adults and the symptoms—when there have been any—seem not to have been grave. We have yet to see how it will affect young children and enfeebled persons. The best account of the microscopical lesions accompanying coccidiosis that is available to me is that of Tyzzer,(15) who studied coccidiosis in the bile ducts of the rabbit. He says (pp. 249 to 251) :

The parasites attack only epithelial cells. The young form inhabits the protoplasm of the cell, which becomes more and more distended as the parasite develops. The nucleus, at first slightly indented, later becomes crescent-shaped. The structure of the chromatin cannot be made out, and the nucleus is stained darkly. Thus at the termination of this process, the epithelial cell is reduced to a sac containing a parasite, having on one side a darkly stained crescent, representing the degenerated nucleus * * *. Ruptured cells are found from which the parasites have been set free. Degeneration and destruction of epithelial cells thus follow their invasion by parasites. Numerous mitoses are seen in the epithelium and, where the infection is not overwhelming, proliferation is in evidence. The epithelium is markedly thickened and its cells are crowded. Accompanying the destruction of single cells, exudative phenomena are absent. With the destruction of small areas of epithelium, there is exudation of fibrin and leucocytes * * *. The latter occurs, however, only occasionally, and is the exception rather than the rule. When bacteria are present, the exudative phenomena are increased. The surrounding connective tissue is rich in cells. There are large numbers of lymphoid and plasma cells. Epithelioid and lymphoid cells occur between the cells of the epithelium. The epithelium oftentimes lacks a definite basement membrane, and young connective tissue and epithelium is so mingled that the resulting relations are

decidedly confusing. Large phagocytic giant cells occur in conjunction with collections of oöcysts, the latter acting as foreign bodies. In some lesions large numbers of eosinophile cells are found scattered through the connective tissue.

The formation of the papilliform projections is to be explained by the hyperplasia of the connective tissue, which pushes through the defects in the epithelial layer. The question arises as to whether the proliferation is primarily of the epithelium or of the connective tissue. As proliferation is never confined solely either to epithelium or to connective tissue, it is to be presumed that the process involves both tissues at the same time. The steps of the process may be summarized as follows:

Following the invasion of its protoplasm by a parasite, the epithelial cell undergoes gradual but inevitable degeneration and finally becomes destroyed. The death of the cell produces a defect in the epithelial lining of the bile-duct. With the destruction of several adjacent cells the injury is greater and exudation of fibrin and leucocytes may take place. On account of the defect in the epithelium, the underlying connective tissue is stimulated and proliferates. Pushing through the break in the epithelial layer, it forms the papilliform projections before described. At the same time the epithelium proliferates in an attempt to repair the defect in its continuity. As the parasites multiply, many mature forms become free in the bile-ducts, where they cause irritation, acting as foreign bodies.⁷

Evidence of this irritation is seen in the thickening and hyperplasia of the epithelium of the small ducts and in the hyperplasia of the surrounding connective tissue. In some instances the biliary epithelium is desquamated and portions of it are passed down the ducts. The epithelial cells often present a peculiar change in their nuclei * * *. The chromatin is condensed into several intensely staining masses which lie against the nuclear membrane. The nuclear material apart from the chromatin is unstained. The nucleus as a whole is abnormally large and appears hollow. Councilman has described similar changes in the corneal corpuscles of the rabbit's cornea. In that instance this arrangement of the chromatin preceded the direct division of the cell and was regarded as a degenerative change.

It seems to me that the contingency mentioned in Tyzzer's footnote is one that may have to be reckoned with in heavy intestinal infections. Both my case and that of Noc showed that many epithelial cells are cast off during the progress of the infection. Tyzzer summarizes, in part, as follows:

The lesion is of the nature of a chronic inflammatory process. The tissues react to the irritation which the parasites cause by their presence in the bile ducts. With the removal of the irritation, repair takes place. Thus the whole is to be regarded as a physiological process, checking the inroads

⁷ There is no evidence that the parasites of themselves secrete any toxic substance, but their presence in the biliary epithelium renders it more liable to bacterial invasion. In some instances the effect of bacteria is to produce an abscess cavity, in which but few coccidia are to be found. (This footnote is Tyzzer's.—F. G. H.)

of the parasite. * * * The process is self-limited and repair follows the destruction of the parasites.

I have noted, in connection with the study of some coccidia found in the little wall lizards that are common about Manila, that infections seem at times to progress rather far, distally, along the intestine. This is something I believe other workers have noted in the past. It is quite conceivable that a vigorous race of coccidia might make a rather long journey along the intestine before sporogony intervened, and it is possible that effects may be seen in the functioning power of the mucosa long after the infection has actually gone.

TREATMENT

Treatment for intestinal coccidiosis remains to be worked out. In fact, it may be maintained that, in as much as these coccidial infections tend toward self-limitation, the matter is of little moment. Before adopting that stand as a matter of policy it would seem to me to be wise to follow some of the old cases and see how they are faring, to give close clinical study to such new cases as may be detected and, moreover, to make a careful study of any cases that may occur in children and in people of enfeebled constitution.

So far, emetine has failed absolutely, and nothing conclusive is shown by Noc's case⁽¹²⁾ that he treated with novarsenobenzol and thymol. Miss Porter,⁽¹³⁾ in speaking of one of her Johnnesburg cases says (p. 27): "After the elimination of the parasite by appropriate treatment the man recovered." This patient was at first thought to be suffering from amœbic dysentery, but *Isoospora* was the only protozoan parasite found and Miss Porter says (p. 19): "* * * with its destruction and elimination the symptoms also disappeared." Unfortunately, the writer gives no information as to the nature of the treatment that was instituted in this case.

Attempts at treatment of these coccidial infections are likely to meet the same obstacles that are encountered with *Giardia* infections. It is barely possible that the intracellular forms may be reached with some arsenical preparation. Merozoites entering the lumen of the bowel might be reached by a drug such as thymol or oil of chenopodium, but the drug would have to be exhibited at a time when merozoites were being discharged and it might not reach those deep in the intestinal crypts. On

theoretical grounds, it would seem appropriate to outline the campaign against the parasites much as is done in malaria, and deliver the drug to the bowel lumen at about the time that schizogony is taking place, for the merozoites would appear to be the most vulnerable forms in the life cycle.

The difficulty here lies in the determination of the time at which schizogony takes place through some physical sign exhibited by the patient. It would also be useful to know if schizogony in these coccidia is synchronous and rhythmic as it is in *Plasmodium*. It is reasonable to expect that such is the case, for the mature spores ingested by the host are all fixed at one stage in the life cycle, and those entering the small intestine might be expected to open rather promptly so that the sporozoites would begin their development in the epithelial cells at approximately the same time.

During the progress of my case I tried, so far as possible, to discover some sign that would tend to fix the time at which schizogony was taking place, but I failed. In questioning the patient about the character of the stools he passed each day I was told by him that he had noted some periodicity in the diarrhoea. That is to say, on one day the stool would be normal, on the next day it would be soft or watery, the following day normal, and so on. In other words he was inclined to believe that the periodicity was tertian. As I had asked rather leading questions, I tried not to place too much stress on the periodicity, especially as it seemed to lead very little nearer to what I was seeking. However, I note that Noc,⁽¹²⁾ in speaking of diarrhoea in his patient, says (p. 786):

La diarrhée actuelle a débuté vers la fin d'août, 3 ou 4 selles par jour, liquides fétides, noirâtres, survenant surtout le matin. *Courtes rémissions de 24 heures.*^{*}

This is offered merely as a suggestion for later work and not because I believe that it is particularly definite. It may be that the simultaneous penetration of a large number of merozoites into epithelial cells at approximately the same time causes sufficient irritation of the intestine to set up a diarrhoea. That being the case, it would only remain to determine the time, making suitable allowance for the appearance of the diarrhoea and then administer a drug (yet to be determined) at a time when it would find the merozoites seeking new host cells. This

* The italics are mine.—F. G. H.

would seem to me to establish a scientific basis for treatment, if the facts could be determined.

ACKNOWLEDGMENT

I would, indeed, be ungrateful were I to close this paper without a word of thanks to this patient who faithfully and patiently brought me the material that forms the basis of it. Notwithstanding he was feeling really ill much of the time and was pressed with business in the bargain, he visited my laboratory several times for the purpose of furnishing me with fresh material. A worker in another branch of science unrelated to zoölogy, he entered into the spirit of the study with interest and with as much enthusiasm as it is possible for a man to assume when he feels sick and is uncertain as to the outcome of it all. He received no treatment other than the assurance that the infection would, in time, die out. It was very pleasant to tell him on the day of his departure for the United States that his infection was dying out and that he probably soon would be rid of it.

LITERATURE CITED

- (1) CRAGG, F. W. Observations on dysentery cases from Mesopotamia. *Indian Journ. Med. Res.* 5 (1917-18) 301.
- (2) DOBELL, CLIFFORD. Amoebic dysentery and the protozoölogical investigation of cases and carriers. *Spec. Rept., Ser. No. 4, Med. Res. Comm., London* (1917) 68.
- (3) IDEM. A Revision of the *Coccidia* parasitic in man. *Parasitol.* 11 (1919) 147.
- (4) IDEM. *The Amoebae Living in Man—a Zoölogical Monograph.* London, John Bale Sons & Danielsson (1919).
- (5) IDEM. A note on the new species of *Eimeria* found in man by Dr. E. P. Snijders. *Parasitol.* 12 (1920) 433.
- (6) IDEM. A report on the occurrence of intestinal protozoa in the inhabitants of Britain. *Spec. Rept., Ser. 59, Med. Res. Council, London* (1921) 54.
- (7) FANTHAM, H. B. Some parasitic protozoa of man and their probable evolution. *Med. Journ. of South Africa* 13 (1917) 33. Cited by Dobell, No. 3.
- (8) HAUGHWOUT, FRANK G. The teaching of protozoölogy to medical students. *Journ. Am. Med. Assoc.* 68 (1917) 1470.
- (9) IDEM. Infections with *Coccidium* and *Isospora* in animals in the Philippine Islands, and their possible clinical significance. *Philipp. Journ. Sci.* § B 13 (1918) 79.
- (10) KOFOID, CHARLES A.; KORNHAUSER, SIDNEY I; and PLATE, J. T. Intestinal parasites in overseas and home service troops of the U. S. Army. *Journ. Am. Med. Assoc.* 72 (1919) 1721.
- (11) KOFOID, CHARLES ATWOOD, and SWEZY, OLIVE. On the prevalence of carriers of *Endamoeba dysenteriae* among soldiers returned from overseas service. *N. O. Med. and Surg. Journ.* 73 (1920) 4.

- (12) NOC, F. Nouveau cas de Coccidiose intestinale humaine a Isosopora. Bull. Soc. path. exot. 13 (1920) 785.
- (13) PORTER, ANNIE. A survey of the intestinal entozoa both protozoal and helminthic, observed among natives in Johannesburg from June to November, 1917. Pub. S. African Inst. Med. Res. No. 11 (1918).
- (14) SNIJDERS, E. P. On the cysts of a hitherto undescribed species of Eimeria in human stools. Parasitol. 12 (1920) 427.
- (15) TYZZER, E. E. Coccidium infection of the rabbit's liver. Journ. Med. Res. N. S. 2 (1902) 235.
- (16) WENYON, C. M. Observations on the common intestinal protozoa of man: their diagnosis and pathogenicity. Journ. Roy. Army Med. Corps 25 (1915) 600.
- (17) IDEM. The protozoological findings in five hundred and fifty-six cases of intestinal disorder from the eastern Mediterranean war area. Journ. Roy. Army Med. Corps 26 (1916) 445.
- (18) WOODCOCK, H. M. Notes on the protozoan parasites in the excreta. See Ledingham and Penfold, Brit. Med. Journ. 2 (1915) 704.

ILLUSTRATIONS

[Figures drawn by Haughwout from camera lucida sketches. Map drawn by Macario Ligaya.]

PLATE 1

FIGS. 1 to 10. Stages of sporoblast formation in *Isospora hominis* (Rivolta).

PLATE 2

FIG. 1. Late sporoblast stage in *Isospora hominis* (Rivolta).

FIGS. 2 and 3. Sporocyst stages.

FIG. 4. Early development of sporozoites.

FIGS. 5 to 11. Types of cysts in full development.

FIG. 12. Fully developed cyst after one week of dessication.

PLATE 3

FIGS. 1 to 12. Types of degenerated cysts of *Isospora hominis* (Rivolta).

PLATE 4

Map showing geographic distribution of human coccidiosis.

TEXT FIGURE

FIG. 1. Oscillation of sporoblasts following cell division in *Isospora hominis* (Rivolta).

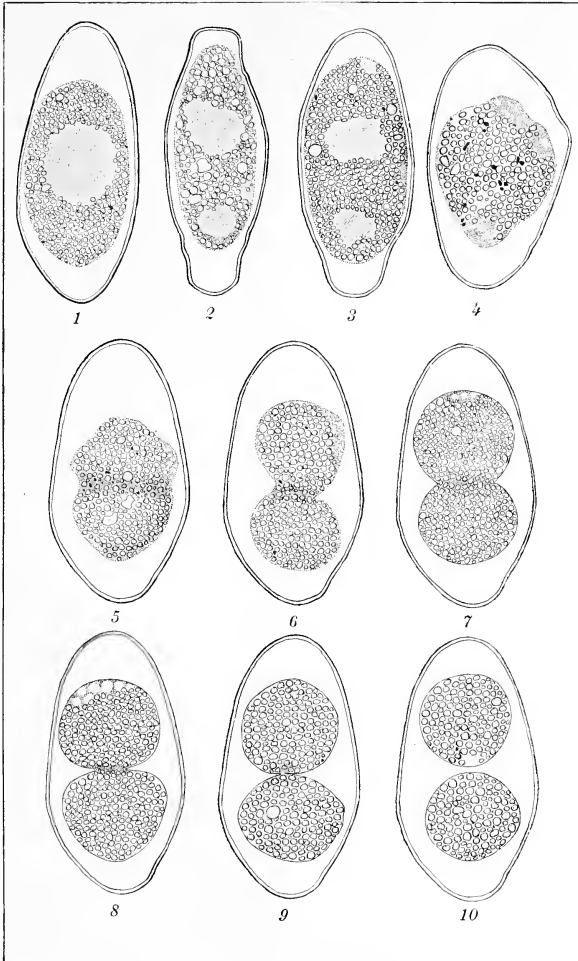

PLATE 1. ISOSPORA HOMINIS (RIVOLTA).

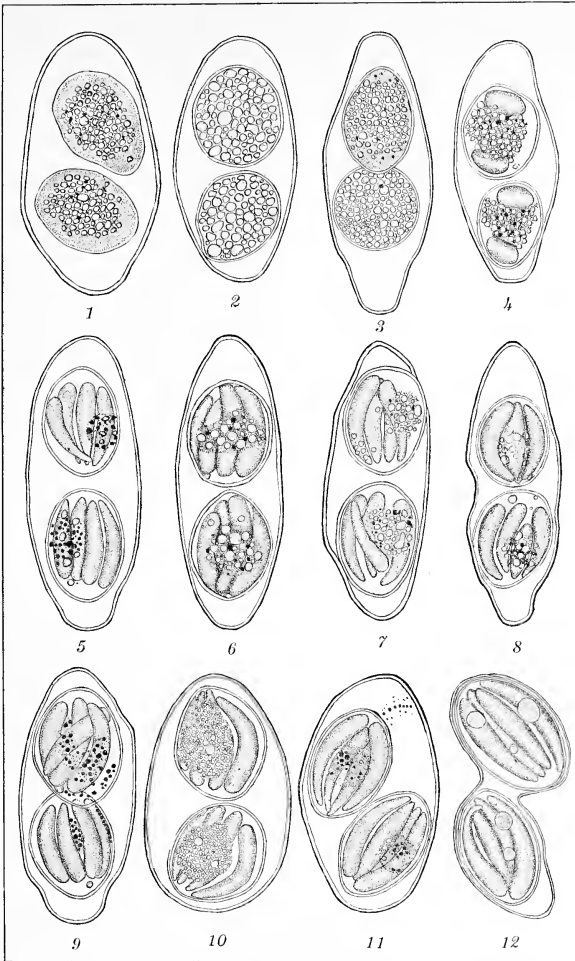

PLATE 2. ISOSPORA HOMINIS (RIVOLTA).

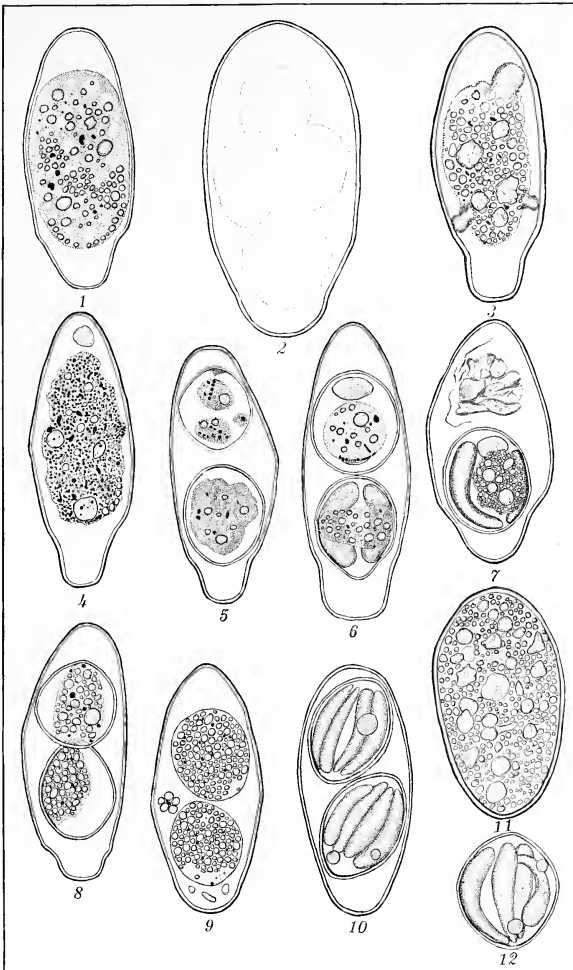
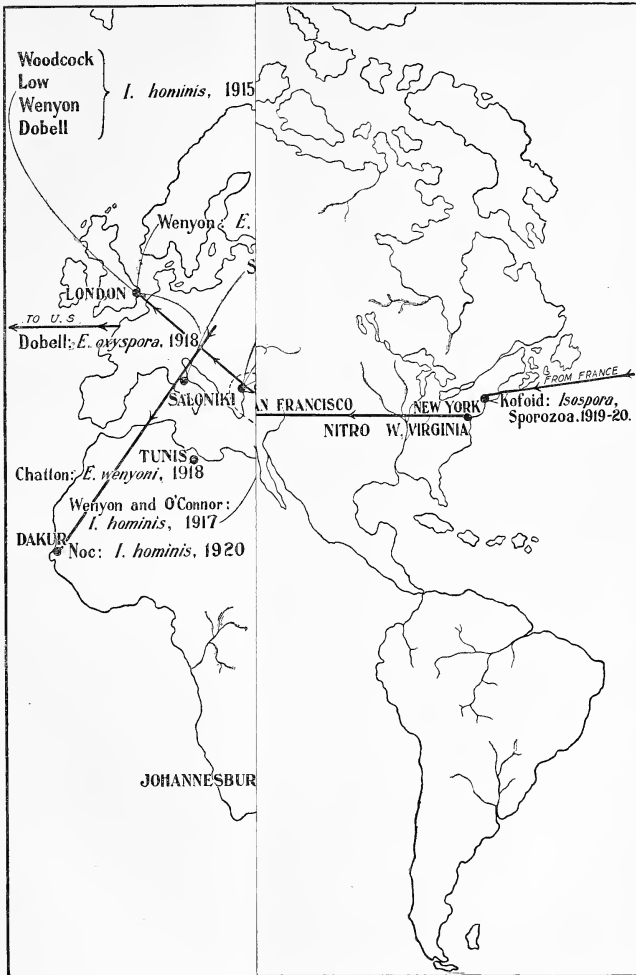

PLATE 3. ISOSPORA HOMINIS (REVOLTA).



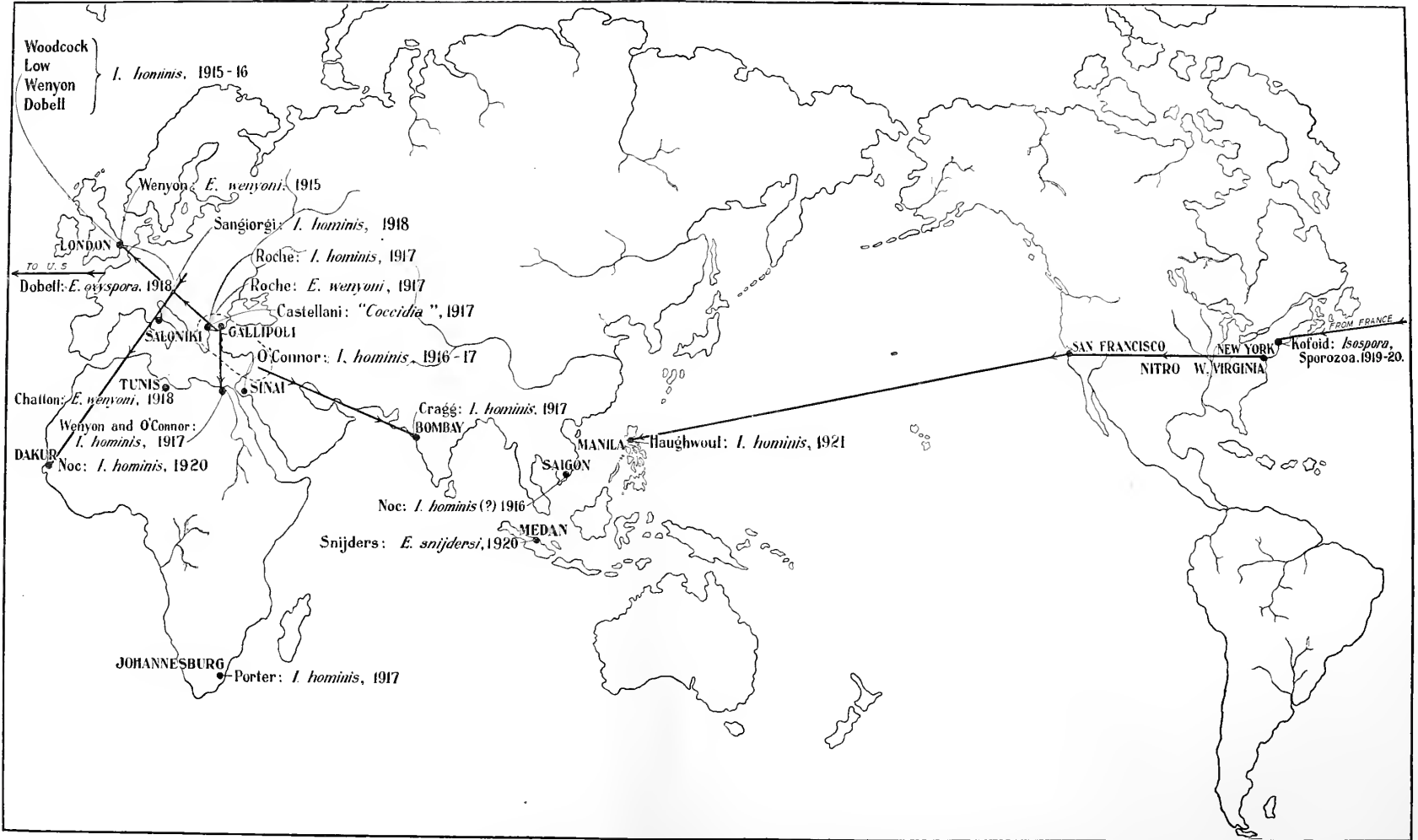

PLATE 4. THE GEOGRAPHIC DISTRIBUTION OF HUMAN COCCIDIOSIS.

THE PHILIPPINE BUREAU OF SCIENCE

RECENT PUBLICATIONS

AN INTERPRETATION OF RUMPHIUS'S HERBARIUM AMBOINENSE

By E. D. MERRILL

Based on the collections made in Amboina by the late Charles Budd Robinson

Order No. 450. Bureau of Science Publication No. 9. Paper, 595 pages and 2 maps.

Price, \$3 United States currency, postpaid.

SPECIES BLANCOANAE: A CRITICAL REVISION OF THE PHILIPPINE SPECIES OF PLANTS DESCRIBED BY BLANCO AND BY LLANOS

By E. D. MERRILL

Order No. 461. Bureau of Science Publication No. 12. Paper, 423 pages and 1 map.

Price, \$2.25 United States currency, postpaid.

PHILIPPINE WATER SUPPLIES

By George W. Heise and A. S. Behrman

Order No. 460. Bureau of Science Publication No. 11. Paper, 218 pages, 19 plates, and 4 text figures.

Price, \$1.75 United States currency, postpaid.

VEGETATION OF PHILIPPINE MOUNTAINS

The relation between the environment and physical types at different altitudes

By WILLIAM H. BROWN

Order No. 473. Bureau of Science Publication No. 13. Paper, 434 pages, 41 plates, 30 text figures.

Price, \$2.50 United States currency, postpaid.

PLEASE GIVE ORDER NUMBER

Orders for these publications may be sent to the Business Manager, Philippine Journal of Science, Bureau of Science, Manila, P. I., or to any of the following agents:

AGENTS

THE MACMILLAN COMPANY, 64-66 Fifth Avenue, New York, U. S. A.
W.M. WESLEY & SON, 28 Essex Street, Strand, London, W. C., England.
MARTINUS NIJHOFF, Lange Voorhout 9, The Hague, Holland.
KELLY & WALSH, Limited, 32 Raffles Place, Singapore, Straits Settlements.
THACKER, SPINK & CO., P. O. Box 54, Calcutta, India.
THE MARUZEN CO., Limited, 11-16 Nihonbashi, Tori-Sanchome, Tokyo, Japsa.

CONTENTS

	Page.
PERKINS, GRANVILLE A. The structure of the electron	325
PERKINS, GRANVILLE A. Absolute units and the relativity principle	341
FISHER, W. S. New Coleoptera from the Philippine Islands. Family Buprestidæ, tribe Agrilini	349
HAUGHWOUT, FRANK G. A case of human coccidiosis detected in the Philippine Islands, with remarks on the development and vitality of the cysts of <i>Isospora hominis</i> (Rivolta)	449

The Philippine Journal of Science is issued twelve times a year. The sections were discontinued with the completion of Volume XIII (1918).

Yearly subscription, beginning with Volume XIV, 5 dollars United States currency. Single numbers, 50 cents each.

Publications sent in exchange for the Philippine Journal of Science should be addressed: Library, Bureau of Science, Manila, P. I.

Subscriptions may be sent to the BUSINESS MANAGER, Philippine Journal of Science, Bureau of Science, Manila, P. I., or to any of the agents listed on the third page of this cover.

VOL. 18, No. 5

MAY, 1921

THE PHILIPPINE JOURNAL OF SCIENCE



MANILA
BUREAU OF PRINTING
1921

THE PHILIPPINE JOURNAL OF SCIENCE

Published by the Bureau of Science of the Government of the Philippine Islands

ELMER D. MERRILL, M.S., *Editor*

R. C. MCGREGOR, A.B., *Associate Editor*

ALBERT H. WELLS, A.B.; GRANVILLE A. PERKINS, PH.D.; A. P. WEST, PH.D.
T. DAR JUAN, A.B., PHAR.D.; F. AGCAOLI, A.B.; A. S. ARGUELLES, B.S.
ALBERT E. W. KING

Chemistry

WARREN D. SMITH, PH.D.; ROY E. DICKERSON, PH.D.

Geology

H. W. WADE, M.D.; OTTO SCHÖBL, M.D.
F. G. HAUGHWOUT; STANTON YOUNGBERG, D.V.M.

Experimental Medicine

LIBORIO GOMEZ, M.D., PH.D.; F. CALDERON, B.A., L.M.
VICENTE DE JESUS, M.D.

Clinical Medicine

W. H. BROWN, PH.D.; C. F. BAKER, M.A.; ATHERTON LEE, M.S.
O. A. REINKING, B.S.A., M.S.; L. M. GUERRERO, PHAR.D.

Botany

ALBERT C. HERRE, PH.D.; C. F. BAKER, M.A.; S. F. LIGHT, M.A.
C. S. BANKS, M.A.; L. D. WHARTON, M.A.; W. SCHULTZE

Zoölogy

H. O. BEYER, M.A.; OTTO JOHNS SCHEERER, M.A.

Anthropology

ANNA B. BANYEA, *Copy Editor*

Manuscript intended for publication and books for review should be sent to the editor. One hundred separates of papers published in the Journal are furnished to authors without charge. Additional copies may be had at authors' expense.

Publications sent in exchange for the Philippine Journal of Science should be addressed: Library, Bureau of Science, Manila, P. I.

The Journal is issued twelve times a year. The subscription price is 5 dollars, United States currency, per year. Single numbers, 50 cents each.

Subscriptions may be sent to the BUSINESS MANAGER, Philippine Journal of Science, Bureau of Science, Manila, P. I., or to any of the agents listed on the third page of this cover.



THE PHILIPPINE JOURNAL OF SCIENCE

VOL. 18

MAY, 1921

No. 5

MECHANICAL TESTS OF SOME COMMERCIAL PHILIPPINE TIMBERS¹

By F. V. VALENCIA

Mechanical and Testing Engineer, Bureau of Science, Manila

ONE PLATE AND NINETEEN TEXT FIGURES

A general knowledge of the mechanical properties of different woods is essential to the safe and economical use of timbers for any structural purpose.

This preliminary paper, on the mechanical tests of Philippine woods being conducted by the Bureau of Science with the co-operation of the Bureau of Forestry, gives data which will serve as a basis for the comparison of species as well as for the establishment of working stresses. The results given should also be of use in determining proper factors of safety in connection with the design of timber structures, and in studying the relation of the physical characteristics and defects of timber to its strength.

The tests made may be divided into two general series: namely, tests of structural timbers, and standard tests of small specimens free from defects.

MATERIAL TESTED

It is universally agreed that the fundamental qualities of timber for structural purposes are strength and durability, but the availability of wood in the sizes required and the cost of the material often determine what kind of timber should be used in

¹ These tests were started by Mr. F. R. Ycasiano with the coöperation of the writer, and later, when Mr. Ycasiano left the Bureau of Science, the writer performed the rest of the tests.

any specific case. Ordinarily not only will native wood found in the local market serve the purpose of the engineer, but it can be secured in better grades and at lower prices. In such cases the local material will very likely be used, provided reliable information regarding its properties is available. Without such information, however, the tendency of the builder is to use imported wood whose mechanical properties are known to him.

SMALL CLEAR SPECIMENS USED

Small clear specimens are used in the tests in order that consideration of the influence of defects may be eliminated from calculations to determine the relation between strength and density, moisture, locality of growth, etc. These various relations are not referred to in a specific way in the present publication, on account of the very small number of timbers available for tests. The specimens are 2 by 2 inches in cross section. Bending specimens are 30 inches long; others shorter, depending on the kind of test made.

The materials first tested came from the local market, and the rest, which were botanically determined, came from the Bureau of Forestry. Mr. E. E. Schneider, wood expert, Philippine Bureau of Forestry, kindly furnished the descriptions of the woods.

TENSILE STRENGTH

Timber used in construction is practically never subjected to pure tensile stress, for the reason that the end connections cannot be so devised that they do not involve either shear along the grain or compression perpendicular to the grain. The resistance offered by any timber to compression across the grain, or shearing stress parallel with the grain, never amounts to more than a small fraction of the tensile strength, as shown by the tests. Therefore, the tensile strength of timber is not an important property except in so far as the tensile strength is involved in all cases of transverse loading. For reasons of economy in the erection of structures, iron and steel should be used in parts that are to be subjected to purely tensile stress.

TANGLE

Tangle [*Shorea polysperma* (Blanco) Merr.] is a very widely distributed and fairly abundant species. Foxworthy² estimates that it makes up about 7 per cent of the volume of the forests of the Islands. Botanical collections of tangle are re-

² Philippine Dipterocarpaceae, II, Philip. Journ. Sci. § C 13 (1918) 165.

ported from the following provinces and islands: Cagayan, Cagayan, Isabela, Ilocos Norte, Pangasinan, Nueva Ecija, Bulacan, Zambales, Bataan, Laguna, Tayabas, Polillo, Camarines, Albay, Sorsogon, Marinduque, Samar, Leyte, Cebu, Mindoro, Negros, Capiz, Biliran, Basilan, Surigao, Cotabato, Davao. Commercial material from other regions indicates that probably the species occurs in some places where it has not yet been reported.

Tangile is a tall, straight tree, reaching a diameter of 1.60 meters or more and a clear length of 22 meters or more. The average diameter of merchantable trees in regions where the species is fairly abundant ranges between 75 and 100 centimeters.

Tangile is soft to moderately hard and light to moderately heavy; the sapwood is thin (2 to 5 centimeters), pale grayish brown, not quite sharply marked off from the heartwood; the heartwood is pale pinkish red to dark reddish brown; the grain is distinctly crossed, producing a broad, conspicuous ribbon when quarter-sawn; silver grain small, but distinct; texture somewhat denser than most other lauans and taking a glossier surface under a sharp plane; seasons well and is easy to work. Not durable in contact with ground or when severely exposed to weather, but rarely attacked by insects, except by termites.

Structure.—Pith rays fine, less conspicuous than in most other lauans; pores small to fairly large, less numerous than in other lauans, evenly scattered; soft tissue much scantier than in most other red lauans; resin rings frequent, distinct, but very irregular.

Tangile is used chiefly for all kinds of interior finish and furniture. It is one of the woods that have been exported to America under the name of Philippine mahogany and, when finished properly, closely resembles true mahogany.

The logs for the present test were collected, with botanical specimens, in the cutting area of the Cadwallader-Gibson Lumber Co., at Limay, Bataan Province.

APITONG

Apitong (*Dipterocarpus grandiflorus* Blanco) is a very widely distributed and abundant species. There are several species of the same genus, the wood of which is not practically distinguishable and which is sold as apitong. It is therefore not possible to give an estimate of the quantity furnished by each species. Foxworthy³ estimates the total amount of apitong (including

³ Philip. Journ. Sci. § C 13 (1918) 164.

under this name the product of all the species of *Dipterocarpus*) at 20 per cent of the volume of the commercial forests. Apitong (*Dipterocarpus grandiflorus*) has been reported from the following provinces and islands: Cagayan, Isabela, Ilocos Sur, Abra, Benguet, Pangasinan, Nueva Ecija, Zambales, Bataan, Bulacan, Rizal, Laguna, Tayabas, Camarines, Albay, Mindoro, Sibuyan, Capiz, Negros, Samar, Biliran, Palawan, Agusan, Misamis.

Apitong is a tall, straight tree, ranging up to 1.80 meters or more in diameter and up to 30 meters in clear length. The average diameter of merchantable trees is probably between 60 and 90 centimeters.

Apitong is moderately hard to hard, stiff and strong, and moderately heavy to heavy. The grayish or brownish sapwood is from 2 to 8 centimeters thick, not quite sharply marked off from the heartwood; the heartwood is light ashy red to reddish brown or dark brown; grain generally fairly straight or slightly crossed, often forming a very regular diagonal figure on the face of a plank; texture rather coarse and rough; strong odor of resin when fresh, noticeable even in old dry pieces when worked over; resin exudes from ends of logs and even old pieces when exposed to sun; harder to saw than most of the other, less resinous woods of the family, but not otherwise difficult to work. Durability not high when in contact with ground or severely exposed to weather, but not commonly attacked by boring beetles.

Structure.—Pith rays generally distinctly of two kinds, fine and moderately thick, one to four or five fine ones between every two thick ones; pores small to medium, oval, rarely partitioned, numerous, evenly scattered, often with whitish resin deposits; resin canals sometimes very few, sometimes very numerous, scattered or forming many and conspicuous incomplete rings; soft tissue very variable, in rather thin rings or in irregular patches about pores, and numerous, scattered, broken, ill-defined crosslines between rays; no growth rings.

Apitong is probably the most widely used general-construction wood in the Islands, being available in large quantities and fit for all uses where extreme durability is not absolutely required. Besides being used in ship, bridge, wharf, and house construction, it is also used for flooring, wagon beds, interior finish, and cheap and medium-grade furniture.

The logs for the present tests were collected, with botanical specimens, from the cutting area of the Cadwallader-Gibson Lumber Co., at Limay, Bataan Province, Luzon.

GUIJO

Guijo [*Shorea guiso* (Blanco) Blume] is a very widely distributed and fairly abundant species. Foxworthy⁴ estimates that it makes up about 5 per cent of the volume of the forests. This figure includes probably the product of one or more undetermined species of *Shorea*, but undoubtedly the greater bulk of it is from the species named above. Botanical collections of guijo are reported from the following provinces and islands: Cagayan, Isabela, Bontoc, Ilocos Norte, Ilocos Sur, Abra, Union, Nueva Vizcaya, Nueva Ecija, Pangasinan, Tarlac, Zambales, Bataan, Pampanga, Bulacan, Rizal, Laguna, Batangas, Tayabas, Camarines, Albay, Sorsogon, Marinduque, Ticao, Mindoro, Masbate, Samar, Leyte, Negros, Capiiz, Agusan, Misamis, Davao, Cotabato, Zamboanga.

Guijo is a tall, straight tree ranging up to 1.80 meters or more in diameter and up to about 30 meters in clear length. The average diameter of merchantable trees will probably run from 60 to 90 centimeters.

Guijo is moderately heavy to heavy, moderately hard to hard, tough, and difficult to split; the sapwood is thin (2 to 5 centimeters), light grayish brown, not sharply distinguished from the heartwood; the heartwood is light ashy brown to brown, sometimes with a distinct reddish tint; grain distinctly crossed; texture rather fine, taking a glossier surface, both in longitudinal and in cross sections, than apitong; has a faint odor of resin; seasons slowly and is liable to split and warp if not seasoned very carefully; not hard to saw, but on account of the crossed grain rather difficult to shape and surface. Not durable when in contact with ground or severely exposed to weather, but good under cover, being rarely attacked by insects, except termites.

Structure.—Pith rays fine, not conspicuous; pores rather small, scattered; soft tissue less abundant than in apitong, in thin, irregular rings about pores and in short, indistinct, tangential lines; resin rings frequent, narrow, distinct; growth rings sometimes faintly indicated in young trees; all the elements* in guijo are smaller and more sharply defined than in apitong, so that the cross section has generally a cleaner look, so to speak, than in the latter.

Guijo is used for all kinds of general construction work where it is not severely exposed or where extreme durability is not absolutely required. It is preferred to apitong for practically

⁴ Philip. Journ. Sci. § C 13 (1918) 165.

all uses, being stronger and tougher; for almost all parts of vehicles, it is probably the most widely used wood in the Islands.

The logs for the present test were purchased in the Manila market. There is practically no doubt that they were true guijo [*Shorea guiso* (Blanco) Blume].

LUMBAYAN

Lumbayan (*Tarrietia javanica* Blume) has been found only in Misamis, Cotabato, Zamboanga, and Basilan. It is estimated that it constitutes not over 5 per cent of the total stand in those regions where it occurs. Lumbayan is a tall, straight tree, reaching 40 to 50 meters in height and 130 centimeters in diameter.

The sapwood of lumbayan is very pale red merging rather gradually into the light red to reddish brown heartwood. The heartwood is moderately heavy, soft to moderately hard, straight or slightly cross-grained, fairly durable, being rarely attacked by insects, flexible and tough, rather easy to split, and easy to work. In color and texture it resembles the red lauans except that, when quarter-sawn, the silver grain is more conspicuous than in most lauans.

Structure.—Pith rays moderately thick, distinct, forming a small but conspicuous silver grain in radial sections and visible as minute vertical lines in tangential sections; pores few, moderately large to large, evenly scattered, sometimes with dark red, glistening deposits; soft tissue in smooth thin rings about pores; no growth rings.

Lumbayan is used for flooring, interior finish, furniture, ship planking, and ship cabin work.

The material for the present test was secured from the Bureau of Supply, having been purchased by that bureau from one of the large mills in Zamboanga.

GISOK (YAKAL)

The woods known in commerce as yakal are the product of *Isoptera borneensis* Scheff., and of several species of the genera *Hopea* and *Shorea*. The material used in the present test was commercial yakal from Zamboanga, identified as being practically without doubt of the species known as gisok [*Shorea bangeran* (Korth.) Dyer].

Gisok is a large tree, reaching a height of 35 to 45 meters and a diameter of 180 centimeters. It has been reported by botanical collectors from the following islands and provinces: Nueva Ecija, Pangasinan, Pampanga, Zambales, Tayabas, Ca-

marines, Albay, Samar, Leyte, Samal, Agusan, Zamboanga; but there is reason to believe, from commercial specimens, that it is more widely distributed than botanical collections made up to date would indicate. The amount of yakal in the Islands is estimated by Foxworthy⁵ at 3 per cent of the total volume of the commercial forests; of this amount, gisok undoubtedly forms a very considerable share.

The sapwood of gisok is about 3 centimeters thick, light yellow when fresh, often staining in seasoning to a light yellowish gray; the heartwood when fresh is only slightly darker, gradually turning on exposure to a deep yellowish brown; it is very hard, very heavy, tough, and almost impossible to split in a radial direction, being strongly cross-grained. For a hard wood, it is not difficult to work, except that the crossed grain makes it difficult to plane radial sections. It is very durable, even when exposed to the weather or in contact with the ground, being destroyed very slowly by fungi and rarely attacked even by termites, but is poor in salt water, as teredos riddle it in a short time.

Structure.—Pith rays fine, numerous, distinct, light yellow, showing clearly against the background of brownish wood tissue; pores fairly numerous, scattered singly, rarely in groups of two or three, frequently with a tendency to form curved or oblique lines; soft tissue in rather thin rings about pores, sometimes confluent about groups or lines of pores but never forming continuous tangential bands; wood tissue very dense and homogeneous in appearance, occupying a very large proportion of the total area of the cross section and taking a glossy cut under a sharp tool.

Gisok (invariably sold and used under the name yakal) is used for all kinds of construction where great strength and durability are required, except for salt-water piling; for ax, peavey, and cant-hook handles, capstan bars, levers of all kinds; railroad ties; paving blocks.

RELATION OF PROPERTIES TO USES⁶

The most important strength values are: For large beams, modulus of rupture, modulus of elasticity, and shear; for long columns, modulus of elasticity and crushing strength in compres-

⁵ Philip. Journ. Sci. § C 13 (1918) 166.

⁶ For a more complete discussion see Bull. U. S. Dept. Agr. 556 (1917) 6, 7.

sion parallel to grain; for flooring and railroad ties the desirable properties are hardness and compression perpendicular to grain.

TESTING METHOD

A complete description of the testing method employed is given by the United States Forest Service.⁷ A brief description of the different tests will aid the reader in attaching the proper significance to the results presented. The testing machines were calibrated before starting the tests. The formulæ used in calculating the different results contained in the tables will be found in the appendix.

BENDING TESTS

STRINGERS AND HEAVY JOISTS

Fig. 1 shows the apparatus used for bending tests on large beams. The testing machine is provided with an extension weighing platform. The beam is placed on two knife-edge supports, AA, which rest on this platform. The load is applied at

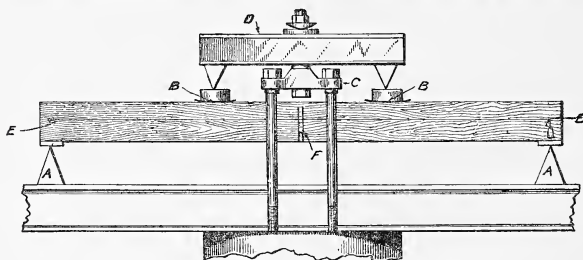

FIG. 1. Apparatus used for bending tests on large beams.

two points, BB, one-third as far apart as the distance between the knife-edge supports. As the head of the screw press, C, moves down, the straining beam, D, bears with increasing force on the specimen under test. As the load increases the beam deflects. A fine wire, EE, kept taut by a weight, is strung between two small nails driven midway between the top and bottom faces of the beam vertically above the knife-edge supports. This wire crosses the face of a scale, F, fastened to the beam midway be-

⁷ Instructions to Engineers of Timber Tests, Circular (revised) U. S. Forest Service 38 (1909).

tween the supports. As the beam deflects, the scale moves down, while the wire does not change its original position. The distance the scale moves relative to the wire indicates the amount of deflection or bending. This method gives deflection to 0.01 inch, which is sufficiently accurate for tests on structural sizes. The load deformation readings are recorded as indicated in figs. 2 and 3, and the load at elastic limit is determined by drawing a straight line through the greatest possible number of points, the point at which the curve departs from the straight line being taken as the load at elastic limit. This method of locating the elastic limit is clearly indicated in the figures.

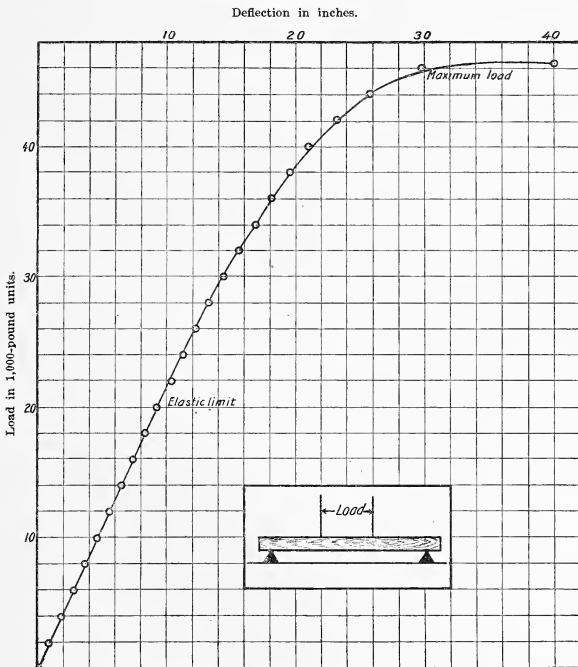

FIG. 2. Bending; 7.88 inches by 11.85 inches; 15-foot span; third-point loading; apitong.

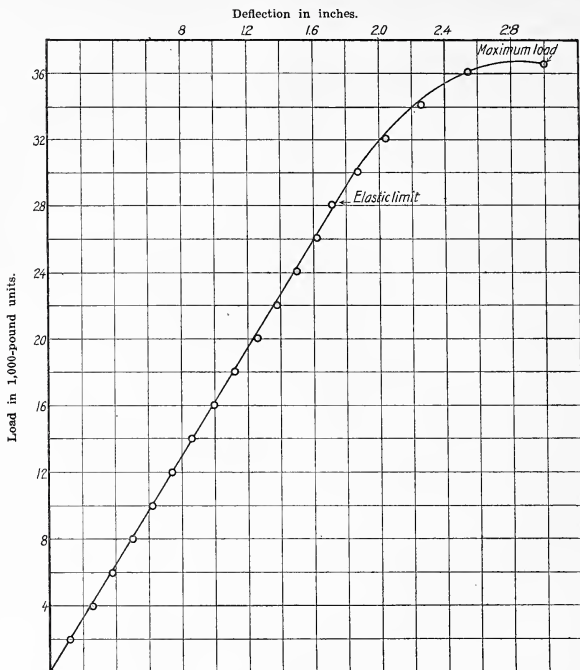

FIG. 3. Bending; 6.70 inches by 12.21 inches; 16-foot span; third-point loading; Borneo camphorwood.

SMALL CLEAR BEAMS

In tests on small clear beams the load is applied at the center of the span, and a special deflectometer is used for measuring deflection. A small beam under test is shown in fig. 4.

COMPRESSION PARALLEL TO GRAIN

Fig. 5 shows the method of making tests in compression parallel to grain. The ends of the specimen are carefully squared, and it is then placed, with the grain vertical to the base of the machine, upon a flat block having a spherical bearing, which

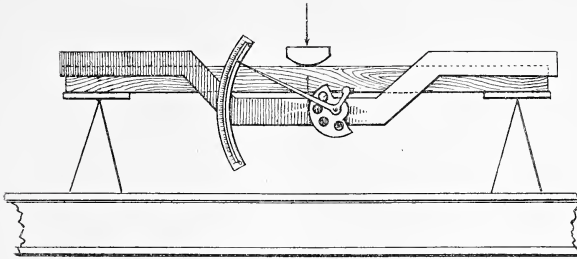

FIG. 4. Apparatus used for testing small clear beams.

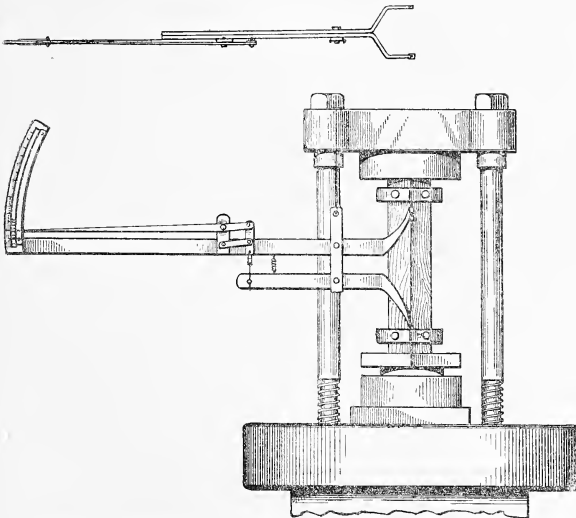

FIG. 5. Apparatus used in making tests of compression parallel to grain.

rests upon the weighing table of the machine. In tests where the modulus of elasticity is desired, two yokes, 6 inches apart, are placed on the specimen. The load is applied by moving the crosshead down very slowly. The decrease in length between the yokes is measured by means of a deflectometer which

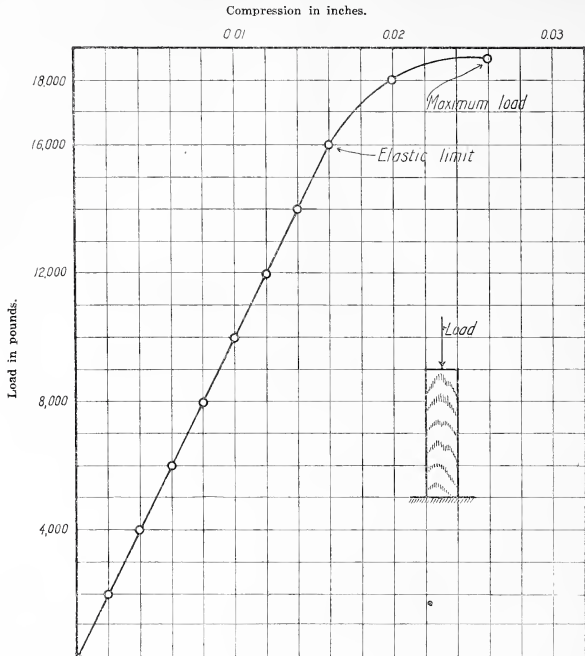

FIG. 6. Compression parallel to grain; stress area, 2 inches by 2 inches; height, 8 inches; apitong.

is clearly shown in the illustration. The readings given by the deflectometer are used in plotting the stress-strain diagram. Fig. 6 shows a typical diagram for tests in compression parallel to grain. The load at elastic limit is located in the same manner as that described for the tests of beams.

COMPRESSION PERPENDICULAR TO GRAIN

Fig. 7 shows the method of making tests in compression perpendicular to grain. In these tests the specimen is so placed that the grain is horizontal or parallel to the base of the machine. A steel plate, 2 inches wide, is adjusted on top of the specimen. The moving crosshead of the machine descends upon this plate,

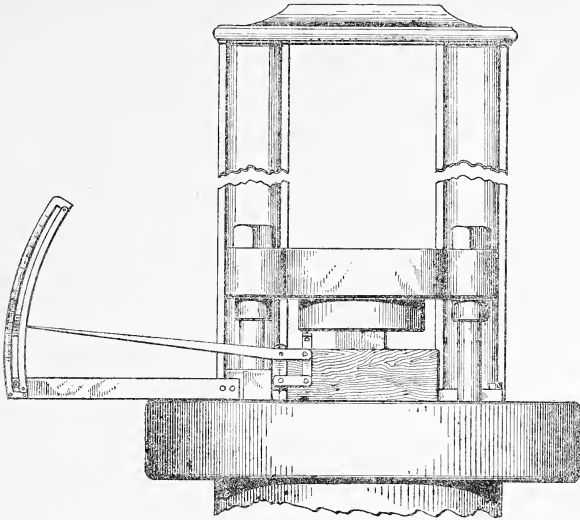

FIG. 7. Apparatus used in making tests in compression perpendicular to grain.

and the amount of deformation produced by a given load is indicated by the deflectometer. Fig. 8 shows a typical load deformation diagram for tests in compression perpendicular to grain. This diagram also shows the method of correcting deflections for loads below the load at elastic limit when the straight-line portion of the curve does not pass through the origin. The corrected deflections are used in calculating the modulus of elasticity.

SHEARING TESTS

The method of making shearing tests used is indicated in fig. 9. The block to the left shows the test specimen prepared with a projecting tongue which is to be sheared off parallel to the grain. The body of the block is held firmly in the shearing tool by means of set screws, the movable plunger bearing on the projecting tongue. When the specimen is in place the shearing tool is placed in the testing machine and the load is applied to the specimen by means of the plunger. The maximum load is the quantity desired in this test.

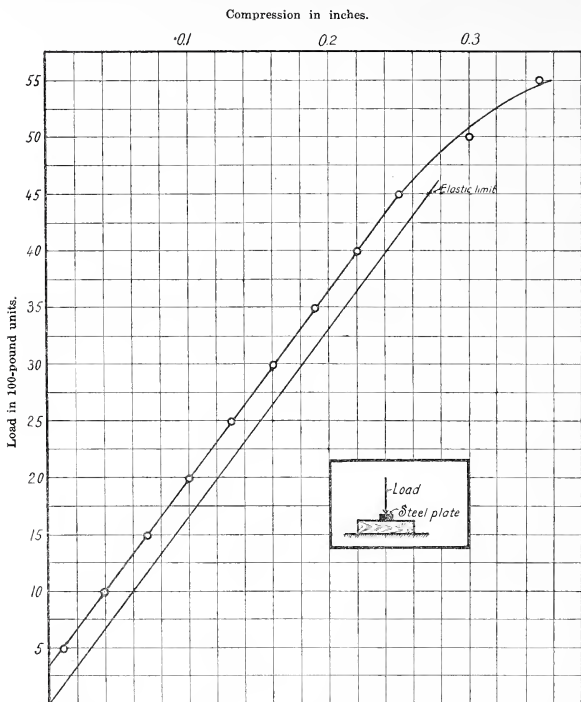

FIG. 8. Compression perpendicular to grain; stress area, 2 inches by 2 inches; lumbayan.

HARDNESS

Hardness is tested by measuring the load required to embed a 0.444-inch ball to one-half its diameter in the wood as shown in fig. 10.

The hardness test is applied to end and side surfaces of the timber. End hardness is usually greater than side hardness. The quality is important in woods to be used for paving blocks, railroad ties, furniture, flooring, etc.

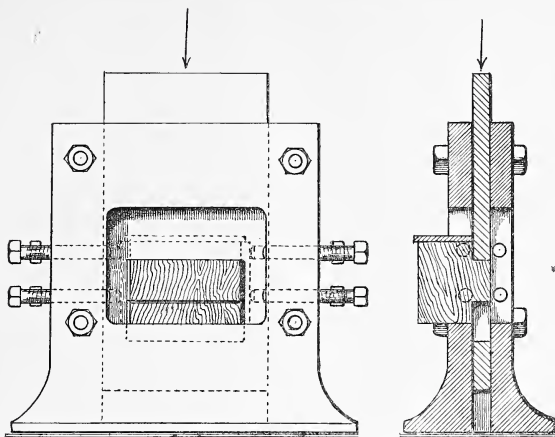

FIG. 9. Apparatus used in making shearing tests.

MOISTURE CONTENT

Tiemann⁸ says:

Water exists in green wood in two forms: As liquid water contained in the cavities of the cells or pores, and as "imbibed" or hygroscopic water intimately absorbed in the substance of which the wood is composed. The removal of the free water from the holes or pores will evidently have no effect upon the physical properties or shrinkage of the wood, but as soon as any of the "imbibed" moisture is removed from the cell walls shrinkage begins to take place and other changes occur. The strength also begins to increase at this time. The point where the cell walls, or wood substance, become saturated is called the "fiber saturation point," * * * The fiber saturation point lies between moisture condition of 25 and 30 per cent, of the dry weight of the wood, depending on the species. * * *

Air-dried wood will rarely dry below 12 to 14 per cent.

Moisture content is the weight of water contained in the wood, expressed in per cent of the oven-dry weight of the wood. It is determined by weighing a small section of the test specimen and then drying it at 100° C. in an electric furnace until its weight becomes constant; the loss of weight is then divided by

⁸ Journ. Franklin Inst. 188 (1919) 27-50.

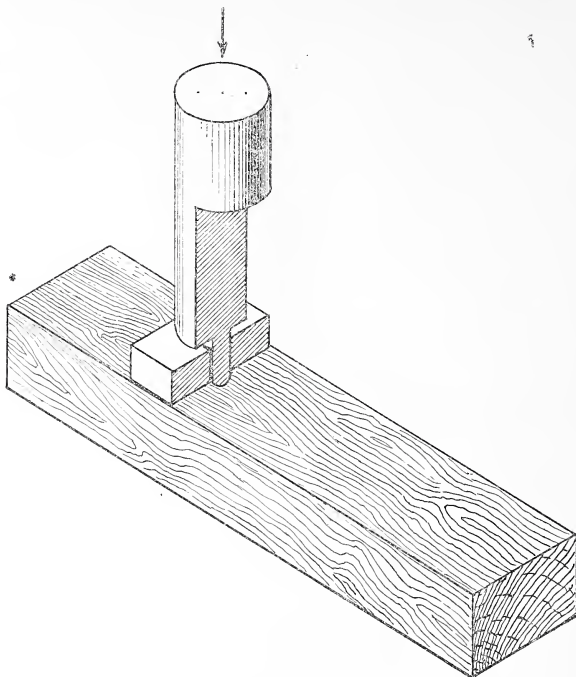

FIG. 10. Apparatus used in testing hardness of timber.

the dry weight, to give the proportion of moisture, and this is usually expressed in per cent of the dry weight.

SPECIFIC GRAVITY

Specific gravity is the weight of any given substance divided by the weight of an equal volume of pure water at its greatest density.

VARIABILITY IN THE STRENGTH OF TIMBER

The mechanical properties of the woods tested were found to vary greatly, not only of the specimens from different trees of the same species, but also of those cut from different portions

of the same tree. This is largely due to the defects they contained, and to the fact that they are not so homogeneous as are manufactured materials such as steel and other metals. The mechanical properties of a certain timber of a given variety can, therefore, be predicated upon the results obtained in tests of timber of that variety in a most general way only, until detailed information is obtained concerning the many factors governing the mechanical properties of both test timber and commercial timber.

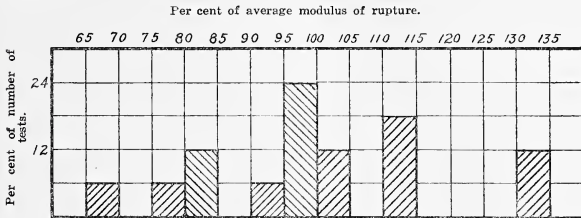

FIG. 11. Variability in modulus of rupture; tangile, structural sizes, 16 tests; average modulus of rupture, 7,640 pounds per square inch.

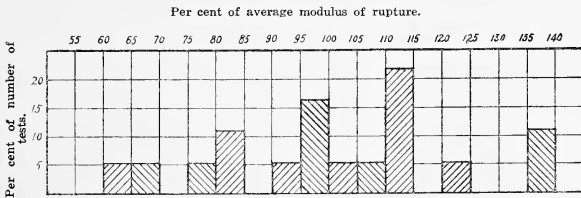

FIG. 12. Variability in modulus of rupture; apitong, structural sizes; 18 tests; average modulus of rupture, 6,820 pounds per square inch.

Figs. 11, 12, 13, and 14, inclusive, show how the individual results of the modulus of rupture vary from the average. The cross-hatched areas between the adjacent vertical lines represent graphically the percentage of the total number of tests that fell within the limits indicated on the scale at the bottom, which gives the strength of the pieces in percentages of the average strength. The percentage of the number of pieces is expressed by the figures at the left. For example; by referring to fig. 11, it will be seen that 18 per cent of the tests fell between 110 and

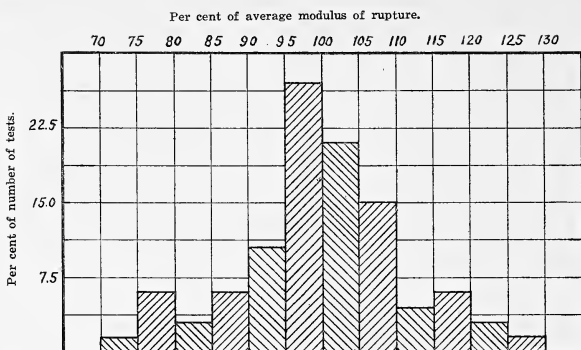

FIG. 13. Variability in modulus of rupture; tangile, small specimens; average modulus of rupture, 1,000 pounds per square inch; 70 tests.

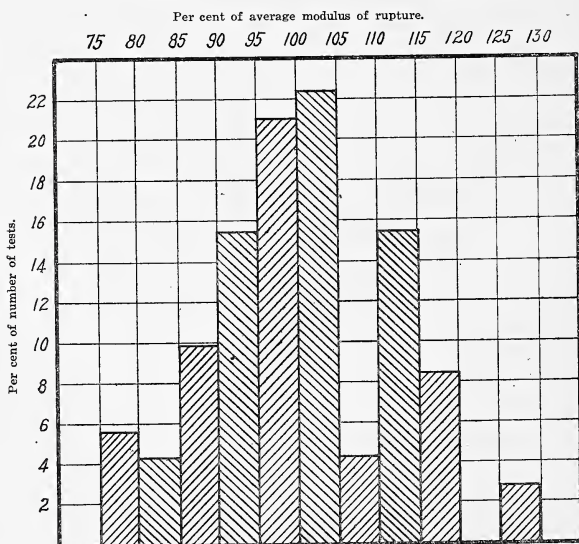

FIG. 14. Variability in modulus of rupture; apitong, small specimens; 78 tests; average modulus of rupture, 10,080 pounds per square inch.

115 per cent of the average; in the case of apitong (fig. 12), 22 per cent of the tests fell between 110 and 115 per cent of the average.

Had the tests been more numerous there would not be gaps between the cross-hatched areas in figs. 11, 12, and 14, and the diagrams would be more symmetrical with respect to the median line or the line showing average modulus of rupture. The diagrams would be very short at the ends and highest at the middle, somewhat like fig. 13. Small specimens are less variable in strength than the structural sizes. The reason for this is that the small specimens are free from defects.

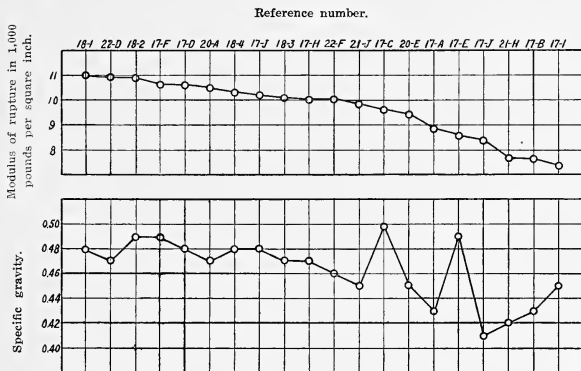

FIG. 15. Tangile No. 2; small specimens.

Figs. 15, 16, and 17 show the relation between dry weight and the modulus of rupture obtained from tests on small clear beams free from defects. Figs. 18 and 19 show the relation between dry weight and modulus of rupture, based on results obtained from tests on large beams. In general it will be observed that the dry weight has a distinct tendency to increase as the modulus of rupture increases. Where a heavy timber of structural size had a low modulus of rupture, it will generally be found, by referring to the tables of results in the appendix, that the timber had serious defects on or near the tension face which in all probability greatly weakened it. The strength of specimens having the same dry weight sometimes varies considerably. This

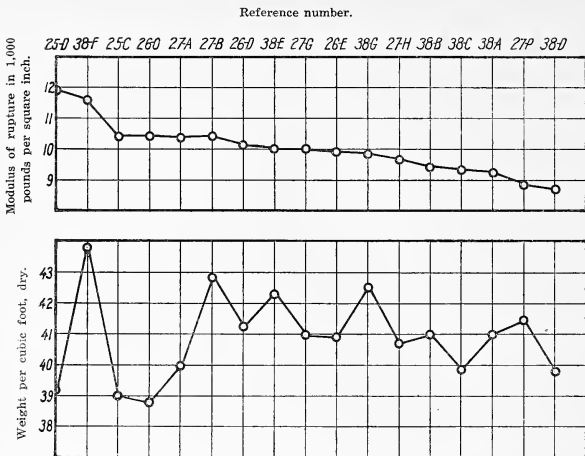

FIG. 16. Apitong No. 4; small specimens.

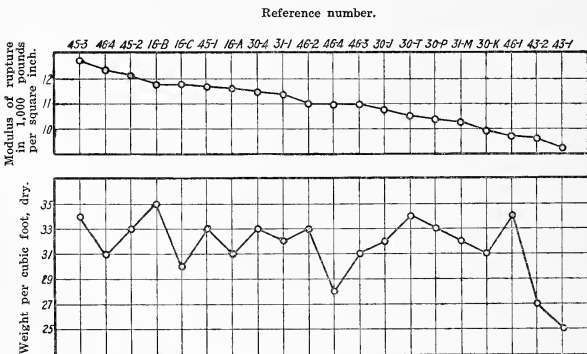

FIG. 17. Tangile No. 1; small specimens.

is due probably to irregularity in grain and to the great difference in moisture of some of the specimens at the time of the tests. Other things being equal, the strength of wood varies directly with its dry weight.

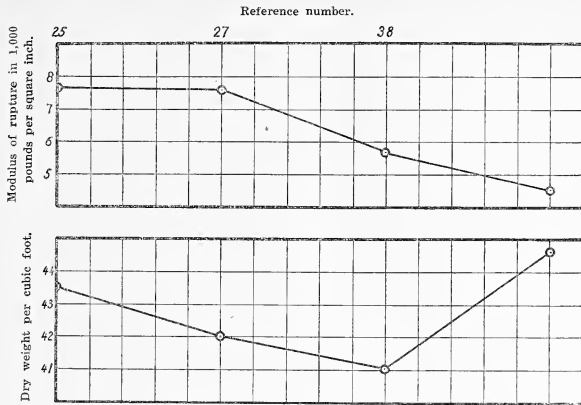

FIG. 18. Apitong No. 4.

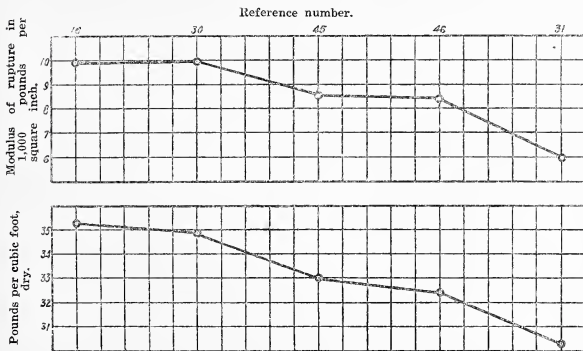

FIG. 19. Tangile No. 1; structural sizes.

The tests undertaken in the Bureau of Science were not sufficiently numerous or typical of the trees growing in different localities to establish very representative data concerning the mechanical properties of each particular species. However, the data presented give a general idea of the mechanical properties of the timbers tested.

STRENGTH AS AFFECTED BY MOISTURE CONTENT

A comparison of the results of tests on air-seasoned material with those on green material shows that, in general, all of the mechanical properties are improved by seasoning.⁹ Increase in strength is especially marked on small pieces free from defects. Increase in strength of wood fiber due to drying is, in the case of large timbers, largely offset by a weakening of the timber due to the formation of checks.¹⁰ Hatt¹¹ says that if the moisture content of a seasoned timber is increased it loses strength rapidly and if thoroughly soaked with water it will become slightly weaker than when green. On this account it is not safe in practice to depend upon an increase in strength of timbers due to seasoning. When, however, large beams are seasoned with ordinary care, it is safe to assume that they will not at any time be weaker than they were when green.

*The time factor in timber tests.*¹²—Variations in the rate of application of load have a very pronounced effect upon strength and stiffness, as was shown by a specimen under test. If a timber compression block or beam is loaded rapidly, it will appear to have a higher elastic limit and ultimate strength, and will also appear to be stiffer, than when loaded less rapidly. Mills¹² says that this behavior is due to the fact that the deformation lags far behind the load, and if a load is permitted to remain upon a specimen for a perceptible interval of time the deformation increases, the amount of increase becoming greater for heavier loads. Actual failure appears to be consequent upon the attainment of a certain limiting amount of deformation or strain, rather than a limiting load or stress. This condition of affairs makes it necessary to standardize tests by adopting certain speeds of loading for each class of specimens or, rather,

⁹ Tests of Structural Timbers, Bull. U. S. Forest Service 108 (1912).

¹⁰ Materials of Engineering Construction, Trans. International Engineering Congress 5 (1915).

¹¹ Marks, L. S., Mechanical Engineer's Handbook. McGraw Hill Book Co. (1916).

¹² The first mechanical tests of Philippine woods published were made by the Bureau of Forestry of the Philippines. Those tests were made on small specimens only, and the testing machine was operated at the following speeds: For cross-bending, 0.3 inch per minute; for compression along the grain, 0.06 inch per minute. See Bull. Philip. Bur. Forestry 4 (1906).

¹³ Mills, A. P., Materials of Construction. New York, John Wiley & Sons Inc. (1915) 647.

so to proportion the speed of the moving head of the testing machine to the dimensions of the specimen that the resultant fiber strain will be a certain specified amount. The usual practice is to adhere to the standards established by the Forest Service for the use of engineers of timber tests. These standards are as follows:¹⁴

Character of test.	Specimen.	Rate of fiber strain per minute.
		<i>Inches.</i>
Bending tests	Timber of structural size.....	0.0007
Do.....	Small test specimen.....	0.0015
Compression parallel to grain.....	Timber of structural size.....	0.0015
Do.....	Small test specimen.....	0.0030
Compression perpendicular to grain.....	Timber of structural size.....	0.0070
Do.....	Small test specimen.....	0.0150
Shearing parallel to grain.....	do.....	0.0150

When constant loads, amounting to a large fraction of the ultimate strength of timber, are sustained for very long periods, the deformation may continue to increase until rupture occurs, even though the stress encountered is far below the ultimate strength of the timber as originally determined.

Johnson¹⁵ says that the strength of timber under any kind of permanent load is only about one-half its strength as found by actual, short-time tests.

Factors of safety.—The factors of safety used in the design of timber structures in the United States, as given by different authorities, are as follows: Merriman¹⁶ gives 8 for steady stress, 10 for varying stress, and 15 for shocks; Rankine¹⁷ gives 4 to 5 for dead load and 5 to 10 for live load; the Cambria Steel Co. Handbook gives 10 for tension, 6 for extreme fiber stress in bending, 5 for compression along the grain, and 4 for compression across the grain and for shear; and the (1909) Committee on Wooden Bridges and Trestles of the American Railway Engineering Association used the following factors of

¹⁴ Instructions to Engineers of Timber Tests, Circular (revised) U. S. Forest Service 38 (1909).

¹⁵ Johnson, J. B., *Materials of Construction*. New York, John Wiley and Son (1912).

¹⁶ Merriman's *Mechanics of Materials*, 468.

¹⁷ Rankine's *Handbook of Civil Engineering*.

safety; namely, 5 for extreme fiber stress in bending, 4 for shear along the grain, 3 for compression along the grain, and 2 for compression across the grain. For steady loads these factors become $3\frac{1}{2}$, $2\frac{2}{3}$, 2, and $1\frac{1}{2}$, respectively. The variability of the factors given by different authorities indicates that the factor of safety for timber is largely a matter of guesswork on account of lack of confidence in the reliability of values of strength upon which designing is based. An exhaustive series of tests on the mechanical properties of Philippine timbers will some day give very reliable data upon which to base the design of timber structures. The United States Forest Service¹⁵ seems to have solved this problem for timbers grown in the United States and recommends the following factors of safety: 5 for modulus of rupture, 3 for compression parallel to grain, 1.5 for compression perpendicular to grain, 8 for shearing, and 5 for tension perpendicular to grain.

In applying factors of safety to strength values for timbers it is important to know the moisture of the wood tested, and whether the tests were made only on small, thoroughly seasoned specimens free from defects or on timber of structural sizes. This information is essential, because the results of the tests show that the stresses developed in large timbers were less than the stresses developed in small specimens. The ratio for modulus of rupture varies from 60 to 90 per cent. This difference in values was due to the facts that the small specimens were free from defects and that they contained less moisture.

In conclusion I will say that the character and location of defects in timber have much to do with its strength. Checks in beams weaken their resistance to horizontal shear, especially if the defects are found near the neutral plane. The tests have shown that knots occurring in the central lower part of a beam weaken the timber much more than similar defects found in another part.

APPENDIX

FORMULÆ¹⁶ USED IN COMPUTATIONS

LEGEND

- A = Area of cross section, square inches.
- B = Area under plate, square inches.
- CS = Crushing strength, pounds per square inch.

¹⁵ Bull. U. S. Forest Service 556 (1912).

¹⁶ Instructions to Engineers of Timber Tests, Circular (revised) U. S. Forest Service 38 (1909).

- E = Modulus of elasticity, pounds per square inch.
 EL = Fiber stress at elastic limit, pounds per square inch.
 J = Greatest calculated longitudinal shear, pounds per square inch.
 K = 27.7 where weight is in pounds, and 0.061 where weight is in grams.
 MR = Modulus of rupture, pounds per square inch.
 P = Maximum load, pounds.
 P' = Load at elastic limit, pounds.
 S = Dry specific gravity.
 W = Weight of specimen, pounds.
 Δ = Total deflection or compression at elastic limit, inches.
 b = Width, inches.
 d = Distance between centers of collars, inches.
 h = Height, inches.
 l = Span, inches (compression, l=length).

BENDING

<i>Load applied at center.</i>	<i>Uniformly distri- buted load.</i>	<i>Load applied at third points.</i>
$J = \frac{0.75 \times P}{b \times h}$	$J = \frac{0.75 \times P}{b \times h}$	$J = \frac{b \times h}{0.75 \times P}$
$MR = \frac{1.5 \times P \times l}{b \times h^2}$	$MR = \frac{0.75 \times P \times l}{b \times h^2}$	$MR = \frac{l \times (P + 0.75 W)}{b \times h^2}$
$EL = \frac{1.5 P l}{b \times h^2}$	$EL = \frac{0.75 \times P \times l}{b \times h^2}$	$EL = \frac{l \times (P' + 0.75 W)}{b \times h^2}$
$E = \frac{P \times l^2}{4 \times b \times h^3 \times \Delta}$	$E = \frac{P \times l^3}{6.4 \times b \times h^3 \times \Delta}$	$E = \frac{P \times l^3}{4.7 b \times h^3 \times \Delta}$

COMPRESSION PARALLEL TO GRAIN

$$CS = \frac{P}{A} \qquad EL = \frac{P'}{A} \qquad E = \frac{P' \times d}{A \times \Delta}$$

COMPRESSION PERPENDICULAR TO GRAIN

$$EL = \frac{P'}{B}$$

SHEARING PARALLEL TO GRAIN

$$\text{Shear} = \frac{P}{A}$$

SPECIFIC GRAVITY

$$S = \frac{\text{Wet weight} \times K}{(1 + \text{per cent } \frac{\text{moisture}}{100}) \times \text{volume in cubic inches}}$$

In large beams the weight should be taken into account in calculating the fiber stress. Three-fourths of the weight is added to the load for this reason.

GLOSSARY ²⁰

Elastic limit.—The elastic limit is that point where the distortion ceases to be in proportion to the load. A timber stressed beyond the elastic limit will not resume its original form immediately upon the removal of the load.

Elasticity.—Elasticity is the property of changing form with the application of force and recovering at once upon release from the force. In any elastic material the amount of compression or deformation is proportional to the force applied.

Fiber stress at elastic limit.—Fiber stress at elastic limit is the stress obtained in a timber by loading it to its elastic limit. It is the greatest stress the timber will take under a given loading and immediately return to its former position.

Mechanical properties.—Mechanical properties are the properties of wood which enable it to resist deformations, loads, shocks, or forces. Thus the ability to resist shearing forces is a mechanical property of timber.

Modulus of elasticity.—Modulus of elasticity is the ratio of stress per unit area to corresponding strain per unit length, the distortion or strain being within the elastic limit. It is the measure of the stiffness or rigidity of a substance.

Modulus of rupture.—Modulus of rupture is the computed fiber stress in the outermost fibers of a beam at the maximum load and is a measure of the ability of a beam to support a slowly applied load for a very short time. The formula by which modulus of rupture is computed is the same as that for fiber stress at elastic limit, the maximum load being substituted for the elastic limit load. It is a definite quantity, and the personal factor does not enter to any great extent into obtaining it. It is consequently not so subject to error as the fiber stress at elastic limit, and for that reason is used more than any other value to represent the strength of wood. Modulus of rupture should always be considered in calculating the strength of beams to be used as stringers, floor joists, etc.

²⁰ Mechanical Properties of Woods Grown in the United States, Bull. U. S. Dept. Agr. 556 (1917) 20-22.

Shear.—Shear is the name of the stress which tends to keep two adjoining planes or surfaces of a body from sliding, one on the other, under the influence of two equal and parallel forces acting in opposite directions. A force which produces shear in a material is called a shearing force.

Strain.—The deformation or distortion produced by a stress or force is known as strain.

Stress.—Stress is the force or set of forces applied to a body, and which tend to produce a strain. Fiber stress is the distributed force tending to compress, tear apart, or change the relative position of the wood fibers.

TABLE 1.—Data on individual bending tests of Bataan tangile No. 1.

[S, horizontal shear failure; C, compression failure; T, tension failure.]

STRUCTURAL SIZES.

Reference No.	Size.	Span.	Moisture.	Weight (green).	Modulus of rupture.	Fiber stress at elastic limit.	Modulus of elasticity.	Greatest tested longitudinal shear.	Defects.	Manner of failure.	Causes of first failure.
	in.	Per cent.	Lbs. per sq. ft.	Lbs. per sq. in.	Lbs. per sq. in.	Lbs. per sq. in.	1,000 lbs. per sq. in.	Lbs. per sq. in.			
31	5.9 by 13.90	132	28.8	39	5,940	4,390	1,921	469			
45	4.0 by 7.95	132	24.2	41	8,608	5,200	2,002	390			
30	5.0 by 13.85	132	44.4	51	9,928	5,080	2,184	770			
16	4.0 by 7.90	120	33.5	47	9,930	5,390	2,030	490			
46	4.0 by 8.00	132	23.6	40	8,470	4,120	2,097	385			
Average		129	31.9	43	8,575	4,944	2,046	500			

SMALL SPECIMENS.

45-1	2 by 2	28	20.8	40	11,680	5,250	2,010	417	None	T	Not apparent.
46-4	2 by 2	28	20.7	34	10,940	3,660	2,278	391	do	T	Do.
46-3	2 by 2	28	20.0	38	10,920	5,240	1,955	391	do	T	Do.
46-2	2 by 2	28	22.3	41	10,970	6,300	2,612	392	do	T	Do.
46-1	2 by 2	28	20.3	41	9,640	4,200	1,851	345	do	T	Do.
16-A	2 by 2	28	32.6	42	11,536	6,030	1,969	412	do	T	Do.
16-B	2 by 2	28	20.2	43	11,760	6,024	1,874	420	do	T	Do.
16-C	2 by 2	28	38.1	42	11,760	6,037	1,792	420	do	T	Do.
31-C	2 by 2	28	21.4		9,408	5,765	1,751	336	do	T	Do.
30-J	2 by 2	28	32.9	43	10,696	6,291	1,868	382	do	T	Do.
30-K	2 by 2	28	23.0	39	9,856	2,621	1,630	352	do	T	Do.
30-N	2 by 2	28	25.3		10,500	6,287	1,867	375	do	T	Do.
30-P	2 by 2	28	25.3	42	10,304	6,298	1,714	368	do	T	Do.
30-C	2 by 2	28	25.0		10,080	5,775	1,796	360	do	T	Do.
45-3	2 by 2	28	19.2	41	12,780	6,280	1,954	457	do	T	Do.
31-m	2 by 2	28	25.0	40	10,220	4,716	2,124	365	do	T	Do.
31-1	2 by 2	28	24.0	40	11,310	6,299	2,007	404	do	T	Do.
30-t	2 by 2	28	19.6	41	10,444	2,624	1,632	373	do	T	Do.
30-u	2 by 2	28	21.2	40	11,480	5,766	1,883	410	do	T	Do.
43-2	2 by 2	28	20.9	33	9,510	4,185	1,955	341	do	T	Do.
45-4	2 by 2	28	20.0	37	12,350	4,185	1,852	442	do	T	Do.
43-1	2 by 2	28	18.4	30	9,150	4,200	1,711	327	do	T	Do.
45-2	2 by 2	28	20.8	40	12,100	5,250	1,906	429	do	T	Do.
Average		28	23.3	39	10,844	6,186	1,909	387		T	

TABLE 2.—Data on individual bending tests of Bataan tangile No. 2.

[C, compression failure; T, tension failure.]

STRUCTURAL SIZES.

Reference No.	Size.	Span.	Moisture	Weight (green).	Modulus of rupture.	Fiber stress at elastic limit.	Modulus of elasticity.	Greatest calculated longitudinal shear.	Defects.	Manner of failure.	Causes of first failure.
	in.	in.	Per cent.	Lbs. per cu. ft.	Lbs. per sq. in.	Lbs. per sq. in.	1,000 lbs. per sq. in.	Lbs. per sq. in.			
22	4.00 by 7.90	180	25.7	38	7,625	2,880	2,050	251	Checks	C	Checks.
20	4.00 by 8.00	180	30.2	38	7,410	3,363	1,779	247	None	C	Not apparent.
21	3.95 by 7.95	180	27.8	37	7,325	4,484	1,750	234	Checks and knots.	C	Checks and knots.
18	7.95 by 11.85	168	39.5	40	8,684	4,880	2,006	460	do	CT	Not apparent.
17	6.02 by 11.97	168	43.9	54	7,880	4,880	1,823	421	do	CT	Do.
Average		175	33.4	41	7,786	4,057	1,861	322			

SMALL SPECIMENS.

18-1	2 by 2	28	18.7	36	11,000	3,142	1,465	393	None	T	Not apparent.
18-2	2 by 2	28	21.3	37	10,900	3,140	1,464	390	do	T	Do.
18-3	2 by 2	28	21.3	36	10,100	2,092	1,710	361	do	T	Do.
18-4	2 by 2	28	19.0	36	10,820	2,100	1,830	369	do	T	Do.
17-J	2 by 2	28	30.4	39	10,248	5,737	1,874	366	do	T	Do.
17-H	2 by 2	28	35.1	40	10,060	5,286	1,809	360	do	T	Do.
17-I	2 by 2	28	41.7	40	7,364	4,208	1,617	263	do	T	Do.
17-F	2 by 2	28	21.0	37	10,660	5,508	1,843	345	do	T	Do.
17-G	2 by 2	28	35.9	35	8,400	4,462	1,500	300	do	T	Do.
17-C	2 by 2	28	18.5	37	9,660	4,450	1,615	345	do	T	Do.
17-D	2 by 2	28	19.4	36	10,640	4,360	1,460	380	do	T	Do.
17-E	2 by 2	28	19.9	36	8,540	4,467	1,762	305	do	T	Do.
17-A	2 by 2	28	18.0	32	8,876	4,202	1,715	317	do	T	Do.
17-B	2 by 2	28	17.3	32	7,640	4,068	1,483	280	do	T	Do.
20-A	2 by 2	28	18.7	35	10,500	5,250	1,182	375	do	T	Do.
20-C	2 by 2	28			9,884	5,243	1,712	363	do	T	Do.
20-E	2 by 2	28	20.8	34	9,436	6,290	1,680	337	do	T	Do.
22-D	2 by 2	28	19.1	35	10,948	6,235	2,003	391	do	T	Do.
21-J	2 by 2	28	20.9	34	9,825	5,759	1,881	351	do	T	Do.
22-F	2 by 2	28	18.5	34	10,052	5,238	1,901	359	do	T	Do.
21-S	2 by 2	28			10,752	5,244	1,903	384	do	T	Do.
21-H	2 by 2	28	18.7	31	7,680	5,250	1,682	274	do	T	Do.
Average											
		28	22.7	36	9,704	4,624	1,683	345			

TABLE 3.—Data on individual bending tests of Bataan tangile No. 2.

[S, horizontal shear failure; T, tension failure.]

COMMERCIAL SIZES.

Reference No.	Size.	Span.	Moisture.	Weight (green).	Modulus of rupture.	Fiber stress at elastic limit.	Modulus of elasticity.	Greatest lateral longitudinal shear.	Defects.	Manner of failure.	Causes of first failure.
	in.			<i>Lbs. per cu. ft.</i>	<i>Lbs. per sq. in.</i>	<i>Lbs. per sq. in.</i>	<i>1,000 lbs. per sq. in.</i>	<i>Lbs. per sq. in.</i>			
50	7.95 by 15.95	180	Per cent. 25.9	38	7,177	4,088	1,535	477			
32	5.90 by 11.90	180	33.8	40	6,453	4,082	1,525	320	Checks and knots. -----do-----	TS T	Checks. Large knot, 12 inches from center of lower face.
Average		180	29.8	39	6,815	4,084	1,530	398			

SMALL SPECIMENS.

32-Q	2 by 2	28	24.2	37	9,296	6,284	1,466	382	None	T	Not apparent.
32-M	2 by 2	28	31.7	38	7,812	5,242	1,317	279	-----do	T	Do.
32-L	2 by 2	28	23.4	36	8,708	5,770	1,507	311	-----do	T	Do.
32-K	2 by 2	28	18.6	38	8,204	4,717	1,467	293	-----do	T	Do.
32-N	2 by 2	28	23.3	38	7,880	4,970	1,443	285	-----do	T	Do.
32-O	2 by 2	28	27.6	34	8,820	4,710	1,538	315	-----do	T	Do.
50-3	2 by 2	28	21.6	37	9,750	4,190	1,710	349	-----do	T	Do.
50-4	2 by 2	28	22.0	33	9,660	3,150	1,955	346	-----do	T	Do.
50-1	2 by 2	28	23.4	35	9,200	4,192	1,520	329	-----do	T	Do.
50-2	2 by 2	28	21.5	34	9,950	4,900	1,764	356	-----do	T	Do.
Average		28	23.7	35	8,488	4,812	1,588	319			

TABLE 4.—Data on individual bending tests of *Bataan tangile* No. 4.

[C, compression failure; T, tension failure.]

COMMERCIAL SIZES.

Reference No.	Size.	Span.	Moisture.	Weight (green).	Modulus of rupture.	Fiber stress at elastic limit.	Modulus of elasticity.	Greatest stress at longitudinal shear.	Defects.	Manner of failure.	Causes of first failure.
	<i>in.</i>	<i>in.</i>	<i>Per cent.</i>	<i>Lbs. per cu. ft.</i>	<i>Lbs. per sq. in.</i>	<i>Lbs. per sq. in.</i>	<i>Lbs. per sq. in.</i>	<i>Lbs. per sq. in.</i>			
19	4.30 by 7.84	180	27.1	35	7,550	2,770	1,770	216	Knots and checks.do.....	C CT	Not apparent. Knot at the center of upper face.
23	4.00 by 8.00	180	27.6	33	5,220	2,107	1,464	174			
24	3.96 by 7.95	180	24.0	38	7,516	3,308	1,794	249	None Checks and knots.	CT TC	Not apparent. Irregular grain caused by knot.
29	3.95 by 11.90	180	20.9	38	6,272	2,573	1,733	311			
Average		180	24.9	36	6,714	2,659	1,650	237			

TABLE 4.—Data on individual bending tests of Bataan tangle No. 4—Continued.

SMALL SPECIMENS.

Reference No.	Size.	Span.	Moisture.	Weight (green).	Modulus of rupture.	Fiber stress at elastic limit.	Modulus of elasticity.	Greatest calculated longitudinal shear.	Defects.	Manner of failure.	Causes of first failure.
	in.	in.	Per cent.	Lbs. per cu. ft.	Lbs. per sq. in.	Lbs. per sq. in.	Lbs. per sq. in.	Lbs. per sq. in.			
19-1	2 by 2	28	18.15	34	10,190	2,100	1,960	363	None	T	Not apparent.
19-2	2 by 2	28	18.40	34	9,440	5,240	1,430	337	do	T	Do.
19-3	2 by 2	28	16.20	34	9,420	4,190	1,830	337	do	T	Do.
19-4	2 by 2	28	18.15	34	9,680	4,200	1,615	346	do	T	Do.
23-9	2 by 2	28	18.7	36	10,556	6,286	1,642	377	do	T	Do.
23-h	2 by 2	28	18.7	34	10,276	6,284	1,579	367	do	T	Do.
-N	2 by 2	28	19.1	35	9,632	6,298	1,714	344	do	T	Do.
24-G	2 by 2	28	19.9	35	9,548	3,147	1,370	341	do	T	Do.
24-a	2 by 2	28	18.3	33	9,688	5,760	1,539	346	do	T	Do.
29-A	2 by 2	28	20.6	35	9,828	4,193	1,826	351	do	T	Do.
29-B	2 by 2	28	20.4	35	9,968	5,246	1,370	356	do	T	Do.
29-b	2 by 2	28	2.05	35	9,968	5,770	1,443	356	do	T	Do.
29-c	2 by 2	28	18.1	35	10,472	5,249	1,714	374	do	T	Do.
29-f	2 by 2	28	13.0	38	9,296	5,760	1,254	332	do	T	Do.
I	2 by 2	28	19.0	35	9,744	5,768	1,712	348	do	T	Do.
Average		28	18.8	35	9,847	5,032	1,600	351			

TABLE 5.—Data on individual bending tests of *Bataan opitong* No. 1.

[S, horizontal shear failure; T, tension failure.]

COMMERCIAL SIZES.

Reference No.	Size.	Span.	Moisture.	Weight (green).	Modulus of rupture.	Fiber stress at elastic limit.	Modulus of elasticity.	Greatest calculated longitudinal shear.	Defects.	Manner of failure.	Causes of first failure.
48	5.90 by 14.05 in.	132	Per cent. 42.8	Lbs. per cu. ft. 57	Lbs. per sq. in. 6,989	Lbs. per sq. in. 4,075	Lbs. per sq. in. 3,162	Lbs. per sq. in. 558	Checks	S	Large checks 2 inches above neutral plane. Large checks at neutral plane.
52	7.88 by 14.0 in.	132	48.1	59	6,285	4,099	1,669	500	Checks and knots.	S	
Average		132	45.4	58	6,637	4,087	2,415	529			

SMALL SPECIMENS.

48-1	2 by 2	28	23.8	52	9,160	3,370	2,200	328	None	T	Not apparent.
48-2	2 by 2	28	31.7	56	10,500	4,190	2,620	378	do	T	Do.
48-3	2 by 2	28	27.0	53	11,280	5,240	2,282	402	do	T	Do.
48-3	2 by 2	28	24.8	52	11,220	3,670	2,668	400	do	T	Do.
48-4	2 by 2	28	24.7	54	11,400	4,190	2,281	407	do	T	Do.
52-5	2 by 2	28	27.8	51	12,840	4,660	2,540	458	do	T	Do.
52-6	2 by 2	28	28.10	55	11,180	2,120	2,286	400	do	T	Do.
52-7	2 by 2	28	26.4	52	11,820	4,200	2,040	420	do	T	Do.
52-8	2 by 2	28	25.9	52	11,660	5,250	2,145	416	do	T	Do.
Average		28	26.6	53	11,228	4,068	2,339	401			

TABLE 6.—Data on individual bending tests of *Bataan apitong* No. 2.

[S, horizontal shear failure; C, compression failure; T, tension failure.]

COMMERCIAL SIZES.

Reference No.	Size.	Span.	Moisture.	Weight (green).	Modulus of rupture.	Fiber strength at elastic limit.	Modulus of elasticity.	Greatest calculated longitudinal shear.	Defects.	Manner of failure.	Causes of first failure.
23	3.92 by 9.95	156	75.3	51	9,323	4,890	2,188	446	Checks	CT	Not apparent.
39	4.04 by 11.92	156	39.2	55	6,543	3,257	2,210	375	do	TS	Checks.
47	5.95 by 14.06	156	43.1	58	6,804	2,413	1,778	458	do	CS	Do.
49	5.30 by 14.05	156	55.8	59	4,115	2,678	1,974	278	Knots and checks.	S	Do.
Average		156	53.3	55	6,586	3,292	2,087	389			

SMALL SPECIMENS.

Reference No.	Size.	Span.	Moisture.	Weight (green).	Modulus of rupture.	Fiber strength at elastic limit.	Modulus of elasticity.	Greatest calculated longitudinal shear.	Defects.	Manner of failure.	Causes of first failure.
28-M	2 by 2	28	25.6	50	9,632	5,249	1,758	344	None	T	Not apparent.
28-K	2 by 2	28	27.1	49	10,668	5,760	1,792	381	do	T	Do.
28-c	2 by 2	28	21.6	48	11,340	5,761	2,214	405	do	T	Do.
28-J	2 by 2	28	19.5	51	11,220	7,232	1,817	451	do	T	Do.
28-F	2 by 2	28	28.9	52	9,576	6,296	1,713	342	do	T	Do.
28-L	2 by 2	28	22.6	48	10,116	6,280	1,712	372	do	T	Do.
28-1	2 by 2	28	19.62	52	11,800	4,200	2,355	420	do	T	Do.
28-2	2 by 2	28	22.3	50	11,450	4,720	2,130	408	do	T	Do.
28-3	2 by 2	28	17.30	50	12,850	4,200	2,390	460	do	T	Do.
28-4	2 by 2	28	13.4	49	11,150	5,240	2,142	398	do	T	Do.
28-5	2 by 2	28	22.0	50	9,820	2,100	2,492	350	do	T	Do.
Average		28	22.3	49	10,910	5,136	2,040	393			

TABLE 7.—Data on individual bending tests of *Bataa apitong* No. 3.
[C, compression failure; T, tension failure.]
COMMERCIAL SIZES.

Reference No.	Size.	Span.	Moisture.	Weight (green).	Modulus of rupture.	Fiber stress at elastic limit.	Modulus of elasticity.	Greatest calculated longitudinal shear.	Defects.	Manner of failure.	Causes of first failure.
	in.	in.	Per cent.	Lbs. per cu. ft.	Lbs. per sq. in.	Lbs. per sq. in.	Lbs. per sq. in.	Lbs. per sq. in.			
33	4.00 by 11.95	132	43.0	60	7,850	4,155	1,953	538	Knot and checks	C	Knot.
41	3.90 by 7.80	132	25.9	58	8,596	5,826	2,251	381	Checks	C	Not apparent.
42	5.92 by 7.78	132	45.6	59	7,424	3,488	1,952	337	Checks and knots.	C	Checks.
44	8.00 by 8.02	132	40.5	58	7,549	3,586	2,022	344	do	T C	Knots.
Average		132	38.7	59	7,854	4,263	2,044	388			
SMALL SPECIMENS.											
33-h	2 by 2	28	33.7	57	9,884	5,243	1,903	353	None	T	Not apparent.
33-m	2 by 2	28	25.4	57	11,284	4,719	2,055	403	do	T	Do.
33-e	2 by 2	28	35.6	57	9,660	4,188	1,710	345	do	T	Do.
33-f	2 by 2	28	26.5	56	10,948	7,344	1,999	391	do	T	Do.
33-g	2 by 2	28	39.4	59	8,484	5,760	1,792	303	do	T	Do.
33-l	2 by 2	28	31.8	57	10,248	5,244	2,234	366	do	T	Do.
33-j	2 by 2	28	34.5	56	9,296	5,243	2,014	332	do	T	Do.
41-1	2 by 2	28	30.2	55	10,500	4,180	2,180	375	do	T	Do.
41-2	2 by 2	28	19.8	50	12,080	5,250	2,452	430	do	T	Do.
41-3	2 by 2	28	26.6	52	10,640	5,230	1,952	381	do	T	Do.
41-3	2 by 2	28	28.1	55	11,490	5,250	2,452	410	do	T	Do.
41-4	2 by 2	28	29.4	58	10,500	4,200	1,960	375	do	T	Do.
42-1	2 by 2	28	22.1	52	10,220	3,148	2,170	365	do	T	Do.
42-2	2 by 2	28	22.2	56	10,100	4,180	1,955	360	do	T	Do.
42-3	2 by 2	28	24.2	53	10,140	3,150	2,055	362	do	T	Do.
44-2	2 by 2	28	29.0	54	10,440	2,100	2,480	373	do	T	Do.
44-4	2 by 2	28	35.0	54	9,350	4,190	2,110	334	do	T	Do.
Average		28	29.0	55	10,327	4,514	2,060	368			

TABLE 8.—Data on individual bending tests of *Bataan apitong* No. 4.

[C, compression failure; T, tension failure.]

COMMERCIAL SIZES.

Reference No.	Size.	Span.	Moisture.	Weight (green).	Modulus of rupture.	Fiber stress at elastic limit.	Modulus of elasticity.	Greatest calculated longitudinal shear.	Defects.	Manner of failure.	Causes of first failure.
	<i>in.</i>	<i>in.</i>	<i>Per cent.</i>	<i>Lbs. per cu. ft.</i>	<i>Lbs. per sq. in.</i>	<i>Lbs. per sq. in.</i>	<i>1,000 lbs. per sq. in.</i>	<i>Lbs. per sq. in.</i>			
25	3.90 by 7.72	180	31.3	57	7,659	4,460	1,900	245	Checks	T	Checks.
26	3.91 by 7.92	180	34.7	60	4,515	2,327	1,757	149	Knots and checks.	T	Knots and checks.
27	7.88 by 11.85	180	46.5	62	7,594	3,502	2,027	375	Checks	C	Not apparent.
33	4.00 by 7.92	180	36.4	56	5,696	2,888	2,153	188	Checks and knots.	T	Checks.
Average		180	36.9	58	6,116	3,536	1,961	239			

SMALL SPECIMENS.

25-d	2 by 2	28	18.5	47	10,500	6,825	1,988	375	None	T	Not apparent.
25-D	2 by 2	28	19.9	47	11,956	5,248	1,903	427	do	T	Do.
25-C	2 by 2	28	20.60	47	10,472	7,848	1,714	374	do	T	Do.
25-o	2 by 2	28	25.9	49	10,472	5,249	1,905	374	do	T	Do.
25-E	2 by 2	28	22.3	50	9,968	6,820	1,856	356	do	T	Do.
25-D	2 by 2	28	26.0	52	10,108	6,234	1,785	361	do	T	Do.
26	2 by 2	28	22.0	49	8,400	5,250	1,559	300	do	T	Do.
27-a	2 by 2	28	22.1	49	10,414	6,297	2,006	373	do	T	Do.
27-b	2 by 2	28	18.9	51	10,416	7,846	1,845	372	do	T	Do.
27-p	2 by 2	28	25.2	52	8,820	6,231	1,709	315	do	T	Do.
27-H	2 by 2	28	25.4	51	9,688	5,772	1,933	346	do	T	Do.
27-G	2 by 2	28	22.0	50	10,052	5,249	2,017	359	do	T	Do.
38-A	2 by 2	28	31.7	54	9,296	3,666	1,842	332	do	T	Do.
38-B	2 by 2	28	24.9	51	9,408	5,765	1,024	336	do	T	Do.
38-C	2 by 2	28	23.0	49	9,380	6,288	2,003	335	do	T	Do.
38-D	2 by 2	28	33.3	55	9,708	4,721	1,542	311	do	T	Do.
38-E	2 by 2	28	32.4	56	10,080	3,665	1,995	360	do	T	Do.
38-F	2 by 2	28	25.8	55	11,648	7,845	1,999	416	do	T	Do.
38-G	2 by 2	28	29.6	55	8,856	5,772	1,795	352	do	T	Do.
Average		28	24.9	51	9,982	5,851	1,808	356			

TABLE 9.—Data on individual bending tests of *Bataa apitong* No. 5.

[T, tension failure.]

COMMERCIAL SIZES.

Reference No.	Size.	Span.	Moisture.	Weight of (green).		Modulus of rupture.	Fiber stress at elastic limit.		Modulus of elasticity.	Greatest calculated longitudinal shear.	Defects.	Manner of failure.	Causes of first failure.
				<i>Lbs. per cu. ft.</i>	<i>Lbs. per sq. in.</i>		<i>Lbs. per sq. in.</i>	<i>Lbs. per sq. in.</i>					
35	4.00 by 11.90 in.	132	53.7	62	5,546	3,259	1,410	375	375	Checks and knots.	T	Checks and knots.	
36	4.00 by 11.98	156	48.2	60	9,559	4,480	2,151	366	366	do.	T	Do.	
37	3.96 by 7.80	132	23.8	58	6,543	2,725	1,625	290	290	do.	T	Do.	
Average		132	43.5	60	7,209	3,488	1,728	343	343				

SMALL SPECIMENS.

34-o	2 by 2	28	31.1	58	8,708	5,245	1,713	311	None	T	Not apparent.
34-f	2 by 2	28	23.6	58	9,660	5,759	1,791	845	do	T	Do.
34-b	2 by 2	28	38.9	58	8,848	5,235	1,628	316	do	T	Do.
34-c	2 by 2	28	18.7	56	8,652	3,146	1,712	309	do	T	Do.
34-h	2 by 2	28	27.6	54	7,812	4,188	1,351	279	do	T	Do.
35-a	2 by 2	28	25.3	58	10,388	4,197	1,713	371	do	T	Do.
35-A	2 by 2	28	25.6	55	9,520	5,769	1,597	340	do	T	Do.
35-I	2 by 2	28	27.5	54	8,092	3,666	1,596	289	do	T	Do.
35-H	2 by 2	28	34.2	54	9,324	4,200	1,751	333	do	T	Do.
35-G	2 by 2	28	35.1	59	9,100	3,669	1,598	325	do	T	Do.
36-B	2 by 2	28	28.8	53	9,604	5,248	1,672	343	do	T	Do.
36-C	2 by 2	28	26.9	54	7,932	3,666	1,496	284	do	T	Do.
36-D	2 by 2	28	37.3	57	8,786	3,668	1,432	312	do	T	Do.
36-F	2 by 2	28	31.8	58	9,325	4,133	1,710	351	do	T	Do.
36-E	2 by 2	28	25.8	53	8,512	4,723	2,257	304	do	T	Do.
37-C	2 by 2	28	30.4	56	9,100	4,712	1,539	325	do	T	Do.
37-e	2 by 2	28	33.9	57	7,980	2,093	1,367	285	do	T	Do.
37-d	2 by 2	28	26.3	56	8,968	4,713	1,502	321	do	T	Do.
37-f	2 by 2	28	25.2	55	9,322	2,094	2,280	334	do	T	Do.
Average		28	25.9	55	8,945	4,146	1,659	319		T	

TABLE 10.—Data on individual bending tests of *Bataan apitong* No. 6.

[T, tension failure.]

COMMERCIAL SIZES.

Reference No.	Size.	Span.	Moisture.	Weight (green).	Modulus of rupture.	Fiber stress at elastic limit.	Modulus of elasticity.	Calculated longitudinal shear.	Defects.	Manner of failure.	Causes of first failure.
40	in. 5.20 by 11.59	in. 156	Per cent. 40.6	Lbs. per cu. ft. 60	Lbs. per sq. in. 5,222	Lbs. per sq. in. 3,122	1,000 lbs. per sq. in. 1,291	Lbs. per sq. in. 291	Knots and checks.	T	Knots and checks.
SMALL SPECIMENS.											
40-a	2 by 2	28	22.4	49	9,160	4,200	1,712	328	None	T	Not apparent.
40-1	2 by 2	28	21.8	54	9,950	3,150	1,960	355	do	T	Do.
40-2	2 by 2	28	20.1	54	11,480	3,150	1,955	410	do	T	Do.
Average		28	21.2	52	10,196	3,500	1,875	364			

TABLE 11.—Data on individual bending tests of apitong (from market).
[S, horizontal shear failure; C, compression failure; T, tension failure.]

COMMERCIAL SIZES.

Reference No.	Size.	Span.	Moisture.	Weight (green).	Modulus of rupture.	Fiber strength at elastic limit.	Modulus of elasticity.	Calculated longitudinal shear.	Defects.	Manner of failure.	Causes of first failure.
	in.	in.	Per cent.	Lbs. per cu. ft.	Lbs. per sq. in.	Lbs. per sq. in.	1,000 lbs. per sq. in.	Lbs. per sq. in.			
7	4.00 by 11.75	144	19.0	43	9,600	4,680	2,200	587	None	CT	Not apparent
8	3.80 by 12.55	144	46.9	50	9,300	4,330	1,959	608	Knots and checks	CT	Checks
9	3.72 by 11.70	144	76.6	55	6,070	3,390	1,710	370	do	C	Do.
15	4.00 by 14.00	120	52.3	62	6,500	5,200	1,690	560	Checks	S	Do.
Average		138	48.7	52	7,867	4,400	1,889	531			

SMALL SPECIMENS.

7-a	2 by 2	28	18.2	39	11,116	7,340	1,967	397	None	T	Not apparent.
7-b	2 by 2	28	17.9	40	11,928	6,816	2,071	426	do	T	Do.
7-c	2 by 2	28	17.5	42	11,900	6,814	2,023	425	do	T	Do.
7-e	2 by 2	28	17.5	42	11,340	8,380	1,824	405	do	T	Do.
7-f	2 by 2	28	17.4	41	10,610	6,297	1,714	379	do	T	Do.
8-D	2 by 2	28	23.5	42	11,340	5,700	1,714	405	do	T	Do.
8-E	2 by 2	28	31.1	46	11,172	6,288	1,711	399	do	T	Do.
8-F	2 by 2	28	27.4	45	12,544	4,198	2,109	448	do	T	Do.
9-a	2 by 2	28	24.7	35	8,372	3,149	1,714	299	do	T	Do.
9-c	2 by 2	28	30.0	35	7,952	5,238	1,368	284	do	T	Do.
9-d	2 by 2	28	18.1	32	8,568	4,725	1,470	306	do	T	Do.
15-1	2 by 2	28	16.82	54	10,020	5,240	2,282	380	do	T	Do.
15-2	2 by 2	28	15.4	53	9,900	5,250	1,960	354	do	T	Do.
Average		28	21.1	42	9,789	5,802	1,839	377			

TABLE 12.—Data on individual bending tests of *guijo* (from market).

[C, compression failure; T, tension failure.]

COMMERCIAL SIZES.

Reference No.	Size.	Span.	Moisture.	Weight (green).	Modulus of rupture.	Fiber stress at elastic limit.	Modulus of elasticity.	Calculation of longitudinal shear.	Defects.	Manner of failure.	Causes of first failure.
	in.	in.	Per cent.	Lbs. per cu. ft.	Lbs. per sq. in.	Lbs. per sq. in.	1,000 lbs. per sq. in.	Lbs. per sq. in.			
2	4.00 by 12.00	144	60.7	64	11,540	7,400	1,820	720	Knots	CT	Not apparent.
3	4.00 by 12.00	144	72.6	71	11,850	8,700	2,440	739	do	CT	Do.
5	4.00 by 12.00	144	63.4	69	11,850	7,990	2,870	740	do	CT	Do.
6	3.75 by 12.00	144	58.6	64	11,400	8,000	2,300	710	Knots and checks	CT	Do.
Average		144	63.3	67	11,660	8,022	2,357	727			

SMALL SPECIMENS.

2-A	2 by 2	28	42.2	55	13,636	8,331	2,192	457	None	T	Not apparent.
2-B	2 by 2	28	43.8	57	13,323	8,395	2,255	476	do	T	Do.
2-C	2 by 2	28	45.8	56	13,440	8,400	2,286	480	do	T	Do.
2-D	2 by 2	28	45.2	54	13,748	6,296	2,285	491	do	T	Do.
2-E	2 by 2	28	46.7	55	13,244	6,294	2,254	473	do	T	Do.
3-A	2 by 2	28	46.6	57	11,223	8,394	1,823	401	do	T	Do.
3-B	2 by 2	28	35.5	63	11,116	7,340	1,844	397	do	T	Do.
3-C	2 by 2	28	51.7	59	12,150	7,350	1,778	438	do	T	Do.
3-D	2 by 2	28	53.9	60	11,284	6,298	1,870	408	do	T	Do.
3-E	2 by 2	28	54.5	61	11,928	7,340	1,998	426	do	T	Do.
5-A	2 by 2	28	27.3	53	13,216	7,870	2,056	472	do	T	Do.
5-B	2 by 2	28	26.6	52	13,496	7,861	2,445	482	do	T	Do.
5-C	2 by 2	28	30.5	53	12,850	7,345	2,340	460	do	T	Do.
5-f	2 by 2	28	30.5	56	13,076	8,920	2,285	467	do	T	Do.
5	2 by 2	28	17.8	---	14,250	9,450	2,374	510	do	T	Do.
6-a	2 by 2	28	25.0	49	13,104	7,338	2,179	468	do	T	Do.
6-b	2 by 2	28	22.8	49	12,292	8,386	2,191	439	do	T	Do.
6-c	2 by 2	28	27.4	49	13,020	5,763	2,091	465	do	T	Do.
6-A	2 by 2	28	21.7	42	12,908	8,395	2,102	461	do	T	Do.
	Average	28	36.8	54	12,810	7,675	2,142	457			

TABLE 13.—Data on individual bending tests of *Iambayan* (from market).
[C, compression failure; T, tension failure.]
COMMERCIAL SIZES.

Reference No.	Size. in.	Span. in.	Moisture. Per cent.	Weight (green).		Modulus of rupture.		Fiber stress at elastic limit.		Modulus of elasticity.	Calcul- ated lon- gitudinal shear.	Defects.	Manner of failure.	Causes of first failure.
				Lbs. per cu. ft.	Lbs. per sq. in.	Lbs. per sq. in.	Lbs. per sq. in.	Lbs. per sq. in.	Lbs. per sq. in.					
1	3.98 by 11.75	144	18.0	30	8,463	5,222	1,753	518					CT	Not apparent.
10	3.95 by 11.75	144	16.9	38	5,050	3,960	1,270	350			Checks		T	Knots and checks.
51	4.45 by 12.15	144	46.9	48	4,682	2,547	1,746	254			Checks		T	Not apparent.
Average		144	27.2	39	6,065	3,913	1,589	374						
SMALL SPECIMENS.														
1-A	2 by 2	28	17.3	29	9,660	4,200	1,614	345			None		T	Not apparent.
1-B	2 by 2	28	17.7	31	9,436	4,138	1,651	337			do		T	Do.
1-C	2 by 2	28	14.4	32	10,080	4,200	1,614	360			do		T	Do.
1-D	2 by 2	23	17.4	31	10,080	6,283	1,620	360			do		T	Do.
10-a	2 by 2	28	19.5	43	10,696	5,767	1,569	382			do		T	Do.
10-b	2 by 2	28	17.2	37	9,436	5,766	1,385	337			do		T	Do.
10-c	2 by 2	23	18.8	36	8,680	5,769	1,385	310			do		T	Do.
10-d	2 by 2	28	18.0	37	9,464	3,670	1,712	338			do		T	Do.
10-e	2 by 2	28	17.6	37	9,072	4,719	1,508	324			do		T	Do.
51-7	2 by 2	28	32.8	45	8,920	5,260	1,454	318			do		T	Do.
51-8	2 by 2	28	37.0	47	7,500	2,095	1,440	268			do		T	Do.
51-9	2 by 2	28	22.6	45	8,400	5,250	1,374	300			do		T	Do.
51-10	2 by 2	28	23.3	42	9,020	4,190	1,610	322			do		T	Do.
51-11	2 by 2	28	21.4	39	8,400	3,150	1,585	300			do		T	Do.
Average		28	21.2	38	9,202	3,623	1,524	328						

TABLE 14.—Data on individual bending tests of *gisk* (from market).

[C, compression failure; T, tension failure.]

COMMERCIAL SIZES.

Reference No.	Size.	Span.	Moisture.	Weight (green).	Modulus of rupture.	Fiber stress at ultimate limit.	Modulus of elasticity.	Calculated longi-tudinal shear.	Defects.	Manner of failure.	Causes of first failure.
	in.	in.	Per cent.	Lbs. per cu. ft.	Lbs. per sq. in.	Lbs. per sq. in.	1,000 lbs. per sq. in.	Lbs. per sq. in.			
11	3.73 by 10.45	144	17.3	63	9,400	7,420	2,620	510			
12	3.75 by 11.55	144	16.8	60	15,370	9,480	2,702	925	Knots and checks.	T	Not apparent
13	3.72 by 10.55	144	18.9	62	17,500	11,150	3,420	960	do	T	Do.
14	3.75 by 10.54	144	16.8	57	14,300	9,310	3,120	785	do	CT	Do.
Average		144	17.4	60	14,142	9,340	2,965	795	Checks	CT	
SMALL SPECIMENS.											
11-e	2 by 2	28	17.9	61	18,480	11,550	2,484	660	None	T	Not apparent.
11-E	2 by 2	28	15.3	64	17,080	10,488	2,740	610	do	T	Do.
11-D	2 by 2	28	14.6	63	17,206	11,548	2,694	617	do	T	Do.
11-d	2 by 2	28	15.3	66	19,132	10,455	2,978	684	do	T	Do.
12-1	2 by 2	28	17.0	59	17,460	11,550	2,741	623	do	T	Do.
12-2	2 by 2	28	13.25	59	18,100	11,620	3,008	646	do	T	Do.
12-3	2 by 2	28	14.4	61	16,710	11,540	2,292	597	do	T	Do.
13-1	2 by 2	28	18.0	61	20,300	13,620	3,420	725	do	T	Do.
13-2	2 by 2	28	17.6	62	19,350	9,420	3,510	692	do	T	Do.
13-3	2 by 2	28	18.5	61	18,420	10,500	3,422	658	do	T	Do.
14-1	2 by 2	28	18.11	59	18,740	13,150	2,740	695	do	T	Do.
14-2	2 by 2	28	17.3	59	19,050	11,540	3,010	680	do	T	Do.
14-3	2 by 2	28	20.6	61	17,190	10,490	2,979	615	do	T	Do.
Average		28	16.7	61	18,256	11,338	2,920	653		T	

TABLE 15.—Average results of bending tests of timber of structural sizes and small specimens.

Species.	Tests.	Moisture.	Specific gravity oven dry, based on volume when green.	Modulus of elastic resilience.	Modulus of rupture.	Fiber stress at elastic limit.	Modulus of elasticity.	Greatest calculated longitudinal shear.	Ratio of the modulus of rupture of structural sizes and small specimens.
		Per cent.		Lbs. per cu. in.	Lbs. per sq. in.	Lbs. per sq. in.	1,000 lbs. per sq. in.	Lbs. per sq. in.	Per cent.
Tangile No. 1:									
Structural sizes.....	5	31.9	0.53	1.13	8,570	4,940	2,040	500	79
Small specimens.....	23	23.7	0.52	1.05	10,840	5,190	1,910	390	-----
Tangile No. 2:									
Structural sizes.....	5	33.3	0.49	0.97	7,790	4,060	1,860	320	80
Small specimens.....	22	26.3	0.46	0.81	9,700	4,620	1,680	340	-----
Tangile No. 3:									
Structural sizes.....	2	29.8	0.48	1.30	6,820	4,080	1,530	390	76
Small specimens.....	10	22.75	0.46	1.04	8,940	4,810	1,570	320	-----
Tangile No. 4:									
Structural sizes.....	4	24.9	0.46	0.45	6,710	2,690	1,690	240	68
Small specimens.....	15	18.8	0.47	1.08	9,850	5,030	1,600	350	-----
Tangile average:									
Structural sizes.....		29.9	0.49	0.96	7,640	3,940	1,780	360	76
Small specimens.....		29.9	0.48	0.99	10,000	4,910	1,690	350	-----
Apitong No. 1:									
Structural sizes.....	2	45.4	0.64	0.86	6,640	4,090	2,420	530	59
Small specimens.....	9	26.1	0.64	0.48	11,230	4,100	2,340	400	-----
Apitong No. 2:									
Structural sizes.....	4	53.3	0.58	0.51	6,690	3,290	2,030	390	61
Small specimens.....	11	22.1	0.64	1.17	10,910	5,180	2,040	390	-----
Apitong No. 3:									
Structural sizes.....	4	38.7	0.68	0.83	7,850	4,260	2,040	400	76
Small specimens.....	17	28.5	0.68	0.63	10,330	4,510	2,090	370	-----
Apitong No. 4:									
Structural sizes.....	4	36.9	0.64	0.63	6,120	3,530	1,960	240	61
Small specimens.....	19	24.9	0.65	1.05	9,980	5,850	1,803	350	-----
Apitong No. 5:									
Structural sizes.....	3	41.9	0.69	0.56	7,210	3,490	1,730	340	66
Small specimens.....	19	29.9	0.68	0.71	8,950	4,150	1,660	320	-----
Apitong No. 6:									
Structural sizes.....	1	40.6	0.69	0.69	5,220	3,120	1,290	290	51
Small specimens.....	3	21.7	0.69	0.28	10,190	3,500	1,870	360	-----
Apitong average:									
Structural sizes.....		42.8	0.65	0.68	6,820	3,630	1,900	260	62
Small specimens.....		25.5	0.66	0.72	10,080	4,550	1,970	370	-----
Apitong (from market):									
Structural sizes.....	4	48.7	1.56	1.19	7,870	4,400	1,890	540	80
Small specimens.....	13	21.1	0.56	1.14	9,790	5,800	1,840	380	-----
Guijo (from market):									
Structural sizes.....	4	63.3	0.66	3.13	11,660	8,020	2,360	730	91
Small specimens.....	19	37.1	0.64	1.55	12,810	7,680	2,140	460	-----

TABLE 15.—Average results of bending tests of timber of structural sizes and small specimens—Continued.

Species.	Tests.	Moisture.	Specific gravity oven dry, based on volume when green.	Modulus of elastic resilience.	Modulus of rupture.	Fiber stress at elastic limit.	Modulus of elasticity.	Greatest calculated longitudinal shear.	Ratio of the modulus of rupture of structural sizes and small specimens.
		<i>Per cent.</i>		<i>Lbs. per cu. in.</i>	<i>Lbs. per sq. in.</i>	<i>Lbs. per sq. in.</i>	<i>1,000 lbs. per sq. in.</i>	<i>Lbs. per sq. in.</i>	<i>Per cent.</i>
Lumbayan (from market):									
Structural sizes....	3	27.2	0.49	1.06	6,070	3,910	1,590	370	66
Small specimens....	14	21.8	0.50	0.89	9,200	3,620	1,520	330	-----
Gisok (from market):									
Structural sizes....	4	17.4	0.83	2.90	14,140	9,340	2,970	800	77
Small specimens....	13	16.9	0.84	2.47	18,260	11,340	2,920	650	-----
Borneo Camphor (Kapor):									
Structural size.....	1	55.3	0.57	1.47	7,610	5,840	2,260	360	58
Small specimens....	5	55.3	0.57	1.47	13,400	6,550	2,070	470	-----

TABLE 16.—Average strength values for compression parallel to grain, compression perpendicular to grain, shear, and hardness
 [Test specimens, 2 by 2 by 8 inches.]

Specimen.	Compression parallel to grain.				Compression perpendicular to grain.				Shear.			Hardness to a depth of 0.441 inch ball to one-half its diameter.		
	Test.	Moisture.	Fiber stress at elastic limit.	Maxi-mum crushing strength.	Stress area.	Height.	Tests.	Moisture.	Fiber stress at elastic limit.	Tests.	Moisture.	Shearing strength.	End.	Side.
			<i>Lbs. per sq. in.</i>	<i>Lbs. per sq. in.</i>					<i>Lbs. per sq. in.</i>			<i>Lbs. per sq. in.</i>	<i>Lbs.</i>	<i>Lbs.</i>
Tangle No. 1	33	22.1	2,620	4,980	4	2	26	19.5	660	30	20.0	1,010	740	710
Tangle No. 2	19	18.8	3,880	4,810	4	2	22	20.1	590	22	18.6	870	860	700
Tangle No. 3	11	21.5	2,640	4,450	4	2	9	20.8	650	14	20.2	920	660	670
Tangle No. 4	19	20.1	2,960	4,700	4	2	16	21.8	840	24	18.6	1,080	650	630
Average		20.6	2,900	4,720				20.5	685			958	728	677
Apitong No. 1	6	22.3	2,530	4,600	4	2	6	26.3	740	13	17.9	1,300	1,230	1,050
Apitong No. 2	14	20.6	2,660	5,580	4	2	18	21.9	840	22	20.5	1,080	1,240	1,180
Apitong No. 3	6	20.30	3,330	5,720	4	2	11	26.1	830	29	18.7	1,140	1,240	1,080
Apitong No. 4	17	21.4	3,030	5,230	4	2	14	20.7	980	21	18.5	1,230		
Apitong No. 5	6	21.9	3,000	4,890	4	2	16	22.1	1,050	28	18.6	1,160	1,180	1,150
Apitong No. 6	2	21.2	2,750	5,680	4	2	5	21.0	970	7	19.1	1,210	1,330	1,080
Average		21.3	2,897	5,285				23.0	884			1,187	1,244	1,068
Guijo	19	24.20	3,990	6,280	4	2	14	17.61	1,130	20	15.2	1,400	1,270	1,210
Gisek	12	16.11	5,170	8,440	4	2	12	17.11	2,100	16	15.5	1,830	1,670	1,850
Lumbayan	10	21.65	2,900	5,310	4	2	10	18.60	840	14	20.7	1,160	860	660
Apitong	7	17.90	3,000	5,360	4	2	10	16.50	840	15	15.5	1,110	1,070	940
Borneo Camphor (Kapor)	5	55.30	2,970	6,200	4	2	5	55.30	850	5	55.3			483

ILLUSTRATIONS

PLATE 1

Testing machine equipped for timber testing.

TEXT FIGURES

- FIG. 1. Apparatus used for bending tests on large beams.
2. Deformation curve.
3. Deformation curve.
4. Apparatus used for testing small clear beams.
5. Apparatus used in making tests of compression parallel to grain.
6. Diagram for tests in compression parallel to grain.
7. Apparatus used in making tests in compression perpendicular to grain.
8. Typical load deformation diagram for tests in compression perpendicular to grain.
9. Apparatus used in making shearing tests.
10. Apparatus used in testing hardness of timber.
11. Percentage of average modulus of rupture.
12. Percentage of average modulus of rupture.
13. Percentage of average modulus of rupture.
14. Percentage of average modulus of rupture.
15. Relation between dry weight and modulus of rupture obtained from tests on small clear beams.
16. Relation between dry weight and modulus of rupture obtained from tests on small clear beams.
17. Relation between dry weight and modulus of rupture obtained from tests on small clear beams.
18. Relation between dry weight and modulus of rupture obtained from tests on large beams.
19. Relation between dry weight and modulus of rupture obtained from tests on large beams.



PLATE 1. TESTING MACHINE EQUIPPED FOR TIMBER TESTING.

BIRDS OF ANTIQUE PROVINCE, PANAY, PHILIPPINE ISLANDS

By RICHARD C. MCGREGOR

Ornithologist, Bureau of Science, Manila

TWO PLATES

This paper records the observations of myself and two assistants on the birds of Antique Province, Panay. From Iloilo we reached Tibiao by steamer on May 8, 1918. As there was no forest whatever in this locality, we moved to Culasi in the vicinity of which and at Flores somewhat better collecting ground was found. We finally took a small sailing boat at Lipata, which transported us around the northwestern point of Panay to the town of Ibajay where we took a steamship for Manila.

Antique Province consists of a strip along the entire western side of Panay and includes also four small islands—Maralison, Batbatan, Manining, and Caluya. Its eastern boundary lies in a more or less continuous range of hills and mountains. In the northern and southern extremities this range approaches the coast so that the width of the province is less than 12 kilometers, but this gradually increases toward the center, in the region of Caritan and Bugason, where the eastern boundary is about 35 kilometers from the coast. If the four islands mentioned above be disregarded, the province seems extremely long for its width.

Except at the extremities the coast line is nearly straight, being thus very different from the outline presented by the northern and eastern coasts of Panay. On the entire coast of Antique Province Lipata Point, near Culasi, is the only place affording protection to vessels during storms from the south and the southeast. The water is deep close to shore along nearly the entire coast, so that at many places, when the sea is calm, small steamers can anchor just outside the surf and carry a stern line to the beach. These features combine to bring water transportation to a standstill during the southeast monsoon. A remarkable feature of this province is the great number of rivers, most of which are of necessity short, but many of them carry

so much water during rainy weather that all except very limited travel along the coast is rendered impossible.

With few exceptions there are high beaches of sand or gravel from San José de Buenavista to Pandan. Above high tide there is a scanty growth of strand plants among which a species of *Pandanus* is the most conspicuous. A short distance inland the land is usually lower than the beach and supports groves of coconuts or, near the mouths of some rivers, nipa palms. From this coastal strip to the hills there are level areas of varying width on which rice, sugar cane, and corn are grown. The forest has been stripped from the lower hills; here rice and corn are grown without irrigation and, in many places, on extremely steep and rocky ground. When one of these areas is not replanted, it becomes covered with a thick growth of tall grass. Occasional patches of forest can be seen on many hills. When one of these is examined, it is found that the trees and shrubs are growing on very steep hillsides or among boulders of extremely rough coral crag. Progress through the latter type of forest is slow and tiresome and not without danger, for deep holes are often hidden by the leaves of the undergrowth. Bird collecting in this forest, except along paths, is useless, as the entire attention is required to secure safe footing.

The higher hills, which may be called mountains because of their steep slopes and broken sky line, in the vicinity of Culasi are well forested, and the summits are usually narrow ridges on which the mossy type of forest grows, down to about 900 meters' altitude. Chickadees, nuthatches, *Rhipidura albiventris*, *Edolisoma panayensis*, and *Culicicapa helianthea* were found in this forest, but fog was so prevalent that not a single clear day of observation was had.

The maps of this region are somewhat indefinite and incomplete with regard to the mountains. In Tibiao and in Culasi the highest elevation of a long range was pointed out as Mount Madjaas; this seems to be considered the highest mountain in this region, and it is probably the one marked Madia-ás on old maps. Because of weather conditions I could not see if there were other mountains higher than the one called Madjaas. An attempt was made to reach the summit of Madjaas from Flores by climbing a steep spur on the northeast side. At about 1,000 meters this became a knifelike ridge covered with typical mossy forest through much of which it was necessary to clamber on hands and knees. At about 1,500 meters a thicket of high coarse grass was encountered through which it would

have taken an entire day to cut a trail, and precipitous slopes on each side prevented going around the grass so I reluctantly returned to Flores.

We planned to climb the mountain from the south, but very rainy weather prevented the attempt.

On June 18 we visited Maralison Island, where we noted birds of the following species:

<i>Streptopelia dussumieri.</i>	<i>Hirundo javanica.</i>
<i>Demigretta sacra.</i>	<i>Cisticola exilis.</i>
<i>Halcyon chloris.</i>	<i>Cyrtostomus jugularis.</i>

On June 24 we visited Batbatan Island, where we were storm-bound for five days by almost continuous rain and wind. On July 1 we were able to return to Culasi. Birds of the following species were noted on Batbatan Island:

<i>Streptopelia dussumieri.</i>	<i>Cisticola exilis.</i>
<i>Sterna boreotis.</i>	<i>Artamus leucorhynchus.</i>
<i>Charadrius fulvus.</i>	<i>Cyrtostomus jugularis.</i>
<i>Demigretta sacra.</i>	<i>Anthus rufulus.</i>
<i>Fregata aquila ?</i>	<i>Oriolus acorhynchus.</i>
<i>Centropus javanicus.</i>	<i>Lamprocorax panayensis.</i>
<i>Rhipidura nigritorquis.</i>	

During July we were able to do very little work because of almost continuous bad weather. The only steamer on the coast was stormbound at Lipata Point for a week, and travel by land was out of the question because of the numerous rivers.

In Flores, the only good collecting locality that we found, we were unable to do more than three days' work, and our collections from Antique are therefore not very satisfactory. The following species collected or seen by us are believed to be unrecorded from Panay:

<i>Porphyrio pulverulentus.</i>	<i>Tyto longimembris.</i>
<i>Tachybaptus philippensis.</i>	<i>Caprimulgus manillensis.</i>
<i>Charadrius fulvus.</i>	<i>Collocalia marginata.</i>
<i>Ægialitis peroqi.</i>	<i>Xantholæma roseum.</i>
<i>Heteractitis brevipes.</i>	<i>Hirundo striolata.</i>
<i>Heteropygia acuminata.</i>	<i>Muscicapula westermanni.</i>
<i>Fregata aquila ?</i>	<i>Copsychus mindanensis.</i>
<i>Elanus hypoleucus.</i>	<i>Kittacincla superciliiaris.</i>
<i>Ninox philippensis.</i>	<i>Budytes leucostriatus.</i>

The ornithology of Panay is fairly well known and is practically the same as that of Negros. The only important difference is that *Phapitreron maculipectus*, *Oriolus steeri*, *Æthopyga bonita*, *Dasyrotapha speciosa*, *Halcyon moseleyi*, *Brachypteryx brun-*

neiceps, *Planesticus nigrorum*, and *Rhinomyias albigularis* are known to occur in Negros and have not been collected in Panay. The first four will probably be found in Panay when a collector finds good forest. *Halcyon moseleyi* is one of those rare species that cannot be looked for with confidence even where it is known to occur. The last three species can be expected only in forest at considerable altitude, and the chances of their discovery in Panay are very slight.

ENUMERATION OF SPECIES OF BIRDS OBSERVED IN
ANTIQUÉ PROVINCE

Excalfactoria lineata (Scopoli).

Individuals of the island painted quail were flushed several times on grassy hills near Culasi.

Gallus gallus (Linnæus).

Male jungle fowls were heard in the forest near Culasi, at altitudes of from 200 to 500 meters; and a female with young was seen on June 14, at an elevation of about 400 meters.

Turnix fasciata (Temminck) ?

Button quails were flushed several times near Culasi, and a bird from which all the feathers had been removed was seen in the hands of a man at Tibiao. As no specimen was collected, there is the possibility that some species other than *T. fasciata* was seen.

Osmotreron axillaris (Bonaparte).

Specimens of this green pigeon were collected at Tibiao on May 13 and at Culasi on May 26.

Osmotreron vernans (Linnæus).

Three specimens of this species were killed at Culasi on July 18, and another, on July 28. This dove appears to be rare in Antique Province.

Phapitreron nigrorum Sharpe.

A female of this white-eared pigeon, with large ovules, was killed at Tibiao on May 9, and another specimen was killed at 800 meters' altitude near Culasi on May 19. A nesting female was collected near Culasi on May 30.

Muscadivores chalybura (Bonaparte).

An adult fruit pigeon in molt and a fully grown young bird of the year were collected between Culasi and Tibiao on July 22.

Columba griseigularis (Walden and Layard).

Four specimens of this beautiful wood dove, one of which was killed, were seen in a second-growth thicket near Culasi on May 26.

Streptopelia dussumieri (Temminck).

Specimens of Dussumier's dove, feeding on corn and rice, were killed near Tibiao on May 13. This species was rare near Culasi, and only three or four individuals were seen between Culasi and Pandan. We were informed that there were many doves on Maralison Island, but only three specimens of Dussumier's dove were seen. No other species of dove was found on Maralison. On Batbatan Island this species was very abundant; as it was feeding almost exclusively on rice, it was doing considerable damage.

Chalcophaps indica (Linnæus).

The bronze-winged dove was seen near Culasi.

Hypotænidia striata (Linnæus).

One male was collected at Culasi on June 19.

Poliolimnas ocularis (Ingram).

Poliolimnas cinerea MCGREGOR, Man. Philip. Birds (1909) 73 (Philippine records).

Porzana cinerea ocularis INGRAM, Bull. Brit. Orn. Club 29 (1911) 22.

The Philippine ashy crane was abundant at Culasi, where several specimens were collected; another was collected at Tibiao.

Ingram has separated the ashy crane of the Philippine Islands as a subspecies of *Porzana cinerea* and has validated Gray's name by giving the characters for the Philippine race. This race is said to be darker than *P. cinereus*, especially on the head; the gray tints on the head and the olivaceous tints on the back purer and more strongly contrasted with one another; the neck and breast conspicuously grayer and strongly washed with slate gray.

Sharpe¹ indicates two specimens collected by Cuming as "Types of *O. ocularis*," with Philippine Islands as the locality. However, as Gray's name is a nomen nudum, the types of his species are of no interest unless designated as types by another author. Ingram designated neither type nor type locality for his subspecies. It is possible that two or more races of this rail may be found within the Philippine Islands; it would then

¹ Cat. Birds Brit. Mus. 23 (1894) 133.

be necessary to fix the type locality for *Poliolimnas ocularis*. It is strange that ornithologists continue to publish names and descriptions without paying attention to types and exact localities.

Gallinula chloropus (Linnæus).

The moorhen was abundant in a small marsh just outside of Culasi during May and the early part of June. When the rice fields became flooded these birds scattered over an immense area, and specimens were then obtained with difficulty.

Gallicrex cinerea (Latham).

A few specimens of the watercock were killed.

Porphyrio pulverulentus Temminck.

Specimens of the large blue gallinule were killed in a bit of marsh near Culasi. This species has not been previously recorded from Panay.

Tachybaptus philippensis (Bonaterre).

One specimen of the Philippine grebe was collected near Culasi on June 16; the species has not been previously recorded from Panay.

Sterna boreotis (Bangs).

A few specimens of this large tern were seen about Batbatan Island; specimens collected there on June 27 were in full plumage, the crown being entirely black.

Charadrius fulvus (Gmelin).

A small flock of Eastern golden plovers was seen on Batbatan Island. Two specimens were killed near Culasi on July 6. This common migrant does not appear to have been recorded from Panay.

Ægialitis dubia (Scopoli).

Specimens of the little ringed plover were collected at Tibiao and at Culasi.

Ægialitis peroni (Bonaparte).

Malay sand plovers were the only shore birds seen during the long tramp from Culasi to Pandan and return; one male was killed near Sebaste on July 13. This species has not been recorded from Panay.

Heteractitis brevipes (Vieillot).

A female of this species was collected at Lipata on July 9; the species has not been recorded from Panay.

Actitis hypoleucos (Linnæus).

One specimen of the common sandpiper was collected at Tibiao in May.

Heteropygia aurita (Latham).

A small flock of sharp-tailed sandpipers was seen near Culasi on May 16. One female was very fat, and its ovary contained large ovules. The plumage of this specimen agrees well with the description of the breeding plumage and is indistinguishable from that of a female collected by me in Batan Island, Batanes, north of Luzon, on May 29, 1907. Panay is the fourth Philippine island from which this sandpiper is now known.

Rostratula capensis (Linnæus).

Specimens of the painted snipe were collected near Culasi.

Pyrherodia manilensis (Meyen).

Specimens of this large heron were collected near Culasi.

Demigretta sacra (Gmelin).

A reef heron from Maralison, June 18, is almost entirely pure white. There are a few blackish feathers on the head, the neck, the wings, and the thighs. The neck is well sprinkled with blackish feathers, and the dark color is conspicuous on the axillars and the wing lining. This heron, while not abundant, is widely distributed in the Philippine Islands, but I do not remember having seen a white one before. An individual in the ordinary dark blue plumage was seen on Batbatan.

Nycticorax manillensis Vigors.

An immature specimen of the Philippine night heron was killed near Culasi on July 21.

Butorides javanica (Horsfield).

This small heron was seen near Culasi.

Ixobrychus astrologus Wetmore.

Ixobrychus sinensis MCGREGOR, Man. Philip. Birds (1909) 178 (Philippine localities).

Ixobrychus sinensis astrologus WETMORE, Proc. Biol. Soc. Washington 31 (1918) 83 (Paete, Laguna, Luzon, type locality; and Panay).

This neat little bittern was abundant near Culasi; two specimens were preserved. Wetmore has separated the Philippine little yellow bittern as a subspecies with the following characters:

Characters.—Similar to *Ixobrychus sinensis bryani* (Seale) from Guam but smaller, bill in adult more slender, back darker, more brownish, under tail coverts somewhat more buffy, upper breast and foreneck slightly paler, back of neck slightly paler, more reddish.

The type is a specimen from Paete, Laguna Province, Luzon, collected by McGregor and Celestino.

Ixobrychus cinnamomea (Gmelin).

One specimen of the cinnamon bittern was collected near Culasi.

Dendrocygna arcuata (Horsfield).

Specimens of this tree duck were collected near Culasi on May 28 and on June 2.

Anas luzonica Fraser.

About the middle of May there were a few mallards in the marsh at Culasi, and pairs were found later at various places in the vicinity of that town.

Fregata aquila (Linnæus)?

On June 30 after four days of wind and rain a man-of-war bird was seen flying over Batbatan Island. On July 11 three more man-of-war birds were seen at Panganta, about 3 kilometers north of Culasi, and the next day a solitary bird of this species was seen over the beach at Sebaste. For seven days preceding July 11 there was heavy wind and much rain. Man-of-war birds may be expected to appear near the shore of any of the islands after a heavy wind. This genus has not been previously recorded from Panay. As we could not collect a specimen the species seen is in doubt.

Spilornis panayensis Steere.

One female of the Panay serpent eagle was collected at Culasi, and a young female was collected at Flores.

Haliastur intermedius Gurney.

A hawk of this common species, which was abundant at Tibiao and at Culasi, attempted to catch some small chickens, but at the noisy warning of two hens the chickens ran to the protection of a bamboo thicket. On another occasion one of these hawks succeeded in taking a small fish that a fisherman had left on the beach a short distance behind him.

Elanus hypoleucus Gould.

One specimen, a male, of this kite was collected at Culasi; the species has not been previously recorded from Panay.

Ninox philippensis Bonaparte.

A female of the Philippine hawk owl was collected at Culasi on May 21. This species has not been previously recorded from Panay.

Tyto longimembris (Jerdon).

The dried remains of an owl found on the road near Sebaste were easily recognized as those of a grass owl. This species has not been previously recorded from Panay.

Eurystomus orientalis (Linnæus).

The oriental roller was as abundant in Panay as it is in many other parts of the Philippine Islands.

Halcyon gularis (Kuhl).

Common at Tibiao and at Culasi.

Halcyon chloris Boddaert).

Common at Tibiao and at Culasi and noted on Maralison Island.

Penelopides panini (Boddaert).

Hornbills were very scarce in the localities visited by us, and only one specimen was collected.

Merops americanus P. L. S. Müller.

One specimen of the chestnut-headed beebird was collected at Culasi.

Caprimulgus manillensis Walden.

A specimen of the Manila nightjar was killed on the ground in a second-growth thicket on May 27. No species of this genus has been previously recorded from Panay.

Collocalia troglodytes Gray.

Swiftlets of this species were seen about grassy hills near Culasi at about 700 meters' altitude.

Collocalia marginata Salvadori.

About a dozen nests of Salvadori's swiftlet were found plastered to the walls of a small cave near Tibiao at 130 meters' altitude. One bird was caught on the nest with an insect net. The nest is composed of fibers of *Usnea* species and a few other fine plant stems, fastened together and to the rock wall by means of a small quantity of the glutinous substance that is

characteristic of the nests of many species of *Collocalia*. The nest is 3 centimeters deep, outside; 6.5 centimeters in greatest diameter (parallel to the supporting surface); and 5 centimeters from back to front—that is, the diameter at right angles to the supporting surface. The side that was against the rock is somewhat flattened and wings of the glutinous substance, attached to the rock and extending 2 centimeters from each side of the nest, serve as additional support. Other nests from this cave are composed of fine plant stems fastened together and to the rock wall in the usual manner.

In each of three sets of eggs collected one egg was slightly incubated and the other egg was noticeably more advanced in incubation. The eggshells are pure, dull white and unspotted. Measurements in millimeters are as follows: 17 by 11.4, 17.3 by 11; 16.5 by 10.6, 16.4 by 10.3; 16.4 by 10.2, 16.3 by 10.6.

Salvadori's swiftlet has not been previously recorded from Panay.

Coccyzus merulinus (Scopoli).

This common cuckoo was noted at Tibiao and at Culasi. A nearly full-grown young was killed near Culasi on July 28.

Centropus viridis (Scopoli).

This species was noted at Culasi.

Centropus javanicus (Dumont).

This species was noted at Culasi and on Batbatan Island.

Xantholæma roseum (Dumont).

This barbet was fairly abundant in the forest on hills near Culasi, but the coral rock on which the trees grow made it difficult to get near the birds. However, a few specimens were collected, June 3 to 14. The species has not been previously recorded from Panay.

Thriponax hargitti Sharpe.

One specimen, a female, was taken near Culasi at 600 meters' altitude.

Pitta erythrogaster Temminck.

Several specimens were taken near Culasi.

Hirundo javanica Sparrman.

This species was noted at Culasi and on Maralison Island.

Hirundo striolata Boie.

A few pairs of mosque swallows were building nests in the small cave near Tibiao where *Collocalia marginata* was found nesting. No nest appeared to be completed on May 13. This swallow has not been previously recorded from Panay.

Cyornis philippinensis Sharpe.

Specimens of this species were collected at Culasi.

Muscicapula westermanni Sharpe.

A specimen of this mountain flycatcher was collected at Flores on June 7. This species has not been previously recorded from Panay.

Hypothymis occipitalis (Vigors).

This widely distributed species was noted near Culasi, where one specimen was collected.

A nest of this flycatcher containing two heavily incubated eggs was found near Flores on June 8. It was securely saddled in the upright fork of a small tree. The principal material is small rachises of some compound leaf; the interior has a thin lining of fine fibers or grass. On the outside are a few bits of grass, leaves, strands of scale moss, small white masses that seem to be insects' cocoons, and possibly material from certain scale insects or leaf hoppers. The whole is held together by very slender threads that may be cobwebs. The nest is deep, both inside and outside, as is characteristic of the nests of many of the small flycatchers; but it is not so neatly finished, especially about the rim, as in some of the better examples of the nests made by members of this family. Measurements of this nest in centimeters are: Outside depth, 7; inside depth, 3.5; outside diameter, 6.5; inside diameter, 4.5.

The eggshells are smooth and very slightly glossy; their ground color is uniform, pale ivory yellow; the markings are dots and small irregular spots of light chestnut, most of which are near the larger end of the egg, but they do not form a zone. On one egg the markings are concentrated to form about one-third of a zone near the larger end, while the opposite side of the egg has scarcely any marks. These two eggs measure, in millimeters, respectively, 17.5 by 13.0 and 16.7 by 12.8.

Rhipidura albiventris Sharpe.

A pair of specimens of this forest flycatcher was collected near Culasi in mossy forest at 1,000 meters' altitude.

Rhipidura nigritorquis Vigors.

This species was noted at Tibiao and at Culasi and on Batbatan Island.

Culicicapa helianthea (Wallace).

A male of this beautiful yellow flycatcher was collected at 800 meters' altitude near Culasi, and a breeding pair was collected near Flores on June 6.

Artamides panayensis Steere.

This species was found in the hill forests near Culasi; one specimen was preserved.

Edolisoma panayense Steere.

Two males and a female of the Visayan cuckoo shrike were collected near Culasi in the mossy forest at 1,000 meters' altitude.

Lalaga niger (Forster).

This species was noted at Culasi.

Iole guimarasensis Steere.

Steere's bulbul was not abundant in Panay; it was noticed at Tibiao, and one specimen from Culasi was preserved.

Pycnonotus goiavier Boie.

This common species was noted at Tibiao and at Culasi. A nest of *Pycnonotus goiavier* found near Flores on June 8 contained two heavily incubated eggs. The nest is compactly made of rootlets and grass stems; on the bottom are several broad pieces of plants like the leaves of grasses. The lining consists of fine grasses. This nest fits neatly into one of the cardboard boxes in which twenty-five 12-gauge shotgun shells are packed, so that its outside dimensions are about those of this box, namely, 6 by 10.5 centimeters.

The eggshell is smooth and slightly glossy. The ground color is shell pink, but this is extensively obscured by the heavy markings, which form almost a solid mass of color near the larger end of the shell. These markings are mahogany red and burnt sienna, the undershell markings are liver brown and seem to be deeply embedded. The measurements in millimeters of these two eggs are 22.4 by 16.4 and 21.3 by 16.5.

Copsychus mindanensis Wagler.

This species, not previously recorded from Panay, was noted near Tibiao on May 9.

***Kittacincla superciliaris* Bourns and Worcester.**

Cittocincla superciliaris BOURNS and WORCESTER, Minnesota Acad. Nat. Sci., Occ. Papers 1 (1894) 23.

Cittocincla nigrorum GRANT, Ibis (1896) 547 (Negros).

Kittacincla superciliaris MCGREGOR, Philip. Journ. Sci. § D 6 (1911) 44 (Negros).

I have already suggested that specimens of *Kittacincla* from Masbate (*superciliaris*) and from Negros (*nigrorum*) seemed to represent one species. I have before me one male from northern Negros, one male from Tibiao, two males from Masbate, and six males from Culasi, Panay, and I do not see that these differ in any way. The "partially concealed patch of white feathers in the middle of the lower back" is a variable character; it may be absent or may consist of a small white patch on one web of one or two feathers. Therefore, I believe that the *Kittacincla* of the central Philippines (Negros, Guimaras, Panay, Masbate, and Ticao) is *Kittacincla superciliaris*. No specimen of this genus has been previously recorded from Panay, and none is known from Guimaras.

Kittacincla superciliaris is one of the most distinct species discovered by the Menage Expedition. It was described from Masbate specimens. In Panay we found it rather common in the small forest growing on coral-limestone hills near Culasi; but it was very difficult to collect, and each specimen cost a day's patient hunting. On only one day were two specimens secured. Only one of our specimens is marked as a female, and this is doubtless a mistake as its plumage is not different from that of the others. A female from Negros agrees with Grant's description of the female. While we were at Culasi this species was breeding, and the females were probably on their nests and for this reason were not seen.

This species should be called Visayan shama rather than white-eyebrowed shama, as the eyebrow stripe is practically as conspicuous in the Luzon species.

***Pratincola caprata* (Linnæus).**

This species was noted at Tibiao and at Culasi.

***Orthotomus castaneiceps* Walden.**

This cheerful little tailor bird is one of the most abundant species along the coast of Antique Province. From the steamer it was heard singing at San José and at Bugasong, and it was a noticeable element of the lowland avifauna from Tibiao to Culasi and farther north.

At Tibiao a nest of the tailor bird, containing two fresh eggs, was found on May 15. The nest is composed of soft cottony and silklike fibers with a few bits of fine grass on the outside. It is fastened to and suspended among three leaves; the leaves are fastened to it in the classical tailor bird way by means of threadlike fibers. The nest is 6 centimeters deep and about the same in diameter.

The eggshells are smooth, white, and glossy. The markings are rather numerous dots and small blotches of liver brown to chestnut brown. Undershell markings are numerous and nearly as distinct as those on the surface. The markings are more numerous on the larger half of the shell, but do not form a distinct zone. The measurements of the eggs in millimeters are 16.0 by 11.2 and 17.2 by 12.0.

Cisticola exilis (Vigors and Horsfield).

This species was noted at Tibiao and at Culasi and on Batbatan and Maralison Islands.

A nest of *Cisticola exilis*, containing three fresh eggs, was found near Culasi on June 20. It was supported among large grass stems. It is composed of a loosely felted mass of the soft hairy spikelets of cogon (*Imperata*); on the outside are a few grass leaves and several large broad leaves; the latter are fastened together and held against the nest by means of threadlike fibers, which pass through holes in the leaves in the same manner as in the nests of tailor birds. The nest is about 8 centimeters deep and 6 centimeters in diameter, outside measurements.

The eggshell is smooth and very slightly glossy. The ground color is uniformly pale Nile blue. Most of the markings are rather large, somewhat irregular spots, mostly near the larger end of the shell, but without indication of a zone. The smaller markings are scattered spots and pin-point dots. All of the surface markings are liver brown to chestnut brown, the under-shell markings are lighter brown. The measurements of the eggs in millimeters are 16.0 by 11.8, 15.7 by 12.1, and 15.7 by 12.0.

Megalurus tweeddalei McGregor.

Megalurus ruficeps GRANT and WHITEHEAD, Ibis (1898) 240, pl. 5, fig. 7 (egg).

This species was seen near Tibiao on May 9, and a young bird was collected at Culasi on May 26.

On June 1 a nest containing three heavily incubated eggs was found in the hills near Culasi. The shell is smooth and slightly glossy; general color pale pinkish buff; dots and irregular spots of liver brown, chocolate, and black are most numerous in a zone near the larger end; undershell markings numerous. The measurements in millimeters are 22.2 by 16.0, 22.0 by 15.8, and 21.8 by 16.1. These eggs do not resemble the figure given by Grant and Whitehead. The nest consists of an inner part composed of fine grass, surrounded by a large quantity of broad grass leaves very loosely put together; the entrance is at one side and is overhung by part of the outer broad-leaf material. The nest is very bulky; from back to front it measures at least 25 centimeters due to the projecting outer material. As the nest was placed in a thick growth of cogon (*Imperata*) it is considerably compressed and is only about 7 centimeters thick at right angles to the longest diameter. From top to bottom it measures about 15 centimeters.

Acanthopneuste borealis (Blasius).

This widely distributed migrant was noted at Tibiao on May 9.

Artamus leucorhynchus (Linnæus).

This swallow shrike was noted at Tibiao and was abundant about the plaza in Culasi; it was also seen on Batbatan Island.

Pardaliparus panayensis Mearns.

Pardaliparus elegans panayensis MEARNS, Proc. U. S. Nat. Mus. 51 (1917) 57.

Although titmice were frequently seen in the vicinity of Tibiao and Culasi, only two specimens were preserved; one is a female in worn plumage, the other is a young, yellow-throated bird of the year.

Mearns reviewed the genus as it exists in the Philippine Islands and recognized seven subspecies. There is certainly much difference between the large pale birds (*Pardaliparus edithæ* McGregor), of Calayan Island, at the northern limit of the Philippine range of this genus, and the small dark birds of some of the southern islands. It will be necessary to have a large series of adult birds in fresh plumage before the ranges of the various forms can be defined.

Callisitta œnochlamys (Sharpe).

Nuthatches were seen in the mossy forest at 1,000 meters' altitude near Culasi.

Zosterops nigrorum Tweeddale.

A few silvereyes were obtained at Tibiao and at Culasi.

Dicaeum haematostictum Sharpe.

Specimens of this beautiful flowerpecker were collected at Tibiao and at Culasi.

Æthopyga magnifica Sharpe.

One male specimen of this truly magnificent species was collected at Flores; the species was not seen in any other locality in Panay.

Cinnyris guimarasensis Steere.

One male specimen of this rare sunbird was collected at Flores.

Cyrtostomus jugularis (Linnæus).

An incomplete nest of this sunbird was seen at Tibiao on May 8, and the species was abundant near Tibiao, Culasi, and other localities visited. It also occurs on Maralison and Batbatan Islands.

Budytes leucostriatus Homeyer.

This species was noted near Tibiao early in May. The species has not been previously recorded from Panay.

Anthus rufulus Vieillot.

This pipit was seen near Culasi and on Batbatan Island; one specimen was preserved.

Munia jagori Martens.

This species was noted near Tibiao and Culasi; four specimens were preserved at the latter locality.

A nest of *Munia jagori*, containing five slightly incubated eggs, was found near Culasi on May 23. The nest is large considering the size of the bird; it is nearly spherical, with a diameter of about 15 centimeters. The entrance is a hole 2.5 centimeters in diameter above the center on one side and is slightly protected by a roof of grass. The nest is so deep that it is difficult to remove the eggs except with the aid of a spoon. The entire nest is composed of grasses—fine grass inside and broad grass leaves outside.

The eggshells are smooth and dull; they are white and without markings. Their measurements in millimeters are 16.4 by 11.9, 14.4 by 11.2, 15.0 by 11.4, 15.5 by 11.9, and 15.0 by 11.1.

Oriolus acrorhynchus Vigors.

The Philippine oriole was fairly common near Tibiao and Culasi and was noted on Batbatan Island.

Dicrurus mirabilis Walden and Layard.

This species was not abundant in the parts of Panay visited by us. Two specimens were collected at Culasi.

Sarcops melanonotus Grant.

Two specimens of the bald starling from Culasi belong to the black-backed form of *Sarcops*.

Lamprocorax panayensis (Scopoli).

This starling was noted as abundant between Tibiao and Culasi, and on May 9 it appeared to be nesting in buri palms. It occurs also on Batbatan Island.

Corone philippina (Bonaparte).

The Philippine crow was seen along the road between Tibiao and Pandan, but the species does not appear to be as abundant as in many other islands.

ILLUSTRATIONS

PLATE 1

Map of the Philippine Islands.

PLATE 2

A relief map, showing Panay, Guimaras, and a part of Negros. The elevations are exaggerated.



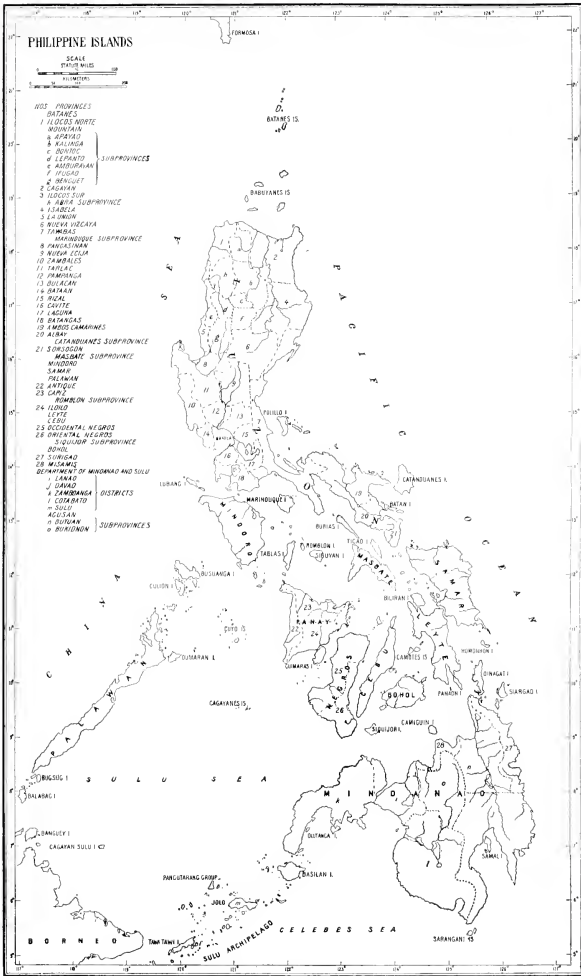

PLATE 1. THE PHILIPPINE ISLANDS.



PLATE 2. PANAY, GUIMARAS, AND A PART OF NEGROS. THE ELEVATIONS ARE EXAGGERATED.

CHIRONOMIDES DES PHILIPPINES ET DE FORMOSE

Par J. J. KIEFFER

Docteur ès sciences, professeur à Bitché

Les Diptères dont il sera question dans ce travail, ont été recueillis les uns, aux îles Philippines, les autres, à l'île de Formose. Les premiers ont été capturés à la lumière, par M. Baker, professeur à l'Université des Philippines; les seconds ont été recueillis à l'île de Formose, par M. Sauter et sont conservés au Musée entomologique de Berlin-Dahlem. Aucun représentant de la famille des Chironomides n'avait été décrit jusqu'ici pour les Philippines. Quant aux Chironomides de Formose, j'en ai traité dans quatre travaux différents.¹

CERATOPOGONINÆ

Genus CERATOPOGON Meigen

Subgenus Prohelea Kieffer

1. Bord antérieur de l'aile blanc, avec un point blanc sur la cellule radiale; 11^e article antennaire du ♂ aussi long que les deux suivants réunis..... C. (P.) *chrysothrix* sp. nov.
Bord antérieur de l'aile sans point blanc; 11^e article antennaire du ♂ seulement d'un tiers plus long que le 12^e... C. (P.) *fuscimanus* sp. nov.

¹ 1^o Tendipedidæ (Chironomidæ) von Formosa, Supplementa Entomologica, 1 (1912) 27-43, pl. 2 et 16 fig. dans le texte. 2^o Tendipedides (Chironomides) de Formose, Ann. Mus. Hung. 14 (1916) 81-121, 23 fig. (Dans ce travail, les figures 12 et 13 ont été interverties; la fig. 12 représente le dernier article du tarse antérieur de *Bezzia kerteszi* ♀ et non celui de *Palpomyia spinifera*; la fig. 13 au contraire représente le dernier article du tarse antérieur de *Palpomyia spinifera* ♀ et non pas de *Bezzia kerteszi*). 3^o Tendipedidæ von Formosa, Supplementa Entomologica 5 (1916) 114-117. 4^o Chironomides d'Asie et d'Afrique conservés au Museum national hongrois de Budapest, Ann. Mus. Hung. 16 (1918) 31-136, 48 fig. dans le texte. Dans ce travail, à la page 135, *Leptoconops flavipennis* et *hyalinipennis* ont été mis, par suite d'une confusion, dans le genre *Holoconops*; ces deux insectes reviennent au genre *Schizoconops*. Dans un autre travail, paru dans la même Revue et intitulé Chironomides d'Amérique 15 (1917) 292-364, 48 fig., il se trouve une erreur à la page 364; le type du genre *Microhelea* est *Atrichopogon microtomus* Kieff. page 299 et non pas *A. tropicus*, qui n'existe pas; ce dernier nom avait été employé primitivement dans mon manuscrit, mais remplacé ensuite par celui de *A. microtomus* avant l'impression; j'avais oublié de faire le même changement à la page 364.

Ceratopogon (Prohelea) chrysothrix sp. nov.

Mâle et femelle.—Brun. Antennes du mâle jaune brunâtre, articles 11–14 ensemble à peine plus longs que 2–10 réunis, panache fauve, 2^e article globuleux dans sa moitié distale, aminci en pétiole dans sa moitié basale, 3–10 subglobuleux, sans col, graduellement moins gros; 11^e le plus long, aussi long que les deux suivants réunis, subcylindrique, à base renflée sur un côté et portant des poils du panache, 12^e presque deux fois aussi long que le 10^e, un peu plus long que le 13^e, tous deux subcylindriques, à base globuleuse et portant un verticille de longs poils, mais non pas des poils du panache, 14^e plus gros que les trois précédents, aussi long que le 12^e, cylindrique, sans verticille, avec un stylet terminal. Antennes de la femelle fauves, articles 2–9 ensemble presque deux fois aussi longs que les 5 derniers réunis, glabres, subglobuleux, à extrémité amincie en un col transversal; verticilles composés de 20 poils bruns et presque deux fois aussi longs que l'article; soies sensorielles blanches, obtuses, au moins d'un tiers plus courtes que les poils des verticilles et deux fois aussi grosses qu'eux; articles 10–14 poilus, serrés, sans col, 10–13 subcylindriques, pas plus longs ou à peine plus longs que gros, avec un verticille basal composé de quelques poils longs, 14^e article à peine plus gros, aussi long que les deux précédents réunis, terminé par un stylet. Thorax plus haut que long, brun roux, couvert dorsalement de poils denses, appliqués et d'un jaune d'or. Balanciers d'un blanc pur. Aile sombre, à cause de la pilosité noirâtre; bord antérieur brun noir, avec une petite tache d'un blanc de lait sur la cellule radiale, qu'elle dépasse un peu; à partir de là, un trait brun noir longe le bord jusque près de la pointe alaire; nervures brun noir, radiale et cubitale blanches dans la tache, confluentes dans leurs deux tiers proximaux qui sont brun noir, cellule radiale unique, très petite, subcirculaire, n'atteignant pas le milieu du bord, fourche intercalée avec pétiole. Pattes jaune clair, à longs poils dorsaux, moitié distale du fémur postérieur, large anneau près de la base du tibia et le métatarse brun noir; 2^e article du tarse postérieur de deux tiers plus long que le 1^{er}, 3^e aussi long que le premier, d'un tiers plus long que le 4^e, 5^e le plus court, pas trois fois aussi long que gros; crochets égalant la demi-longueur de l'article, empodium atteignant au moins l'extrémité des crochets. Abdomen du mâle grêle, brun, tergites à large bande transversale jaune; abdomen de la femelle brun, à poils jaunes et épars, ventre jaunâtre.

Longueur, ♂, 2 millimètres; ♀, 1.5 millimètres.

Formose, Taihoku, 4 ♂ ♂, 1 ♀; Philippines, Luzon, Laguna, Los Baños, 2 ♀ ♀.

Ceratopogon (Prohelea) fuscimanus sp. nov.

Mâle.—Brun noir. Bouche rousse, aussi longue que la hauteur de la tête. Panache brun noir et dense; articles 2–10 à peine plus longs que 11–14 réunis, subglobuleux et sans col, graduellement plus minces; 11° seulement d'un tiers plus long que le 12°, mince et subcylindrique, sa base renflée sur un côté et portant un anneau de poils du panache; 12° conformé comme le 11°, sauf que la base est renflée en globule et porte un verticille de quelques longs poils, mais pas de poils du panache; 13° et 14° plus gros, subcylindriques, à base munie d'un verticille de longs poils, mais non renflée, le 13° d'un tiers plus court que le 12°, 14° égalant à peine le 12°, terminé par un stylet. Thorax brun roux, mesonotum à poils jaunes peu abondants (peut-être tombé en partie). Balanciers blancs. Aile hyaline, non lobée, à poils gris, cubitale n'atteignant pas le milieu, entièrement noire ou brun noir, soudée à la radiale, sauf au tiers distal, qui forme une cellule radiale très petite et subcirculaire, radiale brun noir, les autres nervures pâles, rameau antérieur de la discoïdale aboutissant un peu avant la pointe alaire, rameau postérieur un peu en arrière d'elle, bifurcation de la posticale sous l'extrémité de la cubitale, son rameau antérieur continue la direction de la tige. Pattes d'un jaune clair, sauf les hanches, à longs poils dorsaux, les 4 tarsi antérieurs brun noir, fémur postérieur à peine obscurci; métatarse antérieur égalant le 2° article, métatarse postérieur d'un tiers plus court que le 2° article, 5° article le plus court, crochets et empodium d'égale longueur.

Longueur, 2 millimètres.

Formose, Hokuto.

Genus *ATRICHOPOGON* Kieffer²

- | | |
|---|------------------------------|
| 1. Corps noir brillant..... | 2. |
| Corps brun, thorax pruveux de gris; articles antennaires 3–9 trans- | |
| versaux..... | <i>A. pruinosis</i> sp. nov. |
| Corps jaune ou rouge..... | 3. |

² Ce genre diffère, outre les caractères indiqués dans mon travail: Chironomides d'Europe (Ann. Budapest), par l'antenne de la ♀, dont les verticilles sont moins denses et se composent seulement de 5 ou 6 poils en règle générale.

2. Pattes roux pâle, hanches brun noir, extrémité de l'abdomen roux clair (♀)..... *A. hæmorrhoidalis* sp. nov.
 Pattes jaune pâle ou jaune blanchâtre; abdomen de la ♀ noir en entier..... *A. insularis* sp. nov.
3. Jaune sale; aile de la ♀ à soies microscopiques, par endroits à soies plus longues; article 10 de l'antenne 2 fois aussi long que gros, 3-9 fortement transversaux..... *A. flavidus* sp. nov.
 Vitellin; articles antennaires 3-9 globuleux, 10^e presque 5 fois aussi long que gros..... *A. flavellus* Kieff.
 Rouge; aile de la ♀ couverte uniformément de soies assez longues.... 4.
4. Mat; 2^e cellule radiale de la ♀ un peu moins de deux fois la 1^e.
A. rufescens sp. nov.
 Brillant; 2^e cellule radiale de la ♀ 2.5 fois aussi longue que la 1^e.
A. ruber Kieff.

Atrichopogon pruinosus sp. nov.

Femelle.—Brun. Tête et thorax pruinoux de gris. Bouche égalant la demi-hauteur de la tête. Antennes brunes, articles 10-14 ensemble presque deux fois aussi longs que 2-9 réunis, subcylindriques, graduellement un peu plus longs, le 10^e aussi long que les trois précédents réunis, le 14^e avec un stylet terminal; 2^e transversal dans sa moitié distale, graduellement aminci en pétiole dans sa moitié proximale; 3-9 assez transversaux, verticilles de 6 poils, ceux-ci pas plus minces et un peu plus longs que les soies sensorielles. Scutellum jaune roussâtre. Balanciers blancs. Aile hyaline, peu lobée, à soies microscopiques, sauf au bord distal qui porte des soies plus longues, depuis l'extrémité du rameau antérieur de la posticale jusqu'à la fourche intercalée inclusivement; nervures brunes, cubitale 2.5 fois aussi longue que la radiale, 2^e cellule radiale plus large que la 1^e, discoïdale brièvement pétiolée, bifurcation de la posticale un peu distale de celle de la discoïdale, le rameau postérieur très oblique, le rameau antérieur un peu plus distant de la pointe alaire que la cubitale. Pattes jaune blanchâtre, sans longs poils.

Longueur, 1.5 millimètres.

Formose, Taihoku.

Atrichopogon hæmorrhoidalis sp. nov.

Femelle.—Noir brillant. Yeux confluent. Bouche égalant la demi-hauteur de la tête. Antennes roux brun, scape jaune, articles 10-14 ensemble d'un tiers plus longs que 2-9 réunis, subcylindriques, graduellement un peu plus longs, le 10^e pas plus long que les deux précédents réunis, le 14^e double du 10^e terminé par un stylet; 2^e pas plus gros et à peine plus long que le 3^e, graduellement aminci à sa base, 3-9 aussi longs que gros, subcylindriques, verticilles à 6 poils pas plus minces et un peu

plus longs que les soies sensorielles. Balanciers blancs. Aile hyaline, paraissant glabre à la loupe, à soies microscopiques seulement, peu lobées, nervures antérieures grosses et brunes, cubitale deux fois la radiale, plus distante de la pointe alaire que le rameau antérieur de la posticale, discoïdale brièvement pétiolée, bifurcation de la posticale un peu distale de celle de la discoïdale, son rameau inférieur oblique, le supérieur continuant la direction de la tige. Pattes roux pâle, hanches brun noir, métatarse postérieur distinctement plus court que les 4 articles suivants réunis. Extrémité de l'abdomen roux clair.

Longueur, 1.5 millimètres.

Formose, Hokuto.

Atrichopogon insularis sp. nov.

Mâle et femelle.—Noir brillant. Bouche égalant la demi-hauteur de la tête. Antennes de la ♀ brunes, articles 10-14 ensemble presque deux fois aussi longs que 2-9 réunis, subcylindriques, graduellement un peu amincis distalement, à poils épars assez longs, le 14^e le plus long, terminé par un stylet; le 2^e distinctement plus gros et plus long que le 3^e, aminci au quart basal; 3^e à peine transversal, 4-9 aussi longs ou un peu plus longs que gros, verticilles à 5 ou 6 poils à peine plus longs et aussi gros que les soies sensorielles. Balanciers blancs. Aile de la ♀ subhyaline, pas distinctement lobée, à soies assez longues partout, cubitale 2.5 fois aussi longue que la radiale, à peine plus proche de la pointe alaire que le rameau antérieur de la posticale, bifurcation de la discoïdale un peu distale de la transversale, celle-ci située avant le milieu de l'aile, comme d'ordinaire, bifurcation de la posticale sous l'extrémité de la 1^e cellule radiale, rameau inférieur subperpendiculaire, fourche intercalée longuement pétiolée. Aile du ♂ seulement à soies microscopiques, cubitale à peine plus de deux fois la radiale, un peu plus loin de la pointe alaire que le rameau antérieur de la posticale. Pattes jaune pâle ou jaune blanchâtre, tarses un peu plus sombres. Le ♂ a les antennes brunes, le panache brun noir, dense, gris à l'extrémité, les 4 derniers articles ensemble de moitié plus longs que 2-10 réunis, le 2^e plus mince que le 3^e, mais de moitié plus long, aminci fortement dans sa moitié basale, 3-10 subglobuleux, avec un verticille de poils du panache, à col transversal et à peine distinct; 11^e deux fois le 10^e, cylindrique, à base grossie sur un côté et portant des poils du panache; 12^e le plus long, deux fois un quart aussi long que le 11^e, subcylindrique comme les deux suivants et ayant comme eux un trait transversal près de la base,

portant un verticille de poils; 13° de trois quarts plus que le 11°, à peine plus long que le 14°, celui-ci avec un stylet. Pince du ♂ jaune ou rousse, à longs poils gris; articles terminaux presque aussi longs que les basaux, presque droits, graduellement un peu amincis, extrémité un peu courbée et faiblement bidentée.

Longueur, ♂, 1.5 millimètres; ♀, 1-1.5 millimètres.

Formose, Hokuto, Taihoku et Daitotei.

Atrichopogon flavidus sp. nov.

Femelle.—Jaune sale. Tête transversale vue de devant. Yeux confluent. Bouche égalant au moins la hauteur de la tête, pièces buccales dentelées. Palpes jaunes, peu longs, 1^{er} article cylindrique, à peine plus court que le 2^e, celui-ci deux fois aussi long que gros, un peu grossi médialement après son milieu, et portant à cet endroit un organe sensoriel subcirculaire, 3^e et 4^e ensemble à peine plus longs que le 3^e et un peu plus minces, le 3^e largement uni au 4^e et un peu plus court que lui. Antennes brunes, articles 10-14 ensemble presque deux fois aussi longs que 2-9 réunis, subcylindriques, graduellement un peu amincis distalement, à poils épars pas plus longs que la grosseur des articles, sauf ceux de la base, 10-12 égaux, un peu plus de deux fois aussi longs que gros, 13^e un peu plus long, 14^e le plus long, muni d'un stylet terminal; 2^e article beaucoup plus gros que le 3^e et plus long, 3-9 assez fortement transversaux, verticilles à 6 poils bruns pas plus longs et pas plus minces que les soies sensorielles, celles-ci hyalines. Balanciers blancs. Aile hyaline, non lobée, à soies microscopiques, des soies plus longues se trouvent sur toutes les nervures, y compris celles de la fourche intercalée, sur l'espace entre l'embouchure de la cubitale et de la fourche intercalée, sur la cellule formée par celle-ci, sur la cellule discoïdale antérieure sauf la base et les côtés, sur la moitié distale de la cellule discoïdale postérieure, sur le milieu de la cellule posticale, sur la cellule anale, sauf l'extrémité distale et le bord antérieur, 2^e cellule distale deux fois et demie aussi longue que la 1^e, cubitale distale de la pointe alaire de sa longueur, discoïdale à peine pétiolée, bifurcation de la posticale un peu plus distale que celle de la discoïdale, rameau antérieur aussi distant de la pointe alaire que la cubitale. Pattes jaunes, sans longs poils, non grossies, métatarse postérieur aussi long que les 3 articles suivants réunis, 2-4 graduellement un peu raccourcis, 4^e et 5^e subégaux, un peu plus longs que gros.

Longueur, 1.5 millimètres.

Philippines, Luzon, Laguna, Los Baños.

Atrichopogon flavellus Kieff.

Femelle.—Articles antennaires 3-9 globuleux, 10 presque cinq fois aussi long que gros; verticilles à 6 poils.

Philippines, Luzon, Laguna, Los Baños.

Atrichopogon rufescens sp. nov.

Femelle.—Rouge et mat. Tête manque. Balanciers blancs. Aile subhyaline, non distinctement lobée, uniformément couverte de soies assez longues, 2^e cellule radiale un peu moins de deux fois aussi longue que la 1^e, cubitale $1\frac{2}{3}$ fois plus long que la radiale, discoïdale brièvement pétiolée, bifurcation de posticale un peu plus distale que celle de la discoïdale. Pattes jaune pâle, grêles, cils du tibia postérieur deux fois aussi longs que sa grosseur, métatarse postérieur au moins aussi long que les 4 articles suivants réunis.

Longueur, 1 millimètre.

Formose, Taihoku.

Atrichopogon ruber Kieff.

Femelle.—Roux brillant, flagellum brun, balanciers blancs, pattes jaune pâle, abdomen roux brun. Métatarse postérieur plus long que les 4 articles suivants réunis.

Formose, Taihoku, Hokuto.

Genus CULICOIDES Latreille

1. Articles antennaires 3-9 de la ♀ globuleux, taches alaires formant 3 rangées transversales..... *C. alboguttatus* sp. nov.

Articles antennaires 5-9 de la ♀ au moins deux fois aussi longs que gros, taches alaires ne formant pas des rangées transversales.

C. philippinensis sp. nov.

Culicoides alboguttatus sp. nov.

Femelle.—Brun, y compris les balanciers. Bouche aussi longue que la hauteur de la tête. Articles 10-14 des antennes d'un cinquième plus longs que 2-9 réunis, graduellement un peu amincis distalement, à poils épars plus longs que la grosseur des articles, le 10^e aussi long que les deux précédents réunis, les suivants graduellement un peu plus longs, 14^e dépassant d'un tiers la longueur du 13^e, sans stylet; article 2^e plus gros et un peu plus long que le 3^e, aminci à l'extrême base, 3-9 subglobuleux et glabres, verticilles à 5 ou 6 poils, ceux-ci plus de deux fois aussi longs qu'un article, soies sensorielles plus courtes qu'un article. Mesonotum avec deux lignes longitudinales et rapprochées grises, divergeant en arc au bout antérieur; de chaque côte, une petite ligne longitudinale et interrompue grise, forme deux petits

traits. Aile enfumée, avec trois rangées transversales de petites taches blanches et circulaires; rangée distale en forme d'arc, touchant presque le bord distal de l'aile, formée de 3 taches, l'une à l'extrémité de la cellule cubitale, l'autre à l'extrémité de la cellule discoïdale antérieure, la 3^e à l'extrémité de la cellule discoïdale postérieure; 2^e rangée composée de 5 taches, la 1^e sur le bord antérieur, à l'extrémité de la cubitale, la 2^e dans la cellule cubitale, la 3^e dans la cellule discoïdale antérieure, la 4^e dans la cellule discoïdale postérieure, la 5^e dans la cellule posticale; 3^e rangée formée de 4 taches, dont la 1^e sur le bord antérieur, la 2^e sur la transversale, 3^e entre la médiane et la tige de la posticale, la 4^e transversale, sur l'extrémité de l'anale; en outre deux taches plus proximales sur le bord inférieur de la cellule anale et une 3^e, vis-à-vis d'elles, entre la médiane et la tige de la posticale; entre la 2^e et la 3^e rangée, le bord costal est gros et brun noir; transversale blanche, 1^e cellule radiale très mince, 2^e plus longue et plus de deux fois plus large que la 1^e, discoïdale brièvement pétiolée, bifurcation de la posticale sous l'extrémité de la 1^e cellule radiale, rameau anterior un peu arqué. Pattes blanchâtres ou jaune pâle, tibia postérieur à longs poils, métatarse postérieur seulement de moitié plus que le 2^e article.

Longueur, 1 millimètre.

Formose, Taihoku.

Cette espèce a beaucoup de ressemblance avec *C. polystictus* Kieff. du Paraguay, mais chez cette dernière, les taches de la 1^e rangée sont éloignées du bord distal de l'aile de deux fois leur diamètre et les articles antennaires 4-13 sont d'égale longueur.

Culicoides philippinensis sp. nov.

Femelle.—Brun ou brun noir. Tête vue de devant à peine transversale. Yeux glabres, très arqués, larges en haut, où ils sont séparés de la demi-largeur du scape. Bouche à pièces dentelées, égalant les trois quarts de la hauteur de la tête. Palpes brun noir, dépassant à peine la bouche, 2^e article le plus long et le plus gros, grossi médialement avant le milieu, 3^e et 4^e largement fixés l'un à l'autre, un peu plus longs que gros, ensemble aussi longs que le 1^{er}. Antennes brunâtres, articles 10-14 ensemble aussi longs que 2-9 réunis, subcylindriques, graduellement plus longs, à poils épars presque deux fois aussi longs que la grosseur des articles, le 14^e sans stylet, presque deux fois aussi long que le 10^e, celui-ci d'un tiers plus long que le 9^e; 2^e plus de deux fois aussi gros que le 3^e, presque transversale, aminci graduellement à sa base, 3^e et 4^e de moitié plus longs que gros,

5-9 au moins deux fois aussi longs que gros, un peu amincis aux deux bouts, verticilles de 6 poils, ceux-ci guère plus longs qu'un article, les soies sensorielles un peu plus longues, mais pas plus grosses que les poils des verticilles. Balanciers brun noir. Aile enfumée, à nombreuses taches blanches, dont 3 sur le bord antérieur, l'une à peine proximale de la nervure transversale, la 2° sur l'extrémité de la cubitale, la 3° à égale distance de la 2° et de la pointe alaire, la 1° traverse en partie la transversale et atteint la discoïdale, les 2 autres sont aussi transversales mais n'atteignent pas la discoïdale; 4 autres taches plus petites et sub-circulaires sont disposées le long du bord postérieur, mais sans le toucher, la 1° entre les deux rameaux de la discoïdale, la 2° dans la cellule discoïdale postérieure, la 3° entre les deux rameaux de la posticale, la 4° dans la cellule anale, près du bout distal; deux autres taches se trouvent encore dans la cellule anale, une circulaire sous le milieu de la tige de la posticale, l'autre allongée, traversant obliquement le tiers basal de la cellule; une tache occupe encore la base de la cellule posticale, une se trouve au-dessus de la bifurcation de la posticale, une au-dessus et une au-dessus du milieu du rameau postérieur de la discoïdale; enfin la cellule médiane est entièrement blanche; surface à soies microscopiques, parsemée de soies plus longues; transversale oblique, égalant la 1° cellule radiale, celle-ci très étroite, allongée, aussi longue et de moitié aussi large que la 2°; cubitale éloignée de la pointe alaire du double de sa longueur; discoïdale brièvement pétiolée, bifurcation de la posticale sous l'extrémité de la 1° cellule radiale, rameau antérieur faiblement arqué. Pattes brunâtres, base des tibias jaune, tarses jaunâtres, métatarse antérieur égalant les 4 articles suivants réunis, 4° un peu plus court que le 5°, empodium atteignant le milieu des crochets, ceux-ci avec des soies à leur base.

Longueur, 1.2 millimètres.

Philippines, Luzon, Laguna, Los Baños.

Genus *DASYHELEA* Kieffer

Dasyhelea formosana sp. nov.

Femelle.—Tête et thorax gris, mats. Antennes brun roux, 2° article un peu plus gros et un peu plus long que le 3°, aminci à sa base; 2-13 subégaux, graduellement à peine un peu plus longs, leur moitié distale graduellement et faiblement amincie, leur base striée jusqu'au verticille, celui-ci formé de 6 ou 7 poils un peu plus longs, mais moins gros que les soies sensorielles, les articles 10-13 ne se distinguent de 2-9 que par la présence de

petits appendices ou poils très courts et cylindriques, épars sur la moitié distale de ces articles; 14° strié à sa base, avec verticille et soies sensorielles comme les précédents, mais dépourvus d'appendices, presque deux fois aussi long que le 13°, graduellement aminci en pointe dans son tiers distal. Mesonotum à petites taches noires; épaules et scutellum jaunes. Balanciers blancs. Aile hyaline, cubitale dépassant le milieu de l'aile, soudée à la radiale et formant avec elle un trait allongé brun noir, 2.5 fois aussi longue que la transversale; bifurcation de la discoïdale sous la transversale, celle de la posticale sous l'extrémité de la cubitale; surface finement pubescente, base peu lobée. Pattes blanchâtres, genoux et le 5° article des tarses noirs, tibia postérieur et tarse postérieur à longs poils dorsaux, métatarse postérieur presque aussi long que les quatre articles suivants réunis, 2° et 3° subégaux, 4° plus court que le 5°. Abdomen noir, déprimé, bord postérieur des tergites blanchâtre, dessous de l'abdomen jaune.

Longueur, 1.5 millimètres.

Formose, Hokuto.

Genus *STILOBEZZIA* Kieffer

Stilobezzia decora Kieff.

On ne connaissait que la ♀ de cette espèce. Le mâle a le thorax d'un blanc jaunâtre en entier, abdomen sombre dans la moitié postérieure, blanchâtre dans la moitié antérieure. Panache d'un jaune d'or, avec l'extrémité brune; antennes jaunâtres, 2° article deux fois aussi long que le 3°, à base longuement pétiolée, les suivants subglobuleux ou subfusiformis, d'abord aussi gros que longs, puis graduellement un peu plus longs et plus minces, le 11° presque deux fois aussi long que gros, 12-14 longuement cylindriques, graduellement plus longs, ensemble presque aussi longs que 2-11 réunis. Pattes colorées et conformées comme chez la ♀, sauf que les crochets sont petits et simples. Ailes comme chez la ♀, mais l'extrémité de la cubitale est moins grossie.

Longueur, 2 millimètres.

Formose, Anping, 1 ♂, 6 ♀ ♀, octobre 1912; une ♀ avait le thorax brun sombre.

Genus *DICROHELEA* Kieffer

Dicrohelea albiclava sp. nov.

Femelle.—Brun noir, mat. Yeux séparés par une fine ligne. Bouche plus courte que la demi-hauteur de la tête, en forme de

bec. Palpes de 4 articles, les deux premiers cylindriques, un peu plus de deux fois aussi longs que gros, les deux derniers beaucoup plus minces, ensemble à peine plus longs que le 2°, le dernier plus long que l'avant-dernier, cylindrique, un peu plus de deux fois aussi long que gros. Scape roux brun, articles 10-14 ensemble de moitié plus longs que 2-9 réunis, subcylindriques, 14° arrondi au bout, chacun 2.5 fois le 9°; 2° presque double du 3°; 3-9 graduellement un peu amincis et allongés, le 3° de moitié plus long que gros, le 9° deux fois. Mesonotum subglabre, pruineux de gris, sans dent en avant. Balanciers blancs. Aile hyaline, faiblement lobée, dépassant l'abdomen, presque linéaire, nervures antérieures jaunes, transversale et base de cubitale brun noir; 1° cellule radiale 2.5 fois aussi longue que large, se terminant au milieu de l'aile, la 2° trois fois plus longue que la 1°, mais encore plus mince, cubitale atteignant le dernier $\frac{1}{8}$ de l'aile, éloignée de la pointe alaire presque de sa demi-longueur; partie distale de la radiale un peu plus courte que la proximale, deux fois aussi longue que la base de la cubitale; bifurcation de la discoïdale proximale de la transversale, celle-ci perpendiculaire et plus courte que la base de la cubitale, les deux rameaux pâles, subparallèles, un peu divergents distalement, l'antérieur aboutissant près de la pointe alaire; bifurcation de la postcale sous le milieu de la 1° cellule radiale, rameau antérieur continuant la direction de la tige; anale bifurquée; pas de fourche intercalée. Les quatre premiers articles tarsaux blanc brunâtre; pattes antérieures les plus courtes, pattes postérieures les plus longues, fémurs antérieurs subcylindriques, avec 6 spinules noires, dans leur moitié distale; fémurs intermédiaires de même forme, avec 3 spinules; fémurs postérieurs graduellement grossis distalement, avec 4 spinules; tibias tous un peu plus minces que les fémurs, beaucoup plus gros que les tarsi, avec des spinules alignées sur leur côté dorsal, ces spinules moins grosses que celles de fémurs, mais plus longues; métatarse antérieur égalant les trois suivants réunis, métatarse postérieur égalant les quatre articles suivants réunis; 2° article de moitié plus long que le 3° aux quatre tarsi antérieurs, deux fois le 3° au tarse postérieur; 3° article de moitié plus long que le 4° aux quatre tarsi antérieurs, deux fois le 4° au tarse postérieur; 4° article un peu plus long que gros, obliquement tronqué au bout; 5° article de tous les tarsi égalant presque le 3° et le 4° réunis, armé ventralement de trois rangées de six batonnets noirs, ceux-ci environ deux fois aussi longs que la grosseur

de l'article; crochets de toutes les pattes égaux, grands, bifides, les rameaux inégaux, le grand trois fois aussi long que le petit, atteignant les trois quarts de la longueur de l'article. Les deux premiers segments abdominaux un peu plus minces que les suivants.

Longueur, 3.5 millimètres.

Formose, Iushifun, Taihoku District, juin 1914.

Genus MIXOHELEA Kieffer

Mixohelea ciliaticrus sp. nov.

Femelle.—D'un jaune d'ambre sale. Tête un peu transversale, vue de devant. Yeux confluent au vertex. Bouche plus courte que le tiers de la hauteur de la tête. Articles 3 et 4 des palpes plus minces que les deux premiers. Antennes brunes, scape, tiers basal des articles 2-9 et extrême base des articles 10-14 jaunes; articles 10-14 ensemble de $\frac{2}{3}$ plus longs que 2-9 réunis, graduellement un peu plus longs, subcylindriques, un peu grossis à la base, à poils épars et longs, comme chez l'espèce précédente, le 10° de trois quarts plus long que le 9°, le 14° de $2\frac{2}{3}$ plus long que le 9°, un peu aminci à l'extrémité; le 3° subcylindrique comme les suivants, deux fois aussi long que gros, d'un tiers plus court que le 2°, dont la base est un peu amincie; 3-9 graduellement un peu plus longs, les derniers amincis en col dans leur tiers distal, le 9° trois et demie aussi long que gros; verticilles composés de 4 ou 5 poils, comme chez l'espèce précédente, soies sensorielles pas plus grosses que les poils des verticilles. Thorax aussi haut que long. Mesonotum glabre, pruinéux de gris, mat, parsemé de points noirs, sans dent au bord antérieur. Balanciers blancs. Ailes hyalines, dépassant l'abdomen, sublinéaires, à peine lobées; nervures antérieures jaunes, 1° cellule radiale linéaire, au moins 3 fois aussi longue que large, 2° cellule radiale 3 fois aussi longue que la 1° et un peu plus large qu'elle, partie distale de la radiale un peu plus courte que la proximale, au moins trois fois aussi longue que la base de la cubitale; transversale très courte; cubitale aussi proche de la pointe alaire que le rameau antérieur de la discoïdale, dont la bifurcation est proximale de la transversale; bifurcation de la posticale un peu distale de la transversale, son rameau antérieur continue la direction de la tige; anale bifurquée. Pattes brun roux, tarsi blancs, extrémité des articles 1-4 et le 5° en entier noirs; pattes antérieures un peu plus courtes que les 4 autres, tous les tibiaux un peu plus longs que les fémurs, pattes postérieures pas plus

longues que les intermédiaires sauf le tarse, qui est plus long que les 4 tarsi antérieurs; fémurs antérieurs un peu arqués, presque deux fois aussi gros que le tibia, à 6 spinules dans la moitié distale; fémurs intermédiaires et postérieurs à 5 spinules, ces derniers un peu grossis distalement, où ils sont médiocrement velus; tibias postérieurs à longs cils alignés dorsalement; tarsi beaucoup plus minces que les tibias, métatarse antérieur de deux tiers plus long que le 2^e article, métatarse postérieur plus de deux fois aussi long que le 2^e article; celui-ci presque double du 3^e au tarse antérieur, plus de deux fois le 3^e au tarse postérieur; 3^e de moitié ou de deux tiers plus long que le 4^e, celui-ci à peine plus long que gros, obliquement tronqué à l'extrémité; 5^e article de tous les tarsi au moins aussi long que 3 et 4 réunis, avec 3 rangées longitudinales de 5 ou 6 bâtonnets noirs; crochets inégaux et simples, l'un égalant les trois quarts de l'article, l'autre égalant les deux tiers du grand. Abdomen brun.

Longueur, 3 millimètres.

Formose, Iushifun, Taihoku District, juin 1914.

Genus *PALPOMYIA* Meg. in Meigen

Palpomyia atriclava sp. nov.

Femelle.—Noir brillant, subglabre. Bouche petite, n'ayant pas le tiers de la hauteur de la tête. Articles 3 et 4 des palpes moins gros que le 2^e. Yeux séparés par une ligne brillante. Front, face, palpes et bouche jaune sale et brillant. Antennes brunes, scape et 2^e article jaunes, articles 2-9 ensemble à peine plus de moitié aussi longs que 10-14 réunis et un peu plus clairs que ceux-ci, le 2^e double du 3^e, graduellement aminci à la base, les suivants subcylindriques, graduellement un peu plus longs, le 3^e deux fois aussi long que gros, le 9^e deux fois un tiers; verticilles composés de 4 ou 5 poils; 10-14 subcylindriques, graduellement un peu plus longs, le 10^e deux fois et quart le 9^e, 14^e d'un tiers plus long que le 10^e, un peu aminci au bout. Balanciers brun noir, tige blanc sale. Ailes faiblement teintées d'enfumé, à peine lobées, dépassant un peu l'abdomen, nervures brun noir, cubitale atteignant le quart distal de l'aile, aussi loin de la pointe alaire que le rameau postérieur de la discoïdale, 1^e cellule radiale linéaire, trois fois aussi longue que large, la 2^e deux fois et demie aussi longue que la 1^e et d'égale largeur, base de la cubitale oblique et plus longue que la transversale, bifurcation de la discoïdale sous la transversale, comme aussi celle de la posticale, dont le rameau antérieur continue la direction de la tige; anale bifurquée. Pattes blanc jaunâtre, toutes les hanches, fémurs

et tibias des deux pattes postérieures brun sombre, tarses tous blanc sale en entier; pattes antérieures plus courtes que les quatre autres, les deux postérieures un peu plus longues que les intermédiaires; fémur antérieur un peu plus gros que l'intermédiaire, armé de 6 spinules noires, les 4 autres fémurs inermes; tarse intermédiaire un peu plus long que le tibia ou que les quatre articles suivants réunis, 2° article deux fois le 3°, celui-ci de moitié plus long que gros, 4° transversal, cordiforme, la partie prolongée sous le 5° densément poilue, 5° égalant le 3° et le 4° réunis, ayant dans sa moitié distale, à toutes les pattes, trois soies grosses, effilées, arquées et une semblable au tiers proximal; articles 1 et 2 du tarse postérieur à trois rangées de soies bulbeuses sur le dessous; crochets de tous les tarses égalant la moitié de l'article, égaux, avec une minime dent au côté medial.

Longueur, 2.5 millimètres.

Formose, Macuyama, juin 1914.

Genus PROBEZZIA Kieffer

1. Abdomen brun noir, pattes brunes, quatre premiers articles tarsaux blancs..... *P. bakeri* sp. nov.
 Abdomen et pattes d'un blanc sale..... *P. myrmedon* sp. nov.

Probezzia bakeri sp. nov.

Femelle.—Noir. Yeux largement confluent en haut. Bouche blanchâtre, égalant la demi-hauteur de la tête. Antennes brun noir, articles 2-9 ensemble aussi longs que les 5 derniers réunis, le 2° de deux tiers plus long que le 3°, qui est de moitié plus long que gros, les suivants graduellement un peu plus longs, le 9° deux fois et demie aussi long que gros, 10° de deux tiers plus long que le 9°, 10-14 égaux. Thorax sans dent au bord antérieur, scutellum et balanciers jaune blanchâtre. Aile blanchâtre, nervures très pâles, cubitale un peu plus de deux fois la radiale, distante de la pointe alaire de sa demi-longueur, aboutissant vis-à-vis de l'extrémité du rameau antérieur de la posticale, bifurcation de la discoïdale proximale de la transversale. Pattes brunes, tarses blancs, 5° article noir; fémurs non grossis, inermes, les deux premiers articles du tarse postérieur à trois rangées ventrales de soies bulbeuses, le premier égalant les quatre suivants réunis, le 2° de deux tiers plus long que le 3°, qui est de moitié plus long que le 4°, celui-ci cylindrique, comme les précédents, trois fois aussi long que gros, 5° un peu plus de deux fois le 4°, armé à tous les tarses de deux ou trois rangées longitudinales, et ventrales de six batonnets noirs presque deux fois aussi longs que la grosseur de l'article; crochets de tous les tarses égaux, bifides, ra-

meaux inégaux, le grand rameau à peine plus court que l'article, quatre fois aussi long que le petit; empodium nul. Abdomen brun noir.

Longueur, 3,5 millimètres.

Philippines, Luzon, Laguna, Los Baños.

Probezzia myrmedon sp. nov.

Mâle.—Noir. Antennes jaunes et courtes, articles 2-10 égalant les quatre derniers, le 2° plus long et beaucoup plus gros que le 3°, 3-10 d'abord subglobuleux, puis à peine plus longs que gros, à panache peu développé, les poils ne dépassant pas le 3° article suivant; 11° article subcylindrique, comme les suivants, d'un tiers plus long que le 10° et aussi gros que lui, 12° d'un tiers plus long que le 11°, de moitié plus court que le 13°, celui-ci assez fortement aminci distalement, à peine aussi long que le 14°, qui est arrondi à l'extrémité et subcylindrique. Balanciers d'un blanc sale. Aile hyaline, cubitale à peine deux fois la radiale, éloignée de la pointe alaire autant que le rameau antérieur de la posticale, bifurcation de la discoïdale proximale de la transversale, celle de la posticale un peu distale de la transversale, base alaire peu lobée. Pattes d'un blanc sale, fémurs inermes, non grossis, 4° article court, tronqué obliquement, le 5° long, inerme, crochets petits, simples, égaux. Abdomen blanc sale.

Longueur, 1 millimètre.

Formose, Anping, octobre 1912.

Genus *BEZZIA* Kieffer

1. Yeux confluents; pattes brun sombre, tarses et anneau distal des 4 fémurs antérieurs blanc jaunâtre..... *B. insularis* sp. nov.
Yeux séparés par une fine ligne; pattes jaunes, anneau distal des 4 fémurs postérieurs, extrémité des 2 tibias postérieurs et 5° article tarsal brun noir..... *B. nigriclava* sp. nov.

Bezzia insularis sp. nov.

Femelle.—Noir, mat. Yeux confluents. Front avec une verrue au-dessus des antennes. Bouche plus courte que le quart de la hauteur de la tête. Les deux derniers articles des palpes à peine plus minces que le 2°. Antennes brunes, scape jaune, articles 2-9 ensemble un peu plus courts que 10-14 réunis, un peu allongés, 10-14 plus sombres. Thorax très convexe, plus haut que long, bien plus haut que le vertex, brun noir, ayant en avant deux petites taches blanches et obliques, et deux autres plus petites, plus en arrière et plus en dehors. Balanciers noirs. Aile subhyaline, très faiblement teintée d'enfumé, atteignant l'extré-

mité de l'abdomen, lobe arrondi, nervures antérieures brunes, cubitale un peu plus de deux fois la radiale, un peu plus loin de la pointe alaire que le rameau postérieur de la discoïdale, dépassant faiblement le second tiers de l'aile, bifurcation de la discoïdale proximale de la transversale, celle de la postcale un peu distale de la transversale, celle-ci proximale du milieu de l'aile, anale bifurquée; sans fourche intercalée. Pattes brun sombre, brillantes, un anneau avant l'extrémité des 4 fémurs antérieurs et tous les tarsi blanc jaunâtre, pattes postérieures les plus longues, antérieures les plus courtes, fémurs non grossis, les antérieurs armés de quatre spinules, les quatre autres inermes, tarse postérieur de moitié plus long que le tibia, celui-ci aussi long que le fémur, métatarse un peu plus long que les trois articles suivants réunis, 3° deux à trois fois aussi long que gros, 4° cordiforme, transversal vu d'en haut, 5° long, inermes à tous les tarsi; crochets petits, plus courts que la moitié de l'article, à dent médiale à peine perceptible.

Longueur, 1.5 millimètres.

Formose, Anping, octobre 1912.

Bezzia nigriclava sp. nov.

Femelle.—Tête jaune brunâtre, occiput cendré. Front avec une verrue au-dessus des antennes. Yeux à peine séparés par une fine ligne. Antennes brunes, scape jaune, base des articles 2-9 jaunâtre, 10-14 ensemble un peu plus longs que 2-9 réunis, 10-13 égaux, cylindriques, chacun deux fois aussi long que le 9°, 14° de moitié plus long que le 10°, 2° au moins deux fois le 3° et à peine plus gros, sa base amincie en pétiole, 3-9 graduellement à peine plus longs, presque ellipsoïdaux, le 9° presque deux fois aussi long que gros, verticilles composés de 4 ou 5 poils. Thorax mat, brun, avec trace de 3 bandes raccourcies brunes, confluentes et bordées d'une fine ligne cendrée; en avant se voit de chaque côté de la bande médiane une tache blanche. Balanciers brun noir, tige plus claire. Aile hyaline, lobée, dépassant l'abdomen, lobe arrondi, nervures antérieures brunes, extrémité de la cubitale noire, celle-ci double de la radiale, atteignant le quart distal, aussi distante de la pointe alaire que le rameau postérieur de la discoïdale, bifurcation de la discoïdale sous la transversale, celle de la postcale à peine distale, son rameau antérieur continuant la direction de la tige; anale bifurquée. Pattes jaunes, hanches brunes, faible anneau avant l'extrémité des 4 fémurs postérieurs, extrémité des 2 tibia postérieurs et 5° article tarsal brun noir; fémurs non grossis, pattes antérieures

les plus courtes, leur femur aussi long que le tibia, armé de 2 spinules, les 4 autres fémurs inermes, tibia postérieur égalant le tarse, métatarse postérieur aussi long que les quatre articles suivants réunis, à 3 rangées de soies ventrales bulbeuses, comme le 2^e article, celui-ci à peine plus court que les trois suivants réunis, 3^e de moitié plus long que gros, 4^e cordiforme, transversal vu d'en haut, 5^e aussi long que le 3^e et le 4^e réunis, inermes à toutes les pattes; crochets égaux, égalant la moitié de l'article, à dent médiale à peine perceptible. Abdomen brun noir.

Longueur, 2 millimètres.

Formose, Macuyama, 2 ♀ ♀ juin 1914.

TANYPINÆ

Procladius philippinensis sp. nov.

Mâle.—Blanchâtre. Yeux à tiers supérieur très aminci, linéaire, 2.5 fois aussi long que large, ils sont séparés de quatre fois leur largeur terminale. Vertex brun. Palpes longs, 1^{er} article deux fois aussi long que gros, 2^e le moitié plus long que le 1^{er}, un peu plus court que le 3^e, 4^e égalant presque 2 et 3 réunis. Antennes brunes, de 15 articles, scape et 15^e article noirs, panache gris, articles 3-13 transversaux, 14^e à peine plus long que 2-13 réunis. Metanotum, trois bandes confluentes du mesonotum, dont les latérales sont raccourcies en avant et mesosternum brun noir. Balanciers blancs. Aile hyaline, finement pointillée, glabre, lobée, peu large, nervure sous-médiane à poils espacés, transversale antérieure noire et bordée de noir, comme les parties adjacentes de la cubitale et de la discoïdale, ce qui forme une tache en arc noire, l'endroit où la transversale postérieure touche la posticale forme un point noir, les deux transversales se touchent, l'antérieure oblique, la postérieure perpendiculaire, radiale à deux rameaux bien marqués, cubitale dépassée par la costale de la longueur de la transversale antérieure, pas plus distante de la pointe alaire que la discoïdale, tige de la fourche de la posticale aussi longue que le rameau inférieur, celui-ci non subitement incurvé. Pattes blanchâtres, un faible anneau brunâtre avant l'extrémité des fémurs, extrémité des tibias et des métatarses et les quatre articles suivants noirs; tibia antérieur plus long que le fémur, de deux tiers plus long que le métatarse, à éperon au moins aussi long que sa grosseur et pectiné dans sa moitié basale, les 6 ou 7 branches filiformes, pointues et un peu sinueuses, articles 1-4 graduellement raccourcis, 5^e égal au 4^e et cylindrique comme lui; au tarse postérieur, le 4^e un peu plus court que le 5^e; crochets grands et noirs, empodium court, pulvilles nuls. Abdomen et

pince brun noir, bord postérieur des quatre premiers segments formant une étroite ceinture blanche. Articles terminaux de la pince gros, presque triangulaires, pubescents, terminés par un long stylet noir.

Longeur, 2.8–3 millimètres.

Femelle.—Brun sombre, mat; mesonotum avec trois bandes raccourcies et se touchant, d'un brun noir, espace situé en avant de chacune des bandes latérales du mesonotum, haut des méso-pleures et le pronotum blanc sale; scutellum jaune, balanciers et pattes comme chez le δ . Tête blanc sale. Yeux séparés de trois fois leur terminale, partie amincie pas plus longue que large, subcarrée. Antennes brunes, de 14 articles, dont le 2^e obconique et deux fois aussi long que le 3^e, 3–13 serrés, un peu transversaux ou à peine aussi longs que gros, à verticilles de poils courts, pas deux fois aussi longs que la grosseur des articles, 14^e grossi, aussi long que les trois précédents réunis, avec verticille et court stylet avec soie. L'aile blanche a, outre l'arc noir du δ , quelques taches grises, irisées et peu distinctes, dont la plus grande est transversale, large, et s'étend de l'extrémité de la radiale jusqu'au milieu du rameau antérieur de la posticale; l'autre, moins grande, depuis le milieu de la nervure anale jusqu'au bord postérieur, large et un peu transversale; la 3^e, plus petite encore, sur le milieu du rameau postérieur de la posticale.

Longueur, 1.5 millimètres.

Philippines, Luzon, Laguna, Los Baños, 3 δ δ , 4 φ φ .

Tanypus monilis Linn.

Philippines, Luzon, Laguna, Los Baños, 1 φ ; Formose, Anping, octobre 1912, et Daitotei.

Protenthes punctipennis Meig.

Les taches de l'aile sont plus grandes que chez le type d'Europe, plus ou moins confluentes, la couleur enfumée occupant autant d'espace que la couleur blanche. Antennes de la φ de 15 articles, dont le 2^e et le 3^e sont peu distinctement séparés.

Formose, Taihoku et Daitotei, 1 δ , 6 φ φ .

Trichotanypus insularis sp. nov.

Femelle et mâle.—Tête et thorax du δ roux brun, mesonotum avec trois bandes raccourcies, peu marquées, plus sombres, pruinées en avant, metanotum et mesosternum brun noir, scutellum jaune, balanciers blanc pur. Tête et thorax de la φ brun sombre, trois bandes plus sombres, luisantes, raccourcies, sur le

mesonotum, scutellum jaune brunâtre, balanciers blanc pur. Yeux du ♂ séparés de deux fois leur largeur terminale, partie amincie linéaire, deux fois aussi longue que large. Antenne du ♂ jaune sale, panache brun noir. Antenne de la ♀ jaunâtre. Aile enfumée, moins sombre et plus étroite chez le ♂ que chez la ♀, irrisée sur les parties sombres, avec 3 taches blanches formant une bande transversale arquée qui occupe l'extrémité de l'aile, à savoir le quart distal de la cellule cubitale, l'extrémité de la cellule discoïdale et de la cellule posticale; 2 autres taches blanches formant une bande transversale, l'une est transversale et va du bord antérieur, un peu distalement des nervures transversales, jusqu'à la posticale; l'autre, dans la cellule anale, sous la bifurcation de la posticale, subarrondié, éloignée du bord postérieur; base alaire blanchâtre; poils noirâtres sur les parties sombres, blancs sur les taches blanches; les deux nervures transversales noires et bordées de noir, se touchant, l'antérieure oblique, l'inférieure perpendiculaire; radiale bifurquée, costale dépassant longuement la cubitale et atteignant presque la pointe alaire, dont elle est plus rapprochée que la discoïdale, celle-ci arquée; posticale longuement pétiolée, sa tige presque aussi longue que le rameau postérieur, celui-ci non incurvé au bout; lobe alaire ressortant semicirculairement. Pattes jaune sale (♂) ou brun noir (♀); extrémité des tibias du ♂, des trois premiers articles tarsaux et les deux derniers en entier brun noir; targes de la ♀ blanc, extrémité des deux premiers articles et les deux derniers en entier brun noir; tarse antérieur non barbu, métatarse double du 2^e article, un peu plus court que le tibia, 2-5 graduellement raccourcis et cylindriques. Abdomen brun noir, droit et déprimé (♂) ou arqué et fortement comprimé (♀). Pince brun noir; articles terminaux pubescents, petits, bilobés, le lobe proximal, qui continue la direction du lobe distal, est obtus et à peine plus court que long, lobe distal plus mince et 2 à 3 fois plus long, presque droit, graduellement aminci, son extrémité formant une petite pointe noire; chez toutes les espèces connues le lobe proximal est long et le lobe distal court, mais il se peut que, sur l'exemplaire examiné ici, les deux articles terminaux de la pince aient été retournés par accident.

Longueur, ♂, 2.5 millimètres; ♀, 1.8 millimètres.

Formose, Daitotei.

Var. transiens var. nov.

Femelle.—Couleur du corps et des pattes comme chez le ♂ du type; la bande blanche distale manque chez une ♀, ou n'est

représentée que par une trace chez l'autre ♀; mesonotum brillant, sans bande distincte. Antenne de 13 articles, et non de 14 comme chez *T. iris* Kieff.; 2^e article obconique, plus de deux fois aussi long que le 3^e, 3-12 un peu transversaux, verticilles à 6-8 poils courts, pas deux fois aussi longs que la largeur des articles; 13^e article brun, grossi, un peu plus long que les trois précédents réunis, muni d'un verticille basal et d'un court stylet terminal, celui-ci avec une soie médiocre.

Longueur, 1.8 millimètres.

Avec le type.

Clinotanypus formosæ Kieff.

Femelle.—Posticale brièvement pétiolée, la tige plus courte que la moitié du rameau postérieur, celui-ci non incurvé distalement. Empodium court, n'atteignant pas le milieu des crochets, ceux-ci peu arqués; grand éperon du tibia postérieur égalant la grosseur du tibia, graduellement aminci en pointe et dentelé.

Formose, Anping; était signalé déjà pour Takao.

CHIRONOMINÆ

ORTHOCLADIARIÆ

Trichocladus nitens sp. nov.

Femelle et mâle.—Roux ou roux brun, brillant. Yeux pubescents. Antennes du mâle brunes, comme le panache, 14^e article à peine plus long que 2-13 réunis, 3-13 à peine transversaux. Antennes de la femelle brun jaunâtre, 2^e article non rétréci au milieu, plus gros et deux fois aussi long que le 3^e, 3-5 un peu amincis aux deux bouts, deux fois aussi longs que gros, 5^e un peu plus long que le 4^e, 6^e subcylindrique, presque trois fois le 5^e. Thorax dépassant la tête en avant, metanotum noir, mesonotum du mâle avec trois bandes raccourcies d'un brun noir, celui de la femelle sans bande. Balanciers blancs. Aile très faiblement assombrie, glabre, peu lobée, nervures brunes, cubitale médiocrement dépassée par la costale, chez le mâle double de la radiale et aussi proche de la pointe alaire que la discoïdale, chez la femelle 2.5 fois aussi longue que la radiale et moins proche de la pointe alaire que la discoïdale, 2^e longitudinale aboutissant à égale distance de la radiale et de la cubitale, pas de nervure intercalée entre la cubitale et la discoïdale, bifurcation de la posticale sous la transversale ou à peine distale. Pattes du mâle blanchâtres, quart distal des fémurs brun, tibia antérieur blanc pur, à tiers distal noir, tarse antérieur brun sombre, 5^e article des quatre autres tarsi un peu assombri; chez la

femelle les pattes antérieures sont jaune brunâtre, les quatre autres blanc sale, extrémité des fémurs brune, tibia antérieur blanc pur, à tiers distal noir, tarse antérieur brun noir, extrémité des quatre tibias postérieurs brun noir, tarse, surtout les derniers articles, assombris; tibia antérieur d'un tiers plus long que le métatarse chez le mâle, de moitié plus long chez la femelle, métatarse double du 2^e article, 2-4 graduellement raccourcis, 4^e de moitié plus long que le 5^e, empodium filiforme, aussi long que les crochets, pulvilles nuls. Abdomen jaune clair; chez le mâle, une tache latérale transversale au bord antérieur du 2^e segment, le 3^e segment presque en entier, une étroite bande transversale sur le devant du 4^e et 5-7 presque entièrement brun noir, segment anal noir profond, pince blanche; chez la femelle, les tergites 2 et 3, 5 et 6 et le segment anal brun noir.

Longeur, ♂, 2,5 millimètres; ♀, 1,5 millimètres.

Formose, Daitotei, 1 ♂; Taihoku, 1 ♀.

Cricotopus carnosus Kieff. var.

Femelle.—Jaune citrin. Antennes brunes. Thorax ne dépassant pas le thorax en avant. Mesonotum brillant, trois bandes raccourcies, metanotum et mesosternum noirs. Balanciers blancs. Aile comme chez le type. Pattes blanc sale, extrémité des fémurs brune, tibia antérieur à large anneau blanc, les deux extrémités noires, les quatre autres tibias ont seulement les extrêmes bouts noirs; tarse antérieur, extrémité des articles 1-3 et les deux derniers en entier aux autres torses, brun noir; empodium égalant les crochets, pulvilles larges, atteignant le milieu des crochets. Tergites 2 et 3, une mince bande transversale du 4^e, une autre plus large sur le 5^e et sur le 6^e, noirs.

Longueur, 1 millimètre.

Formose, Daitotei.

CHIRONOMARIÆ

Genus POLYPEDILUM Kieffer

1. Aile hyaline ou subhyaline, sans tache..... 2.
Aile brune, fortement irrisée, avec sept taches blanches.
P. iricolor Kieff.
- Aile blanchâtre à taches brunes..... 3.
2. Article 5^e de l'antenne de la ♀ à col transversal..... P. nanulus Kieff.
Article 5^e de l'antenne de la ♀ sans col, pas distinctement séparé
du 6^e..... P. macrotrichum sp. nov.
3. Transversale noire, les autres nervures claires..... P. atrinerve sp. nov.
Transversale pas plus sombre que les autres nervures..... 4.
4. Aile à tache unique, située dans la base de la cellule cubitale.
P. monostictum Kieff.
- Aile à taches nombreuses..... 5.

5. Article 5° des antennes de la ♀ en forme de bouteille, avec un col allongé; trois taches brunes entre la cubitale et la discoïdale.

P. pelostolum Kieff.

Article 5° des antennes de la ♀ sans col, ellipsoïdal, seulement deux taches dans la cellule cubitale..... 6.

6. Pas de tache dans la cellule discoïdale..... *P. sauteri* sp. nov.

Deux taches dans la cellule discoïdale..... *P. consobrinum* Kieff.

Polypedilum macrotrichum sp. nov.

Femelle.—Brun noir. Antenne jaune brunâtre, 2° article à peine rétréci au milieu, deux fois et demie aussi long que gros, à col aussi long que gros, 3° et 4° globuleux ou en ovoïde court, à col plus de deux fois aussi long que gros, 5° en ovoïde court, pas distinctement séparé du 6°, son verticille dépassant l'article terminal, composé de 6 ou 7 poils d'inégale longueur, comme c'est aussi le cas pour le verticille du 3° et du 4°; 6° article mince, brun noir, deux fois un tiers aussi long que le 5°, ayant à l'extrémité quatre poils aussi longs que lui. Balanciers brun noir, tige blanc brunâtre. Aile subhyaline, très faiblement assombrie, sa moitié proximale jusqu'à la bifurcation de la posticale et l'origine de la cubitale plus sombre, transversale située au milieu ou peu avant le milieu de l'aile, cubitale aboutissant à la pointe alaire ou à peine avant, discoïdale bien plus éloignée de la pointe alaire, bifurcation de la posticale à peine distale; les nervures de la moitié proximale un peu plus sombres que celles de la moitié distale. Pattes sauf les hanches, d'un jaune pâle, deux derniers articles tarsaux assombris, métatarse antérieur au moins double du tibia, 2° article un peu plus court que le tibia, de moitié plus long que le 3°, 4° au moins aussi long que le 3°, deux fois le 5°.

Longueur, 2 millimètres.

Formose, Taihoku, 7 novembre 1912.

Polypedilum atrinerve sp. nov.

Femelle.—Roux brun. Palpes longs. Antennes d'un jaune sale, 6° article brun, de deux tiers plus long que lui, 3-5 en ovoïde court, à col deux fois ou plus de deux fois aussi long que gros, verticille de 8 poils, dont deux de moitié plus courts que les autres, ceux du 5° dépassent l'article terminal. Mesonotum gris roussâtre, à trois bandes raccourcies rousses. Balanciers blancs, extrémité de la massue assombrie. Aile blanchâtre, avec trois taches grises et allongées, visibles seulement sous un certain jour, la 1° au milieu de la cellule cubitale, la 2° à l'extrémité de cette cellule, la 3° dans la cellule discoïdale, à égale distance

de la 1^e et de la 2^e; en outre, les deux rameaux de la posticale et l'anale sont légèrement bordés d'enfumé; radiale dépassant le milieu de la cubitale, mais n'en atteignant pas les deux tiers, cubitale aboutissant aussi près de la pointe alaire que la discoïdale, bifurcation de la posticale sous la transversale, celle-ci au milieu de l'aile ou un peu proximale du milieu, d'un noir profond, base alaire lobée à angle droit. Pattes d'un jaune pâle, extrémité des quatre premiers articles tarsaux et le 5^e en entier assombris, tarse antérieur brisé; peignes, éperons, pulvilles comme d'ordinaire. Abdomen long, brun noir, à longs poils gris, bord postérieur des tergites blanchâtre; cerci jaunâtres.

Longueur, 2,5 millimètres.

Formose, Taihoku, 7 novembre 1912.

Polypedilum sauteri sp. nov.

Femelle.—Brun noir. Antennes jaune brunâtre 2^e article presque deux fois aussi long que le 3^e, fortement rétréci au milieu, avec un col presque aussi long que large; 3^e et 4^e en forme de bouteille, renflement ellipsoïdal, col de moitié ou deux fois aussi long que gros; 5^e subfusiforme, sans col; verticilles à 5 ou 6 poils, ceux du 5^e article n'atteignent pas l'extrémité du 6^e, celui-ci mince, deux fois et tiers aussi long que le 5^e, avec un poil distal égalant sa demi-longueur. Mesonotum roussâtre en avant sur chaque côté. Balanciers brun noir, tige blanc brunâtre. Aile hyaline ou à peine blanchâtre, avec trois taches grises peu distinctes, dont l'une remplit la base de la cellule cubitale, l'autre allongée, située vers le milieu de cette cellule, la 3^e très petite, sur l'extrémité du rameau postérieur de la posticale, encore un point sous l'extrémité de la cubitale et sous celle de la discoïdale et un trait oblique dans la moitié proximale de la cellule anale; base alaire lobée; radiale, cubitale et transversale brunâtres, celle-ci située au milieu ou proximale du milieu, cubitale un peu plus distale de la pointe alaire que la discoïdale, bifurcation de la posticale distale du double de la transversale. Pattes jaune pâle, sauf les hanches, les quatre tibias postérieurs à poils dorsaux un peu plus longs que leur grosseur, les quatre derniers articles du tarse antérieur et les trois derniers des quatre autres tarses assombris, métatarse antérieur au moins deux fois aussi long que le tibia, 2^e article égalant à peine le tibia, 2-4 graduellement raccourcis, le 4^e de deux tiers plus long que le 5^e.

Longueur, 2 millimètres.

Formose, Taihoku, 7 novembre 1912; Daitotei, juin 1914.

Polypedilum pelostolum Kieff.

Femelle et mâle.—Tibia antérieur à écaille obtuse, plus longue que large; éperon des tibias postérieurs unique et long. Les articles antennaires 2-5 du ♂ ont de chaque côté une soie sensorielle arquée, hyaline, aussi longue que la grosseur des articles.

Formose, Anping, octobre 1912; Daitotei, juin 1914.

Polypedilum consobrinum Kieff.

Femelle.—Article 6° des antennes à trois longs poils distaux, plus longs que l'article, articles 3-5 glabres, verticilles de 7 poils très longs, ceux du 5° article dépassent de beaucoup le 6°. Pattes blanches, trois premiers articles tarsaux avec un large anneau distal brun; métatarse antérieur de deux tiers plus long que le tibia, 2° article égalant le tibia, de moitié plus long que le 3°, 4° un peu plus court que le 3°, de deux tiers plus long que le 5°. Balanciers brun noir.

Longueur, 2.5 millimètres.

Formose, Anping, octobre 1912; Taihoku, 7 novembre 1912.

Genus *MICROTENDIPES* Kieffer

1. Aile tachetée..... *M. stictopterus* sp. nov.
Aile non tachetée..... *M. dimidiatus* sp. nov.

Microtendipes stictopterus sp. nov.

Femelle.—Tête jaune brunâtre, transversale vue de devant. Yeux séparés par leur largeur terminale, partie amincie à peine plus longue que large, faisant un angle droit avec la partie élargie. Palpes blanchâtres, longs, 1^{er} article un peu plus long que gros, 2° plus de deux fois le 1^{er}, plus court que le 3°, 4° égalant presque le 2° et le 3° réunis. Antennes jaunâtres, 2° article rétréci au milieu, un peu plus long que le 3°, à col aussi long que gros, 3° et 4° à col égalant le nœud, qui est subellipsoïdal, verticille à 7 poils, ceux du 3° dépassent le 4° article, les articles suivants brisés. Thorax roussâtre. Balanciers noirâtres, à tige blanchâtre. Aile blanchâtre, à taches grises, dont 3 dans la cellule cubitale, la proximale la plus grande, distante de sa demi-longueur de la base de cette cellule, la 2° au milieu, la 3° à l'extrémité; 3 dans la cellule discoïdale, la 1° un peu proximale de la nervure transversale, la 2° en forme de bande longitudinale, la 3° à l'extrémité; 2 dans la cellule posticale, la 1° remplissant la moitié proximale de cette cellule, sans toucher la base, la 2° petite, située sous l'extrémité du rameau antérieur; une tache médiocre entre le milieu de la tige de la posticale et le bord

postérieur de l'aile, un point à l'extrémité de la nervure anale et une petite tache à l'extrémité de la cellule anale, contre le rameau postérieur; base lobée; nervures blanchâtres, cubitale un peu arquée au bout, d'un tiers plus longue que la radiale, aboutissant plus près de la pointe alaire que la discoïdale; bifurcation de la posticale distale de une fois et demie la longueur de la transversale. Pattes blanches, hanches et fémurs, sauf le quart distal bruns, le quart (tarse antérieur), le tiers (au tarse intermédiaire) ou la moitié basale (au tarse postérieur) des articles 1-4 noirs, 5^e article brunâtre; fémur antérieur presque deux fois aussi long que le tibia, celui-ci à écaille allongée, terminée subitement par une pointe plus courte que la partie élargie; peigne des 4 tibias postérieurs occupant les trois quarts du contour, l'unique éperon long et arqué; empodium à peine plus court que les crochets, les deux pulvilles larges, un peu plus courts que l'empodium, ayant au côté médian six branches filiformes et longuement poilues; tarse antérieur très grêle, blanc, extrémité des articles noire, métatarse au moins deux fois le tibia. Abdomen brun noir, droit, d'un tiers plus long que le reste du corps; cerci blancs.

Longueur, 2.6-3.8 millimètres.

Philippines, Luzon, Laguna, Los Baños, nombreux exemplaires.

Microtendipes dimidiatus sp. nov.

Femelle.—Jaune roussâtre. Antennes jaunâtres, 2^e article de moitié plus long que le 3^e, légèrement rétréci au milieu, peu aminci à l'extrémité, 3^e et 4^e avec un col pubescent et presque aussi long que le renflement, celui-ci en ellipse, 5^e sans col, en ellipsoïde allongé, les 6 ou 7 poils des verticilles d'inégale longueur, ceux du 5^e, dépassent le 6^e article, celui-ci un peu plus de deux fois aussi long que le 5^e, mince, à trois poils distaux presque aussi longs que lui. Mesonotum avec trois bandes raccourcies et plus ou moins confluentes rousses. Scutellum blanc jaunâtre. Balanciers brun noir. Aile sans tache, atteignant ou dépassant un peu l'extrémité de l'abdomen, à peine lobée, moitié proximale blanchâtre jusqu'à l'origine de la cubitale et la bifurcation de la posticale, moitié distale très faiblement assombrie et un peu brun rosé, ce qui n'est visible que sous un certain jour; cubitale arquée au bout, aboutissant presque à la pointe alaire, dont elle est bien plus proche que la discoïdale, bifurcation de la posticale distale, rameau antérieur continuant la direction de la tige, transversale très petite, toutes les nervures jaunes. Pattes jaunâtres, tarse antérieur brisé, fémur anté-

rieur avec un large anneau brun avant le milieu, un peu plus long que le tibia, celui-ci avec une écaille obtuse et allongée, l'unique éperon des 4 tibias postérieurs long et un peu arqué, empodium atteignant presque l'extrémité des crochets, les deux pulvilles larges, à longs poils. Abdomen brun, de moitié plus long que le reste du corps, un peu aminci en avant.

Longueur, 2.5 millimètres.

Formose, Taihoku, 7 novembre 1912.

Genus **CRYPTOCHIRONOMUS** Kieffer

1. Articles antennaires 3-5 de la ♀ avec un petit col..... *C. petiolatus* sp. nov.
Articles antennaires de la ♀ sans col..... 2
2. Aile non lobée mais graduellement amincie à la base.. *C. subroseus* sp. nov.
Aile lobée 3
3. Noir et brillant; pattes noires en majeure partie... *C. pelochloris* Kieff.
Thorax jaune, à 3 bandes plus sombres; pattes blanchâtres en majeure partie, abdomen vert..... 2
4. Articles antennaires 3-5 de la ♀ presque globuleux, un peu plus longs que gros, à verticille court, celui du 5° n'atteignant que le milieu du 6° article, celui-ci 3.5 fois aussi long que le 5°.... *C. sauteri* sp. nov.
Articles antennaires 3-5 de la ♀ subfusiformes, presque deux fois aussi longs que gros, à verticille long, celui du 5° dépasse le 6° article, celui-ci 2 fois le 5°..... *C. olivaceus* sp. nov.

Cryptochironomus (?) *petiolatus* sp. nov.

Femelle.—Tête pâle. Palpes longs. Yeux rapprochés. Antennes blanchâtres, 2° article rétréci au milieu, à col transversal, 3-5 à col à peine plus long que gros, poils des verticilles longs, ceux du 5° article dépassent le 6°, celui-ci deux fois aussi long que le 5°, à deux poils distaux égalant sa demi-longueur. Thorax fauve. Mesonotum vert, mat, avec trois bandes raccourcies fauves. Balanciers vert sombre. Aile hyaline, dépassant l'abdomen, nervures brunâtres, cubitale arquée au bout, atteignant presque la pointe alaire, dont elle est plus proche que la discoïdale, dépassant la radiale de plus du tiers, transversale proximale du milieu de l'aile, bifurcation de la posticale assez distale de la transversale. Pattes blanchâtres, tibia antérieur et tous les tarses assombris, métatarse antérieur deux fois aussi long que le tibia, 2° article plus court que le tibia, 2-5 graduellement raccourcis; peignes des quatre tibias postérieurs occupant les $\frac{2}{3}$ du pourtour, les deux éperons courts; empodium un peu plus court que les crochets, à poils ventraux bifurqués; pulvilles un peu plus courts que l'empodium. Abdomen vert sombre, courbé, guère plus long que le reste du corps.

Longueur, 1.8 millimètres.

Formose, Taihoku.

Cryptochironomus (?) *subroseus* sp. nov.

Femelle.—Blanc rosé. Yeux très arqués, distants d'au moins leur demi-longueur. Antennes blanchâtres, 6^e article brun, deux fois aussi long que le 5^e, 3-5 sans col, ellipsoïdaux. Mesonotum blanchâtre, brillant, à trois bandes raccourcies jaunes et peu distinctes. Balanciers blancs. Aile blanche, dépassant l'abdomen, non lobée, mais graduellement amincie à la base, glabre, finement pointillée, radiale, sous-costale et cubitale à longs poils espacés; cubitale arquée, au moins deux fois aussi longue que la radiale, aboutissant presque à la pointe alaire; transversale petite, oblique, comme chez *Chironomus*, bifurcation de la posticale assez distale. Pattes blanc sale, tibia et tarse des pattes antérieures assombrés, métatarse deux fois aussi long que le tibia, 2^e article un peu plus court que le tibia, 2-5 graduellement raccourcis; éperons, pulvilles et empodium? Abdomen de moitié plus long que le reste du corps, faiblement arqué et comprimé.

Longueur, 1.2 millimètres.

Formose, Taihoku.

Cryptochironomus sauteri sp. nov.

Femelle.—Tête et thorax jaunes ou verdâtres. Yeux très arqués, séparés de deux fois leur largeur terminale, partie amincie deux fois aussi longue que large, faisant un angle droit avec la partie élargie. Front sans lobes. Article 1^{er} des palpes un peu plus long que gros, 2^e et 3^e presque trois fois aussi longs que gros, 4^e de beaucoup le plus long. Antennes blanc sale ou brunâtres, 2^e article à peine deux fois aussi long que le 3^e, subcylindrique, pas distinctement rétréci au milieu, 3-5 subglobuleux, d'un cinquième plus longs que gros, verticilles à 5 ou 6 poils inégaux et peu longs, ceux du 5^e article n'atteignent que le milieu du 6^e, celui-ci mince, un peu plus de trois fois le 5^e, avec un poil distal égalant sa demi-longueur. Mesonotum avec trois bandes raccourcies d'un brun noir ou brunes ou jaune roussâtre. Balanciers verdâtres, extrémité de la massue assombrie. Aile hyaline, pointillée, lobe à angle droit, nervures pâles, cubitale presque double de la radiale, un peu plus éloignée de la pointe alaire que la discoïdale, 2^e longitudinale aboutissant très près de la radiale, bifurcation de la posticale à peine distale. Pattes blanchâtres, quatre derniers articles du tarse antérieur un peu assombrés, métatarse antérieur de deux tiers plus long que le tibia, double du 2^e article, 2-4 graduellement à peine raccourcis, 4^e de deux tiers plus long que le 5^e, empodium un peu plus court que les

crochets, pulvilles larges, égalant l'empodium, à longs poils; peignes atteignant les trois quarts du pourtour, les deux éperons très courts. Abdomen vert sombre.

Longueur, 1.8 millimètres.

Formose, Anping, octobre 1912, 35 ♀ ♀.

Cryptochironomus olivaceus sp. nov.

Femelle.—Jaune. Palpes assez longs. Antennes blanchâtres, 6^e article brun, deux fois aussi long que le 5^e, à deux poils distaux égalant sa demi-longueur, 2^e article fortement rétréci au milieu, 3-5 subfusiformes ou subellipsoïdaux, environ deux fois aussi longs que gros, verticilles à poils longs, ceux du 5^e article dépassent le 6^e. Mesonotum verdâtre, luisant, trois bandes racourcies, metanotum et mesosternum d'un jaune plus foncé que le reste du thorax. Balanciers vert brun. Thorax aussi long que haut, dépassant la petite tête. Aile hyaline, pointillée finement, à lobe presque à angle droit, nervures pâles, transversale un peu proximale du milieu de l'aile, cubitale aboutissant à la pointe alaire, bifurcation de la posticale notablement distale. Pattes blanchâtres, tibia et tarse antérieurs, et les 2 ou 3 derniers articles des quatre tarses postérieurs un peu assombris, métatarse antérieur presque deux fois le tibia, plus de deux fois le 2^e, 2-4 graduellement raccourcis, le 3^e de moitié plus long que le 4^e, qui est de deux tiers plus long que le 5^e, empodium et pulvilles atteignant le milieu des crochets, les pulvilles larges, à longs poils, probablement rameux médialement; peignes atteignant les $\frac{2}{3}$ du pourtour, les deux éperons courts. Abdomen vert brun, arqué, guère plus long que le reste du corps.

Longueur, 2 millimètres.

Formose, Taihoku, 7 septembre 1912.

Cryptochironomus pelochloris Kieff. (sub *Chironomus*).

Femelle.—Aile subhyaline, très faiblement assombrie, moitié proximale de la cellule cubitale et presque la moitié proximale de la cellule posticale, comme aussi l'extrémité alaire depuis l'embouchure de la cubitale et de celle du rameau antérieur de la posticale, un peu plus assombries mais peu visiblement, ces parties fortement irrisées. Tibia postérieur à deux éperons courts, métatarse postérieur à crochets ventraux dans sa moitié distale, pulvilles égalant l'empodium, plus court que les crochets, à longs poils. Abdomen arqué.

Longueur, 2.2 millimètres.

Formose, Taihoku, 7 septembre 1912.

Genus *LIMNOCHIRONOMUS* Kieffer

Limnochironomus niveicauda sp. nov.

Femelle et mâle.—Brun noir. Tête transversale vue de devant. Yeux glabres, très arqués, peu amincis en haut, où ils sont séparés de leur largeur terminale. Palpes bruns, 1^{er} article guère plus long que gros, 2^e plus de deux fois le 1^{er}, dépassant un peu la bouche, 3^e plus long que le 2^e, 4^e égalant le 2^e et le 3^e réunis. Antennes du ♂ brun noir, comme leur panache, 2^e article jaune sale, presque deux fois le 3^e, 3–11 un peu transversaux, à deux rangées transversales de poils du panache, 12^e un peu plus de deux fois aussi long que 2–11 réunis, pointu au bout. Antennes de la ♀ jaunes, scapes brun noir, séparés de deux fois leur diamètre, 2^e article fortement rétréci au milieu, plus long que le 3^e, un peu aminci à l'extrémité, 3–5 fusiformes, 2.5 fois aussi longs que gros, verticilles à 4 ou 5 poils longs, ceux du 5^e article dépassent un peu le milieu du 6^e article, celui-ci un peu plus de deux fois aussi long que le 5^e. Balanciers brun noir. Aile de la ♀ n'atteignant pas l'extrémité de l'abdomen, enfumée faiblement, avec une bande blanchâtre transversale, allant du milieu de la tige de la posticale au bord postérieur de l'aile, et une autre occupant la moitié distale de la cellule posticale et traversant la partie distale de la cellule discoïdale et de la cellule cubitale, mais l'extrême bout distal de ces deux dernières cellules reste enfumé; base alaire faiblement lobée; surface finement pointillée, un peu plus sombre le long du bord antérieur, radiale et cubitale à soies; cubitale un peu plus de deux fois la radiale, droite, plus proche de la pointe alaire que la rameau antérieur de la posticale, bifurcation de celle-ci distale de deux fois la longueur de la transversale; aile du ♂ subhyaline, à peine assombrie le long du bord antérieur. Pattes noires, trochanters blanchâtres, moitié proximale du métatarse antérieur, et les quatre tarses postérieurs blancs, ceux-ci ont l'extrémité des articles 1–3 et les articles 4 et 5 bruns; tarse antérieur non barbu, métatarse de deux tiers plus long que le tibia, plus de deux fois le 2^e, 2–5 graduellement raccourcis, 5^e encore 5 à 6 fois aussi long que gros, au tarse intermédiaire le 4^e et le 5^e à peine plus longs que gros, au tarse postérieur le 4^e de moitié plus long que le 5^e, celui-ci de deux tiers plus long que gros, empodium à peine plus long que les pulvilles, plus court que les crochets; tibia antérieur avec une écaille pointue; peigne des 4 tibias postérieurs occupant les trois quarts du pourtour, à 2 épérons courts. Abdomen de la ♀ arqué, d'un tiers plus long que le reste du corps; cerci

d'un blanc pur. Abdomen du ♂ très grêle, au moins deux fois aussi long que le reste du corps, les 5 premiers tergites blanchâtres sur le dessous, segments allongés. Pince à articles terminaux blancs, articles basaux et lamelle brun noir, comme les appendices inférieurs; lamelle largement arrondie et sans pointe; articles terminaux bien plus longs que les basaux, très minces dans les deux tiers proximaux, tiers distal deux fois plus gros, renflé en massue, muni à son côté médial de sept soies alignées longitudinalement et, à son extrémité, d'une soie plus courte; côté latéral des articles à poils épars et très longs; appendices supérieurs insérés près de l'extrémité des articles basaux, qu'ils dépassent, jaunes, glabres, transparents, très minces à leur base, graduellement élargis jusqu'à l'extrémité, où ils sont plus de deux fois aussi larges que la base des articles terminaux; appendices inférieurs minces, en forme de lanière, arqués, atteignant presque le milieu des articles terminaux, leur extrémité renflée en massue et portant dorsalement de longs poils arqués.

Longueur, ♂ 4.5 millimètres; ♀, 3.5 millimètres.

Philippines, Luzon, Laguna, Los Baños, plus de 100 exemplaires.

Genus PHYTOCHIRONOMUS Kieffer

Phytochironomus philippinarum sp. nov.

Femelle et mâle.—Jaune sale ou jaune brunâtre. Tête un peu transversale vue de devant. Yeux très arqués, très amincis en haut, où ils sont séparés de deux fois leur largeur terminale (♂). Palpes longs, 1^{er} article pas plus long que gros, 2^e double du 1^{er}, 3^e de moitié plus long que le 2^e, 4^e de moitié plus long que le 3^e. Antennes du ♂ brunes, à panache gris brun, scapes noirs ou jaunes, se touchant, 2^e article deux fois aussi long que le 3^e, 3-11 très transversaux, trois fois aussi gros que longs, 12^e presque quatre fois aussi long que 2-11 réunis. Yeux de la ♀ plus amincis en haut que chez le ♂ et séparés de 3-4 fois leur largeur terminale, partie amincie 2-3 fois aussi longue que large. Antenne de la ♀ de 6 articles, 2^e article de moitié plus long que le 3^e, rétréci au milieu, à col aussi long que gros, 3^e le plus court, graduellement aminci distalement et sans col, 4^e et 5^e fusiformes, col un peu plus long que gros, verticilles de six poils, ceux du 5^e article atteignent le milieu du 6^e, celui-ci de moitié plus long que le 5^e. Mesonotum blanchâtre et prumineux, comme le scutellum, avec trois bandes raccourcies fauves. Aile hyaline, atteignant à peine le 6^e tergite (♂ et ♀), transversale

distale du milieu, brun noir, cubitale d'un tiers plus longue que la radiale, droite, aboutissant peu avant la pointe alaire, deux fois plus loin que la discoïdale, bifurcation sous la transversale, lobe rectangulaire. Article terminal des tarsi assombri; tarse antérieur barbu chez le ♂, tibia antérieur à peine plus court que le fémur, à écaille obtuse, graduellement amincie, de moitié plus longue que large, métatarse de moitié plus long que le tibia, deux fois le 2°, 2-5 graduellement un peu raccourcis, 5° cinq fois aussi long que gros, pulvilles atteignant presque le milieu des crochets, allongés, à poils longs; empodium dépassant le milieu des crochets. Abdomen unicolore, celui-du ♂ deux fois aussi long que le reste du corps, segments 2-7 allongés, segment anal graduellement aminci en avant; abdomen de la ♀ presque aussi gros que le thorax, droit, 2.5 fois aussi long que le reste du corps, segments à peine transversaux; le segment anal dorsalement, à chaque angle du bord postérieur, un petit lobe brun, graduellement aminci et un peu plus long que les cerci, à poils longs et denses; dessous du même segment à deux lobes se touchant presque; cerci bruns. Pince du ♂ ayant la pointe de la lamelle noire; articles terminaux un peu plus longs et aussi larges que les basaux, un peu amincis au tiers distal, côté médial droit, à poils assez denses dans son tiers distal, côté latéral très convexe; appendices supérieurs longs, très minces, arqués, dépassant l'article basal; appendices inférieurs dépassant le milieu des articles terminaux, peu larges, sauf un peu plus de tiers distal qui est élargi en massue, un peu courbé et portant dorsalement, sur un côté, des poils bruns, arqués, longs et gros, sur l'autre côté des poils droits, bien plus fins et un peu plus courts.

Longueur, ♂, 5 millimètres; ♀, 6-7 millimètres.

Philippines, Luzon, Laguna, Los Baños, plus de 100 exemplaires.

Proche de *tainanus* Kieff., qui en diffère par les appendices inférieurs de la pince pointus au bout, par la lamelle à pointe concolore et par la couleur de l'abdomen.

Genus **KRIBIODOXA** Kieffer

Kribiodoxa pulchripennis sp. nov.

Femelle.—Brun noir. Antenne jaunâtre, de 6 articles; scape brun, 3° et 4° article graduellement amincis distalement, 5° ellipsoïdale, à verticille de cinq poils atteignant l'extrémité du 6° article, celui-ci deux fois aussi long que le 5°, avec un poil distal égalant sa demi-longueur. Thorax s'avancant presque en bec au-dessus de la tête. Balanciers blancs. Aile blanche, non

transparente, sans lobe, à taches d'un noir profond, dont la plus grande est presque carrée, à peine transversale, aussi large que la longueur du rameau postérieur de la posticale, également distante de la pointe alaire et de l'origine de la discoïdale, reliant le bord antérieur au rameau antérieur de la posticale, elle est traversée par la discoïdale, qui est blanche en entier; une seconde tache subcarrée, petite, située contre la nervure médiane, s'arrêtant à l'origine de la cubitale et ne touchant pas la tige de la posticale; une 3^e, égale à la 2^e, est située dans la cellule posticale, contre le milieu du rameau antérieur et fait suite à la 1^e; une 4^e, allongée en forme de bande longitudinale et étroite, est située dans la cellule anale, un peu plus distante du bord inférieur et du rameau postérieur que de la tige de la posticale; cubitale droite, très rapprochée de la costale, aboutissant à peine plus près de la pointe alaire que le rameau antérieur de la posticale; transversale pâle, proximale du milieu de l'aile, bifurcation de la posticale distale de la longueur du rameau postérieur, celui-ci oblique, l'antérieur continue la direction de la tige. Pattes blanches, moitié distale des fémurs brun noir, empodium très court, pas de pulvilles, peignes occupant les deux tiers du pourtour, à deux épérons courts. Abdomen noir mat, fortement comprimé, guère plus long que le reste du corps.

Longueur, 1 millimètre.

Philippines, Luzon, Laguna, Los Baños, c'est à ce genre qu'il faut rapporter aussi les trois insectes de Formose, que j'ai décrits sous les noms de *Paratendipes nigrofasciatus*, *P. concoloripes* et *P. astictus*.

Genus ENDOCHIRONOMUS Kieffer, 1918

Il faut rapporter à ce genre *Chironomus pekanus* Kieff. de Formose. Les caractères de ce genre sont: Antennes de 14 articles chez le ♂, de 7 chez la ♀; tibia antérieur avec une écaille distale terminée par un petit éperon; articles terminaux de la pince sans rangée distale de soies rigides au côté médian, appendices inférieurs dépassant les articles basaux, à longs poils dorsaux et incurvés. Le type est: *Chironomus alismatis* Kieff.; il faut encore y ajouter les espèces européennes suivantes; *bryozoarum* K., *danicus* K., *dispar* Meig., *calolabis* K., *leucolabis* K., type, *longiclava* K., *meinerti* K. (sub *Glyptotendipes*), *miki* K., *nymphella* K., *nymphoides* K., *occultus* K., *signaticornis* K., *sparganii* K. (*nymphææ* Will. ? larve et nymphe), *tendens* Fabr., et *xantholabis* K.

Genus **CHIRONOMUS** Meigen

Chironomus sauterianus sp. nov.

Mâle.—Brun noir. Yeux amincis en haut, très arqués, séparés par leur largeur terminale. Palpes longs. Antennes brun clair, comme le panache, scape noir, articles 3–11 transversaux, 12° un peu plus de deux fois aussi long que 2–11 réunis. Lobes frontaux distincts. Mesonotum brun roux, brillant, a trois bandes raccourcies brun noir. Balanciers blancs, extrémité de la massue brun noir. Aile hyaline, lobe à angle droit, nervures jaunâtres, cubitale aussi près de la pointe alaire que la discoïdale, bifurcation de la posticale notablement distale. Pattes jaunâtres, tarse antérieur et deux ou trois derniers articles des autres tarses assombris, articles 2–4 du tarse antérieur barbus, poils 3–4 fois aussi longs que la grosseur des articles, métatarse de moitié ou presque de deux tiers plus long que le tibia, 2–4 graduellement raccourcis, empodium dépassant un peu le milieu des crochets, pulvilles égalant l'empodium, larges, à longs poils; peignes occupant les $\frac{2}{3}$ du pourtour, les deux éperons courts. Abdomen graduellement élargi en arrière, tergites 2–6 allongés, deux fois aussi longs que larges, 7° de moitié plus long que large, très élargi, 8° un peu plus long que large, graduellement aminci en avant, bien plus mince que le précédent. Pince aussi mince que le 8° segment; articles terminaux plus longs que les basaux, arqués, peu larges, graduellement élargis dans la moitié proximale, partie distale ayant au côté médian six soies rigides alignées, extrémité avec une soie plus courte; appendice supérieur inséré près de l'extrémité des articles basaux, arqués, courts, très minces; appendice inférieur dépassant le tiers basal des articles terminaux, un peu élargi au bout, où il porte dorsalement de longs poils arqués; lamelle avec une longue pointe.

Longueur, 5 millimètres.

Formose, Taihoku, 7 novembre 1912.

Chironomus aurantiacus sp. nov.

Femelle.—Jaune orangé et mat. Yeux séparés de leur largeur terminale. Lobes frontaux presque punctiformes. Antennes jaunes, 6° article assombri, de deux tiers plus long que le 5°, 2° rétréci au milieu, col aussi long que gros, 3–5 à col allongé. Mesonotum blanchâtre, à trois bandes raccourcies d'un jaune roux, la médiane un peu luisante. Aile blanche, nervures blanchâtres, transversale noire, lobe rectangulaire, cubitale aussi proche de la pointe alaire que la discoïdale, bifurcation de la posticale sous la transversale. Pattes d'un blanc pur, hanches

fauves, fémurs blanc jaunâtre, extrémité des tibias et des quatre premiers articles tarsaux ainsi que le 5^e article bruns; métatarse antérieur de deux tiers plus long que le tibia, deux fois le 2^e, 3^e plus court que le 2^e, 4^e au moins de moitié plus long que le 3^e, deux fois et demie aussi long que le 5^e. Abdomen comprimé et arqué.

Longueur, 4 millimètres.

Formose, Taihoku, 7 novembre 1912.

Chironomus circumdatus Kieff.

Mâle et femelle.—Yeux séparés de leur largeur terminale; tibia antérieur beaucoup plus court que le fémur.

Formose, Daitotei, juin 1914; Taihoku, 7 novembre 1912; 12 ♂, 14 ♀.

Var. *anomalus* var. nov.

Mâle et femelle.—Articles 2^e et 3^e du tarse antérieur subgaux, le 4^e distinctement plus long que le 3^e, plus de deux fois aussi long que le 5^e, tous deux d'un brun noir; les deux éperons des tibias postérieurs très courts, comme chez le type. Quant au reste, semblable au type.

Longueur, ♂, 5–6 millimètres; ♀, 4 millimètres.

Formose, Daitotei et Taihoku.

Chironomus inermifrons Kieff.

Femelle.—Yeux très arqués, amincis en haut, distants au plus de leur largeur terminale. Nervures jaunâtres, cubitale aussi près de la pointe alaire que la discoïdale, 2^e longitudinale aboutissant plus près de la radiale que de la cubitale, lobe rectangulaire. Pulvilles à longs poils, dépassant un peu le milieu des crochets, aussi longs que l'empodium.

Formose, Anping, en octobre 1912.

Chironomus chlorophorus Kieff.

Mâle.—Tarse antérieur assombri, non barbu, métatarse au moins de moitié plus long que le tibia, deux fois le 2^e article, 4^e double du 5^e, plus court que le 3^e. Tergites 3–6 allongés, 7^e aussi long que large, brunâtre comme le 8^e, celui-ci graduellement aminci en avant. Pince brunâtre, articles terminaux blanchâtres.

Formose, Anping, en octobre 1912.

Genus *CARTERIA* novum

Caractères comme *Chironomus* sauf: Pulvilles rameux dès leur base; articles terminaux de la pince très larges et courts, sans rangée de soies rigides, à contour obovale, avec un petit

ongle triangulaire au bout, appendices inférieurs très longs, lamelle dépourvue de pointe.

Type, *Chironomus longilobus* Kieff.

Ce genre est dédié au diptérologiste anglais H. F. Carter, F. E. S.

Carteria longilobus Kieff. var. *fulviventris* var. nov.

Mâle.—Jaunâtre. Yeux arqués, amincis en haut et séparés par leur largeur terminale. Palpes longs. Antennes brunâtres, panache fauve, scape jaune, 2^e article deux fois aussi long que le 3^e, 3-11 un peu transversaux, 12^e deux fois aussi long que 2-11 réunis. Thorax brillant, trois bandes raccourcies du mesonotum, metanotum et mesosternum d'un jaune plus foncé. Balanciers blanchâtres. Aile hyaline, à lobe rectangulaire, nervures pâles, cubitale presque aussi près de la pointe alaire que la discoïdale, bifurcation de la posticale un peu distale de la transversale, celle-ci au milieu de l'aile. Pattes blanchâtres, extrémité du fémur antérieur, moitié basale du tibia antérieur, son extrémité et le tarse un peu obscurcis, métatarse de deux tiers plus long que le tibia, 2^e article un peu plus long que le tibia, 3^e plus court que le 2^e, subégal au 4^e, celui-ci double du 5^e; peignes occupant les trois quarts du pourtour, les deux éperons courts; pulvilles atteignant les deux tiers des crochets, larges, rameux, les rameaux sortant tous de la base, empodium mince. Abdomen entièrement jaune sale, comme la pince. Celle-ci conformée comme chez le type, sauf les appendices inférieurs, dont des deux tiers proximaux sont presque trois fois aussi larges que les appendices supérieurs, tiers distal élargi en demi-cercle; chez le type, les appendices inférieurs ont leur moitié distale un peu élargie, 2.5 fois aussi longue que large et graduellement amincie en pointe, leur moitié basale non deux fois aussi large que les appendices supérieurs, lamelle obtuse, mais presque triangulaire chez le type, tandis qu'elle est largement arrondie en arrière chez la variété.

Longueur, 3 millimètres.

Formose, Anping.

Genus DITANYTARSUS Kieffer

Ditanytarsus formosanus Kieff. (sub *Tanytarsus*).

Mâle et femelle.—Yeux très arqués, graduellement amincis, distants de leur demi-longueur ou de 5 fois leur largeur terminale. Eperon du tibia antérieur aussi long que la demi-grosseur du tibia.

Formose, Anping, 16 ♂♂, 2 ♀♀.

Genus RHEOTANYTARSUS Bause

Rheotanytarsus formosæ sp. nov.

Mâle et femelle.—Vert (♂) ou jaune verdâtre (♀). Yeux très arqués, séparés de trois quarts de leur longueur. Palpes longs, articles 1-4 graduellement plus longs. Antennes du ♂ grises comme le panache, articles 2-13 graduellement plus longs, les premiers un peu transversaux, les derniers presque deux fois aussi longs que gros, 14^e à peine égal à 2-13 réunis. Antennes de la ♀ jaunâtres, de 5 articles, dont le 2^e un peu rétréci au milieu, presque deux fois aussi long que le 3^e, les suivants ellipsoïdaux, verticilles à 5 ou 6 longs poils, ceux du 4^e article dépassent le 5^e, celui-ci deux fois et demie aussi long que le 4^e, un peu grossi au-dessus de la base et muni à cet endroit d'un verticille double de 6 longs poils, extrémité avec un poil médiocre. Mesonotum avec trois bandes raccourcies jaunes. Balanciers blancs. Aile hyaline, glabre, non lobée, extrémité de la cellule cubitale et de la cellule discoïdale, ainsi que le milieu du tiers distal de la cellule discoïdale à longs poils, cette pilosité un peu plus étendue dans les trois mêmes cellules chez la ♀ que chez le ♂; transversale comme chez *Chironomus*, cubitale droite, plus proche de la pointe alaire que le rameau antérieur de la posticale, bifurcation un peu distale, un peu proximale du milieu de l'aile. Pattes blanches, 4 tibia postérieurs à longs poils, tibia antérieur égalant la moitié du fémur, métatarse un peu plus de deux fois aussi long que le tibia, double du 2^e, 2-4 graduellement raccourcis, 4^e de deux tiers plus long que le 5^e, pulvilles nuls, empodium très court, éperon du tibia antérieur aussi long que la demi-grosueur du tibia, peignes des 4 tibia postérieurs séparés, courts, chacun avec un éperon. Abdomen du ♂ élargi en arrière, segment anal graduellement aminci en avant, subtriangulaire. Pince verte comme l'abdomen, articles terminaux graduellement amincis distalement, appendices inférieurs dépassant les articles basaux, à longs poils dorsaux arqués; brosse courte, à poils simples; lamelle graduellement amincie en pointe.

Longueur, ♂, 1,8 millimètres; ♀, 1,2 millimètres.

Formose, Anping, octobre 1912, 8 ♂ ♂, 1 ♀.

Genus PENTAPEDILUM Kieffer

Pentapedilum pygmæum sp. nov.

Femelle.—Blanc sale, à poils gris, nombreux et longs. Antennes de 6 articles, dont les deux derniers sont soudés, 2^e plus de moitié plus long que le 3^e, subcylindrique, à peine aminci au

bout; 3° et 4° avec un col un peu plus long que gros, nodosité à peine plus longue que grosse; 5° globuleux; verticilles à 8 ou 9 longs poils, ceux du 5° article dépasse le 6°, celui-ci soudé au 5°, mais très mince et plus de trois fois aussi long que lui, avec deux poils distaux aussi longs que l'article. Thorax dépassant de beaucoup la tête en avant. Aile très velue de gris, graduellement amincie à la base, transversale oblique comme chez *Chironomus*, cubitale dépassant la radiale de plus d'un tiers, aboutissant près de la pointe alaire, discoïdale aboutissant à la pointe alaire, bifurcation assez distale. Balanciers blancs. Pattes blanchâtres, fémur antérieur d'un tiers plus long que le tibia, métatarse de deux tiers plus long que le tibia, double du 2° article, 2-4 graduellement un peu raccourcis, 4° de moitié plus long que le 5°, empodium égalant presque les crochets, à poils ventraux bifurqués, pulvilles un peu plus courts que l'empodium, probablement à 4; tibia antérieur avec une écaille graduellement amincie et un peu plus longue que large; pattes postérieures à longs poils, peignes du tibia occupant les trois quarts du pourtour, éperon unique, plus long que la grosseur du tibia.

Longueur, 1 millimètre.

Formose, Anping, octobre 1912, 4 ♀ ♀.

FUNGI SINENSIS ALIQUOT A CL. PROF. OTTO A. REIN-
KING COLLECTI ET COMMUNICATI

Par P. A. SACCARDO

Padova, Italy

A. TELEOMYCETAE

HYMENOMYCETINEAE

SCHIZOPHYLLUM Fries

SCHIZOPHYLLUM COMMUNE Fr. Syll. Fung. 5: 655.

Hab. in ramis emortuis Mori albae (4623).

Kwang Tung, Heung Shan, *Reinking 4623*, May 27, 1919.

PSATHYRA Fries

PSATHYRA SPADICEO-GRISEA (Schäff.) Quél. Syll. Fung. 5: 1065.

Hab. ad terram (4553).

Kwang Tung, Tung San Pang, *Reinking 4553*, May 26, 1919.

PUCCINIACEAE

PUCCINIA Persoon

PUCCINIA PRUNI-SPINOSAE Pers. [Uredosporae] Syll. Fung. 7: 648.

Hab. in foliis vivis Pruni persicae (4718).

Kwang Tung, Canton, *Reinking 4718*, May 7, 1919.

PUCCINIA LONGICORNIS Pat. et Har. [Uredosporae] Syll. Fung. 11: 200.

Hab. in foliis vivis Bambusae sp. (3953).

Fukien, Foochow, *Skvortzow 3953*, June, 1918.

KUEHNEOLA P. Magnus

KUEHNEOLA FICI (Cast.) Butl. [Uredosporae] Syll. Fung. 7: 847

(*Uredo*).

Hab. in foliis vivis Fici Caricae (4730).

Kwang Tung, Canton, *Reinking 4730*, May 7, 1919.

KUEHNEOLA MORICOLA P. Henn. [Uredosporae] Syll. Fung. 17: 451.

(*Uredo*).

Hab. in foliis vivis Mori albae (4632).

Kwang Tung, Canton, *Reinking 4632*, June 15, 1919.

SPHAEROPHRAGMIUM P. Magnus

SPHAEROPHRAGMIUM ACACIAE (Cke.) Magn. [Teleutosp. et Uredosp.]
Syll. Fung. 11: 209.

Hab. in foliis vivis Albizziae Lebbek (3962).

Fukien, Foochow, *Skvortzow 3962*, June, 1918.

USTILAGINACEAE

USTILAGO Persoon

USTILAGO PENNISETI Rabenh. Syll. Fung. 7: 462.

Hab. in ovariis Penniseti sp. (3956).

Fukien, Foochow, *Skvortzow 3956*, June, 1918.

USTILAGO SACCHARI Rabenh. Syll. Fung. 7: 456.

Hab. in vaginis et interiore culmi Sacchari officinarum (4679).

Kwang Tung, Paak Shan, *Reinking 4679*, May 16, 1919.

PERONOSPORACEAE

PERONOPLASMOPARA (Berlese) Clinton

PERONOPLASMOPARA CUBENSIS (Berk. et Curt.) Clint.

Peronospora cubensis B. et C. Syll. Fung. 7: 261 (*Peronospora*).

Hab. in foliis vivis Cucumeris sativi (4633, 4634) et Cucurbitae maximae (4701).

Kwang Si, Tang Uen, *Reinking 4633*, June 8, 1919; Kwang Tung, Canton, *Reinking 4634*, May 8, 1919; Kwang Tung, Heung Shan, *Reinking 4701*, May 27, 1919.

SPHAERIACEAE

PHYSALOSPORIA Niessl

PHYSALOSPORIA REINKINGIANA Sacc. sp. nov.

Peritheciis globulosis, subcutaneis, saepius gregatim seriatis, 200–250 μ diam., vix palpillatis, nigris, initio intus albis, contextu pachydermatico, indistincte celluloso, fuligineo, ascis tereti-clavatis, breviter sensim stipitatis, 115–120 x 12, obsolete paraphysatis, 8-sporis; sporidiis oblique monostichis v. distichis, fusiformibus, rectis curvulivae 30–33 x 5.5–6, raro brevioribus, intus nubilosus, hyalinis.

Hab. in culmis emortuis Bambusae vulgaris, socio Melanconio sphaerospermo (4738). Imprimis sporidiis fusoides, longis dignoscenda, et a Phys. Bambusae omnio diversa.

Kwang Tung, Canton, *Reinking 4738*, May 14, 1919.

PHYSALOSPORA PROPINQUA Sacc. sp. nov.

Peritheciis gregariis, saepius seriatis, globulosis, obtuse papillatis, subcutaneo-erumpentibus, prominulis, intus albis, 0.25–0.33 mm diam., ascis crasse clavatis, breviter stipitatis, crasse tunicatis, 85–95 x 18–20, octosporis, obsolete paraphysatis; sporidiis distichis, oblongo-fusoideis, saepe inaequilateris, utrinque obtuse tenuatis, 18–20 x 6, hyalinis.

Hab. in ramis emortuis Ricini communis (4676). Affinis Ph. gregariae, sed sporidiis subfusoideis, angustioribus et Ph. Reinkingiana sed sporidiis brevioribus diversa.

Kwang Tung, Canton, *Reinking 4676*, May 12, 1919.

ANTHOSTOMELLA Saccardo

ANTHOSTOMELLA PROFUNDA Sacc. sp. nov.

Peritheciis gregariis, strato ligneo profunde immersis, globulosis, 0.5–0.7 mm diam., et collo longiusculo, cylindrico, matricis superficiem circulariter e sporis nigro-foedatam, attingentibus, contextu molliusculo, olivaceo-fusco; ascis cylindricis, breviter stipitatis, apice rotundatis, 140–150 x 9–10, filiformi paraphysatis, octosporis; sporidiis, recte monostichis, ellipsoideis 14 x 9, fuligineis, initio strato hyalino obvolutis.

Hab. in culmis emortuis Bambusae sp. (4733). A ceteris congeneribus bambusicolis diversa.

Kwang Tung, Canton, *Reinking 4733*, May 12, 1919.

DIDYMOSPHAERIA Fuckel

DIDYMOSPHAERIA INFOSSA Sacc. sp. nov.

Peritheciis gregariis strato ligneo profunde immersis, globulosis 0.3–0.5 mm diam. et collo elongato, cylindrico matricis superficiem attingentibus, nigris, contextu minute celluloso, fuliginis; ascis cylindratis, brevissime stipitatis, apice rotundatis, 190–200 x 12, 8-sporis, obsolete paraphysatis; sporidiis monostichis, fusoideis, utrinque acutatis, rectis v. inaequilateris, 1-septatis, non constrictis, 28 x 8; eximie longitrorsum striatis, olivaceis v. fusco-olivaceis.

Hab. in culmis emortuis Bambusae vulgaris (4732). A ceteris **speciebus bambusicolis** rite dignoscenda; cum praecedente situ perithecorum mire convenit, etsi diversissima.

Kwang Tung, Canton, *Reinking 4732*, May 12, 1919.

DIDYMELLA Saccardo

DIDYMELLA EUMORPHA (B. et C.) Sacc. Syll. Fung. 1: 560.

Asci paraphysati, 45-50 x 8-10; sporidia 11-12 x 2, 3-2, 5, saepe curvula, fusioidea.

Hab. in culmis Bambusae sp. (4688).

Kwang Tung, Canton, *Reinking 4688*, May 7, 1919.

APIOSPORA Saccardo

APIOSPORA MONTAGNEI Sacc. Syll. Fung. 1: 539.

Hab. in culmis emortuis Bambusae sp. (4694).

Kwang Tung, Canton, *Reinking 4694*, May 20, 1919.

METASPHAERIA Saccardo

METASPHAERIA CONOIDEA Sacc. sp. nov.

Peritheciis gregariis, globoso-conicis, erumpentibus, nigris, 0.5 mm diam., duriusculis, ostiolo subrostellato emergenti; ascis cylindricis, 170-180 x 8-9, octosporis, breviter stipitatis; sporidiis oblique monostichis, oblongo-fusioideis, utrinque acutulis, interdum inaequilateris, 3-septatis, non constrictis, 4-guttatis, 26 x 7, hyalinis.

Hab. in ramis emortuis Psidii guajavae (4672).

Kwang Si, Tang Uen, *Reinking 4672*, June 7, 1919.

PERONEUTYPA Saccardo

PERONEUTYPA HETERACANTHA Sacc. Syll. Fung. 1: 177 (*Eutypa*).

Hab. in ramis emortuis Citri nobilis (4508).

Kwang Si, Tang Uen, *Reinking 4508*, June 7, 1919.

EUTYPELLA Nitschke

EUTYPELLA CITRICOLA Speg. Syll. Fung. 16: 423. Forma *eutypa*.

Hab. in ramis emortuis Citri grandis (4576).

Kwang Si, Tang Uen, *Reinking 4576*, June 7, 1919.

EUTYPELLA BAMBUSINA Penz. et Sacc. Syll. Fung. 14: 486 (*Eutypa*).

Asci clavulati, 23-25 x 4, 5 p. sporif., sporidia allantoidea, 5-6 x 1, 5-1, 8, hyalina curvula.

Hab. in culmis emortuis Bambusae sp. (4609 et 4696).

Kwang Tung, Canton, *Reinking 4609, 4696*, May, 1919.

DIATRYPELLA Ces. et de Notaris

DIATRYPELLA VERRUCIFORMIS (Ehrb.) Nke. Syll. Fung. 1: 201.

Hab. in ramis emortuis Mori albae (4705).

Kwang Si, Tang Uen, *Reinking 4705*, June 8, 1919.

HYPOXYLON Bulliard

HYPOXYLON SERPENS (Pers.) Fr. Syll. Fung. 1: 378.

Hab. in radicibus emortuis Punicae granati (3960), Citri nobilis (4567) et arboris indet. (4683).

Fukien, Foochow, *Skvortzow 3960*, June, 1918. Kwang Si, Tang Uen, *Reinking 4567*, June 7, 1919. Kwang Tung, Teng Oo, *Reinking 4683*, June 12, 1919.

NUMMULARIA Tulasne

NUMMULARIA PUNCTULATA (B. et Rav.) Sacc. Syll. Fung. 1: 399.

Hab. in trunco non determinato (4604).

Kwang Tung, Canton, *Reinking 4604*, May 20, 1919.

HYPOCREACEAE

STILBONECTRIA Karsten

STILBONECTRIA LATERITIA Karst. Syll. Fung. 9: 986.

Hab. in ramis emortuis Manihot utilissimae, socio Stilbo lateritio (4636); in cortice indeterminato. (4558).

Kwang Tung, Heung Shan, *Reinking 4558*, May 27, 1919: Kwang Tung, Tung San Pang, *Reinking 4636*, May 26, 1919.

MEGALONECTRIA Saccardo

MEGALONECTRIA PSEUDOTRICHIA (Schw.) Speg. Syll. Fung. 2: 560;
var. OLIGOSPORA Sacc. var. nov.

Ascis tetrasporis, 90–105 x 18; sporidiis 30–35 x 12 cribroso, 6 ad 7-septatis, dilutissime fuscis.

Hab. in cortice indeterminato.

HYPONECTRIA Saccardo

HYPONECTRIA SINENSIS Sacc. sp. nov.

Maculis corticalibus subalutaceis, versiformibus; peritheciis dense gregariis, subcutaneis, globulosis, 0.20–0.25 mm diam., pallidis, ostiolo subumbilicato albo erumpenti; contextu laxo celluloso, sordide aureo; ascis cylindratis, breviter stipitatis, 130–150 x 17–19, apice rotundatis, tunica initio incrassata praeditis, paraphysibus diffluentibus, octosporis; sporidiis oblique monostichis oblongo-limoniformibus, apicibus brevissime apiculatis, rectis v. inaequilateris, 28 x 12, hyalinis, farctis.

Hab. in ramis morientibus Citri sp. (4670). Ad genus *Phylosporinam* nutat.Kwang Tung, Paak Shan, *Reinking 4670*, May 16, 1919.

DOTHIDEACEAE

DOTHIDEA Fries

DOTHIDEA TETRASPORA B. et Br. Syll. Fung. 2: 640; var. CITRICOLA
Sacc. var. nov.

Sporidiis quam typi paullo brevioribus, 16 x 7, rufo-fuliginis, articulis subaequalibus; ascis 70 x 11-12.

Hab. in trunco emortuo Citri trifoliatae (3961).

Fukien, Foochow, *Skvortzow 3961*, June, 1918.

PHYLLACHORA Nitschke

PHYLLACHORA SINENSIS Sacc. sp. nov.

Stromatibus minutis, subcircularibus, amphigenis in maculis flavidis innatis, paucilocularibus, loculis epiphyleis non v. vix emergentibus; ascis cylindricis, praelongis, 190 x 9-11; sporidiis monostichis, fusoides, utrinque obtusatis, 28 x 9; hyalinis, farctis.

Hab. in foliis vivis Bambusae sp. (3958). Phyll. eximiae Syd. (in Arundinaria) affinis, differt imprimis ascis multo angustioribus.

Fukien, Foochow, *Skvortzow 3958*, June, 1918.

B. DEUTEROMYCETAE

HYSTERIINEAE

GLONIOPSIS de Notaris

GLONIOPSIS AUSTRALIS (Duby) Sacc. Syll. Fung. 2: 774 et 9: 117.

Hab. in ramis emortuis Pruni Persicae (4671).

Kwang Tung, Tung San Pang, *Reinking 4671*, May 26, 1919.

HYSTEROGRAPHIUM Corda

HYSTEROGRAPHIUM MORI (Schw.) Rehm. Fung. 2: 783.

Hab. in ramis emortuis Mori albae (4679). Videtur haec species, sed asci immaturi.

Kwang Tung, Canton, *Reinking 4679*, May, 1919.

SPHAERIOIDACEAE

AOSPHAERIA Berkeley

AOSPHAERIA FUGAX Sacc. sp. nov.

Pycnidiiis gregariis, subepidermicis sed mox liberis et facile secedentibus, globoso-lenticularibus 100-125 μ diam., nigris, valde regularibus, contextu minute celluloso olivaceo-fuligineo, ostiolo circularis 7-8 μ diam.; sporulis ovoideo-oblongis, 11-12

x 5, 5-6, guttulatis, hyalinis; conidiophoris acicularibus, 5-7 x 2-3, hyalinis.

Hab. in ramis emortuis *Manihot utilissimae* (4650).

Kwang Tung, Canton, *Reinking 4650*, June 15, 1919.

AOSPHERA FUSCO-MACULANS Sacc. Syll. Fung. 3: 174.

Hab. in ramis emortuis *Pruni Persicae* (4734).

Kwang Tung, Canton, *Reinking 4734*, May 7, 1919.

PHOMA (Fr.) Desmaziere

PHOMA MEDIA Ell. et Ev. Syll. 10: 184.

Sporulae fusoidae 12 x 24, hyalinae.

Hab. in caulibus emortuis *Asparagi officinalis* (3967).

Fukien, Foochow, *Skvortzow 3967*, June, 1918.

SPHAERONAEMA Fries

SPHAERONAEMA REINKINGII Sacc. sp. nov.

Pycnidiis gregariis e basi incrassata latenti, subulato-conicis, erumpentibus, nigris, fragilibus, 0.50-0.75 mm, altis, carbonaceis, apice obtusulis; sporulis cylindraceis, utrinque rotundatis, rectis, 8 x 3 hyalinis, sporophoris bacillaribus, raro furcatis, 23-26 x 2, 3, hyalinis.

Hab. in ramis emortuis *Aleuritis moluccanae* (4668). Pycnidii contextus obscure parenchymaticus non fibrosus.

Kwang Si, Tang Uen, *Reinking 4668*, June 7, 1919.

SPHAERONAEMA REINKINGII Sacc. var. **CITRICOLA** Sacc. var. nov.

A typo dignoscitur pycnidiis basi profundis infossis globosisque, rostro aequali; sporulis paullo majoribus, obtusioribus, medioque interdum leviter constrictis, 10 x 4. 5-5.

Hab. in ramis emortuis *Citri grandis* (4568). Rectius forte specificè distinguenda species.

Kwang Si, Tang Uen, *Reinking 4568*, June 7, 1919.

SPHAEROPSIS Lévillé

SPHAEROPSIS MAGNOLIAE Magnaghi Syll. Fung. 16: 313.

Hab. in foliis emortuis *Magnoliae* sp. (3965).

Fukien, Foochow, *Skvortzow 3965*, June, 1918.

SPHAEROPSIS VALSOIDEA Cke. et Ell. Syll. Fung. 3: 299.

Hab. in ramis emortuis *Mori albae* (4720).

Kwang Tung, Sun Wai, *Reinking 4720*, May 23, 1919.

DIPLODIA Fries

DIPLODIA MORICOLA B. et C. Syll. Fung.

Hab. in ramis emortuis *Mori albae* (4704).

Kwang Si, Tang Uen, *Reinking 4704*, June 8, 1919.

DIPLODIA PERSICAE Sacc. *Syll. Fung.* 3: 341.

Hab. in ramis emortuis Pruni Persicae, socia Aposphaeria fuscomaculanti (4734).

Kwang Tung, Canton, *Reinking* 4734, May 7, 1919.

DIPLODIA MANIHOTI Sacc. *Ann. Mycol.* (1914): 310.

Hab. in ramis emortuis Manihot utilissimae (4637).

Kwang Tung, Tung San Pang, *Reinking* 4637, May 26, 1919.

PERISPORIACEAE

MICROXYPHIUM Saccardo

MICROXYPHIUM OBTUSULUM Sacc. sp. nov.

Epiphyllum, effusum, tenue, fuliginosum, secedens; hyphis modo repentibus, filiformibus, ramosis, modo erectis, moniliformibus 40–50 x 4–5, fuligineis; ceratopycnidiis cylindraceis, brevibus, simplicibus, apice obtusis, non v. vix fimbriatis, 50–90 x 20, atro-fuligineis; sporulis globulosis, hyalinis, 4–5 x 3–4.

Hab. in foliis vivis Psidii Guajava (4725).

Kwang Tung, Paak Shan, *Reinking* 4725, May 15, 1919.

MELANCONIACEAE

COLLETOTRICHUM Corda

COLLETOTRICHUM SEPTORIOIDES Sacc. sp. nov.

Acervulis punctiformibus, atris, erumpentibus, gregariis v. seriatis, 0.25–0.50 mm long.; setulis ex hypostromate dense, indistincte celluloso, fuligineo emergentibus, filiformibus, brevibus, continuis, fuligineis, 33 x 3–4, apice obtusulis; conidiis filiformibus, arcuatis, 14 x 1, 7, hyalinis, continuis; conidiophoris brevissimis.

Hab. in culmis emortuis Bambusae vulgaris (4743). Impri-
mis conidiis septorioideis distinguenda species.

Kwang Tung, Canton, *Reinking* 4743, May 12, 1919.

MELANCONIUM Link

MELANCONIUM SPHAEROSPERMUM (Pers.) Link. *Syll. Fung.* 3: 759.

Hab. in culmis morientibus Bambusae sp. (4687, 4697, 4708, 4710).

Kwang Tung, Canton, *Reinking* 4687, 4697, 4708, 4710, May, 1919.

MELANCONIUM HYSTERINUM Sacc. *Syll. Fung.* 11: 572.

Hab. in culmis emortuis Bambusae sp. (4608).

Kwang Tung, Canton, *Reinking* 4608, May 20, 1919.

MELANCONIUM BAMBUSINUM Speg. Syll. Fung. 10: 479.

Hab. in culmis morientibus Bambusae sp. (3969). Conidia 22–24 x 14–15, nempe paullo minora quam in typo Spegazziano, ubi indicantur 30 x 20.

Fukien, Foochow, *Skvortzow 3969*, June, 1918.

MELANCONIUM SACCHARI Cooke Syll. Fung. 14: 1019.

Hab. in culmis emortuis Sacchari officinarum (4699, 4739, 4740).

Kwang Tung, Canton, *Reinking 4699*, May 26, 1919; Kwang Tung, Paak Shan, *Reinking 4739, 4740*, May 16, 1919.

MELANCONIUM (ENDOCALYX) MELANOXANTHUM B. et Br. Syll.

Fung. 3: 758. Cfr. Petch in Ann. Bot. 22 (1908) 389.

Hab. in petiolis emortuis Livistonae chinensis (4723).

Kwang Tung, Heung Shan, *Reinking 4723*, May 27, 1919.

EXOBASIDIINEAE

MICROSTROMA Niessl

MICROSTROMA MINIMUM Sacc. sp. nov.

Maculis amphigenis sed superne distinctioribus, circularibus, azescendo candidis, 2 mm diam., anguste fusco-marginatis; acervulis punctiformibus, candidis, ut videtur erumpentibus; conidiis oblongo ellipsoideis, 4, 5–5 x 2.5, hyalinis, conidiophoris acicularibus brevissimis et parum distinctis suffultis.

Hab. in foliis vivis Ricini communis (4719). A typo generis satis differt, imprimis forma conidiophorum.

Kwang Tung, Canton, *Reinking 4719*, May 12, 1919.

DEMATIACEAE

CONIOSPORIUM Link

CONIOSPORIUM BAMBUSAE (Thüm. et Bolle) Sacc. Syll. Fung. 4: 244.

Hab. in culmis emortuis Bambusae sp. socio Melanconio hystero (4608).

Kwang Tung, Canton, *Reinking 4608*, May 20, 1919.

HADROTRICHUM Fuckel

HADROTRICHUM CAESPITULOSUM Sacc. sp. nov.

Caespitulis laxe gregariis, punctiformibus, nigris, interdum aliquot congestis, 100–150 μ diam., superficialibus, hypostromate pulvinato praeditis; conidiophoris ex hypostromate emergentibus, filiformibus, continuis v. parce septatis, 16–20 x 3.5–4, fuligineis, apice obtusulis; conidiis e fronte globosis, 10–12 μ diam., 1- ad 2-guttulatis, fuligineis, levibus, e latere 7 μ crassis.

Hab. in vaginis foliorum emortuorum Bambusae sp. (3968).
Hypostromate pulvinato a typo generis recedit et ad Tuberculiaceas dematieas referri potest.

Fukien, Foochow, *Skvortzow 3968*, June, 1918.

TETRAPLOA Berkeley et Broome

TETRAPLOA ARISTATA B. et Br. Syll. Fung. 4: 516.

Hab. in culmis putrescentibus Bambusae sp. socia Didymella eumorpha, sed parce (4688).

Kwang Tung, Canton, *Reinking 4688*, May 7, 1919.

CLADOSPORIUM Link

CLADOSPORIUM HERBARUM (Pers.) Link. Syll. Fung. 4: 350; var.

LABLAB Sacc. var. nov.

A typo imprimis distinguitur hyphis conidiisque sub microscopio olivaceo-tabacinis; conidiis modo continuis 5-7 x 3.5-4, modo fusoidis 1-septatis 18-20 x 7; hyphis 115-150 x 6, simplicibus, leviter flexuosis.

Hab. in leguminibus siccis Dolicis Lablab (3954).

Fukien, Foochow, *Skvortzow 3954*, June, 1918.

HELMINTHOSPORIUM Link

HELMINTHOSPORIUM CANTONENSE Sacc. sp. nov.

Effusum, olivaceo-nigrum, adpressum, maculiforme; conidiophoris erectis, simplicibus, ratione brevibus, 80-95 x 6 subseptatis, apice obtusulis, pallidioribus; conidiis obclavatis, 7- ad 9-septatis, ochraceo-fuligineis, 50-62 x 8, sursum obtusule cuspidatis, pallidioribus, saepe curvulis.

Hab. in culmis emortuis Bambusae sp. (4689).

Kwang Tung, Canton, *Reinking 4689*, May 7, 1919.

PODOSPORIUM Schweinitz

PODOSPORIUM MINUS Sacc. sp. nov.

Caespitulis dense et late gregariis, punctiformibus, nigris; synnematibus paucis fasciculatis, 500 μ altis, obclavatis, medio 30-40 μ crassis, basi duplo crassioribus, sursum in conidiophora filiformia 16-18 μ longa, patentia fuliginea solutis capitatisque; conidiis cylindracois v. cylindraco-clavatis, 5 ad 7-septatis, interdum subconstrictis, 35 x 6, 5-7, interdum usque ad 50 μ longis.

Hab. in culmis emortuis Bambusae sp. (4715). Podosporio japonica affine sed multo minus.

Kwang Tung, Canton, *Reinking 4715*, May 10, 1919.

STEMPHYLIUM Wallroth**STEMPHYLIUM MACROSPOROIDEUM** (Berk.) Sacc. Syll. Fung. 4: 519.

Hab. in culmis emortuis Bambusae sp., socio Helminthosporio cantonensi (4689).

Kwang Tung, Canton, *Reinking 4689*, May 7, 1919.**CERCOSPORA** Fries**CERCOSPORA BETICOLA** Sacc. Syll. Fung. 2: 456.

Hab. in foliis Betae vulgaris (4625). Videtur ipsa, sed specimina nimis vetusta.

Kwang Tung, Canton, *Reinking 4625*, May 7, 1919.**CERCOSPORA HENNINGSII** Allesch. Syll. Fung. 14: 1104.

Hab. in foliis Manihot utilissimae (4620).

Kwang Tung, Canton, *Reinking 4620*, May 15, 1919.**FUMAGO** Persoon**FUMAGO VAGANS** Pers. Syll. Fung. 4: 547.

Hab. in foliis vivis Pruni Persicae (4630).

Kwang Tung, Teng Oo, *Reinking 4630*, June 11, 1919.**STEIROCHAETE** Broome et Caspini**STEIROCHAETE CAPSICI** (Syd.) Sacc. (*Vermicularia Capsici* Syd.) Ann. Mycol. (1913): 329.

Pycnidium vere nullum, sed tantum hypostrona ut in aliis Vermiculariae speciebus; hinc ad Tuberculariaceas dematiales potius ducenda species.

Hab. in caulibus emortuis Capsici annui (4706).

Kwang Tung, Canton, *Reinking 4706*, May 15, 1919.**FUSARIUM** Link**FUSARIUM MICROPUS** Sacc. sp. nov.

Parasiticum (ut videtur) in Cladosporio, punctiforme, album, tenellum, conidiis, falcatis, utrinque acutis, initio 1-, dein 3-septatis, non constrictis, albo-hyalinis, 33 x 4.7; conidiophoris assurgentibus e parce mycelio, simplicibus 12 x 4, apice plerumque bidentatis, hyalinis.

Hab. parasitice in Cladosporio herbarum late effuso in foliis ramulisque Mori albae (4669). Forma a typo generis deflectens et ulterius inquirenda.

Kwang Tung, Canton, *Reinking 4669*, May 20, 1919.



KATYDIDS (TETTIGONIOIDEA) OF THE PHILIPPINE
ISLANDS, COLLECTED BY C. F. BAKER

By H. H. KARNY
Of Buitenzorg, Java

Some years ago, Prof. Charles Fuller Baker sent to me some katydids from the Philippine Islands for determination. All of these specimens were collected in Laguna Province, Luzon. Hitherto I have not had the opportunity to examine this very interesting material, but now I have determined all the specimens and here present the complete list. It contains thirty species, of which eleven, indicated by the asterisk (*), were new to science; seven of the new species are described in another place¹ and four are described in this paper. The species new for the Philippine Islands are marked with a dagger (†).

COPIPHORINAE

Euconocephalus pallidus (Redtenbacher).

Conocephalus pallidus REDTENBACHER, Verh. zool.-bot. Ges. Wien 41 (1891) 383, 414.

Conocephaloides pallidus KIRBY, Syn. Cat. Orthoptera 2 (1906) 250.

Euconocephalus pallidus KARNY, General Insectorum fasc. 139 (1912) 35.

One testaceous female from Los Baños (Baker).

Further distribution.—India, Ceylon, Burma, Tonkin, Penang, Singapore, Java, Borneo.

Euconocephalus gracilis (Redtenbacher).

Conocephalus gracilis REDTENBACHER, Verh. zool.-bot. Ges. Wien 41 (1891) 383, 415.

Conocephaloides gracilis KIRBY, Syn. Cat. Orthoptera 2 (1906) 250.

Euconocephalus gracilis KARNY, Genera Insectorum fasc. 139 (1912) 35.

One greenish female from Los Baños (Baker).

Further distribution.—Penang, Java, Borneo, Caroline Islands, Yap, Pelew.

¹ Dodecas Conocephalidarum novarum, Verh. zool.-bot. Ges. Wien (1920) 21-23.

Euconocephalus insulanus (Redtenbacher). †

Conocephalus insulanus REDTENBACHER, Verh. zool.-bot. Ges. Wien. 41 (1891) 383, 416.

Conocephaloides insulanus KIRBY, Syn. Cat. Orthoptera 2 (1906) 250.

Euconocephalus insulanus KARNY, General Insectorum fasc. 139 (1912) 35.

One green female from Los Baños (*Baker*).

Further distribution.—Borneo, Singapore.

Homorocoryphus sp. (*dubius?* *interruptus?*). †

Only one green male from Los Baños (*Baker*). It is impossible to decide from the male only, whether it belongs to *dubius* or *interruptus*, because the principal difference between these two species is in the length of the ovipositor.

Distribution of dubius.—Japan.

Distribution of interruptus.—India, Japan.

CONOCEPHALINÆ = XIPHIDIINÆ

Teratura xiphidiosis Karny.* †

Teratura xiphidiopsis KARNY, Verh. zool.-bot. Ges. Wien (1920) 23.

One female from Mount Maquiling, Luzon (*Baker*).

Teratura simplex Karny.* †

Teratura simplex KARNY, Verh. zool.-bot. Ges. Wien (1920) 24.

One female from Mount Maquiling, Luzon (*Baker*).

Xiphidion longipenne (de Haan).

Locusta (Xiphidium) longipennis DE HAAN, Temminck, Verhand. Orthopt. (1842) 188, 189.

Xiphidium longipenne REDTENBACHER, Verh. zool.-bot. Ges. Wien. 41 (1891) 496, 512.

Anisoptera longipenne KIRBY, Syn. Cat. Orthoptera 2 (1906) 278.

Xiphidium (Xiphidion) longipenne KARNY, Abh. zool.-bot. Ges. Wien 4 (1907) 92.

Conocephalus (Xiphidion) longipennis KARNY, Genera Insectorum fasc. 135 (1912) 11.

One female from Los Baños (*Baker*).

Further distribution.—India, Ceylon, China, Cambodia, Cochinchina, Penang, Sumatra, Aru Islands.

Xiphidion bakeri Karny.* †

Xiphidion bakeri KARNY, Verh. zool.-bot. Ges. Wien (1920) 26.

One female from Los Baños (*Baker*).

Xiphidion affine Redtenbacher.

Xiphidium affine REDTENBACHER, Verh. zool.-bot. Ges. Wien 41 (1891) 497, 513.

Anisoptera affine KIRBY, Syn. Cat. Orthoptera 2 (1906) 278.

Xiphidium (Xiphidion) affine KARNY, Abh. zool.-bot. Ges. Wien 4 (1907) 92.

Conocephalus (Xiphidion) affinis KARNY, Genera Insectorum fasc. 135 (1912) 11.

One male and two females from Los Baños (*Baker*).

Further distribution—Fiji, Aru, Samoa.

Xiphidion maculatum Le Guillou.

Xiphidium maculatum LE GUILLOU, Rev. Mag. Zool. 4 (1841) 294.

Locusta (Xiphidium) lepida DE HAAN, Temminck, Verhand. Orth. (1842) 188, 189.

Xiphidium maculatum REDTENBACHER, Verh. zool.-bot. Ges. Wien 41 (1891) 497, 515.

Xiphidium maculatum JACOBSON and BIANCHI, Orthopt. Pseudoneur. Russ. (1903) 385.

Anisoptera maculatum KIRBY, Syn. Cat. Orthoptera 2 (1906) 278.

Xiphidium (Xiphidion) maculatum KARNY, Abh. zool.-bot. Ges. Wien 4 (1907) 93.

Conocephalus (Xiphidion) maculatus KARNY, Genera Insectorum fasc. 135 (1912) 11.

One female from Los Baños (*Baker*).

Further distribution.—Africa, Madagascar, India, Ceylon, Burma, Penang, Borneo, Celebes, Amoy, Java, Sumatra, Macassar, Malacca, Japan.

Conocephalus sannio Karny.* †

Conocephalus sannio KARNY, Verh. zool.-bot. Ges. Wien (1920) 27.

One male and one female from Los Baños (*Baker*).

Bakerella signifrons Karny.* †

Bakerella signifrons KARNY, Verh. zool.-bot. Ges. Wien (1920) 29.

One female from Mount Maquiling (*Baker*).

LISTROSCELINÆ

Phisis philippinarum Karny.* †

Phisis philippinarum KARNY, Verh. zool.-bot. Ges. Wien (1920) 31.

One female from Los Baños (*Baker*).

Phisis pectinata (Guerin-Meneville).†

Listrosceles pectinata GUERIN-MENEVILLE, Voy. Coquille, Ins. (1830) 153.

- Listroscelis pectinata* SERVILLE, Hist. Nat. Ins. Orth. (1839) 398.
Listroscelis pectinata BURMEISTER, Handb. Ent. 2 (1839) 716.
Locusta pectinata DE HAAN, Temminck, Verhand. Orth. (1842) 216, 217.
Phisis pectinata STÅL, Freg. Eugenies Res. Ins. (1860) 324.
Listroscelis pectinata BRUNNER, Verh. zool.-bot. Ges. Wien 12 (1862) 92, 96.
Nocera pallida WALKER, Cat. Derm. Salt. Brit. Mus. 2 (1869) 10J.
Nocera pectinata WALKER, Cat. Derm. Salt. Brit. Mus. 2 (1869) 214.
Teuthras pectinatus STÅL, Recensio Orthopt. 2 (1874) 116.
Teuthras pectinatus REDTENBACHER, Verh. zool.-bot. Ges. Wien 41 (1891) 540, 542.
Phisis pectinata KIRBY, Syn. Cat. Orthopt. 2 (1906) 286.
Phisis pectinata KARNY, Abh. zool.-bot. Ges. Wien 4 (1907) 104.
Teuthras pallidus HOLDHAUS, Denkschr. Akad. Wiss. Wien 68 (1908) 12, 22.
Phisis pallida KARNY, Genera Insectorum fasc. 131 (1912) 9.
Phisis pectinata KARNY, Genera Insectorum fasc. 131 (1912) 9.

A widely distributed species, diverging into several local races. One female from Mount Maquiling (*Baker*).

Further distribution.—Ceylon, Nicobar Islands, Borneo, Moluccas, Bouru, New Guinea, Tahiti, Samoa.

Hexacentrus spiniger Karny.* †

Hexacentrus spiniger KARNY, Verh. zool.-bot. Ges. Wien (1920) 32.

One female from Mount Maquiling (*Baker*).

Hexacentrus unicolor Serville.

- Hexacentrus unicolor* SERVILLE, Ann. Sci. Nat. 22 (1831) 146.
Locusta unicolor SERVILLE, Hist. Nat. Ins. Orthopt. (1839) 531.
Hexacentrus unicolor BURMEISTER, Handb. Entom. 2 (1839) 714.
Hexacentrus plantaris BURMEISTER, Handb. Entom. 2 (1839) 714.
Locusta plantaris DE HAAN, Temminck, Verhand. Orth. (1842) 215, 216.
Hexacentrus unicolor REDTENBACHER, Verh. zool.-bot. Ges. Wien (1891) 548, 552.
Hexacentrus unicolor KIRBY, Syn. Cat. Orthopt. 2 (1906) 287.
Hexacentrus unicolor KARNY, Abh. zool.-bot. Ges. Wien 4 (1907) 108.
Hexacentrus unicolor KARNY, Genera Insectorum fasc. 131 (1912) 16.

One male from Los Baños (*Baker*) and one female from Mount Maquiling (*Baker*).

Further distribution.—India, Burma, Singapore, Amoy, Java, Sumatra, Celebes, Amboina, Borneo, Moluccas, Cochinchina, China, Formosa, Japan.

PSEUDOPHYLLINÆ

Togona unicolor Matsumura and Shiraki.†

Togona unicolor MATSUMURA and SHIRAKI, Journ. Coll. Agric. Sapporo 3 (1908) 30; KARNY, Suppl. Entom. 4 (1915) 74.

One male from Los Baños (*Baker*).

Further distribution.—Formosa.

Phyllomimus detersus (Walker).

Pseudophyllus detersus WALKER, Cat. Derm. Salt. Brit. Mus. 2 (1869) 406.

Pseudophyllus sinensis WALKER, Cat. Derm. Salt. Brit. Mus. 2 (1869) 406.

Phyllomimus granulosus STÅL, Oefv. Vet.-Akad. Förh. 30 (1873) 48.

Phyllomimus granulosus STÅL, Recensio Orthopt. 2 (1874) 69.

Phyllomimus truncatifolia PICTET and SAUSSURE, Icon. Saut. Vertes (1894) 19.

Phyllomimus granulosus BRUNNER, Monogr. Pseudophyll. (1895) 54, 55.

Phyllomimus detersus KIRBY, Syn. Cat. Orthopt. 2 (1906) 299.

One female from Los Baños (*Baker*).

Further distribution.—China, Java, Celebes, Moluccas.

Phyllomimus bakeri sp. nov.* †

Olive green. Antennæ yellowish, not annulated. Hind margin of pronotum rounded; lateral lobes with the lower margin nearly straight. Elytra near the apex narrowed, at apex rounded; their posterior margin nearly straight. Radial area without darker spots. Radial veins diverging at the middle of elytra, with the principal branch not undulated. Hind wings perfectly developed, not shorter than elytra. Anterior and middle femora beneath on both margins 7 to 9 denticulated; the anterior ones in female a little longer than the pronotum. Posterior femora on the inner side without a blood red stripe, beneath on both margins about 12 denticulated, with the basal denticles smaller than the distal ones. Supra-anal lamina of female longer than broad, at apex roundly pointed. Ovipositor rather narrow, with the superior margin slightly sinuated and serrulated. Subgenital lamina of female obtuse triangular, emarginated at apex.

Measurements of female.

	mm.
Length of body	36.5
Length of pronotum	7.3
Length of elytra	55.7
Breadth of elytra	13.3
Length of fore femora	9.6
Length of hind femora	18.7
Length of ovipositor	19.0
Breadth of ovipositor	3.4

I take pleasure in naming this species in honor of Prof. Charles Fuller Baker, who discovered it in the Philippine Islands.

One female from Mount Maquiling (*Baker*).

This new species is very closely related to *Ph. detersus*, but may be distinguished by its slenderer body, the distinctly longer elytra, and the formation of the ovipositor. The measurements given by Brunner² seem to be the same in *detersus* as in *bakeri*, but an accurate comparison of my new species with the examples of *detersus* in Brunner's collection (Vienna) shows that the ovipositor of *bakeri* is relatively longer and slenderer than in *detersus*. The breadth at base, indeed, is the same, but in *bakeri* the ovipositor is distinctly narrowed quite from the base, in *detersus* the breadth is nearly the same to the middle and only the apical half is distinctly narrowed.

MECOPODINÆ

Mecopoda elongata (Linnæus).

- Gryllus* (*Tettigonia*) *elongatus* LINNÆUS, Syst. Nat. ed. 10 1 (1758) 429.
Gryllus (*Tettigonia*) *elongatus* LINNÆUS, Mus. Ludov. Ulric. (1764) 127.
Gryllus javanus JOHANSSON, Amoen. Acad. 6 (1763) 398.
Locusta elongata FABRICIUS, Syst. Ent. (1775) 284.
Gryllus (*Tettigonia*) *ferruginea* STOLL, Spectress, Saut. (1813) 13.
Gryllus (*Tettigonia*) *rufa* STOLL, Spectress, Saut. (1813) 13.
Conocephalus elongatus THUNBERG, Mem. Acad. Petersb. 5 (1815) 279.
Locusta longipes THUNBERG, Mem. Acad. Petersb. 5 (1815) 280.
Locusta scalaris THUNBERG, Mem. Acad. Petersb. 5 (1815) 282.
Mecopoda maculata SERVILLE, Ann. Sci. Nat. 31 (1831) 155.
Mecopoda virens BRULLE, Hist. Nat. Ins. 9 (1835) 140.
Mecopoda virens SERVILLE, Hist. Nat. Ins. Orth. (1839) 533.
Mecopoda elongata BURMEISTER, Hand. Ent. 2 (1839) 685.
Mecopoda ferruginea BLANCHARD, Hist. Nat. Ins. 3 (1840) 12.
Mecopoda virens BLANCHARD, Hist. Nat. Ins. 3 (1840) 12.
Locusta (*Mecopoda*) *javana* DE HAAN, Temminck, Verhand. Orth. (1842) 187.
Locusta (*Mecopoda*) *macassariensis* DE HAAN, Temminck, Verhand. Orth. (1842) 188.
Locusta (*Mecopoda*) *niponensis* DE HAAN, Temminck, Verhand. Orth. (1842) 188.
Decticus pallidus WALKER, Cat. Derm. Salt. Brit. Mus. 2 (1869) 262.
Decticus tenebrosus WALKER, Cat. Derm. Salt. Brit. Mus. 2 (1869) 262.
Lucera bicoloripes WALKER, Cat. Derm. Salt. Brit. Mus. 2 (1869) 265.
Mecopoda rufa WALKER, Cat. Derm. Salt. Brit. Mus. 3 (1870) 458.
Mecopoda elongata REDTENBACHER, Verh. zool.-bot. Ges. Wien 42 (1892) 212, 214.

² Monogr. Pseudophyll. (1895) 55.

Mecopoda elongata TANI, Ins. World 9 (1905) pl. 6.

Mecopoda elongata KIRBY, Cat. Orth. 2 (1906) 364.

Mecopoda elongata CAUDELL, Genera Insectorum fasc. 171 (1916) 24.

One dark grayish brown female from Mount Maquiling (*Baker*), with blackish legs and lateral lobes of pronotum; elytra with rounded black spots in the precostal and costal areas, and with larger, triangular ones between the radial and medial veins. Medial vein of hind wings with 5 branches (f. *macassariensis* de Haan).

One pale green male with shorter tegmina and wings, from Los Baños (*Baker*). Eyes and the upper part of lateral lobes of pronotum dark brown. Legs brownish, the hind ones with a darker stripe on the outer side. Tegmina green without dark spots, only the tympanum brown. Medial vein of hind wings with 4 branches (f. *niponensis* de Haan).

Further distribution of the species.—China, Japan, India, Ceylon, Malacca, Sunda Islands, Aru, Key, Moluccas, Australia.

PHANEROPTERINÆ

Mirollia carinata (de Haan).

Locusta (Phylloptera) carinata DE HAAN, Temminck, Verhand. Orth. (1842) 196, 199.

Phaneroptera carinata STÅL, Freg. Eugenies Res., Orth. (1860) 321.

Mirollia carinata STÅL, Recensio Orthopt. 2 (1874) 27.

Mirollia carinata BRUNNER, Monogr. Phaneropt. (1878) 107.

Mirollia carinata DOHRN, Stettin. Entom. Zeit. 53 (1892) 66.

Mirollia carinata KIRBY, Syn. Cat. Orthopt. 2 (1906) 398.

One female from Mount Maquiling (*Baker*).

Further distribution.—Java.

Ducetia thymifolia (Fabricius).

Locusta thymifolia FABRICIUS, Syst. Entom. (1775) 283.

Locusta japonica THUNBERG, Mem. Acad. Peters. 5 (1815) 282.

Locusta (Phaneroptera) quinquenervis DE HAAN, Temminck, Verhand. Orth. (1842) 191, 193.

Phaneroptera neochlora WALKER, Cat. Derm. Salt. Brit. Mus. 2 (1869) 342.

Phaneroptera privata WALKER, Cat. Derm. Salt. Brit. Mus. 2 (1869) 344.

Ducetia japonica STÅL, Recensio Orthopt. 2 (1874) 26.

Ducetia japonica BRUNNER, Monogr. Phaneropt. (1878) 109, 110.

Ducetia japonica BRUNNER, Verh. zool.-bot. Ges. Wien 41 (1891) 53.

Ducetia japonica JACOBSON and BIANCHI, Orthopt. Pseudoneur. Russ. (1902-3) 336, 374.

Ducetia thymifolia KIRBY, Syn. Cat. Orthopt. 2 (1906) 398.

One green male from Mount Maquiling (*Baker*) and two orange yellow females, one from Los Baños (*Baker*) and one from Paete (*Baker*).

Further distribution.—India, Ceylon, Cambodia, Japan, Java, Borneo, Australia.

Casigneta spinicauda sp. nov.* †

Pale green. Vertex conical, deeply sulcate, with slightly diverging lateral carinæ. Radial vein of tegmina brown at base. Ovipositor sickle-shaped, strongly compressed, pointed at apex, with the upper margin almost entirely serrulated, the lower margin only in the distal third. Subgenital lamina of female in the middle part elongated-oval, transversely truncate at apex; on both sides laterally an acute, spiniform process.

Measurements of female.

	mm.
Length of pronotum	5.5
Length of elytra	36.6
Breadth of elytra	7.0
Length of front femora	9.5
Length of hind femora	26.0
Length of ovipositor	8.0

One female from Mount Maquiling (*Baker*).

This very interesting species is distinguished from the hitherto known *Casigneta* at once by the sharply pointed processes on the sides of subgenital lamina (female). Such processes are wanting in *cochleata* Brunner³ and *pellucida* Brunner.⁴ In *cochleata* the subgenital lamina of the female is triangular, transversely truncated at apex, in *pellucida* elongated-triangular, pointed. Of *lamellosa* Brunner⁵ only the male is known. That *lotiifolia*⁶ does not belong to this genus, I have already shown elsewhere. By its whole appearance and the shorter ovipositor, *Casigneta spinicauda* most nearly approaches *C. pellucida*, but the formation of subgenital lamina (female) is a very characteristic one.

Phaula teretiusscula sp. nov.* †

Yellowish green. Of smaller size. Disk of pronotum rounded, smooth, its front part compressed. Elytra a little broader than the length of pronotum; radial vein with 3 or 4 not furcated branches, running into the hind margin. Anterior

* Monogr. Phaneropt. (1878) 164.

† Op. cit., 165.

³ Verh. zool.-bot. Ges. Wien 41 (1891) 77.

⁴ De Haan, Temminck, Verhand. Orthopt. (1842) 191, 194.

and middle femora with the front margin spined. Hind femora on the outer margin with 9 to 11, on the inner one with 8 or 9 spines. Fore and middle tibiae sulcated above. The outer tympanum open, the inner one obtected. Ovipositor sickle-shaped, pointed at apex, with the margins in the distal part slightly serrulated. Subgenital lamina (female) triangular.

Measurements of female.

	mm.
Length of body	17.3
Length of pronotum	4.5
Length of elytra	31.0
Breadth of elytra	7.0
Length of fore femora	6.0
Length of hind femora	20.0
Length of ovipositor	9.6

One female from Los Baños (*Baker*).

This species approaches *Phaula rugulosa* Brunner⁷ by its whole habitus, building of tegmina, and form of lateral lobes of pronotum but is distinguished from it by the entirely smooth pronotum, which agrees with *Ph. laevis* Brunner⁸ and *compressa* Brunner.⁹ From *laevis*, it may be separated by the considerably narrower elytra, from *compressa* by its less compressed pronotum and the slenderer ovipositor. The subgenital lamina of female is not emarginated as in *rugulosa*, but triangular and more acuminate than in *compressa*.

Phaula phaneropteroides Brunner.

Phaula phaneropteroides BRUNNER, Verh. zool.-bot. Ges. Wien 41 (1891) 79, 81; KIRBY, Syn. Cat. Orthopt. 2 (1906) 426.

One greenish male from Los Baños (*Baker*). Known only from the Philippine Islands.

Holochlora javanica Brunner.[†]

Locusta (Phaneroptera) javanica DE HAAN, Temminck, Verhandl. Orth. (1842) 191, 194 (nec Thunberg, 1815).

Holochlora javanica BRUNNER, Monogr. Phaneropt. (1878) 175, 180.

Holochlora javanica BRUNNER, Verh. zool.-bot. Ges. Wien 41 (1891) 90, 91.

Holochlora javanica KIRBY, Syn. Cat. Orthopt. 2 (1906) 431.

One female from Los Baños (*Baker*).

Further distribution.—Java, Sumatra; farther India.

⁷ Monogr. Phaneropt. (1878) 167.

⁸ Op. cit., 168.

⁹ Verh. zool.-bot. Ges. Wien 41 (1891) 79, 81.

Liotrachela lobata Brunner.

Liotrachela lobata BRUNNER, Verh. zool.-bot. Ges. Wien 41 (1891) 93;
KIRBY, Syn. Cat. Orthopt. 2 (1906) 432.

One green specimen from Mount Maquiling (*Baker*).
Known only from the Philippine Islands.

Phaneroptera subcarinata Bolivar.†

Phaneroptera subcarinata BOLIVAR, Ann. Soc. Ent. France 68 (1900)
746; KIRBY, Syn. Cat. Orthopt. 2 (1906) 436.

One greenish yellow male from Los Baños (*Baker*) agrees perfectly with this Indian species (after Bolivar's description). but the elytra reach the hind knees in repose. They are almost coriaceous, with slightly prominent secondary veins. Their marginal area is of the same color as the other parts of elytra and equally reticulated. Fore coxæ armed with a distinct spine. The end of male abdomen is distinctly different from the following species and is well described by Bolivar. It agrees very well with the African *Ph. nana*. Brunner's collection (at Vienna) possesses *subcarinata* under the name "nana" from several places in the Indo-malayan region.

Further distribution.—India.

Phaneroptera furcifera Stål.

Phaneroptera furcifera STÅL, Recensio Orthopt. 2 (1874) 29; BRUNNER, Monogr. Phaneropt. (1878) 210, 216; KIRBY, Syn. Cat. Orthopt. 2 (1906) 436.

Two green females with red-veined hind wings from Los Baños (*Baker*). This species forms with *brevis* Serville (syn. *gracilis* Burmeister 1839 nec. Germar 1817) a peculiar group, diverging from the other *Phaneropteras* by the exceedingly long subgenital lamina of the male and by the lack of spines on fore coxae. Brunner has placed the genus *Phaneroptera* in the group with fore-coxal spines (as they are present in the other species) and has not mentioned that in *furcifera* and *brevis* this spine is quite rudimentary or entirely wanting, but in his collection he has declared it on the labels. Therefore Brunner's table of genera leads, in the determination of these two species, never to *Phaneroptera*, but to *Pyrrhicia* (*Letana*). But the texture of the tegmina is totally different in these two genera and places *furcifera* and *brevis* in the genus *Phaneroptera*. Further, the ovipositor is considerably shorter than in *Letana despecta*, and the hind wings are distinctly longer. The hind femora distinctly surpass the elytra in *furcifera*, in *brevis* not or scarcely at all.

Phaneroptera furcifera has been recorded only from the Philippine Islands.

Furnia bakeri sp. nov.* †

Green. Fastigium of the vertex narrow, nearly as broad as the first antennal joint, deeply sulcated with the frontal fastigium almost contiguous. Disk of pronotum rather flat; lateral lobes roundly inserted, higher than long. Tegmina nearly transparent, linear; their first radial branch in the distal part furcated, the second simple. Hind wings distinctly exceeding the elytra. Fore femora slightly sulcated beneath, armed with a few very small spines on the front margin. Middle femora in the distal half of outer margin finely spined. Hind femora with spines on both margins. Anal segment of female in the middle distinctly emarginate, on each side with sharply triangular projection. Ovipositor nearly twice as long as the pronotum, broadest after the middle, sickel-shaped, pointed at apex; its lower margin in the distal half crenulated. Subgenital lamina of female shorter and broader than in *F. incerta*; rounded at apex.

Measurements of female.

	mm.
Length of body	24.3
Length of pronotum	6.0
Length of elytra	39.5
Breadth of elytra	9.0
Length of fore femora	7.4
Length of hind femora	35.5
Length of ovipositor	11.5

I have named this new species in honor of its discoverer, Charles Fuller Baker.

One female from Mount Maquiling (*Baker*).

This species agrees by its whole habitus rather with *F. incerta* Brunner¹⁰ but is a little larger. By the formation of vertex, the new species approaches *F. exotica* Brunner,¹¹ but differs by its larger size, its more regular venation of elytra, and its more extended hind wings. The *exotica* female is unknown. In *incerta* (female) the anal segment is only slightly emarginated, without projections; and the subgenital lamina are longer and slenderer than in *F. bakeri*, being a little emarginated at the extreme apex.

¹⁰ Monogr. Phaneropt. (1878) 296.

¹¹ Op. cit., 286.

THE PHILIPPINE BUREAU OF SCIENCE

RECENT PUBLICATIONS

AN INTERPRETATION OF RUMPHIUS'S HERBARIUM AMBOINENSE

By E. D. MERRILL

Based on the collections made in Amboina by the late Charles Budd Robinson

Order No. 450. Bureau of Science Publication No. 9. Paper, 595 pages and 2 maps.

Price, \$3 United States currency, postpaid.

SPECIES BLANCOANAE: A CRITICAL REVISION OF THE PHILIPPINE SPECIES OF PLANTS DESCRIBED BY BLANCO AND BY LLANOS

By E. D. MERRILL

Order No. 461. Bureau of Science Publication No. 12. Paper, 423 pages and 1 map.

Price, \$2.25 United States currency, postpaid.

PHILIPPINE WATER SUPPLIES

By George W. Heise and A. S. Behrman

Order No. 460. Bureau of Science Publication No. 11. Paper, 218 pages, 19 plates, and 4 text figures.

Price, \$1.75 United States currency, postpaid.

VEGETATION OF PHILIPPINE MOUNTAINS

The relation between the environment and physical types at different altitudes

By WILLIAM H. BROWN

Order No. 473. Bureau of Science Publication No. 13. Paper, 434 pages, 41 plates, 30 text figures.

Price, \$2.50 United States currency, postpaid.

PLEASE GIVE ORDER NUMBER

Orders for these publications may be sent to the Business Manager, Philippine Journal of Science, Bureau of Science, Manila, P. I., or to any of the following agents:

AGENTS

THE MACMILLAN COMPANY, 64-66 Fifth Avenue, New York, U. S. A.
WM. WESLEY & SON, 28 Essex Street, Strand, London, W. C., England.
MARTINUS NIJHOFF, Lange Voorhout 9, The Hague, Holland.
KELLY & WALSH, Limited, 32 Raffles Place, Singapore, Straits Settlements.
THACKER, SPINK & CO., P. O. Box 54, Calcutta, India.
THE MARUZEN CO., Limited, 11-16 Nihonbashi, Tori-Sanchome, Tokyo, Japan.

CONTENTS

	Page.
VALENCIA, F. V. Mechanical tests of some commercial Philippine timbers	485
MCGREGOR, RICHARD C. Birds of Antique Province, Panay, Philippine Islands.....	537
KIEFFER, J. J. Chironomides des Philippines et de Formose	557
SACCARDO, P. A. Fungi Sinensis aliquot a cl. Prof. Otto A. Reinking collecti et communicati.....	595
KARNY, H. H. Katydids (Tettigonioidea) of the Phil- ippine Islands, collected by C. F. Baker.....	607

The Philippine Journal of Science is issued twelve times a year. The sections were discontinued with the completion of Volume XIII (1918).

Yearly subscription, beginning with Volume XIV, 5 dollars United States currency. Single numbers, 50 cents each.

Publications sent in exchange for the Philippine Journal of Science should be addressed: Library, Bureau of Science, Manila, P. I.

Subscriptions may be sent to the BUSINESS MANAGER, Philippine Journal of Science, Bureau of Science, Manila, P. I., or to any of the agents listed on the third page of this cover.

VOL. 18, No. 6

JUNE, 1921

THE PHILIPPINE JOURNAL OF SCIENCE



MANILA
BUREAU OF PRINTING
1921

179044

THE PHILIPPINE JOURNAL OF SCIENCE

Published by the Bureau of Science of the Government of the Philippine Islands

ELMER D. MERRILL, M.S., *Editor*

R. C. MCGREGOR, A.B., *Associate Editor*

ALBERT H. WELLS, A.B.; GRANVILLE A. PERKINS, PH.D.; A. P. WEST, PH.D.
T. DAR JUAN, A.B., PHAR.D.; F. AGCAOLLI, A.B.; A. S. ARGUELLES, B.S.
ALBERT E. W. KING

Chemistry

WARREN D. SMITH, PH.D.; ROY E. DICKERSON, PH.D.

Geology

H. W. WADE, M.D.; OTTO SCHÖBL, M.D.
F. G. HAUGHWOUT; STANTON YOUNGBERG, D.V.M.

Experimental Medicine

LIBORIO GOMEZ, M.D., PH.D.; F. CALDERON, B.A., L.M.
VICENTE DE JESUS, M.D.

Clinical Medicine

W. H. BROWN, PH.D.; C. F. BAKER, M.A.; ATHERTON LEE, M.S.
O. A. REINKING, B.S.A., M.S.; L. M. GUERRERO, PHAR.D.

Botany

ALBERT C. HERRE, PH.D.; C. F. BAKER, M.A.; S. F. LIGHT, M.A.
C. S. BANKS, M.A.; L. D. WHARTON, M.A.; W. SCHULTZE

Zoölogy

H. O. BEYER, M.A.; OTTO JOHNS SCHEERER, M.A.

Anthropology

ANNA B. BANYEA, *Copy Editor*

Manuscript intended for publication and books for review should be sent to the editor. One hundred separates of papers published in the Journal are furnished to authors without charge. Additional copies may be had at authors' expense.

Publications sent in exchange for the Philippine Journal of Science should be addressed: Library, Bureau of Science, Manila, P. I.

The Journal is issued twelve times a year. The subscription price is 5 dollars, United States currency, per year. Single numbers, 50 cents each.

Subscriptions may be sent to the BUSINESS MANAGER, Philippine Journal of Science, Bureau of Science, Manila, P. I., or to any of the agents listed on the third page of this cover.



THE PHILIPPINE JOURNAL OF SCIENCE

VOL. 18

JUNE, 1921

No. 6

THE COMPOSITION, SOLUBILITY, AND OXIDATION OF LUMBANG OIL

By AUGUSTUS P. WEST

Professor of Chemistry, University of the Philippines
and

ZOILA MONTES

Instructor in Chemistry, University of the Philippines

THREE PLATES

INTRODUCTION

Lumbang oil is obtained from the nuts of *Aleurites moluccana*, which is a large tree reaching a diameter of 80 to 160 centimeters. The genus *Aleurites* contains a number of species which yield nuts having a valuable oil. Perhaps the best known of these oils is Chinese wood oil (tung oil). This is derived from at least two Chinese species of the genus, *Aleurites fordii* Hemsley and *Aleurites montana* Wilson, which do not occur in the Philippines. Tung oil, which has properties quite similar to those of Philippine lumbang oil, has been investigated extensively. It is used in large quantities for the preparation of paints, varnishes, linoleum, and for other similar purposes. In the Philippines, oil is obtained from the nuts of two species of the genus *Aleurites*. Oil from *Aleurites moluccana* is known as lumbang oil, while that obtained from *Aleurites trisperma* is called baguilumbang. The oil now obtained in the Philippines from the genus *Aleurites* is almost entirely the product of *Aleurites moluccana* which is fairly abundant in a wild state in many parts of the Philippines and is also planted. *Aleurites trisperma* is reported from many localities but is probably not so abundant. Both species can be grown readily in plantations.

The Philippine Bureau of Forestry is using large numbers of both species in its reforestation projects and is also distributing seed and encouraging the people to plant these species. During 1918, there were exported 184,428 kilograms of lumbang oil from *Aleurites moluccana*, valued at 129,838 pesos. One American concern, which has experimented with lumbang oil, inquired as to the possibility of obtaining 4,000 tons per month. This fact would seem to indicate that there is a good market for considerable quantities of this oil.

The species *Aleurites moluccana* is also distributed through Polynesia, the Malayan region, and the Hawaiian Islands. In Hawaii the oil from *Aleurites moluccana* is called kukui, or candlenut oil. The latter name is also used in other parts of the world. According to Wilcox and Thompson¹ the Hawaiians strung the nuts on sticks and used them for lighting their houses. This use of the kernels gave rise to the name "candlenut."

Lumbang oil is used for various purposes such as the preparation of paints, varnishes, and linoleum, and for illumination, wood preservation, etc. It has been manufactured in the Philippines in very primitive mills for years and is used locally for illumination, mixing paints, and for protecting bottoms of dugout canoes and other small craft against water and against marine borers.

The oil manufactured locally is made in a few Chinese shops in Manila, with primitive hand apparatus. The nuts are hot-pressed to save labor, but it is said that cold-pressing produces a better grade of oil.

Lumbang oil has a light yellow color and an agreeable odor and taste. It is a drying oil and dries in thin films when allowed to stand. In this respect it resembles linseed oil and also Chinese wood oil (tung oil). Lumbang and linseed oils differ, however, from tung oil when heated. Tung oil heated to a temperature of about 200° solidifies and in this condition is unsuitable for making varnishes. Lumbang and linseed oils do not behave in this manner when heated. Oil from *Aleurites moluccana* (lumbang) or *Aleurites trisperma* (baguilumbang) when heated to a temperature of about 315° and allowed to cool does not gelatinize. When heated continually these oils begin to distill regularly at about 315° and do not gelatinize until about one-third has been volatilized.² In so far as this property is con-

¹ Wilcox, E. V., and Thompson, A. R., Press Bul. Hawaii Agr. Exp. Station 39 (1913).

² West, A. P., and Brown, W. H., Bull. P. I., Bur. Forestry 20 (1920) 121.

cerned the Philippine lumbang oils are more suitable for varnish making than is tung oil.

Several investigations³ of lumbang oil have been made and a review of the literature is given by West and Brown.⁴

Investigations have shown that lumbang nuts are composed of about 66 per cent of shells and 34 per cent of kernels. Analysis of the kernels shows that the principal constituents are oil (consisting largely of fat) and protein. The percentage of fiber and ash is very low. The kernels when eaten are strongly purgative and produce also a very nauseating effect. They yield about 50 to 60 per cent of oil. The constants and general properties of lumbang oil are very similar to those of tung and of linseed oil. These three oils are drying oils and are characterized by high iodine and saponification values. Analysis of lumbang-oil cake, obtained by expelling the oil from the crushed kernels, shows that it is valuable as fertilizer, but it cannot be used as cattle food because it has a poisonous effect upon stock.

The object of the present investigation was to ascertain the composition of lumbang oil and to study some of its properties.

SAMPLE

The nuts of *Aleurites moluccana* have very hard shells which are difficult to crack; and, moreover, it is not easy to separate the kernel from the shell. Various practical methods have been used for preparing the oil from the nuts. The sample of lumbang oil used in this investigation was obtained from Mr. R. H. Aguilar, of the Bureau of Science, who used his own method⁵ to extract the oil from the nuts. The nuts were heated in an oven at 95° C. from three to four hours, thrown quickly into cold water, and allowed to remain overnight. The next morning the shells had burst and the kernels were easily separated. The kernels were then ground into a meal, placed in a small press, and the oil separated from the oil cake, after which the oil was filtered. The oil was preserved in a large glass-stoppered bottle which was paraffined and kept in a dark closet. Owing to pressure of other duties we were not able to begin our work until

³ Richmond, G. F., and Rosario, M. V. del, *Philip. Journ. Sci.* § A 2 (1907) 439; Wilcox, E. V., and Thompson, A. R., *Press Bull. Hawaii Agr. Exp. Station* 39 (1913); Brill, H. C., and Agcaoili, F., *Philip. Journ. Sci.* § A 10 (1915) 111; Aguilar, R. H., *Philip. Journ. Sci.* § A 12 (1917) 235 and 14 (1919) 275.

⁴ West, A. P., and Brown, W. H., *op. cit.*, 122.

⁵ Aguilar, R. H., *Philip. Journ. Sci.* 14 (1919) 279.

about eight months after the sample had been prepared. The results obtained in this investigation really represent the condition of the oil after storing.

The sample of lumbang oil used in this investigation had a saponification value of 214, and an iodine value (Hübl) of 140. Both the saponification and the iodine values were determined according to the method of Lewkowitsch.⁶

The specific gravity of the oil °C. $\frac{31}{4}$ was 0.9206.

COMPOSITION

Lumbang oil is a quick-drying oil and resembles linseed oil and Chinese wood oil (tung oil) in its general properties. These three oils have somewhat similar constants and are characterized by high iodine and saponification values. Although the exact composition of both tung and linseed oils is still somewhat uncertain, it is generally believed that tung oil consists chiefly of the glycerides of oleic and elaeomargaric acids, while linseed oil contains linolenic, linolic, a small percentage of solid acids, and possibly oleic acid. The composition of tung oil is therefore quite different from that of linseed oil. Since both tung and lumbang oils are obtained from the same genus, *Aleurites*, we were inclined to think that probably lumbang oil had a composition more like that of tung than linseed oil and, like tung oil, contained elaeomargaric acid. We therefore tested our sample of lumbang oil for the presence of elaeomargaric acid. In making this test we used the method of Schumann⁷ which depends upon the fact that elaeomargaric acid has the property of crystallizing in rhombic flakes from dilute alcohol solution at 0°. We did not obtain any crystals and examination of the solution under the microscope showed the entire absence of crystals.

Tung oil when tested by the bromo-derivative method of Eibner and Muggenthaler⁸ gives no crystalline precipitate of ether-insoluble brominated glycerides, whereas linseed oil gives a copious precipitate amounting to about 38 per cent. This test is regarded as an important test for the purity of linseed oil. We tested our sample of lumbang oil by the bromo-derivative method and found that, like linseed oil, it also yields a large crystalline

⁶ Lewkowitsch, J., *Chemical Technology and Analysis of Oils, Fats, and Waxes* 1 (1913) 380 and 397.

⁷ Schumann, C. L., *Journ. Ind. Eng. Chem.* 8 (1916) 9.

⁸ Lewkowitsch, J., *Chemical Technology and Analysis of Oils, Fats, and Waxes* 1 (1913) 568-578.

precipitate of brominated glycerides. Since lumbang oil contains no glyceride of elaeomargaric acid and yields bromo derivatives we concluded that lumbang oil has a composition quite different from that of tung oil and probably shows a closer resemblance to linseed oil. Accordingly we decided to investigate the composition of lumbang oil by means of the lead-salt-ether method of Gusserow and Varrentrapp⁹ and the bromo-derivative method of Eibner and Muggenthaler.⁹

The lead-salt-ether method is used to separate the saturated from the unsaturated (liquid) acids in an oil and the bromo-derivative method is used to separate the various unsaturated acids from each other. Recently these methods have apparently been used very successfully by Baughman and Jamieson in their investigations on hubbard squash seed¹⁰ oil and also on okra,¹¹ cottonseed,¹² and cantaloup seed¹³ oils.

These investigators do not state, however, the exact experimental procedure they used in carrying out these methods. Lewkowitsch points out that the results obtained by the lead-salt-ether method vary with the experimental procedure and the accuracy depends principally upon the temperature and quantity of ether used.

In endeavoring to separate the saturated from the unsaturated acids in lumbang oil we carried out a number of experiments by means of the lead-salt-ether method. Although our results at first were not very uniform, we found that by adopting a standard method of procedure we could obtain fairly uniform results. Our method for preparing the lead salts of the saturated and unsaturated acids and for separating the lead salts of the saturated from those of the unsaturated acids was practically the same as that given by Lewkowitsch and also by Villavecchia.¹⁴ Our subsequent procedure for preparing the saturated and unsaturated acids from their lead salts was, however, somewhat different.

In using the lead-salt-ether method we proceeded in the following manner: About 9 grams of lumbang oil were saponified

⁹ Lewkowitsch, J., *op. cit.* 545, 568-578.

¹⁰ Baughman, W. F., and Jamieson, G. S., *Journ. Am. Chem. Soc.* 42 (1920) 152.

¹¹ *Ibid.* (1920) 166.

¹² *Ibid.* (1920) 1197.

¹³ *Ibid.* (1920) 2398.

¹⁴ Villavecchia, V., *Treatise on Applied Analytical Chemistry* 1 (1918) 384.

in a liter flask by heating (reflux) for two hours with 100 cubic centimeters of half normal alcoholic potassium hydroxide. The alcohol used in preparing the potassium hydroxide solution was previously purified by Dunlap's method,¹⁵ which consists in treating the alcohol with silver nitrate and potassium hydroxide, heating (reflux), and distilling. The reaction product obtained by saponifying lumbang oil was treated with a few drops of alcoholic phenolphthalein solution and acidified with glacial acetic acid, after which it was neutralized with half normal alcoholic potassium hydroxide solution. The bulk of the alcohol was then eliminated by distillation. Sixty cubic centimeters of 10 per cent lead acetate solution were diluted with 300 cubic centimeters of distilled water, brought to boiling, and gradually added with frequent shaking to the residue in the flask. The flask was then filled completely with hot distilled water, and allowed to cool. Upon cooling, the solution in the flask became clear and the lead soap adhered to the flask. The clear solution was then decanted to a filter paper, and the lead soap in the flask was washed four or five times with hot water until no more traces of lead acetate could be detected in the washings. Each time the lead soap was washed the solution was cooled before decanting.

To the lead soap in the flask, 300 cubic centimeters of ether previously purified were added and the resulting ethereal mixture was heated (reflux) on a water bath with frequent shaking for about half an hour until most of the lead soap was apparently dissolved. The ethereal solution was then allowed to stand for twenty-four hours, after which it was filtered through a plaited filter kept covered with a watch glass. The residue on the filter paper containing the lead salts of the solid saturated acids was washed thoroughly with ether. The ethereal filtrate containing the lead salts of the liquid unsaturated acids was placed in a flask, stoppered securely, and set aside in a dark closet until the work on the lead salts of the solid acids was completed.

SOLID ACIDS

The precipitate of the lead salts of the solid fatty acids together with the filter paper was placed in a flask and boiled about an hour with 200 cubic centimeters of dilute hydrochloric acid (1:4). The solution was then cooled, and the solid acids resulting from the decomposition of their lead salts were extracted with ether. The ethereal layer after separating from the acid solution was washed with water until free from acid. It was

¹⁵ Dunlap, F. L., *Journ. Am. Chem. Soc.* 28 (1906) 397.

then dehydrated with anhydrous sodium sulphate, filtered, and the ether distilled off in a weighed flask.

The solid acids melted at 54° and had an iodine value (Hübl) of 18.05. We did not have enough material to determine accurately the neutralization value and consequently did not calculate the mean molecular weight. We also did not endeavor to separate and identify the solid acids by converting them into their methyl esters and distilling fractionally.¹⁶

LIQUID ACIDS

The ethereal solution containing the lead salts of the liquid unsaturated acids was shaken with dilute hydrochloric acid (1 : 4) and the lower acid layer with the precipitated lead chloride separated. The treatment with hydrochloric acid was repeated and the separated ethereal solution washed thoroughly with distilled water until the wash solution was no longer acidic, after which it was filtered through a plaited filter kept covered with a watch glass. The solution, which was somewhat turbid due to the presence of moisture, was then dehydrated with a considerable quantity of anhydrous sodium sulphate. When working on rainy days a second dehydration with sodium sulphate is usually necessary to render the solution absolutely clear. The solution was then filtered and the clear filtrate distilled in a 500-cubic centimeter Florence flask to eliminate most of the ether. When the volume of the solution was reduced to about 100 cubic centimeters it was transferred to a 200-cubic-centimeter, flat-bottomed distilling flask previously weighed, and the ether completely distilled off.

The liquid acids had an iodine value (Hübl) of 135.8. The neutralization value was 191.9, and the calculated mean molecular weight, 292.5.

The figures given in Table 1 show the results we obtained by the lead-salt-ether method.

TABLE 1.—Separation of the solid acids from the liquid unsaturated acids in lumbang oil by the lead-salt-ether method.

Experiment.	Oil used.	Liquid acids.	Solid acids.	Liquid acids.	Solid acids.
	Grams.	Grams.	Grams.	Per cent.	Per cent.
1	9.6670	9.0644	0.2588	93.77	2.68
2	10.3420	9.5474	0.2870	92.32	2.77
Mean				93.04	2.73

¹⁶ Lewkowitsch, J., *Chemical Technology and Analysis of Oils, Fats, and Waxes* 1 (1913) 555 and 665.

As shown by the figures in Table 1, lumbang oil contains 93.04 per cent of liquid unsaturated acids and 2.73 per cent of solid acids. These figures are the average of the results obtained from two closely agreeing duplicate analyses.

The liquid unsaturated acids were separated and estimated by the bromo-derivative method of Eibner and Muggenthaler,¹⁷ which is based upon the different solubilities of the bromine derivatives of the liquid acids. We followed, in general, the directions given by Lewkowitsch, performing duplicate experiments. About 4 grams of the liquid acids were dissolved in 40 cubic centimeters of dried purified ether. The ethereal solution was then cooled, treated with bromine, and allowed to stand about three hours at -10° . The solution contained a crystalline precipitate (ether-insoluble bromide), showing the probable presence of linolenic acid, since linolenic hexabromide is insoluble in ether. The solution containing the precipitated bromide was then filtered through a weighed filter paper which had been previously dried and kept in a desiccator. The filtrate from the insoluble bromide was set aside and investigated after the work on the insoluble bromide was completed. The insoluble bromide was dried at 50° and weighed. When treated with benzene the insoluble bromide dissolved completely, showing the absence of any octobromides, since the octobromides likely to be present are insoluble in benzene. The crystals obtained by evaporating the benzene solution gave the figures which are compared with the corresponding data for linolenic hexabromide in Table 2.

TABLE 2.—Compound from lumbang oil and linolenic hexabromide.

Compound.	Melting point.	Bromine content.
	$^{\circ}\text{C}$.	Per cent.
Compound from lumbang oil	178.5	63.59
Linolenic hexabromide	180.0	63.32

The bromine content was determined by boiling about 0.1 gram of the crystals with about 0.5 gram of solid silver nitrate and 30 cubic centimeters of pure concentrated nitric acid. The precipitated silver bromide was collected on a Gooch funnel.

The figures given above show that these crystals were linolenic hexabromide and that lumbang oil contains linolenic acid as linolenic glyceride.

¹⁷ Lewkowitsch, J., *Chemical Technology and Analysis of Oils, Fats, and Waxes* 1 (1913) 568 to 578.

The filtrate from the ether-insoluble bromide (linolenic hexabromide) was shaken in a separating funnel with 10 per cent sodium thiosulphate solution to remove the excess of bromine. This treatment was repeated to remove the last traces of bromine, after which the separated ethereal solution was dehydrated with anhydrous sodium sulphate, filtered, and distilled to eliminate the ether. The slightly yellow-colored residue which remained was then treated with 1.5 liters of purified petroleum ether (boiling point 35° to 55°) and the mixture heated (reflux) until nearly all the crystals were dissolved. The solution was then cooled and filtered through a weighed filter paper. By concentrating the petroleum ether filtrate to a volume of about 300 cubic centimeters and allowing the solution to stand overnight, a second crop of crystals was obtained. Repeated experiments showed that the second crop of crystals always gave a sharper melting point than the first crop and the bromine content was considerably nearer the theoretical value for linolic tetrabromide. As oleic dibromide is very soluble in petroleum ether while linolic tetrabromide is difficultly soluble, the crystals thus obtained were probably linolic tetrabromide while the filtrate from these crystals contained, possibly, a mixture of linolic tetrabromide and oleic dibromide. The crystals that we suspected to be linolic tetrabromide gave figures which are compared to the corresponding data for linolic tetrabromide in Table 3.

TABLE 3.—Compound from lumbang oil and linolic tetrabromide.

Compound.	Melting point.	Bromine content.
	°C.	Per cent.
Compound from lumbang oil	112 to 113	53.10
Linolic tetrabromide	113	53.33

The bromine content was determined as in the case of linolenic hexabromide. These figures show that these crystals were linolic tetrabromide and that lumbang oil contains linolic acid as linolic glyceride.

The petroleum ether filtrate from the crystalline linolic tetrabromide was concentrated to a volume of about 100 cubic centimeters, transferred to a small distilling flask which had been previously weighed, and the solution distilled until no more petroleum ether passed over. The dark residue thus obtained was then weighed and the bromine content determined. The bromine content of linolic tetrabromide is 53.33 per cent; and of oleic dibromide, 36.18 per cent. Knowing the bromine content of the residue, the percentage of linolic tetrabromide and

of oleic dibromide (if present) is calculated readily. In carrying out these experiments we found that the ordinary commercial petroleum ether did not give very good results; but, by redistilling the commercial product and using only the fraction boiling from 35° to 55°, fairly good results could be obtained. Our residue, however, still had a perceptible odor of petroleum ether, which we were unable to eliminate by distilling. Probably better results could be obtained, if some other solvent suitable for this work could be used in place of petroleum ether.

In investigating the liquid unsaturated acids of lumbang oil by means of the bromo-derivative method we performed duplicate experiments. The results of these experiments are recorded in Tables 4 and 5. In Table 6 is given a summary of the results recorded in Tables 4 and 5.

TABLE 4.—*Analysis of liquid unsaturated acids of lumbang oil (bromo-derivative method). Experiment I.*

	Grams.
Sample of liquid acids	2.8400
Hexabromide (ether-insoluble bromide); melting point, 178.5°; bromine content, 63.59 per cent	0.5502
First crop of tetrabromide; bromine content, 53.92 per cent	0.1308
Second crop of tetrabromide; melting point, 112° to 113°; bromine content, 53.10 per cent	0.6666
Residue (dibromide and tetrabromide); bromine content, 41.80 per cent	3.9546
Dibromide in residue, 67.23 per cent	2.6586
Tetrabromide in residue, 32.77 per cent	1.2960
Total tetrabromide found	2.0934
Linolenic acid equivalent to hexabromide	0.2019
Linolic acid equivalent to tetrabromide	0.9778
Oleic acid equivalent to dibromide	1.6960

TABLE 5.—*Analysis of liquid unsaturated acids of lumbang oil (bromo-derivative method). Experiment II.*

	Grams.
Sample of liquid acids	2.6372
Hexabromide (ether-insoluble bromide); melting point, 178°; bromine content, 63.69 per cent	0.4586
First crop of tetrabromide; bromine content, 53.78 per cent	0.1826
Second crop of tetrabromide; melting point, 112°; bromine content, 53.08 per cent	0.5316
Residue (dibromide and tetrabromide); bromine content, 42.04 per cent	3.6032
Dibromide in residue, 65.83 per cent	2.3722
Tetrabromide in residue, 34.17 per cent	1.2310
Total tetrabromide found	1.9452
Linolenic acid equivalent to hexabromide	0.1684
Linolic acid equivalent to tetrabromide	0.9086
Oleic acid equivalent to dibromide	1.5150

TABLE 6.—Analysis of liquid unsaturated acids of lumbang oil.
Summary of experiments I and II.

Acid.	Experiment I.	Experiment II.	Mean.
	<i>Per cent.</i>	<i>Per cent.</i>	<i>Per cent.</i>
Linolenic	7.11	6.89	6.75
Linolic	34.43	34.46	34.44
Oleic	59.78	57.44	58.61
Total	101.32	98.29	99.80

As previously stated, a determination of the iodine value of the mixed liquid acids separated by the lead-salt-ether method gave us a value of 135.8. A mixture of linolenic, linolic, and oleic acids in the proportions given in the table above would have a calculated iodine value of 133.8. The calculated iodine value of the liquid acids therefore agrees fairly well with the observed value.

The mean percentages of linolenic, linolic, and oleic acids in the mixture of unsaturated acids, as given in Table 6, were calculated into percentages of glycerides in the original oil. The results are recorded in Table 7. In calculating these results we used the average data obtained by the lead-salt-ether method, which showed that lumbang oil when decomposed yields 93.04 per cent of liquid unsaturated acids.

TABLE 7.—Calculation of unsaturated acids to glycerides in lumbang oil.

Acid.	Mixture of unsaturated acids.	Original oil.	Glycerides in original oil.
	<i>Per cent.</i>	<i>Per cent.</i>	<i>Per cent.</i>
Linolenic	6.75	6.28	6.56
Linolic	34.44	32.04	33.48
Oleic	58.61	54.53	56.98
Total	99.80	92.85	97.02

The average results we obtained by the lead-salt-ether method showed that lumbang oil can be decomposed into 93.04 per cent liquid unsaturated acids and 2.73 per cent solid acids. The liquid acids separated by the bromo-derivative method and calculated on the basis of the original oil gave a total percentage of 92.85 (Table 7), which agrees very closely with the figure 93.03 obtained by the lead-salt-ether method.

The percentage of solid acids (2.73) calculated as stearic glyceride gives the figure 2.85, which really represents the percentage of glycerides of the mixed solid acids.

According to our investigation, lumbang oil therefore has the composition shown in Table 8.

TABLE 8.—*Composition of lumbang oil.*

	Per cent.
Linolenic glyceride	6.56
Linolic glyceride	33.48
Oleic glyceride	56.98
Glycerides of solid acids	2.85
	<hr/>
Total	99.87

Our experiments show that lumbang oil contains the glycerides of linolenic and linolic acids. Both linolenic and linolic acids and their glycerides absorb oxygen rapidly from the atmosphere. The drying power of oils such as linseed and lumbang is due to the glycerides of linolenic and linolic acids which these oils contain. In general, the more of these compounds an oil contains the quicker it dries. Our results show that lumbang oil has a composition quite similar to that of linseed oil and therefore should be an excellent drying oil.

In addition to ascertaining the composition we determined the solubility of lumbang oil in various solvents and also carried out a series of oxidation experiments.

SOLUBILITY

Lumbang oil at 28° C. is insoluble in cold ethyl and methyl alcohols and acetic acid. It is very soluble in cold turpentine, chloroform, ether, carbon tetrachloride, carbon bisulphide, petroleum ether, and acetone. It is also soluble in ethyl acetate, ethylene bromide, toluene, and nitrobenzene.

OXIDATION

Lumbang oil, like other drying oils, has the characteristic property of absorbing oxygen from the air and drying to an elastic skin when exposed to the air in a thin layer. Brill and Agcaoili¹⁸ investigated the drying properties of lumbang oil by spreading the oil on small glass plates and allowing it to dry (glass-plate method). They found that lumbang oil compares very favorably with tung and linseed oils in the rate of dry-

¹⁸ Brill, H. C., and Agcaoili, F., *Philip. Journ. Sci.* § A 10 (1915) 119.

ing, quality of film, and the percentage change in weight when drying. They did not, however, determine any of the oil constants during the drying process.

The ability to absorb oxygen may be regarded as an indication of the drying power of an oil. We have carried out experiments on the oxidation of lumbang oil by allowing a slow current of dried air to pass through the oil which was heated to a certain temperature and stirred constantly. The apparatus was arranged in the following manner: A glass salt bottle containing about 400 cubic centimeters of lumbang oil was placed in a water bath which was heated to a temperature of 80°. The glass bottle contained a stopper having three holes. Through one hole passed a stirrer operated by a hot-air motor. The second hole held an entrance tube reaching to the bottom of the bottle and drawn out to a fine opening. The third hole contained a short exit tube also drawn out to a fine opening. A slow current of air was passed through a Drechsel wash bottle containing concentrated sulphuric acid, after which it was passed through three tubes containing soda-lime, and then into the oil. The experiment was started each morning and discontinued at night. At frequent intervals samples of about 15 cubic centimeters were taken and these were later analyzed by determining various constants such as the iodine and saponification numbers. This method of procedure enabled us to follow the changes caused by slow oxidation. The results of these experiments are recorded in Table 9.

TABLE 9.—Constants of lumbang oil blown at 80° C.

Time of blowing.	Saponification No.	Iodine value (Hüb.).	Acid No.	Specific gravity $\frac{31}{4}$ °C.
0	214.0	140.0	4.962	0.9206
9	229.1	135.3	-----	-----
15	237.7	126.8	-----	-----
24	242.6	112.9	-----	-----
31	252.3	101.0	-----	-----
47	258.9	81.2	-----	-----
62	262.6	67.1	7.542	0.9222

As a result of continued oxidation the oil gradually became slightly darker in color and very thick and viscous, and the specific gravity increased considerably. The figures in Table 9

show a gradual increase in the saponification and acid values. This would seem to indicate an increase in the amount of oxidized acids of lower molecular weights. Our results with lumbang are quite similar to those which have been obtained with linseed oil. Since the constants of these two oils are very much alike and they have a similar composition, it is not surprising that they act in a similar manner when oxidized.

The commercial valuation of an oil suitable for the manufacture of varnish depends on its drying power. This is determined by the amount of oxygen it absorbs and also by the time it requires for drying to an elastic skin. It is well known that the oxygen absorption of an oil is closely related to the iodine absorption; in fact, as pointed out by Lewkowitsch,¹⁹ a rough proportionality exists between the quantity of oxygen actually absorbed by an oil and the amount calculated by multiplying the iodine number by 0.063. A determination of the iodine number of an oil which is being oxidized gives us, then, an idea of the amount of oxygen absorbed. The results recorded in Table 9 show a decided, gradual decrease in the iodine numbers, indicating the gradual absorption of oxygen.

When these iodine values are multiplied by the factor 0.063, the resulting figures show the absorbed oxygen calculated from the iodine value, and from these data the average rate per hour of oxygen absorbed in successive intervals can be calculated. Our calculated values showed that the rate of oxidation, under the conditions of our experiment, increased up to a period of thirty-one hours, after which, owing probably to increased viscosity, the rate decreased. Our results would seem to indicate that this oxidation process is an autocatalytic reaction and the oxidation products which are formed in the early stage of the reaction act as autocatalysts and accelerate the reaction. Genthe²⁰ obtained similar results in his experiments on the drying of linseed oil and was inclined to think that the autocatalyst had the character of a peroxide, though he was not able to isolate such compounds.

The oxidation of lumbang oil for various temperatures and intervals of time is now being investigated, and further discussion of this point will be reserved for a future contribution.

¹⁹ Lewkowitsch, J., *Chemical Technology and Analysis of Oils, Fats and Waxes* 1 (1913) 468.

²⁰ Genthe, A., *Zeits. f. angew. Chem.* 19 (1906) 2087.

SUMMARY

Lumbang oil apparently has the following composition:

	Per cent.
Linolenic glyceride	6.5
Linolic glyceride	33.4
Oleic glyceride	56.9
Glycerides of solid acids	2.8
	<hr/>
Total	99.6

Lumbang oil was found to be soluble in eleven solvents and insoluble in three.

The oxidation of lumbang oil appears to be an autocatalytic reaction.

ILLUSTRATIONS

[Half-tone etchings loaned by the Bureau of Forestry.]

PLATE 1

Aleurites moluccana (lumbang), the source of lumbang oil. Bark, fruits, and leaves.

PLATE 2

Aleurites moluccana (lumbang), the source of lumbang oil. Dried fruits and seeds; natural size.

PLATE 3

Aleurites moluccana (lumbang), the source of lumbang oil. Bark, flowers, and leaves.



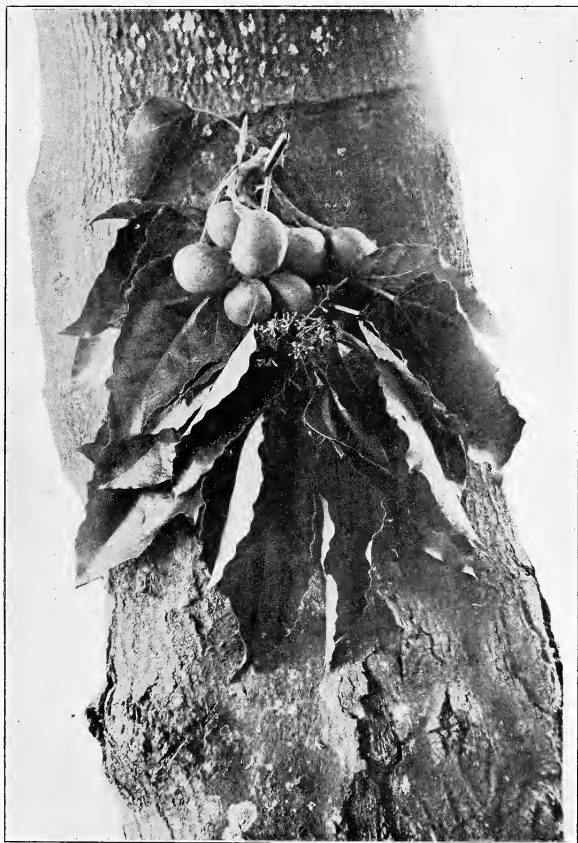

PLATE 1. ALEURITES MOLUCCANA (LUMBANG), THE SOURCE OF LUMBANG OIL.
BARK, FRUITS, AND LEAVES.

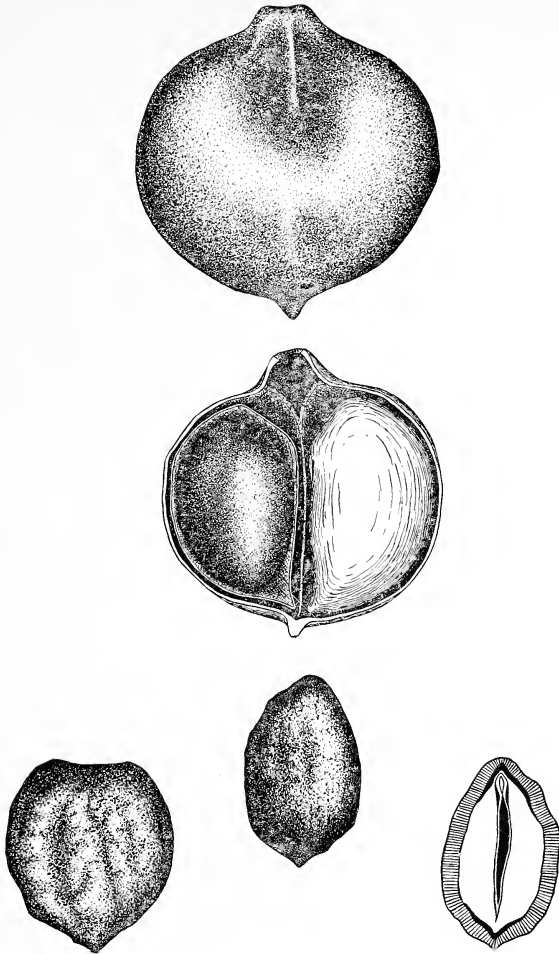

PLATE 2. ALEURITES MOLUCCANA (LUMBANG), THE SOURCE OF LUMBANG OIL.
DRIED FRUITS AND SEEDS: NATURAL SIZE.



PLATE 3. ALEURITES MOLUCCANA (LUMBANG), THE SOURCE OF LUMBANG OIL.
BARK, FLOWERS, AND LEAVES.

SOME NONDIASPINE COCCIDÆ FROM THE MALAY
PENINSULA, WITH DESCRIPTIONS OF
APPARENTLY NEW SPECIES¹

By HAROLD MORRISON

*Of the Bureau of Entomology, United States Department of Agriculture,
Washington, D. C.*

ONE PLATE AND THIRTEEN TEXT FIGURES

The work reported on in the following pages was begun on the basis of two small collections of coccids sent for possible identification to the Bureau of Entomology by Prof. C. F. Baker in 1918. In the following year, I received from Professor Baker a compiled list of the known Singapore Coccidæ, prepared by himself and Mr. I. H. Burkill. This list included a number of manuscript new species names assigned by Mr. E. E. Green, these giving me my first intimation that Mr. Green was actively engaged in working on Singapore coccids. Following some correspondence regarding the best means of avoiding confusion or duplication, Mr. Green, with his usual generosity, forwarded to me specimens of all of his new nondiaspine species, together with certain notes on the same, and gave me the privilege of describing these new species and of adding them to the work which had been completed on Professor Baker's specimens.

All of the specimens forwarded for description by Mr. Green, and some of those from Professor Baker, were collected by Mr. I. H. Burkill, to whom I am thus indirectly much indebted for the opportunity to examine some very interesting coccids.

Some of the species found in this small collection have presented serious difficulties with respect to proper generic assignment and specific differentiation, and certain of these questions have been settled tentatively only.

All information regarding host, locality, and date of collection was copied from the notes in the packages containing the specimens, and all of the specimens were collected either by Mr. Burkill or by Professor Baker. The drawings illustrating the

¹ Published with the permission of the Secretary, United States Department of Agriculture.

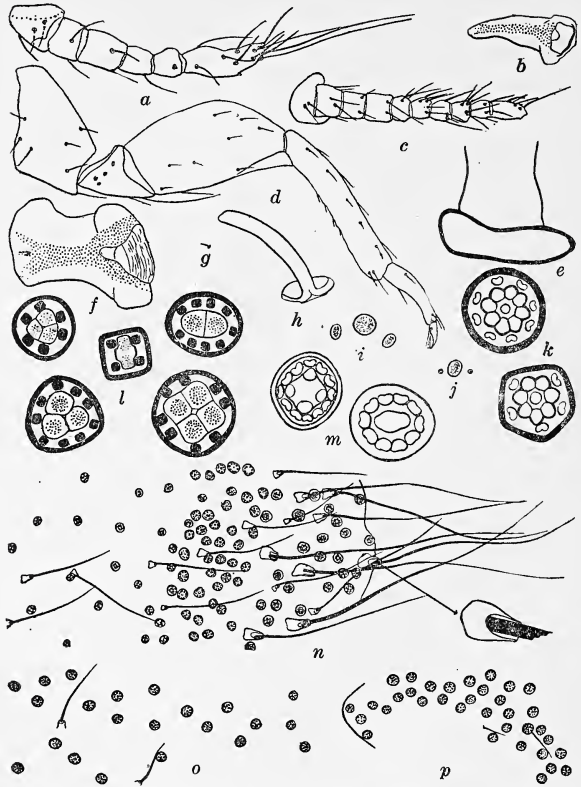

FIG. 1. *Paleococcus pulcher* Leonardi; a, intermediate-stage female, antenna, $\times 115$; b, intermediate-stage female, thoracic spiracle, $\times 57.5$; c, adult female, antenna, $\times 57.5$; d, adult female, middle leg, $\times 57.5$; e, adult female, anal ring, $\times 165$; f, adult female, thoracic spiracle, $\times 165$; g, adult female, abdominal spiracle, $\times 165$; h, same, $\times 640$; i, adult female, ventral abdominal cicatrices, $\times 57.5$; j, intermediate-stage female, ventral cicatrices, $\times 57.5$; k, adult female, types of dorsal and ventral body pores, $\times 1,500$; l, same, types of pores from marginal tufts of body, $\times 1,500$; m, same, types of pores from region close to genital opening, $\times 1,500$; n, same, a lateral abdominal cluster of pores and setae, $\times 220$, with detail of base of seta, $\times 640$; o, same, portion of ventral abdominal pore band between hind legs, $\times 220$; p, same at point where curve around body margin commences, $\times 220$.

structural characteristics of the species have been made by Emily Morrison, who has also been of assistance in other ways; the plate figures showing the superficial appearance of certain of the species have been prepared by Miss Aime Motter.

COCCIDÆ²

MONOPHLEBINÆ

Genus **PALEOCOCCUS** Cockerell

Paleococcus pulcher Leonardi.

Paleococcus pulcher LEONARDI, Ann. R. scuola Sup. Agr. Portici 7 (1907) 1.

Leonardi's placing of this species in the genus *Paleococcus* is followed here without critical consideration.

This species has been identified from a comparison of specimens received from Mr. E. E. Green collected on *Michelia champaca* at the Botanic Gardens, Singapore, April 8, 1916, by Burkill, and on *Rhopaloblasta* palm, Singapore, February, 1917, by Burkill, with a translation of Leonardi's original description. This description, while not so detailed in some respects as is desirable, seems quite sufficient to establish the identity of the Singapore specimens. Mr. Green had tentatively placed these two lots of material under the manuscript names *Icerya ordinata* and *I. palmarum*, respectively, but as careful a comparison of the structural characters of the two lots of specimens as is possible from the limited number of each present fails to disclose any differentiating characters, while the only difference indicated in Mr. Green's notes is in the color of the secretion covering, the surface coating of that of *ordinata* being lemon yellow, while *palmarum* is supposed to have a pure white coating.

This species is briefly redescribed herewith, with particular emphasis on the structure of the derm pores and the setæ.

Adult female.—Ovate, broadened behind, somewhat convex; maximum length of specimens examined, 6.5 millimeters; width, 4.25; dorsally with a dense coating of white secretion usually strongly tinged superficially with lemon yellow, broken up into distinct plates, these broadly transverse in the center of the dorsum, bordered by a double row of square to oblong plates running clear around the body, with the outer, or marginal, row

² The scheme of classification followed is that used by Fernald, M. E., Catalogue of the Coccidae of the World, Bull. Hatch Exp. Sta. Mass. Agr. College 88 (1903).

produced into triangular teeth, giving a serrate appearance; ovisac not developed, the eggs laid beneath the body; maximum length of mounted specimens examined, 6 millimeters; shape when mounted uniformly broad oval; antennæ 9-segmented (normal for genus), sometimes with an indication of a division of the terminal segment; legs normal, rather slender for the group; with two pairs of large thoracic spiracles, and three pairs of very much smaller, simple, abdominal spiracles, the latter placed at the posterior apex of the body; derm pores all multilocular disk, possibly to be considered as of one type, but showing at least three sorts, as shown in figures, one (*k*) grouped along the body margin together with a number of setæ in rather distinct clusters, another (*l*) scattered over the body surface, and the third (*m*) present ventrally around the genital opening; ventrally near the margin with a heavy band of pores running around the abdomen as in typical *Icerya*; derm setæ numerous, varying in size very decidedly, the largest in the tufts along the body margin, all long, slender, rather delicate and hairlike, mostly with long stout sockets, but some with a very short and flat triangular base; anal opening a short, simple tube; with three small ventral cicatrices, the median much the largest.

? *Perissopneumon* sp.

I desire to place on record here collections of a few specimens of a monophlebine coccid of uncertain affinities in the hope that more material, including larvæ, fully developed adult females, and males, will be discovered by some collector at Singapore, as the correct placing of this species will be almost impossible without such additional material. The collection records are as follows: From rhizomes of *Alpinia conchigera* (Baker 9020) and from fruit scales of *Garcinia mangostana* (one specimen) (Baker 9023), both from the Botanic Gardens, Singapore, October, 1917. I have had only the brief description of *Perissopneumon ferax* available for consideration in the generic placing of these specimens, but they appear to be more closely related to Newstead's genus than to any other at present known to me.

ORTHEZIINÆ

Genus *ORTHEZIA* Bosc d'Antic

Orthezia insignis Douglas.

This species is represented among Professor Baker's material by a few specimens collected on *Clerodendron penduliflorum*, Botanic Gardens, Singapore, August, 1917 (Baker 8941).

DACTYLOPIINÆ

Genus **ANOMALOCOCCUS** Green

Anomalococcus multipori sp. nov. Plate 1, fig. 1.

Adult female.—Occurring on the stems of the host, beneath the cartons or sheds of some species of ant; inclosed in a rather dark brownish or reddish sac, which is irregular in shape, circular to oval, usually broader behind, somewhat convex, typically with rounded, clear, shining, median longitudinal ridge, bordered on each side by a pitted longitudinal groove of varying distinctness, all the surface except the median ridge covered over with white wax, which becomes thick and almost platelike along the margin, while varying in thickness in different spots dorsally; the sack itself homogeneous, tough, but fracturing when torn or broken, translucent, with a nearly circular to slitlike opening dorsally at the posterior end of the median ridge, and the latter sometimes broken into; the inclosed insect much wrinkled and shriveled, strongly convex medially, but flattened along the body margins, almost completely filling the sac, but probably shrinking very decidedly on the birth of the young; light brown, but mottled with piceous, and otherwise discolored.

Body of adult female.—Maximum length mounted on a slide, a little more than 2 millimeters; irregularly broad oval; maximum width, nearly 2 millimeters, most individuals somewhat smaller; antennæ 6- to 8-segmented, the lengths of the different segments quite variable, the measurements in microns as follows:

II.	III.	IV.	V.	VI.	VII.
21.4	32.1	21.4	19.6	10.7	12.5
21.4	39.3	17.8	14.3	10.7	12.5
32.1	25	42.8	17.9	14.3	14.3
23.6	25	25.7	17.9	14.3	14.3
32.1	30.4	32.1	17.9	14.3	10.7
25	43	17.9	17.8	10.7	10.7
32.1	26.8	39.3	17.9	12.5	10.8
23.6	25	*39.3	-----	14.3	17.9
21.4	25	25	19.4	17.9	*21.4
14.3	23.2	23.5	14.3	14.3	14.3
17.9	25	25	16.1	*21.4	

* With a pseudojoint.

Legs wanting; spiracles large and stout, placed at the body margin and continuous with a heavily chitinized, crescentic, marginal area at the outer or dorsal end of which is usually, with the posterior spiracle a single, and with the anterior spiracle

two, stout, usually slightly clavate, spiracular spines, none of these to be found in some specimens, and all probably easily broken off, these spiracular characters so easily disarranged in mounting that it is almost impossible to determine the exact relations; submentum apparently 1-segmented, broadly rounded apically; body margin with two rows of slender setæ, those in the lower row smaller, set relatively close together, the other row with the setæ much more widely separated, larger, the bases of the hairs in both about the same diameter, none of the larger setæ quite so long as the spiracular spines; with an occasional small dorsal seta; with numerous 8-shaped pores and elongate tubular ducts dorsally, these particularly crowded along the body margin; and with two groups of cribriform plates running cephalad, one on each side of the middle line, from opposite the anal ring region, these groups distinctly separated from each other, and each made up of numerous plates, the number of these varying considerably, but averaging around seventy to eighty; ventrally with a cluster of multilocular disk pores around and immediately posterior to the anal ring region, with some similar transversely scattered ones anterior to this, and with smaller quinquelocular pores in the chitinized marginal plate of each spiracle; anal ring about 54 to 64 μ long, nearly circular, broadly open behind, with ten large, flattened setæ, these as much as 132 μ long, and with a single row of pores, this anal ring surrounded by a heavily chitinized structure, with its upper and anterior half arched and its lower half broadened posteriorly on each side into a sort of triangular lobe with recurved posterior margin; with a pair of setæ in the bottom of the ventral groove thus formed and a pair, arranged longitudinally, on the posterior margin of each lateral lobe; in only one specimen, of those examined, with more than ten anal ring hairs, in this case with seven on one-half of the ring and five on the other, the extra setæ apparently resulting from the division of the two anterior ones of that side.

Intermediate-stage female.—Such intermediate-stage specimens as have been available for examination show only a lesser development of the adult structures, except that the cribriform plates are wholly wanting.

Larva.—Only embryonic larvæ have been available for examination, so only certain structures can be characterized. Antennæ 6-segmented, legs stout and short, total length about that of antennæ, the tarsal claw large, all four digitules long, slender and slightly knobbed at apices, the tarsal projecting a little beyond those of claw, both extending beyond apex of claw;

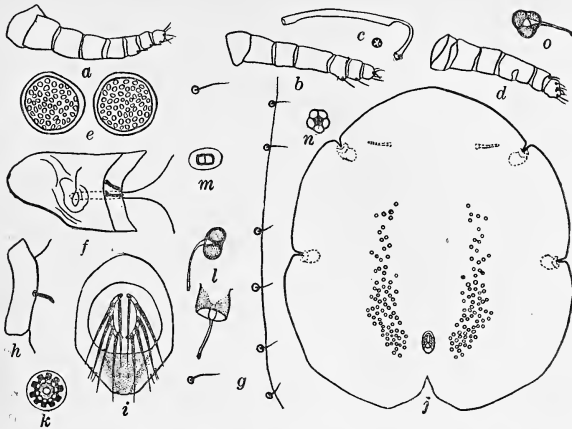

FIG. 2. *Anomalococcus multipori* sp. nov., adult female; a, antenna, showing eight segments, $\times 165$; b, same, showing seven segments, $\times 165$; c, tubular body duct, $\times 640$; d, antenna, showing six segments, $\times 165$; e, detail of two cribriform plates, $\times 640$; f, anterior spiracle, with plate and spines, $\times 165$; g, margin of body, showing size and position of two sizes of setae, $\times 335$; h, posterior spiracular plate, with single spine, $\times 165$; i, anal ring, with surrounding chitinous band, $\times 165$; j, outline of body, showing especially the position of the cribriform plates, $\times 20$; k, anal multilocular disk pore, $\times 1,500$; l, 8-shaped pore, side and diagonal views, $\times 1,500$; m, same, dorsal view, another focal point, $\times 1,500$; n, quinquelocular disk pore from spiracular plate, $\times 1,500$; o, normal 8-shaped pore modified to form trilocular pore, $\times 1,500$.

spiracles close to body margin, with two spiracular spines opposite anterior and one opposite posterior spiracles; body margin with a single row of slender setae, about as long as spiracular spines, and set rather widely apart; the chitinous structure surrounding the anal ring well developed, quite plainly composed of a dorsal and ventral half, anal ring circular, with six setae and two rows of pores; without anal lobes, but with a pair of long setae at the apex of the body, these as much as one-third the body length; dorsally and at margin with a few longitudinal rows of minute 8-shaped pores, ventrally with similar rows of small setae; with one or two tiny quinquelocular pores between each spiracle and the body margin.

This species has been described from twelve specimens and parts of specimens mounted on slides, and from additional unmounted material in position on the host, collected by Prof. C. F. Baker on stems of *Nephelium lappaceum* beneath ant cartons, under collection No. 9028, and on the leaves of *Oncosperma*

horrida, collection No. 9026, both from the Botanic Gardens, Singapore, October, 1917. The second lot of material is badly infested by an undeterminable fungus. The types are in the United States National collection of Coccidæ.

This species would be included in *Lecaniodiaspis* Targ., if one adhered strictly to the limitations of this genus and *Anomalococcus* as defined by Green,³ but it is evidently so closely related to *A. cremastogastris* Green, the genotype, that it is certainly congeneric with it. From *A. cremastogastris* it is separable by a number of characters: The grouping of the dorsal cribriform plates into two longitudinal clusters, instead of a single transverse band; the persistence of the spiracular spines in the adult female; the occurrence of normally 7-segmented antennæ, instead of 8-segmented, although this structure shows the considerable variability noted in the description; the presence of a pair of spiracular spines opposite each anterior spiracle of the immature stages, instead of a single one; and the presence of a fairly complete tough test, or sac, in the adult stage.

Genus PSEUDOCOCCUS Westwood

Pseudococcus bromeliæ (Bouché).

This species, as it is at present identified, has been collected at quarantine, Washington, D. C., on pineapple plants, received from Singapore. The records are as follows: On *Ananas*, July 19, 1916, F. H. B. 18520 (coll. *H. Morrison*); on Rubby pineapple, August 18, 1916, F. H. B. 18730 (coll. *H. Morrison*).

Pseudococcus hispidus sp. nov.

Adult female.—Nothing regarding superficial appearance before mounting known (only two mounted specimens available for examination); length of body as mounted, a little more than 2 millimeters; width, about 1.5; oval, perhaps a little narrowed anteriorly and broadened posteriorly; derm clearing completely after treatment; antennæ normally 7-segmented, the measurements of those available as follows (in microns):

II.	III.	IV.	V.	VI.	VII.
50	43	46.5	32	35.7	87
57	43	50	35.7	39.3	85.6
50	(*)				
50	39.3	35.7	32	39.3	82

* Broken.

³ Coccidæ of Ceylon, pt. 4 (1909) 295, 297, 302.

The terminal segment longest, a little slenderer than the others; legs (only parts available) stout, heavy and short, the tarsal digitules normal, slender, long, slightly knobbed at apices, claw digitules probably similar, but broken, claw probably without denticle, but the extreme tips of those available for examination broken off, hind coxæ with numerous pores, hind tibiæ also with similar pores, but their extent not determin-

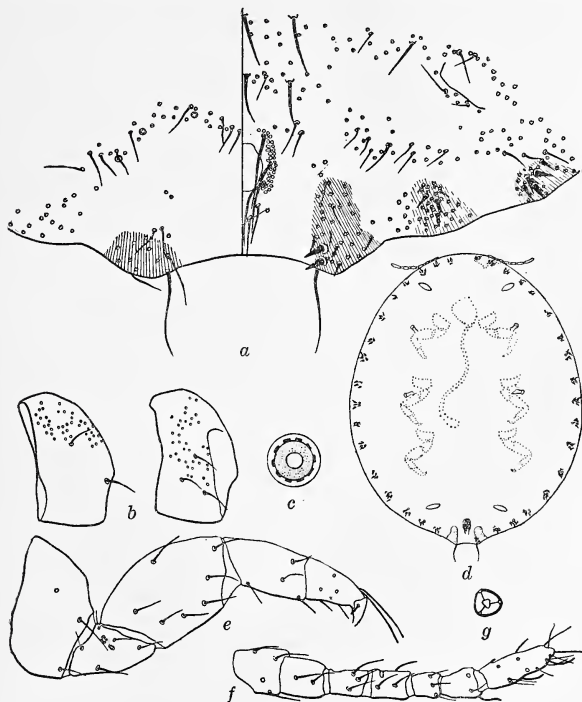

FIG. 3. *Pseudococcus hispidus* sp. nov., adult female; a, posterior apex of abdomen, showing anal ring, cerarii, pores, and unusually large dorsal setæ, $\times 165$; b, hind coxa, showing both surfaces, $\times 165$; c, large ventral multilocular disk pore, $\times 1,500$; d, outline of body, showing number and position of cerarii, etc., $\times 30$; e, foreleg, $\times 165$; f, antenna, $\times 165$; g, triangular pore, $\times 1,500$.

able as only a fragment of a tibia is present; beak apparently 2-segmented; with both posterior and anterior pairs of dorsal ostioles well developed; with eighteen pairs of cerarii, each of these with more than two spines, these varying in size, and each with a loose cluster of triangular pores and with a few more or less distinctly associated accessory setæ, the posterior pairs, at least, and particularly the anal lobe cerarii, with a large chitinized area around the spines and pores; the number of spines in the cerarii of one of the two specimens studied as follows (beginning in front): I, 4-5; II, 4; III, 5; IV, 4-6; V, 5-6; VI, 4-5; VII, 3-6; VIII, 5; IX, 4; X, 4-5; XI, 4-6; XII, 5-6; XIII, 5-7; XIV, 6-7; XV, 5; XVI, 4-6; XVII, 6; XVIII, 3 (the last perhaps with more, as some of the spines and the setæ approach each other very closely in size and shape); anal lobes not developed, apical seta about as long as anal ring setæ (93μ), but a little slenderer; dorsal thickening of posterior cerarius continued around the margin and onto the venter as a broadly rounded lobe, the anal seta situated on the inner side of this chitinization at the margin; anal ring oval, of normal pseudococcine appearance, with a double row of pores on each half and with six rather short setæ, the longest about 93μ ; with two pairs of rather long, slender setæ below the anal ring and between the apical cerarii, the longest of these about 71μ ; with numerous but scattered, small, triangular and trilocular pores both dorsally and ventrally, but somewhat more abundant dorsally, these in fairly distinct transverse rows on the abdomen, but apparently scattered without order anteriorly; ventrally near posterior apex of body with a few larger, multilocular disk pores; derm setæ rather numerous, although not in such quantity as to give a "hairy" appearance to the body, varying greatly in size, but all rather long, and either slender or stout, arranged in fairly distinct transverse rows on abdomen, and the center of the body dorsally with about four conspicuously larger setæ to each segment, these as much as 71.5μ long, but less conspicuous anteriorly.

Immature stages.—None known.

This species has been described from two mounted specimens, kindly transmitted by Mr. E. E. Green, bearing the following information: "On *Gordonia*, Singapore, Malaya, coll. I. H. Burkill."

The type is in the United States National collection of Coccidæ; the paratype is in Mr. Green's collection.

Mr. Green had placed this species in *Tylococcus* Newst., and had given it the specific name *hispidus*, used above. As there is

very considerable question regarding both the validity and the characteristics of *Tylococcus* Newst., I consider it preferable to assign the species to *Pseudococcus*, for the present, at least.

TACHARDIINÆ

Genus TACHARDIA R. Blanchard

Tachardia aurantiaca Cockerell.

After a careful comparison with the type material of this species, three lots of specimens have been placed here. The most noticeable differences from the type lie in the size and shape, and the coloration of the test covering the insect, since in the Singapore specimens the test shows no traces of lateral ribbing and is more convex than type, approaching globular, with a practically uniform color which is much darker than that found in the typical *aurantiaca*. Morphologically the Singapore specimens appear to agree completely with the type, although none of the material available for examination has been in entirely satisfactory condition. The data for the lots examined are as follows: On *Acacia sphaerocephala*, Singapore (coll. *Burkill*), material received from Mr. E. E. Green; on *Cajanus indicus*, Botanic Gardens, Singapore, October, 1917 (*Baker 9027*); on *Ixora macrothyrsa*, Botanic Gardens, Singapore, August, 1917 (*Baker 8936*).

COCCINÆ

Genus CEROPLASTODES Cockerell

Ceroplastodes virescens Green.

This species is represented by a very small amount of material from “? *Artocarpus* sp.,” Botanic Gardens, Singapore, October, 1917 (*Baker 9021*). These specimens agree exactly with Green’s characterization of the color and surface texture of the test. The dried specimens are dark reddish brown, however; and, while the marginal spines may be considered as being typically three or even four deep, there are many points along the margin where they are quite plainly only two deep.

Genus CEROPLASTES Gray

Ceroplastes floridensis Comstock.

Ceroplastes floridensis COMSTOCK, Green, Coccidae of Ceylon 4 (1909) 277.

A few specimens agreeing exactly with Green’s description and figures, cited above, have been received from Professor Baker with the following data: On *Gleichena dichotoma*, Penang (coll. *I. H. Burkill*).

Genus **ALECANIUM** novum

Coccine form, female flattened, oval, with a median elevated ridge, covered by a transparent, thin, easily deciduous, waxy coat; antennæ and legs very much reduced, of the rudimentary type; derm not chitinized, only the mouth parts, spiracles, body margin, anal plates and a band surrounding these chitinized; the thickened margin deeply, irregularly incised, with a single row of long, slender setæ dorsally and an alternating double row of much stouter setæ ventrally; spiracular spines apparently wanting, their normal position indicated by quadrate chitinized plates; anal plates elongate, narrow dorsal surface bearing numerous setæ distributed over the whole plate surface, each plate terminating caudally in a single much longer seta; fringe setæ numerous, anal ring with ten to twelve setæ and pores, small, inclosed within the plates; derm with quinquelocular disk pores of two sizes ventrally, with tubular ducts with cup-shaped bases ventrally, with minute tubular ducts dorsally and with disk pores, possibly with loculi, dorsally grouped near the anal plates; larva elongate oval, antennæ 6-segmented, legs normal, with a single marginal row of slender setæ, three spiracular spines, approximately equal in length, in each group and anal plates similar in shape to those of the adult, slightly reticulate, but with only a long terminal and two or three other setæ.

This genus appears to differ from any other known to me in the characters of the anal plates and the marginal region of the body; it is, unfortunately, not possible to indicate any genus of the subfamily Coccinæ as a close relative of this one and little can be said at present regarding its probable position within that subfamily.

Type of the genus, *Alecanium hirsutum* sp. nov.

Alecanium hirsutum sp. nov. Plate 1, fig. 2.

Adult female.—Not definitely known to occur in the material studied, and possibly not observed; the form examined probably either the next to the last stage female, or the immature last stage; occurring on the twigs of the host, accompanied by male puparia; oval, somewhat pointed anteriorly, flattened dorsally, with a distinct, rounded, longitudinal ridge medially, the elongate oval pair of anal plates placed in this ridge about one-third of the total body length from the posterior end; body dorsally, irregularly wrinkled and pitted on each side of the median ridge; yellow-brown, more or less suffused with darker brown, anal

plates and the narrow chitinized ring surrounding them distinctly reddish; probably uniformly, moderately convex in life, without definite longitudinal ridge; covered by a thin, transparent, easily shed film of brittle wax, this appearing somewhat whitish when removed from the insect; maximum length of specimens examined, 1.75 millimeters.

Body of female.—Maximum length mounted on a slide, about 1.75 millimeters; body clearing when boiled in caustic potash, except for the anal plate and marginal regions; oval, somewhat pointed anteriorly, lateral margins slightly lobed due to shallow incisions opposite the spiracles; antennæ minute, rudimentary, indistinctly 3-segmented, the apex bearing a cluster of six setæ, some of these nearly as long as the whole antenna; preapical segment with at least one long seta, total length, averaging 36 μ ; legs minute, rudimentary, broadly triangular from base to apex, the width at base, including the extended attachment sclerite, about 68 μ ; the total length to apex of claw, about 25 μ , the divisions between the different parts so faintly indicated that it is impossible to trace them; with numerous relatively large chitinous circles, these the bases for the short setæ, present on the leg, claw present but poorly developed, both the tarsal and claw digitules present, relatively well developed, about 17 μ long; claw, about 5 μ long; beak apparently 1-segmented, short, stout and broad; spiracles rather large, placed nearer the margin than the center of the body, each connected with the margin by a line of scattered pores, which passes through a chitinous thickening at the edge and then barely up onto the upper surface; spiracular spines wanting in all specimens examined and no traces such as presence of chitinized bases visible; marginal spine and hair arrangement unusual, the margin just at the edge or a very little on the dorsum with a row of relatively long, slender, hairlike setæ, below this broken up by deep irregular incisions and crenulations, some of which extend the whole width of the chitinized portion, and bearing, usually on the inner portion of the chitinization, an unevenly spaced and irregularly placed row of stout but long setæ, these about half the length of the dorsal setæ or a little more, and as much as two or even three deep at the posterior end of the body; dorsally with fairly numerous but scattered setæ, similar in shape and base to those occurring dorsally at the margin, but smaller, present over the whole surface, slightly larger near the margin than near the middle; ventrally with more numerous, similar, but smaller setæ, those just anterior to the anal plates arranged in fairly definite straight transverse rows;

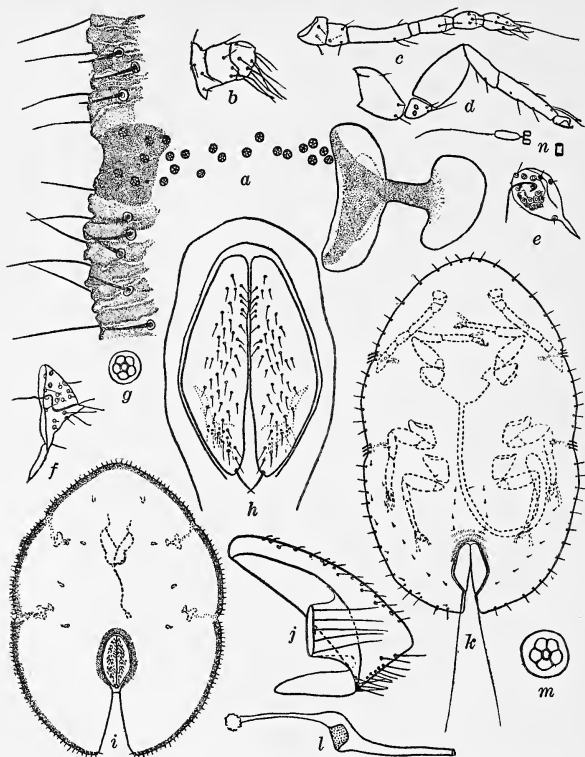

FIG. 4. *Alecanium hirsutum* g. et. sp. nov.; a, adult female, body margin opposite spiracle, $\times 335$; b, adult female, antenna, $\times 335$; c, larva, antenna, $\times 165$; d, larva, leg, $\times 165$; e, adult female, disk pore from spiracular row, $\times 1,500$; h, adult female, anal plates, $\times 165$; i, adult female, outline of body, $\times 30$; j, adult female, anal plates, lateral view, somewhat diagrammatic, $\times 165$; k, larva, outline, $\times 90$; l, adult female, ventral tubular duct, $\times 1,500$; m, adult female, quinquelocular disk pore from anal plate region, $\times 1,500$; n, adult female, dorsal pore, $\times 1,500$.

dorsally with numerous, but well-separated and scattered, minute, circular to quadrate pores over the whole surface, these with small internal ducts and long internal filaments, and with somewhat larger but unequal-sized pores with heavy borders in scattered groups on each side of the anal plates, the groups ex-

tending both anterior and posterior to the plates, and having the appearance of poorly constructed bi-, tri-, or quadrilocular pores, with a circular or slightly oval outline; ventrally with at least two types of pores, the circular disklike multilocular pores, apparently all quinquelocular, a small row running from each spiracle to the body margin, and a few, widely separated, for some distance around the anal plates, the nearest approach to grouping coming just posterior to the plates, the latter noticeably larger than the first, and the elongate, slender, tubular ducts with deep asymmetrical cup-shaped bases, most numerous along the margin, here apparently opening into the margin itself, and again somewhat more numerous along the median ventral line anteriorly, but scattered more or less over the whole surface; anal plates surrounded by a narrow chitinous band about as long as the whole of the mouth parts, plates about 265 μ long, and each about 80 to 85 μ wide, bluntly rounded anteriorly, more or less pointed posteriorly, widest at a point about one-third of the total length from the posterior apex, the outer angle rounded or very bluntly angular, dorsally with numerous, rather long, slender setæ scattered from base to apex, arranged in very indefinite transverse and usually diagonal rows, the number varying from forty to fifty-three, with forty-four or forty-five as the commonest number, each plate with a large apical seta about twice as long as the dorsal setæ, with six to eight somewhat stouter setæ on the short posterior ventral ridge, the inner lower corner of the ridge attached to a chitinized plate which extends downward and cephalad along the median line, and together with the anal plates completely incloses the anal ring, except for the narrow dorsal and apical slit between the plates; this chitinized plate bearing eight or nine setæ at its upper posterior extremity, these appearing to correspond to the fringe setæ found in other species, and standing two or sometimes three deep; with a cluster of small spinelike setæ visible in mounts just posterior to the apex of the anal plates, these possibly homologous with the hypopygial setæ of some other species, but more probably merely a group of ventral setæ; anal ring small, placed within the posterior half of the anal plates, the setæ about a third or a little more of the plate length, the total number varying from at least ten to twelve, the ring itself with a double to triple row of pores.

Larva.—Oval, pale brown in dried condition, flat, naked; length, about 0.77 millimeters; width, about 0.48; becoming clear when boiled in caustic potash; legs and antennæ well developed, the

former 6-segmented, the third segment longest, somewhat curved and slightly clavate, nearly twice as long as the terminal which is next longest; legs with all the parts well developed, the tarsus distinctly longer than the tibia, the tarsal digitules much longer than those of the claw, slender, both slightly knobbed, extending just beyond the apex of the claw, this faintly denticulate close to the apex; spiracles elongate, rather slender, slightly enlarged at each end; three spiracular spines opposite each spiracle, nearly equal or the middle one very slightly longer; margin with a single row of fairly large setæ, these spaced irregularly, and with an occasional much smaller submarginal seta ventrally; dorsally with at least a single row of very small setæ extending cephalad from the anal plates on each side and about halfway between margin and median line, the individual setæ widely separated, only about six altogether; ventrally with two similar rows on each side, the setæ in these slightly larger; without pores except for three or four quinquelocular disk pores between each spiracle and the margin; anal plates elongate, each about 100 μ long and 32 μ wide, broadly rounded anteriorly, tapering to a point posteriorly, broadest just caudad of the middle, the apical hair very long, slender, about 268 μ long; plates with a single tiny seta at a point about one-third the length from the anterior apex, another about the same distance from the posterior apex, both close to the inner margin of the plate, and a larger subapical seta at the outer margin and just anterior to the apical seta; with a single rather large seta at the base of the ventral ridge, with a single rather large fringe seta below the plate on each side; anal ring and hairs located in the middle of the anal plates, the hairs a little more than half the length of the plate, apparently six in number, this not definitely determinable.

Male puparium.—Elongate oval, fairly convex, about 1.25 millimeters long, broadest opposite the anal plates, of thin transparent wax, only the slightly flattened margins whitish: the lines indicating the plates faint, with a submedian on each side dorsally, the others all quite indistinct, with traces of a cross-line probably joining these two just before the anal plates and another close to the cephalic apex, and additional lines running diagonally from these meeting points to the body margin, occasionally with traces of a line dividing each lateral plate into anterior and posterior parts; without any traces of transverse dorsal carinæ.

Male pupa and larva (second stage).—The inclosed male pupa almost uniformly reddish brown, shaped much as is the

puparium; the poorly developed male pupa surrounded by the larval skin, but whether this condition continues through the entire pupal period cannot be stated; the male larval structure appears intermediate between the young larva and the oldest female form as already described; legs and antennæ much reduced; anal plates elongate, slender, with about seven or eight dorsal pores, possibly bearing setæ, scattered through the whole length of the plate; apical seta broken; with two relatively large fringe setæ on each side; with three spiracular spines of equal length in each group; marginal spine arrangement much as in young larva; multilocular disk pores observed only between spiracles and margin; cup-shaped tubular ducts numerous, especially along the margin and, in transverse groups, on each side anterior to the anal plates; the short developing legs and antennæ of the male pupa about twice as large as those of the larva; the pupa not sufficiently developed to show any characters for description.

This species has been described from five females mounted on a slide, five young larvæ mounted on a slide, two male larvæ and pupæ mounted on a slide, and a number of specimens attached to the host. The specimens were found on *Alsodeia echinocarpa*, Botanic Gardens, Singapore, August, 1917 (*Baker 8935*) and were covered by a carton and attended by ants. The types are in the United States National collection of Coccidæ.

I have described this material as representing a new genus and species with great hesitancy, as there is considerable evidence to indicate that the species may be founded on the immature female. There is no evidence of the development of the ovaries in any of the specimens examined, the difference in size of young larva and the largest female found is much less than might be expected normally, and the male puparia are much larger in proportion to the size of the largest female than is usual in the subfamily. In spite of this, however, the differences noted, particularly with reference to the anal plates and the marginal region, are such as to indicate a considerable divergence from the typical condition in the subfamily; and, assuming that the females described are only second or preadult stage, any further modifications of structure in the adult might reasonably be expected to follow along the lines shown by the form described.

Genus **COCCUS** Linnæus

With the possible exception of the first, the species that are placed in this genus in this paper are a decided puzzle in respect

to their true generic relationships. The whole group of new species described here have a similar habit and are evidently closely related, possibly excluding the first new species, and in view of the chaotic condition of the genera of the Coccinæ it has seemed advisable to place them in a well-known genus, from which they can be readily transferred to their proper position if this should prove necessary.

Coccus discrepans (Green).

This record is based on some specimens from the undersides of leaves of *Murraya caloxylon*, Botanic Gardens, Singapore, August, 1917 (*Baker 8940*), the individuals attended and covered by ants. These specimens have been compared with mounts made from material forwarded to the United States National collection of Coccidæ from Ceylon by Mr. E. E. Green, the describer of the species. Green lists this species as belonging to the genus *Saissetia* as recognized by the Fernald Catalogue of Coccidae; but from an examination of the material at hand, I can see no reason for not including it in *Coccus* as this genus is at present recognized by American coccidologists. The only structural differences noted in the Singapore specimen, as compared with the description and the Ceylon specimens, are that the anal plates are wider in proportion to their length in the former than in the latter and that no submarginal tubercle has been located between the groups of spiracular spines on the Singapore specimens, although they are present elsewhere. Both of these apparent differences are in all probability due to the condition of the mounts obtained from the specimens from Singapore, since all these have been rather poor and have apparently been so badly crushed in mounting that the anal plates have been flattened.

For the present another lot of specimens, from the leaves of an unknown host, Singapore, August, 1917 (*Baker 8934*), colonized by ants under carton nests, is also considered as of this species, although these specimens show some structural differences as compared with the other specimens of the species that have been examined. There are six well-developed submarginal tubercles on each side, two anterior to the first spiracle, one between the spiracles, and three posterior to the second spiracle, all widely separated. The body of the female, which is fully developed, as evidenced by the presence of young larvæ beneath it, averages about one-fourth smaller than the Ceylon specimens; and, while the marginal setæ are frayed apically and curved as in the typical specimens from Ceylon, the two lateral spiracular spines are

quite noticeably smaller in proportion to the length of the middle spine in this lot of specimens as compared with typical material.

Coccus tumuliferus sp. nov. Plate 1, fig. 3.

Adult female.—Occurring within the hollow stems of the host, probably attended by ants; rarely broad oval, but usually broadened behind and triangular with the angles rounded; plane of dorsal surface flat, but in dried specimens covered with relatively large knobs having a fairly definite arrangement of a median longitudinal single row and on each side of this two other rows, the outer one forming a continuous row around the body at the margin; dorsally covered with a thin, brittle, whitish but more or less translucent, glassy secretion, very easily broken and usually more or less wanting, molded into elevations and depressions corresponding to those of the body, this covering normally wanting over the flattened extreme margin of the body; body color dull brown, of secretory covering, as stated, translucent whitish; maximum length noted, 2 millimeters; width, 2; body as mounted on slide similar in shape and size to unmounted specimens; derm in fully matured individuals becoming somewhat chitinized, more especially along the margin where the inner border of the chitinized zone is broadly scalloped, corresponding to the borders of the adjacent knoblike elevations, the tongues of these scallops continued inward and united with a chitinized pattern corresponding exactly with the deep grooves running between the conspicuous body knobs; antennæ normally 8-segmented, the measurements of those available for study as follows (in microns): II, 43–50; III, 39–43; IV, 32–35.7; V, 18; VI, 16–18; VII, 14; VIII, 18–21; legs of normal form, rather small and slender, claw rather stout and strongly curved, without denticle, all digitules slender, threadlike, with slightly swollen tips, spiracles not unusual, placed rather near the body margin and each with a slight depression in the margin opposite it; with a wide band of scattered pores between spiracle and margin; mentum apparently 1-segmented, short, and broad triangular, apex rounded; derm pores of several sorts, tiny tubular ducts scattered over the dorsum, large tubular ducts with cup-shaped inner ends mostly close to the body margin, and a very few circular disk pores, apparently simple, in line anterior to the anal plates; ventrally with multilocular disk pores of two sizes, a few large, with eight to ten loculi beneath the anal plates, the others smaller, normally with five loculi in wide bands between spiracles and margin; marginal setæ long, slender, hairlike, in a

scattered and irregular row, this at times appearing double, and with a number of somewhat smaller submarginal setæ; apparently without dorsal setæ, ventrally with a number of setæ, much smaller and stiffer than those of margin, these appearing as if scattered, but probably actually in transverse rows, and largest near the antennæ and anterior to the anal plates; spiracular spines possibly normally occurring in threes, but no more than one noted opposite each spiracle in any of the specimens examined, this fairly long and stout, but much shorter

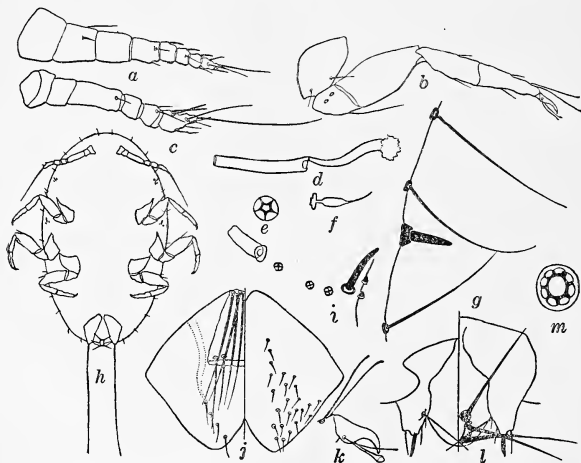

FIG. 5. *Coccus tumuliferus* sp. nov.; a, adult female, antenna, $\times 165$; b, larva, leg, $\times 335$; c, larva, antenna, $\times 335$; d, adult female, large tubular duct, $\times 1,500$; e, adult female, spiracular disk pore, $\times 1,500$; f, adult female, small tubular duct, $\times 1,500$; g, adult female spiracular and marginal spines, $\times 640$; h, larva, outline, $\times 115$; i, larva, spiracle to margin, $\times 640$; j, adult female, anal plates, $\times 220$; k, adult female, claw, $\times 500$; l, larva, anal plates, $\times 335$; m, adult female, posterior ventral disk pore, $\times 1,500$.

than the marginal setæ; anal plates triangular, posterolateral margin somewhat shorter than anterolateral, the corners usually rounded; plates high and, consequently, subject to considerable distortion on mounting; dorsally with as many as twenty-four small slender setæ scattered over the posterior two-thirds of each plate, with three or four ventral ridge setæ, somewhat larger than the dorsal setæ, and with two pairs of relatively large and long fringe setæ; anal ring placed below and within the

plates, small, stout, with pores and eight relatively large and long setæ; no hypopygial setæ.

Intermediate-stage female.—Similar to adult, except for smaller size, reduced number of pores and setæ, and the presence of a pair of stout spiracular spines, one larger than the other, opposite each spiracle.

Larva.—Oval, tending toward oblong, antennæ 6-segmented, the third longest; legs normal, rather slender, claw long, slightly curved at apex, with denticle, digitules long and slender, slightly knobbed; margin of body with a row of rather widely separated slender setæ; spiracular spines three in each group, two short, rounded-conical, one, the median, much larger and cylindrical, all about same diameter at base; with a ventral submarginal row of smaller setæ, and a few longer, very slender ones anterior to the anal plates and near antennæ; with three or four quadricocular pores between each spiracle and margin, no other pores noted; anal plates triangular, slender, with a large and long apical seta, three much smaller subapical marginal setæ and one ventral ridge seta on each.

This species has been described from five mounted adults, several mounted larvæ, and a number of unmounted specimens, all received from Mr. E. E. Green with the following information: In hollow stems of *Macaranga hypolema*, Singapore (coll. I. H. Burkill). The name used above is the manuscript one assigned to the species by Mr. Green, who had also tentatively assigned the species to the genus *Ctenochiton* Mask. I have examined the type of this genus and consider the correctness of such an assignment to be very questionable, and consequently I have placed the species in the genus *Coccus*, though from our present knowledge of the genera of the Coccinæ there is little more to be said in favor of its location here than in *Ctenochiton*. The species itself appears to be a very distinct one, and there should be little danger of confusing it with other species that have been assigned to *Coccus*. The most conspicuous characters are the external appearance, the size and shape of the marginal setæ, the number and size of the spiracular spines, and the numerous dorsal setæ on the anal plates. The types are in the United States National collection of Coccidæ.

Coccus penangensis sp. nov.

Adult female.—Normally short oval, flat, dorsal surface dull, naked, wrinkled radially near margin, outer portion light brown, central disk usually much darker brown to blackish; maximum length, about 2.5 millimeters; width, a little less than 2; mounted

specimens similar in size and shape; derm clearing to a considerable degree on treatment with caustic potash, but showing more or less distinctly numerous, large, rather closely crowded areolations, each with a tiny pore, these areolations similar to those found in species of *Saissetia*, but much less conspicuous on account of the much lighter chitinization, more pronounced along the body margin; antennæ normally 7-segmented, the third sometimes incompletely divided, the measurements of those examined as follows (in microns): II, 35-39; III, 39-48; IV, 35-37; V, 22; VI, 18-22; VII, 35-39; legs normal, rather small and slender, claws rather strongly curved at tips, digitules all long, slender, knobbed at tips, but one of claw about three times as thick as the others; spiracles not unusual; beak apparently 1-segmented, very short; derm with numerous, but scattered simple pores over dorsum in center of areolations,

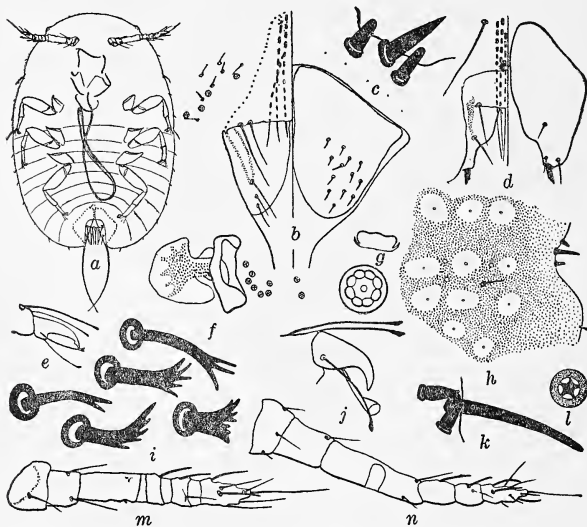

FIG. 6. *Coccus penangensis* sp. nov.; a, larva, outline from beneath, $\times 115$; b, adult female, anal plates, $\times 220$; c, adult female, spiracular spines, $\times 640$; d, larva, anal plates, $\times 335$; e, larva, claw, $\times 640$; f, adult female, spiracle, $\times 220$; g, adult female, posterior disk pore, $\times 1,500$; h, adult female, portion of derm showing areolations, $\times 220$; i, adult female, marginal setæ, showing range of variation, $\times 1,500$; j, adult female, claw, $\times 640$; k, larva, spiracular spines, $\times 1,500$; l, adult female, spiracular pore, $\times 1,500$; m, larval antenna, $\times 440$; n, adult female, antenna, $\times 220$.

laterally with small long-tubular ducts with cup-shaped bottoms; ventrally with a row of quinquelocular pores between each spiracle and margin, and with a few somewhat larger disk pores, each with about eight loculi, below the anal plates; body with rather variable, but usually fairly stout, short, marginal setæ, normally bifid, trifid, or fringed at apices, rarely with one or more lateral teeth; spiracular spines normally in threes, with one plainly but not conspicuously longer than the other two, rarely with four in a group, the median rather sharp conical, the laterals rounded conical; dorsal surface with an occasional, isolated, fairly long, slender but stiff seta, these setæ probably in definite arrangement, but this not determinable from the material at hand; ventrally with the setæ more numerous and, in general, smaller than dorsally, but with a few, anterior to anal plates and near antennæ, much larger; anal plates rather broadly triangular, but much subject to distortion in mounting, the apical angle rounded, dorsally bearing about sixteen to eighteen short, rather stiff setæ on the apical half of each plate, ventrally with three larger setæ on the ridge, and a pair of still larger fringe setæ on each side; no hypopygial setæ; anal ring with pores and eight setæ.

Larva.—Rather stout oval, antennæ 6-segmented, legs rather stout, margin of body with widely separated slender setæ, spiracular spines in threes, the median much longer than the laterals; anal plates triangular, with a long apical seta, about three subapical dorsal setæ, a single larger ventral seta and a single large fringe seta.

This species has been described from two mounted adults, three mounted larvæ, and a few unmounted specimens, all of the material kindly transmitted by Mr. E. E. Green and bearing the following information: In hollow stems of *Macaranga triloba*, Penang Ids. (coll. I. H. Burkill). The types are in the United States National collection of Coccidæ.

The salient characters which distinguish this species from the closely related forms found in similar situations and in the same locality are indicated in the key which follows this series of descriptions of new species of *Coccus*.

Coccus caviramicolus sp. nov. Plate 1, fig. 4.

Adult female.—Flat, broad oval, approaching circular, dull brown, central area darker, dull or faintly shining, without or with a very slight secretory coating; maximum length, 2.5 millimeters; width, about 2; individuals mounted on slides similar in size and shape; some individuals showing faint traces

of areolations similar to those described for *C. penangensis*, mostly near the posterior apex of the body; antennæ normally 7-, rarely 8-segmented, the measurements of the 7-segmented form in microns as follows: II, 43; III, 53.5-60.5; IV, 27-39; V, 14-18; VI, 18-21.5; VII, 44-50 (3 antennæ); of the 8-segmented form: II, 46.5; III, 43; IV, 18; V, 14; VI, 21.5; VII, 25; VIII, 46.5; legs not unusual, claws without denticle, one digitule about three times as large as the other, all elongate, slender, knobbed at apices; spiracles normal; derm dorsally with numerous, scattered, tiny quadrate pores with internal tubular prolongations, also with

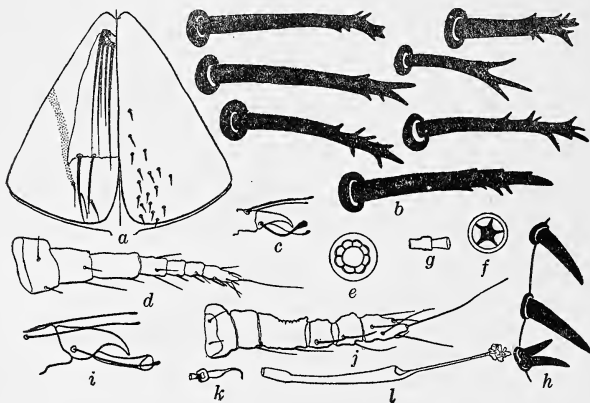

FIG. 7. *Coccus caviramicolus* sp. nov.; a, adult female, anal plates, $\times 220$; b, adult female, marginal setæ, $\times 1,500$, showing range of variation; c, larva, claw, $\times 460$; d, adult female, antenna, $\times 165$; e, adult female, posterior ventral disk pore, $\times 1,500$; f, same, spiracular disk pore, $\times 1,500$; g, adult female, ventral tubular duct, $\times 1,500$; h, adult female, spiracular spines, $\times 640$; i, adult female, claw, $\times 640$; j, larva, antenna, $\times 440$; k, adult female, dorsal tubular duct, $\times 1,500$; l, adult female, long tubular duct, $\times 1,500$.

a few larger, scattered, simple disk pores anterior to anal plates; ventrally with some tiny, short tubular ducts, some larger, long tubular ducts near the body margin, with a narrow band of quinquelocular disk pores between each spiracle and the margin, and with a few somewhat larger disk pores beneath the anal plates, these with six to eight loculi; marginal setæ fairly large and stout, nearly as long as the spiracular spines, the apical third of each more or less strongly frayed laterally and apically; spiracular spines normally in threes, the median somewhat larger, rarely with four present, all stout, tapering, pointed at

tips; ventrally with a submarginal row of fairly large, slender, entire setæ, and with others near antennæ and anterior to anal plates; no dorsal setæ noted; anal plates triangular, the anterolateral margin of each longer than the posterolateral, but the shape of the plates much subject to distortion through mounting, inner and posterior half of each plate with about seventeen to twenty small setæ; ventral ridge with three larger setæ and with two pairs of much larger fringe setæ, the inner smaller; anal ring small, with pores and ten setæ.

Larva.—So far as can be determined from the very limited material available, the larva is entirely similar to that of *C. penangensis*, previously described.

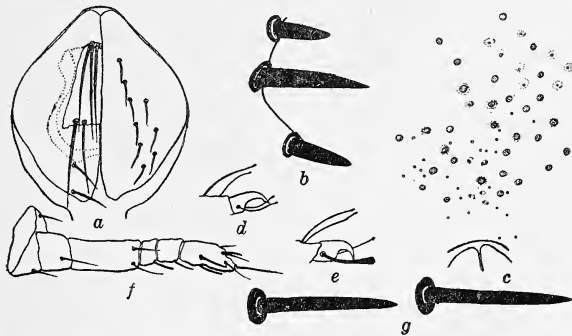

FIG. 8. *Coccus secretus* sp. nov.; a, adult female, anal plates, $\times 220$; b, adult female, spiracular spines, $\times 640$; c, adult female, derm dorsally immediately anterior to anal plates, $\times 220$; d, larva, claw, $\times 640$; e, adult female, claw, $\times 640$; f, adult female, antenna, $\times 335$; g, adult female, marginal setæ, $\times 1,500$.

This species has been described from the following specimens mounted on slides: One adult (holotype) from hollow stems of *Macaranga* sp., Singapore (*I. H. Burkill X-2*); two adults, in hollow stems of *Macaranga triloba*, Kendong, Malacca, Malay Peninsula (*I. H. Burkill 1440*); one adult, in hollow stem of *Macaranga triloba*, foot of Tampin Hill, north of Malacca, Malay Peninsula (*I. H. Burkill 1331*); one intermediate stage, the same; one late larva, the same; and from one or more unmounted specimens of each of these lots of material, all of which was received from Mr. E. E. Green. The types are in the United States National collection of Coccidæ.

The salient characters of the species are indicated in the key at the end of this series of descriptions of new species.

Coccus secretus sp. nov.

Adult female.—Slightly longer than wide, flat, the center usually slightly elevated, with faint radiating ridges around the margin, dirty pale brown, appearing as if covered with a thin film of dust; maximum length, 1.75 millimeters; width, 1.5; usually a little smaller than this; body as mounted similar in shape and size; derm clearing completely on treatment with caustic potash, without traces of the *Saissetia*-like areolations of some related species; antennæ small, normally 6-segmented, the measurements of the segments in microns as follows:

II.	III.	IV.	V.	VI.
11	45	12	12	29
11	43	15	(*)	-----
14	43	18		32
14	39	14	14	29
14	39	12.5	12.5	32
14	36	12.5	14	32
14	40	21		27
14	32	18		27
14	43	14	14	32
14	32	14	14	32
14	25	7	9	25
14	25	11	11	27
14	28.5	11	11	25
11	36	8	11	25
11	36	11	11	25

* Broken.

Legs small, normal, the digitules slender, knobbed, that on claw larger and heavier than the other; spiracles not unusual, placed rather near body margin; derm dorsally with a fairly close cluster of relatively large, circular to oval, apparently simple pores placed just anterior to anal plates, and with numerous other much smaller circular pores (probably the openings of tiny tubular ducts) scattered almost uniformly over the dorsal surface; ventrally with long tubular ducts with cup-shaped bottoms near margin, with quinquelocular disk pores between each spiracle and the margin and with larger disk pores, usually with eight loculi, beneath the anal plates; marginal setæ large, entire, stout and stiff, tapering to a blunt point, each set in a heavy socket, and separated from adjacent spines by, usually, more than its own length; spiracular spines in threes, stout, the laterals tapering to a rounded apex, about as long as the marginal setæ, the median plainly but variably longer, tapering to a sharper point; dorsally with an occasional small seta, ventrally

with somewhat more numerous and larger, but scattered setæ, and with a few pairs, still larger, anterior to anal plates and near antennæ, anal plates triangular, the anterolateral margin more or less distinctly longer than the posterolateral, the angles, especially the outer, rounded; dorsally with eight to ten comparatively large, stout setæ, scattered through the posterior two-thirds of each plate; with a single larger ventral ridge seta and two pairs of fringe setæ, the outer of these larger; anal ring with pores and six setæ.

No other stage has been available for examination.

This species has been described from ten mounted adults having the following information: "In hollow stems of *Macaranga triloba*, Penang Id. (*I. H. Burkill 2693a*)" (holotype and paratypes) and "in hollow stems of *Macaranga*," Singapore (*I. H. Burkill 1318*) (paratypes). Certain differences in these two lots of material, notably a little greater length to the dorsal anal plate setæ and the middle spiracular spines of each group, have been noted, but nothing that I can consider as sufficient to justify even varietal segregation. The types are in the United States National collection of Coccidæ.

The salient characters of the species are indicated in the key following this series of descriptions of new species.

Coccus macarangæ sp. nov. Plate 1, fig. 5.

Adult female.—Short oval, pale reddish brown, darker in middle, flat, with faint radiating ridges near margin; dorsal surface appearing naked, possibly with a very thin film of secretion; maximum length, 3.25 millimeters; width, 2.25; size and shape when mounted similar; derm clearing almost completely, but retaining indistinct traces of an areolation similar to that developed in *C. penangensis*, especially around the margin and anteriorly; antennæ normally 8-segmented, the measurements of the single entire example available for examination as follows (in microns): II, 36; III, 36; IV, 21.5; V, 34; VI, 18; VII, 21.5; VIII, 33; legs normal but small, the digitules slender, knobbed, one of tarsus somewhat larger than the other; spiracles not unusual; derm dorsally with a rather conspicuous but irregular cluster of relatively large, circular, simple pores anterior to anal plates; elsewhere over the dorsum with numerous and rather uniformly scattered tiny circular pores, the openings of minute tubular ducts; ventrally near margin with long tubular ducts with cup-shaped inner ends, these also unusually small,

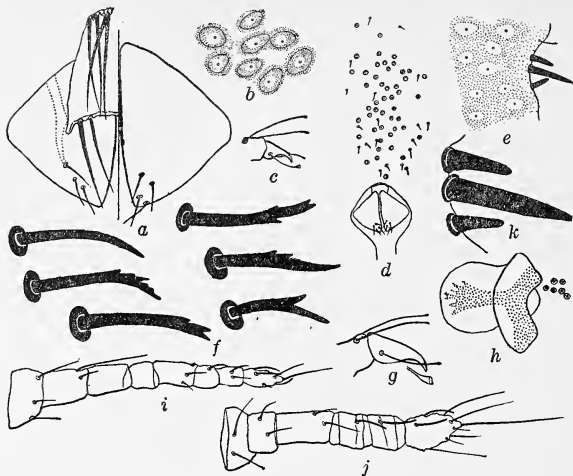

FIG. 9. *Coccus macarangæ* sp. nov.; a, adult female, anal plates, $\times 220$; b, adult female, derm showing areolation, $\times 220$; c, larva, claw, $\times 640$; d, adult female, derm anterior to anal plates, showing dorsal circular pores, $\times 57.5$; e, adult female, derm and spiracular spines, $\times 220$; f, adult female, marginal setæ, showing range of variation, $\times 1,500$; g, adult female, claw, $\times 640$; h, adult female, spiracle, $\times 220$; i, adult female, antenna, $\times 220$; j, larva, antenna, $\times 440$; k, adult female, spiracular spines, $\times 640$.

with quinquelocular disk pores between spiracles and margin, and slightly larger disk pores with six to eight loculi beneath anal plates; dorsally with a number of rather large, stiff setæ, scattered apparently indefinitely; ventrally also with scattered setæ, these smaller and perhaps a little less abundant; marginal setæ appearing rather delicate, elongate, the terminal portion ragged or frayed, about as long as or even shorter than dorsal setæ and on the average about as long as lateral spiracular spines; the latter in threes, the middle distinctly longer than the other two, all stout, tapering to a bluntly rounded tip, the bases of the laterals usually somewhat swollen; anal plates triangular, the angles rather sharply rounded, with four rather long dorsal setæ, placed close to the apex of each plate, three ventral ridge setæ and two pairs of much larger fringe setæ, the latter nearly equal in size; anal ring with pores and, apparently, eight setæ.

Larva.—Apparently entirely similar to those of closely related species.

This species has been described from a single mounted adult female, several mounted embryonic larvæ, and two unmounted adults, all "in hollow stems of *Macaranga*, Selander forest, Singapore" (*I. H. Burkill 1319*), received from Mr. E. E. Green. The types are in the United States National collection of Coccidæ.

The more prominent salient characters of this species are indicated in the key following this series of descriptions of new species.

Coccus circularis sp. nov. Plate 1, fig. 6.

Adult female.—Nearly to quite circular, dull grayish, appearing as if sprinkled with gray powder or dust; flat, but slightly ridged transversely about the middle and with low radiating ridges around the margin; anal cleft a little less than one-third the body length; extreme margin of body slightly elevated all the way around, forming a more or less distinct marginal ridge; maximum length, 3 millimeters; width the same; body, as mounted on slide, similar in size and shape to the unmounted form; without traces of dermal areolation in the specimens examined; antennæ normally 7-segmented, the lengths of the segments in microns as follows:

II.	III.	IV.	V.	VI.	VII.
40	46.5	40	12.5	18	46.5
46.5	46.5	36	14	21	50
50	46.5	40	18	18	46.5
50	57	40	14	18	46.5
50	43	43	14	14	43
43	50	36	14	18	46.5

Legs normal, small, spiracles normal; derm dorsally with an occasional small, circular, simple pore, these scattered widely anterior to the anal plates, and with numerous, scattered, very tiny, tubular ducts over much of the surface; ventrally near margin with numerous large tubular ducts with cup-shaped inner ends, with a row of quinquelocular pores between each spiracle and the margin, and with a number of somewhat larger disk pores with six to eight loculi beneath the anal plates; marginal setæ fairly large, stiff, normally simple and tapering to the apex, but occasionally cleft to form two unequal prongs near apex; spiracular spines in threes, the middle one distinctly but not prominently the longest, all stout in basal portion, but tapering to a rounded point at apex; dorsally with an occasional rather large, stiff, pointed seta, ventrally with submarginal setæ

and others anterior to the anal plates and near antennæ; anal plates triangular, the anterolateral margin longer than the posterolateral, the angles rounded, with about six rather long (as compared with related species described herewith) apical and subapical setæ, with three or four ventral ridge setæ, also relatively large, and two pairs of larger fringe setæ; anal ring with pores and ten setæ, of which two pairs are smaller than the others; no hypopygial setæ.

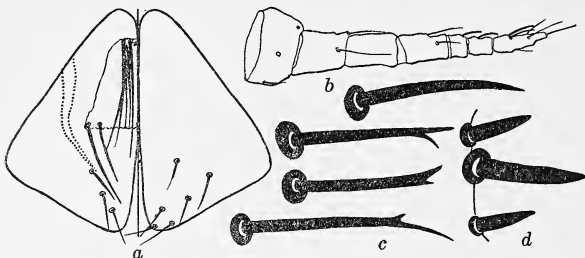

FIG. 10. *Coccus circularis* sp. nov., adult female; a, anal plates, $\times 220$; b, antenna, $\times 220$; c, marginal setæ, showing range of variation, $\times 1,500$; d, spiracular spines, $\times 640$.

Larva.—So far as can be determined from a single not very good mounted specimen, the larva is identical with those of already described species.

This species has been described from three mounted adults, two, including the holotype, in hollow stems of *Macaranga* sp., Singapore (*I. H. Burkill 1389*), one in hollow stems of *Macaranga triloba*, Singapore (*I. H. Burkill 1396*); from a single larva from the same material as the two adults; and from a very few unmounted specimens also from this first lot of material. The types are in the United States National collection of Coccidæ.

The more conspicuous salient characters of this and the preceding newly described species are indicated in the following key:

Key to new species of Coccus Linnæus.

- a¹. Anal plates with numerous (12 to 24) small dorsal setæ; without a distinct cluster of heavy disk pores anterior to anal plates; anal ring with eight or ten setæ.
- b¹. Dorsal surface of body with numerous, large, rounded-conical elevations in definite arrangement; marginal setæ long slender hairs, at least twice length of spiracular spines; dorsum with a brittle, glassy coating, molded to conform to elevations and depressions of body; anal ring with eight setæ..... C. tumuliferus sp. nov.

- b*². Dorsal surface flat, at most slightly wrinkled radially around margin; without elevations or a distinct glassy secretion; marginal setæ much shorter and stouter, not conspicuously longer than spiracular spines.
- c*¹. Marginal setæ short, comparatively stout, and usually strongly fimbriate at apices; anal ring with eight setæ.
C. penangensis sp. nov.
- c*². Marginal setæ longer, slenderer, sometimes entire, usually frayed along both sides near apices; anal ring with ten setæ.
C. caviramicolus sp. nov.
- a*². Anal plates with a few, larger, dorsal setæ, usually four to six; if with as many as ten then with a distinct cluster of circular disk pores anterior to anal plates, and anal ring with six setæ.
- b*¹. Marginal setæ stiff, straight, entire, tapering to bluntly pointed tips; with cluster of simple, heavy disk pores anterior to anal plates dorsally; plates each with nine or ten dorsal setæ; anal ring with six setæ..... C. secretus sp. nov.
- b*². Marginal setæ at least often frayed or cleft before apex; anal plates with four to six large dorsal setæ close to apex of each; anal ring with eight to ten setæ.
- c*¹. Marginal setæ distinctly frayed in most cases; with a distinct cluster of heavy simple disk pores anterior to anal plates dorsally; anal ring apparently with eight setæ.
C. macarangæ sp. nov.
- c*². Marginal setæ rarely frayed, then usually unequally cleft near apex; without a distinct cluster of heavy, simple disk pores anterior to anal plates, but with a few, scattered; anal ring with ten setæ..... C. circularis sp. nov.

Genus *PLATYLECANIUM* Cockerell and Robinson

Platylecanium asymmetricum sp. nov. Plate 1, fig. 7.

Adult female.—Occurring on the under surface of the leaves of the host; length, 4 to 4.5 millimeters; width, 1.5 to 2; elongate, narrowed at each end, flat, dark reddish brown, sometimes almost blackish in the dried specimens, with more or less black mottling, probably due to the drying of the internal organs; eye spots pale, surrounded by a blackish area; all specimens prominently asymmetrical, with either the left or the right margin nearly straight and the opposite side broadly rounded; with slight incisions opposite the spiracles; fading out to yellow or reddish brown when boiled in caustic potash, the discal area darker; cleared derm showing numerous faint areolations, especially in the caudal region and dorsally pores of two sizes, the larger of these scattered over the surface, particularly near the margin; and in about six irregular rows extending across the body between the eyespots and the anal plates, the smaller pores occurring mostly in irregular groups on each side and cephalad of the

anal plates, in a semicircular arrangement, three groups on each side of the plates, these the "cribriform plates" of the describers of the genus, most of the larger pores apparently with a flexible extrusible portion with a small seta at the apex; body margin unevenly crenulate, a narrow strip more heavily chitinized; antennæ small, of the rudimentary type, indistinctly 2-segmented, with faint traces of a third segment occurring as a narrow chitinized strip at the base of each antenna, this bearing a long, slender seta, the apical segment with five or six setæ; the whole antennæ about 54 to 57 μ long; legs apparently wholly wanting; spiracles small, shank slender, outer end widely expanded, inner end less so; marginal setæ slender, hairlike, scattered, apparently occurring in groups of twos or threes, with relatively long intervals between the groups; spiracular spines stout, not tapering, apices rounded, somewhat longer than the marginal setæ, placed in a deep closed incision in the body margin; dorsal surface setæ apparently confined to those mentioned in connection with the pores; ventral setæ not observed; with a single row of minute, quinquelocular disk gland pores running from each spiracle to the corresponding group of spines, and with a few, similar, but much larger pores with more loculi, ventrally in the anal plate region; no other gland pores noted; anal plates triangular, together diamond-shaped, length about 190 to 203 μ ; width of each, about 71 μ ; the anterolateral and posterolateral margins about equal in length; normally with an apical and three dorsal setæ close to the posterior end of each plate, with four or five ventral setæ on each and with one fringe seta on each side, all of these minute; anal plates with two or three minute dorsal pores near and posterior to the middle of each; anal ring small, thick, approximately circular, with six relatively long and prominent setæ, these somewhat swollen just before the base, the longest about 268 μ .

Young larva.—Elongate oval, more narrowed anteriorly, nearly 0.5 millimeter long and 0.22 wide; yellowish brown before treating with caustic potash; antennæ 6-segmented, the last longest, the third nearly as long, average lengths of these (in microns): II, 14; III, 43; IV, 16; V, 10; VI, 53; total length of legs about a fourth greater than that of antennæ; with a few, widely separated, tiny marginal setæ; with a single, relatively stout, spiracular spine set in a heavily chitinized incision in the body margin opposite each spiracle; with four or five minute multi-ocular disk pores between each spiracle and its spine; no other ducts or pores noted; anal plates proportionately more elongate

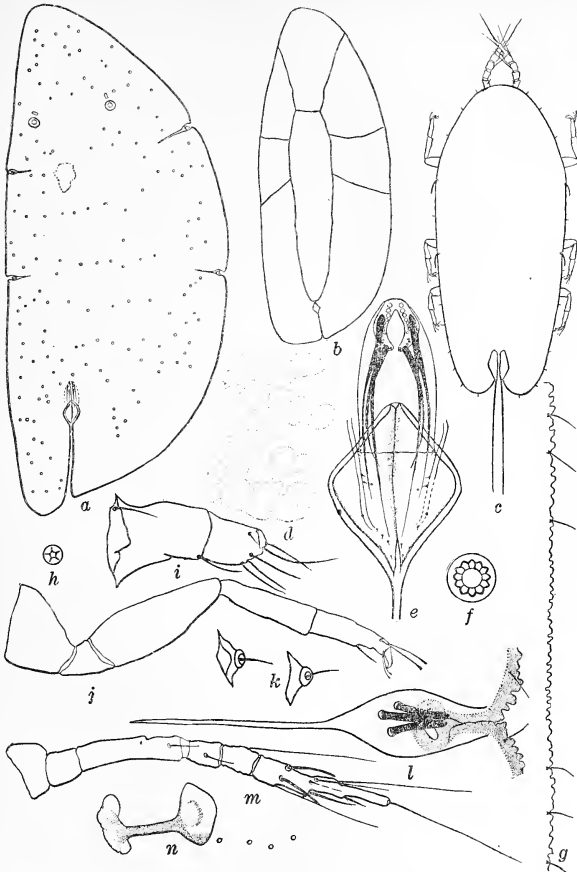

FIG. 11. *Platylecanium asymmetricum* sp. nov.; a, adult female, outline of body, showing shape, arrangement of large pores, etc., $\times 17.5$; b, male puparium, $\times 30$; c, larva, outline, $\times 165$; d, adult female, dermal areolations, $\times 335$; e, adult female, anal plates, $\times 165$; f, adult female, pore from beneath anal plates, $\times 1,500$; g, adult female, body margin, $\times 335$; h, adult female, spiracular pore, $\times 1,500$; i, adult female, antenna, $\times 640$; j, larva, leg, $\times 640$; k, adult female, dorsal setae, $\times 640$; l, adult female, spiracular spines, $\times 335$; m, larva, antenna, $\times 640$; n, adult female, spiracle, $\times 640$.

and slenderer than in adult, broadly rounded anteriorly, acutely pointed posteriorly, terminating in a long seta measuring about 182μ , the plates themselves about 53μ long; anal ring apparently with only four rather long setæ, this not definitely determinable.

Male puparium.—Of thin transparent wax, also slightly asymmetrical, about 2.25 millimeters long and 0.9 wide, flat dorsally, with a pair of longitudinal lines running cephalad from the anal plate region close together and diverging near the cephalic end of the body after being united by a single transverse line; with a pair of transverse lines running to the body margin on each side, posterior to the median transverse line.

This species has been described from seven specimens mounted on slides, and about twenty-five specimens on or detached from the host, all from the undersides of the leaves of *Pinanga*, Government Hill, Singapore, August, 1917, collected by I. H. Burkill (*Baker 8942*). The types are in the United States National collection of Coccidæ.

The conspicuously asymmetrical character of all the stages of this species, except the young larva, is quite probably due to the method of attachment of the insect close to one of the deep, but narrow, riblike veins of the host leaf, but this characteristic is constant and pronounced in every specimen examined.

Three species are now known to belong in the genus *Platylecanium*—the type, *P. cribrigerum* (Cockerell and Robinson), *P. pseudexpansum* (Green), and the species just described; all agree in being flat with a very thin film of dorsal secretion, in having reduced antennæ, no legs, marginal setæ minute, simple, well separated, spiracular spines cylindrical or slightly tapering, in groups of three, set in deep incisions opposite each spiracle, diamond-shaped anal plates bearing minute setæ, anal ring with six setæ and a dorsal semicircular row of "cribri-form plates," three on each side of the anal plates. The most-nearly related genus known to me is *Paralecanium* Cockerell, which is definitely differentiated from the genus under discussion only by the modification of the marginal setæ to form broadly expanded and flattened, closely set, usually circular or oval, striate flabellæ. The more conspicuous differences between the adult females of the three species included in *Platylecanium* are indicated in the following key. This cannot be considered final, on account of lack of specimens of the genotype, only a small portion of one specimen being available for examination, and indeed it is possible that the new species described here is actually *cribrigerum* (Cockerell and Robinson), and that the

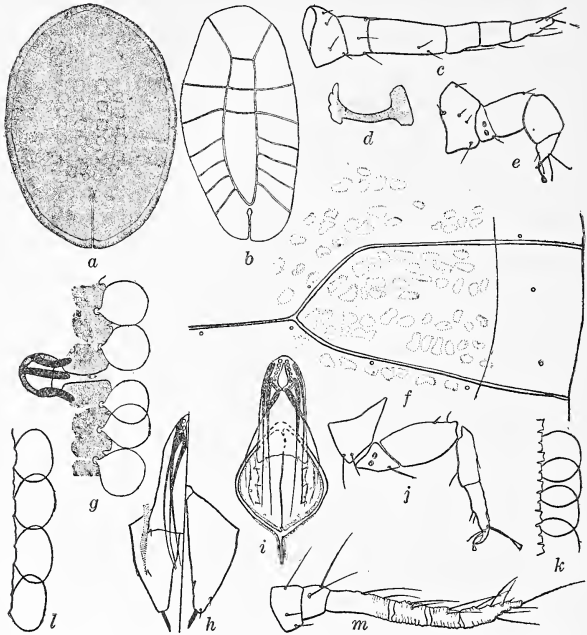

FIG. 12. *Paralecanium ovatum* sp. nov.; a, adult female, outline, $\times 16.5$; b, male puparium, $\times 30$; c, adult female, antenna, $\times 335$; d, larva, spiracle, $\times 335$; e, adult female, leg, $\times 335$; f, adult female, section of body margin showing areolation, etc., $\times 165$; g, adult female, spiracular spines, $\times 335$; h, larva, anal plates, $\times 440$; i, adult female, anal plates, $\times 165$; j, larva, leg, $\times 335$; k, marginal flabellae of younger adult female, $\times 335$; l, same, of older adult female, $\times 335$; m, larva, antenna, $\times 335$.

found in some other species; marginal third or a little more of the dorsum divided into large plates by thin transparent lines through the derm, the resulting arrangement at the margin somewhat similar to that found in *Eucalymnatus tessellatus*; antennæ small, 6-segmented, average lengths of the segments about as follows (in microns): I, 18; II, 14; III, 46.5; IV, 18; V, 17; VI, 27; the third segment nearly twice as long as any other; antennæ sometimes even more reduced than indicated by the preceding measurements, and some of the joints indistinct or apparently wanting; legs present, but much reduced, approach-

ing the rudimentary type; spiracles small, with slender shank and expanded ends; marginal flabellæ fan-shaped, large, broadly expanded, roughly circular in outline, widest at or a little beyond the middle, the edge entire, faintly striate, the striæ diverging from base; in older individuals the flabellæ usually distinctly wider than long and widest about the middle, overlapping more or less, this varying from adjacent flabellæ only slightly, overlapping to alternate flabellæ nearly meeting across the intervening one; spiracular spines three to a group, stout, but not very large, each group set in a distinct chitinized incision of the margin, all three approximately equal in size; body margin with tiny incisions between the insertions of the flabellæ, usually with only a single incision, making two lobules, sometimes with two incisions and three lobules, this arrangement inconspicuous, and sometimes obliterated in the older, mature individuals; with an occasional minute dorsal seta at least near the margin; no differentiated ducts or pores observed on the dorsum; ventrally with a single row of quinquelocular pores running from each spiracle to its corresponding spines, and with some similar, but larger, pores with more loculi around the anal plates; anal plates small, each about 125μ long by 46μ wide, set at the apex of a short cleft with contiguous sides; each plate sharply angulate anteriorly and posteriorly, the outer angle rounded off, widest at or a little behind the middle, the posterolateral margin faintly crenulate; perhaps with two very minute subapical setæ dorsally, apparently with three ventral setæ and a single fringe seta on each side, all these minute; with two minute dorsal pores on each plate at and posterior to the middle; anal ring small, normally placed well anterior to the anal plates, the setæ longer than the plates, curved and noticeably expanded at base, six in number.

Larva.—Elongate oval, about 0.63 millimeter long by 0.32 wide; antennæ 6-segmented, fairly well developed, average measurements as follows (in microns): I, 14; II, 13.5; III, 35.7; IV, 21.4; V, 17.8; VI, 35.7; legs fairly well developed; the lengths of a middle leg, coxa, 29μ ; trochanter and femur, 64μ ; tibia, 35μ ; tarsus, 32μ ; tibiotarsal articulation indistinct; marginal setæ slender, hairlike, in no way resembling the flabellæ of the adult; spiracular spines set in a chitinous incision of the margin, three in number, the intermediate the largest; anal plates elongate, slender, rounded anteriorly, sharply pointed posteriorly, about 50μ long, with an apical seta about 46μ long.

Second-stage female.—About twice as large as the larva, somewhat broader, with the legs and antennæ much reduced as in the adult, the apical seta of anal lobes reduced in size, the marginal setæ widely separated and still hairlike.

Male puparium.—Apparently characteristic of the genus as described and figured for other species; see figure.

This species has been described from seven specimens mounted on slides and from a few additional specimens on the host. The material was collected on *Pandanus* sp. at the Botanic Gardens, Singapore, October, 1917 (*Baker 9029*). The types are in the United States National collection of Coccidæ.

This species appears to differ from the other described species of the genus most conspicuously in having the legs and antennæ present, but semirudimentary. Disregarding this difference, the species would run to the pair *zonatum* and *maritimum* in Green's key to the Ceylon species of the genus,⁴ and from these two it appears to be separable by the distinctly greater width of the anal plates in proportion to their length, and by having the anterolateral margin of each of these at least slightly longer than the posterolateral.

Paralecanium vacuum sp. nov. Plate 1, fig. 8.

Adult female.—Occurring on the upper surface of the leaves of the host; very faintly convex, nearly circular, somewhat broadened behind; length, about 10 millimeters; width, about 9; margin not or only slightly sinuate opposite the spiracles and at the anal cleft; light brown, varying and variegated, the median area with numerous irregular blackish blotches, apparently produced by the discoloration of the dried internal organs; marginal area irregularly areolate with lighter streaks, with most of the extreme edge light; all this not constant; coated dorsally with a relatively thick, rather brittle, detachable layer of nearly transparent wax, this densely and minutely areolate, and showing near the margin radial rows of tiny holes corresponding in position to small conical elevations of the underlying derm, these bearing small setæ, showing also clusters of similar holes corresponding to the group pores, arranged in a semicircle on each side of the anal plates, and finally six very faint and slightly depressed longitudinal rows of quadrate areas of the sort usually found in the genus; derm clearing almost completely on treating with caustic potash, but showing numerous faint areolations, these scattered or irregularly grouped in the central

⁴ Coccidæ of Ceylon, pt. 3 (1904) 185.

area, but very closely crowded along the margin, although interrupted at intervals here by solid radial clear streaks, each bearing a few tiny setæ; with some additional small setæ, widely scattered, dorsally; antennæ probably, but not certainly, present, development not known; legs probably, but not certainly, wanting; spiracles and mouthparts not observed; dorsally with eight clusters of pores and small cicatrices, arranged in a semicircle, four on each side of the anal plates, the rows curving forward; no other specialized dorsal gland pores observed; ventrally with small quinquelocular pores between spiracles and margin, no others noted, probably due to condition of specimens; dorsally

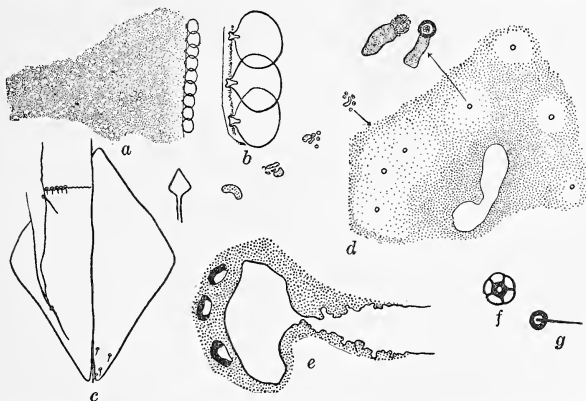

FIG. 13. *Paralecanium vacuum* sp. nov., adult female; a, portion of derm at margin, showing flabellæ and areolation, $\times 57.5$; b, detail of body margin and flabellæ, $\times 220$; c, anal plates, $\times 115$; d, number and position of "cribriform plates," $\times 12$, with detail of one plate, $\times 220$, and detail of single pore from plate, $\times 1,500$; e, spiracular spine incision, showing bases of spines, $\times 500$; f, spiracular disk pore, $\times 1,500$; g, dorsal seta, $\times 1,500$.

with the small, stiff, scattered setæ already mentioned; spiracular spines in threes, but all broken, so the size and shape indeterminate; marginal flabellæ small as compared with the total size of the insect, broader than long, but varying to some extent, nearly sessile, normally slightly overlapping; no ventral setæ observable, due to condition of specimens; marginal interspaces between insertions of flabellæ very indefinitely incised, with from three to six visible incisions at some points, these indistinct at others, and with only minute crenulations showing; anal plates

long triangular, each more than twice as long as wide, all the angles rather sharp, the posterior and anterior acute, dorsally at or close to the apex of each with four small, stiff setæ, ventral ridge with one larger seta at base and another, still larger, at apex, with five fringe setæ on each side; no hypopygial setæ; anal ring placed anterior to the plates, small, with pores and six relatively large, stout setæ.

This species has been described from a few broken specimens received from Mr. E. E. Green with the following information: "On *Ficus* sp., Singapore, coll. I. H. Burkill." The name assigned to it here is the manuscript one given to the species by Mr. Green. The types are in the United States National collection of Coccidæ.

This species has been very reluctantly described, as no whole specimen has been available for study, and such broken pieces as have been mounted fail to show some characters satisfactorily.⁵ The species is the largest one described in the genus, a possible factor in its recognition, and in all the material examined fails to exhibit the ventral, marginal, chitinous zone usually present in the species of this genus.

⁵ As a result of informing Mr. Green of the incompleteness of the preceding description, he has supplied the following descriptive notes from specimens in his possession, the quotation of which almost in toto seems desirable:

"Adult female broadly oval, usually symmetrical, sometimes slightly asymmetrical; almost flat, very slightly convex above; below with a shallow cavity on each side of abdomen, forming a receptacle for the ova or young larvae. Colour dull pale castaneous, or brownish ochreous. After treatment with clearing reagents, the insect appears unusually featureless, owing to the complete absence of limbs and the rudimentary condition of the antennae. Rostral apparatus small and inconspicuous. A pair of circular vacuoles (each with an approximate diameter of 0.25 mm.) at a distance of 1 mm. within the margin, represent eye spots. Antennae 0.15 mm. long; with from four to five confused segments; a few short stout setae upon the apical point. Valves of anal operculum with acute apices; narrow; outer angle rounded; basal margin equal to outer margin. Two scattered series of beaded pores on each side of anal aperture. Stigmatic clefts extending to a distance of 0.25 mm. within the margin; terminating in a semilunar chitinous plate bearing three to five stout club-shaped spines. Spiracle at a distance of 2 mm. from the base of each stigmatic cleft. Length of anal cleft approximately 2 mm. Length of complete insect, 10 mm.; breadth, 8.5 mm. Very near *expansum* Green (which see). Differing in little but its extreme size. It is a question if it should rank as more than a variety or subspecies."

ILLUSTRATIONS

PLATE 1

- FIG. 1. *Anomalococcus multipori* sp. nov.; actual length, about 2 millimeters.
2. *Alecanium hirsutum* gen. et sp. nov.; actual length, about 1.75 millimeters.
3. *Coccus tumuliferus* sp. nov.; actual length, about 2 millimeters.
4. *Coccus caviramicolus* sp. nov.; actual length, about 2.5 millimeters.
5. *Coccus macarangæ* sp. nov.; actual length, about 3.25 millimeters.
6. *Coccus circularis* sp. nov.; actual length, about 3 millimeters.
7. *Platylecanium asymmetricum* sp. nov.; actual length, about 4.5 millimeters.
8. *Paralecanium vacuum* sp. nov.; actual length, about 10 millimeters.

TEXT FIGURES

- FIG. 1. *Paleococcus pulcher* Leonardi.
2. *Anomalococcus multipori* sp. nov.
3. *Pseudococcus hispidus* sp. nov.
4. *Alecanium hirsutum* gen. et sp. nov.
5. *Coccus tumuliferus* sp. nov.
6. *Coccus penangensis* sp. nov.
7. *Coccus caviramicolus* sp. nov.
8. *Coccus secretus* sp. nov.
9. *Coccus macarangæ* sp. nov.
10. *Coccus circularis* sp. nov.
11. *Platylecanium asymmetricum* sp. nov.
12. *Paralecanium ovatum* sp. nov.
13. *Paralecanium vacuum* sp. nov.

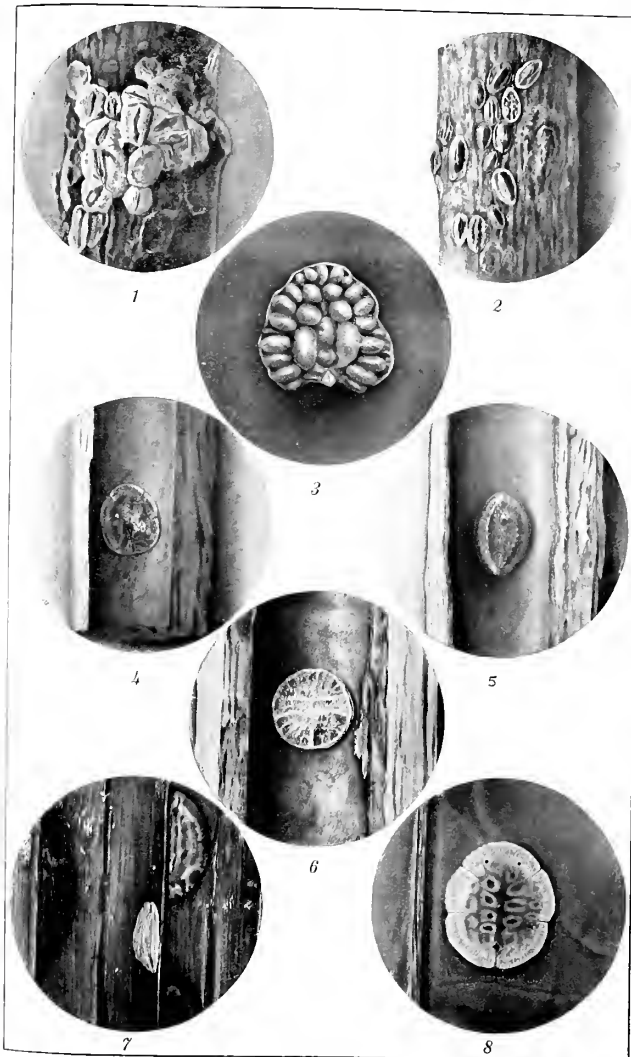

PLATE 1. NEW COCCIDS.

NEW GENERA AND SPECIES OF PHILIPPINE
MEMBRACIDÆ

By W. D. FUNKHOUSER

Of the Zoölogical Laboratory of the University of Kentucky

ONE PLATE

Recent collecting by Prof. C. F. Baker, of Los Baños, in some of the hitherto unexplored parts of the Philippine Islands has yielded new species of Membracidæ so remarkable in appearance that it seems desirable to give them a place in the literature of the family as soon as possible after their discovery.

Six of these new species are here described, two of which are so peculiar in character as to demand new genera for their accommodation.

All of these insects were collected by Professor Baker, to whom I am greatly indebted for the privilege of studying much interesting Philippine material.

Genus **CLONAUCHENIA** novum

Near *Hypsauchenia* Germ., but differing greatly in the shape and position of the pronotal elevation which is laterally branched.

Scutellum present but entirely concealed by the pronotum; tibiæ foliaceous; sides of thorax extended to form two small teeth; tegmina largely coriaceous and almost entirely opaque, venation very irregular; hind wings with four apical areas; anterior process of pronotum widely, horizontally extended at top to form a heavy trilobed expansion; posterior process elevated to form a high, flattened, foliaceous plate, the tip extending almost to the anterior process; head foliaceous; clypeus strongly trilobed.

This genus may be separated at once from the genera *Hypsauchenia* Germ., *Pyrgonota* Stål, *Pyrgauchenia* Bredd., *Pyrgolyrium* Bredd., and *Pyrgophyllum* Bredd., all of which are closely related, by the remarkable development of the anterior process, which is so greatly modified at the distal end that it forms a central bulbous lobe with a heavy swollen horn on each side.

The genus is erected for the accommodation of the following species which is proposed as the type:

Clonauchenia mirabilis sp. nov. Plate 1, figs. 1 and 2.

Dark brown, roughly sculptured, coarsely punctate, sparingly pubescent; head trilobed; anterior pronotal process elevated, widely expanded above to form a heavy, trilobed, transverse branch, the outer lobes of which are modified to form swollen horns; posterior process elevated to form a flattened subtriangular plate which reaches almost to the middle lobe of the anterior process; tegmina opaque and coriaceous; mesothorax and metathorax covered with white tomentose pubescence; legs foliaceous.

Head dark brown, finely punctate, sparsely pubescent, irregularly sculptured, longer than wide, subtriangular; base irregularly rounded; eyes very dark brown; ocelli large, prominent, pearly, glistening, much farther from each other than from the eyes and situated well above an imaginary line drawn through centers of eyes; margins of genæ sinuate and produced; clypeus longer than wide, strongly trilobed, tip pilose.

Pronotum dark brown, irregularly sculptured with anastomosing ridges, coarsely punctate, not pubescent except on sides of anterior process which are slightly white tomentose; metopidium convex; median carina irregularly prominent; anterior pronotal process rising as a column above the head and spreading out at the tip to form a swollen transverse expansion, this expansion roughly trilobed, the central lobe more or less globular, the lateral lobes projecting outward to form heavy swollen nodular horns with ends suddenly acute; posterior process elevated to form a high, laterally compressed plate, which is roughly triangular in shape, the anterior margin concave, the posterior margin twice as long as the anterior and convex, the tip sharp and almost reaching the posterior margin of the middle lobe of the anterior process; the opening between the anterior and posterior processes smoothly ovate as seen from a side view; posterior process in type specimen broken at tip but extending beyond internal angles of tegmina.

Tegmina long and narrow, dark brown, base and two-thirds of costal margin opaque, coriaceous and strongly punctate, distal half semiopaque; tips diagonally truncate; venation irregular, in type specimen five apical and five discoidal cells. Hind wings with four apical cells.

Scutellum entirely concealed by the pronotum. Sides of mesothorax and metathorax covered with white tomentose pubescence which extends in a faint irregular area up the pronotum behind the eye and almost to the top of the anterior process; lower mar-

gins of mesothorax and metathorax extended to form rough toothlike projections.

Legs moderately foliaceous and flattened; finely pilose and closely spined; lighter in color than the rest of the body; tarsi ferruginous and finely pilose; claws flavous.

Undersurface of body very dark brown with white tomentose hairs on undersurface of abdomen.

Length to tips of tegmina, 8 millimeters; width between humeral angles, 2.6; maximum width of anterior process, 6.8; height of anterior process above head, 5.5.

Type, a male, in Professor Baker's collection.

MINDANAO, Surigao (*Baker*).

In sending me this specimen, Professor Baker writes:

I am sending a single unique specimen of the *most remarkable* of Philippine Membracidae. It is very strange that it should have taken eight years of collecting to produce this one specimen. It only indicates that of the great fauna of the *high forests* we yet know but little.

It is certainly a remarkable insect and the specific name was naturally suggested.

Genus MESOCENTRUS novum

Near *Cryptaspidia* Stål but differing in having four apical cells in the hind wing and in having a high central elevation of the pronotum, suggesting the genus *Telamona* of the subfamily Smiliinæ.

Tibiæ simple; hind trochanters unarmed; hind wings with four apical areas; tegmina with five apical and three discoidal areas; scutellum present but entirely concealed by the pronotum; suprahumeral horns absent; dorsal crest simple, erect, without branches or extensions of any kind; posterior process heavy, curved, the tip bearing a sharp, narrow, carinate projection on the undersurface; head subquadrate; clypeus simple.

I have never seen a specimen of Melichar's genus *Monocentrus*¹ to which this genus is apparently closely related, but according to the description the insects belonging to *Monocentrus* have the pronotal crest branched and the posterior process angular as in *Anchon* Buckton.

Mesocentrus pyramidatus sp. nov. Plate 1, figs. 3 and 4.

Very dark brown with golden pubescence; pronotal crest arising in a pyramid above the humeral angles, this pyramid flat-

¹ Wien. ent. Zeit. (1905) 297.

tened laterally and nearly triangular as seen from a side view; no suprahumeral horns; posterior process heavy, curved, carinate above, tip compressed below into a sharp keel, just reaching internal angles of tegmina; tegmina black, punctate, pubescent and coriaceous at base, bronze and coriaceous from base as far as apical end of posterior process, apical end fuscous hyaline; legs and undersurface of body uniform brown.

Head subquadrangular, broader than long, very dark brown, roughly sculptured, finely punctate, sparingly pubescent with long golden hairs; base strongly sinuate, raised above ocelli; eyes large, brown, prominent; ocelli small, pearly, inconspicuous, farther from each other than from the eyes and situated well above a line drawn through centers of eyes; genæ curved, edges produced forward in a slight flange; clypeus broad, extending for half its length below the lateral margins of the genæ, tip semicircular, strongly pilose; antennæ slender and black.

Pronotum very dark brown, covered with dense golden pubescence, finely punctate, single pronotal crest raised in a laterally compressed elevation on median dorsal line, this elevation not quite as high as its width at base, nearly triangular, tip rounded and blunt, center of crest slightly posterior to humeral angles, both front and back margins sloping but front margin more declivous; humeral angles broad, heavy, blunt; no suprahumeral horns; metopidium strongly convex at median line; median carina percurrent, only faintly indicated on metopidium but very sharp on posterior process; scutellum present but entirely concealed by pronotum; posterior process heavy, impinging on tegmina, curved, blunt, strongly carinate above and extended below at tip to form a narrow bladeliike keel, tip just reaching the internal angles of tegmina.

Tegmina narrow, pointed; base black, punctate, and coriaceous, this portion extending farther along the costal than the internal margin; the area extending from this black coriaceous portion to a point as far caudad as the apex of the posterior process is shining dark brown and more or less opaque and ends in a rather definite margin; the apical portion of the tegmina is hyaline with the tip slightly tinged with fuscous; veins prominent and strongly pilose; free margin beyond veins narrow and slightly wrinkled; five apical and three discoidal areas.

Undersurface of body entirely brown with dense golden pubescence which changes to a silvery tinge on the undersurface of the abdomen.

Legs simple, very dark brown, strongly pilose.

Length from front of head to tips of tegmina, 7 millimeters; width between humeral angles, 3.3; height from top of head to tip of crest, 2.6.

Type, a female, in Professor Baker's collection.

MINDANAO, Iligan (*Baker*).

Emphusis globosus sp. nov. Plate 1, figs. 5 and 6.

Near *E. obesus* Fairm., but differing in the formation of the pronotal elevation.

Very dark purplish brown, irregularly sculptured and coarsely punctate; white tomentose pubescence on sides of pronotum under suprahumeral horns and on mesothorax; pronotal elevation very large, nearly globular; suprahumeral horns short, blunt, continuing line of metopidium; posterior process heavy, impinging on tegmina; tegmina bronze translucent except along basal costal border which is coriaceous and punctate.

Head subtriangular, longer than wide, roughly sculptured, finely punctate, brown; base sinuate; eyes large, brown; ocelli conspicuous, amber-colored, shining, farther from each other than from the eyes and situated slightly above a line drawn through centers of eyes; a prominent longitudinal ridge just inside each ocellus; genæ extended strongly cephalad in a sinuate flange; clypeus longer than wide, strongly trilobed, outer lobes continuing line of margins of genæ, concolorous with the rest of the head, finely punctate, sparingly pilose.

Pronotum extended upward in a large globular swelling above the head, dark purplish brown, irregularly sculptured with anastomosing lines, coarsely punctate with deep irregularly shaped punctures; metopidium extremely convex, narrow at base and suddenly expanding to form a globe above; median carina strongly percurrent from head to extremity of posterior process; lateral angles large, prominent, blunt; suprahumeral horns very heavy, thick, wide, blunt, continuing curve of metopidium, extending outward and backward and very slightly downward; base of pronotum below horns on each side thickly covered with a white tomentose patch which extends downward over the mesothorax and metathorax behind the eye; posterior process thick and heavy, tip broken in type specimen but undoubtedly reaching beyond the internal angles of the tegmina on which it impinges.

Tegmina long, narrow, blunt, bronze-colored, wrinkled, subtranslucent or subcoriaceous except at base and basal costal area which is punctate, entirely coriaceous and opaque; marginal area beyond veins narrow; five apical and three discoidal areas. Hind wings hyaline; four apical areas.

Legs and undersurface of body uniform brown; tibiae subquadrate, pilose; tarsi somewhat lighter in color, pubescent.

Length from front of head to tips of tegmina, 7 millimeters; height of pronotal elevation above head, 5; width between tips of suprahumeral horns, 5.

Type, a male, in Professor Baker's collection.

MINDANAO, Dapitan (*Baker*).

Pyrgonota noditurris sp. nov. Plate 1, fig. 7.

Entirely luteous, coarsely punctate, very sparingly pubescent; anterior horn long, nearly straight, swollen at tip and strongly nodose on posterior margin; posterior process long, sinuate, gradually acuminate, extending beyond internal angles of tegmina, toothed on dorsal ridge; tegmina wrinkled, hyaline, punctate on basal half; legs strongly foliate; undersurface of body entirely luteous.

Head subquadrate, finely punctate, yellow, tinged with red, convex; base bluntly angulate; eyes small, black; ocelli very small, white, not conspicuous, about equidistant from each other and from the eyes and situated slightly above a line drawn through center of eyes; clypeus very large, strongly trilobate, extending for more than half its length below anterior margins of genæ, tip pilose.

Pronotum luteous, slightly tinged with darker on posterior margin of anterior horn; anterior horn extending upward and forward, longer than the body, strongly and coarsely punctate, two prominent swellings on posterior margin below tip, tip swollen, rounded, marked into irregular areas by ridges, sides of horn very slightly tricarinate below tip; metopidium nearly straight; humeral angles not prominent; a deep depression between eye and humeral angle; posterior process luteous, tinged with red at tip, sinuate, strongly toothed on dorsal margin, gradually acuminate, extending to a point about midway between internal angles and tips of tegmina.

Tegmina luteous hyaline, wrinkled, angular, basal half strongly punctate and somewhat coriaceous, tips pointed, venation at tips very irregular. Undersurface of body entirely luteous, lightly pubescent; legs strongly foliaceous, entirely clay yellow except claws which are brown.

Length from front of head to tips of tegmina, 5.6 millimeters; length of anterior horn from top of head, 6; width between humeral angles, 2.

Type, a female, in Professor Baker's collection.

MINDANAO, Surigao (*Baker*).

Leptobelus elevatus sp. nov. Plate 1, figs. 8 and 9.

Black, shining, punctate, partly pubescent; pronotal elevation very high, branching at top into two long, sharp, lateral horns; posterior process long, slender, decurved, arising well below bases of lateral horns and extending beyond internal angles of tegmina; scutellum entirely exposed, much longer than wide, gradually acuminate; tegmina bronze hyaline with black punctate base and brown veins; undersurface of body dark brown; legs black; tarsi flavous.

Head subquadrangular, wider than long, convex, black, shining, faintly longitudinally striate, lightly punctate, base strongly convex; eyes large, brown, mottled with flavous; ocelli small, pearly, farther from each other than from the eyes and situated well above an imaginary line drawn through centers of eyes; clypeus smooth, black, shining, flat, neither pubescent nor punctate, more or less trilobed at apex, extending for more than half its length below the apical margins of the genæ.

Pronotum black, very coarsely punctate, shining, without pubescence in front but lightly pubescent behind, rising in a cone-shaped turret above the humeral angles to a height equal to its width and then extending upward and slightly forward as a roughly cylindrical process from which is given off the posterior process at about its middle and two long, sharp, lateral horns at its extremity; lateral horns sharp, irregularly quadricarinate, extending almost directly outward, very slightly downward and with tips bent slightly backward, each horn about as long as the maximum width of the metopidium; posterior process long, slender, sharp, almost uniform in thickness throughout its length, sharply and distinctly quadricarinate, very highly elevated above the body and extending to a point about one-third the distance from the internal angles to the tips of the tegmina; humeral angles small, blunt, not prominent; metopidium convex, higher than wide; scutellum entirely exposed, longer than wide, gradually acuminate, base densely pubescent, the pubescence extending upward on the pronotum to the base of the posterior process, tip very roughly punctate and slightly decurved; tegmina smoky hyaline, bases narrowly black, coriaceous and punctate, veins brown, tips extending beyond end of abdomen.

Undersurface of body very dark brown, almost black, sparingly pubescent, with short silvery hairs; legs black, femora smooth, tibiæ strongly spined, tarsi and claws flavous.

Length from front of head to tips of tegmina, 7.6 millimeters; width between humeral angles, 3; height of pronotal process from top of head, 3.8; distance between tips of lateral horns, 5.9.

Type, a female, in Professor Baker's collection.

PALAWAN, Puerto Princesa (*Baker*).

This species may be distinguished from any previously described species of the genus by the fact that the posterior process arises well below the lateral horns.

Cryptaspidia pilosa sp. nov. Plate 1, fig. 10.

Near *C. impressa* Stål but smaller and differs in having the metopidium without a keel, the head nearly flat, the tegmina without ferruginous fascia and the clypeus only feebly pubescent.

Black, shining, punctate, pilose; pronotum strongly convex in front, smooth on metopidium, carinate on posterior process; posterior process just reaching internal angles of tegmina; tegmina hyaline except at base which is black; veins of tegmina strongly pilose; undersurface of body black; femora dark brown or black; tibiae and tarsi ferruginous.

Head much wider than long, nearly rectangular, only feebly convex between ocelli, strongly depressed between ocelli and eyes, finely punctate, closely pubescent, with short golden hairs, base sinuate; eyes large, prominent, luteous mottled with ferruginous; ocelli small, pearly, semitransparent, much farther from each other than from the eyes and situated well above an imaginary line drawn through centers of eyes; clypeus short, nearly triangular, apical margin rounded and almost continuing the lower margin of the genæ, finely punctate, feebly pubescent, with very short hairs.

Pronotum black, shining, regularly and strongly punctate, strongly pilose, with long golden hairs; metopidium wider than high, regularly rounded, not carinate, strongly pilose; lateral angles prominent, triangular, blunt, extending farther laterad than the outside margins of the eyes; posterior process short, depressed at base, gradually acuminate, tricarinate, strongly pilose, slightly deflexed at tip which just reaches internal angles of tegmina; tegmina hyaline, wrinkled, five apical and two discoidal areas, immaculate except at base which is black, punctate and pilose, the black coriaceous area extending for one-third the length of the tegmina along the costal margin but less than half that distance along the internal margin, this black area also being divided by a hyaline line through the center, veins brown,

those in center of tegmen being darkest and all strongly pilose, with long golden hairs; hind wings entirely hyaline.

Undersurface of head and thorax black; undersurface of abdomen dark brown with each abdominal segment margined posteriorly with a narrow band of sordid white.

Femora dark brown except at distal ends which are ferruginous; tibiæ ferruginous and densely pilose, those of the last pair of legs bearing small, sharp, black spines; tarsi ferruginous; claws brown.

Length from front of head to tips of tegmina, 4 millimeters; width between tips of humeral angles, 2.

The type specimen, a male, bears Professor Baker's duplicate No. 13879.

BASILAN (*Baker*).

It should be noted that the insects of the genus *Cryptaspidia*, in addition to being longer-bodied and slenderer than those of the genus *Gargara* to which they are closely allied, differ also in having the scutellum entirely concealed. They may be separated from the genus *Tricentrus* by the lack of suprahumeral horns, and from the genus *Centrotoscelus* by the absence of spines on the hind trochanters. The character of the two discoidal cells, considered by Stål as generic, does not always hold.

ILLUSTRATIONS

PLATE 1

- FIG. 1. *Clonauchenia mirabilis* sp. nov., lateral view.
2. *Clonauchenia mirabilis* sp. nov., frontal outline.
3. *Mesocentrus pyramidatus* sp. nov., lateral view.
4. *Mesocentrus pyramidatus* sp. nov., frontal outline.
5. *Emphusis globosus* sp. nov., lateral view.
6. *Emphusis globosus* sp. nov., frontal outline.
7. *Pyrgonota noditurris* sp. nov., lateral view.
8. *Leptobelus elevatus* sp. nov., lateral view.
9. *Leptobelus elevatus* sp. nov., frontal outline.
10. *Cryptaspidia pilosa* sp. nov., lateral view.

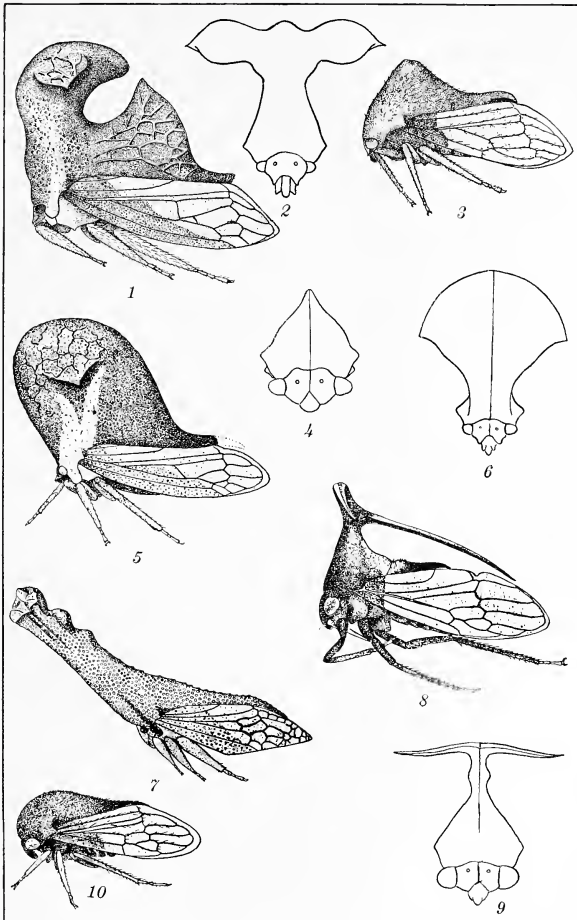

PLATE 1. PHILIPPINE MEMBRACIDÆ.

SOME PHILIPPINE WASPS OF THE FAMILY
CHRYSIDIDÆ

By S. A. ROHWER

Honorary Custodian of Hymenoptera, United States National Museum

In some Philippine Hymenoptera received for identification from the Philippine Bureau of Agriculture was a new subspecies of *Stilbum cyanurum*. This new subspecies is described and some synonymy indicated in the present paper. In addition to this all the specimens of Philippine chrysidids in the collections of the United States National Museum are listed.

Ellampus (Holophris) bakeri Mocsáry.

A single female of this species was collected by C. R. Jones and is recorded under No. 1708, Bureau of Agriculture, P. I.

Hedychrum stantoni Ashmead.

The single male type from Manila, collected by W. A. Stanton.

Chrysis (Hexachrysis) comottii var. *igniceps* Mocsáry.

A single female under accession No. 1403, Bureau of Agriculture, P. I., collected by C. R. Jones.

Stilbum cyanurum var. *chrysocephalum* Buysson.

Stilbum splendidum var. *chrysocephalum* BUYSSON, Ann. Soc. Ent. France 66 (1897) 544.

Stilbum cyanurum var. *flammiceps* MOCsÁRY, Philip. Journ. Sci. § D 8 (1913) 288.

There is nothing in the original descriptions of these two varieties which would indicate that they are different, and I believe the above synonymy is correct.

Stilbum cyanurum subsp. *amethystinum* Fabricius.

Uniformly dark blue with purplish reflections. Specimens from the following localities: LUZON, Manila (*Robert Brown, C. V. Piper*); Bacoor (*P. L. Stangl*, November); San Rafael (*A. P. Ashby*).

Stilbum cyanurum subsp. *amethystinum* variety.

Uniformly blue-green except the third segment which is dark blue. Specimens from the following localities: LUZON, Manila

(*W. A. Stanton, M. B. Mitzmain, January 22, 1911*). PANAY, Culasi (*R. C. McGregor, June, 1918*). Accession Nos. 363, 826, Bureau of Agriculture, P. I.

Stilbum cyanurum subsp. *luzonensis* subsp. nov.

Female.—Length, 15 millimeters. Uniformly light green with strong coppery reflections; third tergite dark green; wings fuscous; mesoscutum sculptured as in *amethystinum*; produced portion of metanotum truncate posteriorly.

Type locality.—Philippine Islands.

Type.—Catalogue No. 23738, United States National Museum.

Described from one female (*C. R. Jones*), accession No. 1402, Bureau of Agriculture, P. I.

DESCRIPTION D'UN CANTHYDRUS (COLEOPTERA-
DYTISCIDÆ) NOUVEAU, DES ILES PHILIPPINES

Par R. PESCHET

Paris, France

Canthyrus bakeri sp. nov.

Forme assez convexe en avant, acuminée en arrière. Noir brillant, labre roux clair, partie antérieure de la tête ferrugineuse, angles antérieurs du pronotum largement, marge latérale étroitement ferrugineux. Elytres maculés d'une tache sublatérale rougeâtre, petite, située un peu en arrière du milieu, visiblement transverse et de forme un peu irrégulière.

Ponctuation nulle sur la tête et le prothorax, réduite sur les élytres à une série discale visible à la base, obsolète au sommet où elle est réduite à quelques petits points très espacés et très peu imprimés; série latérale presque nulle, à peine indiquée par quelques points superficiels à la base et au milieu de l'élytre.

Réticulation très fine, visible seulement sous un fort grossissement, simple, à mailles égales, rondes sur la tête, très légèrement transverses sur le prothorax, nettement et fortement transverses sur les élytres.

Dessous noir brillant; antennes, palpes, pattes, sommet et bords latéraux de l'apophyse coxale d'un roux ferrugineux rembruni sur les pattes postérieures.

Longueur: 2.8 à 3 millimètres.

Types: Luzon, Laguna, Los Baños (*Baker*), 3 individus.

Espèce extrêmement voisine, à première vue, du *Canthyrus guttula* Aubé de Madagascar et d'Afrique tropicale, et confondue avec celle-ci par le Dr. M. Régimbart.¹ Elle en diffère par sa forme un peu moins convexe, par sa tache élytrale transverse (elle est ronde et plus grande chez *C. guttula* Aubé), et surtout par sa réticulation bien caractéristique. Celle-ci, chez *C. guttula* Aubé, est formée sur le pronotum de mailles très fortement transverses (plus de quatre fois plus larges que longues) dont les bords latéraux, plus imprimés, déterminent des lignes longitudinales flexueuses bien visibles. Enfin la ponctuation élytrale du *C. guttula* Aubé est beaucoup plus imprimée, la série latérale est

¹ Ann. Soc. Ent. France (1889) 247.

bien visible, prolongée avec la série discale jusqu'au sommet, où elles sont entremêlées de points épars assez nombreux et bien imprimés.

Ces caractères, très constants, permettent de différencier nettement ces deux espèces.

Distribution géographique.—Philippines: Los Baños (types); Nouvelle-Guinée: Rigo; Timor; Causip² (collection M. Régimbart, sous le nom de *Canthydrus guttula* Aubé); Laos: Xiengkhouang; Vientiane; Son Hat (Vitalis de Salvaza).

² Cette localité de Causip est énigmatique et ne figure sur aucune carte: le Dr. M. Régimbart la situe avec doute dans les Philippines ou à Bornéo (voir *Hydrocoptus scapularis* Rég.).

POSITION AND SIZE OF THE KIDNEYS AMONG FILIPINOS¹

By JUAN C. NAÑAGAS

*Of the Department of Anatomy, College of Medicine and Surgery,
University of the Philippines*

THREE TEXT FIGURES

This preliminary report on the study of the position and the size of the kidneys among Filipinos is based upon measurements of forty-eight cases from the dissection laboratory of the department of anatomy, of which twenty-four were males and twenty-four females.

I am considering in this paper only the position and the measurements of the organ. The incompleteness of the work is principally due to the limitations attendant upon the dissection of cadavers and to the lack of facilities for studying the other renal conditions in fresh cadavers.

POSITION OF THE KIDNEYS

Some textbooks in anatomy and surgery would lead one to believe that the kidneys are invariably placed in a fixed position. This so-called "normal position," however, is in reality an indefinite condition. Its determination is beset with serious difficulties, for many are the factors which influence the variability of its location. Among the principal factors of influence we may mention:

Congenital lax condition or absence of renal fascia or peritoneal support (perinephric and paranephric fat).

Ptoses of neighboring viscerae, or any abnormal position of the surrounding organs.

Pregnancy, intra-abdominal tumors, accumulations of fluid or their disappearance, thereby producing laxity and weakness of the abdominal wall.

Atonicity of the posterior muscles of the abdomen, especially of those concerned with the formation of the renal fossa, occurring either locally or as part of the general weakness of the body musculature.

¹ Read before the Manila Medical Society, October 4, 1920.

Elongation of the renal vessels under such accidental conditions as jars, jolts, etc., caused by jumping, falling, coughing, tight lacing, etc., which tend to lengthen those vessels as well as to stretch the peritoneum.

Changes due to different postures assumed by the body and to respiratory movements.

In my determination of the renal position, I have used as points of reference the vertebral column for the horizontal planes of the renal poles and the mid-dorsal line of the body in relation to the vertical planes of the medial and lateral borders. I have not considered relations to any great extent because of the fact that the material in the hands of the students did not offer reliable fixed relations and, moreover, the relatively long period of time elapsing between death and embalment made difficult a study of this part of the subject.

I deplore that more points of reference such as the iliac crest, ribs, umbilicus, etc., are not considered in this paper. To have considered these would have necessitated delays in the dissection work, which could not very well be afforded.

I was able to collect data relative to the levels of the renal poles in thirty-four cases, eighteen males and sixteen females.

In general I found the relative levels of the kidneys as follows:

	Cases.	Per cent.
Right kidney lower than left.....	27	79.4
Right kidney higher than left.....	4	11.7
Right and left kidneys at level.....	3	8.8

My detailed findings are recorded in Table 1 and illustrated by fig. 1, the latter adapted from Rauber-Kopsch,(4) from which we deduced the following:

UPPER POLES OF THE KIDNEYS

The upper right pole in males occupied a level varying from the upper third of the second lumbar vertebra to the middle of the eleventh dorsal, while that of the female was found from the disk between the first and second lumbar vertebræ to the disk between the eleventh and twelfth dorsal.

In the left side in males the kidney varied in level from the disk between the first and second lumbar vertebræ and the upper third of the eleventh dorsal, and in females it was found between the middle of the first lumbar vertebra and the lower third of the eleventh thoracic.

TABLE 1.—Vertebral levels of the two kidneys in the two sexes.

POSITION OF THE UPPER POLE.

Vertebral level.	Right kidney.				Left kidney.			
	Male.		Female.		Male.		Female.	
	Cases.	Per cent.	Cases.	Per cent.	Cases.	Per cent.	Cases.	Per cent.
XI.....	3	16.6	0	0.0	3	16.6	1	6.2
XI and XII.....	1	5.5	1	6.2	6	33.3	4	13.0
XII.....	11	61.0	7	43.7	6	33.3	6	37.5
XII and I.....	1	5.5	2	12.5	2	11.1	3	18.7
I.....	1	5.5	5	31.2	0	0.0	2	12.5
I and II.....	0	0.0	1	6.2	1	5.5	0	0.0
II.....	1	5.5	0	0.0	0	0.0	0	0.0
POSITION OF THE LOWER POLE.								
Vertebral level.	Right kidney.				Left kidney.			
	Male.		Female.		Male.		Female.	
	Cases.	Per cent.	Cases.	Per cent.	Cases.	Per cent.	Cases.	Per cent.
II.....	1	5.5	1	6.2	1	5.5	1	6.2
II and III.....	0	0.0	0	0.0	4	22.2	1	6.2
III.....	9	50.0	7	43.7	9	50.0	8	50.0
III and IV.....	4	22.2	5	31.2	2	11.1	2	12.5
IV.....	1	5.5	1	6.2	2	11.1	2	12.5
IV and V.....	2	11.1	0	0.0	0	0.0	2	12.5
V.....	1	5.5	2	12.5	0	0.0	0	0.0

In 61 per cent of the male cases I found the right upper pole at the level of the twelfth dorsal vertebra, and in 33.3 per cent the left upper pole was either at the level of the twelfth thoracic vertebra or at the disk just above it. In both sides the next frequent levels were higher.

In 43.7 per cent of the female cases the right upper pole was found at the level of the twelfth dorsal vertebra, and in 37.5 per cent the left; in the other cases they were below these points.

It will be seen, therefore, that the upper poles in the two sides reached a higher level in males than in females by half of one vertebra.

LOWER POLES OF THE KIDNEYS

The right renal pole in males was found in varying levels from the middle of the fifth lumbar vertebra to the middle

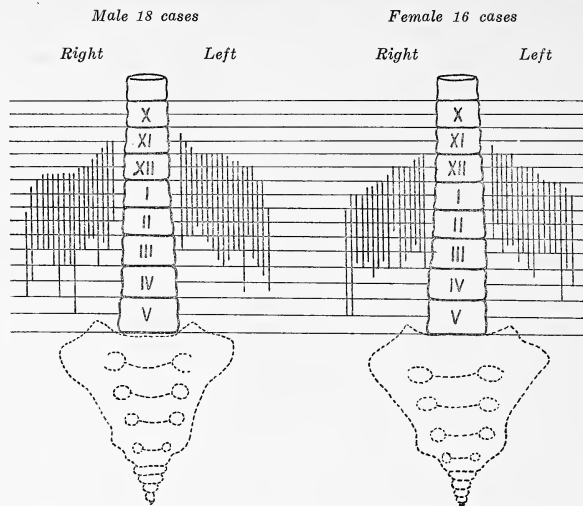

FIG. 1. Varying positions of the kidneys in the two sexes in Filipinos; thirty-four cases.

of the second, while in females it was between the middle of the fifth and the lower third of the second lumbar.

The highest level, therefore, reached in males was higher than in females by one-third of one vertebra, but the lowest level was the same in both sexes.

The left lower pole in males was between the lower third of the fourth lumbar vertebra and the lower third of the second; in females, between the disk of the fourth and fifth lumbar vertebrae and the middle of the second. The highest female level was one-third of one vertebra higher than that of the males, while the lowest female level was lower than that of the males by the same extent.

In terms of percentage, I found that the lower pole was at the level of the second lumbar vertebra in 50 per cent of the males, and in 43.7 to 50 per cent of the females, the tendency being downward in females and in the right side of males, and upward in the left side of the males.

Piersol(3) states that the kidneys ordinarily are found opposite the twelfth dorsal and the upper two lumbar vertebrae;

I found them opposite the twelfth and extending to the body of the third lumbar. This agrees with Addison's(1) findings. I agree with Piersol's(3) statement that the axial level of the two organs is subject to considerable variation, differing even in the two sides of the same individual.

All authors consulted claimed that the right kidney was lower than the left in both sexes. This I have been able to confirm in 79.4 per cent of my cases, though 11.7 showed reversed conditions.

I further found that the male kidneys were correspondingly higher than the female, although in a few cases the lowest level in the female right lower pole was the same as in that of the male.

As to measurements of the borders of the kidneys with relation to the mid-dorsal line, I am sorry to be able to record data from only six cases; my results are tabulated below.

TABLE 2.—Distances of renal borders to mid-dorsal line of abdomen.

MEDIAL SUPERIOR BORDER FROM MID-DORSAL.

No.	Male.		Female.	
	Right.	Left.	Right.	Left.
	cm.	cm.	cm.	cm.
1.....	4.0	3.5	2.8	2.0
2.....	3.0	3.2	3.0	2.5
3.....	3.0	2.0	-----	-----
4.....	3.3	3.3	-----	-----
Average.....	3.3	3.0	2.9	2.2

LATERAL INFERIOR BORDER FROM MID-DORSAL.				
No.	Male.		Female.	
	Right.	Left.	Right.	Left.
	cm.	cm.	cm.	cm.
1.....	8.2	8.5	7.2	6.2
2.....	8.5	8.5	9.3	8.1
3.....	10.0	9.3	-----	-----
Average.....	8.9	8.8	8.2	7.1

We can deduce two general conclusions from the above table:

1. That, regardless of sex, the right kidney is found further from the median plane than the left.

2. That, in corresponding sides, it is found further from the median line in males than in females.

Such findings are in accord with those of Cunningham,(2) and others.

DIMENSIONS OF THE KIDNEYS

I have records of forty-eight cases, twenty-four males and twenty-four females. My results are shown in Table 3 and figs. 2 and 3.

TABLE 3.—Dimensions of the kidneys at different ages in the two sexes.
[Dimensions are given in centimeters.]

MALE.							
Age.	Cases.	Right.			Left.		
		Length.	Width.	Thick-ness.	Length.	Width.	Thick-ness.
<i>Years.</i>							
20 to 30.....	6	9.75	6.07	3.92	10.13	5.96	4.10
30 to 40.....	9	9.88	5.50	3.50	10.87	5.74	3.30
40 to 50.....	3	9.36	5.90	3.50	9.56	4.95	3.50
50 to 60.....	3	9.23	4.90	3.50	9.60	4.50	3.50
60 to 70.....							
70 to 80.....	2	8.50	4.6	4.50	10.25	5.15	4.40
80 and over.....	1	8.00	5.00	2.00	8.00	4.20	3.00
General average.....	24	7.82	4.56	2.99	8.34	4.36	3.11
FEMALE.							
Age.	Cases.	Right.			Left.		
		Length.	Width.	Thick-ness.	Length.	Width.	Thick-ness.
<i>Years.</i>							
20 to 30.....	5	10.12	5.26	4.30	10.50	5.14	4.42
30 to 40.....	1	9.80	4.50	3.40	10.20	4.80	3.30
40 to 50.....	4	9.40	5.20	3.10	10.05	4.67	3.00
50 to 60.....	2	10.00	5.00	4.20	9.00	6.50	4.50
60 to 70.....	2	8.65	4.25	3.05	8.70	4.50	2.95
70 to 80.....	3	7.63	4.43	3.60	7.70	4.80	3.45
80 and over.....	7	8.50	4.45	3.50	9.05	4.71	3.00
General average.....	24	9.16	4.73	3.59	9.31	5.02	3.52
MALE AND FEMALE.							
Age.	Cases.	Right.			Left.		
		Length.	Width.	Thick-ness.	Length.	Width.	Thick-ness.
<i>Years.</i>							
20 to 30.....	11	9.93	5.64	4.11	10.32	5.55	4.26
30 to 40.....	10	9.84	5.00	3.45	10.80	5.10	3.30
40 to 50.....	7	9.38	5.57	3.30	9.80	4.81	3.20
50 to 60.....	5	9.76	4.93	3.85	9.30	5.50	4.00
60 to 70.....	2	8.65	4.25	3.05	8.70	4.50	2.95
70 to 80.....	5	8.06	4.51	4.05	8.97	4.97	3.92
80 and over.....	8	8.25	4.72	2.75	8.52	4.45	3.00
General average.....	48	9.12	4.95	3.47	9.49	4.98	3.66

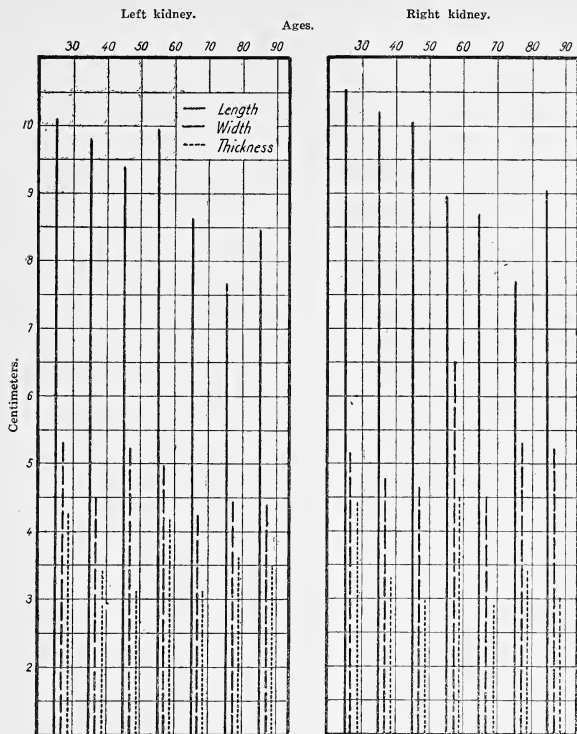

FIG. 2. Dimensions of the kidneys of females in relation to age.

From the above we find that in general the left kidney is larger than the right, exceeding it by 0.37 centimeter in length, 0.03 centimeter in width, and 0.19 centimeter in thickness. Piersol(3) bears out my findings with reference to the larger size of the left kidney.

The female kidneys were decidedly larger than those of the males, taken in general or by corresponding sides.

In relation to different ages, I found a gradual increase in size, which in males attained its maximum at the age of 30 to 40 years, a gradual decline being noted with advancing age.

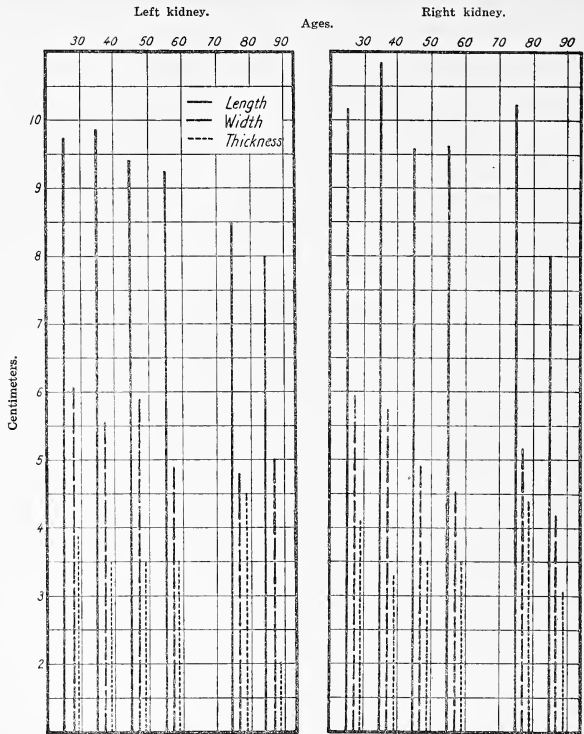

FIG. 3. Dimensions of the kidneys of males in relation to age.

In females there is also an increase in size up to the age of 30 and a very slow diminution up to the age of 80, with a secondary increase beyond that time.

SUMMARY

Briefly, my findings may be summarized as follows:

1. The kidneys were in general at higher levels in males than in females.
2. The variability of the horizontal planes of both kidneys was greater in males than in females.

3. The upper pole of both male kidneys was generally found at the lower half of the twelfth dorsal vertebra, and in the case of the left often at the level of the disk above it, with a tendency in both sides to be higher. In females it is also found at the level of the twelfth dorsal vertebra, though apparently not so frequently as in males, with a tendency to occupy lower levels.

4. The right kidney is found farther from the median line of the back than the left, regardless of sex, and in corresponding sides it is found farther from that point in males than in females.

5. In general the left kidney is larger than the right.

6. The female kidneys, considered either in general or by corresponding sides, were larger than those in the males.

7. There is a gradual increase in size of both kidneys with age, up to a certain maximum, attained in males between 30 and 40 years, and in females up to the age of 30 with a gradual decline thereafter.

I wish to thank Dr. Arturo Garcia for helpful suggestions in the preparation of this paper.

REFERENCES

1. ADDISON, CHRISTOPHER. *Journ. of Anat. and Phys.* 35 (1901) 294.
2. CUNNINGHAM. *Text book of Human Anatomy*, 5th ed. Wm. Wood & Co. (1918) 1425.
3. PIERSOL. *Text book of Human Anatomy*, 1st ed. Lippincott & Co. (1907) 1870.
4. RAUBER-KOPSCH. *Lehrbuch der Anat. des Menschen* 4 (1909) 241.

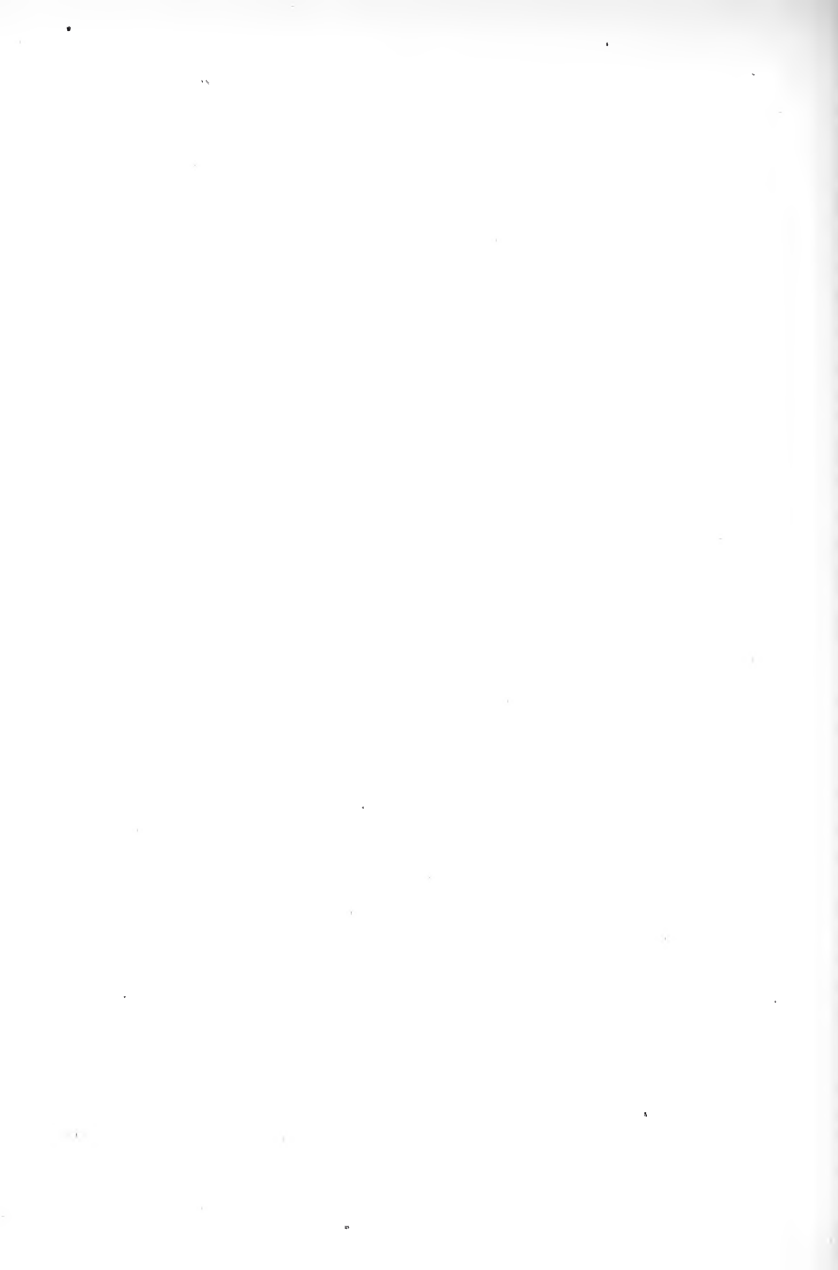

ILLUSTRATIONS

- FIG. 1. Diagram showing vertebral levels of kidneys in the two sexes.
2. Chart showing dimensions of kidneys in females.
3. Chart showing dimensions of kidneys in males.

LENGTH AND POSITION OF THE VERMIFORM APPENDIX IN FILIPINOS¹

By ARTURO GARCIA and JUAN SOLLOZA

*Of the Department of Anatomy, College of Medicine and Surgery,
University of the Philippines*

ONE TEXT FIGURE

The present paper covers a short preliminary anatomical survey of the vermiform appendix in Filipinos and is intended to be followed by a more comprehensive study. While the work may be devoid of clinical interest and importance, yet it is felt that, from the anatomical point of view at least, it may initiate a series of investigations on the anatomy of the other organs which may establish some fixed Filipino standards.

We are here considering only the length and the position of the appendix. Our series includes some three hundred forty cases, the majority of which were autopsied in the department of pathology, which naturally limited the scope of our work. Some of our measurements were taken by Dr. Juan C. Nañagas, of the department of anatomy, and in a few cases by ourselves. In the latter instances, we have invariably measured the appendix in situ, following uniformly the same technic in every case. The position of the appendix was first studied while in the body, and, after dissecting away the mesoappendix, we measured the organ stretched in a straight line on a flat surface.

The distribution of our cases is as follows:

TABLE 1.—*Distribution of the cases.*

Age.	Females.	Males.	Total.
CHILDREN.			
Stillbirths.....	85	54	-----
Under 1 year.....	34	26	-----
Between 1 and 14 years.....	26	11	236
ADULTS.			
Between 14 and 20 years.....	12	9	-----
Between 20 and 30 years.....	19	12	-----
Between 30 and 40 years.....	13	9	-----
Between 40 and 50 years.....	11	1	-----
Between 50 and 60 years.....	3	3	-----
Between 60 and 70 years.....	6	2	-----
Between 70 and 80 years.....	1	3	104

¹ Read before the Manila Medical Society, October 4, 1920.

LENGTH OF THE APPENDIX

Notwithstanding the fact that Berry,⁽¹⁾ in his detailed survey of one hundred cases, claimed that the length of the vermiform appendix is not so variable nor so long as textbooks would lead one to believe, yet the review of the literature on the subject has convinced us that the range of variation of this measurement is indeed great. Tables 2 and 3 give an idea of such variation:

TABLE 2.—Showing extremes and combined general average in length of appendix.

Authors.	Cases.	Extremes of length.	Combined average.
		<i>cm.</i>	<i>cm.</i>
Piersol(21)		1.0-24	8.4
Jackson and Morris(12)		2.0-25	8.0-10.0
Fawcett and Blachford(6)	350	1.5-19	8.44
Berry(1)	100	3.1-13.3	8.3

TABLE 3.—Showing combined general average length of appendix in children and adults.

Authors.	Cases.	Combined average in—	
		Adults.	Children.
		<i>cm.</i>	<i>cm.</i>
Valentin(35)		(^a)	4
Couveilhier(4)		3-16	
Krause(15)		5.4-8.1	
Luschka(18)		5-8	
Tarenetzki(52)		^b 8.6	6.6
Tarenetzki(32)		^c 6.6	
Nowicki(20)	420	7.4	
Fillimoski(8)	100	6-8	
Clado(3)		8	
Ribbert(23)	400	8.3	
Berry(1)	100	8.3	
Fawcett and Blachford(6)	350	8.4	
Sprengel(29)	98	8.5	
Sudsuki(30)	500	8.6	
Kelynack(14)		9.0	
Struthers(31)		9.0	
Bryant(2)		9.0	
Smith(27)		9.0	
Fowler(10)		9.0	
Ransohoff(22)		10.2	
Treves(33)		10.2	
Ferguson(7)		11.4	

^a Newly born.

^b Adults up to 49 years.

^c Adults up to 83 years.

Our three hundred forty cases showed extremes of length to be 2 centimeters and 20, the combined average being 8.5.

Regarding the general average of the appendicial length, we found that different authors obtained different results. We give below another table setting forth these facts:

In our three hundred forty cases the combined average length in adults was 8.5 centimeters.

From Table 3 we can deduce that the average length, as measured by different authors, is a variable factor. We might perhaps account for this variability by differences in technic and the probable fact that the point of commencement of the appendix is not uniformly determined by the different investigators. Following the procedure of Berry,⁽¹⁾ averaging the different general averages in order to minimize the coefficient of error, we have found the combined average of all to be from 7.7 to 8.6 centimeters.

The shortest appendix on record is reported by Fawcett and Blachford,⁽⁶⁾ to be 1.5 centimeters. Unusually long appendices were reported up to the present as follows:

	cm.
Sonneberg (28)	25
Lafarelle (16)	23
Luschka (18)	23
Ribbert (23)	21

In our series, the shortest was 2 centimeters and the longest 20.

Textbooks as a rule state the average length of the appendix without any reference to age or sex relation. Berry and Nowicki claimed to have obtained definite variations in these relations. On the other hand, Fawcett and Blachford⁽⁶⁾ conclude that, while there may be a definite relation between the length and the sex, the relation to age is not very conclusive. Tables 4 and 5 illustrate these points.

While no sweeping conclusion can be drawn from these tables, yet we agree with Nowicki⁽²⁰⁾ that there is a gradual, steady growth in the length of the appendix up to a certain age, which in his cases happened to be between 20 and 40 years (in ours between 20 and 50), from which time a gradual decline is noted until, at the age of 80 or over, he found the difference or loss to be about 1 inch, while our combined average was 4.4 centimeters less than our longest average.

The general statement frequently made that the appendix is longer in the young than in the aged appears to find confirmation in our findings as well as in those of the authors quoted in tables 4 and 5.

TABLE 4.—Relation of length of appendix to age.

Age.	Fawcett and Blachford. (6)		Nowicki. (20)		Berry. (1)		Our cases.	
	Cases.	Average length.	Cases.	Average length.	Cases.	Average length.	Cases.	Average length.
		cm.		cm.		cm.		cm.
Birth to 10 years				5.2	18	7.4	229	4.2
10 to 20 years	9	8.0		7.2	1	11.5	29	8.1
20 to 30 years	31	7.7		8.4	8	8.8	31	8.6
30 to 40 years	65	9.06		8.8	19	8.9	22	8.6
40 to 50 years	66	8.5		8.7	15	8.3	12	9.6
50 to 60 years	59	8.66		8.0	18	8.3	6	8.0
60 to 70 years	58	8.62		7.7	5	8.0	8	8.2
70 to 80 years	49	7.48		6.9	6	7.6	3	5.2
80 to 90 years	10	8.8		6.3				
90 to 100 years	3	7.3		6.0				

TABLE 5.—Showing relationship of the length of appendix to age and sex.

Age.	Fawcett and Blachford. (6)				Nowicki. (20)				Our cases.			
	Male.		Female.		Male.		Female.		Male.		Female.	
	Cases.	Average.	Cases.	Average.	Cases.	Average.	Cases.	Average.	Cases.	Average.	Cases.	Average.
		cm.		cm.		cm.		cm.		cm.		cm.
Stillbirths						3.3		3.0	85	3.7	54	3.6
Under 1 year ^a						5.0		5.4	34	4.1	26	4.1
1 to 10 years						7.0		7.3	21	7.0	9	6.6
10 to 20 years	5	9.2	4	6.5		8.8		8.0	17	8.1	12	7.9
20 to 30 years	13	8.92	18	6.8		9.5		8.2	19	9.3	12	7.8
30 to 40 years	43	8.95	22	9.2		9.5		8.0	13	9.4	9	7.5
40 to 50 years	40	8.96	26	7.9		8.6		7.4	11	9.6	1	9.0
50 to 60 years	32	9.1	27	8.1		8.4		7.1	3	10.1	3	6.0
60 to 70 years	30	9.4	28	7.7		7.7		6.1	6	8.4	2	7.5
70 to 80 years	24	7.8	25	7.1		5.5		6.6	1	6.0	2	4.8
80 to 90 years	8	8.4	2	10.3		(^b)						
90 to 100 years	2	7.0	1	8.0		6.0		6.0				

^a Vallée (36) as cited by Scammon (25) in an analysis of 100 cases of infants from birth to 1 year gives the length of the appendix from 2.5 to 13.0 centimeters with an average of 4.6.

^b Over 80 years.

As to the relation between sexes the majority of the authors seem to agree that, in general, the appendix of the male is longer than that of the female.

In our cases the male appendix averaged 9.10 centimeters and the female, 7.30.

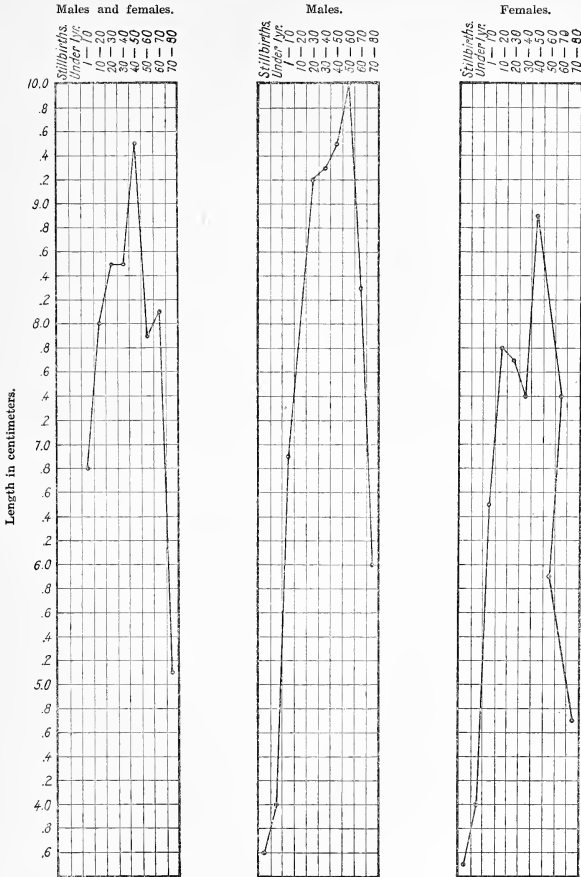

FIG. 1. Length of appendix in relation to age.

On the other hand, Finnell(9) and Kelynack(14) reverse the above findings. The former gives an excess of 1 centimeter and the latter 1.4 millimeters in favor of females. The excess found

	Male average.	Female average.
	<i>cm.</i>	<i>cm.</i>
Fawcett and Blachford(6).....	8.88	7.87
Nowicki(20).....	7.40	7.20
Berry(1).....	8.60	8.00

by Kelynaek(14) is so small that it may be ascribed to an error of procedure. The difference in our figures appears larger than that of other investigators, and we believe this to be due to the personal equation because, as stated in the forepart of this paper, our measurements were taken by several persons.

It is said that the length of the appendix has an important bearing upon the functional activity of the organ and that it plays a part in the etiology of appendicitis. It is certainly conceivable that a long appendix is more prone to become adherent in any pericæcal inflammatory process or hernial formation than a short one.

POSITION OF THE APPENDIX

We must realize from the start that the position of the vermiform appendix, even in normal conditions, is exceedingly variable. The absence of adhesive bands, its great mobility in the abdomen, the influence of such factors as the contents of the bowel, the pelvis, and various other conditions which affect its topography make the task of defining the position of the appendix a very difficult and uncertain proposition.

Robinson(24) says that the position of the appendix is greatly influenced by the following factors:

- Length of the mesoappendix.
- Degree of fullness of the stomach, colon, cæcum, etc.
- The size and position of the uterus.
- The sex of the individual.
- Pressure and rigidity of the abdominal wall.
- Presence or absence of adhesions.

To the above conditions Nowicki(20) further adds the uncertainty of the point of the cæco-appendicial union. Moreover, the conditions in the abdominal cavity of the living are so different from those in the dead that Piersol(21) goes so far as to say: "The position after death is, except in certain cases, no guide to that during life."

Cunningham⁽⁵⁾ and Berry⁽¹⁾ attempt to classify appendicial positions into:

- The pelvic position.
- The retrocæcal position.
- The inward position (pointing toward spleen).
- Variable.

They lay special emphasis upon the futility of assigning any percentage of frequency to any one of the positions, but believe that they occur in the order given.

Giannelli,⁽¹¹⁾ in his topographic study of the vermiform appendix in fifty cadavers, classified them as follows:

	Per cent.
Retroileal	36.3
Retroileal-mesenteric	31.5
Retrocæcal	22.7
Pelvic	9.0

Regarding direction he reports:

Retroileal and pelvic, the appendix is rectilinear.

Retroileal and retroileal-mesenteric, it either forms an ansa or a figure of 8.

Piersol⁽²¹⁾ claims that, in the majority of cases, the appendix is wholly behind the cæcum, either below or mesial to it.

Ferguson,⁽⁷⁾ in a record of one hundred twenty-three cases of presumably normal appendix, found the organ hanging downward in eleven cases; placed mesially in eighteen; on the right of the cæcum in nineteen; and behind it in seventy-five.

Müller⁽¹⁹⁾ says that of all the various positions of the appendix, the "positive sub coecal" is the most commonly found.

Waldeyer⁽³⁷⁾ regards the pelvic position, or that in which the appendix overhangs the brim of the pelvis crossing the iliopsoas muscle and common iliac vessels, as the normal and most common position. Nowicki⁽²⁰⁾ agrees with him and claims to have found it in one hundred eighty-nine cases out of a series of four hundred twenty. He believes the downward and the lateral positions to be rare, being present in only seventeen cases of his series. In forty-five he found the appendix to be retrocæcal; in forty-eight directed upward (forty upward and medially and eight upward and laterally); in fifty-eight (forty men and eighteen women) the appendix was parallel to the ileum up to the ileocæcal junction, in which position Jawroski and Lapinski⁽¹³⁾ believed that it was palpable in 51 per cent of the eight hundred cases which they studied.

Schoppler⁽²⁶⁾ and Liertz⁽¹⁷⁾ consider the antecæcal position as very rare.

We found Turner's⁽³⁴⁾ classification of the topography of the appendix the most varied and complete in details. He gives the following types:

Appendix lies free in the abdominal cavity.

	Cases.
Hangs down in the pelvis proper	51
Lies across the psoas toward the promontorium	20
Lies free on the musculus iliacus or psoas	6
Runs parallel to the lateral surface of the colon	2
Lies in the central abdominal region, under the right part of the colon transversum	2
Lies under the sigmoid flexure in the right iliac region	1
Total	82

Appendix lies behind the initial part of the colon ascendens between this and the posterior abdominal wall or iliac wall.

	Cases.
Lies rolled up behind the ileo-cæcal junction	4
Lies behind the cæcum bent into the fossa subcæcalis	5
Runs along the posterior or the posteromedial surface of the colon upward	6
Runs the same way but completely extraperitoneal	2
Same as the next preceding but only partially extra- peritoneal	4
Lies beyond the cæcum which has previously turned up and backward	?

From the above different classifications we can deduce that the range of positions in which the adult appendix may be found is indeed great. If we further consider the pathologic immobilizations which may affect it, we can conclude that to set a definite position for the appendix is next to impossible. There are even cases in which the topographic variability of the appendix has gone beyond the confines of the abdominal cavity, when it was found included either in inguinal, or femoral, or other types of hernial protrusions.

It seems, however, the consensus of opinion that, among the more frequent positions, the "pelvic type" is the most commonly encountered and the "antecæcal" the most rare. In children, especially in those of tender age, the difficulties of classifying positions become more apparent for the reason that we must consider, in addition, the mobility and the descent of the cæcum.

In studying the position of the appendix we were able to find topographic records of thirty-five adult cases and of

seventy-five children. Seventeen per cent of the adults showed adhesions; in children, with the exception of two cases, the appendix was lying free in the abdominal cavity.

Following Turner(34) we divided the positions encountered into:

Appendix found behind the cæcum, behind the colon, or behind the ileum.

Retrocæcal, where the appendix is behind the cæcum coiled upon itself, or crossing toward the median line or laterally, or lodged in the subcæcal fossa.

Retrocolic where the appendix is lying behind the ileum running upwards either along the posteromedial or posterolateral border of the colon.

Retroileal, where the appendix is behind the ileocæcal junction curled upon itself or winding around the ileum.

Appendix found below the cæcum.

Subcæcal, where the appendix is found below the cæcum in the fossa iliaca dextra crossing the iliopsoas muscle either toward the promontory or turning laterally toward the iliac spine, or simply coiled on itself and pointing downward.

Pelvic, where the appendix is found overhanging the brim of the true pelvis.

Antecæcal, appendix found in front of the cæcum.

Anteileal, appendix found in front of the ileocæcal junction.

We found adult cases distributed as follows:

Retrocæcal, 28 cases (21 males, 7 females), or 80 per cent.

Retroileal, 3 cases (2 males, 1 female), or 8.5 per cent.

Subcæcal, 2 cases (males), or 5.7 per cent.

Anteileal, 1 case (male), or 2.8 per cent.

The cases of children were distributed as follows:

Subcæcal, 31 cases (21 males, 10 females), or 41.3 per cent.

Retrocæcal, 15 cases (12 males, 3 females), or 20 per cent.

Retrocolic, 15 cases (10 males, 5 females), or 20 per cent.

Retroileal, 12 cases (7 males, 5 females), or 16 per cent.

Antecæcal or anteileal, 2 cases (1 male, 1 female), or 2.6 per cent.

Our results in adults seem to agree with those of Gianelli(11) in that the retrocæcal and retroileal positions were most frequent, differing, however, in that we found the retrocæcal position the commonest, while in his series the retroileal was most frequently encountered. Piersol(21) and Ferguson(7) also reported similar findings; but others, among them Waldeyer, (37) Nowicki,(20) Turner,(34) Cunningham,(5) and Berry,(1) have made the statement that the "pelvic position" was the most frequently encountered and some of them have even gone so far as to claim that this position was "normal." We have not found it in a single case.

We can confirm the statement that "antecæcal positions" are infrequent. We met it in only 2.8 per cent of our adults and in 2.6 per cent of the children.

The appendix in the children was situated higher in the right lumbar region, in front of the kidney and just below the liver. The subcæcal position was the common position encountered, and the retro positions came next. The pelvic position was not seen. These facts are to be expected because of the progressive descent of the cæcum and the appendix in childhood.

While it is rather difficult to draw very definite conclusions from the above work, due to its rather incomplete nature, yet we can safely deduce the following salient facts:

1. That the length of the human appendix is very variable and does not seem to keep any definite relation to race.
2. That in Filipinos the length of the appendix bears a definite relation to age, being relatively longer in younger than in older persons and, furthermore, that it gradually grows in length with age, attaining its maximum between the ages of 20 and 50 years, gradually declining thereafter.
3. That it is longer in males than in females.
4. That it is higher in children than in adults and that in the former the subcæcal is the commonest position and the retrocæcal in the latter, the antecæcal being very rare in either.
5. That the pelvic position considered normal by some authors was not even found in this series and must be considered infrequent in Filipinos.

Our thanks are due to Prof. H. Windsor Wade, of the department of pathology and bacteriology, for courtesies extended in turning over to us the records of autopsies of his department, and to Dr. Juan C. Nañagas for permitting us to include in this work his measurements of the appendix.

REFERENCES

1. BERRY. *Anat. Anz.* 10 (1895) 761.
2. BRYANT. *An. Surg.* 17 (1893) 164.
3. CLADO. *Compt. Rend. Soc. de Biol.* (1892) 133.
4. COUVEILHIER. Cited by Nowicki.
5. CUNNINGHAM. *Text book of Human Anatomy*, 5th ed. W. Wood (1918) 1215.
6. FAWCETT and BLACHFORD. *Proc. Anat. Soc. Great Britain & Ireland. Journ. Anat. & Physiol.* 34 (1900) xx-xxiii.
7. FERGUSON. *Am. Journ. Med. Sci.* 101 (1891) 62.
8. FILLIMOSKI. Cited by Nowicki.
9. FINNELL. *Med. Rec.* 4 (1869) 66.
10. FOWLER. *An. Surg.* pt. 13 (1894) 6.

11. GIANNELLI. *Archiv. Ital. de Biol.* 41 (1904) 474.
12. JACKSON and MORRIS. *Text book of Human Anatomy*, 5th ed. P. Blakiston's Sons & Co. (1914) 1173.
13. JAWROSKI and LAFINSKI. Cited by Nowicki.
14. KELYNACK. Cited by Nowicki. *The Pathology of the Vermiform Appendix* (1893).
15. KRAUSE. Cited by Nowicki.
16. LAFARELLE. Cited by Nowicki and by Sprengel.
17. LIERTZ. Cited by Schoppler.
18. LUSCHKA. Cited by Nowicki.
19. MÜLLER. Cited by Nowicki.
20. NOWICKI. *Virch. Archiv. Anat.* 195 (1909) 175.
21. PIERSOL. *Text book of Human Anatomy*, 1st ed. Lippincott & Co. (1907).
22. RANSCHOFF. *Journ. Am. Med. Assoc.* 11 (1888) 40.
23. RIBBERT. *Beitr. z. norm. u. path. Anat. des. wormf. Dies. Arch.* 132, cited by Nowicki.
24. ROBINSON. *Am. Journ. Obst.* (1903) cited by Nowicki.
25. SCAMMON. *Tables of foetal measurements* (unpublished).
26. SCHOPPLER. *Wiener med. Wochenschr.* 60 (1910) 2882.
27. SMITH. *Journ. Am. Med. Assoc.* 10 (1888) 77.
28. SONNEBERG. Cited by Nowicki.
29. SPRENGEL. *Stuttgart* (1906) cited by Nowicki.
30. SUDSUKI. *Mittheil. aus d. Grenzgeb.* 7 (1901); cited also by Nowicki.
31. STRUTHERS. Cited by Berry.
32. TARENETZKI. Cited by Nowicki.
33. TREVES. Cited by Berry.
34. TURNER. *Zentralblatt f. Chir.* (1892) 840.
35. VALENTIN. Cited by Nowicki.
36. VALLEÉ. Cited by Scammon.
37. WALDEYER. Cited by Nowicki.

ILLUSTRATION

TEXT FIGURE

FIG. 1. Length of appendix in relation to age.

PHILIPPINE AND BORNEAN SPECIES OF HOPLIONOTA
(COLEOPTERA)¹

By FRANK SPAETH

Of Vienna, Austria

Through the kindness of Dr. L. O. Howard of the Bureau of Entomology, United States Department of Agriculture, I have received two small collections containing Cassidæ, collected during recent years in the Philippines, Singapore, Penang, and Borneo by Prof. Charles F. Baker. Among the specimens I found the new species of *Hoplionota* described in this paper, which bring the number of species of this interesting genus, that are known from the Philippines, up to fifteen, of which nine have been discovered by Professor Baker.

Hoplionota dapitana sp. nov.

Oblong-quadrata, parum convexa, nitida, rufotestacea, discis prothoracis elytrorumque laete ferrugineis, elytris biseriatim nigro-tuberculatis; antennae breves clava valde incrassata; crista frontalis oculos sat superans, apice dilatata et subtruncata; prothorax brevis, transversus, disco laevi, transversim biimpresso ibique punctato, lateribus profunde, crebre punctatis; elytra prothorace parum latiora, lateribus subparallelis, disco punctatostriato sinecarinis; protectum deplanatum, sat crebre punctatum; femora antica sat incrassata; 5.5 x 4.25 mm.

MINDANAO, Dapitan (*Baker*).

Rechteckig, nicht ganz doppelt so lang als breit, schwach gewölbt, glänzend, unten gelb, oben rötlich-gelb, die Scheiben des Halsschildes und der Flügeldecken hell rostrot, welche Färbung hinter der Seitendachbrücke auf den inneren Teil des Seitendaches verbleichend ausläuft; die Flügeldecken mit schwarzen Höckern.

Kopfschild rechteckig, doppelt so lang als breit, mit lanzettförmigem, grubig ausgehöhltem Mittelstück; die Stirnlinien schwach gebogen, an der Fühlerwurzel zusammenstossend, hier

¹ In the present paper the critical notes following the descriptions are published in German as written by the author. The title and introduction have been translated into English.—EDITORS.

vom Augenrand weit entfernt; die Kopfplatte vor die Augen weit vorgezogen und hier erweitert, an der Spitze abgestutzt, mit einer kaum merklichen Ausrandung und verwachsener Naht. Fühler hell rötlich, kurz, die Halsschildseiten nicht erreichend, mit 4-gliederiger, stark verdickter Keule; das fünfte und siebente Glied länger als die anderen, das neunte und zehnte mehr als doppelt so dick als lang.

Halsschild kurz, mehr als doppelt so breit als lang, mit trapezförmigem Ausschnitt; die Basis ausserhalb der Basalzähnen schwach vorgezogen, die Hinterecken stumpf gerundet, fast schon in der Längsmittle, die Seiten nach vorne sehr schräg, schwach gebogen, gesägt; die Scheibe bis auf die punktierten zwei Quereindrücke glatt, die Seiten des Vordaches mit sehr groben, ziemlich dichten Punkten.

Flügeldecken wenig breiter als der Halsschild, an der Basis abgestutzt, die Seiten bis vor die Mitte sehr schwach erweitert, dann fast parallel; die Scheibe sehr flach gewölbt mit bis zum Abfall sehr schwach ansteigender, gerader, dann in schnellem Bogen abfallender Profillinie; die Punkte in regelmässigen, aber wenig heraustretenden Streifen, wobei Zwischenräume und Abstände nicht breiter sind als die Punkte; Rippen fehlen; die isolierten Höcker sind schwarz, stark glänzend und zuweilen in der Dorsalreihe vier, davon der Haupthöcker schmal, messerförmig, länger, kaum höher als die anderen, in der Humeralreihe fünf, hievon die vier vorderen strichelförmig mehr minder quergestellt, der letzte Knopfförmig, klein; der vorderste geht von der Basis auf die Schulterbeule, der zweite ist länger, schwach S-förmig, der dritte an der Seitendachbrücke, ein Rest der Pontalleiste, länger als die anderen, S-förmig, reicht schräg nach hinten gerichtet bis über die Mitte in die Scheibe hinein. Seitendach breit, flach ausgebreitet, nicht geneigt, gröber als die Scheibe, wie das Vordach punktiert, am Rande mit einem Saume sehr dicht gereihter, kleinerer Punkte. Die Schenkel sind besonders an den Vorderbeinen verdickt.

Unter den bisher von den Philippinen beschriebenen Arten hat nur die mir unbekannt *H. granulosa* Weise² von Palawan eine ähnliche Skulptur der Flügeldecken; sie ist aber gerundet und ganz anders gefärbt; auch die von den Sunda-Inseln bekannten *Hoplionoten* ohne Rippen haben durchwegs gerundeten Umriss und sind oben viel dunkler.

² Deutsche ent. Zeitsch. (1915) 511.

Im Vergleiche zu *taeniata*, von der sie sich natürlich schon durch die ganz andere Skulptur unterscheidet, ist sie schlanker und länger, weniger gewölbt; der Halsschild ist kürzer, an den Hinterecken mehr vorgezogen, die Seiten sind schräger, das Seitendach ist schmaler, die Fühler sind kürzer, die Keule dicker.

Für die freundliche Ueberlassung der Typen dieser und der folgenden Arten bitte ich Herrn Professor Charles F. Baker auch noch an dieser Stelle meinen Dank entgegenzunehmen.

Hoplionota hedysma sp. nov.

Quadrata, parum convexa, nitida, rufotestacea, supra flavotestacea, discis prothoracis elytrorumque saturatorbus, luridis, tuberculo principali et apicali vittaque indeterminata longitudinali hiscoiuneta piceis; protecto pone medium vitta lata transversa ferruginea; crista frontalis oculus sat superans, apice acuminata, apice incisa, incisione basi emarginata; prothorax transversus, angulis posticis haud porrectis rectangulis, disco laevi, transversim biimpresso, ibique punctulatus, lateribus profunde, minus crebre punctatis; elytra punctatostrata, carina dorsali, pontali suturali, apicali et terminali tuberculis parvis; fusca externa, interna et costa humerali subobsoletis; protectum latum, deplanatum, minus crebre punctatum, limbatum; 6.5 x 5.5.

LUZON, Mount Banahao (*Baker*).

Eiförmig, annähernd rechteckig, um die Hälfte länger als breit, an den Seiten wenig erweitert, mit der grössten Breite in der Mitte der Flügeldecken; mässig gewölbt, stark glänzend, rötlich gelb, die Scheiben des Halsschildes und der Flügeldecken gesättigt braungelb, der Haupt- und der Apikalhöcker, die Pontal-, Sutural- und Apikalleiste, sowie ein breiter, unbestimmter Längswisch aussen auf der Scheibe pechbraun, eine breite Querbinde hinter der Mitte des Seitendaches rostrot.

Kopfschild mehr als doppelt so lang als breit, mit lanzettförmigem, an der Basis gegabelten, undeutlich längsgekieltem Mitteleindruck. Kopfplatte vor die Augen mässig vorgezogen, zugespitzt, mit einem tiefen, innen erweitertem Einschnitt. Fühler bei dem einzigen, übersendeten Stücke stark beschädigt. Halsschild quer, mehr als doppelt so breit als lang, an der Basis aussen wenig vorgezogen, mit scharf rechtwinkligen Hinterecken und zu Anfang fast parallelen, dann stark gerundeten Seiten; die glatte Scheibe hat zwei Quereindrücke, deren vorderer schmaler, feiner punktiert und in der Mitte unterbrochen ist;

die Punkte auf dem Vordache sind grob, mässig dicht. Die Flügeldecken sind an der Basis kaum breiter als der Halsschild, haben rechtwinklige Schulterecken und schwach gerundete Seiten; die Punktstreifen auf der Scheibe sind grob, fast regelmässig; der Dorsalkiel ist nirgends unterbrochen, aber vor und nach dem Postbasalhöcker sehr schwach; seine vier Höcker sind in die Länge gezogen, niedrig, nur der Haupthöcker höher, stumpf, vierkielig; der Humeralkiel ist vorne erloschen, vor der Pontalleiste sehr schwach, geradlinig; die Pontalleiste setzt als Suturalleiste bis nahe an die Naht fort; ebenso beginnt die Apikalleiste noch innerhalb des Apikalhöckers, sendet von der Marginalhöckerstelle, die nicht höher ist als die umgehenden Kiele, die *costa ultima*, dann die *costa terminalis* zum Seitendache, während *furca interna* und *externa* nur rudimentar sind. Das Seitendach ist flach ausgebreitet, breit, auch hinten nur wenig verschmälert, ziemlich zerstreut und nur mässig grob (feiner als das Vordach des Halsschildes) punktiert, auf der rostroten Querbinde quergefaltet, aussen mit einer schwach erhabenen, durch eine nicht dichte Punktreihe abgesetzten Randleiste.

Hoplionota hedysma ist in Grösse und Körperform der *H. modesta* Wag. und *sexnotata* Weise ähnlich, hat mit der ersteren die Bildung des Kopfschildes, mit der letzteren die des Halsschildes gemeinsam; von *modesta* ist sie durch andere Färbung und Zeichnung, nach vorne weniger rasch verengte Seiten des Seitendaches, weniger entwickelten Basal- und Postbasalhöcker, nicht so stark einwärts gestellten Apikalhöcker, den Ansatz der *furca interna*, von *sexnotata*, abgesehen von der ganz anderen Zeichnung, dadurch verschieden dass bei der letzteren Apikal Kiel und Apikalhöcker vollständig fehlen und nur eine isolierte Gabel, bestehend aus Ansätzen der *furca interna* und *externa* mit einem gemeinsamen Stiele, übrig geblieben ist.

Hoplionota benguetina sp. nov.

Obquadrangularis, parum convexa, nitida, flavotestacea, supra fuscobrunnea, prothorace apice utrinque protecto que albido-flavis, hoc ramis duobus latis piceofuscis; antennae minus breves, clava crassa; crista frontalis oculos valde superans, antice rotundata, dentibus duobus minimis instructa; prothorax brevis, transversus lateribus oblique rotundatis, disco laevi transversim biimpresso; ibique punctato, lateribus profunde punctatis; elytra prothorace parum latiora, mox pone humeras breviter ampliata ibique latissima, tum oblique angustata, apice subtruncata, disco

striatopunctato, carina dorsali, pontali, suturali, apicali et humerali, hac basi obsoleta, tum furca interna et externa abbreviatis, tuberculis parvis, principali parum altiore; protectum sat latum in macula albida media sublaeve; 4.7 x 4.2 mm.

LUZON, Benguet, Baguio (*Baker*).

Verkehrt-trapezförmig mit der grössten Breite bald hinter den Schultern, von hier nach vorne schnell, nach hinten schwach und allmählig, fast geradlinig verengt, am Ende fast abgestutzt; mässig gewölbt, glänzend; gelb, Kopf und Fuhler rötlichgelb, oben hell pechbraun, auf dem Vordache und dem Seitendache dunkler; der Umkreis der Vorderecken des Halsschildes und der Basalsaum zunächst den Basalzähnen weisslichgelb; auf den Flügeldecken eine Makel aussen vor den Schulterbeulen und die Dorsalrippe in der Vertiefung zwischen Haupt- und Apikalhöcker gelblichrot, das Seitendach weissgelb mit je zwei dunkleren Randästen als die Scheibe.

Kopfschild schmal, um die Hälfte länger als breit, mit lanzettförmigem, durch konvergierende Stirnlinien begrenzten Mittelstück. Die Fühler überragen wenig die Halsschilddecken, ihre Basalglieder sind ziemlich gestreckt, einschliesslich des siebenten Gliedes glänzend; die vier Endglieder bilden eine stark verdickte, dicht behaarte Keule, deren innere Glieder (neunte und zehnte) doppelt so breit als lang sind. Halsschild quer, doppelt so breit als lang, an den Seiten viel kürzer als in der Mitte, die Basis ausserhalb der Basalzähnen vorgezogen, die Ecken daher in einer fast die Längsmittlinie schneidenden Querlinie, rechtwinklig, die Seiten vor ihnen in sehr schwachem Bogen schräg zu den Vorderecken gerundet, die Scheibe bis auf zwei Quereindrücke, von denen der vordere fein, der rückwärtige grob punktiert ist, glatt, das Vordach mit den gewöhnlichen, tiefen Grubenpunkten.

Auf den Flügeldecken verläuft der Dorsalkiel von der Basis bis zur Spitze ohne Unterbrechung; von seinen vier Höckern ist der Postbasal sehr klein, der Basal und Apikal sind niedrig, stumpf, in die Länge gezogen, der Haupthöcker ist nur wenig höher, so hoch wie bei *rufa* Wag., vierkielig; der Humeralkiel fehlt hinter der Basis, ist anfangs bogenförmig nach innen gezogen, sehr niedrig, und erlischt am Pontalkiel; dieser quer, nicht nach hinten gezogen, steigt zum Haupthöcker an und setzt sich als Sutural bis zur Naht fort; der Apikalkiel beginnt innen vom Dorsalkiel, ohne jedoch die Naht zu erreichen, bildet einen sehr kleinen Apikalhöcker und hat kurze Ansätze der costa terminalis, furca externa und interna. Die Punktstreifen der Scheibe

sind mässig grob, kaum deutlich gereiht. Das Seitendach ist flach, wenig breit, innen an der Seitendachbrücke auf der hellen durchscheinenden Makel glatt, vorne und am Rande punktiert, hinten innen quergefaltet mit zwei Punkten in jeder Falte.

Hoplionota benguetina steht am nächsten der indischen *lenta* m., der sie auch in der Zeichnung ähnlich ist; aber bei dieser ist die grösste Breite viel weiter rückwärts, hinter der Mitte der Flügeldecken, sie ist nach vorne mehr als nach hinten verengt, an den Seiten mehr gerundet, am Ende viel breiter verrundet als vorne, während bei *benguetina* der umgekehrte Fall vorliegt; bei *lenta* ist ferner der Dorsalkiel zwischen dem ersten und zweiten Höcker unterbrochen, die Punktierung der Flügeldecken ist feiner und dichter, die *furca externa* fehlt, die *furca interna* und *costa terminalis* sind schwächer, der Humeralkiel ist nicht gebogen; übrigens ist auch die Oberseite weniger glänzend, die Brust schwarz, die Fühlerkeule dunkel.

Hoplionota modesta Wagener.

Durch die Erwerbung der Typen von *H. modesta*, *vittata*, *undulata*, und *biramosa* Wagener konnte ich mir über diese, mir zur Zeit der Verfassung meiner "Studien über die Gattung *Hoplionota*"³ noch unbekanntem Arten von den Philippinen Klarheit verschaffen.

Hoplionota modesta ist mit der unrichtigen Vaterlandsangabe "Ostindien" beschrieben, während sie auf den Philippinen vorkommt, wo sie bisher nur auf Luzon von Herrn Professor C. F. Baker bei Los Baños und dem Mount Maquiling gefunden wurde. Ich habe dieselbe Art⁴ als *H. chapuisi* beschrieben und zwar jene Form, bei der die Zeichnung aus einer pechbraunen Punktmakel am äusseren, rückwärtigen Abfall des Haupthöckers und einer braunen Querbinde an der Unterseite des Seitendaches besteht, die auf der Oberseite nur heller durchscheint. Bei der typischen *modesta* fehlt die Makel am Haupthöcker, während *nitida* Weise,⁵ von Herrn Professor Baker ebenfalls auf dem Mount Maquiling gesammelt, anscheinend auf ein Stück derselben Art aufgestellt ist, bei dem auch die Binde des Seitendaches fehlt. *Hoplionota chapuisi* und *nitida* sind daher nur als Aberrationen von *modesta* zu betrachten. *H. modesta* ist an der stark zugespitzten, vorgezogenen Kopfplatte, die an der Spitze einen, hinten erweiterten Einschnitt hat, an der wachs-

³ Verh. zool-bot. Gesellsch. Wien. (1913) 381.

⁴ Op. cit. 523.

⁵ Deutsche Ent. Zeitschr. (1915) 511.

gelben, auf den Scheiben nur wenig gesättigteren Färbung und an der Kielbildung leicht zu erkennen; der Sutura Kiel ist stark nach vorne, der Apikalhöcker nach innen gezogen, die furca interna vollständig erloschen, während die übrigen Fortsätze des Apikalkiels, mit Ausnahme der costa ultima, rudimentar sind.

Hoplionota undulata Wagener.

Von der Insel Mindanao ohne näheren Fundort beschrieben; von Herrn Professor C. F. Baker bisher nicht eingesendet, also wahrscheinlich noch nicht aufgefunden.

Hoplionota undulata gleicht im Umriss der *H. modesta*, doch ist sie etwas grösser und verhältnismässig schmaler; die Farbe ist gesättigter braungelb; die Umgebung des Basalhockers und zwei aneinander stossende Flecke auf jeder Flügeldecke rückwärts sind pechbraun, wenig scharf; der vordere dieser Flecke reicht vom Haupthöcker und dem vorderen Abfall der Pontalleiste schräg nach hinten bis an das Seitendach, so dass der Raum zwischen der Pontalleiste, der furca interna und der Terminalleiste von ihm ausgefüllt wird; der rückwärtige wird annähernd von der Apikalleiste, dem Ende des Dorsalkiels und der costa ultima begrenzt. Die Kopfplatte ist weit vor die Augen vorgezogen, breiter als bei *modesta*, vorne weniger zugespitzt, seichter eingeschnitten. Die Punktierung der Flügeldecken ist viel gröber und dichter, die Zwischenräume und Abstände sind viel kleiner als die Punkte; die Kiele sind an den Höckerstellen so wenig überhöht dass man eigentlich, mit Ausnahme des Haupthockers, von Höckern überhaupt nicht sprechen kann; der Dorsalkiel ist nur hinter dem Basalhöcker kurz unterbrochen; der Postbasal ist kaum angedeutet, der Haupthöcker sehr niedrig, vierkielig; die Sutura alleiste ist zur Naht weniger vorgezogen als bei *modesta*; die Pontalleiste geht aussen bis zum vorletzten Zwischenraum, während sie bei *modesta* schon im viert-letzten erlischt. Der Apikal Kiel, die costa ultima, terminalis, die furca externa und interna sind kräftig, jedoch erreicht die letztere nicht den Haupthöcker. Das Seitendach ist grob, etwas feiner als die Scheibe punktiert, flach, hinten wenig verschmälert, schmaler als bei *modesta*.

Hoplionota vittata Wagener.

Nach der Beschreibung des Autors ist die Art schwer zu erkennen, da zumeist nur solche Merkmale hervorgehoben werden, die mehr minder ausgeprägt sich bei allen *Hoplionoten* finden, und ußerdem die Angaben über die Färbung und Zeichnung einer Richtigstellung bedürfen. Wagener nennt die Makeln auf

den Flügeldecken dunkel olivengrün, während ich von dieser Farbe bei dem aus seiner Sammlung stammenden Typus absolut nichts finden kann, sondern sie als ziemlich tief pechbraun und die Querbinde hinter der Mitte des Seitendaches als unten pechbraun, oben heller durchscheinend braun bezeichnen möchte; ferner kann man auch nicht, wie es Wagener tut, von einzelnen Flecken sprechen, da sie eine durch schmale Stellen zusammenhängende Längsbinde bilden. An der Basis der Flügeldecken beginnt diese sehr breit, indem sie vom ersten bis zum neunten Punktstreif reicht und sonach ausser dem letzten Zwischenraum nur einen schmalen Nahtsaum freilässt; quer über den Dorsalkiel hinter dem Basalhöcker hinziehend, verengt sie sich auf die Breite zwischen dem fünften und dem siebenten Punktstreif; nun folgt die zweite mit der ersten durch diesen Ast zusammenhängende Makel, die vom Postbasal bis weit über die Pontalleiste reicht, aussen vom achten Punktstreif, innen vom (gelben) Dorsalkiel begrenzt wird und die sich am Haupthöcker noch über ihn zu beiden Seiten der kurzen Suralleiste fortsetzt; weiter wendet sich die Binde mehr nach aussen, reicht hier bis an das Seitendach und hängt mit der dunklen Seitendachbinde in deren ganzer Breite zusammen um durch einen schmalen Ast längs der äusseren Partie des Apikalkiels mit der dritten Makel (im Sinne Wageners) zusammenzuhängen, die den Raum vom inneren Teil des Apikalkiels, einschliesslich seines vorderen Absturzes bis vor die Spitze und von der costa ultima bis sur Naht einnimmt. Die Scheibe ist gelblichrot; von den Kielen zeigen diese Grundfarbe nur der Dorsalkiel vor und nach dem Haupthöcker und die furca interna; die übrige Ober- sowie die Unterseite sind heller gelb, die Fühler rötlich.

Die Kiele sind schwach, die Höcker selbst der Haupthöcker treten kaum darüber hinaus; der Dorsalkiel ist nur zwischen dem ersten und zweiten Höcker unterbrochen; der Humeralkiel ist vorne S-förmig gebogen, vor der Pontalleiste erloschen; am Apikalkiel sind die costa terminalis vollständig, die furca externa und interna in Ansätzen vorhanden; Pontal- und Apikalleiste setzen sich innen über den Dorsalkiel fort. Die Punktstreifen sind grob, regelmässig, grösser als die Zwischenräume und Abstände.

In der Körperform steht *H. vittata* unter den asiatischen Arten ganz vereinzelt; sie ist rechteckig, fast doppelt so lang als breit, an den Seiten kaum erweitert; sie erinnert an jene mancher madagassischer Arten, zum Beispiel, *gemmata* Keug und *nigriclavis* m.; der Halsschild ist an den Seiten sehr schräg

zugerundet, wenig gebogen, daher aussen kürzer als in der Mitte; die Grubenpunkte auf den seiten des Vordaches stehen weit zerstreut, die Scheibe ist bis auf die Eindrücke glatt. Der Kopfschild hat eine tiefe Grube; die Kopfplatte ist vor die Augen mässig vorgezogen, verrundet zugespitzt und nur schwach eingeschnitten. Die Fühler sind sehr kurz, nur ihr viertes und fünftes Glied etwas gestreckt, die Keule dick, ihre inneren Glieder doppelt so breit als lang, 5.5 x 4.25 mm. (nach Wagener 5 x 4.5). Der Typus stammt von der Insel Bohol.

Hoplionota taeniata F. und *biramosa* Wagener.

In meinen Studien über die Gattung *Hoplionota*⁶ habe ich die bis dahin ungedeutete *Cassida taeniata* F. auf die häufigste der auf den Philippinen vorkommenden *Hoplionota* Arten bezogen und die Beschreibung entsprechend ergänzt. Die Type von Wageners *H. biramosa* die ich seitdem erworben habe, zeigt dass sie ein Stück derselben Art zur Grundlage hat; bei demselben ist die Scheibe der Flügeldecken gesättigter braungelb, die Höcker, die Pontalleiste und die Aeste des Seitendaches sind hell pechbraun, die Seitendachmakel und die Flecken neben der Spitze treten durch ihre hellere Farbe lebhafter hervor; ein ähnliches Stück mit noch kräftigeren Färbungskontrasten und zur Spitze mehr verengt wurde von Herrn Professor C. F. Baker in Baguio, Benguet, gesammelt und mir unter No. 6099 eingesendet. Von Mr. Whitehead wurde die gleiche Form in Nord Luzon gesammelt.

Während sonach *biramosa* Wag. mit *taeniata* F. zusammenfällt, muss ich meine seinerzeit⁷ ausgesprochene Ansicht, dass auch *rufa* Wag. nur eine Unterform derselben Art ist, abändern. Das reichere Material, welches mir jetzt von *taeniata* und *rufa* vorliegt, zeigt dass hier zwei von einander verschiedene Arten vorliegen. *Hoplionota taeniata* von Luzon und Balabac ist eiförmig, stets wesentlich länger als breit, mit der grössten Breite vor der Mitte der Flügeldecken, an den Seiten fast gerade, oft nach hinten stärker verengt und dann von schwach trapezförmigem Umriss; die Höcker der Flügeldecken sind über die Kiele wenig erhöht, auch der Haupthöcker viel breiter als hoch, sehr stumpf; an der Seitendachbrücke ist stets ein glassheller, weisslicher Fleck zwischen den dunkleren Randästen, der innen schwächer punktiert, fast glatt ist. Die Halsschildseiten fallen zu den Hinterecken schräg ab. *Hoplionota rufa* Wag. ist

⁶ Verh. zool.-bot. Gesellsch. Wien (1913) 496.

⁷ Op. cit. 497.

stets von breiterem, fast gerundetem Körperbau, mit der grössten Breite weiter rückwärts, in oder selbst nach der Mitte der Flügeldecken, an den Seiten mehr gerundet, hinten breiter abgerundet; die Höcker sind durchwegs höher, der Haupthöcker spitzig, so hoch als breit; die Bildung der Kiele, der Fühler und des Kopfschildes ist die gleiche; auf dem Seitendache fehlen Randäste, an der Seitendachbrücke ist ein hellerer Innenfleck nicht oder kaum erkennbar, diese Stelle nicht schwächer punktiert als der übrige Teil; die Halsschildseiten fallen rechtwinklig zur Basis ab. Die Oberseite ist einfarbig rostrot (*ferruginea* m.), zu welcher Form auch die mir gehörige Type Wageners seiner *rufa* gehört, oder die Kiele sind dunkler, gebräunt (*rufa* Wag. nach der Beschreibung). Letztere Form kenne ich ausser aus Java besonders von Bogor, wo sie von Kannegieter gesammelt wurde und woher auch ein Stück mit ganz pechschwarzen Scheiben des Halsschildes und der Flügeldecken stammt. Die einfarbige Form *ferruginea* dagegen liegt mir von Java, Sumatra, Mentawai, Malakka, Perak vor und wurde von Herrn Professor C. F. Baker auf Penang und Singapore gesammelt.

Als eine durch grössere und breiteres Seitendach ausgezeichnete Rasse der *rufa* Wag. ist *sarawacensis* m.⁸ zu betrachten; dagegen ist die ebenfalls als Rasse der *taeniata* beschriebene *H. quadra* m.⁹ aus Nord Borneo eine eigene Art, die sich bei sonst gleicher Skulptur der Flügeldecken von *taeniata* und *rufa* durch viel kleinere Gestalt, annähernd quadratischen Umriss, kürzere Fühlerkeule, viel dunklere Farbe der Flügeldeckenscheibe, von *taeniata* überdies durch höhere Höcker und den Mangel von Randästen, von *rufa* durch weiter vorne gelegene grösste Breite und schräg, aber fast gerade nach hinten verengte Seiten unterscheidet.

Hoplionota calligera sp. nov.

Subquadrata, parum convexa, sat nitida, fulvotestacea, disco elytrorum piceo, prothorace, scutello protecto que fuscis, hoc basi, in ponte apiceque maculis laete testaceis, duabus primis callosis; antennae sat longae, clava parum incrassata; crista frontalis oculos valde superans, antice dilatata, apice subacuminata ibique incisa, incisione basi emarginata; prothorax longitudine duplo latior, basi extus haud producta; elytra basi subtruncata, angulis humeralibus subrectis, lateribus ante medium vix dilatatis, ad

⁸ Op. cit. 497.

⁹ Stett. ent. Zeit. (1915) 269.

apicem parum attenuatis, disco striatopunctato, carina dorsali, humerali, pontali, suturali et apicali, costa terminali et furcis brevibus, tuberculis primo, segundo et quarto dorsalibus parvis, principali (tertio) sat acuto, sed minus alto; protecto sat lato, deplanato transversim plicatulo et punctato, tenuiter limbato, callis laevibus, nitidioribus; 5 x 4 mm.

BORNEO, Sandakan; exemplar No. 11903 a domine professore C. F. Baker detectum et liberalissime communicatum in collectione mea asservatum est.

Nahezu quadratisch, wenig gewölbt und mässig glänzend; Unterseite, Kopf und Fühler bräunlichgelb, Halsschild und Schildchen hellbraun, das Seitendach gesättigter braun mit schmalem, hellerem Saum, die Scheibe der Flügeldecken dunkel pechbraun, der Dorsalkiel bis zum Postbasal und die Basis des sechsten Punktstreifs braungelb; auf dem Seitendache sind eine kleine Makel an der Basis innen vor der Schulterbeule und eine grössere an der Seitendachbrücke gelb, stärker glänzend und schwielig erhaben; ausserdem ist an der Spitze neben der Naht jederseits ein heller, durchscheinender, verwaschener, gelber Fleck.

Kopfschild doppelt so lang als breit, mit tiefen, vom Augenrande ziemlich entfernten, konvergierenden Stirnlinien und lanzettförmigem, vertieften, verloschen gekielten Mittelstück. Stirnplatte vor die Augen stark vorgezogen, zuerst erweitert, dann zugespitzt, an der Spitze tief eingeschnitten, der Einschnitt an seiner Basis ausgerandet. Die Fühler überragen mit dem Ende der Keule die Seiten des Halsschildes; das vierte und fünfte Glied sind gestreckt, fast dreimal so lang als dick, das sechste und siebente merklich kürzer; die viergliederige Keule ist sehr schlank, nur wenig dicker als der Schaft, ihre inneren Glieder etwas länger als dick.

Halsschild stark quer, nicht halb so lang als breit, an der Basis aussen wenig vorgezogen, mit rechtwinkligen Hinterecken, die Seiten vor diesen zuerst gerade, senkrecht zur Basis, dann stark zu den Vorderecken gerundet, ihr Rand grob gesägt, der Kopfausschnitt tief, trapezförmig; die Scheibe glatt, vorne mit einem bogenförmigen, glatten, vor der Basis mit einem dicht, runzelig punktierten, geraden Quereindruck, die Seitenflügel mit den gewöhnlichen, groben Punkten. Flügeldecken an der fast abgestutzten Basis mässig breiter als der Halsschild, mit nicht vorgezogen, rechtwinkligen Schulterecken und kaum erweiterten, vor der Mitte am breitesten, dann sehr schwach verengten Seiten; die Scheibe mit dichten, engen Punktstreifen.

Der Dorsalkiel ist vollständig, aber zwischen dem ersten und zweiten und zweiten und dritten Höcker sehr niedrig, hinter dem Haupthöcker höher; der Basal- und Postbasalhöcker sind wenig hoch, aber ziemlich spitz, der Apikalhöcker stumpfer und niedriger; der Haupthöcker ist so hoch als seine Entfernung vom Postbasal beträgt, spitzig, vierkielig; der Humeralkiel ist schwach gebogen, von der Basis bis zur Pontalleiste ausgebildet, diese quer, mit einem kurzen Suturalfortsatz; die Apikalleiste welche noch innerhalb des Dorsalkiels beginnt, ist niedrig, ebenso die *costa terminalis*, die *furca externa* und *interna*, welche beide abgekürzt sind. Das Seitendach ist verhältnismässig breit, flach ausgebreitet, mit groben Punkten besetzt, deren Abstände zu schwach erhabenen Querfalten zusammenfliessen; am Aussenrande ein schmaler, feiner punktierter, innen durch ein erhabenes Leistchen begrenzter Saum.

Hoplionota calligera steht in der Verwandtschaft der *H. quadra* m.¹⁰ und der *H. weyersi* m., die beide ebenfalls auf Borneo vorkommen, am nächsten, unterscheidet sich aber durch die viel schlankere, weniger abgesetzte Fühlerkeule, breitere, verhältnismässig weniger gewölbte Gestalt, viel höheren und spitzigeren Haupthöcker, breiteres und flacheres Seitendach, endlich durch Färbung und Zeichnung.

¹⁰ Stett. ent. Zeit. 76 (1915) 269.

REVIEWS

- A. Badoureau | Ingénieur en chef des Mines, en retraite | causeries | philosophiques | Paris Gauthier-Villars et Cie, Editeurs | Libraires du Bureau des Longitudes, de l'école polytechnique | 55, Quai des Grands-Augustins, 55 | Paper, pp. i-xx + 1-227 including errata.
- Vaccination | in the | Tropics | by | W. G. King, C. I. E., | Colonel I. M. S. (Retired). | [three lines of titles] | 1920. | London | Tropical Diseases Bureau, | 23, Endsleigh Gardens, N. W. I. | Boards, pp. i-vi + 7-64, 5s. nett.
- Cocoa and | Chocolate | Their History | from Plantation to Consumer | by | Arthur W. Knapp | B. Sc. (B'ham.), F. I. C., B. Sc. (Lond.) | [three lines of titles] | London | Chapman and Hall, Ltd. | 1920 | Cloth, pp. i-xii + 1-210 including index.
- Optical Methods | in | control and research | laboratories | published by | Adam Hilger Ltd. | 75A Camden Road, London, N. W. I. | England | pp. 30. Price 1s. 6d. nett. Post free 1s. 8d. Limp Cloth.
- Practical | Bacteriology, Blood Work | and | Animal Parasitology | including | Bacteriological Keys, Zoölogical Tables | and Explanatory Clinical Notes | by | E. R. Stitt, A. B., Ph. G., M. D., Sc. D., LL. D. | [ten lines of titles] | Sixth Edition, Revised and Enlarged | with 1 plate and 177 other illustrations containing 637 figures | Philadelphia | P. Blakiston's Son & Co. | 1012 Walnut Street | Cloth, pp. i-xi + 1-633 including index.
- The Development of | the Human Body | a manual | of human embryology | by | J. Playfair McMurrich, A.M., Ph. D., LL.D. | [two lines of titles] | sixth edition, revised and enlarged | with two hundred and ninety illustrations several | of which are printed in colors | Philadelphia | P. Blakiston's Son & Co. | 1012 Walnut Street | Cloth, pp. i-x + 1-501 including index. Price, \$3.25 net.

FROM PREFACE TO THE SIXTH EDITION

The increasing interest in human and mammalian embryology which has characterized the last few years has resulted in many additions to our knowledge of these branches of science, and has necessitated not a few corrections of ideas formerly held. In this sixth edition of this book, as in previous ones, the attempt has been made to incorporate the results of all important recent contributions upon the topics discussed, and at the same time, to avoid any considerable increase in the bulk of the volume. Several chapters have, therefore, been largely recast, and the subject matter has been thoroughly revised throughout, so that it is hoped that the book forms an accurate statement of our present knowledge of the development of the human body.

Epidemic Respiratory Disease | The pneumonias and other infections of the | respiratory tract accompanying | Influenza and measles | By | Eugene L. Opie, M.D. | [two lines of titles] | Francis G. Blake, M.D. | [two lines of titles] | James C. Small, M.D. | [two lines of titles] | Thomas M. Rivers, M.D. | [two lines of titles] | Illustrated | St. Louis | C. V. Mosby Company | 1921 | Cloth, pp. 1-402 including index. Price, \$6.50.

Microbiology | A text-book of | microorganisms general and applied | [names of twenty-five contributors] | edited by | Charles E. Marshall | Amherst, Massachusetts | [two lines of titles] | third edition revised and enlarged | with 200 illustrations | Philadelphia | P. Blakiston's Son & Co. | 1012 Walnut street | Cloth, pp. V-XXVIII + 1-1043 including index. Price, \$4 net.

INDEX

[New generic and specific names and new combinations are printed in clarendon; synonyms and names of species incidentally mentioned in the text are printed in *italic*.]

A

- Ablerus Howard, 97.
 perspicuosus Girault, 97.
 Absolute units and the relativity principle, 341.
Acacia sphaerocephala, 647.
Acanthopneuste borealis (Blas.), 551.
Acromitus, 42.
 mauculosus Light, 27.
Actitis hypoleucos (Linn.), 543.
Adelothyreus Chevr., 72.
Aegialitis dubia (Scop.), 542.
 peroni (Bp.), 539, 542.
Aethopyga bonita, 539.
 magnifica Sharpe, 552.
 Agrilini Cast. & Gory, 350.
Agrilus Steph., 350, 356, 447.
 abdominalis Saund., 356.
 acutus Thunb., 356.
 aegnicollis Esch., 356.
 aguinaldoi Fisher, 357, 382.
 albocinctus Fisher, 356, 369.
 atomus Kerrem., 356.
 attenuatus Fisher, 357, 390.
 bakeri Kerrem., 357, 376.
 balnearis Kerrem., 356.
 banahaensis Fisher, 356, 366.
 benguetensis Fisher, 356, 361.
 bisignatus Fisher, 357, 383, 384, 385.
 butuanensis Fisher, 357, 358, 393, 400.
 dapitanensis Fisher, 357, 387.
 davaoensis Fisher, 358, 402.
 discicollis Deyr., 356.
 fontanus Kerrem., 356.
 fulvovittatus Fisher, 357, 378, 379.
 iliganensis Fisher, 358, 400.
 immaculatus Fisher, 358, 397.
 inconstans Fisher, 357, 373.
 inermis Fisher, 358, 395.
 innotatus Fisher, 357, 381.
 inquinatus Saund., 364.
 luzonicus Kerrem., 356, 364.
 malinaoensis Fisher, 358, 399.
 manilensis Fisher, 357, 392.
 maquilingensis Fisher, 356, 367.
 mindanaoensis Fisher, 358, 403.
 minutus Fisher, 358, 396.
 monticola Kerrem., 358, 375.
 nigrocinctus Saund., 356, 364.
 occipitalis Esch., 349, 356, 369.
 oreophilus Fisher, 358, 375.
 oreophilus Fisher (monticola Kerrem.), 356.
 ornatus Deyr., 356, 364.
 palawanensis Fisher, 357, 383.
 philippinensis Fisher, 357, 388.
 pilicauda Saund., 356.
 piperi Fisher, 356, 362.
 pulcher Deyr., 358, 397.
 quadriplagiatus Fisher, 356, 358.
 rotundipennis Fisher, 357, 374, 376.
 rubifrons Deyr., 356.
 semipubescescens Fisher, 357, 377.
 semperi Saund., 356.
 sexsignatus Fisher, 356, 360.
 straticollis Kerrem., 356.
 subpubescens Fisher, 356, 369, 370.
 subspinosis Fisher, 356, 364.
 subviridis Fisher, 357, 376.
 subvittatus Fisher, 357, 378.
 tayabensis Fisher, 357, 386.
 villis Saund., 356.
 zamboangensis Fisher, 356, 372.
Albizia lebeck, 596.
Alecanium Morrison, 648.
 hirsutum Morrison, 648, 650.
 Aleurites, 622.
 fordii, 619.
 moluccana, 601, 619-621.
 montana Wilson, 619.
 trisperma, 619, 620.
Alpinia conchigera, 640.
Alsodeia echinocarpa, 653.
Alstonia scholaris R. Br., 270, 271.
 Ambard, L., notice of his Clinique des voies urinaires de la Faculté de Médecine de Paris. Physiologie normale et pathologique des reins, 104.
Amorphosoma Cast., 350, 408.
 marmoreus Deyr., 408.
 Anai, 248.
Ananas, 644.
Anas luzonica Fraser, 544.
 Anay, 243, 248.
Anchon Buckt., 681.
Anisoptera affine Kirby, 609.
 longipennis Kirby, 608.
 maculatum Kirby, 609.
Anomalococcus Green, 641, 644.
 cremastogastri Green, 644.
 multipori Morrison, 641, 643.

- Anomalorhiza* Light, 32, 41.
 shawi Light, 27, 28, 32, 33, 34.
Anteliotringa tenuirostris Mathews, 76:
Anthaxomorphus Deyr., 350, 434.
 philippinensis Fisher, 434.
Anthostomella Sacc., 597.
 profunda Sacc., 597.
Anthus rufulus Vieil., 539, 552.
Anubing-cagyos, 53.
 na-nangca, 53.
Aphalarini (Löw), 260.
Aphalaroida Crawf., 261.
Aphalara Först., 260, 261.
 dahl Rübs., 261.
Aphanisticus Latr., 250, 435.
 bakeri Fisher, 435, 436.
 bodongi Kerrem., 435, 439.
 costipennis Fisher, 435, 436, 438, 440.
 excavatus Fisher, 435, 437, 438.
 foveicollis Fisher, 435, 440.
 mindanaensis Fisher, 435, 439.
 nigroaeneus Kerrem., 435.
 piceipennis Fisher, 435, 438, 439.
 trachyformis Fisher, 435, 442.
 unicolor Fisher, 435, 441.
Aphelinini Ashm. 97.
Aphelininae Howard, 97.
Aphelinus Dalman, 97.
 fuscipennis Howard, 97.
 japonicus Ashm., 97.
 mytilaspidis Le Baron, 98.
Apospora Sacc., 598.
 montagnei Sacc., 598.
Aposphaeria Berk., 600.
 fugax Sacc., 600.
 fusco-maculans Sacc., 601.
Archenomus Howard, 100.
 orientalis Silv., 100.
Arhagus Fleut., 72.
 bakeri Fleut., 72.
Artamides panayensis Steere, 548.
Artamus leucorhynchus (Linn.), 539, 551.
Artocarpus Forst., 49, 251, 252.
 acuminatissima Merr., 49.
 communis Forst., 50.
 pinnatisecta Merr., 50.
 superba Becc., 49, 51.
 woodii Merr., 49, 52.
 sp., 647.
Asparagus officinalis, 601.
Aspidiotus perniciosus Comst., 97, 99.
Atolla bairdii Fewkes forma *gigantea* Maas, 26.
 bairdii Fewkes forma *valdiviae* Vanhöffen, 26.
 bairdii Fewkes forma *wyvillei* Haeck., 26.
Atrichopogon Kieff., 559.
 flavellus Kieff., 560, 563.
 flavidus Kieff., 560, 562.
 haemorrhoidalis Kieff., 560.
 insularis Kieff., 560, 561.
 microtomus Kieff., 557.
 prunosus Kieff., 559, 560.
 ruber Kieff., 560, 563.
 rufescens Kieff., 560, 563.
Aulacaspis pentagona Targ., 97-100.
Aurelinae L. Ag., 31.
Aurella Pér. & Les., 31.
 aurita Lam., 26.
 labiata Cham. & Eysen., 27, 28, 31.
Azotus Howard, 98.
 capensis Howard, 98.
 chionaspidis Howard, 98.
- B**
- Badoureaux*, A., notice of his *Causeries philosophiques*, 733.
Bakerella signifrons Karny, 609.
Balantidium, 470.
 coli, 473.
Balete, 55.
Bambusa vulgaris, 596, 597, 602.
 sp., 595, 597, 598, 600, 602-605.
Barringtonia, 253, 254.
Beta vulgaris, 605.
Bezzia Kieff., 571.
 insularis Kieff., 571.
 kerteszi, 557.
 nigriclava Kieff., 571, 572.
Birds in Antique Province, 540.
Blake, Francis G., see *Opie*, *Blake*, *Small*, and *Rivers*.
Bondoc, 247.
Bordet, Jules, notice of his *Troité de L'immunité dans les maladies infectieuses*, 103.
Bothrion Fleut., 71.
 bakeri Fleut., 71.
Brachypteryx brunneiceps, 539.
Budytes leucostriatus Hom., 539, 552.
Bultic, 295.
Buratu, 53.
Butorides javanica (Horsf.), 543.
- C**
- Caesalpinia sappan* Linn., 252.
Cajanus indicus, 647.
Callaeops, 82.
 periophthalmica Grant, 79-82.
Callisitta oenochlamys (Sharpe), 551.
Calophyllum inophyllum Linn., 273.
Calotermes, 246.
 (Notermes) *lagunaensis* Oshima, 250.
 (Notermes) *malatensis* Oshima, 250.
Canthyrus bakeri Peschet, 693.
 guttula Aubé, 693, 694.
Canutus canutus rogersi Mathews, 75.
 rogersi Mathews, 75.
 tenuirostris (Horsf.), 75, 76.
Capparis horrida Linn., 77.
Caprimulgus manillensis Wald., 539, 545.
Capritermes paetensis Oshima, 254.
Capsicum annum, 605.
Carsidarinae Crawf., 279.
Carteria Kieff., 590.
 longilobus Kieff. var. *fulviventris* Kieff., 591.
Carybeidae Gegenbauer, 26, 29.

- Carybea Pér. & Les., 29.
 alata var. *grandis* Ag. & Mayer, 26, 28, 29.
 alata var. *grandis* Mayer, 29.
 alata var. *moseri* Mayer, 26.
 philippina Semper, 26.
 rastonii Haacke, 26.
 Casca Howard, 100.
 chinensis Howard, 100.
 Casigneta *cochleata* Brunner, 614.
 lamellosa Brunner, 614.
 lotifolia, 614.
 pellucida Brunner, 614.
 spinicauda Karny, 614.
 Cassida *taeniata* F., 729.
 Cassiopea *andromeda* var. *baduensis* Mayer, 27.
 medusa Light, 27.
 ornata Haeck., 27.
 polypoides Keller var. *culionensis* Light, 27.
 Catostylus L. Ag., 41, 42.
 mosaicus (Q. & G.) L. Ag., 27.
 purpureus Mayer, 27, 29, 41.
 Centropus *javanicus* (Dumont), 539, 546.
 viridis (Scop.), 546.
 Centroscelus, 687.
 Cephea Pér. & Les., 32.
 cephæa (Forsk.) Mayer, 27, 28.
 cephæa (Forsk.) sensu Mayer, 32.
 cephæa Mayer, 32.
 cephæa var. *coerulea* (Vanhöffen) Mayer, 27.
 octostyla (Forsk.) Mayer, 27.
 papua Less., 42.
 Ceratopogoninae, 557.
 Ceratopogon Meig., 557.
 (Prohelea) *chrysothrix* Kieff., 557, 558.
 (Prohelea) *fuscimanus* Kieff., 557, 559.
 Cercospora Fr., 605.
 beticola Sacc., 605.
 henningsii Allesch., 605.
 Cerithium, 8.
 bandongensis, 12, 16.
 herklotsi, 12, 16.
 jenkinsi K. Mart., 8, 12, 16.
 Ceroplastes Gray, 647.
 floridensis Comst., 647.
 rubens Mask., 98.
 Ceroplastodes Ckll., 647.
 virescens Green, 647.
 Chalchophaps *indica* (Linn.), 541.
 Charadrius *fulvus* (Gm.), 539, 542.
 Charybdea *grandis* A. Ag. & Mayer, 29.
 Chionaspis sp., 97.
 difficilis Ckll., 98, 100.
 Chironomides des Philippines et de Formose, 577.
 Chironomariae, 577.
 Chironominae, 576.
 Chironomus Meig., 589, 590, 592, 593.
 alismaticus Kieff., 588.
 aurantiacus var. *anomalus* Kieff., 589, 590.
 chlorophorus Kieff., 590.
 circumdatatus Kieff., 590.
 Chironomus—Continued.
 inermifrons Kieff., 590.
 longilobus Kieff., 591.
 pekanus Kieff., 588.
 sauterianus Kieff., 589.
 Chiropsalmus, 38.
 quadrigratus Haeck., 26.
 Chrysaora Pér. & Les., 30, 31.
 melanaster Brandt, 26.
 Chrysididae, 691.
 Chrysis (Hexachrysis) *comottii* var. *igniceps* Moesáry, 691.
 Cinnerys *guimarasensis* Steere, 552.
 Cisseicoraebus Kerrem., 350.
 grandis Kerrem., 350.
 Cisticola *exilis* (Vig. & Horsf.), 539, 550.
 Citrus *aurantium*, 88.
 grandis, 598, 601.
 hystrix, 88.
 maxima, 88, 89.
 mitis, 88.
 nobilis, 88, 598.
 sinensis, 88.
 trees, mottled leaf of, 85.
 trifoliata, 600.
 sp., 599.
 Cittocincla *nigrorum* Grant, 549.
 superciliaris Bourns & Worc., 549.
 Cladosporium Link, 604, 605.
 herbarum var. *lablab* Sacc., 604.
 Clerodendron *penduliflorum*, 640.
 Clinotanypus *formosae* Kieff., 576.
 Clonauchenia Funkh., 679.
 mirabilis Funkh., 680.
 Coccidiosis in the Philippine Islands, 449.
 Coccophagus Westw., 98.
 lecanii Fitch, 98.
 yoshidae Nakayama, 98.
 Coccidae, 639.
 Coccinae, 647.
 Coccus Linn., 653, 654, 657, 659, 666.
 caviramicolus Morrison, 659, 660, 667.
 circularis Morrison, 665, 666, 667.
 discrepans Green, 654.
 hesperidum Linn., 98, 99.
 macarangae Morrison, 663, 664, 667.
 penangensis Morrison, 657, 658, 660, 661, 663, 667.
 secretus Morrison, 661, 662, 667.
 tumuliferus Morrison, 655, 656, 666.
 Coccomantis *merulinus* (Scop.), 546.
 Coleoptera from the Philippine Islands, 349.
 Coléoptères (Elateridae), deux especes nouvelles, 73.
 (Melasiidae), deux genres nouveaux de, 71.
 Colletotrichum Corda, 602.
 septorioides Sacc., 602.
 Collocalia, 546.
 marginata Salv., 539, 545, 547.
 trogodytes Gray, 545.
 Columba *griseigularis* (Wald. & Lay.), 541.
 Columbella bandongensis, 12.
 Coniosporium Link, 603.
 bambusae (Thüm. & Bolle) Sacc., 603.

- Conocephalinae xiphidiinae, 608.
Conocephaloides gracilis Kirby, 607.
insulanus Kirby, 608.
pallidus Kirby, 607.
Conocephalus Blume, 49, 51.
elongatus Thunb., 612.
gracilis Redt., 607.
insulanus Redt., 608.
mollis Merr., 51.
pallidus Redt., 607.
sannio Karny, 609.
(Xiphidion) affinis Karny, 609.
(Xiphidion) longipennis Karny, 608.
(Xiphidion) maculatus Karny, 609.
Conus hardi, 12.
striatellus, 12.
 Copiphorinae, 607.
Copsychus mindanensis Wagler, 539, 548.
Coptotermes, 247, 254.
flavicephalus Oshima, 250.
formosanus Shiraki, 250, 256.
travians Hav., 250, 256.
Cornebus Cast. & Gory, 350, 405, 414.
azureus Fisher, 405.
bajulus Deyr., 405, 406.
caelestis Saund., 405.
cissacoides Saund., 405, 407.
hastanus Cast. & Gory, 405.
melibaeiformis Saund., 405, 406.
piperi Fisher, 405, 406.
pullatus Saund., 405.
spinus Cast. & Gory, 405, 406.
transversus Kerrem., 405.
 Coronatae, 26.
Corone philippina (Bp.), 553.
Cotylorhiza, 36, 38, 41.
pacifica Mayer, 29, 37-40.
tuberculata, 39.
Cotylorhizoides Light, 33, 36, 38, 44.
pacificus, 39.
pacificus (Mayer), 29, 37, 40.
punctatus, 38.
(Cotylorhiza) pacificus (Mayer), 27.
Covellia, 58, 68.
Cricotopus carnosus Kieff., var., 577.
Cryptaspidia Stål, 681, 687.
impressa Stål, 686.
pilosa Funkh., 686.
Cryptochironomus Kieff., 582.
olivaceus Kieff., 582, 584.
pelochloris Kieff., 582, 584.
petiolatus Kieff., 582.
sauteri Kieff., 582, 583.
subroseus Kieff., 582, 583.
Cryptodactylus Deyr., 350, 418.
philippinensis Saund., 418.
Ctenochiton Mask., 657.
Cucumis sativus, 596.
Cudrania Tréc., 49, 52.
grandifolia Merr., 52.
javanensis Tréc., 52.
Cuitib, 247.
Culicicapa helianthea (Wallace), 538, 548.
Culicoides Latr., 563.
albuguttatus Kieff., 563.
philippinensis Kieff., 563, 564.
polystictus Kieff., 564.
 Cuyutil, 247.
Cycloclypeus communis K. Mart., 14.
Cyclospora caryolytica, 476.
Cylindromorphus Kies, 350.
orientalis Kerrem., 350.
Cyornis philippinensis Sharpe, 547.
Cyrtostomus jugularis (Linn.), 539, 552.
- D**
- Dactylometra* L. Ag., 30, 31, 38.
africana Vanhöffen, 26, 28, 30.
quinquecirrha L. Ag., 26, 28.
quinquecirrha (Desor) L. Ag., 30.
 Dactylopiinae, 641.
Dasyrotapha speciosa, 539.
Dasyhelea Kieff., 565.
formosana Kieff., 565.
Decaspermum Forst., 289.
microphyllum Merr., 289.
Decticus pallidus Walk., 612.
tenebrosus Walk., 612.
 De Forcrand, R., notice of his Cours de chimie. A L'usage des étudiants P. C. N. et S. P. C. N., tome I, 103; tome II, 103.
 Dematiaceae, 608.
Demigretta sacra (Gm.), 539, 543.
Dendrocrygna arcuata (Horsf.), 544.
 Deuteromycetae, 600.
Diatrypella Ces. & de Not., 598.
verruciformis (Ehrb.) Nke., 598.
Dicaeum haematostictum Sharpe, 552.
 DICKERSON, ROY E., A fauna of the Vigo group; its bearing on the evolution of marine molluscan faunas, 1.
Dicrohelea Kieff., 566.
albiclava Kieff., 566.
Dicrurus mirabilis Wald. & Lay., 553.
Didymella Sacc., 598.
eumorpha (B. & C.) Sacc., 598, 604.
Didymosphaeria Fuckel, 597.
infossa Sacc., 597.
Diodontus Curtis, 309.
ajax Rohwer, 310, 320.
bakeri Rohwer, 310, 312, 313.
basilanensis Rohwer, 310, 318.
luteopictus Rohwer, 310, 314, 319.
luzonensis Rohwer, 310, 313.
maurus Rohwer, 310, 316.
multipectus Rohwer, 310, 314.
philippinensis Rohwer, 310, 317.
scutatus Rohwer, 309, 310.
tuberculifrons Rohwer, 310, 315, 316.
xanthognathus (Rohwer), 310, 312.
Diplodia Fr., 601.
manihoti Sacc., 602.
moricola B. & C., 601.
persicae Sacc., 602.
Dipterocarpus grandiflorus Blanco, 487, 488.
Discomedusa philippina Mayer, 25, 26.

- Ditarytarsus Kieff., 591.
 formosanus Kieff., 591.
Dolichos lablab, 604.
 Dothideaceae, 600.
 Dothidea Fr., 600.
 tetraspora B. & Br., 600.
Duettia japonica Brunner, 613.
 japonica Jacobson & Bianchi, 613.
 japonica Stål, 613.
 thymifolia (Fabr.), 613.
 thymifolia Kirby, 613.
- E**
- Edolisoma panayense Steere, 538, 548.
Eimeria, 449, 469, 471, 474, 476.
 oxyispora, 470.
 snijdersi Dobell, 469, 470.
 wenyoni, 470.
 (*Coccidium*) *schubergi*, 474.
 sp., 470.
 Elanus hypoleucus Gould, 539, 544.
 Ellampus (Holophris) bakeri Mocsáry, 691.
Emphusis globosus Funkh., 683.
 obesus Fairm., 683.
Endeius Deyr., 350, 443.
 aeneipennis Fisher, 443, 447.
 agrilliformis Fisher, 443, 446.
 bakeri Kerrem., 443, 445.
 cornutus Kerrem., 443.
 difformis Deyr., 444.
 lunatus Fisher, 443, 445.
 palawanensis Fisher, 443, 444.
 scintillans Deyr., 446.
 violaceipennis Fisher, 443.
Endochironomus Kieff., 588.
 bryozoarum Kieff., 588.
 calolabis Kieff., 588.
 danicus Kieff., 588.
 dispar Meig., 588.
 leucolabis Kieff., 588.
 longiclava Kieff., 588.
 miki Kieff., 588.
 nymphella Kieff., 588.
 nymphoides Kieff., 588.
 occultus Kieff., 588.
 signaticornis Kieff., 588.
 sparganii Kieff., 588.
 tendens Fabr., 588.
 xantholabis Kieff., 588.
 (*Glyptotendipes*) *meinerti* Kieff., 588.
Entamoeba coli, 476.
 histolytica, 463.
Epipsylla Kuw., 281.
 forcipata Crawl., 281.
Eucalymnatus tessellatus, 672.
Euconocephalus gracilis Karny, 607.
 gracilis (Redt.), 607.
 insulanus Karny, 608.
 insulanus (Redt.), 608.
 pallidus Karny, 607.
 pallidus (Redt.), 607.
Eueugenia, 291.
Eugenia Linn., 289, 290.
 attenuatifolia Merr., 299.
 bernardoi Merr., 304.
 bordenii Merr., 298.
 brittonianae C. B. Rob., 300, 301.
 cagayanensis Merr., 304.
 calubcob C. B. Rob., 291.
 capizensis Merr., 305.
 cardiophylla Merr., 305.
 caudatifolia Merr., 305.
 clavellata Merr., 302.
 claviflora Roxb., 303.
 consanguinea Merr., 300.
 diffusa Merr., 301.
 dura Merr., 308.
 elliptifolia Merr., 291.
 ilocana Merr., 291, 307.
 martelinii Merr., 306.
 megalantha C. B. Rob., 297.
 mindorensis C. B. Rob., 300.
 neei Merr., 301.
 panayensis Merr., 292.
 parva Merr., 301.
 pascasioi Merr., 307.
 peñasi Merr., 293.
 perpallida Merr., 301.
 ramosii C. B. Rob., 299.
 rizalensis Merr., 302.
 robinsoniana Elm., 295.
 santosii Merr., 294.
 sarcocarpa Merr., 295.
 sargentii Merr., 290.
 sessililimba Merr., 296.
 siderocola Merr., 303.
 speciosissima C. B. Rob., 292, 293, 297.
 surigaensis Merr., 297.
 tula Merr., 297.
 urdanetensis Elm., 305.
 wenzelii Merr., 294.
 xiphophylla Merr., 298.
 zeylanica Wight, 305.
Euryaulacus Bonv., 71.
Eurystomus orientalis (Linn.), 545.
*Euterme*s, 245, 246, 254.
 minutus Oshima, 253, 256.
 (Ceylonitermes) *mcgregori* Oshima, 252.
 (Euterme) *balintauacensis* Oshima, 252.
 (Euterme) *castaneus* Oshima, 253.
 (Euterme) *gracilis* Oshima, 253.
 (Euterme) *las-pifasensis* Oshima, 253.
 (Euterme) *manilensis* Oshima, 253.
 (Grallatoterme) *luzonicus* Oshima, 253.
 (Grallatoterme) *panayensis* Oshima, 253.
 (Hospitaliterme) *hospitalis* Hav., 252.
 (Hospitaliterme) *luzonensis* Oshima, 252.
 (Hospitaliterme) *sariensis* Oshima, 252.
 (Rotunditerme) *culasiensis* Oshima, 254.
 (Trinerviterme) *menadoensis* Oshima, 253.
Eutypella Nitschke, 598.
 bambusina Penz. & Sacc., 598.
 citricola Speg., 598.
 Evolution of marine molluscan faunas, I.
 of pelecypods and gastropods, 17.

Excalfactoria lineata (Scop.), 540.
Exobasidiineae, 608.

F

Ficus Linn., 49, 53, 254.
ahernii Merr., 61.
anomala Merr., 64.
appendiculata Merr., 57.
balet Merr., 55.
benjamina Linn., 56.
binuangensis Merr., 67.
blepharostoma Warb., 65.
brunnea Merr., 56.
carica, 595.
chrysolepis, 54.
confertifolia Merr., 59.
crininervia Miq., 49, 69.
cucurbitina King, 54.
cumingii Miq., 65.
decussata Warb., 64.
edañol Merr., 62.
elliptifolia Merr., 53.
fenicis Merr., 66.
fiskei Elm., 68, 69.
fiskei Elm., var. cebuensis Merr., 68.
fiskei Elm., var. laevifolia Merr., 69.
formosana Maxim., 60.
geocarpa Teysm., 59.
glomerata Roxb., 268.
haggeri Merr., 62.
hallieri Merr., 54.
hauü Blanco, 65.
heteropoda Miq., 64.
lamaensis Merr., 56.
lanata Blume, 60.
leucantatoma Poir., 65.
linearis Merr., 65.
mearnsii Merr., 62.
mirabilis Merr., 58.
multistipularis Merr., 66.
nota Merr., 279.
obtusa Hassk., 61.
paucinervia Merr., 68.
philippinensis Miq., 57.
propinqua Merr., 60.
ramosii Merr., 60.
samarensis Merr., 60.
sargentii Merr., 63.
sparsifolia Merr., 64.
tinctoria Forst., 66.
ulmifolia Lam., 268, 276.
variegata Blume, 265, 266.
sp., 676.

FISHER, W. S., New Coleoptera from the Philippine Islands; family Buprestidae, tribe Agrilini, 349.

FLEUTIAUX, ED., Deux genres nouveaux de Coléoptères (Melasidae), 71; Deux espèces nouvelles de Coléoptères (Elate-ridae), 73.

Fossils from the Vigo group, 10.

Fregata aquila (Linn.), 539, 544.

Fumago Pers., 605.
vagans Pers., 605.

Fungi sinensis, 595.

FUNKHOUSER, W. D., New genera and species of Philippine Membracidae, 679.

Furnia bakeri Karny, 617.
exotica Brunner, 617.
incerta Brunner, 617.

Fusarium Link, 605.
micropus Sacc., 605.

G

Gallerix cinerea (Latham), 542.
Gallinula chloropus (Linn.), 542.
Gallus gallus (Linn.), 540.

GARCIA, ARTURO, and SOLLOZA, JUAN, Length and position of the vermiform appendix in Filipinos, 707.

Garcinia mangostana, 640.

Gargara, 687.

Geology and engineering, 221.

Gerygone fusca (Gould), 77.
rhizophorae Mearns, 77.
simplex Cab., 76, 77.

Giardia, 479.

Gleichenia dichotoma, 647.

Gloniopsis de Not. 600.
australis (Duby) Sacc., 600.

Gryllus javanus Johansson, 612.
(*Tettigonia*) elongatus Linn., 612.
(*Tettigonia*) ferruginea Stoll, 612.
(*Tettigonia*) rufa Stoll, 612.

Gymnartocarpus Boerl., 49, 52.
venenosa (Zoll.) Boerl., 52, 53.
woodii (Merr.) Merr., 52, 53.

H

Hadrotrichum Fucel, 603.
caespitosum Sacc., 603.

Haleyon chloris (Bodd.), 539, 545.
gularis (Kuhl), 545.
moseleyi, 539, 540.

Haliastur intermedius Gurney, 544.

Haplaphalara Uichanco, 260.
dahli (Rübs.), 260, 261.

HAUGHWOUT, FRANK G., A case of human coccidiosis detected in the Philippine Islands, with remarks on the development and vitality of the cysts of *Isopora hominis* (Rivolta), 449.

Hedychrum stantoni-Ashm., 691.

Helminthosporium Link, 604.
cantonense Sacc., 604, 605.

Hemichionaspis aspidistrae Sign., 98.

Heteractitis brevipres (Vieil.), 539, 542.
Heteropygia acuminata, 539.
aurita (Latham), 543.

Hezacentrus plantaris Burm., 610.
spiniger Karny, 610.
unicolor Burm., 610.
unicolor Karny, 610.
unicolor Kirby, 610.
unicolor Redt., 610.
unicolor Serville, 610.

Hilger, Adam, Ld., notice of their Optical Methods in control and research laboratories, 733.

- Hirundo javancia* Sparrman, 539, 546.
striolata Boie, 539, 547.
Holochlora javanica Brunner, 615.
javanica Kirby, 616.
Holoconops, 557.
Homorocoryphus dubius, 608.
interruptus, 608.
 sp., 608.
Hopcia, 490.
Hoplonota benguetina Spaeth, 724, 726.
bramosa Wag., 726, 729.
calligera Spaeth, 730, 732.
chapuisi Spaeth, 726.
dapitana Spaeth, 721.
ferruginea Spaeth, 730.
gemmata Keug, 728.
granulosa Weise, 722.
hedysma Spaeth, 723, 724.
lenta, 726.
modesta, 724, 726, 727.
nigriclavus Spaeth, 728.
nitida Weise, 726.
quadra Spaeth, 730, 732.
rufa Wag., 725, 729, 730.
sarawacensis Spaeth, 730.
sexnotata, 724.
taeniata F., 729.
undulata Wag., 726, 727.
vittata Wag., 726-728.
weyersi Spaeth, 732.
 Huyghens, Christian, notice of his Les maitres de la pensée scientifique. Collection de mémoires publiés par les soins de M. Solovine. *Traité de la lumière*, 103.
Hydrocoptus scapularis Reg., 694.
 Hymenomycetinae, 595.
 Hypocreaceae, 599.
Hyponeetria Sacc., 599.
sinensis Sacc., 599.
Hypotaenidia striata (Linn.), 541.
Hypothyms occipitalis (Vig.), 547.
Hypoxydon Bull., 599.
serpens (Pers.) Fr., 599.
Hypsauchenia Germ., 679.
 Hysteriinae, 600.
Hystero-graphium Corda, 600.
mori (Schw.) Rehm., 600.
- I
- Icerya*, 640.
ordinata, 639.
palmarum, 639.
Imperata, 550, 551.
Iole guimarasensis Steere, 548.
Isoptera borneensis Scheff., 490.
Isospora, 452, 454, 457, 463, 464, 471, 473-475, 479.
bigemina, 464, 468, 469.
bigemina var. *hominis*, 469.
hominis (Riv.), 449, 451, 456, 468-470, 475-477.
 infections, detection of, 456.
Ixobrychus astrologus Wetmore, 543.
cinnamomea (Gm.), 544.

- Ixobrychus*—Continued.
sinensis McG., 543.
sinensis astrologus Wetmore, 543.
sinensis bryani (Seale), 544.
Izora macrothyrsa, 647.

J

- Japanese Aphelininae, 97.

K

- Kamosia* Kerrem., 351.
 KARNY, H. H., Katydids (Tettigonoidea) of the Philippine Islands, collected by C. F. Baker, 607.
 KIEFFER, J. J., Chironomides des Philippines et de Formose, 557.
 KING, ALBERT E. W., Physical properties of Philippine concrete and concrete aggregates, 105.
 King, W. G., notice of his Vaccination in the Tropics, 733.
Kittacina superciliaris Bourns & Worc., 549.
Kleinhofia hospita L., 276.
 KNAPP, Arthur W., notice of his Cocoa and Chocolate Their History from Plantation to Consumer, 733.
Kribiodoxa Kieff., 587.
pulchripennis Kieff., 587.
Kuehneola F. Magn., 595.
fici (Cast.) Butl., 595.
moricola P. Henn., 595.

L

- Lac-ha*, 248.
Lalaga niger (Forst.), 548.
Lamprocorax panayensis (Scop.), 539, 553.
Lecaniodiaspis Targ., 644.
 LEE, H. ATHERTON, The relation of stocks to mottled leaf of citrus trees, 85.
Lepidocyclus, 15.
richthofeni Smith, 14, 15.
Leptobelus elevatus Funkh., 685.
Leptoconops flavipennis, 557.
hyalinipennis, 557.
Leptynoptera Crawl., 271.
sulfurea Crawl., 271.
sulfurea rubrocincta Uichanco, 271.
Letana despecta, 616.
 LIGHT, S. F., Further notes on Philippine scyphomedusan jellyfishes, 25; Notes on Philippine termites, I., 243.
Limnochironomus Kieff., 585.
niveicauda Kieff., 585.
Linuche unguiculata (Schwartz) var. *aquila* Mayer, 26.
Liotrachela lobata Brunner, 616.
 Listrosclinae, 609.
Listrosclis pectinata Brunner, 610.
pectinata Burm., 610.
pectinata Guer.-Men., 609.
pectinata Serville, 610.
Lithobius forficatus, 474.
Lithothamnion ramosissimum Reuss, 15.
 Liviinae Löw, 260.

- Livistona chinensis*, 603.
Lobonema Mayer, 31, 38, 39, 41, 43.
 mayeri Light, 27, 29, 43, 44.
 smithii Mayer, 27, 29, 43, 44.
Lobonemoides gracilis Light, 28.
Locusta elongata Fabr., 612.
 japonica Thunb., 613.
 longipes Thunb., 612.
 pectinata de Haan, 610.
 plantaris de Haan, 610.
 seclaris Thunb., 612.
 thymifolia Fabr., 613.
 unicolor Serville, 610.
 (*Mecopoda*) *javana* de Haan, 612.
 (*Mecopoda*) *macassariensis* de Haan, 612.
 (*Mecopoda*) *niponensis* de Haan, 612.
 (*Phaneroptera*) *japonica* de Haan, 615.
 (*Phaneroptera*) *quinquenervis* de Haan, 613.
 (*Phylloptera*) *carinata* de Haan, 613.
 (*Xiphidium*) *lepida* de Haan, 609.
 (*Xiphidium*) *longipennis* de Haan, 608.
Lorifera flagellata (Haeckel) Mayer, 28.
 lorifera var. *pacifica* (Schultze) Mayer, 28.
Lucera bicoloripes Walk., 612.
 Lumbang oil, composition, solubility, and oxidation of, 619.
Lychnorhiza bartsehi Mayer, 27.

M

- Macaranga*, 663, 665.
 hypolema, 657.
 triloba, 659, 661, 663, 666.
 sp., 661, 666.
Macrotermes spp., 248, 254, 255.
Magnolia sp., 601.
 Makwer, W., et Geiger, H., notice of their Mesures pratiques en radioactivité, 103.
 Malananca, 53.
 Malasugui, 299.
Mallotus philippensis (Lam.) Muell.-Arg., 285.
Manihot utilisima, 599, 601, 602, 605.
 Maramaatan, 304.
 Marshall, Charles E., notice of his Microbiology, A text-book of microorganisms general and applied, 734.
Mastigias L. Agassiz, 40, 42.
 ocellata (Modeer) Haeckel, 27.
 papua (Lesson) L. Agassiz, 27, 29, 39, 42.
 MCGREGOR, RICHARD C., New or noteworthy Philippine birds, III, 75; Birds of Antique Province, Panay, Philippine Islands, 537.
 McMurrich, J. Playfair, notice of his The Development of the Human Body, a manual of human embryology, 733.
 Mecopodinae, 612.
Mecopoda elongata Burm., 612.
 elongata Caudell, 613.
 elongata Kirby, 613.
 elongata (Linn.), 612.
 elongata Redt., 612.
 elongata Tani, 613.
Mecopoda—Continued.
 ferruginea Blanch., 612.
 macassariensis de Haan, 613.
 maculata Serville, 612.
 niponensis de Haan, 613.
 rufa Walk., 612.
 virens Blanch., 612.
 virens Brulle, 612.
 virens Serville, 621.
Medusa cephea Forsk., 32.
Megalonectria Sacc., 599.
 pseudotrichia (Schw.) Speg., var. *oligospora* Sacc., 599.
Megalurus ruficeps Grant & Whitehead, 550.
 tweeddalei McG., 550.
Megatrioza Crawl., 281.
 armata Crawl., 283.
 banksi Uichanco, 281.
 pallida Uichanco, 283.
 Melanconiaceae, 602.
Melanconium Link, 602.
 bambusinum Speg., 603.
 hysterinum Sacc., 602.
 sacchari Cooke, 603.
 sphaerosperum (Pers.) Link., 602.
 (Endocalyx) *melanoxanthum* B. & Br. 603.
Melanoxanthus bimaculatus Fleut., 73.
 illustris Fleut., 73.
 insignis Fleut., 73.
 melanurus Candeze, 73.
 quadrilineatus Schwarz, 74.
 quadrripunctatus Candeze, 73.
Melibaes Deyr., 350.
 aneifrons Deyr., 350.
 bakeri Kerrem., 350.
 Merops americanus P. L. S. Müll., 545.
 MERRILL, ELMER D., New Philippine Moraceae, 49; New Philippine Myrtaceae, 289.
Mesocentrus Funkh., 681.
 pyramidatus Funkh., 681.
Metasambus Kerrem., 419.
Metasphaeria Sacc., 598.
 conoidea Sacc., 598.
Michelia champaca, 639.
Microcerotermes, 245, 247.
 los-bañosensis Oshima, 254, 255.
Microhelea, 557.
Microstroma Niessl, 603.
 minimum Sacc., 603.
Microtendipes Kieff., 580.
 dimidiatus Kieff., 580, 581.
 stictopterus Kieff., 580.
Microxyphium Sacc., 602.
 obtusulum Sacc., 602.
Mirollia carinata Brunner, 613.
 carinata (de Haan), 613.
 carinata Dohrn, 613.
 carinata Kirby, 613.
 carinata Stål, 613.
Mitra bucciniformis, 12, 16.
 javana, 12, 16.
 jenkinsi, 12, 16.
 junghuhni, 12, 16.

- Mixohelea Kieff., 568.
 cillaticrus Kieff., 568.
 Monophlebinae, 639.
 MONTEZ, ZOILA, see WEST and MONTES.
 MORRISON, HAROLD, Some nondiaspine
 Coccidae from the Malay Peninsula,
 with descriptions of apparently new
 species, 637.
Morus alba, 595, 598, 600, 601, 605.
Munia jagori Martens, 552.
Murraya caloxyylon, 654.
 Muscivores chalybura (Bp.), 540.
Muscicapula calayensis McG., 76.
luzoniensis Grant, 76.
luzoniensis McG., 76.
westermanni Sharpe, 539, 547.
- N
- NAKAYAMA, SHONOSUKE, An enumeration
 of the Japanese Aphelininae, with de-
 scriptions of two new species, 97.
 NAKAGAS, JUAN C., Position and size of
 the kidneys among Filipinos, 695.
 Neosambus Fisher, 350, 351.
cupricollis Fisher, 351, 352.
glabrus Fisher, 352, 355.
ornatus Fisher, 352, 353.
viridipennis Fisher, 352, 354.
 Neotoxoscelus Fisher, 350, 418.
bakeri Fisher, 418, 419, 421.
luzonicus Fisher, 420.
 Neoxocephus McG., 79.
Nephelium lappaceum, 643.
Ninox philippensis Bp., 539, 545.
Nocera pallida Walk., 610.
pectinata Walk., 610.
 Nondiaspine Coccidae from the Malay Penin-
 sula, 637.
 Nummularia Tul., 599.
punctulata (B. & Rav.) Sacc., 599.
 Nycticorax manillensis Vig., 543.
- O
- Odontotermes*, 245, 248.
mediodentatus Oshima, 252.
Oncosperma horrida, 643.
 Opie, Eugene L.; Blake, Francis G.; Small,
 James C.; Rivers, Thomas M.; notice
 of their Epidemic Respiratory Disease;
 the pneumonias and other infections of
 the respiratory tract accompanying in-
 fluenza and measles, 734.
 Opli, 63.
Orbitoides, 15.
gigantea Martin, 14.
radiata Martin, 14.
Oriolus acrorhynchus Vig., 539, 553.
steeri, 539.
 Ortheziinae, 640.
 Orthezia Bosc d'Antic, 640.
insignis Doug., 640.
 Orthocladiarinae, 576.
Orthophragmina, 15.
Orthotomus castaneiceps Wald., 549.
- Osmotreron axillaris* (Bp.), 540.
ocularis, 541.
vernans (Linn.), 540.
Ostrea sp., 8.
- P
- Paleococcus Kkll., 639.
pulcher Leonardi, 638, 639.
 Palpomyia Meg., 569.
atriclava Kieff., 569.
spinifera, 557.
Pandanus, 538.
 sp., 674.
 Pandaraga, 290.
Paralecanium Kkll., 670, 671.
maritimum, 674.
ovatum Morrison, 671, 672.
vacuum Morrison, 674, 675.
zonatum (Green), 671, 674.
Paratendipes nigrofasciatus, 588.
 Paratrachys Saund., 350, 421.
pilifrons Kerrem., 421.
Paraliparus edithae McG., 551.
elegans panayensis Mearns, 551.
panayensis Mearns, 551.
 Pairocephala Crawl., 274.
kleinholiae Uichanco, 274.
psyloptera Crawl., 276.
psyloptera maculipennis Uichanco, 276.
 Pairopsyllinae Crawl., 263.
 Pairopsylla Rübs., 263.
bakeri Crawl., 266.
montana Uichanco, 265.
trioptera Crawl., 266.
tuberculata Crawl., 268.
udei Rübs., 263, 265.
 Pelagidae Gegenb., 30.
 Pelagia panopyra Pér. & Les., 26.
panopyra var. *placenta* (Haeck.) Mayer,
 26.
quinquecirrha E. Desor, 30.
 Penelopides panini (Bodd.), 545.
Penniseti sp., 596.
 Pentapedilum Kieff., 592.
pygmaeum Kieff., 592.
 Periphylla hyacinthina Steenstrup, 26.
 Perisporiaceae, 602.
Perissolax blakei, 20.
Perissoneumon ferox, 640.
 sp., 640.
 Perissopterus Howard, 99.
mexicanus Howard, 99.
 PERKINS, GRANVILLE A., The structure
 of the electron, 325; Absolute units and
 the relativity principle, 341.
 Peroneutypa Sacc., 598.
heteracantha Sacc., 598.
 Peronoplasmodora (Berlese) Clint., 596.
cubensis (Berk. & Curt.) Clint., 596.
 Peronosporaceae, 596.
 PESCHET, R., Description d'un Canthydrus
 (Coleoptera Dytiscidae) nouveau, des
 Iles Philippines, 693.
 Phaneropterinae, 613.

- Phaneroptera brevis* Serville, 616.
carinata Stål, 613.
furcifera Stål, 616, 617.
gracilis Burm., 616.
nana, 616.
neochlora Walk., 613.
privata Walk., 613.
subcarinata Bolivar, 616.
- Phapitreron maculipectus*, 539.
nigrorum Sharpe, 540.
- Phaula compressa* Brunner, 615.
laevis Brunner, 615.
phaneropteroides Brunner, 615.
rugulosa Brunner, 615.
teretiuscula Karny 614.
- Phenacoccus pergandei* Ckll., 98.
- Philippine birds, 75, 537.
- Hoplinota (Coleoptera), 721.
- Katydid, 607.
- Membracidae, 679.
- Moraceae, 49.
- Myrtaceae, 289.
- termites, 243.
- timbers, 485.
- wasps, 309, 691.
- Phisis pallida* Karny, 610.
pectinata (Guer.-Men.), 609.
pectinata Karny, 610.
pectinata Kirby, 610.
pectinata Stål, 610.
philippinarum Karny, 609.
- Pholadomya nasuta*, 20.
- Phoma* (Fr.) Desm., 601.
media Ell. & Ev., 601.
- Phyllachora Nitschke*, 600.
- sinensis* Sacc., 600.
- Phyllonimus bakeri* Karny, 611.
detersus, 612.
detersus Kirby, 611.
detersus (Walk.), 611.
granulosus Brunner, 611.
granulosus Stål, 611.
truncatifolia Pictet & Saussure, 611.
- Phyllorhiza luzoni* Mayer, 27.
- Physalospora* Niessl, 596.
propinqua Sacc., 597.
reinkingiana Sacc., 596.
- Physical properties of Philippine concrete and concrete aggregates, 105.
- Phytochronomus* Kieff., 586.
astictus, 588.
concoloripes, 588.
philippinarum Kieff., 586.
tainanus Kieff., 587.
- Pikpikuag*, 51.
- Pinanga*, 670.
- Pithecolobium*, 253, 254.
- Pitta erythrogaster* Temm., 546.
- Placuna placenta*, 7.
- Planesticus nigrorum*, 540.
- Plasmodium*, 480.
- Platyecanium* Ckll. & Rob., 667, 670, 671.
asymmetricum Morrison, 667, 669, 671.
cribrigerum (Ckll. & Rob.), 670, 671.
pseudexpansum (Green), 670, 671.
- Podosporium* Schw., 604.
minus Sacc., 604.
- Poliolimnas cinereus* McG., 541.
ocularis (Ingram), 541.
- Polypedium* Kieff., 577.
atrinerve Kieff., 577, 578.
consobrinum Kieff., 578, 580.
iricolor Kieff., 577.
macrotrichum Kieff., 577, 578.
monostictum Kieff., 577.
nanulus Kieff., 577.
pelostolum Kieff., 578, 580.
sauteri Kieff., 578, 579.
- Pongi, 53.
- Porphyrio pulverulentus* Temm., 539, 542.
- Porzana cinerea*, 541.
cinerea ocularis Ingram, 541.
- Pratincola caprata* (Linn.), 549.
- Probezzia* Kieff., 570.
bakeri Kieff., 570.
myrmedon Kieff., 570, 571.
- Procladius philippinensis* Kieff., 573.
- Prohelea* Kieff., 557.
- Prospaltella* Howard, 99.
aurantii Howard, 99.
berlesii Howard, 99, 100.
niligatae Nakayama, 99, 100.
- Protenthes punctipennis* Meig., 574.
- Prunus persica*, 595, 600-602, 605.
- Psathyra* Fr., 595.
spadiceo-grisea (Schäff.) Quél., 595.
- Psen* Latr., 321.
aureohirta Rohwer, 321.
melanosoma Rohwer, 321.
pulcherrimus Bingham, 319.
rufiventris Cam., 317.
 (Mimesa) *aureohirta* Rohwer, 322.
 (Mimesa) *melanosoma* Rohwer, 322.
 (Mimesa) *politiventris* Rohwer, 321.
- Psenus* Kohl, 309.
interstitialis Cam., 312.
- Pseudococcus* Westw., 644, 647.
bromelinae (Bouché), 644.
hispidus Morrison 644, 645, 646.
- Pseudophyllinae*, 610.
- Pseudophyllus detersus* Walk., 611.
sinensis Walk., 611.
- Psidium guajava*, 598, 602.
- Psyllidae from the Philippine Islands, 259.
- Psyllinae Puton, 281.
- Psylla* Geoff., 281.
simlae Crawf., 281.
- Pteroptrici* Ashm., 100.
- Pucciniaceae, 595.
- Puccinia* Pers., 595.
longicornis Pat. & Har., 595.
pruni-spinosae Pers., 595.
- Pulvinaria citricola* Kuw., 98.
- Punica granatum*, 599.
- Pycnonotus goiavier* Boie, 548.
- Pyrgauchenia* Bredd., 679.
- Pyrgolyrium* Bredd., 679.
- Pyrgonota* Stål, 679.
- noditurris* Funkh., 684.
- Pyrgophyllum* Bredd., 679.

Pyrrherodia manilensis (Meyen), 543.
Pyrrhicia, 616.

R

REVIEWS:

- Ambard, L., Clinique des voies urinaires de la Faculté de Médecine de Paris. Physiologie normale et pathologique des reins, 104.
- Badoureau, A., Causeries Philosophiques, 733.
- Bordet, Jules, Troite de L'immunité dans les maladies infectieuses, 103.
- De Forcrand, R., Cours de Chimie. A L'usage des étudiants P. C. N. et S. P. C. N., tome I, 103.
- De Forcrand, R., Cours de Chimie. A L'usage des étudiants P. C. N. et S. P. C. N., tome II, 103.
- Hüger, Adam, Ld., Optical Methods in control and research laboratories, 733.
- Huyghens, Christian, Les maîtres de la pensée scientifique. Collection de mémoires publiés par les soins de M. Solovine. Traité de la lumière, 103.
- King, W. G., Vaccination in the Tropics, 733.
- Knapp, Arthur W., Cocoa and Chocolate Their History from Plantation to Consumer, 733.
- Makover, W., et Geiger, H., Mesures pratiques en radioactivité, 103.
- Marshall, Charles E., Microbiology, A textbook of microorganisms general and applied, 734.
- McMurrich, J. Playfair, The Development of the Human Body, a manual of human embryology, 733.
- Opie, Eugene L.; Blake, Francis G.; Small, James C.; Rivers, Thomas M.; Epidemic Respiratory Disease; the pneumonias and other infections of the respiratory tract accompanying influenza and measles, 734.
- Ronchese, A. D., La réaction de Bordet-Wassermann pour le sérodiagnostic de la syphilis étude théorique et pratique-méthodes recommandées interprétation des résultats, 103.
- Rosanoff, Aaron J., Manual of Psychiatry, 103.
- Stitt, E. R., Practical Bacteriology, Blood Work and Animal Parasitology including Bacteriological Keys, Zoological Tables and Explanatory Clinical Notes, 733.
- Rhectantarsus* Bause, 592.
formosae Kieff., 592.
- Rhinomyias albicularis*, 540.
- Rhinoterms (*Schedorhinoterms*) *bidentatus* Oshima, 250.
(*Schedorhinoterms*) *longirostris* Brauer, 250.
(*Schedorhinoterms*) *tarakensis* Oshima, 251.
- Rhipidura albiventris* Sharpe, 538, 547.
nigritorquis Vig., 78, 539, 548.
- Rhizostomae* Cuv., 27, 32.
- Rhizostomata dichotoma* Vanhöffen, 32, 33, 35, 36, 40, 41.
lorifera Vanhöffen, 45.
triptera Vanhöffen, sensu Maas, 40, 41.
- Rhopaloblasta*, 639.
- Rhopilema visayana* Light, 28.
- Ricinus communis*, 597, 603.
- Rivers, Thomas M., see Opie, Blake, Small, and Rivers.
- ROHWER, S. A., Descriptions of new Philippine wasps of the subfamily Pseninae, 309; Some Philippine wasps of the family Chrysididae, 691.
- Ronchese, A. D., notice of his La réaction de Bordet-Wassermann pour le sérodiagnostic d la syphilis étude théorique et pratique-méthodes recommandées interprétation des résultats, 103.
- Rosanoff, Aaron J., notice of his Manual of Psychiatry, 103.
- Rostratula capensis* (Linn.), 543.

S

- SACCARDO, P. A., Fungi sinensis aliquot a cl. Prof. Otto A. Reinking collecti et communicati, 595.
- Saccharum officinarum*, 596, 603.
- Saissetia*, 654, 658, 662.
- Samanea saman* Merr., 250.
- Sambus* Deyr., 350, 351, 408.
- aenicollis* Fisher, 409, 416.
auricolor Saund., 408.
bakeri Fisher, 408, 410.
confusus Fisher, 408, 412.
fasciatus Fisher, 409, 414.
gibbosus Fisher, 408, 409.
lugubris Saund., 409, 417.
luzonicus Fisher, 409, 415.
nigricans Fisher, 409, 415.
ornatus Fisher, 408, 413.
parallelus Fisher, 408, 411.
- Sanderia malayensis* Götte, 26.
- Sarcops melanonotus* Grant, 553.
- Schizoconops*, 557.
- Schizophyllum* Fr., 595.
commune Fr., 595.
- Scyphomedusan jellyfishes, notes on, 25.
- Semaestomae* L. Ag., 26, 30.
- Semecarpus cuneiformis* Blanco, 77.
- Shorea balangeran* (Korth.) Dyer, 490.
guiso (Blanco) Blume, 489, 490.
polysperma (Blanco) Merr., 486.
- Small, James C., see Opie, Blake, Small, and Rivers.
- SMITH, WARREN D., Tropical geology and engineering, 221.
- SOLLOZA, JUAN, see GARCIA and SOLLOZA.
- SPAETH, FRANK, Philippine and Bornean species of Hoplionota (Coleoptera), 721.
- Sphaeriaceae, 596.
- Sphaerioidaceae, 600.

- Sphaeronaema* Fr., 601.
 reinkingii Sacc., 601.
 reinkingii Sacc. var. *clitricola* Sacc., 601.
Sphaerophragmium P. Magn., 596.
 acaciae (Cke.) Magn., 596.
Sphaeropsis Lév., 601.
 magnoliae Magnaghi, 601.
 valsoida Cke. & Ell., 601.
Spilornis panayensis Steere, 544.
Spondias, 253.
Steirochaete Br. & Casp., 605.
 capsici (Syd.) Sacc., 605.
Stemphylium Wallroth, 605.
 macrosporoideum (Berk.) Sacc., 605.
Sterna boreotis (Bangs), 539, 542.
Stilbonectria Karst., 599.
 lateritia Karst., 599.
Stilbum cyanurum, 691.
 cyanurum subsp. *amethystinum* Fabr., 691, 692.
 cyanurum subsp. *amethystinum* variety, 691.
 cyanurum subsp. *luzonensis* Rohwer, 692.
 cyanurum var. *chrysocephalum* Buysson, 691.
 cyanurum var. *flammeiceps* Mocsáry, 691.
 splendidum var. *chrysocephalum* Buysson, 691.
Stilobezzia Kieff., 566.
 decora Kieff., 566.
 Stitt, E. R. notice of his Practical Bacteriology, Blood Work and Animal Parasitology including Bacteriological Keys, Zoological Tables and Explanatory Clinical Notes, 733.
Streptopelia dussumieri (Temm.), 539, 541.
 Structure of the electron, 325.
Sulipa, 53.
Sulum, 246, 247.
- T
- Tachardiinae*, 647.
Tachardia R. Blanch., 647.
 aurantiaca Kll., 647.
Tachybaptus philippensis (Bonnaterre), 539, 542.
Tanypininae, 573.
Tanypus monilis Linn., 574.
Tarrietia javanica Blume, 490.
Telamona, 681.
Teleomycetaceae, 595.
Teratura simplex Karny, 608.
 xiphidioides Karny, 608.
Terebra bicincta, 12, 16.
 javana, 12, 16.
Termes, 245, 246.
 carbonarius, 247.
 copelandi Oshima, 251.
 distans Hav., 248, 254.
 dives Hagen, 248, 251.
 gilvus Hagen, 248, 251.
 (Macrotermes) *copelandi* Oshima, 248, 249, 251, 255.
 (Macrotermes) *luzonensis* Oshima, 251.
 (Macrotermes) *manilanus* Oshima, 251.
- Termes*—Continued.
 (Macrotermes) *philippinensis* Oshima, 249, 252.
 (Macrotermes) *copelandi* Oshima, 251.
 Termites reported from the Philippines, 250.
Termitogitonella Oshima, 254.
 tibiaensis Oshima, 251.
Terpsiphone, 78.
 incii (Gould), 81.
 nigra McG., 79-81.
 periophthalmica (Grant), 79.
 princeps (Temm.), 81, 82.
Tetraploa Berk. & Br., 604.
 aristata B. & Br., 604.
Tetragonioides, 607.
Teuthras pallidus Holdhaus, 610.
 pectinatus Redt., 610.
 pectinatus Stål, 610.
Thespesia macrophylla Blume, 263.
 populnea (Linn.) Sal., 263.
Thriponax hargitti Sharpe, 546.
Thysanostoma L. Ag., 45.
 thysanura Haeck., 28, 29, 45.
Togona unicolor Matsumura & Shiraki, 610.
Totanus tenuirostris Horsf., 76.
Toxoscelus Deyr., 350, 418, 419.
 rugicollis Saund., 418.
Trachys Fabr., 350, 421.
 bakeri Kerrem., 421.
 cornuta Kerrem., 421.
 cuneliformis Fisher, 422, 425.
 cupripypa Deyr., 422, 429.
 cyanipennis Fisher, 422, 429.
 dubia Saund., 421.
 formosana Kerrem., 421.
 fraterna Kerrem., 421.
 glabra Fisher, 421, 422.
 lunata Fisher, 422, 430.
 luzonica Kerrem., 421.
 marmorata Fisher, 422, 431.
 metallica Fisher, 421, 423.
 mindanaoensis Fisher, 422, 426.
 ovata Fisher, 422, 433.
 palawana Kerrem., 421, 423.
 philippinensis Fisher, 421, 424.
 piceiventris Fisher, 422, 428.
 picta Fisher, 422, 427.
 princeps Saund., 422, 431.
 rufescens Kerrem., 421.
 viridula Kerrem., 422, 434.
Tricentrus, 687.
Trichocladus nitens Kieff., 576.
Trichotanypus insularis Kieff., 574.
 insularis var. *transiensis* Kieff., 575.
Tringa canutus Sharpe, 75.
 crassirostris Temm. & Schleg., 76.
Trioxinae Puton, 281.
Trioza diptera Crawford, 274.
Tubog, 58.
Tula, 298.
Tulisayan, 290.
Tumaluhu, 290.
Turnix fasciata (Temm.), 540.
Turris coronifer, 12, 16.
Tuyokay na digtoy, 58.

Tylococcus Newst., 646, 647.

Tyoria Walk., 279.

indica Crawf., 279.

Tyto longimembris (Jerdon), 539, 545.

U

UICHANCO, LEOPOLDO B., New records and species of Psyllidae from the Philippine Islands, with descriptions of some preadult stages and habits, 259.

Ulmariidae Haeck., 31.

Urostigma, 55.

Usnea, 545.

Ustilaginaceae, 596.

Ustilago Pers., 596.

penniseti Rabenh., 596.

sacchari Rabenh., 596.

V

VALENCIA, F. V., Mechanical tests of some commercial Philippine timbers, 485.

Vermetus javanus, 12, 16.

Vermicularis capsici Syd., 605.

Versura maasi Mayer, 27.

Vicarya callosa Jenkins, 12, 13, 16.

Villaria, 291.

W

WEST, AUGUSTUS P., and MONTES, ZOLA, The composition, solubility, and oxidation of lumbang oil, 619.

X

Xantholaema roseum (Dumont), 539, 546.

Xeocephus cinnamomeus, 78.

cyaneus Sharpe, 79.

rufus (Gray), 78.

Xiphidion affine Redt., 609.

bakeri Karny, 608.

longipenne (de Haan), 608.

maculatum Le Guillou, 609.

Xiphidium longipenne Redt., 608.

maculatum Jacobson & Bianchi, 609.

maculatum Le Guillou, 609.

maculatum Redt., 609.

(*Xiphidion affine* Karny, 609.

(*Xiphidion longipenne* Karny, 608.

(*Xiphidion maculatum* Karny, 609.

Z

Zeocephus cyaneus Sharpe, 79.

Zosterops nigrorum Tweedl., 552.

THE PHILIPPINE BUREAU OF SCIENCE

RECENT PUBLICATIONS

AN INTERPRETATION OF RUMPHIUS'S HERBARIUM AMBOINENSE

By E. D. MERRILL

Based on the collections made in Amboina by the late Charles Budd
Robinson

Order No. 450. Bureau of Science Publication No. 9. Paper, 595 pages
and 2 maps.

Price, \$3 United States currency, postpaid.

SPECIES BLANCOANAE: A CRITICAL REVISION OF THE PHILIPPINE SPECIES OF PLANTS DESCRIBED BY BLANCO AND BY LLANOS

By E. D. MERRILL

Order No. 461. Bureau of Science Publication No. 12. Paper, 423 pages
and 1 map.

Price, \$2.25 United States currency, postpaid.

PHILIPPINE WATER SUPPLIES

By George W. Heise and A. S. Behrman

Order No. 460. Bureau of Science Publication No. 11. Paper, 218 pages,
19 plates, and 4 text figures.

Price, \$1.75 United States currency, postpaid.

VEGETATION OF PHILIPPINE MOUNTAINS

The relation between the environment and physical types
at different altitudes

By WILLIAM H. BROWN

Order No. 473. Bureau of Science Publication No. 13. Paper, 434 pages,
41 plates, 30 text figures.

Price, \$2.50 United States currency, postpaid.

PLEASE GIVE ORDER NUMBER

Orders for these publications may be sent to the Business Manager, Philippine Journal
of Science, Bureau of Science, Manila, P. I., or to any of the following agents:

AGENTS

THE MACMILLAN COMPANY, 64-66 Fifth Avenue, New York, U. S. A.
WM. WESLEY & SON, 28 Essex Street, Strand, London, W. C., England.
MARTINUS NIJHOFF, Lange Voorhout 9, The Hague, Holland.
KELLY & WALSH, Limited, 32 Raffles Place, Singapore, Straits Settlements.
THACKER, SPINK & CO., P. O. Box 54, Calcutta, India.
THE MARUZEN CO., Limited, 11-16 Nihonbashi, Tori-Sanchome, Tokyo, Japan.

CONTENTS

	Page.
WEST, AUGUSTUS P., and MONTES, ZOILA. The composition, solubility, and oxidation of lumbang oil.....	619
MORRISON, HAROLD. Some nondiaspine Coccidæ from the Malay Peninsula, with descriptions of apparently new species.....	637
FUNKHOUSER, W. D. New genera and species of Philippine Membracidæ.....	679
ROHWER, S. A. Some Philippine wasps of the family Chrysididæ.....	691
PESCHET, R. Description d'un Canthydrus (Coleoptera-dytiscidæ) nouveau, des Iles Philippines.....	693
NAÑAGAS, JUAN C. Position and size of the kidneys among Filipinos.....	695
GARCIA, ARTURO, and SOLLOZA, JUAN. Length and position of the vermiform appendix in Filipinos.....	707
SPAETH, FRANK. Philippine and Bornean species of Hoplionota (Coleoptera).....	721
REVIEWS.....	733
INDEX.....	735

The Philippine Journal of Science is issued twelve times a year. The sections were discontinued with the completion of Volume XIII (1918).

Yearly subscription, beginning with Volume XIV, 5 dollars United States currency. Single numbers, 50 cents each.

Publications sent in exchange for the Philippine Journal of Science should be addressed: Library, Bureau of Science, Manila, P. I.

Subscriptions may be sent to the BUSINESS MANAGER, Philippine Journal of Science, Bureau of Science, Manila, P. I., or to any of the agents listed on the third page of this cover.

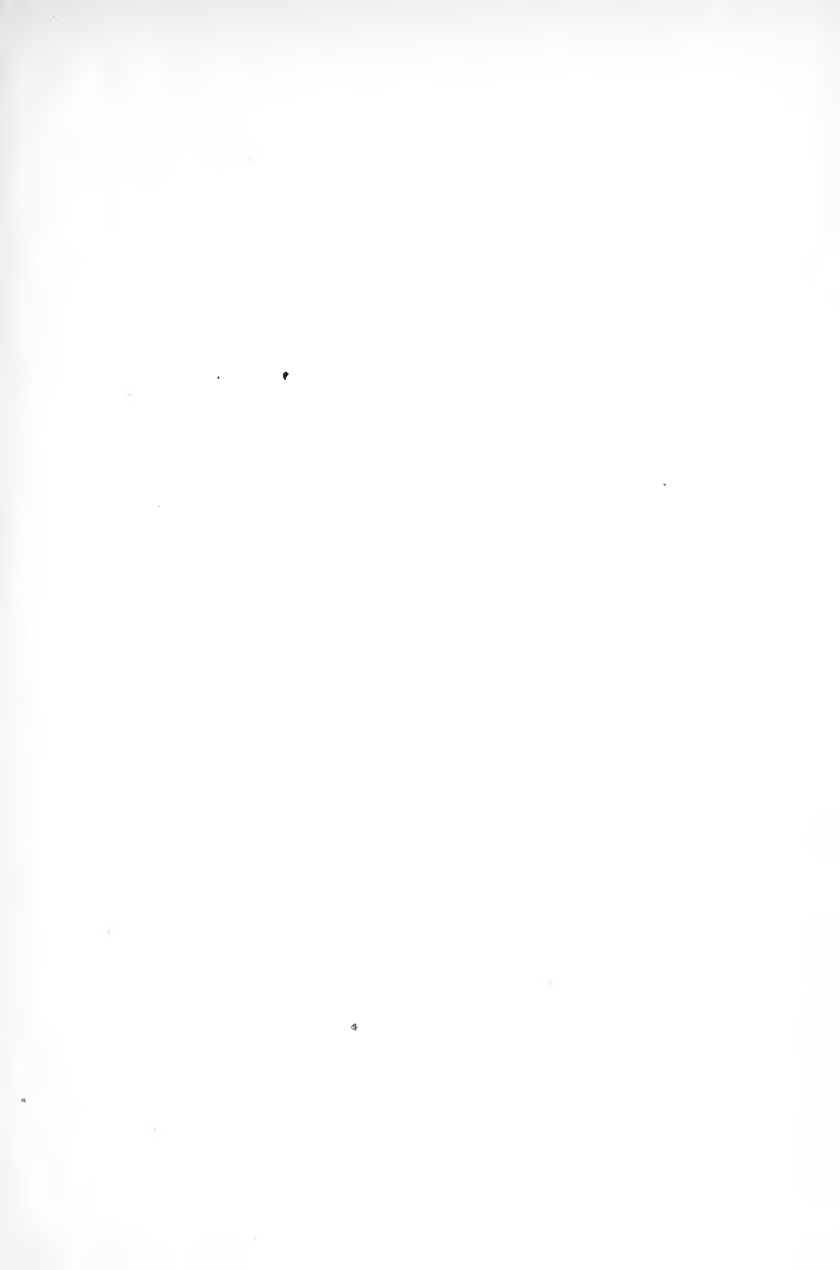

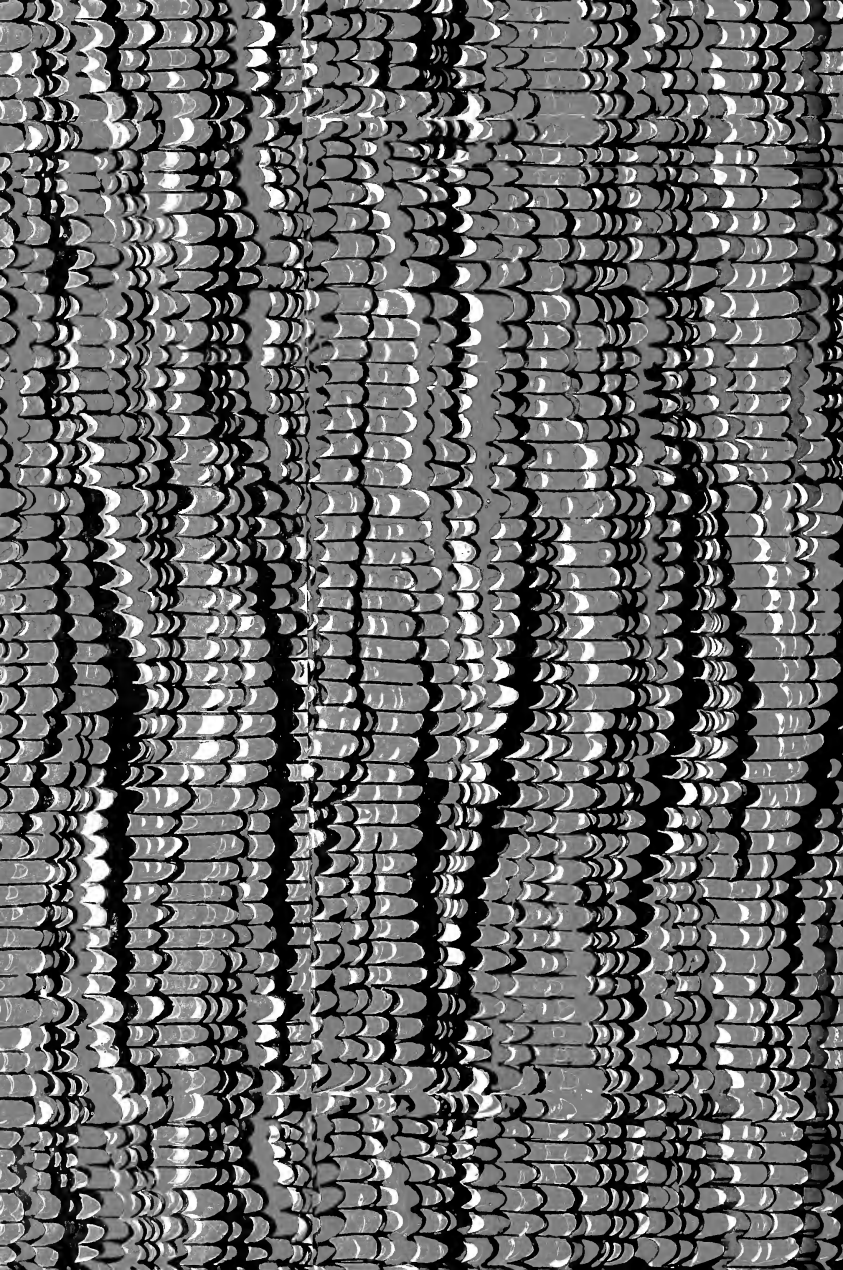

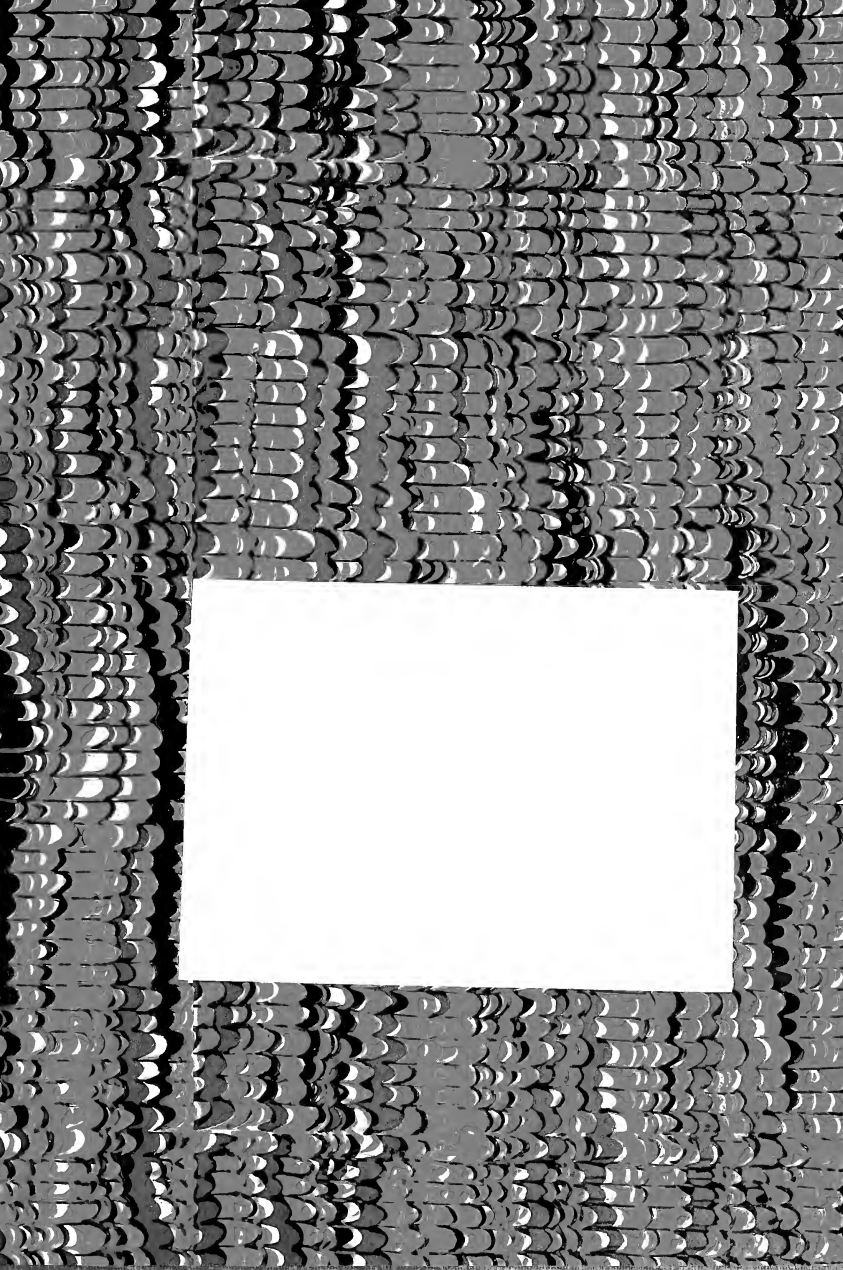

SMITHSONIAN INSTITUTION LIBRARIES



3 9088 01307 7003