



UNIVERSITY OF  
ILLINOIS LIBRARY  
AT URBANA-CHAMPAIGN  
BIOLOGY

APR 09 1992





# FIELDIANA

## Zoology

NEW SERIES, NO. 63

APR 1 1991

### Phylogenetic Systematics of the *Amolops* Group of Rapid Frogs of Southeastern Asia and the Greater Sunda Islands

Da-Tong Yang

THE LIBRARY OF THE

MAR 26 1991

UNIVERSITY OF ILLINOIS  
URBANA-CHAMPAIGN

February 28, 1991  
Publication 1423

PUBLISHED BY FIELD MUSEUM OF NATURAL HISTOR

## Information for Contributors to *Fieldiana*

**General:** *Fieldiana* is primarily a journal for Field Museum staff members and research associates, although manuscripts from nonaffiliated authors may be considered as space permits.

The Journal carries a page charge of \$65.00 per printed page or fraction thereof. Payment of at least 50% of page charges qualifies a paper for expedited processing, which reduces the publication time. Contributions from staff, research associates, and invited authors will be considered for publication regardless of ability to pay page charges, however, the full charge is mandatory for nonaffiliated authors of unsolicited manuscripts. Three complete copies of the text (including title page and abstract) and of the illustrations should be submitted (one original copy plus two review copies which may be machine-copies). No manuscripts will be considered for publication or submitted to reviewers before all materials are complete and in the hands of the Scientific Editor.

Manuscripts should be submitted to Scientific Editor, *Fieldiana*, Field Museum of Natural History, Chicago, Illinois 60605-2496, USA.

**Text:** Manuscripts must be typewritten double-spaced on standard-weight, 8½- by 11-inch paper with wide margins on all four sides. If typed on an IBM-compatible computer using MS-DOS, also submit text on 5¼-inch diskette (WordPerfect 4.1, 4.2, or 5.0, MultiMate, Displaywrite 2, 3 & 4, Wang PC, Samna, Microsoft Word, Volkswriter, or WordStar programs or ASCII).

For papers over 100 manuscript pages, authors are requested to submit a "Table of Contents," a "List of Illustrations," and a "List of Tables" immediately following title page. In most cases, the text should be preceded by an "Abstract" and should conclude with "Acknowledgments" (if any) and "Literature Cited."

All measurements should be in the metric system (periods are not used after abbreviated measurements). The format and style of headings should follow that of recent issues of *Fieldiana*.

For more detailed style information, see *The Chicago Manual of Style* (13th ed.), published by The University of Chicago Press, and also recent issues of *Fieldiana*.

**References:** In "Literature Cited," book and journal titles should be given in full. Where abbreviations are desirable (e.g., in citation of synonymies), authors consistently should follow *Botanico-Periodicum-Huntianum* and *TL-2 Taxonomic Literature* by F. A. Stafleu & R. S. Cowan (1976 *et seq.*) (botanical papers) or *Serial Sources for the Biosis Data Base* (1983) published by the BioScience Information Service. Names of botanical authors should follow the "Draft Index of Author Abbreviations, Royal Botanic Gardens, Kew," 1984 edition, or *TL-2*.

References should be typed in the following form:

- Croat, T. B. 1978. Flora of Barro Colorado Island. Stanford University Press, Stanford, Calif., 943 pp.
- Grubb, P. J., J. R. Lloyd, and T. D. Pennington. 1963. A comparison of montane and lowland rain forest in Ecuador. I. The forest structure, physiognomy, and floristics. *Journal of Ecology*, 51: 567-601.
- Langdon, E. J. M. 1979. Yage among the Siona: Cultural patterns in visions, pp. 63-80. In Browman, D. L., and R. A. Schwarz, eds., *Spirits, Shamans, and Stars*. Mouton Publishers, The Hague, Netherlands.
- Murra, J. 1946. The historic tribes of Ecuador, pp. 785-821. In Steward, J. H., ed., *Handbook of South American Indians*. Vol. 2, *The Andean Civilizations*. Bulletin 143, Bureau of American Ethnology, Smithsonian Institution, Washington, D.C.
- Stolze, R. G. 1981. Ferns and fern allies of Guatemala. Part II. Polypodiaceae. *Fieldiana: Botany*, n.s., 6: 1-522.

**Illustrations:** Illustrations are referred to as "figures" in the text (not as "plates"). Figures must be accompanied by some indication of scale, normally a reference bar. Statements in figure captions alone, such as "x 0.8," are not acceptable. Captions should be typed double-spaced and consecutively. See recent issues of *Fieldiana* for details of style.

All illustrations should be marked on the reverse with author's name, figure number(s), and "top."

Figures as submitted should, whenever practicable, be 8½ x 11 inches (22 x 28 cm), and may not exceed 11½ x 16½ inches (30 x 42 cm). Illustrations should be mounted on boards in the arrangement to be obtained in the printed work. This original set should be suitable for transmission to the printer as follows: Pen and ink drawings may be originals (preferred) or photostats; shaded drawings must be originals, but within the size limitation; and photostats must be high-quality, glossy, black-and-white prints. Original illustrations will be returned to the corresponding author upon publication unless otherwise specified.

Authors who wish to publish figures that require costly special paper or color reproduction must make prior arrangements with the Scientific Editor.

**Page Proofs:** *Fieldiana* employs a two-step correction system. The corresponding author will normally receive a copy of the edited manuscript on which deletions, additions, and changes can be made and queries answered. Only one set of page proofs will be sent. All desired corrections of type must be made on the single set of page proofs. Changes in page proofs (as opposed to corrections) are very expensive. Author-generated changes in page proofs can only be made if the author agrees in advance to pay for them.

---

---

# FIELDIANA

---

---

## Zoology

NEW SERIES, NO. 63

### Phylogenetic Systematics of the *Amolops* Group of Ranid Frogs of Southeastern Asia and the Greater Sunda Islands

**Da-Tong Yang**

*Kunming Institute of Zoology  
Academia Sinica  
Kunming, Yunnan Province  
People's Republic of China*

Accepted November 9, 1988

Published February 28, 1991

Publication 1423

---

---

PUBLISHED BY FIELD MUSEUM OF NATURAL HISTORY

---

---





## Table of Contents

INTRODUCTION .....	1
MATERIALS AND METHODS .....	1
ANALYSIS OF CHARACTERS .....	2
PHYLOGENETIC ANALYSIS .....	5
KEY TO GENERA OF THE <i>AMOLOPS</i> GROUP .....	5
<i>AMOLOPS</i> COPE (1865) .....	6
Key to Species of <i>Amolops</i> .....	6
<i>Amolops afghanus</i> (Gunther) .....	7
<i>Amolops chunganensis</i> (Pope) .....	8
<i>Amolops formosus</i> (Gunther) .....	10
<i>Amolops granulosis</i> (Liu and Hu) .....	10
<i>Amolops hainanensis</i> (Boulenger) .....	11
<i>Amolops himalayanus</i> (Boulenger) .....	12
<i>Amolops hongkongensis</i> (Pope and Romer) .....	13
<i>Amolops jinjiangensis</i> (Su et al.) .....	14
<i>Amolops kaulbacki</i> (Smith) .....	16
<i>Amolops larutensis</i> (Boulenger) .....	16
<i>Amolops lifanensis</i> (Liu) .....	17
<i>Amolops loloensis</i> (Liu) .....	18
<i>Amolops macrorhynchus</i> Yang .....	20
<i>Amolops mantzorum</i> (David) .....	20
<i>Amolops monticola</i> (Anderson) .....	22
<i>Amolops nepalicus</i> sp. nov. ....	23
<i>Amolops ricketti</i> (Boulenger) .....	23
<i>Amolops torrentis</i> (Smith) .....	24
<i>Amolops viridimaculatus</i> (Jiang) .....	26
<i>Amolops wuyiensis</i> (Liu and Hu) .....	27
<i>HUIA</i> GEN. NOV. ....	27
Type Species: <i>Rana cavitympanum</i> Boulenger .....	27
Key to Species of <i>Huia</i> .....	28
<i>Huia cavitympanum</i> (Boulenger) .....	29
<i>Huia javana</i> sp. nov. ....	29
<i>Huia nasica</i> (Boulenger) .....	31
<i>Huia sumatrana</i> sp. nov. ....	31
<i>MERISTOGENYS</i> GEN. NOV. ....	33
Type Species: <i>Hylarana jerboa</i> (Gunther) ..	33
Key to Species of <i>Meristogenys</i> .....	33
<i>Meristogenys amoropalamus</i> (Matsui) ..	33
<i>Meristogenys jerboa</i> (Gunther) .....	34
<i>Meristogenys kinabaluensis</i> (Inger) .....	35
<i>Meristogenys macrophthalmus</i> (Matsui) ..	36
<i>Meristogenys orphnocnemis</i> (Matsui) ..	36
<i>Meristogenys phaeomerus</i> (Inger and Gritis) .....	37
<i>Meristogenys poecilus</i> (Inger and Gritis) ..	39
<i>Meristogenys whiteheadi</i> (Boulenger) ..	40

ACKNOWLEDGMENTS .....	41
LITERATURE CITED .....	41

## List of Illustrations

1. Plesiomorphic outgroup relations for <i>Amolops</i> .....	2
2. Tadpole, <i>Amolops lifanensis</i> .....	3
3. Beak forms, <i>Amolops</i> group tadpoles .....	3
4. Tadpoles of <i>Amolops</i> group: <i>Meristogenys</i> sp., <i>Huia</i> sp., <i>Amolops torrentis</i> .....	4
5. Proposed phylogenetic relationships among <i>Amolops</i> subgroups .....	5
6. Hyoid body measurements and landmarks .....	7
7. <i>Amolops afghanus</i> .....	8
8. <i>Amolops chunganensis</i> .....	9
9. <i>Amolops granulosis</i> .....	11
10. <i>Amolops hainanensis</i> .....	12
11. <i>Amolops himalayanus</i> .....	13
12. <i>Amolops hongkongensis</i> .....	14
13. <i>Amolops jinjiangensis</i> .....	15
14. <i>Amolops larutensis</i> .....	17
15. <i>Amolops lifanensis</i> .....	18
16. <i>Amolops loloensis</i> .....	19
17. <i>Amolops macrorhynchus</i> .....	21
18. <i>Amolops mantzorum</i> .....	22
19. <i>Amolops ricketti</i> .....	24
20. <i>Amolops torrentis</i> .....	25
21. <i>Amolops viridimaculatus</i> .....	26
22. <i>Amolops wuyiensis</i> .....	28
23. <i>Huia cavitympanum</i> .....	29
24. <i>Huia javana</i> .....	30
25. <i>Huia nasica</i> .....	31
26. <i>Huia sumatrana</i> .....	32
27. <i>Meristogenys kinabaluensis</i> .....	36
28. <i>Meristogenys orphnocnemis</i> .....	37
29. <i>Meristogenys phaeomerus</i> .....	38
30. <i>Meristogenys poecilus</i> .....	39

## List of Tables

1. Summary of polarity of character states of the <i>Amolops</i> group of species .....	4
2. Distribution of character states in subgroups of species of <i>Amolops</i> .....	5



# Phylogenetic Systematics of the *Amolops* Group of Rapid Frogs of Southeastern Asia and the Greater Sunda Islands

---

## Introduction

The genus *Amolops* is a large group of rapid frogs that lives in mountain brooks of southeastern Asia. The distinctive characters of the group are the presence in tadpoles of an abdominal sucker and ventral and dorsal poison glands.

Cope (1865, p. 117) erected the genus *Amolops* for *Polypedates afghana* Gunther, 1858, and diagnosed the genus as "terminal phalanges short; transverse limb long; tongue without median inferior prominence; no dorso-lateral glandular folds; vomerine teeth." On the same page, Cope described another new genus, *Stauroids*, which he diagnosed by "terminal phalanges slender, with short transverse limb; tongue with median inferior prominence; no dorso-lateral folds; no vomerine teeth; ethmoid widely separating prefrontals, and these from frontoparietal." The type species of *Stauroids* is *Ixalus natator* Gunther, 1858 (by subsequent designation of Boulenger, 1918).

In 1887 Boulenger described three tadpoles of *Rana afghana* (Gunther) (= *Polypedates afghana*), collected from rapid streams in the Kakhi Hills, India. These tadpoles had an adhesive abdominal disk (Hora, 1932) and a denticle formula of III:5-5/1-1:III. Noble (1927, p. 107) wrote, "One natural group of species often referred to *Rana* is characterized by mountain-brook larvae equipped with a large adhesive or friction disk on the abdomen. . . . The only other Salientia possessing such tadpoles have been grouped together as a distinct genus *Stauroids*. . . . I have referred them all to *Stauroids*." Noble obviously did not recognize the genus *Amolops*, despite the presence of an abdominal sucker and poison glands in larvae. After Noble (1927), some herpetologists such as Pope (1927), Noble (1931), Pope and Boring (1940), Bourret (1942), Liu (1950), and Liu and Hu (1961),

as well as the Herpetology Group of Sichuan Institute of Biology (1977), continued to use the name *Stauroids*. Inger (1966) presented the basic arguments for treating *Amolops* as distinct from *Stauroids*. In fact, *Stauroids* is different from *Amolops* in five characters: poison glands and abdominal sucker absent in larvae; vomerine teeth absent; two foramina on the exoccipital bone, and a cartilaginous edge on the posterior horn of the hyoid present in adults.

The most recent checklist (Matsui, in Frost, 1985) included 23 species of *Amolops*. Three new Bornean species were described by Matsui (1986), and one new species from Yunnan was described by Su et al. (1986). I described a new species from Yunnan, China (Yang, 1987) and am describing three new species from Java, Sumatra, and Nepal in this paper. Therefore, there are 32 known species of the *Amolops* group in southeastern Asia and the Greater Sunda Islands.

## Materials and Methods

I have examined specimens from AMNH, FMNH, NMNH, UMMZ (United States); KU (Japan); BMNH (England); RMNH, ZMA (Netherlands); and CIB, FTC, KIZ, SMNH (People's Republic of China). I dissected and examined skulls, sterna, hyoid apparatuses, metacarpalia, and some muscles of the hand of most species of *Amolops*, as well as external characters of all. I also examined the same characters in the eight outgroups (see below). I include detailed descriptions of the tadpoles of each species. Measurements were made following the system outlined by Liu and Hu (1961). Snout-vent length is abbreviated as SVL. Head width is the distance

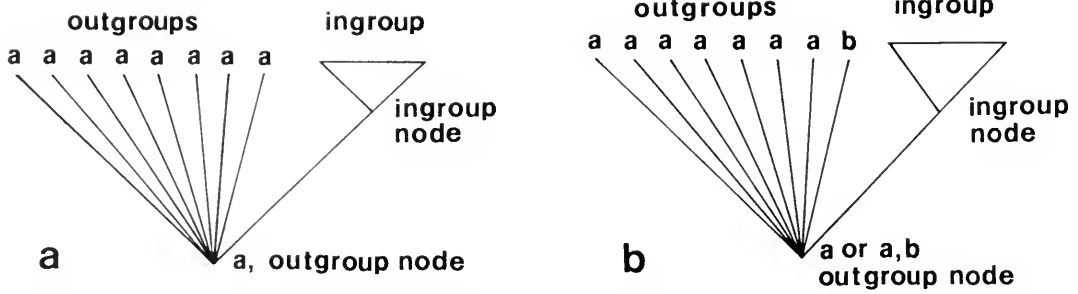

FIG. 1. Outgroup relationships for *Amolops*. **a**. In eight outgroups a simple state exists for characters 1, 2, 7, 8, and 9 (see Table 1) that is plesiomorphic to the ingroup, *Amolops*. **b**. In this diagram the predominant-states method has been used to select the most common state (designated *a*) occurring among eight outgroups as the plesiomorphic state, or an equivocally plesiomorphic state (*a,b*) has been assigned with respect to the ingroup, *Amolops*, for characters 3, 4, 5, 6, and 10.

between the angles of the jaw, head length the distance between the tip of the snout and the posterior angle of the jaw, diameter of eye the distance between the anterior and posterior corners, tympanum the horizontal width of the tympanum, and tibia the length the distance between both ends of the tibia with the leg folded. Tadpoles are staged according to Gosner (1960). The formula for larval denticles follows the standard method, designating the number of continuous rows by Roman numerals and interrupted rows by Arabic numerals. Thus, III:4-4/1-1:II indicates a total of seven rows on the upper lip, of which three rows are continuous; and three rows on the lower lip, of which only the innermost is divided.

## Analysis of Characters

In this section I present a description of the characters used and their polarities. I have chosen to compare character states of *Amolops* with those of Asiatic species of *Rana*, which is probably the group closest to *Amolops*. I have used eight groups of *Rana* depicted by Liu and Hu (1961, p. 217) and Boulenger (1920): *Rana cyanophlyctis* and *R. hexadactyla*; *R. tigerina*; *R. boulengeri*; *R. kuhli plus R. blythi*, *R. laticeps*, and *R. magna*; *R. pleuraden* and *R. nigromaculata*; *R. japonica*; *R. andersoni*; *R. nigrovittata plus R. erythraea* and *R. chalconota* (fig. 1).

For some characters only a single state occurs in the outgroups and another state occurs in all or one of the subgroups of *Amolops* (see below). In such cases, the state common to the outgroups is designated plesiomorphic. Where several states

occur among the outgroups, I have selected the most common one as the plesiomorphic state, following the predominant-states method of Maddison et al. (1984). Because the relationships among outgroups are uncertain, four of the decisions made using the predominant-states method are equivocal.

1. Abdominal sucker (fig. 2). A sucker with a raised rim and a free border is found immediately behind the oral disk of tadpoles of *Amolops*. Diaphragmatic muscles attach to the body wall opposite the center of the sucker (Noble, 1929). Usually a band of specialized, roughened epidermis lies just inside the posterior and lateral margin of the sucker.

Suckers with these characters are unknown in other ranid larvae. Therefore, by direct comparison with the outgroups, its presence is the derived state. Only one ranid larva, that of *Rana sauteri*, has a weak sucker-like disk on the abdomen. But, as pointed out by Kuramoto et al. (1984), the sucker in *R. sauteri* is very different from that of *Amolops* because the rim is not free of the abdominal wall, the sucker has no roughened surface area, and the diaphragmatic muscles are absent.

2. Upper beak of larva (fig. 3). An undivided upper beak with a smooth outer surface appears in larvae of all ranoid families and is characteristic of all of the outgroups (fig. 3, part 1); therefore, this state is plesiomorphic. The derived state, in which the keratinized portion of the upper beak is divided and its outer surface is ribbed (Inger, 1985), occurs in a number of larval *Amolops* from Borneo.

3. Postorbital glands in larva (fig. 4). Postorbital glands in tadpoles of *Amolops* are grouped in patches behind the eye. These glands have vis-

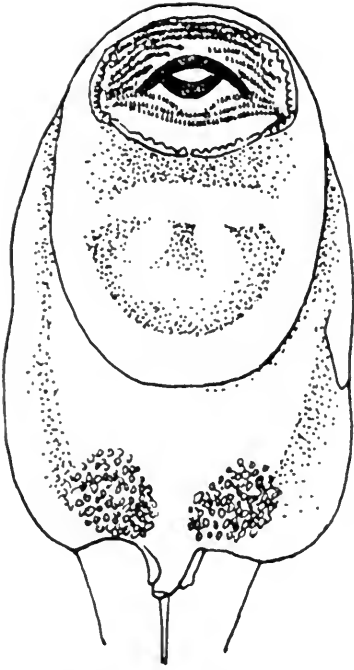

FIG. 2. Tadpole of *Amolops lifanensis*, ventral aspect, showing abdominal sucker and ventral glands ( $\times 5$ ).

ible openings and are brown. Postorbital glands also occur in some tadpoles of the *Hylarana* group, such as *R. chalconota* and *R. nigrovittata*, but not in *R. erythraea*. Using the predominant-states method, I assume that absence of postorbital glands is the plesiomorphic state at the outgroup node.

4. Lateral glands (fig. 4). Glands similar to the postorbital ones occur in patches at infraorbital, prespiracular, and midlateral areas and on the caudal fin of tadpoles in *R. chalconota* and *R. nigrovittata*, as well as in some species of *Amolops* from Borneo, Java, and Sumatra. These glands are not visible in species of *Amolops* from the main-

land. By the predominant-states method, absence of these lateral glands is the plesiomorphic state.

5. Ventral glands in larva (fig. 2). Glands grouped in patches on the belly just before the tail occur in tadpoles of *Amolops* from the mainland, Sumatra, and Java, as well as in tadpoles of a few species of the *Hylarana* group, *R. chalconota* and *R. nigrovittata*. These glands differ from the lateral glands in that they consist of smaller glandules, are yellow in color, and lack visible openings. Seven of eight outgroups do not have ventral glands. By the predominant-states method, I consider the absence of these glands to be the plesiomorphic state and their presence apomorphic. Some species of *Amolops* exhibit a secondary loss of ventral glands, which becomes a second apomorphic state.

6. Scattered glands on back in larva (fig. 4). In one of eight outgroups, the *Hylarana* group species such as *R. chalconota* and *R. nigrovittata*, glandular glands are present in patches on the back; they are found in no other outgroup. Only a few species of *Amolops* have them. On the basis of the predominant state, absence of these glands is considered to be the plesiomorphic state.

7. Uninterrupted rows of denticles on lower lip in larva. All larvae of species of *Rana* from China and Southeast Asia (except *R. alticola*) have three or fewer continuous rows of denticles on the lower lip. This state is also present in most larval *Amolops* from China. Larval *Amolops* from the Sunda Islands and those from Menyang, Yunnan, have four or more undivided rows. On the basis of simple comparison with the outgroups, the presence of more than three uninterrupted rows is the derived state.

8. Length of first metacarpal (fig. 7). In all species in the outgroup ranids, the first metacarpals are attached to one another and surrounded by an expanded pad. In males of all of these groups, the first metacarpal is less than 0.58 times the length of the second. The same state occurs in some spe-

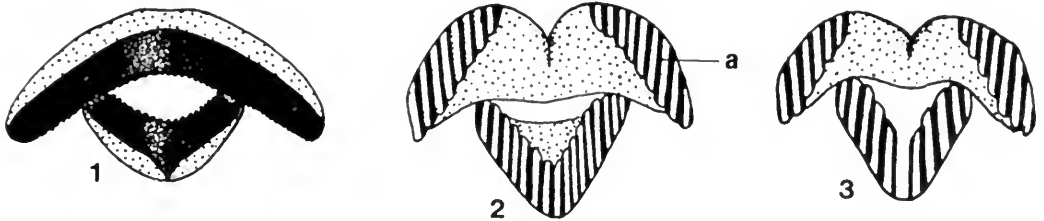

FIG. 3. Beak forms of *Amolops* group tadpoles. 1. *Amolops granulosus*, both beaks single ( $\times 14$ ; from Liu & Hu, 1961). 2 and 3. *Meristogenys* sp. B: upper beak divided and ribbed (2a, from Inger, 1966); both beaks divided and ribbed (3).

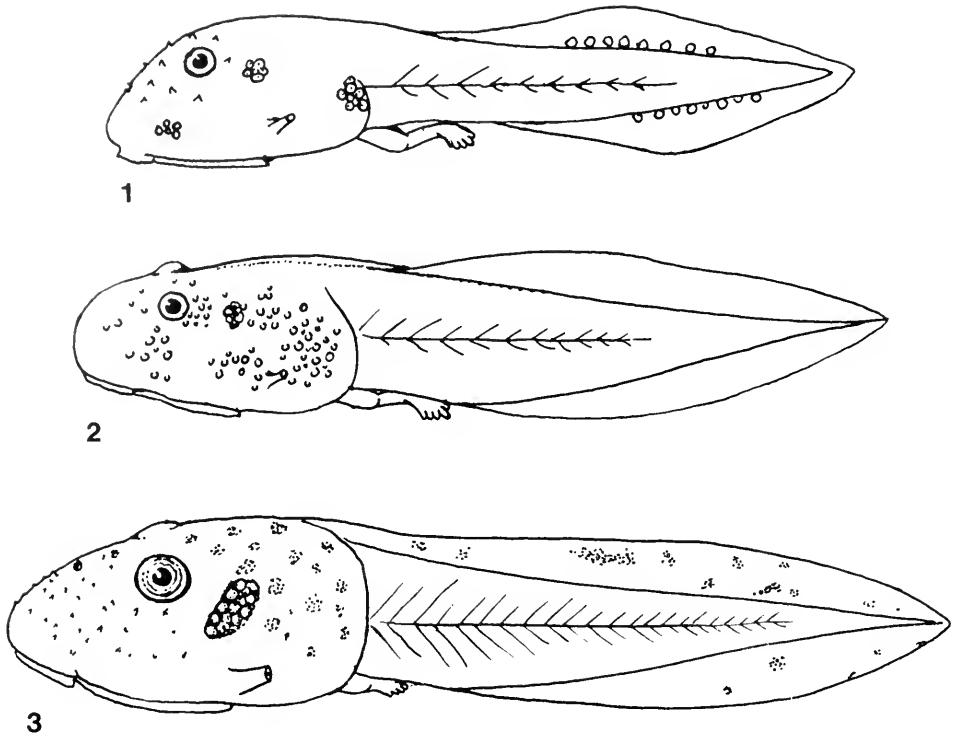

FIG. 4. Tadpoles of *Amolops* group. 1. Tadpole of *Meristogenys* sp., showing infraorbital, midlateral, and caudal glands ( $\times 2$ ). 2. Tadpole of *Huia* sp. ( $\times 2$ ; collected in Menyang, Yunnan, China; from Liu & Hu, 1961). 3. Tadpole of *Amolops torrentis*, with posterior glands present ( $\times 4$ ; from Liu et al., 1973).

cies of the *Amolops* group from Borneo. In the remaining species of *Amolops* from mainland Asia, Java, and Sumatra, the first metacarpal is greater than 0.5 times the length of the second. This latter state is considered to be apomorphic on the basis of comparison with the outgroups.

9. Ratio of length of tibia to snout-vent length (SVL). The ratio of tibia length to SVL is less than

0.62 (0.39–0.62) in all outgroups as well as in most species of *Amolops* from the mainland. By outgroup comparison this is the plesiomorphic state. Most Bornean, Javan, and Sumatran species of *Amolops* and *A. nasica* from Thailand have a tibia length-SVL ratio of more than 0.7, which is considered to be the apomorphic state.

10. Shape of terminal phalanx of third finger

TABLE 1. Summary of polarity of character states of the *Amolops* group of species.

Character	Plesiomorphic	Apomorphic
1. Abdominal sucker of larva	Absent	Present, with raised rim
2. Upper beak of larva	Single, smooth	Divided, ribbed
3. Postorbital glands of larva	Absent	Present
4. Lateral glands of larva	Absent	Present
5. Ventral glands of larva	Absent	Present
5. Ventral glands of larva		Secondary loss
6. Dorsal glands of larva	Absent	Present
7. Uninterrupted rows, lower denticles, larva	Three or fewer	Four or more
8. Length of first metacarpal, adult	<0.5 length of second	>0.5 length of second
9. Ratio of tibia length to SVL	<0.63	>0.63
10. Shape of terminal phalanx, third finger	Not T-shaped	T-shaped

TABLE 2. Distribution of character states in subgroups of species of *Amolops*.

Character	Subgroups of <i>Amolops</i>		
	A	B	C
1. Abdominal sucker	1	1	1
2. Upper beak	0	0	1
3. Postorbital glands	1	1	1
4. Lateral glands	0	1	1
5. Ventral glands	1	1	1'
6. Dorsal glands	0	1	0
7. Rows of denticles	0	1	1
8. First metacarpal	1	1	0
9. Tibia length	0	1	1
10. Terminal phalanx	1	1	1

0 = primitive state; 1 = derived state; 1' = secondary loss of derived state. Species content of subgroups given in text. Full definition of characters in text and Table 1.

*torrentis*, *viridimaculatus*, *wuyiensis*; B, *cavitympanum*, *javana*, *nasica*, *sumatrana*, sp. (tadpole from Menyang, Yunnan); and C, *amoropalamus*, *jerboa*, *kinabaluensis*, *macrophthalmus*, *orphnocnemis*, *phaeomerus*, *poecilus*, *whiteheadi* sp. (tadpoles from Borneo).

A cladogram of phylogenetic relationships among these groups, based on the information in Table 2, is presented in Figure 5. The entire group shares three apomorphies, subgroups B and C share three, and subgroups A and B share two. Subgroup C has one reversal and B and C each have one unique derived state. One apomorphy appears to have been derived twice.

Hennig (from Wiley, 1981, p. 84) defined a monophyletic group as: (1) a group of species descended from a single ("stem") species and which includes all species descended from this stem species; (2) a group of species in which every species is more closely related to every other species than to any species that is classified outside the group; and (3) a group based on synapomorphous similarity. The three subgroups of *Amolops* fit this definition and are recognized in this paper as distinct genera: *Amolops* (A), *Huia* (B), and *Meristogenys* (C). The last two are new taxa and are described in succeeding pages.

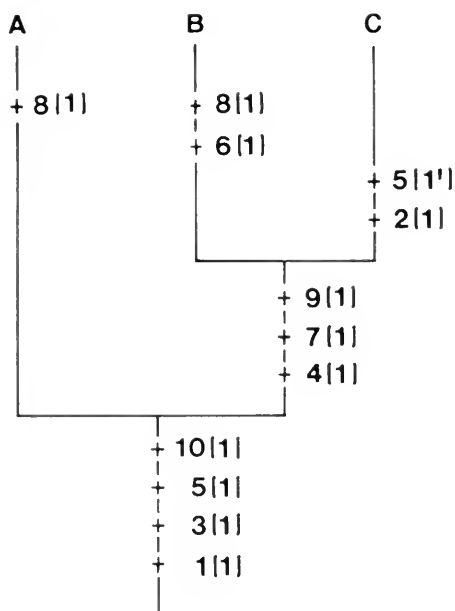

FIG. 5. Proposed phylogenetic relationships among *Amolops* subgroups. Derived states are indicated by character number and state (in parentheses) (see Table 2).

(fig. 7). Species of *Amolops* have expanded disks at the tips of the fingers, with the terminal phalanges T-shaped. Among the outgroups, only members of *Hylarana*, such as *chalconota*, *erythraea*, and *nigrovittata*, have the same condition. On the basis of predominant state in the outgroups, absence of T-shaped phalanges is the plesiomorphic state.

## Phylogenetic Analysis

Polarity of character states is summarized in Table 1. Table 2 shows the distribution of derived states in subgroups of *Amolops* species. The contents of these subgroups are: A, *afghanus*, *chunganensis*, *formosus*, *granulosus*, *hainanensis*, *himalayanus*, *hongkongensis*, *jinjiangensis*, *kaulbacki*, *larutensis*, *lifanensis*, *loloensis*, *macrorhynchus*, *mantzorum*, *monticola*, *nepalicus*, *ricketti*,

## Key to Genera of the *Amolops* Group

- In tadpoles, upper beak divided; length of first metacarpal in adult less than 0.6 times length of second ..... *Meristogenys*  
In tadpoles, upper beak not divided; length of first metacarpal in adult more than 0.6 times length of second ..... 2

2. In tadpoles, some scattered glands on back; crossbar of terminal phalanx less than 0.6 times length in adults ..... *Huia*  
Tadpoles without scattered glands on back; crossbar of terminal phalanx more than 0.6 times length in adults ..... *Amolops*

### *Amolops* Cope (1865)

Type species: *Amolops afghanus* (Gunther) = *Polypedates afghana* Gunther.

*Amolops* Cope, 1865, Nat. Hist. Rev., n.s., 5: 117, type species: *Polypedates afghana* Gunther, 1859, "1858," type locality: "Afghanistan" (in error).

*Staurois* (part), Noble, 1927, Ann. N.Y. Acad. Sci., 20: 107.

DIAGNOSIS—Adults with (1) crossbar of terminal phalanx greater than 0.6 times length of phalanx; (2) first metacarpal greater than 0.6 times length of second; and (3) tibia less than 0.7 times SVL. Tadpoles with (4) abdominal sucker behind oral disk; (5) beaks undivided, with outer surface smooth; (6) no more than 3 continuous rows of denticles on lower lip (except in *A. larutensis*, which has 4); (7) clusters of glands ventrally near end of body; and (8) no scattered glands on back. *Amolops* differs from *Huia* in characters 3, 6, and 8, and from *Meristogenys* in characters 1, 2, 3, 5, and 7.

CHARACTERS OF *AMOLOPS*—Body depressed and

slender; tips of fingers with large disks, diameter of third finger disk larger than tympanum, except in *A. chunganensis*; tympanum usually distinct; length of tibia usually less than 0.7 times SVL; disks of toes usually smaller than those of finger; length of first metacarpal equal to or greater than  $\frac{2}{3}$  second; anterior  $\frac{2}{3}$  of nasal bone wide, oval.

Head of tadpole oval, snout round (dorsal view), flat below; eye dorsal; nostril nearer to eye than to snout; oral disk ventral, followed by large abdominal sucker; upper lip lacking papillae except at sides of mouth; upper denticles usually III:1–1 to III:5–5, two species with II:2–2 to II:4–4, one IV:5–5, III:1–1 (2–2, 4–4, 5–5 from the mainland); lower denticles usually 1–1:II, rarely III, one species 1–1:IV; beaks single, with fine serrations and smooth outer surface; abdominal sucker with rough, marginal band of cornified epidermis and two isolated patches of similar tissue near the terminals of the marginal band; tadpoles with post-orbital and ventral glands.

This genus includes 20 species.

DISTRIBUTION—Southeastern Asia (mainland).

### Key to Species of *Amolops*

1. Ventral surface of tarsus with glandular fold ..... 2  
Glandular fold lacking on tarsus ..... 4
2. Bony projections at front of mandible ..... *hainanensis*  
Bony projections absent ..... 3
3. Tympanum invisible ..... *hongkongensis*  
Tympanum large, with obvious rim ..... *torrentis*
4. Vomerine teeth grouped in ovoid transverse patches ..... *afghanus*  
Vomerine teeth grouped in long oblique patches or vomerine ridge present ..... 5
5. Horny spinules on back or on side of head and body ..... 6  
Spinules absent ..... 7
6. Horny spinules distributed over entire back and top of head in males, on upper surface of thigh and base of forearm in both sexes ..... *granulosus*  
Horny spinules confined to side of head and shoulder and grouped in small clusters ..... *himalayanus*
7. Both sexes with axillary glands or areolae ..... *larutensis*  
Axillary glands or areolae absent ..... 8
8. Canthi parallel (bridge from nostril to eye) ..... *macrorhynchus*  
Canthi converging ..... 9
9. Fringe of skin on third finger ..... *formosus*  
No fringe of skin on third finger ..... 10



10. Pair of large tubercles on side of anus	<i>jinjiangensis</i>
Lacking pair of large tubercles on side of anus	11
11. Green above with sharply defined round or oval reddish brown spots on head and body	<i>loloensis</i>
Not green above	12
12. Reddish brown above with yellowish green markings on back	<i>viridimaculatus</i>
Not as above	13
13. Dorsolateral fold present	14
Dorsolateral fold absent	15
14. Skin smooth on back	<i>monticola</i>
Skin rough on back	<i>chunganensis</i>
15. Male with paired gular pouches	<i>nepalicus</i>
Gular pouches absent	16
16. Toes fully webbed	17
Fourth toe webbed to distal subarticular tubercle and with narrow fringes on both sides to disk	18
17. Skin on back rough	19
Skin on back and belly smooth	<i>lifanensis</i>
18. First finger shorter than second	<i>kaulbacki</i>
First finger almost equal to second	<i>mantzorum</i>
19. Vomerine teeth absent; male with paired vocal sacs	<i>wuyiensis</i>
Vomerine teeth in groups converging posteromedially; vocal sacs absent	<i>ricketti</i>

**Amolops afghanus** (Gunther). Figures 6, 7.

*Polypedates afghana* Gunther, 1858, Cat. Batr. Sal. Brit. Mus., p. 81. Type locality: Afghanistan (in error).

*Amolops afghanus* Cope, 1865, Nat. Hist. Rev., n.s., 5: 117.

*Ixalus kakhensis* Anderson, 1879, Anat. Zool. Res., p. 845. Type locality: Nampoung Valley.

*Polypedates marmoratus* Anderson, 1879, Anat. Zool. Res., p. 842. Type locality: Khasi Hills, India; Pensee in Kakhien, Yunnan, China.

*Rana afghana* Boulenger, 1882, Cat. Brit. Sal., p. 69.

*Rana latopalmeta* Boulenger, 1890, Fauna Brit. India, Rept., p. 462. Type locality: Tenasserim.

*Staurois afghanus* Pope and Boring, 1940, Peking Nat. Hist. Bull., 15: 47; Liu, 1950, Fieldiana: Zool., 2: 358; Liu and Hu, 1961, Tailless Amphibians of China, p. 230.

**DIAGNOSIS**—This is the only species in which vomerine teeth are in transverse groups between the choanae.

**DESCRIPTION**—A moderate-sized frog, males 37–43 mm (10 males from Thailand), females 72–81 mm (8 females from Thailand); snout sloping from level of nostril to tip and projecting beyond lower jaw for distance shorter than distance from nostril to lip; canthi sharp; lores oblique to near lips; pineal body visible (a rounded tubercle between eyes); tympanum distinct and rounded, 0.5 times diameter of eye; vomerine teeth in transverse groups. Fingers moderately long, first finger almost equal to second; tips expanded into large disks with cir-

cummarginal grooves; subarticular tubercles rounded and bulging; supernumerary tubercles visible on three outer fingers; three palmar tuber-

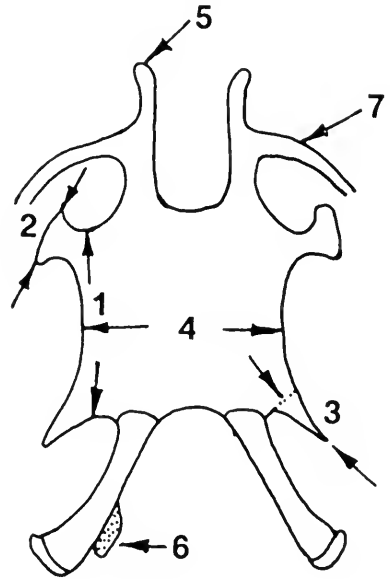

FIG. 6. Hyoid body measurements and landmarks. 1. Length of hyoid: shortest length. 2. Length of processus alaris: greatest length. 3. Length of posterolateral process: distance between posterolateral process and junction of posterolateral process with posterior horn. 4. Width of hyoid: narrowest width. 5. Anterior process. 6. Medial cartilage on posterior horn. 7. Anterior horn.

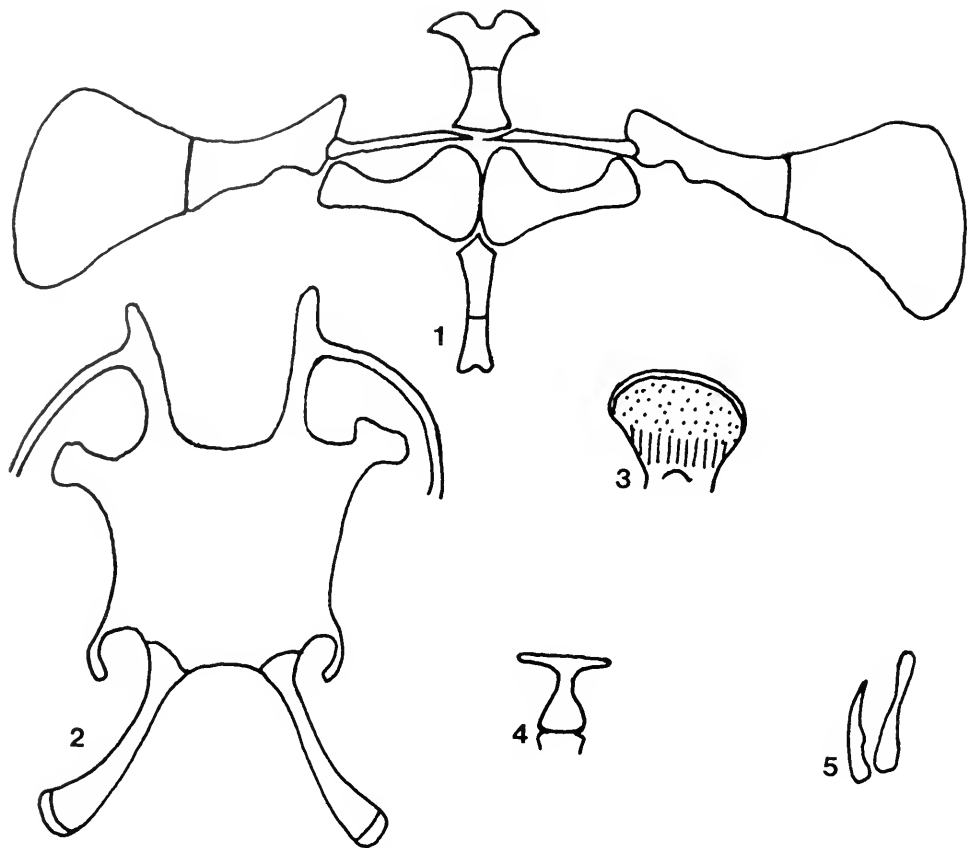

FIG. 7. *Amolops afghanus*: 1, sternum ( $\times 3$ ); 2, hyoid ( $\times 4$ ); 3, ventral aspect of third finger ( $\times 6$ ); 4, terminal phalanx of third finger ( $\times 6$ ); 5, first and second metacarpals ( $\times 4$ ).

cles present; hind limbs moderately long; tibia 0.6 times SVL; disks of toes smaller than those of fingers; toes fully webbed; subarticular tubercles small, oval, and bulging; inner metatarsal tubercle present, outer metatarsal tubercle absent. Skin rough with small tubercles on back and side of body; dorsolateral fold absent; temporal fold weak; belly with tubercles smaller than those of back. Mottled greenish olive on back in life, dark brown crossbars on limbs; light gray spots on throat.

Male with yellowish, velvety nuptial pad; vocal sacs and gular pouches present.

Body of hyoid narrower than long; anterior horn with anterior process present, length of alary process  $\frac{1}{3}$ – $\frac{1}{2}$  length of hyoid body; posterolateral process length  $\frac{1}{3}$ – $\frac{1}{2}$  length of body of hyoid; medial cartilage absent on posterior horn. Mesosternum simple, transverse, length 2 times width; metasternum small, feebly expanded, slightly notched with limbs parallel. Musculus palmaris longus undivided; m. p. profundus attaches to rim of aponeurosis

palmaris. Length of first metacarpal 0.77 times second; width of crossbar on terminal phalanx of third finger equal to length.

Tadpole with a large abdominal sucker; denticular formula III:5–5/1–1:II; postorbital and ventral glands present.

**DISTRIBUTION**—**Thailand**: Chiang Mai province. **India**: Sikkim, at 900 m; Khasi Hills. **China**: Yunnan: Longchuan.

#### *Amolops chunganensis* (Pope). Figure 8.

*Rana chunganensis* Pope, 1929, Amer. Mus. Novit., no. 325: 3. Type locality: Chungan, Fujian, China. *Staurois chunganensis* Liu, 1941, Peking Nat. Hist. Bull., 15(4): 291, 190; 1950, Fieldiana: Zool. Mem., 2: 337.

**DIAGNOSIS**—Three species, *Amolops chunganensis*, *A. granulatus*, and *A. monticola*, have a dorsolateral fold. However, of these, *A. chunganensis*

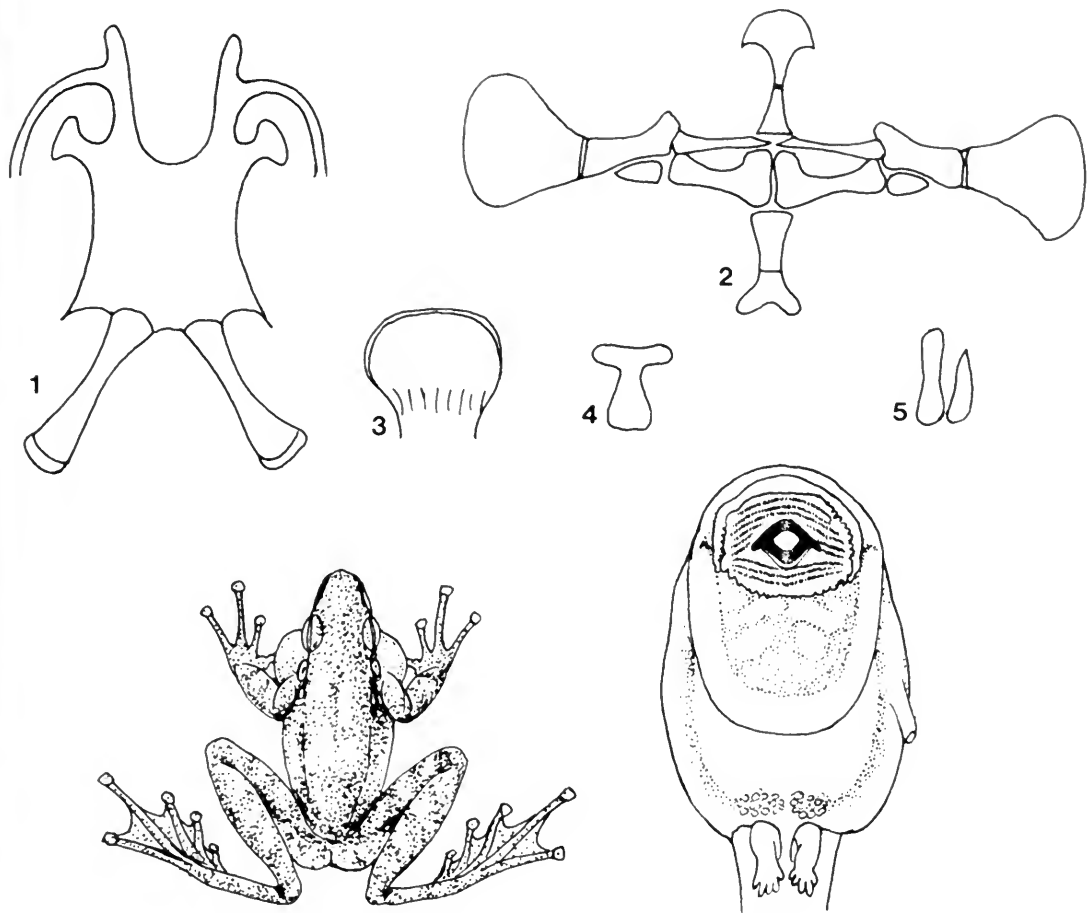

FIG. 8. *Amolops chunganensis*: 1, hyoid ( $\times 6$ ); 2, sternum ( $\times 6$ ); 3, ventral aspect of third finger ( $\times 6$ ); 4, terminal phalanx of third finger ( $\times 6$ ); 5, first and second metacarpals ( $\times 6$ ). Below: dorsal aspect of male, life-sized; ventral aspect of tadpole ( $\times 3$ ).

*nensis* has rounded, horny granules on the back, *A. granulatus* has spinules on the back and *A. monticola* has smooth skin.

**DESCRIPTION**—A small frog, trunk moderately slender, males 34–39 mm, females 44–54 mm; head length greater than width; snout short, equal to or less than eye diameter; snout blunt, projecting slightly beyond lower jaw; canthi rounded; lores oblique to near lip; pineal body visible; tympanum visible, diameter 0.46 times eye; vomerine teeth converging backward. Finger slender, first finger almost equal to second; disks of all fingers small and with circummarginal grooves; subarticular tubercles rounded and bulging; supernumerary tubercle at bases of three outer fingers; three palmar tubercles present; hind limbs moderately long, length of tibia 0.59 SVL; fourth toe fully webbed to distal subarticular tubercle and with narrow

fringes of skin on both sides to disk; the rest of toes fully webbed to disks laterally; subarticular tubercles small, oval, and bulging; inner metatarsal tubercle oval; no outer metatarsal tubercle. Skin rough above; dorsolateral fold distinct; temporal fold indistinct; small horny granules on back. Olive green on back in life, or grayish brown or reddish brown.

Male with gular pouches; large velvety nuptial pad on first finger.

Hyoid width greater than length; anterior horn with anterior process present; length of processus alaris equals  $\frac{1}{3}$ – $\frac{1}{2}$  length of hyoid; posterolateral process more than  $\frac{1}{3}$  length of hyoid; medial cartilage of posterior horn absent.

Posterior end of mesosternum simple, transverse; length of mesosternum 1.2–2.0 times width; metasternum notched and limbs diverging. Length

of first metacarpal bone 0.82 times second; width of crossbar on terminal phalanx third finger 0.4 times length. *Musculus palmaris longus* not divided; all fibers of *m. p. profundus* attached to rim of aponeurosis palmaris.

Tadpole with a large abdominal sucker; denticle formula usually III:4-4/1-1:II, rarely III:3-3/1-1:II; ventral and postorbital glands present.

HABITAT—Forest streams.

DISTRIBUTION—China: Fujian; Gansu; Guangxi; Guizhou; Hunan; Shanxi; Sichuan; Yunnan.

### *Amolops formosus* (Gunther)

*Polypedates formosus* Gunther, 1875, Proc. Zool. Soc. Lond., p. 571. Type locality: Khasi Hills, India.

*Rana formosa* Boulenger, 1881, Cat. Batr. Sal., p.70; 1890, Fauna Brit. India, Rep., p. 463; 1920, Rec. Ind. Mus., 20: 220.

*Amolops formosus formosus*, Dubois, 1974, Bull. Mus. Natl. Hist. Nat., Paris, (3), 213, Zool. 143: 37.

DIAGNOSIS—Five species of this genus—*Amolops formosus*, *A. kaulbacki*, *A. macrorhynchus*, *A. wuyiensis*, and *A. ricketti*—have a fringe of skin on the third finger. *Amolops formosus* differs from *A. macrorhynchus* in having no granules on the side of the head; from *A. wuyiensis* and *A. ricketti* in having smooth skin on the back; and from *A. kaulbacki* in having a granulate belly.

DESCRIPTION—A moderate-sized frog, male 53 mm (1 specimen, from Nepal), females 53–75 mm; head as long as it is broad or slightly broader than long, and much depressed; snout round, projecting beyond lower jaw, a distance less than 1/2 depth of snout at level of nostril; nostril midway between tip of snout and eye; canthi obtuse, lores feebly oblique, concave; pineal body visible; tympanum small, round, and distinct; vomerine ridge converging backward, teeth grouped at end of ridge. Fingers very long; first finger shorter than second; tips of fingers with large disks and circummarginal grooves (except first finger); subarticular tubercle round and bulging; supernumerary invisible; two palmar tubercles; hind limbs long, length of tibia 0.6 (male), 0.57 (6 females) times SVL and almost equal to length of foot; disks of toes smaller than those of fingers; toes fully webbed to distal subarticular tubercle and with narrow fringes on both sides to disks; subarticular tubercles oval and bulging; an oval inner but no outer metatarsal tubercle. Skin smooth above; dorsolateral fold absent; tympanal fold present; belly granulate. Bright green above, with sharply defined blackish or brownish

spots on head and body, the spots often with small green dots (Boulenger, 1920); crossbars on limbs; hinder side of thighs marbled with black; belly mottled.

Males with vocal sacs, but gular pouches absent; with a velvety nuptial pad on first finger.

DISTRIBUTION—India: Khasi Hills; Darjeeling.

### *Amolops granulosus* (Liu and Hu). Figure 9.

*Staurois granulosus* Liu and Hu, 1961, Tailless Amphibians of China, p. 233. Type locality: Mao Kian, Sichuan.

DIAGNOSIS—This is one of two species in the genus having dorsal spinules, *A. granulosus* and *A. himalayanus*. In *A. granulosus* the spinules are distributed over the entire back and top of head in males, on the upper surface of the thigh and base of the forearm in both sexes, and on the rear of the dorsum and side of the head behind eye in females. In the second species, *A. himalayanus*, the spinules are confined to the side of the head and shoulder and are grouped in small clusters.

DESCRIPTION—A small frog, male 36–42 mm (10 males), females 49–52 mm (2 females), body slender; length of head slightly greater than width; snout rounded and weakly pointed, projecting beyond lower jaw for distance less than depth of snout at nostril; pineal body visible in line between anterior corners of eye; canthi distinct and converging; diameter of tympanum relative to diameter of eye, 0.36 in males (mean of 10), 0.40 in two females; vomerine toothrows short, converging backward. Fingers slender, first finger shorter than second; tips of fingers with large disks with circummarginal grooves except on first finger; subarticular tubercles rounded and bulging; disks of toes smaller than those of fingers; fourth toe fully webbed to middle subarticular tubercle and with narrow fringes on both sides to disk; second and third toes fully webbed to disks laterally, fifth toe webbed to disk medially; subarticular tubercles small; inner metatarsal tubercle present, outer metatarsal tubercle absent; tibia length 0.6 times SVL. Skin with white spinules as in Diagnosis above; dorsolateral glandular fold interrupted; temporal fold weak; venter smooth. Purple-brown on back in life, with a few green spots; a dark line from side to snout to groin.

Males with strong forelimb and velvety nuptial pad; with vocal sac but no gular pouches.

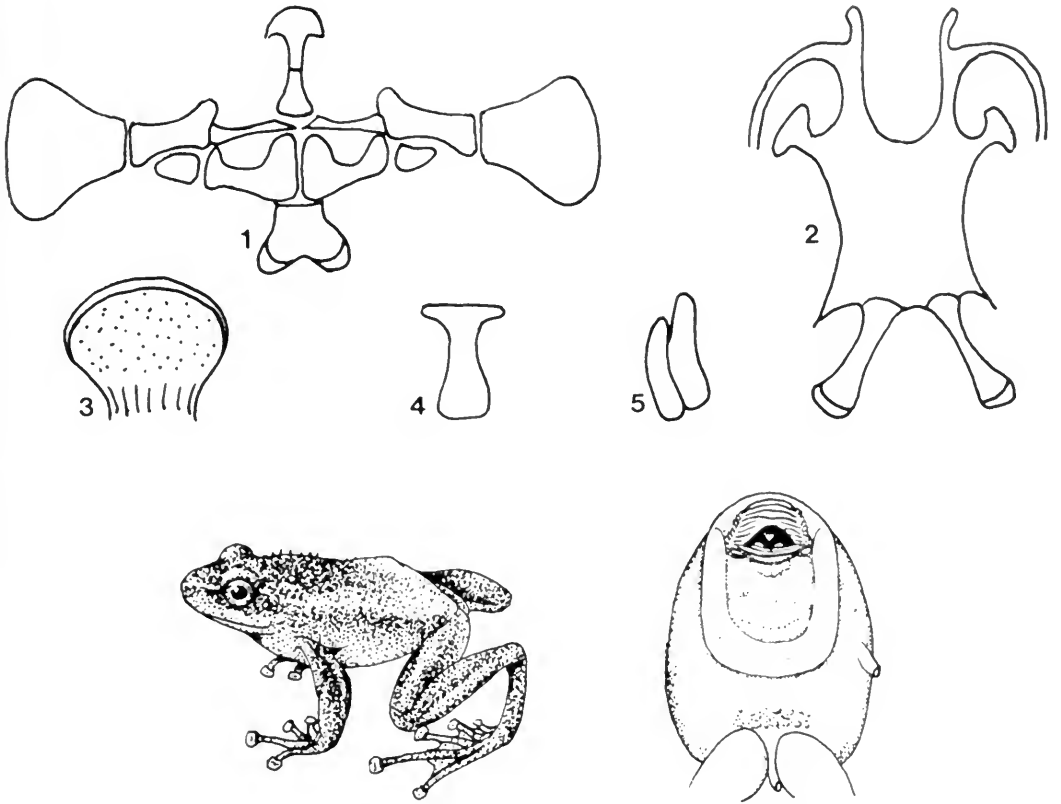

FIG. 9. *Amolops granulosis*: 1, sternum ( $\times 2$ ); 2, hyoid ( $\times 6$ ); 3, ventral aspect of third finger ( $\times 4$ ); 4, terminal phalanx of third finger ( $\times 4$ ); 5, first and second metacarpals ( $\times 4$ ). Below: life-sized male; ventral aspect of tadpole ( $\times 3$ ) (from Liu & Hu, 1961).

Hyoid width greater than length; anterior horn with anterior process present; length of processus alaris more than  $\frac{1}{3}$  length of body of hyoid; posterolateral process  $\frac{1}{3}$ – $\frac{1}{2}$  length of body of hyoid; medial cartilage absent on posterior horn. Mesosternum notched posteriorly, width equal to length; metasternum in two parts, notched, with diverging limbs. First metacarpal bone 0.86 times second; width of crossbar on terminal phalanx of third finger 0.8 times length. Musculus palmaris longus undivided; all fibers of m. p. profundus attach to rim of aponeurosis palmaris.

Tadpole with a large abdominal sucker; denticle formula II:4–4/1–1:II; a pair of yellow posteroventral glands and two postorbital groups of glands.

HABITAT—Altitude about 1500 m; forest streams.

DISTRIBUTION—China: Sichuan: Mao Xian, Guan Xian.

#### *Amolops hainanensis* (Boulenger). Figure 10.

*Stauroids hainanensis* Boulenger, 1899. Proc. Zool. Soc. Lond., p. 958. Type locality: Hainan; Liu et al., 1973, Acta Zool. Sinica, p. 396.

*Rana hainanensis* Boulenger, 1920, Rec. Ind. Mus., 20: 222.

DIAGNOSIS—Three species, *A. hainanensis*, *A. hongkongensis*, and *A. torrentis*, possess a glandular fold on the ventral surface of the tarsus; but *hainanensis*, with a pair of bony projections on the front of the mandible, differs from *hongkongensis* and *torrentis*.

DESCRIPTION—A large species, males 71–93 mm (N = 20), females 68–78 mm (N = 20); width of head equals length; snout short and projecting slightly beyond lower jaw; nostril nearer to tip of snout than to eye; canthi distinct and converging; lores vertical; pineal body invisible; tympanum dis-

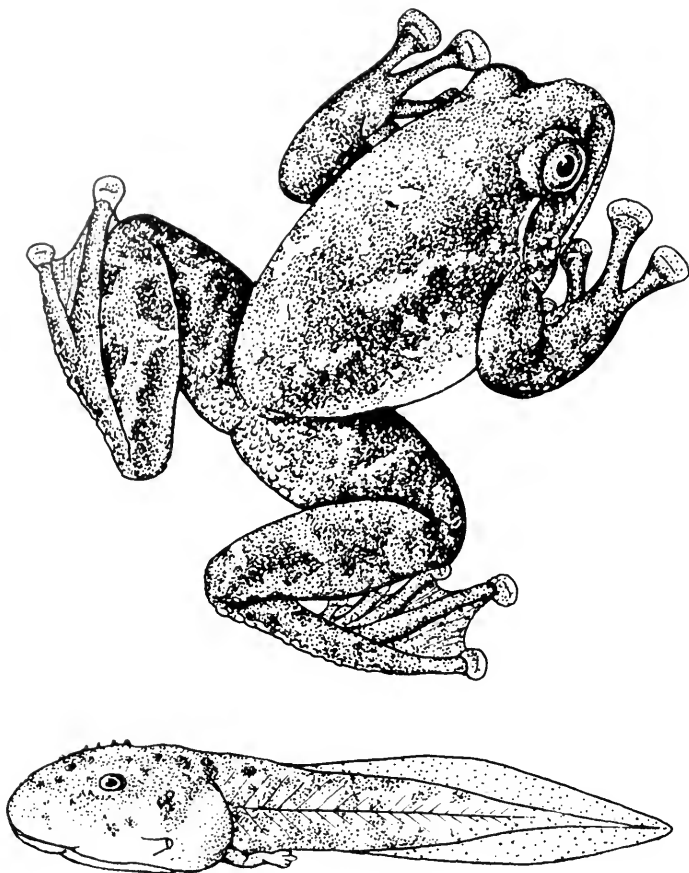

FIG. 10. *Amolops hainanensis*: top, life-sized male, dorsolateral aspect; bottom, tadpole, about stage 37 ( $\times 1\frac{1}{2}$ ) (from Liu et al., 1973).

tinct, 0.28 times eye; vomerine teeth absent; a pair of bony projections on the front of mandible. Fingers moderately long, first finger as long as second; disks of fingers large, with a circummarginal groove; outer palmar tubercle absent; hind limb short, length of tibia 0.52 times SVL; disks of toes smaller than those of fingers; all toes fully webbed; sub-articular tubercles large; obvious fringe of skin at inner side of first and outer side of fifth toe; inner metatarsal tubercle flat; outer metatarsal tubercle absent. Skin rough; back with many small tubercles; larger tubercles scattered on back; dorsolateral fold absent; temporal region, side of body, and dorsal surface of thigh granular; interrupted glandular ridge on ventral surface of tarsus to inner metatarsal tubercle; small flat tubercles on belly. Olive on back, with black and dark olive spots; rear of thigh with black network; dark brown crossbars on limbs; venter reddish.

Male without vocal sac or nuptial pad.

Tadpole with a large abdominal sucker; denticle formula III:2-2/1-1:II; postorbital and ventral glands present.

**HABITAT**—Living in streams having rocky, bushy banks.

**DISTRIBUTION**—**China**: Hainan: Five Fingers Mountains.

***Amolops himalayanus* (Boulenger). Figure 11.**

*Rana himalayana* Boulenger, 1888, Ann. Mag. Nat. Hist., (6)2: 507. Type locality: Darjeeling; 1890, Fauna India, Rept., p. 463; 1920, Rec. Ind. Mus., 20: 219.

*Amolops formosus himalayanus*, Dubois, 1974, Bull. Mus. Natl. Hist. Nat., Paris, (3), 213, Zool. 143: 357.

**DIAGNOSIS**—The only other species having light spinules is *A. granulatus*. In *A. himalayanus* the

spinules are in small, distinct clusters and are limited to the side of the head and base of the forelimb.

**DESCRIPTION**—A large frog, male to 76 mm, female 88 mm; body depressed and slender; width of head equal to length; snout rounded and projecting beyond lower jaw a distance less than depth of snout at level of nostril; canthi rounded and converging; lores vertical at canthi and oblique near lip; nostril nearer to eye than to tip of snout; pineal body visible; tympanum without obvious rim and indistinct; groups of vomerine teeth short and converging backward. Fingers slender, first finger shorter than second; tips of fingers expanded into large disks with circummarginal grooves except on first finger; large, long supernumerary tubercles at bases of three outer fingers; outer palmar tubercle absent; hind limbs moderately slender; tibia 0.63 times SVL; disks of toes smaller than those of fingers; toes fully webbed; oval subarticular tubercles; a long narrow metatarsal tubercle; outer metatarsal tubercle absent. Skin smooth on back; light horny spinules on side of head; spinules in small clusters; dorsolateral fold absent; temporal fold very thick and straight; small tubercles under anus and rear of thigh; skin on rear of belly with tubercles. Color in alcohol brownish on back; yellowish brown on belly.

Male with paired vocal sacs; no gular pouches; a velvety nuptial pad on inner and upper surfaces of first finger.

Length of first metacarpal bone 0.89 times second; width of crossbar of terminal phalanx of third finger 1.17 times length.

**DISTRIBUTION**—**India:** Darjeeling. **Nepal:**

***Amolops hongkongensis*** (Pope and Romer). Figure 12.

*Stauroids hongkongensis* Pope and Romer, 1951, Fieldiana: Zool., 50: 606. Type locality: Hong Kong.  
*Stauroids diayunensis* Liu and Hu, 1975, Acta Zool. Sinica, 21: 268. Type locality: Daiyun Mountain, Fujian.

**DIAGNOSIS**—*Amolops hongkongensis*, *A. hainanensis*, and *A. torrentis* are the only three species of this genus that have a glandular ridge on the ventral surface of the tarsus. However, *A. hongkongensis* has two bony projections at the front of the mandible; *A. torrentis* has a large tympanum with an obvious rim and *A. hongkongensis* has a tympanum that is invisible.

**DESCRIPTION**—A moderate-sized frog, males to 58 mm, females to 63 mm; width of head greater

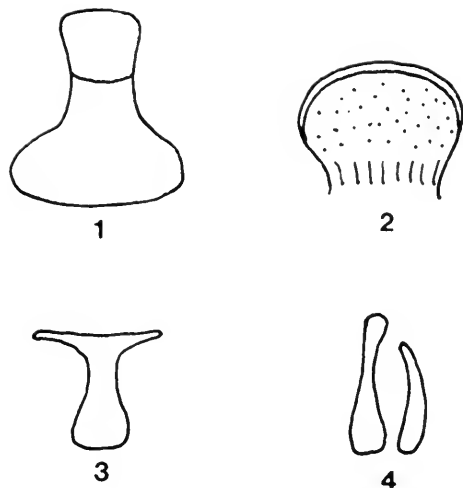

FIG. 11. *Amolops himalayanus*: 1, mesosternum and metasternum ( $\times 4$ ); 2, ventral aspect of third finger ( $\times 4$ ); 3, terminal phalanx of third finger ( $\times 4$ ); 4, first and second metacarpals ( $\times 4$ ).

than length; snout short, slightly narrowed and rounded, projecting beyond lower jaw less than depth of snout at level of nostril; canthi distinct; lores oblique to near lip; nostril midway between tip of snout and eye; pineal body visible; tympanum invisible; vomerine teeth absent. Fingers depressed; first finger shorter than second; tips of fingers expanded into large disks with circummarginal grooves; subarticular tubercles of fingers rounded and bulging; supernumerary tubercle on third finger; two palmar tubercles; hind limbs moderately long; tibia 0.57 (males), 0.52 (females) times SVL; disks of toes smaller than those of fingers; toes fully webbed; inner side of first and outer side of fifth toe with fold of skin; subarticular tubercles oval and bulging; inner metatarsal tubercle present, no outer metatarsal tubercle. Skin rough above, dorsolateral fold absent; temporal fold distinct; many small tubercles on side of body from rear of eye to groin; belly smooth. Brown on back, with indistinct darker and lighter markings; crossbars on limbs; throat with melanophores.

Male with paired vocal sacs but no gular pouches; a yellowish white velvety nuptial pad on inner base of first finger.

Hyoid width greater than length; anterior horn with anterior process present; length of processus alaris more than  $\frac{1}{2}$  length of body of hyoid; posterolateral process  $\frac{1}{4}$ – $\frac{1}{3}$  length of body of hyoid; medial cartilage of posterior horn absent. Mesosternum simple, posterior end transverse, length

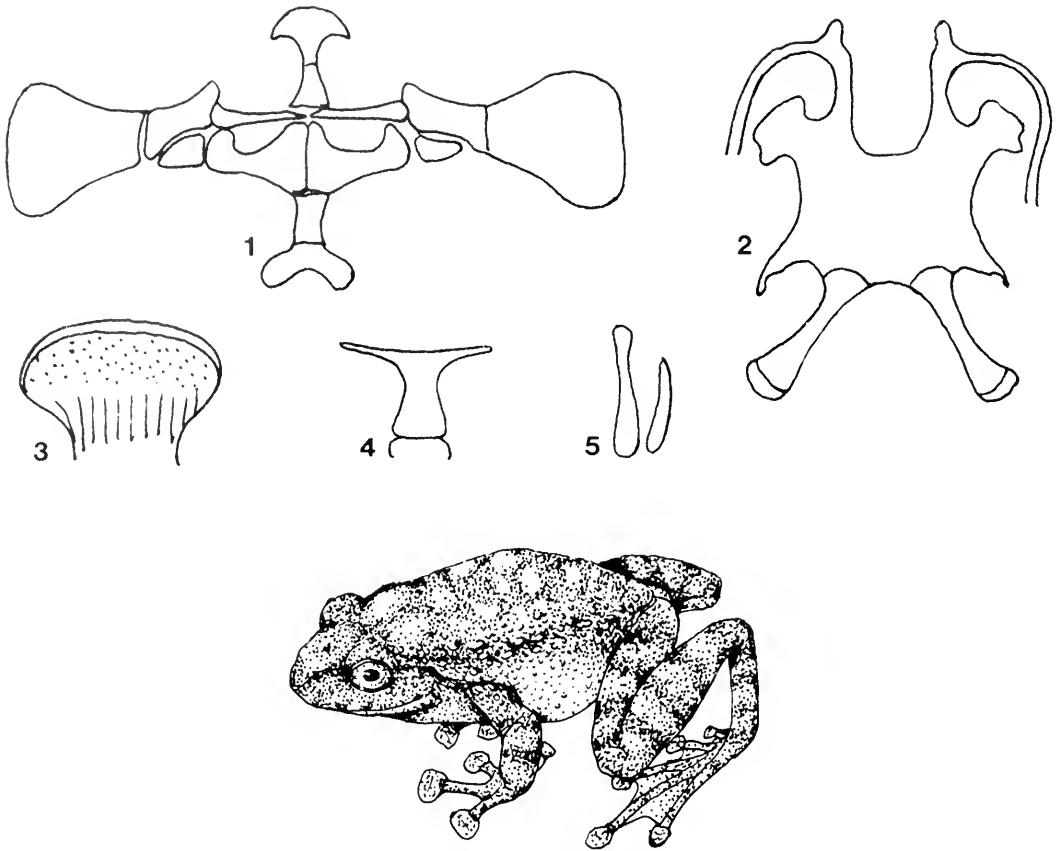

FIG. 12. *Amolops hongkongensis*: 1, sternum ( $\times 2$ ); 2, hyoid ( $\times 6$ ); 3, ventral aspect of third finger ( $\times 6$ ); 4, terminal phalanx of third finger ( $\times 6$ ); 5, first and second metacarpals ( $\times 6$ ). Below, life-sized male.

1.2–2.0 times width; metasternum notched and limbs diverging. Length of first metacarpal bone 0.82 times length of second; width of crossbar on terminal phalanx of third finger 0.46 times length. *Musculus palmaris longus* undivided; all fibers of *m. p. profundus* attached to rim of aponeurosis palmaris.

Tadpole with a large abdominal sucker and denticle formula III:1–1/1–1:II; postorbital and ventral glands present.

HABITAT—Altitude 300–1400 m.

DISCUSSION—I have compared 10 males and 10 females of *S. daiyunensis* from Fujian with types of *A. hongkongensis* (14 males, 10 females). Both samples agree in the following: vomerine teeth absent; tarsal fold present; toes fully webbed; large disks at the tips of the fingers; many small tubercles on the side of the body from the rear of the eye to the groin; an obvious temporal fold; indistinct tympanum; indistinct darker and lighter markings on the back; crossbars on limbs. These samples

differ, however, in SVL from Hong Kong (males 34–41 mm [N = 3], females 31–46 mm [N = 10]) and from Fujian (males 36–58 mm [N = 10], females 44–63 mm [N = 10]).

DISTRIBUTION—China: Fujian: Daiyun Mountain; Guangdong: Hong Kong.

#### *Amolops jinjiangensis* (Su et al.). Figure 13.

*Staurois mantzorum jinjiangensis* Su et al., 1983, Acta Herp. Sinica, 2(3): 31. Type locality: Benzilang, Deqing, Yunnan.

*Staurois jinjiangensis* Su et al., 1986, Acta Herp. Sinica, 5(3): 204.

DIAGNOSIS—Six species of *Amolops*—*A. jinjiangensis*, *A. granulosus*, *A. himalayanus*, *A. lifanensis*, *A. loloensis*, and *A. mantzorum*—have no circummarginal groove at the tip of the first finger, but *A. jinjiangensis* is the only one of these



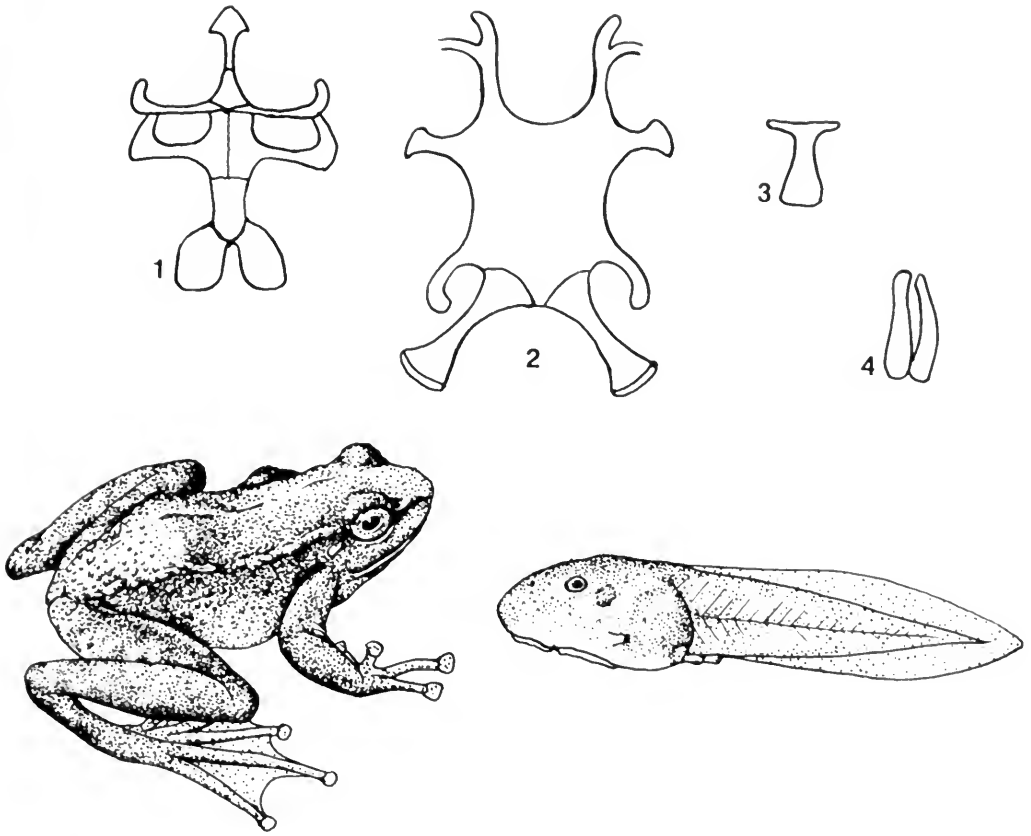

FIG. 13. *Amolops jinjiangensis*: 1, sternum ( $\times 2$ ); 2, hyoid ( $\times 4$ ); 3, terminal phalanx ( $\times 6$ ); 4, first and second metacarpals ( $\times 4$ ). Below, life-sized male, dorsolateral aspect; tadpole at stage 34 ( $\times 2$ ).

possessing dorsolateral glandular folds and a pair of large tubercles at the side of the anus.

**DESCRIPTION**—A moderate-sized species, males 43–52 mm, females 54–66 mm; body weakly depressed; width of head slightly less than length; snout rounded, projecting beyond lower jaw for distance equal to  $\frac{1}{2}$  depth of snout at level of nostril; lores feebly concave; nostril midway between tip of snout and eye; pineal body visible; tympanum invisible; vomerine teeth converging backward. Fingers slender; first finger almost equal to second; with large disks having circummarginal grooves except on first finger; subarticular tubercles oval and bulging; supernumerary tubercles present at bases of three outer fingers; palmar tubercle distinct and divided. Hind limbs moderately long; length of tibia 0.58 (15 males), 0.57 (15 females) times SVL; toe disks slightly smaller than those of fingers and with circummarginal grooves; full web to distal subarticular tubercle of fourth toe and with fringe on both sides to disk; the rest

of toes fully webbed; inner side of first toe and outer side of fifth toe with fringe of skin; a small inner metatarsal tubercle; outer metatarsal tubercle absent. Skin smooth on back, dorsolateral fold present; sides of head and body with few small tubercles; side of anus, a pair of large tubercles; temporal fold obvious. In life, green with some brown spots or brown with green spots on back; crossbars on limbs; throat with blackish brown patches.

Male with strong arms; velvety nuptial pad on base of first finger; vocal sac and gular pouch absent.

Hyoid width equal to length; anterior horn with anterior process present; processus alaris length less than  $\frac{1}{3}$  length of body of hyoid; posterolateral process more than  $\frac{1}{3}$  length of body of hyoid; medial cartilage absent on posterior horn. Mesosternum wide and unnotched; metasternum deeply notched. Musculus palmaris longus undivided into two bundles of fibers at the farthest end; m. p.

profundus attached to rim of aponeurosis palmaris.

Tadpoles blackish brown in color; large abdominal sucker; denticle formula III:3-3/1-1:II (25 tadpoles), III:4-3/1-1:II (4 tadpoles); postorbital and ventral glands present.

HABITAT—Altitude: 2010–2050 m; stream width 5–7 m.

DISTRIBUTION—China: Yunnan: Deqing; Sichuan: Chaochiao.

### *Amolops kaulbacki* (Smith)

*Rana kaulbacki* Smith, 1940, Rec. Ind. Mus., 62: 472.

Type locality: Pangnamdim, Burma.

*Amolops kaulbacki* Dubois, 1974, Bull. Mus. Natl. Hist. Nat., Paris, (3), 213 (Zool.) 143: 361.

DIAGNOSIS—This is the only species of *Amolops* in which width of head is slightly greater than length.

DESCRIPTION (from Smith, 1940)—A large frog, male 70–72 mm (two specimens, from Pangnamdim); head a little broader than long; snout round, projecting slightly beyond the mouth; tympanum feebly distinct, 0.5 times diameter of eye; nostril midway between tip of snout and eye; vomerine teeth in oblique groups. Fingers very long, first finger shorter than second; tips expanded into large disks; subarticular tubercles well developed; hind limbs long; tibia little longer than the foot, 0.62 times SVL; disks of toes smaller than those of fingers; toes completely webbed, the web feebly emarginate and involving the bases of all the disks; subarticular tubercles moderate, bulging, and oval; inner metatarsal tubercle oval and flat; no outer tubercle. Skin smooth on back and belly; no dorsolateral fold; temporal fold narrow; hind part of thighs coarsely granulate. Bluish above, green in life with black spots and marblings; numerous black crossbars on limbs; hind parts of thighs yellowish; belly grayish.

Male with no vocal sacs; gray, velvety nuptial pad.

DISCUSSION—Dubois (1974) suggested *A. kaulbacki* is probably a subspecies of *A. afghanus*. I consider *A. kaulbacki* to be a good species, differing from *A. afghanus* in having width of head slightly greater than length, vomerine teeth in oblique groups, first finger shorter than second, and skin smooth.

DISTRIBUTION—Burma: Pangnamdim.

### *Amolops larutensis* (Boulenger). Figure 14.

*Rana larutensis* Boulenger, 1899, Ann. Mag. Nat. Hist., (7)3: 273. Type locality: Larut Hills, Perak.

*Staurois larutensis* Boulenger 1918, Ann. Mag. Nat. Hist., (9)1: 374.

DIAGNOSIS—Three species, *A. larutensis*, *A. nepalicus*, and *A. torrentis*, have an outer metatarsal tubercle. However, *A. larutensis* differs from *A. nepalicus* and *A. torrentis* in having axillary glands.

DESCRIPTION—Males 35–40 mm (5 males from Thailand and Malaya), females 53–57 mm (3 females); length of head slightly greater than width; snout short, 0.14 times length of body (5 males, 3 females), tip of snout slightly pointed and rounded, projecting beyond lower jaw equal to ½ depth of snout at level of nostril; canthi distinct; lores vertical; nostril midway between eye and tip of snout; pineal body visible; tympanum small and distinct, 0.28 times diameter of eye; vomerine teeth oblique, grouped between choanae. First finger shorter than second; tips of fingers with large disks with circummarginal grooves; subarticular tubercles of fingers rounded and bulging; supernumerary tubercle at base of fourth finger; hind limbs moderately long, tibia 0.55 (males), 0.52 (females) times SVL; disks of toes smaller than those of fingers; toes fully webbed; subarticular tubercles oval and bulging; inner metatarsal tubercle present; small and rounded outer metatarsal tubercle. Skin rough on back; no dorsolateral fold; temporal fold indistinct; some flat enlarged pustules on back; on side of head and body with small tubercles; both sexes with axillary glands.

Darker and lighter markings on back; crossbars on limbs; light brown spots on throat; light yellow on belly.

Male with gular pouches; velvety nuptial pad on first finger.

Hyoid body width less than length; anterior horn with anterior process present; length of processus alaris ⅓–½ length of body of hyoid; posterolateral process ⅓–½ length of body of hyoid; medial cartilage present on posterior horn. Mesosternum simple, posterior end transverse, length greater than 2 times width; metasternum small, feebly expanded, slightly notched, with limbs parallel. First metacarpal bone 0.91 times second; width of crossbar on terminal phalanx of third finger 0.89 times length. Musculus palmaris longus divided into two bundles of fibers; all fibers of m. p. profundus attached to dorsal surface of aponeurosis palmaris.

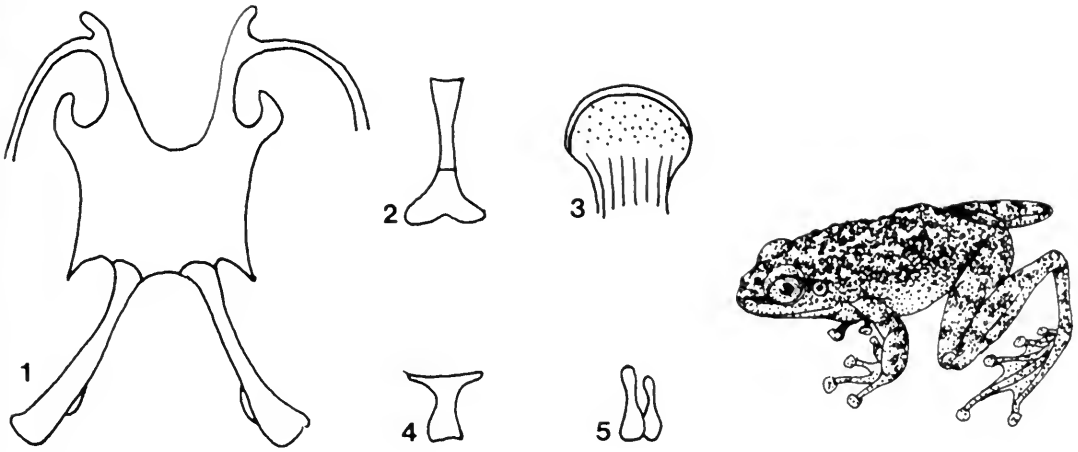

FIG. 14. *Amolops larutensis*: 1, hyoid ( $\times 6$ ); 2, mesosternum and metasternum ( $\times 4$ ); 3, ventral aspect of third finger ( $\times 6$ ); 4, terminal phalanx of third finger ( $\times 6$ ); 5, first and second metacarpals ( $\times 6$ ). Right, full-sized male.

Tadpole with a large abdominal sucker on belly; denticle formula III:5-5/1-1:IV; postorbital and ventral glands present.

HABITAT—Altitude to 1800 m.

DISTRIBUTION—**Thailand:** Pattani, Yala, Chumphon. **Malaya:** Kuala Lumpur.

#### *Amolops lifanensis* (Liu). Figure 15.

*Staurois lifanensis* Liu, 1945, J. West China Board. Res. Soc., 15: 33, Type locality: Li Xian, Sichuan; Liu and Hu, 1961, Tailless Amphibians of China, p. 241.

DIAGNOSIS—Six species of this genus, *A. granulatus*, *A. himalayanus*, *A. jinjiangensis*, *A. loloensis*, *A. mantzorum*, and *A. lifanensis*, have no circummarginal groove on the first finger. *Amolops lifanensis* differs from *A. granulatus* in lacking white spinules on the dorsum, from *A. loloensis* and *A. jinjiangensis* in having a yellowish back with dark brown spots, from *A. mantzorum* in having toes fully webbed to disks, and from *A. himalayanus* in lacking clusters of spinules.

DESCRIPTION—A moderate-sized species; body stocky; males 52–56 mm (6 males), females 61–79 mm (10 females); width of head equal to length; snout rounded and projecting beyond lower jaw a distance less than depth of snout at level of nostril; canthi rounded; lores oblique to near lip; nostril nearer eye than to tip of snout; pineal body distinct; tympanum invisible; vomerine teeth con-

verging backward. Forelimb slender, first finger almost equal in length to second; fingers with moderate disks and circummarginal grooves, first finger lacking groove; subarticular tubercles rounded and bulging; two palmar tubercles; supernumerary tubercles visible at bases of three outer fingers; hind limb moderately long, length of tibia 0.65 times SVL; toes with disks smaller than those of fingers and with circummarginal grooves; toes fully webbed; inner side of first toe and outer side of fifth toe with fringe to disk; inner metatarsal tubercle long and narrow; no outer metatarsal tubercle. Skin smooth; no dorsolateral fold; temporal fold distinct; some small tubercles on side of body and around the anus; belly smooth. Olive on back, with dark irregular marks; dark crossbars on limbs.

Male with no vocal sac or gular pouch; strong forelimb and a large velvety nuptial pad.

Hyoid width less than length; anterior horn with anterior process present; length of processus alaris less than  $\frac{1}{3}$  length of body of hyoid; posterolateral process  $\frac{1}{4}$ – $\frac{1}{3}$  length of body of hyoid. Posterior end of mesosternum pointed and forming a triangle; metasternum notched with diverging limbs. Musculus palmaris longus undivided; m. p. profundus attached to rim of aponeurosis palmaris. Length of first metacarpal bone 0.88 times second; width of crossbar on terminal phalanx of third finger 0.86 times length.

Tadpole with a large abdominal sucker; denticle formula III:4-4/1-1:II; ventral and postorbital glands present.

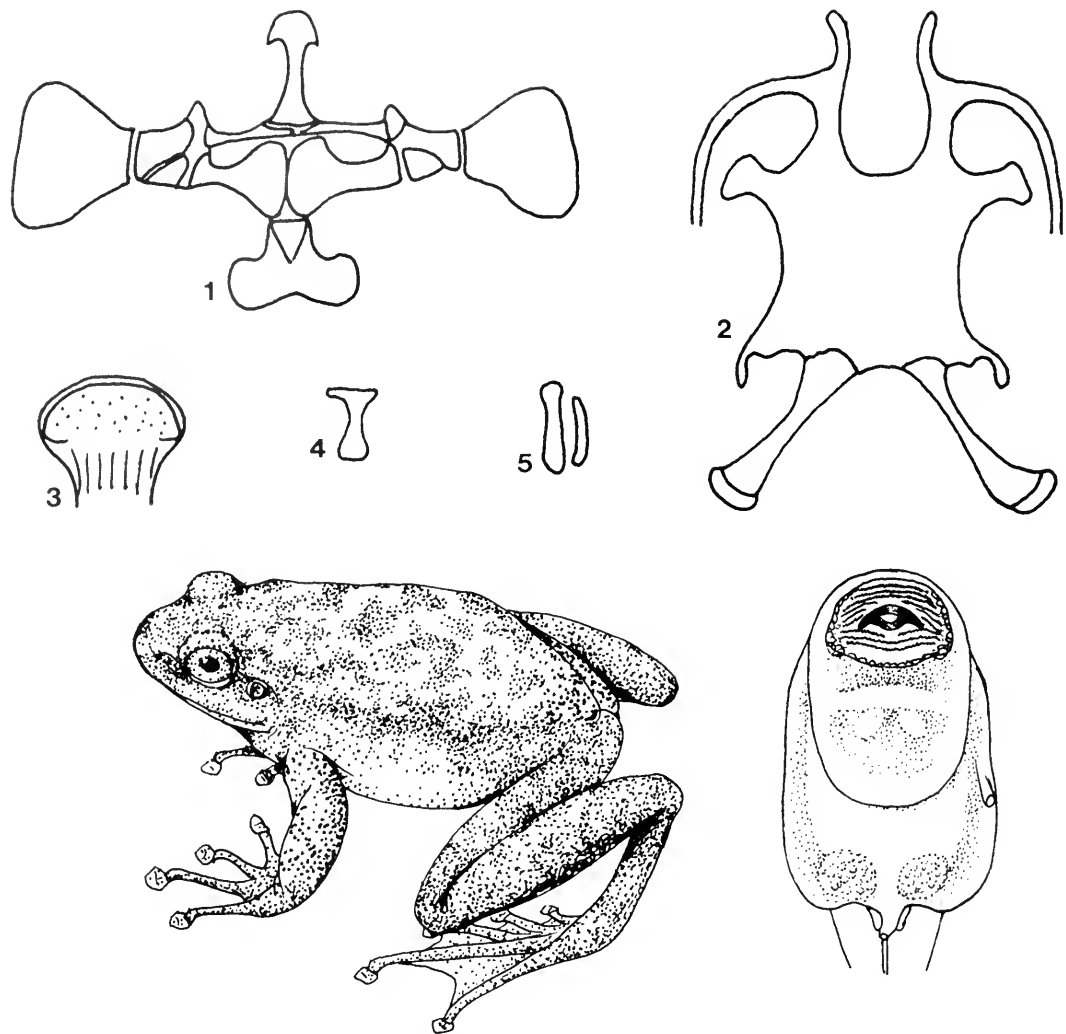

FIG. 15. *Amolops lifanensis*: 1, sternum ( $\times 2$ ); 2, hyoid ( $\times 6$ ); 3, ventral aspect of third finger ( $\times 6$ ); 4, terminal aspect of third finger ( $\times 4$ ); 5, first and second metacarpals ( $\times 4$ ). Below, full-sized male; ventral aspect of tadpole ( $\times 2\frac{1}{2}$ ) (from Liu & Hu, 1961).

HABITAT—Altitude about 1800 m.

DISCUSSION—Dubois (1974) suggested that *lifanensis* is a junior synonym for *kaulbacki*. In fact, *A. lifanensis* is a good species and differs from *A. kaulbacki* in length of head equal to width in males, a little longer in females; nostril nearer to eye than to tip of snout; the tibiotarsal articulation reaching the nostril or a little beyond; SVL 52–56 mm in five males; and vomerine teeth in oblique groups, commencing at the level of the central choanae and extending posteriorly behind them.

DISTRIBUTION—China: Sichuan: Li Xian.

*Amolops loloensis* (Liu). Figure 16.

*Stauroids loloensis* Liu, 1950, Fieldiana: Zool. Mem., 2: 352. Type locality: Chaochiao, Sichuan; Liu and Hu, 1961, Tailless Amphibians of China, p. 235.

DIAGNOSIS—*A. loloensis* is one of seven species—*A. mantzorum*, *A. himalayanus*, *A. jijiangensis*, *A. lifanensis*, *A. granulatus*, *A. viridimaculatus*, and *A. loloensis*—with no circummarginal groove at the disk of the first finger. But *A. loloensis*

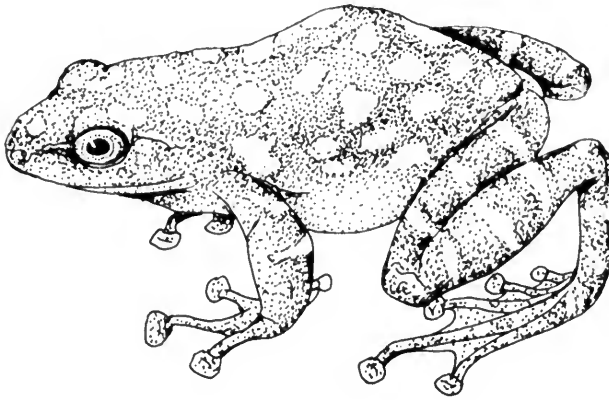
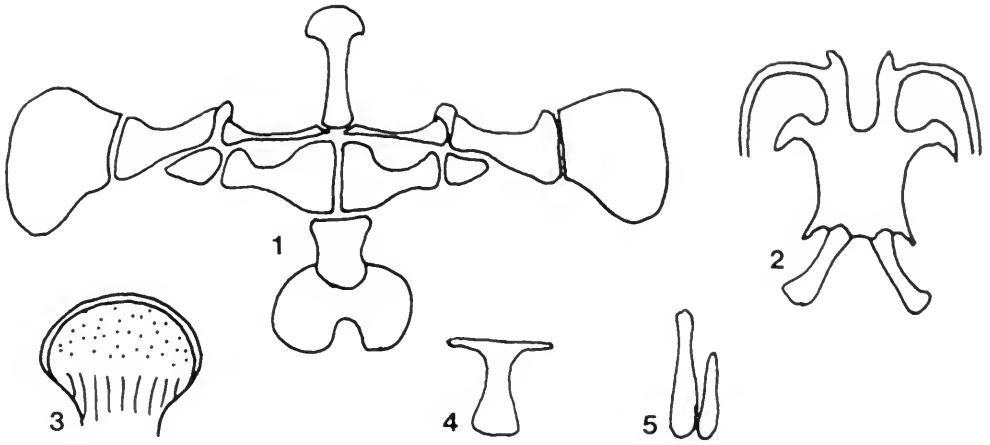

FIG. 16. *Amolops loloensis*: 1, sternum ( $\times 2$ ); 2, hyoid ( $\times 2$ ); 3, ventral aspect of third finger ( $\times 4$ ); 4, terminal phalanx of third finger ( $\times 4$ ); 5, first and second metacarpals ( $\times 4$ ). Below, life-sized male.

is unique among these in having a dark green back with many reddish brown round spots.

**DESCRIPTION**—A moderate-sized species, males 54–62 mm, females 70–78 mm; length of head equal to width; snout rounded and projecting beyond lower jaw a distance equal to  $\frac{1}{2}$  depth of snout at level of nostril; nostril nearer to eye than to tip of snout; canthi rounded; lores oblique to nearer lip; pineal body visible; tympanum indistinct; vomerine ridge without teeth. Fingers slender, first finger as long as second; tips of fingers with large disks with circummarginal grooves except on first finger; subarticular tubercles rounded and bulging; supernumerary tubercles at bases of three outer fingers; hind limbs slender; length of tibia 0.58 times length of body; fourth toe with full web to second subarticular tubercle and with narrow fringe to disk; other toes fully webbed;

narrower inner metatarsal tubercle, no outer metatarsal tubercle. Skin smooth above; side of head, angle of mouth, and side of body with small tubercles; temporal fold distinct; venter smooth. Dark green on back, with round or oval reddish brown spots; reddish brown crossbars on limbs; yellowish gray on belly.

Male with no vocal sac or gular pouch; a large velvety nuptial pad on first finger.

Hyoid body width greater than length; anterior horn with anterior processus alaris  $\frac{1}{3}$ – $\frac{1}{2}$  length of body of hyoid; posterolateral process  $\frac{1}{3}$ – $\frac{1}{2}$  length of body of hyoid; medial cartilages absent on posterior horn. Posterior end of mesosternum rounded, length 1.2–2.0 times width; metasternum expanded, notched, with limbs parallel. First metacarpal bone 0.79 times second; width of terminal phalanx of third finger 1.2 times length.

Musculus palmaris longus divided into two bundles of fibers; m. p. profundus undivided and attached to rim of aponeurosis palmaris.

Tadpole with a large abdominal sucker; denticle formula III:4-4/1-1:II; postorbital and ventral glands present.

HABITAT—Altitude 2100–3200 m; forest streams.

DISTRIBUTION—China: Sichuan: Chaochiao, Baoxing.

**Amolops macrorhynchus** Yang. Figure 17.

*Amolops macrorhynchus* Yang, Herpetologica, 4(3): 95. Type locality: Hekou, in Yunnan.

DIAGNOSIS—One of the largest species in the genus *Amolops*, males 80–84 mm, females 78–100 mm; gular pouches present in males; snout longer than eye, depressed, strongly projecting; canthi parallel.

DESCRIPTION—Body moderately slender; head flat, length greater than width; snout projecting beyond lower jaw for a distance equal to depth of snout at level of nostril; canthi distinct, parallel; nostrils lateral, midway between tip of snout and eye; lores vertical at canthi, oblique near lip; eye diameter less than snout length; pineal body visible; tympanum small, round, in slight depression, about  $\frac{2}{5}$  eye diameter, distance to eye about 0.7 times tympanum; top of head behind eye slightly bulging laterally; vomerine teeth strong, oblique, their anterior ends in a line between the posterior border of the choanae, separated by a space about  $\frac{1}{2}$  length of each series. Fingers slender, first shorter than second; tips expanded into large disks with circummarginal grooves; fringes of skin along three outer fingers; subarticular tubercles rounded and bulging; large long supernumerary tubercles at bases of three outer fingers; an indistinct outer palmar tubercle; hind limbs slender; toes fully webbed; disks of toes smaller than those of fingers, with circummarginal grooves; subarticular tubercles long and narrow; inner metatarsal tubercle present; no outer metatarsal tubercle. Skin smooth on back; dorsolateral fold absent; temporal fold distinct, curved, reaching to insertion of forelimb; throat and belly smooth except granular in rear; thigh granular adjacent to vent. Color in life dark brown, with small greenish yellow spots and a few brown spots on the back; black crossbars on dorsal surface of thigh and tibia; brownish on ventral surfaces.

Male with paired gular pouches; a strong grayish nuptial pad on inner and upper surfaces of first finger from disk to base of finger.

Hyoid width greater than length; anterior horn with anterior process present; processus alaris length less than  $\frac{1}{3}$  length of hyoid; posterolateral process  $\frac{1}{3}$ – $\frac{1}{2}$  length of body of hyoid; medial cartilage absent on posterior horn. Mesosternum notched, length equal to 1.2–2.0 times width; metasternum notched and limbs parallel at posterior margin. Musculus palmaris longus divided into two bundles of fibers; most of m. p. profundus attached to dorsal surface of aponeurosis palmaris. Length of first metacarpal bone 0.73 times second; width of crossbar on terminal phalanx of third finger 1.4 times length.

HABITAT—Forest streams; altitude 800–1700 m.

DISTRIBUTION—China: Yunnan: Hekou.

**Amolops mantzorum** (David). Figure 18.

*Polypedates mantzorum* David, 1871, Nouv. Arch. Mus. Nat. Hist. Paris, 7: 95. Type locality: Baoxing, Sichuan.

*Rana jugans* Stejneger, 1926, Proc. Biol. Soc. Wash., 39: 53. Type locality: Wenchuan, Sichuan.

*Staurois jugans* Pope and Boring, 1940, Peking Nat. Hist. Bull., 15(1): 47.

*Staurois mantzorum* Liu, 1950, Fieldiana: Zool. Mem., 2: 330; Liu and Hu, 1961, Tailless Amphibians of China, p. 239.

*Staurois kangtingensis* Liu, 1950, Fieldiana: Zool. Mem., 2: 349. Type locality: Kangting, Sichuan.

DIAGNOSIS—Six species of this genus—*A. mantzorum*, *A. jinjiangensis*, *A. lifanensis*, *A. granulatus*, *A. himalayanus*, and *A. loloensis*—have no circummarginal groove at the tip of the first finger. *Amolops mantzorum* lacks the spinules that occur in *A. granulatus* (see p. 10) and does not have reddish spots on a green dorsum as in *A. loloensis*. It differs from *A. himalayanus*, *A. jinjiangensis*, and *A. lifanensis* in having a full web to the distal subarticular tubercle of the fourth toe.

DESCRIPTION—A moderate-sized species, males 49–57 mm, females 60–72 mm; body weakly depressed; width of head equal to length (width/length = 0.99); snout rounded, projecting beyond lower jaw for distance less than depth of snout at level of nostril; canthi distinct; lores feebly concave; nostril midway between tip of snout and eye; pineal body visible; tympanum visible; vomerine teeth converging backward. Fingers slender; first finger almost equal to second; with large disks having circummarginal grooves except on first finger; sub-

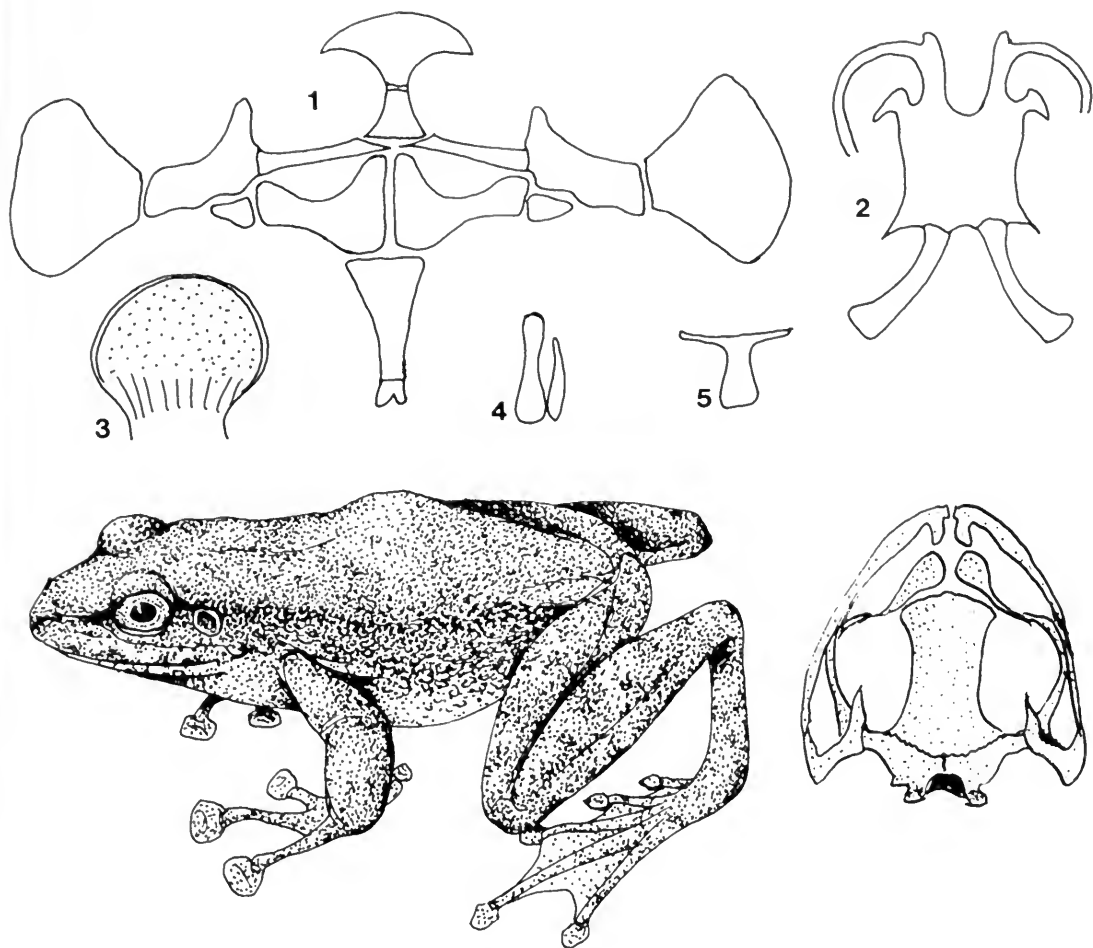

FIG. 17. *Amolops macrorhynchus*: 1, sternum ( $\times 2$ ); 2, hyoid ( $\times 2$ ); 3, ventral aspect of third finger ( $\times 4$ ); 4, first and second metacarpals ( $\times 4$ ); 5, terminal phalanx ( $\times 4$ ). Below, life-sized male; dorsal view of skull ( $\times 2$ ).

articular tubercles rounded and bulging; supernumerary tubercles present at bases of three outer fingers; palmar tubercle indistinct; hind limbs moderately long; length of tibia 0.61 (10 males), 0.59 (10 females) times SVL; disks smaller than those of fingers and with circummarginal grooves; toes with full web to distal subarticular tubercle of fourth toe and with fringe on both sides to disk; the rest of toes fully webbed; inner side of first toe and outer side of fifth toe with fringe of skin; small inner metatarsal tubercle, no outer metatarsal tubercle. Skin smooth, with few small tubercles on back and on side of body; rounded anus; no dorsolateral fold; temporal fold obvious. Green or bluish green in life with irregular brown spots and scattered black points or brown above, with large green spots; blackish gray on throat and chest; yellowish on belly and ventral surface of limbs.

Male with strong arms and velvety nuptial pad on base of first finger; without vocal sac or gular pouch.

Hyoid width greater than length; anterior horn with anterior process present; processus alaris length less than  $\frac{1}{3}$  lateral length, posterolateral process length more than  $\frac{1}{3}$  length of body of hyoid; medial cartilage absent on posterior horn. Mesosternum notched and limbs diverging; metasternum notched and limbs diverging. Musculus palmaris longus divided into two bundles of fibers at the farthest end; m. p. profundus attached to rim of aponeurosis palmaris.

Tadpoles with a large abdominal sucker; denticle formula III:4-4/1-1:II; rarely III:5-5/1-1:II; posterior and ventral glands present.

HABITAT—Altitude 1000-3800 m; wide forest streams.

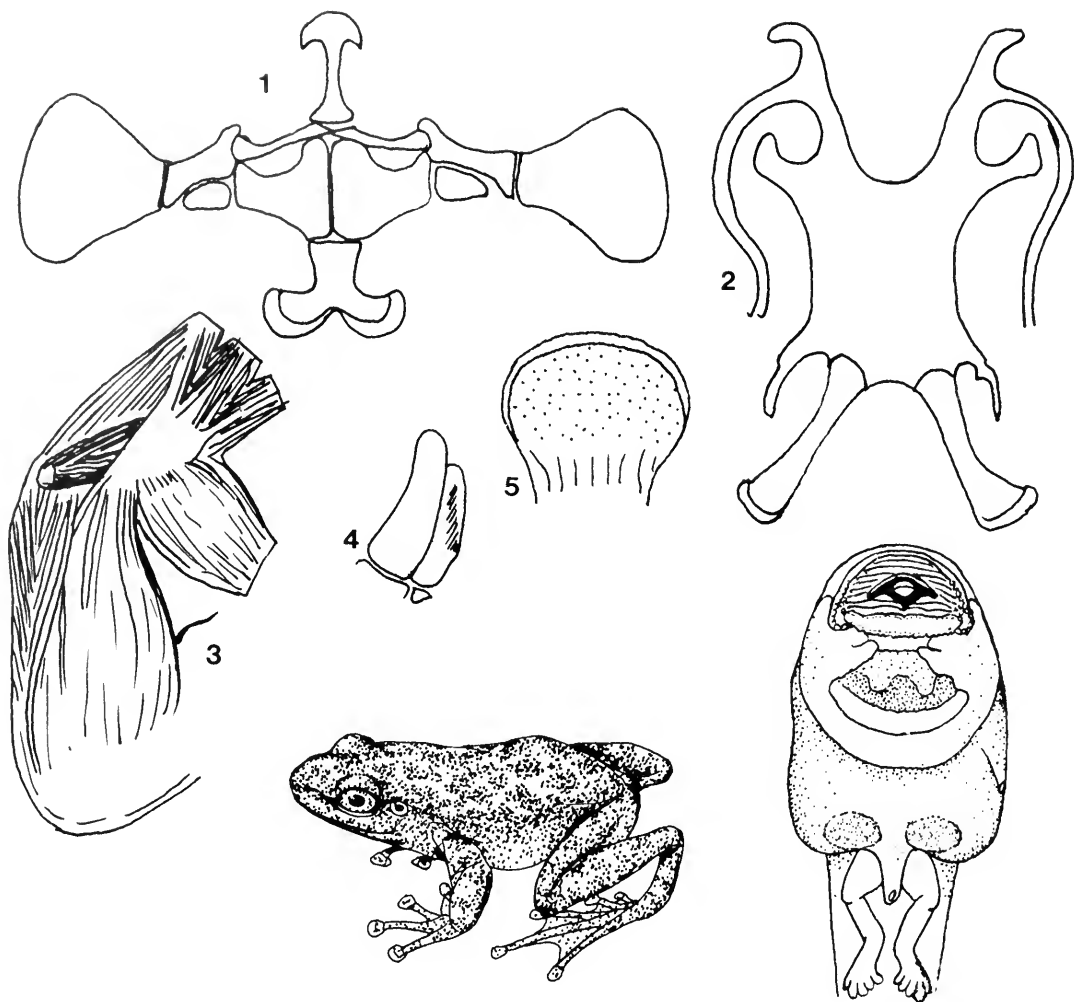

FIG. 18. *Amolops mantzorom*: 1, sternum ( $\times 4$ ); 2, hyoid ( $\times 6$ ); 3, muscles of hand ( $\times 4$ ); 4, first and second metacarpals ( $\times 6$ ); 5, ventral aspect of third finger ( $\times 9$ ). Below, life-sized male; ventral aspect of tadpole ( $\times 2\frac{1}{2}$ ).

**DISTRIBUTION—China:** Sichuan: Baoxing, Kangting, Muping, Wenchuan; Yunnan: Jingdong.

***Amolops monticola* (Anderson)**

*Hylarana monticola* Anderson, 1871, J. Asiat. Soc. Bengal, p. 25. Type locality: Darjeeling, India; Stoliczka, 1872, Proc. Asiat. Soc. Bengal, p. 105  
*Rana monticola* Boulenger, 1890, Fauna Brit. India, Rept., p. 461.  
*Staurois monticola* Hu et al., 1977, Acta Zool. Sinica, 23: 56.

**DIAGNOSIS—**Four species of this genus—*A. chunganensis*, *A. granulatus*, *A. jinjiangensis*, and *A. monticola*—have a dorsolateral fold. Of these,

only *A. monticola* has smooth skin on the back; *A. chunganensis* has rounded, horny granules, *A. granulatus* scattered spinules, and *A. jinjiangensis* has two large tubercles on side of anus.

**DESCRIPTION—**A large-sized frog, male 41 mm, female 65 mm (both specimens from Darjeeling) and 72–75 mm (two females from Xizang); width of head almost equal to length and much depressed; snout rounded or obtusely pointed, feebly projecting beyond lower jaw; canthi distinct; lores feebly oblique to near lip; pineal body visible; nostril midway between tip of snout and eye; tympanum distinct,  $\frac{1}{3}$ – $\frac{1}{2}$  diameter of eye; vomerine teeth converging backward. Fingers slender, first finger shorter than second; large disks at tips of finger with circummarginal grooves; subarticular



tubercles rounded and bulging; supernumerary tubercles indistinct; no outer palmar tubercle; hind limbs slender; tibia 0.63 times SVL; disks of toes smaller than those of fingers; fourth toe with full web to distal subarticular tubercle and with narrow fringes on both sides to disk; the rest of toes fully webbed; inner metatarsal tubercle long and narrow, no outer metatarsal tubercle. Skin smooth on back; narrow, feebly prominent, glandular dorsolateral fold from above the tympanum to the hip; temporal fold distinct; ventrum smooth. Gray or brown above, dark crossbars on limbs.

Male with gular pouch and velvety nuptial pad.

Tadpole with a large abdominal sucker; denticle formula III:4-4/1-1:II; postorbital gland present.

HABITAT—Altitude 1300–2300 m; forest streams.

DISTRIBUTION—**India:** Darjeeling; Xizang: Zayu, Medog, and Bomi.

### ***Amolops nepalicus* sp. nov.**

HOLOTYPE—UMMZ 132063, adult male, collected from Sabhaya Kbota, Nepal.

DIAGNOSIS—Six species of this genus—*A. nepalicus*, *A. afghanus*, *A. macrorhynchus*, *A. monticola*, *A. larutensis*, and *A. chunganensis*—have paired gular pouches. But *A. nepalicus* differs from *A. chunganensis* in lacking a dorsolateral fold; from *A. monticola* in lacking a dorsolateral fold; from *A. afghanus* in having the vomerine tooth groups oblique instead of transverse; from *A. macrorhynchus* in having the canthi converging rather than parallel; and from *A. larutensis* in lacking axillary glands.

DESCRIPTION OF HOLOTYPE—SVL 37.3 mm; length of head slightly longer than width; snout narrowed, rounded, and projecting beyond lower jaw for distance less than depth of snout at level of nostril; nostril midway between tip of snout and eye; canthi distinct and converging; lores vertical; pineal body invisible; tympanum visible, diameter 0.24 times eye; vomerine teeth in oblique groups between choanae. Fingers slender, length of first finger equal to second; tips of finger expanded into large disks with circummarginal grooves; subarticular tubercles rounded and bulging; small, rounded supernumerary tubercles at bases of all fingers; two palmar tubercles; hind limbs moderately slender, length of tibia 0.61 times SVL; disks of toes smaller than those of fingers; toes fully webbed; subarticular tubercles small; inner metatarsal tubercle present; a small, rounded outer

metatarsal tubercle. A few flat rounded tubercles scattered on back; no dorsolateral fold; an obvious temporal fold; many small tubercles on outer side of thigh; belly smooth. Light brown on back with dark brown spots on tubercles in alcohol; darker brown crossbars on limbs; belly yellowish gray.

Male with paired gular pouches and yellowish white velvety nuptial pad on first finger.

Five specimens of tadpoles, stages 30 (2), 32, 34 (2), collected from Nepal. Head-body oval, rounded at snout, flat below; eye dorsal; nostril nearer to eye than to tip of snout; spiracular tube low on side, as long as diameter of eye, free of body. Oral disk ventral, followed by a large abdominal sucker; upper lip lacking papillae except at side of mouth; denticle formula II:4-4/1-1:II, one tadpole has an additional very weak outer row on the lower lip and the others a ridge devoid of denticles; neither beak divided, margin with many fine serrations, outer surface smooth. Abdominal sucker with a narrow, rough, marginal band of cornified epidermis and two isolated patches of similar tissue anteriorly.

DISTRIBUTION—**Nepal:** Sabhaya Kbota.

### ***Amolops ricketti* (Boulenger). Figure 19.**

*Rana ricketti* Boulenger, 1899, Proc. Zool. Soc. Lond., p. 168. Type locality: Guadun, Fijian.

*Staurois ricketti* Noble, 1929, Bull. Amer. Mus. Nat. Hist., 58: 291; Liu and Hu, 1961, Tailless Amphibians of China, p. 231.

DIAGNOSIS—Seven species of this genus—*A. ricketti*, *A. granulosus*, *A. lifanensis*, *A. loloensis*, *A. mantzorum*, *A. hainanensis*, and *A. viridimaculatus*—have no vocal sac or gular pouch. But *A. ricketti* differs from *A. granulosus*, *A. loloensis*, *A. lifanensis*, and *A. mantzorum* in having a circummarginal groove on first finger; from *A. hainanensis* in lacking bony projections at the front of the mandible; and from *A. viridimaculatus* in having no yellowish green marking on back.

DESCRIPTION—A moderate-sized frog, males 42–61 mm, females 54–67 mm; body depressed; width of head slightly greater than length; snout blunt and rounded, projecting beyond lower jaw for distance less than depth of snout at level of nostril; canthi distinct; lores oblique to near lip; nostril nearer to eye than to snout; pineal body visible; tympanum invisible; vomerine teeth in groups converging toward the rear. Forelimb slender; first finger shorter than second; tips of fingers with large disks and circummarginal grooves; subarticular

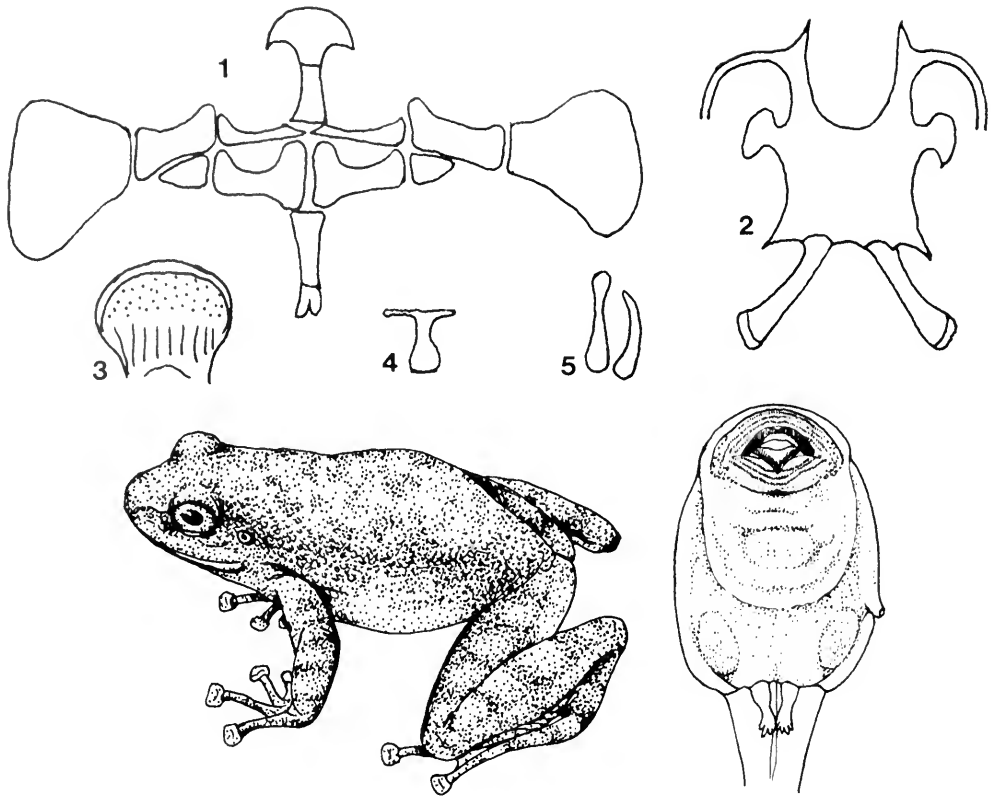

FIG. 19. *Amolops ricketti*: 1, sternum ( $\times 2$ ); 2, hyoid ( $\times 3$ ); 3, ventral aspect of third finger ( $\times 6$ ); 4, terminal phalanx of third finger ( $\times 4$ ); 5, first and second metacarpals ( $\times 3$ ). Below, life-sized male; ventral aspect of tadpole ( $\times 3$ ) (from Pope).

tubercles small and round; second and third finger with supernumerary tubercles; two palmar tubercles; hind limbs long, length of tibia 0.54 times SVL; disks smaller than those of fingers; toes fully webbed; an oval inner but no outer metatarsal tubercle. Skin rough, with small tubercles tipped with round horny granules; no dorsolateral fold; temporal fold distinct; small flat tubercles or wrinkles on belly. Olive above in alcohol, with large dark spots or marblings; limbs with regular dark crossbars.

Male without vocal sac or gular pouch; with yellowish spinules forming nuptial pad on first finger.

Hyoid width greater than length; anterior horn with anterior process present; length of processus alaris more than  $\frac{1}{3}$  length of hyoid; posterolateral process more than  $\frac{1}{3}$  length of body of hyoid; posterior horn without median cartilage. Mesosternum simple, posterior end transverse, length 1.2–2.0 times width; posterior margin of metasternum notched, limbs diverging. *Musculus palmaris* lon-

gus divided into 2 bundles of fibers; *m. p. profundus* undivided and attached to rim of aponeurosis palmaris. First metacarpal bone 0.93 times second; width of crossbar on terminal phalanx of third finger 1.17 times length.

Tadpole with a large abdominal sucker; denticle formula III:1–1/1–1:II; posterobital and ventral glands present.

HABITAT—Altitude 400–1500 m; forest streams.

DISTRIBUTION—China: Fujian: Guadun; Guangdong; Guangxi; Guizhou: Fanjing-Shan; Hubei; Hunan: Yizhan; Sichuan: Nanchuan; Zhejiang: Vietnam.

#### *Amolops torrentis* (Smith). Figure 20.

*Micrixalus torrentis* Smith, 1923, J. Nat. Hist. Soc. Siam, 6: 209. Type locality: Hainan.  
*Staurois torrentis* Liu and Hu, 1973, Acta Zool. Sinica, 19: 398.

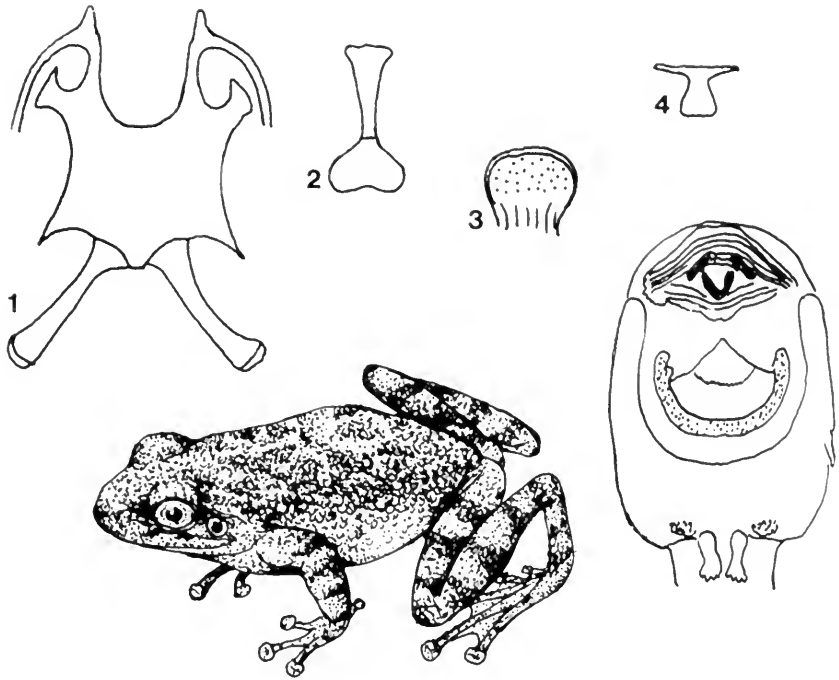

FIG. 20. *Amolops torrentis*: 1, hyoid ( $\times 6$ ); 2, mesosternum and metasternum ( $\times 6$ ); 3, ventral aspect of third finger ( $\times 4\frac{1}{2}$ ); 4, terminal phalanx of third finger ( $\times 4\frac{1}{2}$ ). Below, male ( $\times 2$ ); ventral aspect of tadpole ( $\times 3$ ) (from Liu et al., 1973).

**DIAGNOSIS**—Three species—*A. torrentis*, *A. hainanensis*, and *A. hongkongensis*—have a glandular ridge on the ventral surface of the tarsus; but *A. torrentis* lacks the bony projections found at the tip of the mandible in *A. hainanensis* and, unlike *A. hongkongensis*, has a distinct tympanum.

**DESCRIPTION**—Smallest species of this genus; males 28–33 mm, females 34–41 mm; length of head equal to width; snout broadly rounded, projecting beyond lower jaw for distance less than depth of snout at nostril; nostril midway between tip of snout and eye; canthi distinct, converging; lores oblique from canthi to near lip; pineal body visible; tympanum large with an obvious rim, 0.36–0.38 times diameter of eye; vomerine teeth absent. Fingers moderately long, first equal to second; tips of fingers with large disks with circummarginal grooves; subarticular tubercles rounded and bulging; 2 palmar tubercles; hind limb moderately long, length of tibia 0.6 times SVL; disks of toes smaller than those of fingers; with circummarginal grooves; toes fully webbed; an inner metatarsal tubercle, no outer metatarsal tubercle. Skin smooth with small

tubercles on back; no dorsolateral fold; some larger tubercles on side of body; ventral area of tarsus with thick glandular ridge; venter smooth. Brown or black in life; with scattered, irregular, dark brown spots on back; dark crossbars on limbs; reddish purple on belly.

Male with paired vocal sacs; no gular pouches; without nuptial pads.

Hyoid width greater than length; anterior horn with anterior process; length of processus alaris greater than  $\frac{1}{3}$  length of body of hyoid; length of posterolateral process more than  $\frac{1}{3}$  length of body of hyoid; medial cartilage absent on posterior horn. Mesosternum simple, posterior end transverse, length greater than width; posterior margin of metasternum notched, with limbs diverging. Length of first metacarpal bone 0.26 times second; width of crossbar on terminal phalanx of third finger 1.67 times length.

Tadpole with a large abdominal sucker; denticle formula II:2–2/1–1:II; postorbital and ventral glands present.

**HABITAT**—Altitude 80–780 m.

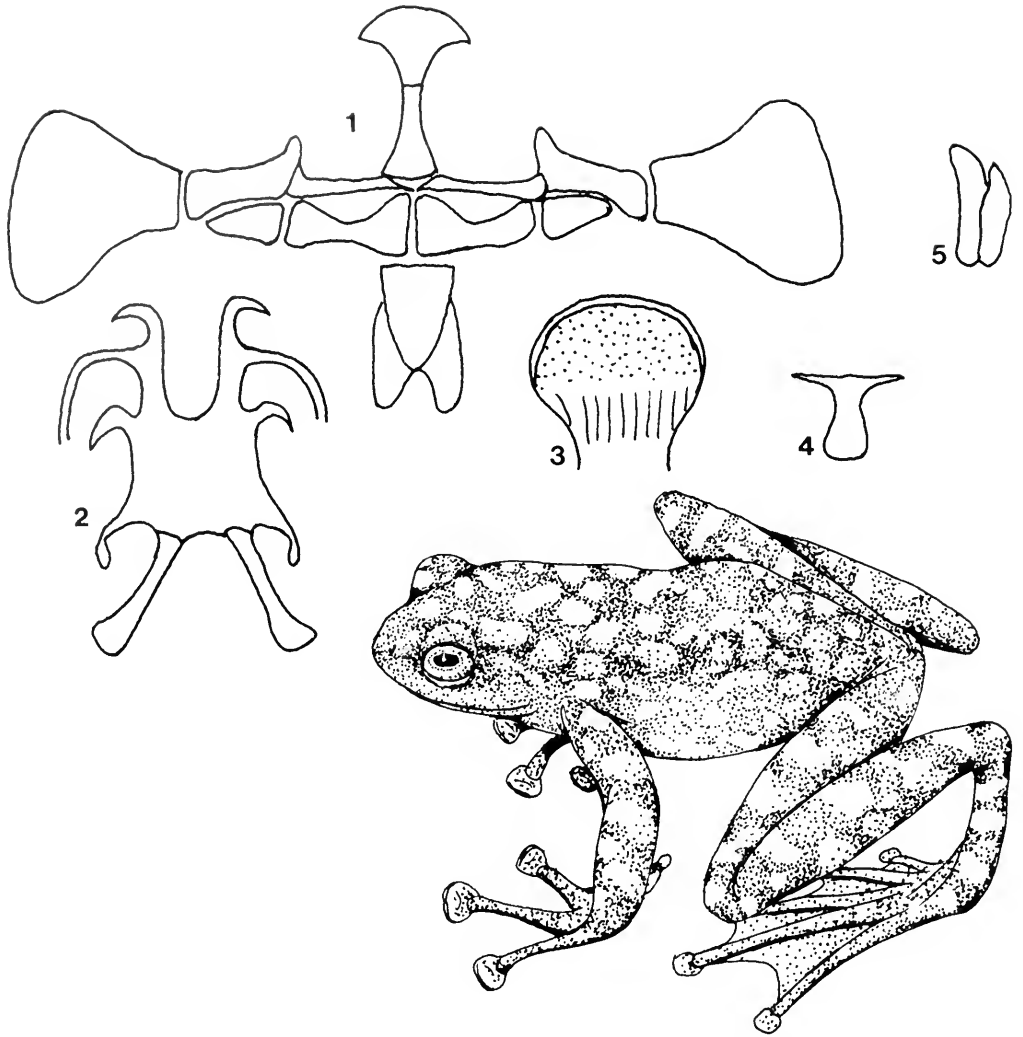

FIG. 21. *Amolops viridimaculatus*: 1, sternum ( $\times 2$ ); 2, hyoid ( $\times 2$ ); 3, ventral aspect of third finger ( $\times 4$ ); 4, terminal phalanx of third finger ( $\times 4$ ); 5, first and second metacarpals ( $\times 4$ ). Below, life-sized male.

**DISTRIBUTION**—**China:** Hainan: Iy Xian, Dan Xian, Diaoluoshan, Wushiling, Ying-ge-ling, Jian-Feng-Ling.

***Amolops viridimaculatus* (Jiang). Figure 21.**

*Stauroids viridimaculatus* Jiang, 1983, Acta Herp. Sinica, 2(3): 71. Type locality: Tenchung, Yunnan.

**DIAGNOSIS**—This is one of the largest frogs in the genus *Amolops*, males 63–77 mm (13 males), females 84–100 mm (14 females). The coloration of the back, reddish brown with rounded yellowish green spots, is unique.

**DESCRIPTION**—Body very depressed; width of head slightly greater than length; snout sloping from level of nostril to tip, projecting beyond lower jaw for distance less than depth of snout at nostril; canthi rounded; lores oblique to near lip; nostril lateral, midway between tip of snout and eye; top of head flat; area behind eye swollen; pineal body visible; tympanum small and indistinct; vomerine teeth strongly converging backward between choanae. Fingers slender, first finger shorter than second; large disks at fingertips with circummarginal grooves except on first; subarticular tubercles large, rounded, and bulging; supernumerary tubercles indistinct; three long palmar tubercles; hind limb long and slender, tibia 0.6 times length of body;

toes fully webbed; disks of toes smaller than those of fingers and with circummarginal grooves; inner metatarsal tubercle narrow, flat; no outer metatarsal tubercle. Skin smooth above and on belly; no dorsolateral fold; temporal fold visible. Reddish brown above, with yellowish green markings on back and crossbars on limbs.

Male without vocal sac, no gular pouches; velvety nuptial pad on first finger.

Hyoid width greater than length; anterior horn with anterior process present; processus alaris length less than  $\frac{1}{3}$  length of hyoid; posterolateral process length  $\frac{1}{3}$ – $\frac{1}{2}$  length of hyoid; medial cartilage absent on posterior horn. Mesosternum simple, posterior end transverse, length 1.2–2.0 times width; metasternum notched, limbs parallel. Musculus palmaris longus divided into two bundles of fibers at distal end; most of m. p. profundus attaches to dorsal surface of aponeurosis palmaris. Length of first metacarpal bone 0.73 times second; width of crossbar on terminal phalanx of third finger 1.4 times length.

Tadpole with a large abdominal sucker; denticle formula III:4–4/1–1:II; postorbital and ventral glands present; a row of papillae between margin of lower lip and outer row of denticles; a transverse wavy ridge on lower lip.

HABITAT—Forest streams; altitude 1400–2000 m.

DISCUSSION—Jiang (1983) assigned to this species black tadpoles collected in small streams with adults of *A. viridimaculatus*. Although this tadpole had a large abdominal sucker with a free, raised border, the absence of diaphragmatic muscles and glands on the body indicates that it is not a larval *Amolops*. In stages 40–41 these larvae had no disks at the tips of the fingers and toes, in contrast to all true larvae of *Amolops*. The coloration, shape of digits, and the denticle formula II/III suggest that the black tadpoles belong to a form of *Bufo*idae.

DISTRIBUTION—China: Yunnan: Gaoligong Shan (Tenchung Xian and Gongshan Xian).

#### *Amolops wuyiensis* (Liu and Hu). Figure 22.

*Stauroids wuyiensis* Liu and Hu, 1975, Acta Zool. Sinica, 21: 266. Type locality: Wuyi Mountain, Fujian.

DIAGNOSIS—Three species of this genus have vomerine ridges but no vomerine teeth: *A. torrentis*, *A. wuyiensis*, and *A. loloensis*. *A. wuyiensis* differs from *A. loloensis* in lacking round or oval

reddish brown round spots on the back, and from *A. torrentis* in having an obscured tympanum.

DESCRIPTION—A small species, males 37–45 mm, females 45–53 mm; body slightly depressed; width of head greater than length; snout blunt and projecting beyond lower jaw a distance less than depth of snout at nostril; canthi distinct; lores oblique to near lip; pineal body visible; tympanum invisible; a pair of vomerine ridges without teeth converging backward between choanae. Tips of fingers expanded, all with circummarginal grooves; subarticular tubercles at bases of outer fingers; hind limbs moderately long; length of tibia 0.55 times SVL; disks of toes smaller than those of fingers; toes fully webbed; subarticular tubercles oval and bulging; an inner but no outer metatarsal tubercle. Skin rough, no dorsolateral fold; temporal fold distinct; many small tubercles on back; a few glands at angle of mouth; small flat tubercles on belly. Greenish yellow or brownish gray, with irregular marks on back in life; dark brown crossbars on limbs.

Male with paired vocal sacs, no gular pouches; black spinose nuptial pad on first finger.

Hyoid width less than length; anterior horn with anterior process present; processus alaris length  $\frac{1}{3}$ – $\frac{1}{2}$  length of hyoid; posterolateral process  $\frac{1}{3}$ – $\frac{1}{2}$  length of body of hyoid; medial cartilage absent on posterior horn. Posterior end of mesosternum simple, transverse; length of mesosternum 1.2–2.0 times width; metasternum notched, limbs parallel. Musculus palmaris longus divided into two bundles of fibers; m. p. profundus undivided and attached to rim of aponeurosis palmaris.

Tadpole with a large abdominal sucker; denticle formula III:1–1/1–1:II; postorbital and ventral glands present.

HABITAT—Altitude 100–1100 m; forest streams.

DISTRIBUTION—Fujian: Chong'an, Sangong; Anhui: Huang-Shan; Zhejiang: Yandang-Shan.

#### *Huia* gen. nov.

Type species: *Rana cavitympanum* Boulenger.

DIAGNOSIS—Lower continuous denticles of tadpoles of *Huia* more than five rows; larvae with some scattered glands on head, back, and tail; length of tibia more than 0.7 times SVL in adults. Upper beak M-shaped, lower beak V-shaped, neither beak divided in tadpoles; width of crossbar of T-shaped terminal phalanx less than 0.6 times

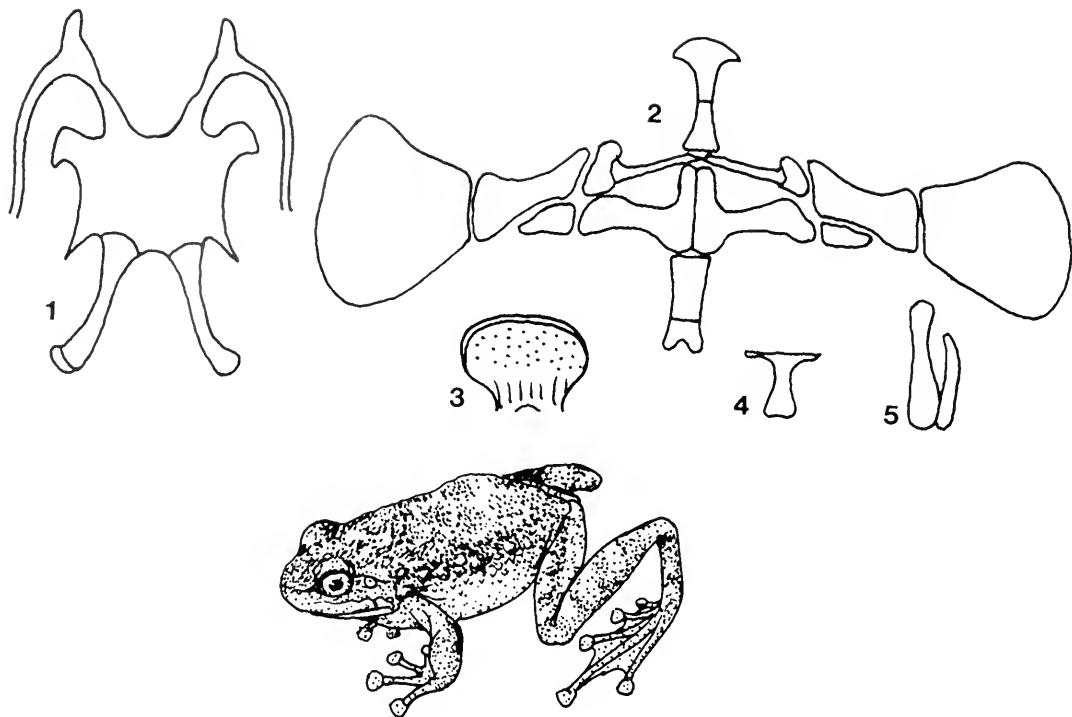

FIG. 22. *Amolops wuyiensis*: 1, hyoid ( $\times 4$ ); 2, sternum ( $\times 2$ ); 3, ventral aspect of third finger ( $\times 6$ ); 4, terminal phalanx of third finger ( $\times 6$ ); 5, first and second metacarpals ( $\times 6$ ). Below, life-sized male.

length in adults (differs from *Meristogenys*). Differs from *Amolops* in having longer tibia and from *Meristogenys* in length of crossbar on terminal phalanx.

**CHARACTERS OF HUIA**—Body depressed and slender; first finger same length or slightly longer than second; tips of fingers expanded into disks smaller in width than diameter of tympanum; tympanum translucent, near eye (in male); length of tibia more than 0.7 times SVL; disks of toes almost equal in size to those of fingers; toes almost fully webbed to disks; first metacarpal bone  $\frac{1}{2}$ – $\frac{2}{3}$  times length of second; anterior  $\frac{2}{3}$  of nasal bone narrowed and parallel-sided.

Male with paired gular pouches.

Head of tadpole oval, snout round, flat below; eyes dorsal; nostril nearer to eye than to snout;

ventral oral disk followed by a large abdominal sucker; upper lip usually lacking papillae, but present in tadpoles from Menyang, Yunnan (Liu & Hu, 1961, p. 242); lower denticles of three species and undetermined tadpoles with I–I:V–VIII; upper beak M-shaped, lower beak V-shaped, neither beak divided, margins with many fine serrations, outer surface smooth. Postorbital glands always present, usually some glands scattered dorsally on head-body; ventral and caudal glands present or absent.

**DISTRIBUTION**—Java; Sumatra; Borneo; Thailand; China: Yunnan.

**ETYMOLOGY**—*Huia* is a patronym for the Chinese herpetologist Shuchin Hu.

#### Key to species of *Huia*

- |  |                       |
|--|-----------------------|
| 1. Tympanum in deep cavity .....                           | <i>cavitytympanum</i> |
| Tympanum on surface .....                                  | 2                     |
| 2. Fourth toe webbed to distal subarticular tubercle ..... | <i>javana</i>         |
| Fourth toe with full web .....                             | 3                     |

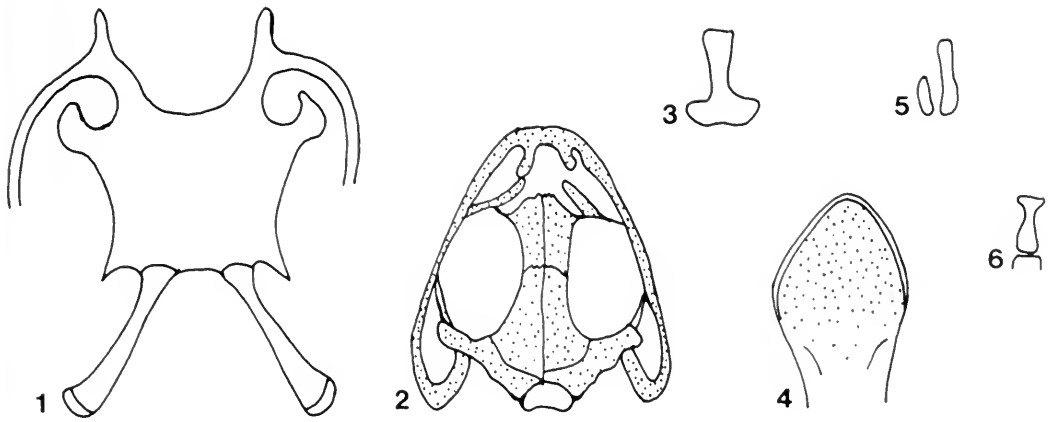

FIG. 23. *Huia cavitympanum*: 1, hyoid ( $\times 4$ ); 2, skull ( $\times 2$ ); 3, mesosternum and metasternum ( $\times 4$ ); 4, ventral aspect of third finger ( $\times 3$ ); 5, first and second metacarpals ( $\times 2$ ); 6, terminal phalanx of third finger ( $\times 2$ ).

3. Pineal body invisible' ..... *nasica*  
 Pineal body visible ..... *sumatrana*

***Huia cavitympanum* (Boulenger). Figure 23.**

*Rana cavitympanum* Boulenger, 1893, Proc. Zool. Soc. Lond., p. 525. Type locality: Kinabalu, Sabah in Borneo; 1920, Rec. Ind. Mus., 20: 193; van Kampen, 1923, Amph. Indo-Austr. Arch., p. 211.  
*Amolops cavitympanum* Inger, 1966, Fieldiana: Zool., 52: 260.

DIAGNOSIS—This species is unique in the genus *Huia* in that the tympanum is set deep in a cavity on the side of the head.

DESCRIPTION—A moderate-sized frog, adult males 42–48 mm, females 67.8–74 mm; width of head less than length; snout narrowed and rounded, projection beyond lower jaw equal to  $\frac{1}{2}$  depth of snout at level of nostril; nostril between tip of snout and eye; canthi distinct and converging; lores vertical; pineal body visible; tympanum visible and set deep in cavity; vomerine teeth in slightly oblique groups between choanae. Finger slender, first finger as long as second; disks of fingers slightly longer than wide and with a circummarginal groove; subarticular tubercles oval and bulging; weak supernumerary tubercles at least on two outer fingers; three palmar tubercles present; hind limbs long, tibia 0.73–0.75 times length of body; disks of toes smaller than those of fingers; all toes fully webbed; subarticular tubercles small, oval, and bulging; an inner but no outer metatarsal tubercle. Skin smooth on back, dorsolateral foldlike structure present; numerous oval glands on sides

of body; thick, supratympanic fold from eye to axilla. Color in life, dark purplish brown above; irregular light-colored spots on head, with light-edged blackish crossbars on limbs; below uniformly whitish.

Male with gular pouches; yellowish, velvety nuptial pad on first finger.

Body of hyoid narrower than long; anterior horn with anterior process present; length of processus alaris more than  $\frac{1}{3}$  length of body of hyoid; posterolateral process  $\frac{1}{3}$ – $\frac{1}{2}$  length of body of hyoid; medial cartilage absent on posterior horn. Mesosternum simple, posterior end transverse; length 1.2–2.0 times width; metasternum not notched. Musculus palmaris divided into two bundles of fibers; all fibers of m. p. profundus attached to rim of aponeurosis palmaris. Length of first metacarpal bone 0.54 times second; width of crossbar on terminal phalanx of third finger 0.5 times length.

Tadpole with a large abdominal sucker; denticle formula III:8–8(9–9)/1–1;V; long, narrow poison gland in posterior third of body along ventrolateral edge; postorbital gland present.

HABITAT—Altitude 100–900 m; forest streams.

DISTRIBUTION—Borneo: Kinabalu, Sabah.

***Huia javana* sp. nov. Figure 24.**

HOLOTYPE—ZMA 7780, an adult male; collected at Tjibodas, Java, by M. Weber.

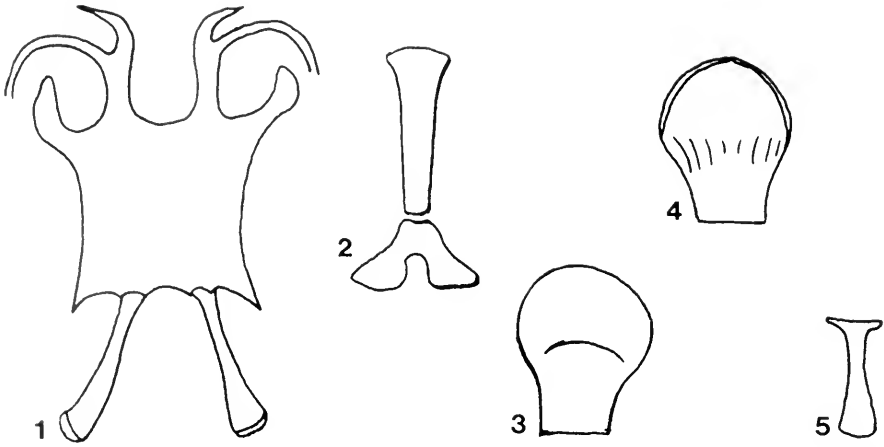

FIG. 24. *Huia javana*: 1, body of hyoid ( $\times 4$ ); 2, metasternum and mesosternum ( $\times 4$ ); 3, dorsal aspect of fourth finger ( $\times 6$ ); 4, ventral aspect of fourth finger ( $\times 6$ ); 5, terminal phalanx ( $\times 6$ ).

PARATYPES—ZMA 7780, an adult female, same data as holotype; ZMA 5101, 2 adult females, and ZMA 5102, an adult female, from Tjibodas, collected by H. Boschma.

DIAGNOSIS—The superficial tympanum of *H. javana* differs from that of *H. cavitympanum*. Full webbing only as far as the distal subarticular tubercle distinguishes *H. javana* from *H. nasica* and *H. sumatrana*.

DESCRIPTION—A moderate-sized species, body slender, male (holotype) 43 mm SVL, females 66–71 mm (N = 4). Width of head less than length; snout long, rounded, and slightly pointed, projecting beyond lower jaw less than depth of snout at level of nostril; nostril nearer to tip of snout than to eye; canthi distinct and converging forward; lores concave and oblique; pineal body visible; tympanum large and with a visible rim, 0.63 (holotype), 0.48–0.56 of eye in females; vomerine teeth in short, oval, almost transverse groups. Fingers slender, first finger equal to second; fingers with small round disks with circummarginal grooves; disk of third finger equal to 0.5 times tympanum in females, 0.35 in males; subarticular tubercles oval and bulging; no supernumerary tubercles at bases of fingers; three palmar tubercles; hind limb slender; tibia 0.72 times SVL; disks of toes equal to those of fingers; full web to distal subarticular tubercle of fourth toe, with fringe of skin to disk; first to third toes fully webbed to disk on outer margin, fifth fully webbed to disk; subarticular tubercles oval and bulging; an oval inner metatarsal tubercle, and a small outer one. Dorsolateral fold distinct; temporal fold present; very

small granules on the back; some larger rounded granules on the side of body; belly smooth. Color in alcohol based on paratypes; type faded. Brown dorsally and laterally; a dark horizontal brown bar just below canthus; an oblique dark bar from below rear of eye to below tympanum; a vertical dark bar behind tympanum; limbs with dark crossbars; rear of thigh brown, without light markings; ventrally light with obscure brown marking on chest and throat.

Male with paired gular pouches and velvety nuptial pad on first finger.

Hyoid body length greater than width; anterior horn with anterior process; length of process alaris about  $\frac{1}{3}$  length of body; no medial process on posterior bone. Mesosternum simple, posterior end transverse, length more than twice width; metasternum notched, limbs diverging. Length of first metacarpal bone 0.61 times second; width of terminal phalanx of third finger 0.35 times length.

SVL 43 mm (male), 66–71 mm (2 females); length of head 0.39–0.41 times SVL; width of head 0.35–0.38 times SVL; tympanum 0.63 of eye diameter in male, 0.48–0.56 in females; length of tibia 0.70–0.76 of SVL.

TADPOLES—Four specimens: stages 30, 31, 32 (2). Head–body oval, rounded at snout, flat below; eye dorsal; nostril nearer eye than to snout; spiracular tube low on side, as long as diameter of eye, free of body. Oral disk ventral, followed by a large abdominal sucker; upper lip lacking papillae except at sides of mouth; denticle formula 1–1:III: 4–4/1–11:VIII; outermost lower rows weak and broken (one tadpole); upper beak strongly



M-shaped, lower beak V-shaped, neither beak divided, margin with many fine serrations, outer surface smooth. Abdominal sucker with a narrow, rough marginal band of cornified epidermis narrowly interrupted posteriorly and with two isolated patches of similar tissue anteriorly.

Glands in a wide band around snout and on side of body, band extending upward to postorbital region; a group of 4–6 glands adjacent to anteromedial corner of eye; a group of glands midlaterally near end of body; a few widely scattered glandules in vertebral line near end of body; a group of glands ventrally at end of body; glandules at base of dorsal fin in posterior half.

Head–body length (HBL) 14.5–16.3 mm; width of body 0.59–0.63 times HBL; length of abdominal sucker measured from tip of snout 0.56–0.63 of HBL; width of sucker 0.46–0.50 of HBL.

**Huia nasica** (Boulenger). Figure 25.

*Rana nasica* Boulenger, 1903, Ann. Mag. Nat. Hist., (7)12: 187. Type locality: Tonkin; 1920, Rec. Ind. Mus., 20: 171.

*Stauroides nasica* Liu and Hu, 1959, Acta Zool. Sinica, 11: 511.

**DIAGNOSIS**—In three species of this genus—*H. cavitympanum*, *H. nasica*, and *H. sumatrana*—all toes are fully webbed to the disk. Of these, only *H. cavitympanum* has the tympanum in a depression. In *H. nasica* the pineal body is invisible, whereas in *H. sumatrana* it is visible.

**DESCRIPTION**—A moderate-sized species, males 41–46 mm (4 type specimens from Thailand); body slender; width of head less than length; snout long and rounded, projection beyond lower jaw less than depth of snout at level of nostril; nostril nearer to tip of snout than to eye; canthi distinct; lores vertical; pineal body invisible; tympanum large and translucent, with raised rim, diameter 0.57 times diameter of eye; groups of vomerine teeth short, in rounded patches, and weakly converging backward. Fingers slender, first finger longer than the second (types) or equal to second (frogs from Thailand); disks of fingers smaller in width than diameter of tympanum, with circummarginal grooves; subarticular tubercles oval and bulging; supernumerary tubercles at bases of two outer fingers; 3 palmar tubercles; hind limb slender; disks of toes smaller than those of fingers; toes fully webbed; inner side of first and outer side of fifth toe with fringe of skin; subarticular tubercles rounded and bulging; an oval inner metatarsal tu-



FIG. 25. *Huia nasica*: mesosternum and metasternum ( $\times 4$ ) (specimen from Thailand).

bercle and a small outer metatarsal tubercle. Dorsolateral fold present; many small horny granules on back; grayish olive or brown above; dark cross-bars on limbs.

Male with paired gular pouches; velvety nuptial pad on first finger.

**HABITAT**—Altitude ca. 1000 m.

**DISCUSSION**—The types from Tonkin and the 2 males from Thailand have a velvety nuptial pad and all toes fully webbed to the disks. In 2 males and a female from Menyang, Yunnan, the fourth toe is fully webbed only to the distal subarticular tubercle; the Yunnan males have spinose nuptial pads. These three Chinese specimens likely do not belong to *H. nasica*. A tadpole from Menyang assigned to *H. nasica* by Liu and Hu (1961), is certainly *Huia* even if not larval *H. nasica*. About stage 36, this tadpole has scattered glands on head and body, no ventral glands, and M-shaped upper beak, and denticles II:3–3/1–1:VII.

**DISTRIBUTION**—**Thailand**: Tonkin.

**Huia sumatrana** sp. nov. Figure 26.

**HOLOTYPE**—FMNH 209922, an adult male, collected at Bukit Lawang Forest Reserve, Bohorok, Sumatra (3°31'N, 98°8'E) by Harold K. Voris, 22 July 1976.

**PARATYPES**—FMNH 209924, 11 juveniles and one stage 43 individual; all collected at type locality; ZMA 5090, adult female, collected at Gambir, Deli, Sumatra, by L. P. Debussey in August 1905.

**DIAGNOSIS**—*H. sumatrana* is distinguished from *H. cavitympanum* by the superficial tympanum on the side of the head, from *H. javana* by the fully webbed fourth toe, and from *H. nasica* by an oblique vomerine tooththrow.

**DESCRIPTION**—A small species, males 29–31 mm, females 61–70 mm; length of head greater than width; snout slightly pointed, projection beyond lower jaw equal to 1/2 depth of snout at level of nostril; nostril nearer to tip of snout than to eye; canthi distinct; lores concave; pineal visible;

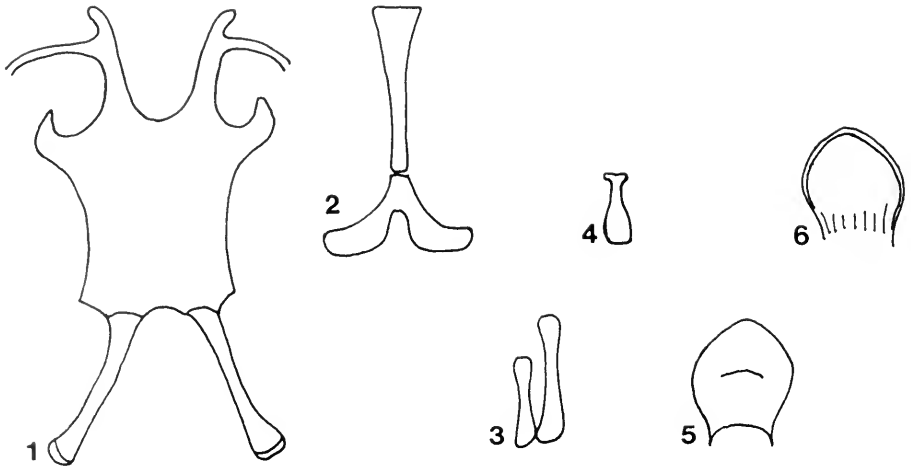

FIG. 26. *Huia sumatrana*: 1, hyoid body ( $\times 6$ ); 2, metasternum and mesosternum ( $\times 6$ ); 3, first and second metacarpals ( $\times 6$ ); 4, terminal phalanx ( $\times 6$ ); 5, dorsal aspect of disk of third finger ( $\times 6$ ); 6, ventral aspect of disk of third finger ( $\times 6$ ).

tympanum large, round, and translucent, without raised rim, about  $\frac{1}{2}$ – $\frac{3}{4}$  diameter of eye; vomerine teeth forming an oblique row on narrow ridges. Fingers slender, first finger slightly longer than second; tips of all fingers expanded into small round disks with circummarginal grooves, disk of third finger 0.61 times diameter of tympanum in males, 0.44–0.53 in females; subarticular tubercles present; no supernumerary metacarpal tubercles; hind limb long, length of tibia about  $\frac{3}{4}$  SVL; disks of toes equal to those of fingers; toes including fourth fully webbed to disks laterally; subarticular tubercles oval and bulging; a small oval inner metatarsal tubercle; outer metatarsal tubercle present. Skin slightly rough on back, smooth on belly; dorso-lateral and temporal folds present. In alcohol, light brown on back and limbs; dark brown bar below canthus; an oblique, dark infraorbital bar from eye to angle of mouth; a dark mark along temporal fold and another one on shoulder; two dark cross-bars on forearm; four widely spaced crossbars on thigh, three on tibia, and three on tarsus; rear of thigh brown with small light-colored spots; small dark spots on lower jaw; belly light without markings.

Male with gular pouches; velvety nuptial pad on first finger.

Length of head 0.40–0.43 times SVL; width of head 0.33–0.35 times SVL; diameter of tympanum 0.53 of eye diameter in females, 0.62–0.74 in males; length of tibia 0.72–0.79 times SVL.

Length of hyoid body greater than width; anterior horn with anterior process; length of processus alaris about  $\frac{1}{3}$  length of hyoid; posterolateral process short; no medial cartilage on posterior horn. Mesosternum simple, posterior end transverse, length more than 2 times width; metasternum notched, limbs diverging. Length of first metacarpal 0.69 times length of second; width of terminal phalanx of third finger 0.4 times length.

TADPOLES—Four individuals: ZMA 5093, stages 30, 38, ZMA 5104, stage 41 (2); collected at Deli, Sumatra. The advanced larvae have characters of adults of this species; fully webbed toes and a visible outer metatarsal tubercle.

Head–body oval, broadly rounded at snout, flat below; eye dorsal; interorbital width greater than diameter of eye; nostril midway between tip of snout and eye; spiracular tube low on side, free of body, as long as diameter of eye. Oral disk ventral, followed by a large abdominal sucker; upper lip lacking papillae except at side of mouth; denticle formula III:4–4/1–1:VII; upper beak M-shaped, lower V-shaped, neither beak divided, margins with fine serrations, outer surfaces of both beaks smooth. Abdominal sucker with a marginal band of cornified epidermis around entire margin, small patch of similar tissue anteriorly.

Glandules scattered around snout, a circumorbital ring, many glandules low on side of head near oral disk and below and behind the eye; a mid-dorsal band beginning behind eyes and continuing

midlaterally near end of body; 2–4 ventrolaterally; about 10 at base of ventral fin beyond middle of tail.

Head–body length 12.3–18.2 mm; width of body 0.63–0.65 times HBL; length of snout 0.39 times HBL; interorbital width 0.19–0.20 times HBL; internasal 0.17–0.19 times HBL; diameter of eye 0.21–0.23 times HBL; length of abdominal sucker 0.57 times HBL; width of sucker 0.48–0.54 times HBL.

DISCUSSION—Two males, one immature (ZMA 5091, Pantjan Batu, Sumatra), one with vocal pouches and nuptial pads (ZMA 5904, Pantjahan, Sumatra), have dorsolateral folds as in *H. sumatrana* but differ from this species in lacking an outer metatarsal tubercle and having the fourth toe webbed only as far as the distal subarticular tubercle. Both of these specimens are badly faded, but the immature one has 7 crossbars on the thigh. These two probably represent a separate species. SVLs are 24 mm (5091) and 30.5 mm (5094).

### Meristogenys gen. nov.

Type species: *Hylarana jerboa* (Gunther).

DIAGNOSIS—Tadpoles with upper beak divided, coarsely serrated, and outer surfaces ribbed (fig. 3,

parts 2,3); length of first metacarpal less than 0.5 times second; first finger greater than second; length of tibia more than 0.7 times SVL, disk of at least the inner toe slightly larger or equal to those of fingers. These characters distinguish *Meristogenys* from *Amolops* and *Huia*.

CHARACTERS OF *MERISTOGENYS*—Body slender, width of head less than length; snout pointed; first finger usually longer than second; finger tips have small disks, smaller in diameter than tympanum; length of tibia greater than 0.7 times SVL; disks of at least three inner toes slightly larger or equal to those of fingers except in *M. kinabaluensis*; with a small, rounded outer metatarsal tubercle, except in *M. kinabaluensis*.

Males with gular pouches, velvety nuptial pad on first finger; skin rough above, usually with small horny granules except in *M. kinabaluensis*; first metacarpal less than 0.5 times second; anterior  $\frac{2}{3}$  of nasal bone narrowed and parallel-sided.

Tadpoles with large abdominal suckers with raised free borders immediately behind the oral disks; upper or both beaks divided, with coarsely serrated margins and ribbed outer surfaces; post-orbital glands, midlateral glands, infraorbital glands, and spiracular glands (and sometimes caudal glands) present.

DISTRIBUTION—**Borneo.**

ETYMOLOGY—*Meristogenys* refers to the divided beaks of the tadpoles.

### Key to Species of *Meristogenys*

1. Outer metatarsal tubercle absent ..... *kinabaluensis*
- Outer metatarsal tubercle present ..... 2
2. Fourth toe webbed only to distal subarticular tubercle ..... 3
- Toes fully webbed ..... 4
3. A smaller tympanum,  $\frac{2}{5}$ – $\frac{3}{5}$  diameter of eye ..... *whiteheadi*
- A larger tympanum,  $\frac{4}{5}$  diameter of eye ..... *amoropalamus*
4. Posterior rim of tympanum at level of angle of jaw in males ..... 5
- Posterior rim of tympanum behind angle of jaws of males ..... 6
5. Ventral surface of tibia with a few scattered melanophores ..... *jerboa*
- Ventral surface of tibia dusky ..... *orphnocnemis*
6. SVL 2.3 times length of head ..... *macrophthalmus*
- SVL 2.6 times length of head ..... 7
7. Rear of thigh dark brown, dusted with small, irregular, light-colored spots ..... *phaeomerus*
- Rear of thigh blotched dark brown and cream ..... *poecilus*

### *Meristogenys amoropalamus* (Matsui)

*Amolops amoropalamus* Matsui, 1986, Copeia, 3: 628.

Type locality: Sungai, Pa Rimau, Gunung Tapai Sai, Sarawak in Borneo.

DIAGNOSIS—Only three species of this genus—*M. amoropalamus*, *M. whiteheadi*, and *M. kinabaluensis*—do not have the fourth toe fully webbed. *M. amoropalamus* differs from *M. kinabaluensis* in having an outer metatarsal tubercle and from

*M. whiteheadi* in having a smaller tympanum, at most  $\frac{3}{5}$  the diameter of the eye.

**DESCRIPTION**—A moderate-sized species of this genus, males 32–38 mm, female 62 mm (only 1 specimen); body moderately slender; width of head less than length; snout obtusely pointed, projection beyond lower jaw greater than  $\frac{1}{2}$  depth of snout at level of nostril; nostril nearer tip of snout than eye; canthi very distinct and converging; lores slightly oblique near lip; pineal body visible; tympanum with obviously raised rim, translucent, diameter  $\frac{1}{5}$  length of eye; vomerine teeth weak, converging backward. Fingers slender; first finger slightly longer than second; tips of all fingers expanded into disks with circummarginal grooves; disk of third finger  $\frac{1}{3}$  diameter of tympanum; subarticular tubercles oval and bulging, supernumerary tubercles faintly visible at least on two outer fingers; three separated palmar tubercles; hind limbs slender, tibia 0.72 times SVL; disks of at least three inner toes equal to those of fingers; toes fully webbed except fourth which has two phalanges free; subarticular tubercles oval and bulging; a long narrow inner metatarsal tubercle; outer metatarsal tubercle present. Skin with some granules on back; sides of body with large and small granules; dorsolateral fold distinct; temporal fold visible and curved, posterior side of thigh with granules; belly smooth. Light brown on back, granules dark brown; dorsolateral fold dark brown; dark brown crossbars on limbs; thigh mottled; ventral surface of tibia dusky.

Male with paired gular pouches; small velvety nuptial pad on first finger.

*Musculus palmaris longus* undivided; m. p. profundus attached to dorsal surface of aponeurosis palmaris. First metacarpal bone 0.46 times length of second; width of terminal phalanx of third finger 0.50 times length.

**TADPOLES**—FMNH 229861 (stages 25, 28, 37 [2], 38, and 41), 229862 (28, 29, 30, 38 [2]), 229863 (29, 31, 36, 38, 41), 130893 (29), 228007 (31). These tadpoles are assigned to *M. amoropalamus* on the basis of two characters of transforming individuals; fourth toe with full web only to distal subarticular tubercle; outer metatarsal tubercle present; rear of thigh brown with small light-colored spots dusted with melanophores.

Head–body oval, broadly rounded at snout, flat below; maximum width just behind eyes, 0.63–0.76 times head–body length (HBL); eyes dorso-lateral, not visible from below, eyeball width 0.13–0.18 times HBL (stages 24–41), nostril open, rim not raised, much closer to eye than to tip of snout, internarial 0.19–0.21 times HBL.

Oral disk ventral, upper lip separated from snout by a groove; margin of upper lip smooth; lower lip and corner of oral disk with papillae; upper denticles III:4–4 (9 individuals), IV:4–4 (one individual, stage 28), lower denticles 1–1:V (stage 25), 1–1:VI (28), 1–1:VI:1–1 (29), 1–1:VII (30, 37, 38), 1–1:VIII:1–1 (36, 37, 38); upper beak divided into two parts, ribs 6+6 (25, 28), 9+9 (28), 10+10 (29), 12+12 (30, 38), 13+13 (36), 15+15 (37, 41), 16+16 (41), 17+17 (38); lower beak usually undivided, ribs 18–26 (stages 29–38), lower beak narrowly divided in three 5+5 (25), 7+7 (28), 11+11 (41). Abdominal sucker with a marginal band of brown cornified epidermis formed around the entire circumference and two small patches of similar tissue.

Tail heavily muscled, tapering near end to a point; origin of upper fin from end of body, origin of lower fin beginning at second third of tail. Head-body with postorbital, infraorbital, spiracular, and midlateral glandular patches, every granular gland with visible opening; both fins with glands at their bases.

Color in formalin, grayish brown on back, grayish white on belly.

**HABITAT**—Altitude 1300 m; forest streams.

**DISTRIBUTION**—**Borneo**: Sarawak: Sungei Pa Riman; Sabah: Kinabalu National Park.

### *Meristogenys jerboa* (Gunther)

*Hylarana jerboa* Gunther, 1872, Proc. Zool. Soc. London, p. 599. Type locality: Matang, Sarawak.

*Rana jerboa* Boulenger, 1882, Cat. Batr. Sal. Brit. Mus., p. 67; 1920, Rec. Ind. Mus., 20: 196; van Kampen, 1923, Amph. Indo-Austr. Arch., p. 208; Smith, 1925, J. Sarawak Mus., 3: 33, 1931, Bull. Raffles Mus., 5: 17.

*Rana whiteheadi* Boulenger, 1887, Ann. Mag. Nat. Hist., (5), 20: 86; Mocquard, 1890, Nouv. Arch. Mus. Nat. Hist. Nat., 2: 144 (part); Brongersma, 1937, Zool. Meded., 20: 17.

*Amolops jerboa* Inger, 1966, Fieldiana: Zool., 52: 236.

**DIAGNOSIS**—This is one of two species (*jerboa* and *orphnocnemis*) of *Meristogenys* in which the posterior rim of the tympanum is at the level of the angle of the jaws in males. In all other *Meristogenys* species the rim of the tympanum is behind the angle of the jaws in males. In *M. jerboa* the ventral surface of the tibia has, at most, a few scattered melanophores, but in *M. orphnocnemis* the ventral surface of the tibia is dusky.

**DESCRIPTION**—A slender, moderate-sized species, males 31–53 mm, females 60–82 mm; width of head less than length; snout slightly pointed,

projection beyond lower jaw equal to  $\frac{1}{3}$  of depth of snout at level of nostril; nostril nearer to tip of snout than to eye; canthi very distinct; lores oblique; pineal body visible; large and translucent tympanum with obvious rim, diameter about  $\frac{1}{2}$ – $\frac{2}{5}$  diameter of eye; vomerine teeth grouped at rear edges of vomerine ridges, converging backward between choanae. Fingers slender, first finger slightly longer than second; tips of all fingers expanded into small disks with circummarginal grooves; subarticular tubercles oval and bulging; supernumerary tubercles visible at least on two outer fingers; three separate palmar tubercles; hind limbs slender; length of tibia 0.66–0.76 times SVL; disks of three inner toes equal to or slightly larger than those of fingers; toes fully webbed to disks laterally; subarticular tubercles present; outer metatarsal tubercle round. Skin coarsely shagreened on back; posterior side of thigh near anus with very small horny granules in both sexes; dorsolateral fold usually visible; temporal fold weak, from above tympanum to axilla; belly weakly rough posteriorly, smooth anteriorly. Reddish brown on back in alcohol, dark brown just below dorsolateral fold; dark cross bars on hind limbs; venter cream or whitish; ventral surface of tibia usually without melanophores.

Male with gular pouches; velvety nuptial pad on first finger.

Hyoid body width less than length; anterior horn with anterior process present; processus alaris length less than  $\frac{1}{3}$  length of body of hyoid; medial cartilage absent on posterior horn. Mesosternum simple, posterior end transverse, length greater than 2 times width; metasternum expanded, not notched. Musculus palmaris longus undivided; most of m. p. profundus attaches to dorsal surface of aponeurosis palmaris. First metacarpal bone 0.25 times length of second; width of terminal phalanx of third finger 0.29 times length.

HABITAT—Altitude 100–2200 m; forest streams.

DISTRIBUTION—**Borneo**: Sarawak. This species has been reported from Malay Peninsula (Boulenger, 1912), Java, Sumatra, and Burma (Boulenger, 1920). Because of the close similarity of the species in this group, Boulenger's specimens cannot be assigned clearly to any of these species based solely on his descriptions.

### **Meristogenys kinabaluensis** (Inger). Figure 27.

*Rana whiteheadi* (non Boulenger) Mocquard, 1890, Nouv. Arch. Mus., 2: 144 (part); van Kampen, 1923,

Amphib. Indo-Austr. Arch., p. 210; Smith, 1931, Bull. Raffles Mus., 5: 17.

*Amolops kinabaluensis* Inger, 1966, Fieldiana: Zool., 52: 266. Type locality: Kiau, Mt. Kinabalu, Sabah, Borneo.

DIAGNOSIS—This is the largest species of the genus, male 65 mm (1 specimen), females 93 mm (5 specimens); no outer metatarsal tubercle; skin smooth above; upper beak of larva divided into two parts with 17–20 serrae.

DESCRIPTION—Body slender, width of head less than length; snout obtusely pointed, projection beyond lower jaw greater than  $\frac{1}{2}$  depth of snout at level of nostril; nostril nearer to tip of snout than to eye; canthi very distinct and converging; lores concave; pineal visible; tympanum round and translucent with obvious rim, diameter about  $\frac{1}{3}$  diameter of eye; vomerine teeth in strong oblique groups converging backward between choanae. Fingers slender, first finger slightly longer than second; tips of all fingers expanded into small disks with circummarginal grooves; subarticular tubercles oval and bulging; supernumerary tubercles visible at least on three outer fingers; three separate palmar tubercles; hind limbs slender; length of tibia 0.68 (1 male), 0.65 (5 females) times SVL; disks of inner three toes equal to those of fingers; full web to distal subarticular tubercle, narrow fringes on both sides to disk; subarticular tubercles oval and bulging; inner metatarsal tubercle narrow and long; no outer metatarsal tubercle. Skin smooth on back; a narrow, interrupted dorsolateral fold; temporal fold weak and curved; belly smooth anteriorly, posteriorly rugose. Dark brown, with indistinct small darker spots on back and on dorsolateral and supratympanic folds; limbs with dark crossbars in alcohol.

Male with gular pouches; velvety nuptial pad on first finger.

Hyoid body width less than length; anterior horn with anterior process present; processus alaris length less than  $\frac{1}{3}$  length of body of hyoid; posterior process length  $\frac{1}{3}$ – $\frac{1}{2}$  length of body of hyoid; medial cartilage absent on posterior horn. Mesosternum simple, posterior end transverse, length equal to 1.2–2.0 times width; metasternum notched and limbs parallel. Musculus palmaris longus undivided; m. p. profundus attaches to dorsal surface of aponeurosis palmaris. First metacarpal bone 0.5 times length of second; width at crossbar of terminal phalanx of third finger 0.58 times length.

Tadpole with a large abdominal sucker; denticle formula III:4–4/1–1:VI; postorbital, midlateral, infraorbital, and spiracular glands present, no

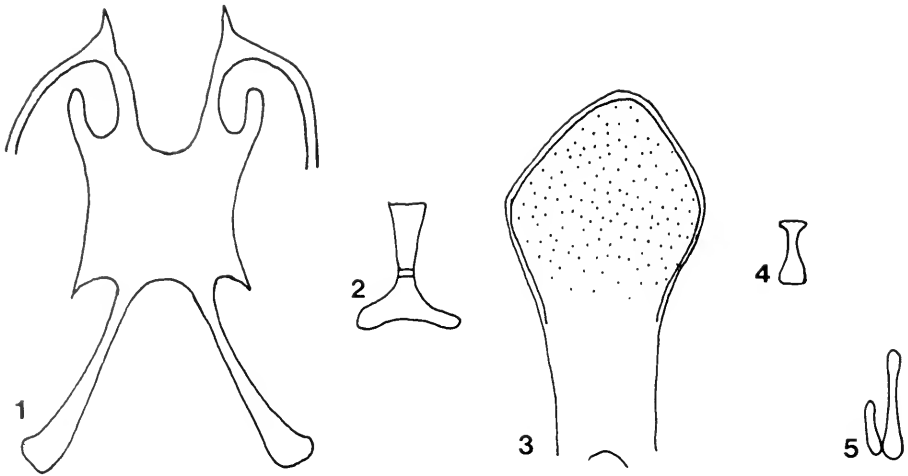

FIG. 27. *Meristogenys kinabaluensis*: 1, hyoid ( $\times 4$ ); 2, mesosternum and metasternum ( $\times 4$ ); 3, ventral aspect of third finger ( $\times 8$ ); 4, terminal phalanx of third finger ( $\times 4$ ); 5, first and second metacarpals ( $\times 4$ ).

glands on tail; upper beak divided, 17–20 serrae; lower beak undivided, 24 serrae.

HABITAT—Forest streams.

DISTRIBUTION—**Borneo**: Sabah: Kiau, Mt. Kinabalu.

### *Meristogenys macrophthalmus* (Matsui)

*Amolops macrophthalmus* Matsui, 1986, Copeia, 1986: 623. Type locality: Sungai Metallum, Sungei Pesu Camp, Bintulu District, Sarawak.

DIAGNOSIS—In three species—*M. macrophthalmus*, *M. phaeomerus* and *M. poecilus*—the posterior rim of the tympanum is at the level of the angle of the jaws in males. In *M. macrophthalmus* the body is shorter, only 2.3 times the length of the head, in contrast to 2.6 times in *M. phaeomerus* and *M. poecilus*.

DESCRIPTION—A moderate-sized species, male 36.7 mm; body moderately depressed and slender; width of head slightly less than length; snout obtusely pointed, projection beyond lower jaw equal to  $\frac{1}{2}$  depth of snout at level of nostril; nostril midway between tip of snout and eye; canthi sharp and converging; lores vertical at canthi; pineal visible; tympanum slightly greater than  $\frac{1}{2}$  diameter of eye; vomerine tooth patches oval, converging backward between choanae. Fingers slender, first equal to second; tips of all fingers expanded into disks with circummarginal grooves; disk of third finger less than  $\frac{1}{2}$  diameter of tympanum; subar-

ticular tubercles oval and bulging; supernumerary tubercles present on three outer fingers; three separated palmar tubercles; hind limb moderately long, tibia 0.62 times SVL; disks of at least three inner toes slightly larger than those of fingers; toes fully webbed to disk laterally; excision of web to middle subarticular of fourth toe; a narrow fringe on medial edge of first toe; subarticular tubercles oval and bulging; inner metatarsal tubercle narrow; outer metatarsal small and round. Skin rough on back; on side of body; posterior side of thigh, and temporal fold, light horny granules on tubercles; dorsolateral fold straight; belly rough. Gray-brown on back in alcohol; below dorsolateral fold dark brown; grayish and dark brown crossbars on limbs; ventral surface light brown.

Male with paired gular pouches; velvety nuptial pad on first finger.

Musculus palmaris longus undivided; m. p. profundus attaches to rim of aponeurosis palmaris. First metacarpal bone 0.43 times length of second; width of terminal phalanx of third finger 0.5 times length.

HABITAT—Forest streams.

DISTRIBUTION—**Borneo**: Sarawak.

### *Meristogenys orphnocnemis* (Matsui). Figure 28.

*Amolops orphnocnemis* Matsui, 1986, Copeia, 1986: 625. Type locality: Kampong Bundu Tuhan, near Kinabalu in Borneo.

**DIAGNOSIS**—In two species of this genus, *M. jerboa* and *M. orphnocnemis*, the posterior rim of the tympanum is at the level of the angle of the jaws in males; in all other species the rim of the tympanum is behind the angle of the jaws. In *M. jerboa* the ventral surface of the tibia has a few scattered melanophores, but in *M. orphnocnemis* ventral surface of tibia is dusky.

**DESCRIPTION**—A small-sized species of this genus, males 32–37 mm (12 specimens), females 60–61 mm (2 specimens); body slender and moderately depressed; width of head less than length; snout obtusely pointed, projection beyond lower jaw equal to 1/2 depth of snout at level of nostril; nostril nearer tip of snout than to eye; canthi distinct, converging; lores slightly oblique, concave; pineal body visible; tympanum with raised rim, translucent, diameter 0.62 (males), 0.42 (females) times diameter of eye; vomerine tooth groups oval, converging backward between choanae. Fingers slender; first finger slightly longer than second; tips of all fingers expanded into disks with circum-marginal grooves, disk of third finger 1/4 diameter of tympanum; subarticular tubercles oval and bulging; supernumerary tubercles not visible, light spot at base of two outer fingers in appropriate position; three separate palmar tubercles; hind limbs slender, tibia 0.71 times SVL; disks of at least three inner toes equal to those of fingers; fully webbed to disks of all toes; subarticular tubercle with narrow fringes on both sides to disk; inner sides of second the third toes fully webbed to distal subarticular tubercle and with fringes of skin to disks; an oval inner metatarsal tubercle; outer metatarsal tubercle round. Skin rough, some light horny granules on back; dorsolateral glandular fold visible; temporal fold visible; side of body coarsely granular; belly weakly rugose. Chocolate brown on back in alcohol; grayish and dark brown crossbars on limbs.

Male with gular pouches; velvety nuptial pad on first finger.

Mesosternum simple, posterior end transverse, length greater than 2 times width; posterior margin of metasternum notched, limbs diverging. Musculus palmaris longus undivided; m. p. profundus attaches to dorsal surface of aponeurosis palmaris. First metacarpal bone 0.57 times length of second; width of terminal phalanx of third finger 0.38 times length.

**TADPOLES**—FMNH 229867 (stages 38, 41 [3]), collected from Sabah, Mt. Kinabalu, August 1985. Assigned to this species on the basis of the following characters: ventral surface of tibia dusky; all



FIG. 28. *Meristogenys orphnocnemis*: mesosternum and metasternum ( $\times 4$ ).

toes with full web to disk; a narrow fringe of skin along medial edge of first toe.

Head–body oval, broadly rounded at snout, flat below; maximum width just behind eyes, 0.65 (stage 41), 0.69 (stage 38) times length of head–body; eyes dorsolateral, not visible from below, eyeball width 0.16 (stage 38), 0.19 (stage 41) times HBL; nostril open, rim not raised, much closer to eye than to tip of snout; internarial 0.17–0.19 (stage 41), 0.20 (stage 38) times HBL. Oral disk ventral, upper lip separated from snout by a groove; margin of upper lip smooth; lower lip and corner of oral disk with papillae; denticles III:2–2/1–1:V–VIII (stages 38, 41); both beaks divided, upper with 8–10 ribs in each half, lower with 6–8. Abdominal sucker with a marginal band of brown cornified epidermis around the entire circumference and two more medial patches of similar tissue.

Tail heavily muscled, tapering near end to a point; origin of upper fin from end of body, origin of lower fin beginning at second third of tail.

Head–body with postorbital, infraorbital, spiracular, and midlateral glandular patches; lower fin with a few glands.

Forelimbs (stage 41) with disk at tip of fingers, disks of toes larger than those of fingers; inner and outer metatarsal tubercles present.

Color in formalin, grayish brown on back; grayish white on belly.

**HABITAT**—Forest streams.

**DISTRIBUTION**—Borneo.

**Meristogenys phaeomerus** (Inger and Gritis). Figure 29.

*Amolops phaeomerus* Inger and Gritis, 1983, Fieldiana: Zool., n.s., no. 19: 9. Type locality: Nanga Tekalit, Kapit District, Seventh Division, Sarawak.

**DIAGNOSIS**—Rear of thigh dark brown, dusted with small irregular light spots; mature larvae lacking spinules on head and body; denticle formula

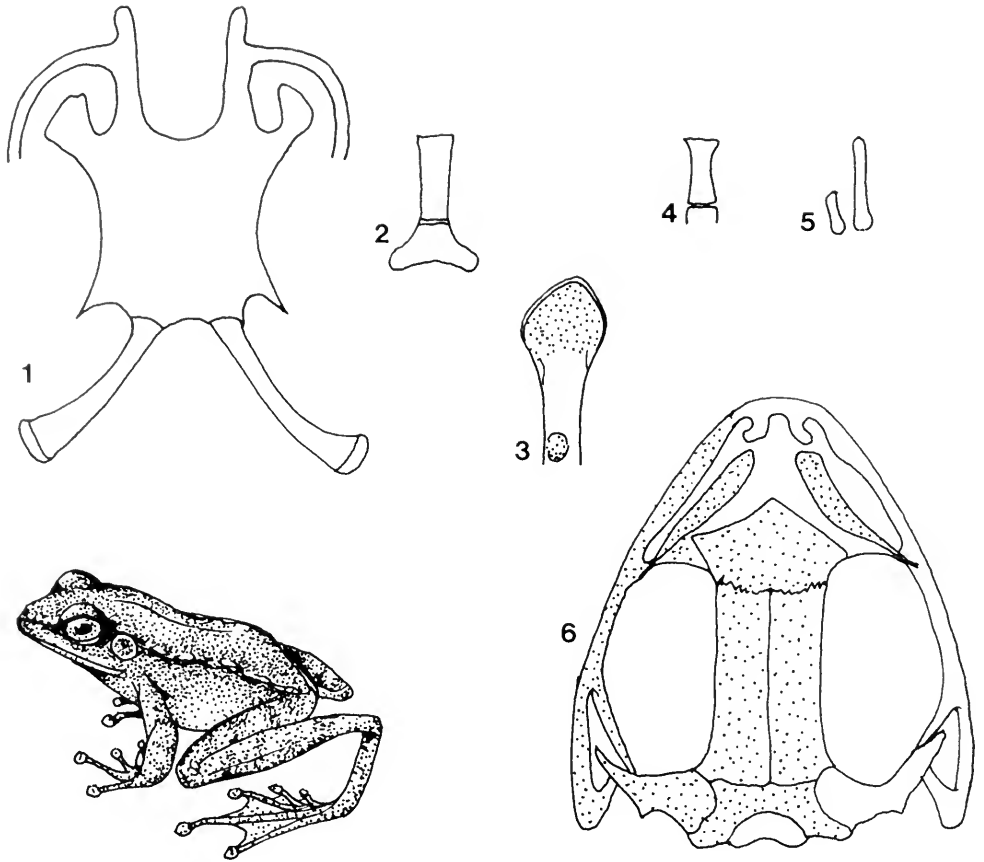

FIG. 29. *Meristogenys phaeomerus*: 1, hyoid ( $\times 5$ ); 2, mesosternum and metasternum ( $\times 4$ ); 3, ventral aspect of third finger ( $\times 6$ ); 4, terminal phalanx of third finger ( $\times 6$ ); 5, first and second metacarpals ( $\times 6$ ); 6, skull ( $\times 4$ ). Below and left, life-sized male.

III:3-3/1-1:V; both beaks divided, ribbed, 6-8 serrae in each half of each beak.

**DESCRIPTION**—A small species, males 33-44 mm, females 57-72 mm, body moderately slender; width of head less than length; snout obtusely pointed, projection beyond lower jaw greater than  $\frac{1}{2}$  depth of snout at level of nostril; nostril closer to tip of snout than to eye; canthi distinct, sharp, and converging; lores vertical at canthi, oblique near lip; pineal body visible; tympanum with raised rim, distinct and translucent, diameter  $\frac{1}{2}$  length of eye; vomerine teeth weak, in short groups and converging backward between choanae. Fingers slender, first finger slightly longer than second; tips of fingers expanded into disks with circummarginal grooves; width of disk of third finger  $\frac{1}{2}$  diameter of tympanum; subarticular tubercles oval and bulging; no supernumerary tubercles; outer palmar tubercle present; hind limbs slender, tibia

0.7 times SVL; disks of toes equal to or slightly larger than those of fingers; toes fully webbed, with excision of the web between fourth and fifth toes distal to middle subarticular tubercle of fourth toe; inner metatarsal tubercle oval, shorter than distance between it and subarticular tubercle of first toe; a round, raised outer metatarsal. Skin rough, granular on back; dorsolateral glandular fold present but weak; skin rough on belly. Chocolate brown on back in life, with small dark spots; alternating grayish and dark brown crossbars on limbs.

Male with gular pouches; velvety nuptial pad on first finger.

Hyoid body width less than hyoid body length; anterior horn with anterior process present; processus alaris length less than  $\frac{1}{3}$  length of body of hyoid; posterior process length  $\frac{1}{3}$ - $\frac{1}{2}$  length of body of hyoid; medial cartilage absent on posterior horn. Mesosternum simple, posterior end transverse,



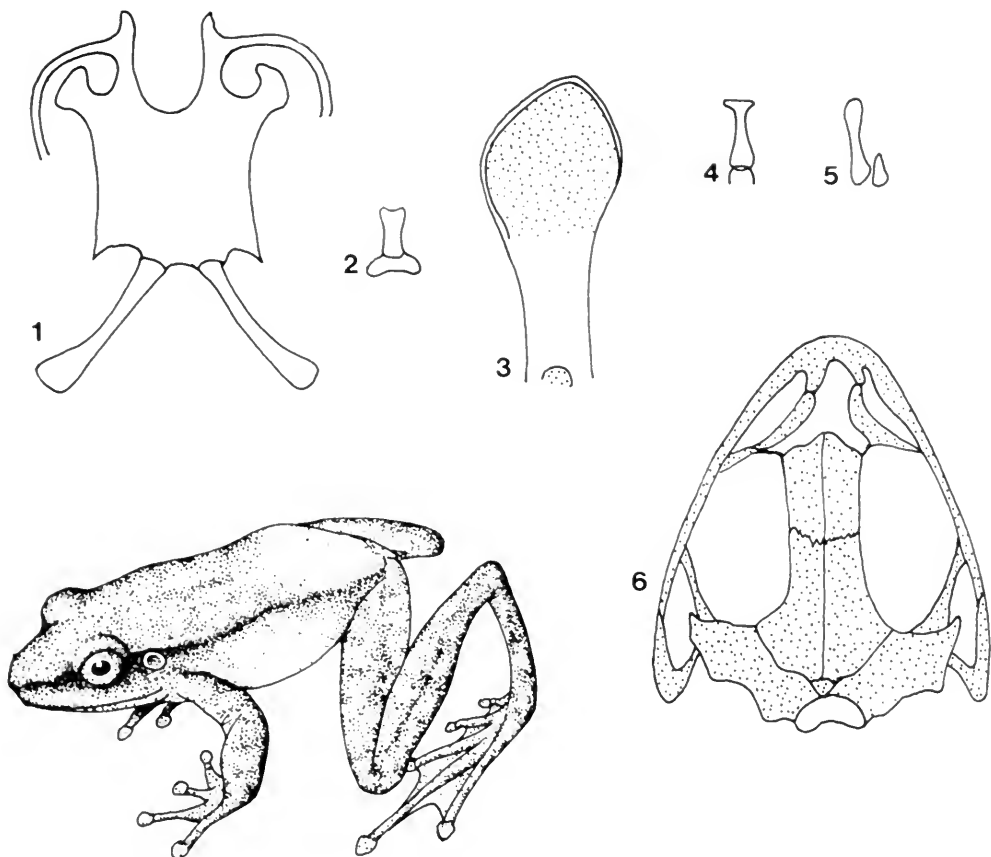

FIG. 30. *Meristogenys poecilus*: 1, hyoid ( $\times 4$ ); 2, metasternum and mesosternum ( $\times 3$ ); 3, ventral aspect of third finger ( $\times 8$ ); 4, terminal phalanx ( $\times 4$ ); 5, first and second metacarpals ( $\times 4$ ); 6, skull ( $\times 3$ ). Below, life-sized male.

length greater than 2 times width; posterior rear of metasternum notched and limbs diverging. *Musculus palmaris longus* undivided; *m. p. profundus* attaches to dorsal surface of aponeurosis palmaris. First metacarpal bone 0.41 times length of second; width of terminal phalanx of third finger 0.22 times length.

Tadpole with large abdominal sucker; denticle formula III:3-3/1-1:V:1-1 (stage 38); postorbital, midlateral, infraorbital, and spiracular glands present; both beaks divided as in diagnosis.

HABITAT—Forest streams.

DISTRIBUTION—Borneo: Sarawak.

***Meristogenys poecilus* (Inger and Gritis). Figure 30.**

*Amolops poecilus* Inger and Gritis, 1983, *Fieldiana: Zool.*, n. s., no. 19: 11. Type locality: Nanga Tekalit,

Kapit District, Seventh Division, Sarawak, in Borneo.

DIAGNOSIS—Rear of thigh pied or blotched dark brown and cream; tadpole with denticle formula III:3-3/1-1:V:1-1 (stage 38); both beaks of tadpole divided, ribbed, 7-8 serrae in each half of upper beak, 6 in each half of lower.

DESCRIPTION—A large-sized species, males 34-52 mm, females 60-78 mm; body slender; width of head less than length; snout obtusely pointed, projection beyond lower jaw equal to  $\frac{2}{3}$  of depth of snout at level of nostril; nostril nearer to tip of snout than to eye; canthi very distinct, sharp and converging; lores vertical at canthi and oblique near lip; pineal body visible; tympanum with raised rim, distinct and translucent, diameter less than  $\frac{1}{2}$  length of eye; vomerine teeth in small groups oblique nad converging backward between choanae. Fingers slender, first finger slightly longer than

second; tips of fingers expanded into disks with circummarginal grooves; width of disk of third finger  $\frac{2}{3}$  diameter of tympanum; subarticular tubercles oval and bulging; no supernumerary tubercles; outer palmar tubercle present; hind limbs slender, tibia 0.76 times SVL; disks of toes slightly larger than those of fingers, at least three inner disks of toes; toes fully webbed, excision of web between fourth and fifth toes at level of proximal edge of outer subarticular tubercle of fourth toe; first toe with narrow fringe of skin on medial edge; inner metatarsal oval; a small, round, outer metatarsal tubercle. Skin rough on back, with weak dorsolateral fold; skin rough on belly. Chocolate brown on back in life; venter yellow; forelimb medium brown with dark brown speckles; dorsal surface of leg with gray-brown and blackish brown bars.

Male with gular pouches; velvety nuptial pad on first finger.

Hyoid body width less than length; anterior horn with anterior process present; processus alaris length less than  $\frac{1}{3}$  length of body of hyoid; posterior process length  $\frac{1}{3}$ – $\frac{1}{2}$  length of body of hyoid; medial cartilage on posterior horn absent. Mesosternum simple, transverse, length greater than 2 times width; metasternum notched and limbs parallel. Musculus palmaris longus undivided; m. p. profundus attaches to dorsal surface of aponeurosis palmaris. First metacarpal bone 0.48 times second; width at crossbar of terminal phalanx of third finger 0.43 times length.

Tadpole with a large abdominal sucker; denticle formula III:3–3/1–1:IV:1–1; postorbital, midlateral, infraorbital, spiracular, and caudal glands present; both beaks divided into two parts and with ribbed formula as in Diagnosis.

HABITAT—Small forest streams.

DISTRIBUTION—**Borneo:** Sarawak.

### *Meristogenys whiteheadi* (Boulenger)

*Rana whiteheadi* Boulenger 1887, Ann. Mag. Nat. Hist., (5)20: 90. Type locality: Kinabalu; Mocquard, 1890, Nouv. Arch. Mus. Natl. Hist. Nat., (3)3: 144 (part); Brongersma, 1937, Zool. Meded., 20: 17.  
*Amolops jerboa*, Inger, 1966, Fieldiana: Zoology, 52: 263.

*Amolops whiteheadi*, Inger and Gritis, 1983, Fieldiana: Zool., n.s., no. 19: 8; Matsui, 1986, Copeia, 1986(3): 623.

DIAGNOSIS—In three species of this genus—*M. amoropalamus*, *M. kinabaluensis*, and *M. whiteheadi*—the fourth toe is fully webbed to the distal

subarticular tubercle, with narrow fringes on both sides to the disk. *Meristogenys whiteheadi* has a smaller tympanum than *M. amoropalamus* and is a much larger frog. This species differs from *M. kinabaluensis* in having a larger tympanum.

DESCRIPTION (from Boulenger, 1920)—A moderate-sized species, males 43–64 mm (N = 3), females 63–93 mm (N = 9); length of head equal to or slightly greater than width; snout rounded or obtusely pointed, feebly projecting beyond the mouth; nostril nearer the tip of the snout than the eye; canthi distinct; loreal region feebly oblique, deeply concave; tympanum very distinct,  $\frac{2}{5}$ – $\frac{3}{5}$  the diameter of the eye; vomerine teeth in short transverse or oblique series, in line with the posterior border of the choanae or just behind them.

Fingers rather long and slender; first finger as long as or longer than the second; tips of all fingers dilated into disks with circummarginal grooves; subarticular tubercles very prominent; hind limbs very long and slender, tibia 0.7 (3 males), 0.69 (9 females) times SVL; toes full webbed to distal subarticular tubercles, with narrow fringes on both sides to disks; subarticular tubercles very prominent; inner metatarsal tubercle oval or elliptic; outer metatarsal tubercle very small or absent.

Skin with granules on back or shagreened; glandular fold present, sometimes continued to about halfway between it and the second or followed by a series of warts; lower parts smooth, or posterior part of belly and posterior half of thighs feebly granulate.

Dark gray, purplish brown, or reddish brown above, sometimes with darker spots or marblings, or with scattered small, light-colored spots; a blackish streak below the canthus rostralis and on the supratemporal fold; temporal region blackish or with blackish spots; limbs with or without more or less distinct dark crossbands; hinder side of thighs purplish brown.

Male with paired gular pouches; large pad on the first finger.

Nasal bones narrow, oblique, widely separated from each other; ethmoid largely exposed above, obtusely pointed in front, extending to between the nasals; terminal phalanges T-shaped.

Tadpole with a large ventral sucking disk behind the mouth, free on its borders, truncate in front; tail obtusely pointed, the upper crest not extending to the origin of the muscular part. Beaks black, each formed of two pieces, separated in the middle by a considerable space; these pieces ribbed and strongly toothed; lips large, lower with a fringe of papillae; denticle formula II:3–3/1–1:IV.

DISTRIBUTION—Borneo: Sabah: Mt. Kinabalu; Sarawak: Pata River.

## Acknowledgments

I am grateful to Dr. Robert F. Inger, Field Museum of Natural History (FMNH); Dr. George R. Zug, National Museum of Natural History (NMNH); Dr. Richard G. Zweifel, American Museum of Natural History (AMNH); Dr. Ronald A. Nussbaum, University of Michigan, Museum of Zoology (UMMZ); Dr. Masafumi Matsui, Kyoto University (KU); Mr. Barry Clarke, British Museum (Natural History) (BMNH); Dr. Dirk Hillenius, Zoologisch Museum Amsterdam (ZMA); Dr. Marinus Hoogmoed, Leiden, The Netherlands; Ms. Zhong Yu, Shanghai Museum of Natural History (SMNH); Mr. Cai Minzhong, Fujian Teaching College, P.R.C. (FTC); and Ms. Tian Wanshu, Chengdu Institute of Biology, Academia Sinica, P.R.C. (CIB) for making specimens available to me. I also thank Mr. Su Chenye and Mr. Li Siming, Kunming Institute of Zoology, Academia Sinica, P.R.C. (KIZ) for their help in collecting some specimens. I thank Drs. Inger and E. D. Brodie for helpful criticisms of this manuscript. Ms. M. Ozaki, Mr. Paul A. Gritis, and Mr. Gary Mazurek, FMNH, and Mr. Wu Baolu, KIZ, provided technical assistance.

## Literature Cited

- ANDERSON, J., JR. 1879. Reptilia and Amphibia. Anatomical and Zoological Researches: Comprising an Account of the Two Expeditions to W. Yunnan in 1868 and 1875. Quaritch, London, 2 vols., pp. 705–806.
- BOULENGER, G. A. 1887. An account of the Batrachians obtained in Burma by M. L. Fea, of the Genoa Civic Museum. *Anali di Museo Genoa*, 2nd ser., 5: 418–424.
- . 1888. Description of two Indian species of *Rana*. *Annals and Magazine of Natural History*, 6th ser., 2: 506–508.
- . 1890. Fauna of British India Including Ceylon and Burma: Reptilia and Batrachia. Taylor and Francis, London, 541 pp.
- . 1893. Descriptions of new reptiles and batrachians obtained in Borneo by Mr. A. Everett and Mr. C. Hose. *Proceedings of the Zoological Society of London*, 1893: 522–528.
- . 1899. On the reptiles, batrachians and fishes collected by the late Mr. John Whitehead in the interior of Hainan. *Proceedings of the Zoological Society of London*, 1899: 956–962.
- . 1903. Description of new batrachians from Tonkin. *Annals and Magazine of Natural History*, 7th ser., 12: 186–188.
- . 1912. A Vertebrate Fauna of the Malay Peninsula: Reptilia and Batrachia. Taylor and Francis, London, 294 pp.
- . 1918. Remarks on the batrachian genera *Cornifer*, Tschuli, *Platymantis*, Gthr., *Simomantis*, g.n., and *Stauroids*, Cope. *Annals and Magazine of Natural History*, 9(1): 372–375.
- . 1920. A monograph of the south Asian, Paupuan, Melanesian, and Australian frogs of the genus *Rana*. *Records of the Indian Museum*, 20: 1–266.
- BOURRET, R. 1942. Les batraciens de l'Indochine. *Memoires de l'Institut Oceanographique Indochine*, Hanoi, 547 pp.
- CHENGDU INSTITUTE OF BIOLOGY. 1977. The Key to Species of Amphibians of China. Science Press, Beijing, 92 pp.
- COPE, E. D. 1865. Sketch of the primary groups of Batrachia: Saliientia. *Natural History Review*, 1865: 97–120.
- DUBOIS, A. 1974. Liste commentée d'amphibiens recoltés au Nepal. *Bulletin du Museum d'Histoire Naturelle de Paris*, (3), 213 (Zool), 143: 341–411.
- FROST, D. R. 1985. Amphibian Species of the World. Association of Systematics Collections, Lawrence, Kan., Allen Press, 732 pp.
- GOSNER, K. L. 1960. A simplified table for staging Anuran embryos and larvae with notes on identification. *Herpetologica* 16: 183–190.
- GUNTHER, A. 1858. Catalogue of the Batrachia Saliientia in the Collection of the British Museum. *British Museum of Natural History*, Department of Zoology, 160 pp.
- HORA, S. L. 1932. Development and probable evolution of the suctorial disk in the tadpoles of *Rana afghana* Gunther. *Zoological Survey of India*, 57: 469–472.
- INGER, R. F. 1966. The systematics and zoogeography of the Amphibia of Borneo. *Fieldiana: Zoology*, 52: 1–402.
- INGER, R. F., AND PAUL A. GRITIS. 1983. Variation in Bornean frogs of the *Amolops jerboa* species group, with descriptions of two species. *Fieldiana: Zoology*, n.s., 19: 1–13.
- JIANG, Y. M. 1983. A new species of the genus *Stauroids* (Ranidae)—*Stauroids viridimaculatus*. *Acta Herpetologica Sinica*, 2(3): 71.
- KURAMOTO, M., C. S. WANG, AND H. T. YU. 1984. Breeding, larval morphology and experimental hybridization of Taiwanese brown frogs, *Ranba longicrus* and *R. sauteri*. *Journal of Herpetology*, 18: 387–395.
- LIU, C. C. 1950. Amphibians of western China. *Fieldiana: Zoology*, Memoir, 2: 1–400.
- LIU, C. C., AND S. C. HU. 1961. Tailless Amphibians of China. Science Press, Beijing, 364 pp.
- LIU, C. C., S. C. HU, L. FEI, AND C. C. HUANG. 1973. On collections of amphibians from Hainan Island. *Acta Zoologica Sinica*, 19(4): 385–404.

- MADDISON, W. P., M. J. DONOGHUE, AND D. R. MAD-  
DISON. 1984. Outgroup analysis and parsimony. *Systematic Zoology*, **22**: 83–103.
- MATSUI, M. 1986. Three new species of *Amolops* from  
Borneo. *Copeia*, **1986**: 623–630.
- NOBLE, G. K. 1927. The value of life history data in  
the study of evolution of Amphibia. *Annals of the New  
York Academy of Sciences*, **20**: 31–128.
- . 1929. The adaptive modification of the ar-  
boreal tadpoles of *Holophryne* and the torrent tadpoles  
of *Staurois*. *Bulletin of the American Museum of Nat-  
ural History*, **58**: 291–334.
- . 1931. *The Biology of the Amphibia*. McGraw-  
Hill Book Co., New York, 577 pp.
- POPE, C. H. 1927. Frog hunting in Fukien, China. *Nat-  
ural History*, **27**: 467–474.
- . 1929. Four new frogs from Fukien Province,  
China. *American Museum Novitates*, **352**: 1–5.
- POPE, C. H., AND J. D. BORING. 1940. A survey of  
Chinese Amphibia. *Peking Natural History Bulletin*,  
**15**: 13–86.
- POPE, C. H., AND J. D. ROMER. 1951. A new ranid frog  
(*Staurois*) from the colony of Hongkong. *Fieldiana*:  
*Zoology*, **31**: 609–612.
- SICHUAN INSTITUTE OF BIOLOGY. 1977. A survey of  
amphibians in Xizang (Tibet). *Acta Zoologica Sinica*,  
**23**: 54–63.
- SMITH, M. A. 1923. Narrative of a journey to the in-  
terior of Hainan: Reptilia and Amphibia. *Journal of  
the Natural History Society of Siam*, **6**: 195–212.
- . 1940. The amphibians and reptiles obtained  
by Mr. Ronald Kaulback in upper Burma. *Records of  
the Indian Museum*, **62**: 465–486.
- STEJNEGER, L. 1926. Two new tailless amphibians from  
Western China. *Proceedings of the United States Na-  
tional Museum*, **66**(25): 1–115.
- SU, C.-Y., D.-T. YANG, AND S.-M. LI. 1986. A new  
species of *Amolops* from the Hengduan-shan Moun-  
tains. *Acta Herpetologica Sinica*, **5**: 204–206.
- VAN KAMPEN, P. N. 1923. *The Amphibia of the Indo-  
Australian Archipelago*. E. J. Brill Ltd., Leiden, 304  
pp.
- WILEY, E. O. 1981. *Phylogenetics: The Theory and  
Practice of Phylogenetic Systematics*. John Wiley &  
Sons, New York, 439 pp.
- YANG, D.-T. 1987. A new species of *Amolops* (Anura:  
Ranidae) from Yunnan, China. *Herpetologica*, **41**: 95–  
97.
- YANG, D.-T., C.-Y. SU, AND S.-M. LI. 1983. A study  
on amphibians and reptiles from the Hengduan-shan  
Mountains of Yunnan. *Acta Herpetologica Sinica*, **2**(3):  
37–48.









Field Museum of Natural History  
Roosevelt Road at Lake Shore Drive  
Chicago, Illinois 60605-2496  
Telephone: (312) 922-9410





UNIVERSITY OF ILLINOIS-URBANA

590 5FIN S C001  
FIELDIANA ZOOLOGY \$ NEW SERIES \$CHGO  
55-65 1990-91



3 0112 009378750