

# POPULAR SCIENCE

DEC. 1946  
25 CENTS

MONTHLY

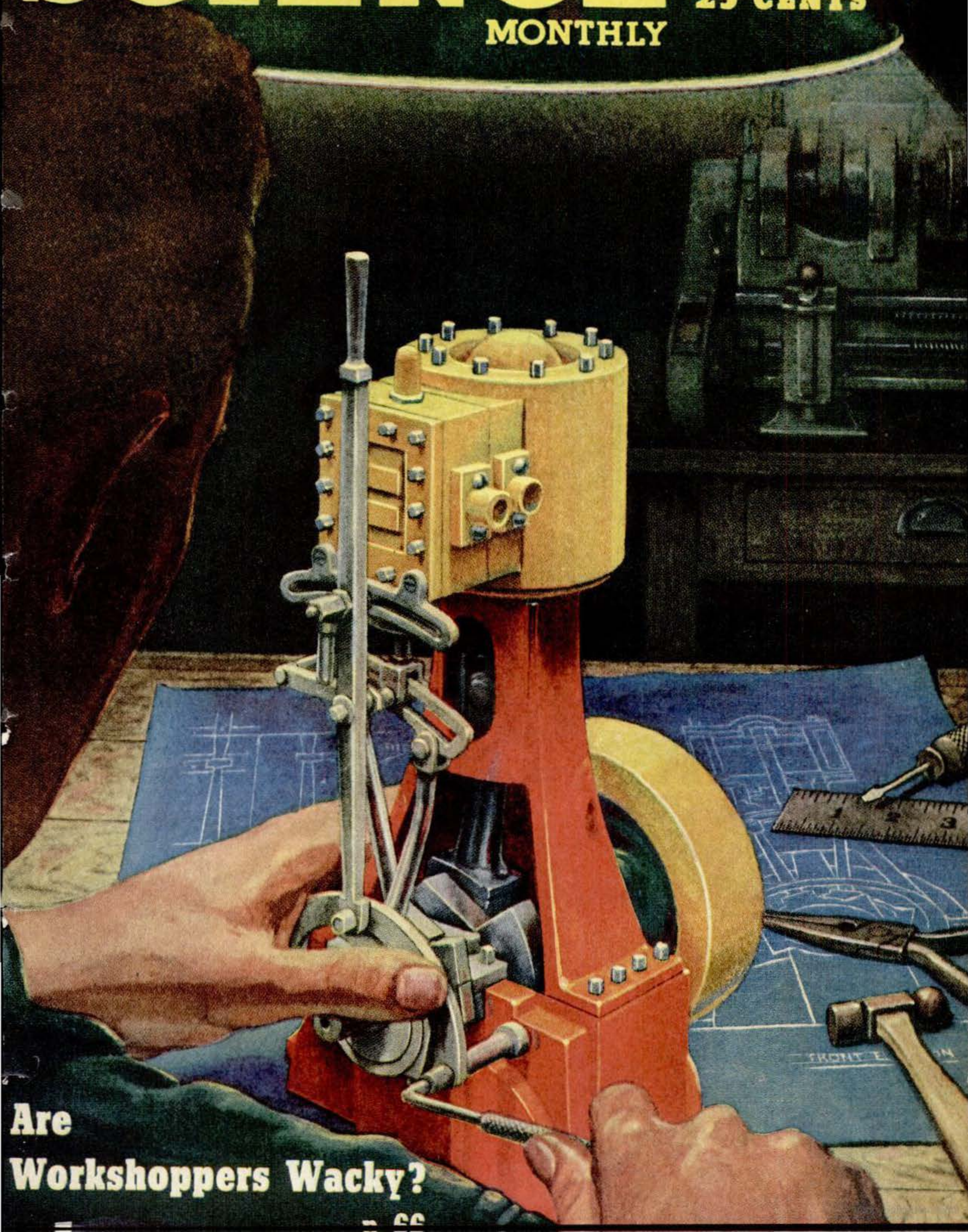

**Are  
Workshoppers Wacky?**

56





*Gain a complete  
mastery of*

# MATHEMATICS

Get a better job in America's great industries, and prepare to seize your coming opportunities—learn mathematics. Mathematics is the basic requirement of all mechanical and scientific work, and of all business or industry based on science. Without this essential knowledge even the most capable man is left behind while others forge ahead to better jobs, bigger contracts, more money.

You need mathematics to understand all technical work, to supervise operations, to improve, speed up and check on your work and the work of others. Such basic training is quickly recognized today and gladly paid for. It singles you out from the crowd and gives you an advantage whether it is a matter of a job, a promotion or a contract. Now you can learn mathematics—the foundation of all technical work—by an easy, inexpensive and time-saving method. A very simple and extremely interesting course in book form has been prepared for you by an expert who has devoted a lifetime to teaching practical men the fundamentals of this important subject.

**Get this Basic Training  
for Executives**

**IN ONLY 10 MINUTES A DAY**

Now you can gain all the benefits of a mathematical training if you will devote as little as ten minutes each day to these easy lessons. Spend only the time that is usually wasted, and you will be amazed how quickly you will notice an improvement in your all around efficiency—how soon you will feel a new impetus toward successful work in your business, your profession, or your industrial activity.

**5 VOLUMES, 1,598 PAGES  
ILLUSTRATED**

Every minute you spend on this complete course will pay you big dividends. It will give you the ability to grasp readily all basic business principles. It will help you develop the quick, accurate judgment that is essential to job advancement, to executive positions, to success!

**EXAMINE THESE BOOKS FOR 10 DAYS FREE!**

**NEW  
EDITION**

Revised for present-day needs. More useful, more practical than ever before!





**THIS PRACTICAL SELF-STUDY COURSE  
WILL QUICKLY GIVE YOU THE ESSENTIAL  
KNOWLEDGE FOR SO MANY OF TODAY'S  
JOBS IN BUSINESS AND INDUSTRY**

# MATHEMATICS for Self Study

By J. E. Thompson, B. S. in E. E., A. M., Dept. of Mathematics, Pratt Institute

## A COMPLETE COURSE AND REFERENCE LIBRARY

NEW EDITION — *More useful, more practical*

These books start right from the beginning with a review of arithmetic that gives you all special short cuts and trick problems that save countless hours of your time and make you more valuable to yourself and your job. Then they go right into higher mathematics and show how simple it is when an expert explains it for you.

Don't let appearances fool you, mathematics is *easy*. You can get these books on approval and see for yourself how much enjoyment you will have while getting this valuable training and solving interesting practical problems that puzzle your friends and fellow workers. In no time at all you will be tackling with ease the most difficult question on this subject.

These are but a few of the hundreds of subjects simplified and explained in the new edition of this complete self-study course in mathematics.

**ARITHMETIC:** Starting with a quick review of principles, it presents all the special calculation methods used in business and industry. Fundamental in all computations in engineering, in both plant and field. Essential methods for rapid calculation such as is needed in setting lathes, etc. Hundreds of other applications to technical work.

**ALGEBRA:** This volume makes algebra a live, interesting subject. It shows you, step by step, how to apply algebraic methods to the most complex problems. Explains how to solve problems which are involved in all business and industrial work relating to machines, engines, ships, autos, planes, etc. Logarithms and slide rule, and many other practical applications.

**GEOMETRY:** States clearly all needed facts about plane figures, circles, polygons, etc., covers all the topics essential in drafting and engineering. It deals at length with angles, triangles, circles, and the many other geometric figures that are basic to engineering design. Sheet-metal work, so important in airplane construction, is a direct application of these principles.

**TRIGONOMETRY:** This volume makes easy the principles of angles and triangles, shows you how to use tables that explain their functions. Practically every problem in machine work, land surveying, mechanics, astronomy and navigation is solved by methods of trigonometry. These methods are explained simply, with actual examples of calculations of height and distance, the construction of buildings, bridges and dams, the cutting of gears, etc.

**CALCULUS:** You will enjoy mastering calculus in this interesting new way and will find it will enable you to solve problems that can be solved in no other way. This branch of mathematics deals with rate problems. It is essential in computation involving objects moving with varying rates of speed. It also enables us to find the most efficient design for any kind of mechanism, engine, or moving vehicle.

### AN EXPERT GIVES YOU HIS SIMPLIFIED METHODS

Mr. Thompson, the author of these books, is not an ordinary teacher of mathematics. He has had many years' experience in giving students the kind of mathematical training they need in practical work. He presents each method and problem in the clearest and simplest way. He gets right down to the kind of information that you need in your daily work.

**SEND NO MONEY**

The coupon at the right brings you the 5 books for 10 days' trial. After 10 days, if not completely satisfied, return the books to us without obligation. If you keep them, send us the small down payment of \$2.95, balance in three monthly payments. Make this test at our expense. Mail the coupon today.

**D. VAN NOSTRAND  
COMPANY, INC., Publishers**  
250 Fourth Avenue • New York 3, N. Y.

### MAIL THIS COUPON

D. Van Nostrand Company, Inc., Publishers, 250 Fourth Ave., New York 3, N.Y.

Send me MATHEMATICS FOR SELF STUDY in 5 volumes. Within 10 days I will either return the books or send you \$2.95 as first payment and \$2.00 per month for three months until the total price of \$8.95, plus a few cents postage, is paid.

(If you send remittance of \$8.95 with this coupon, we will pay the postage. Same return privilege, refund guaranteed.)

Name.....  
Please Print

Address.....

City..... (Zone).... State.....

Reference.....

Address.....

PS 12-46

DEC. 1  
1946



# POPULAR SCIENCE

Mechanics & Handicraft MONTHLY

REG. U. S. PAT. OFF.

**EDITOR:**

Perry Githens

MANAGING EDITORS: Fred O. Newman, Volta Torrey

ART EDITOR: Robert Reid Macguire

**HOME & WORKSHOP EDITOR:**

Harry Walton

ASSOCIATE EDITORS: Alden P. Armagnac, Devon Francis, Robert Gorman, Wesley S. Griswold, Hartley E. Howe, Martin Mann, Frank Rowsome, Jr., John F. Stearns, R. P. Stevenson

WESTERN EDITOR: Andrew R. Boone (Los Angeles, Cal.)

ART DIRECTORS: Harry Samuels, Francis Sweeney

ART ASSOCIATES: Stewart Rouse, Frances Cooper (Production)

STAFF PHOTOGRAPHERS: W. W. Morris, Hubert Lockett, Robert F. Smith

EDITORIAL ASSISTANTS: Elsie E. Brandt, Michael Cerniello, Carol Ennis, David McNamara, Lillian Thalenfeld, Saverio Rada, Ruth Westphal

**PUBLISHER:**

Godfrey Hammond

DECEMBER 1946

## SCIENCE NEWS

Picture of the Month.....	65
Dam "Submarine".....	78
Flyweight Home.....	80
Scientific Dishwashing.....	84
Gridiron Oxygen Tank.....	85
Britain Mass-Produces Homes.....	98
New French Farm Hand.....	99
Plastic Bearings Tell All.....	112
Better Air for Commons.....	126
Weapon Against Polio.....	126
Leak Detector.....	130

## SCIENCE AT WORK

Taking Steel's Temperature.....	79
Conveyor-Belt Harvesting.....	116
Glass in the Atomic Age.....	127
Mine Dress.....	130
How Nylon Yarn Is Made.....	132

## PSM FEATURES

Are Workshoppers Wacky?.....	66
Fuselage Fueler.....	85
Exposing the Chameleon.....	100
How to Drive a Locomotive.....	102
The Return of the Toys.....	104
Models of John Henry Folk Saga.....	113
Durable Orchid.....	116
What's New in Home Heating?.....	152
Chemistry Answers the Fire Alarm.....	202

## AVIATION

Ear-Saver.....	81
Sway-Back Prop.....	81
New Tricks for Fido.....	82
Wood Carvers for the Air Age.....	86
Inside the Dreamboat.....	91
Lockheed Saturn (Pin-up).....	97
Camera Theodolite Tracks "Old Needle-nose".....	112
Britain Goes Supersonic.....	114
300-m.p.h. Air Liner.....	120
Soaring with a Buzzard.....	131

## AUTOMOBILES

Willys Springs a New One.....	77
Air-Bubble Tire.....	90
Roadless Road Test.....	90
Turret Truck.....	120
How Good Are Synthetic Tires?.....	121
Speeding Up the Roaring Beetles.....	134
Gus Beats the Clock.....	139
Quick-Charge Your Battery?.....	142
Heaters End Starting Troubles.....	144

## INVENTIONS

Camera Develops Its Own.....	78
Sidehill Gouger.....	85
I'd Like to See Them Make.....	111
New Ideas from the Inventors.....	118

## PHOTOGRAPHY

Putting an Old Tripod on Its Feet.....	184
Camera Smaller Than Cigarette Pack.....	188
Darkroom Workbench in Cabinet.....	188
Five-Minute Print Drier.....	189

(CONTINUED ON PAGE 4)

Published monthly at 353 Fourth Avenue, New York 10, N. Y., by Popular Science Publishing Co., Inc. Godfrey Hammond, President and Treasurer. R. C. Wilson, Raymond J. Brown, Stephen P. Glennon, B. Ray Keefer, Vice-Presidents; F. W. Briggs, Secretary. Entered as second-class matter Dec. 28, 1918, at the Post Office at New York under the act of March 3, 1879; additional entry as second-class matter at Dayton, Ohio. Entered as second-class matter at the Post Office Department, Canada. Printed in U. S. A. Copyright, 1946, by Popular Science Publishing Co., Inc. All rights reserved in the United States, Great Britain, and in all countries participating in the International Copyright Convention and Pan-American Copyright Convention. Yearly subscriptions to United States, its possessions and Canada, \$2.50; foreign countries, \$3.50. Subscribers must notify us of change of address four weeks in advance of the next publication date. Be sure to give both old and new addresses, including zone numbers.



*Check the Extras  
You Get with*

# DeJUR

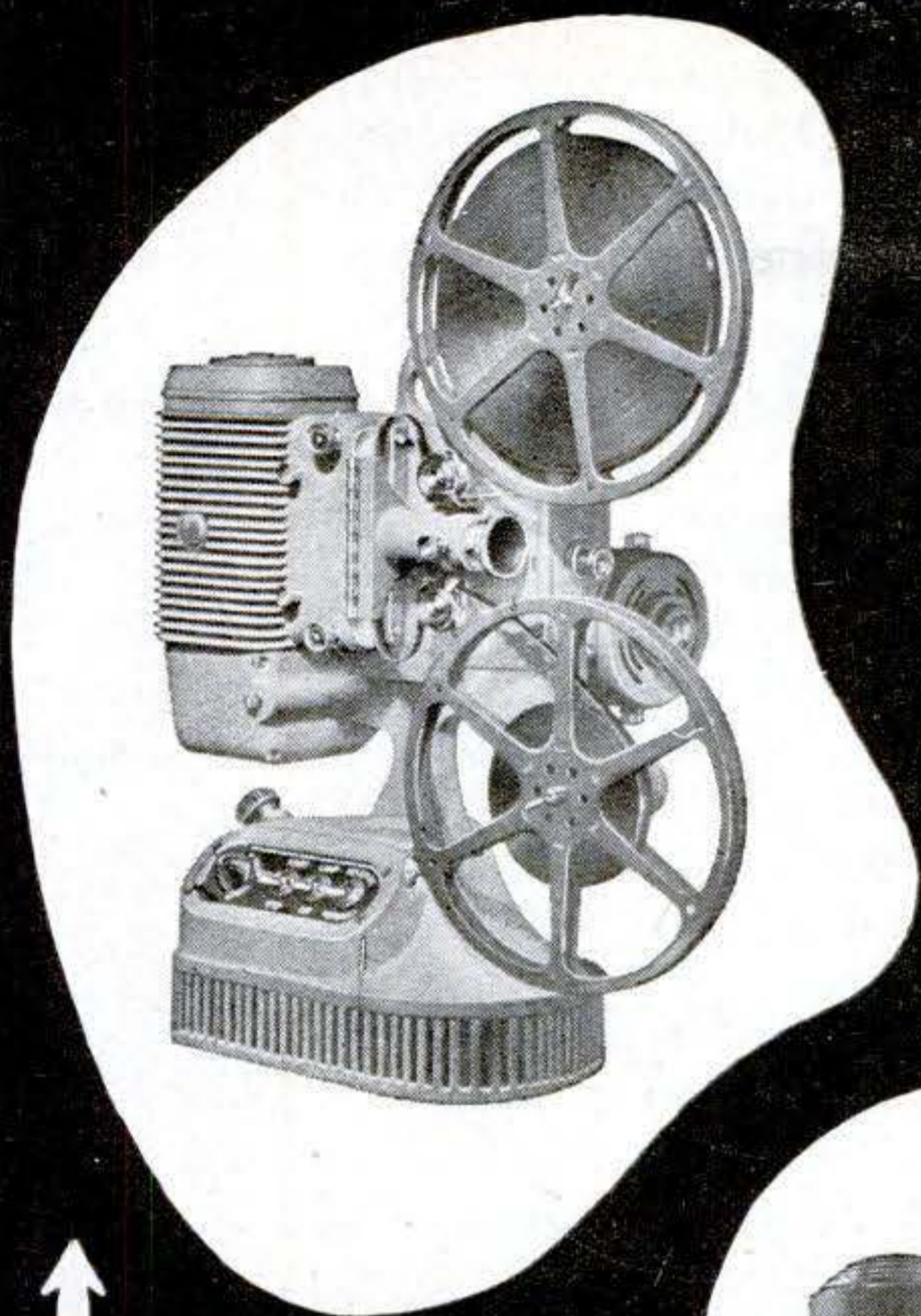

↑  
**BRIGHTER, CLEARER HOME  
MOVIE PROJECTION ...**

**DeJUR** "1000" — the *first* 1000\*-watt "8". Extra light gives "theatre" brilliance and steadiness to your home movies. Stays cool ... can be reversed or stilled ... 400-foot reel ... rapid re-wind ... over-size condensers ... Cord-o-matic cord.

\*Standard Equip-  
ment 750  
WATT.

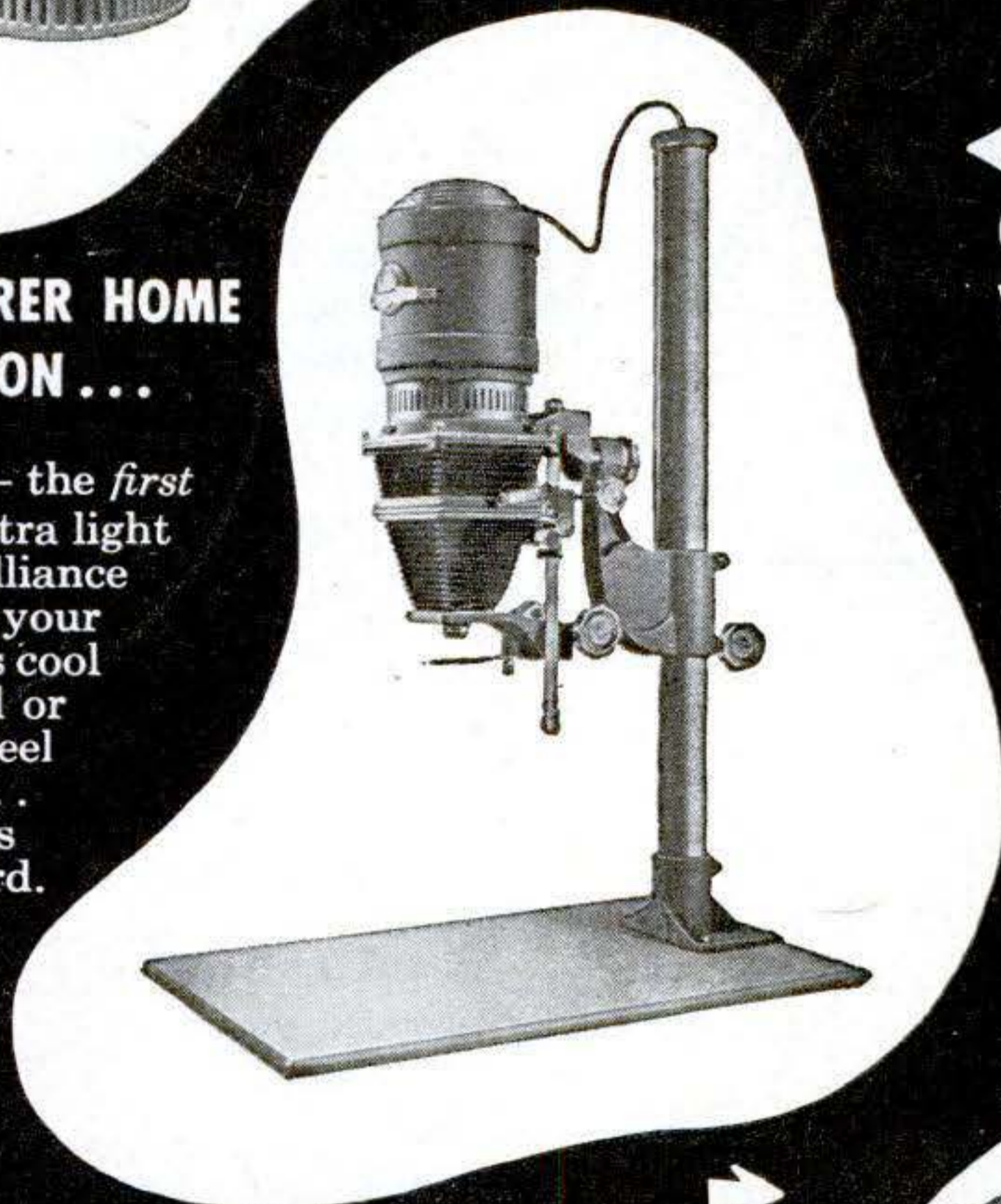

←  
**ONLY LIGHT-TIGHT AND  
VENTILATED ENLARGER**

**DeJUR** "Versatile" Enlarger. Unique lamphouse design prevents light-leakage. "Dual-Draft" ventilation keeps negatives cool. Use for enlargements, copying, titles, table-top photography, color separation, etc.

→  
**ONLY EXPOSURE METER  
WITH ALL 3 CONVENIENCES**

**DeJUR** "Autocritic" — gives you the right exposure every time. Has all three—A. S. A. film speeds, direct-reading scale (no numbers to transpose), one-handed convenience for black-and-white or color films.

MORE OF THE EQUIPMENT  
YOU NEED FOR THE PICTURES YOU WANT



Ask your dealer,  
"What's new  
with DeJUR?",  
and find out  
what's best in  
movie projectors,  
exposure  
meters and  
enlargers.

**DeJUR**  
USA.



**DeJUR** AMSCO CORPORATION, 45-26 Northern Boulevard, Long Island City 1, N. Y.

DEC. 3  
1946



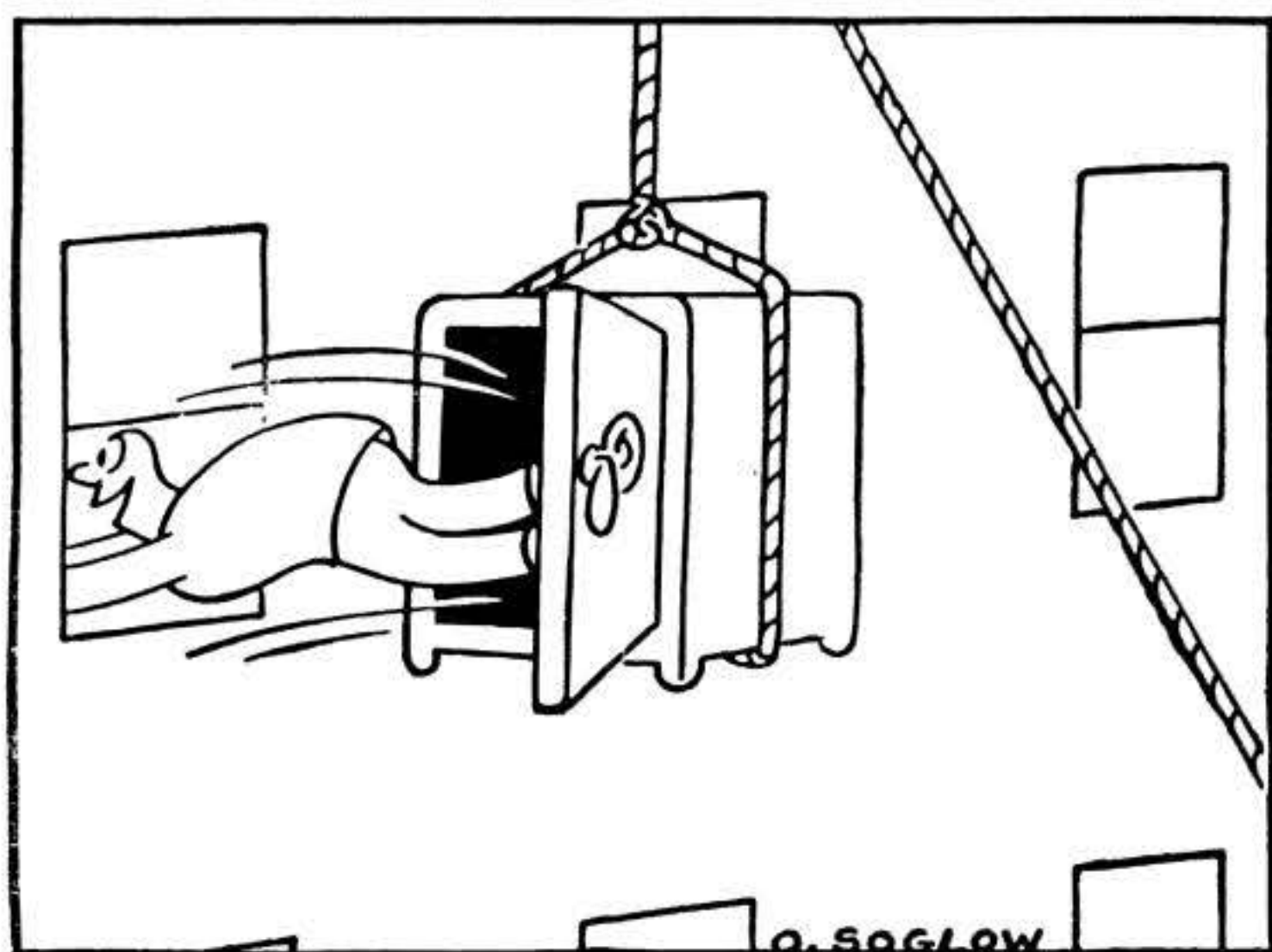
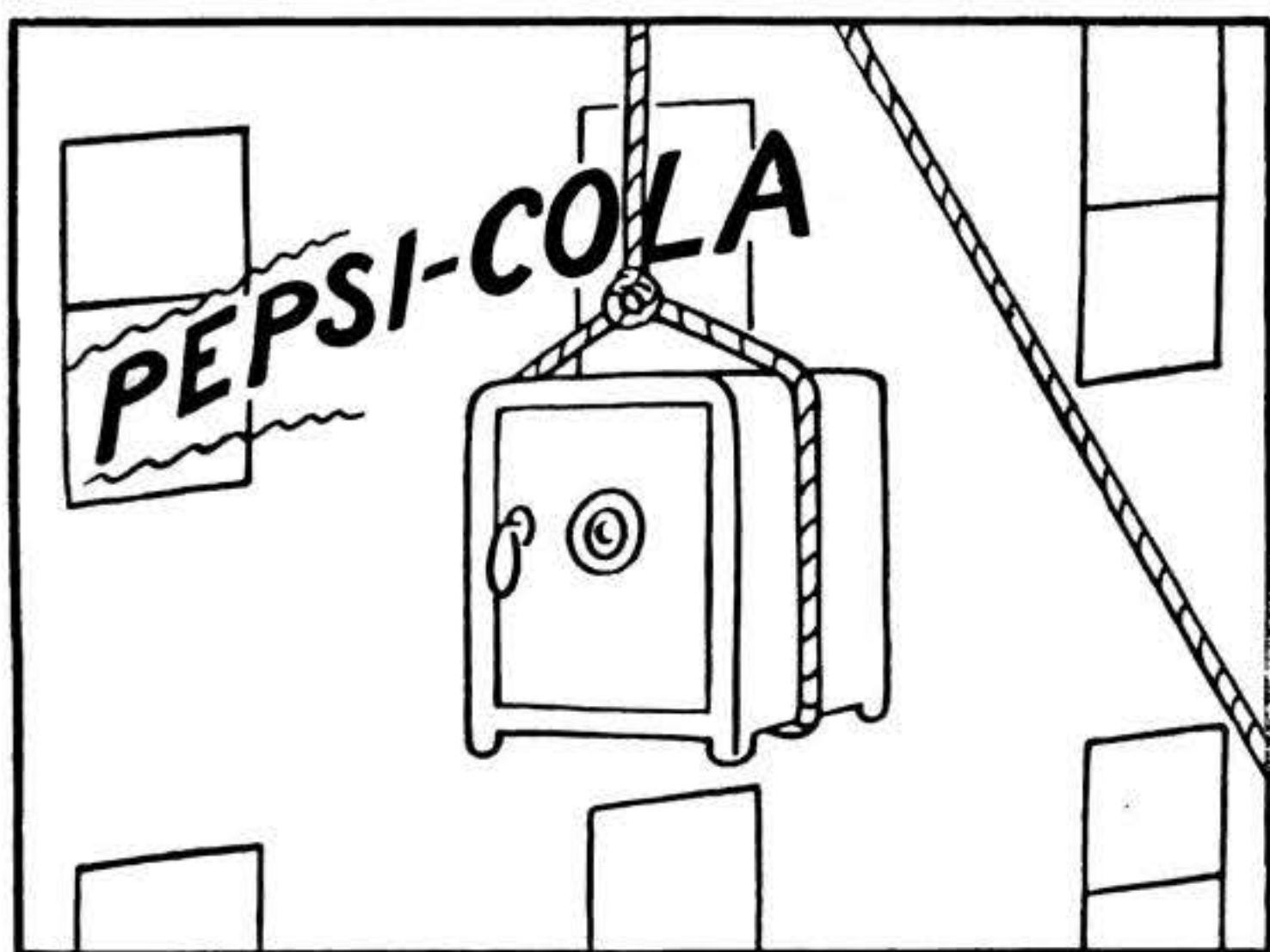
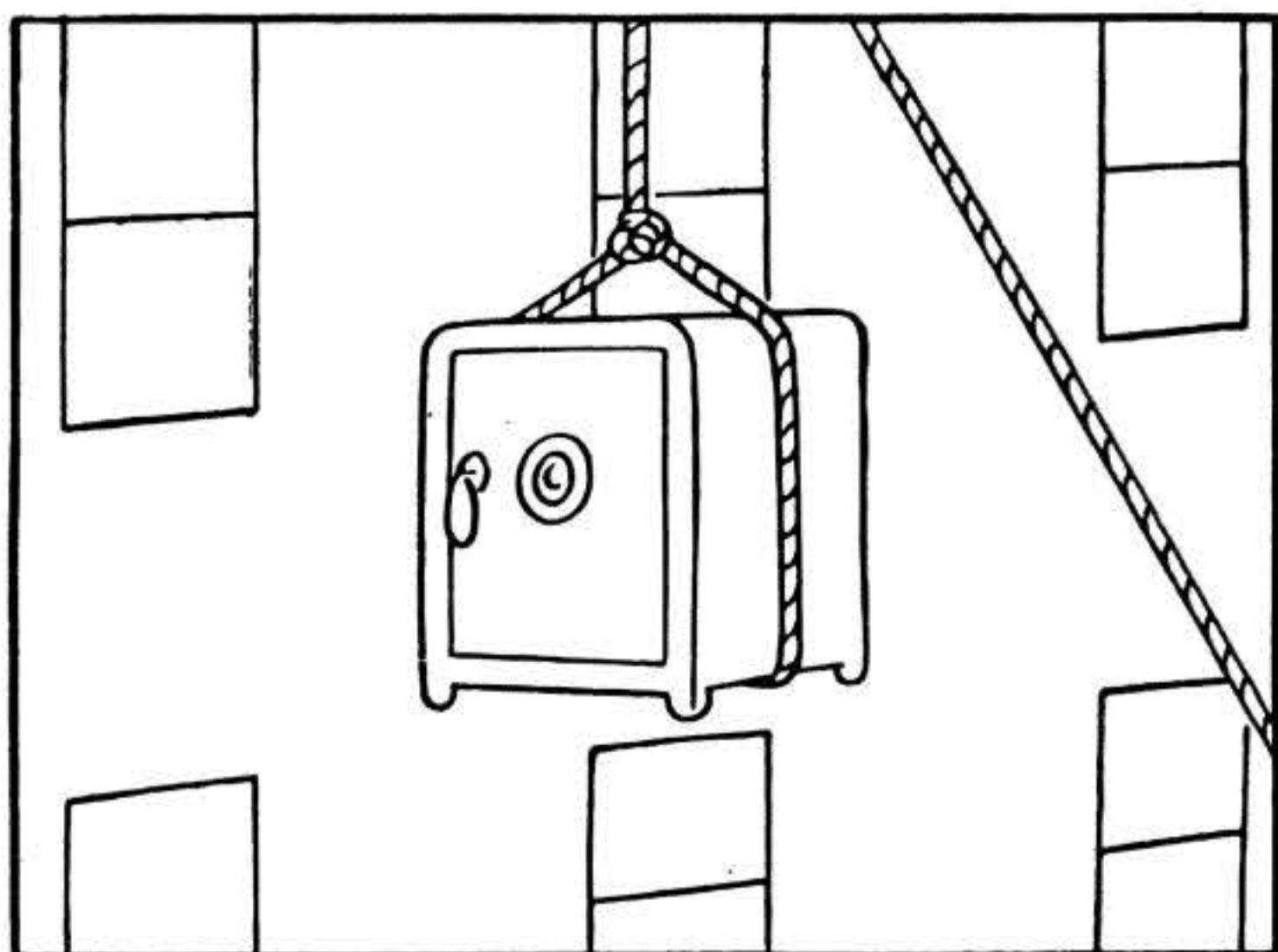
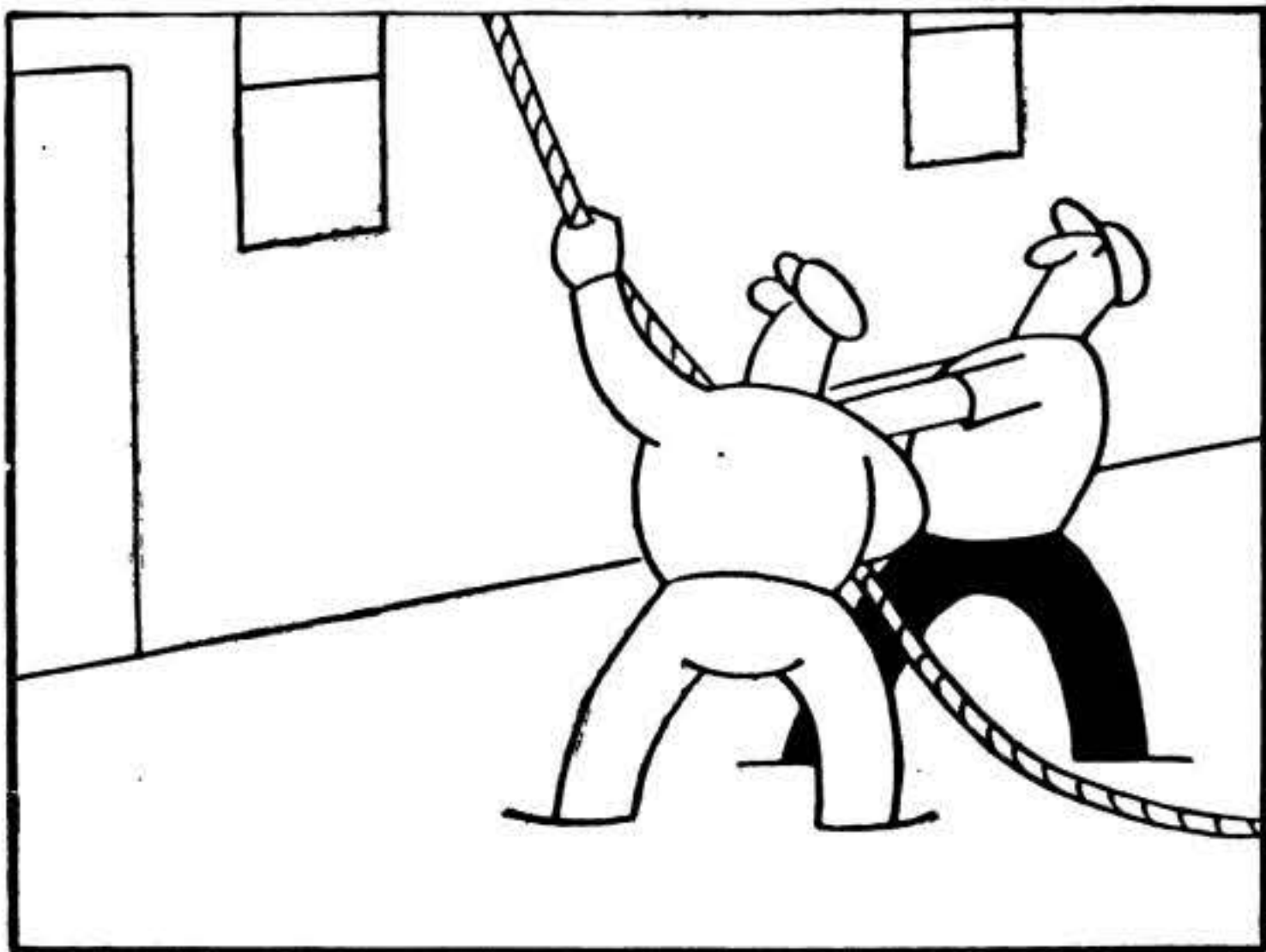

## MECHANICS & SHOPCRAFT

<a href="#">Tom Thumb Craftwork.....</a>	<a href="#">160</a>
<a href="#">You Can Make It of Stainless.....</a>	<a href="#">174</a>
<a href="#">Dovetail Cutter from Drill Rod.....</a>	<a href="#">179</a>
<a href="#">Small Arbor Press from C-Clamp.....</a>	<a href="#">179</a>

## HOME MECHANICS & HANDICRAFT

<a href="#">Cushion Stools for Extra Comfort.....</a>	<a href="#">148</a>
<a href="#">Modern Wastepaper Basket.....</a>	<a href="#">150</a>
<a href="#">Wall-Size Knickknack Shelf.....</a>	<a href="#">150</a>
<a href="#">Shooting-Disk Game.....</a>	<a href="#">151</a>
<a href="#">Clear Plastic Candy Basket.....</a>	<a href="#">151</a>
<a href="#">Laced Leather Belt, Gaucho Style.....</a>	<a href="#">158</a>
<a href="#">Doll Has Movable Arms and Legs.....</a>	<a href="#">159</a>
<a href="#">Ring-Toss Game for Table Play.....</a>	<a href="#">159</a>
<a href="#">Workbenches in Dress Suits.....</a>	<a href="#">161</a>
<a href="#">Painted Metal Lamp.....</a>	<a href="#">162</a>
<a href="#">Chest for Child's Treasures.....</a>	<a href="#">163</a>
<a href="#">Wood Sculpture with a Penknife.....</a>	<a href="#">164</a>
<a href="#">Model Engine Pulls One-Ton Load.....</a>	<a href="#">165</a>
<a href="#">Pin-up Lamp of Wrought Iron.....</a>	<a href="#">166</a>
<a href="#">Forge Tongs Welded to Order.....</a>	<a href="#">166</a>
<a href="#">Making Window and Door Frames.....</a>	<a href="#">170</a>
<a href="#">What's Wrong?.....</a>	<a href="#">198</a>
<a href="#">Circular-Saw Bench.....</a>	<a href="#">199</a>
<a href="#">Covered Feeder Protects Bird Food.....</a>	<a href="#">200</a>
<a href="#">Home Repairs with Rubber Tape.....</a>	<a href="#">206</a>
<a href="#">Grain Scoop from Scrap Pipe.....</a>	<a href="#">207</a>

## RADIO & ELECTRICITY

<a href="#">X-Ray Detective.....</a>	<a href="#">79</a>
<a href="#">Electric Fly Killer.....</a>	<a href="#">98</a>
<a href="#">Radio Pulls a Plow.....</a>	<a href="#">99</a>
<a href="#">DC from Your AC Lines.....</a>	<a href="#">180</a>
<a href="#">Record Changers.....</a>	<a href="#">190</a>
<a href="#">News in Electronics.....</a>	<a href="#">194</a>
<a href="#">Pillow Phone Mutes Late Music.....</a>	<a href="#">195</a>
<a href="#">Doorstop Pegs Radio.....</a>	<a href="#">195</a>
<a href="#">High-Voltage Fun with Spark Coil.....</a>	<a href="#">196</a>

## DEPARTMENTS

<a href="#">Voice of Science.....</a>	<a href="#">7</a>
<a href="#">March of Science.....</a>	<a href="#">78</a>
<a href="#">Modern Living.....</a>	<a href="#">136</a>
<a href="#">Auto Hints.....</a>	<a href="#">138</a>
<a href="#">Auto Ideas.....</a>	<a href="#">146</a>
<a href="#">What's Your Ingenuity Quotient?.....</a>	<a href="#">157</a>
<a href="#">New Tools.....</a>	<a href="#">167</a>
<a href="#">Keeping the Home Shipshape.....</a>	<a href="#">168</a>
<a href="#">New Shop Ideas.....</a>	<a href="#">178</a>
<a href="#">Photo Ideas.....</a>	<a href="#">186</a>
<a href="#">For Easier Farming.....</a>	<a href="#">208</a>
<a href="#">Editorial Memo.....</a>	<a href="#">294</a>



# How to pass a genius

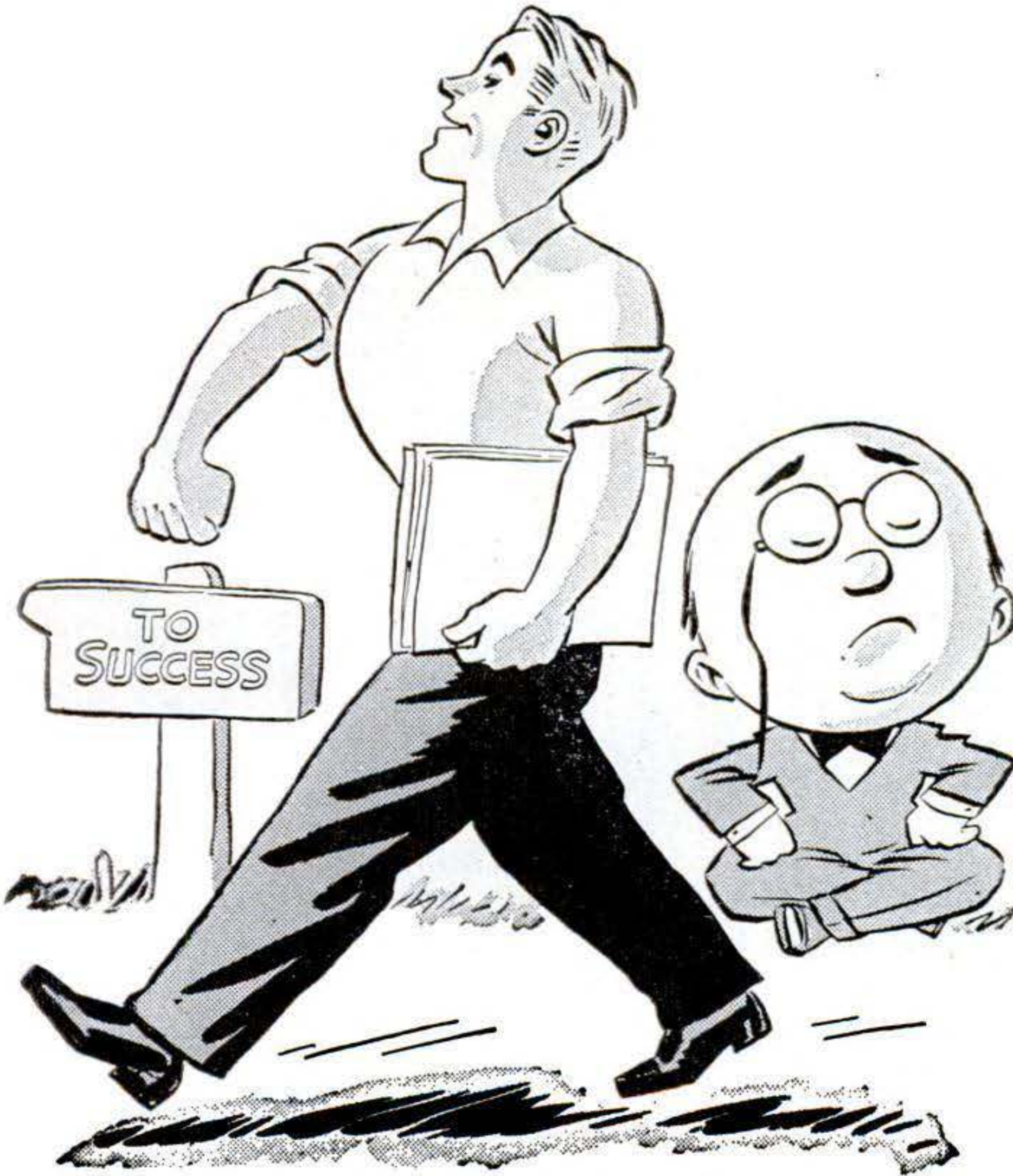

All of us can't be geniuses. But any ordinarily talented mortal can be a success—and that's more than some geniuses are.

Now, as in Æsop's time, the race doesn't always go to the one who potentially is the swiftest. The *trained* man has no trouble in passing the genius who hasn't improved his talents.

In good times and bad times, in every technical and business field, the *trained* man is worth a dozen untrained ones, no matter how gifted.

The International Correspondence Schools can't make you into a genius. For more than 50 years, however, I. C. S. has been helping its students to become *trained, successful leaders*—and it can do the same for you.

Mark your special interest on the coupon. Don't be like the unsuccessful genius who wastes his life in dreaming of what he intends to do. *Act now!*

## INTERNATIONAL CORRESPONDENCE SCHOOLS



BOX 6660-L, SCRANTON 9, PENNA.

Without cost or obligation, please send me full particulars about the course *before* which I have marked X:

- |                                                                                                                                                                                                                                                                                                                                                                                                                                                                                                                                                                                                                                                                                                                                                                                                                                                                                                                                                                                                                                                                                                                                                                                                                                                           |                                                                                                                                                                                                                                                                                                                                                                                                                                                                                                                                                                                                                                                                                                                                                                                                                                                                                                                                                                                                                                                                                                                                                                                                                                                                                                                                                                                                                                                                                                                                                                |                                                                                                                                                                                                                                                                                                                                                                                                                                                                                                                                                                                                                                                                                                                                                                                                                                                                                                                                                                                                                                                                                                                                                                                                                                                                                                                                                                                                                                                               |                                                                                                                                                                                                                                                                                                                                                                                                                                                                                                                                                                                                                                                                                                                                                                                                                                                                                                                                                                                                                                                                                                                                                                                                                                                                                                                                                                                                                                                                                                                                                                                                                                                                                                                                               |
|-----------------------------------------------------------------------------------------------------------------------------------------------------------------------------------------------------------------------------------------------------------------------------------------------------------------------------------------------------------------------------------------------------------------------------------------------------------------------------------------------------------------------------------------------------------------------------------------------------------------------------------------------------------------------------------------------------------------------------------------------------------------------------------------------------------------------------------------------------------------------------------------------------------------------------------------------------------------------------------------------------------------------------------------------------------------------------------------------------------------------------------------------------------------------------------------------------------------------------------------------------------|----------------------------------------------------------------------------------------------------------------------------------------------------------------------------------------------------------------------------------------------------------------------------------------------------------------------------------------------------------------------------------------------------------------------------------------------------------------------------------------------------------------------------------------------------------------------------------------------------------------------------------------------------------------------------------------------------------------------------------------------------------------------------------------------------------------------------------------------------------------------------------------------------------------------------------------------------------------------------------------------------------------------------------------------------------------------------------------------------------------------------------------------------------------------------------------------------------------------------------------------------------------------------------------------------------------------------------------------------------------------------------------------------------------------------------------------------------------------------------------------------------------------------------------------------------------|---------------------------------------------------------------------------------------------------------------------------------------------------------------------------------------------------------------------------------------------------------------------------------------------------------------------------------------------------------------------------------------------------------------------------------------------------------------------------------------------------------------------------------------------------------------------------------------------------------------------------------------------------------------------------------------------------------------------------------------------------------------------------------------------------------------------------------------------------------------------------------------------------------------------------------------------------------------------------------------------------------------------------------------------------------------------------------------------------------------------------------------------------------------------------------------------------------------------------------------------------------------------------------------------------------------------------------------------------------------------------------------------------------------------------------------------------------------|-----------------------------------------------------------------------------------------------------------------------------------------------------------------------------------------------------------------------------------------------------------------------------------------------------------------------------------------------------------------------------------------------------------------------------------------------------------------------------------------------------------------------------------------------------------------------------------------------------------------------------------------------------------------------------------------------------------------------------------------------------------------------------------------------------------------------------------------------------------------------------------------------------------------------------------------------------------------------------------------------------------------------------------------------------------------------------------------------------------------------------------------------------------------------------------------------------------------------------------------------------------------------------------------------------------------------------------------------------------------------------------------------------------------------------------------------------------------------------------------------------------------------------------------------------------------------------------------------------------------------------------------------------------------------------------------------------------------------------------------------|
| <p><b>Business and Academic Courses</b></p> <ul style="list-style-type: none"> <li><input type="checkbox"/> Accounting</li> <li><input type="checkbox"/> Arithmetic</li> <li><input type="checkbox"/> Business Correspondence</li> <li><input type="checkbox"/> Business Management</li> <li><input type="checkbox"/> Certified Public Accounting</li> <li><input type="checkbox"/> Commercial</li> <li><input type="checkbox"/> Cost Accounting</li> <li><input type="checkbox"/> Federal Tax</li> <li><input type="checkbox"/> First Year College</li> <li><input type="checkbox"/> Foremanship</li> <li><input type="checkbox"/> Good English</li> <li><input type="checkbox"/> Higher Mathematics</li> <li><input type="checkbox"/> Illustrating</li> <li><input type="checkbox"/> Postal Service</li> <li><input type="checkbox"/> Salesmanship</li> <li><input type="checkbox"/> Sign Lettering</li> <li><input type="checkbox"/> Spanish</li> <li><input type="checkbox"/> Traffic Management</li> </ul> <p><b>Air Conditioning and Plumbing Courses</b></p> <ul style="list-style-type: none"> <li><input type="checkbox"/> Air Conditioning</li> <li><input type="checkbox"/> Heating</li> <li><input type="checkbox"/> Refrigeration</li> </ul> | <p><b>Chemistry Courses</b></p> <ul style="list-style-type: none"> <li><input type="checkbox"/> Chemical Engineering</li> <li><input type="checkbox"/> Chemistry, Analytical</li> <li><input type="checkbox"/> Chemistry, Industrial</li> <li><input type="checkbox"/> Chemistry, Mfg. Iron &amp; Steel</li> <li><input type="checkbox"/> Petroleum Refining</li> <li><input type="checkbox"/> Pulp and Paper Making</li> </ul> <p><b>Civil Engineering, Architectural and Mining Courses</b></p> <ul style="list-style-type: none"> <li><input type="checkbox"/> Architectural Drafting</li> <li><input type="checkbox"/> Architecture</li> <li><input type="checkbox"/> Building Estimating</li> <li><input type="checkbox"/> Civil Engineering</li> <li><input type="checkbox"/> Coal Mining</li> <li><input type="checkbox"/> Contracting and Building</li> <li><input type="checkbox"/> Highway Engineering</li> <li><input type="checkbox"/> Lumber Dealer</li> <li><input type="checkbox"/> Reading Structural Blueprints</li> <li><input type="checkbox"/> Sanitary Engineering</li> <li><input type="checkbox"/> Structural Drafting</li> <li><input type="checkbox"/> Structural Engineering</li> <li><input type="checkbox"/> Surveying and Mapping</li> </ul> <p><b>Communications Courses</b></p> <ul style="list-style-type: none"> <li><input type="checkbox"/> Electronics</li> <li><input type="checkbox"/> Practical Telephony</li> <li><input type="checkbox"/> Radio, General</li> <li><input type="checkbox"/> Radio Operating</li> </ul> | <p><input type="checkbox"/> Radio Servicing <li><input type="checkbox"/> Telegraph Engineering</li> <p><b>Electrical Courses</b></p> <ul style="list-style-type: none"> <li><input type="checkbox"/> Electrical Drafting</li> <li><input type="checkbox"/> Electrical Engineering</li> <li><input type="checkbox"/> Electric Light and Power</li> <li><input type="checkbox"/> Lighting Technician</li> <li><input type="checkbox"/> Practical Electrician</li> <li><input type="checkbox"/> Power House Electric</li> <li><input type="checkbox"/> Ship Electrician</li> </ul> <p><b>Internal Combustion Engines Courses</b></p> <ul style="list-style-type: none"> <li><input type="checkbox"/> Auto Technician</li> <li><input type="checkbox"/> Diesel-Electric</li> <li><input type="checkbox"/> Diesel Engines</li> </ul> <p><b>Mechanical Courses</b></p> <ul style="list-style-type: none"> <li><input type="checkbox"/> Aeronautical Engineering</li> <li><input type="checkbox"/> Aircraft Drafting</li> <li><input type="checkbox"/> Flight Engineer</li> <li><input type="checkbox"/> Forging</li> <li><input type="checkbox"/> Foundry Work</li> <li><input type="checkbox"/> Heat Treatment of Metals</li> <li><input type="checkbox"/> Industrial Engineering</li> <li><input type="checkbox"/> Industrial Metallurgy</li> <li><input type="checkbox"/> Machine Shop</li> <li><input type="checkbox"/> Machine Shop Inspection</li> </ul> </p> | <p><input type="checkbox"/> Mechanical Drafting <li><input type="checkbox"/> Mechanical Engineering</li> <li><input type="checkbox"/> Mold-Loft Work</li> <li><input type="checkbox"/> Patternmaking—Wood, Metal</li> <li><input type="checkbox"/> Reading Shop Blueprints</li> <li><input type="checkbox"/> Sheet-Metal Drafting</li> <li><input type="checkbox"/> Sheet-Metal Worker</li> <li><input type="checkbox"/> Ship Drafting</li> <li><input type="checkbox"/> Ship Fitting</li> <li><input type="checkbox"/> Tool Designing</li> <li><input type="checkbox"/> Toolmaking</li> <li><input type="checkbox"/> Welding—Gas and Electric</li> <p><b>Railroad Courses</b></p> <ul style="list-style-type: none"> <li><input type="checkbox"/> Air Brake</li> <li><input type="checkbox"/> Car Inspector</li> <li><input type="checkbox"/> Diesel Locomotive</li> <li><input type="checkbox"/> Locomotive Engineer</li> <li><input type="checkbox"/> Locomotive Fireman</li> <li><input type="checkbox"/> Railroad Section Foreman</li> </ul> <p><b>Steam Engineering Courses</b></p> <ul style="list-style-type: none"> <li><input type="checkbox"/> Boilermaking</li> <li><input type="checkbox"/> Combustion Engineering</li> <li><input type="checkbox"/> Engine Running</li> <li><input type="checkbox"/> Marine Engineering</li> <li><input type="checkbox"/> Steam Electric</li> <li><input type="checkbox"/> Steam Engines</li> </ul> <p><b>Textile Courses</b></p> <ul style="list-style-type: none"> <li><input type="checkbox"/> Cotton Manufacturing</li> <li><input type="checkbox"/> Rayon Weav'g</li> <li><input type="checkbox"/> Textile Design'g</li> <li><input type="checkbox"/> Woolen Manufacturing</li> </ul> </p> |
|-----------------------------------------------------------------------------------------------------------------------------------------------------------------------------------------------------------------------------------------------------------------------------------------------------------------------------------------------------------------------------------------------------------------------------------------------------------------------------------------------------------------------------------------------------------------------------------------------------------------------------------------------------------------------------------------------------------------------------------------------------------------------------------------------------------------------------------------------------------------------------------------------------------------------------------------------------------------------------------------------------------------------------------------------------------------------------------------------------------------------------------------------------------------------------------------------------------------------------------------------------------|----------------------------------------------------------------------------------------------------------------------------------------------------------------------------------------------------------------------------------------------------------------------------------------------------------------------------------------------------------------------------------------------------------------------------------------------------------------------------------------------------------------------------------------------------------------------------------------------------------------------------------------------------------------------------------------------------------------------------------------------------------------------------------------------------------------------------------------------------------------------------------------------------------------------------------------------------------------------------------------------------------------------------------------------------------------------------------------------------------------------------------------------------------------------------------------------------------------------------------------------------------------------------------------------------------------------------------------------------------------------------------------------------------------------------------------------------------------------------------------------------------------------------------------------------------------|---------------------------------------------------------------------------------------------------------------------------------------------------------------------------------------------------------------------------------------------------------------------------------------------------------------------------------------------------------------------------------------------------------------------------------------------------------------------------------------------------------------------------------------------------------------------------------------------------------------------------------------------------------------------------------------------------------------------------------------------------------------------------------------------------------------------------------------------------------------------------------------------------------------------------------------------------------------------------------------------------------------------------------------------------------------------------------------------------------------------------------------------------------------------------------------------------------------------------------------------------------------------------------------------------------------------------------------------------------------------------------------------------------------------------------------------------------------|-----------------------------------------------------------------------------------------------------------------------------------------------------------------------------------------------------------------------------------------------------------------------------------------------------------------------------------------------------------------------------------------------------------------------------------------------------------------------------------------------------------------------------------------------------------------------------------------------------------------------------------------------------------------------------------------------------------------------------------------------------------------------------------------------------------------------------------------------------------------------------------------------------------------------------------------------------------------------------------------------------------------------------------------------------------------------------------------------------------------------------------------------------------------------------------------------------------------------------------------------------------------------------------------------------------------------------------------------------------------------------------------------------------------------------------------------------------------------------------------------------------------------------------------------------------------------------------------------------------------------------------------------------------------------------------------------------------------------------------------------|

Name \_\_\_\_\_ Age \_\_\_\_\_ Home Address \_\_\_\_\_

City \_\_\_\_\_ State \_\_\_\_\_ Present Position \_\_\_\_\_

Working Hours \_\_\_\_\_ A.M. to \_\_\_\_\_ P.M. Length of Service in World War II \_\_\_\_\_

Special tuition rates to members of the Armed Forces. Enrollment under the G.I. Bill of Rights approved for War II Veterans.

Canadian residents send coupon to International Correspondence Schools Canadian, Ltd., Montreal, Canada.



8 MM

16 MM

*Gifts that  
Projector Owners  
Appreciate*

**CASTLE HOME MOVIES**



**Give "FOOTBALL PARADE OF 1946"**

Exciting highlights from the greatest college gridiron events! Thrill-packed plays and dramatic moments seen from the perfect vantage point! Here is the *best* in collegiate football, all in ONE film eagerly awaited by thousands of fans from coast to coast. Get your order in NOW!

**ALL THIS IN ONE FILM!**

Army—Navy, Yale—Harvard, Northwestern—Ohio State, Notre Dame—Iowa, Illinois—Pittsburgh, Cornell—Dartmouth, California—Stanford, Georgia Tech—Duke. (subject to change)

SEE YOUR  
PHOTO DEALER  
IMMEDIATELY  
OR SEND HANDY  
ORDER FORM  
TODAY!

**FREE!** To All Projector Owners! Send TODAY for new Castle Films DeLuxe Catalog describing wide variety of thrilling home movies.

**CASTLE FILMS**  
INC.

30 ROCKEFELLER PLAZA  
NEW YORK 20

FIELD BLDG.  
CHICAGO 3

RUSS BLDG.  
SAN FRANCISCO 4



**Give "THE NIGHT BEFORE CHRISTMAS!"**

Now it comes to life . . . the famous poem that millions of children know and love! Will rekindle the Christmas spirit in older people, and heighten the youngster's enjoyment of the Yuletide. A wonderful combination of studio photography and animated cartoon! A Castle Films classic!



**Give "CHIMP THE AVIATOR"**

A howling thriller! Astonishing "Shorty" goes flying . . . walks wings in mid-air . . . does stunts on struts . . . repents when pilot starts stunting! Surprising and uproarious climax . . . a new high in monkey shines!



**Give "3 LITTLE BRUINS MAKE MISCHIEF"**

Own the funniest, cutest animal comedy ever produced! Cubs raid farm kitchen with hilarious antics in custard pies, flour and sugar! Roars of laughter every second! See them go swimming, try to catch fish, feud with farm animals.

**ORDER FORM**

Send Castle Films' Home Movies Indicated in the size and length checked.	8 mm.		16 mm.		
	50 ft.	Complete	100 ft.	Complete	Sound complete
"Football Parade of 1946"	\$175	\$550	\$275	\$875	\$1750
"The Night Before Christmas"					
"Chimp the Aviator"					
"3 Little Bruins Make Mischief"					

PS-12

Name \_\_\_\_\_  
Address \_\_\_\_\_  
City \_\_\_\_\_ Zone \_\_\_\_\_ State \_\_\_\_\_  
Remittance enclosed  Ship C. O. D.  Send Castle Films' Free DeLuxe Catalog





## Should Scientists Take An Oath?

*(A Statement by the Editor of Popular Science Monthly)*

**F**RESH-SHINGLED Doctors of Medicine commonly take the Oath of Hippocrates and thus subscribe to a code of medical ethics. There has been proposed a similar oath for scientists, whereby they would swear by whatever gods or immutable truths they hold sacred to work only for the welfare of mankind, and to avoid that scientific sin which is secrecy—military or national.

The idea has its merits. The orderly curiosity that is science is as international as the wind, and your true scientist is in the business of secret-smashing. It has also been suggested that an international priesthood of science might prevent war by some kind of scientific sit-down strike.

But the scientists are also discovering that they are people, too. And it is the scientist as a human being and a citizen who is shocked by his responsibility in the perversion of science to destruction. Furthermore, no scientists' oath to work only for the welfare of

humanity could mean much for the simple reason that no one could foretell what any discovery would entail. A research into the cure of cancer, for instance, might ultimately reveal enough knowledge of the cause to make the dread disease another weapon.

If the scientist is to be the saviour of frightened, ignorant humanity, no negative oath will help. Our trouble now is that the so-called social sciences have not caught up with nuclear physics. We need to know why humans behave like animals; what makes people stupid, greedy, bloodthirsty; how to stop a war, or start a crusade for decent brotherhood.

An intensified inquiry into human nature calls for the best scientific brains in the world. And it's just about the only way to make biological warfare into the farmers' friend, or atomic bombs into doctors' tools.

*Penry Withers*



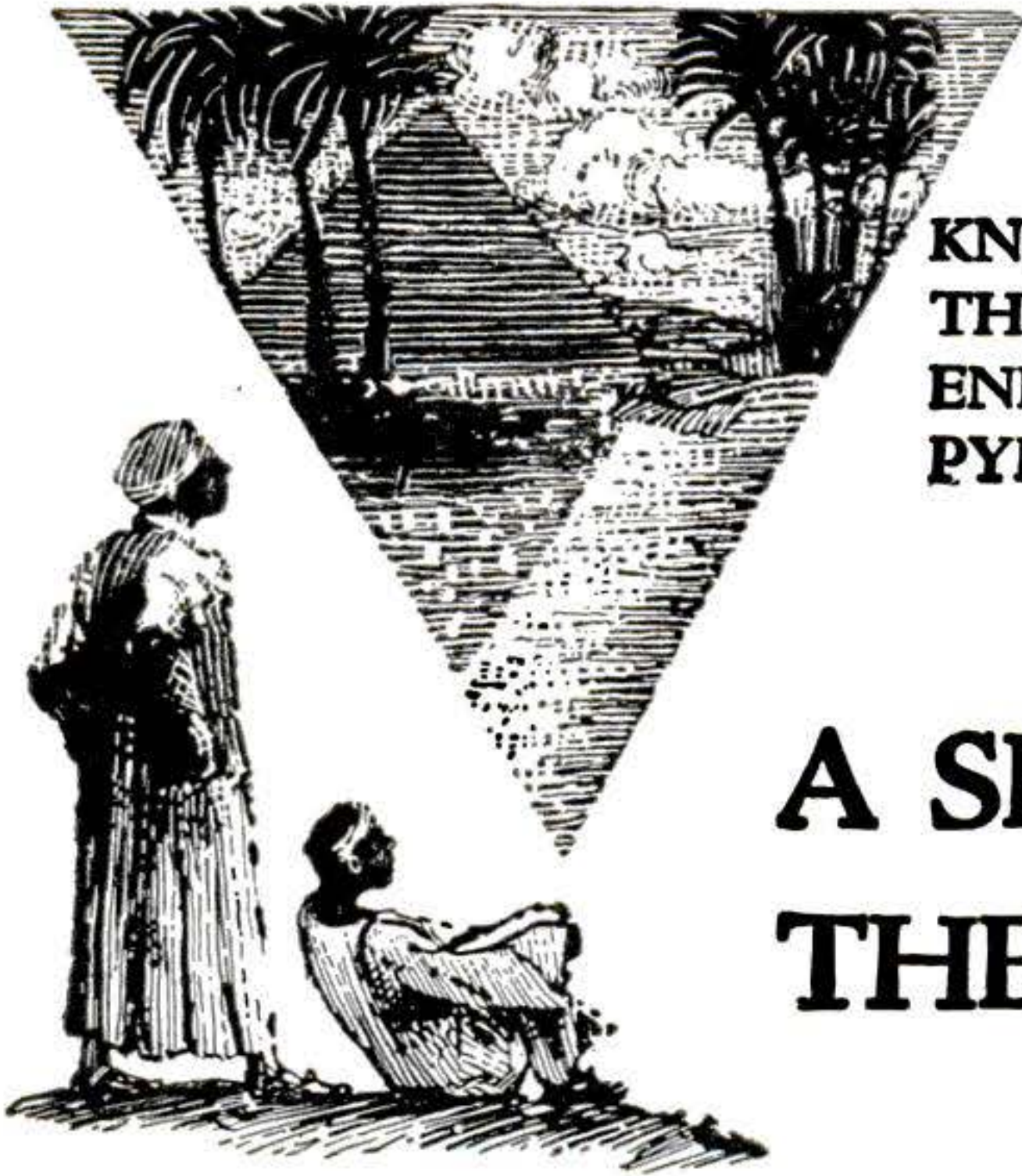

**KNOWLEDGE  
THAT HAS  
ENDURED WITH THE  
PYRAMIDS**

## **A SECRET METHOD FOR THE MASTERY OF LIFE**

**W**HENCE came the knowledge that built the Pyramids and the mighty Temples of the Pharaohs? Civilization began in the Nile Valley centuries ago. Where did its first builders acquire their astounding wisdom that started man on his upward climb? Beginning with naught they overcame nature's forces and gave the world its first sciences and arts. Did their knowledge come from a race now submerged beneath the sea, or were they touched with Infinite inspiration? From what concealed source came the wisdom that produced such characters as Amenhotep IV, Leonardo da Vinci, Isaac Newton, and a host of others?

Today it is known that they discovered and learned to interpret certain *Secret Methods* for the development of their inner power of mind. They learned to command the inner forces within their own beings, and to master life. This secret art of living has been preserved and handed down throughout the ages. Today it is extended to those who dare to use its profound principles to meet and solve the problems of life in these complex times.

### **This Sealed Book—FREE**

Has life brought you that personal satisfaction, the sense of achievement and happiness that you desire? If not, it is your duty to yourself to learn about this rational method of applying natural laws for the mastery of life. To the thoughtful person it is obvious that everyone cannot be entrusted with an intimate knowledge of the mysteries of life, for everyone is not capable of properly using it. But if you are one of those possessed of a true desire to forge ahead and wish to make use of the subtle influences of life, the Rosicrucians (not a religious organization) will send you A Sealed Book of explanation without obligation. This Sealed Book tells how you, in the privacy of your own home, without interference with your personal affairs or manner of living, may receive these secret teachings. Not weird or strange practices, but a rational application of the basic laws of life. Use the coupon, and obtain your complimentary copy.

## **The ROSICRUCIANS**

**SAN JOSE**

**(AMORC)**

**CALIFORNIA**



**AMENHOTEP IV**  
Founder of Egypt's  
Mystery Schools

*Use this  
coupon for  
FREE  
copy of book*

SCRIBE E.Z.X.  
The Rosicrucians (AMORC)  
San Jose, California

Please send free copy of Sealed Book,  
which I shall read as directed.

NAME.....

ADDRESS.....

CITY.....





# Are YOU doing bookkeeping "chores"?

## CLIMB HIGHER!

## BECOME an ACCOUNTANT

As you go along you absorb the principles of auditing, business law, statistical control, cost accounting, organization, management and finance, etc.

This way is not magic. It is not easy. It requires giving up certain spare time to serious study. How long will it take you to acquire

this accountancy training is strictly up to you—you can go as fast or as slowly as you choose. But after you have gone part way (you need not wait until you are clear through the training) you will find yourself stepping up to better positions.

And once you have mastered this fascinating profession—once you have become an accountant—then you will have the money and the standing to make your dreams come true. You will be a respected member of the best paying profession and equipped to go out into public accounting or to climb to a top management position.

Our free 48-page booklet, "Accountancy, the Profession That Pays," tells you what you must know to be an accountant and how you can prepare in your leisure time at moderate cost. The coupon below will bring this booklet quickly without cost or obligation. You already have a start in this field; now find out how you can go all the way. Do it today.

**G. I. APPROVED**

## LASALLE EXTENSION UNIVERSITY

### A Correspondence Institution

Dept. 1283-H 417 S. Dearborn Street, Chicago 5, Illinois

I'd like to know more about your home study program to help me prepare for an accounting career. Please send me your free 48-page booklet, "Accountancy, the Profession That Pays."

Name.....Age.....

Present position.....

Address.....

City & State.....

**IF** you are doing the "chore" work, of accounting as a bookkeeper, ledger clerk, cost clerk, or in one of the other many record keeping jobs—

You should consider climbing higher—becoming an accountant.

Why be satisfied all your life with a small salary and an ordinary job when there is such a large future for the man or woman who understands accountancy in all its forms and phases?

One big difference between you and the successful accountant is that he doesn't do the chores. He bosses those who do the drudgery and he gets the money and prestige. And he does that because he knows the principles behind the records you keep—can plan those records and interpret them to management. He knows what you know—and a lot more.

There are two ways in which you can get this knowledge which will qualify you for an accountant's position.

First—the old way of day-by-day experience on the job. This is the long route—taking many, many years, sometimes a lifetime. Most people taking this way never get anywhere. Why sacrifice years of success—lose time and money—when there is a better and easier way?

Second, the LaSalle way of learning in your spare time—studying and preparing for the step ahead. You learn by doing—you study accounting principles and solve accounting problems. You cover accountancy from the basic principles right up through Accounting Systems and Income Tax Procedure—C.P.A. training if you so desire.





# BEYOND YOUR

*I will show you how to start  
a Radio Service Business  
Full Time or Spare Time without capital*

J. E. SMITH, President  
National Radio Institute  
The man who has directed the Home Study Training of more men for the Radio Industry than any other man in America.

## I Trained These Men



**\$35 - \$45 A Week In Own Shop**  
"Previous to enrolling for your Radio training I made \$12 per week in a hardware store. Now I operate my own repair shop, and often clear \$35 to \$45 a week."—FREDERICK BELL, 76 Golf Ave., St. Johns, Newfoundland.

### \$250 A Month In Own Shop

"I am now operating a radio shop for myself and own all my equipment. Right now repairing radios pays me an average of about \$250 a month."—J. M. SCRIVENER, JR., Aberdeen, Miss.



**Averages Over \$60 A Week**  
"Not long ago I was working 16 hours a day in a filling station at \$10 a week. Now I have my own Radio business and average over \$60 a week. The N. R. I. course is fine."—ALBERT C. CHRISTENSEN, 1116 Tenth Ave., Sidney, Neb.

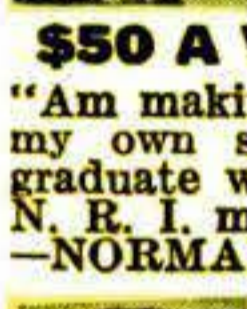

**\$50 A Week From Own Shop**  
"Am making over \$50 a week profit from my own shop. Have another N. R. I. graduate working for me. I like to hire N. R. I. men because they know Radio."—NORMAN MILLER, Hebron, Neb.



**\$50 A Month In Spare Time**  
"I have a spare time Radio and Electrical business of my own which has been very profitable, due to the efficient training I received from your Course. Last year I averaged over \$50 a month."—FRED H. GRIFFIE, Rt. 3, Newville, Pa.

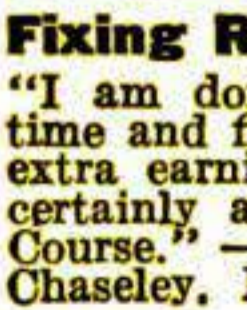

**Fixing Radios Profitable Hobby**  
"I am doing Radio work in my spare time and find it a profitable hobby. My extra earnings run about \$10 a week. I certainly am glad I took your N. R. I. Course."—FERDINAND ZIRBEL, Chaseley, N. Dak.



## SAMPLE LESSON FREE SEE OPPOSITE PAGE

Do you want a good-pay job in Radio—or your own money-making Radio Shop? Mail Coupon for a FREE Sample Lesson and my FREE 64-page book, "Win Rich Rewards in Radio." See how N. R. I. gives you practical Radio experience at home—building, testing, repairing Radios with 6 BIG KITS OF PARTS I send!

### Many Beginners Soon Make Good Extra Money in Spare Time While Learning

The day you enroll I start sending EXTRA MONEY JOB SHEETS. You LEARN Radio principles from my easy-to-grasp, illustrated lessons—PRACTICE what you learn with parts I send—USE your knowledge to make EXTRA money fixing neighbors' Radios in spare time while still learning! From here it's a short step to your own full-time Radio Shop or a good Radio job!

### Future for Trained Men Is Bright in Radio, Television, Electronics

It's probably easier to get started in Radio now than ever before because the Radio Repair business is booming. Trained Radio Technicians also find profitable opportunities in Police, Aviation, Marine Radio, Broadcasting, Radio Manufacturing, Public Address work. Think of even greater opportunities as Television and Electronics become available to the public! Send for free books now!

### Find Out What N. R. I. Can Do For You

Mail Coupon for Sample Lesson and my 64-page book. Read the details about my Course. Read letters from men I trained, telling what they are doing, earning. See how quickly, easily you can get started. No obligation! Just MAIL COUPON NOW in an envelope or paste it on a penny postal. J. E. SMITH, President, Dept. 6NP3, National Radio Institute, Pioneer Home Study Radio School, Washington 9, D. C.

Our 32nd Year of Training Men for Success in Radio

**MY COURSE INCLUDES  
TELEVISION  
ELECTRONICS  
FREQUENCY MODULATION**

**A TESTED WAY**



# OWN BOSS

**LEARN RADIO BY PRACTICING IN SPARE TIME  
with 6 Big Kits of Radio Parts I Send You!**

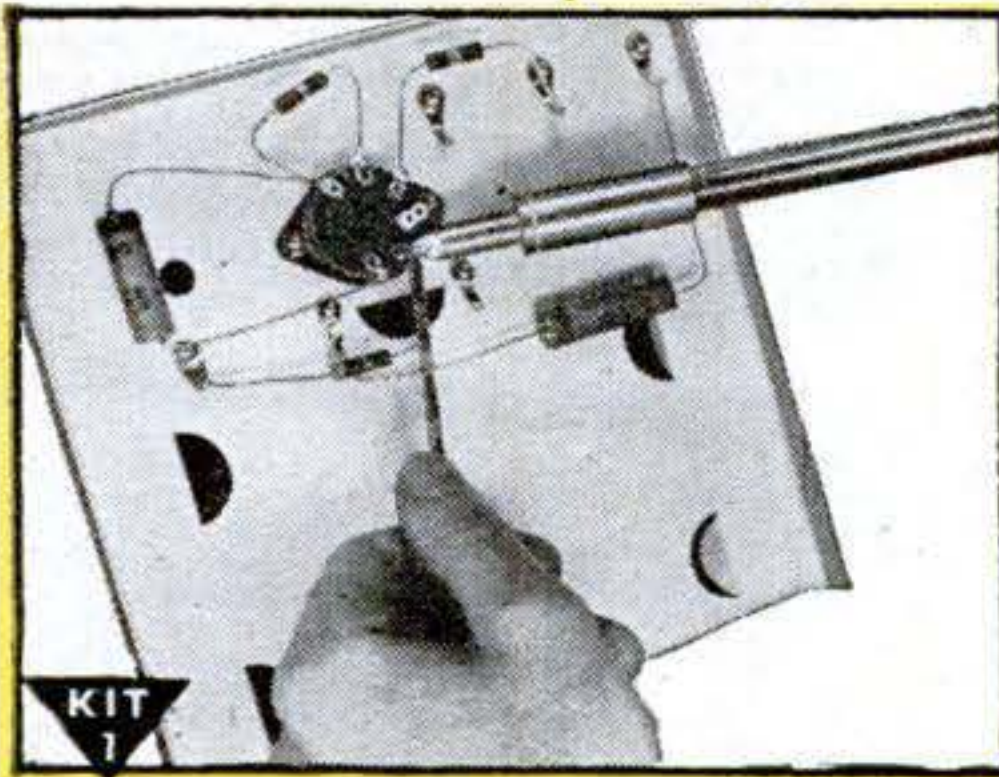

**KIT 1**

I send you Soldering Equipment and Radio Parts; show you how to do Radio soldering; how to mount and connect Radio parts; give you practical experience.

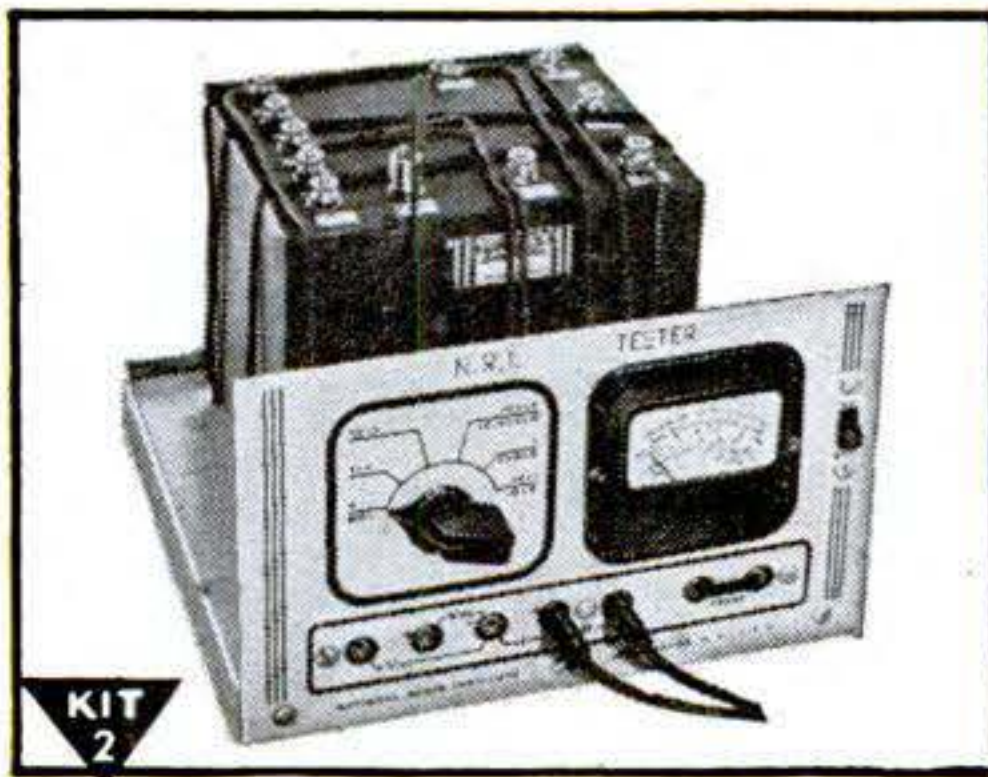

**KIT 2**

Early in my Course I show you how to build this N.R.I. Tester with parts I send. It soon helps you fix neighborhood Radios and earn EXTRA money in spare time.

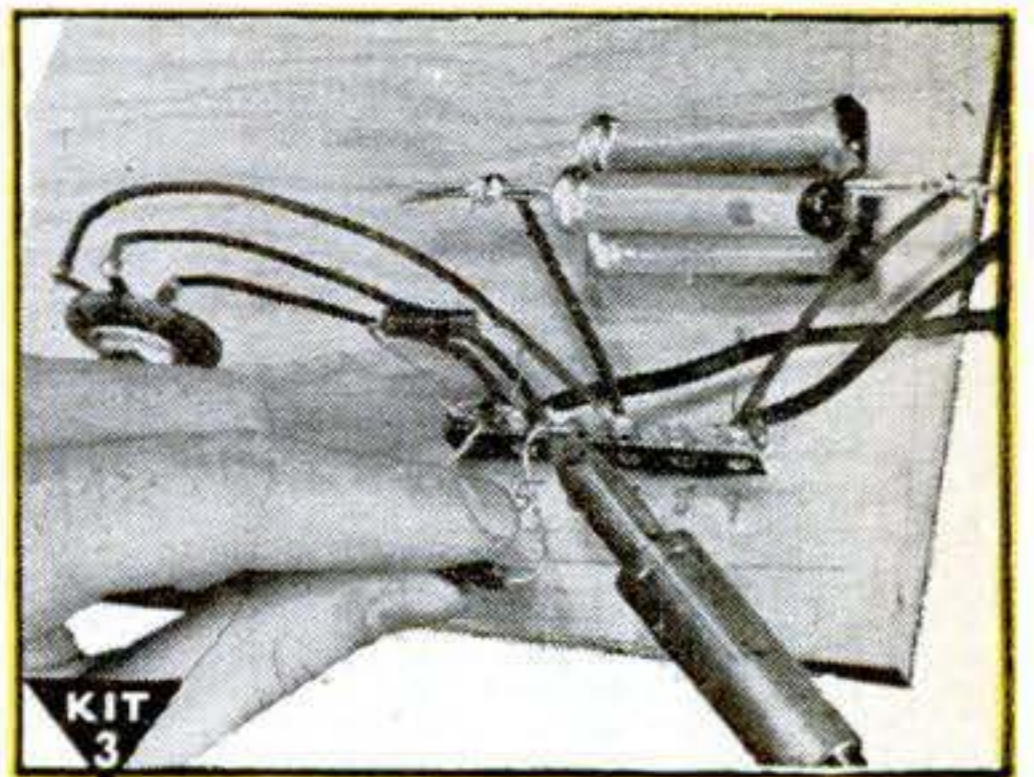

**KIT 3**

You get parts to build Radio Circuits; then test them; see how they work; learn how to design special circuits; how to locate and repair circuit defects.

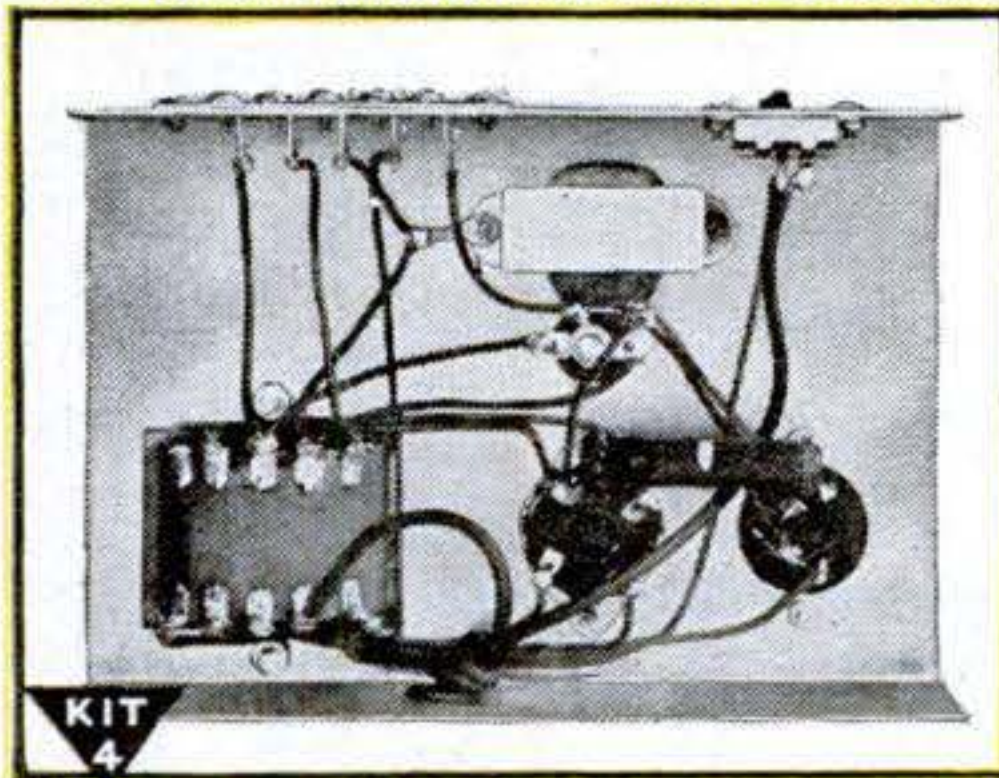

**KIT 4**

You get parts to build this Vacuum Tube Power Pack; make changes which give you experience with packs of many kinds; learn to correct power pack troubles.

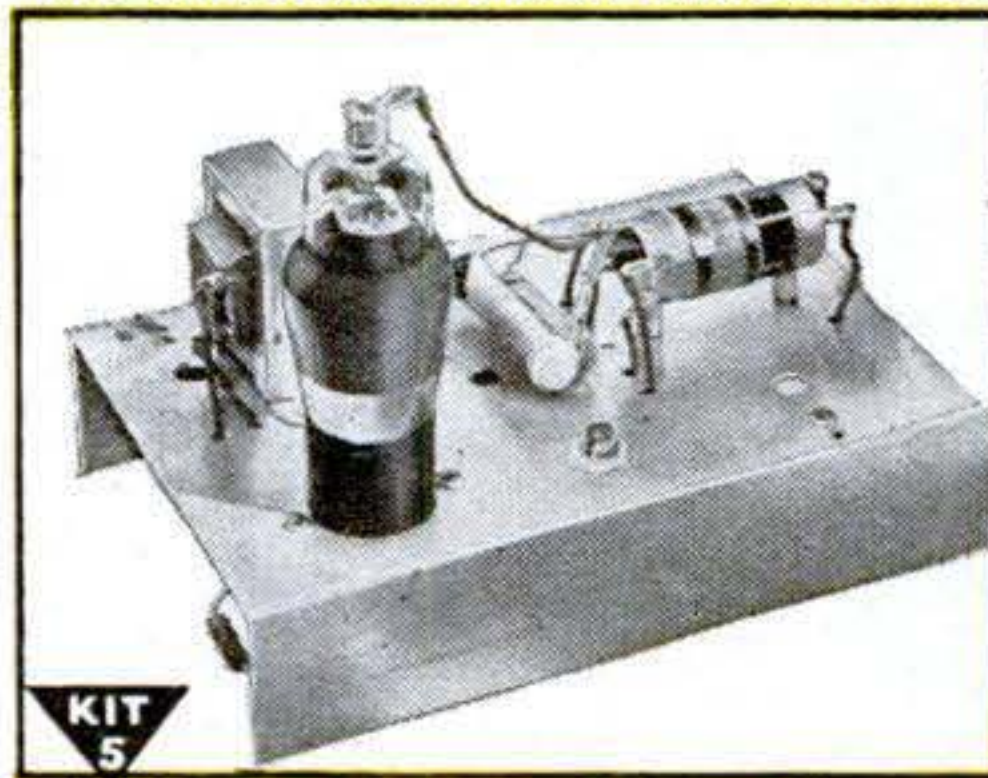

**KIT 5**

Building this A. M. Signal Generator gives you more valuable experience. It provides amplitude-modulated signals for many tests and experiments.

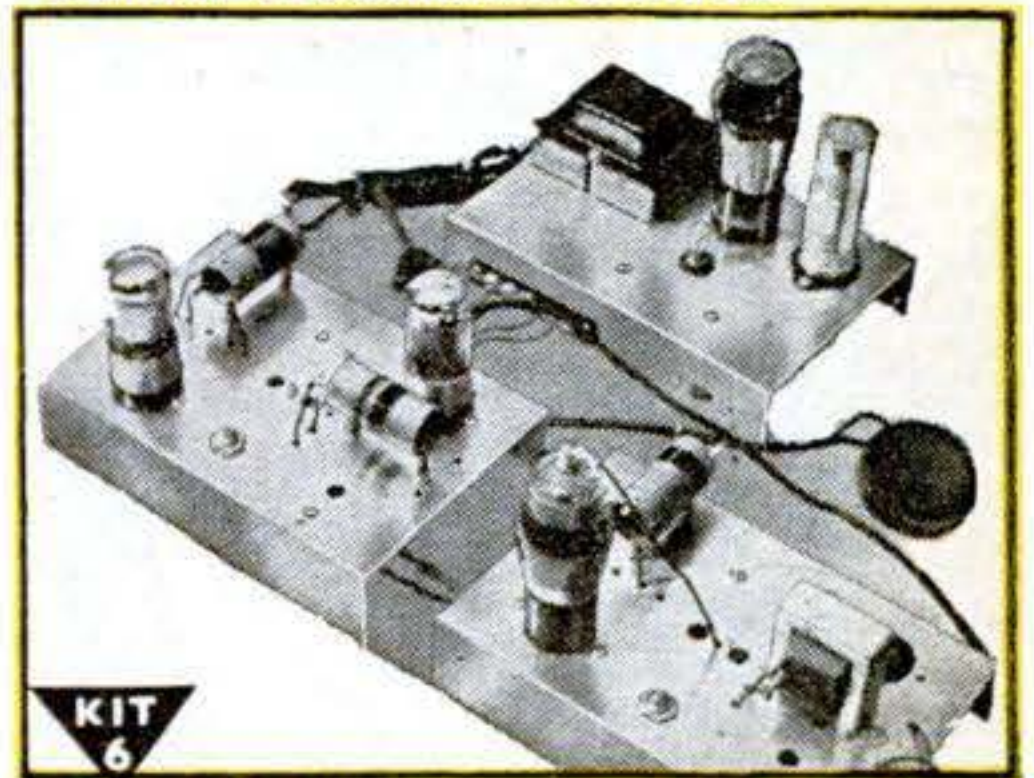

**KIT 6**

You build this Superheterodyne Receiver which brings in local and distant stations—and gives you more experience to help you win success in Radio.

## SAMPLE LESSON

# FREE

I will send you a FREE Lesson, "Getting Acquainted with Receiver Servicing," to show you how practical it is to train for Radio at home in spare time. It's a valuable lesson. Study it—keep it—use it—without obligation! Tells how Superheterodyne Circuits work, gives hints on Receiver Servicing, Locating Defects, Repair of Loudspeaker, I.F. Transformer, Gang Tuning, Condenser, etc. Thirty-one illustrations.



**MAIL COUPON FOR FREE LESSON  
AND 64 PAGE BOOK**

**Good for Both FREE**

Mr. J. E. SMITH, President, Dept. 6NP3  
National Radio Institute, Washington 9, D. C.  
Mail me FREE, without obligation, Sample Lesson and 64-page book about how to win success in Radio and Television—Electronics. (No salesman will call. Please write plainly.)

Age.....

Name.....

Address.....

City.....Zone.....State.....

**APPROVED FOR TRAINING UNDER GI BILL**



**TO GOOD PAY**



# Ghirardi Makes it Easy for You to LEARN RADIO-ELECTRONICS

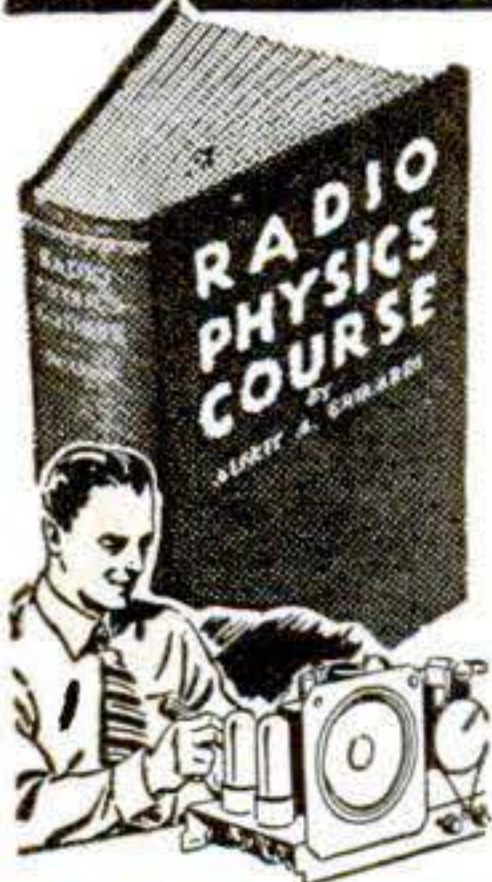

**AT HOME . . . IN SPARE TIME FOR ONLY \$5** for the complete training

We'll PROVE Ghirardi's famous RADIO PHYSICS COURSE book can teach you basic Radio-Electronics quicker and easier than any other book or course—for only \$5 COMPLETE. We'll prove you'll be pleasantly surprised how quickly it helps you understand every one of the hundreds of subjects covered. We'll prove that this 972-page book is so fine and so complete that, if broken into lesson form as a correspondence course, you'd regard it as a bargain at \$50 or more! If not more than satisfied after reading it for 5 full days, send it back. EVERY CENT will be cheerfully refunded.

## 36 BIG COURSES IN ONE

Ghirardi's RADIO PHYSICS COURSE book is more widely used for home study, by more Signal Corps and Navy Schools than any other book of its kind. Nothing is omitted, nothing condensed. Starting with Basic Electricity, it takes you step by step through the entire Radio field. Everything is made crystal clear. No lessons to wait for. Many students have completed it in a few weeks—and a high percentage of them are now successful Radio experts! 508 illus. 856 Self Test Review Questions.

**9 OUT OF 10!**

On actual survey among 817 radio experts, engineers, etc., 9 OUT OF 10 said Ghirardi's RADIO PHYSICS COURSE was their 1st choice—far better than any other radio instruction on the market!

**5-DAY MONEY-BACK GUARANTEE**

Dept. PS-126, Murray Hill Books, Inc., 222 Madison Ave., New York 16, N. Y.

Enclosed find \$5 (\$5.50 foreign) for which send Ghirardi's RADIO PHYSICS COURSE book postpaid. Or,  send C.O.D. (no foreign C.O.D.'s) for this amount plus postage. In either case, if not fully satisfied I reserve right to return book within 5 days for full refund.

Name.....  
Address.....  
City & Dist. No..... State.....

# No Waiting to LEARN START NOW TO EARN!

This BIG BOOK SHOWS HOW



**IF IT'S RESULTS YOU WANT—GET ACTION QUICKLY WITH THESE PRACTICAL IDEAS**

Never before has a more helpful book been printed for those planning a business of their own. Gathered in this large illustrated volume are the formulas, recipes, facts and secrets that have contributed so largely to America's great industrial progress. Capitalize on this information for making most any conceivable product without experience, special equipment or previous knowledge of chemistry. Start at home, expand with profits—build for a profitable independence.

The experts who compiled this book are authorities, and present this information in simple, understandable language. They also give you wholesale supply sources for needed materials, short cuts and economy methods for the most profitable results. Hundreds of good paying businesses have been built on a product made from a simple

recipe. Opportunities in this field exist everywhere. Choose from any of the 162,000 facts and 10,000 formulas of which the following are only a very few: Adhesives, Alloys, Anti-Freeze Solutions, Cosmetics, Beverages and Liquors, Candy, Gum, Casein, Celluloid, Ceramics, Cheese, Cleaning Preparations, Concrete, Copper, Cotton, Dentifrices, Depilatories, Dyes, Embalming Fluids, Enameling, Glass, Glazes, Household Formulas, Inks, Insecticides, Iron, Jewelers' Formulas, Lacquers, Laundry Preparations, Leather, Linoleum, Lubricants, Manicure Preparations, Marble (artificial), Metals, Mirrors.

### —SELL BY MAIL!

You will profit by the ideas contained in this big book for setting up a mail business you can easily run from your home in your spare time.

Thousands of others for making all sorts of profitable and practical things.

### FORTUNES MADE FROM A SINGLE IDEA!

This comprehensive book is an accepted authority by chemists, schools, industry, etc. and is the largest and most comprehensive book of its kind ever issued. Nothing else like it in existence. A single formula has been worth a thousand times this book's small cost to countless owners. Crammed with money-making ideas. Invaluable for reference. Ideal for Factory, Home, Farm, Office or Workshop. As necessary as the dictionary and more useful for manufacturers, chemists and salesmen who put up products for profit.

\$3.50 postpaid, Canada or Foreign. \$3.85 U. S. Funds. (C.O.D. shipments U.S.A. only.) Immediate Shipment—Safe Delivery Guaranteed.

**ADAMS BROWN COMPANY BOOKS OF APPLIED SCIENCE**  
Dept. 262, Chestnut Hill 67, Massachusetts, U. S. A.

POSTPAID!  
**\$3.50** U.S.A.  
**\$3.85** FOREIGN

The great SUCCESS instruction for men and women now in business . . . or planning to get into PRODUCTIVE earnings . . . The PROFITABLE, EASY, SURE method . . . Get it NOW

# How to Make Money by Mail

Enlarged to 640 pages, 15th edition

Down-to-earth facts, directions (illustrated) for running business profitably, using expertly for YOUR good fortune the employees, trains, planes which Gov't places at your disposal CHEAP. Get orders by mail, ship by express or freight or mail, get out of the kindergarten . . . 15th edition, enlarged to 640 pages, now selling. It's YOUR winner. Make this year and the following years worth more. . . . THIS knowledge really PAYS OFF.

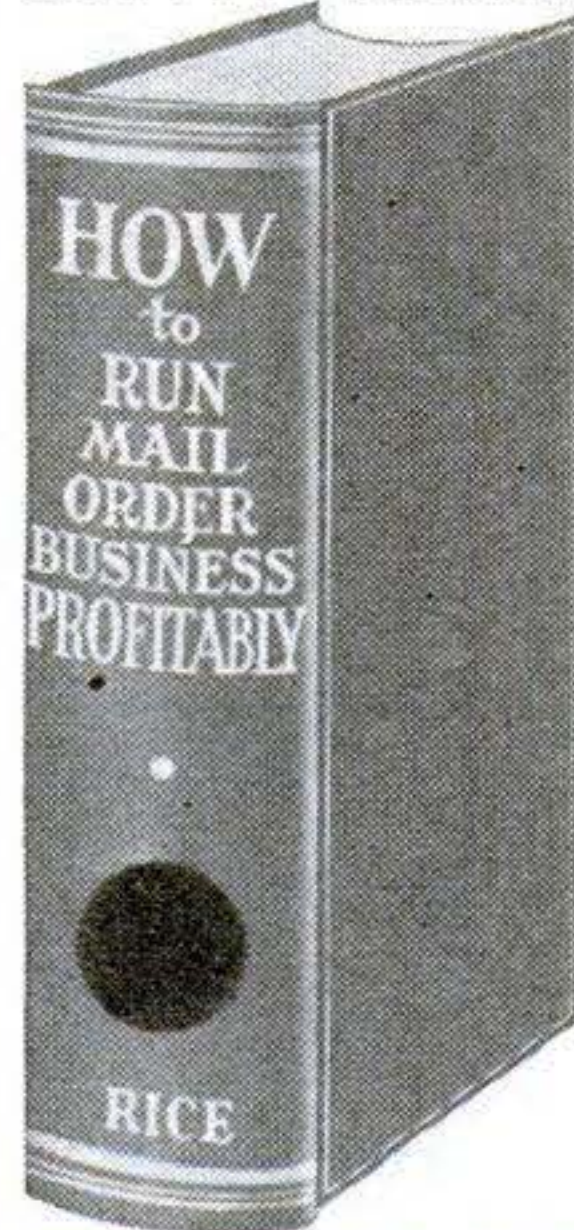

**THE EASY WAY** to start new or expand your present occupation. Do it NOW.

Extraordinary plain, simple skill, know-how. No theory. Fact story of rich experience of author E. Rice day-by-day. How many times have we heard: "I wish I had some money, this patent would earn me a fortune." or "why can't my crop pay better?" or "I wish I knew how to sell this gadget myself," or "why should my boss alone do this when I too know how the money is made? . . . Listen, You do not need money to start this Rice way. His method automatically pays all bills same day rendered, no bank loans, pay as you go, no borrowing from relatives or friends, no salesmen. Also no worry, quickly a home of your own all paid for. Rice paid off \$5000 in mortgages a year after using this skillful idea.

## 46 Years of PROOF

Sounds fishy? Sure but this has been done steadily for 46 years, depression or no depression, by the author; that is why he wrote this book, to pass the good word along. Make it go with anything you have which is salable, or with what you are now doing. Rice made his pay plan go from the start when living in one room in a city lodging house. Turn your city or country home, your work, your hobby, into money. How to get orders coming steadily at cost of only \$4 for

each \$100 taken in. The popular error to avoid in trying for sales. Business won free while others have to pay for it. How to conceive the money-getting advertisement . . . Profitable changes from ordinary ideas and methods. Not usual cut-and-dried pattern. 250 adventures, a dictated book in everyday talk by Rice doing day by day what he discloses in his book can be done by his method. No dictionary writing. . . . Read how others are profiting big. Take a chance on this book being worth a fortune to you and yours and send \$2.95. Book mailed same day order is received. Hundreds of buyers whose letters we show you declare emphatically its superlative goodness. Follow its easy pattern for success. Cloth bound. 640 pages, 8 1/2 by 5 1/2. Best seller. 15th edition now selling. Cut out the \$2.95 HOW BOX here, pin or stick it to sheet of paper bearing your name and address, mail in envelope with money order or check for \$2.95 to

**HOW**  
Enlarged  
640 pages  
**\$2.95**

**HOWARD ST. HOUSE, Melrose 76E, Massachusetts**



# Be an ARTIST!

Learn at home in your spare time

Prepare now for a fascinating and profitable Art career. Our practical method has trained men and women since 1914. COMMERCIAL ART, CARTOONING, and DESIGNING all in one complete course. Trained Artists are capable of earning \$40, \$60, \$75 a week. No previous Art experience necessary. FREE BOOK, "Art for Pleasure and Profit" describes course, commercial opportunities. TWO ART OUTFITS included with training. Veterans! Course G.I. Approved.

## FREE BOOK gives details!

Washington School of Art, Studio 1312C  
1115—15th St., N.W., Washington 5, D.C.

Please send me full information and your Free Book, "Art for Pleasure and Profit."

Name..... AGE.....  
Street.....  
City..... Zone.... State.....



# How to Make YOUR Body Bring You FAME

... Instead of SHAME!

ARE YOU  
Skinny?  
Weak?  
Flabby?

Will You Let Me Prove I Can Make You a New Man?



*Charles Atlas*

Holder of title, "The World's Most Perfectly Developed Man." This actual snapshot is not retouched in any way.

I KNOW what it means to have the kind of body that people pity! Of course, you wouldn't know it to look at me now, but I was once a skinny weakling who weighed only 97 lbs! I was ashamed to strip for sports or undress for a swim. I was such a poor specimen of physical development that I was constantly self-conscious and embarrassed. And I felt only HALF-ALIVE.

But later I discovered the secret that turned me into "The World's Most Perfectly Developed Man." And now I'd like to prove to you that the same system can make a NEW MAN of YOU!

### What "Dynamic Tension" Will Do For You

I don't care how old or young you are or how ashamed of your present physical condition you may be. If you can simply raise your arm and flex it I can add SOLID MUSCLE to your biceps—yes, on each arm—in double-quick time! Only 15 minutes a day—right in your own home—is all the time I ask of you! And there's no cost if I fail.

I can broaden your shoulders, strengthen your back, develop your whole muscular system INSIDE and OUTSIDE! I can add inches to your chest, give you a vise-like grip, make those legs of yours lithe and powerful. I can shoot new strength into your old backbone, exercise those inner organs, help you cram your body so full of pep, vigor and red-blooded vitality that you won't feel there's even "standing room" left for weakness and that lazy feeling! Before I get through with you I'll have your whole frame "measured" to a nice new, beautiful suit of muscle!

### Only 15 Minutes A Day

No "ifs," "ands" or "maybes." Just tell me where you want handsome, powerful muscles. Are you fat and flabby? Or skinny and gawky? Are you short-winded, pepless? Do you hold back and let others walk off with the prettiest girls, best jobs, etc.? Then write for details about "Dynamic-Tension" and learn

how I can make you a healthy, confident, powerful HE-MAN.

"Dynamic Tension" is an entirely NATURAL method. Only 15 minutes of your spare time daily is enough to show amazing results—and it's actually fun. "Dynamic Tension" does the work.

"Dynamic Tension!" That's the ticket! The identical natural method that I myself developed to change my body from the scrawny, skinny-chested weakling I was at 17 to my present super-man physique! Thousands of other fellows are becoming marvelous physical specimens—my way. I give you no gadgets or contraptions to fool with. When you have learned to develop your strength through "Dynamic Tension," you can laugh at artificial muscle-makers. You simply utilize the dormant muscle-power in your own body—watch it increase and multiply into real, solid LIVE MUSCLE.

My method—"Dynamic Tension"—will turn the trick for you. No theory—every exercise is practical. And, man, so easy! Spend only 15 minutes a day in your own home. From the very start you'll be using my method of "Dynamic Tension" almost unconsciously every minute of the day—walking, bending over, etc. to BUILD MUSCLE and VITALITY!

Mail Coupon For My FREE Book

CHARLES ATLAS, Dept. 1M  
115 East 23rd Street, New York 10, N. Y.

I want the proof that your system of "Dynamic Tension" will help make a New Man of me—give me a healthy, husky body and big muscle development. Send me your free book, "Everlasting Health and Strength."

Name.....  
(Please print or write plainly)  
Address.....  
City..... State.....  
 Check here if under 16 for Booklet A.

### FREE BOOK "Everlasting Health and Strength"

In it I talk to you in straight-from-the-shoulder language. Packed with inspirational pictures of myself and pupils—fellows who became NEW MEN in strength, my way. Let me show you what I helped THEM do. See what I can do for YOU! For a real thrill, send for this book today. AT ONCE. CHARLES ATLAS, Dept. 1M, 115 East 23rd Street, New York 10, N. Y.





# ELECTRICIANS! RADIO MEN!

## Valuable BOOK

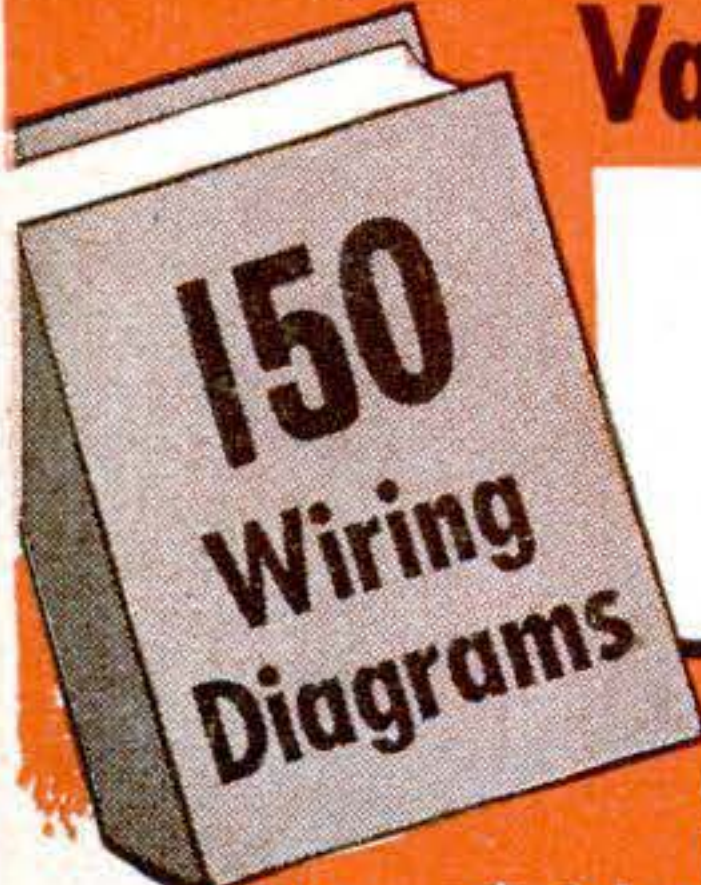

# FREE

It's My Gift to Help You Get Ahead



B. W. COOKE, Dir.

### 5 to 1 Satisfaction GUARANTEE

I personally guarantee that at the end of 1 year from the date you receive these books that they must have earned 5 times their cost or you may return them and I'll refund every cent you paid.

HERE'S one of the greatest "get acquainted" offers ever made. This new book of 150 selected Electrical Shop Prints and Wiring Diagrams is YOURS — absolutely FREE.

This book is 'chuckfull' of valuable charts, diagrams, wiring methods and instructions for reading and using wiring shop prints. All the shop prints are full size 8 1/2" x 11" with full explanatory information. Here's all you have to do to get this free book:

### 150 Diagram Book Free FOR MERELY EXAMINING COYNE'S NEW 7 Volume Set

To get your FREE copy of this Shop Print Book, all you have to do is to let me send you my complete new 7 volume set of electrical books—COYNE APPLIED PRACTICAL ELECTRICITY for 7 days' FREE Examination. Here's a set of books written for the "beginner" or "old-timer" in electrical work who is anxious to get ahead.

This 7 volume set contains thousands of "show how" methods and photos—the latest information in "easy-to-understand language." Electricity from "A" to "Z" presented in new, practical, modern methods of explanation. A leader in electricity today must "know his stuff." To succeed from now on you must know many branches.

**SEND NO MONEY** You have to see this new 7 volume set to really appreciate how much it can mean to you and your future. I'll send you the complete set of 7 volumes (pictured below) at my risk, postpaid for 7 days' FREE Examination. I'll also send you the New Coyne Book of 150 Shop Prints and Motor Diagrams as my FREE gift to you TO KEEP REGARDLESS OF WHETHER OR NOT YOU DECIDE TO KEEP THE 7 VOLUME SET COYNE PRACTICAL APPLIED ELECTRICITY.

**7 AMAZING VOLUMES**  
Covers everything from home wiring to DC - AC Motors and Equipment. Over 3000 subjects - 2000 Illustrations - 5000 facts.

### Coupon is Not an Order

Just a Request to See the Books FREE YOU ARE NOT BUYING THE 7 VOLUME SET WHEN YOU SEND THIS COUPON. You are merely asking to see the books free for 7 days. The coupon only becomes an order if you decide to keep the 7 volume set after 7-Day Free Examination. OFFER IS LIMITED—Don't delay! Fill in and Mail FREE BOOK Coupon Now!

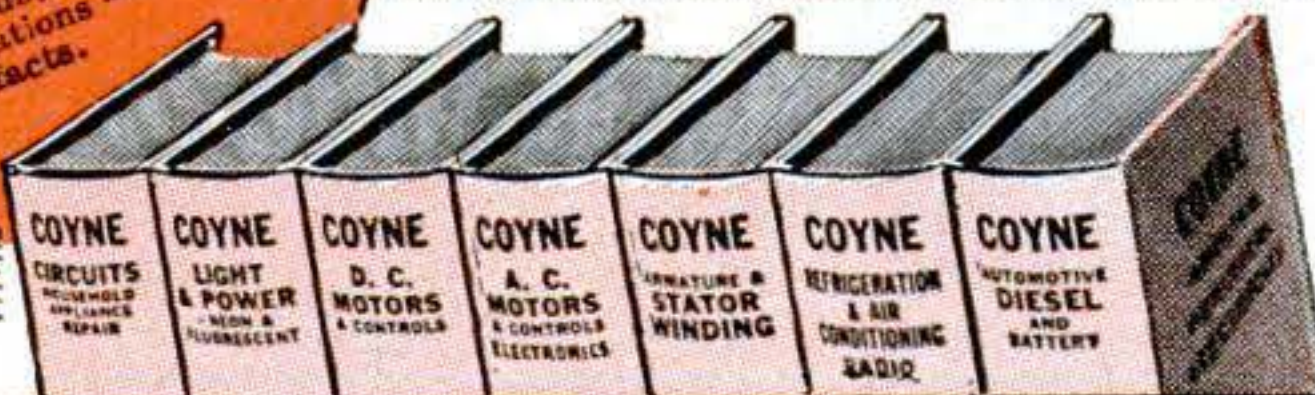

## FREE BOOK COUPON

B. W. Cooke, Dir., COYNE ELECTRICAL SCHOOL, Dept. 96-R8 500 S. PAULINA ST., CHICAGO 12, ILLINOIS

Send me the NEW 7 Volume COYNE APPLIED PRACTICAL ELECTRICITY. Also send the Bound Volume of 150 Shop Prints and Diagrams which I am to keep FREE whether I keep the 7 Book Set or not. I'll either return the 7 Book Set in 7 days and owe you nothing or pay \$3 within 7 days and \$3.00 a month until \$21 is paid, or I'll send the cash price of \$19.75. You also include FREE one full year of Consultation service and technical bulletins.

NAME \_\_\_\_\_ Age \_\_\_\_\_

ADDRESS \_\_\_\_\_

TOWN \_\_\_\_\_ Zone \_\_\_\_\_ STATE \_\_\_\_\_

Check here if you want to pay postman cash price of \$19.75 (you save \$1.25) delivered. Same 7 day examination privilege and Money-Back Guarantee.

# LEARN ISOGONIC DRAFTING

## The Drafting of Tomorrow

The first great advancement in Drafting in over 100 years!

INVESTIGATE this NEWEST development in the Drafting and Engineering fields. ISOGONIC Drafting opens up a NEW FRONTIER to those trained in its technique. Fits into EVERY branch of Engineering. ISOGONIC Drafting saves time and money, increases shop efficiency, steps up production. Pays well. Minimum background for success in this lucrative field—two years High School. Men now in drafting, by adding ISOGONIC Drafting to what they know now, become more capable, efficient and valuable. Spare time study at home. All texts and instruments furnished. For full details and descriptive folder, WRITE TODAY—give background of education and experience.

### ISOGONIC INSTITUTE

Dept. "S," 1095 Market Street, San Francisco 3, California

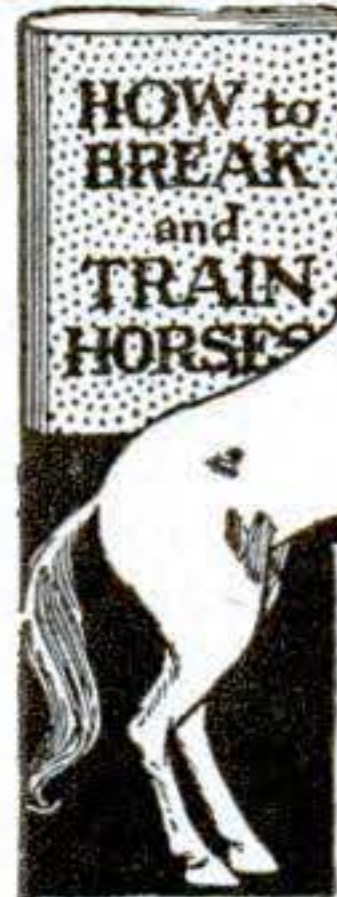

### SEND FOR THIS

# FREE!

Make money with horses. Every farmer, every lover of horseflesh should have a copy of this booklet. If you want to know how to break, train and make money with horses, write today for full information FREE, together with my special offer of a course in Animal Breeding. If you are interested in Gaiting and Riding the saddle horse check here.  Do it today—now. You'll never regret it.

BEERY SCHOOL OF HORSEMANSHIP  
Dept. 5812 Pleasant Hill, Ohio

# AVIATION Career

## MAXIMUM TRAINING IN MINIMUM TIME

CAL-AERO TECH TRAINING will add dollars to your pay check all the rest of your life. Specializing in AERONAUTICAL ENGINEERING and MASTER AVIATION MECHANICS since 1929, Cal-Aero Tech training is carefully designed for just one thing—TO MAKE MORE MONEY FOR YOU. An alumni of over 6000 successful graduates proves our career training is unsurpassed.

**VETERANS** —Write us about Aviation Training, as provided under "G.I. Bill of Rights."



**CAL - AERO TECHNICAL INSTITUTE**  
MAJOR C. C. MOSELEY PRES. SINCE 1929  
FORMERLY CURTISS-WRIGHT TECHNICAL INSTITUTE

GRAND CENTRAL AIR TERMINAL  
GLENDALE 1, CALIFORNIA  
LOS ANGELES COUNTY

## MAIL THIS COUPON TODAY!

Cal-Aero Technical Institute, Grand Central Airport, Glendale 1, California  
Please send full information on Aviation Training FREE—without obligation. Dept PS-12

Name \_\_\_\_\_ Birth Date \_\_\_\_\_

Street \_\_\_\_\_

City \_\_\_\_\_ State \_\_\_\_\_





# INVENTORS



The patent laws provide that any new and useful art, machine, article of manufacture, composition of matter, or design, or any new and useful improvement thereof, may be patented if the act of invention is involved. Therefore, every inventor with a valuable invention should take advantage of the patent laws and proceed for patent protection in order to safeguard his rights.

A patent gives the inventor the exclusive right to prevent others from making, using, or selling the invention claimed in the patent for a period of 17 years.

The patent laws were enacted for the benefit of the inventor to give him protection for the features of his invention which are patentable. These features must be properly and concisely set forth and claimed in a formal application for patent in order to comply with the requirements of the U. S. Patent Office. For that reason, the Patent Office advises the inventor to engage a competent registered patent attorney to prepare his application for patent and represent him before the U. S. Patent Office Examiner.

A specially prepared booklet containing detailed information with respect to patent protection and procedure will be forwarded to you without obligation upon request.

**Patents**

**Trademarks**

**Copyrights**

**Registered Patent Attorneys**

**CLARENCE A. O'BRIEN & HARVEY B. JACOBSON**  
Registered Patent Attorneys

62-M Adams Building, Washington 4, D. C.

Please send me booklet containing information regarding patent protection and procedure. This request does not obligate me.

Name \_\_\_\_\_

Address \_\_\_\_\_

City \_\_\_\_\_ State \_\_\_\_\_

(Please write or print plainly.)

**CLARENCE A. O'BRIEN**  
**& HARVEY B. JACOBSON**

62-M Adams Building ✚ Washington 4, D. C.

DEC. 15  
1946

Copyrighted material



# PROTECT YOUR NEW '46 or lengthen the life of Your '38 '39 '40 '41 or '42 with PYROIL

Pyroil adds life to your car by providing oil with the property of clinging to metal surfaces. Dry starts cause wear that leads to breakdown. Pyroil also reduces battery drain, removes carbon formations and sludge. Ask your gas station attendant to add Pyroil . . . he has it and recommends it.

### Pyroil for Aircraft Engines

Use Aircraft Pyroil B for lubricating oil, Aircraft Pyroil A for gasoline. Manufactured and Guaranteed by Pyroil Company, W. V. Kidder, Founder, 184 Main Street, La Crosse, Wisconsin.

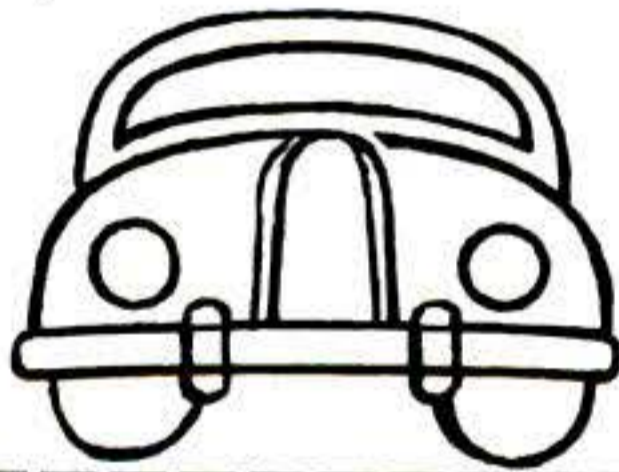

**PYROIL COMPANY**  
184 Main Street, La Crosse, Wisconsin

I want my car to last and run properly. Please tell me more about Pyroil and how it can accomplish this for me.

Name.....

Address.....

City or Town..... State.....



Jerry, the talking dog, is entertaining hospitalized veterans, by courtesy of the PYROIL Company. Picture of Jerry, sent on request.

## LETTERS

### Tricky Meters

Sir:

In your September article on how to read gas and electric meters—my daily job—I noticed that the examples did not include the thing that makes meter reading hard and catchy. Here is an example to show what I mean:

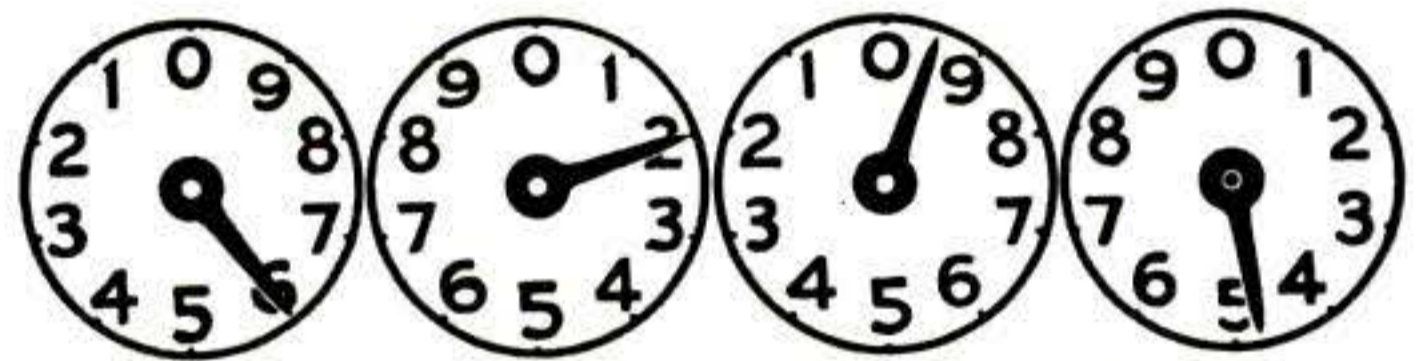

Many people would read it as 6294, but they would be wrong. It really reads 6194, because the second dial from the right has not reached the 0; so the third dial from the right is not a 2, as it appears, but is rightfully a 1. . . . I read an average of 160 meters a day, and I wager I'll find at least 20 of the tricky type. A hand can become loose at the pivot, causing it to slip ahead coming down from the 0 and fall behind on its way up after passing the 5.

HENRY HARRISON, JR.

Pawtucket, R. I.

Sir:

. . . The article states that the gas meters register 5,883,000 cubic feet for the four-dial meter and 328,000 for the three-dial meter. This is incorrect. The four-dial meter registers 588,300 cubic feet; the three-dial meter, 32,800 cubic feet. Incidentally, I read over 100,000 meters a year.

HERBERT ZIELKE

Bronx, N. Y.

*What with slipping hands and erroneous extra zeros, meter reading is tricky. PSM's thanks to two experts.*

### More Waste at Work

Sir:

Readers of your interesting article, "Putting Waste to Work in the Air," (PSM, July '46, p. 112) may be interested in another



# INVENTORS

• **T**he Rules of Practice of U. S. Patent Office advises—unless the inventor is qualified to handle such matters—that he employ the services of a competent Patent Attorney in the preparation of his Patent Application. We are Registered Patent Attorneys fully qualified to represent you at the Patent Office. Our long and varied experience in patent practice, we believe, enables us readily to understand inventors' disclosures, to advise what is probably patentable, after conducting preliminary patentability investigation of prior U. S. patents, and to draw your specifications and claims in such manner as to present clearly the novel features.

## Patent Laws Favor the Inventor Who Acts Promptly

Remember, the details of your invention do not have to be 100% perfect before you can obtain patent. Unwise inventors often

devote considerable unnecessary time working on unimportant details of their devices. This is expensive, hazardous and unnecessary. First step is to have us conduct search for the prior U.S. patents and render a report as to its patentability. Our Search Report is very valuable to you in that it clears up the course you should take in regard to your invention. If our Report is favorable, this report of the patentability of your device shows that your chances of patent protection are in your favor.

## Have Patent Protection First

Unless you safeguard your invention by obtaining a patent, thereby securing a monopoly on same, it may become "public property," free to be made, used and sold by anyone, or it may be patented by some other person.

## McMORROW, BERMAN & DAVIDSON

Registered Patent Attorneys  
142-Y Victor Building, Washington 1, D. C.

**COPYRIGHTS**

**PATENTS**

**TRADE MARKS**

### McMORROW, BERMAN & DAVIDSON

Registered Patent Attorneys

142-Y Victor Building, Washington 1, D. C.

Send me further particulars on how to protect my invention and "Invention Record" form at once. I understand that this request does not obligate me.

Name.....

Address.....

City.....State.....

-(Write or print name clearly)-

DEC. 17  
1946



Give yourself the Backing of a  
GREAT GROWING INDUSTRY



# REFRIGERATION AIR CONDITIONING

•Refrigeration and Air Conditioning have leading place in fast growing fields of our time. Trained men paid well to service, install, maintain, repair, rebuild household and commercial refrigerators. Important new developments such as Frozen Foods and many new industrial uses. Demand for commercial installations in restaurants, butcher shops, taverns, florists, bakeries, etc.—air conditioning in homes, offices, shops.



## START NOW—Full and Part Time Earnings

There may never again be such opportunities for men who want better jobs or business of their own to get in on ground floor and go up fast!



Many started with small investment who built good, growing business. If over 17 and under 60 learn how you can get started. CONSULTATION AND PLACEMENT SERVICE WHETHER YOU ARE INTERESTED IN WORTHWHILE JOB OR SETTING UP YOUR OWN BUSINESS.

## Begin Training at Home or Come Directly to Shops

Begin your training at home in spare time, finish in our big, modern shops, or come directly to shops. At home you get C.T.I.'s SHOP PROVED HOME STUDY instruction—actual shop experience has gone into the practical lesson assignments. That is why it is easy for mechanically inclined men to learn by our Home Study training and start on actual refrigeration work.



## A NATIONALLY KNOWN INSTITUTION

C.T.I. was only civilian school selected by Army to train service men for refrigeration. Same quality training available to you now. The method that has made rapid progress possible. Commercial Trades Institute has established its place in Air Conditioning and Refrigeration Industries, and that is important to you in making your start.

## VETERANS

Veterans qualifying under "G.I. Bill" have all expenses paid by Government plus monthly subsistence allowance. Just mail coupon, we will handle all details. (LOW TUITION, EASY TERMS if you are not a veteran.)

Commercial Trades Inst., Dept. A-112  
1400 W. Greenleaf Ave., Chicago 26, Ill.



**FREE**—Important Information Telling How to Get Started  
CUT COUPON ALONG THIS LINE

→ **Fill Out, Cut Out, Mail Today** ←

**FACTS FREE for Men Who Want to Get Ahead**  
COMMERCIAL TRADES INSTITUTE, Dept. A-112,  
1400 W. Greenleaf, Chicago 26, Ill.

Send free illustrated Brochures and other information about Refrigeration and Air Conditioning.

Veteran  Non Veteran

NAME.....

ADDRESS.....

CITY.....STATE.....

function of escaping gases that we have utilized in our FR-1 Fireball—"jet pump augmented cooling." Basically, this amounts to getting extra cooling for your engine by exhausting the engine gases just within the edge of the cooling air exit slots. As the hot exhaust rushes from the stacks, it pulls some of the air surrounding the stacks along with it in a sort of jet pump action. As the air at the rear of the engine nacelle rushes out with the engine gases, a partial vacuum is created near the forward section of the engine that helps pull more cooling air through the cowling and past the cylinders.

One of the reasons why we were able to enclose the forward engine of the Fireball so completely was this augmented cooling by jet pump action. We also used jet thrust from the exhaust to get added speed. It sounds almost like the story of using every part of a pig in the slaughterhouse.

WILLIAM P. BROTHERTON

Technical Editor  
Ryan Aeronautical Company  
San Diego, Calif.

## No Grading Ring

Sir:

In your October issue, an illustrated write-up regarding our ball-grading machine . . . referred to "grading rings" whereby the steel balls are guided to numbered chutes. . . . The picture to which you referred represents an exaggerated cross-section of a ball bearing, showing the result of using one oversized ball in a bearing assembly.

WHIT HILLYER

Bell & Howell Company  
Chicago, Ill.

*PSM stands corrected.*

## Light on Filters

Sir:

. . . What prompted me to write this letter was Kenneth S. Johnson's article, "Filters . . . Magic Eyes of Photography," in your September 1946 issue. I have read quite a bit on this matter in other books and have talked to salesmen about filters. Still, my mind wasn't too clear on this theory—until Mr. Johnson's article put the light on in my mind. His method of explaining is very clear and concise. . . .

EDWARD GRAY

Jersey City, N. J.



**AUDELS REFRIGERATION & AIR CONDITIONING GUIDE.....\$4**

New from Cover to Cover—1280 Pages, Fully Illus. Covering basic principles, servicing, operation & repair of household, commercial & industrial refrigeration & air conditioning. A gold mine of essential important facts for engineers, servicemen, users.

**AUDELS CARPENTERS & BUILDERS GUIDES—4 Vols. ....\$6**

A practical illustrated trade assistant on modern construction for carpenters, joiners, builders, mechanics and all woodworkers. 4 vols., 1600 pages, 3700 illustrations, flexible covers. Pocket size. Each volume sold separately \$1.50 a vol.

**AUDELS AUTOMOBILE GUIDE.....\$4**

A practical quick ready reference book for auto mechanics, service men, operators & owners. Explains theory, construction & servicing of modern motor cars, trucks, buses & auto type Diesel engines. 1540 pages, fully illustrated. 55 chapters. Indexed. A standard book for mechanics. New fluid drive covered.

**AUDELS DIESEL ENGINE MANUAL.\$2**

A practical, concise treatise with questions and answers on the theory, operation and maintenance of modern diesel engines including General Motors 2 cycle Diesel. 384 pages, fully illus., flexible binding, pocket size. All details plainly brought out, this book is of extreme value to engineers, operators & students.

**AUDELS WIRING DIAGRAMS.....\$1**

210 Pages. Illustrated. Gives practical facts on wiring of electrical apparatus. It shows clearly how to wire apparatus for practically all fields of electricity. Each diagram is complete & self-explanatory. Highly Endorsed Pocket Companion.

**AUDELS PLUMBERS & STEAMFITTERS GUIDES—4 Vols. ....\$6**

A Practical Trade Assistant & Ready Reference. Explains in plain language & by clear illustrations, diagrams, charts, graphs, pictures principles of modern plumbing practice including Marine Pipe Fitting and Air Conditioning. 4 Vols.—1670 Pages—3642 Diagrams. Pocket size. Each Vol. Sold Separately \$1.50 a Vol.

**AUDELS SHEETMETAL WORKERS HANDY BOOK.....\$1**

Practical inside information. Fundamentals of Sheet Metal Work. 888 pages. Illustrated. 11 sections. Clearly written. Essential & important facts, figures, pointers in everyday language. Ref. Index.

**AUDELS SHEETMETAL PATTERN LAYOUTS.....\$4**

Developed by Experts for Sheet Metal Workers, Layout Men & Mechanics. A Practical Encyclopedia in 10 Sections, size 7 x 10 x 2—1125 Pages—350 Layouts—1600 Illustrations. 1001 Key Facts. Fully indexed for ready reference in answering your layout problems. Covers all phases of sheet metal work including Pattern Cutting, Pattern Development & Shop Procedure.

**AUDELS ANSWERS ON BLUE PRINT READING.....\$2**

For Mechanics & Builders. Covers all types of blue print reading including ship & airplane. 376 pages, fully illustrated.

**AUDELS NEW MACHINIST & TOOLMAKERS HANDY BOOK...\$4**

Covers modern machine shop practice in all its branches. 5 practical books in 1. New from cover to cover. Tells how to set up & operate lathes, screw and milling machines, shapers, drill presses and all other machine tools. 1600 pages, fully illustrated, 5 x 6 1/2 x 2. Indexed. 5 sections. 1—Modern Machine Shop Practice. 2—Blue Print Reading & How to Draw. 3—Calculations & Mathematics for Machinists. 4—Shop Physics. 5—How to Use the Slide Rule. 60 chapters. Easy to read and understand. A shop companion that answers your questions.

**AUDELS MATHEMATICS & CALCULATIONS FOR MECHANICS \$2**

Mathematics for home study or reference. 700 pages, 550 illus. Practical mathematics from beginning. How to figure correctly. Easy, correct methods covering a complete review. Ill. & Indexed.

**AUDELS HANDY BOOK OF PRACTICAL ELECTRICITY.....\$4**

For maintenance engineers, electricians & all electrical workers. 1440 Pages, 2600 Illus. Covers important electrical information in handy form—including Marine Wiring, Radio Principles, Welding. Indexed. A Key to a practical understanding of electricity.

**AUDELS RADIOMANS GUIDE.....\$4**

A key to the practical understanding of radio including Frequency Modulation, Television, etc., Aircraft & Marine Radio. For radio engineers, servicemen, amateurs. 772 pages. 400 Illustrations & Diagrams. Photos. Review Questions & Answers, Reference Index. Authentic, clear, concise.

**AUDELS ELECTRONIC DEVICES...\$2**

Tells What You Want to Know About Electric Eye. Easily Understood. Covers photo-electric cells & their applications. Amplifiers, illumination, frequencies, voltage, photocell, tubes, Ohm's Law, wiring diagrams, etc.

**AUDELS WELDERS GUIDE.....\$1**

A concise, practical text on operation & maintenance of all welding machines for all mechanics. Over 400 pages, illustrated. Covers all methods of electric and acetylene welding including airplane work.

**AUDEL, Publishers, 49 W. 23 St., N. Y. 10**

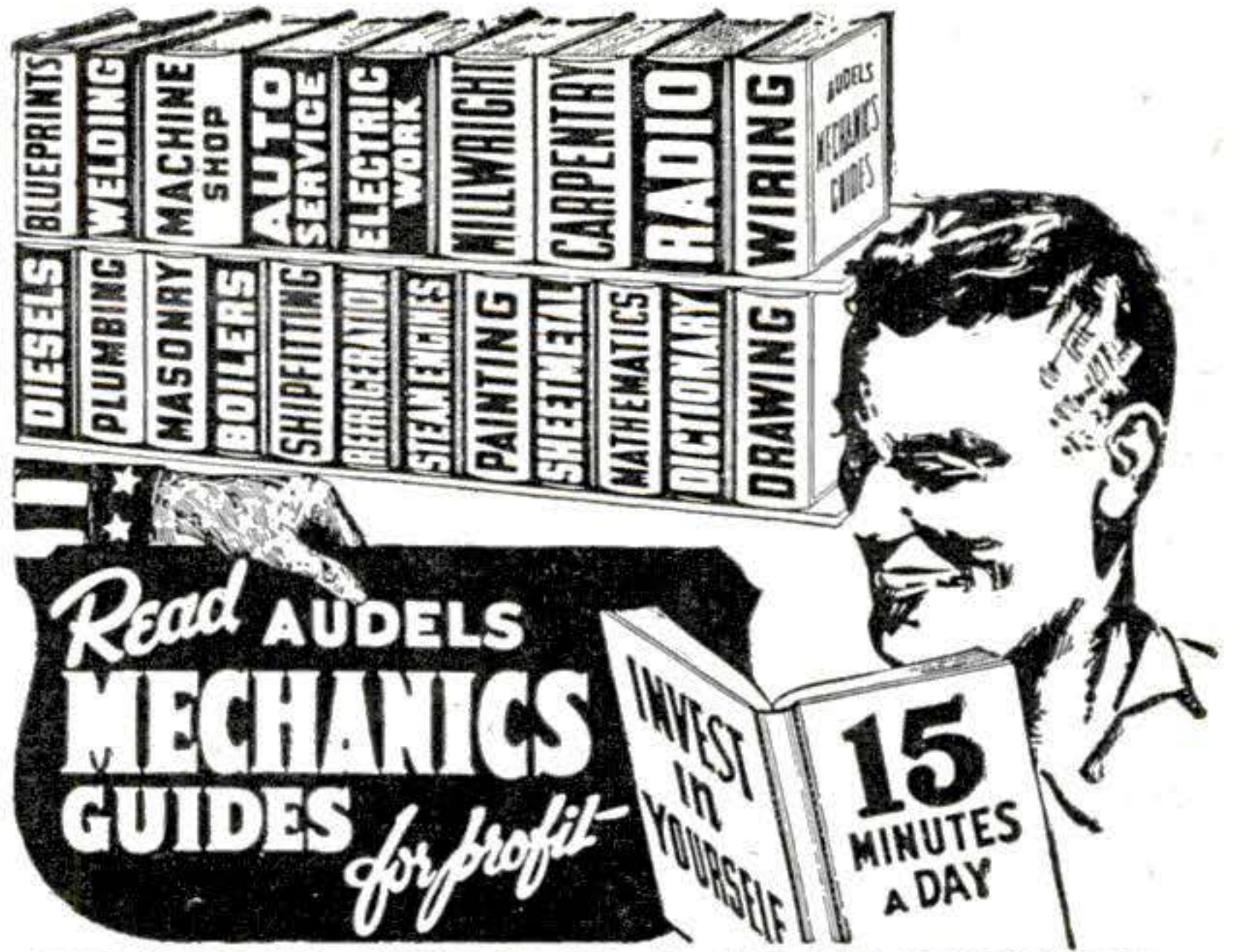

**AN AUDEL GUIDE IS A GOOD FRIEND!**

Use the brains and experience of others in these Guides of the Trades. Save time and money with right methods, short cuts, labor saving ideas. CHECK NOW! You can look over any Audel Guide in your home. Start the Easy Payments if satisfied.

**CUT HERE MAIL ORDER**

**THEO. AUDEL & CO., 49 W. 23 St., New York 10, N.Y.**

Please mail me for 7 days' free examination the books marked (X) below. I agree to mail \$1 in 7 days on each book or set ordered, and to further mail \$1 a month on each book or set ordered until I have paid purchase price.

If I am not satisfied with Guides I will return them.

- Audels OIL BURNER GUIDE . . . . . \$1.
- Audels REFRIGERATION & Air Conditioning Guide. 4.
- Audels POWER PLANT ENGINEERS GUIDE . . . . . 4.
- Audels PUMPS, HYDRAULICS & AIR COMPRESSORS . . . . . 4.
- Audels WELDERS GUIDE . . . . . 1.
- Audels BLUE PRINT READING . . . . . 2.
- Audels SHEET METAL WORKERS Handy Book . . . . . 1.
- Audels SHEET METAL PATTERN LAYOUTS . . . . . 4.
- Audels AIRCRAFT WORKER . . . . . 1.
- Audels MATHEMATICS and CALCULATIONS . . . . . 2.
- Audels MACHINISTS & TOOLMAKERS Handy Book . . . . . 4.
- Audels MECHANICAL Dictionary . . . . . 4.
- Audels AUTOMOBILE GUIDE . . . . . 4.
- Audels DIESEL ENGINE MANUAL . . . . . 2.
- Audels MARINE ENGINEERS Handy Book . . . . . 4.
- Audels SHIPFITTERS Handy Book . . . . . 1.
- Gueths MECHANICAL DRAWING COURSE . . . . . 1.
- Rogers DRAWING and DESIGN . . . . . 2.
- Audels MILLWRIGHTS and Mechanics Guide . . . . . 4.
- Audels CARPENTERS and Builders Guides (4 vols.) . . . . . 6.
- Audels PLUMBERS and Steamfitters Guides (4 vols.) . . . . . 6.
- Audels MASONS and Builders Guides (4 vols.) . . . . . 6.
- Master PAINTER and DECORATOR . . . . . 2.
- Audels GARDENERS & GROWERS GUIDES (4 vols.) . . . . . 6.
- Audels ENGINEERS & FIREMANS EXAMINATIONS . . . . . 1.
- Audels ENGINEERS and Mechanics Guides Nos. 1, 2, 3, 4, 5, 6, 7 and 8 complete . . . . . 12.
- Audels Answers on Practical ENGINEERING . . . . . 1.
- Audels ELECTRICIANS EXAMINATIONS . . . . . 1.
- Audels WIRING DIAGRAMS . . . . . 1.
- Audels Handy Book of PRACTICAL ELECTRICITY . . . . . 4.
- Audels ELECTRICAL POWER CALCULATIONS . . . . . 2.
- Audels ELECTRONIC DEVICES . . . . . 2.
- Audels ELECTRIC Dictionary . . . . . 2.
- Audels RADIOMANS GUIDE . . . . . 4.
- Audels NEW ELECTRIC LIBRARY at \$1.50 a Volume Vols. I, II, III, IV, V, VI, VII, VIII, IX, X, XI, XII

Name \_\_\_\_\_  
 Address \_\_\_\_\_  
 Occupation \_\_\_\_\_  
 Employed by \_\_\_\_\_ PSM



**"I'll show YOU  
how to make yourself  
COMMANDO-TOUGH**

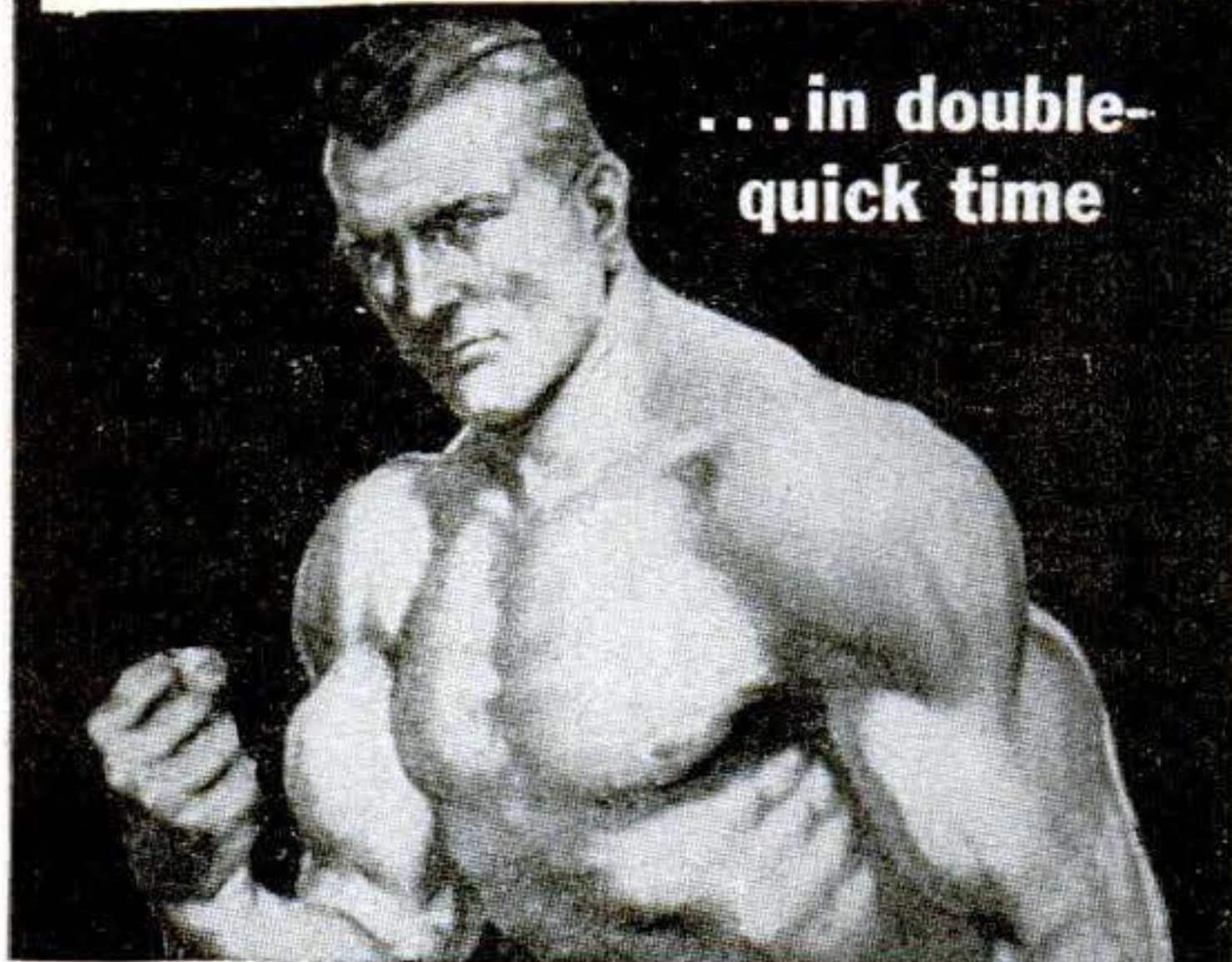

**...in double-  
quick time**

**...OR IT WON'T COST YOU A CENT!"**

*says George F. Jowett*

**WORLD'S GREATEST BODY BUILDER**

Let me prove to YOU that you can put inches of dynamic muscles on your arms! Add inches to your chest! Broaden your shoulders and power-pack the rest of your body. I can do for you what I've done for thousands the world over, including many officers and men now in the U. S. and British Armed Forces!

**GIVE ME 10 MINUTES A DAY!**

**I'll Show You My Secrets Of Body Building**

I'll help you learn the "Progressive Power Method" through which I rebuilt myself from a physical wreck to the holder of more strength records than any other living athlete or teacher! No matter how skinny or flabby you are, you can learn my methods right in your own home. Through my proved secrets I show you how to develop your power, inside and out, until YOU are fully satisfied that you are the man you want to be. "The Jowett System," says R. F. Kelly, Atlantic City, Physical Director, "is the greatest in the world!"

**PROVE TO YOURSELF  
IN ONE NIGHT!**

Send only 25c for test Course, "Molding a Mighty Arm." Read it the evening it arrives—learn from experience the thrill you can give your muscles!

**SEND FOR THESE FIVE FAMOUS  
COURSES IN BOOK FORM**

**ONLY 25c EACH  
or ALL 5 for \$1.00**

**BOOK WITH PHOTOS OF FAMOUS STRONG MEN  
MAIL COUPON NOW**

**FREE**

If you want a physique that will inspire respect from men, and admiration from women... **ACT LIKE A HE-MAN!** Decide at once! The famous book, "Nerves of Steel—Muscles Like Iron" will be included **FREE!** Priceless for the strength fan! Full of photos of marvelous power-bodied men who will show you what Jowett has done for them and how he can do the same for you. Reach out... Grasp this Special Offer today!

Jowett Institute of Physical Culture  
230 Fifth Avenue  
Dept. PS-69  
New York 1, N. Y.

*This  
Book  
Free!*



Jowett Institute of Physical Culture  
230 Fifth Avenue, Dept. PS-612, New York 1, N. Y.

George F. Jowett: Your proposition looks good to me. Send by return mail, prepaid, the courses checked below, for which I enclose ( ). Include **FREE** book of PHOTOS.

George F. Jowett  
Champion of  
Champions

- All 5 courses for.... \$1
- Molding Mighty Legs 25c
- Molding a Mighty Arm 25c
- Molding a Mighty Grip 25c
- Molding a Mighty Back 25c
- Molding a Mighty Chest 25c
- Send all 5 C.O.D. (\$1 plus postage.) No orders less than \$1 sent C.O.D.

NAME..... Age.....  
(Please print plainly. Include Zone Number.)

ADDRESS.....

20 POPULAR SCIENCE

**MODERN SHOP TRAINING  
APPLIANCES  
SERVICE  
REPAIR • INSTALL**

Active and growing field for men who want good jobs or business of their own. Practical shop training on all kinds of appliances—washers, ironers, mixers, heaters, vacuum cleaners, stoves. Learn polishing, plating, motor rewinding, welding, how to use precision and necessary power tools. Good pay for repairing, maintaining, servicing, installing, selling electric appliances. Chance to get in on ground floor, go up fast! If over 17 and under 60 learn how you can get started. Write for **FREE FACTS** today. If a Veteran, we'll take care of all details if you qualify under G. I. Bill.

**APPLIANCE TRAINING SCHOOL, DEPT. C-112  
6312 N. Broadway, Chicago 40, Illinois**



**Learn to Repair  
ELECTRIC  
APPLIANCES**

**WRITE  
TODAY  
for  
FREE  
BOOK**

Prepare now for a permanent future, independence and security with a business of your own. Our practical, easy-to-learn home course teaches you, during your spare time, how to repair washing machines, vacuum cleaners, electric ranges, lamps, motors, irons, etc., and do house wiring. Also how to get started on little capital. Write today for **FREE BOOKLET**. No obligation.

**PACIFIC TRAINING SCHOOL  
7217 S. Broadway, Dept. S-12, Los Angeles 3**

**LAW**

**STUDY AT HOME for PERSONAL SUCCESS and LARGER EARNINGS.** 38 years expert instruction—over 108,000 students enrolled. LL.B. Degree awarded. All texts furnished. Easy payments. Send for **FREE BOOK**—"Law and Executive Guidance"

**AMERICAN EXTENSION SCHOOL OF LAW  
Dept. 72-S, 646 N. Michigan Ave., Chicago 11, Ill.**

**ACCOUNTING**

**STUDY AT HOME for C.P.A. and BIG PAY Accounting opportunities with 42 year old school.** No previous training needed. Texts furnished. **EASY PAYMENTS.** Send for **FREE BOOK.**

**MacCORMAC EXTENSION SCHOOL  
Dept. 10-C 1170 E. 63rd St., Chicago 37, Ill.**



**APTITUDE TESTS**

discover the kind of work or studies best for your success! You get a personal report—a guide for life—more happiness—more prosperity. (for men, women, boys, girls.) Write for complete facts.

**VOCATIONAL COUNSELING INSTITUTE  
5057 Woodward Ave., Detroit 2, Michigan**

**WAR SURPLUS**

Without bidding, new products, stock articles, how to buy, prices, addresses. Advance information. Catalog sheets, free literature. If you want sample catalog sheets by return mail include \$1.00. **THE WAYNE ENGINEERING COMPANY, Dept. 1112, Greenville, Ohio**

**MONEY for MEN ALL DATA FREE**

THE PLASTEX Industry needs manufacturers on small scale and for big production of Lamp and Clock Stands. Art Goods and Novelties in Plastex and Marble imitation. Experience unnecessary. 1/2c material makes regular 10c store sellers. Rubber moulds furnished for speed production. Small investment brings good returns. Big chain store orders now being placed. Ambitious men have chance for real prosperity. Our Free booklet will interest and benefit you.

**PLASTEX INDUSTRIES, Dept. 2, 1085 Washington Av., New York 56, N.Y.**



# NOW SPRAYBERRY RADIO TRAINING

GIVES YOU

# 8 BIG KITS OF RADIO EQUIPMENT

WITH A COMPLETE 6 TUBE SUPER-HETERODYNE RECEIVER

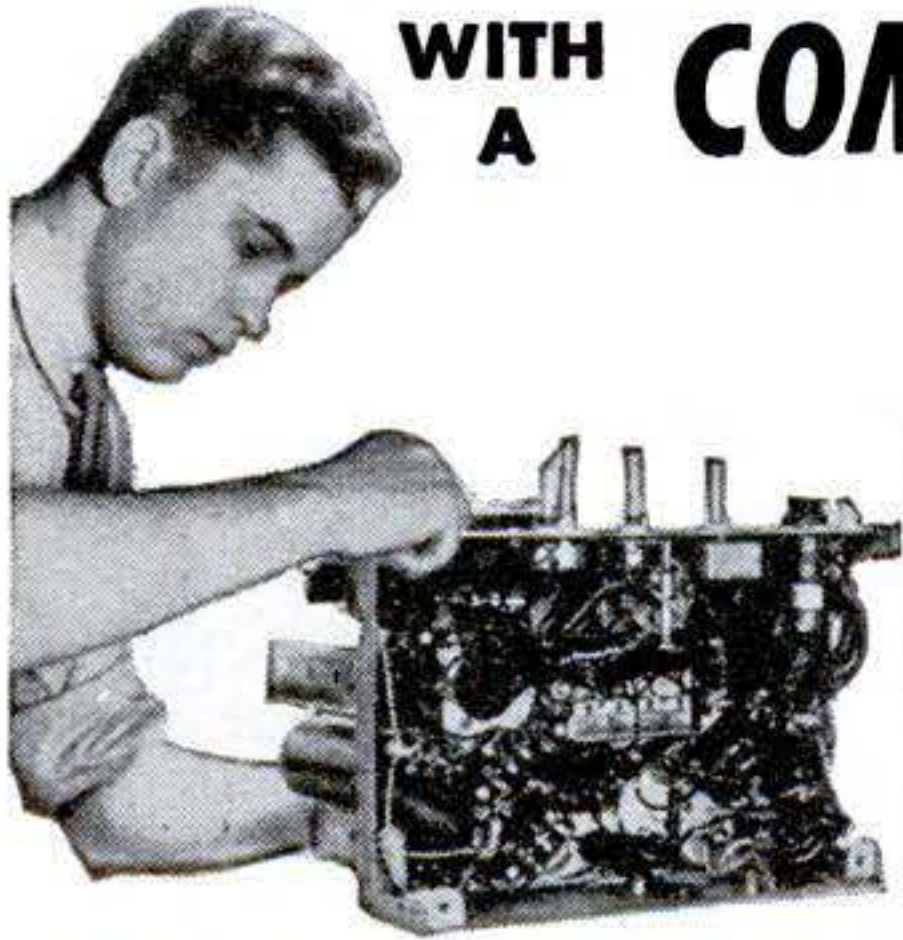

**YOU LEARN RADIO SERVICING THROUGH INTENSIVE "SHOP-BENCH" PRACTICE**

## YOU DO EXPERIMENTS, CONSTRUCTION, TROUBLE-SHOOTING

I'll show you how to perform over 175 instructive Experiments—how to build countless Radio Circuits. You'll learn a new, fast way to test Radio Sets without mfg. Equipment.



I give you a fine, moving-coil type Meter Instrument on Jewel Bearings—with parts for a complete Analyzer Circuit Continuity Tester. You learn how to check and correct Receiver defects with professional accuracy and speed.

You'll get valuable experience and practice building this Signal Generator and multi-purpose Tester. Makes a breeze out of fixing Radios and you don't have to spend money on outside, ready-made equipment.



Soldering, wiring, connecting Radio parts . . . building circuits with your own hands—you can't beat this method of learning. When you construct this Rectifier and Filter, Resistor and Condenser Tester, etc., you get a really practical slant on Radio that leads to a money-making future.



## HERE'S THE LATEST, SIMPLEST WAY TO TRAIN at HOME for a GOOD LIVING in RADIO-ELECTRONICS & TELEVISION

I train your mind by putting you to work with your hands on a big 6-Tube Superheterodyne Receiver. And, believe me, when you get busy with real Radio Parts — 8 big Kits of them — you really LEARN Radio and learn it RIGHT! You get the practical stuff you need to be useful in Radio, and that's what it takes to make money. You don't have to worry about what to do with these 8 Kits of Parts. Step by step, I show you how to build circuits, test, experiment, trouble-shoot. And you don't need any previous experience. The Sprayberry Course starts right at the beginning of Radio! You can't get lost! Simplified lessons, coupled

with real "Shop" practice, makes every subject plain and easy to understand and remember.

### A BUSINESS OF YOUR OWN . . . OR A GOOD RADIO JOB

Soon after you begin Sprayberry Training, I'll send you my sensational BUSINESS BUILDERS. You'll find out how to get and do neighborhood Radio repair jobs for nice profits and rich experience while learning. This sort of work can easily pave the way for a Radio Service business of your own. But with Sprayberry Training, you're not limited. You can swing into any one of the swiftly expanding branches of Radio-Electronics INCLUDING Radio, Television, FM, Radar, Industrial Electronics. Be wise! Decide now to become a fully qualified RADIO-ELECTRONICIAN. Get full details about my Training at once! Mail coupon below for my 2 big FREE Books.

## SEND FOR THESE FREE BOOKS



### "How to Read Radio Diagrams and Symbols"

Here's a valuable and wonderfully complete new book which explains in simple English how to read and understand any Radio Set Diagram. Includes translation of all Radio symbols. Send for this volume at once! It's free! Along with it, I will send you another Big Free book describing in detail my Radio-Electronic Training.

### SPRAYBERRY ACADEMY OF RADIO

F. L. Sprayberry, President, Room 55126 Pueblo, Colorado

Please rush my FREE copies of "How to MAKE MONEY in RADIO, ELECTRONICS and TELEVISION," and "HOW to READ RADIO DIAGRAMS and SYMBOLS."

Name ..... Age .....

Address .....

City ..... State .....

(Mail in envelope or paste on penny postcard)

**MAIL COUPON TODAY!**



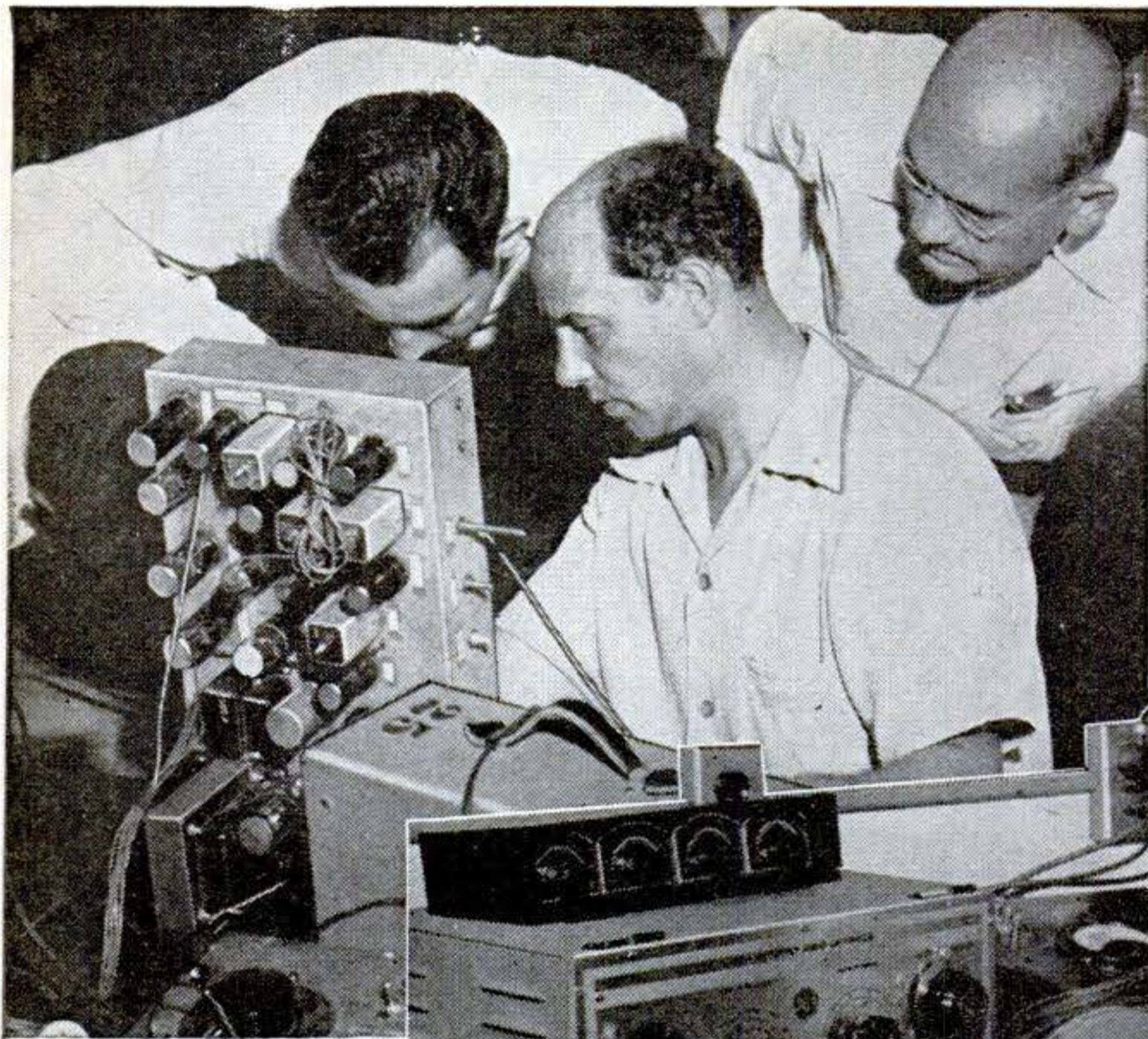

Individual instruction is necessary in teaching television. Here an instructor helps a student. Each student must build 7 radio sets before he is allowed to start on a television set.

Expert Television Technician, Bob Cohen, using \$625.00 RCA Sweep Generator to check television set for engineering inaccuracies. It is expected that television test equipment will be reduced in cost as the television industry gets into its stride.

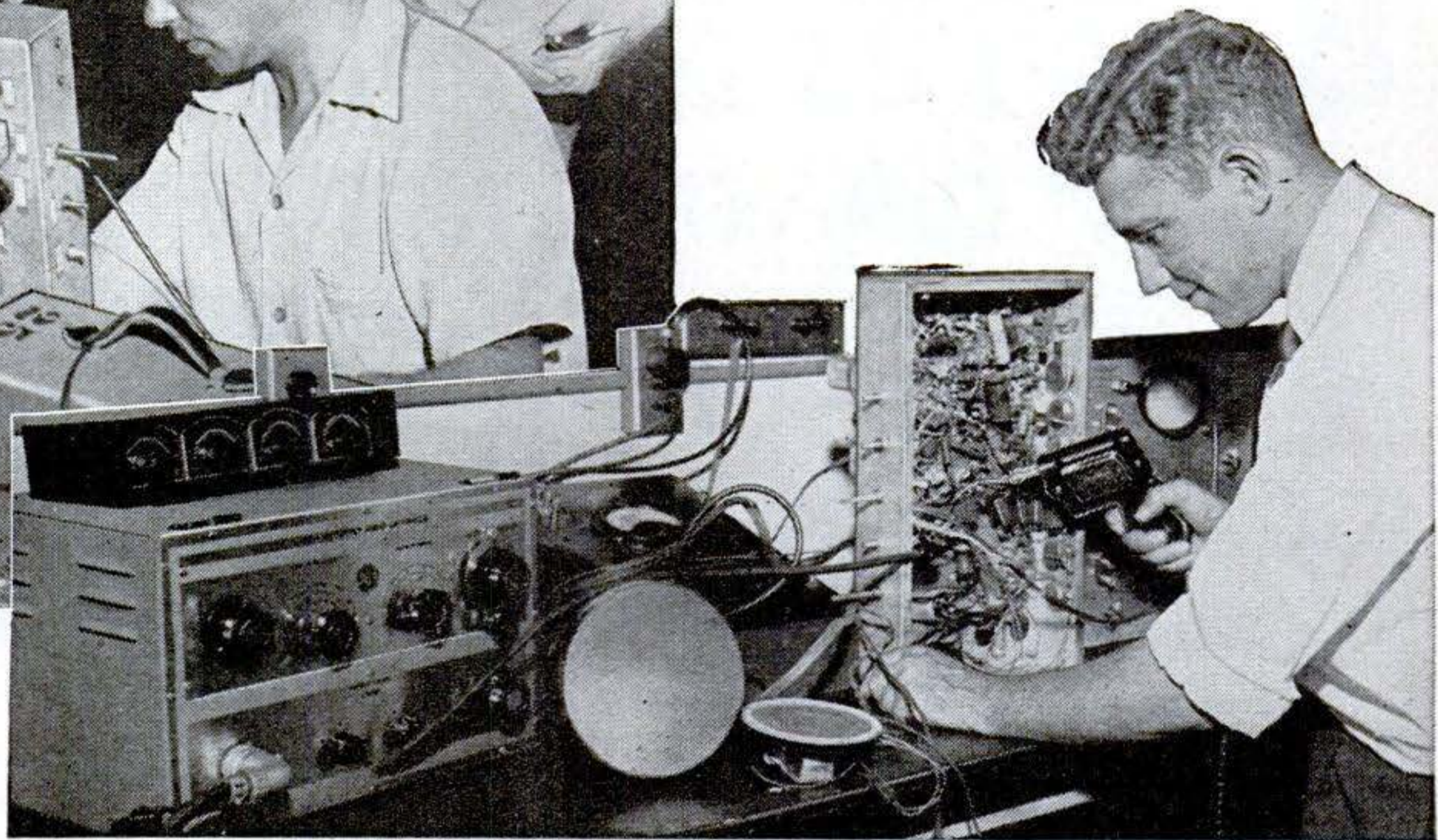

# THEY BUILT THEIR OWN

**M**ANY veteran students are now attending N.Y.T.I. of N.J. under the generous provisions of the G.I. Bill of Rights, which allows any approved school of the veteran's choice to charge the Veterans Administration up to \$500 a school year against the educational expenses of qualified veteran students. Full-time students, with dependents, are also paid a sub-

Student Walter E. Stevens, making engineering checks with \$395.00 United States Television Sweep Generator. The school is lavishly equipped with the most advanced test equipment.

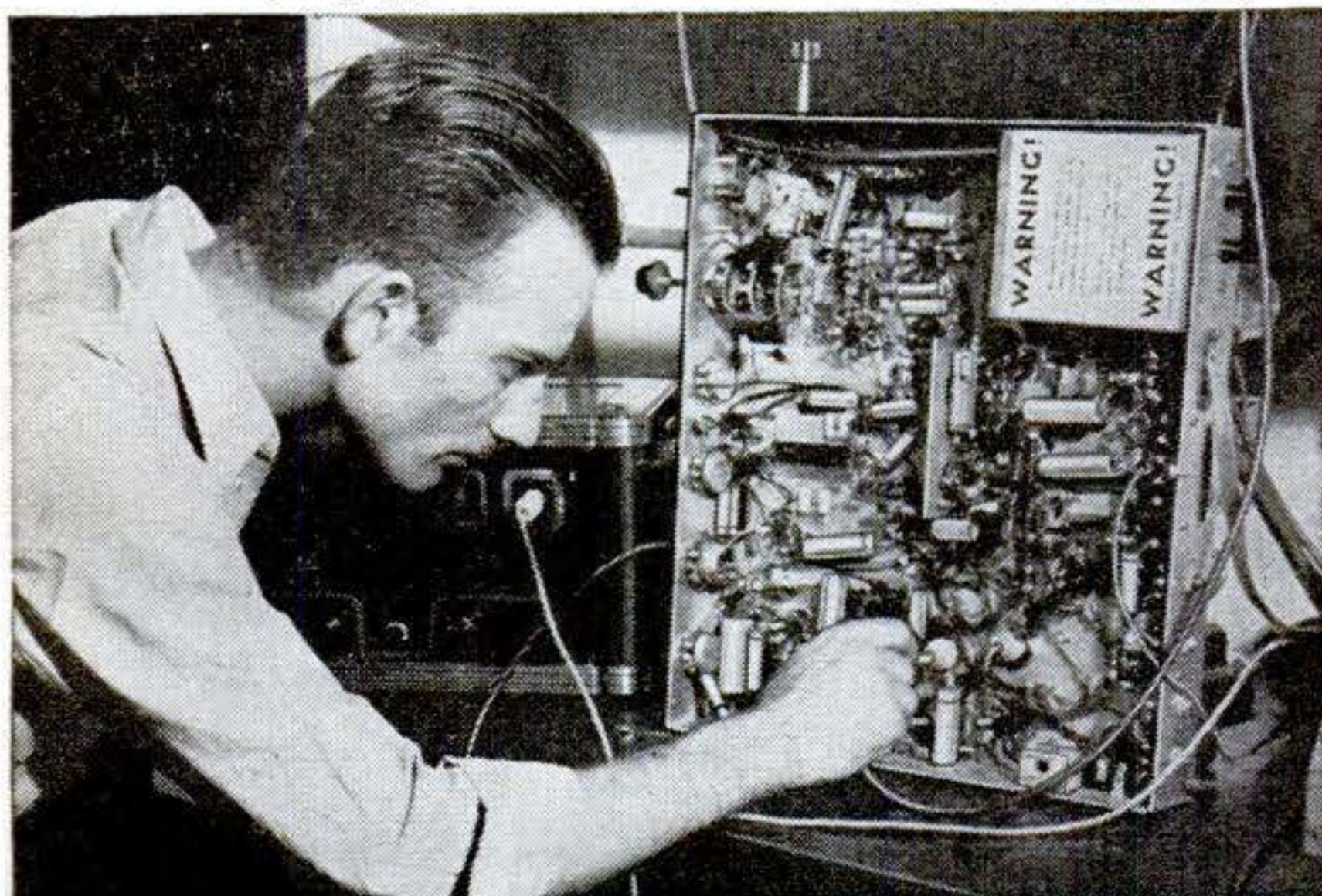

sistence allowance of \$90 monthly by the VA, and those without dependents, \$65. Many students hold part-time jobs, thus augmenting their monthly payments. However, you do not have to be a veteran to be accepted as a student.

A considerable number of out-of-state students attend the school because of its excellent, practical type of radio and television courses, so difficult to get anywhere else in the world today. Living quarters are obtainable by single students, but married students report considerable difficulty in finding quarters for their families.

No high-school diplomas are required. Every student must have at least a grammar-school education; however. And the school requires that a student be earnest, sincere and technically inclined. Students without proper mathematical backgrounds are taught the radio and television mathematics they need.

You probably have been wondering what N.Y.T.I. of N.J. means. It stands for the New York Technical Institute of



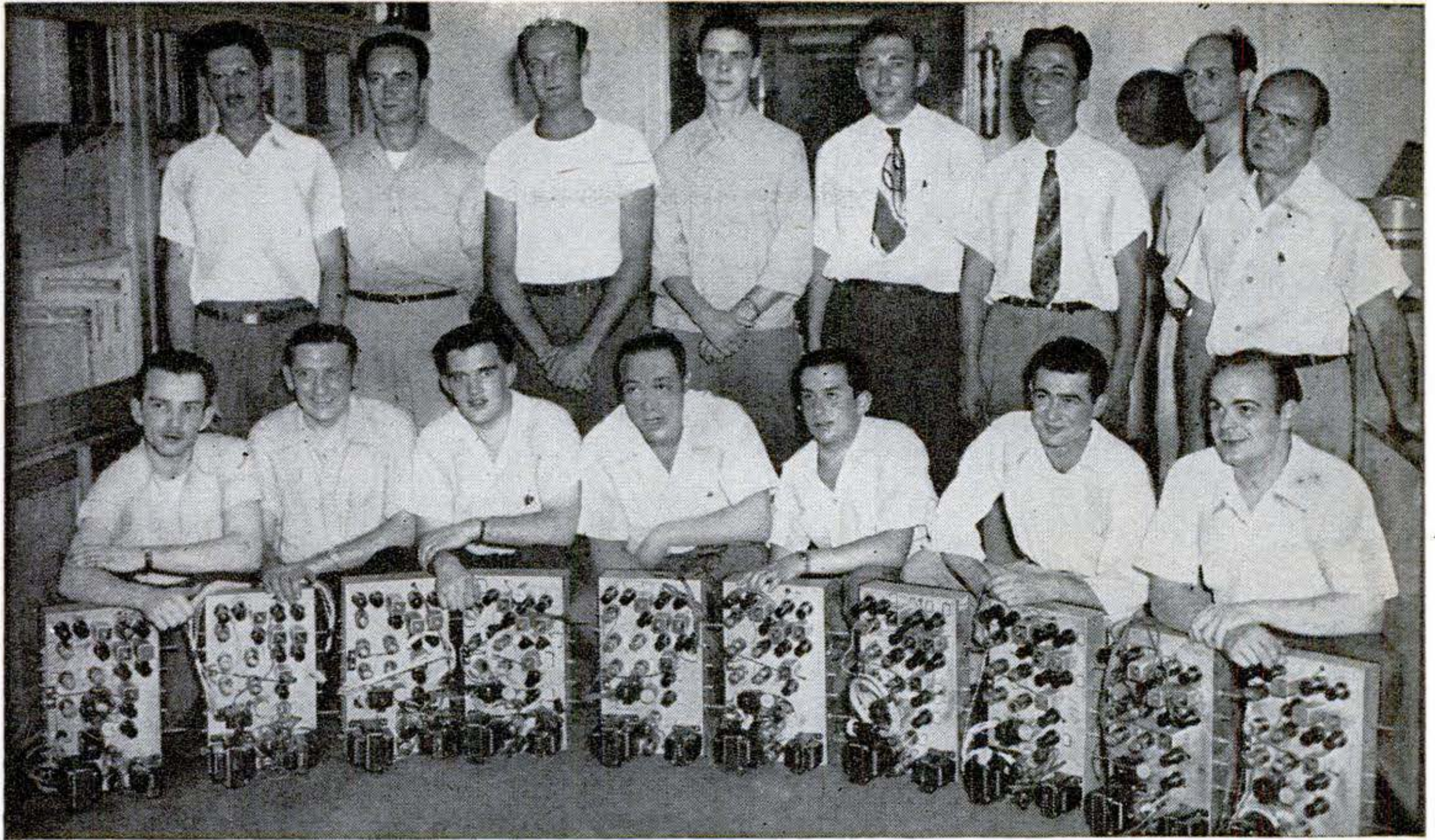

An Advanced Class in Television at N.Y.T.I. of N.J., famous television school, and the 17-tube television sets they built. Students at this school have been building television sets as part of their courses since 1939, when television programs were first broadcast regularly. School officials

found that this practical method of instruction is productive of very satisfactory results. Each student may build a set and keep it to use in his own home laboratory, if he chooses to. The school is located in the heart of the radio, television, electronics industry.

# TELEVISION RECEIVERS!

New Jersey, a resident school located in Newark, N. J., just across the river from New York City (Only 20 minutes from Broadway by subway or train). The school is located in the heart of America's great radio and electronics industry. Such leading television, radio and electronics manufacturers as Western Electric, Du Mont, Federal and Edison are nearby. Newark also is near Radio Stations WJZ, WEAJ, WABC and WOR; each a leader in broadcasts going on networks all over the country. This means that the school offers numerous advantages, as it is in touch with most recent developments in radio and television. This also means that qualified radio and television engineers are available to the school for teaching purposes.

During the war N.Y.T.I. of N.J. was approved for the training of Signal Corps personnel by the Army. When the war ended the enrollment increased because of the influx of veterans desirous of getting practical television training. At the present time, there are

120 openings for new students for the several classes beginning in October & November 1946.

The school issues a special Bulletin, Numbered 312, which illustrates and describes its facilities and equipment and shows students using its varied laboratory equipment. Bulletin 312 also describes classes that may be attended, housing conditions, costs, hours, etc. To get complete information write for Bulletin 312 (for which no charge is made) to the New York Technical Institute of New Jersey, 158 Market Street, Newark, New Jersey.

A line of RCA television receivers used for comparative test purposes at N.Y.T.I. of N.J.

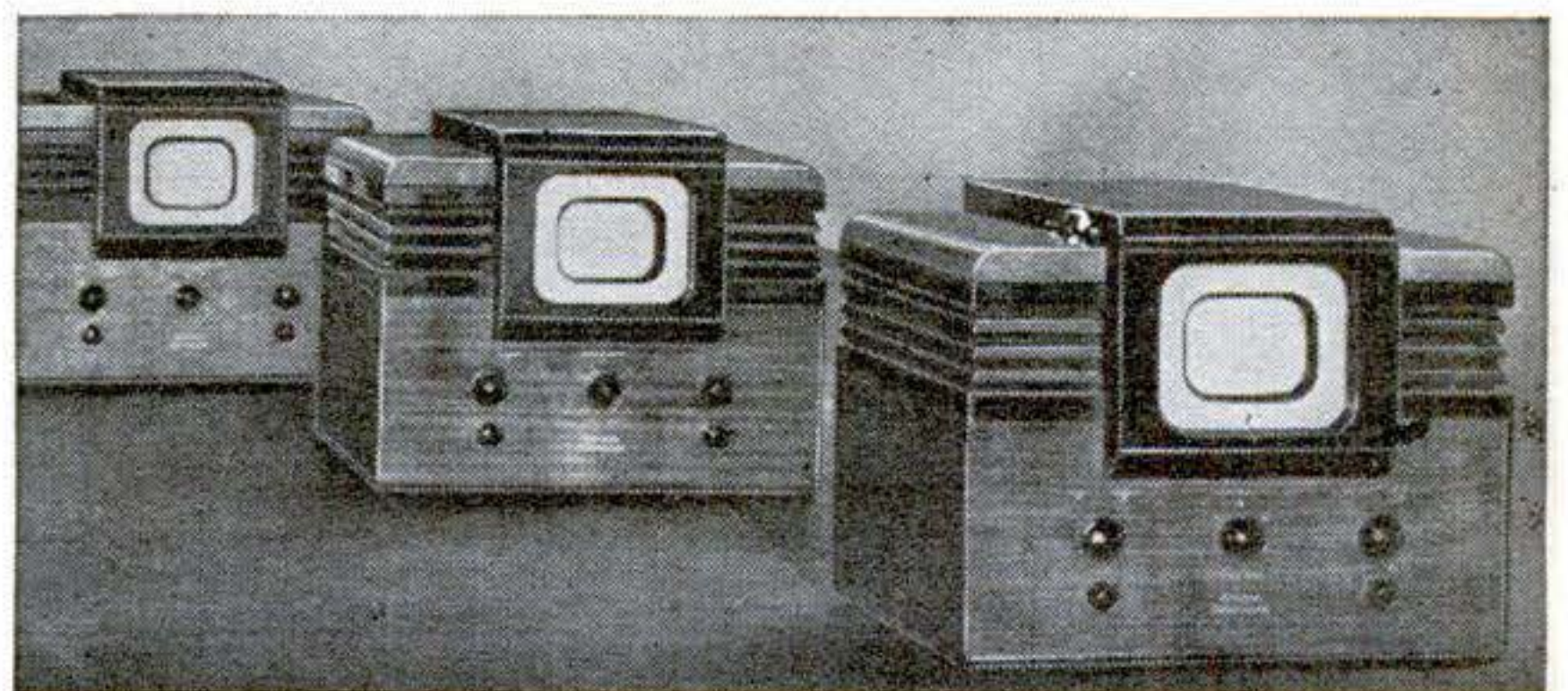

Advertisement

DEC. 23  
1946



This 186-page

**FREE BOOK**

is also your

**GUIDE for the FUTURE**



Let this free book help you to plan your future. It is issued by an organization known throughout the world for thorough engineering training. The examination subjects listed below are only a few of those dealt with. Without obligation write today to Canadian Institute of Science & Technology, 218 Chester Building, 219 Bay Street, Toronto 1, Canada.

<b>A.M.I.Mech.E.</b> Mechanical Plastics Production Engineering A.M.I.E.E. Electrical	<b>A.F.R.Ae.S.</b> Aeronautical A.M.Brit.I.R.E. Radio and Telegraphy A.M.I.C.E. Civil A.M.I.Struct.E.	<b>Structural</b> Automobile Mining Geology and Mineralogy London Matriculation B.Sc. (Pure Science)
---------------------------------------------------------------------------------------------------------	-------------------------------------------------------------------------------------------------------------------------	------------------------------------------------------------------------------------------------------------------------

Canadian Institute of Science & Technology Limited,  
218 Chester Building,  
219 Bay St., Toronto 1, Canada.

Please forward us free of cost or obligation of any kind your 186-page handbook, "ENGINEERING OPPORTUNITIES."

Name.....  
Address..... Age.....  
Course interested in.....

# OIL BURNER

INFORMATION IN A HANDY FORM

JUST OUT!

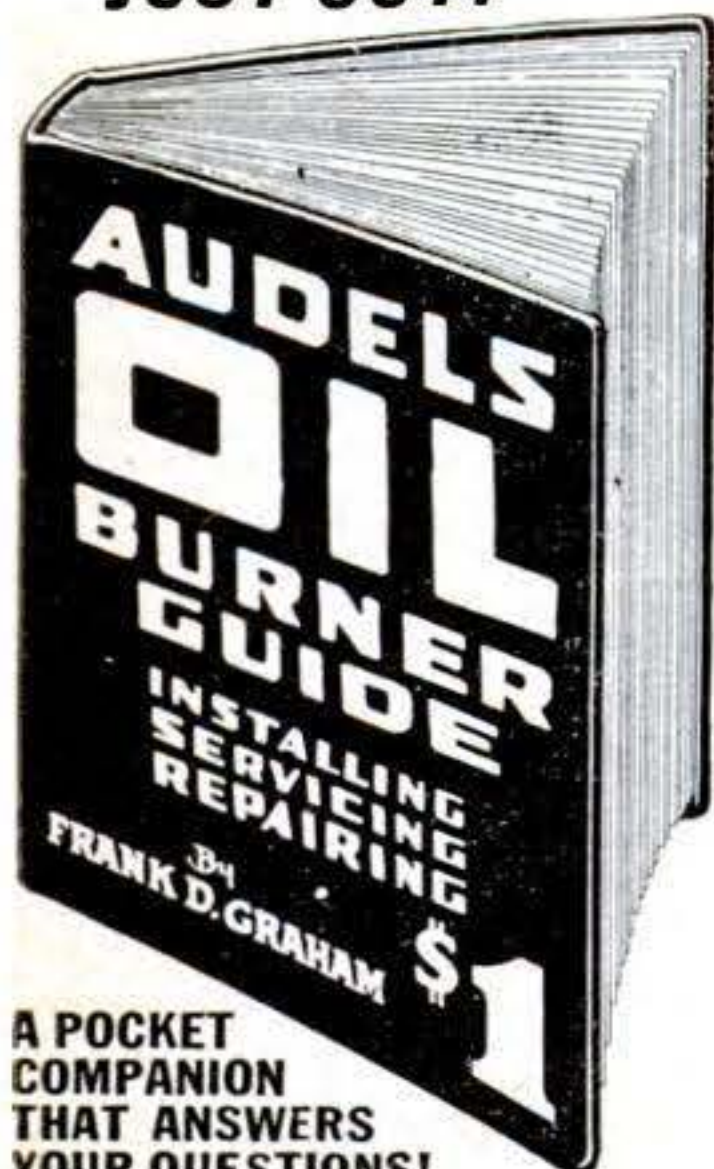

A POCKET COMPANION THAT ANSWERS YOUR QUESTIONS!

## AUDELS OIL BURNER GUIDE

- A new practical, concise treatise, 384 pages-31 Chapters - 321 Diagrams and Illustrations - covering Domestic and Industrial Oil Burners.

New from Cover to Cover, for mechanics interested in Oil Burners. Gives practical inside working knowledge of theory, construction, installation, operation, testing, servicing and repair of all types of oil burners. Includes electrical hook-ups and wiring diagrams of automatic control systems.

PRICE \$1 POSTPAID

Get this information for yourself. Mail coupon today. No obligation unless satisfied.

ASK TO SEE IT

**AUDEL, Publishers, 49 W. 23rd St., New York 10, N.Y.**

Please mail AUDELS OIL BURNER GUIDE (Price \$1). If satisfactory, I will remit \$1 on its safe arrival, otherwise I will return the book.

Name.....  
Address.....  
Occupation.....  
Employed by..... PSM

24 POPULAR SCIENCE

BE A

# LANDSCAPE ARCHITECT

WORK OUTDOORS



Healthful, pleasant outdoor work in an uncrowded field.

The field of Landscape Gardening offers unusual opportunities for trained men... greatly augmented by the huge home-building and modernizing program ahead. We provide thorough, interesting home-training during your spare time... adapted to your regional conditions.

APPROVED for VETERANS

## BE YOUR OWN BOSS

A graduate says, "I finished the course about two months ago and now I average about \$2.00 per hour net for my time."

There are many employment opportunities in this profitable, uncrowded field or you can easily start your own business. Write today.

Service from Coast to Coast

**NATIONAL LANDSCAPE INSTITUTE**  
DEPARTMENT PS 756 SOUTH BROADWAY - LOS ANGELES 14

# ELECTRICAL TRAINING

Intensive 32 weeks residence course in fundamentals of industrial electrical engineering, including radio, electronics. Prepares for technician, engineering aides. Approved for veteran training. 54th year. Write for catalog.

**BLISS ELECTRICAL SCHOOL**  
7622 Takoma Ave., Wash. 12, D.C.



## MAKE MONEY CASTING AT HOME

FREE FACTS SENT



Make thousands of perfect casts; plaster, imitation marble, Artificial marble, Etc. Quick, easy; ENORMOUS PROFITS. Rubber molds for speed productions. NO PREVIOUS EXPERIENCE NEEDED. LITTLE CAPITAL needed. Start in basement or garage. \$1.00 raw material makes \$25.00 finished products.

PLASTIC ARTS STUDIOS, Route 5, Dept. 45, Muncie, Ind.

## LEARN MONEY-MAKING CARTOONING

IN SPARE TIME - by Easy Picture Chart Method Same Simplified Method that has helped train creators of "Terry & Pirates," "Freckles," "Out Our Way," "Winnie Winkle," "Reg'lar Fellers," "Strange As It Seems," "The Neighbors," and many others. Earn while learning. Send 10c for Picture Chart (to test your ability). Samples of successful students, and full details. (State age.)



Landon School of Cartooning, Dept. 4632, Philadelphia 1, Pa.

# LAW

## LEARN AT HOME

Are you adult, alert, ambitious, willing to study? Investigate LAW! We guide you step by step-furnish all texts, including 14-volume Law Library. Training prepared by leading law professors and given by members of bar. Degree of LL.B. conferred. Low cost, easy terms. Send NOW for Free, 48-page "Law Training for Leadership." G. I. APPROVED.

**LASALLE Extension University**  
A CORRESPONDENCE INSTITUTION  
417 S. Dearborn St., Dept. 1283-L Chicago 5, Ill.



# Prepare for YOUR FUTURE Now

You'll Need "ALL-AROUND" Training to Meet New Conditions!

Get Ready QUICK—in 1 of these 2 Opportunity Fields!

**ELECTRICITY OF RADIO-ELECTRONICS**  
INDUSTRIAL ELECTRONICS TELEVISION



**ELECTRICITY including INDUSTRIAL ELECTRONICS** . . . Prepare for the opportunities in such branches as Power Plant Work, Motors, Armature Winding, Industrial and House Wiring, Maintenance, INDUSTRIAL ELECTRONICS, etc., with COYNE shop training.



This big fire-proof building is occupied entirely by the Coyne Electrical School.

**RADIO-ELECTRONICS** . . . A great field now, even greater growth ahead. Prepare for a real Radio career. Learn construction, operation, trouble-shooting on Radio Receivers, Public Address Systems, Sound Picture Units, FM, Photo-Cells, Television — the practical COYNE way.

**"LEARN BY DOING" RIGHT HERE IN THE SHOPS OF COYNE IN A FEW WEEKS**

**TRAIN FOR A GOOD JOB NOW THAT OFFERS STEADY WORK WITH A REAL FUTURE!**

Conditions today are different. Many "one-operation" jobs that paid well in the past, no longer exist. Do you have a good job with a real future? Plan for steady pay and advancement by training NOW, while there's still time! Come to the big shops of COYNE in Chicago, for "all-around" training in Electricity or Radio-Electronics—the 2 great opportunity fields of today and tomorrow.

**PICK FIELD YOU LIKE—SEND FOR BIG BOOK**



**FREE** B. W. Cooke

Some men prefer Electricity, others Radio-Electronics. Whichever interests you most, we will train you in a few short weeks at Coyne—on full-size equipment, by our famous "Learn-by-Doing" method. We have a big, fully illustrated book on each course, and we'll send you the one you want, without the slightest cost or obligation. Simply check below, then mail coupon in envelope or paste on postcard. No salesman will call. You are the sole judge. Don't delay. Your future is at stake. Rush coupon to COYNE—TODAY.

**TRAIN ON ACTUAL EQUIPMENT!**

Our famous "Learn-by-Doing" method gives you practical experience on full-size equipment. Not by correspondence, but actual shop work plus necessary theory. You are trained right here in the Coyne shops, that has been training men and young men for over 47 years. Men from 16 up to 40, with or without experience, Coyne training is for you.

**Student Finance Plan START NOW—PAY LATER!** **LIFETIME JOB SERVICE TO COYNE GRADUATES**

Don't let lack of money hold you back. Our "Student Finance Plan" has helped thousands to get ahead. Coupon brings details. Many earn while learning, to help take care of living expenses while here.

First we train you for a good job and future, then assist you in getting located. As a Coyne graduate, use this service whenever you need it—no charge. Also FREE review privileges at any time. Get the facts!



**ELECTRIC REFRIGERATION**

**Included With Either Course**  
Added training in the great field of ELECTRIC REFRIGERATION makes you more valuable to employer, leads to opportunities for bigger pay. This valuable TRAINING now included with either our Electrical or Radio Course. We also have facilities for men with physical disabilities whether due to war or other causes. Check coupon for details if you have a physical disability of any kind.

**VETERANS—**

Coyne is also equipped to train those who qualify for training under G. I. Bill of Rights. Check coupon for our Special G. I. Bulletin.

**COYNE ELECTRICAL SCHOOL**

500 So. Paulina Street, Dept. 96-73H, CHICAGO 12, ILL.

B. W. COOKE, Director **Founded 1899**

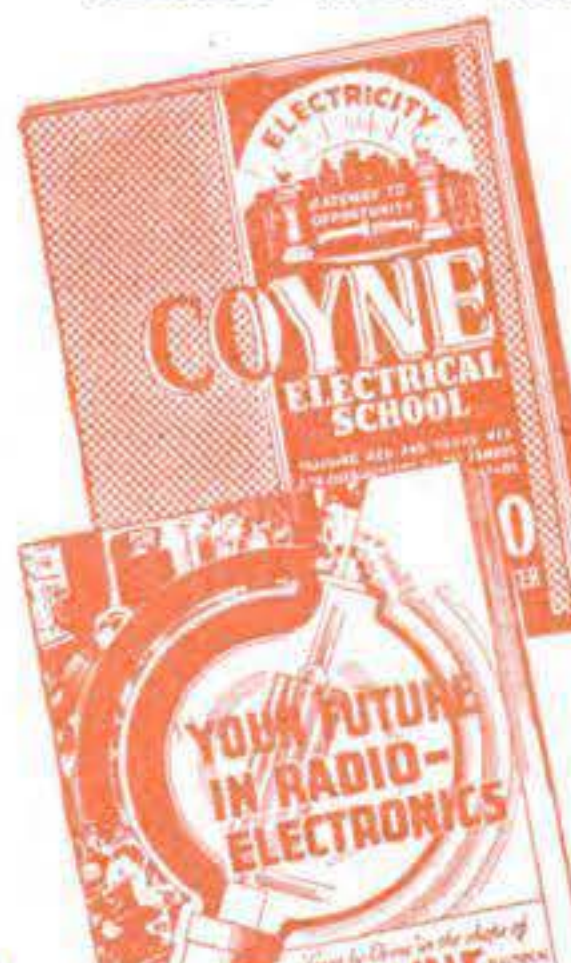

B. W. COOKE, Director  
COYNE ELECTRICAL SCHOOL  
500 S. Paulina St., Dept. 96-73H, Chicago 12, Ill.

Send me your BIG FREE BOOK — for the course checked below. Also full details of your "Student Finance Plan."

- ELECTRICITY  RADIO-ELECTRONICS
- Send special G.I. Bulletin  Physical disability

NAME.....

ADDRESS.....

CITY..... STATE.....



If you are between 15 and 55

**\$200**  
a month

**is all you have to pay for  
Old Line, Legal Reserve  
LIFE INSURANCE**

This is half the Permanent Rate, payable until the 6th year. You get \$1,754 of Protection all your life if you are now 20, \$1,460 if you are 30, \$1,142 if 40, etc. Proportionate amounts at other ages. Budget your Insurance like Rent.

**YOUR POLICY WILL BE  
FULLY PAID-UP IN 30 YEARS**

with no more premiums to pay and all benefits continued. Send Coupon at once! for full details and amount of life long Protection offered at your age!

**MAIL COUPON NOW FOR FREE BOOKLET**

Postal Life Insurance Company  
511 Fifth Ave., Dept. D-650  
New York 17, N. Y.

Mail me complete information about your new "\$2.00-per-month", 30-Payment Modified 5 Whole Life Policy at my age.

Name \_\_\_\_\_

Occupation \_\_\_\_\_ Date of Birth \_\_\_\_\_

Address \_\_\_\_\_

Include P. O. District Number, if any

**HIGHWAY ENGINEERING**

Practical training in Highway Design and Practice. Interesting home study. Taught by mail only. Prepare for work offering security. Become an employee of your State, County, City or Federal Government. Let us help you now. Write for descriptive literature to-day.

**SCHOOL OF HIGHWAY PRACTICE**  
DEPT. C, 2161 SHATTUCK AVE., BERKELEY 4, CALIF.

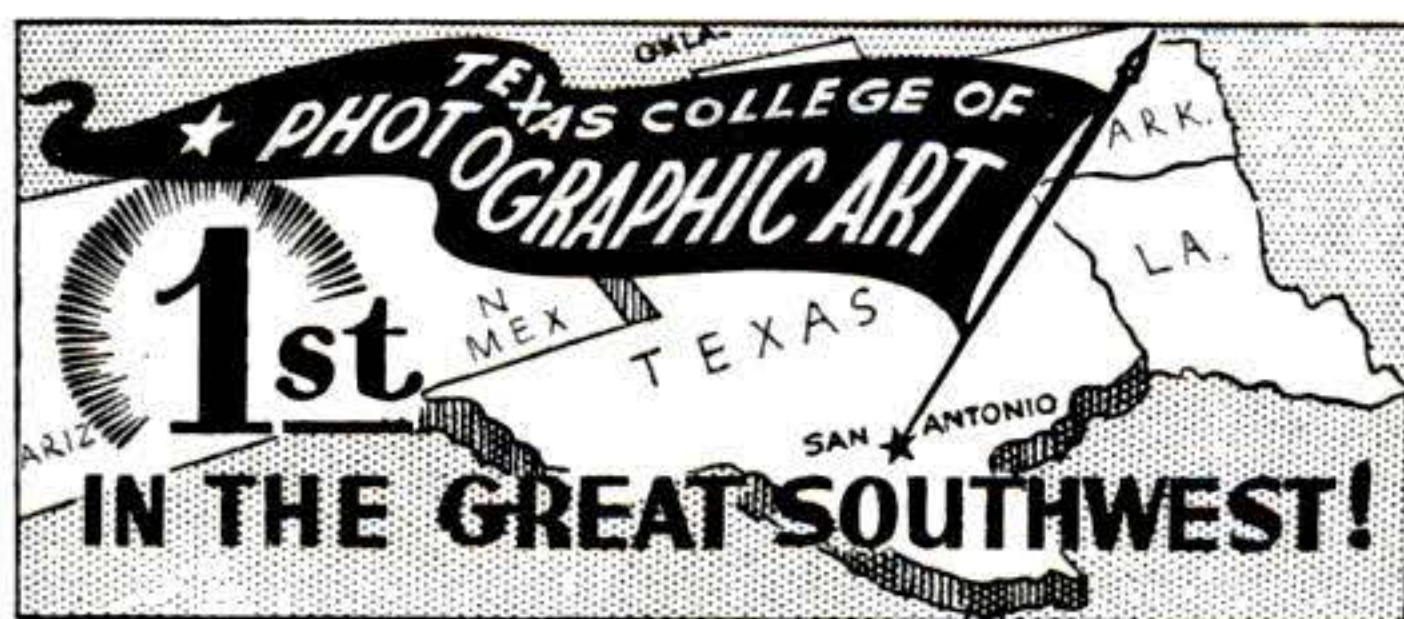

Men and Women—Get set NOW in an INTERESTING and PROFITABLE LIFETIME CAREER  
Veterans: MANY LIBERAL ALLOWANCES UNDER "GI" BILL OF RIGHTS  
Address: Dept. A

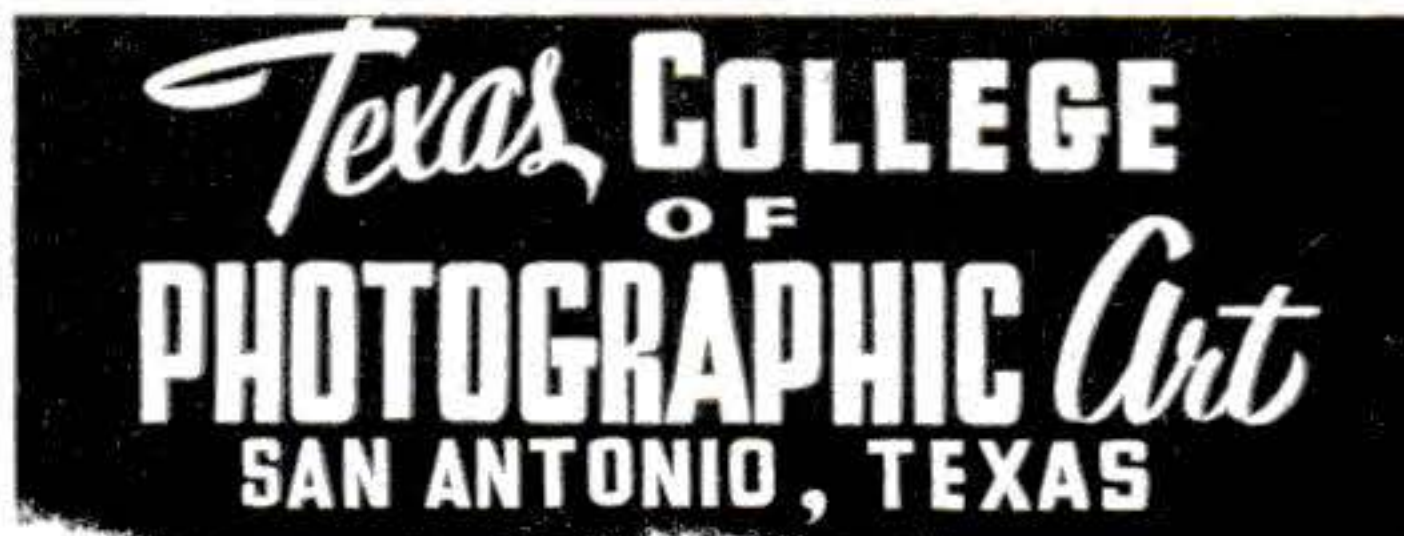

**TRI-STATE COLLEGE**

B.S. Degree in 27 months in Engineering (all branches), Bus. Admin., Acctg. and Sec. Science. 63rd year. School now filled to capacity. No applications can be accepted until further notice. 5126 College Ave., Angola, Ind.



You can learn plain, rapid writing or fancy ornamental writing for social and business advancement, right in your own home during spare time by my Simplified Method. Write for my free book, "How to Become an Expert Penman," which shows what others have accomplished by taking my Courses. Send 10c for one of my favorite Pen Points and your name with a beautiful flourished bird written on a card. Write today.

T. M. TEVIS, BOX 25R, CHILlicothe, MO.

**REFRIGERATION AND AIR CONDITIONING SERVICE MECHANICS COURSE**

Learn at home—how to start your own repair shop on little capital. No previous experience needed. Common school education sufficient. Splendid opportunity for older men. Prepare now. FREE illustrated booklet.

**MECHANICS TRAINING SCHOOL**  
7217 So. Broadway Dept. S-12 Los Angeles 3, Calif.

★ **GET ON "UNCLE SAM'S" PAYROLL** ★

**\$1,756 TO \$3,021 FIRST YEAR**  
Veterans Get Special Preference

Railway Postal Clerks—Mail Carriers—Mail Clerks—Patrol Inspectors—Storekeeper Gaugers—Positions at Washington, D.C.—Etc. Mail Coupon immediately—

**32-Page Civil Service Book—FREE**

26 POPULAR SCIENCE

FRANKLIN INST., Dept. C-82, Rochester 4, N. Y.

Gentlemen: Rush to me, without charge, 32 page book with list of U. S. Government big paid positions. Advise me also regarding salaries, hours, work, vacations, etc. Tell me how to prepare for a position.

Name.....  
Address..... Vet?.....



Now IN YOUR OWN HOME Learn

# RADIO ELECTRONICS

The Practical  
"HOME-TESTED"  
Modern "A-B-C" Way

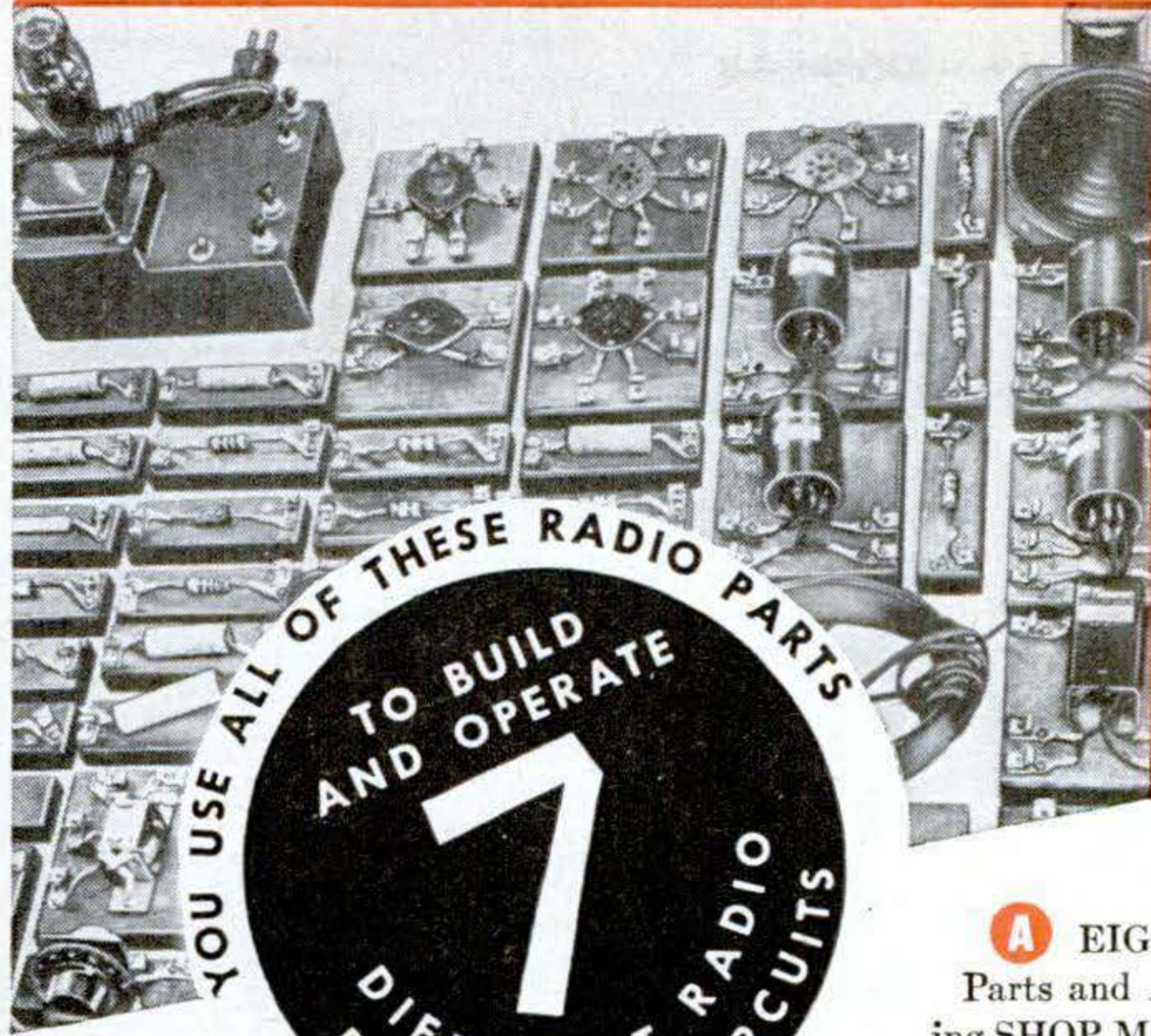

YOU USE ALL OF THESE RADIO PARTS  
TO BUILD AND OPERATE  
**7**  
DIFFERENT RADIO RECEIVING CIRCUITS

## NO PREVIOUS RADIO OR ELECTRICAL EXPERIENCE NECESSARY

DeForest's Training, Inc. provides every major home study aid to help you learn Radio-Electronics rapidly and thoroughly . . . to give you the *experience* and *confidence* needed for a responsible, Good-Pay Job, or to Start a Business of Your Own! Here is a REAL opportunity field for YOU . . . when you are a trained Radio-Electronics man! Just think of the tremendously exciting future ahead of FM Radio, Aviation and Broadcast Radio, Sound Motion Picture Equipment, Servicing and Sales of Radio Equipment, etc. Put yourself in this picture . . . See how you can benefit from a PRACTICAL training in this fascinating work! Think, too, of the coming possibilities ahead of Radar, Facsimile and Television. Send TODAY for the interesting, opportunity-revealing book, "Victory for You!" See how others probably no more talented or ambitious than you, have advanced in earning power after this training . . . how YOU can do it too! Mail the coupon NOW!

### INCLUDING:

1. Simple Receiver
2. Two Tube Receiver
3. Tuned Radio-Frequency Receiver
4. Short Wave Receiver
5. Aviation Band Receiver
6. 4-Tube Superheterodyne
7. 5-Tube Superheterodyne with Magic Tuning Eye

... PLUS SCORES OF OTHER FASCINATING, INSTRUCTIVE RADIO-ELECTRONIC EXPERIMENTS

### WITH THE HELP OF

**A** EIGHT Big Kits of Actual "Learn-by-Doing" Radio Parts and Assemblies with which you make 133 fascinating SHOP METHOD EXPERIMENTS in your own home! Imagine building 7 different Radio Receivers that operate!

**B** A 16 mm Home Movie Projector and Twelve Reels of "Learn-by-Seeing" Home Movie Films . . . for picture-clear, fast understanding of Radio Fundamentals!

**C** Modern, well-illustrated, Loose-leaf Lessons, prepared in clear, simple, understandable language . . . to guide you throughout your training!

### THEN GET THE HELP OF OUR EFFECTIVE EMPLOYMENT SERVICE

YOU USE "LEARN-BY-SEEING" MOVIES



DEFOREST'S TRAINING, INC. INCLUDES INSTRUCTION IN MOTION PICTURE SOUND EQUIPMENT, FM RADIO AND TELEVISION . . . RESIDENTIAL TRAINING IN OUR MODERN CHICAGO LABORATORIES ALSO AVAILABLE—ASK US FOR INFORMATION!

#### VETERANS!

Big things are happening at DeForest's Training, Inc. for veterans! See how you can prepare yourself WITHOUT COST for a GOOD JOB or a BUSINESS OF YOUR OWN in the vast Radio-Electronic opportunity field.



E. B. DEVRY, President  
DeFOREST'S TRAINING, INC.  
2535-41 North Ashland Ave., Dept. PS-C12  
Chicago 14, Illinois, U.S.A.

Send FREE "VICTORY FOR YOU!" BOOK, showing how I may make my start in Radio Electronics.

Name \_\_\_\_\_ Age \_\_\_\_\_

Address \_\_\_\_\_ Apt. \_\_\_\_\_

City \_\_\_\_\_ Zone \_\_\_\_\_ State \_\_\_\_\_

If under 16, check here for special information.

If a discharged Veteran of World War II, check here.

**DeFOREST'S TRAINING, INC.**  
CHICAGO 14, ILLINOIS



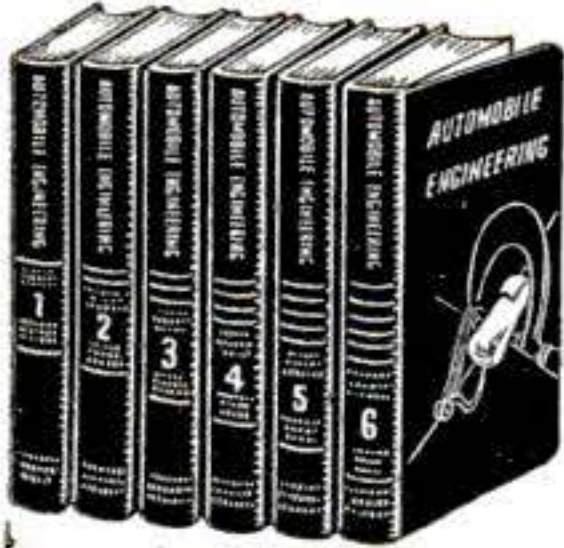

# AUTO BOOKS ON APPROVAL



## CAN YOU FIX IT?

These wonder books tell step by step HOW to make difficult repairs and adjustments, how to keep a car at maximum efficiency, including latest improvements in car design and operation. Engine troubles and how to correct them well covered.

### 6 BIG VOLUMES

2800 pages, 2000 illustrations, wiring diagrams, etc., including Diesel engines. Beautiful modernistic, washable cloth binding.

**SEND NO MONEY.** Just mail the coupon for a complete set of Six Big Auto Books. 20th Edition. Whether you are a mechanic or helper, expert or apprentice, auto owner or driver, take immediate advantage of this FREE EXAMINATION OFFER.

### MAKE GOOD MONEY NOW HOLD A PERMANENT JOB

America wants its automobiles kept in good repair. Men with "know how" are in demand, at big pay. These books will help you get and hold an important job, or give you a chance to go into business for yourself now or later. Any man who half tries to improve himself can learn auto servicing and repairing by this quick reference method. Use the JIFFY INDEX to find easily understood answer to any auto problem. These wonder books prepared by eleven of America's great automobile engineers. Many hundreds of valuable illustrations. Send the coupon TODAY.

**[A year's consulting privileges with our engineers now given with these books without extra charge.]**  
Vocational Publishers Since 1898

AMERICAN TECHNICAL SOCIETY, Dept. A920, Drexel Ave. at 58th St., Chicago 37, Ill.

I would like to examine your Six-Volume Set of Auto Books. I will pay the delivery charges only, but if I choose I may return them express collect. If after 10 days' use I prefer to keep them, I will send you \$2 and pay the balance at the rate of only \$3 a month until \$24.80 has been paid. Please include consulting service as offered above

Name.....

Address.....

City.....State.....

Please attach letter stating age, occupation, employer's name and address, and name and address of at least one business man as reference. Men in service, also please give home address.

# INVENTORS

The inventor who believes he has a new and useful invention, and finds himself in need of advice, should consult a competent registered patent attorney.

The question as to whether a subject matter is patentable can be substantially determined by a search of the U. S. Patent records.

Without obligation, write us for information as to what steps an inventor should take.

## RANDOLPH & BEAVERS

Registered Patent Attorneys

905-L Columbian Bldg., Washington 1, D. C.

### RANDOLPH & BEAVERS

905-L Columbian Bldg., Washington 1, D. C.

Please send me full information on how to secure Patents & Trademarks.

Name.....

Street.....

City.....State.....

## TRAIN NOW

# AUTO MECHANICS and BODY & FENDER WORK

ENGINE OVERHAUL  
REPAIR SERVICE  
TROUBLE SHOOTING  
IGNITION  
CARBURETION  
TRANSMISSION  
ETC., ETC.

## MOST COMPLETE TRAINING PROGRAM OF ITS KIND

This old established shop training organization inaugurates a new all inclusive training program in advanced auto mechanics and modern Body and Fender work. Big, modern, fully equipped shop and expert instructors get you into practical do-it-yourself training immediately. Low tuition fee. Veterans, ask for "G.I." Bulletin. Write today for free Booklet.

## Chicago MOTIVE TRADES Institute

DIV. COMMERCIAL TRADES INSTITUTE Dept. B-112  
1400 W. GREENLEAF AVE. • CHICAGO 26, ILL.



## Get Started in Radio TEN "HOW-TO-DO-IT" BOOKS

Get a solid foundation in radio by means of these 10c timely text books. Each clearly written, profusely illustrated, contains over 15,000 words. You'll be amazed at the wealth of information packed into these handy books. Excellent for reference—ideal for technical library. Your money back if not satisfied.

5 BOOKS FOR 50c—10 BOOKS FOR \$1.00

- SENT TO YOU POSTPAID
- No. 1—How To Make Four Doerle Short Wave Sets
- No. 2—How to Make The Most Popular All-Wave 1 and 2 Tube Receivers
- No. 3—Alternating Current for Beginners
- No. 4—All About Aerials
- No. 5—Beginners' Radio Dictionary
- No. 6—How To Have Fun With Radio
- No. 7—How To Read Radio Diagrams
- No. 8—Radio for Beginners
- No. 9—Simple Electrical Experiments
- No. 10—Television

Remit by check or money order—register letter if you send cash or stamps.  
RADIO PUBLICATIONS 27-P West Broadway New York (7)



**AMAZING DEVICE!** Guides your hand—corrects poor penmanship in few days—big improvement in three hours, no failures. Complete Outline Free. Write, C. Ozment, 35-B, St. Louis, Mo.

# LAW

STUDY AT HOME for PERSONAL SUCCESS and LARGER EARNINGS. 38 years expert instruction—over 108,000 students enrolled. LL.B. Degree awarded. All texts furnished. Easy payments. Send for FREE BOOK—"Law and Executive Guidance"

AMERICAN EXTENSION SCHOOL OF LAW  
Dept. 72-S, 646 N. Michigan Ave., Chicago 11, Ill.

## Correspondence Courses in RADIO and ELECTRICAL ENGINEERING LOW AS \$25

**ELECTRICAL ENGINEERING.** Get good grasp of wide electrical field. Modern. Very understandable. Theory made easy.  
**RADIO ENGINEERING.** Extra fine course in radio, public address, photo-electric work. Trains you to be super-service man, real vacuum tube technician. Tuition ONLY \$25, either course. Deferred payment plan. Servicemen needed badly.

Write for free copies of school catalogs, student magazines, etc.  
**FREE** LINCOLN ENGINEERING SCHOOL, Box 931-S-96 LINCOLN, NEBR.

## FENCING

EXCITING FUN HARMLESS

Just Out! Two 3 ft. Spring Steel Foils with Safety Rubber Buttons. Complete Outfit 2 foils (swords) with hand guards and Free Instruction Book NOW ONLY \$1.98 Postpaid. A Healthful & Clean Sport makes you Strong & Alert. Instruction Book teaches Quickly-Easily. MAIL CHECK or M.O. today for \$1.98. Add 28c for Foreign Postage.

**LEE PRODUCTS CO., Dept. 19—1613 First Ave., New York 28, N. Y.**

# BOOKS FOUND FREE!

## WHAT BOOKS DO YOU WANT?

We quote the lowest market prices. No charge for locating Hard-to-Find and Out-of-Print Books. All books, OLD or NEW, mailed POST-FREE.

SEARCHLIGHT BOOK CENTRE  
22 East 17th Street New York City





Have you  
considered a  
career in  
**PLASTICS?**



A job with a promising future goes a long way toward making you happy —at work and at home.

**Do** you know of the fine opportunities for advancement that are available in the plastics industry? Do you want to share in the development of a great new plastics era? *Trained men*, who have plastics know-how, will fill the well-paying positions in the industry. If **YOU** want to be one of them act **NOW** to prepare yourself.

Every day you can read glowing descriptions of how plastics are improving old products and creating new ones. Learn the hundreds of interesting phases of the plastics industry and be ready for the position that will give you the security and satisfaction you want.

**LEARN AT HOME**—Continue your present job and learn plastics in your spare time! The thorough, easy-to-understand Home Training Course presented by Plastics Institute requires no previous technical experience.

**A COMPLETE COURSE**—Everything you should know about plastics is included... materials, de-

signing, molding, fabricating, laminating and testing. You will acquire a basic knowledge of plastics that can be invaluable in getting you a fine position in this great, new industry.

**YOU MAKE THINGS**—To give you practical experience in working with plastics, we supply handsome, colorful, rods, sheets and tubes of plastics from which you can if you wish, make useful, attractive creations. You cement, saw, buff, form, dye, decorate, cast and laminate various types of plastics. You design plastic articles—develop your own ideas. You may earn money while learning.

**START YOUR FUTURE TODAY**—Mail the coupon below, now! You will get an interesting, illustrated, free booklet with valuable information about plastics. You will see how, at small cost you can prepare for a bright future in the expanding plastics industry. Clip the coupon and mail it **TODAY!**

Write Dept. PS6-12, 1601 S. Western Ave., Los Angeles 6, California  
**Home Training Courses and Resident School APPROVED FOR VETERANS**

*Plastics*

**INDUSTRIES TECHNICAL INSTITUTE**  
NEW YORK CHICAGO LOS ANGELES

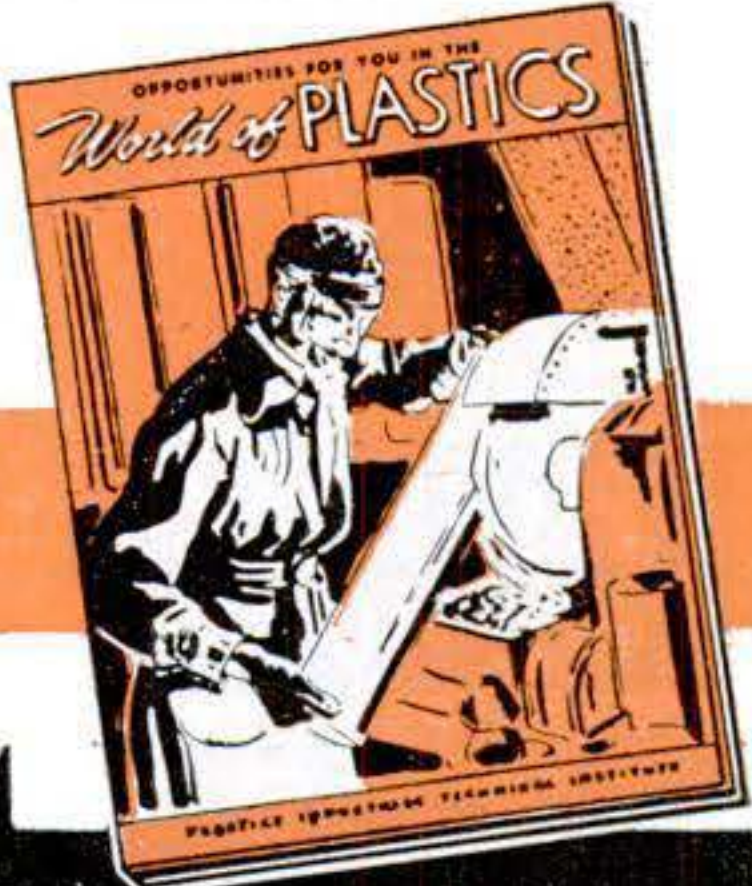

**FREE BOOKLET**  
**Send For It Today!**

Plastics Industries Technical Institute  
Dept. PS6-12 1601 S. Western Ave., Los Angeles 6, Calif. Mail in Envelope or  
paste on penny postcard

Gentlemen: Please send me the booklet "World of Plastics" and information on your Home Training Course , Resident School . I understand there is absolutely no obligation.

Name..(PRINT).....Occupation.....

Street. (PRINT).....Age.....

City.....Zone.....State.....

Important: Please fill out coupon *completely*. If Veteran, please check.



# NOW! Build Your Future On



## DIESEL Opportunities

LOOK around you. See the way tractors, trucks, buses, railroads, ships, power plants and equipment of many kinds are "going Diesel." Every day new opportunities are opening—in industrial and farming communities—for trained men who can install, maintain, operate and repair Diesel engines. Plan now to build your future in this growing field.

### Diesel Knowledge is Earning Power

You don't have to give up your present job. Now, you can begin learning DIESEL in spare time at home. UEI practical training teaches you, step by step, how Diesel engines operate, how fuel systems work, repairs, accessories and auxiliary equipment; a world of Diesel "know how." Includes actual practice on Diesel equipment in our shop under expert guidance. UEI training methods are successful. For 20 years they have helped mechanically inclined men better themselves.

### NOW IT'S UP TO YOU!

Coupon below brings you all the facts without cost or obligation. Get going today! MAIL COUPON NOW.

**UTILITIES ENGINEERING INSTITUTE**  
Diesel Division  
1314 W. Belden  
Dept. 112D,  
Chicago 14, Ill.

Founded 1927

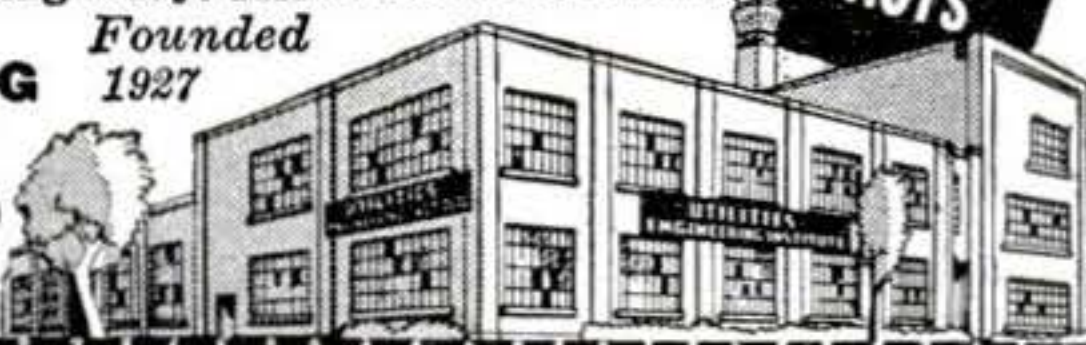

Send Coupon for FREE FACTS

UTILITIES ENGINEERING INSTITUTE, Diesel Division  
1314 W. Belden Ave., Dept. 112-D, Chicago 14, Ill.  
Please send me Free Facts about Diesel opportunities and training.

NAME \_\_\_\_\_ Age \_\_\_\_\_  
ADDRESS \_\_\_\_\_  
CITY \_\_\_\_\_ Zone or County \_\_\_\_\_ STATE \_\_\_\_\_  
 Check here for special information if you are under 17.  
 Check here if Veteran of World War II.

# Do you want

- .. to go to College?
- .. or to enter a Profession?  
(Such as Accounting, Architecture, Nursing, Dentistry, Teaching, Social Work, Osteopathy, Beauty Culture, Optometry, Embalming, Chiropody, Law, Medicine, etc.)
- .. or get an Office Position?

To get anywhere, you practically MUST finish High School FIRST. You can complete our simplified High School Course in SPARE time at home, as FAST as your time and abilities permit. Equivalent to resident school work—prepares you for college, pre-professional examinations, business, industry. Standard texts furnished. Diploma. Credit for H.S. subjects already completed. Single subjects if desired. Low tuition, easy terms. American School, Chicago, est. 1897—endorsed by educators. Finish your high school education NOW. Write TODAY!

## High School Course at Home

Many Finish in 2 Years

American School, Dept. H946, Drexel Ave. at 58th St., Chicago 37

Gentlemen: Send me FREE information covering special training in subjects checked below. No obligation on my part.

- |                                                      |                                                                |
|------------------------------------------------------|----------------------------------------------------------------|
| <input type="checkbox"/> High School Course          | <input type="checkbox"/> Diesel Engineering                    |
| <input type="checkbox"/> Electronics, Industrial     | <input type="checkbox"/> Drafting and Design for Men and Women |
| <input type="checkbox"/> Architecture and Building   | <input type="checkbox"/> Plastics                              |
| <input type="checkbox"/> Automotive Engineering      | <input type="checkbox"/> Private Secretary                     |
| <input type="checkbox"/> Business Management         | <input type="checkbox"/> Mechanical Engineering                |
| <input type="checkbox"/> Electrical Engineering      | <input type="checkbox"/> Aviation                              |
| <input type="checkbox"/> Elec. and Gas Refrigeration | <input type="checkbox"/> Salesmanship                          |
| <input type="checkbox"/> Air Conditioning            | <input type="checkbox"/> Radio                                 |
| <input type="checkbox"/> Railway Training            |                                                                |

Name .....

Address .....

# Learn PHOTOGRAPHY at Home Now—Portraiture, Press, Commercial or Hobby



Whether it's for a full-time career or just plain fun, you'll enjoy learning photography this new, easy way. Every phase of photography is carefully covered, with the latest techniques and methods fully explained. There are thousands of opportunities in photography as a career, and hours of pleasure as a hobby, so make the most of them today.

## 12-Month Home Study Course

Written and directed by expert photographers with years of teaching experience at one of America's leading educational institutions. A really THOROUGH education in photography, taught in easy steps and simple terms. Write today for complete information.

## MOODY EDUCATIONAL INSTITUTE, Inc.

208 E. Wisconsin Ave. Dept. 11-B6 Milwaukee 2, Wis.



# PHOTOGRAPHY

for Fun or Profit  
STUDY AT HOME. Photography offers leisure time enjoyment and well-paid, fascinating career. Ever-increasing opportunities! Success-proved N.Y.I. training qualifies you at home. Also resident courses. Details FREE!

NEW YORK INSTITUTE OF PHOTOGRAPHY  
Dept. 5, 10 West 33 St., New York 1, N. Y., (37th Year)

# SHORTHAND in 6 Weeks at Home

Famous Speedwriting system. No signs or symbols; uses ABC's. Easy to learn; easy to write and transcribe. Fast preparation for a job. Surprisingly low cost. 100,000 taught by mail. Used in leading offices and Civil Service. Write for free booklet. Speedwriting, Dept. 2612-6, 55 W. 42 St., N. Y. 18, N. Y.

# THERE'S MONEY IN CARTOONS!

RAYE BURNS will teach you HOW to CREATE ORIGINAL CARTOONS at home that you may SELL! Course contains 26 lessons and over 600 illustrations. All for Only \$2.85

Send name and address for free details.  
RAYE BURNS SCHOOL, Dept. S, Box 3583, CLEVELAND, OHIO

# LEARN MASTER MACHINIST MECHANICAL DRAFTING

Expert training on Lathes, Milling Machines, Shapers, Grinders, etc.—Mechanical Drafting, Blueprint Reading and Designing. Allied shops are completely equipped and modern. Approved for G. I. Training • Days, Evenings  
ALLIED SCHOOL OF MECHANICAL TRADES  
1332 South Michigan Avenue • Chicago 5, Illinois

# Become a Doctor of PSYCHOLOGY

Win the degree of Ps.D. Teach the secret of contentment, happiness; Solve mental worries. Experience the revelation of truth. Chartered college. Individual help. Write for FREE book. COLLEGE OF UNIVERSAL TRUTH 5153-A North Clark St., Chicago.

# Big Money for Workers In Home or Shop



Licensed Concrete Specialists wanted. No experience needed. Make Colorglazed concrete pottery without molds. New, low cost, patented method. Cemetery products, novelties, tiles, floors, etc. Basement leaksealing. Other big pay projects. Booklet, details free. Men only.

NATIONAL POTTERIES COMPANY  
542 West Lincoln, Fergus Falls, Minnesota



# SCHOOL for VETERANS!

Learn while you earn!

You're in a class  
by yourself with  
I.C.S.—and Courses  
are free to you  
under the G.I. Bill  
of Rights!



● I. C. S. Courses, paid for by the Government, are now available to honorably discharged World War II Veterans. And the Government's investment in your training will NOT be deducted from any future bonus.

● Get started now on your studies for success in business or industry! With I. C. S. you can do this in your spare time *while holding down a job!* You're in a class by yourself. There's no one to

hold you back . . . you progress just as fast as your abilities and ambition permit!

● Courses cover more than 400 commercial and technical subjects—many listed below. Check the subject that interests you—or write it in. We'll send you full information on the Course—and complete instructions on how to enroll with us under the G.I. Bill of Rights. Act now!

## INTERNATIONAL CORRESPONDENCE SCHOOLS



BOX 7673-L, SCRANTON 9, PENNA.

Without cost or obligation, please send me full particulars about the course *before* which I have marked X:

- |                                                                                                                                                                                                                                                                                                                                                                                                                                                                                                                                                                                                                                                                                                                                                                                                                                                                                                                                                                                                                                                                                                                                                                                                                                                                                                                                                  |                                                                                                                                                                                                                                                                                                                                                                                                                                                                                                                                                                                                                                                                                                                                                                                                                                                                                                                                                                                                                                                                                                                                                                                                                                                                                                 |                                                                                                                                                                                                                                                                                                                                                                                                                                                                                                                                                                                                                                                                                                                                                                                                                                                                                                                                                                                                                                                                                                                                                                                                                                                                                                                                                                                            |                                                                                                                                                                                                                                                                                                                                                                                                                                                                                                                                                                                                                                                                                                                                                                                                                                                                                                                                                                                                                                                                                                                                                                                                                                                                                                                                                                                |
|--------------------------------------------------------------------------------------------------------------------------------------------------------------------------------------------------------------------------------------------------------------------------------------------------------------------------------------------------------------------------------------------------------------------------------------------------------------------------------------------------------------------------------------------------------------------------------------------------------------------------------------------------------------------------------------------------------------------------------------------------------------------------------------------------------------------------------------------------------------------------------------------------------------------------------------------------------------------------------------------------------------------------------------------------------------------------------------------------------------------------------------------------------------------------------------------------------------------------------------------------------------------------------------------------------------------------------------------------|-------------------------------------------------------------------------------------------------------------------------------------------------------------------------------------------------------------------------------------------------------------------------------------------------------------------------------------------------------------------------------------------------------------------------------------------------------------------------------------------------------------------------------------------------------------------------------------------------------------------------------------------------------------------------------------------------------------------------------------------------------------------------------------------------------------------------------------------------------------------------------------------------------------------------------------------------------------------------------------------------------------------------------------------------------------------------------------------------------------------------------------------------------------------------------------------------------------------------------------------------------------------------------------------------|--------------------------------------------------------------------------------------------------------------------------------------------------------------------------------------------------------------------------------------------------------------------------------------------------------------------------------------------------------------------------------------------------------------------------------------------------------------------------------------------------------------------------------------------------------------------------------------------------------------------------------------------------------------------------------------------------------------------------------------------------------------------------------------------------------------------------------------------------------------------------------------------------------------------------------------------------------------------------------------------------------------------------------------------------------------------------------------------------------------------------------------------------------------------------------------------------------------------------------------------------------------------------------------------------------------------------------------------------------------------------------------------|--------------------------------------------------------------------------------------------------------------------------------------------------------------------------------------------------------------------------------------------------------------------------------------------------------------------------------------------------------------------------------------------------------------------------------------------------------------------------------------------------------------------------------------------------------------------------------------------------------------------------------------------------------------------------------------------------------------------------------------------------------------------------------------------------------------------------------------------------------------------------------------------------------------------------------------------------------------------------------------------------------------------------------------------------------------------------------------------------------------------------------------------------------------------------------------------------------------------------------------------------------------------------------------------------------------------------------------------------------------------------------|
| <p><b>Air Conditioning and Plumbing Courses</b></p> <p><input type="checkbox"/> Air Conditioning<br/><input type="checkbox"/> Heating <input type="checkbox"/> Plumbing<br/><input type="checkbox"/> Refrigeration <input type="checkbox"/> Steam Fitting</p> <p><b>Chemistry Courses</b></p> <p><input type="checkbox"/> Chemical Engineering<br/><input type="checkbox"/> Chemistry, Analytical<br/><input type="checkbox"/> Chemistry, Industrial<br/><input type="checkbox"/> Chemistry, Mfg. Iron &amp; Steel<br/><input type="checkbox"/> Petroleum Refining <input type="checkbox"/> Plastics<br/><input type="checkbox"/> Pulp and Paper Making</p> <p><b>Civil Engineering, Architectural and Mining Courses</b></p> <p><input type="checkbox"/> Architectural Drafting<br/><input type="checkbox"/> Architecture<br/><input type="checkbox"/> Bridge and Building Foreman<br/><input type="checkbox"/> Building Estimating<br/><input type="checkbox"/> Civil Engineering<br/><input type="checkbox"/> Coal Mining<br/><input type="checkbox"/> Contracting and Building<br/><input type="checkbox"/> Highway Engineering<br/><input type="checkbox"/> Lumber Dealer<br/><input type="checkbox"/> Reading Structural Blueprints<br/><input type="checkbox"/> Sanitary Engineering<br/><input type="checkbox"/> Structural Drafting</p> | <p><input type="checkbox"/> Structural Engineering<br/><input type="checkbox"/> Surveying and Mapping</p> <p><b>Communications Courses</b></p> <p><input type="checkbox"/> Electronics<br/><input type="checkbox"/> Practical Telephony<br/><input type="checkbox"/> Radio, General<br/><input type="checkbox"/> Radio Operating<br/><input type="checkbox"/> Radio Servicing<br/><input type="checkbox"/> Telegraph Engineering</p> <p><b>Electrical Courses</b></p> <p><input type="checkbox"/> Electrical Drafting<br/><input type="checkbox"/> Electrical Engineering<br/><input type="checkbox"/> Electric Light and Power<br/><input type="checkbox"/> Lighting Technician<br/><input type="checkbox"/> Practical Electrician</p> <p><b>Internal Combustion Engines Courses</b></p> <p><input type="checkbox"/> Auto Technician <input type="checkbox"/> Aviation<br/><input type="checkbox"/> Diesel-Electric<br/><input type="checkbox"/> Diesel Engines <input type="checkbox"/> Gas Engines</p> <p><b>Mechanical Courses</b></p> <p><input type="checkbox"/> Aeronautical Engineering<br/><input type="checkbox"/> Aircraft Drafting<br/><input type="checkbox"/> Flight Engineer<br/><input type="checkbox"/> Foundry Work<br/><input type="checkbox"/> Heat Treatment of Metals</p> | <p><input type="checkbox"/> Industrial Engineering<br/><input type="checkbox"/> Industrial Metallurgy<br/><input type="checkbox"/> Machine Shop<br/><input type="checkbox"/> Mechanical Drafting<br/><input type="checkbox"/> Mechanical Engineering<br/><input type="checkbox"/> Mold-Loft Work<br/><input type="checkbox"/> Patternmaking—Wood, Metal<br/><input type="checkbox"/> Reading Shop Blueprints<br/><input type="checkbox"/> Sheet-Metal Drafting<br/><input type="checkbox"/> Sheet-Metal Worker<br/><input type="checkbox"/> Ship Drafting <input type="checkbox"/> Shipfitting<br/><input type="checkbox"/> Tool Designing<br/><input type="checkbox"/> Toolmaking<br/><input type="checkbox"/> Welding—Gas and Electric</p> <p><b>Railroad Courses</b></p> <p><input type="checkbox"/> Air Brake <input type="checkbox"/> Car Inspector<br/><input type="checkbox"/> Diesel Locomotive<br/><input type="checkbox"/> Locomotive Engineer<br/><input type="checkbox"/> Locomotive Fireman<br/><input type="checkbox"/> Railroad Section Foreman</p> <p><b>Steam Engineering Courses</b></p> <p><input type="checkbox"/> Boilermaking<br/><input type="checkbox"/> Combustion Engineering<br/><input type="checkbox"/> Engine Running<br/><input type="checkbox"/> Marine Engineering<br/><input type="checkbox"/> Steam Electric <input type="checkbox"/> Steam Engines</p> | <p><b>Textile Courses</b></p> <p><input type="checkbox"/> Cotton Manufacturing<br/><input type="checkbox"/> Rayon Weaving<br/><input type="checkbox"/> Textile Designing<br/><input type="checkbox"/> Woolen Manufacturing</p> <p><b>Business and Academic Courses</b></p> <p><input type="checkbox"/> Accounting <input type="checkbox"/> Advertising<br/><input type="checkbox"/> Arithmetic <input type="checkbox"/> Bookkeeping<br/><input type="checkbox"/> Business Correspondence<br/><input type="checkbox"/> Business Management<br/><input type="checkbox"/> Certified Public Accounting<br/><input type="checkbox"/> Commercial<br/><input type="checkbox"/> Cost Accounting<br/><input type="checkbox"/> Federal Tax<br/><input type="checkbox"/> First Year College<br/><input type="checkbox"/> Foremanship <input type="checkbox"/> French<br/><input type="checkbox"/> Good English <input type="checkbox"/> High School<br/><input type="checkbox"/> Higher Mathematics<br/><input type="checkbox"/> Illustrating <input type="checkbox"/> Motor Traffic<br/><input type="checkbox"/> Postal Service<br/><input type="checkbox"/> Salesmanship <input type="checkbox"/> Secretarial<br/><input type="checkbox"/> Sign Lettering<br/><input type="checkbox"/> Spanish <input type="checkbox"/> Stenography<br/><input type="checkbox"/> Traffic Management</p> |
|--------------------------------------------------------------------------------------------------------------------------------------------------------------------------------------------------------------------------------------------------------------------------------------------------------------------------------------------------------------------------------------------------------------------------------------------------------------------------------------------------------------------------------------------------------------------------------------------------------------------------------------------------------------------------------------------------------------------------------------------------------------------------------------------------------------------------------------------------------------------------------------------------------------------------------------------------------------------------------------------------------------------------------------------------------------------------------------------------------------------------------------------------------------------------------------------------------------------------------------------------------------------------------------------------------------------------------------------------|-------------------------------------------------------------------------------------------------------------------------------------------------------------------------------------------------------------------------------------------------------------------------------------------------------------------------------------------------------------------------------------------------------------------------------------------------------------------------------------------------------------------------------------------------------------------------------------------------------------------------------------------------------------------------------------------------------------------------------------------------------------------------------------------------------------------------------------------------------------------------------------------------------------------------------------------------------------------------------------------------------------------------------------------------------------------------------------------------------------------------------------------------------------------------------------------------------------------------------------------------------------------------------------------------|--------------------------------------------------------------------------------------------------------------------------------------------------------------------------------------------------------------------------------------------------------------------------------------------------------------------------------------------------------------------------------------------------------------------------------------------------------------------------------------------------------------------------------------------------------------------------------------------------------------------------------------------------------------------------------------------------------------------------------------------------------------------------------------------------------------------------------------------------------------------------------------------------------------------------------------------------------------------------------------------------------------------------------------------------------------------------------------------------------------------------------------------------------------------------------------------------------------------------------------------------------------------------------------------------------------------------------------------------------------------------------------------|--------------------------------------------------------------------------------------------------------------------------------------------------------------------------------------------------------------------------------------------------------------------------------------------------------------------------------------------------------------------------------------------------------------------------------------------------------------------------------------------------------------------------------------------------------------------------------------------------------------------------------------------------------------------------------------------------------------------------------------------------------------------------------------------------------------------------------------------------------------------------------------------------------------------------------------------------------------------------------------------------------------------------------------------------------------------------------------------------------------------------------------------------------------------------------------------------------------------------------------------------------------------------------------------------------------------------------------------------------------------------------|

Name \_\_\_\_\_ Age \_\_\_\_\_ Home Address \_\_\_\_\_

City \_\_\_\_\_ State \_\_\_\_\_ Present Position \_\_\_\_\_

Working Hours \_\_\_\_\_ A.M. to \_\_\_\_\_ P.M. Length of Service in World War II \_\_\_\_\_

Special tuition rates to members of the Armed Forces. Enrollment under the G.I. Bill of Rights approved for War II Veterans.  
Canadian residents send coupon to International Correspondence Schools Canadian, Ltd., Montreal, Canada.



# TRAVEL - for 'UNCLE SAM'

## RAILWAY POSTAL CLERKS

\$2,300 First Year regular

### MANY OTHER GOVERNMENT JOBS

Postoffice Clerks—Mail Carriers—Stenographers—Typists, Statistical Clerks, etc. 32 Page Civil Service Book—FREE.

MEN—WOMEN

Veterans get special preference  
Mail Coupon immediately—today sure.

**\$1,756 to \$3,021  
FIRST  
YEAR**

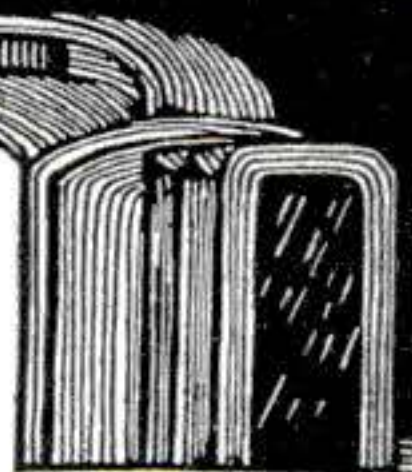

#### COUPON

FRANKLIN INST., Dept. C81, Rochester 4, N. Y.

Gentlemen: Rush to me, without charge, 32 page book with list of U. S. Government big paid positions. Advise me also regarding salaries, hours, work, vacation, etc. Tell me how to prepare for a position.

Name .....

Address..... Vet?.....

# Photography

for



## PLEASURE or PROFIT

Learn at home. Spare time. Practical basic training. Long-established school. Many have earned while learning. Send coupon below for free booklet, "Opportunities in Modern Photography" and full particulars.

#### AMERICAN SCHOOL OF PHOTOGRAPHY

1315 Michigan Avenue Dept. 1369 Chicago 5, Illinois  
Send booklet, "Opportunities in Modern Photography," full particulars and requirements.

Name..... Age.....

Address.....

City..... Zone..... State.....

## HOW TO BE YOUR OWN BOSS!

Send today for amazing book, "How To Start Your Own Business"! Explains in complete detail:—how much money you need to start . . . how to advertise, add new business . . . fees to charge, pitfalls to avoid. Covers 60 fields including: radio, advertising, publishing, credit agency, travel bureau, retailing, camera exchange! Send no money now! Pay postman \$1.98 when book arrives—or \$2.48 for handsome DeLuxe edition. If not delighted after 7 days' free trial return book for full refund. Write:

FOREMOST BOOKS, Dept. 12-46, 104 E. 26 St., New York 10, N. Y.

# STUDY AT HOME

### With An Educational Institution

Men with specialized training win higher positions, insure larger earnings, and are bigger successes in business and public life. Opportunities NOW greater than ever before. Send for our Catalog.

### ARTS and SCIENCES

Courses in Philosophy; Education; Letters; Public Health; Medical Jurisprudence; Psychology; Sociology; Physics; Chemistry; Plastics; Geology; Political Science; Theology; Business and Commerce; Accounting; Mathematics; Statistics; Agriculture.

### ENGINEERING

Courses in Electrical, Civil, Mechanical, Drafting, Architectural, Steam, Aeronautical, Radio, Structural, Mining, Industrial, Petroleum, Marine, Chemical, Diesel, Automobile, Refrigeration, and Air Conditioning Engineering.

### LAW

Complete Professional Law Course includes 18 Hornbook Series college grade textbooks. Courses also in Commercial Law, Patent Law and Medical Jurisprudence.

McKinley-Roosevelt Incorporated, 4610-AB, Sheridan Rd., Chicago 40, Ill.

32 POPULAR SCIENCE

# WELDING



## Offers Outstanding Opportunities

for steady income or a business of your own. Properly trained Technicians in Arc and Gas Welding are in great demand everywhere. Learn by doing in 6 months. Write for FREE 64 page illustrated book—"Dawn of a Giant Industry".

### MILWAUKEE SCHOOL OF ENGINEERING

PS-1246A Broadway and E. State, Milwaukee, Wis.



## GET INTO CARTOONING!

Learn to cartoon! Big pay! Easy, enjoyable work! Cartoon Course, Gag Course, Anatomy Course & Business Course full of plans, markets, ideas. Drawing set and criticisms. All one low price. Rush card for details. Hartman Studios, 2776 California Court, Lincoln 1, Nebr.



Begin today. Write now for our Free Book, "How to Become a Good Penman," it contains specimens and tells how others learned to write in spare time. Enclose 10c for your name beautifully written and a pen point suitable for shaded writing. Write today. THE TAMBLYN SCHOOL OF PENMANSHIP, N-439 Ridge Building, Kansas City, Mo.

# RADIO

ENGINEERING, Broadcasting, Servicing, Electronics, Aviation, Marine & Police Radio taught thoroughly. 48 weeks' Engineering course equivalent to 3 years' college radio work. Approved Veteran Training. Co-educational. Catalog upon request.

Valparaiso Technical Institute. Dept. 503, Valparaiso, Ind.

## LEARN SHORTHAND AT HOME

Maude E. Frank's Perfected Copyrighted System of 20 lessons. Used successfully 17 years from Coast to Coast. Send \$5 for Book and ONE FREE LESSON. Write—Maude E. Frank Secretarial School, 2000 E. Linwood Blvd., Kansas City, Mo.

## ● Earn HIGH SCHOOL DIPLOMA at Home ●

Guided study permits you to complete High School education in shortest possible time. Modern methods make it interesting, easier. Prepare for better jobs, pre-professional, college entrance exams. Recognition for H.S. credits already earned. Books supplied. low tuition. easy terms. Write for FREE information. HOME STUDY INSTITUTE, Dept. 212, 209 Vine Ave., Park Ridge, Illinois.

Say You Saw  
It In Popular Science



# MECHANICAL DENTISTRY

A profession offering unlimited opportunities. Most modern and complete course embracing every branch from Plate to Porcelain Work, which prepares you to work for Dentists or start your own business. Individual instruction—practical training in day or night school. No books—no classes. Catalog upon request. MCCARRIE SCHOOL OF MECHANICAL DENTISTRY 207 N. Broad St. Dept. 857 Philadelphia, Pa.





# GET INTO RADIO TELEVISION ELECTRONICS... NOW

A BIG, POWERFUL RADIO AND EXPERIMENTAL EQUIPMENT ARE INCLUDED WITH YOUR TRAINING

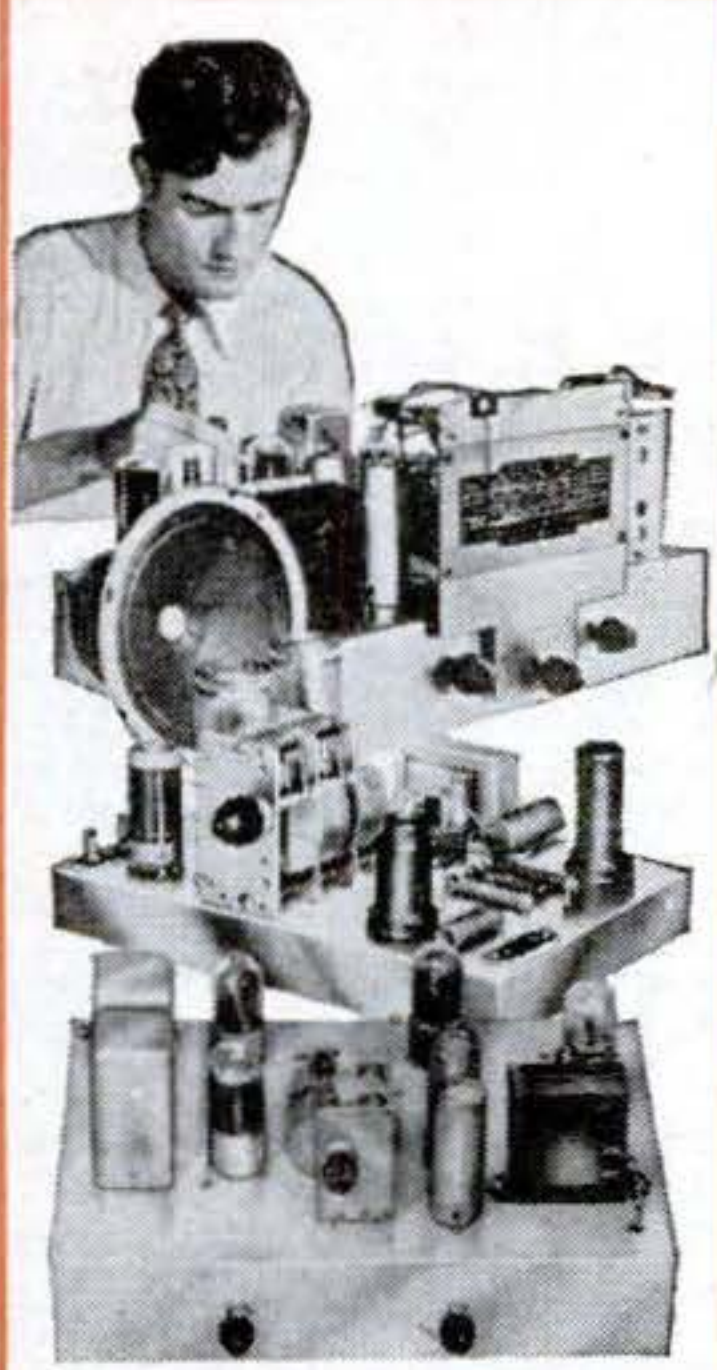

Here is some of the Radio equipment that is furnished you at no extra cost with National's Shop Method Home Training. BUILD A BIG, SEVEN TUBE, LONG DISTANCE SUPERHETERODYNE, an audio oscillator, a signal generator (low powered radio transmitter) and many other units. Really Learn by Doing! Earn money early in the Course doing spare time Radio work.

**Get Ready—at Home—in Spare Time—for Opportunities of Peacetime Industrial Expansion**  
**PREPARE NOW—With Shop Method Home Training BY A REAL ESTABLISHED RESIDENT SCHOOL**

No doubt about it!—Radio, Television and Electronics is a dynamic, growing industry that offers opportunity TODAY for the Trained Radio Technician. It is a field with a proved future. Good jobs, interesting and profitable jobs are available in Radio Service, Broadcasting, Marine and Police Radio, Manufacturing, Public Address, and other specialized phases. Untold Radio sets are in use—they need maintenance and repair. Many, many more must be built to satisfy even normal demand. **Trained men are constantly needed to keep this pulsating industry moving ahead.** If you are mechanically inclined, if you are sincere and will follow instructions, you too can find your opportunity in Radio, Television and Electronics—either in business for yourself or in a responsible position in industry. **TAKE THE FIRST STEP TODAY! FOR FACTS PACKED WITH OPPORTUNITY FOR YOU JUST MAIL THE COUPON BELOW.**

**Learn By Doing Right At Home**  
 The secret of the success of this practical training method is the experience of working with actual full size, standard equipment during your training. Here's a fully tested and approved method—simple and direct, easy to understand and put into PRACTICE! You check what you know as you go along. You can see progress right from the start. It will only take a moment to fill out and send the coupon for a sample trial lesson. **PROVE TO YOURSELF HOW MUCH YOU CAN ACCOMPLISH IN A SHORT TIME.**

**National Training Is More Than Book Theory**  
 National Schools can furnish you this modern, complete, up-to-date training in Radio, Television and Electronics for National has the Shops and Laboratories where instructors work with students and technicians to bring you—right in your own home—in

your spare time—the kind of practical instruction, practice and experience that assures definite progress—step-by-step through the entire field.

**Rush Coupon Today For Full Details**

See what definite practical progress YOU YOURSELF CAN MAKE WITH JUST A SINGLE LESSON, sent to you with no obligation. No salesman will call on you from National. You make up your own mind. IT COSTS YOU NOTHING TO READ THE INTERESTING FACTS.

**VETERANS**—if you qualify for training under the G.I. Bill of Rights check the coupon for a Special Bulletin.

**41 Years Experience Training Men for Success!**

**NATIONAL SCHOOLS**  
 LOS ANGELES 37, CALIFORNIA EST. 1905

**MAIL OPPORTUNITY COUPON FOR QUICK ACTION**

**National Schools, Dept. PS-12**  
 4000 So. Figueroa St.  
 Los Angeles 37, Calif.

Send me the free trial lesson and a copy of your opportunity book.

Name.....Age.....

Address.....

City.....Zone.....State.....

Check here if Veteran of World War II

**THESE MEN KNOW**  
 For over 40 years National training has given ambitious men their start in life and helped them win success and security. National graduates everywhere gratefully admit that they owe their success to National Training. They all started the same—by investigating what National has to offer.

Joseph Michel, Jr., Granite City, Illinois, says: "I am enclosing a letter I received very shortly after enrolling... I shall receive a salary advance of \$225 per month with an increase of \$300 shortly. Had I not taken advantage of the work National Schools sent me I would not have been able to interest this employer."

Clifford Hannah, Portage La Prairie, Manitoba, Canada, writes: "My training has brought results as I'm in line for another raise, thanks to National's encouragement and thorough training. You can count on me as a real National booster."



**SAMPLE LESSON Free!**



Get this complete, special manual "Modern Radio Servicing." It's full of valuable how to do it information. See for yourself how YOU can become a thoroughly qualified Radio, Television and Electronics Specialist. No obligation. You may keep the manual. IT IS YOURS FREE.



**ALSO THIS BIG OPPORTUNITY BOOK FREE!**

Tells of the many fine, good-pay jobs in Radio, Television and Electronics—How to start your own life-time business. **FILL OUT AND SEND THIS COUPON—NOW!**





# "Haven't got what it takes? Who? ME?"

Yes, it often is a shock to discover what others really think about you. And while they may be completely wrong, still . . .

Why not *prove* that you're going places—why not make more money?

Do you *dare* say you lack the opportunity when thousands are winning raises, promotion, through LaSalle's new home-study training?

Let us send you free that fascinating book: "Ten Years' Promotion in One." Write for it *today!* There's no obligation—nothing but a challenge, an inspiration, that can make money for you!

## G. I. APPROVED

Ask also for one of these interesting books on your chosen field.



## LaSalle Extension University

**A Correspondence Institution**

Dept. 1283-R 417 South Dearborn Street, Chicago 5

Please send me, without cost or obligation, "Ten Years' Promotion in One" and also the book on the business field checked below:

- Accountancy     Law     Traffic Mgt.  
 Business Mgt.     Modern Salesmanship

Name.....

Address.....

City..... State.....

## Get into Good Paying AUTO BODY and FENDER WORK



Men 18 to 60. If you are mechanically inclined, start now to learn to become an auto body mechanic and fender repair man. U. E. I. spare time, home-study training combined with actual shop practice gives you sound, basic knowledge of practical methods so you may get the experience which may bring you big pay. Course includes acetylene welding, spray painting, use of hand and power tools.

**WRITE FOR FACTS**

**THOROUGH, RELIABLE TRAINING**  
Auto body and fender repairing is one of the best profit-makers in any garage or service station. Employment placement service included, or we'll show you how to go about to get started in your own shop. Get the facts FREE today!

**AUTO-CRAFTS DIVISION • UTILITIES ENGINEERING INSTITUTE**  
1314 BELDEN AVENUE, DEPT. 3126X, CHICAGO 14, ILLINOIS

## EARN \$5—\$10 EXTRA EACH WEEK

In your spare time recommend our helpful books to fellow workers. 2300 books show how to do jobs better, easier; advance faster. Every worker a prospect. Join the hundreds now earning big commissions. Write for details: Dept. PS, McGraw-Hill, 330 W. 42 St., N.Y.C. 18.

TRAIN



## Your VOICE!

Results GUARANTEED

We build, strengthen the vocal organs—not with singing lessons—but by sound, scientifically correct silent and vocal exercises and absolutely guarantee complete satisfaction with results. Write for Voice Book, FREE. Sent to no one under 17 years old unless signed by parent.

Perfect Voice Studios, Studio 1369, Kimball Hall Bldg., Chicago 4, Ill.

## ARTISTS MAKE MONEY

Do you like to draw? Send name, address, age and occupation for FREE ART TEST, to find out your ability.

**ART INSTRUCTION, INC.**

12146 Art Instruction Bldg., Minneapolis 15, Minn.

## STAMMER?

This new 128-page book, "Stammering, Its Cause and Correction," describes the Bogue Unit Method for scientific correction of stammering and stuttering—successful for 45 years. Benj. N. Bogue, Dept. 1892, Circle Tower, Indianapolis 4, Ind.

GET THIS FREE BOOK!

## SUPER YOUR GREATEST ASSET!

MEMORY

FACTS—FIGURES—FACES

at your command through the new improved SUPERMEMORY course  
THOR BOOKS, Y-1, Box 1210, Chicago

## Learn BAKING At Home

Baking is one of America's high industries in wages. Nearly depression-proof. Thorough basic home course lays sound foundation. If you have aptitude, write for FREE BOOKLET, "Opportunities in Commercial Baking."

National Baking School, 1315 Mich. Ave., Dept. 1369, Chicago 5



## FREE BARGAIN CATALOG of BOOKS

25,000 books of all publishers listed in our 52nd Annual Bargain Catalog of 320 pages. Old-time favorites—latest "best sellers." Reference, Fiction, Juvenile, History, Scientific, etc. Supplying schools, colleges, libraries and thousands of individual customers. Send postcard today for our new 1947 catalog, "Bargains in Books."

**THE BOOK SUPPLY COMPANY, DEPT. 145**  
564-566 West Monroe St. Chicago 6, Ill.



## Learn Profitable Profession in 90 days at Home

**MEN AND WOMEN, 18 TO 50**—Many Swedish Massage graduates make \$50, \$75 or even more per week. Large full time incomes from doctors, hospitals, sanatoriums, clubs or private practice. Others make good money in spare time. You can win independence and prepare for future security by training at home and qualifying for Diploma. Anatomy Charts and 32-page Illustrated Book FREE—Now! THE College of Swedish Massage, Dept. 670R, 100 E. Ohio St., Chicago 1, Ill.



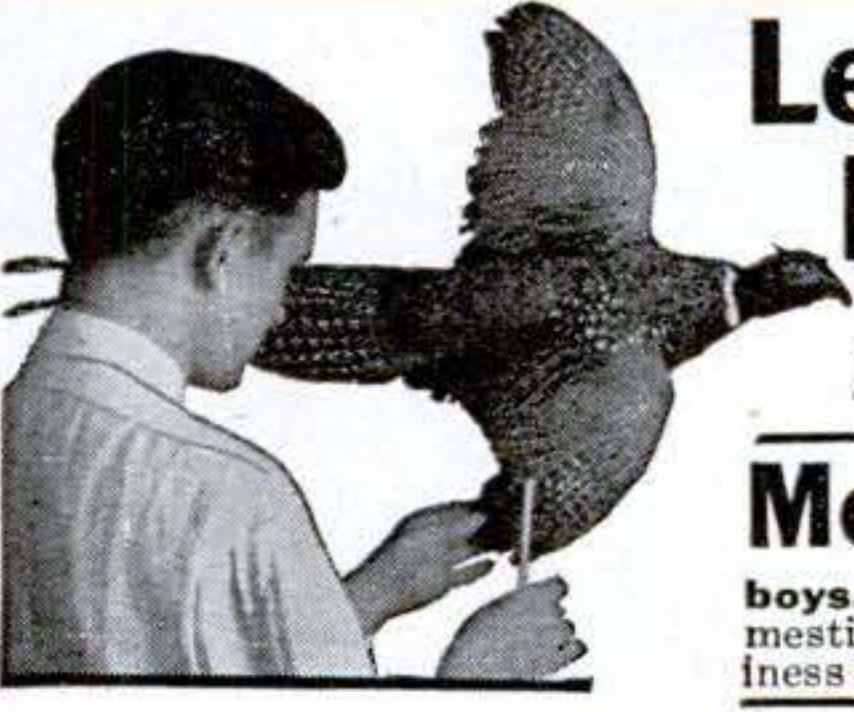

# Learn by Mail to Mount Birds

Animals, Game-Heads, Fish, Pets, to Tan Skins

**Men, Boys!** Be a **Taxidermist**. Learn at home in spare time. Easily, quickly learned. Grand **Fun**. A wonderful, profitable hobby, for expert hunters, also for amateurs, even young boys. Mount wild-game, although wild-game is not necessary. Use common, domestic specimens, squirrels, pigeons, even frogs. This famous, reliable school in business more than 35 years. **More than 300,000 delighted students. Think of that!**

## Hunters Save Your Trophies — Have a Home-museum Be a Taxidermy Artist

You will be **THRILLED** and **DELIGHTED**. You learn **QUICKLY**, easily **AT HOME**. Your friends will be amazed. Hunters from near and far will bring their **TROPHIES** to be mounted. You can earn fine **profits** in **spare time**. Many students earn \$60 to \$100 a month, in season. **Rush the coupon today**, and learn all about wonderful taxidermy. **DO IT NOW!**

Save your own hunting trophies. Have a lifelong hobby. Have a home museum that you are proud of, and that makes you popular and well-known far and wide. **BOYS**, wild-game is **not** necessary. Use common specimens, squirrels, pigeons, owls, domestic birds and animals. **It's wonderful**. Inquire **today**. **Kill fewer game-birds. Double your fun and pleasure.**

## Fun — Fascination — Profit

And so easily learned in spare time. Wild-game is growing scarcer. Help preserve it. Shoot only a **FEW** fine ducks and other game-birds, **MOUNT THEM** for home and den, and have **MORE FUN** and **PLEASURE** than killing the legal limit every day. **Help preserve the wild-game.**

Remember you learn to mount expertly, **birds, animals, game-heads, fish, pets, to tan skins and furs**. Investigate! You will be delighted. Send for **free book today**. "Eat your trophies and have them too."

**THE N. W. SCHOOL OF TAXIDERM, 3399 Elwood Bldg., Omaha 8, Nebr.**

## FREE BOOK!

Yes **FREE**, 44 pages, with 100 unique pictures of taxidermy work. No other book in the world like this. It will amaze and thrill you. **Ask today for your free copy. State your AGE.**

## Send the Coupon!

Write name plainly in coupon or margin, or a **post card** will do. **Rush** your request, as **free books** may be exhausted quickly. **Decide now**. Don't wait a moment. **State your age.**

## FREE BOOK

**Northwestern School of Taxidermy, 3399 Elwood Bldg., Omaha, Neb.** Send me your free illustrated book, "How to Mount Game". Also tell me how I may learn this fascinating art easily and quickly by mail. No obligation. State your age.

Name \_\_\_\_\_ Age \_\_\_\_\_  
 Address \_\_\_\_\_



# GRASP THIS OPPORTUNITY TO TRAIN YOURSELF FOR A WELL PAID JOB IN ELECTRICITY

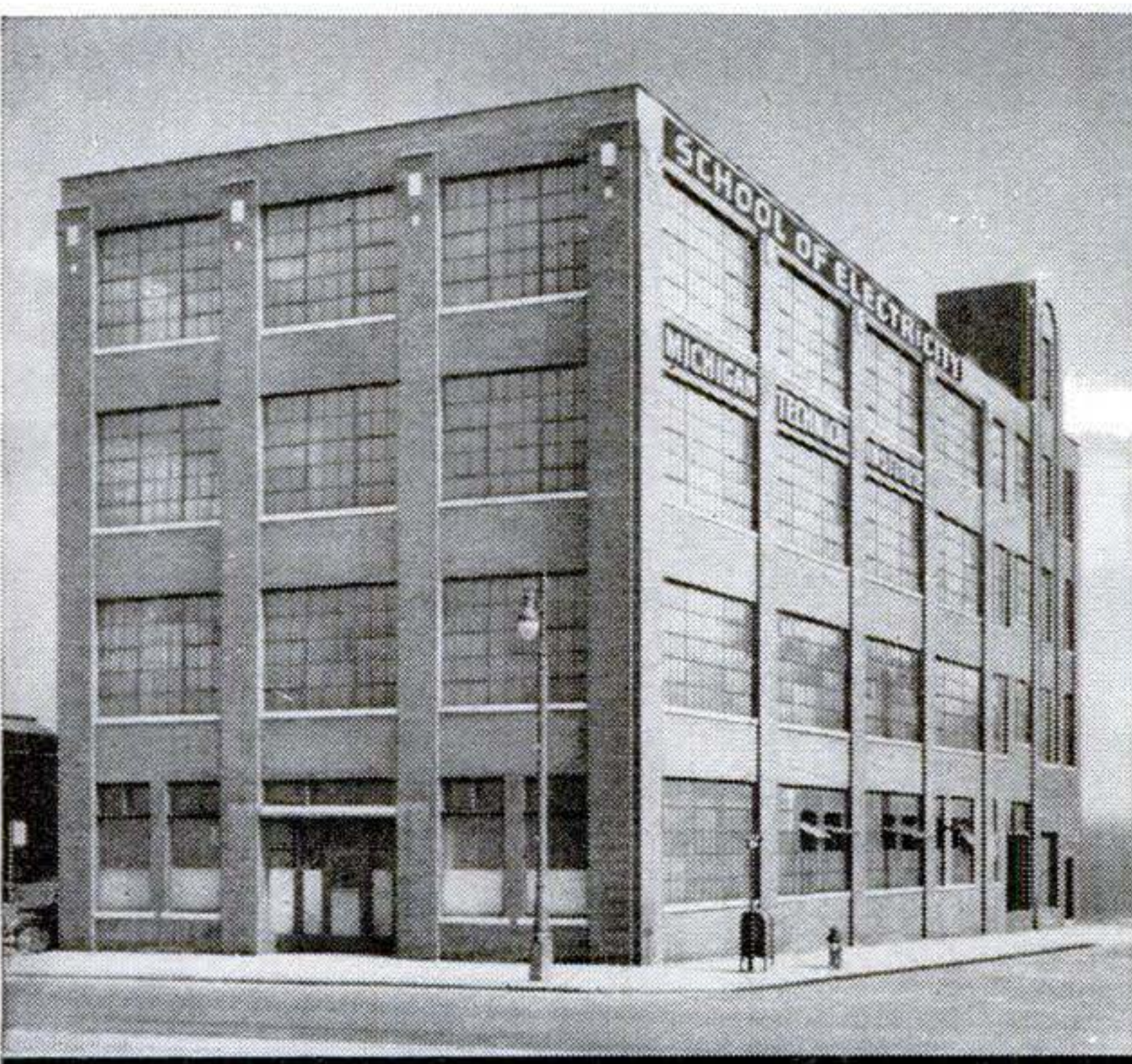

This large, four-story building completely equipped with first class electrical equipment for *on-the-job, up-to-the-minute* methods of training in Armature and Motor Winding, Factory Wiring, House Wiring, Electrical Maintenance, Appliance Repair. Entire building—4 floors devoted exclusively to this one course. No crowding, plenty of space and light. Well staffed with instructors to give individual attention to students. Living quarters arranged for if desired.

*Pay after you graduate . . .* Lack of money need not hold you back. We will finance your training. After you graduate you can pay us back in small monthly payments.

## VETERANS!!!

School approved for training under the GI Bill. Take this course at no cost to you, and receive \$65 to \$90 per month while training. Complete details furnished.

-----MAIL COUPON TODAY-----

MICHIGAN TECHNICAL INSTITUTE, Dept. S-12  
 2281 W. Fort St., Detroit 16, Michigan

- Please send me literature about your training.
- I am a G.I.

NAME.....  
 ADDRESS.....  
 CITY.....STATE.....

**MAIL COUPON today**



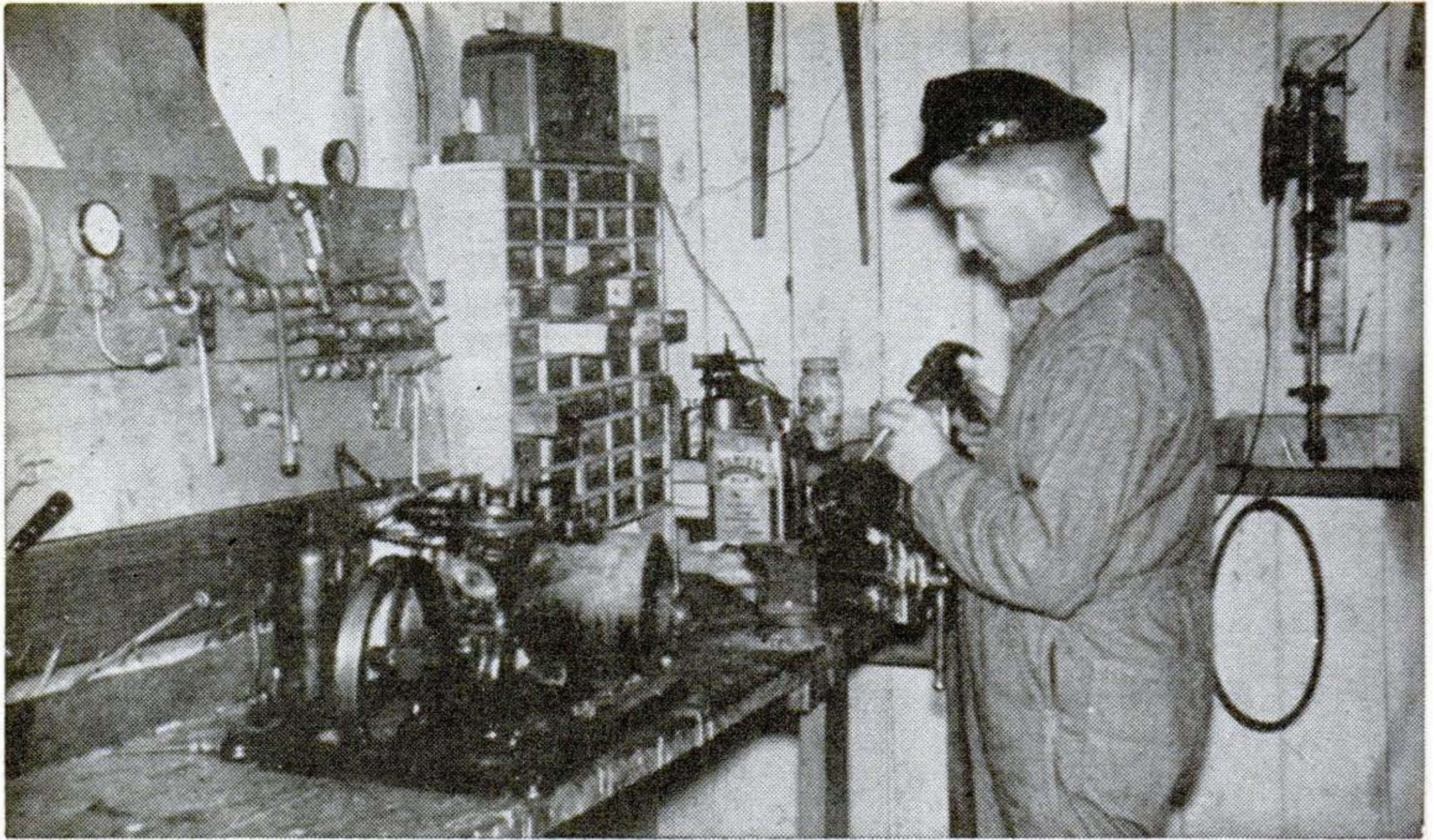

# SO IT NEEDS FIXING

By S. T. CHRISTENSEN

*the "Fix-it-Man"*

**W**ELL, I guess I'm the fellow to see, for I've repaired thousands of refrigerators (home and commercial both), vacuum cleaners, radios, washing machines, irons, fans, lamps, mangles, motors, etc. In fact, many of my customers call me their "electrical appliance doctor." And "doctoring," I might add has paid me a good substantial income for quite a few years. Funny, in a way, how I got started. Always liked to tinker and by experimenting around I found that most electrical appliances had many things in common. That, regardless of what the appliance was used for, or who the manufacturer was, the basic principles were much the same. From fixing my own appliances to fixing friends' and then for strangers at a fee, seems now to have been but a small step.

## What to Charge?

At first, I let the owner decide the charge and, frankly, I was amazed at what I earned per hour. But then, when one figures what initial costs are involved in buying most electrical appliances, one can readily see that spending extra dollars for repairs is well worth while. Before long I was making more in my spare time repairing than from my regular job. The result . . . I went into business for myself. When war came, business boomed, for new appliances were not available.

For a while, repair parts (needed on some jobs) were a little difficult to get. But that

situation quickly adjusted itself and many repair parts were given the high priority rating of AA2. After all, we had to provide for the health and well-being of our civilian population.

## The Future Offers

Friends ask me about my future. And, I think I've got a grand one. Age is no handicap in repairing. I have in my files enthusiastic letters from repairmen ranging in age from 18 to 79 years. Now the war is over we are certain to see hundreds of new products on the market . . . products that the average person never dreamt of. These new products and our old appliances are all going to need at some time or other "fixing." Well, I'll still be the fellow to do it. The field open for appliance repairmen is unlimited. I don't worry at all about too much competition.

## If You Are Ambitious

To the contrary, I've prepared a complete course, chuck full of simple, easy to understand photos and drawings and written in the same non-technical language as this article. I know the course is good, because I have hundreds of men all over the country writing to me telling me how the course has helped swell their pockets with cash. If you too want to prepare now for your future, I suggest you read the next page and send me the handy coupon."

ADV.





**BIG MONEY  
INDEPENDENCE**

*A PROFITABLE  
LIFETIME  
BUSINESS  
OF  
YOUR OWN!*

# LEARN ELECTRICAL APPLIANCE REPAIRING

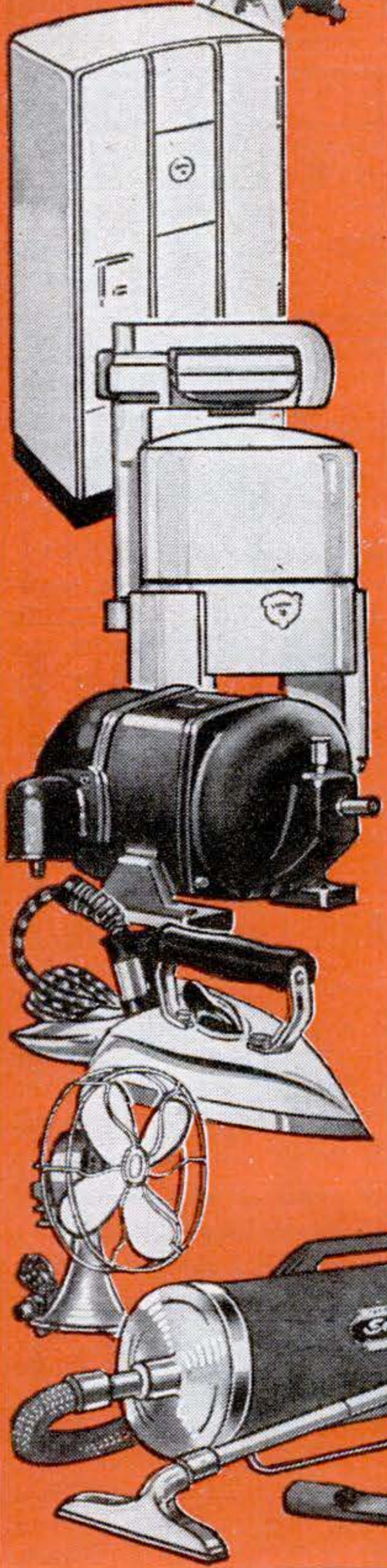

## PREPARE NOW FOR THE FUTURE

If now employed, start your home appliance repair business NOW in your spare time and be set with a business of your own no matter what happens. You don't need elaborate fixtures or expensive equipment to be a successful repairman. Operate from your garage, basement, vacant store, etc. Work as many hours as you wish—the home appliance repairman is his own boss. It is a profitable occupation for on many types of repairs it is not unusual for a repairman to charge on the basis of \$5.00 to \$6.00 per hour. Don't gamble with your future—learn a trade that will always support you. Remember, as long as electrical appliances are used, there will be a need for electrical appliance repairmen.

If you are at all mechanically inclined—can hold and use tools—then you have all of the qualifications required for becoming a big money earning home appliance repairman. It does not matter if you have not had a great deal of schooling or had previous experience along these lines—**WE WILL TEACH YOU.** Age should be no barrier—nor should any minor physical handicap.

## New Course Tells All

Profusely illustrated, our new course shows you in simple, easy to understand language and drawings how to make each repair on refrigerators, vacuum cleaners, washing machines, motors, etc. Explains and gives you a working knowledge of electricity, welding, nickel plating, etc. Shows you how to build the power tools you need and how to solicit and keep business coming to you. Not a theory course but an honest to goodness course written by and used by repairmen the country over. Price of course is so low that the savings on your own household appliance repairs will quickly pay for it. Act now! Mail the handy coupon below today.

### -----Read What Our Students Say About Course-----

I really believe your course the best investment a mechanically minded man can make.—Claude E. Allen, Indianapolis, Ind.

I have received your Course in Appliance Repairing and I must say I am well pleased with same. I am only sorry I did not have said Course some years ago. I have learned so much more through this course I would not part with it.—Charles Schwarz, Hamilton, Ohio.

The Course in Appliance Servicing arrived a few days ago. Want to take out a few minutes of my valuable time to let you know that this is just what I have been looking for ever since I opened up my Fix-It shop. I must admit that you told the truth when you said that it contains quite a bit more information than I bargained for. — P. J. Bretl, Sebring, Ohio.

I am a mechanic for the Western Union Telegraph Co. Three days after receiving the lessons in refrigeration I earned the exact cost of the course.—Henry S. Lee, Washington, D. C.

I work day times at the shipyard and after 4:00 P.M. I operate from my cellar and garage. I average \$10.00 to \$15.00 clear every day.—Walter Hanhy, Brockton, Mass.

## GET STARTED TODAY—MAIL THIS COUPON

**CHRISTY SUPPLY CO.**  
2835 N. Central Ave., Dept. D-4701  
Chicago 34, Illinois

Please send me free illustrated literature about America's Fastest Growing Industry—ELECTRICAL APPLIANCE REPAIRING.

Name.....

Address.....

City.....State.....



## • INVENTORS

The U. S. Patent Office recommends that, "an applicant is advised, unless familiar with such matters, to employ a competent registered patent attorney or registered patent agent, as the value of patents depends largely upon the skillful preparation of the specifications and claims."

## PATENT PROTECTION

This well-known organization will supply inventors promptly upon request and without obligation, detailed information concerning the steps to take to protect their inventions by United States Patents.

- PATENTS
- TRADEMARKS
- COPYRIGHTS

FORM BELOW FOR YOUR CONVENIENCE

# VICTOR J. EVANS & Co.

*Merlin M. Evans*  
REGISTERED PATENT ATTORNEY

Main Office: 140-P Merlin Building, Washington 6, D.C.  
Pittsburgh Office: 521-C Empire Building  
Los Angeles Office: 738-C Security Building

Please forward to me detailed information regarding procedure to obtain Patent Protection.

Name.....  
Address.....  
City and State.....

LEARN

## WATCH REPAIRING

AT HOME



Construction, repair, adjustment. New complete "PRACTICAL COURSE" for beginners and professional repairmen. All essential steps. Theory, operation. Many test cases. Full coverage of tools, materials. Fully illustrated. **ONLY \$2.95** (If C.O.D. plus postage fee.) **Post Paid**

**Money Back Guarantee**

**We Supply Tools, Materials at Lowest Cost**  
Illustrated catalog of tools and materials. Send 50 cents, credited to first order.—We specialize in all books on Watch-making, Jewelry, Metalcraft, Gem cutting, Optics.

**MODERN TECHNICAL BOOK CO., Dept. M.S.**  
55 WEST 42ND ST. NEW YORK 18, N. Y.

**JOIN OUR NEW TECHNICAL BOOK CLUB - free -**  
Members receive current literature, guidance on all book problems, premiums. No obligation. **ALL BOOKS:** Technics, Chemistry, Physics, Plastics, Refrigeration, Air-conditioning, Building, Construction, Electricity, Radio, Television, Electronics, Automotives, Mathematics, Wood-working, Homecraft, Business, Language, Farming, Sports, Photography, etc. — Write for free literature, please specify subject.

## "YOU ARE UNDER ARREST!"



**Help Bring Crooks to Justice Through Scientific CRIME DETECTION!**

I have taught thousands this exciting, profitable, pleasant profession. Let me teach you in your own home. Learn Fingerprinting, Firearms Identification, Police Photography, Secret Service Methods thoroughly, quickly, at small cost. 53% of all American Bureaus of Identification employ I. A. S. students or graduates. I can prepare you for this fascinating work, during spare time. Write today, stating age, for "Blue Book of Crime."

**INSTITUTE OF APPLIED SCIENCE, 1920 Sunnyside Ave., Dept. 1369, Chicago 40, Ill.**



### SPLENDID OPPORTUNITIES

**Sell • Appraise • Manage Full Time or Part Time**

Learn quickly, all the fundamentals of this profitable profession. Complete Home Study or Resident Course. Write for Free Catalog today. Now is the best time to get started.

Approved for G. I. Training Etab. 1936

**WEAVER SCHOOL OF REAL ESTATE, Dept. H-1**  
15 East Pershing Road Kansas City 8, Mo.

## PRINTING PAYS BIG

"Make your future secure. Prepare for a highly paid position or a print shop of your own. Students throughout the world are enthusiastic in their praise of our training program and the personal attention given each student. Rush name today for free literature and sample lesson. No salesman will call." Write Dept. P-106.

**International School of Printing, Box 334, Dayton, Ohio**



### LEARN LANDSCAPING

Profitable career—absorbing hobby for men and women! Thorough home-study course in landscaping, garden design. 45 lessons beautifully printed and illustrated. Learn in spare time 8-12 months. Hundreds of successful graduates all over the world. 31st year. Write for Free Catalog.

**AMERICAN LANDSCAPE SCHOOL**  
6382 Grand Ave.  
Des Moines, Ia.



### Thrilling Work COLORING PHOTOS

Fascinating vocation learned at home by those with aptitude. Thrilling pastime. National method brings out life-like colors. Free booklet.

**NATIONAL PHOTO COLORING SCHOOL**  
1315 S. Michigan, Dept. 1369, Chicago 5

EASY TO LEARN



### LEARN MEAT CUTTING

**At Home — In Spare Time**

Get into the vital meat industry. Concise, practical Home Training based on 25 years proven instruction methods used at National's famous resident school. Prepares you for bigger pay as Meat Cutter, supervision, market manager or more money in your own store. Go as rapidly as your spare time permits. Diploma. Start NOW to turn your spare hours into money. Send for FREE bulletin today. No obligation.

**National School of Meat Cutting Inc., Dept. 0-49, Toledo 4, Ohio**



# TOMORROW'S LEADERS ARE TRAINING

NOW IS THE TIME TO GET  
READY FOR A KEY JOB OR  
BUSINESS OF YOUR OWN

IN

**REFRIGERATION and  
AIR CONDITIONING**

*Today*

AMERICA'S FOREMOST  
SCHOOL OF  
**PRACTICAL TRAINING**  
FOR INDUSTRY

Here is an industry that offers every opportunity you could ask for. Good jobs—security—plenty of chance for advancement—a business of your own.

And here is a school equipped in every way to train you for Refrigeration and Air Conditioning work—one of the largest and most completely equipped schools of its kind in America—a school that already has trained thousands of men for just such opportunities.

### GET READY NOW!

Learn Refrigeration and Air Conditioning—now, while the time is ripe. You don't need any advanced schooling or previous experience. If you are at all mechanically inclined and have gone to high school for at least one year or have an equivalent education, we can teach you Refrigeration and Air Conditioning.

### LEARN AT HOME OR COME TO OUR SCHOOL

You can take most of your training at home, in your spare time—or you can come to Chicago and take your entire training in our completely equipped shops and laboratories. Either way you quickly acquire the fine points, practical skill, and broad, technical "know how" that makes the expert Refrigeration and Air Conditioning Technician.

Get all the facts about the opportunities in this interesting field of work, and about the I. T. I. system of training that has helped so many men into key jobs in this industry. Fill out the information coupon below and mail it TODAY. You will be under no obligation whatsoever.

**AUTHORIZED TO ACCEPT VETERANS FOR G. I. TRAINING**

### FACTS ABOUT THE INDUSTRIAL TRAINING INSTITUTE

Founded in 1916. Has trained more than 400,000 men for practical work in industrial fields. From 1942 through 1945 trained specialized technicians, exclusively, for the Army, Navy and Marine Corps. Now training thousands of veterans under the G. I. Bill, both in its Residence Schools and by home-study. Occupies five buildings of its own. Has over \$500,000 invested in training facilities, with an instruction staff of more than 100 men. Known everywhere as America's foremost school of practical training for industry.

**GET THE FACTS TODAY!**



**INDUSTRIAL TRAINING  
INSTITUTE WILL TRAIN  
YOU**

SEND FOR THIS BIG  
FREE BOOK



**REGISTRAR P 2M  
INDUSTRIAL TRAINING INSTITUTE  
2150 Lawrence Ave. • Chicago, 25, Ill.**

Please send me, FREE, your "Camera Visit" booklet and information about the opportunities for trained men in Refrigeration and Air Conditioning. It is understood that I will be under no obligation.

Name.....

Address.....

City.....State.....

Are you a veteran?.....

DEC. 39  
1946



# Can a Man MY Age Become a HOTEL EXECUTIVE

Even Though He Has No Previous Hotel Experience?

Would you like to step into a well-paid position as Hotel or Club Manager, Purchasing Agent, Social Director, Restaurant or Inn Manager, Assistant Manager? Would you like to be able to look forward happily to the future? The success of Lewis graduates from 18 to 50 PROVES you can—though you never had a minute's experience in hotel work.



Now Assistant Club Manager  
Although Without Previous Hotel Experience  
"When my employment with a shipbuilding concern was terminated, I decided to build my career on a sounder basis. I saw a Lewis advertisement, sent for their booklet; and enrolled. Shortly after graduation I was appointed Assistant Manager. As a result of Lewis training I can look forward to a bright future," writes R. A. Asmus.

Step Into a Well-Paid Hotel Position  
FREE Book Gives Fascinating Facts

Our FREE Book, "Your Big Opportunity," explains how you can qualify for a well-paid position at home, in leisure time. It tells how you are registered FREE of extra cost in the Lewis National Placement Service; shows how you can be a Lewis Certified Employee—certified to "make good" when placed in a position. Mail the coupon NOW!

VETERANS: Course approved for Veterans' Training

LEWIS HOTEL TRAINING SCHOOL  
Room HX-2724, Washington 7, D. C.

31<sup>st</sup> SUCCESSFUL  
YEAR

Send me the Free Book, "Your Big Opportunity," without obligation. I wish to know how to qualify for a well-paid position at home, in my leisure time.

Name.....

Address.....

City..... Zone..... State.....

( ) Check here if you are eligible under the G.I. Bill of Rights.

## Opportunities and Advancement Get Started QUICK in DRAFTING



I Will Train You Until You Get  
a GOOD PAY JOB! — *Engineer Dobe*

Act Now! Get ready for a better job, advancement, more pay and security. Drafting is the field of big opportunities and now bigger than ever before. Thousands of draftsmen and designers must come first—before any kind of production can begin. Get into Drafting. Engineer Dobe will train you at home in your spare time. You'll get experience on actual work—the same kind of jobs you will do for the best paying firms. You will be trained until you are competent, experienced, and are actually holding a position that will bring advancement and pay raises as deserved. Write today for details.

PREVIOUS EXPERIENCE  
NOT NEEDED

I train you through practical jobs and give your experience as a reference to employers when you become competent. Lack of starting experience or higher education won't hold you back. Low cost—and monthly payments, if desired. Write today for illustrated book and all details. No salesman will call. Give your age to get reply.

WORKING TOOLS FURNISHED

Professional instruments, drawing table and other tools included and sent when you start.

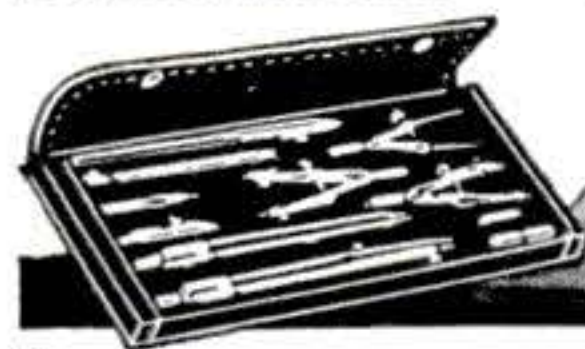

MAIL  
COUPON  
FOR VITAL  
FACTS

Engineer Dobe, Div. 29, Libertyville, Ill.

Send me the Vital Facts on Drafting and Industrial Designing, your FREE BOOK and advertised list of positions for Draftsmen and Designers wanted.

Name..... Age.....

Address.....

City..... Zone..... State.....

40 POPULAR  
SCIENCE

## LET US TEACH YOU TO Mount Birds



Animals, Fish, Heads; to TAN. Hunters, Trappers, be a Taxidermist. Let this old reliable school teach you—at home, in spare time. Our school has over 300,000 students. Save your fine trophies. Mount and keep ducks, deer, ALL wild-game. Tan skins, make robes and rugs, double your interest in HUNTING

AND FISHING. Have a home museum.

Free Book

Yes, FREE, this great strange book, with 100 fine wild-game pictures. Tells how YOU can become a real TAXIDERMIST, easily and quickly. It is amazing, thrilling, and may bring you a lifetime of PLEASURE and PROFIT. SPORTSMEN, grasp this opportunity. SEND NOW. A postal will do. But WRITETODAY—don't fail. State your age.

N. W. SCHOOL OF TAXIDERMY

3399 ELWOOD BLDG., OMAHA 2, NEBR.



## BE A BUILDING CONTRACTOR

FREE FACTS: Use Our Training Plan  
to Learn at Home in Spare Time

Do you want to be on the inside in the building boom—where big money is made? Learn about opportunities for Building Contractors whether or not you have previous experience in this field. Millions of dollars are going to be made in home and farm buildings, in construction of stores, garages, small industrial buildings. The building industry uses men with organizing ability by thousands in construction, supervision, management, sales. Properly trained men needed in production, distribution, finance, installation, marketing. Government estimates housing demand at 40 billion dollars. Others are preparing to get in now! Act immediately—get the facts! Mail postcard today—no obligation.

HOME BUILDERS TRAINING INSTITUTE, Dept. D-112  
7050 Glenwood Chicago 26, Illinois

## Learn Public Speaking

Learn theory and fundamentals at home—in spare time. Then acquire actual experience and practice. Send for FREE booklet "Power of Effective Speech."

North American School, Dept. 1369  
1315 S. Michigan Ave., Chicago 5, Illinois

## "How to Make Money With Simple Cartoons"

A book everyone who likes to draw should have. It is free; no obligations. Simply address

CARTOONISTS' EXCHANGE

Dept. 14412-D

Pleasant Hill, Ohio

## LEARN MOVIE PROJECTION THEATRE MANAGEMENT



The Motion Picture Theater Business offers big opportunities for trained men. Get into a fascinating field with a post-war future. Train at home in spare time. Free Catalog. Established 18 years.

THEATRE INSTITUTE

385 Washington St.,  
Elmira, New York

## Be Your Own Boss — In Your Own Business

Start at home . . . small capital needed . . . prepare for exciting plastics jobs or Your Own Plastics Business. We teach you Fabrication and Casting right in your own home. All materials furnished. Send ad with name and address for information. VETERANS: Eligible for resident training under G. I. bill, Check here

LEARN

## PLASTICS

PLASTICS TECH  
School of America, Inc.  
Dept. S-12  
5200 Euclid Avenue  
Cleveland 3, Ohio







# Now A DYNAMIC HEAVY DUTY INDUSTRIAL WELDER

**FOR ONLY \$23.50 COMPLETE...**

**Ideal and Practical Gift for Any Man**

Get details on our 10 day trial offer

Member Chicago Association of Commerce

**IDEAL FOR AUTO - HOME APPLIANCE AND FARM REPAIRS**

DESIGNED TO DO HIGH GRADE WELDING INEXPENSIVELY—Maintenance Men; Farmers; Mechanics; Machine Shops; Foundries; Auto, General Repair and Job Welding Shops; all using the DYNAMIC find it so indispensable and useful that they cannot afford to be without it. If inexperienced, you can easily learn to do a variety of high grade welding jobs by following the practical, simplified operating and welding instructions furnished. Once you see a DYNAMIC in operation, you won't want to be without it. Its simplicity will amaze you. In a year the DYNAMIC only costs you about 6c a day. Helmet, rods, cables, holder and operating instructions, etc., furnished.

**SAVES YOU VALUABLE TIME AND MONEY!**

This portable DYNAMIC WELDER—easily carried to the job—can be operated from any convenient, properly wired 110 volt, 60 cycle line. Can also be supplied for 220 volt, 60 cycle operation and for other voltages and cycles at slight additional cost. Works on IRON, STEEL, BRASS, BRONZE, AND OTHER METALS—has 8 metallic and carbon arc welding heat stages—does work you would think only possible with larger more expensive machine.

**DYNAMIC WELDER CO. • 13 East 23rd St., GP, Chicago 16, Ill.**

## PRACTICAL TECHNICAL TRAINING FOR YOU

Specialize in Electronics, Radio, Electricity, Refrigeration, Heating and Air Conditioning, or Welding

Prepare in six or twelve months for position as Technician, or in three years secure your B.S. Degree in ELECTRICAL ENGINEERING with a Machinery or Electronics Major.

Write for booklet, "Career Building."

**MILWAUKEE SCHOOL of ENGINEERING**  
Institute of Electrotechnics

P. S. 1246 North Broadway and E. State Milwaukee, Wis.

## MUFFLERS

**STEELS and ALUMINUMS with a motorboat tone**

SINGLES, Chev, V-8, Plymouth, Steels \$5.50, Aluminum \$6.50. Chry., Olds., Buicks, etc., Steels \$7.50, Aluminum \$8.50. V-8 and MERCURY DUALS, Steel \$17.50, Aluminum \$20.00. Aluminums are guaranteed for life of your car.

**DEALERS WANTED**

**SANDEE MUFFLER CO.**  
7523 S. WESTERN AVE., LOS ANGELES 44, CALIF.

**WRITE FOR FREE 48 PAGE BOOK "Success with Dogs"**

• Get this information-packed illustrated booklet about the care, feeding, and training of dogs. It's free.

**W LABORATORIES**  
DEPT. 8 PLAINFIELD, N. J.

*Is it worth \$1000.00 TO YOU TO READ THIS?*

It can be worth much more—yes, it can be worth thousands of dollars to you each year. Vocational and aptitude tests will find the career for which you are best suited and put you onto the RIGHT road to business and financial success. Should you be in accounting, radio, salesmanship, copywriting or elsewhere? Before taking a job or starting a course of study KNOW what you should do. Save weeks, maybe years, of work. Why postpone success? Vocational tests are SURE—they can be taken in your own home. Satisfaction is guaranteed.

Write today for complete information

**VOCATIONAL TESTING LABORATORY** Dept. S-12 2019½ Main St. Dallas 1, Texas

**Wake Up and Win!**

Are you "PUSHED AROUND" by Nerves, Fears, Inferiority, Poor Health? We offer you personal help with a money-back guarantee of results in your case. Our **Home Study Course** is a "Must" for those who want **New Powers** to meet life's demands. Write today for FREE LECTURE. **No obligation.**

**SCHOOL OF PERSONAL PSYCHOLOGY, INC.**  
1008-1009 Washington Bldg., Louisville 2, Ky.

**Say You Saw It In Popular Science**

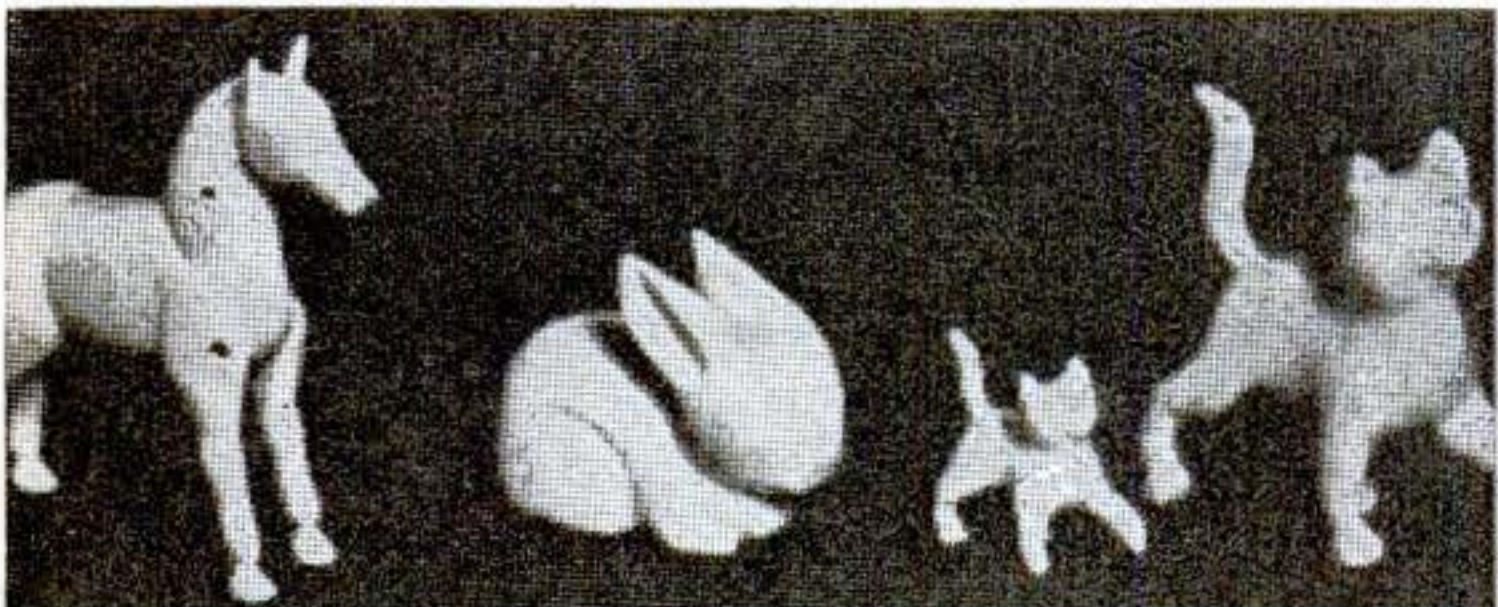

**YOU CAN WHITTLE AND CARVE**  
By Hellum F. H. Gottshall

There's something challenging about a small block of clean wood that makes the fingers itch to start whittling away at it. You can really get results in turning out all kinds of amusing and artistic little pieces by following the simple directions given in this book and how and what to carve. Once you have your sharp knife in one hand and your "blank" of wood in the other, these complete directions and full-size detail drawings guide you in making your carving perfect down to the sixteenth of an inch. Actual size photographs clearly show various stages in the process of carving. It won't be many chips later before an attractive wall plaque, a pair of dashing book ends, or a bit of personalized jewelry will seem to carve itself. Send only \$2.25, postpaid, or we'll ship C.O.D. plus postage. Money-back guarantee if not fully satisfied. Write today to

**HOBBY BOOK MART, Dept P-66, 150 Nassau St., New York 7, N.Y.**

**BIG MONEY FOR YOU IN PLASTICS**

SEND Offer includes 2 books: New Fabrication Manual & Giant Catalog, listing the most complete stock of Plastic Materials, Accessories, Tools.

**10¢**

**BERTON PLASTICS, INC.**  
19 W. 21st St., N. Y. 10, N. Y.

**ACT TODAY!**

**Locksmithing AND KEY MAKING Now Made Easy!**

Practical up-to-date course teaches you how to pick locks, de-code, make masterkeys, repair, install, service, etc. New self-instruction lessons for every handyman, a homeowner, carpenter, mechanic, service station operator, fix-it shop, hardware dealer, gunsmith. 53 easy illustrated lessons. **Low price! Satisfaction!** Free details, write **NELSON CO.**

**1139 S. Wabash, Dept. 1 M01 Chicago 4**

**Big Success-Catalog yours FREE**



# Plan Your Way to **BIGGER PAY**

**FREE** Occupational Success Chart and How To Study Guide



Big jobs go to men who know how to make most of themselves. Valuable OCCUPATIONAL SUCCESS CHART and HOW TO STUDY GUIDE prepared by college authorities to help you get most from CENTRAL EDUCATIONAL SERVICE quality books. Get into one of the big, growing fields NOW when there is a chance to go up fast. ORDER

FROM THIS LIST TODAY. Every book guaranteed to fully satisfy you or your money back. Even if you return books YOU STILL KEEP OCCUPATIONAL SUCCESS CHART and HOW TO STUDY GUIDE as our free gift to you.



**EVERY BOOK GUARANTEED FULL SATISFACTION OR MONEY BACK**

**Order Now—Earn More, Win Promotion and Security**

**DIESEL.** Here is a practical manual of Diesel engines covering Diesels on the road, on rails, on the water, in the air. . . . \$1.50  
**WELDING.** Beginning and complete course for man who wants to learn welding by himself. Gas, A.C. arc, brazing, metal cutting. . . \$1.35  
**ELECTRICITY.** Practical how-to-do-it volume covers simple wiring diagrams, circuit layouts, knob and tube wiring plans. . . \$1.35  
**PLASTICS.** How to work with plastics, tools needed, how to make dozens of useful objects for home use or own business. . . . \$1.35  
**REFRIGERATION.** Here is a practical, self-study service manual dealing with home and commercial installations of many types \$2.00

Central Educational Service, Dept. L-3  
 6009 Belmont Avenue, Chicago, Ill.

**YOURS FREE—**Even if you do not order any book, you still may send for Occupational Success Chart and How to Study Guide. Just fill out name and address, mail today!

**AIR CONDITIONING.** Practical, self-training text treats air conditioning of all types of buildings together with general applications of steam, hot-water, vacuum heating. . \$4.00  
**RADIO.** A practical text for the man who wants useful information in learning how to do trouble shooting and repairs. . . . \$2.00

**CARPENTRY.** Excellent self-teaching volume written for carpenters and apprentices. Clearly written, easy to understand. . . . \$2.50  
**BODY & FENDER REPAIR.** Big earning opportunities keeping new cars beautiful, preparing used cars for resale. Practical book for man without previous knowledge who wants own business or good job. . . . \$3.50  
**AVIATION ENGINES.** Very complete, from elementary step-by-step to big engines \$3.25  
**PLUMBING.** Complete self-study course on how to install, design plumbing. . . \$3.00  
**PAINTING & DECORATING.** Practical how-to-do-it information on principles and applications of paints, varnishes, etc. . . . \$1.85  
**INVENTOR'S COURSE.** Ingenious Mechanisms for Designers and Inventors. Basic volume every man with inventive mind should have. . \$5.00

**Send No Money or Remit With Order as You Prefer**

**CENTRAL EDUCATIONAL SERVICE, Dept. L-3  
 6009 Belmont Avenue, Chicago, Ill.**

Send books checked on FREE TRIAL. If I am not thoroughly satisfied, I will return books in 7 days and you will refund my money.

- I am enclosing payment with order.
- Send C.O.D. I will pay postman plus postage and C.O.D. fee. (No C.O.D. outside U. S.)
- Send free OCCUPATIONAL SUCCESS CHART and HOW TO STUDY GUIDE.

Name.....  
 Address.....  
 City..... State.....

- Diesel .....\$1.50
- Welding .....\$1.35
- Electricity .....\$1.35
- Plastics .....\$1.35
- Air Conditioning ....\$4.00
- Refrigeration .....\$2.00
- Radio .....\$2.00
- Carpentry .....\$2.50
- Body & Fender .....\$3.50
- Aviation Engines ....\$3.25
- Plumbing .....\$3.00
- Painting & Dec't ....\$1.85
- Ingenious Mech. for Inventors.....\$5.00

## To those who think **LEARNING MUSIC IS HARD**

Just strike these notes and you're playing the beginning of the "Merry Widow" Waltz. Look at the diagram. The first note of the music is "D." Following the dotted line to the keyboard you'll find "D" is the white key between the two black keys near the middle of the keyboard. Now read below how you can learn to play any instrument quickly and easily.



Look at the diagram. The first note of the music is "D." Following the dotted line to the keyboard you'll find "D" is the white key between the two black keys near the middle of the keyboard. Now read below how you can learn to play any instrument quickly and easily.



### Easy as A-B-C—this "Print and Picture" way!

Perhaps you think learning music is a tedious grind. It isn't any longer! Long hours of practicing scales and monotonous exercise are over.

You have no excuse for not getting started toward musical good times now! For through an easy method you can now learn to play right at home—without a teacher—for less than 7c a day.

### Learn to Play by Playing

The lessons come to you by mail from the famous U. S. School of Music . . . complete instructions, clear diagrams, and all the music you need. You learn to play by playing real tunes by note. First you are told how to do a thing. Then a picture shows you how. Then you do it yourself and hear it. Remember, don't confuse our method with any system claiming to teach music "by ear" or by trick methods. We teach you to play only from real notes!

**SUCCESS!**  
 Here's what one of our thousands of pupils writes: "I learned more from your course than many of my friends who studied under private teachers have for years. The fact that I've already taken 2 courses and am now enrolling for a third should speak for itself." F. A. S., Indiana.

Don't delay. Send now for our illustrated Free Booklet and "Print and Picture" Sample which fully explain this remarkable method. So decide which instrument you want to play and mail the coupon today. U. S. School of Music, 812 Brunswick Bldg., New York 10, N. Y. (Successful 48th Year)

### FREE! Print and Picture Sample

U. S. School of Music  
 812 Brunswick Bldg., New York 10, N. Y.  
 Please send me Free Booklet and Print and Picture Sample. I would like to play instrument checked below.

<input type="checkbox"/> Piano	<input type="checkbox"/> Saxophone	<input type="checkbox"/> Modern Elementary
<input type="checkbox"/> Guitar	<input type="checkbox"/> Trumpet, Cornet	<input type="checkbox"/> Harmony
<input type="checkbox"/> Hawaiian Guitar	<input type="checkbox"/> Reed Organ	<input type="checkbox"/> Mandolin
<input type="checkbox"/> Violin	<input type="checkbox"/> Tenor Banjo	<input type="checkbox"/> Practical Finger
<input type="checkbox"/> Piano Accordion	<input type="checkbox"/> Clarinet	<input type="checkbox"/> Control

Name..... Have You Instrument?.....  
 Address.....  
 City..... State.....

Save 2c—Stick Coupon on Penny Postcard



# ★ BRAND NEW WAR SURPLUS

**POSTPAID WITHIN THE U.S.A.**



#647 U.S. Navy Alarm Siren 7<sup>00</sup>



2 Pc. Cook-Eat Messkit #518- 1<sup>00</sup>

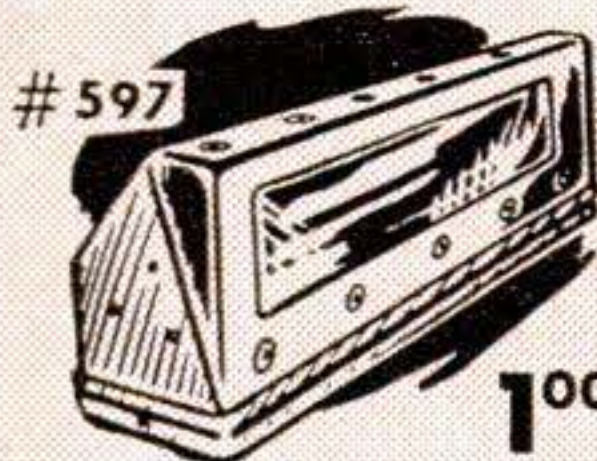

#597 Metal Tank Periscope 1<sup>00</sup>



ZIPPER Carryall-Pac #743 May be worn on back or carried by hand. Canvas. 4<sup>00</sup>



#587 Small, med., lge. 1<sup>00</sup>



O.C.D. Gas Masks 1<sup>00</sup>



6 pk't Apron Tool Kit #634 75c



#557 2 1/2 Gallon Canteens 2<sup>00</sup>



100% Wool Sleeping Bag #522 7<sup>00</sup>

BRAND NEW! G.I. Type 100% wool. Heavy-duty 30" zipper front



2-Man Mountain Tent #753 10<sup>00</sup>

Regulation Army type. NYLON, reinforced seams! Complete with poles, guy ropes.



Rucksacks #520-U.S. Army duck. Steel frame. Add 20% Fed Tax. 5<sup>00</sup>



Air Inflating Rubber Boat #544 20<sup>00</sup>

Holds 1 or 2 people



U.S.N. Emergency Fish Kit #726 5<sup>00</sup>

Can contains 7 drop lines, hooks, lines, gloves, bait, knife, gaff, apron, etc.



Nylon Net Jungle Hammock #752 10<sup>00</sup>

Insectproof! Army style. Waterproof roof. Complete with nylon ropes, rings, etc.



Army Training Rifles #561 4<sup>00</sup>

Made of wood and metal. Won't shoot!



Signal Corps Jack Knife #660 2<sup>00</sup>

2 1/2" Blade

**BAYONET TYPE KNIFE** #611 - Polished 6 1/4" blade Metal and plastic guard handle, case. 3<sup>75</sup>

**U.S. ARMY CANTEENS** #688 - All metal regulation. Plastic cap, One quart size. 1<sup>25</sup>

**FOX-HOLE SPADE** #517 - Steel blade 6" wide, red finish, hardwood handle. 24" long. 75c

**G. I. PISTOL BELTS** #687 - Khaki 2 1/4" web, non-rust hardware. Adjust to 42". (White belts \$2.00) 1<sup>75</sup>

**ALCOHOL STOVE** #652 - All metal. Burners have caps. 9" x 3 1/2" w. x 1 1/2" h. 75c

**SIGNALLING MIRROR** #683 - Metal with cord. Size 4" x 5". 35c

**COLEMAN G. I. STOVE** #632 - Sensational! Metal telescoping case. Burns gasoline 8 1/2" h. x 4 1/2" dia. 10<sup>95</sup>

**TOBACCO POUCH** #651 - Rollup style. O. D Poplin fabric. Moistureproof lining. 35c

**CANTEEN CASE** #689 - O.D. Cloth. Shoulder strap. Will hold qt. size canteen. 60c

**COLLAPSIBLE BUCKET** #671 - Heavy waterproof white canvas. Rope carrying handle. 12 1/2" diameter. 3<sup>00</sup>

**WRIST COMPASSES** #596 - Liquid type Plastic case. Adjustable strap. 1<sup>50</sup>

**TARGET BALLOONS** #681 - Red rubber target balloons that blow up to 7 feet. 75c

100% WEATHER PROOF 2 PIECE

**STORM SUIT**



#751 Double textured fabric. Parka jacket. Bib style pants with zipper fly, button flap. Small, med., lge. 7<sup>00</sup> SUIT



25 Pc. Camp-Scout Kits #514 - Plastic case. Has scout knife, safety razor, blades, plastic oil can, whistle, fire tabs. 3<sup>50</sup>

#514 - Plastic case. Has scout knife, safety razor, blades, plastic oil can, whistle, fire tabs.



Army Angle Flashlights #700 - Plastic case. Metal clip. 2 bulbs (1 in cap), 2 batteries included. 1<sup>75</sup>

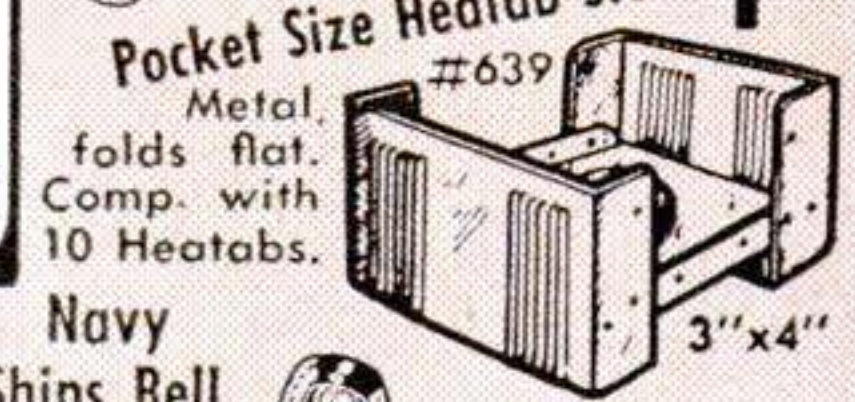

Pocket Size Heatab Stove #639 - Metal, folds flat. Comp. with 10 Heatabs. 3" x 4" 1<sup>00</sup>

Waltham Jewelled Compass #507 2<sup>50</sup> O.P.A. 3.95



Sprayer Pump #543 Sprays pumps, bails! 27" high 10 ft. hose. 1<sup>50</sup>

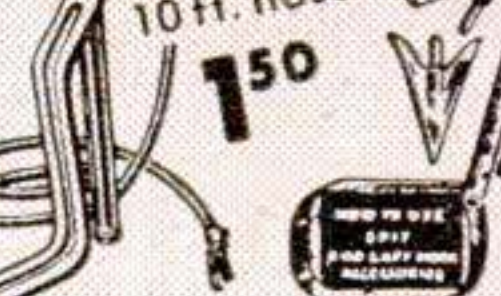

14-pc. Spit Gaff Set #579 1<sup>00</sup>



Navy Ships Bell #502 Steel 10" X 9 3/4" dia. 8<sup>50</sup>



U.S.N. Sheath Knife #703 - Parkerized no-glare 6" blade. Leather washer handle. Genuine leather sheath. 2<sup>50</sup>

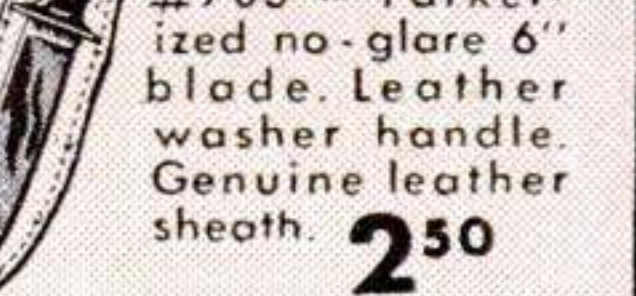

**FEDERAL SURPLUS CORP.** 5 EAST 4th ST. NEW YORK 3.

**HOW TO ORDER** Order by number. Remit by money order or bank draft. Send 50% deposit on COD orders. No COD orders for less than \$5.00 total.



POPULAR  
SCIENCE

# Classified Opportunities

*Save time - Save Money*



Classified Ads only 60c per word per insertion, payable in advance. Minimum ad 10 words. To be included in January issue copy should be in our office by November 29th. January issue on sale January 1st.

POPULAR SCIENCE MONTHLY—351 FOURTH AVE.—NEW YORK CITY 10

## 1 ADVICE

**FREE** if dissatisfied. Amazing Booklet, Psychology for the Masses. Prevents disasters. P.O. Box 801, Ottawa, Canada.

**PERSONAL**, educational, unemployment, vocational problems unsolved? Consult experienced, ethical counselor. Fee \$1, returnable if dissatisfied. Personal Service, 3070-A Hull Avenue, New York 67, N. Y.

**MIRACLE** Personality Analyzer! Introduces You to Yourself—Write. Enclose \$1.00. Beeler's Personal Problem Clinic, 1925B Grove, Berwyn, Illinois.

**LEARN** How to find Missing Person's and make money doing it. A great spare time Hobby. Send 25c for Information, and copy of Magazine offering hundreds of "Cash Rewards" for locating "Missing Persons." Address, The Searcher Magazine, J. J. Wilcox, Mgr., G. P. O. Box 112, New York 1, N. Y.

**SCIENTIFIC** Work easier. Library Scrapbooks \$1.70 Free Folder. Abalton, 131 West 42nd, New York.

**BARGAINS**, New Lists, thousands of scarce products wholesale, a post war sensation. 10c Home Systems, Box 12B, Oaklandon, Indiana.

**WHAT** shall I Study? Which books will help assure a profitable trade or profession? Expert assistance and a copy of "Books Current" Free. Center Book Club, 243 Market, Newark 2, N. J.

**BEAUTIFUL** Mirrors from ordinary glass. Complete instruction folio, \$1.00. Tesco, PS-1, P. O. Box 189, Wilkes Barre, Pa.

**ANALYSIS** of personal worries or business problems \$1.00. If unable to analyze money refunded. Research Clinic, Box 302, Altadena, Calif.

**HEAL** The sick, eliminate disease, fulfill every need through the spoken word. "Vitascience" tells how. Free details. Cedric S. Moore, 1313 South Union, Kokomo, Indiana.

**DRUNKENNESS** is a disease which responds to treatment. In 68 years, Keeley's brief, pleasant treatment has brought new health, happiness, opportunities to many. Endorsed by thousands of physicians. All correspondence confidential. For free, descriptive booklet in plain wrapper, write (PT) Nelson, Keeley Institute, Dwight, Illinois.

## 2 ADVERTISING

**ADVERTISE** Profitably: \$20.00 reaches 5,000,000 Sunday newspaper readers with 24-word ad. Newspaper, magazine, mailing-list ratebook free. Chicago Advertising Agency, 20-PS West Jackson, Chicago 4.

**24 WORDS** in 64 Weeklies \$4.96. J. Darnell, 730 Hays, Jackson, Tenn.

**INCH** display advertisement, mail order World, year \$24. Wood's Popular Service-S, Atlantic City, N. J.

**"1000 USEFUL** Words for Advertisers." Every advertising writer needs this booklet. Unique classification produces right word quickly. Lends tone, variety, emphasis to copy. Starts ideas. 50c postpaid (no stamps). AAA Press, 260 W. Ash, Burbank, Calif.

**ADVERTISE:** 24 words, 40 Newspapers \$3.50. List Free. Advertising Bureau, 4515-P Cottage Grove, Chicago 15.

## 5 AGENTS WANTED

**SCHOOL** Seniors!!! Your postal will bring our wonder. Kwick-Sell Cardalog of popular Graduation Name Cards. Biggest profits!!! Only firm giving free souvenir chest and Card Case. Don't miss out! Hurry that postal!!! Craftcards, Box 235 (M), Pittsburgh 30, Pennsylvania.

**GOOD** Paying Business Silvering mirrors, plating autoparts, reflectors, bicycles, bathroom fixtures, etc., by late method. No tanks or shop required, outfit furnished. Free Booklet. Gunmetal Co., Ave. G, Decatur, Illinois.

**LICK** After-war layoffs; Start own business; home, office. Booklet describing "Collection of 127 Tester Plans" free. Elite Co., 220 Grand St., New York.

**FREE** Water and our concentrates makes flavors, lotions, shampoos. 72 products, labels, bottles furnished. Qualco, F-20030 Russell, Detroit.

**FREE!** Latest issue Opportunity Magazine. Salesman's Guide. Inspiring, constructive. Shows how to earn money selling for others or in your own business. Hundreds postwar opportunities. Send name and describe what you have sold or are selling. Illustrated copy sent Free. Opportunity Magazine, 620 N. Michigan, Dept. 18, Chicago 11, Ill.

**JUST** Out! History of World II. Huge volume. Popular price. Authentic text. Official Photographs. Big profits. Riverside Book Co., Iowa Falls, Ia.

**START** Your Own Business on our capital. Always your own boss. Hundreds average \$6,000 to \$25,000 annual sales year after year. We supply stocks, equipment on credit. 200 home necessities. Selling experience unnecessary to start. Wonderful opportunity to own pleasant, profitable business backed by world wide industry. Write Rawleigh Co., Dept. L-U-PSC, Freeport, Ill.

**BIG** bargains for big profits. Over 100 sensational values. Men's used suits \$2.00, pants 35c, topcoats \$1.25, overcoats \$2.00, shoes 20c. Experience unnecessary. Free wholesale catalog. Superior, 1250-FA, Jefferson, Chicago 7.

**100% PROFIT** on famous popular Pines Birthday, Christmas, and all-occasion Greeting Cards. Wonderful 12 to 24 Card boxed assortments sell on sight for \$1.00. Write today for information and Extra Bonus Distributor's Plan, S. Pines, Box 32, Flushing, N. Y.

**SCHOOL** Seniors—Sell classmates America's most beautiful, distinctive Graduation Name Cards. 40% commission. Largest selection. Lowest prices. Free cards and sample kit. Printcraft, 1425 E. Elm St., Scranton 5, Pa.

**"OUR** Flag"—famous picture. Four colors. 500,000 sold. Sample print—Free. Our Flag Sales Corp., Dept. C-1065, Excelsior Springs, Mo.

**GROW** bean sprouts for market in dark room winter and summer. Quick returns. Literature free. Mrs. Nickell, Rt. 1, Box 456, Bend, Oregon.

**AGENTS**—Big Line Including Food Products. Fast selling premium and bargain deals. Low Prices. Send card for big outfit offer with gift. HO-RO-CO, 2794 Dodier, St. Louis 7, Mo.

**GOOD**—By Corns, Callouses and Warts. Minton's improved corn salve removes them. Stops pain and soreness over night. Money refunded if unsatisfactory. Price 35c, trial size 10c. Exclusive territory for appointed distributors. Minton, Box 71, Brighton Station, Rochester 10, N. Y.

**GOLD** lacquered Window Sign Letters. Large Sizes Penny Each. New Foils. Absolutely Beautiful. Free Samples. Atlas, 544 W. 79th, Chicago 20.

**AGENTS**—300% profit selling genuine gold window letters; stores and offices. Free samples. Metallic Letter Co., 437 N. Clark, Chicago.

**SELL** Superb Line Personal Printed Stationery. High quality items, year 'round sales. Attractive sample book, supplies free. Writewell Stationery, Dept. 112, 108 Massachusetts Ave., Boston.

**ORANGES**, most delicious, bursting full with Health giving Juice and Vitamins from our famous Indian River Groves direct to consumers. Employers are Now placing Christmas orders for Employees and customers. Salesmen earn over \$100.00 commission weekly. Sunset Valley, Oak Hill 12, Fla.

**EXCELLENT** Sideline for printing and advertising salesmen. Decalcomania name plates in small quantities. Great demand. Also make money applying initials on automobiles. Free samples. Ralco, XL-Roxbury, Boston 19, Mass.

**QUICK** Profits with individualized belts, buckles, cap badges, tie holders, uniforms. Choice of thousand emblems. Sure repeat orders. Easy-Selling outfit offer. Write Hook-Fast Company, Dept. 14, Roanoke, Va.

**SELL** Greeting Cards, Display Signs, Pictures, Books, Novelties. Big Profits. Bulletin Free. Elfco, 432 North Wells, Chicago 10.

**BIG** Profits stamping Key Protectors Social Security plates. Key Check Stamping Outfits. Sample key checks with name and address 25c. General Products, 11 No. Pearl (PS), Albany, N. Y.

**AGENTS** Wanted for our coin operated amusement machines in every town and community. Sell to clubs and homes, or start a route. Webb Distributing Co., Dept. S9, 6 S. Kedzie Ave., Chicago 12, Ill.

**BIG** commissions—selling to stores celluloid Pricing Tickets, Metal shelf moulding—to restaurants, menu covers, signs. Pricing Press, 124 White St., Dept. C, New York 13, N. Y.

**SELLING** to housewives? Double your sales with inexpensive premiums. Postal brings interesting details. C. Kinford, Wayne, Pa.

**\$1.44** PROFIT on \$2.00 sale to dealers. Killsem Baits, Painesville, Ohio.



**PAINT** plaster plaques for Christmas! Sell locally. Beautiful, clear detail. Strong, hard castings. Fascinating fun! Paying profits! Popular prices! Molding rubber. Artists' brushes, paints, instruction books available. List free. Pioneer, 394-BZ, Austin, Minnesota.

**\$1.00 BOX** Christmas cards 60c. Thriftmaster, Box 61-S, Times Square, New York 18.

**\$1.00 STARTS** you in business. Sell DeLuxe ties, 100% wool interlining. Costs you only \$7.00 per dozen, you make \$5.00 dozen. Send \$1.00 for special introductory offer two DeLuxe ties. Catalog complete line Free. Philip's Neckwear, 20 West 22nd St., Dept. P-6, New York 10.

**\$3 FIRE** Extinguisher sells wholesale or direct. "Fire-Killer", 101 Franklin, Syracuse, New York.

**2 PROFITABLE** Sellers . . . Silver Plating Liquid (NuSilver . . . RePlateO . . . trademarks). Simply apply with a cloth and polish-up . . . or immerse article in Liquid 1 minute and polish-up. This is a method of chemically-applying silverplating in 1 minute to certain affinitive metal surfaces, like Sterling and silverplated ware, nickel-silver, german-silver, brass, copper, bronze, zinc, and some other metal compositions. Deposits genuine pure silver 1000 Fine. Gives a durable and lasting finish. Formula perfected in 1926-27 and sold successfully now for over 19 years. Has over a thousand uses. A very profitable seller at about 4 for 1 . . . Lectrik-Silver Kleaner Atomic Metal Electrode Plates, for de-tarnishing silverware (and other metals, too) quick. As many as 100 pieces of tableware can be de-tarnished in 1 minute. This is the original metal de-tarnishing Plate invented in 1907, and now sold successfully for over 39 years. This is a demonstrating money-maker with a margin of 5 for 1 . . . Both of these items are thrilling demonstrators. To any one who will get out and cover territory and demonstrate and sell, real money can be made. Exclusive territory demonstrating sales-distributors are wanted in all territory not being worked now. Wholesale and retail. Men and Women. Work yourself and appoint agents and dealers throughout territory. This work is permanent if you will do the job. Complete details free by letter mail. NuProcess Products Laboratories, Dept. 261, Aurora, Illinois.

**NEW Cleaner 95% Profit** Fast Seller. Alliance Chemical, 415 Laramie, Alliance, Nebraska.

**WONDER** Silver Plating Liquid. Applied with cloth or by dipping. Plates without tanks or electricity. New, improved, concentrated, double-strength formula; silver-plates larger surface with heavier coating. Good carded item for stores. Wonderful Demonstration. Big Profits. Free Details. Wonder Products, 1265A Broadway, New York 1, N. Y.

**SELL** appliances! New Automatic electric ready. Sample, \$6.50. McSwain Appliance, Fort Smith, Arkansas.

**MYSTERY** Drinking Bird. Drinks constantly. Super attraction. \$3.00 prepaid. Box 1D, Blue Earth, Minnesota.

**SELL** Personalized soap. Name on every cake. Ideal for gifts. Get sample offer. Dunbar Soap, New Brunswick, N. J.

**PLASTONE**—Amazing new polishes for floors, furniture, autos. Beautifully packaged. Low priced. Whirlwind seller to stores, gas stations, homes, fast repeater. Big profits. Unconditional money back guarantee. Write for free samples offer now! Plastone Company, 2207-B West Chicago Ave., Chicago 22, Ill.

**JOKERS** Novelties. Wholesale. Hundred Pieces, Dollar. Wholesaler Pauly, 2295 Concourse, New York 53, N. Y.

**200 MONEY** Making Deals. Plans, Rare formulas, Schemes. Folio Free. Formico Co. Box 572, Dayton, Ohio.

**IMMEDIATE** Profits! Take orders for new amazingly beautiful life-time laminated Plastic Reproductions of any pictures, snapshot or negative. Build a profitable full or part-time business without investment. Write for details today. Gotham Products Co., Box 5427, Kingsessing Station, Philadelphia 43, Pa.

**STRANGE** "Dry" Window Cleaner. Sells like wild. Replaces messy rags, liquids. Simply glide over glass. Samples sent on trial. Kristee, 129 Akron, Ohio.

**46 POPULAR SCIENCE**

**WONDER** cleaner, new bubble bath, Glass-lean—three profits. Fast sellers, homes and stores. Circulars free. Courier, 3829-H Delmore, Cleveland Heights 21, Ohio.

**SOMETHING** new sensational Pin Up Girls. Business card samples. Prices 25 cents. Select, Little Falls, N. J.

**WOULD** you pay 3%—first \$350 made? Color-illustrated book "505 Odd Successful Enterprises" free! Proven! Work at home, office. Expect something odd! Pacific, 2207½ Cloverfield, Santa Monica, Cal.

**EARN \$2** an hour soliciting subscriptions. P. O. Box 371, New Orleans 9, La.

**PHOTO** Enlargements. Picture Men, Distributors and Crew Managers—Beautiful enlargements done for you direct at Special Rates, or on Commission Basis. Rich Photo, 215 W. 98th, New York City.

**100% PROFIT**—\$20.00 worth polishes, etc. \$10.00. Renschler's, Carrollton (1), Kentucky.

**AGENTS**—big money for men, women, boys, girls—selling gorgeous night-glowing orchids, gardenias: perfect imitation real flowers: last for years: all the rage for wear on hair or clothes. Write for wholesale prices. Marney's, Dept. S-2, P. O. Box 581, Ogden, Utah.

**SALES** representative to call on radio, music, appliance dealers, servicemen with nationally advertised line of test equipment. Generous Commission. Metropolitan Electronics, 6 Murray St., N. Y. C.

**LARGE** earnings! Your own business, supplying household food & drug necessities to consumers! Free details, Hollenbush Products, Dept. PS, Pottsville, Penna.

**SELL** by Mail! Books and Novelties! 35 different items! Large Profits! Catalog Free! Elfco, 432 N. Wells, Chicago, 10.

**HOUSE** Numbers that glow in the dark. Luminous pictures, etc. Large mfr. wants factory representative. Wonderful new product. Fast seller. Free samples. Madison Mills, 303 4th Ave., N. Y. C.

**QUICK** Profits with individualized belts, buckles, cap badges, tie holders, uniforms. Choice of thousand emblems. Sure repeat orders. Easy-Selling outfit offer. Write Hook-Fast Company, Dept. 14, Roanoke, Va.

**OUR** Monthly Exclusive New Products Bulletin Service brings you listings of 100 Newest Items and where to get them. Latest release \$1.00. Wm. E. Neubauer Publ., 4815 "A" Street NE., Philadelphia 20, Pa.

## 6 AIR CONDITIONING & HEATING

**FLOOR** Furnace 3 to 5 rooms. Easily installed. Get your order to us. Peerless Sales, Lincoln 6, Nebraska.

## 7 AMERICAN POLICE JIU JITSU

**DEADLY** Judo-Fiercest fighting technique. Trick knockouts. (200 photographs—plus illustrations.) Expert instructions—Three volumes. Complete \$2.25. Variety House, Box 46-AL, Wall Station, N.Y.C. 5.

## 8 ANTIQUES, RELICS, INDIAN GOODS

**SWORDS**, rapiers, daggers, pistols, armor; illustrated catalog. 50c. Robert Abels, 860½ Lexington Ave., N. Y.

**4 FINE** perfect Ancient Arrowheads \$1.00. 4 perfect tiny bird arrowheads \$1.00. List Free. Lear's, Box 569, Galveston, Texas.

**ANTIQUE** Firearms, Swords, Daggers, Powderhorns, Flasks, Catalogue 10c. Nagy, 8 South 18th St., Philadelphia 3, Pa.

**350 ANTIQUE** Firearms;—3,000 Bargains: Indian Relics, Flintlocks, Minerals, Coins, Swords, Cartridges, Fossils, Rifles, Carbines. Catalog-Photographs 25c. Heike, Wenona, Ill.

## 10 AUTHORS SERVICE

**I WANT** New Writers to cash hundreds of checks for \$1 to \$100, offered each month. The easiest way to write for pay. No previous experience necessary. Send for Free details. No obligation. Saunders M. Cummings, 467-S Independence Bldg., Colorado Springs, Colo.

## 12 AUTOMOBILES

**SEE** our ad under motorcycles for midget car bargains. Midget Motors Directory, Athens, Ohio.

**RACING** Car performance for all cars. Increase power, speed. Special "Custom built" equipment. Free literature. Write Lee Motorcraft, 1412-B Great Northern Bldg., Chicago 4, Illinois.

**INDIANAPOLIS** Model Race car polished cast aluminum, free running wheels, looks like models selling for \$12.00. A beautiful Christmas Gift, send \$2.98 Postpaid. Dealers inquiries invited. S. & P. Merchandise, 12199 Flanders, Detroit 5, Mich.

**AUTOMOBILE** Racing Book. Fifth Edition—Revised. Tells how to build dirt tracks bodies, frames, engines. Records, superchargers, rules, formula, plans, stock conversions, roadster racing, fast Fords. \$1.00 postpaid; \$1.15 C.O.D. Ray Kuns Department 274, Madisonville, Cincinnati, Ohio.

**NEW** Racing Books. Dick Seaman, Racing Motorist, \$3.50. Road Racing, \$3.50. Wheels that speed, \$3.50. Wheelspin, \$3.50. Midget Automobile 1946 Racing Year Book, \$1.10. All Postpaid. Clymer, Dept. B-122, 2125 W. Pico, Los Angeles 6, Calif.

**CUSTOMIZE** your automobile. Illustrated new restyling ideas, instructions, specific model changes by simple methods, \$1. Speed-wheel, Box 723-C, Arcadia, California.

**DUALTONE** TWIN muffler sets for Fords and Mercurys. Instructions included \$20. Replacement mufflers, all automobiles. Prices quoted on request. Designed to eliminate back pressure, giving increased gas mileage and horsepower. Has deep mellow tones. Three inch chrome tailpipe extension \$3.00. Dualtone Mufflers, 2636C India Street, San Diego (1), Calif.

**BUILD** speedy Midget track racer from castoff parts! Plans, specifications, construction information, \$1.00 Motor Supply, Box 1682-CS, Toledo, Ohio.

**"FASTEST** On Earth" History book every World's Straightaway Speed Record. 200 pages. 70 illustrations world famous drivers, cars. \$2.00 postpaid. Clymer, Dept. B-124, 2125 W. Pico, Los Angeles 6, Calif.

**STREAMLINE** Your Automobile! Hollywoodized, Custom, Newer, by inexpensive easy beautifying methods. Illustrations, instructions, model changes, refinishing. Restyling Manual \$1. Almqvist Engineering (H) 447-64th St., Brooklyn 20.

**POWER & Speed** Handbook—New, different! Shows simplified "Speed Tuning", power-mileage boosting! Instructions on building speed equipment, economizers, superchargers, mufflers, fast conversions, engines, fuel formulas, etc. Also speed boat, motorcycle, racing information. Postpaid \$2. Commander Almqvist, 447 64th St., Brooklyn 20.

**PHOTOGRAPHS**, world's finest automobiles. List 10c. Box 1028, Minneapolis, Minnesota.

**CLYMER**-Tone finest California style Dual Mufflers, V-8 Ford, Mercury. Increases power, reduces back pressure. \$20.00 complete with pipes. Easy installation. Specify model car. Clymer, Dept. B-127, 2125 W. Pico, Los Angeles 6, Calif.

**HENRY** Ford, His Life — His Work, book. 384 pages, 50 photographs. Complete, detailed history book of Ford Motor Company and founder genius Henry Ford. Revised to date. \$3.00; De Luxe Cloth-bound, \$4.00, postpaid. Clymer, Dept. B-125, 2125 W. Pico, Los Angeles 6, Calif.

**FREE** catalog describes racing, historical, automobile, motorcycle books. 25 titles. Write Clymer, Dept. B-123, 2125 W. Pico, Los Angeles 6, Calif.

**1947 SUPERIGNITIONITER** \$5.50 atomic starting, pep, mileage. E G Mfg., 355B East 149, N. Y. 55.

**CHRISTMAS** Gift Books: Power & Speed \$2.50 Motor Racing With Mercedes-Benz \$2.00 Motor History of America \$3.00 Speed, How to Obtain It \$1.50 Ab Jenkins' Racing Book \$1.50

Fastest on Earth racing Book \$2.00 Clymer's Motor Scrapbooks (old cars) Editions 1, 2 & 3 each different \$1.50 each Steam Automobile Book \$2.00 Motorcycling Manual \$2.00 Motorcycles, How to Manage Them \$1.50 Full Throttle \$3.50 Indianapolis Race History Book 1909-1946 \$3.50 1946 Indianapolis Racing Book \$1.00; postpaid. Motorbook catalog Free. See our ad Motorcycles classification. Clymer, Dept. B-121, 2125 W. Pico, Los Angeles 6, Calif.



**INDIANAPOLIS 1946 Race History**, including 80 illustrations, charts, drawings. World famous car, driver data. Highlights George Robson Career; \$1.00. Complete Indianapolis Race History every speedway race since 1909 including 1946. 1100 illustrations, 352 pages. \$3.50 postpaid. Clymer, Dept. B-120, 2125 W. Pico, Los Angeles 6, Calif.

**BUILD Auxiliary Driving Lights** that turn with wheels. Construction plans, \$1. Harry Epstein, 124 Kingsley St., Leonia, N. J.

**MIDGET Automobile Racing Book**, 45 photos. Complete history 1946 California Racing. \$1.10 postpaid. Clymer, Dept. B-126, 2125 W. Pico, Los Angeles 6, Calif.

### 13 AUTO SUPPLIES & EQUIPMENT

**"HYDRO-Charger"** Water Injector-Increases power, mileage, octane! Eliminates knock, carbon! Simple, inexpensive to build. Plans \$1.98. Free Speed Equipment Plans folio! Almquist Engineering (H) 447 64th St., Brooklyn 20.

**HAVING Car Trouble?** New, Used, guaranteed auto, truck parts save money. Transmission specialist. Describe needs; immediate reply. Victory, 2930 1/4 No. Western, Chicago 18.

**AUTO parts** for all autos and trucks. Trans, motors, differentials, fenders, carburetors. Also Body Parts. Security Auto and Truck Parts, 1941 BP Eddy, Chicago 13.

**GRILLES** for most all cars. Meyers Auto Parts, 820 Dryades, New Orleans, La.

**1000 MOTORISTS** Needed to make gas saving test. Up to 30% savings. For trial test offer write Vacu-matic Carburetor Co., 7617-1299 W. State Street, Wauwatosa, Wis.

**MONOGRAMMED** automobile seat covers personalized with your initials in gold. Fit your car perfectly. Finest pre-war quality leatherette in 18 beautiful combinations with fibre, sail cloth or mercerized cotton. Priced low. Mono Auto Seat Cover Co. of Hollywood, 608 South Hill Street, Los Angeles, California.

**MUFFLER** manual. Convert easily to Hollywood, Laguna, Westwood, duals, etc. Includes construction details, regulations diagrams. Postpaid \$1. Mellotone, Box 723C, Arcadia, Calif.

**CARBURETOR** repair kits containing all the essential parts for completely rebuilding a specific carburetor. Over 400 kits available. Carburetor Service, 600-B La-Prairie, Ferndale 20, Mich.

**NEW Auto Parts**. Write Needs, Eddy, 1516 169th, Hammond, Ind.

**CARB-D-LETOR** Nationally Known Automatic Motor Injector. Easier Cold weather starting, faster pickup, better car performance, \$5.50 Complete. Simple installation. Postage Paid Anywhere United States. Special offer, order 4, Pay For Only 3. Install Friends Cars. Profit. Send Money Order or C.O.D., include Car Model, Year. Neerco, 307 Laurel, Los Angeles 36, California.

**PATENTED** gasoline-saving Vacuum Supercharger using gasoline motors waste, same principle now being used standard equipment high priced motors only, price \$7.90 self-addressed stamped envelope for pamphlet. McDowell Company, 2000 NE. Union, Portland, Ore.

**RENEW Wornout Battery**, complete guaranteed chemical and instruction \$1.50. Pioneers, 2012 Clement, Alameda, Calif.

**GARAGES** use our Puller for all Generator Pulleys, Bearings, \$35.00. Satisfaction Guaranteed. Winfield Associates, 13 Overbrook Terrace Natick, Mass.

**"STOP OIL Pumping Without Overhaul!"** New, safe, effective method. Easy instructions \$2. Almquist Engineering, (H) 447 64th St., Brooklyn 20.

### 14 AUTO TRAILERS

**BUILD** your own Trailer! Save Money! Have every feature you want! Plans for House, Sport, Camp and Utility trailers. Catalog describing 9 models 10c. (15c in Canada and overseas). Jim Dandy, Box 125-B, Wausau, Wisconsin.

### 15 AVIATION

**JET Propulsion**—Easy ways to make experimental Jet Engine Shells—25c coin. Circulars free. Rush order. Maupin, Tipp City 7, Ohio.

**AIRPLANES**—Used—Best buys in the country. Ready to fly. Directory 20c. Aero Trades, Adams, Massachusetts.

**PROPELLERS**—Exclusive manufacturers Airliner 3 blade, all metal, fine quality, needs no tipping. Also wooden 2 blades, fit any motor. Aircool motor diagram 50c. Standard Aircraft, Ft. Worth, Texas.

**VETERANS**: Flight training under the G.I. Bill. Private, Commercial and Flight Instructor Ratings. Write for information. Gottschalk School of Aeronautics, Adrian, Michigan.

**CUBS**, Wacos, Taylorcrafts, Aeroncas. Big catalog 25c, lists these and thousands of other sensational airplane bargains. Some are "easy to repair" crackups. National, Box 1682-CS, Toledo, Ohio.

**AIRMINDED** surplus rate of Climb Indicators graduated 0 to 4000 ft. These instruments are brand new. Never used. They are, self contained, sensitive, have luminous dial and unbreakable face. Unbelievable price, \$10.95 prepaid. Satisfaction or your money refunded. Herron Sales Service, 2607 Oak Park Ave., Cleveland 9, Ohio.

**GIANT** Four foot maneuverable target kites. Rayon covered. Army Surplus. \$2.50. Head phones, \$1.00, used. Throat mikes, \$1.00 used. No C. O. D. Aero Instrument Company, Municipal Airport, Houston, Texas.

### 17 BATTERIES, GENERATORS, ETC.

**MIDGET** Magnetic Motor: Flashlight cell operates. Parts plus instructions 30c. Eltro, 171D, Deer Park, N. Y.

### 18 BLUEPRINTS AND PLANS

**"BLUEPRINT Reading Made Easy"**—ready reference book for reading any type blueprint. 596 pages. 463 pictures. Formerly \$8.95, now only \$1.98. Popular Science, Dept. 126-C, 353 4th Ave., New York 10, N. Y.

**FREE**. Descriptive circular on toy plans. Production Engineering, 403 City Hall Bldg., Rockford, Illinois.

### 19 BOATS, OUTBOARD MOTORS, ETC.

**FULL** size, cut to shape boat patterns, blueprints, 7 1/2—38 feet. Illustrated "Build a Boat" catalog, 10c (coin). "How to Build Boats" book, \$1.00. Cleveland Boat Blueprint Co., Dept. A-77, Cleveland, Ohio.

**MARINE** Power—Easily convert any Ford and Jeep motor (domestic and foreign) with Osco parts and kits. Complete catalogue 25c (coin). Osco Motors Corp., 2020 East Orleans St., Dept. P, Philadelphia 34, Pa.

**SAILS** for Skates, Ice Boats, Canoes, Yachts. Canvas for recovering boats, trailers, autos. Wing dope, cement. Nylon rope, sailcloth. Alan-Clarke, 96 Chambers, N.Y.C.

**FORD** Marine Conversions. Catalog 10c. Lehman Manufacturing Co., Dept. A, Newark 2, N. J.

**INBOARD** marine motors, conversions, supplies. Catalog on request. Stokes Marine Supply, Coldwater, Michigan.

**MOULDED** Plywood Hulls For Home-craftsmen, see Page 284.

**PLYWOOD** Boat Kits! Complete materials for building "Deltacraft," "Junior Dinghy," "Tadpole Skiff." Mahogany marine plywood and oak construction! Send 10c today for illustrated folder featuring these Boat Kits and other marine materials and supplies. Carmen-Bronson, Marine Department, Mount Vernon, N. Y.

**COMPLETE** plans specifications easily home built row boat by designer, \$1.00 cash. K. R. Maloon, 82 Webster St., La-coma, N. H.

**KAYAK** Blueprints, Deluxe Models—catalogue 10c. Viking Kanoes, Merrick, N. Y.

### 20 BODY-BUILDING COURSES

**BAR-BELLS**, Dumbbells, Exercise equipment, Courses, Special offers! Free booklet. Good Barbell Co., Reading, Pa.

**HANDBALANCING** quickly learned. Mail card for details. Power, 923 W. Vine, Kalamazoo, Michigan.

**BARBELLS!** Catalog! Bur Barbell Co., 319 Orient Way, Lyndhurst, N. J.

### BOOKS, PERIODICALS, ETC.

**EDUCATIONAL** Books sold cheaply or rented for small fee. Books bought. Money back guarantee. 4,000 Bargains. Catalog Free. (Courses Bought). Lee Mountain, Pisgah, Alabama.

**WHAT** Every Mason wants We have Masonic books for Blue Lodge, Chapter, Commandery Scottish Rite and Shrine. Our rituals are used the world over. Send for our free catalog of books and rituals for Masons, Odd Fellows, Knights of Columbus, etc. Eza A. Cook, Publisher, Inc., P.O. Box 796-RMY, Chicago 90, Ill.

**MAGAZINES** (back dated)—foreign, domestic, arts, Books, booklets, subscriptions, pin-ups, etc. Catalog 10c. (refunded). Cicerone's, 863 First Ave., New York 17, New York.

**BIG** Profits Taking Subscriptions For All magazines. Agents' Confidential Catalog listing over 2500 periodicals and complete starting supplies Free. Pines Subscription Agency, Flushing, N. Y.

**"30,000 JOB** And Business Opportunities In Alaska"—Based on two years' Alaskan experience, this 15,000-word copyrighted report gives latest facts on Fur Farming, Mining, Agriculture, Lumbering, Transportation, Commercial Fishing, Construction, Business Opportunities. Special section on climate, homesteading, mineral resources, rights, etc. Private firms and Government projects listed—tells How, When, Where to apply. \$1. Return for refund in 7 days if not satisfied. Pacific Industrial Research Bureau, Dept. 2C, 907 Terminal Sales Bldg., Portland 5, Oregon.

**GOOD "Used"** self-instruction educational books on all subjects bought, sold, rented, exchanged. Satisfaction guaranteed. Complete information and 100-page illustrated bargain catalog Free! Write—Nelson Co., Chicago 5.

**"100,000 POST-WAR** Jobs Abroad." South America, China, India, Burma, Japan, Russia, Malaya. How, When and Where to Apply. U. S. participation in world reconstruction and trade demands thousands of American-trained mechanics, salesmen, technicians, engineers, foremen, laborers and business representatives—every trade needed. Our 15,000-word copyrighted report—compiled from business, professional and government sources—lists over 200 big U. S. firms with foreign interests, gives job information, salary brackets, contract tips, application letters, passport information, climatic conditions, etc.—everything needed for your immediate application. \$1.00. Return for refund in 7 days if not satisfied. Pacific Industrial Research Bureau, 907-D Terminal Sales Bldg., Portland 5, Oregon.

**BOOKFINDERS!** (Scarce, out-of-print unusual books) Quickly supplied. Send wants. Clifton, Box 1377-PS, Beverly Hills, Calif.

**YOU** too can read handwriting! Ten lessons, beautifully illustrated, \$1.00. Astonish your friends, make money. Satisfaction guaranteed. \$1.00 analysis of your handwriting free. St. John, Noel, Missouri.

**FREE** Copy! "The Western Socialist", 27 Dock Square, Boston 8, Mass.

**"RADIO** For The Millions"—practical book. Complete instructions for building 78 radios, phonographs, other sets. 192 pages. 648 pictures. DeLuxe edition, \$1.98. Popular Science, Dept. 126-C, 353 4th Avenue, New York 10, N. Y.

**"FIX** It Yourself"—home repair book. How to fix appliances, furniture, plumbing, etc. 256 pages. 163 pictures. \$1.49. Popular Science, Dept. 126-C, 353 4th Avenue, New York 10, N. Y.

**BOOKS**, Save Money. Lastest Best Sellers. Details (stamp), Box 3253, Terminal Annex, Los Angeles 54.

**I'LL** Bet You Can't! Easy, sure-fire Challenge tricks with pocket objects. No skill, 120 illustrations. At bookstores, or \$1.00 postpaid, Lewis Kohrs Company, 2208-S Stuart Street, Berkeley 5, California.

**LOST** Western Mines, 22 real tales. Landmarks, Hints. Vast treasure waiting. \$1.00 P.P. Lost Mines Press, 1047 Irolo St., Los Angeles 6, California, Dept. 4-A.

**MAGAZINE** Export Sales Co., 2084 First Ave., New York 29, N. Y. Over-issue popular American Magazines and Pocket-Size Books, Comic, Screens, Fashions Pictorials, Romances, Pulp and many others. Export Only.



**MAGAZINES** — Business-Vocational-Professional. Profit by being informed on developments, opportunities, etc., in your line. Current single copies—choice of over 800 publications—all fields. Free price-list. Directory 3342 publications with addresses and subscription rates, \$1.00. Commercial Engraving Publishing Company, 34S North Ritter, Indianapolis 1, Indiana.

**INSTRUCTIVE** Books, trade journals. Catalog 10c (refunded). Egan Bookhouse, Box 84, Vanderveer Station, Brooklyn 10, New York.

**ADULT** Books 25c Five—\$1.00! Free Bookalogues! Hirsch, Spring Valley 3, N.Y.

**BOOKS**, Portraits, Lithographs, Photographs, Details 10c. Barringer, 1242 Lilac Place, Los Angeles 26, Calif.

**FREE** bargain catalogue for adult book buyers. Kissin, Box 134, Madison Sq. Sta., New York City.

**A GUIDE** To Good Reading, is the best book selection and buying catalog published. Contains 6,000 titles for all ages, described and classified. Our free book offer is explained in detail on page 3. Send for your copy today! Absolutely free! Follett Book Co., Dept. 643, 1255 So. Wabash, Chicago 5, Ill.

**BOOKLOVERS!** Our Members Save on every book in print. Plan new and different. Write for interesting particulars and Free Copy of "Books Current". Center Book Club, 243 Market, Newark 2, N. J.

**WHOLESALE** Catalog, Directory, 10c. Scarce Merchandise, Latshaw Sales, Sunnyside—C, Indianapolis, Ind.

**AMAZING** new book gives instant solutions to 100,000 practical problems. Details free. Columbia Graphs, Columbia 2, Connecticut.

**NATIONAL** Geographic Magazine, 1888-1946. Any issue. Periodical Service, Box 327-S, Swarthmore, Penna.

**WHOLESALE** Catalog, Directory 10c. Thousands of articles. Stafford Sales, 961 1/2 N. Jefferson, Indianapolis 1, Indiana.

**BOOKS** (out-of-print, new, used), quickly supplied, many 35c bargains. Catalog Mid-West Book Service, 18870 Marx Ave., Detroit 3, Michigan.

**ADULT** Books, Catalog and Sample, 10c. Oudeman, Box 1840, Cleveland 6, Ohio.

**ADULT** Book, Revealing sex truths. "Illustrated." 50c. Kogan, 1032-SF, New York 8.

**TECHNICAL**, Religious and Information Books, New and Used, Free Information. Edwards, 324 N. 18th St., Quincy, Ill.

"**CARTOONING**—Drawing Manual" Fun, Profit \$1. Shusner, 6749 Clyde St., Forest Hills, New York.

**WICKSTEAD'S** book on Stud Poker. Authoritative history, philosophy, mathematics of game. Teaches expert play. Postpaid \$1.50. AAA Press, 260 W. Ash, Burbank, Calif.

"**I LOVE** Ruthbella!" (Famous Sansicchi Diary) . . . hardened girl meets implacable lover—irresistible force against immovable object—result: TNT-love at its excitingest! Original 1939 deluxe private collector's edition still only \$5.00 postpaid! Confidential listing "Lonely Hour Books" included. Send \$5 today and make this picturesque, surpassingly beautiful, intensely revealing book your heart's prized treasure! Supply limited! Poets Art Press, publisher-distributor, 309-3, Palisades Park 12, N. J.

**RUTHBELLA** (Sansicchi Love Diary)—handy Reprint Edition (abridged) now available, price \$2.00 postpaid. Poets Art Press, 309-3, Palisades Park 12, N. J.

**BOOKS!** (Out-of-print, scarce); quickly supplied. Send wants. Spotlight, 141 Broadway, New York.

**YOUR** Love Letters made irresistible. Complete instructions plus world's 20 most passionate letters. Xmas special, \$1.00. Foreman, 245 E. 72, New York City.

**EUROPEAN** Campaign war photos. Absolutely authentic and unpublished, 8 for \$1.00. Lawrence, 932, 175th Street, Hammond, Ind.

**BOOKS!** Magazine Subscriptions! Stamp brings list. Monica Lake, 815-B East 14th St., Brooklyn 30, N. Y.

## 23 BUILD IT YOURSELF

"**BUILD** Cabins"—book offers complete instructions and plans for building your own cabin, lodge, tourist home, or wayside stand. 251 Pages, 200 plans and pictures. \$1.98. Popular Science, Dept. 126-C, 353 4th Ave., New York 10, N. Y.

**NOVEL** brick incinerator. Simple inexpensive construction. Complete Combustion. Plans \$.25. C. Lightfoot, Richboro, Pa.

**HOT** Water Free—from sunlight. System efficient any locality year 'round. Standard Materials—easily built—low cost. Facts free. Solar Water Co., Box 175, Dept. U, Coral Gables, Florida.

**BUILD** Concrete Mixer. Power driven. Simple, inexpensive. Details free. Horne, 206 West Wilder, Tampa, Florida.

**BUILD** Concrete Block Machine. Vibration and hand operated types. 100 blocks per hour. Easy, inexpensive. Sell blocks, build home, garage, barn at low cost. Details free. Horne, 206 West Wilder, Tampa, Florida.

"**PLYWOOD** cabinet kitchen plans. 25c. Playne Cabinets, 4617 Johnson Avenue, Western Springs, Illinois.

**BUILD** Garden Cultivator from your old lawnmower powered by 1/2 H.P. gasoline washing machine motor. Can be built in your home work shop. No expensive machine work necessary. Send \$1.00, no stamps, for Blueprint and instructions. W. J. Musch, Box 55, Hartford, Kansas.

**LAMP** parts—for repair or building, catalog 10c. Gyro Lamps, 5416 N. Clark, Chicago 40.

**BOATS**, engines, model, real, catalog plans, 25c, Marinepress, Groton, Conn.

**AIRPLANE** Jettison gasoline tank, streamlined 10' 6" x 2' 4". 165 gallon, twenty gauge terne coated steel. Ideal for making boats, bob sleds, midget auto, etc. Price \$10.00 per tank or \$7.50 per tank quantities of five or more. General Truck Sales, Inc., 205 Market South West, Grand Rapids, Michigan.

**BUILD** heavy duty machines using our production tested plans. 30" bandsaw, 12" lathe, farm type sawmill, planer, concrete block machines. Dozens other machines for shop, farm, home. Free catalog. Nichols Equipment Co., Purvis, Miss.

**NOVEL** brick incinerator. Simple inexpensive construction. Complete Combustion. Plans \$.25. C. Lightfoot, Richboro, Pa.

**WIZZ** Electric Motor (large size) Flashlight cell operates. Parts complete plus illustrated instructions 35c. Eltro, 171S, Deer Park, N. Y.

**NOVEL** brick incinerator. Simple inexpensive construction. Complete Combustion. Plans \$.25. C. Lightfoot, Richboro, Pa.

## 24 BUSINESS OPPORTUNITIES

**GOOD** Paying Business Silvering mirrors, plating autoparts, reflectors, bicycles, bathroom fixtures, etc., by late methods. No tanks or shop required, outfit furnished. Free Booklet. Gunmetal Co., Ave. E, Decatur, Illinois.

**MAKE** Plaster Novelties! Special Molding Rubber. Free Sample Quart \$3.00, Gallon \$10.50. Free Instructions. Universal Sales, Box 1076-B, Peoria, Ill.

**START** Home business making statuary, plaques, art goods, pottery, garden furniture, artificial marble flooring, liquid marble. Make flexible molds yourself. Amazing profits. Folder free. Creative Publishers, Box 236-M, Winnetka, Ill.

**\$25 WEEKLY** working two hours daily. No canvassing. No Manufacturing. Lycke, Box 2471, Cleveland 12, Ohio.

**MOLD-MAKING**, Plaster casting. Money-making Business. Literature Free. Kemilo, Park Ridge, Illinois.

**MAIL** Order Business course shows you how to make money, spare or fulltime. Teaches professional mail order technique—not penny-snatching schemes. Fascinating 100-page illustrated Success-Catalog Free! Write—Nelson Co., Dept. 4-01, Chicago 5.

**BOOKKEEPERS** — Operate Your Own "Dollar-A-Week" Bookkeeping & Tax Service. Full or spare time. Details free. Ellis, Box 203, Cedar Grove, N. C.

**137 PLANS** to make money local, mail order. Particulars free. Elite Co., 220-A Grand St., N. Y.

**YOUR** own business. Big profits, very small capital. National organization teaches, helps, supplies everything. Interesting service business. Big demands. Everywhere. Americlene, 211 N. 7th St., St. Louis 1, Mo.

**METALIZE** Baby Shoes! Easily Learned. Universal Sales, Box 1076-B, Peoria, Ill.

**AT** Home—Your own manufacturing business; making popular \$1.00 novelties. Cost you 3c to 15c. Everything supplied. Write So-Lo Works, Dept. M-601, Cincinnati, Ohio.

**SPECIALTY** Manufacturing, the big money business that can be operated anywhere, start on a very small capital; we supply dependable formulas and complete instructions; get interesting Free booklet, "Money-making Opportunities in Specialty Manufacturing." Howard Robinson, Ph. G., 1300-B S. Ohio St., Sedalia, Mo.

**LIQUID** Marble—Colorful, glazed! Molded, brushed, sprayed! Composition floors, Rubberlastic Molds, Plastic Homes. Particulars free. Marbelizing Service, Edwardsville, Illinois.

**\$565.00 PROFIT** from every \$15.00 invested. Standard Service System, La Grange 2, Indiana.

**MAKE** "DDT" Products. My Ten Master Formulas shows how. Literature Free. Howard Robinson, Ph.G., 1302-B So. Ohio, Sedalia, Mo.

**COLORGLAZED** Concrete Pottery made without molds. New, low cost, patented method. Cemetery products, novelties, tiles, floors, etc. Basement leaksealing. Other money-making projects. Booklet, details free. Men only. National Potteries, Fergus Falls, Minnesota.

**1946** Gigantic Directory of Opportunities, Advertisers Supplies, Sources, Trade Information. Mail Order Ideas, Products, Wholesalers. Valuable tips—just published! Descriptive literature Free. Wilkin & Co., 118-CS East Main St., Hillsboro, Ohio.

**OPERATE** profitable home business selling merchandise by mail. Fast sellers. Large profits. Powell Service, 5713 Euclid, Cleveland 3, Ohio.

**HAVE** your own office! Learn new profitable business in uncrowded field. No selling. Many earn up to \$5,000-\$15,000 yearly. Write for Free details. No obligation. No salesman will call. Franklin School, Dept. 203-N, Roanoke 7, Virginia.

**RAISE** Giant Chinchilla rabbits. Tremendous profits from gorgeous fur, delicious meat. Ideal business. Willow Farm, R 16A, Sellersville, Pa.

**RECAST** old batteries into new. Latest achievements. Battery Laboratories, Minneapolis.

**REAL** \$100 weekly opportunity! Details, stamp. McCormack, A-12, Maderia, Ohio.

**SIX** Mail order Magazines, All Different. 16 to 72 pages each. Full of money making information, 25c. Kraft, Aurora 12, Mo.

**BIG** Pay jobs in welding. Complete welding lessons and reference books, 516 pages, 41 lessons, \$2.00 copy. Money-back guarantee. Hobartweld, Box P-1065, Troy, Ohio.

**BIG** profits and your own business casting latest 1947 Metal Toy Autos, Airplanes, Ashtrays, Savings Banks, etc., Enormous wholesale and chain store demand keeps manufacturers busy, Spare or full time. No experience or special place needed. For full information write Metal Cast Products Co., Dept. E, 1696 Boston Road, New York 60, N. Y.

**AVERAGE** \$1.00 Hourly Working For Yourself. Interesting spare-time work. Positively no selling. Convincing particulars Free. American Business Service, Nescopeck, Penna.

**FLASH**. New Novelty Large Profits, Dime, Hurry. Martin, P. S., 57 Hart, New Britain, Connecticut.

**MECHANICALLY** Inclined Men—Own and operate general Appliance Repair Shop. Complete, illustrated course shows you how. Welding, Refrigeration, Motor repair. How to get business, etc., all phases covered. Free literature. Christy Supply, Dept. 770, 2835 N. Central Ave., Chicago.

**REDUCING** Salons make money. Start at home. We supply automatic equipment. National Products, Portland 2, Oregon.



**WHY Job Worry? Learn Electroplating.** Highly Paid, uncrowded. Interesting Business. Gold, Silver, Nickel, Chromium, etc. Send Postcard for Free booklet and proof. Plater Hyde, Dept. SC P. O. Box 176, National City, Calif.

**MAILING Lists, 3,000 Mail order buyers.** \$5.00 Per 1,000. Box 29, Sugarhouse 5, Utah.

**OPERATE profitable Home Mail order business on \$5.00 Capital.** Details Free. Swiger, 1009 West Pike, Clarksburg, West Virginia.

**LEARN Shell Jewelry Manufacturing.** No tools or experience needed. Learn-earn within a week! Complete home instruction course, beautifully photographed, shows how to make 75 styles of Pins, Earrings, Brooches, Hair Ornaments, Dress Clips, Necklaces, Bracelets, Candy Dishes, Wall Plaques, Ash Trays, Candle Sticks, etc. Includes Pearlizing, Golding, Dyeing, Luminous methods. Illustrates 55 species of sea shells. Lists hundreds of raw materials with wholesale prices. Complete course \$1.00, postpaid. Beginner's Kit, \$3.00 (\$3.50 in Canada). House of Gifts, Box 4550-AS, Coral Gables, Fla.

**LOOKING For New Opportunities? Mail Order and others? Get "The Practical Idea."** Write: Veteran, Charleston 19, Illinois.

**UPHOLSTERING—Do your own, Free details.** Lyle, Box 385-B, Lombard, Illinois.

**MEN-Women who can sew, Write, Lyle, Box 385-B, Lombard, Illinois.**

**SUPER X Liquid Molding Rubber.** Sample Jar 25c, Quart \$3.00, Gallon \$10.00. Free Sample, W. Wooley, 115-B Donald, Peoria, Ill.

**FELLOW Workers—Down with Bosses—Start own business—Be Independent—Booklet describing 137 Tested Plans, free.** P. Padney, 307 York St., Jersey City, N. J.

**LIQUID Marble—make in any color.** Soundproof Plastic Flooring. Flexible Molds. Cast novelties, plaques, statuary. Big Money—your own business. Catalog Free. Write—Bing Products, 88-B2D Broad Street, Boston 10, Mass.

**START profitable concrete block business.** Details free. Wm. Horne, 206 West Wilder, Tampa, Florida.

**COPPERIZE Baby-Shoes.** Complete Instructions, Tested Sales Plan. Metalloids, Box 8087-a, Pittsburgh 16, Pa.

**"HOW To Make Simple Molds and Plaster Plaques."** Profitable business or hobby! Instructive booklet 25c. Plastercraft Supply Company, 1406 East 43rd Street, Cleveland 3, Ohio.

**MAKE Shell Jewelry—Easy, profitable.** Illustrated book instructions 75c. Free Catalogue. Florida Shellcraft Co., Box 1840, Sarasota, Florida.

**LIQUID Rubber for making flexible molds.** Literature and Sample free. Chaney, 1130 E. 16th St., Jacksonville 6, Fla.

**TYPEWRITER Repairmen urgently needed.** Earn \$40 to \$50 weekly spare time. Our easy to learn home study course teaches how to repair typewriters. Write for free information. Houston Typewriter Repair Service, P.O. Box 5357, Houston 12, Texas.

**START a clock shop while clock repairing is booming.** Our easy to learn home study course with pictures and illustrations teaches you how to repair all kinds of clocks. Information free. Houston Clock Shop, P.O. Box 5086B, Houston 12, Texas.

**TYPEWRITER Repairing instructions,** standard typewriters. Webers', Box 1008, Canton, Ohio.

**SYNTHETIC Latex with Neoprene base for making flexible molds! Quick Drying! Safe!** For home, classroom, or industry. Quart \$2.00, Gallon \$5.95. Full instructions. Plastercraft Supply Company, 1406 East 43rd Street, Cleveland 3, Ohio.

**\$5,000 YEARLY possible in spare time selling by mail, with expert assistance.** Small investment. Details free. George Diafas, 109 Mt. Hope, Dover 5, New Jersey.

**BABY Shoes preserved.** Formulas, instructions, \$1.00. Novelty Bronzing, Box 51, Hyde Park 36, Mass.

**UNLIMITED opportunities in Mail Order.** Read "How to start a successful Mail Order Business", the guide to sound, profitable Mail Merchandising, only 25c. Manhattan House, 126-C Lexington, New York 16.

**UNPAINTED Wall Plaques 2½c up.** Beautiful Designs, Easily Painted. Illustrated list Free. Write today, Omman, 642-S, Broadway, St. Paul 1, Minnesota.

**WHOLESALE Distributors! Amazing patented screw-holding screw drivers!** No competition. Removes, holds, inserts screws instantly hard-to-get places! Factories, garages, mechanics, electricians, retail stores, buy quantities. Counter displays, advertising furnished. Fast sales, large profits, big repeats. Refundable trial order! Millen Mfg., 369 Miller Building, Boston, Mass.

**OWN your own business automotive and household products and service.** Exclusive territory. \$1000 to \$1500 Merchandise and Equipment. Hinson & Co., Inc., Richmond, Ind.

**OPERATE profitable mail order business.** Splendid Opportunity. For details write Wolf Novelty Co., Box 841, Salina, Kansas.

**BATTERY Repairing, Rebuilding.** Plate making plans, L. Wertz, Pekin, Ill.

**\$5000 PER year.** Interested? Write for free literature showing how you can make this much and more with a spare time home business of your own. Experience not necessary. King Supply Co., 3401 Johnston Ave., Redondo Beach, California.

**OPERATE profitable mailing merchandising business.** Literature Free. Riegel, 1111 Harrison, Philadelphia 24, Penna.

**PROFITABLE Home sparetime business.** Making wallets, belts, other fast-selling leather novelties. Simple to make. Tools not necessary. Amazing opportunity. Send for free catalog. Gold Leathercraft, 632 Desplaines Ave., Forest Park, Ill.

**CONCRETE block machines \$295. to \$1680.** Pallets all sizes, shapes; 8" x 16" 48c. Mass production aluminum castings. Mail drawing. Fla. Die Casting Foundry, Orlando, Fla.

**FORTUNES in Formulas and Trade secrets.** Practical, Authentic, Reliable. Details Free. Stillmans, 555 Kingston Ave., Brooklyn 3, N. Y.

**BUILD Miracle Homes.** Yours. Others. Chamberlain, Fitzsimons Building, Pittsburgh 22, Pa.

**START a spare time mail order business.** Make extra money. Big profits. Experience unnecessary. (Dealership Available). Richard Ponto, Elkton 2, S. Dak.

**START Your Own Advertising Agency,** in spare time at home. Opportunity for big earnings and permanent business. Complete operation revealed. No stock or equipment needed. Folder and proof Free. S. Snyder, Box 4907-A, Philadelphia 19, Pa.

**ADVERTISEMENT writer.** Long, successful experience creating powerful mail-order letters, literature, campaigns. Investigate! Les Finkle Advertising, 408 South Spring, Los Angeles 13, Calif.

**MAKE Strange plastic Rub-R-Slate—1c pound.** Makes durable, attractive floors, walls, mantels. Build for half. Bays Laboratory, Oklahoma City 9.

**BRONZING and Metallizing baby shoes!** Gold, Silver, Copper, Nickel, Bronze, Pearl, Ivory and "Luminous glow" colors! Big profits! New Field! Details free! Write R. O. Morgan, Box 349, Long Beach 2, Calif.

**SPECIALIZED Mail Business Earned \$1400 Monthly.** Copyrighted Instructions, \$1.00. Will Boyd, 331 Fourth, Pittsburgh 22, Pa.

**DO it with Shellcraft Attractive Jewelry.** Big Profits. Illustrated Instructions \$1.00. Werts, 1429-56th Avenue, Oakland 1, Calif.

**LOOKING for business? No matter what you have to offer, an office in New York, under your own name, is bound to increase your business.** Rates—\$7.30 and \$14.60 yearly. Established 1926. Cooperative Offices, 126 Lexington Ave., New York 16.

**MAKE good money in own advertising business.** Unique service. Fascinating. Profitable. E. J. Matteson, Box 580, Hanford 1, California.

**MAKE flexible molds! Few cents each!** Cast plaques, novelties, bookends! Free sample! H. Tooker, 630-R Chestnut, Hamilton, Ohio.

**HOW and Where to obtain capital.** Particulars free. Star Service, Wapakoneta, Ohio.

**START Mailorder Bookshop—Everything furnished; publisher cooperation.** 25c brings booklet, exclusive setup, samples, exciting ideas. General Publications, Ossining 1, New York.

**INVESTIGATE Mail Selling! What's the One Best Thing to Sell, Happily, Honestly, Profitably? We Know! Get Free Particulars.** Free Samples. What-To-Do-Shop, Box 1082, Tacoma, Wash.

**GET into mail order business! Operate from home! Big profits! New book tells how!** Details free. Holden, Dept. 109, 4903 Rhodes Ave., N. Hollywood, Cal.

**MAKE extra money now.** Build to financial independence by selling office supplies by mail from your home. I tell you how. Jo Troutwine, 8654 S. W. Ninth, Portland 1, Oregon.

**OPERATE profitable mail order business.** Write Robert L. Brill, 647 E. Frederick St., Lancaster, Pa.

**INVITATION To Income.** Contact. Mib Associates, 331 Fourth, Pittsburgh 22, Pa.

**OPERATE Profitable Mail order business.** Splendid Opportunity. For details write Roy McKinzie, 6320 Southern St., Detroit 10, Michigan.

**IMMENSE Wealth! Perhaps a Million Dollars!** Impossible to lose, even a dime. Greatest Mail Order plan ever conceived. Amazing information 25c. Al E. Siddall, R.R. 1, Atascadero, Calif.

**START coin machine route.** Buy new machines. Immediate delivery. Prices \$35.00 to \$285.00. Write for circular. Webb Distributing Co., Dept. P60, 6S, Kedzie Ave., Chicago 12, Ill.

**START a profitable Mail Order Business right in your own home.** Large money making possibilities. Particulars free. Beir's, 837-R North Hoffert St., Bethlehem, Pa.

**QUICK Money! "Repairing Car Batteries."** At home! Easy too! Write, Batteryman, Grand Junction 1, Colorado.

**GO into rug and upholstery cleaning and mothproofing business.** Extra double profits selling these two professionally used products to stores and homes. Russell-Johnson Co., Clarkfield, Minn.

**200 Money Making Deals.** Plans, Rare formulas. Schemes. Folio Free. Formico Prod., Box 572, Dayton, Ohio.

**HANDYMEN—Earn money home operating Community "Fix-It" Shop.** Write, Stafford, 708 Rawlings, Carbondale, Ill.

**COLOR Concrete with Chemicals.** Big money making Hollywood style pottery, birdbaths, without molds. Wishing-wells, stucco-rock, benches. Marbling, cement waterpaint. 10c brings sample, literature. Pictures. Hollywood Cementcraft, 8530 Wonderland, Hollywood 46, California.

**SIX Mail order Magazines, All Different.** 16 to 72 pages each. Full of money making information, 25c. Kraft, Aurora 12, Mo.

**INCORPORATE in Delaware.** Many advantages. Free details. Corporation Fiscal Company, Inc. Delaware Trust Building, Wilmington, Delaware.

**BABY Shoes Preserved.** Complete Instructions. Exclusive Rights. M. E. Watson, Bellefontaine, Ohio.

**10c BRINGS You Hundreds of moneymaking propositions, plans, ideas, tips,** wholesale supply sources, magazines. Gardenville Publishers, Gardenville 9, New York.

**ENJOY the profits, security and dignity of your own business.** Less than \$5.00 needed. Midwest Drug Co., Columbus 15, Ohio.

**OPERATE profitable mail order business.** Splendid Opportunity. Free details. Kelley Service Bureau, 215 So. Monroe, Kansas City 1, Mo.

**MUNGOFUNGRO Sprouting beans.** Free sample, instructions. Snyder, 406D West 47, New York 19.

**PROFITABLE business of your own, spare or full time.** Write Tes-Co Enterprises, Wilkes-Barre, Pa. Box 189.

**WOULD you pay 3%—first \$350 made?** Color-illustrated book "505 Odd, Successful Enterprises" free! Some offer occasional "day off." Work home. Expect something odd! Pacific, 2207½ Cloverfield, Santa Monica, Cal.



ARE You "Fed up" working for a boss? Own a permanent mail order business. Write: Gordon Crompton, P. O. Box 2567-S, Hollywood 28, Calif.

ASTOUNDING modern mail order plans. Brings quick profits. Darrah, Orono 8, Maine.

"NOTICE" 25c coin brings the greatest legitimate plan ever devised to secure a big mailing list and a stream of dimes. Killion Mail Order Systems, Box 3096 Terminal Annex, Los Angeles 54, Calif.

GOT \$24; 500 using three schemes from "Schemer" Magazine, Alliance, Ohio. 48th year, \$1.00; three samples, 25c.

MOLDS for Lamps, Ash Trays, etc. Valance Art Products, 1873 E. 70 St., Cleveland, Ohio.

USED Battery Business, start in your home, no equipment necessary, send postal, Pioneers, 2012 Clement, Alameda, Calif.

BECOME a Finance Man. Particulars free. George Lenhoff, Lincoln 8, Nebr.

CASTONE—Hardest coldcasting composition on earth, snow white and colors. sample 10-1/2 pounds assorted colors \$2.00; Hundred pounds \$6.00. New Era Products, 1321-SE Belmont, Chicago.

RUBBER-Airlastex, genuine "Red Diamond" pre-war mold making liquid. Sample pint \$1.25 with instructions. New Era Products, 1321-SE Belmont, Chicago.

PLASTIC-Liquid "Fiber-Glass" China glazes, protects any plaster object. Pint \$1.00, Gallon \$3.00. New Era Products, 1321-SE Belmont, Chicago.

OPERATE Profitable Appliance and Building Repair Business. Information Free. Cline-Porter, Box 6346 C, Pittsburgh 12, Penna.

MAIL Order Profit Maker. Beginners, dealers, no matter what you've tried or are selling by mail now, get next to this new, different, fast seller. 25c brings sample, plans, details. Pass judgement on this fast selling profit maker. Money back if you say so. L. Mallery, Neillsville, Wisconsin.

CALIFORNIA Business chances list over 100 to choose from \$1 pays for investigation report on any chosen one. Gaugh, 424 S. Broadway, Room 900, Los Angeles (13) Calif.

500% PROFIT. Cast our fastest sellers. \$: 3. - : Magic Rubberliquid for 20 Rubber molds, Model, Instructions. Hugue, 571 Central Avenue, Brooklyn 7, N. Y. Established 1902.

\$\$\$ IN baby shoes complete mail order plan. No-Co-Ro, Oakland 6, California.

72 PAGE, 25c mail-order magazine. Sample 10c. Publishers, Box 1302-E, Detroit 31.

HEALTH First! New Drugless Method. Dynamic technique; quickly learned. Results Unbelievable. Big earnings operating a "Health Conditioning Club". Metabasic, B9128-C, Sta. S., Los Angeles.

LATEX for making flexible rubber moulds. Thoroughly tested. No shrinkage. Complete instructions with each order. Stoneham Rubber Co., Box 244, Stoneham 80, Mass.

RUBBER Moulds for casting novelties. Latex for making Molds. Use thoroughly tested and approved products. Eastern Latex Laboratories, Box 153, Mattapan 26, Mass.

AMAZE others. Add faster than adding machine. Free details. Maths Institute, Box 633, Mobile 4, Ala.

METALLIZE baby shoes! Learn this money making business from Nationally recognized consultant. Get "know how" from outstanding authority! See Kushner Ad., page 265.

START toy factory making fascinating Top-O-Copter. The top that flies. Wood or plastic \$1.00 for plans. W. Darst, Leonard, Texas.

OPERATE profitable mail order business. Splendid Opportunity. For details write W. H. Baker, 87 Boiling Springs Ave., E. Rutherford, N. J.

SOOT Remover for stoves, furnaces; Easily made, sells fast, profits big; season just starting. Formula \$1.00. Maumee Co., Paulding, Ohio.

MAIL Order Opportunities. Read oldest Mail Magazine. Copy 25c. Mail Order News, Somerville 47, N. J.

BOOKKEEPERS: General ledger and tax report experience. Operate permanent, profitable accounting service for the smaller business. Part or full time. Simplified method. Write now! L. A. Bell, 1402 West 25th St., Cleveland 13, Ohio.

WHY Financial Worry? Manufacture fast-selling novelties at home. Low cost. Big profit. Everything supplied. Free particulars. Modern Products, 1216-C, Park Row Bldg., New York 7.

LEARN Piano Tuning, Repairing, at home. Tremendous field! Piano parts, tools furnished. Established 1935. Empire School of Piano Tuning, 606-A East University Ave., Champaign, Ill.

"LOS ANGELES Boom." Post-war industrial expansion creates thousands of job opportunities at good pay. Los Angeles workers enjoy year-round delightful climate near the ocean, mountains and desert. Our copyrighted booklet lists over 300 firms. Gives data on expansion programs. Includes sample application letter telling how and where to apply. Also up-to-the-minute bulletin listing best job chances, newest projects, housing tips. \$1.00. Refund if not satisfied. Los Angeles Research Services, 507-A N. Windsor Blvd., Los Angeles, Calif.

20th CENTURY "Business Opportunities Book". 144 pages of Formulas. Mail-order Homeworkers Plans. \$1.00 postpaid or C.O.D. plus postage. Money back guarantee. Silver Crest Products, Dept. 3A, 3040 North Ave., Chicago 47.

PROFITABLE spare—or full-time business of your own! Operate coin-controlled amusement machines all types in your community in stores, taverns, bowling alleys, etc. Meet interesting people, make influential contacts. We show you how. Our plan has made others independently well-to-do. Ideal for ex-GI's. Write for Free details. Monarch Coin Machine Co., Dept. PO-1, 1545 N. Fairfield Ave., Chicago 22, Ill.

MAKE money at home by mail. 137 real moneymakers! Free information. Heydt, 827 E. 233 St., Dept. A1246, New York 66.

## 25 BUSINESS SERVICE

GOOD "Used" self-instruction educational books on all subjects bought, sold, rented, exchanged. Satisfaction guaranteed. Complete information and 100-page illustrated bargain catalog Free! Write—Nelson Co., Chicago 5.

HOLLYWOOD Mailaddress? It Pays! Scheun's Service since 1923. 5642 Hollywood, Hollywood, Calif.

TO Whom It May Concern: We will represent you in all principal cities of the world. Personal or business assignments \$1 per hour. James W. Farley, Citizens Bldg., Cleveland 14, Ohio. Note: Would appreciate hearing from someone who wishes to enter this business in your city. Will send you assignments immediately. References exchanged. State qualifications.

NEW York Mail Address (or branch office). Complete service. Lowest rates. Multiservices, 3A Park Row, New York 7, N. Y.

## 26 CAMERAS, PHOTO SUPPLIES

HAVE you a camera. Improve your hobby of photography and learn how to make better pictures. Write today for our latest book catalog and sample copy of American Photography, containing articles and pictures by the world's foremost writers and photographers. Camera House, 603, 353 Newbury St., Boston 15, Mass.

PHOTOGRAPHY for pleasure or profit. Learn at home. Practical basic training. Long established school. Write for booklet. American School of Photography, 1315 Michigan. Dept. 1742, Chicago 5.

CASH! Spot cash for cameras, lenses, binoculars, movie and still equipment. Send full description for prompt cash offer. Over 36 years of dependability. Bass Camera Co., Dept. SP, 179 W. Madison St., Chicago 2.

USED Camera Directory, Box 1031-K, Canton, Ohio—lists hundreds of War-Bargain Used Cameras—35mm. Speed Graphics, Kodaks, Rolleiflex—many others. Send 25c for latest issue.

REPAIRS made on all Cameras and other Photographic Equipment. Free Estimates. Dept. PS, Northwest Camera Repair Co., 209 Loeb Arcade, Mpls. 2, Minn.

127 FILMS, Fast Pan. Surplus \$3.49 Dozen. Other Sizes. "Cameramen" 542Z, Fifth Ave., New York 19.

BASS Says: Trade Cameras? For 36 years Finest equipment available. Always Satisfaction Guaranteed Or Your Money Back! Bass buy 'em, trades 'em. Bass Camera Co., Dept. SP, 179 W. Madison St., Chicago 2.

ART Studies of Hollywood's most beautiful models! 200 masterpieces of the female figure! For adults only. Available as: Slides for projector or viewer, and fine grain Negatives for enlargements of any size. Prices: 2" x 2" Color Slides 10 for \$4.00. 2" x 2" B & W Slides 10 for \$1.50. 35mm Negatives 10 for \$1.00, 100 for \$8.00. All different! Colorcraft, 1302-A, Broadway, Burbank, Calif.

FILM. The Welcome Christmas Gift! High speed Panax. Four rolls, eight exposures, postpaid: No. 127-\$1.20, 120-\$1.45, 620-\$1.45, 116-\$1.65, 616-\$1.65. Artex Photo, Union, New Jersey.

PROFESSIONAL Compofinder! For better landscapes, portraits, news shots or movies, the Compofinder will help you evaluate composition and solve problems of correct angle. The Compofinder was designed by a professional photographer, whose pictures appear regularly in nationally circulated magazines, to simplify his own problems of photographic composition. Do you want professional Quality Pictures instead of just snapshots? Special introductory price 35c. No Stamps, please. Hollywood Foto Products, Springfield, Mass.

SPEED-O-COPY groundglass focusing attachment for Leica, Contax, Argus C-2, C-3. Send for literature. D. Paul Shull, Dept. PS-12, 240 S. Union Avenue, Los Angeles, California.

CAMERAS—movie projectors—enlargers—free catalog. Cavalier Camera, 1822 Center, Pittsburgh 19, Pa.

200 POWER telephoto camera easily made. Instructions 10c. Perfect telephoto lens and instructions \$2.00. Carl Jamer, Manorville, N. Y.

## 27A CANDY MAKING

MEN—Women—"Everybody Likes Candy". Learn to manufacture professionally at home. (Our 36th Year). Ragsdale Candies, East Orange, N. J.

## 29 CARNIVAL OUTFITS

MAKE Your own Hi-Striker illustrated plans 25c. Make them for others. We have ever since 1906. Write Mooremade, Lapeer, Mich.

## 30 CARTOONING, SIGN PAINTING, DRAWING AIDS

"HOW To Make Money With Simple Cartoons"—A book everyone who likes to draw should have. It is Free; no obligation. Simply address Cartoonists' Exchange, Dept. 14412-C, Pleasant Hill, Ohio.

LEARN showcard writing at home in spare time. Fascinating. Lifetime business of your own. No special skill needed. Free information. Sherwood Publishing Co., Irvington 32, N. J.

SIGNS Made easily. Instruction and ten sets modern alphabets, numerals, patterns. Sizes up to eight inches. All for \$1.00. Co-operative Business, Box 638, Chicago.

EARN Money evenings, copying and duplicating comic cartoons for advertisers. Adservice, Argyle (2-B), Wisconsin.

31 LESSON Art Course. Cartooning and Drawing with over 600 illustrations. \$1.00 Complete. Dorba Service, D-PSM, Cashton, Wisconsin.

AMAZING Bargains—Quick Landscape Painting, Poster Art-Lettering, Art Studies. Free Literature. Art Book Shop, Arnold, IN, Mo.

STUDENT'S Cartoons printed. Free literature. School of Cartoons, P.O. Box 3291, San Francisco 19, Calif.

MAKE Signs, 9 complete alphabet pattern sets, 3 complete numeral pattern sets and catalog \$1.00. Sign Letter Distributors, P.O. Box 101, Mineola, N. Y.

## 31 CHALK TALK STUNTS

CHALK Talks, Laugh Producing Program. \$1.00. Illustrated Catalog 10c. Cartoonist Balda, Oshkosh, Wisconsin.



## CHEMICALS AND APPARATUS

**LUMINOUS** Paints will glow in dark. Six colors. Fairmount Chemical Co., 136 Liberty St., New York City 6.

**THE House of Winn**, home of supplies for amateur chemists. See Winn's New Idea chemical kits and apparatus outfits for home experimenting. Send 10c for retail catalog. Established 1931. John H. Winn, Dept. 607, 124 W. 23rd St., New York 11, N. Y.

**STUDENTS' Laboratory Supplies**. Send 5c for Catalog. Mel-Glo Chemical Co., 258 Fourth Avenue., Brooklyn, N. Y.

**LABORATORY Supplies**. Chemicals and Apparatus all descriptions. 36 Page Book 10c. Standard Science Supply Co., 1232 N. Paulina St., Chicago 22, Illinois.

**CHEMISTS**—Chemical questions answered. Formulas, Analyses, Minerals, Platoz, 26 Erwin Place, New Britain, Conn.

**CHEMICALS** and apparatus for industrial, analytical, and private laboratories. Complete supply service for correspondence school students. Send 3c for catalog. Dept. M-26, Biological Supply Co., 1176 Mt. Hope Ave., Rochester 7, N. Y.

**FREE Scientific Catalog**: Tracey Laboratories, 1907 Harrison, Evanston, Illinois. When in Evanston visit our new retail store.

**REFILLS** for chemical sets. Lowest prices. Send for Free catalog. Blackmore Laboratory, 8436 Fountain Ave., Hollywood 46, Calif.

**HANDBOOK** for Chemical Experimenters. Hundreds of experiments; illustrated: 50c. Experiment Booklet, 15c. Supply Catalog, 5c. Reading Scientific Co., Reading, Pa.

**CARBON Dioxide Cylinders** for use in Flizz-Water bottles, inflating life-rafts and life-belts, experimentation. Box of six, —50c postpaid, 64 Page Handbook Of Chemical Information — Contains Tables And Charts. Indispensable to Amateur and Professional Chemists — 50c postpaid. Chemical Set for Beginners—\$2.00 postpaid. Fingerprint Kit, includes roller, inking glass, fingerprint ink, fingerprint cards, magnifying glass, brush, two containers of fingerprint powder and instructions—\$1.50 postpaid. Chemical Catalog—Free. Amaco Laboratories, Box 3246, Amarillo, Texas.

**CHEMICALS**, ounce quantities, apparatus, catalog 5c. Fleischer's Laboratories, Everett 49, Mass.

**BUY Laboratory supplies** at big savings direct from the manufacturer. Catalogue 10c. Est. 1916. National Scientific Co., 2204 W. North Ave., Chicago 47, Ill.

**FINEST** chemicals apparatus lowest prices, catalog 5c. Kemic Supply, Box 14D Boulevard, New York 59.

## 36 COIN COLLECTING

**100 Diff. Foreign Coins** \$5.00. 2 Small or 1 Large Genuine Roman Coins 2000 years old. \$1.00 Lists approvals. DelMonte 40 W. 18, N. Y. 11.

**FOREIGN Coins**—25 Different \$1.00. Royal Coin, 40 Province, Boston.

**FREE!** Foreign coin, banknote and Coin Collectors' Illustrated Catalog to approval service applicants. Send 3c postage. Tatham Coin Co., Springfield-D50, Mass.

**10 INDIAN Head cents**, different dates also price list, 50c. Schultz, 1053 $\frac{3}{4}$  Richwood, Cincinnati, Ohio.

**WORLD Coins list free**. Harry Elsholz, Box 9014, Pittsburgh 24, Penna.

**WE pay \$2.00 to \$500**. Each for Hundreds of Old or Odd Coins, Indian-Head, Lincoln or Foreign Coins Wanted. Keep all until posted. Send 20 cents for New Illustrated Coin Value Book, 4 x 6. Buying and Selling Prices, 40 Years in Business. Coin Exchange, (1), Le Roy, N. Y.

**12 DIFFERENT Indian Head cents**, 50c. Price list 5c. E. Walton, 7 Water, Boston 9, Mass.

**50,000 COINS**, Medals, paper money, Colonial, Confederate, Philippines. Illustrated lists free. Nagy 8-M South 18th, Philadelphia 3, Penna.

**INDIAN head cents**, 10 diff. dates 80c; 20 diff. dates \$2.00; wanted to buy coin stamp collections. Federal Coin Exchange, 812 Carnegie Hall, Cleveland (15), Ohio.

**100 FOREIGN coins** \$3.00 postpaid. Parker Fogler, 693 Mission, San Francisco 5, Calif.

**350 ANTIQUE Firearms**;—3,000 Bargains: Indian Relics, Flintlocks, Minerals, Coins, Swords, Cartridges, Fossils, Rifles, Carbines. Catalog-Photographs 25c. Heike, Wenona, Ill.

**WILL Pay \$10.00 each** for certain Lincoln pennies! Indianheads \$50.00; Dimes \$1,000.00. Catalogue 10c. Federal Coin Exchange, 1-PS, Columbus, Ohio.

## 38 CONSULTING ENGINEERS

**TECHNICAL** problems answered \$2.00 each. Practicing professional engineers' advice, electrical, electronic, mechanical, aeronautical, automotive. Associated Engineering Consultants, Box 627, Palo Alto, California.

## 42 DETECTIVES

**DETECTIVES**—Work home—Travel. Experience unnecessary. Write Wagoner P-125 West 86th, N. Y., N. Y.

**DETECTIVE Training**. Phillips Secret Service, 1917-C North Kenneth, Chicago 39, Illinois.

**BE A Detective**—Send for price-list of self-instructional courses at reduced prices. Perkins Publications, 300-C Brandeis Theatre Bldg., Omaha, Nebraska.

## 43 DOGS, BIRDS, PETS, RABBITS

**ANGORAS, Chinchillas, White Giant Rabbits**—"Rabbitry Management" tells everything. \$1.00. Self-cleaning Hutch plans \$1.00. Automatic Feeder plans \$1.00. All three \$2.50. Catalog finest Pedigreed Rabbits free! Grinsteeds, Dept. 16-D, Edwardsville, Ill.

**SPORTSMEN: 200 Pointers, Setters, Straight cooners, Combination Hunters, Rabbit and Fox Hounds.** Reasonable. List Free. Ramsey Creek Kennels, Ramsey 2, Ill.

**RAISING Rabbits, Cavies, Hamsters, Chinchillas** is a growing and profitable industry. Magazine 10c. Descriptive Book and magazine 25c. Book and magazine (monthly) one year \$1.00. Address Small Stock Farmer, Pearl River 16, N. Y.

**RAISE giant Chinchilla rabbits.** Year round income. Ideal occupation. Tremendous demand for gorgeous furs, delicious meat. Great scarcity means large profits. We buy your youngsters. Willow Farm, R16, Sellersville, Pa.

**RAISE Birds For Us.** Canaries, Love Birds, Finches and others. Interesting, profitable spare time work. Breeders supplied. Catalog and instructions free. Universal Aviaries, 1218 S. Michigan St., South Bend, Indiana. "Successors to Tom & Ann."

**RAISE Guinea Pigs.** Make money at home. Big demand. Booklet free. Taylors Cavy Farm, Hapeville, Georgia.

**ST. BERNARD Pups:** Champion sired beauties. Franklin Young, R. 3, Riverhead, Long Island, New York.

**\$2500 EARLY** raising angora rabbits. We market your output. Contract particulars free. Wilson's, 1065 Shryer, St. Paul 8, Minn.

**RAISE Moneymaking Angora Rabbits.** Also New Zealand Whites. Wool \$15 pound. Plenty cash markets. Particulars free. White's Rabbitry, Lawrence, Kansas.

**PET Animals** many kinds for sale illustrated catalogue, literature, 25c. Trails End-14, St. Stephen, S. C.

**MONEY in Rabbits** with our revolutionary hutch system, reduces overhead; details free. Send 10c for trial subscription to magazine Rabbit Profits, tells how. Reliable Fur Industries, Dept. PSM, Montebello, Calif.

**500 XMAS puppies**, \$4.00, our Choice—Stamp—Fay's, Madrid, N. Y.

## 45 DRAFTING INSTRUMENTS

**SAVE on drafting materials.** Free catalog. Draftsmen's Supply Co., 32 North Wells, Chicago 6.

## 46 DRAWING & ART SUPPLIES

**SHADSCOPE** makes image appear on drawing surface. Plans 50c. 1950 Ley, Pittsburgh 12, Pa.

## EDUCATIONAL AND INSTRUCTION

**GOOD "Used"** self-instruction educational books on all subjects bought, sold, rented, exchanged. Satisfaction guaranteed. Complete information and 100-page illustrated bargain catalog Free! Write—Nelson Co., Chicago 5.

**MODERN Welding School** gives thorough training for one of industry's best paid jobs. Experienced instructors. Individual attention. Nonprofit institution. Qualified under G. I. Bill. Write for literature and details. Hobart Brothers Co., Box P-1067, Troy, Ohio.

**HOME Study course**, drugless therapy. Free Literature. Inst. of Drugless Therapy, Tama, Iowa.

**CLINICAL Laboratory Technicians** in great demand. We train you in your spare time, in your own home. You can practice while studying. Write for free catalogue. Imperial Technical Institute, Box 973-B, Austin 5, Texas.

**FOR an extremely profitable lifetime business**, operate a Collection Agency-Credit Bureau. Easily learned. Write: Cole & Associates, Syracuse 2, New York.

**A SUPER Memory is Yours**—New, Improved, Simple Course Available To You Now! Write! YC-3, Thor Books, Box 1210, Chicago.

**BECOME a Doctor of Psychology or Metaphysics.** Teach secret of contentment, happiness. Win degree of PsD or MsD. Solve mental worries. Free book College of Universal Truth, 5153-A.N. Clark, Chicago.

**CHIROPODY**—Home study course. Degree. Alaska Chiropody College, Juneau, Alaska.

**"UNCLE Sam" Jobs!** Start \$1756-\$3021 year. Paid vacations. Men-Women. Prepare immediately for next examinations. Thousands of permanent appointments expected soon. Particulars Free. Franklin Institute, Dept. C-23, Rochester, N. Y.

**LEARN Trigonometry** better than others. Master method instructions \$1.00. Guaranteed. J. Ziemba, 6123-B Orchard, Dearborn, Mich.

**"RADIO Announcing."** A new book of instruction designed to teach beginners and aid professional radio announcers. Book contains pictures, quotations, and biographies of many top ranking announcers. \$2.00 postpaid. Hollywood Radio Publishers, 5855 Hollywood Blvd., Hollywood 28, California.

**PREPARE** for civil service examination. Pay for course after securing position. Write Free School, Dept. PS, Kokomo, Ind.

**NON-Resident.** High school, college, professional courses. Bulletin free. Capital City College, Washington 5, D. C.

**HYPNOTISM.** Instruction. Eighteen parts. Complete \$5. Dr. Lonk, D-1619, Palatine, Ill.

**SECRETS and Tricks of Hypnotism** exposed in "Confessions of a Hypnotist." \$1.00. William-Frederick Press, 313 W. 35th St., N. Y. 1.

**SHORTHAND** in thirty days. Free trial. Cook's Uniscript, Bartow, Fla.

**NEW edition** simplified bookkeeping and income tax record for small business, postpaid \$3.75. S & A Bookkeeping Systems, 8858 Ladue, St. Louis 5, Mo.

**MAGIC shorthand** and typewriting course 25c. Moyer, B-252, Milton, Penna.

**USED Correspondence courses, books,** bought and sold. Free catalogue! Spotlight, 141 Broadway, New York.

**CIVIL Service Jobs.** Men-Women. Examinations coming. Valuable information free. Columbian Correspondence College, Washington 2, D. C.

**YOU can play the piano by ear** in one week. Quick short cut. E. E. Morrison, Box 9312-P Station S, Los Angeles 5, California.

**DEGREES:** Home study letter brings catalogue. "Esoteric School of Cosmic Science" Incorporated, Chesterfield 10, Indiana.

**HAVE your own office!** Many earn up to \$5,000-\$15,000 Annually. Learn credit-collection agency business by home study course. Experience unnecessary. Write for Free bulletin. No obligation. Franklin Credit School, Dept. 203, Roanoke 7, Virginia.



**LOCKSMITH** Course. Lock-picking, key-fitting, etc. \$1.00 prepaid. Miller's Key Shop, Canadian, Texas.

**MEDICAL** Hypnotism and Suggestion. Lessons in Hypnotism and Suggestive Therapeutics. Postpaid 30c. Kirk Sales, Box 84, Wellington, Ohio.

**HOME** Study course, drugless therapy. Free Literature. Inst. of Drugless Therapy, Tama, Iowa.

**USE** hypnotism to overcome inferiority complexes, Smoking, Drinking, Nail-biting, Insomnia, Stuttering Nervousness, Delinquency, Depressiveness, Poor memory, \$2.00. Mohr, Suite 810, 75 Kneeland, Boston 11, Mass.

**USED** Correspondence Courses, Educational and Technical Books Bought, Sold, Rented, Catalog Free. Educational Exchange, Henagar, Ala.

#### 49 ELECTRICAL SUPPLIES & EQUIPMENT

**ELECTRIC** Pencil: Writes-Engraves all Metals. \$1.00 postpaid. Bever Mfg., 4515-C Cottage Grove, Chicago 15.

**NOW**—Repair your own electrical appliances with Chanite Self-welding, Electrical Heating, Element Flux. Instructions, delivered, price \$1.00. Stick Form 25c each, \$2.00 dozen. Chanite Sales Company, 914 South Main, Fort Worth, Texas.

**ELECTRIC** fan assemblies. Make your own. Ted Riseman, 425 East Jefferson, Springfield, Illinois.

**ELEMENTS**, Irons, Toasters, 65 cents Postpaid. Claudio, 67 West 101 Street, New York.

**ELECTRIC** Meters, prompt shipments, any quantity, all sizes, D. C. or A. C. New and Used, Ditto Pyrometers, Thermocouples. Service on all Types. Write Cleveland Electric Laboratories, 1988 E. 66 St., Cleveland 3, Ohio.

**SELSYN** motors, Bendix 3 1/2" x 5 1/2" heavy duty 115 volts, 60 cycles, \$10.25 per pair. J. A. Weber, 150 Maple, Hershey, Pa.

**TOASTERS**; Clocks; Mixers; Irons, other Appliances. Immediate delivery. Price list. Mailorder Electric, 705 South Dearborn, Chicago.

**CHRISTMAS** tree lites, radios, heaters, toasters, automatic irons, broilers, etc. Jeannette Electric, 159 W. 23rd St., N. Y. 11, N. Y.

**CONTROLS** for every practical purpose—parts. Controls Company, 2519 Wilson-Arlington, Virginia.

**MINIATURE** Electric Switch lights closet when door is opened, sounds alarm when window is opened, turns radio on and off; many other uses. Instruction booklet included free. Send \$1.00 to R. H. Lee & Co., Whitestone, N. Y.

**AMAZING** Value. New 110 volt-sixty cycle Ball Bearing precision motors. Operate grinders, fans, etc. Cost government \$48.75. Sent express prepaid. Only \$3.69. LECO Engineering Company, 908-PS12, Lincoln, Nebraska.

#### 50 EMPLOYMENT SERVICE

**STOP** Looking for a job. Good paying jobs available in Florida. Here is something you can put your hands on. Send for free booklet, "Florida Opportunities." Florida Businessmen's Service, Box 767-A, Panama City, Florida.

**INTERESTED** Foreign employment? Thousands jobs throughout world. Names and addresses over 200 firms with sample application \$1.00. "We search the world" Wonder-World Research Bureau, Box 731, Gladewater, Texas.

#### 51 ENGINES, MOTORS, ETC.

**WINDING** Data, listing 225 motors, single and three phase, \$1.00. Motor Data, Box 7631 Kansas City 3, Mo.

**"BUILD Your Own"** gas drive arc welder easily with Hobart Generator. Save \$300 to \$500, and need only add used auto engine and chassis to build portable gas drive welder that goes everywhere after profitable construction and repair jobs. Write for free instruction book, further details. Hobart Brothers Co., Box P-1066, Troy, Ohio.

**ALTERNATING** Electric Motors 1/40 horsepower \$4.50, 907 N. 5th, Phila., Pa.

#### 52 POPULAR SCIENCE

**150 AMPERE** generator for welding \$47.50. Extra Flexible Cable, 8 ft. lengths \$2.75. Other bargains. Butler Electric Company, 1885 Milwaukee, Chicago 47.

**MOTORS** 6v DC new, high power 1/20th Hp \$3.95 plus postage. Greyhound Co., 2303 Surf Avenue, Brooklyn 24, N. Y.

**ELECTRIC** Motors-Household. Repair them yourself. Simple easy to understand instructions. \$2.50. Value-Special \$1.00. Rush Check or Money Order to Tradecraft Sales Co., P. O. Box 695, Wheeling, W. Va.

#### 52 FARMS, OTHER REAL ESTATE

**GOOD** Farms — Ranches. Washington, Minn., Montana, Idaho, Oregon, North Dakota. Dependable crops, favorable climate. Write for literature, lists describing typical postwar farm opportunities. Specify which state. J. W. Haw, 120 Northern Pacific Ry., St. Paul 1, Minn.

**OZARK** Lands for All purposes. Actual river frontages. 5 acres \$90.00 and upwards. Free list and literature. Hubbard, 424H, Minnesota Ave., Kansas City 4, Kans.

**STROUT'S** Blue Farm Catalog—27 States —Coast to Coast—over 1300 bargains, money-makers—132 pages. Write Today. Mailed Free. Strout Realty, 255-ZB 4th Ave., New York 10, N. Y. 7 So. Dearborn St., Chicago 3, Ill. 453 So. Spring, Los Angeles 13, Calif.

**CHEAP** Homes, Stock Ranches. Free stock range, lovely climate in healthful, fertile, beautiful Ozarks. Free literature. Write Barnsley, Ozone, Ark.

**WANT To Be Your Own Boss?** A good farm in Canada is your answer. Low prices. Favorable terms. Drop a postal today, giving your preferences as to size and kind of farm, and province in which you are interested. Address H. R. Cresswell, Canadian Pacific, Montreal.

**HOMESITES** \$450—convenient payments. California's finest garden section. On Morro Bay's scenic shores. Wonderful fishing, hunting, boating, bathing. Fertile soil, softest water, temperate climate, congenial community. Free literature. Richard Otto, 6560-Z, Hollywood Blvd., Hollywood 28, California.

**FLORIDA**—Several 10 acre tracts in high dry section, fine for fruit and vegetables. Only 50 miles from coast and St. Petersburg. Priced only \$245.00, \$10.00 down, \$10.00 month. For further information write G. B. Potterfield, Union Bldg., Charleston, W. Va.

**\$1.00 DOWN**—\$1.00 monthly per acre—\$32.00 per acre. Fertile Farms 45 miles North of Pensacola, Florida. Half oil rights. Fred G. Delker, 2219 W. Venango St., Phila. (40), Pa.

**40 ACRES** Virgin Missouri Land \$155. \$5 per month. Free information. Mr. Armstrong, Shook, Mo.

#### 53 FIELD GLASSES, TELESCOPES, ETC.

**BUILD** Your Own Reflecting Telescope Copy of Instructions 10c, Catalog Free, Mayfloor, Katonah, N. Y.

**60 POWER** telescope, \$2.95. 250 power microscope, \$2.45. Also bargains in binoculars and surplus lenses. Send for free catalog. Brownscope Co., 24 W. 45th St., New York.

**TELESCOPES** 36 inch 3 section 17 power precision ground and polished lenses including carrying case \$2.50 postpaid. Microscope 50 power complete with specimen slides \$2.98 postpaid. Dept. PS, Criterion Co., 438 Asylum St., Hartford, Conn.

**REFLECTING** Telescope, complete 3 1/2" diameter, equatorially mounted. View planets, stars, \$19.75. Write Skyscope Co., 475-5th Ave., New York.

**TELESCOPES**, Microscopes, Binoculars, Barometers, Books, Bought, sold, repaired. All lists: 10c. Rasmussen & Reece, 41 Market, Amsterdam, N. Y.

**60 POWER** telescope, \$2.95. 250 power microscope, \$2.45. Send for free catalog of Telescopes, Binoculars and Microscopes. Brownscope Company, 24 West 45th Street, New York.

**EXTREMELY** clear 100X and 300X astronomical telescope easily made. Instructions 10c. Full set perfect lenses and instructions \$2.00. Carl Jamer, Monorville, N. Y.

#### 56 FRUITS AND FOODS

**ORANGES**, grapefruit direct from grower, \$2.95 Bushel F.O.B., Garlits, Seffner, Florida.

#### 57 FOR THE HOME

**REPLACEMENTS** — Stoves, Furnaces, Grates, Firepots, Linings, Craxmend, Magoprodox, Royal Oak, Mich.

**FIREPLACE** Owners: Are you proud of your fireplace? Add beauty with Sunset Glow, exclusive fire color, \$1.00 per box. Free Sample. Amity Products Co., Waltham 54, Mass.

#### 58 FOR INVENTORS

**INVENTORS**: Avoid unnecessary expense. Write for free booklet explaining how our Consulting and Advisory Service can assist you in deriving greatest profit from inventing. Institute of American Inventors, Dept. 30-A, 1926 Eye St., N.W., Washington 6, D. C.

**CASH** for practical ideas and inventions. Mr. Ball, BB-9441 Pleasant, Chicago.

**DRAWINGS** of your ideas—Inventions, by college draftsmen, drawings approved by Patent Attorneys. Chrisman, College, Box 375, Manhattan, Kansas.

**THE** Inventor who believes he has a new and useful invention, and needs advice, should consult a competent registered patent attorney. Without obligation, write for full information on how to secure Patents and Trademarks. Randolph & Beavers, Registered Patent Attorneys, 340-E Columbian Bldg., Washington 1, D. C.

**INVENTORS**—your commercially valuable invention, any kind, patented, unpatented, may have cash, royalty possibilities in today's markets. Write today. Explanatory booklet, disclosure form, references, free. Invention Reporter, 3A-11106 So. Longwood Drive, Chicago 43.

**INVENTORS**. Have patent Protection first. Remember, the details of your invention do not have to be 100% perfect before you can obtain patent. First step is to have us conduct search of prior U.S. Patents and render a report as to its patentability. Send at once for further particulars and "Invention Record" form. Request does not obligate you. McMorro, Berman & Davidson, Registered Patent Attorneys, 143-V Atlantic Bldg., Washington 4, D. C.

**INVENTORS**: Learn how to protect your invention. The patent laws were enacted for the benefit of the inventor to give him protection for the features of his invention which are patentable. The United States Patent Office advises the inventor to engage a competent, registered patent attorney to represent him. We offer the inventor experienced, conscientious counsel and prompt, confidential service. A specially prepared booklet containing detailed information concerning patent protection and procedure with "Record of Invention" form will be forwarded to you upon request—without obligation. Clarence A. O'Brien & Harvey Jacobson, Registered Patent Attorneys, 62A-L Adams Building, Washington, D. C.

**INVENTORS**—A Patent is a Valuable Right. Detailed information and the steps to be taken to obtain Patent Protection will be sent to you upon request. Victor J. Evans & Co., 142-P, Merlin Building, Washington 6, D. C.

**INVENTORS**, have your patent personally presented to the manufacturer. P. O. Box 1141, Akron 9, Ohio.

**INVENTORS**—Market study; Developing; Manufacturing; Models. J.-M. Burlington, Kentucky.

**"INVENTOR'S** Guide" free on request. Frank Ledermann, Registered Patent Attorney, 154 Nassau St., New York 7, N. Y.

**INVENTION** Selling, Patented or unpatented depends on reaching Right Manufacturers. Find out "How It's Done". Will have preparation, filing your invention by Registered Patent Attorney including drawings, investigation, analysis on Monthly Payments. Details free. Charles R. Morton, Patent Broker, 11 West 42nd St., New York.

**MANUFACTURING**, stamping, designing, developing and experimental work; tools, dies, jigs, fixtures, models made by experts. A complete service available once again following interruption by war work. Technical Development Co., 157 Chambers St., N.Y.C. 7. (Dept. S-12).



**INVENTORS:** Avoid unnecessary expense. Let us market your inventions, ideas. Write Polk, 4857 State St., Chicago 9, Ill.

**INVENTORS Models:** Let us make yours. Blueprints unnecessary. We work from pencil sketch or patent drawing. Inventors Model Service, 33 Saily Ave., Plattsburg, N. Y.

**INVENTIONS, New Products, Ideas, Models, Special Machines, Tools** are our business. Write Model Crafters Inc., Box 612, Hamilton, Ohio.

**SCIENTIFIC Models, instruments, designed, built, repaired.** Enzinger, 496 Fourth St., Brooklyn 15, N. Y.

**INVENTIONS** developed from idea stage. Circular Free. Aye & Dee Technical Corp., 743 Carroll St., Brooklyn, N. Y.

#### 59 FORMULAS, PLANS, ETC.

**137 MONEY-making plans, also formulas** for salable products. Descriptive booklet free. Elite Co., 220-A Grand St., N. Y.

**FORMULAS—All kinds. Latest money-makers; literature Free.** Kemi-Kal, Park Ridge, Ill.

**FORMULAS** for practically any product you want \$1.00. Write Us, No obligation. Research Clinic, Box 302, Altadena, California.

**10,000 FORMULAS and Trade secrets.** Free Literature. Stillmans, 555 Kingston Ave., Brooklyn 3, N. Y.

**SOAPLESS Soap!** Easily, cheaply, made. Sold. Formula, 25c. Duffy, L 42, Covington, Ky.

**NEED chemists? Formulas? Analyses? Technical services? Consulting Scientific Co., Swarthmore, Pa.**

**FORMULAS—Latest Best, Analysis, Giant formula catalog and chemical Instruction Sheet 10c.** Refunded first order. E-Belfort, Engineering Building, Chicago 6.

**RACING FUELS;** six tested guaranteed auto racing formulas \$1.00 postpaid. Formula Research, 481 Pacific, San Luis Obispo, Calif.

**FORMULAS Guaranteed Manufacturing.** Expert Chemist. Lists Free. G-Riviere, 521 Provident Bank Bldg., Cincinnati, Ohio.

**WIN at poker!** Play scientific poker—don't gamble. Percentage flaws exposed; fine points. \$1. Patrick Williams, P. O. Box 4620, Pittsburgh 6, Pennsylvania.

#### 60 FROG RAISING

**TADPOLES** make frogs, tremendous demand. Both make you money, 25c brings valuable information. Chariton Corp., Century Bldg., Chicago 4.

#### 62 FUR FARMING

**RAISE profitable giant Chinchilla rabbits.** Great scarcity means large profits for gorgeous furs and delicious meat. Little space. Pleasant occupation. Contact world's largest breeder. Willow Farm, R16-B, Sellersville, Pa.

#### 63 GAMES, ENTERTAINMENT

**SLOT machines and games.** List—10c. Lydiard, Rocky Hill, Conn.

**RACE horse cribbage, colored design 12" x 12".** Round track—four lanes. Novel advances. Speed game. Dice or cards. Top fun. Children and adults. Send 25c. Lock Box 163, Point Richmond, Calif.

**FUN for Everyone!** Here is different entertainment for your guests! Add one or two of our automatic amusement devices to your game room for loads of exciting fun. New or guaranteed pinball games and other popular machines, to operate with or without coin. Write for Free illustrated folder. Monarch Coin Machine Co., Dept. PH-1, 1545 N. Fairfield Ave., Chicago 22, Ill.

#### 64-A GENEALOGY

**TRACE Your family history with "Guidex"!** Literature free. Family Guidex, P.O. Box 829-P, Annapolis, Maryland.

**PRESERVE Your Family Tree on a Gallo-way Ancestry Chart.** Durable—Beautiful—Complete, \$1.00 each, postage paid. Gallo-way Ancestral Charts, 318 E. Union St., Pasadena 1, Calif.

#### 66 HANDWRITING ANALYSIS

**ANALYZE handwriting for fun, knowledge, and profits!** Full instructions. \$1.98. Details Free. N. W. Oliver, Box CA, Mansfield, Tenn.

#### 68 HELP WANTED

**NATIONAL Business Service and Reporting Syndicate** offers attractive proposition to reliable persons in each city or county as our exclusive representative. Full or part time. Universal, Box 2707, New Orleans, La.

**PARAMOUNT Atmospheric conversion gas burners.** Quickly installs into any heating plant. AGA approved. Sell and install. Peerless Sales, 4322 Sheridan, Lincoln 6, Nebr.

#### 69 HIGHGRADE SALESMEN

**POCKET Pal: The All-Purpose Cutting Tool, Wagon Jobbers-Salesmen.** Sell to retailers and jobbers. 50c seller. Steady repeat item. Exceptional profit. Sample 25c. Nelson Mfg. Co., 222 W. Kellogg, St. Paul 2, Minn.

#### 70 HOBBIES, COLLECTIONS

**JEWELRY stones removed from rings, etc.,** 100 assorted \$2.40; 50 large ones \$2.40. B. Lowe, Holland Building, St. Louis 1, Mo.

**INVENTING** can be an interesting and profitable hobby. Write for complete particulars. Institute of American Inventors, Dept. 30-E, 2926-Eye St., N. W., Washington 6, D. C.

**CAMPAIGN Ribbons—Beginner's Package—Introductory Price—50c,** contains 15 Assorted Ribbons. Collectors desiring Special Ribbons specify your requirements. MDSE. Distributing Co., 19 E. 16 St., New York 13.

**KLONDIKE! For Hobby Jewelry Makers!** Novelty Jewelry Findings from tables of large manufacturers—parts for Bracelets—Pins—Earrings, etc.—unfinished. Chains—Rings—Pins—Stones—Clips—Beads—many other items—1 Lb. Bags—\$2.00 Per Bag in 5 Bag Lots. Sample Bag—\$3.00. Prepaid only. MDSE. Distributing Co., 19 E. 16 St., New York 13.

**EXCHANGE Your duplicate stamps, match covers, post cards or any hobby, with collectors everywhere!** Exchange register listing swappers, 10c. (Mention hobby). World Hobby House, Box 721-B, Olympia, Wash.

**TWELVE Issues Worldwide Hobby Magazine \$1.00, Sample 10c.** Klings' Exchange, Blue Island, Illinois.

**SWAPPER'S Hobby Bulletin.** Whatcha got? Whatcher Hobby? Three times two dimes. Royal Oak, Mich.

**INTRODUCTORY Offers:—10 Officers Insignias 25c; 22 different American or 15 different foreign—\$1.00.** Illustrated catalog 10c. Hobbyguild, 35X, West 32nd St., New York.

**OFFICIAL Nuremberg War trial, Bikini Atom bomb test pictures, 20 4 x 5 glossy prints \$1.50.** Other sets available. Official War Pictures Co., 64-40 98th St., Forest Hills, L. I., N. Y.

**UNUSED Match Book Covers, 100 all different \$1.00.** 35 Royal Flash Covers \$1.00. Free list. Charles Edelman, 1311 P East 84, Cleveland 3, Ohio.

**SWAPPER? Collector? Send 10c for sample copy Hobbyswap Contacts.** 1326 South 27th, Omaha 5, Nebraska.

**EXCHANGE duplicates. Swappers everywhere.** List 10c particulars free. Box 2166, Denver 1, Colorado.

**SQUIRTING nickel, actually squirts tiny stream of water, lots of fun, send \$1.00 to, Augustin, 4534 N. Oakley Ave., Chicago 25, Ill.**

**WASHINGTON Bicentennial Genuine Steel Engraving, Beautiful Portrait of our First President 25c.** Levitt, 102 Fulton St., New York 7, N. Y.

#### 71 HOME CRAFTSMEN

**LEATHER Scraps for Hobbyist six pounds \$2.00.** Hobby Books "Applied Leathercraft" \$3.00. "Art of Whittling" \$2.00. "Wooden Toymaking" \$2.25. Hobby Books catalog Free. Northern Supply Co., Dept. 3, Sheboygan, Wis.

**TOY patterns, Circus wagons, trucks, carts, pull toys, etc.** 35 patterns 1.00. Continental Homecrafters, 907 Birch, Eau Claire, Wisconsin.

**"ELECTROPLATING"—book on how to set up and operate a complete home electroplating workshop.** 260 pages, over 150 diagrams, \$2. Popular Science, Dept. 126-C, 353 4th Avenue, New York 10, N. Y.

**WOODWORKING Outfit—includes lumber, designs, tools, equipment, instructions.** Make many fine toys, novelties, gifts for fun and profit! Only \$2.00 Postpaid. Handicraft Creators, Dept. S, 1734 President Street, Brooklyn 13, N. Y.

**PATTERNS 70 Lawn ornaments and novelties \$1.00.** Five new hanging shelf \$1.00. Doll stroller, colonial cradle, circus group, table and chairs \$1.00. Milne's Hardware, 1501 Wadsworth, Saginaw, Mich.

**JEWELRY Accessories, Findings, Plastic and metal pinbacks earwires, clasps, chains, rings, pearls, stones, cameos.** Assortment \$1. Prompt shipping service. List 10c. Doremby Co., Chisholm, Maine.

**SHELL Jewelry Supplies. Wholesale only.** McFarland Plastic Co., Sarasota, Fla.

**KNOCKDOWN Cedar Chest Lumber Veneers Free Price List.** Giles-Kendall, Box 435, Huntsville, Alabama.

**FINISHES for any type material.** Electroplating chemicals and supplies, wood and metal finishes; shop chemicals; industrial and novelty finishes. Write for price list now being prepared. Craft-Finishes, Box 467 S. Arlington, Virginia

**HERALDIC Insignia Pattern Kit of 200 Distinctive Designs—\$2.00.** "IHB", P.O. Box 508, Annapolis, Maryland.

**WHITTLES'S supplies, readicut blanks, special woods, knives.—Old Whittler, 1402 Charles, LaCrosse, Wis.**

**PATTERNS 3 pinup lamps .25, plans bridge lamp .50.** Ainsleigh, 71 Arborway, E. Braintree 84, Mass.

**MAKE Christmas tree ornaments from egg shells.** Angel, Santa, Humpty Dumpty, and kitten, 10c each pattern with instructions and materials for 2. Send coin please. Pink Lady Studios, Box 835, St. Louis 1, Mo.

**\$46 From Square Foot Plywood; Jigsaw necessary.** Write: Woodarts, X-44, Bridgewater, Mass.

**LEATHER Craftsmen! Are you tired of the same old designs? Are you tired of laboriously tracing these designs? Now!!!** Something new! Tiresome tracing eliminated. Lampkin Artcraft Transfers imprint design on leather instantly. May be used repeatedly. Exciting new designs. Decorate belt, billfold, bookends, cigarette case, blotter strip, handbag, etc., with special introductory transfer designs. Send \$1.00 for this offer and literature describing Lampkin Artcraft Transfers. Lampkin Artcrafts, P.O. Box 641-S, Culver City, California.

**EXPERIMENTERS! Interested in Electrical, Mechanical devices from war surplus? List Free.** F. Siefke, Box 18, Station E. Buffalo, N. Y.

**TOOLING Leather felt, Beads, Sequins, also Scrap Leather, Craft Books.** "Mad Money Pins". Storr-Nelson Co., 79 E. San Fernando, San Jose, Calif.

**CATALOG: Patterns plywood Novelty Furniture—Letters—Numerals—Plaques—Frames—Weathervanes—Silhouettes—Lawn Ornaments.** 100 Books & Booklets on Crafts & Hobbies. Picture Frame Mouldings, Tools, Large line Decal Transfers. Other lines. Hundreds articles finely illustrated. Write Wo-Met Shop, Ashburn, Georgia.

**LEATHERCRAFTERS! Send for catalog listing leathers, kits, supplies.** Kit Kraft, 1607 South Western, Los Angeles 6, Calif.

**LAPEL Pin Paper Patterns, Money Makers 12 for 25c.** Patty Ann, 2200 Lincoln, Des Moines 10, Iowa.

**REWIND electric motors. Demand is great.** Instructions how to get started \$1.00. Frank J. Ives. Coopersville, Mich.

**PANTOGRAPHES. Professional enlarging instruments.** Eliminates squares. Postpaid \$2.50. Details free. Pantographs, Munising 2, Mich.

**MAKE money assembling our pre-fabricated plastic kits.** Sample kit 50c. Fabros, Box 156, Station F-2, Buffalo 12, N. Y.



**73 HUNTING**

**LEATHER** pants sheepskin lined zipper front, U. S. Air Corp. issue all sizes \$10.00. Satisfaction guaranteed. N. Y. Clothing Co., 2079 Second Ave., New York 29.

**74 INFORMATION**

**WHOLESALE** Sources. Any item. Addresses supplied. "Service", 1332 Findlay, New York City 56.

**75 INVENTIONS WANTED**

**WANTED**—Patented, unpatented inventions having profit possibilities, all kinds. If will sell, reply immediately. Descriptive booklet, references, free. Invention Reporter, 3B-11106 S. Longwood Dr., Chicago 43.

**INVENTORS:** Hundreds of manufacturers have requested our assistance in locating marketable new products. Complete information, free. Institute of America Inventors, Dept. 30-C, Washington 6, D. C.

**CASH** for Inventions—Patented, unpatented. Mr. Ball, BC-9441 Pleasant, Chicago.

**INVENTIONS** Promoted. Patented or Unpatented. Write Adam-Fisher Co., 183-A Enright, St. Louis, Mo.

**WANTED:** Practical inventions for marketing through chain, drug and cigar stores. Particularly desire lighters, smokers' articles, etc., in plastic, wood or metal. Write Matt, 1412-GN, Great Northern Bldg., Chicago 4.

**PATENTED.** UnPatented Inventions Promoted. M. Joyce Humphries, 1424 Landtitle, Philadelphia 10, Pa.

**INVENTORS!** Save time and money by reading the book "Selling Inventions With and Without Patents," contains methods for selling before patenting, court rulings, mechanical principles; how to market finance inventions successfully. \$1.00 prepaid, Metzler, 11 West 42nd, New York.

**WANTED:** Practical Inventions of all kinds by manufacturers. Patented or unpatented. Write:—John D. & Son, 285 Howard Ave., Box 3213, Bridgeport 5, Conn.

**EARN** Up To \$2,000 year, inventing simple items for special cash markets. Ideas only. No patents. Hendrickson, Argyle, (8-A), Wisconsin.

**INVENTIONS** Wanted. Patented or Pending. Inventors Exchange, Dept.-D, Hartford 1, Connecticut.

**MIDWESTERN** manufacturer desires to obtain new products for manufacture and sale. Forward general particulars of your product together with information concerning patent status to Box 125, Parma, Mich.

**76 JEWELRY**

**CERAMIC** Jewelry Supplies, Bar Pins, ear screws, for ceramic and woodworkers, also, glass and sea shell assemblers. Free catalog. Philadelphia Badge Co., 1007 Filbert St., Philadelphia, Pa.

**SHELL** Jewelry instruction book with illustrations, plastics, shells, pinback, earbobs, for one set. Send only \$1.00 to Williams Shells, P.O. Box 8635, Sulphur Springs, Fla.

**MAKE** beautiful shell jewelry, easily. Big complete Kit \$3.50 Postpaid. Instruction Booklet alone 35c. Wholesale List, Shelart Studios, 2100 Tangerine Ave., St. Petersburg, Fla.

**JEWELRY** Findings, Chain, Watch Bands, etc. Send dime for Catalog. George Sassen, 154 Nassau Street, New York City.

**GENUINE** diamonds, out-of-pawn low prices, wonderful values. Unredeemed loans and big buying power enable us to offer beautiful gems at prices far less than original cost. Shipped Free for Inspection. Appraisal. Send for Big Free list showing fine diamonds at startling low prices. Lloyd J. Butler, President, Prudential Loan Association, 133-UN, N. Clark St., Chicago 2.

**SOLID** Sterling Silver Ring—Ideal Xmas Gift—Girlfriend—Sweetheart or self. State type, send string for size, \$2.00, Tax included, plus sensational free offer. Gold Plated \$4.00. Bellcraft, 811 East 39 St., Brooklyn N. Y.

**54 POPULAR SCIENCE**

**XMAS** gifts aluminum trays compact \$1.95 prepaid. Inquire about jewelry novelties silverware Petersiel, 459 Albany, Brooklyn, N. Y.

**77 LANGUAGE OUTFITS**

**29 LANGUAGES** by Linguaphone, Russian, Spanish, Portuguese—Direct Conversational Method for Mastering any language quickly, easily, correctly at home. Available under GI Bill of Rights. Send for free Book. Linguaphone Institute, 54 RCA Bldg., New York, CI 7-0830.

**80 MACHINERY, TOOLS, SUPPLIES**

**IT'S** Easy to build your own metal and woodworking tools from Lewis castings. Materials and blueprints—and at savings up to 80%! Lewis mills, shapers, drill-presses and other shop tools have ample capacity and performance for home workshop jobs. New catalog sent on receipt of 10c to cover mailing—describes 23 Lewis tools. Address Lewis Machine Tool Co., 3217 Union Pacific Ave., Dept. S, Los Angeles 23, Calif.

**WAR** Surplus in small tools for machine shop—Send 10c for bulletin. Travers Tool Co., Dept. S, 5 Court Square, Long Island City 1, N. Y.

**NEW** portable paint sprayers, compressor, tank and gauge \$14.50, Gun \$4.95, Hose \$1.70. Dealers wanted! Checks payable to W. Van Nossdall, Miracle Radio Shop, 675 Courtlandt Ave., Bronx, N. Y.

**HARDNESS** Tester: Portable type reading Rockwell B & C scales. Free literature. Amity Products Company, Box 207A, Waltham 54, Mass.

**CONCRETE** block machines \$295. to \$1680. Pallets all sizes, shapes; 8" x 16" 48c. Mass production aluminum castings. Mail drawing. Fla. Die Casting Foundry, Orlando, Fla.

**MAGNETIC** Chucks, Indicator bases, \$3.45! Unbelievable? Write, Eyrich, Box 849-A, Milwaukee 1.

**GEARS** For inventors, experimenters, model makers, schools, work shops, laboratories, etc. Government surplus made of brass, bronze, dural steel and stainless steel. 12 matched pairs; 24 gears, bevel, spur and ratchet. List price \$12.00, our price \$2.50. 25 matched pair; 50 gears, includes larger gears, also sets of worm gears. List price \$30.00, our price \$5.00. 50 matched pairs; 100 gears better assortment, including worm sets. List price \$75.00, our price \$10.00. Limited quantity. Order now. Write for our bulletins on ball bearings, rectifiers, Relays, Selsyns, Horns and Government surplus materials. Met Exchange, 323 Canal Street, New York.

**GRINDER** Kit, for all small hand grinders, contains 10 rotary files, five ball and five inverted cone type, 3/32 diameter shaft, 25 abrasive disks and mandrel, 6 chamols buffing heads. All for \$2.00. Radioco, 1110 S. Marshall Bldg., Cleveland, Ohio.

**TAPS & Dies** direct from manufacturer. Equip your shop at small cost. Write for free price list. King Tap & Tool Co., Inc., North Attleboro, Mass.

**AIR** Compressors, Electric, 3 Stage, Value over \$200.00. New 27 Volt AC-DC. Convert Easily with Transformer or 4 1000 Watts Heating Elements. Weight 28 lbs.—instructions Free. A real buy \$15.00. Immediate Delivery. Write For Quantity Prices—General Vacuum Co., 1439 Grand Ave., Kansas City 6, Mo.

**VERY** inexpensive. Sixty-two different divisions. All degrees and half degrees of circle. Used on lathes up to 20" swing, drill-press, milling machine, etc. Very accurate and durable. Write for free folder. Satisfaction Guaranteed. Long's Index Heads, Box 537, Torrington, Wyo.

**OIL** Heater conversion (pot burner) units. Cement mixers, block, brick machines. Blue Squares, Excelsior, Minn.

**TWELVE**-In-One Precision tool. Fine tempered steel, Fits pocket. One piece unit includes: adjustable nut wrench, alligator wrench, screw driver, file, glass cutter, wire stripper, staple and tack puller, straight edge, magnet, rule, knife sharpener, bottle opener. \$1.00 postpaid; guaranteed. Bishop Engineering, 111 W. Washington, Chicago 2.

**VENETIAN** Blind Paint Machine, automatic. Will teach use. \$550.00. 279 E. Burnside Avenue, Bronx, New York.

**DRILL** Grinder for twist drills \$2.95. See ad on page 282.

**UNIVERSAL** Tools Dandy 10 Piece Set: Rigid Pipe Wrench, Channellock Pliers, Adjustable Wrench, Ceetee Pliers, Diagonal Cutter, Ballpein Hammer, Plastic Screwdriver, Waterpump Pliers, Hacksaw & Blade, Cold Chisel, \$19.85. Order Now. Universal Tool Co., 1527 Grand, PM 12, Kansas City, Mo.

**CIRCULAR** Saws \$1.00 each. Approx. 6". Used but good condition. Route 6, Box 97, Mt. Clemens, Mich.

**81 MAGIC TRICKS, PUZZLES, ETC.**

**MAGICIANS'** Gamblers' secrets exposed. Cards, Dice, Punchboards, Slot Machine. Catalog 10c. Book Co., Box 671, St. Louis 1, Mo.

**500 TRICKS** you can do! Douglas' famous Catalog of 500 Tricks, now only 10 cents. America's fastest service on magic for pocket, parlor, stage, professional, amateur. Douglas' Magicland, Dallas, Texas.

**MAGIC** Races! Touch of a cigarette and "They're Off" in a thrilling six horse race! It's fun! It's exciting! 12 for 25c. Wynn Novelty House, Dept. RE126, 3232 Lorain, Cleveland 13, Ohio.

**BE** a Magician. Large professional magic catalog of latest tricks, 25c. Ireland, F-109 North Dearborn, Chicago.

**VENTRILOQUISM** Exposed. First time published. Free Booklet. Quackenbush, Big Flats, N. Y.

**"MAGIC** Vanishing Card". Throw it into air, it completely disappears, reproduce it later from spectators pocket. Easy to do. Complete 25c with magic catalog. The Magician, 2463-D, Kensington Ave., Philadelphia, 25, Pa.

**EASY** to be a radio mind reader. Our book tells how. \$1.00 postpaid. Free magic catalogs and lists. Thayer Mfg. Co., 814 S. La Brea, Los Angeles 36, California.

**FREE!** Large Catalog of magical apparatus if you remit 25c for "Magic Is Fun" magazine. Robbins Co., 152-F West 42nd Street, New York.

**VANISHING** Quarter and Catalog 25c. Sterling Magic, Box 191, Royal Oak, Mich.

**FAKIR** Monthly includes free trick every issue 25c. Fakir, 114 Grand, Brooklyn 11, N. Y.

**HYPNOTISM**—15 illustrated lessons complete, postpaid. State age. For professional use only. Hypno Studio, 7028 5th Ave., Los Angeles 43, Calif.

**200** ELECTRIC Stunts, 110 volts. \$1. Cutting Sons, Campbell 3, Calif.

**MAGIC:** Big 160 page Illustrated Catalog, latest Magic Goods, 25c. For over 1/3 century we have supplied Professional as well as Beginner. Chicago Magic Co., 2300 N. Mason, Chicago 39.

**TANGLED** wire puzzle, 10c. Scheetz, 98 Branch Street, Sellersville, Penna.

**AT** Wholesale Jokes Tricks Puzzles and Novelties. List on request. Harry Schwamm, 237 E. Ninth St., New York 3, N. Y.

**VENTRILOQUISM**—Handy, 54 page pocket size volume 25c. Joseph Jones, Box 1192, Columbus, Ga.

**LOOK!** Diminishing Card Trick—5c. Northeast, Box 6618, Kansas City, Mo.

**WORLD'S** largest professional magic shop, keeps you in touch with latest tricks. To receive mailings, send 35c for new catalog. Holden's, 220-P West 42nd St., New York.

**TRICKS.** Secrets, Cards, punchboards, etc., explained. Big illustrated circular free. Mack, Box 1278-P, San Francisco.

**81-A MAGNETS**

**MAGNET.** "Alnico" 4 oz. Horseshoe, powerful (lifts about 5 lbs.). \$1.00 Postpaid. Ross, 66 W. Broadway, New York 7, N. Y.

**POWERFUL** Alnico Magnet. Ten pound pull. \$1.00. Many others, literature free. Ronald Eyrich, Box 849, Milwaukee.

**MAGNET** "Alnico" 4 oz. Horseshoe; powerful (lifts and pulls up to 10 lbs.). \$1.00 postpaid. Ross, 68 W. Broadway, New York 7, N. Y.

**SPECIAL.** 12 Alnico Magnets plus 100 experiments, \$3.00. 100 experiments only, 25c. Eljay, Box 891, Newark 1, N. J.



**82 MANUFACTURING**

**NAME** plates for manufactured products. Any quantity. Ad-Crafts, LaCrosse, Wis.

**MODELS**, small lot manufacturing, metals, plastics, etc. Millburn, Burlington, Kentucky.

**PLASTIC** Gifts assembled from prefabricated kits. Ideal Xmas gifts. Catalogue 10c. Plastic Products Co., Box 384-U, Massillon, Ohio.

**83 MILK GOATS**

**MONEY** from dairy goats! Booklet free. Introductory 3-month subscription to leading magazine 25c. Dairy Goat Journal, Dept. 668, Columbia, Missouri.

**84 MILITARY INSIGNIA**

**COLLECT** colorful Army Patches. Pictures. Price and sample patch only 10c. Insignia Mart, 703 Broadway, N. Y.

**22 DIFFERENT** emblems—\$1.00 (Value \$4.60). Introductory offer, never before equalled. Price and Insignia Guide 10c. Hobbyguild, 35X West 32nd St., New York.

**FOREIGN** medal ribbon packet, United Nations, Axis \$1.00. Sample 20c. Insignia-craft, 236 28th Ave. N.W., Calgary, Canada.

**85 MINERALS & PRECIOUS STONES**

**GEMS**, precious and semi-precious, all genuine from world wide sources. Deal direct, no overhead, save money. Catalog 10c. Hill Co., Route 7-K, Salem, Oregon.

**AGATES**, three for \$1.00. Rockhound, Box 555, Grand Junction, Col.

**"GENUINE"** Arizona Rubies (Garnets). Send quarter for packet. Mineral Specimens Company, Box 2651, Phoenix, Arizona.

**PANNING** Gold—Learn How. Illustrated booklet and catalogue of mining books, supplies. Free. Old Prospector, A13, Dutch Flat, Calif.

**WYOMING** Jade: Square inch each light green, black, mottled. Also square inch each Montana Moss & Turritella Agate. Diamond sawed. Money back guarantee. All for \$1.00. Jade & Agate Mfg. Co., Box 166, Casper, Wyoming.

**86 MISCELLANEOUS**

**GOOD "Used"** self-instruction educational books on all subjects bought, sold, rented, exchanged. Satisfaction guaranteed. Complete information and 100-page illustrated bargain catalog Free! Write—Nelson Co., Chicago 5

**MEXICAN-Aztec** Featherwork Tropical Bird Picture Cards. Samples 25c. Bulletin Free. Mexican Products Co., 126 N. Main, Tulsa 3, Okla.

**BOOKFINDERS!** (Scarce, out-of-print unusual books) Quickly supplied. Send wants. Clifton, Box 1377 PSM, Beverly Hills, Calif

**THE Lord's Coming!** Get free undeniable proofs today. Write International Evangelism, Box 263, Duluth, Minnesota.

**"TRUE Christian Religion"**. To obtain a free copy of an 80-page digest of this remarkable work by the famous scientist, philosopher and theologian, Emanuel Swedenborg, send your name and address to Swedenborg Foundation, Inc., Room 1648, 51 East 42St., New York 17.

**FIREWORKS**, any time, any quantity, newest ideas, highest quality, best values. Giant salutes, aerial bombs, skyscreamers, battle-in-the-clouds, new jet-propulsion plane rocket. 150 piece combination offer \$4.95. Satisfaction guaranteed. Write for big new catalog. Banner Fireworks, Dept. 42, Toledo, Ohio.

**MEDICAL** Laboratory Technicians in great demand. We train you in your spare time, in your own home. You can practice while studying. Write for free catalogue. Imperial Technical Institute, Box 973-S, Austin 5, Texas.

**JEEP** Hats 10c, Meskits 35c, Canteens 50c, Covers, Cups 15c, Leggings 25c, Holsters 50c, Gunsling 75c, Pistol Cartridge Belts 75c, Field Bags 95c, Tool Box, Steel Helmets, Raincoats \$1.00; Wading Boots \$3; Catalogue. New York Salvage Co., 144 Chambers St., New York City.

**LUCITE** Wedding—Baby Album, Swiss Musical movements, Swiss Musical Powder, Cigaret-Candy Boxes, Novelties of Distinction, 131 W. 42nd, N. Y. C.

**MECHANICAL** Drawing Instrument—Veeco, 4 piece, compact, precision set, brand new in lined case, value \$12.50. Special, \$7.25, \$10.00—Charvos 9 piece set, \$8.50. Army Surplus Slide Rules, slightly used, 75c each. Hull Automobile Compass, for accurate road direction, brand new, \$2.50. Brand new folding valise knapsacks made of heavy olive green duck, heavily bound and reinforced, repellent to fire or water. Inside 3 large snap fastened pockets, heavy webbed straps, hand and shoulder handles, size opened 22"x54", closed 22" rolled. Useful to Hunters, Boy Scouts, Hikers and for all traveling use. A \$7.50 value, Special \$2.25 Postpaid. Prisms for 6x30 or 8x30 Binoculars brand new \$1.50 each. Offset prisms to be attached to 7x50 B. & L. Binoculars gives double the field of the ordinary 7x50 Binocular. Cost \$98.00, Special \$25.00. Green Sunshades for Binoculars size 6x30 and 7x50 snap on type value \$7.50, Special \$1.25 per pair. Forward money order. No C.O.D. shipments. Public Sport Shops, 13 S. 16th, Philadelphia, Pa.

**WISE** Nut Cracker. Patented steel construction. Quickly shells Pecans in halves; all sizes and varieties. Guaranteed. \$1.00 postpaid; C.O.D. Plus postage. Wise Nut Cracker Co., Box 5524, Fort Worth, Texas.

**UNUSUAL** Novelties, samples 10c. Modern. Box 2, Knickerbocker Station, New York 2.

**GET** Lots Of Mail: Name Listed Three Directories 25c. Harvey Teeple, Decatur, Indiana.

**PICTURES**. Books, List Free. Samples 25c. Assortment \$1.—Nu-Art, 436 N. Y. Ave., Brooklyn 25, N. Y.

**LATEX**; Distributor's Special! \$2.00! Three doz. popular brand & 1 "Super"! Wholesale prices with order. Lotz Bros., Dept. 1, 418 Kemper Rd., Rte. 5, Lockland, Ohio.

**MAKE** Your Own Plastoplate printing cuts. Simple, easy process. Plastoservice, Argyle (2) Wisconsin.

**FOR** Laundered Curtains—Use a Modern And Easy roll-on curtain pinner for attaching curtains to the stretchers. Complete with instructions 25c postpaid. Yarger Tool & Manufacturing Co., Dept. PS, Morgantown, West Virginia.

**NYLONS**, \$14.00 Doz. Details, 25c. Stafford, Box 5211, Indianapolis 1, Ind.

**RECEIVE** Moneymaking Opportunities. Samples, Mails, Catalogs, Magazines. Your Name in Thousand Mailing Lists. 25c. Glassminex, 1654-P Amsterdam Avenue, New York 31.

**FREE** literature how to locate buried treasure and minerals. Fisher Laboratory, Palo Alto, Calif.

**HYPNOTIZE** anyone! Get the most perfect, easily learned, modern scientific course of "Genuine Hypnotism" in the world. Fully illustrated. Only \$1.00. Money back guarantee. Fowler, Soldiers Field, Boston 63, Mass.

**DUPLICATORS** \$32.50 complete. Automatic-Feed, Nudevelle, 102 Greenwich, Stamford, Conn.

**STAG**, Book Matches, 10 for \$1.00. Logan Novelty Co., Bellefontaine, Ohio.

**GLAMOUR** Photos! Sample set \$1.00. Risque-Pix, Box 699-E, Westfield, New Jersey.

**GLAMOR** Photographs, 10 for \$1.00. Wilkins, 417 Hill, London, Canada.

**POWERFUL** Mental Telepathy. Practical, free literature. Elgin, 912 Benton, Nashville 4, Tenn.

**CARPENTERS**—50c Vestpocket Calculator. Simplifies everything! Free particulars. Box 1414, Great Falls, Montana.

**LADIES'** beautiful alligator skin handbags, shoes, bedroom slippers \$8.00 up, extra sheer Nylon like stockings \$2.50 pair up, unique merchandise for gifts, cigars, Panama hats, embroiderers, souvenirs, Yarey straw articles, bags. Free particulars. Export, 656 Enna, Havana, Cuba.

**NYLONS!** Address, 50c. Ten pounds Washing Powder—Billfolds, \$2.50. Christmas Cards—Fountain Pens, \$1.10. Grabbags, \$5.00. Renschler's, Carrollton (1), Kentucky.

**CUTTERS** Dental Burs reclaimed assorted 125 — \$1.90; 400 — \$4.90. Am-Standard, 1208 N 13th, Philadelphia 22, Pa.

**50 BEAUTIFUL** 1946 Christmas cards assorted Box \$1.00 postpaid. Circular free. Shipp Greeting Card Company, 625 N. W. 19th Street, Oklahoma City 3, Okla.

**BED-BUG** Cockroach Killer. Positive death, harmless, with instructions. \$1.00, Box 98, New Hyde Park, N. Y.

**FAMOUS** fire gun thaws, heats water in stock tanks, disinfects, burns weeds, destroys tree stumps. 100 uses. Valuable literature free. Sine Equipment, 16S, Quakertown, Pa.

**SENSATIONAL** exposé for sophisticates only! Send 3c stamp for particulars. Box 392, Westfield 12, N. J.

**CEDAR** Boxes, natural glossy finish. Free price list. Sims, P. O. Box 485, Malakoff, Texas.

**COPPER** plaques and molds for plastics easily made by electroforming; complete outline of secret commercial process with personal guidance letter. \$2.50. A. Manning, Box 165, Tuckahoe, N. Y.

**AUTO**, House locks, Keys, sold, repaired. Favorite, 824 East 149, New York.

**87 MODELS, MODEL SUPPLIES**

**MOST** complete Illustrated Catalog—"O-HO OO" Model Railroad Parts ever published. Send 5c for mailing. Selly, 1377 Gates Ave., Dept. 836, Brooklyn, N. Y.

**SHIP** Model and yacht supplies, complete large 64 page catalogue. 30c. Wm. Wild, 510 E. 11th St., New York City.

**MODEL** Engine Catalog, Railroad Supplies, 25c. Refunded. Simonsen, P3054 Greenview, Chicago 13.

**BUILD** model gas and steam engines using our "No Casting" plans. Very fast. Only lathe and scrap required. Free Folder. R. Rowe Engineering, 8889 Appoline, Detroit 27, Michigan.

**MODEL** Ship Builders! Are you looking for authentic, precision ship models? Send for richly illustrated fully descriptive catalogue in full color of famous ships of all kinds. Only 10c. Halesite Yacht Service Inc., Dept. C-24, Halesite, Long Island, N. Y.

**SHIP** model kits and fittings. Complete line Fisher model yacht equipment. All Boucher, Fisher, Marine Model and Ideal Kits, fittings and blueprints at standard prices. Most complete stock in New England. Send 10c for price lists. James Bliss & Co., Inc., 220 State St., Boston, Mass.

**BUILD** Model Ships, Airplanes, Railroads, catalog 10c Ideal, 21 West 18th Street, New York 11, N.Y.

**"MODEL** Railways"—book with simple instructions for building, laying out, operating a complete model railway 256 pages, 365 diagrams and charts. \$2. Popular Science Dept. 126-C, 353 4th Ave., New York 10, N. Y.

**"SHIP** Model Making"—book filled with complete plans for making any type galleon, clipper ship, etc. Nautical glossary. 193 pages. 133 pictures, \$1. Popular Science, Dept. 126-C, 353 4th Ave., New York 10, N. Y.

**ENGINE** castings. Supplies. Catalogue 10c. Howard, P3, 2417 N. Ashland, Chicago, Ill.

**CATALOGS** (Illustrated) for Modellers! Airplanes, 60 page book on solids. Features construction data, specifications, camouflaging, 15c. Railroads: 128 page 'HO' guide. Equipment, accessories, fittings, 25c (includes refund coupon). Send coin or stamps for each profusely illustrated catalog desired. Polk's, "Nations Leading Hobby House." 314-P Fifth Ave., New York City 1.

**SHIP** models, coaches, covered wagons, blueprints, supplies, catalog .25c coin. Roy Hancock, 323 Douglas Ave., Portsmouth, Virginia.

**AMERICA'S** Newest Hobby Model Engine Driven Ice Sled, Speed, Thrills, \$4.95 Less Motor. Model Planes, Race Cars, Trains. Free Bargain List. Ridgway's Hobbies, 3312 Monroe, Kansas City, Mo.

**SHIP** and Yacht model fittings; blueprints. Send 25c for illustrated catalog No 20—Listing hundreds of items. A. J. Fisher, 1002-2 Etowah Ave., Royal Oak, Mich.

**BRASS** Gears and model supplies for the inventors. Send 10c for catalog. Pierce Model Works, Tinley Park, Ill.



**STEAM engines—boilers—castings.** Catalog 25c. Anton Bohaboy, 2297 Price, Rahway, New Jersey.

**STEAM or Compressed Air Engine Rotary valve high speed single cylinder 7/16 bore 9/16 stroke.** Will power small boats ETC Complete Engine Assembled \$5.00 blue print \$1.00 Parts list dime. Amstoy Mfg. Co., P.O. Box 2638, Gravois Station, St. Louis, Mo.

**BIG illustrated model engine catalog 10c.** Active Products & Supply Co., 53 W. Jackson, Chicago 4.

**RADIO Control, 10 tube unit, Revolutionary Design.** Write for details, Box 1097, N. Y. 8, N. Y.

**GIANT Scale Catalog in HO or O gauge, 25c each.** (Refund Coupon.) Lionel list, model Airplane or Boat list, 3c stamp each. Trilor Hobbyist, Box 260, N. Dartmouth, Mass.

**REMEMBER,** when selecting Model Equipment at GMCO, you will find a complete stock of model airplanes, gas engines, ship models, railroads, race cars, supplies and tools. Chances are we have just what you want in stock. Send 25c for your copy of our new catalogue to GMCO Modelcraft, Hobbies, 91-17 (S11) 173rd St., Jamaica 3, New York.

**SPEEDY 1" Motor,** runs on top of flashlight cell! Parts, instructions, 35c. Arthur Fonskov, 655 Amboy Ave., Perth Amboy, N. J.

**MIDGET steam engines \$2.98, Boilers \$2.65,** stamp for literature. R. Looker, Box 105, Michigan City, Ind.

**BALSA Wood Ideal for Modelers, Craftsmen** Sample carving block 25c. List Free. Sanlader, Manitowoc, Wis.

**GASOLINE Motor—for model airplane, etc.** Build it on your lathe! Simple design, no castings! 3" high, 1/6 horsepower, 6 1/2 ounces. Descriptive pamphlet free. Eleven page instruction book plus blueprints \$2.00 postpaid. Spartan Industries, 235 Lake Avenue West, Kirkland, Wash.

**MANUFACTURING Inventions for fifty years.** Models, Machines. Baum's, Kansas City, Mo.

**ORANGE Crate** will provide all wood needed to build "North Star", 3 masted trading schooner, sailing model. New, simple construction. Full sized plans and instructions \$1.00. Milton Sailing Models, Box 466, Rye, N. Y.

## 88 MONEY MAKING OPPORTUNITIES

**DETECTIVES Earn Big Money.** Experience unnecessary. Particulars free. Wagoner, P-125, West 86th, N. Y., N. Y.

**ELITE Collection** describes 137 money-making plans; local, mail order. Particulars free. Elite Co., 220-A Grand St., N. Y.

**MECHANICALLY Inclined Men—own and operate general Appliance Repair shop.** Complete, illustrated course shows you how. Welding, Refrigeration, Motor repair. How to get business, etc., all phases covered. Free literature. Christy Supply, Dept. 1470, 2835 N. Central Ave., Chicago.

**EARN money at home—steady income—** Write Successful Income Builders, 508-B, Hollywood 28, California.

**LEARN Metascience.** Remarkable drugless healing. No manipulation. No apparatus. Unbelievable simplicity and results. Inexpensive correspondence course. Write Metascience, De Land, Florida.

**\$10,000,000 FREE—Annually—Prize Contests.** You can win fortune. We offer expert help. Bulletin, Free, Cash Register-B, 210 Fifth Avenue, New York 10.

**SILVOGOLD, America's Finest 1,000 Signature Embossing \$1.00 Kit.** Glass Packed, Two toned, Proposition Free. Bender Products, Mastic 3, N. Y.

**21 POPCORN, Candy Apple, etc. Formulas.** All money-makers, \$1.00. We can supply equipment. Concession Supply Co., Dept. "A", Box 133 Sta. "B", Toledo, Ohio.

**HARMONICAS: Musical Instruments—** Pricelist Free. Wholesalers, 11 E. Centre Street, Baltimore 2, Md.

**SCRAP Metal** costing 5c pound brings Dollars in finished castings. Lifetime profits. Information, Fritz Foundry & Supply, 622A N. Fulton, Allentown, Pa.

56 POPULAR SCIENCE

**EARN Extra Cash—full time or spare time—** selling Pines' 1947 Greetings. Profits over 100% for producers. These sensational easy-sellings boxed assortments must be seen to be fully appreciated. The complete line includes over 100 different money-making assortments for all occasions—birthday, anniversary, convalescent, congratulations, announcements, invitations, gifts, special occasion and holiday cards; distinctive social stationery for men and women. Climb this big-profit band wagon by sending \$3.00 now for your saleable samples (value \$6.00) of six different current feature dollar box assortments together with full details of our no-risk money-back guarantee on our complete line. Just print your name and address, attach \$3.00, and mail to: Pines, Box 32, Flushing 2, New York.

**START Your own business! Big money manufacturing novelties, plaques, statuary.** Free catalog. Write Bing Products, 88-B2F Broad Street, Boston 10, Mass.

**ELECTRIC Clocks** are everywhere you go. buildings, homes, parking-lots, factories. Repairs increasing. Our easy to learn course with pictures and drawings teach You how to repair these clocks. Electronic Supply Co., Box 2350-B, Houston 1, Texas.

**EARN up to \$2,000 year,** inventing simple items for special cash markets. Ideas only. No Patents. Hendrickson, Argyle (8) Wisconsin.

**WIN Contest Money.** General Contest Bulletin shows how. 15 Big pages of helps. Many current contests listed. Sample 25c. General Contest Bulletin, 1609-A East 5th, Duluth 5, Minn.

**CLEAN up \$5000 yearly** selling specialties, just like I do. Write me. Carelton, Bethany, Okla.

**200 MONEY Making Deals, Plans Rare** formulas. Schemes. Folio Free. Formico Crafts, Box 572, Dayton, Ohio.

**CARNIVAL Ride Plans: Kiddie Auto \$5; Toonerville Trolley \$8; Brill, 228-C, North University, Peoria, Illinois.**

**"THERE'S Big Money In Junk,"** and repairing batteries. Write, Batteryman, Grand Junction 1, Colorado.

**NEW Xmas sensation, photo developer, entire outfit including chemicals \$1.00.** Home Sales, Box 12T, Oaklandon, Indiana.

**EARN Money evenings, copying and duplicating comic cartoons for advertisers.** Adservice, Argyle (2), Wisconsin.

**HAMMERED aluminum giftware extremely profitable—** Details — 299 College, Kingston, Ont.

**WASHING Machines.** Parts any make. Old New, Northeast 1358, H Street, Wash. 2, D. C.

**A \$100-a-month hobby at home! No soliciting, No mail order, no meeting people.** Easy, enjoyable pastime. Details, 25c. (Refundable.) Laura Dickson, 808-PS Elizabeth Street, Anderson, S. C.

**WANTED persons free of criminal record to Foot Print Children, Identification Protection Territories Everywhere, Life Time Opportunity.** The Smith System, 217 W. Keefe, Milwaukee 12, Wis.

**\$246.50 MAKING baffling secret device without skill, machinery, from former top priority war material costing \$1.50!** Guaranteed simple, revolutionary new discovery, unbelievably profitable. Universal appeal. Frank, illustrated proofs, free! Rolls Enterprises, 115 West 16th., New York 11.

**ASSEMBLE colorful handmade jewelry with interlocking plastic links.** Free details. Hughes, 712 Kimball, Danville 2, Illinois.

**STOP — Be independent — 360 business plans, formulas, for local and mail order, descriptive booklet free.** Star Enterprises, Box 41, Brooklyn 14, N. Y.

**DOLLARS Daily! Learn How.** Read "Timely Tips Magazine," Paulding, Ohio, 19th Year, \$1.00. Three copies 25c.

**EARN money at home! Thousands do!** "Home Worker Magazine" tells how. Sample, 25c (coin). Six issues, \$1.00. Arthur Sizemore, Pub., Box 870-S, St. Petersburg, Fla.

**DOES \$1500 A Year "On the Side" Interest You?** Details Free. Southern Specialty Service, 210 North E., Lake Worth, Florida.

**SHELLCRAFT Kits for beginners.** Shells and complete supplies for making pins, earrings, combs, and novelties. Instructions free with \$2.00 and \$5.00 kits. We carry a complete line of shells and parts. Free price list. Immediate shipment. Member of Miami Chamber of Commerce. Herbert Diamond & Co., 1121 North East First Ave., Miami, Florida.

**FREE Nylons! (legitimate)—25c (refundable)** gets information. Renschler's, Carrollton (1), Kentucky.

**OUR Idea—We Back it.** Earnings unlimited. Plans, dollar refundable. Griswold & Morris, Wholesalers, 176 W. 4th, St. Paul, Minn.

**MONEY for your spare time.** Send 15c for literature describing over 50 mail order unusual educational books for adults. Standard System, 408 So. Spring, Los Angeles 13, Calif.

**NEW Lawn Mower Sharpeners.** Details for stamp. Anton Wellert, 142 Gaylord St., Binghamton, N. Y.

**MAKE Big Money Preserving Baby Shoes** in metal Bronze, Pearl, Gold and Silver. Kiktavi Co., 8620 S. Ruthelen, Los Angeles 44, Calif.

## 89 MONUMENTS

**WRITE For Direct Prices \$14.00 Up.** Freight Paid. Guaranteed. Free Catalog. Granite-Marble Factory, A49, Oneco, Fla.

## 90 MOTION PICTURES, SOUND EQUIPMENT

**RENT 8mm—16mm and Sound Films** by week. New catalogs. Lowest rates. Dayton Film, 2227 Hepburn, Dayton 6, Ohio.

**8-16mm SILENT-sound films.** Complete rental library. All latest subjects. Free catalogue. (sample film 10c). Garden Film, 317 W. 50th, N. Y. 19.

**FIVE Slide Views—Oldest Convict Ship** afloat 25c. Slide Supply Service, 3111 West Tuscarawas, Canton, Ohio.

**CONVERT any 16MM Silent Projector to Sound** for only \$97.90. Complete Sound Head and Adapter (Sound Head alone \$59.95.) Easily installed. New 2000' reel arms necessary. \$9.90 to \$29.90 according to make and model number of present projector. Reel arms C.O.D. Send check or money order for \$97.90 to National Cinema Service, 71 Dey St., New York 7, N.Y.

**UNUSUAL 8-16mm, film subjects.** Big Catalog with sample film, 10c. National Film Exchange, Sta. E-Broadway, Toledo, Ohio.

**KODACHROME movies, 8-16mm, Color sample, lists-dime.** Projection length color sample-dollar. Also slides. Campus Films, 668-C, Ithaca, N. Y.

**EXCITING Films — Bullfights, Movie Stunts.** Unusual subjects. Send only dime for sample film and special List. Exciting Films, 1071-E El Centro, Hollywood, California.

**HOLLYWOOD Films! Sample and catalog** 10c. Stone, Lunenburg 10, Mass.

**BEAUTIFUL Girls—Life studies in Natural Color 2x2 Art Slides.** Magnificent! Different! Sparkling Poses! 2 for \$1.00; 5-\$2.00; 10-\$4.00; 25-\$10.00. Art Color Slide Co., PS-1, P. O. Box 59, New York 67, N.Y.

**NEW 1600' reels \$1.75, Cans \$1.25, Combination \$2.50.** 8-16mm, films bought, sold, exchanged. Literature, End title 10c. International-S, 2120 Strauss, Brooklyn, N. Y.

**16mm, SOUND films, Complete subjects, good condition, \$1.95 per 400' reel, up.** Write for list of over 100 available titles. Blackhawk Films, Dept. PS24, Davenport, Iowa.

**BEN Turpin and Snub Pollard comedies.** 16mm sound. Dealers discount. Jubilee, 723 7th Ave., New York.

**USED 16mm subjects—sold—rented—exchanged.** Odel's Film Service, 138 Tehama St., Brooklyn 18, N. Y.

**CHILD Is Born By Caesarean Delivery.** Original, Authentic, outstanding home movie production. Project it free. Send postal card today. Preferred Films, Hamilton 31, Ohio.

**8mm.-16mm. FILMS, Equipment, Bargains!** Towers, 935 North Fortieth, Philadelphia 4.

**HOME Movies.** Rent-buy-swap 8/16mm silent and sound at money-saving rates. Details for a dime. Midland, Box 429, Oak Park 3, Ill.



16 35mm SILENT Sound Films Projectors. Bedner, 5300 So. Talman, Chicago.

UNUSUAL home movies: Travel, adventure, sports, comedies, Silent-Sound. Many film bargains. Big illustrated 1947 catalog, sample-dime. Audet, Box 6520-AG, Philadelphia 38, Pa.

UNUSUAL Movie! "Temptation" featuring beautiful Models. 126 ft. 16 mm \$5, 63 ft. 8mm \$3. C.O.D.'s accepted. Fine Arts Productions, (PS) Box 2084, San Antonio 6, Tex.

LEARN movie projection, management. Free catalog. Theatre School, Elmira, N. Y.

NEW! Sensational! "Miss America of 1946". 8mm., 50 ft., \$2.00; Kodachrome, \$7.50. 16mm., 100 ft., \$4.00; Kodachrome, \$14.75. Kodachrome projection sample, "Waikiki Hula", \$1.00. Catalog, 25c. World in Color, Box 392-A, Elmira, N. Y.

8MM Desirable Films \$1.00 up. 357 8th St., Gloucester N. J. List 15c.

PRIZED Personal movies processed free end title, write for price list details. MK Photo, 449 Continental, Detroit (14), Michigan.

16mm SOUND Comedies, Musicals, Shirley Temple, Bob Hope, Bing Crosby, Stoopnagle, others. Comedy House, 130 W. 46, New York 19.

SEND stamp for 16mm, 8mm lists, Sterling's, 679 Northampton, Easton, Pennsylvania.

"THE World's Greatest Passion Play". All sizes. Rent or Purchase. Write Hemenway Film, 33 Z Melrose St., Boston 16, Mass.

FRESH Movie Film 100' 16mm \$2.25, three rolls \$6.00. 25' double 8mm \$1.25 developing included. Ambassador, 479-A Quincy St., Brooklyn, N. Y.

FILM—Movetone is back. It's Weston 12, nonhalation. Free processing—100 ft. 16 mm, \$3.25; 25 ft. Double 88, \$1.50. Bulk film without processing—100 ft. 16 mm, \$2.25; Double 88, \$2.45. Free Circulars. Fromader Genera, Davenport 5, Iowa.

ART Model Films. 16mm rentals exclusively. Adults. List, enclose stamp. Larm Company, 3023 Seyburn, Detroit 14, Mich.

FREE Catalog: Movies, Cameras, Projectors; Photographic Supplies; Enlargers, Printers, Cameras. Goodwill Company, Jackson, Tennessee.

HOME Movie Headquarters offers latest information on new films and slides. Write for free catalogues today. Dept. 3, Bailey Films, Box 2528, Hollywood 28.

NEW Movie Films Wholesale! Free Catalogue! Surprise Samples, 10c. Superior, 126 Fourth, Paterson 4, N. J.

HOME movie headquarters offers latest information on new films and slides. Write for free catalogues today. Dept. 3, Bailey Films, Box 2528, Hollywood 28.

FREE catalogues.—8mm, 16mm, 35mm. Silent-sound. Meginnis, 115-H Anchor, Oceanside, New York.

BEAUTIFUL Models in 20 new, daring subjects. 100 feet 16mm, \$5.50. Immediate delivery. National Cinema Service, 71 Dey Street, New York 7, N. Y.

16MM MOTOR Driven Projector \$18.00 Postpaid. Selco Products, Danvers, Mass.

GUARANTEED Fresh movie film! Dalite loading! Processing free! Three spools double 8mm \$3.45! Six single 8mm for Univex, \$3.50! Postpaid, ESO-S, 828-A West 39th, Kansas City 2, Missouri.

MOVIE Camera Films. 100' 16mm \$2.50. 25' double 8mm, \$1.25. Free Developing. Better Films, 742 New Lots, Brooklyn 7, N. Y.

TALKIES: Convert your silent 16mm Projector into sound with our guaranteed parts kit. Plays all 16mm sound films. Quickly assembled at home. Special introductory offer: Send this ad now with \$19.95, check or money order, and we will include sound test film, instruction manual and full information on how to use with your radio. Kit includes photocell, exciter lamp, optic, which makes a sound head complete. Or send \$1.50 for complete blue prints showing how to make adapter yourself. Sound Tech, Box 3071, Hollywood 28, California.

## 91 MOTORCYCLES, BICYCLES, SUPPLIES

FLOYD Clymer's Popular Motorcycle Books: Motorcycles, How to Manage Them \$1.50 Motorcycling Manual \$2.00 English Motorcycle Service Manual \$1.50 Speed, How to Obtain It \$1.50 sample English Motorcycle Magazine 50c Plans build attractive motor scooter \$2.00 Plans Electric Bicycle \$1.50. Prices postpaid. See classified advertisement under "Automobiles". Motorbook catalog free. Clymer, Dept. B-129, 2125 W. Pico, Los Angeles 6, Calif.

WHEELS, Tires, Tubes for Motor Scooters, Midget Cars, Wheelbarrows, and Industrial equipment. All sizes. Bicycle Parts, accessories. Largest stock in United States. Send dime for list. Cycle Transport Company, 1241 S. Michigan Ave., Dept. C, Chicago 5, Illinois.

CUSHMAN MOTORSCOOTER \$40. Briggs motor \$5, tires \$1.00! Send 25c for new bargain catalog packed with money saving buys in motorscooters, motorbikes, midget cars, motors, wheels, tires and parts. Gail and Company, 538 Erie, Toledo, Ohio.

LARGE stock Indian parts. Expert motor rebuilding. New and rebuilt Chief Motorcycle, motors only. Indian Motorcycle Sales, Kansas City 1, Mo.

MOTORCYCLE Racing Books: Speedway History, 256 pages, 50 photos world famous riders, machines, \$2.00 Stenner's Motorcycle Speedway Annual, 46 photos, complete history English, Australian Racing, \$1.00 postpaid. Clymer, Desk B-121, 2125 W. Pico, Los Angeles 6, Calif.

WHEELS! Build wagons, scooters, mowers, trailers, wheelbarrows, grocery carts, baby carts, play pens, baby carriages. 4" to 16". Free list. Trulsen Mfg. Co., 811 E. 31, Kansas City, Mo.

GENUINE Moto-Scoot parts. Amsco centrifugal clutch, Windshield side cars. All other parts and accessories. Write for parts list. Also genuine engine parts for Briggs and Stratton, Lauson American Moto-Scoot Co., 1319 W Carroll Ave., Chicago 7, Ill.

FACTORY Built midget racer chassis \$35.00 less motor; Clipper motorscooter \$30.00; Cushman less motor \$15.00; motors \$4.50 up; 49 army surplus Briggs & Stratton and Lauson motors; more than 5000 small balloon tires, 10 to 20 inches high, \$1.50 up. Mailorder only. Send 25c for Big War-Bargain catalogue Number 16 listing these and hundreds of other bargains in new and used motorscooters, small cars, parts, plans, etc. (35c by first class mail). Midget Motors Directory, Athens, Ohio.

MOTORSCOOTER \$10 Motor \$3, Tires \$2! Send 25c for big new catalog Number 934 listing scores of other sensational bargains in motors, wheels, motorscooters, motorbikes, Servicycles, tires, etc. Associated, Box CS-1764, Toledo, Ohio.

FLOYD Clymer publications Book of Ariel, BSA, Morton, Triumph, Villiers Engine. Complete authentic service manuals, \$1.50 each, postpaid. Specify title wanted. Motorcycle Speedway Racing, 256 pages, \$2.00 postpaid. Clymer, Dept. B-128, 2125 W. Pico, Los Angeles 6, Calif.

BUILD America's lowest priced motor-scooter speedster! Complete plans, specifications, \$1.00. Big list bargain priced used motors, etc., included free! Motor Supply, Box 1682-CS, Toledo, Ohio.

PROFESSIONAL Midget Racer, Motor-scooter, Midget Roadster and Midget Motorcycle. Plans, specifications for all four contained in illustrated handbook, 25c. Big list bargain priced used motors, motorscooters, Servicycles, etc., included free! Midwest, 3839 Drummond, Toledo, Ohio.

SCOOTER-CAR runabout! Two passenger, three wheeled, motorized, speedy. More than a motor-scooter! Simple construction from available second hand parts. Detailed plans \$1.00. Plans for midget "Jeep" included free. Universal, 2671 Algonquin, Toledo, Ohio.

MOTORBIKE Manual containing easy to build Motorbike and scooter plans, motor tune up information \$1.00. Veco, A2D6 Box 124, Evansville 5, Ind.

BUILD the first five passenger half-ton three wheeled motorcycle in your locality, from Ford parts. Show your genius. Easy built, useful handy. Nothing like it. Instructions \$1.00. Motorcycle Designers, 73-B South Shirley, Pontiac 20, Mich.

NEW Bicycle Engines, 120 miles gallon. Easy installation any bicycle. Send dime for folder. Clymer, Desk B-120, 2125 W. Pico, Los Angeles 6, Calif.

## 92 MUSIC, MUSICAL INSTRUMENTS

SONGWRITERS: Send poem. (Any Subject). For Free Examination and outstanding offer. Write for Free Instructive Booklet outlining opportunities. Recordings Furnished. United Music Service 140, Salem, Indiana.

HARMONICAS \$1.50, \$2, \$2.90. Double Row \$3.00, \$5.00, 7.75, 9.75. Send .25c now for our 64 page Harmonica Music-Instrument Pricelist. Musician's Shop, 2 E. Centre Street, Baltimore 2, Md.

LEARN Piano Tuning. Prepare for Career in fascinating profession. \$5000 year easily earned. Real security, pleasant easy work. No profession paying so well can be mastered so quickly. Natural Aptitude, desire to get ahead chief requirements. Prospectus and full information on request. Harmony School of Piano Tuning, Box 582, Harrisburg, Pa.

PIANO tuning for everyone. Vibration method. Chart, lesson, and details \$1.00. Oscar Fything, 841 Robinson, Oroville, Cal.

ACCORDIONS wholesale prices. Request circular. New streamline accordions. All sizes and makes. Monarch Accordion Co., 44 N. Albany Ave., Chicago, Ill.

PIANO Playing For Fun! You can learn this internationally popular way! Complete, \$3.95 postpaid. Musiquest Publications, 2028-B, Potter, Eugene, Oregon.

HARMONICAS \$1.50 \$2.00 \$2.90 \$3.50. Double Row \$5.00 \$7.75 \$9.75 \$12.75. Accordions—Guitars—Drums. Free Lists. Musician's Shop, 2 E. Centre Street, Baltimore 2, Md.

IF You Don't Have Our Musical Instrument Catalog you are missing something. It's full of hard to get items. Accordions, Guitars, Bass Viols, Vibraharpes. At lower prices too. Harden and Son, Musical Merchandisers, Marion, Ohio.

## 93 NAME LISTS

MAILING Lists, certified, productive, inexpensive, \$5.00 1000. Homeworkers, agents, buyers, etc. Write Dixie Service, King, N.C.

MILLIONS of names state your needs. Q Service, 422 S. Dearborn, Chicago, Ill.

\$1.00 BRINGS 2,000 late 1946 actual cash mail order customers Northern Co., Lake City, Arkansas.

200 NAMES & addresses guaranteed \$1.00. Monica Lake, 815-B, East 14th Street, Brooklyn 30, N. Y.

## 95 OLD GOLD, WATCHES, ETC.

GOLD \$35.00 Ounce—Mail old gold teeth, diamonds, jewelry, watches—receive cash by return mail. Satisfaction guaranteed. Free information. Dr. Weisberg's Gold Refining Company, 1500-B Hennepin, Minneapolis, Minn.

WANTED—Old, broken jewelry. Cash paid immediately. Mail gold teeth, watches, rings, silverware, diamonds, spectacles. Satisfaction guaranteed. Information free. Rose Smelting Co., 29-Y East Madison, Chicago.

OLD GOLD in any form: Highest price. Mail old or broken jewelry, rings, watches, gold teeth. Receive cash by return mail, 100% satisfaction or your articles returned. The Old Gold Specialist, Robert Wyndham, 1035 East A. Street Ontario 2, California.

## 96 OLD STAMPS WANTED

WHAT have you to offer? A collection? A "Shoe Box" accumulation? Anything in stamps. We urgently need them. Spot cash paid. Cosmopolitan Stamp Co., 1457 Broadway (Times Square), New York.

V. F. Well Centered U. S. Stamps Will Pay From 1c To \$100. Each, Law, Box 725, Lynn, Mass.



**PATENTS**—U. S. and Foreign Patents Secured. Trade-marks and Copyrights Registered. Searches made to determine Patentability and Validity. Patent, Trade-mark and Unfair Competition Causes. Lancaster, Allwine & Rommel, Registered Patent Attorneys, Suite 413, 815—15th St., N. W., Washington 5, D. C.

**INVENTORS:** Without obligation, write us for information as to what steps an inventor should take to secure a Patent. Randolph & Beavers, Registered Patent Attorneys, 340-A Columbian Bldg., Washington 1, D. C.

**INVENTORS,** Have Patent Protection first. Remember, the details of your invention do not have to be 100% perfect before you can obtain patent. First step is to have us conduct search of prior U. S. Patents and render a report as to its patentability. Send at once for further particulars and "Invention Record" form. Request does not obligate you. McMorro, Berman & Davidson, Registered Patent Attorneys, 143-W, Atlantic Bldg., Washington 4, D. C.

**INVENTORS:** Write for free brochure "Evidence of Invention." Labiner, World Building, New York 7.

C. A. Snow & Co., S-427 Snow Bldg., Washington 1, D. C. Registered Patent Attorneys. Established 1875. Literature mailed on request.

**INVENTORS:** Learn how to protect your invention. The patent laws were enacted for the benefit of the inventor to give him protection for the features of his invention which are patentable. The United States Patent Office advises the inventor to engage a competent, registered patent attorney to represent him. We offer the inventor experienced, conscientious counsel and prompt, confidential service. A specially prepared booklet containing detailed information concerning patent protection and procedure with "Record of Invention" form will be forwarded to you upon request—without obligation. Clarence A. O'Brien & Harvey Jacobson, Registered Patent Attorneys, 62B-L, Adams Building, Washington, D. C.

**PATENT Protection**—This well known organization will supply inventors, promptly upon request and without obligation, detailed information concerning steps to take to protect their inventions by a U. S. Patent. Victor J. Evans & Co., Merlin M. Evans, Registered Patent Attorney, 141-P, Merlin Building, Washington 6, D. C.

**INVENTOR'S Guide** free on request. Frank Ledermann, Registered Patent Attorney, 154 Nassau St., New York 7, N. Y.

**PATENTS**—Trade marks. Irving L. McCathran, 316 McLachlen Bldg., Washington 1, D. C. Registered Patent Attorney.

## 99 PATENTS

**INVENTORS:** Test the commercial value of your patented or unpatented inventions, quickly and inexpensively. Write for free information. Institute of American Inventors, Dept. 30-B, 1926 Eye St., N. W., Washington 6, D. C.

**INVENTORS:** You save up to 300% when dealing with your patent searcher direct. Complete search with patent copies \$6.00. Reports mailed in 5 days. Invention protection forms free. Write Raymond L. Smith, Patent Searcher, 703-S Albee Bldg., Washington 5, D. C.

**CAPTURED** German and Jap patents, 18,000 enemy alien formulas, patents, ideas, plans, drawings. Use immediately; royalty-free. Bishop Engineering, 111 W. Washington, Chicago 2.

## 100 PATENTS FOR SALE

**INVENTORS**—your patented, unpatented invention, if practical, may have specific cash, royalty value in correct markets. Find out now. Explanatory booklets free. Invention Reporter, 3D-11106, So. Longwood Drive, Chicago 43.

"SUPER" Nail Puller . . . Combination sprinkler and hose nozzle . . . leather punch . . . patents applied for . . . an investigation will reveal their great possibilities. Emmett Seifert, 124 E. Chestnut, San Gabriel, Calif.

**NEW** kill tipe steel animal trap pat. No. 2292695. Attachment to fit and trap pat. pending No. 695258. Cash or Royalty. L. C. Johnson, Riv, Wis.

**BOLTLESS Rail Joint** Patent for sale adapted to all kinds of Railroad Construction, easy to apply. Children will want their Toy Railroad equipped with the latest invention in Railroad Construction. Hurry for particulars. Write Russell Conner, Inventor, P. O. Box 17, Delaware, Ohio.

## 101 PERSONAL

**HOW You Can Find Out!** Information discreetly developed, any matter, person, problem anywhere. Personal-business assignments, representations, undertaken. Nationwide. Officially Licensed and Bonded Service establish 1922. Reasonable. All inquiries confidential. William Herman, 170 Broadway, N. Y.

**RUPTURED?** Positive comfort, no understraps, no steel, no elastic. Write Smith Manufacturing Co., Preston, Ontario.

**LEARN Ventriloquism:** 3c stamp brings particulars. Smith, Dept. 407, 801 Bigelow, Peoria, Illinois.

**SUGAR Diseases,** Regeneration, Arthritis, Piles, Prostate, Tonsils, Health-Centers, Warsaw, Ind.

**FALSE teeth wearers.** If your dental plate is loose and uncomfortable I have good news for you. Send name on postcard. No obligation. Dr. Reese, Dentist, Box 268-W, Winnetka, Ill.

**SENT Photograph,** \$3.00 for 50 Christmas Cards with Name and Photograph on each. Artcraft, 1600 Coney-Island, Brooklyn 30, N. Y.

**PSORIASIS Sufferers:** Has everything failed to bring even temporary relief from scales, lesions and itching? Then write today for Free important information. You needn't invest one cent! Pixacol Company, Dept. S, Box 3583, Cleveland, Ohio.

**HAIR Falling? Dandruff?** Write Trichologist, 139 Lewis Street, Phillipsburg, N. J.

**POWERFUL Prescription** for achieving personal and business success; works without expense or guesswork. You can use it. Write for free literature. Menders, 15857-B-Coram Ave., Detroit 5, Michigan.

**MEXICAN Law, General Practice Attorney,** 1203 Arizona Street, El Paso, Texas.

**CHRIST'S Birth and Genealogy,** 25c, Bulletin, Box 87, Station H, New York 25.

**BUY Vitamins Direct.** Amazing Savings. Money Back Guarantee. Our 9th year! Postcard, Matoska Products, White Bear Lake, Minn.

**BORROW By Mail!** Loans \$50.00 to \$1,000.00 to employed men and women. Easy, quick. Completely private, confidential. No endorsers. Repay in convenient monthly payments. Details Free in plain envelope. Write First Loan Co., World Herald Bldg., Dept. F-15, Omaha, Neb.

**MIAMI Beach Vacation!** Fool your friends! Send \$1.00 we mail you 4 Postcards, hotel-Beach scenes. You address, stamp return, we mail Florida gifts, fruits, souvenirs purchased, cost plus 25%. Satisfaction Guaranteed. "At Your Service." 555 Lincoln Road, Miami Beach, Florida.

**HEALTH, happiness, success** obtained through corrective thinking. Reynolds, Counselor, 5510 Le Moyne, Chicago 51.

**HAVE Fun!** Pretend visiting California, 3 postcard views 20c. You address, return. I remail. Letters mailed 15c. Free information. Smith, 708-A Ellis, San Francisco 9, Calif.

**NYLONS!** Want six pair for Xmas? "Service," 418 Gregory, Rockford, Ill.

**INFORMATION** for single people by Human Relation Consultant. University Graduate. Dr. B. Long, Box 375, Los Angeles 53, Calif.

**BALDNESS is Serious** and should be taken care of. It is your crown of Glory from God. Hair. People 84 Years old have grown their hair with our Hair Gro Gro Hair. 14 treatments for only \$25.00. You just pat-a-pat in the liquid. Massage in the ointment, put on a warm wet towel and give it time to grow, office proof Before and after pictures to full heads of hair. Loreene Johnston, 9200 Hough Ave., Cleveland, Ohio, office hrs. Sundays, Mondays, Tuesdays. Tel. R A 3773.

**GLAMOUR Photos!** Sample set \$1.00. Risque-Pix, Box 699-F, Westfield, New Jersey.

**FREE.** Expert relief information on skin diseases. Write: Relief Company, Box 8, Olden, Texas.

**HATE War?** Get "How To Prevent Future wars." 50c Postpaid. Robt. Gale, 4842 North Spaulding, Chicago 25.

**SINGLE Persons** desiring information concerning their future, personal affairs, may obtain Free particulars. Your confidence respected. Write Strone, Box 157, New York 11.

**ATHLETE'S Foot** cured in a few applications, with Truitt's Solution. Send 35 cents (no stamps) for treatment, to Edward S. Truitt, P. O. Box 42, Belleville, N. J. Postage Prepaid.

**WHAT about your future?** Know yourself and your possibilities. Write for free information. Janet Caldwell, Box 330, Chicago 90, Ill.

**STOP smoking, chewing.** Easy, drugless, guaranteed. Write: Perfected Services, 1527-C West Washington, Phoenix, Arizona.

**ATHLETE'S foot remedy** Guaranteed \$1.00 bottle postpaid. Dr. Renz, Room Three Chavanne Bldg., Lake Charles, La.

## 102 PHOTO FINISHING

**PHOTOGRAPHY,** for pleasure or profit. Learn at home. Practical basic training. Long established school. Write for booklet. American School of Photography, 1315 Michigan, Dept. 1721, Chicago 5.

**SENSATIONAL introductory offer!** Send snapshot or negative, this ad, and 3c. We'll send you a beautiful 7" x 5" enlargement! Or, Kodak roll developed with 16 guaranteed deckle-edge velox fadeproof prints or 8 double-size prints, 25c! Special! From your negatives, 16 regular-size or 8 double-size reprints 25c! Candid Rolls—36 exp. 35mm developed, vaporated, enlarged to 3x4, \$1.00! 18 exp. 50c. Reprints, 3x4, 3c each. We have new, perfect 35mm film. Low prices. Free Mailer, details on request. American Studios, Dept. 280, LaCrosse, Wis.

**BIGGEST \$1.00 value** in 35 MM finishing today. 36 exposure fine grain 3 1/4 x 4 1/2 enlargements; deckled, embossed margin and date. Eighteen exposures 75c; 16 exposure splits 55c; 36 exposure reloads 50c. Special: return this ad with \$2.00 and we will send five 36 exposure reloads. Free mailers. 8 exposure rolls in beautiful, deckled contact finish with embossed wide margin, 25c. Mailbag Film Service, Box 5440-A, Chicago 80.

**OIL coloring photographs** can be a fascinating hobby or profitable sideline for those with artistic talent. Learn at home. Easy simplified method. Send for free booklet. National Photo Coloring School, 1315 Michigan, Dept. 1721, Chicago 5, Ill.

**ROLL Developed and 8 beautiful enlargements** 2 to 6 times larger. Deckled Edge. High Gloss. Any 8 exposure roll 25c coin. 12 ex. 35c. 16 ex. 50c. 36 ex. \$1.00. Reprint Enlargements 3c each. Alden Photos, 94-4 Astor Station, Boston, Mass.

**CENTURY delivers work and service** that can't be beat. Sixteen Famous Century-Tone prints each 8-exp. roll 30c. Free Mailers. Century Photo Service, LaCrosse, Wis.

**CHRISTMAS Greeting cards** from your own snapshots, send negative and \$1.00 for 18 (including envelopes). Rolls developed, 8 prints 25c, over 8 exposures 40c. Reprints 3c. Fred E. Eastman, Bode, Iowa.

**FIVE beautiful 5x7 enlargements \$1.** Photocraft, 110 Harris, LaGrange, Ill.

**PRESERVE Forever** your favorite snapshots or your Social Security Card! We'll lock them permanently within a sheet of unbreakable, beautiful crystal-clear plastic. Special offer to mail order buyers, only 50c each. Send snapshots or cards with remittance to Photo-Craft, Box 670, Canton 1, Ohio.

**ROLL Developed Printed 20c.** Reprints 50 for \$1.00. Howards, 3760 Fremont, Chicago (13).

**OVERNIGHT service.** Roll developed and 8 prints 30c. Finest quality guaranteed. Our 13th year. Tri-Plex Photo Service, Box 375-A, San Francisco 1, Calif.



**BEAUTIFUL** double size Pictures 3½c each, from 116 and 120 negatives. 3¼x4½ from all other sizes. All work guaranteed. Overnight service. Roll developed and 8 pictures 30c. Roll 12 pictures 45c. Roll 16 pictures 60c. Enlargements on double weight portrait paper 5x7—30c, 8x10—50c. Copies made from any picture 75c. Pacific Photo Service, Box 666, San Francisco, California.

**SPECIAL** 50 re-prints, \$1.00. Suburban Studio, 1410-S Bond, Rockford, Ill.

**CASH** for your pictures! Invaluable folio lists over 100 markets for your photographs. Tells where, how to sell, \$1.00 postpaid. Picmarts, 3-D Park Row, New York 7, N. Y.

**ROLL** Developed 8 brilliant fadeproof Vexel prints and two Professional Enlargements 25c. Overnight service. Young Photo Service, 406-C Albany 2, N. Y.

**LET** us make your Christmas cards from your favorite snapshot: 12 cards with envelopes 85c; 25 cards \$1.50; 100 cards \$6.00. For best results send size 620, 120, 616 or 116 negatives. Rapid Foto Service, G. P. O. Box 413, New York 1, N. Y.

**ANY** size roll developed and 4 x 6 or 3¼ x 4½ oversize glossy velox prints: 8 exposure 30c, 12 exposure 45c, 16 exposure 60c. Cimet Photo Service, 1318 W. Columbia Ave., Philadelphia 22, Pa.

**ENLARGEMENTS**—8x10—50c; from any size negative. Highest quality, custom grade. Finest points and features brought out in every negative. Your negatives returned with prints. If unsatisfactory, return enlargement, money refunded. Film Capitol Studio, P. O. Box 226, Hollywood, Calif.

**BEAUTIFUL** 4 x 6 enlargements, a .75c value for only .30c a roll. Photo Service, 107 Dewy St., Newark, N. J.

**GORGEOUS** Color prints for your transparencies, 4x5—\$1.00, 5x7—\$1.98, 8x10—\$2.98. Broad Camera, 953 Broad St., Newark, N. J.

**TWO** beautiful prints from each picture on roll 25c. Twenty five years of satisfied customers. Quick Service, Lens Photos, Dept. J-9, Janesville, Wis.

**BEAUTIFUL** enlargement from each picture on roll 25c. Cut Rate Photos, Dept. A-6, Janesville, Wis.

**AT** Last: We Have Films: 116 & 616—38c ea., 120 & 620—33c ea., 127—27c ea., 8 exposure roll developed, all your snapshots hand-colored as beautiful as most actual colored photography—50c. Hand colored reprints—6c each, 8 exposure roll developed and black & white prints—35c. Reprints—4c each. Midwest Photo, Janesville 27, Wisc.

#### 104 PHOTOPRINTS, PHOTOCOPIES

**PROFESSIONAL** 8x10 Enlargements: Fine Portrait likenesses of your favorite picture, Artistically finished in golden sepia and mounted in beautiful frame, \$3.95. Arden Studios, Franklin Park, Illinois.

**VETERAN'S** discharge papers photocopied—\$1.00. Each copy notarized. Baltimore Photocopy Service, 2859-A2 W. North Ave., Baltimore 16, Md.

#### 106 PLASTICS

**PLASTICS** Plexiglas Lucite Catalin Jewelry craftsman supplies including 48 page illustrated catalogue 10c. Douglas Home-craftsman, Box 34, Stamford, Conn.

**LEARN** at home "Working with Plastics". Full information on sheets, blocks, rods, tubes. Trade names, sizes, colors for fabrication. Designing, tooling, bending, cementing, polishing. Also for homework-shop. Only \$1.25 postpaid. Money back guarantee. Modern Technical Book Co., Dept. M.S. 55 West 42nd St., New York 18.

**PLEXIGLAS**—Everything for the plastic-craftsman. Free catalogue. Novalte Plastic, P. O. Box 106, Brooklyn 19, N. Y.

**PLEXIGLAS**, clear, masked. Prices per square foot. 1/16—\$1.17, 1/8—\$1.46, 3/16—\$1.77, 1/4—\$2.09, 3/8—\$3.10, plus 10% postage. M. Raffel, Rethel Plastics, 15 Walnut Street, Steelton, Penna.

**RUBBER** Molds to order, also originals. Casting instructions and formulas. Plastics, Box 1574, Boston 4, Mass.

**MONEY** in Plastics! Lucite Plastic Hobby Kit Two pounds Lucite material, coloring dye, cement, Instructions. Send \$2.50 to Plastic Specialty Co., (Dept. S), 192 Lexington Ave., New York 16, Also Swiss Music Movements, \$3.50 each.

**PLASTICS** And Supplies—New Plexiglas, Lucite, Catalin, Sheets, Rods, Tubes, Etc. Exceptional Kits \$2.00, \$5.00, \$8.00. Attractive Prices, We Pay Postage. Free List. Plas-met Sales and Engineering, 4648 Shirley Pl., St. Louis 15, Mo.

**PLASTICS** make yours at home. Formula and moulding instructions \$1.00. Forest, Box 84, Station K, Toronto, Canada.

**LUCITE** Plexiglas prices you can't beat. Prime grade masked sheets 12"x12" 1/16" \$1.00, 1/8" \$1.25, 3/16" \$1.55, 1/4" \$1.85, 10% postage jewelry findings shells accessories. Free listings. Craft Plastics, Box 129S, Somerville, N. J.

**PLASTICS**; sheets, rods, tubes. Free List. Plastic Supply Co., 2618 St. Louis Ave., St. Louis 6, Mo.

**PLEXIGLAS** Lucite slashed, free listings. Douglas Home Craftsman, Dept. S, Stamford, Conn.

**PLASTICOR** injection molding press produces 100 ¼ ounce acetate moldings hourly! Mechanical pressure, electric heat 2½x2x1" molds. Commercial results! Money-back guarantee! \$34.95 complete! Limited quotas. Technicraft, 1156 Commonwealth, Boston 34, Mass.

**PLEXIGLAS** sheets .1"x12"x16"—85c; 1/8"x 11-½"x12"—60c; 3/16"x12"x16"—\$1.35; Plastic rod assortment 9 colors and phosphorescent \$4.00; Julian Rhodes Muench Co., 1527 W. Alabama, Houston 6, Texas.

**LUCITE** sheets—\$1.00 per lb. postpaid. Sizes available (inches)—1x2, 1x4, 2x2, 2x3. Send order with payment to—Bellite Co., 173 Utica Ave., Brooklyn 13, N. Y.

**MAKE** \$15.00 daily in plastics. How? Send your favorite snap shot and \$1.00 for sample and complete details. Plexart, Box 1976, San Antonio, Texas.

**MOLD** Your Own Cameos, Precious Stones, Fishing Lures, etc. from colored or clear plastic, trial kit with instructions \$1.00. Infante Labs., 92 Lexington Ave., Bloomfield, N. J.

#### 107 A POTTERY & CERAMICS

**MANUFACTURE**: Genuine-pottery new easy fool-proof process, illustrated instructions; include names and addresses of low priced equipment and material sources. Send one dollar for full instructions, or one dollar for finished sample or two dollars for both. Theron Brown Studios, 905 S. W. 9th Terrace, Fort Lauderdale, Florida.

#### 108 POULTRY AND SUPPLIES

**RAISE** turkeys the new way, write for free information explaining how to make up to \$3000.00 in your own backyard, address National Turkey Institute, Dept. 57, Columbus, Kansas.

**YOUR** greatest poultry problem will look simple when you read American Poultry Journal regularly. 500,000 poultrymen do, why not you? 2 years 50c, 5 years \$1.00. American Poultry Journal, 529, So. Clark, Chicago.

**PRACTICAL** Money-Making poultry raising helps from Experimental Farm for only 25c per year. Five years, 1.00. Subscribe today! Poultry Tribune, Dept. 42, Mount Morris, Ill.

#### 109 PRINTING, MULTIGRAPHING, ETC.

**DISTINCTIVE** Printing — Stationery, Checks, Cards. Reasonable. Samples, Prices Free. Stumpprint, South Whitley 2, Ind.

**SEASON'S** Greetings to all. Mango Printing Company, 555-B South 20th Street, Newark 3, N. J.

**350 BUSINESS** cards \$1.00 postpaid. Art-craft, 40-06 97th, Corona 2, N. Y.

**200 SHEETS** 5½ x 8½, 100 Envelopes. Hammermill bond, \$2.00 postpaid. Samoset Press, Plymouth, Mass.

**QUALITY** Printing: Business, personal stationery. Prepaid delivery. Samples free. Mero Products, 99 Morrison, Punxsutawney, Penna.

**BUSINESS**, Personal Stationery, State requirements. Samples. Price Lists Free. How Printing Company, 717-23 Eunice, Webster Groves 19, Missouri.

**QUALITY** Printing, Embossing, Planographing—Lowest Cost. Samples Free. Adams-PS 30 West Washington, Chicago 2.

**250 LETTERHEADS**, envelopes \$3.00. Mallo Press, 767 Leith, Flint 5, Mich.

**AT LAST!!** Satisfactory Printing—Samples, Mail Printing, P93, Danvers, Mass.

**SEND** 10c Now, for our 36-page 1946 price-list—refunded first order. McCall Press, 1326 S. 27th, Omaha 5, Nebr.

**MIMEOGRAPHING**. Reasonable, quick service, good work. Ritter Sales, Sioux Falls, S. Dak.

**BETTER** Printing, Attractively Priced! Letterheads, envelopes, booklets, cards, labels. Samples Estimate Free. Lonelm Printers, Paulding, Ohio.

#### 110 PRINTING OUTFITS, SUPPLIES

**CUTS**—Make real halftones, linecuts yourself! Samples 25c. Particulars free. Rapid Chemical Service, Edwardsville, Illinois.

**"PRINTOMATIC"** Selffeeding Post Card Stencil Printing Duplicators \$9.50 Up. Office Size Duplicators, Speedoprints, Hilcos, Excellographs \$33.41 Up. Literature Free. Pittsburgh Typewriter Supply, 339-WE Fourth Ave., Pittsburgh 22, Pa.

**INEXPENSIVE** home-made printing press. Details free. Novelty Shop, Downsville, Louisiana.

**HOME-MADE** Printing Presses. Proofs Free. Riegels, 1111 Harrison, Philadelphia 24, Penna.

**PRINT** At Home—Send 10c for Catalogue—Type, Presses, Supplies, Barnhard Co., 6 Columbia St., Newark 5, N. J.

**NEW** type 44c Font. Catalog Dime. Box 123A, Jackson, Michigan.

**PRINTING** Presses, Type, Supplies. Lists 3c. Turnbaugh Service, Loysville, Pa.

#### 111 PROFITABLE OCCUPATIONS

**ANNOUNCING** home study course in commercial baking. Practical basic training. Good field for those with aptitude. Nearly depression proof. Send for free booklet. "Opportunities in the Baking Industry." National Baking School, 1315 Michigan Ave., Dept. 1721, Chicago 5, Ill.

**\$5000 FROM** Half Acre! Growing Ginseng. Seed, contract supplied. Particulars 10c. Associated Growers, Dept. 12, St. Norbert, Manitoba.

**\$40.00 WEEKLY**. Made growing mushrooms. Fresh. Dried. Dominion Patent 331,583, free spawn. North American, 169Y Yonge, Toronto, Canada.

**LOCKSMITHING**—Profitable Business or Hobby! New course teaches you how to pick locks, fit keys, de-code, masterkey, etc. Easy self-instruction lessons. Bargain price. Fascinating 100-page illustrated catalog Free! Write Nelson Co., Dept. 2-01, Chicago 5.

**SHELL** Jewelry, Novelties. Easy to make at home as hobby or to sell. Beginners kit \$1.00. Catalog 5c. Burton, Box 27, Station A, St. Petersburg, Fla.

**WELDING**—Electric Arc. Learn profitable trade quickly through actual practice. Individual welder instructions at bare cost of materials. Full particulars free. Valuable welding lessons book 50c. Hobart Welding School, Box P-1064, Troy, Ohio.

**MUSHROOMS** Grown. Boxes, Barrels. Illustrated Instructions 50c. Spawn \$1.00. Gordons, 553 William, Winnipeg, Manitoba.

**ACCOUNTANTS** Make Big Pay. We will train you for one of these good paying positions at home in your spare time. No previous knowledge or experience necessary. Write today for free information and aptitude test. Modern School of Accounting, Dept. P S, 735 No. Throop St., Chicago 22, Ill.

**GROW**. Sell potted flowers, vegetable plants. Write Bowers, Loyaltown, Penna.

**BIG** year around profits! Fascinating! Also is popular Xmas item. Operate by mail from own home. Details free. James A. Randall, P.O. Box 582, Mt. Vernon, Ohio.



**BEAUTIFUL** Mirrors from ordinary glass. Complete instruction folio, \$1.00. Tesco, PS-2, P. O. Box 189, Wilkes Barre, Pa.

**STORY** writing simplified! Home study. Ideal Christmas gift. Free circular. Segment System, Box 834, Spokane, Washn.

**\$1,000 IN** backyard! Soilless agriculture! Astounding results scientifically. \$1.50 brings seven tested easily prepared formulas to grow any plant without soil postpaid. Formula Research, 481 Pacific, San Luis Obispo, Calif.

**OPERATE** newspaper clipping bureau. Steady paying home business. Fascinating rewriting work. Free details. Clipping Institute, P-617 Portsmouth, Ohio.

**EARN** Money at home spare time with typewriter! Addressing Envelopes, Circulars, Typing. Write for Details. Ace-4, Box 183, Birmingham, Ala.

**SELL** by mail. Interesting, profitable. Free details. W. Gillen, 33 18th Ave., Paterson 3, New Jersey.

**\$3000 a YEAR.** Your own business—no boss—no time clock— independence. Complete Details \$1.00. Satisfaction guaranteed. Home Industries, A1354, Hollywood, Columbus, Ohio.

## 112 RADIOS, SUPPLIES & EQUIPMENT

**MAKE** Simple, Tubeless, Batteryless, Distance-Getting Crystal Radios. Crystal and illustrated instructions 25c postpaid. Allen, 427-S, Clinton, Mo.

**FREE** New Radio Catalog Is Ready! Radionic's catalog lists hard-to-get radio parts, books, amateur, test and P.A. Equipment. All available for immediate shipment. Send today to: Radionic Equipment Co., T-12, 170 Nassau St., New York 7, N.Y.

**RADIO** Service men and experimenters send stamp for our giant radio catalogue. Save dollars. United Radio Co., (1000-V) Newark 1, N. J.

**FAMOUS "Allen"** Midget semi-Fixed Crystal Detector. Set Building Plans and 100 late Crystal Set Distance Reports all for 50c postpaid. Allen, 427-1, Clinton, Missouri.

**NAVY** Surplus Bargain "Operators Control Box" Eighty useful parts. Only one dollar Postpaid. Van Sickle Radio Supply, Indianapolis 6, Ind.

**RADIO** book:—"Everybody's Radio Manual." Tells how to service all radios at home. 256 pages. 216 pictures. DeLuxe edition, \$1.49. Popular Science, Dept. 126-C, 353 4th Avenue, New York 10, N. Y.

**IMMEDIATE** delivery. Hallicrafters Receivers, S-38, \$39.50. S-40, \$79.50. Standard broadcast and short-wave coverage. All amateur supplies and equipment. Send \$5.00 deposit and we will ship C.O.D. for balance. Henry Radio, Los Angeles 25, California and Butler, Mo.

**"RADIOBUILDER"**—parts, data, Sample free. Laboratories, Box IT, San Carlos, California.

**"LOUDER"** Crystal Set Just Developed. Instructions, 20c. "All About Crystal Sets." Booklet, 45c. Amoroses—Route Four, Richmond, Virginia.

**CRYSTAL** radio receiver. Complete assortment of apparatus. Easily assembled by schoolboy. Only \$1.95 postpaid. Hulet, Fairfield, Conn.

**RADIO** Tubes—Attention Radio Repair Service Men. For satisfaction in Radio Tubes. Le-Hi Electrical Co., 660 Broadway, Newark 4, New Jersey. Distributors of guaranteed Radio Tubes.

**HEAD** Phones: Finest quality, adaptable for use in making crystal sets. Used sets without head bands \$1.25. With head bands \$2.50. New sets without head bands \$1.75. New sets with head bands \$3.75. Add 25c for mailing, send check or money order—quantity limited. Department C, Nico Supply Co., 540 N. 17th St., Philadelphia 30, Penna.

**TUBES.** Parts. Test Equipment for service men and radio hams. Wholesale prices immediate delivery. Variety, 601 Broad, Newark 2, N. J.

**CHRISTMAS** kit—2 megacycle receiver \$6.95. Single tube Army Transmitter \$7.50. Navy Transmitter! (BC375E), nine separate units, 120 watts, 200-12,500 kilocycles, \$87.50! Free literature. Daniel Atkinson, 124-A Chester Pike, Norwood, Pennsylvania.

60 POPULAR SCIENCE

**RADIO** Tubes, Standard Brands, all Types, O.P.A. retail prices—Phono Crystals, Radio Mail Order Co., 46-13 188 St., Flushing, N. Y.

**LEARN** Radio at home. Earn money. Have fun building our "Educational Radio Kits". We teach you every step. Simple, easy to understand instructions. Free literature. Write immediately. Chapin Electronics, Inc., Dept. 1946 AD, 134 W. Onondaga, Syracuse, N. Y.

**ELECTRONIC** Organ easily constructed from radio parts. Plans \$1.00. Quaker Radio, Box 68, Salem, Ohio.

**FLAT** rate schedules improve profits, compiled from 500,000 jobs. Write for information. Radio Equipment Co., 1415 W. Franklin Ave., Minneapolis 5, Minn.

**LOUD** Speaking Crystal Radio, improved design. Illustrated plans 30c. Radio Clinic, 10631 A Euclid, Cleveland 6, Ohio.

**BUILD** this world's smallest A. C.-D. C. radio with built in loudspeaker! Uses one tube! Easily fits in ladies' handbag or briefcase. Send 50c, for plans, photos, instructions. Louis Toth, P. O. Box 110 Sta. H, New York 25.

**CRYSTAL** Radio Kit. Includes accurately made parts; simple instructions and drawing. No tubes or batteries needed! Receives distant stations. Ask your hobby dealer or order direct. Kit \$2.25, Headphones \$1.95. Postpaid. Hobby Specialties Co., Dept. 1246, 904 S. 104th St., Milwaukee 14, Wis.

1946 **RADIOS.** Zenith, Philco, Refrigerators, Washers, Appliances. Order Now. Gravlee And Son, Kenndy, Alabama.

**QUALITY** Record Players \$16.00 postpaid. Attaches to any radio. Wonderful tone. R. Carson, 505 Norman, Portsmouth, Va.

## 113 RAZOR BLADES, SHAVERS

**GEM** Safety Razor with ten micromatic blades, postage paid \$1. Army Goods Distributors, 1207 Farnam, Omaha 11, Nebraska.

## 118 RUBBER STAMPS

**LINE** 20c; 2 35c; 3 50c. DeLuxe Stamps, Auburn, Nebr.

**RUBBER** Stamps All types. Free catalogue. Print & Stamp Co., Box 172, Boston, Mass.

3 **LINES** 40c; Signatures \$1.75; Pads 25c; 35 Personalized Pencils \$1.50. Printrite, Wauwatosa, Wis.

**BETTER** Rubber Stamps. Ezy-Order Literature Free. Lee-Vall Press, Box 1242, Indianapolis 6, Indiana.

## 119 SCIENTIFIC EQUIPMENT

**METAPHYSICIAN** Sick treating book \$3.55 New. Artisan Psychiatrist, 281 East Main, Watertown, N. Y.

## 122 SONG WRITERS

**POEMS** Wanted to be set to music. Free examination. Send poems. McNeil, Master of Music, 510-PS, S. Alexandria, Los Angeles, California.

**SONGWRITERS.** Songs Published Monthly. Advance Royalty. Send your songs or poems today for our exciting offer. Hollywood Tunemiths, Dept. 10F-C, 1537 N. Vine, Hollywood 28, Calif.

**WANTED!** Lyrics, melodies for songs. We arrange, publish, sell. Superior Song Studios, Passaic, N. J.

**POEMS** Wanted for musical setting. Send poem for immediate consideration and Free Rhyming Dictionary. Richard Bros., 46 Woods Bldg., Chicago.

**POEMS** Wanted for Musical Setting. Send poem for immediate consideration. Five Star Music Masters, 646 Beacon Building, Boston.

**SONGWRITERS**—Send Poems for immediate examination and Free Book. "Your Future in Songwriting". Radio City Music Academy, 1674 Broadway, New York 19.

**SONGWRITERS:** \$100 Cash Awarded Each Month For Best Song or Song Poem. Melodies supplied Without Charge By Hollywood composers. Lead sheets and records furnished. Cinema Song Co., Dept. B-40, Beverly Hills, Calif.

**SONGWRITERS.** Have your songs completed by an honest, experienced arranger. Submit songs for free analysis. Tommy Kilbourne, Box 1253, Bakersfield, Cal.

**SONGWRITING** — Publishing. Liberal Plan. Barnhart, 1320 48th, Des Moines, Iowa.

**SONGS** Completed. Send poems or melodies with 50c for complete analysis. Harmony Masters, P. O. Box 155, New Haven, Conn.

**SONGWRITERS!** Amazing, ethical offer. Hibbeler, C15, 2157 N. Avers, Chicago.

**SONGWRITERS**—Free explanatory booklet, attractive offer. Song Service, 331-J West 46th, New York.

**POEMS** Wanted! Send poem for immediate consideration. Eliot Wright, Master Composer, 106 Rivoli Theater Building, Portland, Oregon.

**PROFESSIONAL** Copies, Extra Copies, Your music, Musicopy Service, Box 181, Cincinnati 1, Ohio.

**SONG** Writers Attention! The amazing demand for phonograph records, accelerated by more than 300,000 Juke Boxes and the Hits accredited them warrants your immediate consideration. We are offering song-poem writers the rare opportunity of having established composers collaborate on appealing material received this month. Recola Records, Box 987S, Hollywood 28, Calif.

## 123 SOUVENIRS

**GENUINE** German Medals, secured from overseas. Quantity limited. Other Military Souvenirs. Price list 10c. Hobbyguild, S35 West 32nd St., New York.

## 124 SPORTING GOODS, GUNS, FISHING TACKLE, ARCHERY

**BOWS**—Arrows for Recreation—**Hunting-Fishing.** Beautiful Archery instruction book, 70 pages, 50 illustrations, only 50c. Illustrated catalogue Free. Archery Sales-Service, 617 South State, Chicago.

**"AMMUNITION"**—New and Used "Shotguns"—"Rifles"—"Handarms". List 10c. Rudolph's, Atchison, Kansas.

**DEALER & Collector:** World-wide Firearms Publication; \$1.00 yearly—Foreign \$2.00. Dealer & Collector, 71 BS, Flushing, N. Y.

**SEND** 10c for list 100 used guns. Frayseths, Wilmar, Minnesota.

**ISSUES** 12 gauge 00 buckshot shot gun shells 75 rounds \$5.00 money order. Rudolph, Atchison, Kansas.

2000 **BARGAINS,** firearms, binoculars, war relics, catalog 30c. Smith Museum, Runnemedede, N. J.

**FISHING** Poles: Bamboos, Tonkins, Native Canes. Dealers only. Sample jointed native cane prepaid \$2.50. Bob Pace, Combs, Ark.

350 **ANTIQU** Firearms;—3,000 Bargains: Indian Relics, Flintlocks, Minerals, Coins, Swords, Cartridges, Fossils, Rifles, Carbines. Catalog-Photographs 25c. Heike, Wenona, Ill.

## 127 STAMP COLLECTING

**ZOWIE-E-E!** A Barrel of Fun for only a Dime! 500 United States Stamps—Absolutely unpicked and unsorted, just as received from church missions. Many varieties, including large commemoratives, airmails, high denominations up to \$5.00! Stampdom's biggest package of fun, and you might find something really valuable!! Price only 10c to serious approval service applicants. Money back if not delighted. Illustrated bargain lists with each order. Mystic Stamp Co., Dept. 55, Camden, New York.

**WORLD'S** Largest Diamond And Triangle Stamps, Free Stamp Magazine. Stamps from Fighting Free French. 20 stamps from 20 different Countries. Pictorials. Airmails. Big Bargain 5c with approvals. Capital Stamps, Dept. 10, Little Rock, Ark.

**BRITISH** Empire! 55 Different including Batum, Burma, Cyprus, Gwalior, Tasmania. 5c to Approval Buyers. Lyman, 97 Nassau St., New York 7.

**FREE**—Canadian Sets, Royal Visit, George VI, George V, Coronation, Jubilee, others, to approval applicants. Ensign, Box 118-P, So. Orange, N. J.

118 **DIFFERENT** stamps including commemoratives, charities, airmail, sets, etc. Only 3c to approval buyers. We buy collections. Badger Stamp Co., Milwaukee 3, Wisconsin.



**COMPLETE "United States" catalog with 1000 illustrations. Send 10c for mailing. Harris & Co., 99 Transit Bldg., Boston, Mass.**

**SCARCE "Pole To Pole" Packet! Stamps from strange, mysterious countries only—Greenland (North Pole) Solomons, Spanish Morocco, Bhopal, Patiala, Siberia, Grahamsland (South Pole), Djibouti, Zanzibar, etc., and including stamps cataloging up to 25c each! Our Price only 5c to approval applicants. Big Dime Packet List free! Methuen Stamp Service, Inc., Dept. 146, Lawrence, Mass.**

**DEALER'S Wholesale Catalog. Postage 3c. Franksco, 5031 Queensberry, Baltimore, Maryland.**

**BOX Stamps containing hundreds all different cataloging up to 25c each. Everything \$1.00. Longacre Shop, 100-C West 42nd, N.Y.C. 18.**

**WOW! \$10.00 Worth Of Fun Only 10c. What a treasure hunt! Big package 500 Foreign Stamps—just as received from foreign missions other sources. Includes stamps from Africa, South America, Philippines, Free French, Cape Juby, Palestine, etc., including airmails, commemoratives, and stamps worth up to .50c and 75c. This amazing offer is given for 10c to serious approval applicants only. One to a customer, money back if not more than delighted. Jamestown Stamp Co., Dept. 5, Jamestown, New York.**

**FREE! The Stamp Finder! Send today for big new edition, fully illustrated, enabling you instantly to identify all difficult stamps! Also fine packet strange, fascinating stamps from Bosnia-Herzegovina, Monaco, Patiala, Cyprus, etc., including maps ships, animals and strange scenes. All free to approval applicants including 3c postage. Garcelon Stamp Co., Box 918, Calais, Maine.**

**FREE—Pick 25c worth of stamps from our first U.S. Approval Selection . . . Approximately 100 stamps to choose from . . . Excellent value . . . No obligation to buy. Lists illustrating the most popular U. S. stamps—at prices you can afford—will be included. Don't miss this opportunity! Write today, S. D. Engel Co., 38 Park Row, New York City.**

**AIRMAILS of World—19 different including Bolivia Triangle, World's Fair, Commemoratives, new issues 5c with approvals. Continental Co., Dept. C, Box 639, New Rochelle, New York.**

**GORGEOUS Colors, scarce Airmail, Surcharges, Charities, Sets, etc. All in our Big Premium packet only 3c to approval Buyers, Dixie Stamp Co., Dept. PS, Milwaukee 3, Wis.**

**50 DIFFERENT including scarce diamond-shaped airmail 3c to approval service applicants. Avalon Stamp Co., Dept. S, Springfield 8, Mass.**

**PORTUGUESE Colonies 25 different 5c with approvals. Loran Brown, Marion, Mich.**

**CUBA'S Latest Retirement Set shows aged couple receiving pension check. This set sent to approval applicants for only 5c. Bryson Stamp Company, Drawer F-1, Rossford, Ohio.**

**EXCLUSIVE, Serious approval applicants. 8c Hong Kong #157a 50c. Newfoundland #257 surcharge two cents on 30c 15c Haiti, Roosevelt Mourning Issue set 35c, 40 rare Philippine \$1.50. Morris Stamp Co., Rockaway, N. J.**

**YOUR Money's Worth! Seychelles, Djiboute, Angola, Chinese Hunger Stamps and over 100 different other stamps. Everything 10c to approval applicants. Atlas Stamps, 4220 West 16th., Dept. M, Little Rock, Ark.**

**FREE! Rhodesian Bi-colored Waterfall; old El Salvador issues;—plus 25 different worldwide stamps. All free to approval applicants. Pladon Stamps, 1717 -S Idaho, Toledo 5, Ohio.**

**100 DIFFERENT Foreign stamps and Mexican banknote only 10 cents. Nagle, 1101 Marion, Reading, Penna.**

**UNITED STATES approvals complete coverage fine quality, attractive prices. Seminole Stamps, Box 378, Coconut Grove, Florida.**

**FINE Approvals, freshly mounted. Fast, personal service. Tell me what countries you prefer and I'll send their stamps. Milton Skinner, 438 Locust, Long Beach 2, Calif.**

**COMPLETE Roosevelt set (4), Army, Navy, Coast Guard, Marines, Merchant Marine (25c value) only 10c to U. S. Approval applicants. Metropolitan, 140 Nassau, New York 7.**

**FREE! Leeward Is., Cayman Is., Turks and Caicos plus 54 different mint World's Fair poster stamps, to approval service applicants sending 3c postage. Tatham Stamp Co., Springfield, Mass.**

**PHILATELIC printing—Stockforms, Samples. Acmeprint, East Flat Rock, North Carolina.**

**GOYA Nude (2) 5c approvals. Hannay's, 310 Quail, Albany 3, N. Y.**

**EXCELLENT Pictorial Approvals. Reasonably Priced. Crown Stamp Company, Box 331, Toronto, Canada.**

**GENERAL U. S. And Foreign Approvals, Packets, Covers. Prospect Stamp Co., Poland 2, New York.**

**POSITIVELY Greatest free offer—Latest Scott's International \$5.00 stamp album—covering entire world, contains 36,000 illustrated descriptive spaces; Scott's 1947 Standard \$5.00 catalogues 'Philately's Encyclopedia'—absolutely free to applicants for foreign approvals becoming customers. Bargain Stamp Service, Palm Springs, California.**

**PORTUGAL 30 different 10c approvals. Reidenbach, Lexington Ave., Troy, N. Y.**

**ROCK of Gibraltar Packet Free. A nice collection of stamps from Gibraltar, the mightiest fortress in the world—also New Zealand Centennial—British Uganda—French Colonials—Early British Colonial—West Indies—South American and War stamps plus sample copy Philatopic Monthly Magazine. Send only 5c for postage. Empire Stamp Company, Dept. PR, Toronto 5, Canada.**

**EXCHANGE stamps all Countries, Particulars free. "Exchangers", Bry 118, near Paris, France.**

**25 DIFFERENT India-3c with approvals. Premiums with purchases. Brandwein Stamp Co., Box 92P, Bayonne, N. J.**

**31 DIFFERENT with George Washington Stamps from Brazil and Ecuador; Pirate Island; Victory issue; Medical set; others—all 4c with approvals. Grayson Stamps, Sherman, Texas.**

**BLACK Harding Cover 55 United States. 10c Approval applicants. Standard, 3817 Sackett, Cleveland 9, Ohio.**

**COMPLETE set of eight Berlin Bears and 100 different stamps only 10c to approval applicants. Reich Stamp Co., 4647 Kenmore, Chicago 40, Ill. Dept. S11.**

**JAPANESE Invasion Money and 100 different foreign Stamps, 10 Cents. Nagle, 1101 Marion, Reading, Penna.**

**WONDERFUL Bargain—Includes triangle, Diamond shaped, Air-post, Giant, Midget Stamps, 10c to Approval Applicants. Box 4821, San Francisco, Calif.**

**FREE Stamps to approval buyers, Hohowski, 305 Philadelphia Block, Canonsburg, Pa.**

**HITLER Stamps! 12 Different, unused, 25c. Unterfutztdie Strip! 15c. Both only 35c. Hartunian, 1625 Laguna, Santa Barbara, Calif.**

**UNITED States Collection 104 Different Commemoratives, including Columbians, Pan-American, Pan-Pacific, Bicentennials Parks Famous Americans Price \$1.00 Approval Applicants only. Fort Orange Stamps, Albany 3, New York.**

**35 MINT U. S. Commemoratives \$2.00. Fine Foreign Stamps on Approval. Charles Mekeel, 2101 East Market, York, Pa.**

**"MUTINY" Island!—Fabulous Bird! Sun-Yat-Sen! Sword and Shield-Pirate Map! and others! 3c to Approval Applicants. Star Stamps, Lakewood, New York.**

**FREE! Negro Triangle; Turks Islands "Cactus"; Dakar; Guinea; Palestine; "Fairy Tale", Pirate Chart, Map, Ship, Sea Lion and Snake stamps; French, British, Portuguese Colonies, etc., Free for 3c postage. Approvals. Potomac Stampco, Washington 10, D. C.**

**UNITED States and Foreign stamps sent on approval; outstanding quality, low prices. Fred Herzberg, PS 168 Oak St., Elmhurst, Ill.**

**25 DIFFERENT United States used Commemoratives 25c. Steger, 1165 Downing, Denver 3, Colorado.**

**MEXICO 400 mixed \$1.00, numerous pictorials and commemoratives. Biel's, Apartado 2887, Mexico City.**

**TRY "Potluck" Stamp Packet 15c each, 7 for Dollar. Wollner, 2536-C Brown, Philadelphia, Penna.**

**UNITED STATES Price list. Send Postage. State Stamp Corp., 1225 Park Bldg., Pittsburgh 22, Penna.**

**10 DIFFERENT U. S. Over 40 Years Old, 5c. Foreign, U. S. approvals. Scott, 30 Baker Ave., Lexington 7, Mass.**

**FIVE Vatican City Stamps Free to approval applicants. Florida Stamp Co., Box 807, Miami 5, Fla.**

**AIRMAILS—100 different \$1.00. John MacDonald 30-P, Seaman Ave., New York 34.**

**1000 WELL mixed U. S. 25c. Monjar, 1750 Fairmount, Cincinnati, Ohio.**

**1,000 GRABBAGS, 15c each. Special Bags 25c. Sandy, 630 Bingaman, Reading, Pennsylvania.**

**BRITISH, Spanish and French Colonies, Vatican, Hitler heads, and airmail packet, free with approvals. Pan-American Stampco, Box 145, New York 33, N. Y.**

**LOOK! 500 Different only \$1.00. F. Lobdell, 625 South 18th St., Salem, Oregon.**

**FREE—Abyssinia, Cayman Islands, Tuna Triangle, Indochina, Syria, Ivoire, Philippines (Jap "Shame" issue), Turkish Harem, Damascus, Cambodia, African "Beauty", Pirate Islands, Colonials, others—All Free for 3c postage with approvals. Belmont Stampco, Washington 10, D. C.**

**FREE—Liberia Triangle, set Hitler Stamps, Half-Stamp Triangle, Devils Island, others. Approvals Postage 3c. Pilgrim, 6404 Old Harford, Baltimore 14, Md.**

**FREE—Complete Unused 50 year old Guatemala set. Approvals. Dobres, 4108 Garrison, Baltimore 15, Md.**

**JUST A Postcard With Your Name And Address Brings You Pleasant Surprise. Stamp World, 536 30 S. Omaha 5, Nebraska.**

**ASCENSION Island (Yank Airbase), Chinese Midget, Japanese "Booty Stamp" cataloging 10c, Cambodia, Polynesian Cannibal, Chaco Radio Stamp, Indochine, School Tax Stamp, others—All for 4c. Approvals. Rogel, 5149 N. Lincoln, Chicago 25, Ill.**

**PACKETS, 500—\$1.00, 1000—\$3.00, 2000—\$8.00, 3000—\$14.00, 4000—\$24.00, 5000—\$36.00, Ewing Stamps, 109 N. Dearborn, Chicago 2, Ill.**

**UNITED States Seconds Priced Cheap. Reference, Bay State Stamp, 44 Bromfield, Boston 8, Mass.**

**SPAIN'S "Nude Goya" set complete 30c. Approvals. Royal Stamp Company, Tamaqua 2, Penna.**

**CHRISTMAS, Global Packet one hundred different 25c, Eclipse, Box 635, St. Louis 1, Mo.**

**OLD scarce U.S. Seconds on approval. Slightly defective, nice appearance, bargain prices. Hearnfeld, 551 Clinton, Newark 8, N. J.**

**ARE You Serious? Then request unhinged approvals, enclosing 25c for mint special, including Hitler Blocks and Roosevelt. Verity Stamps, 47 Jane, New York 14.**

**FREE U. S. Price list postage 3c. M. Hanna, 335 5th Ave., Pittsburgh 22, Pa.**

**FLAG Stamp Free with U. S. Approvals. E. Wenigman, 929 Oakdale, Chicago.**

**WORLD-Wide Packet, commemoratives, pictorials, etc. only 25c. Worth much more. Schneider, 6609 S. Bishop, Chicago 36.**

**\$3.35 CATALOGUE value for only 10c. Gorgeous bicolored issue depicting Greece glories (12 values). Send dime today for this outstanding offer. Imperial Stamp Co., P.O. Box 1491, Tampa 2, Florida.**

**50 DIFFERENT Italy, 5c, with approvals. Gross Stamp Company, 1330 East 28th Street, Brooklyn 10, N. Y.**

**UNRIVALED Bargain! Includes set Seychelles, set Cyprus, assortment Libia, assortment Uruguay, also Bolivia, Albania, Angola, etc. Everything 10c to approval applicants. Wollaston Stamps, Wollaston 70, Mass.**



**FREE.** Irish Commemorative Collection. Including Dramatic Easter Rebellion Issue With Approvals. Raymax, 123-X William St., N. Y. C.

**FREE!** Mint Set with approvals. Deane Stampco, Box 1002, Miami Beach 39, Florida.

**50 DIFFERENT** United States 10c. Price list free. No approvals. Seidenberg, Casopolis, Mich.

**MINT** Set Flags Complete \$1.00 to Approval Applicants. Louis Merrill, 1623 5th, Portsmouth, Ohio.

**ROOSEVELT,** Churchill, Stalin, Hitler and Vatican City Stamps Free to Approval Applicants. Eliot Stampco, 86-31 Eliot Avenue, Rego Park, N. Y.

**PENNY** Approvals that satisfy. Neil Gronberg, Box 5441S, Philadelphia 43, Pennsylvania.

**UNITED** Nations, scarce 5c U. S. Commemorative and packet 30 different U. S., including Airmail, Commemoratives, Revenues, etc. Catalogs 65c—to approval applicants for 5c. Curhan Stamp Company, Dept. G., Gloucester, Mass.

**30 BEAUTIFUL** Airmails 10c. Selected Approvals. Louis Morrison, Milmont Park 2, Pa.

**BAVARIA** 17 different 5c with approvals. Boerger Stamp Company, 202½ Main St., Toledo 5, Ohio.

**25 DIFFERENT** Stamps 10c. Tunis And Carpenter, Wakeman Ave., Newark 4, New Jersey.

**NETHERLANDS** War Set, 10c with Interesting approvals. Rheume, 8949 Routhier, Montreal 12, Canada.

**200 DIFFERENT,** 15c. Approvals. Best Stamps, Box 139, Bangor, Maine.

**FREE!** Argentine Roosevelt Stamp. Quality approvals. William Deems, Ravenswood, W. Va.

**FREE** Persia packet to approval applicants. Everglades Stamps, Box 3222 Station F., Atlanta, Georgia.

**300 DIFFERENT** given free with approvals. Postage 3c. Windsor Stamps, 1435 E. 67th Place, Chicago 37.

**RICH** Man's approvals, poor man's prices. Grand value packet containing five Foreign sets. Free with approvals. Stoll Stamp Service, 2632 W. Burnett, Louisville 10, Ky.

**5 HITLER** stamps, 3c with approvals, lists. Gaydos, Kenosha, Wis.

**LIBERAL** Offer, thick packet with Seychelles, Gilberts, Reunion, Inhambane, Mozambique, Inini, Porto Rico, Philippines and multitude others, everything 10c to approval applicants. Burmaster, Box 191OK, Los Angeles 53, Calif.

**1000 MIXED** U. S. Old and New, 25c, 2# \$1.25. Weatherby, Medina, Ohio.

**25 DIFFERENT** Switzerland 10c with ¼-½-1c Approvals. Carroll's, 4357-C S. Hoover, Los Angeles 37, Calif.

**1933 VATICAN** set, .25 with approvals. Vargo Stamps, 6044 South Fairfield, Chicago 29, Illinois.

**WHOOPIE!** Wowie! 25c worth of U. S. stamps free! No obligations! Write: M & N Co., 742 Sheffield Ave., Brooklyn 7, N. Y.

**FREE—18** different Switzerland with approvals. Excel Stamp Service, Box 1315, Chicago 90.

**30 FULL** size Toy Patterns 50c. 40 Novelty and Lawn Ornament Patterns 50c. Other Patterns; Craft Supplies; Lists 10c. Lynds, Medway, Mass.

**105 DIFFERENT** including Vatican Cardinal set 10c to approval applicants. Quality Stamp Company, Dept. S, Box 202, Sta. F, Buffalo 12, N. Y.

**SPECTACULAR!** Thrilling! You build fine collections with our U. S. Mint stamps. Railroad, steamship, telegraph, movie, Florida, Iwo Jima, Army, Navy, Coastg'rd, Marine, Hyde Park, Texas, Discharge, Tennessee, Iowa, Smithsonian, Corregidor, Win War, Suffrage, Red Cross. Pick one or more, 5c each. All complete \$1.00, lists included. Frontier Stamps, 38 Park Row, New York 7.

**A STAMP** from President Roosevelt's own collection! Only few still left at special price of ten cents with approvals. Detroit Stamp, 10304 Dexter, Detroit 6, Mich.

**MISSION** Mixtures—U. S., 50c lb.—foreign, \$1.00. Stamps, Box 64, Racine, Wis.

**EXCELLENT** foreign approvals. Thomas Stephens, 932-B Wilson Avenue, Chickasaw, Ala.

**10 BEAUTIFUL** foreign pictorials. Free to approval applicants. Joy's Stamp Service, 2001 Mamie St., Hattiesburg, Miss.

**United States** Mint. #279D, #487A, #602, #611, #649, #655, #687. Fine. Send 65c. Approvals accompany. Whiton Stamps, Westport 1, Connecticut.

**WORLDWIDE** Mixture, 500 Stamps 25c. Garrow, 84 Montevista, Chula Vista, California.

**HITLER** Portrait Stamps 6 different 5c. Approval Bargains included. Beeken, 13814 Gallagher, Detroit 12, Michigan.

**ROOSEVELTS,** Nicaragua (2) 5c to approval applicants. Collins', 71 Coleridge, San Francisco 10, Calif.

**\$2000 IN** Stamps free to Contest Winners. Particulars, entry blank, to approval applicants enclosing only 10c for scarce Roosevelt Mourning Stamps from Nicaragua, Greece & Argentina, plus photograph of "Roosevelt Collecting Stamps." National Stamp Sales, 276 R, West 43rd St., New York 18, N. Y.

**U. S. 797 SPA** Sheet only 5c to applicants for U. S. approvals. M. Haycock, 61 O'Brien Pl., Brooklyn, N. Y.

**GENUINE** Souvenir Luggage labels. Five different—25c, 25—\$1.00. View Cards, 50 Different—\$1.00. Distributors wanted. Nabers Distributor, 242-SL, Gordon, Laurens, S. C.

**EXCHANGE** stamps with collectors everywhere. Send dime for latest list. Details Free. Exchange, Box 995, New Haven 4, Conn.

**FREE:** France Lost Colonies to serious Approval Applicants. J. E. Braford, Cloquet, Minn.

**YOUR** album problems ended. The "Phila-tegraph" accurately prints spaces. Any arrangement. Easily. Simply. Create beautiful album pages "Tailored" to your collection. \$9.95 postpaid. Circular. Dealers attention! JV. Novelties, Box 1858, Milwaukee, Wis.

**FREE—Jamaica** Coronation! Bargain approvals. Gramatan, Box 1002, Church Street Annex, New York 8, N. Y.

**FREE** premium to New Foreign approval applicants. Wesken Stamp Co., Box 66P, Queens Village 9, N. Y.

**BIG** Inducement! Over 25 countries including Grenada, Morocco, Rhodesia, Albania, Angola, Mozambique, St. Pierre, Kenya, Inini, etc. Everything 10c to approval applicants. Allen, 252 So. 3rd, Brighton, Colorado.

**NEW** Zealand Triangles! Good Semipostal set usually 15c only 6c to new approval applicants. George Richie, 368 Josephine, Memphis, Tenn.

#### 129 TATTOOING SUPPLIES

**TATTOOING** Outfits—Engraving Outfits. Circulars Free. Write, Zeis, 728 Lesley, Rockford, Illinois.

#### 130 TAXIDERMY

**GLASS** Eyes, finest American made, all Taxidermy supplies. Free Catalog. Elwood Company, Dept. 235, Omaha 2, Nebr.

#### 131A TENTS

**PUPTENTS** newest type complete with poles. Army Surplus postage paid \$6.50. Children love them. Army Goods Distributors, 1207 Farnam, Omaha 11, Nebraska.

#### 132 TOBACCO & PIPES

**CIGARETTES**—Popular brands; minimum 3 cartons. Price \$1.46 per carton; postpaid. Send check or money order. Ace Mail Order Co., East Orange 82, N. J.

**CIGARS,** 100 Choicest Quality. Handmade. \$5.95 Postpaid. Money Order, Check or Cash. S. & E. Co., Dept. PS, Red Lion, Penna.

**FREE** To Pipe Smokers—For new pipe smoking thrills, write us your brand of tobacco and get Freec Package Mild, Tasty "Green River". Pete Moberly, Box 996, Owensboro, Kentucky.

#### 134 TREASURE FINDERS

**MT-SCOPE** Metal Locator fully guaranteed and unsurpassed in efficiency. Time payment plan, trade-in and accessories. Free literature. Fisher Research Laboratory, Palo Alto, Calif.

#### 135 TREES, SHRUBS, ROOTS, HERBS

**FAMOUS** Croft Easter Lilly six inch bulb \$1.00 postpaid anywhere. Wheeler Bulb Farms Sixes, Currey County, Oregon.

**TRE-TEX** saves trees from rabbits, mice, borers, scab. \$1 package, 100 trees, lasts year. Sold thirty-eight states. Trade mark and business for sale account age. E. L. Eckerley, Noblesville, Ind.

#### 136 TYPEWRITERS

**RECONDITIONED** Typewriters, Printing Devices, Office Appliances Supplies Dixie-graph, King, N.C.

#### 138 WANTED MISCELLANEOUS

**WANTED—Old** Cars. Interested old cars manufactured prior 1910, particularly Stanley Steamers. Conditions not important as long as parts available and car was stored under cover. Communicate details to: Savage, 1883 Brooklyn Ave., New York.

**MERCHANDISE** of any kind. Paul, 425 East Jefferson, Springfield, Illinois.

**WANT to Swap—Buy—Sell** anything?? Send 25c for National Swapper's Guide. It's full eager Swappers-Buyers-Sellers, coast to coast and opportunities to Swap-Buy-Sell almost anything under sun. National Swapper's Guide, P. O. Box 415, Evansville, Indiana.

**MERCURY—Highest** prices. Free Containers. Write Mercury Terminal, Norwood, Mass.

#### 139 WATCHES

**WATCH** and clock repairing — complete practical course in modern horology, 66 illustrated self-instruction lessons. Just out! Low price. Fascinating 100-page illustrated catalog Free! Write—Nelson Co., Dept. 8-01, Chicago.

**WATCH** and clock repairing increasing. complete home study course with drawings and pictures. Information free. Houston Chronometer and Watch Co., P.O. Box 1140B Houston 12, Texas.

**OFFERING** fine Watches very cheap for resale, write Box 18—93 Fourth Ave., New York.

**EXPERT** watch repairing guaranteed quick service, free estimates. Divers & Son, Box 135, Hertford, North Carolina.

**FREE** catalog on watch repairing, radio, aeronautics, optics, etc. Engineers' Book Service, 19 West 44th St., New York City 18.

**"WHAT** Every Watchmaker Must Know" crammed with instructions; formulas alone \$100.00 worth. Your copy \$3.50. Advice given. No more stoppers; use "Simplex" pivot polisher; 25c, five \$1.00. For hard-to-get parts, watch cases, any problem write. F. S. Horological Co., Box 43, Planetarium Station, New York 24.

#### 140 WELDING, SOLDERING

**NEW** Model electric welder 110 volt AC-DC; will weld all metals; easy to use, full directions. Complete with power unit, flame and metallic arc attachments, carbons, fluxes, rods, mask; all for \$19.95—Used by the Navy. Magic Welder Mfg. Co., 239-PS-12 Canal St., New York City.

**FARMERS,** Repairsmen, garagemen: New, Guaranteed, 110/220 volt A.C. Heavy-duty welder, 20 to 160 amperes output, uses 1/16" to 3/16" rods, complete supplies, \$135.00. Light or Heavy welding, all metals. Others, \$68.00 to \$245.00. Details free. Williams Company, Box 4100, Portland 8, Oregon.

**"BUILD** Your Own Arcwelder" Inquiries Welcome. Welders Club, WB-3432, Chicago 54.

**MAKE** 400 Amp. AC. Welder from burned-out pole transformer. 6 plans. Various sizes \$1.00. Information Dime. Hi-Point Electric, Box 539, Leesburg, Fla.

**NEW** Atlas Heavy duty transformer Welder 110 V. AC, 6 heat stages, complete with metallic arc and flame attachments. Supplies and illustrated simple instructions. Really 2 Welders in one; including carrying case. Only \$34.50. Guaranteed one year. Magic Welder Mfg. Co., 241 GS, Canal St., New York City.



**HAND MICROPHONE**  
 Top quality hand microphone with control button in handle. Highly sensitive. Has rubber covered cord and tel. plug. Fine for use on home recorders, public address systems, etc. Brand new—perfect. Shp. wgt. 2 lbs. Stock No. 170. Each... **\$1.95**



**HAIR CLIPPER**  
 Browne & Sharpe Size. Brand new. Clean cutting—easy working. Stays sharp thru long service. Bright finish. Shp. wgt. 1 lb. No. 333—Each... **\$3.75**



**Shatterproof Goggles**  
 All purpose type. Sponge rubber frame. Red shatterproof flexible lens. Adj. head band. With case. New. Wgt. 1 lb. No. 139—Each... **39c**



**POPULAR RECORD ASSORTMENT**  
 Fifty records of modern dance, race, blues and hillbilly selections. No two alike. Famous name bands and artists included. Used in juke boxes, but guar. perfect. Shipped exp. collect only—no exchanges or refunds. Wgt. 28 lbs. No. A303—50 records... **\$9.64**



**PROF. TELEGRAPH KEY**  
 Purchased from the gov't. Finest design and construction. Base measures 3 x 4 3/4 inches. Original value \$2.50. All parts of instrument brass. Adjustable. A-147. Each... **98c**



**2 Man Mountain Tent**  
 Regulation Army type two man mountain tent, complete with poles, guy ropes, etc. Of durable nylon with reinforced seams. Ideal for outdoorsmen, campers, etc. Shp. wgt. 10 lbs. A splendid value. Stock No. 202—Each... **\$9.95**



**PUP TENTS**  
 Regulation Army Pup Tents of durable, brown canvas. Used, but in good condition. Fine for campers, outdoorsmen, boy scouts, etc. Grand Xmas gift for children. Wgt. 8 lbs. A1—Tent only... **\$3.95**  
 A110—Tent, new... **\$7.95**  
 A101—Ropes, wooden poles and stakes for above. Per set **\$1.00**



**MOSQUITO TENTS**  
 Completely covers cot or hammock. Of fine mesh marquisette with taped seams. Metal rods and cross bars included. New! Shp. wgt. 4 lbs. No. 104—Each... **\$2.95**

**SATCHEL POUCH**  
 Heavy canvas pouch. Ideal for toting lunches, shopping, books, etc. Has three 11 x 12 inch pockets. Brand new, guaranteed perfect. Has oversize flap with single strap fasteners. A113—EACH **\$1.69**



# WAR SURPLUS AND HUNDREDS OF OTHER BARGAINS

**SIGNAL MIRROR**  
 Used by downed airmen for rescue signalling. Brand new. Measures 4x5 in. with sighting guide. Shp. wgt. 1 lb. Stock No. 527—Each... **98c**



**KAPOK LIFE JACKET**  
 A bargain surplus. Made of heavy OD material treated to be fire resistant. Filled with genuine Kapok—more buoyant than cork. Worth twice this price. A real "buy" for boat owners, etc. Shp. wgt. 3 lbs. No. 546—Each... **\$2.95**



**7 LB. EXPERIMENTER PARTS ASSORT. KIT**  
 A "gold mine" for the radio serviceman. Hundreds of valuable radio parts, new radar and electronic parts and subassemblies, coils, resistors, trimming condensers—worth many times this low price. A130R—7 lbs... **\$1.79**



**LIFE PRESERVER BELTS**  
 Right from the invasion beaches. Consists of two air chambers. May be inflated automatically with "sparklet" cartridges or manually by attached hose. Adjustable in waist size. One air chamber guaranteed air tight—other may need a tire patch. All belts are used and slightly soiled but a bargain at this low price. No. 1261—**\$1.00** Each...



**SPARKLET CARTRIDGES**  
 May be used with above belts. Also for making charged water. In boxes of 10. Stock No. 254. Per Box... **50c**

**6x30 PRISM BINOCULARS**  
 Bausch & Lomb make. Prism type individual eye focus. With leather case. Power 6x30. Used but perfect. \$100 value. Wgt. 5 lbs. No. 505—Price **\$45.00** plus \$7.50 tax. Total...



**JUNGLE HAMMOCK**  
 For backyard, country home and camp use. Has waterproof roof with mosquito-proof nylon netting sides. Lets you sleep outdoors safely. Finest construction. Originally designed for U. S. Army use. Shp. wgt. 7 lbs. No. 134—Each... **\$9.95**



**G.I. POCKET STOVES**  
 Famous Coleman make. Burns gasoline. Use it for cooking, heating, etc. Metal container makes 2 cooking pots. Folds to 8 1/2 x 4 1/2 ins. Remarkably efficient—well made. Brand new. Shp. wgt. 3 1/2 lbs. No. 5530. Each... **\$10.95**



**U.S. Govt. BOLO KNIFE**  
 Extra heavy. For farm, home or jungle use. Blade of Gov't. formula cutlery steel. Walnut riveted handle. 3 1/2 inch hilt. 10 1/2 inch blade. You'll find hundreds of uses for a Bolo knife. Blade will take and hold a keen cutting edge. Wt. 2 lbs. A112—with Army Sheath... **\$4.95**



**MESS KITS**  
 Regulation two-piece Army Mess Kits with folding handle. Used, but perfect. Weight 2 lbs. No. A116—Ea... **69c**



**CANTEENS**  
 Reg. U. S. issue canteens. Plastic screw top chained to body. Slightly used but perfect. Wgt. 1 lb. 117—Metal **69c**  
 118—Plastic—Ea... **69c**



**CANTEEN CUPS**  
 All metal. Folding handle. Wgt. 1 lb. No. A120—Each... **25c**

**CANTEEN COVERS**  
 Heavy canvas. Button fastener. New No. 530—Each... **69c**  
 Used No. 119—Each... **35c**

**ARMY BANDOLERS**  
 Of fine heavy khaki. Big roomy pockets with snap button fasteners. Fine for hunters, campers, boy scouts, etc., also for shop work in carrying small parts, etc. Material alone is worth this price. Shp. wt. 1 lb. 11 Pocket Type No. **49c** | 5 Pocket Type No. **29c**  
 120 Each



**Wool Blanket**  
 Full size and 100% wool. Used but renovated for reissue. Use for camping, etc. Shp. wgt. 3 lbs. No. 233—Each... **\$4.89**



**ORDER DIRECT FROM THIS AD**

Values galore! Hundreds of hard-to-find items for home, shop and outdoors. Make remittances by money-order, bank draft or personal check. Send 25% deposit on C.O.D. orders. No C.O.D.'s on orders for less than \$5.00. Include sufficient postage on parcel-post orders—any overage will be promptly refunded. All quotations F.O.B. Chicago. Used items and materials are guaranteed serviceable and as described. Your money back if not more than satisfied.

**Big Illustrated Catalog Free**  
 Dept. PS1246  
 509 So. State St.  
**STARK'S** CHICAGO 5, ILL.

**BRONSON FISHING REEL**  
 New! Level winding, 100 yd. capacity. Quadruple multiplying. Bright nickel finish. New improved click. Shipping wgt. 8 ozs. No. F1133 Each... **\$2.35**



**WIRE PLIER**  
 Genuine Bernard 6 1/2 inch wire cutting plier. Parallel opening jaws. Reg. \$3.00 value. Wgt. 1 lb. No. 168—Each... **\$1.29**





# PRINCE ALBERT

## SMOKING TOBACCO

*Whether he smokes a pipe—or rolls his own cigarettes—a gift of Prince Albert is sure to please*

Dealers everywhere are featuring this 16-ounce tin of Prince Albert for Christmas gifts. It's all ready to give—gay Christmas wrapping—even space for your own greeting.



**16-OZ. TIN**  
Also available  
in 1/2-lb. size

**ALSO IN  
POCKET SIZE**

★ For pipes or roll-your-own cigarettes, there's no other tobacco quite like Prince Albert. It's crimp cut to pack better in a pipe—or to roll up fast in a "makin's" cigarette. And P. A. is specially treated to remove bite...to smoke cool, rich, and tasty.

*FOR PIPES OR ROLL-YOUR-OWNS*

**THE NATIONAL JOY SMOKE**

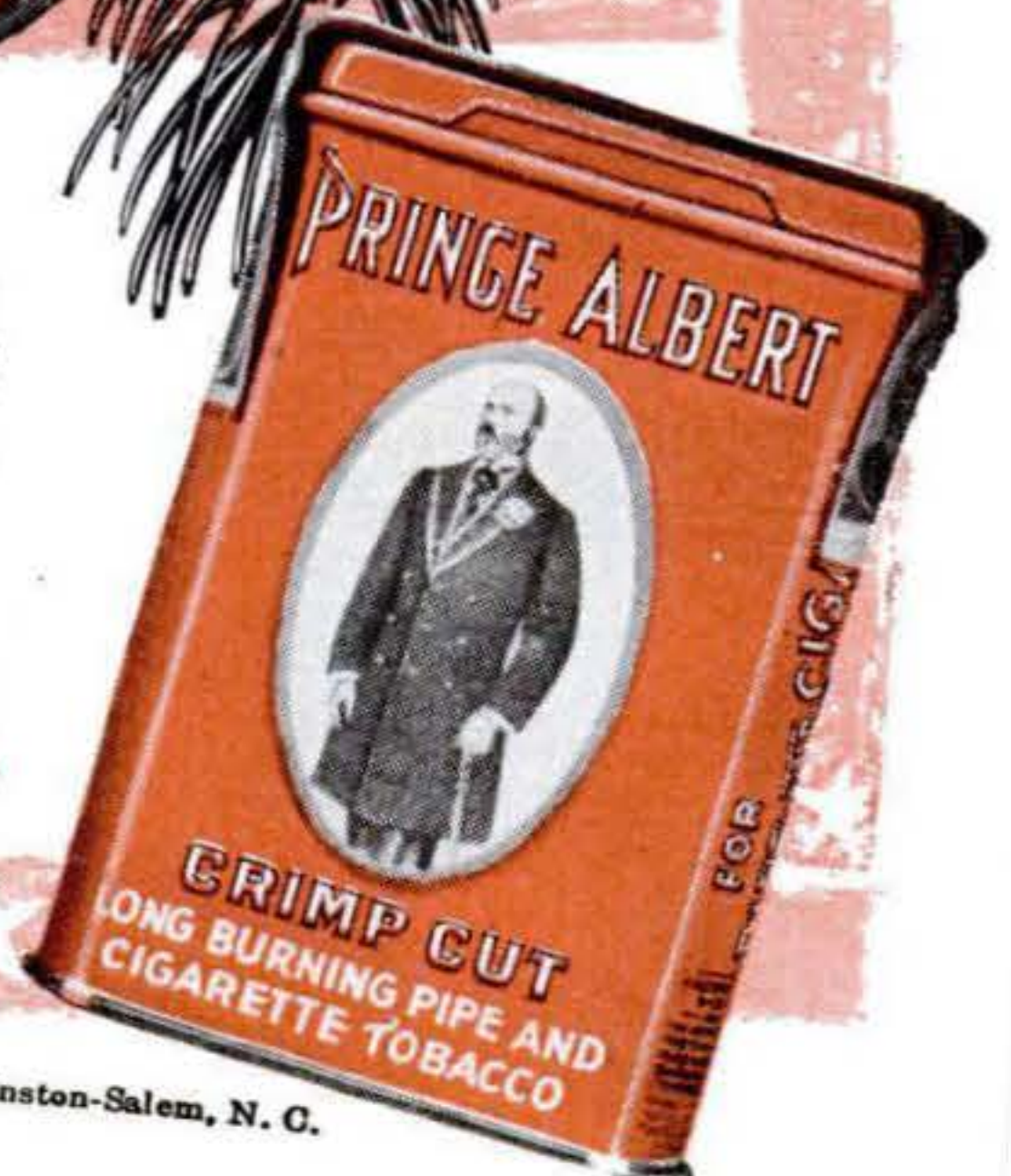

R. J. Reynolds Tob. Co., Winston-Salem, N. C.





## **BIGGEST TANK is Newest Antique**

THIS LUMBERING MONSTER, the largest tank ever built for the U.S. Army, was designed to crack Germany's West Wall — but American troops were behind that fortification before T-28 could fire a shot. Recently unwrapped at Aberdeen Proving Grounds, it weighs 100 tons, mounts a 105-mm. gun, is already obsolete for atomic warfare.



# Are Workshoppers

By HAL BORLAND

IN CHICAGO there is a steely-faced banker who would rather duck into his cellar on a sunny Saturday than shoot 19 holes of golf. In Hollywood there is a movie actor who prefers tinkering with old clocks to night-clubbing along the Strip. In Boston there is an auto mechanic who passes up the movies to sneak back to the shop and whittle bronze into chessmen. All over America, the breed of male who keeps the cellar light on half the night is increasing.

Who are these artists who scorn the conventional pastimes, and why do they do it? To be blunt: *Are workshoppers wacky?* Most of their wives think so, and some of their best friends are sure of it.

But what is a workshopper, anyway?

That's not so easy to answer—and maybe that is one way of replying to the charge of wackiness—for outwardly the man looks



normal. A little more contented, perhaps. Probably a little more competent in carving up the Christmas turkey. But what makes the workshopper different from his fellow clerks, vice-presidents, and machine operators is an appreciation of the well-made thingumajig, plus the ability to use his hands as well as his head.

Your workshopper likes to make things for himself. And he knows how: how to run a lathe or a band saw, how to read a micrometer or an oscilloscope, how to mix developer or paint. So he spends hours making



something he might buy for a fraction of its time-cost. But in his own shop he can afford to hire himself, and his product is as personal as a baby, bringing out the usual smugness of paternity.

Who is he? He is the lawyer who relaxes from the courtroom by making inlaid wooden bowls on a lathe. He is the accountant who clears his mind of statistics by carving figurines from plastic. He is the writer who "wastes" a day making a fancy belt for his wife out of a worn-out pair of boots.

There are probably 10,000,000 of his kind here in America, men who have developed skills and ingenuities that add immeasurably to their lives. They aren't a new breed. Their American line goes clear back to Franklin and Whitney, and it comes down through Henry Ford, who mended clocks and dreamed of building an automobile; through the Wright brothers, who ran a bicycle shop





# WACKY?



Hal Borland is no newcomer to the pages of POPULAR SCIENCE MONTHLY. A special writer for nearly 20 years, his articles, essays, poetry and fiction have covered many facets of American life. His latest book, "An American Year," was published last spring.

and dreamed of flying; through "Boss" Kettering, who worked with telephones and dreamed of building a self-starter for the automobile.

It is inevitable that in our specialized modern life we should turn from the job to something wholly different. The human mind needs more than one narrow track. That explains the dentist who is far prouder of his intricately carved tabletops than of his best dental inlays. It explains the doctor who would rather make a new fly rod than attend a medical convention. And that's why one famous musician is reluctant to make more than one concert tour a year—he begrudges the time he could otherwise spend in his workshop designing new tools for industry.

In his shop the workshopper is his own



boss. His time is his own, and so are his materials. When he has finished, the product is his; so are all the things he learned along the way, and so is the deep pride of personal achievement.

Sometimes the workshopper develops his manual skills on a doctor's orders. Handwork has a healing effect on those under severe mental strain. A well-known German editor came here as a political refugee and in a sanitarium learned to use his hands at a lathe. Physically recovered, he resumed his writing, but his hand-turned bowls and trays are now better known than his books. He would

never have done that abroad; it would have been beneath his dignity, and neither tools nor materials would have been readily avail-

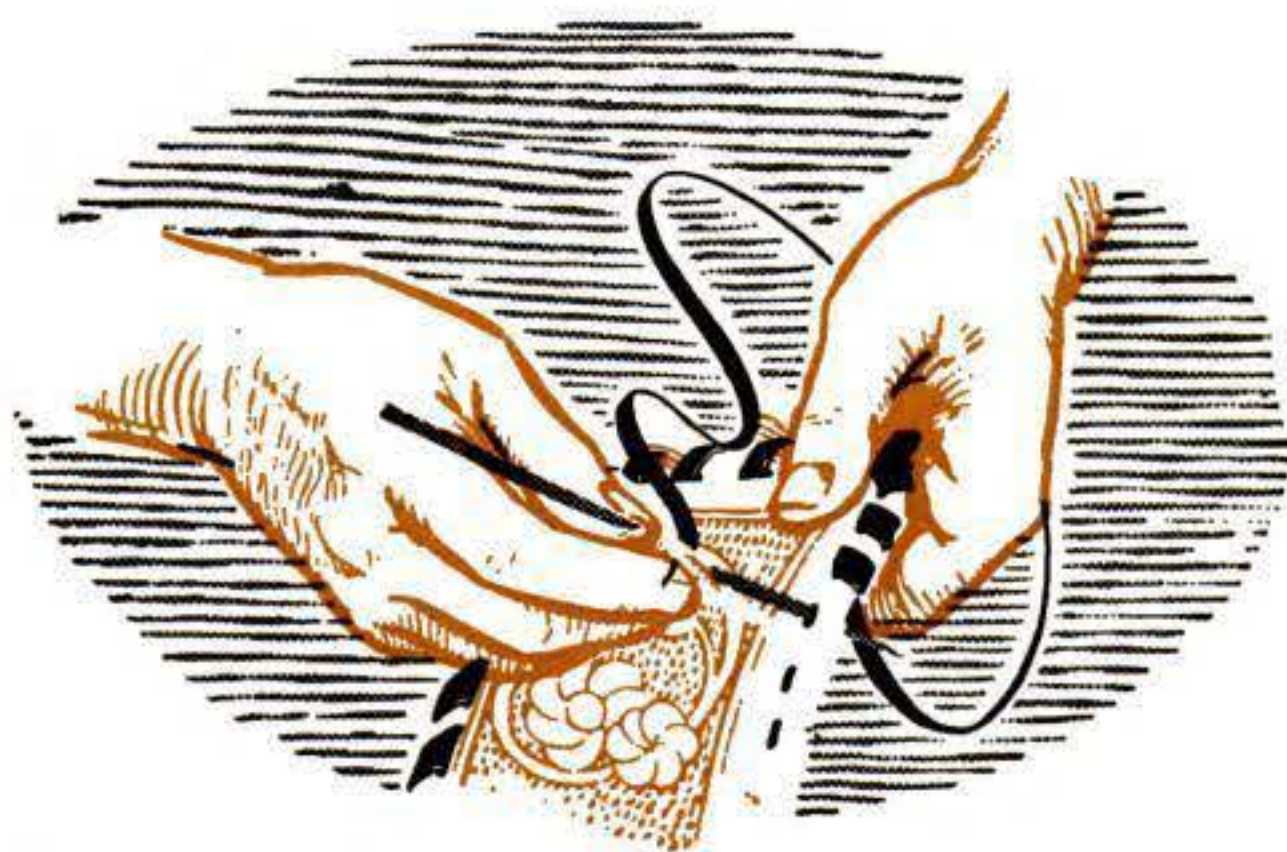

able. Here in America, any man can equip his own shop with excellent power tools for relatively little money. And there is respect here for any job well done.

America has always had room for the man who could make things. The pioneers made their own furniture and most of their own tools, of necessity, and those who proved most adept at it soon had a respected craft. Out of their skills and imagination came still other crafts, and as demand increased they invented new tools, new methods. From water power they turned to steam, and eventually to electricity. Today the workshop of even the most casual home craftsman has tools that would have been unbelievable to Eli Whitney.

The workshopper of today has electricity for power—clean, compact, and quiet. If he works in wood he probably has a lathe, a drill press, a sander, and a power saw. If metal is his medium he probably has a precision lathe, a drill press, a router, and dozens of special attachments. If he works in radio or electronics, he has gauges and meters, vacuum tubes and condensers. Even such a simple tool as his electric soldering iron would have been a marvel anywhere 50 years ago. If he is a photographer, he has a



whole cabinetful of chemicals, hot and cold running water, any kind of light he wishes, his own enlarger, and a wide choice of printing papers.

Even specialized knowledge is his for the taking. Fundamentals are available in school textbooks, and beyond these are bookstores, libraries and magazines, popular and technical, for background information or current developments. And for broader schooling in any field, there are night schools and correspondence and extension courses. The workshopper today has a base of known fact from which to work, and whatever he can add to it is new knowledge, his own contribution.

### The Inner Glow

There lies one of the deepest urges of the serious workshopper: He can contribute. True, nine out of every ten of those working in a basement shop are working for their own satisfaction. Their time is not wasted, however, for inner satisfaction, the glow of accomplishment, is important to any person. And the tenth one is, in effect, a lone researcher seeking new truth. Sometimes he finds it.

Edison started as a workshopper. Go over the inventions of the past half-century and you will find dozens of such men, who worked alone in their spare-time shops or laboratories—questioning, seeking, eventually finding.

No, most of those in today's home workshops are not inventors. They are craftsmen. I remember the executive whom I found at home one Sunday morning making a pair of plastic link pins for his small daughter's wrist watch. He might have bought those pins at a jeweler's, any day but Sunday. But his daughter wanted to wear the watch that day, and she was firmly convinced that her father could make anything. So he made those pins, turned and polished and fitted them. On a time-cost basis they probably represented close to \$50, for he is a high-salaried executive. I suspect that he actually got at least \$100 worth of satisfaction out of the job—not to mention the fact that he further enhanced

his reputation as a capable, versatile father.

The workshopper has any number of reasons to offer for his part-time preoccupation. There is a surgeon who keeps both mind and fingers supple by doing miniature woodcarvings, mostly of animals. There is a physicist who carves costume jewelry out of nuts. He says it satisfies his artistic sense. And there is the architect who makes scale-model trains because, as he says, it keeps his mind aware of the detail necessary in his daily job. All these men, of course, get the mental stimulus of handcraft and the relaxation of concentrating on something wholly different from their daily jobs.

You will sometimes find a man who holes up in his workshop to get away from a nagging wife or demanding children. At least, he is doing something constructive, and he is probably wiser than the man who goes down to the tavern to get away from it all.

### A Collector at Heart

Occasionally, too, you strike the magpie type of workshopper who accumulates tools and materials and spends most of his spare time listing them and keeping them free from rust. Even he is no worse at heart, I suspect, than the stamp collector.

But for the most part the man in the workshop is a good average citizen who knows, or wants to learn, what makes things tick. When he buys an automobile, he wants to know about its bearings and its ignition as well as its paint and upholstery. When he buys or builds a house he checks on its foundation and its piping as well as the view from the picture window.

Why does he cling to that workshop? Because it is his own kingdom. It is the place where he can prove to himself that his own industry and ingenuity have their value. He can adventure there as he will. He can make a shelf to hold his wife's kitchen spices, or he can build a canoe with which to explore the near-by river, or he can build a telescope with which to reach out to remote galaxies. He can undertake anything his imagination or ambition suggests, and his success or failure in that undertaking is wholly dependent upon his own resources.

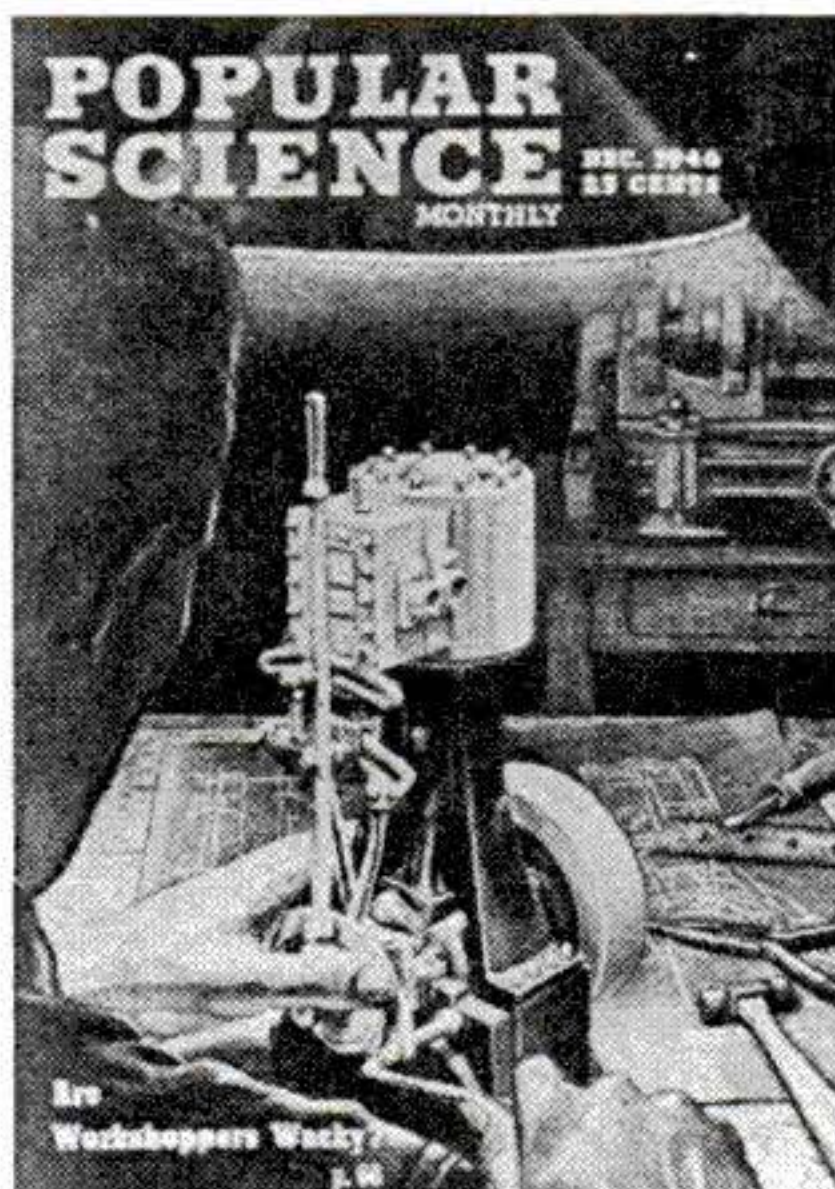

**COVER:** This painting by Ray Pioch illustrates the dream of many a top-flight workshopper—a real single-cylinder, double-acting steam engine, plans for which will appear in PSM.



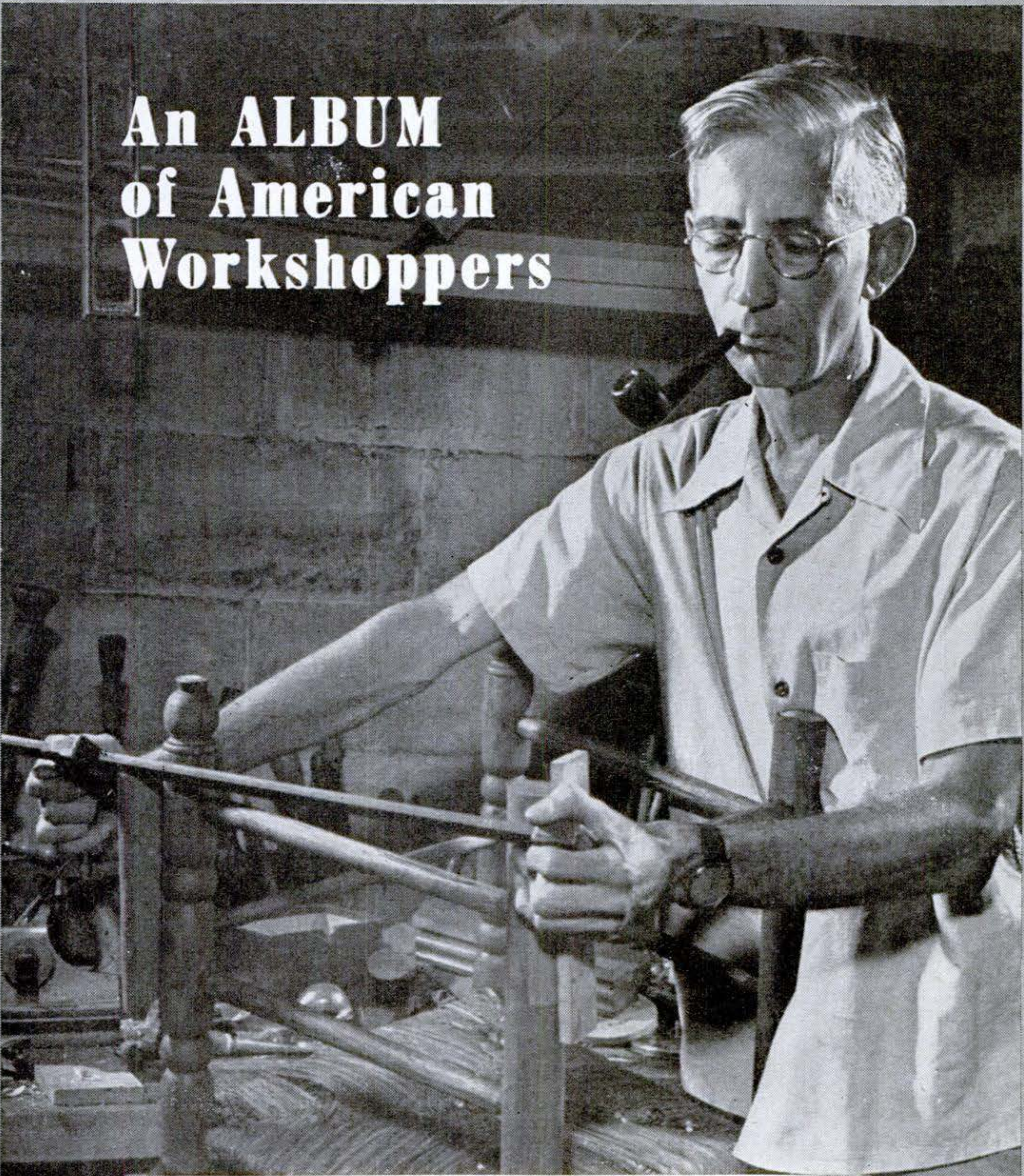

# An ALBUM of American Workshoppers

## HENRY R. DIAMOND

An artist by profession, his hobby is woodworking and furniture design. His Long Island home contains many products of the cellar workshop where he combines artistry and craftsmanship to create furnishings and fixtures that range from a beamed living-room ceiling to a studio couch with built-in space for storage and books.



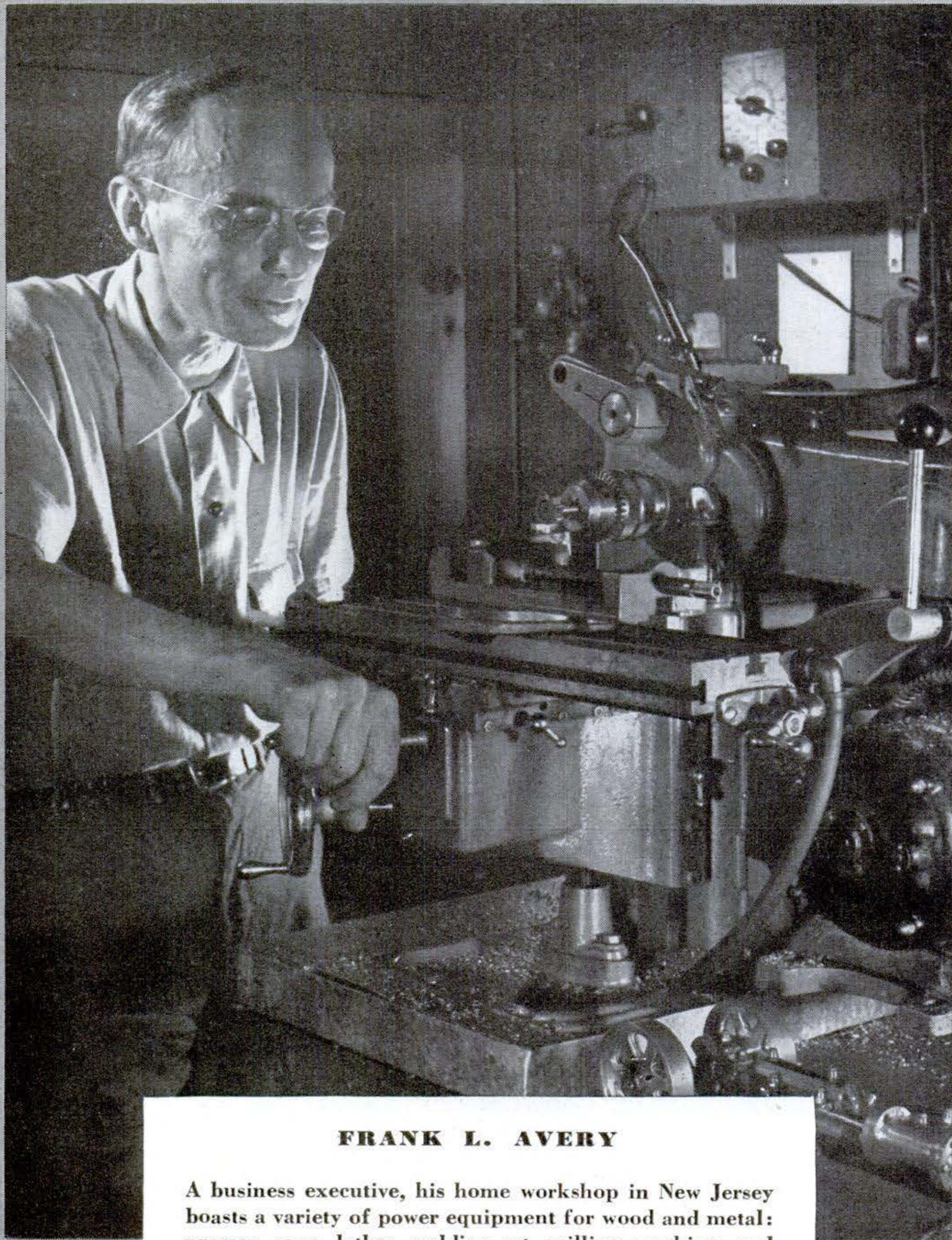

**FRANK L. AVERY**

A business executive, his home workshop in New Jersey boasts a variety of power equipment for wood and metal: presses, saws, lathes, welding set, milling machine, and a foundry for small castings. During the war he taught a class for shop foremen. Here, he is milling a part for the model steam engine shown at lower right.



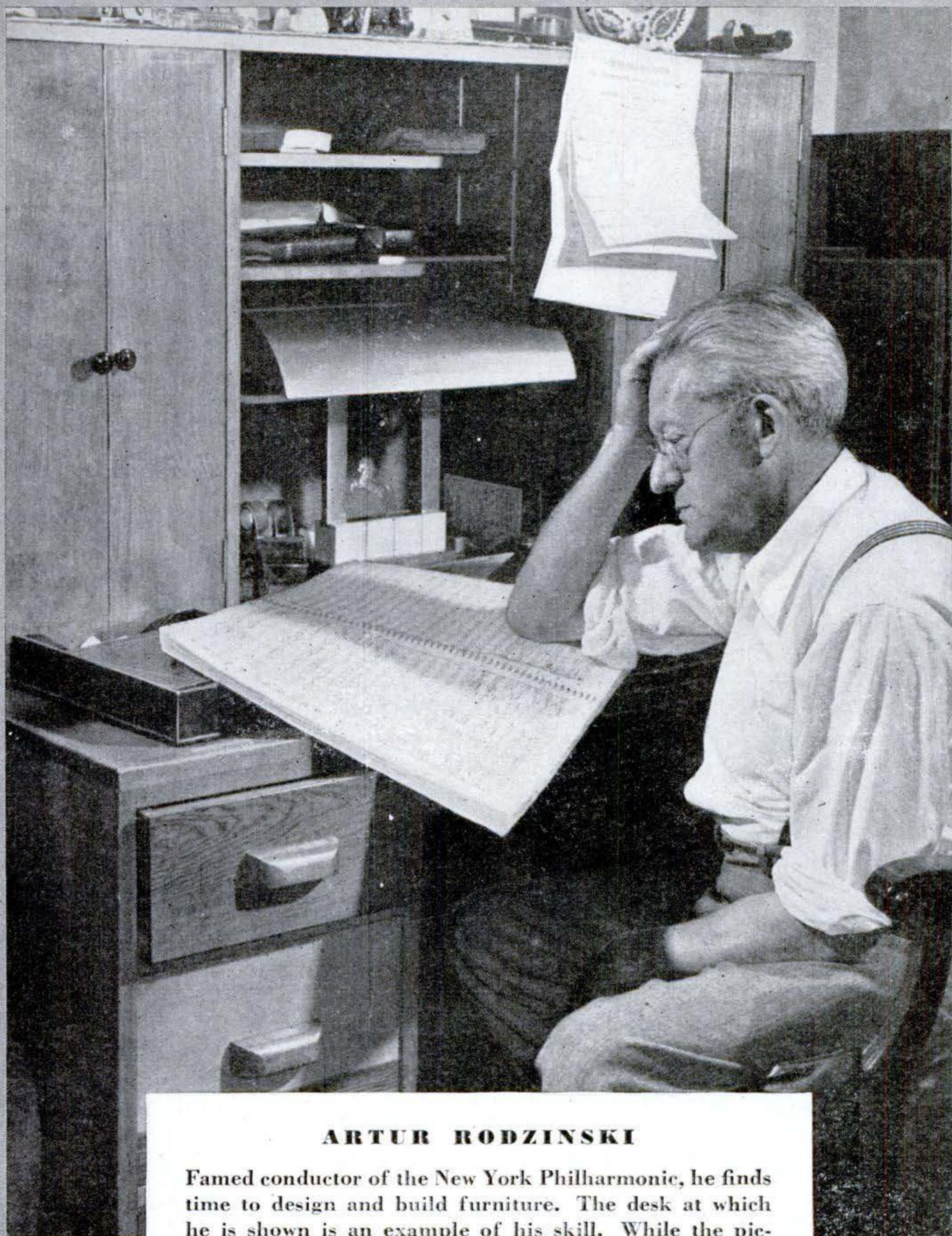

### **ARTUR RODZINSKI**

Famed conductor of the New York Philharmonic, he finds time to design and build furniture. The desk at which he is shown is an example of his skill. While the picture was being made, he also discussed a bedside radio installation, matched darkroom lore with photographer. Without a workshop at present, he is planning a new one.





### **BOB BURNS**

A radio comedian who classifies himself as a farmer, his chief hobby is precision woodworking. His workshop activities, however, extend to general tinkering, home mechanics, and inventing gadgets, several of which he has put to use on his California ranch. Here, at his workbench, he adjusts a vane on a miniature windmill.





**DONALD R. DOREMUS**

He counts photography, archery, gunsmithing, metal- and woodworking among his many hobbies, and his New Jersey workshop—planned with an eye to all of them—even includes a pistol range. Some of its equipment he had to design himself to satisfy the demands of his varied interests. His job is assembler in a steel works.



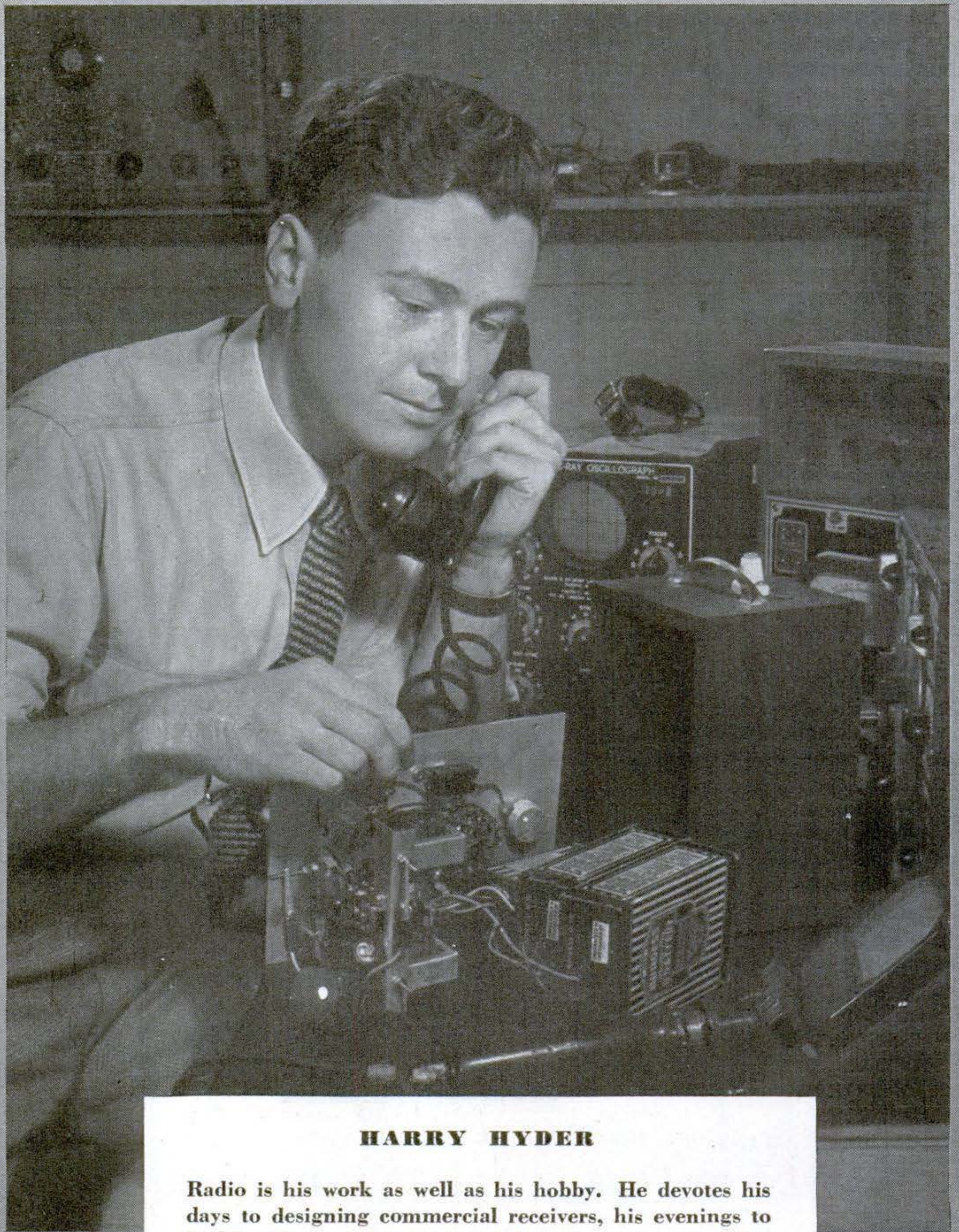

### **HARRY HYDER**

Radio is his work as well as his hobby. He devotes his days to designing commercial receivers, his evenings to building ham and experimental equipment—or writing about it. His first article, sold to PSM, dealt with the two-meter set he is checking here. A marine radio operator during the war, he holds ham license W2LIW.



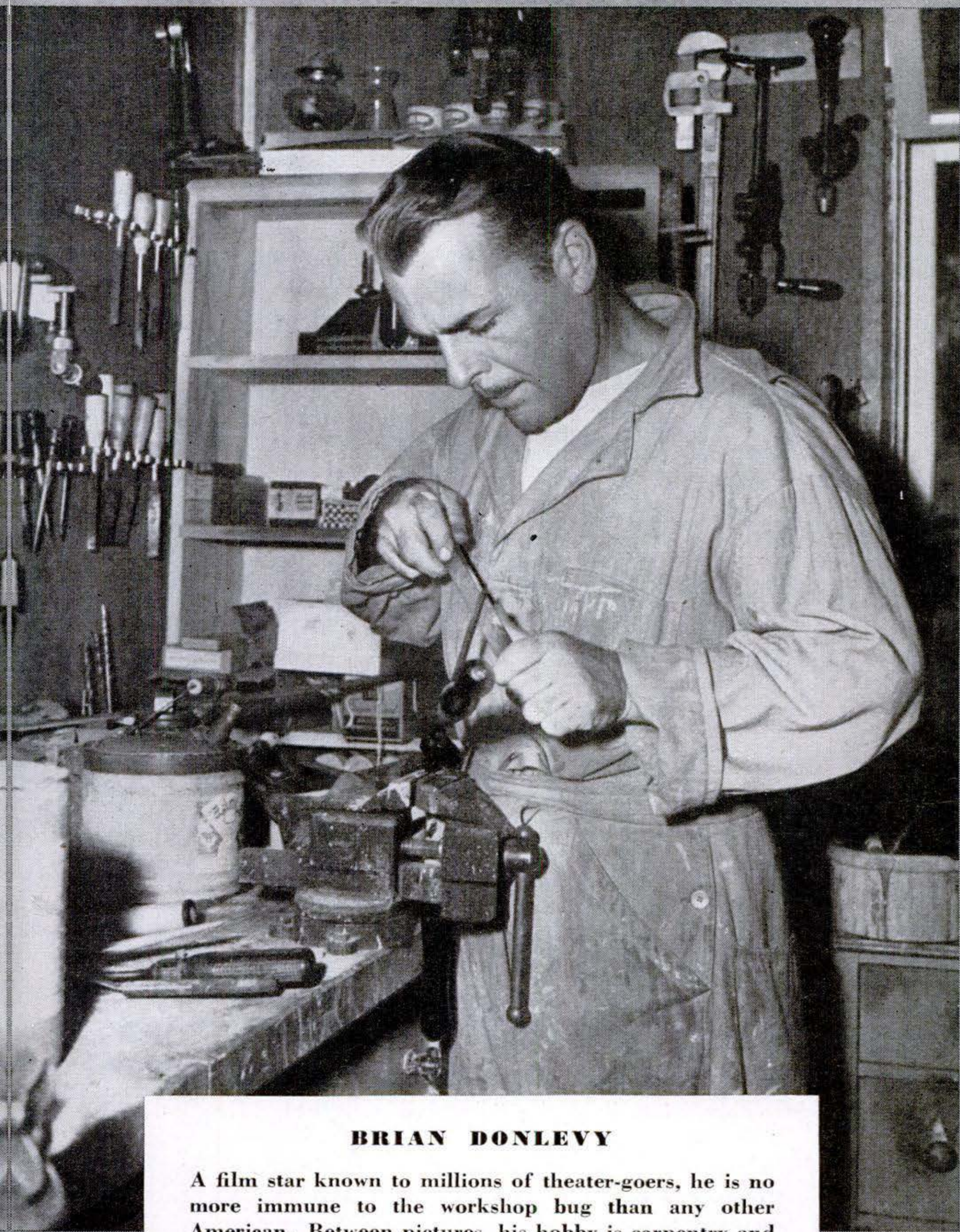

### **BRIAN DONLEVY**

A film star known to millions of theater-goers, he is no more immune to the workshop bug than any other American. Between pictures, his hobby is carpentry and cabinetwork, but the variety of tools above his workbench suggests the diversity of his other interests. Here he is engaged in sharpening a pair of hedge shears.





**LESTER D. FRIEND**

Owner of a Massachusetts paper-box factory, his workshop talents are devoted to turning out scale-model, live-steam locomotives. President of the New England Live Steamers, Inc., he operates a machine shop that produces parts for other model makers, and he has turned his factory grounds over to them to accommodate track.



# Willys Springs



## a New One

**D**ESCRIBED as the first American stock car with independent suspension of all four wheels, the Willys-Overland 6-70 is a new entry in the lightweight division for 1947. A sedan seating three in front and two in the rear with room to spare, it has a wheelbase of 104 inches and weighs about 2,500 pounds.

Individual suspension of the rear wheels is achieved by using universal joints where the axles enter the differential. In front,

the traditional axle is replaced by a transverse spring connected to steering-gear assemblies. Rubber inserts in the spring make lubrication unnecessary.

As its name implies, the car has a six-cylinder, 70-horsepower engine, designed to give 31 miles to the gallon at 30 m.p.h. and a top speed of 78 m.p.h. Because Willys is maintaining priority for its utility Jeep line, the new model will not be put into production until mid-1947.

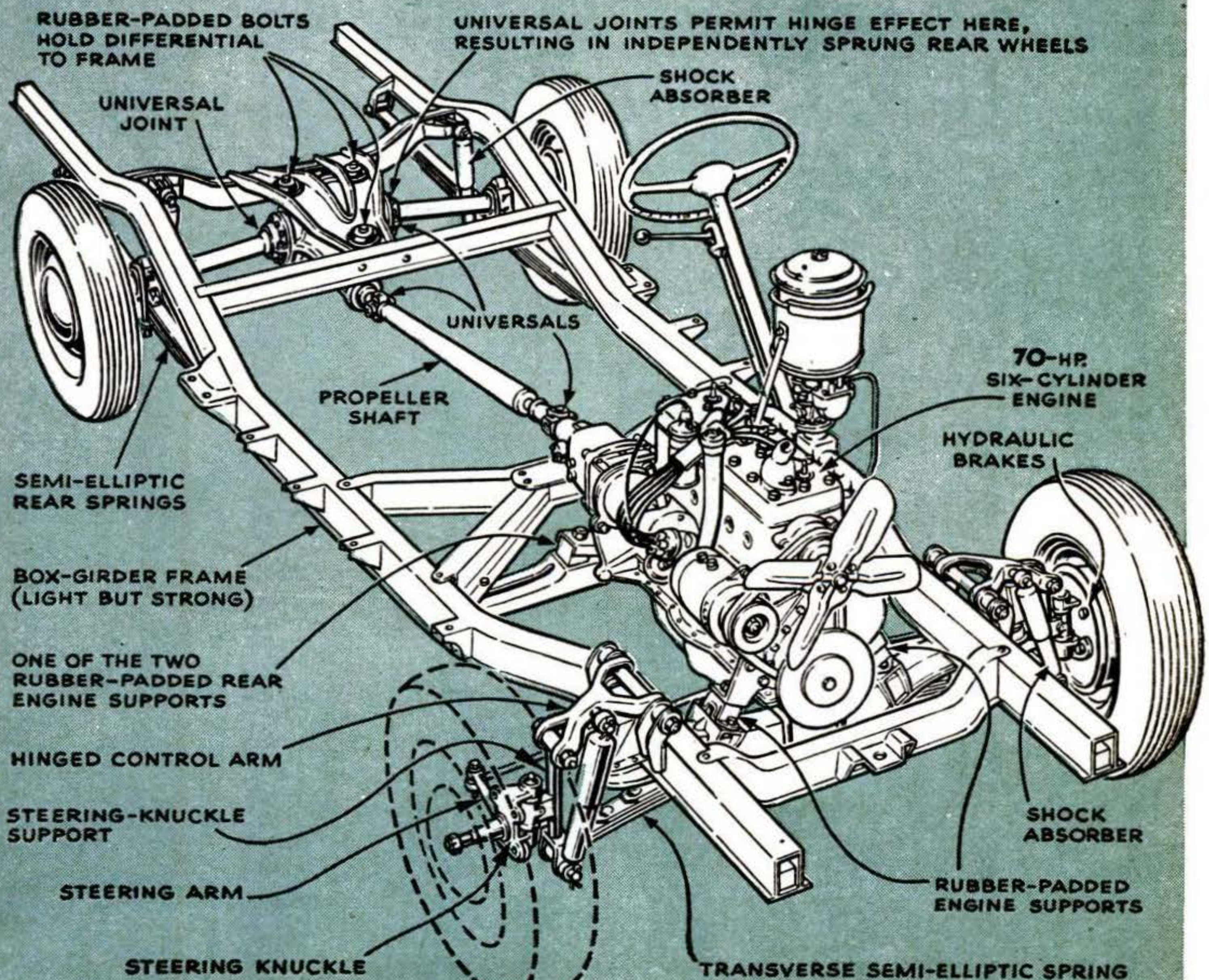



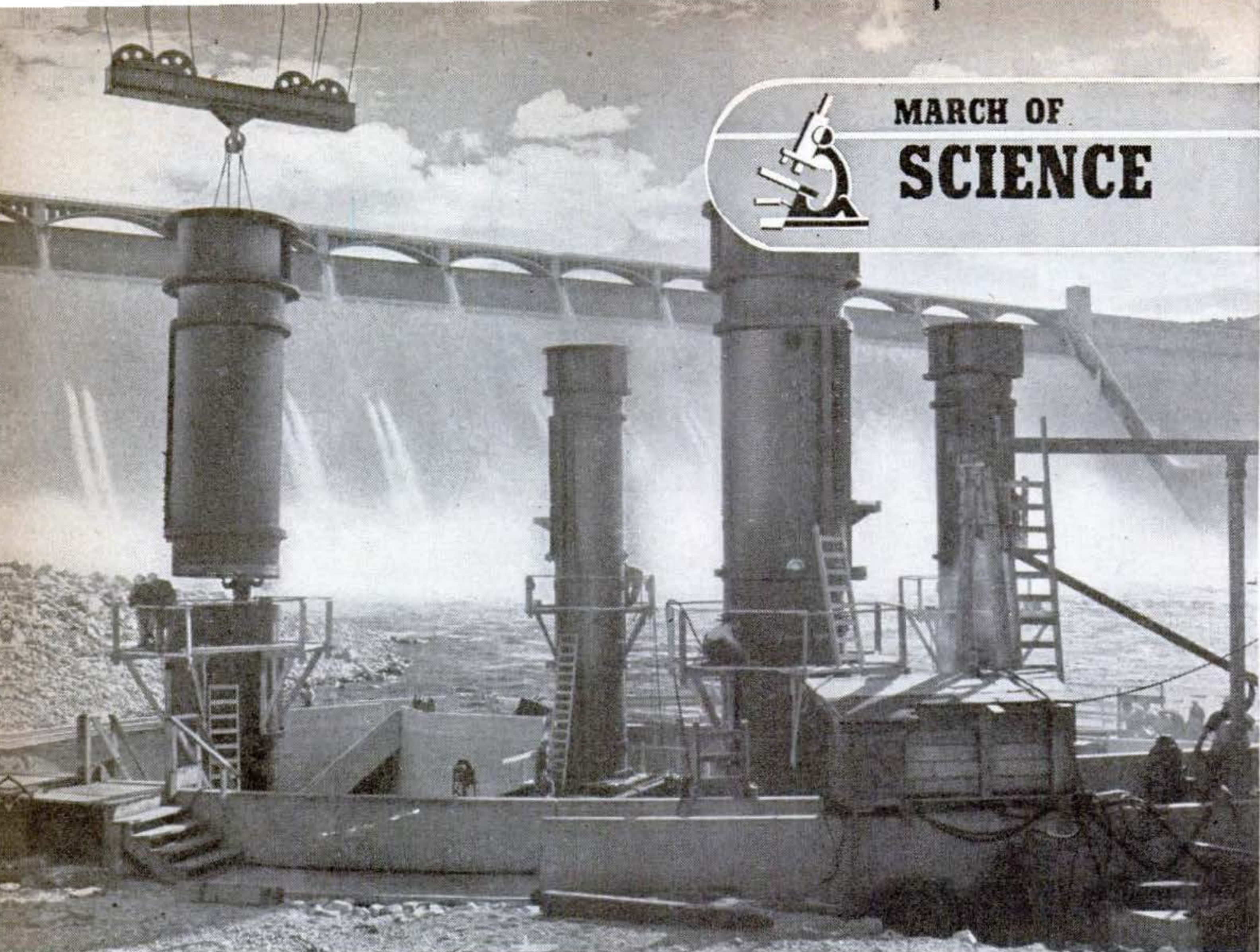

**Dam "Submarine."** Steel access tubes  $7\frac{1}{2}$  feet in diameter are shown above being fitted to a huge caisson at Grand Coulee Dam, Wash. The caisson, to be floated to the dam when ready, will permit workers to repair a damaged spillway bucket. Air, materials, and service lines will be fed to an underwater working chamber through the tubes, one of which contains an elevator. A rubber seal keeps water out.

**Camera Prints Its Own.**

Entirely automatic, the supercamera at right takes a picture, develops it, and throws it on a screen in 15 seconds. Designed secretly during the war by Eastman Kodak Co., it takes photos at a  $1/10,000$ -second speed on special 16-mm. film. A container squirts chemicals heated to  $140^{\circ}$  F. on the film and a vacuum processes the picture in 9 seconds. It is then ready for the projector.





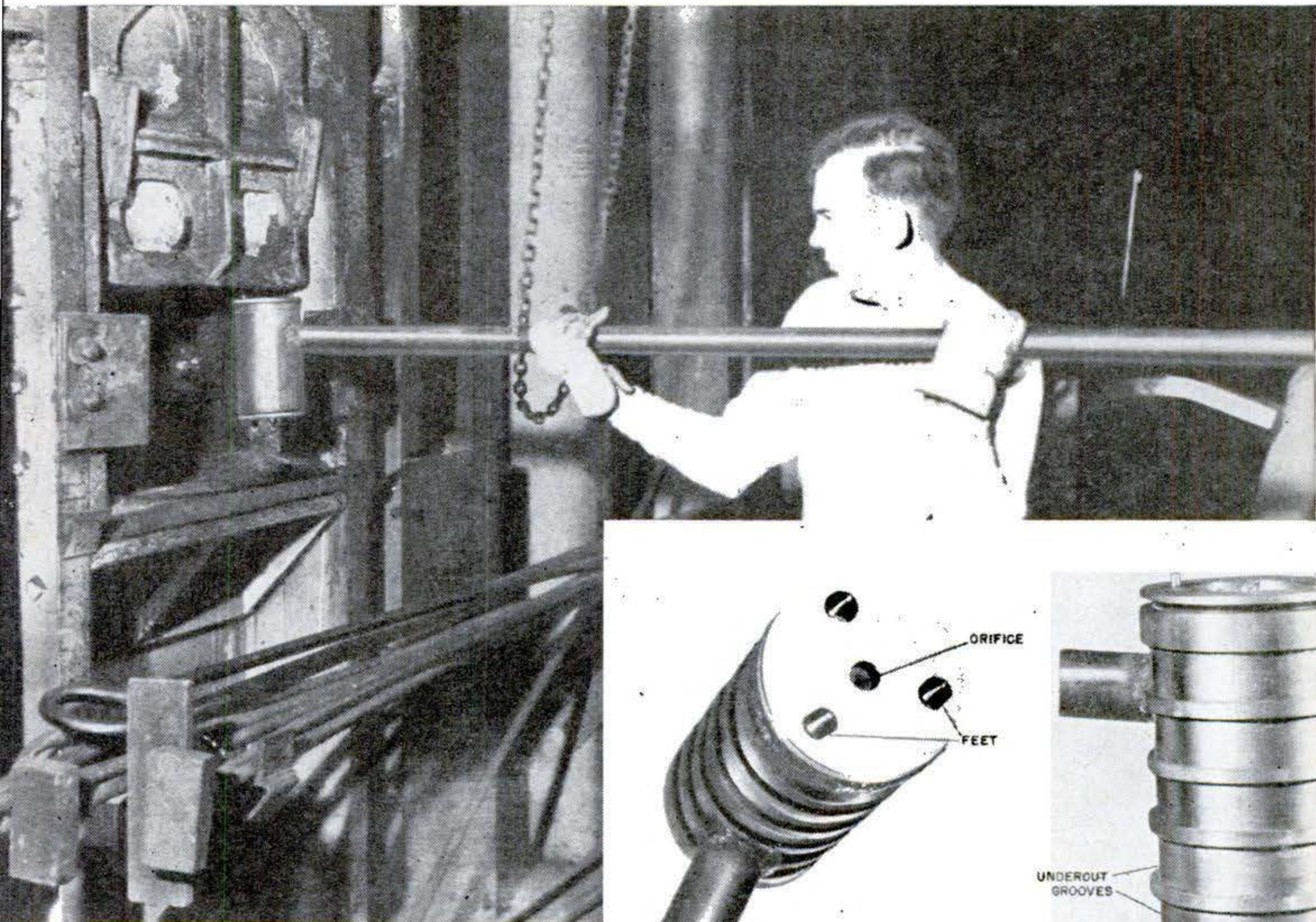

**Taking Steel's Temperature.** To test temperatures of white-hot steel slabs while they are in a furnace, U. S. Steel has devised a new, long-handled, heat recorder. The water-cooled head (inset) is rested on a slab and picks up heat radiations through an eye in its bottom. Wires through handle transmit reading to recording potentiometer. Surface temperatures to 2,400 degrees F. can be measured.

**X-Ray Detective.** By giving a small electronic photomultiplier tube a fluorescent vest and a black paper coat, Westinghouse has developed an X-ray counter (right) that covers a wide intensity range. The black coat blocks out room light but lets X-rays reach the fluorescent screen. The tube then measures the intensity of fluorescence and records changes as rapidly as 1/1,000,000-second.

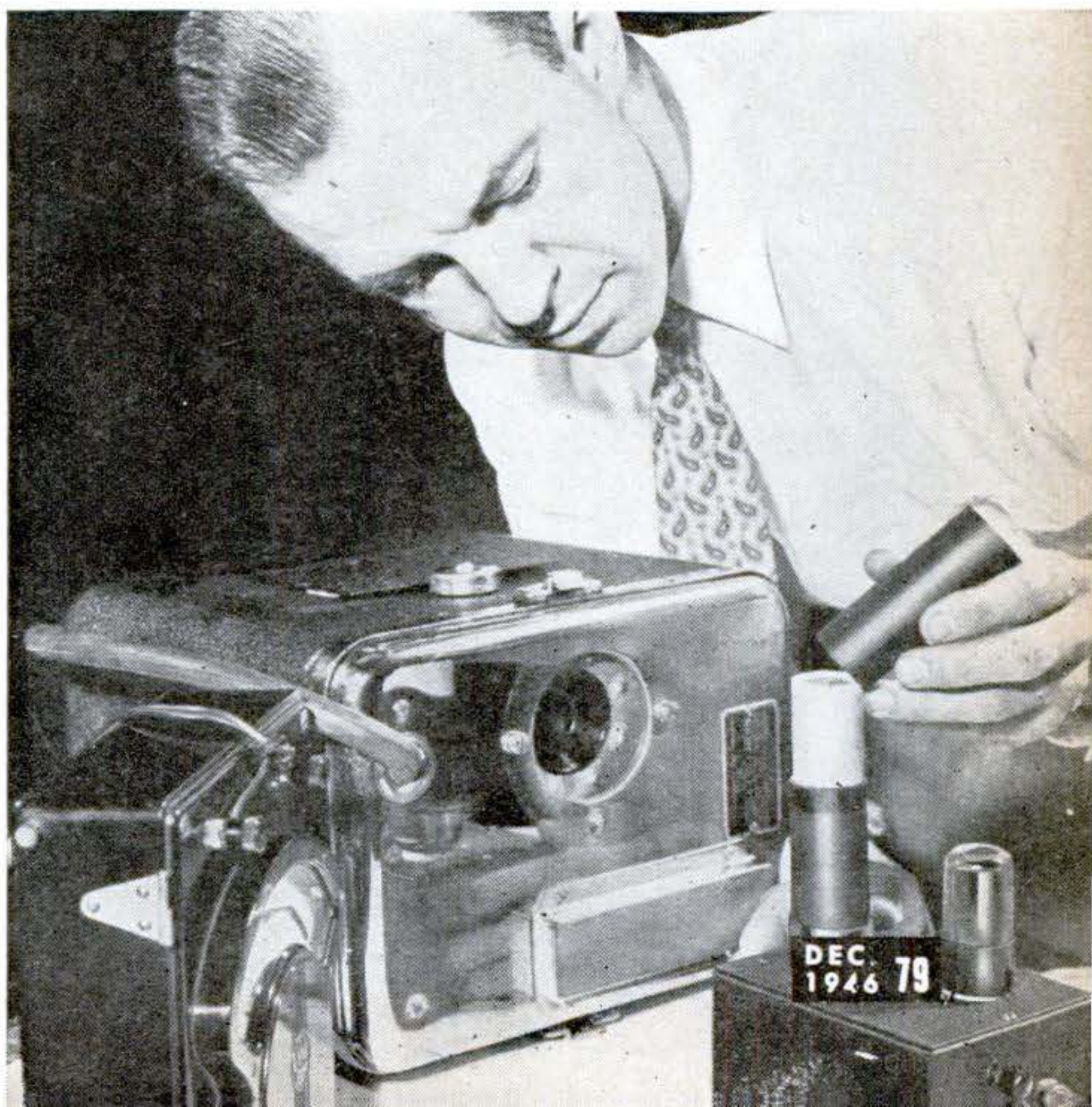



# FLYWEIGHT HOMES

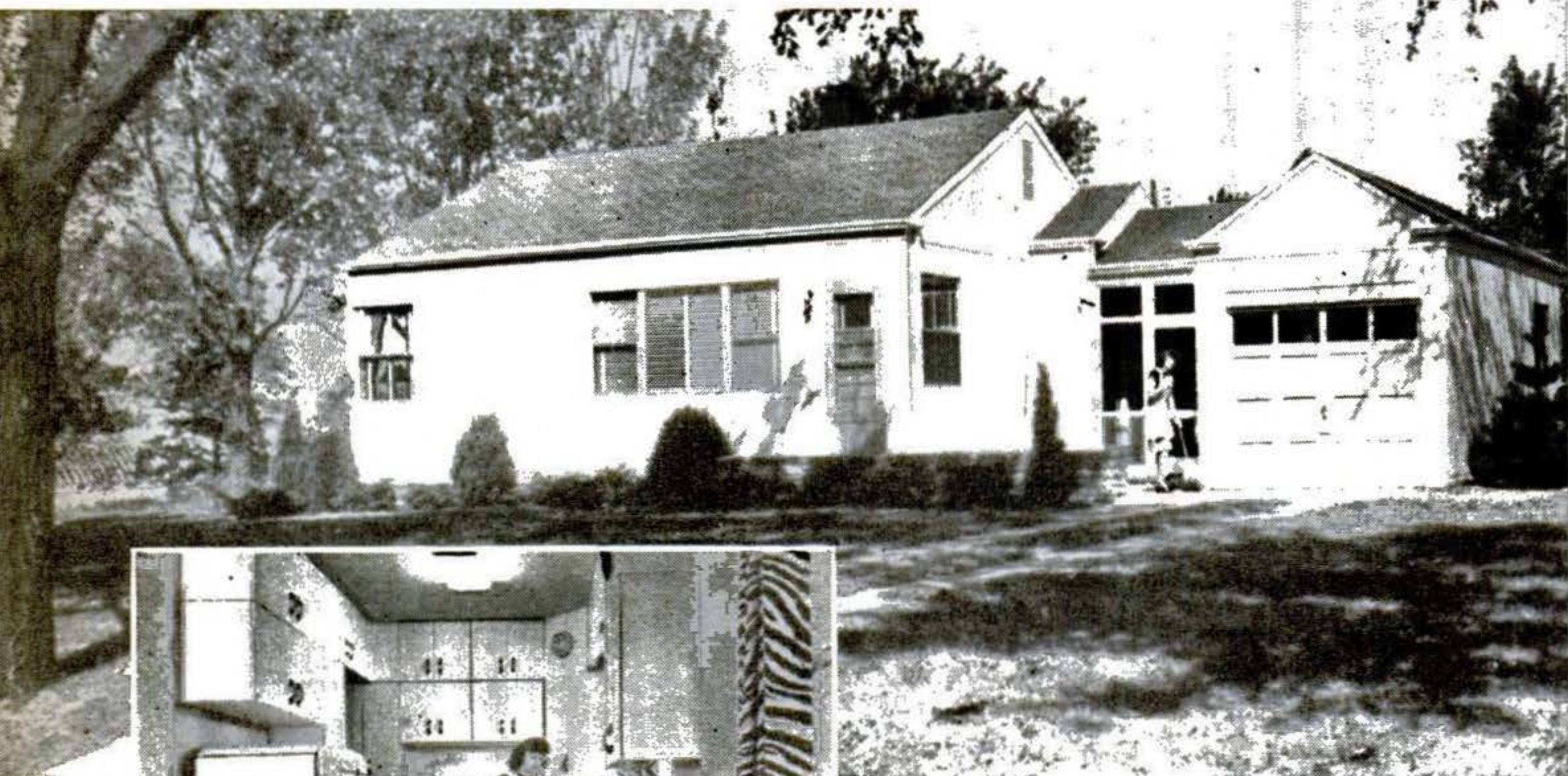

A new and unusually light prefabricated unit to combat the housing shortage is the "Boulevard Aluminum Home" shown above. Made by the Butler Manufacturing Company, of Galesburg, Ill., the two-bedroom structure is 24 by 33 feet. Wall panels are aluminum but the house contains 2,300 pounds of steel, most of it in rafters for the roof. The modern kitchen at left is part of the package.



Workers assemble the aluminum panels, which will not warp, burn, rot, or rust. The house can be set up in about two-and-a-half weeks.

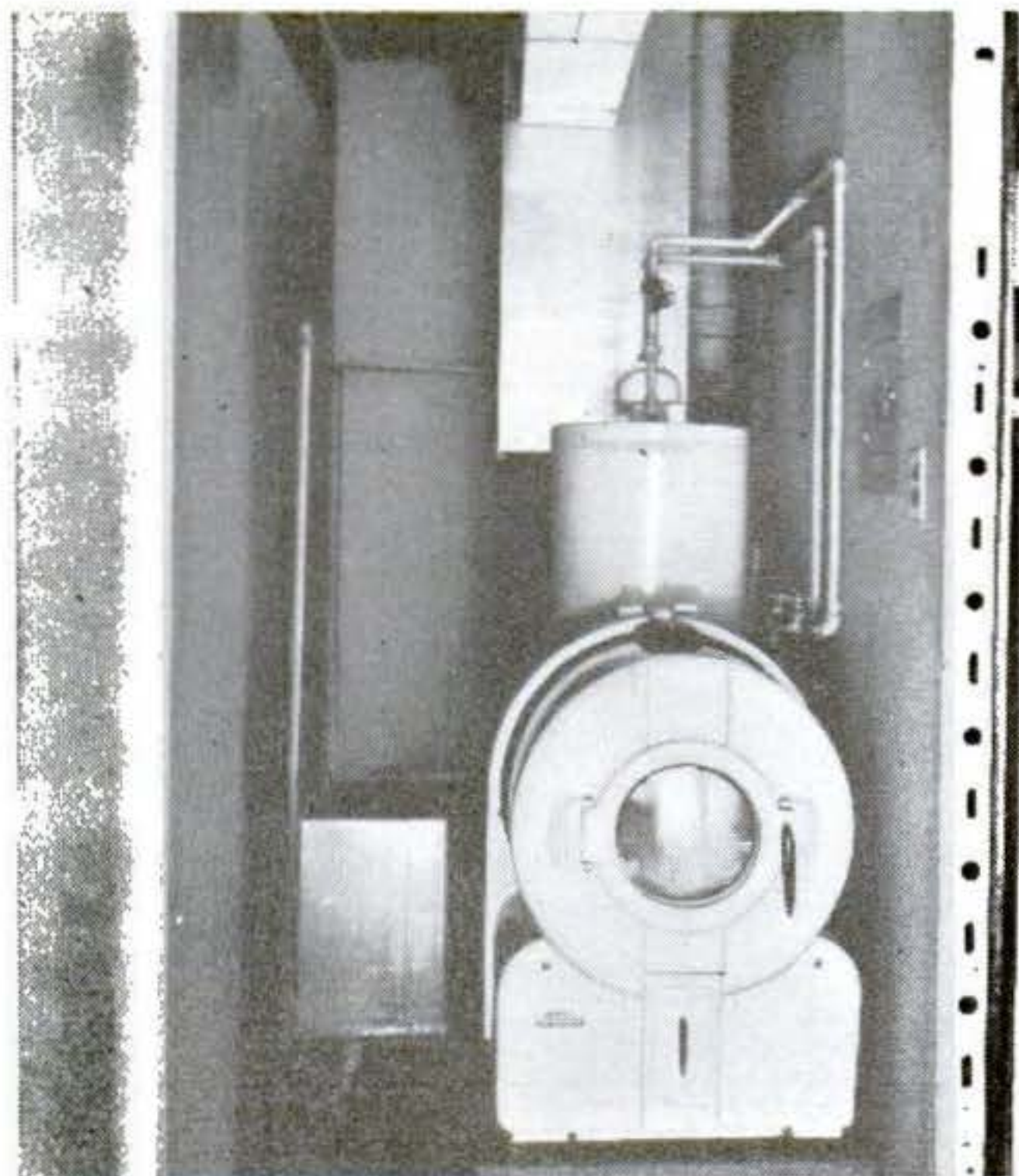

Washing machine, furnace, and hot-water heater are shoehorned into the utility room. If house has basement, the room becomes a stair well.





# WHAT'S NEW in AVIATION

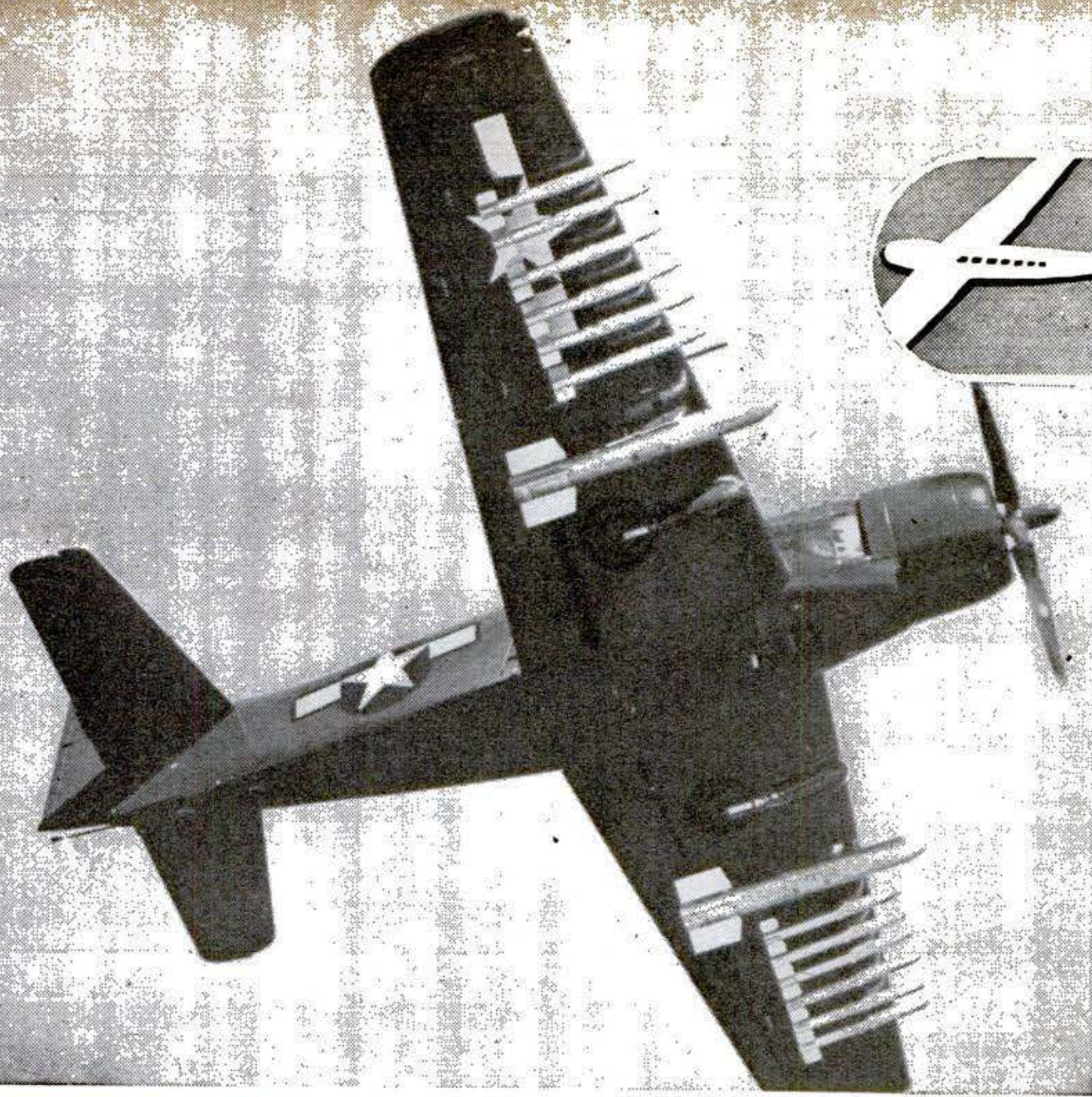

**Rocket Raider.** Packing the firepower of a broadside from the guns of a light cruiser, the Navy's first Douglas AD-1 Skyraider is shown at left with batteries of five-inch and 12-inch rockets under its wings. This new type of seagoing attack craft can carry 6,000 pounds of munitions on long flights.

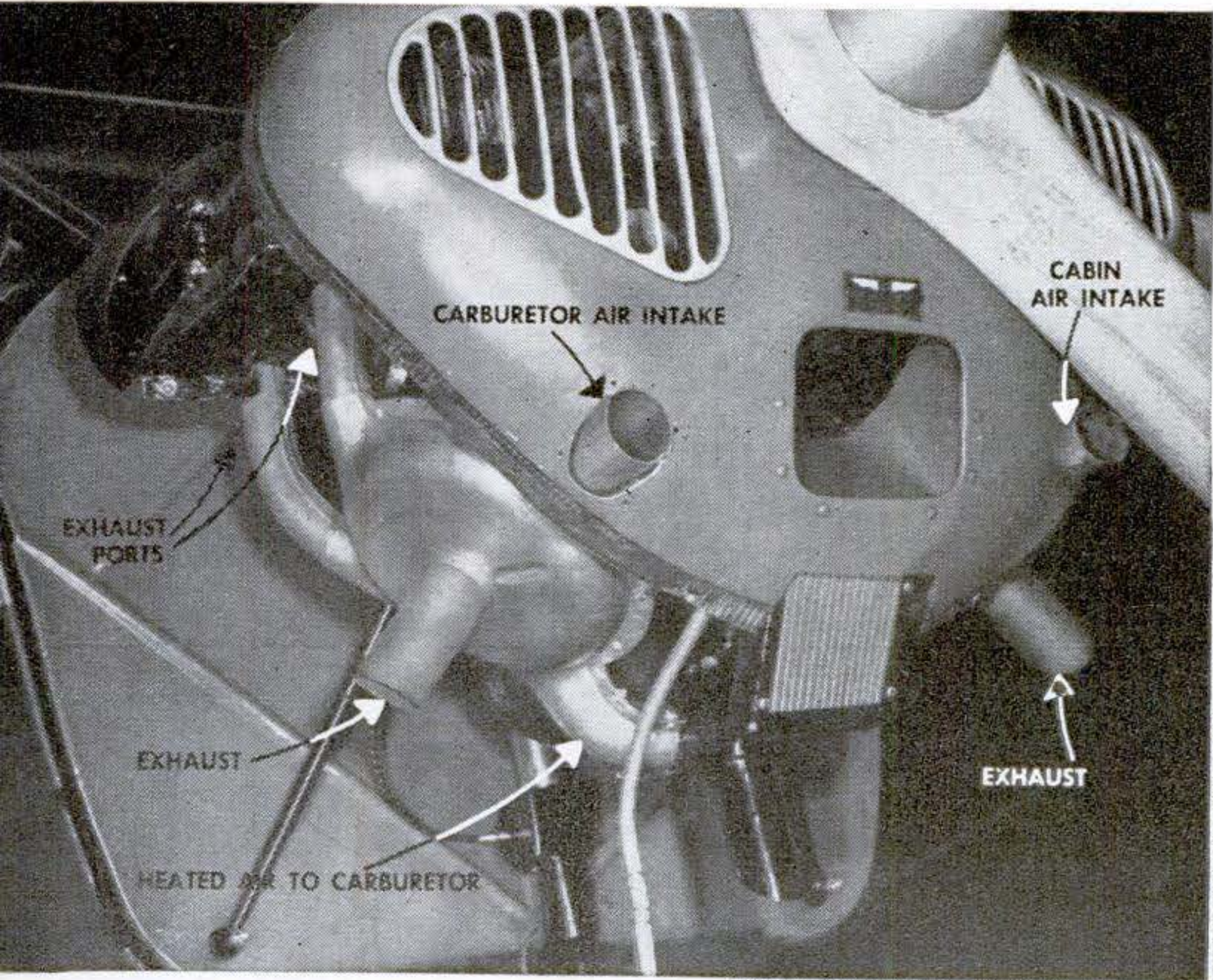

**Ear-Saver.** The eight-pound muffler at left forms a complete exhaust system and swallows 90 percent of aircraft engine noises. Developed by Ryan Aeronautical Co., it is designed for planes powered by 65-85 hp. engines. The system heats carburetor air and also directs warm air into the aircraft's cabin.

**Sway-Back Prop.** Swept-back blades (right) feature Curtiss-Wright's new propeller, designed for use on future Army planes that may rival turbo-jets in efficiency at speeds up to 700 m.p.h., with much greater efficiency at lower speeds.

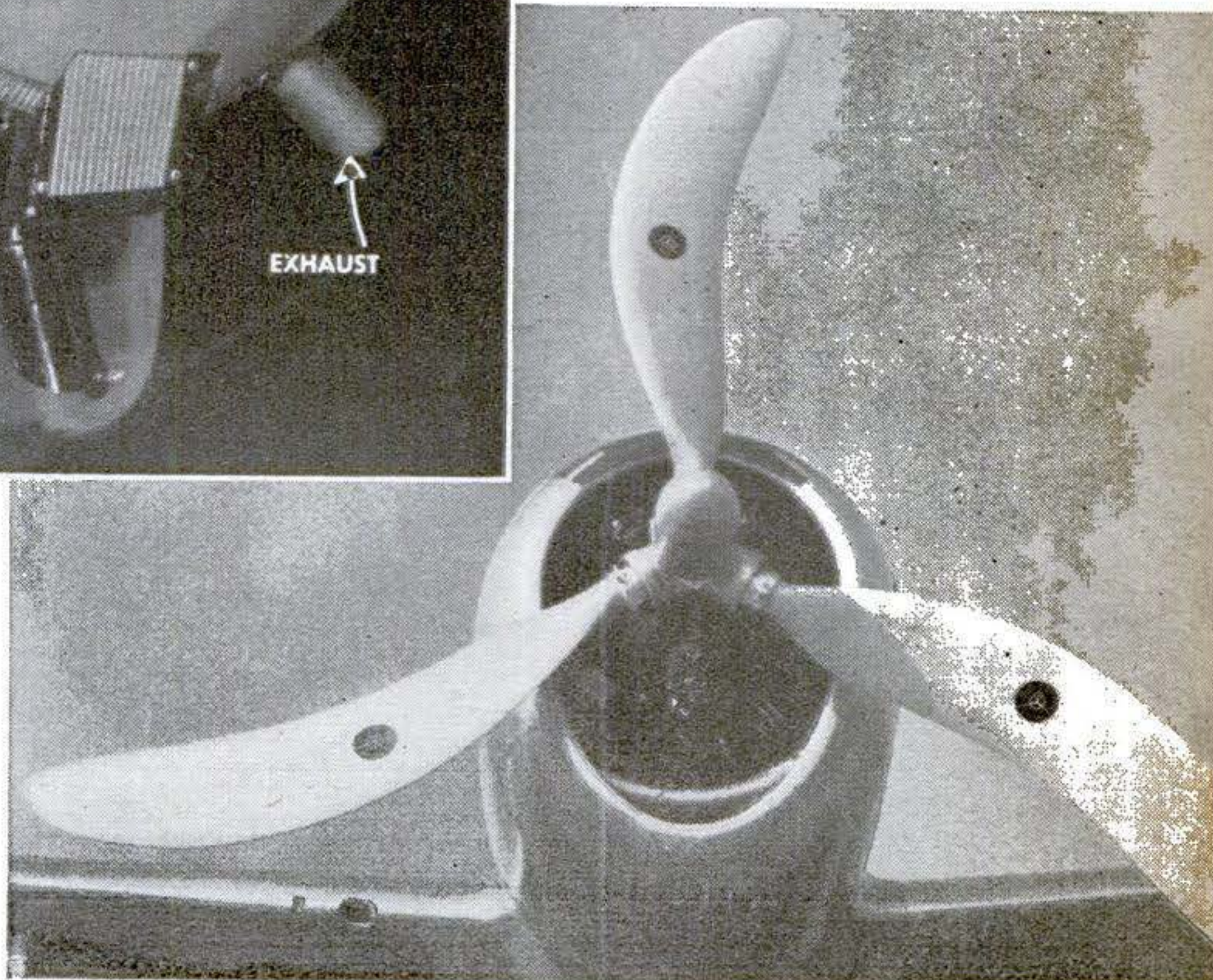



## WHAT'S NEW in AVIATION

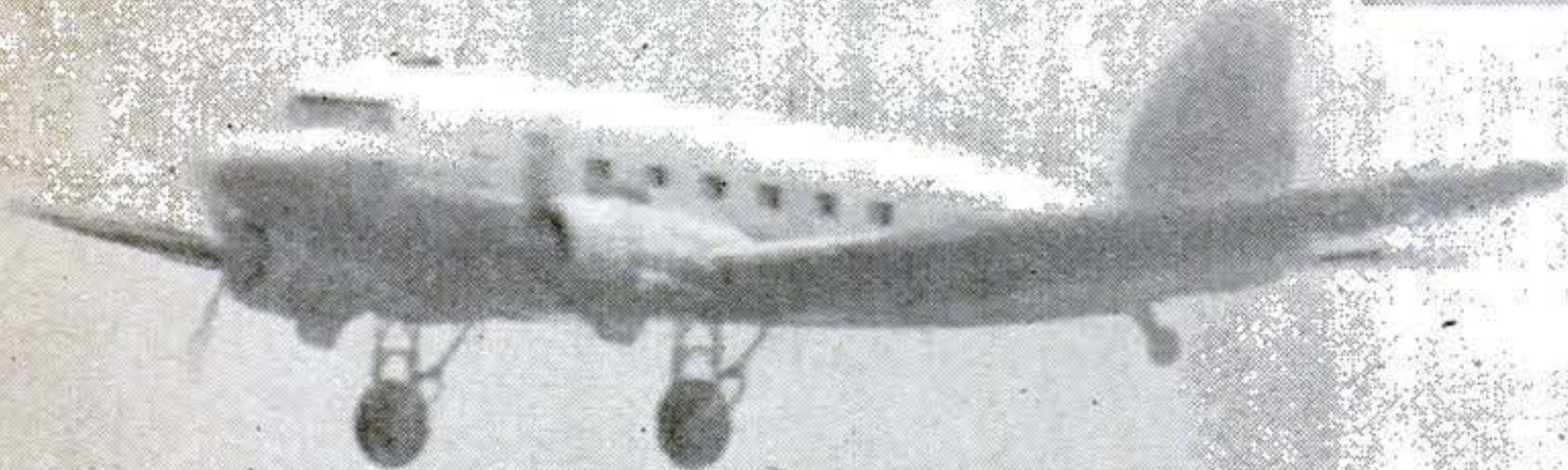

Gliding out of a fog and into fair visibility, a C-47 prepares to land at the Navy's Landing Aids Experiment Station, Arcata, Calif. The flames burning off the mist are part of a new fog-dispersion system called ELMER—a refinement of Britain's wartime FIDO.

At a central control board, an operator turns on lights and fog-chasing burners at Arcata. ELMER has cut the costs of landing a plane in a fog to \$150 as compared with the \$4,000 average expense of using FIDO.

ELMER, in full glory below, is a line of tri-nozzle heads that atomize Diesel oil under high pressure and shoot curtains of flame into the air on both sides of the runway to vaporize the fog. A hot-wire setup provides instantaneous ignition of the oil.

# NEW TRICKS for FIDO



Most unusual medium used in fog-dispelling is sound. Fog particles bombarded by sound waves collide, form heavier drops and fall as rain. Recently, however, the noise of a battery of 12 sirens nauseated personnel. Now the Navy thinks it can beat this with ultrasonic waves that humans can't hear. At right is a generator and horn built by Ultrasonic Corp.

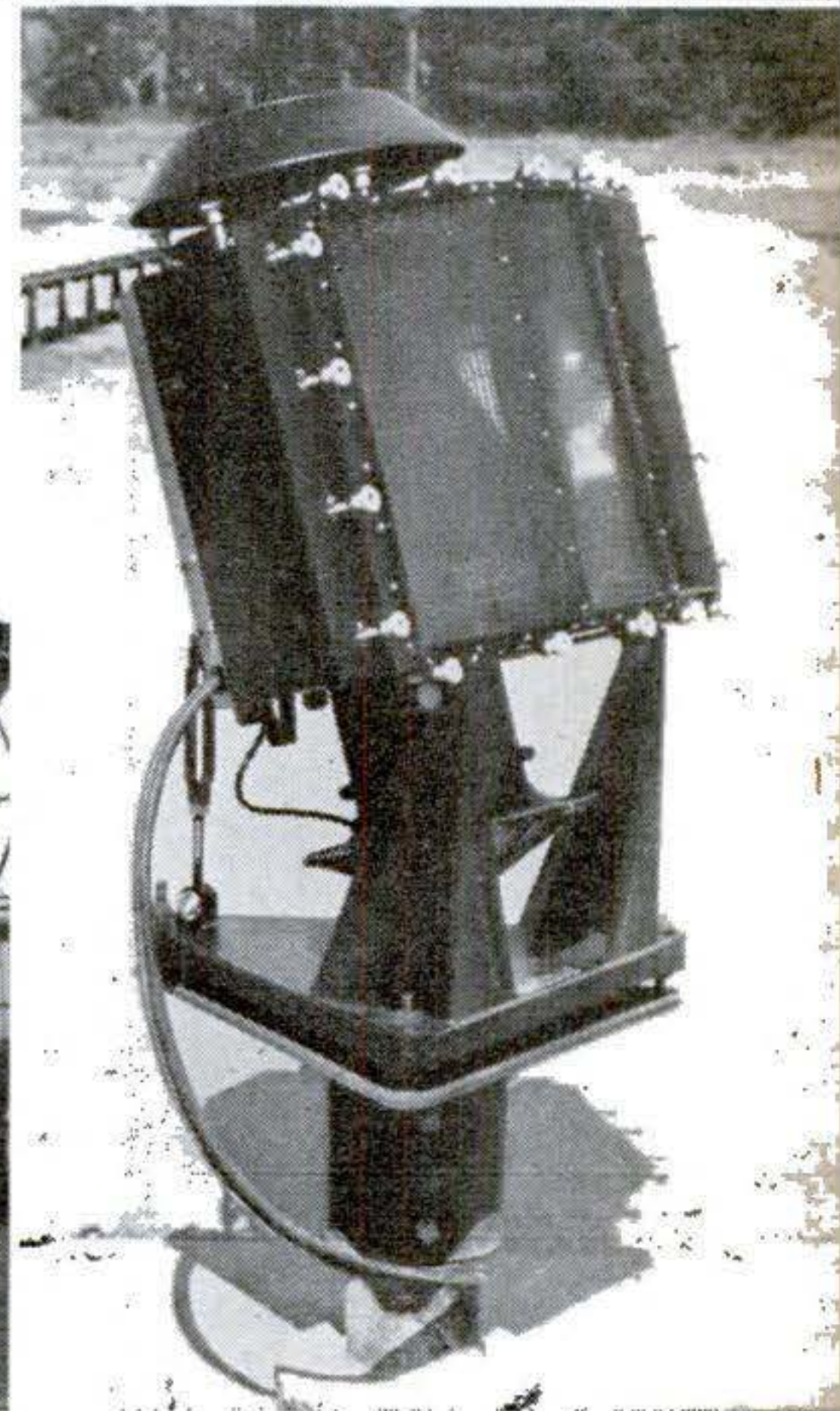
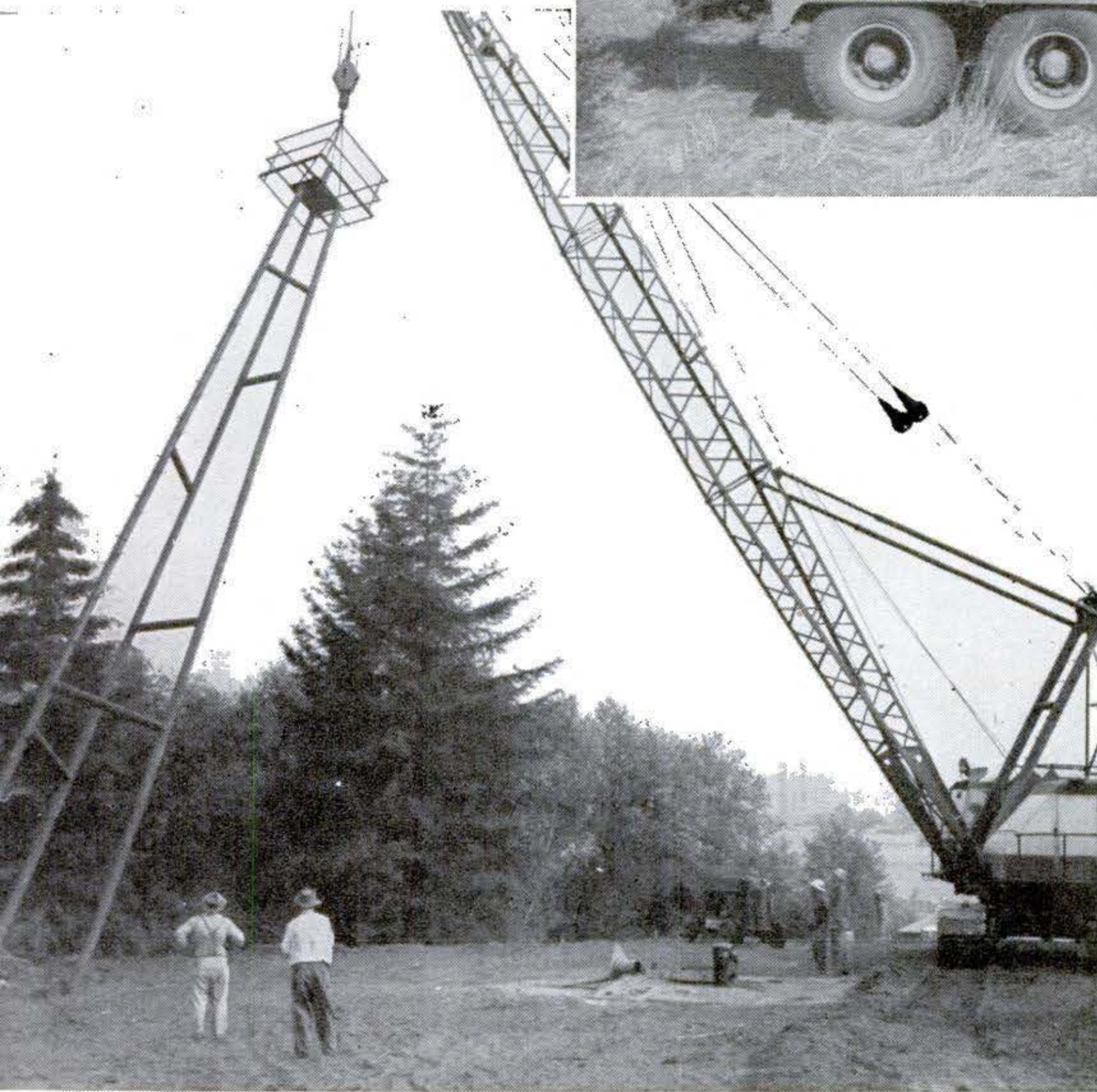
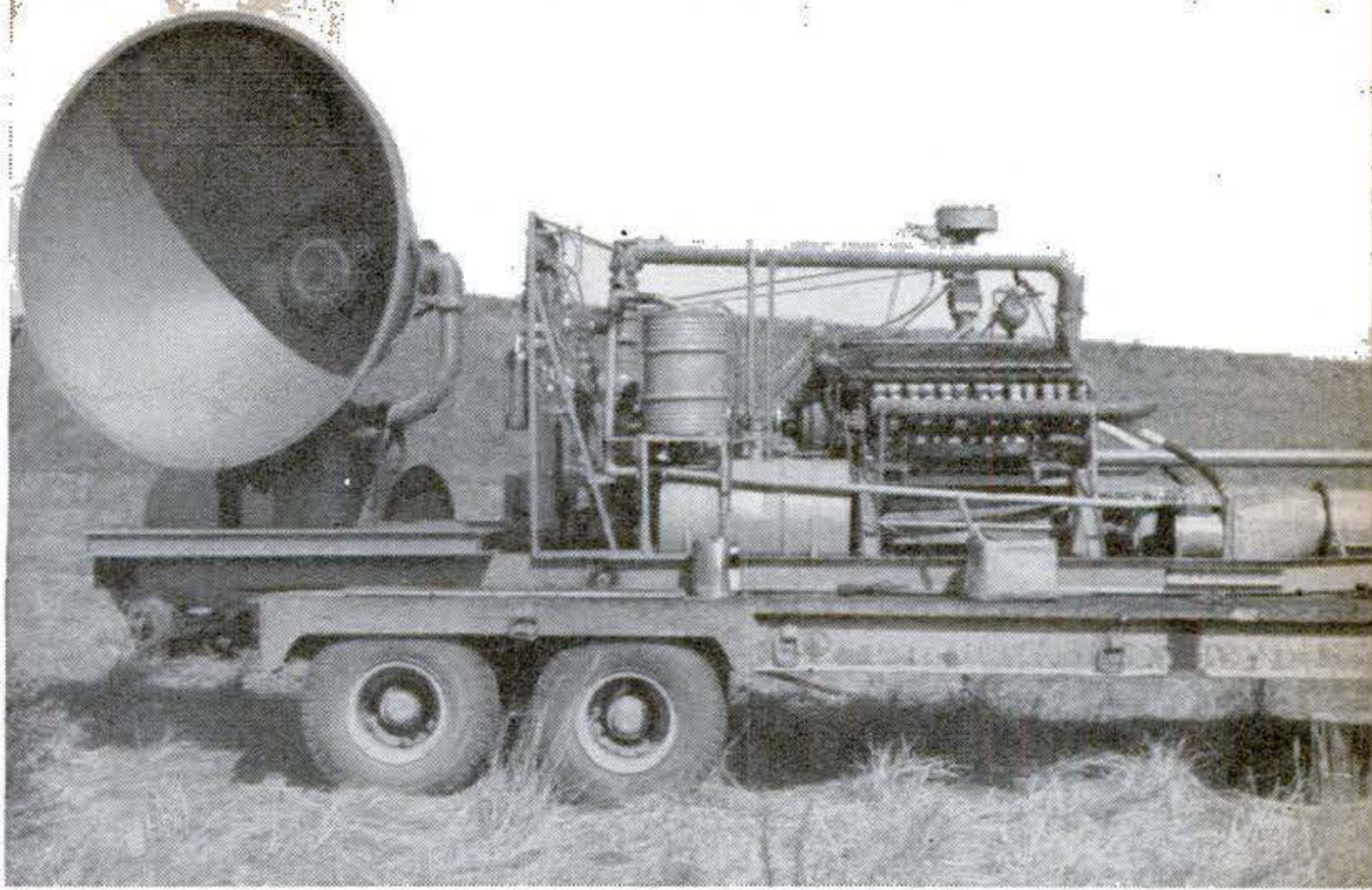

Fog is also being routed by light. Workmen above raise one of 38 towers carrying approach lights at Arcata. The 75-foot tripod standards are arranged in two rows of 19 each along a 3,500-foot approach

zone. They give the Naval station the most brilliant airport lighting in the U. S. Above, right, is a 5,000-watt American Gas Accumulator Co. light, one of which is atop each of the towers.

## Improved weapons enter the battle against airport fog.

**F**LAME, sound, and electric lights have all been drafted in the latest skirmish of the endless fight against the airplane's arch foe—fog. At Arcata, Calif., where the Navy has its Landing Aids Experiment Station, the Navy, Army, and United Air Lines are constantly improving on FIDO, the vaporization of fog by heat. FIDO (Fog Investigation and Dispersal Operations) was

initiated by the British during the war.

Even as they explore the possibilities of fire, light and sound, Government and commercial forces seek other new anti-fog weapons. Experimental curtains of wind and 100-foot screens of water are to be thrown up alongside runways. Drying agents will be tested. The battle will go on until our airports win freedom from fog.





**Dishing Up "Dirt."** Is restaurant dishwashing dangerous? The National Sanitation Foundation was worried about it and enlisted the scientific resources of Michigan State College to determine just how great a threat these methods are to public health. At left, Dr. W. L. Mallman, public health professor, prepares an artificial concoction containing food products similar to those found on dirty dishes. It was used to coat china for the tests.



## Scientific Dishwashing



**Watching the Wash.** One conventional way in which cafes wash dishes is to place them in wire racks where they are then flushed with sprays of water. Above, Paul De Koning, associate professor at Michigan State, watches a machine do its stuff.

**Tattletail Germs.** By counting bacteria cultures, Dr. Mallman (left) found that machines wash dishes better than the human hand. However, he warns against dirty machines, improper loading of racks, too little cleanser, and low water pressures and temperatures. He recommends a 40-second wash in 140° F. water and 10-second rinse at 170°.





**Gridiron Oxygen Tank.** Outfitted with 11 masks, the rolling oxygen tank above can reduce fatigue for an entire football team during time-out periods. It was used by Georgetown University during this past season. Tried on backs after long runs, the oxygen was found to restore normal breathing in 30 seconds.

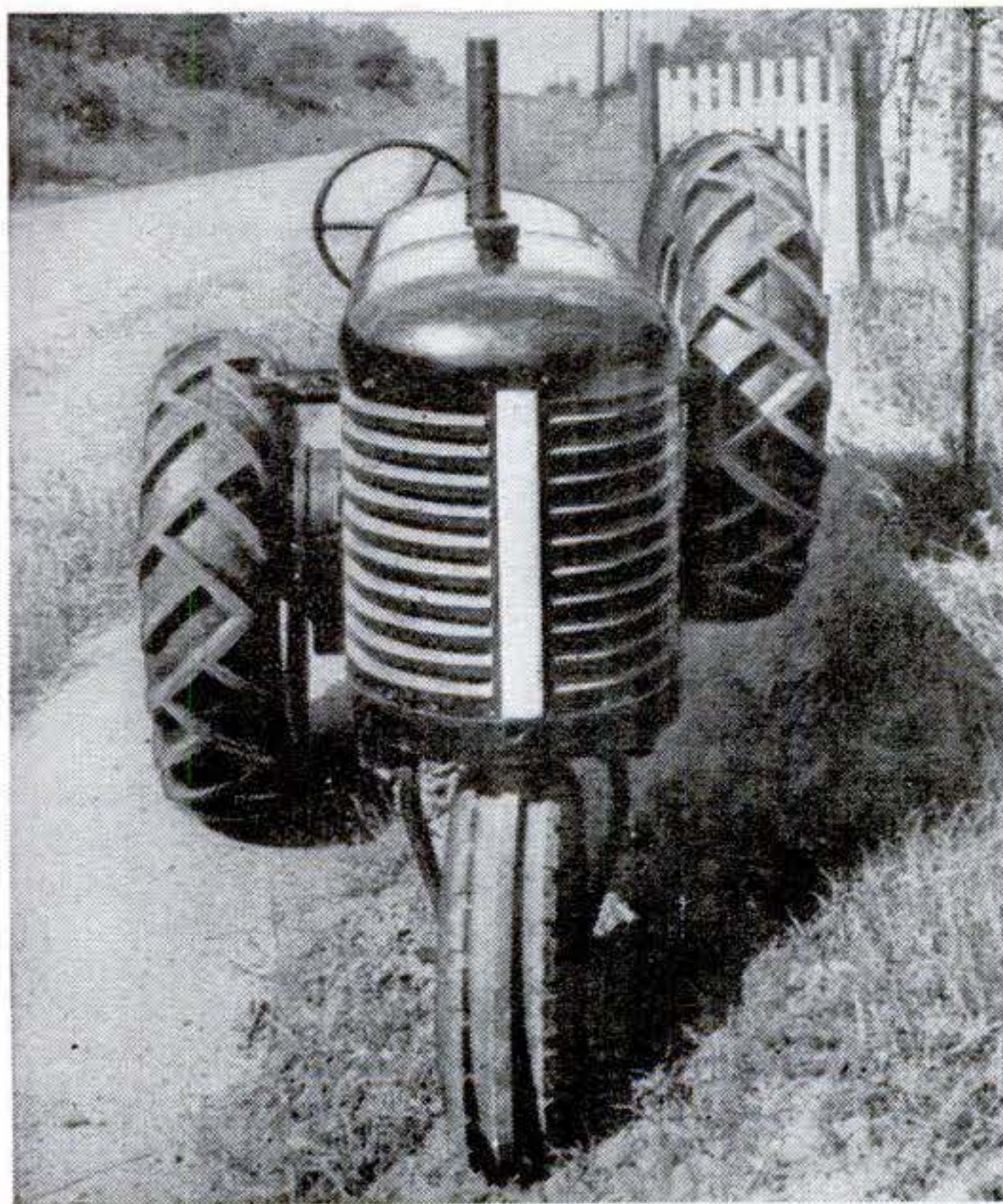

**Sidehill Gouger.** That mythical animal comes to mechanical life in a new tractor built by L. C. Burton, of Akron. Its wheels automatically adjust to grades as steep as a drop of two feet in three. To do this, two differentials are housed one within another; the first to drive the rear wheels, the second to level the tractor.

**Fuselage Fueler.** The shortage of building materials didn't faze Byron Chedester and J. E. Franks, of Fort Worth, Tex., when they wanted to go into the gasoline service station business. They simply bought the body of a Conestoga plane—engine and instruments removed—and opened up. The plane cost the pair \$500; the moving, \$100.

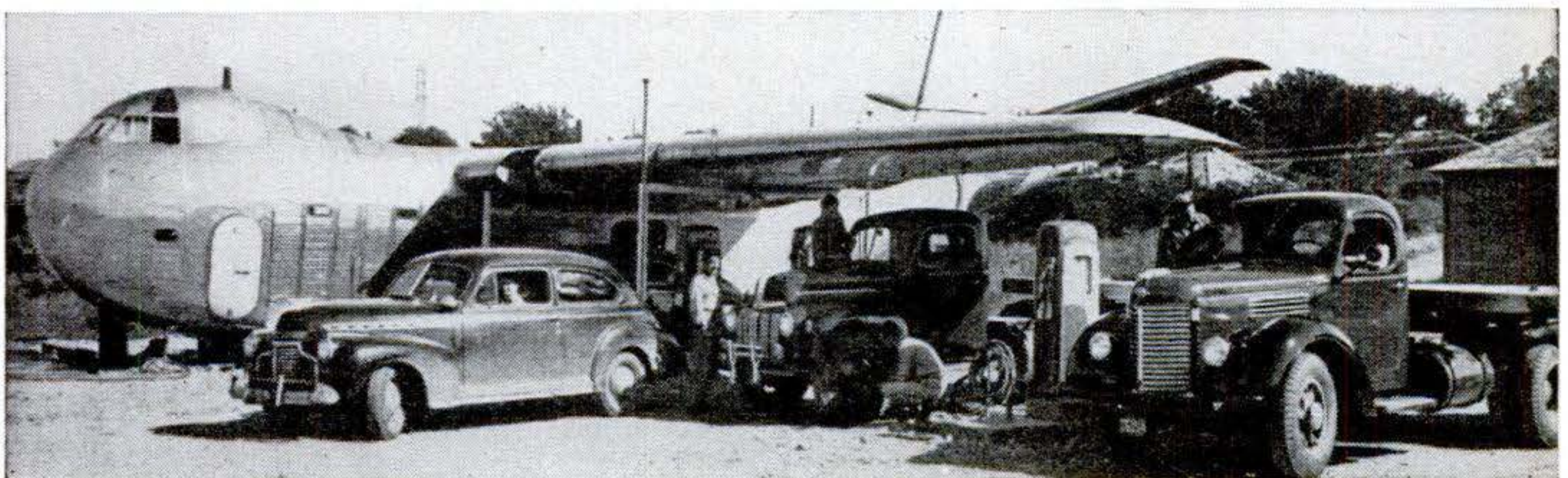



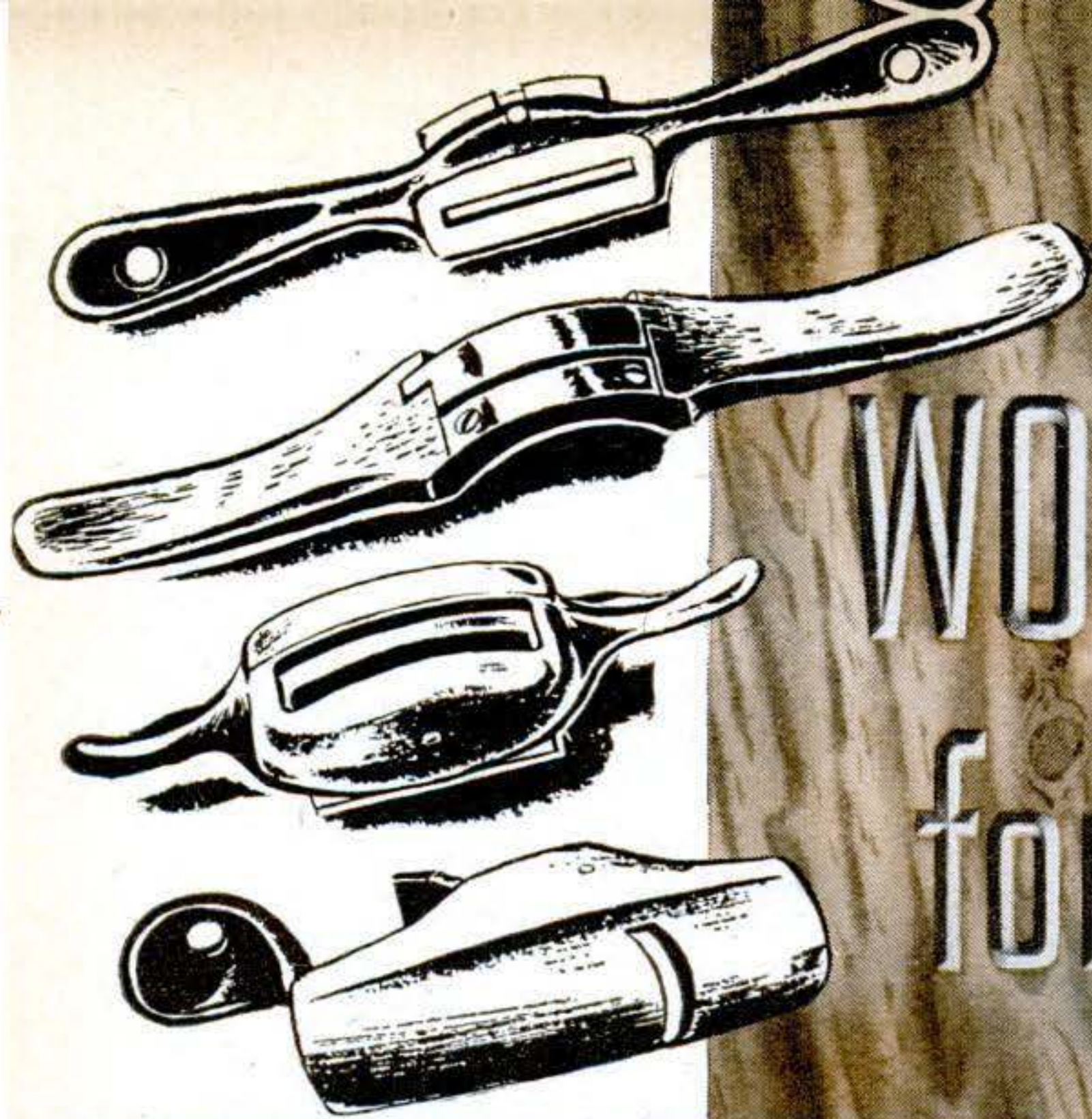

# WOOD CARVERS for the AIR AGE

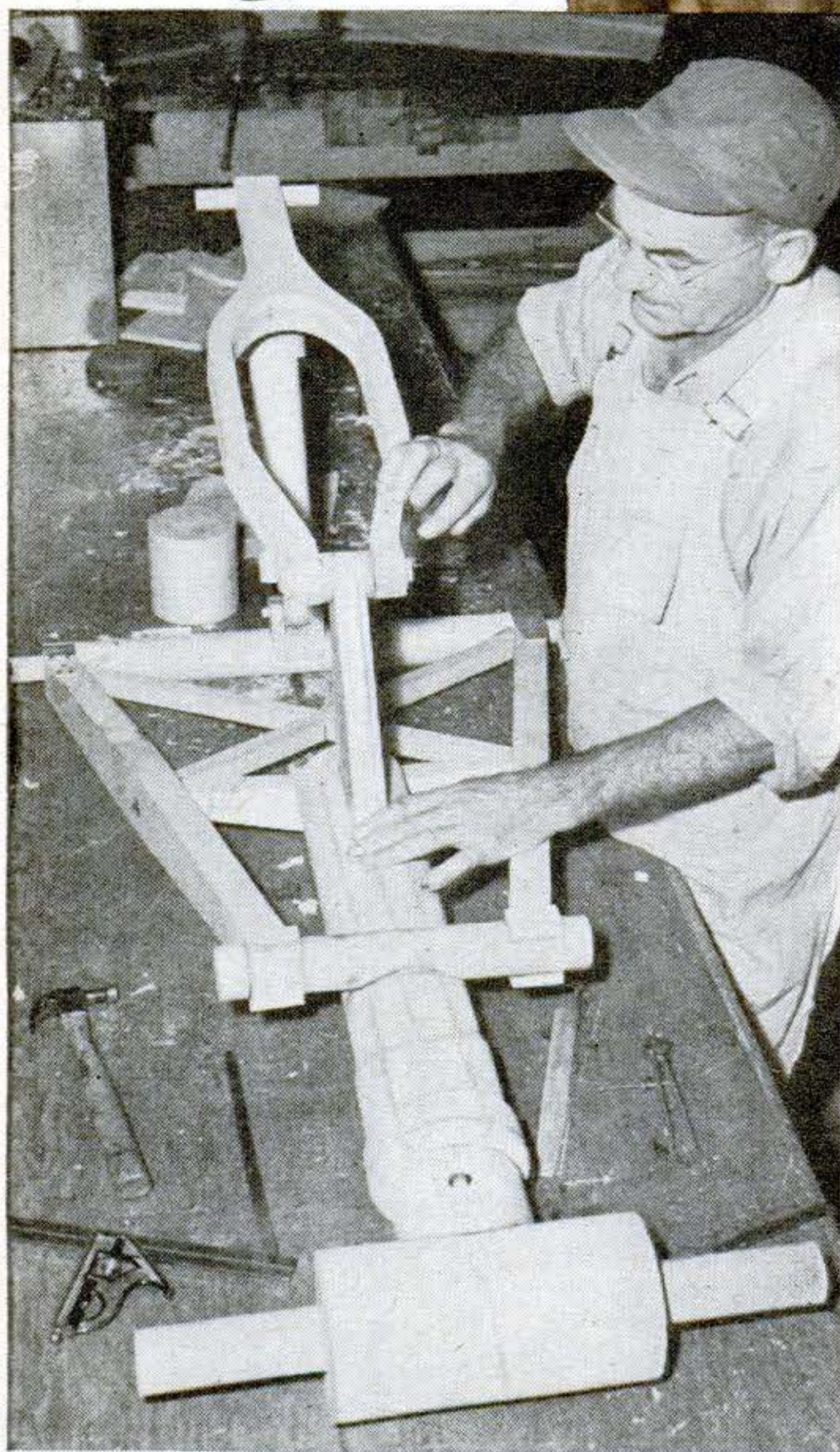

Thirty-five pine and plywood parts, with tolerances of 1/10,000 inch, went into this model of a nose-wheel strut for a secret plane. The woodworker is Fred Molle, Northrop veteran. At top of page are four of an aviation carpenter's most important tools. From top to bottom, they are: straight-edge and rounded-edge spokeshaves, pattern-maker's spokeshave and round-bottom plane. Last two are used for roughing out work, first two for finishing it.

EVERY plant that builds airplanes, from the tiniest single-seater to the mightiest air liner, relies on a small group of skilled carpenters to translate engineering drawings into three-dimensional reality. Artisans in wood, they play an increasingly important role in an air age that depends on metal for its advancement.

When designers complete blueprints for a new plane, they turn to these carpenters for faithful models of its intricate parts and assemblies. And the woodworkers, blending shop trigonometry, imagination and the skill of their trade, create the forms and patterns from which metal parts of the plane are later made. With chisel and spokeshave they fashion air ducts, landing gear units, valves, airfoil shapes, engine accessories and scores of other parts.

Some of their work can be rough, but other models and dies contain up to three dozen parts and must be built to tolerances as close as 1/10,000 inch. Since different jobs require different materials, the woodworkers have to know whether to use maple, pine, birch, walnut, mahogany or the versatile plywood, or combinations of them, for a specific task.

Most of the woodworkers are young men, able to adapt their skill to the rapidly advancing art of plane design. The pictures on this and the following three pages show how well that skill is applied.





Running a band saw along lines photographed on an emulsified panel of plywood, Harvey Boston, of Douglas, shapes a lofting section, used in establishing a plane's contours. Plywood is sealed and painted before the emulsion is applied.

Ted Weimer, of Douglas, fairing a skeletoned check jig to its mold lines with a straight-edge glass spline to eliminate any bumps or hollows. The finished part carries air to a carburetor.



Pattern-maker's spoon, a development of the carving chisel, is used by Sid Gladwell in cutting out a line on the mahogany pattern of a carburetor intake duct designed for the Lockheed Saturn.

Gladwell checks a mahogany model of large air duct with metal template to insure accuracy. Mahogany holds its shape well, with little shrinkage, and is easier to work than pine despite its toughness.

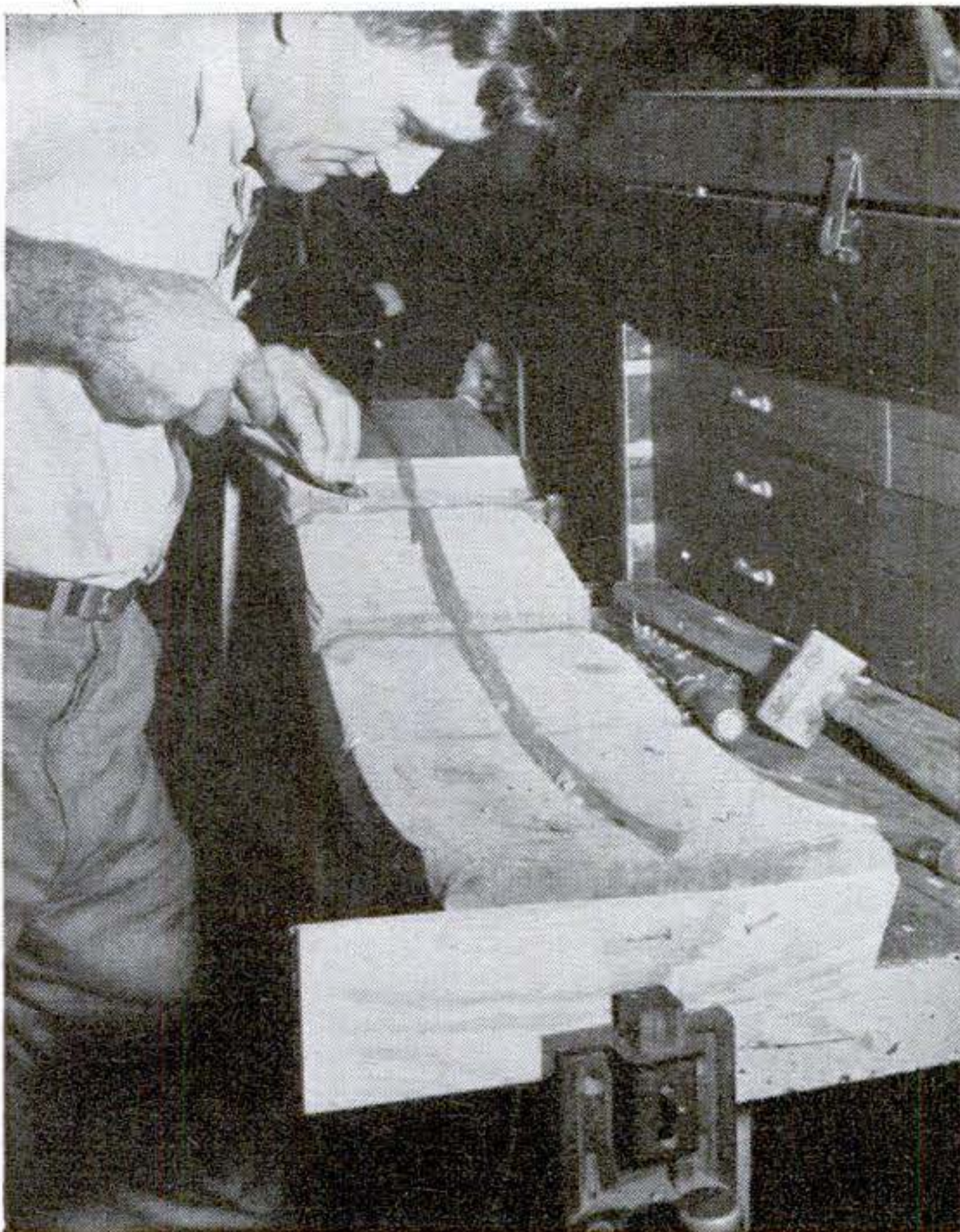



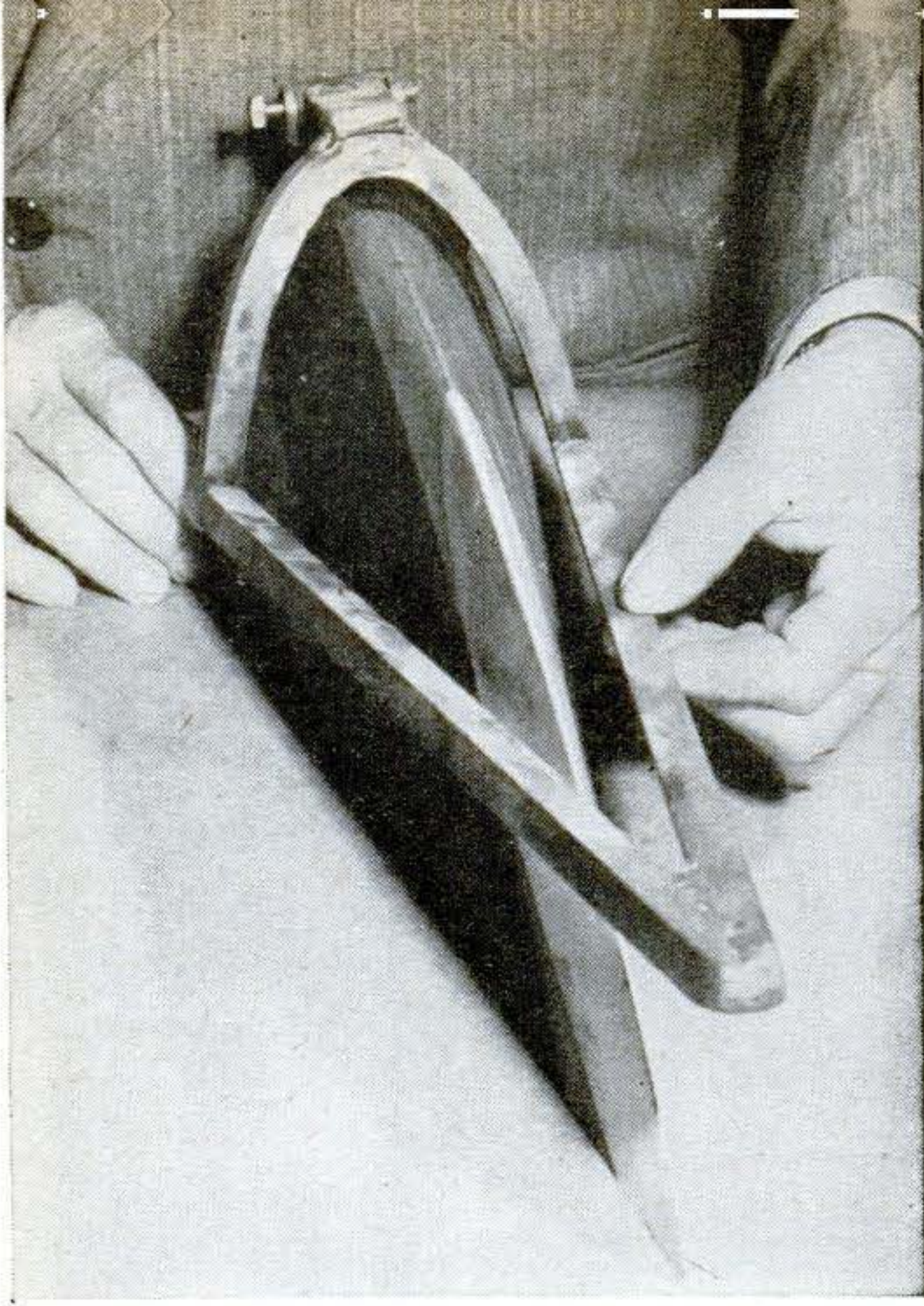

Wooden forming die and metal gate, tipped with aluminum, is used to form plastic wing tip of a small plane. The wood part is made of birch, which has largely replaced maple in aviation woodworking.



Art Russo, of Northrop, wields a fine-toothed rasp to smooth white-pine tail section of a droppable gas tank. The maple cone at right is a copy of the nose of an air-duct diffuser.



Newest lightweight plywood has mahogany surfaces and a plastic honeycomb core, called micarta. At left, a hand-guided electric router cuts channel through a panel of the material, which is used to form such models as the stairwell and bannister, below, of Lockheed's huge Constitution. The mahogany surface of the new plywood provides an extremely smooth finish that takes lacquer well.

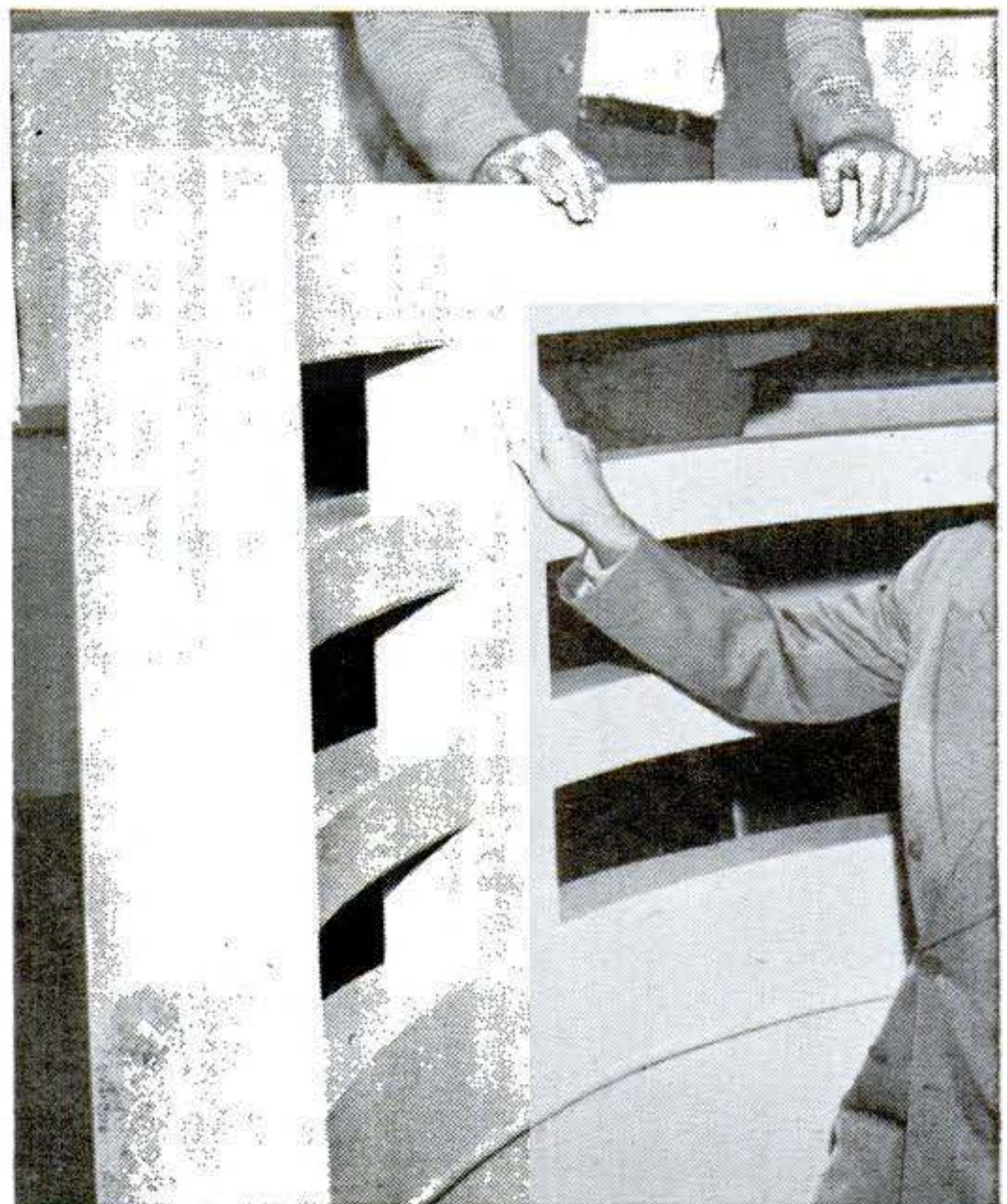





A dozen pieces of sugar pine were put together with waterproof glue to form this model of the Lockheed Saturn's carburetor intake valve. Engineers use the model in making clearance studies of accessories.



Using a 1/2-inch bent-shank carving chisel, Northrop's Stanley Ton smooths plywood bracket on a reproduction of oxygen pressure regulator. Other parts of the complex assembly are made of white pine.

Lynn Covington, of Northrop, makes a final check of wooden gunsight model being prepared for a bomber. Painted black to resemble its metal counterpart, the model enables designers to plan working layout before final assembly of the airplane.

Covington fits precision-made wood assemblies into a prototype airplane's radio compartment. By thus simplifying details of arrangement, the aviation woodworkers' creations save time, money and effort—and assure greater efficiency in new planes.

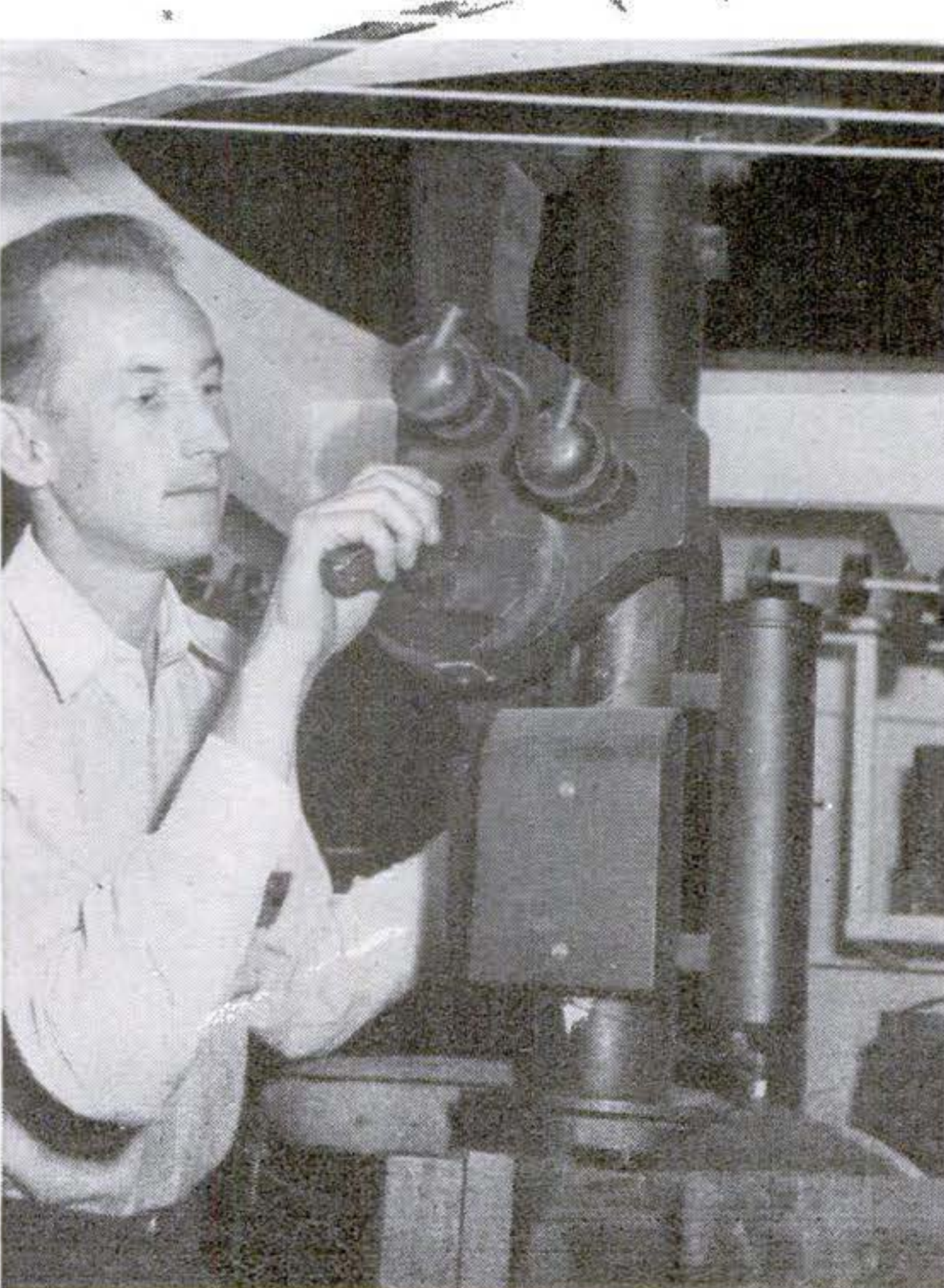



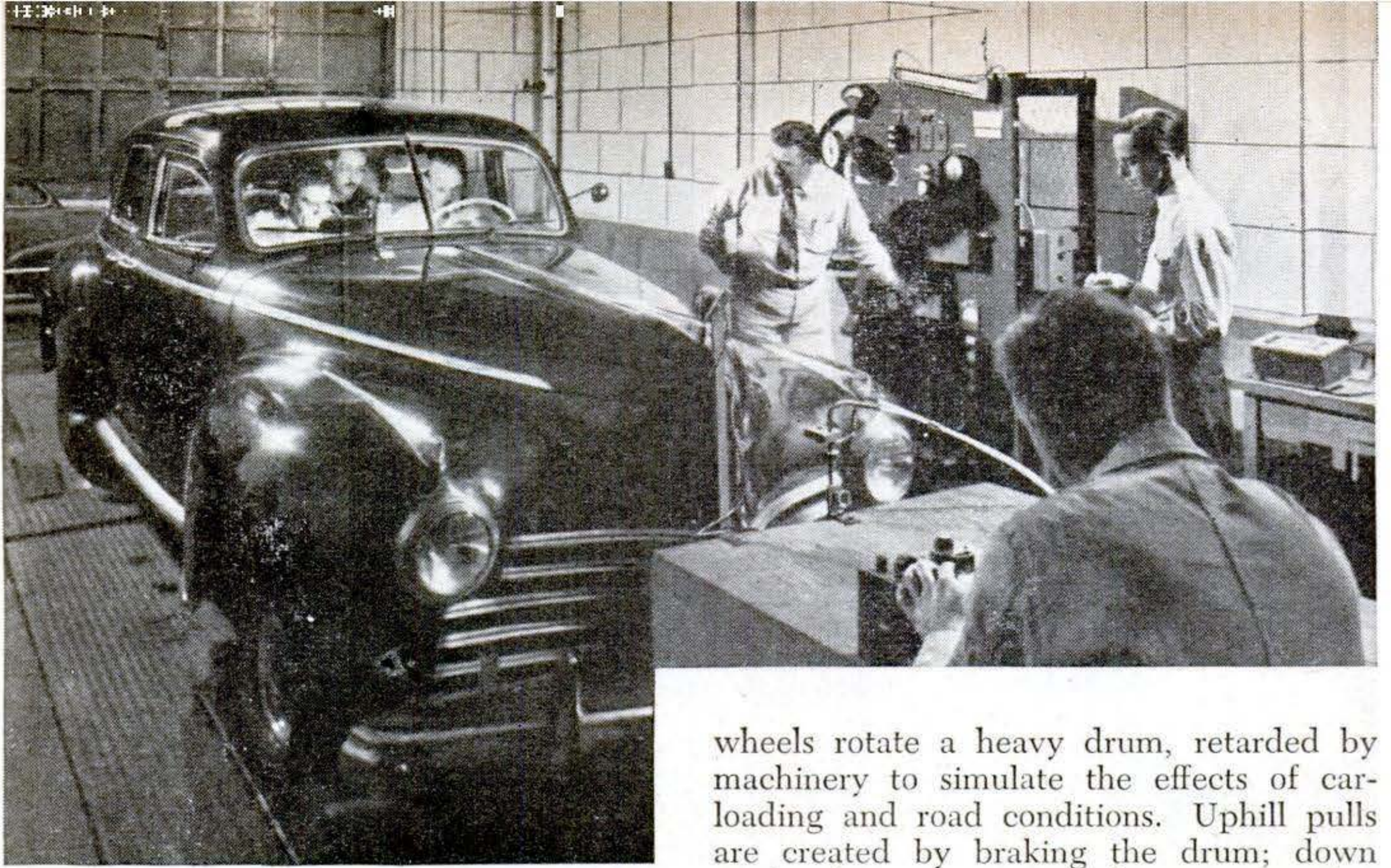

**Roadless Road Test.** To test new gasolines, Gulf Oil Corp. has installed a "highway" in its Harmarville, Pa., laboratory. The front wheels of the car are chocked on a road-test dynamometer. The rear

wheels rotate a heavy drum, retarded by machinery to simulate the effects of car-loading and road conditions. Uphill pulls are created by braking the drum; down grades, by cutting in an electric motor that helps rotate it. A fan blows wind at the car at its assumed speed. The "driver" calls off mileage. Man in back seat records findings. Elimination of variable factors found in real road tests increases accuracy.



**Slow-Leak Tube.** For greater safety, the U. S. Rubber Co. has designed a new inner tube (above) that curbs rapid deflation in case of a puncture. The tube's secret lies in a wafflelike crown whose square pockets contain extra butyl rubber. When the tube is punctured, this rubber presses around the piercing object.

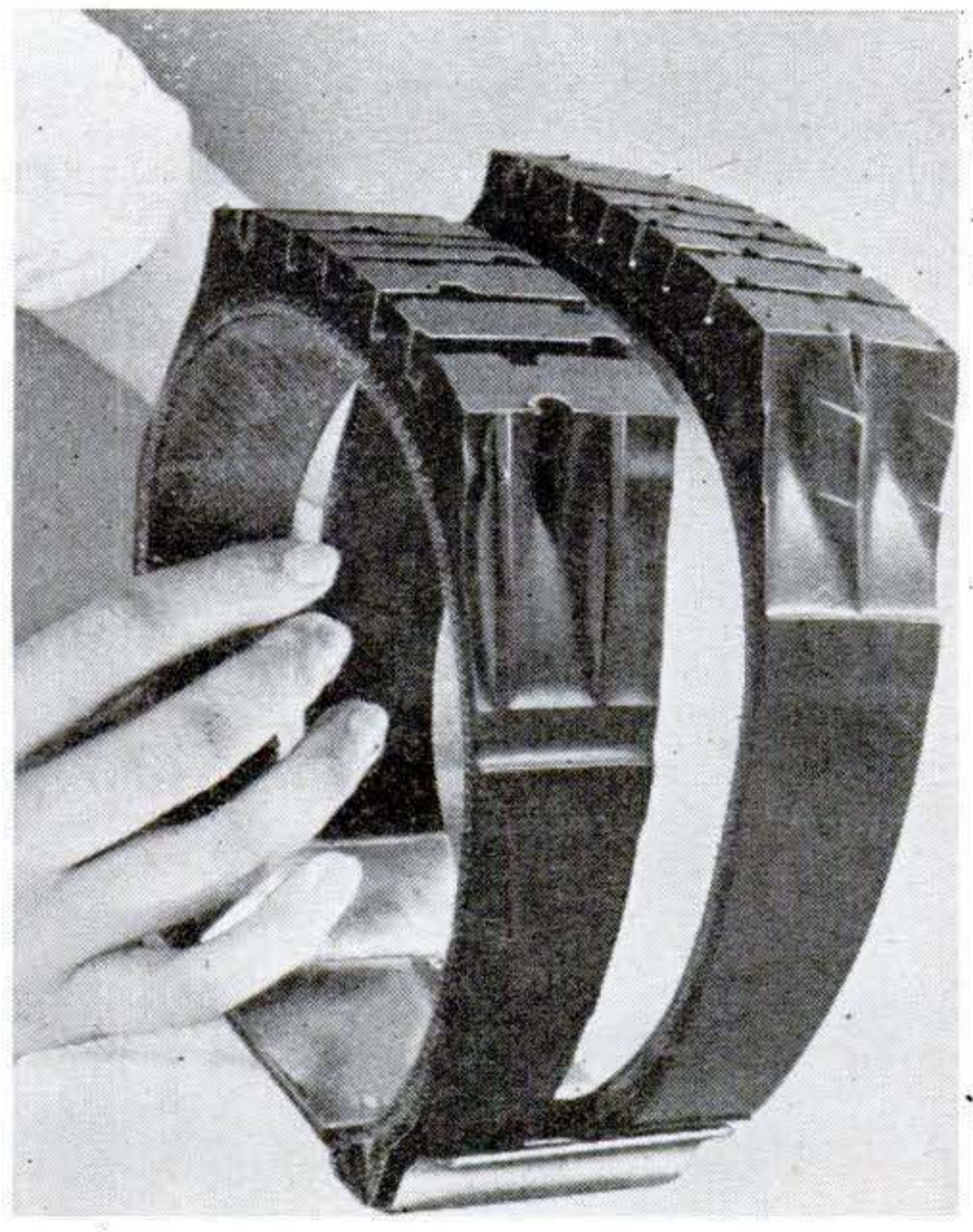

**Air-Bubble Tire.** Lighter and tougher is the new air-bubble tire produced by the U. S. Rubber Co. Designed for 14 percent more air volume and eight percent lower pressure, its flatter tread and sharply defined shoulders use less rubber—sharply cutting road heating. A section of the new casing is shown at right above; at left, the old.



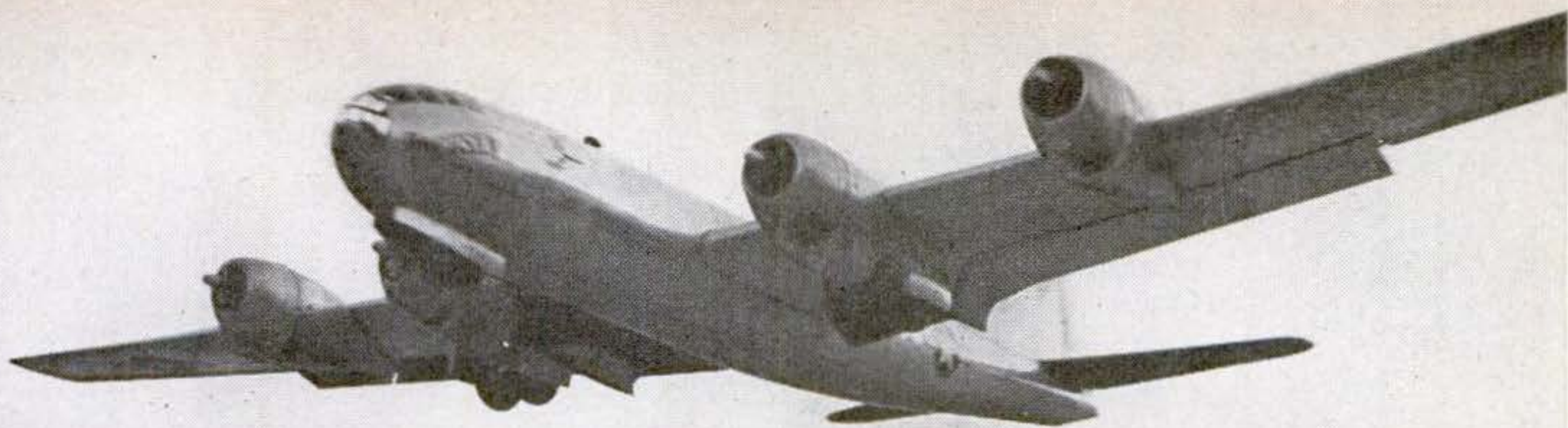

# Inside the Dreamboat

More planning than flying went into the Army's long hop over the top of the world.

At 5:51 a.m., local time, on October 4 the Boeing Superfortress "Pacusan Dreamboat," under command of Col. Clarence S. (Bill) Irvine of the Army Air Forces, took off from the island of Oahu, Hawaii, for a flight over the top of the world. Less than 40 hours and 9,422 statute miles later it touched down at Cairo, Egypt.

The Dreamboat had proved that routing tomorrow's air traffic across the Arctic—using the shortest distances between most points on the habitable parts of the globe—was practicable. Nor was the flight without military significance. "He who rules Alaska," said the Air Corps' immortal Billy Mitchell, "rules the world."

Here is the inside story of the Dreamboat's flight as told to Popular Science Monthly's Devon Francis by five members of its 10-man crew.



**Col. Clarence S. Irvine,** of St. Paul, Nebr., pilot: We knew our approximate take-off time. It had to be between 5:30 and 6:30 in the morning. That was because we had to leave the ground *with* the prevailing wind instead of

upwind, and the lowest velocities occurred at that time of day. If we took off upwind, we would pass right over the city of Honolulu,

**PSM** FEATURE  
EXCLUSIVE

with mountains in front of us. We couldn't take that chance, heavily loaded as we were.



**Richard B. Snodgrass,** of Seattle, a civilian and chief engineer: The weight of the airplane at the start of the flight was approximately 148,500 pounds. That's about five tons more than the Superfortresses grossed during

the war when they took off to bomb Japan.

**Colonel Irvine:** But we weren't worried. We had planned this flight for too long a time, and we knew exactly what we were to do in any contingency. By building a piece of runway 100 feet long, we had linked up the Navy's John Rodgers Field and the Army's adjoining Hickam Field. That gave us about 13,000 feet in which to get off the ground. I had posted markers along the runway at each 2,000-foot mark up to 12,000 feet to judge distance at high speed. The markers were check points. We had to be sure of where we would get airborne.





**Lt. Col. Beverly H. Warren**, of Plainview, Tex., and Omaha, Nebr., co-pilot: Our minimum calculation at the start was that we would be airborne at 5,600 feet. That took into account the weight of the air-

plane, the rolling friction on the asphalt runway, and the drag against our thrust horsepower available. We figured we could do that if we held the brakes, ran the engines up to full power, and then released the brakes.

But when we tried it in practice flights the propeller torque threw us off directionally just as we started rolling. It was impossible to get the airplane pointed down the runway again without using brakes. That cost us speed. So we decided to start right out from zero and use the throttles to maintain direction. We figured that would cost us another 1,000 feet of runway. We added 1,000 feet to that for the human element, and arrived at the conclusion that we would be off the ground in 7,500 feet.

**Colonel Irvine:** We knew that we could lose an engine on take-off at the 6,000-foot mark on the runway at an indicated airspeed of 145 m.p.h. and still get airborne on three engines at what we estimated would be 155 m.p.h. If we lost an engine on take-off the procedure called for gaining some altitude, dumping gasoline from tanks in the bomb bay, burning more gasoline for an hour, and coming back to land approximately 25,000 pounds lighter than we were at take-off.

If we lost an engine under the 6,000-foot mark, we could come to a stop before reaching the end of the runway, and without using the brakes, by reversing the pitch of the propellers. I had reversible propellers installed for just that reason.

**Colonel Warren:** We sat there at the end of the runway with the engines ticking over. I had run them up, and we were squared away for the take-off, facing the length of runway No. 26. I turned around and said to the crew, "Here we go!" Then I opened the throttles.

We had a four-mile wind on our tail. The flaps were down 25 degrees, which is normal. The airplane felt good as we gained speed. We had the trim set exactly where it should be for fore-and-aft balance. That, I must say, was accidental. It's hard to figure trim. It

was a very short time until we had full power on. That was 2,800 revolutions on the engines with 52½ inches of manifold pressure.

It was at about 2,000 feet of our run, maybe 2,500, that the least back pressure on the control wheel brought the nose wheel up just enough to clear the runway. I just held it there until the airplane flew itself off. It came off smoothly and cleanly. I don't think anyone in the plane actually knew the instant when we left the ground. Our indicated airspeed was 148 m.p.h. We had consumed 6,500 feet of runway. The controls felt firm, not soft.

As we lifted off I turned to Colonel Irvine and said, "Bill, this is no different from a thousand other take-offs we've made together."

He replied, "If you ever had a take-off in your system, this was the time to do it."

We got the landing gear up and pulled up the flaps very slowly, meantime gradually reducing power. We were climbing gently as we rounded the southwest end of Oahu.



**Maj. Norman P. Hays**, of Seneca, Mo., navigator: We held the take-off heading for a few minutes as the airplane gained speed. The directional gyro was set. It was checked with the astrocompass. We used

dead reckoning from the point of departure to the point of first climb. Then radio-compass fixes were obtained.

**Mr. Snodgrass:** We pulled 1,450 horsepower from each engine at the start of the flight, once we were leveled off. That was 72.5 percent of rated power.

**Colonel Irvine:** The flight was going just the way we had planned it. The planning had been the hard part. In attempting a flight over an area where our best information indicated that communications would be undependable and ground-radio aids scarce, and where rescue certainly would be slow in coming if we were forced down, the first requirement was insuring the utmost reliability in the operation of the airplane. This involved two things: first, a thorough training of the crew to get the most out of the plane and its equipment, and exercises in the use of emergency equipment for both water and ice landings; and, second, the en-



gineering preparation. We devoted three months to nothing but engineering calculations.

**Mr. Snodgrass:** We ran fuel flow-power calibration curves for the engines at 1,000, 5,000, 10,000, and 15,000 feet. Torque meters showed us exactly how much horsepower was being drawn from each engine. At a preset altitude we used a given power setting to get an indicated speed, and calibrated that for every altitude and power setting we expected to use. That, of course, had to be refined by calibrations for various weights. We tested the fuel-flow meters, the air-speed indicators, engine thermocouples, and everything else that would have to be calibrated in flight.

**Major Hays:** It looked as though navigation would be something of a problem. There were no charts available of the kind I wanted for polar navigation. In fact, there were few polar-navigation charts at all. So I got a stereographic (three-dimensional) map at a scale of 1:5,000,000. Then a grid was constructed and superimposed on the chart. Greenwich was used as grid North reference. The best available lines of magnetic variation were converted to grid variations and plotted on the chart.

We didn't take along any equipment like Loran. It was too heavy. For the same reason we didn't take any navigation tables. We did take an air almanac and a new addenda sheet for correction of low-altitude refraction. The most important item we took was the directional gyro—the magnetic compasses would be useless. Then, of course, we took two sextants for sun and star sights.

**Colonel Irvine:** We did a lot of things to the airplane. In addition to installing bomb-bay tanks, we replaced two center-section regulation tanks with nylon cells to save weight. We installed a special fuel system. We fixed up the oil reservoirs of the four engines so we could pump oil from a reserve supply in the fuselage to any one of them. But, more important, we could withdraw all the oil from any one engine if we wanted to and use it for the other engines. If an engine went bad, its oil wouldn't be wasted.

We replaced the regular landing-gear retracting system, which brought up the wheels in 30 seconds, with one that brought them up in nine seconds. That was for added safety in take-off because half of the total

drag of a B-29 at speeds under 150 m.p.h. is in the landing gear.

We pumped up the tires to 110 pounds, about half again as much air as they normally carried, and let them stand for a week so they would get a permanent "set." Then we measured them and altered their wells to accommodate the stretch.

By reducing the cowl-flap openings we knew we could pick up a few miles an hour in speed. By repeated flights we discovered we could open the two upper flaps on the inboard engines no more than  $1\frac{1}{4}$  inches and those same two on the outboards about an inch and still get sufficient cooling with all side flaps completely closed. The cooling on the inboards was more of a problem, quite naturally, due to fuselage interference with the air flow.



**Lt. Col. Frank J. Shannon, Sr., of Philadelphia, communications officer:**

The Dreamboat was equipped with a low-frequency adapter to cut through ionospheric disturbances if they developed. I had talked with

"fringe" fliers who had been on the edge of the auroral radio disturbances, and they had told me that, in the Arctic, communications simply went out. All of our air-ground communication was to be in International Morse, of course.

We confidently counted on radio blackouts at from 60 to 70 degrees North. The "fringe" fliers said there would be no static; a receiver would just go ahead. The only thing we would hear would be the hiss of the thermal effect of the transformers, of the wiring and filament emission of the vacuum tubes. Low-frequency sending and receiving would cut through, but it would be practicable only at short range.

I was prepared for another phenomenon—ionospheric "skip." That comes from the high-frequency signals hitting the gaseous envelope surrounding the earth and bouncing back beyond the station you're trying to contact.

But I figured we were covered for any kind of a contingency. I over-planned, in fact. Among many other things, I had asked that "hams" all over the country belonging to the American Radio Relay League cover my frequencies. They did—in volume. I got their reports when I got home.



**Colonel Irvine:** We had adequate safety devices if we were forced down. We took along the standard Air Forces emergency kit containing rations and medicines. To that we added a sea-landing kit, essentially the same one used on flights against the Japs, and an ice-cap kit—carbines, ammunition, a special gasoline cook stove, food for three weeks, three complete sets of sock-lined felt boots for each man, fur parkas and trousers, and gloves. We studied the procedure for survival in the Arctic.

If we were forced down at sea, we would have two seven-man life rafts. In addition, each man would have his own raft attached to his 'chute, his Mae West, fishing tackle, pyrotechnic signals, and equipment to make salt water drinkable. Our safety equipment weighed 120 pounds per man.

It was because we had prepared so carefully that we weren't surprised that everything seemed so routine once we were under way.

**Colonel Warren:** When we had reached our maximum speed at original cruising power we were indicating 233 m.p.h. That was good. We had figured it would be only 228. For the first five hours or so we held 1,000 feet of altitude. Then we hit a weather front and had to climb to between 5,000 and 6,000 feet. It was soupy there. We climbed slowly, using no additional power. That would have cost us slightly more fuel.

We held that altitude until we were 30 minutes off the coast of Alaska, at Sitka. Then, still not increasing power above that for cruising, we climbed to between 15,000 and 16,000 feet. It got dark just before we hit Sitka. Through a few breaks in the clouds we caught glimpses of lights below. We saw Juneau, too, by luck, but mostly we had to fly in soup.

A weather-reconnaissance plane we talked to assured us we wouldn't pick up ice, but we did. It was rime ice. That's not the dangerous kind, and it did not become serious. We had no de-icing boots on the wing. They would have added weight and drag to the Dreamboat.

**Colonel Shannon:** Communication was perfect. We were equipped with frequencies of 11,445, 8,200 and 6,355 kilocycles, and we were not out of touch with the Airways Communication System (formerly Army ACS) at any time. We worked WZJ at Hickam Field until we got past Fairbanks. I knew we could

work stations at Seattle, Anchorage, and Fairbanks—or try to—but then came a long break of more than 2,000 miles between Fairbanks and Frobisher Bay, Baffin Island. I assumed we would have trouble there. We didn't.

From Frobisher Bay we had the facilities of a station on the west coast of Greenland known as Blue West 8, another on the southern tip of Greenland known as Blue West 1, and others at Reykjavik, Iceland, and in Europe.

By the time we were breaking out of Alaska and entering the Yukon Territory I was in touch with Blue West 8.

**Mr. Snodgrass:** Meantime, we were keeping a constant check on the fuel. We used our lift-over-drag ratios and refined them with considerations of propeller efficiency and the most economical fuel consumption we could reach. The consumption at the start of the flight had been 436 gallons an hour. That dropped steadily.

**Major Hays:** We had to use dead reckoning when the airplane was between layers of clouds or in the soup. We had anticipated a nine-knot tail wind. The forecast winds were very accurate over the Arctic, and we checked them with celestial fixes when we could. These winds held good until we approached Greenland. Then we hit head winds where tail winds were forecast.

**Colonel Irvine:** It was plenty cold. But we encountered the arctic temperature moderation at altitudes that I had anticipated. Our outside temperature at 20,000 never went lower than minus 36 degrees Centigrade. But that drives you to bundling up—and then you sit there and shiver. A B-29 isn't insulated.

**Colonel Warren:** We were in intermittent soup for about 1,000 miles inland. We picked up more rime ice. The amount of it never reached the danger point, though. Pretty soon the clouds began breaking up around us. We found ourselves over a low undercast. There were times when the undercast was broken and even scattered.

We could see mountains and lakes in the moonlight. It looked like pretty rugged country. You didn't want any part of it.

Just before sunup we approached Baffin Island. On its westward side and in the interior it looked as though it had been shaved off by a glacier. There wasn't nearly as much



snow as we had expected to see. There was plenty of snow, but we also could see bare patches of ground. As we passed the center of the island and got over the eastern part, the ground got tortuous in contour. On the east coast there were numerous big rivers, deep and not frozen over. There were convoys of icebergs in them.

Colonel Irvine took a look and said, "Here's where we sit back and listen to the sound of the engines."

We had some fun about then. I was sitting in the pilot's seat. We had noticed a few light spots on the horizon, and supposed they were due to the Northern Lights. We had watched the Northern Lights during the night. They weren't very brilliant, nor did they have any color in them. One light spot appeared about 20 degrees left of the nose of the airplane, now. It seemed to grow lighter. If that proved to be the sun, we would be off our course. The sun had to come up to the right of our nose.

I started kidding Norman Hays. Nobody was worried. He's an excellent navigator. Moreover, he had had chances to get celestial fixes. But he got somewhat concerned himself. It took a long time for the sun to appear. We couldn't see it yet but we could see its reflections on clouds. Finally it showed up—at five degrees to the right of the nose, where it was supposed to be. The first rays of dawn came on the wrong side of the airplane due to the rotation of the earth and the high latitude.

**Colonel Irvine:** Sunrise in the Arctic is the most spectacular thing I have ever seen. Just before the sun cleared the horizon it was suddenly shaded by a greenish cast. It must have been a prismatic effect of ice particles.

**Colonel Warren:** For about an hour after we hit the coast of Greenland we could see the ice cap. From altitude it looks like water. It has a characteristic wave formation. Here and there are cracks and crevasses, but on the whole it's flat and smooth except for the waves.

We passed a couple of hundred miles north of where the magnetic pole is plotted, and the compass needle still swung back and forth in a northerly direction. It swung the whole time we were in the Arctic, as much as 30 degrees off course.

**Colonel Shannon:** Over Iceland we picked up another weather-reconnaissance plane. I

asked him what his conditions were and whether there was any icing. He gave me a report and told us not to reduce altitude. We were flying at 20,000, and I relayed that information to the airplane commander.

The weather plane's call was WX-2. That puzzled me because those were the same as the call letters on the weather recon plane that had contacted us out of Sitka. I said to him, "Hey, I thought you were on the ground. Are you airborne?"

He said, "Yes."

I said, "The last time I worked you, you were landing at Whitehorse (Yukon Territory)."

He replied, "I'm a weather-reconnaissance plane out of the 35th Reconnaissance Squadron."

I said, "Where is that?"

But he wouldn't go beyond saying, "Our headquarters is in Newfoundland."

I called Colonel Irvine and said, "Hey, we've got a weather recon plane."

Colonel Irvine replied, "Let's get on him." So as soon as we could we changed to voice, 4,220 kc., and the weather plane and Colonel Irvine talked back and forth.

**Colonel Warren:** The soup began breaking up about 300 miles from England. The sun went down. We caught a glimpse of Prestwick, Scotland, and some other towns. Then the undercast became solid. We missed a sight of London and Paris entirely. London told us its Northolt radar station had identified us, but we never did make contact with a British bomber that was supposed to come up and meet us.

We swung about 50 miles south of our course in crossing the Alps, in response to a warning from the Paris radio that thunderstorms were building up ahead of us. We saw none.

**Mr. Snodgrass:** Just after we cleared the Alps we shut off No. 4 engine and feathered the propeller. That was because we needed so little horsepower—the airplane had become so light—and I couldn't get the total power output down by throttling back. We were pulling only 740 horsepower each from the three remaining engines. That was a special condition with this B-29, of course. We were stripped down and very clean.

Our speed toward the end of the flight was only 174 m.p.h. The drop in speed had to do with the most economical power settings for the weight of the airplane. We could go far-



ther at the reduced speed for our weight. Our fuel consumption at the end was only 156 gallons an hour. Our gross weight was 73,088 pounds when we reached Cairo. All that reduction, of course, was not due to fuel consumption. The engines each used about 38 gallons of oil on the flight.

**Colonel Irvine:** The worst weather of the trip was still ahead of us after we left the heel of Italy. Over the Mediterranean we ran into thunderstorms, icing conditions—clear ice, too, the dangerous kind—and even a fancy display of St. Elmo's fire. We were all over the sky from the turbulence. Then, suddenly, the weather cleared. All around us were fleecy clouds. Pretty soon the sun came up.

The landing at John Payne Field in Cairo was routine. The Dreamboat tilted her nose

and put her heels on the ground like a lady. With the head winds we had encountered, we figured we would have 500 gallons of fuel left in the tanks. Actually we had 414.

I'll take the Arctic. It's navigable. Communication can be maintained.

**Major Hays:** Except for what it does to a magnetic compass, arctic flying is just like flying over Missouri.

**Colonel Irvine:** The Dreamboat stood the trip all right, too. When we got on the ground I asked Master Sgt. G. S. Fish—he's the engineer attached to the Dreamboat and he really owns the airplane, you see—to check up on both airplane and engines.

Pretty soon he came back and reported. "Boss," he said, "all she needs is some gas and oil, and she's ready to go." **END**



Members of the Dreamboat's crew at Cairo after completing their over-the-top flight: Left to right (standing), Col. C. S. Irvine, flight commander; Lt. Col. B. H. Warren, co-pilot; Majs. N. P. Hays and J. T. Brothers, navigators; Maj. J. R. Dale and R. B. Snodgrass, flight engineers; (kneeling) Lt. Col. F. J. Shannon and M/Sgt. E. G. Vasse, radio operators; Maj. J. R. Kerr and M/Sgt. G. S. Fish, aircraft engineers.

**PLW-UP**

**LOCKHEED SATURN.** Designed to serve small towns with limited airport facilities, this twin-engine transport uses exhausts for more power and a laminar-flow wing for more speed; takes off with a 1,500-foot run. It needs no special servicing devices, and both passengers and cargo can be taken aboard without ramps.







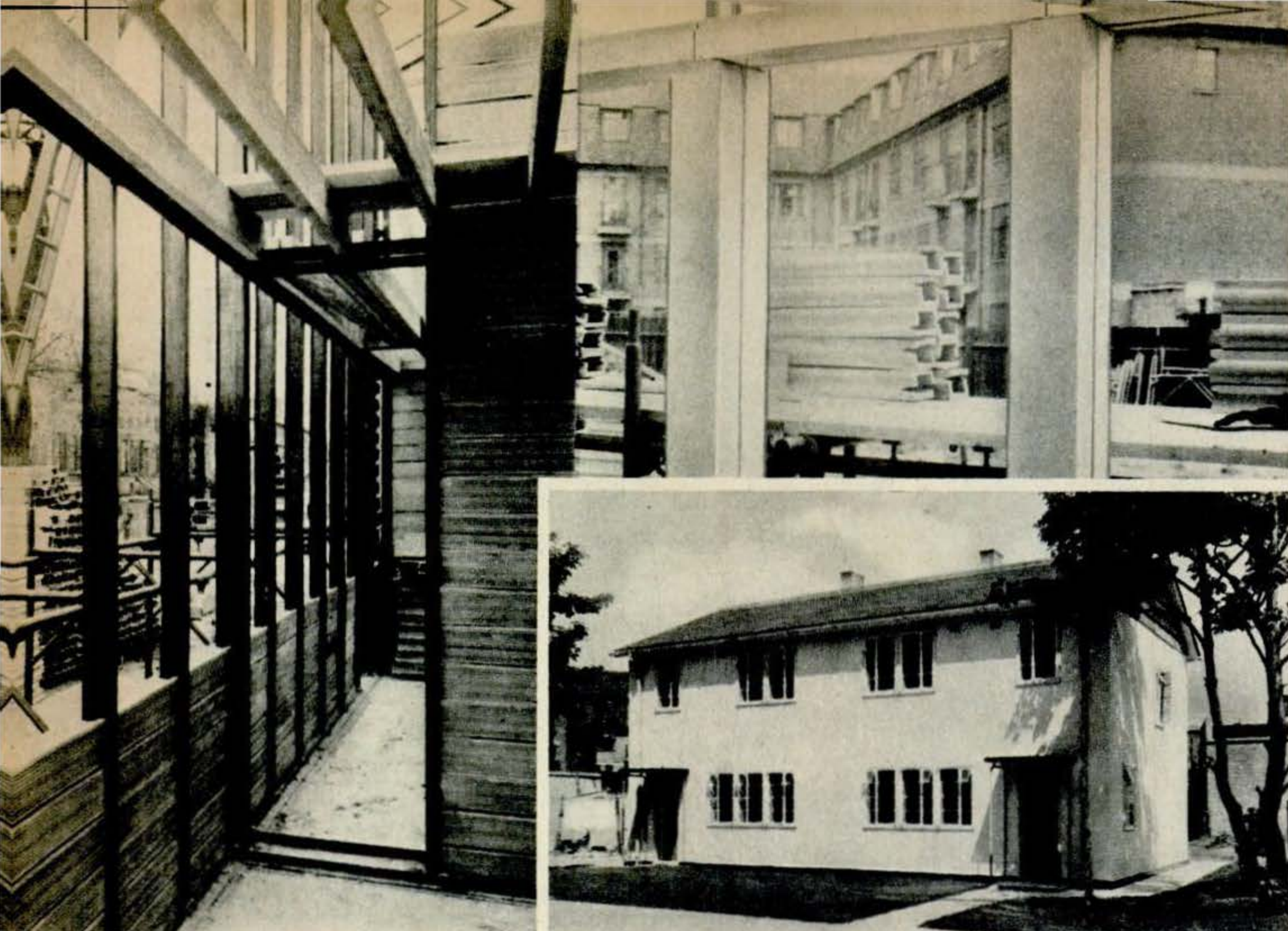

**Britain Mass-Produces Homes.** Cranwell House (inset) is one of England's answers to the problem of 4,500,000 homes leveled or damaged by Nazi bombs. Cranwell is a two-home unit that costs \$13,000 and takes three weeks to build. It is built of 3-foot-by-9-inch hollow fire-clay blocks, shown above, at right. Since these are simply dropped into place and locked together, unskilled labor can be largely used.

**Electric Fly Killer.** Fatal to flies and harmless to man, the electric screen shown below, at right, consists of horizontal bars spaced  $\frac{3}{8}$  inch apart, with every other bar positively charged by one pair of vertical struts. The alternate bars are negatively charged by the other pair of struts. Moisture from an insect's body closes the 10-milliampere circuit from one bar to another. The screen is produced by the Detjen Corp.

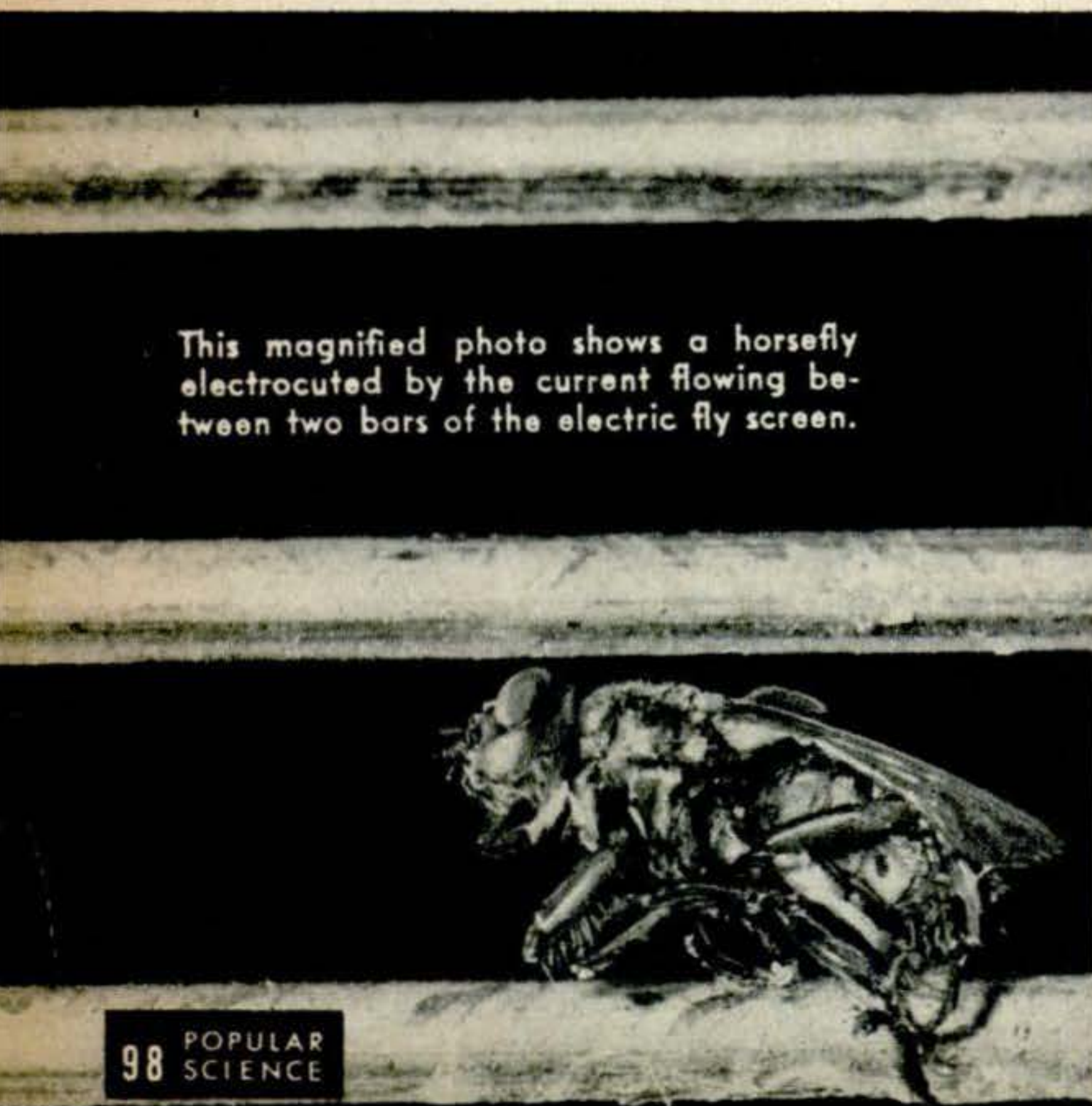

This magnified photo shows a horsefly electrocuted by the current flowing between two bars of the electric fly screen.

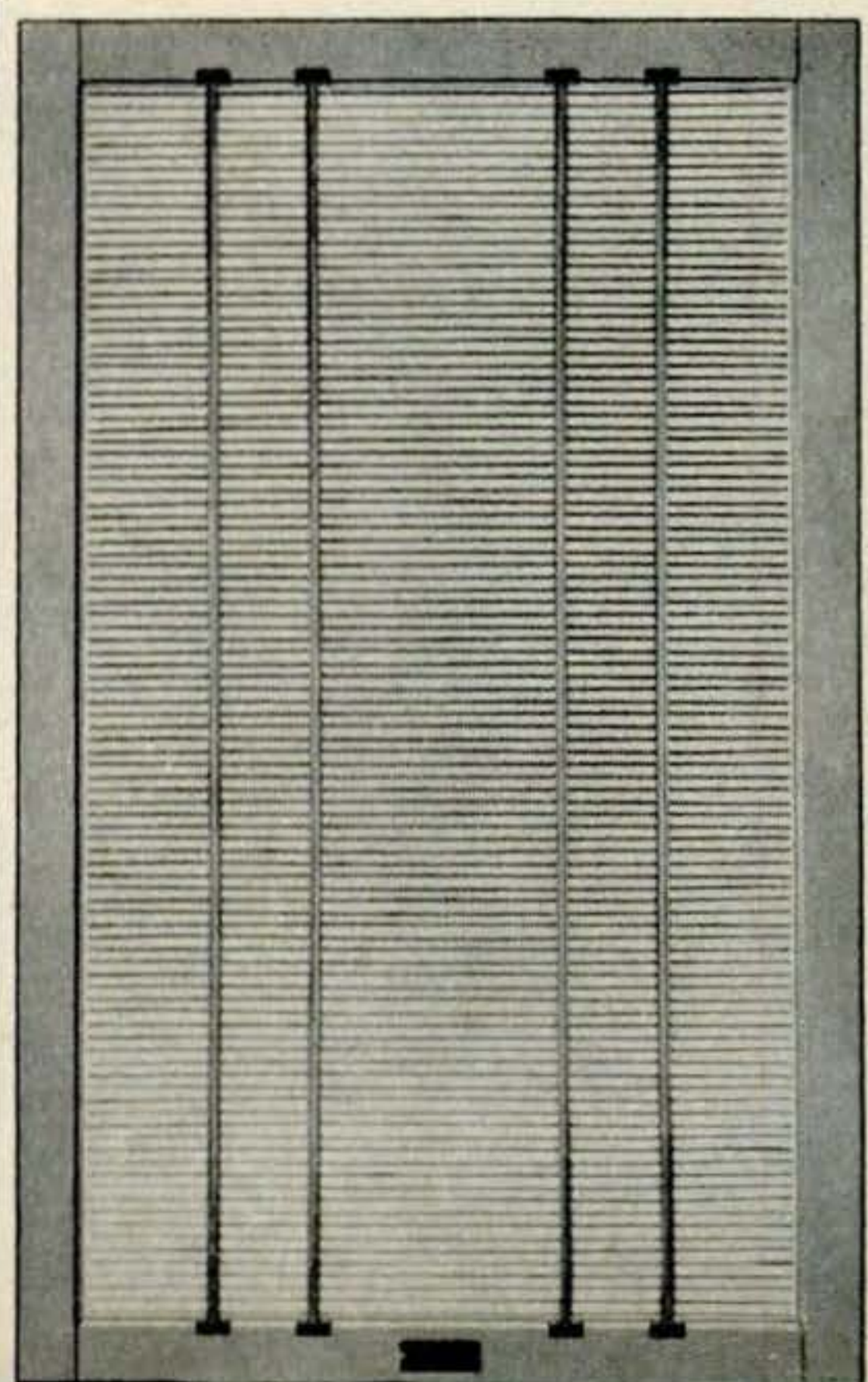





**Radio Pulls a Plow.** The British have borrowed from their Queen Bee radio-controlled aircraft to build a Queen Bee experimental farm tractor with remote control. The machine's controls are operated by motors powered by compressed air, which in turn are controlled by electrical relays actuated by radio signals. A demonstrator is shown above directing the tractor with a hand control box. The Queen Bee makes turns and plows a straight furrow. The fortunate farmer of the future will be able to sit at ease out of



the weather and direct as many as six such robots staggered one behind another. The tractor is still in test stage.

**New French Farm Hand.** The tractor below is a postwar product of the Societe Nationale de Constructions Aeronautiques of France. The machine has five speeds forward and laterally adjustable wheels in the rear. It is now being tested on French farms preparatory to going into full production.





It's pure myth that a chameleon has the innate power to change its color to match its background. The popular fallacy springs from the fact that the sub-lizard does change its hue from time to time. But this change has nothing to do with the color upon which a chameleon is placed. It is involuntary; there's nothing the chameleon can do about it. The forces that dictate its color are variations in light, temperature and the way it feels. In the pictures on these pages an American chameleon of the genus *Anolis* is given ample chance to exhibit its color prowess, but it falls down in every instance. At right, the reptile stays green on a red background.

PSM photos by W. W. MORRIS

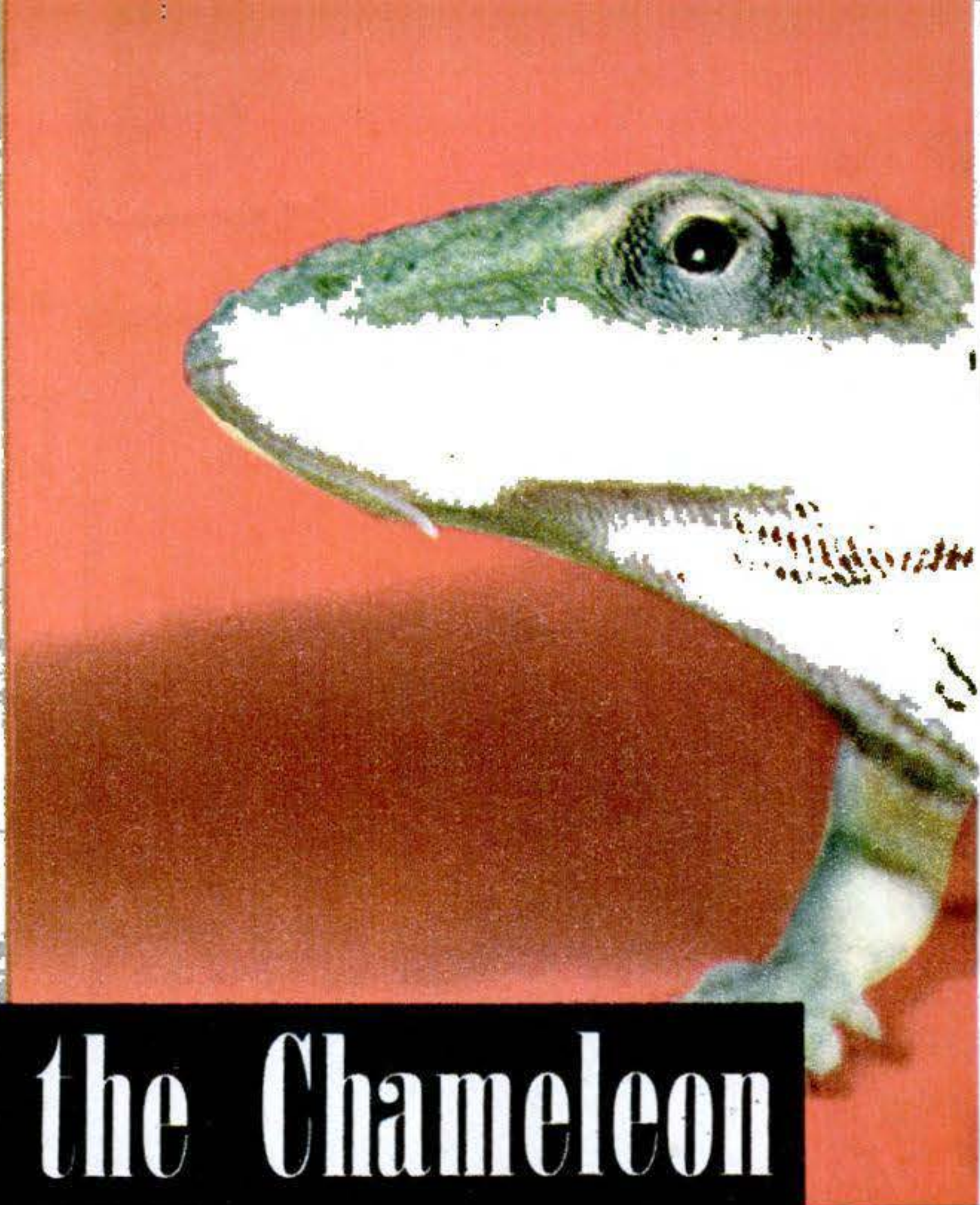

## EXPOSING the Chameleon

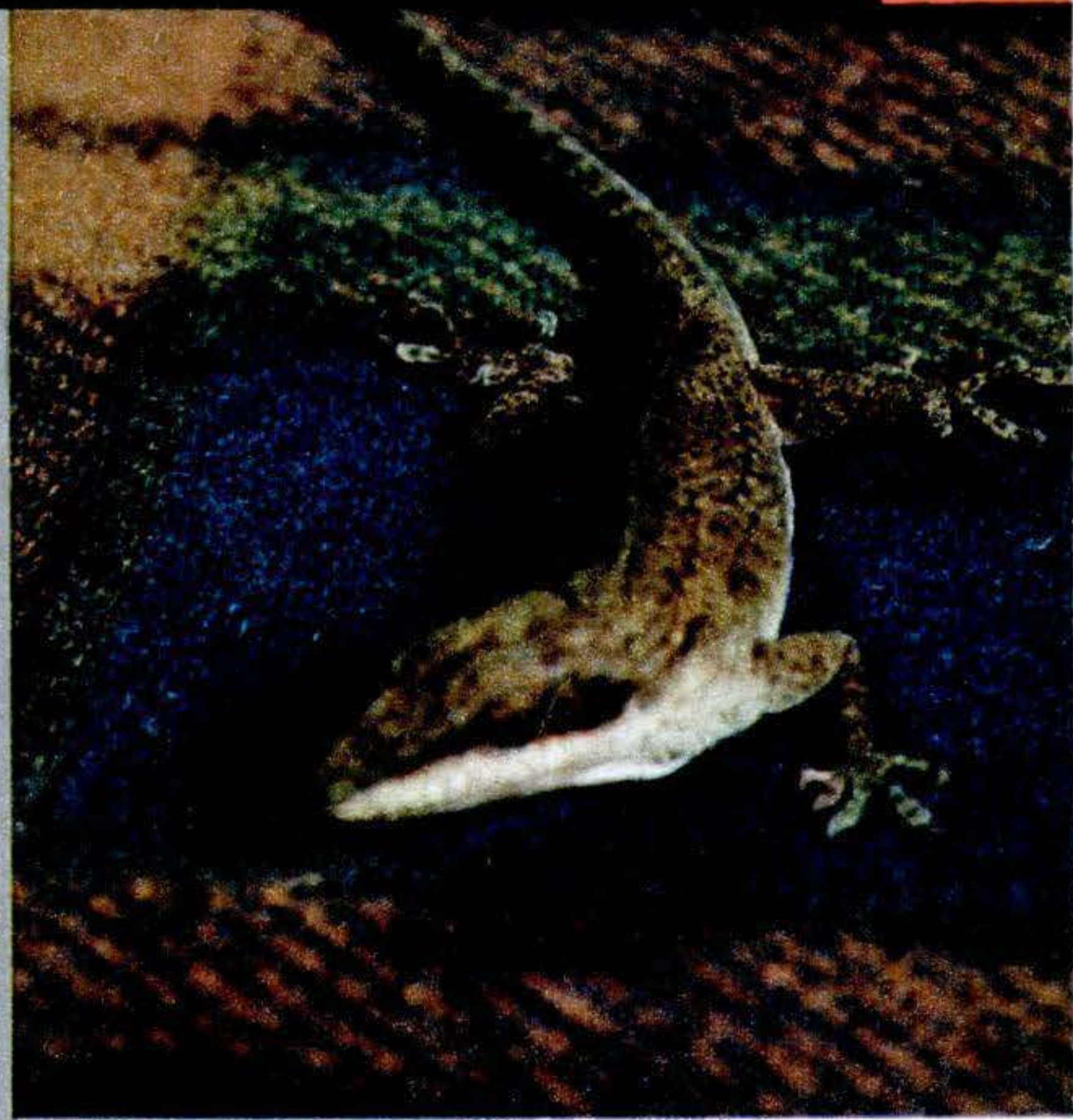
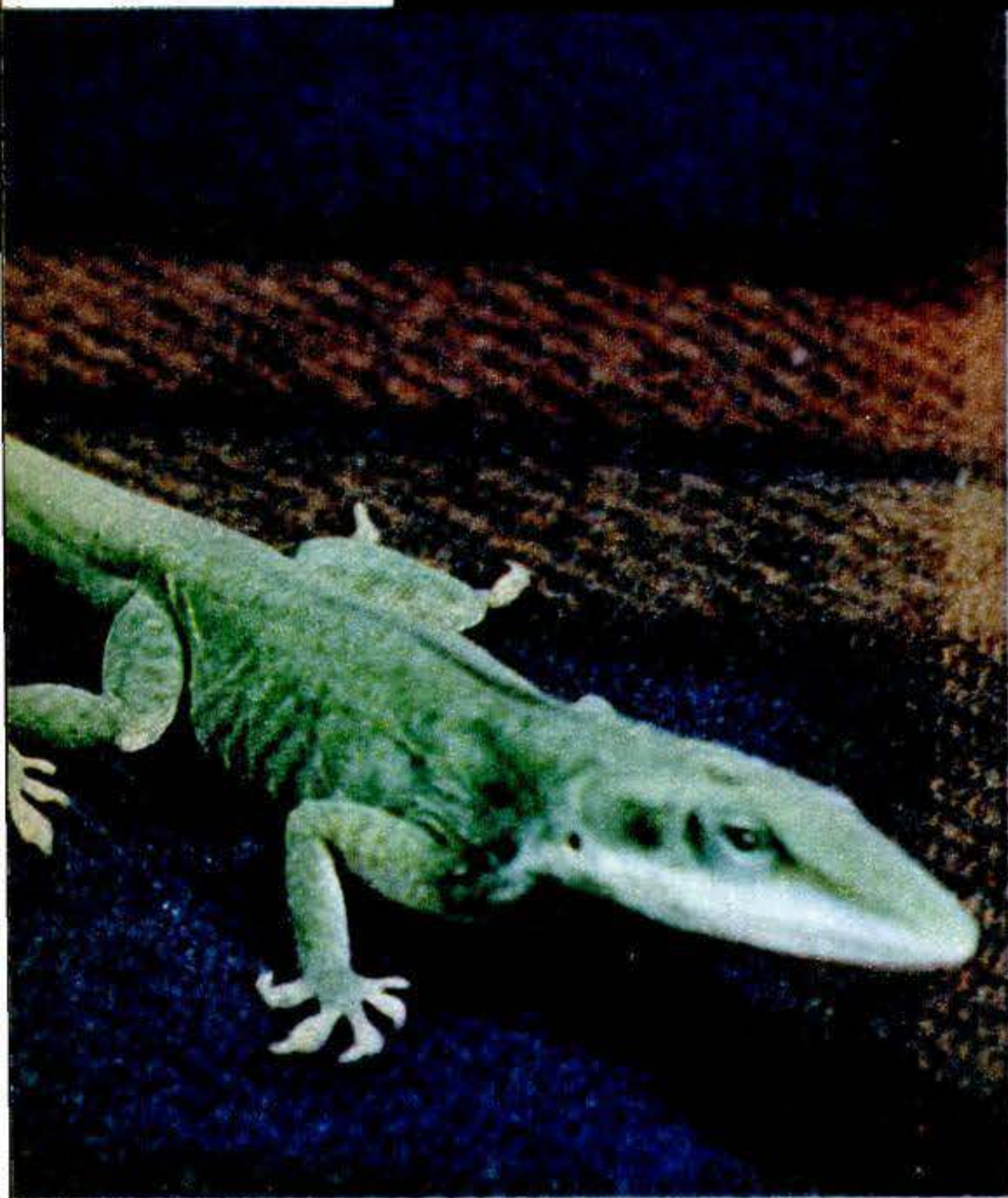

Probably the story of the chameleon that went crazy trying to match a Scottish plaid has contributed to the unfounded belief that a chameleon can conform to the coloring of its surroundings. When the picture above was taken, the reptile showed no mental instability over its failure to do something about the plaid on which it crouched. Zoologists agree that the sub-lizard assumes a green phase when it is excited, frightened, angered, asleep or dead—and for no other condition.

The color of the plaid on which the chameleon rests in this photo remains the same. Outward conditions have changed, however, and the chameleon has been forced to abandon its green hue for brown. The reptiles take on a brown discoloration in response to low temperatures, hunger or strong sunlight. In this test the creature still displays no signs of losing its senses over its futile struggle with the plaid. It takes about three minutes for a chameleon to change completely from one color to another.



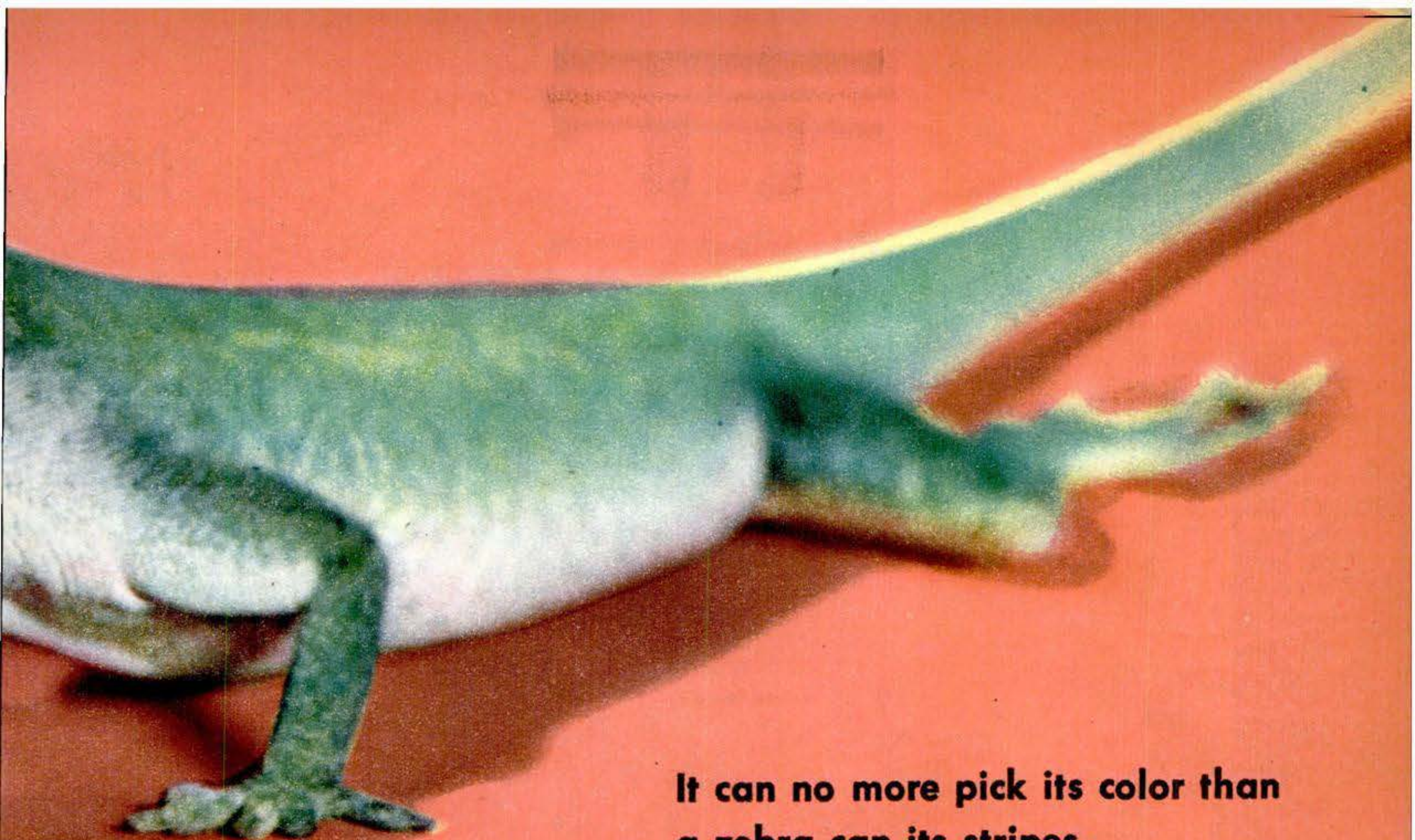

**It can no more pick its color than a zebra can its stripes.**

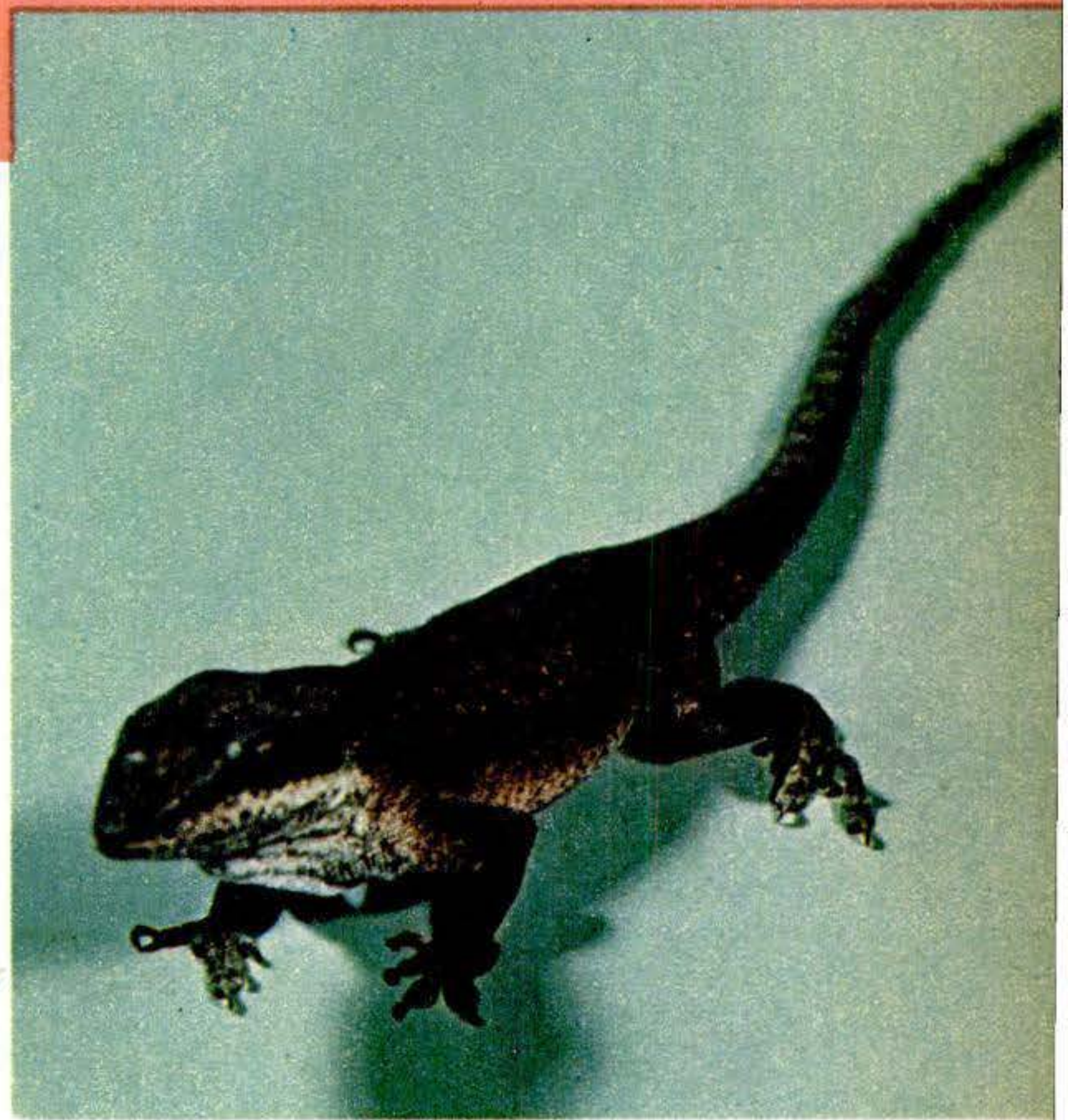
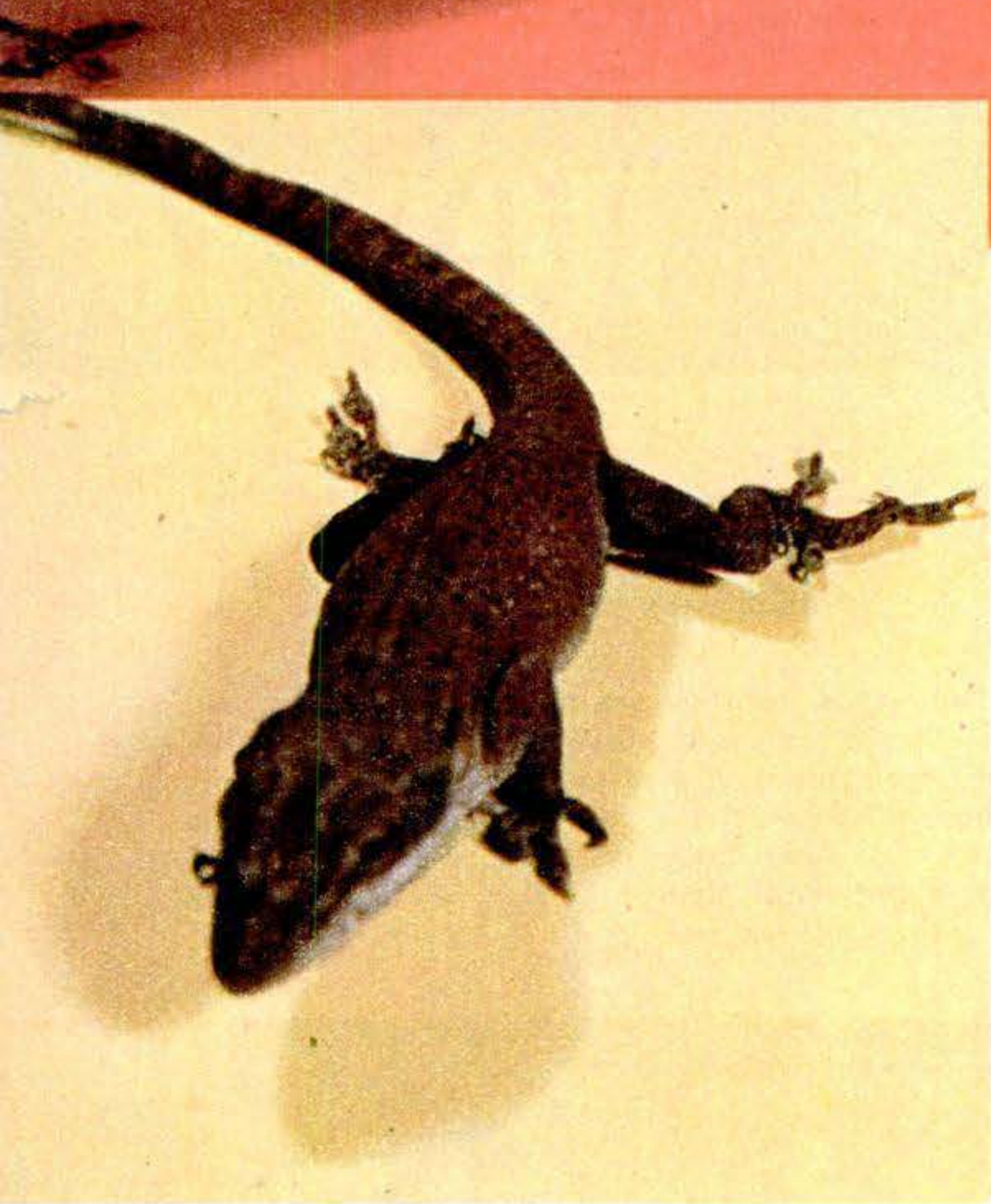

The chameleon in this picture remains brown against a background of yellow. The New York Zoological Society, where these tests were staged, explains that the sub-lizard has three types of color changes: (1) uniform brown above and flecked with brown below; (2) pure, pale green above and white below; (3) mottled brown above and flecked with brown below. Sometimes the color is bright green or intermediate shades of light brown, yellow, yellow green or emerald green. American chameleons are found in Southern states.

Blasting forever its reputation for free-wheeling color changes, the chameleon in this final photo remains brown against a green background. In the picture at the top of these pages the reptile showed that it had the ability to turn green, yet here with all the encouragement of its surroundings it retains its brown color. Brayton Eddy, acting curator of reptiles for the New York Zoological Society, points out that male chameleons in courtship or combat sometimes display a brilliant red dewlap, or throat fan.



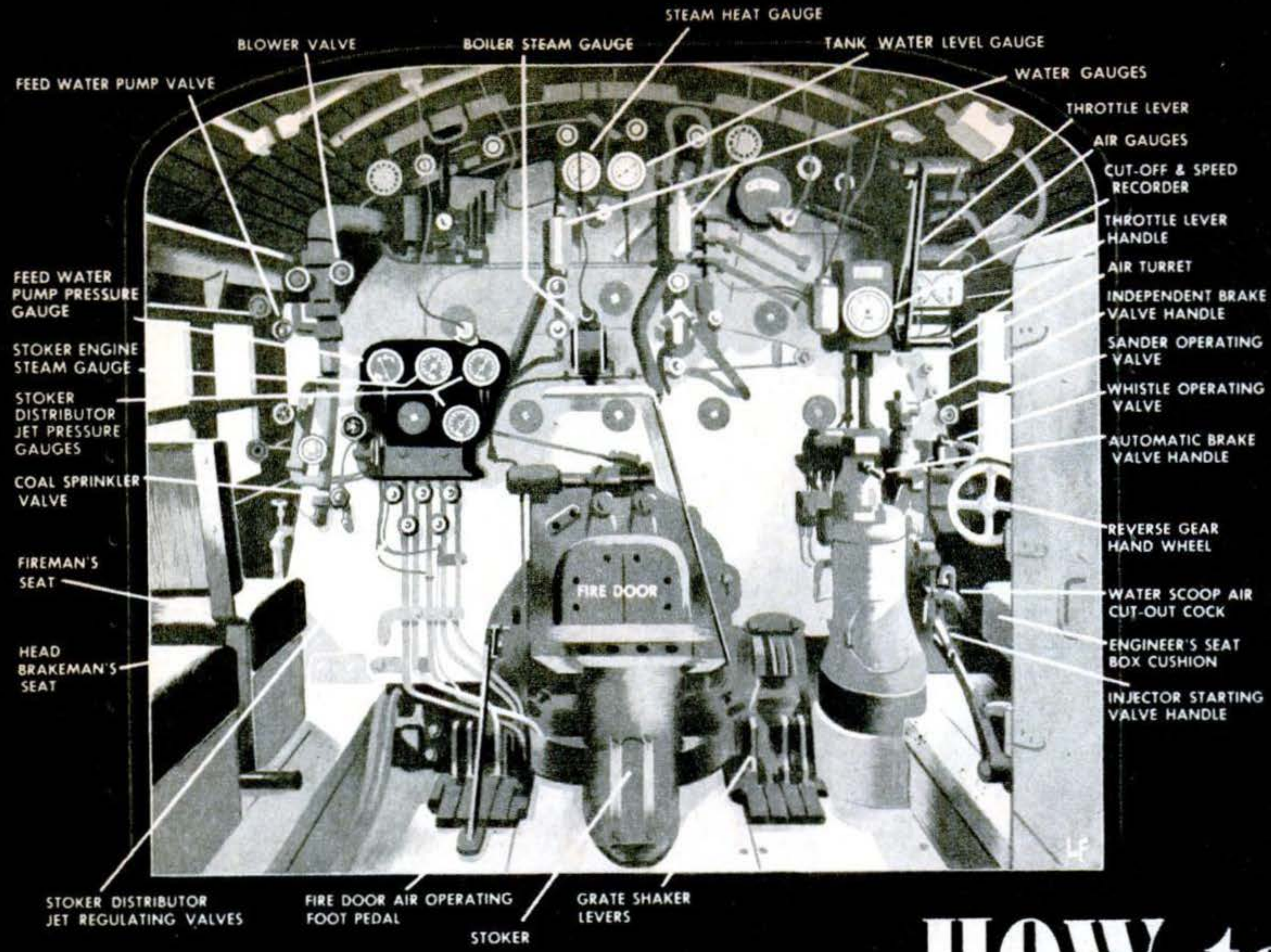

# HOW to

Driving a locomotive is essentially simple, but the finer points of an engineman's work make it one of transportation's most demanding jobs. The pictures on these pages show the principal parts of the job and give some idea of the myriad details that make

it hard. Above is a simplified drawing of the cab of a New York Central Niagara-type locomotive. With tender two-thirds loaded, the engine weighs 808,400 pounds; it is 115½ feet long. Your seat for the demonstration is on the right of the cab.

1. With brakes, water level, steam pressure and dozens of other items checked, your engine is coupled to a 17-car passenger train. You turn the reversing screw full right for maximum piston stroke. Note that independent engine brake (A) is in "on" position. It had to be set while pictures were taken on a siding. Train brake (B) is in "off" position.

2. You release the independent brake, used to hold train in station, before opening throttle. As train gains momentum, the reversing screw is gradually turned left, toward the neutral position, to shorten piston stroke and increase speed. The screw's function is somewhat similar to that of the spark on an automobile engine.

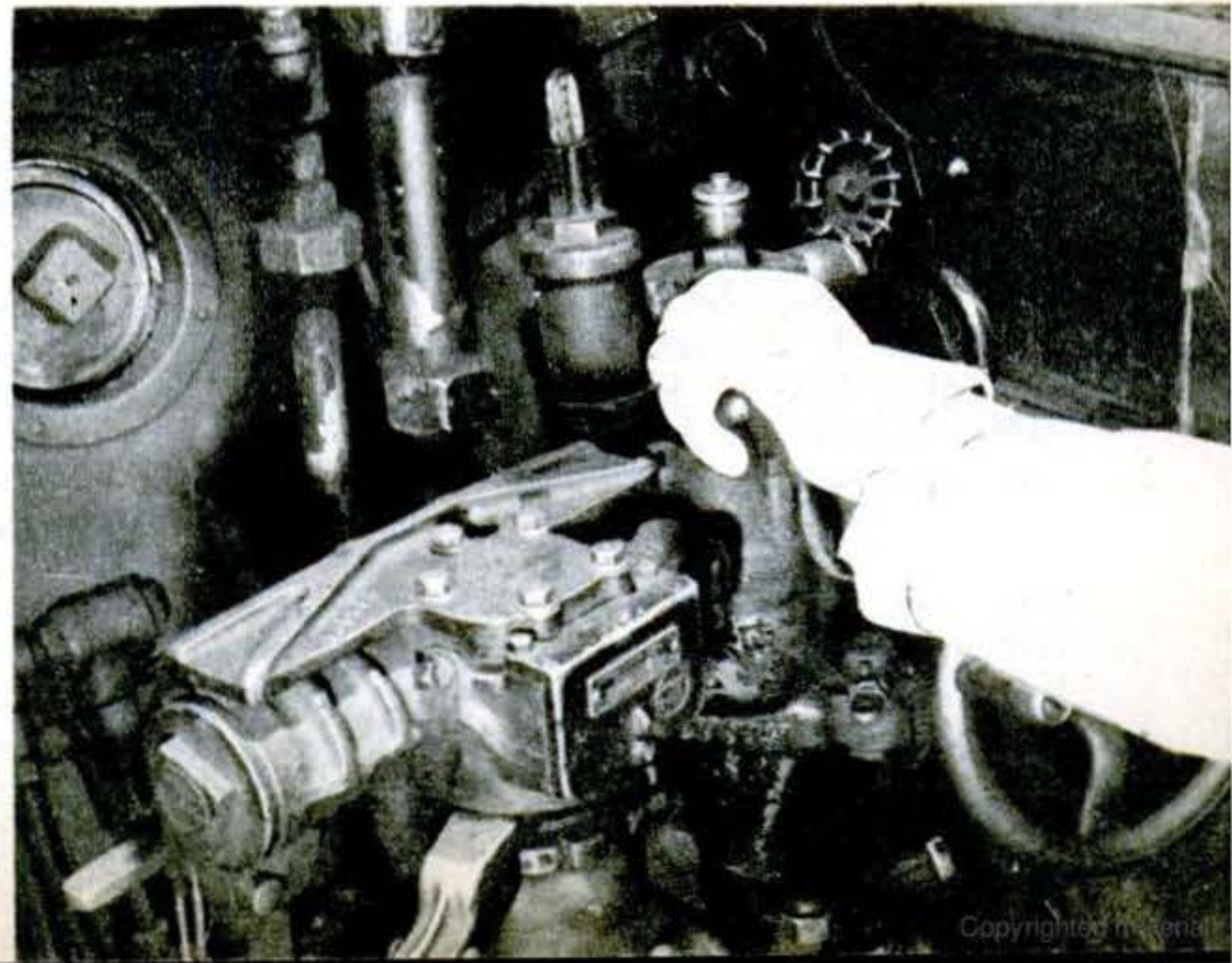
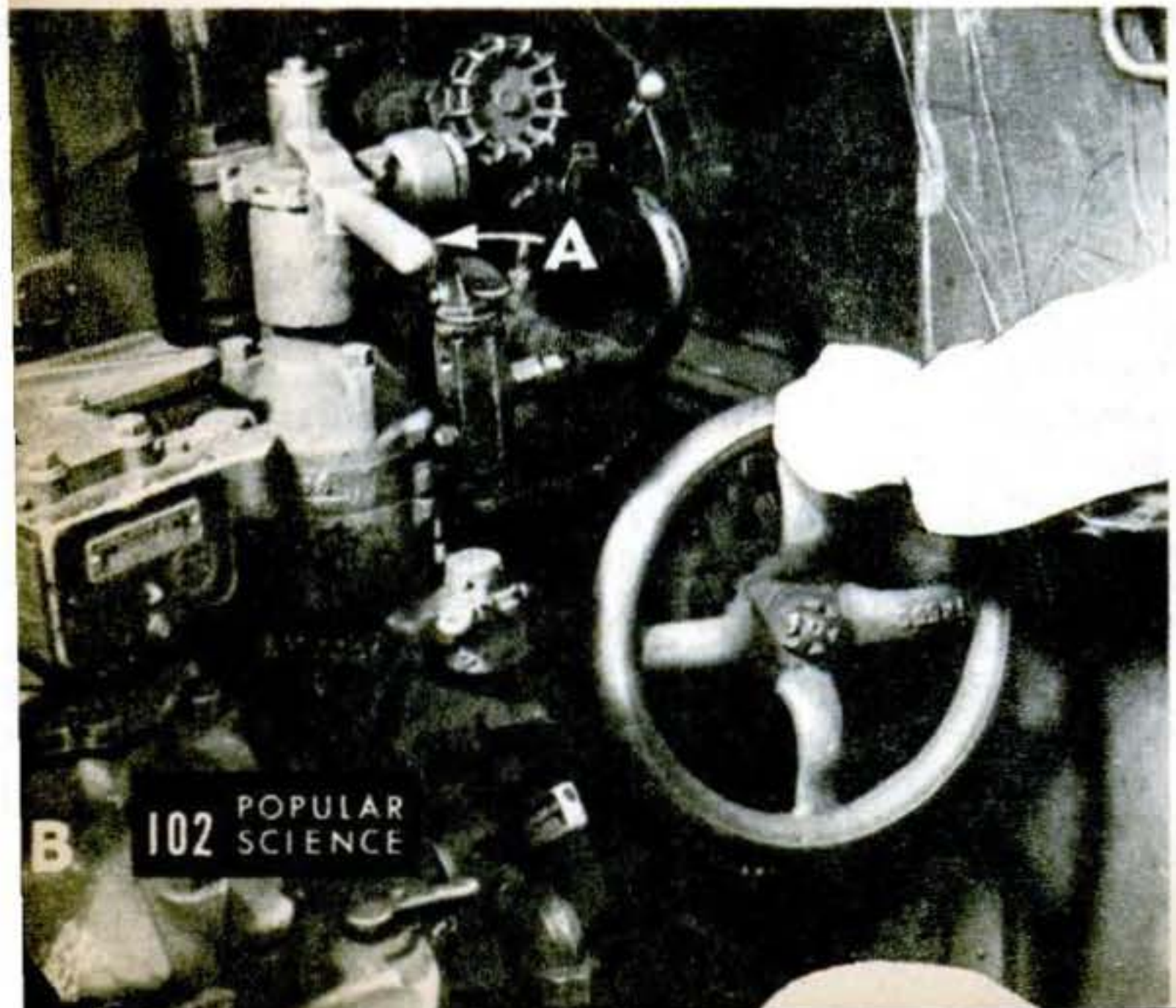



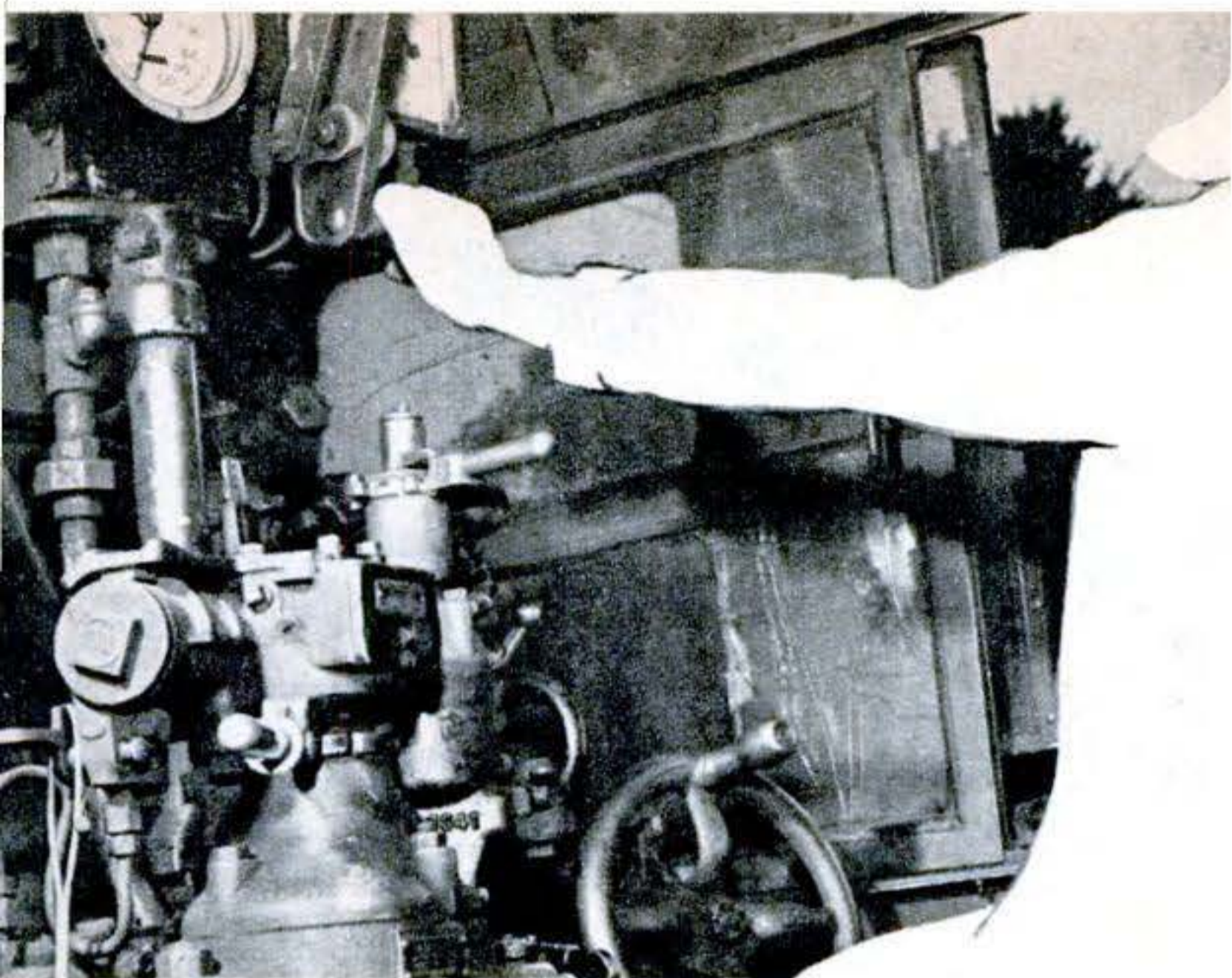

3. Open the throttle gradually, depressing the latch to disengage teeth from ratchet that sets the throttle for a given speed. The locomotive's eight drivers carry 275,000 pounds of its weight, giving sufficient friction to start the train. The \$300,000 engine is so powerful that it isn't necessary to "take the slack"—bunch the cars to lighten initial load—before starting.

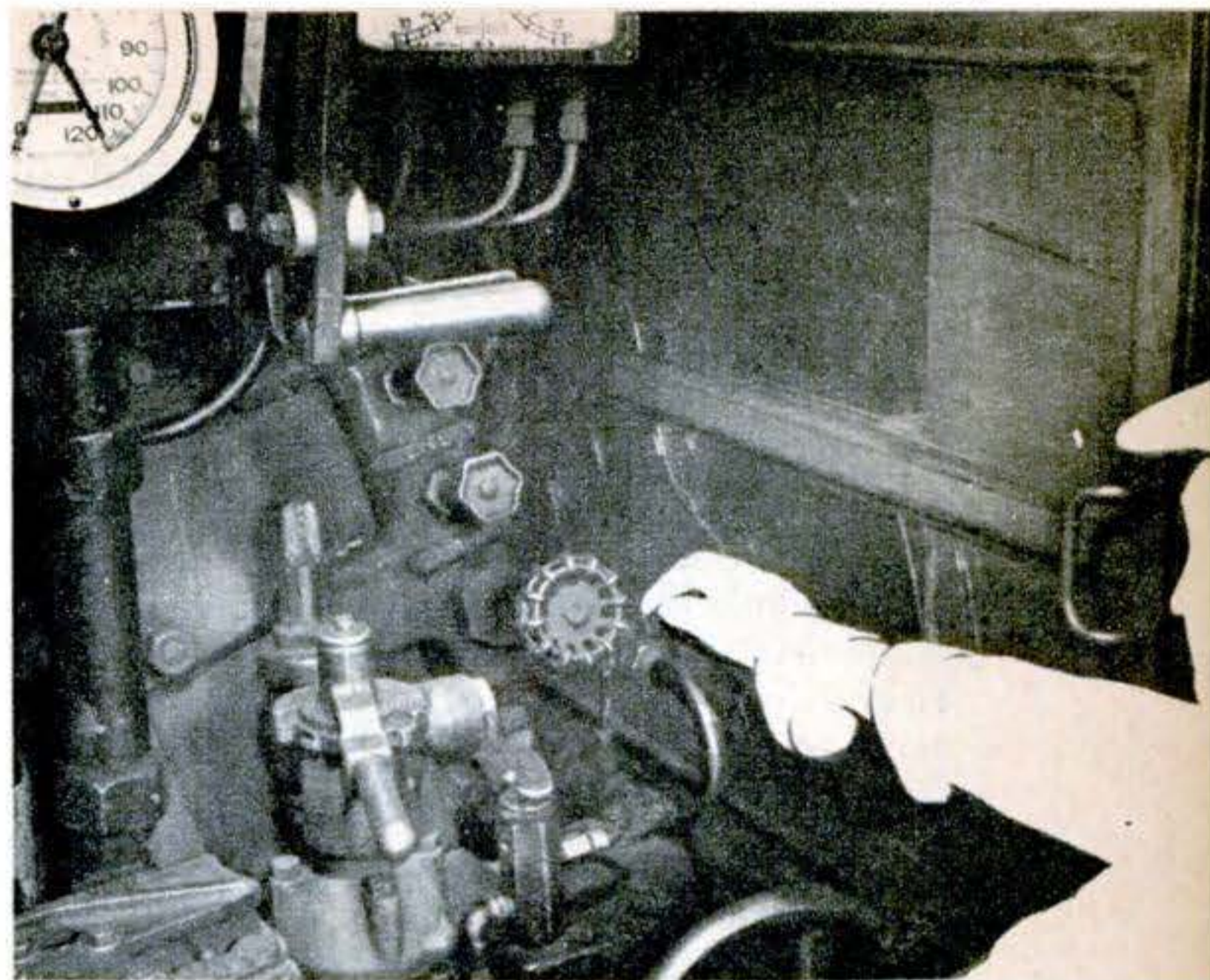

4. To keep from "losing the rail," or slipping, you put some sand on the track—but it isn't as easy as it sounds. The throttle has to be closed to let the engine "drift" during sanding, or the sudden jolt as wheels catch might break pins on drive wheels or loosen their tires. A whistle in the cab blows while the sander is in operation so that engineman won't forget to shut it off.

## DRIVE a LOCOMOTIVE

5. Well on the way, you encounter the first yellow caution signal and slow down so that you can stop within the range of your vision, as the next signal block may order you to do. To pass a caution signal, the forestalling lever is pulled back. If lever is not pulled, brakes will be set automatically by the block signal system's safety devices. If the forestalling lever is held back for more than 15 seconds, the brakes set anyway.

6. A clear track ahead. Occasionally, you glance at boiler water level, steam gauge and other dials. If the water level is too high, water may seep into the cylinders, sacrificing power; too low a water level invites damage to crown sheet and a possible explosion. All the way, you keep your eyes open for signals. In engineman's parlance, the track on this side of a signal is yours, that beyond the signal belongs to the railroad company.

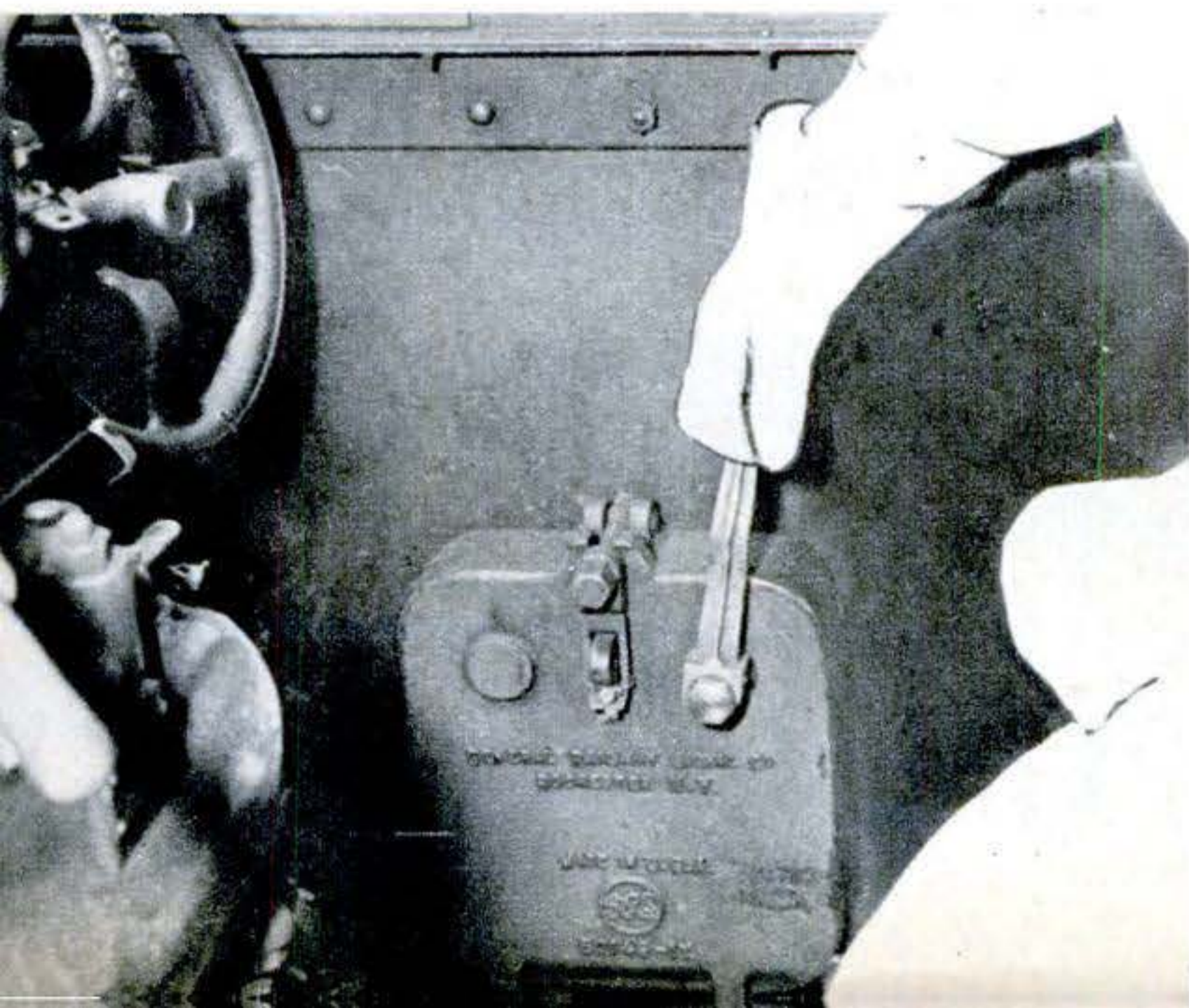



The 19-inch station wagon at right has a hardwood body like an original. The doors open and close and there are enough seats for a whole doll family. Made by Buddy "L" Toys, of Glens Falls, N. Y. About \$6.

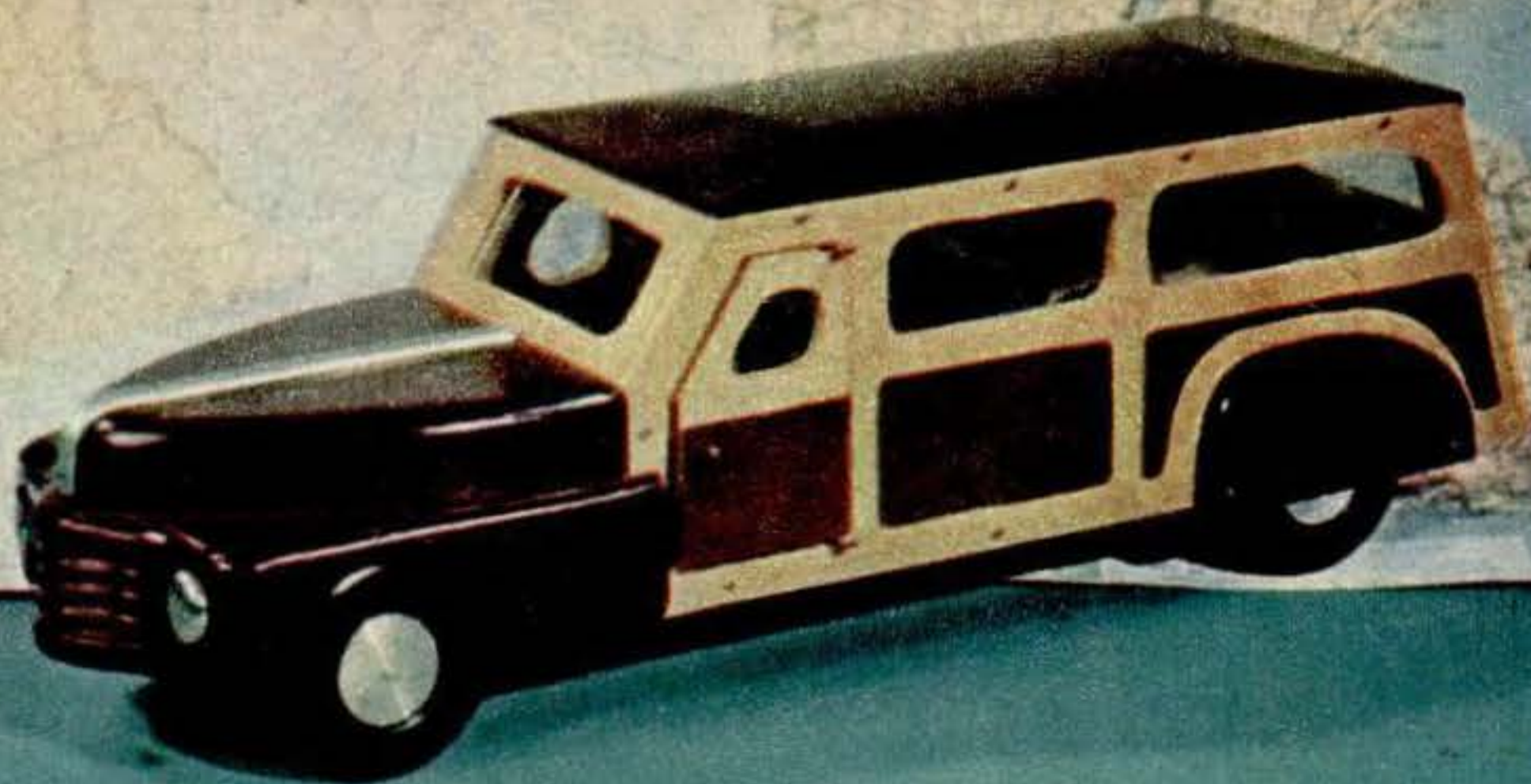

At left: A calliope for the nursery circus makes music electronically with regular radio tubes. Produced by Tee Gee Metal Industries, of Brooklyn, N. Y., it has sharps and flats to familiarize a child with the piano keyboard. About \$20.

# The Return

This year's mechanical marvels are sturdier, more realistic—and more expensive.



At left: This 8½-lb. racing car is driven at speeds of 75 to 90 m.p.h. by its two-cycle gasoline motor. The cast parts are magnesium; the tires semi-pneumatic. It is manufactured by Dooling Bros., of Los Angeles, Calif. Body, \$45; engine from \$22 to \$35 more, depending on type.

At right: When Junior pulls the string, Flippo will flounder along on his flippers across the floor, spinning a block on his nose. Flippo, who has no springs or wheels, is manufactured by the Noma Electric Corp., of New York. About \$2.

At right: This streamlined ship, unlike many models, is a liner of the future, not the past. The two-foot E-Z Craft Model comes as a kit of prefabricated parts to be assembled and painted. About \$3.

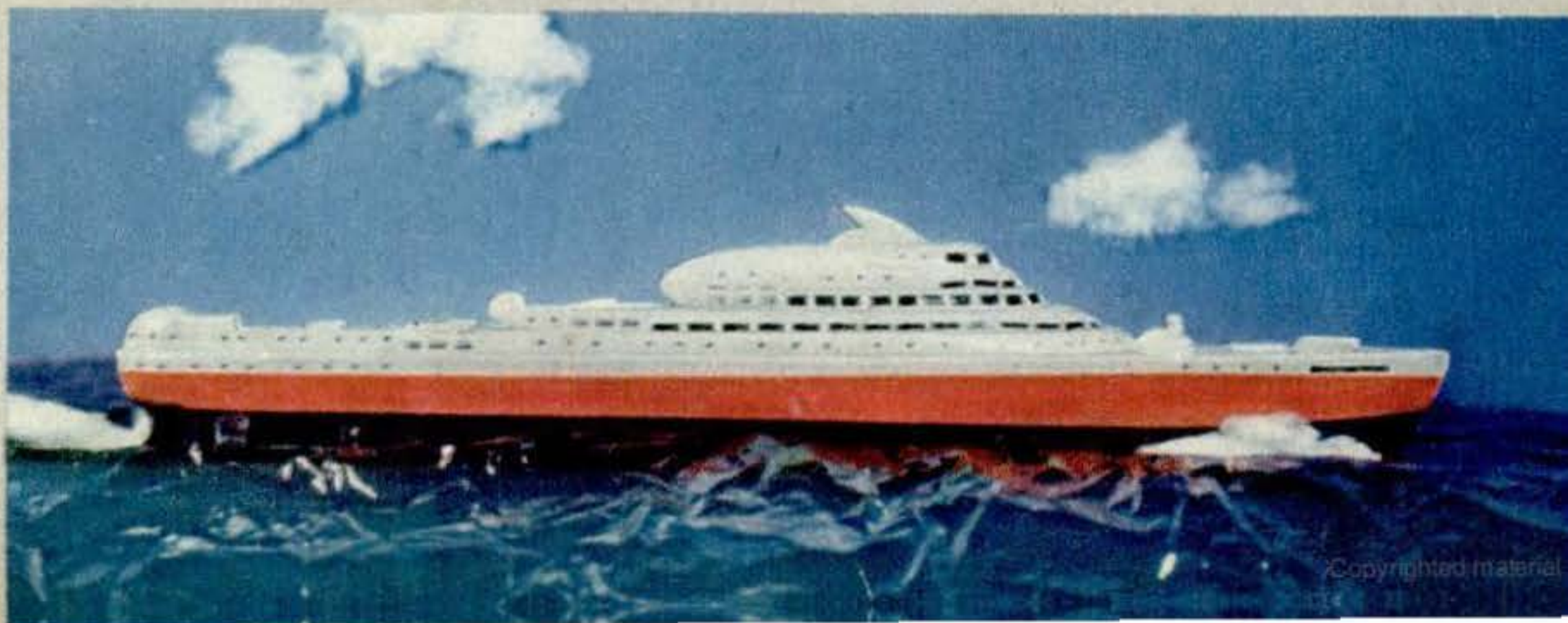





The sturdy little "Buzza" choo-choo, above, goes 'round and 'round and 'round on a self-contained flashlight battery. The current vibrates a spring shoe in the engine that pushes against the notched track. No wires or winding. About \$5.

A child will find himself making invisible ink before he can say "potassium thiocyanate" with Lionel's new Chem-Lab, above. A comic book, each page explaining a chemical experiment, carries him along to the story's conclusion. About \$8.

# of the TOYS

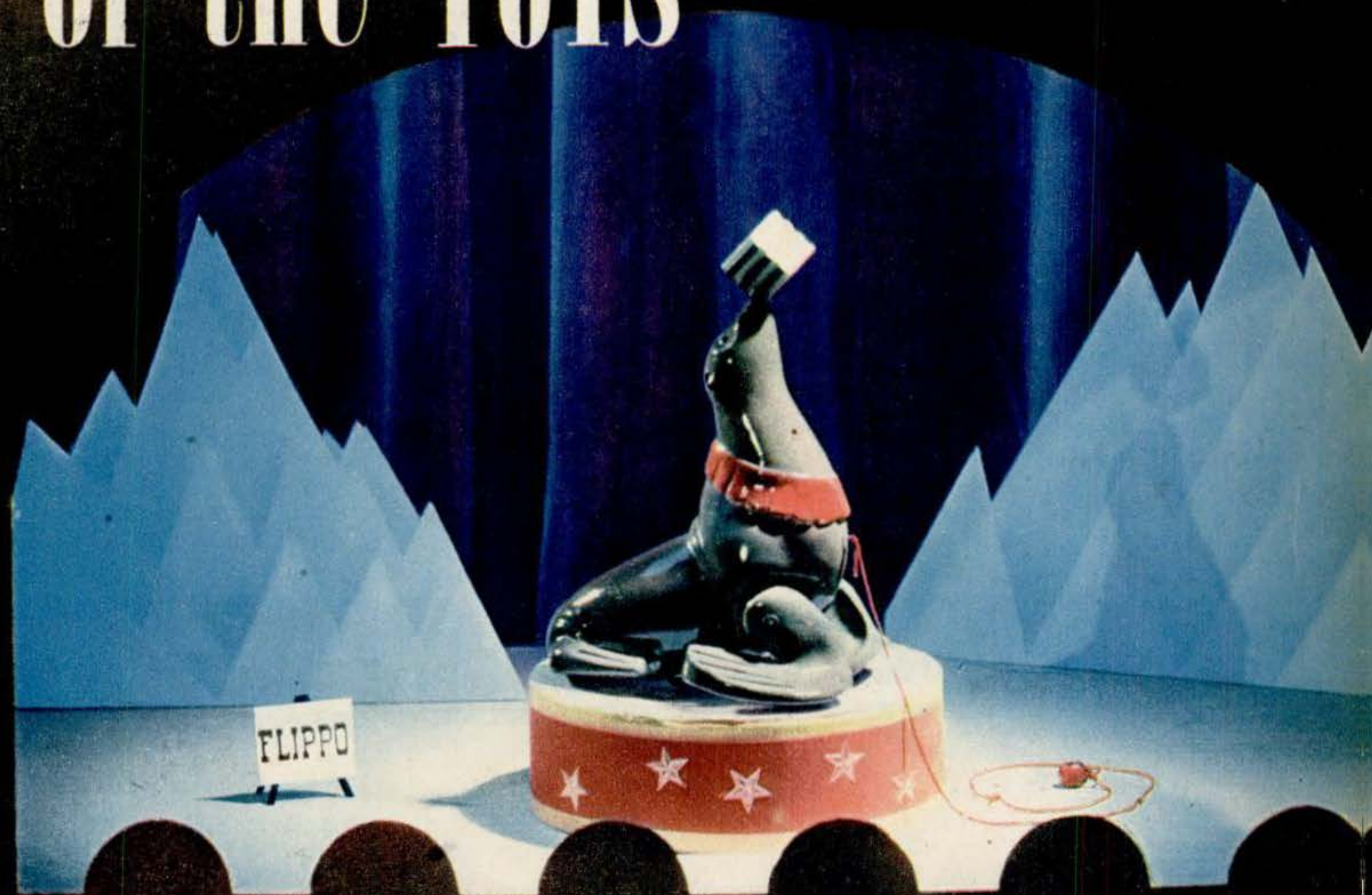





New scooters. At left: A three-wheel model made by the Tennessee Aircraft Corp. About \$15. Above: A ratchet-drive model made by Coaster Craft Scooter. About \$15.

Below: This 26-pound, 40-inch-long "handcar" operates like the real thing—by moving its hand levers forward and backward. It is made by the Kalamazoo Mfg. Co. About \$18.



Below: This miniature reaction engine is made by Minijet Motors for model planes, racing cars and speedboats. It uses regular gasoline, has a three-pound thrust, weighs 16 ounces. About \$35.

Above: Bridges, skyscrapers and a variety of other structures can be built with this aluminum construction set. It includes a riveting tool and blueprints. It is a Fox Toy Co. product. About \$3.

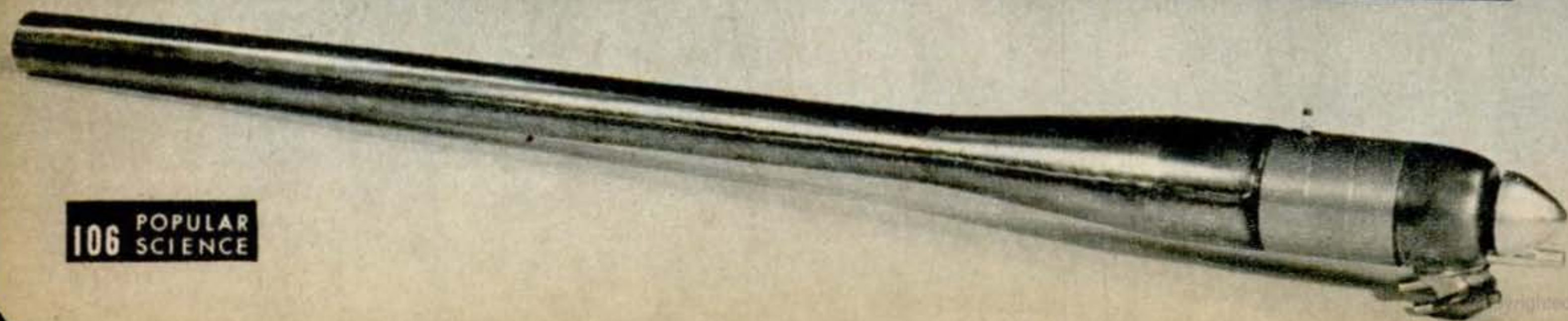
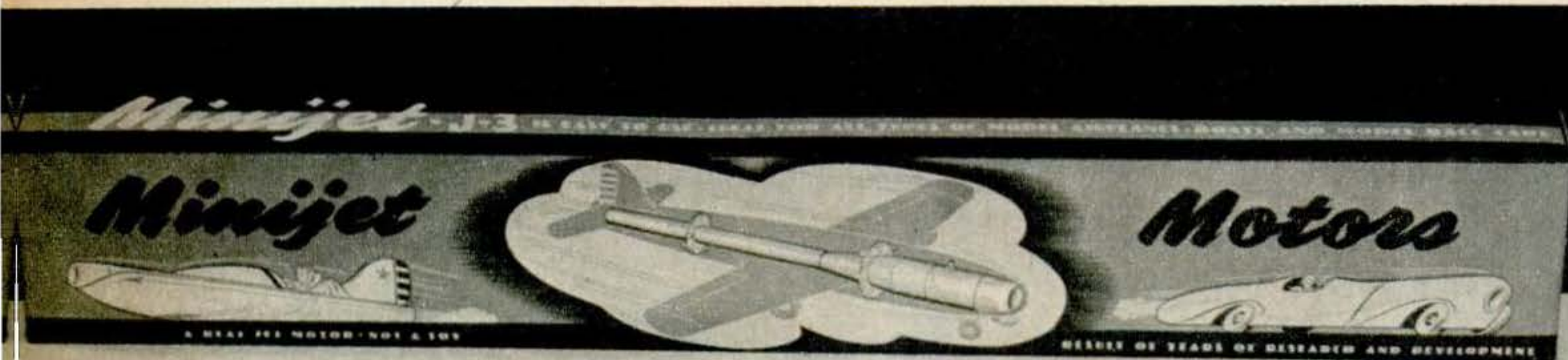



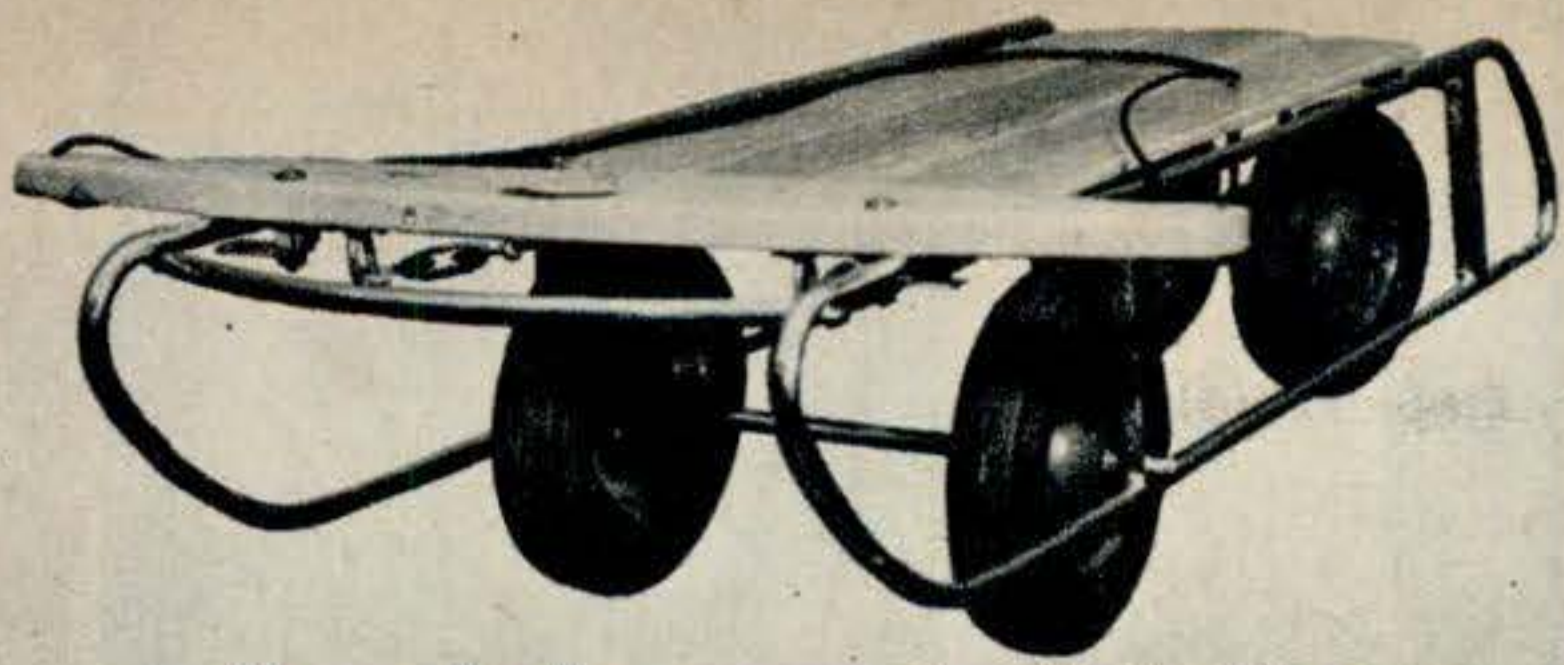

Above: In the summer the Sledmobile can be used as a wagon and in the winter, with its cotter-pinned wheels removed, as a sled. It's a space saver—and handy. About \$30.

At right: Keeping up with the times, model-airplane builders now stress jet planes. Mel Farrell's Shooting Star kit is made to scale. About 75 cents.

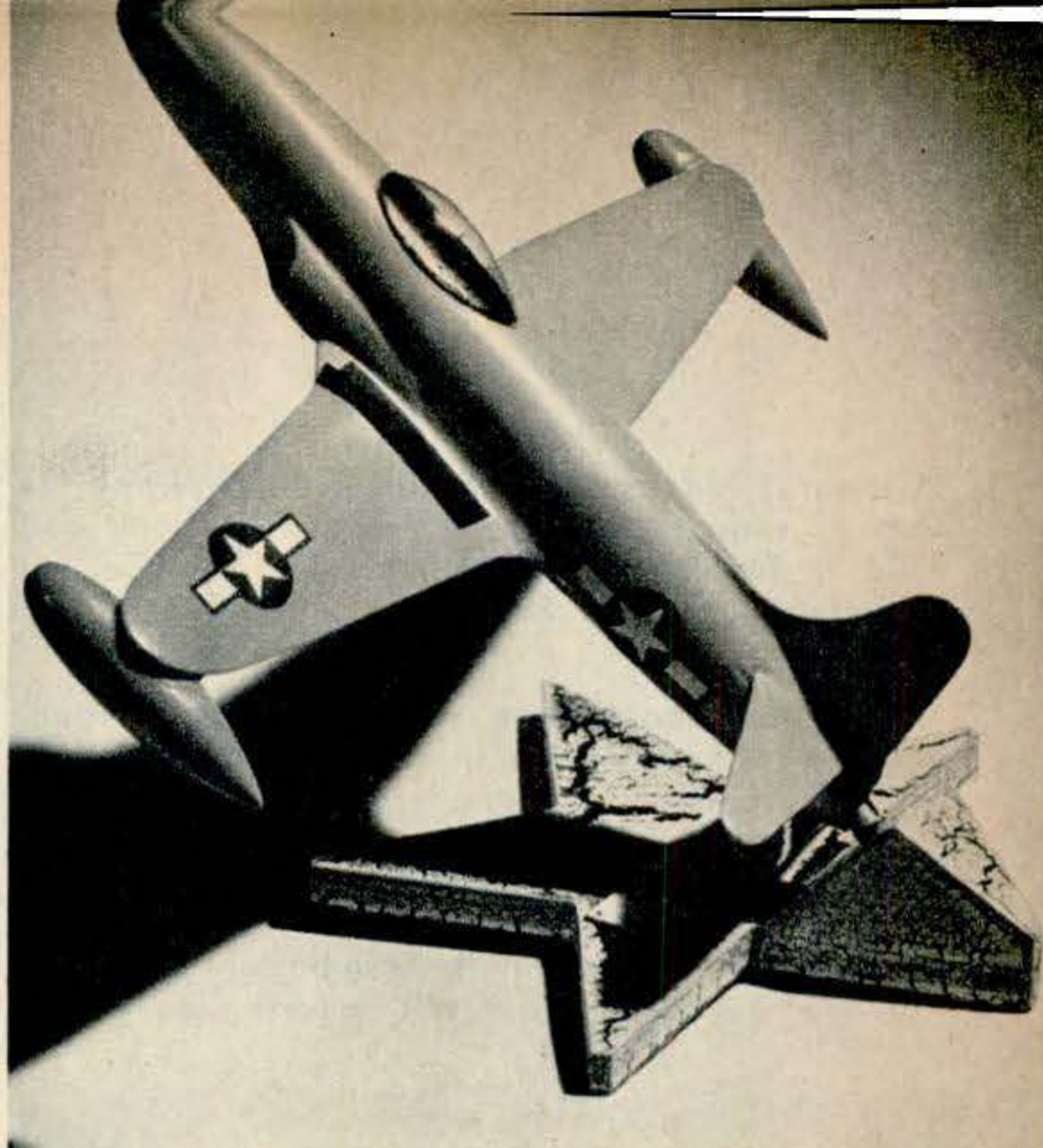

Below: Precision-molded for balance, with a smooth surface that reduces air and point-of-contact friction, the plastic top is a marathon spinner. Made by Plastic Molded Products, Inc. About 50 cents.



Below: This three-quarter-size telephone set can be used for room-to-room calls. Flashlight batteries supply its current. Pengo, Inc., makes the set, which includes 50 feet of wire. About \$12.

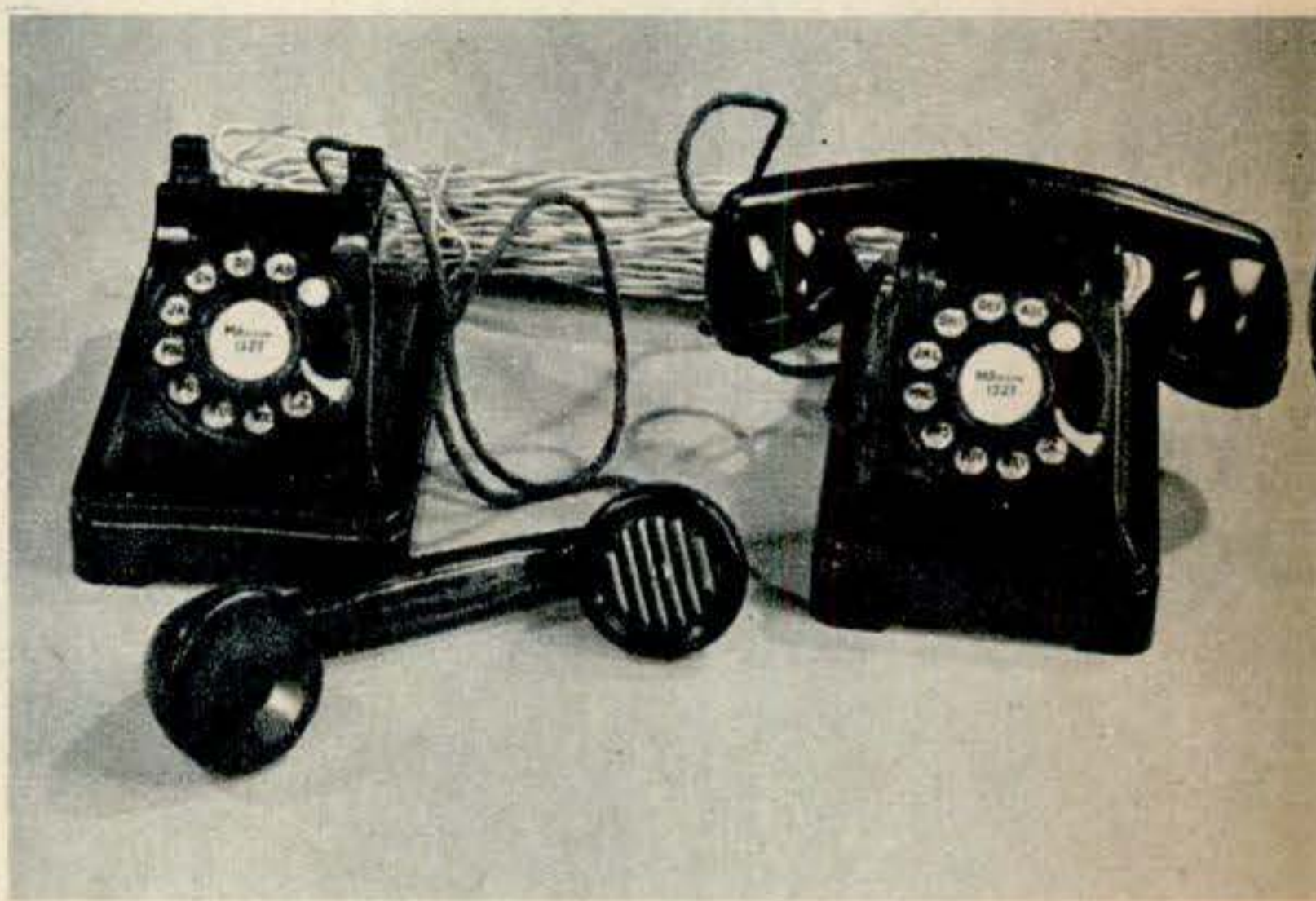

Below: Knee-action wheels are featured in the Keeco Flyer aluminum roller skates. A pair of the skates weighs a pound, needs no oil. About \$7.50.

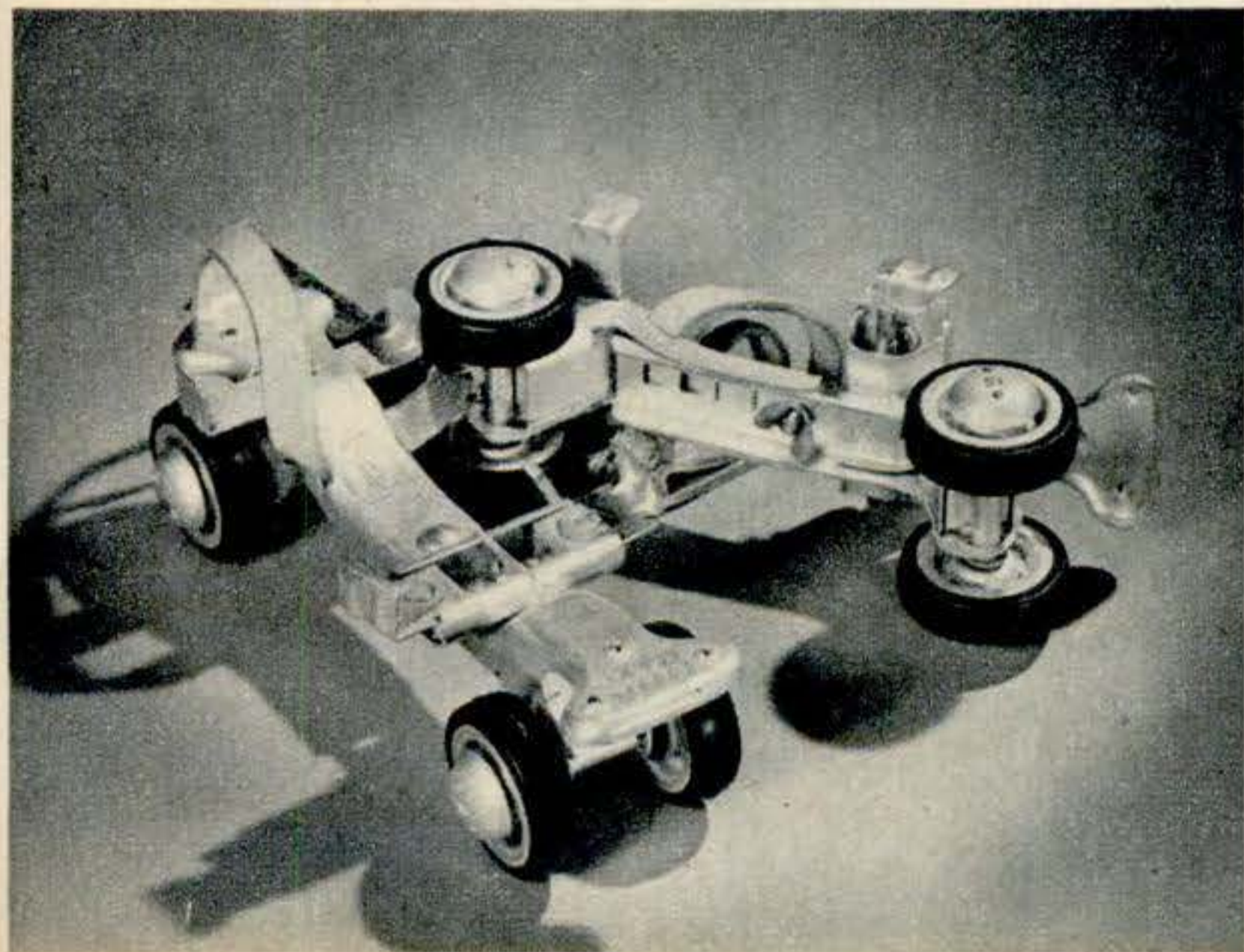

Below: The 8½-pound McCoy car has gone 116.4 m.p.h. A ram-air-intake gas engine costs from \$22 to \$35; the car, without engine, about \$42.50.

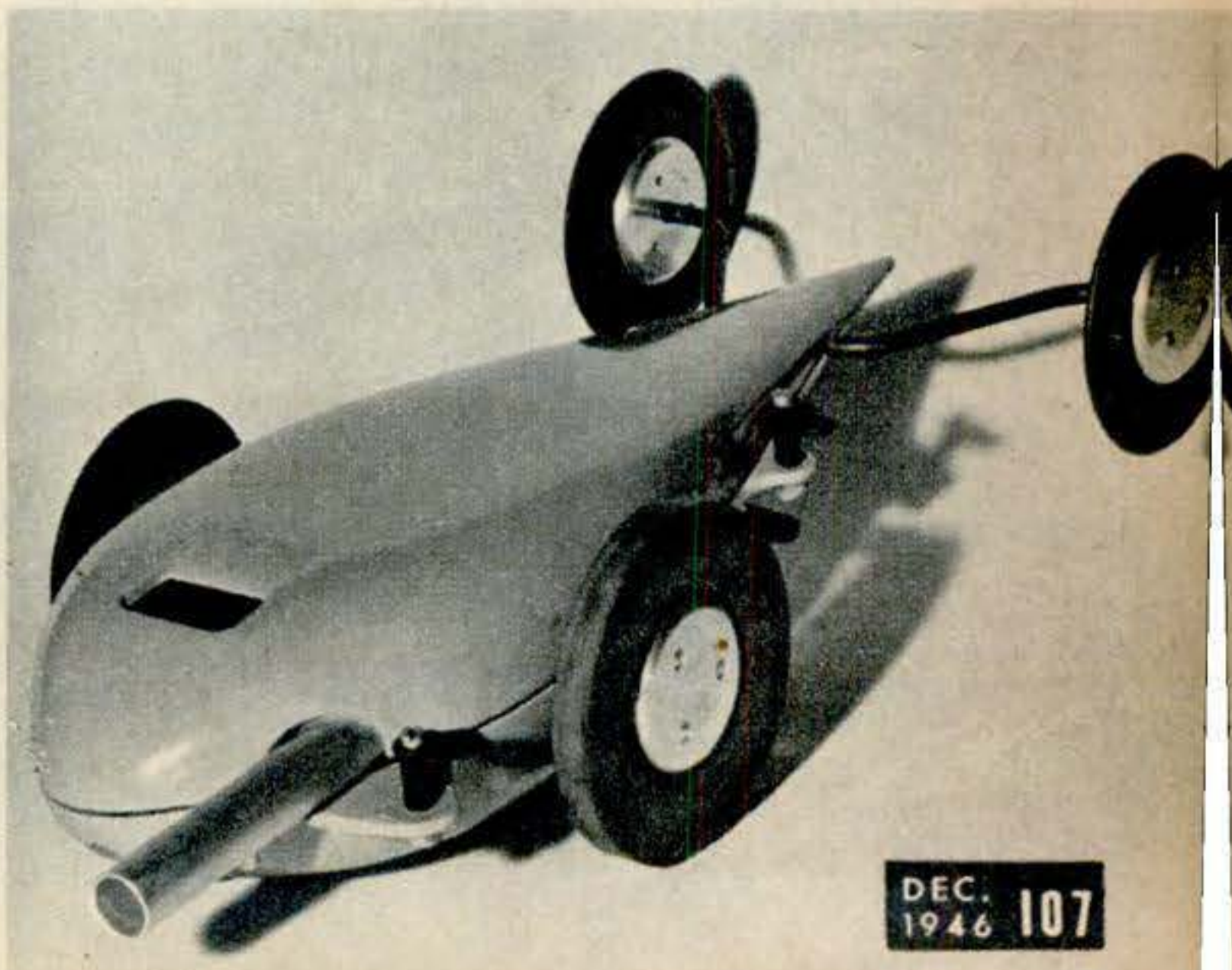



A magnet hidden in his mouth enables Nippy the Pup to snap at a metal-cored plastic bone and hold it fast. Made by Winchester Toy Co., of Philadelphia. About \$6.

Lionel trains have gone electronic. Ten different medium-frequency waves, controlled by buttons on the transformer below, stop and start trains, couple and uncouple cars, sound the whistle, and activate unloading devices—all anywhere along the line. The tiny receivers are no bigger than a watch. The smoke-puffing train in bottom photo sells for \$75. Service stations will convert older types.



Below: Gilbert's American Flyer trains are now powered by motors developed to operate Grumman Hellcat wing flaps. The locomotives smoke, too.

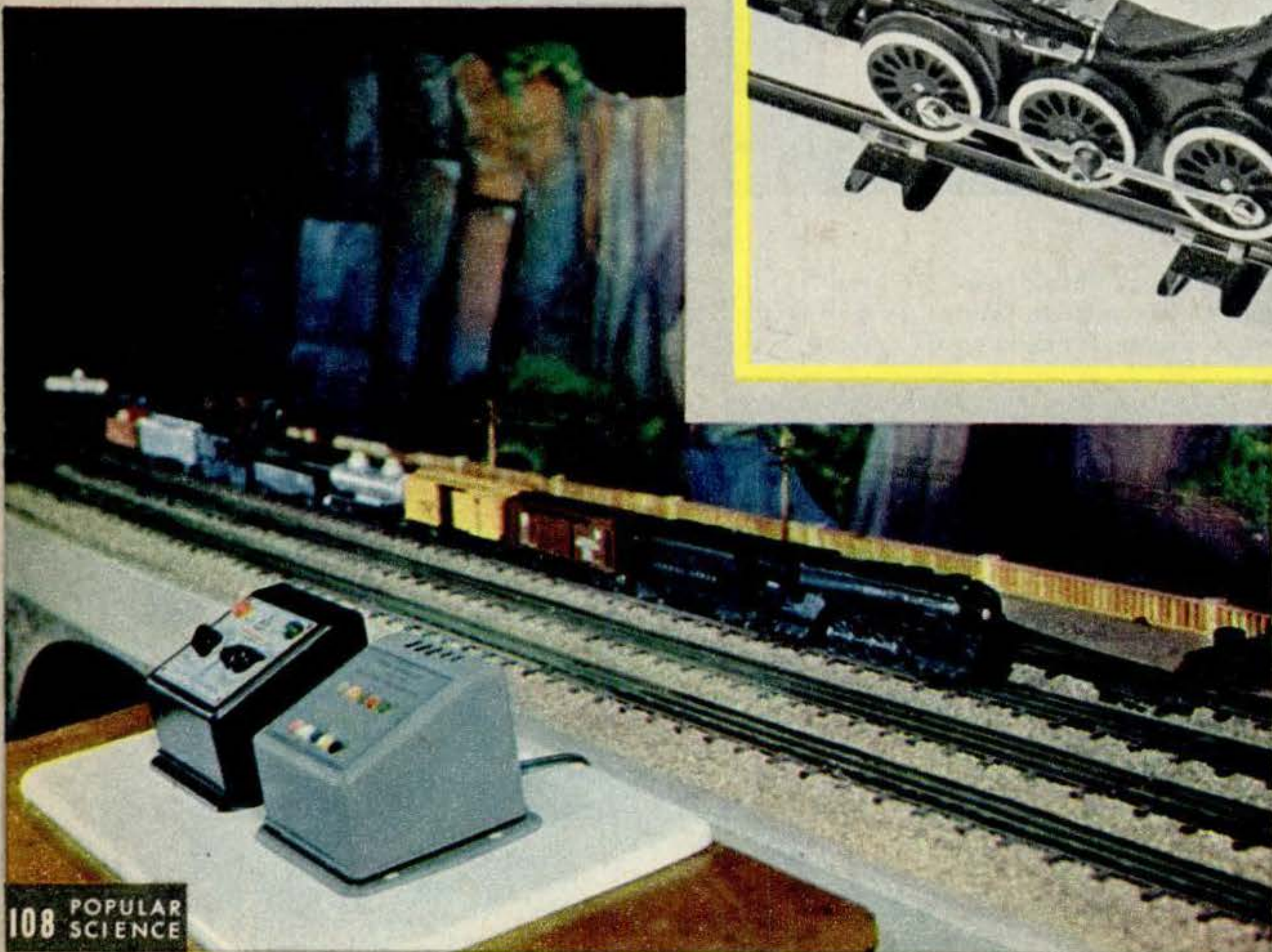
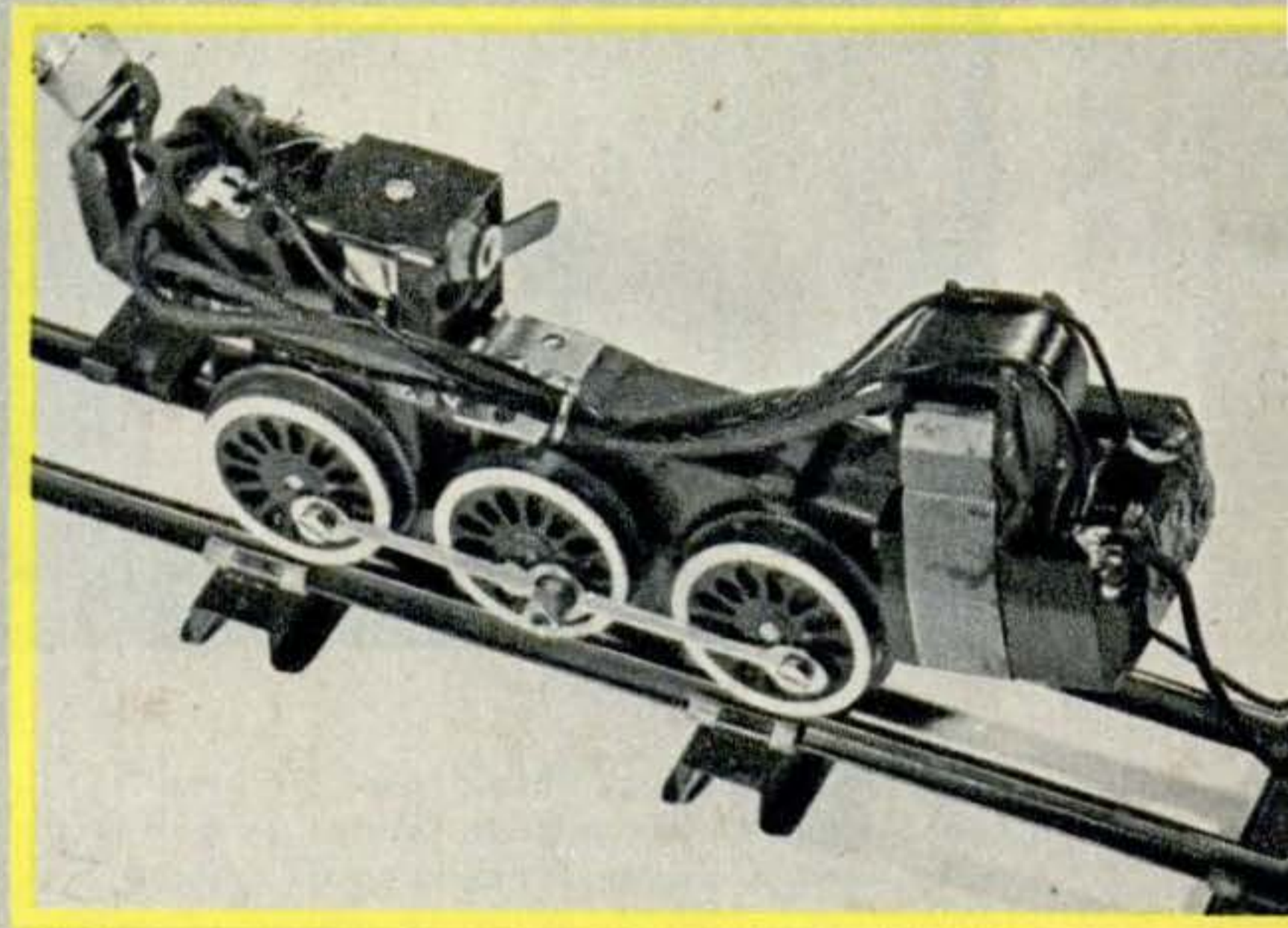





Below: The scale-model American Flyer cars are plastic and weigh only one-third as much as metal cars, permitting longer, more realistic trains.

Above: From England come these miniatures of standard English automobiles, powered by spring motors. They are made by Tri-Ang Minic Lines Bros., Ltd., of London. The larger types, \$2; the smaller, \$1.25.

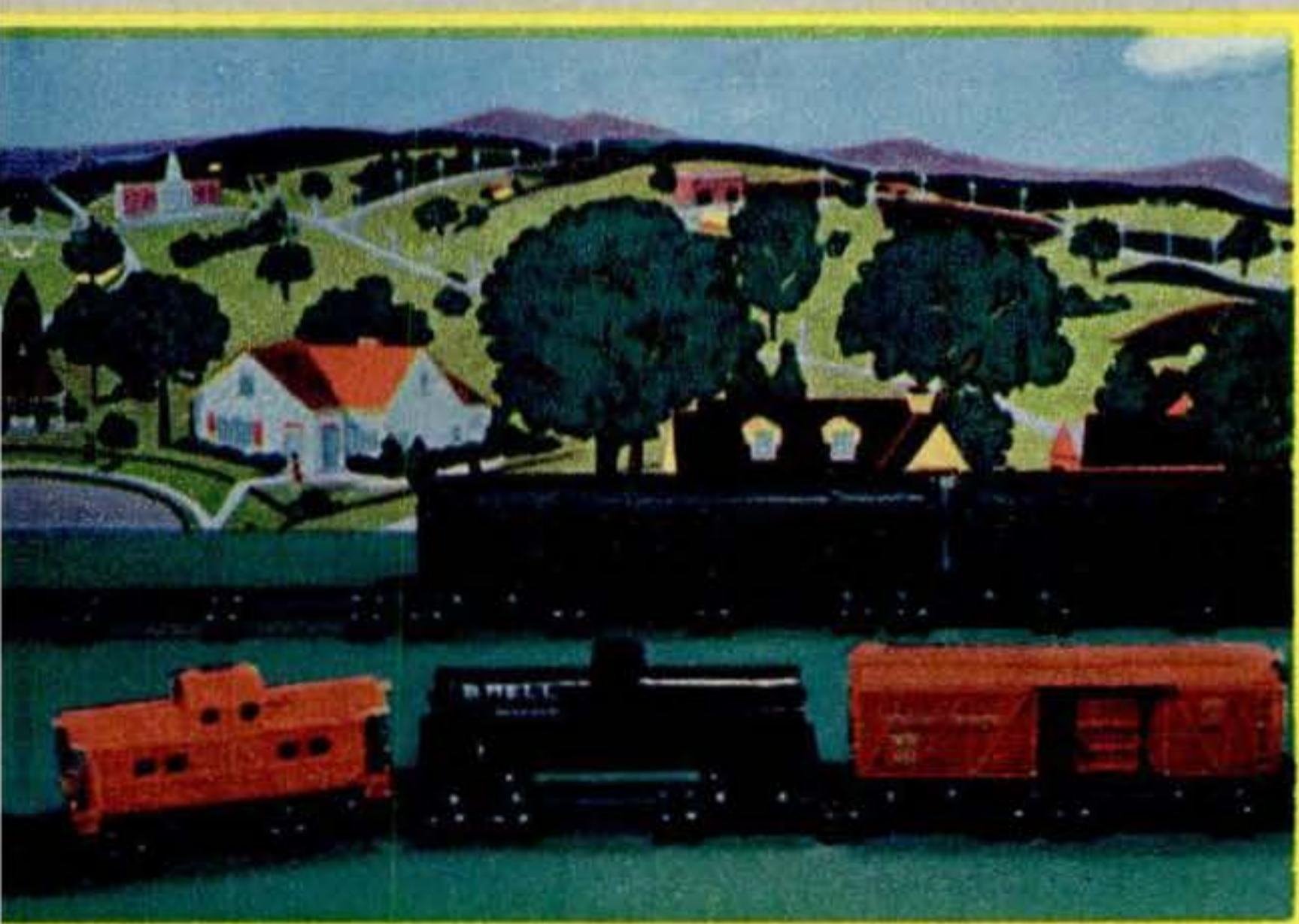

This scale-model bucket loader works just like an original. The model earth hauler dumps its load when a lever is pressed. The Charles W. Doepke Mfg. Co., of Cincinnati is not yet in full production. Bucket loader, about \$14; earth hauler, \$12.75.





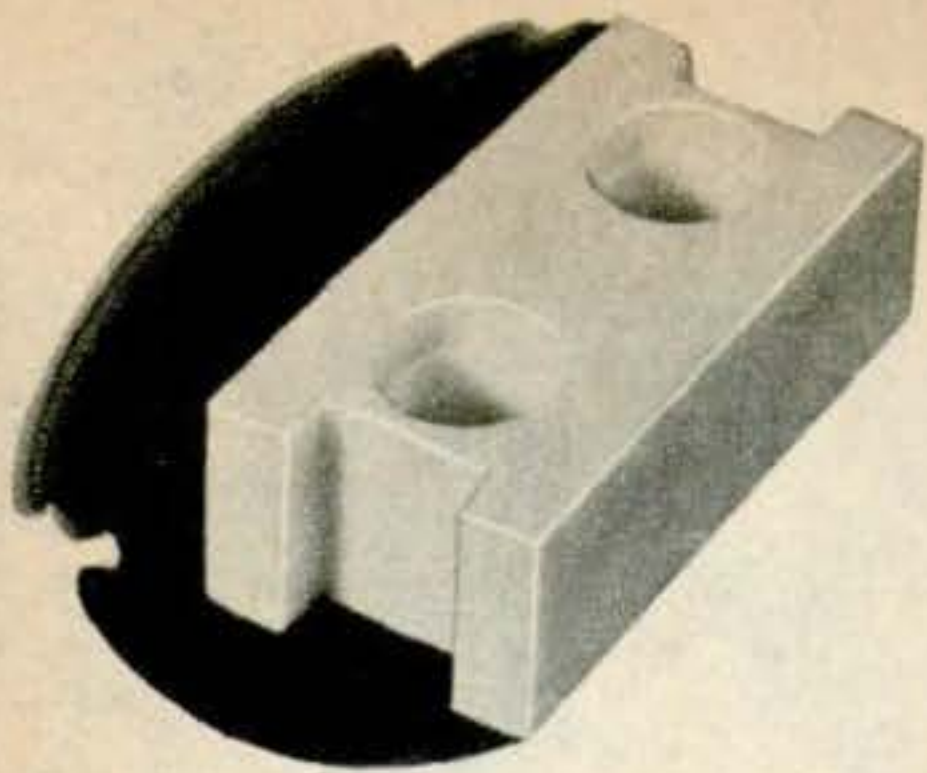

Latent construction talents of the playroom set can be developed—if father doesn't steal the act—with the Vinylite plastic building sets produced by the Du Page Plastics Co. A complete village (upper right) of 30 buildings can be built with plastic bricks (above), scaled  $\frac{1}{4}$  inch to one foot. In building, dowels are inserted in a perforated baseboard and the blocks are slipped on the dowels. The village comes with homes, stores, factory, public buildings, gas station, theater, hamburger stand, airport building and a real electric-light plant. Then there are windows, doors, shutters, flower boxes, imitation glass bricks, sandpaper strips for streets, and toweling to represent grass and shrubbery. The boy at right is building a typical home. Below is a wall showing the supporting dowels. The sets come in 10 sizes, the smallest with 400 pieces for \$4, the largest with 3,500 pieces for \$27.50.

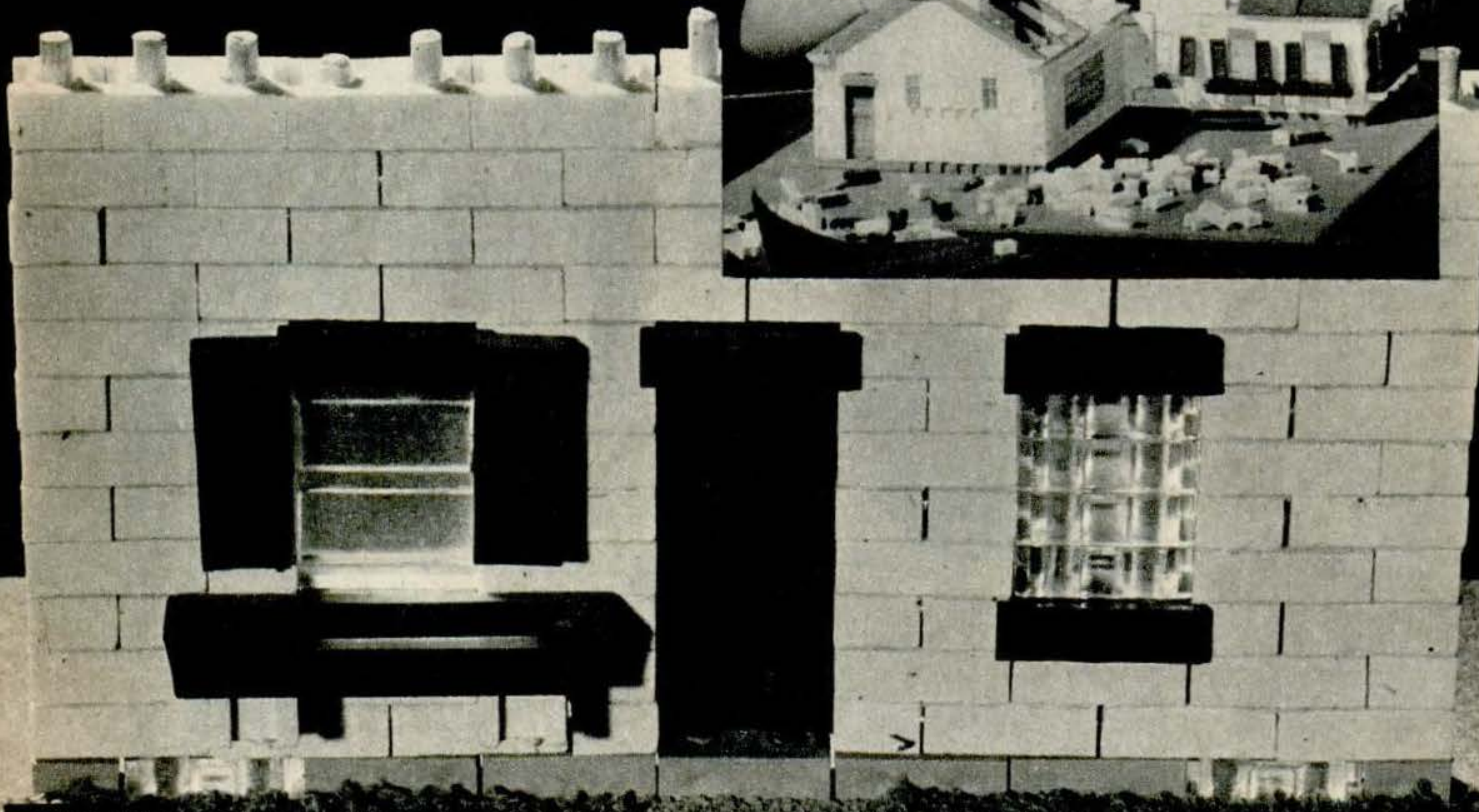
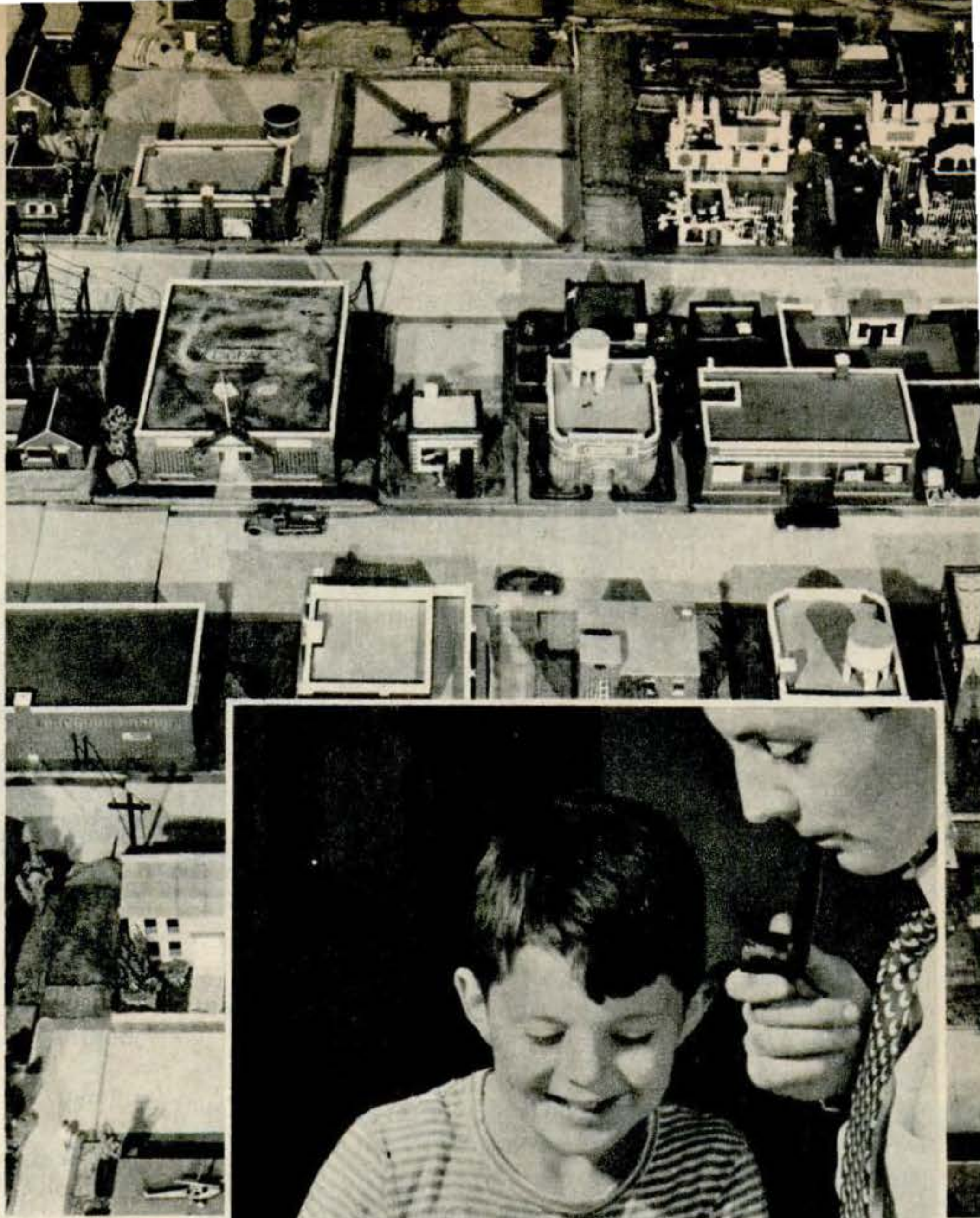



# I'd like

Cartoons by  
SYD LANDI

Everybody has his own pet idea of some gadget he would like to see in general use. What is YOURS? *Popular Science Monthly* will pay five dollars for every such suggestion that its editors decide to publish.



**Ball-Repelling Panes.** Windowpanes of a plastic able to shrug off a wild baseball without damage would be reassuring to Frank Raimo, Jersey City.



**Sneeze Trap.** Coughers or sneezers who attend shows and concerts should carry small, soundproof boxes to catch their noises, thinks Hildagarde Herzinger, Chicago.



**Bandit Catcher.** To disarm bandits, James Ledbetter, Atlanta, Ga., would equip stores with loudspeakers that, when set off by a clerk's foot, bark "Drop that gun!"

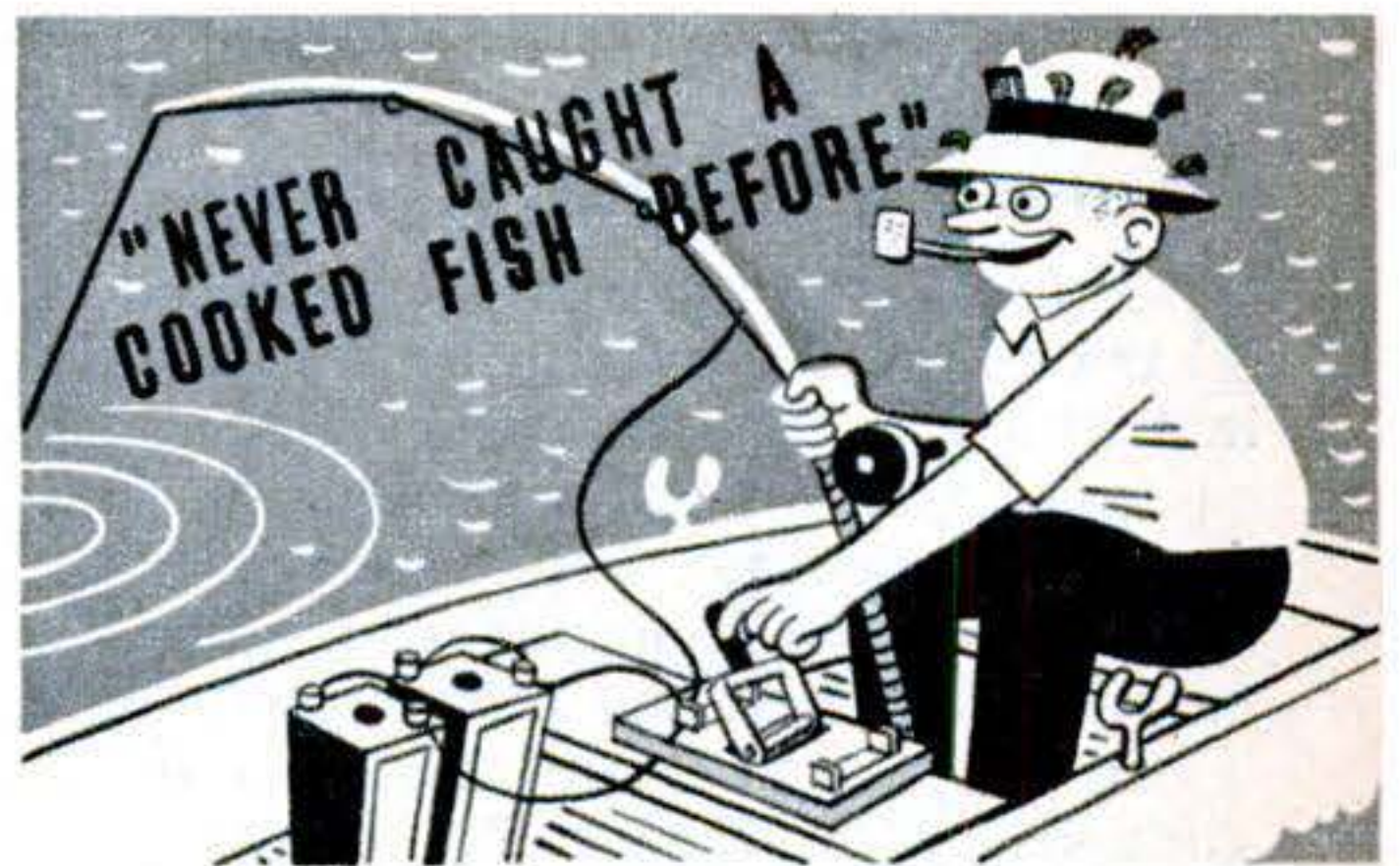

**Electric Fishhook.** To stun hooked fish and make certain the big ones are landed, Paul G. Cluver, Watseka, Ill., suggests a fishhook charged with electricity.



**Eraser Key.** An extra typewriter key that would merely have to be pressed to erase mistakes would be a boon, according to John Dosland, Moorhead, Minn.

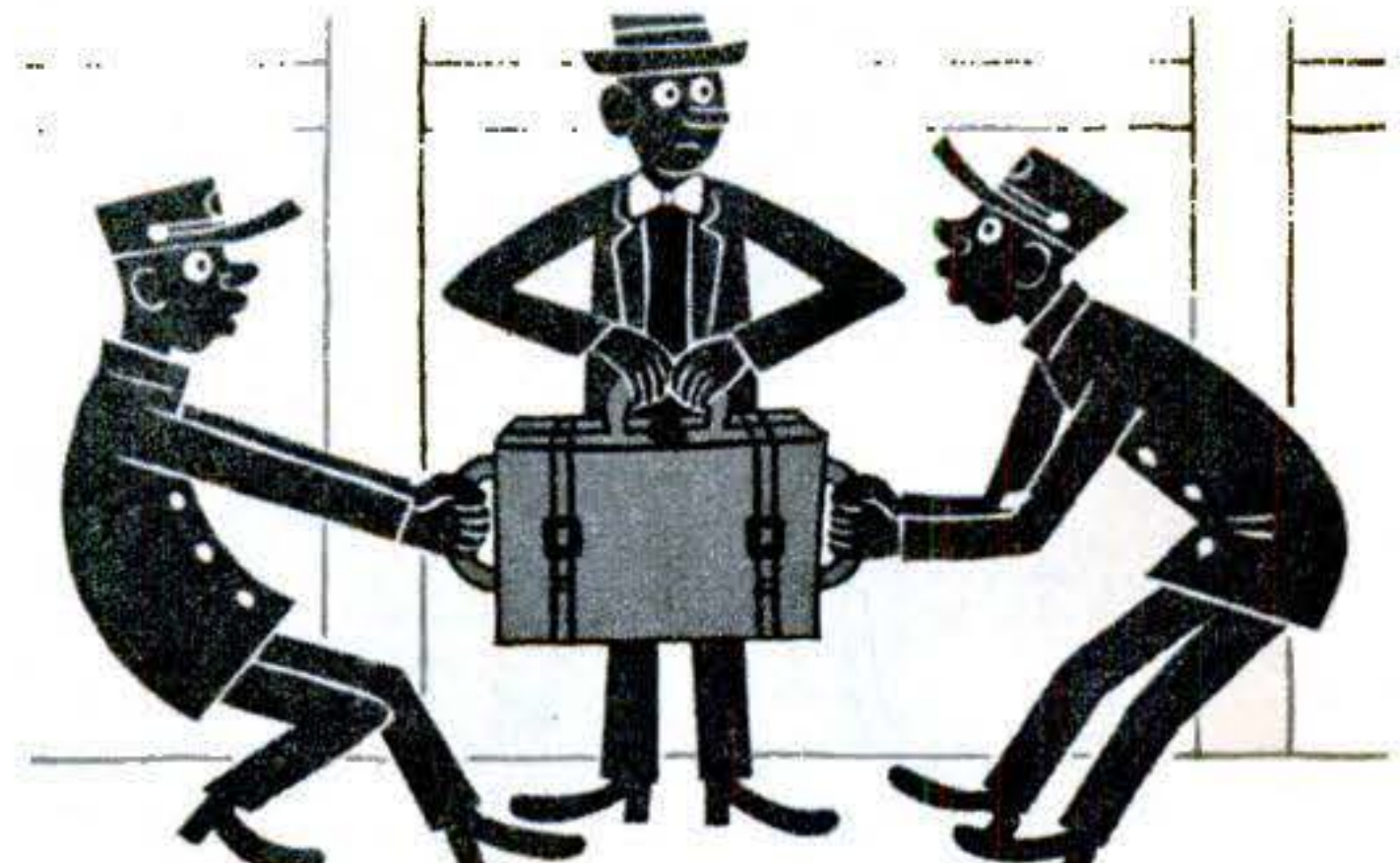

**End Handles on Luggage.** Aboard crowded trains, end handles would let bags be carried the long way and thus save space, says Mrs. Robert Graham, Cameron, Ill.





## Plastic Bearings Tell All

**N**EW transparent plastic replicas of bearings are helping Westinghouse engineers design smaller motors with more power. They can look right into the bearing while the machine is running and watch the oil, dyed red, flow into the various parts of the bearing. Thus a check can be made on whether the seals are working properly, oil passages are allowing the correct flow of lubricant, and relief points are properly located. Bad design starves some areas of oil and the bearing cannot carry a full load. Previously, designs were determined largely by trial and error. The bearing models are machined out of Lucite with the same close tolerances as the metal originals.

## Camera Theodolite Tracks "Old Needlenose"

**F**OLLOWING the flight of pilotless aircraft that travel at supersonic speeds requires special instruments. The tracking theodolite, below, is equipped with recording apparatus and geared to an automatic motion-picture camera. By using this device in combination with radar, a missile can be followed from the moment of launching until it comes to earth again. The theodolite, being examined by engineers S. L. Lewis and Waine Archer, permits a permanent record to be made for later study.

Boeing photos by Verné Manton.



The camera theodolite was developed for use with Boeing's "Gapa" rocket, here shown soaring aloft. Theodolite and radar stations, one to six miles from the launching tower, will record flight of the missile, nicknamed "Old Needlenose."





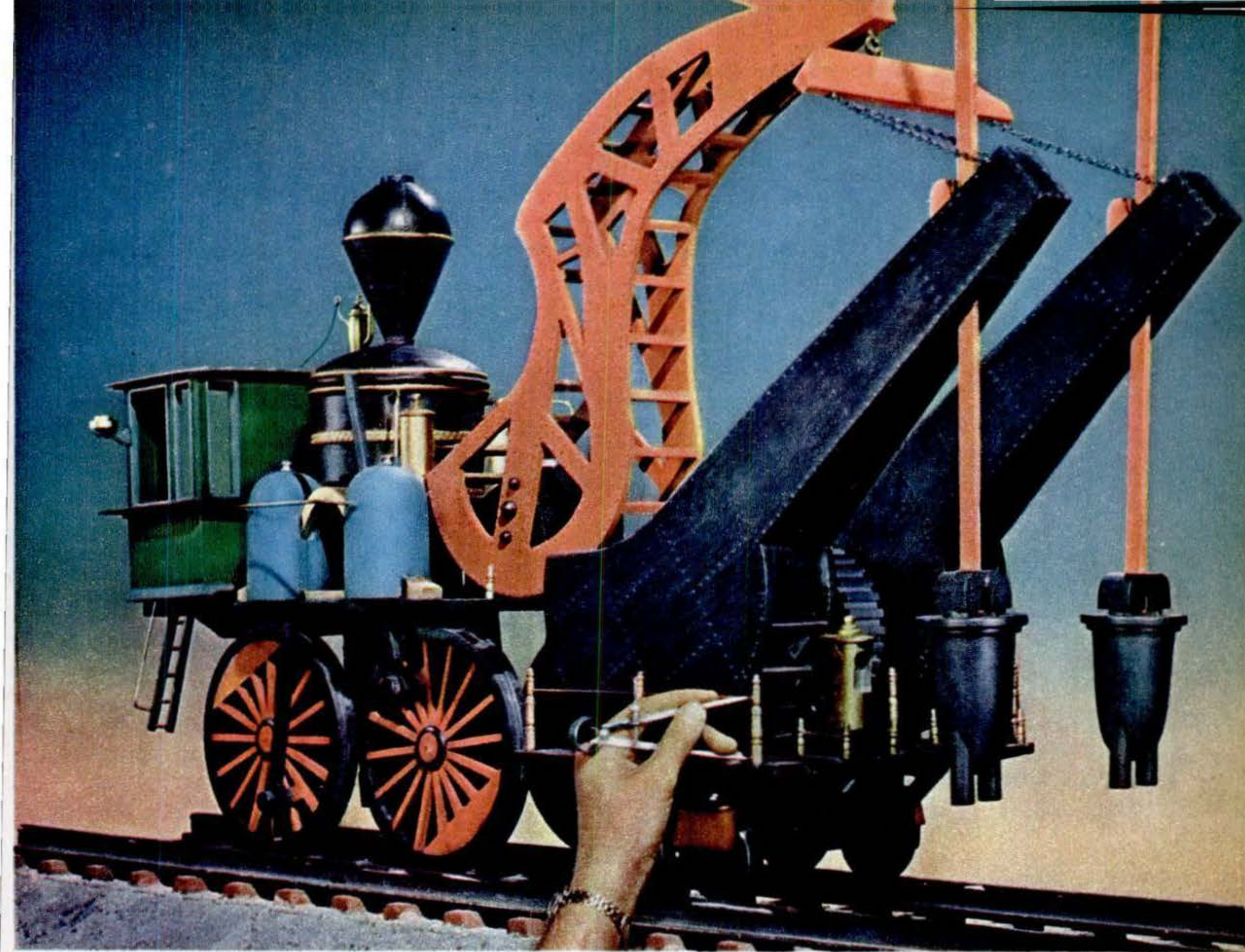

Inky Poo, the machine that drives spikes by the pair, is John Henry's opponent. It is an imaginative creation of plastic, metal and rubber to delight any model maker. Hand indicates the scale.

## Ingenious Models Bring John Henry Folk Saga to Movie Life

**J**OHN HENRY was the fabulous super-strong man of the workers who built the railroads, just as Paul Bunyan was of the lumbermen. John Henry's great contest against the machine is an epic of American folklore. Now George Pal, cartoon-movie maker, has brought the story to the screen,

matching John Henry against a fantastic steam track-laying and spike-driving machine named "Inky Poo." Seven plastic torsos, 73 pairs of wooden legs and 42 rubber heads make John Henry "move," and Inky Poo, of course, is also shifted into a new position between each frame.

Inky Poo and John Henry start at the mouth of a tunnel to see who can first lay track to the finish.

True to legend, John Henry wins the race with his mighty hammers flying but kills himself to do it.

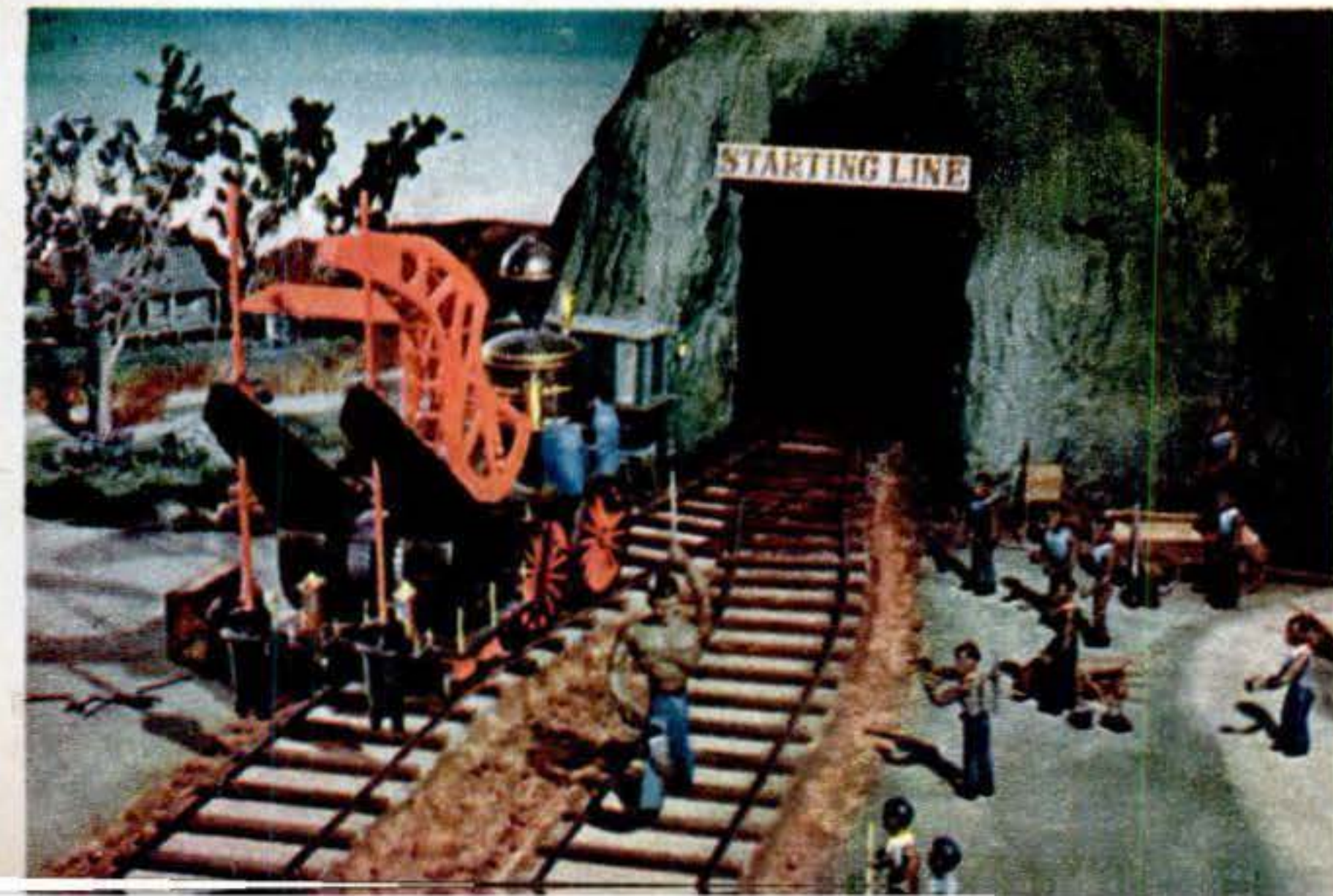



Reputedly obsolete, this supersonic Miles 52 has been canceled, but a small rocket-motor model of it will be launched at 36,000 feet.

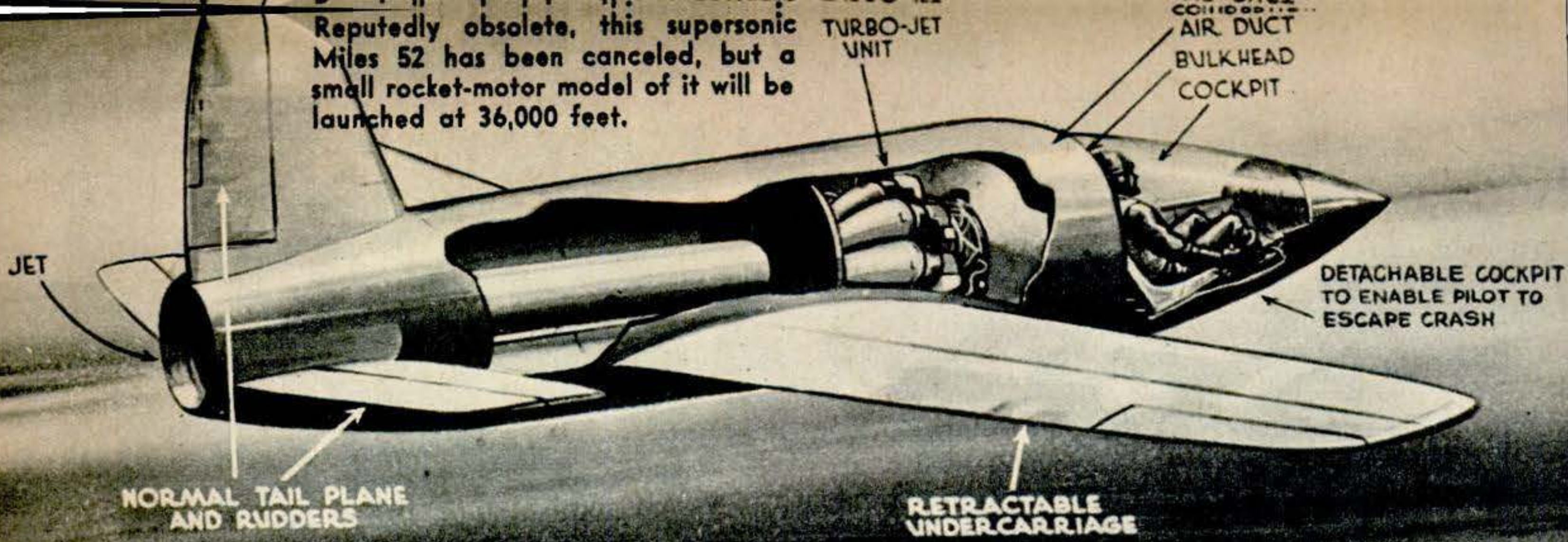

## Britain Goes Supersonic

### Engineers race to design first plane to fly faster than sound.

**B** RITISH engineers are making an all-out attempt to build aircraft that fly faster than the speed of sound. To do it they are concentrating on developing gas turbines, jet propulsion and rocket engines.

British airplanes have broken existing world speed records in recent months. Now British experts are developing engines and planes to set fresh marks. Hint of what they are like is given by the canceled Miles 52, apparently obsolete even before completion. The M-52's 17,000-hp. three-stage power plant almost filled the fuselage. Ex-

haust from a jet engine with centrifugal blower ran a gas turbine. This brought more air into the stream and pushed it into a duct. Here more fuel was burned to give an extra push. The plane was expected to hit 1,000 m.p.h., 250 m.p.h. faster than sound. The ones under wraps presumably are planned to do even better.

The solution of supersonic difficulties is complicated by the fact that ordinary wind tunnels cannot be used for testing. Air bounding off the sides sets up disrupting currents, and a shock wave "chokes" the tunnel. For this reason British engineers are using various types of pilotless models, some dropped from high altitudes, some depending on rockets.

THE "FLYING DUCK" TYPE.  
AN AIRCRAFT DESIGNED TO FLY FASTER THAN THE SPEED OF SOUND, HAVING REAR WINGS WITH LARGER SPAN THAN CHORD (I.E. HAVING LARGE ASPECT RATIO)



Various designs proposed for supersonic aircraft. The swept-back wings and delta designs are intended to cut drag but offer control difficulties if used at low speeds.

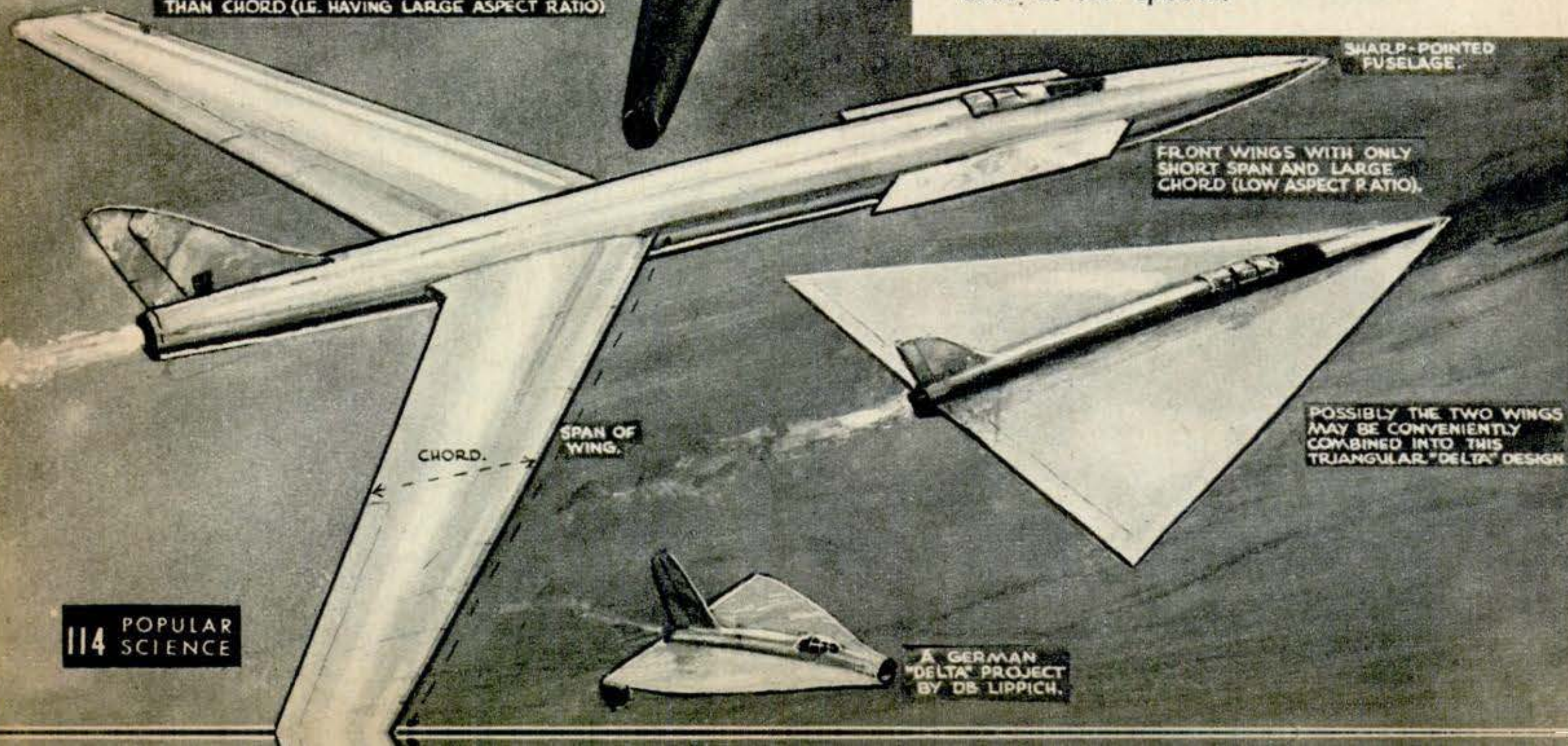



TO AVOID COMPRESSIBILITY AND REDUCE "WAVE DRAG" THE WINGS OF SUPER-SONIC AIRCRAFT MUST BE THIN, BI-CONVEX AND SWEEPED BACK.

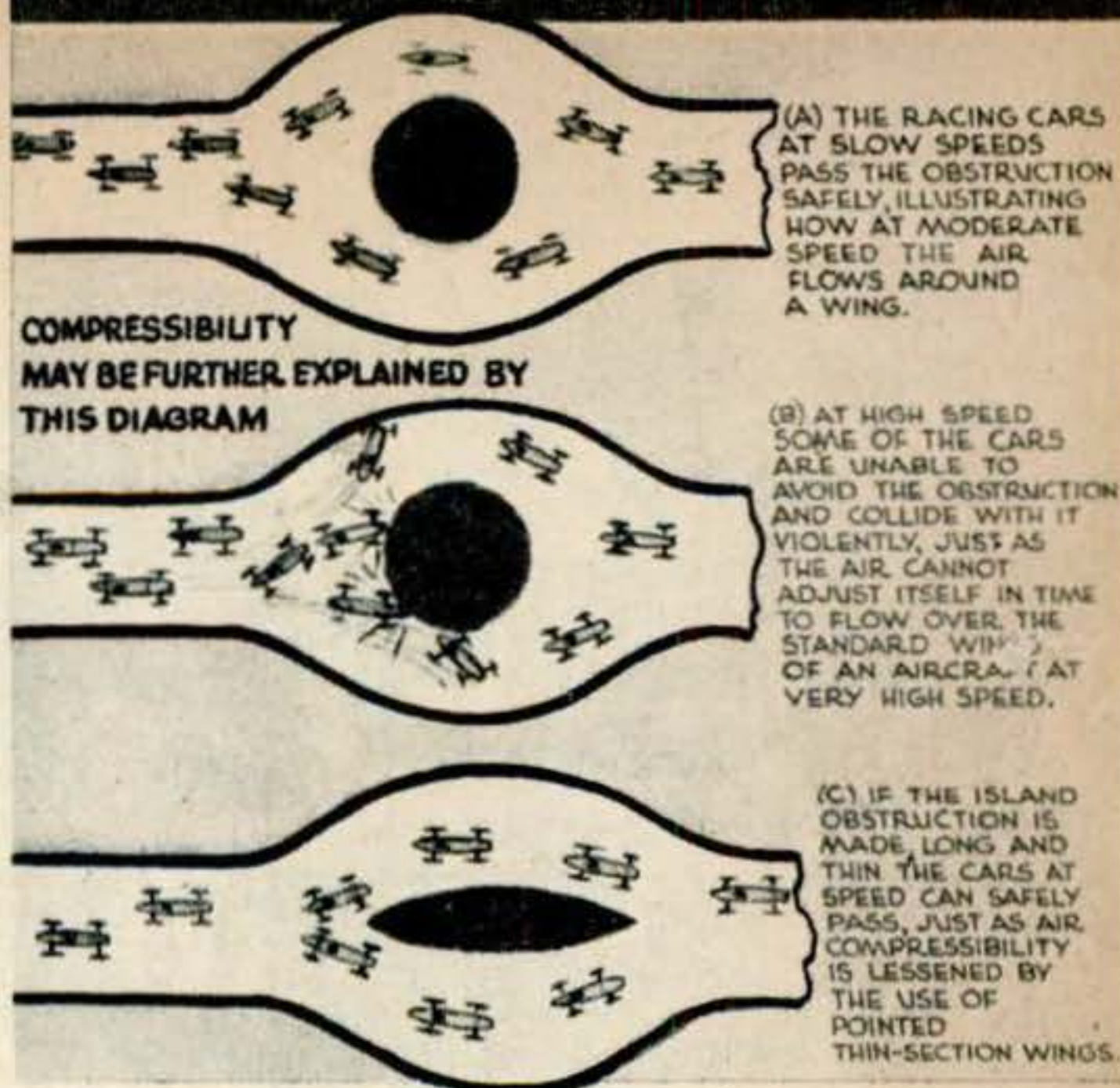
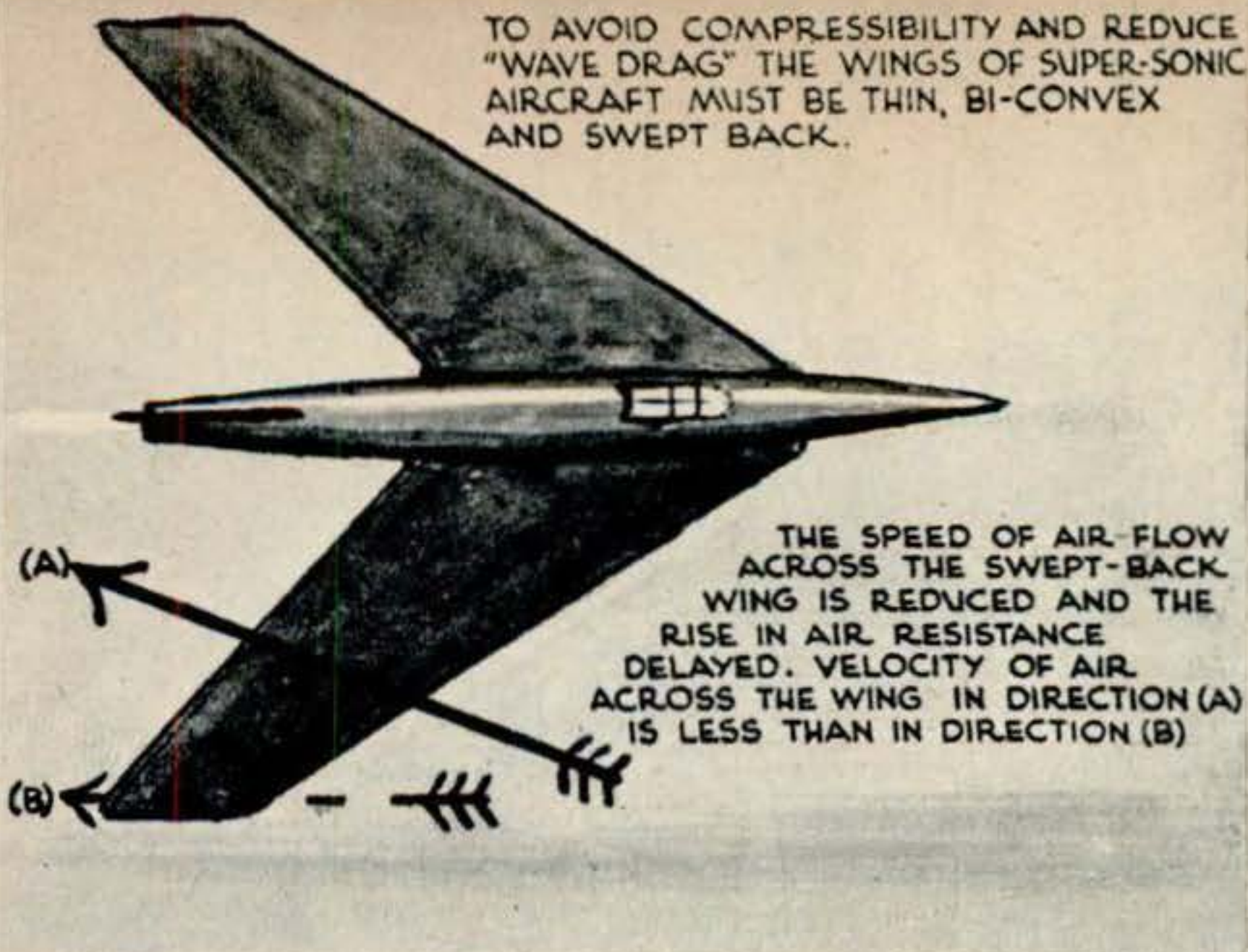

The subsonic wing, at left below, piles up compressed air ahead of it at speeds approaching that of sound. The supersonic wing, at left above, is "biconvex,"—thinner and more pointed to cut through the air.



"STABILITY CHANGE" ASSOCIATED WITH FLIGHT THROUGH THE SPEED OF SOUND

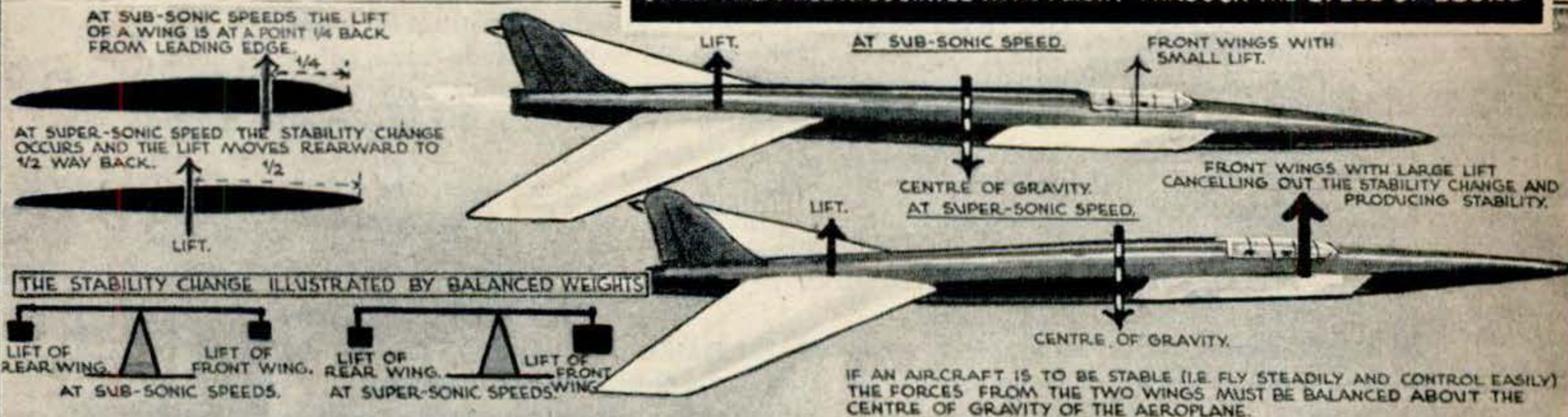

Above: Rearward shift of the center of lift at supersonic speeds must be balanced by front wings whose lifting power increases. Below: These aircraft, British, American and German, have special shapes to delay compressibility troubles.

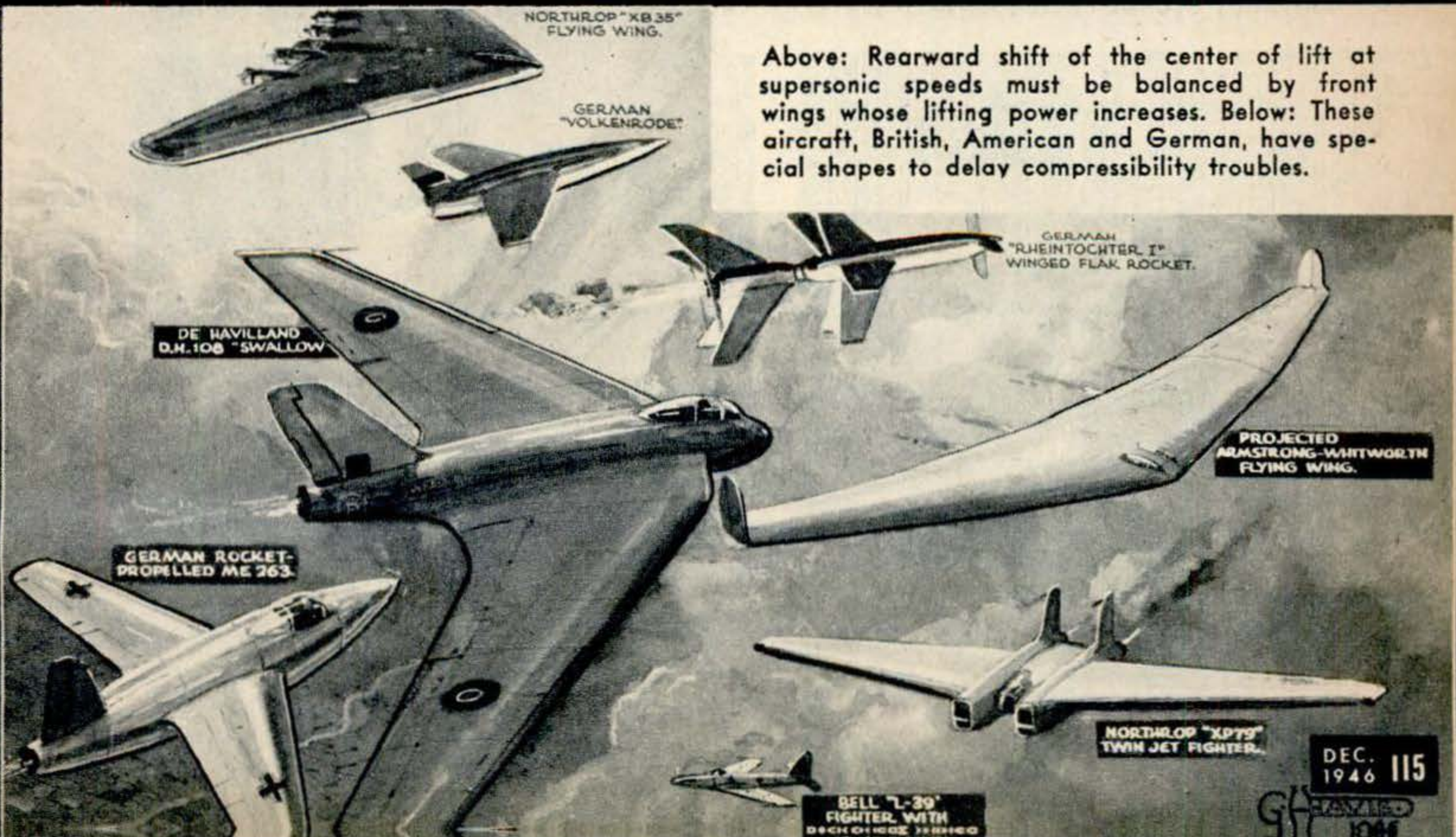





**Conveyor-Belt Harvesting.** Lettuce and other crops on big western ranches are being gathered more quickly with the help of conveyor belts like the one shown above in an Arizona lettuce field. Fifteen men feed each of the belts, which move through the huge fields at two miles an hour.

The belts, rumbling along on gas-pipe rollers, are 30 inches wide and 135 feet long, and each is powered by two 85-hp. Ford engines. They carry the produce up above tractor-drawn trailers and drop it into steel baskets. The machines are made by the Gaudin Motor Co., of Salinas, Calif.

**Aluminum Rowboat.** Douglas Aircraft makes this rowboat of airplane-type .040-gauge dural. The surface is anodized to make it corrosion-proof, seams are riveted and spot welded, and air tanks maintain buoyancy even if craft fills with water.

**Durable Orchid.** Made of Lumarith plastic, the once-fragile orchid becomes washable and long-wearing. William Farris, of Alhambra, Calif., began making the flowers in a navy hospital; now 10 disabled veterans turn them out in his home factory.

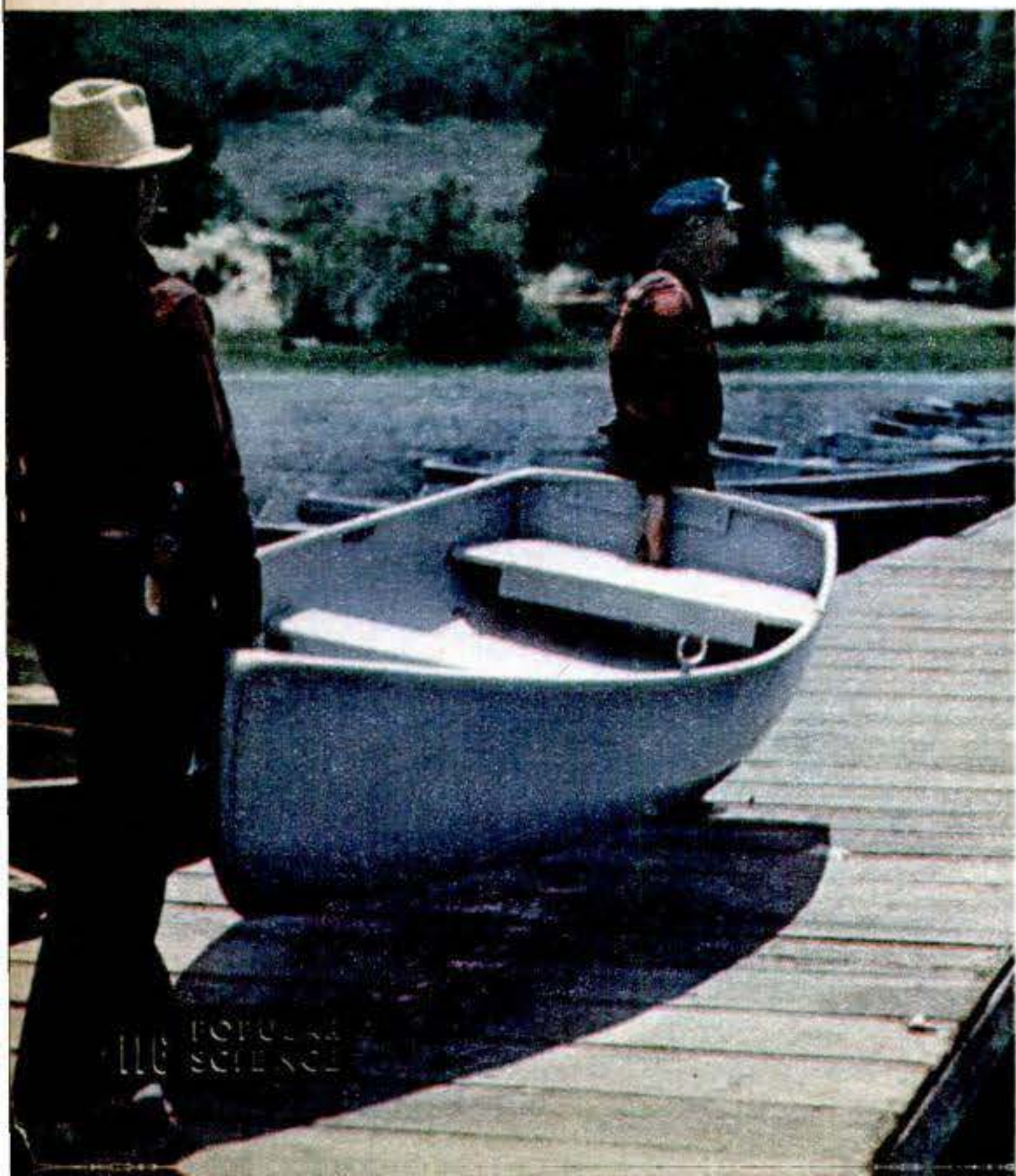



# CRAFTWORK

## PROJECTS OF THE MONTH

**S**HOPPING days before Christmas don't count when the presents are turned out in your own home workshop. Despite appearances, the three projects here can be built in short order, and with little cost for the materials used.

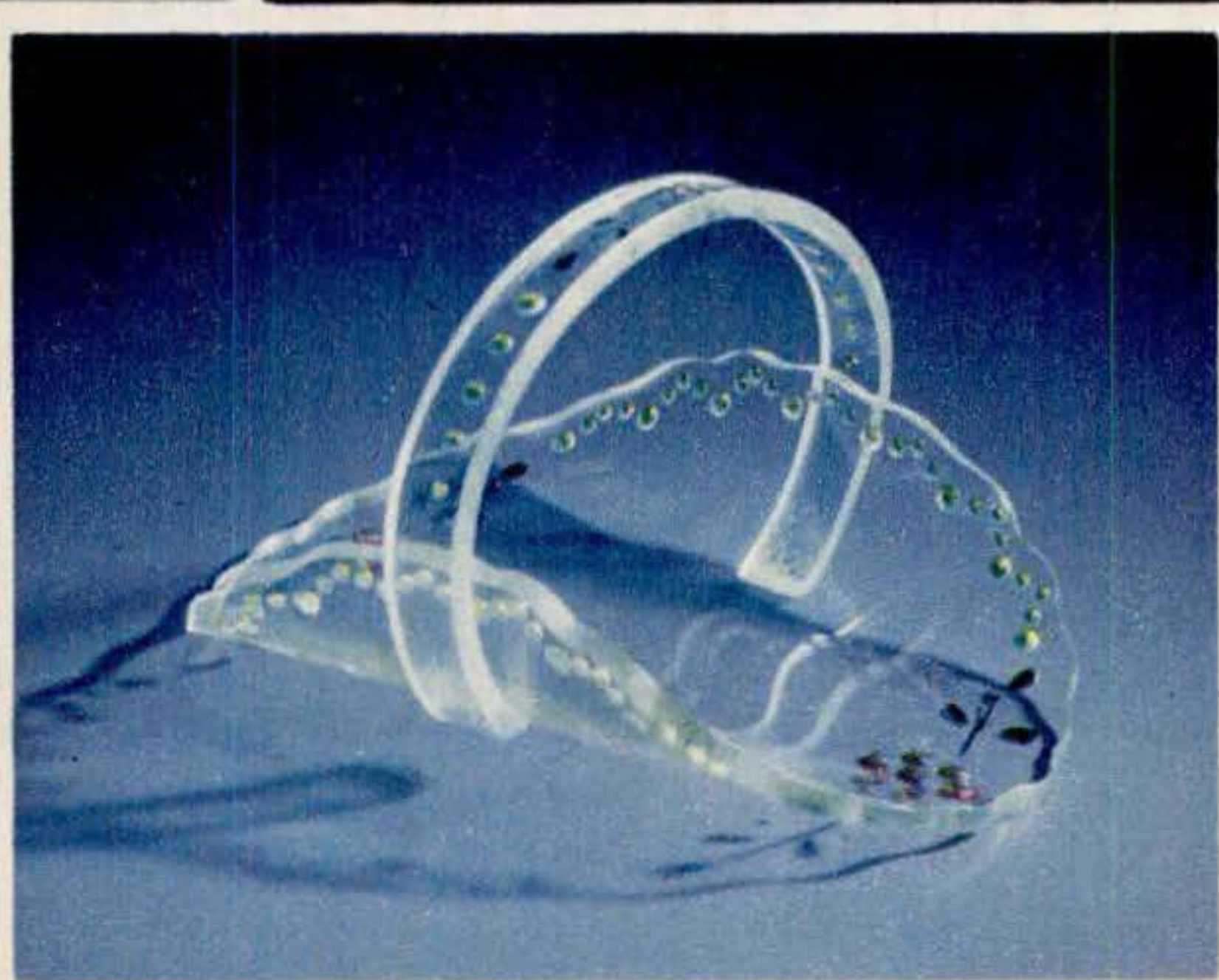

**TIN-CAN STOCK IN THE LAMP** shown at top is good material for decorating with paint and decals and may be cut from a 2- or 5-gal. can. The project is described on page 162.

**A GAME OF SHOOTING DISKS**, in the photo at center, calls for just enough skill to give all members of the family a thrill. How it is built and played is told on page 151.

**DIMPLES IN COLOR** make the little basket of clear plastic just at left something different. Construction steps are also on page 151.





## NEW IDEAS from the INVENTORS

### Combination Spoon and Fork.

This ingenious instrument, designed by Samuel Lapin, of New York City, works both ends with one handle. One end is a conventional spoon; the other, a two-pronged fork. It spoons or spears fruit from a jar, or from a drink that it also stirs. The fork is suitable for sea food.

**Hammer-Head Lock.** The menace of hammer heads that fly off the handle is met by a device developed by Vincent Iavarone, of New York City. The inner face of the hole in the head is notched and the handle recessed to hold a hairpin-shaped spring. The two ends of this spring, pushed together when the handle is forced into the hole, spring apart once it is in position, catching one end in the notches and locking on the head.

INSERT NAIL  
THROUGH HOLE  
TO RELEASE  
SPRING

SPRING

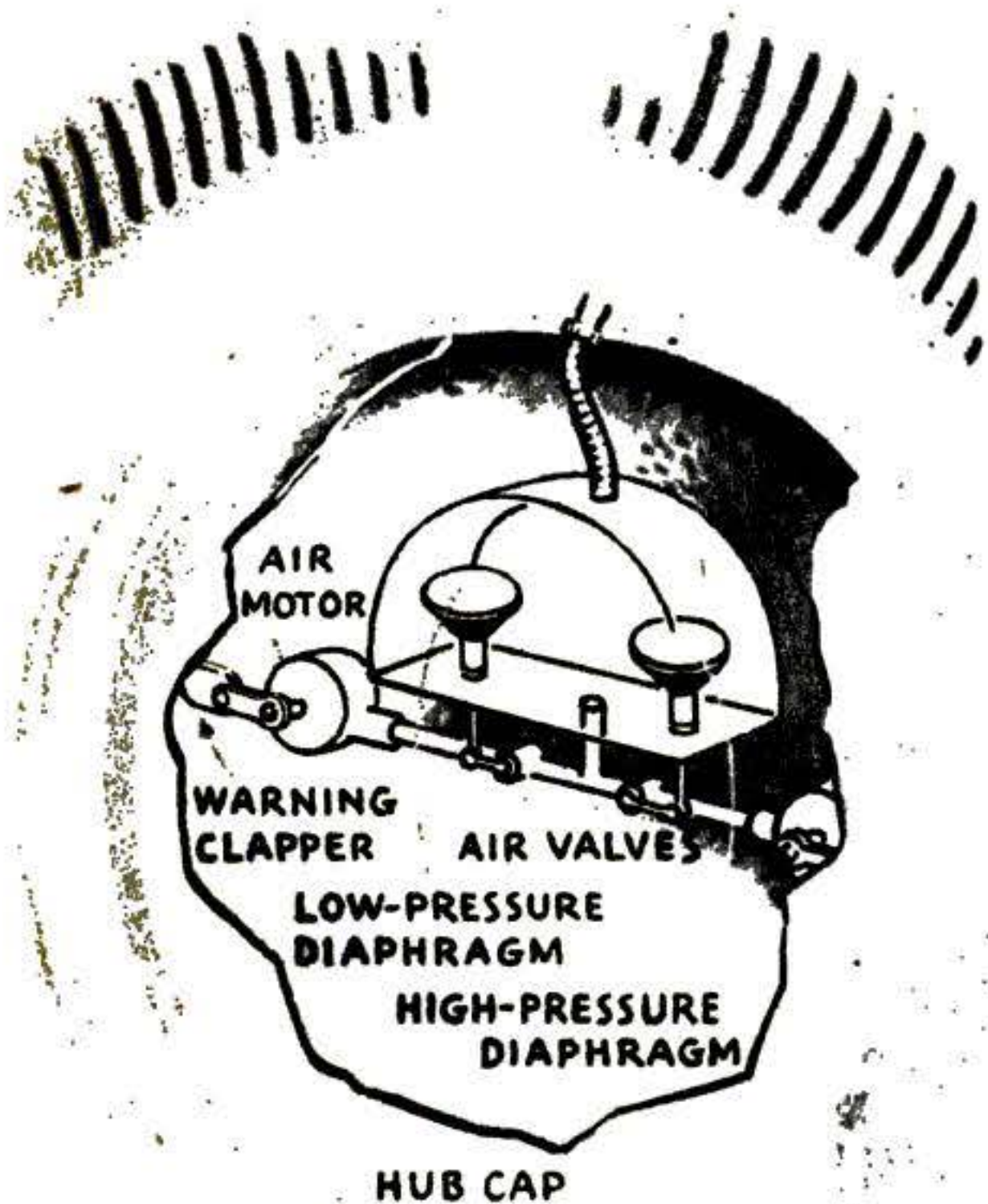

**Leaky-Tire Alarm.** A clapper warns you of improper tire inflation in a device invented by Arthur M. Heath, of Houston, Tex. A double-action valve, set inside the hub cap and connected with the inner tube, remains closed only when the pressure is just right. Low pressure or over-inflation opens the valve, allowing air to operate a tiny motor that bangs the clapper against the inside of the hub cap.

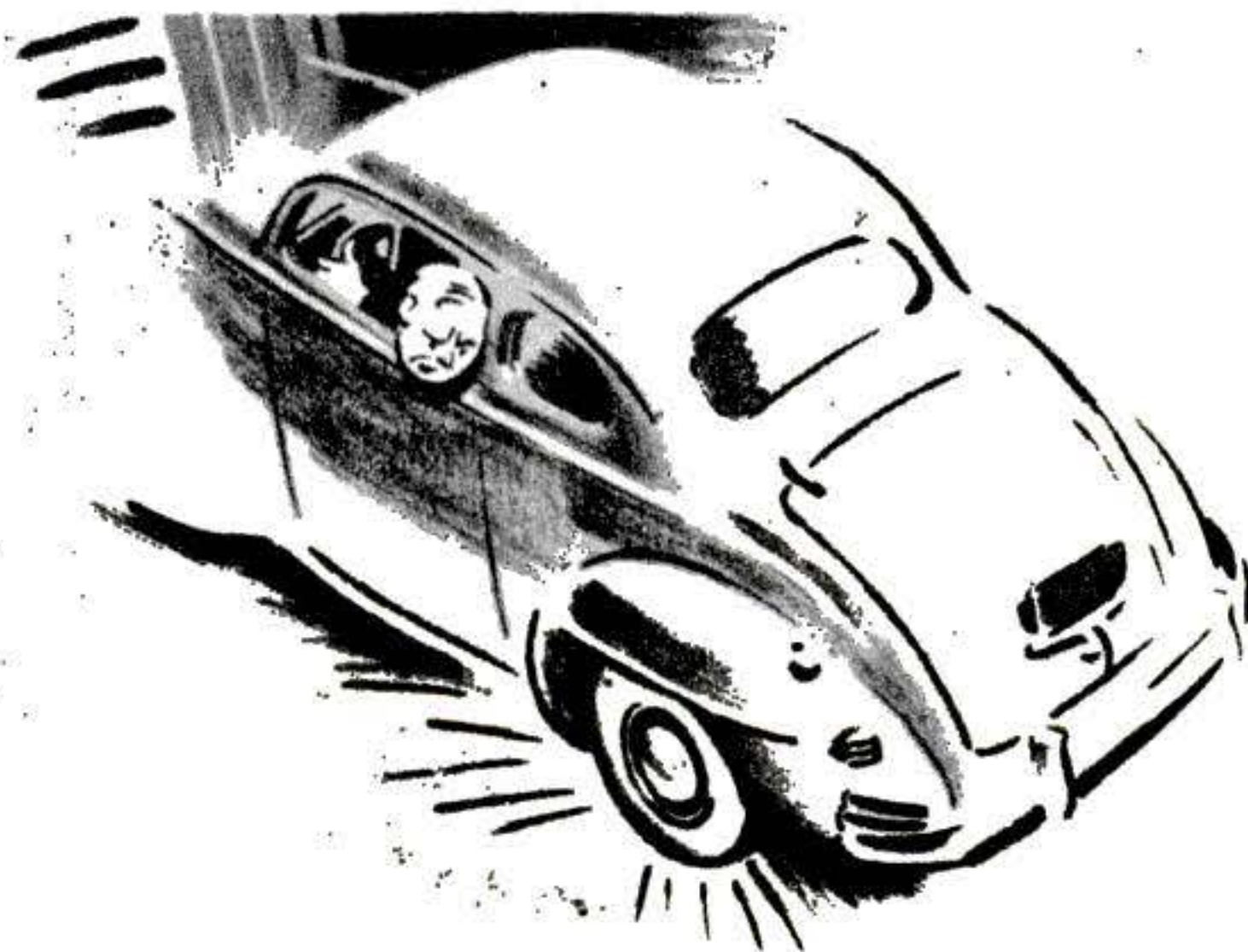



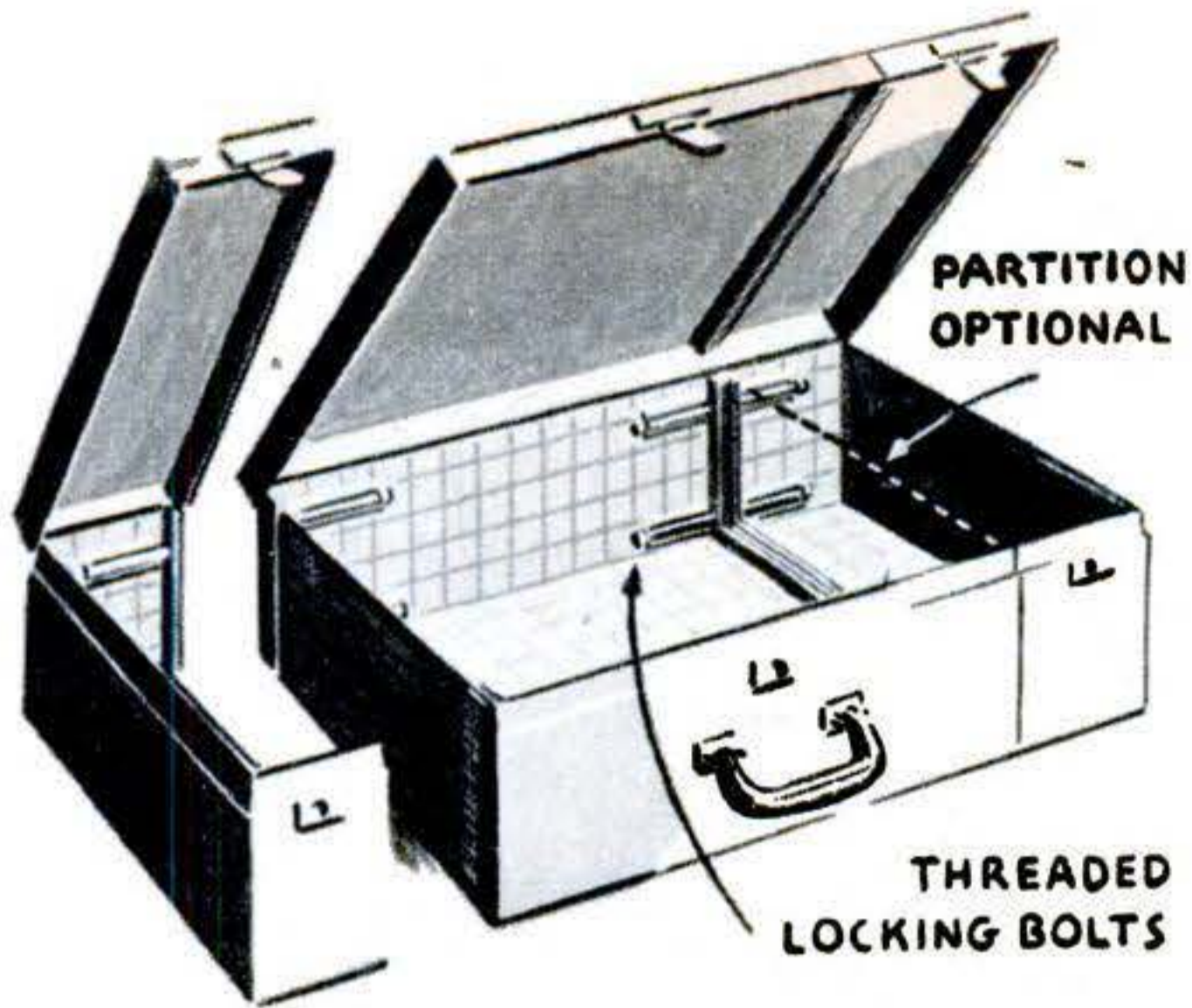

**Expansible Suitcase.** Added room to cram in an extra pair of shoes without bulging the suitcase is provided in a novel piece of luggage invented by Pearl Frandsen, of New York City. Extra compartments can be bolted to the ends of the suitcase to provide more space. Any of the three sections can also be used individually.

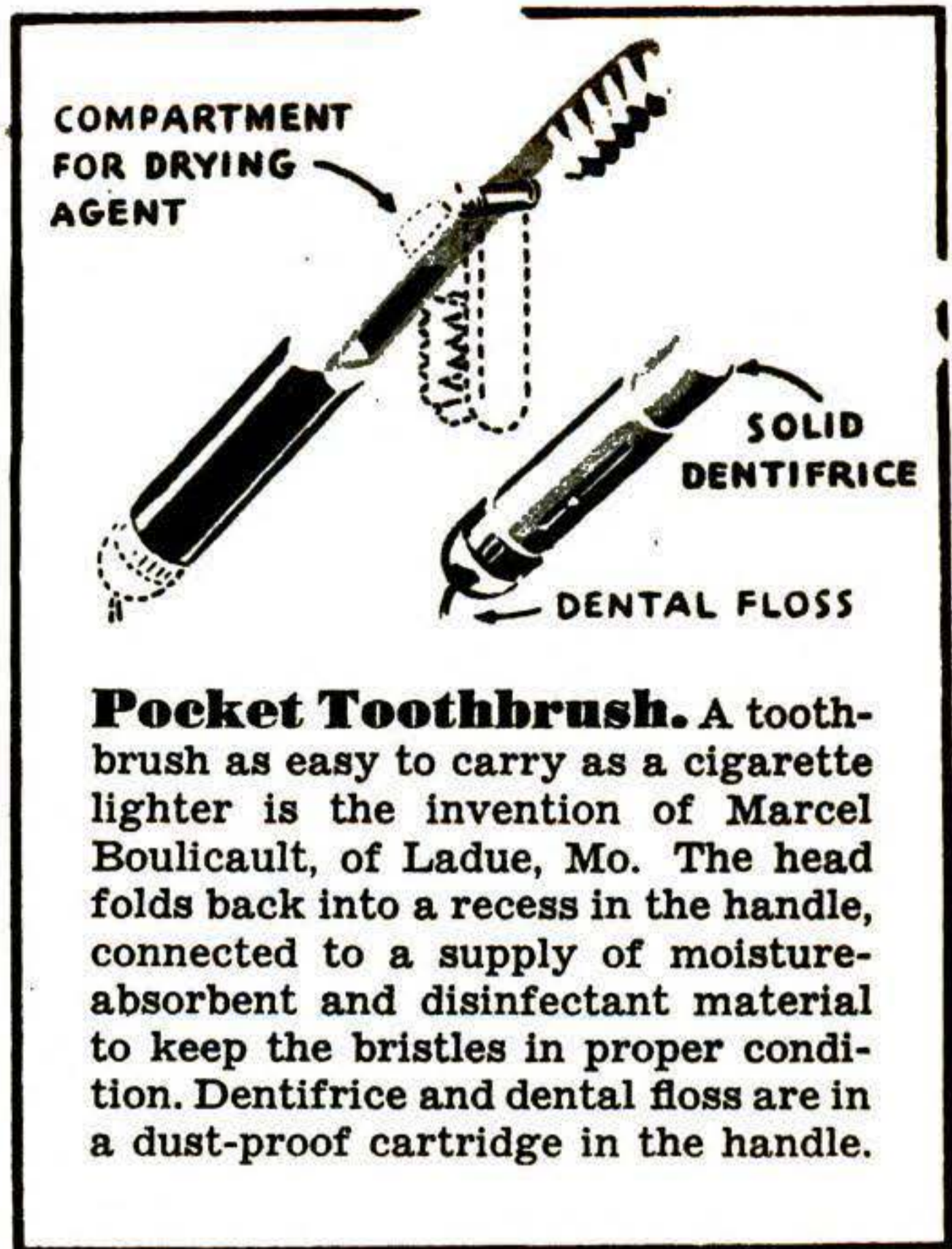

**Mechanical Flash Lamp.** A signal light needing neither electricity nor fuel has been invented by Robert A. Adams, of Brawley, Calif. Eight flints, set in a circle, spark simultaneously into a reflector when a button is pushed. Corrugated wheels set next to each flint are geared to a flexible shaft, which is turned by a spring in the handle to spark the flints.

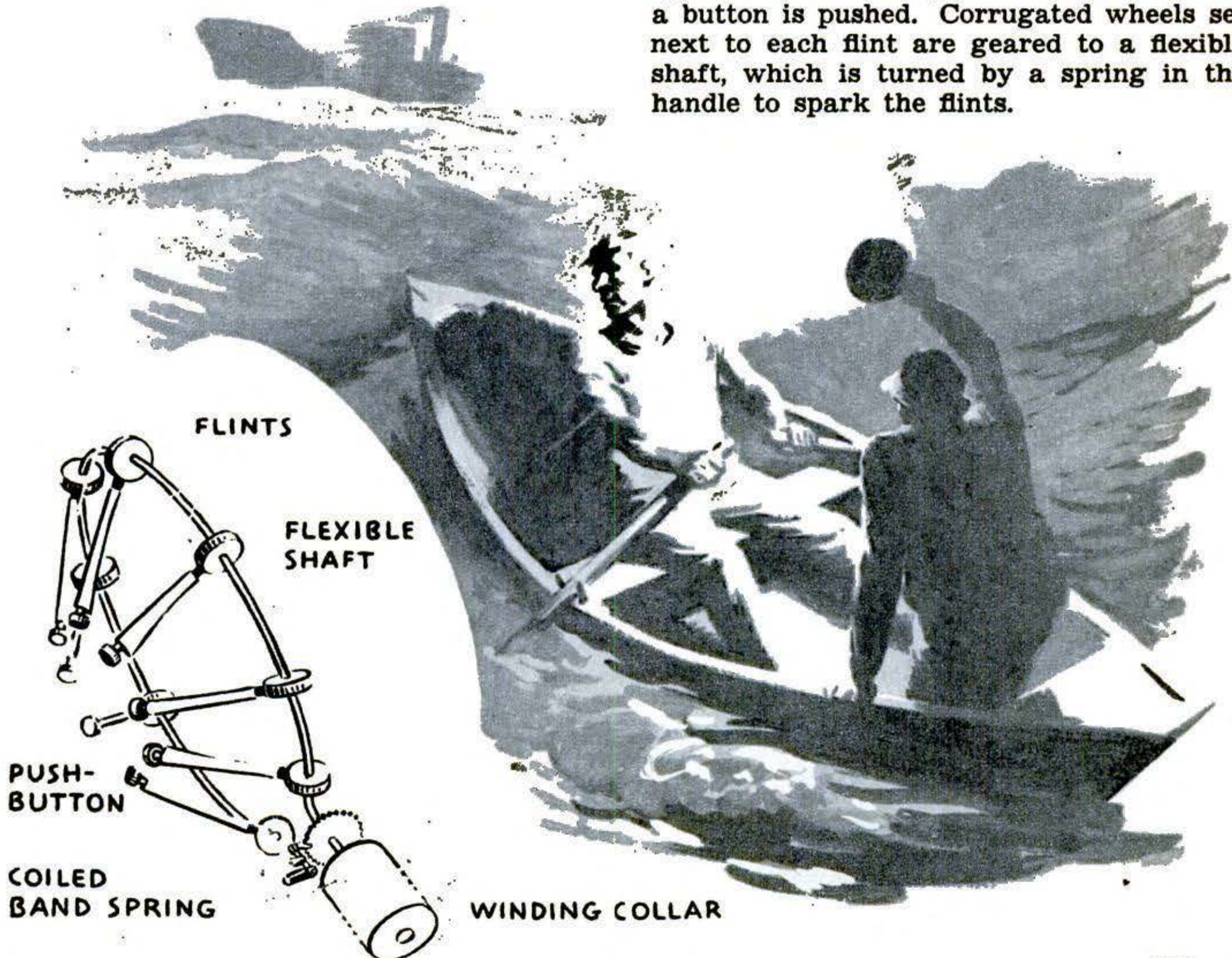





**Turret Truck.** Something new in equipment for moving factory materials is a truck with its power plant and drive wheel built as a single rotatable unit. The design eliminates the need for a reverse

gear. Power is supplied by a six-horsepower, single-cylinder, air-cooled engine through an automatic transmission and clutch. The truck, a Salsbury Motors, Inc., product, attains a speed of eight miles per hour.

**300-M.P.H. Air Liner.** Sixty-eight passengers can be carried by day and 26—in berths—by night in the new Douglas

DC-6, a four-engined, 8,400-horsepower transport that cruises at 300 m.p.h. The cabin is pressurized, sound-insulated and air-conditioned. The red on the outboard engines on the plane in the picture below signifies that it is on an experimental flight. More than 150 of these transports have been ordered by domestic and foreign lines. To learn how its engines operate, air-line pilots, shown in the inset, are studying one-half of a Pratt and Whitney R-2800 power unit used on the DC-6.

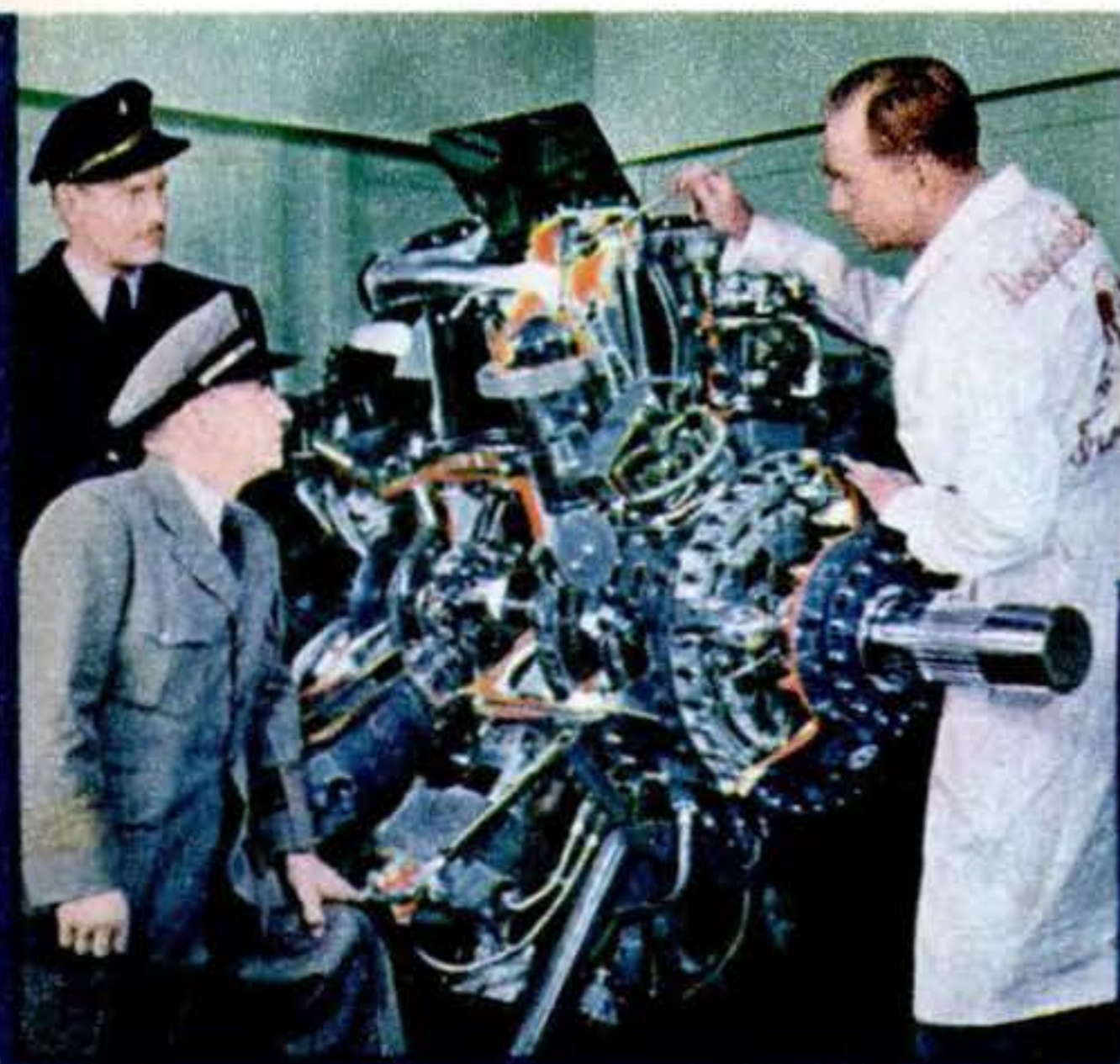



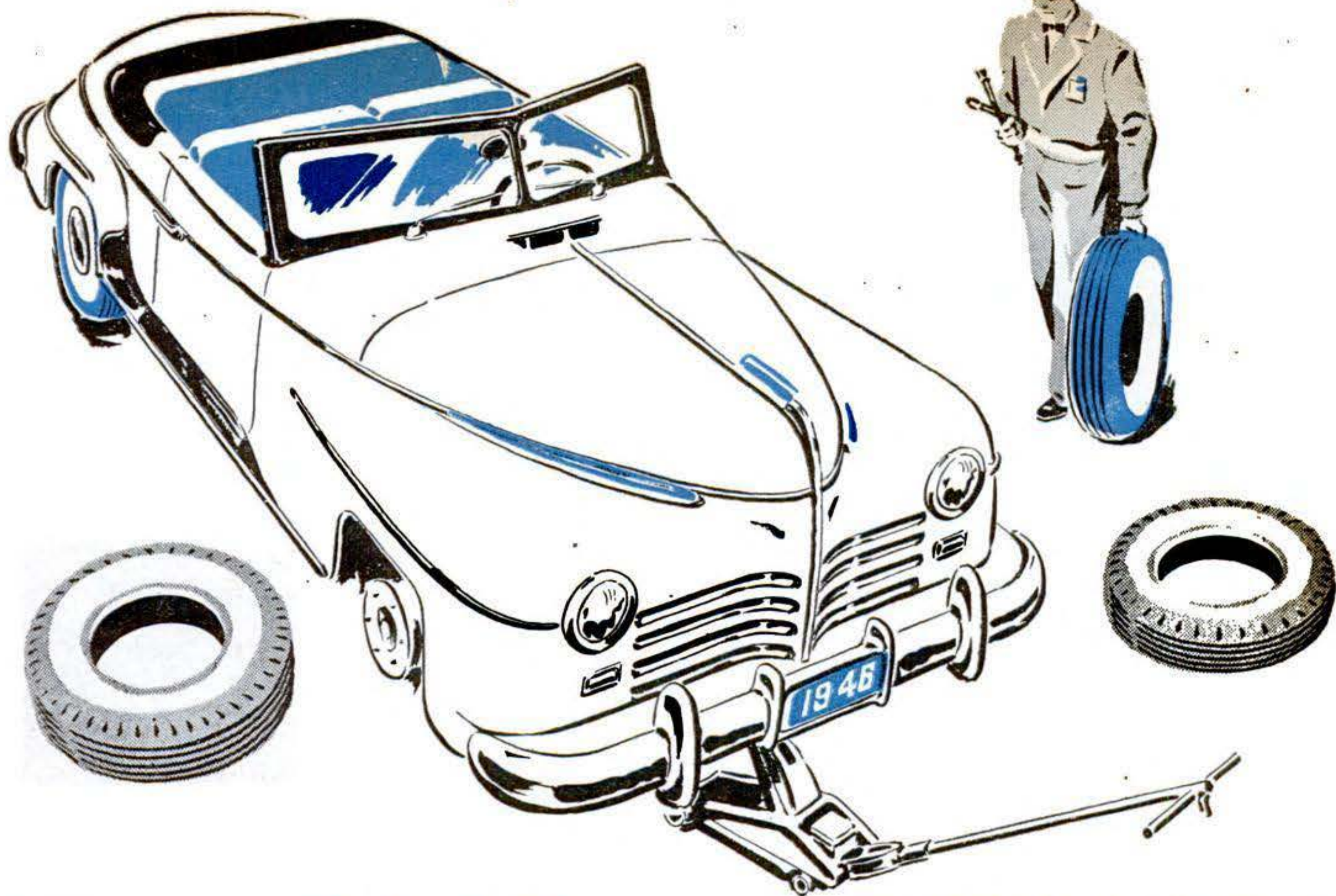

By GEORGE H. WALTZ, JR.

# How GOOD are Synthetic Tires?

**Very good—and getting better: they'll be tougher and good-looking, too.**

**I**N LESS than five years you will be able to buy a tire that will go 100,000 miles—much farther than most owners drive their cars. Dr. R. P. Dinsmore, the Goodyear Tire and Rubber Company's vice-president in charge of research, makes this prediction. Improved synthetic rubbers used in smarter ways will make that tire possible.

Our first synthetic tires were poor substitutes for the natural article—they wore out quickly at normal speeds. They cracked, they overheated, they tore apart. But each year brought improvements, and by pooling research efforts the major rubber companies, under the Government Office of Rubber Reserve, soon produced a synthetic tire that would stand up. *Today, severe road tests prove that the modern synthetic tire for passenger cars wears as well or better under normal use than the prewar natural-rubber product.* As for inner tubes, today's synthetic tubes have proved themselves so far superior in some respects that natural-

rubber tubes may never again be produced.

During the war the rubber industry's production problem was one of quantity. Millions of tires were needed by our armed forces and our civilian transportation system. Now, the tire makers can concentrate on quality. Research is progressing in many directions. By using radioactive isotopes in blends of synthetic mixtures, laboratory technicians are seeking particularly to find out more about special-purpose rubbers. With radio-sulphur in place of ordinary sulphur, they hope by the tracer technique (PSM, May '46 p. 91) to solve the secrets of vulcanization processes for both synthetic rubber and natural rubber. By studying the molecular construction of synthetic rubber, they hope to learn why it has a tendency to heat up more than natural rubber when it is flexed.

One of the biggest pieces of research news to come from the rubber laboratories recently is "white" carbon black. For 35



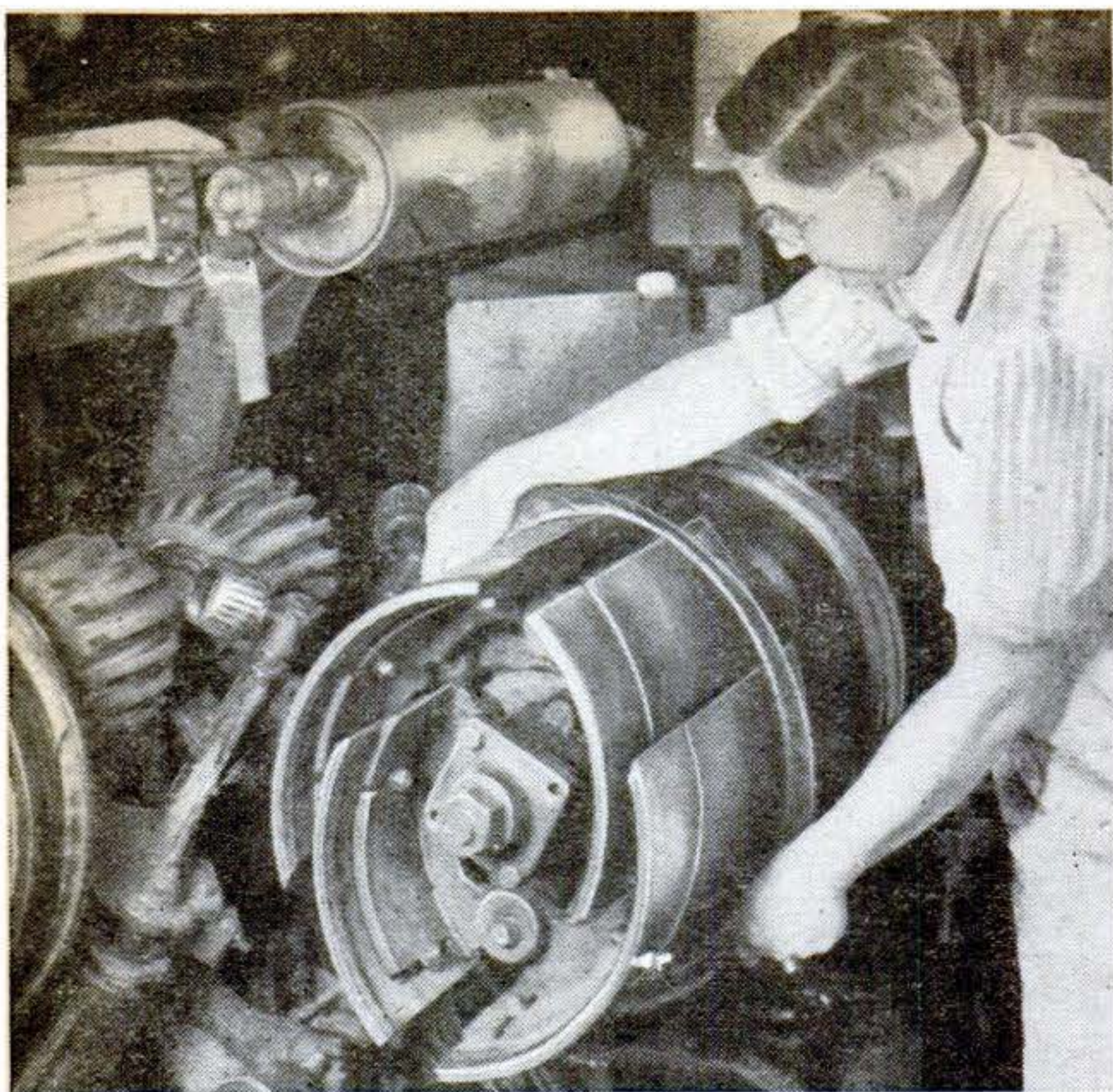

**1.** First step in making a 6.00-16, four-ply tire with new semiautomatic machines is to place inside beads over collapsed drum, which is then expanded.

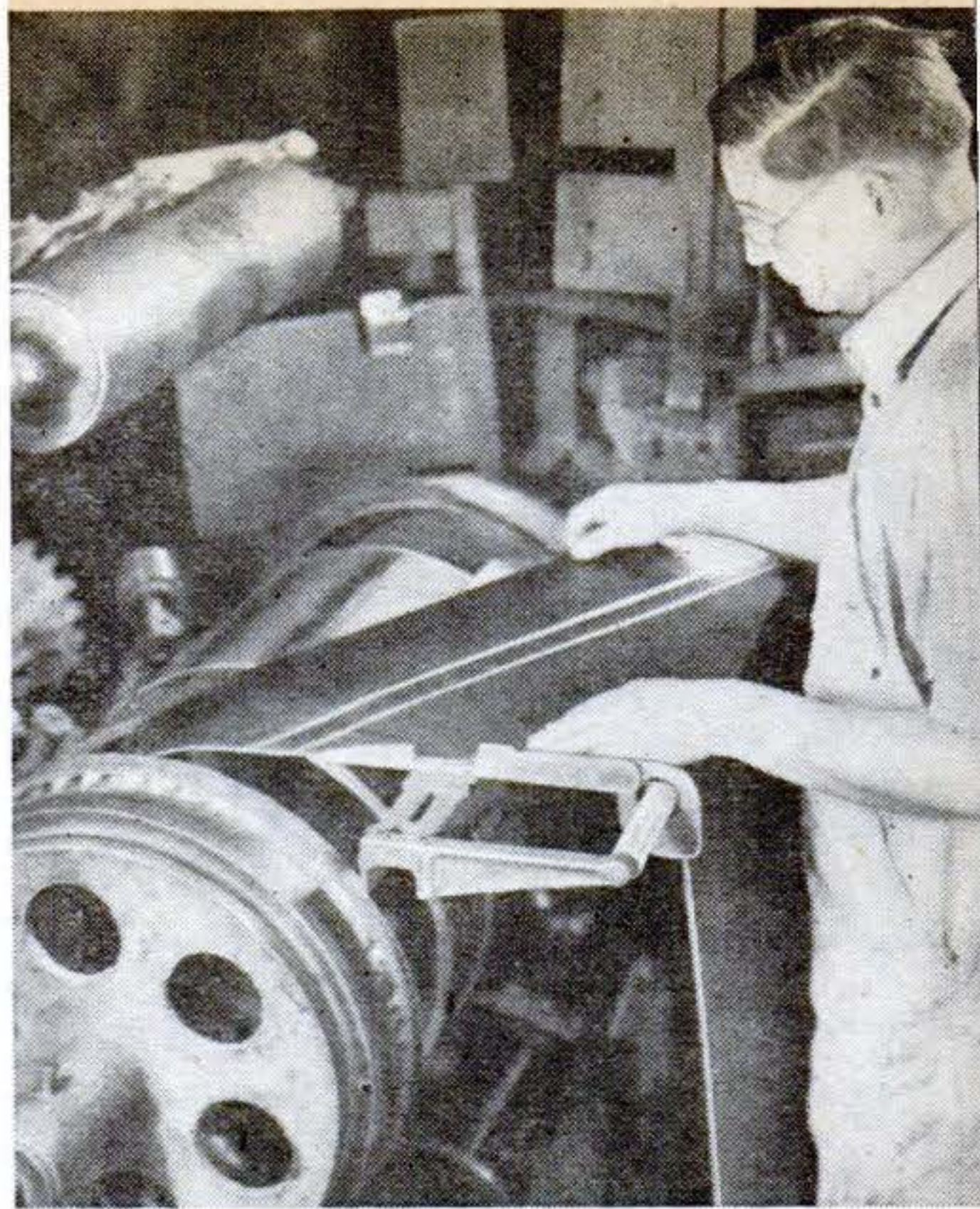

**2.** As the drum rotates, tire builder lays on first of fabric plies, cut on proper angle. This method assures uniform product, lessens emphasis on skill.

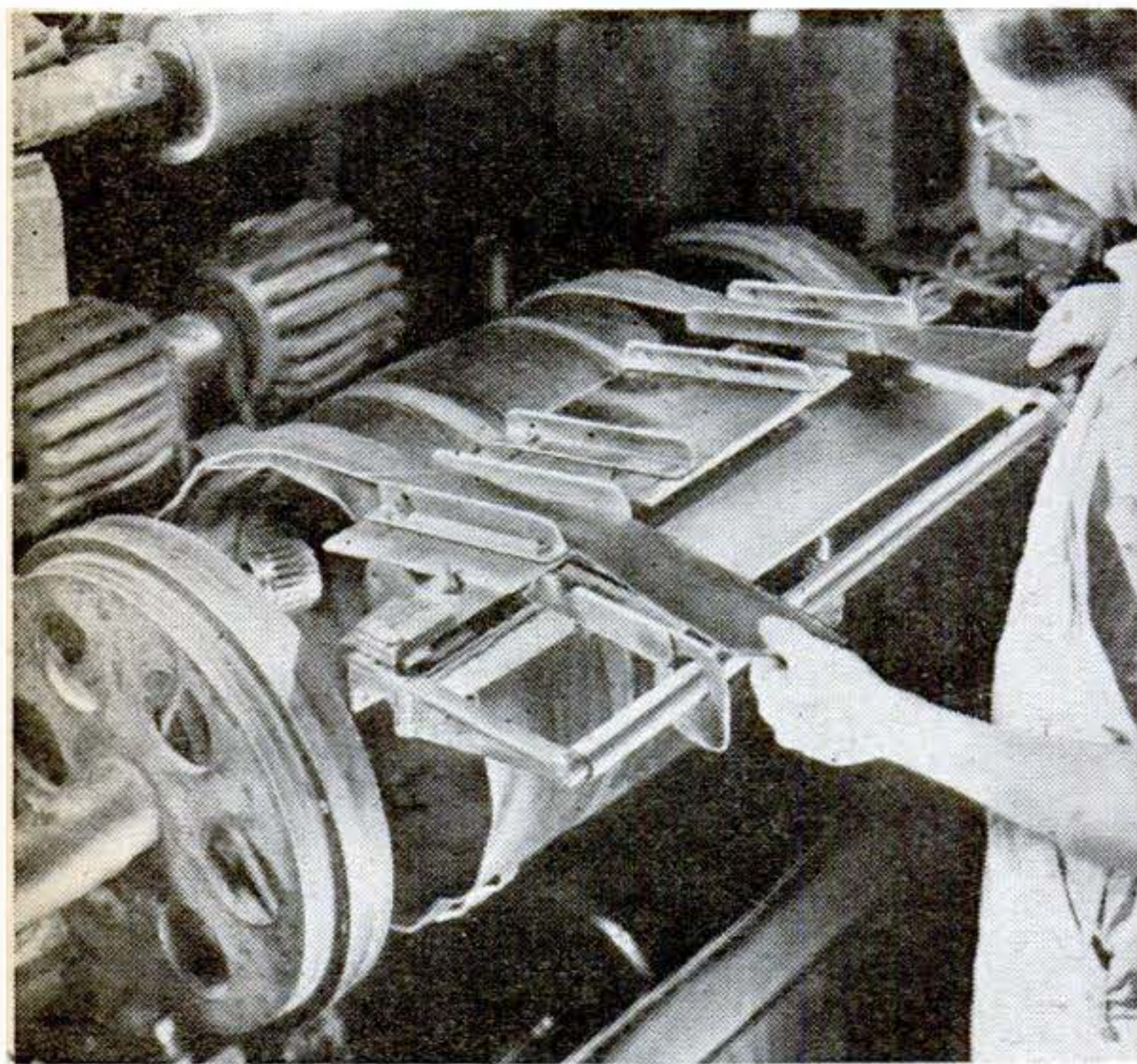

**4.** When final plies and a breaker strip have been added to the tire structure, strips of fabric known as "chafers" are applied. These are to keep beads of the finished tire from chafing against wheel rim.

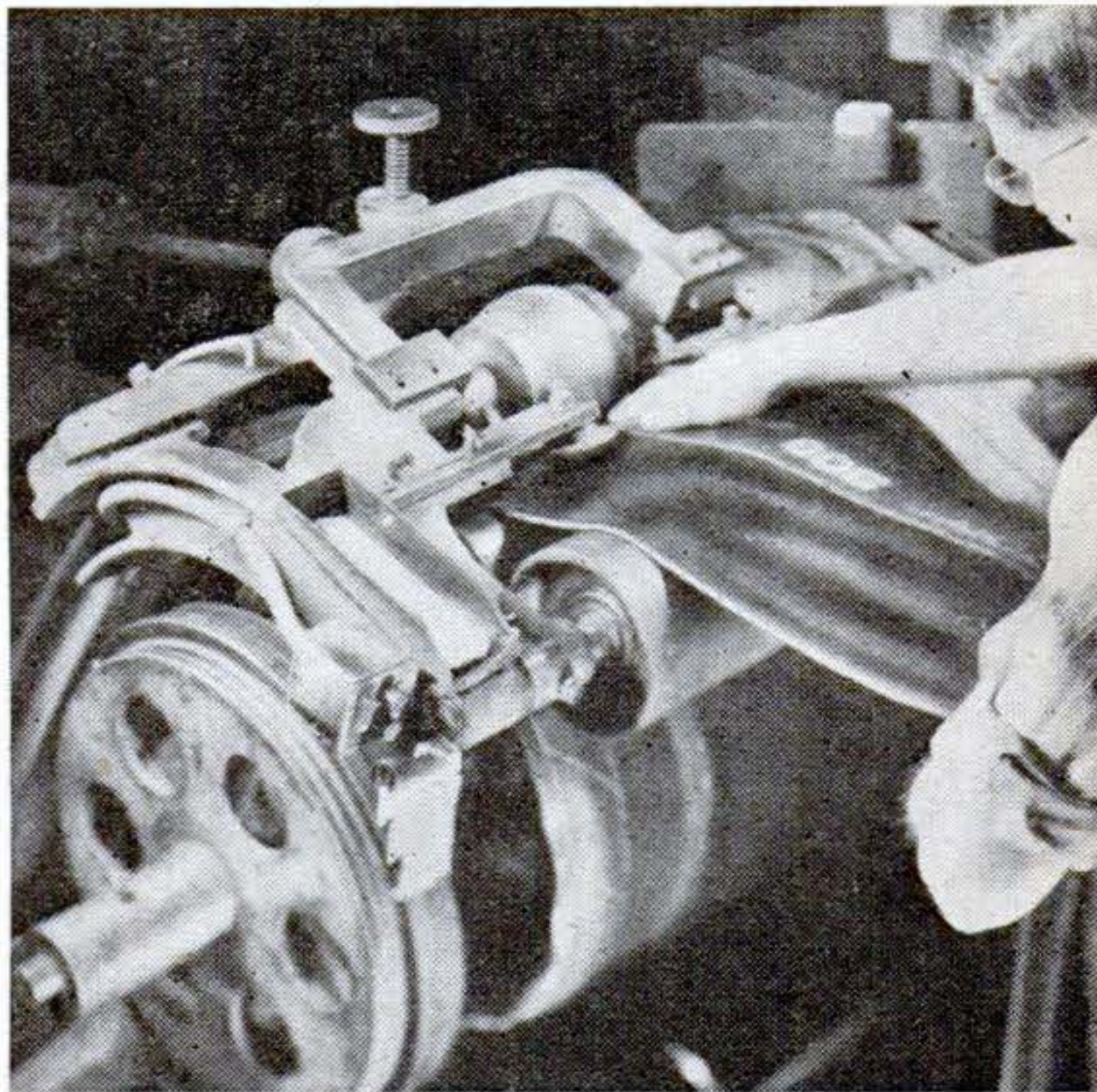

**5.** In applying tread, upon which the design appears after tire is bagged and cured, the operator merely guides material; as in other steps, machine supplies precision, this time with a tread roller.

years tire builders have used carbon black—ordinary black soot—as a binder to give added tear resistance, abrasion resistance, and tensile strength. This meant that all strong rubber had to be black. To build whitewall tires, strips of weaker white rubber had to be bonded to the outer wall of the black casing. With "white" carbon black, pure white—or even baby blue, orchid, or

almost any shade to suit the color of your car—can be made with all the strength and wearing properties of black rubber. "White" carbon black, a development of B. F. Goodrich Company, is made from an easily obtained natural source—white sand. Ethyl silicate, a highly volatile liquid obtained from sand and alcohol, is burned and white soot results.



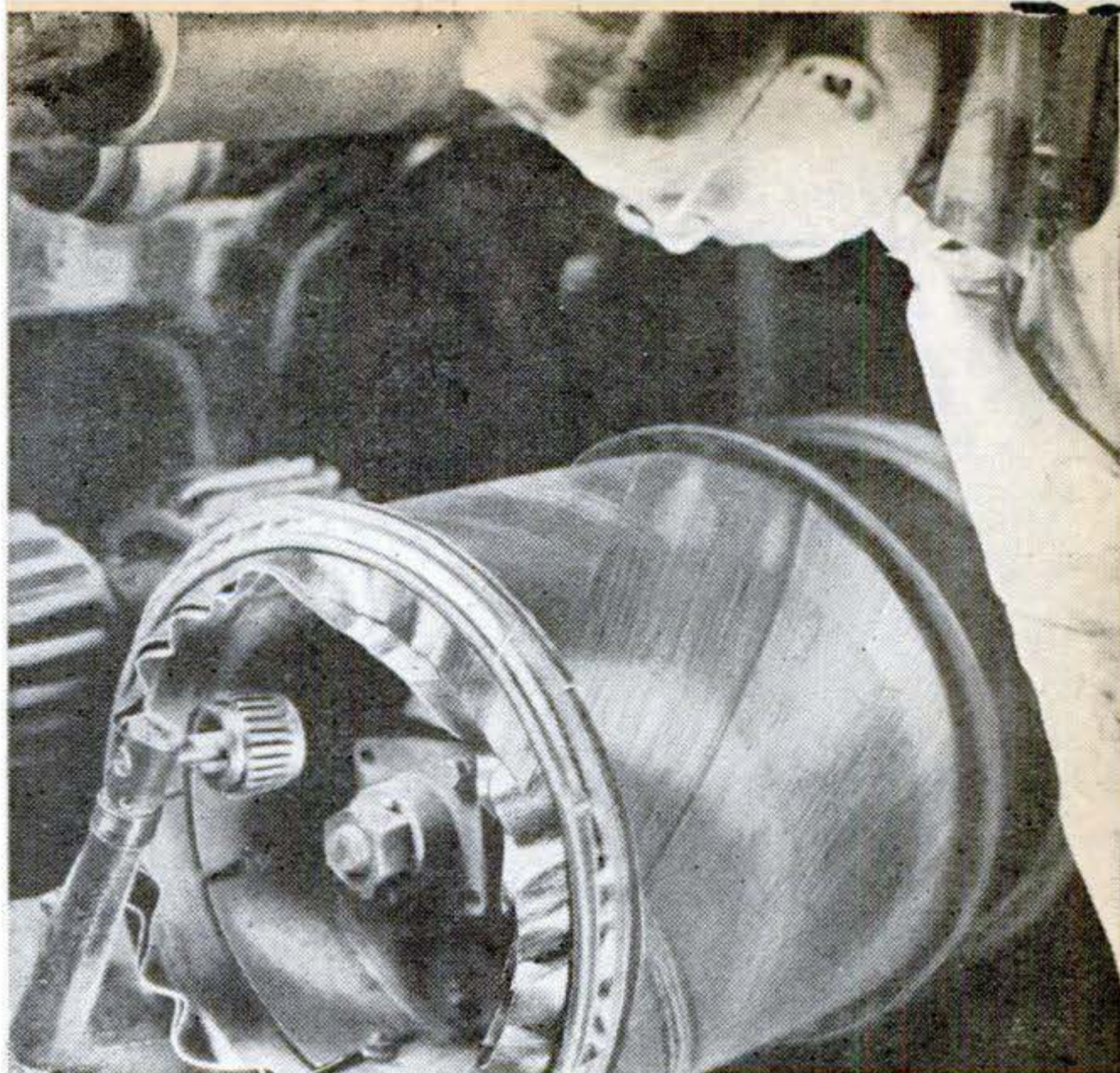
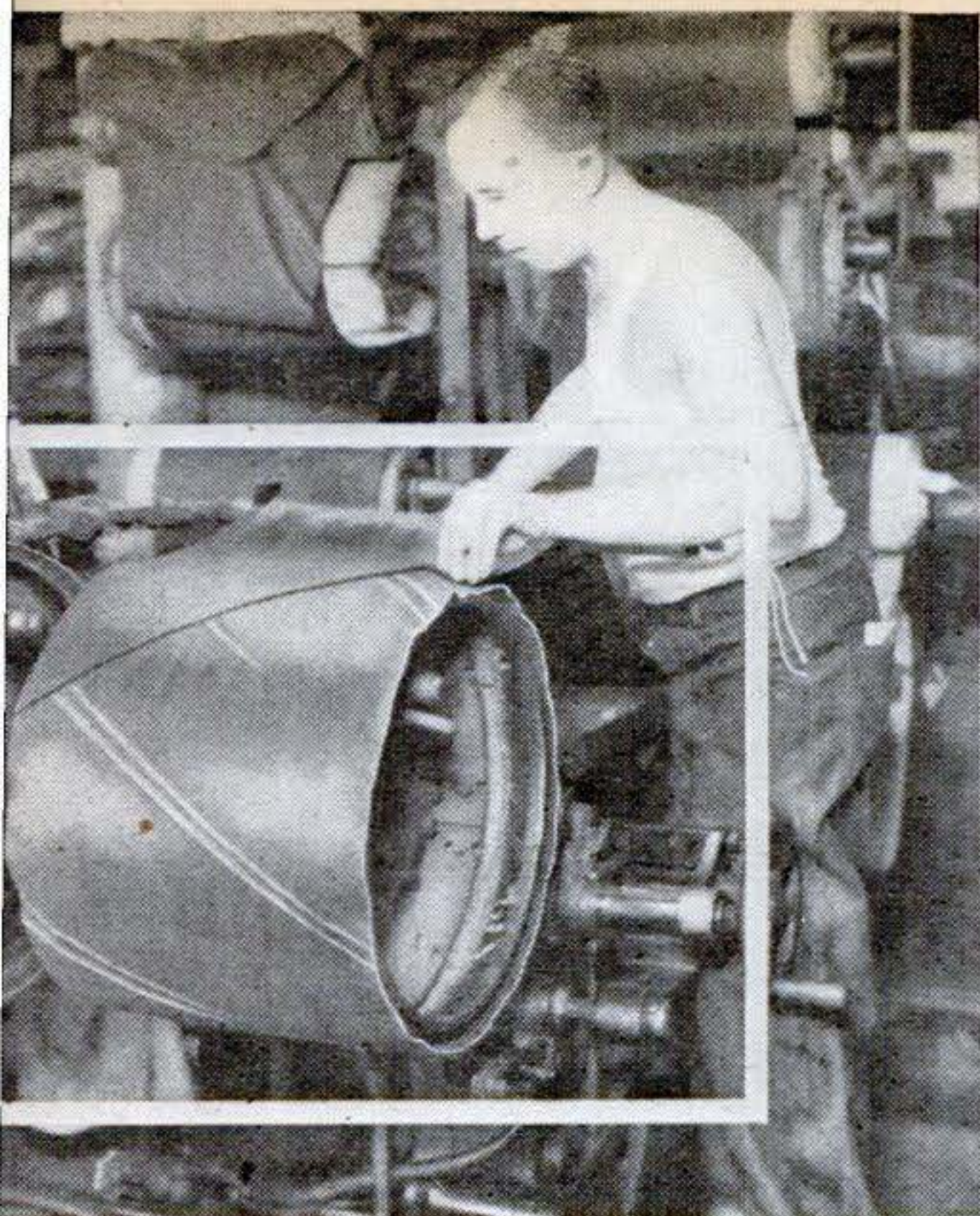

For contrast, here is the prewar system of laying on plies. With such machinery, finished product's quality depended largely on dexterity of operator.

3. After beads are set by the machine, automatic stitchers come into position to make a turn-up of the first two plies, securely wrapping the beads.

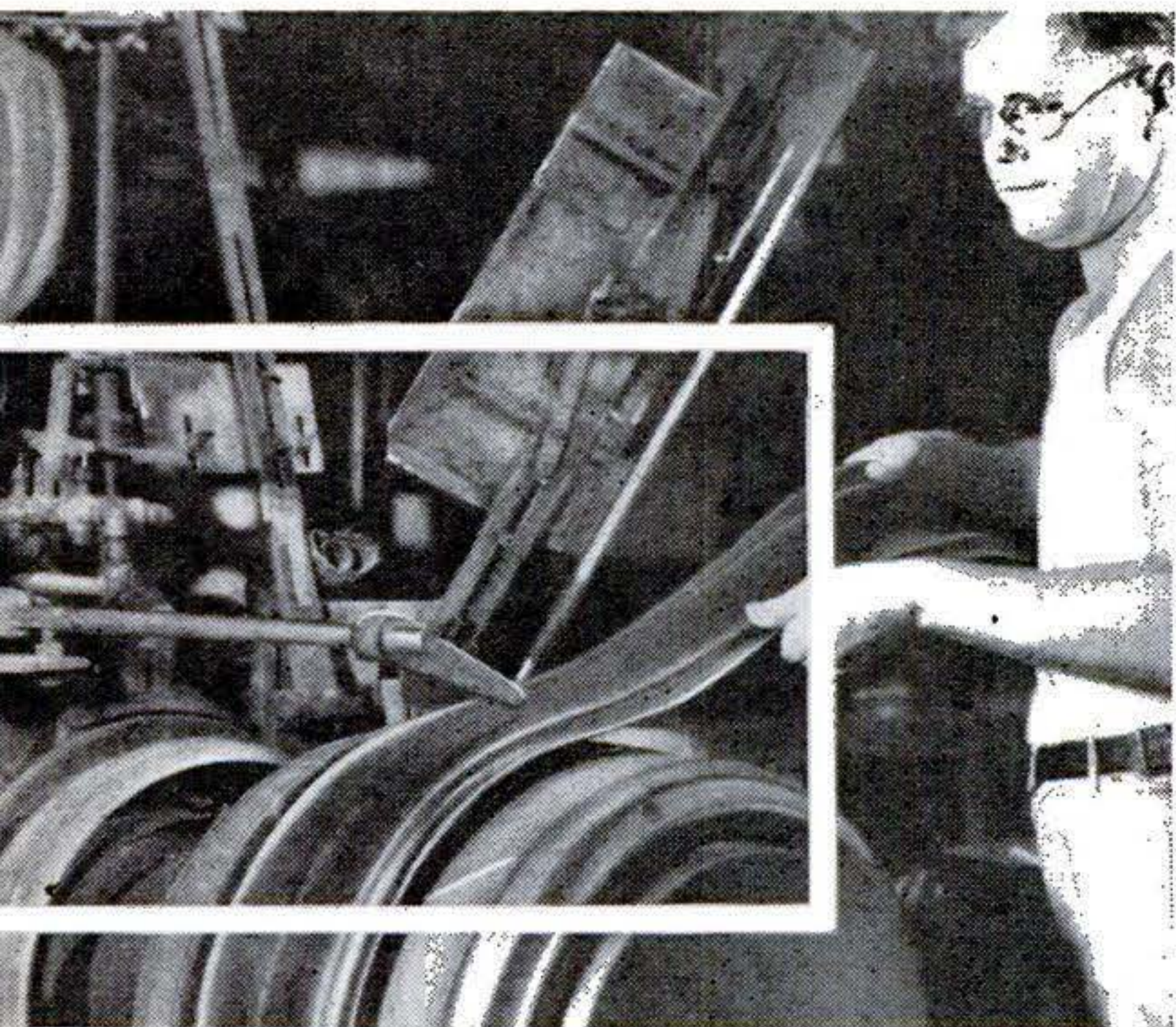

The old method of putting on a tread. Here again, besides being slower, the machinery allowed greater chances of human error and put most of the responsibility for quality on the operator.

6. Looking like a barrel with both ends removed, tire is taken off the collapsed drum. Operator gives it a quick check before placing it on conveyor to go to inspection station. (Goodyear photos.)

Research has also improved tire manufacturing methods. Before the war, the building of a tire was primarily a hand operation. Much depended on the skill and dexterity of the individual worker. Now semiautomatic machines controlled by a network of photoelectric cells and electronic tubes turn out uniform tires more than 50 percent faster than the older methods.

Even when we again can get all the crude rubber we want from the East Indies—a matter of 12 to 18 months—synthetic rubber will probably still be used to make a lot of passenger-car tires. First, the current high price of 23½ cents a pound for crude rubber, as against 18½ and possibly 15 cents for synthetics, favors synthetic rubber. The average automobile tire uses about 11



pounds of rubber, so the raw-material cost for natural rubber would be at least 55 cents more. Second, rubber experts have tremendous faith in future synthetic developments. And we have a \$750,000,000 investment in Government-owned synthetic rubber factories.

At present, as during the war, we are producing four principal types of man-made rubber: GR-S (Government Rubber-Styrene); GR-I, or butyl rubber; GR-M, or neoprene, and GR-A, or buna-N.

GR-S is the standard bulk, general-purpose synthetic rubber for tire casings, shoe soles and heels, rubber boots and mechanical goods. More of it is made than any other synthetic rubber. It is doing a good job of filling our needs, but rubber technologists are by no means convinced that it is the ultimate. They feel that research eventually will come up with a man-made rubber that not only will be "just as good or better" but will far surpass nature's product.

In a single laboratory maintained by the Office of Rubber Reserve at the University of Illinois, at least 50 new types of synthetic rubber have been produced. One of these, called sodium rubber, shows promise in laboratory tests of being a better general-pur-

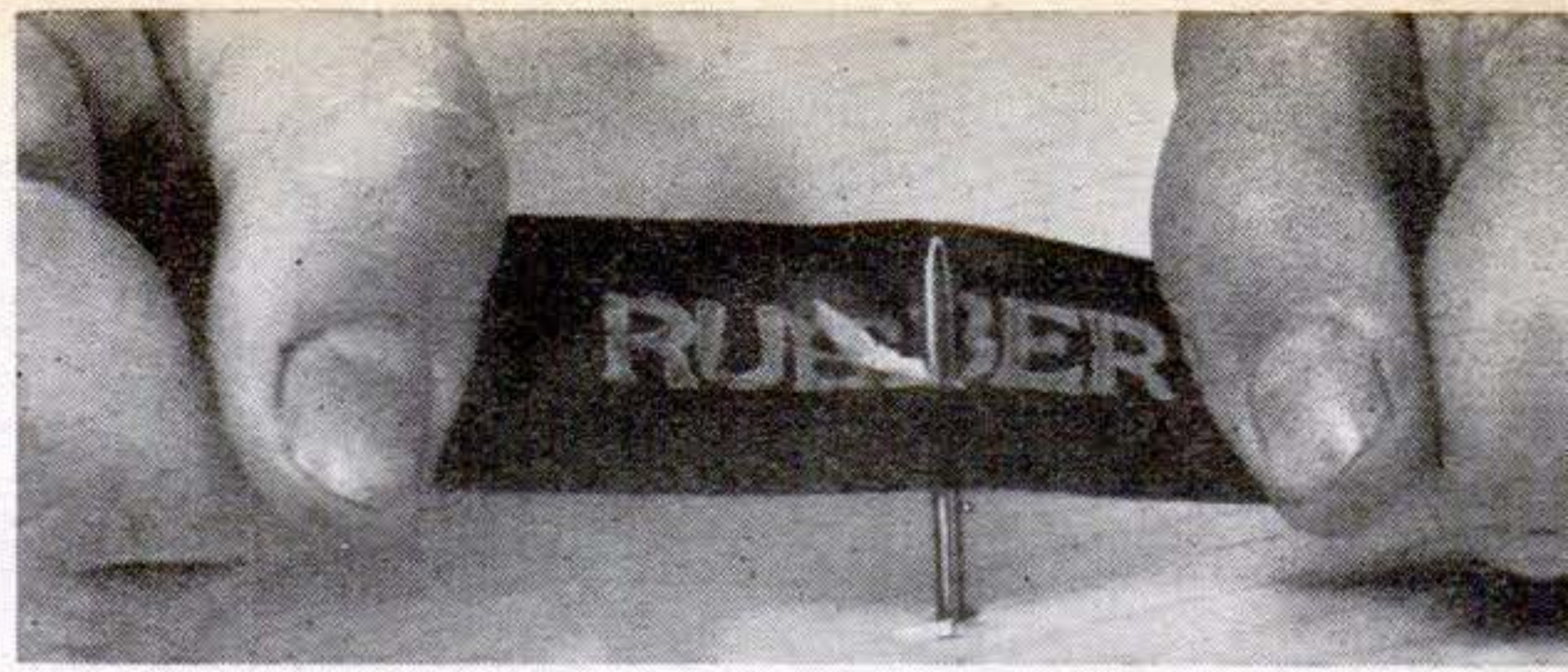

Why butyl tubes are better: Natural rubber, above, tends to tear if punctured. Butyl, below, does not tear and actually clings to nail. A 90-mile test run with identical nail-pierced tires left a natural tube flat while its butyl rival still had 25 pounds' pressure, 10 pounds of which it held for 12 hours.

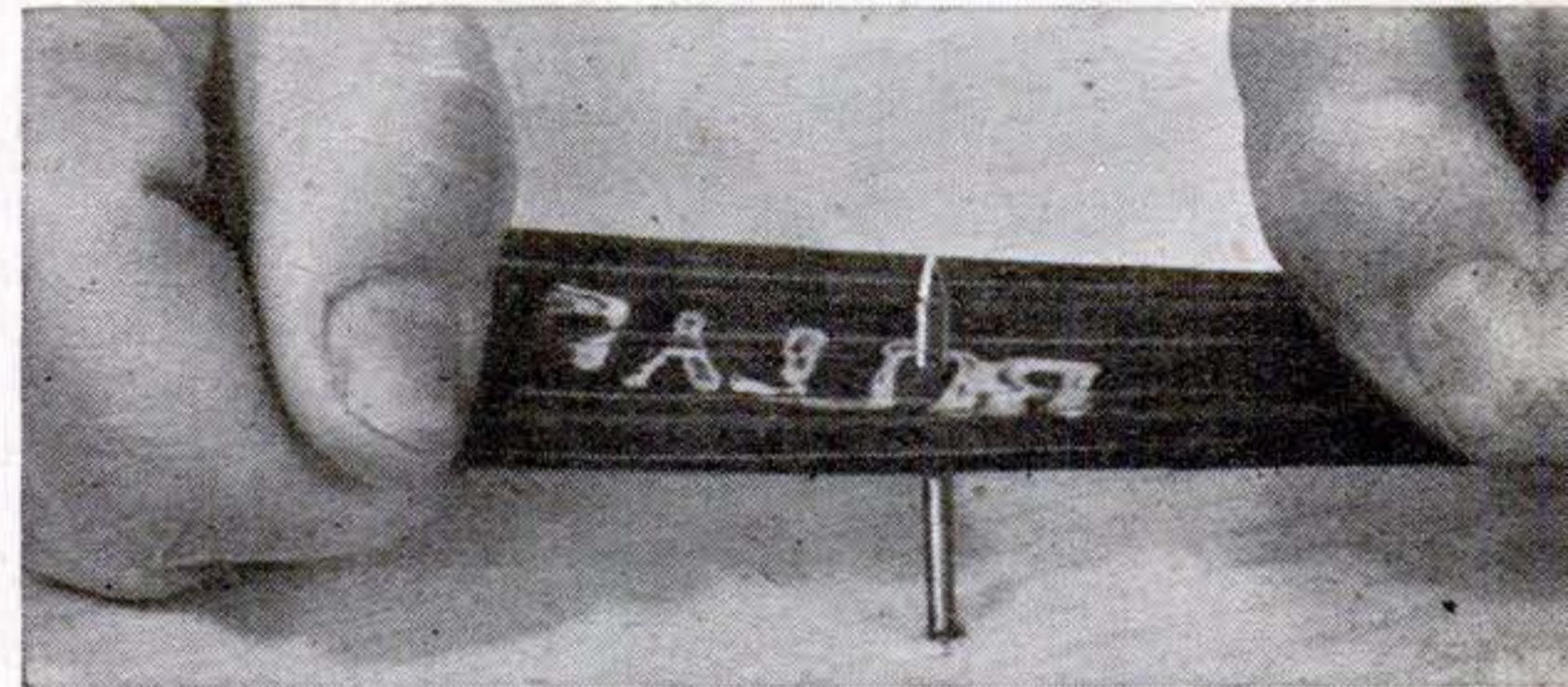

pose product than GR-S, particularly in its resistance to overheating and cracking—important in the manufacture of tires. Enough of this new sodium rubber has been pro-

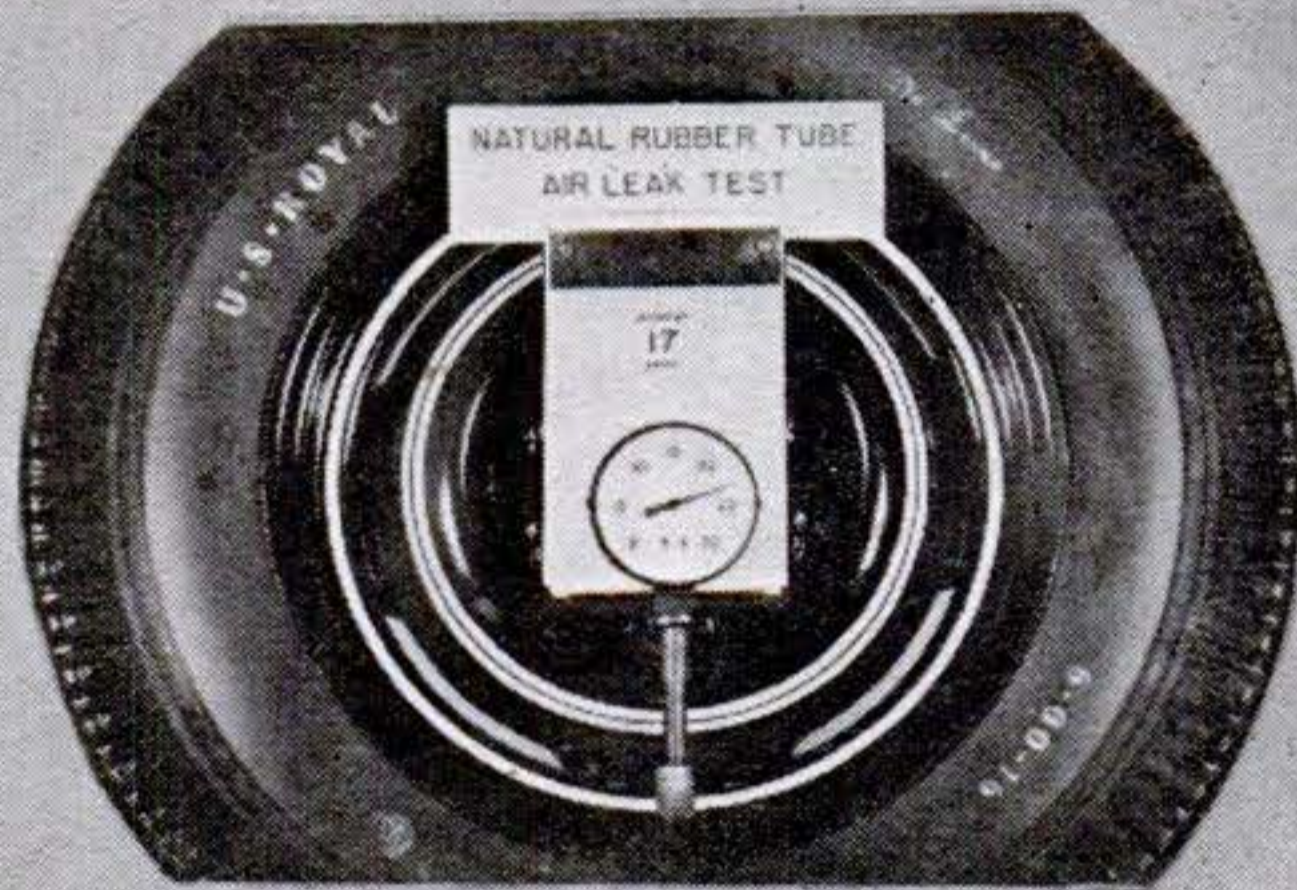
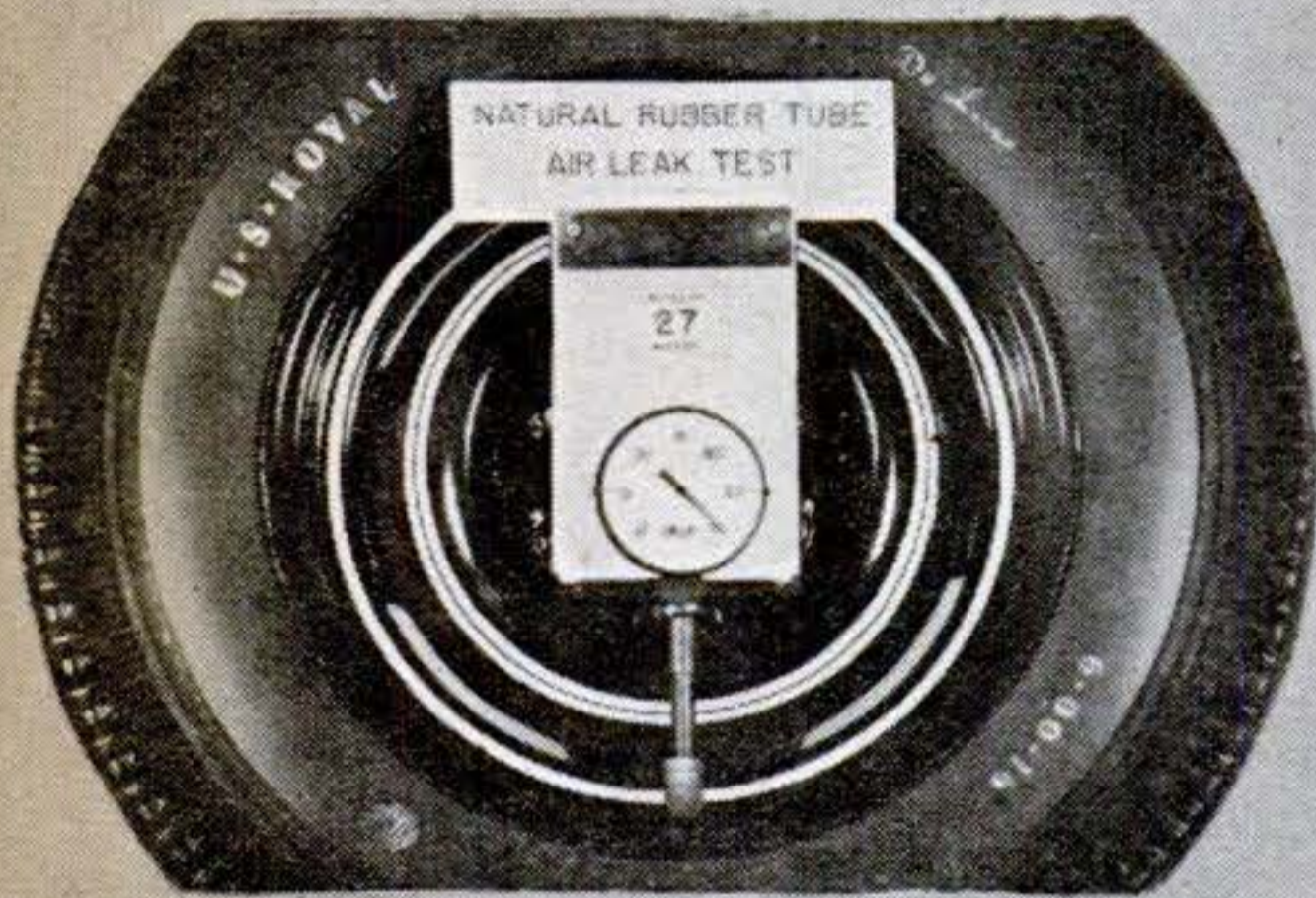

A comparative air-diffusion test shows why pre-war tubes needed air every two weeks while butyl tubes require attention only three or four times a year. Tire with natural tube, above, lost seven pounds' pressure in three weeks; butyl

tube, below, lost none. Butyl's superiority is important because a four-pound pressure drop, particularly in synthetic casings, cuts tire life more than 15 percent, boosts gasoline consumption by one gallon in 12. (U. S. Rubber Co. photos)





duced experimentally for use in a test tire.

GR-I, or butyl rubber, is the one that gives us our better-than-natural rubber tire tubes. Butyl inner tubes have proved far more durable than those of the natural product. Once inflated, they hold air 10 times better than a natural-rubber tube, and they perform much better after being punctured.

Our two other synthetic rubbers—GR-M and GR-A—both have proved excellent for specific purposes, in which they out-perform natural rubber. GR-M's superior properties are its resistance to chemicals, oil, heat, air, light and flame, making it valuable in the production of oil-resistant hose, electrical insulation, gaskets, aviation gasoline tanks and belting. GR-A, both oil and cold-resistant, is a perfect material for self-sealing fuel hose and fuel tanks for airplanes, oil-proof and coldproof fabrics, and as a binder for abrasive wheels. These two synthetics perform jobs that natural rubber could not do.

The end of the war brought no lull in synthetic production. On the contrary, 1946 will be the biggest production year in the history of the industry. By year's end we will have used approximately 1,000,000 long tons of rubber (a long ton equals 2,240 pounds), over 70 percent of it synthetic. In 1940, the record prewar year, the total was 651,000 tons, of which only 2,500 tons

were synthetic. In 1947, with more natural rubber available, the balance is expected to level off to a 50-50 percentage.

One plan in the minds of tire builders is a combination of synthetic and natural rubbers to produce a supertire that will be superior to one made wholly of either. Each product would be used as an independent building material—natural rubber in the spots where it does the best job, synthetic at the points where it excels.

The rubber industry's research chemists today have two main goals: to produce a synthetic rubber that can be tailor-made to fill every need, and someday actually to synthesize natural rubber from chemicals.

In the offices of each of the major rubber companies stands a row of half a dozen or more three-drawer metal filing cabinets. These contain the thousands of reports issued by the Office of Rubber Reserve outlining the results of all experiments and tests made by the Government and the rubber companies since the start of the war. According to Dr. Waldo L. Semon, famous rubber technician and director of research of the B. F. Goodrich Company, "Those files may well contain the hint that will lead to a synthetic rubber better than natural rubber or any man-made substitute so far known."

Perhaps even a tire that will last as long as the car is not too much to expect. **END**

## A One-Minute Primer of Synthetics

TYPE	MAIN INGREDIENTS	MAIN USES
GR-S (BUNA-S)	Petroleum or Alcohol (Butadiene) and Coke (Styrene)	Tire Casings (As good as natural for passenger-car tires)
GR-I (BUTYL)	Petroleum	Inner Tubes (better than natural)
GR-M (NEOPRENE)	Acetylene, Salt, and Sulphuric Acid	Heat-, Oil-, and Flame- Resistant Rubbers (better than natural)
GR-A (BUNA-N)	Crude Oil or Alcohol (Butadiene) and Acrylonitrile	Oil- and Cold-Resistant Rubbers (better than natural)



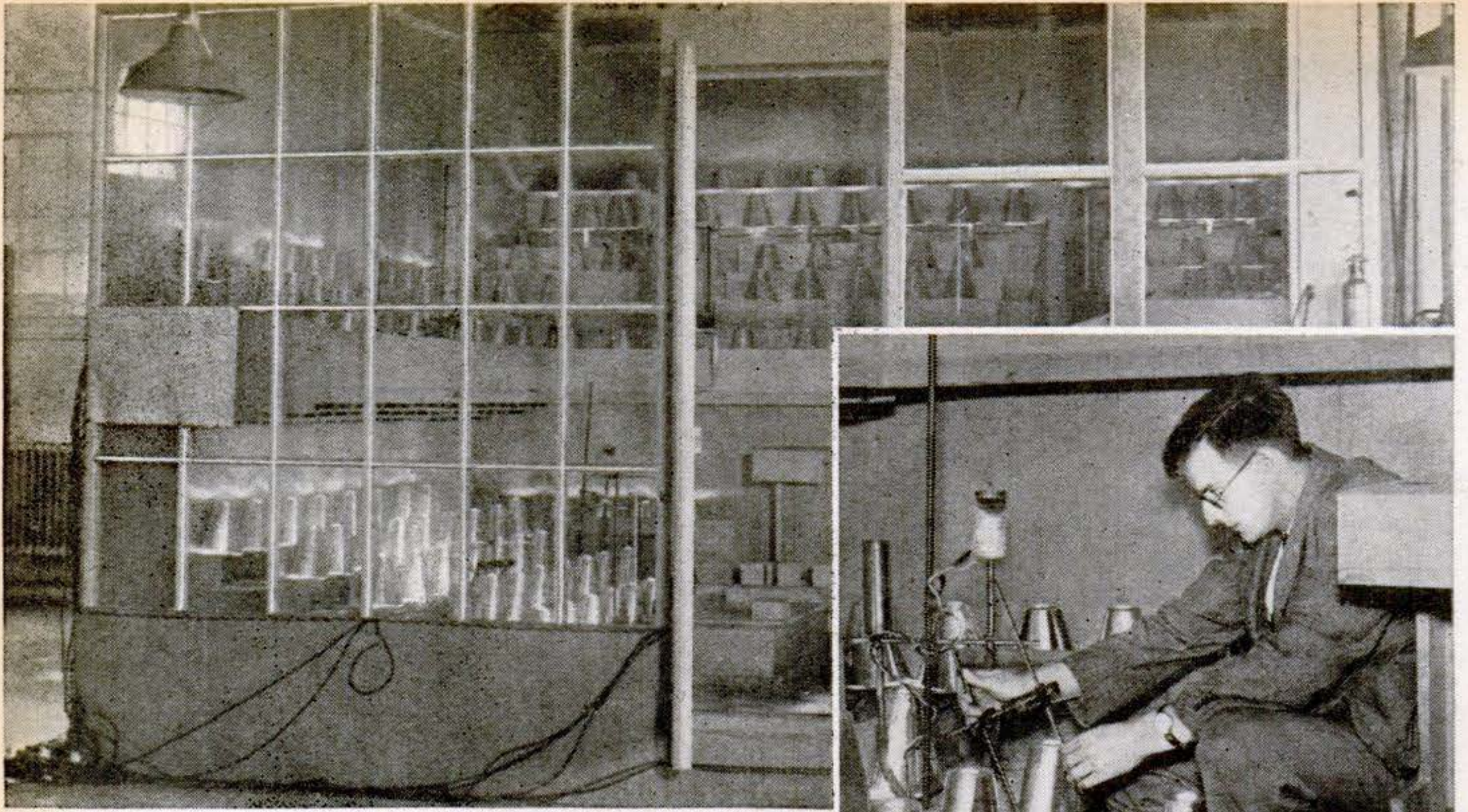

**BETTER AIR FOR COMMONS.** The British National Physics Laboratory has built a model of half of a proposed debating chamber (above) for the new House of Commons to test the ventilation system. Each conelike lamp on the benches emits the body heat of two persons. The air inlet can be seen at left under the gallery. Inset: A physicist checks the temperature of a lamp.

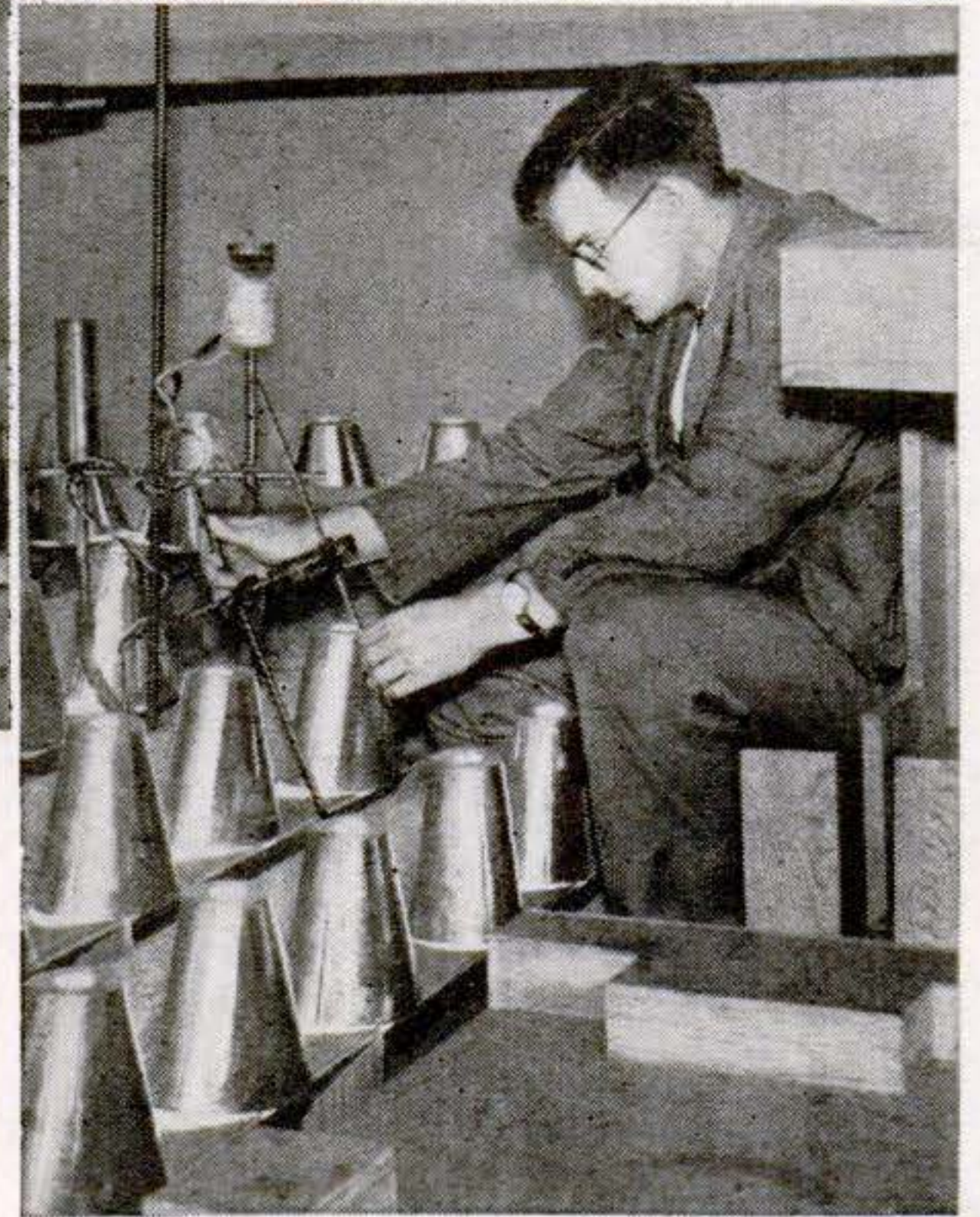

**WEAPON AGAINST POLIO.** A "baby lung" that can replace an iron lung in polio cases has been devised by the AAF Aero Medical Laboratory. Originally built to combat oxygen deficiency among air crews, it provides intermittent oxygen pressure.



# GLASS in the Atomic Age



World's oldest plastic will shield health and machines.



Here a soldier of some unwanted future day enters an atom-bombed area wearing an artist's concept of uranium-glass clothing and respirator. Even ground under his feet would be a peril, as evidenced by cloudy photo of a key, above. It was made by radioactivity of sand fused in Alamogordo blast.



**T**HE PET idea of self-styled camouflage experts early in the war was to build warplanes of glass so that they could not be seen. Glass airplanes never flew, but glass is being used, because of its strength, in airplanes, artificial arms and legs, bullet-proof armor, arctic clothing, boats and canoes, fertilizer, surgical bandages and fillings for teeth. One large glass company now is producing glass in more than 4,000 different forms and has experimental projects covering some 300 more potential uses.

The world has passed progressively through a Stone Age, a Bronze Age and a Steel Age. Glass experts believe that we now are entering a Glass Age.

A major glass-research program at the University of Pittsburgh, directed by Dr. Alexander Silverman, head of the University's chemistry department, is aimed at the solution of some of the age-old secrets of



glass. By using radio-isotopes as tracers, Dr. Silverman hopes to find out how the raw materials in glass melt, how the glass flows during melting—and what causes defects in glass. His findings may take many of the “ifs” out of glass manufacturing and open important new fields for future research regarding the world’s oldest plastic.

A firm believer in a Glass Age, Dr. Silverman foresees great advances within five years. One of his most spectacular prophe-

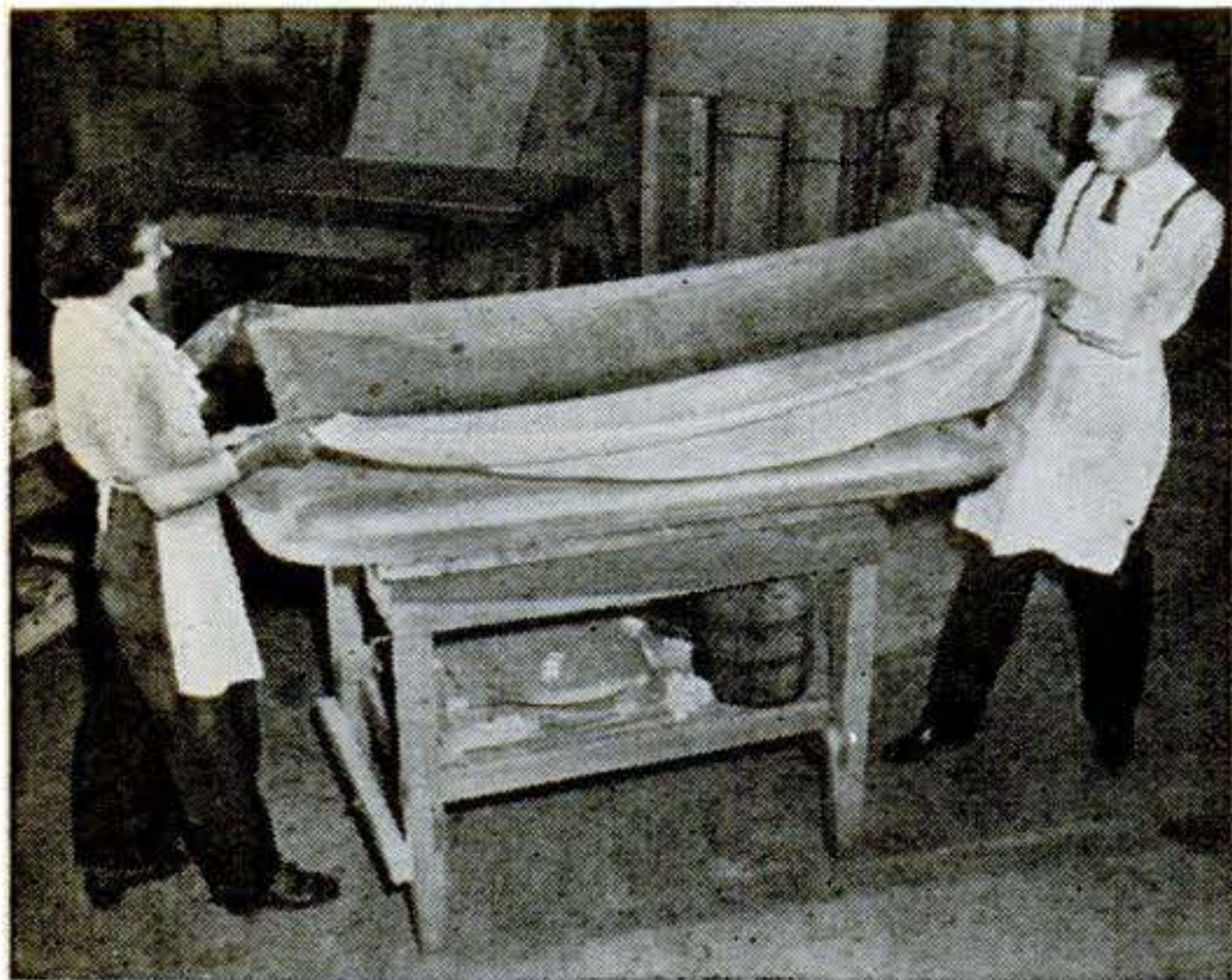

**1.** Illustrative of the many new uses of glass is the making of molds that permit electronic vulcanization of sponge-rubber auto seat cushions. First step is to place glass-cloth layers on wood form.

cies is that glass will be used as a defense against the atomic bomb. The same element that is used to make the bomb—uranium—can be used to produce a glass that provides good protection against harmful radiations. Garments and helmets made of cloth spun from uranium-glass or lead-glass fibers, says Dr. Silverman, would permit safe entry into atom-bombed areas. Special oxygen respirators, equipped with glass-insulated high-frequency precipitators, would keep radioactive dust out of lungs of rescue workers.

One of the most important recent glass-fiber developments is the perfection of a method for reinforcing other plastics with glass, just as we reinforce concrete with steel rods. Glass-reinforced plastics have many metal-like qualities, yet can be fabricated easily and inexpensively without complicated dies or high-powered presses. Almost as light as aluminum, they have the strength of many of our stronger structural metals. Designers and engineers are finding them ideal for use in molding railroad-car, bus and automobile bodies, airplane fuse-

lages and parts, boats and canoes, fishing rods, luggage, football helmets, artificial arms and legs, furniture, kitchen and bathroom assemblies and home appliances.

Fabricating a glass-reinforced plastic product is like making a layer cake or using a pressure cooker, and almost as simple. The process is similar to that used in making low-pressure laminated plastics, except that glass cloth is used in place of plywood, sisal or paper as the filling for the plastic sandwich (PSM, May '46, p. 122). Successive layers of glass-fiber cloth, impregnated with the desired liquid plastic, are simply laid one on top of the other in a form,

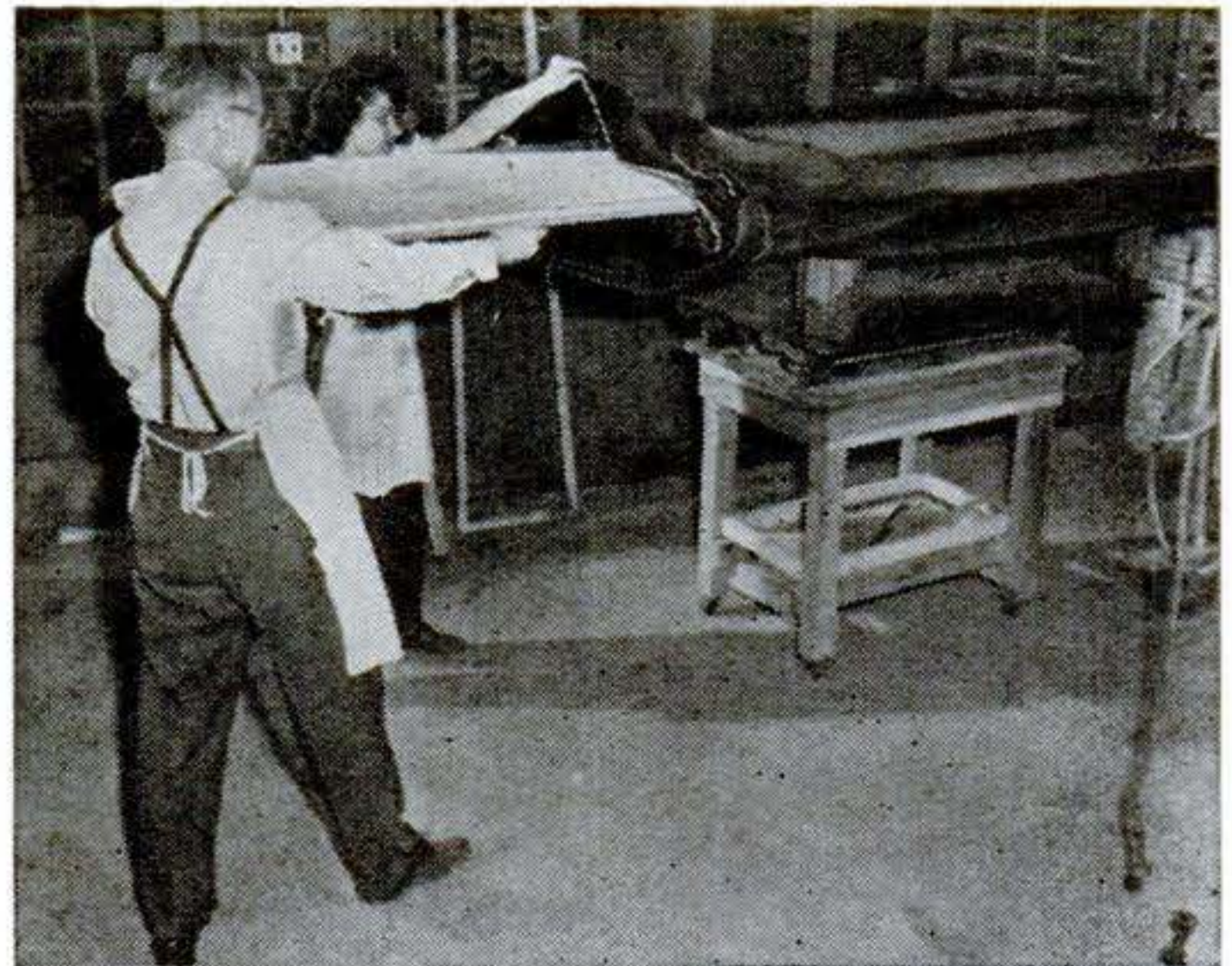

**2.** When enough of the resin-impregnated layers have been applied, the mold is put in a rubber bag for curing. Fiberglass materials, used in this process, meet all the varied demands of electronic heating.

or mold, of the desired shape. When enough layers have been built up to obtain the required thickness and strength, heat and pressure are applied in an autoclave that resembles a giant pressure cooker.

Technologists are devising all sorts of new uses for glass cloth and glass fibers. The same qualities that have made glass cloth valuable as heat-insulating material for use in buildings, bus tops and airplane cabins are now being put to use in new arctic clothing being tested by the U. S. Army. Field jackets, parkas, boots and mittens lined with glass cloth are expected to give good lightweight protection against subzero temperatures. An experimental glass-cloth-lined parka, worn by an observer during the recent Operation Musk Ox in northern Canada, afforded complete comfort at temperatures as low as -40 degrees F.

Glass-reinforced plastics also have made possible a lightweight bulletproof body ar-



mor for soldiers, which surpasses metallic armor in ballistic efficiency. Doron, as the glass-plastic armor is called, will stop missiles up to and including a .45-caliber revolver bullet. At the moment, Doron-armored jackets are undergoing rigid tests in the jungles of Colombia. Eighteen jackets have been supplied to American scientists and drill crews of an oil company, several of whose employees have been wounded by natives.

Other experiments under way include the use of milled glass fibers as a reinforcing

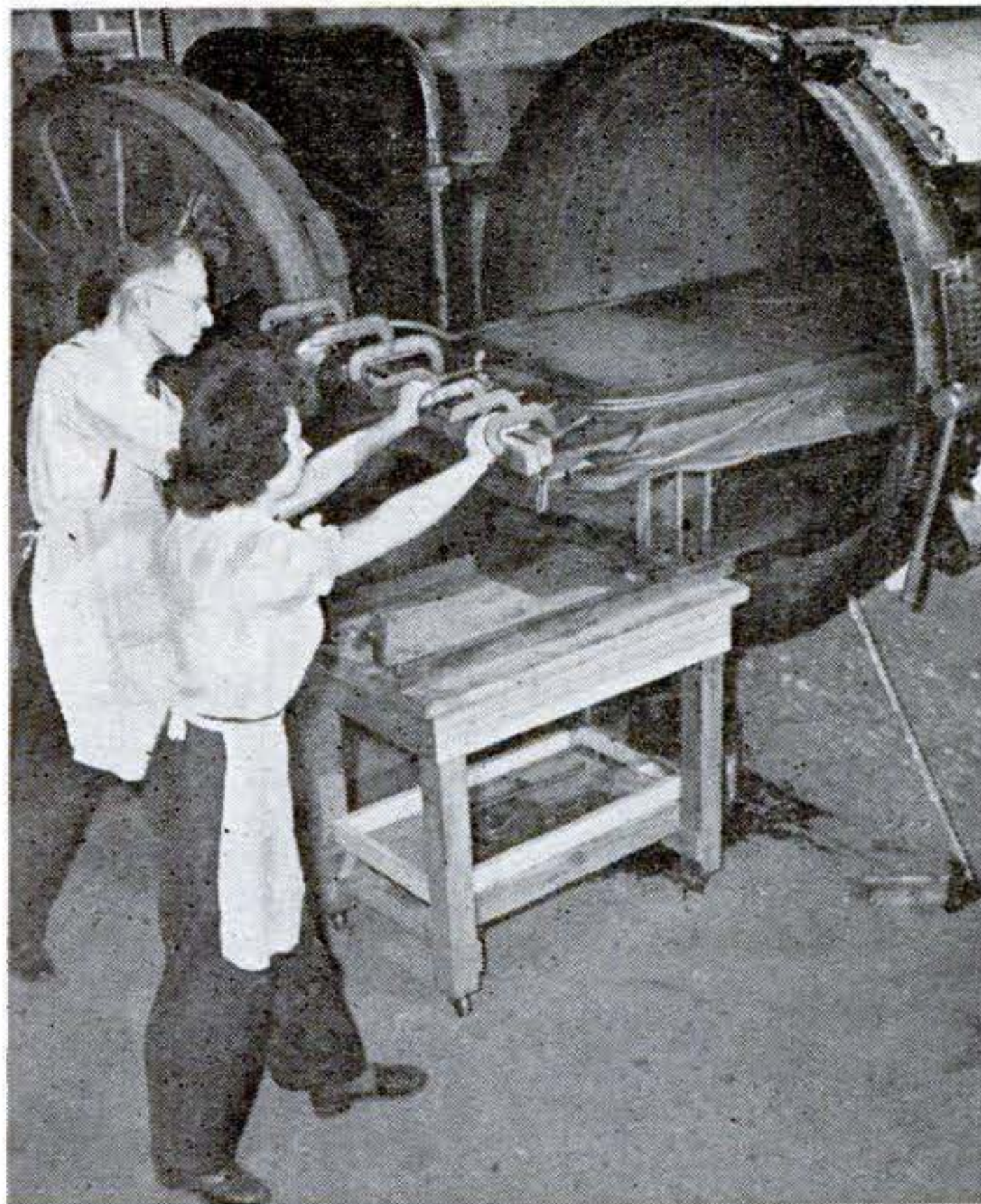

**3.** The mold, inside its rubber container, is then put in an autoclave, an oven providing temperatures of 280 degrees F., pressures of 63 lbs per sq. in.



**4.** After curing, the glass-cloth mold is removed from the autoclave, taken off its wooden form, and finished with a coat of thermosetting varnish.

agent for special papers, as a material for strengthening phonograph records, and as an ingredient of paint to improve its sound-deadening qualities. It is even being used in yarn form by dentists to fill the root canals of teeth. Surgeons also are turning to glass yarn and cloth for sutures, special bandages and filters for blood plasma.

In the future it may even be possible to fertilize your garden by sprinkling the ground with glass wool. In an experimental process being developed by Drs. Alfred E. Badger and Roger H. Bray at the University of Illinois, a special glass containing the principal plant foods is so mixed that it is soluble in water and dissolves slowly in the soil, giving off chemicals necessary for plant life. By altering the composition of the glass, the rate at which it dissolves can be controlled. In this way, one application of the glass fertilizer can be made to serve over a period of several years.

Science has not only learned how to do new things with new glass, but it has learned how, by the use of special coatings, to improve the older conventional forms of glass. One is the new transparent and durable electricity-conducting coating that can be applied to windshields of airplanes and automobiles to eliminate the dangers of icing and fogging (PSM, Oct. '46, p. 92).

Uncle Sam now leads the world in glass technology. Even in the field of optical glass, long dominated by Germany, we now excel, according to the Bureau of Standards. As research continues, the miracle of glass will continue to unfold. Glass as a material is thousands of years old. But glass as an industry is just coming of age. **END**

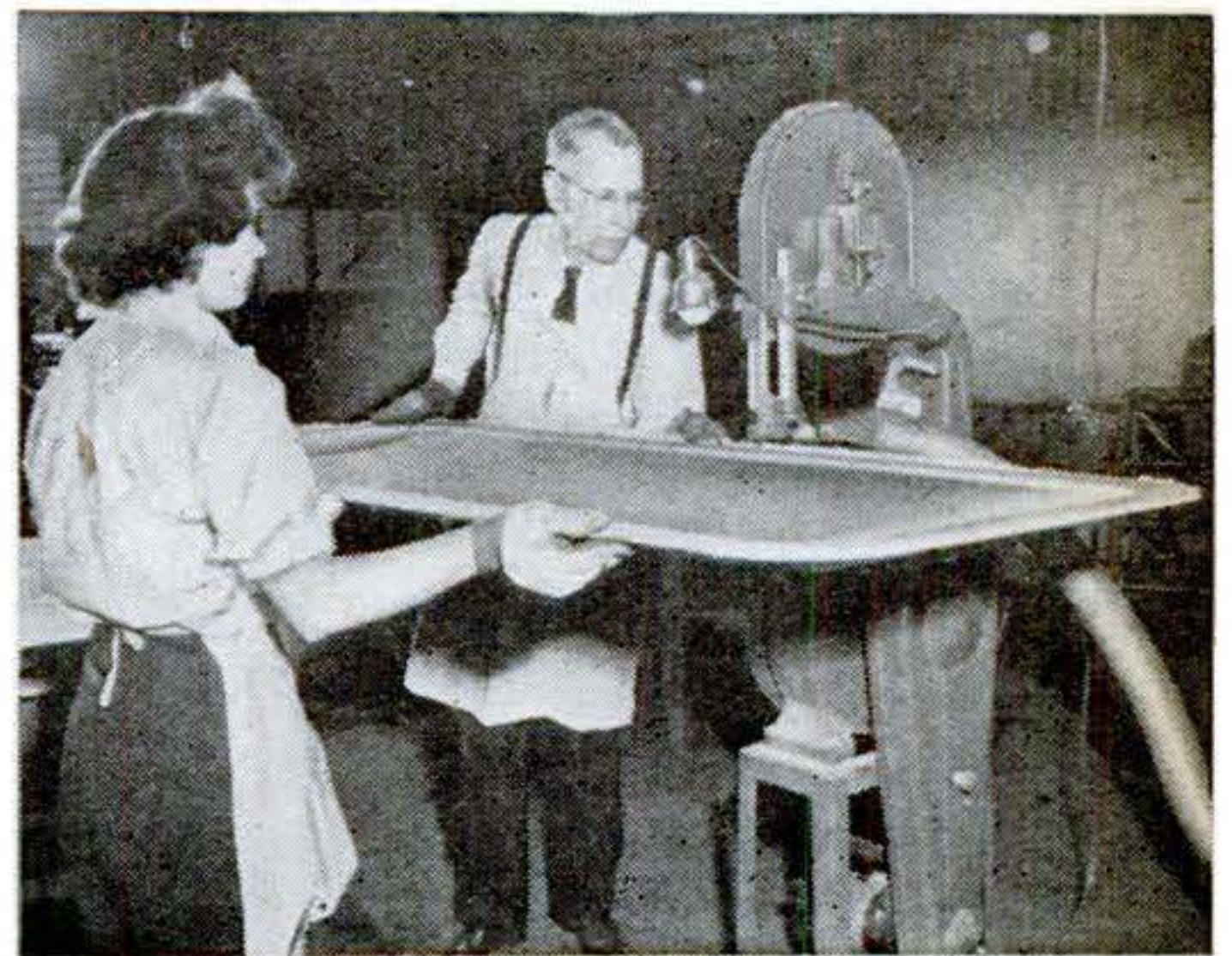

**5.** Edges of the mold are trimmed, just as metal would be handled, in the final step. Molds like this speed rubber processing as much as 90 percent.



**X-Ray Model.** This replica of a hospital wing (right) helps Westinghouse plan replacement of X-ray facilities worn out during the war. Such three-dimensional models replace blueprints.



**Mine Dress.** For miners' safety, the U. S. Bureau of Mines recommends the outfit above. It includes shoes with reinforced toes, coveralls tied at the ankle, a feather-light dust mask, shatter-proof eyeglasses and a helmet that withstands a 500-pound blow. The respirator at the belt allows normal breathing for an hour if a miner is cut off from air.



**Leak Detector.** A leak detector that can spot a leak small enough to let only a gallon of air out of a container in 60,000 years has been perfected by General Electric. The lad below is trying it on his balloon. The detector tests electronic tubes for vacuum tightness.

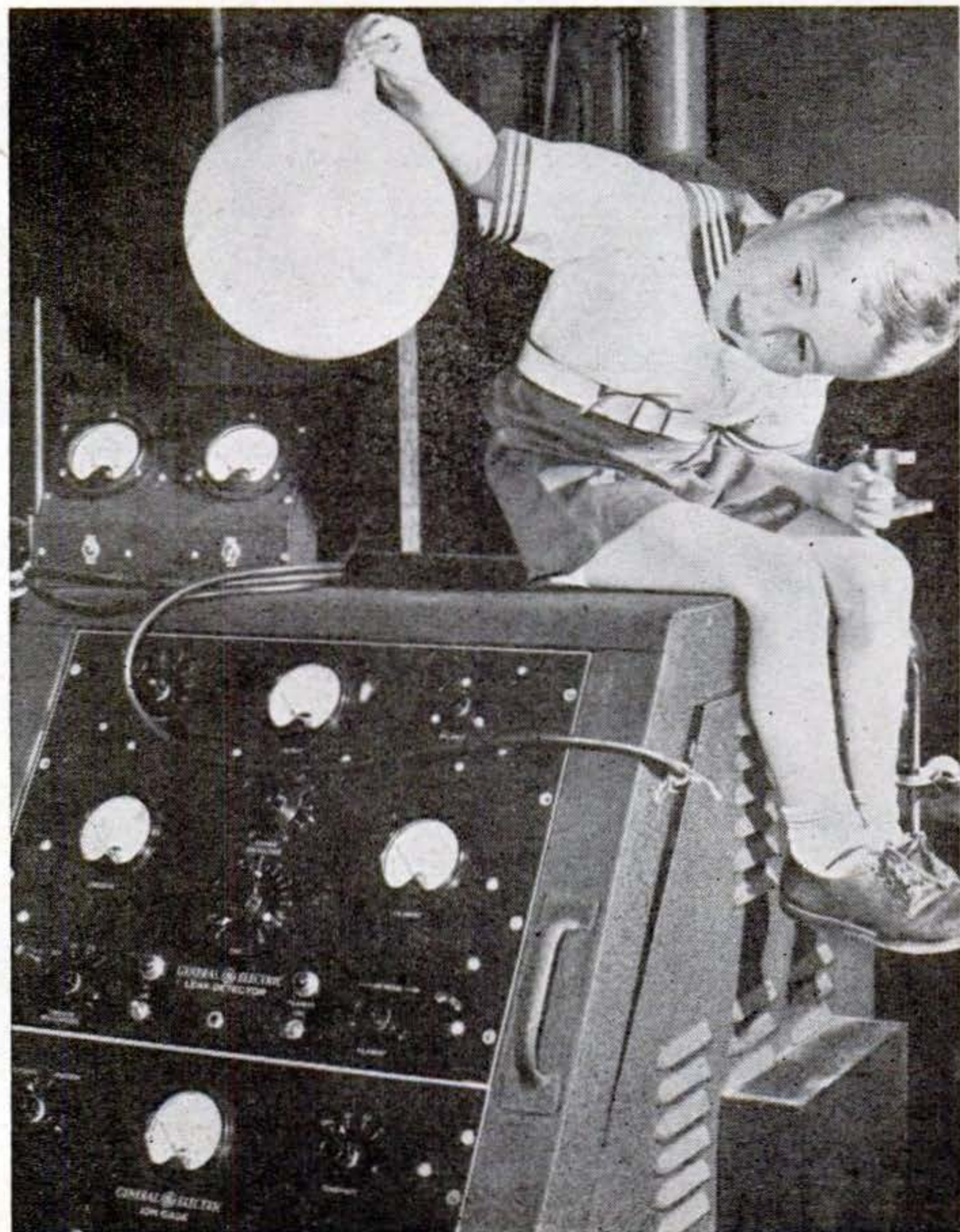





Dr. August Raspet, inventor of microbarograph.

## Soaring with a Buzzard

GLIDER pilots know that one sure way to locate a rising current of warm air is to find the nearest buzzard and then fly formation with it. The buzzard, an ace among soarers, always knows where the invisible thermals are.

To learn how buzzards know where to fly, Dr. August Raspet, of Locust Valley, L. I., the Soaring Society of America's research director, has invented a one-ounce barograph. The barograph, two inches long and one inch wide, will be strapped to a tame buzzard's breast and will record altitude variations as far up as 3,000 feet.

Like the two-to-three-pound barographs that gliders and P-61s carried into thunderstorms over Florida last summer (PSM, Oct. '46, p. 94), Dr. Raspet's model is an aneroid barometer. Changes in pressure (the result of altitude variations) move a stylus over the smoked rim of a recorder drum driven by a wrist-watch mechanism.

When the buzzard soars with its meter, Dr. Raspet will get an accurate picture of "thermal microstructure"—the composition of individual warm-air currents.

A buzzard named Fritz was ready to wear Dr. Raspet's microbarograph but died from swallowing a bone before the instrument was completed. George F. Carter, of Kendallville, Ind., captured the bird when it was only a few weeks old. He kept it in his cellar until its wing span reached five and a half feet.

When the captive buzzard first took to the air it was unaware of the effects of wind on flight. It tried to land downwind on a telephone-pole crossbar and ended up hanging by its claws, flapping furiously. The buzzard knew nothing about soaring, either, until one day it blundered into the traffic pattern of some wild buzzards and learned about thermals from them.

Carter is hunting another fledgling that he can train to wear Dr. Raspet's barograph. He even hopes to teach it to fly in a wind tunnel where, by inclining the tunnel and regulating the flow of the air stream, the buzzard's sinking speed can be calculated. Then the bird's flight can be followed through a theodolite and the vertical velocity of a thermal can be measured exactly.



# How NYLON Yarn is Made

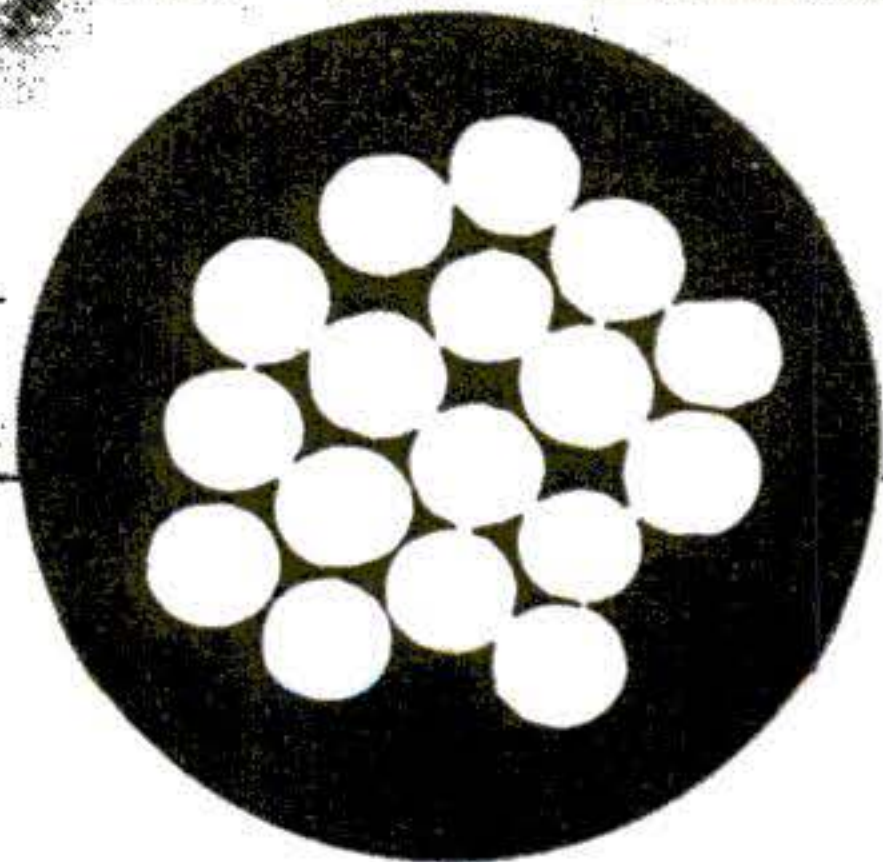

This photomicrograph, taken at a magnification of 660, shows the cross section of a nylon thread. The 17 filaments form a strand used in sheer stockings.

**N**YLON, silk's young but overwhelming rival, is spun out of air, water and coal. The drawings at the right take the raw materials through the process that chemists worked out in the 1930s to produce the tough, lustrous thread.

About 90 percent of this yarn is used today in the manufacture of women's stockings. The first nylon hosiery appeared in the stores on May 15, 1940; to date, the supply has never equaled the demand. During the war all nylon yarn was allocated to the armed services, largely for use in the manufacture of parachutes. Du Pont now plans to deliver up to 23,000,000 pounds of the thread annually, enough to make 450,000,000 pairs of women's stockings.

As many as 32 pairs of nylon stockings are knit simultaneously on machines 40 feet long. Gauge, or sheerness, is determined by the number of needles per inch and a half on the knitting needle bar—51 needles make a 51-gauge stocking.

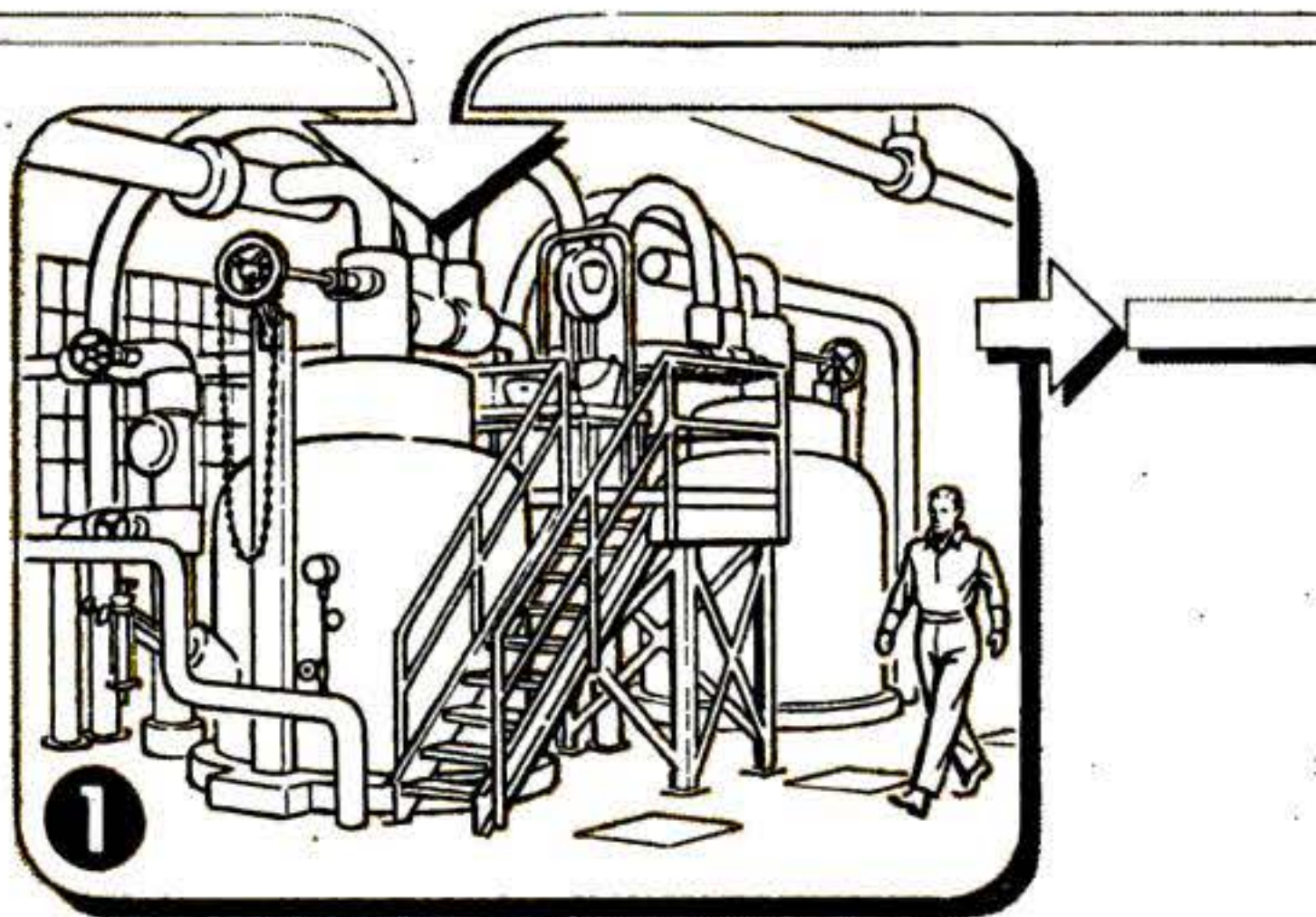
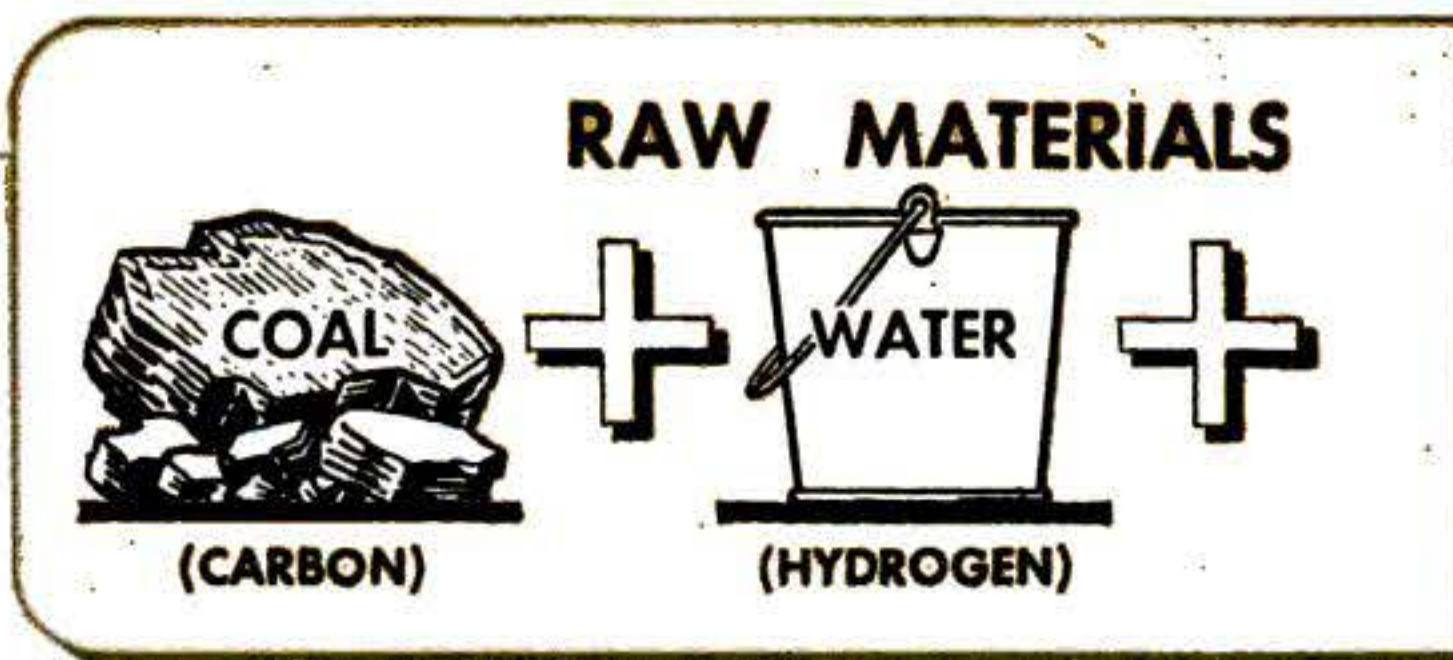

1 In these great vessels the nylon salt solution, composed of coal, air and water, is evaporated until almost all of the moisture has been removed.

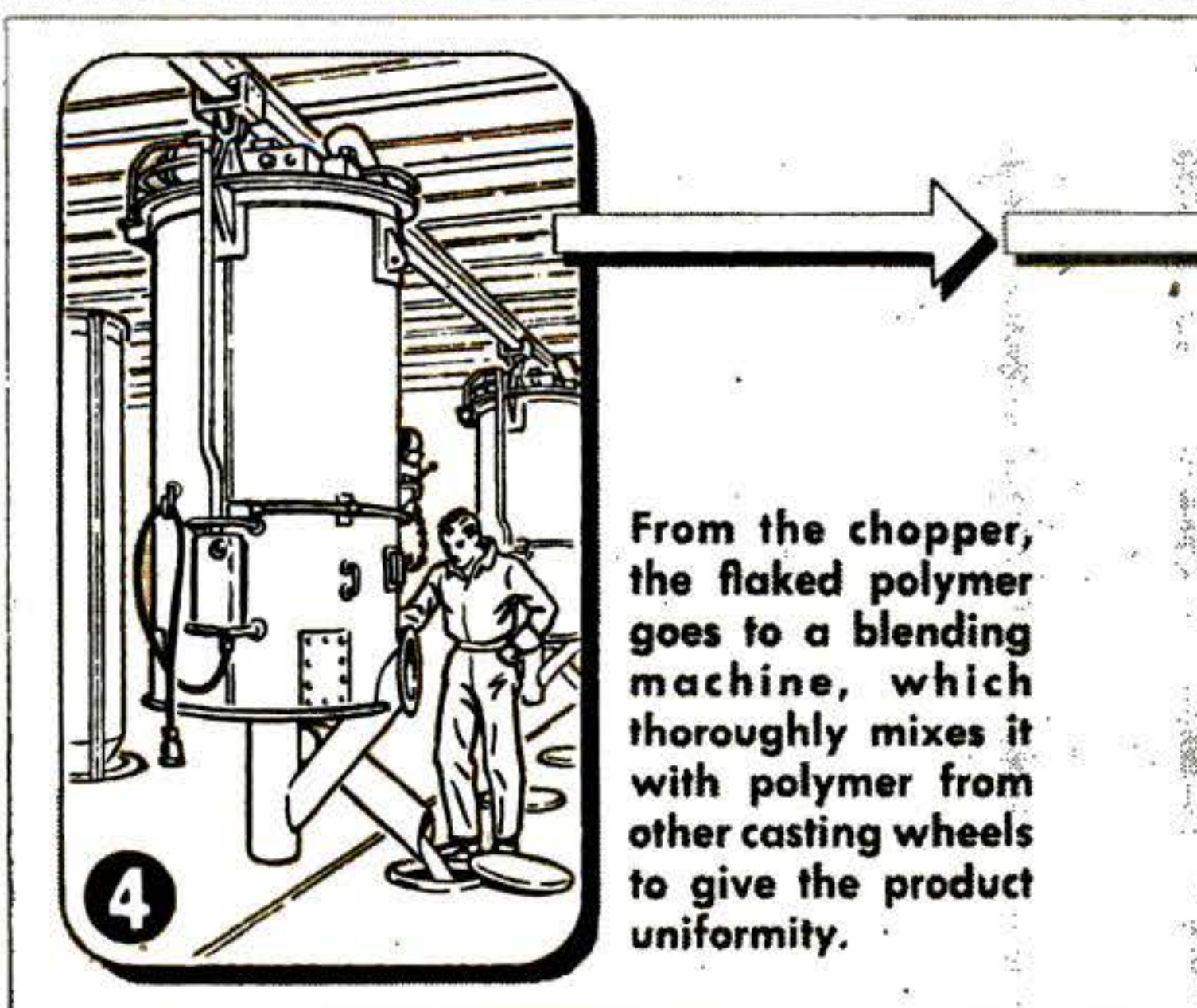

4 From the chopper, the flaked polymer goes to a blending machine, which thoroughly mixes it with polymer from other casting wheels to give the product uniformity.

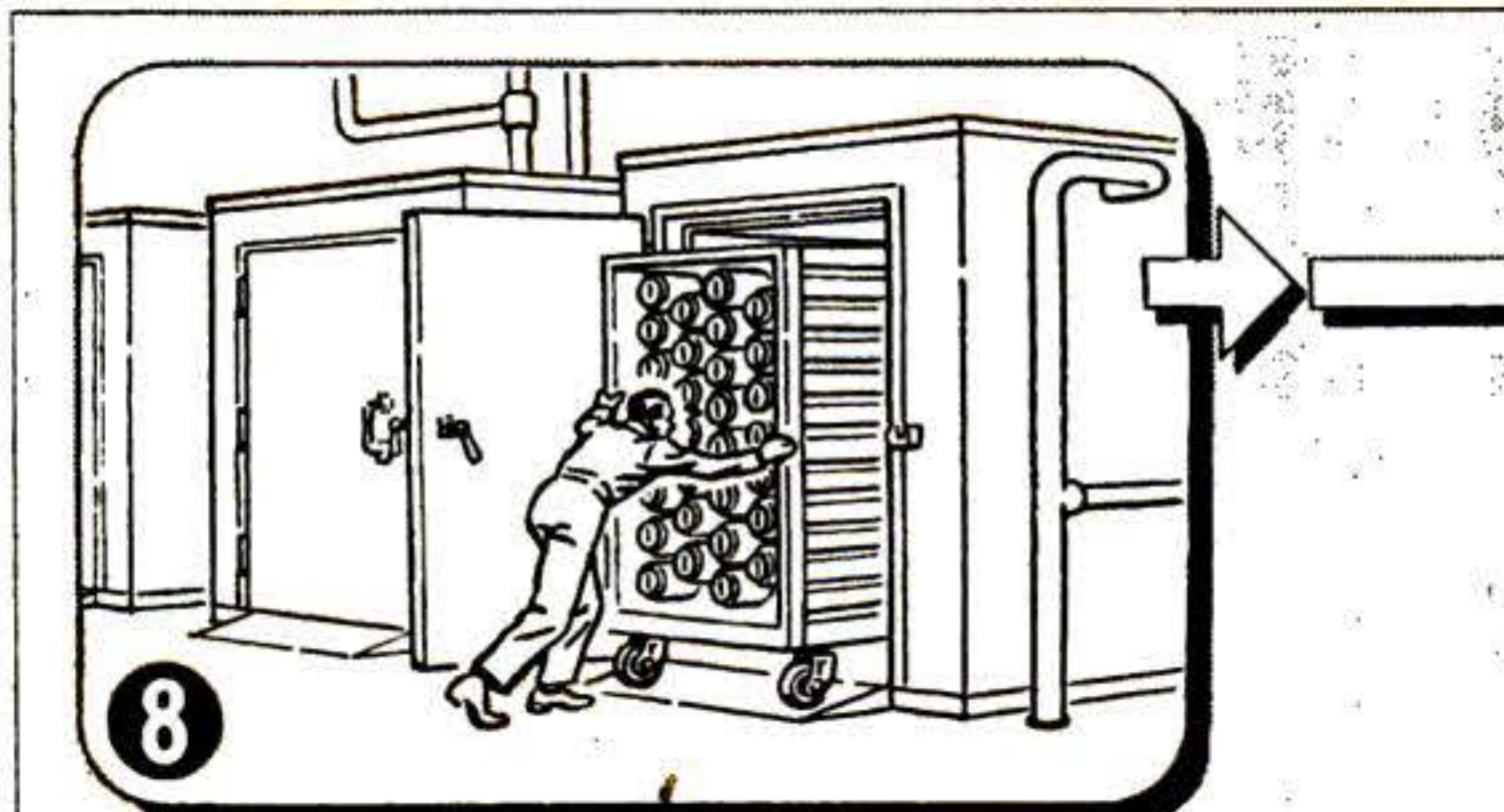

8 Bobbins are put into trucks and baked in the nylon yarn "twist-setting" ovens before the yarn is wound on spools and cones.



**USED**

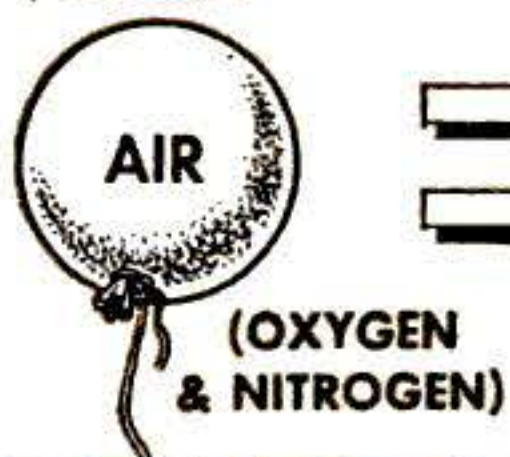

**BASIC NYLON MATERIAL**

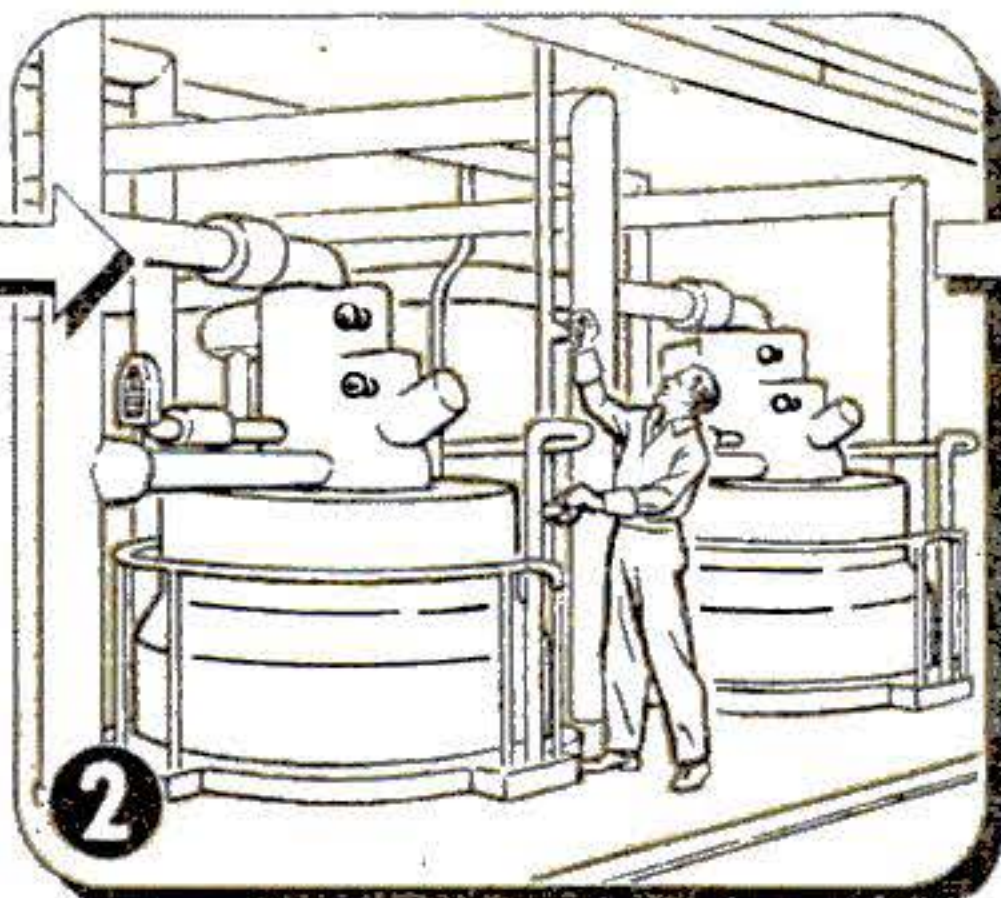
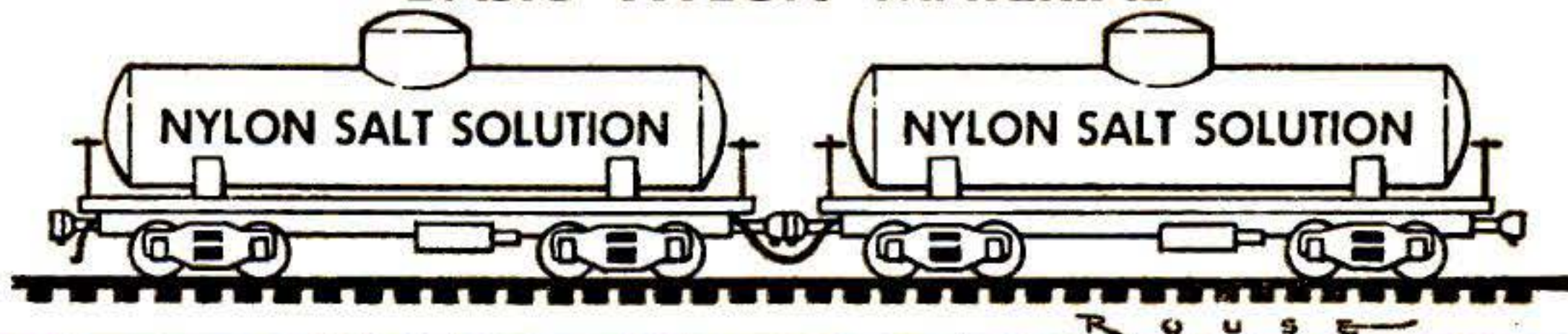

These vats polymerize the material at high temperatures, making the small molecules join to form "long-chain" molecules.

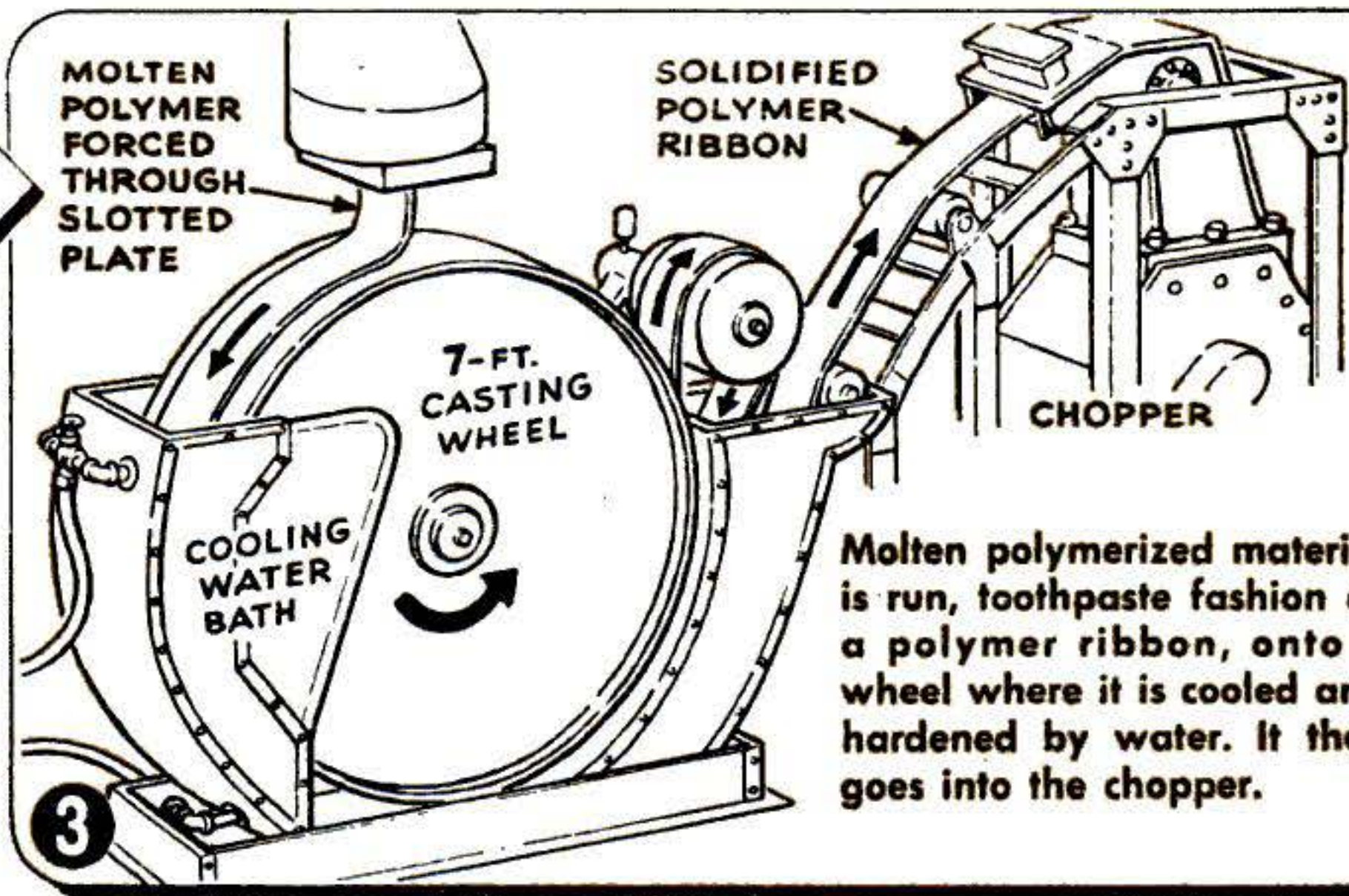

Molten polymerized material is run, toothpaste fashion as a polymer ribbon, onto a wheel where it is cooled and hardened by water. It then goes into the chopper.

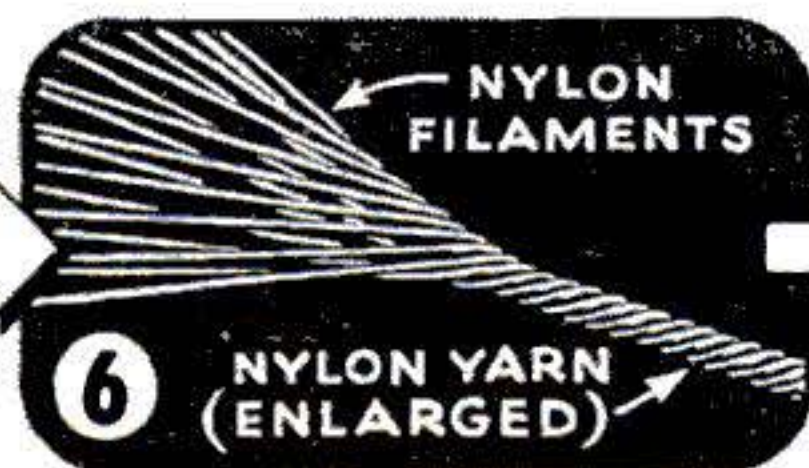
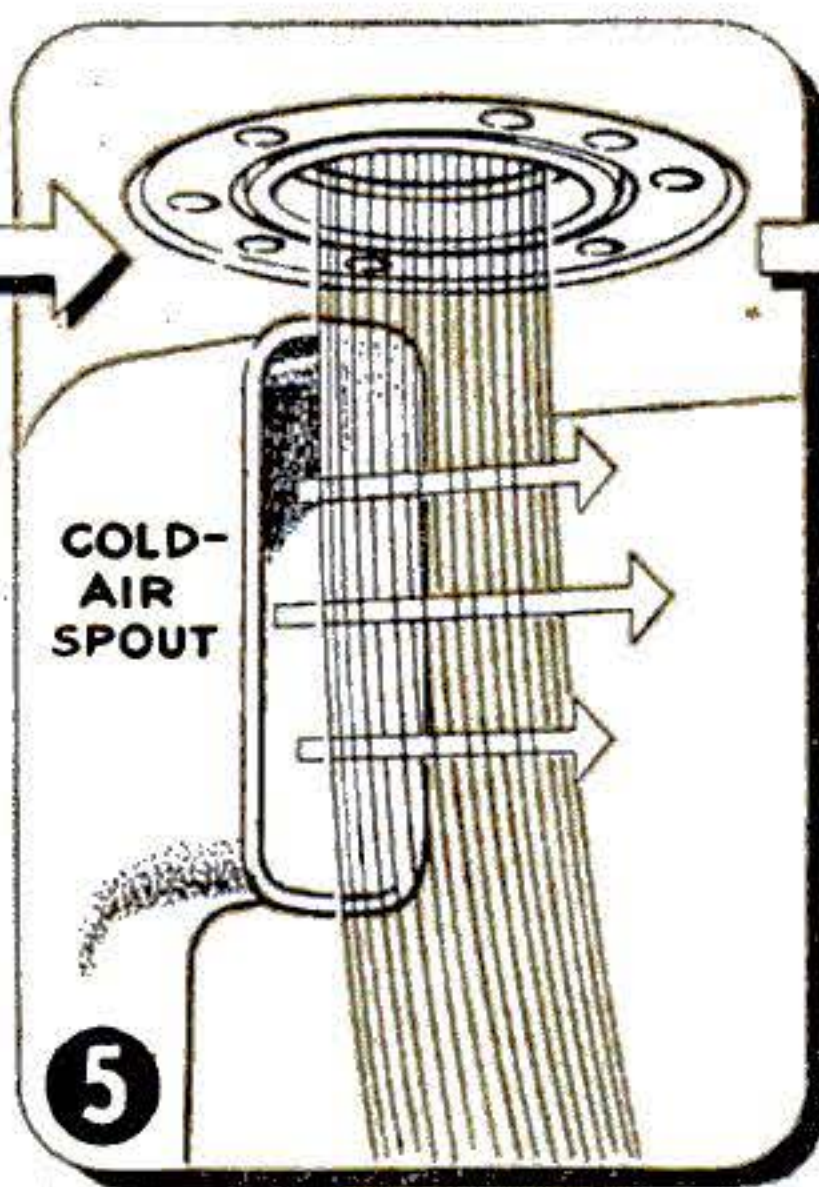

After the blended polymer is melted again, it is forced through tiny holes in a metal plate (left) to make nylon filaments (above). These harden immediately in cool air and are then spun on spinning machines to make nylon yarn.

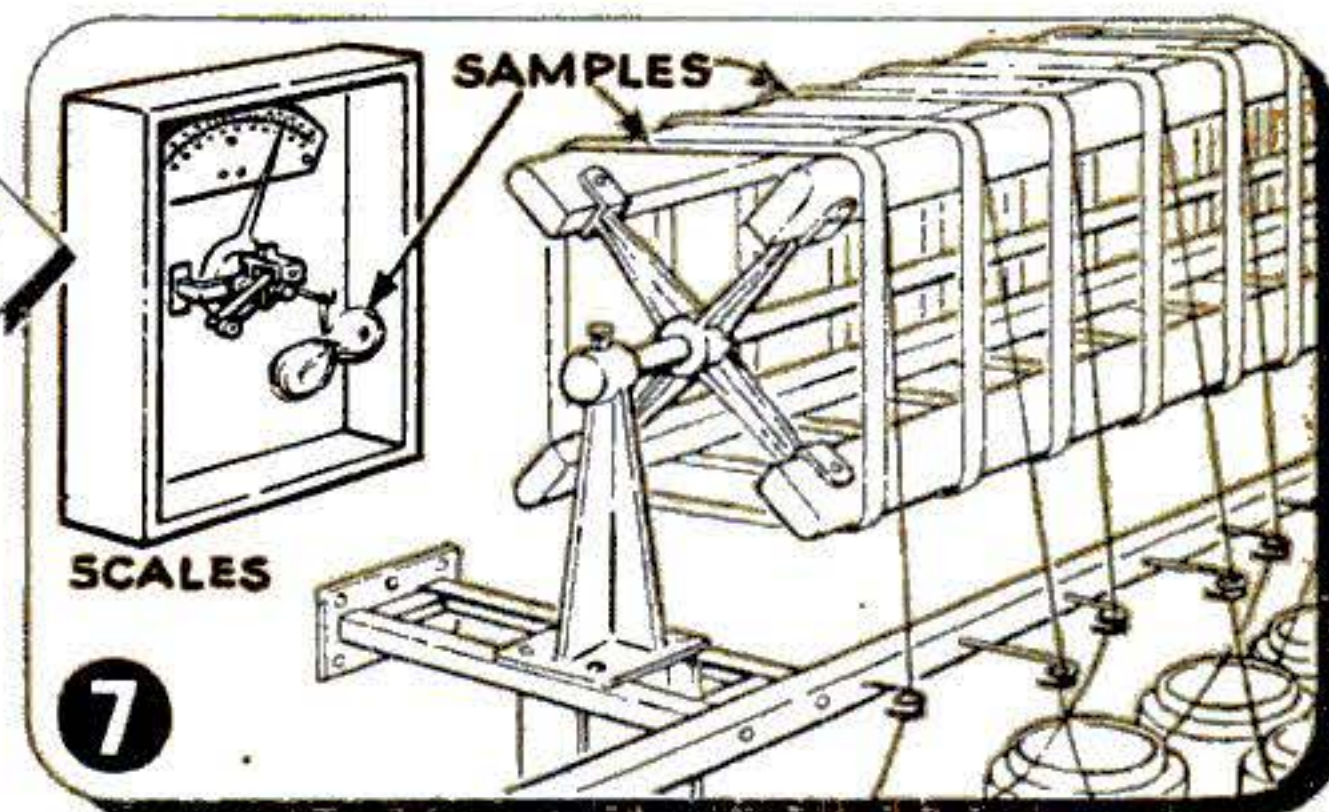

Sample of yarn of predetermined length is taken from each bobbin and weighed to determine yarn's "denier," or size. This sample is clipped off at the reel. Thus the bobbin can be classified for nylon's thickness.

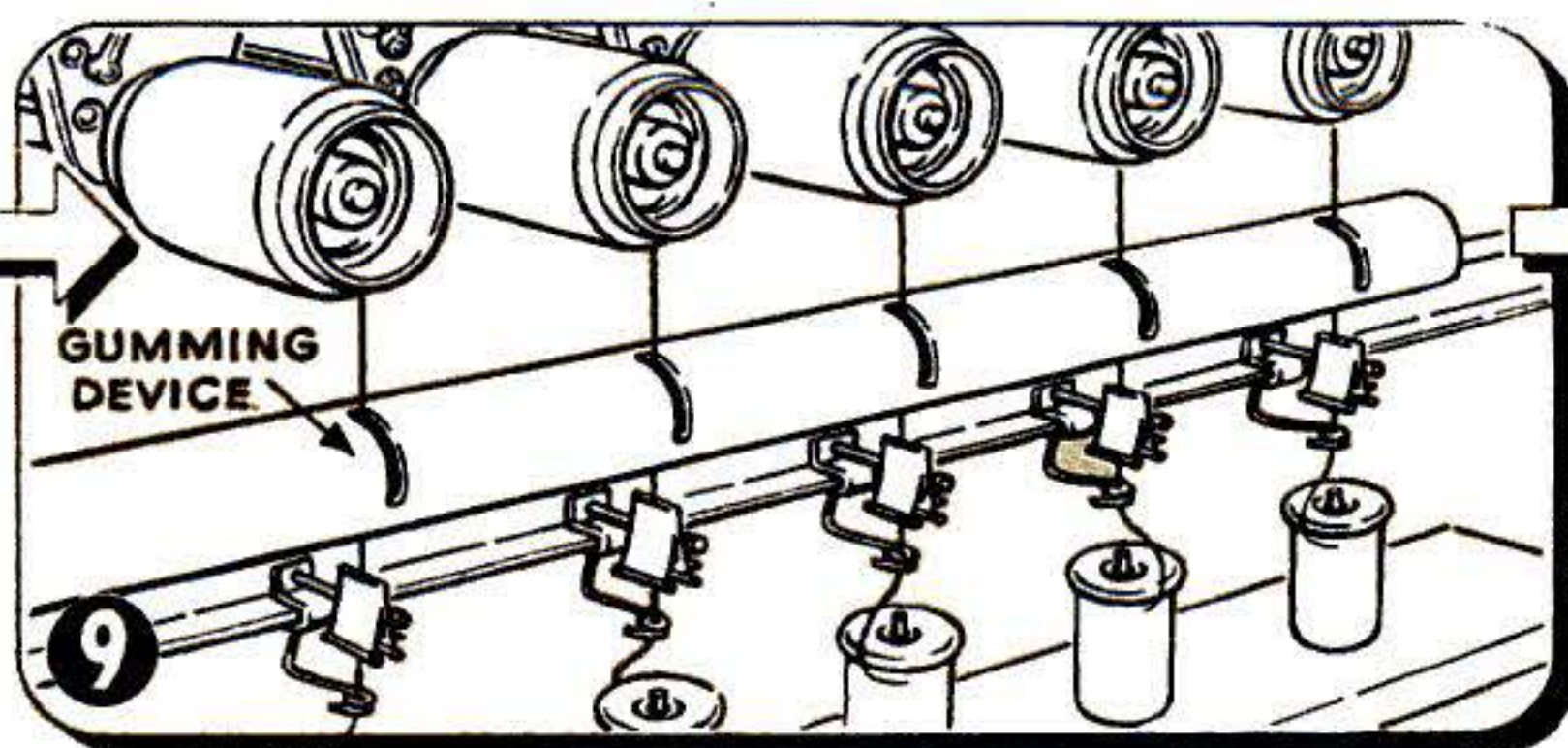

The thread is wound from one spool to another, passing through a mechanism which applies a gummy substance. This protects the yarn while it is being knit into stockings or nylon fabrics.

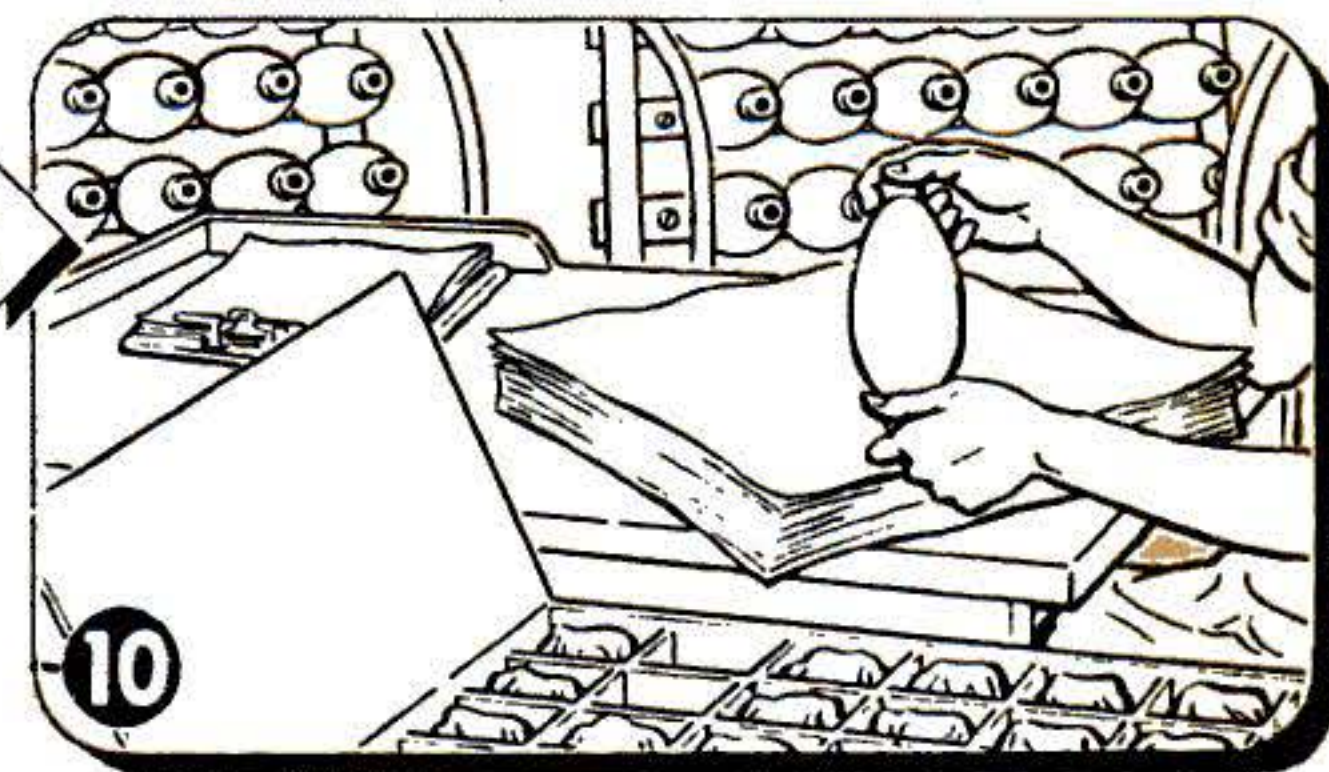

The mills require that each spool or bobbin of nylon thread be carefully inspected and found in flawless condition before it is packaged for shipping to knitters.



A midget's cockpit is a shoehorn fit. Indicated are: (1) steering mechanism gear box; (2) button to stop engine in an emergency; (3) hand brake; (4) hand oil-pressure pump; (5) radius rod aligning axle and frame; (6) gear shift.

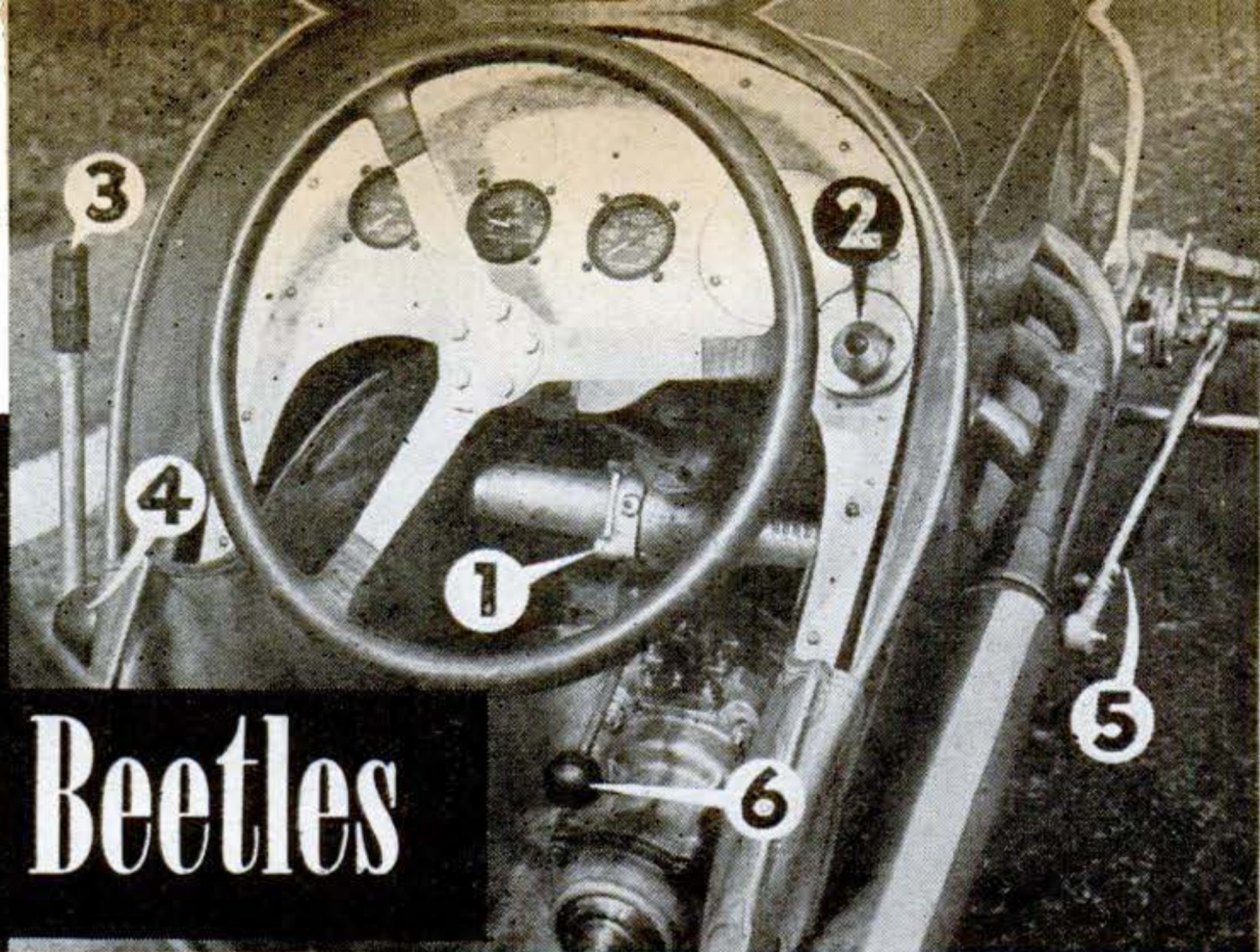

# Speeding Up The Roaring Beetles

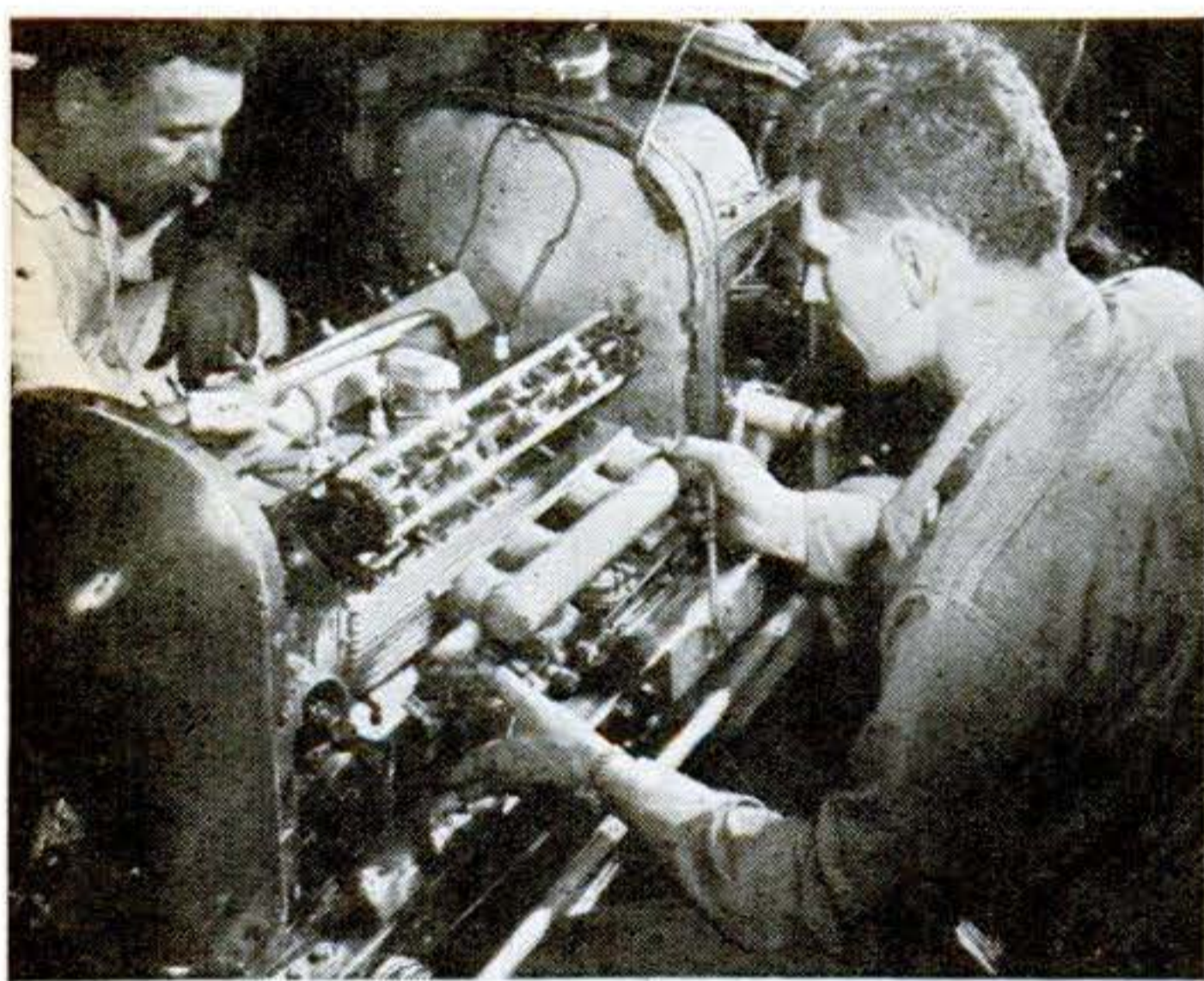

Most popular and successful engine for midget racers is the Offenhauser, which costs up to \$2,000. The photo above shows the unconventional but easily accessible twin cam towers that operate the power plant's overhead valves.

## How the midget racers are tuned to win

**R**AZZLE-DAZZLE and rough, midget auto racing is winding up its first postwar East Coast season with important money in its pocket to testify to its success as a crowd pleaser. On 20 eastern tracks the noisy sport drew throngs approaching 200,000 a night, and some 250 drivers are now on their way to tracks in the south and west.

Midgets race on tracks a quarter or a fifth of a mile around. Some crack drivers earn as much as \$10,000 a season—in 1941, one cleaned up \$23,000 in 14 weeks. The average midget weighs about 850 pounds and has a 74"-78" wheelbase. Accidents are plentiful, but more spectacular than lethal—the midgets and their drivers are tough.

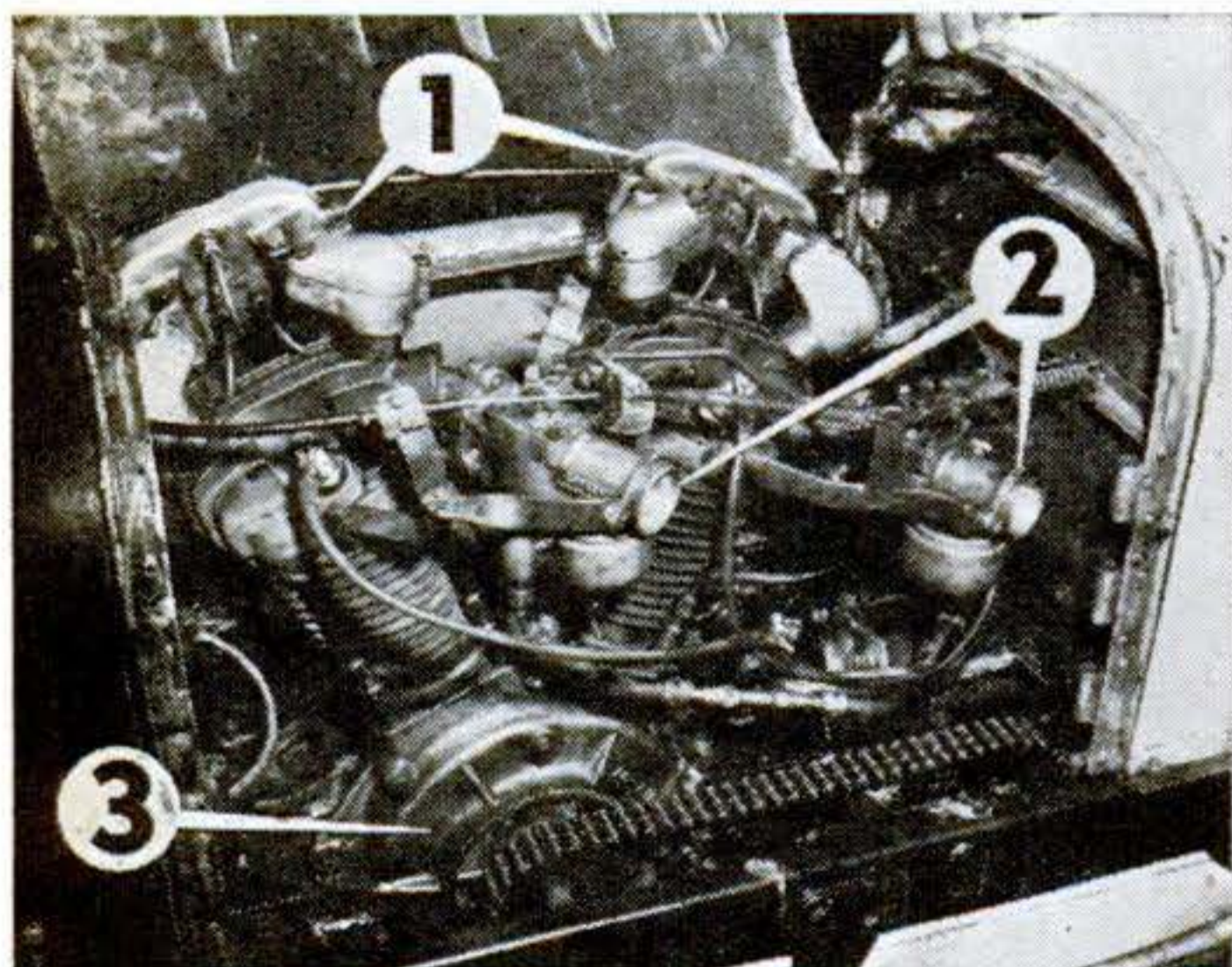

Every type of power plant—from converted outboards to souped-up motorcycle engines—is used in midgets. This made-over motorcycle engine shows: (1) housings for valve mechanisms; (2) twin carburetors; (3) crankcase with chain drive.

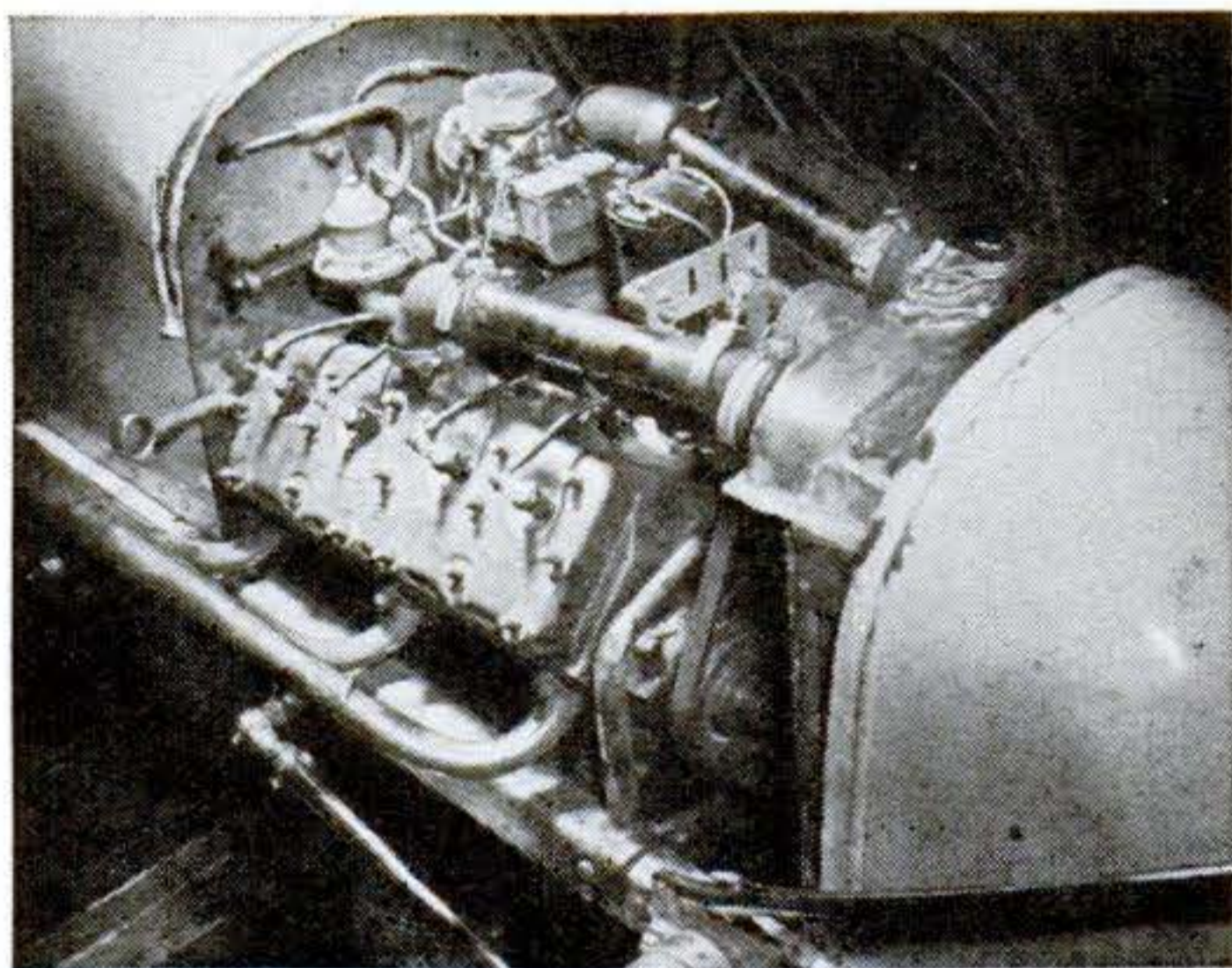

Here is how a Ford V-8 is converted into a package compact enough to fit a midget. "Cold" spark plugs are used on such engines when they are new but are replaced by "hot" ones as wear develops. Midgets have made 125 m.p.h. on a straightaway.



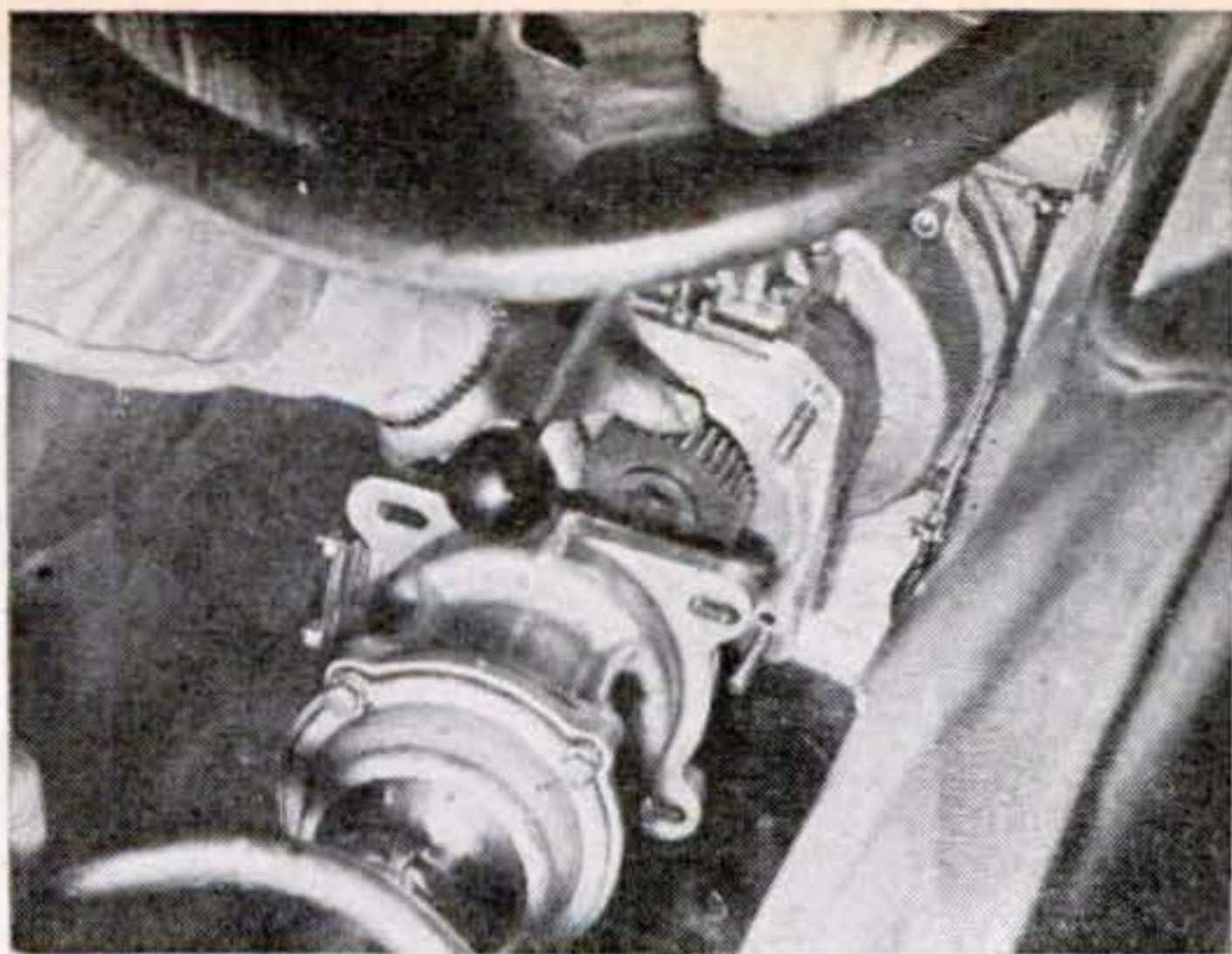

Gear ratio between crankshaft and wheels can be changed on most racers in 15 minutes. Here the assembly is exposed by removing only four bolts. Most drivers are skilled mechanics and spend considerable time keeping cars tuned up.

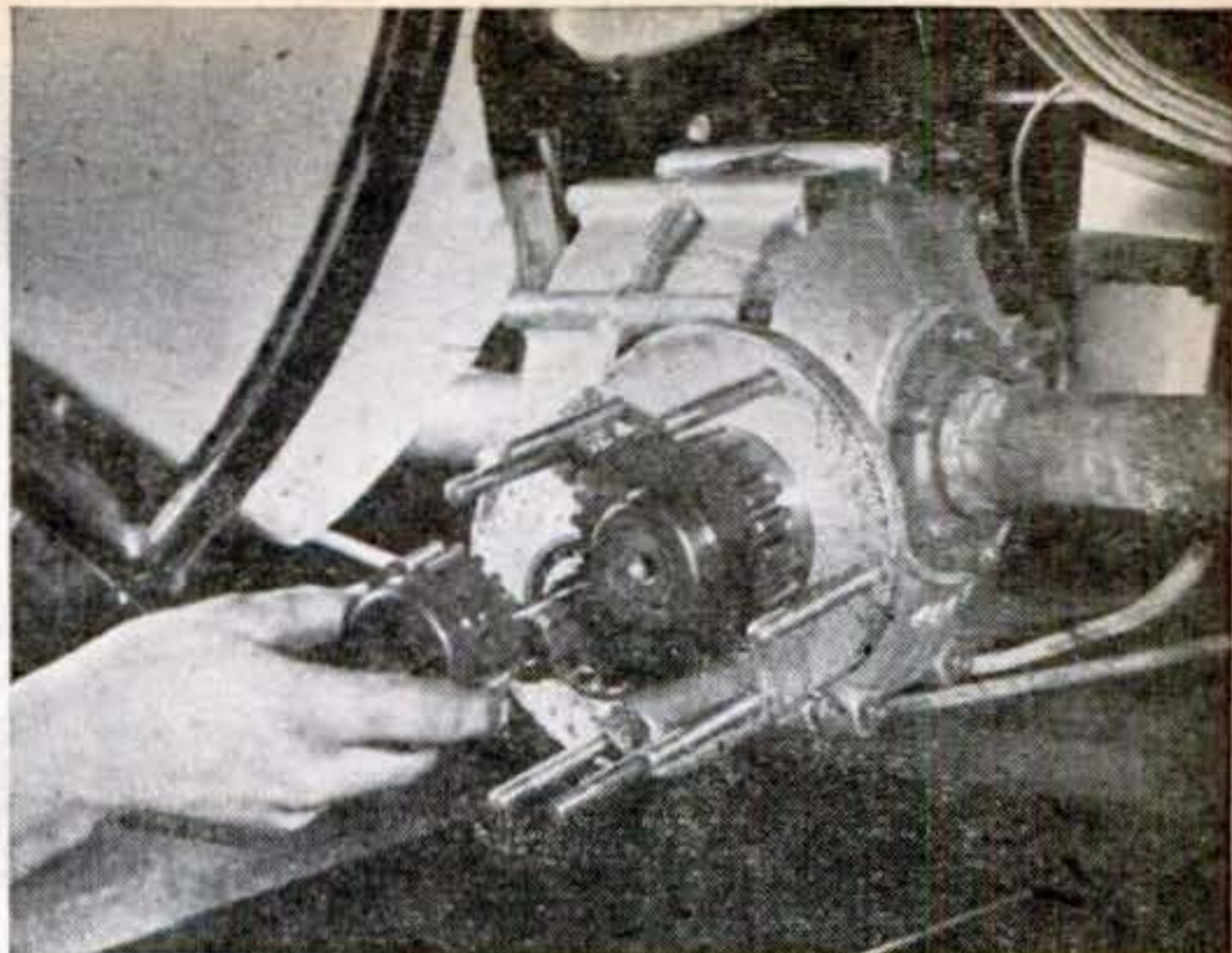

Here the gear ratio is changed on a Ford-powered racer. Good "beetles" cost around \$6,000, even though, largely assembled from parts out of junk yards or home machine shops. Their drivers are seldom seriously hurt, though accidents are frequent.

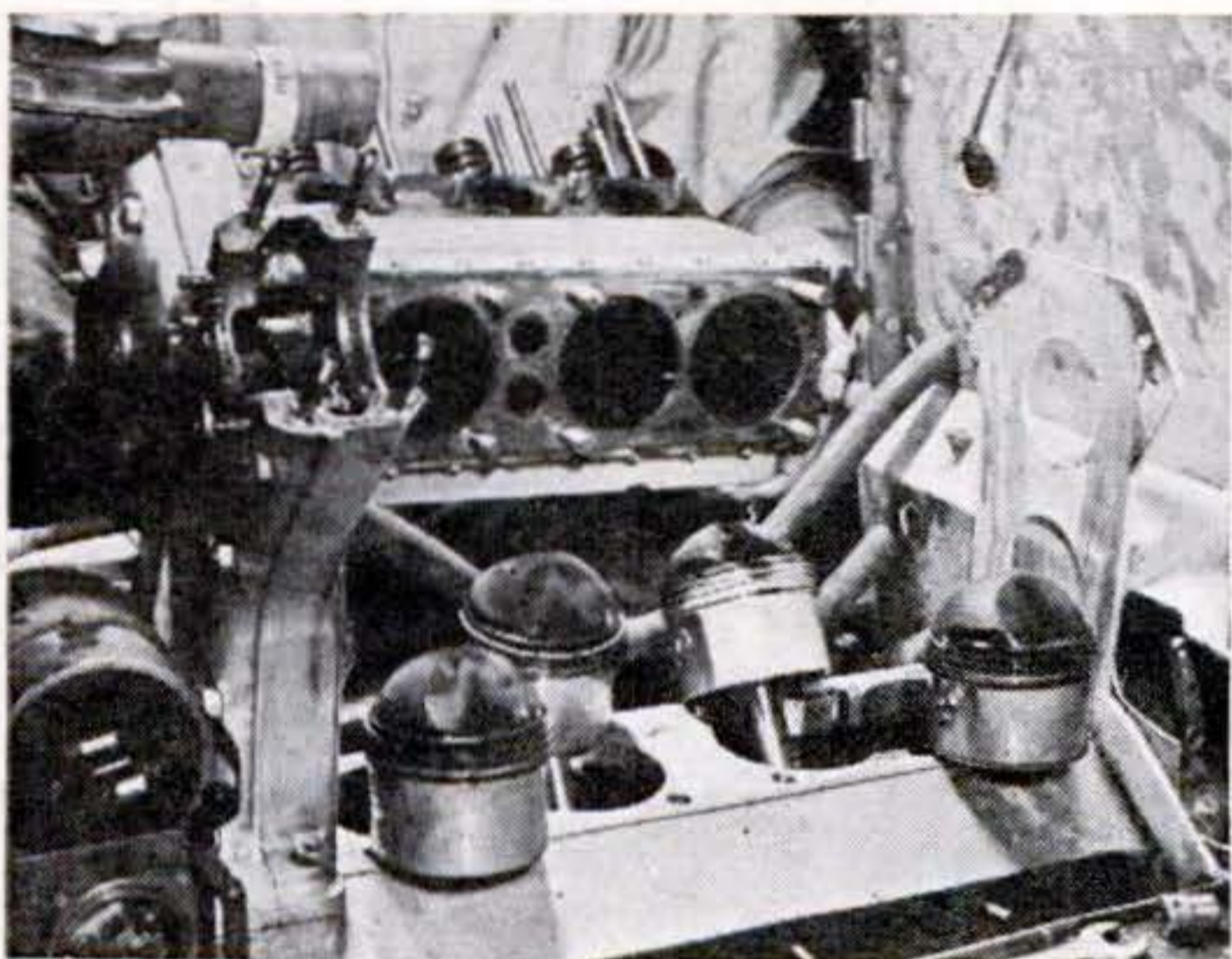

An Offenhauser, above, has rounded piston heads that boost turbulence and combustion. The compression ratio is 14 to 1. Piston displacement is limited to 140 cu. in. for flathead engines, 105 cu. in. for overheads, 65 cu. in. for outboards.

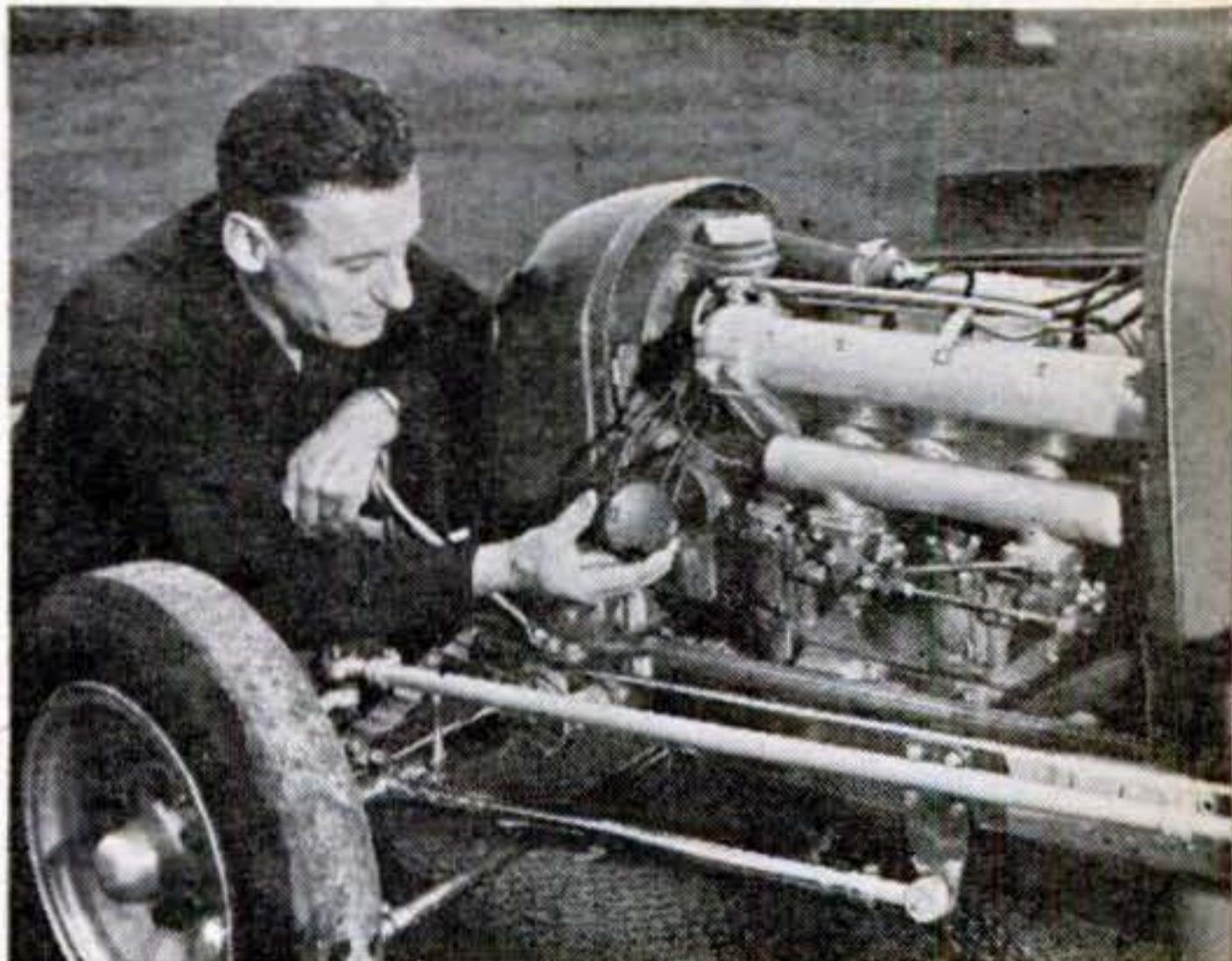

Walter Gerner, a midget owner, checks a distributor cap. Many drivers do not own machines but race for a percentage of winnings. Eastern owners and drivers pay dues to American Race Drivers' Club or American Racing Association.

Front end of midget shows: (1) special steering rod; (2) bumper. Car's right tire is larger than left one for stability on turns. Tires are beveled on edge opposite direction of turn to hold them on rims. Track speeds seldom exceed 70 m.p.h.

With a meet over, driver and crew haul their tiny breadwinner to the next speedway on two-wheeled trailers. Some drivers race as often as five days a week. The payoff is for speed, and the midgets grow faster and faster year by year.

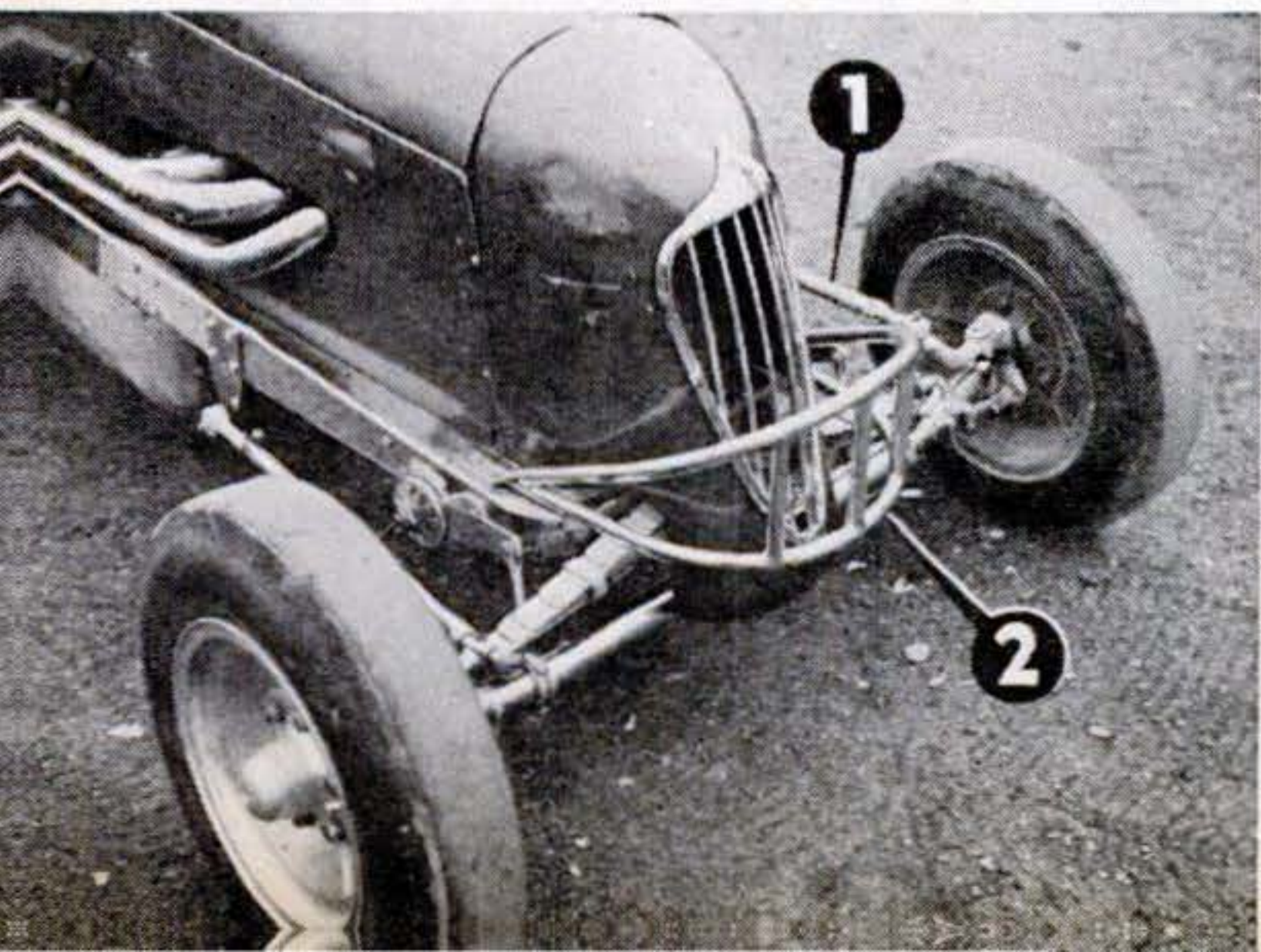





**INDUCING SLEEP** through mental suggestion is the aim of a special record created and recorded by Ralph Slater, a hypnotist. Entitled "Time to Sleep," the 12" unbreakable record is produced by the De Luxe Record Company, of Linden, N. J. One side is devoted chiefly to an explanation of what the record is intended to accomplish; the other, carrying the voice of the hypnotist with an accompaniment of soft music, gets down to the job of creating a state of mind that will help the listener go to sleep.

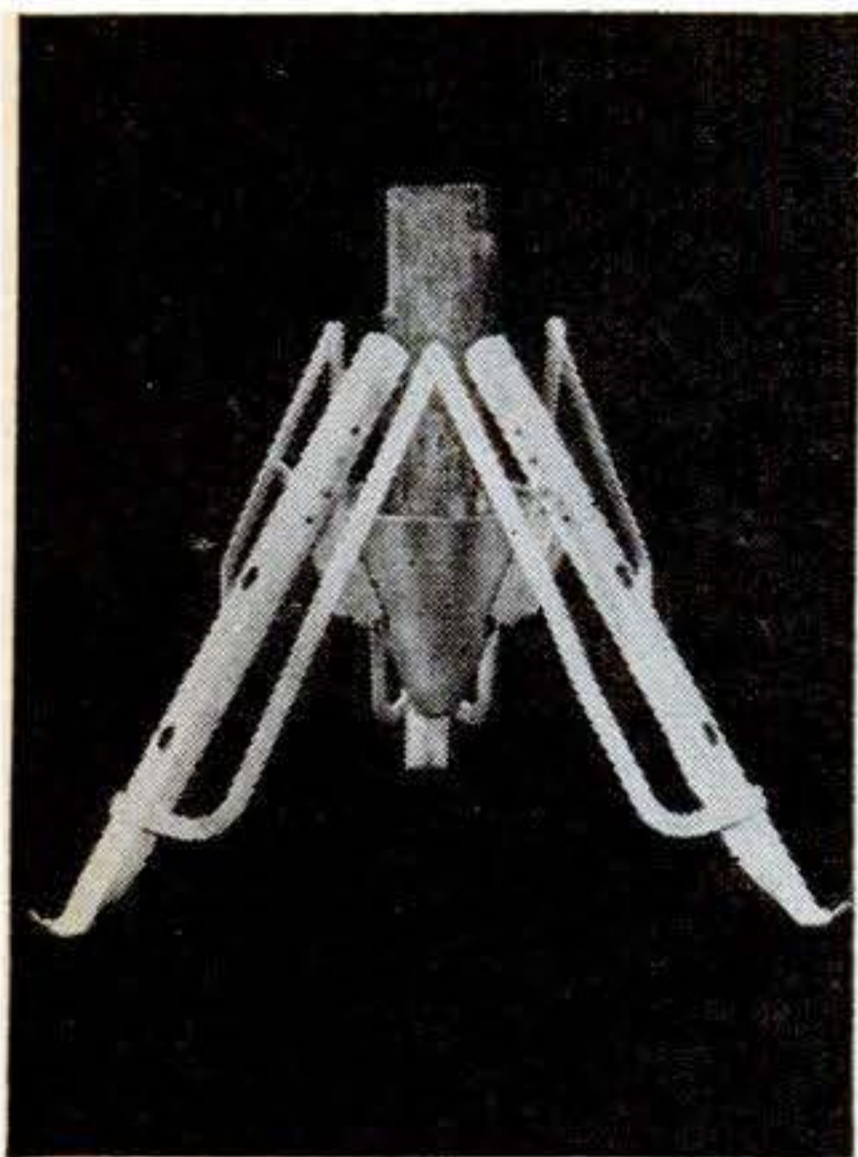

**A CHRISTMAS-TREE** stand distributed by Bradley, Laurens & Campbell, New York, adjusts itself automatically. When the butt is placed in the funnel-like base, the weight of the tree actuates clamps that grip the trunk.

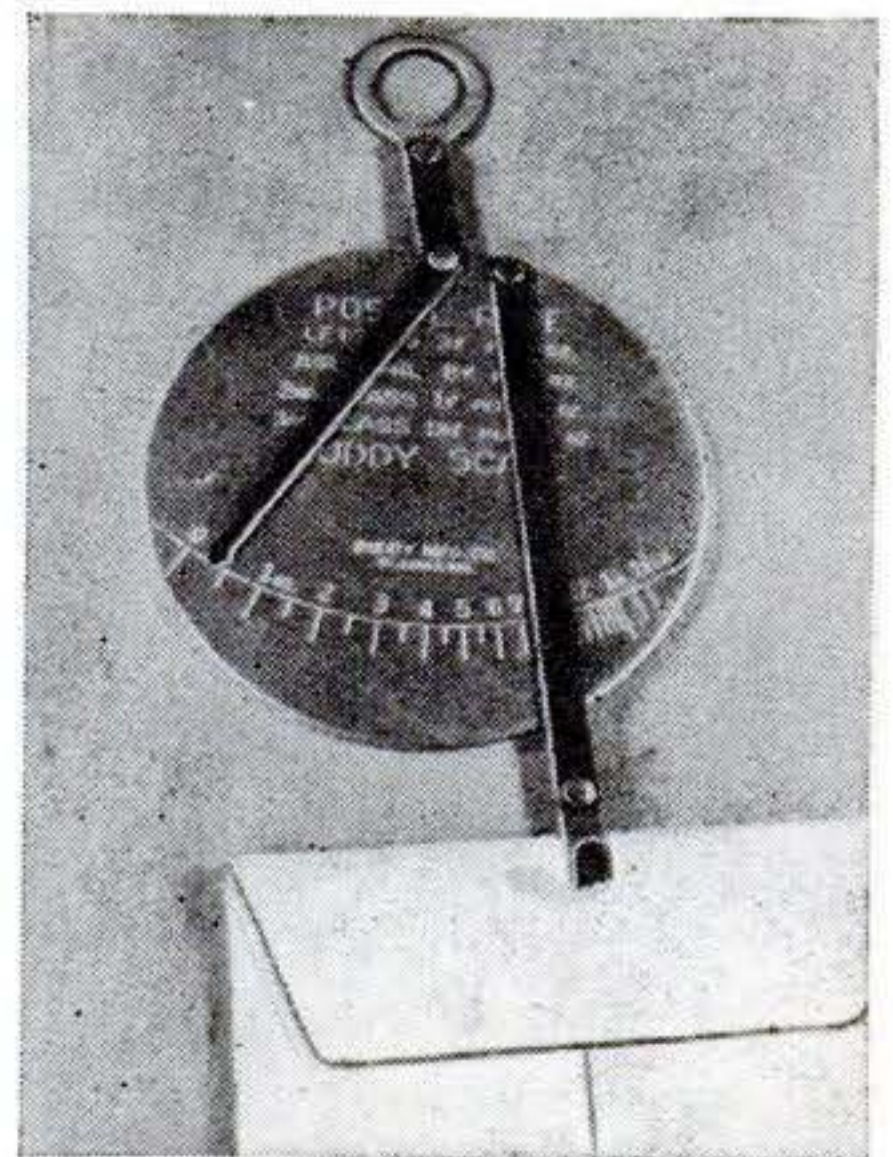

**NO SPRINGS.** A postal scale made by Buddy Mfg. Co., St. Louis, gives a reading when the disk is swung upward by the weight of a letter or a package hung on the off-center lever.

**STERILIZED NIPPLES** stay that way when placed on the bottle with the gadget illustrated below. Produced by I. B. Kleinert Rubber Co., New York, it consists of a cir-

cular aluminum frame with three compressible prongs that slip inside the nipple. As the frame is pushed over the bottle, the prongs spread the nipple so that it goes on easily.





**GARAGE DOORS** of the overhead type can be unlocked and opened without leaving the driver's seat by installing a "Driv-Rite-In" made by the Era Meter Company, Chicago. It consists of an electrical mechanism in the garage connected to a key-operated switch on a post beside the driveway within arm's reach of the car. The system also works in reverse to close the door after you have taken out the car. As an additional convenience, a garage light turns on when the doors open and turns off when they close. A control also is located inside.

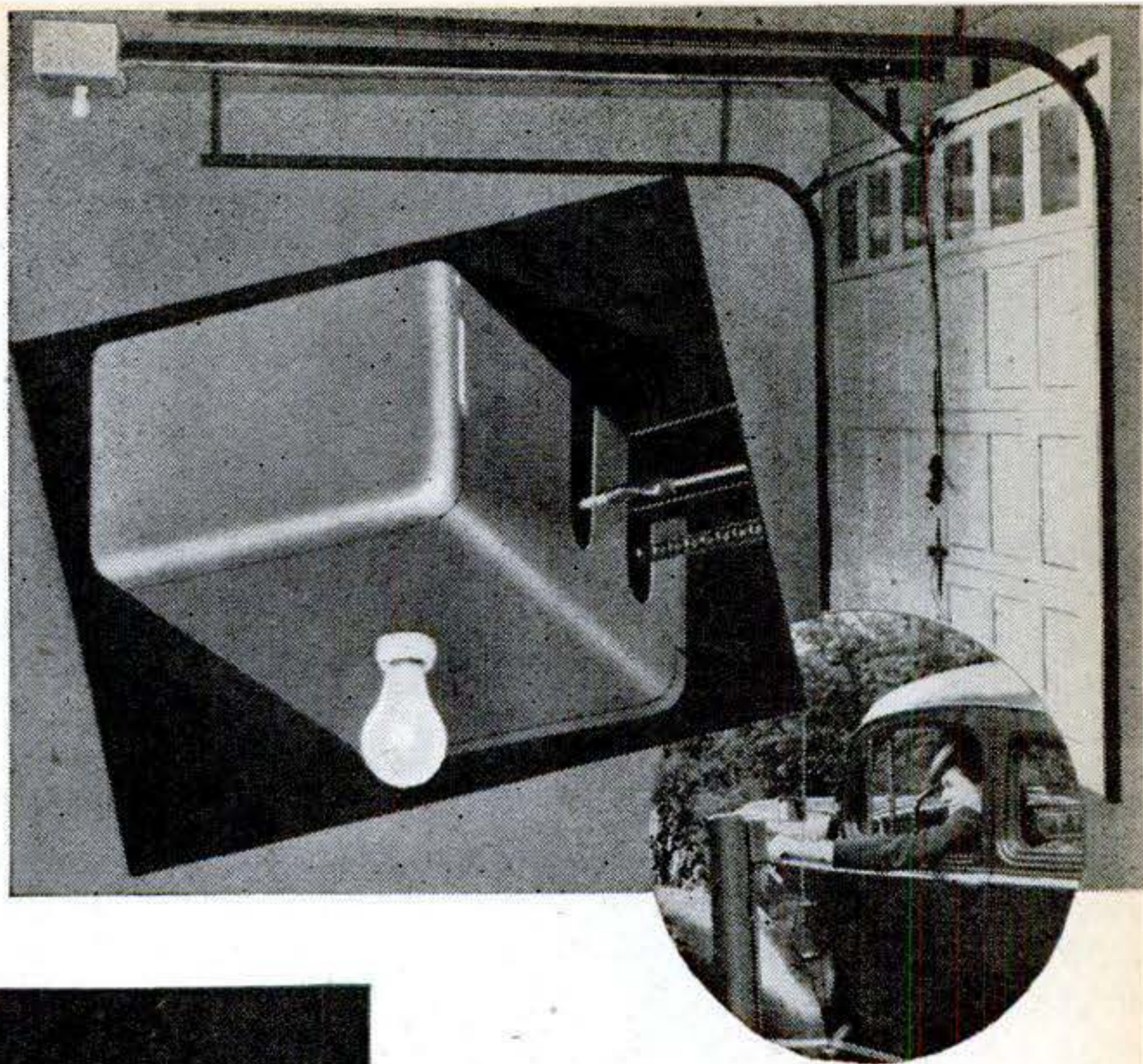

**CONDENSED-MILK CANS** may be sealed, as well as opened, with a device distributed by Bernard Paul & Co., Berkeley, Calif. When milk is needed, the opener-sealer may be raised as above to permit pouring. Allowed to go down, it seals the can.

**ONE-HAND OPERATION** makes this flour sifter a kitchen convenience. A product of the Foley Mfg. Co., Minneapolis, Minn., it has a tapering bottom to prevent flour from spilling outside the measuring cup as it is being sifted.

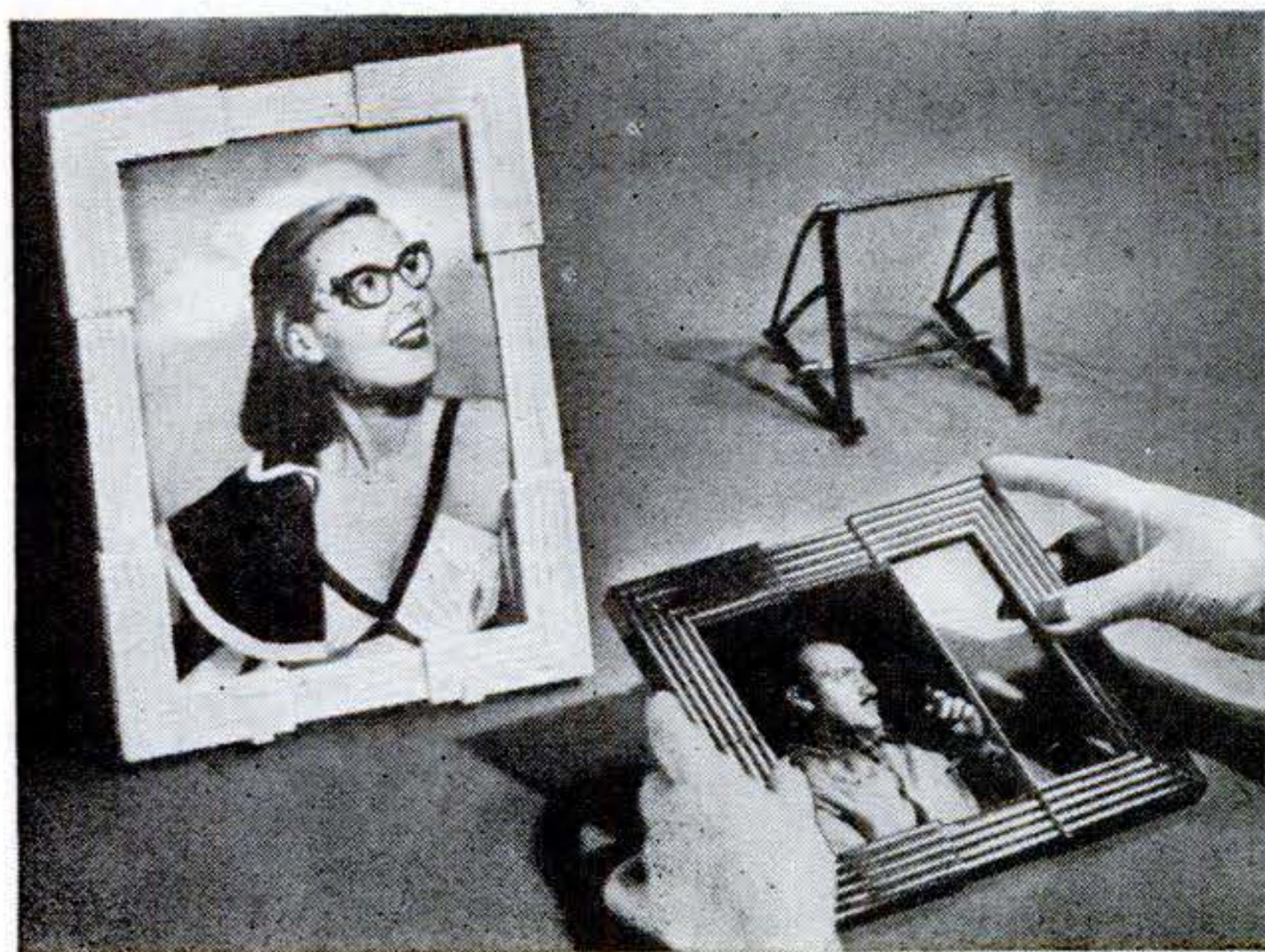

**THIS PLASTIC FRAME** expands or contracts to fit any picture between 4" by 5" and 8" by 10", and concealed springs hold it rigid at any size. Barrett Plastic Products, Inc., makes it in a variety of colors. It can be set on an accompanying easel or hung from a hook on a wall.



# AUTO HINTS



**1 LIGHT UP FRONT** for reading road maps and the like can be supplied by an inexpensive parking lamp mounted on a bracket above the rear-view mirror and connected to the car wiring system. A toggle switch should be wired in the circuit.—W. D. S.

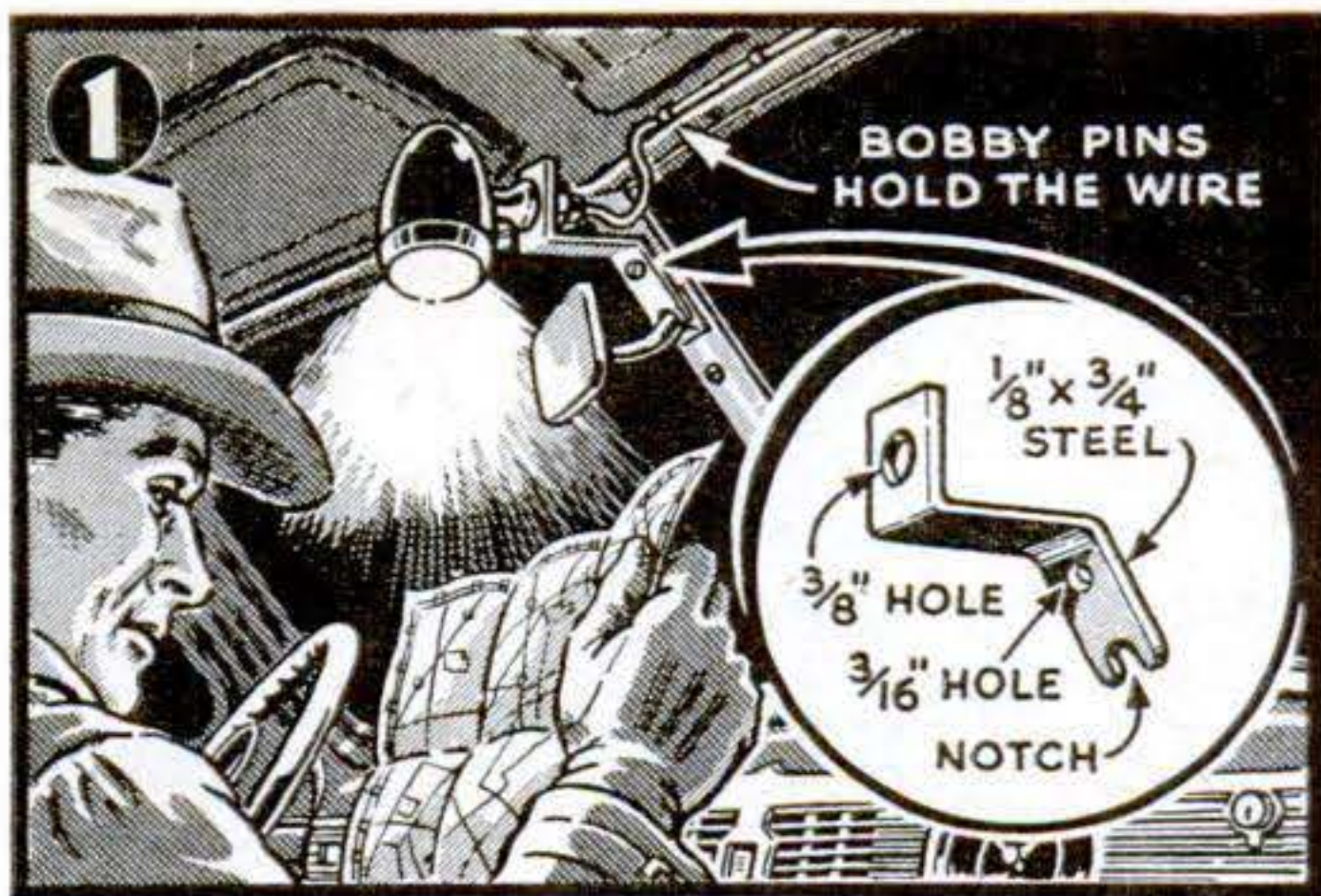

**2 REMOTE IGNITION CONTROL** is an important safeguard if you push a stuck car. Use a metal strip bolted to the key and attached to a cord that can be pulled to turn the switch off. Then, when you're alone and stuck in slush or mud, you can push the car yourself with the motor in low gear and still turn off the ignition instantly.—H. K. F

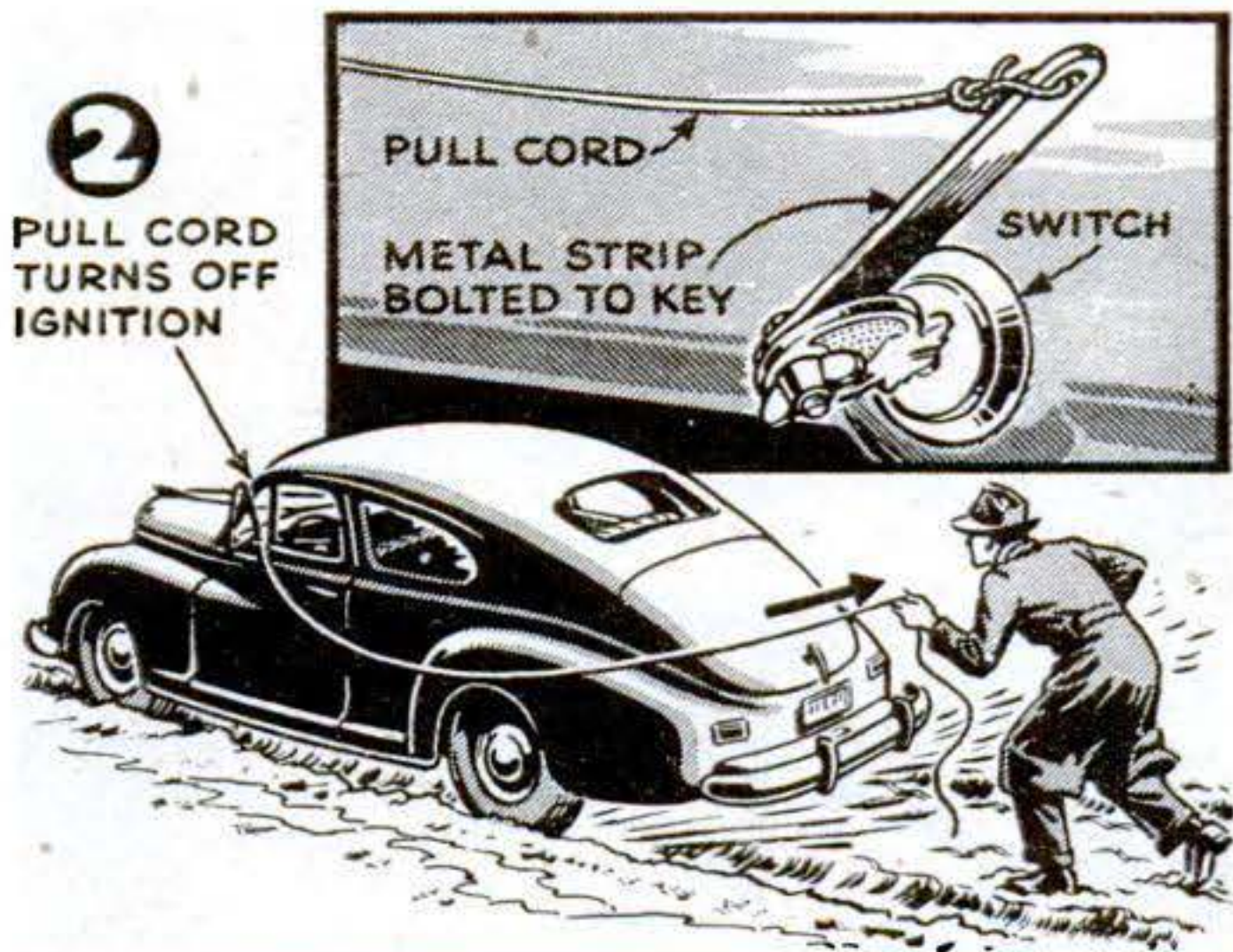

**3 HEATING A BABY'S MILK** while on a motor trip can be simplified by wiring a bottle holder to the car heater. Use a tin can to hold the bottle and cut out part of one side to admit heat. Run wires through holes and around the top and bottom and then through fins of the heater, twisting them together at the back—C. W. N.

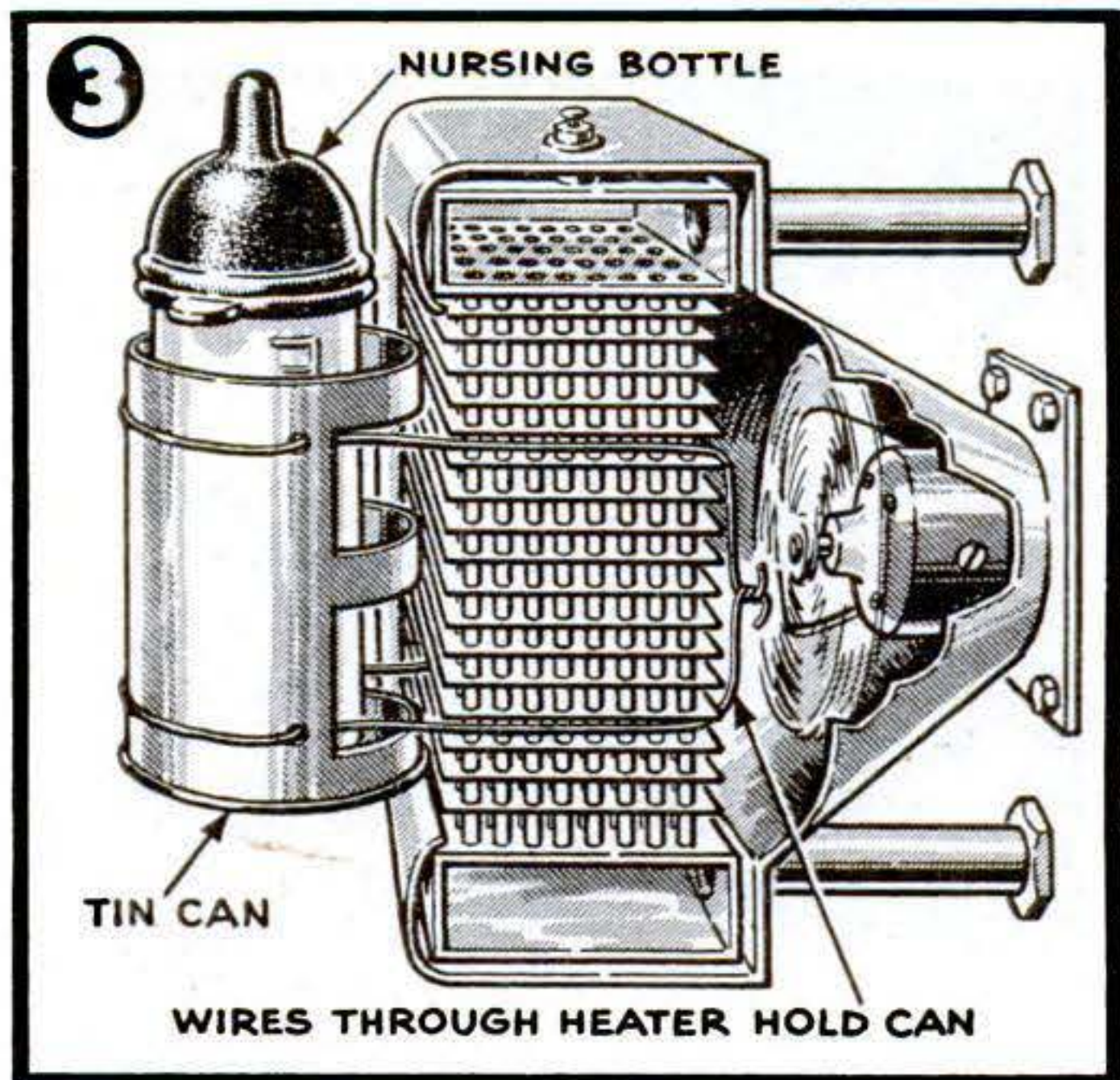

**4 BOOSTING A WEAK BATTERY** with current from a strong one is a trick performed with a length of heavy battery cable and two heavy-duty spring clips. Place the bumpers in firm contact for a common ground and attach the cable to the ungrounded terminals. The engine of the car with the strong battery should be kept running at a good charging speed. Make sure that the grounded sides of both batteries are of the same polarity.—J. H. D.

Drawings by STEWART ROUSE

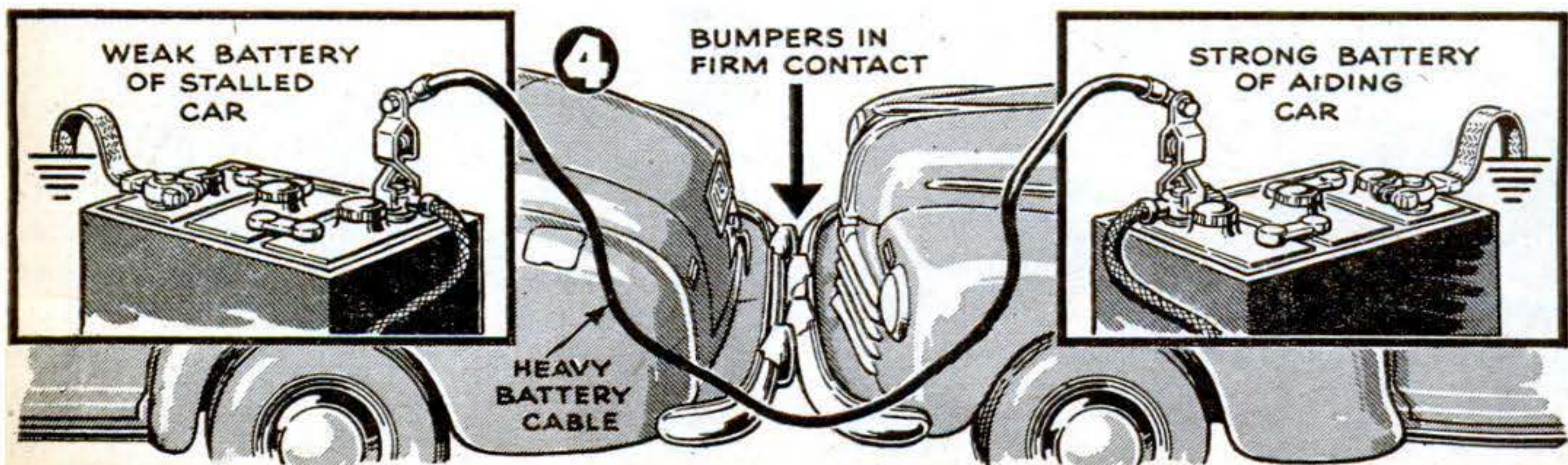



# Gus Beats the Clock by Two Cylinders



By MARTIN BUNN

**W**ITHOUT warning the street door to the Model Garage office was thrust open and a breathless voice shouted: "Where is everybody? Can I use the phone?"

Gus Wilson looked up from the car he was working on and into the office through the open shop door.

"Sure," he told the newcomer, a young man in a brand-new conservative gray suit, and he put down his wrench and walked into the office, wiping his hands on a piece of waste.

Joe Clark had knocked off an hour early that afternoon, and Gus was keeping his eye on his partner's office while finishing up a job on the shop floor. The young man, obviously a veteran even without the discharge button in his lapel, had already given a number down in the city and was nervously watching the clock on the office wall.

"That you, Mr. Beldon?" he said anxiously into the phone. "This is Clyde—Roger Clyde . . . Yes—yes, I'm on my way, but I'm having—I mean, something came up that delayed me . . . What's that?"

His face lost all remnants of its ruddy outdoor glow, and beads of perspiration broke out on his forehead.

"But you can't do that!" he pleaded. "You promised . . . Well, I'll make it."

He hung up the phone with a look of

almost desperate determination on his face.

"Know the Riverside Apartments in the city?" he asked Gus. "I've got to be there in exactly 45 minutes, and you've got to get me there!"

"Why me?" Gus wanted to know. "You've got a car. I hear its motor running outside. You can easily drive it in a half hour."

"But you don't understand," retorted Clyde. "Two cylinders are missing . . ."

"So what?" Gus cut in. "Even with two cylinders missing, you can make it."

"Don't argue with me," Clyde shouted. "I want it hitting on all eight."

Gus began to suspect that his visitor was AWOL from some psychiatric ward. "Take it easy, son," he said soothingly. "I'll be glad to help you, but . . ."

"Quit stalling," the man said and dragged him outside. "There can't be anything serious. The car's just out of the shop."

Gus listened to the motor of the sedan. "Two cylinders are missing, all right," he agreed. "When did you lose them?"

"What difference does it make *when* I lost them?" Clyde returned. "Do something!"

Gus is usually even-tempered, but he decided the time had come for plain talk.

"Look here," he said. "If I do this job, I'll do it my way. There isn't time to check your engine, so answer my questions or take the car somewhere else."

Clyde tried to smile. "You're right," he admitted. "I've come from Hilton just after having the motor overhauled. The car ran fine for about 10 miles, and then began to miss. First it hit on seven cylinders; then on only six. I stopped at the first garage, and the mechanic put in new spark plugs. Everything was fine again—for another 10 miles. Then the motor began hitting on only six again. At the next garage, the mechanic tested all the plugs and the ignition wiring, and finally decided there was dirt in the carburetor."

Clyde paused to catch his breath.

"He charged me plenty for cleaning and



adjusting the carburetor—and what was the result? Here I am, and on six again.”

He looked at his watch. “Man, we’re wasting time!” he yelled. “Get busy!”

“O.K.,” Gus told him and lifted the hood. For thirty seconds he peered beneath it. “Stan,” he called in to the Model Garage grease monkey, “get me some tape.”

Even as he did mysterious things with the tape, the rough-running engine settled to a smooth pace. Gus straightened and dropped the hood back in place.

“All right, mister, there are your eight cylinders,” he grinned. “That’s 50 cents—and you’ve still time to get to the Riverside.”

“No, you don’t,” Clyde told him. “Those other fellows fixed it so it ran all right for a while. You’re coming with me in case it starts missing again.”

“Say, what is this?” Gus demanded.

“It’s a—a matter of life and death, almost,” Clyde pleaded. “Please come.”

Gus knew he shouldn’t, but he felt sorry for the young fellow and agreed. He told Stan to look after the shop.

“I’ll drive my own bus,” he said. “You follow. I know a short cut, and I know the cops.”

Ordinarily Gus Wilson doesn’t drive fast, but when he wants to get some place in a hurry, he can do it. When he pulled up at the Riverside with young Clyde just behind him, they had two minutes to spare.

A fat man was standing on the sidewalk with a dozen or more people grouped around him—all with that same harried, anxious look that had been Clyde’s.

The fat man looked at his watch as Clyde got out of the car.

“You cut it pretty close,” he said. “That the car?” And he got in and drove away.

Gus, looking at the disappointed faces in the crowd, couldn’t hold in any longer.

“What is this, anyway?” he asked.

“Beldon’s got an apartment he’s going to sublet to me in return for selling him my car,” Clyde told him. But the relief on his face gave way to anxiety again, and he muttered: “I hope it doesn’t start missing.”

“It won’t,” Gus assured him. “But what’s this apartment deal?”

“Beldon and I are salesmen for the same

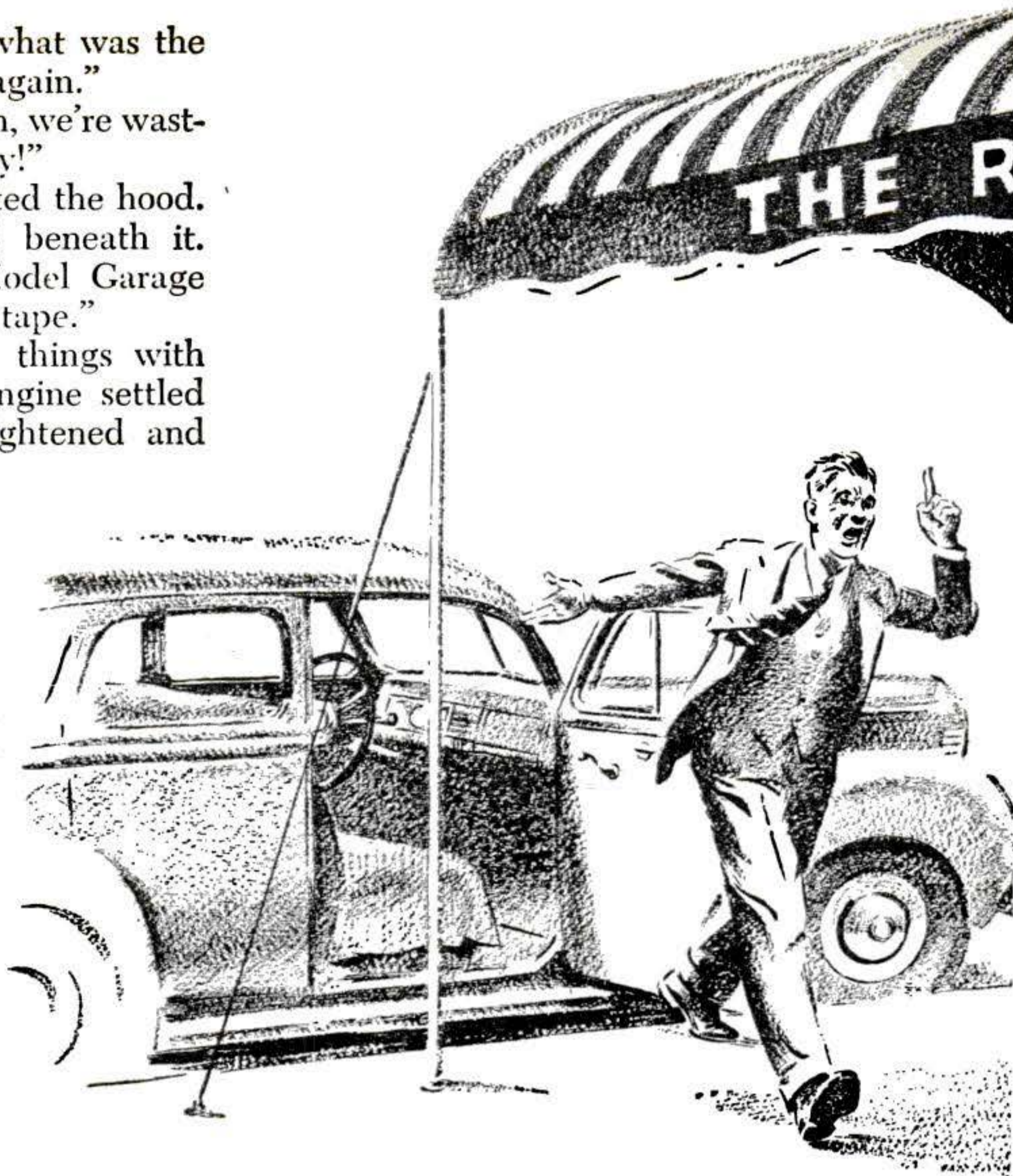

The fat man looked at his watch as Clyde got out of the car. “You cut it pretty close,” he said.

company,” Clyde explained. “I’m being transferred from Hilton to the city, where I don’t need a car, and Beldon is being transferred upstate where he does need one. I offered to sell him my car in exchange for his apartment. But he’s a tough customer, and he’d give me only until 5:30 this afternoon to deliver the car. If I hadn’t shown up, he’d have traded with one of these other people.”

“Now I see,” Gus laughed. “I knew cars were hard to get because I’m sort of in the car business, but I never dreamed the housing shortage was this bad.”

Beldon drove back in Clyde’s car and got out. “Sorry, folks,” he called to the crowd. “Clyde here has a priority on my apartment, since his car’s in good shape. I gave him my word. But if he’d been a minute late—”

“Gee, thanks, Mr. Beldon,” Clyde beamed. “You keep the car, and I’ll be down Thursday to take over the apartment and close the deal with you.” He looked at his watch. “I’ve got to catch the six o’clock train back





to Hilton. Will you drive me to the station, Mr. Wilson?"

They climbed into Gus's old but well-kept coupe, and Clyde asked what he owed. Gus added the time for the trip to the original 50 cents and pocketed the money.

"It's Beldon's worry now," Clyde said as they neared the station, "but what *was* the matter with the car?"

"Oh, nothing much," Gus laughed. "The mechanic who overhauled your engine was careless in replacing the hose that feeds hot water to the heater. In your car it passes straight over the engine and, as soon as I lifted the hood, I saw it was sagging and touching two spark plugs. Besides, you had just had your engine tuned, the spark plugs were new, and the carburetor had been cleaned, so I was looking for a short."

"But the hose is rubber," Clyde protested, "a nonconductor. It wouldn't short."

"No?" Gus grinned. "But yours must have had a little leak. I felt it, and the outside was wet—and water is a conductor. But taping the hose to a radiator tie rod kept it from sagging onto the spark plugs. That corrected the short."

"But why did it run fine for a few miles each time it was fixed?"

"Oh, those mechanics pushed the hose aside to check the plugs," Gus replied. "But it jogged back again on the road."

They pulled up at the station, and Clyde got out.

"Maybe I ought to tell you, Mr. Wilson," he said hesitatingly. "The real reason I needed that apartment so bad is because I'm going to be married Thursday, the day I'm to transfer to the city, and we would have had to postpone it if we couldn't have found a place to live. Wait until I see Eloise tonight! Won't she be happy!"





# Should you

# QUICK-CHARGE YOUR BATTERY?

By **WILLIAM H. CROUSE**

**T**WO basic methods are employed in charging an automobile battery. One is the procedure that has been common for years—removal of the battery from the car so that it can be charged for a day or two at a low rate. The other, which is becoming increasingly popular, is the convenient quick-charge method that many garages and service stations now provide.

A quick-charger, usually mounted on wheels so that it can be rolled right up to the car, is capable of delivering up to 100 amperes. This high charging rate brings the battery up to a reasonably charged condition in an hour or less. Because of its speed and because it usually does not involve the inconvenience of taking the battery from the car and installing a rental, quick-

charging is commanding wider and wider acceptance.

Both methods have their place, but quick-charging has certain limitations. Because of the high charging current used—the power involved may be the equivalent of 1 hp.—a great deal of damage can result from improper use of a quick-charger.

To prolong the life of your battery, it is obvious that you should check its condition periodically. This should be done with a hydrometer. But even without a hydrometer you usually can tell when a battery needs recharging, for this shows up in slow cranking and other starting difficulty.

Before a battery is quick-charged (or charged by any method, for that matter) the gravity of each cell should be checked. This will disclose three things, all of which it is well for the motorist to understand



before permitting his battery to be placed on a quick-charger.

First of all, a hydrometer check will show whether there is enough electrolyte in each cell. If there is too little for a gravity reading, the tops of the plates and separators will be exposed to air, allowing them to dry out and become damaged. In such cases, water should be added before recharging is started.

Secondly, the color of the electrolyte should be noted. If it is discolored with brownish sediment, you will know that the battery plates are shedding active material and the battery is wearing out. Such a battery should be charged by the slow method only—and for the same reason that an older person must avoid violent exercise. Quick-charging is strong medicine and would hasten the death of the battery.

The third thing that the hydrometer test tells you is the gravity of the electrolyte. A

reading above 1.250 means it is fully charged; 1.215 to 1.250 that it is only half charged and that it is time for recharging; 1.170 to 1.215, about a quarter charged, and below 1.170 completely discharged. If the gravity readings of the separate cells are more than 25 points apart, you may well suspect that the low cell has an internal defect; for instance, a partial short. A battery in this condition should be slow-charged and carefully watched to see whether the low cell comes up normally. If it does not, you may find it possible to have the cell repaired or replaced.

A further check of the comparative condition of the cells can be made by testing the cell voltages after a battery has been on charge for a few minutes. If one reading proves to be more than .2 volt lower than the others, stop the charging, for the low cell probably is shorted internally. Here again, repair may enable you to get additional service from the battery if the condition is not too bad.

If the electrolyte looks clear and gravity readings are fairly uniform, it is safe to quick-charge the battery. But there is one final caution. Battery electrolyte temperature must never be allowed to go above 125 deg. F., for high temperature and high charging rate together add up to irreparable damage.

Sometimes a service-station attendant will try to gauge temperature during the charge by feeling the battery case. This is wholly unreliable since the case is an effective insulator. Heat created inside the battery by the charging process will not warm the outside immediately and it is possible, particularly during quick-charging, for the electrolyte to reach a ruinously high temperature long before the case itself begins to feel warm. The only way to check the temperature is by use of a bulb thermometer. Insert it in the center cell and make sure the bulb is covered with electrolyte when the reading is taken.

In connection with battery charging, you sometimes may see advertised or be offered chemical substances or powders that are supposed to speed up the process, or even do the entire job of recharging. The American Association of Battery Manufacturers (which includes all major battery makers) and the U. S. Bureau of Standards have found that such materials do no good and very likely will ruin the battery. Hence, it is best to avoid use of all such substances.

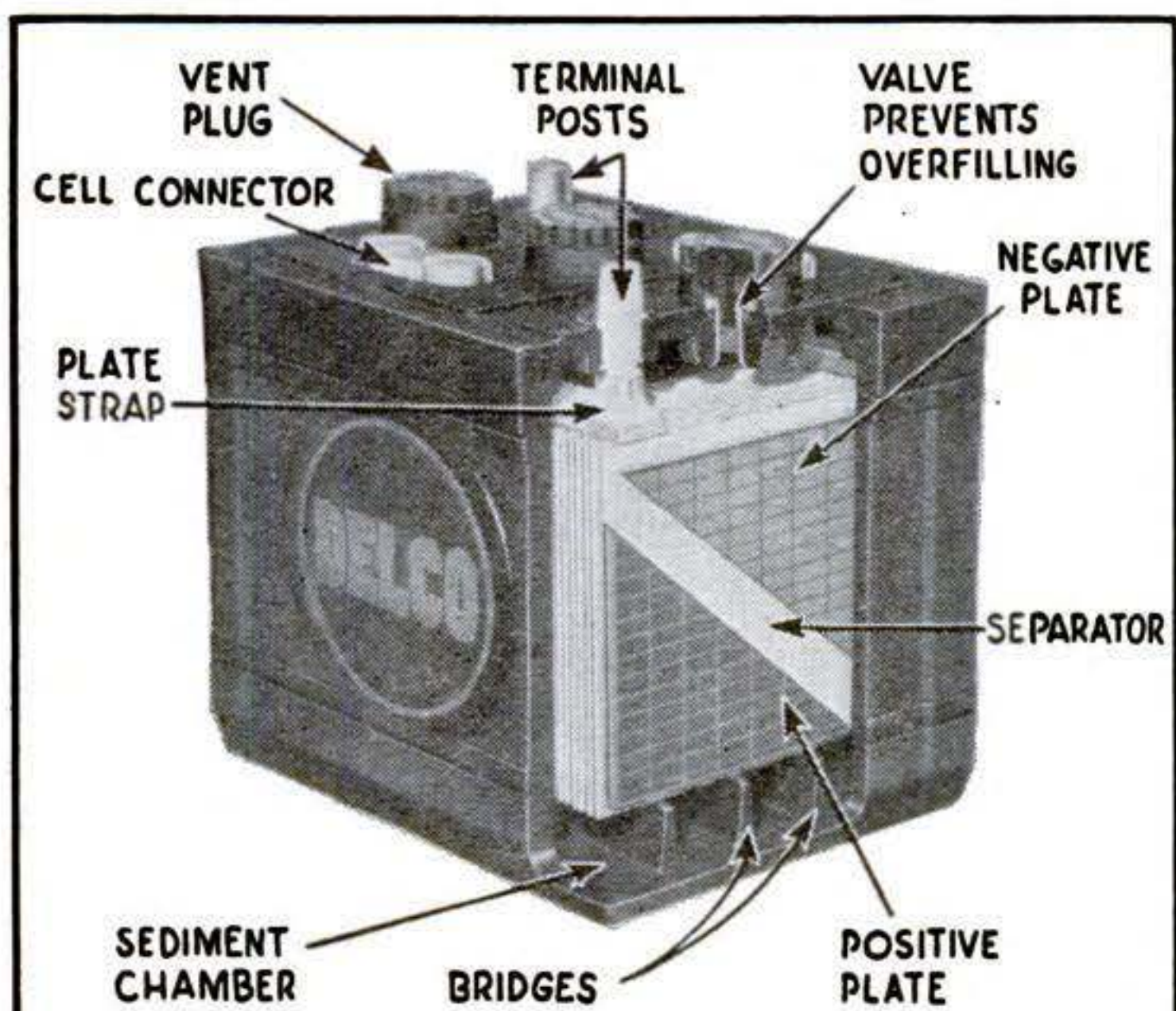

Here is a typical automobile storage battery, the end being cut away to show construction of one cell. How to use a hydrometer is shown below.

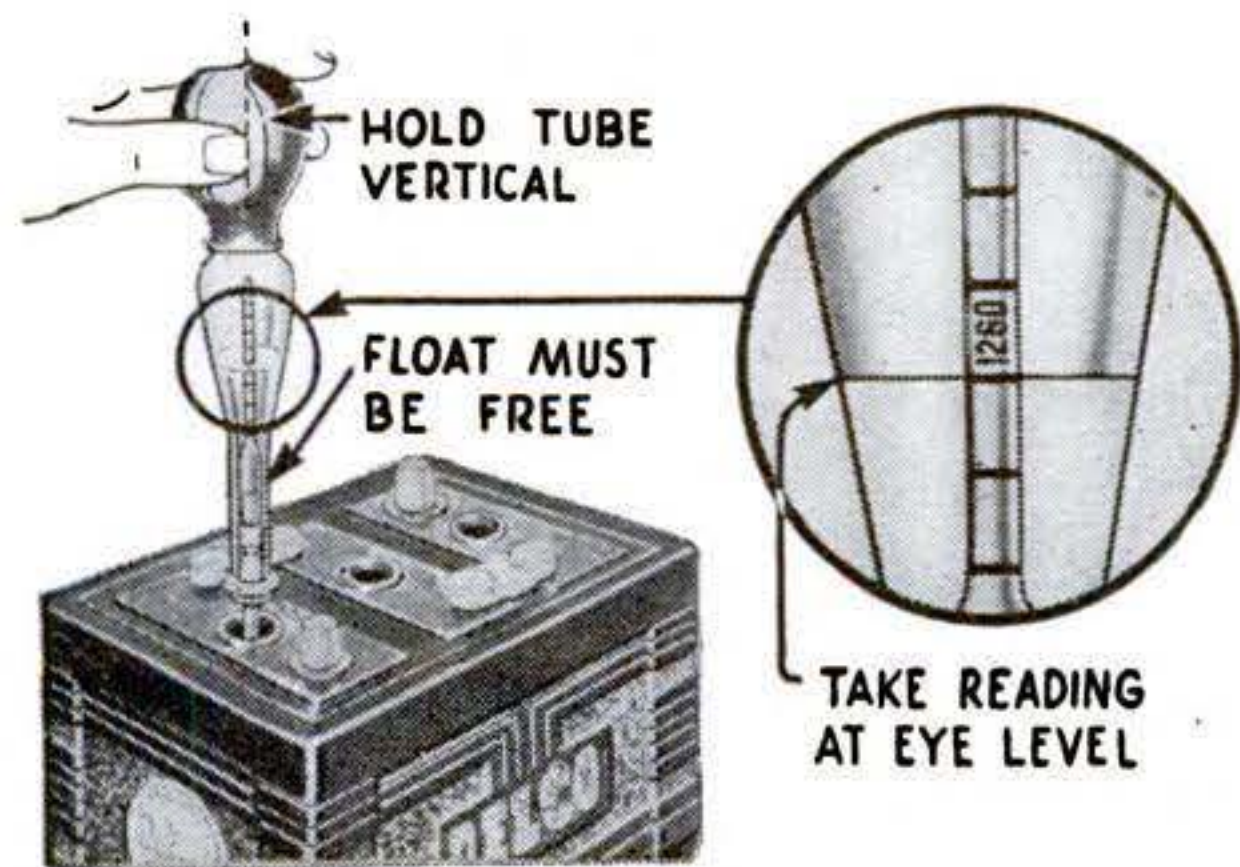



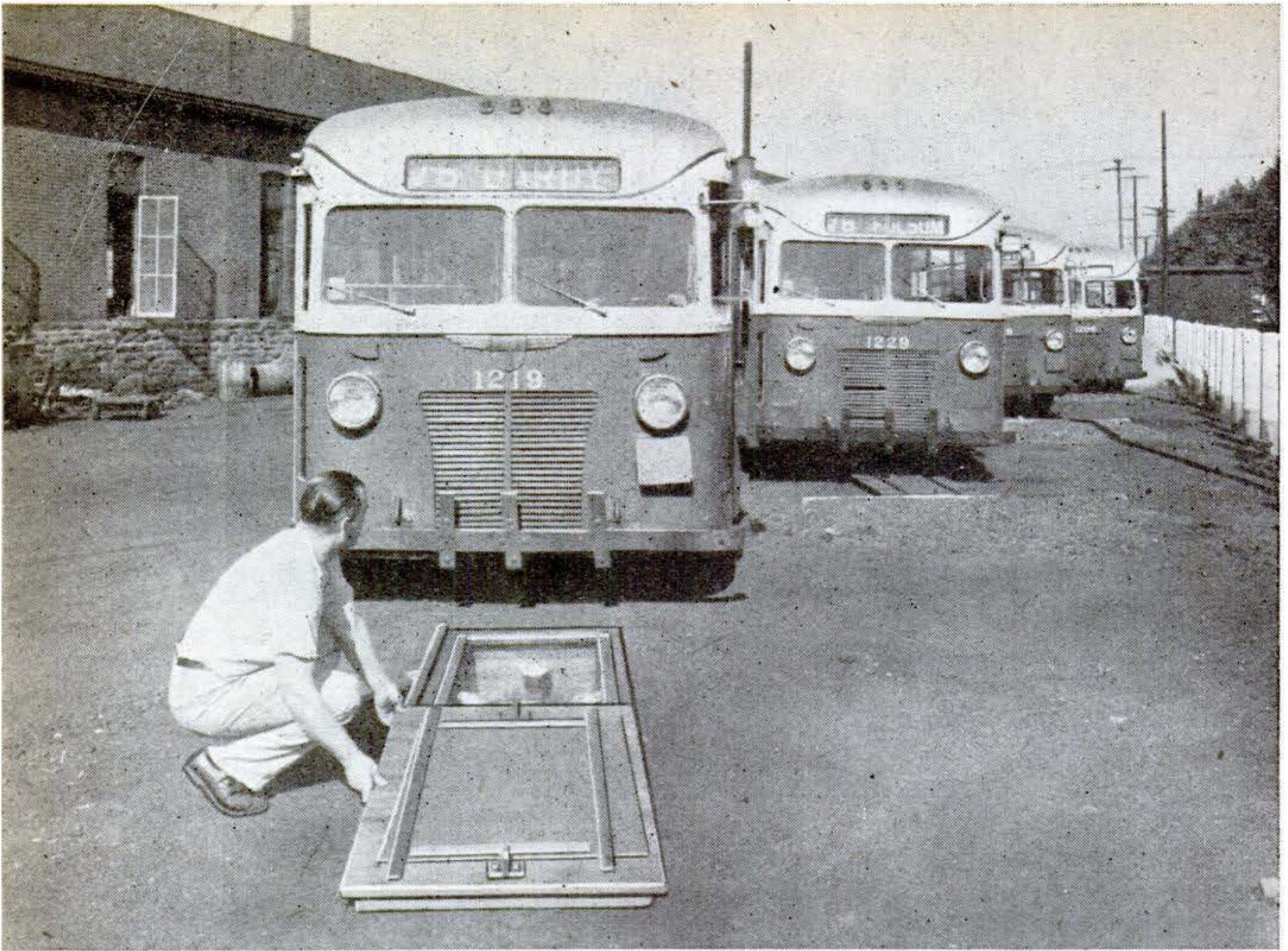

Four infrared lamps in a pit keep warm the underfloor engine of a bus left in the open in cold weather.

## ELECTRIC HEATERS End Cold-Weather Starting Troubles

**A** FORTY-MILE wind is rocking the garage, and the temperature is diving toward zero. It'll be much colder by morning. You pick up an electric cord, plug one end into a socket concealed in a louver of the car hood, and flip a switch. Then you lock up the garage and go into the house for dinner, secure in the knowledge that in the morning the engine will start almost the moment you touch the starter button.

That's a preview of the application of electric immersion heaters to passenger cars stored in unheated garages. The method has already been tested and found efficient and economical with commercial vehicles. A different way of achieving the same effect—with a bank of infrared bulbs placed beneath the vehicle to throw heat up against the oil pan—has also given promising results.

Immersion heaters were tested several years ago by the Atlantic Refining Company, which maintains a considerable fleet of trucks not stored in heated garages. According to Emil P. Gohn, engineer for the company, the heaters have thoroughly proved their worth. Kept outside overnight in near-zero weather, the unheated engine of a heavy truck might not even turn over in the morning, despite a fully charged battery. With a 500- or 750-watt heater installed in the water jacket, the engine would under the same conditions respond with a quick and reliable start. Best results were achieved when the cylinder-wall temperature was brought to approximately 45 deg. F. If the temperature was raised somewhat less, say to 35 deg., starting time was almost tripled.

What's the cause of hard cold-weather



starting? Improper handling of the controls, an inefficient ignition system, or an incorrectly adjusted carburetor are all possible troublemakers. But the basic difficulty springs from the cold itself. Thick, sluggish oil on the cylinder walls and in the bearings imposes an enormous current drain on the battery (itself less efficient in cold weather); the engine is thus cranked over very slowly and the ignition system is starved of the voltage it needs to deliver a hot spark. At the same time the ice-cold carburetor and intake manifold impair fuel vaporization.

With an immersion heater at work to keep the engine's blood warm, chances of starting failure are greatly lessened. Cylinder walls, bearings, and lubricant are ready for use. The starting motor can spin the crankshaft at almost normal speed, and the spark coil isn't deprived of its share of current. Enough warmth has been conducted to the intake manifold and carburetor to take the chill off the surfaces the vaporized fuel-air charge will touch. Hence the probability of a fast start is greatly increased. But water-jacket heaters aren't a sure-cure panacea—faulty starting technique, or poor condition of the ignition or fuel systems, can still mean a dead battery and a silent engine.

An immersion heater, usually a copper-sheathed, watertight cylinder containing a length of resistance wire, should be mounted as low as possible in the cooling system, and should be located so that the heat is concentrated in the engine block rather than the radiator. One or more line thermostats in the hose or hoses leading to the lower radiator tank keep the warmed antifreeze solution from circulating through the radiator, with resultant heat loss. While installations can be made in the lower hose connection, or (preferably) in the lower inlet elbow of the

block, the ideal place for the unit is within the block itself. This would of course generally require that blocks be designed for the purpose.

Engineers estimate that for the average light car a 200- or 250-watt heater would be ample. Though a night-long current drain of this size may not seem economical, proponents of immersion heaters point out that heating an entire garage by conventional means is hardly cheap, and that the savings on battery-charging and tow-starting fees can be considerable. Because the already warm engine doesn't have to pass through the dangerous, high-wear time when the engine has started but the lubricant isn't flowing right, the heaters probably also save money on major repair bills.

Compelled by a shortage of garage space to keep many of its buses in the open, the Philadelphia Transportation Company turned to the use of familiar infrared heat lamps. Shallow pits were dug under 27 outdoor parking berths, lined with creosoted wood, and fitted out with four 250-watt bulbs apiece. The lamps were placed so that their heat was concentrated on the underfloor engines of the buses.

According to R. H. Dalglish, Jr., an operating executive of the company, the method has shown itself to be both practical and economical at temperatures down to 2 deg. F. He reports that less starting difficulty has been encountered with buses kept warm in this way than with those in garages where the temperatures were 35 or 40 deg.

For the car owner having either an unheated garage or none, electric engine heating has much in its favor. But pending the day when such heaters are built in at the factory, ingenious motorists will have to devise their own equipment.

Here is the immersion heater used in experimental Atlantic Refining installations. Below, two views of the heater itself in the inlet fitting of the cylinder block. The photo at right shows two heater units in place on the engine of a big truck.

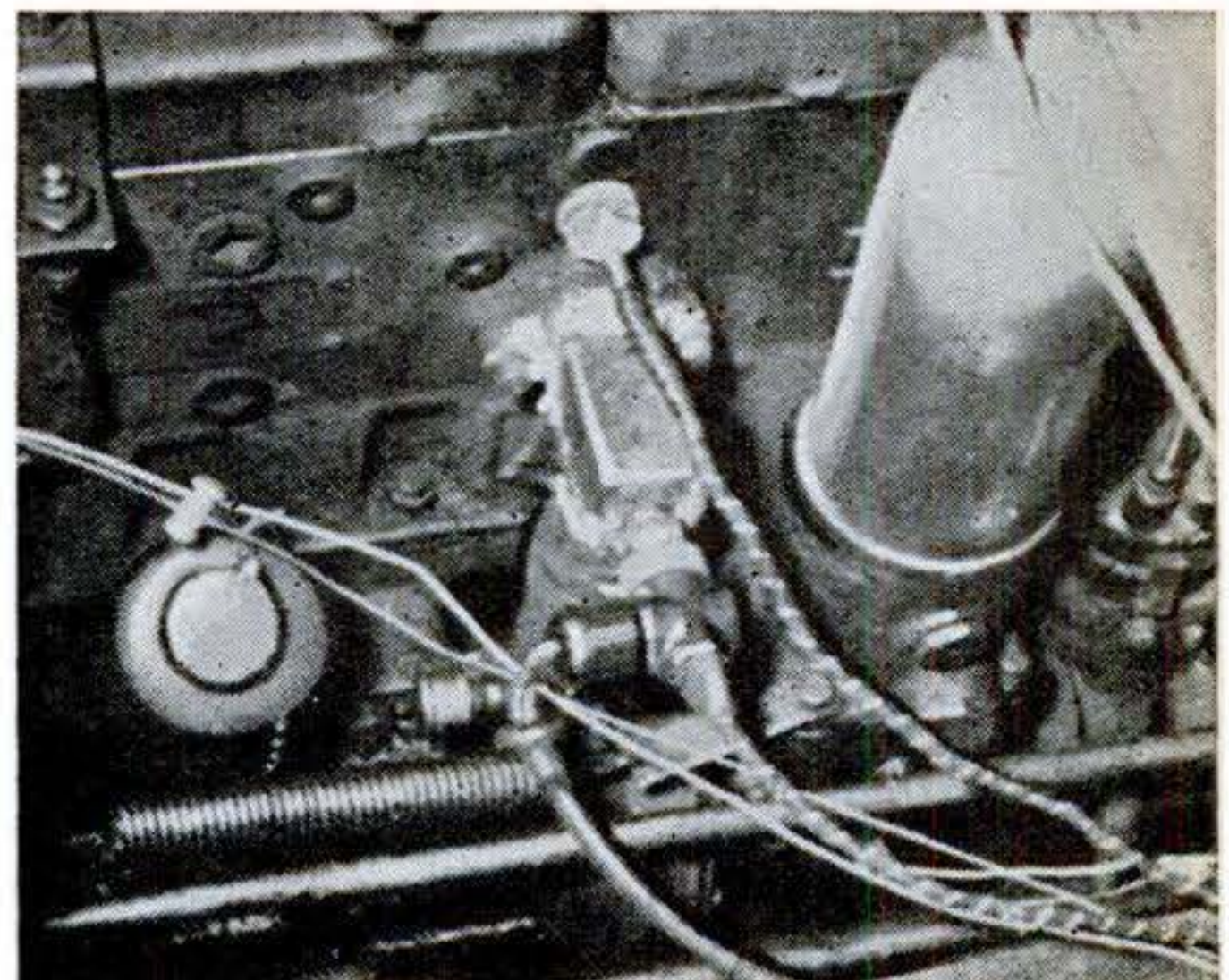
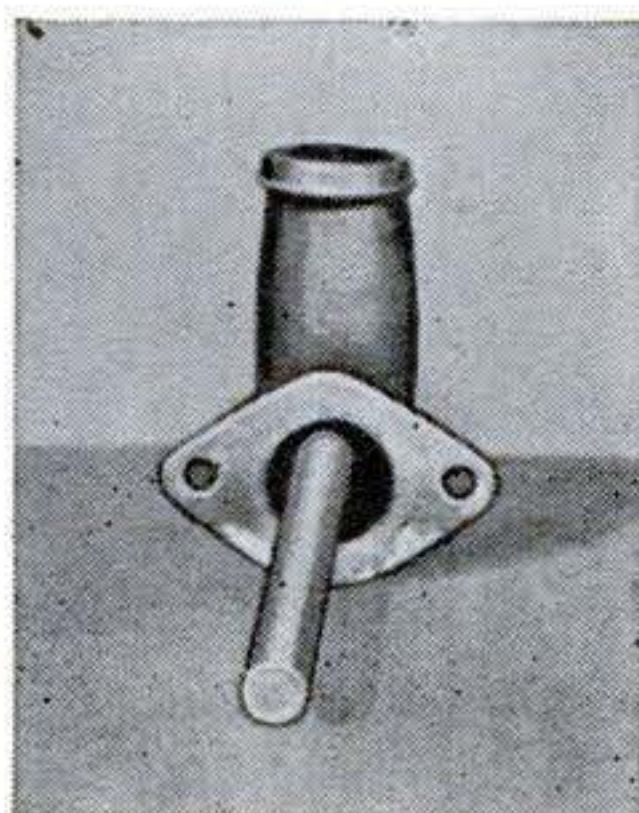
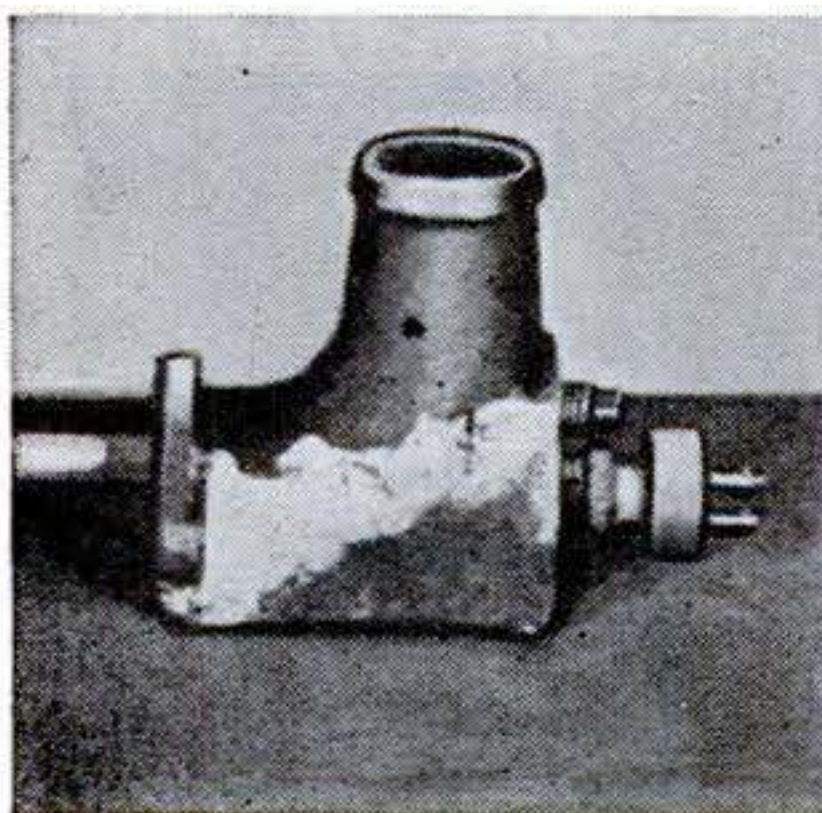



# AUTO IDEAS

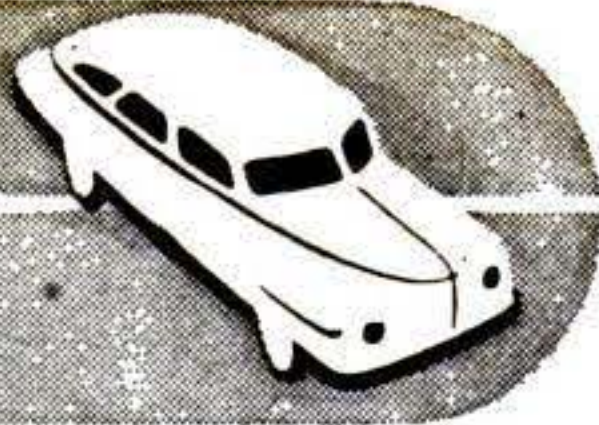

**RECESSED DOOR HANDLES** that can't catch on clothing are released for turning by pressure on a ring around the lock. Once extended, a handle remains so as long as the door is open. Shutting the door automatically returns it to its recess, flush with the door contour. Opening from inside leaves the door handle recessed. Leonard Manufacturing Co., of Los Angeles, is the maker.

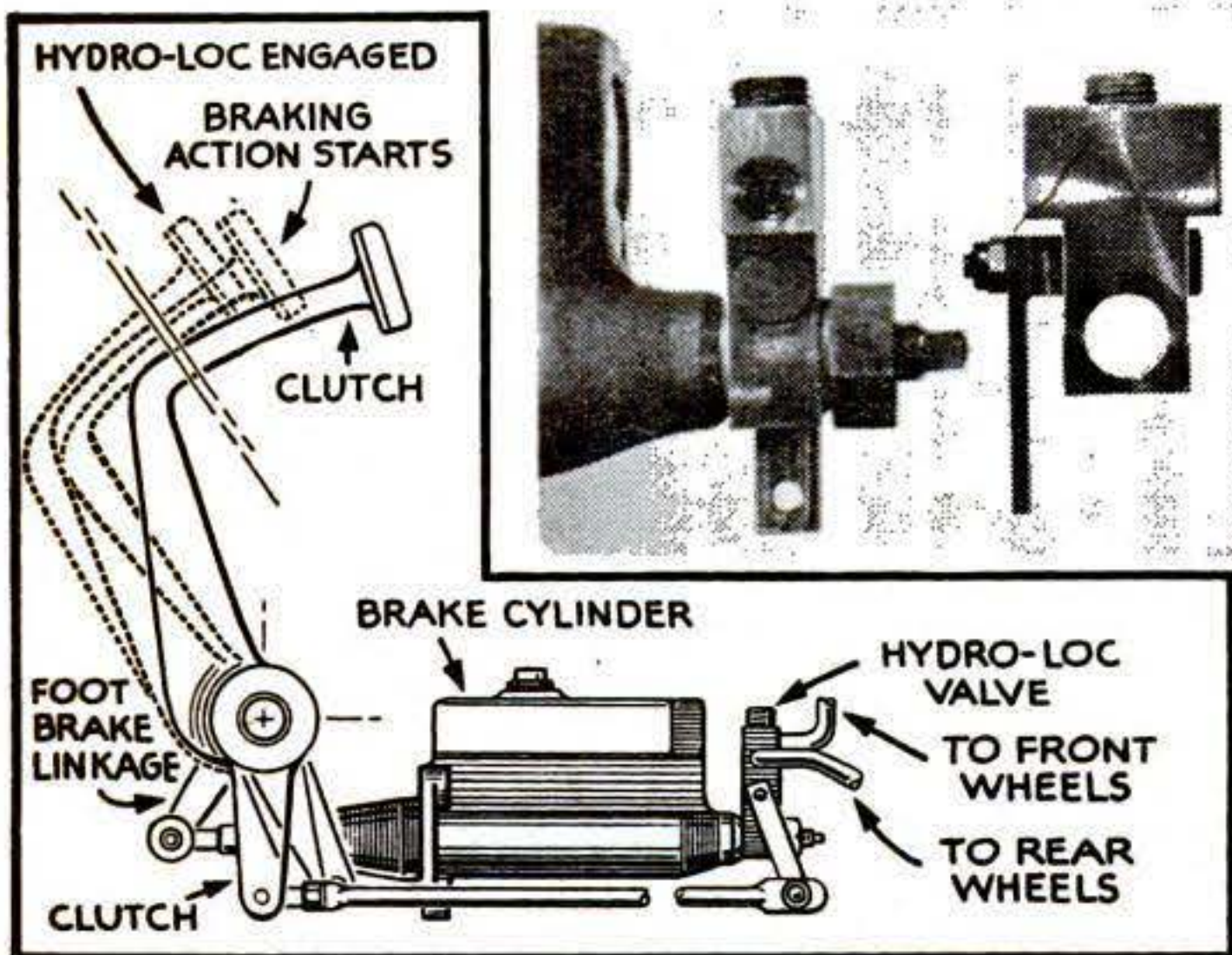
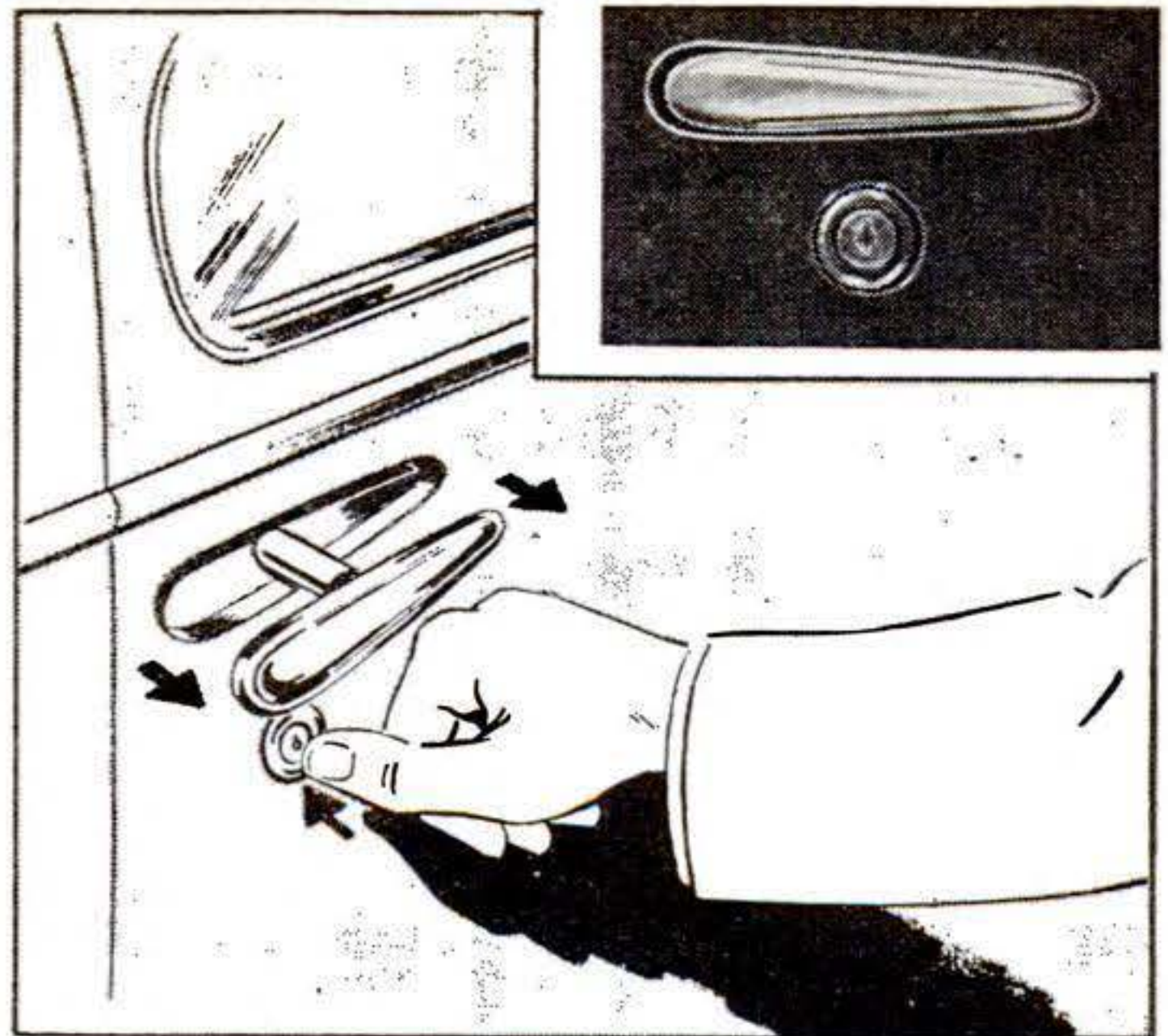

**ROLL-BACK ON HILLS** as the right foot is shifted from brake to accelerator at starting is prevented by a new hydraulic-brake control made by Hydro-Aire, Incorporated, of Los Angeles. Foot brakes are applied as usual, but the control holds them on until the clutch begins to engage. Ordinary clutch operation is not affected.

**PLASTIC REFLECTORS** can now be tailored to fit and mounted over nonreflecting road signs, markers, and guard rails, saving the expense of complete replacement. The reflector material consists of tiny glass lenses



**FILTER EFFICIENCY** is indicated visually by the height of the aluminum spool in the glass tube shown below. The attachment, called a Filter-Meter and made by Hunter and Company, of Cleveland, is connected in the oil line to warn when a change of the filter cartridge is necessary.

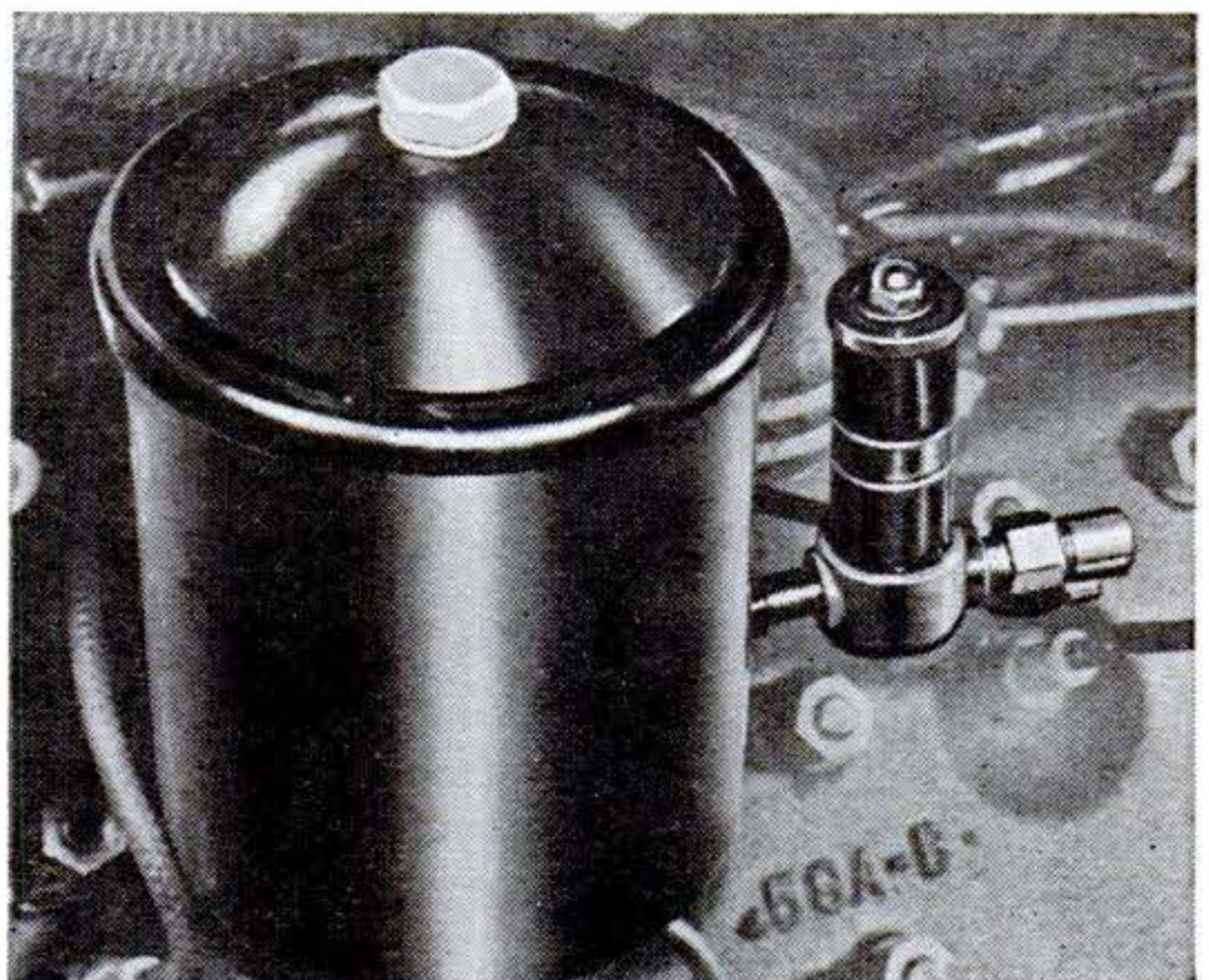

embedded in flexible plastic and is available both in roll form and in ready-made signs. It is a product of the Minnesota Mining & Manufacturing Co., of St. Paul, and is known as Scotchlite.







- **Installing Record Changers**
- **Working Stainless Steel**
- **News in Home Heating**
- **Circular-Saw Stand**
- **Simple A. C. Rectifier**



# CUSHION STOOLS

## for EXTRA COMFORT Anywhere



Used singly, cushion stools will seat one or even two persons.

By **EDWARD E. THORP**

**L**ARGE, square cushion stools that you can make yourself can be a big money saver in your budget for furnishing a small home or apartment. Their advantage over one-purpose pieces is easily apparent.

Placed together in a group of six, they make a comfortable bed; in threes, they form twin beds; against the wall in a corner, they turn into a corner divan; while for a large gathering each stool becomes a roomy seat for two people, answering the chair problem without the need of in-between storage.

The basic unit is a low stool fitted with a deep, comfortable cushion and nonskid feet. Since each piece is square and the sides are flush with the legs, almost any number of combinations is possible. The 24" width will provide maximum seating space with the least area of

floor space lost to other uses.

Only three sizes of lumber are needed—stock that will finish to 2½" by 2½" for the legs, ¾" by 7¼" for the sides, and almost any width ¾" boards for the top. If machine tools are not available for recessing the legs, you can use 1¾" by 1¾" stock and build up the bottom section on two sides. Neat joints for such built-up sections call for a miter box, though butt joints will serve if the exposed end grain and joint are filled with a wood filler. For six stools you will need enough stock for 24 legs, 24 sides, and six tops.

Time can be saved if all sides are cut 23¼" long and all corners assembled alike with the flush board always on the same side. Assemble one board to each leg with glue and nails; then, when the glue has set, assemble the four sides and legs in standing position on the bench to avoid wobble. The top strips may be put on solid or spaced not more than 1". A 1½" by 2½" cleat put in edgewise across the center will prevent any possible sag. Finish the exposed legs with stain and a good varnish to match the other furniture.

Grouped in double rows of three, six stools become a comfortable double bed, or in single rows of three, the six make twin beds.







Many furnishing schemes are possible with a set of stools. Here six are used against two walls to form a modern corner divan.

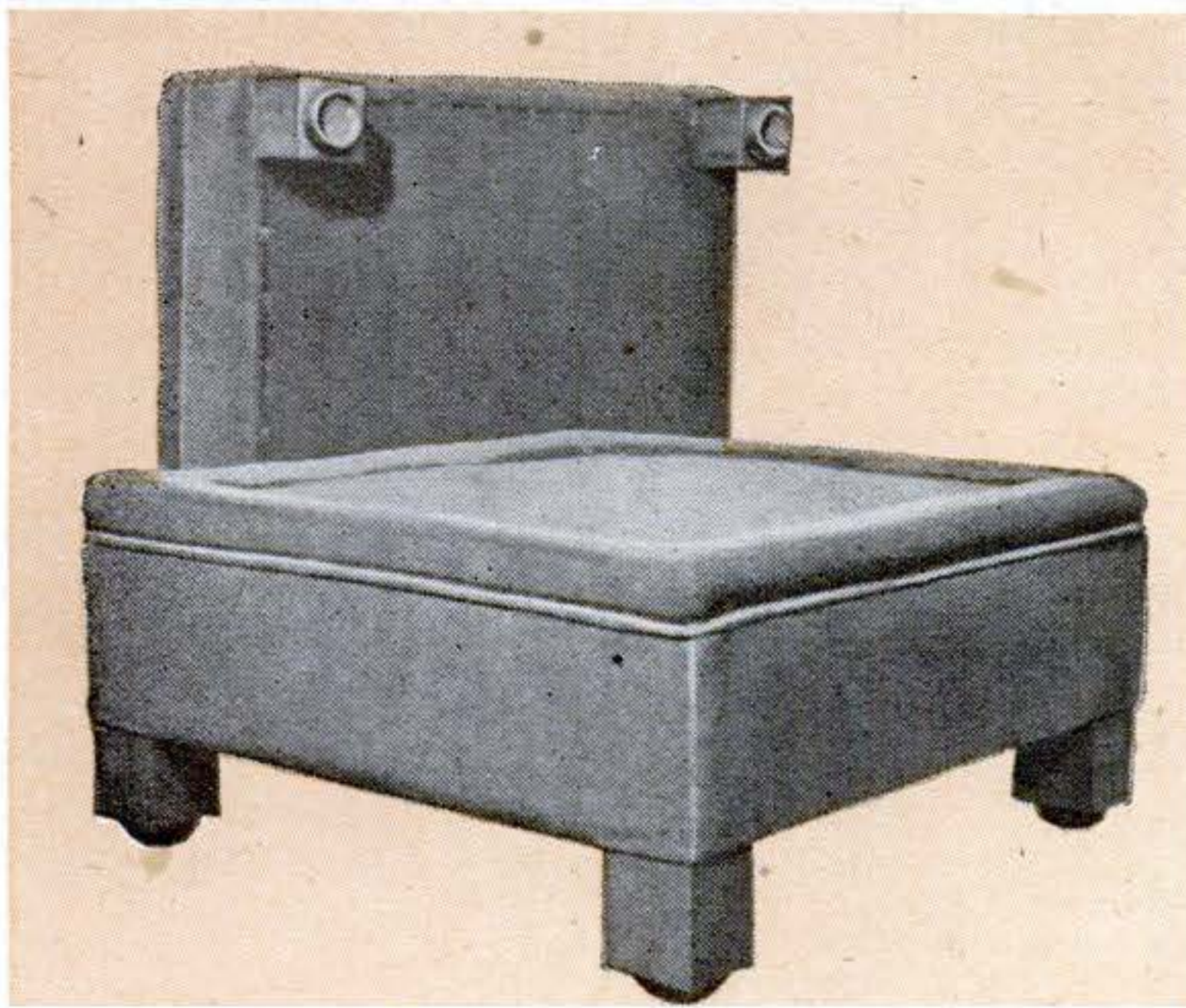

Pad the top with two thicknesses of cotton batting and tack muslin over it. Then tack a 12" strip of upholstering material around the stool by its bottom edge, place two thicknesses of padding all around the sides, and bring up and stitch the upholstery lightly to the muslin. Pull out any wrinkles toward the corners and turn them in, and then stitch the upholstery material permanently to the muslin. It can be tacked also if the stools are likely to get rough usage. Muslin may also be stretched across the bottom and tacked under the sides. Inverted rubber caster cups tacked to the feet will keep the pieces from sliding.

Comfortable cushions can be made much more cheaply than they can be bought. Layer filling stands up well under use, but other types will serve if put in an inside bag and quilted or tufted to prevent lumping. Reinforcing the top and bottom edges with stitched braid will not only prevent stretching out of shape but will add to the life of the cushions by taking much of the wear from the upholstery material.

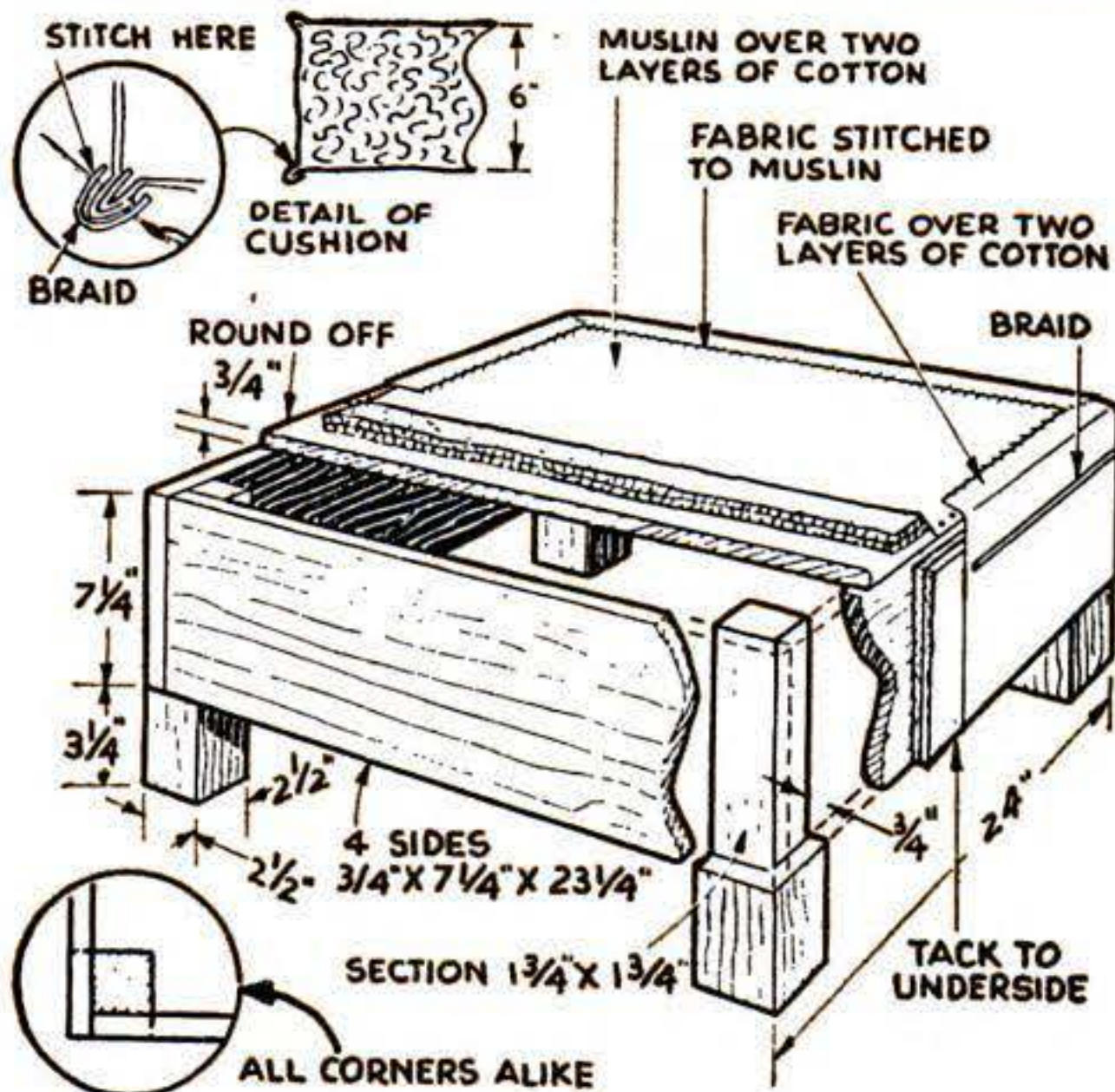



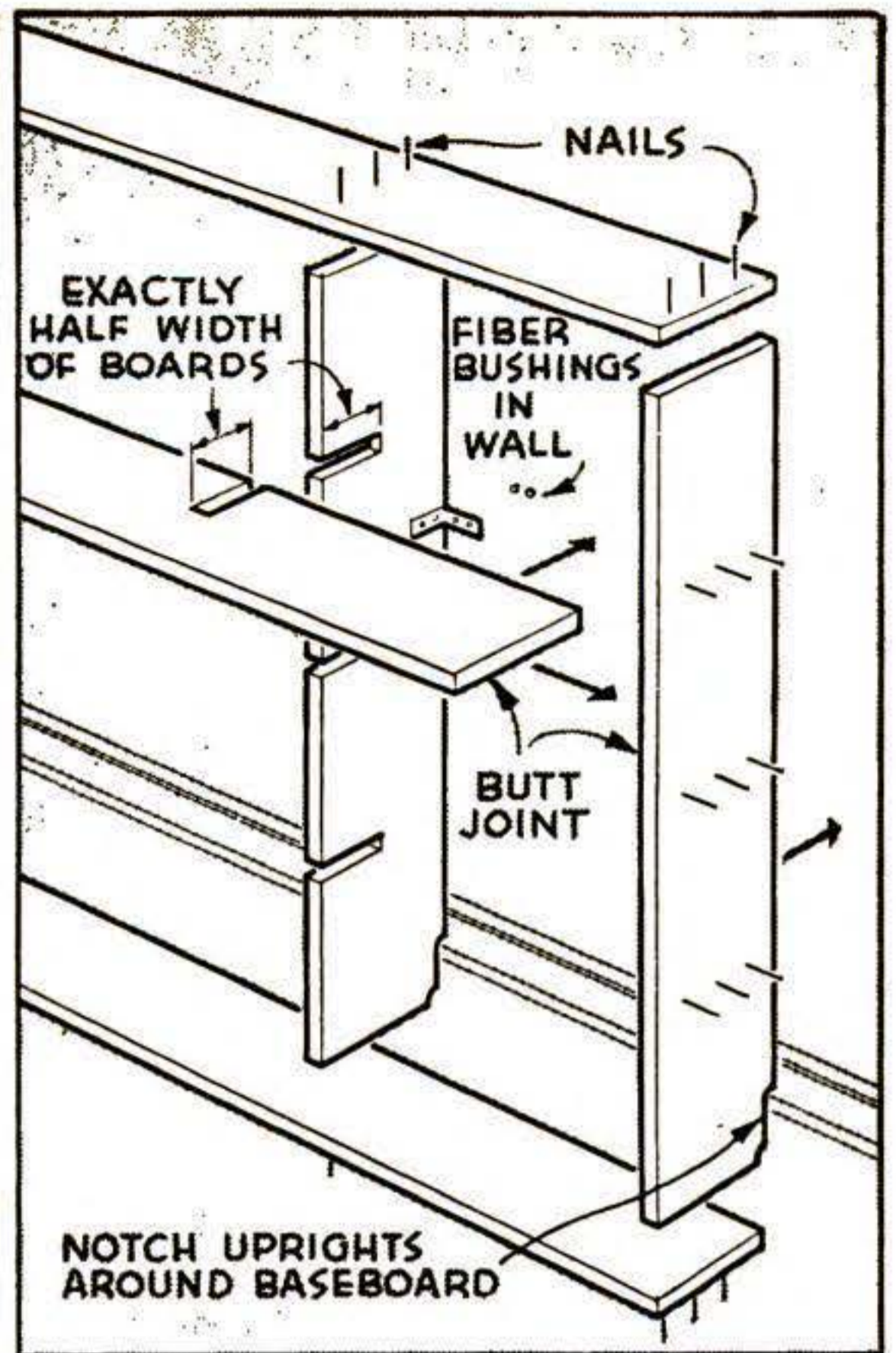

## Wall-Size Knickknack Shelf Fills Blank Space at End of Room

FACED with a big expanse of bare wall at one end of a sun room, we decided on a knickknack shelf. It had to be wall-size, and it holds those odd pieces that just don't belong anywhere in particular but provide an eye-filling bit of variety.

We built our shelf the hard way, by first nailing in uprights and then toe-nailing in short shelf sections to fit between. It might have been better to notch the uprights and shelves egg-carton style, as in the drawing, or to set the shelves in conventional book-case dadoes.

To get the piece flush against the wall, notch the uprights at the bottom to fit over the baseboard. And to keep the whole works from coming down with a crash, screw three or four small angle brackets under the middle shelf where they won't show. Anchor them to the wall with screws set in a stud or in fiber plugs driven into holes in the plaster.

Dimensions are up to you, since it's your wall, but make the shelves wide enough to hold your biggest knickknacks. Boards  $\frac{3}{4}$ " by  $5\frac{1}{2}$ " should do.—JEAN BLACKBURNE.

## Wastepaper Basket Built on Modern Lines

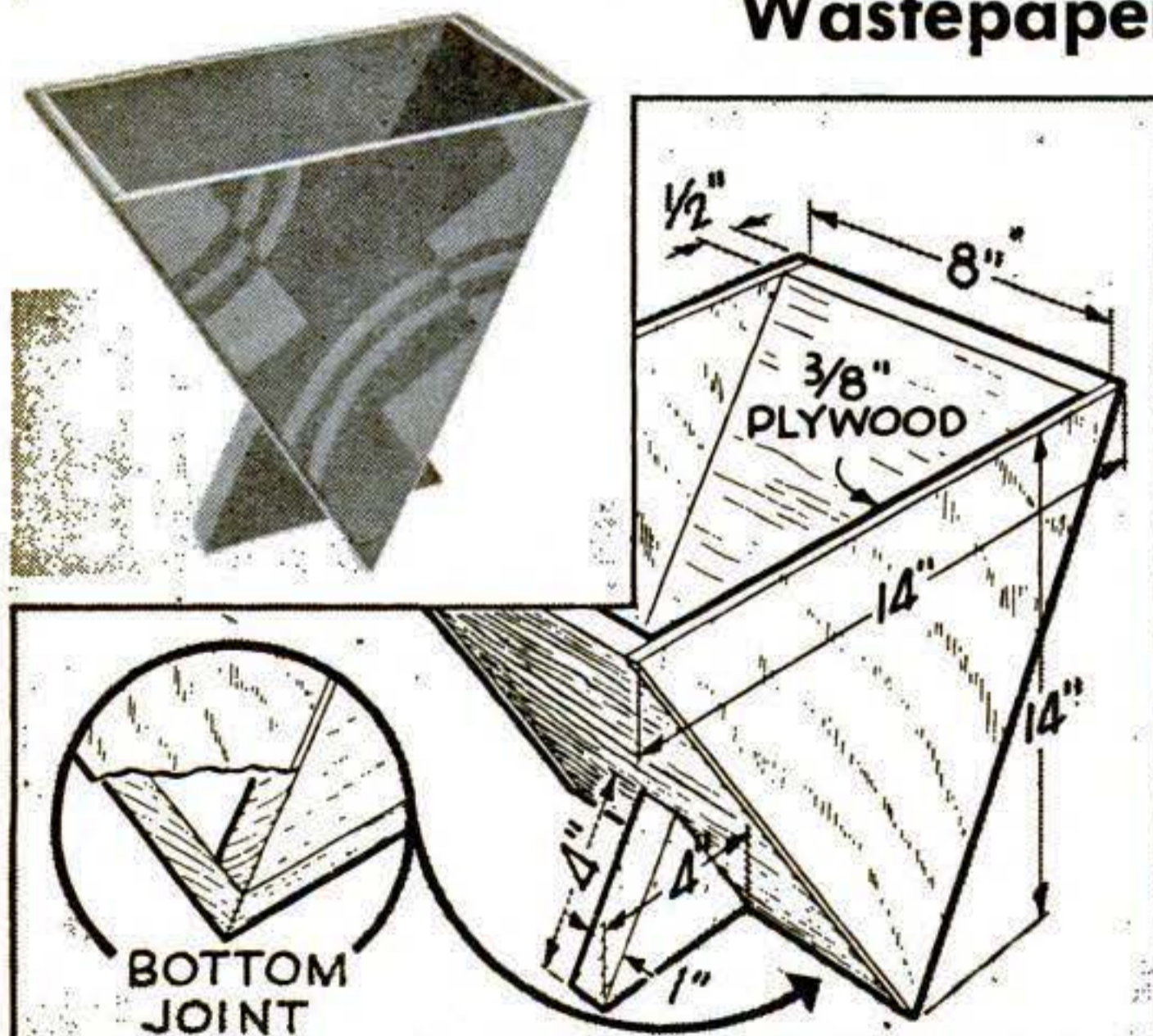

THOUGH modern in looks, this wastepaper basket is not so extreme that it won't fit in most decorating schemes. Make the sides of thin stock or plywood. Two are square, and the other two are equilateral triangles. They are butt-joined with nails and screws, but the bottom edges of the two square pieces should be mitered for a neat fit. Two feet, also equilateral triangles, are cut from 1" stock. Despite the seemingly narrow base, the basket is quite stable.

The piece may be stained and varnished, given a natural finish with clear varnish and well-rubbed wax, or enameled and decorated with decal transfers.—E. E. T.



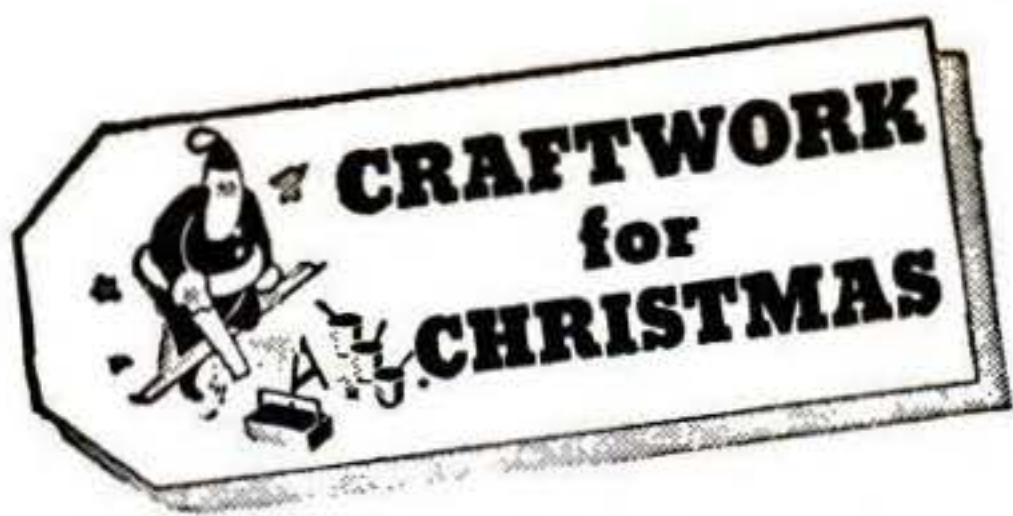

## Luck and Skill Needed For Shooting-Disk Game

WITH a sharp eye and a steady hand you might be able to beat Junior at this made-for-Christmas game that's fun all year 'round. The disks are sped by gravity down an inclined gun and roll along the floor to the slotted target. Set the target at one end of the room. About 6' away, rest the end of the gun on the floor at an angle of approximately 35 deg. Then let each of the three disks roll down the gun. With luck, they will wheel into the slots.

The score is computed from numbers on each slot and on the square hubs that support the disks in the slots. Number each slot in multiples of five, lowest in the center and highest for the edge slots. The sides of

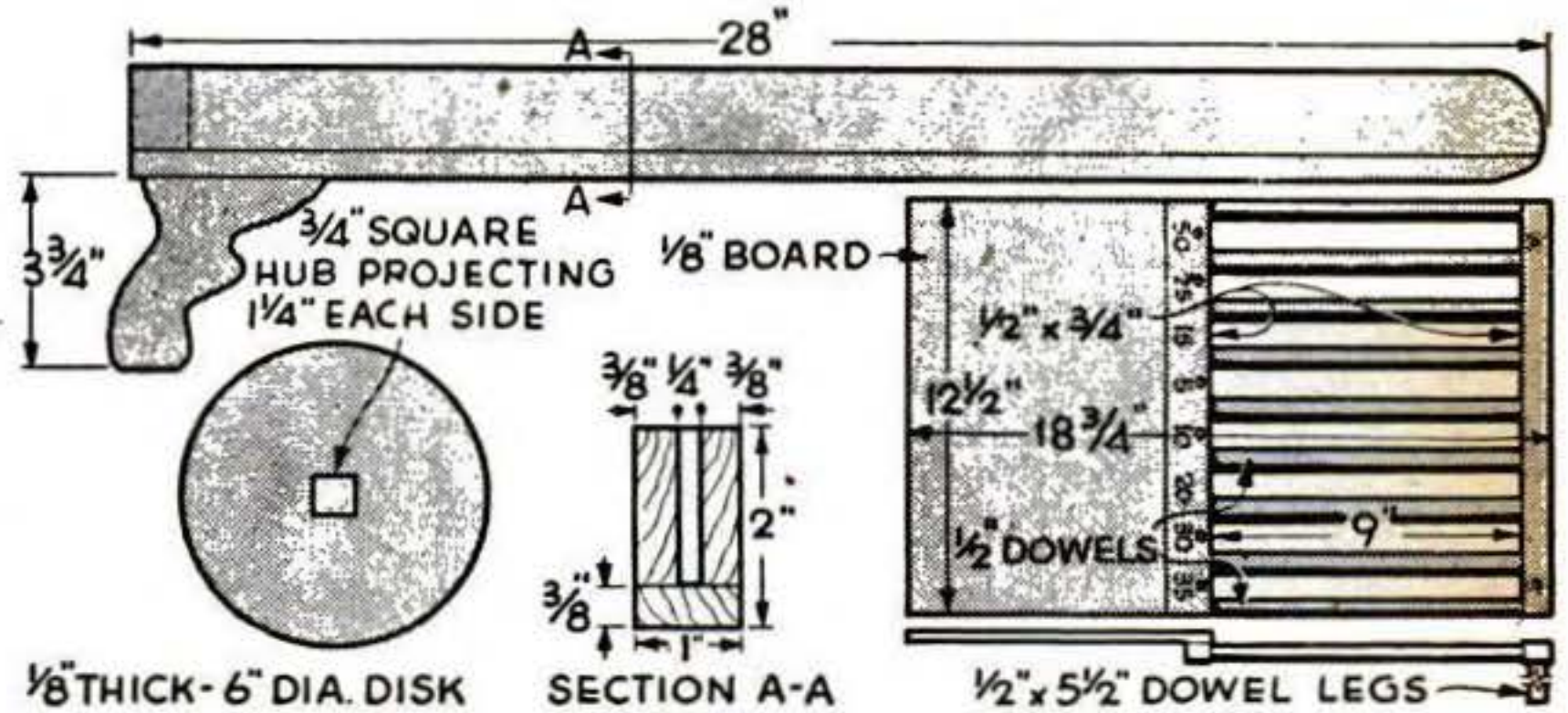
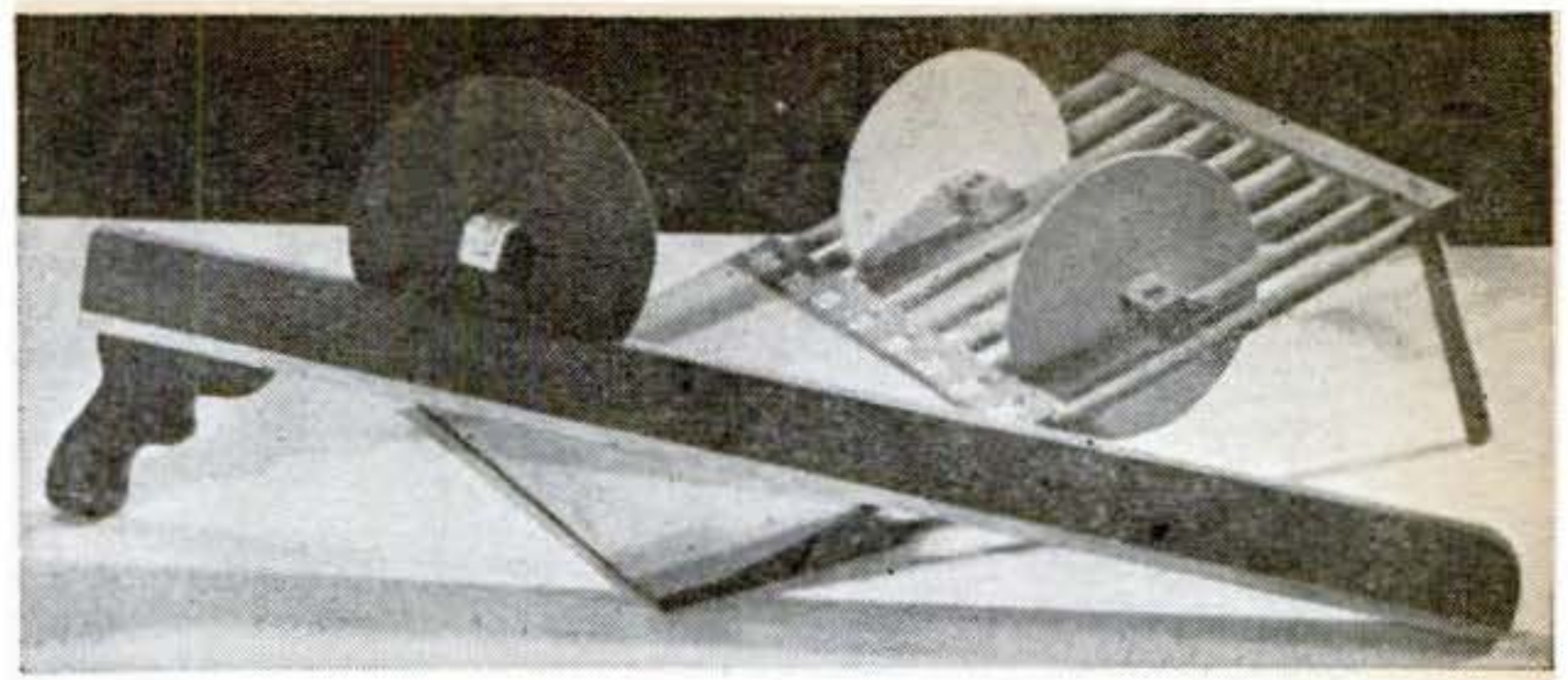

the hubs are numbered 1, 2, 3, and 4. To secure the total score, multiply the uppermost hub number on each disk by the number of its slot, and add together. High man wins. Pressed composition board or plywood, dowels, and scrap wood are needed to make the game.—MYRON FLEISHMAN.

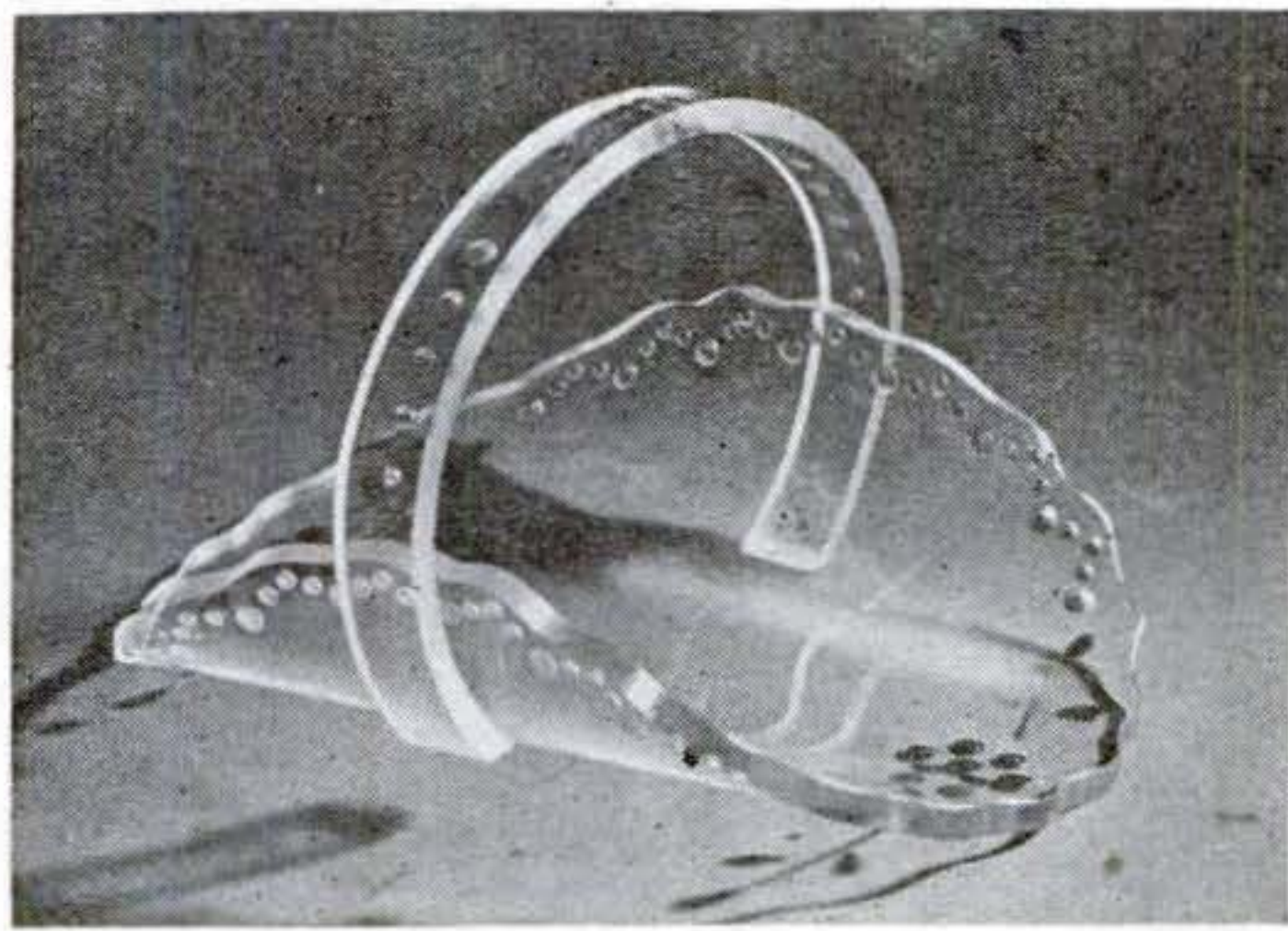

This useful candy and fruit basket sparkles with a flower design made by drilling holes halfway through and coloring the dimples. The pattern is below.

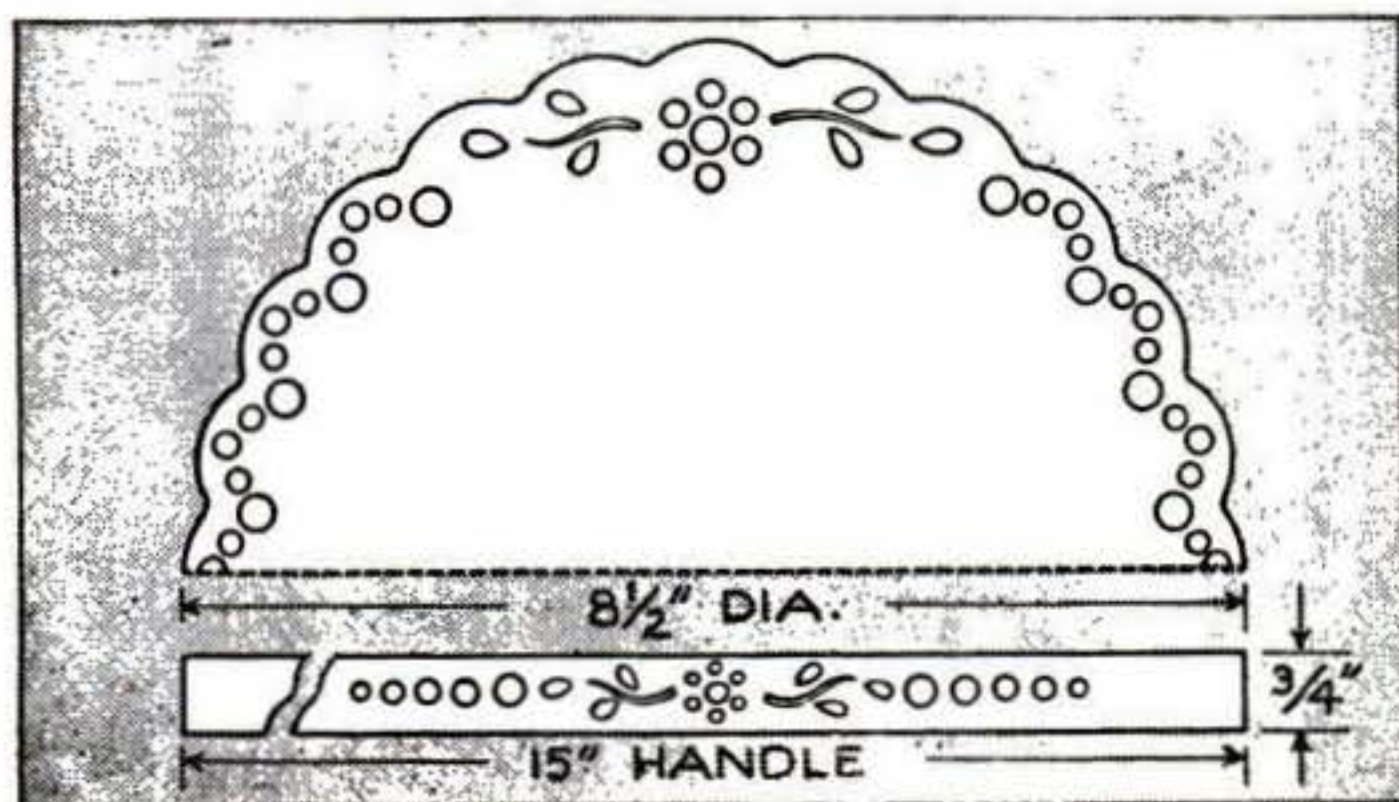

## Clear Plastic Candy Basket Decorated with Blind Holes

COLORING blind holes provide sparkling decorations for this clear plastic candy or fruit basket, pictured in color on page 117. By drilling halfway through the plastic with different drills, a simple flower design is created. Finishing touches like the stems and leaves are burred on with a hand grinding tool.

The basket section is made from an 8 1/2" circle of 1/8" or 1/4" clear plastic with scalloped edges. The handle is a 3/4" by 15" strip of the same material. To apply the coloring, wrap the tip of a round toothpick with cotton. Dip this swab in the color and twist around inside the holes. For this design, the flowers were tinted red, the leaves and stems green, and the edge holes yellow.

Shape the basket by heating in an oven at 250 deg. and bending so that the holes will be on the underside. The two ends with the flower decoration should remain flat. The handle is formed in the same way by heating and bending until its ends fit flat against the sides. Cement in place.—ELMA WALTNER.



# What's New in HOME HEATING

Keeping warm in winter without a fire sounds impossible, but a new system offers just this.

By R. P. STEVENSON

**H**HEATING engineers are giving new meaning to the old expression, "all the comforts of home." It wasn't so long ago that the development of various types of automatic heating began to banish the coal shovel and its attendant drudgery. Now the experts are promising us even more. Before long—as a matter of fact right now if you wish—you'll be able to discard not only your shovel, but the furnace fire itself.

Historically speaking, heating a home without a fire is a major milestone. Always before, we have depended on the combustion of wood, coal, coke, oil, or other fuel to keep us warm. Now we can do it by expend-

ing electrical energy to pump into our homes some of the heat that is always present, winter and summer, deep under the ground. And strangely enough, the apparatus that does the job is little more than your electric refrigerator working in reverse.

Nor is this the only break with tradition in the field of heating. In planning a new home, you can forget about a chimney—at least as a draft-producing device. Several types of furnaces now on the market, or soon to appear, create their own drafts and need only a vent in the wall. Neither do you need a cellar, since a small utility room, or even a closet, provides adequate space for one of the compact new heaters, whatever it burns. And by installing radiant heat pipes in the



This midget furnace burns hard coal in a fire chamber only 8" in diameter. It was developed from the Anthratube, a pipelike, experimental heater announced two years ago. Fuel is fed by an Archimedes screw.

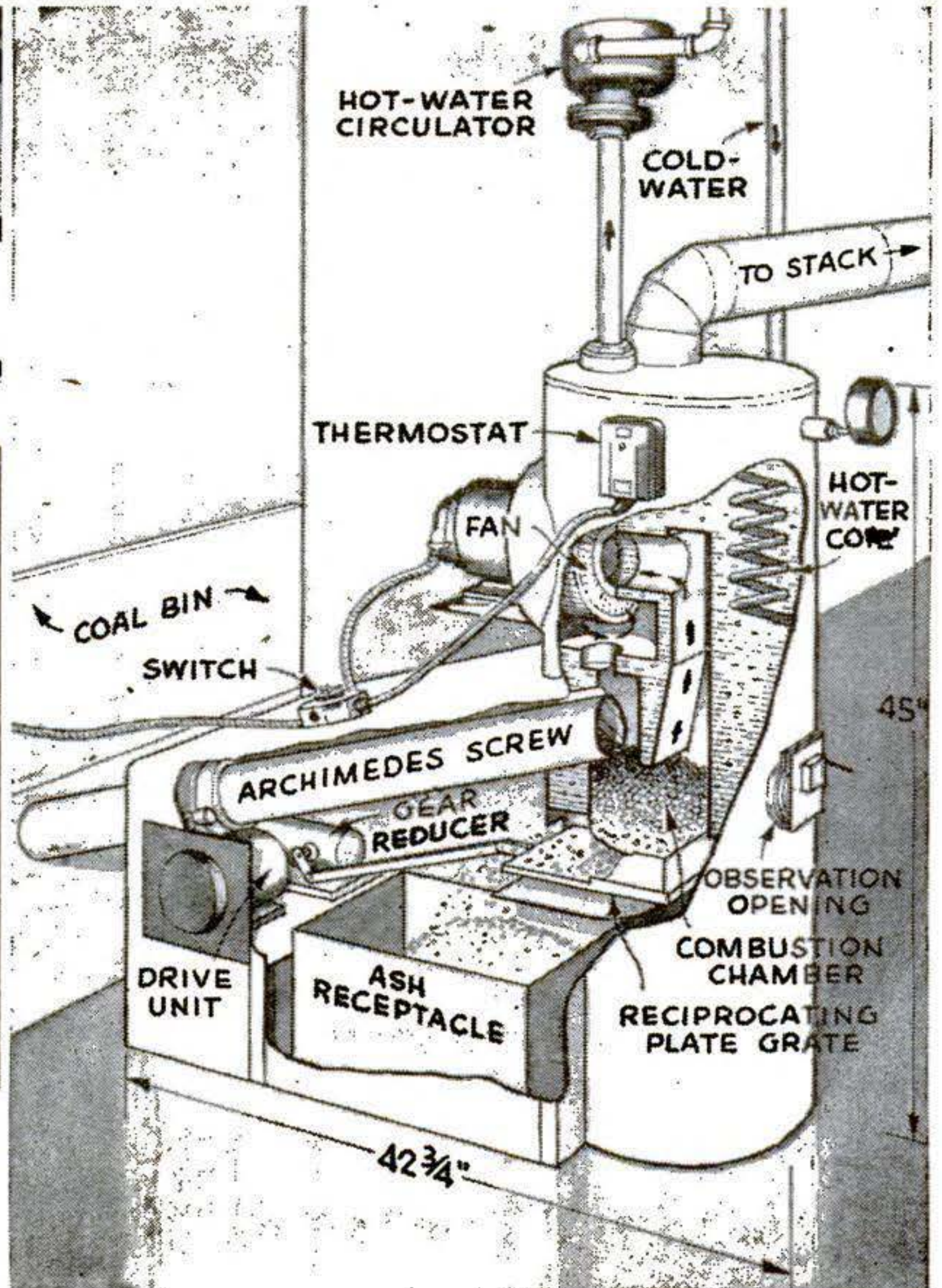



# HOW REFRIGERATION TAKES HEAT FROM THE GROUND

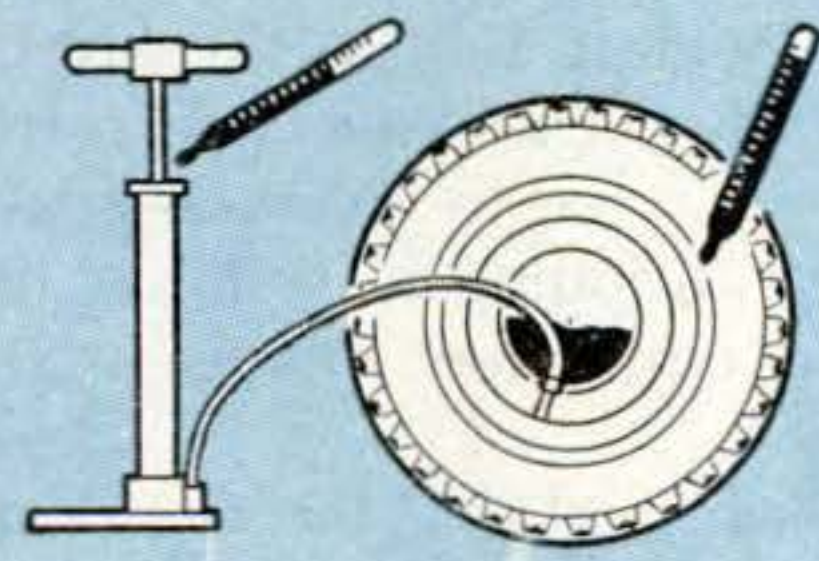
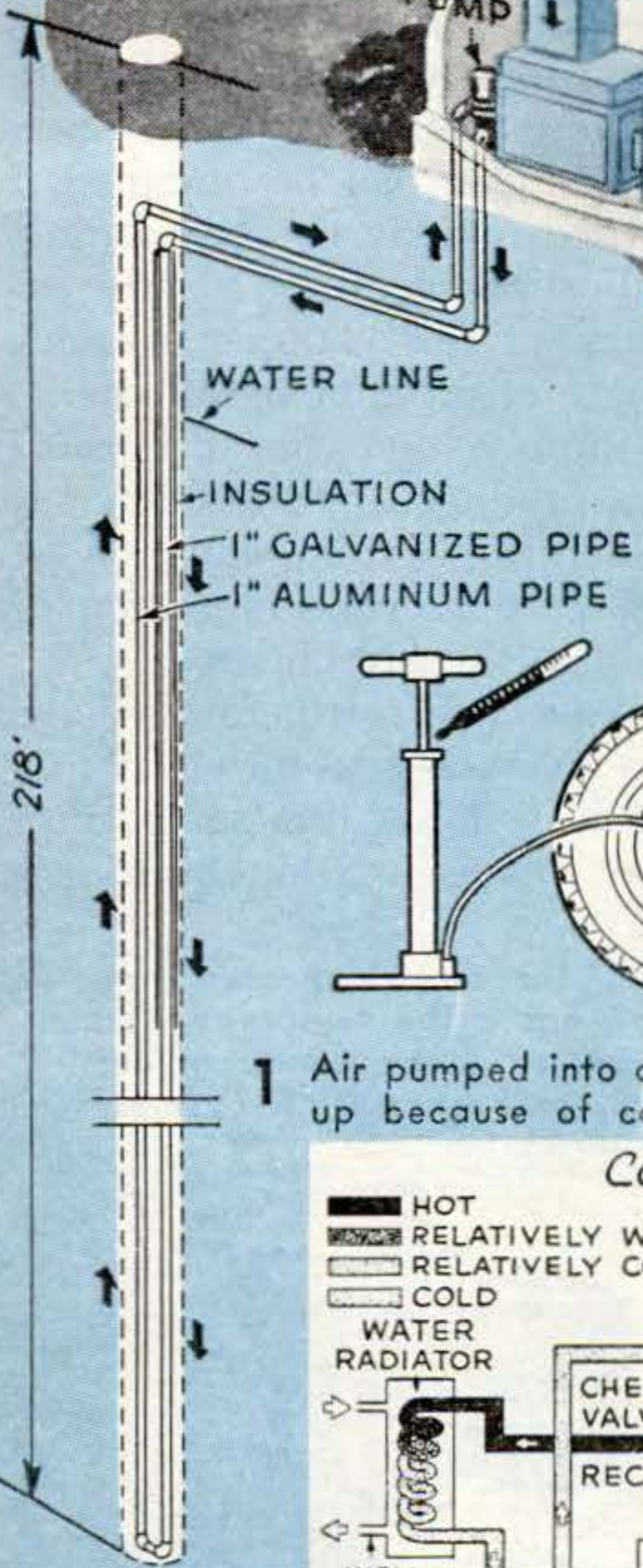
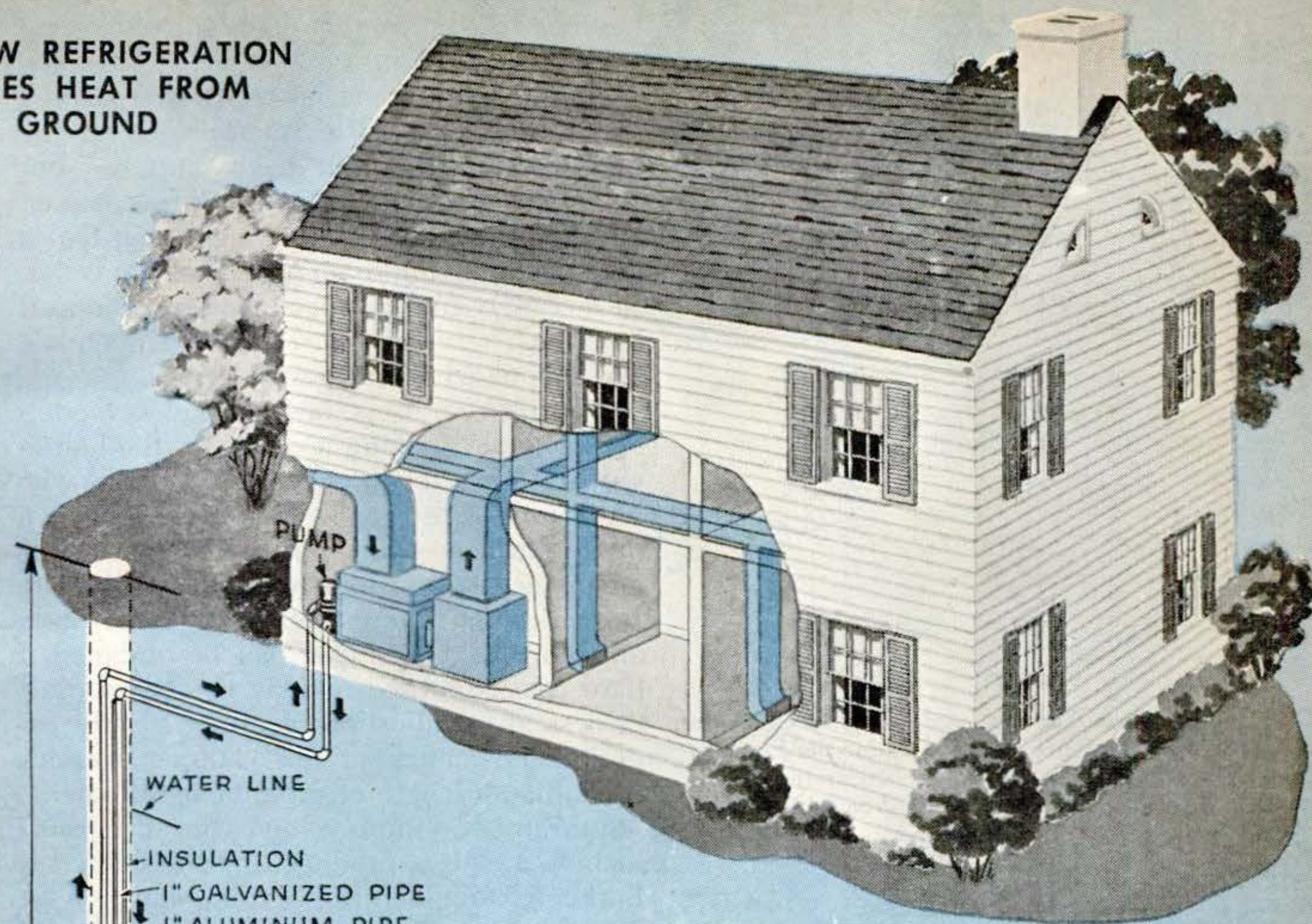

1 Air pumped into a tire heats up because of compression.



2 Cooled while compressed, then released, the air is much colder.

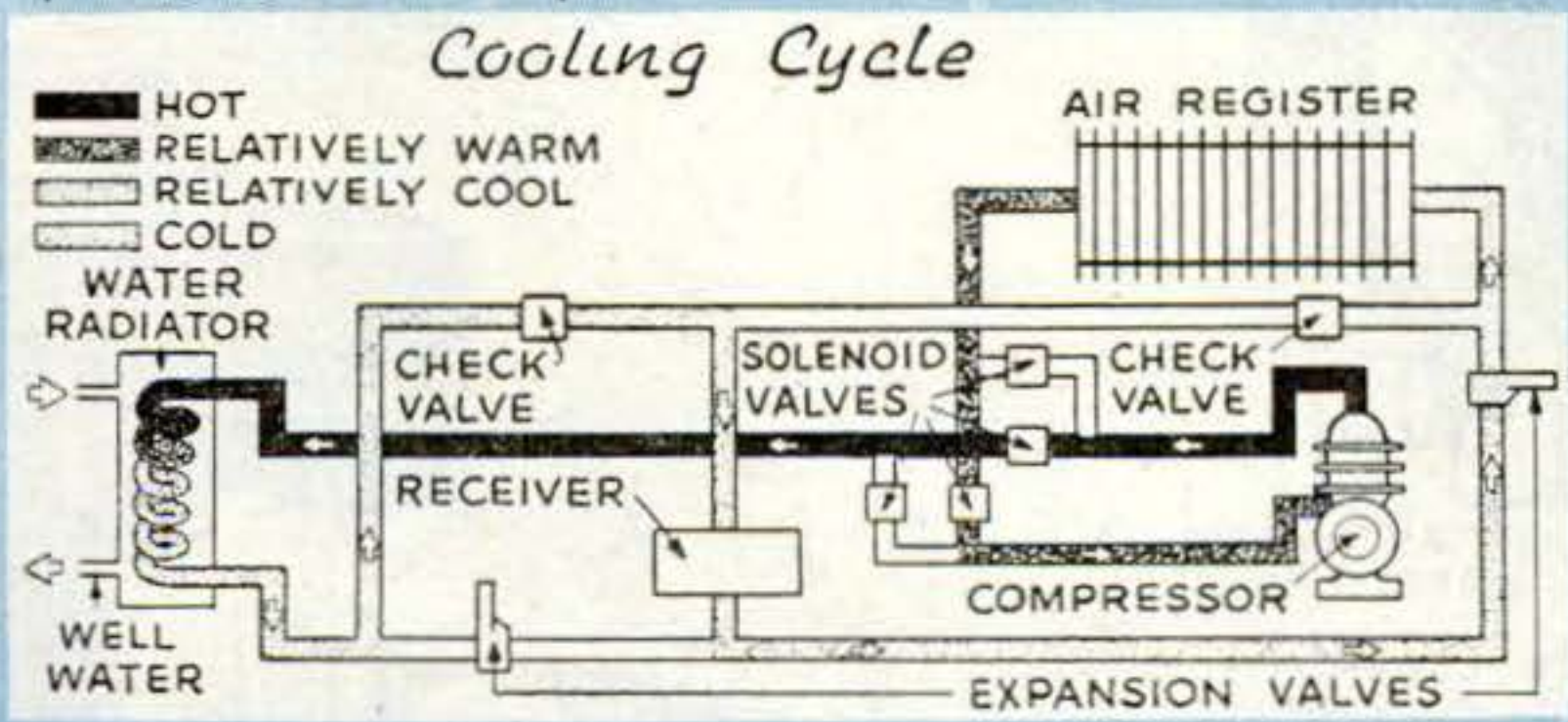

3 At left, the compressed refrigerant is cooled by well water. Then, allowed to expand in plates in the air stream, it takes heat from the house.

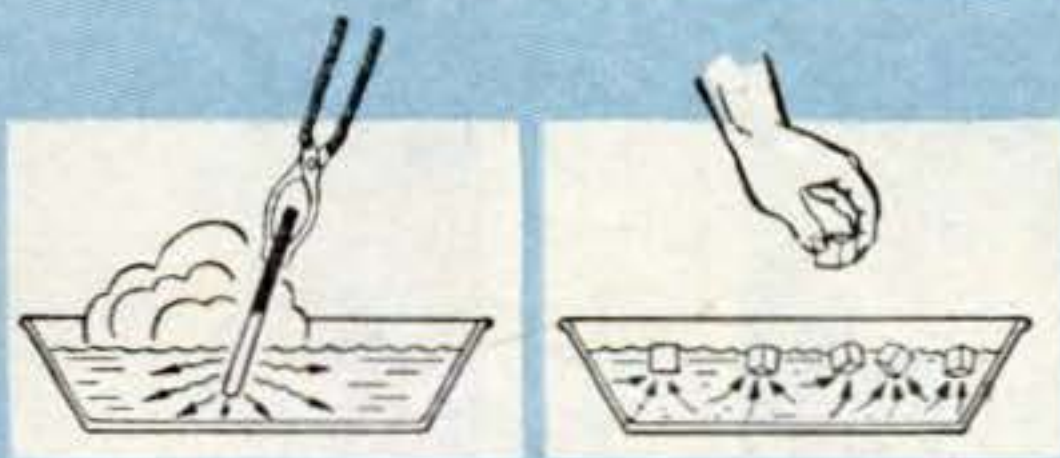

5 As tepid water cools a hot poker, but melts ice cubes, so the well absorbs or provides heat as needed.

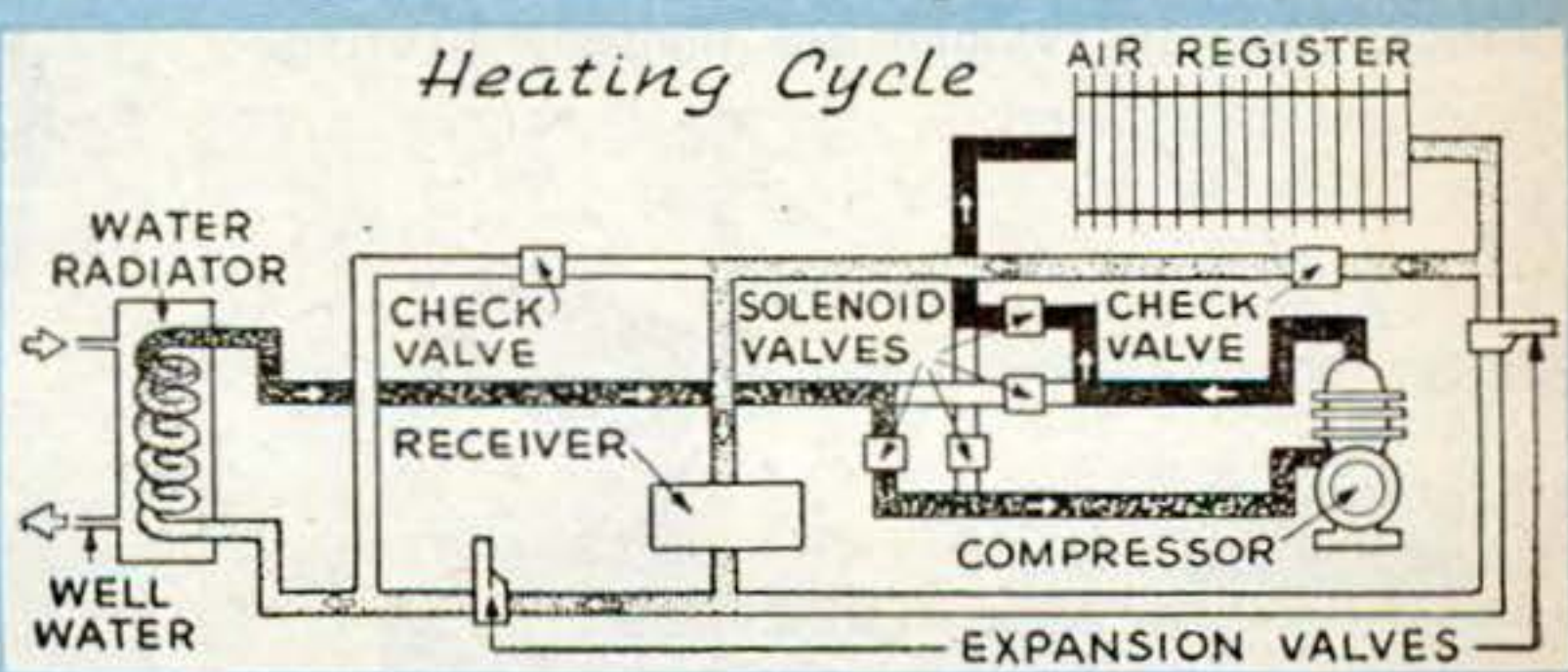

4 For heating, the cycle is reversed. Refrigerant takes heat from water, gives it to the house.



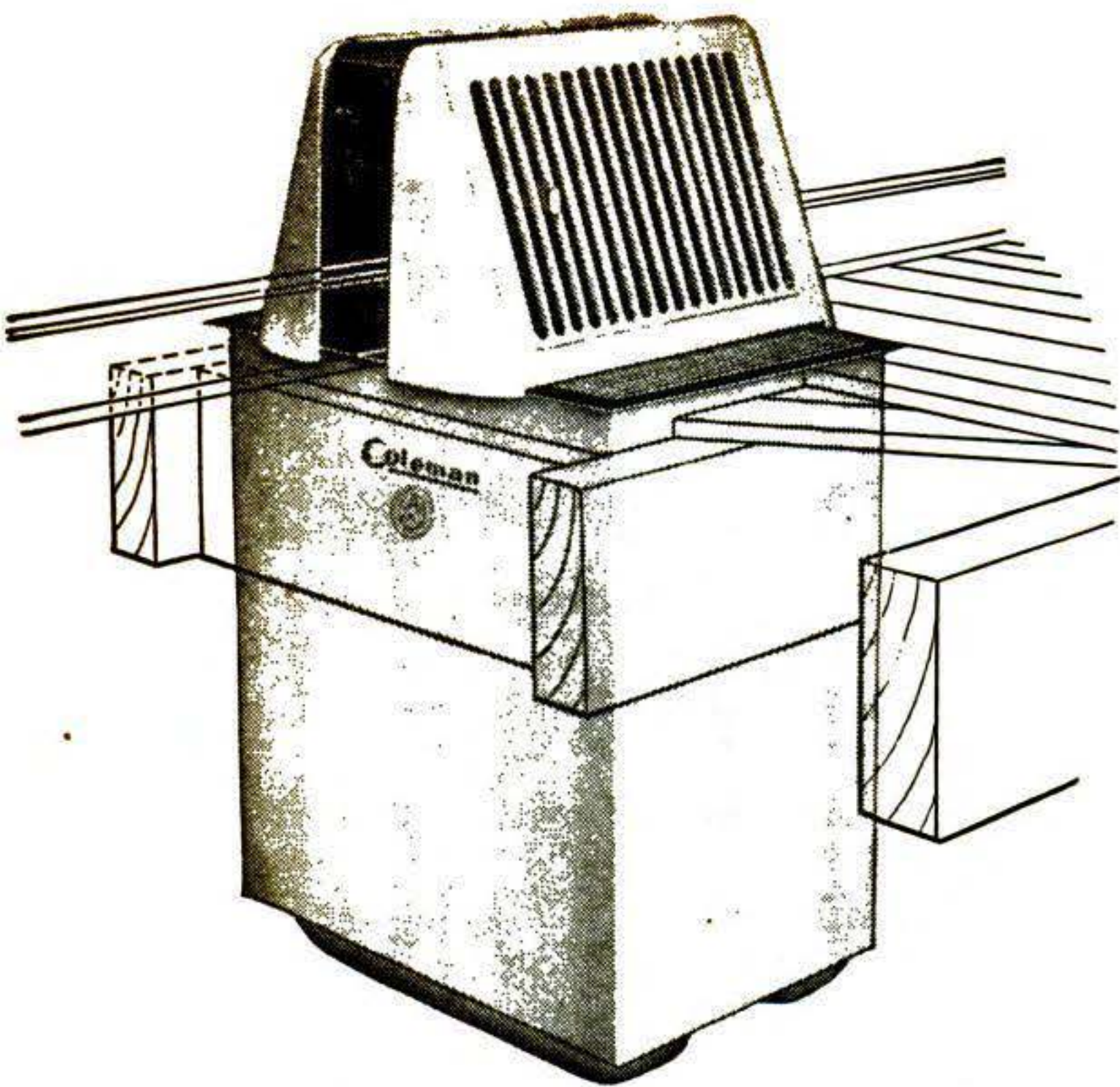

Oil-burning space heaters made by the Coleman Co., Wichita, Kan., are installed under the floor, as seen above and below. A similar heater that burns gas is produced by the Rheem company, New York.

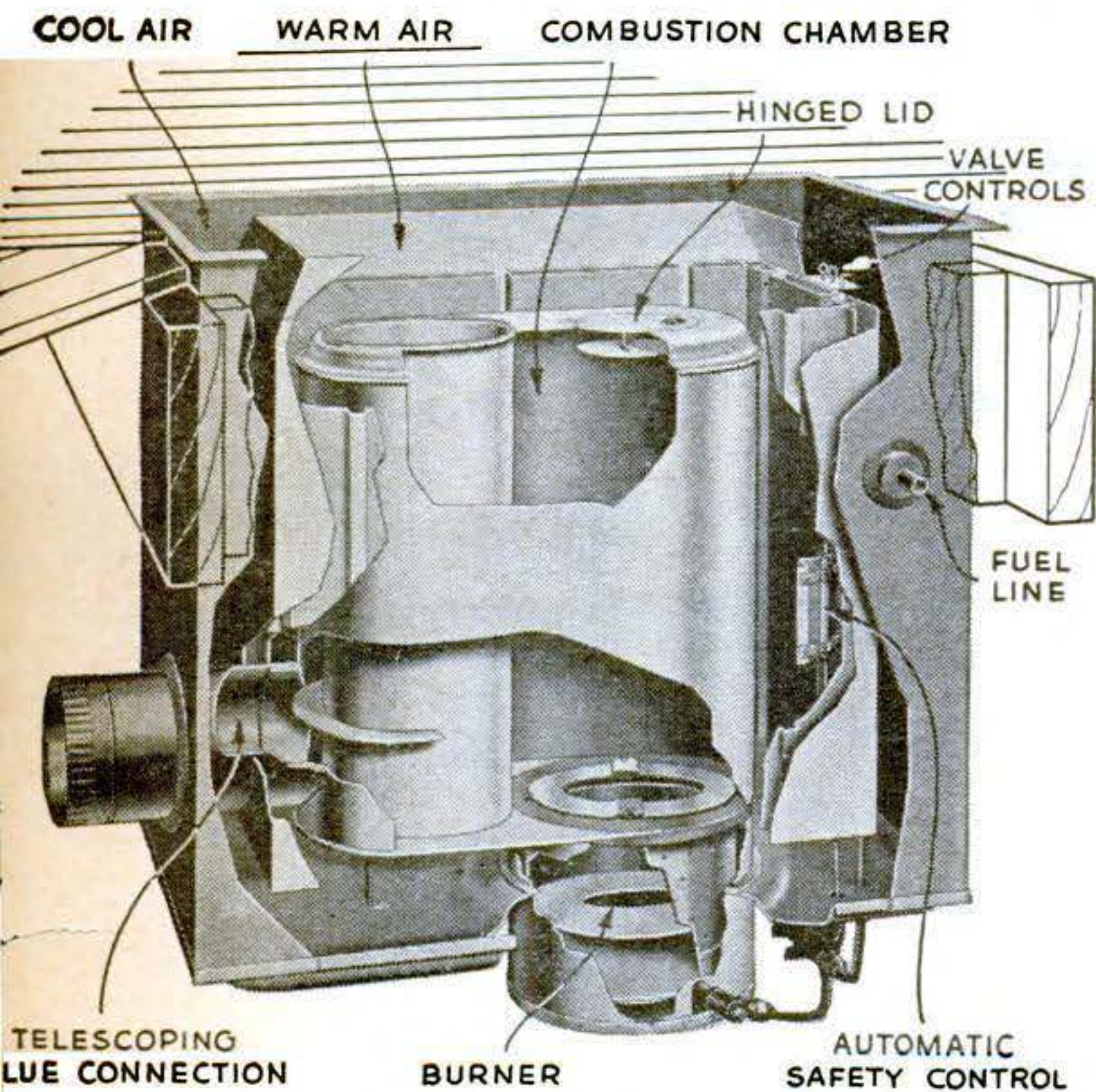

Below is a stoker with a single cone-drive gear and pinion designed by the Stoker Drive Company, Frederick, Md., to replace old multiple gearing.

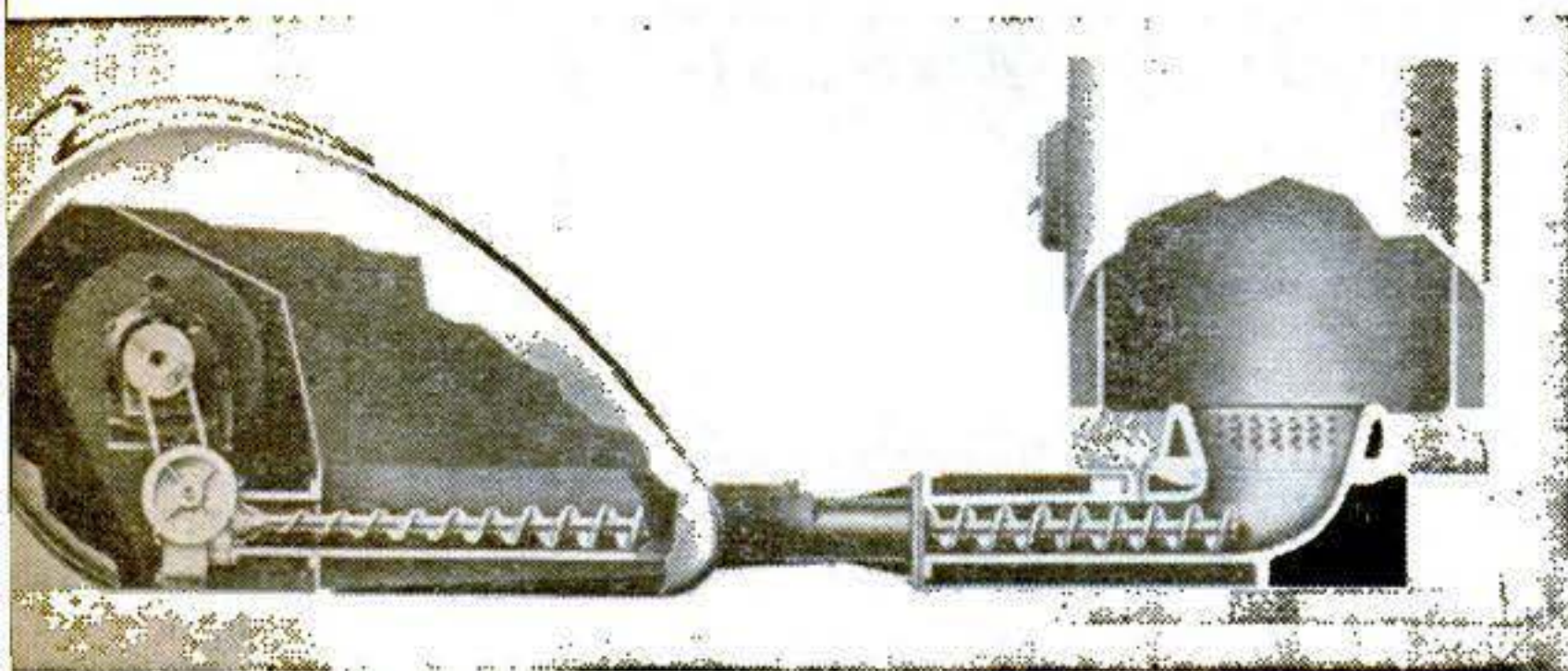

floors or walls, or by using the new radiant baseboards, you can eliminate the old space-consuming radiators.

In appearance, the heaters now reaching the market bear little resemblance to the ugly contraptions that have cluttered our cellars for so many years. More compact and better designed, they might well find a place in the living room instead of the cellar. In fact, new fuel-oil space heaters produced by Duo-Therm are based on Chippendale and Hepplewhite furniture designs.

For soft-coal users, new smokeless models are available, making it easier for the housewife to keep the home clean. Those who burn anthracite soon will be able to buy a midget furnace which puts to use a principle announced two years ago by the Anthracite Institute—that more complete combustion and greater heat output can be obtained if hard coal is burned quickly by forced draft in a small combustion chamber. Early experimental models of this compact furnace resembled a length of pipe; hence the name "Anthratube." Improvements in oil burners include a clutch, produced by the Gilbert & Barker Manufacturing Company, West Springfield, Mass., to prevent formation of heat-stealing soot in the fire chamber.

Both gas and electric refrigerators have been adapted to give you heat in winter and air conditioning in summer, the same automatic equipment being used in both sea-

Installed in a wall, the electric heater shown in cross section below has a fan to spread its heat. The resistance is sealed in an aluminum casting. Electromode Corp., of Rochester, N.Y., makes it.

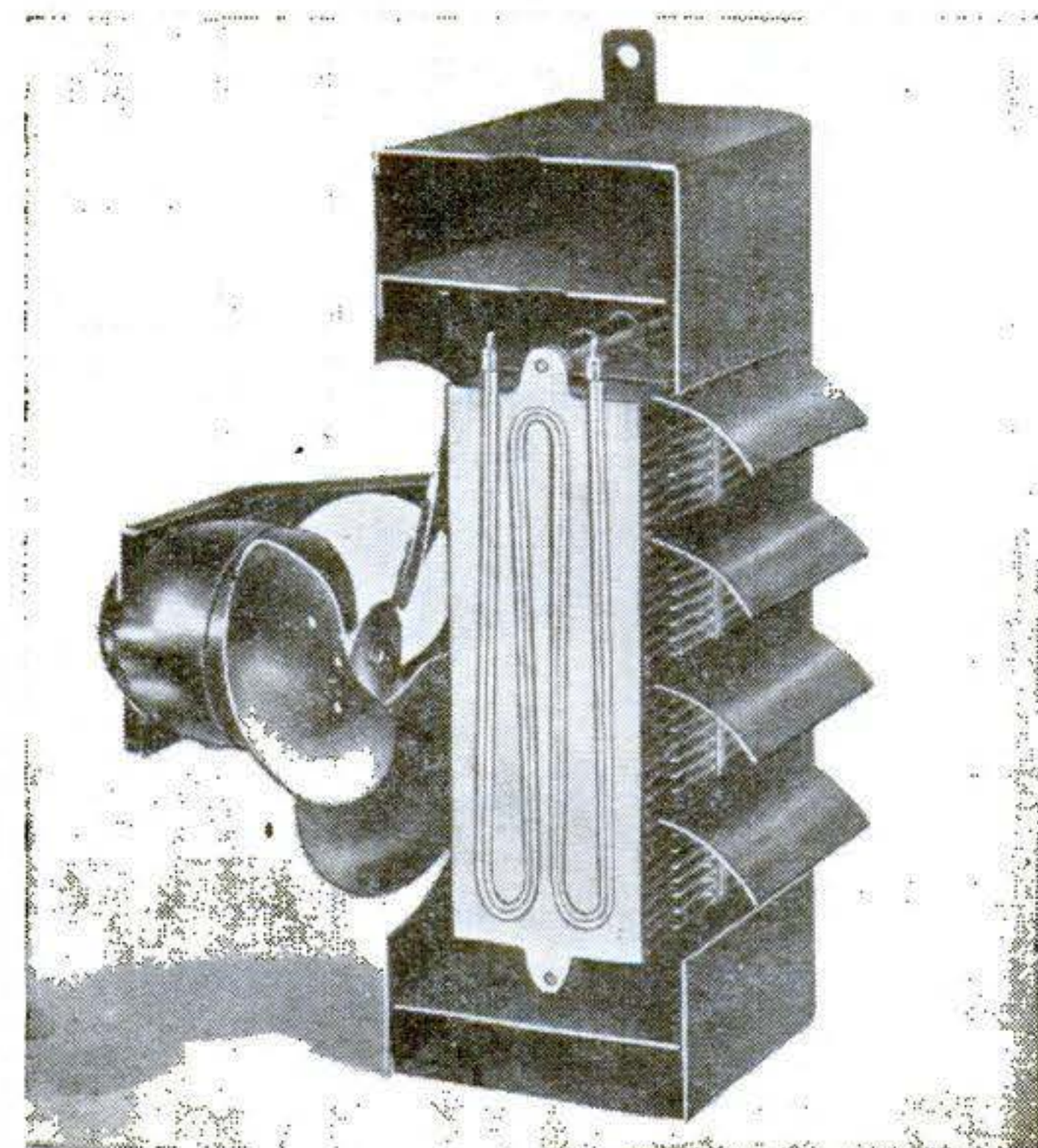



sons. It is an electrical refrigeration system that will enable you to have heat without combustion, the refrigeration cycle being reversed and giving us the designation "reverse cycle heating." It also is called a "heat pump" because heat is transferred from one temperature level to a higher one.

During the past year, a commercial model produced by the Muncie Gear Works, Inc., made its bow in more than 100 homes in Muncie, Indiana. Marketed under the trade name of Marvair, this system is illustrated on page 153. It takes heat from the ground by circulating water in a closed pipe system, placed in a well of 4" or 5" bore drilled to a depth of approximately 200' below the natural water level. Aluminum pipe is used for the return leg because it absorbs heat better. Even in the northern latitudes of the United States, underground temperatures are surprisingly high. For example, around New York and Chicago the temperature is approximately 52 degrees at a depth of 30' to 60'.

The compressor of any refrigerator creates some heat directly, but this should not be mistaken as the source of the heat that warms a home in the reverse-cycle system. The compressor merely lends a helping hand to get heat from the ground.

When the underground heat units contact the cold pipe, they are absorbed by the circulating water. Pumped up the pipe, the

water carries the heat units to a water radiator, where they again contact a colder fluid, this time the refrigerant. As before, the heat units go to the cooler region. Moving on to the compressor, the refrigerant is put under pressure. As in all cases where the pressure of a gas is increased, its temperature also goes up. Now compressed, the refrigerant travels to the air radiator, still carrying the heat that came from the earth. Once again the heat units seek a cooler region, this time an air stream on its way through ordinary ducts to the rooms that are being heated. There, they keep you warm.

Operated like an ordinary refrigerator, the Marvair system also cools your home. But in this case, the transfer of heat is reversed—from the home to the ground. Automatic controls, including four solenoid valves, make the change from heating to cooling and vice versa as the need arises.

Anyone who has pumped up an automobile tire has observed the generation of heat, usually by feeling how hot the pump hose is. Air in the tire is also hotter than that outside, but if released from the valve, the escaping air is found at its original temperature. Now suppose that the compressed air is first cooled by placing the tire in a huge refrigerator. If you then allowed the air to escape, it would lose the same amount of heat it gained when the tire was pumped up, but since its temperature already is lower, it

In starting or stopping, most oil burners give off a soot-creating puff of smoke because enough air for complete combustion is not delivered by the fan. The clutch below is designed to prevent this.

Several heaters need only a simple vent instead of a chimney because they create their own draft. One of these is the new Norge oil furnace. It has a fan to pull air through the combustion chamber.

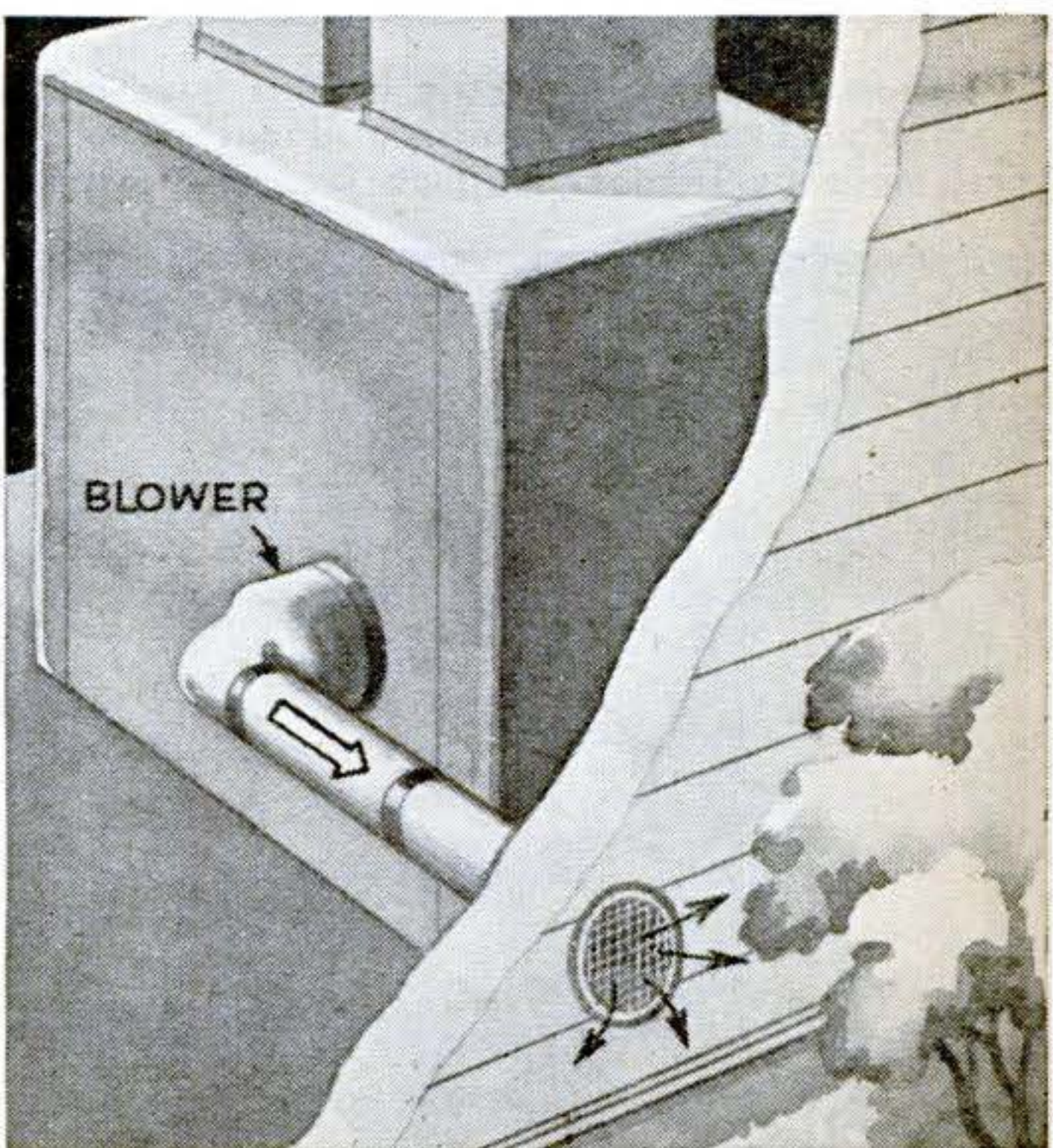
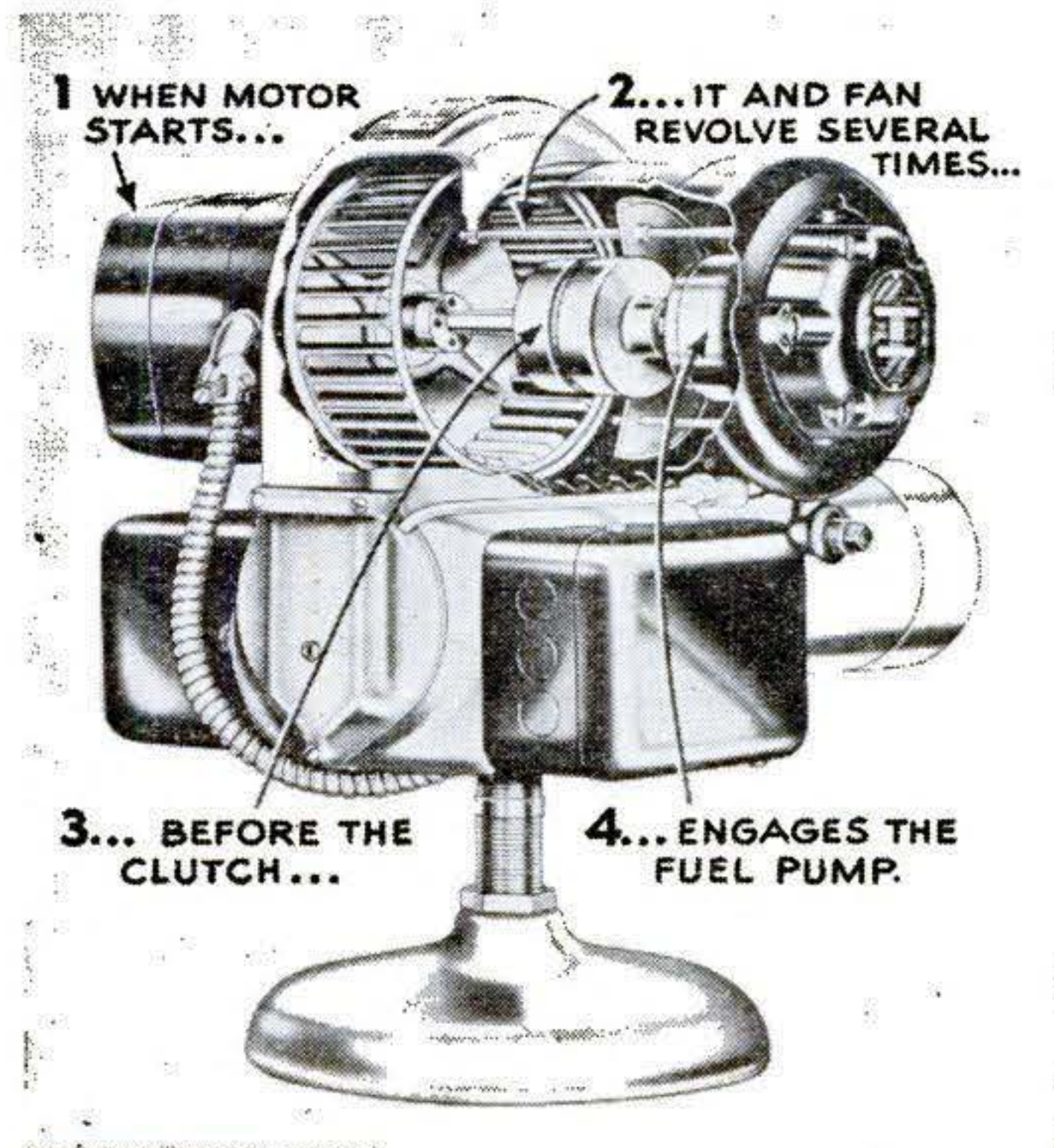



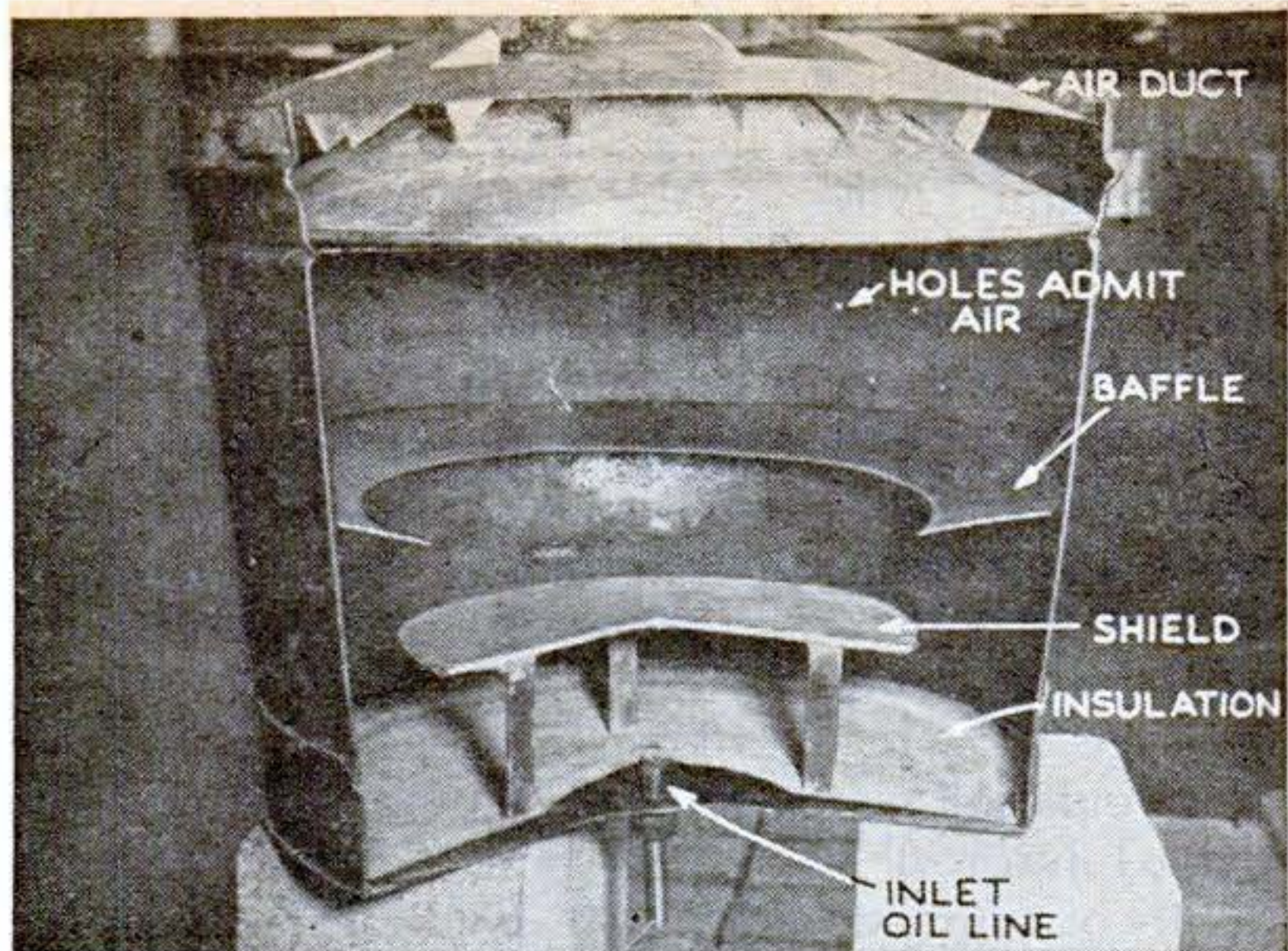

Ordinarily, pot burners require high grade oil because heat from the flame cracks a cheaper grade while it is vaporizing. Socony-Vacuum engineers now have developed a pot-type heater which prevents cracking, making it possible to use the more economical fuel. It is shown above under test and in a cutaway view.

would descend far below the original point.

This illustrates what happens in the cooling cycle of a combination cooling-heating system. The refrigerant, heated by the compressor, passes directly to the water radiator. Since the refrigerant at this point is warmer than the water, it loses heat to the water; that is, the refrigerant is cooled as the air was in the tire example. Consequently, when the refrigerant passes through the expansion valve, it loses the same amount of heat it took on in the compressor but it goes below its original temperature by the same amount it gave up in the water radiator. Continuing on to the air radiator, the refrigerant then extracts heat from air circulating in the home. When the home needs heat, exactly

Designers of portable electric heaters have made them safer. Even a baby faces no danger from this one, made by Trilmont Products Co., Philadelphia.

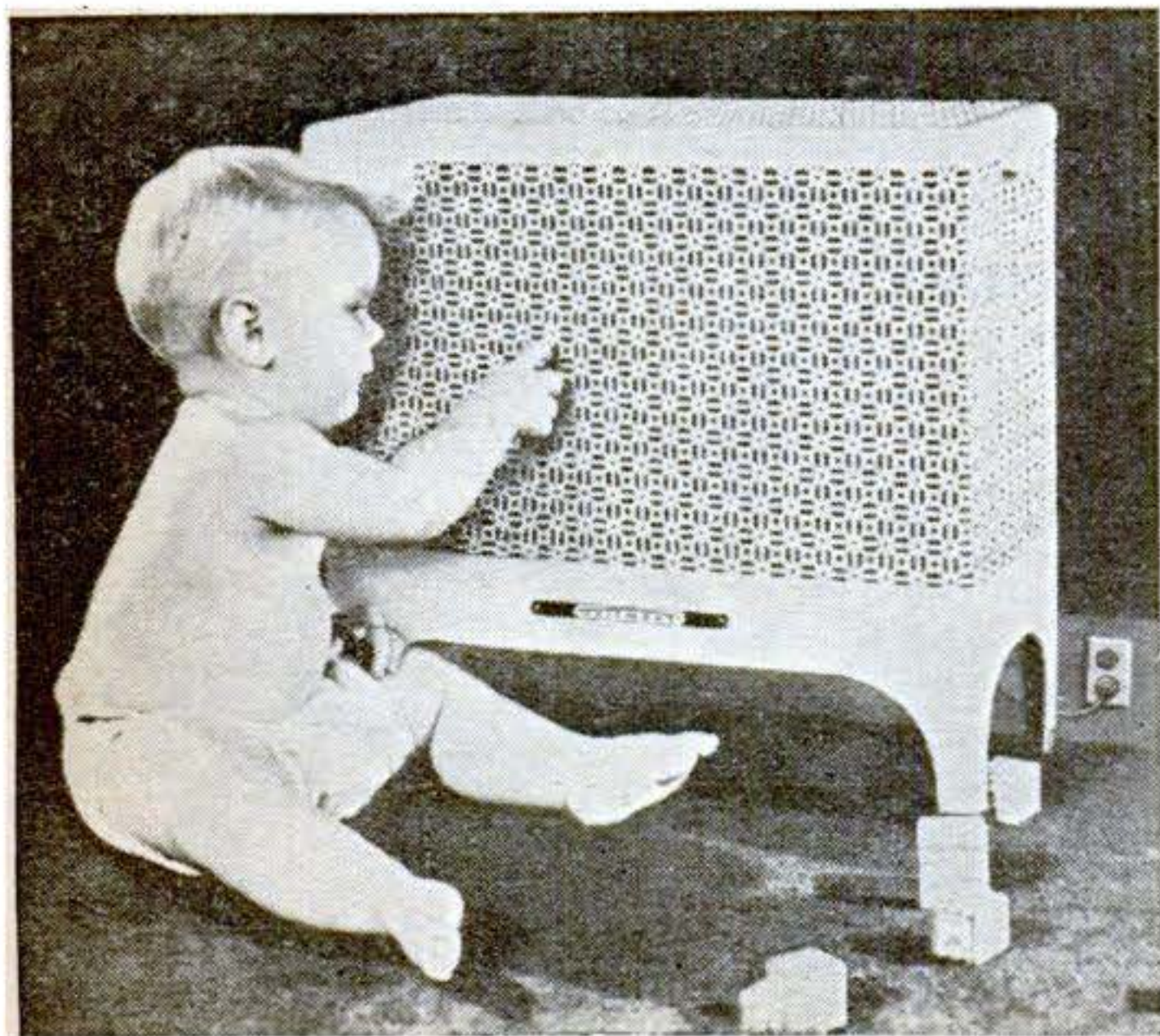

the reverse occurs, the water giving heat.

Although current models of the Anthra-tube no longer resemble a length of tubing, the advantage of compactness has been retained. The automatic hot-water unit illustrated on page 152 has a boiler 16" in diameter and 45" high and, with the automatic feed mechanism, the entire furnace occupies a floor area only 20" by 42 $\frac{3}{4}$ ".

Combustion takes place in a chamber only 8" in diameter, but the suction draft created by a fan produces an extremely hot fire. Fuel feeds from the bin through an Archimedes screw. Since the coal falls from the screw to the firebed by gravity, feeding stops when the combustion chamber is full—even though the tube continues to turn at its normal rate of about 15 r.p.m. A crank and connecting rod from the reduction gear operate the grate horizontally at the rate of one 2" stroke a minute. This shears off the ash, allowing it to drop into a removable ash receptacle below.

A thermostatic-type switch controls the position of the fire as well as the operation of the fuel and ash-removal mechanisms. Located so that it is sensitive to the temperature of the lower section of the firebed, this bi-metal switch turns on the motor, setting the Archimedes screw and grate in operation, when the coal in the bottom of the bed has been consumed and the ash begins to cool. After the ashes have been ejected and hot coals take their place, the increased temperature shuts off the switch and the motor stops. If the fire should go out, another control cuts out the entire mechanism and prevents unburned coal from being wasted.



## WHAT'S YOUR INGENUITY QUOTIENT?

# IQ

**MUSIC HAS CHARMS** to soothe the restless baby. Mine is apt to wake up crying for reasons that only he understands. A music box under his crib seems to be the perfect pacifier. At the first bellow I turn it on and let the faint tinkle waltz him back to sleep.—**JAMES CARPENTER.**



**ARE YOU A PIGGY-BANK SHAKER?** I can't trust myself when my back is turned, so I bury my loose change in any empty oil can. A length of pipe chutes the coins into the can, and a rubber collar around the opening keeps the ground moisture from seeping in.—**GEORGE L. PAYNE, JR.**



**Have you pulled off a smart one lately? We will pay for acceptable contributions showing ingenious solutions of problems in the home, shop, garage, or camp. It doesn't matter if it's wacky—if it works.**



**YOU'RE AT YOUR ROPE'S END** when it begins to fray. This brings out the Scotch in me, so I twist the frayed ends tightly and serve them with Scotch tape. In return pieces so salvaged serve me for everything from emergency shoelaces to apron strings.—**A. H. STEVENS, JR.**



**WELL, FLAP ME DOWN!** That's the way I felt when I held a phonograph album wrong side up and the records slithered out of their sleeves. Now I've pasted cardboard flaps over the envelopes, so no matter who does what to them, the disks stay put within, snug and safe.—**JAMES ROBERTS.**



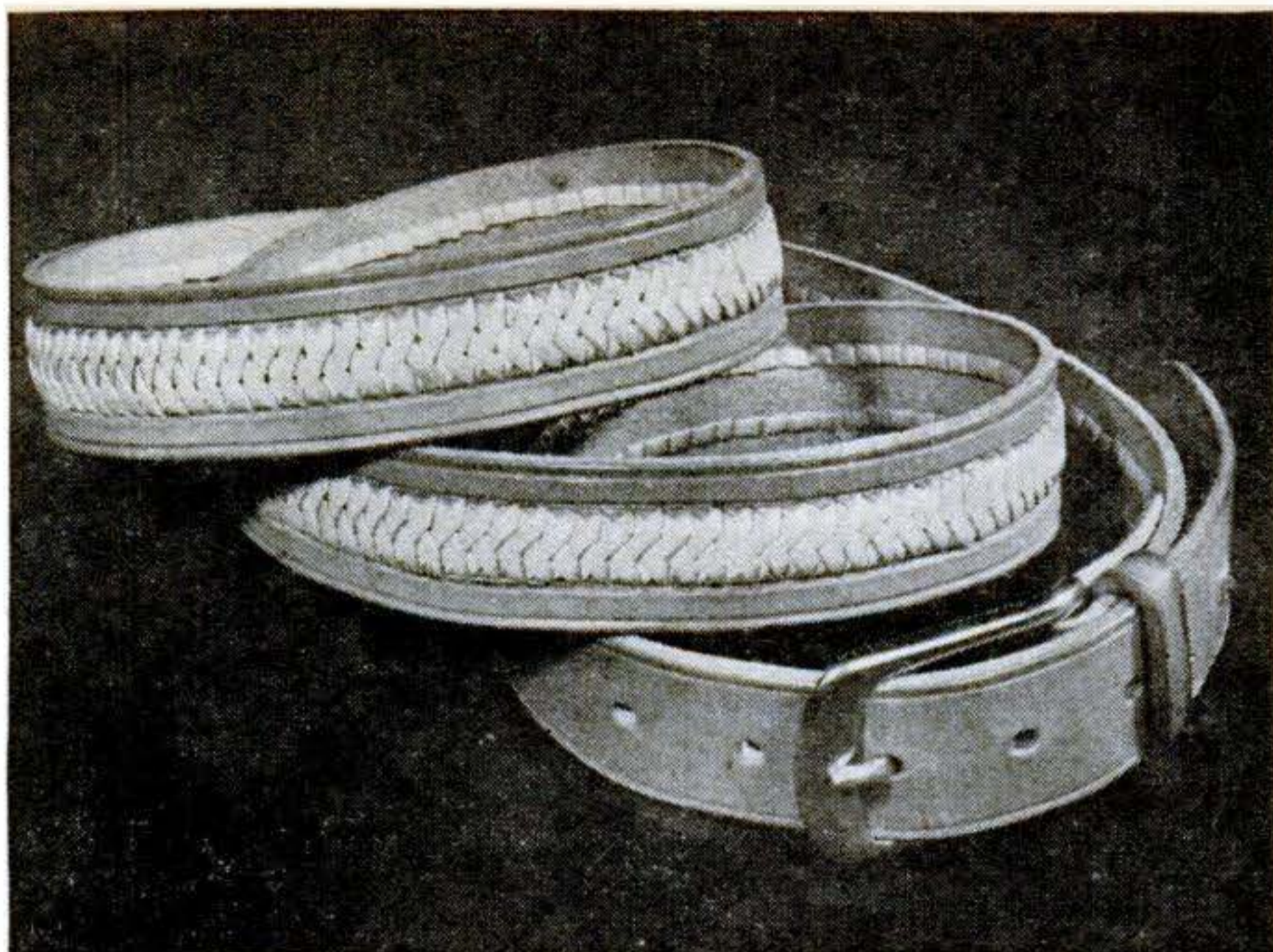

## LACED LEATHER BELT . . . GAUCHO STYLE

**H**ARD-RIDING gauchos no longer rule the wide Argentine pampas. But the fine leather handicraft developed by these South American cattle punchers has been preserved, unlike the lost craftwork of our own cowboys, in government museums. From examples of their handsome bridles, knife handles, and other gear can be copied details like the typically gaucho "costura" braidwork that decorates the belt above.

To make this, you will need a piece of belt leather 1" wide and several inches longer than your waist measurement (see drawing), a buckle, and 1 yd. of  $\frac{1}{8}$ " leather thong for every 3" of braid. The plastic or fiber lacing employed for whistle lanyards might be used in place of leather, and the braidwork could be added to an old belt, if desired. Contrasting colors are most effective; the gauchos themselves preferred

to use white costura applied to a black belt.

Depressing the braid in a "bed" improves the appearance. Dampen the belt, and when it has dried so that no moisture can be squeezed out of it, mark the bed area and cut along the two sides to one third depth. Next bevel inward with a tap beveler. After the belt has thoroughly dried, lay off the holes  $\frac{1}{8}$ " apart. Punch them with a single-pointed thonging chisel or a nail filed sharp.

Now begin lacing the braid by passing the thong, its point stiffened with glue or held in a lacing needle, through hole number 1 from the back to the front, and continue through the numbered sequence shown in the drawings. At the buckle end, the braid goes through two pieces of the belt at once to hold on the buckle. Finally, tap down the lacing and finish to a soft sheen with saddle soap.—BRUCE GRANT.

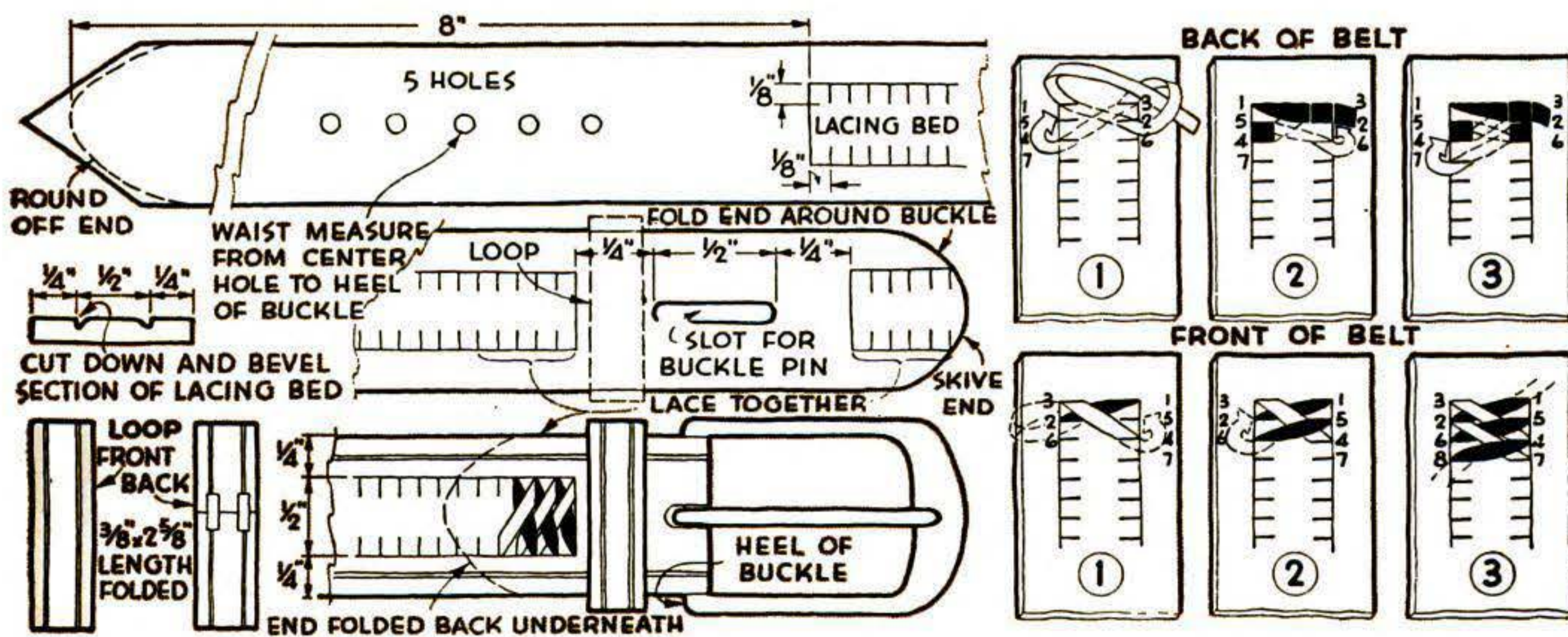



**CRAFTWORK  
for  
CHRISTMAS**

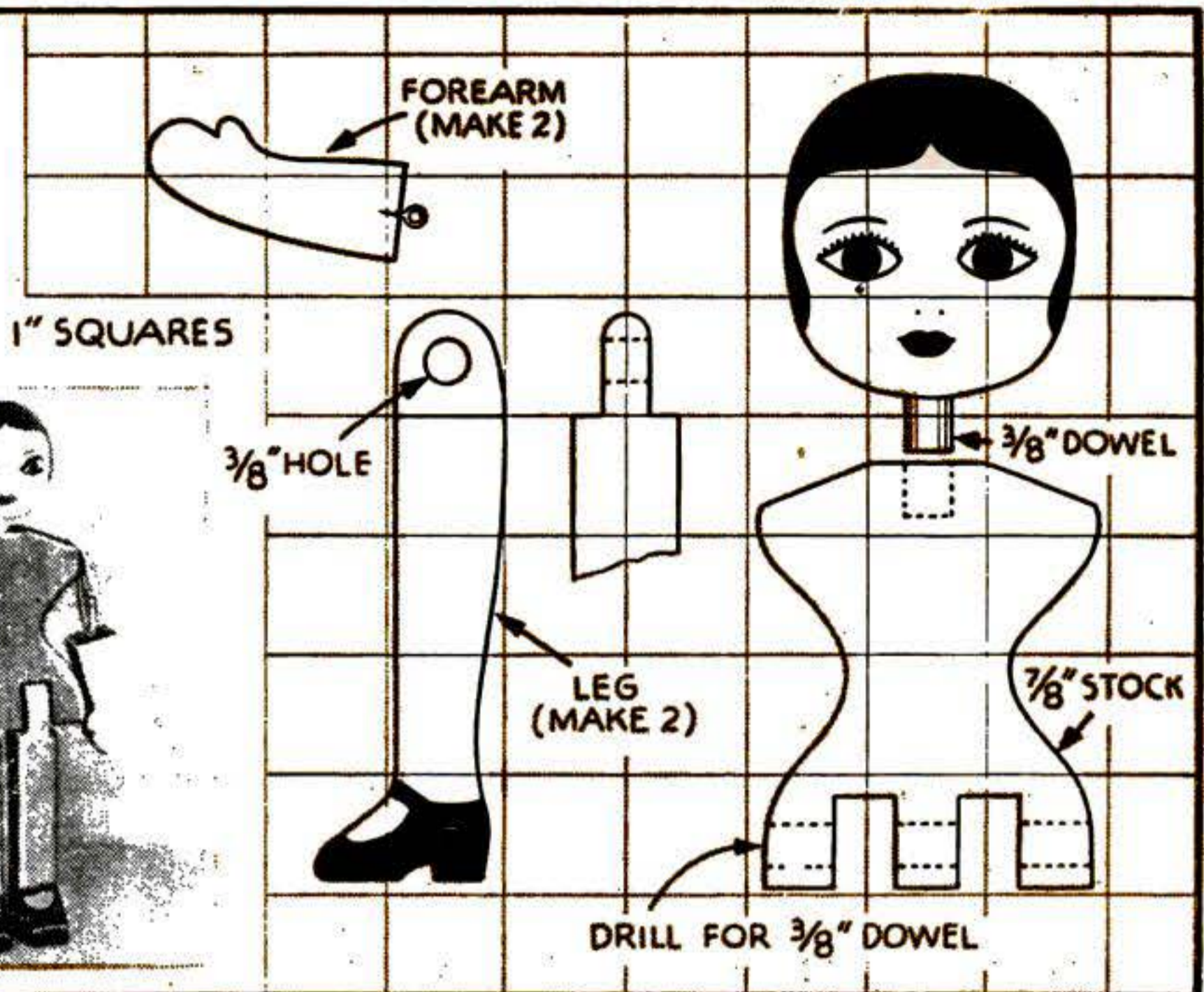

**Wood Doll of Covered-Wagon Days Has Movable Arms and Legs**

QUAINT wooden dolls whittled painstakingly by fathers and dressed by mothers made many a trip across the plains in the days of the covered wagon. This "modern" old-fashioned miss will be no less cherished by a little girl this Christmas. Instead of being whittled, its body and movable arms and legs can be sawed out with power or hand tools; its head is a turning or a wood ball.

Make the parts of hardwood and round the edges. Drill the hips for a hardwood

dowel; then round the ends of the legs until they move freely on it in the notches. The forearms hang on stout cord knotted through small screw eyes or held with staples.

Shellac over the wood provides a natural complexion. Paint in features, hair, and shoes with enamel to which a few drops of clear varnish have been added.

The doll wears long pantalettes, the traditional one-piece dress with kimono sleeves, a sash, and a bonnet.—DORIS ALLER.

**Ring-Toss Game for Table Play**

HERE is a ring-and-peg game for indoor play on rainy days. The base is 1/2" plywood, as is the glued or nailed center disk with the short peg. Mark the base radially and paint the spaces black and light blue alternately; then number the long outer pegs 1 to 4, the disk 5, and the short peg 10. Cut three rings from 14-ply show-card stock.

Note that the short peg is driven into a hole in the center of its disk and not into the board itself, while the outer pegs are put in holes drilled in the board.

Players stand 4' from the board, and their score is what they ring. When two rings go over one peg, the number counts twice; but if three go over a long peg, the entire score is wiped out. A third ring over the short peg counts. Rings tilted on the center disk without going over the peg count 5; those that fall cleanly around the disk as well as the peg count 15.—DONALD W. CLARK.

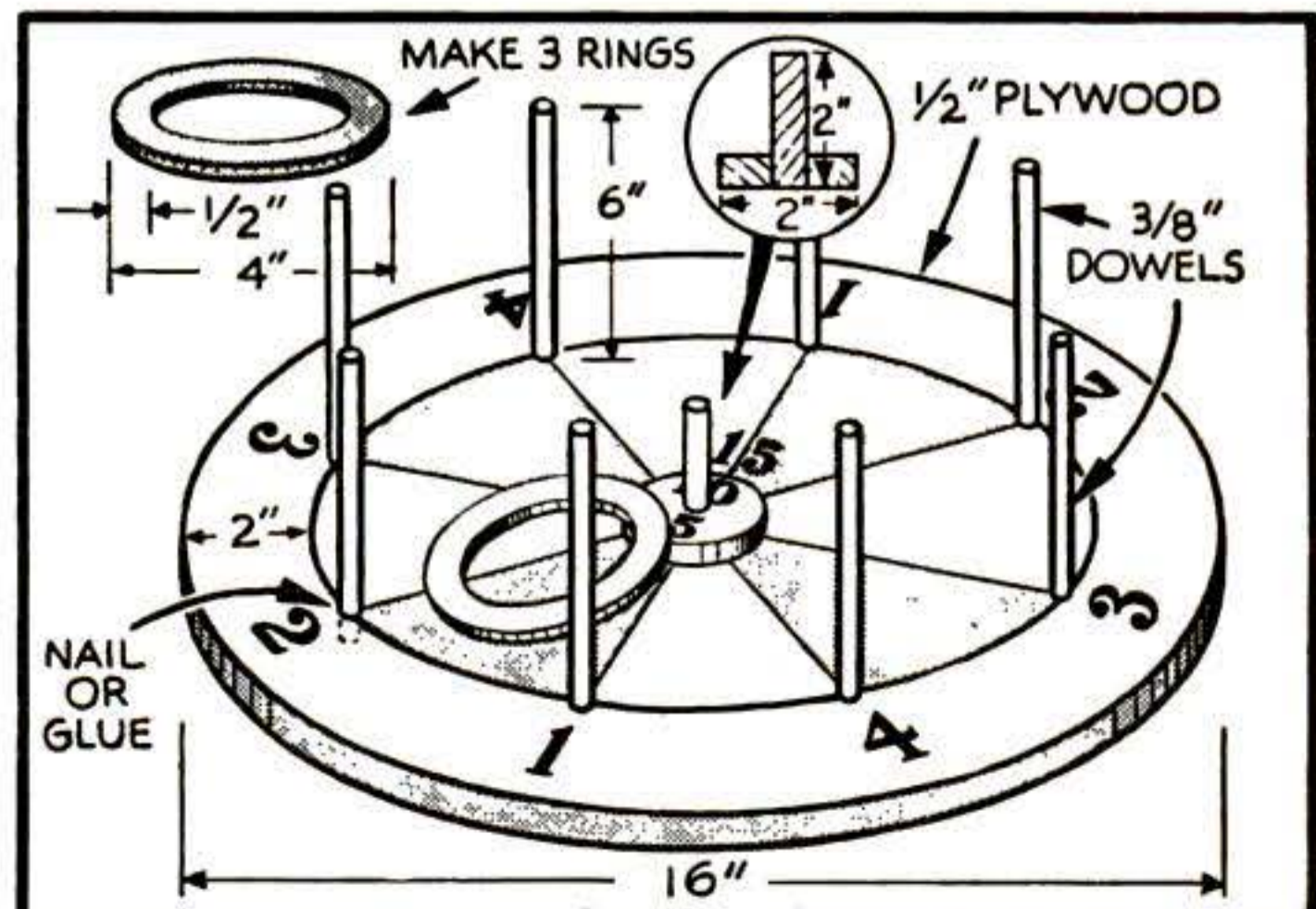



# Tom Thumb CRAFTWORK

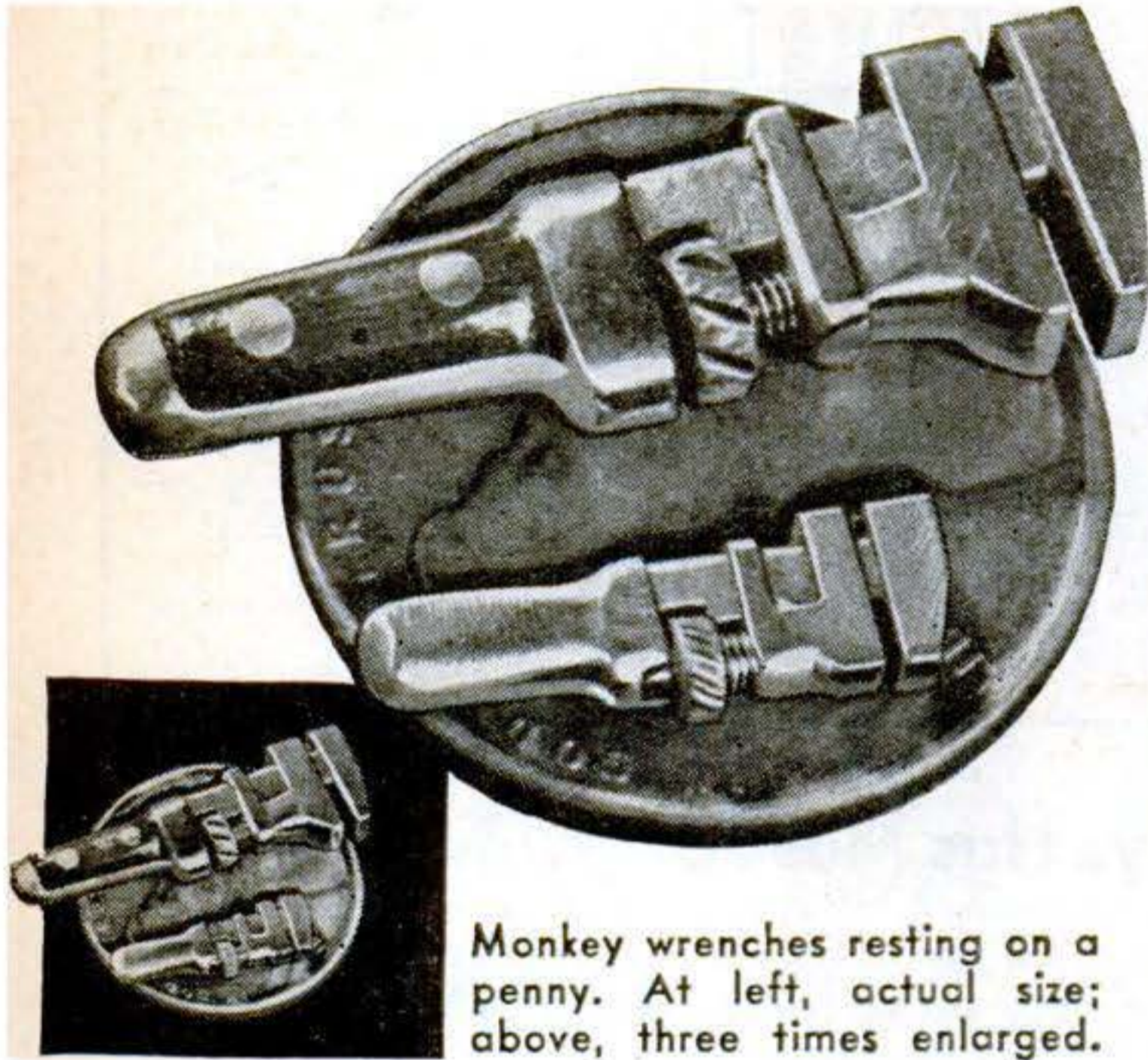

Monkey wrenches resting on a penny. At left, actual size; above, three times enlarged.

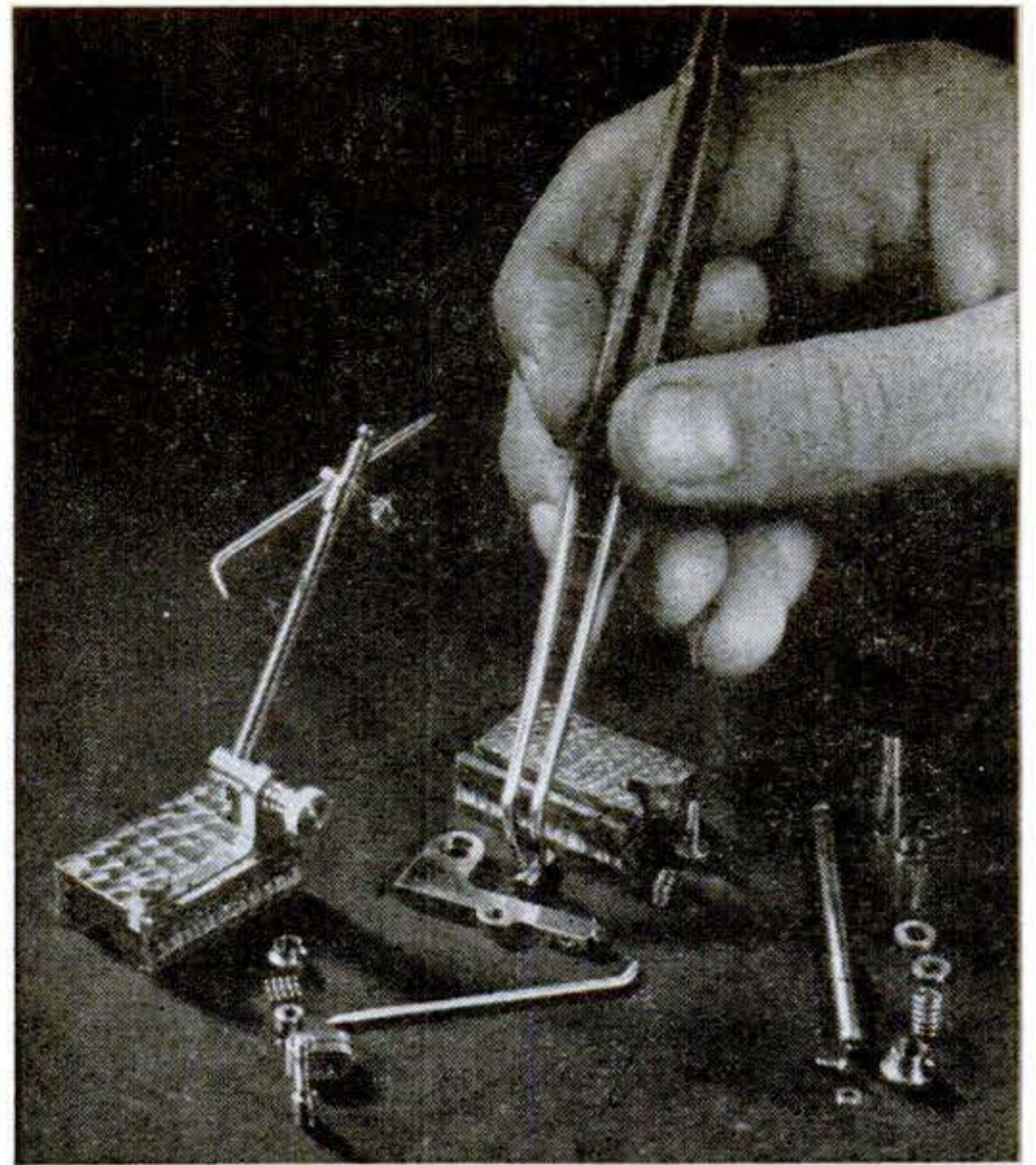

Every part of this model surface gauge works as in the standard tool. The little vise shown holding a paper clip below is only  $2\frac{3}{8}$ " long.

**N**O MATTER how small the finished work is to be, skilled modelmakers pride themselves on faithfulness to detail and scale. A. F. Hofmann, of Ridgewood, N. Y., followed that cardinal rule in making the tiny tools in the photos above and at right, and so did Amy Elizabeth Jensen, of Wausau, Wis., in fashioning the Lilliputian furniture shown below.

Both miniature monkey wrenches have movable jaws. They are models of the same 13" wrench, one at a scale of 1" to 1' and the other at a  $\frac{1}{2}$ " scale. The surface gauge, half the size of the smallest on the market, is reduced exactly to scale in every detail.

Most of the vise was made on a milling machine, but a lathe, of course, was required for the screw. Swiveling on its base, the vise can be locked in any position. It

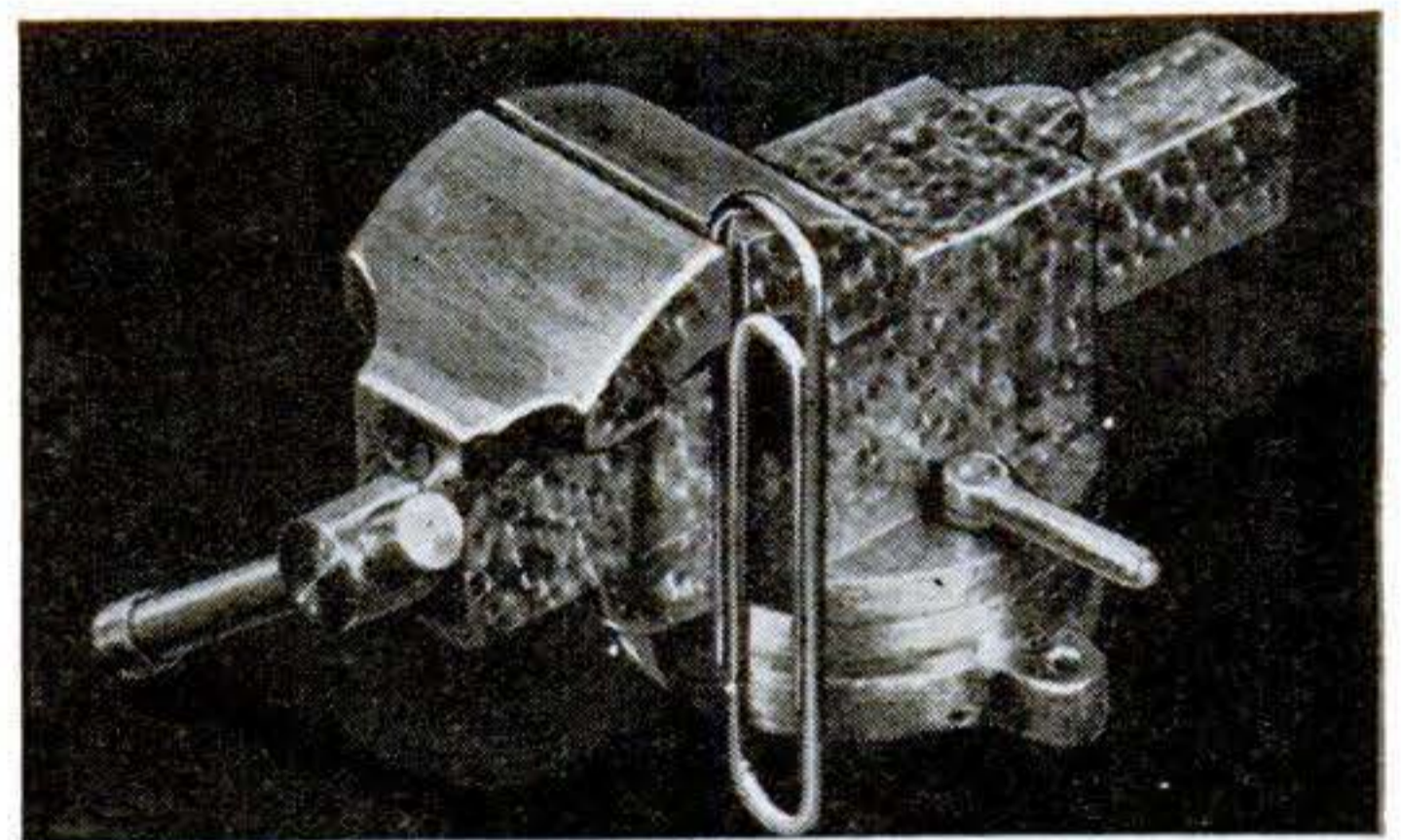

measures only  $2\frac{1}{32}$ " by  $1\frac{3}{16}$ " by  $2\frac{3}{8}$ ".

The model furniture is a size suitable for doll houses. It is made from plywood and other scraps, and the accessories from discarded materials. Though much is copied, the work leaves room for original design.

Model furnishings of doll-house size are faithful copies of antique pieces on a scale of  $1\frac{1}{4}$ " to 1'.

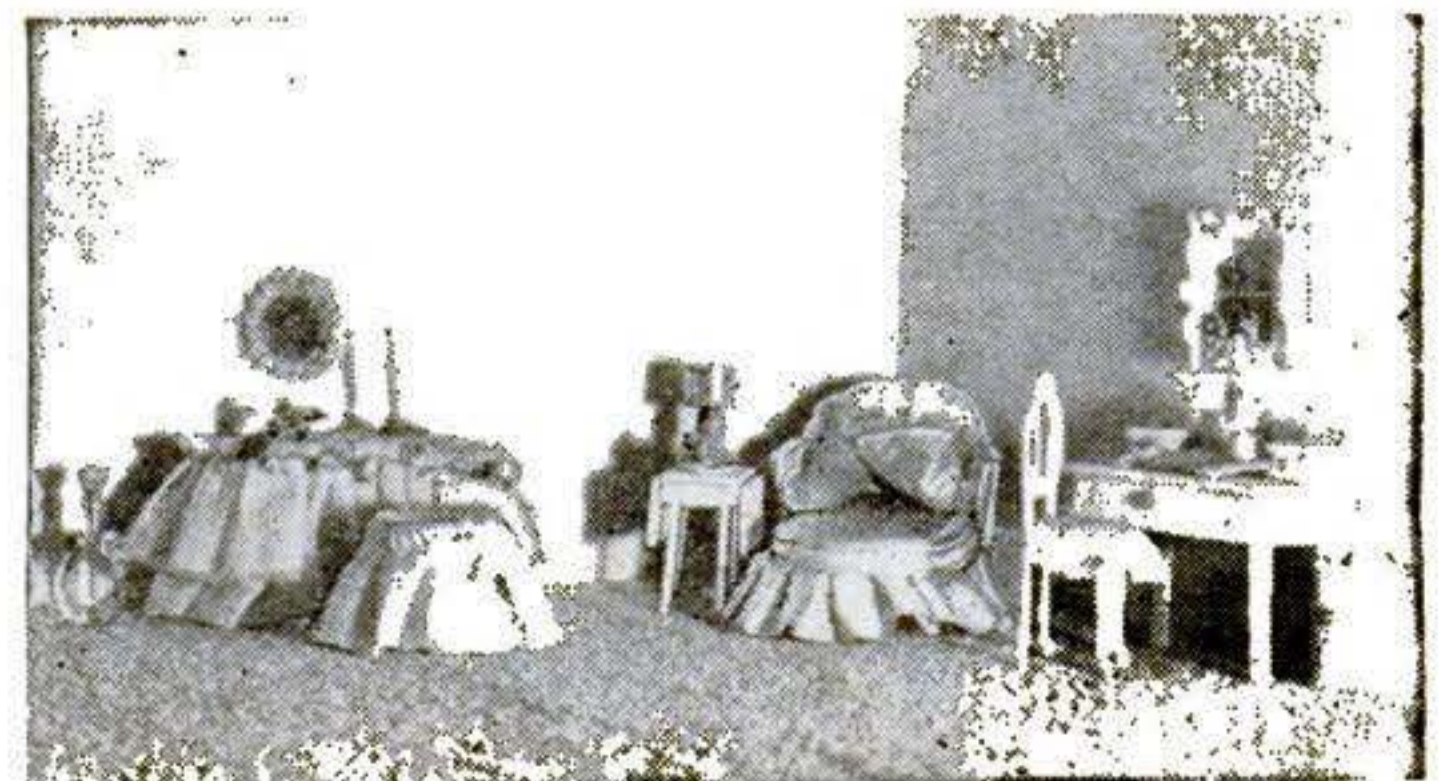
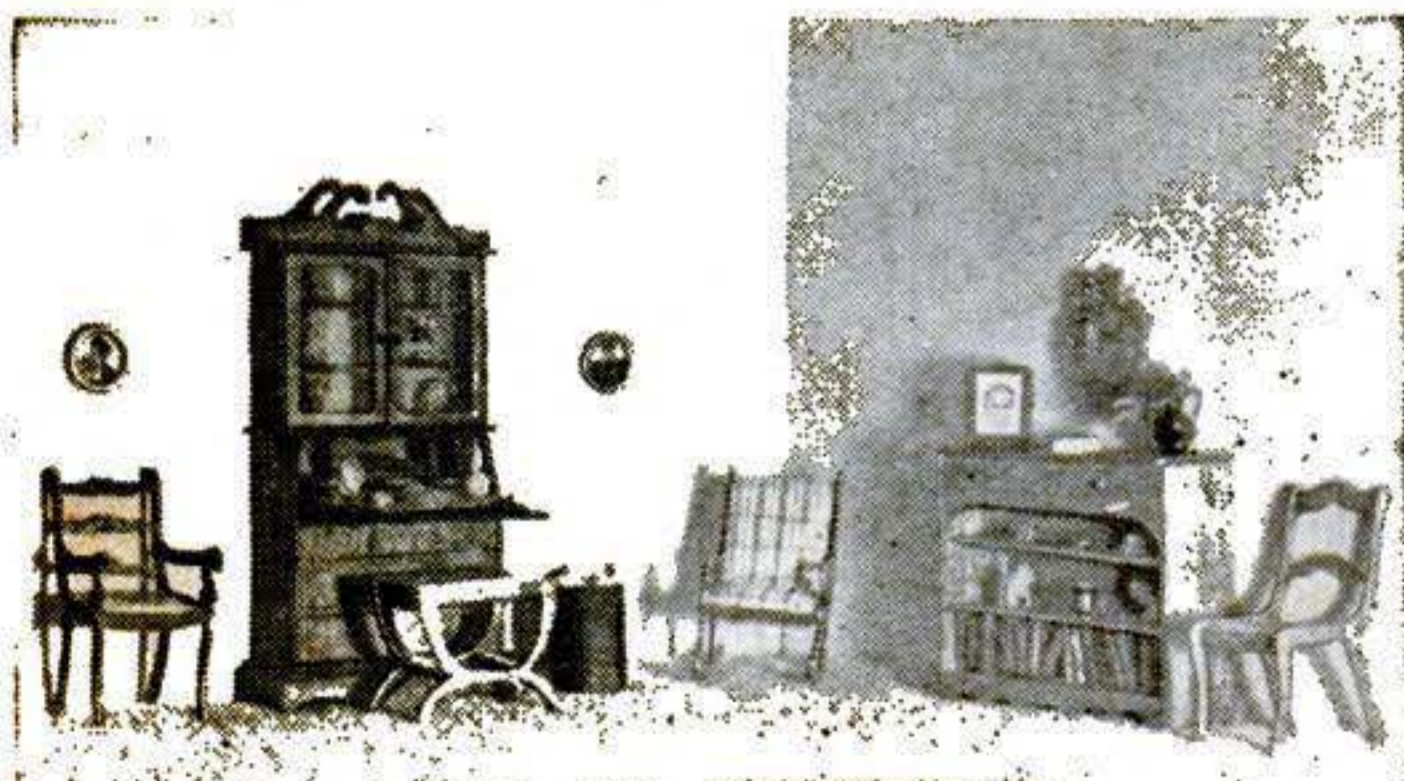



This cabinet conceals a complete assortment of woodworking equipment. Ample bench space is provided by a smooth-surfaced top.

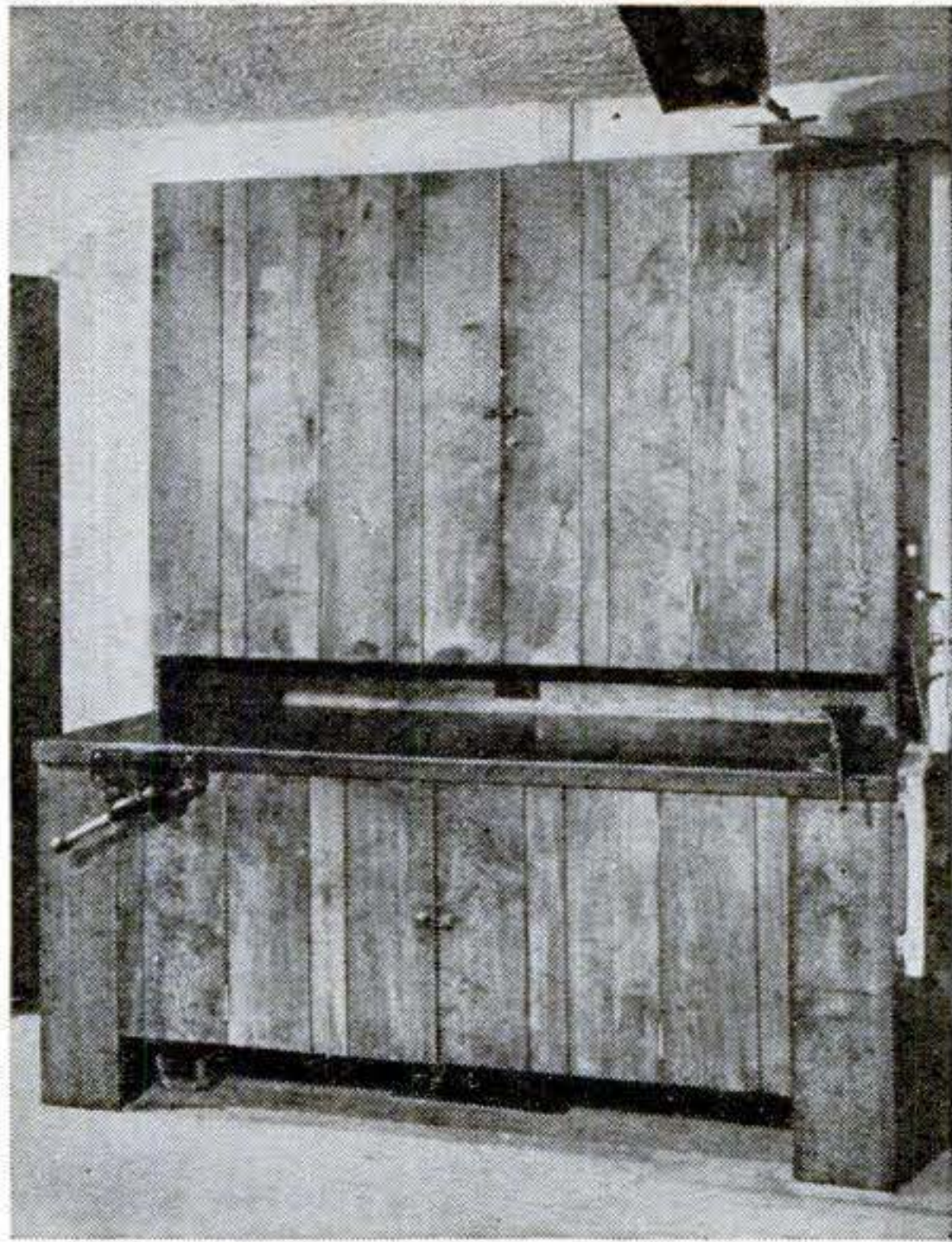

## Workbenches in Dress Suits

**C**RAFTSMEN who object to working in the cellar can move into a rumpus room or even the parlor by concealing workbenches in handsome cabinets and tables. As shown by these samples, such dressed-up benches are not only good looking, but their orderliness simplifies work.

For the compact yet exceptionally roomy cabinet in the photographs above, Sydney Oshrin, of Huntington, N. Y., made a frame of bolted two-by-fours. The workbench top is  $\frac{1}{4}$ " composition board glued on 2" by 10" planks, while other parts are  $\frac{3}{8}$ " pine finished with walnut stain. An organized system of storage adds to convenience. Jars of nails, nuts, and bolts are in front, with saws, electric drill, and other large tools above. The right door holds screwdrivers, chisels, and hammers; the left files, pliers, and bits.

At right, a modern table camouflages the workbench of Parker E. Hart, of New York City. A hinged whitewood cover and plywood sheathing hide working parts scavenged from several old pieces—pedestal drawer sections of an old desk for the sides, a filing cabinet for the center, and a carpenter's workbench top.

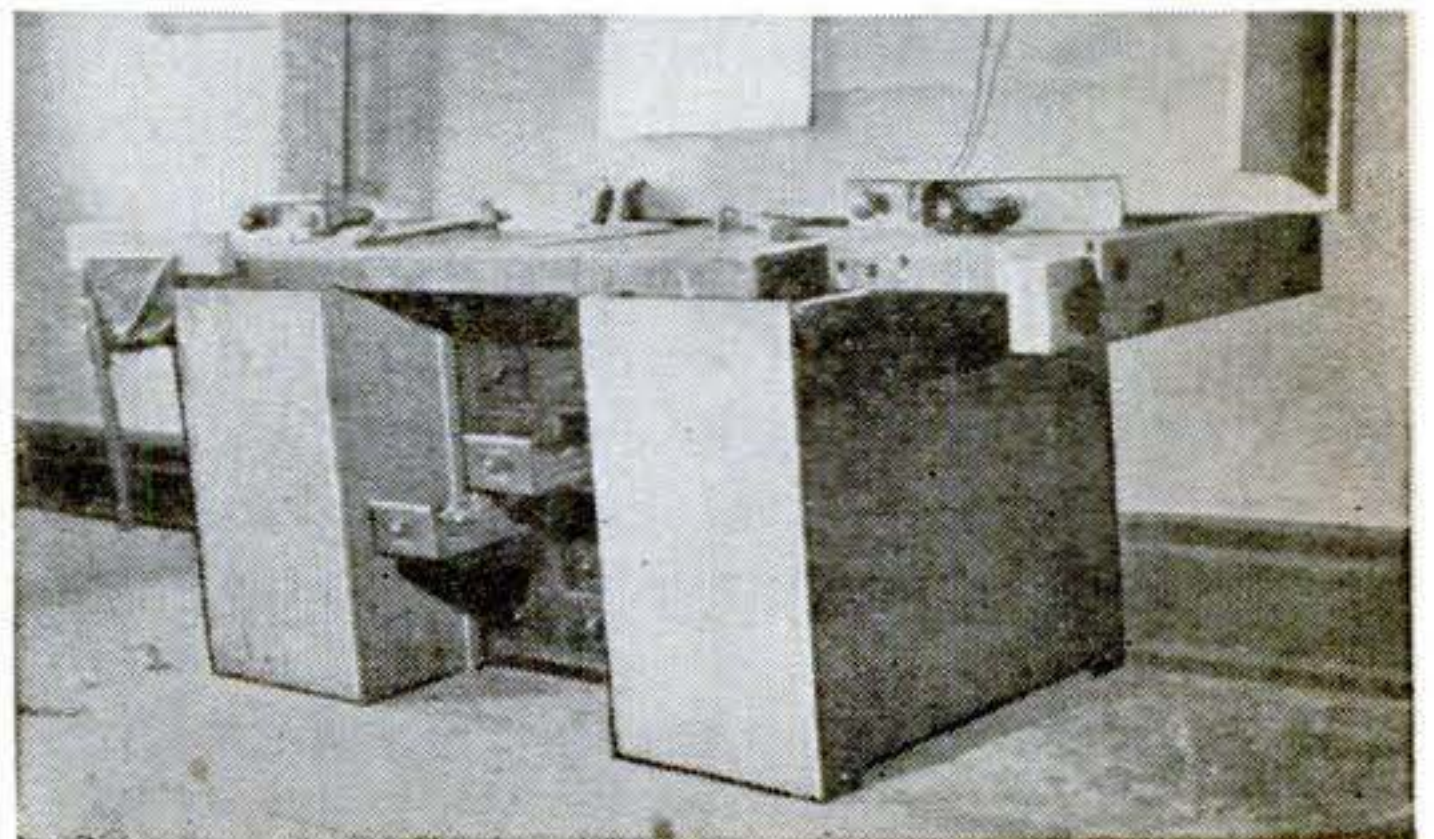

Lowering the hinged cover on the workbench at the right converts it into a living-room table. Even the vise, set in a recess, is entirely hidden.



**CRAFTWORK  
for  
CHRISTMAS**

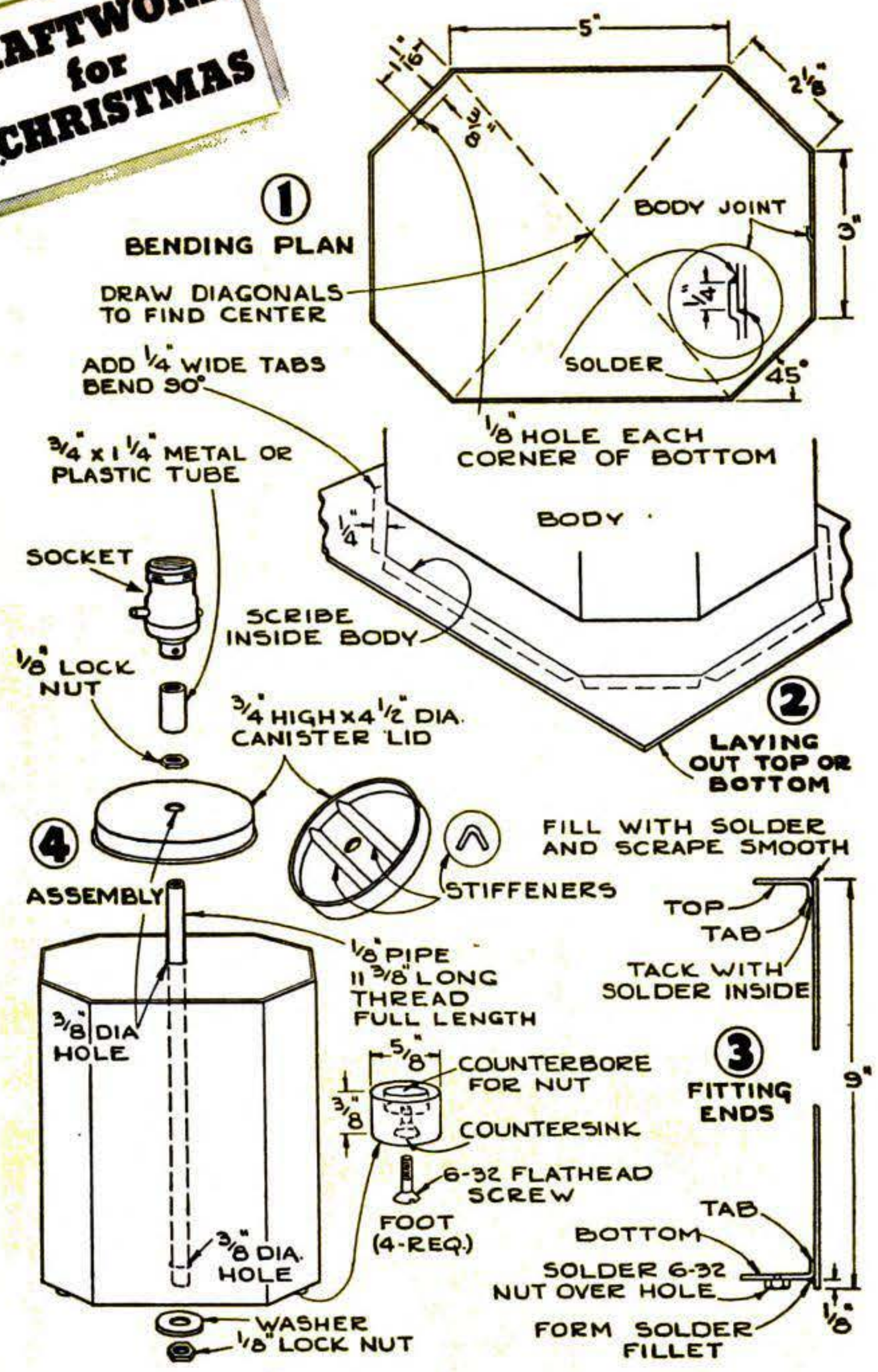
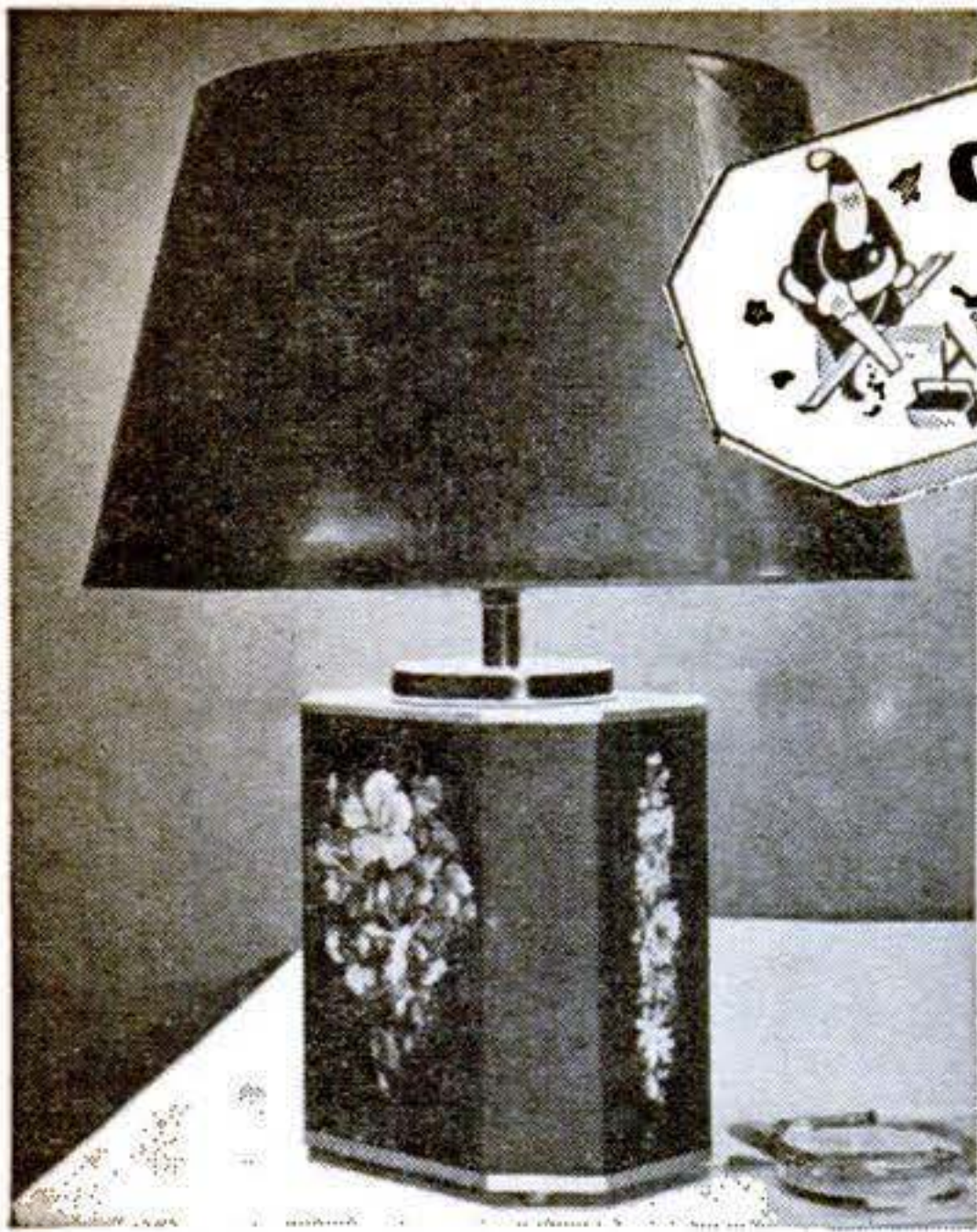

# Painted METAL Lamp

RESEMBLES OLD TÔLE WARE

A PROJECT that lends itself well to decoration with transfers is a sheet-metal lamp. The one shown here and in color on page 117 was made of extra heavy tin plate, enameled, and trimmed with decalcomanias and gilt borders. It resembles the lacquered tôle ware, or painted pewter and sheet iron, that was popular in Holland, Belgium, and France in the eighteenth and nineteenth centuries.

On a 9" by 24 3/4" piece lay out the corner bends called for in Fig. 1. With a bending

brake or by clamping the stock between two iron bars or angle irons, form 45-deg. bends along the scribed lines, taking care to keep them all parallel. The extra 1/4" strip at one end is offset as shown to form a flush joint. Solder inside and outside the seam; then scrape the outside smooth.

Place the eight-sided body so formed on another piece of stock and scribe around inside each end to mark out the top and bottom of the lamp. Do not cut on the scribed lines, but on others drawn 1/4" outside them,



as in Fig. 2. Cut out and bend the tabs thus formed at 90 deg. to fit inside the body. Tack the top with solder from the inside; then fill the joint with solder from the outside and scrape smooth to a sharp 90-deg. angle. The bottom can be soldered only from the outside, so use plenty of solder to form a fillet, as shown in Fig. 3.

Find the center of each end by drawing diagonals and drill a  $\frac{3}{8}$ " hole there. Drill a  $\frac{1}{8}$ " hole midway of each corner panel and  $\frac{3}{8}$ " from the edge in the bottom. Over each of these four holes, solder a 6-32 nut, as in Fig. 3.

Four feet are next cut from  $\frac{3}{8}$ " dowel, and then drilled, countersunk, and counterbored. They are held on by 6-32 flathead bolts.

A lid from a kitchen canister or a press-top can, a small metal bowl, or even a pie tin may be used to distribute the strain over the top. It is best to reinforce this member by soldering V-shaped sheet-metal stiffeners inside as shown in the drawing.

The upper lock nut is turned up against this, a metal or plastic tube slipped over the nut, and the socket threaded tightly against the tube. Then the lamp cord is run through the pipe and out under the bottom. If desired, a double cluster fixture may be mounted instead of a single socket. The lamp can be weighted by pouring sand in through the top hole after inserting the  $\frac{1}{8}$ " pipe in the bottom hole.

For a neat trim to the enameled surface, the edge of the canister lid and the feet may be painted a bright contrasting color. Gilt edging, as on the lamp shown, may be put on cleanly by the use of masking tape. Transfers may be applied to all eight sides or to the four widest panels only. A coat of varnish over all, followed by waxing, will protect the decalcomanias.

If a single lamp is used, the shade can be mounted on a harp screwed on the socket, as in the photos. A brass or plastic finial completes the effect.—HARRY WALTON.

## A Roomy Wooden Pirate's Chest to Hold a Child's Treasures

NEATNESS in putting away toys and the like is an easy habit to teach children if it is made into a game. This pirate's chest, especially if it is fitted with a hasp and a simple padlock a child can work, will appeal as a place to store "treasures."

The chest shown is poplar with a pine top and pine cleats, but any stock on hand will serve. It should be  $\frac{3}{4}$ " thick to make the chest sturdy enough to withstand moving. The chest shown, a good size for the small playroom, is about 15" wide by 30" long and 12" deep.

Put the box together with nailed or screwed butt joints. Wood of full width will save work but may be hard to obtain. Since cleats give sufficient support, narrower boards can merely be jointed with a plane to avoid cracks; but a more workmanlike job will result if the edges are rabbeted or doweled and glued and if glue is also used in the butt joints before nailing.

In matching boards for lid, sides, and bottom, warping can be offset by alternating heart and sap sides. It is also well to put the cleats on with the concave side next to the boards and to nail from the center outward.

Use small-headed nails or screws, covering them with upholstery tacks driven in close by for a studded effect. Apply a decal and finish with varnish and wax.—ELMA WALTNER.

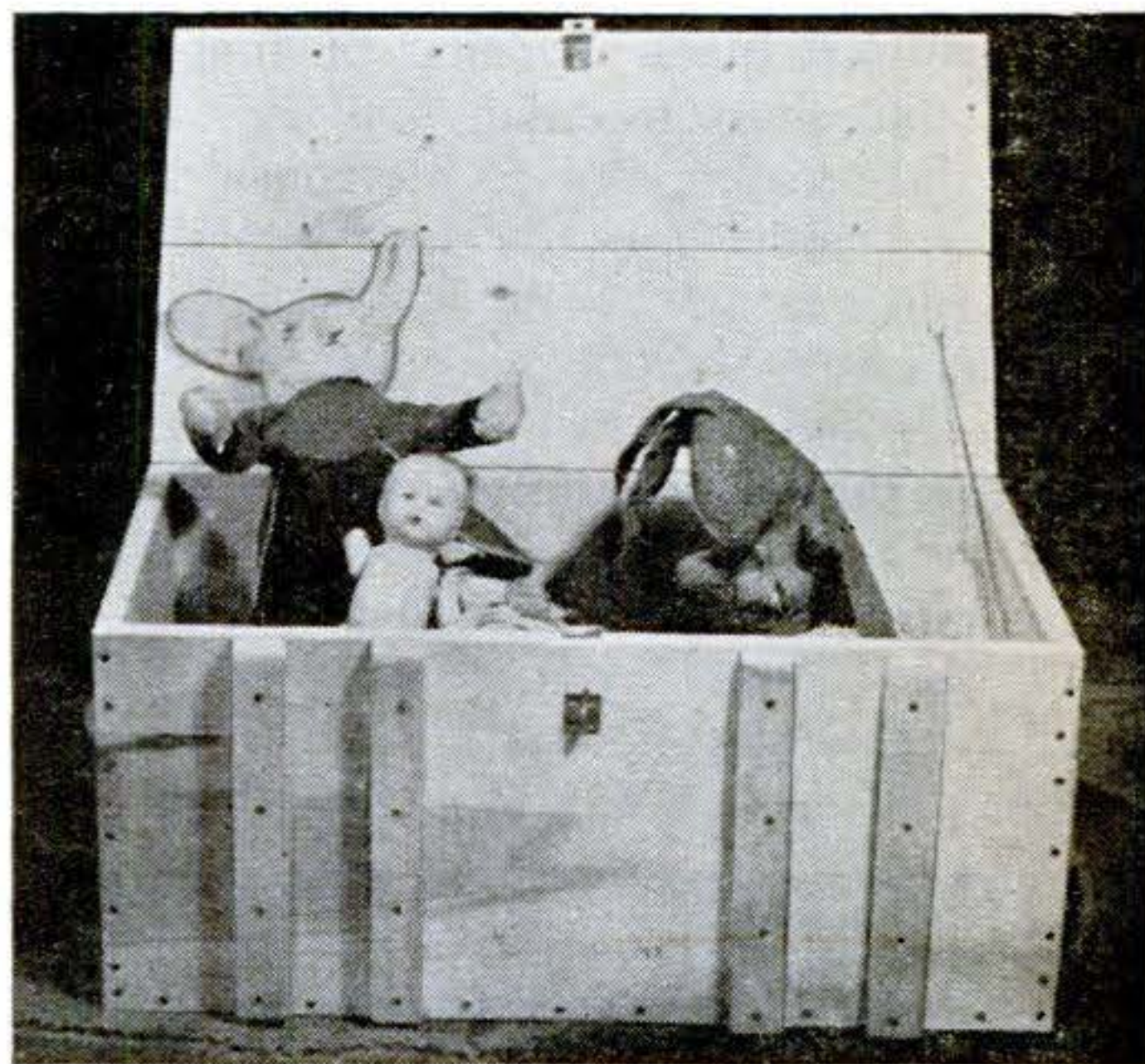



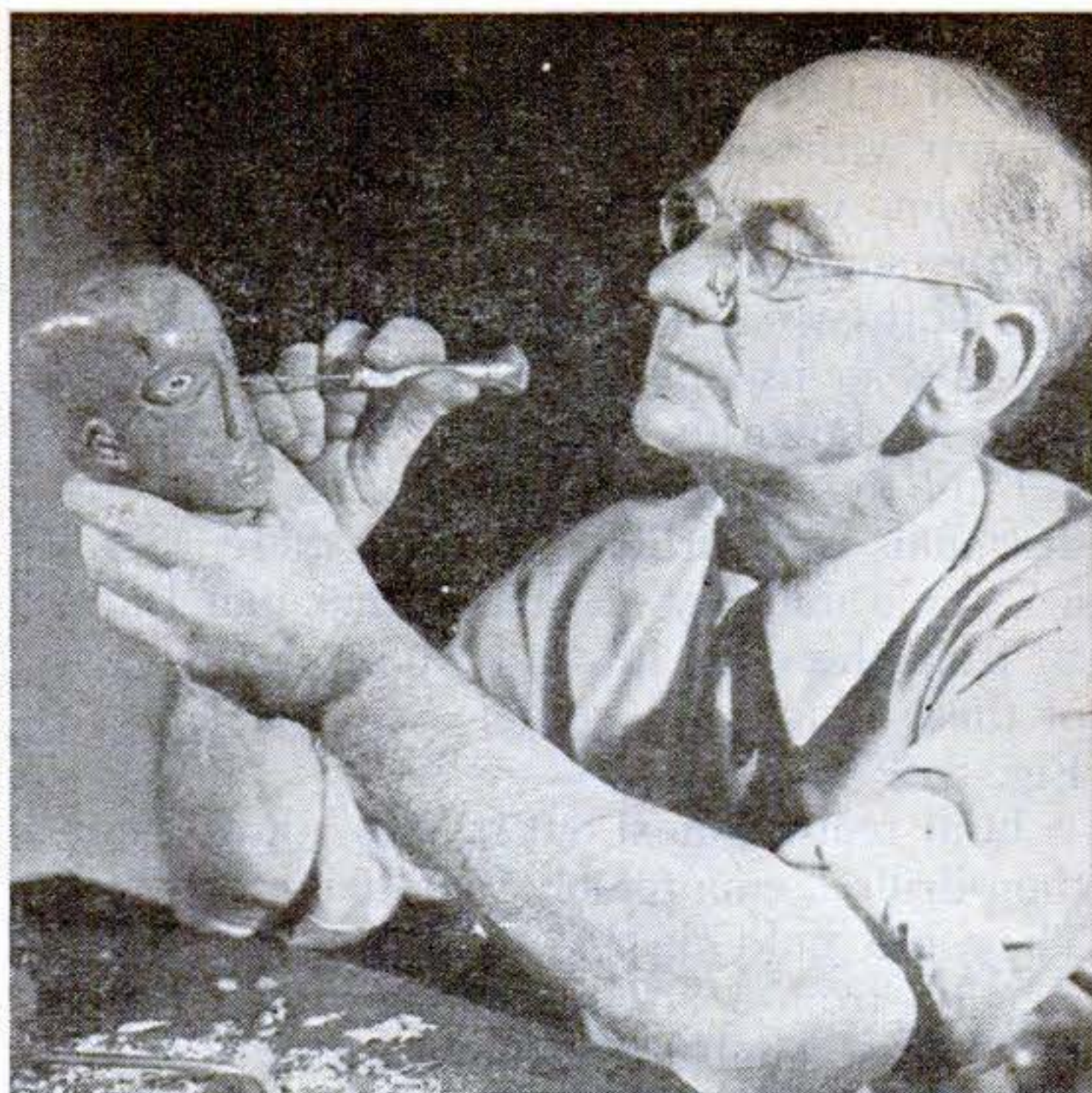

Carving these primitive heads is the avocation of Leo Whelan, repair-shop foreman for the Tucson, Ariz., bus system. At right he uses a small auger for shaping the deep undercut around the eyes.

## Wood Sculpture with a Penknife

**L**EO WHELAN just likes to carve these distorted faces. During business hours he's repair-shop foreman for the Tucson, Ariz., bus system, but in his spare time he whittles primitive heads and animals from wood blocks.

Whelan's free-hour work is art for art's sake. He sells none of it. Most of the figures are purely decorative, although he has made a few functional pieces, such as a lapel pin with a painted African face, and

a penholder in the form of a small deer.

No complicated tools are required. Whelan uses a lathe to turn the preliminary rough cuts on a head, and then finishes with knives. In addition to two pocketknives, he employs a special, extra-sharp knife ground from a file, which holds its cutting edge longer than most tools. A small auger held in a pin vise provides special effects like the grooves around the eyes of the heads, and a coping saw cuts the flat surfaces on the

Whelan uses a lathe to turn the rough outlines of his figures; then he finishes the work with knives. Final touches are applied with a tool he made himself, a razor-sharp knife that was ground from a file.







A coping saw cuts the flat surfaces on the miniature animals. The cigarette is shown for size comparison.

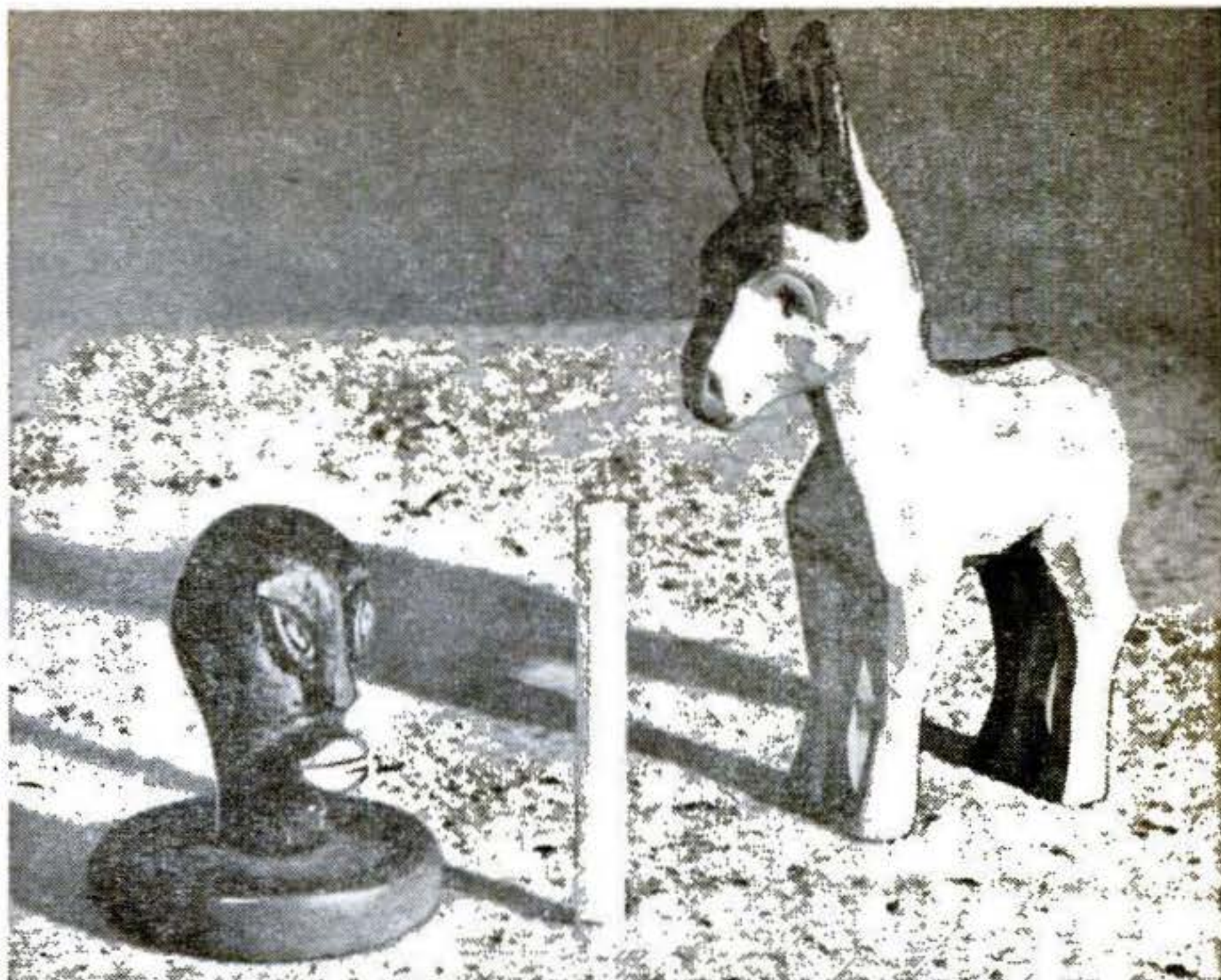

little dogs, donkeys, and other animals.

Almost any type of wood furnishes the raw material for the small figures. Whelan has carved mahogany, redwood, soft pine, desert mesquite, and ironwood. For finish-

ing, paint and varnish are used. The time required to produce a head varies with the size and intricacy; a lapel pin can be made in three hours, while one of the large heads might take 25.

## Scale-Model Steam Engines Can Pull Loads as Heavy as One Ton

ACCURATE scale models that really work come from the basement workshop of John Matthews, Chicago plumber. Specializing in steam engines, he has built miniature replicas of a Hudson locomotive, an Atlantic passenger locomotive, and an early mine pump by James Watt, as well as the "Pug"

quarry engine and the Stephenson's Rocket shown in the photographs below. Matthews spent 2,000 hours making the Hudson, which is 6' long and weighs 200 lb. It can pull a one-ton load. The 4' long "Atlantic" races along its small tracks under 250-lb. boiler pressure. Matthews works from the original shop blueprints and makes all parts himself.

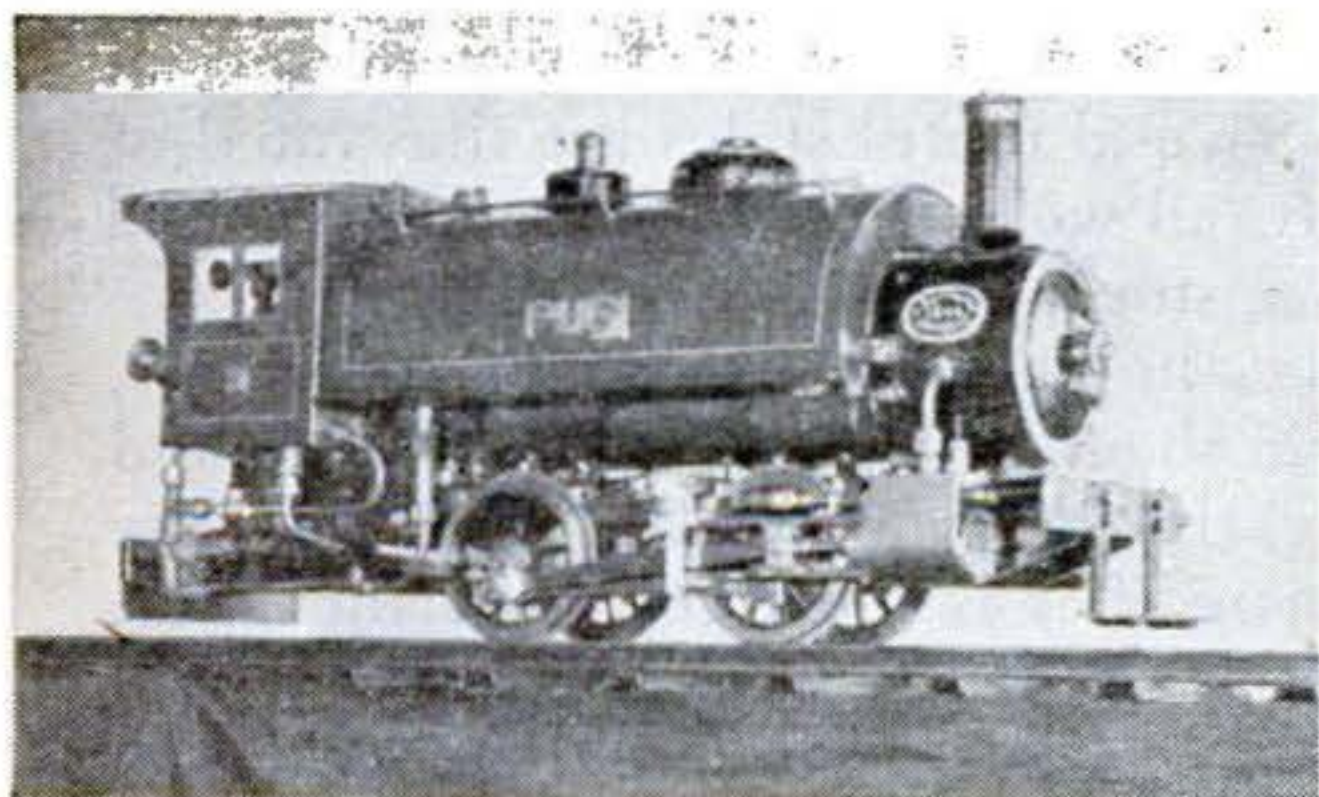

This "Pug" locomotive, scaled  $\frac{1}{4}$ " equals 1', is a type frequently used in quarries. John Matthews made all parts for the working model himself.

In 1829 the original of the model at right was the latest thing on wheels. A reproduction of George Stephenson's first locomotive, the Rocket, it runs under its own steam.

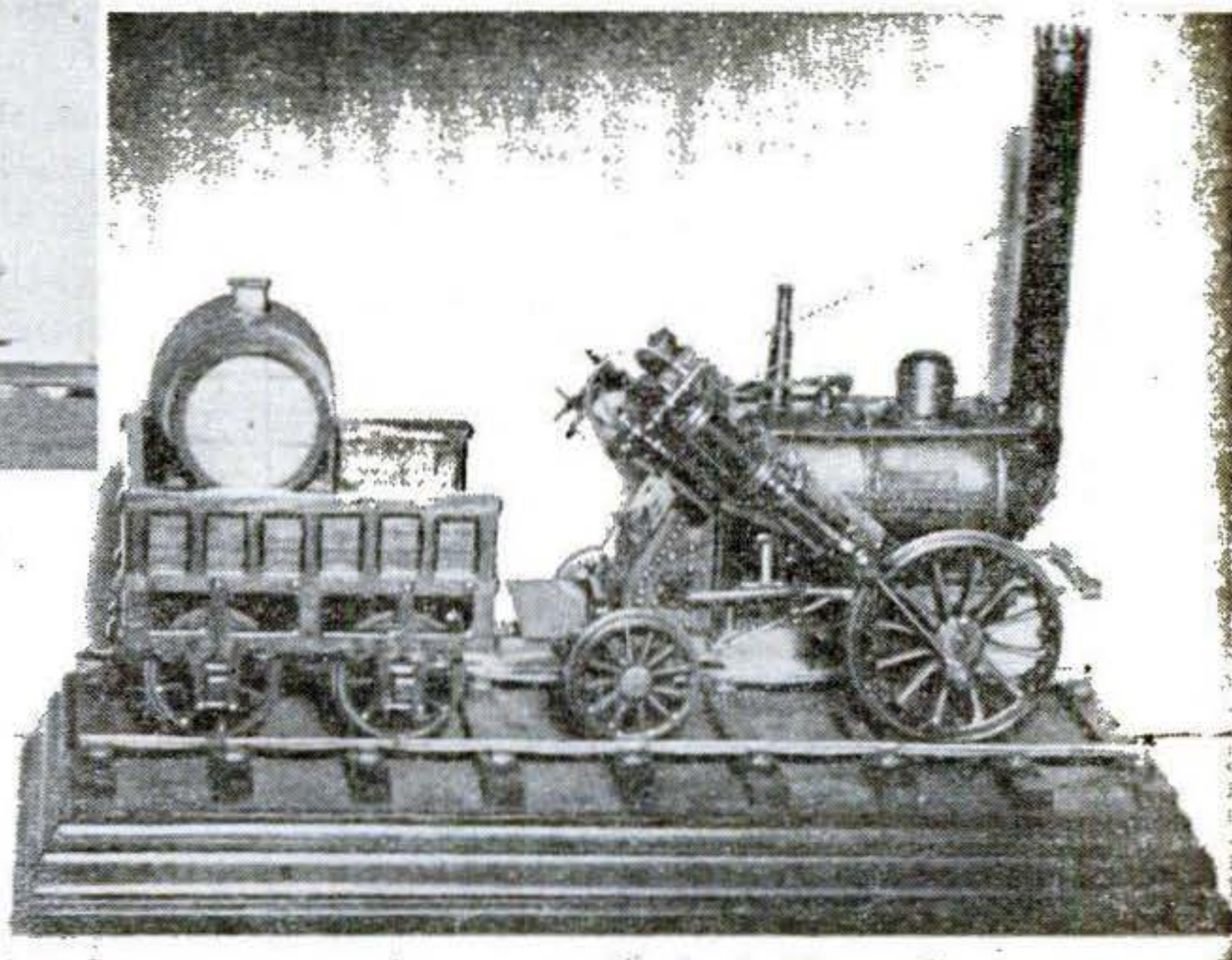



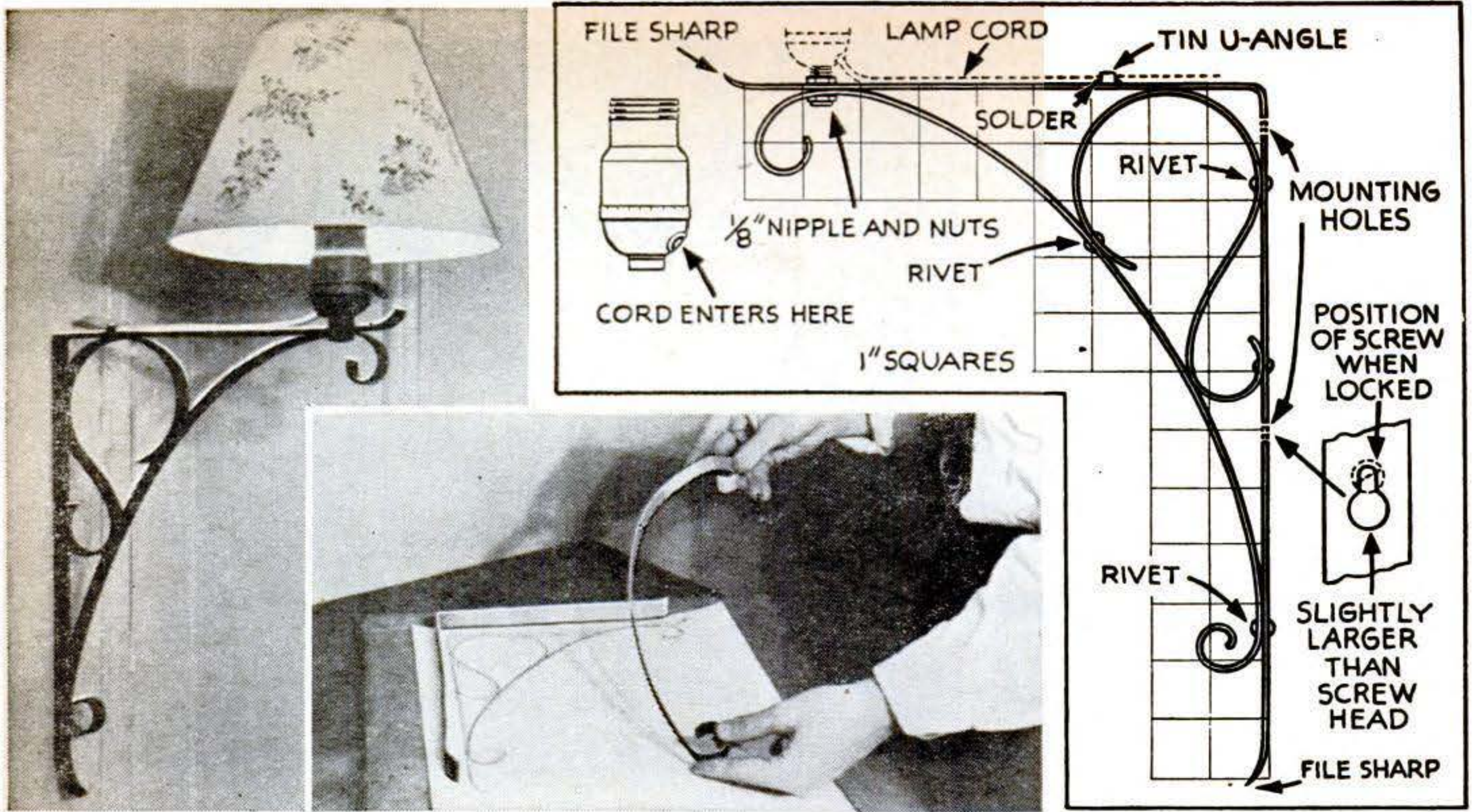

## Pin-up Lamp of Wrought Iron Will Brighten Any Dark Corner

Just the thing for a dark corner or over a favorite chair, this lamp was made of  $\frac{3}{8}$ " strap iron, the S-brace being hammered around a piece of pipe and the other parts shaped over a full-size layout.

The upper ends of the two main members were bored to take a  $\frac{1}{8}$ " nipple for the key

socket, and two thin nuts placed on the nipple clamp these parts of the bracket together. Mounting holes were bored large enough to slip over the heads of the screws to be used, and slots were then filed upward to accommodate the screw shanks. A coat of black finishes the project.

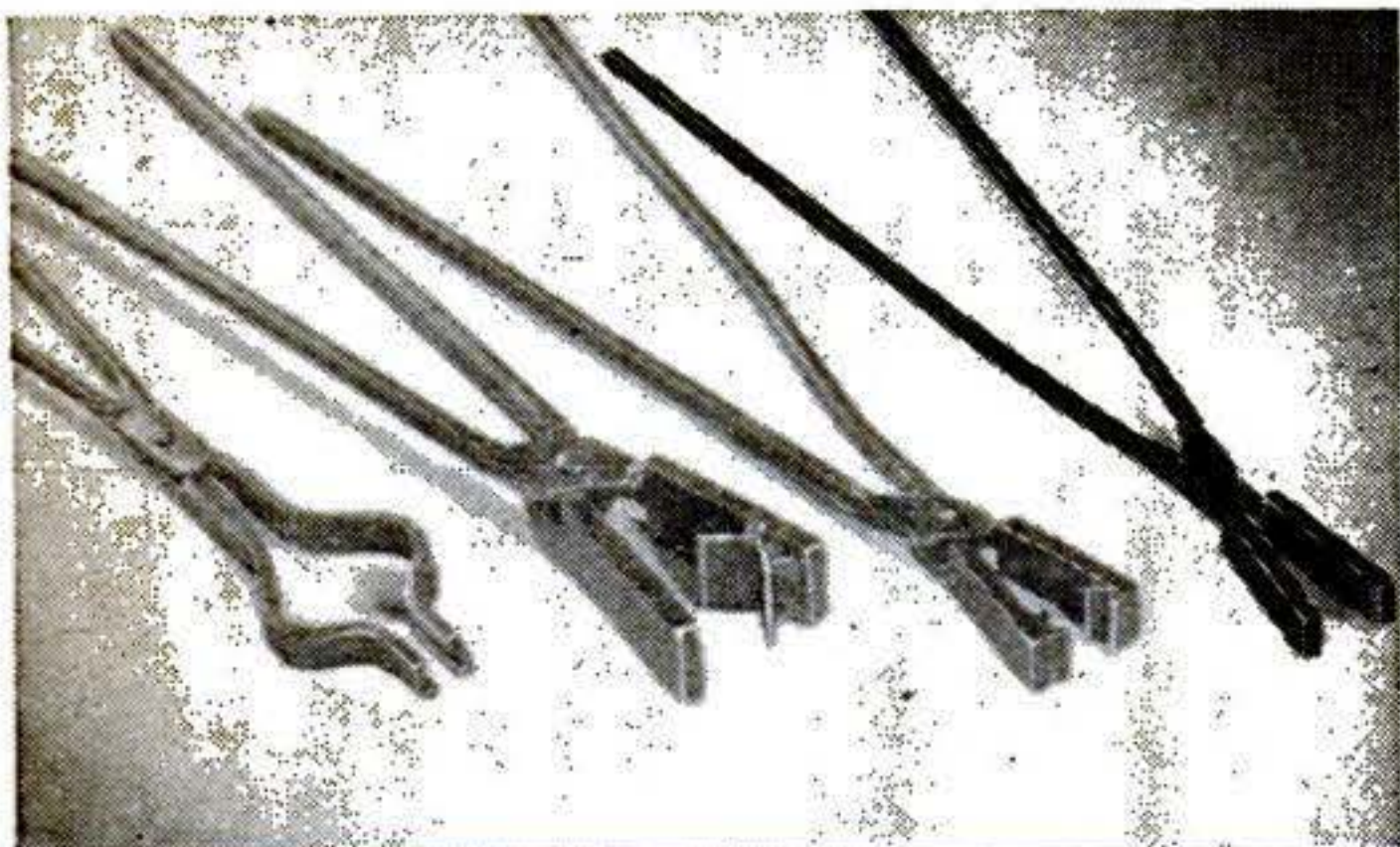

## Forge Tongs Welded to Order

STANDARD forge tongs will pull most of your chestnuts out of the fire, but if your forging problem is one that requires extra safety or extra efficiency, it may be well worth your while to weld a pair of tongs with exactly the right grip for your special work. Several useful styles are illustrated at the left, all welded up from standard round and bar stock.

Make the halves of the tongs separately, and join them with a rivet. The hole should be slightly larger than the rivet for easy operation; if it is too tight, heat the tongs to a bright red and work the jaws up and down to loosen. Before welding, grind all butting edges so that they form a "V" when placed together and allow plenty of surface for the weld metal to form a sturdy joint. A piece of angle iron welded into the jaw will hold various sizes of round stock; halves of pipe are useful for a single round-stock size. The recessed semicircle in the jaw makes the tongs suitable for either round or flat stock.—JERRY POKORNY.

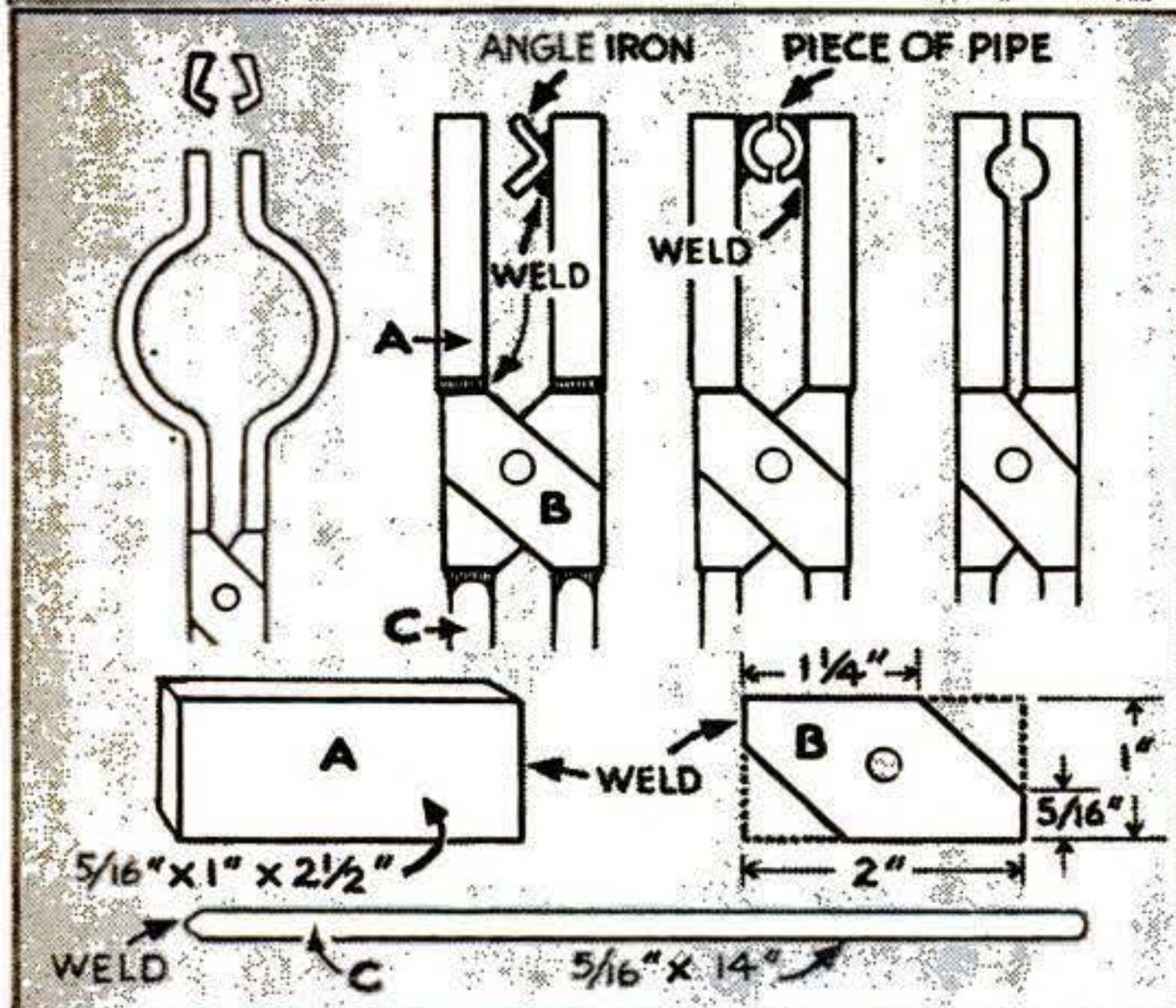



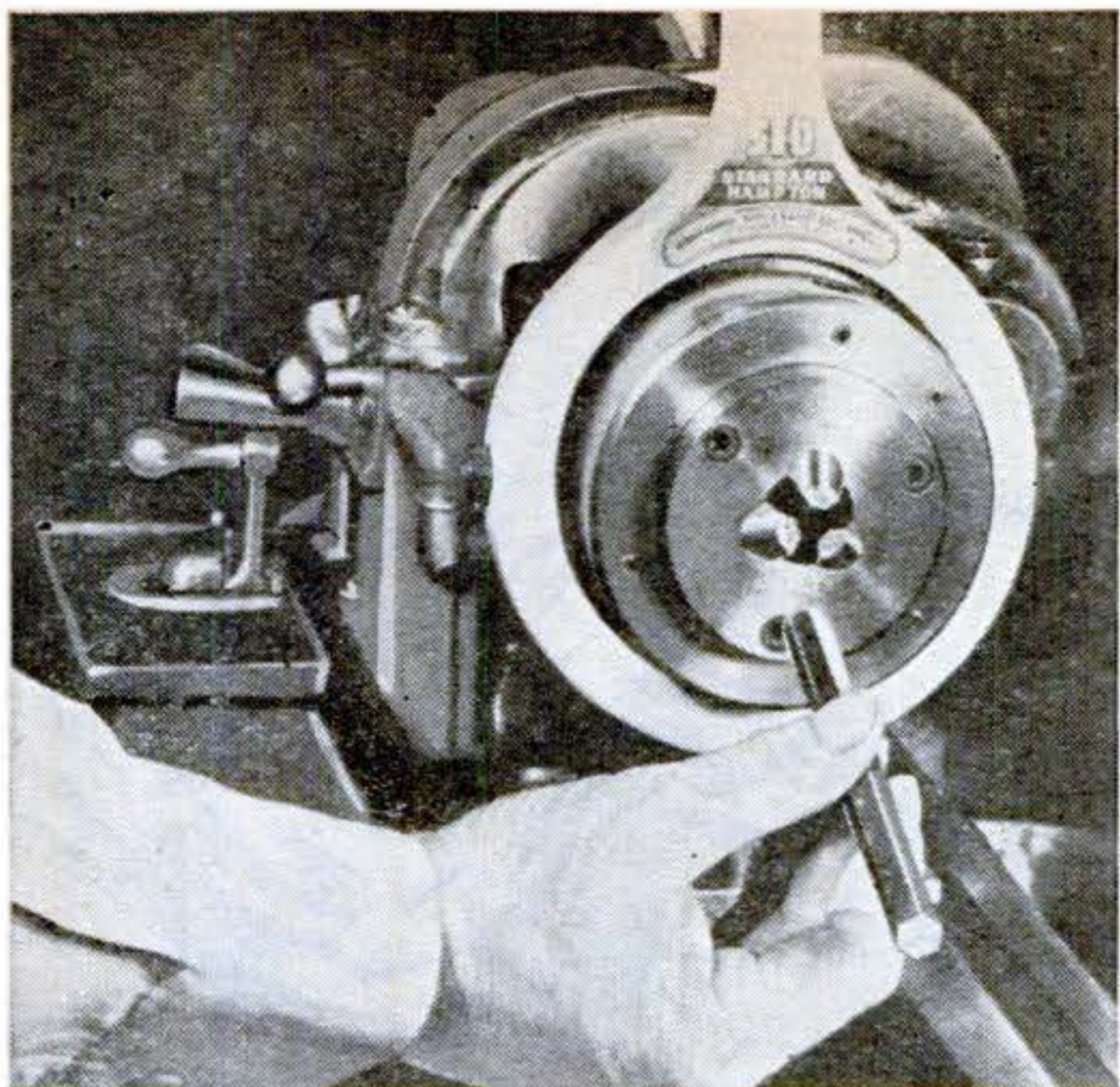

**A HIGH-SPEED CHUCK** designed to increase production and lower costs on short-run shop work can be opened and closed without stopping motor or spindle. The chuck is said to compensate for spindle run-out, and it adjusts for close-tolerance concentric or eccentric turning operations. Quickly installed spacer and stop accessories are available for the "Standard-Hampton Speed Chuck," says its maker, the Standard Tool and Gage Co., of Cleveland.

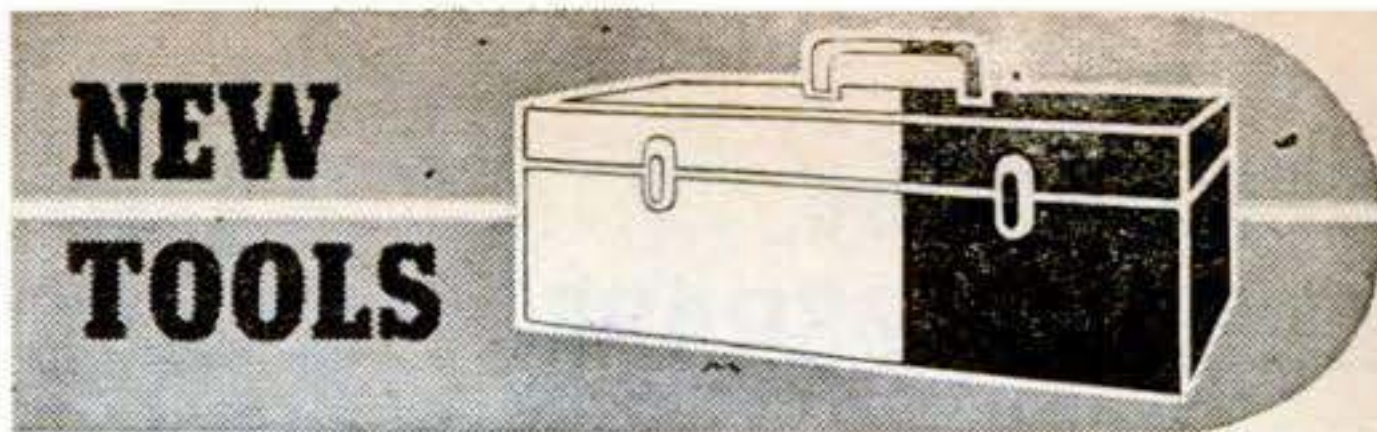

**MULTIPURPOSE TOOLS** that carry an assortment of interchangeable bits in their hollow plastic handles are being made for shop, home, and farm use. Bits adapting the different tools to socket-screw, socket-wrench, or auto work as well as general home repairs snap over a swivel mount that reaches hidden parts. Standard Pressed Steel Co., Jenkintown, Pa., is the maker.

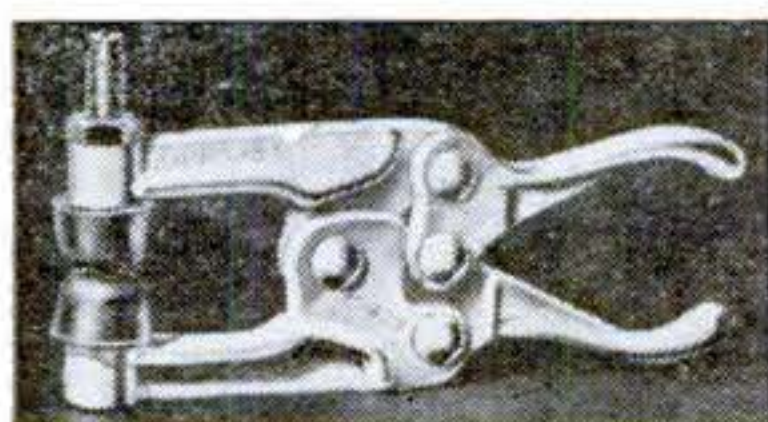
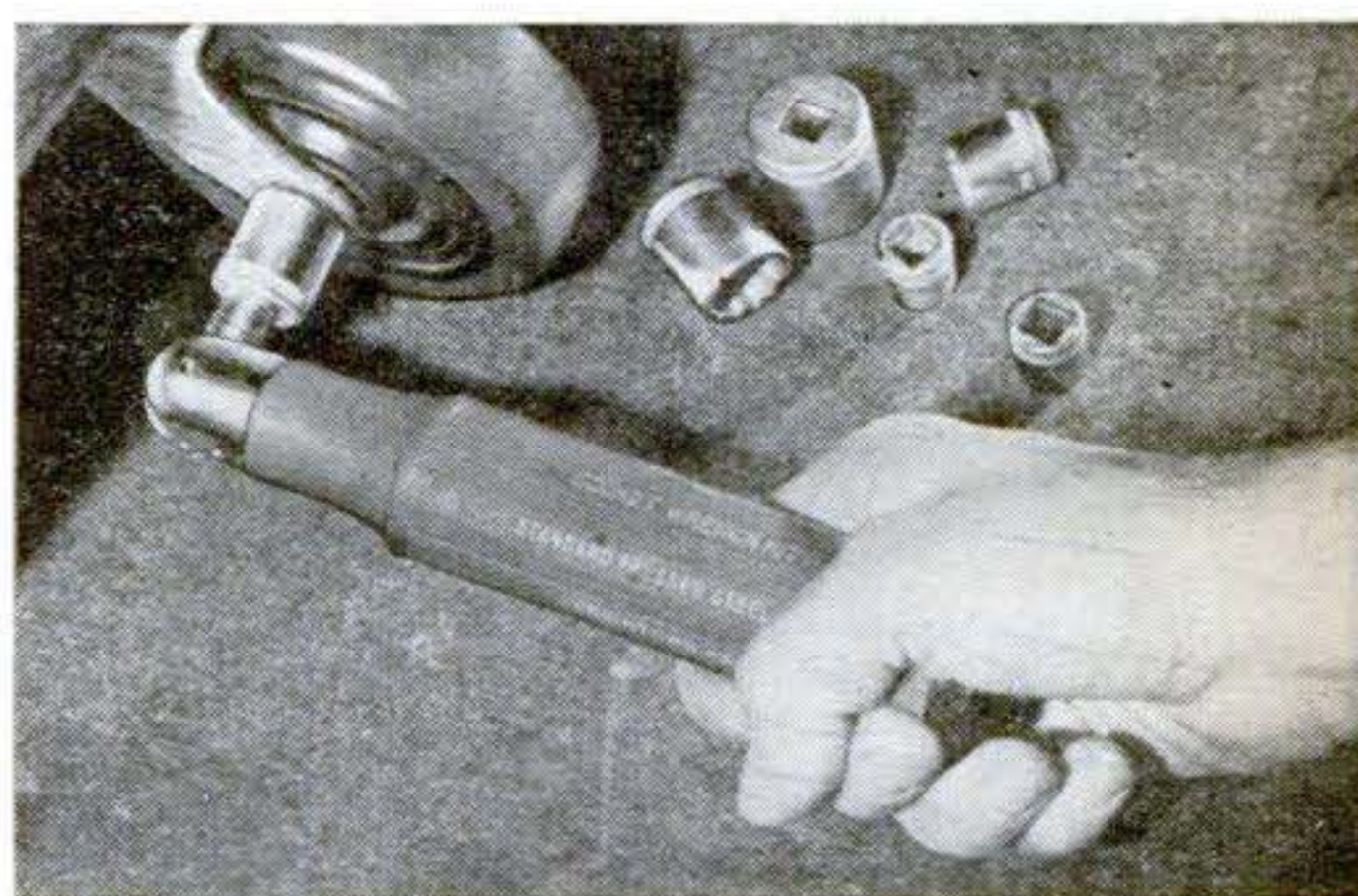

**TOGGLE PLIERS** that multiply a 40-lb. pressure on the handles to 400 lb. on the work have been developed to hold small parts for welding, drilling, and the like in cramped spaces. Rubber-capped pressure pads prevent depression marks on soft metal pieces. The manufacturer is Knu-Vise, Inc., of Detroit.

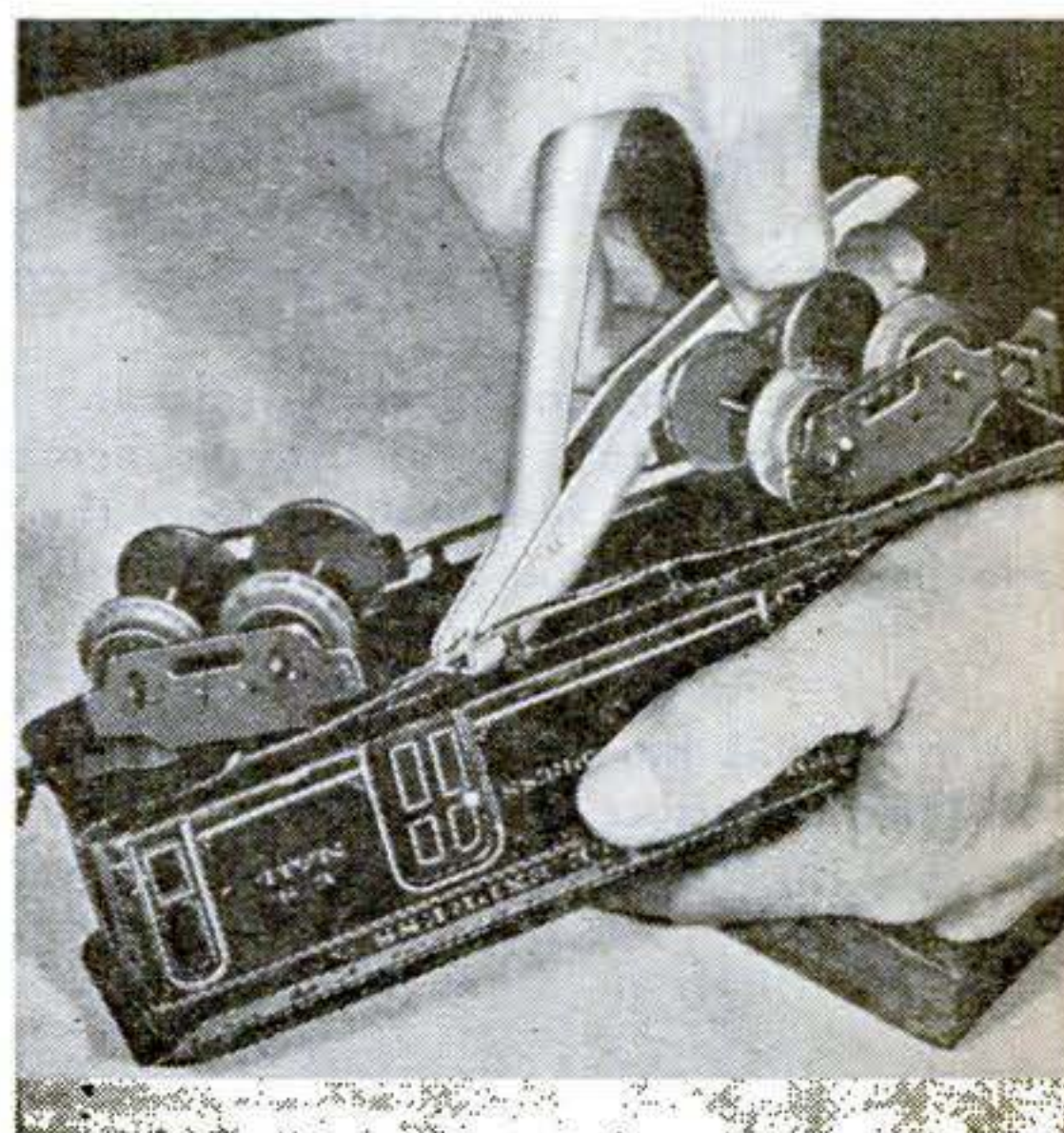

**RIVETED FASTENINGS** can be used on models and other small shop work easily and quickly with a new lightweight riveting gun of the type used in airplane construction. A one-hand plierlike tool that installs blind  $3/32$ " rivets with a simple pull, it is made by Cherry Rivet Co., of Los Angeles.

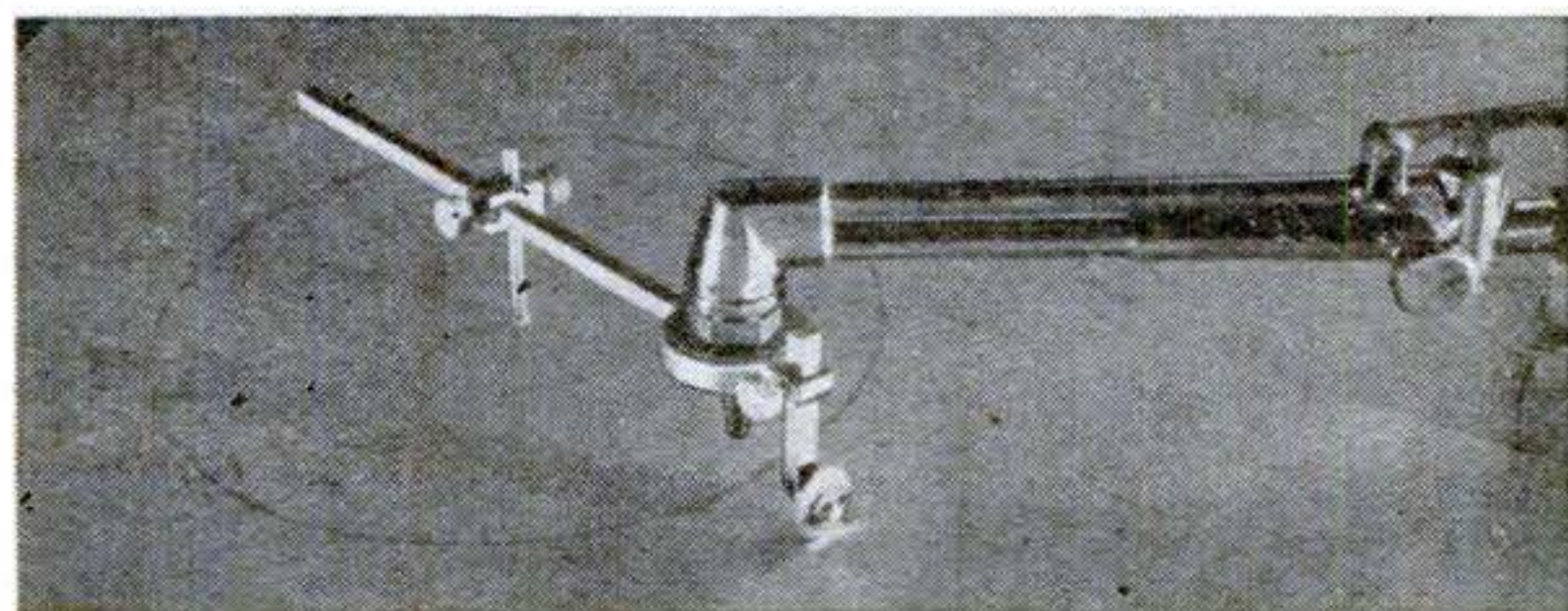

**PERFECT CIRCLES ARE CUT** from boiler plate or heavy sheet metal with the help of a new adapter for flame-cutting torches. A square radius bar swings the torch jet around on a tracking wheel. The Scientific Research Co., Portland Ore., makes it.



## KEEPING the HOME SHIPSHAPE



In many hammer-and-saw jobs around the house or shop, it is unnecessary to conceal nail or screw heads on the face of the work. Even such projects, however, can profit from the regular spacing of screws or nails that is the mark of good craftsmanship. A thin strip of scrap wood, notched evenly along one edge, will assure this uniform spacing.

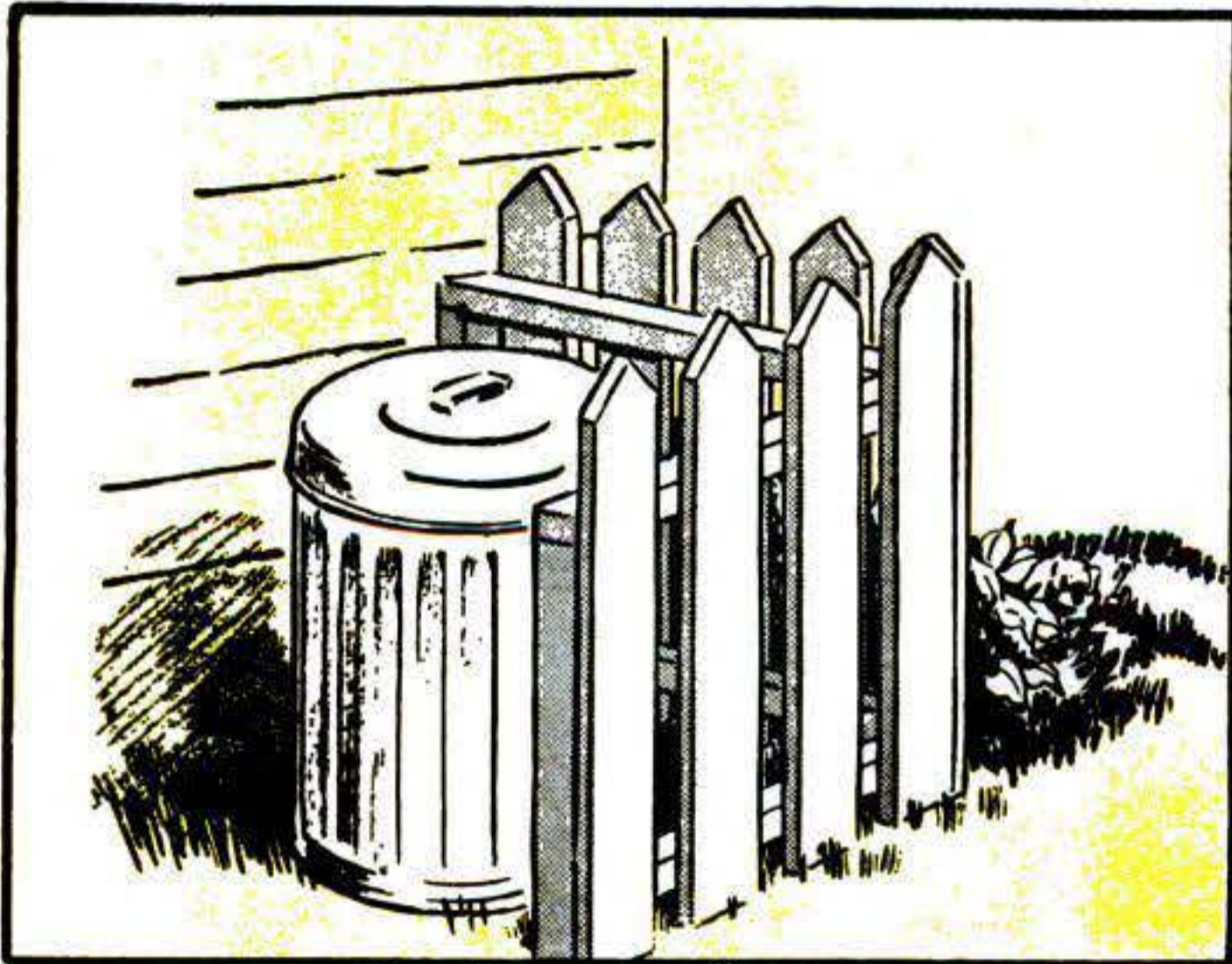

Garbage or ash cans left outside the house for collection tend to mar the appearance of a yard. A small L-shaped fence will conceal the can while leaving it accessible for filling and emptying.

Before sweeping up a dusty workshop, pour some oil-type furniture polish into the heel of the broom. The liquid will tend to damp the sweepings and help prevent the agitated dust from rising and resettling in other parts of the workroom.

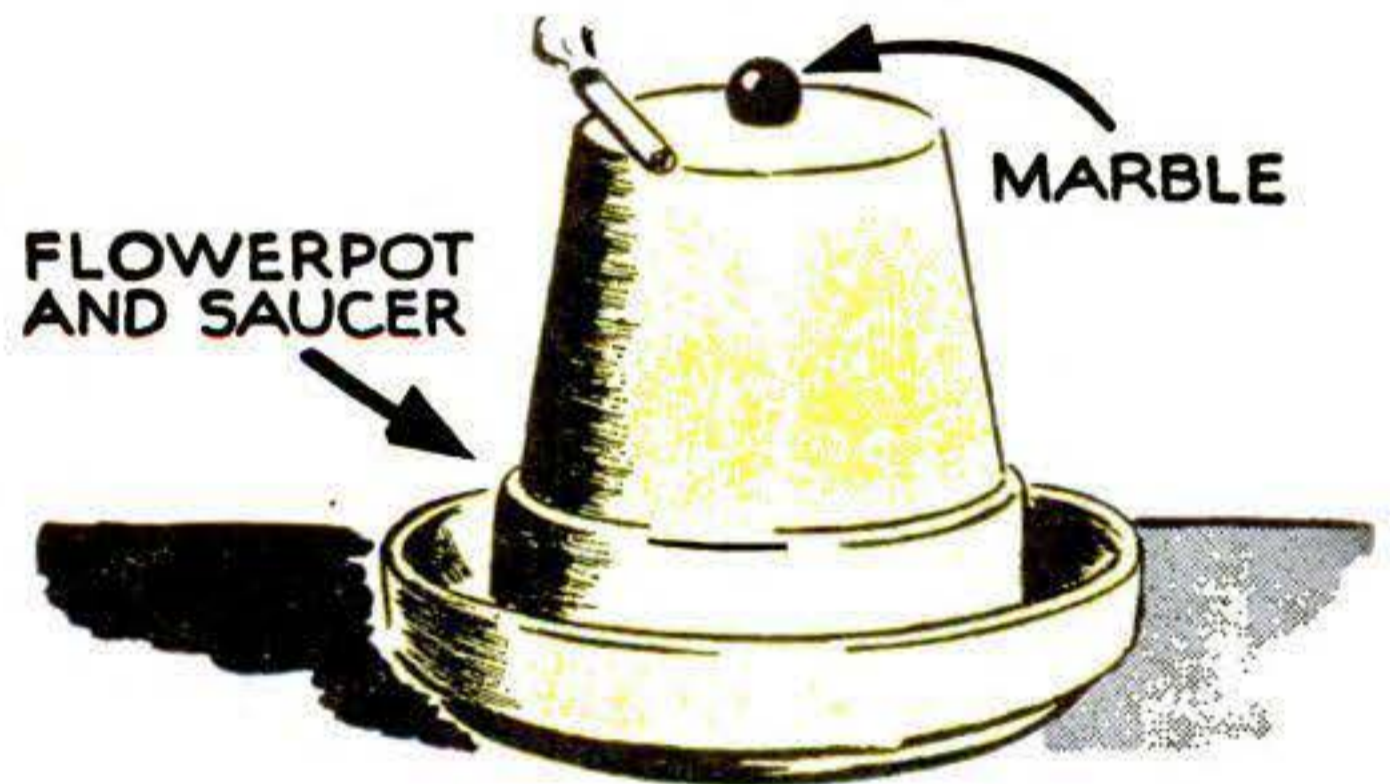

A fireproof smoking set for the workbench can be assembled from a flowerpot, saucer, and marble. Lighted stubs dropped into the pot are quickly extinguished by placing the marble over the hole.

When hanging rugs out for beating or airing, use trouser hangers in place of clothespins as shown below. The hangers can't split on the bulky fabric and they will provide a firm grip without pinching the cloth or pressing down the nap of the rug.

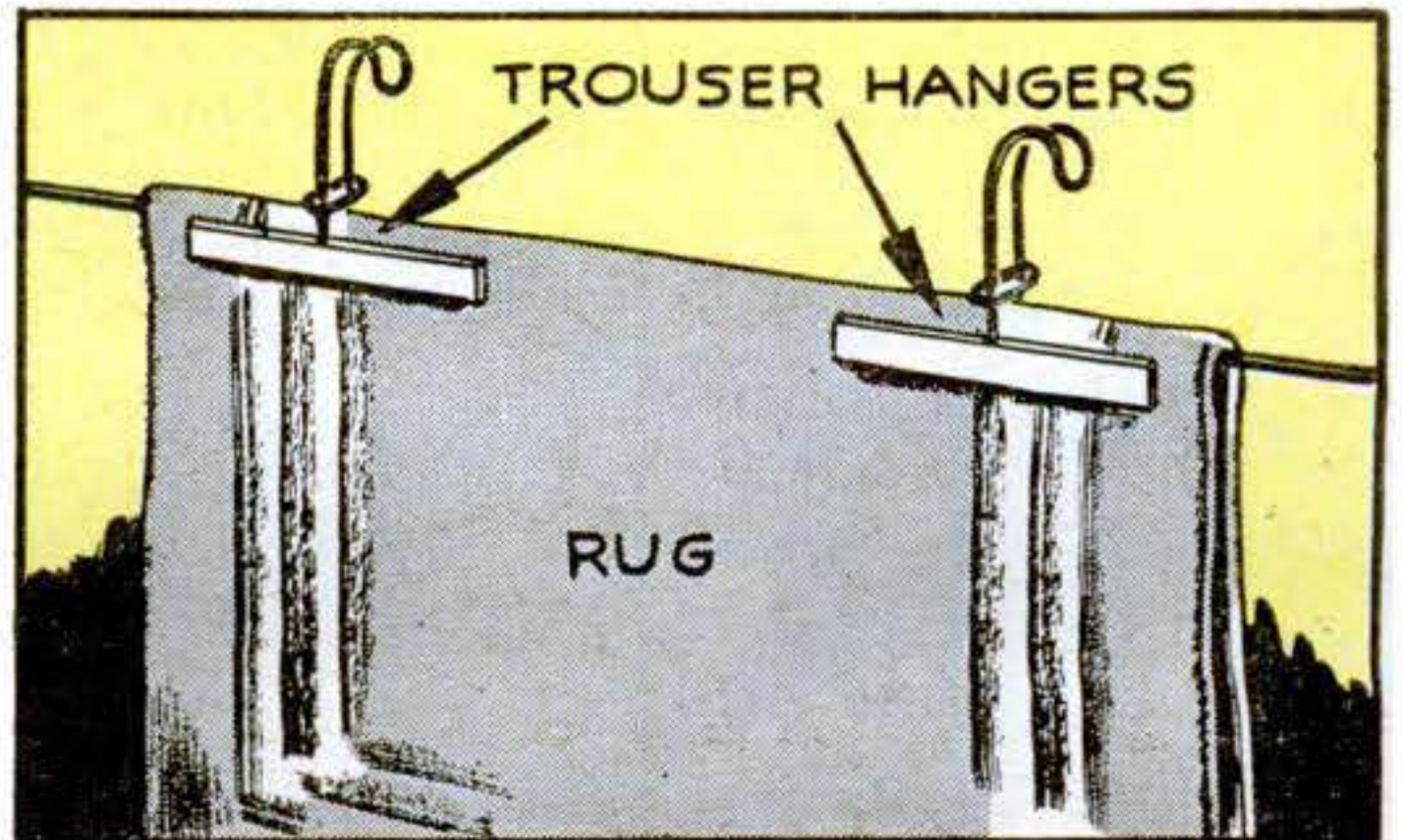



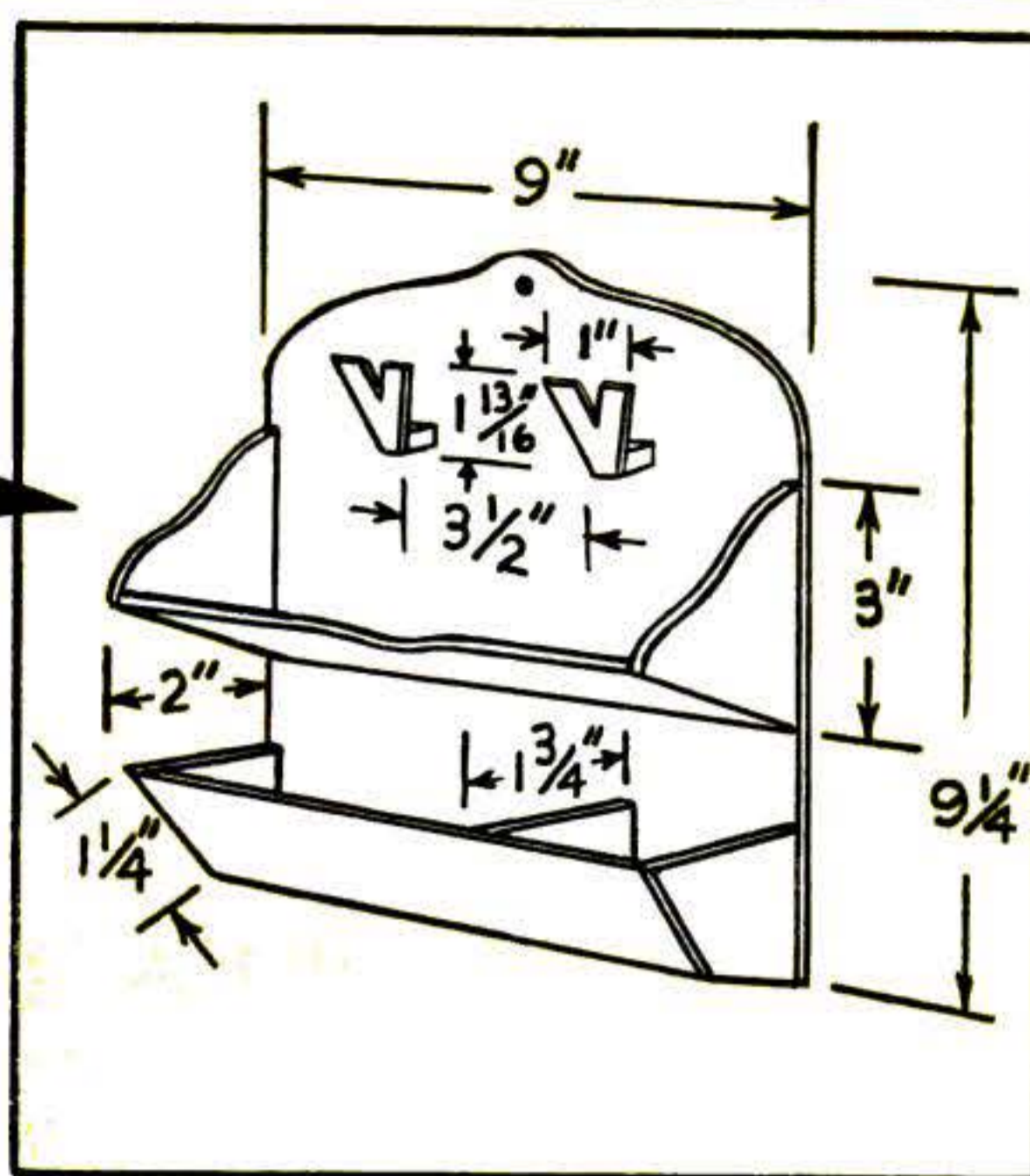

Unclutter your bathroom shelves with a hair-do rack that will have a place for a comb, brush, hairpins, and barrettes. Make the rack of plastic or thin wood. The upper trough holds the brush, the lower is divided to separate pins and clips.

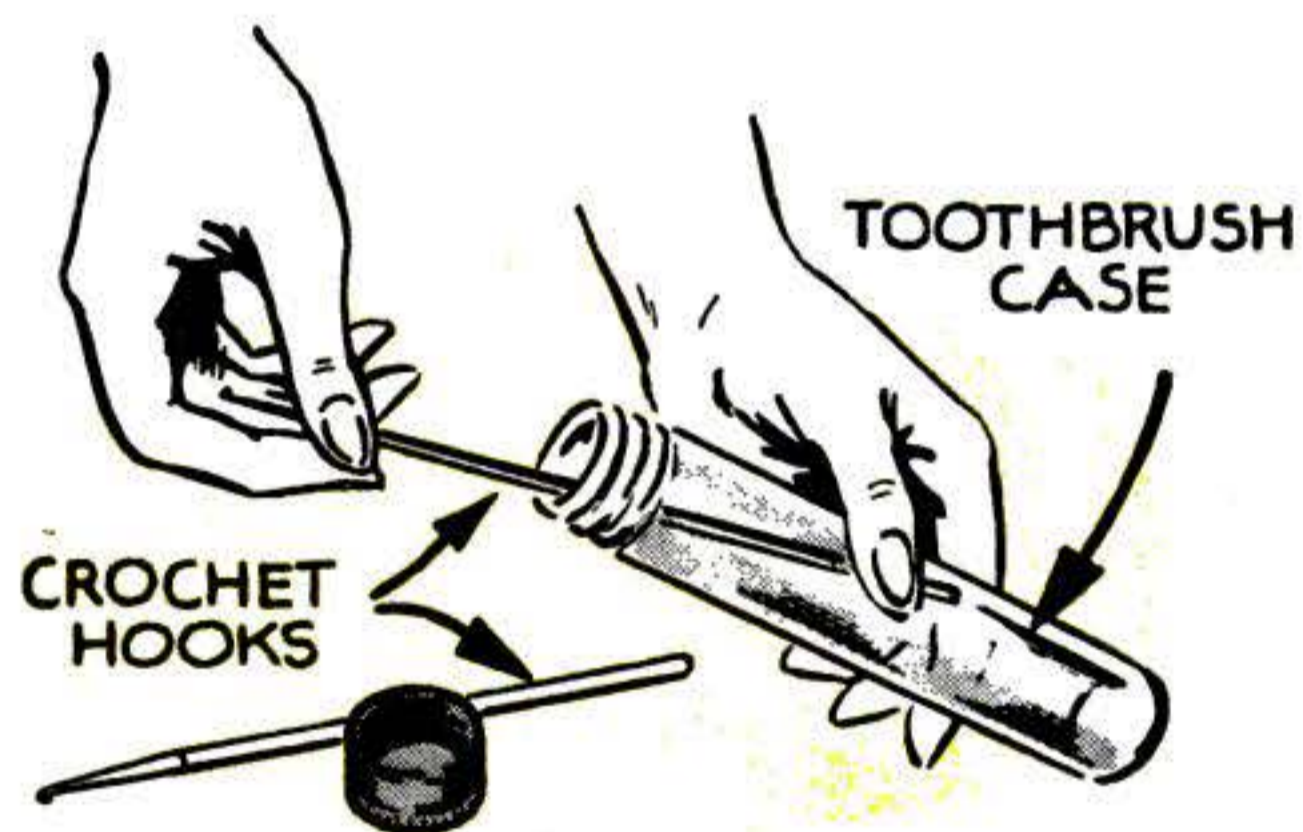

Storing your crochet hooks in a discarded toothbrush case makes it possible for you to find and select hooks at a glance; it also keeps them from getting tangled in and snagging yarn or material.

Most clothes hampers are too small to hold the larger articles that go into the family wash. If you are apt to forget such items when you clean out the hamper, fasten a reminder to the cover with easily removable, nonmarring cellulose tape.

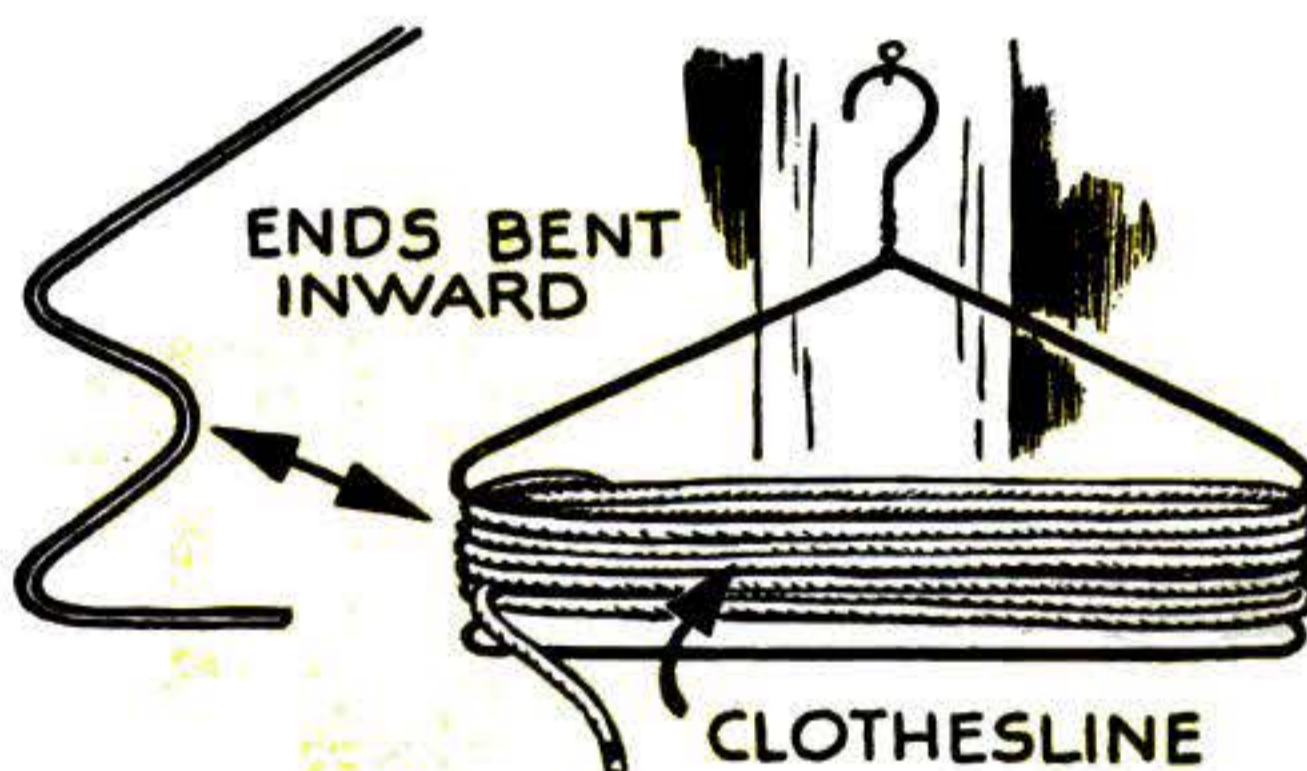
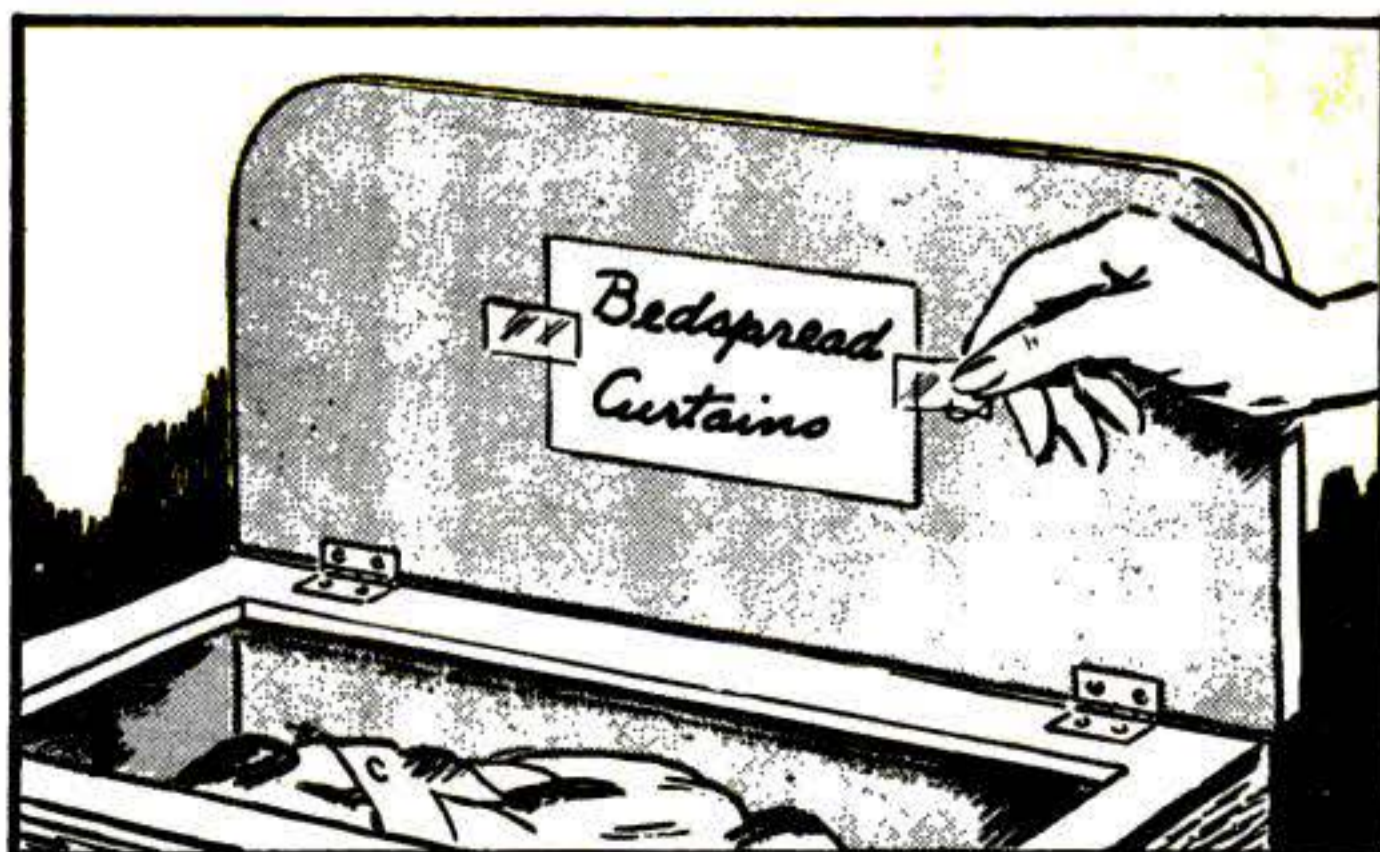

No tools are needed to make this winder for temporary clotheslines. Bend the ends of a wire coat hanger inward, as shown above, and reel the cord around it. Hang it over any convenient hook.

Heavy garments hung outside to air will generally slide together at the center of a sagging line. To keep them properly separated, string a short section of chain between two supports, and hook the hangers through the links at fixed intervals.





# Window and Door Frames for Stucco Construction

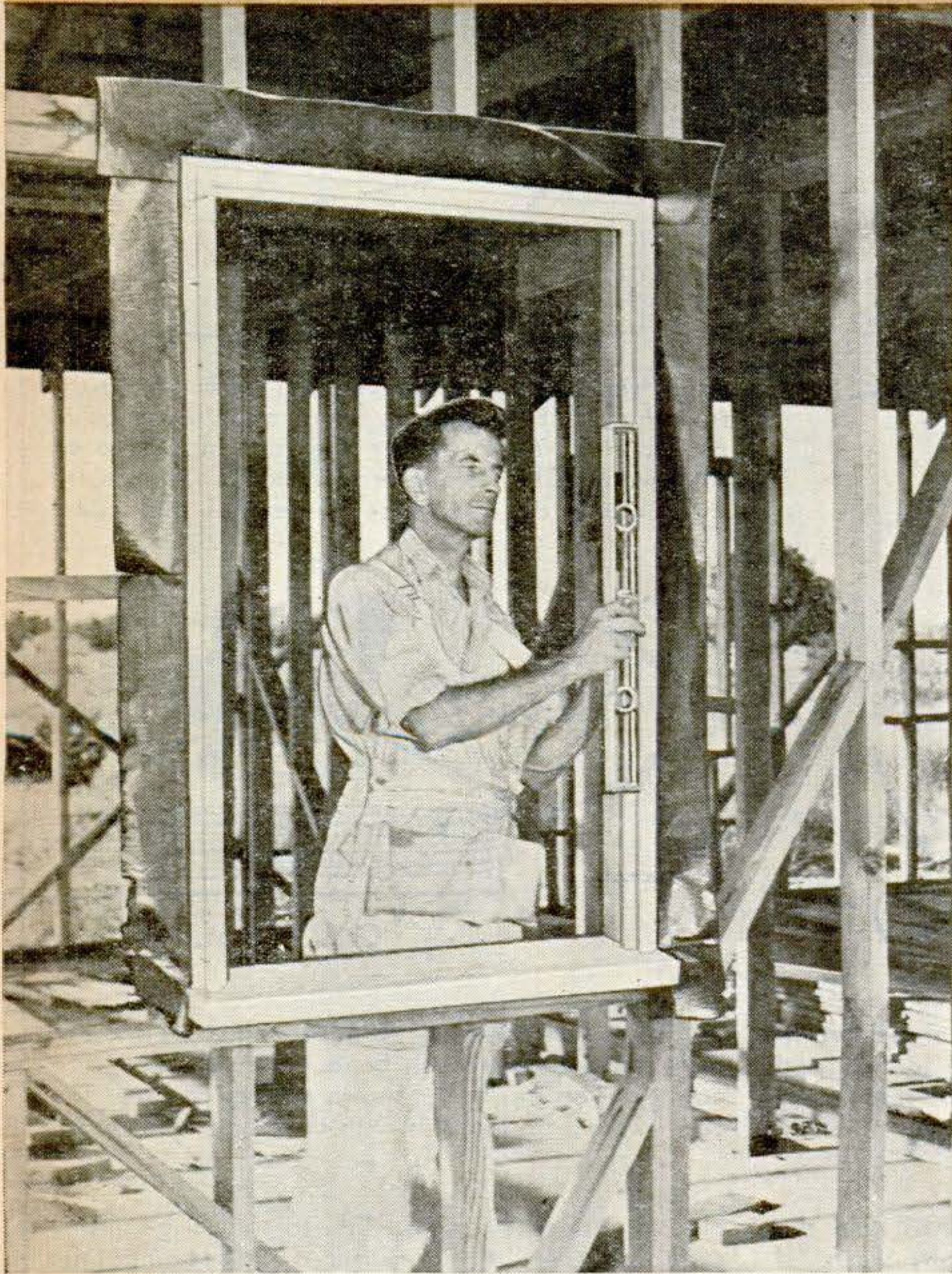

Plumbing a pulley stile in a window frame after leveling the head.

## SEVENTH OF A SERIES

**W**INDOW frames are always set before the plastering is begun on interior walls, while door frames can be set at any time. Frames set beforehand serve as grounds, or the wood to which the plaster can be brought flush and on which the moldings are attached. They should be well oiled or primed as a protection against moisture.

The size of a frame for a double-hung window will depend, of course, on the size

By

**EDWIN M. LOVE**

of the sash chosen. In many parts of the country, double-hung sash is listed according to over-all dimensions, and thus the frame for a 2' 6" by 4' 0" window would be built with an opening that size.

Windows in some sections, however, are figured from stock-size glass, such as panes 26" wide and 20" or 22" high. Allowing for a 2" stile on each side, the width would thus be the same, or 2' 6", but the height would be 3' 10" or 4' 2", that is, the height of two panes, a 2" upper rail, a 3" lower rail, and an allowance of only 1" for the meeting rails since they overlap. Windows cut into four or more lights must be figured for bar thicknesses as well.

The house described in this series and shown under construction in the accompanying photos is to have a stucco finish, so the photos and drawings show the addition of stucco molding having a recess or groove into which the stucco is anchored. For another outside finish, the essential difference would be only in the outside molding or other trim. Flashing is inserted between the stucco molding and frame and nailed right in with the molding.

How the window frame is constructed is shown in Fig. 1. The width of the jamb or pulley stile must allow for double the sash



thickness, standard for which is  $1\frac{3}{8}$ ", and also for  $1/16$ " clearance for each sash and for a  $3/8$ " parting bead, or a total of  $3\frac{1}{4}$ ". In addition, with the blind stop nailed on, it must equal the width of the trimmer plus the thickness of plaster and sheathing. If wall-board is substituted for plaster and no sheathing is used, this width will be so narrow that there will be no room for an inside stop unless the blind stop is made thin, and even with a minimum blind stop of  $3/8$ " it may be necessary to nail the inside trim flush with the face of the stile and lap the inside stop over its edge, as in the drawing.

Stock pulley stile comes grooved and ready to saw to length and dress to width. If it becomes sprung edgewise, straightening can only be done when the frame is nailed in the building. Because of a shortage of materials, some carpenters resort to use of clear sheathing boards for frame stock, racking it for as long as possible with cross strips between to permit air seasoning. Even then a board is likely to spring edgewise when ripped and should be left with  $1/2$ " surplus width to allow for jointing one edge and ripping and jointing to width. Little spring results from the second ripping. The grooves

for parting beads are then plowed and the faces smoothed.

Measure window length along the inside edge of the grooves when locating the dados to take the head and sill. The dado for the head is cut square; that for the sill on an angle of  $5$ " in  $24$ " or a slope taken from the sill level.

Spring balances are often used instead of weights and pulleys. They permit the frame to sit snugly between the trimmers, and narrow casing is easily applied. Figure 2 shows the cutout for a typical spring balance. Bore corner holes; then rip first with a compass saw and finish by crosscutting the ends; or cut the waste out on a power saw. Handle the stile carefully to avoid breaking the slender strip left.

An extra  $1/2$ " must be added to the head for housing in the pulley-stile dados, and the same allowance is made when notching the sill. The "horns" of the sill are also notched flush with the front of the blind stops to clear the trimmers. Sometimes  $1/8$ " extra width is allowed in the frame to reduce planing of the sash in fitting.

Never paint the faces of pulley stiles. Oil them instead, or coat them with hot paraffin,

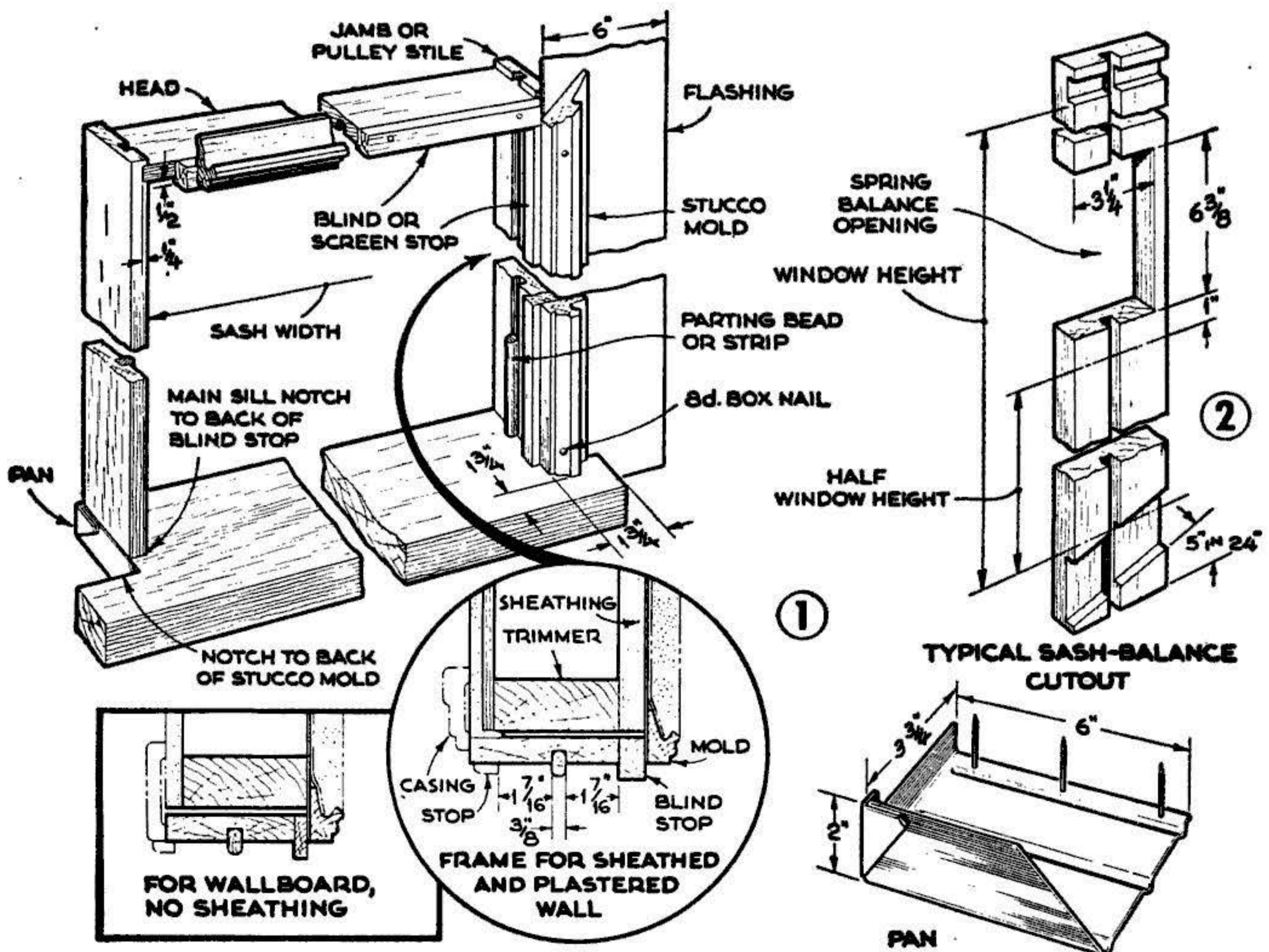



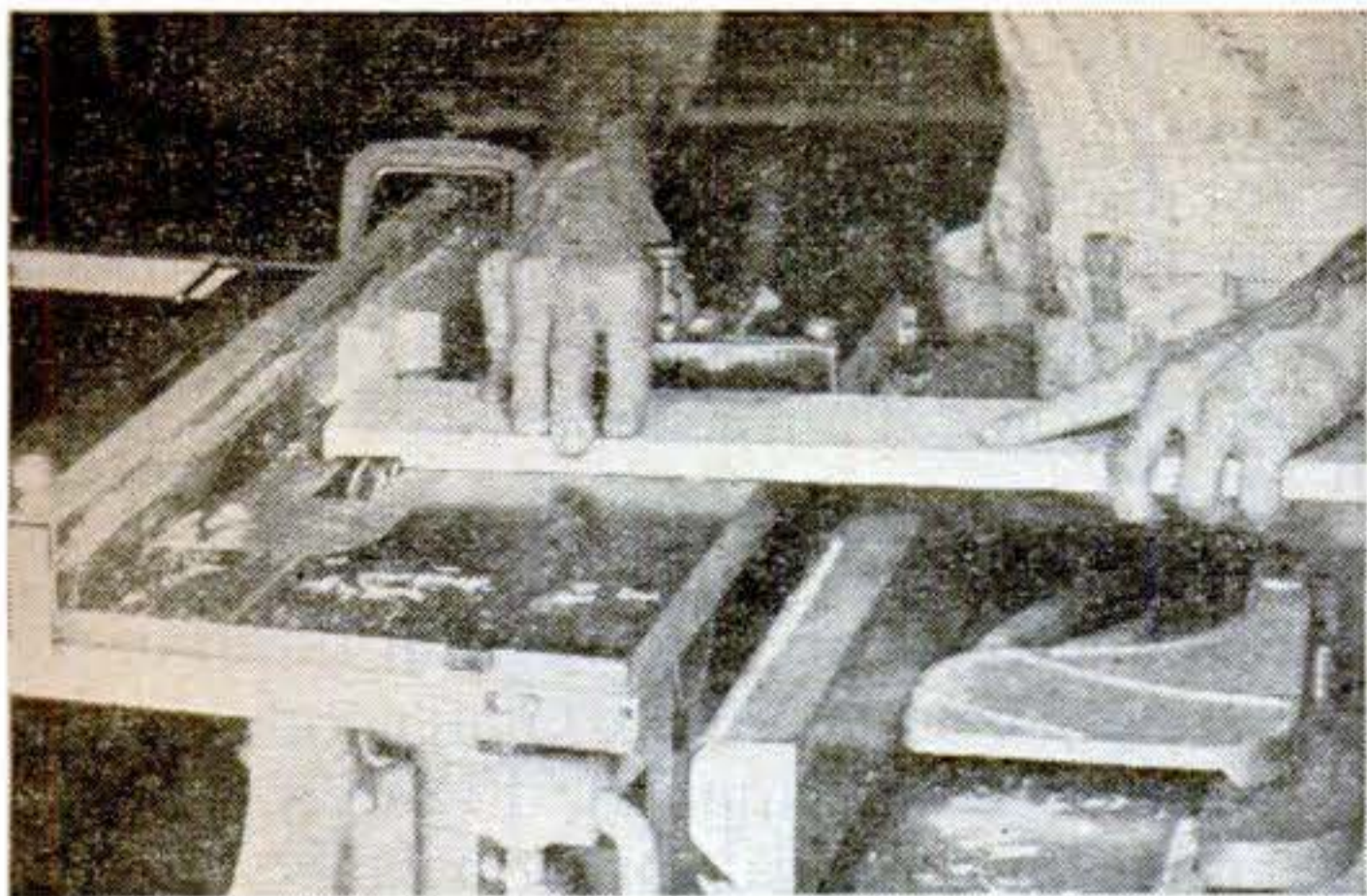

Dadoes for housing the sills in pulley stiles are cut on a slope that can usually be taken from the sill bevel, or an angle of 5" in 24" can be used.

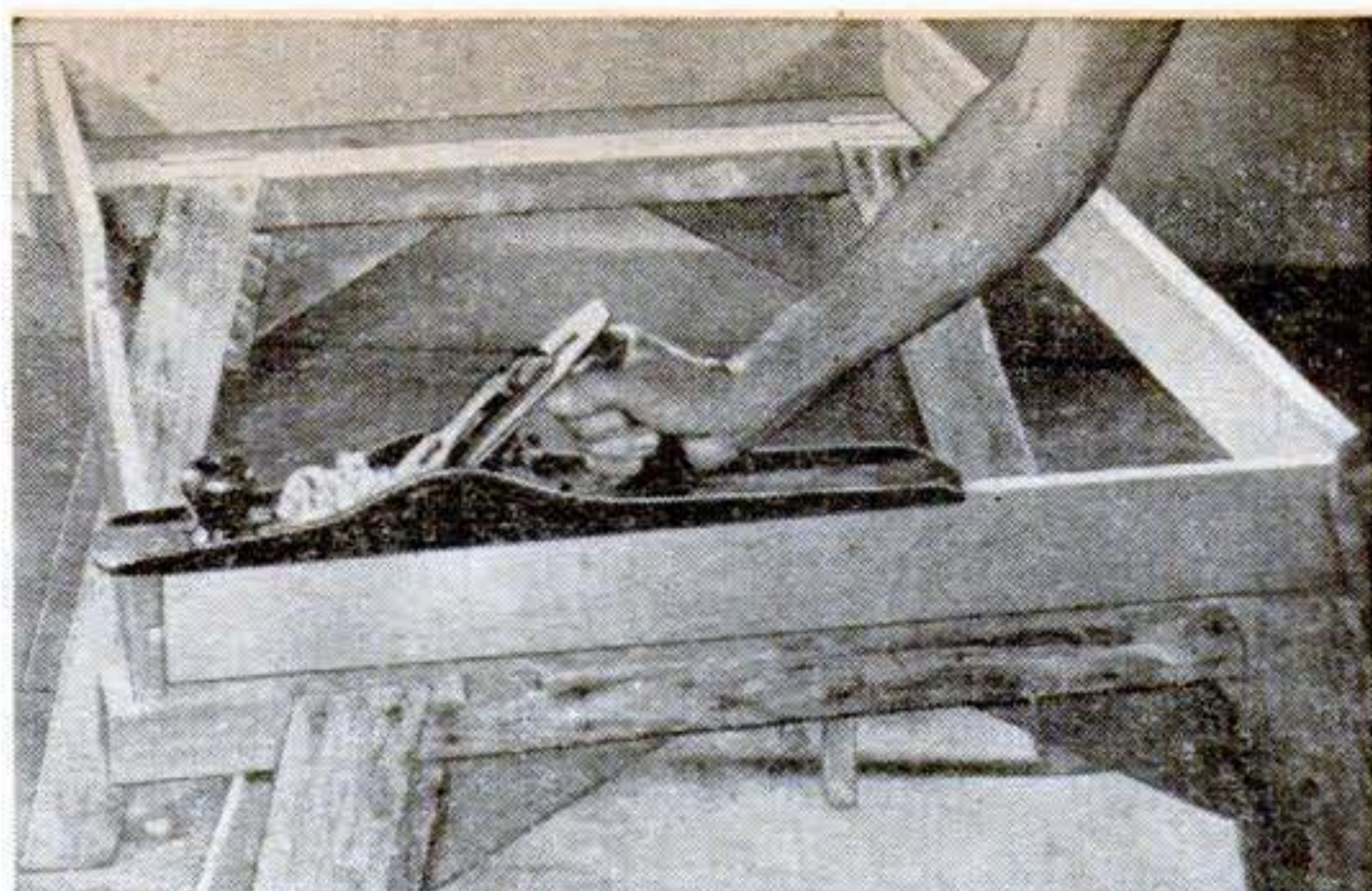

When assembling the window-frame head and pulley stiles, take care to get the parting-bead grooves aligned; then dress down projecting edges.

Blind stops are best nailed on while holding a 1/2" block against the stile face to gauge projection.

Nailing stucco molding to a gauged line. Flashing is inserted under the molding and nailed with it.

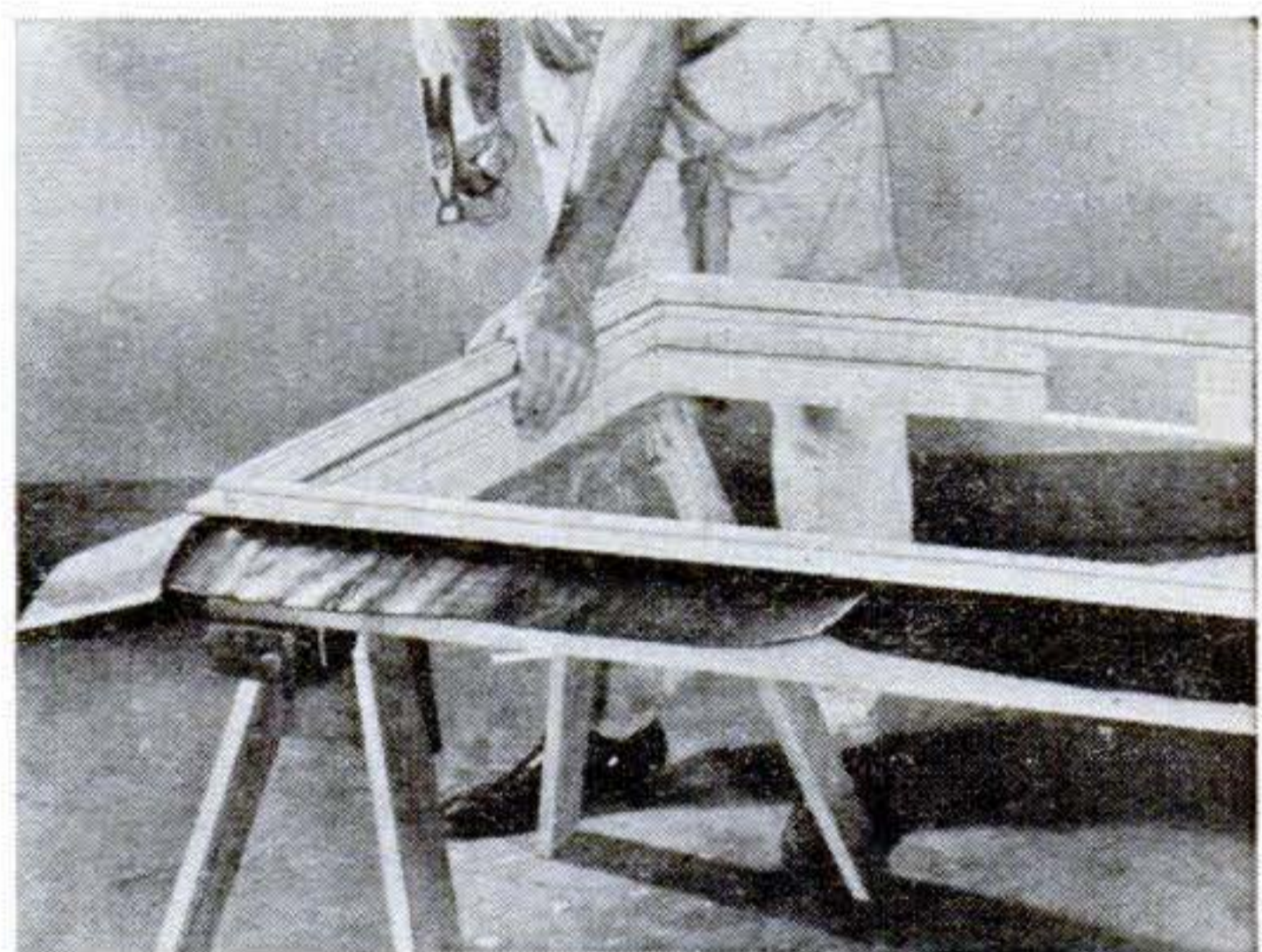
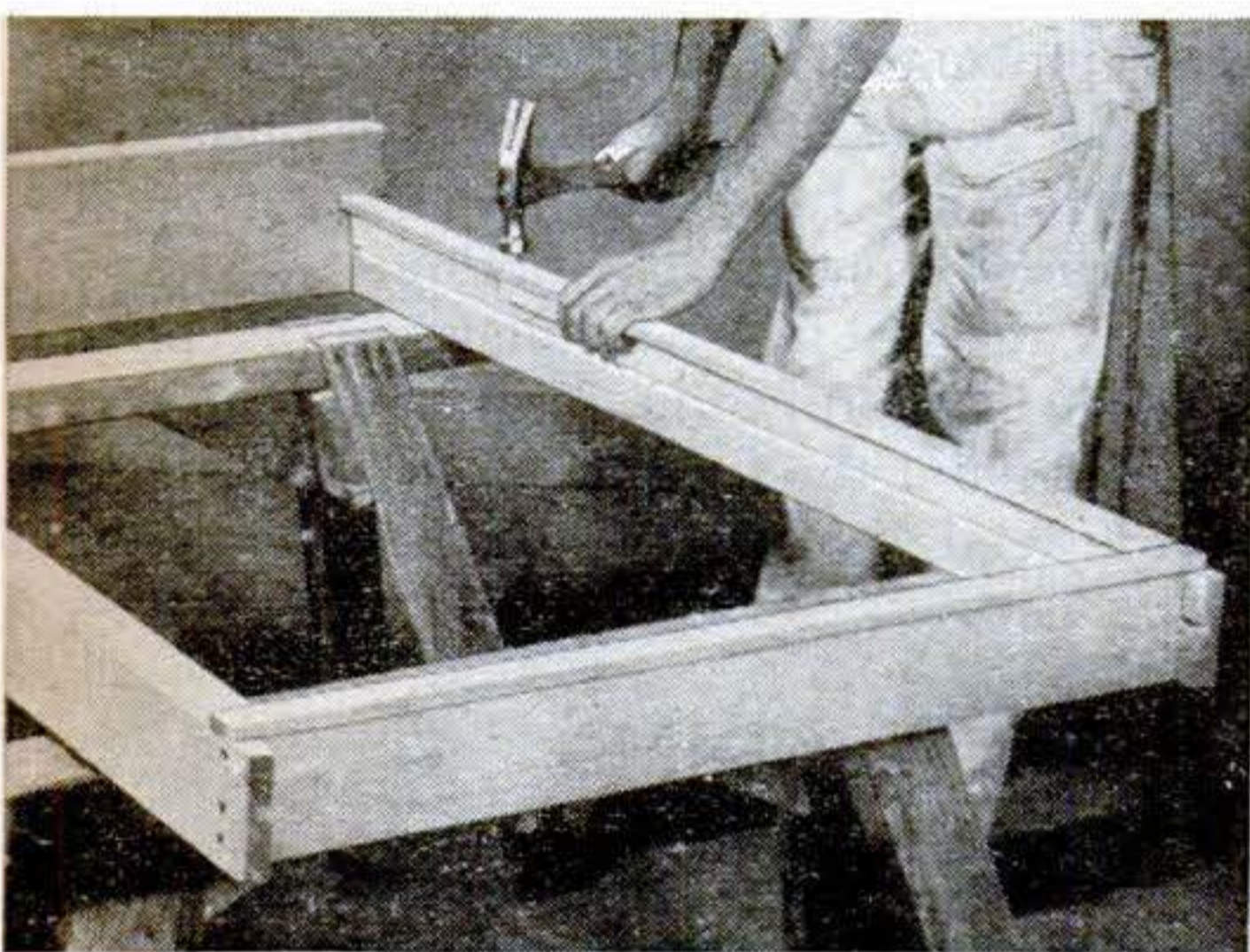

and scrape off any surplus. It is good practice to paint the joints before assembly, and after the frame has been built paint the backs, sill, and stucco molding.

Use 8d. box nails for nailing in the sill and head. If a dado is loose, drive a chisel in the joint at the outer side to take up the looseness before nailing. Square the frame by equalizing corner-to-corner measurements, nailing diagonal strips across the inside edges to hold the frame true. Nail the head blind stop in place and fit the side blind stops between it and the sill. Gauge the projection of the stops with a 1/2" block, as in the photo at lower left above.

For correctly setting a window frame, a prop equal in length to the height of the header above the floor will be needed at one corner. Start a nail in the side stucco molding next to the prop near the top, swing the frame approximately level, and tack. Level the sill and tack the opposite molding. Plumb the pulley stile and nail the mold-

ings solidly; then drive nails through the stiles. Wedge with shingles to straighten the face of a stile.

Frames for outside doors can be made from 1" stock with jamb width equal to that of the window pulley stiles. Inside frames require jambs equal in width to the trimmer plus the thickness of the plaster or wallboard on both sides. The length of the jambs from the head to the bottom is simply the length of the door plus an extra 1/2" for clearance. Assemble the door frames on the floor, nailing the joints.

To set an inside-door frame (Fig. 3), stand it in the rough opening and slide a shingle point first from each side behind one jamb. If there is to be a finish floor, place a block the thickness of the floor under the lower end. Tack fast through the shingles while holding a block against the trimmer to gauge the projection for plaster or wallboard.

Tack the upper end of the opposite jamb in the same way. Then wedge out and nail



the lower end of the first jamb, plumbing the face with level and straightedge to align top and bottom, and plumbing the edge with the level alone. If the wall is too out of plumb, it may be necessary to have the jamb lean with it in order to align them at the top and bottom.

Cut a spreader gauge to lie on the floor between the lower ends of the jambs, as in Fig. 4, and nail the second jamb. Place shims behind the hinge and lock positions and wherever needed for straightening out concave bends in the face.

If the molding and flashing are left off outside-door frames until after they have been set, the open edges will make it easy to wedge jambs for straightening, as in the photo below, but some carpenters prefer to nail them in when assembling as for windows. Usually it also saves time to cut hinge

mortises in a jamb when it can be handled on the bench before assembly.

Stucco molding used at the head of a door frame and on window-frame heads is usually not in alignment, but the difference will not be noticed if the door is not close to a window. The molding is somewhat higher on a door frame since it must be  $\frac{1}{4}$ " to  $\frac{5}{16}$ " up from the face of the door head to show a margin, while that on the window heads is set flush with the face.

One method that simplifies the installation of a door frame in a large opening, such as that for a garage door, is to nail up the head first after leveling it from end to end. Then the jambs are straightened with shingles, as shown below, and nailed in with the upper ends fitted against the head. Flashing and stucco molding or other trim are finally added to complete the installation.

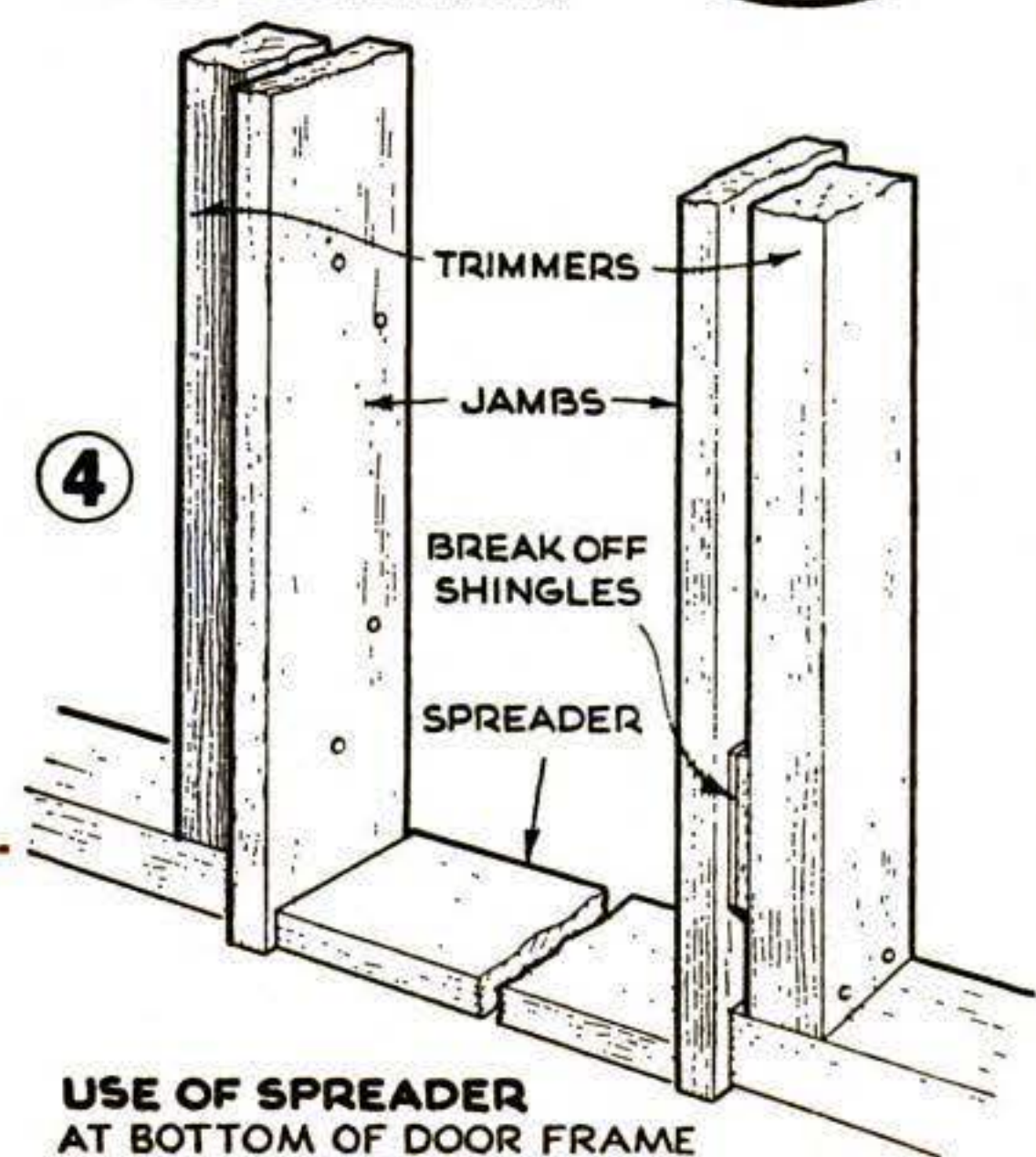
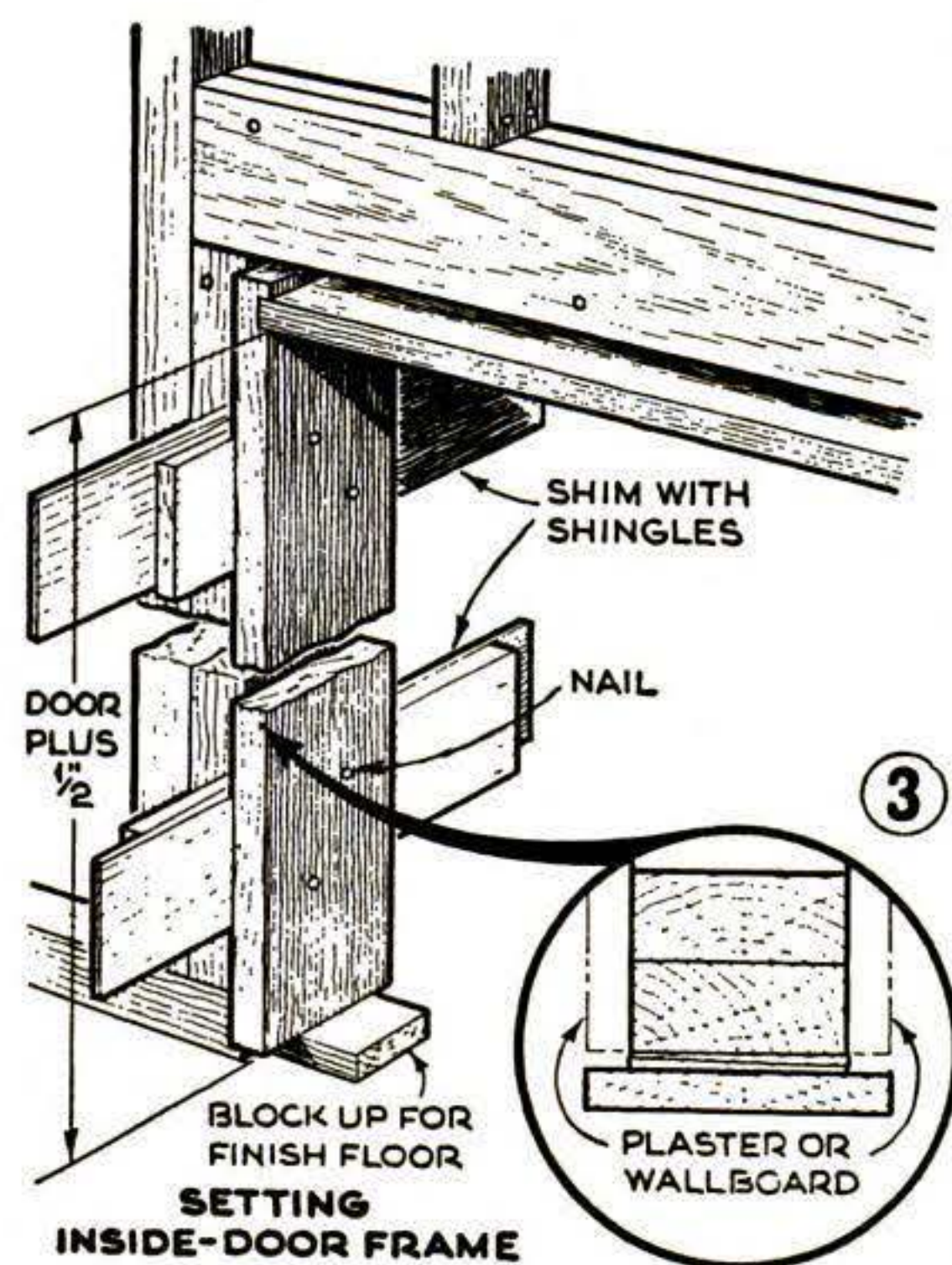





Enduring strength and gleaming beauty  
distinguish things fashioned of the  
steel that's king of metals.

YOU CAN MAKE IT OF

STAINLESS

By WALTER E. BURTON

**F**ABULOUS metals, once undreamed of in the average home workshop, can be yours for little more than some junkyard prospecting. Stainless steels are among the most fascinating of the alloys developed in recent years. Many types can be found at hardware stores and in scrap-metal yards as war surplus, or may be obtained from regular steel distributors.

With stainless steel you can make a variety of things for the home, shop, darkroom, laboratory, or wherever its enduring brightness and resistance to rust and corrosion are desirable. You can make covers for photo developing tanks, trays for print-processing solutions, special film racks, and movie-film reels. Numerous kinds of kitchen knives, forks, and other utensils can be fashioned from the alloy. It can be made into tweezers of all sorts, tools for modeling clay, and trowels for handling molding sand, plaster of Paris, concrete, and the like.

Also possible are rings, earrings, brooches, fittings for boats, thin-sheet monograms for automobile doors, handbags, and the like, and dials for gauges and other instruments. Shown on these pages are sugar tongs, a spatula, a darkroom stirrer and print lifter, and a pancake turner—all made from stainless gathered in an afternoon of exploring at a neighborhood junk dealer's.

In searching for stainless steel, probably your first clue will be the absence of rust. If the piece is covered with grease and dirt, rub a spot clear with waste or a stick, and if the metal shows bright, the chances are it's what you want (unless it is obviously too light, in which case it may be aluminum or magnesium alloy). A sure test to tell stainless from other steels is immersion in a strong copper sulphate solution after the surface has been cleaned bright and free of grease. If it is stainless, no red copper deposit will form.

There are magnet and heat tests, too,

Stainless sheet laid on an iron or steel plate can be cut with a chisel. It's best to cut almost through and finish by bending until the cut breaks.

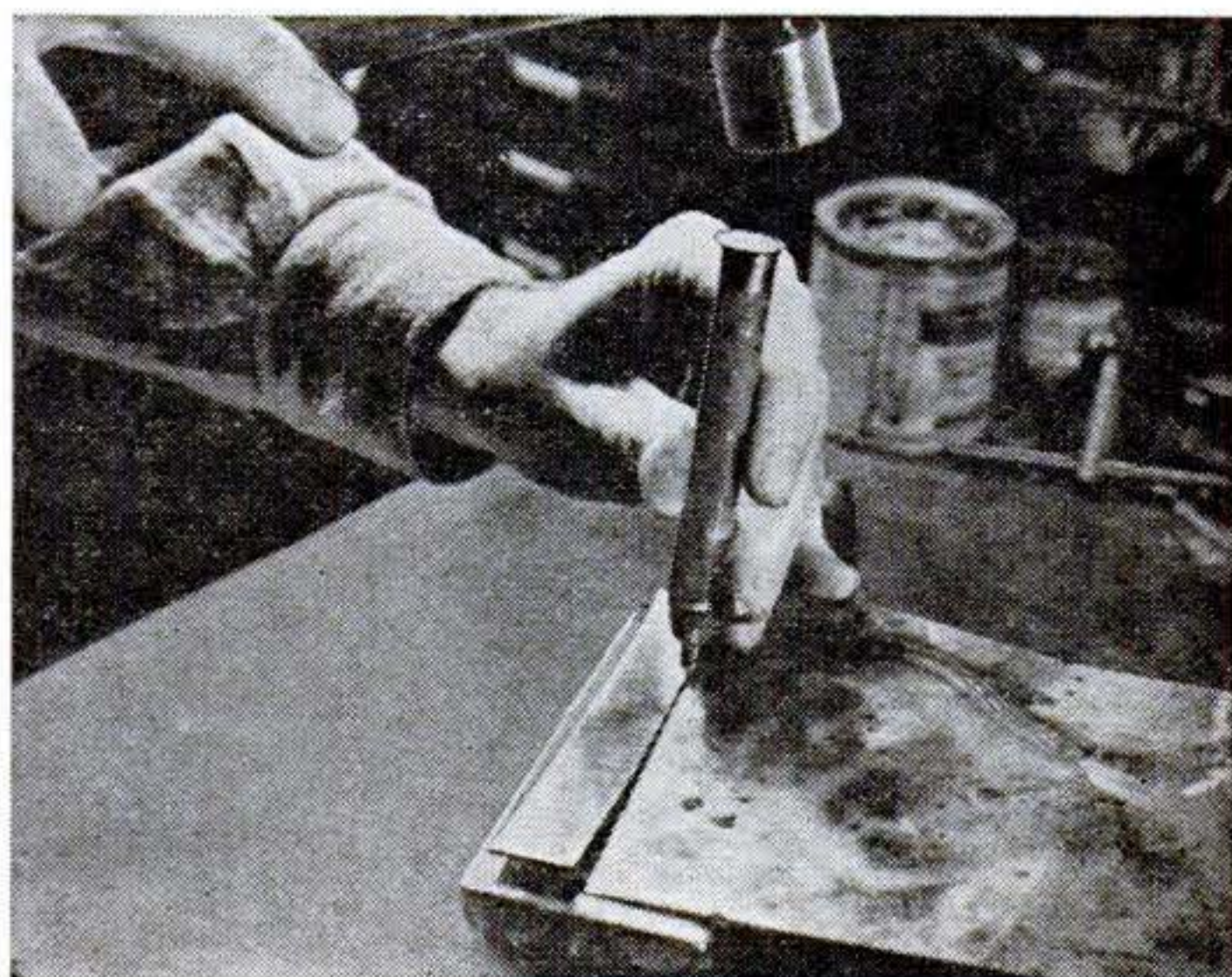



that will identify the type of stainless steel, as described in the data sheet on page 176. These are important when the steel is to be used for making certain projects. Group A, for instance, contains the only stainless that can be hardened by heat treatment for a really good knife blade that will keep an edge, while a developing tray or other object that requires maximum resistance to corrosion is best made from a steel in Group C. This group contains the well-known 18-8 alloy (18 percent chromium and 8 percent nickel) and is the only group that is nonmagnetic.

Despite its hardness, stainless steel can be worked readily with proper tools. Drills and cutting tools should be of high-speed steel and should be sharp. They must be fed into the work at a slower speed than that for cold-rolled steel and with constant pressure, for even the slightest relaxation may cause the alloy to glaze over and resist further cutting. Punch marks should be shallow, as the steel has a tendency to work-harden. Since Group B and Group C stainless steel may already be work-hardened before you get them, annealing by heating yellow-hot and plunging in water may save

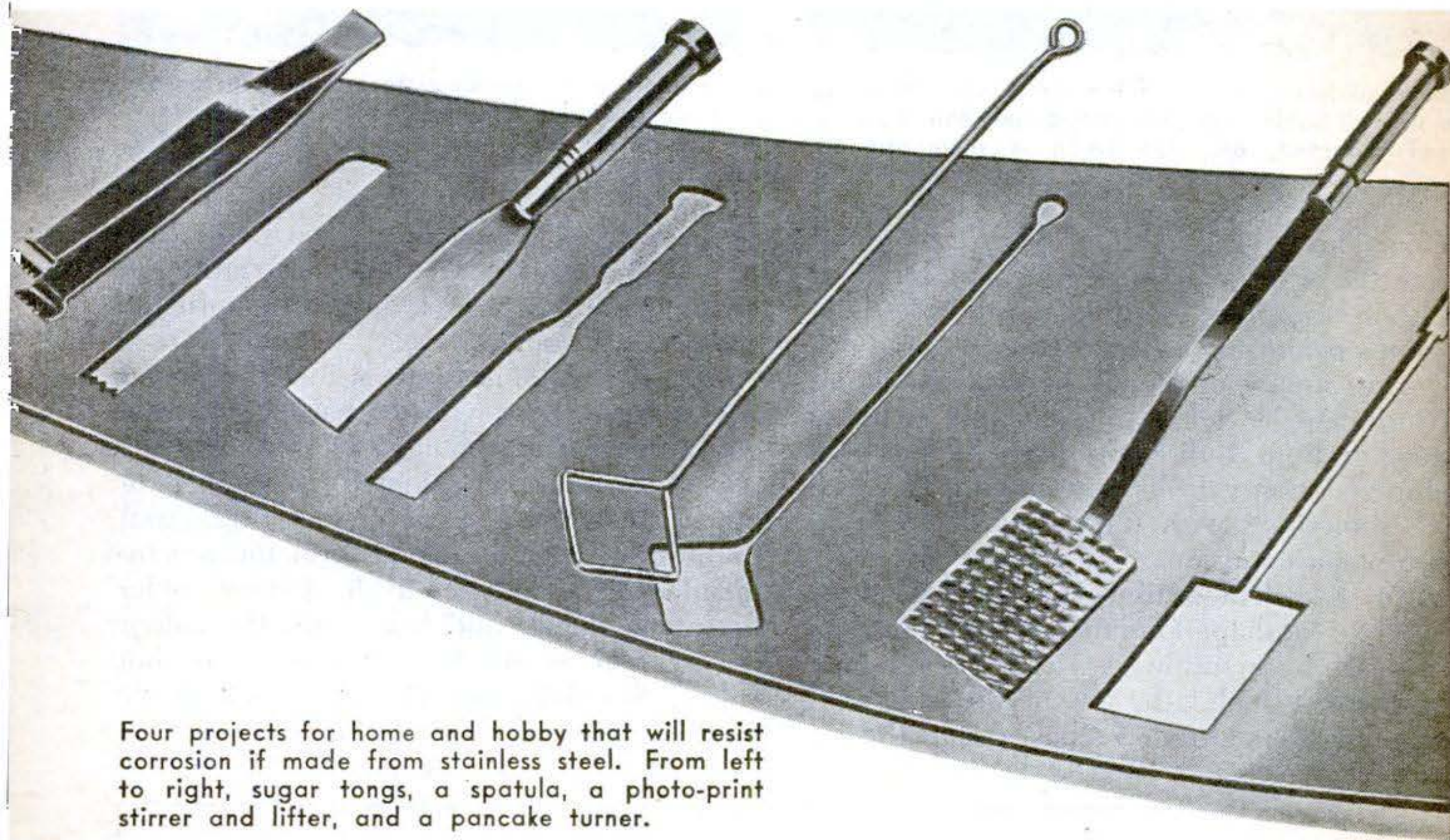

Four projects for home and hobby that will resist corrosion if made from stainless steel. From left to right, sugar tongs, a spatula, a photo-print stirrer and lifter, and a pancake turner.

Inserting a stainless spatula blade in a handle made from an aluminum bolt. Stainless rivets cut from wire are shown on the bench at lower left.

Stainless-steel wire can be annealed for easier working by heating yellow hot and plunging into water, just opposite to method for common steels.

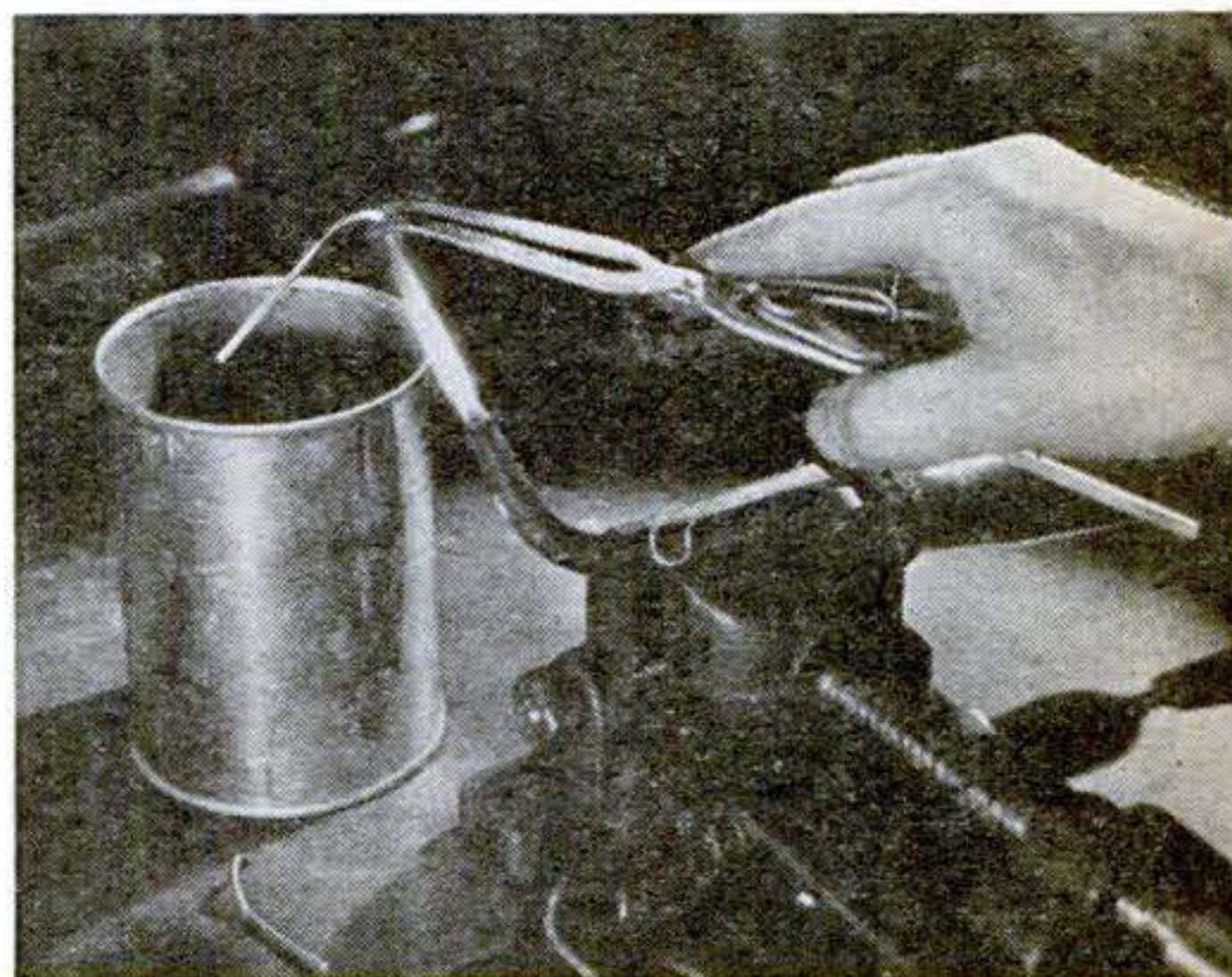
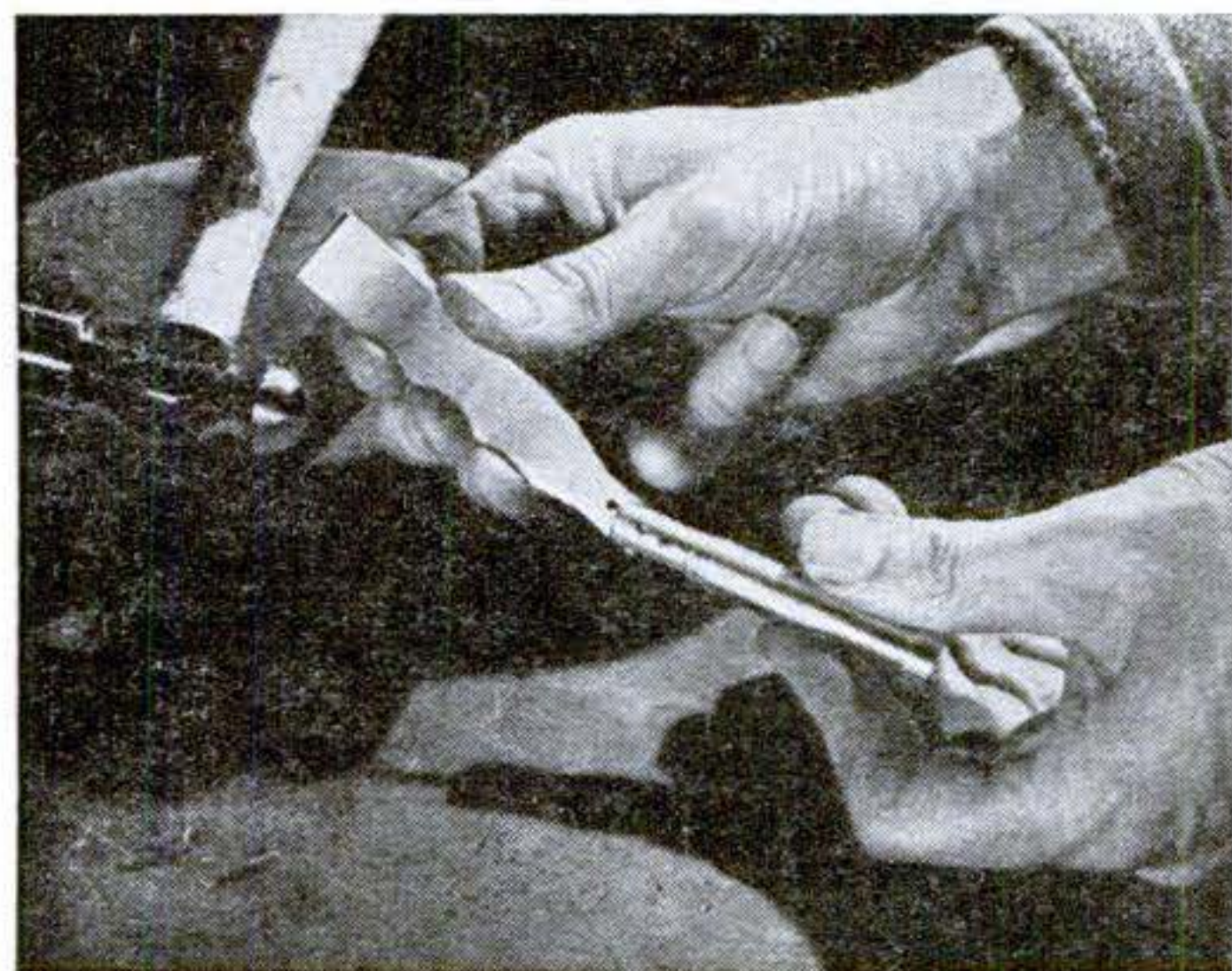



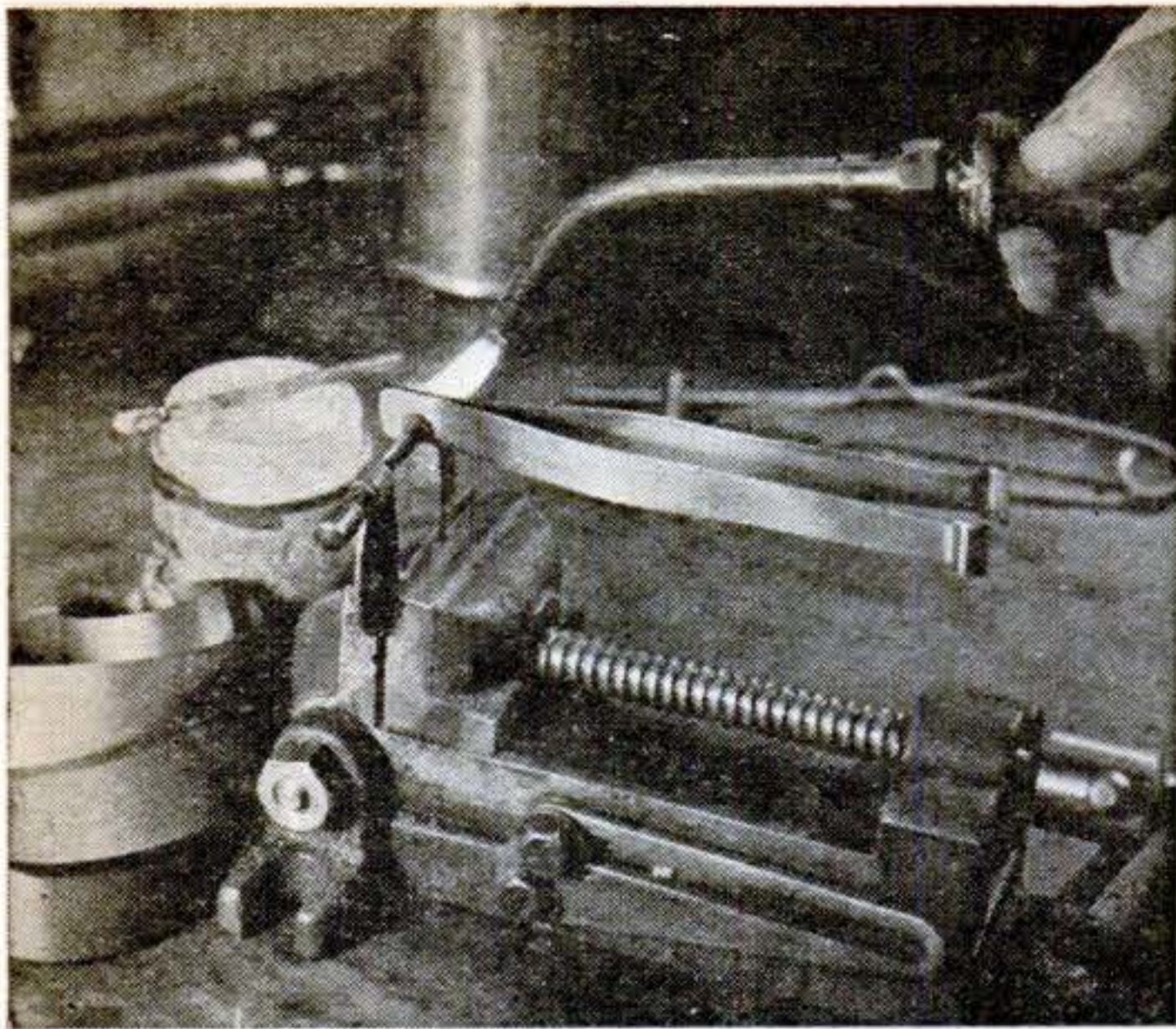

Silver-soldering a set of kitchen tongs. Flux and a shim of solder are sandwiched between the steel and clamped, and the torch is then applied.

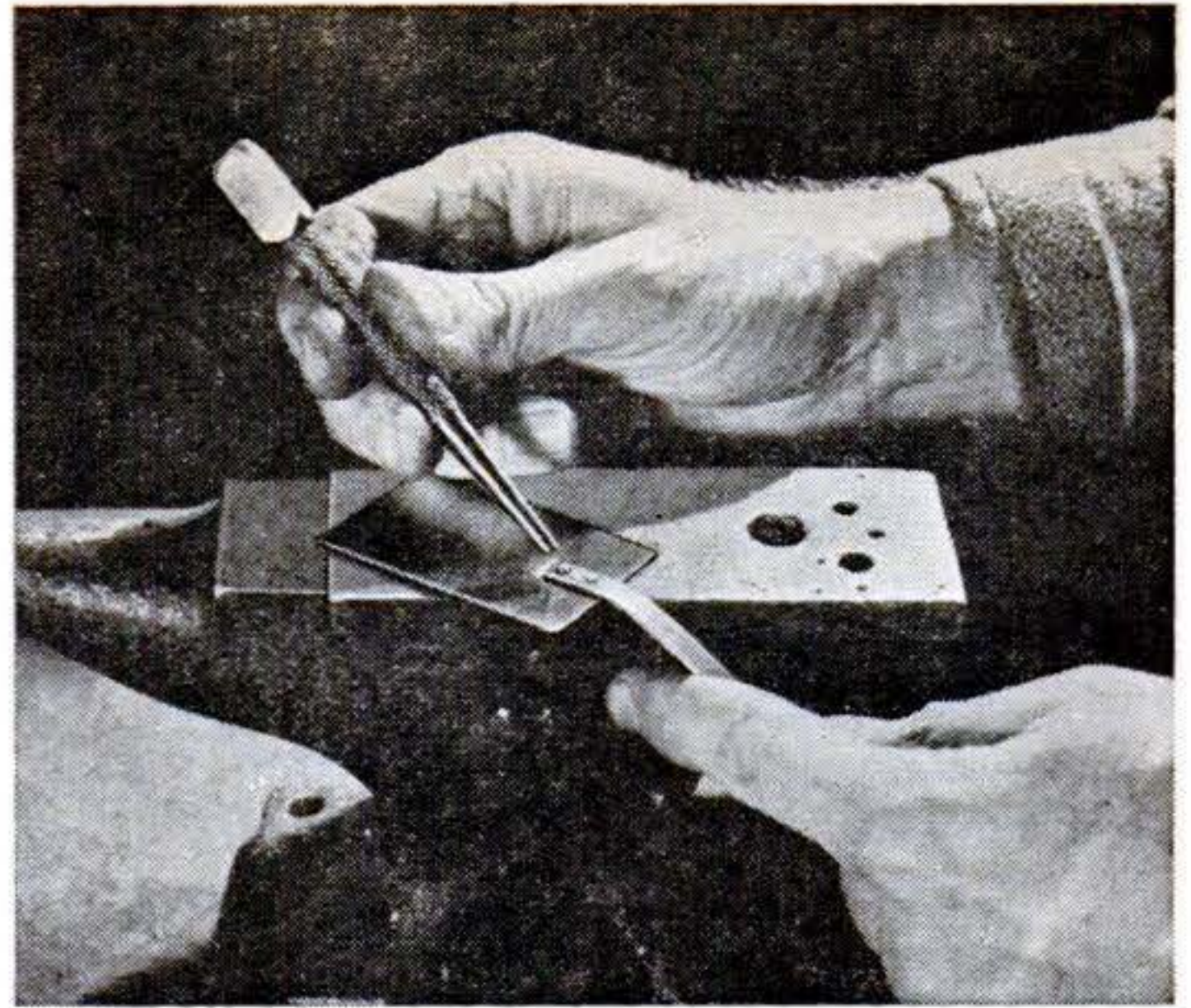

Short lengths of stainless-steel wire are riveted by peening the ends with a coarse nail set. Here the handle is riveted to a pancake turner.

time. This procedure is, of course, the exact opposite to ordinary steel annealing methods and, as it implies, the stainless steels in these groups cannot be heat-hardened.

Thin stock can usually be drilled without a lubricant if backed by a block of ordinary steel or iron. Lubricants used include sulphurized mineral oils and sulphurized lard oil, sometimes with turpentine added, and also water emulsions.

An excellent chisel for cutting sheet roughly to shape preliminary to filing can be made by mounting a  $\frac{1}{4}$ " round or square high-speed-steel lathe bit in the end of a piece of  $\frac{1}{2}$ " cold-rolled stock. Grind the bit

to a chisel edge that is not too blunt. Cut part way through the sheet and finish by bending the metal back and forth until the cut breaks through.

All of the stainless steels may be joined with soft solder or with the harder soldering alloys melting at about 1,175 deg. F. They may also be silver-soldered to copper or other steels. When silver-soldering, coat both surfaces to be joined with the recommended flux, sandwich a bit of sheet solder between, clamp, and heat until the solder flows; then wash off excess flux with hot water. Stainless-steel rivets can be made by annealing and cutting Group C wire.

## PROPERTIES OF STAINLESS STEEL

[ METAL WORKING ]

Metallurgists classify stainless or chromium steel in the following three groups:

*Group A (martensitic)*, containing less than 0.4 percent carbon, less than 16 percent chromium. Tungsten, nickel, silicon, columbium, aluminum, and molybdenum may also be present. The steel is magnetic.

*Group B (ferritic)*, containing low carbon percentage, more than 16 percent chromium. Copper, nickel, silicon, molybdenum, tungsten, and nitrogen may also be present in small quantities. The steel is magnetic.

*Group C (austenitic)*, containing at least 24 percent alloy, including sufficient nickel to make the steel austenitic and either twice as much or half as much chromium as nickel. Low carbon. The steel is nonmagnetic.

By cross-checking with two tests, a sample can usually be identified. If it is attracted by a magnet, it is in Group A or Group B; if not, it is in Group C. When heated yellow-hot (about 1,800 deg. F.) and quenched in water, it is in Group A if it hardens like tool steel, in Group B or Group C if it does not harden.

Steels in Group A are tough, not brittle, after heat treatment, are readily forged, pierced, or rolled at 2,000 to 1,700 deg. F., and can be machined satisfactorily with properly designed tools. Those in Group B are sufficiently tough when properly rolled and heated; they may be forged, rolled, or pierced when heated quickly, and can be machined with properly designed tools. The Group C steels are extremely tough. They may be forged, rolled, or pierced, but are difficult to machine even with super-high-speed and carbon tools. Use sharp tools, with greater top rake than usual, and cut continuously.

Group A resists corrosion by weather, water, steam, and mild corrosives; Group B resists also nitric and other oxidizing agents; Group C resists nearly all corrosives and is especially resistant to organic acids.

POPULAR SCIENCE MONTHLY SHOP DATA



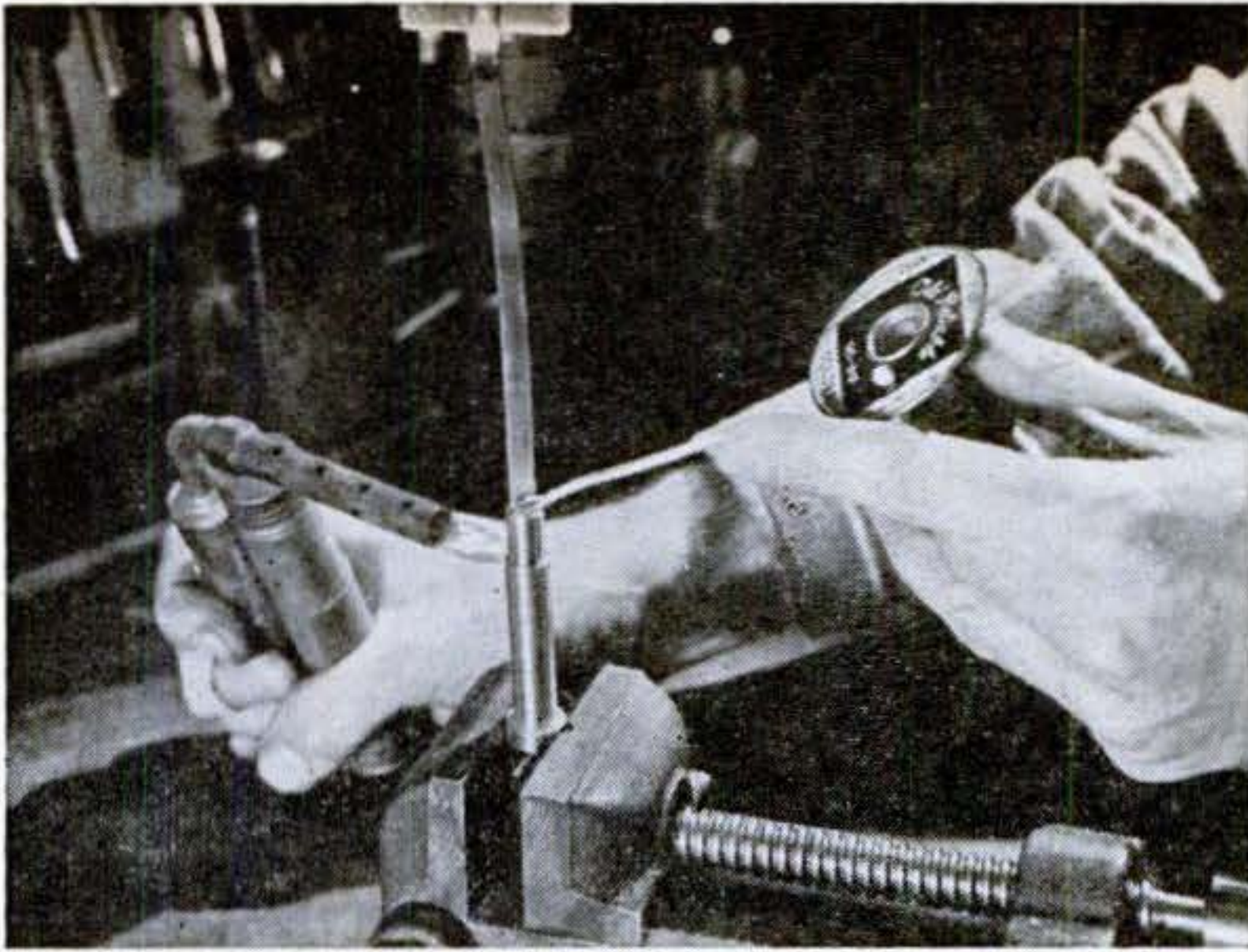

When a flat shank is driven into a round hole, the spaces around it can be filled with solder. Drill holes in the shank first; solder, flowing in, will anchor it.

While the chemical composition of stainless steels makes them resistant to corrosion, a fine polish will increase this resistance; but use aluminum buffing compounds, not iron compounds (rouge), embedded particles of which may later rust. Before polishing, it is advisable to place the finished piece in a solution of equal parts of concentrated nitric acid and water for about an hour and a half, taking care to keep the acid off the skin and clothing. This dissolves bits of the tool embedded in the surface.

The tongs shown were made from  $1/32$ " springy 18-8 stainless bent cold so the jaws stand 1" apart. Similar ones may be of one-piece construction, or identical halves may be riveted or silver-soldered. The spatula, of the same steel, was made with a short tang and riveted in a slot in an aluminum-bolt handle that had been machined to remove the threads. Annealed first for easier bending,  $3/32$ " Group C wire was shaped into the stirrer-lifter. The pancake-turner blade was spot-polished  $.020$ " by  $1\frac{1}{2}$ " by  $2\frac{5}{16}$ " stainless, the shank  $.050$ " by  $\frac{1}{4}$ " by  $6\frac{1}{4}$ " stainless, and the handle a  $7/16$ " by  $2\frac{1}{2}$ " aluminum-alloy aircraft bolt.

**FORKS OF STAINLESS STEEL** won't be discolored by foods. This one, made of  $3/32$ " sheet, is for serving olives and pickles. The prongs are cut with a hacksaw and lubricant, and the shape is then roughed out on a grinding wheel and filed smooth. Contours are bent between soft jaws in a vise.

Polish with several grades of emery cloth from coarse to fine, and finish with aluminum buffing compound.—WILLIAM GORDON.

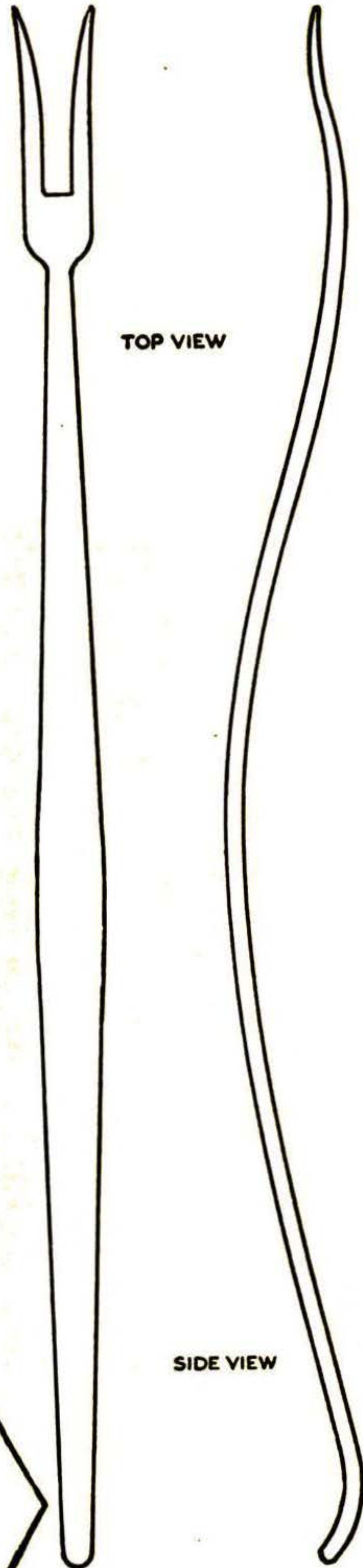

TOP VIEW

SIDE VIEW

FULL SIZE



# NEW SHOP IDEAS

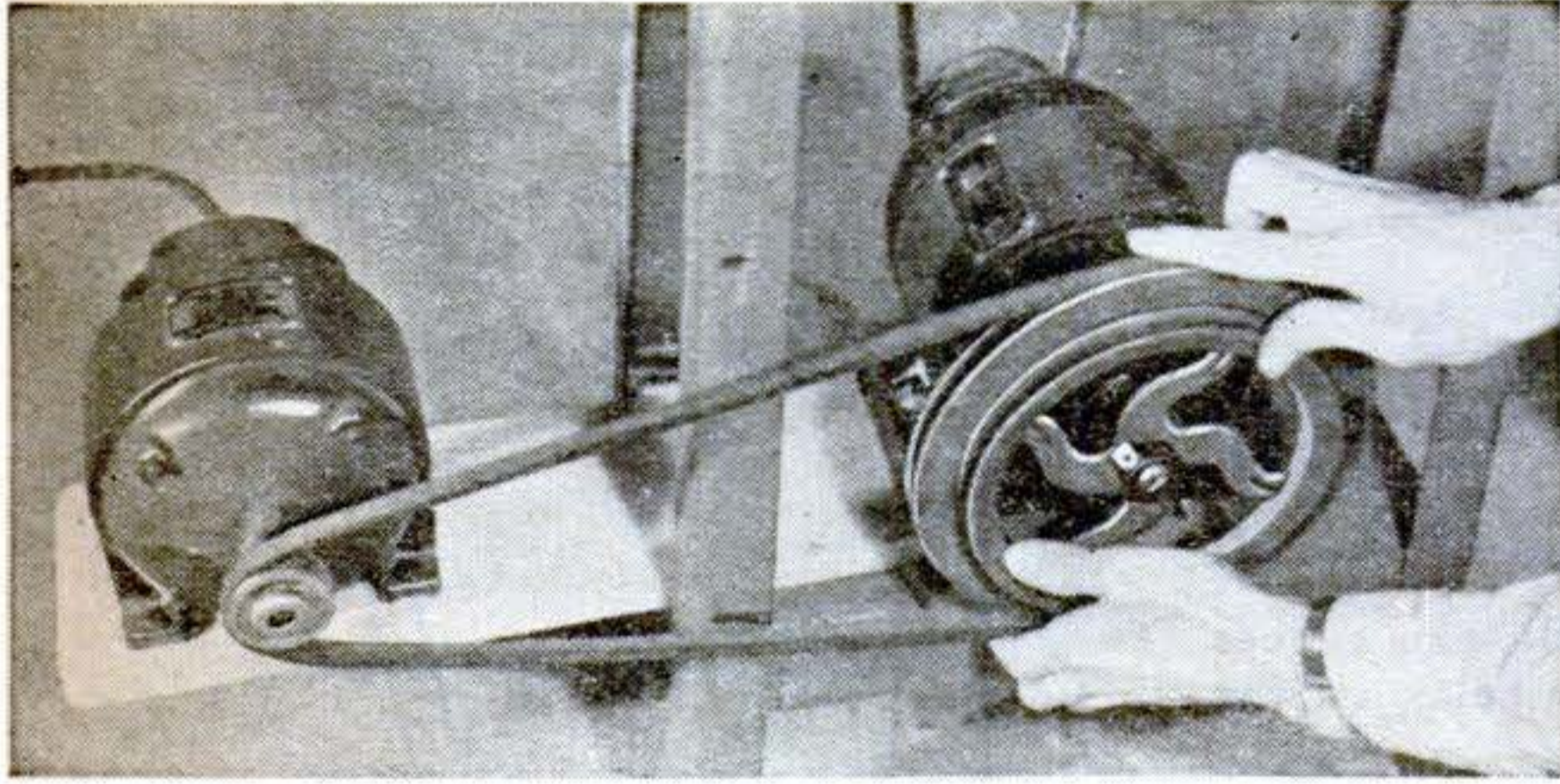

**METAL-CUTTING SPEEDS** can be obtained on a wood bandsaw with the saw motor running as a countershaft driven by a second motor. Provided the extra motor is on hand, this arrangement avoids disturbance

of the original mounting and permits switching from metal to wood cutting simply by removal of the belt. Step pulleys on both the saw motor and driving wheel would give a variety of speeds.—HENRY HANSCOM.

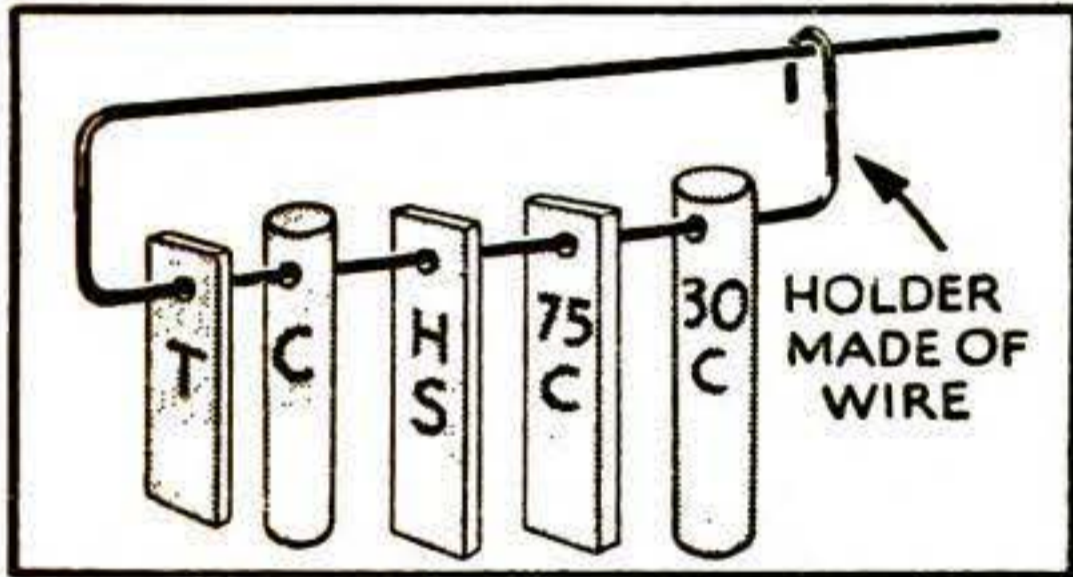
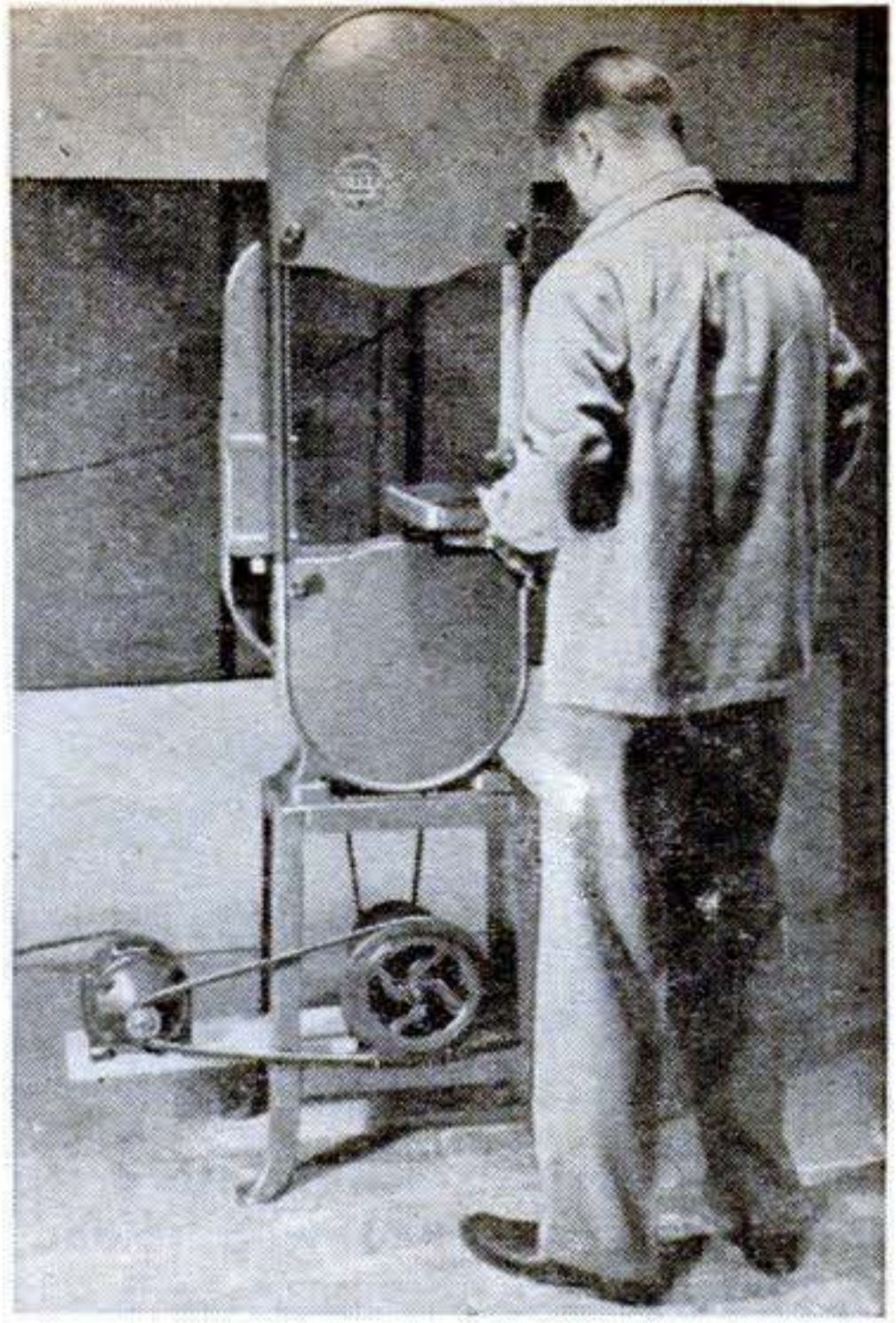

**LABELED KNOWN SAMPLES** of iron and steel, drilled and kept on a wire holder, help in identifying new stock. Compare sparks thrown off a wheel when grinding the new stock with those when grinding the samples. Labels may be such as T, tungsten steel; C, cast iron; H S, high-speed steel; and 75 C and 30 C, 75- and 30-point carbon steel.—RUFUS E. DEERING.

**AUTOMOBILE GREASE FITTINGS** inserted in holes drilled in the grease-cup covers of shop machines will permit quick refilling from a grease gun. The cup covers are simply backed off as far as possible, and the gun nozzle is applied to the opening of each fitting. Drill an undersize hole in each cup cover and tap it to take the threaded end of a fitting, or make the fittings cut the threads.—H. H.

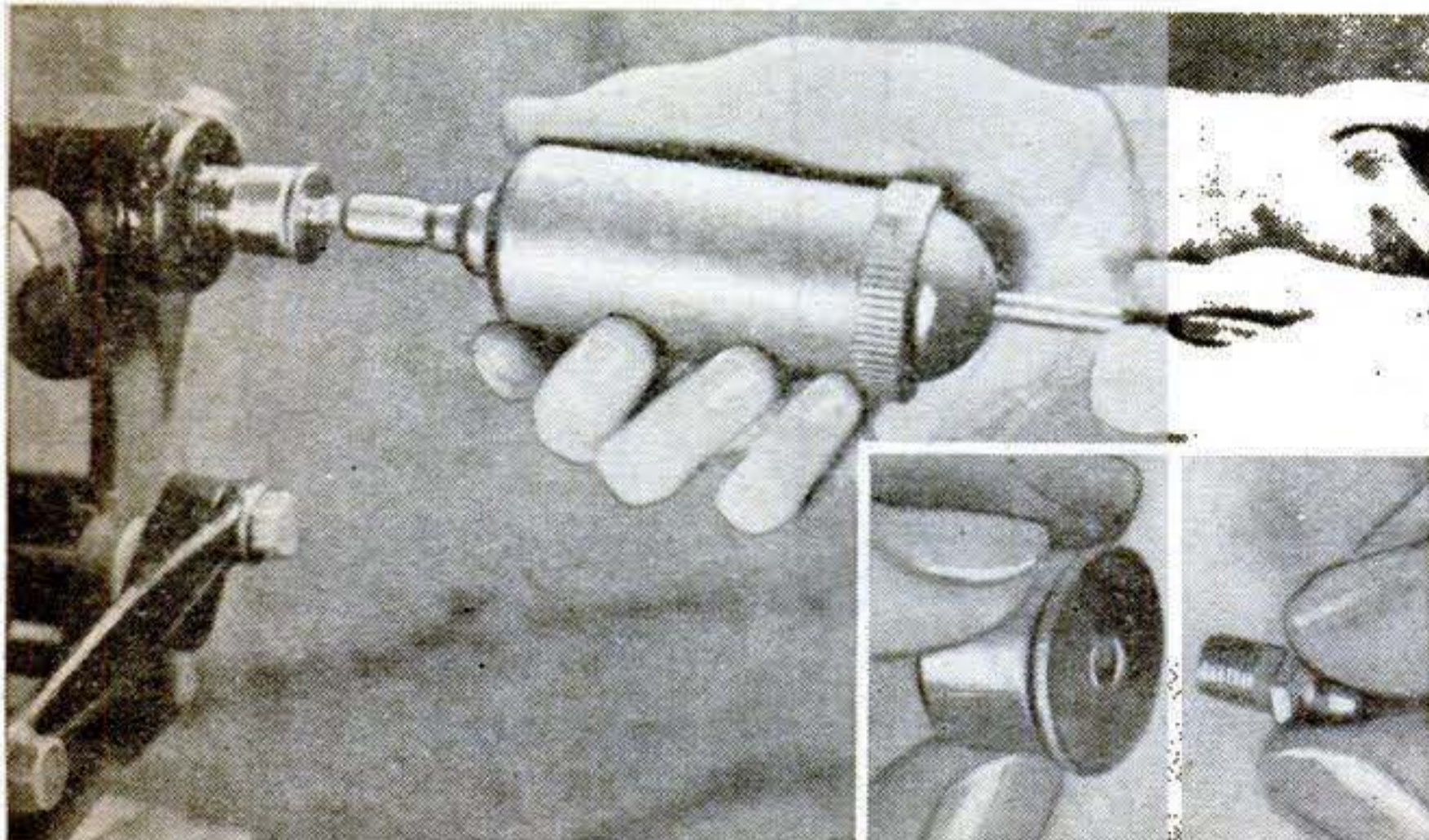

**A CHIP CHUTE** of plywood made for the lathe bench provides an easy means of collecting chips and keeping them off the floor. If the lathe is used for both metal and wood, have two containers so wood chips can be kept separate and burned.—D. C. DOREMUS.



## Tool Turned from Drill Rod Cuts Smooth Dovetail Joints

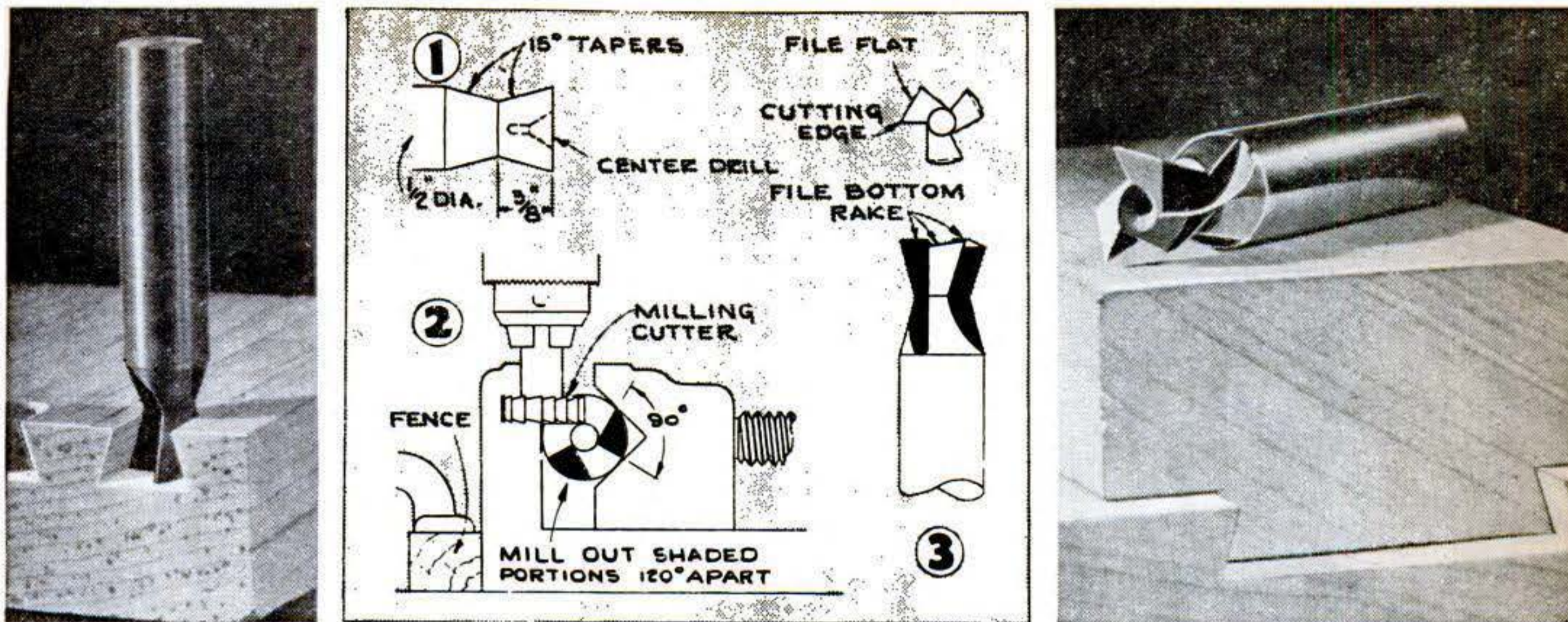

THIS dovetail cutter will make blind dovetail recesses in drawer fronts, as at left above, and smooth-sliding dovetail joints like that at right. It will cut both the tongue and socket in the latter piece.

Turn the cutter blank from  $\frac{1}{2}$ " drill rod, as in Fig. 1, and lay out three equal divisions with lines at 90 deg. Clamp the blank in the drill-press vise, set up a small milling cutter (see PSM, Nov. '46, p. 175) as in Fig.

2, and slide the vise against a fence clamped to the drill-press table as above. File the side of each tooth to a flat angle (Fig. 3), using the file lightly to finish the edge, and then produce the bottom rake with a file, as also shown in Fig. 3.

Harden the cutting end, temper by heating the shank until the straw color travels to the top of the side teeth, and then quench immediately.—HERBERT PFISTER.

## Arbor Press for Handling Small Work Is Made from C-Clamp

SCALED to modelmaking size, this little arbor press will push studs in or out and, in its own small way, do anything a large press can do. It consists of a  $3\frac{1}{2}$ " or 4" C-clamp, preferably one of good quality, held to a slotted hardwood block with two angle brackets.

Recess the block with a chisel to take the clamp web at the stationary-jaw end snugly

up to the flange, and bevel the edges of the block. Drill bolt holes in the clamp frame, bolt it between the brackets, and screw the latter firmly to the block. Paint the clamp, brackets, and block machine gray, but take care not to get paint on the threads.

In use the press is bolted to the bench. Oil the clamp-screw swivel foot to make it work freely.—H. P. S.

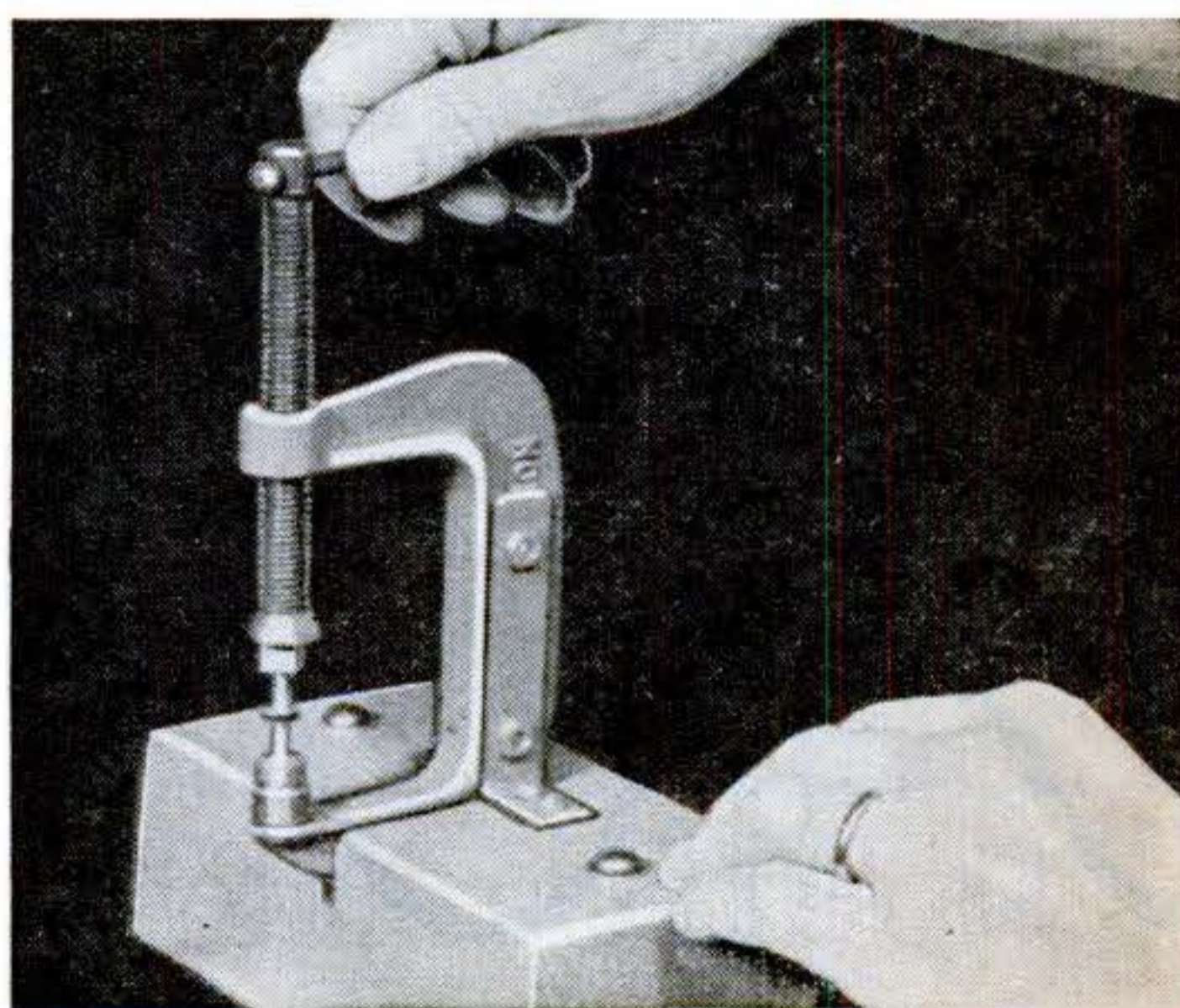
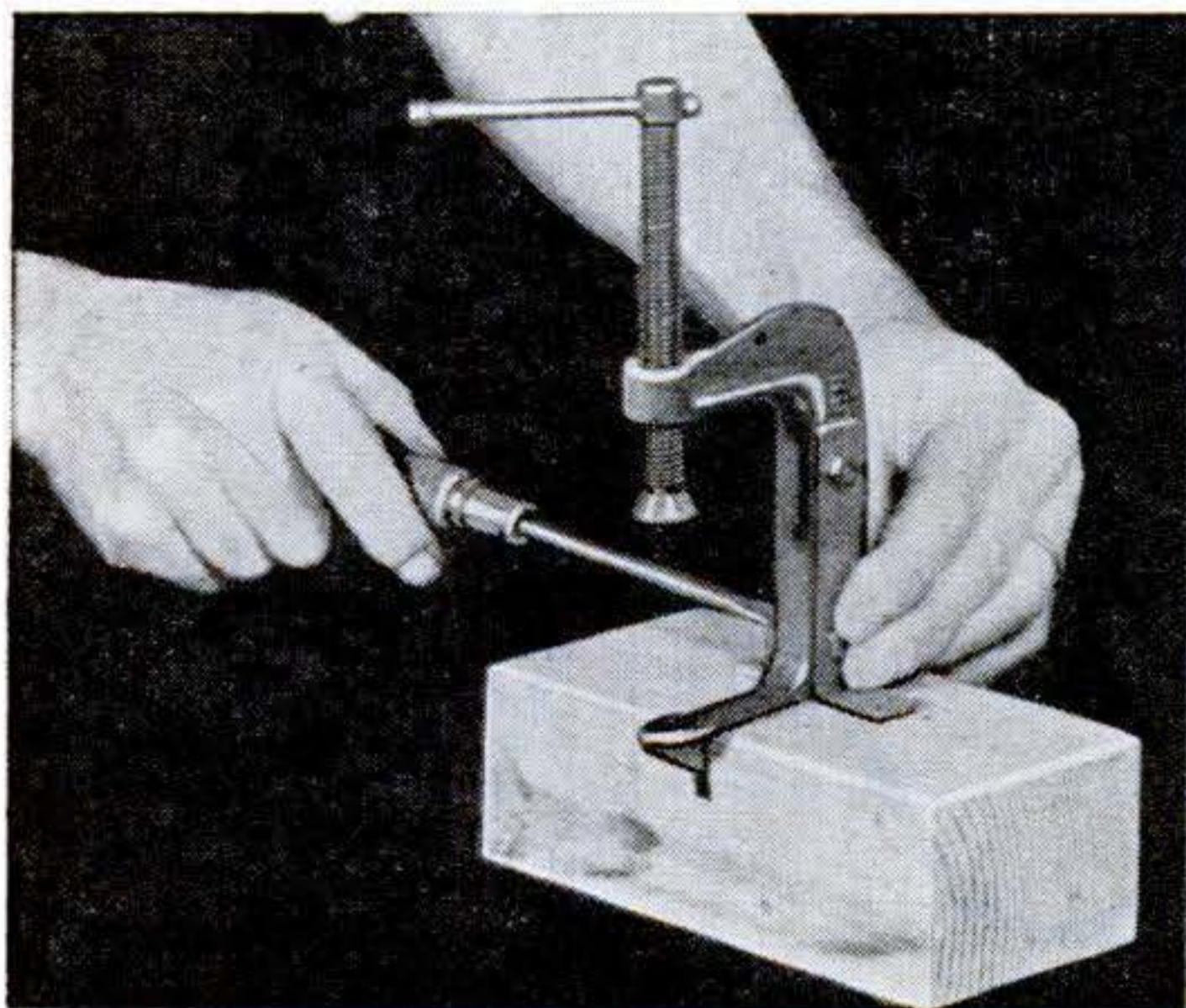





# D. C. from Your A. C. Lines

NEED DIRECT CURRENT?  
IT'S YOURS WITH A LOW-  
COST, EASILY ASSEMBLED  
ELECTROLYTIC RECTIFIER.

By Harold P. Strand

**C**RUDE as it may seem to engineers and the fortunate few who do their experimenting in well-equipped laboratories, the electrolytic rectifier can boast of advantages over its more efficient rivals. It is cheaper and easier to build than vacuum-tube, dry-disk, or motor-generator rectifiers, yet it is a reliable source of low-voltage D.C., useful for electroplating, charging batteries, and operating model railroads.

Practically all the needed materials will be found around the house or in the scrap box. Chief items are a resistance or transformer to drop the line voltage, a 1-gal. stoneware crock or jar, two small sheets of  $\frac{1}{8}$ " aluminum, one of  $\frac{1}{8}$ " or  $1/16$ " lead, and a panel of bakelite or similar material large enough to span the mouth of the crock. Any one of several chemical solutions will serve as the electrolyte.

In the photo on the facing page, the rectifier is shown in operation as a battery charger. Maximum efficiency is obtained when a transformer with a centertapped secondary is used as shown in Fig. 1. The charging rate as indicated on the D.C. meter is 6 to 8 amp.; current draw from the line is 3.7 to 4 amp. Output can be varied by altering either the spacing of the plates or the input voltage. A transformer that can deliver 20 volts from either side to the center tap and 10 to 12 amp. without overheating is required. The wire marked with the "plus" sign goes to the corresponding battery terminal or to the anode (plating metal) in an electroplating bath.

For half-wave operation, either a series resistance (Fig. 2) or a transformer (Fig. 3) will serve to reduce the line voltage. In the first case, to get an equivalent charging rate

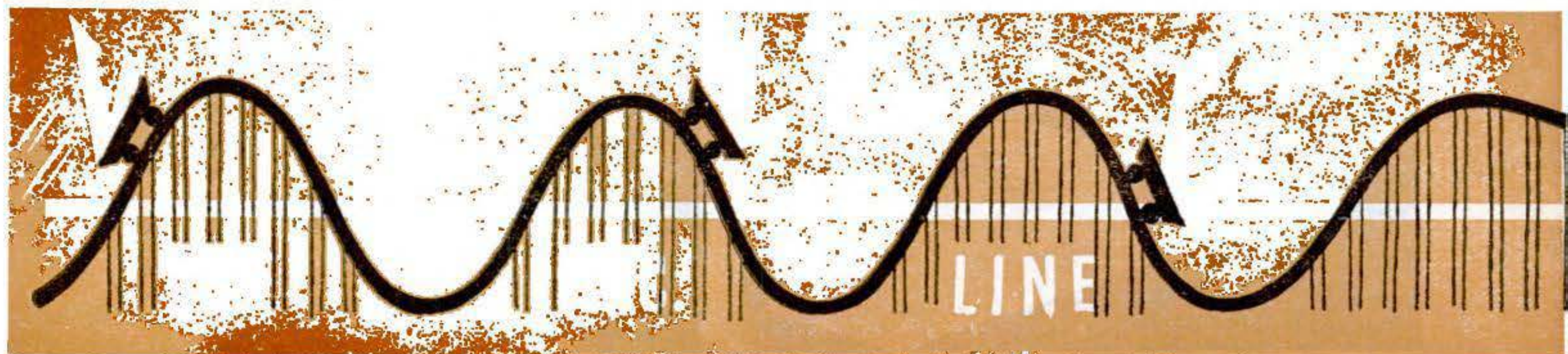



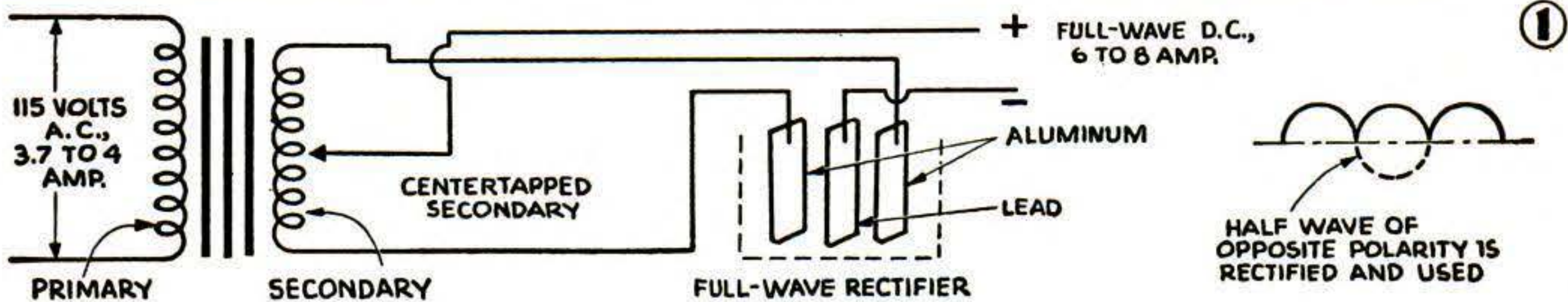
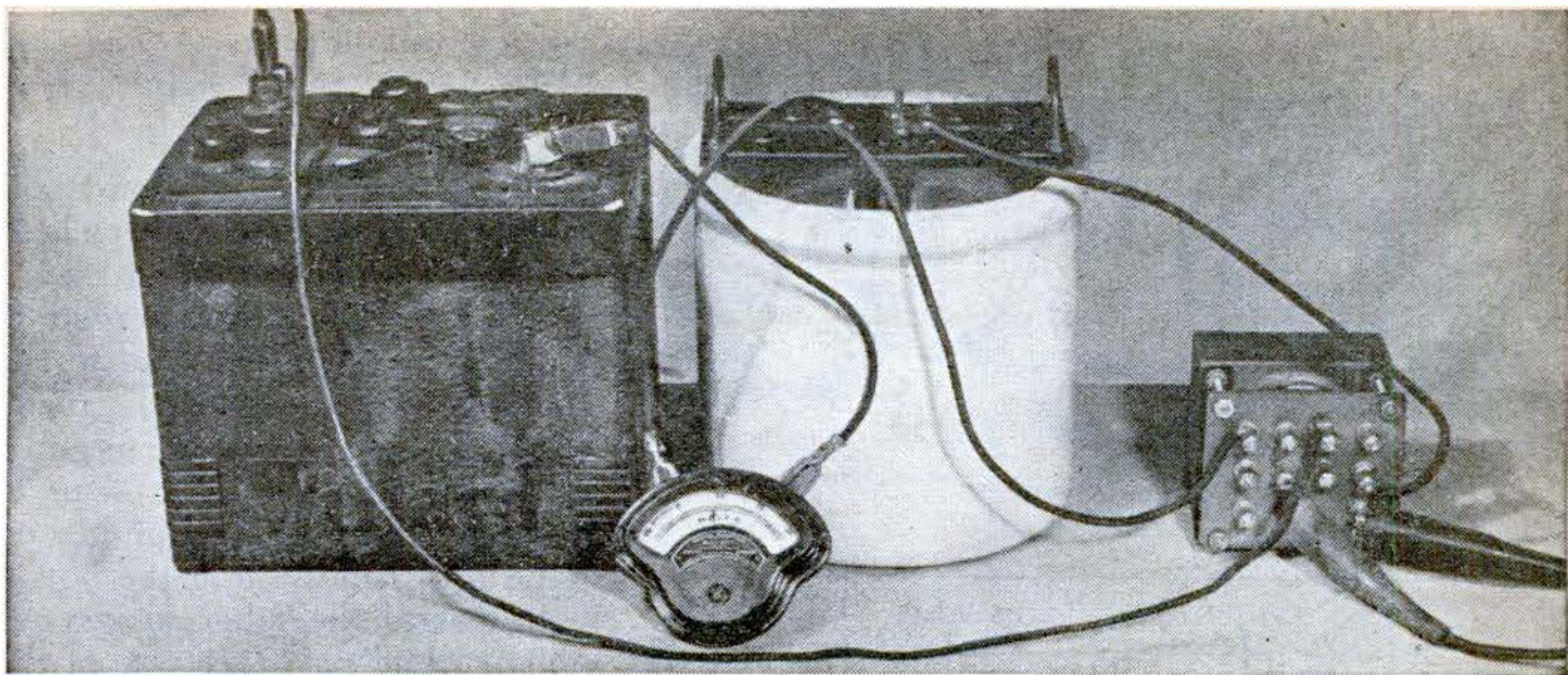

of 8 amp. would impose a line draw of 15 to 20 amp. because of heat losses in the resistance.

With a heating-unit resistance, shown in the photo at the top of page 182, a charging rate of 1.5 to 2 amp. is obtained at a line-current cost of 4 amp. Substituting a lower resistance will increase the output but it will also cause a sharp rise in the input.

A more flexible half-wave rectifier is made with a transformer capable of delivering 18 volts at 11 to 12 amp. Using the connections shown in Fig. 3, it is possible to obtain the relatively efficient charging rate of 5 to 6 amp. with only 2.6 to 3 amp. being drawn by the line.

To build the electrolytic unit, cut one lead and two aluminum plates as shown in Fig. 4, notching the two adjacent ends of one pair so that the plates can be brought close

together without making electrical contact. A strip of bakelite or other insulating plastic is attached to each side of the lead plate as additional insurance against touching.

Assembly of the pieces presents no difficulties. The lead plate is attached to the panel with two 8-32 brass machine screws, and a knurled thumb nut is placed over one of the hold-down nuts to act as a terminal post for the negative lead. Use an extra thumb nut on the screw holding each of the aluminum plates.

Sodium phosphate, obtainable at any drug store, makes a suitable electrolyte. Ammonium phosphate and household borax are two of the other readily available chemicals that can be used. First prepare a saturated water solution—that is, add the phosphate or other chemical until no more can be absorbed by the water and it begins to settle out to the

RECTIFIER

THE D.C. LINE



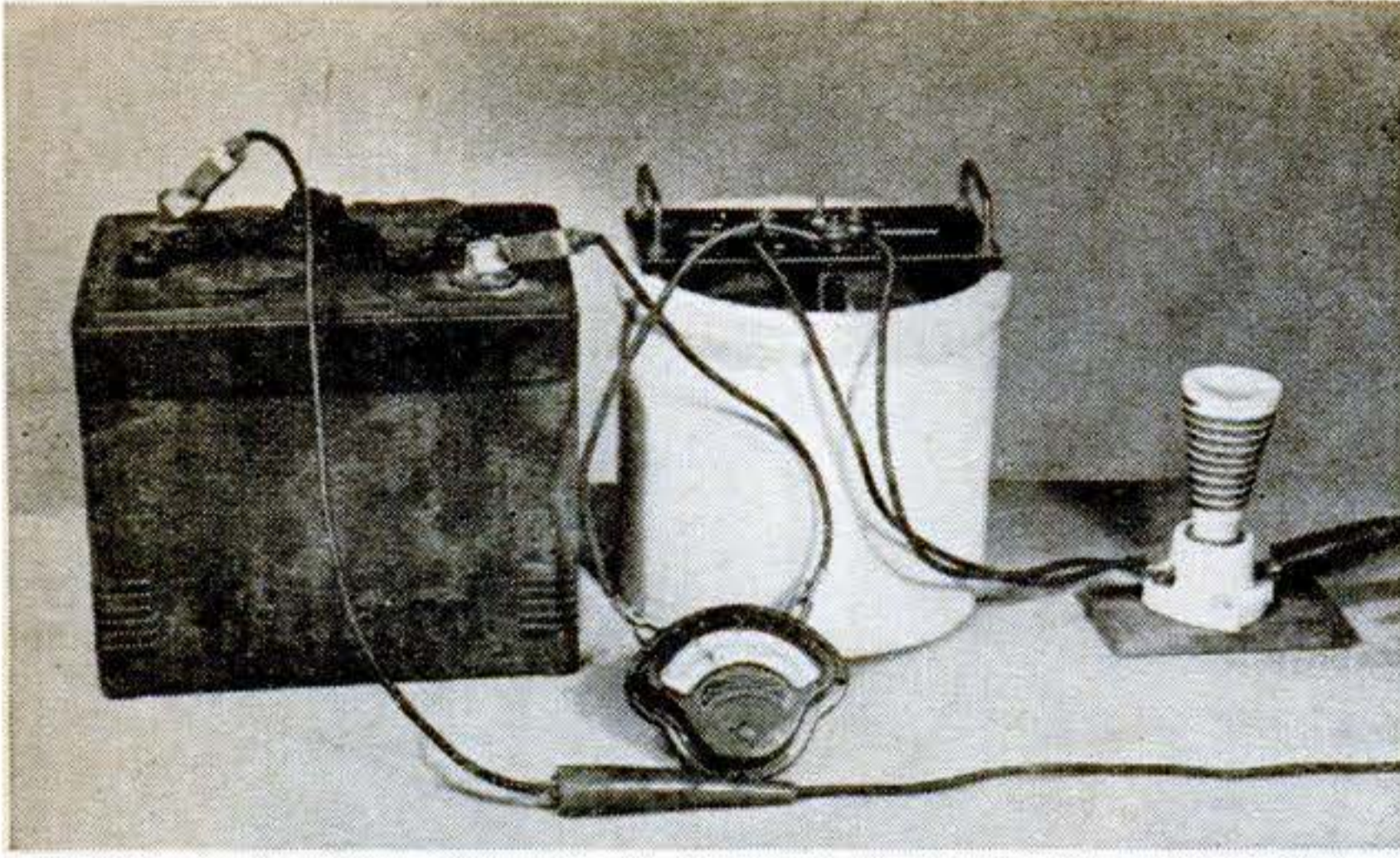

When efficiency is not a factor, the use of the series resistance shown at the left is satisfactory. Wiring connections are given in Fig. 2, below.

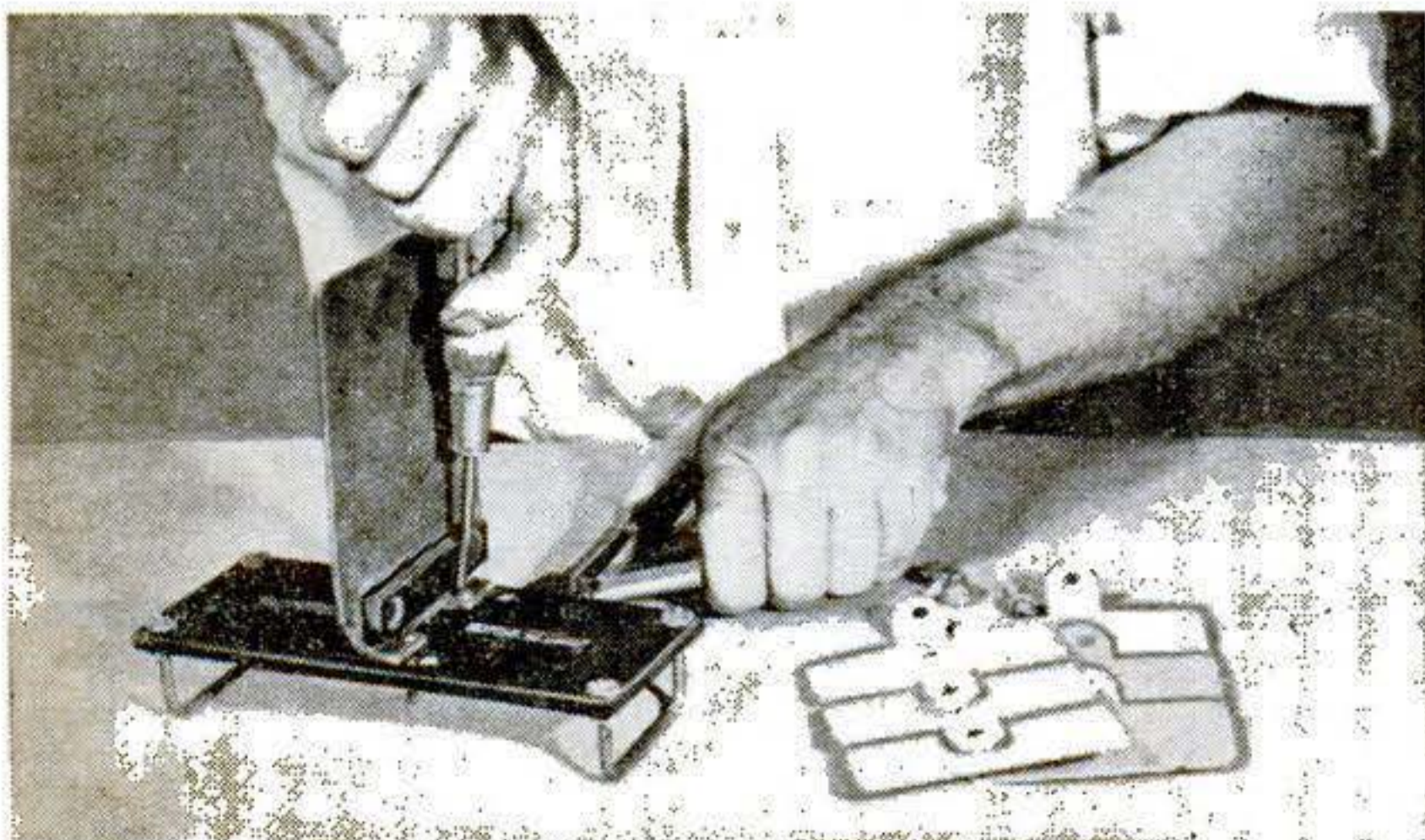
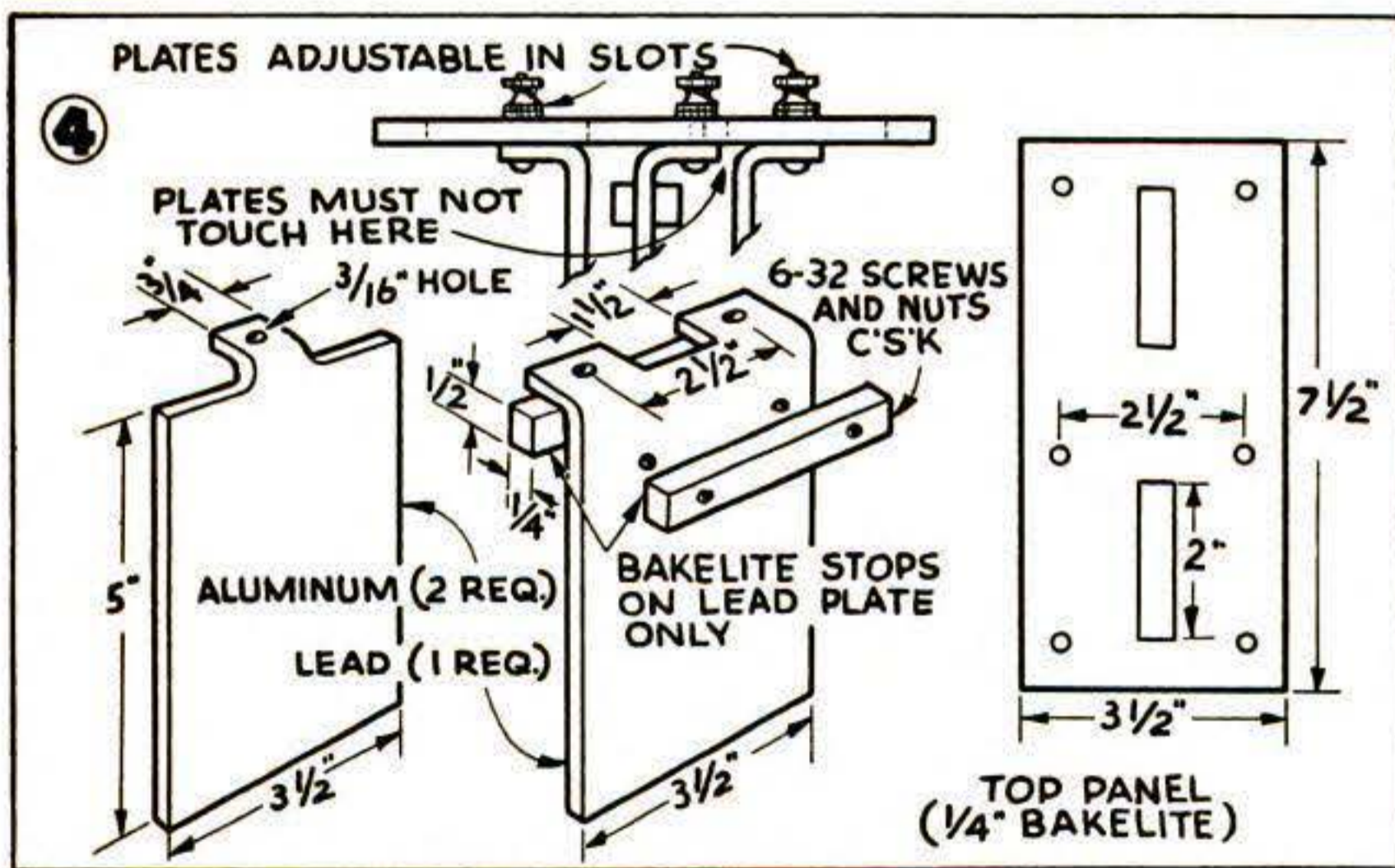
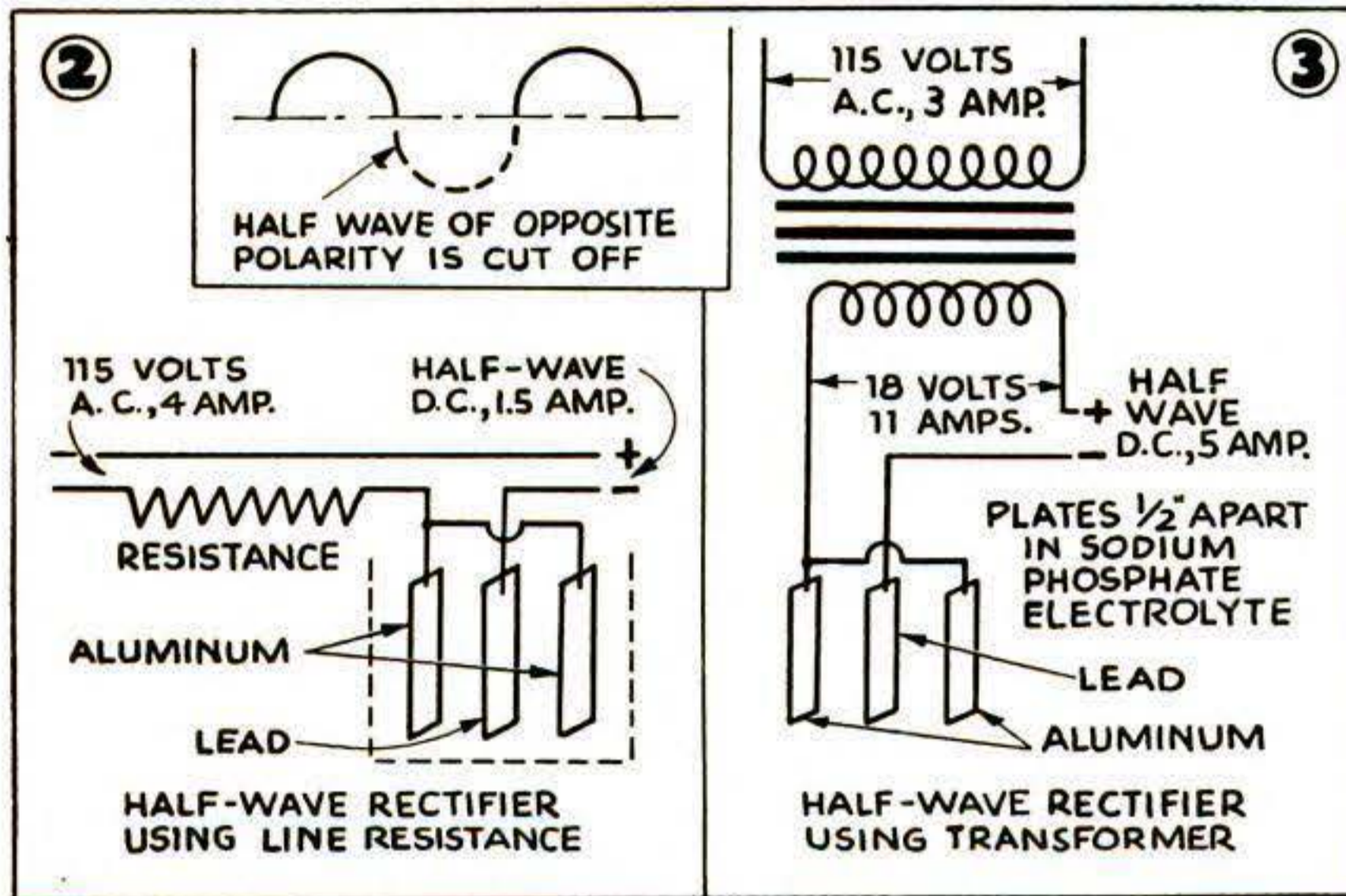

bottom. Stir the solution thoroughly and wait for it to clear; then pour it off into the crock.

With the plates submerged in the liquid, connect a wire to the binding post atop each plate. Join the outer pair at one terminal of a porcelain socket as seen in the upper righthand photo on page 183. One side of the power line goes to the other socket terminal, while the other side of the line and the wire from the lead, or center, plate constitute the output or charging lines.

Add a teaspoonful of table salt to a glass of water and place the bared ends of the output wires in this solution. When the power is turned on, tiny bubbles will be seen to form around the wire coming from the lead or negative plate. Touch the wires together and bubbles will begin to form around the aluminum plates. Hold the connection for about 20 minutes to permit a film of aluminum hydroxide to form on the positive plates. This film, acting as a rectifying agent, offers extremely high resistance to the flow of current in one direction and a low resistance in the other.

To measure output voltage, set up a complete circuit so that current will flow; this can be done by connecting a resistance across the rectifier and measuring the voltage across this load. An ammeter in series will tell the current in the circuit.

Servicing boils down chiefly to the problem of offsetting the effects of chemical action. Connections are liable to corrode, especially where screw heads make contact with the plates; the aluminum plates may also wear out

At left, attaching the lead plate with brass machine screws. Note the handles on which the panel rests; simple knobs can be used in place of the handles.



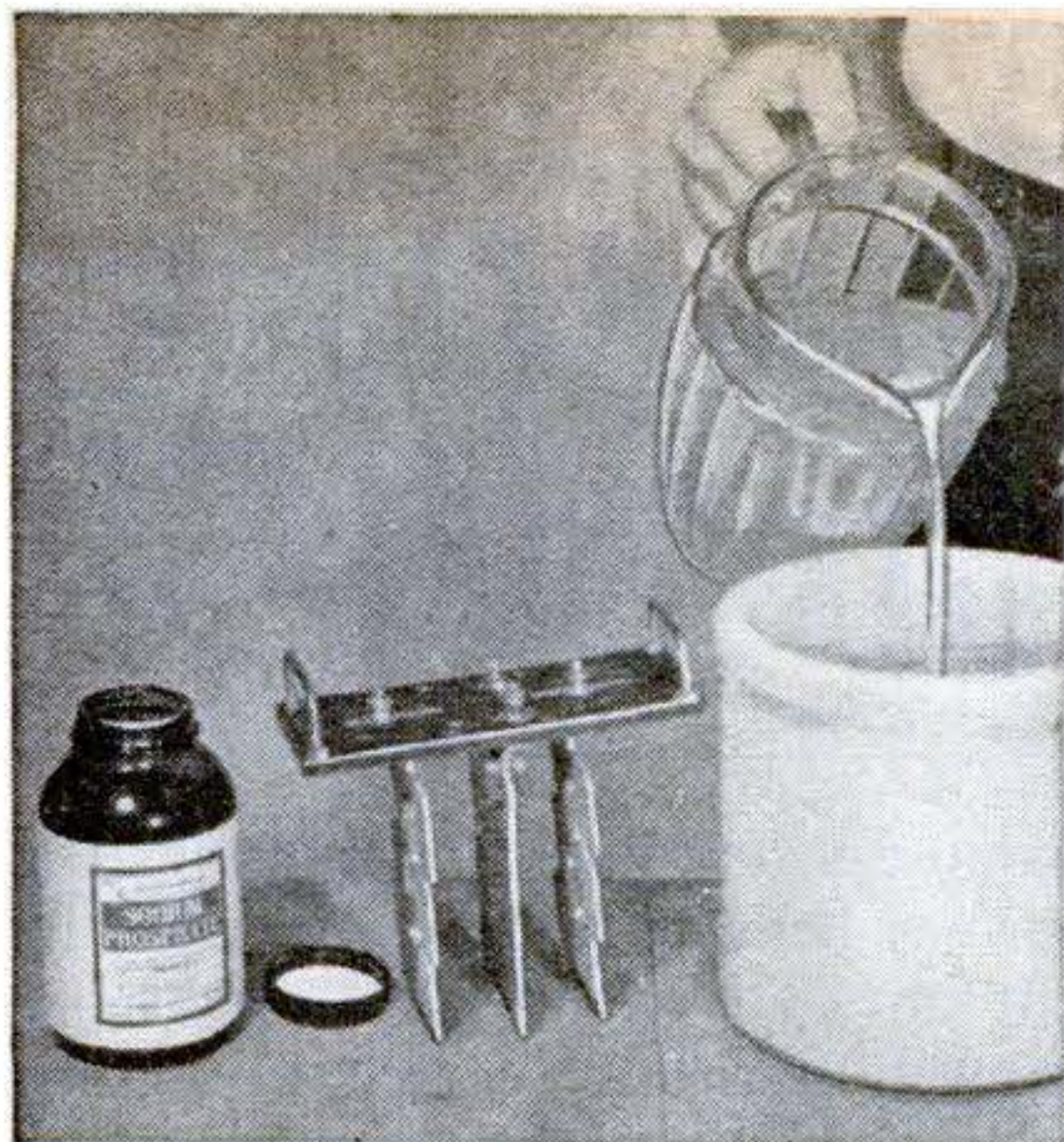

Mix the chemical and water in a saturated solution, stir it well, allow the liquid to clear, and pour it off into the crock.

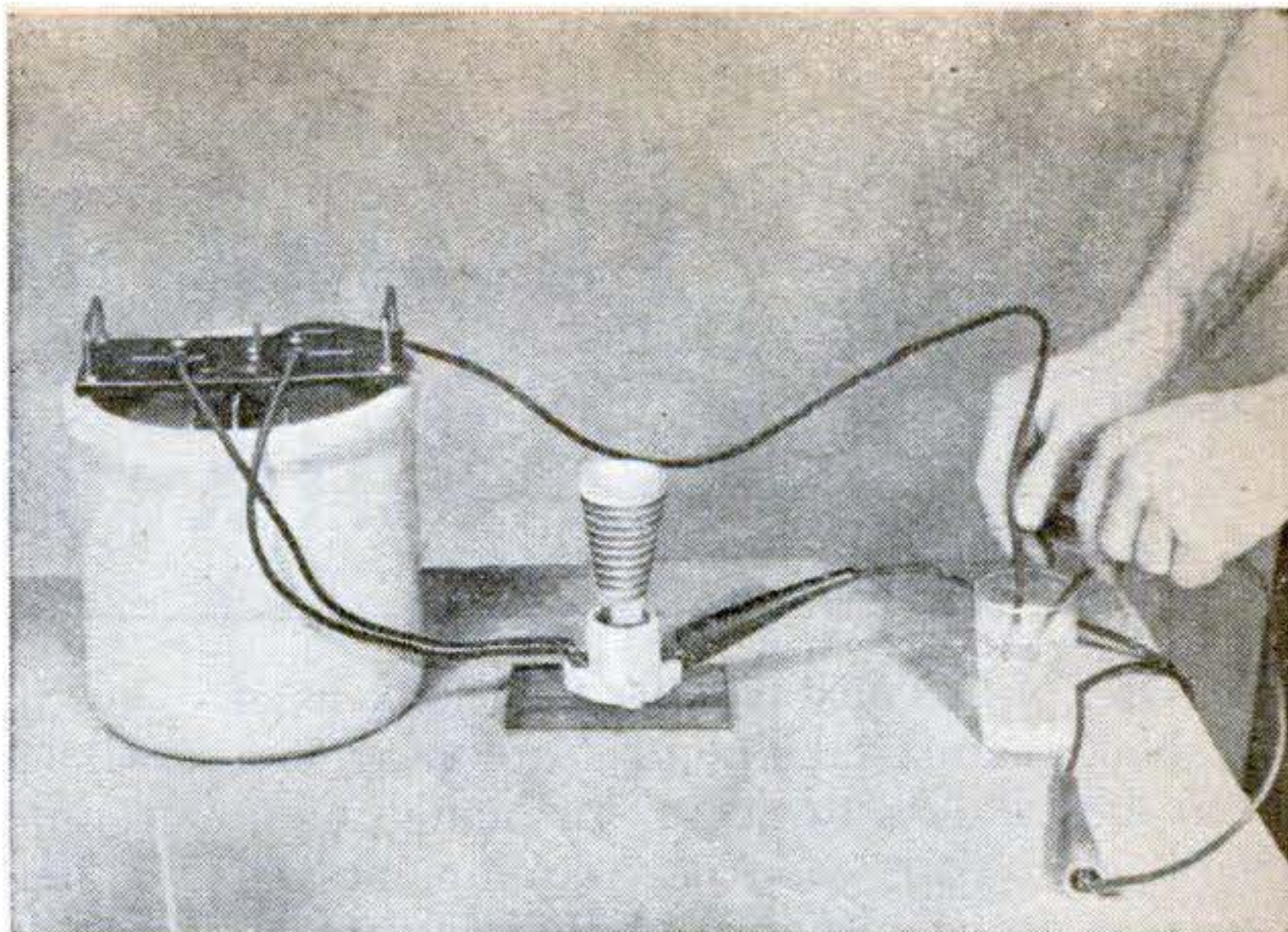

When both leads are submerged in a salt solution, bubbles will form around the negative wire. Short-circuit the wires to permit a hydroxide film to form on the aluminum plates.

and have to be replaced. Clean the plates from time to time and repeat the forming process to allow the hydroxide film to form again. When the solution shows signs of persistent overheating, and the charging rate cannot be brought up to scratch, it is time to throw out the old liquid and prepare a new batch.

In continuous operation the solution will gradually rise in temperature. If it becomes too hot, or if a heavy current is being drawn, place the crock in a larger vessel and allow a stream of water to run in the space between.

For experimental use, where low-voltage, short-duration D.C. is needed, a simple electrolytic rectifier is illustrated in Fig. 5 and the photo below. Two plates provide half-

wave rectification; the container is an empty fruit jar of about 1-qt. capacity. One lead and one aluminum plate, spaced about  $\frac{1}{4}$ " apart and supported by 8-32 screws and nuts, constitute the vital parts. The same electrolyte may be used in this outfit as in the larger one.

Since the output of the smaller unit is low at best, it should be used only with a transformer. A heavy-duty toy train transformer able to deliver about 30 volts in the secondary should serve nicely. With the latter input, an output of about 1 amp. at 6 to 6.5 volts can be obtained. The output can be raised somewhat by using a higher input voltage, but if more service is required of the rectifier, it would probably be better to build the larger one described above.

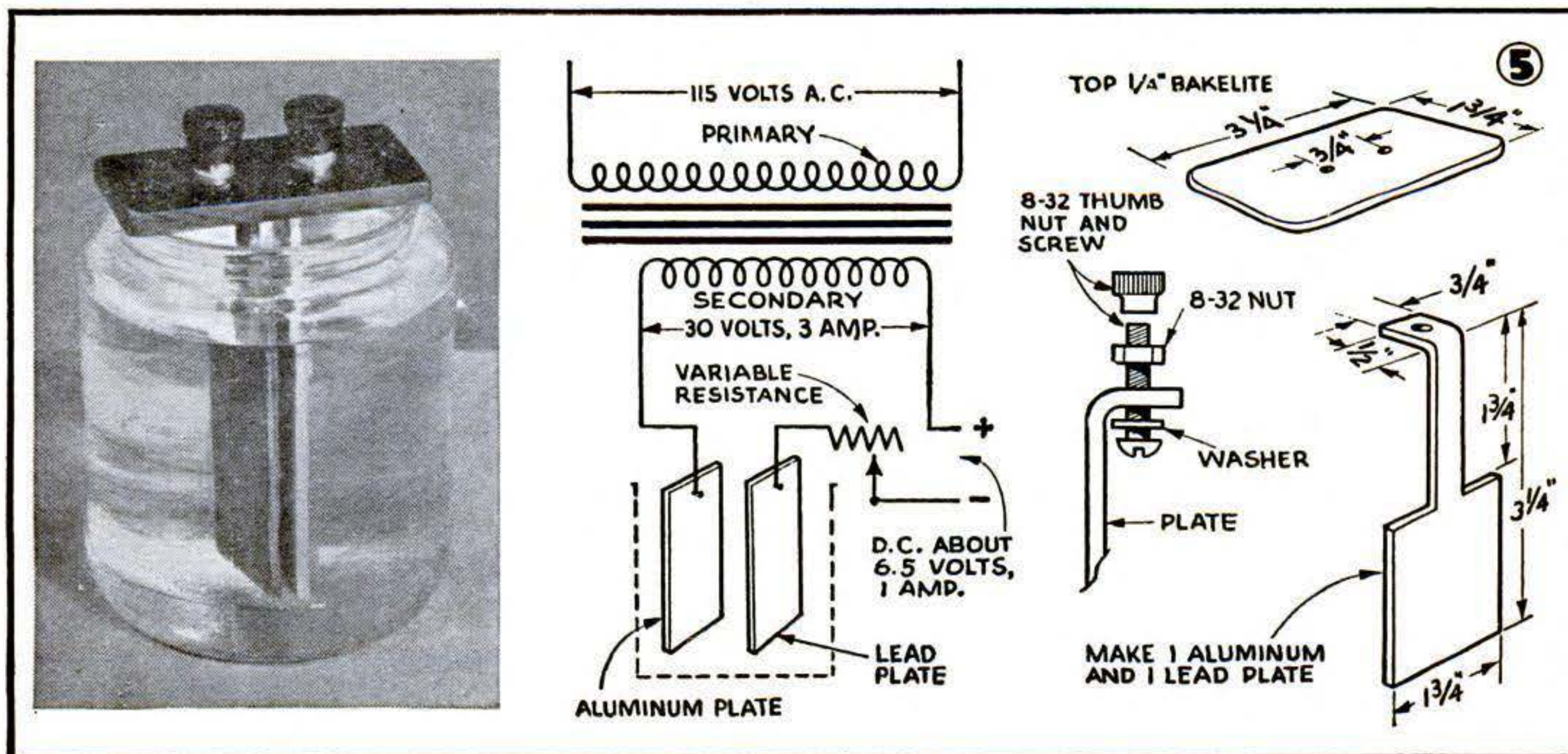





# Putting an Old Tripod Back on its Feet

**B**ROKEN-DOWN tripods that look as if their picture-taking days are over can often be rebuilt to serve for many more years. And with good new equipment still scarce, even extensive rehabilitation may be worth the effort. The illustrations below show the most commonly needed repairs.

Start by examining the top carefully for cracks, holes, and loose screws. Minor cracks in metal tops can be stopped by drilling a small hole just ahead of the split. More serious damage requires soldering, or brass reinforcing plates held with machine screws. In wood tops, use plastic filler to plug cracks

and pack loose screw holes. Sometimes the whole top may have to be separated into its component plies and reglued.

The screw fitting the camera socket, subject to much hard wear, frequently must be replaced. A standard  $\frac{1}{4}$ "-20 bolt can be used, or a special screw having these threads made up in the lathe with either a knurled head or a transverse pin as a finger grip. To keep the screw from coming out of the plate, form a neck on the screw as shown in the drawing, thread the plate, and burr the threads in the plate after the screw is on. Or make up a plate of metal disks with cen-

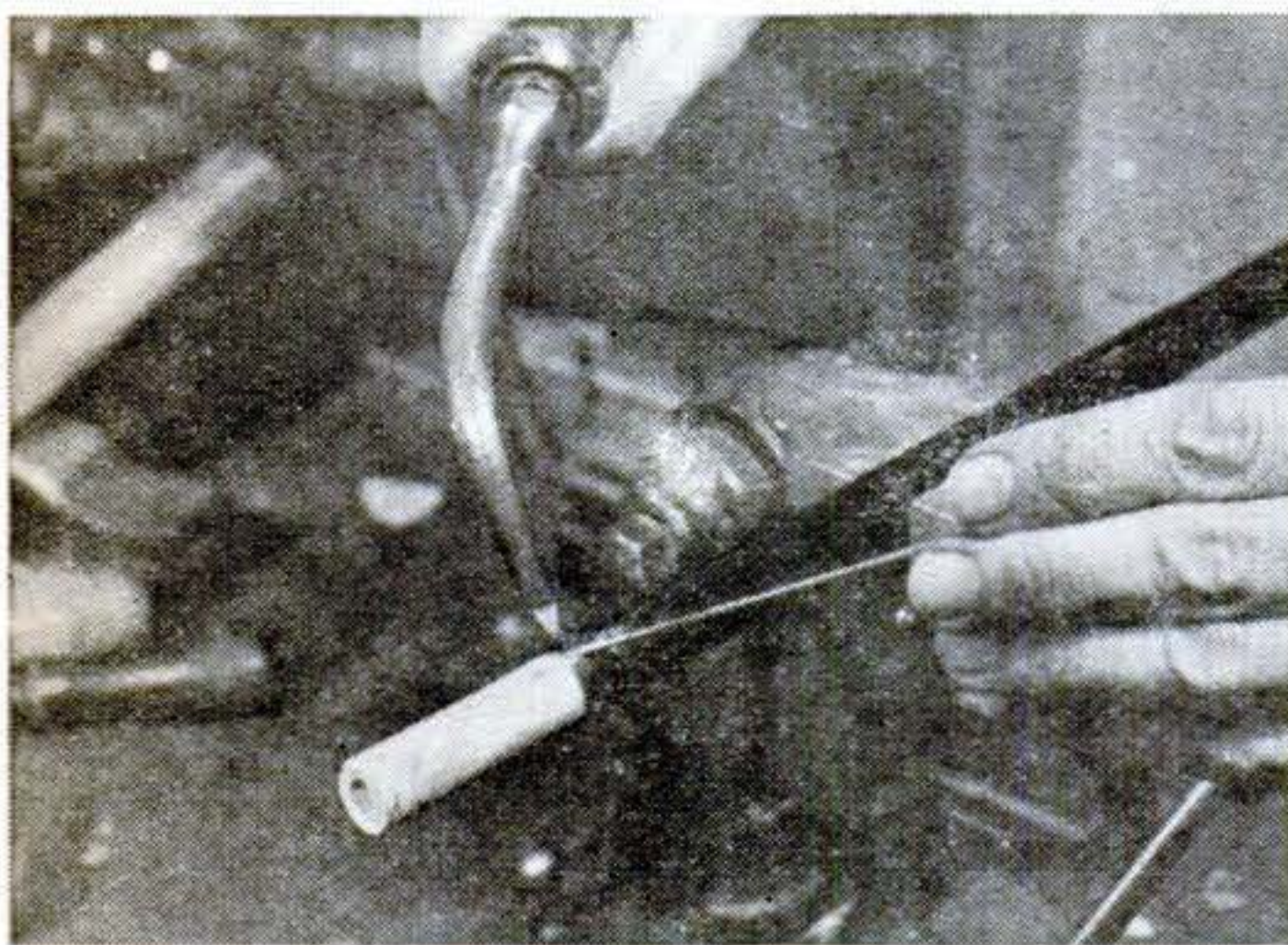

Splits in metal tripod legs are fixed by soldering the break over a porcelain tube and filing flush.

To restore brightness to tarnished brass hardware, dip in nitric acid and neutralize in washing soda.

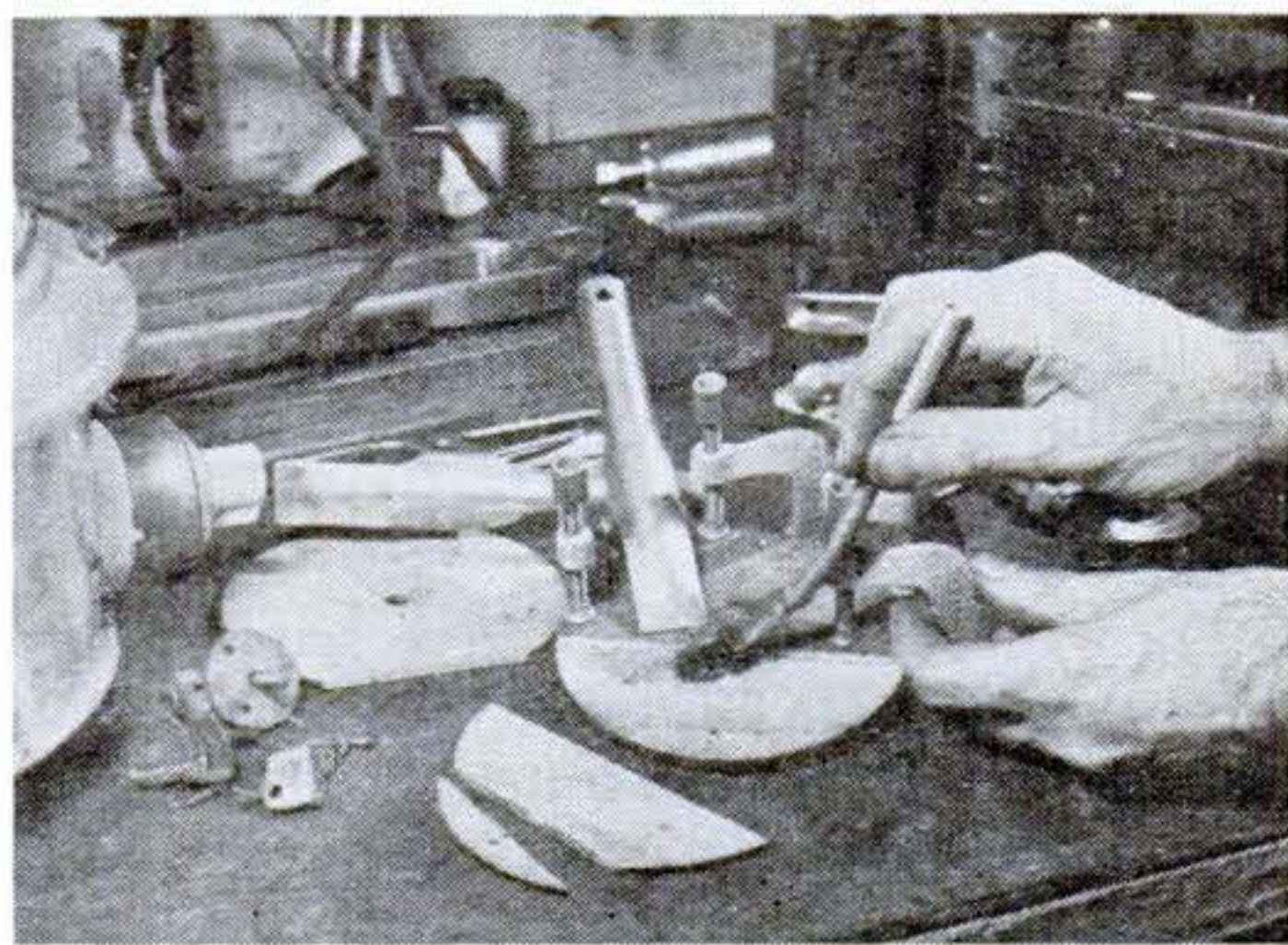
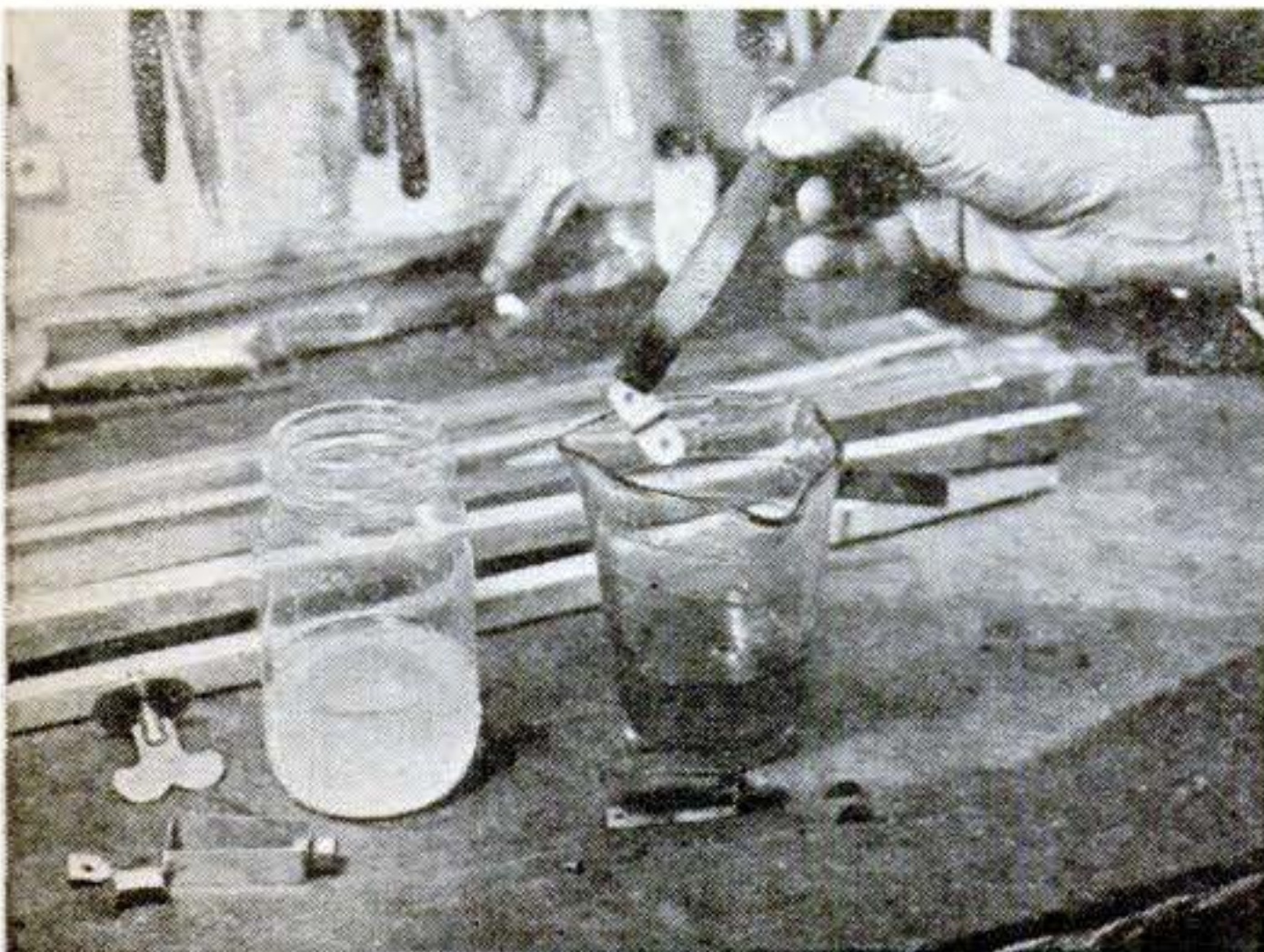

Open plies in wood tops are separated, sanded clean, and reassembled after coating each with glue.

Broken legs should be carefully glued together and reinforced with dowels or recessed brass strips.

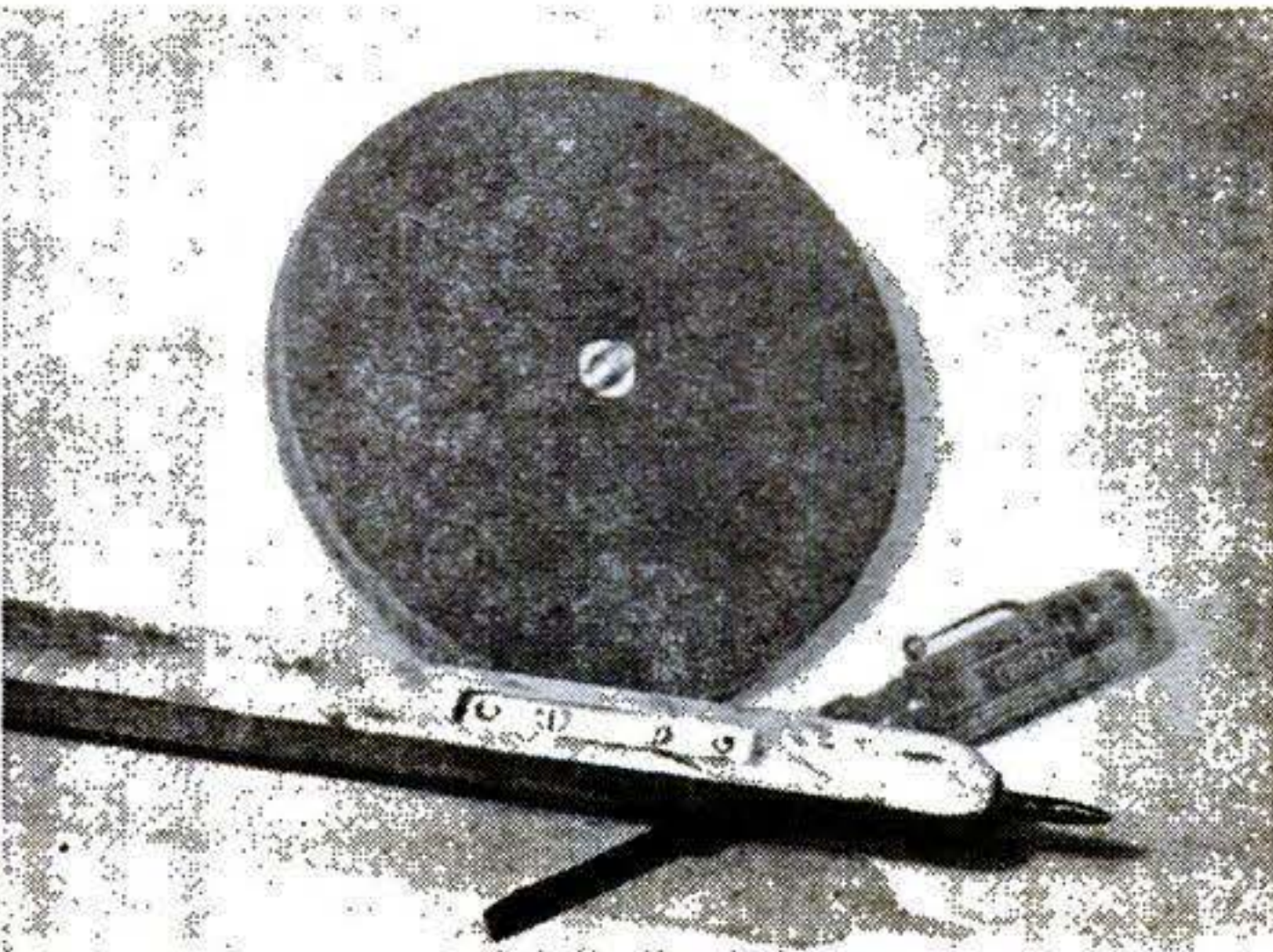



tral holes just large enough for the screw shoulder, but too small for the threads. Both disks, slit from edge to hole, are bent to slip around the screw and then flattened and fastened to the tripod top.

Other parts that often wear badly are knurled knobs. Sore fingers can be avoided by turning down the screw head and soldering on a wing nut. In many tubular metal tripods, push-button catches adjust for height. They can be removed for repairs, if necessary, by disassembling the legs, removing the pin in the spring, and pulling out the spring and button. The legs of metal tripods may also have dents that cause them to stick. Hammer out the dents, using a metal rod as an anvil.

Secondhand wood tripods generally need refinishing. Remove the old finish, sand rough spots and sharp edges, and apply varnish or linoleum lacquer, or rub with boiled linseed oil. Leave sliding surfaces unfinished, lubricating them with wax or soap.—ERWIN WALTERS.

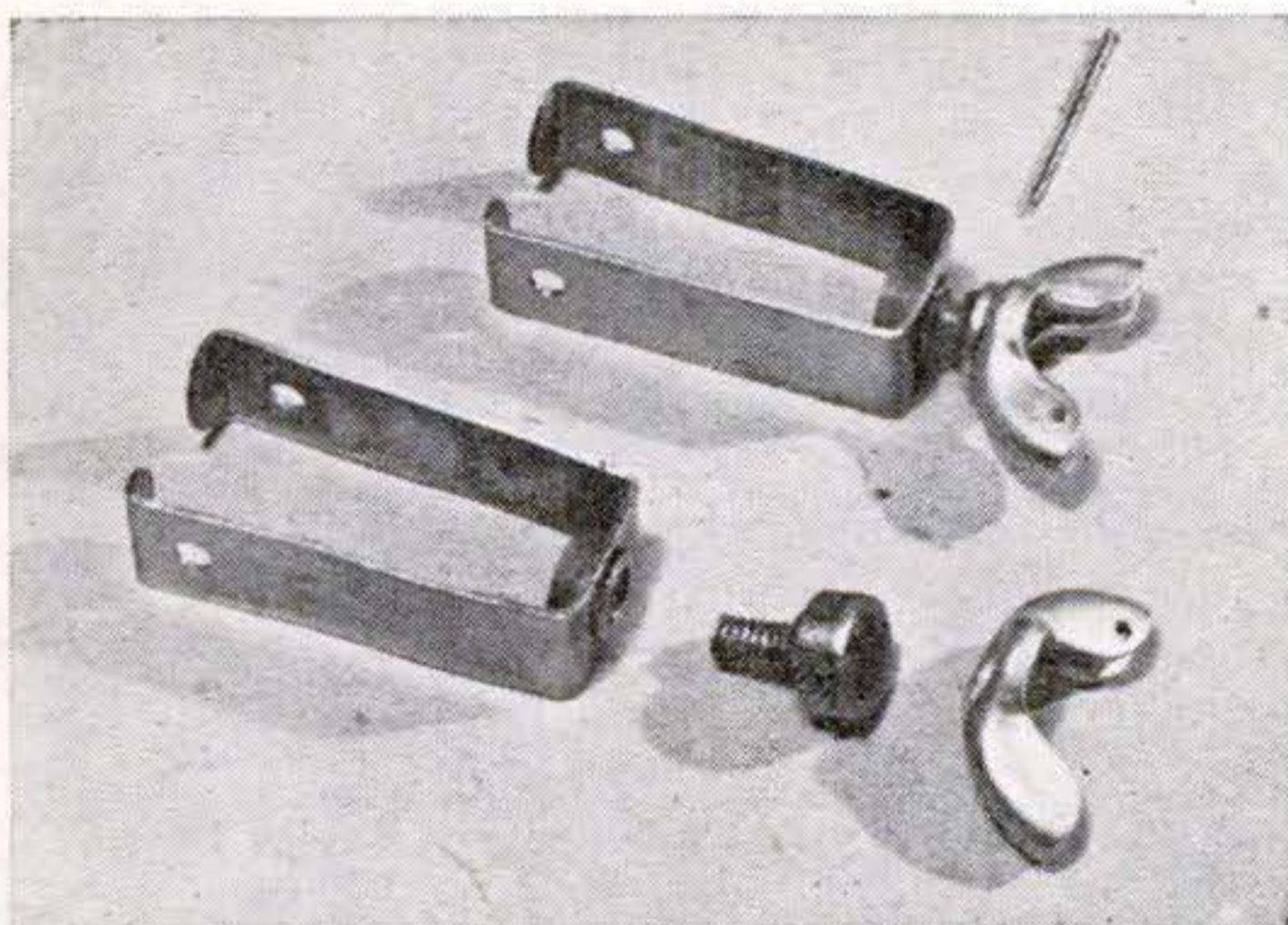
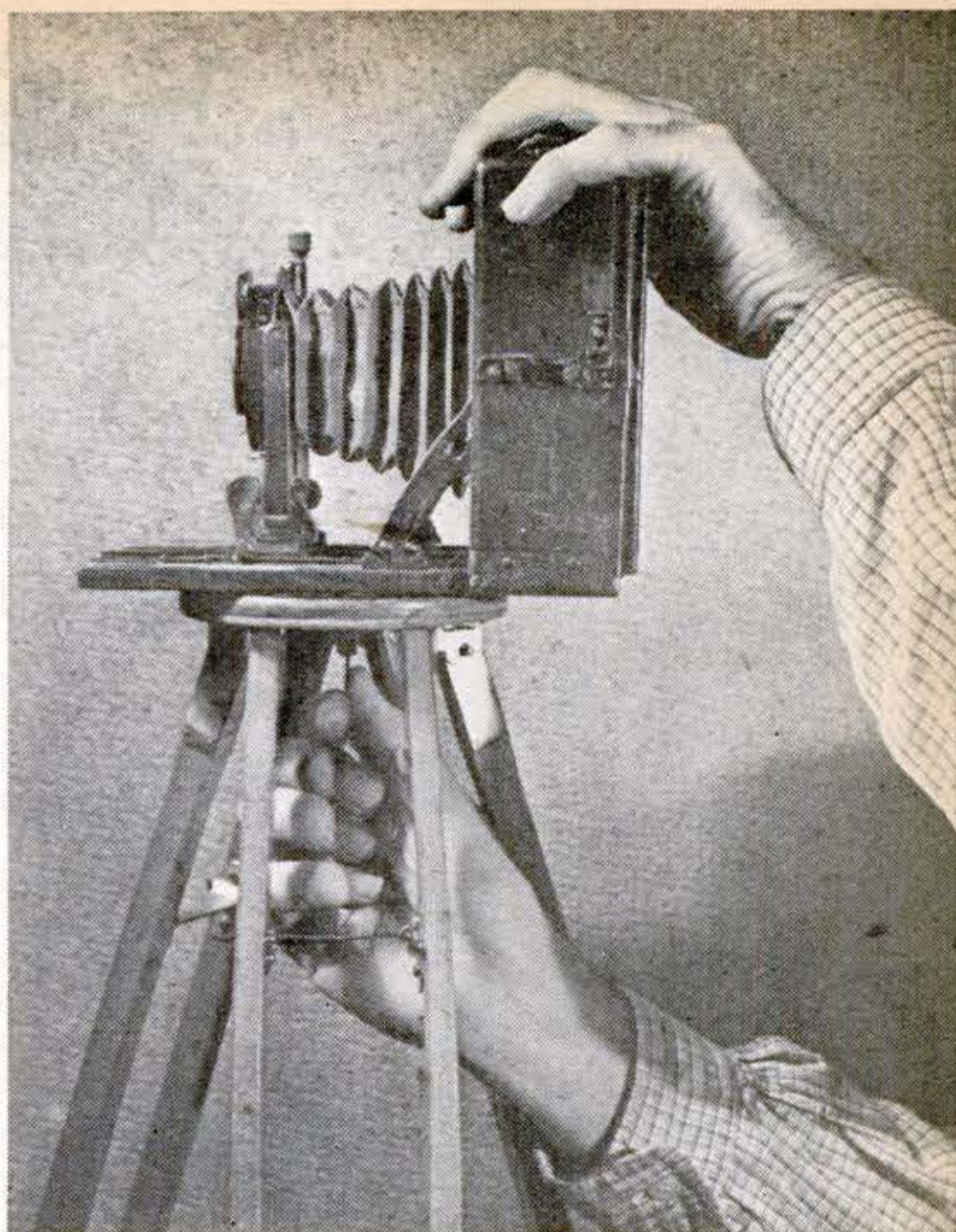

With split top, broken leg, and worn fittings, this tripod went for a quarter at an auction. But only a few hours' work readied it for hard service again.

Screws on the height-adjusting clamps were rebuilt better-than-new by shouldering down the heads on a lathe, and then soldering on wing nuts.

The sketches below illustrate several methods for making commonly needed repairs to height-adjustment fixtures and tops on wood and metal tripods.

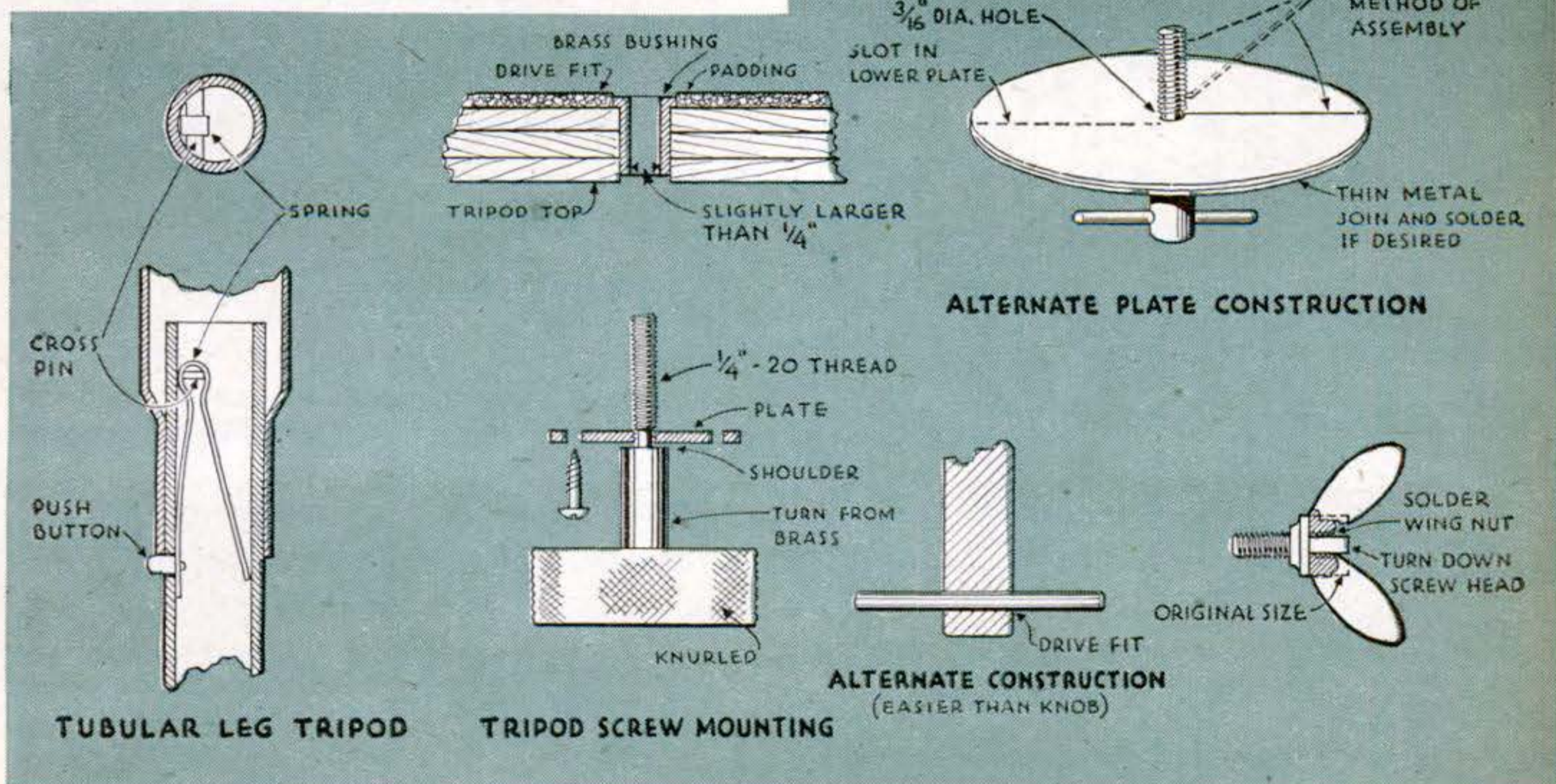



## PHOTO IDEAS and EQUIPMENT

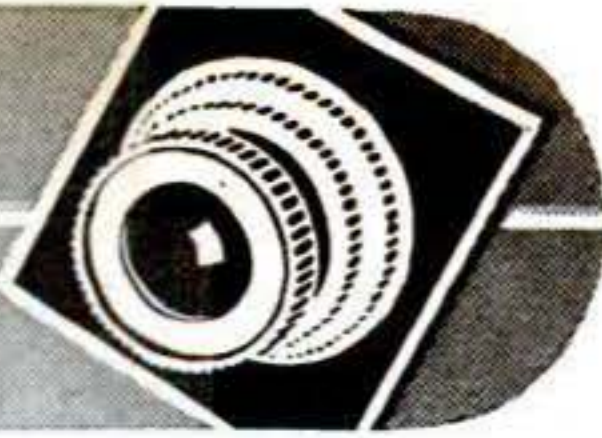

**REFLEX FOCUSING** of miniature cameras, instead of eye-level operation, is possible with a new view finder equipped with a 50-mm. lens and an automatic focusing arm that moves with the camera lens. The ground glass is masked to show a picture area the size of standard color film, and the mask moves with the lenses to correct for parallax. DeMornay-Budd, of New York, makes two models—to fit Leica and Contax cameras—and plans them also for other miniatures.

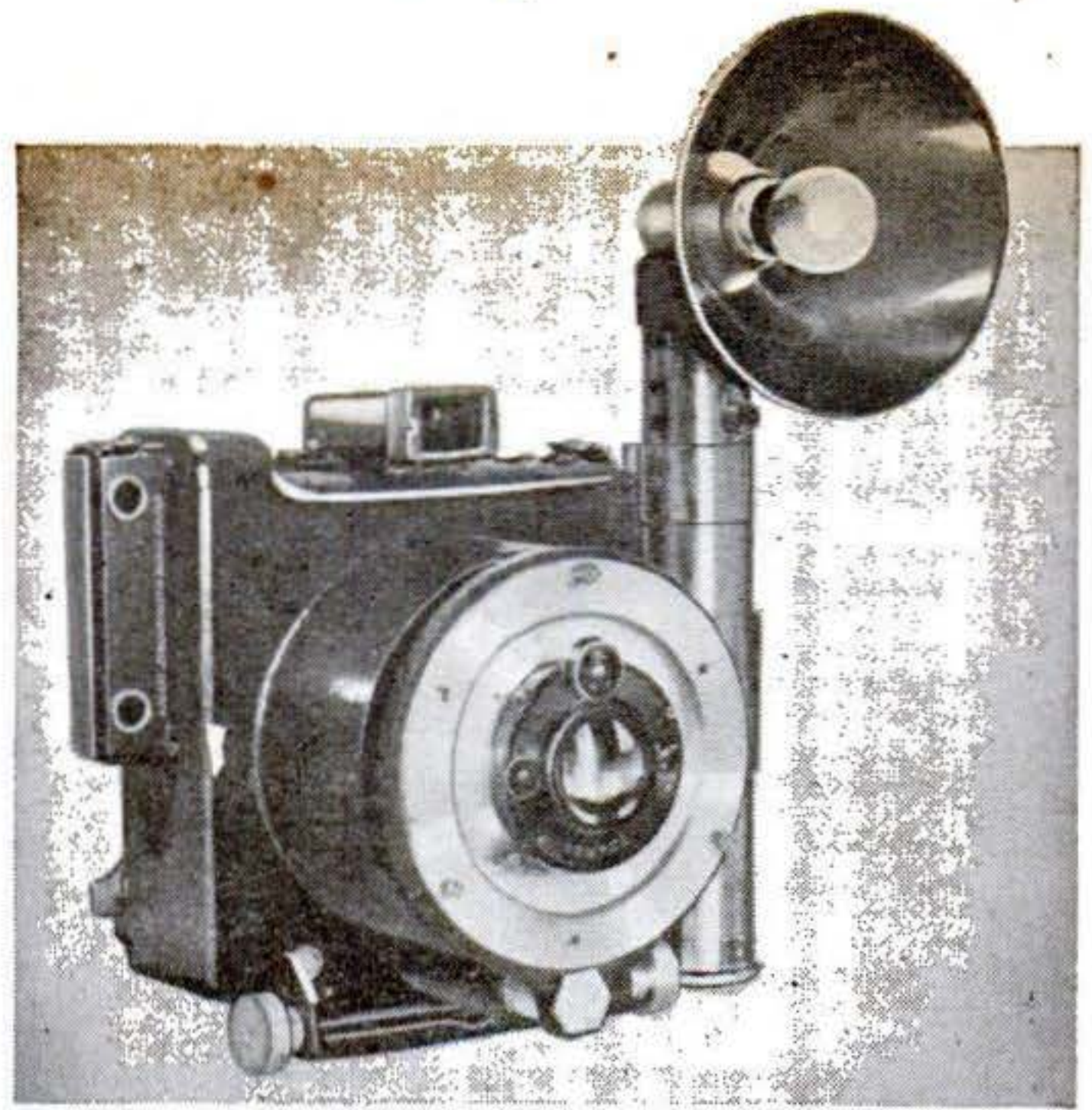
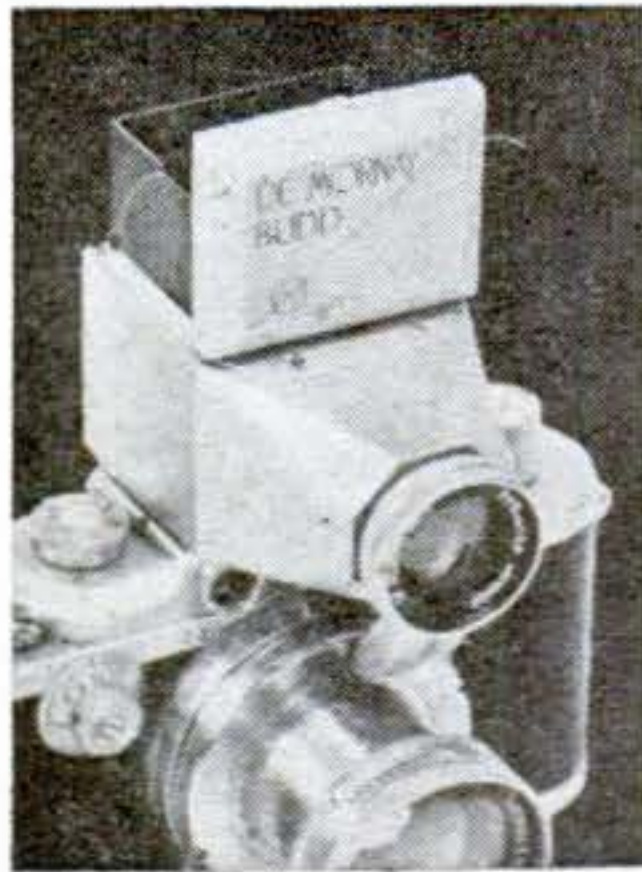

**METAL "BELLOWS"** in the form of a telescoping lens mount are provided on two new Printex press cameras—a 4" by 5" size and a 2¼" by 3¼" "mini-press." Both models are supplied with a recessed metal lens board taking a wide-angle 3½" lens or reversing to take 6" or 6½" lenses. An optional flat board is for 5" to 5½" lenses.

**WOODEN ALBUM COVERS** can be built up of tongue-and-grooved strips glued at right angles to prevent warp. Make the front cover 1" shorter than the back to allow for a 1" hinged binder. Surface all parts to 5/16" thickness. Decorate the front with a title; the letters are glued on as overlays of thin wood and may be painted to contrast. Lace through the holes and filler sheets.—E.M.L.

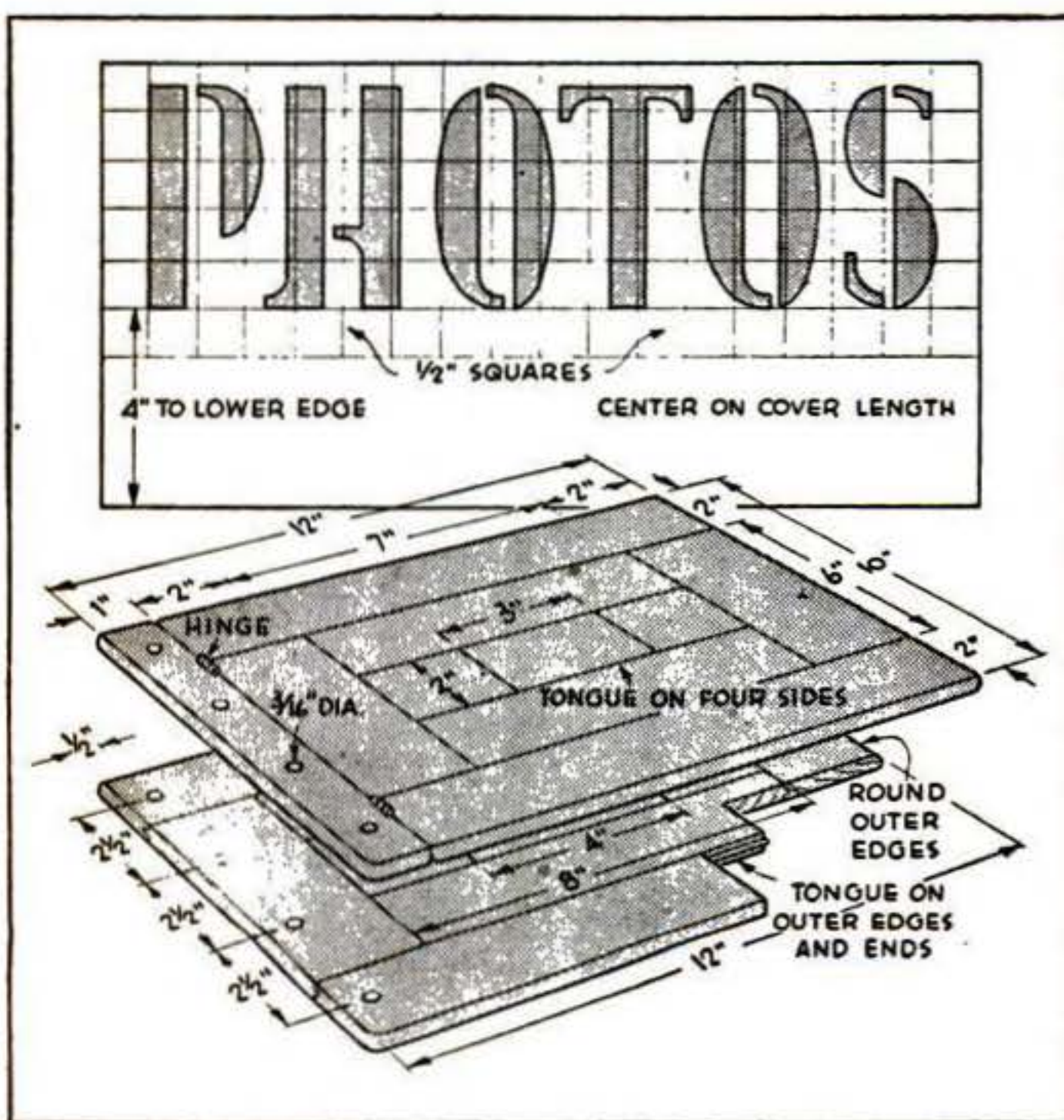

**COLOR CORRECTION** in light is simplified by use of a meter scaled for Harrison & Harrison's set of 22 filters. Source light reflected from a white card is viewed through the meter, which is rotated to show red in an indicator window and further rotated until the color turns almost completely blue. The designated filter for the film being used is then taken from the scale. Two flanking indicator windows provide checks. One should show a definite blue and the other a tinge of red.



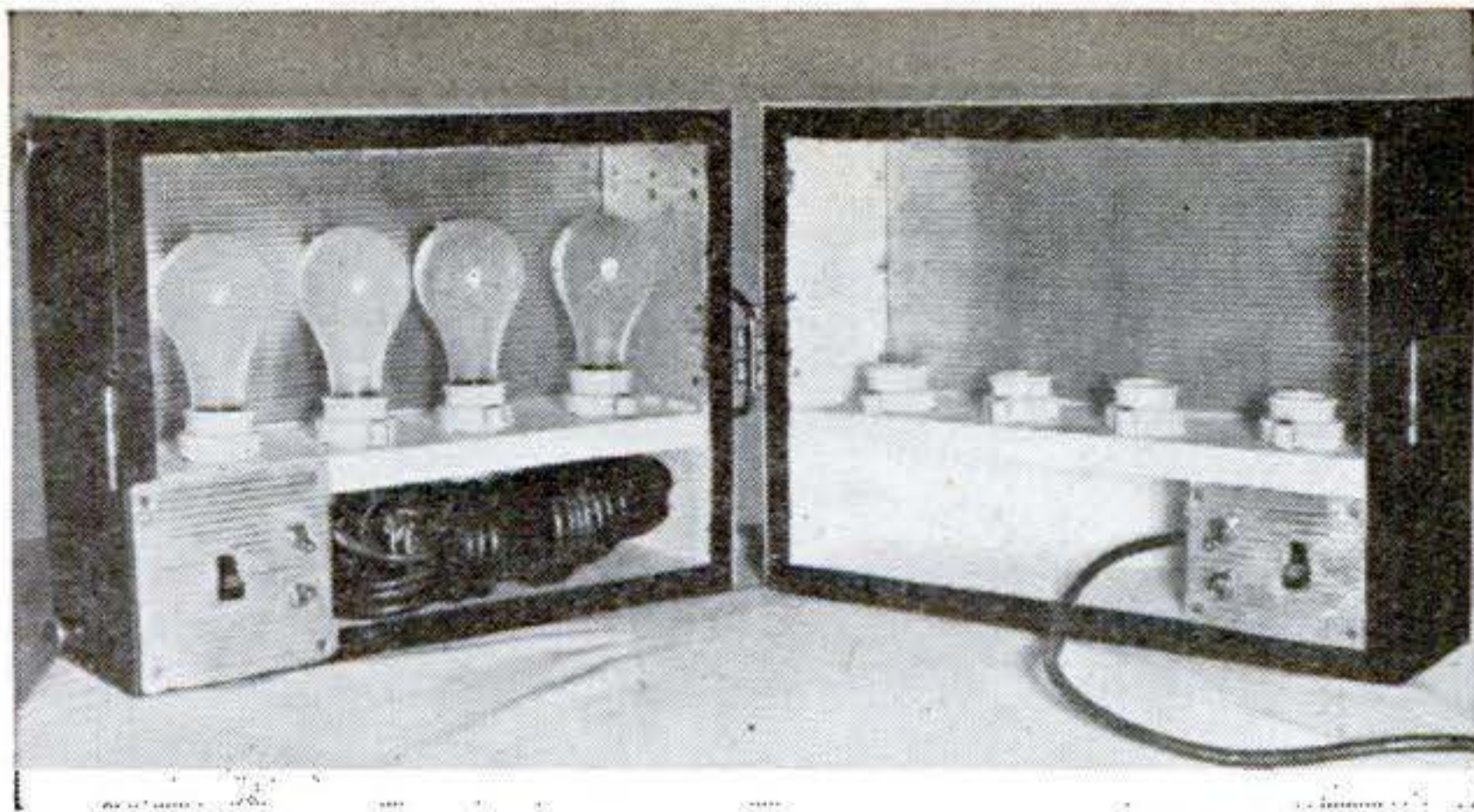

**TWIN PHOTOFLOOD BANKS** having a variety of light combinations can be built of ordinary equipment. Identical housings with hard composition-board backs are locked by pull-pin hinges to form a portable case. A reflector lining of metal-covered asbestos stove pads prevents scorching. Use No. 1 photoflood bulbs only and switches and wire that will carry 10 amp.

With the line switch (No. 3) closed, the combinations are: No. 1 closed, No. 2 at B, all lamps bright; No. 1 open, No. 2 at A, all lamps dim; No. 1 open, No. 2 at B, x lamps bright, y out; and No. 1 closed, No. 2 at A, y bright, x out.—R. A. BREWER.

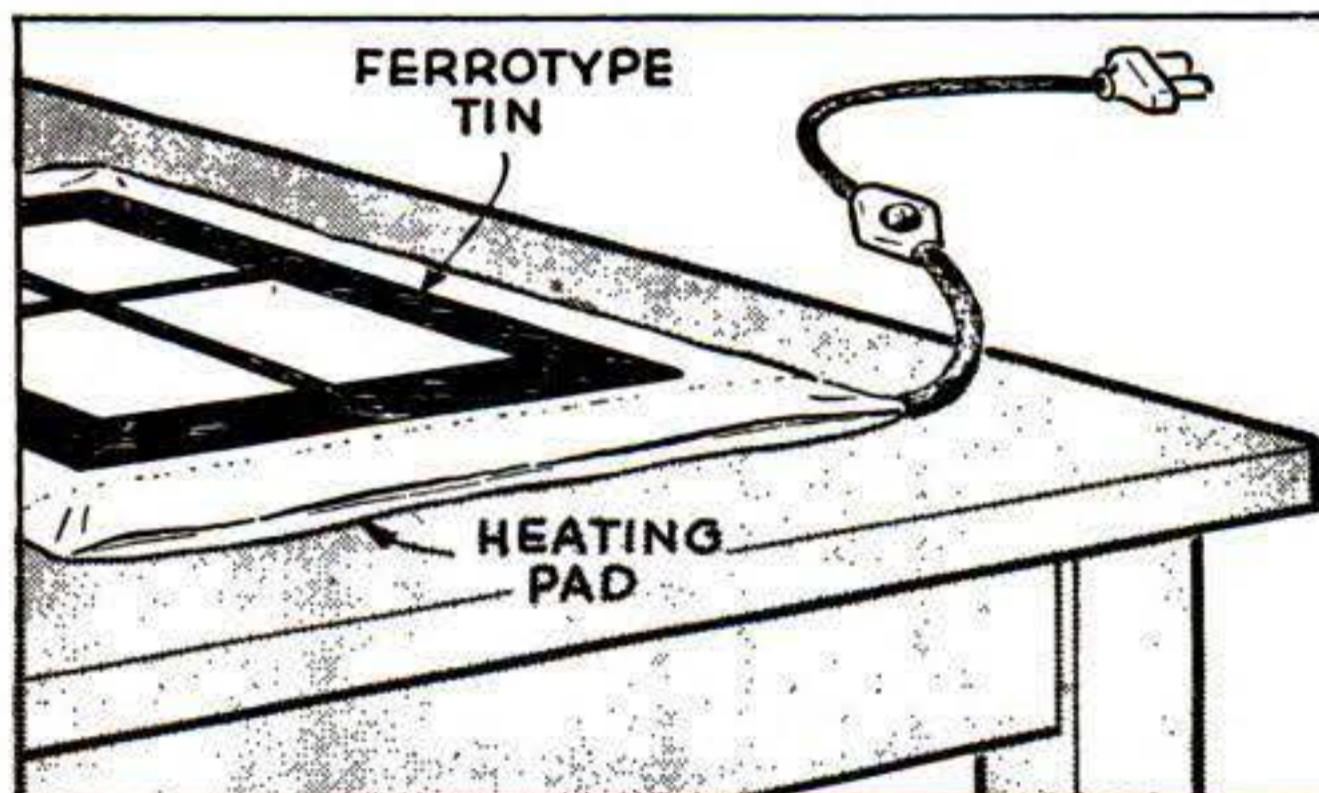
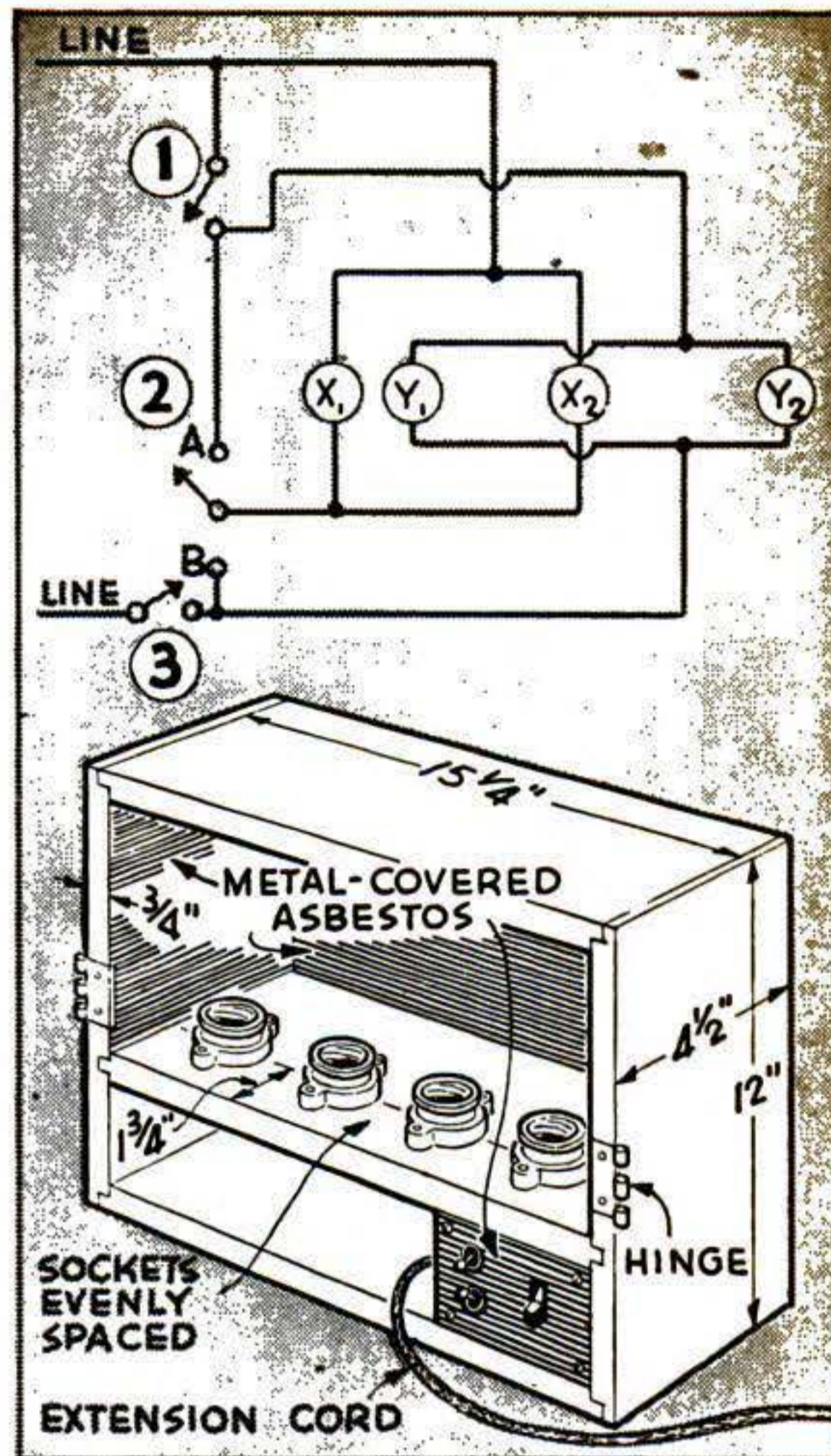

**SPEEDIER PRINT DRYING** results if the ferrotyping plate on which prints have been rolled is placed on a heating pad. Take care not to bend the plate and loosen the prints when moving it. Turn the pad on high, and when it gets warm, turn to medium.—W. E. DANNEMAN.

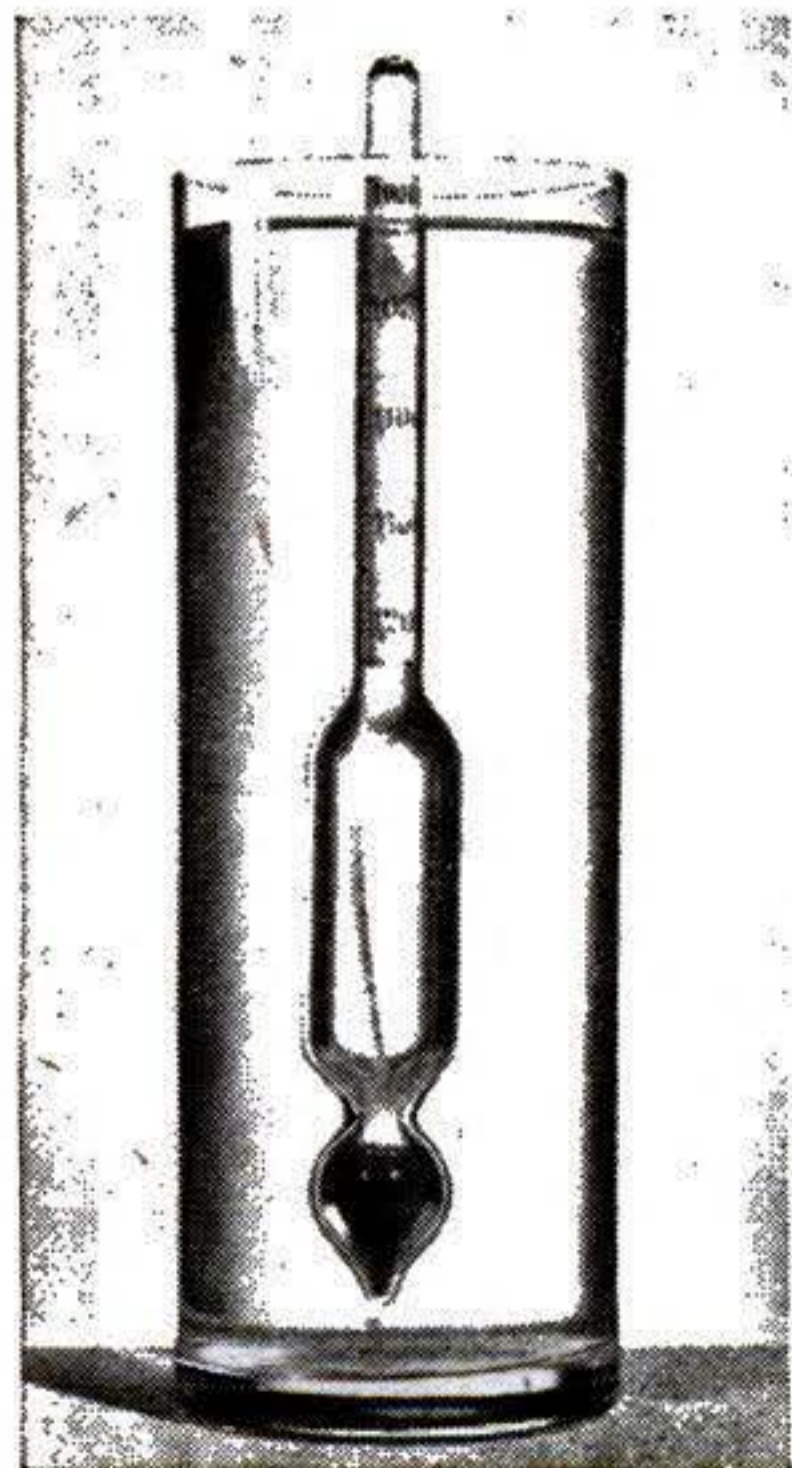

**GLYCERIN BATHS** are frequently used for final print rinsing to prevent curling and brittleness from excessive drying. The same solution can be employed over and over again if checked with a hydrometer and kept at proper strength.

Use a hydrometer designed for liquids heavier than water and having a low scale. For a 5-percent solution, add glycerin to the bath until the hydrometer registers 1.01; for a 10-percent solution, 1.02. Hydrometers may be obtained at a laboratory-supply house.

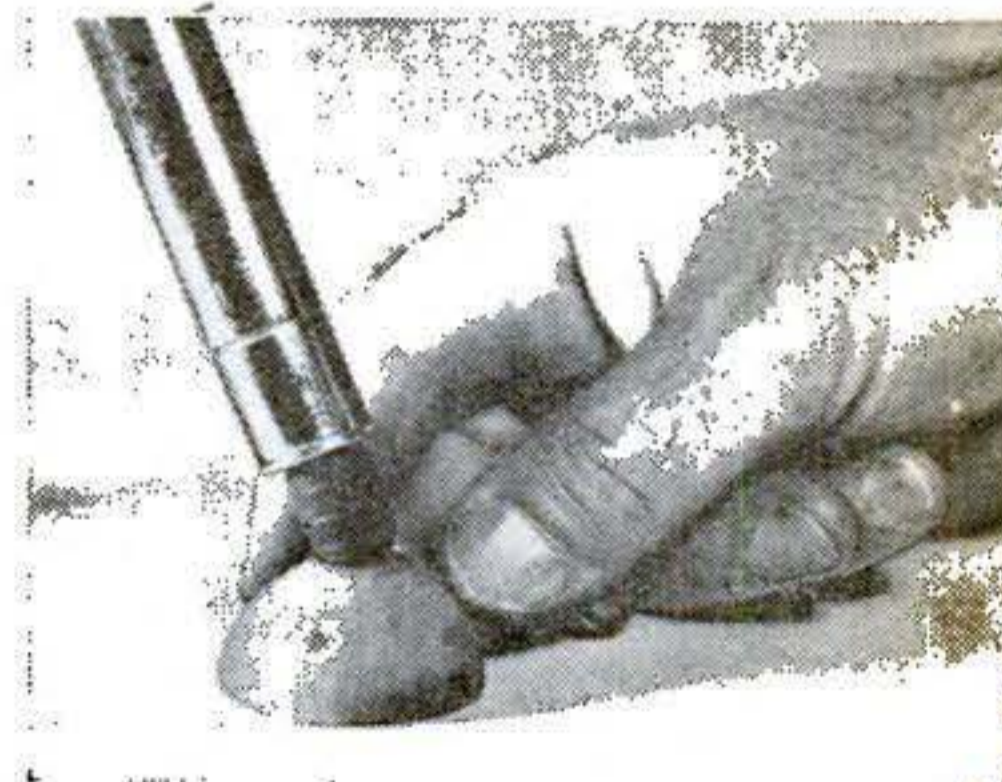

**CAMERA VIBRATION** can be minimized in a shop, factory, or the like if each tripod foot is cushioned with half of a sponge-rubber ball. Several thicknesses of rubber from a kneeling pad may be used just as well.—KENNETH MURRAY.



## Still Camera Smaller Than Cigarette Pack Uses 16-mm. Film



TRULY vest-pocket in size, a camera smaller than a package of cigarettes takes 24 pictures on a cartridge of 16-mm. film. The Micro 16 has a universal-focus lens with three diaphragm stops that focuses objects sharply as close as 3'.

A small trigger on top of the camera operates the shutter, while a plunger on the side advances the film, at the same time moving the internal frame counter. The special film cartridges are enlarged to 2½" by 3½" prints without additional charge by the manufacturer, William R. Whitaker Co., Hollywood, Calif.

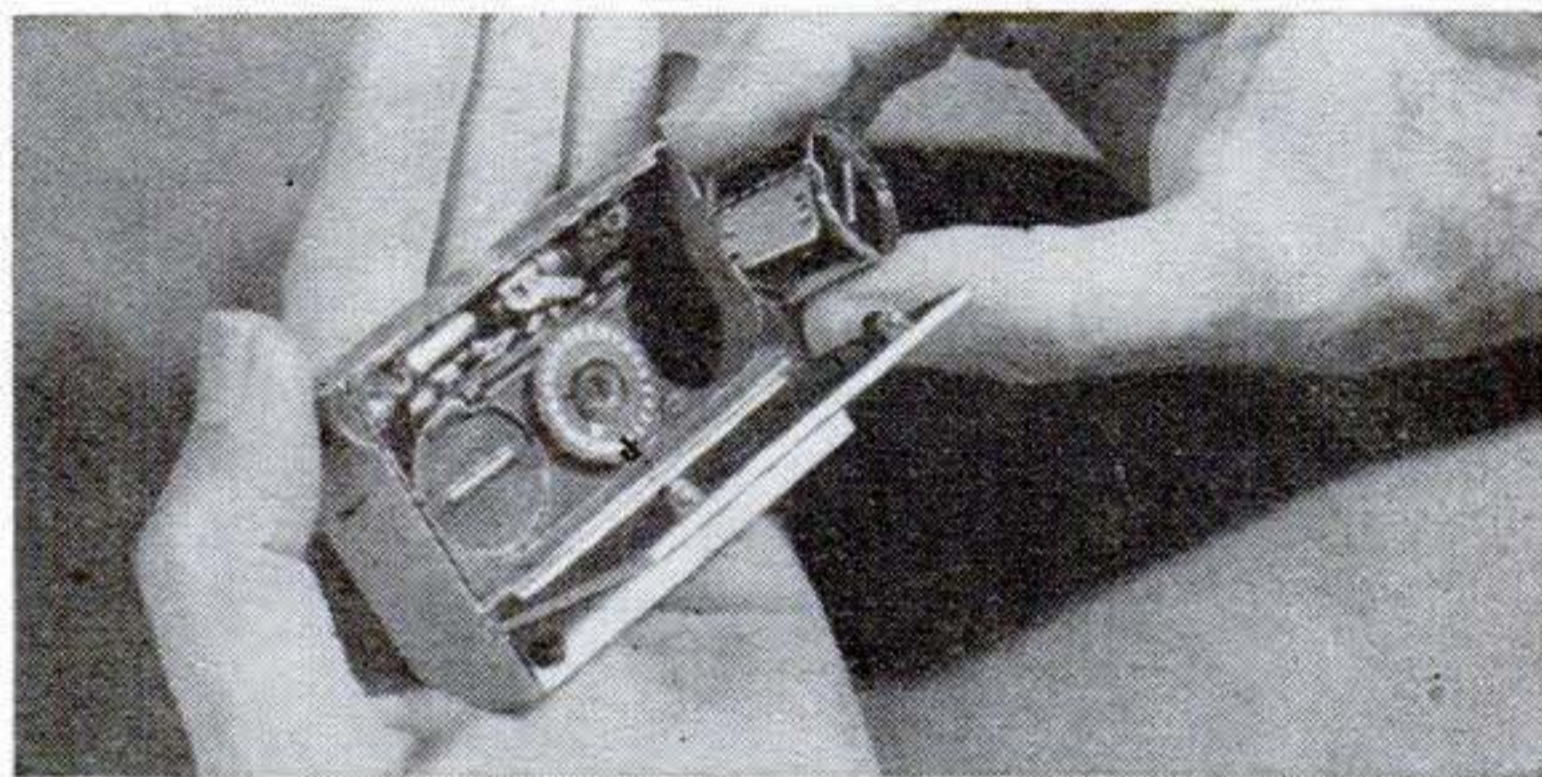

## Cabinet Conceals Darkroom Workbench

THE problem of finding darkroom space in small homes and apartments is answered neatly by the "Photo-Bar," a walnut cabinet that conceals hypo and developer instead of Scotch. The top opens to provide a well for three trays, a firm base for the enlarger, and an eye-level cupboard for the timer and safelight.

Inside the wide doors are shelves that can be set at various heights to make economical storage space for bottles of all sizes. A towel rack is mounted on the back of one door, and a paper safe is built in beneath the enlarging easel. Other equipment includes a drain, a box for graduates and thermometer, and a lock. The Hi-Standard Manufacturing Corp., Baldwin, L. I., N. Y., makes it.

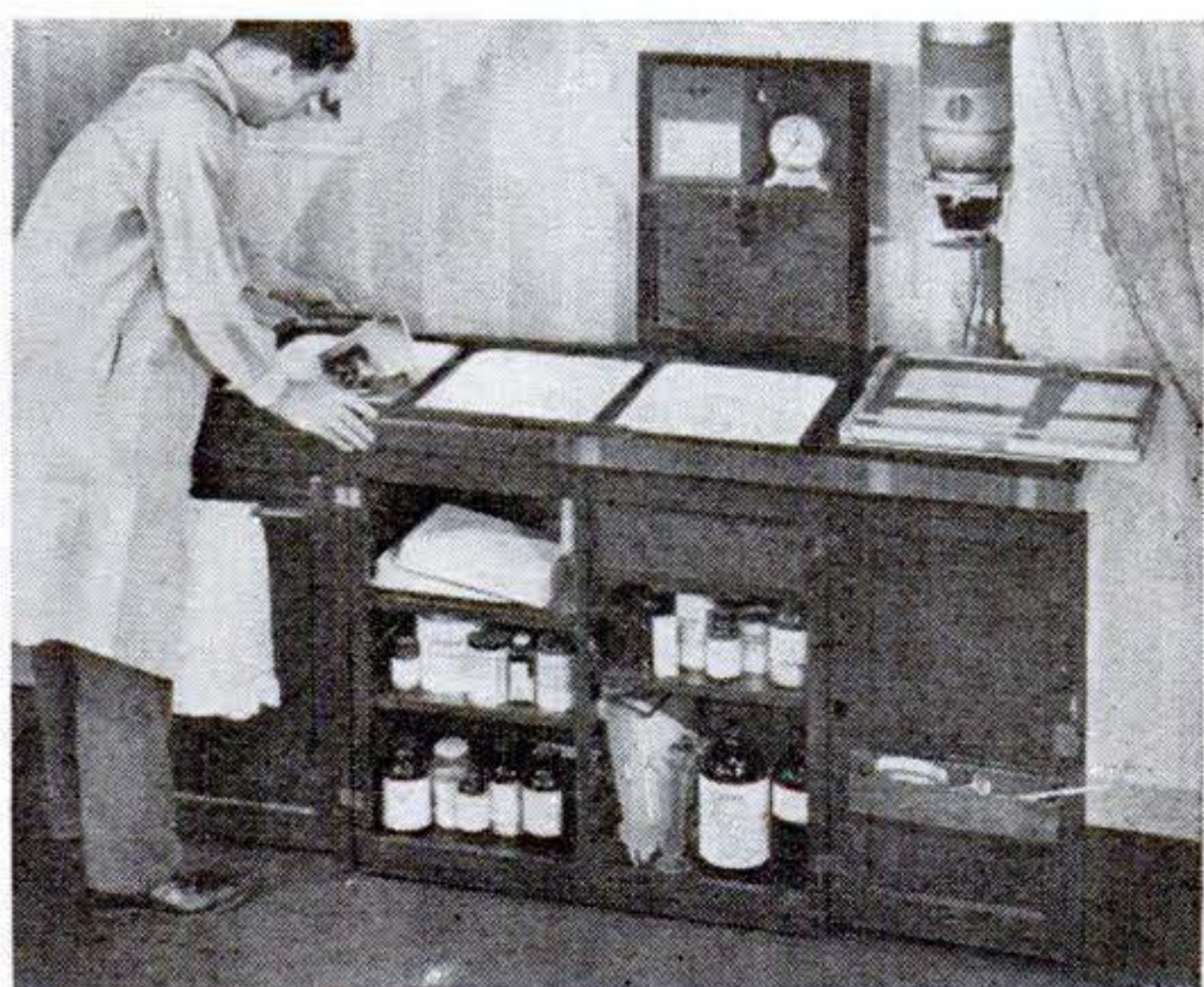



# FIVE-MINUTE PRINT DRIER



**H** EAT for this print drier is furnished by two 660-watt coil-type heater elements connected in series. These elements are generally available as replacements for use in heaters or hot plates. Stretch each coiled

wire to 50", and connect them together. Every 10" form a loop that will accommodate the machine screw on the end of a stand-off insulator. Eleven of these, which are obtainable at radio supply stores, are aligned 2" above the base to hold the wire. If a line switch is used, be sure it will handle 5 amp. at 115 volts (the actual current draw will be around 3 amp.).

Line the box with sheet asbestos and attach the ferrotype tin with flathead wood screws driven down flush with the metal. A window-shade roller, its pawl removed to give constant spring tension, holds the canvas cover. To use, place glossy prints face down on the warm, wet tin; squeegee them, and leave under the cover for about 5 min. after pulling it forward and hooking under the projecting ends. Matte prints may be dried face up.—GEORGE O. SMITH.

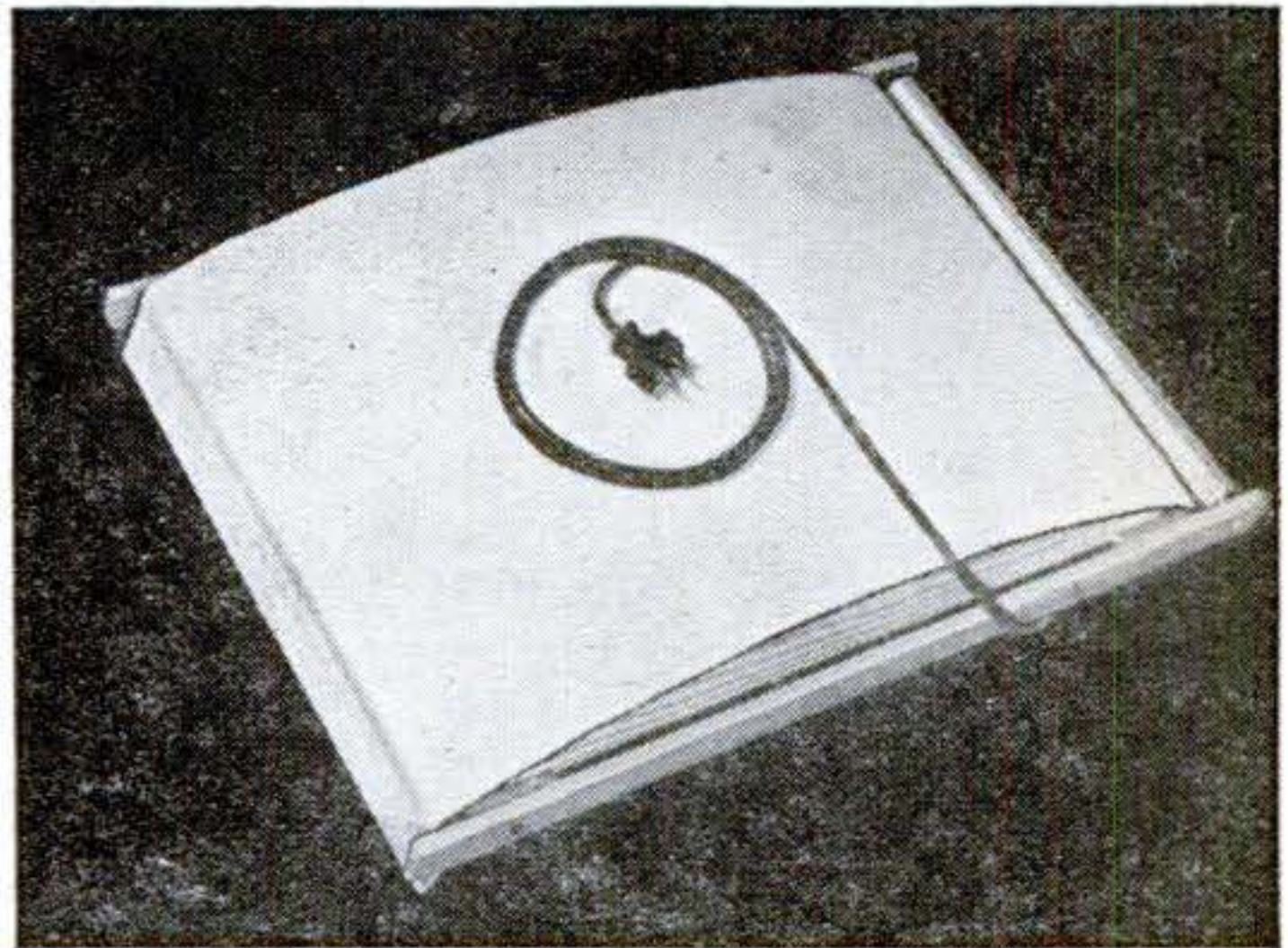
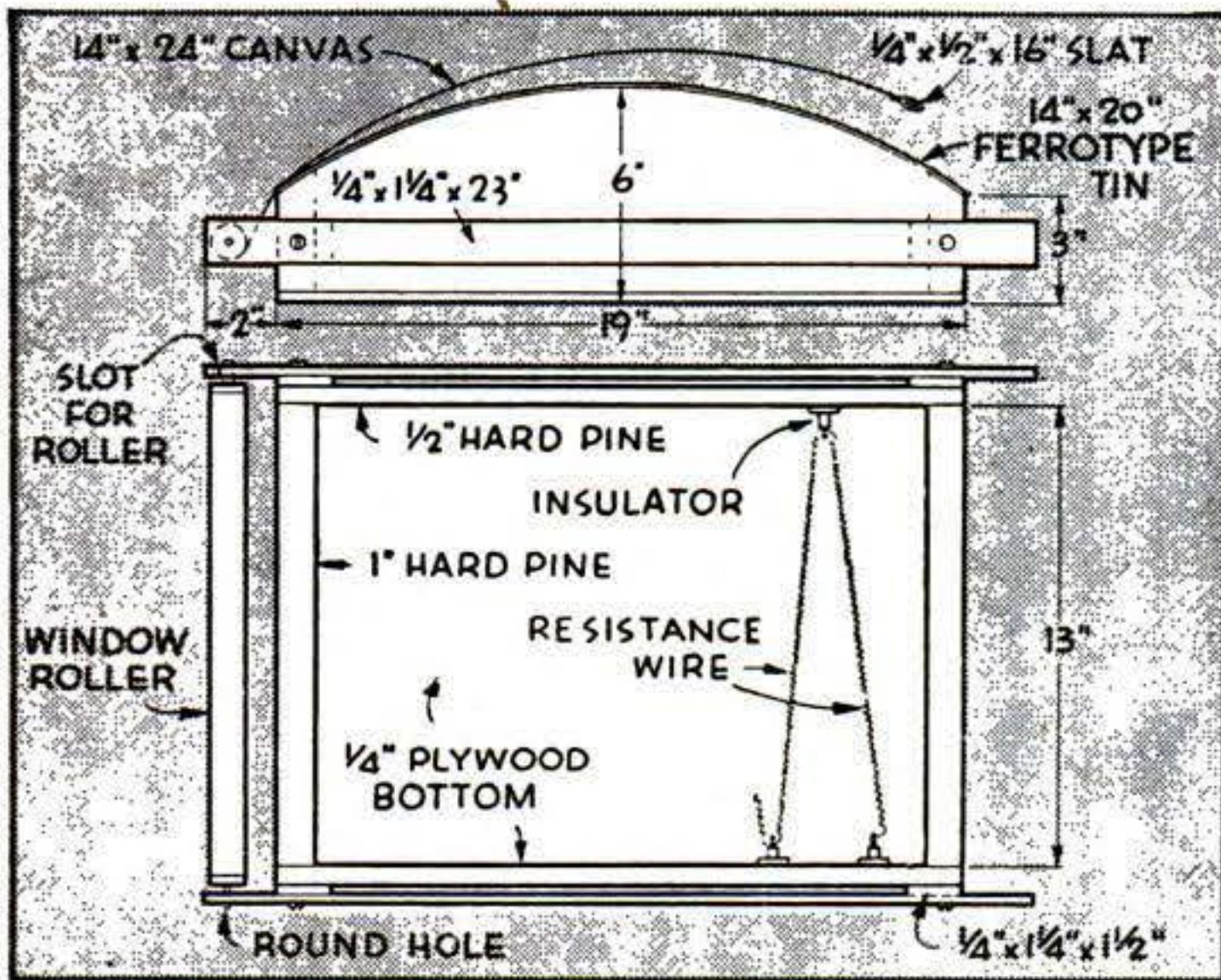

Since dampness will occur on and near the drier, shellac all of the wood parts before assembling.

Bevel the end pieces of the box to suit the curve of the tin. The roller is mounted as shown below.

A slat hooks under the projecting side pieces to keep the canvas tight while the drier is in use.

Insulators for the wire are spaced evenly on each side. The cord goes through a hole at one corner.

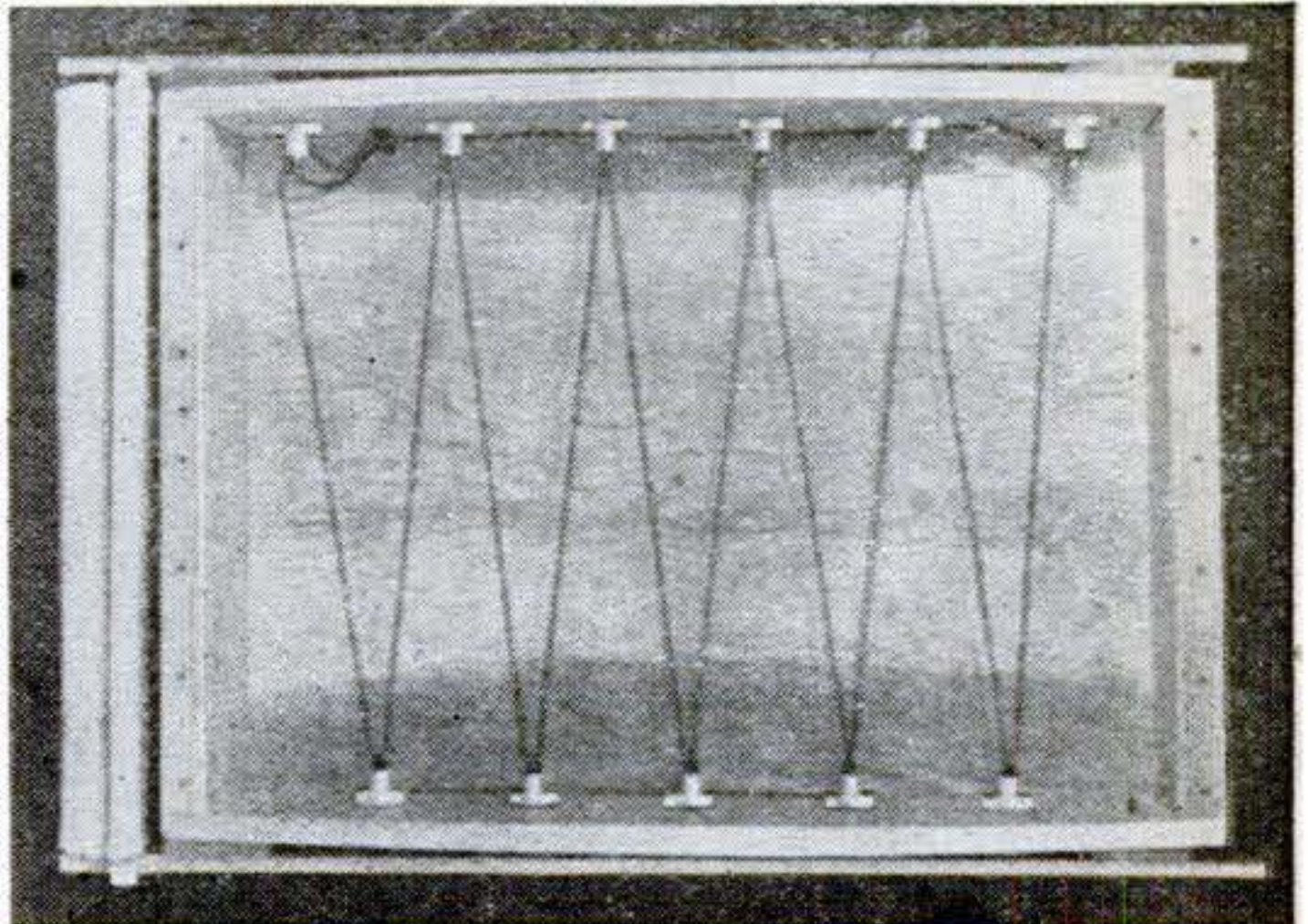
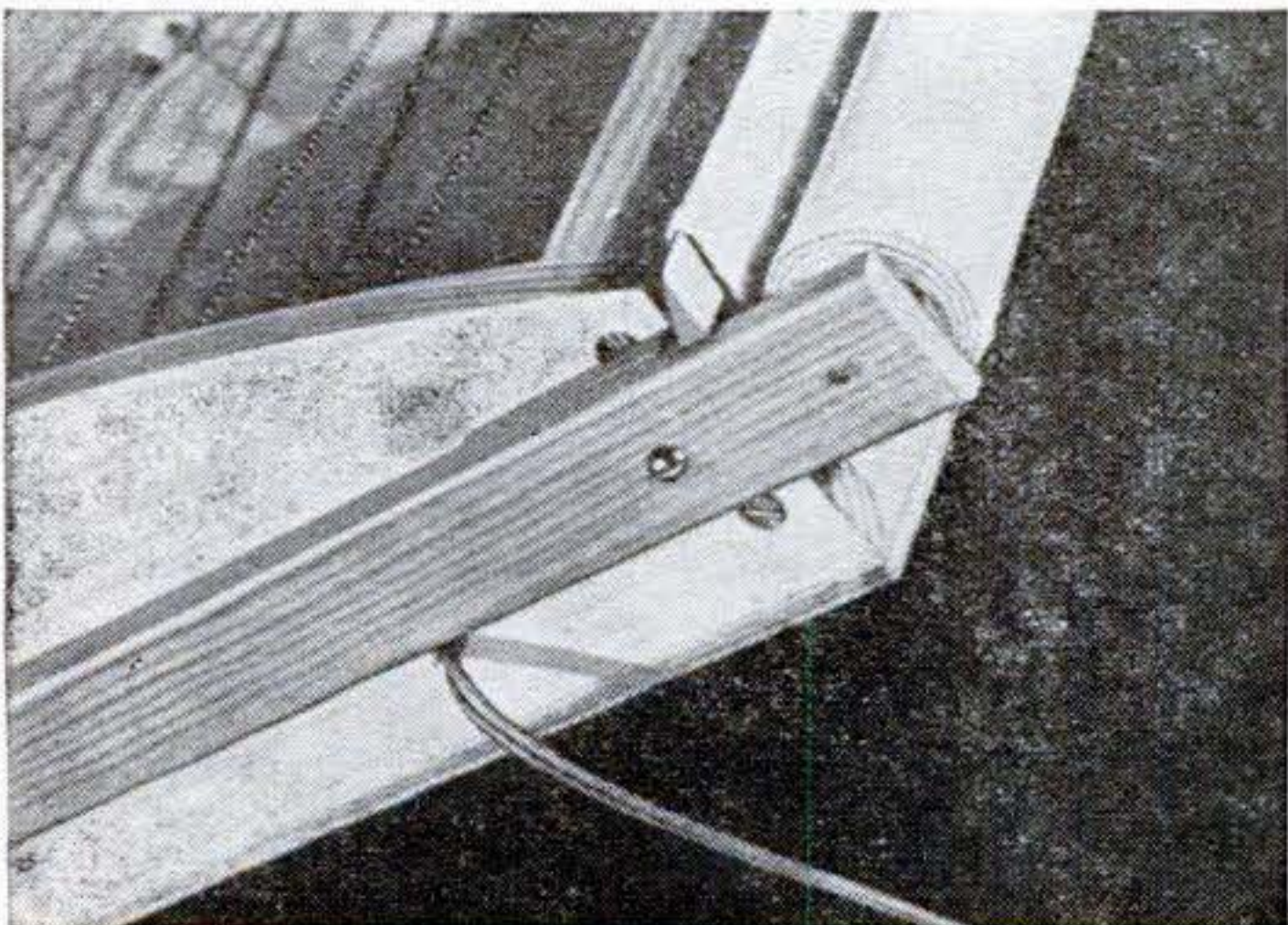



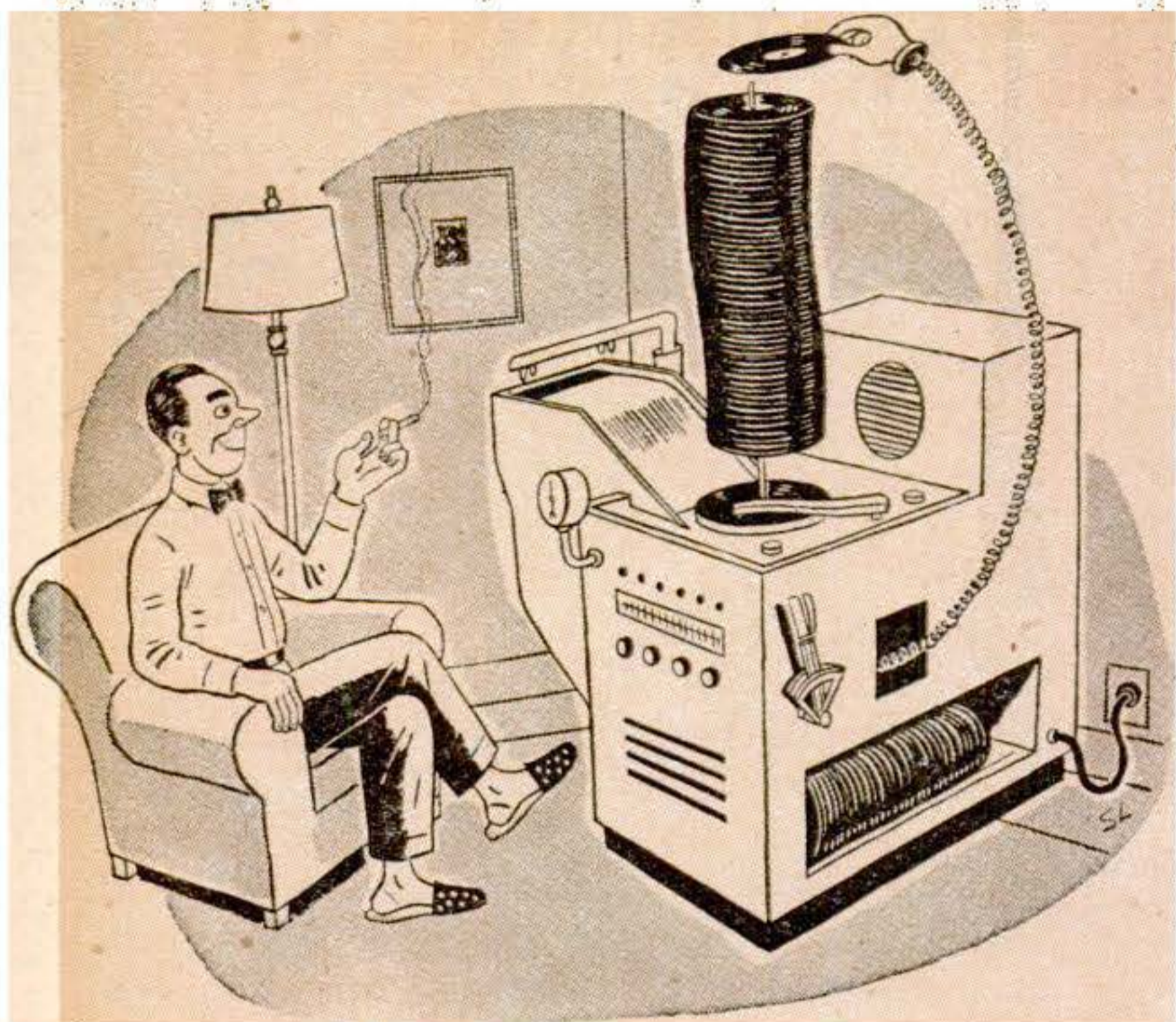

# LET Record Changers MAKE MUSIC FOR YOU

**They can be used with any radio to take the labor out of listening.**

By HARRY R. HYDER

ACCORDING to current estimates, 300,000,000 phonograph records will have been made in 1946 by the time New Year's Eve rolls around. Forget about the hundreds of millions of records left over from past years, and you still have a lot of work for the music-hungry public that has to feed this endless stream of disks into America's 8,000,000 phonographs. If each of these records were played only once—and we know that the average is many times that—you'd still have too many operations for a traditionally mechanical and labor-saving nation to take in its stride.

Of course the problem isn't new, and necessity has long since mothered her

inventions, but technology and increasing public demand are still working at the job of rearing that once-awkward child, the record changer, into a respectable member of our gadget family. Altogether, they haven't done too badly.

Back in the remote twenties when electric phonographs began to replace player pianos as a favorite source of canned music, the joy of having a turntable you didn't have to crank was enough to make even the laziest of us forget that switching records after each playing was an awful lot of work. Then the early record changers made their appearance. With plenty of reason they came to be known as "platter busters." Action was the one thing they had plenty of, but records rarely had better than a 50-50 chance of survival when they went through the clanking mill.

Breakage has continued to be a problem in the mechanical handling of relatively fragile records, but in general it is no longer a serious consideration. Automatic changers now in production have proven themselves quite gentle. Curiously enough, the low-priced units are almost foolproof, while the more expensive jobs still give a small amount of trouble because they have more moving parts to get

out of adjustment.

Record changers are most commonly found in radio-phonograph combinations, but they can also be purchased separately and connected to any radio set. All of the inexpensive and some of the higher priced models operate on one or both of the two principles illustrated in Figs. 1 and 2, and in the accompanying photos. The first of these employs rotating fingers or plates to suspend the stacked records over the turntable. When the changing mechanism is set in motion, the plates swivel around, releasing the lowest record in the stack and permitting that one to drop while the others stay suspended.

Equally popular is the eccentric-spindle type. The records waiting to be played are



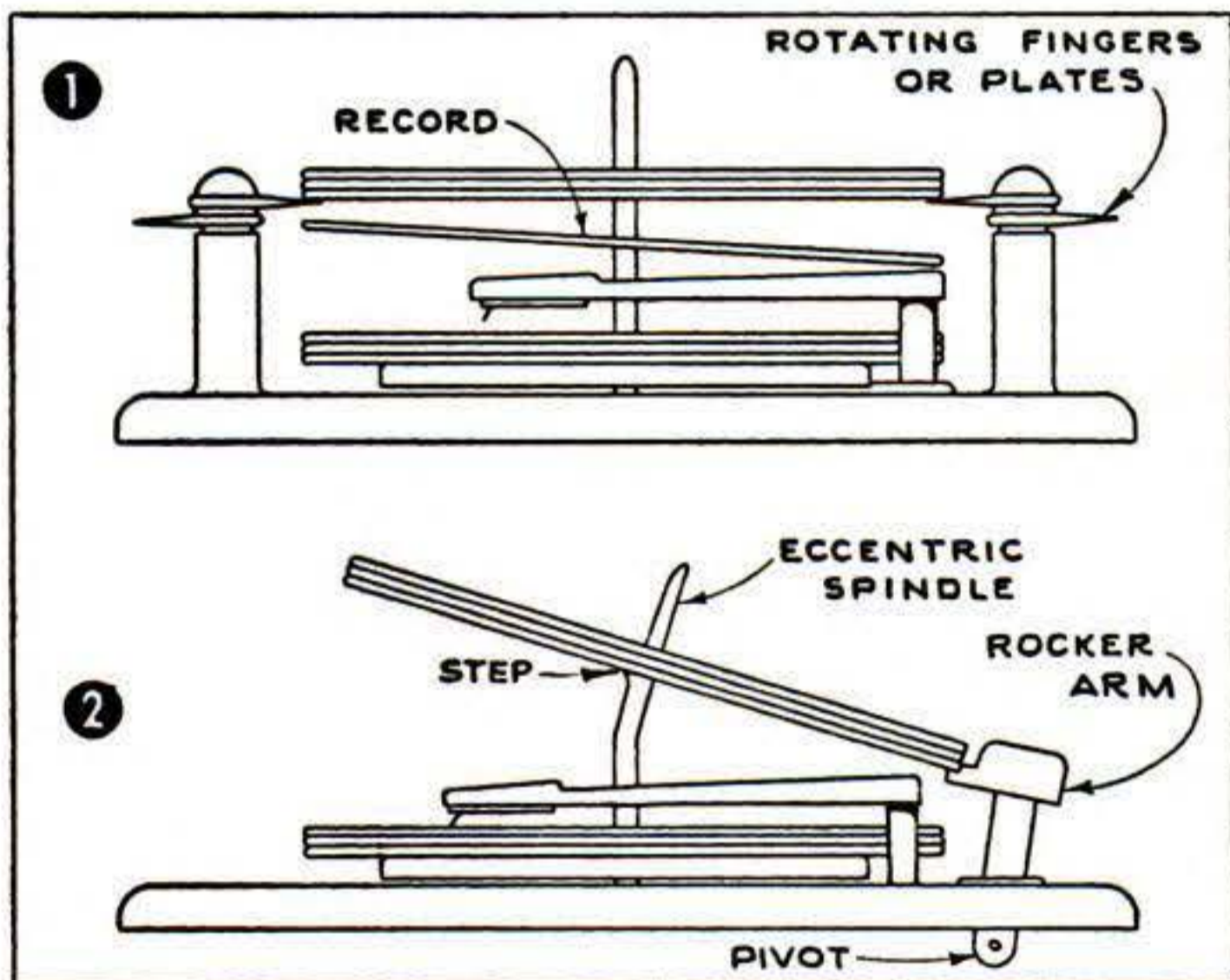
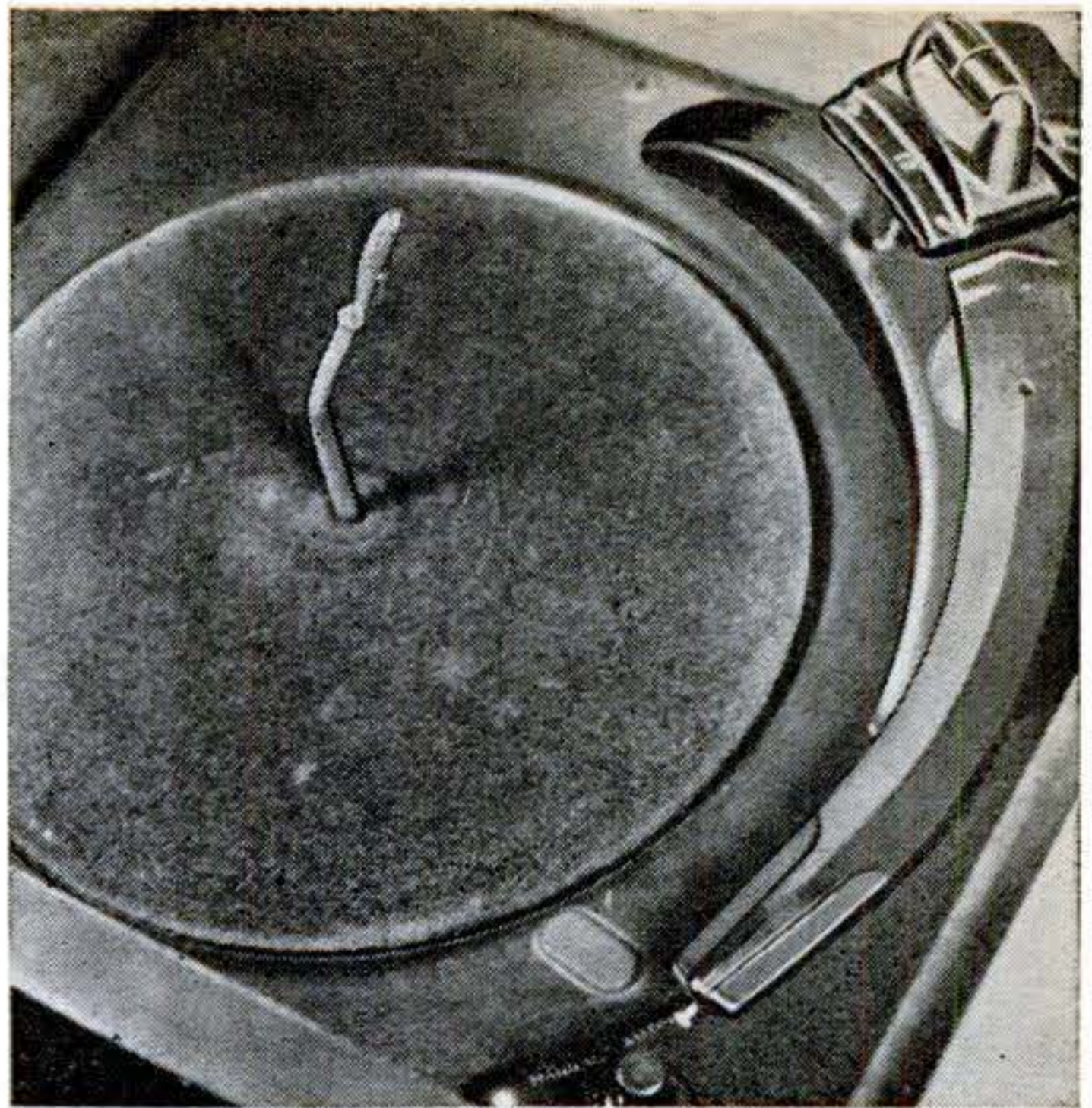
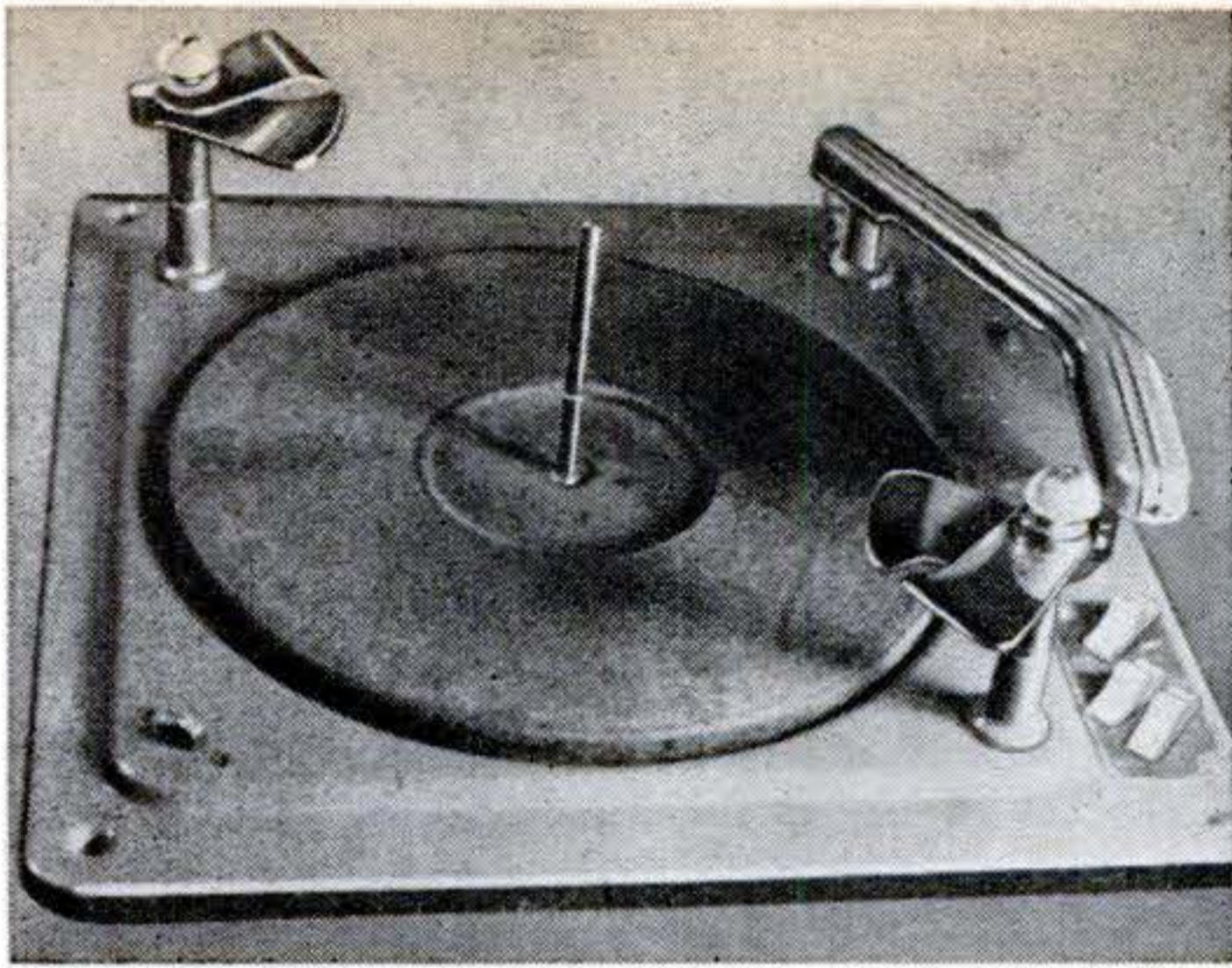

The two principles on which most changers operate are illustrated in the diagrams and photos at left and above. In one form or another they turn up in practically all automatic disk handlers.

damage the fragile records than the first.

With various modifications and combinations, these principles keep reappearing in practically all except the highest-priced record changers. Below at right is a unit that employs the eccentric spindle and rocker arm plus two supporting fingers; alongside it is a model that is more conventional in appearance but boasts the additional feature of playing an intermixed stack of 10" or 12" records. One of the most elaborate and distinctive outfits is illustrated on the following page.

balanced on an inclined, off-center portion of the spindle. A rocker arm at the side of the turntable supports most of the weight of the disks, and when the change cycle is in full swing acts to push the bottom record from the curved to the straight portion of the spindle, from where it can fall to the playing surface. Other things (such as precision of machining) being equal, the second type of changer is less disposed to chip or

In all types, the change mechanism is triggered by the relatively broad swing of the pickup arm when it engages the run-out spiral at the center of the record. The pickup



The Webster 70, left, uses the eccentric-spindle principle, but plays a mixed stack of 10" and 12" records. Below, rotating fingers and an inclined spindle are combined in the Farnsworth P-50.





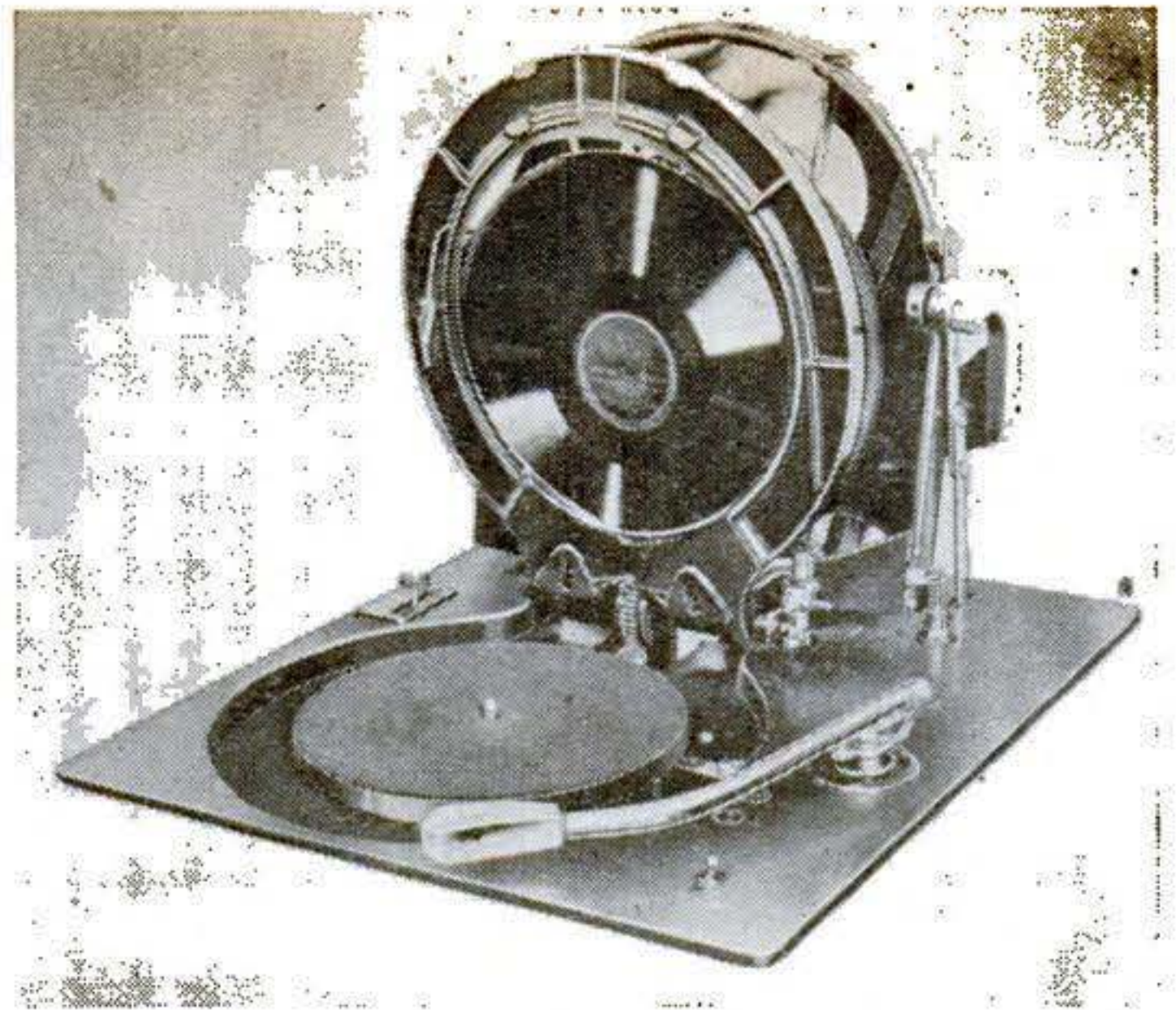
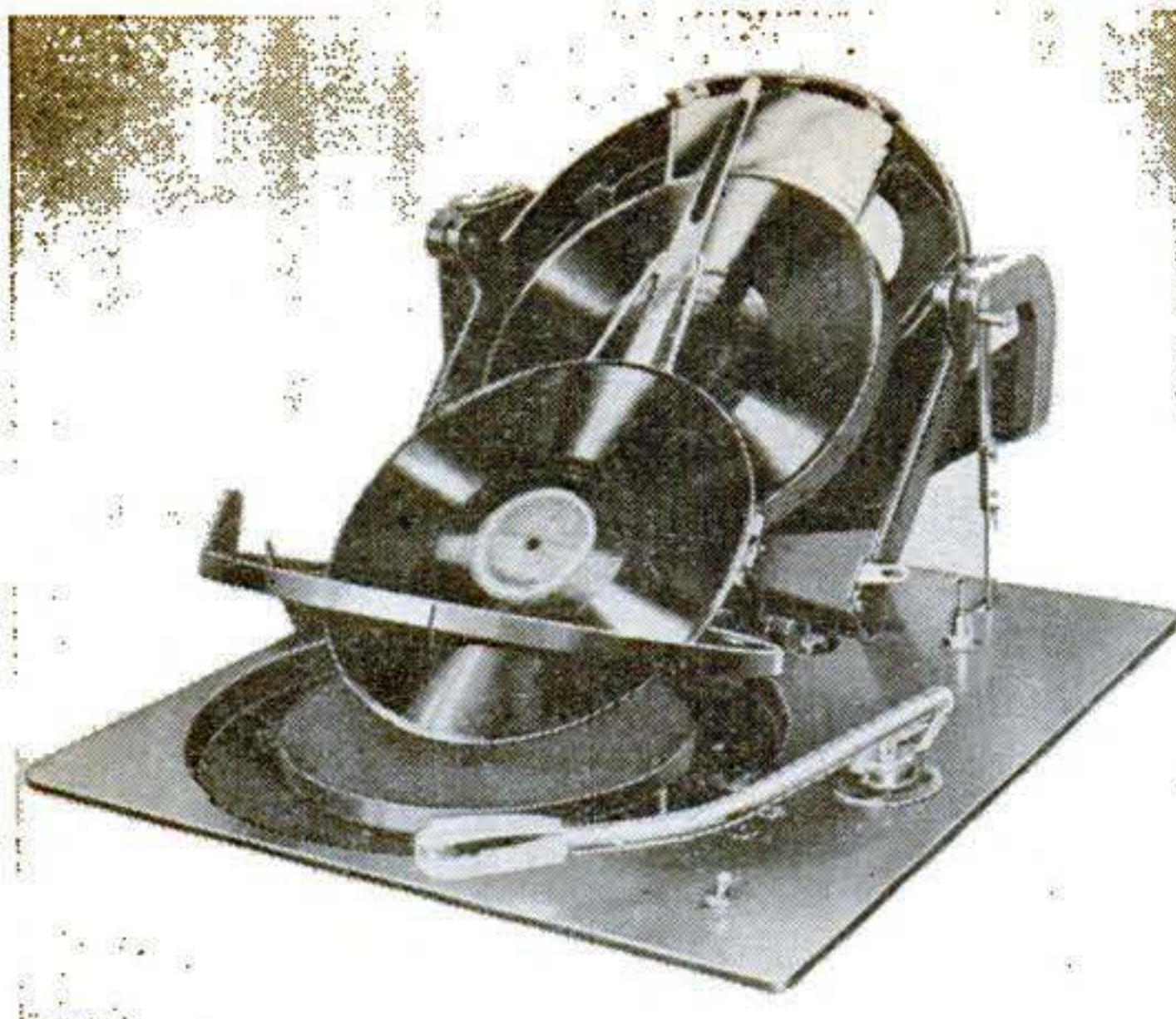

Unique in its field, and more costly than the other changers described, the Capehart, above, will play the first side of successive records to the end of the stack, then turn them all over automatically. In addition, it will turn over individual records, playing first one side, then the next, then change disks.

arm is withdrawn to the side while the new disk drops to the turntable; then the pickup swings back to the first groove and the playing cycle starts afresh.

If you're in the market for a player, bear in mind that pickups are a commodity that must never be bought by the pound. Needle pressure on the better changers is generally 1 oz. or less, and the lightweight pickups are highly desirable from the standpoint of tonal quality as well as for minimum needle scratch and record wear. A permanent or semipermanent needle is, of course, necessary with all changers; there would be little point in saving you the trouble of changing records if you had to change needles after each playing. Semipermanent needles are good for a dozen or more plays, while the permanent variety may be used thousands of times. Once a needle is used, it should never be touched until it is to be removed, since the needle quickly wears down to the shape of the grooves, and even the most minute displacement will cause its sharp edges to cut and scour the sound track.

A cabinet of some sort should be provided for the changer. It is usually most convenient when used in combination with its radio amplifier, but if the radio is too small, or the box cannot be adequately soundproofed, a separate cabinet can be made or purchased for the purpose. A template for cutting the mounting panel is provided by the manufacturer of the changer in most cases. If the unit is intended to be mounted on spring supports, adjusting these so that the changer is free to move slightly will tend to discourage operating noises and

electromechanical feedback known as "howls."

One annoying characteristic of crystal pickups is "needle chatter," a mechanical noise produced by the needle itself, particularly at high frequencies. When volume is low, the chatter may mask the sound coming from the loudspeaker, causing the set to sound tinny. Soundproofing the cabinet by lining it completely with a soft, absorbent material such as acoustic felt should remedy the situation. Another way is to place the changer in an adjoining room, away from the speaker.

This type of noise should not be confused with needle scratch, which is characteristic of records worn by repeated playings and cannot be eliminated except by means of a high-frequency cutoff filter. Unfortunately, the filter also results in a loss of tonal brilliance.

Connecting a separate record changer to a radio is usually a simple operation. Where phono jacks are built into the set's chassis, the problem is solved; where no connection is provided for, the center lead of the pickup cable can be soldered to the "hot" side of the volume control and the shield grounded to the chassis (Fig. 3). To differentiate the volume-control terminals, remove the set from its cabinet and, while it is playing at full volume, touch each of the stator terminals of the control with a screwdriver. Touching the hot terminal will cause a hum in the speaker.

A single-pole double-throw toggle switch installed on some accessible portion of the chassis allows the amplifier to be turned from radio to phonograph operation. Where





Adjusting the pickup so that the needle will engage the first groove of the record. The position of the screw varies on different models.

the pickup cable is not long enough to reach the radio, an extra length of shielded wire may be spliced on and the braid of the two pieces securely bonded together.

Sets of the A.C.-D.C. type should never be grounded externally, since one side of the A.C. line is already grounded to the chassis, and a short circuit would result from plugging the set in with incorrect polarity. Lead wires for the motor should be spaced as far as possible from the braided cable to minimize hum pickup.

Since the output of crystal pickups is not uniform at all frequencies, and since different processes are employed for cutting rec-

ords, some type of compensating circuit is usually considered desirable on phonograph amplifiers. Two such equalizers are shown in Figs. 4 and 5. Placed between the pickup and the amplifier, the filter shown in Fig. 4 will give a moderate amount of bass boosting and high-frequency attenuation; it is recommended for table model sets having 5" or 6" speakers. Treble boosting is accomplished by the circuit in Fig. 5, and is best for a console with an 8", 10" or 12" speaker and a fairly good audio system. Larger and more elaborate consoles usually have built-in tone controls which permit additional equalization.

Properly handled, modern record changers give surprisingly little trouble. Jamming is often caused by warped or off-size records, and failure of the change mechanism to operate is probably due to use of old-style records on which the run-out groove has not been carried far enough over the disk. Sometimes the pickup fails to drop neatly into starting position, but this can be corrected on most changers. The photo at the upper left shows one type being set for proper operation by means of an adjusting screw located near the pickup pivot. On other models the screw is found behind or underneath the pickup arm.

All in all, most of the current crop of record changers will deliver years of trouble-free, pleasurable service. If you like recorded music, you can hardly find a better investment.

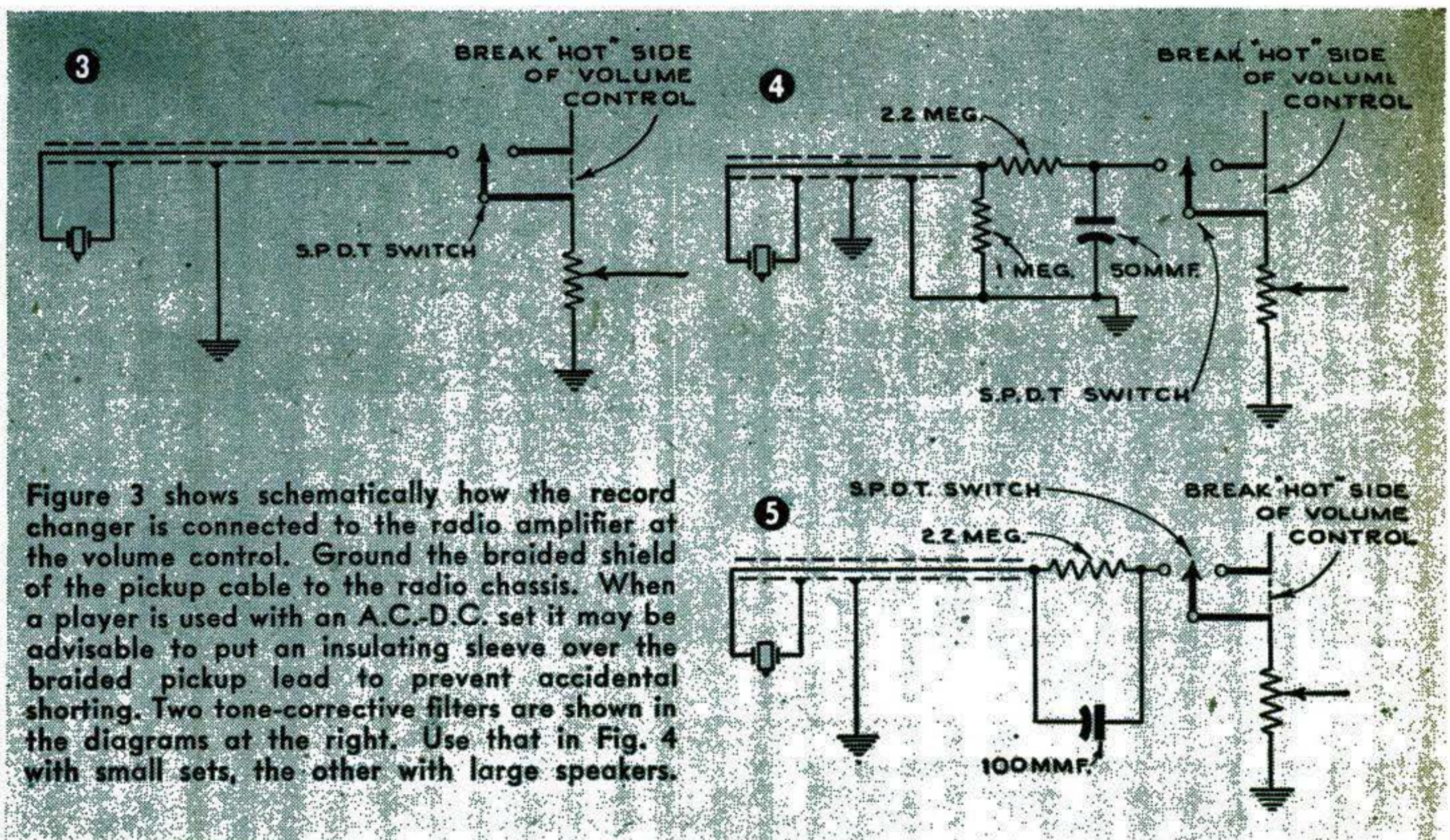
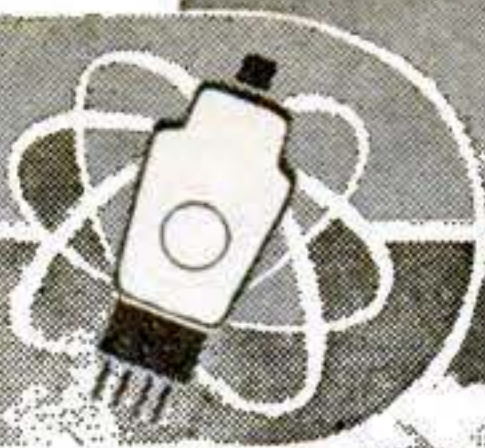

Figure 3 shows schematically how the record changer is connected to the radio amplifier at the volume control. Ground the braided shield of the pickup cable to the radio chassis. When a player is used with an A.C.-D.C. set it may be advisable to put an insulating sleeve over the braided pickup lead to prevent accidental shorting. Two tone-corrective filters are shown in the diagrams at the right. Use that in Fig. 4 with small sets, the other with large speakers.



# NEWS IN ELECTRONICS



**DISTANCE** is no obstacle to communication on this remote Colorado ranch. Eight ranch houses in the eastern part of the State have been connected by two-way radio with the Cheyenne Wells, Colo., exchange of the Mountain States Telephone Co., from where they can be linked with any phone in the country. Still in the experimental stage, this development is expected to bring service to places where regular wire lines are impractical because of distance. This antenna is 21 miles from the central office.

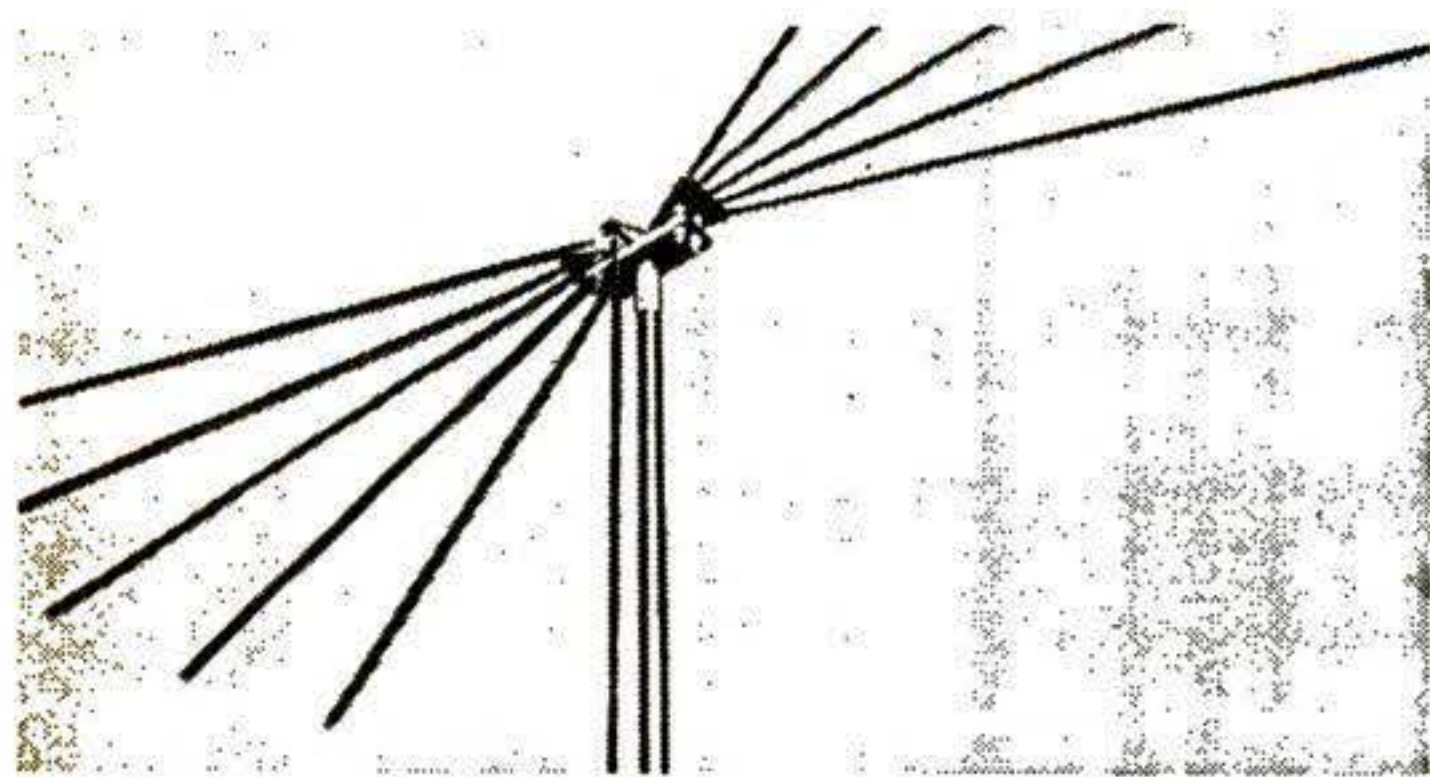
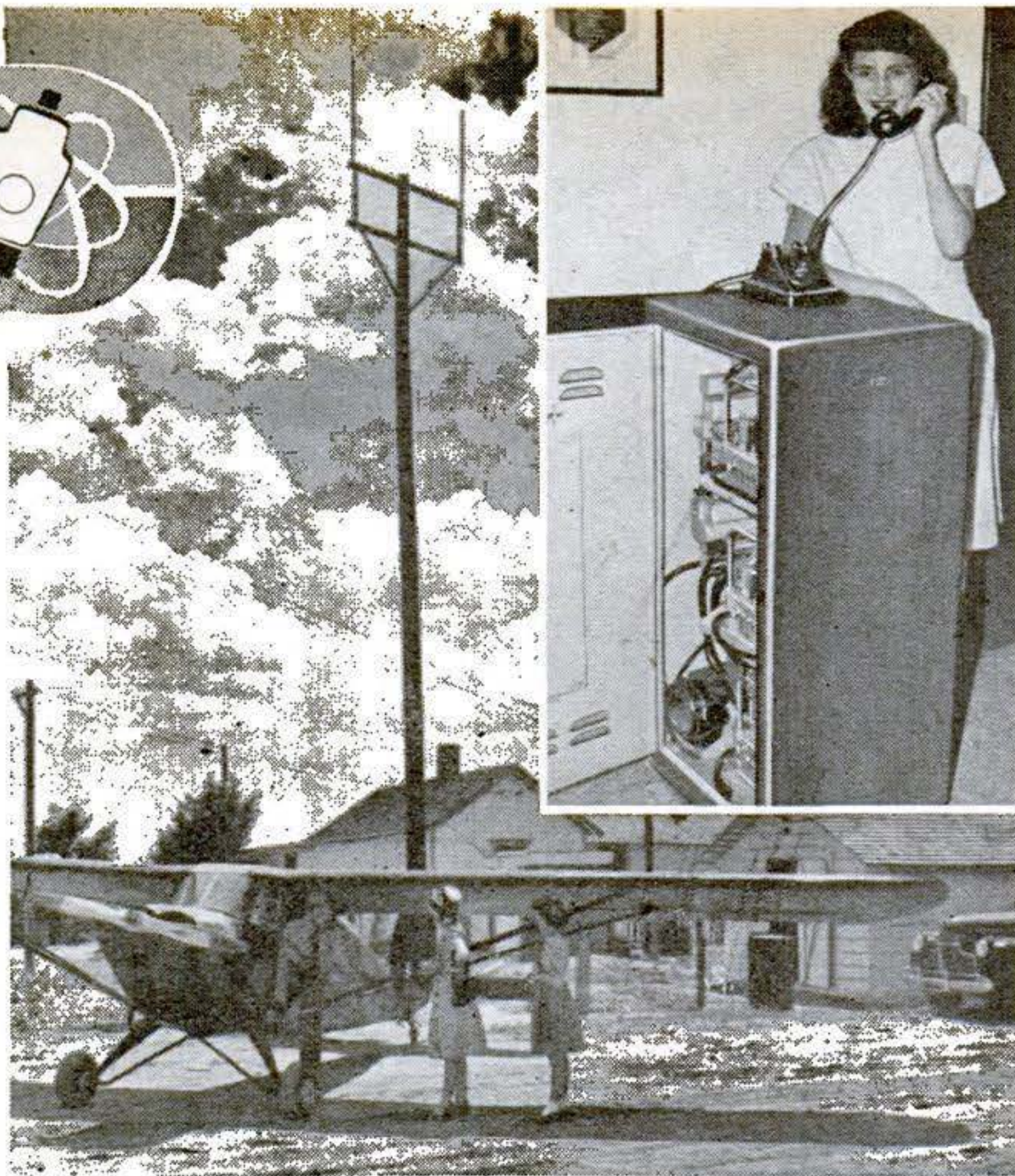

**RECEPTION ON ALL CHANNELS** in the F.M. and television bands is promised for this antenna, manufactured by the Andrew Co., of Chicago. Called the "Di-Fan," the unit consists of a fanlike array of five elements extended in two directions; its impedance is matched to that of the lead-in lines. It is sold with brackets for mounting it to chimney or roof.

**SILICON CRYSTAL CONVERTERS**, developed for radar receivers, are now available through civilian distribution channels. As space-saving first detectors in superheterodyne circuits, the permanent, present crystals are capable of handling frequencies up to 10,000 mc. The model at the right is offered by the Sylvania Electric Products Co.

**A PHONOGRAPH PICKUP** employing the principle of torsional magnetostriction has been announced by the Magnetostriction Devices Co., of Boston. The effect of magnetism on the size or shape of an object is said to have made possible a light-pressure, low-cost pickup with uniform response and relative freedom from harmonic distortion as well as from "needle chatter" and hum pickup.

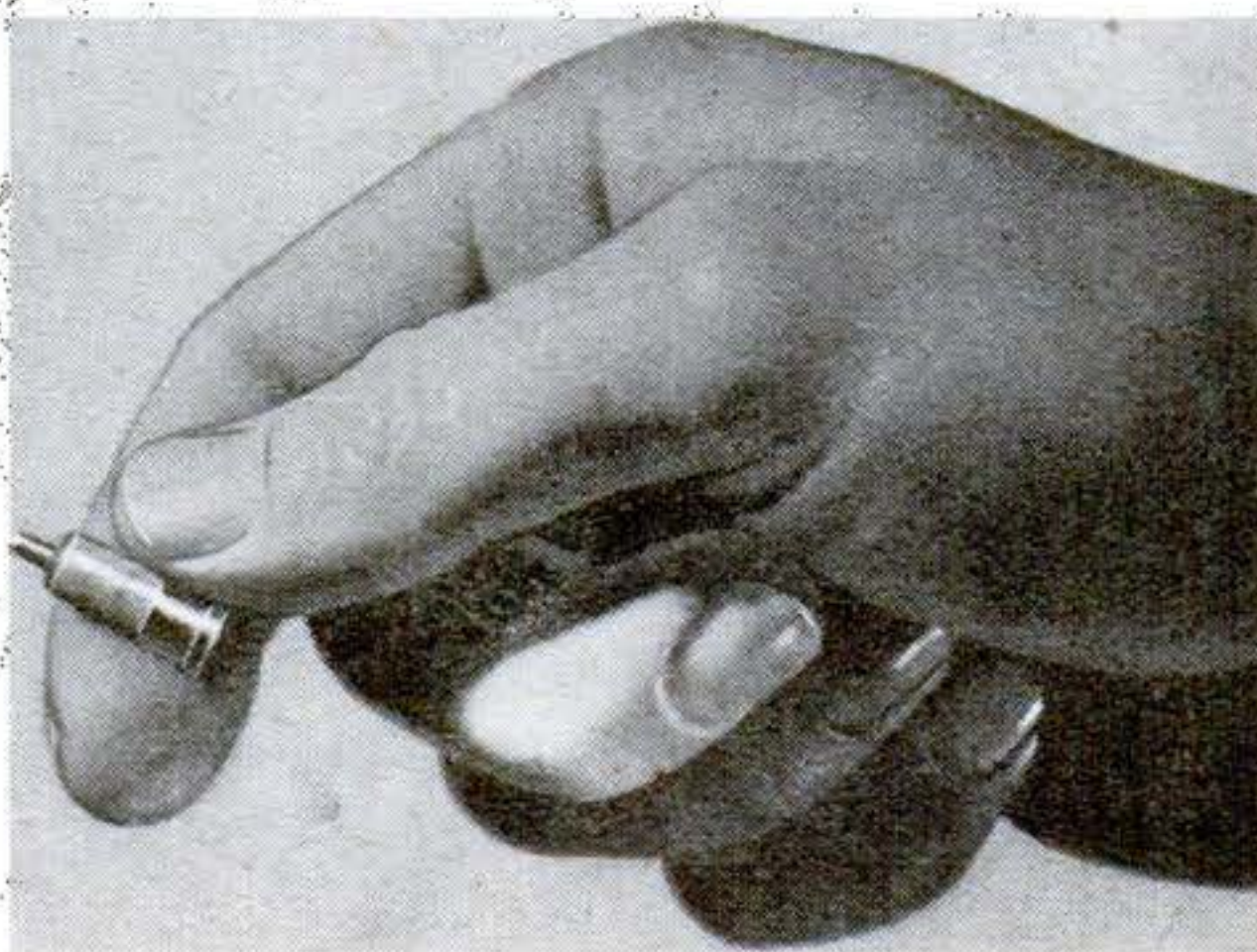



## Pillow Phone Mutes Late Music

IF YOU like to let that last musical night-cap rock you off to sleep like one of mother's lullabies, try this way of doing your midnight listening. It's as comfortable for you as it is for the other members of the family who have already succumbed to the sandman. A suitable pillow can be made with tightly packed cotton. Wire any good-quality headphone to the output of your radio as shown, and stitch the phone into a depression formed in the pillow. When used with large consoles, the headphone should come off the second detector instead of the last audio stage.—W. E. DANNEMAN.

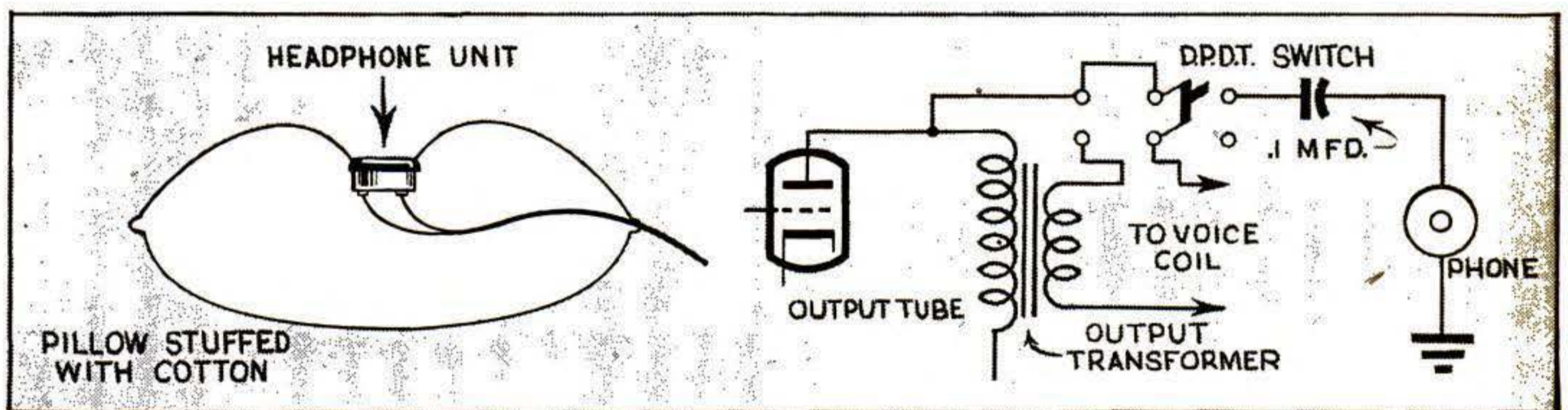
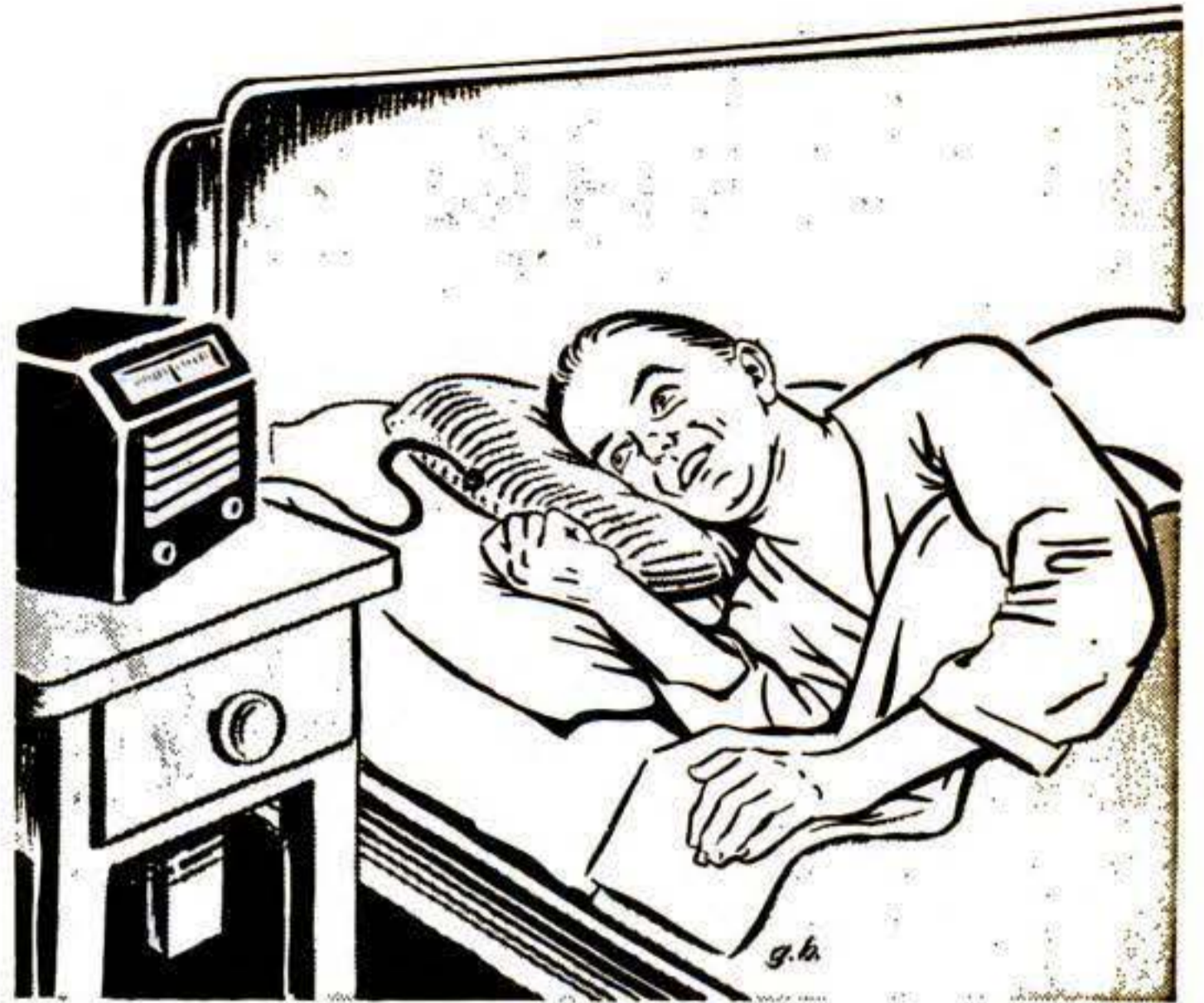

## Reinforcements Stop Record Slipping



STACKED phonograph records sometimes skid over the records underneath, resulting in musical distortion. One frequently effective method of preventing this slippage consists of gumming three or four loose-leaf reinforcements on each record to increase the friction between the disks.—G.O.S.

## Doorstop Pegs Radio

WHEN you stand a radio on end for servicing, slip a wedge-shaped doorstop under some solid part to keep the weight of the set off tubes and coils and prevent the chassis from tipping. Flexible stops of the type illustrated below can be purchased at hardware, novelty or dime stores.—H. LEEPER.

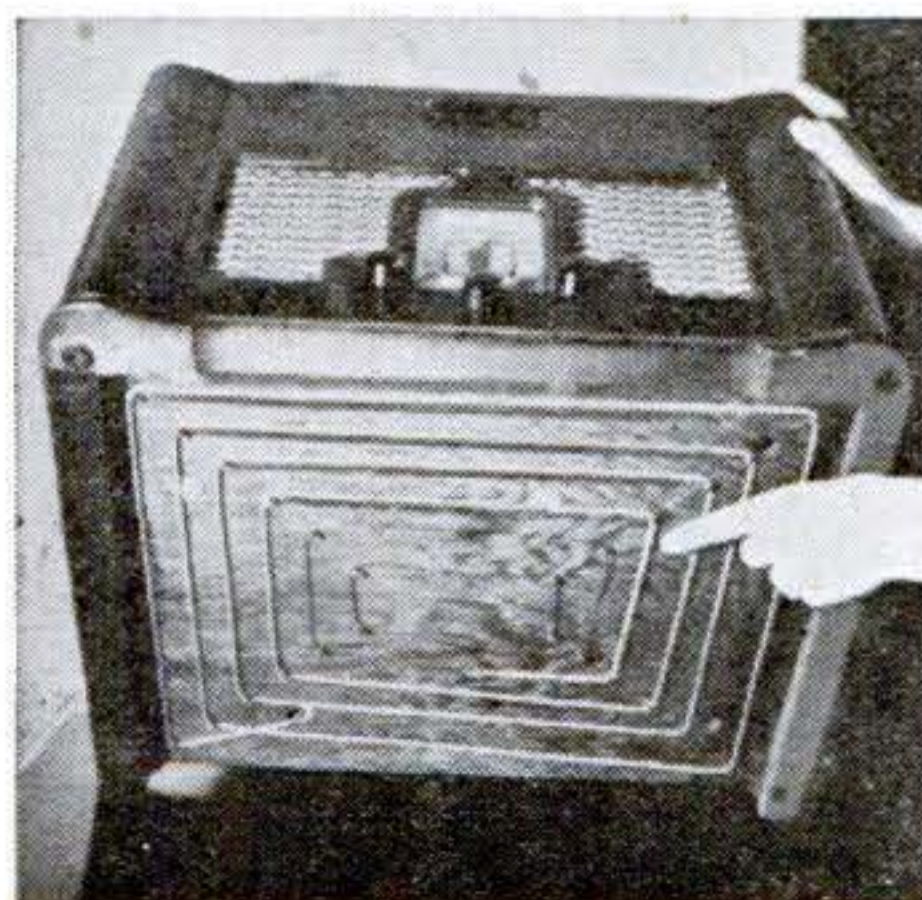
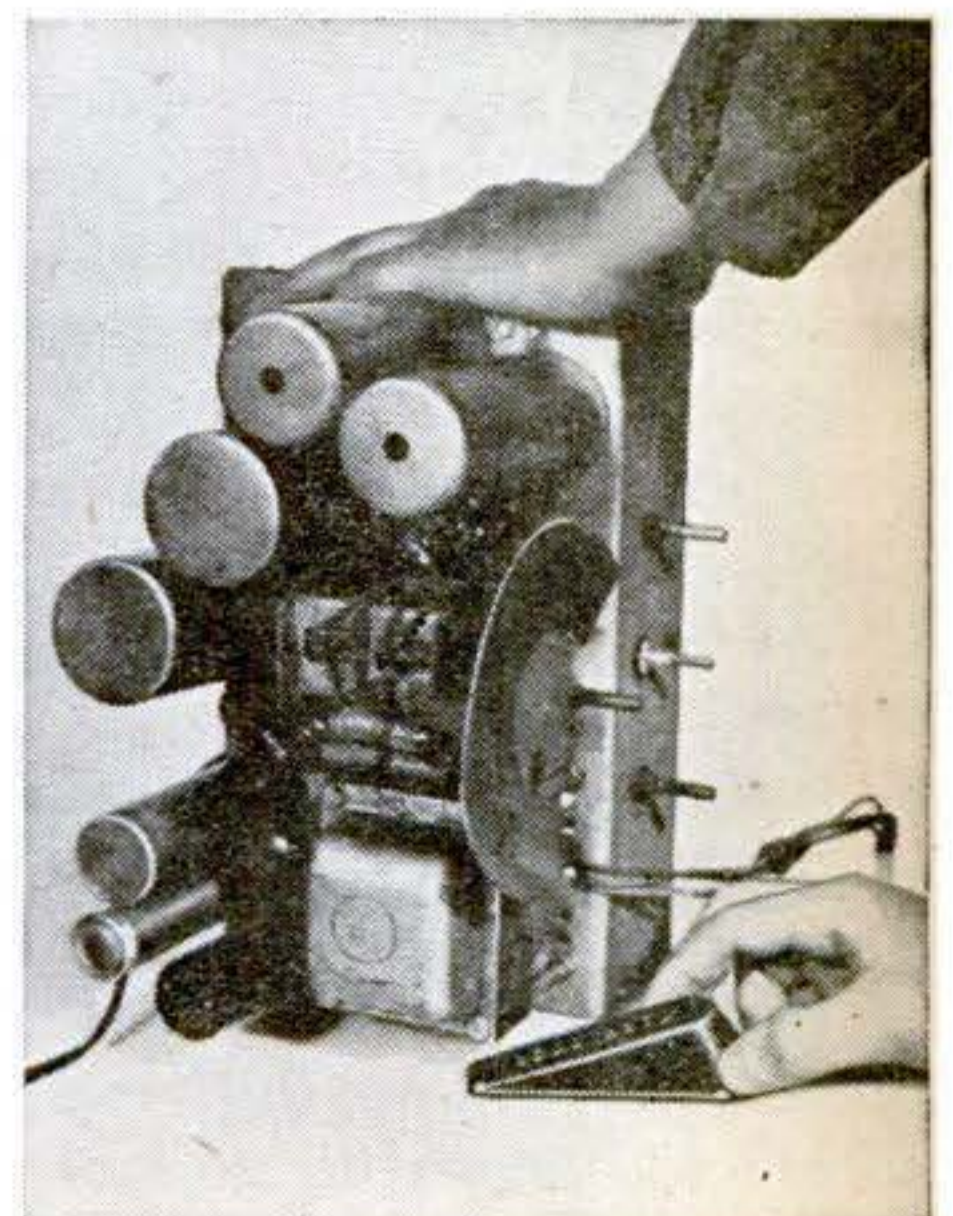

## Concealed Antenna

SHORT antennas need not consist of wires dangled out the window or bunched up behind the furniture. Screws driven into the bottom of the radio cabinet diagonally from each corner make convenient pegs for antenna wire as shown at the left.—ROBERT H. DALTON.



# HOME EXPERIMENTS

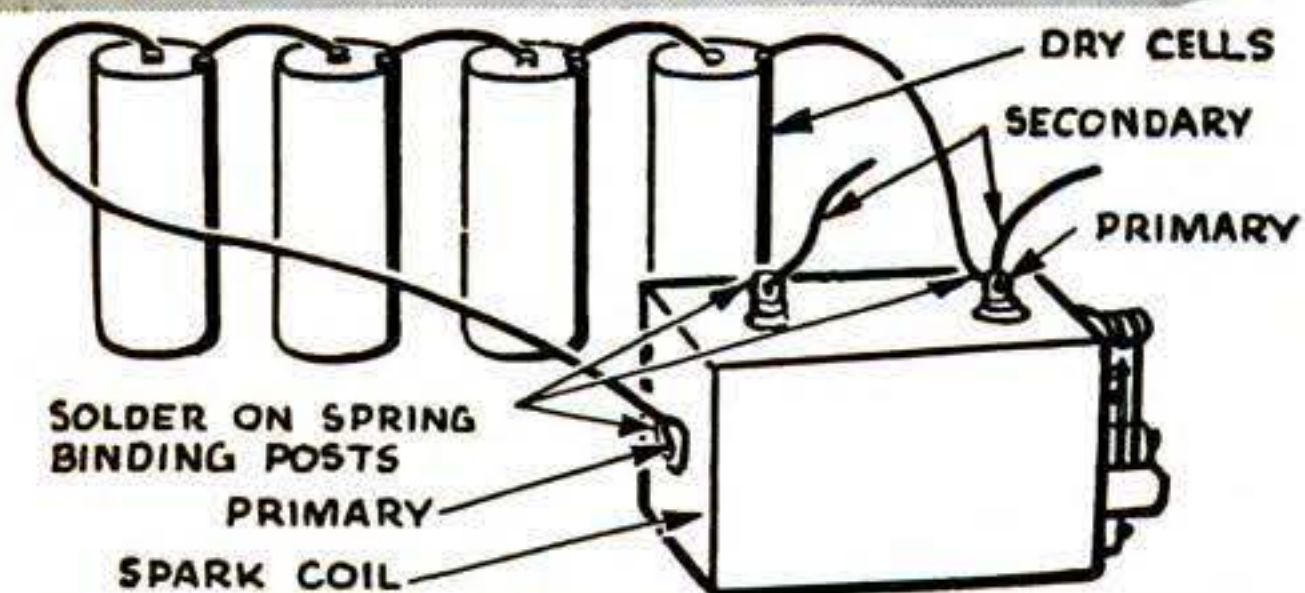

**FOUR DRY CELLS** connected in series with a spark coil of the type used in the Model T Ford will enable you to perform the experiments on these pages. For convenience, solder a spring-type binding post to each of the three terminals of the coil. As shown at left, one lead of both the primary and secondary goes to the side terminal near the vibrator end.

## High-Voltage Fun with a Spark Coil

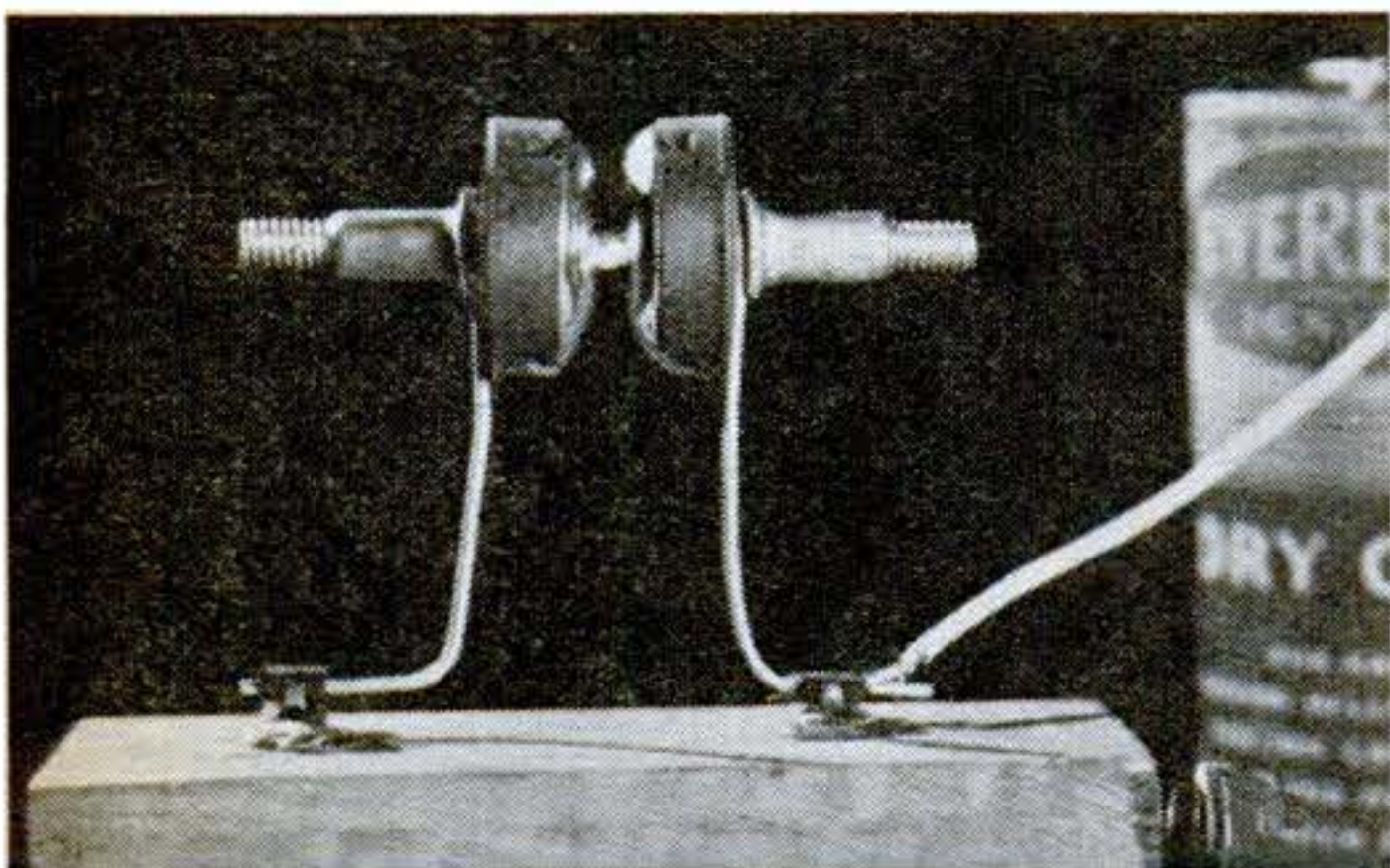

**ELECTRIC LIGHTS** normally require a closed, or complete, circuit. Yet stand a fluorescent tube on the lone secondary terminal of your coil, supporting it with insulating material; close the primary circuit, and the tube lights dimly—even though the secondary is “open”. Balance a pie pan on the tube, and it lights still more strongly. Why? In the first case, the charge in the air about the secondary excites the gas in the tube. In the second, the pan intensifies the electrical flow by acting as the plate of a condenser, accumulating a larger charge than the terminal of the tube alone.

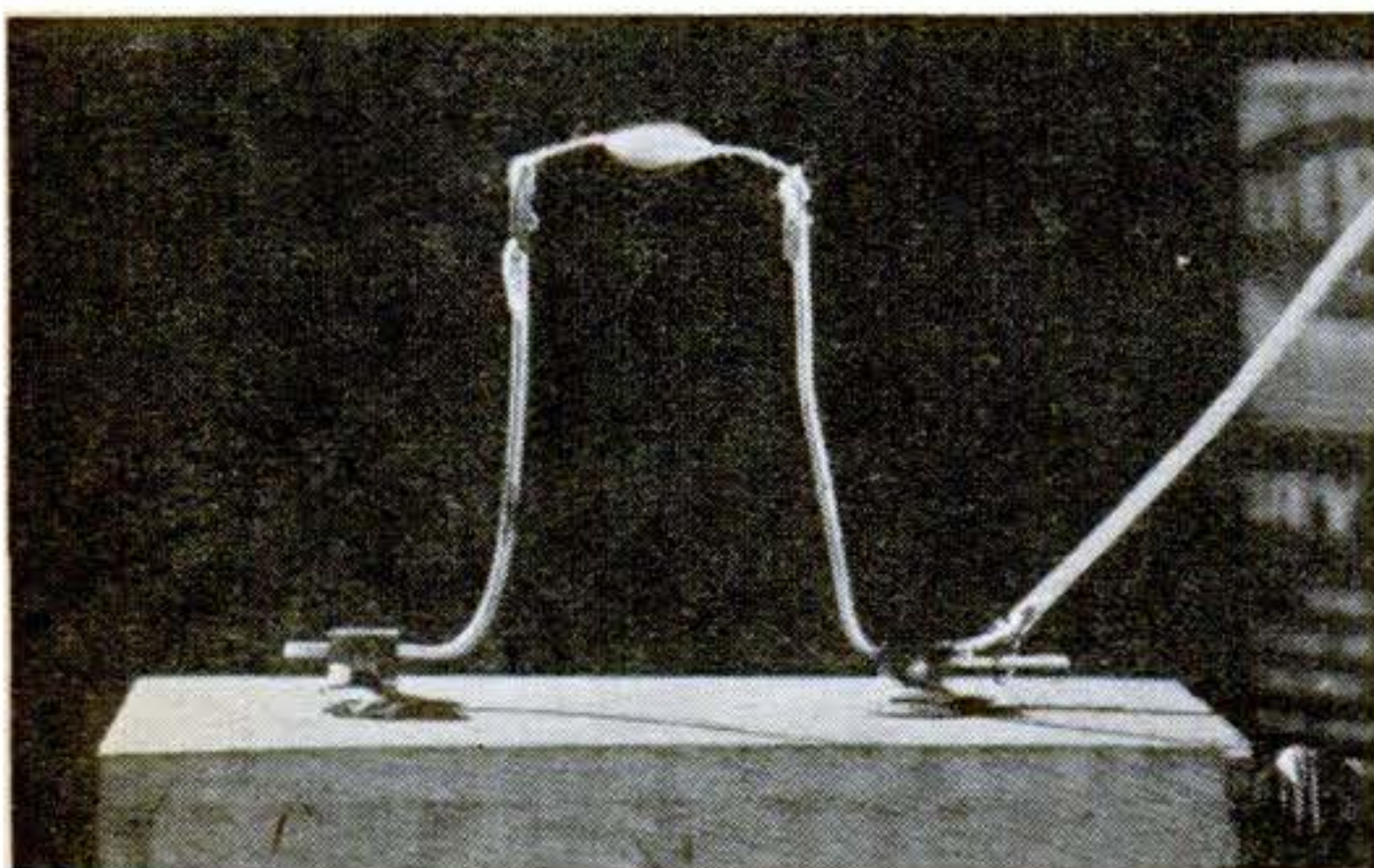

**PRODUCTION OF SPARKS** is the function of a spark coil. It can do this because, although the input potential is only a few volts, the output of the secondary may be from 10,000 to 15,000 volts, this high voltage permitting the secondary current to jump at least  $\frac{1}{2}$ ". The spark length, however, depends on the terminals, as you can show. First improvise a spark gap with sharp points, drawing them apart (with the current off!) until you get the longest possible spark. Substitute metal silence domes for furniture (as above), and the spark will jump only a fraction as far. The reason? In the case of the points, the charge is concentrated right at these points. When the surface is large, the pressure density is less.

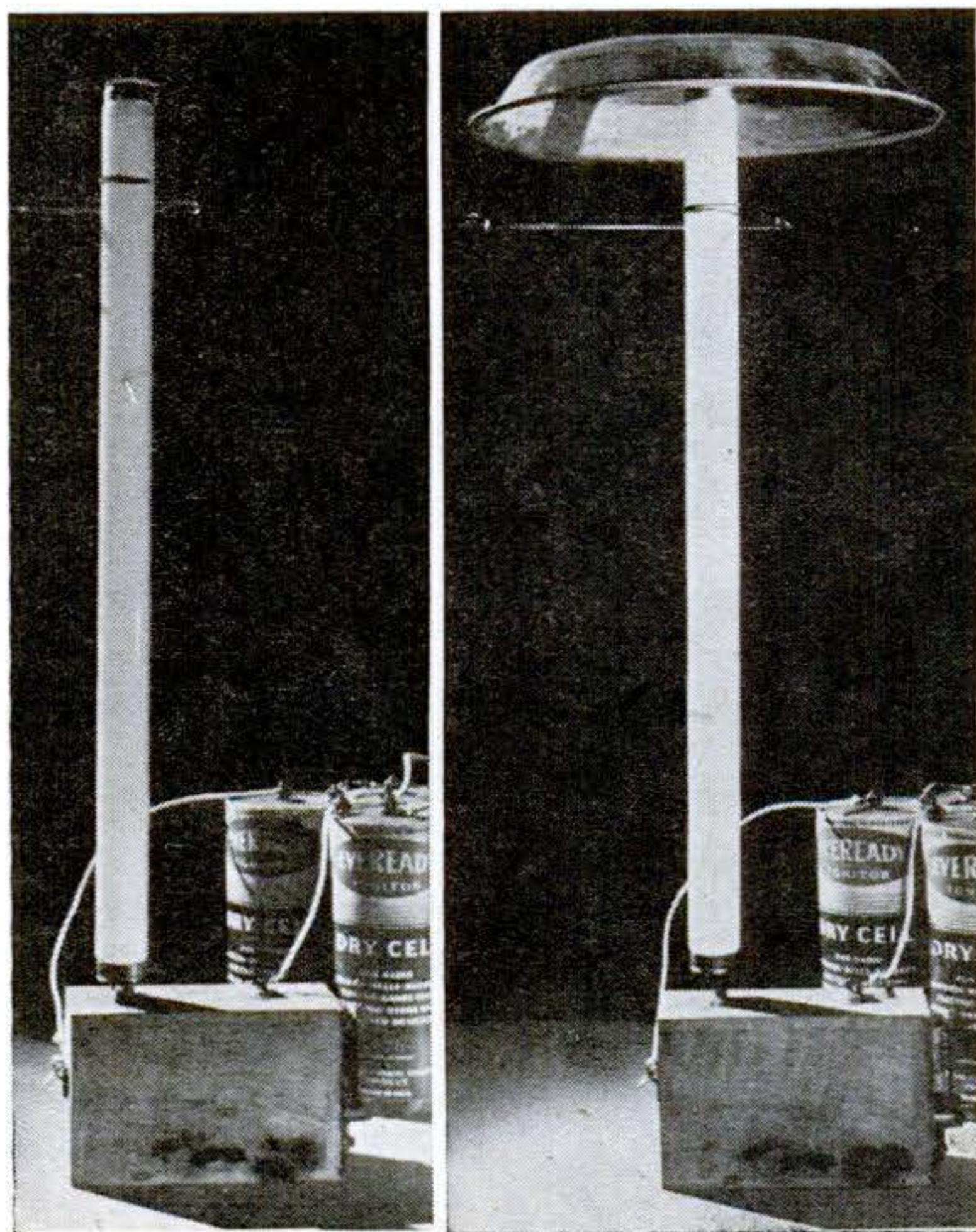



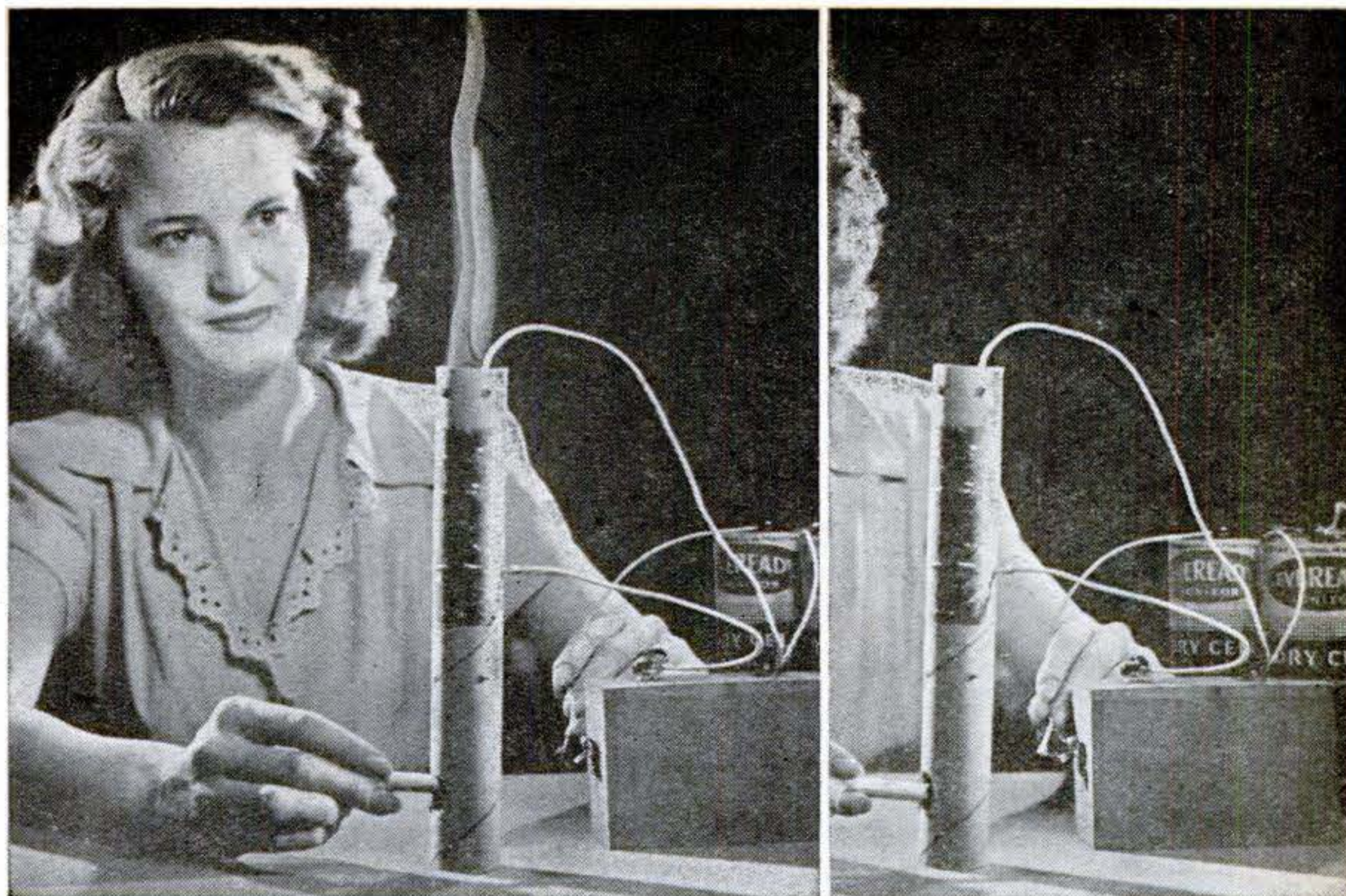
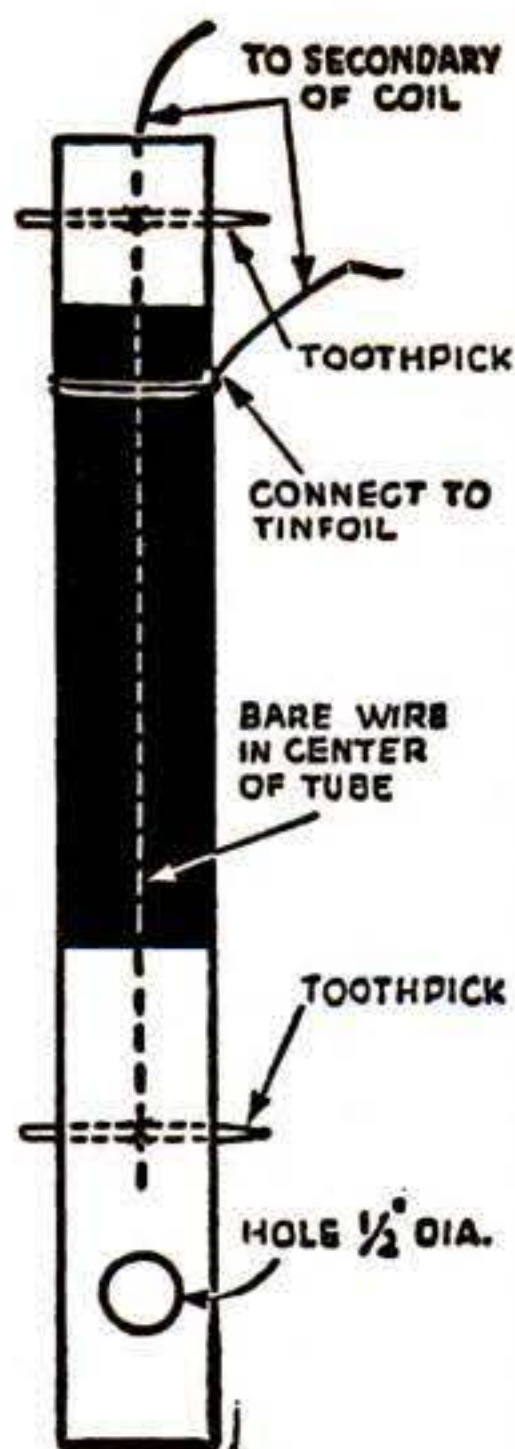

**SMOKE IS REDUCED** in many cities through use of Cottrell precipitators in industrial plants. The diagram above indicates how you can rig up a working model of such a precipitator with a mailing tube and a piece of tin foil. When the setup is ready, thrust a lighted cigarette or incense stick into the

hole in the tube. Smoke will pour from the top. Connect the primary circuit of your spark coil, as at the right, and the smoke will stop. Although nothing visible happens within the tube, the high-voltage electrical field set up inside causes the smoke particles to clump together and fall to the bottom.

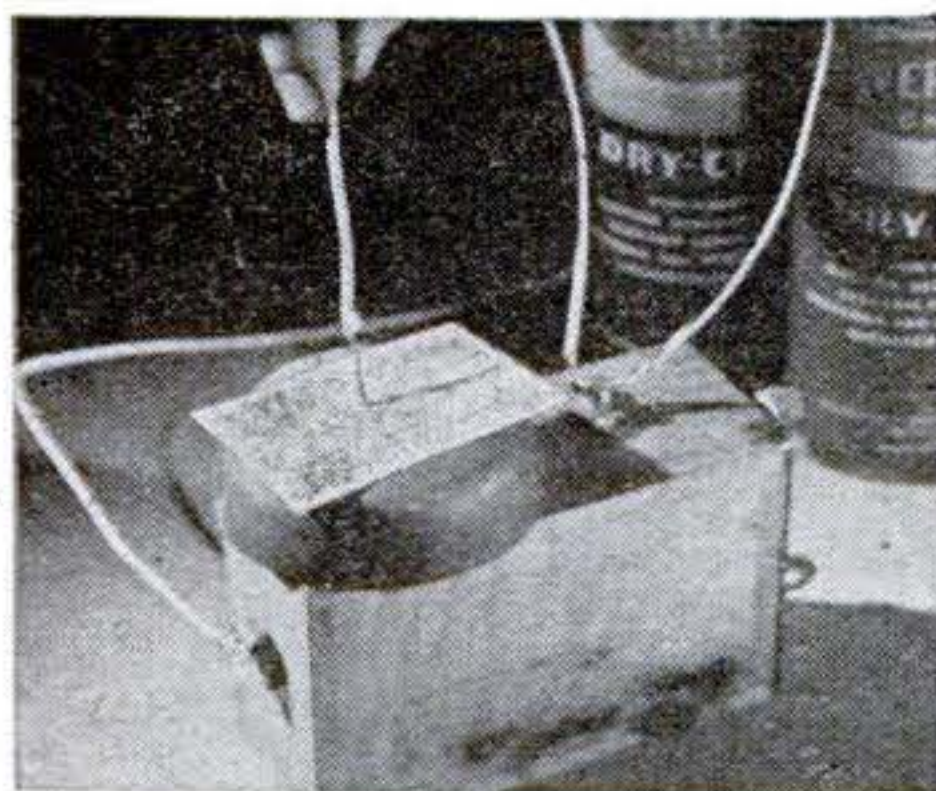

**PRACTICAL JOKERS** might try this idea. Over the single secondary terminal of the spark coil invert a metal ash tray with tin foil underneath to make an electrical connection. Place a cigarette paper on the tray and, with the current on, move a wire from the other secondary terminal back and forth above the paper, not quite touching it. Invisible sparks will perforate the paper with hundreds of microscopic holes. Try to smoke a cigarette made of it. You'll find it impossible.

**HERE'S A TRICK** to mystify your friends. Place a fluorescent tube on a table covered with a cloth. At your command, the tube will light or go out—as often as you wish. Before your performance, however, set the stage by placing two strips of tin foil under the cloth and connecting them to the secondary terminals of your spark coil, concealed under the table. Operate the coil with a concealed push-button switch. The tube must be placed with the terminals over the tin foil as shown in the drawing below.

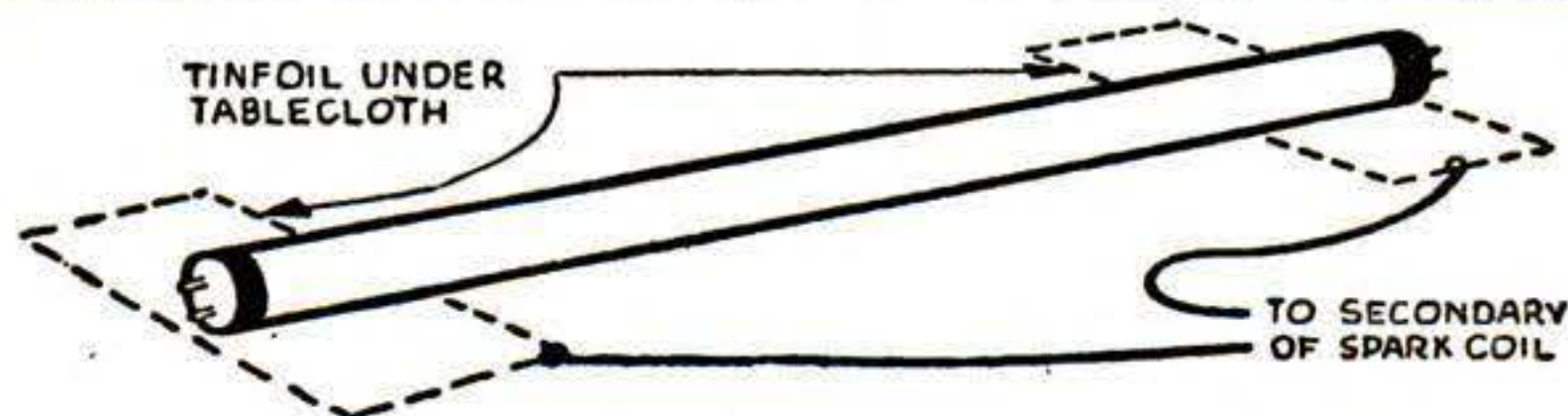



# What's Wrong?

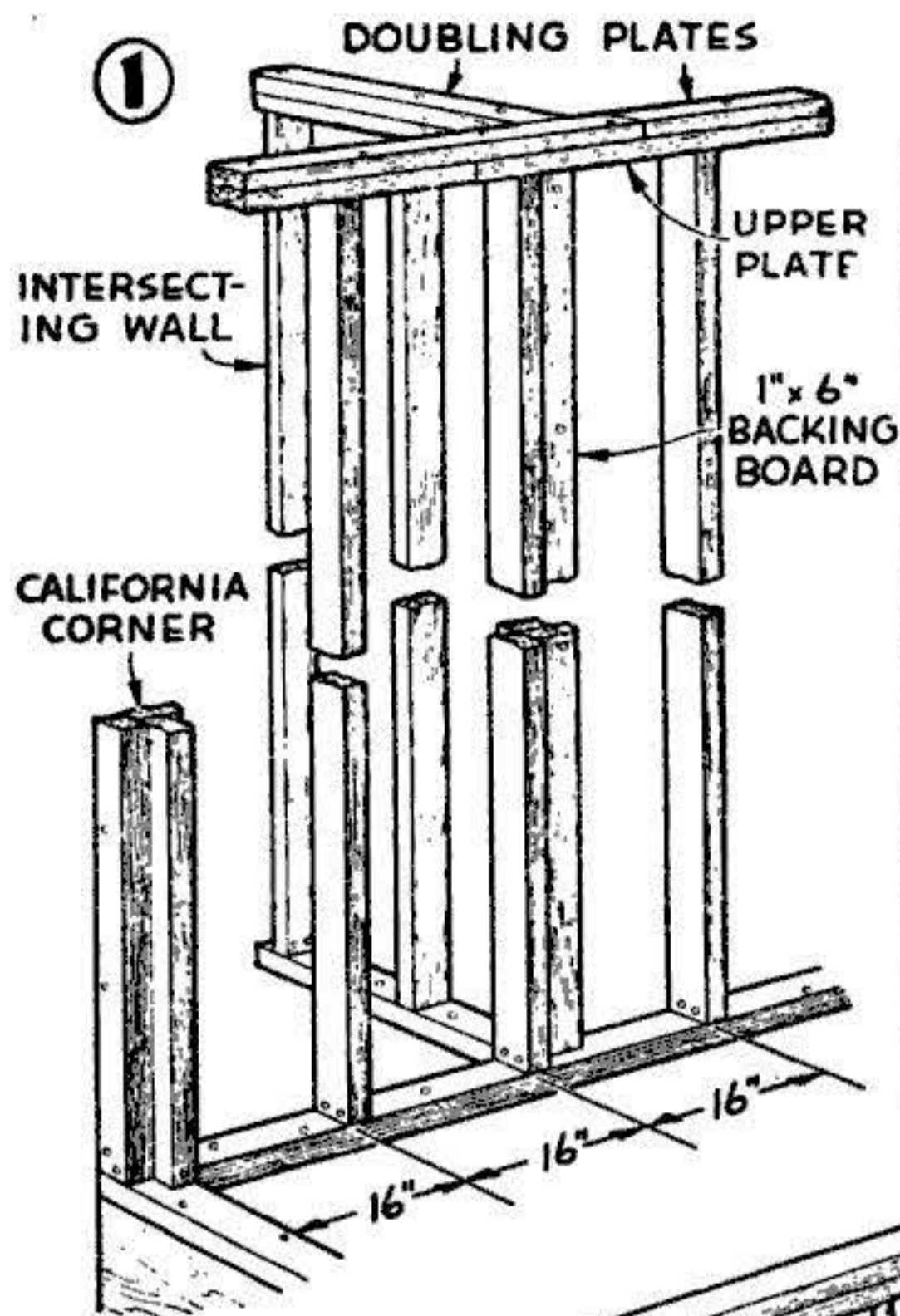

EIGHT errors in framing walls are shown in these drawings—six in Fig. 1 and one each in the other two. Answers are given below.

1. Splice the upper plate on a stud.
2. The doubling-plate splice should be at least 4' from that of the upper plate.
3. Intersecting doubling plates should lap on the upper plate for a secure tie.
4. A regular stud is needed on both sides of the intersecting wall. The 1" backing stock will cause plaster cracks at the corner.
5. Rotate the California stud counterclockwise 90 deg. to get backing studs on both sides of the inside corner.
6. Lay out studs on centers with the third 4' from the corner to avoid cutting lath.
7. Cripples are needed also under both ends of the lower trimming header.
8. Don't extend lath beyond partitions.

## ANSWERS

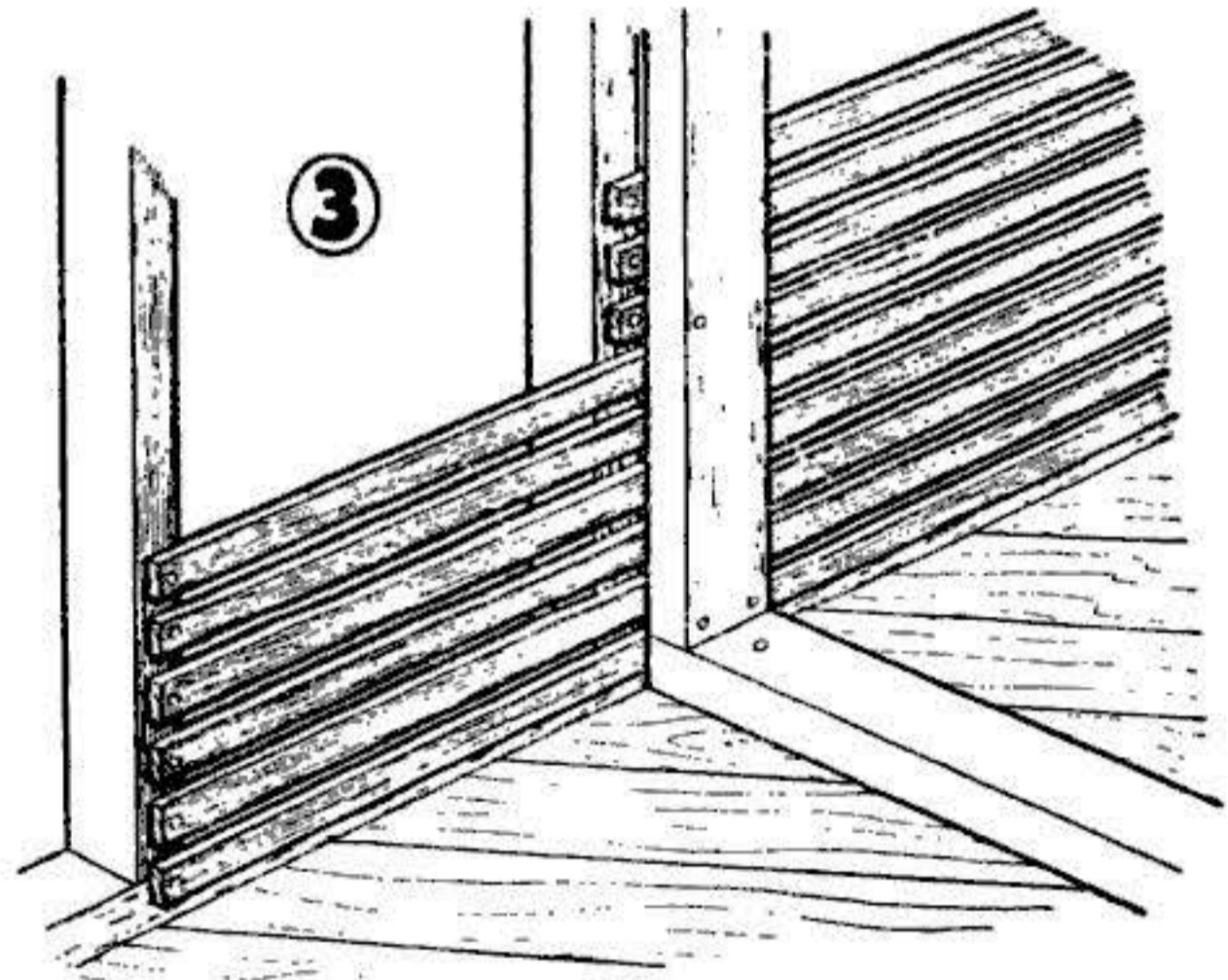
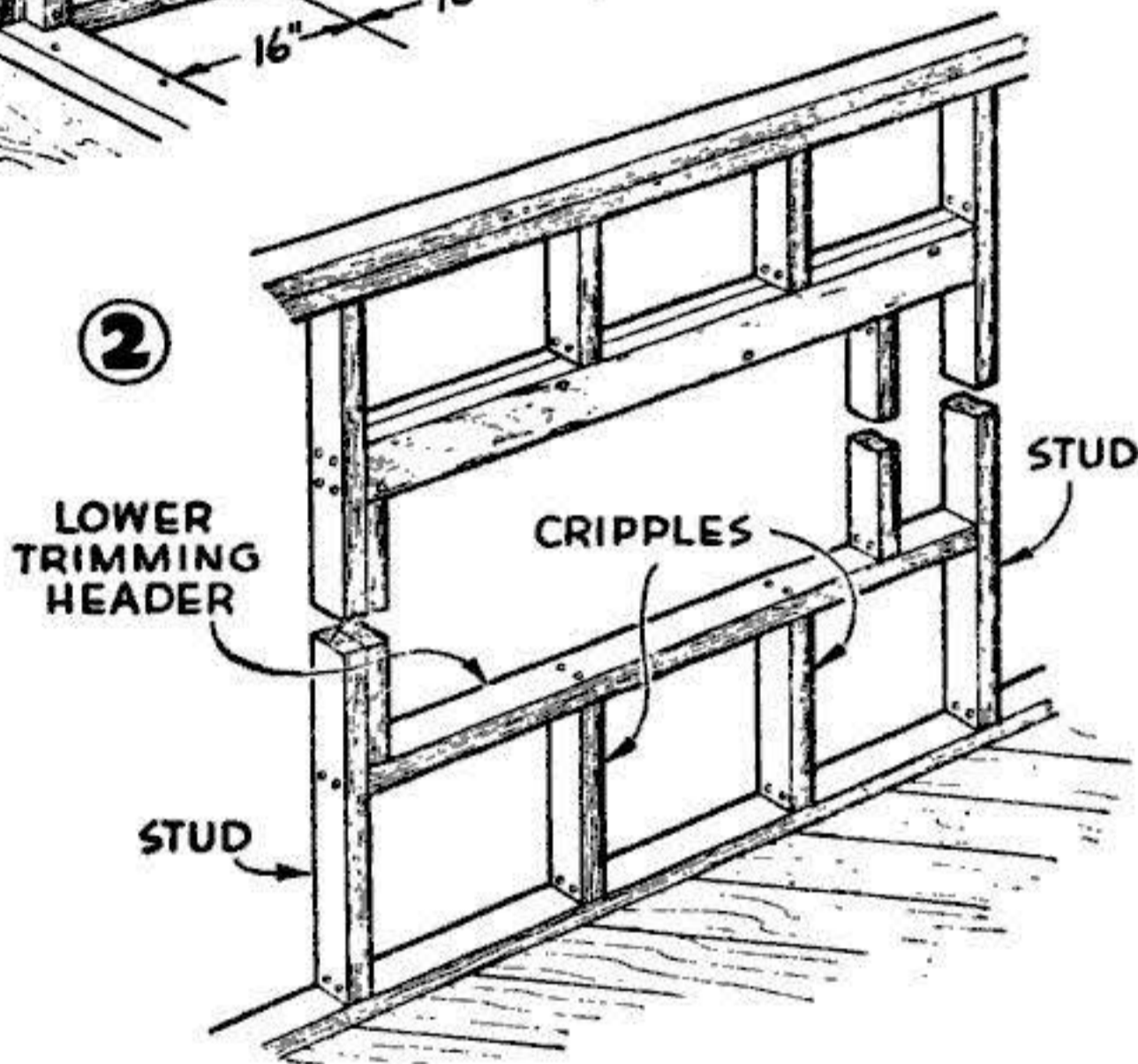

## GRADES OF LUMBER

## [WOODWORKING]

Under the American lumber standards established by the National Bureau of Standards, yard lumber is divided into the following grades:

**Select**—Lumber of good appearance and finishing qualities.

**Grade A**—Practically clear. Suitable for natural finishes.

**Grade B**—Of high quality, generally clear. Suitable also for taking natural finishes.

**Grade C**—Adapted to high quality paint finishes.

**Grade D**—Between higher-finishing grades and common grades, and partaking somewhat of the nature of both. Suitable for paint finishes.

This is the lowest grade listed for use where finishing is required.

**Common**—Lumber not of finishing quality, but suitable for general utility and construction purposes.

**No. 1**—Sound and tight knotted. May be considered watertight. Suitable for use without waste.

**No. 2**—Less restricted in quality than No. 1, but of the same general character. Also suitable for use without waste.

**No. 3**—Prevailing grade characteristics lower than in No. 2. Some waste.

**No. 4**—Low quality. Some waste.

**No. 5**—Lowest recognized grade, but must be usable. Some waste.

Except in the dimension and timber classifications, the grade of yard lumber, rough or surfaced two sides, is determined from the better or face side. Lumber surfaced one side only is graded from the surfaced side.

POPULAR SCIENCE MONTHLY SHOP DATA



# Circular-Saw Bench

## HAS KNEE-OPERATED SAFETY SWITCH

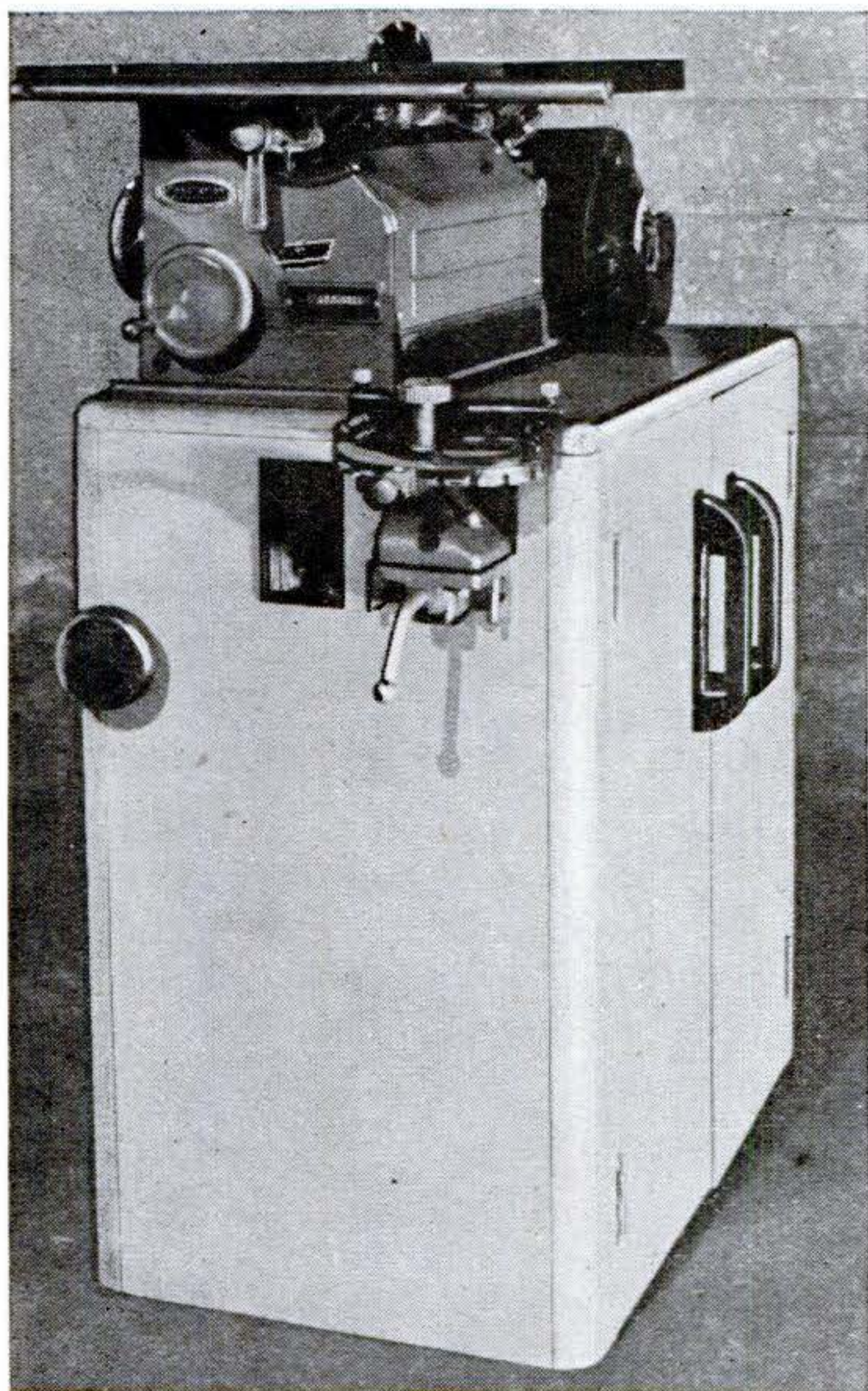

**B**ASIC features for both safety and efficiency are incorporated in the design of this home-built bench for a circular saw. A switch, operated by pressure from one knee, will cut off the motor in an emergency when both hands are occupied, and the starting connection can be locked in the "off" position simply by the removal of a wire U. The bench also has a built-in ripping-fence rack, a miter-gauge holder, a built-in sawdust box, and generous cabinet space for holding accessories.

Both the knee switch and the hand-operated main switch on the side of the cabinet must be "on" for the saw to run. Since the former is pushed in for emergency stopping only, it must be pulled out again by hand before the saw can be started up.

Ordinarily, if there are children about, the only precaution necessary on leaving the saw is to push the knee switch in and turn the toggle switch off, but the wire U connecting the knee-switch dowel to the inside switch can be pulled out as well when the knee switch is in the "off" position. Be sure to have this inside switch in such a position that it can be shut off by the knee plunger even though the U has been removed from the setup.

Parts can be cut on the saw itself if it is

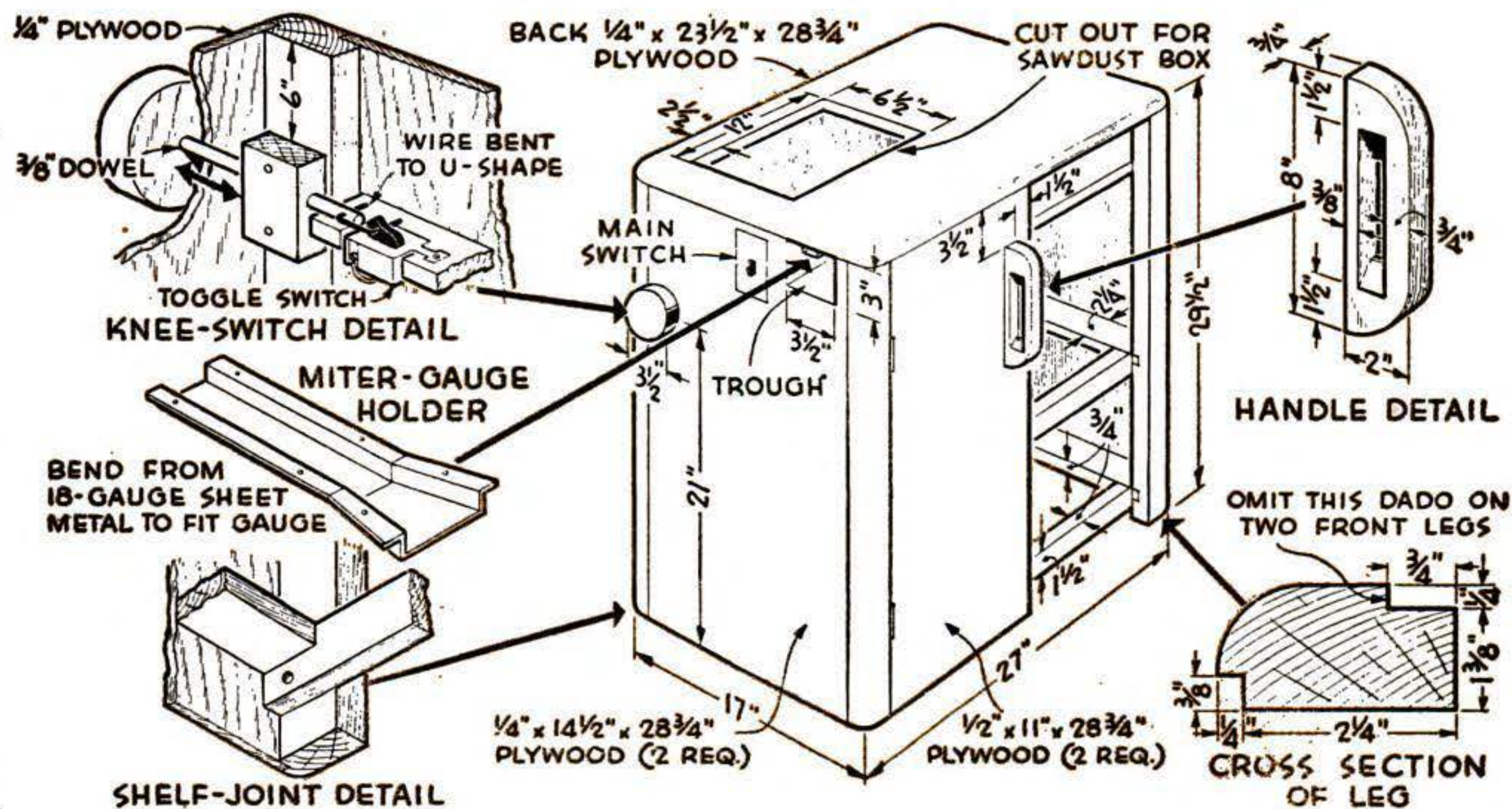



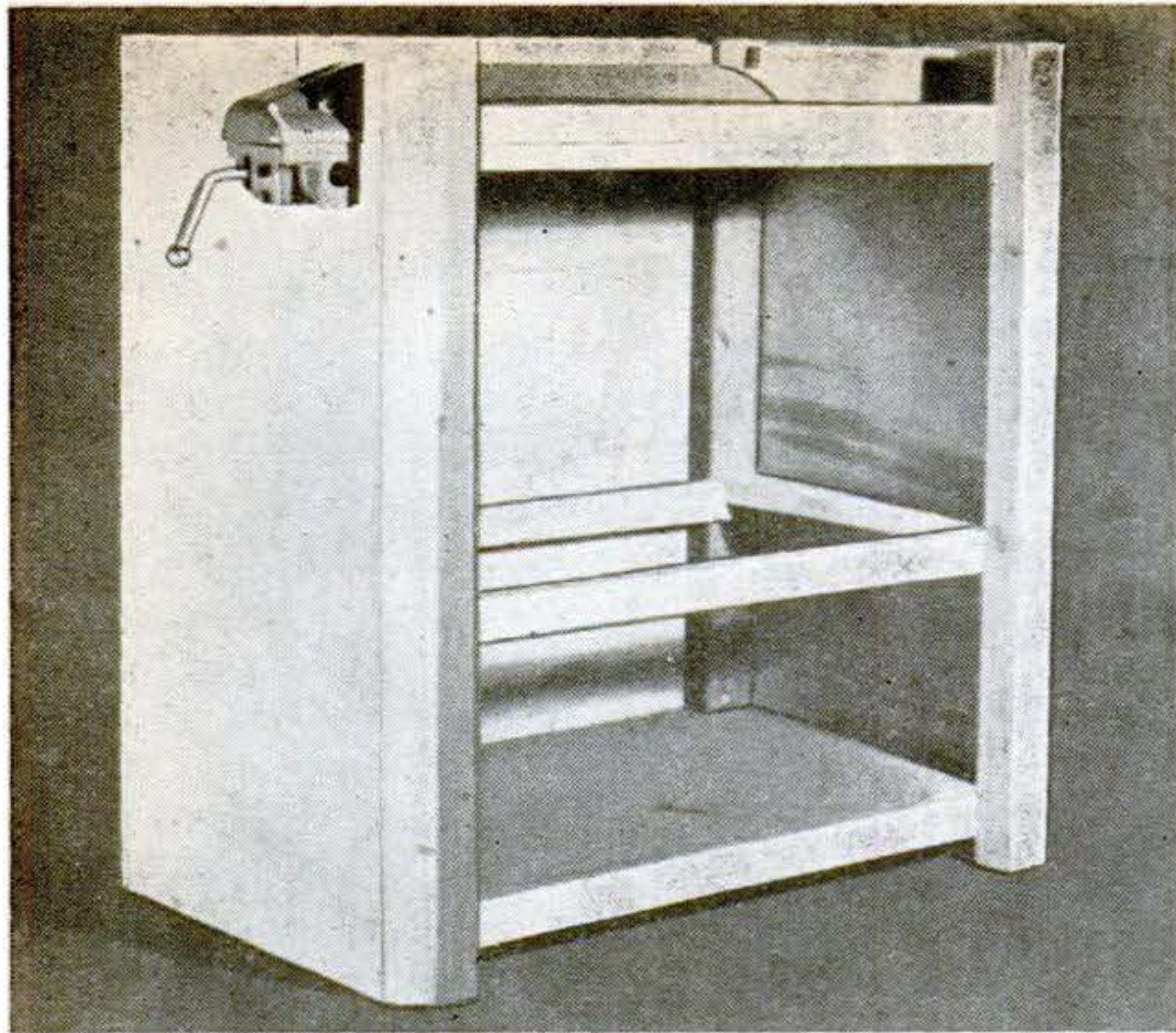

This circular-saw bench cabinet has generous storage space. At right, a view of the table top from the underside. The wiring diagram below shows switch connections.

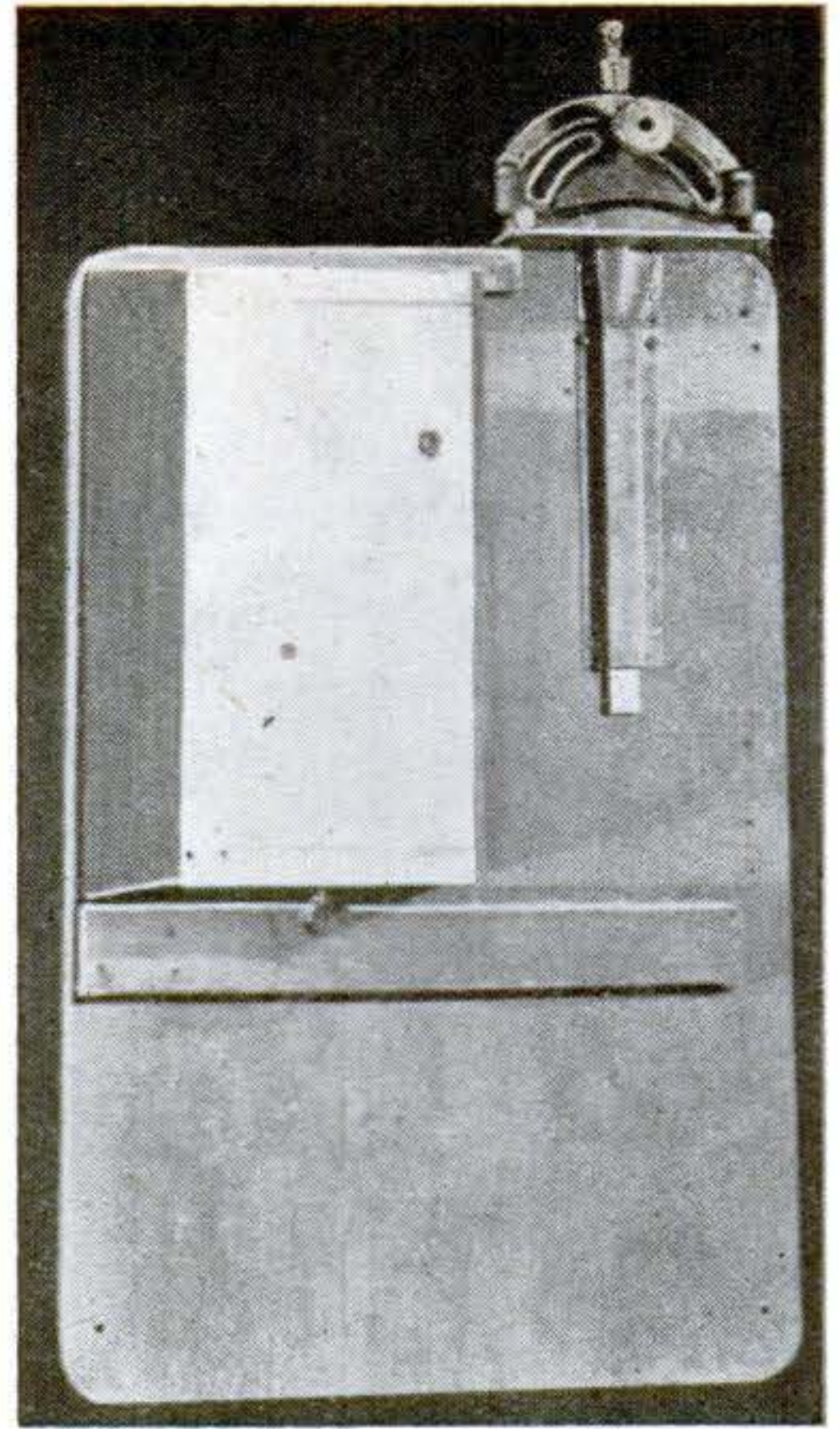

mounted first on a temporary base. Some change in dimensions may be required to suit the saw for which the bench is intended.

The top for the table shown was salvaged from an old gas ironer and was already glued up in a piece of sufficient size. If a piece large enough cannot be found, a strong table top can be glued up.

In cutting out the handles, drop each side on the saw or dado head to put the hand hole through it. Hold the block against a stop

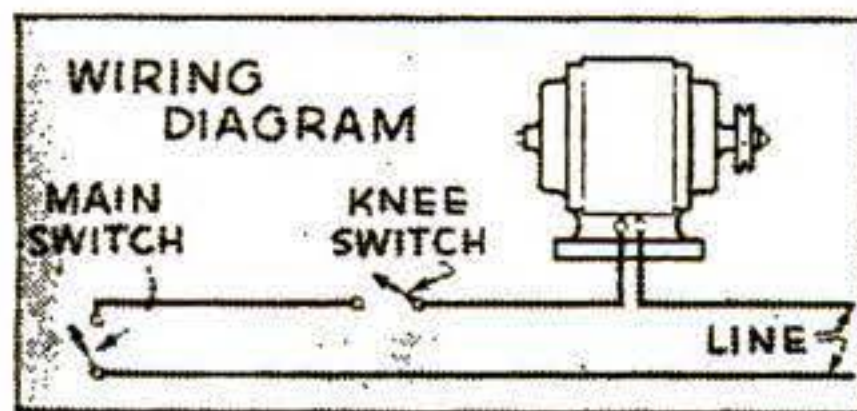

clamped to the fence, lower it on the saw, and push it ahead. Then shape the ends. Time can be saved in rounding the corners if they are first cut off at 45 deg. and

then two thinner cuts taken at about 25 deg. The sawdust box is slightly larger than its hole and is suspended by a horizontal dowel at one end and a hook and eye at the other.

Screw the miter-gauge holder to the top at the middle of the opening for the ripping fence.—R. F. KOEBBEMAN.

## Covered Winter Feeder Protects Birds' Food from Weather

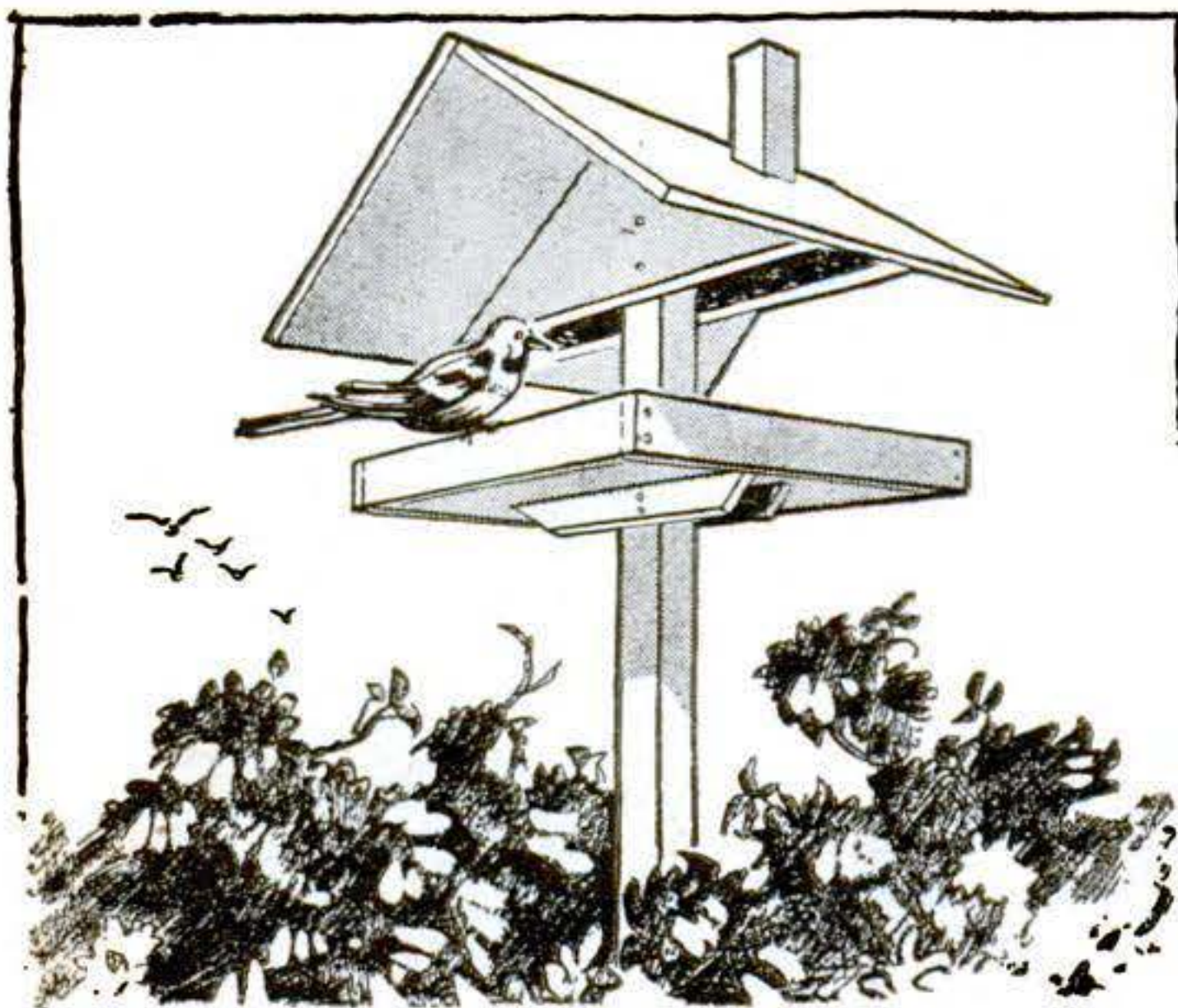

Food left out for birds in winter must be protected from rain and snow, or it will get soggy and freeze. A roof over the feeder will solve the problem, though it may cause the birds to be a little timid at first. If you place the feeder on a post about 15' above the ground, however, the birds will eventually learn to disregard the roof, and your yard will become a gathering place for them all through the winter.

Except for the 2" by 2" upright, which should be a good 18' length, all wood can be scrap or pieces from discarded crates. The outside of the feeder may be painted, but the birds will feel more at home if the inside is unpainted.—R. H. DIRCKS.



## Sawing Off a Tight Ring Safely

IF COLD soapy water has failed to remove a tight finger ring, the following method will be found faster and safer than filing it off. Insert a jeweler's saw blade under the narrowest part with the teeth up. Clamp it in the saw frame and saw upward, away from the finger. Soap may be used as a lubricant. Saw slowly to avoid heating the blade by friction. Once cut through, the ring is easily spread a trifle and slipped off.—C. R. SCHLEGEL.

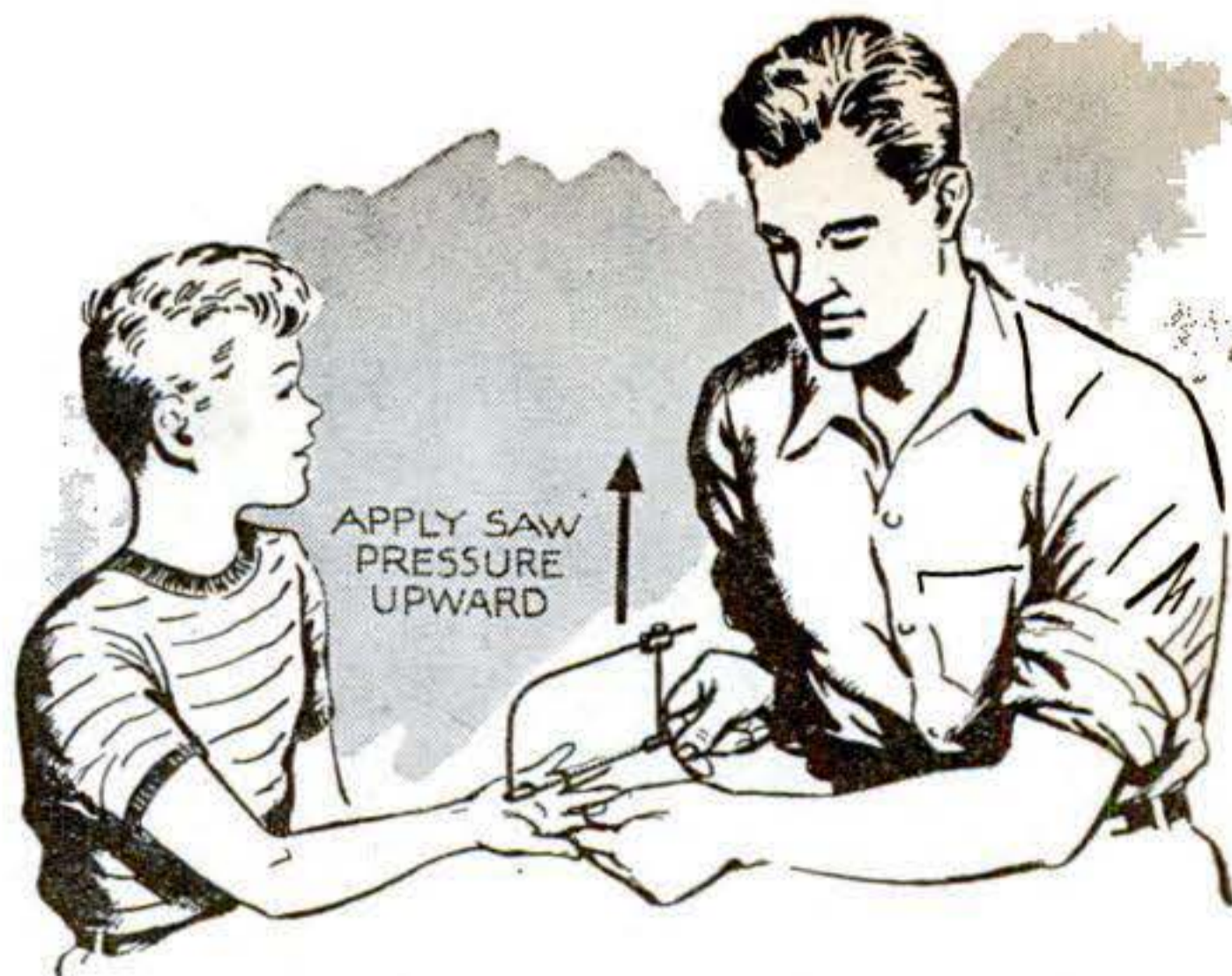

## How to Repair a Clock When Mainspring Won't Stay Wound

A COMMON source of trouble in alarm clocks is a defective click (ratchet pawl) or click spring. When either fails, you can wind the mainspring but it unwinds immediately. To fix these parts, first take out the movement, spread the plates, and remove the main wheel, to which the click is attached, on its arbor.

Some clocks have special clicks, for which you may be able to buy a replacement. If not, use a standard one from an old clock, or make one of sheet brass about as thick as the ratchet. Because of the spacing of the spokes, you may have to devise your own way of anchoring the new parts. The click should be riveted to the wheel so that it can move freely. A shoulder rivet is

best, but a plain one will do. The shape of the spring may vary considerably, but it should hold the click firmly against the ratchet and should be anchored at two places.—WILLIAM SCHOPP.

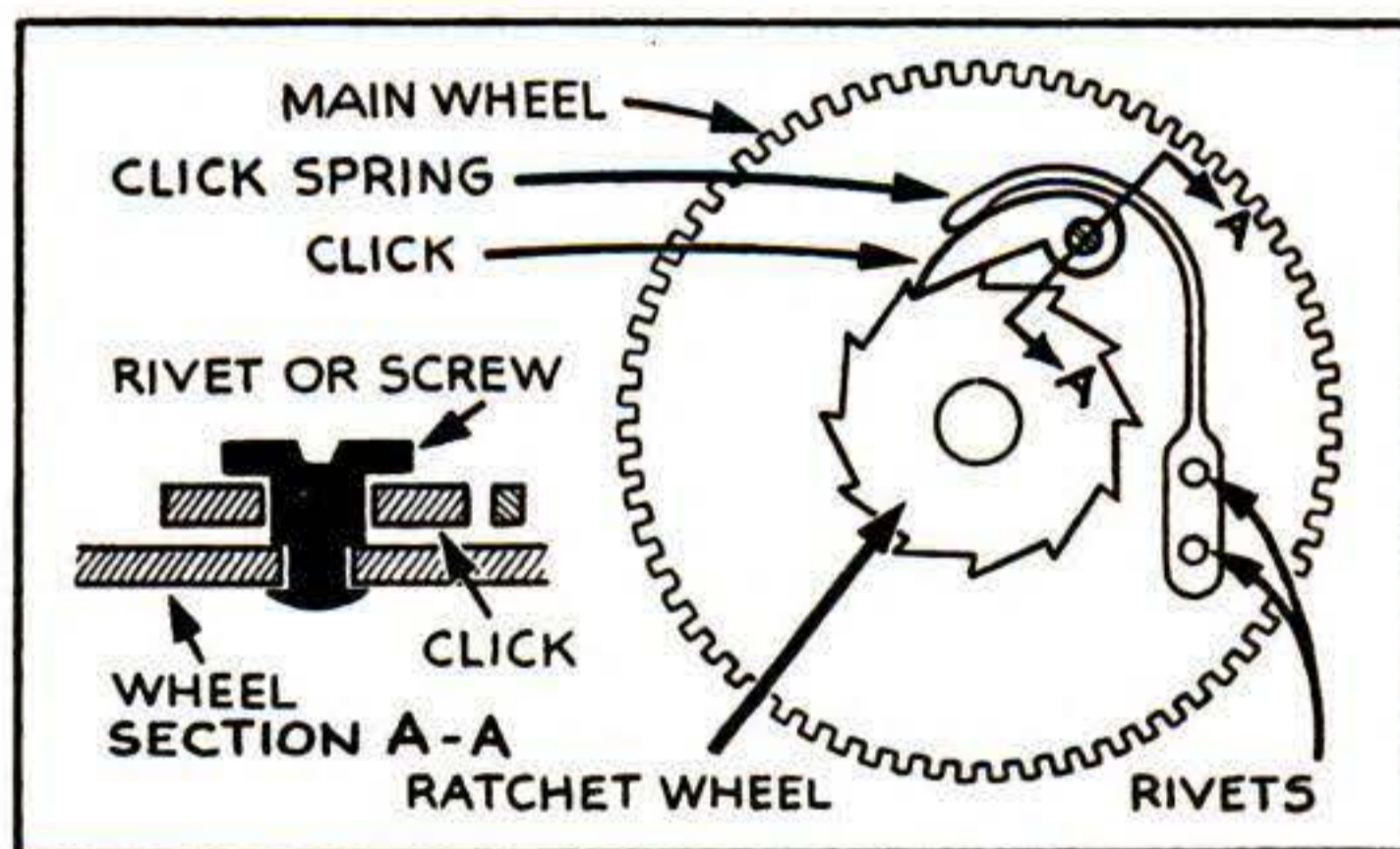

## Weed-Burning Torch Heats Furnace When Oil Burner Quits

A FAILURE of either electrical power or your oil burner needn't leave the house uninhabitable if you can buy or borrow an oil-burning torch of the kind used for burning weeds. Having its own fuel tank and nozzle, it can be adapted to heat the furnace without altering the regular equipment.

Light the torch and place it in the firebox as shown below; then fit a piece of sheet

asbestos over the furnace opening, cutting a notch to admit the torch hose and a certain amount of air. The size of this notch must be determined by experiment while watching the flame. If the regular oil burner is a gun type, remove the access plate at the end of the gun housing to admit extra air. Keep tank pressure up to insure normal combustion.—W. H. JACQUES.

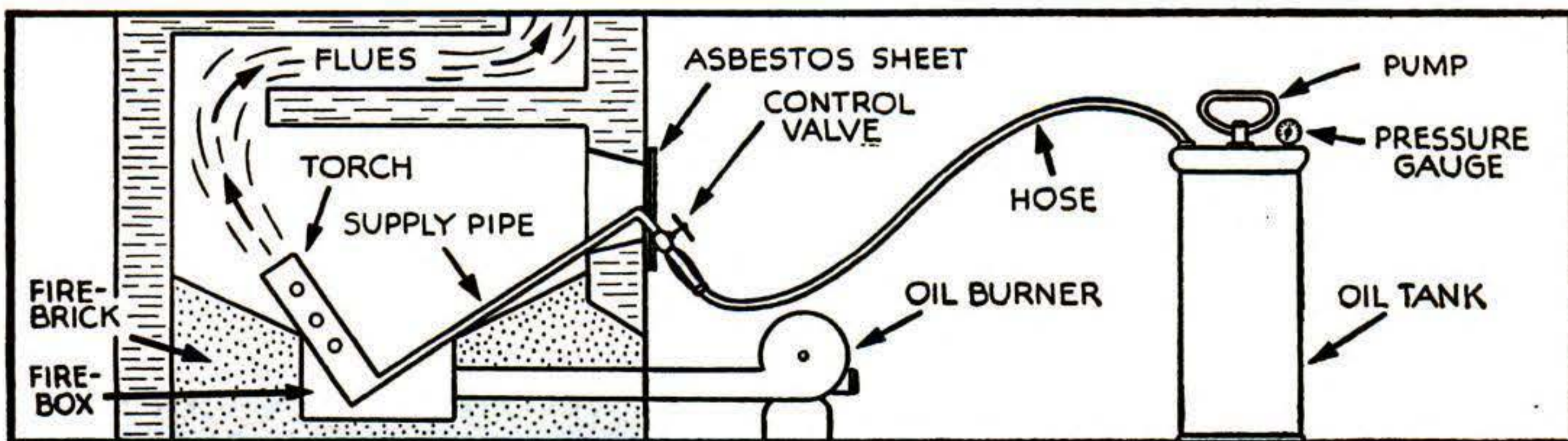



# CHEMISTRY answers the Fire Alarm

By KENNETH M. SWEZEY

PROPERLY controlled, fire is one of the most useful chemical reactions known to man, but out of hand it is an awe-compelling agent of destruction. Despite fire-prevention campaigns and highly efficient fire-fighting equipment, it causes 40,000 casualties and damages nearly half a billion dollars worth of property each year in the United States alone. On the average, a severe fire occurs every 50 minutes.

Most big fires start small. They could be checked easily and with little resultant damage if they were caught in the beginning. Fighting any of the different types of small fires is nothing more than a simple problem in physical chemistry, but the method employed for one fire is not necessarily the best for another.

All ordinary fires are the result of rapid oxidation. For this oxidation to take place,

two conditions must be met: the substance must be heated to its kindling temperature, and there must be sufficient oxygen. Consequently, if we can reduce the temperature of the burning substance below its kindling point or cut off the supply of oxygen, the fire will stop. The two chief methods of fire extinguishing, therefore, are cooling and smothering. Whether one, the other, or both methods should be used depends upon the type of fire.

Soaking the burning material with water is the oldest method of reducing the kindling temperature. With all our modern foams, sprays, and chemical apparatus, water still is the most effective, cheapest, and most abundant medium for extinguishing large fires involving wood, paper, clothing, and

other ordinary inflammable materials. Even the common soda-acid fire extinguisher owes its effectiveness to water.

You can demonstrate this usefulness of water by rigging up an extinguishing apparatus consisting of a 2' length of rubber tubing with the stem of a funnel inserted in one end and the glass part of a medicine dropper in the other. Place a pinchcock at the nozzle end of the tubing to retain the water until needed and fill the funnel and hose with water. Pressure is obtained by elevating the funnel.

Start a small demonstration fire by igniting a wad of paper in a cake tin, which has been placed on an inverted tin to insulate

Water is the oldest method of extinguishing a fire, and still one of the best. You can prove its efficiency with the simple apparatus shown in this photo.

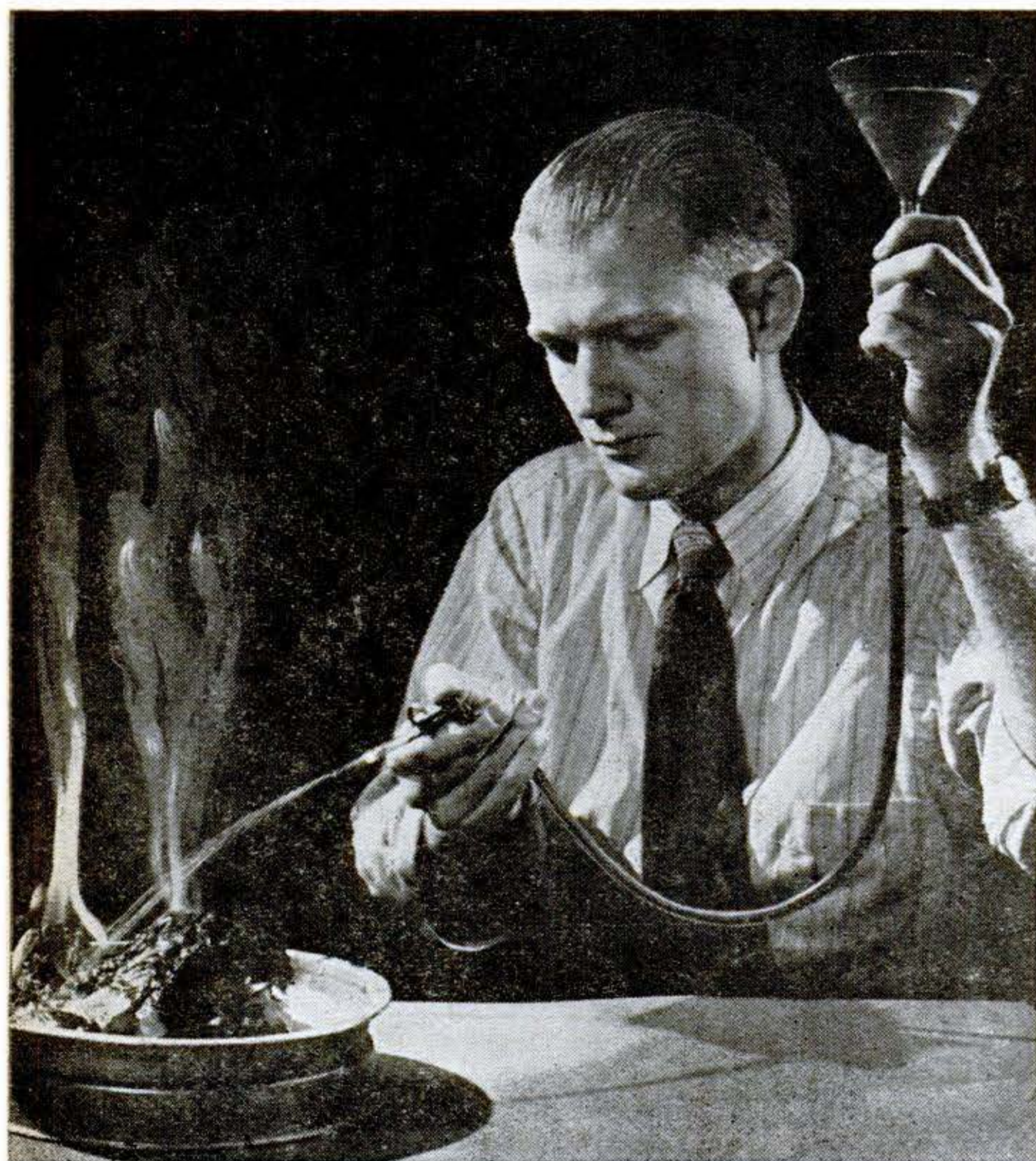





## Different Fires Require Different Extinguishers

ANY good extinguisher may be used on burning wood, paper, clothing, rubbish, and ordinary inflammable materials, but water or soda and acid are the most economical.

For oil, grease, gasoline, or paint fires, use foam, carbon dioxide, methyl bromide, carbon tetrachloride, or dry chemicals; never water.

Use carbon dioxide, methyl bromide, carbon tetrachloride, or dry chemicals for live electrical wiring that is afire. Never use any water, foam, or soda and acid.



If blown as dust, bicarbonate of soda will put out a fire.

the table from the heat. When the fire has begun to blaze strongly, play water over the burning material. By maneuvering the stream, you will see how little water is needed to put out the fire.

Another experiment will indicate why water possesses this great cooling and quenching action. Stand a small beaker of water alongside a similar beaker of carbon tetrachloride on an electric hotplate and watch what happens as the liquid warms up. (Perform this experiment in a well-ventilated room.) In a short time the carbon tetrachloride will begin to boil, followed later by the water. This difference is to be expected, since carbon tetrachloride boils at 76.7 deg. C. and water at 100, but a great difference develops in the rate of boiling away. Under ideal conditions, the carbon tetrachloride will boil away about 10 times as fast as the water.

What does this difference mean in terms of fighting fires? It means that, as far as the cooling effect is concerned, water will extract about 10 times as much heat from a fire,

Carbon tetrachloride boils away faster than water, as shown here, but the water absorbs 10 times more heat. Consequently, water does a better job of putting out a fire, for it cools the flames much more.

pound for pound, as will this other popular fire-extinguishing medium.

A fire sometimes can be extinguished by the cooling effect of water without direct contact between the water and the burning material. To demonstrate this, melt some paraffin wax in a small can over a Bunsen flame and continue heating the wax until the vapors burn continuously after being ignited with a match. Then grasp the can with tongs and carefully lower it nearly to its top in a pan of cold water. (Be careful not to spill water on the burning wax, or it will spatter violently.) Soon the flame will

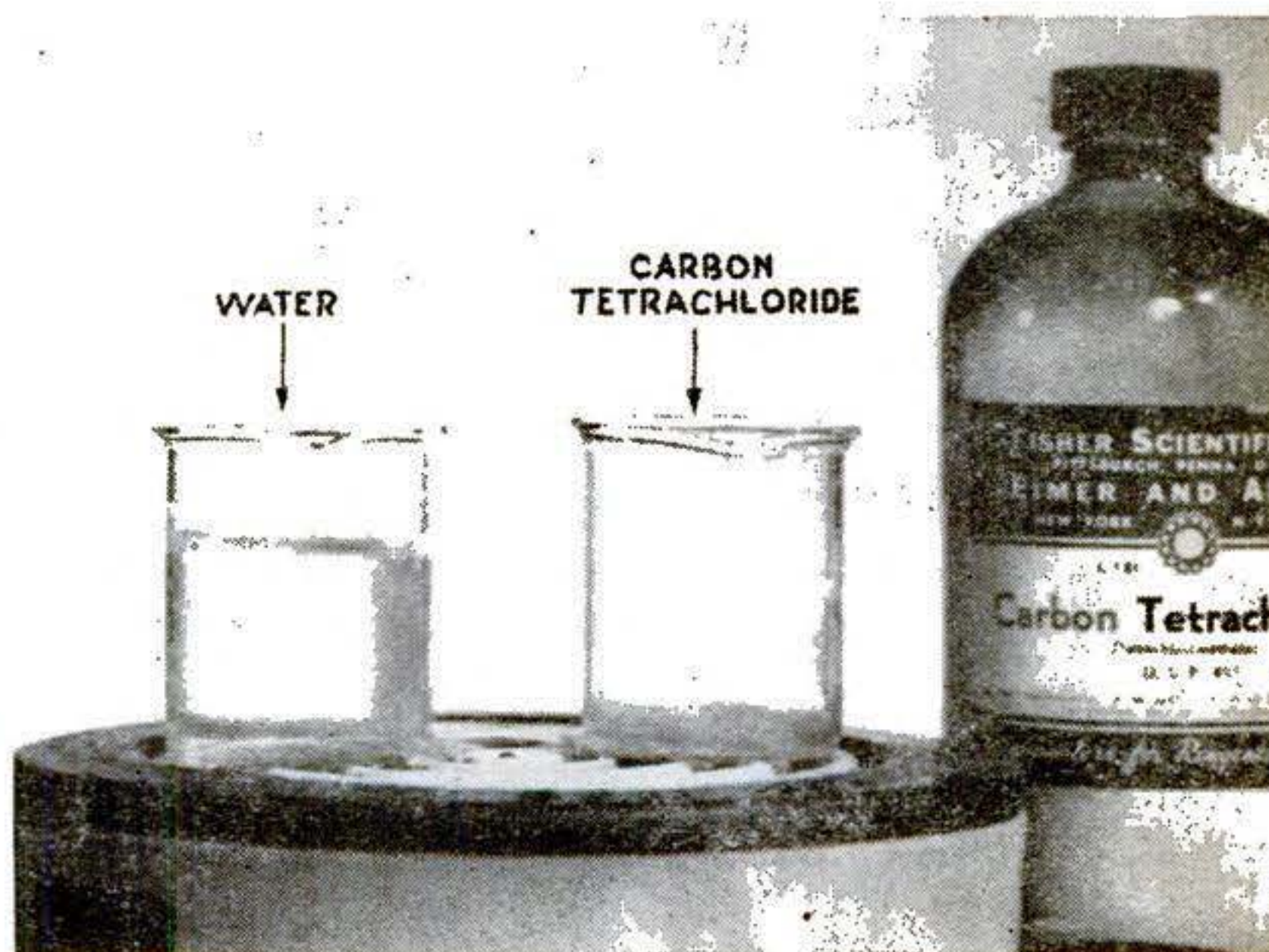



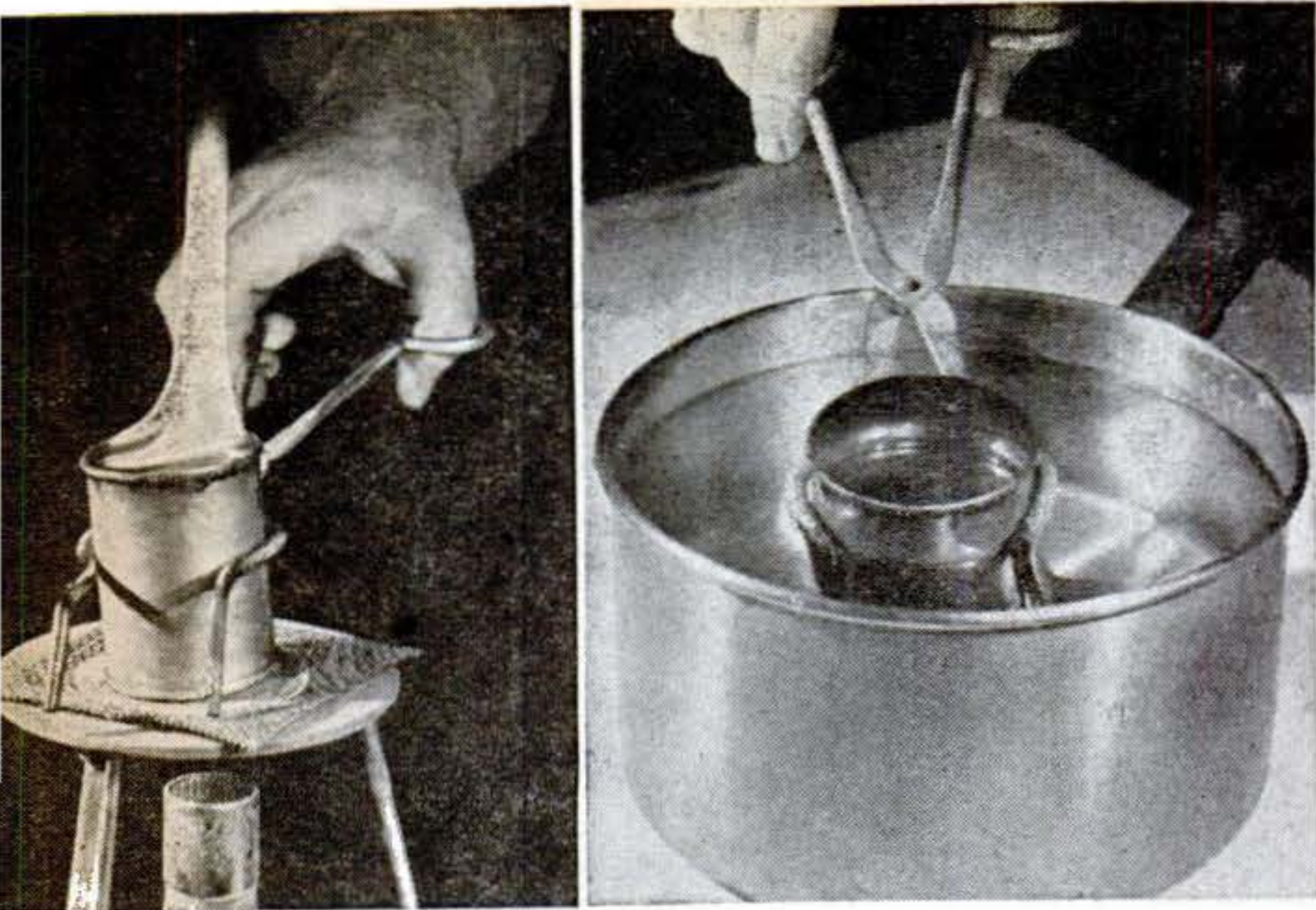

How a fire may be extinguished simply by cooling the burning substance is illustrated above. Heat a can of paraffin wax until a match will ignite the vapor. Then thrust the can in cold water. When the wax has cooled, the flame will go out.

become smaller, then it will flutter, and finally it will go out—the water having lowered the temperature of the wax below its fire point.

Most dry-powder extinguishers depend upon the combined cooling and smothering effect of bicarbonate of soda, sprayed on the flame as a dust. You can show this by placing a little in the end of a paper tube and blowing it suddenly on a small fire similar to the one you made for the first water experiment. If the dust is blown properly, the fire will go out with little or no delay. The explanation of this involves an interesting chemical reaction. Immediately on being heated, bicarbonate of soda decomposes into sodium carbon-



Oil and gasoline fires must be smothered by cutting off the oxygen supply. At the left above is a fire made by lighting a little gasoline floating on water. This fire is easily extinguished by covering the can with cardboard, center. Never use water, for it only spreads the flames, as demonstrated at right.

If allowed to vaporize, carbon tetrachloride will extinguish oil fires. As a demonstration, saturate a bit of cotton with this chemical and hold it over the fire, as at the right. The vapors will smother the flame.

Carbon dioxide also is widely used for oil fires. Prepare a little of this nonburning gas by adding vinegar to ordinary baking soda in a pitcher. Then quickly pour the gas over your fire, as shown at far right, and it will go out.







Foam extinguishers smother a fire because of the presence of carbon dioxide. You can make such a foam by preparing a solution of alum, another of bicarbonate of soda and gelatin, and then mixing the two.

ate and carbon dioxide. The reaction extracts a large amount of heat from the fire and, in addition, the carbon dioxide acts as a smothering agent. Dry extinguishers are especially good for small oil fires.

As we have shown, water is an excellent extinguisher for ordinary combustibles, but it does more harm than good when thrown upon such burning liquids as oil and gasoline. Since water is heavier, it sinks beneath these liquids, often causing them to overflow and spread the flames.

You can prove this fact in a series of simple experiments. For all the tests, stand a small tin can in the center of a cake tin resting on another that has been inverted. Fill the can nearly to the top with water, and then pour a little lighter fluid or gasoline on the water. (Use only very small quantities of inflammable fluids, and perform the experiments in the open if possible.)

When you ignite the fluid or gasoline, the fire will look rather formidable, but it can be extinguished with ease by covering the can with a lid, book, or even a sheet of cardboard. Pour water on the fire and the burning liquid will spill over into the pan. If improperly used, even carbon tetrachloride, the chief chemical used in the small pump-type hand extinguisher, will be ineffective and spread such a fire. Squirted into the flame in a solid stream, the

carbon tetrachloride will go through the layer of burning oil and do no good. But if the stream is directed against the farther inside surface of the can above the burning oil, the carbon tetrachloride will scatter into droplets which the heat will vaporize. The noncombustible vapor will smother the fire.

Carbon dioxide and methyl bromide are our most efficient means of smothering an oil fire. Both are supplied in containers in liquid form. When projected on a fire as a liquid spray, each immediately turns into a heavy nonburning gas. Of the two, methyl

bromide is more expensive, but, weight for weight, it is more effective than carbon dioxide.

Carbon dioxide trapped in foam also is used as an extinguisher. You can make a demonstration foam by dissolving half a teaspoonful of alum in an ounce of water in one tall glass, and a half teaspoonful of bicarbonate of soda plus a little powdered gelatin in

the same amount of water in another glass. When mixed together, the two clear solutions form a thick foam many times the original volume of the liquids. Chemically, the bicarbonate of soda reacts with the alum to release carbon dioxide bubbles. These are stabilized by the gelatin.

Carbon tetrachloride, carbon dioxide, methyl bromide, and dry chemicals are all effective for electrical fires.

### HOW TO FIREPROOF SANTA'S SUIT

IF SANTA is coming to your home this year, it would be well to make his suit and whiskers fire resistant. Prepare a mixture of 2 oz. carbonate of soda, 2 oz. ammonia carbonate, 2 oz. boric acid, and 5 gal. water. Boil, strain, and spray on the material.



# Home Repairs with RUBBER TAPE

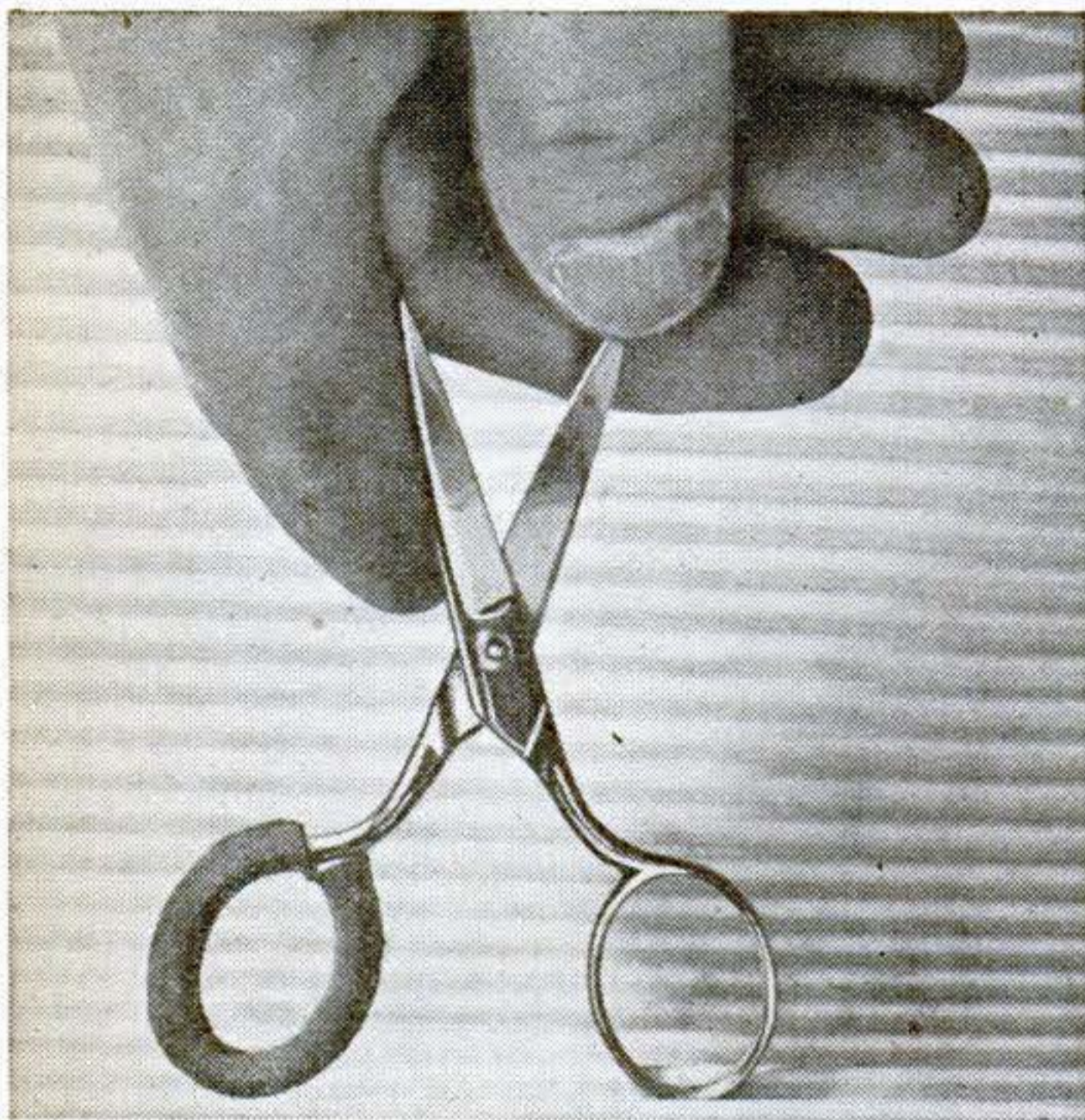

Finger-saving grips for scissors and shears can be made from rubber tape by placing strips around the handles lengthwise and pressing the edges.

**C**OMFORTABLE grips for tools, small protective "bumpers," replacement tires for vacuum cleaners—these and numerous other handy-around-the-house articles can be made from electrician's live-rubber insulating tape (not friction tape), sold in most dime stores.

Since it sticks to almost any dry surface and adheres to itself permanently, smooth and resilient tool grips can be made by closely spiralling tape around the handles and pinching the edges together. Covering furniture legs and backs with inconspicuous bits of rubber tape will prevent scratches on floors and walls. For small no-mar bumpers, simply stretch tape over carpet tacks, gather the excess, and press it on the back of the head, trimming away the remainder.

Worn rubber tires on vacuum cleaners and sweepers can actually be retreaded by covering them with strips of tightly-stretched rubber tape.—KENNETH MURRAY.

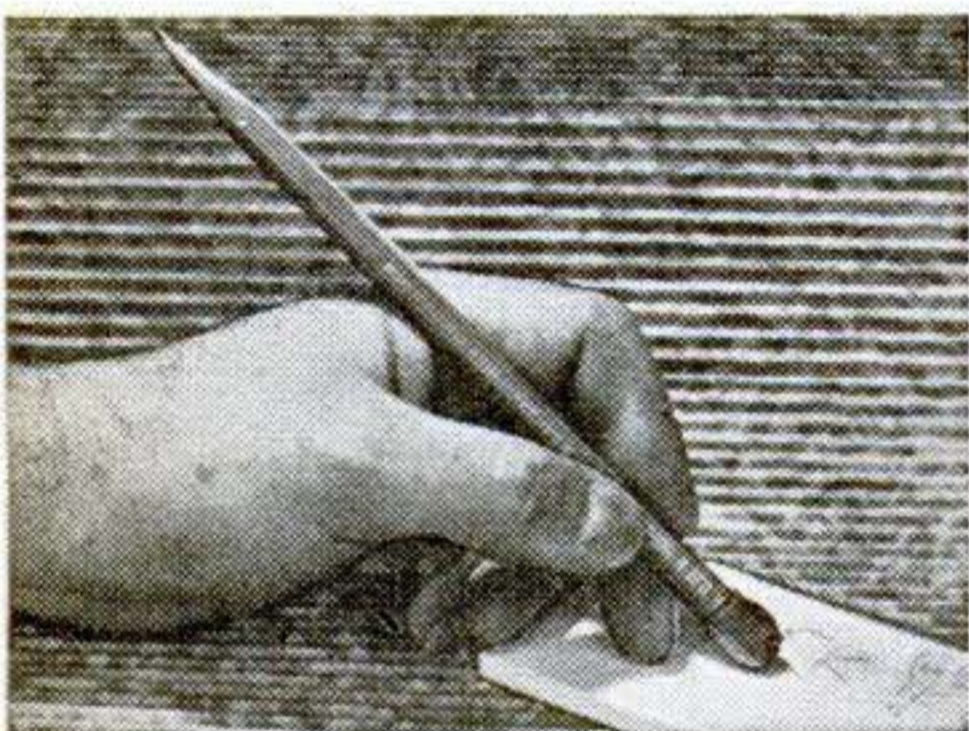

A bit of rubber tape stretched over the end of a drawing pencil provides an efficient eraser.



For one-handed screwdriving, fasten the screw to the screwdriver with a short length of tape.

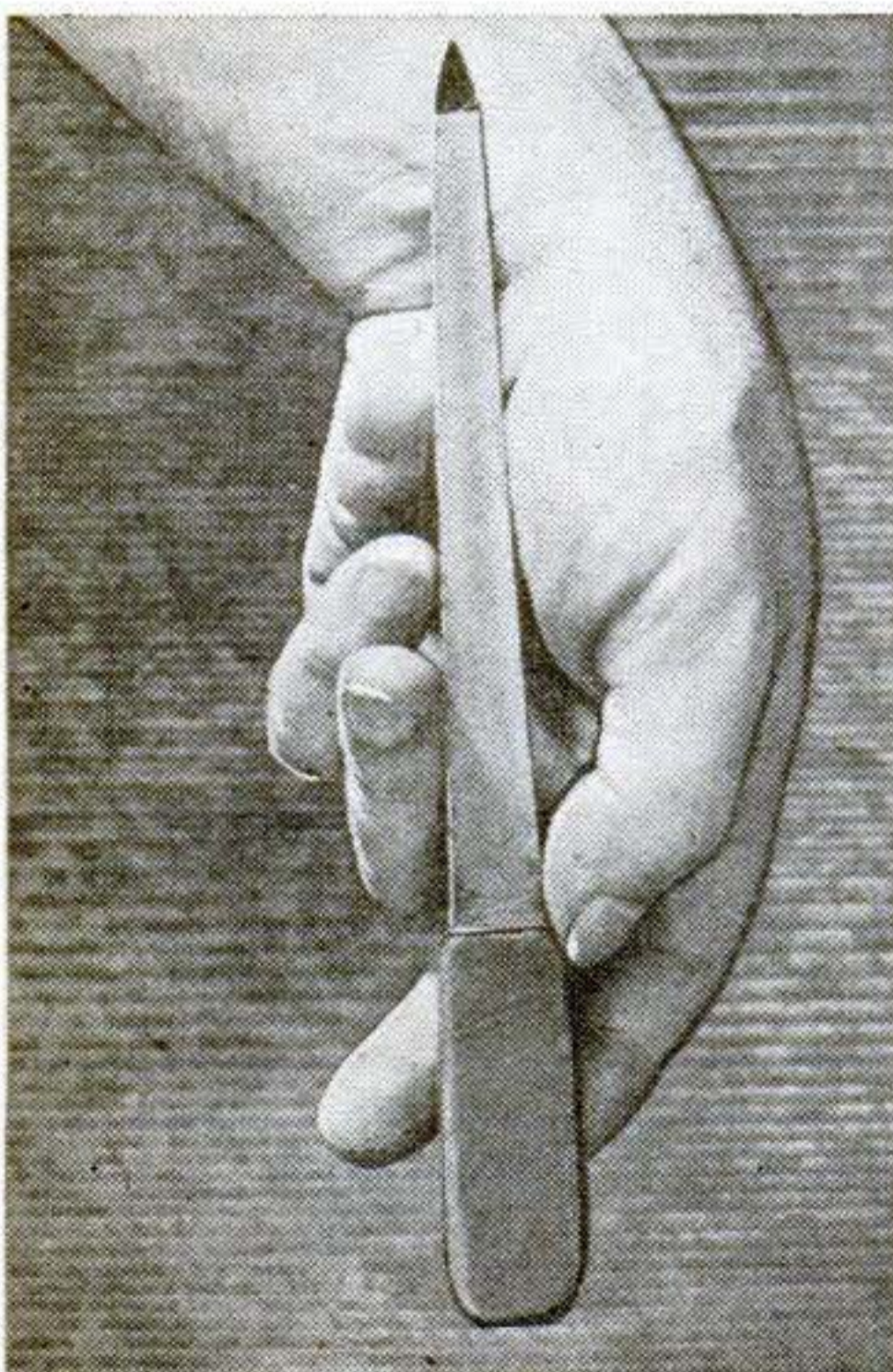
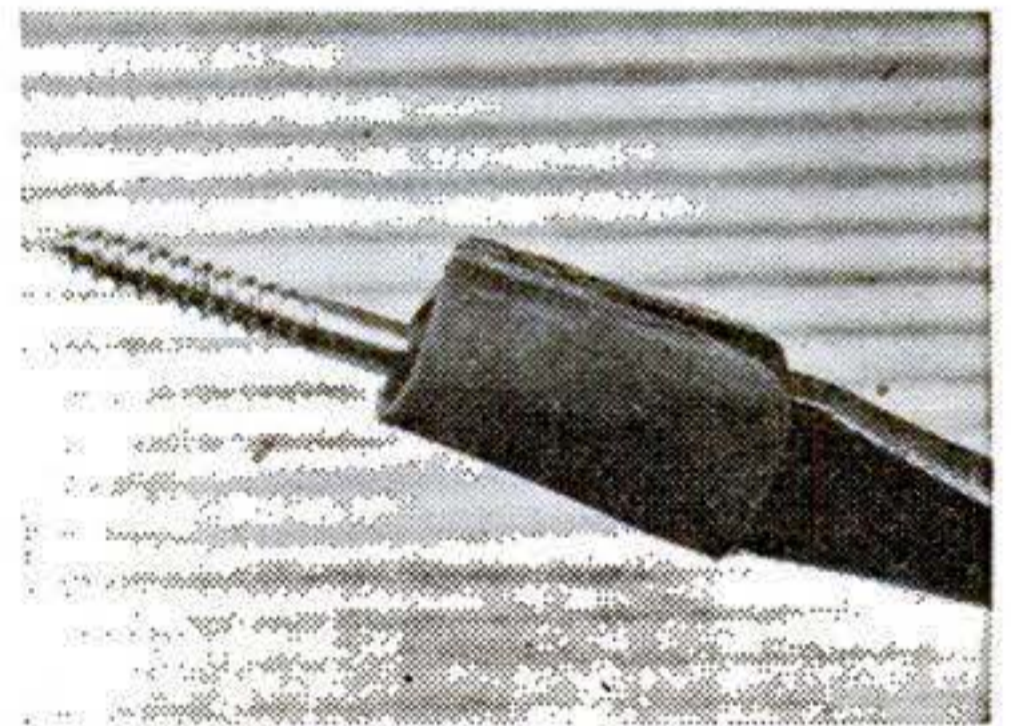

Rubber tape wound in a spiral around a nail file will provide a comfortable handle. Pinch the edges of the tape and trim any overlap to make a neat, permanent job.



To prevent strain on electric cords when they are pulled from sockets, wrap tape around the wire, starting close to the end. Roll over one end to make a protective flange.

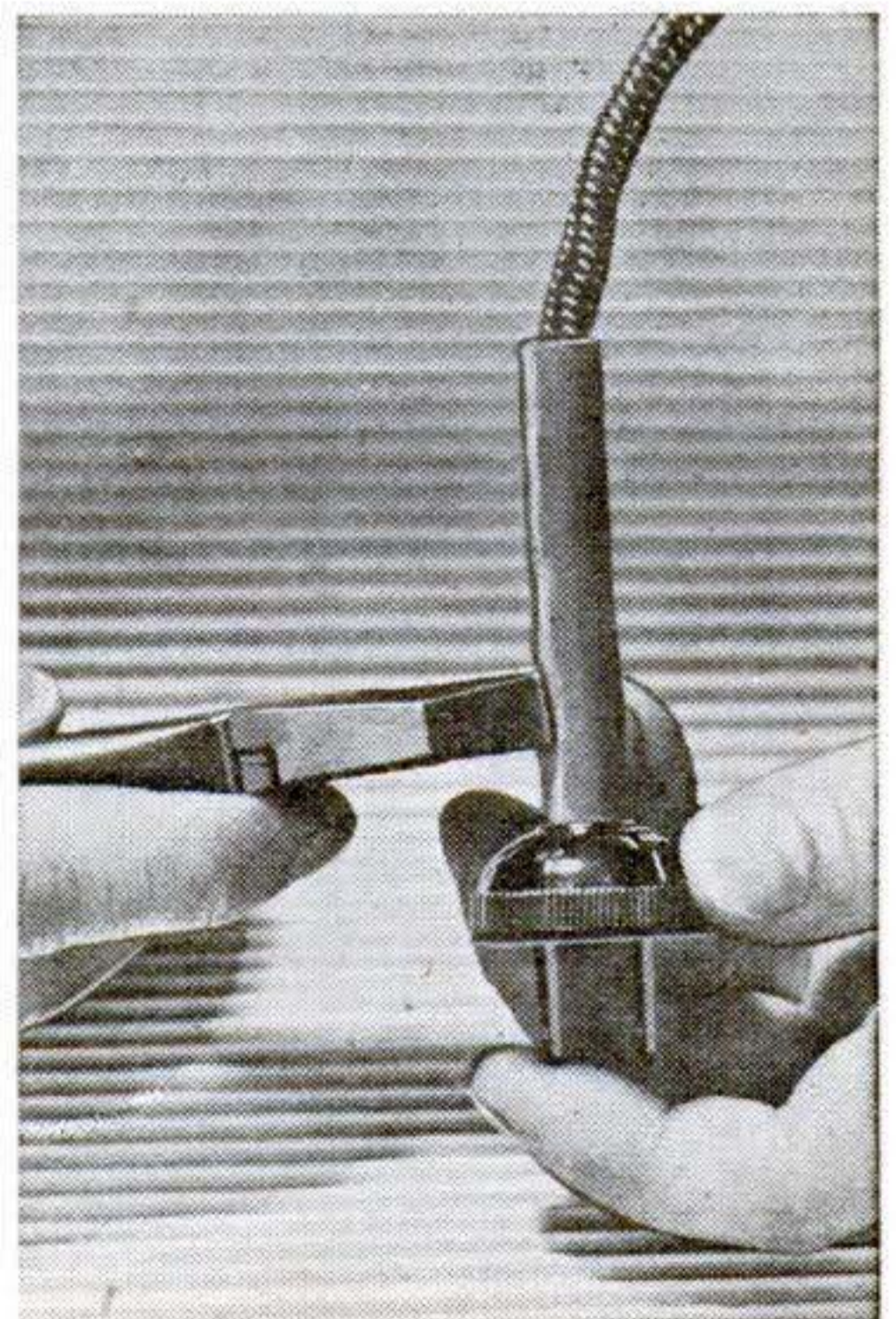



## Grain Scoop from Scrap Pipe

QUICK, accurate distribution of feed is easy with this grain scoop made of junk-pile materials. The scoop section is constructed from a short piece of galvanized stovepipe cut in half and nailed around a semicircular wood back that has been sawed to the same radius as the stove pipe. Taper the front end by cutting off the corners with tin snips.

For the handle, a section of water pipe is used. Slot one end to fit over a brace made of bent strap iron riveted at both ends to the stovepipe. The other end of the pipe handle rests in a snug-fitting hole in the wood back. Finish the grain scoop by smoothing sharp corners on the stovepipe and back.—J. P.

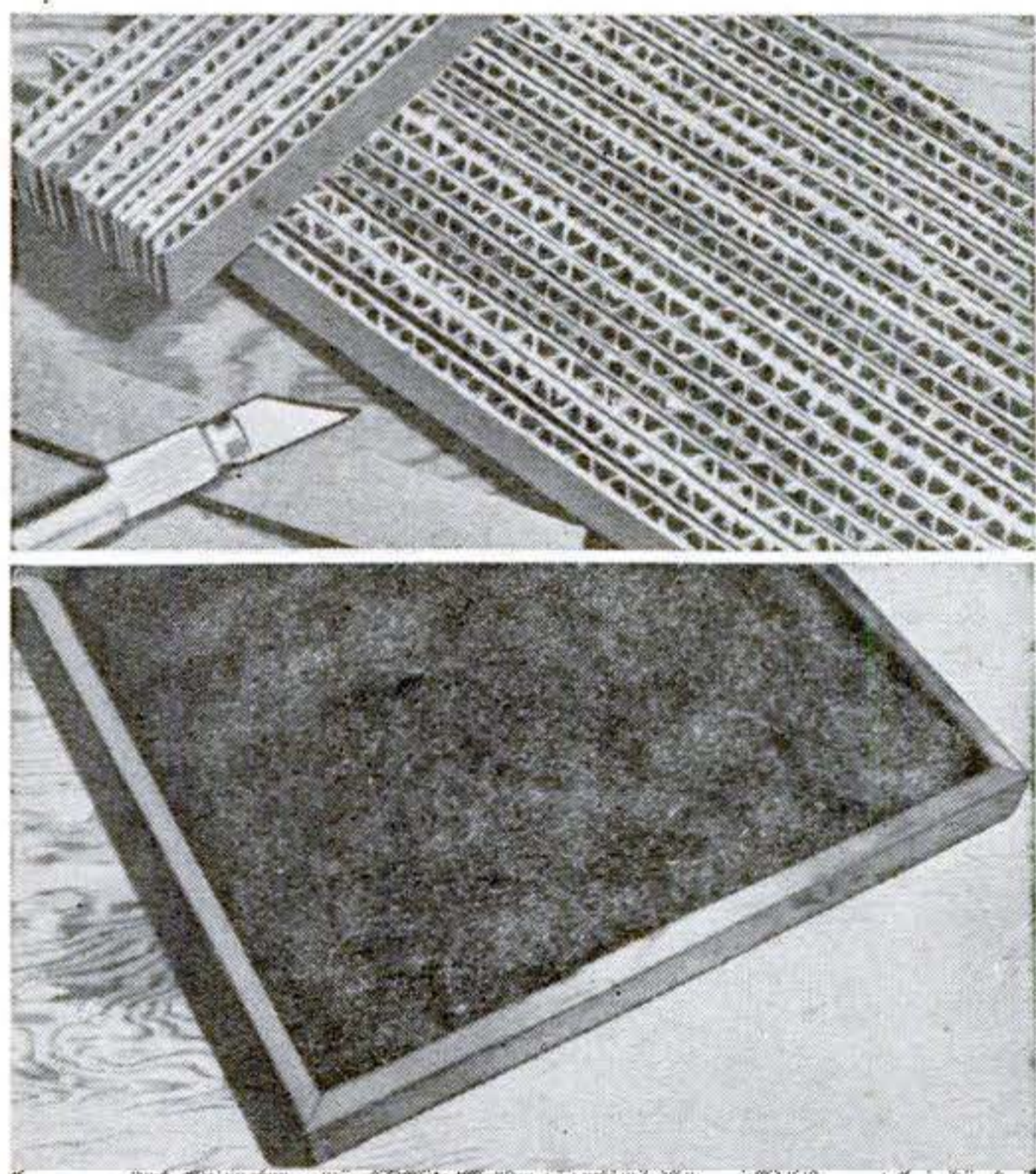

## Make Your Own Furnace Filters

REPLACEABLE filters for the forced-air heating systems installed in many homes can be made easily from inexpensive materials. The frame, dimensioned to fit the particular furnace, consists of four  $\frac{3}{4}$ " strips of scrap wood nailed together with a window-screening bottom.

For filler, either steel wool or corrugated cardboard will serve. Grade 0 or 1 steel wool should be soaked in oil, drained, and packed loosely in the frame. If cardboard is used, cut  $\frac{3}{4}$ " strips with a sharp knife, oil, drain, and stack in the frame in two crisscrossing layers.—WILL THOMAS.

## Blower Stops Smoke Blow-Back

ATMOSPHERIC down drafts will no longer fill rooms with back-firing smoke from the coal range when the stovepipe is equipped with a forced-air blower. The electrically operated blower counters the down drafts common in mountainous regions with a stream of air that keeps the chimney working in the right direction.

For the installation shown in the sketch, an inexpensive blower designed to cool powerful radio tubes was used. Driven by a  $\frac{1}{200}$  hp. motor, its speed can be adjusted to outblow most drafts.—H. T. MILLER.

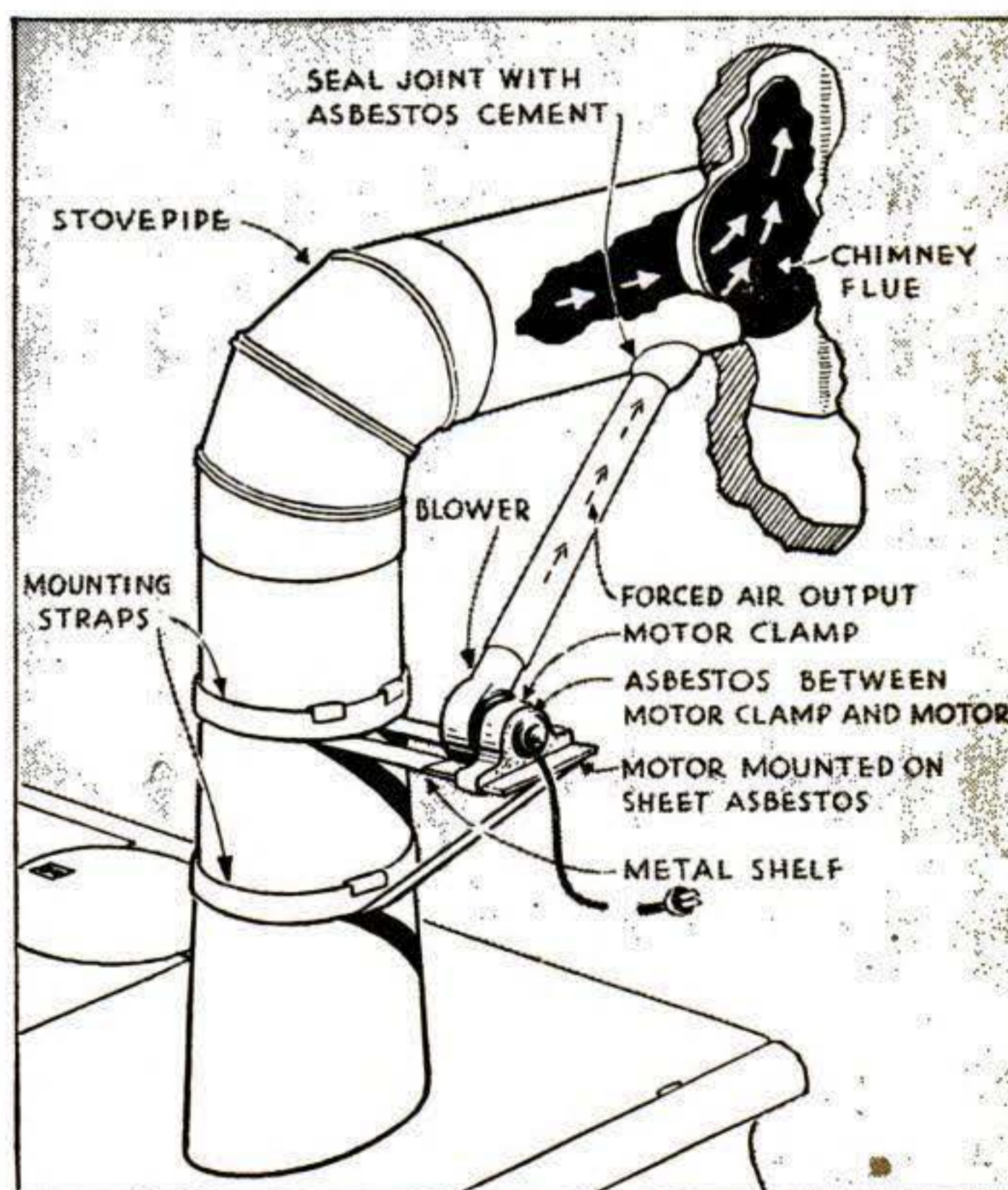



## FOR EASIER FARMING



**EVEN THE SMART RATS** fall for this catcher, a sack tied to a covered runway made by nailing mesh to a board. It's placed in front of the rats' favorite exit from the chicken house. When I go inside with a flashlight, the rodents dive for the exit. I block it with a brick, go outside, and kill them in the sack.—WILLARD D. MORGAN.

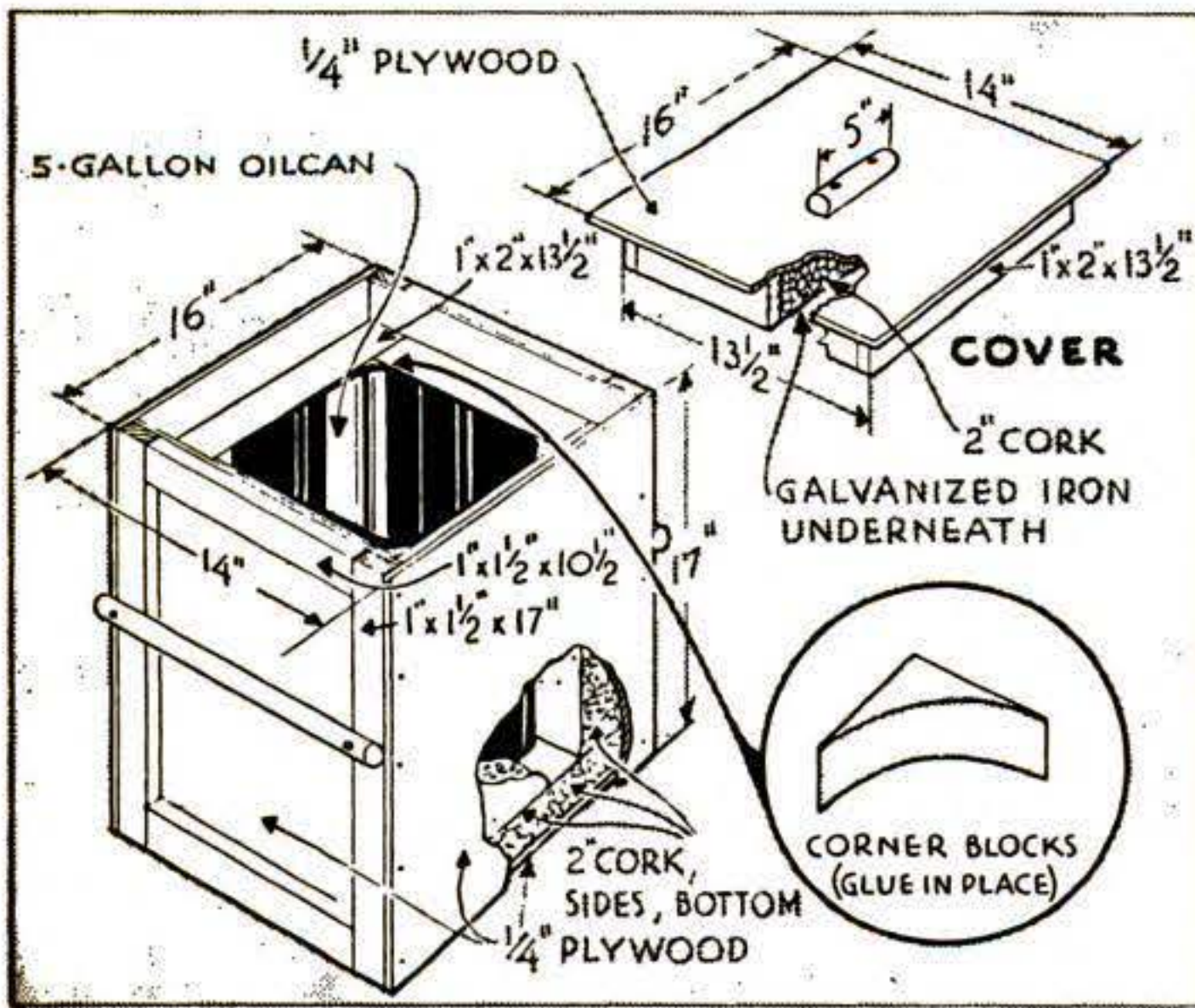

**A FROZEN-FOOD CONTAINER** that prevents thawing when supplies are taken home from the freezer plant costs little to build. A 5-gal. oil can, some 2" cork, and plywood or fiber board are the chief materials needed.

Cut the top off the oil can and enclose the remaining five sides with at least 2" of cork or other good insulation. Build a box of plywood or fiber board around this assembly. The cover, insulated like the can, should be made carefully so that it fits tightly.

With a piece of dry ice inside, the box could also be used to keep ice cream hard or bring freshly caught fish back home from a camping trip.—RALPH S. WILKES.

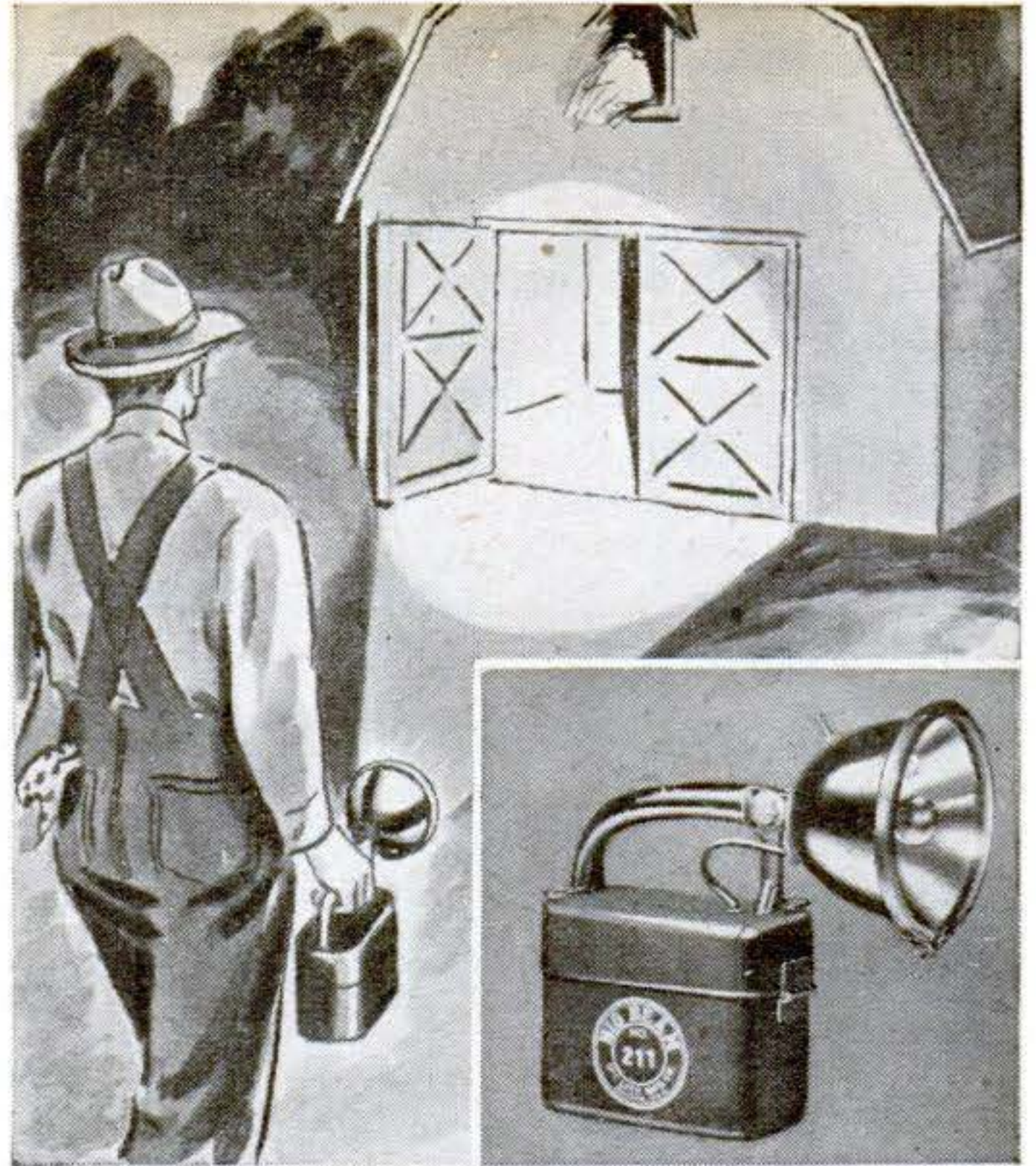

**BRIGHT LIGHT** anytime and anywhere is afforded by an electric hand lantern that focuses a 1,500' beam or a broad spot at the turn of a single adjustment. Weighing only 5 lb., it has an auxiliary bulb for use when less light is needed. Two standard dry cells are connected by pressure contacts that require no wires. U-C Lite Manufacturing Co., Chicago, is the maker.

**PROPERLY SPACED SEEDS** are planted by a new lightweight farm implement made largely of aluminum. The "Equa-Space" seeder, distributed by the Midwest Co., Minneapolis, Minn., can handle a wide variety of seeds from turnips to lima beans. Using a new brush assembly instead of metal parts to control flow, it eliminates waste resulting from broken or crushed seeds. It weighs 28 lb.

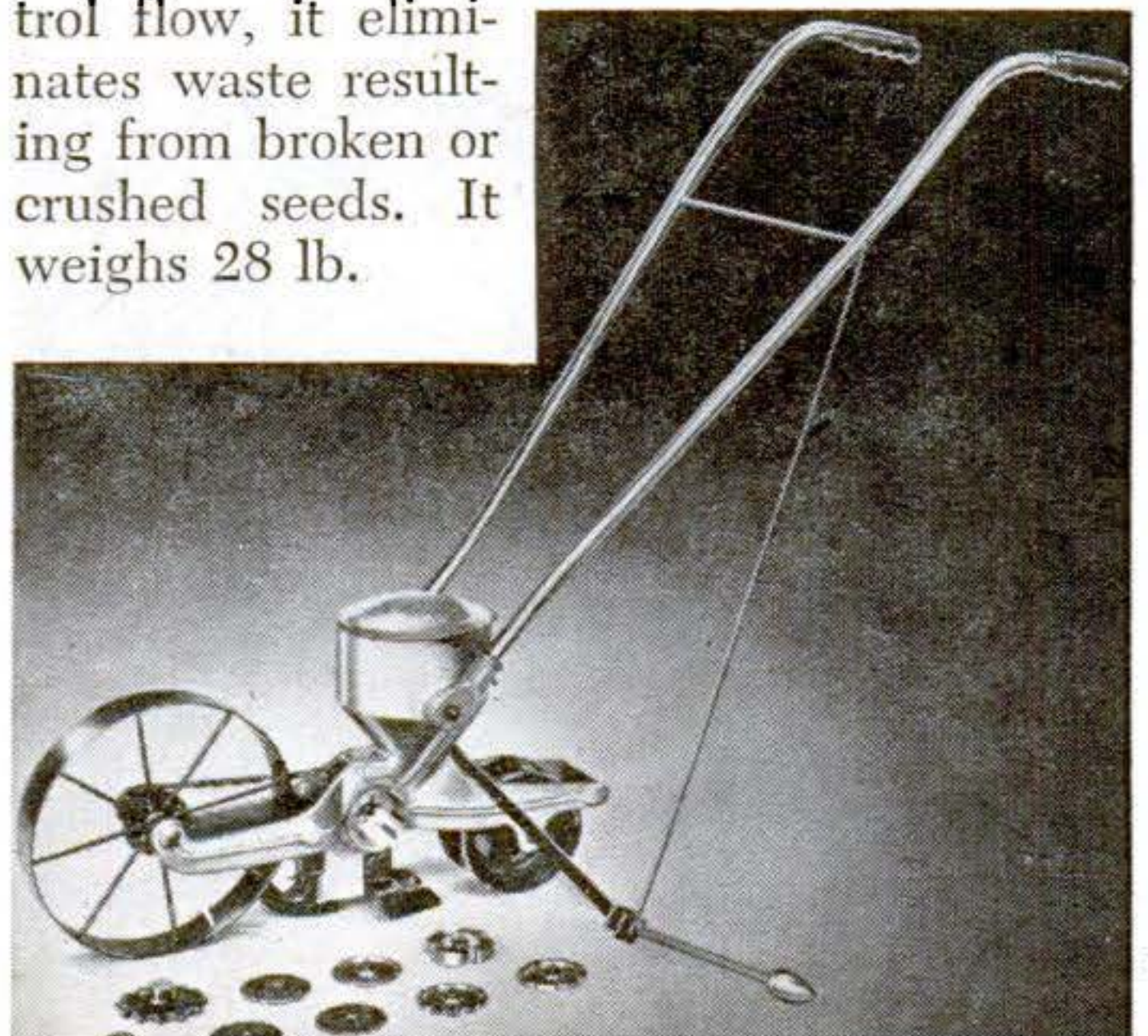



# Kodak

## KODAK MEDALIST II



...now on the way

### A high-precision camera of all-purpose ability

**THE KODAK MEDALIST II** differs from other cameras . . . it is different in appearance, in scope, and in adaptability to an almost endless variety of photographic jobs. For you, this means that it is really several cameras in one—and all of them excellent.

Kodak Medalist II gives you the convenience of 620 ( $2\frac{1}{4} \times 3\frac{1}{4}$ ) roll film—black-and-white or Kodacolor; refinement equal to that of a true precision miniature; and—with various accessories—back extension, ground-glass focusing, and the means for using film in packs or sheets. In sheet film you have a choice of black-and-white, Kodachrome, or Ektachrome Film. And you can readily adapt your Medalist for high-grade enlarging and copying.

**The lens** is the highly corrected Kodak Ektar 100mm.  $f/3.5$ , finest in the  $2\frac{1}{4} \times 3\frac{1}{4}$  field; superbly mounted, and *Lumenized* (hard-coated on all glass-air surfaces) for maximum light transmission and color purity, and minimum loss through reflection.

The shutter is a special model of the Kodak Flash Supermatic, the world's most accurate between-the-lens shutter; nine speeds from 1 to  $1/400$  second; eight apertures from  $f/32$  to  $f/3.5$ ; built-in synchronized-flash contacts with adjustment for Class F (such as SM) or Class M (such as No. 5) Photoflash lamps. The range finder is of the coupled split-field military type.

For further details see your Kodak dealer . . . Eastman Kodak Company, Rochester 4, N. Y.

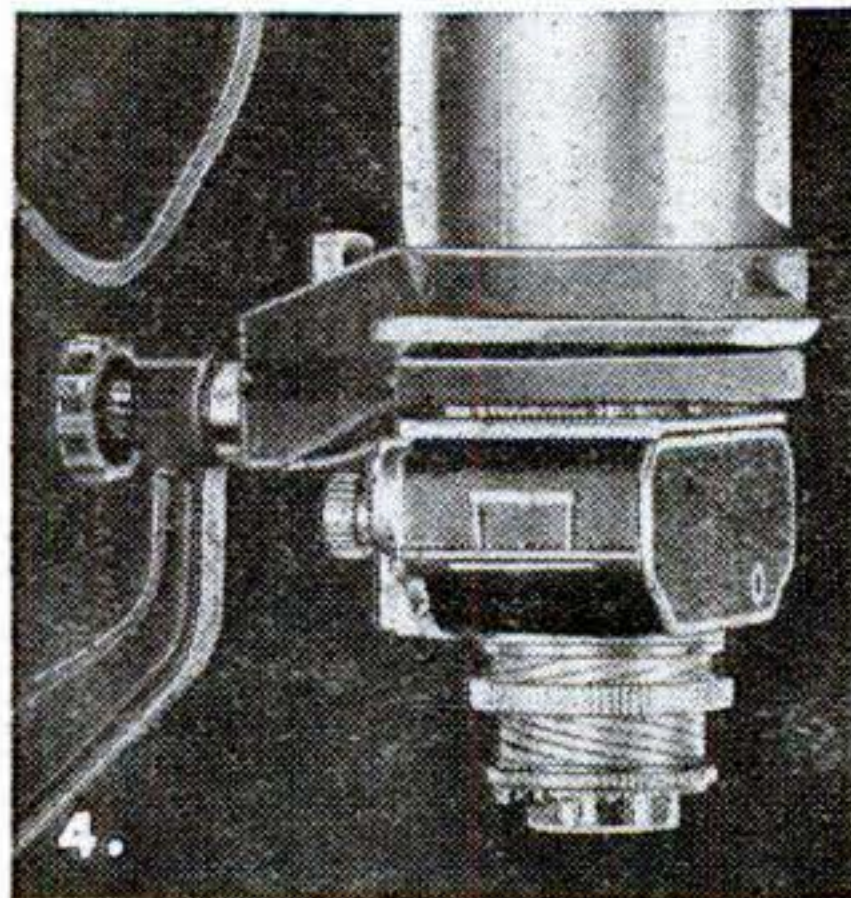
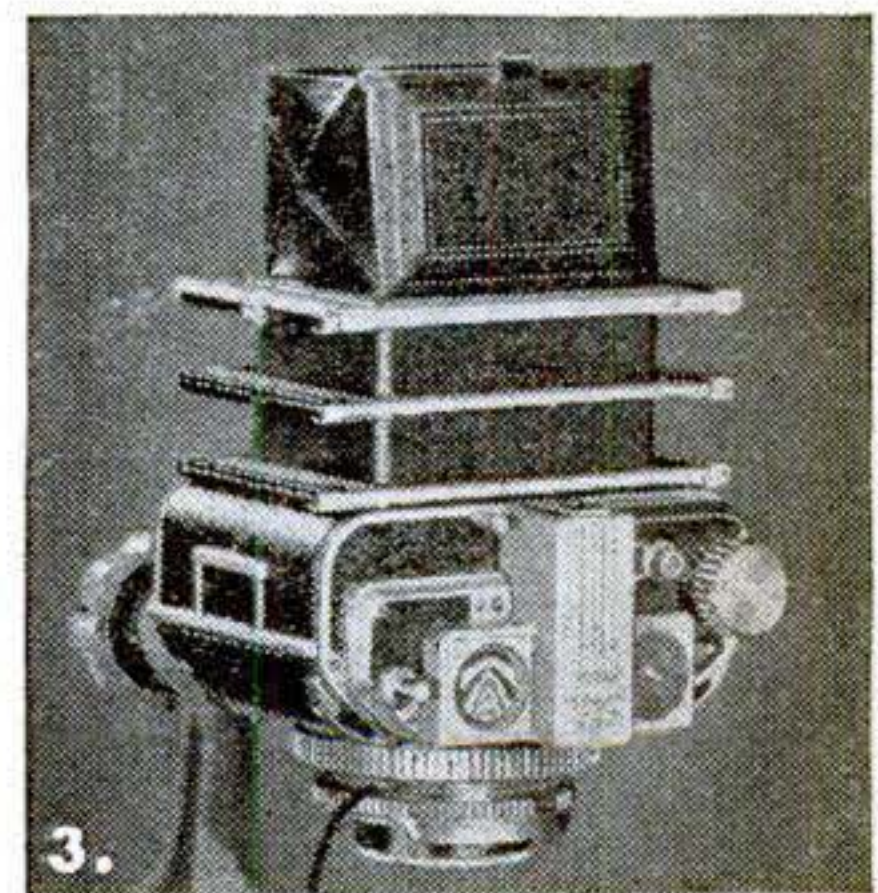
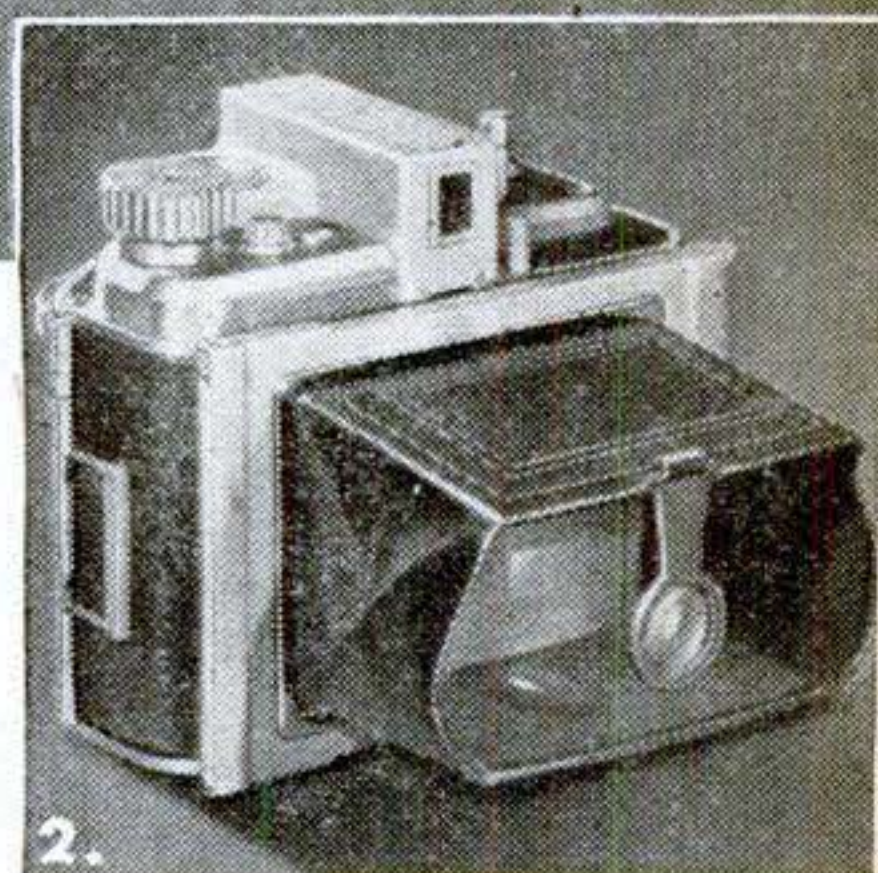

1. A  $2\frac{1}{4} \times 3\frac{1}{4}$  precision-built, roll-film camera for flash, color, and regular black-and-white photography
2. A film-pack, sheet-film camera with both range finder and ground-glass focusing
3. An efficient copying camera
4. An enlarger (with special assembly) for its own negatives

DEC. 1946 209



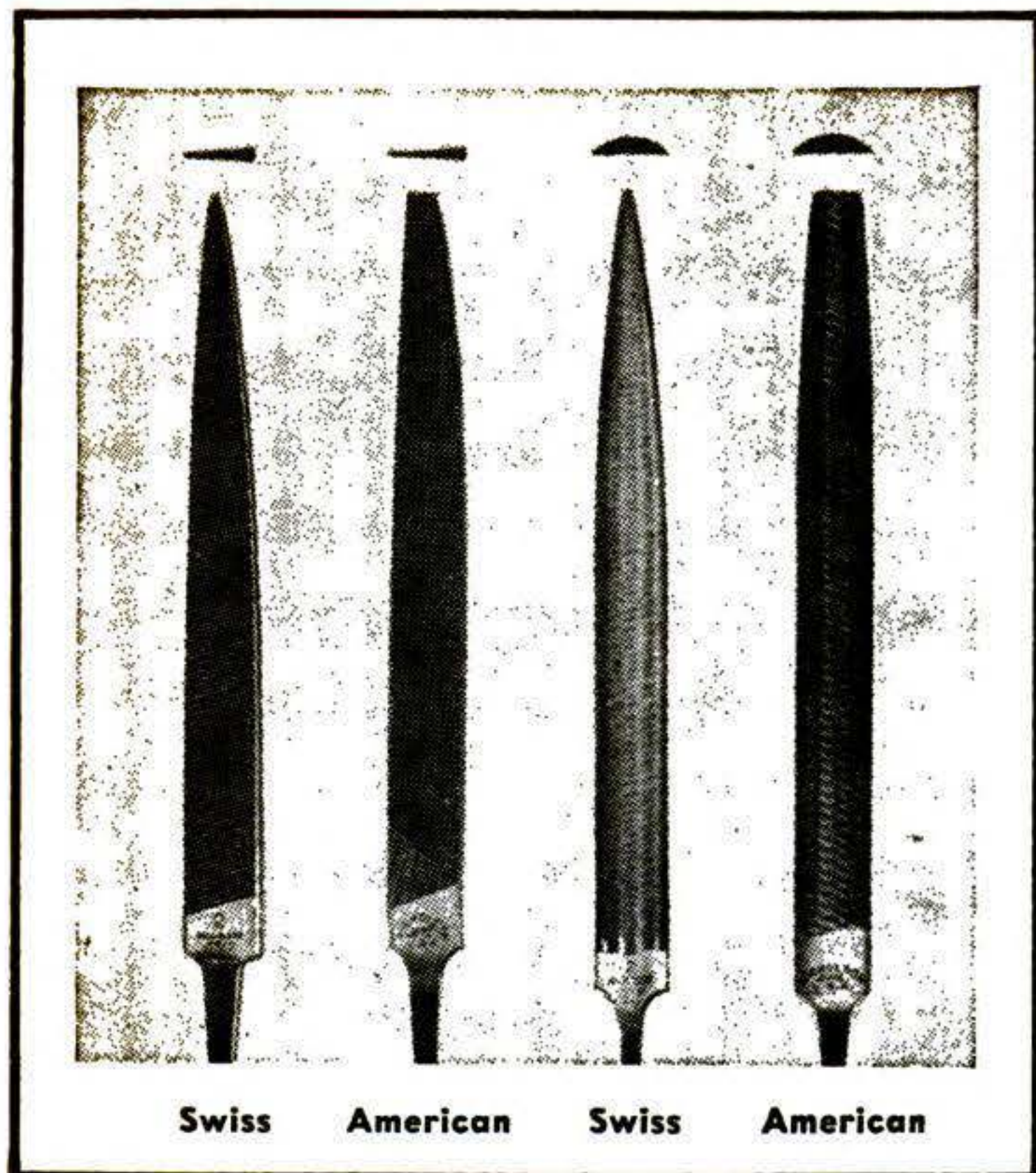

Swiss American Swiss American

HAVE YOU FOUND IT HARD TO OBTAIN SWISS PATTERN FILES?

**JUST SAY "X. F." and get them**



X. F. means *Extra Fine* and is part of the trade-mark which distinguishes the Swiss Pattern Files made by

Nicholson and sold in greater quantities than any other Swiss or Swiss Type brand.

*These widely preferred Swiss Pattern Files are now again available in nearly all kinds, through industrial hardware distributors.*

Nicholson X. F. Swiss Pattern Files are made for every one who does extra-fine filing: for tool and die makers, delicate instrument-parts finishers, model makers, hobbyists—precision craftsmen in general.

More exacting measurements—smaller points and longer tapers . . . these are features that distinguish X F. Swiss Pattern Files from American Pattern (see examples in above illustrations). Highest quality—uniformity in each detail of manufacture—and the sweeping guarantee of *Twelve perfect files in every dozen* . . . these are factors that make them the first choice of most precision-file users.



**NICHOLSON FILE CO.**  
19 Acorn St., Providence 1, R. I.  
(In Canada, Port Hope, Ont.)



**NICHOLSON FILES** FOR EVERY PURPOSE

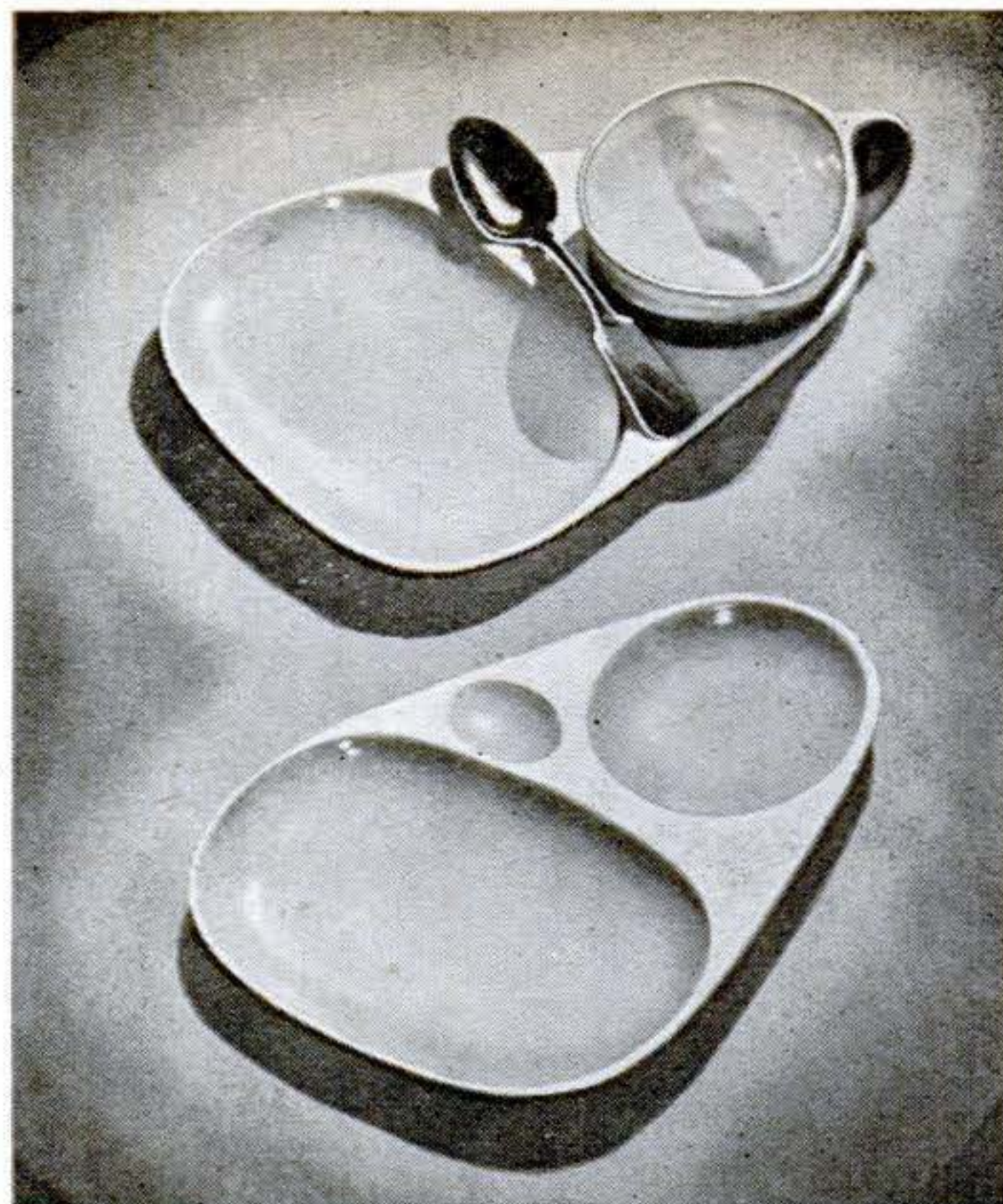

## Experimental Pottery Design

A RECENT exhibition of design trends in home furnishings, held at the Museum of Modern Art, New York City, included these samples of experimental earthen pottery. Developed at the Chicago Institute of Design, pieces of the informal tea service are stamped from sheets of clay.

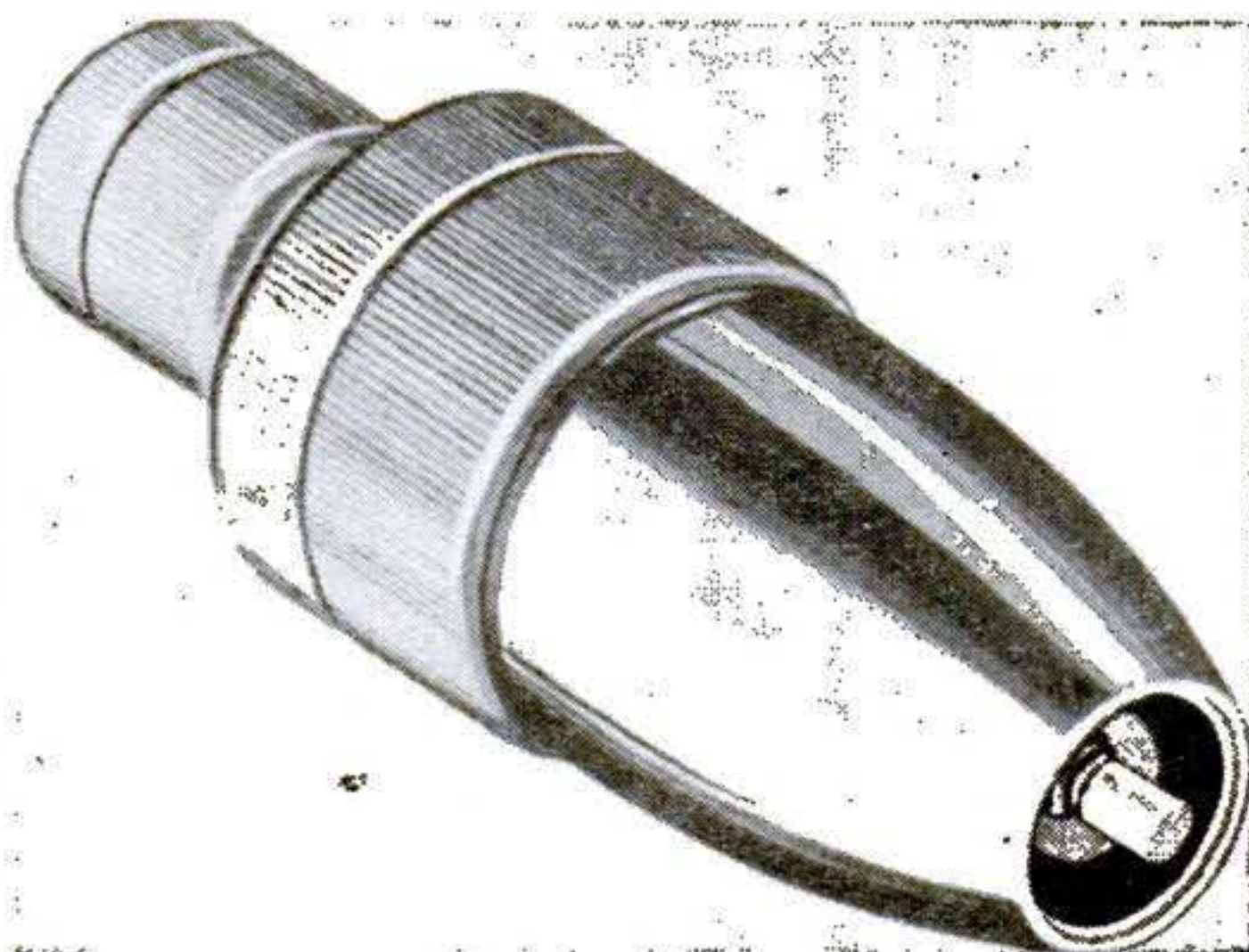

## Cleanable Shower Head

PRESSING a button on the face of the Presto shower head dislodges any accumulation of scale or sediment, insuring a free flow of water. Made by the Reocal Brass Co., of Los Angeles, the bullet-shaped chrome-plated head has no holes or face plates to clog or stick.



# PACKARD *Cable* GRAM

FROM: Your friendly Packard Cable Serviceman TO: Car Owners who like good performance

**YOUR PACKARD CABLE DEALER OPERATES A SERVICE STATION, GARAGE OR CAR DEALERSHIP—KNOWS AUTOMOTIVE WIRING FROM A TO Z.**



**HERE ARE SOME OF THE CAR TROUBLES HE LICKS WITH PACKARD CABLE:**

AND I THOUGHT SEALED BEAM HEADLIGHTS WERE POWERFUL!

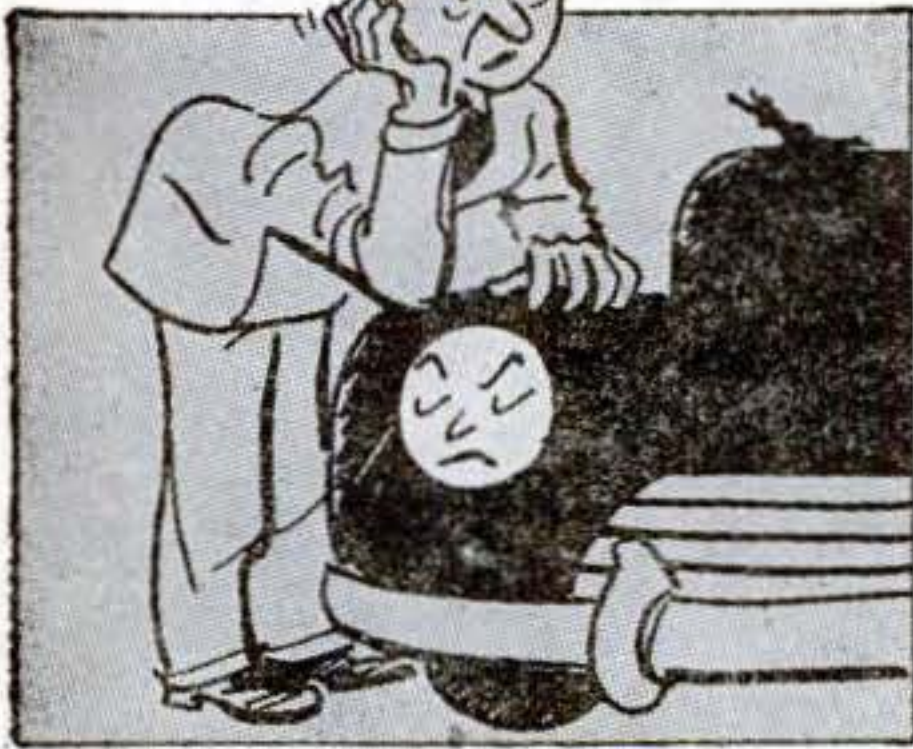

FRAYED OR UNDERSIZED LIGHTING WIRES CAN CUT CANDLEPOWER IN HALF—REPLACE WITH PACKARD CABLE FOR BRIGHTER HEADLIGHTS

WHAZAMATTER WITH THE %\*% BATTERY IN THIS CAR?



DON'T ALWAYS BLAME THE BATTERY—IT MAY BE CORRODED OR UNDERSIZED BATTERY CABLES. FOR SURE STARTING—REPLACE WITH PACKARD BATTERY CABLES.



EVERY WINNER OF THE INDIAN—APOLIS RACE EXCEPT ONE SINCE 1928 HAS USED PACKARD SPARK PLUG WIRES. REPLACE OLD SPARK PLUG WIRES WITH PACKARD FOR PEP, POWER, PERFORMANCE



**PACKARD CERTIFIED RE-WIRING SERVICE**  
This sign means cable service at its best—the right Packard cable and the right methods. Thousands of dealers provide better electrical service as a result of the Packard Certified Re-Wiring Program.



**Packard**  
REG. U.S. PAT. OFF. TRADE MARK

PACKARD ELECTRIC DIVISION  
GENERAL MOTORS CORPORATION  
WARREN, OHIO

FOREMOST BUILDER OF AUTOMOTIVE AND AVIATION WIRING

DEC. 211  
1946



For a Merry Christmas and a

# Hobby New Year

## X-ACTO KNIFE AND TOOL CHESTS

Hobbycrafters' dream gift, for amateurs or experts. Knives are *all-metal*. (No more substitute plastics!) Blades scalpel-sharp, with 13 different shapes. Tools especially designed for those small hobby jobs. Here are three of X-acto's many fine gift chests . . . and there's a barrel o' fun in every one!

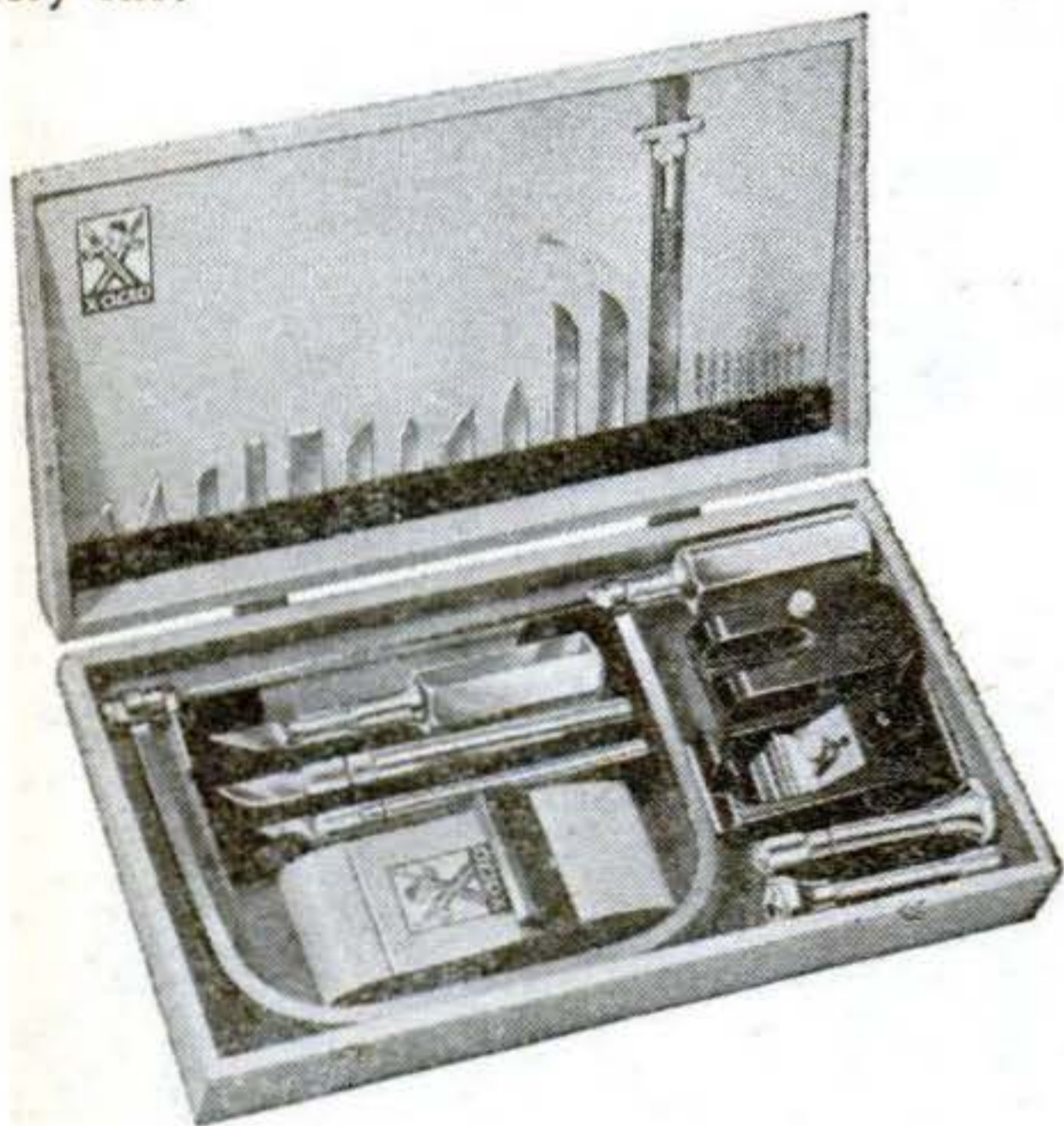

**THE BIG SHOT** — No. 85 X-acto Tool Chest. A Knife, a tool for every job: 3 knives; assorted blades; sander; stripper; saw; drills and holders; ruler. It's got everything! Complete in desk-drawer-size wooden chest, \$12.50.

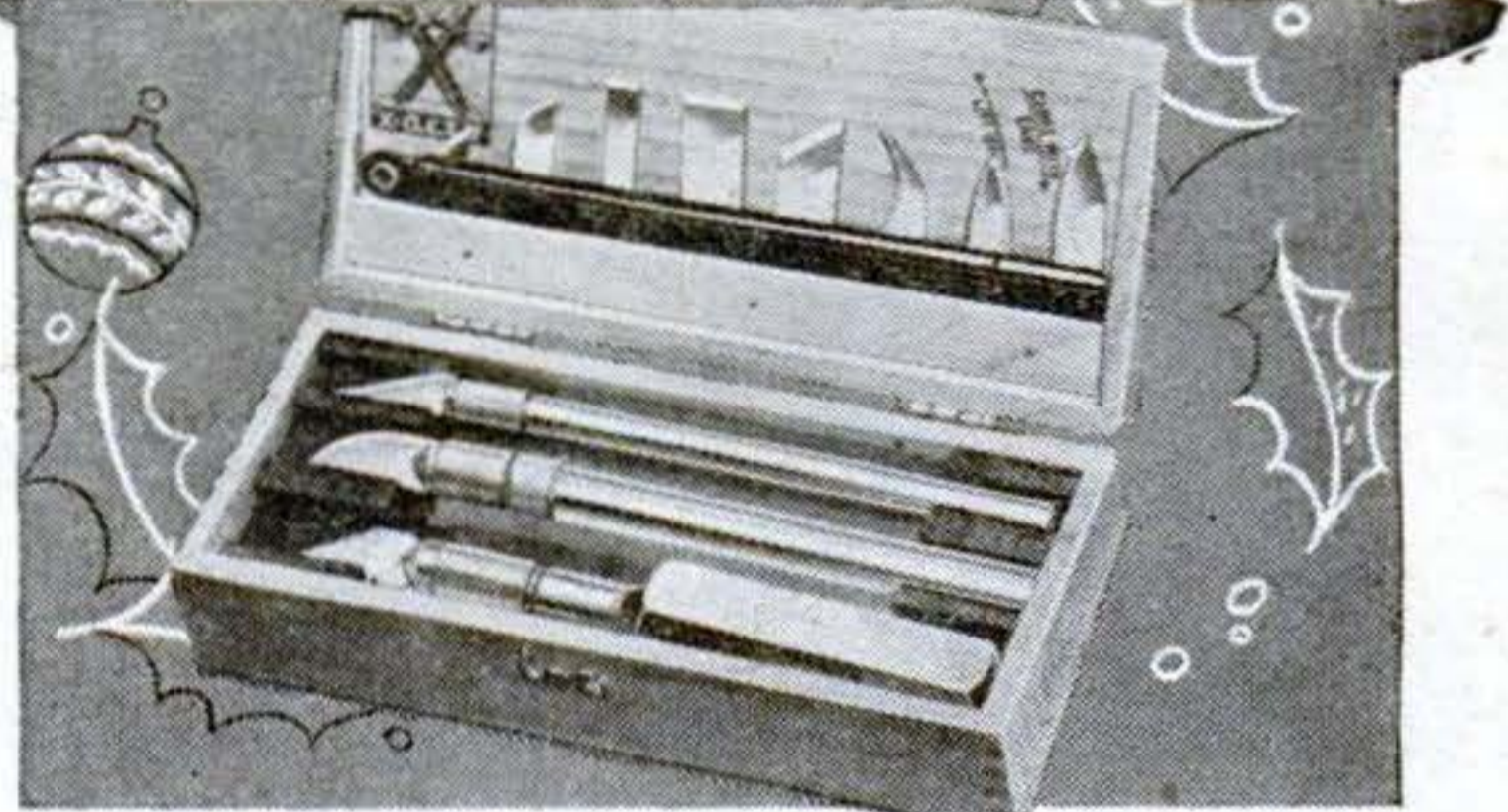

**THE 3 MUSKETEERS** — No. 83 De Luxe X-acto All-Metal Knife Chest: 3 duraluminum X-acto Knives, with 23 assorted blades. Perfect tools for arts, crafts, and model building; for tough or ticklish jobs; for wood, paper, leather, plastics. Chest—complete, \$5.00.

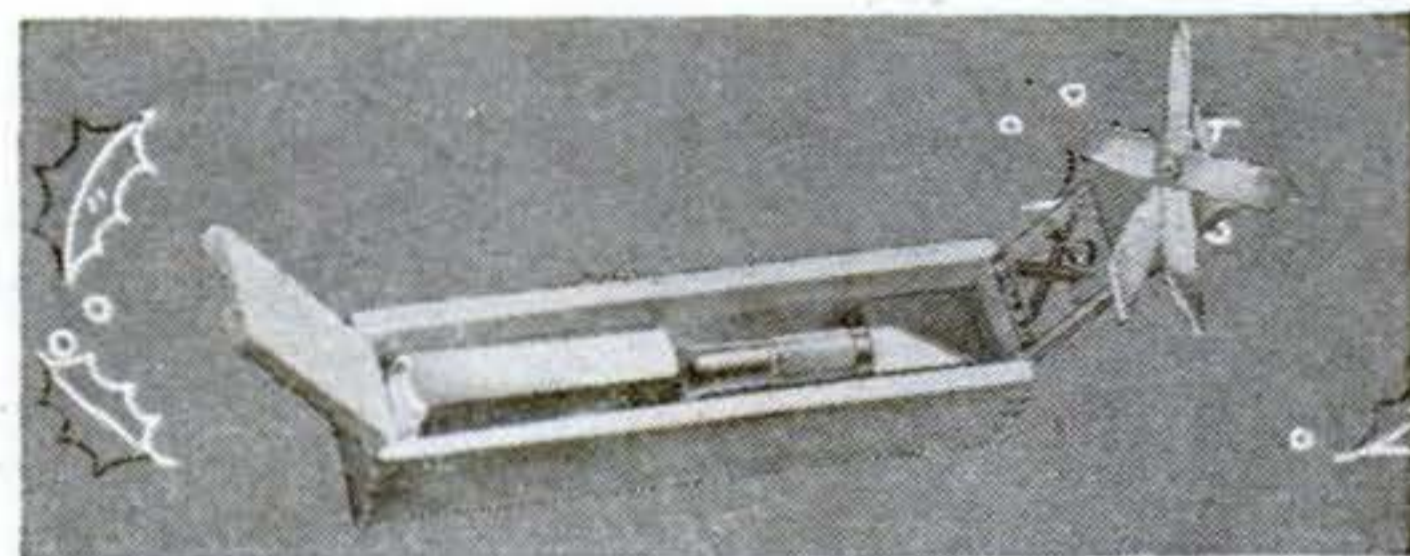

**No. 80 WHITTLER'S SET** — Hefty but easy-to-handle X-acto Knife, with assortment of five extra whittling blades. Vise-like collet locks in blades so they can't fold under. Firm control adds skill to the wrist, makes whittling *easy*! Complete in wooden box, \$2.



**x-acto**  
KNIVES & TOOLS

At hobby, hardware, gift shops



\*REG. U. S. PAT. OFF.

X-acto Hobby Knives and Tools — Singly or in sets —  
50c to \$12.50

X-acto Crescent Products Co., Inc., 440 Fourth Avenue,  
New York 16, N. Y. In Canada: Handicraft Tools,  
Ltd., Hermant Bldg., Toronto.



# Ingenious New Technical Methods

To Help You with Your  
Reconversion Problems

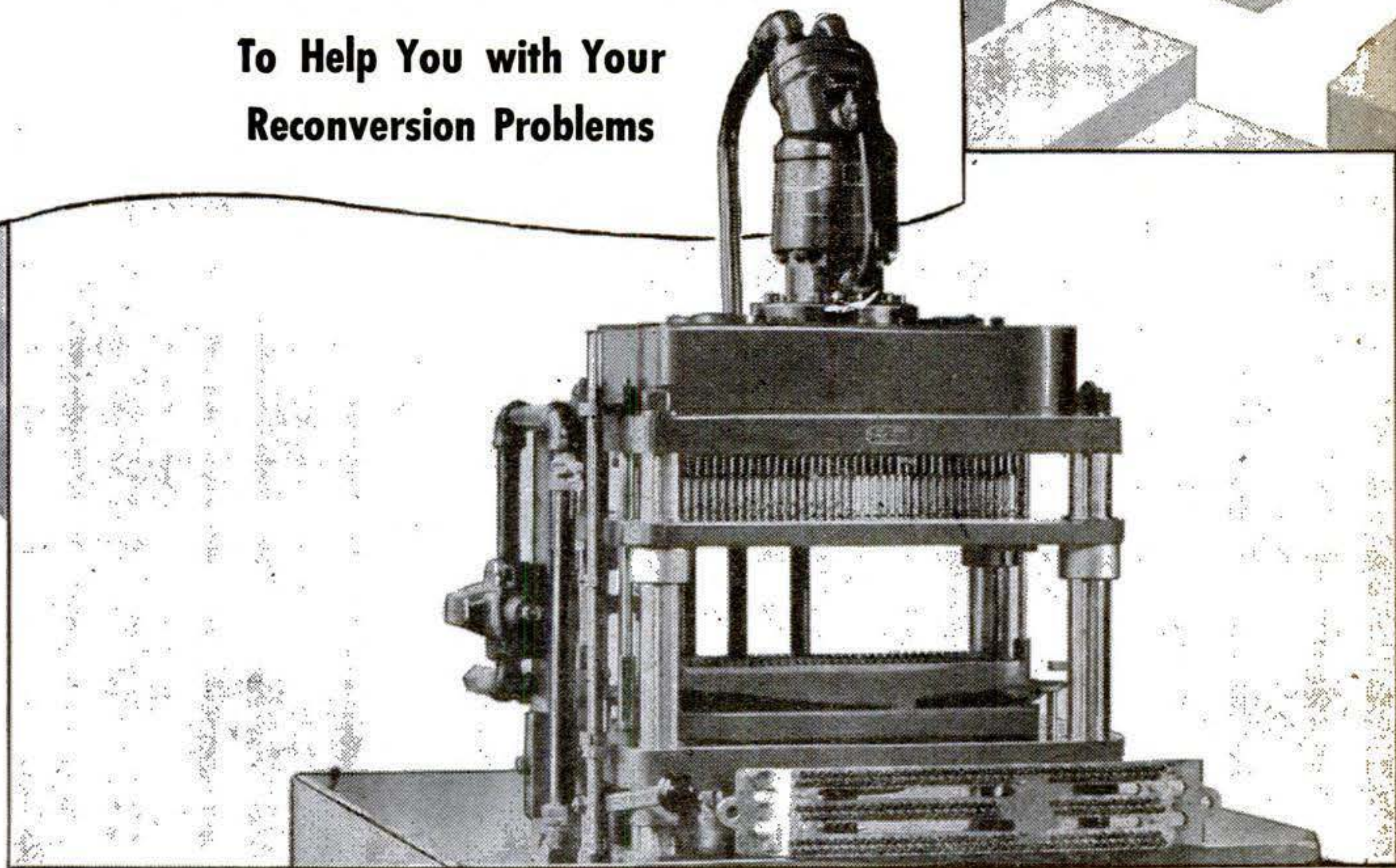

## 12,000 Holes per Hour! With New Gearless Multiple Spindle Drillhead!

The **Zagar Gearless Drillhead** can accommodate up to 400 drills in one head—drill up to 400 holes at one time! This revolutionary unit runs noiselessly and vibration-free on needle, tapered roller and precision ball bearings, and is lubricated by a patented automatic oiling system to insure trouble-free operation.

With this unit all holes are drilled at one pass, and valuable time is saved by the elimination of indexing and extra handling. It may be used on standard drill presses, or furnished as a complete hydraulic machine by the factory.

Another time saver, as well as a help on a tedious job, is chewing gum. The simple act of chewing seems to make the work go faster, easier—helping to relieve worker's fatigue—so that a better piece of work can be turned out with greater safety. Wrigley's Spearmint Gum may be used even when both hands are busy—right where the work is being produced.

*You can get complete information from Zagar Tool, Inc.  
23881 Lakeland Blvd., Cleveland 17, Ohio*

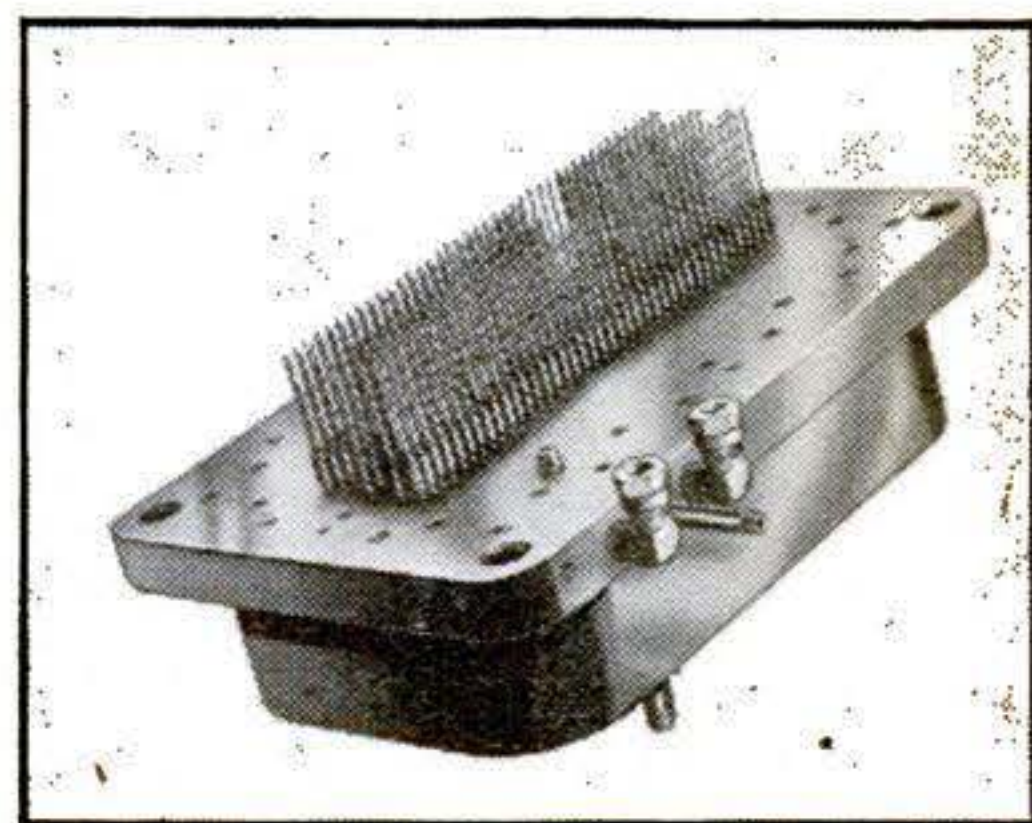

**Zagar 220 Spindle Gearless Drillhead**



AA-202

DEC.  
1946 213



For jobs like this...



**CASCO**

— But for gluing **UNLIKE** surfaces,

# CASCO FLEXIBLE CEMENT

Wood to metal . . .



Leather to fabric . . .



Plastic to felt . . .

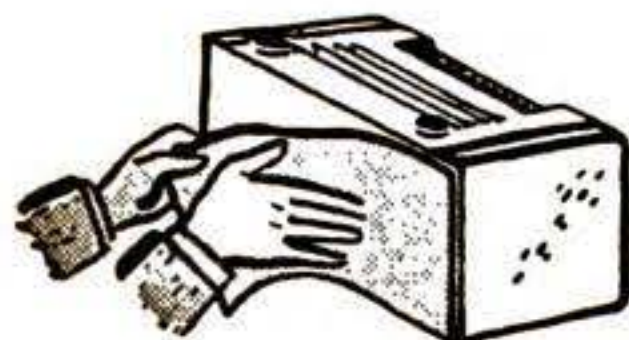

Withstands shocks . . .

resists moisture . . .

clean and easy to use!

25¢ AT YOUR HARDWARE STORE

CASEIN COMPANY OF AMERICA • NEW YORK 17, N. Y.



## Leash Has Automatic Reel

To SIMPLIFY control of a dog, the Promenader leash has a thumb-operated brake that checks it at any length and a reel that automatically rewinds the 10-foot plastic cord when the pull is removed. The Inventors Products Corp., of Chicago, makes it.

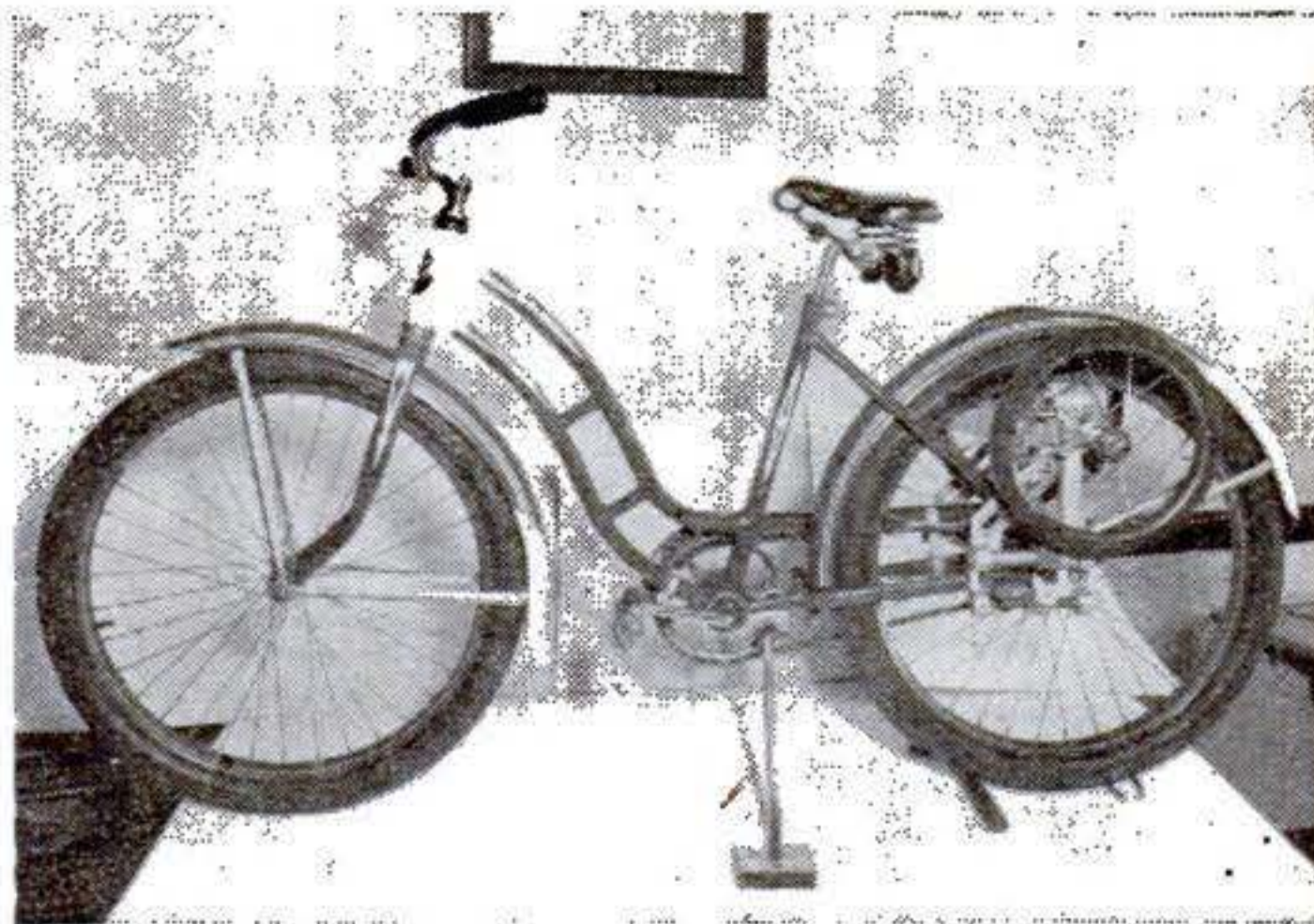

## Bicycle Gets Extra Wheels

THE convertible bicycle devised by Clyde Kutil, of Sioux City, Iowa, can be changed to a "quadricycle" by merely pulling a lever. The two extra wheels at the rear drop to the ground, giving greater stability for beginners or handicapped persons. The same lever raises the wheels when they are no longer wanted.



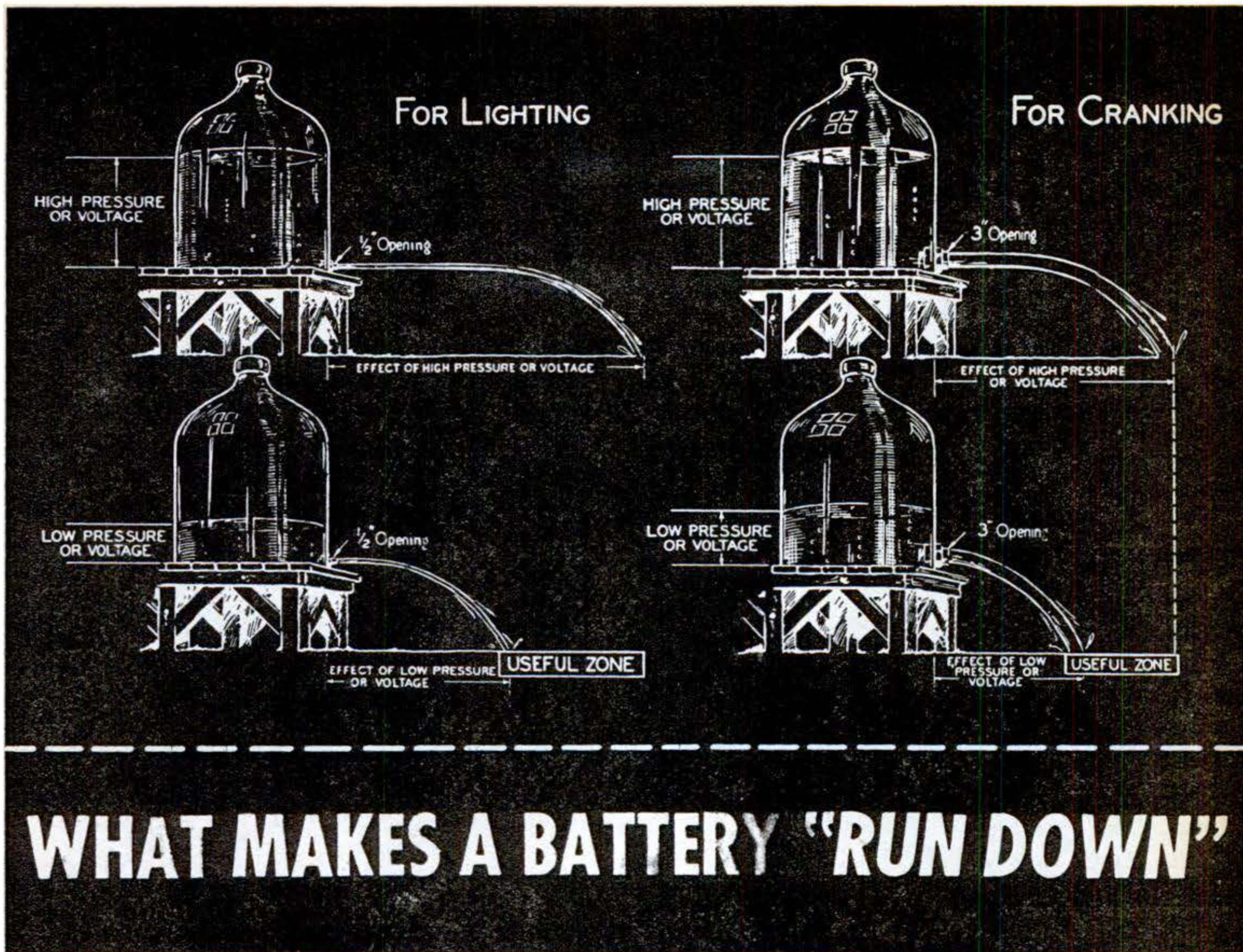

## WHAT MAKES A BATTERY "RUN DOWN"

**A** storage battery, like a water tank, can deliver only what it contains. The quantity of current it can supply is gauged by its capacity—voltage multiplied by amperage.

**VOLTAGE** means pressure of electric current, just as "pounds per square inch" indicate water pressure. **AMPERAGE** measures the flow of electric current per hour, just as "gallons per minute" measures water flow. **CAPACITY** means the quantity of electricity delivered in a definite time.

The faster a battery is discharged, the quicker the pressure drops. More current is consumed in cranking (starting) than in lighting, and power

is more quickly exhausted. This is clearly shown in the illustrations above.

Thus capacity is an important factor in determining the power and quality of a storage battery . . . and the kind of service it gives you.

Exide Batteries are noted for their high capacity, long-life, low cost per mile of operation and strong starting power.

### "WHEN IT'S AN EXIDE YOU START"

Would you like to know more about batteries? The complete story is told in a booklet, "THE STORAGE BATTERY, Its Fundamentals, Use and Maintenance." Mail a postal card today for a FREE copy.

# Exide

## BATTERIES

THE ELECTRIC STORAGE BATTERY COMPANY, Philadelphia 32

Exide Batteries of Canada, Limited, Toronto



Of course it caught your eye . . .

Every man who knows pipes likes the looks of a Sportsman. That unique natural-burl finish is partly the reason. But mostly, it's the way a Sportsman is fashioned. That's fine imported bruyere you see—and there's plenty of it in bowl and shank, to absorb the heat and cool your smoke. If you want a *long* smoke—and a cool, sweet one—put your tobacco in a Sportsman.

**SPORTSMAN**  
*Champion of Pipes*

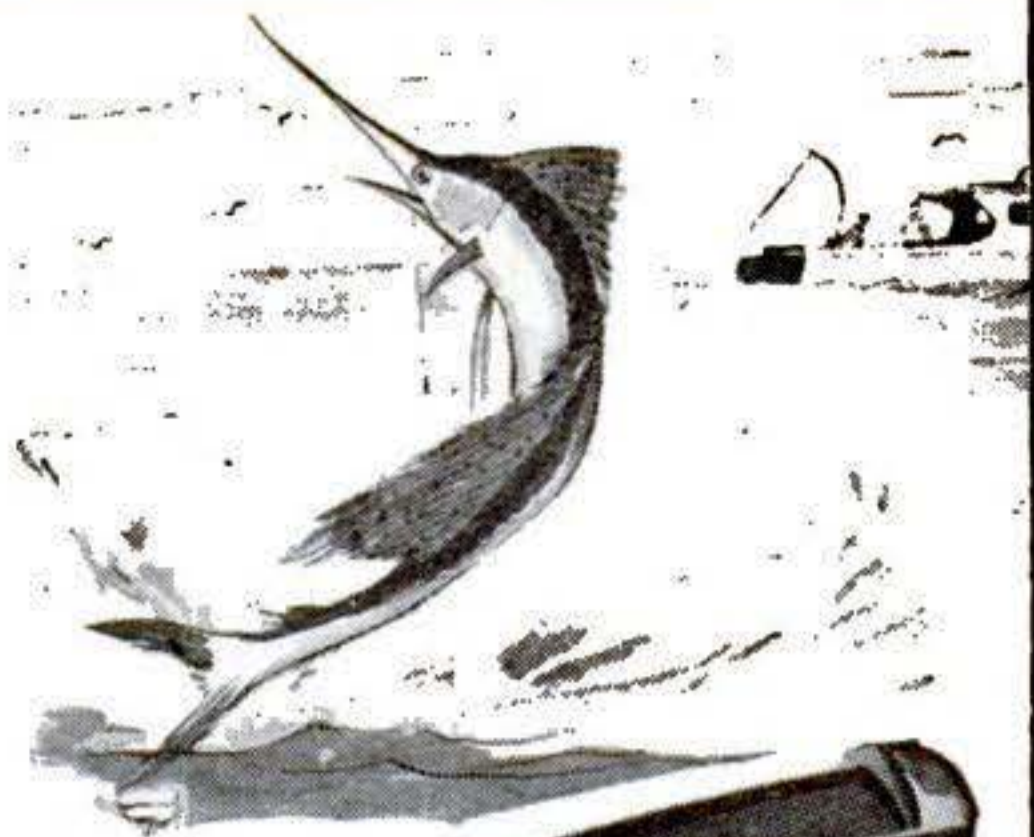

*From \$5 to \$15 in a wide range of shapes and styles, at better stores.*

JOHN HUDSON MOORE, INC., 663 FIFTH AVE., NEW YORK 22

GET THE "BIG 3" OF

**OUTBOARD MOTORING**



It is Johnson that gives you the big three of outboard motoring: 1—Reverse, with 360° Steering. 2—Dual Carburetion, which makes low trolling speed possible in a powerful motor. 3—Perfected Alternate Firing, for silken smoothness. You get them *ALL* in a Sea-Horse! Plus 24 other quality features. Plus the advantage of our famous dealer-service organization trained and equipped to keep your Sea-Horse in tip-top condition.

Write for a copy of the new Sea-Horse Handy Chart, describing all Johnson motors. And see your Johnson dealer. Look for his name under "Outboard Motors" in your classified phone book.

JOHNSON MOTORS, 500 Pershing Rd., Waukegan, Ill.

**JOHNSON SEA-HORSES for DEPENDability**



'ROUND THE TOWN...

Switch to -  
**AUTO-LITE**

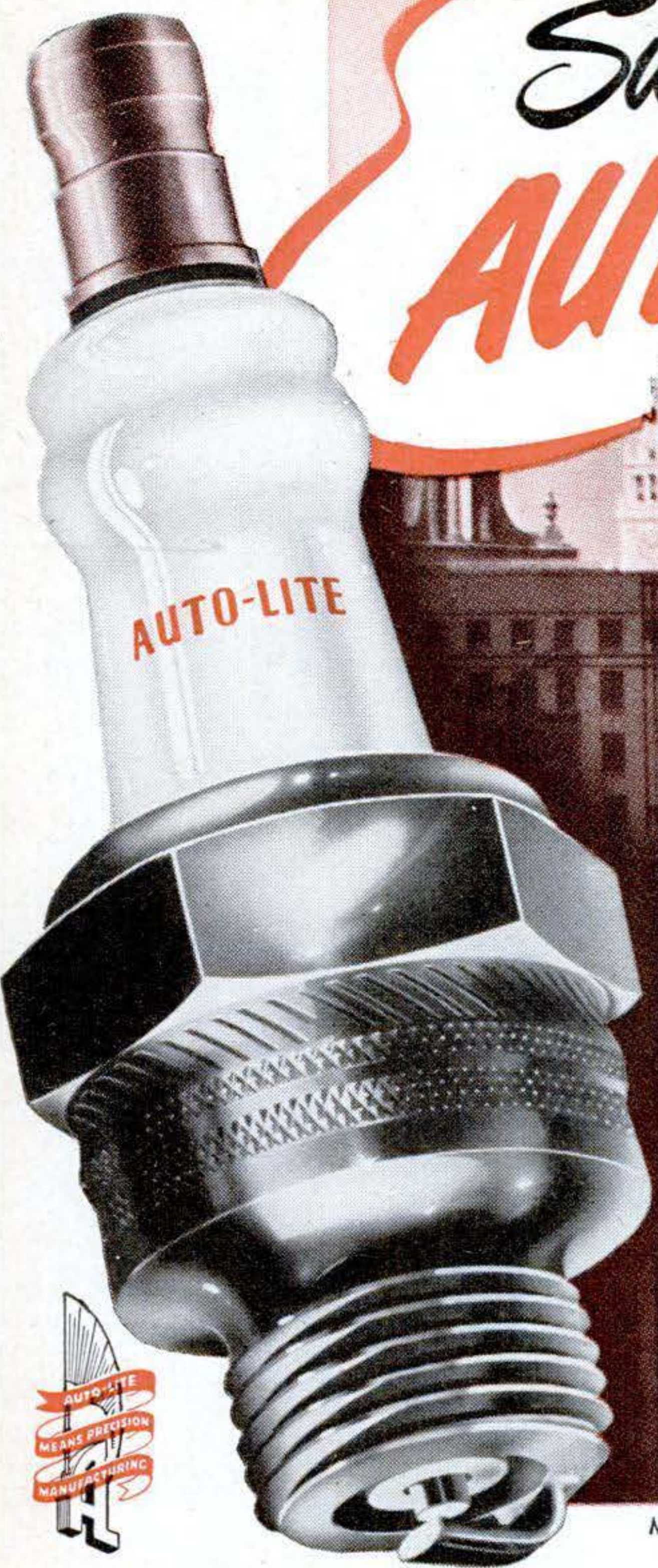

MICHIGAN AVENUE—ONE OF CHICAGO'S BUSIEST TRAFFIC CENTERS

IT'S no fun fighting a stubborn engine in heavy traffic—and often so unnecessary. You may find all that is needed to cure that sluggish, unresponsive engine is to switch lazy, worn-out plugs for a new set of Auto-Lite Spark Plugs. When so

many, leading car manufacturers specify these ignition engineered spark plugs you can be sure money cannot buy a better product. Why take chances! Before another day is done stop at your Auto-Lite Spark Plug Dealer and switch to Auto-Lite.

Toronto, Ont. THE ELECTRIC AUTO-LITE COMPANY Toledo 1, O

Tune in **DICK HAYMES**  
Star of the  
**AUTO-LITE**  
Radio Show with Helen Forresi, Gordon Jenkins Orchestra and Chorus  
**THURSDAYS**  
9 P.M., E.T.—CBS



# **AUTO-LITE** SPARK PLUGS *"Ignition Engineered"*

MONEY CANNOT BUY A BETTER SPARK PLUG

DEC. 217  
1946



## 2 SIGNS VERY VALUABLE TO YOU!

No. 1



identifies the dealer equipped to test your engine oil Free!

No. 2

the AC Oil Test that shows when dirty, gummy engine oil needs cleaning

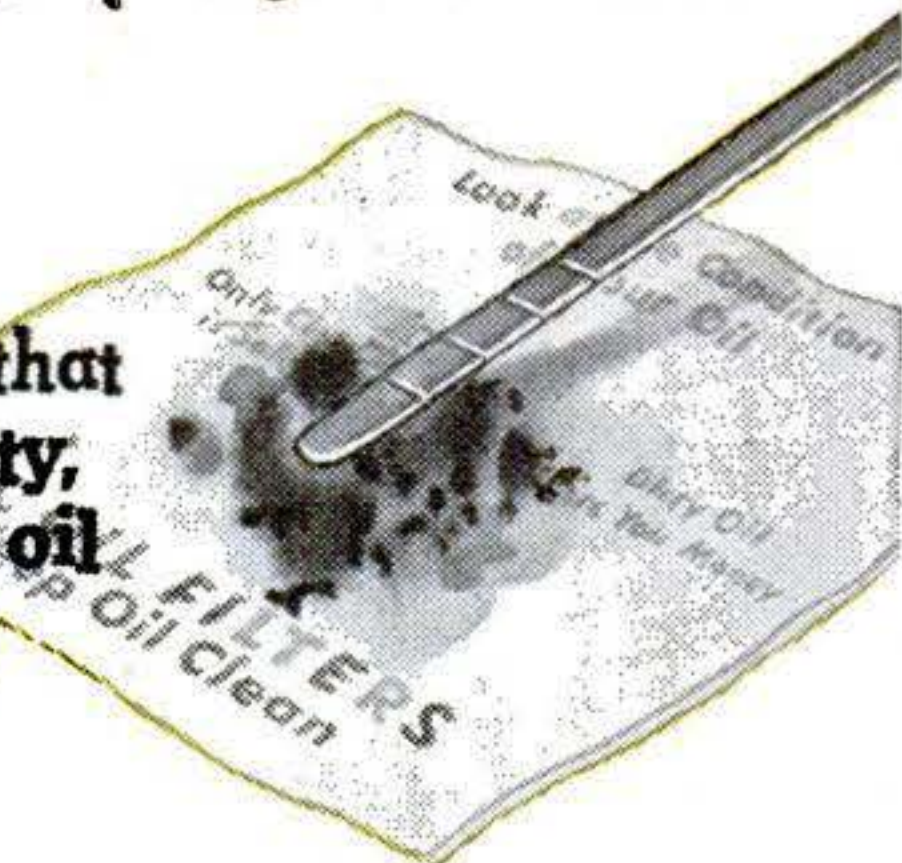

If your engine oil is dirty, the dirt shows *plainly* when your dipstick is wiped on an AC Oil Test Pad. You can get that test, FREE, from any service man who displays the yellow-and-black official AC Sign. If the test shows that you need your oil filter element changed, or should have an oil filter installed, *that same service man* can do that for you. (Better have your oil changed at the same time.)

Don't drive with dirty oil! It wastes gasoline as well as oil. It clogs vital oil slots in piston rings. Let AC Oil Filters and Elements keep your engine oil clean and dependable.

AC SPARK PLUG DIVISION • GENERAL MOTORS CORPORATION

## You'll Save Oil and Money-



If you have this precision engineered AC element installed

If you have this AC Oil Filter installed



# OIL FILTERS



## Flash Bulb Is a Repeater

BY VIRTUE of its open-end spiral design, the new Amglo Speedflash photography lamp can be used thousands of times. In it electricity is passed through an inert gas and the resulting ionization causes a 1/10,000-second flash. Camera filters are unnecessary when it is used with daylight film. The lamp will not function, however, with an ordinary flash synchronizer, and requires its own Speedflash power pack.

## New Plastic for Electronics

TEXTOLITE No. 1422, a new General Electric plastic, is expected to have wide electronic uses. Its electrical properties make it a good insulator, it is highly resistant to heat, and it can be machined to much closer tolerances than most plastics. An unusual chemical inertness further widens the possible applications of the material.

The plastic is particularly suited to microwave radio equipment, television, FM and radar. Tests of the new material indicate that under light electrical loads it maintains its shape at temperatures as high as 200 degrees C. Textolite No. 1422 is adaptable to small-quantity production.



# Tough BUT OH SO GENTLE

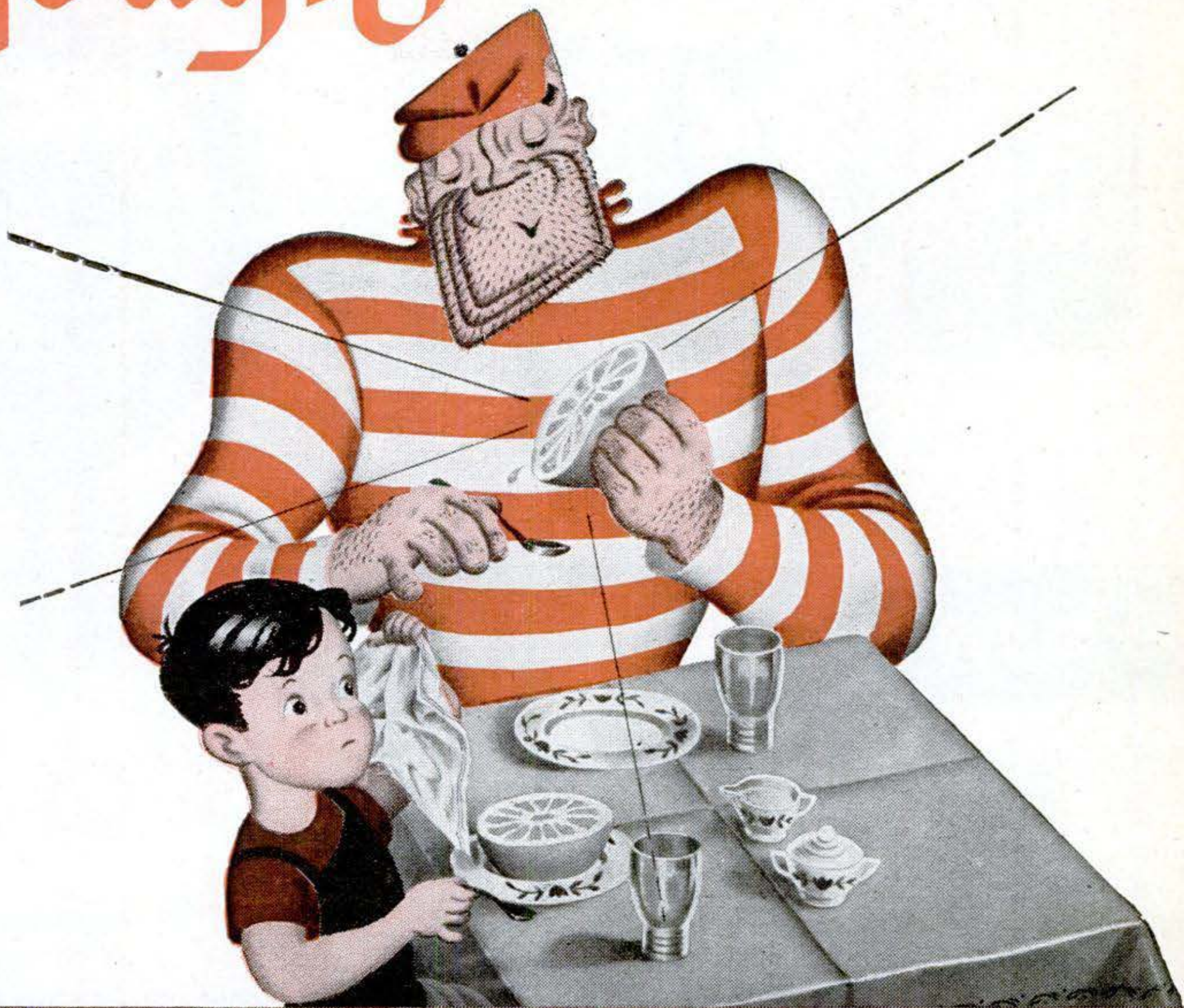

When your automobile engine starts pumping oil or smoking, it will pay you to install Hastings piston rings. They *stop* oil-

pumping, *check* cylinder wear, *restore* engine performance. Ask your motor specialist.

HASTINGS MANUFACTURING CO. • HASTINGS, MICH.  
Hastings Ltd., Toronto

**HASTINGS** STEEL-VENT  
**PISTON RINGS**  
TOUGH ON OIL-PUMPING GENTLE ON CYLINDER WALLS





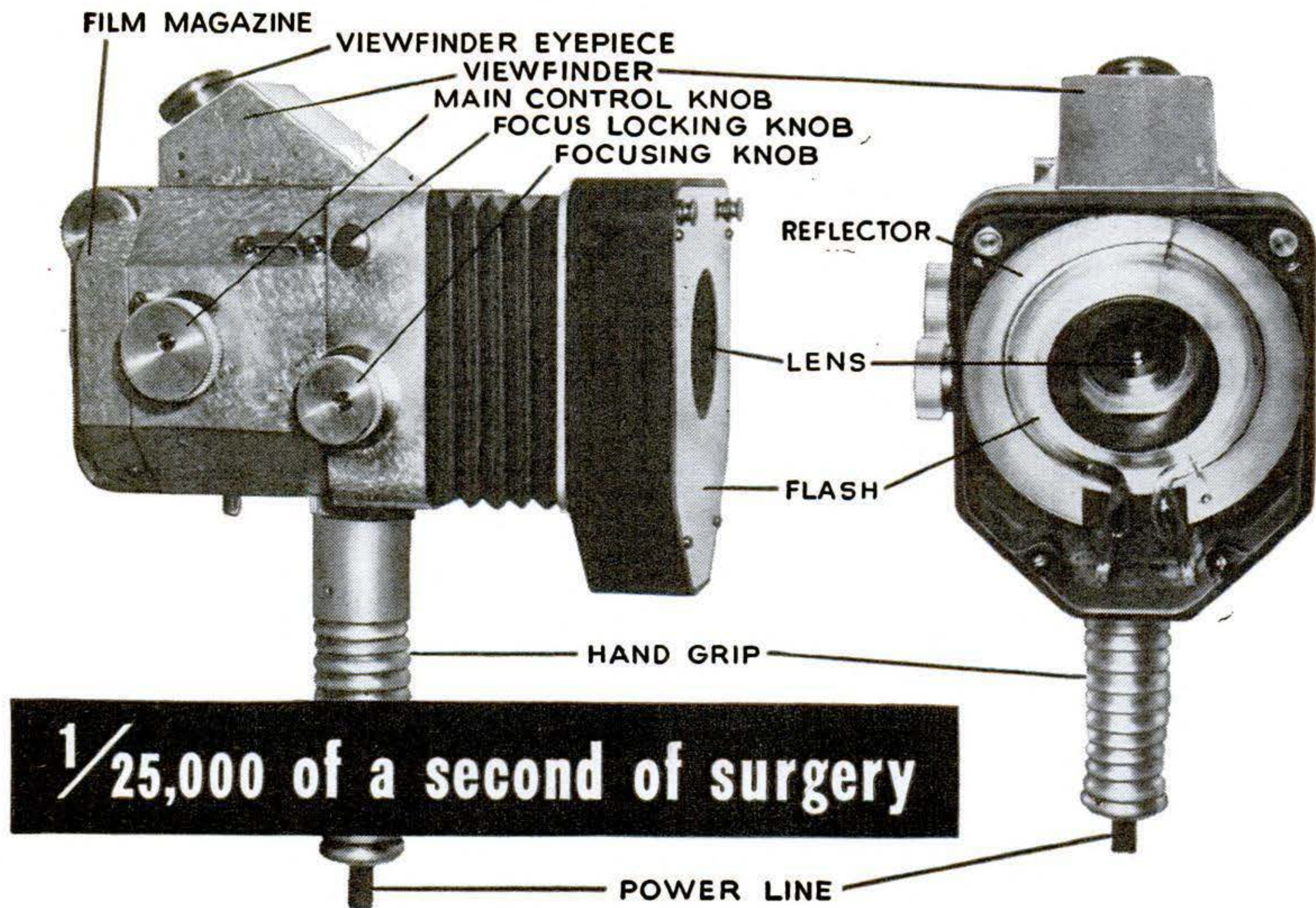

**H**ERE IT IS . . . the clinical recording camera. Developed by the Army Signal Corps for the surgeons of the Medical Department, it can "stop" an intricate operation with a silent, built-in flash lasting 1/25,000 of a second!

Best of all, it can take a consecutive stream of stills without interfering with the progress of the surgeons. Successful solutions of unique surgical problems can now be preserved in picture-story form — in color — for medical personnel throughout the Army, and for civilians as well. The importance of this camera to the future of surgery and the saving of lives can hardly be overestimated.

This is but one post-war stride of the new Regular Army. The civilian fields of tomorrow—such as Radar, Nuclear Energy,

**YOUR REGULAR ARMY SERVES THE NATION  
AND MANKIND IN WAR AND PEACE**

Supersonic Aviation, Advanced Electronics, Jet Propulsion — are the fields of *today* in the Army!

Combine exciting opportunities in these fields with the merits of an Army career, and you've an education that's hard to beat. New higher pay, liberal leave and retirement benefits, and the chance to choose your branch of service from those still open (on 3-year enlistments) make this a job you can't afford to miss! See your nearest Army Recruiting Officer for full details.

• Listen to: "Sound Off," "Warriors of Peace," "Voice of the Army," and "Proudly We Hail" on your radio.

**A GOOD JOB FOR YOU  
U. S. Army  
CHOOSE THIS  
FINE PROFESSION NOW!**



# UNANIMOUSLY ALL-AMERICAN by FRANK WILLIAMS

## DEWITT "TEX" COULTER-

...LAST YEAR'S GREAT ARMY TACKLE...NOW WITH THE NEW YORK GIANTS



...PLACED ON EVERY LEADING 1945 ALL-AMERICAN LINE-UP AFTER HIS FIRST FULL SEASON AS A REGULAR...HE WAS RATED AS ONE OF THE BEST LINEMEN EVER IN COLLEGIATE FOOTBALL!



HE FEELS **SHARP!**

...DESPITE HIS 225 LBS., "TEX" IS AMAZINGLY ALERT AND FAST...

...HIS SPEED AND BULK MAKE HIM ONE OF THE BEST DOWN-FIELD BLOCKERS IN THE GAME!

HE LOOKS **SHARP!**

...AS HE ANTICIPATES ENEMY PLAYS AND STOPS THEM WITH UNCANNY PRECISION!

DON'T ANNOY OUR BALL CARRIERS, SONNY!



look **SHARP**  
feel **SHARP**  
be **SHARP**

use **Gillette Blue Blades** with the **SHARPEST** edges ever honed!



5 for 25¢

HE IS **SHARP!**  
...TEX GETS THE SMOOTHEST, MOST REFRESHING SHAVES A FELLOW CAN HAVE - AND SAVES MONEY, TOO! YOU'VE GUESSED IT! HE USES **GILLETTE BLUE BLADES** WITH THE SHARPEST EDGES EVER HONED...GET HEP, MEN-- **DOUBLE EDGES MEAN DOUBLE ECONOMY!**

ENJOY BOXING FRIDAYS AT 10 PM EST OVER ABC NETWORK. GILLETTE'S CAVALCADE OF SPORTS ALSO AIRS WORLD SERIES AND OTHER CLASSICS YEAR'ROUND.

Gillette Safety Razor Company, Boston 6, Mass.



# Now! The **ONE-UNIT** **HEARING AID**

Thousands Have Waited For

THE NEW **ONE-UNIT**  
*Beltone*  
MONO-PAC  
**HEARING AID**

**THIS IS  
ALL YOU  
WEAR**

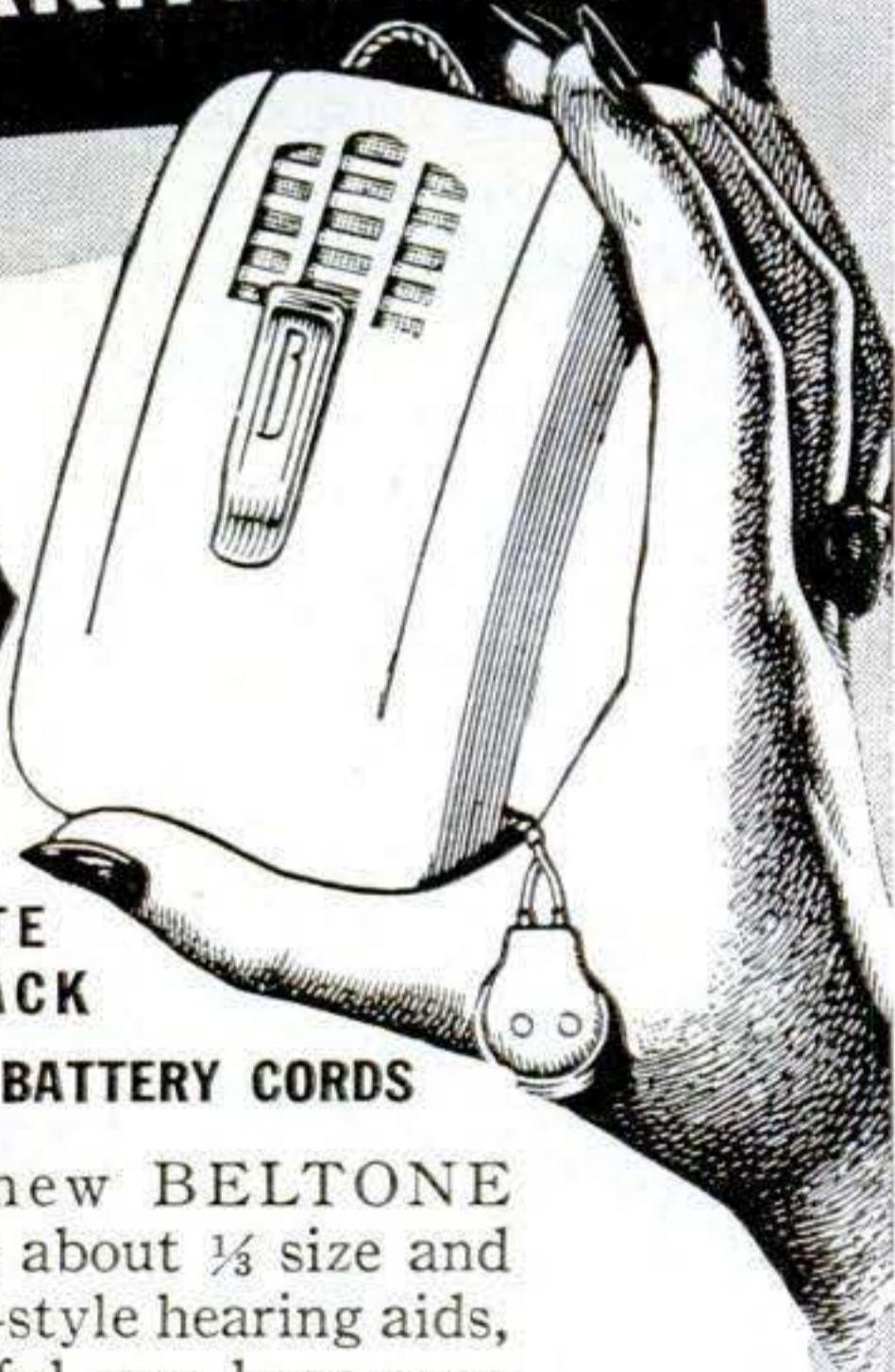

**NO SEPARATE  
BATTERY PACK**

**NO DANGLING BATTERY CORDS**

The tiny new BELTONE Mono-Pac is about  $\frac{1}{3}$  size and weight of old-style hearing aids, yet so powerful you hear even *whispers!* Get helpful facts about this new "MIRACLE" aid in valuable FREE book about deafness.

**BELTONE HEARING AID CO.**  
1450 W. 19th St., Chicago 8, Ill.



**FREE BOOKLET**

**Beltone Hearing Aid Co.**  
Dept. PS-12, 1450 W. 19th St., Chicago 8, Ill.

Please send me FREE booklet about deafness and what can be done to overcome it.

Name \_\_\_\_\_

Address \_\_\_\_\_

Town \_\_\_\_\_

Zone \_\_\_\_\_

State \_\_\_\_\_

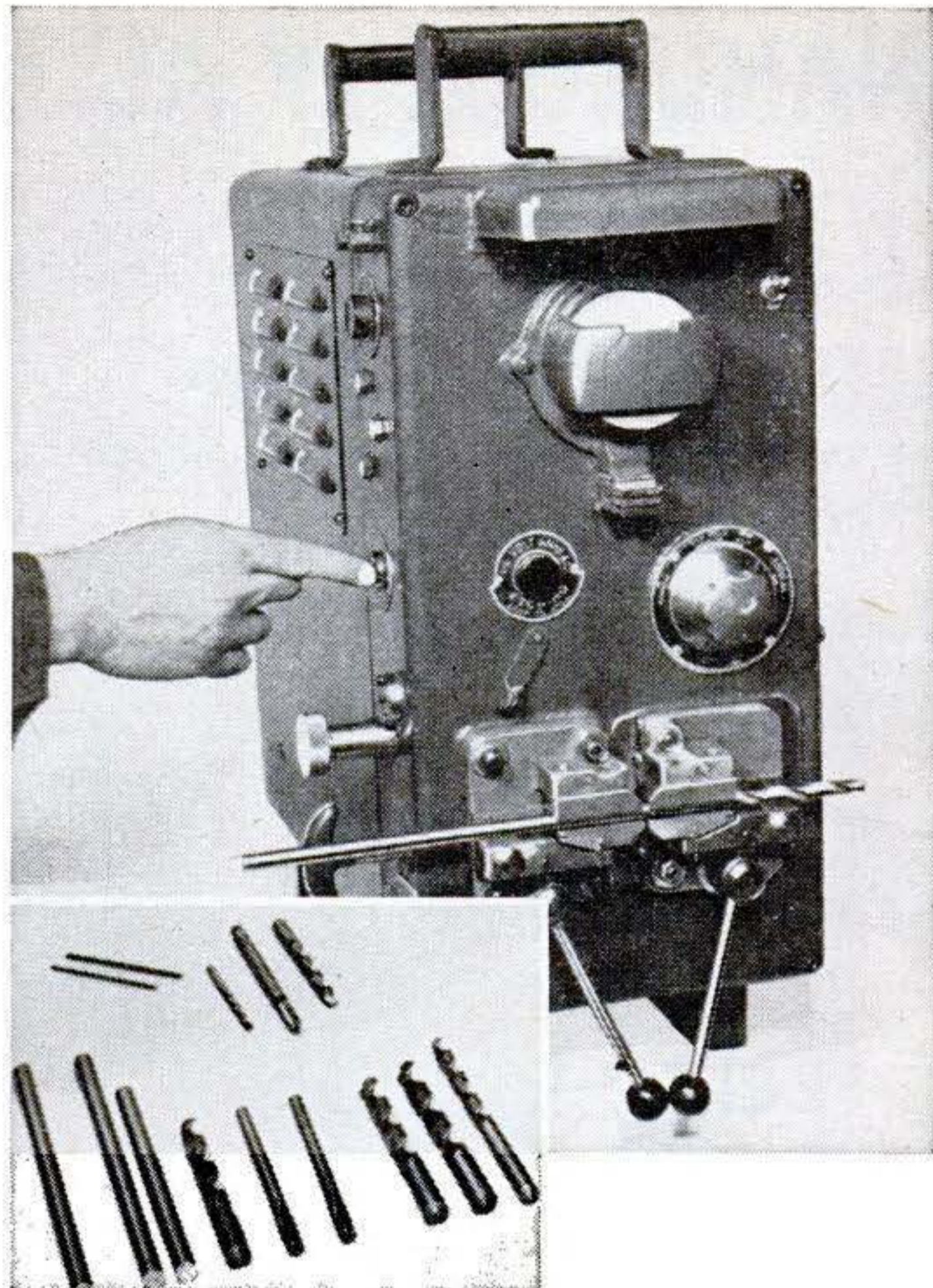

## Portable Flash Butt Welder

A PORTABLE, automatic welder produced by the DoAll Co., of Minneapolis, is designed for production welding of bar and round stock up to  $\frac{5}{16}$ " diameter. Its uses include the repair of small tools and welding of tool-bit extensions. The entire welding cycle is controlled by a single push button. Other special features include a built-in grinder and an automatic motor to control the feed of materials. An etching attachment provides a means of permanently identifying tools, dies, and fixtures. The model is designed for standard AC 220-volt operation, but it can be supplied for other voltage requirements.



**Model Builders  
Attention!**

	V	V-2	V-3
Hex	$\frac{1}{2}$ "	$\frac{3}{8}$ "	$\frac{5}{16}$ "
Thread	$\frac{3}{8}$ "-24	$\frac{1}{4}$ "-32	$\frac{1}{4}$ "-32
Thread Length	$\frac{7}{32}$	$\frac{7}{32}$	$\frac{5}{32}$
Weight, Grams	8	$3\frac{1}{2}$	$2\frac{1}{2}$

Actual Size V-Plug

Champion spark plugs for model gas engines give the same dependable performance as regular Champions. Sillment sealed. Sillimanite insulator. Alloy needlepoint electrodes for easy starting. One piece construction.

**CHAMPION**

SPARK PLUG COMPANY • TOLEDO 1, OHIO





**Snap into  
winter...**



**with dependable  
CHAMPION  
SPARK PLUGS**

PREPARE your car for winter driving by having your dealer check your spark plugs now. If they have lost their efficiency, insist on new Champion Spark Plugs. They will insure instant starts in coldest weather, faster warm-ups and smoother engine performance. Champion dealers everywhere will serve you with the correct size and type for your car to insure maximum efficiency and economy. Snap into winter with dependable Champion Spark Plugs.



***FOLLOW THE EXPERTS***

**DEMAND DEPENDABLE CHAMPIONS FOR YOUR CAR**

DEC. 223  
1946



**BUILD YOUR OWN  
RADIO AND ELECTRONICS DEVICES  
AT LOW COST**



with **NEWARK'S** KITS AND PARTS

You Can Easily Build Radio Receivers and Transmitters—Record Players and Other Exciting Radio and Electronics Devices.

Our **BIG BARGAIN COUNTERS** display new parts and unusual special equipment you'll enjoy seeing. Come in, look around, ask questions . . . it's fun.

Public address systems for every need and purpose.

Make a good radio receiver or fine record player at big savings. You can build these and many other things easily. In any of our stores our staff will gladly show you how — or will explain clearly by mail. **Write for our famous Big Bargain Bulletins**, listing all the newest things available. Send for it today. When writing, address Dept. B3.

<b>NEW YORK</b> 242-50 W. 55th St. New York 19, N. Y.	<b>NEWARK</b>	<b>CHICAGO</b> 323 W. Madison St. Chicago 6, Ill.
<b>ELECTRIC COMPANY, INC.</b>		

N.Y.C. Stores: 115 W. 45th & 212 Fulton St.  
Offices & Warehouse: 242 W. 55th St., N. Y. 19

NOW YOU CAN OWN  
A FAMOUS

★ **ORIS** ★  
WATERPROOF WATCH

An unusual limited offer — lowest price we ever sold an ORIS 7-jewel pin-lever time piece. Chrome top, stainless steel back — modern stainless steel expansion watch bracelet included.

**SHOCK RESISTANT!**  
**NON-MAGNETIC!**  
**RADIUM DIAL!**  
**SWEEP SECOND HAND!**

**Only \$1865** with steel expansion bracelet  
Fed. Tax Included

Write for free illustrated booklet



Mail orders promptly filled  
No C.O.D.'s  
Postage Prepaid

**LAMONT**

Internationally Famous Watches  
SUITE 1006 • 597 FIFTH AVE. • NEW YORK 17

We met in the Army



now I demand

Over 90 million yards of Reeves Army Twill were purchased by Uncle Sam during the war. It has great tensile strength—resists tearing, snagging and scuffing. Its dyes are fast to sun, water and perspiration. Sanforized Shrunk\*, it tailors smartly, holds its lines. It comes in a wide variety of colors. Demand Reeves Army Twill for better, more economical work clothes.  
\*Residual shrinkage less than 1%.

**REEVES BROTHERS, INC.**  
54 Worth Street, New York 13, N. Y.





# NEW

# "EVEREADY" FLASHLIGHT BATTERY LASTS 93% LONGER!

**Tiny cell packs  
enough ENERGY to  
kick 186 field goals**

Like football? Like to sit breathless while the Big Team goes into kick formation for a last-minute try? Then here's news: The great new "Eveready" flashlight cell NOW has energy equal to that used in making 186 big-time field goals from the 25-yard line! Extra power makes "EVEREADY" batteries the All-American choice for brilliant, lasting, low-cost light!



**THE NEW** "Eveready" flashlight cell literally *blasts* darkness with a dazzling beam of powerful white light. And does it for nearly *twice* as long as famous pre-war "Eveready" batteries. Because this new cell packs *93% more energy!* Service from "Eveready" flashlight batteries is nearly *doubled*...yet you *pay no more* for this far greater value! For longer life of brighter light... get these new "Eveready" flashlight batteries!

The registered trade-mark "Eveready" distinguishes products of  
**NATIONAL CARBON COMPANY, INC.**  
30 East 42nd Street, New York 17, N. Y.  
Unit of Union Carbide  and Carbon Corporation

Nearly *twice* the electric energy... almost *two times longer* life of brilliant white light than even famous pre-war "Eveready" batteries...at no extra cost. That's today's *high-energy* "Eveready" battery, as proved by the "Light Industrial Flashlight" test devised by the American Standards Association.

**93% MORE ENERGY**

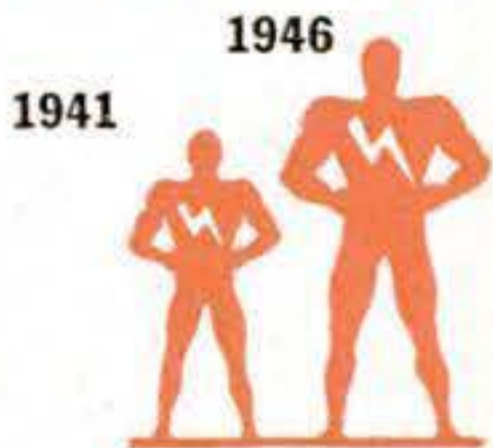

*High Energy* **MEANS**  
**BRIGHTER LIGHT, LONGER LIFE**

**EVEREADY**  
TRADE-MARK  
**FLASHLIGHT BATTERIES**



DEC. 1946 225



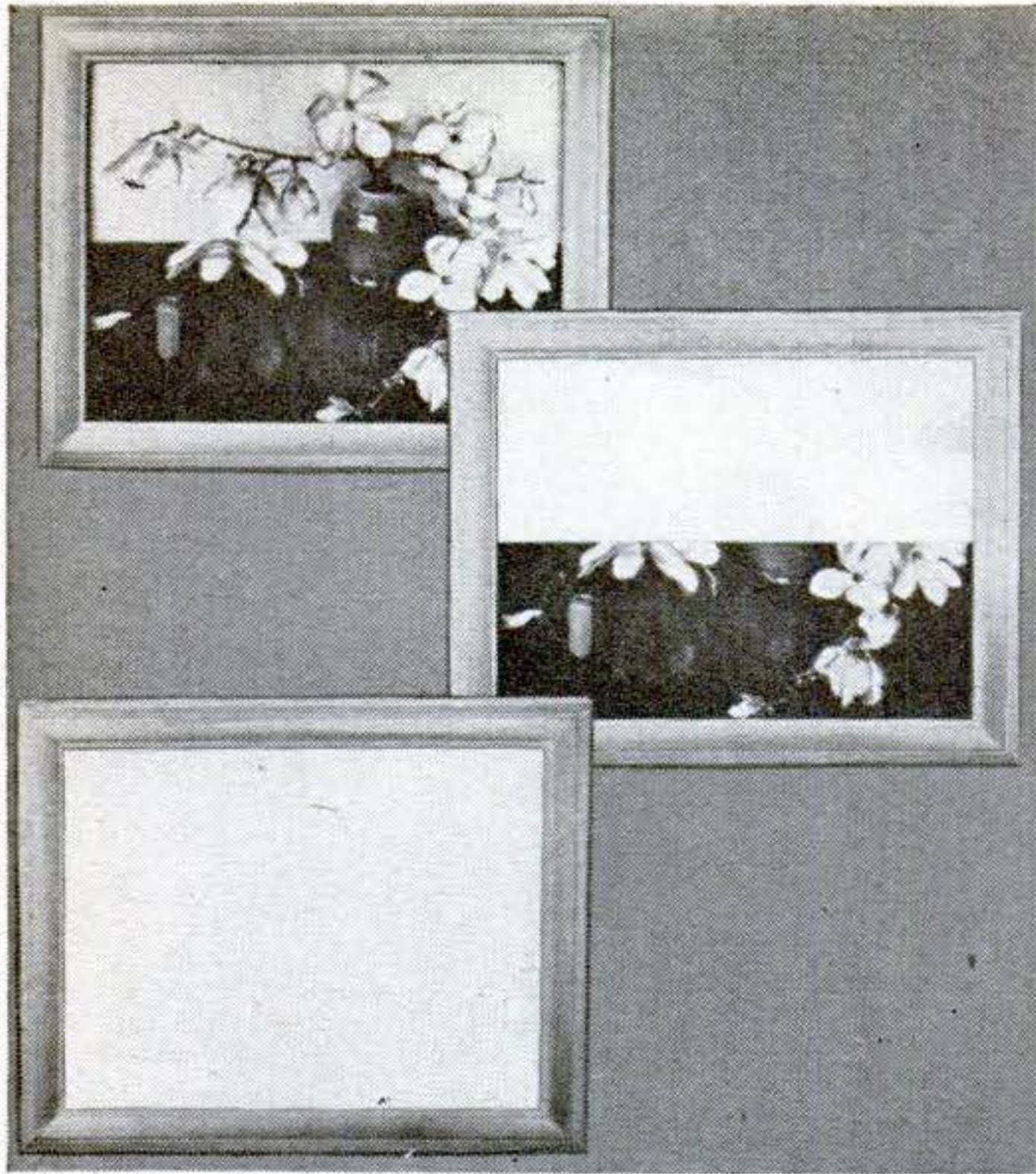

### Concealed Projection Screen

A HOME projection screen that is in effect an oil-painting reproduction when not in use has been developed by the Radiant Mfg. Corp., of Chicago. The screen, of glass-beaded material, is concealed in the upper part of the frame.

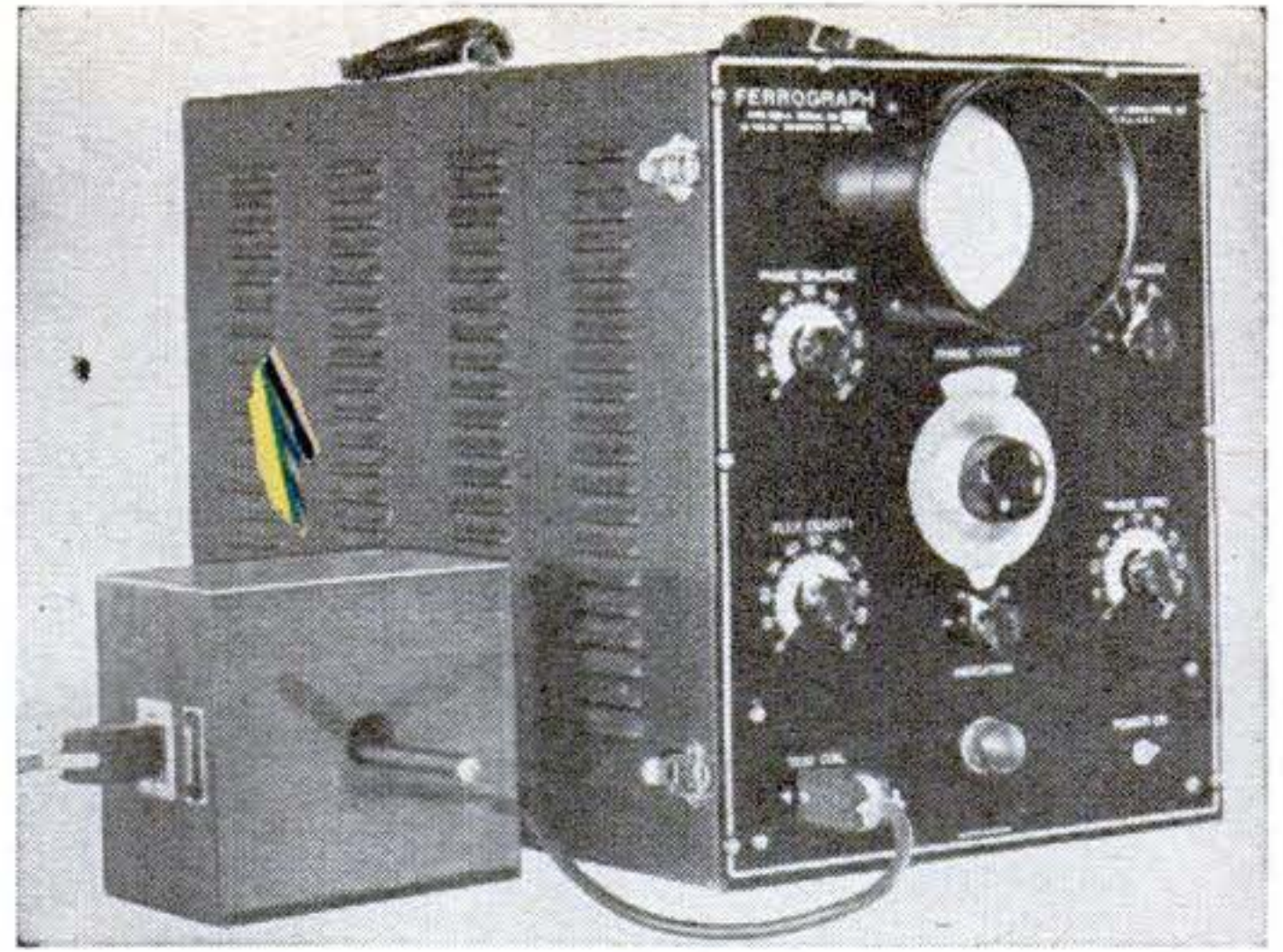

### Magnetic Metal Analyzer

USING the relationship between magnetic and metallurgical properties, the Ferrograph speedily determines the composition of ferromagnetic materials by electrical analysis. Developed by the Allen B. Du Mont Laboratories, of Passaic, N. J., it has a cathode-ray indicator that permits examination of the induced voltage in the secondary of a transformer in which the sample under test is the core. The apparatus simplifies industrial tests by unskilled workers, who have only to compare the machine's indication with known values.

*The first pipe smoke!*



Sir Walter Raleigh, father of pipe smoking, never knew the pleasures of a Sterncrest pipe. Poor chap, he was born too soon to puff an LHS of genuine Imported Briar, vita-fused for sweetness from the first puff.

**IMPORTED BRIAR**

Model #14 \$ **5**

Dozens of others—antique or smooth finish.

LHS STERNCREST 14K, with gold band, imported briar . . . . . \$ **7.50**

Other LHS Pipes: \$25, \$10, \$3.50, \$1.50. at all good dealers

*The best pipe smoke!*



Write for "Pipes—for a World of Pleasure." It's FREE L & H STERN, INC., 56 Pearl St., Brooklyn 1, N.Y.



**STERNCREST**  
**STERLING**

ZEUS Filter Cigarette Holder is back in Aluminum.



# Atlas—the compact, low-cost MILLER for tool rooms, production, commercial & home shops

Atlas—the compact, low-cost MILLER for tool rooms, production, commercial, and home shops.

Precision built . . . engineered for quick set-ups over a wide work range . . . the rugged, versatile Atlas miller greatly increases the scope of your shop. It handles all operations from planing and facing cuts to end milling, keyways, finishing, and layout work. Table travels 10" horizontally, 3½" cross, 6" vertically, spindle speeds from 62 to 2870 RPM provide correct range for all types of work and cutters. Back geared power, complete V-belt drive, Timken bearings. Operates from ⅓ HP motor. Available now for fairly prompt delivery. See your Atlas distributor.



**ATLAS PRESS CO.**  
1255 N. PITCHER ST. KALAMAZOO 13, MICH.

LATHES      DRILL PRESSES

MILLING MACHINES      SHAPERS

**Atlas 4 TOOL TEAM**

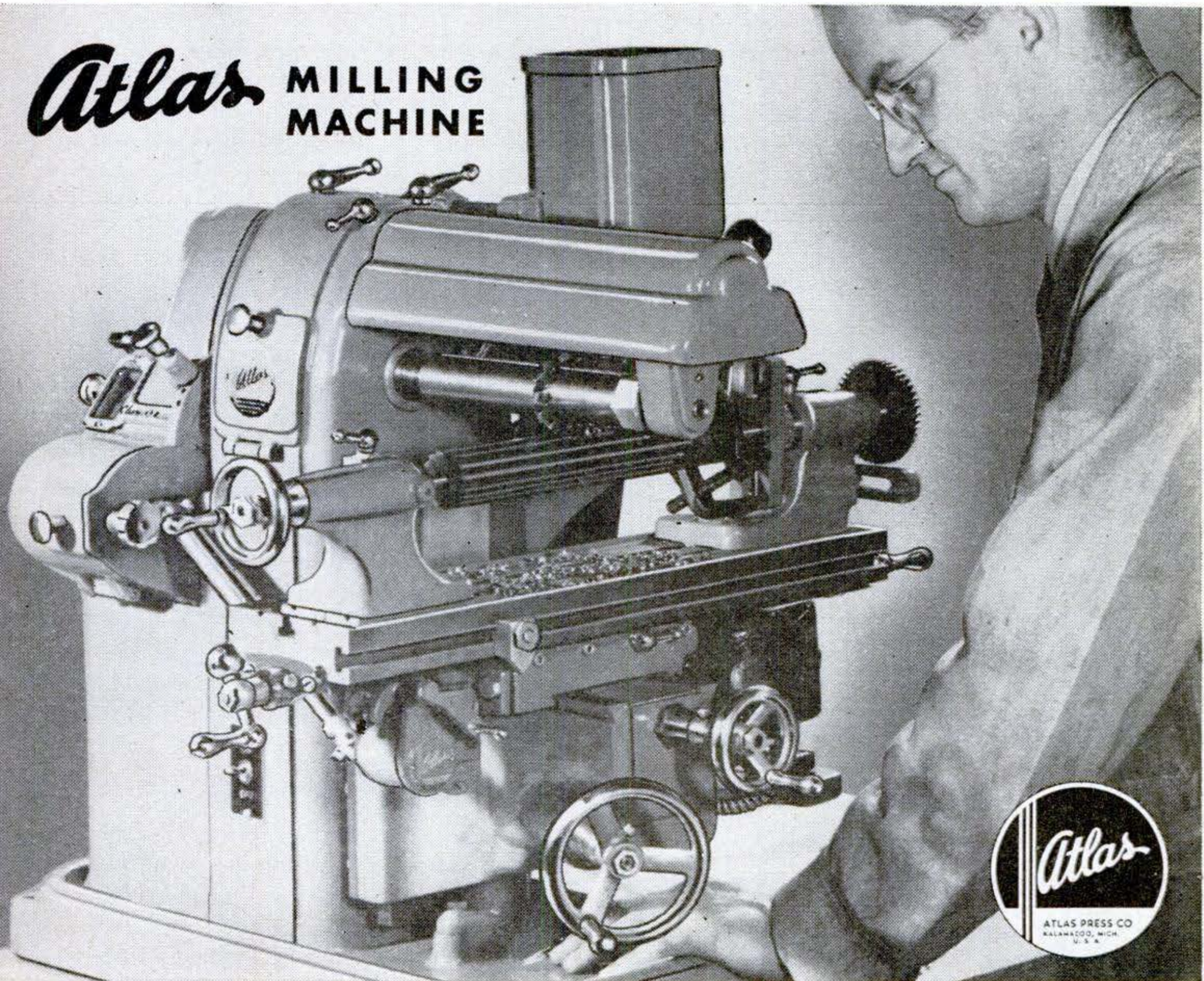

**Atlas MILLING MACHINE**





# ANCO RAIN-MASTER

"Dead-Locker"

WINDSHIELD WIPER  
ARMS and BLADES

BLADE SNAPS ON...  
STAYS PUT

FINGER-  
TIP  
RELEASE



CAN'T FALL OFF  
CAN'T BLOW OFF

(A war-born invention—by ANCO—first)  
for military aircraft—now for your car.)

## DON'T SHOOT YOUR GAS-PUMP MAN!

He's doing the best he can. Sure, he knows how dangerous it is for you to drive your car... in stormy weather... with your dull old windshield wipers that smear and smear. He'd gladly put on for you quickly a pair of keen new ANCO RAIN-MASTER Wiper Blades and Arms. He has them—Newest Models! But he forgets to remind you? Too busy? You can't shoot him for that!



After all, it's *your* car to protect. So *you* remind *him*. Get RAIN-MASTERS... patented features... original equipment on many makes of high grade cars and trucks... used in war—on our fighting tanks and trucks and ships and bombers too... because ANCO RAIN-MASTERS clean quicker, clean cleaner... last longer. May save you a costly smashup.

Ask for RAIN-MASTER Windshield Wiper Arms and Blades next time you buy gas.

**THE ANDERSON COMPANY**  
Established 1918  
GARY, INDIANA

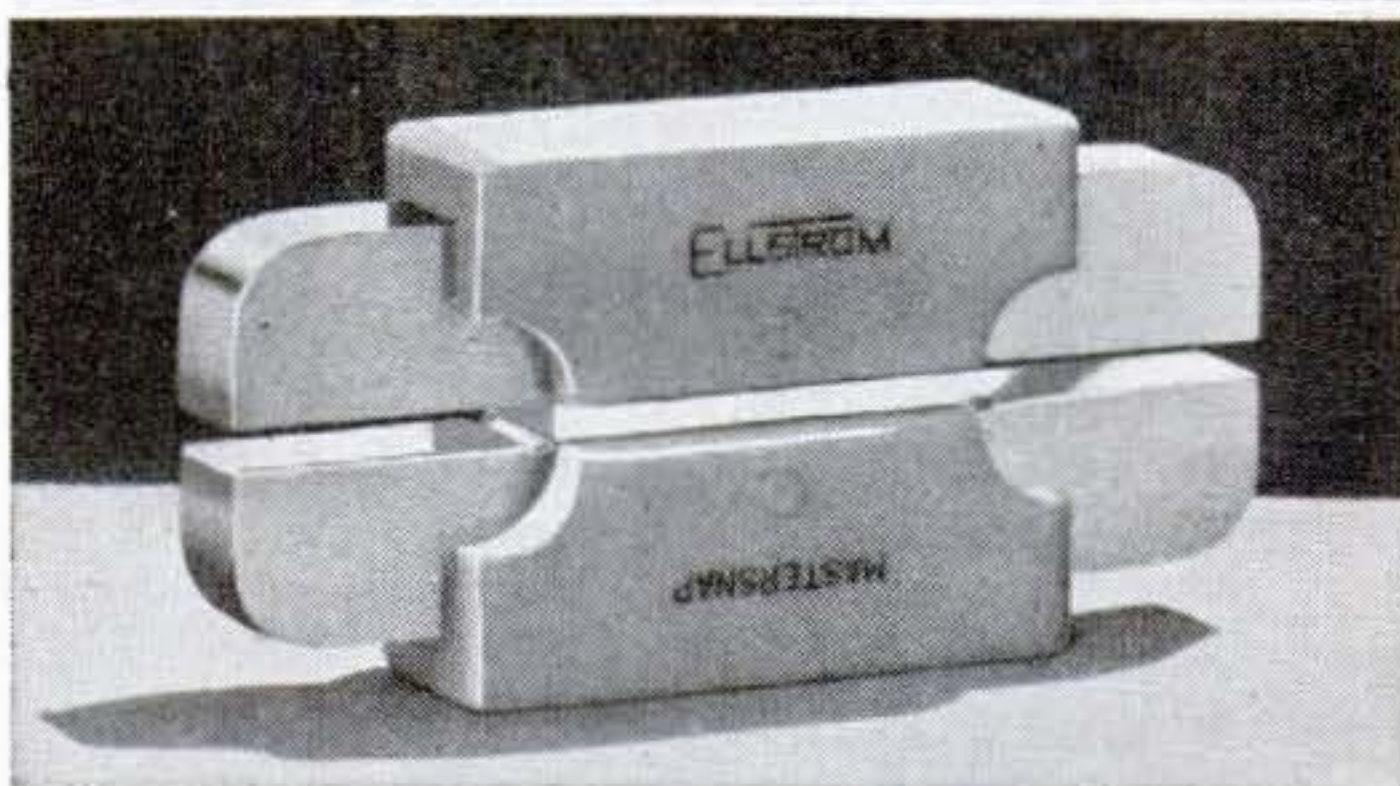
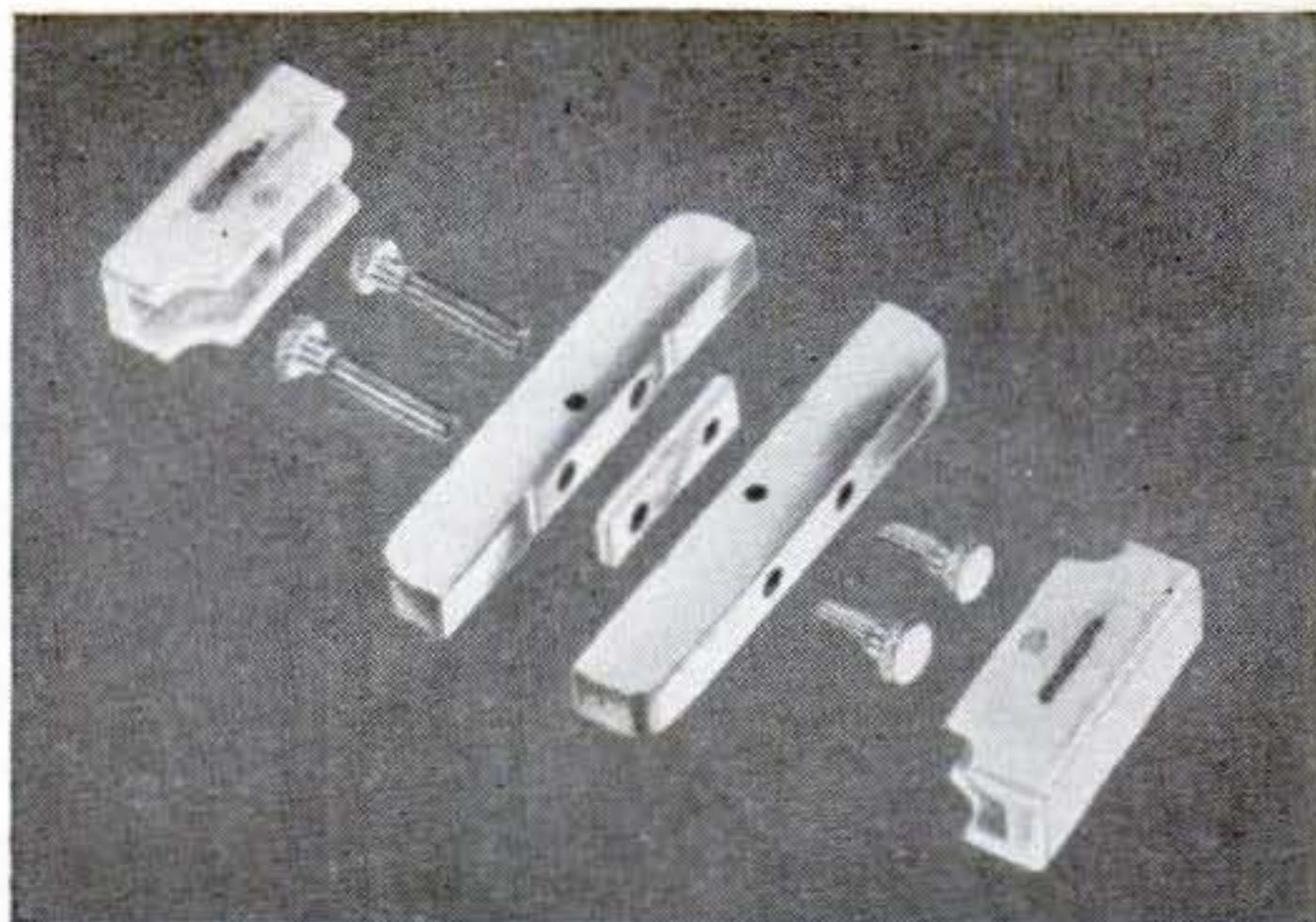

## Gauge Has Nonwearing Blocks

INCORPORATED in a new snap gauge, the special gauge blocks shown above give the instrument nonwearing qualities. Colored plastic insulators, green for "go" and red for "no-go" combinations, are held over the jaws by plastic pins. It is made by the Dearborn Gage Co., Dearborn, Mich.

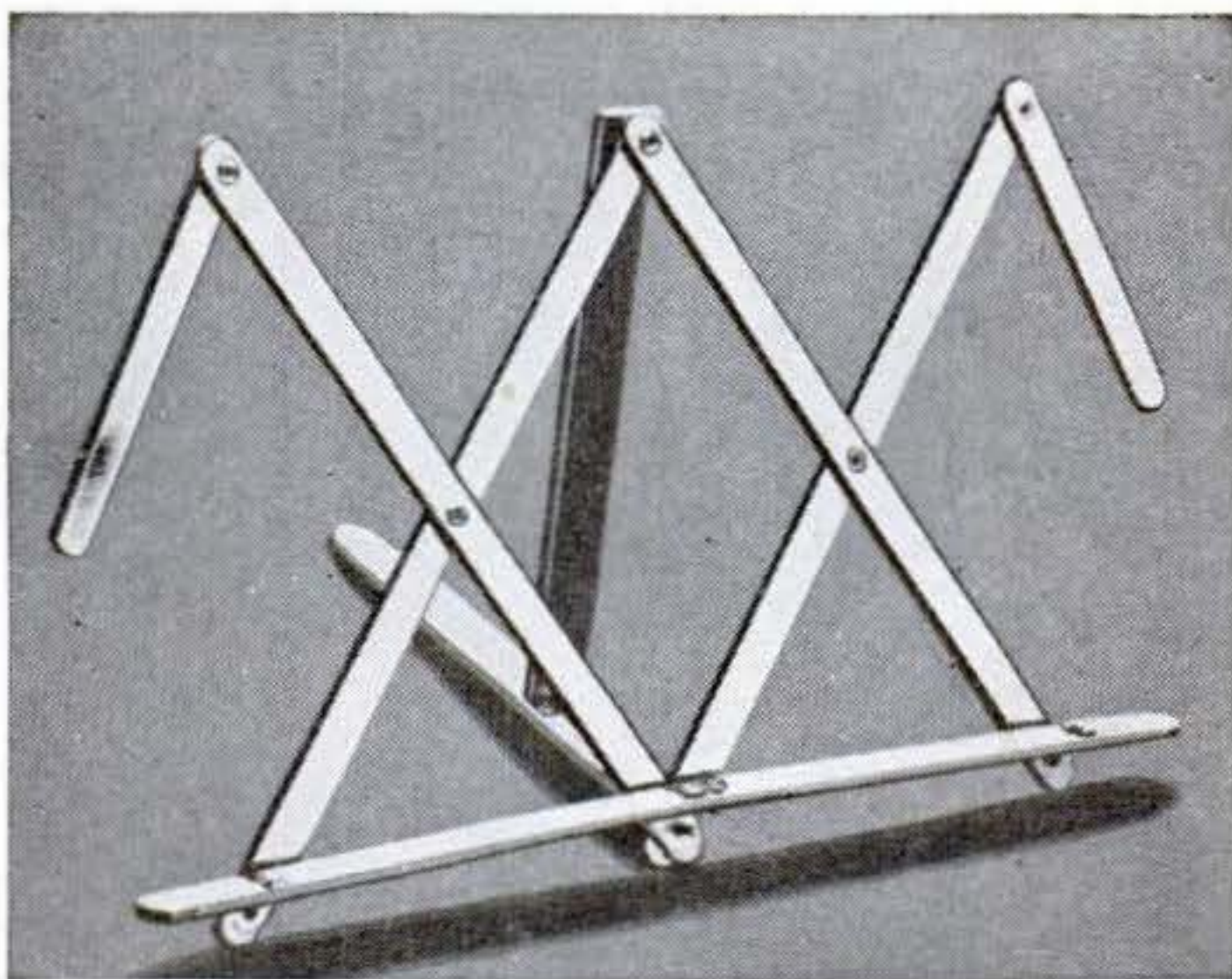

## Pocket-Size Folding Stand

FOR musicians, stenographers, or anyone else who needs something to prop papers against, the J. B. Steven Products Co., of New York City, has designed the Handi-Stand, a compact rack of lightweight magnesium. Folded, it fits a pocket.



# BETTER BY FAR

## *in Construction*



You'd know what we mean if you could watch one of these Fisher Bodies come down the assembly line.

Then you could see the extra steps we take to make them durable and rugged—how added strength and safety are built in by such features as you see listed at the right.

Your eyes tell you the new bodies by Fisher are beautiful when you see them on the road. And your knowledge of good craftsmanship will tell you they're "better by far" through and through, and that cars with Body by Fisher are well worth waiting for.

**1** **TURRET TOP**, pioneered by Fisher Body, is formed of a single sheet of solid steel.

**2** **U-SHAPED STEEL ROOF BOWS** are fused to the steel roof rails, affording extra ruggedness and shock resistance.

**3** **STEEL COWL AND DASH**, ruggedly braced with a triangular truss construction, provide solid support for the front door hinge pillar.

**4** Outer and inner **DOOR PANELS** are welded into one solid unit.

**5** **SOLID STEEL FLOOR**, especially ribbed for extra strength, forms the foundation of the Unisteel Turret Top Body by Fisher.

**6** **BOX-TYPE REAR END BRACES** give extra protection against weaving and twisting.

**PLUS** a long list of other features in design and construction, which would total more than a hundred.

# *Body by Fisher*

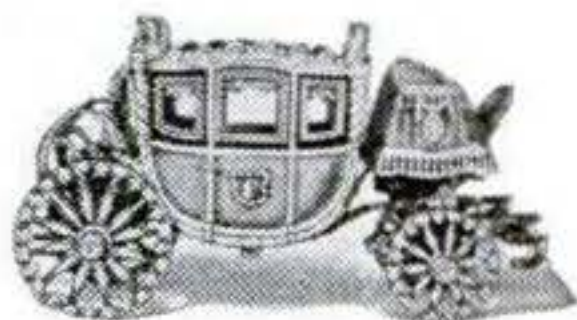

**BETTER BY FAR**

*Fisher Body Craftsman's Guild Model-Building Competition—8 university scholarships, 1212 other awards for boys 12 years of age and older. Enroll now! Headquarters: General Motors Bldg., Detroit 2, Michigan.*

*On the Air: HENRY J. TAYLOR, twice weekly.*

You get Body by Fisher  
only on

**GENERAL MOTORS CARS**

CHEVROLET • PONTIAC  
OLDSMOBILE • BUICK  
CADILLAC



The new 1946 Buick, Model 51  
SUPER 4-door Sedan



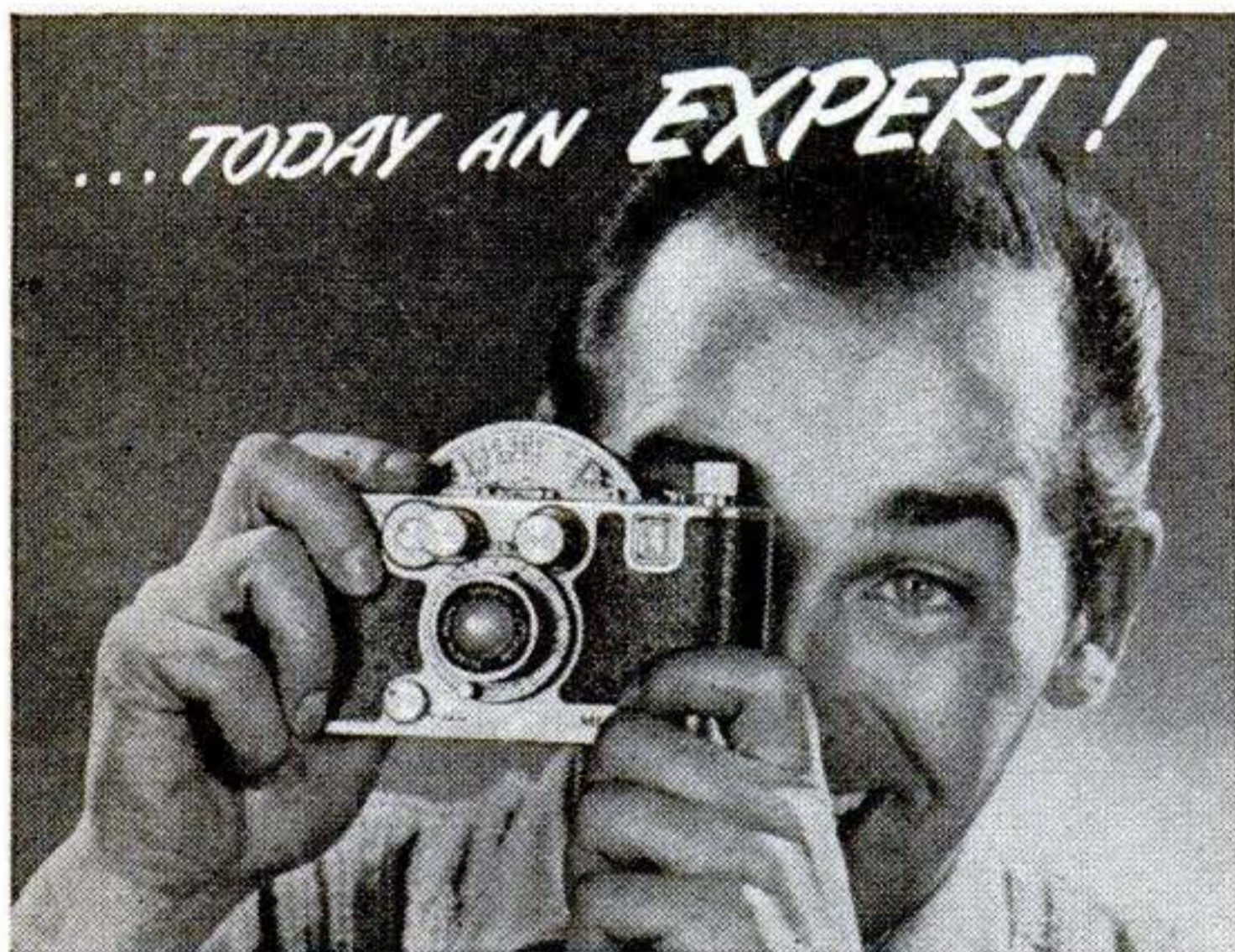

Anybody can be a candid camera expert almost overnight with the new

## MERCURY II (It's a UNIVERSAL)

Expert candid camera shots are a snap with the Mercury II. Foolproof built-in features and unbelievable simplicity make "professional" shots easy for everyone.



DESIGNED ESPECIALLY FOR COLOR, Mercury II will give you sharper, clearer shots. Check Mercury II at your dealer's.



NEW YORK • CHICAGO • HOLLYWOOD

Manufacturers of Mercury, Cinémaster, Corsair Cameras and Photographic Equipment

# KEEP WARM! SAVE FUEL!

## Mortite

### BETWEEN YOU AND THE COLD

- A pliable, plastic weather-stripping, easily, quickly applied to windows, doors, baseboards. Stops expensive heat leaks.

Just press into place. Use inside or outside. Can be painted. Mortite does not shrink or crack. Also plugs cracks around drainboards, bathtubs, etc.

Roll covers about 80 feet, enough for 5 windows.



**\$1.25** AT HARDWARE, PAINT, DEPT. STORES AND LUMBER YARDS

Higher west of Rockies and Canada

Ask for Mortite Booklet!

**J. W. MORTELL CO.**  
534 Burch St., Kankakee, Illinois

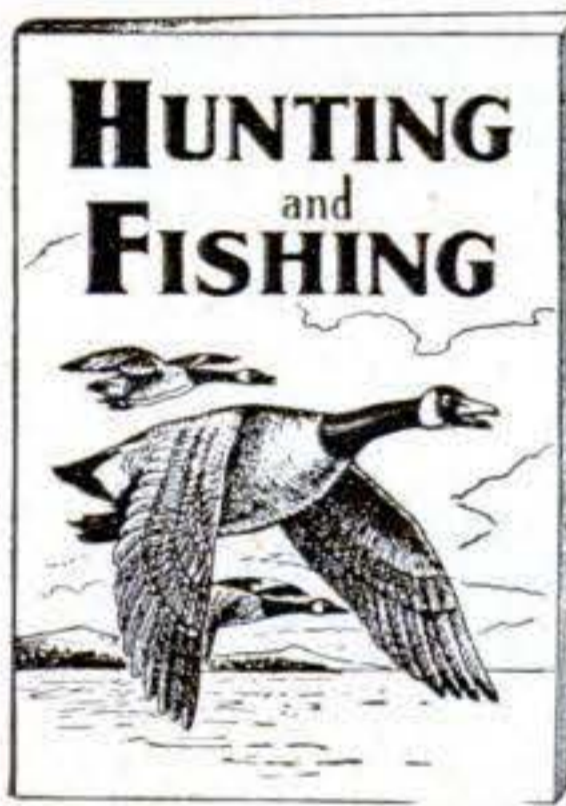

253 Sportsman's Bldg.,

## HUNTING & FISHING

is a monthly magazine crammed full of hunting, fishing, camping, dog and boating stories and pictures, invaluable information about guns, fishing tackle, game law changes, best places to fish and hunt—countless ideas that will add more fun to your days ahead.

### Special Trial Offer

Send 25c in stamps or coin and we will send you Hunting & Fishing for six months.

### HUNTING & FISHING

Boston,

Massachusetts



**WELD ANYTHING ANYWHERE ANYTIME**

**ALL PURPOSE ARC WELDER**

9 Models . . . 32 Volt D.C., 110 to 440 A.C.

A complete workshop in itself! Weld, cut, braze or solder any type metal; iron, castings, aluminum, steel, bronze . . . in any gauge or weight, with equal ease. Compact, complete, sturdy as the Rockies. Formed steel and cast aluminum case, welded steel base, 4" cast wheels. Built with voltage control. Better on R.E.A. lines. No training needed. Sold throughout the world. **Unconditionally guaranteed for 2 years. Fully equipped—ready to use.**

**FORNEY MFG. CO.**  
FORT COLLINS 3, COLORADO





# Boating's more fun

with  
an

# Evinrude "4"



From shove-off to "home again", every mile is more fun when there's an Evinrude "Four" on the stern of your boat. *More fun . . .* with four-cylinder starting ease, flexibility, responsiveness. *More fun . . .* with the thrilling surge of four-

cylinder power that flows with matchless smoothness. Back of Evinrude four-cylinder models are millions of miles of fine performance, years of engineering advancement. A favorite four for small runabouts, fast family and fishing boats is the Lightfour. Weighing only 66 pounds, Lightfour develops 9.7 O.B.C. brake H.P. at 4000 R.P.M. See your Evinrude dealer — look for his name in your classified phone directory under "Outboard Motors". Catalog of complete line of 7 Evinrude models FREE. Address EVINRUDE MOTORS, 5397 N. 27th Street, Milwaukee 9, Wisconsin.

*In Canada:*  
Evinrude Motors, Peterboro, Ontario

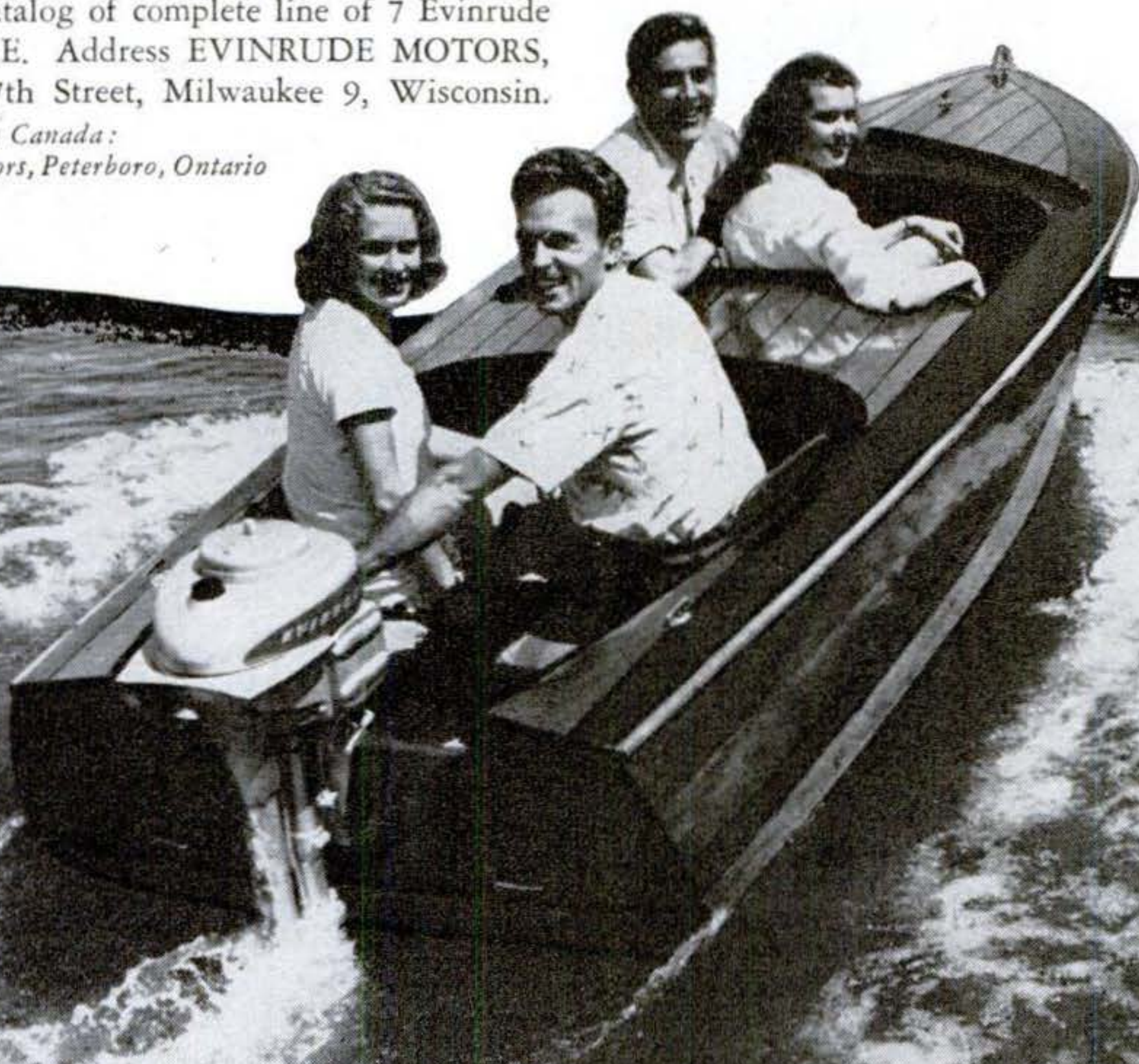

## **EVINRUDE**

OUTBOARD MOTORS



THE ONLY BRUSH THAT

*Keeps the Air Clear  
as it Cleans the Floor*

Also Eliminates  
Sweeping Compound!



Arbitrin Sweeping fluid is put into a steel reservoir in the back of the Dustless brush.

As you sweep Arbitrin filters through the tufts — surrounds particles.

The dust itself is converted into sweeping compound—cannot rise into the air.

**Dustless** brushes used with Arbitrin sweeping fluid are 100 times more effective in controlling dust than ordinary floor brushes used with sawdust. When used daily, Dustless brushes actually reduce bacteria, normally in the air between sweepings, as much as 97%. These facts have been proved in tests made by independent health authorities. Dustless brushes are used in thousands of stores, factories, offices, schools, and institutions. They are unconditionally guaranteed to meet your requirements. Write today for sizes, styles, and prices.

**MILWAUKEE DUSTLESS  
BRUSH COMPANY**

530 North 22nd Street • Milwaukee 2, Wisconsin

MANUFACTURERS OF DUSTLESS, SPEED SWEEP AND SPEED WASH BRUSHES

Milwaukee Dustless Brush Co., 530 N. 22nd St., Milwaukee 2, Wis.  
Please send complete information about Dustless brushes and Arbitrin sweeping fluid.

Name.....  
Address.....  
City and State.....



### 34-Pound Portable Recorder

NEWEST in recorders is the 34-pound machine that New York radio station WOR recently imported from England. Driven by its own spring-powered motor, which is similar but superior to the old phonograph type, it cuts a record in three minutes at 78 r.p.m. British Broadcasting Corporation correspondents used it at the battle fronts.



### Hide-Away Hearing Mold

NEARLY invisible and formed of plastic, the newly developed Hide-Away Ear Mold worn by the model fits any modern hearing aid, according to its distributors, the Universal Distributing Co., of Davenport, Iowa.



Now that the days are short  
play safe—replace with

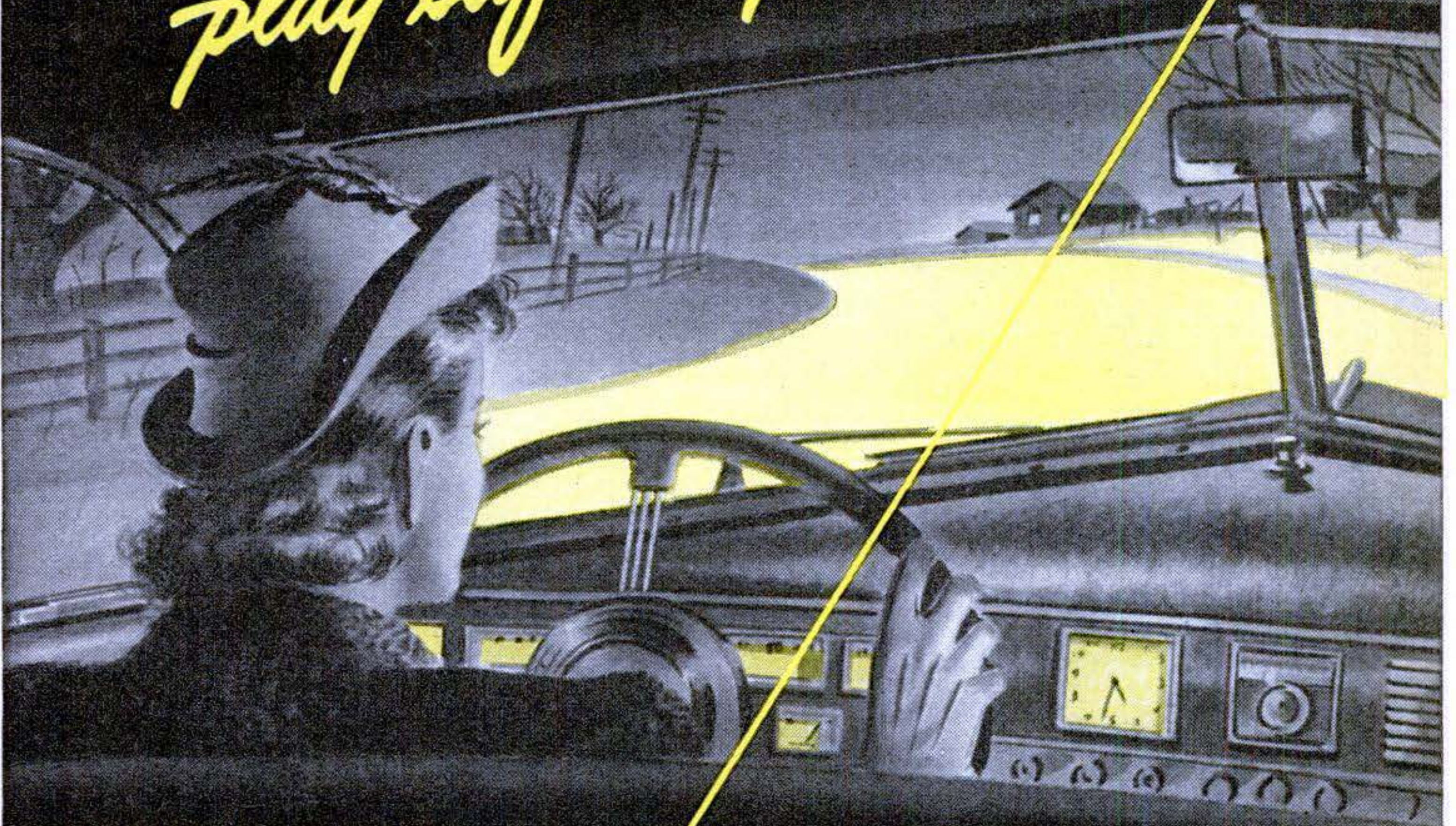

LET SAFETY SHARE THE RIDE—  
REPLACE WITH GUIDE



The more you drive at night, the more you appreciate the safety, efficiency and long life of Guide Sealed Beam headlamp units. The far-ranging upper beam and the glare-free lower beam give you headlighting at its best under every road and traffic condition.

Guide Sealed Beam units are original equipment on leading new cars in every price class. Insist on Guide units for replacement and get this *double* protection at no extra cost.

**NO DIM-OUT**—Because your Guide Sealed Beam unit is sealed against dirt, dust and traffic film, it stays bright throughout its long life—maintains high efficiency without service or maintenance.

**NO BLACK-OUT**—Because there is a separate bulb within the sealed unit, your Guide Sealed Beam unit will not fail in case of a cracked lens—will light the way safely until the damaged unit can be replaced.

GUIDE LAMP DIVISION OF GENERAL MOTORS CORPORATION

SAFE HEADLAMPS ARE "CORRECTLY AIMED" HEADLAMPS—HAVE YOURS CHECKED TODAY



Now! tests prove-

# BRIGHT

# STAR

# BATTERIES



give more  
bright light  
longer

Here is your proof!

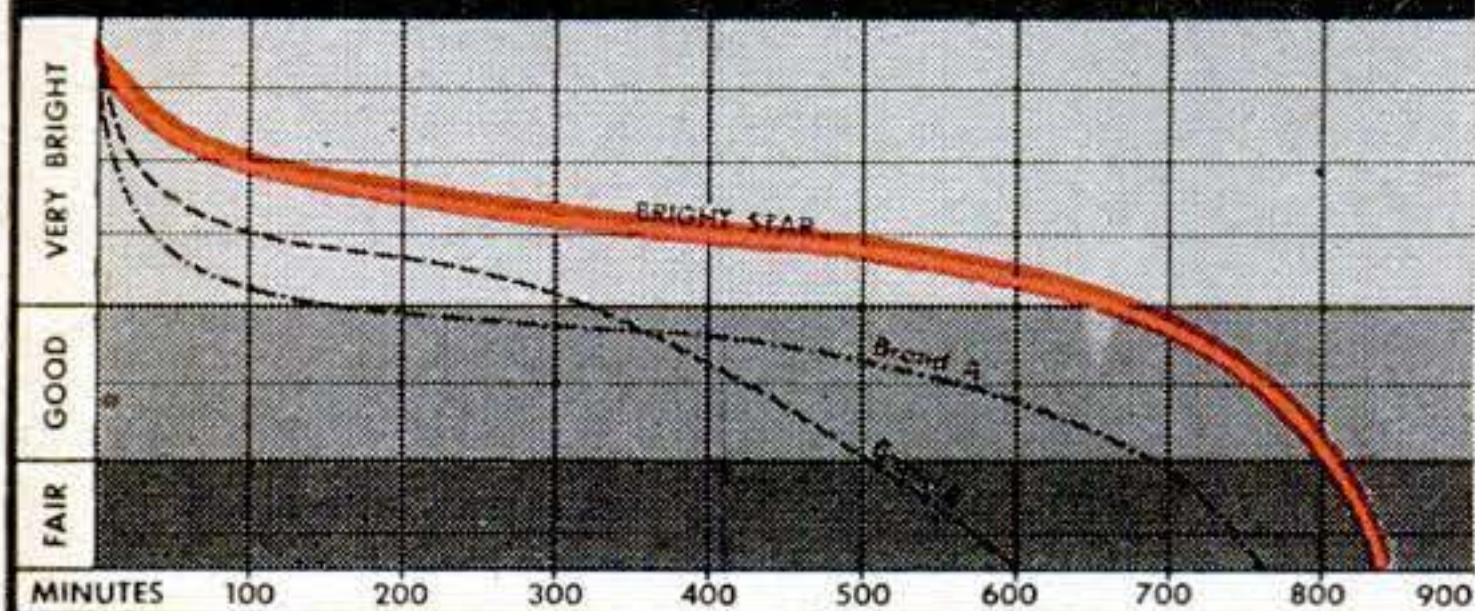

These results of vital service tests\* prove that Bright Star batteries give you more *bright light* longer than the two other leading brands tested. Insist on the best—it's Bright Star by test!

\*Chart based on laboratory tests conducted under government standards.

BRIGHT STAR BATTERY COMPANY, CLIFTON, NEW JERSEY

Special Gifts for Christmas

With a 1 Year Written Guarantee



Back Again

EMPIRE  
PANTS PRESSER

Now you can get it! This popular deluxe model electric Presser! Presses trousers even while worn—coats, ties, pleats, too. No wet cloth or pressure needed. Ready for duty at a minute's notice, anywhere, anytime. Complete with 6 ft. cord and plug. Easy to use—just plug in any AC or DC outlet: operates only 37 watts, and weighs only 10 ounces. Comes individually gift-boxed. No. 2905. Price **\$1.65** Each (Shp. Wgt. 3/4 lb.) Lots of 6 \$1.50 Plus postage

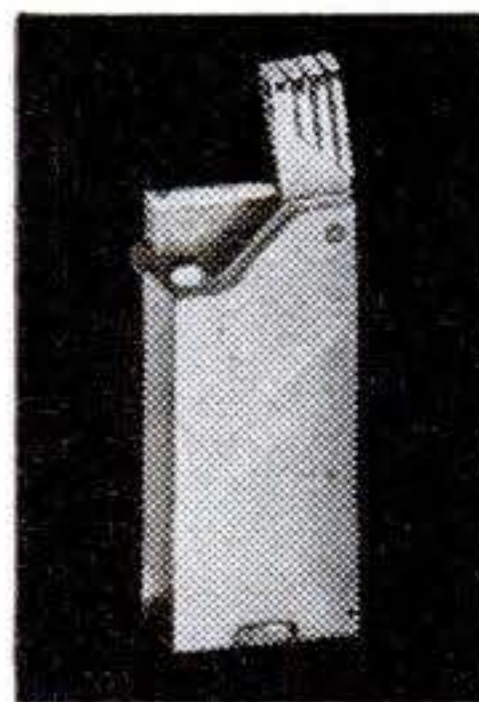

QWIK-LITE  
CIGARETTE LIGHTER

A real prewar-type lighter! Never fails! Smart looking, too, with slim, streamlined design finished in non-tarnishing aluminum. Individually gift-boxed. Price **\$7.75** No. 7205..... 1 doz.

(Shp. Wgt. 2 lbs.) 6 doz. lots, \$7.45 doz. Plus postage SEND Check or Money Order Today. No C.O.D.

Free Catalog—Send for new 1946 G & E Parts Catalog: Hundreds of hard-to-get items at money-saving prices. Write now!

G & E EQUIPMENT SUPPLY CO.

Dept. PS 12, 400 N. Sangamon St.

Chicago 22, Ill.

CROSMAN *Silent* RIFLES



NOW AVAILABLE

America's favorite compressed air rifles for indoor or outdoor shooting are back again! Available in .22 Cal. Single Shot and Magazine Loading types. At your dealer—or order direct. Ask for Crosman SUPERPELLS too—the better ammunition for all compressed air rifles: .177 Cal.—\$2.25 per M; .22 Cal.—\$2.50 per M.

CROSMAN ARMS CO., INC. ROCHESTER 7, N. Y.

AMAZING MYSTERY  
BUTTON



Startles Everybody. With this *Electronic Button* you can make your own Telephone-Amplifier-Detectophone. Attach this button to piece of cardboard—transmit conversation to another room. Music also transmitted to distant places. Most interesting electrical apparatus ever discovered. Enables you to perform hundreds of experiments. So tiny it can be concealed in dozens of places. A Pre-War Product. Electronic Button including 5000 word instruction booklet with 50 illustrated experiments, postpaid, only **\$1.00**

SUPER MYSTERY BUTTON

Many times as sensitive as our regular mystery button. Can be used for the same experiments and uses as the mystery button but with far better results. Needs no diaphragm of any kind. Ideal for musical instruments, intercommunication, recording, talking thru radio, and many other uses. When used with small head phone it makes an ideal inexpensive hearing aid. Shipped with 5000 word, 12 page booklet showing diagrams for dozens of uses, postpaid \$2.00.

Electronic Products Company  
Saint Charles 2, Ill., U.S.A.

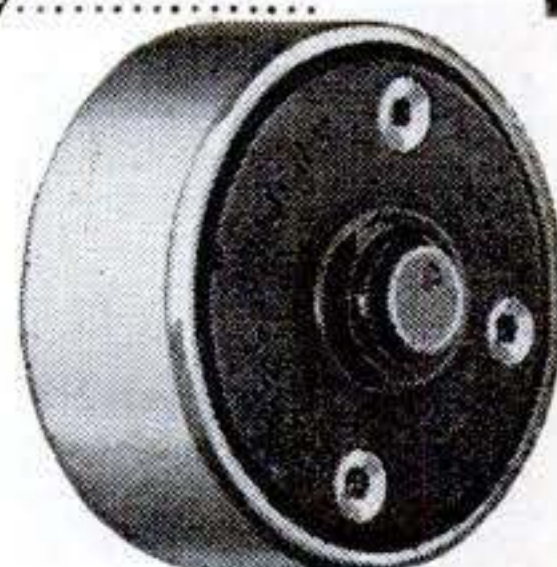





# AMERICAN TOOL CHEST!

## Complete 10-piece Woodworking Outfit

Boys, it's terrific! Make your own furniture, boats, toys. Get this handsomely finished sturdy wooden Tool Chest 12 $\frac{3}{4}$ x5 $\frac{3}{8}$ x3 $\frac{1}{4}$ . Hinged lid and clasp lock. bright red lacquer finish. Full assortment of fine quality wood-working and other handy tools.

### Everything You Need!

12" spring steel cross-cut Saw cuts with or across grain. 12" Ruler with inch and fractional markings in 16ths. Handsomely finished carpenter's Level with standard brass mounted inset bubble gauge. Steel square with inches. Wooden combination vise and clamp holds work rigid. 9" Screw Driver. Chisel with  $\frac{5}{8}$ " cutting edge. 6" Precision Pliers. 10 $\frac{1}{2}$ " Hammer with nail removing claws.

**\$3**

### Special GIFT OFFER!

Limited quantity only. This handsome 10-piece set . . . Wood Chest and 9 Carpenter's Tools at manufacturers Introductory Price of \$3. At your dealers, or shipped direct as Gift in heavy cardboard carton. Get yours while they last. Just send three \$1 bills—\$3.25 West of the Rockies and Canada. Comes to you postpaid.

### GUARANTEED SATISFACTION

If you are not delighted with this Chest after 24 hours inspection you may return for full refund. Act today.

# Electric WONDER PEN Outfit

## Burns Beautiful Designs in Wood

Get this great handcraft tool PLUS all equipment on Special Gift Offer! Finest quality electrically heated WONDER PEN. Etches easily into wood with rich, varied tones of brown. Apply Colors for special effects, and sandpaper and varnish for fine durable finish. Decorate your home with handsome art pieces. Develop your skill. Make good money too, selling your own handwork.

### Only Pen Guaranteed 800 Working Hours

Long life point and heating coils. Comfortable, cool cork grip. Standard 4 $\frac{1}{2}$  ft. cord and plug.

### Decorate Cork, Leather, Etc., Too

Make coasters, trays, highball jackets. Decorate belts, fobs, monograms. Create your own art pieces.

### Easy To Learn

Full instructions included with set. Use all-purpose point for lining, etching, shading.

**\$3 ONLY**

### COMPLETE—PEN and ALL MATERIALS

- Guaranteed Electric Wonder Pen.
- 2 Plaques 6 $\frac{5}{8}$ x4 $\frac{1}{2}$
- 4 Pc Bookends 5x4
- 3 Plaques Approx. 4 $\frac{1}{2}$ x4
- 4 Plaques Approx. 3x4
- 2 Paint Brushes
- 6 Colors Paint
- Pkg. Nails
- 2 Sandpapers
- Bottle Varnish

### IF YOUR DEALER CAN'T SUPPLY—MAIL COUPON

American Toy & Furniture Co., 725 S. LaSalle, Chicago 5  
Enclosed is \$..... Please send me the items checked.

American Tool Chest—\$3  Electric Wonder Pen Outfit—\$3

Name \_\_\_\_\_

Address \_\_\_\_\_

City \_\_\_\_\_ State \_\_\_\_\_

(Add 25c West of Rockies and Canada)



**AMERICAN TOY & FURNITURE CO.**



# RESEARCH

IS THE BASIS

Pick any program on any station, however far away... and you'll marvel at the way the matchless National NC-2-40D brings it into your living room. You'll thrill to its performance... in almost any weather... thanks to the sensitivity and selectivity that earned National receivers a place on three-fourths of the Navy's warships. Years of untiring research are back of its dependability. See and hear it for yourself. Write today for the name of your nearest dealer.

EST.  1914  
MALDEN, MASS

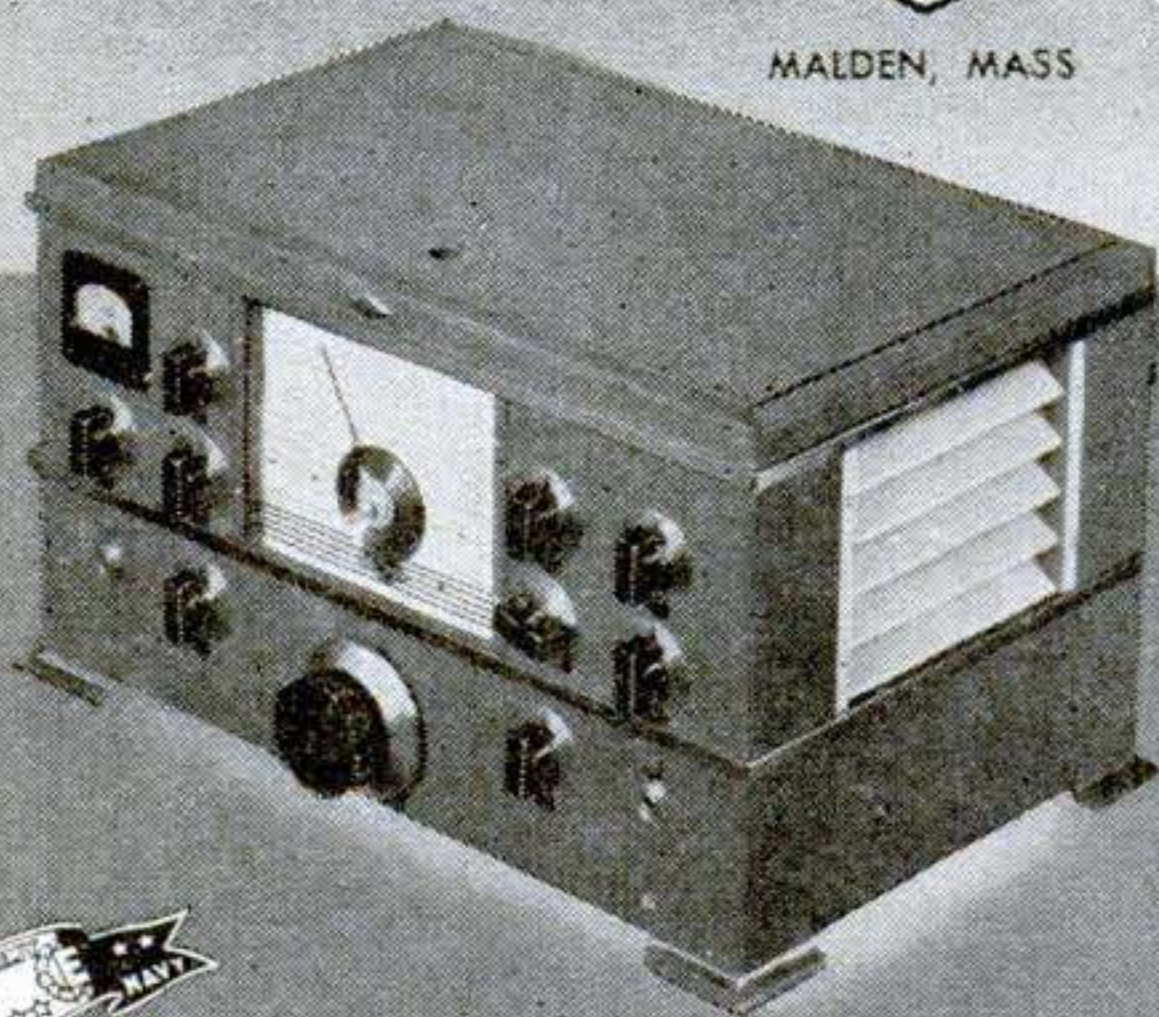

# NATIONAL

COMPANY, INCORPORATED

THE MOST DISTINCTIVE NAME IN RADIO COMMUNICATIONS

## Do Expert Welding At Home WITH THE HANDY *Magic Wand* WELDER



You just plug in on the nearest standard 110-V, 60-cycle AC outlet and do welding and brazing jobs like a professional. Heavy-duty transformer has 6 stages of welding heat. Electrode holders adaptable for electric flame or metallic arc welding. Special polarized outlet plug. All built into strong, shock-proof carrying case, weighing less than 30 lbs. packed. Kit includes welding, brazing and soldering supplies, helmet, instruction manual. Quickly pays for itself. Sold by hardware and auto supply dealers.

COMPLETE

**\$34<sup>50</sup>**

F.O.B. Factory

## FREE Welding Handbook

28 pages of valuable information on welding, brazing, soldering; how and when to use each process; how to handle various metals; new uses for welder, etc. Send postcard for your copy NOW.

**JOHN H. GRAHAM & CO. INC.,**  
General Sales Agent

Dept. E, 105 Duane St., New York 8, N. Y.

MADE BY PATENT SPECIALTIES, INC., NEW YORK, N. Y.

## Imported SWISS POCKET WATCHES

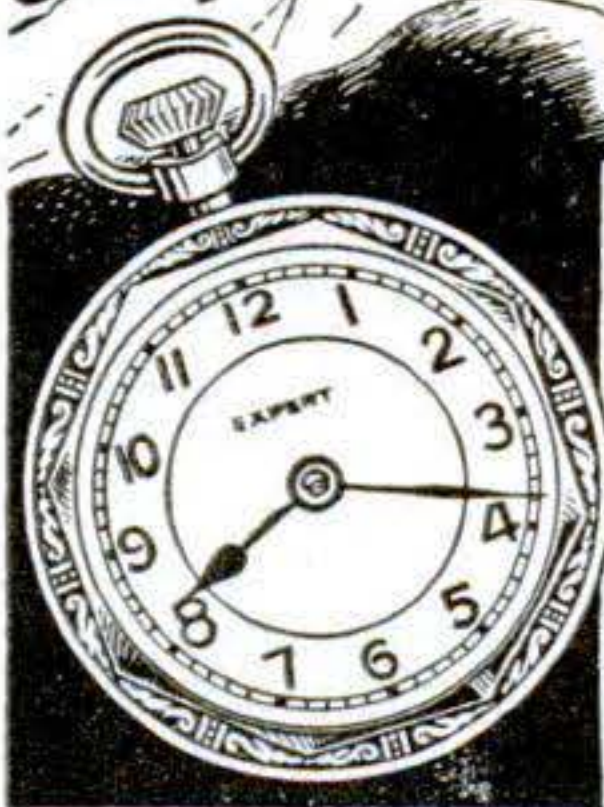

### WRITTEN GUARANTEE WITH EACH WATCH

Handsome, dependable, Swiss watches are renowned as excellent timekeepers because they are made by master watch craftsmen. Sturdy. Fine-constructed. Genuine chrome case.

**WEAR 10 DAYS AT OUR RISK!**

If not completely satisfied, return for refund. SEND NO MONEY. Simply pay postman \$8.50 plus 10% tax and postage on delivery. Cash orders sent postpaid. An exceptional bargain.

**UNITED PRODUCTS CO.**  
7941 S. Halsted, Dept. PW-515,  
Chicago 20, Illinois



A welcome gift that is a  
year-'round reminder of your  
thoughtfulness at Christmas

THE *Deltagram*  
favorite magazine of woodworking hobbyists

Page after page of plans, pictures, projects — expert advice on doing good-looking work easily, quickly, safely. Enough to keep any homemaker happy for a long time! Give this gift of lasting pleasure — The *Deltagram*. Send names and addresses today — with coin, postal note, or money order.

\*Trade Mark Reg. U. S. Pat. Off.

**6**  
Big Issues  
**50¢**

**DELTA MANUFACTURING DIVISION**  
Rockwell Manufacturing Company  
683N E. Vienna Ave., Milwaukee 1, Wis.

HM-44





# OWN A "POCKET SIZE" MACHINE SHOP

## IMPROVED MOTO-TOOL

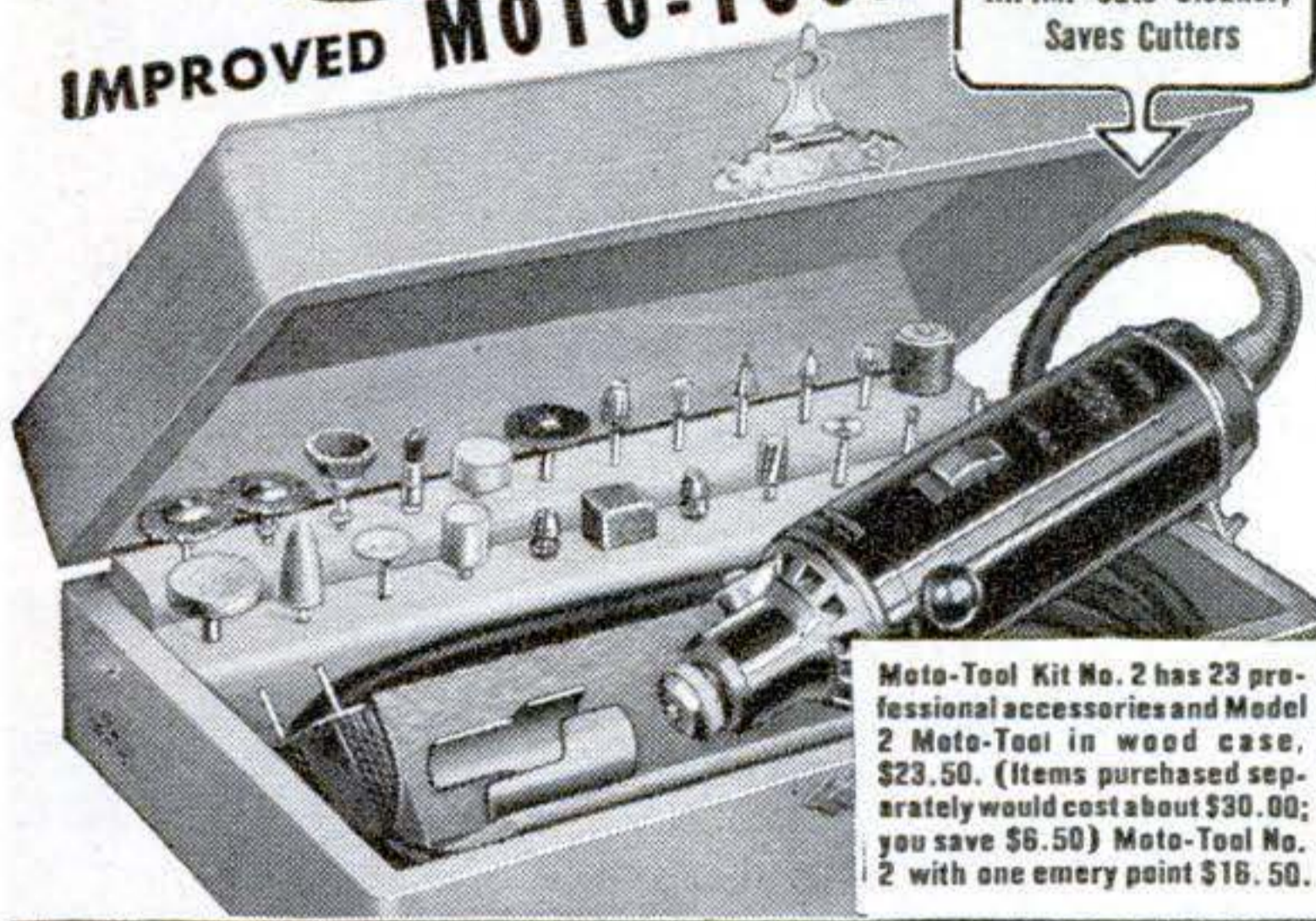

Approximately 27,000 R.P.M. Cuts Cleaner; Saves Cutters

Moto-Tool Kit No. 2 has 23 professional accessories and Model 2 Moto-Tool in wood case, \$23.50. (Items purchased separately would cost about \$30.00; you save \$6.50) Moto-Tool No. 2 with one emery point \$18.50.

## Here's a Craftsman's Gift That Packs Years of Pleasure

Here's a gift to please a man's heart. A gleaming "powerhouse" that holds promise of endless creative hours. This "pocket-size machine shop" is a war veteran . . . used by all branches of the armed forces in far flung repair bases . . . and it helped set production records at General Electric, Westinghouse, Remington Arms, Ford and other plants. Hobby enthusiast or expert craftsman . . . first choice is model 2 Moto-Tool kit, with its handsome, felt-lined, highly finished wood case . . . with rows of tools begging to be put to work. The usefulness of Moto-Tool for precision work is increased by two versatile attachments now available at slight additional cost (see below).



### Look For These Moto-Tool Features

Housing has "pencil-type" finger grip. Instant-action, wrenchless chuck. Oil-less, sealed, trouble-proof bearings. Patented automatic chuck lock pin. Oversize armature shaft, hardened, ground and polished. 110 volt, universal type motor. Easily replaced commutator brushes. Sliding snap type switch. Handy hanger hook. Cord protector. Sturdy, shockproof bakelite housing. Dust-filtered, air-cooling system. Weighs only 13 oz. . . . shaped to fit the hand. Dynamically balanced for vibrationless operation.

### MONEY BACK GUARANTEE

Buy Dremel Moto-Tool and Accessories from your dealer. If he does not handle them, order direct from the factory on a 10 day trial, money back guarantee.

### Do These Better—Faster

- Brushing
- Dressing
- Burring
- Grinding
- Routing
- Sanding
- Drilling
- Inlaying
- Sawing
- Scoring
- Cutting
- Carving
- Sharpening
- Burnishing
- Engraving
- Touching Up
- Mortising
- Polishing
- Finishing
- Cleaning
- Rasping

## Free Both Hands With Moto-Tool Attachments



Moto-Tool Stand (left) made of heavy cast iron, holds Moto-Tool at any position or angle . . . \$4.50

Moto-Tool Shaping Table \$2.50. (Shown with stand, right). Aids accuracy in routing and grinding.



**DREMEL MFG. CO., Dept. 126-M, RACINE, WISCONSIN**

## Sand Casting—Forging—Heat Treating—Case Hardening BRONZE FOUNDRY



is again available in limited quantity without priority. Orders filled in sequence as received. INVENTORS-SCHOOLS-CRAFTSMEN use FOUNDRYETTE for making castings quickly for new inventions, for instruction, and general purpose. Order now for early delivery. Three sizes are available capable of making bronze castings of 1½, 3, and 6 pounds weight, aluminum, copper, brass, etc. \$17.50, \$24.00, \$34.50, f.o.b. Kansas City. Domestic gas supply and 110 volt AC or DC energy required for operation. Write for circular.

**KANSAS CITY SPECIALTIES CO.**  
Box 6022, Dept. S-73 Kansas City, Mo.

## DOWEL TROUBLES?



Now you can make dowels that match your wood! Amazing new SPEE-DOWL makes perfect, burnished dowels for arrows, cabinet work or other projects. Simply rotate wood in lathe or drill press and push on SPEE-DOWL! Works like pencil sharpener. Cast aluminum body, spring steel blade. A necessity for fine craftsmanship.

### GUIDE FINISHED CHUCK BLADE HOLES DOWEL

Available in 2, 3, 4, 5, 6, 7, and 8/16" sizes. Only \$1. Special—any 4 sizes \$3; complete set of 7 for \$5. SENIOR MODEL, 9/16" to 1¼" only \$2.65 ea. Send Postal Note or check NOW for your SPEE-DOWL. Unconditionally guaranteed. Free literature.

**Johns Mfg. Corp., Dept. B-3, 501 Bound Brook Rd., Dunellen, N. J.**

## The Chief WORK BENCH

A CHRISTMAS PRESENT HE'D APPRECIATE

*Built to Last a Lifetime!*

With Bottom Shelf and 18" Sq. Drawer. 2"x6", Solid Plank, Grooved and Dovetailed Top and 1"x8" Back Rail, Shellacked to a Smooth, Satiny Finish.

**MOHAWK LUMBER CO.** Dept. 34  
14525 W. Chicago Blvd. Detroit 27, Mich.  
Enclosed  Check  Money Order for \$  
Ship.....CHIEF WORK BENCHES at

Quantity \$16.95 each, F.O.B. Detroit, Mich.  
 Send C.O.D., \$5 Deposit Enclosed.

NAME.....  
ADDRESS.....  
CITY..... STATE.....  
No Priority Necessary!

• 6 Ft. Long • 34" High • 26" Deep. Shipped Knock-down, with Bolts, Nuts and Screws and ABC Chart for Quick, Simple Assembly.

*Prompt Delivery*  
**MOHAWK LUMBER CO.**

14525 W. Chicago Boulevard  
DETROIT 27, MICHIGAN



**\$16.95**  
F.O.B. DETROIT

Send Check or Money Order, or Will Ship C. O. D. (\$5 Deposit)



USE AC's FOR  
**UTMOST  
RELIABILITY**

"The mail must go through"—and does, with the help of today's AC's in thousands of mail cars and trucks. You can enjoy utmost reliability in spark plug performance by having your spark plugs checked to be sure they are right for today's driving and fuels.



Look for this sign



Spark Plugs cleaned and adjusted "By the AC Method" may save as much gas as 1 gallon in 10



**AC  
SPARK PLUGS**

AC SPARK PLUG DIVISION • GENERAL MOTORS CORPORATION

238 POPULAR SCIENCE

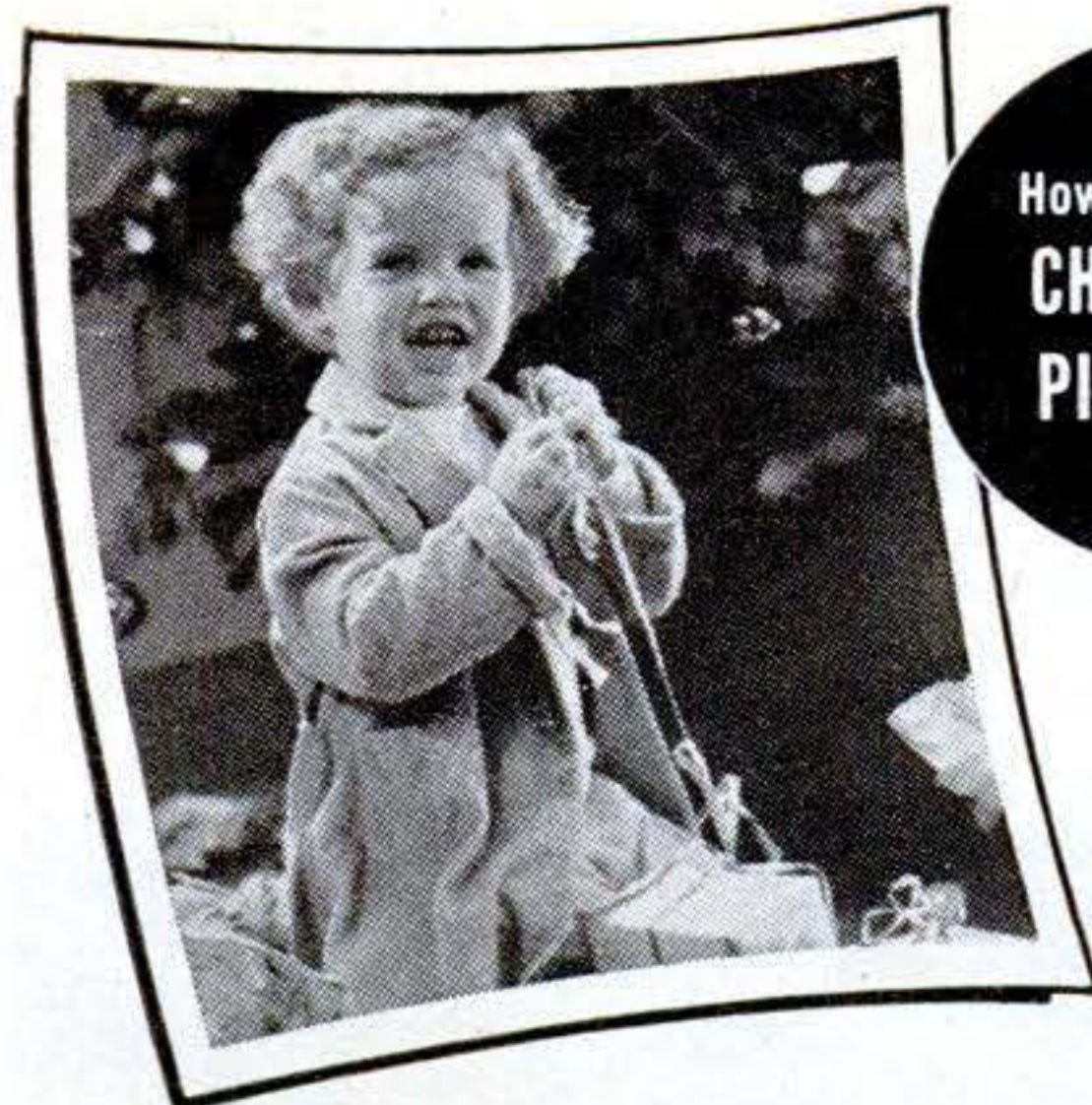

How about your  
**CHRISTMAS  
PICTURES?**



Make sure they're better, get the new, improved  
**G-E exposure meter**

Gives you more from your camera. Correct exposure in a jiffy. Lighter. Sturdier. New, easy-to-read dials. Accuracy you can trust. Get the new G-E meter at your photo dealer's. (Or whisper to Santa!) It's 3 meters in one. General Electric, Schenectady 5, N. Y.

Type DW-58 **\$26.95** Federal tax included



**GENERAL ELECTRIC**  
606-18711-6336

**Supercharge YOUR CAR**

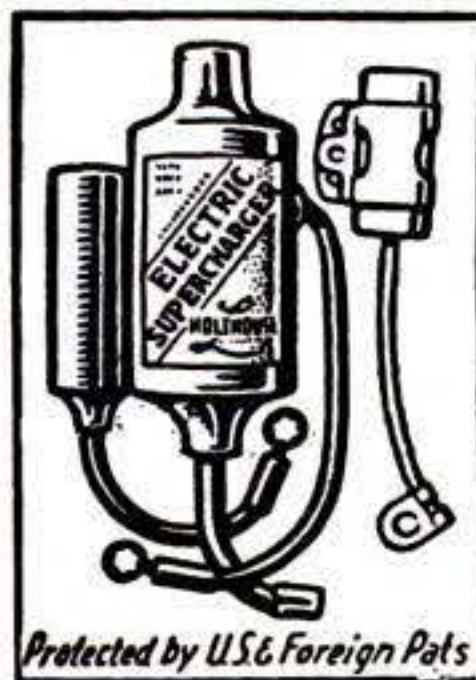

Protected by U.S. & Foreign Pats

**For EASY WINTER STARTING**

Makes Motor Start Quicker—Run Smoother. ELECTRIC SUPERCHARGER is a patented high-frequency transformer designed for POWER, ECONOMY and SUPER PERFORMANCE in motors. Car owners, mechanics and fleet owners report amazing results, even on new cars. NOTHING LIKE IT ON THE MARKET. Gives engine New Life—Increased Power—a 60% Longer and Hotter Spark—more Complete Combustion—less Spark Plug Fouling and Longer Life. Fits all cars except Ford V8 and Mercury. Order Model V Supercharger for 1942-46 Ford or Mercury. ELECTRIC SUPERCHARGER is sold on a 15 DAY TRIAL—MONEY BACK GUARANTEE FOR ONLY \$3.95 in U. S.

**HOLTHOUSE LABORATORY**  
3918 W. Grand Ave., Dept. B-3, Chicago 51, Ill.

**Utica Tools**  
U T I C A

**Pliers for Every Need**  
ASK YOUR DEALER

**UTICA DROP FORGE & TOOL CORPORATION**  
UTICA 4, NEW YORK



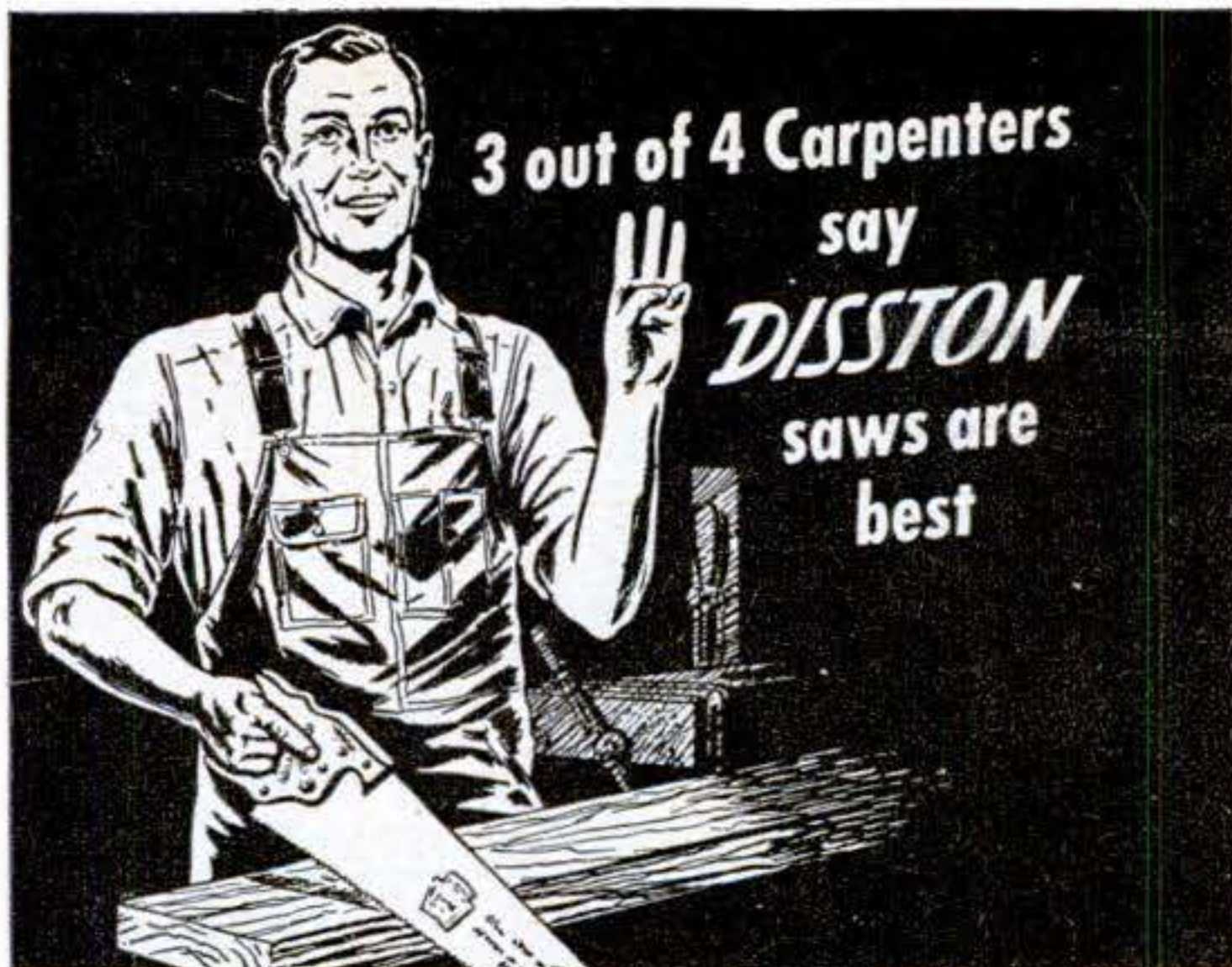

"In your opinion, which make of handsaw is highest in quality?" Thousands of carpenters were asked that question. Three out of four replied, "Disston saws" ... a high tribute indeed, for it comes from men who know saws best.

The reasons for this preference may be summed up in what one carpenter says, "You can't beat a Disston for good, clean cutting and long life."

Ask your Hardware Retailer for a fine looking, fine performing Disston Saw. Also ask him for a FREE copy of "The Disston Saw, Tool and File Manual," or write to us direct.



**HENRY DISSTON & SONS, INC.**  
1210 Tacony, Philadelphia 35, Pa., U. S. A.

**DISSTON** The saw most Carpenters use



## REPAIRS BROKEN ARTICLES

DUCO CEMENT mends most everything—china, glassware, luggage, books, toys, furniture. It's waterproof, transparent and flexible. Keep a tube for instant use!



**DUCO CEMENT**  
REG. U. S. PAT. OFF.

## HERE THEY ARE THE ORIGINAL *Paratroop* *Hunting Boots*

The uppers are *waterproof elk* ... for greater hunting, fishing and general outdoor utility. That's the only difference between these boots and the famous rugged and comfortable Paratrooper Jump Boots, made by Corcoran during the war.

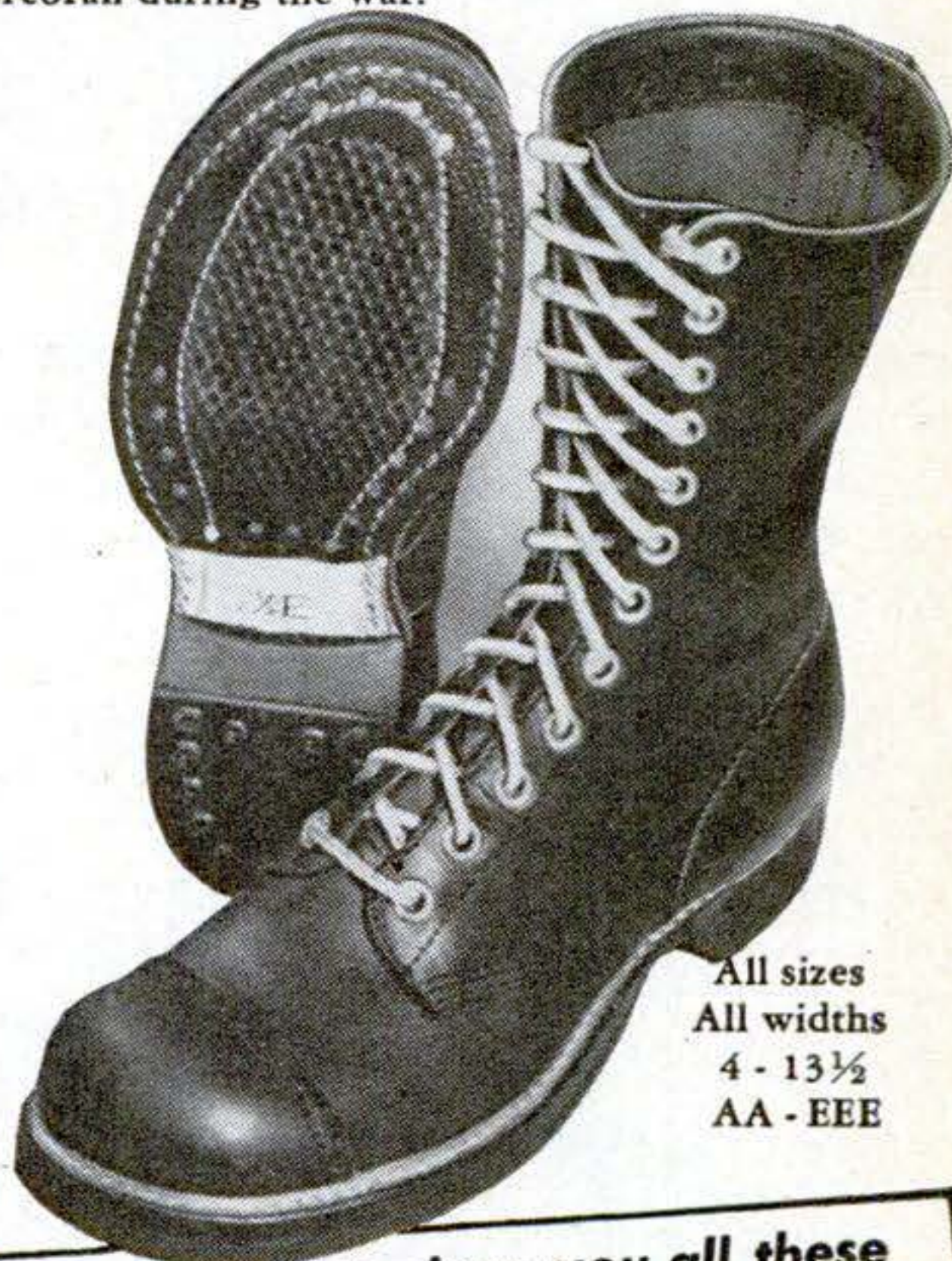

All sizes  
All widths  
4 - 13½  
AA - EEE

### No other boot gives you all these EXCEPTIONAL FEATURES

- Made of soft, pliable elk with extra heavy oil waterproofing.
- Full 10 inch height gives proper support.
- Balanced construction gives ideal walking comfort.
- Special heel and toe construction prevents tiring.
- Counter, box toe and bottom filler all leather. Shank is made of steel.
- Heavy reinforcing tape on sides of instep prevents stretching and assures good snug fit.
- Middle sole is leather of outsole quality. Outside tap is rubber, sewed to middle sole in two places and nailed clear through to insole to prevent ripping off.
- Special Goodyear rubber heel gives maximum springiness and reduces hazard of tripping.

At this Amazing  
Low Price

These boots are not government surplus stock. We can offer them at this unusual low price only by selling direct to you. Money back if not satisfied on receiving them.

ONLY  
**\$ 9.87**  
Plus  
Postage  
Postage only is C.O.D.

**CORCORAN INC., STOUGHTON, MASS.**

Please rush a pair of Paratroop Hunting Boots. Check  Money Order  for \$9.87 is enclosed. I will pay postage C.O.D.

Name \_\_\_\_\_

Address \_\_\_\_\_

Size and width of Shoe \_\_\_\_\_

PS-12

DEC. 239  
1946



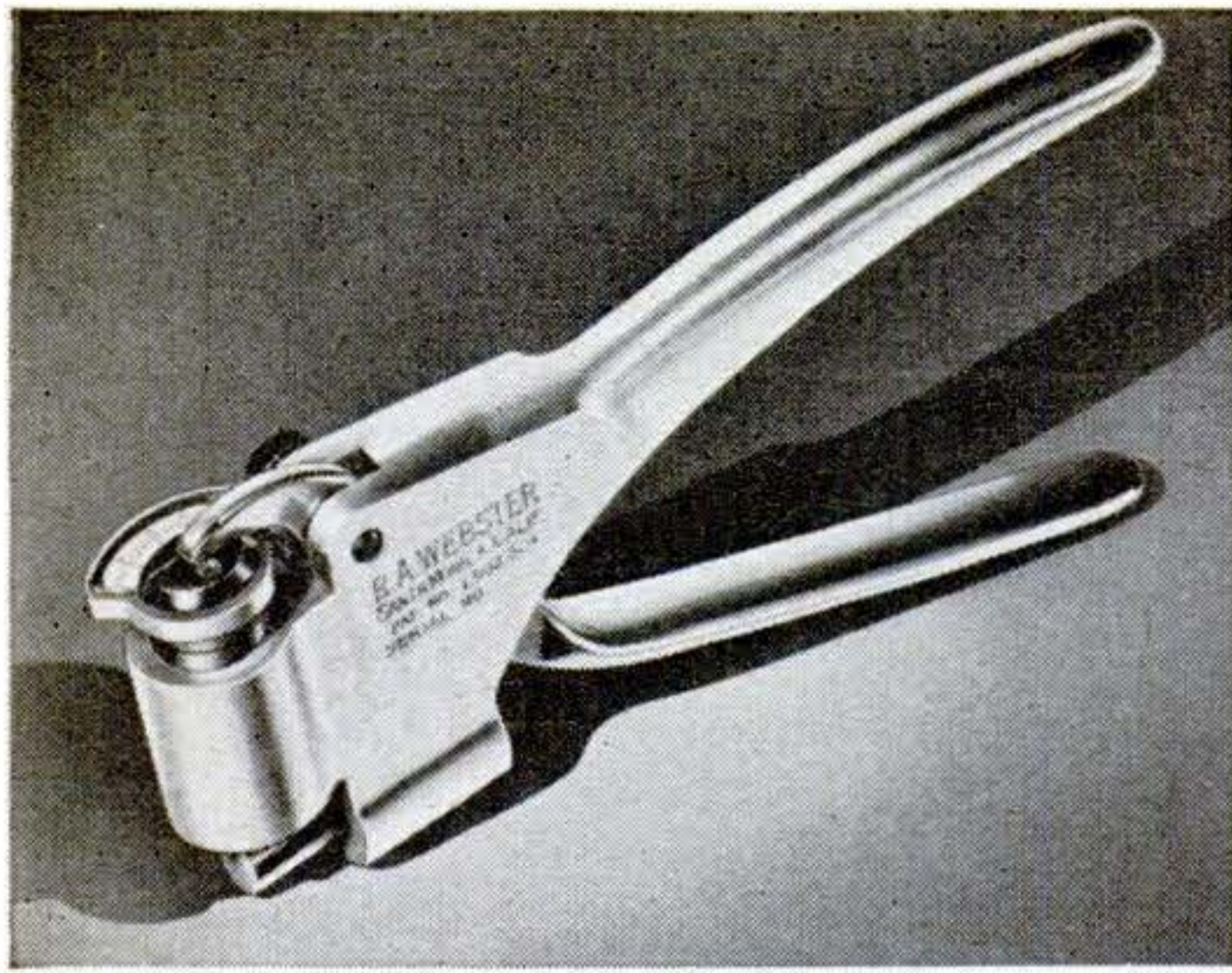

## Hand Metal-Hardness Gauge

A NEW hand-operated, portable gauge for determining variations in the hardness of aluminum and its alloys, and another for testing copper, brass and other nonferrous metals, are introduced by R. A. Webster, a Santa Monica, Calif., company. The instruments look and operate alike. Squeezing the handles actuates a penetrator, and a meter shows the hardness of the material being tested. The penetrator's real pressure is applied by a spring load unrelated to the pressure put on the grips of the

gauge, assuring consistent readings. Both models are equipped with cylindrical anvils that allow testing of strips, sheets, tubes or extrusions with a single tool.

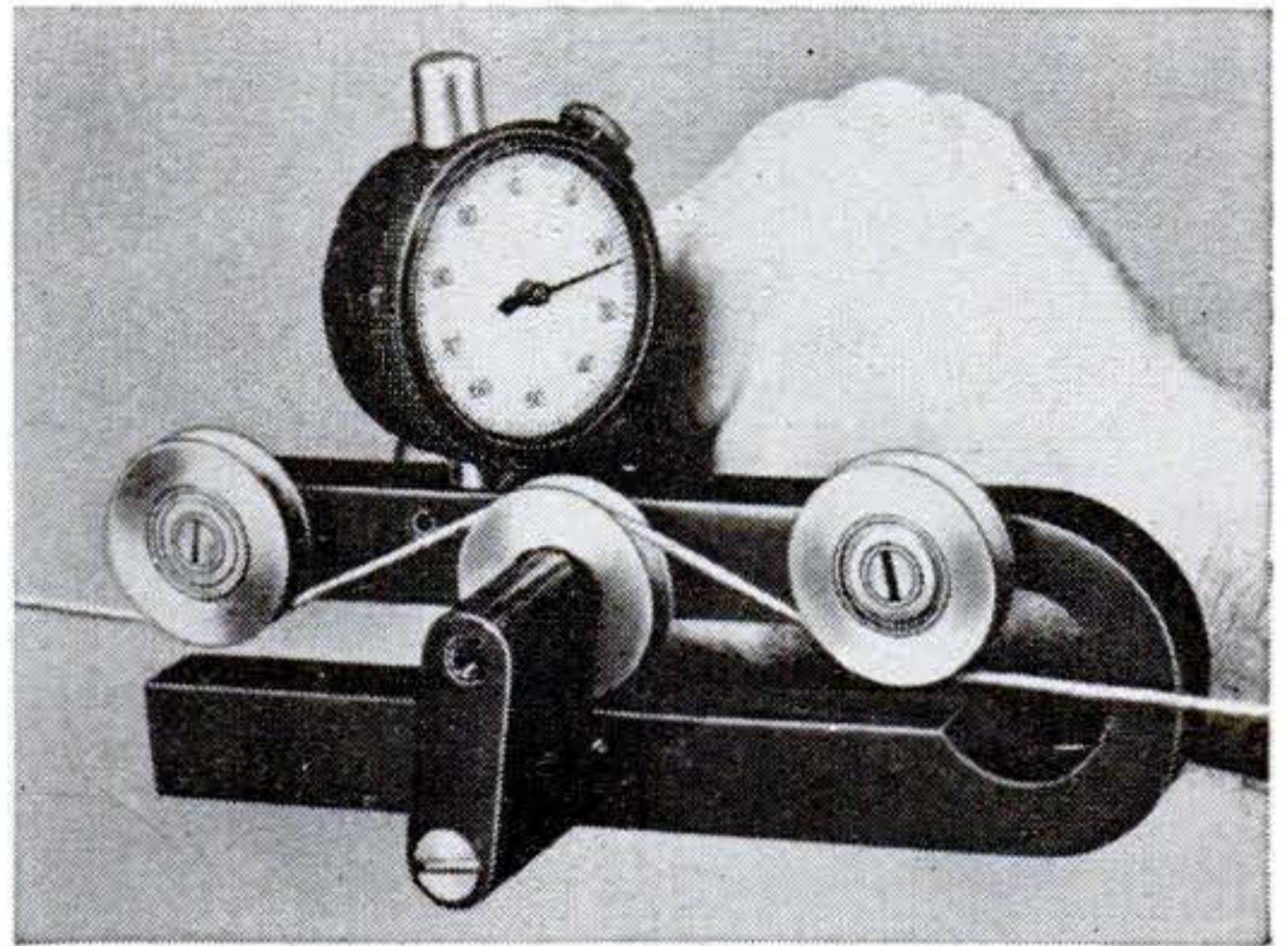

## Tests Tension of Textiles

FOR testing the tensile strength of cord, yarn or thread up to 100 pounds, Walter Kidde & Co., Belleville, N. J., has devised the "tensometer" shown above. The instrument can be clipped onto moving, continuous textile filaments and measures tension directly in pounds.

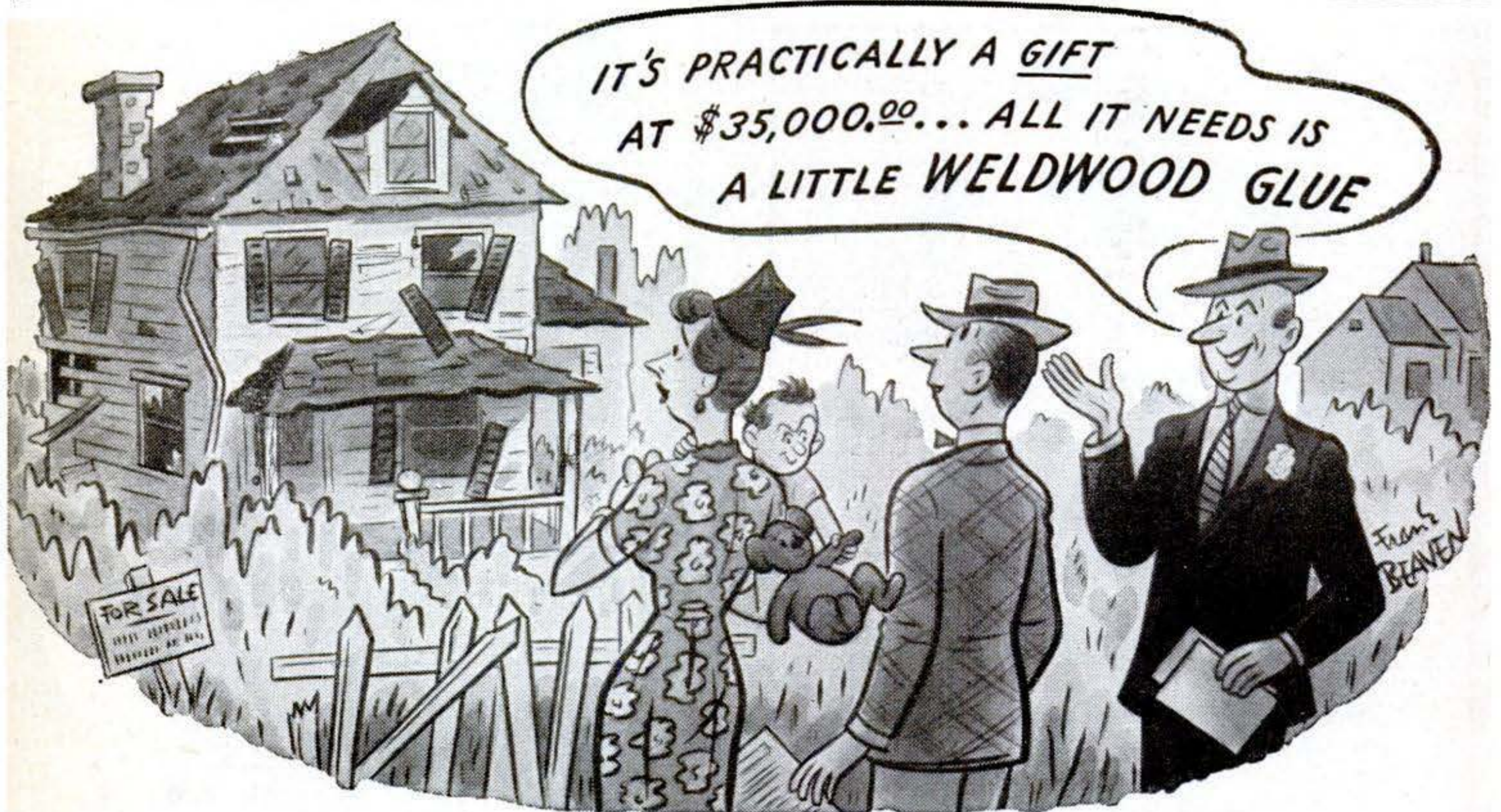

# WELDWOOD

## PLASTIC RESIN WATERPROOF GLUE

UNITED STATES PLYWOOD CORPORATION, NEW YORK 18, N. Y.

240 POPULAR SCIENCE

When you want to fix things fast... remember Weldwood Glue. It's quick to mix... easy to use... tremendously strong... stain-free... rot-proof... and permanent. At hardware stores, lumber yards, chain stores.



**IT'S A GRAND FEELING,  
TO RUN A  
MINIATURE RAILROAD**



**IT'S A GRAND FEELING, TOO,  
WHEN YOUR CAR IS  
CUSHIONED WITH MARFAK  
CHASSIS LUBRICATION**

Miniature railroading is fun, with remote controls, realistic whistles, and real smoke. And a smooth riding car is lots of fun, too.

That "cushioned" ride you feel when your car is lubricated with *Marfak* is evidence that *Marfak* is doing its job . . . is furnishing a lubricating cushion for your vital chassis bearings. And *Marfak* lubricates for longer, too, a thousand miles and more.

It's because *Marfak* is scientifically designed to do its job . . . its special adhesive and cohesive qualities resist wash-out, jar-out, and squeeze-out. *Marfak* clings to the bearing surfaces . . . sealing out dirt and grime.

Yes, it's a grand feeling when your car is "cushioned" with *Marfak* chassis lubricant. See your Texaco Man today, and say: "*Marfak*, please."



*With ordinary grease . . . you're taking the road shocks again after a few hundred miles.*



*Marfak stays on the job hundreds of miles longer — means more velvet smooth riding.*

# TEXACO DEALERS



SKY CHIEF  
GASOLINE



FIRE-CHIEF  
GASOLINE



HAVOLINE AND TEXACO  
MOTOR OILS



MARFAK  
LUBRICATION



THE  
TEXAS  
COMPANY

**TUNE IN:** TEXACO STAR THEATRE presents the new Eddie Bracken show every Sunday night. METROPOLITAN OPERA broadcasts every Saturday afternoon. See newspapers for time and stations.

DEC. 1946 241





*A Christmas GIFT*  
He will Use for YEARS

**BMC**

**PRESSURE LOCK WRENCH**

**..actually Six Tools in One!**

2 Handy Sizes Packed  
in a Handsome Gift Box

It will save his temper . . . improve his skill . . . greatly increase his enjoyment of putting around the house, hobby shop, motor boat, car or plane. If he's a worker on the farm, in the shop or factory, he can't afford to be without a set.

For here is a new marvellously improved kind of wrench that is actually six tools in one—adjustable end wrench, pipe wrench, gripping tool, pliers, hand vise, locking clamp. Fits as it grips . . . and it holds . . . with more than a ton pressure, even when the hand is taken away. Can be released with the flick of a finger.

**JAWS ALWAYS PARALLEL**

An exclusive, patented device keeps the jaws parallel when they close. Prevents rounding of nuts, slipping and accidents . . . assures even pressure and a firm grip to the very tip of the jaws.

**Nos. 7 and 9 in a gift box . . . \$5.40**

- No. 7—Max. jaw opening 3/4" . . . . . \$2.45
  - No. 9—Max. jaw opening 1" . . . . . 2.95
  - No. 11—Max. jaw opening 1 1/2" . . . . . 4.60
- For sale at leading hardware, auto equipment, mill supply, plumbing and electrical departments.

**BMC MANUFACTURING CORP.**  
Binghamton, N. Y.

**BACK AGAIN!**

2 1/4 x 3 1/4  
*Miniature*  
**SPEED GRAPHIC**

The 2 1/4 x 3 1/4 Miniature Speed GRAPHIC is again available—in limited quantities, yes, but more and more are going to GRAFLEX Dealers. It is lightweight, compact, versatile! See the many prize-winning features of this dependable, easy-to-handle American-made camera at your dealer's!

**GRAFLEX, INC.** ROCHESTER 8,  
NEW YORK

VISIT Graflex Information Centers—At 50 Rockefeller Plaza, N. Y. and 3045 Wilshire Blvd., Los Angeles, Cal.

**a real professional microphone**  
**TURNER CHALLENGER**

for hams and home recording. Reproduces voice or music crisp and clear. Precision built with moisture proofed crystal. Works indoors or out. Beautifully finished in rich bronze enamel.

Ask your dealer  
Write for Free Literature describing Turner Microphones.

**THE TURNER COMPANY**  
922 17th Street, N. E., Cedar Rapids, Iowa

Crystals licensed under patents of the Brush Development Co.

MODEL BX  
\$10.85  
LIST

**SHAW and "Peppy-Pal"**  
**"DU-ALL" GARDEN TRACTORS**

• 1 to 9 H.P. Circulars on request. Building more now—We supply repairs for all SHAW Tractors sold in our 42 years in business.

**BUILD YOUR OWN RIDING TRACTOR—"WAR HORSE"**

using old auto parts, powered by 2 H.P. or larger air-cooled engine; or walking type Garden Tractor 1/2 to 3 H.P. or convert truck or auto into Farm Tractor. Each with steel or rubber tires; will plow, cultivate. Plans for building, in few hours, any one of above, postpaid for \$1.00 (state which wanted) or all 3 for \$2.00. Money Back Guarantee!

**SHAW MFG. CO., 5712 FRONT ST.**  
Galesburg, Kansas  
668PS North 4th St., Columbus, Ohio



# Snap-on

Octo-Grip  
TRADE MARK

## SCREW DRIVERS



## THE Right Driver FOR EVERY JOB . . .

● What a difference a good screw driver makes! But what makes a *good* screw driver . . . a Snap-on OCTO-GRIP screw driver? Nickel-molybdenum alloy steel blades, electrically heat treated to give the correct combination of toughness and hardness . . . tested hard-tempered tips, precision ground and shaped to prevent "chewing" and breakage . . . easily grasped, OCTO-GRIP plastic handles, non-rolling and shock-proof . . . balanced design that gives you deftness, sureness and speed under all working conditions. These are the "musts" in a really good screw driver . . . and they are in every Snap-on OCTO-GRIP driver you buy.

Snap-on also makes other fine screw drivers . . . more than 75 different models, including Phillips screw drivers in both one piece and detachable head models, Reed & Prince drivers, offset and hammer

head and spark testing drivers . . . a type and size for every service.

Snap-on screw drivers are part of a complete line of 4,000 tools available through Snap-on's nationwide tool service. Write for free catalog.

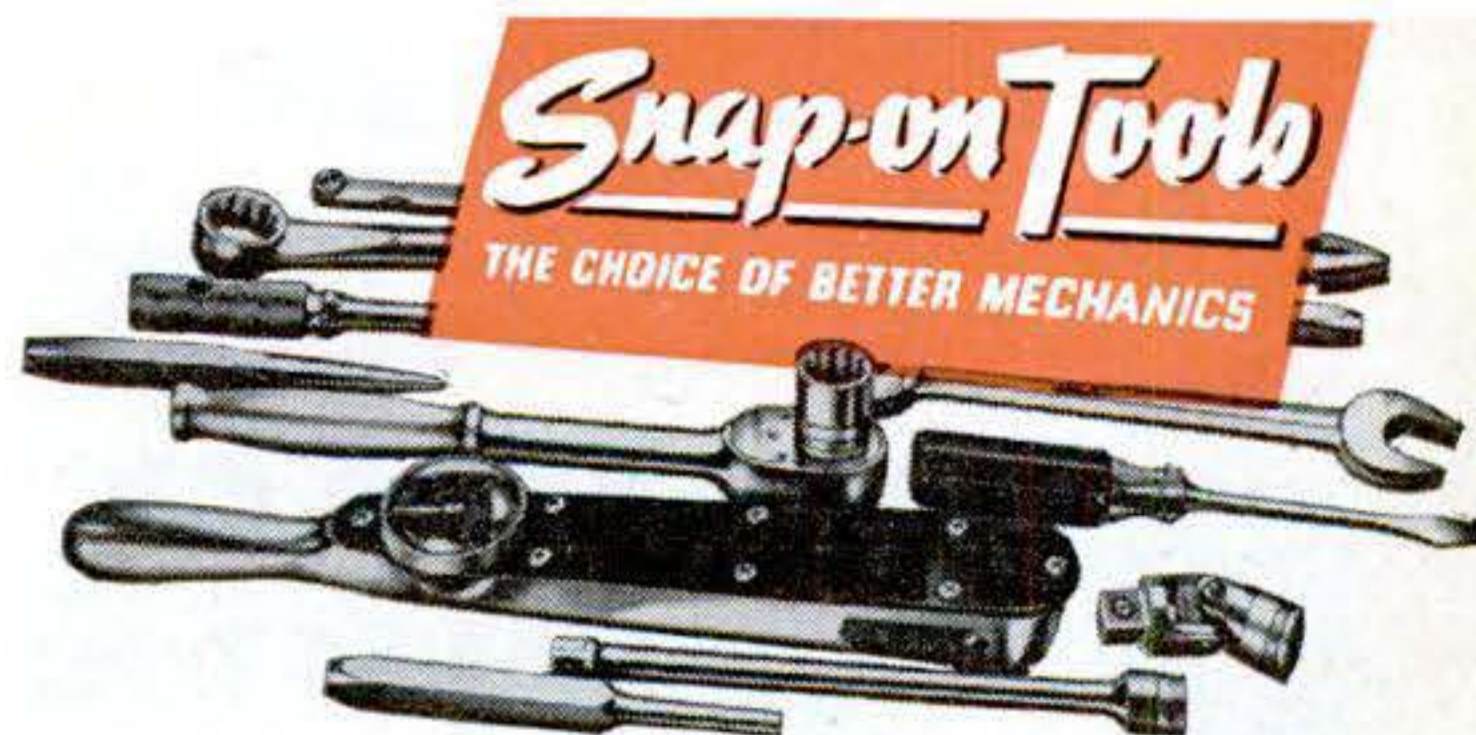

**SNAP-ON TOOLS CORPORATION**  
8060-L 28th AVENUE • KENOSHA, WISCONSIN

DEC.  
1946 243





## A Gift he'll prize!

There's something friendly and cheerful about a pipe that makes it an especially appropriate gift at Christmas-time. Particularly if it's a handsome pipe of fine smoking qualities, such as a Sterling Hall.

These choice pipes are fashioned from selected imported briar, hand-rubbed to a rich finish of lasting beauty. And their appearance is further enhanced by an *inlaid* Sterling Silver band which adds strength to the shank and maintains a perfect fit for the stem.

At better shops in a full range of shapes, individually boxed.

*Sterling Hall, Standard, \$3.50*  
*Sterling Hall, Hand Made, \$5.00*  
*Sterling Hall, Highest Grade, \$7.50*

BRIARCRAFT, INC.  
 347 Fifth Ave., New York 16, N. Y.



## IMPROVE YOUR SHOOTING

BRING HOME  
 MORE GAME  
 with the new

# Nydar SHOTGUN SIGHT

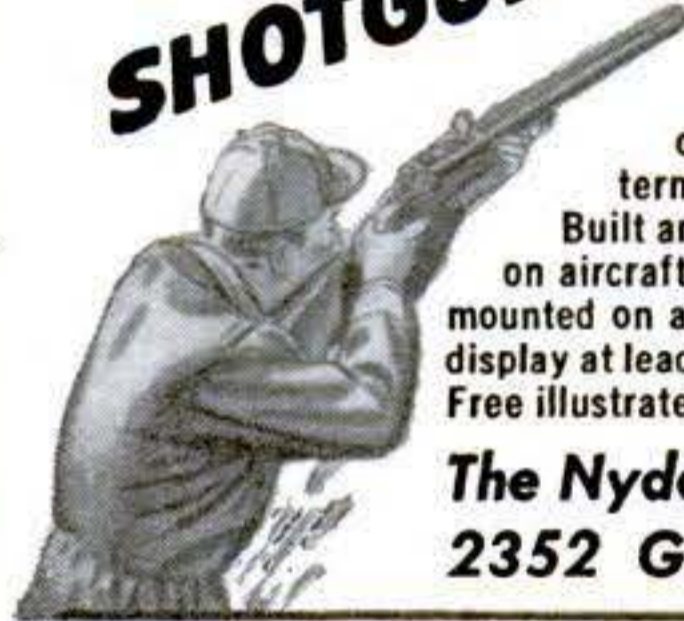

Old timer or beginner, you'll get greater accuracy with the Nydar Shotgun Sight. Puts a "bulls-eye-in-the-sky"—projects a dot and circle into space which indicates the exact center of impact of shot charge. Helps to determine range, and is a guide to correct leading. Built around precision optics on basic principle used on aircraft guns. Ideal for all types of shooting; can be mounted on any type shotgun. \$27.45 plus installation. On display at leading dealers. Makes the perfect Christmas gift. Free illustrated folder!

The Nydar Div., SWAIN NELSON CO.  
 2352 Glenview Rd., Glenview, Ill.

## WORK BENCH

Ideal for hobbyist or shop worker, this sturdy, useful bench makes home handiwork a joy! Heavy top, 2 large drawers. Tool rack, strong shelf, bins for nails and bolts. 59" long—23" wide—36" high. Shipped unassembled, easily set up (from instructions). F.O.B. Phila. factory. Check or money order. Money back if not satisfied.



\$16.95

J. B. NOLAN, Box W, 5040 Walnut St., Philadelphia 39, Pa.



## FREE! Radionic Catalog

New, big, FREE 1947 Catalog full of radios, parts, accessories, tubes, record changers, phono players, etc.

RADIONIC EQUIPMENT CO.  
 170 Nassau St., Dept. 1512 New York 7, N. Y.

## BUILD YOUR OWN ARC-WELDER

For Light or Heavy Work  
 No rewinding necessary—use coils taken from old auto generators. Works on 110 or 220 A.C. Has 20 different heats. Complete plans and BIG Catalog 35c. LEJAY MFG., 3323 Lejay Bldg., Minneapolis, Minn.



DO YOU WANT a permanent business profession of your own? Learn to make and fit arch supports. Earnings of men and women in this profession run as high as \$50 to \$100 weekly. Not medical or chiropody—easy terms for home training—no further capital needed, no goods to buy, no agency. Write for free booklet. 51 years in business.

STEPHENSON METHOD, 6212 Back Bay, Boston, Mass.

"I'LL TAKE THE WHITE ONE EVERY TIME!"



**WYTEFACE**  
 TRADE MARK  
**STEEL MEASURING TAPES**



KEUFFEL & ESSER CO.



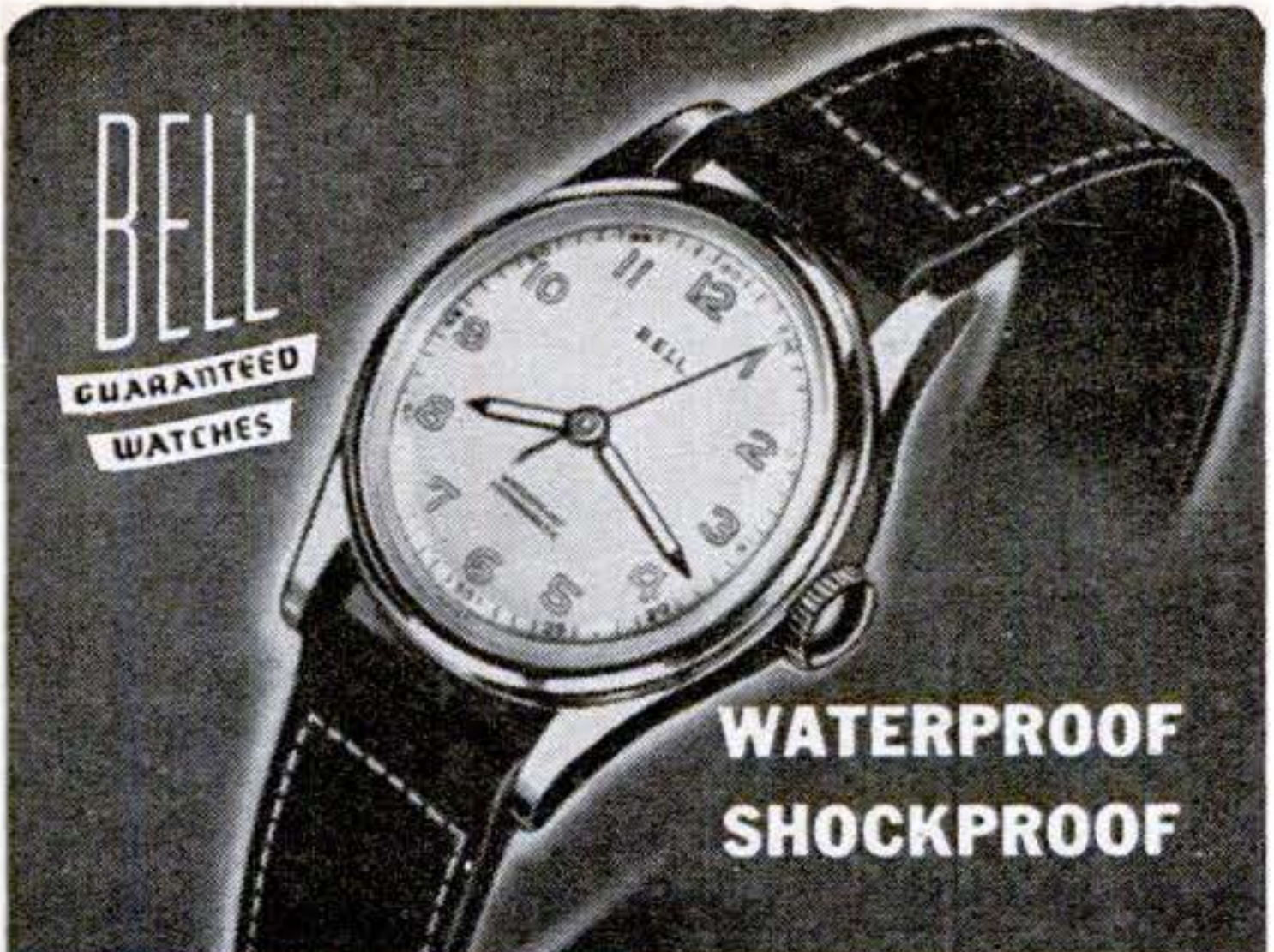

**BELL**  
GUARANTEED  
WATCHES

**WATERPROOF  
SHOCKPROOF**

**THE IDEAL CHRISTMAS GIFT**

Anti-magnetic, radium dial and hands, unbreakable crystal, sweep second hand, precision tested.

No. ON 197  
17 jewels, stainless steel back..... **\$29.75**

No. ON 188  
17 jewels, all stainless steel case..... **\$47.50**

No. ON 328 SELF-WINDING  
17 jewels, all stainless steel case..... **\$59.75**

**ORDER BY MAIL:** Send check, money order, or pay postman C.O.D. Prices Incl. Fed. Tax & Postage. Gift Box. Wide choice of fine watches for men and women.

Write for FREE Illustrated Booklet "ON"

**Repair Service**

All types and makes of watches repaired expertly and promptly. Free estimate on request.

**BELL WATCH COMPANY, INC.**  
Time and Life Bldg., Rockefeller Center, New York 20, N. Y.



**MODEL SHIPFITTINGS**

of authentic design—  
new highs in detail  
and craftsmanship

Castings—Brass—Wood—Kits

MODEL SHIPWAYS  
476 Main St., FORT LEE, N. J.

Price list—10c

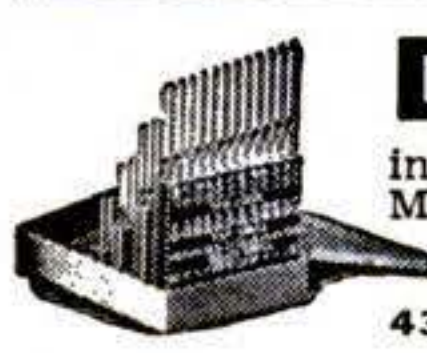

**DRILL-INDEX**

A compact container for indexing and filing twist drills. Eliminates search. Made entirely of steel in nine sizes. See your dealer or write to

**HUOT MFG. CO.**  
436 Foot Schultz Bldg. St. Paul 1, Minn.

**Special Surplus Savings  
on Plastics**

**GRADE A PLEXIGLAS**

Reddish Black, Assorted Sheet Sizes, 1/4 inch thickness  
**\$1.90 per square ft.**

Also Plexiglas sheets new per sq. foot:

1/16	.....	\$1.13	3/16	.....	\$1.79
1/8	.....	\$1.46	1/4	.....	\$2.10

Add 10% for packaging on orders under \$10. Add \$1 for packaging on orders over \$10.

ALSO . . . complete line of RODS, TUBES, SHEETS, ODD SHAPES in all types of plastics. Dyes, cements, buffing compounds.

Franklin Plexiglas Anti-Static Wax, Burnisher & Cleaner

**CADILLAC PLASTIC COMPANY**

657 West Baltimore, Detroit 2, Michigan



**STOP  
Wasteful Leaks  
in your  
Heating System**

Every crack, every leak, every loose connection, part or fixture in your furnace, boiler, tank, radiators and piping uses up heat.

Seal up those leaks promptly and effectively, like professional repair men do, with Smooth-On No. 1 Iron Repair Cement.

Smooth-On makes repairs that stay tight, Requires no heat to apply, no special experience. Keep a supply handy for emergencies. Get Smooth-On No. 1 in inexpensive 1 3/4-oz., 7-oz. or larger size at your regular hardware store. If they haven't it, contact us direct.



**REPAIR HANDBOOK FREE**

Practical, tested directions for ingenious, shortcut repairs around the house and garage. 40 pages. 170 diagrams. Pocket size, conveniently indexed.

-----SEND FOR YOUR COPY-----

Smooth-On Mfg. Co., Dept. 58,  
570 Communipaw Ave., Jersey City 4, N. J.  
Please send me a Smooth-On Repair Handbook.

Name.....

Address.....

12-46.....







## Adjustable Drop-Cord Reel

WITH this drop-cord Reelite it is only necessary to pull the cord to adjust the light at the desired height over a workbench or near a hard-to-see job. It contains a 12-foot, rubber-covered cord. Appleton Electric Co. makes the device.

## Home and Workshop Index Provides Quick Reference

WITH a copy of the new Home and Workshop Index, you can quickly find any article that you may remember seeing during 1946 on the craftwork pages of *Popular Science Monthly*. All articles that appeared from January 1946 to and including December 1946 on craftwork, woodworking, house repairs, new shop ideas, radios, automobiles and related subjects are listed.

To obtain your copy, send a dime to Popular Science Home and Workshop Index, 353 Fourth Avenue, New York 10, N. Y., enclosing a self-addressed, stamped legal-size envelope (No. 10). A limited number of 1941, 1942, 1943, 1944, and 1945 indexes are still available. Send 10 cents for each copy you wish, specifying the year.

# PHOTOGRAPHERS:

PRINT PHOTOS  
ON  
BOOK COVERS!



CHINAWARE!



RECORD  
ALBUMS!

GLASS  
SILHOUETTES!



WOODEN  
JEWELRY!

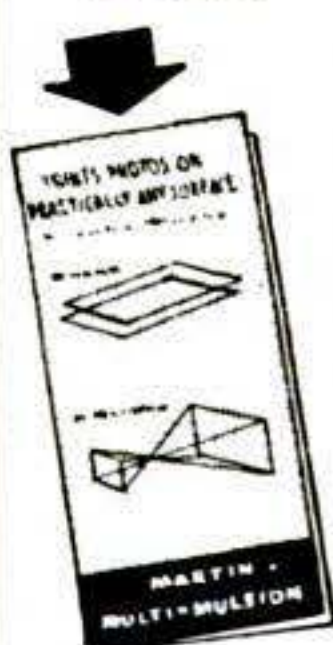

PHOTO MURALS  
ON WALLS!

*Now You* CAN PRINT PHOTOS  
ON PRACTICALLY ANY SURFACE!

EASY TO USE — BY CONTACT, BY PROJECTION  
— ON METAL, GLASS, PAPER, PLASTICS, WOOD, ETC.

Get This  
Free Booklet  
From Your  
Dealer!



Let your imagination go! Find new uses for your photographic hobby! Put those pictures you prize most on display in hundreds of interesting ways. It's all possible with the new Martin Multi-Mulsion—a simple, practical emulsion which sensitizes almost any surface for photographic reproduction. Ready to use. Applied in one coating with a brush or cloth. Works with ordinary darkroom equipment.

THE GLENN L. MARTIN CO., BALTIMORE 3, MD.  
ASK YOUR DEALER ABOUT

GLENN L.

*Martin*

MULTI-MULSION





REAMING TAPER CUTTING TURNING THREADING

*Logan*

A NAME TO REMEMBER WHEN YOU THINK OF **BETTER** LATHES AND SHAPERS

TURNING FACING THREADING DRILLING BORING

REAMING THREADING TAPER CUTTING

TURNING REAMING DRILLING BORING

FACING CUTTING

TURNING THREADING DRILLING BORING

steel • cast iron • non-ferrous metals • plastics

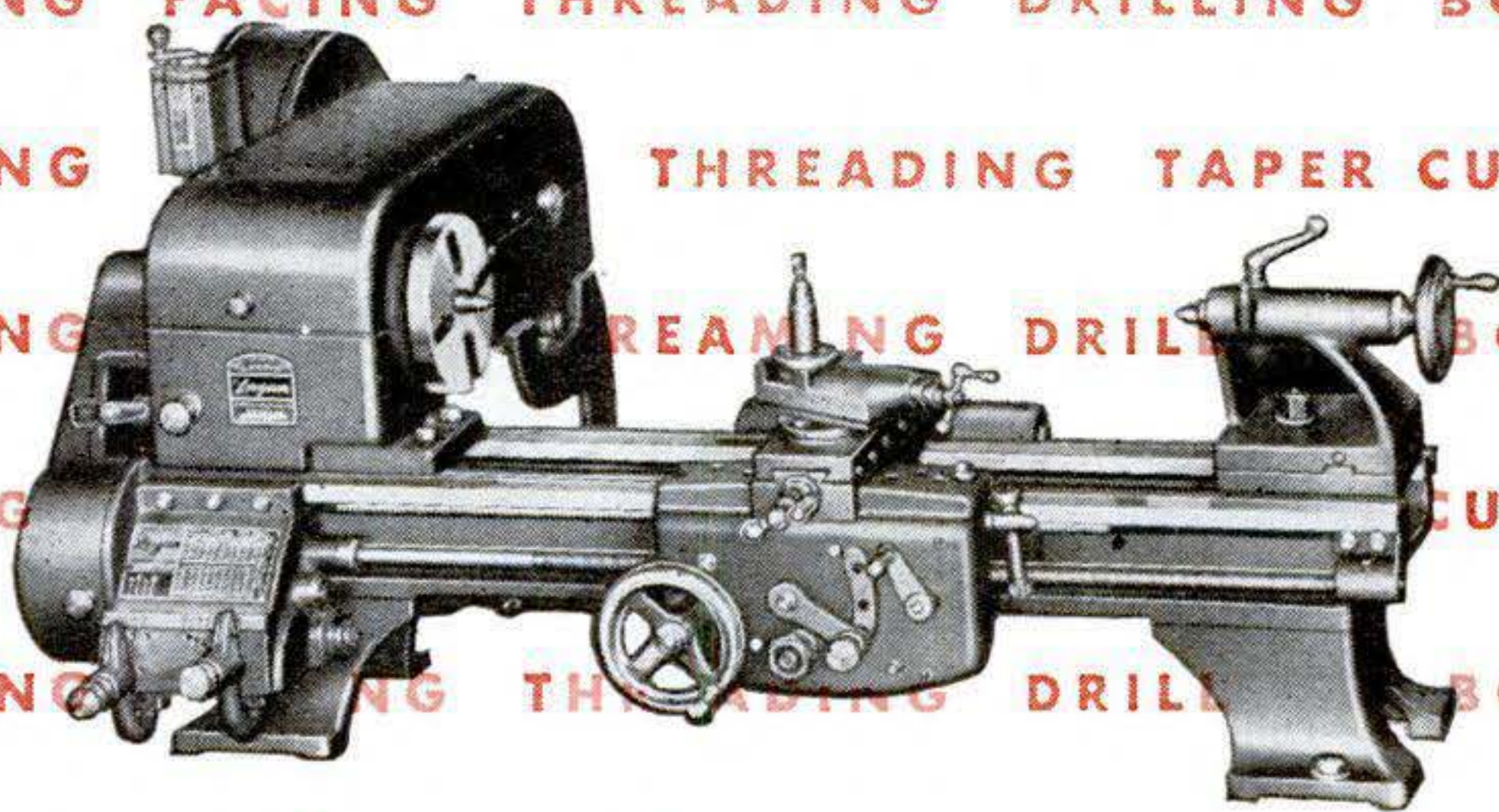

**the right lathe  
for small shops**

**compact Logan Lathe  
performs variety of work with  
speed, ease and accuracy**

**9 reasons why LOGAN Lathes are BETTER lathes**

- 1 BALL BEARING HEADSTOCK**  
for sustained accuracy.
- 2 RUGGED, ACCURATE BED**  
within .0005" of parallelism.
- 3 SELF-LUBRICATING BEARINGS**  
at vital points lengthen life.
- 4 BACK GEARS ENCLOSED IN HEADSTOCK**  
with shifter rack safely and conveniently at your finger-tips.
- 5 RUBBER CUSHIONED COUNTERSHAFT**  
for smoothness and accuracy in working area.
- 6 THREE POINT SUPPORT**  
Steadies the countershaft, prevents rocking.
- 7 ENCLOSED BELTS, GEARS, PULLEYS**  
Prevents accidents. Keeps lathe clean.
- 8 AUTOMATIC BELT TENSION RELEASE**  
Makes belt changing easy and safe.
- 9 PRECISION BUILT THROUGHOUT**  
For tool room accuracy in your shop.

The qualities which make the Logan Lathe a successful industrial tool are equally effective in the small shop. The wide variety of operations which can be handled on one Logan Lathe is an important advantage to the small shop owner. Designed for compactness as well as for efficiency, the Logan Lathe occupies a minimum of floor or bench space. The ball bearing mounted spindle requires no adjustment from 30 to 1450 rpm and permits use of high speed carbide cutting tools. Conveniently located levers and hand wheels enable the operator to work in safety and comfort and without fatigue. Rugged construction throughout, and self lubricating bronze bearings at vital points insure lasting accuracy and low maintenance.

**WRITE FOR THE LOGAN CATALOG** ...complete illustrated descriptions of Logan Lathes, Shapers and Accessories. LH-9

**LOGAN ENGINEERING CO.,** 4923 LAWRENCE AVE., CHICAGO 30, ILL

DEC. 1946 247



**"TOUGH  
JOB?"**



**...not for an**

**ATKINS"**

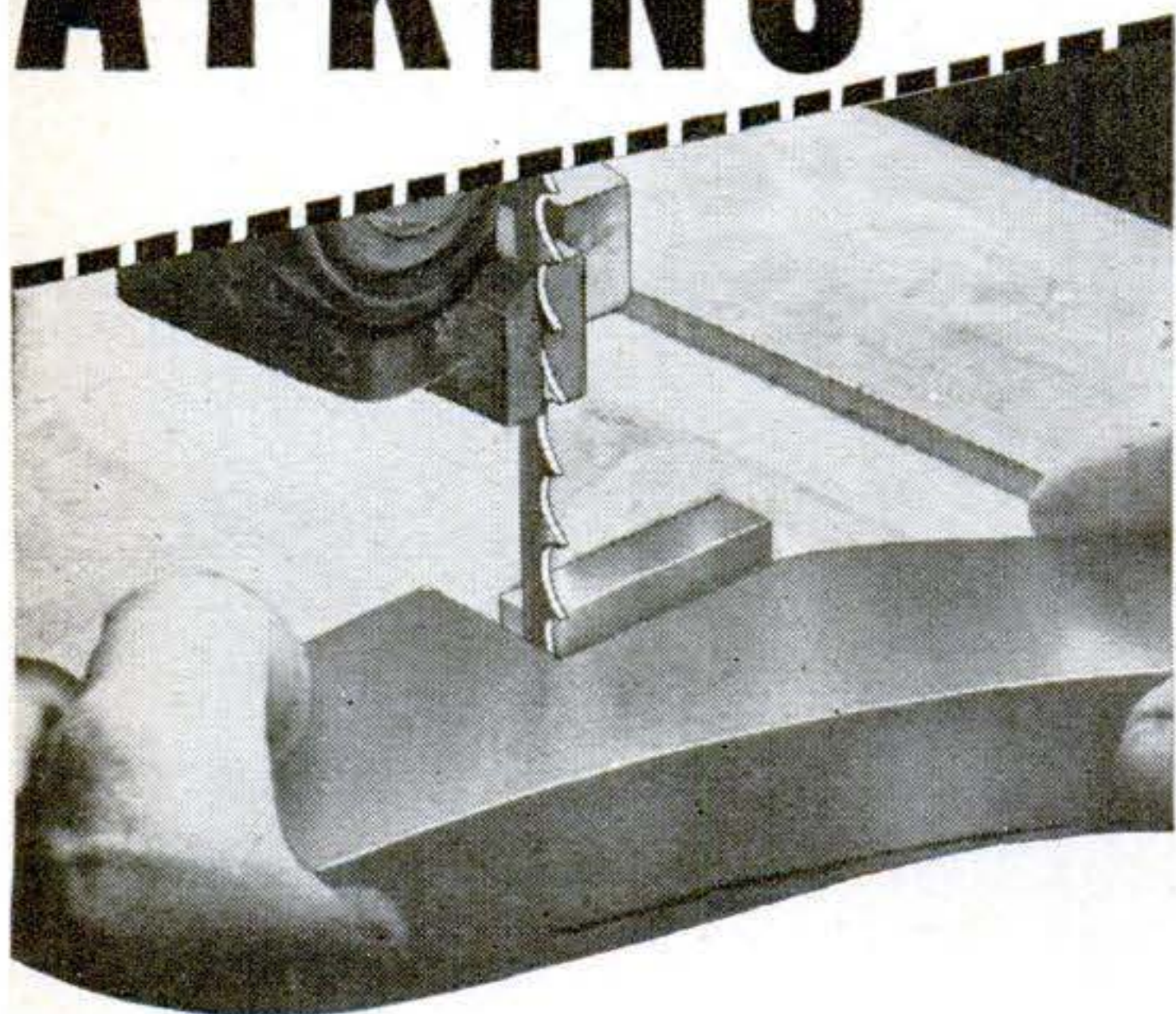

Complicated patterns are no problem to the man using Atkins "Curled Chip" Band Saws. He knows the extra cutting ability in "Silver Steel" blades with "Skip Tooth" design . . . knows how rapidly and smoothly they glide through material . . . knows how easily they can be guided around the "trickiest" contours.

In fact, every Atkins saw is a star performer on the job for which it is intended. That's why present production of all types is still below demands. Your dealer has done his best to keep you supplied with Atkins products — we're making every effort to help him do better.



**E. C. ATKINS AND COMPANY**  
Indianapolis 9, Indiana

PLANES OF ALL NATIONS by *Authenticast*

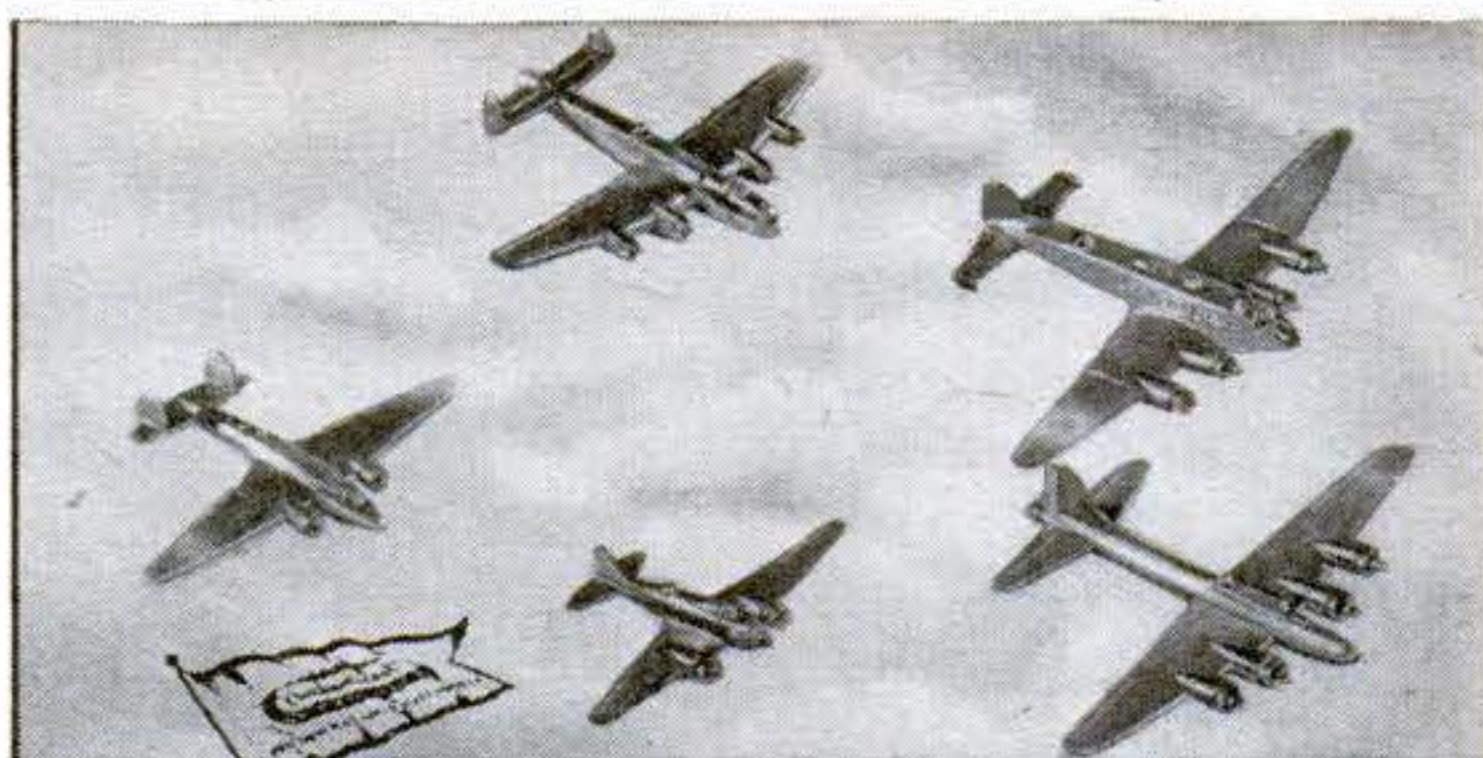

**SOLID!** Every model precision-cast in solid metal for greatest perfection of detail! Gun turrets, nacelles, rudders, reproduced with mathematical accuracy. 93 planes of 7 nations, beautifully finished. Scale: 1 in. to 36 ft.

Priced 30c to 75c; Stands 5c each. Send 35c for *Authenticast* catalog of over 900 models of ships, planes, and tanks.



P-47 Thunderbolt



A-31 Vengeance



P-38 Lightning



OS2U-1 Kingfisher

**COMET METAL PRODUCTS CO.**

91-12 132nd St., Richmond Hill 18, N. Y.

**MAKE MONEY AT HOME**

**RUBBER MOLDS** *Low as*  
**6¢ EA.**

Amazing rubber mold-making outfit makes perfect flexible molds of plaques, ash trays, bookends, etc. Molds cost 6c to 25c each. Each mold makes hundreds of novelties and gifts to sell for \$1.00 apiece and more! No experience necessary. Everything furnished. Quick and easy. Start profitable business in your home—sell to stores, gift shops, friends, resorts, road stands by mail. Full or spare time. Write for complete FREE details and easy instructions.

**SO-LO WORKS, INC., Dept. N-801, Loveland, Ohio**



**HOLD-E-ZEE**

**AUTOMATIC GRIP  
SCREWDRIVERS**

**MORE WORK  
IN LESS  
TIME!**



**UPSON  
BROS., INC.,**  
86 Exchange St.,  
Rochester 4, N. Y.

Hold-E-Zees do the job better, faster. They excel wherever screwdrivers are used. Gripper instantly released by spring action, sliding up out of way when not in use. All materials highest quality.

**AT LEADING DEALERS EVERYWHERE**



*They're Back!* **BETTER THAN EVER BEFORE!**

The New  
1947

# MIDWEST POST-WAR ENGINEERED RADIOS

Featuring this Powerful  
**SERIES 16\***  
AM-FM  
CHASSIS

AT SENSATIONAL  
**FACTORY-TO-YOU  
PRICES**

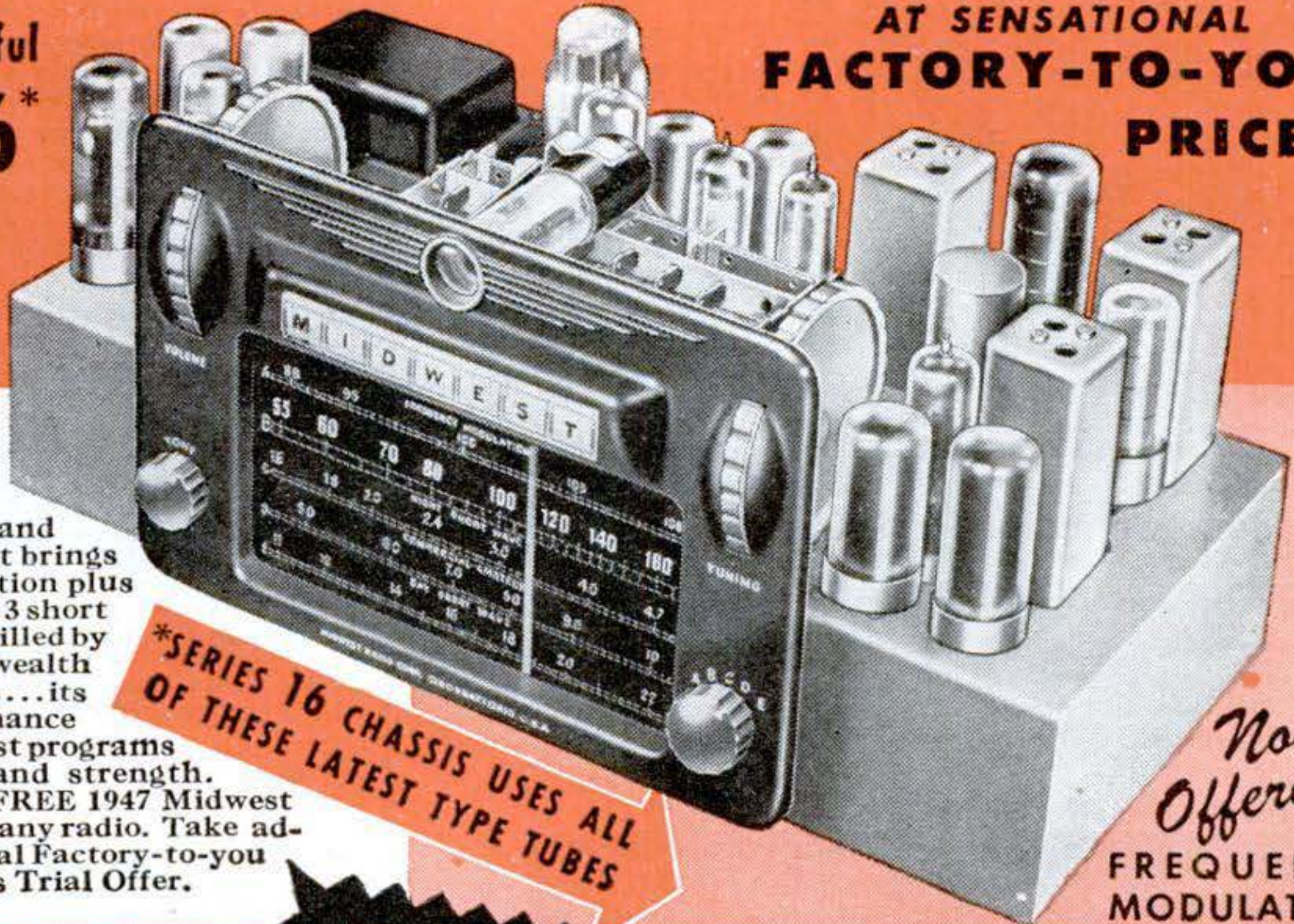

ONCE again Midwest demonstrates its 27 years of leadership with this powerful Super De Luxe Series 16\* 5-band world-ranging radio that brings you noise-free FM reception plus Standard Broadcast and 3 short wave bands. You'll be thrilled by its marvelous tone...its wealth of new post-war features...its world-ranging performance that brings you the finest programs with amazing clarity and strength. Send today for the new FREE 1947 Midwest Catalog before you buy any radio. Take advantage of our sensational Factory-to-you values and liberal 30 days Trial Offer.

**\*SERIES 16 CHASSIS USES ALL OF THESE LATEST TYPE TUBES**

*Now Offering*  
**FREQUENCY MODULATION!**

PUT THIS WORLD RANGING CHASSIS IN YOUR PRESENT CABINET OR SELECT A NEW **MIDWEST** FROM

**30 DAYS TRIAL**

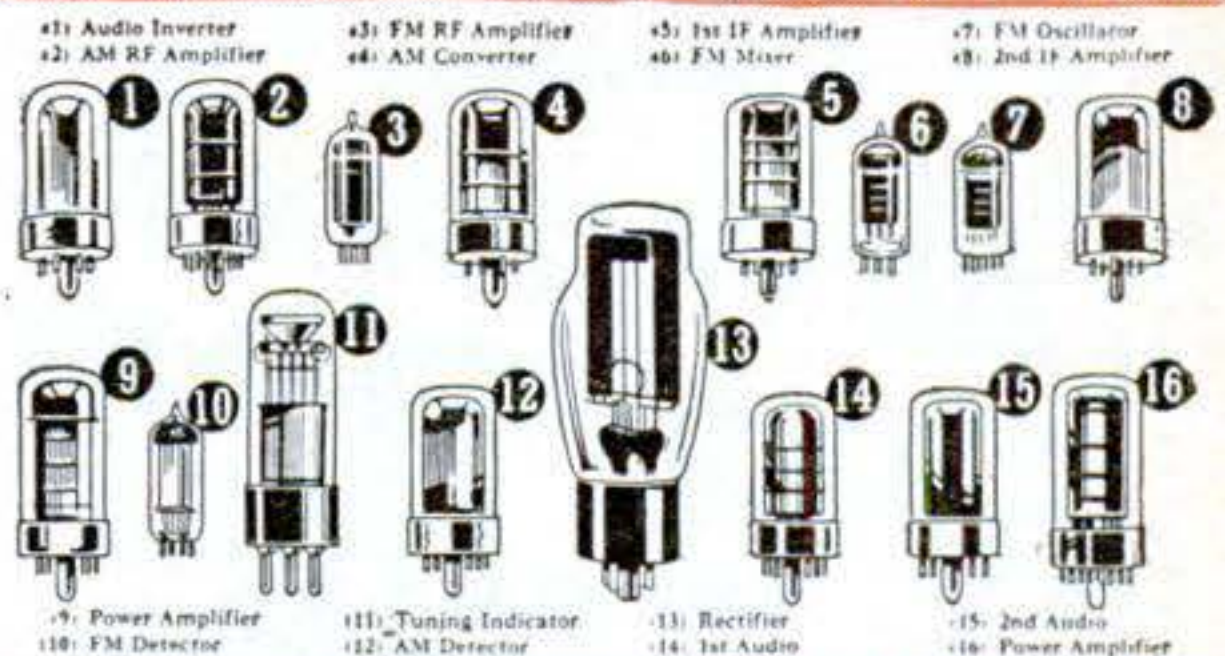

## THE MAGNIFICENT LINE OF BRILLIANT NEW CONSOLE AND TABLE MODEL RADIOS AND RADIO-PHONOGRAPHS

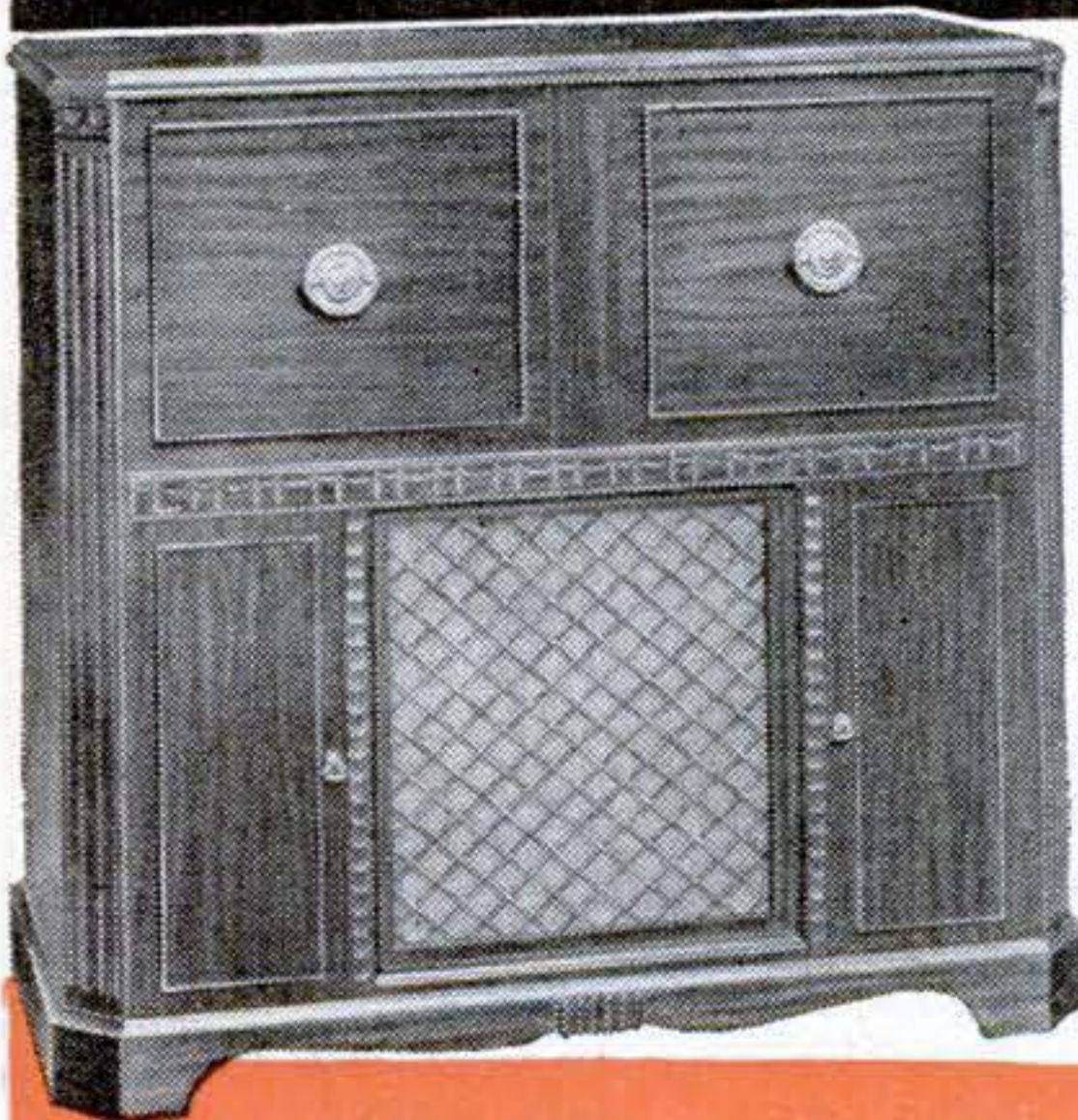

The **SYMPHONY GRAND SERIES 16\*** AM-FM RADIO-PHONOGRAPH CONSOLE with **NEW AUTOMATIC RECORD-CHANGER**

A REAL masterpiece of cabinet design and radio engineering... a luxurious musical instrument that brings you the newest marvels of radio science, including static free FM, automatic record changing, 5 wave bands and scores of new features and improvements for your listening pleasure. For complete details of this and other Midwest Radio models send for your copy of the 1947 Midwest Catalog today.

**EASY TERMS**

*Rush for Free Catalog!*  
FILL IN COUPON AND MAIL TODAY OR JUST SEND YOUR NAME AND ADDRESS ON 1c POSTCARD

MIDWEST RADIO CORP.  
Dept. 24-B, 909 Broadway  
Cincinnati 2, Ohio

Gentlemen: Please send me your new FREE catalog and details of your liberal 30 Days Trial.

Name \_\_\_\_\_  
Address \_\_\_\_\_  
City \_\_\_\_\_ Zone \_\_\_\_\_ State \_\_\_\_\_

**MIDWEST RADIO CORP.**

Dept. 24-B • 909 BROADWAY • CINCINNATI 2, OHIO



# CHEVRON

## THE WORKSHOP SAW



PRICE **\$44.95**

R.O.S. PROVIDENCE  
AS SHOWN  
LESS MOTOR  
LESS SAW

**A SUPERIOR  
Tilting Table  
Wood-Cutting  
SAW**

**14" x 18"**

CAST IRON TABLE ALL STEEL BASE

**Ready NOW for your Home Workshop!**

- ★ It cuts Deeper! (app. 2-11/16" with 8" saw blade)
- ★ It's Sturdier, Heavier (60 lbs.) A Craftsman's Machine Tool!
- ★ No Die Cast Working Parts in **CHEVRON**

Adaptable for use with 1/2 H.P., 1750 R.P.M. motor, 4" pulley recommended, 2" spindle pulley furnished. Table extensions and saws available. Ask for specifications and prices. Complete **CHEVRON** Specifications on Request!

**ORDER NOW - WRITE DIRECT TO -**

**CHEVRON**

c/o Peerless Precision Products  
387 CHARLES STREET  
PROVIDENCE 4, RHODE ISLAND

**Now for EVERY WORK SHOP!**

**NEW Invention Electroplates by BRUSH**



**Easy to Plate CHROMIUM  
GOLD, SILVER, NICKEL, COPPER  
... For Pleasure and Profit!**

If you have a workshop—at home or in business—you need this new Warner Electroplater. At the stroke of an electrified brush, you can electroplate models and projects—you can replating worn articles, faucets, tools, fixtures, silverware, etc. with a durable, sparkling coat of metal... Gold, Silver, Chromium, Nickel, Copper or Cadmium. Method is easy, simple, quick. Everything furnished—equipment complete, ready for use. *By doing a bit of work for others, your machine can pay for itself within a week.* So make your shop complete by getting a Warner Electroplater right away. Send today for **FREE SAMPLE** and illustrated literature. **ACT AT ONCE! Mail Coupon.**  
**WARNER ELECTRIC CO., DEPT. K-7  
1512 Jarvis Avenue, Chicago 26, Ill.**

**FREE Details & Sample!**

WARNER ELECTRIC CO., 1512 Jarvis Avenue, Chicago 26, Dept. K-7  
Gentlemen: Send Free Sample and Details to:

Name \_\_\_\_\_  
Address \_\_\_\_\_  
City \_\_\_\_\_ State \_\_\_\_\_

## IMPROVE YOUR ELECTRIC SHAVE.

Would you like even faster... smoother... cleaner shaves with your electric shaver? ● Get a **RANGER electronic Inverter\***—it gives your old or new shaver up to 88% more cutting efficiency. ● The RANGER Inverter changes a-c to electronically controlled d-c, which increases shaver power. Your electric shaver can then cut easily through patches of thick or heavy beard. ● Complies with shaver manufacturer's guarantees—will not harm any a-c/d-c shaver (Schick, Sunbeam, Remington-Rand, etc.) ● See your dealer. If he is out of stock, use coupon to order direct. Ten-day money-back guarantee. \*Pat. Pend.



**ONLY \$4.95**

"Just Plug It In" • Styled in ivory plastic

**ELECTRONIC SPECIALTY CO.** 3456 Glendale Blvd. Los Angeles 26, Calif.

**ELECTRONIC SPECIALTY CO.** 3456 Glendale Blvd. Los Angeles 26, Calif.

Under your money-back guarantee plan, send me \_\_\_\_\_ RANGER Inverter(s) at \$4.95 each. \_\_\_\_\_ Money order or check enclosed  
Add Sales Tax in California

NAME \_\_\_\_\_  
ADDRESS \_\_\_\_\_  
CITY \_\_\_\_\_ ZONE \_\_\_\_\_ STATE \_\_\_\_\_

## LIVE STEAMERS

Blue Prints and Castings in 3/4" Scale for Six Engines  
Tom Thumb — Pacific 4-6-2 — Atlantic 4-4-2  
Tanker 4-6-6-T — New York Central Hudson  
4-6-4 — Union Pacific Articulated 4-6-6-4

Write for Price List

**YANKEE SHOP, Machinists**  
88 High Street, Danvers, Mass.

## MOTORCYCLISTS

**★ ★ ★ ★ ATTENTION!**

The B & H Footshift for all Harley's eliminates hand gear shift, gives fast getaway, greater maneuverability, maximum driving safety. Improved clutch lever booster. Easy to install. Write for details, prices.  
**SCIENTIFIC RESEARCH CO.** 1618 N. Vancouver Portland 12, Ore.

## ANALYZE HANDWRITING

Qualify for Certified Grapho Analyst Degree at home, spare time. Credit, Employment, Personnel Managers, Business, Professional men, women use grapho-analysis in their work, earn substantial fees in spare time. Many study solely for personal benefit, no desire to earn money, find it so fascinating they start using it to add to their incomes. Entertainment field pays well, up to \$100 in a week reported. Others establishing profitable practices as Vocational and Family Problem Counselors, Personality Teachers, and lecturers.



**GROWING—UNCROWDED PROFESSION**

More and more police use grapho analysis handling suspects and criminals. They understand how criminals think. Their handwriting tells. Men like Hugh Dunlap, university student, Harry Allen, retired preacher, use it in court, win cases, earn fees even before graduation. **Only school in world devoted to teaching grapho analysis** offers thorough training to earnest, ambitious men and women regardless of where you live, small town, farm or city. Send for **GRAPHO ANALYST**, illustrated lesson, personal handwriting analysis offer, **ALL FREE**. Must be 21 or over. Address **A. I. G. A. Inc., 126, Noel, Missouri.**







- Test ALL Home Outlets
- Find Open Circuits

## STAR TEST-PLIERS

- Locate Blown Fuses
- Remove Fuses SAFELY

A must tool for electricians, maintenance men, home owners. Replaceable lamp inside Plier tests 110 to 250 Volts. Plier pulls fuses from 10 to 100 Amperes. Shockproof. Requires the use of only one hand. Can be obtained from General Electric or Westinghouse stores, or from local electric dealers.

Order one TODAY

A VERY WELCOME and USEFUL XMAS GIFT

Price \$2.75 without Leads, \$1.50 additional for Leads

STAR FUSE CO., 237 Canal St., New York 13, N. Y.

## OTTAWA TRACTOR SAW

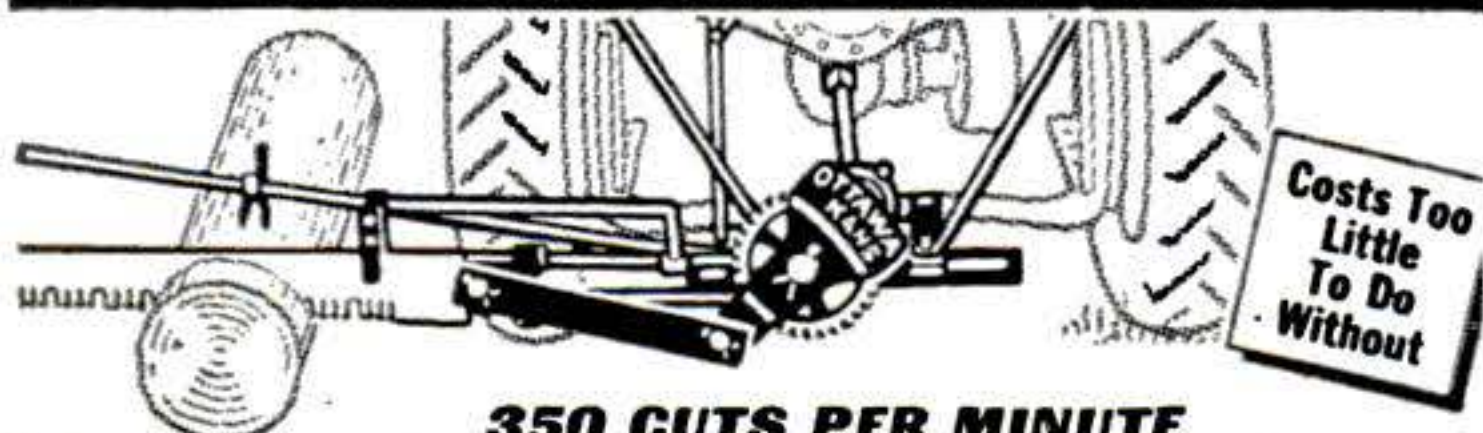

350 CUTS PER MINUTE

Make money sawing wood. Use Ottawa—fastest cutting. Cuts large, small logs easiest way. Fells trees. One man operates. Thousands in use. Built to last with heavy, stiff saw blade. Positive safety clutch control; uses power take-off any tractor. OTTAWA MFG. CO., D-1201 Forest Ave., Ottawa, Kan.



## A NEW TOY FOR XMAS

FUN! EDUCATIONAL! Toy sailor sends semaphore and Morse signals! Mechanically controlled, can send messages like a real bluejacket. Each toy comes complete with codes and instructions. Ideal Xmas gift! Swell for Boy Scouts, Schools and Clubs. Just send \$1.50 to H. Silken, 21 West 46 St., N. Y. C., Pat. Appl. for.

## LAWN ORNAMENT-NOVELTY PATTERNS

28 Lawn Ornament Patterns, 25c. Other patterns; 15-20" high; Dutch Girl, Dutch Boy, Pirate, Bull Terrier, Mexican Girl, Mexican Boy, Dwarf, Penguin, Flower Girl, 10c each. 25 Novelty Patterns, 30c. All 62 Full Size Patterns, \$1.00 Postpaid. Strother Pattern Service, Dept. 7-L, Box 383, Belington, W. Va.

## JET PROPULSION



### GAS TURBINE Model Engine

★ ★ Be one of the first to build a real Turbo-Jet Model Engine. Single-stage centrifugal compressor and turbine. This is a real engine, easily made with ordinary home workshop equipment. Complete plans for construction . . . design formulas and curves for checking performance and testing.

\$2.00  
Post  
paid

THE ROTOJET CO. Department 9  
BOX 757 • LOS ANGELES 25 • CALIFORNIA

# Give Him a WHIZZER for Christmas!

Ride one and you'll buy one!

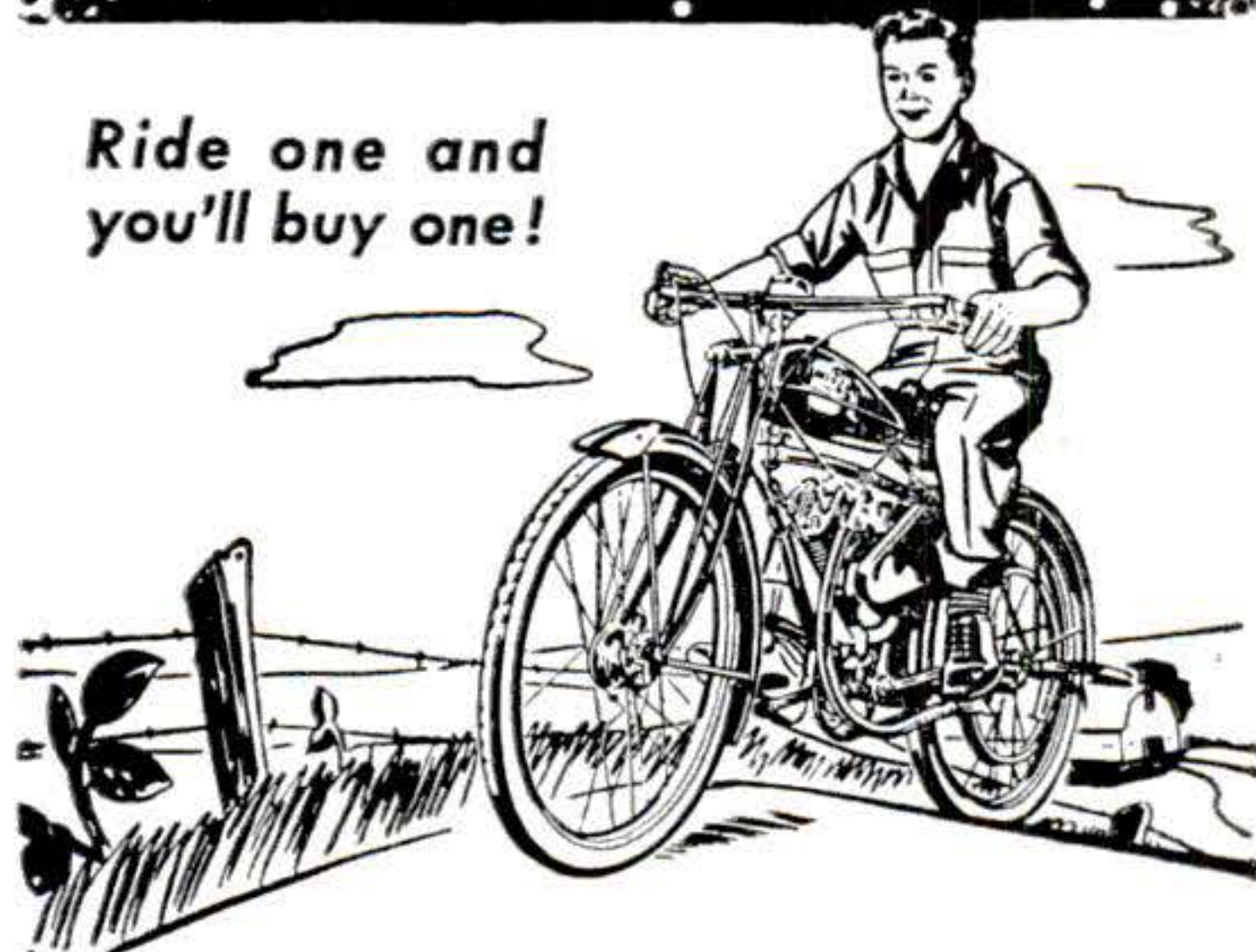

The Whizzer Bike Motor is the real answer to dependable, low cost transportation. Fits any balloon-tired bike. Built by automotive craftsmen in the heart of the auto industry, the Whizzer bike motor installs easily and will carry you fast (5 to 35 miles per hour) and far (125 miles or more on a gallon of gas). Enjoy new freedom and adventures with your Whizzer. Use it for errands, shopping, business, recreation and work. Whizzer's 2½ h.p. will take you there and bring you back! Does not interfere with normal pedaling of bike. Put a Whizzer on his bike for Christmas! WHIZZER MOTOR CO., Pontiac 15, Michigan.

FACTORY PRICE

\$97.55  
PLUS  
TAX

Simple, positive controls. Easy to ride, too . . . Whizzer doesn't change balance or riding qualities of bike!

See your WHIZZER dealer today

IF NO LOCAL DEALER, USE COUPON

WHIZZER MOTOR COMPANY  
Dept. 192, Pontiac 15, Mich.

I enclose \$99.97, which includes \$2.42 Federal Excise Tax, ( ) check or ( ) money order. Send me one Whizzer motor, complete, with full installation instructions. Written guarantee with every motor.

If descriptive literature only is desired, check here ( ).

NAME \_\_\_\_\_

ADDRESS \_\_\_\_\_

CITY \_\_\_\_\_ STATE \_\_\_\_\_



# A TOOLSHOP IN YOUR HAND!

- GRIND • DRILL • ROUT
- POLISH • ENGRAVE
- CUT • SAND • SAW • etc.

MAKE THINGS FROM WOOD  
PLASTICS—METALS—GLASS  
LINOLEUM—LEATHER  
ALLOYS—HORN—STONE  
BONE, etc.

**HANDEE** TOOL OF 1001 USES

Smooth, steady power at your fingertips! Perform precision operations not possible with any other portable tool! With a Handee you can turn out professional looking projects for pleasure or profit—ship, plane and train models, costume jewelry, wood carvings, puppets, initialed tumblers, etc. AC or DC. 25,000 r.p.m. Wt. 12 oz.

**USE THE RIGHT ACCESSORIES!** Choose them from the most complete line . . . more than 300 made right in the Handee plant.



**A GOOD START—THE  
HANDEE KIT**

HANDEE Tool and 45 most popular accessories packed in compact steel carrying case. You'll be amazed at what you can accomplish! Complete, postpaid.

**\$27.50**

Handee only, with 7 accessories, \$20.50

**FOR YOURSELF OR A FRIEND...  
THE GIFT OF A LIFETIME!**

### NEW PRECISION ATTACHMENTS

Fit Handee only, enable novice or craftsman to do perfect work. Magically, easily, your offhand carving, routing, shaping will be exact as to depth of cut, accuracy of line. Set of 6 attachments with instructions, postpaid

**\$7.95**

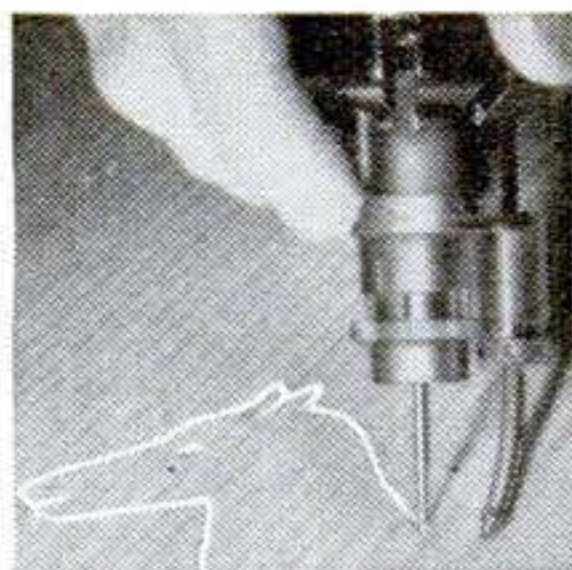

**ORDER NOW! SATISFACTION GUARANTEED!**

**FREE! NEW 52-PAGE MANUAL**

**CHICAGO WHEEL & MFG. CO.**  
1101 W. Monroe St. Dept. PO. Chicago 7, Ill.

Send  Handee Kit  Handee Tool  Precision Attachments  C.O.D.  Remittance enclosed  Send Manual

Name.....

Address.....

252 POPULAR SCIENCE



## Helium Test for Vacuums

DEVELOPED to test vacuum systems used in atomic research and electronic and chemical processes, a new Westinghouse device detects the most minute leaks. In operating the apparatus, helium gas is blown on the equipment to be tested. If there is a leak, the helium gas is drawn into the vacuum system and is detected instantaneously by an electronic tube in the meter box at lower left in the picture. The amount of helium detected by the electronic tube is shown on the dials of the meter box, indicating the size of the leak.

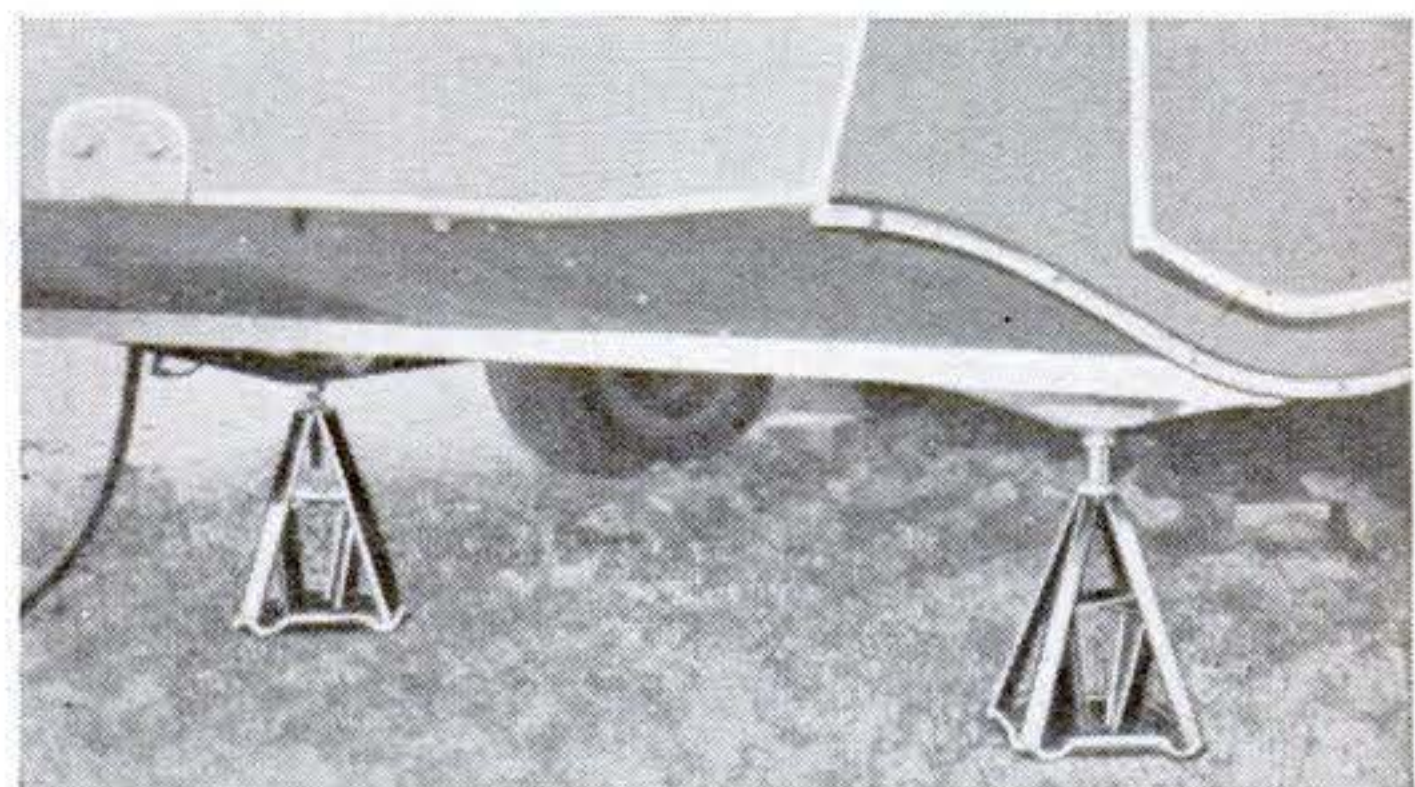

## Jack Supplants Trailer Blocks

ELIMINATING the chore of propping up auto trailers with blocks, the Persson trailer jack provides a foundation on any soil. For leveling, a jackscrew is adjusted after the eight-pound support is in position.



# NAVY BINOCULARS



## 7 x 50

Waterproof • Dustproof  
Fungus Proof  
Coated Lenses

Brand New  
Complete with case

**\$135.\*** Post-paid

# BAUSCH & LOMB

## 6x30 Binoculars \$33.50\*

Made for U. S. Army

These binoculars are used but have been carefully checked and are guaranteed to be in good working order. Leather carrying case with straps included.

\* plus 20% Federal Tax

## BROWNSCOPE CO.

Dept. 12P, 24 West 45th St., New York 19, N. Y.

Telescopes      Binoculars      Microscopes

*Rolling your way!*

## The Great NEW 1947 HARLEY-DAVIDSONS

Thousands of riders — old and new — want the thrill of owning a 1947 Harley-Davidson. The new models, now on their way to dealers, are tops for streamlined beauty — champions in performance. What a wallop they pack in power and speed... ruggedly built for stamina! No wonder the demand is terrific! The sooner you see your Harley-Davidson dealer, the earlier you can enjoy exciting good times that come with owning a 1947 Harley-Davidson.

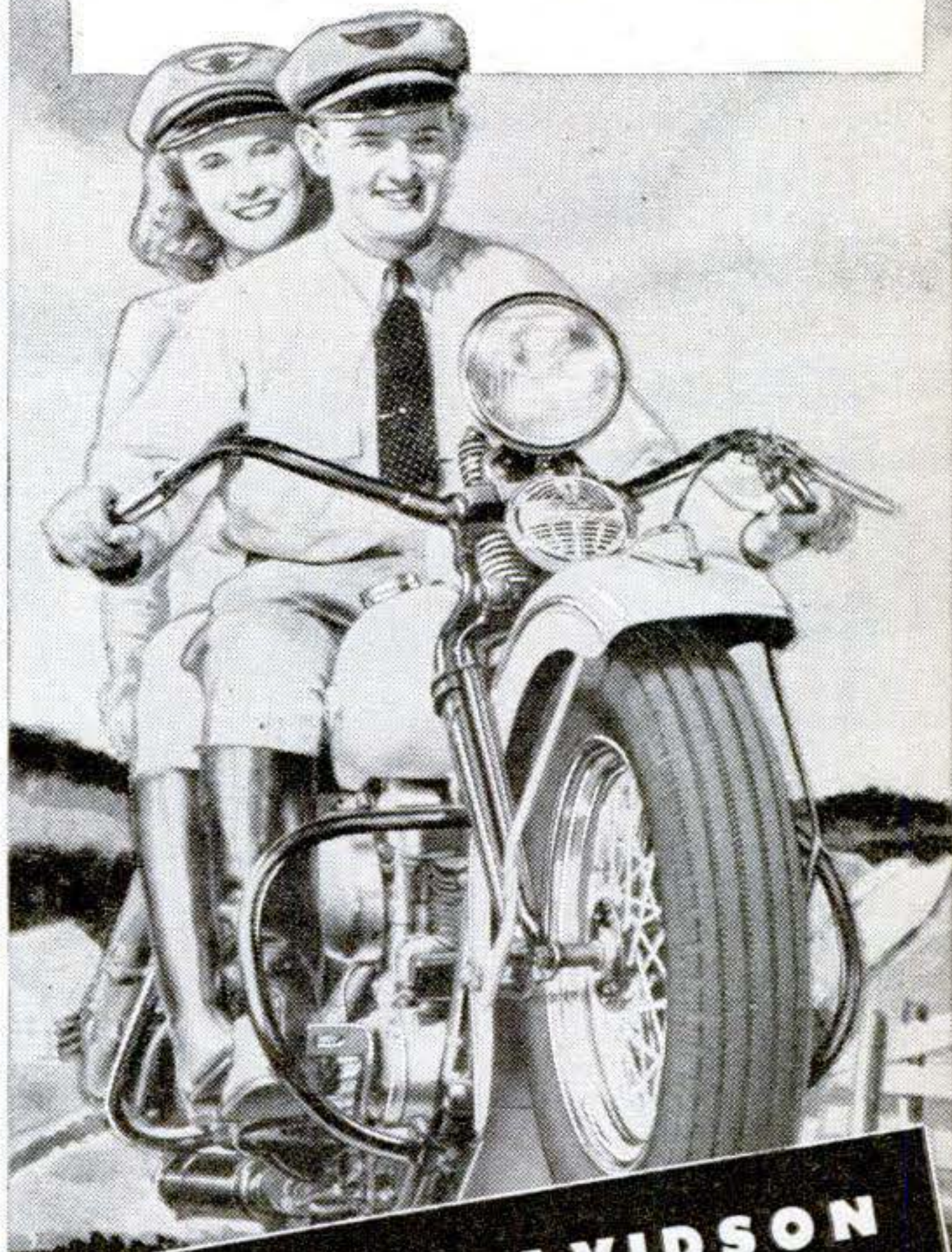

**HARLEY-DAVIDSON**  
*Motorcycles*

HARLEY-DAVIDSON MOTOR CO.  
Department PS, Milwaukee 1, Wisconsin

Send free copy of 24-page "ENTHUSIAST" Magazine, filled with motorcycling pictures and thrilling stories.

Name \_\_\_\_\_

Address \_\_\_\_\_

City \_\_\_\_\_ State \_\_\_\_\_

## USE YOUR BENCH SAW

FOR JOINTING & CUTTING MOULDINGS

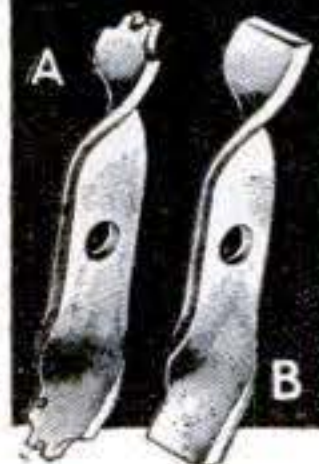

With our six inch tool steel cutters make mouldings, casings, drop-leaf tables, grooves beading and jointing. Moulding cutters, A 1 in. wide \$1.50. 1 1/2 in. \$2.00. Jointing cutters, B 1 in. \$1.50. 1 1/2 in. \$2.00. E 1 in. for drop-leaf tables. \$1.50. E 1 1/2 in. Makes 3/4 in. cove & Quarter. \$2.00. Postpaid. Guaranteed. State size hole. List & Folder free.

JOHN A. SANDSTROM  
Rt. 1-P. Clearwater, Fla.



# MORE PROFITS

with

## MODERN LAWN MOWER SHARPENER

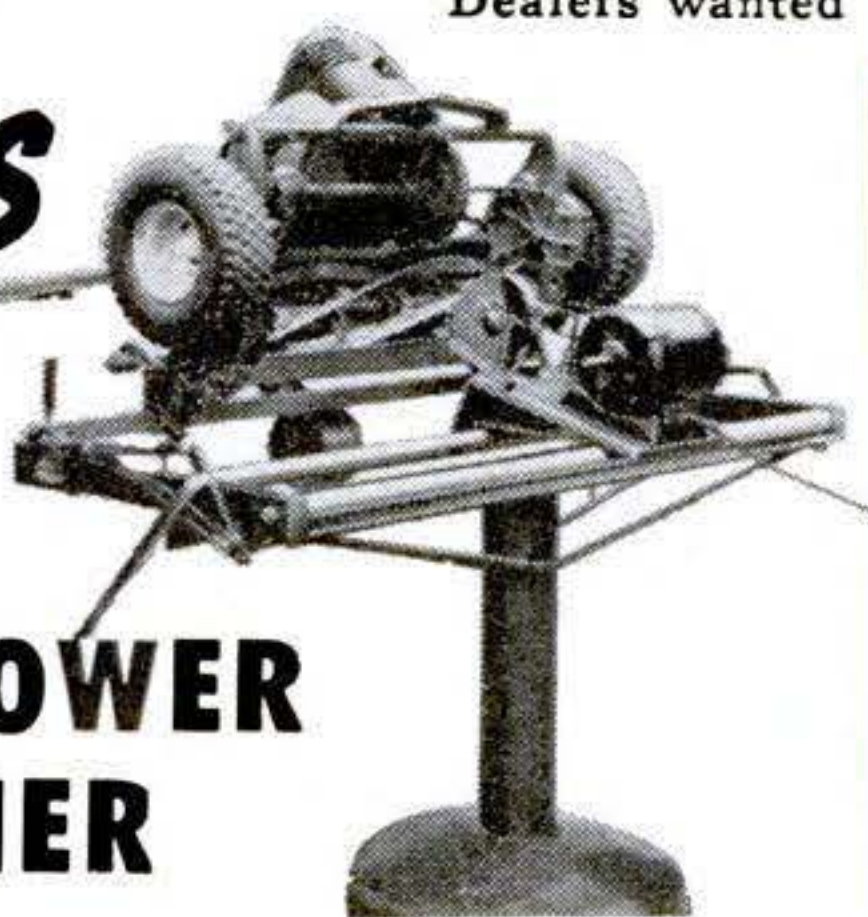

Dealers wanted

**S**HARPEN ANY LAWN MOWER from 5-inch Edger to 36-inch Power Mower in ten to twenty minutes with a MODERN LAWN MOWER SHARPENER because dismantling is unnecessary — neither handle, roller, wheels nor motor need be removed when sharpening any mower. . . the MODERN SHARPENER eliminates all hand filing; it precision grinds to the extreme ends of both left or right reel blades. Bottom knife is held in same brackets for sharpening. NO EXTRA ATTACHMENTS! Order today! Price \$241.50 (less motor) f.o.b. Pasadena. (1/3 or 1/4 H.P. single phase motor recommended.)

Modern Mfg. Co., 156 N. Fair Oaks, Pasadena 1, Calif



**IMMEDIATE  
DELIVERY!**



**\$19.95**

F. O. B.  
ROYERSFORD, PA.

**8 in. BENCH SAW**

**COMPLETE AS SHOWN**

**TABLE SEGMENT**—Shows degree of table tilt—graduated. **SPLITTER**—Hard temper cold rolled steel. **GUARD**—Aluminum. **MITER GAUGE**—Aluminum. Accurately graduated 45° each side of center. **BEARINGS**—(2) Oil-ite bronze. **CAPACITY**—0 to 2 1/4". **TABLE** 12"x14". **SHIPPING WEIGHT**—44 lbs.

This Price is Below the Authorized O. P. A. Ceiling

**AMERICAN MACHINE & TOOL CO., Inc.**

DEPARTMENT 200 • ROYERSFORD, PA.

**NOW AVAILABLE**

**PLASTICS**

**CATALOG and HANDBOOK**

**FUN AND PROFIT AHEAD**

Plastics, colorful and glamorous materials of the future, offer you a fascinating hobby — or a profitable plastics fabricating business of your own.

**CATALOG LISTS NEW MATERIALS**

Ready now, the new 40-page Carmen-Bronson CATALOG gives you complete prices and data on all materials you need. Plexiglas, Lucite, Bakelite, Lumarith, Lignolite, Tenite etc. in sheets, rods, tubes and special forms—crystal-clear and in many rich, glowing colors. Catalog also lists numerous cements, dyes, compounds, accessories, supplies and semi-fabricated kits.

**HANDBOOK GIVES INSTRUCTIONS**

The new Carmen-Bronson PLASTICS HANDBOOK tells how to fabricate plastics easily and simply into beautiful objects for gift or sale. Contains construction plans for many simple and advanced projects. Profusely illustrated. Gives practical advice on how to start your business in this profitable field.

**10¢ BRINGS BOTH BOOKS**

Take the first step TODAY toward your brilliant future in plastics. Send only 10 cents NOW for your copies of the Carmen-Bronson CATALOG and Carmen-Bronson PLASTICS HANDBOOK.

**CARMEN-BRONSON COMPANY**

165 East 3rd Street, Dept. 12-A, Mount Vernon, N. Y.



**10¢  
BRINGS  
BOTH  
BOOKS**

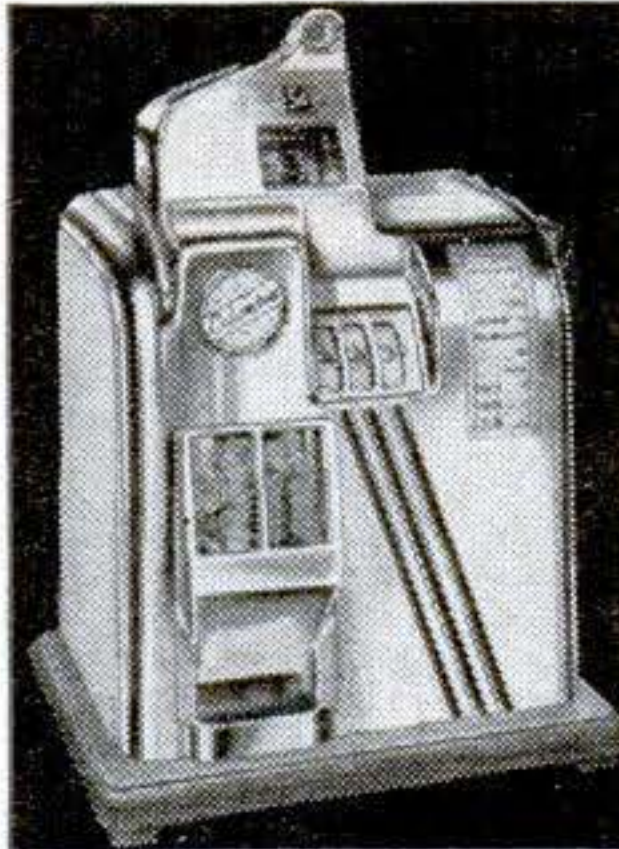

**"JACKPOT"**

**Home Model  
COIN MACHINE**

Great fun-maker for recreation room or club. Soon pays for itself. Fully automatic payout, three reels, with all the usual winning combinations . . . cherries, lemons, plums, etc. Double jackpot. Set for 60% payout to the player, 40% profit for the house. Guaranteed to satisfy or money back. Rugged lifetime construction. Ht. 18 1/2 in.

Takes space only 14 1/2 x 11 1/2 in. CHOICE OF 1¢, 5¢, 10¢, or 25¢ PLAY. Shpg. wt. 47 lbs. Send \$50.00 deposit, balance C.O.D. Express F.O.B. Chicago.

Immediate delivery . . . . . Each, **\$198.00**

**Webb DISTRIBUTING COMPANY**

6 SOUTH KEDZIE AVENUE - CHICAGO 12, ILLINOIS

**HAPPINESS**

Millions seek happiness, but very few find it. Would you like to know the secret of the success of these few? Send 25c for a copy of INTO THE SUN. Its reading can change the entire course of your life. Address Dept. Q-1.

**LEMURIAN FELLOWSHIP**

Box 586

Ramona, Calif.

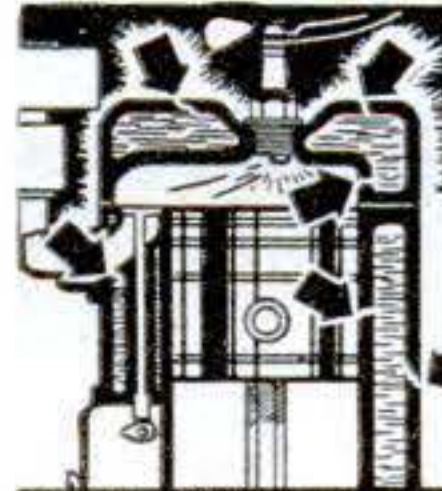

**REPAIR CRACKED  
BLOCKS AND HEADS—**

External and internal leaks in blocks, cylinders and valve ports quickly and easily with LUSCO PLASTIC SEAL. **90 day Service Guaranteed** or your money back. Send money order or check for full pint—more than sufficient for average repair . . . **\$3.00** Postpaid

**C. F. LUSK CO., 4620 EUCLID AVE., CLEVELAND 3, OHIO**

**BUILD YOUR OWN MACHINE TOOLS!  
Blueprints \$1.00 - Catalog FREE**

Detail construction Blueprints on 6 Lewis metal and wood-working tools postpaid for \$1.00. Includes prints for Lewis 10" Shaper, Milling Machine, Drill Press, Vise, 8" Circular Saw, 6" Jointer. Castings for these tools save up to 80% of comparable new tool cost. Illustrated 32-page Catalog—sent free with Blueprint Order—describes 21 Lewis tools. WRITE TODAY!

**LEWIS MACHINE TOOL CO.**

P. O. Box 7446, Sta. L, Dept. S, Los Angeles 23, Calif.

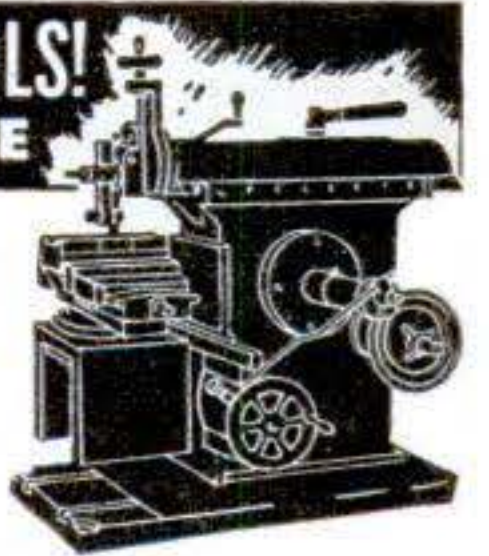

**FREE!  
FAMOUS  
BLUE BOOK  
CATALOG**

**GAME SUPPLIES**

Club Furniture - Counter Games - Punchboards - Magic Cards Readers, Read the backs - Inks - Daubs - Poker Chips - Tops Flats - Layouts - Game Boxes.



**K.C. CARD CO., 838 South Wabash Ave., Chicago 3, Ill.**

**EYE-  
GLASSES  
BY MAIL**

16 Days Trial

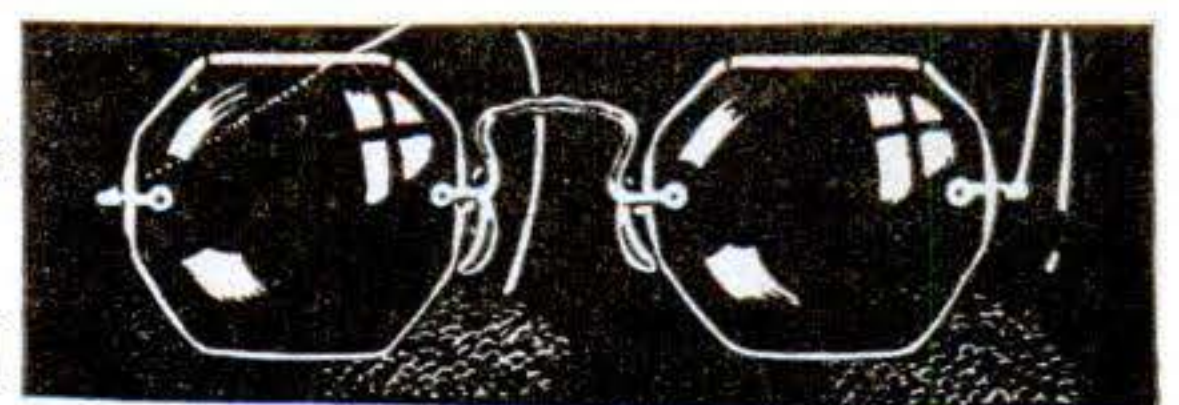

Write Today for Free Catalog. Send no Money

**ADVANCE SPECTACLE COMPANY**  
537 South Dearborn Street, Dept. SP-12, Chicago, Illinois



**Look! Servicemen-Civilians too!**  
**PRECISION BUILT MILITARY WRIST WATCH**



The watch you've been waiting for!  
 Swiss Movement  
 Precision made by  
 Expert Swiss Craftsmen

**WRITTEN GUARANTEE WITH EVERY WATCH**

A fortunate purchase makes this amazing offer possible. Latest military styling, red sweep second hand. Easy to read Extra Fancy Dial. Comes complete with Leather Strap. A watch you'll be proud to wear or give as a gift. Below O.P.A. Price.

Immediate Delivery **\$8.49**  
 ONLY  
 plus 10% Fed. Tax

**SEND NO MONEY—Pay Postman \$8.49 plus 85c Fed. Tax and few cents postal charges, or, send \$9.34 with order and we pay postage Return within 10 days if not delighted for refund providing watch has not been tampered with.**

**Hurry—Order Now—Supply Limited!**

ORDER WITH CONFIDENCE FROM  
**AMERICAN MERCHANDISING CO., INC.**  
 Dept. PSW-6 12 Adams Ave. Montgomery 4, Ala.

**Build this Electric or Gas MOTOR SCOOTER! AS LOW AS \$29.95**

Speed 30-45 MPH. 2 speed transmission. Low gravity spring frame for better control and easy riding. Large 12" tires—ULTRA STREAMLINED! Gas model has 2 H.P. engine. Electric has hi-rate self contained charger—plugs into any 110 volt socket!



Send Only \$1.00 (cash or money order) for complete photos, blueprints, construction (C O.D. \$1.52) details, lists of factory made parts, prices, etc., as well as detailed information on 20 other products—some as follows:

- Electric & Gas Lawn Motors
  - Custom Built Home Freezers
  - Auto & Home Air Conditioners
  - Electric Outboard Motors
  - 2 H.P. Garden Tractors
  - 4 H.P. "Midget" Motorcycle
  - 6 H.P. "Midget" car
  - Electric & Gas Bike Motors
- Motor Industries Incorporated Dept. PS-12 Kearney, Nebraska

**PRODUCTION DIES**

Our Specialty, Give us a try at your production problems.

D. C. MOTORS, good delivery on 1/4, 1/3 and 1/2 H.P. Mfrs. of A.C. Generators, Converters, Frequency Chargers, etc.

**KATO ENGINEERING COMPANY**  
 120 Maxfield St., Mankato, Minn.

**BIG MONEY! SUCCESS!**



★ **BE YOUR OWN BOSS! INCREASE YOUR INCOME! MAKE FRIENDS! "PRICELESS PERSONALITY" and "FACE VALUE" our latest books can show you the way as it has for thousands. Cloth bound, \$2 each. Paper bound, \$1 each. AGENTS WANTED!**  
**THE MARSHALL ADRIAN CO.**  
 367 Colorado Bldg., Denver 2, Colo.



**CONTROLL-O-DICE**

Easy to Operate. No Switching.  
 No Skill or Practice Needed.  
 Complete Instructions with Order.

PASSERS (5/8 Quality Inlaid).....\$3.00  
 MISSOUT (5/8 Quality Inlaid)..... 3.00  
 Both Above Pairs..... 5.00

Order C. O. D. or Cash. PRINT name and address plainly.

**MAGIC HOUSE** P. O. BOX 4322—DESK 2  
 SAN FRANCISCO, CALIF.

**FREE ALLIED'S 1946 RADIO CATALOG**



**LARGEST STOCKS OF EVERYTHING IN RADIO...**

**SERVICEMEN! Dealers! Soundmen! Amateurs! Builders! Experimenters! Send for the handiest, most complete 1946 Buying Guide for Everything in Radio! Features latest radios, sound systems, amateur and builders' gear, thousands of radio and electronic parts—world's largest and most complete quality stocks—at lowest prices. Fastest service; expert help!**

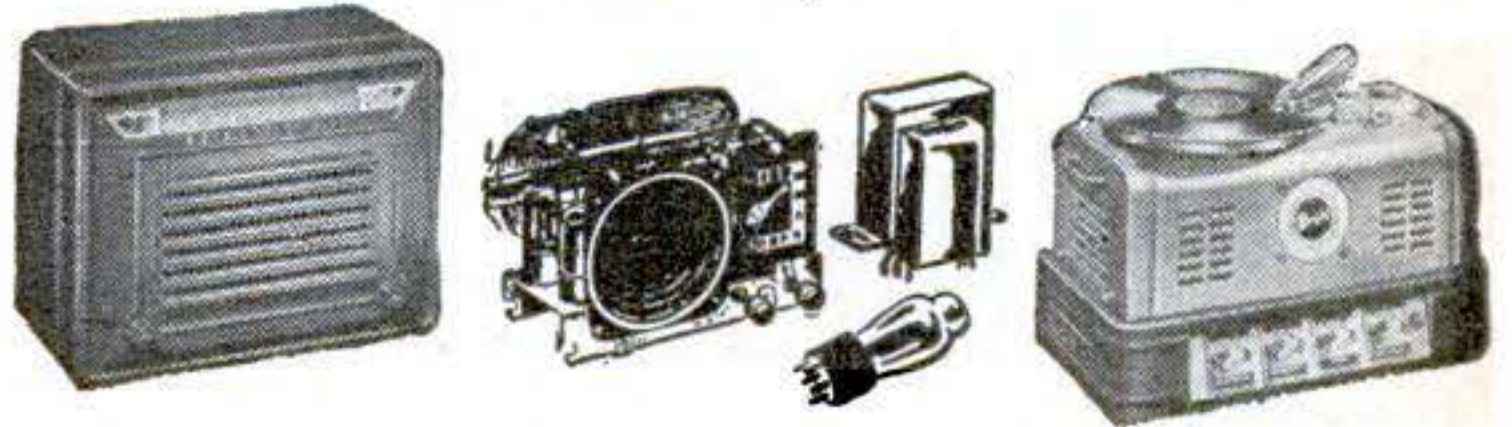

**MORE THAN 10,000 ITEMS**

Everything for every radio use: new model home radios, phono-radios, communications receivers, Ham kits, radio parts, tubes, tools, test instruments, public address equipment, easy-to-build kits, diagrams, instructive books—all at lowest prices!

**HELPFUL RADIO BOOKS**

- Radio Formulas & Data No. 37-752 10c
- Dictionary of Radio Terms No. 37-751 10c
- Radio Circuit Handbook No. 37-753 10c
- Radio Builders' Handbook No. 37-750 10c
- Simplified Radio Servicing No. 37-755 10c
- Radio Data Handbook No. 37-754 ... 25c
- ALL SIX BOOKS No. 37-799..... 75c
- Parallel, Resistance and Series Capacitance Calculator No. 37-960 .. 25c
- R-F Resonance and Coil Winding Calculator, No. 37-955..... 25c

**ALLIED RADIO**

**ALLIED RADIO CORP.**  
 833 W. Jackson Blvd., Dept. 7-M-6  
 Chicago 7, Illinois



- Send FREE 1946 CATALOG
  - Send Six Books No. 37-799
  - Send Books checked above
  - Send Calculators checked above
- } \$...enclosed

Name.....

Address.....

City.....Zone....State.....



**BE PREPARED FOR  
SICKNESS or ACCIDENT**

**THIS HOSPITALIZATION PLAN  
PROTECTS YOU AND  
YOUR FAMILY**



*Costs only*  
**3¢ A DAY • EACH ADULT**  
**1½¢ A DAY • EACH CHILD**

Benefits begin the day you enter a hospital  
**FOR SICKNESS OR ACCIDENT**  
Hospital Expenses paid, up to . . . . . **\$540.00**  
**FOR ACCIDENT**  
Doctor Expense paid, up to . . . . . **\$135.00**  
Loss of Wages reimbursed, up to . . . . . **\$300.00**  
Loss of Life by Accident . . . . . **\$1000.00**  
**WAR COVERAGE AND EXTRA BENEFITS**  
Childbirth Expense paid, up to . . . . . **\$75.00**

• It's easy to run into debt when sickness or accident hit. Under the Family Mutual Plan, you'll be able to pay your hospital bills. And in case of accident, you'll be reimbursed for your doctor expenses, for loss of time from work. You can enter any hospital in the United States. Your family doctor may attend you. Benefits applying to children are 50% of those paid adults.

**MAIL COUPON TODAY—No Agent Will Bother You**

**FAMILY MUTUAL LIFE INSURANCE CO., WILMINGTON 99, DEL.**

**Family Mutual Life Insurance Co.** PS 14  
**601 Shipley St., Wilmington 99, Del.**  
*Please send me, without obligation, complete information on your Economical Hospitalization Plan.*

NAME \_\_\_\_\_  
ADDRESS \_\_\_\_\_  
CITY \_\_\_\_\_ STATE \_\_\_\_\_

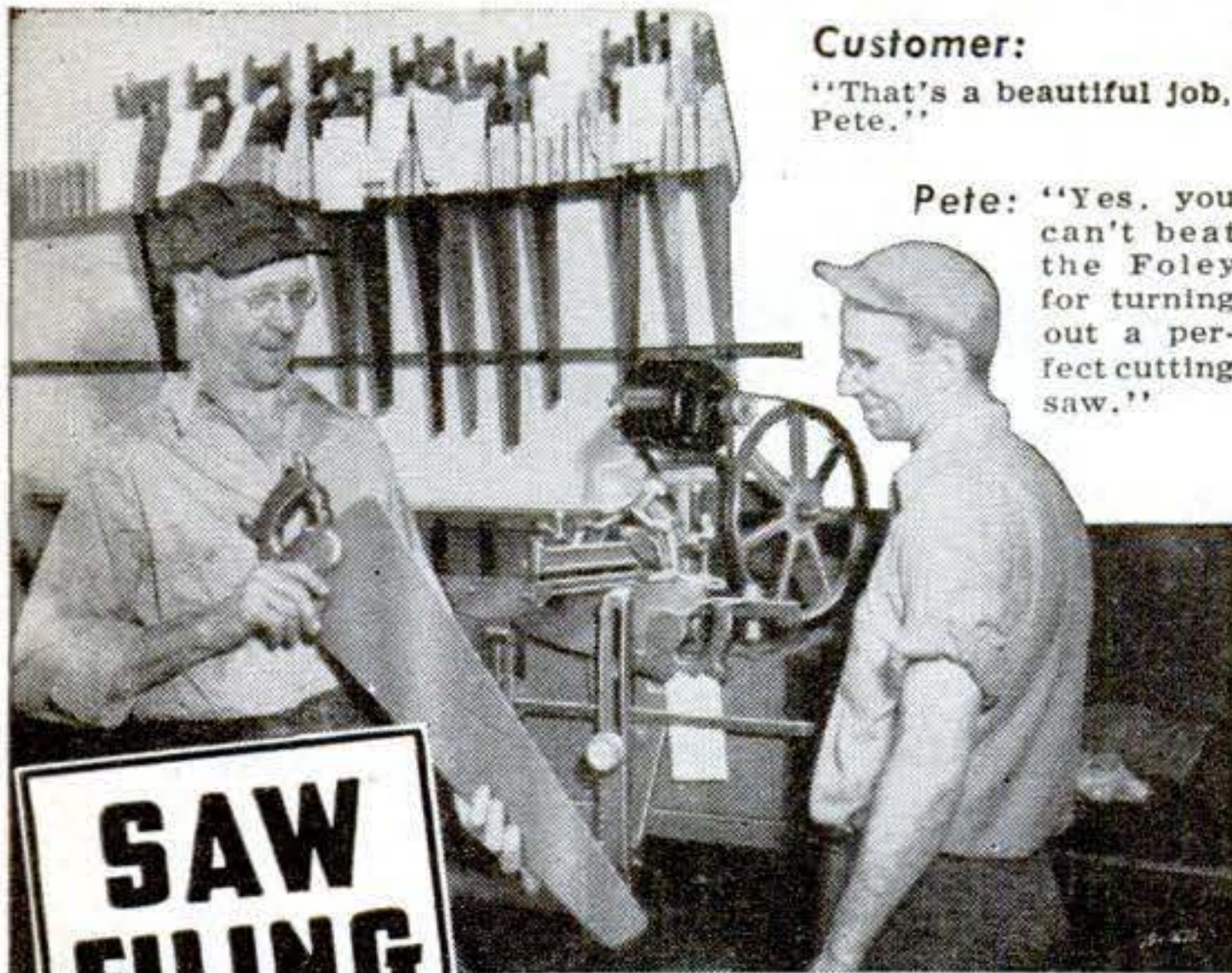

**Customer:**  
"That's a beautiful job, Pete."

**Pete:** "Yes, you can't beat the Foley for turning out a perfect cutting saw."

**SAW  
FILING**

**is a Good Business**

With the Foley Automatic Saw Filer you can put yourself into a fine cash business with steady customers and make a good living. The Foley automatically joints the saw, making all teeth even in size, shape, spacing. The Foley is the only machine that files all hand saws, also band and cross-cut circular saws. **SEND FOR FREE PLAN**—Shows how to start a saw repair shop. No canvassing. Send coupon today.

**FOLEY Automatic SAW FILER**

**FOLEY MANUFACTURING CO.**  
1219-6 Foley Bldg., Minneapolis 13, Minnesota  
Send Free Plan on Saw Filing business, no obligation

Name \_\_\_\_\_  
Address \_\_\_\_\_



**FREE** **COLLECTORS RARITY**  
*Atom Bomb*  
**IDENTIFICATION PATCH**



**COLLECT RARE MILITARY  
SHOULDER PATCHES**

Now you can collect hard-to-get, famous U. S. and foreign military shoulder patches. To start your collection we have created an introductory package of 20 patches worn by some of the fightingest units in Uncle Sam's army. With this special bargain package you get absolutely **FREE** the rare, original *Atom Bomb* patch and a beautiful illustrated catalog and price list containing hundreds of Army, Navy, Marine, Air Force, RAF, German, Jap and other foreign insignia. Start this fascinating hobby today. All patches are authentic . . . embroidered in the original colors. Send \$1.00 for the special introductory package of 20 and the **FREE Atom Bomb** patch, catalog and price list, or 10c for the catalog and price list only.

**THE PATCH KING, Dept. 212**

P.O. Box 101, Madison Square Station, New York 10, N. Y.

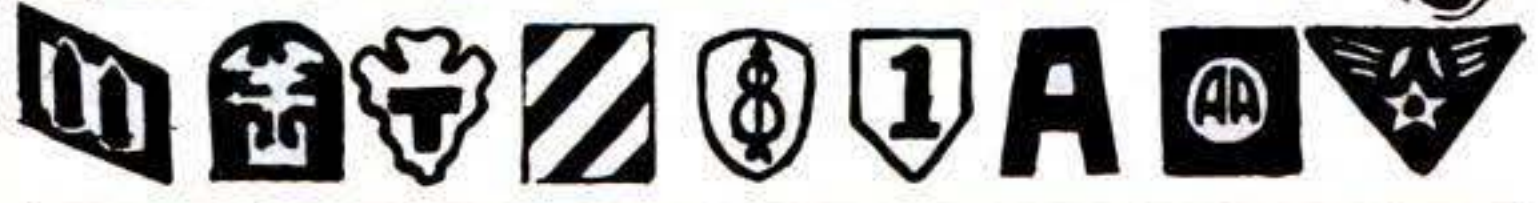

**THE HULL STREAMLINE  
AUTOMOBILE COMPASS**

is a quality instrument of time-proved reliability . . . used by hundreds of thousands of motorists and the armed forces. Universally acceptable, conveniently priced for Christmas giving. Price \$3.95. At your dealer's. Write for circular.



**HULL MFG. CO.**

P. O. Box 246-E13, Warren, Ohio

**WHY JOB WORRY?  
LEARN ELECTROPLATING**

Highly paid, uncrowded, interesting business. Part or full time. Chromium, Nickel, Gold, Silver, etc. Send postcard for **FREE** booklet and proof.

**PLATER HYDE, Dept. S Post Office Box 176,  
National City, California**

**\$\$\$\$\$ if trained in arc welding**  
Big income jobs await you. Learn quickly and thoroughly. Enroll under G. I. Bill. Write today.  
**Hobart Trade School, Inc., Box P.563, Troy, O.**

**WATCHES WANTED**

**BROKEN OR USABLE**

All kinds. Highest Prices paid for jewelry, rings, spectacles, gold teeth, diamonds, Sterling Silver, etc. Cash mailed promptly. Write for free shipping container.

**LOWE'S, Dept. PS, Holland Bldg., St. Louis 1, Missouri**

**DETECTIVES**

**TRAINING—SECRET INVESTIGATIONS—FINGERPRINTS**  
Easy Method — Short Time. — Rewards.  
Home—Travel—Secret Code-Booklet **FREE**—WRITE  
**INTERNATIONAL DETECTIVE SYSTEM**  
1701-P Monroe St., N. E., Washington, D. C. 18

**SAFEGUARD AGAINST  
ATHLETE'S FOOT  
and BLISTERS**

with **DALE VENT-O-SOLE, INC.**  
45-7 Halleck St., Newark 4, N.J.



U. S. Army and British Govt. bought millions. Woven plastic shoe ventilator flows air under feet—helps prevent infection, keeps feet dry, rids shoes of perspiration. Retards fungi. Guaranteed. Free Folder.

**FALSE TEETH  
KLUTCH holds them tighter**

**KLUTCH** forms a comfort cushion; holds dental plates so much firmer and snugger that one can eat and talk with greater comfort and security; in many cases almost as well as with natural teeth. Klutch lessens the constant fear of a dropping, rocking, chafing plate. 25c and 50c at druggists . . . If your druggist hasn't it, **don't waste money on substitutes**, but send us 10c and we will mail you a generous trial box.  
© I. P. INC.

**KLUTCH CO., Box 4694-L, ELMIRA, N. Y.**



# MINIATURE STEAM ENGINE!

REAL Working Model—Not a Toy

for only **\$17.50**

Strongly made of Bronze, Brass and Iron. COMPLETELY ASSEMBLED—READY FOR STEAM! A practical working model that performs and operates like a real steam engine. MADE TO EXACT SCALE. Educational, instructive, entertaining. For students, experiments, display. Suggested use: aerating pump in tropical fish tank. Many more uses. **Specifications:** Over-all length of base—6". Over-all height—3", weight—2 lbs. 4 oz., finish is red enamel with Brass trim.

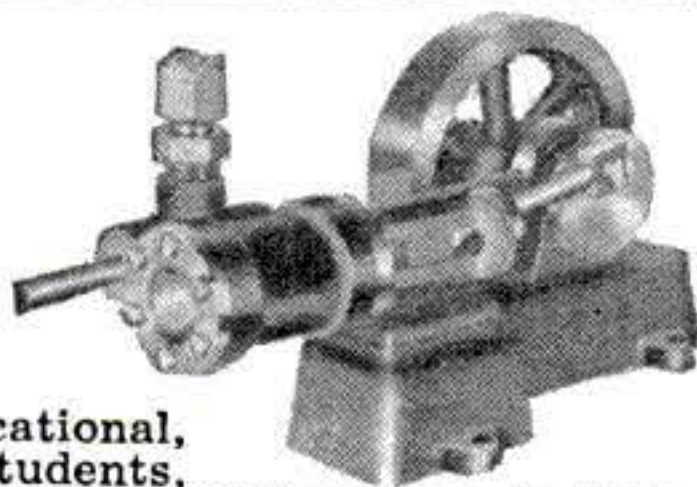

Order today. Remit with order. Sent postpaid.

**HARRY ROSS, 68 West Broadway, New York 7, N. Y.**

## HOME CRAFTSMEN! MOTOR RAIL SET

Use one motor to drive one or a half dozen power tools. Automatically provides correct belt tension and pulley alignment. Sturdily made from cold rolled steel, of arc welded construction, and cadmium plated. Easy to install. Eliminates countershafting. Complete set for motor and one tool . . . \$1.50. Yokes for each additional tool . . . \$.75. Add 25c for postage and handling in U.S.A.

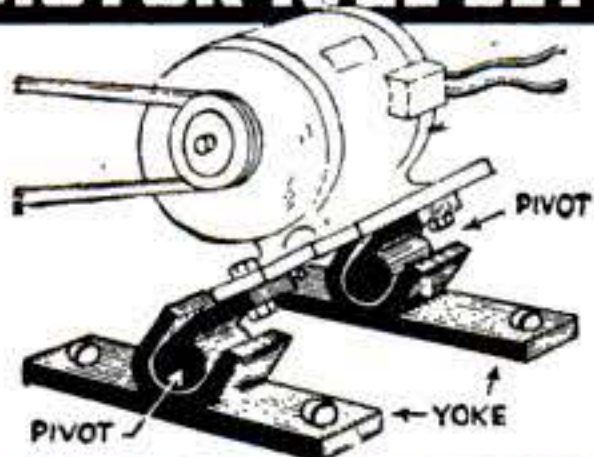

**KELBER INDUSTRIES**  
9601 Baltic Rd., Cleveland 2, Ohio

## YOUR ELECTRIC DRILL

Has 100 Other Uses

when used with K-Jax 1-2-3 Line

1. for Wood and Metal Sawing.
2. for Metal Shearing.
3. for Riveting-Chiseling and Drilling holes in concrete.

Write for illustrated circular

**K-JAX, P.O. BOX 3044, DALLAS, TEXAS**

500,000!!!!

# LENSES

Send 3 cent stamp for "BARGAIN" list.

**A. JAEGER**

**BOX 84B SO. OZONE PARK 20, N. Y.**

## FREE CATALOG Pins and Rings

Finest quality. Over 300 artistic designs. Write for our attractive free catalog and select a beautiful pin or ring for your class or club. Dept. O, Metal Arts Co., Rochester, N. Y.



\$2.95

## TORNADO GAS TORCH

The Modern Way of Soldering

Ideal for hard and soft soldering. Will heat quickly; solder will flow freely and smoothly. No compressed air required. Nothing to pump. Self-adjusting. Safe. Economical. Can be used for annealing small parts and bending metal parts. Generates a heat of 1700° Fahrenheit. Simply connect to any illuminating gas jet with

a rubber hose and operate. Tornado Torch No. 119 comes with three (3) tips, (1/8", 1/4", 3/8" blast). The Tornado Gas Torch No. 119, complete with three tips, is \$2.95. See your dealer or order direct. Send check or money order—post paid.

**Robco Corporation, 204 E. 44th Street, New York 17, N. Y.**



## HERE ARE A FEW "POINTERS" ABOUT BURD "GRAF-FLOX" PISTON RINGS . . .

• When your engine lacks pick-up and starts using gas and oil excessively, just head for your favorite repairman and ask for a re-ring job with Burd "Graf-Flox" Piston Rings. You'll be surprised at the instantly improved performance. Burd Rings are quicker seating . . . require no run-in . . . will not seize or score because of the exclusive "Graf-Flox" process. Electric furnace iron produces castings of uniform strength and tension. Precision grinding and finishing assures minimum wear of cylinder walls. Mail coupon today for two FREE booklets described below.

**BURD PISTON RING CO., Dept. PS, ROCKFORD, ILL.**



## THIS COUPON BRINGS FREE BOOKS

**BURD PISTON RING CO., DEPT. PS, Rockford, Illinois**

Gentlemen:

I'd like a FREE copy of your "Handy Handbook" which tells how to keep my car in good working order. Also send a "Car Economy Record Book."

Name.....

Address.....

City.....State.....





The All-Purpose  
CUTTING TOOL  
for  
HOME WORKSHOP  
CRAFTSMEN!

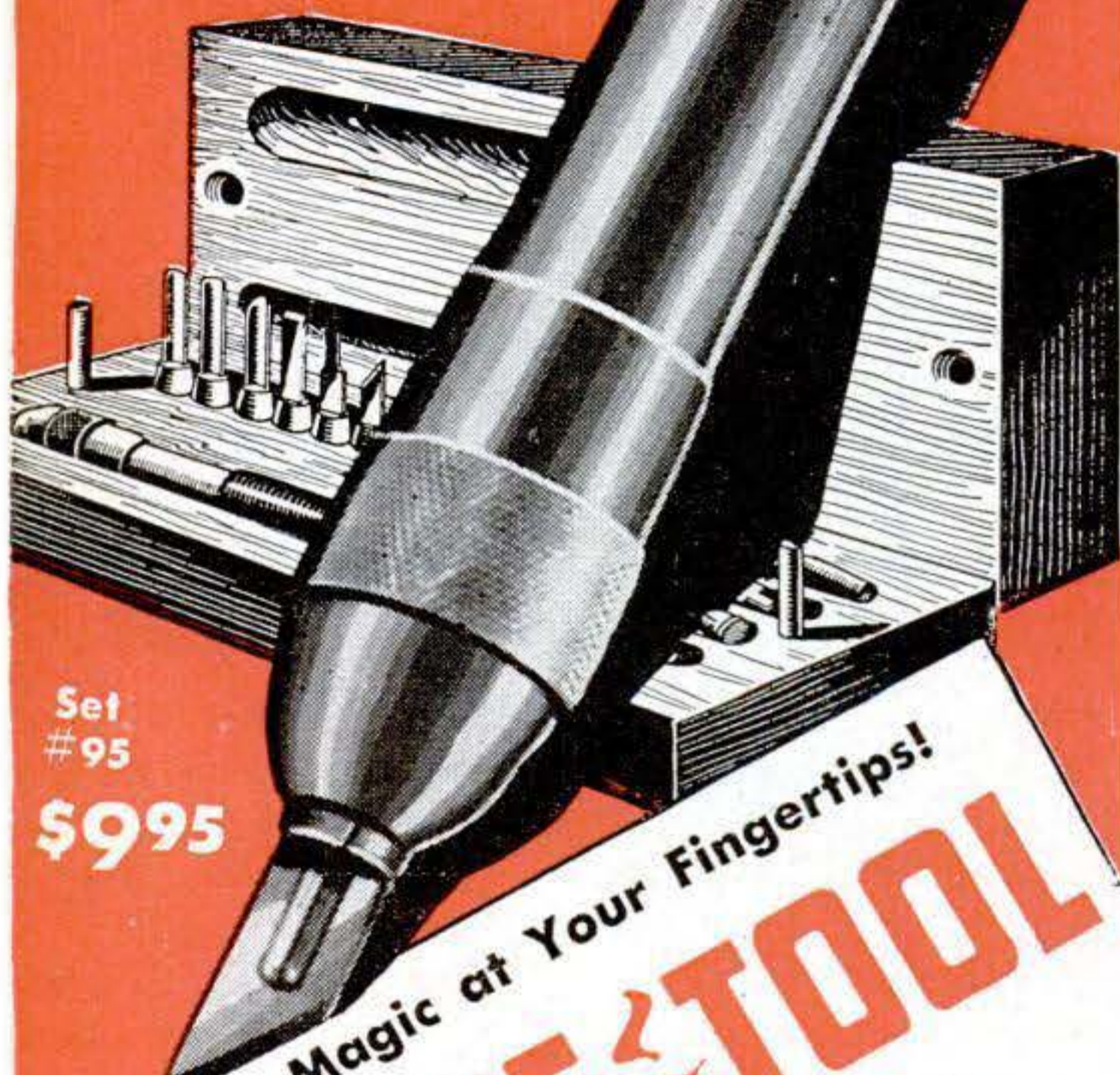

Set  
#95

\$9.95

It's Magic at Your Fingertips!

**GENIE TOOL**

Yes—GENIE TOOL is the hand-tool with a multiplicity of uses. Get yours today—find out how useful this versatile precision tool will be to you. It's without equal for the model builder... indispensable for general home use.

For use on hard or soft woods — plastics — li-noleum and soft metals.

There's a GENIE TOOL Accessory for Every Use!

IT CUTS!  
IT DRILLS!  
IT GOUGES!  
IT FILES!

SEND FOR  
CATALOG  
TODAY!

DEPT. C  
**MODEL TOOLS**  
BOX 30 • BURBANK, CALIF.

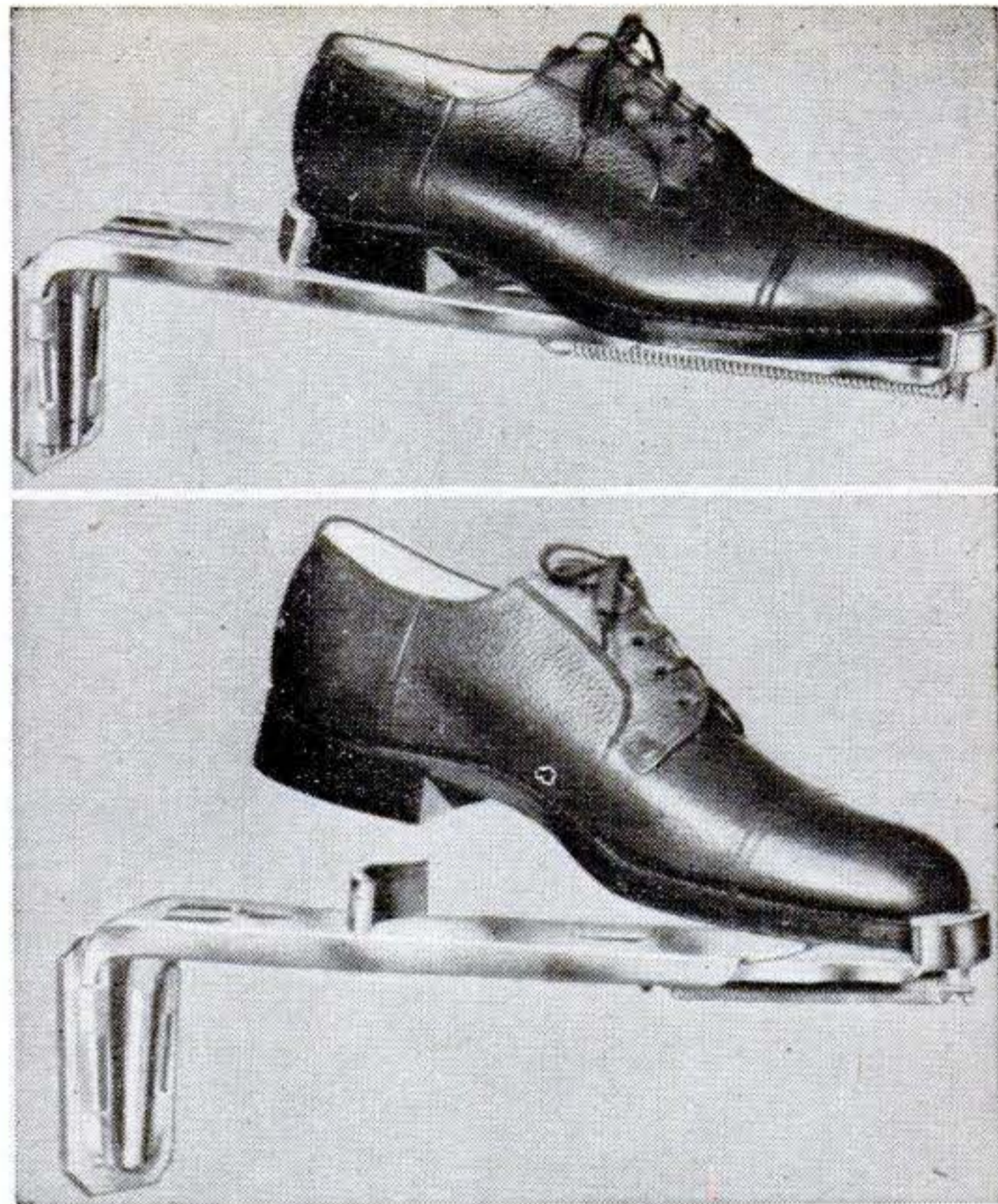

### Self-Adjusting Shoe Holder

A SHOE holder that slips into a wall bracket has been developed by the David Shine-Stick Co., of St. Paul. Self-adjusting springs keep shoes flat on the holder, eliminating the need for shoe trees. Neoprene pads protect heels and toes.

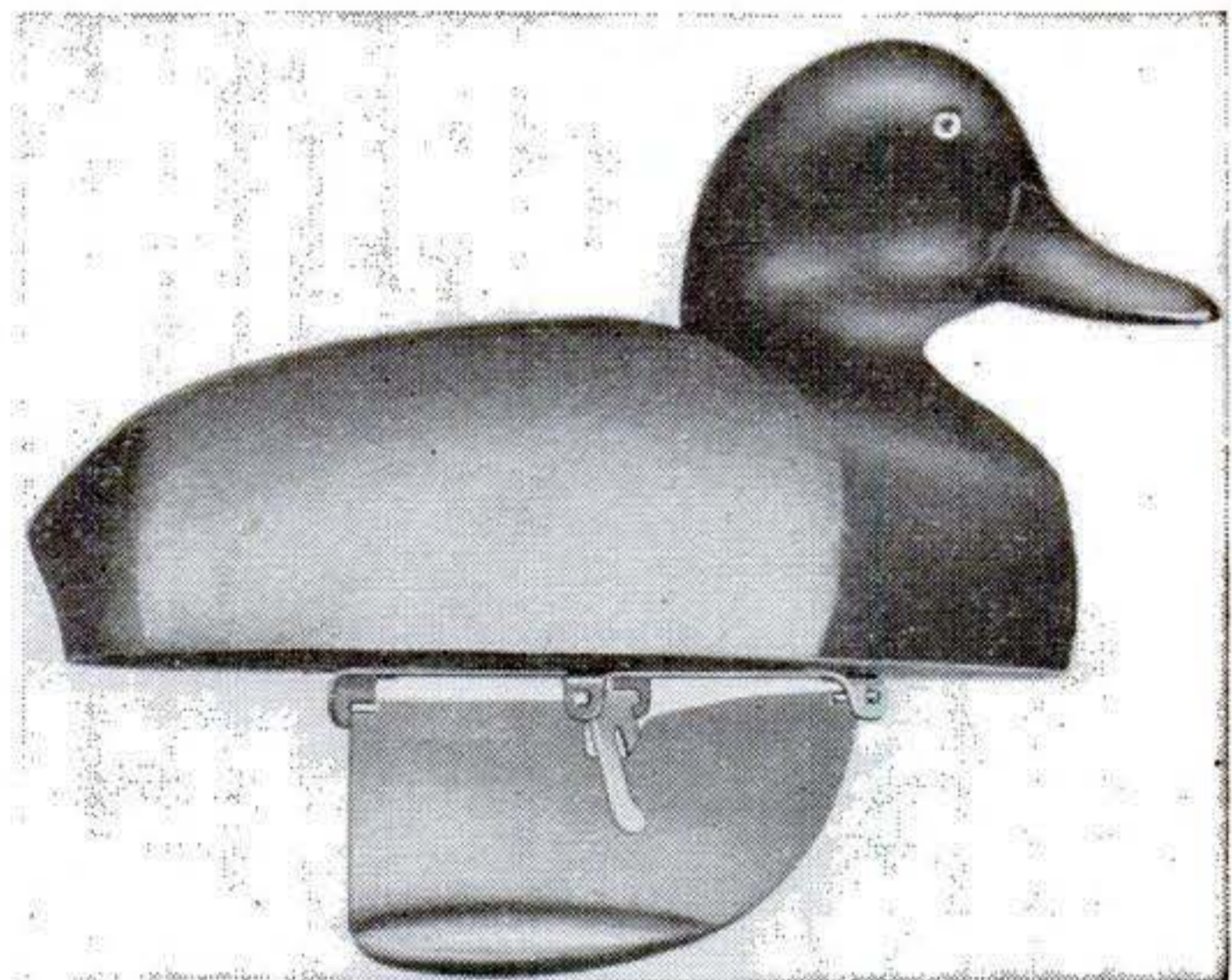

### Keeps Decoys Right Side Up

A KEEL designed to keep duck decoys upright in rough water is manufactured by the Mt. Clemens Specialty Co., of Mt. Clemens, Mich. If the decoy upsets, a trigger drops and allows the keel to fall on one side of the decoy's base, causing it to right itself and thus reset the trigger.



**EASY to  
PLAY**

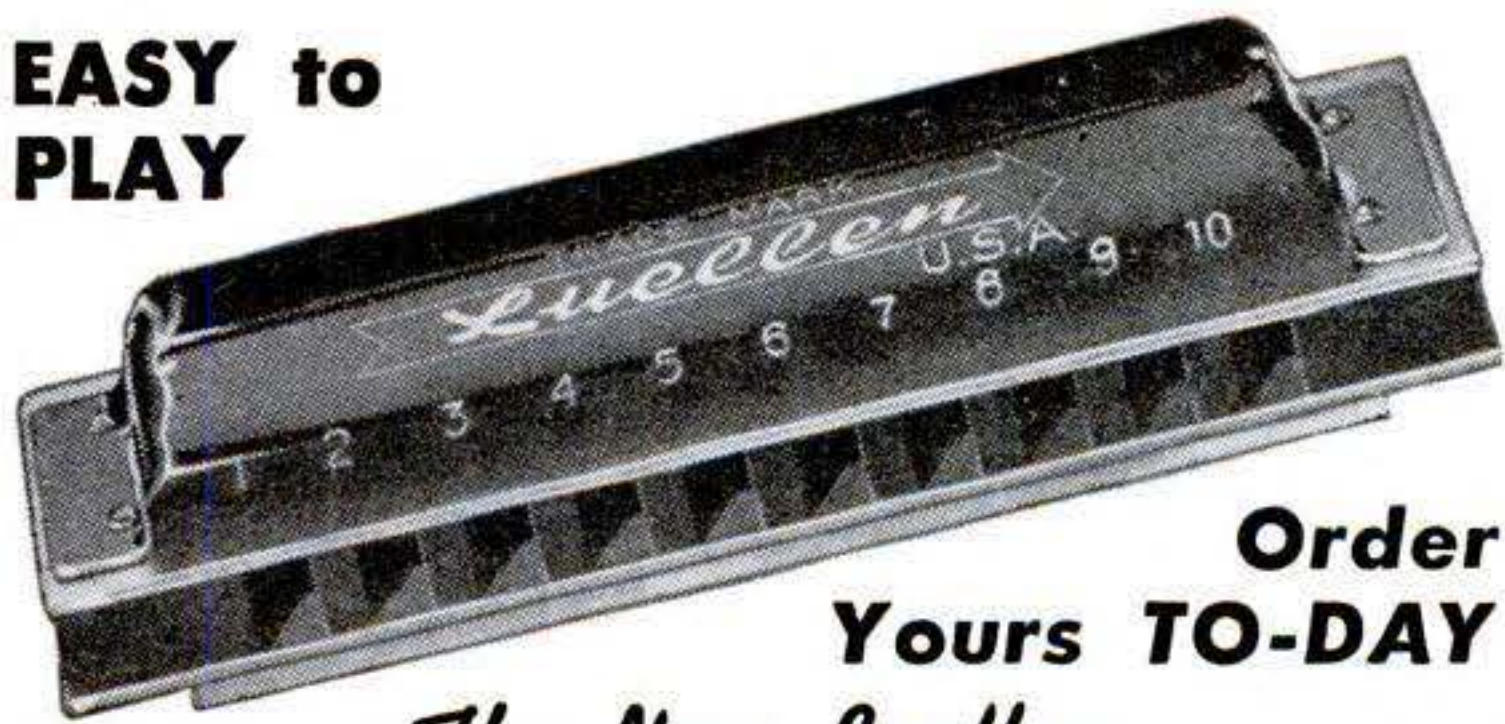

**Order  
Yours TO-DAY**

*The New Luellen*

## HARMONICA

Most wonderful pocket instrument ever made is the harmonica. Easy to master, fun for Everyone. The Luellen has 10 holes, 20 notes. Key of C. Beautiful tone. Now ready. Postpaid Only **\$2.35**

**INSTRUCTION BOOK.** Simple for youngest child. No notes, scales nor exercises. Ten lesson charts show everything. Includes 75 popular songs. Price **\$1.00**. Here's our special introductory offer: The Instructor and the Harmonica, both postpaid, both for **\$2.85**. Send Check or Money Order Today.

**JOHN LUELLEN & CO.,** 17034 Page Avenue, Dept. 1204, Hazelcrest, Ill.

## Steel Wheels

**To Build Your Own Wagon, Cart, Toy, etc.**

Sturdy, rubber tired pressed steel wheels with red enamel finish. Ready to use axles—threaded at both ends. Acorn nuts supplied. Order today, or send stamp for catalog.

### WHEELS WITH SOLID RUBBER TIRES

4" Wheels, 1/4" bearing, Steel Disc.....\$ .75

6" Wheels, 3/8" bearing, Steel Disc..... 1.00

### WHEELS WITH SEMI-PNEUMATIC TIRES

6" x 1.50 with 3/8" Oilite Bearing ..... 1.75

8" x 1.75 with 3/8" Oilite Bearing..... 2.25

### AXLES, COLD ROLLED STEEL

1/4" x 14" long, Nickel Cap Nuts..... .40

3/8" x 16" long, Nickel Cap Nuts..... .60

1/2" x 18" long, Nickel Cap Nuts..... .80

Sent postpaid in U. S. on receipt of price.

**CIRCLE METAL MANUFACTURING COMPANY**

4272 E. PACIFIC WAY LOS ANGELES 23, CALIF.



## MELTCAST IRON

For the first time you can now melt fine gray cast iron on a small scale at home. Produce cast iron at a profit from scrap. Use castings in design problems.

Fourteen detailed blueprints of a proven small cupola and complete text of instructions for \$4.85. Also a complete line of sands, flasks, metals, crucibles, etc. Send 10c for complete catalog and preliminary instructions. **KEN PARR, Box 637-B West Lafayette, Indiana.**

## KLEENLENZ Cleans Lenses!

for Camera Lenses—for Eyeglasses

Removes dirt; leaves transparent, lens-protecting film that lasts for days. Money back guarantee. Send 50c for 1 oz. bottle.

**GREENWICH PRODUCTS CO.,**

Dept. A, Box 438, G. P. O.,

New York 1, N. Y.

## SHARPER CUTTING EDGES

Easy • Accurate • Quick

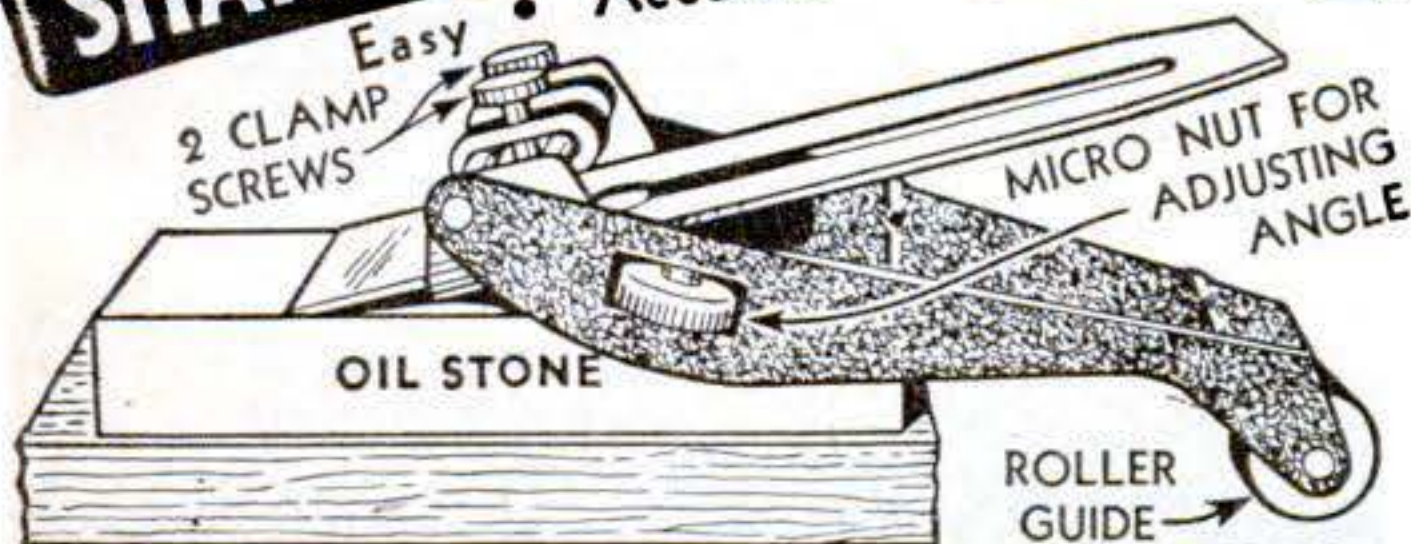

It's easy to hone keen cutting edges on your chisels and plane blades. Precision adjustment for ANY ANGLE of bevel. Roller glide makes every stroke uniform across oil stone. Light, strong—ideal for home craftsmen, hobbyists, carpenters, cabinet makers.

Check or money order

**\$2.95**

POST PAID

**McLAREN INDUSTRIES, INC.,** Box 606, TROY, N. Y.

# BURN WATER IN YOUR CAR

- MORE POWER • FASTER PICK-UP
- CLEANER, COOLER, SMOOTHER MOTOR • GOOD MILEAGE
- ECONOMICAL, TOO.

WATER INJECTION, once a top military aviation secret for fighter-craft airplane engines to increase horsepower and speed; to decrease fuel consumption, keep engines cooler, cleaner, more carbon-free, is now available for Cars and Trucks in the **VANDERPOEL WATER INJECTING CARBURETOR.**



**THOUSANDS  
IN USE**

**\$17<sup>50</sup>**

**TANKS  
EXTRA**

Quickly and easily installed between air cleaner and gasoline carburetor, the **VANDERPOEL** automatically injects a regulated and controlled amount of water, or alcohol-water (for winter) through air-horn of the gasoline carburetor and into the air stream, thus combining . . . with fuel-air mixture.

## DECLARED GREATEST AUTOMOTIVE IMPROVEMENT SINCE 4-WHEEL BRAKES

Your car performs better at night or during a rain because Water Vapor, in mixture with the air and petroleum gases, acts as an internal coolant, reducing high temperatures and peak pressures, suppresses detonation, ("ping") and pre-ignition, permits advanced timing, increases combustion time period of the fuel, dissolves gummy carbon deposits, keeps spark plugs clean, reduces fuel consumption, and produces higher power output from the engine.

### ASK YOUR DEALER

ASK for literature. ASK to see the **VANDERPOEL** ALL Service Stations, Garages, Tune-ups, Tire, Car, Truck, and Tractor Dealers EVERYWHERE in the United States can sell and install the **VANDERPOEL**

(If your dealer can not serve you, order direct.  
Mail post-card for literature.)

## EXOLA PRODUCTS, INC.

2423 E. 57TH STREET • LOS ANGELES 11 • CALIF.

WANTED IMMEDIATELY 500 MEN WITH MECHANICAL ABILITY AS DIRECT, FACTORY, WHOLESALE DISTRIBUTORS TO HELP US SERVICE THOUSANDS OF RETAIL OUTLETS. PLEASE WRITE.

DEC. 1946 259



# MEDICO FILTERED SMOKING

The replaceable filter in  
*Frank MEDICO* Pipes

Cuts down nicotine,  
whirlcools smoke

Reduces tongue-bite,  
collects flakes and  
slugs, absorbs juices

Cleaner, cooler smoke  
enters your mouth

● REPLACE FILTER  
WHEN DISCOLORED



PIPE

\$1

with box of  
10 filters

*Frank MEDICO*

THE LARGEST-SELLING FILTER PIPE



Only these genuine filters give you genuine Medico-Filtered Smoking. Packed only in this red-and-black box.

S. M. FRANK & CO., Inc., NEW YORK 22

## Floyd Clymer's Popular MOTOR BOOKS

1946 INDIANAPOLIS "500" RACING BOOK \$1.00

80 ILLUSTRATIONS, drawings, charts, World famous driver, car data on 1946 race and highlights George Robson racing career. \$1.00. Large 320-page Indianapolis Race History every race since 1909. 1000 illustrations. Includes 1946 book. \$3.50

**FASTEST ON EARTH**, by George Eyston, a racing history book of all world's straightaway land speed records since 1898. \$2.00. **MERCEDES-BENZ** Grand Prix race book, 176 pages, 93 photos. \$2.00.

**Clymer's Motor Scrapbooks** Nos. 1, 2 & 3 available. \$1.50 each; cloth-bound, \$2.50 each. Power & Speed, \$2.50. Ab Jenkins' Race History Book, \$1.50. Speed—How to Obtain It, \$1.50. All books postpaid. See our ad under Autos, Classified section.

**CLYMER, Dept. B-12**  
2125 W. Pico Street  
LOS ANGELES 6, CALIF.

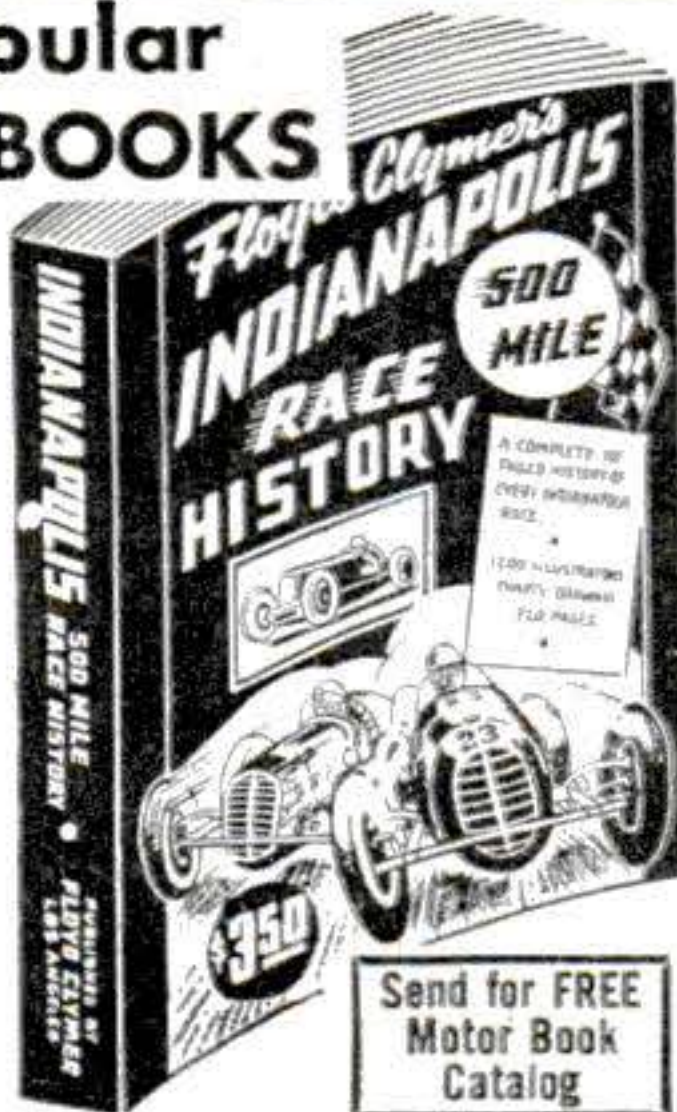

Send for FREE  
Motor Book  
Catalog

260 POPULAR  
SCIENCE

## New Liquid Casting Plastic

**CASTOLITE**, new liquid wonder plastic, now available for hobbyists, designers, amateur sculptors, homecraftsmen, etc., for making bookends, buttons, costume jewelry, toys, other beautiful objects. Crystal clear, pours without heating. Use simple home tools, spoon for mixing, plus any smooth-surface container like glass, cup or ashtray.

### Make Gorgeous Xmas Gifts

Use Castolite to make gorgeous Xmas gifts at amazingly low cost. Delight your friends. This year, present unusual objects that rival costly articles in gift shops

### \$2.95 Kit Now Ready

Send today for beginners' CASTO-KIT; includes 1 lb. Castolite, hardener, dropper, buffing compound, vial, illustrated instruction booklet to make many different beautiful articles. Produce lovely objects very first day. Complete for \$2.95 (check or money order) plus 20c postage. The Castolite Company, Box C-211, Kenilworth, Ill.

THE *Castolite* CO., KENILWORTH, ILL.

## ATTENTION AUTO OWNERS!

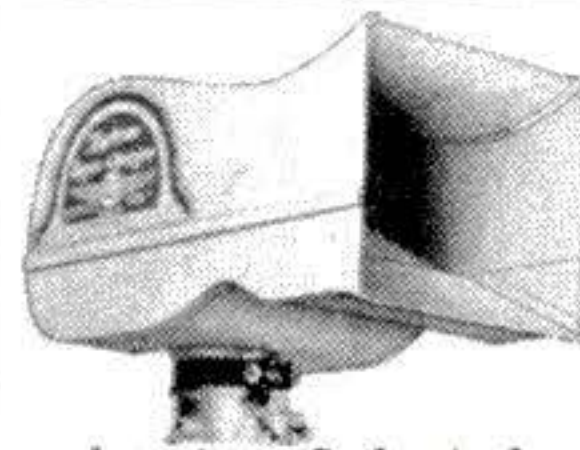

### New Power, Pickup, Pep!

Amazing TYPHOON SUPER-CHARGER is back again, ready to put new life into old motors, add to power, pickup, pep. 41,000 users find gasoline economy, you will, too. Motor knock vanishes... Grease bath air cleaning keeps dust out. Takes 5 minutes to install with screw driver, fits on carburetor. Order today, mention make and car model. Only \$5.95. Ohio orders add 3% tax, west of Rockies add 10%.

**10 DAY MONEY BACK GUARANTEE!**  
**TYPHOON PRODUCTS CO.** 507-R Engineers Bldg., Cleveland 14, Ohio

## LAW

STUDY AT HOME for PERSONAL SUCCESS and LARGER EARNINGS. 38 years expert instruction—over 108,000 students enrolled. LL.B. Degree awarded. All texts furnished. Easy payments. Send for FREE BOOK—"Law and Executive Guidance"

AMERICAN EXTENSION SCHOOL OF LAW  
Dept. 72-S, 646 N. Michigan Ave., Chicago 11, Ill.

## GIVE THIS FOR CHRISTMAS

Get This NEW INVENTION  
**CRACKS BLACK WALNUTS**  
BUTTERNUTS, ENGLISH WALNUTS

NO FLYING  
SHELLS

**75% MEATS IN QUARTERS.** Sold by all Hardware Stores or mailed direct for \$1.50 delivered. Send cash, check, stamps, or money order. Money-back guarantee. **C. E. POTTER, Dept. 279, Sapulpa, Okla.**



## 4 TYPES

Socket Screw Key Kit—9 Tools in 1 ● Auto Key Kit—8 Tools in 1 ● Home Kit—7 Tools in 1 ● Socket Wrench Kit—6 Tools in 1 ● Accessories for 1000 uses. Write for Free Booklet S. **JENCO TOOL CO., 6911 New Utrecht Ave., Bklyn., N. Y.**

## AN OIL BURNER HANDBOOK



Learn how to repair and service oil burners. This book is different. It uses every-day language and takes guessing out of oil burner work. The chapters discuss in detail Domestic and Industrial Burners. Order from **MASTER PLUMBER PUBLISHING CO** Eagle Building Brooklyn 1, N. Y.

Say You Saw  
It In Popular Science

MIKE Jr.

**NOW ONLY \$1.39**



**SING—TALK—AMUSE YOUR FRIENDS—** through your own radio set. Practice to become an announcer. Simple to install—Not a Toy.

**SEND NO MONEY—WRITE TODAY**

Just send your name and address and when your MIKE Jr. arrives, pay postman \$1.39 plus few cents postage. Sent postpaid if check or money order accompanies your order. No stamps.

**MART DISTRIBUTORS, Dept. P-3, P.O. Box 6, Evanston, Ill.**



**PAINTERS' STRIPING TOOL**  
**NEW, IMPROVED**  
**A TOOL... NOT A BRUSH**

Modern—streamlined—fits the hand like a fountain pen! Easy to use as a pencil. Draws parallel lines—straight, curve or circular. Does expert job on autos, furniture, toys, bikes, model planes, signs, bulletins, linoleum. (Makes wall board look like tile.)

Every painter and craftsman needs one! Type "M" MASTER Painters' Striping Tool complete with tip for 1/16" stripe, \$1.00. Extra tips 1/64", 1/32", 3/64", 1/16", 5/64", 3/32", 1/8"—75c each. Tool with complete set of 7 tips \$5.00. (C.O.D. orders 25c extra.) Paint dealers, write!

**EASY AS USING A PENCIL!**

**\$1.00 POST PAID**

**WENDELL MFG. CO.**  
 4234-A Lincoln Ave., Chicago 18, Illinois



**WHEELS AT BARGAIN PRICES**

We Are Overstocked and Must Move This Supply of De Luxe BALL BEARING WHEELS

.....8"x2" Semi Pneumatic tire. 7/16" Ball Bearing.....\$2.75 each  
 .....10"x1.75 Semi Pneumatic tire. 7/16" Ball Bearing....\$3.75 each  
 (Cheaper In Sets Of Four—Write For FREE LIST)

Write number wheels wanted in space provided, tear out and mail this ad with check or money order and your name and address.

Trulson Mfg. Co., Dept. S-2, 811 E. 31 St., Kansas City, Mo.



**WOODBURNING PEN** With 4 Special Tips!

- Woodburning • Foil Writing
- Embossing • Leather Burning
- Cork Decorating

You can draw all kinds of designs. Unconditionally Guaranteed.

**\$2.50**

Postpaid or C.O.D. plus charges

**S. S. MERCHANDISE CO., Dept. 63**  
 23 Flatbush Ave. Brooklyn 17, N. Y.



**Arc Welded Design "Know-How"**

Only \$3.50 each  
 3 different volumes

Each volume contains over 100 welding designs. Write \$10.00 postpaid

Hobart Bros. Co. Box P-561, Troy, O.





**WRITE FOR YOUR FREE COPY OF THE NEW KRW HYDRAULIC PRESS BOOK**

Describes all manner of Production and Shop Work on KRW Hydraulic and Bench Type Arbor Presses. 32 pages illustrating the new KRW Hand-operated, Electric-operated and Air-operated Hydraulic Presses.

*Write for your copy today.*

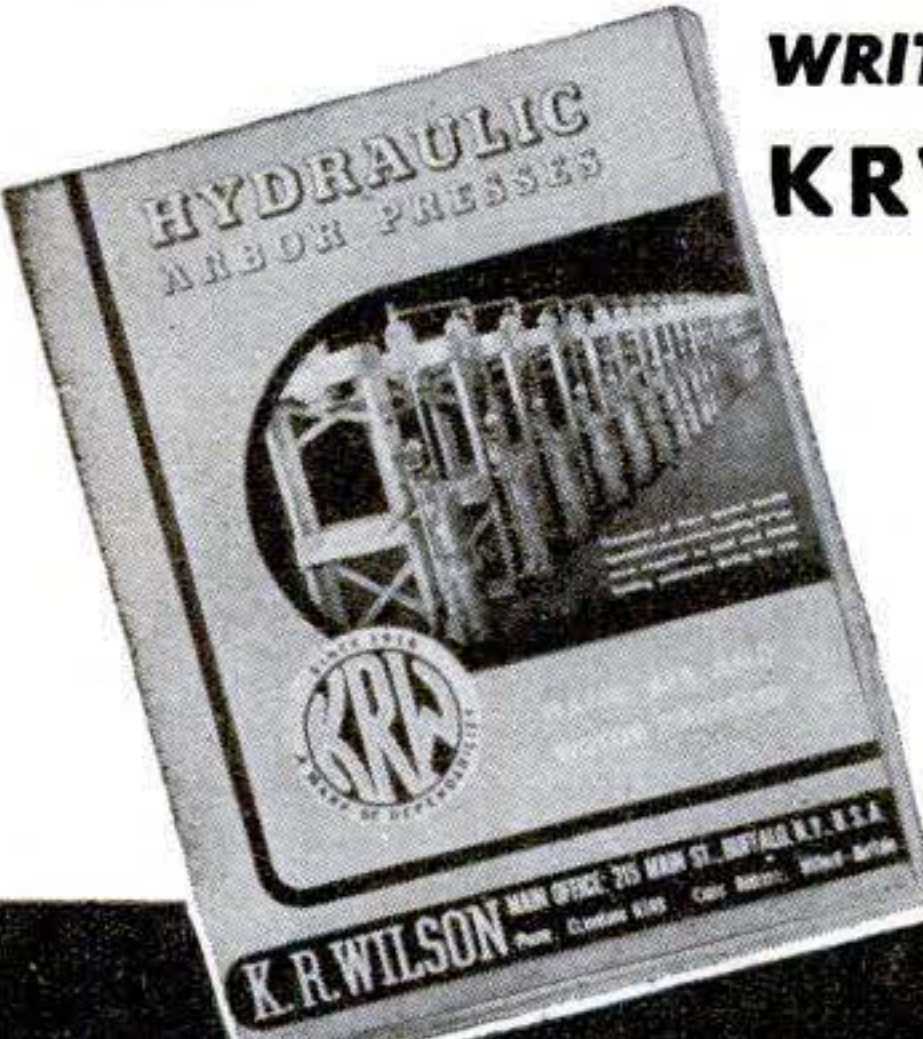
**K. R. WILSON, DEPT. 54, 215 MAIN ST., BUFFALO 3, N. Y.**

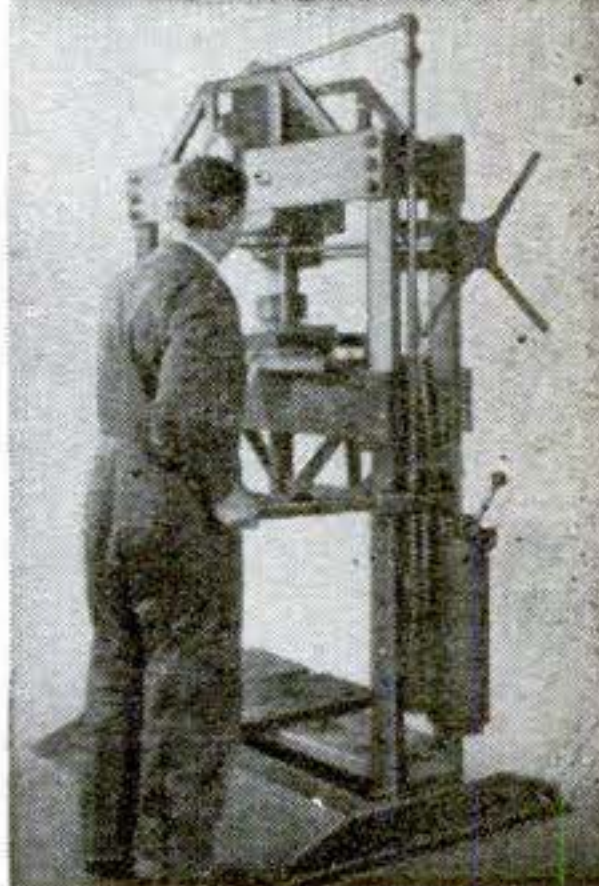
**Lost... in the maze of your Xmas List?**

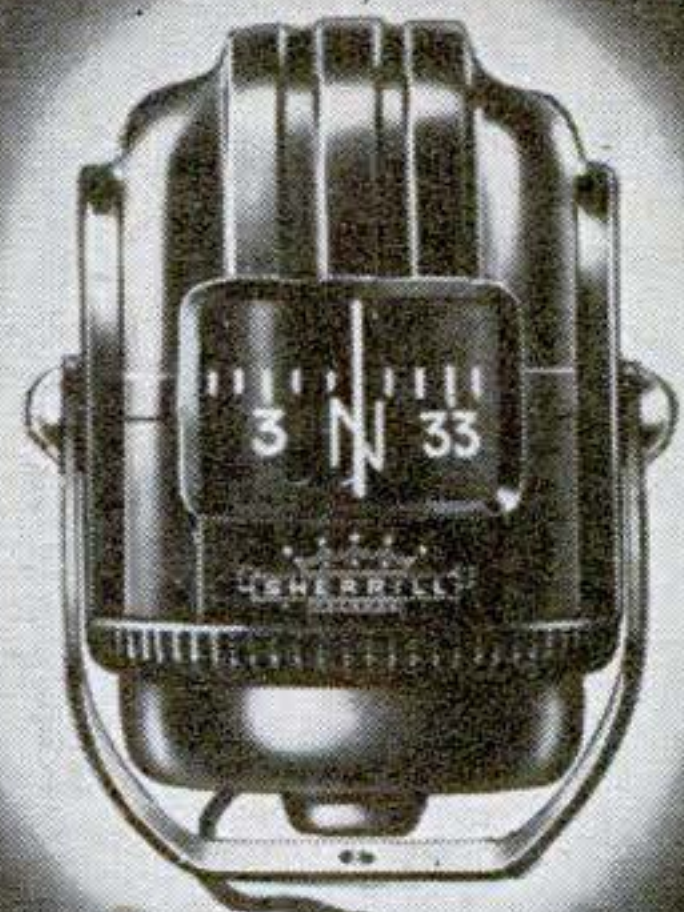

*Be sure with a Sherrill Compass*

Seven harmonizing colors in plastic: Tallyho Red, Streamliner Grey, Sportsman Tan, Burgundy, Jade Green, Walnut and Ebony.

**FOR AUTOS • BOATS • PLANES**

De Luxe illuminated \$5.95, model illustrated...  
 Other Sherrill Compasses from \$1.95.

**AT LEADING RETAILERS**

Send for Amazing Booklet, "How to Find Your Way WITHOUT A Compass!" Write to Dept. 70

*Sherrill*

**INSTRUMENT CORP.**  
 185 N. Wabash Ave. Chicago 1, Ill.



# BANDSANDER

## NEW TOOL READY!

WAR INDUSTRY'S  
MOST VERSATILE MACHINE

Is Now Available  
TO HOME SHOPS



Signs & Display



Model Building



Plastics, Novelties



Ornaments



Pattern Shops



Shows use on  
INSIDE  
cut-out  
openings

The Mead  
Bandsander

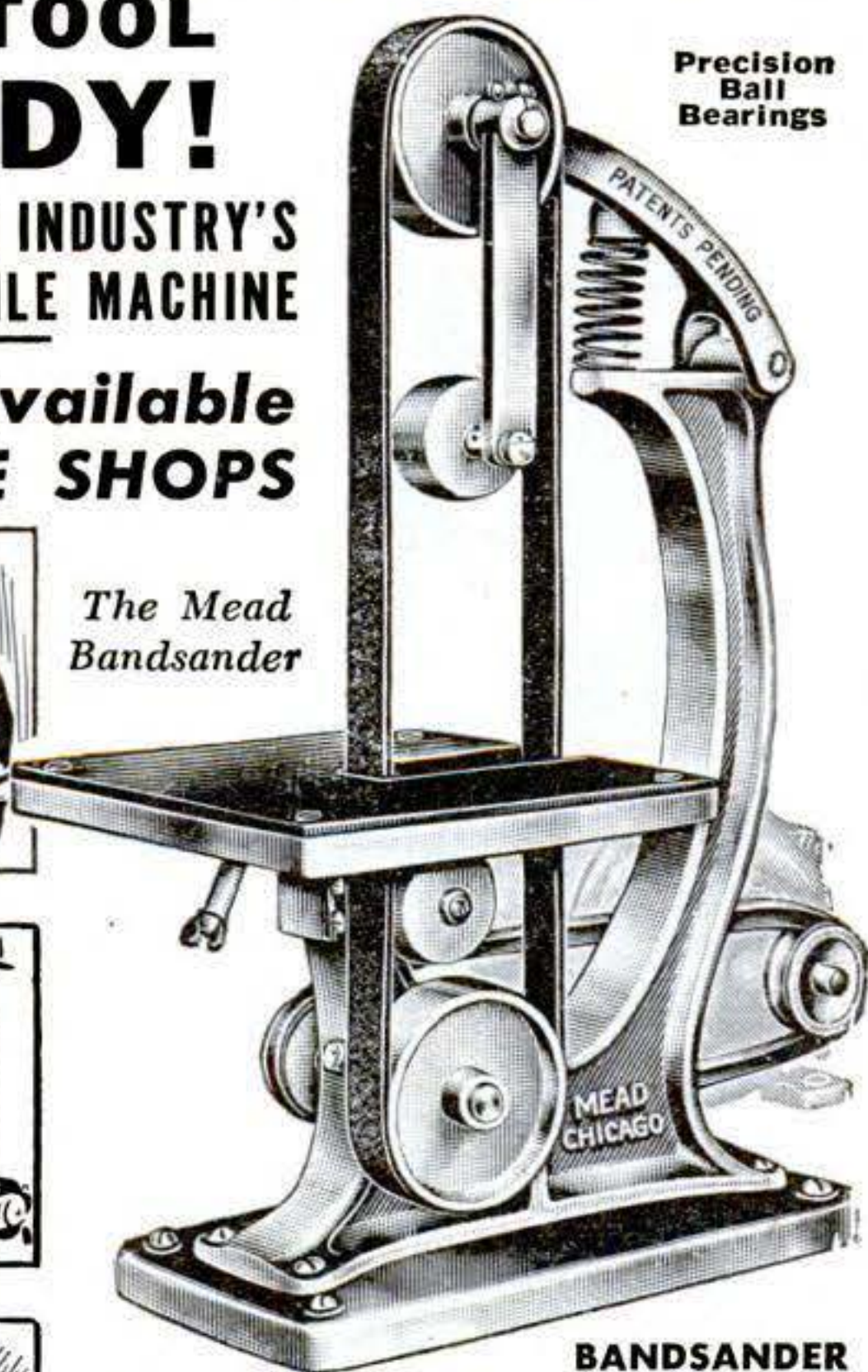

Precision  
Ball  
Bearings

BANDSANDER

Cuts Fast, Clean—Saves  
Filing and Sanding Work!

SHAPES • PROFILES • SMOOTHS  
BEVELS • GRINDS • POLISHES  
SANDS • CARVES • CLEANS

Let the versatile war plant production-proved Mead Bandsander save you sweat and time on hand-filing and sanding jobs—on wood, metal, plastics! A godsend to home craftsmen, hobbyists, model-makers, pattern-makers, industrial shops. Handier than a grinding tool for sharpening drills, chisels, tool bits, garden tools. This all-around utility tool works equally well on irregular outside surfaces or inside cut-out openings. Gets into places no others can. For example, to work inside a cut-out opening, simply lead band through hole in work and in front of idler pulleys. You can work to the center of pieces up to 17" wide! Table tilts back or forward for bevelling or chamfering edges of any contour. Table top is rust-and-sweat proof. Bandsander operates on 1/4 h.p. motor at 1700-2200 r.p.m. Abrasive band surface passes work at 1600 feet per minute cutting fast, cool, clean. Narrow bands may be used for intricate patterns.

### Rush Coupon for FREE Circular

Send no money—simply mail coupon for Free, lavishly illustrated Bandsander Circular. Read about "the machine that amazed the experts." Surprisingly low cost. Sold on 5 Days' "No Risk Money Back" Trial. Ideal to give or get.

MEAD SPECIALTIES CO.  
4114 North Knox Avenue  
Dept. 2126 Chicago 41, Illinois

MEAD SPECIALTIES COMPANY,  
4114 North Knox Avenue, Dept. 2126,  
Chicago 41, Illinois.

Gentlemen: Without cost or obligation, send me your lavishly illustrated Circular on Mead Bandsander—the tool that takes the work out of home workshops!

NAME \_\_\_\_\_  
ST. & NO. \_\_\_\_\_  
CITY \_\_\_\_\_ STATE \_\_\_\_\_

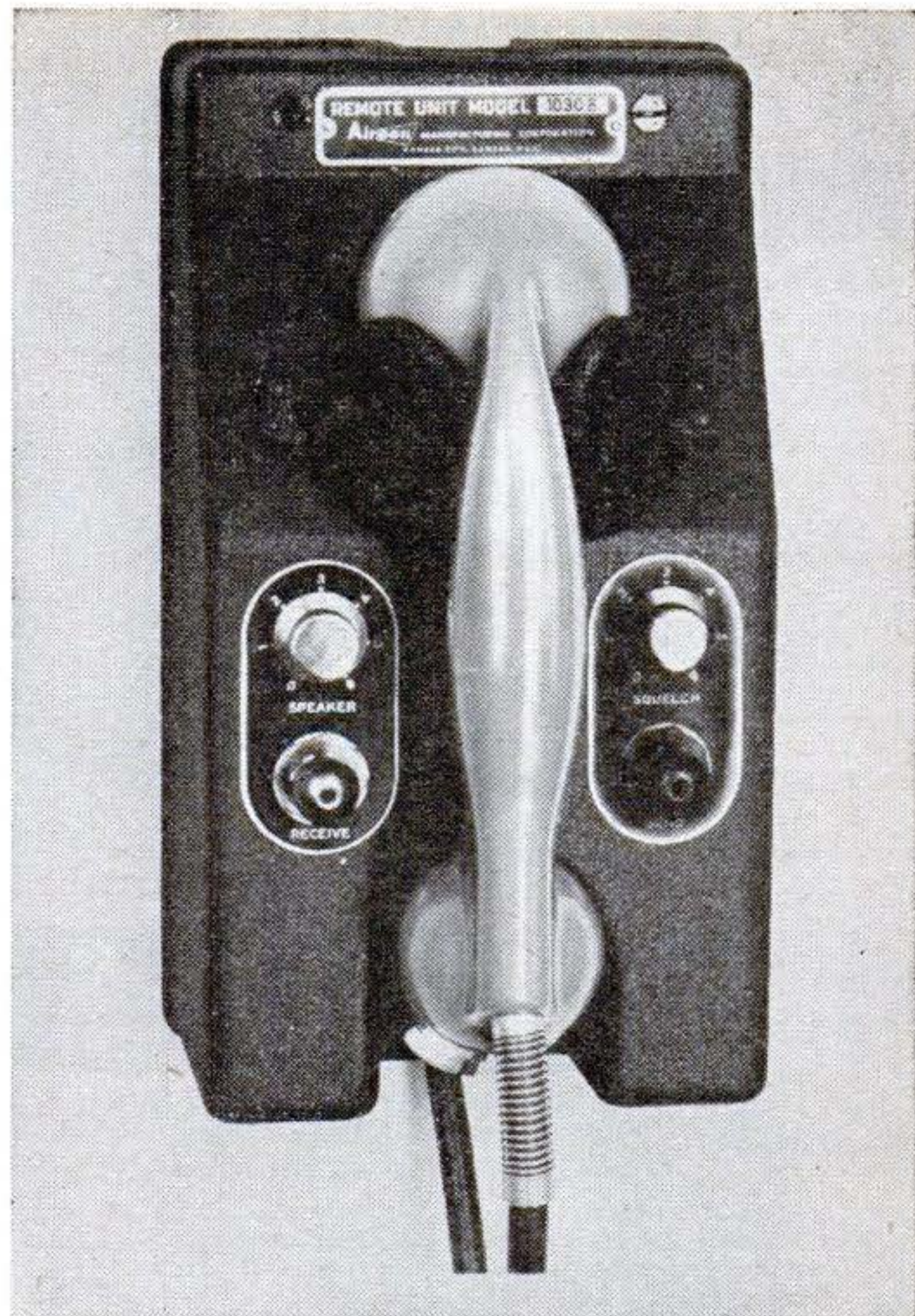

## Locomotive-to-Station Phone

ENGINEERS on moving trains can speak with stations as much as 50 miles away with the Airon radiophone, above. The locomotive's headlight generator can be tapped for power. The handset has a rubber cap over the earpiece and a "lip" microphone that transmits the voice only. Volume controls are alongside the handset. Auditory signals from the receiver, plus "send-receive" lights, warn when a party is calling. The set operates on a frequency of 70-200 kilocycles.

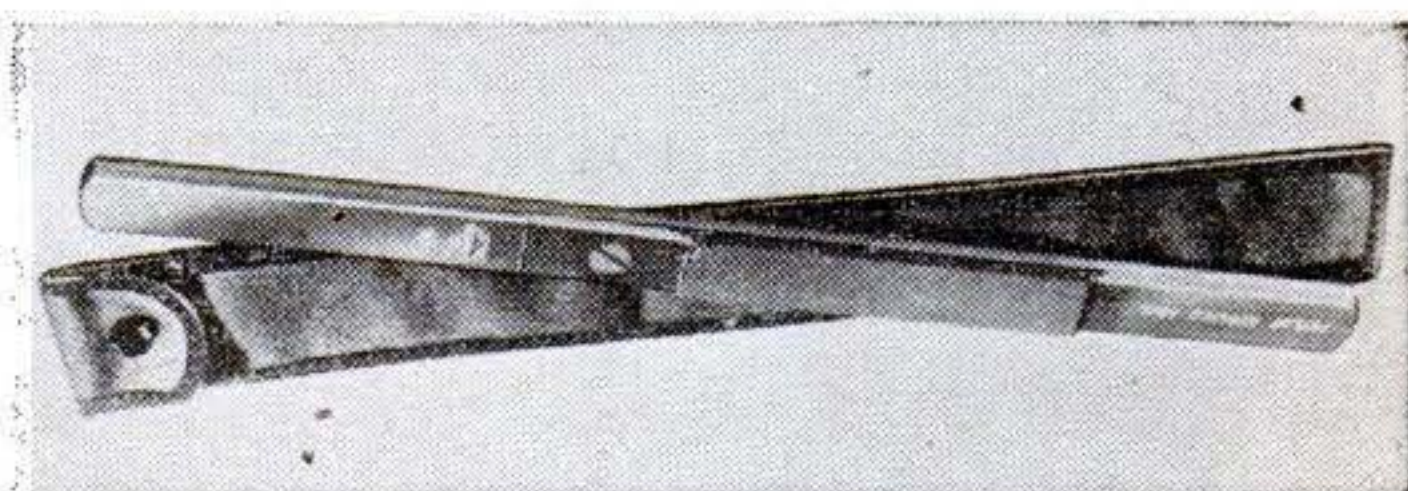

## New Carbide Lathe File

THIS TWO-SIDED, carbide lathe file, devised by Carboloy Co., fits into an aluminum holder. The 4- by 3/4-inch file insert is single cut, 34 teeth to the inch. When one face is worn, insert is turned over.



## New THOR "B" ENGINE-\$6.95

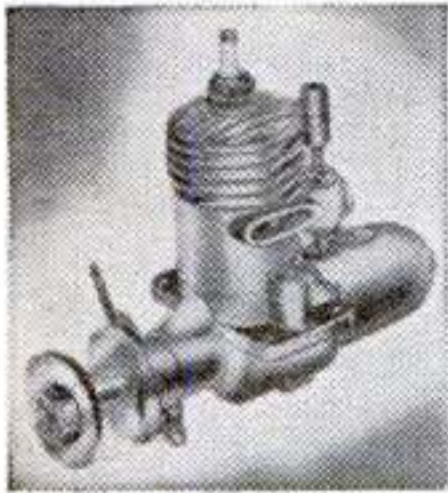

The new THOR "B"—Sensational miniature gasoline engine that really works. Super-power performance. Smooth, velvety power that roars into action with a "twist of the wrist." Over 15,000 already sold, 1/6 H.P. Complete with coil and condenser. Ready to run, only \$9.95. In KIT form, fully machined, 5 minutes to assemble, \$6.95. without coil and condenser. Powers all models. Fully illustrated instructions. Send \$1.00—shipped collect same day. C.O.D. or send full price plus 25c extra and we ship parcel post insured.

**FREE** Just off the Press. Send for big 40-page illustrated hobby catalog with over 300 illustrations and over 1,000 listed items. The "Bible" of wide-awake modelers. Write for it now—no obligation, naturally!

**AMERICA'S HOBBY CENTER, INC.**  
Dept. S126, 156 W. 22nd St., N. Y. 11, N. Y.



**ANYONE CAN DO THIS IF**

**THEY HAVE OUR CHART**

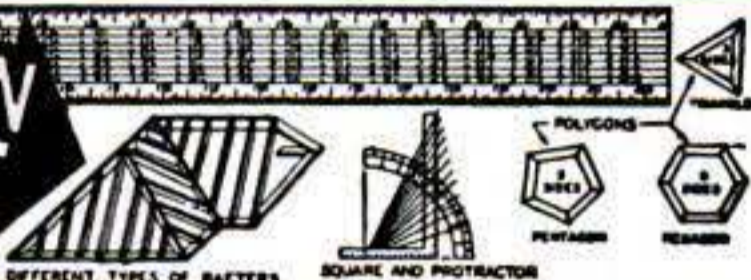

**SPECIAL OFFER FOR AGENTS**

Blue print 27 x 36" now printed on both sides showing squares full size. Shows how to find the length of any rafter, find any angle, in degrees, frame any polygon three to sixteen sides, read the board foot and brace table, octagon scale, rafter tables, many other uses, can be scaled down for model work as well as full scale framing. Also chart changing pitches to degrees. For use with radial saws. About 13 square feet of printed copy sent post paid for \$1.00. No checks or stamps. MASON ENGINEERING SERVICE, 2032 N. Burdick St., Dept. 12, Kalamazoo 81, Mich.

## RACER POLISHED CAST ALUMINUM

8½ inches long. Heavy single unbreakable casting. Free running rubber wheels. Can't rust. Trim, sleek lines. Looks like models selling up to \$12.00. Every youngster wants one.



SEND **\$2.98**

DEALER INQUIRIES INVITED.

Barton Industrial Products Corp. Dept. PS-12  
P. O. Box 1347, Beverly Hills California

## HOW TO CUT RAFTERS

New vest pocket book gives lengths, Side cuts, Plumb cuts, Deductions. For all rafters for any building from one inch to forty feet wide. Gives numbers to cut on square. Also degrees for same cuts for Radial Saws. All standard pitches from 1/8 to 3/8. Just open book to pitch page and there are your lengths, side cuts, etc. Anyone who knows what a jack rafter is can frame a roof if he has this great book. Price one dollar prepaid. Builders' Topics, Dept. S, Lock Box 828, Seattle, Washington. Original teachers of the square in five easy lessons by mail. SEND FOR FREE LIST OF TECHNICAL BOOKS. Learn to read blueprints, etc.

## BUILD Boucher MODELS



CLIPPER TANKER FREIGHTER  
Everything for the Model Ship Builder Since 1905

34 Different Model Kits  
\$5 to \$35

Send 35c for 96 Page Illustrated Catalogue

BOUCHER SHIP MODELS 36 EAST 12<sup>TH</sup> ST. NEW YORK, 3, N.Y.

## MACHINE SHOP EQUIPMENT



Just off the press!—Every man who owns a workshop should have a copy of our new, up-to-the-minute, 200 page catalog of Machine Shop Equipment—the latest tools made by the biggest manufacturers in the U. S. Replete with illustrations, descriptions, prices. Prompt delivery on most tools listed in this book. Available at cost of printing—50c a copy—get yours today! Price of Catalog Refunded on First Order over \$5.00. Send Check or Money Order to

CENTER TOOL CO., 152 Centre Street, New York 13, N. Y.

## MOTORIZE YOUR BIKE

with the sensational  
**WHIZZER**  
BIKE-MOTOR

Now  
**\$97.55**  
PLUS TAX  
or \$23.00  
Bal. C.O.D.

# Boys

**THIS IS IT!**  
**35 Miles per Hr.**  
**125 Miles**  
**per Gal. of Gas**



Now with the modern, sensational, WHIZZER Bike-Motor, you can make your bike a regular light weight "Motorcycle." The new WHIZZER fits any balloon tire bike. Gives you speeds up to 35 miles per hour. 125 miles per gallon of gas. Does not interfere with pedaling. Precision-designed and built by highly skilled, experienced automotive craftsmen. 2½ Horsepowerful, and completely dependable. WHIZZER gets you there — and gets you back!

### FUN—MAKE MONEY

Have a barrel of fun, going places, doing things. Fishing and hunting trips, picnics, camping, seeing country. Or run a "Minute Man" special-delivery service and make enough extra cash to pay for your WHIZZER motor in no time. The low featured price is possible only because of big demand and assembly line production methods. Cash price now \$97.55, F.O.B. Chicago, plus \$2.42 Federal Excise Tax. Or send only \$23 cash and we will ship motor C.O.D. for balance plus delivery charge.

### TIME-TEST Company

8324 West Grand Ave., River Grove, Ill.

**FREE**

**Screw Driver-Plug Tester**

With the first 100 orders received from this ad, we will include *free of charge* the handy quick-fix combination Screw Driver and Spark Plug Tester. Order today and get this valuable motor tool *FREE*.

### IMMEDIATE DELIVERY

Act fast and you can have your WHIZZER by Christmas. Limited number of motors available for immediate shipment. Attach the WHIZZER to your bike and you're off in a flash. Orders filled and shipped as they come in. Act today to get your WHIZZER before our limited present supply of motors is exhausted.

**Look! CUTS IN ANY DIRECTION**

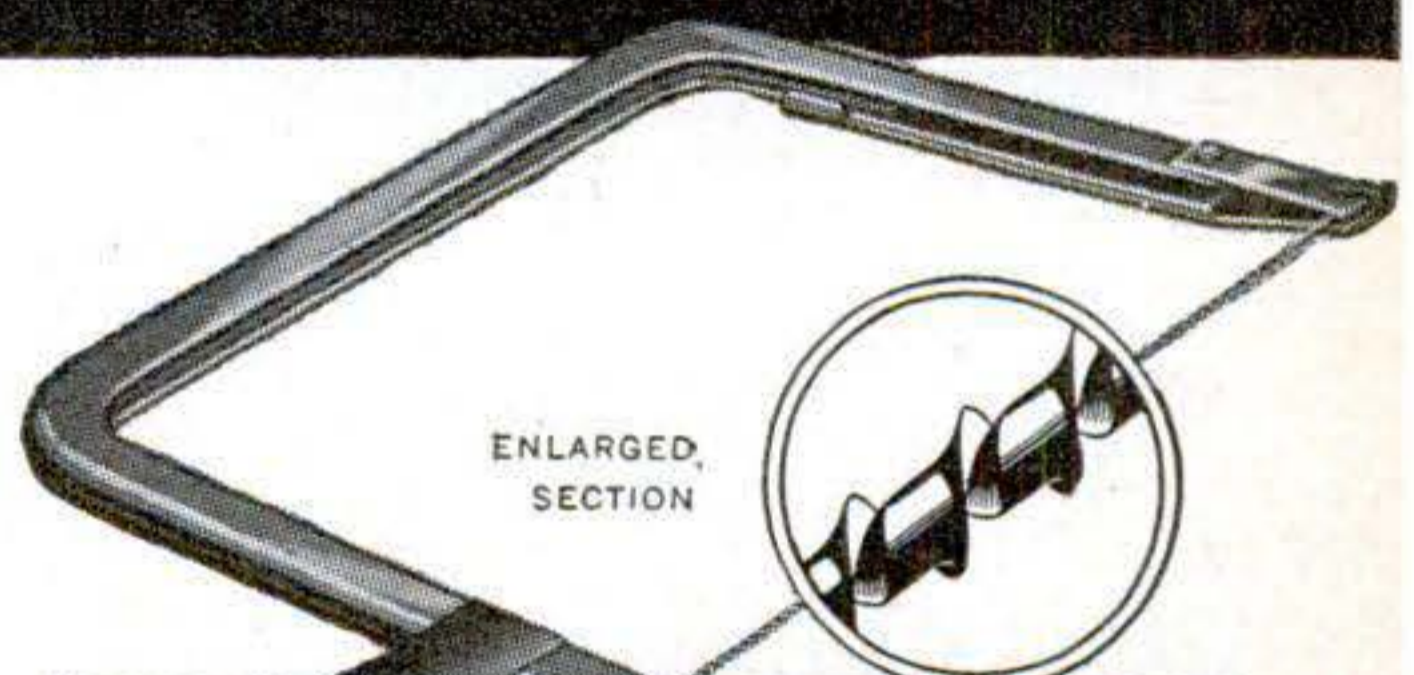

ENLARGED SECTION

**TRY THE NEW REVOLUTIONARY**

**Tyler Spiral Saw**

Now! Saw wood, plastics or light metals as never before. Backwards, sideways —any direction. It's the only saw that cuts difficult curves, square corners—any pattern —without shifting work. The sharp, long-lasting blades *won't break*. And the new Snap-On frame holds the right tension constantly.

Get yours today! Frame, with four blades that also fit most jig saws—only 95c.

**AT YOUR NEAREST HARDWARE STORE**

or send \$1.00 direct for sample, to  
**TYLER MANUFACTURING CO. • 938 Pico Blvd. • Santa Monica, Calif.**

DEC. 1946 263



**The New OFFICIAL FILMS Presents**

# The Perfect Christmas Gift



A HOME MOVIE GIFT that's packed with fun! It's Official Films' "Christmas Night" — the rib-tickling tale of how Soglow's Little King meets Santa.

ANY OFFICIAL FILM MAKES an ideal Christmas gift. There's one to please every type of child. Write for free 32-page Catalog that lists all 230 Official Films' Cartoons, Newsreels, Sportbeams, etc.

Christmas Carols now available in 16 mm. Sound-on-film. Details in Catalog.

ORDER FROM DEALER OR USE THIS FORM  
 OFFICIAL FILMS, 25 W. 45 St., New York 19, N. Y.  
 Please rush me "Christmas Night" in the size checked below:

8 mm. short	8 mm. feat.	16 mm. short	16 mm. feat.	16 mm. S.O.F.
\$1.75	\$5.50	\$2.75	\$8.75	\$17.50
<input type="checkbox"/>	<input type="checkbox"/>	<input type="checkbox"/>	<input type="checkbox"/>	<input type="checkbox"/>

( ) Ship C.O.D. ( ) Remittance enclosed  
 ( ) Check here for free Catalog of over 230 silent and sound subjects

Name.....  
 Address.....  
 City..... Zone No..... State.....

**ATTENTION HOMECRAFTSMEN!**  
**PLANS** For Dutch Windmills, Lighthouses, Bird Houses, Lawn Chairs, Arbors, Trellises, many kinds of fine furniture, also a great variety of Lawn Figure patterns. SEND 10c FOR CATALOG ILLUSTRATING OVER 100 PRACTICAL PROJECTS  
 Craftsman's Model Co., 2030 N. 41st St., Dept. K12, Milwaukee, Wis.

## HERE'S WHAT YOU'VE BEEN WAITING FOR— A High Quality Two-Speed BREAST DRILL ONLY \$5.00



NO. 50. Chuck capacity to 1/2". 3 steel chuck jaws, spring-controlled. Drill has two speed gears. Finished in cadmium nickel and red and black enamel, mahogany-finished handles.

Order today. Send no money. Just pay your postman \$5.00 plus C.O.D. fee and postage.

**MARS PRODUCTS COMPANY**  
 1170 Broadway, Dept. FB, New York, N. Y.



Beautiful brass Social Security plates (illustrated 1/2 actual size), priced at only 50c. Please print your name & number plainly.

**ACME**  
 Stamping Service  
 Box 836  
 Davenport, Iowa



### THE GEM MAKER

Amateurs or professionals . . . hobbyists or jewelers . . . Polish your own gems with a B&I Gem Maker. You will find this a profitable adventure. All necessary lapidary equipment is furnished, including a super-charged diamond blade for sawing, and all wheels for grinding, shaping and polishing, also complete instructions. The complete equipment as shown, less motor and belt, for only \$29.50, f.o.b., Burlington, Wis. Write today for information and literature on the Gem Maker and accessories.  
**B&I MFG. CO., Dept. M, Burlington, Wis.**

## HIGH BLOOD PRESSURE

### A DANGER SIGNAL

Often associated with Hardening of the Arteries, a Stroke, Paralysis, Heart Trouble, Kidney Disease, and other grave complications. Resultful treating methods of the Ball Clinic have proven dependable for nearly a quarter of a century. Send for FREE Blood Pressure Book today. No obligations.

**Ball Clinic, Dept. 36A, Excelsior Springs, Mo.**



**GENUINE U. S. BARGAINS**  
 Army O. D. Wool Blanket, 5 lbs. \$5.95  
 Army Pocket Knife, Scout Style. 2.50  
 Pup Tents, Poles and Pegs, Used 4.85  
 Mess Kit—Knife, Fork and Spoon, Used . . . . . .50  
 Thousands of other bargains in military, outdoor & sport goods for hunter, farmer, scout. Send 10c for 32 page catalog returned with first order.  
**A and N SUPPLY CO.**  
 4784 LESTER ST. RICHMOND 15, VA. EST. 1868



## A VEST POCKET SIZE RADIO!

So small it will slip in your pocket or purse! Actually smaller than a pack of king size cigarettes! Weighs but 1/4 lb. complete ready to play—as shown with self contained earphone for personal use. No extra wires or special attachments required. Streamlined, attractive and durable black and silver plastic cases. Uses new preset "crystal diode" rectifier same as used in Army-Navy ultra hi-frequency radar sets during the war. Has slide tuning dial for station selection. Since no tubes, batteries or electrical socket power "plug-ins" are ever required, the radio should operate for years with little or no upkeep expense. Usually receives local radio broadcasts simply by clipping self contained connection "snap" to metal of telephones.

**GUARANTEED TO WORK** for you in your locality if attached and used according to complete operating instructions sent with each radio. Can be used at home, in offices, hotels, cabin camps, in bed, after hours on farms or most anywhere in the United States or Canada.

**SEND ONLY \$1.00** (currency, express or postal money order, bank draft, or personal check) and pay postman \$2.99 plus delivery and postage fees on arrival or send \$3.99 for postpaid delivery (O.P.A. ceiling). Ideal gift for children or adults alike! A truly practical novelty radio capable of real radio reception! Order your "Pakette" radio today for real enjoyment. Critical material shortages may limit future production so order today—NOW—to assure the earliest possible delivery. (Canada, Mexico and foreign orders \$5.00 U. S. cash with order)

**PAKETTE ELECTRIC COMPANY Department PS-12 Kearney, Nebraska**



# Do a Better Job WITH ONE OF THESE EMPIRE LEVELS

**EMPIRE TORPEDO LEVEL**  
Smallest, most handy and accurate level made. "Cigar-shaped"—no sharp corners to tear pocket. Aluminum stock. Only 3 oz. wgt. 9" long. Has Level, Plumb, 45° Vials.  
No. 26 .....\$1.75



**ALUMINUM LEVEL — No. 151**  
Cast and Machined, a Beautiful Tool, with Patented, Removable Level and Vial.  
With 2 Plumb, 2 Levels, 2 — 45° Vials. 18".....\$5.00  
24".....\$5.50 28".....\$6.25

Order EMPIRE LEVELS from your local dealer.  
Write direct for literature.

**EMPIRE LEVEL MFG. CO.**  
707 S. 6th St. Milwaukee 4, Wis.

## METALLIZE BABY SHOES

Learn this easy, money making business from nationally recognized consultant. Small investment; perpetual market. For free details write Joseph B. Kushner, B.S. Ch.E., Metal finishing Consultant, Stroudsburg, Pennsylvania, RD 3Z.

## Everything in Radio!

Make Radolek your buying headquarters for Radio-Electronic repair and replacement needs. Large stocks assure finest, most complete selections of all available items at lowest prices. Your orders receive special attention for fastest delivery. Send today for FREE Radolek Buying Guide.  
RADOLEK CO., Dept. A-120, 601 W. Randolph St., Chicago 6, Ill.

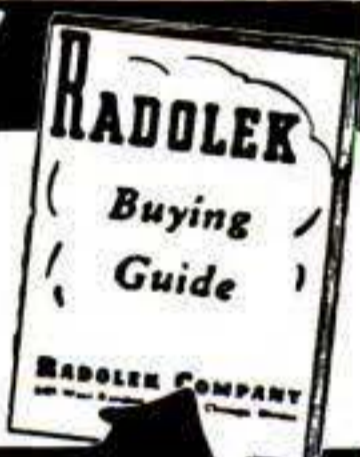

**FREE RADIO BUYING GUIDE**

## No More Bother Solving Problems

100,000 problems solved instantly. Greatest mathematical aid since the invention of the slide-rule. Details free.  
COLUMBIA GRAPHS, Columbia 6, Connecticut

## Low Price The OTTAWA "Buzz" Master

**CLEARs LAND FAST!** Powerful 6-HP motor with friction clutch for safe operation. Cuts down timber, brush, hedge; turn blade vertically and saw logs to length. Can be equipped to fell largest trees. Clutch pulley for belt work. Guaranteed.  
**FREE Details**  
OTTAWA MFG. CO., 1201 Brush Ave., Ottawa, Kansas



## Make Your Own RUBBER MOLDS

with **RED LATEX MOLDING COMPOUND**



Earn money, have fun; make your own molds for plater objects. Produce novelties and gifts for home and to sell to friends. RED LATEX MOLDING COMPOUND (60% density) now available in quart and gallon quantities. Gives perfect results, easy to apply. Send for complete information and prices.  
FRANCIS SUPPLY CO., Dept. P-3, 1836 E. Fulton St., Columbus 9, O.

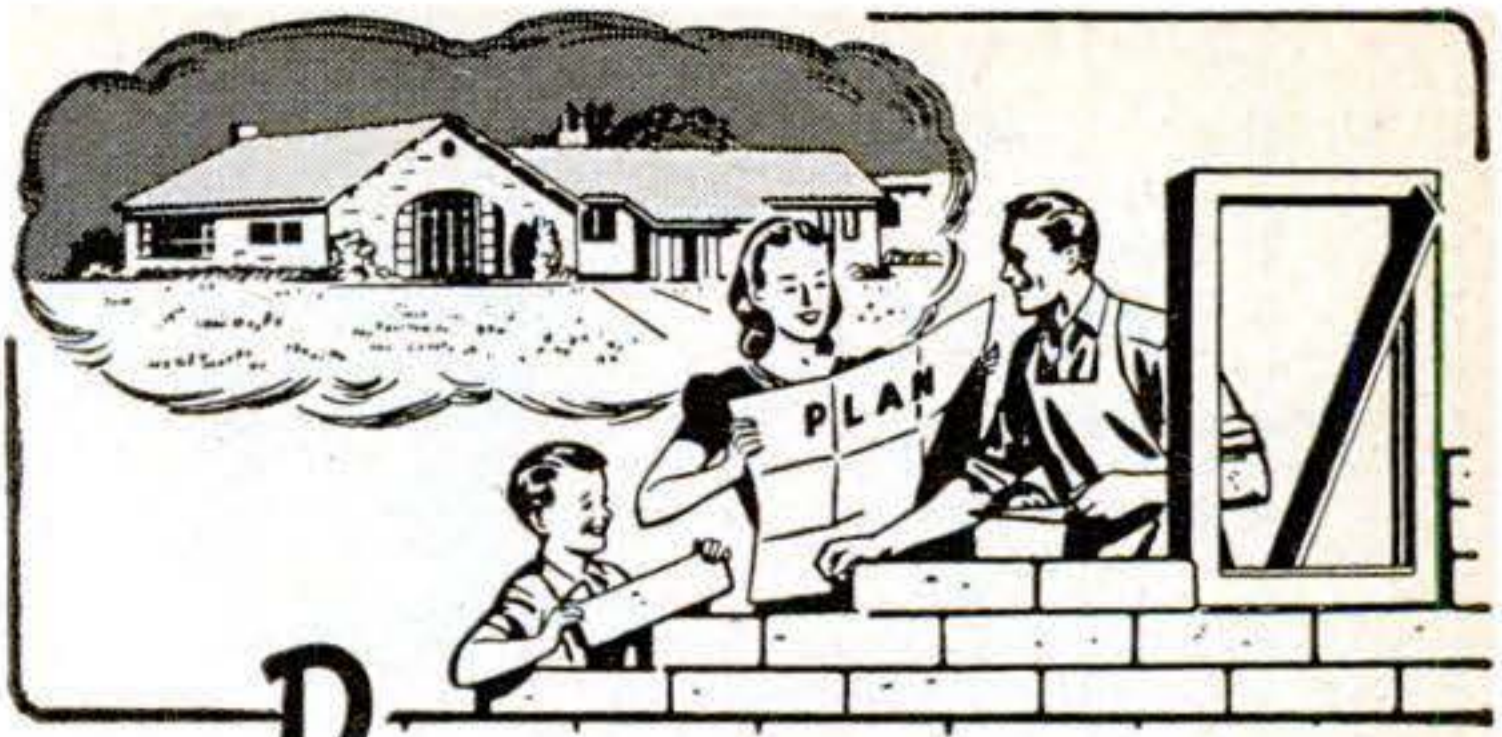

# Build it Yourself

Send for booklet showing how to make your own bricks of Cemadobe and build an attractive low cost home yourself. Amazing discovery in soil stabilization. Bricks of earth and cement. Attractive; heat and cold resisting. Easy to make. A Godsend to anyone who needs a home. Now being used by hundreds of satisfied home builders. Acceptable to loan agencies. Complete instructions in attractive, easy-to-understand booklet entitled "Cemadobe". 50 illustrations and 40 chapters. Money back guarantee of satisfaction. Send \$1.00 to **Cem-Adobe Company, Box 81, Dept. PS-126, West Los Angeles Station, Los Angeles 25, California.**

## Now you see it—Now you don't

# FOLD-HORSE

(Patented)

—folds away into most any out-of-the-way corner in a jiffy when you are not using it. You'll want this sturdy saw-horse if your home workshop has only limited room, because the Fold-Horse folds down to the neat, compact size of only 8" x 9" x 42" in a matter of seconds. And—it's built to last a lifetime. It's so simple to assemble and much stronger than most horses. All

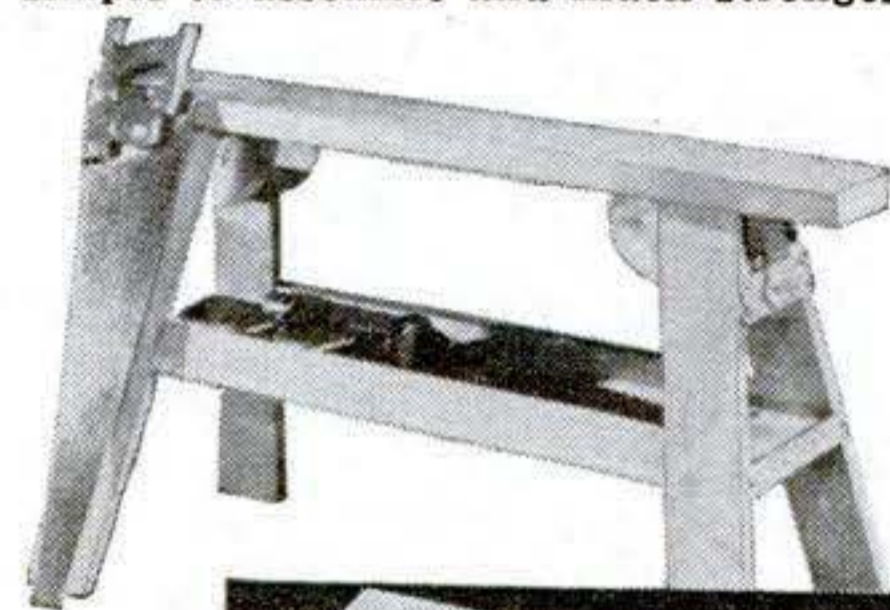

metal parts are 14 gauge steel cadmium plated to prevent rust. The top is standard 2" x 6" x 42" and made of clear pine. Tool tray is 9" x 36". Only a limited number can be manufactured for a while — so get your order in today!

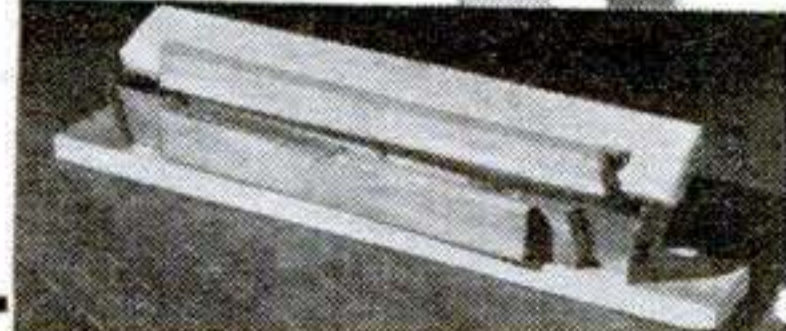

Lists at \$9.95 each

Jobbers Note: a few select territories still open — inquire.

**UNIQUE TOOL PRODUCTS COMPANY**  
4642 N. Clark Street, Chicago 40, Illinois

Gentlemen:  
Your patented Unique 'Fold-Horse' is not available from my local jobber, so please send me..... for which I enclose my check for \$.....

Name ..... Title .....

Firm Name.....

Street.....

City and Zone... State.....

DEC. 1946 265



## A PERFECT CHRISTMAS GIFT

Streamlined—Monogrammed

### CIGARETTE LIGHTER

Modern and up-to-date as today's newspaper . . . sleek, small and the last word in efficiency! No intricate mechanism to get out of fix . . . a "sure-fire" lighter that will give long dependable service. Made of solid, non-tarnishing aluminum. A lighter you'll be proud to give as a gift for any occasion . . . or carry yourself. With three-letter engraved monogram \$2.00 postpaid. Without monogram \$1.50.

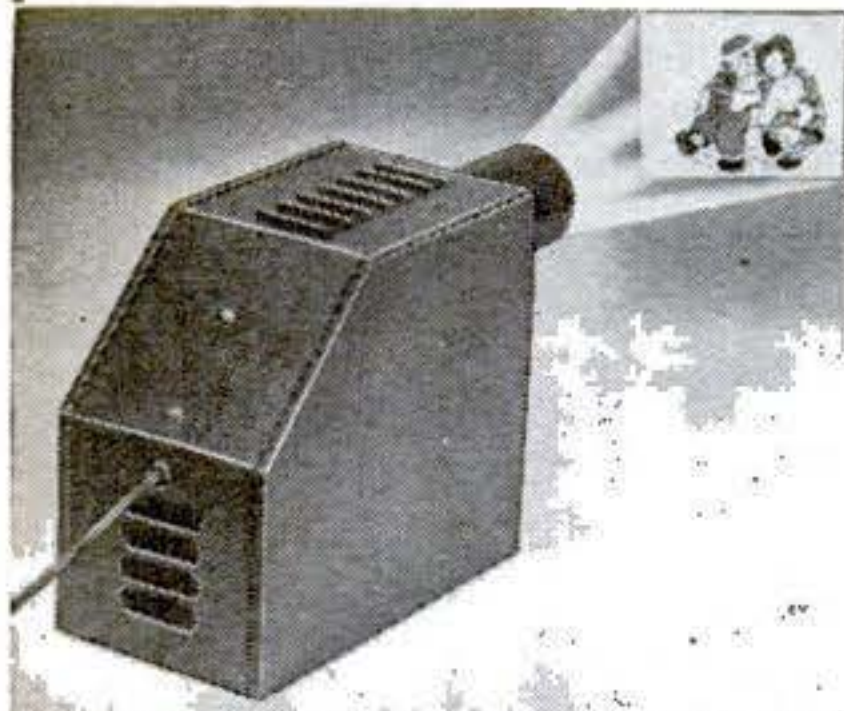
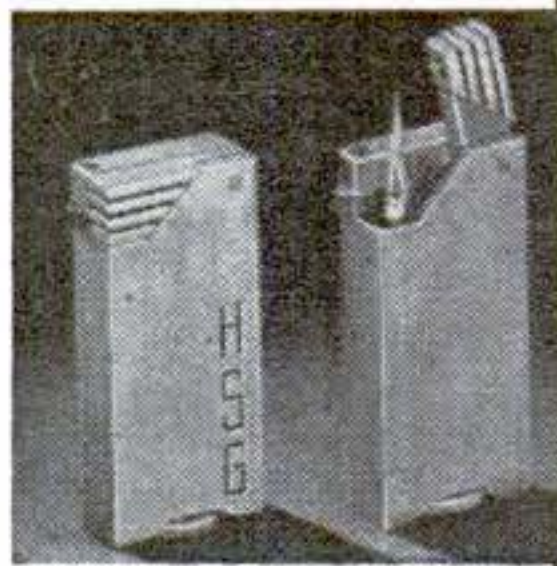

### Boys! Girls! Here's the new ELECTRICAL PROJECTOR

No slides, no film! Projects any picture, comic, photo, stamp, also botanical specimens such as flowers, butterflies, etc. Place object under the projector and presto! On the wall or

screen you have a clear reproduction, colors and all, 2 feet in diameter! All steel construction, optically ground and polished lenses. 7 1/2" high, 10" wide, 4 1/2" deep. \$5.00 postpaid.

Send check or money order.

## mayfair Gifts

72-08P AUSTIN ST.

FOREST HILLS, N. Y.

## A GIFT HE'LL APPRECIATE

# \$34<sup>95</sup>



## 5-IN-1 HOME WORKSHOP

- LATHE
- SANDER
- CIRCULAR SAW
- DRILL PRESS
- EMERY WHEEL

For year 'round fun and profit. Thousands of satisfied owners. Five most useful power tools combined in HEAVY fabricated-steel unit. Runs free in bronze bearings. Lathe 30" between centers. Drill press pulls 1/2" drill in steel. Saw uses 6" or 8" blade. Write for literature or send \$17.50 for prompt shipment, balance COD, with ten-day trial. (Price does not include motor and saw blade. Shipping weight 65 pounds.)

**EMRICK INC.**  
1602-K FULFORD ST.  
KALAMAZOO 24, MICH.

266 POPULAR SCIENCE

## BLACK-LIGHT XMAS DECORATIONS

Find Hidden Colors

**FUN! THRILLS! PROFITS!**

Find colors you'll never see with ordinary light. Designer's kit includes black light, generous supplies of glowing satins, crayons, lacquers, papers, full instructions.

Makes ideal Xmas decorations and gift. Guaranteed, F.O.B. Chicago **\$15.00**

FREE! Write for catalog: "The Invisible Ray"  
BLACK LIGHT PRODUCTS, 67 East Lake St., Chicago 1, Ill.



## Send for Free List of LEADING BOOKS

on Watch Repairing, Clock Repairing, Engraving, Industrial Diamonds, Aircraft Instruments, etc. Dept. 10

HENRY PAULSON & CO. CHICAGO 3, U.S.A.



## SING-TALK thru your own Radio with Radio MICROPHONE

Put on your own broadcast at home with this Radio Mike. Sing, Talk from any room in the house. Make announcements. Lots of fun! It's wonderful voice practice. Easily attached to any radio. SEND NO MONEY. Pay postman \$1.98 plus postage. Send check or money order and save postage.

ROLEY SALES CO., Inc., 154 Nassau St., Dept. PSM-1, New York 7, N. Y.

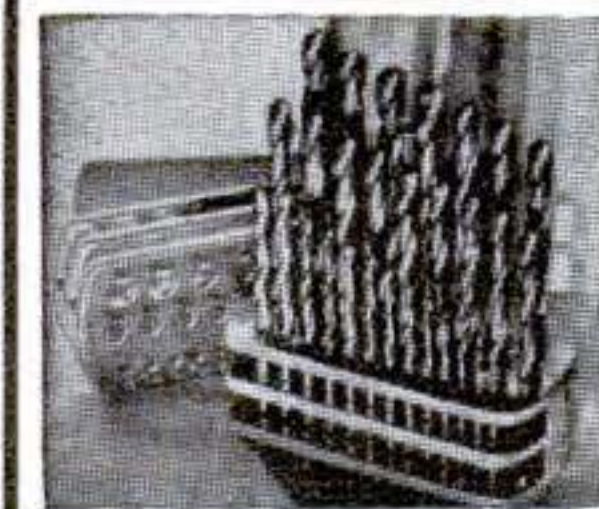

## Why Hunt for Drills?

These Complete High Speed Drill Sets Now Available at Low Prices  
#1 to 60 Drills.....\$12.95 Per Set  
1/16-1/2 by 64ths.....\$16.95 Per Set  
Drill Sets A-Z.....\$15.50 Per Set  
(Drill Stands Free)

SEND FOR FREE CIRCULAR

SID TOOL CO.

MACHINE SHOP SUPPLIES  
Dept. S, 183 Grand St., New York 13, N. Y.



## ARMY SURPLUS BARGAINS

Jacket (illus.)—B-3 type pilots sheepskin lined brown leather, water repellent finish, zipper front, large collar & strap. Newly mfg. from surplus material. 36-46. . \$15.95  
Jacket—O.D. Whipcord, pile lined. . \$10.75  
Write for free illustrated list "D" of jackets, pants, blankets, sweaters, etc. Orders sent postpaid except C.O.D.

Satisfaction or money back

CONSUMERS CLOTHING CO., INC.  
Dept. 5, 2066 First Ave., New York 29, N. Y.

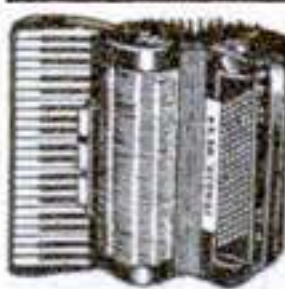

## ITALIAN ACCORDIONS

Hand Made. Very best. Lowest prices. Buy Direct from Factory Representative and Save Money. Send Name and Address for FREE Catalog.

ITALIAN ACCORDION CO.  
323 W. POLK ST., DEPT. PS-12, CHICAGO 7, Ill.

## TINY TIM — \$4.95

Single cyl. Oscillating Steam Engine. A rugged high-speed precision-built miniature engine machined of highest grade brass castings and bar stock. Bench tested and ready to run. Height 2 3/4", weight 6 oz. Ideal for model racing boats and stationary power plants. ORDER NOW for prompt shipment. Remit \$4.95 with order and get preferred shipping prepaid. Or sent C.O.D.

MONEY-BACK GUARANTEE

THE THOMPSON ENGINEERING CO.  
214 Winchester Bldg., Grand Rapids 2, Mich.





## WAR SURPLUS BARGAIN SPECIAL

BRAND NEW  
VACUUM-AIR  
HYDRAULIC  
**FUEL  
PUMP**

Original Cost  
**\$45.00**

Now Only  
**\$9.95**

Postpaid in U.S.A.

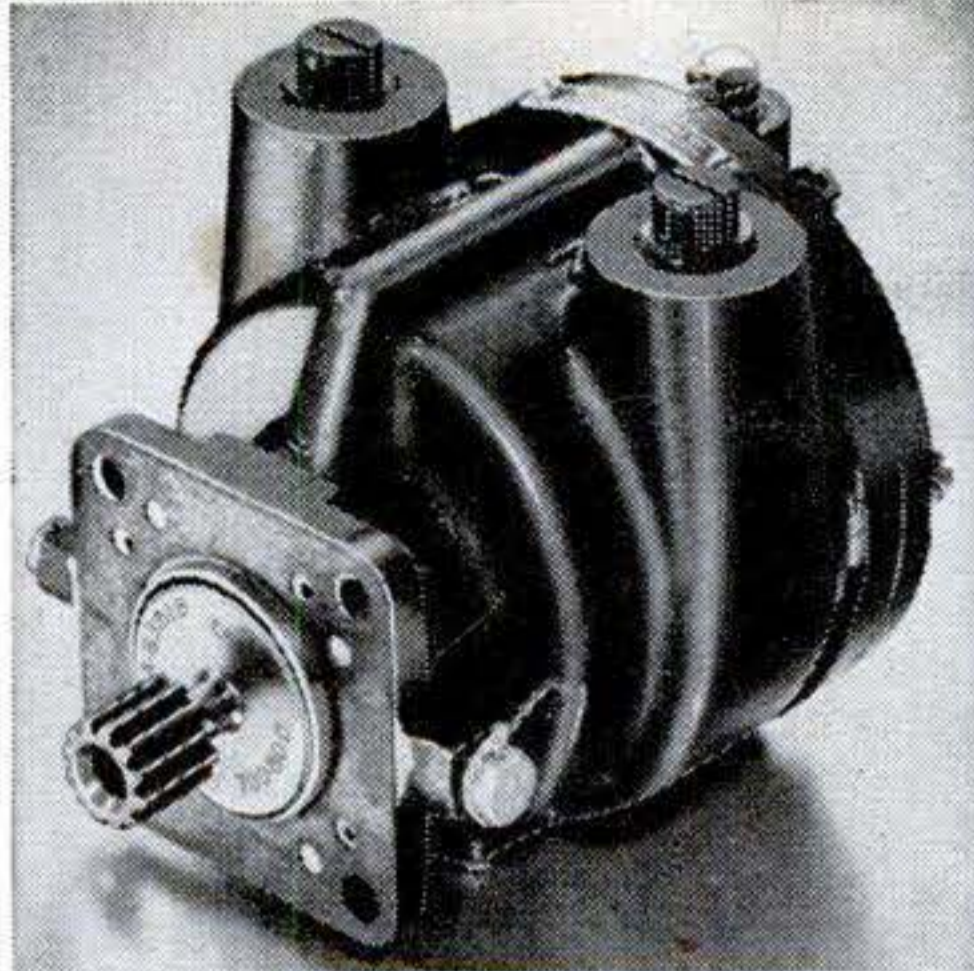

Adaptable for use on Home Oil Burners, Spray Machines, Milking Machines, Compressors, Vacuum Pumps, Hydraulic Systems, Presses, etc. Originally cost \$45.00. Used by the Air Corps to drive bomber de-icer boots, gyroscopes, automatic pilots, etc. May be used as air or fluid pump—for pressure or vacuum. Standard 3/8 inch pipe thread with interchangeable ports. Will pump 7 1/2 gal. SAE 30 oil per minute at 300 RPM. Builds air pressure of 30 lbs. per sq. in. at 1000 RPM. Vacuum will draw 26 inches of mercury at 1750 RPM. Runs forward or reverse. Self aligning shaft. Die cast aluminum housing 6x4x4 inches. Has stainless alloy steel vanes and impeller. Made by Bendix Avia, Corp. Spline terminal for direct drive—readily replaced with a pulley. Rated capacity 1500 RPM with high overload factor. Special price for quantity users. Send check or money order today. Postpaid in U. S. A.

**GROBAN SUPPLY CO.** 1522 So. Michigan Ave.  
Dept. P.S.D. Chicago 5, Ill.

## Walt Disney Films

Your Own Little Theatre

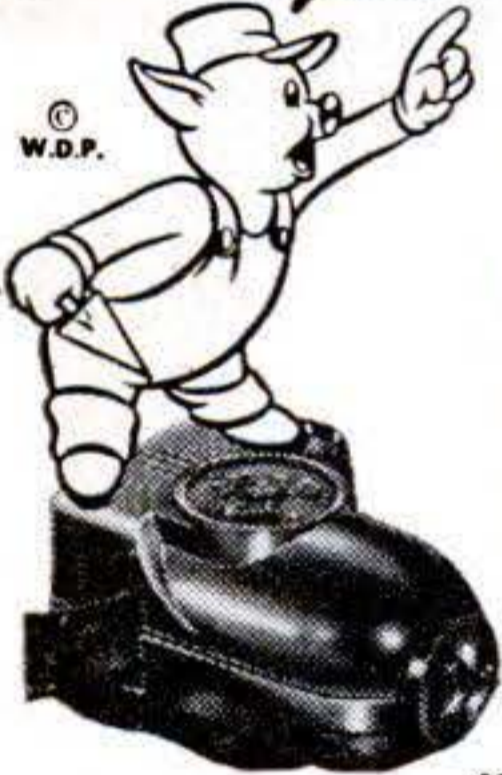

MICKEY MOUSE  
VIEWER and  
No. 1 Film Strip... **\$1**

This beautiful plastic Mickey Mouse Viewer and Walt Disney's world famous "Brave Little Tailor" in an exciting condensed version FULL color 16mm film strip. 16 actual scenes from the original film. The Special Gift Set includes the Mickey Mouse Viewer and 13 thrilling full color condensed version 16mm film strips, each strip showing 16 scenes from Walt Disney's world famous pictures, 3 Academy Award Winners!

- PLEASE SEND ME A SPECIAL GIFT SET FOR ONLY \$3.95
- PLEASE SEND ME A MICKEY MOUSE VIEWER AND "BRAVE LITTLE TAILOR" FOR ONLY \$1.00

REMITTANCE ENCLOSED \$

AT YOUR DEALER'S, OR Dept. PS-12

**CRAFTSMEN'S GUILD**

6916 Romaine St Dept. PS-12 Hollywood 38, Calif

## Moulded Plywood Hulls For Homecraftsmen

If enough homecraftsmen are interested in buying 12-18 ft. plywood shells, a saving of \$150-200 is possible—For further information send name, address, and type desired to  
**P. S. M. Box # D. T. 12**

## DRILL CONCRETE *The Easy Way!*

CONCRETE  
ASPHALT  
BRICK  
SLATE



WALLBOARD  
LIMESTONE  
and all other  
construction  
materials.

SLIP A **CARBOLOY** MASONRY DRILL INTO YOUR ROTARY DRILL, HAND BRACE, OR DRILL PRESS, AND WATCH IT GO—**AND GO FAST!**

- DRILLS 4 TIMES FASTER!
- STAYS SHARP 50 TIMES LONGER!
- CUTS CLEAN, TRUE - SIZE HOLES!

Goodbye to back-breaking masonry drilling! Cut clean, true-size holes in all masonry *jiffy-quick!* Use your rotary drill, hand brace, or drill press. Drill holes 1/8" apart without break-through. Ask about Handy 6-Drill Set (canvas case, free!). See your dealer, or write.

**CARBOLOY COMPANY, INC.**

11173 E. 8 MILE BLVD., DETROIT 32, MICH.

Tipped with Carbide—harder than the hardest steel.

## Service TELEVISION — FM-AM RADIOS with the SENSATIONALLY NEW METROPOLITAN

Model 999 **SIGNAL GENERATOR**

FIRST BATTERY-OPERATED UNIT MADE!  
GREAT VALUE! GREAT TESTER!

Always ready for instant use. Service all kinds of radios with the FIRST self-contained battery-operated Signal Generator. Servicemen and radio repairmen say "fastest and most thorough job of finding defects in radio than any other tester." Generates R.F. Frequencies from 150 KC to 12.5 MC on Fundamentals and from 11 MC to 50 MC on Harmonics.

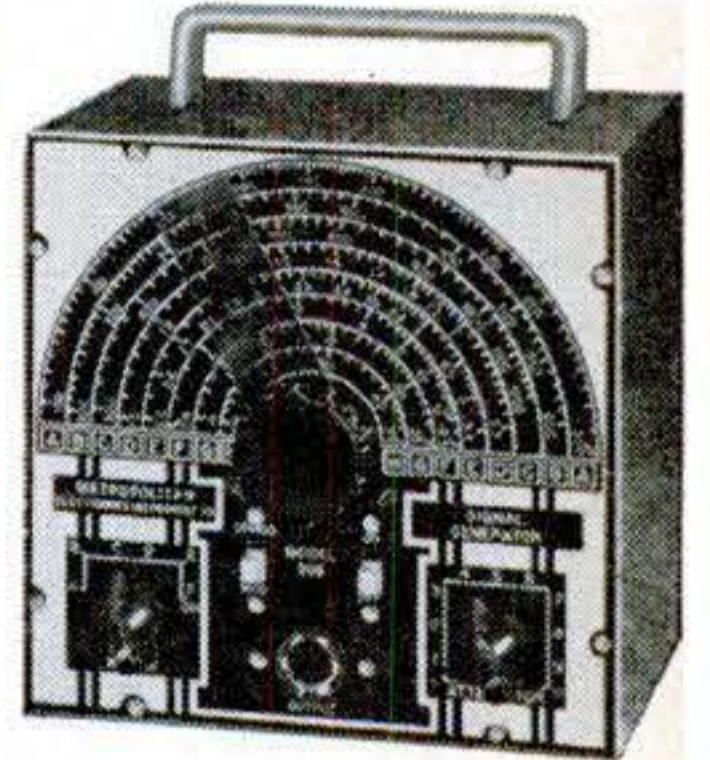

IMMEDIATE DELIVERY  
FROM STOCK!

Complete with test leads and instructions, ready to operate

**\$39.50**

## Metropolitan

ELECTRONIC & INSTRUMENT CO.

6 MURRAY ST. Dept. PS N.Y. 7, N.Y.

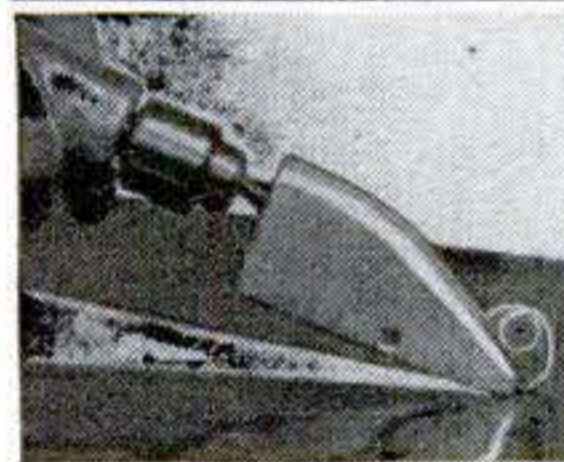

## ROYAL CLIPPER METAL CUTTER

Cuts any light sheet material—metal, fibre, plywood, plastic. Just chuck it up in your drill and you have a handy, easy-to-use cutter. Saves time, leaves smooth workable edge. Buy from your dealer or order direct. **\$15.95**

C-B TOOL CO.

LANCASTER 1, PA.

## MULTI-PURPOSE, RUGGEDLY CONSTRUCTED FLEXIBLE SHAFTS

Sealed Against Dust & Dirt  
53 1/2" Length, 3/8" Diameter (O.D.)



**\$5.75**

Plus Postage

These SHAFTS can be used on 1/2" motor shaft, or by removing the coupling, in a chuck up to 3/8" capacity. Shaft size on operating end is 3/8" diameter, 24 threads per inch. Speed range 1725 RPM to 3600 RPM. Can be bent or looped to small radius for working in hard-to-get-at places. Outer covering of oil-resistant Neoprene. Useful for many purposes, including Buffing, Grinding, and Trans-

Drilling, Polishing, Rotary Filing and Transmission of Power.

## U. S. Navy Battle Lantern

Throws 500-ft. beam. With on-off switch. Waterproof. Convenient handle. Requires two Standard Dry Cell Batteries. Has many uses. A suitable gift. Price, less batteries.... **\$5.75** Plus Postage

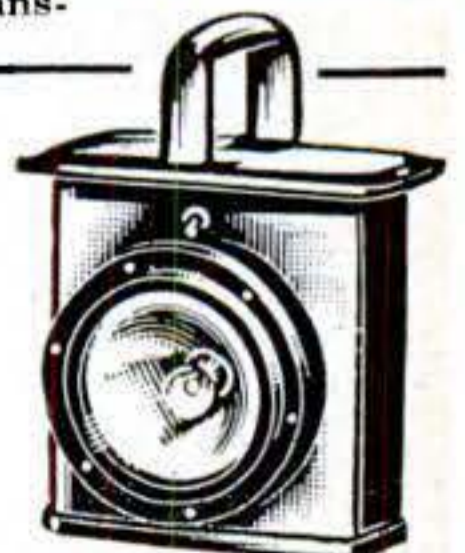

MANY OTHER GOOD VALUES

## ELECTRIC TRADING CO.

313 CANAL ST.

NEW YORK 13, N. Y.

Electric Fans & Blowers in most sizes for every Industrial, Commercial and Domestic use. Table Saws—Air Compressors—Electrical Tools & Paint Spray Equipment in stock.



# War Surplus BARGAINS



## STARTING ROPES

Brand new 54 inch motor starting ropes. Steel cable inside. 300 lb. test. Grooved handle for locking when coiled. Weight 1 lb.....

**65¢**

## GUNSIGHT

Originally cost about \$700. Contains polaroid filter, prism mirror, etc. Can be converted into slide projector, enlarger, microscope, etc. Weight 14 lbs.....

**9.50**



## RADIO SWITCH BOX

This small radio switch box contains 2 windowed selector switches. Multi-terminal receptacle. Priced at only....

**1.75**

## RADIO RECEIVER SWITCH BOX

Contains 2 selector switches, 2 multi-terminal receptacles, phone jack, rheostat. A real buy at only.....

**2.25**



## RECEPTACLES & PLUGS

Mated multi-receptacles and plugs in many sizes. Write for "Receptacle and Plug List." Receptacles and plugs at.....

**35¢**

## OXYGEN TANKS

Brand new. Carried 400 pounds of oxygen. Non-shatterable. Ideal for small air compressor tank, fire extinguisher, etc. 280 cu. in. capacity. Shipping weight 4 1/4 lbs.

**1.75**



## SERVO UNIT

Part of automatic pilot. Includes 1/2 HP motor, 3 gear hydraulic pump, heating element, etc. Ideal for inventors, experimenters and hobby-crafters. Weight 38 lbs. Original cost, \$1900.

**9.75**

## HYDRAULIC CYLINDERS

Many sizes available. Write for "Hydraulic Cylinder list."

TERMS OF SALE—"AS IS"—ALL SALES FINAL. Order from this ad. Send money order or bank draft.

**PARMA SURPLUS CO.**  
7010 Hampstead - Parma 9, Ohio

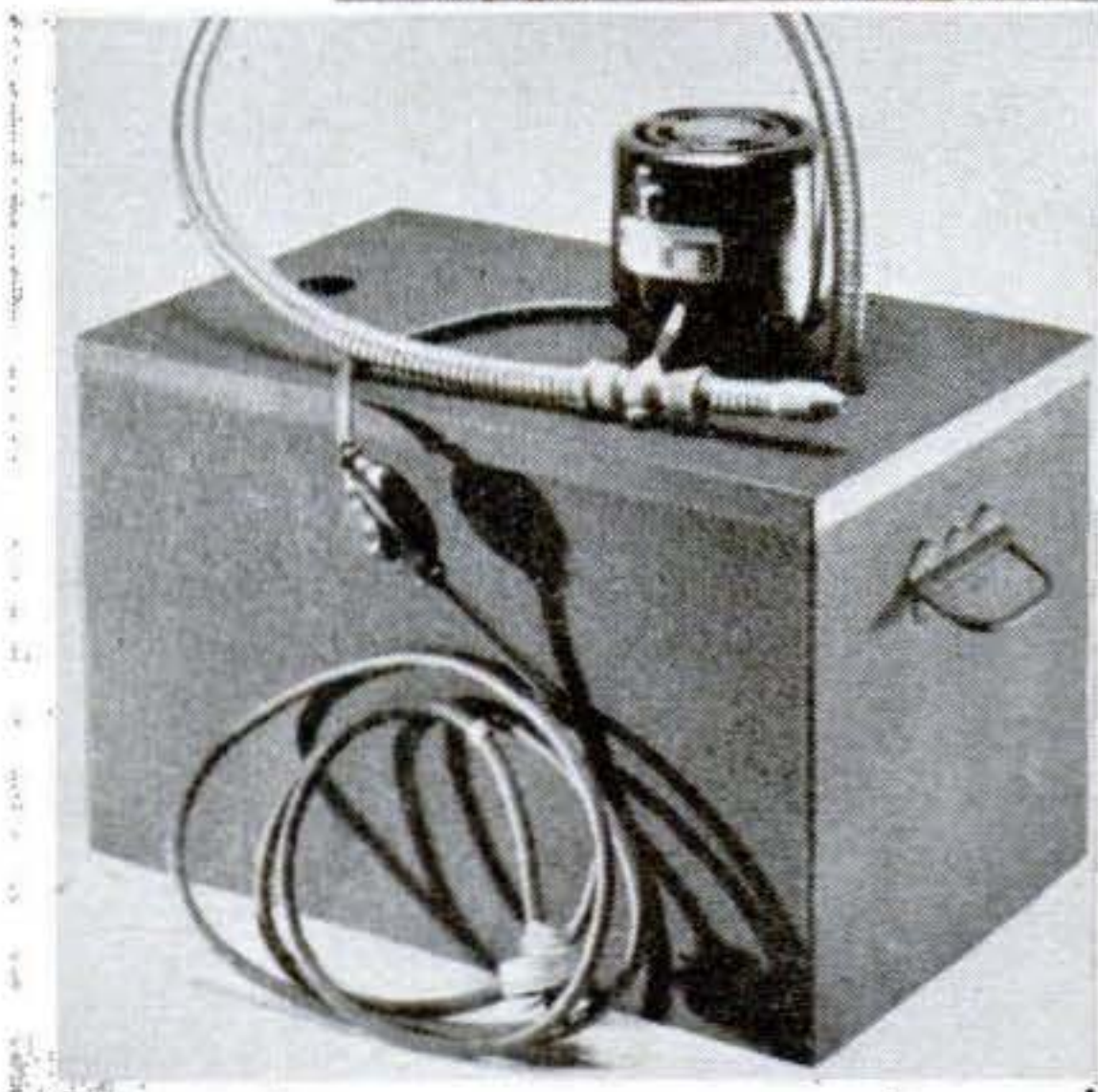
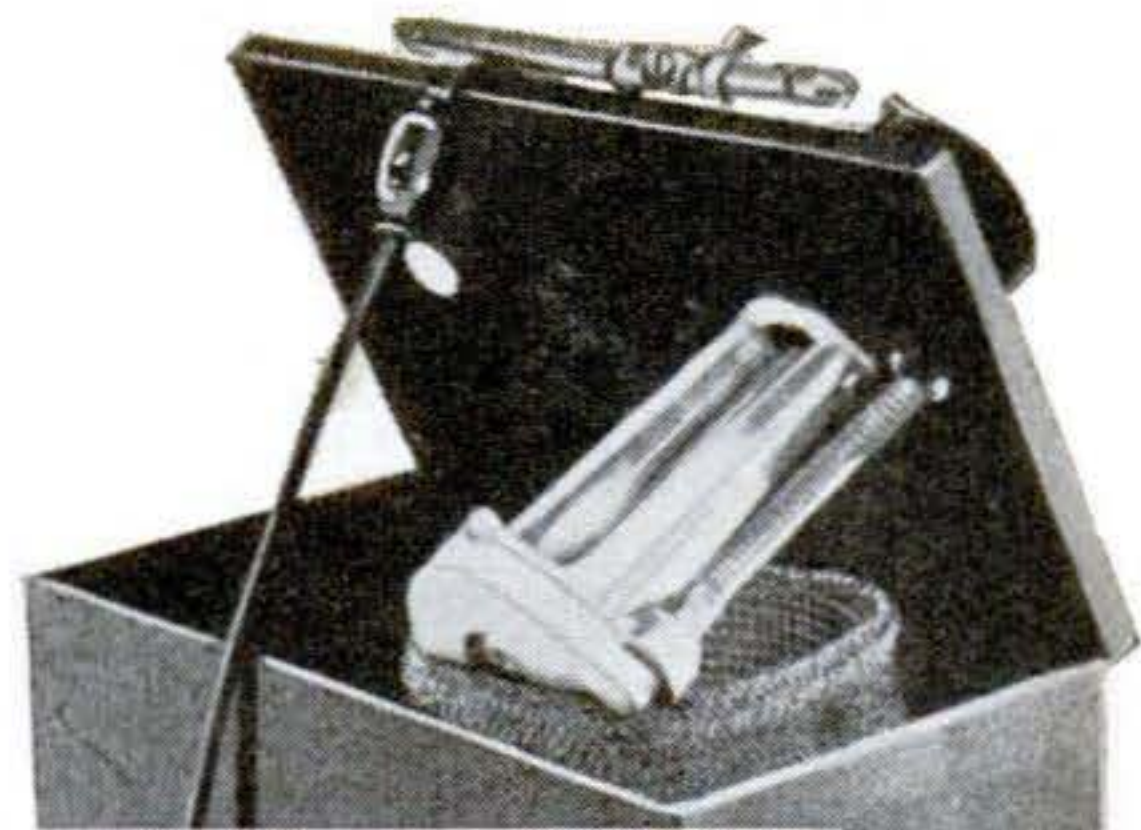

## Filter for Liquid Coolants

A SELF-CONTAINED filtering system to remove metallic particles from liquid coolants for machine tools has been devised by the Inject-A-Flow Pump Co., of Montclair, N. J. At top, unit lid opened to show strainer, designed to filter out fine particles without back pressure. Below it, pump mounted on seven-gallon tank.

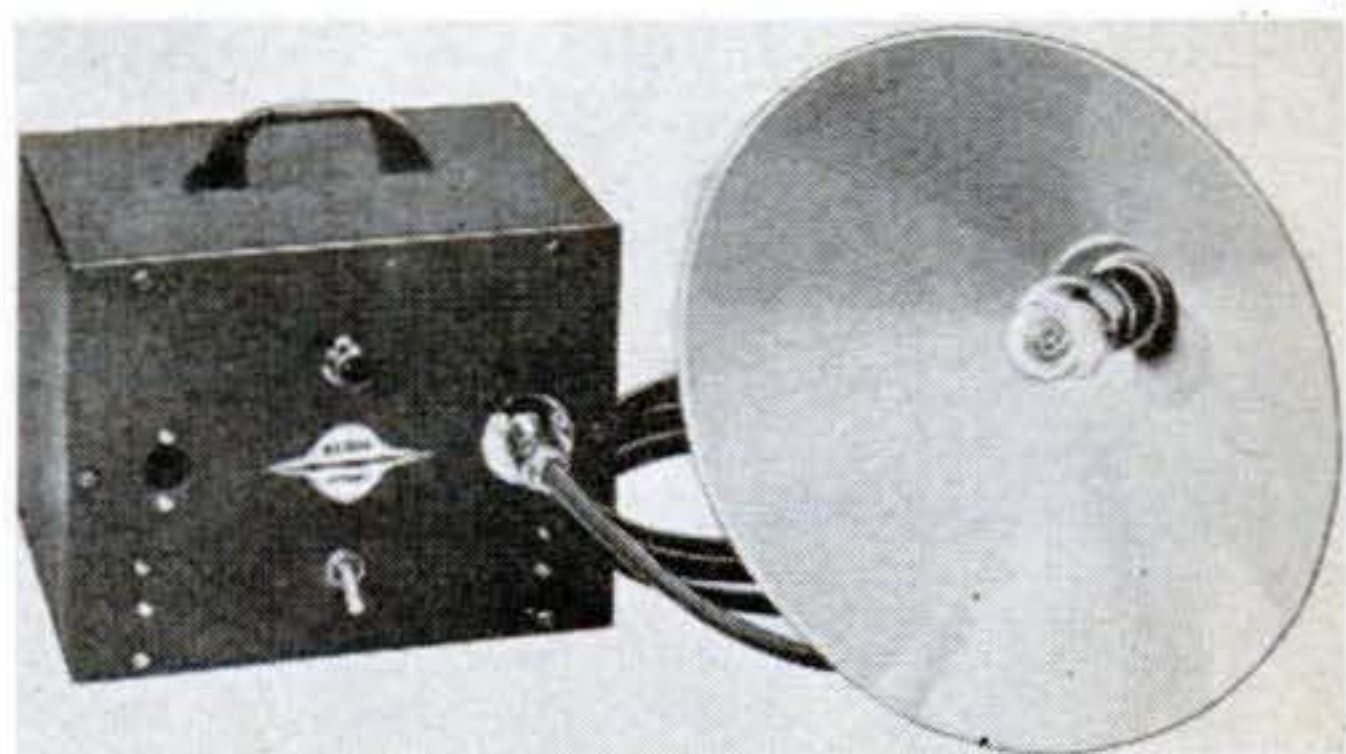

## Repeating Photo-Flash Unit

A REPEATING AC photo-flash unit has been developed by the Kluge Electronics Co., of Los Angeles. The portable unit takes 10,000 pictures with one K-60 Sunlight Spectrum bulb. Light intensity is rated at 100 times that of sunlight.



# Ball-Bearing = SPEED WHEEL = Construction Sets

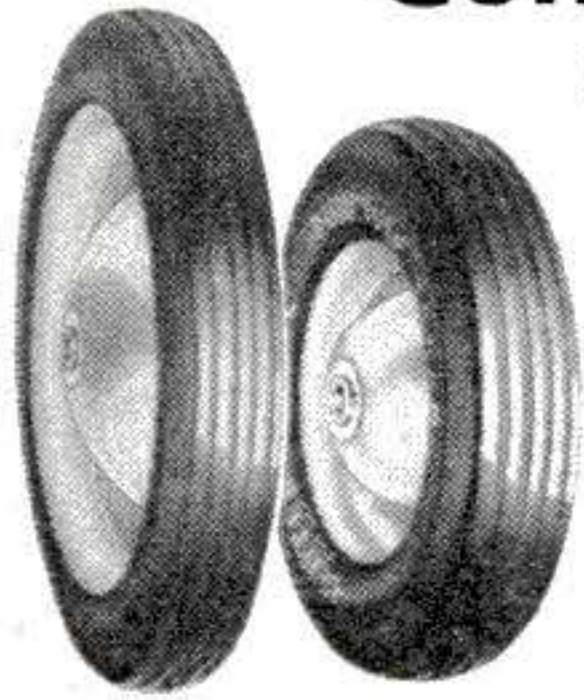

Including blueprints for making

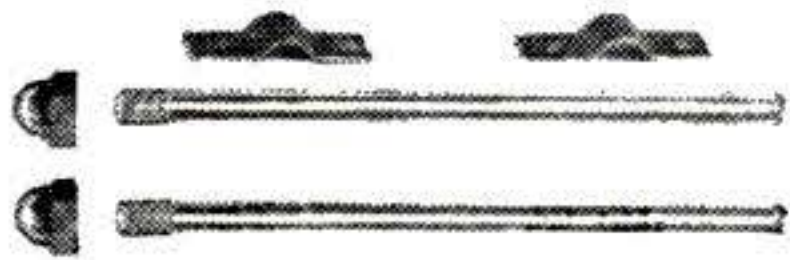

## Build Your Own—

- Express Wagons** \$13.20  
(Includes four 8"x2" Tires, Wheels, Axles, etc.)
- Midget Racers** \$17.70  
(Includes four 10"x1.75" Tires, Wheels, Axles, etc.)
- Wheelbarrow Sets** \$4.85  
(Includes one 10"x1.75" Tire, Wheel, Axle, etc.)
- Bicycle Trailers** \$7.80  
(Includes two 8"x2" Tires, Wheels, Axles, etc.)

ORDER NOW FOR PROMPT DELIVERY

10% required with C.O.D.'s

**JIM BROWN TOY COMPANY**  
873 E. Tallmadge Ave. Akron 10, Ohio

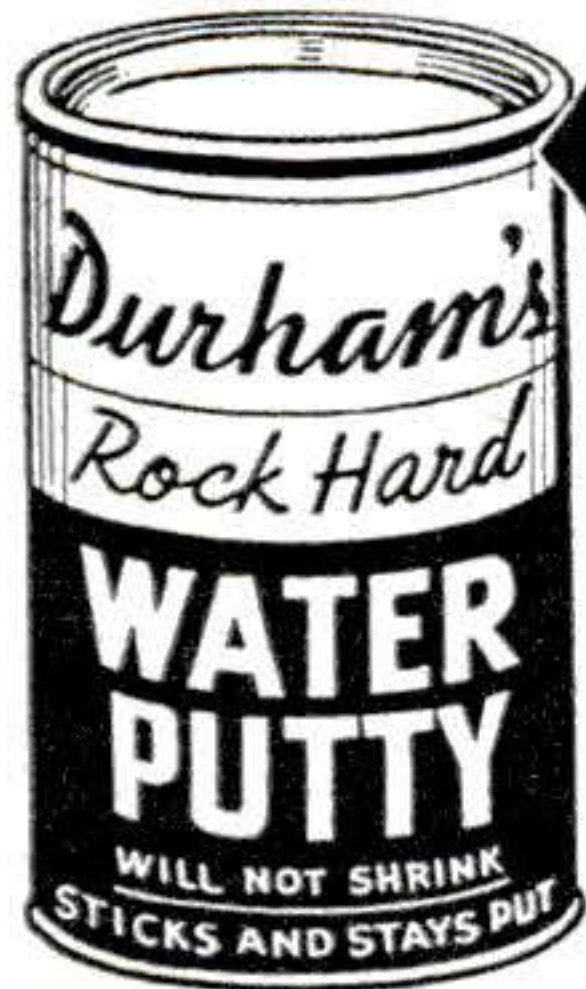

The Modern PLASTIC for lasting Home Repairs

PERMANENTLY mends cracks or holes in wood, tile, stone or plaster. Sticks and stays put—Does not chip, shrink or fall out. Easy to use. Economical. Mold it, chisel it, polish or paint it. If unobtainable from your lumber, paint or hardware dealer, the big 4-lb. can will be sent you postpaid (in U.S.) for only \$1. Full money-back guarantee, order now.

**DONALD DURHAM CO.**  
Box 804-P, Des Moines, Iowa

## FREE Bikini Crossroads Patch



Send only \$1.00 for our beautiful selection of 20 different Flight Squadron and Shoulder Insignia and receive the RARE BIKINI BOMBER leatherette breast patch absolutely FREE. Tremendous value. Colored insignia book with your order at no cost. Send to-day. Offer limited.

THE INSIGNIA MART DEPT. B2  
703 Broadway, New York 3, N. Y.

**CAR OWNERS** At last a water vapor injector within the reach of all. Same principle used by planes during the war. Increases power • Quicker pick up • Extra power on grades. Simple installation in any car. Literature on request. Check or M. O. \$3.95 postpaid.  
**HARMONIC RADIO CO., 580 Rogers Ave., Brooklyn 25, N. Y.**

## Stromberg WINTER LAYERS

**BABY CHICKS!** Our breeders are U. S. APPROVED and U. S. PULLORUM TESTED. Specializing in Large Type WHITE LEGHORNS and High Production WHITE ROCKS. 20 other leading varieties and crosses. Sold under 15-Day Replacement Guarantee. Also STARTED CHICKS. FREE. Big New RECORD-CATALOG. Write STROMBERG HATCHERY, Dept. 814, FT. DODGE, IOWA



Plane • Rabbet • Groove  
Rout • Panel • Tenon  
on Your Drill Press



This exclusive tool fits any drill press, simultaneously planes, panels, rabbets, routs, tenons, beads, grooves. No extra blades to buy. Over fifty thousand now in use by hobbyists, pattern and cabinet workers, etc. Satisfaction guaranteed or your money back. Complete

**\$7.50**

## ALL-METAL DRILL PRESS TABLE

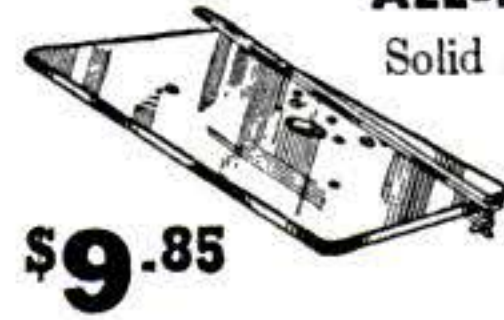

**\$9.85**

Solid Alcoa aluminum heavily ribbed. Blanchard ground top and bottom. Equipped with Barron adjustable steel fence. Extra large working surface 13" x 18". Fits all standard drill presses. Instantly mounted or removed.

## SPIRAL FLUTE ROUTER BITS

New 45° hex angle tool steel design for smoother, faster, accurate routing, grooving, carving, mortising. Extra long cutting flutes. Individual sizes 1/8" to 1/2". Prices on application. Complete set of six graduated sizes. **\$9.50**



## ROTARY SURFACE SANDER



Fits chuck of any drill press. Provides satin smooth, even, accurate surfacing of woods, plastics and metals. No ridges, no striations. Original in design, a great labor saver. Complete with 20 sanding discs. Fully guaranteed. **\$5.95**

Liberal 10 Day Money Back Guarantee

Workshop Guide FREE

**BARRON TOOL CO.**

470 Architects Bldg., Detroit 1, Mich.

**BARRON PRECISION WORK SHOP TOOLS**

Say You Saw

It In Popular Science

## JIG SAW

**XMAS GIFT FOR CRAFTSMEN FOR YOUR WORKSHOP!**

Shipping & Tax Included **\$11.95** Below O.P.A.

Will Last A Lifetime!

RUGGED construction-seasoned Oak and Fir. Oil-less type bearings, no lubrication required. Working throat depth 15 3/4". Has Steel Work Table 9"x9". Will take 1 3/4" soft or hardwoods, plastic, etc. Operates with any motor over 1/6 H.P. SAVE MONEY, EASILY ASSEMBLED. Instructions Included.

SEND \$11.95 or \$1.00 Deposit, Balance C.O.D.

**CROSS & KENT**

Dept. P.S. 4624 Sheridan Road Chicago 40, Ill.

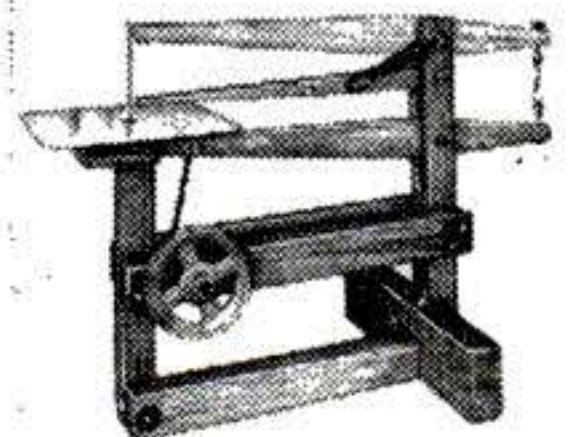

## THERE'S PROFIT in ELECTRICITY—LEARN from PRACTICAL ELECTRICS, \$1.00



Whether you want to enter the electrical field as a profession—or whether you want to know more about fixing electrical gadgets around the house, you will find Practical Electrics a profitable investment. You can find the right answers quickly. It gives you the

fundamentals of electricity, electrical circuits, motors, transformers, electrical symbols, trouble shooting, etc.—all in plain, simple, understandable language. Send \$1.00 today for a copy of Practical Electrics, the ready reference book of electricity.

**AUTOPOWER, INC., 2118 PINE STREET, ST. LOUIS, 3, MISSOURI**



**MILL IT  
ON YOUR LATHE**



WITH A **PALMGREN**



No. 250

**MILLING ATTACHMENT  
Convert Lathe in 10 Seconds**

Now—you can do milling, slotting, grinding, grooving, squaring shafts, sawing at angles, and many other important operations on your lathe. PALMGREN MILLING ATTACHMENT is a necessary fixture for small shops, schools and emergency work in large plants. Fits South Bend, Atlas, Craftsman, Logan, Sheldon and all other makes. It has graduation for rotary angle adjustments, also graduated feed and adjustment screw. Easily mounted by straddling lathe's regular tool post. Try one—it will quickly pay for itself.

**IMMEDIATE DELIVERY**

Nos.	Width Jaws	Depth Jaws	Jaws Open	Weight Pounds	Base Opening	Price F. O. B. Factory
150	1 1/2"	1"	1 5/8"	6 1/2	1"	\$18.75
250	2 1/2"	1 1/16"	2 1/2"	11	1 1/4"	24.75
400	4"	1 1/2"	4"	25	2"	39.75

Order from your dealer or jobber. Write for circular No. 349

**CHICAGO TOOL AND ENGINEERING CO.**

Mfrs. of PALMGREN PRODUCTS for Over 28 Years

8396 South Chicago Avenue

Chicago 17, Illinois

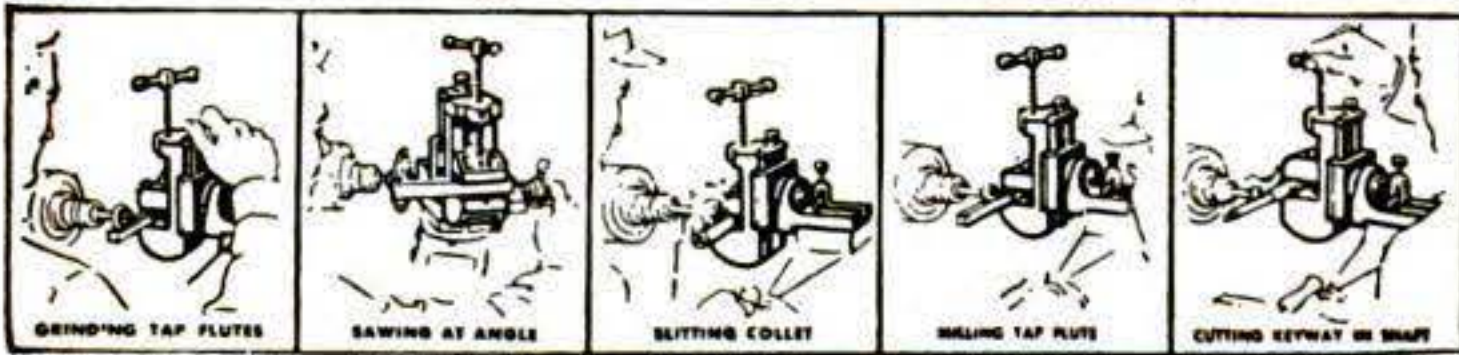

**MAKE MORE  
MONEY**

APPLYING OR SELLING

**CORKSTONE  
PLASTIC FLOORING**



**EASY  
TO  
APPLY**

Here's your opportunity to get into business for yourself applying or selling Corkstone, the economical, top-grade plastic flooring. Plenty of profit. Act without delay!

**Dealers & Agents Wanted**

WRITE FOR DETAILS

**LASTING PRODUCTS COMPANY**  
200 SO. FRANKLINTOWN ROAD, BALTIMORE 23, MD.

270 POPULAR SCIENCE

HAVE YOU TRIED  
**BREATHEASY**  
for **ASTHMA**  
AND HAY FEVER

CAUTION: Use only as directed

Satisfaction  
or Money  
Back

Write to Dept. PS

**BREATHEASY DISTRIBUTORS, INC.**  
65 Cedar Street, Seattle 1, Wash.

**INVENTING**

**—FOR  
PROFIT!**

If you have an inventive turn of mind, write for free 28-page booklet explaining how the Institute of American Inventors is helping inventors pre-test the profit possibilities of proposed devices to fill today's unprecedented demand for new inventions.

**INSTITUTE OF AMERICAN INVENTORS**

Dept. 3. 1926 Eye St. NW, Washington 6, D. C.

**PATENTS  
AND TRADE MARKS**  
**C. A. SNOW & CO.**  
Registered Patent Attorneys Since 1875  
Write for Free Book and "Certification of Invention" form  
427 SNOW BUILDING, WASHINGTON 1, D. C.

**INVENTORS**  
WITH GOOD INVENTIONS

Should write us without delay for FREE BOOKLET. Protective Disclosure Form and facts about The Inventor's Most Logical Markets. Patented, Unpatented inventions, all kinds. Cash, Royalty, needed by specific manufacturers. If your invention is for sale, write today for full particulars. A Post-Card will do! Address:

**THE INVENTION REPORTER**

4C-11106 South Longwood Drive Chicago 43, Illinois

**WINDOW SIGN LETTERS**

For Store Fronts and Office Windows. Anyone can put them on. Samples furnished. Genuine gold and silver.  
**METALLIC LETTER CO., 441 N. Clark, Chicago 10**

**CORROSION TROUBLE?**  
Use an oil that prevents rust while it lubricates  
—shop appliances  
—household devices  
—mechanic's tools  
Hardware and Sports Dealers

It's THE Triple Action Oil! Lubricates Prevents Rust Cleans

3-oz. SPOUT CAN 40¢

**FIENDOIL**



# SAVE MONEY ON CIGARETTES

LOWER PRICES on ALL STANDARD BRANDS

Luckies - Chesterfields  
Camels - Philip Morris  
Old Golds - Pall Mall  
and others

**\$1.41**  
Carton of  
10 Packs

SHIPPED SAME DAY  
TO ANY PART IN U. S. OR ABROAD ON  
RECEIPT OF CHECK OR MONEY ORDER  
90,000 Satisfied Customers

## PERFECT ARRIVAL GUARANTEED!

Minimum 3 Cartons Include Postage and Insurance  
as follows: Within 150 Miles • For 3 Cartons 15c  
• Add 1c for each additional carton •  
Distant orders require extra postage.

WE CARRY A COMPLETE LINE OF POPULAR  
BRANDS OF CIGARS—Write for Price List  
This is our 27th Year in Business.  
Prices subject to change without notice.

## SILVER ROD SALES

Dept. A, Jersey City 6, N. J.

## "MAGIC VANISHING CARD"

Throw it into the Air, It completely disappears; reproduce it  
later from spectator's pocket. It amuses and confuses all.  
Easy to do, 25c with Amazing Catalog of 300 Tricks.

THE MAGICIAN

Dept. 6, 2463 Kensington Ave., Phila, 25, Pa.

## START HOME NOVELTY MFG. BUSINESS

New course tells in simple language how to make plaster  
novelties of many kinds at home. Descriptive folder free.

W. BELFORT

Engineering Building Chicago 6, Illinois

# LAW

STUDY AT HOME for PERSONAL SUCCESS and  
LARGER EARNINGS. 38 years expert instruction—over 108,000 students enrolled. LL.B.  
Degree awarded. All texts furnished. Easy pay-  
ments. Send for FREE BOOK—"Law and Ex-  
ecutive Guidance."

AMERICAN EXTENSION SCHOOL OF LAW  
Dept. 72-S 646 N. Michigan Ave., Chicago 11, Ill.

## EXTRA MONEY FOR XMAS!

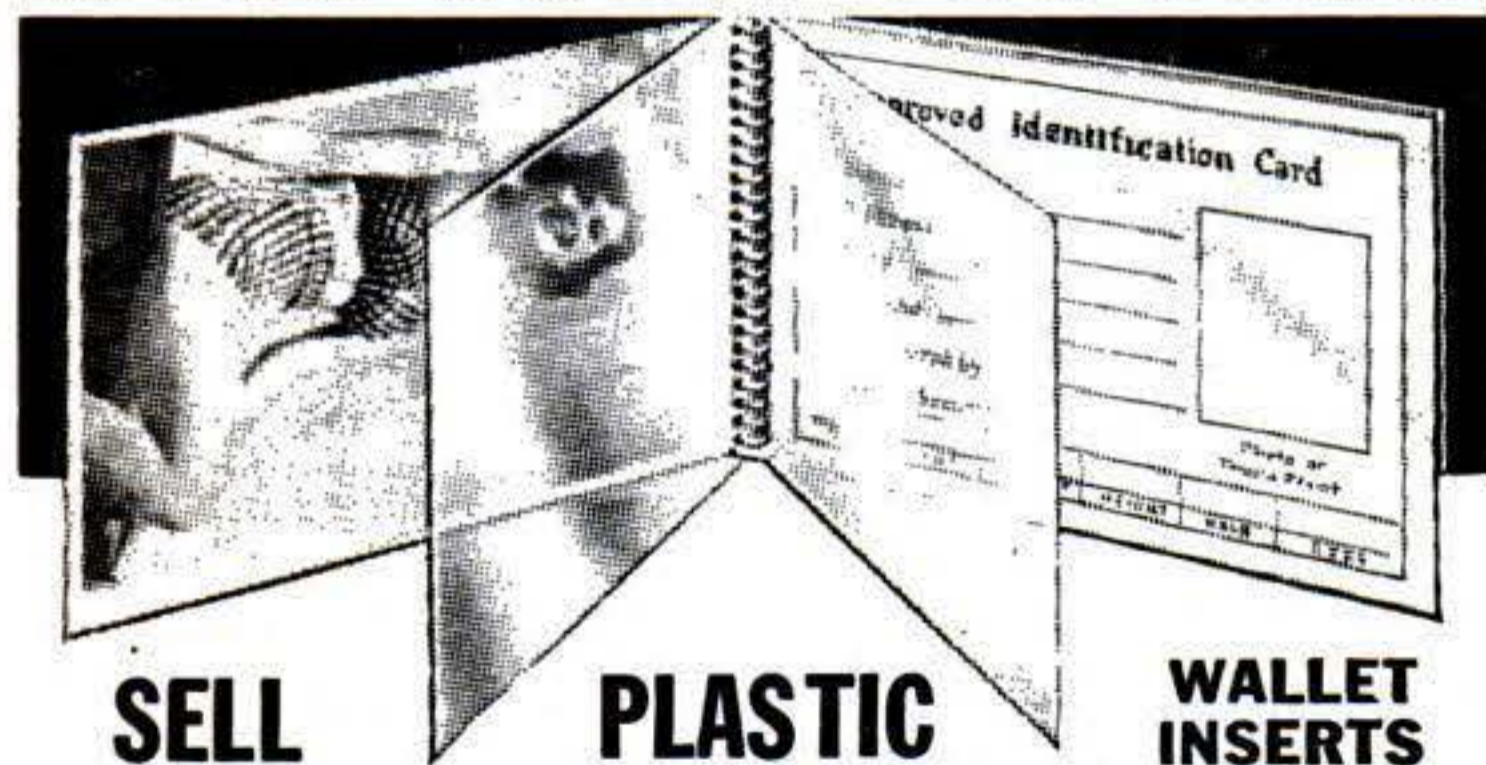

SELL

PLASTIC

WALLET  
INSERTS

IMMEDIATE  
DELIVERY!

**\$1.50**

DOZEN  
ASSORTMENT

Easy to Sell! Big Market! Big Profits!

Get extra money for Xmas gifts, new clothes, etc.,  
without digging into savings! Sell these dozen in-  
serts for 50c to \$1 and make at least \$6 for yourself.  
Easy to sell 10 or 12 dozen to friends, neighbors,  
etc. Assortment has 4, 5, and 6 envelope books,  
Heavy plastic covers. Strong wire spiral binding.  
Identification card in each insert. FREE set-up dis-  
play box with first order. Excellent money-making  
sideline. Easy to carry. MONEY-BACK GUARANTEE  
on inserts you don't sell. Rush \$1.50 for trial  
dozen. Big profits waiting!  
ED MASTERS CO., Dept. PS12, 113 N. 3 St., Brooklyn 11, N.Y.

## Glorious GIFTS at Money-Saving Prices



SAVE by ordering these fine watches directly  
from the importer. Every watch gift boxed,  
dependable, smartly styled, guaranteed.

**A-1** Men's watch, as shown above. Shockproof,  
waterproof, radium dial, sweep second  
hand. 7 Jewels. Compare! . . . **\$16.50**

**A-2** Same style, but with 17 Jewels. Steel  
back case. (\$39.50 value) . . . **\$28.50**

**A-3** Same style, but with 17 Jewels, and 14K  
Gold case. (\$125.00 value) . . . **\$74.50**

ALL PRICES INCLUDE FEDERAL TAX

SHOP BY MAIL. Send check, money order, or  
pay postman C. O. D.

MODERA CO. 562 Fifth Avenue, New York 19, N. Y.  
Dept. S-12



A WHOLE SHOP  
FULL OF TOOLS  
IN ONE!

Use it for grinding,  
routing, drilling,  
sawing, polishing,  
carving, sanding and  
9,994 other uses.  
Increases your skill  
and your scope.  
Precision-engine-  
ered, AC-DC. More  
exclusive features  
than any other tool.

Exclusive  
Safety  
Fingergrip  
for fine  
detail work

**\$22.50**

COMPLETE WITH 36 ACCESSORIES  
IN FITTED STEEL CASE

\$31.75 Value if  
Purchased Separately

Works Wood, Metal,  
Glass, Plastics

## CASCO ELECTRI-CRAFT TOOL KIT

CASCO PRODUCTS CORPORATION, BRIDGEPORT 2, CONN.

DEC. 27  
1946



# Earn Big Money Arc Welding with a HOBART

- welds faster
- more economical
- easier to operate
- heavy duty
- cooler running

Hobart Stationary Electric Drive—Shaft Extension

Hobart "Build Your Own" Generator

Hobart AC Model for Single Phase

Own a profitable business with a minimum investment? It's easy if you establish a welding shop with Hobart Arc Welders. People bring repair work to you—automotive, farm equipment, etc. There's profit in every job—and plenty of jobs to keep you busy.

**WELDING WITH HOBART IS EASIER!** Only with Hobart do you get operation and convenience features that let you complete a job faster while producing better quality, more profitable welds. Write for details on the Electric Drive Welder—ideal for job welding shops.

**"BUILD YOUR OWN" AND SAVE!** With the Hobart Generator Only, a used auto engine and chassis, you can build your own portable gasoline drive arc welder and save hundreds of dollars. This equipment goes everywhere to handle welding jobs. Send coupon.

**COMPLETE HOBART LINE.** You'll find every type and size of arc welder in the Hobart line—electric or gasoline drive, stationary or portable, AC or DC.

**HOBART WELDING SCHOOL.** Instruction in all phases of welding in short, intensive course. Modern building, individual instruction. Qualified under G. I. Bill. A non-profit institution.

Hobart Bros. Co., Box P-126, Troy, Ohio

# Hobart

"One of the World's Largest Builders of arc welders"

**Free!** Vest Pocket Welders' Guide Full of welding tables, charts and data.

HOBART BROS. CO., BOX P-126, TROY, OHIO

I'm interested in the profit-making possibilities of Hobart Arc Welders. Send me free book, and details on items checked.

Electric Drive       A.C. Welder

"Build Your Own"       Welding School

NAME \_\_\_\_\_

ADDRESS \_\_\_\_\_

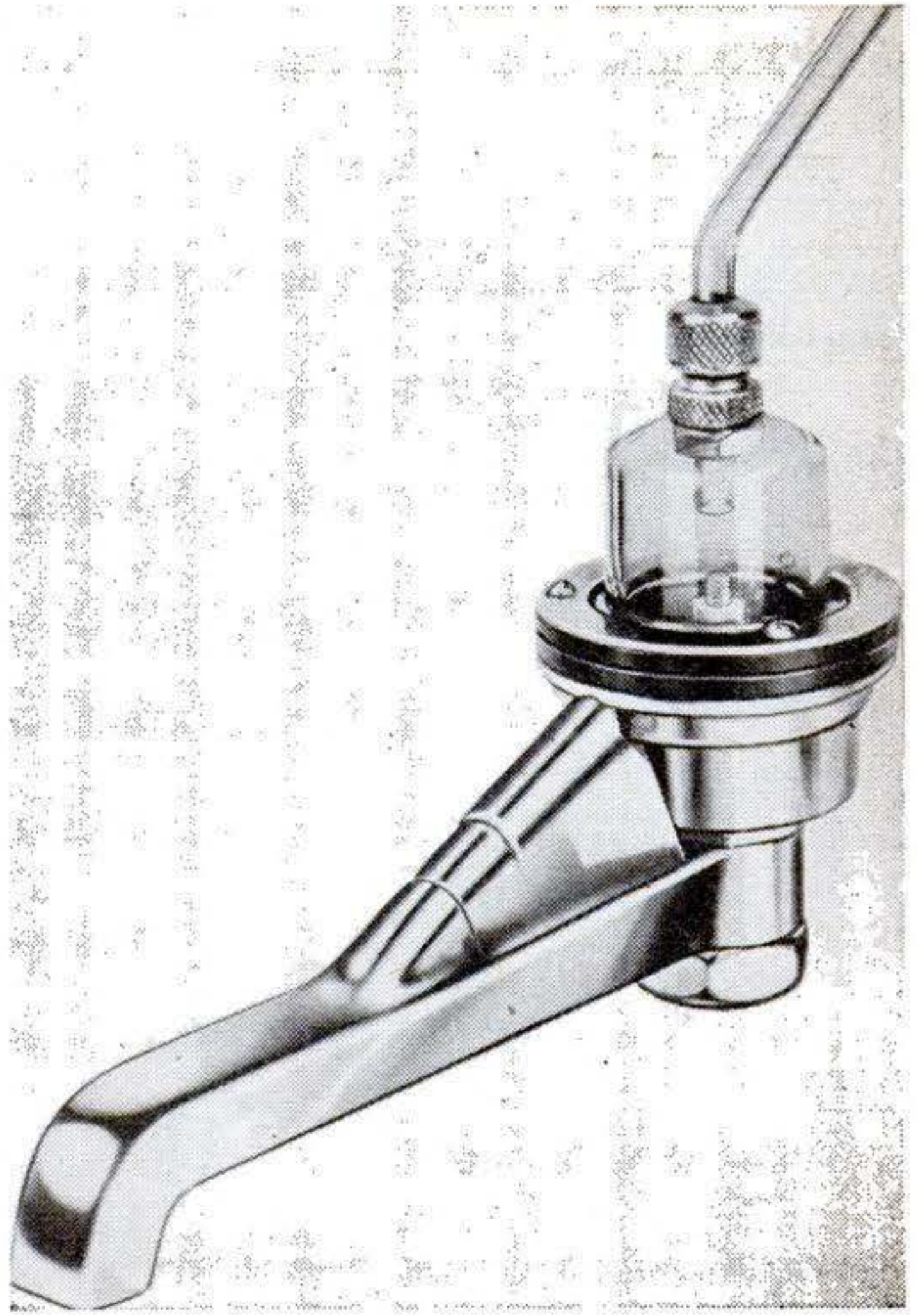

## Microbe-Killing Dispenser

SWIVEL-SPOUTED for disinfecting glass and chinaware, the faucet above releases pure water into one sink and a chemical-and-water solution when switched to another. A plastic "bell" stops or releases the detergent as the spout is swung from sink to sink. All parts of the bell have been dipped in neoprene to check corrosion. Developed by the Solfred Mfg. Co., the faucet releases disinfected water at a rate of 100 drops of chemical to 1,000,000 drops of water.

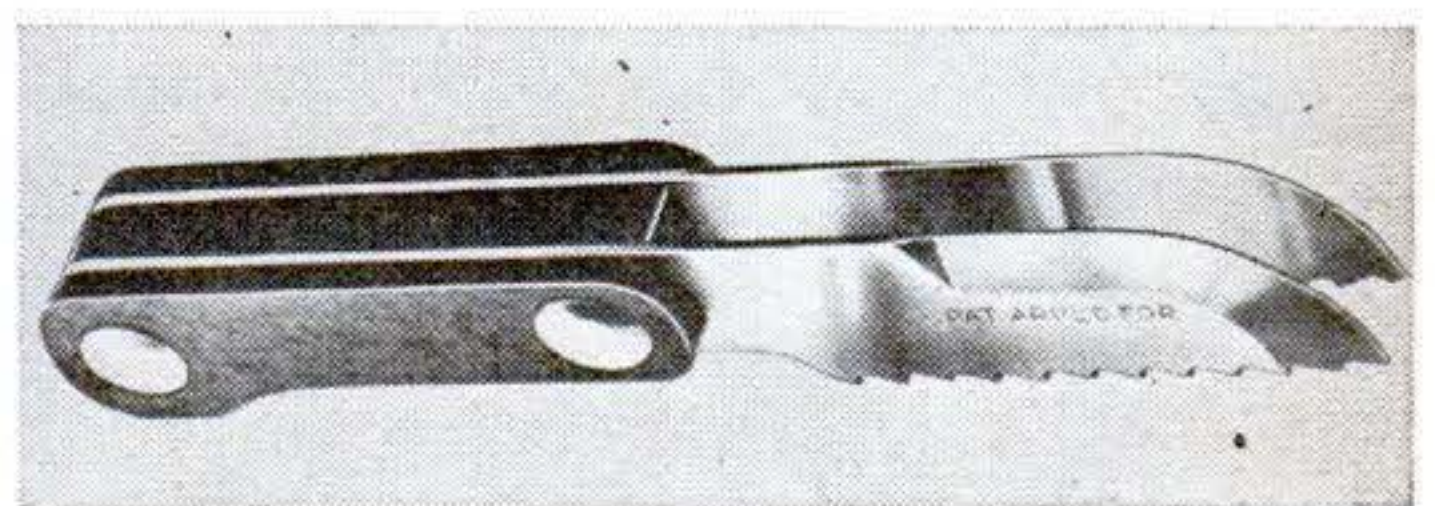

## Two-Bladed Fish Cleaner

THOSE flying scales that get into your hair when you clean fish with an ordinary knife are tamed by the two-blade arrangement on the seven-inch-long, stainless-steel, Handy Action fish boner and scaler above.



## SMALL EFFICIENT SPEED REDUCER

Sturdy, compact (see dimensions). Proved in thousands of industrial installations. Case of heat-treated aluminum. Gears, SAE 65 (British Gear) Bronze. Worm of case hardened steel. Timken Bearings throughout. Available in 4 different assemblies (shown below) and in these standard ratios:

4-1	25-1	64-1	200-1
8-1	30-1	75-1	300-1
10-1	40-1	80-1	400-1
16-1	50-1	100-1	600-1
20-1	60-1	150-1	800-1

Torque capacity 100 inch pounds. Especially suited for bench work, home work shops, light production, animated displays, etc. When ordering be sure to specify assembly and ratio required. Shipping weight in carton, 8 lbs. Full money back guarantee. Prompt deliveries.



**\$15.12**

Ceiling Price  
F. O. B. Cleveland

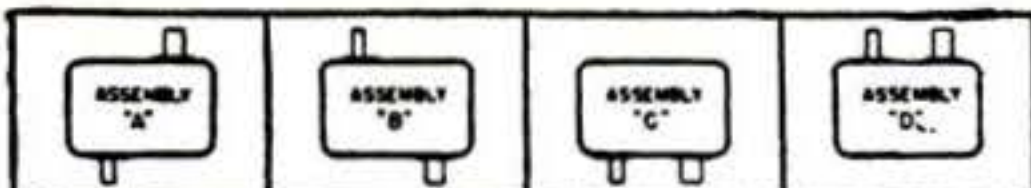
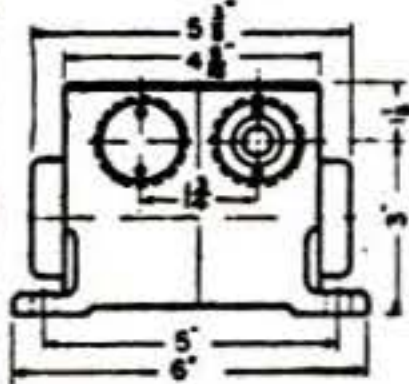
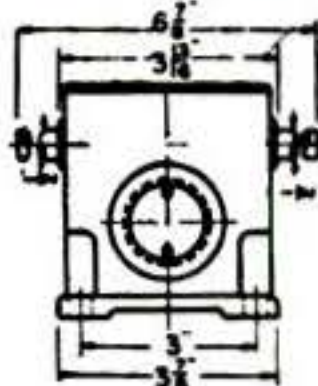

**THE OHIO GEAR CO.**  
1422 EAST 179th ST. • CLEVELAND 10, OHIO



Write Dept. F for Free Catalog  
of 45 Kits Today

**MEIER BRASS & COPPER CO.**  
1155 Bellevue, Detroit 7, Mich.

### BRASS RODS For Home Work Shops

For use on model boats, airplanes, etc., keep a supply of these free-turning brass rods on hand. Kits available for all size requirements.

## MAKE HUNDREDS OF FASCINATING Radio-Electrical EXPERIMENTS

IDEAL XMAS GIFT FOR BOYS!  
Radio Electronic Experiment Kit

50 Piece Genuine Commercial war surplus Electronic apparatus. Includes headphone, capacitors, potentiometers, resistors, fuses, sockets, hook-up-wire, etc. Build hundreds of fascinating experiments. Learn electronics at home. Send \$4.99 for kit, complete instructions, also blueprint for home lab. bench. Or sent COD. LECO ENGINEERING CO., Box 931 pgg Lincoln, Nebraska.



Only  
**\$4.99**  
POSTPAID U.S.A.

## RADIO PARTS GRAB BAG!!

\$25 value assortment of Coils, Condensers, Transformers, Resistors, Controls, etc. An experimenter's dream. Order today! Only

**MARKO SUPPLY, Dept. PS 12**  
2924 Logan Blvd Chicago 47, Ill.

**\$3.98**



## U. S. Army RADIO PHONES

(Water, Shock and Weather Proof)  
Made to U. S. Army Specifications, passed by Signal Corps Inspectors. Dynamic Microphone and Dynamic Receiver of Finest Quality—Water, Shock, Weather and Altitude Proof. used on tank and aircraft (B19) intercom systems. For recording, for battery-less telephone, talk through your radio set or use earphones for pocket-size set loud speaker. Complete two receiver, cord set; head band, and dynamic hand microphone. Including special connecting cord set. A REAL BARGAIN AT THIS PRICE.

ONLY **\$9.95**  
Postpaid  
ORDER YOURS TODAY

## Here It Is: ELECTRIC SWITCH

VERSATILE SWITCH. MILLIONS IN POST WAR APPLICATIONS—Flood-light your porch when the door is opened . . . Sounds alarm when window is opened . . . Signals arrival of mail . . . Controls heating of furnace . . . Filling of water tank, these and many other services are performed by this versatile switch. Shipped with instruction sheet showing numerous illustrated uses. EXCEPTIONAL LOW PRICE.

**KING PRODUCTS CO., Dept. PS, Batavia 2, Ill.**



ONLY **\$1.00**  
Postpaid

## Blow Up Your Snapshots Big and Brilliant with a

**FEDERAL**

"America's Fastest Selling Enlarger"



It's so easy to enlarge with a Federal that even a beginner can turn out salon quality prints with very little practice. And it's great fun to enlarge with a Federal because of the many extra value features your Federal supplies with no extra cost to you. For example, a fully corrected, quality anastigmat lens is included in the modest price of every Federal.

### "ENLARGING IS THRILLING"

Starts at the beginning and takes you step by step through the adventure of enlarging. 48 amusing, illustrated pages.

25c at Camera Stores or Send Coin.



**FEDERAL MANUFACTURING & ENGINEERING CORP.**  
Makers of Photographic & Electronic Devices  
213 STEUBEN STREET • BROOKLYN 5, N. Y.

# FREE!



LAFAYETTE'S  
BIG NEW  
CATALOG

25th ANNIVERSARY

SCARCE PARTS—STANDARD PARTS  
FAMOUS BRANDS—EXPERIMENTERS' KITS

This valuable, 144-page book is a must for all radio men. No matter if you're just starting out in radio, or if you're a top-flight engineer, you need the Lafayette Catalog. It's the world's biggest display of fine radio parts and equipment—at prices that will save you lots of money.

## LAFAYETTE RADIO

**RADIO WIRE  
TELEVISION Inc.**

100 6th Ave. NEW YORK 13  
110 Federal St. BOSTON 10  
24 Central Ave. NEWARK 2

Lafayette Radio, Dept. KL-6  
100 Sixth Ave., New York 13, N. Y.

Please RUSH my FREE copy of the big, new Lafayette Catalog.

Name \_\_\_\_\_

Street \_\_\_\_\_

City \_\_\_\_\_ Zone \_\_\_\_\_ State \_\_\_\_\_

Send for your FREE  
copy of catalog.  
Paste Coupon on  
Post-Card—Today.



# RED-ITCHY-SCALY ECZEMA

**Effective Home Treatment Promptly Relieves Torture!**



First applications of Zemo—a Doctor's soothing yet highly medicated antiseptic formula—promptly relieve itching and burning and also help heal the red, scaly skin. Backed by a 40-year record of continuous success! *Invisible*—doesn't show on skin! First trial of clean, stainless liquid Zemo convinces! In 3 sizes. For severe cases ask for special *Extra Strength* Zemo. At all drugstores.

## ZEMO

## AIR RIFLES BENJAMIN AIR PISTOLS ARE IN PRODUCTION

ORDER BENJAMIN AIR RIFLES & BENJAMIN AIR PISTOLS from your DEALER. Send for our FREE FOLDER and Complete Specifications TODAY. Both Calibre Benjamin H-C Pellets are available now. BENJAMIN AIR RIFLE CO., 811 MARION ST., ST. LOUIS 4, MO.

PRESS THE TRIGGER for HEAT in 6 SECONDS



with the *Flash* SOLDERING GUN

YOU AIM IT AT YOUR WORK with a restful, natural wrist position

Engineered for every type of soldering, the Flash Soldering Gun gets around corners and into minute places. Heats only while pressure is on trigger—intensity of heat controlled at your finger tips. Equipped for immediate operation from our 110 V transformer, or from any standard (6-12V) storage battery in car, tractor, airplane, boat, etc. Ask about extra tips for special work, and for specifications for the heavy duty model, with its 5/8 inch tip. See your distributor, or send coupon.

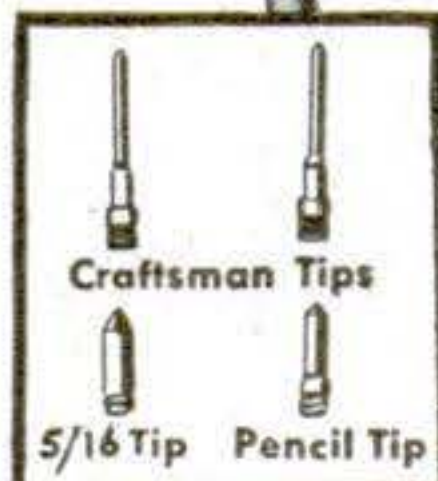

### BAKER-PHILLIPS COMPANY

2816-7 Aldrich Avenue South, Minneapolis 8, Minnesota  
Please send circular on Flash Soldering guns.

Name .....

Address .....

## Here YOU ARE WOODWORKERS

### THE NEW CONSTANTINE MASTER MANUAL

Bigger and better with more new pages of helpful articles and information on materials and supplies. Hundreds of familiar items back again; dozens of new additions including lumber, veneers, inlays, plywood, tools and finishing materials. The greatest 25c worth ever offered craftsmen and woodworkers. In addition, without charge, a year's subscription to Chips & Chats to keep you up to date on craftsmen's activities and many bargains. Send 25c now to ALBERT CONSTANTINE & SON, INC. 793-L East 135th St., New York, 54, N. Y.



**FREE**  
1 YR. SUBSCRIPTION TO CHIPS & CHATS



59c

5 Extra Blades (Year's Supply) 25c

1734 Carew Tower

## COMB-A-TRIM THE NEW QUICK TRIMMER

Something New! Trim your hair without any experience. It's easy! The excess hair comes off smoothly and easily by just pulling trimmer through hair like an ordinary comb. Also removes hair from legs—armpits. Save on hair-cut bills . . . Trim your own hair or the whole family's. Send 59c and your Comb-A-Trim will be sent at once.

**SPECIAL OFFER**  
Send \$1.00 for 2 Comb-A-Trims and save 18c. **2 for \$1**

COMB-A-TRIM CO.

Dept. J-14

Cincinnati, O.

## START HOME MAIL ORDER BUSINESS

Start small—grow big. Amazing new course shows you the way. Write today for full particulars. No obligation. BELFORT (Dept. O) Engineering Bldg., Chicago 6, Ill.

## SELL MERCHANDISE BY MAIL

Operate profitable home business selling merchandise by mail. 75c profit on fast selling \$1 items. Write TODAY. POWELL CO., Dept. C, Sampliner Bldg., Cleveland 3, Ohio

## KIDNEYS MUST REMOVE EXCESS ACIDS

Help 15 Miles of Kidney Tubes Flush Out Poisonous Waste

If you have an excess of acids in your blood, your 15 miles of kidney tubes may be over-worked. These tiny filters and tubes are working day and night to help Nature rid your system of excess acids and poisonous waste.

When disorder of kidney function permits poisonous matter to remain in your blood, it may cause nagging backache, rheumatic pains, leg pains, loss of pep and energy, getting up nights, swelling, puffiness under the eyes, headaches and dizziness.

Kidneys may need help the same as bowels, so ask your druggist for Doan's Pills, a stimulant diuretic, used successfully by millions for over 40 years. Doan's give happy relief and will help the 15 miles of kidney tubes flush out poisonous waste from your blood. Get Doan's Pills.



# 5 lbs. HANDY ASSORTMENT \$1.98

For Mechanics—Garages  
Workshops—Home Use

SCREWS • NUTS • BOLTS • WASHERS  
RIVETS • SPRINGS • BRACKETS • MISC.

MORE THAN 1,000 PIECES—5 full pounds—a veritable treasure chest of fastening devices for every practical use. Satisfaction guaranteed. Order now.....\$1.98  
SPECIAL—2 assortments, over 2,000 pieces, for \$3.69.  
Get on our FREE Bargain Mailing List—Many other valuable assortments to meet every need!

Hudson Trading Corporation  
D1519 N. Wells St.  
Chicago 10, Ill.



## TALK-SING thru your own radio with RADIO MICROPHONE

Be the life of the party. Put on your own broadcasts at home. Talk-Sing, make announcements from any room. Wonderful voice practice. Microphone easily attached to any radio. Follow enclosed instructions. SEND NO MONEY—pay Postman \$1.98 plus postage. Send Money Order or check and save postage.

EMPIRE RADIO & TELEVISION CO. (Dept. R1) 1521 Bedford Ave., Brooklyn 16, N. Y.

## NEW CHEAP OIL BURNER

FOR COOKING & HEATING STOVES-FURNACES  
HEAT YOUR HOME, COOK YOUR MEALS WITH CHEAP FURNACE OIL

NO MORE SHOVELING COAL OR ASHES. A New Fuelizer Starter Vaporizing System turns Cheap 130 Flash Furnace Oil Distillate, Kerosene, etc. into Oil Gas heat without clogging up. LIFETIME GUARANTEE against defects. \$1.00 Bonus Offer for Testing. We will let you try it in your own stove or furnace for one month. Get yours for introducing.

Big Profits QUICK. Be first. Send in your name TODAY.  
NORTHWEST MFG. CO., 562-P 5th, Mitchell, So. Dakota

## Build Your Power Tools With OUR BALL BEARING ARBORS

L. H. Th'ds Also

C5 5/8—\$8.25 PP.  
C6 3/4—\$9.25 PP.

Spindle 12 1/2 Long Housing 2 1/4 x 8  
Heavy Duty Ball Bearing Saw Arbors  
Dealers Wanted

B33—\$4.95 PP. 5/8 x 4 1/2 Spindle Only  
B15 Plain Spindle \$3.45 PP. Also Flange Models

POLY PRODUCTS, 406 S. Chester Ave. Ct. 1, Dept. S11, Pasadena 5, Calif.

Say You Saw  
It In Popular Science

# ELECTRICITY FOR ANY JOB ANYWHERE

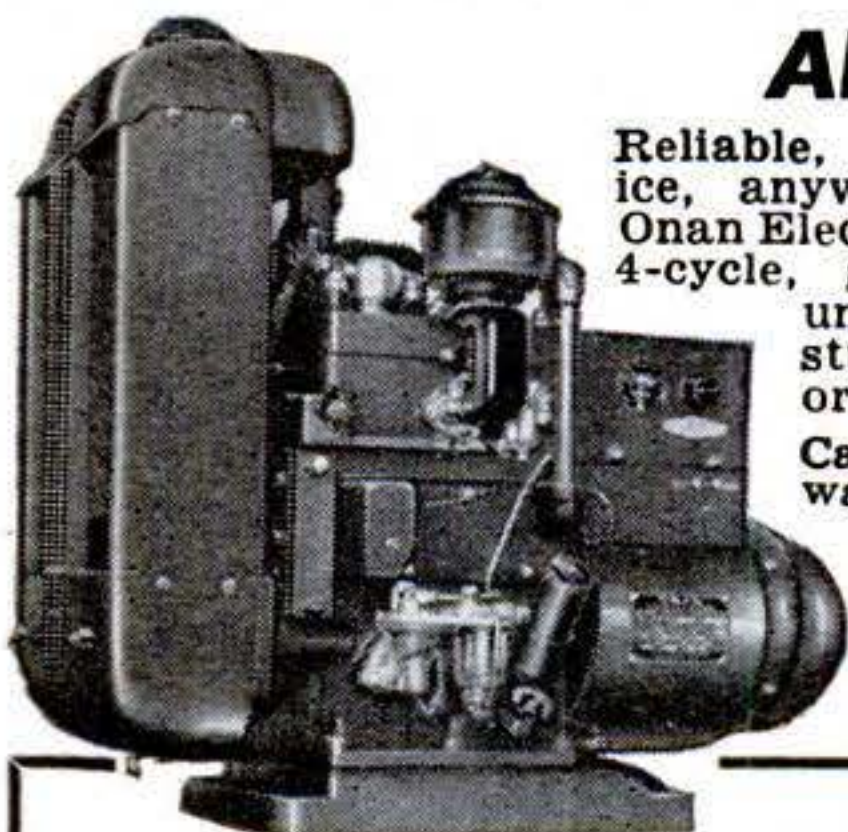

Reliable, economical electric service, anywhere, anytime, with an Onan Electric Plant. Driven by Onan 4-cycle, gasoline engines. Single-unit, compact design and sturdy construction. Water or air cooled.

Capacity range: 350 to 35,000 watts; 115 to 660 volts A.C., 50 to 800 cycles; 6 to 800 volts D.C. Combination A.C.-D.C. types. 65 different models.  
Write for folder.

## ONAN

D. W. ONAN & SONS 1846 ROYALSTON AVE. MINNEAPOLIS 5, MINN.

# They're back again

## ... THOSE NATIONALLY FAMOUS RUBBER TIRED WALTON WHEELS FOR BUILDING YOUR OWN VEHICLES!

You can't buy better Wheels! WALTON DELUXE WHEELS are America's finest—don't be satisfied with anything less to build vehicles of your own design!



### Hardened Steel Roller Bearings

Two sets of scientifically engineered roller bearings and massive jumbo balloon rubber tires give them their rocket speed and provide you with almost unbelievable velvet-smooth rides.

**IDEAL CHRISTMAS GIFT! HUNDREDS OF USES!** Excellent for carts, trailers, golf bag carriers, mobile industrial equipment. Tremendous production direct from manufacturer makes possible our low price for such fine quality!

WHEELS ONLY

### 3 COMPLETE WHEEL KITS

Choose from these kits to make coaster wagons, racers, four-wheel trucks, etc.

**WK1** Four 8x2 Wheels, two 20"x 1 1/2" diam. axles, 4 heavy hangers, 8 washers and cotter pins ready for use. Specially priced.....\$13.95

**WK2** Four 10x1 3/4 Wheels, two 24" x 1 1/2" diam. axles, 4 heavy hangers, 8 washers and cotter pins ready for use. Specially priced.....\$14.95

**WK3** Designed for heavy-duty needs. Includes four extra-heavy, big industrial type deluxe Wheels, two 24" x 1 1/2" diam. axles, 4 heavy hangers, 8 washers and cotter pins. Massive 10-inch rubber tires are 2 3/4 inches thick. Specially priced...\$32.95

8x2" in sets of two. Each.....\$2.95  
\$11.60 set of 4

10x1 3/4" in sets of two. Each.....\$3.25  
\$12.80 set of 4

10x2 3/4" extra heavy industrial type in sets of two. Each...\$7.48  
Single Wheel \$7.95  
\$29.95 set of 4

Fast delivery. Send check or money order. No C.O.D.'s, please.

WALTON WHEEL COMPANY, Dept. B-4  
PLANKINTON ARCADE MILWAUKEE 3, WISCONSIN  
Dealers and Equipment Manufacturers—write for information.

# Build Your Own..

# RADIO INTERCOM AMPLIFIER TRANSMITTER

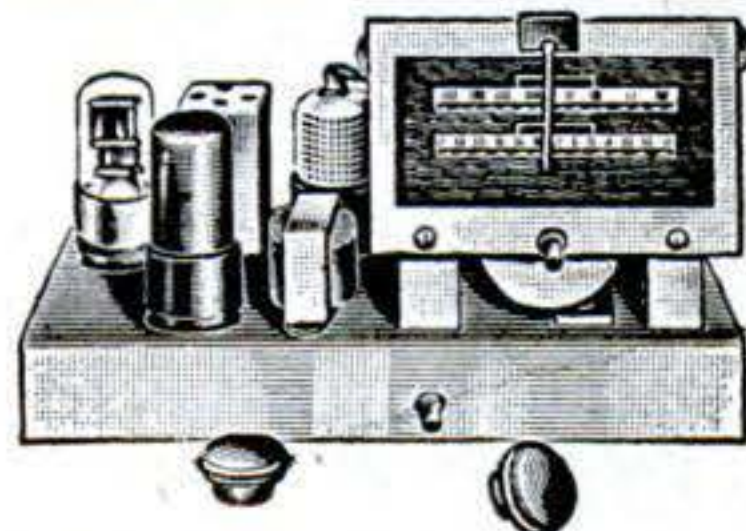

## Famous POPULAR MECHANICS and other KITS

Enjoy thrill of building your own equipment from famous Popular Mechanics, Concord and other radio training Kits—ideal for home radio study and experimenting, and for classroom, radio club and Boy Scout radio training projects. 25 different Kits, various types, each including all parts, hardware, diagrams and instructions, now available from CONCORD.

### MAIL COUPON FOR FREE CATALOG

Fill out and mail coupon below for new complete Concord Catalog listing famous Popular Mechanics and many other Radio Kits—plus complete line postwar-designed Radio Sets and Radio Parts, supplies and equipment for every need. Mail coupon for your free copy—NOW.

# CONCORD RADIO CORP.

LAFAYETTE RADIO CORPORATION  
CHICAGO 7, ILL. 901 W. Jackson Blvd. • 265 Peachtree St. ATLANTA 3, GA.

CONCORD RADIO CORPORATION, Dept. PS-126  
901 W. Jackson Blvd., Chicago 7, Ill.  
Rush FREE copy of new, complete Concord Catalog.

Name.....  
Address.....  
City..... State.....





**SPECIAL OFFER - ONLY 10¢**  
**TIMESAVING WOODWORKING**  
**CALCULATOR, BY GREENLEE**  
**MAKER OF FINE TOOLS**

Let this popular, easy-reading GREENLEE HANDY CALCULATOR swiftly solve your woodworking problems. Just set the dial . . . convert linear feet to board feet . . . get slope per foot in degrees . . . compare hardness, weights, shrinkage, warping and working ease of various woods.

More, too: bit sizes for head, body, thread of screws . . . nail specifications . . . tool sharpening hints . . . protractor, 6" diameter, fits your tool kit. Heavily varnished cardboard. Special offer. Order now, send 10c (not stamps) in next mail. Greenlee Tool Co., Division of Greenlee Bros. & Co., 2132 Columbia Avenue, Rockford, Illinois.



### Light, Safe Magnesium Boat

AIRCRAFT construction marks the Dowcraft magnesium boat, which weighs only 45 pounds although 12 feet long. Of ribless design, the craft has an extreme beam of 44½ inches and a center depth of 16¼ inches. An added safety factor is given by Styrofoam floats installed under each of the three seats. The boat holds five persons and its stern can support a 5½-hp. outboard motor.

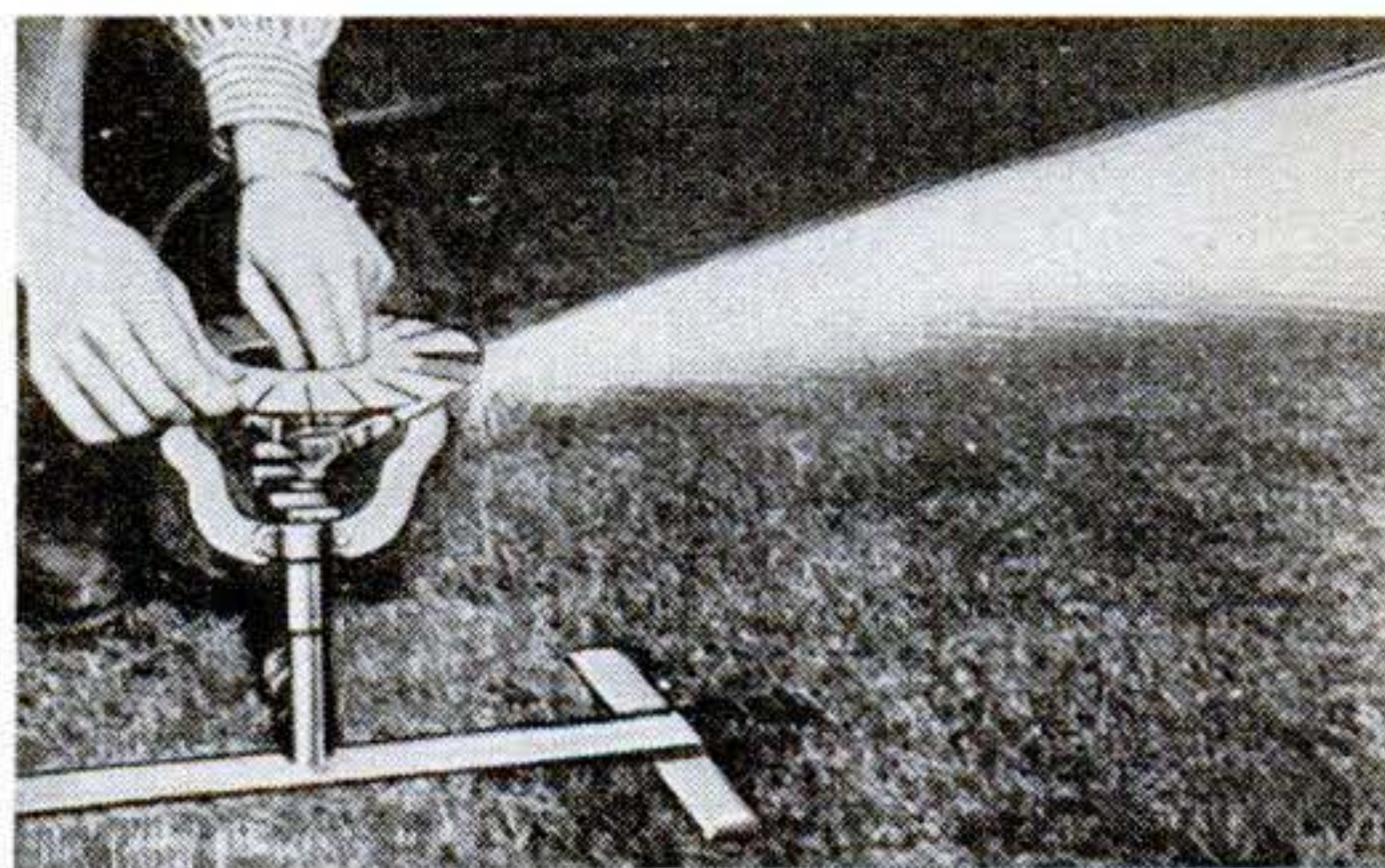

### All-Pattern Garden Sprinkler

ADAPTED from sprinkler heads used in parks, the home sprinkler above can be adjusted to throw water in any pattern of angles and curves. Spray can thus be kept off house walls and sidewalks. The circular, revolving plate above the nozzle has 18 vanes. Each vane can be lowered, raised, or twisted to control the distance that the water travels.



**AT LAST! A HOBBY THAT OFFERS YOU PROFIT AS WELL AS PLEASURE!**

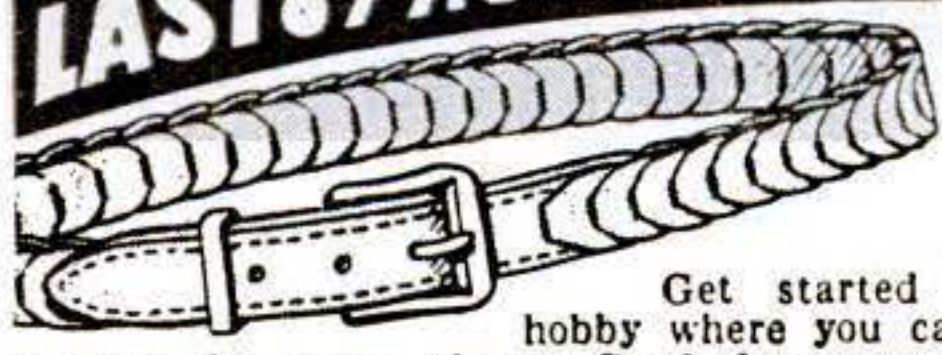

**GENUINE LEATHER Handcrafted LINK BELT EASY-TO-MAKE AND EASY TO SELL**

Get started today on a fascinating hobby where you can earn up to \$10 or \$15 a week in spare time! Send for your complete profit-producing Handicraft Kit with all the material needed to make 6 genuine leather link belts. Sell all you make at \$2 each to people expecting to pay far more for genuine hand-made belts. Kit for 6 belts costs you only \$3.50—can easily be sold for \$12—leaving you a profit of \$8.50. Send \$3.50 for your Kit today, or mail only a dollar for sample Kit! Or C.O.D., you pay postage. Money back if not delighted.

**FREE WITH YOUR ORDER**

**... IF YOU ACT NOW!** Beautiful plastic identification card case. Value 25c. Yours to Keep, even if you return belt Kit. NOTE: Send 10c for big new catalog

DWINNELL CRAFT SHOP, Dept. SC-612, Elm Grove, Wheeling, W. Va.

**BUILDING CONSTRUCTION**



with cement composition and cheap wood builds 3 room house low as \$250. Farm building low as \$50. Homemade forms make blocks, panels and tiles in color, and wallboard of sawdust and other compositions. Wall-high blocks, insulated, with finished sides, Stream-lined roof and walls. Cement gutters, Cabins, stores, sectional, Troweled roofs and floors. Ten formulas, 100 money and labor saving ideas. Mixer and buzz saw easily made from an old auto. Make doors and windows, 50 proved ways to earn \$10.00, \$15.00 a day, 100 illustrations. Guaranteed book, \$1.00. **MAKE FURNITURE OF COMPOSITION** cement, sawdust, paper, asbestos, Homemade cement. Some part scrap wood, and metal make tables, cabinets, chests, racks, shelves, inclosed sinks, lawn novelties and toys. Over 500% profit. 50c. **HOW TO MAKE ACCURATE SHOP MACHINES**, saws, drills, forge lathes, tools, electric weed cutters and many other things from old auto parts and washing machine motors. Illustrated. 50c. **HOME MFG. ENTERPRISES**, 50 selected home shop projects. 50c. Special: All four booklets described above, \$2.00 postpaid. No C.O.D. **HOME INDUSTRIES**, 1318 So. 30th Ave., Dept. PS., Omaha 5, Nebr.

**SHEET METAL PROJECTS**



**OLD SNIP'S BEST SELLERS**  
34" x 44" BLUEPRINTS  
#103 COLONIAL POST-TOP LAMP: Eight paned type. Generously proportioned . . . 17" from post socket base to chimney cap . . . 10" across top of cornice. Hinged door with weathershield, for re-lamping. Makes a particularly beautiful copper project. Full scale 34" x 44" Blueprint \$1.00 plus assembly instructions.  
Guild Design and Manufacturing Company  
Successors to Draftsmen Associates  
EDMUND at HELLERMAN, Philadelphia 35, Penna.

**48 PLANS \$1.00 • FREE 75¢ MARTIN HOUSE PLAN**

Toys ash trays games garden cutouts, wall shelves Dutch boys and girls, animals, etc., etc. Many other new and interesting projects. Finest selection available. Make project any size you desire. Plus FREE 75c 17 family Martin house plan. Send only \$1.00 to . . . . . JACKSON STUDIOS 5440 N. Shoreland Ave. Milwaukee 11, Wis.



**GERSTNER Tool Chests**  
Better, finer, more desirable chests. They have pleased good machinists and Toolmakers for 40 years. Free Catalog.  
**GERSTNER TOOL CHESTS**  
546 Columbia St., Dayton 7, Ohio

**6 handy tools in ONE!**

- 1 MITERING GUIDE
- 2 DIAMETER GAGE
- 3 ACCURATE SQUARE
- 4 MARKING GAGE
- 5 CENTER FINDER
- 6 CONVENIENT RULER



**\$2.00 POSTPAID**

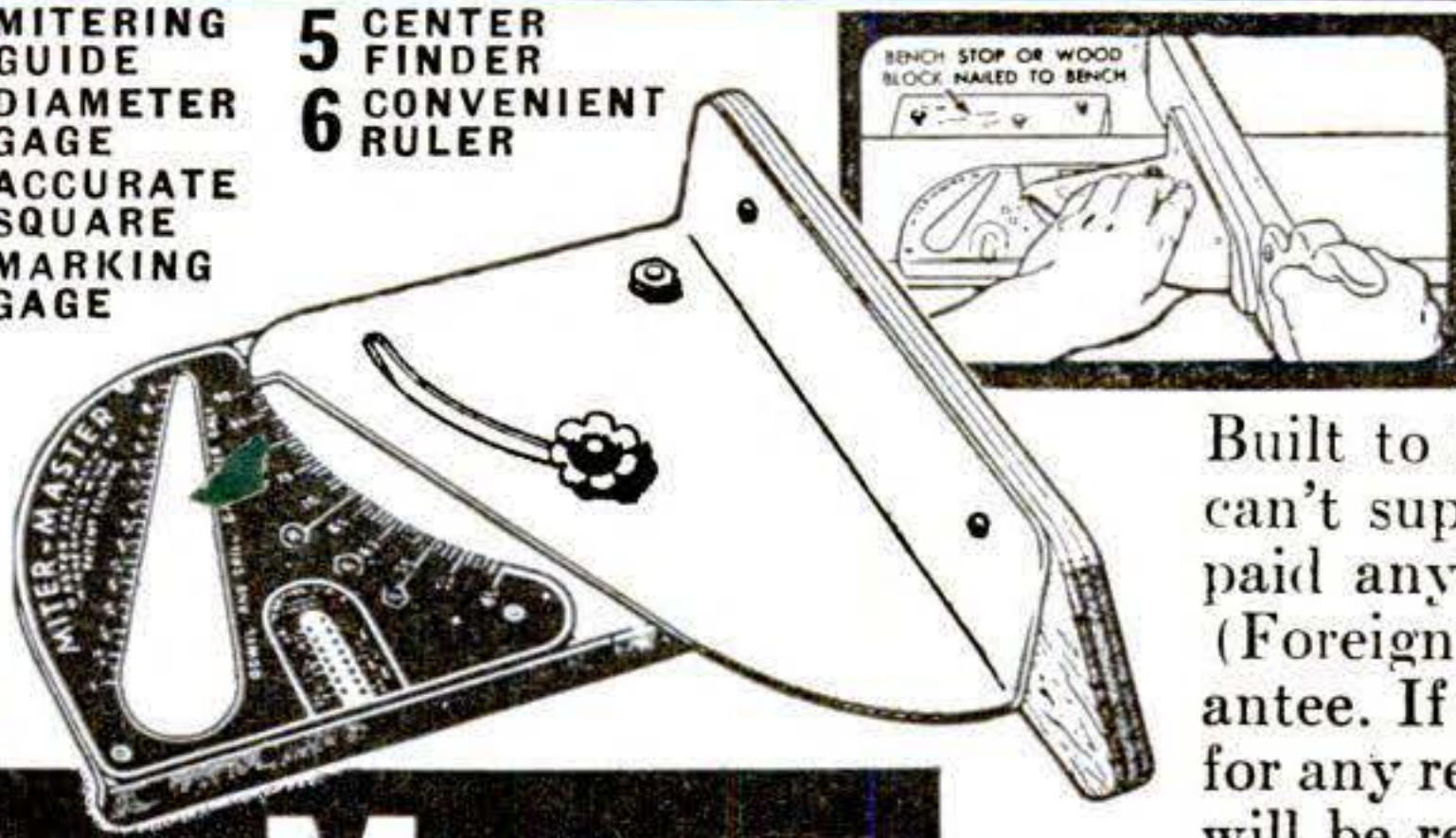

**MITER-MASTER**



**the Gift choice for camera owners**



Makes a perpetual Christmas for the camera owner, because *the dependability of the WESTON lasts throughout the years!* Compact, convenient to carry and use, and with typical WESTON dependability, the Master II assures perfect exposures in color or black-and-white, and with still or movie cameras. At all photo dealers. Reserve one today, to avoid disappointment. Weston Electrical Instrument Corp., 617 Frelinghuysen Avenue, Newark 5, New Jersey.

Miter Master takes the place of an expensive miter box accurately set to any angle. Scale marked for mitering 5, 6, and 8-sided frames. Steel construction. Built to last a lifetime. If your dealer can't supply you we will send it post-paid anywhere in the U.S. for \$2.00. (Foreign \$2.25). Unconditional guarantee. If not satisfied within ten days for any reason whatsoever, your money will be refunded.

**MASTER SPECIALTY COMPANY**  
3024 EAST LAKE STREET • MINNEAPOLIS 6, MINN.





## ... ON NORTHLANDS!

Expert and novice alike find it's easier to ski right on Northlands. Perfectly matched, carefully balanced Northlands are hand-built to give you better controlled skiing—greater skiing pleasure. Quantity limited, look for the Deerhead trademark.

★ Send 15c for Northland Ski Manual edited by Hannes Schneider or write for free booklet. Offer does not apply in Canada.

**NORTHLAND SKI MFG. CO.**

World's Largest Ski Manufacturers

— 94 MERRIAM PARK • SAINT PAUL 4, MINNESOTA —

## Get Acquainted With — LUCITE "The Gem of Plastics"

Write now for your copy of the illustrated booklet which gives step-by-step fabricating instructions, chemistry & properties of Lucite, wholesale and retail price list on CLEAR & COLORED sheets, rods, tubes, dyes, supplies. Booklet & Lucite sample 35c, postpaid; booklet only 10c. GEM-O'-LITE, P.O. Box 686X, North Hollywood, Calif.

## START A BATTERY FACTORY



—at home; the latest achievement; re-cast junk batteries into new. Complete instructions. We supply everything. Big profits!

**THE BATTERY LABORATORIES**  
Dept. PS Minneapolis 13, Minn.

## GIFTS FOR THE "OLD SALT"



New "Frog Man" **DIVING OUTFITS**—Scoop! Self-contained lung—no surface connections to worry about, swim over 2 miles underwater. Treasure hunt, fish with a spear, underwater construction and salvage, explore "Davy Jones' locker" . . . Also have available other standard Shallow and Deep water rigs. Write for details.

New **OUTBOARD MOTORS**—Speed, Power, Thrills with this 50-55 H.P. Surplus New Evinrude, 5500 RPM, net wt. 198 lbs. Save enough to build your boat. Hurry!

**OUTBOARD PROPULSION UNITS**—These heavy duty 115 H.P. Outboards move houseboats or barges as though they were rowboats.

New **RUBBER BOATS**—A "natural" for Duck Hunters and Fishermen. Lots of fun for the children . . . Finest Air Corps Designs . . . 1,000 lb. capacity. 2-4 man New Boats with oarlocks, oars, pump, carrying bag—\$55.00 complete . . . 1 man size, carrying bag, \$12.25.

**CLOCKS**, New Seth Thomas U.S.N. 6" face \$34.50, others.

**SHIPS BELLS**, 9<sup>3</sup>/<sub>4</sub>" bronzed steel \$3.89 up.

**SLEEPING BAGS**, New, Arctic type \$18.65 Pp.

**"MAE WEST"** inflatable Life Jackets. \$2.00 Pp.

**OARS**, Rubber Boat 4', \$1.65—6', \$1.95 Pp.



Check or Money Order—Other Marine Specialty Bargains  
Are you on our mailing list?

**M & E MARINE SUPPLY COMPANY** P. O. Box 601-G  
Camden, New Jersey

278 POPULAR SCIENCE

## DOUBLE your INCOME IN YOUR SPARE TIME

### LEARN SILK SCREEN PROCESS

Jealously Guarded Trade Secrets NOW Available to You

Develop a Profitable Business of Your Own . . . or a Hobby

Prepare yourself for an interesting top paying position. Thousands of jobs open. Silk Screen Process signs, displays, Xmas cards, toys, etc., IN GREAT DEMAND THE WORLD OVER. You may make enough the second week to pay for the entire course. EASY TO DO . . . EASY TO LEARN. No education or mechanical knowledge required. BOOKLET with 3-color Silk Screen Processed cover and Samples sent FREE. Write NOW!

**CALIFORNIA SCHOOL OF SCREEN PROCESS**  
Dept. P-26, 2710 So. Spaulding Avenue, Los Angeles 16, California



**COURSE INCLUDES A COMPLETE KIT OF SUPPLIES**



### NEW CHEMICAL MITT

Sensational! DRY Window Cleaner! Uses no water, no messy liquids. Chemically Treated. Simply glide over windows; leaves glass sparkling clear. No heating water, no heavy buckets to carry. No rags, powders, sponges, chemicals. No mess or muss. No red chapped hands. Dust, dirt, grime, fog disappear like magic. Wonderful for auto windows, windshields!

**SAMPLES FOR AGENTS** Sample offer sent immediately to all who send name at once. A penny postal will do. SEND NO MONEY—just your name. KRISTEE CO., 696 Bar Street, AKRON, OHIO.

## Say You Saw It In Popular Science

Statement of Ownership, Management, Circulation, etc., required by the Act of Congress of March 3, 1933, of Popular Science Monthly, published monthly at New York, N. Y., for October 1, 1946, State of New York, County of New York, ss. Before me, a notary public in and for the State and county aforesaid, personally appeared Godfrey Hammond, who, having been duly sworn according to law, deposes and says that he is the Business Manager of Popular Science Monthly and that the following is, to the best of his knowledge and belief, a true statement of the ownership, management, etc., of the aforesaid publication for the date shown in the above caption, required by the Act of March 3, 1933, embodied in Section 537, Postal Laws and Regulations, printed on the reverse of this form to wit:

1. That the names and addresses of the publisher, editor, managing editors and business manager are Publisher, Popular Science Publishing Co., Inc., 353 Fourth Avenue, New York 10, N. Y.; Editor, Perry Githens, Managing Editors, Fred O. Newman and Volta Torrey, Business Manager, Godfrey Hammond, 353 Fourth Avenue, New York 10, N. Y. 2. That the owners are: Popular Science Publishing Company, Inc., 353 Fourth Avenue, New York 10, N. Y.; Stockholders of Popular Science Publishing Company, Inc., Mansell and Company, 45 Wall St., New York 5, N. Y.; Alice A. Fisher, Greenwich, Conn.; Oliver B. Capen, Bedford Village, N. Y.; Noreen S. Capen, Bedford Village, N. Y.; Robert Cade Wilson, 683 Springfield Avenue, Summit, N. J.; Ada B. Wilson, 683 Springfield Avenue, Summit, N. J.; Marguerite N. Cole, Round Hill Road, Greenwich, Conn.; Raymond J. Brown, 16 Gramercy Park, New York 3, N. Y.; Irma V. Hammond, 163 Brewster Road, Scarsdale, N. Y.; Helen B. Glennon, 50 Howell Ave., Larchmont, N. Y. 3. That the known bondholders, mortgagees and other security holders, owning or holding 1 percent or more of the total amount of bonds, mortgages, or other securities are: none. 4. That the two paragraphs next above giving the names of the owners, stockholders and security holders, if any, contain not only the list of stockholders and security holders, as they appear on the books of the company but also, in cases where the stockholder or security holder appears upon the books of the company as trustee or in any other fiduciary relation, the name of the person or corporation for whom such trustee is acting, is given; also that the said two paragraphs contain statements embracing affiant's full knowledge and belief as to the circumstances and conditions under which stockholders and security holders who do not appear upon the books of the company as trustees hold stock and securities in a capacity other than that of a bona fide owner, and this affiant has no reason to believe that any other person, association, or corporation has any interest direct or indirect in the said stock, bonds, or other securities than as so stated by him.

(Signed) Godfrey Hammond, Business Manager,  
Sworn to and subscribed before me this 26th day of September, 1946, Esther Eyl, Notary Public, Kings County, Kings Co. Clerk's No. 60, Registry No. 70-E-6, New York County Clerk's No. 108, Registry No. 62-E-6. (Seal) My Commission expires March 30, 1948.



# YOU NEED NOT WAIT FOR YOUR NEW HOUSE



HERE'S HOW TO AVOID THE LUMBER SHORTAGE.  
HERE'S HOW TO AVOID INFLATED PRICES.

You can get the home you want — right now — the home you've always dreamed of owning.

Here are details of construction methods and materials in simple, easy-to-understand language! Here are detailed, itemized lists of all the materials needed in your house, lists telling where to get each item, lists telling how much each item costs.

The author, an experienced engineer, shows how a large, modern, six-room, thoroughly insulated, fire-resistant, two-bath house with garage can be had, anywhere in the United States, for \$2800.00.

Included with the book are ten folded drawings, 12" wide x 18" long. These drawings by the author show all the details of such a house — the wiring, the plumbing, the automatic oil-burning heating system and the fluorescent lighting. The book is devoted to showing how similar savings can be made on any house of any style, size or floor plan.

Never has a more helpful book been printed for the person who is planning or building a house.

138 6" x 9" pages Illustrated, Ten Large, Folded Drawings Send \$2.00 to Technical Press, Box 12D Swampscott, Mass. and your copy of

**"A SIX ROOM HOUSE, \$2800 COMPLETE,  
READY FOR YOU TO MOVE IN"**

by George W. Pearce, will be rushed to you postpaid  
Absolute moneyback guarantee

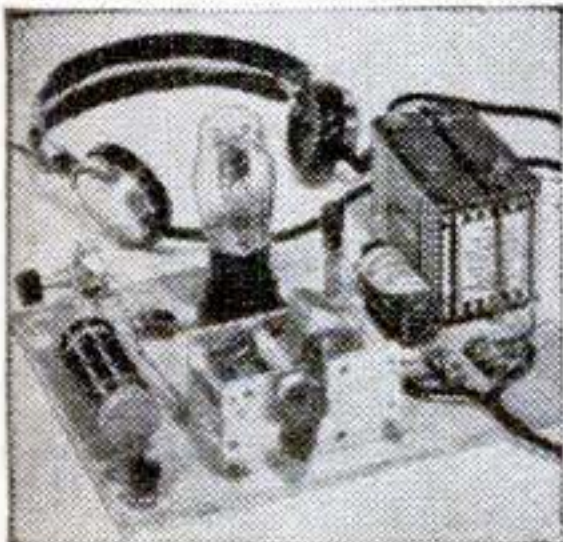

## RADIO TRAINER

Learn the theory and practical side of radio by building this simplified battery tube set. Experimental model teaches you to design larger radios, not just assemble them. Sensitive circuit brings in distant as well as local stations. Covers broadcast and short wave bands. Compact and portable. Can be used on camping trips and on farms without electricity. All parts furnished including Tube, Batteries, Double Earphones, Aerial and Ground Wire and **Easy-to-follow Illustrated Instructions**. Complete, postpaid, only \$9.95. Or send \$1.00—shipped C.O.D. for balance plus postage. Money-back guarantee. **Order today!**  
B. G. FLEMING MFG. CO.  
Dept. 12-B, 906 Main St., Cincinnati 2, O.

## TRAILER AXLES, HITCHES, AND PARTS

● If you are interested in purchasing trailer axles, hitches, and other trailer parts, contact us promptly.

Write for free literature

HAMMER BLOW TOOL COMPANY, Dept. D-16, WAUSAU, WIS.



### MAKE BIG MONEY!

Be a floor surfacing contractor and sand both new and old floors. Sanders are easy to operate and better still, you're your own boss. Write for latest "tell-all" booklet entitled "Opportunities In Floor Surfacing", enclosing 25 cents in coin or stamps to cover handling.

**AMERICAN**  
FLOOR SURFACING MACHINE CO.  
532 So. St. Clair Street • Toledo 3, Ohio

### APPLIANCE TESTER

## \$10<sup>95</sup>

**LOCATES TROUBLE INSTANTLY  
IN ALL ELECTRICAL DEVICES**

In this single unit are all the necessary tests for examining every appliance. Checks thermostats under working conditions. Tells instant it opens or closes. Controls heat on soldering irons. Prevents over-heating. Tests continuity. open circuits. automatic irons. vacuum cleaners. motors. coin machines. bulbs. 3-way switches. etc. Great time and money saver! **ONLY \$10.95 COMPLETE. POSTPAID. NO C.O.D.'s. MONEY-BACK GUARANTEE.**

Pat. Pend.

**FREE** with each Tester. New, Complete Practical Course in electrical appliance repairing. WRITE FOR CIRCULAR.  
**HANLAN CO., 1419-B, West Jefferson, Los Angeles 7, Calif.**

*"The Supreme Authority"*

in courts, schools, homes, newspapers  
and Government offices

# The Merriam- WEBSTER

**Y**ou may have had to wait for a copy of WEBSTER'S NEW INTERNATIONAL DICTIONARY, Second Edition. However, more and more copies are reaching your dealer. He may have one for you now or very soon. The MERRIAM-Webster contains 3,350 pages, illustrations for 12,000 terms, and a total of 600,000 entries — 122,000 more than any other dictionary. It is the only unabridged dictionary completely revised and rewritten in three decades. G. & C. Merriam Company, Springfield 2, Mass.

**WEBSTER'S NEW INTERNATIONAL  
DICTIONARY • Second Edition**

## Diesel Generated Electricity

**WILL SPOTLIGHT  
YOUR BUSINESS**

Your service station, eating place, winter resort or store will be a popular Mecca if you make it inviting with unstinted lighting.

You can afford to be generous with Sheppard Diesel generated electricity because it costs so little—about one cent per K.W. hour. Dozens of small business operators have installed Sheppard Diesel generating sets . . . they all agree;

**DIESEL'S THE POWER . . .**

## Sheppard's the Diesel

Power Units—3<sup>3</sup>/<sub>4</sub> to 56 continuous H.P.  
Marine Engines—3<sup>3</sup>/<sub>4</sub> to 62 continuous H.P.  
**R. H. SHEPPARD COMPANY, INC. 56 Middle St. Hanover, Pa.**



# WAR BARGAINS in LENSES and PRISMS MAKE YOUR OWN BINOCULARS!



**ATTENTION!**  
**COMING ABOUT  
JANUARY 30TH!**

**Complete Optics & Metal  
Parts for Army's 7 x 50  
Binoculars and Army's  
6 x 30 Binoculars**

A rare opportunity to pick up a really fine expensive, precision set of Binoculars, either the 7 x 50 or 6 x 30, at under  $\frac{1}{2}$  their normal retail cost. We will furnish complete assembly instructions. Send your name and address, and request Bulletin #14-N which will give you complete details of this offer the moment it is ready.

**POLARIZING VARIABLE DENSITY ATTACHMENT FOR 7 x 50 BINOCULARS**—An amazingly effective unit for controlling amount of light reaching your eyes. Cuts down glare in sky and overwater observations. Easily snapped on and off over the eye cups of American-made 7 x 50 Binoculars. Govt. cost \$8.30 each.

**Stock #20,000-N** . . . . . **\$2.00 Postpaid**

**CARRYING CASE WITH STRAPS FOR 7x50 BINOCULARS**—Modern synthetic rubber construction—brand new—a regular \$12.00 value.

**Stock #44-N** (Price includes tax) . . . . . **\$4.80 Postpaid**

**SPECTROSCOPE SETS** . . . These sets contain all Lenses and Prisms you need to make a Spectroscope plus **FREE** 15-page Instruction Booklet.

**Stock #1500-N** Hand Type Spectroscope . . . . . **\$3.45 Postpaid**

**Stock #1501-N** Laboratory Type Spectroscope **\$6.50 Postpaid**

**PRISM TELESCOPE**—All the Lenses You Need to Build your own 20 power Telescope! No mounts. Has wide field of view.

**Stock #5012-N** . . . . . **\$7.25 Postpaid**

**MAGNIFIER SET** . . . 5 Magnifying Lenses . . . powers from 1 to 10. Various diam. for many uses. **Free Booklet** on Home-made magnifiers included.

**Stock #1026-N** . . . . . **\$2.00 Postpaid**

**35 MM KODACHROME PROJECTING LENS SET**—Consists of Achromatic Lens for projecting, plus a Condensing Lens and piece of Heat Absorbing Glass with directions.

**Stock #4025-N** . . . . . **\$1.95 Postpaid**

## AIR FORCES GUN SIGHT

**With Polarizing Variable Density Attachment**

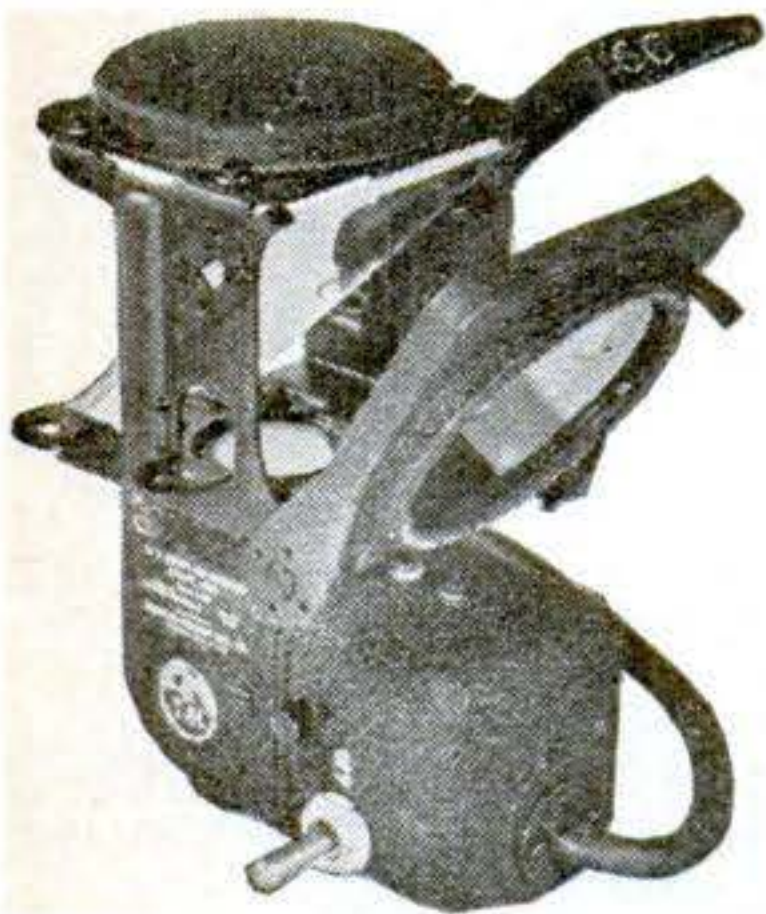

Can be used as Slide Viewer, or take it apart and you can get Polarizing Variable Density Attachment, Mangin Concave Mirror, Reflector Plate, Metal Reticle, Window, Lamp Housing, Ring and Bead Sight. The Polarizing attachment alone is worth many times the price of entire unit. Consists of 2 Polarizing Filters mounted with small handle which rotates one around the other. May be used in Photography, Research, Experiments, as Light Dimmer, etc.

**Stock #908-N** **\$5.00 Postpaid**

**Same Unit Without  
Polarizing Attachment**

**Stock #916-N** **\$2.50 Postpaid**

**BOMBER SIGHTING STATION**—A double end Periscope Type Instrument of highest precision. 6 ft. tall, shipping wt. 360 lbs. Orig. cost \$9.850. Consists of numerous Lenses, Prisms, Mirrors, Gears, Motors, Metal Parts and Electrical Gadgets.

**Stock #914-N** . . . . . **\$50 F.O.B., Oklahoma**

**TANK PRISMS**—90-45-45 deg., 5 $\frac{3}{4}$ " long, 2 $\frac{1}{8}$ " wide, finely ground and polished.

**Stock #3004-N** Silvered Prism (new & perfect) **\$2.00 Postpaid**

**Stock #3005-N** Plain Prism (new & perfect) . . **\$2.00 Postpaid**

**Stock #3100-N** Silvered Prism (Second) . . . . . **\$1.00 Postpaid**

**Stock #3101-N** Plain Prism (Second) . . . . . **\$1.00 Postpaid**

We have literally millions of war surplus lenses and prisms for sale at bargain prices. Write for Catalog "N"—Sent Free!

**Satisfaction Guaranteed • Order by Stock No.**

## EDMUND SALVAGE CO.

**P. O. AUDUBON, NEW JERSEY**

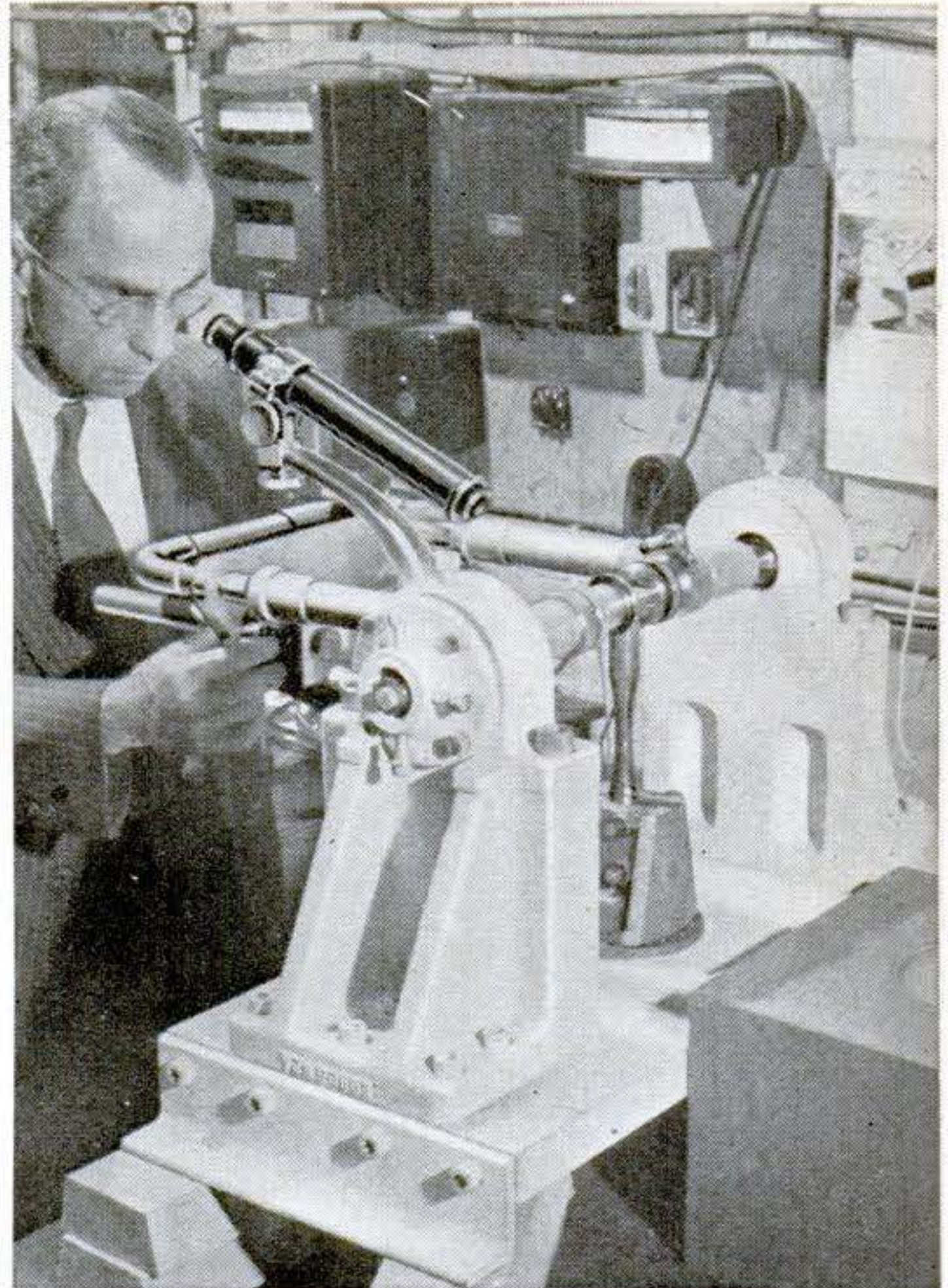

## Tuned Air Column Tortures Metals to Test Strength

UTILIZING the principle of a slide trombone, General Electric engineers have developed a new method of fatigue-testing metals and alloys with a compressed-air machine. A stream of air causes metals to vibrate at their natural frequencies until they crack or break under the strain. The necessary vibration rate is attained by altering the length of the air column, just as a trombone player changes the tone of his instrument.

In operation, the metal or piece of equipment being tested is attached to a piston that fits loosely into two cylinders. The compressed air is directed through the cylinders and tuned to vibrate at the natural frequency of the metal. An optical system measures the amount of vibration, and an electric meter at the base of the machine records the resonating frequency of the metal under test.

The machine permits tests at temperatures as high as 1,700 degrees F., so that even the metal buckets of gas turbines can be checked under the conditions in which they actually operate. The new system is said to be the most rapid yet known for fatigue tests and is expected to bring wide changes in that field.



*New 1947 Models*

# GILBERT CHEMISTRY Laboratories



DEVELOPED at the GILBERT  
HALL OF SCIENCE



The sets that bring boys fame and big awards  
Spectacular new features for extra fun and thrills

More boys have won fame and big awards with Gilbert Chemistry Sets than any other kind. Because they are far more than "toy" sets. Range of chemicals and apparatus are based on real laboratory technique. Write messages in in-

visible or fire ink. Make chemical weather flag. Bleach flowers. Make paints, sparklers, soda water. Hundreds of other spectacular experiments in organic, inorganic and electro chemistry.

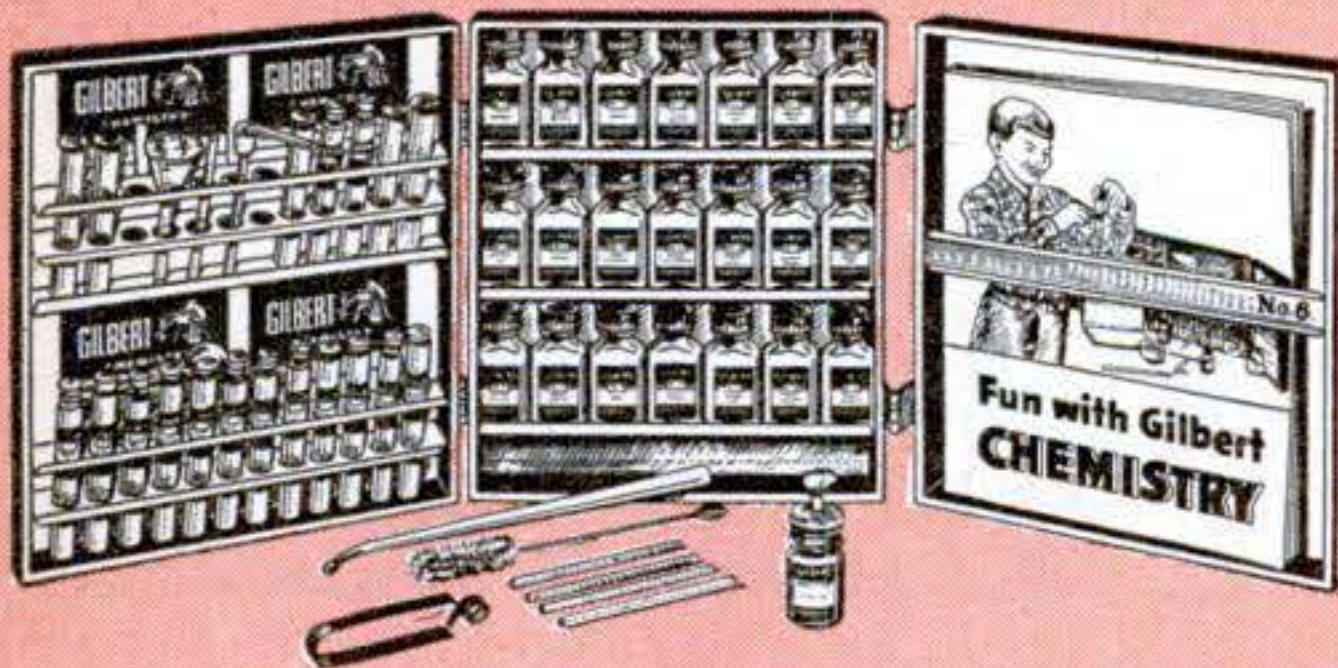

Big, three-compartment blue metal cabinet crammed with chemicals and apparatus. Puts 389 spectacular experiments at your finger tips.



### WINS \$100.00 FOR CHEMICAL RESEARCH

Meet Frank Hoble of Chicago, America's No. 1 boy chemist of the year, who won a check for \$100.00 and national fame for outstanding research. The way is wide open for you to do the same. But be sure to start right—with a genuine Gilbert Chemistry Set.

### ALL THESE ADVANCED FEATURES

**NEW**—All metal construction—rugged and easy to carry.

**NEW**—Each section designed as complete laboratory with trays and racks.

**NEW**—Tip racks for test tubes, for easier handling of test tubes.

**NEW**—Brown, lightproof bottles such as used for fine pharmaceuticals.

**NEW**—Rectangular shaped bottles and shelf spaces, holding bottles with label side out.

**NEW**—Postwar chemistry book. 144 pages profusely illustrated; large type. 8" x 10" page size and stay-open binding. Edited by Prof. Treat B. Johnson, distinguished Yale professor, author of hundreds of publications in the field of organic chemistry, member of the National Academy of Sciences, the National Research Council, the American Chemical Society, the American Institute of Chemists, and other scientific organizations.

### \$200.00 IN CASH AWARDS

To the boy doing what, in my opinion, is the most important research in Chemistry, Microscopy or Electricity in 1947, I will award \$100.00 in cash. To the ten boys doing the next most important research, I will award \$10.00 each. Applicants must not be over 17 years old and must send me a full description of their experiments by May 1, 1947.

*A.C. Gilbert*

Founder of the Gilbert Hall of Science

### ALSO DEVELOPED AT THE GILBERT HALL OF SCIENCE

AMERICAN FLYER TRAINS . . . SEE 'EM PUFF SMOKE . . . HEAR 'EM CHOO-CHOO—World's first scale model trains with realistic smoke and "choo-choo" sound effects—both synchronized with train speed. Authentic 3/16" two-rail track and other spectacular new features make railroading with American Flyer "just like real." Send 10¢ for giant catalog illustrated in 4 colors. The A. C. Gilbert Co., 56 Erector Square, New Haven, Conn.

### ERECTOR—SUPER-MECHANIZED AND ALL-ELECTRIC

—Builds towering, realistic parachute jump—bridges that open and close—dozens of other colossal engineering marvels that buzz with action.

**FREE**—Illustrated catalog on new Chemistry Sets, Erector and other Gilbert scientific toys. Just send name and address on post card. The A. C. Gilbert Company, 102 Erector Square, New Haven, Conn. This offer good only in U. S. A.



## HANG THAT DOOR THE PROFESSIONAL WAY!

USE THE TIME SAVING  
—LABOR SAVING...  
**YOU DO THIS**



AND GET THIS

- Hang more doors better.
- No adjustments. • No errors.
- Used and approved by Master mechanics.
- Comes in 3 1/2" and 4" (standard) sizes.
- Precision made.

Cost ONLY \$1.75 each or \$3.00 a set at your hardware store. If your Dealer can't supply you send only \$1.00 with order and pay Postman balance, plus postage C.O.D.

E-Z MARK TOOLS • P. O. BOX 8377 • LOS ANGELES 16, CALIF.

## E-Z MARK BUTT GAUGE

You get a clean cut deeply etched profile. Removes chips. Repeat this operation on the jamb and hang the door. THAT'S ALL—NO MORE!

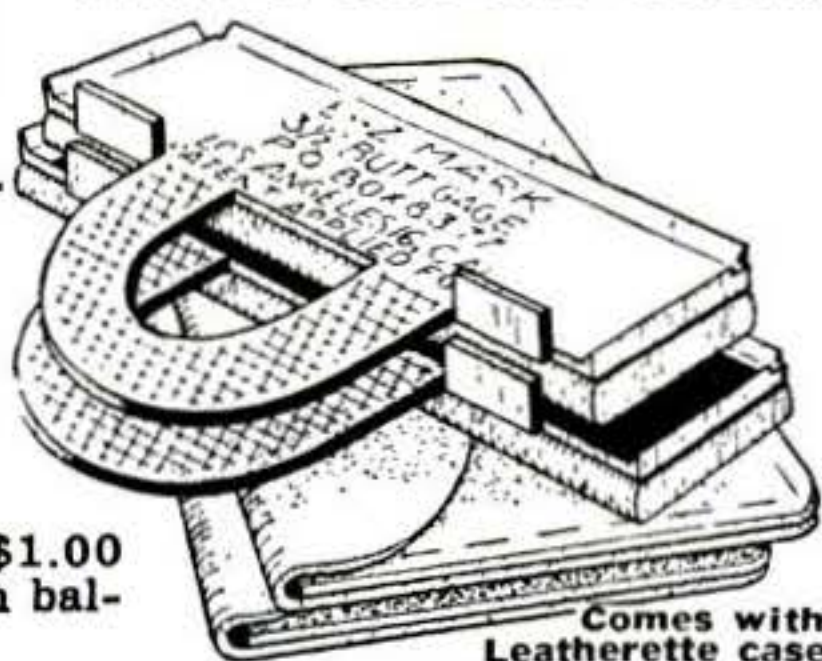

Comes with Leatherette case

## Build and Fly CLEVELAND MODELS

### BELL P-39 AIRACOBRA



30" Bell P-39 AIRACOBRA C-D Kit IT-76..... \$1.00

• Also 30" IT Kits of Ercoupe, Culver V, Curtiss P-40, Shooting Star, Ryan Fireball, Globe Swift, Helicat, Stinson 150, Taylorcraft, Silvalre. Each... \$1.00

See your dealer first. In ordering direct, include 20c extra for packing postage. Get our Jumbo folder (Kits 25c to \$15.00)—Send 3c stamp.

**CLEVELAND MODEL & SUPPLY CO.**  
4512 M22 Lorain Ave. Cleveland 2, Ohio, U.S.A.



### NEW! RYAN FIREBALL

30 3/4" Master Flying Model. First plane designed with conventional front propeller for take-off and rear Turbo Jet unit for high speeds.  
SF-92 Kit ..... \$3.50  
30" Industrial Training Kit, IT-92 ..... \$1.00



### 36" Piper Cub

Industrial Training Model. Kit T-94. .... \$1.50

## Roosting Age CHICKENS or PULLETS

Cheaper than raising them from baby chicks. No brooder needed. Light or Heavy breeds. Pictures, low prices FREE. Write **IMPERIAL FARMS**, Dept. 178, Ottumwa, Iowa.

## LOOKING FOR SOMETHING?

Why go crazy? We'll find it for you! Save your valuable time. Any hard-to-get item located for just \$1! We advise, locate, guarantee our service. Send your request to

Eddie DuPuy, P. O. Box 267, North Hollywood, Calif.

## B-17 BOMB SIGHT

COST  
U.S. GOV'T  
\$6000<sup>00</sup>

Brand  
New

B-17 Bomb Sight with automatic computers. High precision mechanical instruments for engineers, technical schools, inventors, and model makers. Use for study—demonstration—parts. Hundreds of gears, gyros, metal bellows, pressure switches, lenses, motors, spirals, levers, etc.

SEND MONEY ORDER TODAY

**P. WEIS**, 2929 Pulaski Road, Chicago 41, Illinois

YOURS  
FOR  
\$35<sup>00</sup>  
F. O. B.  
CHICAGO

Shipping Weight  
165 lbs.



## SALESMEN FOR CITY AND COUNTY

*Nationally Known Manufacturer*

Build up a business of your own with Nationally Advertised Products bearing Underwriters' label. Sell to schools, factories, service stations, warehouses, hotels, restaurants, public institutions, truck and bus companies, grain elevators, house trailers, autos, farms, homes, etc. **Capable man can earn real money.** Established in 1916. Write letter with details, age, experience, etc.

Dept. 92-24 **FYR-FYTER CO.**, Dayton 1, Ohio

## ONLY 98c ELECTRIC MOTOR



CONSTRUCTION KIT  
EASY TO ASSEMBLE  
FUN—EDUCATIONAL

IDEAL XMAS GIFT

RUNS ON A SINGLE DRY CELL (not included) USE IT TO RUN FANS—PUMPS—PULLEYS—Etc.

SEND CHECK—MONEY ORDER or CASH (at your own risk) to

THE HAYDN CHEMICAL CO., Dept. A, Box 27, Kenmore 17, N. Y.

## CUTTING TOOLS

A catalog of cutting tools and supplies made available for the first time—is yours for the asking. Hard-to-get cutting tools and supplies—hundreds of them—are in our available stock. Send 35c and receive this wonderful catalog immediately by return mail.

Write or Phone **EASTERN TOOL & SUPPLY COMPANY**  
176 Grand Street, New York 12, N. Y.  
Canal 6-3749

## NONE BETTER! SUPER DRILL GRINDER



Sharpens round shank drills from 3/32" to 1 1/16" in diameter, up to 11" long. Grinds old drills like new in 4 different point angles, using hand or power grinding wheels. Money-back guarantee.

Price only \$2.95

At Dealers or Postpaid

**Crandall Mfg. Co.** 1512 W. Slauson, Dept. FB-12 Los Angeles 44, Calif.

## If Ruptured



Do What Others Now Do—  
Wear a Form Fitting  
**MILLER Truss**

which provides natural freedom and comfort in working, walking, playing, horse back riding, dancing, swimming or sleeping. You just cannot afford to be without this protection and convenience.

Wear two weeks then consult your physician before deciding to keep it.

Write me today for **FREE** descriptive circular. Sent in plain, sealed envelope.

**FRED B. MILLER Manufacturer**  
Dept. P.S. Hagerstown, Maryland.



## CARBIDE SCRIBER NON-MAGNETIC

FOR HARDEST STEEL, GLASS, ETC.

Tungsten Carbide—the hardest metal made by man—carefully ground on diamond laps, brazed into stainless steel 6" handle for marking steel and other metals—for etching, marking, cutting glass. Cuts all directions. Easy to follow any contour. In plastic case with pocket clip.



**\$2.00**

PRICE POST PAID

Dealers, Distributors and Salesmen Wanted

**LUCAS-MILHAUPT ENGINEERING CO.**  
5051 SOUTH LAKE DRIVE • CUDAHY, WISCONSIN



## COLLECT U. S. ARMY Shoulder Patches

Send \$1 for sample selection of patches and PATCH CATALOGUE.

**SPRINGER'S**

EL PASO, TEX.

**20  
for  
\$1**

## FUN WITH AMAZING NEW MAGIC DICE

Here's a special pair of fun dice that can do anything you want them to. It's amazingly easy to predict numbers, perform amusing tricks. No one can guess the hidden "secret" unless you tell them! Display amazing "control," yet the real reason is cleverly concealed from everyone. Fun and fascination! Easy directions explain details. Perform many "magic" tricks! Price only \$2.98. Get a pair today. Send no money. Just name and address. On arrival, pay postman only \$2.98 plus postage. Money back if not delighted. Address Mr. Luck's Novelty Co., Dept. 454-D, 215 N. Michigan Ave., Chicago 1, Ill.



## LIQUID MARBLE COLORED POTTERY

Different! Marvelous! Color-glazed, Brush, spray, mold tiles, table-tops, ornaments! **SANITARY COM-POSITION FLOORING**—Dustless, noiseless; put on like plaster, plain or tile designs; yielding as cork, lasting as stone. **RUBBERLASTIC Mold Compound**—For plaster casting, novelties, statuary, toys, plaques, dolls, **TILEX Colored Roofing**. Build Modern **PLASTIC HOMES**. Illustrated literature free.

RAPID MARBLEIZING SERVICE, Dept. 12-A, Edwardsville, Illinois

## OPTICAL ILLUSION

makes any view or object you wish to draw appear on the drawing paper in rich detail. Low-cost invention makes drawing simple tracing. Educates and amuses children and adults. Practical for artists. Free details. Dept. 10L, Beeler Enterprises, No. Hollywood, Calif.

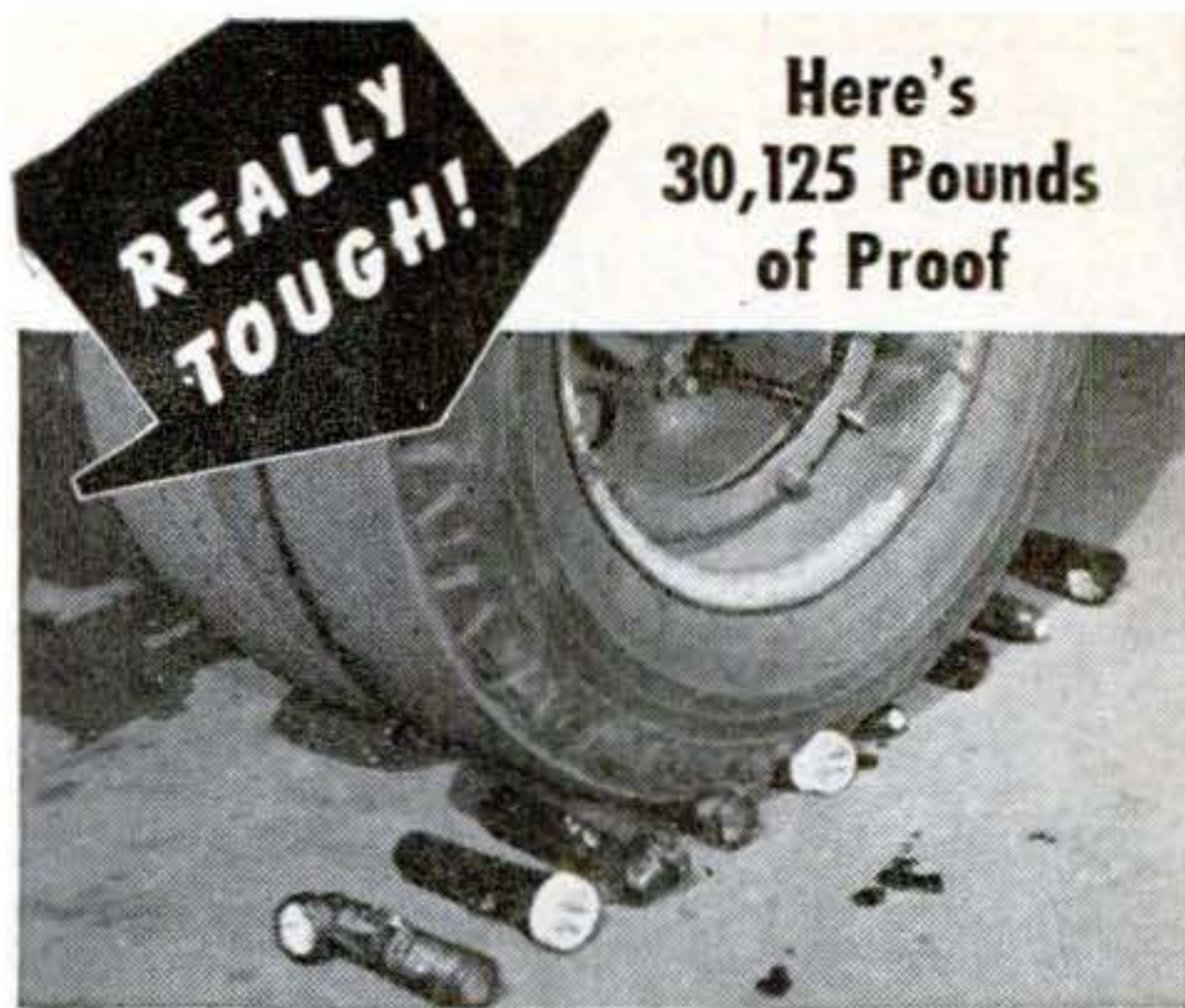

Here's  
30,125 Pounds  
of Proof

**REALLY  
TOUGH!**

## GITS UNBREAKABLE PLASTIC FLASHLIGHTS

A 15-ton truck—running squarely over them—didn't crack any plastic part of these sturdy Gits flashlights! So—normal use cannot possibly damage them. They're made of unbreakable ethyl cellulose plastic. They give you a strong, pre-focused "Mile" of Light beam... cast from brilliant nickel-plated non-tarnishing lacquered brass reflector... thru shatterproof lens. Their 3-way ON-OFF and Signalling switch always works! Available now at your dealer's in lustrous colors or transparent battery-view case. Get a Gits flashlight—and you'll have the best!



A Great Gift!

**GITS**  
Molding Corporation  
CHICAGO

Model 100  
Retails \$1.00

Model 122  
(with extra bulb)  
Retails \$1.75

Say You Saw It  
In Popular Science

## Sensational New Liquid "Plastique" Linoleum Finish OPENS BIG BUSINESS—DOES AWAY WITH SCRUBBING or WAXING

Here is a new experience awaiting you in a BIG PROFIT MONEY MAKER. Makes no difference what you have ever sold or if you never sold anything in your life before... THIS IS YOUR OPPORTUNITY... Every Home is your prospect and every housewife is an enthusiastic buyer... The first introduction in any community arouses unusual interest... You will be busy supplying the demand direct or through stores as you prefer... Sales keep piling up because housewives have been waiting for something like "Plastique." So HERE IT IS! It brushes on in a jiffy and adds LIFE and BEAUTY to the linoleum... This is not an ordinary product... It is sensational and opens a tremendous opportunity for sales and profits... All within your grasp... BUT YOU MUST ACT QUICK!

**BIG MONEY MAKER** Write Today— **DISTRIBUTORS—AGENTS WANTED EVERYWHERE**

Every community offers the same opportunity and as we want Distributors and Agents in every territory we would suggest prompt action on your part. The information is FREE and we are assigning territory NOW... Therefore do not delay... BE FIRST IN YOUR TERRITORY.

**WONDERFUL OPPORTUNITY**

**PLASTIQUE NU-FLO PRODUCTS CO., Dept. PS-12, 109 S. Clinton St., CHICAGO 6**

**DRIES IN 1/2 HOUR**

Marvelous Smooth  
Hard Protective  
High Lustre Finish

**Non-Skid—Waterproof**

**HOUSEWIVES ENTHUSIASTIC**

Saves Time and Work  
and Money



# BELT SANDER AND TOOL GRINDER

**WOODS MODEL 40**—For home work shop woodworking and machine shop production



## HORIZONTAL OR VERTICAL OPERATION—5" x 8 1/2" CAPACITY

Husky sander for metal, plastics, wood, glass and rubber; perfectly-balanced completely machined pulleys (4" dia.) . . . ball-bearing thruout . . . drive shaft supported on both ends. These features assure maximum efficiency, smooth operation and long life. Tested to 5000 rpm. . . . easy adjustment for horizontal or vertical operation . . . reversible platen usable on either face.

Extra belts, 5" x 6" work table, and other accessories available from stock.

Order from your dealer or shipped FOB direct from our S. Norwalk Plant

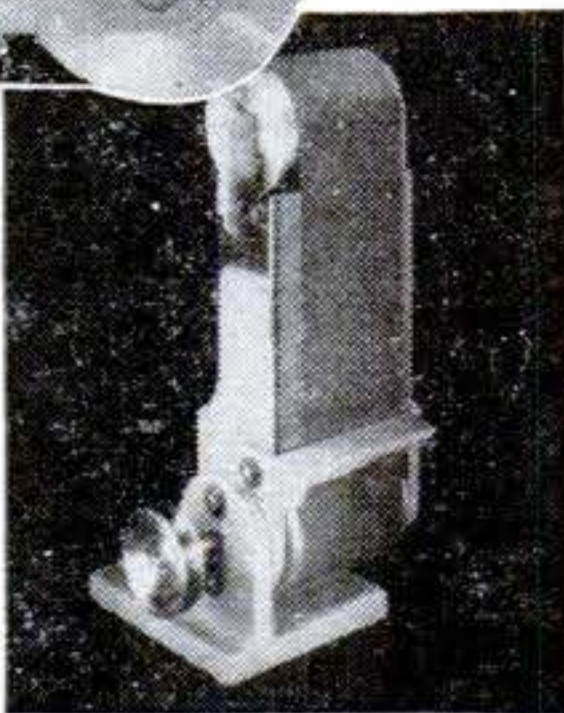

### SPECIFICATIONS

Abrasive Belt	4" X 36"
Bench Space	9" X 15"
Motor Recommended	1/3 hp.
Net Weight	17 1/2 lb.
Shipping Weight	22 lb.



## ATTENTION DEALERS!

A limited number of dealer territories are still open; write for information.

**WOODS ENGINEERING CO.**  
NORWALK 11, CONN.



## Wonders Through The MICROSCOPE

A new book which tells you all about MICROSCOPY. Turn an inexpensive microscope on hundreds of specimens within a stone's throw of your front door and you step off into a new world of wonders. Complete Manual for amateurs. How to use equipment, secure and preserve specimens, take photomicrographs, etc. Numerous illustrations. Full cloth bound DeLuxe edition. \$1.49.

POPULAR SCIENCE MONTHLY, Dept. 12-46  
353 Fourth Ave. New York 10, N. Y.

## —Is Woodworking Your Hobby?—

# JIG SAWS

### IMMEDIATE DELIVERY!

Sturdy fir and oak woods. All movable parts mounted on oil-impregnated bearings . . . needs no lubrication.



Prices F.O.B. Phila.

16 in. SIZE **\$1295** LESS MOTOR 26 in. SIZE **\$1695**

Send Check or Money Order With Order

## WM. H. SHELLINGTON

Machinery Sales and Service  
2055 Hunting Park Ave. Phila, 40, Pa. Dept. P. S.



## HOW TO BUILD YOUR OWN LOG CABIN LODGE OR BUNGALOW!

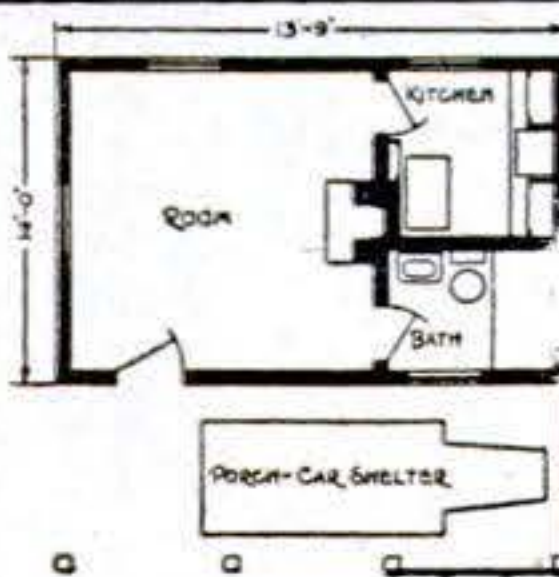

## COMPLETE INSTRUCTIONS IN ONE GREAT BOOK!

Countless thousands say this great volume brings them *complete detailed plans* for building their own log cabins and bungalows!

### 180 PICTURES - 250 PAGES - ONLY \$1.98!

Just take your pick from the scores of cabins, lodges, tourist homes, wayside stands and bungalows jam-packed into this big book, "How to Build Cabins"! You'll learn how to lay a foundation . . . how to build walls . . . how to lay floor boards and roofs. Yes, you'll discover step-by-step details for building porches and garages . . . for cutting doors, windows, and attaching shutters . . . for building fireplaces and chimneys . . . and even for installing plumbing and lighting!

### SAVES YOU HUNDREDS OF DOLLARS!

Now you can have a vacation spot of your own—a place where you won't be gouged by sky-high summer rentals—one that you can build yourself and *save hundreds of dollars* on the construction costs! And don't imagine that it's hard for you to build—for you'll find this great how-to-do-it book makes it as easy as pie—shows you every move!

### SEND NO MONEY - 7-DAY FREE TRIAL!



Imagine! This big book with 180 pictures and 250 pages costs *only* \$1.98! So fill out the order form below right now! When book arrives pay postman only \$1.98 plus a few cents mailing charge as payment in full. If after 7 days' free trial you aren't delighted, return it for a full refund!

## MAIL COUPON TODAY!

POPULAR SCIENCE Publishing Co., Dept. 12-46  
353 Fourth Avenue, New York 10, N. Y.

Send me "How to Build Cabins" in edition checked below. I will pay postman price plus postage. If not delighted I may return it within 7 days for full refund.

- DeLuxe Edition in handsome Buckram binding, only \$2.48
- Regular cloth-bound Edition, only \$1.98

Name.....

Address.....

City..... Zone..... State.....

Check here if you send payment with order, and we will pay shipping costs. Same return privilege.



# How to Start YOUR OWN BUSINESS

Amazing Postwar Development Now Gives  
You the Opportunity to Make Money Fast!

Startling scientific discovery, just now becoming available for general use, will enable you to start your own business and reap great profits!

Plastics, one of the most revolutionizing and rapidly expanding industries, offers a great opportunity to all enterprising men and women. This is one of the few industries in which home manufacturers thrive and prosper. You can start even on a spare time basis in your own home, and expand rapidly into a full time business, paying good profits.

### LIQUID MARBLE

Make LIQUID MARBLE the amazing Plastic, with a thousand uses. LIQUID MARBLE can be poured into FLEXIBLE MOLDS for casting all kinds of artistic and serviceable articles such as: ornaments, novelties, desk sets, paper weights, book-ends, souvenirs, statuary, toys, etc.

### FLEXIBLE MOLDS

Make your own FLEXIBLE MOLDS. The cost is low—in fact, a large sized mold costs but a few cents. Hundreds of casts can be taken from a single mold.

### NO EXPERIENCE NEEDED!

No skill or previous knowledge is necessary. All you do is follow our easy-to-understand instructions.

### UNLIMITED MARKET

The market is literally unlimited. You will find steady year-round demand in your own community. Your problem will not be in selling but in supplying the huge pent-up demand. Moreover, we supply you with names of big buyers for your finished products.

### WRITE TODAY

Bing Products will show you how to start with a small investment and build a permanent, independent, profitable business! Don't fail to grasp this opportunity! Write today for FREE CATALOG.

## BING PRODUCTS

Dept. B13, 88 Broad Street Boston 10, Mass.



## MAKE YOUR OWN COSTUME JEWELRY BIG EARNINGS AT HOME

### SPLENDID HOBBY OR VOCATION

- |               |               |           |           |
|---------------|---------------|-----------|-----------|
| Sea Shells    | Ear Clips     | Wire      | Catches   |
| Pin Backs     | Floral Stones | Boxes     | Plexiglas |
| Ear Screws    | Jump Rings    | Bracelets | Cements   |
| Screw Eyes    | Chains        | Parts     | Dyes      |
| Plastic Discs | Clasps        | Bow Knots |           |

PHILADELPHIA BADGE, 1007 FILBERT ST., PHILA. 7, PA.

## New 12" Sheet Metal Brake Only \$12

Fits in bench vise. Quickly, easily forms all kinds of angles in sheet metal, strap iron and aluminum, wire and plastic. Use it to make useful articles, experimental research work, patent models, etc. Simple gages made for quantity duplicating. Now available. Send for details, or order direct. \$12 p.p. Wt. 10 lbs.

Companion Shear cuts sheet metal, any length. Clamps to bench. Adjustable guide. Same price as brake. Both guaranteed.

### SAMPLES OF WORK



WISE BRAKE MFG. CO., Dept. P. S. 1318 So. 30th Ave., Omaha 5, Nebr.

## 5¢ EACH LITTLE BLUE BOOKS

Send postcard for our free catalogue. Thousands of bargains. Address: HALDEMAN-JULIUS CO., Catalogue Dept., Desk M-2419, GIRARD, KANSAS

## Exquisite Hollywood Models!

32 full color photographic art studies of gorgeous Hollywood Studio Models! These are actual color photographs of breath taking Hollywood models on 16mm filmstrips . . . real . . . lovely and lifelike. And a Hollywood Star Viewer, made of gleaming plastic, which gives crystal clear magnification comparable to theatre screen projection.

All for ONLY \$3.00. Money refunded if not satisfied. NO C.O.D.'s. Write NOW to:

Hollywood Art Studios

955 N. MANSFIELD AVE., DEPT. PS-12 HOLLYWOOD 38, CAL



Only \$3.00

# The Precision Built CLINTON ENGINE

As far ahead as  
the JET PLANE

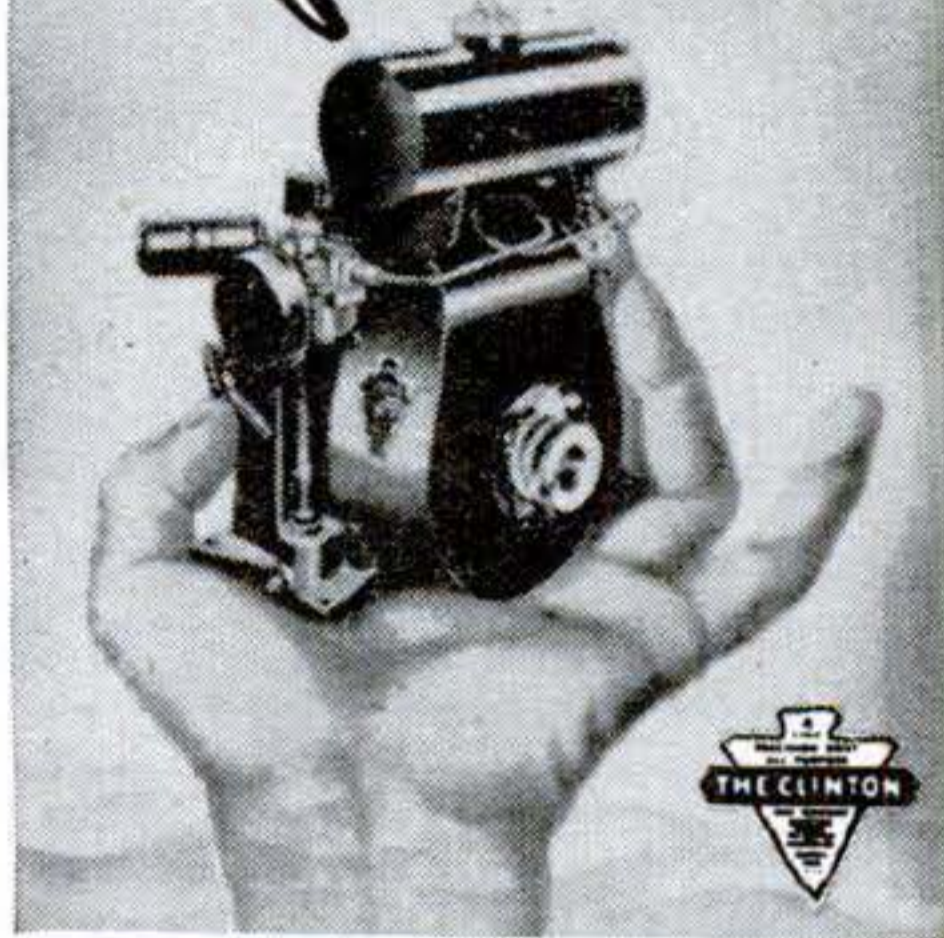

MODERN ENGINEERING has given the world new design, new speed, new efficiency of operation in NEW PRODUCTS . . .

The CLINTON SERIES 700 1½ H. P. 4 CYCLE, AIR-COOLED GASOLINE ENGINE, now in heavy production, is changing the thinking of users, dealers and manufacturers employing compact air-cooled power.

## CLINTON MACHINE COMPANY

CLINTON, MICHIGAN

## NEW MIDGET ELECTRIC

## ARC WELDER

FULLY  
GUARANTEED

RETAILS  
ONLY  
\$3.95



### Plugs into Light Socket AC or DC

It's new! It's handy! It's efficient! Use the Midget Electric Arc Welder for hundreds of light-metal jobs. Does comparable welding work with a 1/16 inch welding rod on thin metal as that of larger and higher priced welders. Operates on 15 ampere fuse, 110 volt 60 cycle A.C. or D.C. current, by use of our special standard-coated 1/16-inch welding rods. Generous supply of rods supplied with machine. Recommended for all light welding like automobile fenders, etc. Take the Midget Arc anywhere to the job. Sturdily built and fully guaranteed. Comes complete—ready to use. Nothing else to buy. No previous welding experience needed to strike an arc. In a short time,

anyone mechanically inclined can learn to weld with this machine.

You'll find hundreds of money-saving, time-saving uses for the Midget Arc around your home, garage, or workshop. Also in garages, factories, repair shops, tin shops, mechanics, farmers, inventors, etc. Order a Midget Electric Arc Welder now! SEND NO MONEY. We'll rush one to you, complete with rods and helmet (equipped with APPROVED welding glass). Pay postman only \$3.95 plus postage charges. If not satisfied, return Midget Arc in 5 days from receipt and we'll refund your money immediately. RUSH YOUR ORDER NOW.

MIDGET ARC WELDER CO., Strader Ave., Dept. R-205, Cincinnati 26, Ohio

DEC. 285  
1946





## HUNTER'S COMPASS

Hunting Case, Watch  
Type, All Metal, **\$2.50**  
Jeweled.....

### RUBBER SPORT GOGGLES

White Plastic Lens and Extra green Polarizing Lens. Plastic Lens are shatterproof. Polarizing Lens a protection against reflected glare, excessive light, dust and wind. Ideal for industrial use. Motoring, skiing and all kinds of outdoor use. Value \$3.50.  
Per pair..... **SPECIAL \$1.50**

Engineers All Metal Army  
Type Hand-Sighting

**LEVELS \$1.50**



**PUBLIC SPORT SHOPS**

13 S. 16th St., Phila. 2, Pa.

No COD's

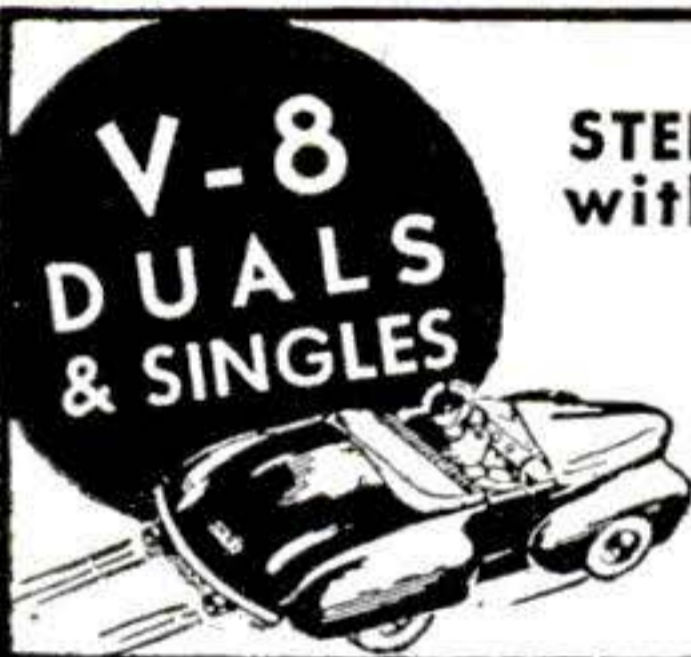

### MUFFLERS STEELS and ALUMINUMS with a motorboat tone

SINGLES, Chev, V-8, Plymouth,  
Steels \$5.50, Aluminum \$6.50,  
Chry., Olds., Buicks, etc., Steels  
\$7.50, Aluminum \$8.50. V-8 and  
MERCURY DUALS, Steel \$7.50,  
Aluminum \$20.00. Aluminums are  
guaranteed for life of your car.  
**DEALERS WANTED**

**SANDEE MUFFLER CO.**

7523 S. WESTERN AVE., LOS ANGELES 44, CALIF.

Say You Saw

It In Popular Science

## 12 lbs. SURPLUS RADIO PARTS \$2.00

A gold mine of parts for repairmen, amateurs, and experimentors . . . relays, condensers, resistors, transformers, coils, hardware, wire, etc., etc. An outstanding bargain in usable parts! Send cash, check or M.O. today!

**ELECTRONIC PARTS, Inc.** Dept. S, 622 W. Randolph St., Chicago 6, Ill.



**WISE-GRIP**

the hand tool with

**TON-GRIP**

**DOUBLE  
ACTION  
LEVER  
Does It**

Does more things easier, quicker than any other tool. Remains locked to the work with hands removed. Holds anything, any shape, with a grip that never slips. Built with strength to back up its power. Made of fine alloy steel. Nickel Plated. Two sizes 7" and 10"

Sold thru Tool Jobbers and Dealers

Invented, Developed and Made World Famous by

**PETERSEN MFG. CO., Dept. S-126, De Witt, Nebr.**

286 POPULAR SCIENCE

# BIG MONEY NOW IN LIQUID MARBLE

**THREE** wonderful new opportunities for your own big money-making business—regardless of your age, sex, or previous experience!

**1. LIQUID MARBLE.** Make beautiful artificial Marble Slabs. Pour from liquid state. Glazed or unglazed. This marble may be mottled, veined, multi-colored or left in original snow-white state. The color is actually a part of the marble! Does not fade or wear away. Liquid Marble is unsurpassed on kitchen or bathroom walls. Easy to make and install.

**2. PLASTIC FLOORING.** May be made in any color or combination of colors. Gives a lifetime of wear. Dustproof, Soundproof, Verminproof. Resilient to the tread. Lay out solid from wall to wall or in pattern design of various shaped blocks.

**3. FLEXIBLE MOLDS.** For plaster casting. Make your own moulds for few cents each. \$1.00 in raw materials will make up to \$25.00 worth of finished goods. We furnish names of buyers. Write now for FREE information about our **BIG THREE** money-making opportunities! Get in on busy season just starting. Send penny postcard or letter. No obligation.

**COMPO-TEX, Box 786-G, ST. LOUIS 1. MO.**

**TOYS**—Five toys easily made from Stanley Project Plan Set No. 16—Wagon, Scooter, Rocking Horse, Wheelbarrow, Push Car. Postpaid, 10c. Stanley Tools, 2126 Elm Street, New Britain, Conn.

**STANLEY**



**arc welding  
manual and text  
book...\$2.00**

Teaches you how to become an arc welding operator — one of highest paid trades today. Write today!

**Hobart Bros. Co., Box P-562  
Troy, Ohio**

## QUICK! "REPAIRING CAR BATTERIES!" MONEY

At Home! Easy Tool! Free Circulars!  
WRITE, BATTERYMAN Dept. S-1 Grand Junction, Colorado

**MICROSCOPES SUPPLIES-ACCESSORIES & SCIENTIFIC INSTRUMENT**  
BEL SPENCER NEW & USED LEITZ ZEISS  
BOUGHT SOLD EXCHANGED REPAIRED  
Send for FREE LIST  
NATIONAL SCIENTIFIC INSTRUMENT CO. 119 CHAMBERS ST. N.Y.

# EXCITING FILMS

THRILL audiences at your 8-16mm. screenings. Glamorous subjects starring Holly-

wood's most beautiful daughters. Models selected by artists as the loveliest in all the world in beautiful scenes; sensational dances.

Breath-snatching BULLFIGHTS showing famous "toreros" facing charging bulls, ending with Death In The Afternoon . . . MOVIE STUNT MEN gambling life and limb in unbelievable feats . . . SAVAGE BEASTS in terrifying action.

Make your shows EXCITING! Send dime for sample film and Special Lists to Exciting Films, 1071 El Centro St., Dept. 12, Hollywood 38, Calif.



Beautiful Swiss  
**WATCHES**

An Amazing Value at only **\$8.50**

**COMPARE!**

Streamlined \* Steel Back  
Sweep Second Hand



Model B—7 jewels, stainless steel, radium dial... \$12.00  
Model C—15 jewels, stainless steel, fancy radium dial... \$22.00

Model D—17 jewels, famous INCABLOCK movement, waterproof, shockproof, radium dial... \$30.00

Each watch is carefully tested and checked by master craftsmen, delivered to you in perfect condition!  
**MONEY-BACK GUARANTEE.** Add 10% Fed. Tax on all WATCH prices.

Send check, money order, or pay postman C.O.D. plus postage.  
**NO EXTRAS!** Agents Wanted **RUSH ORDER NOW!**  
Stainless Steel Expansion Band (Fits Any Wrist)... \$1.00

**GOLDEN RULE CO.** P. O. Kingsbridge Station, Dept. 22, New York 63, N. Y.

**ONE-MAN SAWMILL** LESS THAN **\$200.00**

Easy To Turn Trees Into Money

Makes Lumber ties, shingles, crates, lath, studding, siding.



**BELSAW MODELS**

in 10 to 24 foot sawing lengths. **MECHANICAL FEED,** accurate set works and positive dogs. Use tractor or old auto engine for low cost power. Thousands used for commercial sawing. Pays for itself quickly. Send post card today for **FREE** booklet, "How To Make Lumber" and Catalog of Woodworking Equipment.

**BELSAW MACHINERY COMPANY**  
1846S Field Bldg., 315 Westport Rd., Kansas City 2, Mo.

**MARCOT KEY MACHINE**



Marcot No. 8 Key Machine Mounted on Cabinet... \$75.00  
Book on Modern Locksmithing... 3.95  
Auto Code Book and Auto Depth Keys... 12.50  
162 Doz. Popular Key Blanks... 77.76  
Set Key Files Tools, Pins, Springs, Thimble... 10.50

**\$179.71**

**A. J. MARCOTTE CO.,** 1200 N. KEDZIE AVE., DEPT. PS, CHICAGO 51, ILL.

**500 TRICKS MAGIC TRICKS**

**IT'S FUN TO DO MAGIC**

Amaze—mystify—entertain! You, too, can enjoy this fascinating hobby. Only 10c brings our new 1946-7 Catalog 500 Tricks, containing brand new easy-to-do tricks for pocket, parlor, club, stage. Hundreds of tricks require no skill. Join in the fun—send 10c today!

**Douglas Magicland, Dept. P, Dallas, Texas**

**CODE-SENDING-RECEIVING-SPEED**

Learn to send and receive Radio Code with greater speed. Stop nervous tension. Have confidence. Be proficient. Same system used by radiotelegraph specialists. Thousands of operators needed. Rush name for **FREE** book.

**CANDLER SYSTEM CO.**  
Dept. 6-0, Box 928, Denver 1, Colo., U. S. A.

**SAVES MANY ELECTRIC APPLIANCES**

**NICHROCITE** REPAIRS HEATING ELEMENTS IN A JIFFY . . .

Simply overlap ends, apply Nichrocite Paste and turn on current. Used by large utility companies. Trial order. \$1.00; 4 oz.. \$2.50; 1 pound, \$8.00.

**ARROWHEAD SALES & DIST. CO. Dept. G**  
420 Phoenix Bldg., Minneapolis, Minn.

**New Designs in FRANZITE GRIPS**

**Modernize Your Gun! Improve Your Score!**  
Most durable grips made. Positively unbreakable! For Colt, Smith & Wesson, Hi-Standard, Ortgies, Luger & Mausers in a wide choice of beautiful designs in ivory, pearl, walnut, onyx, etc. Low prices. **FREE CATALOG.** Dealers Wanted.

**SPORTS, INC., (Mfrs.) 5501 Broadway, Dept. S-12, Chicago 40, Ill.**

Convert your 16mm silent projector to



With the APEX Sound Converter use right through your own Radio.

- 1 Sound Adapter
  - 1 Radio-Film Adapter
  - 1 Mounting Bracket
- OR
- 1 Sound Adapter
  - 1 14-Watt Amplifier
  - 1 12" Speaker and Case

**ONLY \$59.95** **ONLY \$97.90**  
Complete

Complete ready to use. Fits any 16mm silent projector. Immediate delivery. Mail money order for full amount or \$10.00 balance COD.

**APEX VIDEO CO.,**  
Dept. PS 4, 7356 Melrose Ave., Hollywood 46, Cal.

**MINERALS**

**IDENTIFICATION AND QUALITATIVE CHEMICAL ANALYSIS OF MINERALS—By Orsino C. Smith, A. B., A. M.**

The most complete handbook on the subject ever published; with every step in identification and analysis clearly explained and illustrated in full color. At last, all the facts about all minerals between the covers of one great book! More than 2,000 minerals listed and classified by specific gravity and hardness. Hundreds of beautiful, full-color photographs and illustrations. Complete directions for determining any known mineral from its physical properties—index of refraction, color, streak, lustre, cleavage, fracture, fusibility, etc.—all organized for instant practical use.

**\$6.50**

**D. VAN NOSTRAND COMPANY, INC.** 250 Fourth Avenue, New York 3, N. Y. **EXAMINE THIS GREAT BOOK FREE**  
Please send me a copy of "Identification and Qualitative Chemical Analysis of Minerals". Within 10 days, I will either return the book or send you \$6.50 plus a few cents postage.

Name.....  
Address.....  
City..... Zone..... State.....  
Pop Sci.-Dec. 1946

**SpeedWay**

No. 69 1/2" Drill \$11.80  
No. 89 1/2" Drill \$29.95

Each month, more SpeedWay Drills come off the production line; are being shipped each day. But, frankly, though we are beginning to cut into our mountainous pile of back orders, there's a deal of people who are ordering SpeedWay Tools today. However, because they are worth waiting for, we suggest that you place your order now with your local SpeedWay dealer for earliest possible delivery.

**SPEEDWAY MFG. CO.**  
1864 S. 52nd Ave.  
Chicago 50, Ill.  
No. 89. Equipped with Snap-Release Chuck. No. 89-J with Jacob Chuck (as illustrated) \$5.00 extra.



# PRECISION DRIVES for your POWER EQUIPMENT

## CONGRESS <sup>DIAMOND BORED</sup> PULLEYS

The CONGRESS pulleys you see on your dealers counter are identical to the pulleys that have been used for years as standard equipment by America's leading industries. They are now available in sizes up to 16" diameter at your local dealer.



Sign of an Authorized Congress Dealer

CONGRESS pulleys increase the performance in your workshop; provide efficient, long wearing service at low initial cost. You pay no more for CONGRESS pulleys than for ordinary pulleys. REMEMBER—You can't buy a better pulley than a CONGRESS pulley.

## CONGRESS <sup>DIAMOND BORED</sup> DRIVES DETROIT 12, MICHIGAN



Keeps on giving every day in the year! Writes names on tools, engraves jewelry, decorates glass, tools leather; cuts out cardboard signs and linoleum blocks. The ideal gift for man or woman—boy or girl... for anyone interested in craft work or home workshop activities.

See your dealer or order direct.

Gives you the tool and 22 accessories, with sharpening stone... all conveniently accessible in handsome hinged, natural polish, wooden box.

60 cycles AC; 110 V.

\$1650

HANDICRAFT DIVISION

## BURGESS BATTERY COMPANY

176 N. Wabash Avenue • Chicago 1, Ill.



288 POPULAR SCIENCE

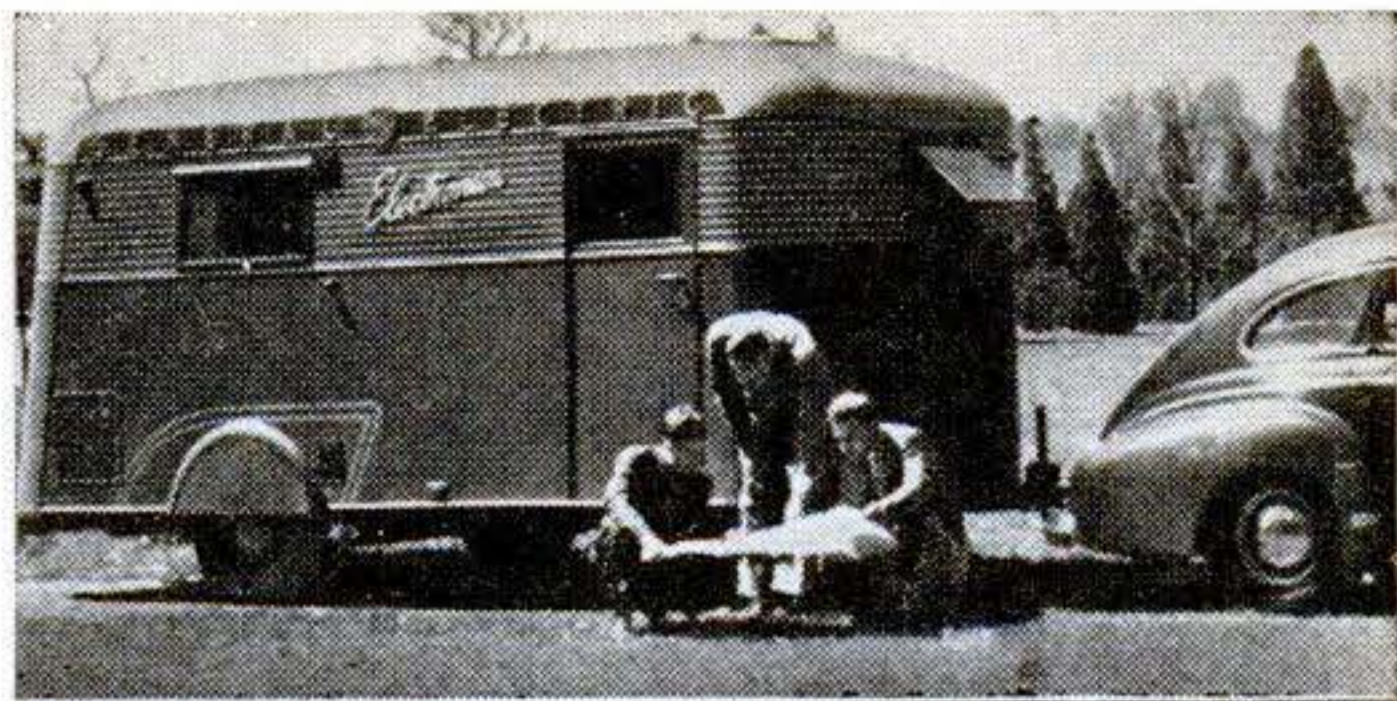

## Gypsy Radio Laboratory

RADIO is mushrooming, and to ease its growing pains General Electric has outfitted eight roving radio laboratories to find the best sites for new transmitters. One of the perambulating labs is shown at top. Under it is a photo of its interior. The laboratories will operate out of Boston, Philadelphia, Albany, Atlanta, Cleveland, Chicago, Kansas City and Dallas.

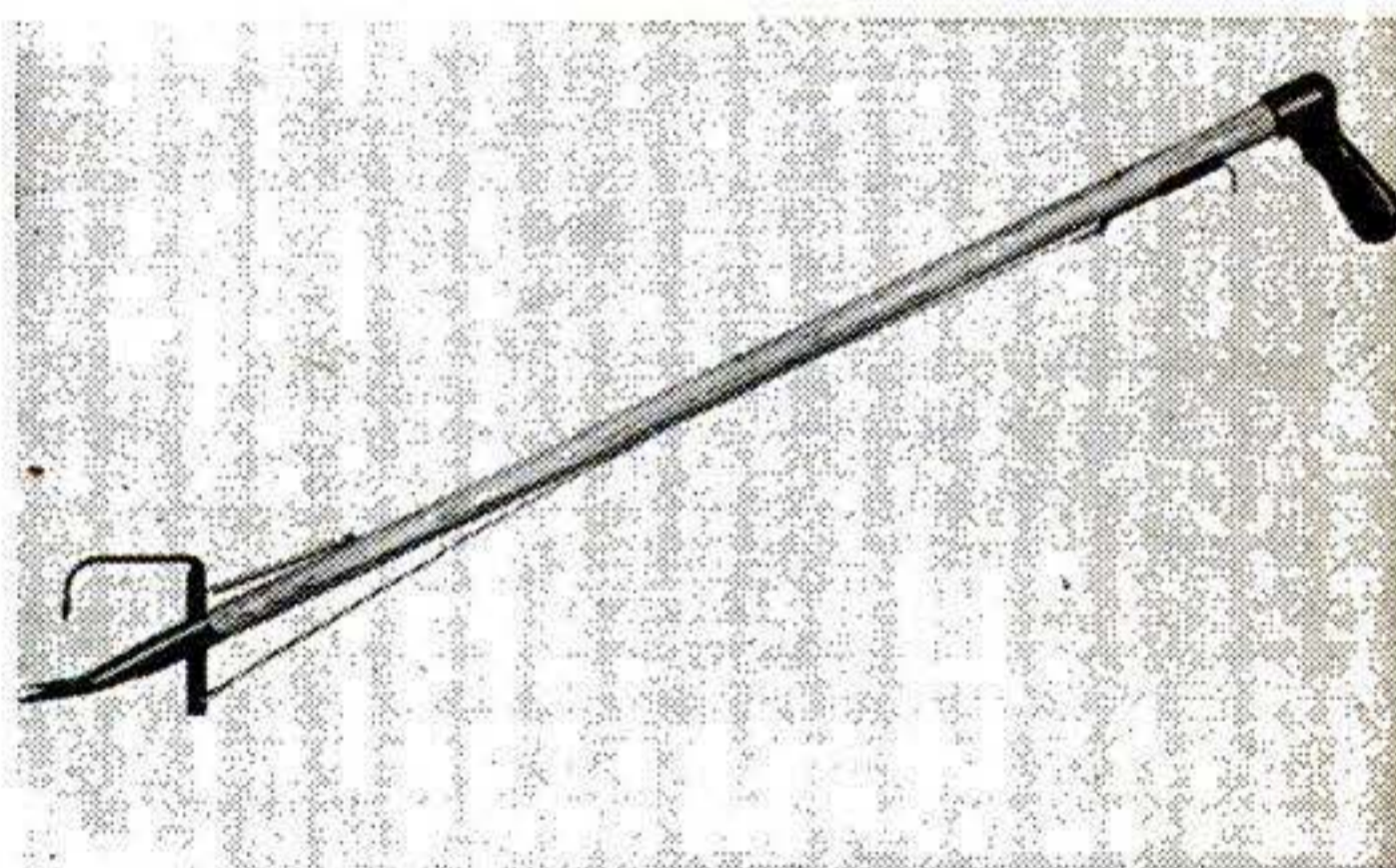

## Weeder Gets at the Roots

BETTER—and easier—weed-killing is promised by the new, three-foot-long weeder, above, made by the S K G Corp., of Minneapolis. It is operated by thrusting its forked blade under a weed to sever the roots. The spring-action trigger under the handle is then snapped and the claw closes on the weed to grip it when the blade is pulled out of the ground.



# THE NEW 20-WHEEL LIONEL STEAM TURBINE

(8 WHEEL - DOUBLE WORM DRIVE)

LIONEL LOCOS  
PUFF CLEAN  
WHITE *Smoke*  
Whistle LIKE  
REAL TRAINS

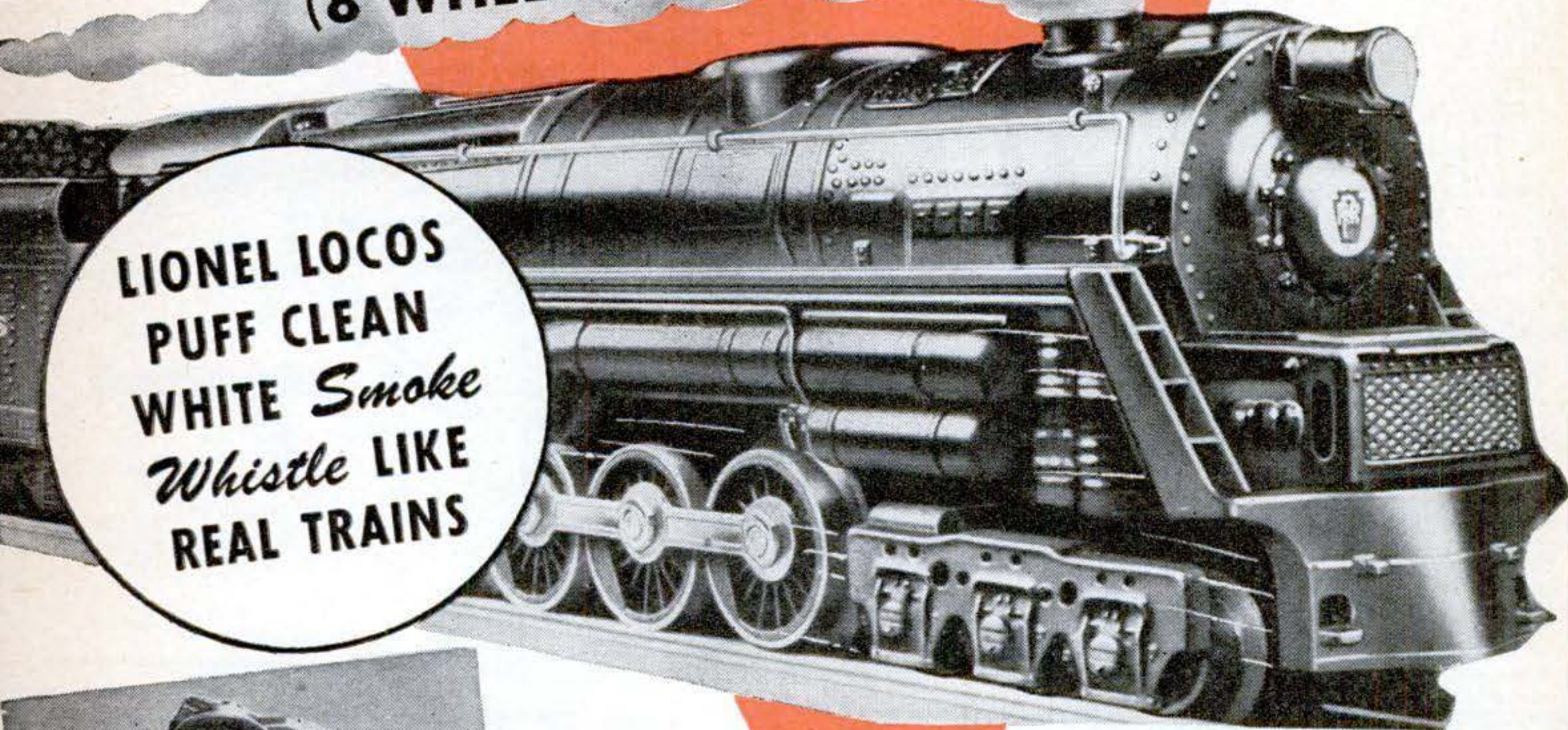

Note realistic real railroad - remote control - electro magnetic knuckle couplers, and solid steel wheels.

This new LIONEL 20-wheel Pennsylvania Steam Turbine Loco - powered by a mighty new motor and LIONEL exclusive double worm drive is the last word in locomotive perfection. Brand new! - it is only one of the many surprises LIONEL has for you this year. Send for the new color catalog and get the full story. Again LIONEL leads the world!

# LIONEL

*write for catalog*

- also scenic effects book, secret "Pop Persuader".



The Lionel Corporation, Dept. PS  
15 East 26th St., New York 10, N. Y.

Please send me the new full color LIONEL TRAIN catalog, also the secret "Pop Persuader" and the book on Scenery Building. I enclose a DIME to cover postage and packing.

Name \_\_\_\_\_

Address \_\_\_\_\_

City \_\_\_\_\_ Zone \_\_\_\_\_ State \_\_\_\_\_

(Please don't delay! Mail today! Send 10c for mailing.)

## LIONEL

*Electronic*  
CONTROL



Sensational operation of locos and cars by radio frequency waves. Fully described in catalog (exclusive with LIONEL).



# It ROARS! MOVES! ROLLS! BANKS! TURNS!

**PROPELLER REVOLVES ON ITS OWN POWER!  
MOVES AND ROARS LIKE A REAL PLANE!**

Educational? Yes! It's the first Toy Plane ever built on the Gyroscopic principle. Just pull the string and watch it Roar, Move, Turn, Bank, and travel across the floor. Any child can operate it!

**\$1.95**

(Dealer's Inquiries Invited)

**HURRY! DON'T DELAY! GET YOURS TODAY!**

**SEND FOR OUR FREE GENERAL CATALOG Dept. MM-6**

### UTILITY STORES

117 S. Wabash Ave., Dept. MM-6, Chicago 3, Ill.

Enclosed find \$... for which ship at once

Gyro-Planes at \$1.95 each complete.

Name.....

Address.....

City..... Zone..... State.....

Make **UTILITY STORES** your Mail Order Shopping Headquarters.

Established 1906



Plane Balances on Special Stand, and Roars Like a Plane!

Plane Moves! And Sounds Like a Real Plane!

## U-MAK-IT New AQUAMOBILE V-18

Cut-to-Fit for quick Home Assembly. Get used Ford motors A. B. VS. Chevrolets, etc. for trifle. Adjustable motorbeds fit all. Assembled frames ready for installation. Fast VEE bottom Marine Plywood hulls.

SEND 10c (Coin) MONEY SAVING CATALOGS. Show Kits for KAYAKS, ROWBOATS, OUTBOARDS, DINGHIES. Kayak Boat Co., 152R East 129th St., New York 35, N. Y.



No Experience Necessary.

## What Every Mason Wants



We have Important Masonic books for Blue Lodge, Chapter, Commandery, Scottish Rite, and Shrine.

OUR RITUALS ARE USED THE WORLD OVER

Send for free catalog of books and rituals for Masons, Odd Fellows, Knights of Pythias, Knights of Columbus, etc. EZRA A. COOK, Publisher, P. O. 796, RD Chicago 90, Ill.

## 3 in 1 OTTAWA SAW

THE WORLD'S FASTEST.

**6-H. P. EASY TO MOVE**

**FELLS TREES, SAWS BIG LOGS, SMALL LOGS, LIMBS**

One motor performs all three operations. Furnished with or without attachments shown below. Thousands in use.

Make **BIG** profits in the ever increasing wood business. Pulley for belt work. Fully guaranteed. Low direct-to-user prices. **FREE** details—write **TODAY**.

**OTTAWA MFG. CO., 1201 Pine St., Ottawa, Kansas**

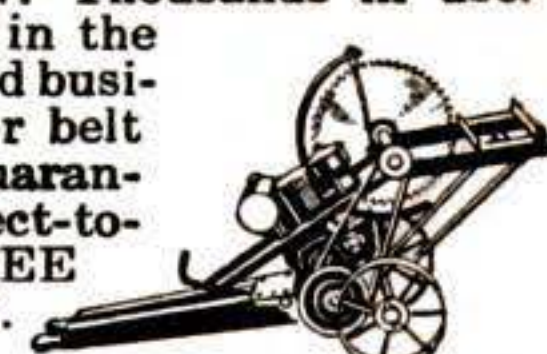

## WHAT EVERY BOY WISHES FOR Complete Racer Chassis WITH LARGE 10 inch WHEELS

Give him a treat that he will always remember! This sturdy built, All-Purpose Chassis will give miles of real pleasure for any age. Little ones or adults... for push or power; engineered into the finest design for electric or gasoline power, giving the choice of body design to build yourself. These racers are just what every boy wants. He will thrill over the **REAL BRAKES** and the **REAL STEERING WHEEL** (built to fit the hand with finger grips). Beautifully designed in bright finish pure aluminum with dome center. Horn button can be placed under dome. All parts sturdy and made to last. He will enjoy the thrill of planning and building a streamlined racer, a jeep, fire engine or truck. All year round sport and pleasure.

- **READY TO ROLL AND STEER.**
- **GIVE HIM A REAL GIFT!**

complete **\$46.00** as illustrated ONLY

WRITE FOR LOWEST PRICES ON 10 in. WHEELS WITH LIFETIME OILLESS BEARINGS

• **FUN • SPEED GALORE • for POWER or PUSH**

**10 x 1.75 GOODYEAR PUNCTURE PROOF SEMI-PNEUMATIC DEEP TREAD TIRES**



**MODEL "A" RACER CHASSIS**  
65 in. LONG 24 in. WIDE With 12 inch STEERING WHEEL  
Weight Approx. 55 Pounds. F.O.B. Doylestown, or, add 10% for Prepaid Shipment in U. S. A.

**Rush Order Today! Buy Direct Save!**  
**OSBORN WHEEL CO. Dept. PS-12**  
115 So. Main Street DOYLESTOWN, Pa.



## 110 VOLT 60 CYCLE A-C MOTOR GENERATOR UNITS

TWO BRAND NEW COMPLETE UNITS COST NAVY \$97.50

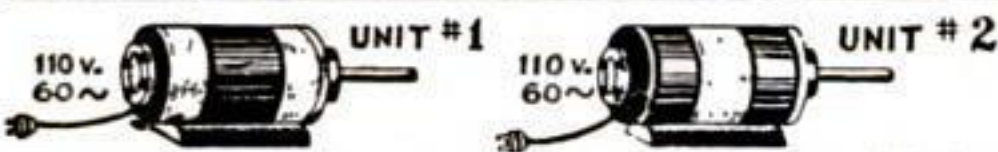

YOUR COST  
**Only \$6.99**  
EXPRESS PAID

Amazing value! You get two separate units. Will operate as two AC motors or as an AC generator. Precision built with ball bearings, polished aluminum housings. Operate small grinders, fans, polishing heads, etc. Students, schools can use to experiment with fascinating AC phenomena. Generate AC electricity, operate as rotary converter, synchronous motor-generator, use as phase shifter, variable transformer, etc. Free with each order—manual of interesting experiments and full instructions. Send money order, personal check, currency or will send C.O.D. Order today or send card for more details.

LECO ENGINEERING CO., Box 908-PS-12, Lincoln, Nebr.

## So You Think You're Living?

Yes, you're going through the motion, all right—eating, sleeping, working and all that. But are you really LIVING? And how do you KNOW you are living? To find out read "Life Unlimited," a message for immortals. Your copy mailed free on request.

LIFE UNLIMITED, Dept. PS-12

3227 Indiana Ave.

St. Louis 18, Mo.

## SUIT YOURS AS A BONUS



### And Big Money in Spare Time, Too

We want you to wear this fine made-to-measure suit! Make it yours by sending a few orders, and earn BIG CASH PROFITS in spare time. Your suit will help you get more orders with scores of rich, quality fabrics, tailored-to-measure to newest styles. Also Ladies' Tailored Suits—complete line. Write today for FREE SAMPLES. No experience, no money needed. For quick action tell us about yourself.

J. C. FIELD & SON, Inc.

Harrison and Throop Sts., Dept. M-1721, Chicago 7, Ill.



### FLAME-PAK PLASTIC CIGARETTE CASE

Something different & economical. ONLY 40c Postpaid.

### LORD LANGLEY EXPANSION WATCH BANDS

Stainless Steel, rust-proof. \$5; 1/2 2012K Gold Filled, \$6.50 Postpaid.

ADAMS MERCHANDISE CO.  
285 Walnut St., Newark 5, N. J.

## BOOKS FOUND FREE!

### WHAT BOOKS DO YOU WANT?

We quote the lowest market prices. No charge for locating Hard-to-Find and Out-of-Print Books. All books, OLD or NEW, mailed POST-FREE.

SEARCHLIGHT BOOK CENTRE  
22 East 17th Street New York City

## "For the SPARK that NEVER Fails"

INSIST ON



**RUMIN FLINTS**  
Gold Coated  
and LIGHTER FLUID

At drug and cigar stores, PX and Ship's Service.

ROCK FLINT CO., 123 Doughty Blvd., Far Rockaway, N.Y.

## How to SHAVE scientifically



Learn how you can harness forces of Nature (heat, cold and pressure) to improve the performance of any razor, any blade and any shaving soap. 16 page booklet 10 cents. Money back guarantee.

RAZOR RESEARCH, 130 Water St., New York 5

Say You Saw  
It In Popular Science

**SIGNS EASILY AND EXPERTLY PAINTED WITH LETTER PATTERNS**  
AND SHOWCARDS MANY SIZES & STYLES WRITE FOR FOLDER!  
JOHN F. RAHN  
1330-33 N. CENTRAL AVE.  
CHICAGO 51, ILL.

## YOU CAN NOW BECOME A PROSPECTOR!

HERE IS ONE OF THE WAR'S TOP SECRETS

### BRAND (NEW) ARMY MINE DETECTORS!

Portable: Will Detect METALLIC and NON-METALLIC objects; Very Sensitive; using 955 Tube in detecting head; two tube amplifier using two 1N5gt; headset; or microphone; also 150 micro meter; Power supply; 3-45v.; one 6-v.; or 2 3-v. batteries. Complete with instr. Less Batteries; packed in original cases; shpg. wgt. 108 Lbs.

FOB. From N. Y. Special

**\$1750** NO C.O.D.

Send order to

**COLUMBO TRADING CO., INC.**  
304 CANAL ST. NEW YORK 13, N. Y.

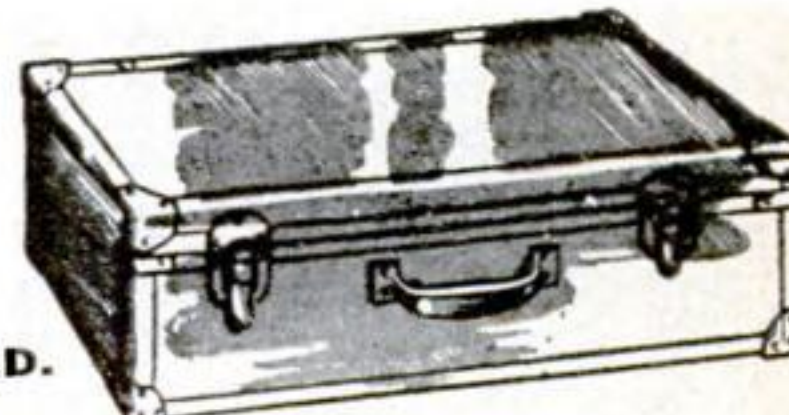

CARRYING CASE CY-91/PRS-1

## NEW MIRACLE CAR PAINT!

NO BRUSH! NO SPRAY! DRIES IN ONE HOUR!

Now! Paint your car easily, quickly, economically with DAB, the new wonder car paint! Apply with rag! Leaves no lap marks! No equipment needed! One qt. paints your car completely. 5 rich colors; Washington Blue, Brewster Green, Lt. Maroon, dk. Maroon, Black. 2 yr. guarantee. Send for DAB today, \$5.95, ck. or money order. Address

DAB 2160 Sunset Blvd. Los Angeles, Calif.

## BUILD THE ATOMIC-FLY IT 100 M.P.H.

**\$350** COMPLETE KIT INCLUDES MANY FINISHED PARTS  
Scientific Model Airplane Co., Dept. S, Newark, N.J.



## WOODY HERMAN "Sweetwind"



NOW \$1.00

Prepaid

### Play It In 5 Minutes

Anyone can play it! Full 2½ octaves. Exactly like Woody's clarinet, in gleaming black plastic with white mouthpiece. Raised finger holes. Complete with instructions.

3-day trial offer!

ESSGEE SALES CO., Box 4457, Miami, Fla.



**WORLD'S**

# LOWEST PRICED ADDING MACHINE

**VEST POCKET SIZE**

Fits vest pocket or purse. Guaranteed Accurate. Operated as easily, and as reliable, as machines costing many times as much. NOT A TOY OR GADGET. Substantially made of 28-gauge steel—guaranteed for life against defects in construction. Beautiful looking, modernized design. Finished in Black, Silver and Red. You positively can't buy a Calculator of equal quality for as little money. ACCEPTED AS THE FINEST LOW PRICED CALCULATOR FOR OVER 30 YEARS! Operates with a flick of your finger. Adds, subtracts, multiplies, divides—counts up to ten million. Pays for itself over and over in mistakes avoided, and time saved.

**MAKES IDEAL GIFT**

Baby Calculator makes an ideal gift—for every Gift occasion. Birthday — Graduation — Christmas — Anniversaries. For men, women, children—teachers, business people, home or shop use. COMES PACKED READY FOR GIFT WRAPPING.

**TEN DAY TRIAL**

**Money Back Guarantee**

Because we know that our machine is the very best Calculator to be obtained at this low price, we make this 10 Day Trial offer on a positive money back guarantee!! Don't buy ANY Calculator without this guarantee! Send only name and address, pay postman \$2.50 plus postage (if cash is sent, we pay postage—you save up to 40c). (Send full cash if outside U. S.) Money back within 10 days if not delighted.



**IDEAL XMAS GIFT**

**FREE TRIAL**

ONLY **\$2.50** TOTAL COST

SEND NO MONEY

**FREE!!**

Each Baby Calculator enclosed in beautiful rich-looking Leatherette Case—at no extra cost.

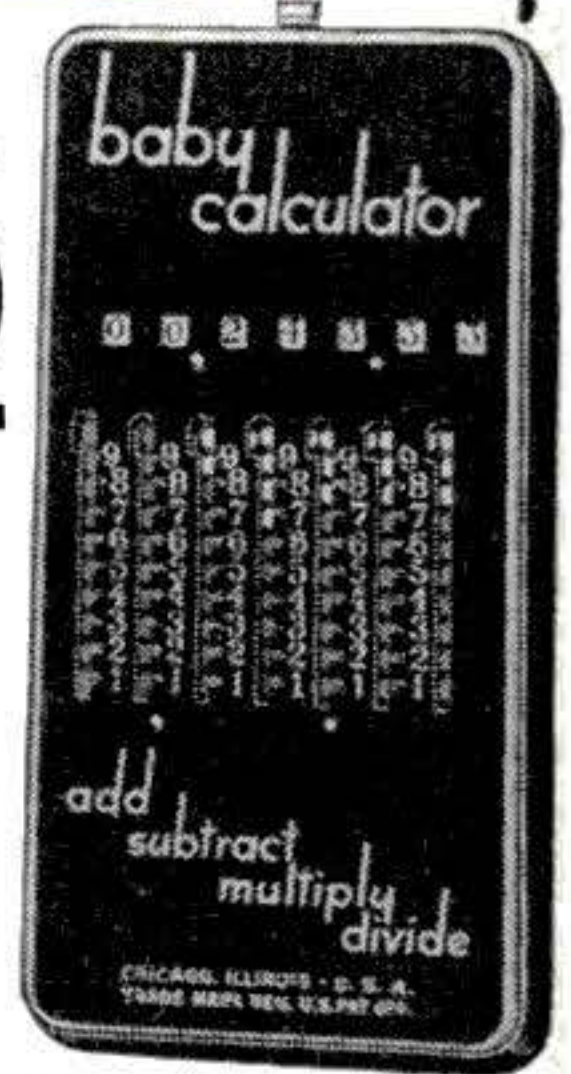

**CALCULATOR MACHINE CO. (Mfrs.)**  
DEPT. 473, P. O. Box 248, GLENVIEW, ILL.

**USE COUPON**

**CALCULATOR MACHINE CO., (Mfrs.)**  
P. O. Box 248, Dept. 473, Glenview, Ill.  
Your Calculator is just what I've been looking for. Send one at once (C.O.D.) or (I am enclosing \$2.50).

Name.....

Address.....

City..... State.....

**AGENTS WANTED**

**WOOD WORKERS**

**Lumber—Plywood Available**  
Harold Hunt wants to send you big new No. 15 Catalog. Over 148 pages of wood-working ideas, 12 pages of rare woods in colors. UNEQUALED BARGAINS in imported and American woods, supplies, hard-to-find hardware. Send only 15c to cover postage and handling.

**CRAFTSMAN WOOD SERVICE CO.**  
2728 S. Marv St. Dept. R-76. Chicago 8 Ill.

**only 15¢**

**WALKIE SIREN**

Formerly \$15.00 - Now Only \$3.95

**GOV'T SURPLUS.** A precision instrument. Easy turn of crank produces CLEAR, FULL SIREN TONE. Can be heard for great distance. Ideal for Boats, Autos, Schools, Sporting Events, etc. Dimensions 7" x 8" x 5". Wt. 4 1/2 lbs. Price includes shoulder strap and waterproof cover. SEND NO MONEY. Just name and address. We'll ship C.O.D. for \$3.95 plus postage, or send money in advance, we'll ship prepaid. Canadian price \$4.50. **ILLINOIS MERCHANT-DISE MART, Dept. 401, 1227 Loyola Ave., Chicago 26, Ill.**

**FIGURE DRAWING WITHOUT A MODEL**

Learn how to draw the human form from every view, in every position. Over 300 "real-life" drawings in Cliff Young's new book. Order today \$1 postpaid full cost. Art books list sent FREE.

**HOUSE OF LITTLE BOOKS, 80-B E. 11th St., N. Y. 3.**

**RHEUMATISM**

**'ARTHRITIS-NEURITIS-SCIATICA'**  
If you suffer the agonizing pains of these diseases when the usual remedies have failed, learn about a new trustworthy, modern, non-surgical treatment method. This marvelous treatment is completely explained in the Ball Clinic's FREE Book. Write today. No obligation.

**BALL CLINIC Dept. 36 Excelsior Springs, Mo.**

**AUTOMOBILE MECHANICS**

A new, sensational split lock remover for Hydraulic brake shoes. Saves time on every job. Order one today, \$1.00 post paid.

**Newfield Welding Machine Co. Dept. PS, Newfield, N. Y.**

**Radio Parts BARGAIN**

Amazing war-surplus radio parts bargain, with new Coils, Condensers, Transformers, Resistors, Controls, others, \$15 to \$25 value. Ideal for experimenters, amateurs, home shop men. Now only \$3.98.

**MARKO SUPPLY, Dept. PS-12a, 2924 Logan Blvd., Chicago 47, Ill.**

**FURNACE HEAT CONTROL UNIT**

automatically controls heat by opening and closing damper. Simple to install. Saves fuel and labor. \$21.50.

**EXHAUST FANS, 12" to 24". \$27 to \$70. Heaters, Iron Repair Kits, Fluorescent Fixtures, Electric Hair Clippers, Motors and many other items at BIG SAVINGS while quantities last! Re-sell for profit! Details FREE!**

**DOMESTIC ELECTRIC CO., 118 E. 28th St., N. Y. 16, N. Y.**

**COMPRESSED AIR INSTANTLY, Anywhere!!**

Portable Air Compressor and storage tank. Ruggedly built of best materials using lifetime lubricated ball-bearing on connecting rod and oil impregnated main bearing on shaft. Unusual design forever eliminates valve trouble, the most common fault in air compressors. **PATENTED** unique air intake system increases efficiency tremendously over other compressors so that air output is much greater than that from larger compressors powered by heavier motors. Will deliver approximately 3500 cu. inches of air per minute at maintained pressure of 30 lbs., or will inflate a 90 lb. truck tire in less than one minute. Comes complete with 100 lb. gauge although finger-tip adjustment allows setting of output pressure at any value, which will automatically be maintained. Works from any 1/4 H.P. motor. Useful for spraying paints or lacquers, disinfectants, insecticides, annealing or brazing with natural gas, inflating tires, etc. Price \$14.50 postage prepaid anywhere in the U. S. Efficient, completely adjustable syphon type spray gun complete with 12 ft. of 100 lb. tested hose available for only \$7.75 with pint container, also prepaid. 25% required on all C.O.D. orders. Send for free catalogs of radio parts and surplus items.

**BUFFALO RADIO SUPPLY; 219-221 GENESEE ST., DEPT. 12S, BUFFALO, N. Y.**



# Now A DYNAMIC HEAVY DUTY INDUSTRIAL WELDER

**FOR ONLY \$23.50 COMPLETE...**

**Ideal and Practical Gift for Any Man**

Get details on our 10 day trial offer

Member Chicago Association of Commerce

**IDEAL FOR AUTO - HOME APPLIANCE AND FARM REPAIRS**

DESIGNED TO DO HIGH GRADE WELDING INEXPENSIVELY—Maintenance Men; Farmers; Mechanics; Machine Shops; Foundries; Auto, General Repair and Job Welding Shops; all using the DYNAMIC find it so indispensable and useful that they cannot afford to be without it. If inexperienced, you can easily learn to do a variety of high grade welding jobs by following the practical, simplified operating and welding instructions furnished. Once you see a DYNAMIC in operation, you won't want to be without it. Its simplicity will amaze you. In a year the DYNAMIC only costs you about 6c a day. Helmet, rods, cables, holder and operating instructions, etc., furnished.

**SAVES YOU VALUABLE TIME AND MONEY!**

This portable DYNAMIC WELDER—easily carried to the job—can be operated from any convenient, properly wired 110 volt, 60 cycle line. Can also be supplied for 220 volt, 60 cycle operation and for other voltages and cycles at slight additional cost. Works on IRON, STEEL, BRASS, BRONZE, AND OTHER METALS—has 8 metallic and carbon arc welding heat stages—does work you would think only possible with larger more expensive machine.

**DYNAMIC WELDER CO. • 13 East 23rd St., GP, Chicago 16, Ill.**

## Rust CORODEX Remover

THE WAR-TIME MIRACLE LIQUID which cleaned millions of parts during war effort. CORODEX positively removes RUST and CORROSION regardless of depth, from iron, steel, brass, bronze, copper, chromium and nickel. Cleans tools, hardware, sports equipment, household utensils, etc., for a few cents a piece. No RUBBING or hard work.

CORODEX IS UNCONDITIONALLY GUARANTEED TO REMOVE RUST when DIRECTIONS ARE FOLLOWED. Valuable Manual of Rust Control free with order.

On sale at Sears Stores, 50c and \$1.00

**SEARS, ROEBUCK AND CO.**  
CHICAGO, ILLINOIS

(CorOdex is made by Allied Products Co., 1133 Newport Ave., Chicago)

### AUTOMATIC RETOOTHING FOR HAND SAWS

**Makes New Profits**

Cuts new teeth in 50 seconds! Any size tooth 4 to 16 points. Old teeth fall off as chips. Simple to operate. A perfect job.

**BURR MFG. CO. 8931 Venice Blvd., Los Angeles 34, Calif.**

## DON'T PULL HAIR FROM NOSE

May Cause Fatal Infection

Use the **Hollis KLIPETTE** Rotating Scissors

REG. U.S. PAT. OFF.

You can cause serious infection by pulling hair from nose. Ordinary scissors are also dangerous and impracticable. No better way to remove hair from nose and ears than with KLIPETTE. Smooth, gentle, safe, efficient. Rounded points can't cut or prick skin.

So Simple! Just turn the end. Surplus hair clipped off gently, safely.

\$1 Made from fine Surgical Steel, Chromium plated—also in 24 Kt. Gold Plate in smart leather case at \$3.50 (plus 70c Fed. Tax)

Guaranteed to Satisfy or Money Back

**HOLLIS CO. • 11 Commerce St., Newark 2, N. J. • Dept. 217**

Enclosed is \$..... for..... KLIPETTE(S) at \$1 (no tax); ..... in gold plate at \$3.50 (plus 70c Federal Tax). If not satisfied, I may return the above for refund in 10 days.

Name \_\_\_\_\_ Address \_\_\_\_\_

## WAKE UP YOUR Scalp

**BE FAIR TO YOUR HAIR** Want better-looking hair? Embarrassed by falling dandruff, itching scalp? Then try VITABRUSH, new electric driven scalp brush that gives your scalp a vigorous and invigorating "workout" in just three minutes of fun. Cleans scalp. Stimulates blood supply. Restful. Pleasant. Write today for complete information and satisfaction-guaranteed offer. Hershey Mfg. Co., 3718 Field Bldg., Chicago 3.

## MAGIC LIQUID MAKES PHOTOS APPEAR

Reproduce any snapshot or negative on Scarves, Ties, Stationery, etc. on Wood, Leather, Cloth, Cards or almost any other surface. Simply apply liquid. Photo appears like magic within 2 minutes in broad daylight. Harmless to negative. Won't wash off. Easy to use. Complete kit and instructions for 100 or more photos now only \$1.50. Send no money, just name. Pay postman \$1.50 plus few cents postage on delivery. (Foreign \$2.00 money order only.) Order today.

**STYLE-ARTS, Inc.**  
Dept. 2-B 4649 Broadway, Chicago 40, Ill.

## NOW CHANITE SELF-WELDING FLUX—REPAIRS all ELECTRIC HEATING ELEMENTS.

So simple anyone can make repairs in your broken or burnt-out electrical appliances—irons, toasters, stoves & etc. Guaranteed nothing like it. From our mines to your appliances. \$1.00 per package. \$7.50 per doz. Stick form 25c. \$2.00 per doz.

**CHANITE SALES COMPANY, 914 South Main, Fort Worth 4, Texas**

## do you WORRY?

Why worry and suffer any longer if we can help you? Try a Brooks Patented Air Cushion. This marvelous appliance for most forms of reducible rupture is GUARANTEED to bring YOU heavenly comfort and security—day and night—at work and play—or it costs you NOTHING. Thousands happy. Light, neat-fitting. No hard pads or springs. For men, women, and children. Durable, cheap. Sent on trial to prove it. Not sold in stores. Beware of imitations. Write for Free Book on Rupture, no-risk trial order plan, and proof of results. All Correspondence Confidential.



**Brooks Company, 360C State St., Marshall, Mich.**



TO:

FROM:

Reader  
Editor

## What Do a Physicist and a Mechanic Have in Common?

**I**T TAKES all kinds of men to make a million readers. One of *Popular Science Monthly's* best friends and keenest critics is an astrophysicist—star-snooper to you and me. He started to read PSM for relaxation, soon discovered he was getting painless information in fields of science other than his own specialty.

Another regular reader I happen to know personally is one of the smartest mechs who ever cocked an ear at an ailing motor and went right to the valve seat of the trouble. He goes for "Gus" first thing. I asked him why. He said, "It's like a puzzle—I try to solve it before Gus does. Sometimes I do; sometimes I pick up some dope I didn't know; and I'm still hoping to catch that guy off base."

Significantly, the scientist who starts PSM from the front betrays a conversational famili-



**ROBERT PRESLEY STEVENSON** got an early start toward PSM when, at 14, he sold an article about a bird-nesting box to a farm magazine. After graduating from Penn State, he worked for the Associated Press for

seven years. He found life exciting as a New York rewrite man but it left him little energy to enjoy a workbench or darkroom. So he eventually came to PSM, where he can think about the things he enjoys. Once an artist insisted that a gadget wouldn't work if made as shown. Stevenson came in the next morning with the gadget, built as specified. It worked.

arity with the new tools and smart gadgets. And the expert mechanic seems to know what is going on in electronics and chemistry. Which shows that one man's end is another's beginning so far as PSM is concerned.

To me, it is quite understandable that so



**ROBERT GORMAN**, during his last year at New York's City College, tried to promote the price of a Grand European Tour by ghostwriting. In a few years he earned for others enough degrees to stock a university and

anonymously authored half a dozen books. Then side ventures left him with one pair of pants and a resolution to stick to writing. He did, until Uncle Sam gave him another pair of pants—olive drab. He returned to civilian life as editor of an encyclopedia and then came to PSM. The Army taught him where electrons go when they leave home, and this lore filters into PSM. He is also expert with saw and hammer, as some slick modern furniture in his apartment testifies.

many hard-handed characters, who didn't finish school, end up grinding their own telescope lenses and studying trigonometry; that so many professional scholars turn out handy with a hammer. For the Ph.D. and the Joe D. have a lot in common.

Both have a deep appreciation of good workmanship, an affection for materials, a



**MARTIN MANN** had an enthusiasm for photography that led him to specialize in optics at MIT, but didn't overshadow an early interest in journalism. The ink was hardly dry on his physics degree when Pearl Harbor

took him away from his first civilian job, designing artillery fuses, and put him into uniform. He spent most of the war writing and helping produce training films in the Army Air Forces, which incidentally gave him an inside look at Hollywood. He left the Army a captain and joined PSM shortly after.

respect for tools. Hal Borland, in this issue, brings them together at the workbench; PSM, in every issue, brings them together in their minds. For what really links these two kinds of men so different in occupation and so alike in taste is a fundamental curiosity about things—what makes them tick, how they are made, how they might be adapted to some other problem.

In fact, I like to think of PSM as a handbook for scientists who use their hands, and mechanics who use their heads. I don't care which end of the train they get on. They are going to the same place.





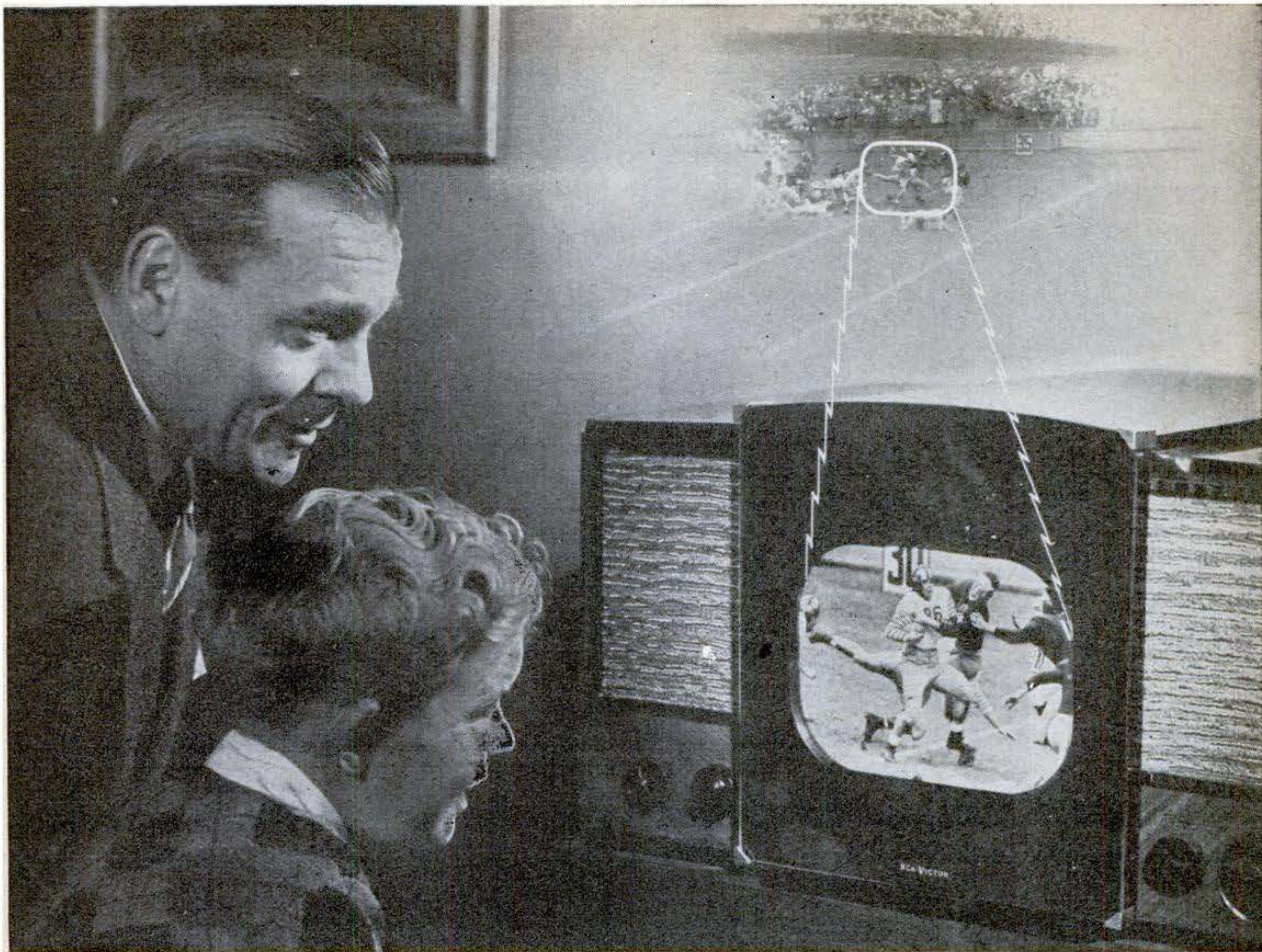

RCA Victor "Eye Witness" television receiver shown above gives you 52 square inches of picture brilliance.

## ***A referee's eye view of every play — by Television!***

You feel as though you were right there at the game—when you see it through RCA television.

Football fans as far as 250 miles away from the stadium have enjoyed watching many of the big games this fall through NBC telecasts. And football fans become television fans when they see how closely the camera follows the ball.

After you've tuned in the game, the RCA Victor "Eye Witness"

Picture Synchronizer automatically "locks" the picture in tune with the sending station—and assures you of *brighter, clearer, steadier* pictures.

For television at its best, you'll want the receiver that features the most famous name in television today—RCA Victor.

• • •

*Radio Corporation of America,  
RCA Building, Radio City, New  
York 20, N. Y.*

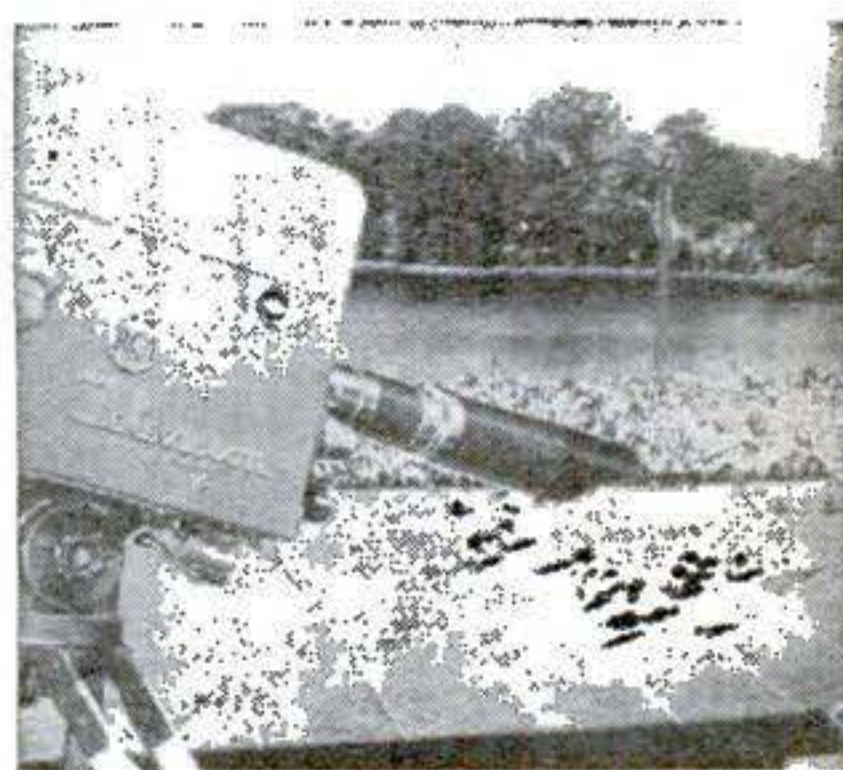

**RCA Image Orthicon television camera** enables television to go anywhere now by freeing it from the need for strong lights or bright sunshine.



**RADIO CORPORATION of AMERICA**



# SOUTH BEND LATHES

## FOR PRECISION WORK

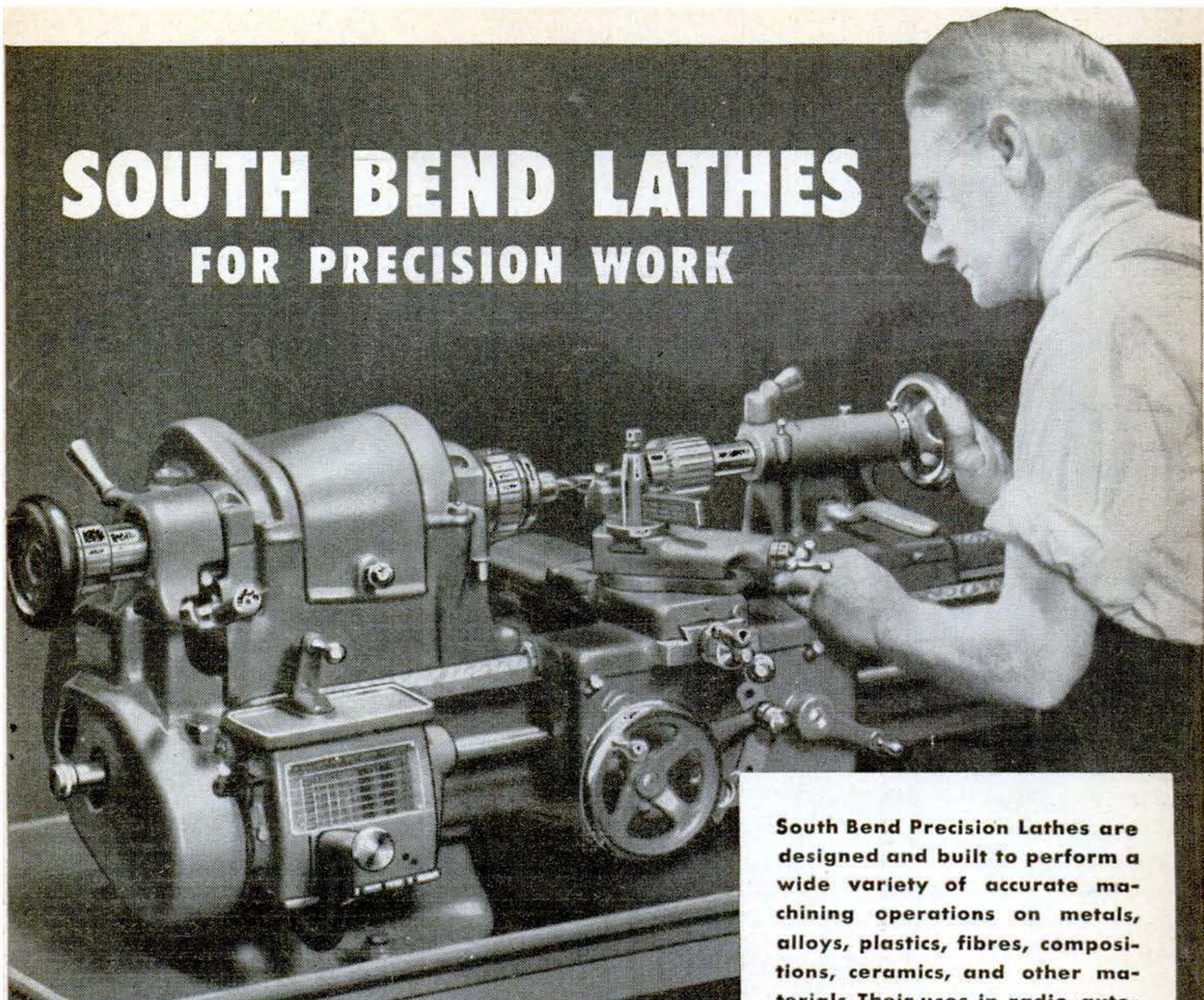

South Bend Precision Lathes are designed and built to perform a wide variety of accurate machining operations on metals, alloys, plastics, fibres, compositions, ceramics, and other materials. Their uses in radio, automobile, appliance, and other repair work, tool and model making, and maintenance are practically unlimited.



10" South Bend Quick Change Gear Precision Bench Lathe.

**Handwheel Draw-in Collet Attachment**  
 Unsurpassed for small diameter precision work. Speeds work and assures accuracy in making small tools, in the manufacture of parts for watches, radios, and instruments of all kinds, and in general service work.

### WRITE FOR FREE CATALOG



Illustrates in full color and describes all types and models of South Bend Lathes in 9", 10", 13", 14½", and 16" sizes. Please mention size in which interested.

South Bend Precision Lathes bring to the small workshop the same split-thousandth accuracy, versatility, and dependability for which they long have been famous in industry. Practical attachments simplify many operations and add to the variety of work that can be done. Prices are moderate because plant facilities are geared to the efficient, large-scale production of these versatile machine tools. It will pay you to investigate the many advantages which South Bend Lathes have to offer before you buy any lathe for your shop. Write today for free catalog.

LATHE BUILDERS SINCE 1906

# SOUTH BEND LATHE WORKS

456 EAST MADISON STREET

• SOUTH BEND 22, INDIANA



296 POPULAR SCIENCE





*Give*

# "TRIUMPH" TUCKAWAY

It's better for her because it's daintier, longer-lasting and easier to write with—because its 14-K *Lifetime*\* POINT will match her personal writing style—exactly! Here's the writing instrument ensemble particularly designed for women, with clasps especially suited for carrying in purse or pocket . . . and the pencil has a jab-proof point. See and compare this better pen and pencil—on sale where quality is the watchword. SENTINEL TUCKAWAY pen, \$12.50; pencil, \$5; complete set, \$17.50. Other sets, \$3.95 up. Complete range of Colors.

*Finer Post-war Models Priced at Pre-war Levels*

## SHEAFFER'S

Copyright 1946, W. A. Sheaffer Pen Co.  
\*Trademark Reg. U. S. Pat. Off.

*She'll Thank  
You Through  
The Years . . .*



**LISTEN EVERY SUNDAY to SHEAFFER'S PARADE  
with Carmen Cavallaro—NBC Complete Network:  
3 P.M. E.T.; 2 P.M. C.T.; 1 P.M. M.T.; 12 Noon P.T.**



Here's Easy High-Speed S  
in all 25 Useful Bra

# Mathem

—to help you qualify for the  
new jobs in America's expanding

Brought to You by 28 Leading Experts from Columbia, M.I.T., Cornell,  
Carnegie Tech., Georgia Tech., Many Others! A Practical Mathematics  
Course in Four Volumes! Used by Over 100,000 Men in Shop and Office!

**C**LIMAXING its achievements in adult education, the NATIONAL EDUCATIONAL ALLIANCE now announces a new streamlined Course in Mathematics especially designed to answer the thousands of urgent peacetime calls for mathematically trained men in virtually every field!

On work bench, in drafting room; in the laboratory; in tool, die and pattern making; in construction and engineering of all kinds; there's hardly a field where a mathematically trained man hasn't a decided advantage. He gets the better job—bigger pay—earns promotion more quickly—and will come out ahead in America's coming industrial boom.

This New N. E. A. Course in Mathematics makes it possible for the average person to acquire—in only a few months—a practical working knowledge of all 25 branches of mathematics and their practical applications. It comes to you complete in four volumes filled with illustrated fascinating lessons designed for home study.

You receive instruction from 28 foremost instructors chosen from outstanding universities. Each instructor has been selected because of his special knowledge of a particular branch of mathematics and because of his ability to simplify and streamline his instructions.

**Over 600 Helpful, Graphic Pictures and Diagrams! Nearly 1300 Pages!**

No previous mathematics knowledge is needed under this ingenious teaching plan. You start with Basic Arithmetic and proceed by easy stages to an understanding of the most advanced branches of mathematics.

You'll learn how to use Algebra for short cuts in daily shop problems, in construction work, in tool and die making, in welding, sheet metal work and pattern making, in office and laboratory. You'll learn how to apply Geometry in chemistry, mechanics, electricity and radio, in the drafting room. You'll learn how

to employ Trigonometry in gearing, lathe centers, blueprints, die punches, etc.; in range finding, aviation, navigation. You'll learn how to utilize Calculus in the design and production of ships, dams, bridges, motors.

You'll learn Practical Applications that you can use to win advancement and bigger pay!

### Yours for FREE TRIAL

Normally, mathematical training as comprehensive as these 25-Courses-in-1 would cost you hundreds of dollars and years of study. Now you get it in these 4 volumes at

a small fraction of the cost and time! Test this Course at our risk and expense. Mail coupon below—get the set for a week's FREE Examination. After a week you may return it and owe nothing; however, if you are thoroughly convinced that it can help you advance to bigger earnings, keep it at the incredible bargain price and easy terms shown in

coupon. But you must ACT NOW! This edition is limited in quantity. There may not be enough to meet nation-wide demand. Avoid disappointment—mail Free-Trial Coupon NOW! National Educational Alliance, 37 W. 47th St., New York 19, N. Y.

Copyright 1946 by the National Educational Alliance, Inc.

See List of Subjects and Instructors on Outside Flap of This Cover

**FREE!** even if you return the set!  
this short-cut to easy figuring!



**Does the Work of a Slide Rule Faster, Easier and More Accurately! 160 Pages!**

This book of Logarithms is the greatest short-cut ever devised for quick and easy multiplying, dividing and all other calculating. Easier to learn; gives answers quickly and far more accurately than a Slide Rule. A complete explanation of the use of logarithmic tables is given. So simple you can grasp it and begin to apply it in a few minutes. Covers logs for all numbers to the 6th place; contains much additional information including a table of circular arcs. Invaluable for mechanics, scientists, business men, etc. **FREE** even if you return the Mathematics Library!

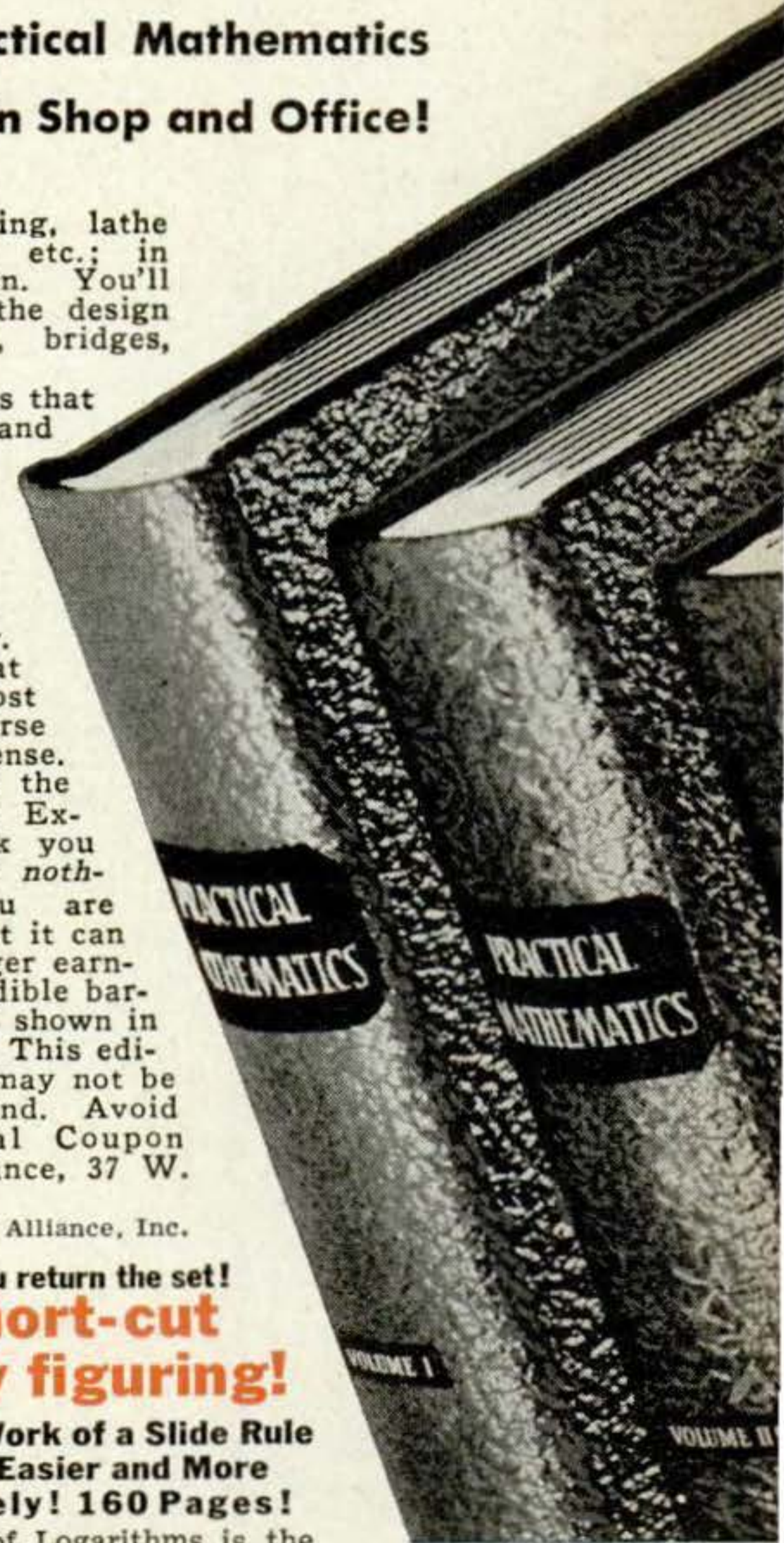

MAIL THIS FREE-TRIAL, FREE-GIFT COUPON TODAY