

# POPULAR SCIENCE

APR. 1947  
25 CENTS

MONTHLY



**Cars Can Be Safer**

p. 82

*Bingman*



HERE IT IS

THE MOST USEFUL

Here, in one great, brand-new volume is **EVERYTHING** you need to know to do **ANY** job in or around your home—repairs, alterations, improvements, and new projects.

# The Home Mechanic's Handbook

THE  
**Home  
Mechanic's  
Handbook**\*

DI BERNARDO

HAINES

ADAMS

VAN TASSEL

THOMPSON

MILLER

BAILEY

NOWAK

D. VAN NOSTRAND  
COMPANY INC.

804 Pages  
Remarkable  
Illustrations  
show every job and  
the use of every tool

**BIG... AUTHORITATIVE...  
TREMENDOUSLY HELPFUL**

## JUST A FEW OF THE PRACTICAL JOBS FULLY DESCRIBED

How to choose the right paint for every job

Figure the quantity of paint needed

Paint a house—inside and outside

Care for brushes

Refinish or "touch up" an auto

Paper a room

Put glass in windows

Replace a sash cord

Shingle or repair a roof

Screen in a porch

Tighten a loose chair, floor board, stair tread

Fix a window, door, or drawer that sticks

Fit screens, storm windows, doors

Build a chicken house, cupboard, workbench, cold-bed frame, storage cabinet

Cut, drill, grind, solder, temper, and forge metal

Measure, cut, thread, join, and assemble pipe

Fix leaks in faucets and valves

Thaw frozen pipes

Install a hot-water heater

Make a flagstone walk, a sidewalk, a wall, concrete steps, a shuffleboard

Build a brick fireplace

Install glass blocks

Install a call-bell system, a front-and-rear-door system, a door-opener circuit, or a burglar alarm

Locate a short circuit

Repair electrical equipment and appliances

## YOU need this Book

• **HOME OWNERS!** It will help you repair, fix up, and redecorate.

• **FARMERS!** You'll find thousands of how-to-do-it instructions for improving your buildings.

• **REPAIR MEN!** It will help you work more efficiently, profitably.

• **BEGINNERS!** You need no previous experience to follow these step-by-step directions.

• **HOME WORKSHOP OWNERS!** You'll find thousands of new ideas, "kinks," practical projects.

• **HOBBYISTS!** You'll get a great kick out of the hundreds of "tricks of the trade," ingenious short cuts, helpful hints.

• **EX-SERVICE MEN!** You'll find it of great help in remodeling a house, a farm, a place of business.



# BOOK YOU'LL EVER OWN!

## COMPLETE INFORMATION ON EVERY PRACTICAL TRADE

**The book every home owner has dreamed of**

Turn to this comprehensive HANDBOOK with confidence. You will find its helpful pages crammed with the latest, most efficient and workmanlike ways of doing every kind of job about the home and in the home workshop. Carpentry, metal work, electrical work, plumbing, masonry, painting and decorating—all explained by master craftsmen. The most detailed information about how to choose, repair, and apply the right materials in the right places.

Every move in the use of tools is shown by vivid hands-at-work photographs. All the important operations, and those "tricks of the trade" that play so great a part in good craftsmanship, are explained and made crystal clear by detailed step-by-step drawings. Complete directions, fully illustrated, for thousands of jobs, small and large—from fixing a broken window to installing a hot-water heater; from varnishing a chair to painting a house.

### PAINTING & DECORATING

Principles of paint mixing, formulas, and how to obtain any desired hue. Full directions for selection and care of brushes and other equipment. How to calculate amount of paint required, and best methods of applying to wood, metal, brick, concrete, stone, stucco, plaster. Exterior house painting—interior house painting—choice of color schemes. Complete directions, fully illustrated, for obtaining decorative effects—stippling, mottling, texturing, stenciling, striping, etc. Methods of finishing with stain, shellac, varnish, and wax. Proper stains for each variety of wood. Detailed step-by-step instructions for wall-papering. How to finish an auto, quickly, easily, and inexpensively.

### WOODWORKING

The many varieties of wood and their relative merits, working qualities, and uses. Plywoods, veneers, and wood substitutes—how to choose the materials best suited for the job. Sizes, types and functions of all carpentry tools—how to use, sharpen, and adjust them. All the basic operations and processes of woodworking—everything from how to avoid warping to full directions for cutting each of the common joints. Wood turning—the different cuts, roughing, facing, sanding and finishing; drilling, boring, morticing, spinning, polishing. Hundreds of repair jobs and new constructions—inside and outside the house—are fully explained with diagrams and every practical fact you need to get the best results.

### METAL WORKING

Complete information about the common metals, and the alloys—wrought iron, cast iron, steel, German silver, pewter, the brasses and bronzes, solders and babbitts—when to use, how to use, and how to work them. Hand tools and machine tools—their specific purposes, sizes, and the most detailed instructions for their use. Hints, ideas, and "tricks of the trade." How to use the engine lathe. Metal jobs and projects for home and shop, complete with bill of material, equipment needed, and a fully illustrated account of every step in the work.

### PLUMBING

The various kinds of pipe, pipe fittings, valves, and fixtures. All the common plumbing tools—types, sizes, functions, and how to use them. How to cut, ream, thread, and assemble iron and brass pipe. How to connect copper tubing and make lead joints. The technique of pipe fitting, and the proper sequence of steps in assembling a piping system. Household plumbing projects—installing a hot-water heater, radiator, and various other units. How to drain a plumbing system when closing the house for the winter. How to fix leaks in faucets and valves, repair a faulty section of pipe. The cleaning, and maintenance of each part of the plumbing system.

### MASONRY

Answers every practical question about concrete, plastering, stucco, brick work, concrete-block and glass-block construction. Describes all tools, and just how to use them. How to specify materials and estimate quantities. How to build forms; mix concrete, color it, make it watertight, finish it off; how to build walls, floors, steps. All the sure methods and special ways of working by which the master mason assures good results. Everything about plastering—from small repairs to doing entire rooms. Complete instructions for stuccoing—reinforcing, methods of applying different coats, and how to obtain various decorative finishes. Kinds of brick—handling and laying. Mixing and coloring mortar. Material charts. Types of construction. Various bonds. Forming cross joints. Fire-place construction. Working with concrete blocks—building the wall, corner construction. Kinds and sizes of glass blocks. Glass-block construction—mortar, full-mortar joints, set-in-wood construction.



### ELECTRICAL WORK

Practical information about every electrical job the home mechanic may undertake around the house or in the home workshop. Principles of electricity—volts, amperes, ohms. Generation of electricity. Electrical energy and power. Fuses and circuit breakers. Parallel and series circuits. Standard electrical symbols. Tools, materials, and requirements of National Electrical Code. Complete, fully illustrated explanations of every step in various operations of general electrical work—splicing, soldering, taping, testing, etc. Installation of various signalling systems—bells, buzzers, and alarms. Wiring methods for power and lighting circuits. Complete projects for the home, such as BX wiring a room, and wiring a garage in conduit and BX. Portable appliances—fans, mixers, clocks, heaters, radios. Fixed equipment—oil burners, refrigerators, lighting plants, pumps, motors, generators, and control devices; all clearly described, with practical suggestions and hints for trouble shooting and adjustment.

**Send No Money**

**Examine this Great Book FREE!**

The coupon at the right will bring you a copy of The Home Mechanic's Handbook for ten days' examination, entirely free. Look it over, spend some time with it, and decide for yourself whether or not you want to keep it. Unless you are convinced that The Home Mechanic's Handbook is the most useful book you have ever seen, you may return it to us and owe nothing; or you may keep it by making a down payment of \$1.95, plus a few cents postage, and the balance in two monthly payments of \$2.00 each, (\$5.95 plus postage). But send in the coupon NOW! The supply is definitely limited.

### MAIL THIS COUPON

D. Van Nostrand Company, Inc., 250 Fourth Avenue, New York 3, N. Y.

Please send me a copy of THE HOME MECHANIC'S HANDBOOK. Within 10 days I will either return the book, or send you \$1.95, plus a few cents postage, and \$2.00 a month for two months until the total price of \$5.95, plus postage, is paid. (If you send the entire amount of \$5.95 with this coupon, we will pay the postage. Same return privilege and refund guarantee if not completely satisfied.)

Name \_\_\_\_\_  
(Please print)  
Address \_\_\_\_\_  
City \_\_\_\_\_ State \_\_\_\_\_  
(Zone No., if you know it)  
Reference \_\_\_\_\_  
Address \_\_\_\_\_

Pop. Sc. April 1947

APRIL  
1947



# POPULAR SCIENCE

Mechanics & Handicraft MONTHLY  
REG. U. S. PAT. OFF.

**EDITOR:**  
Perry Githens

**MANAGING EDITORS:** Fred O. Newman, Volta Torrey

**ART EDITOR:** Howard C. Jensen

**HOME & WORKSHOP EDITOR:**  
Harry Walton

**ASSOCIATE EDITORS:** Devon Francis, Robert Gorman, Hartley E. Howe, Herbert Johansen, Martin Mann, Frank Rowsome, Jr., John F. Stearns, R. P. Stevenson

**WASHINGTON EDITOR:** Leon Shloss

**WESTERN EDITOR:** Andrew R. Boone (Los Angeles, Cal.)

**ART DIRECTORS:** Harry Samuels, Francis Sweeney

**ART ASSOCIATES:** Eric Karminski, Jr., Stewart Rouse, Frances Cooper (Production)

**STAFF PHOTOGRAPHERS:** W. W. Morris, Hubert Luckett, Robert F. Smith

**EDITORIAL ASSISTANTS:** Mae G. Dyer (Chief), Carol Ennis, Sheldon Gallager, Saverio Rada, Lillian Thalenfeld, Ruth Westphal

**PUBLISHER:**  
Godfrey Hammond

APRIL 1947

## SCIENCE NEWS

Navy Rebuilds V-2's Cradle.....	88
Steering by Electrons.....	90
Submarines for Atomic War.....	95
Whirling Atoms.....	105
Huge Bell Jar Aids Research.....	114
Ionosphere Makes Short-wave "Weather"....	142
Sun Bin Saves Fuel.....	149
Silver Shields Superpyrometer.....	151

## SCIENCE AT WORK

Picture of the Month.....	65
Pound of Poison Kills 200,000 Rats.....	91
Carrying the Ball for Science.....	108
It Magnifies Mistakes.....	114
Houses Pop Up When Cradle Rocks.....	115
Look Out for the Rocket Express!.....	118
Tractor Fits in Orchards.....	128
Corn Turned into Fuel.....	150

## PSM FEATURES

Pipe Solves Match Problem.....	90
Bulldozer Rides the Rails.....	101
How Men's Shoes Are Made.....	106
Miniature Assembly Line.....	112
Motorized Spray Gun.....	114
Plastic Murals Are Painted with Light.....	123
Combine That Pulls Itself.....	128
Three-hull Boat.....	129
Miniature Fort Guards Movie Budget.....	132
Models Help Make Industry Tick.....	134
Gear in a Goldfish Bowl.....	151
Your Own Water-power Plant (Part I).....	186
Radiant Energy Nips Jack Frost.....	216
Chemistry—Household Detective.....	220

## AVIATION

Flying Wing Goes Jet.....	89
One-man Air Control Panel.....	102
Crash Landing in a Pool.....	103
P-82 Sets Distance Record.....	104
Republic Seabee (Pin-up).....	113
Teletype Goes Aloft.....	114
5-Passenger Pusher.....	136
Three Cylinders, Six Pistons.....	141

## AUTOMOBILES

Cars Can Be Safer.....	82
Pancake Engine Has Slide Valves.....	154
Czech and French Dream Cars.....	156
Gus Tames a Bucking Flivver.....	160

## INVENTIONS

I'd Like to See Them Make.....	127
New Ideas from the Inventors.....	130

## PHOTOGRAPHY

Souped-up Darkroom Runs Itself.....	120
3rd Dimension Put into Photos.....	137
Slide Viewer Shaped from Tin.....	198
Shoot Less, Show More.....	199

## MECHANICS & SHOPCRAFT

Home-built Hydraulic Press.....	172
Fitting Doors and Windows.....	180

(CONTINUED ON PAGE 4)

Published monthly at 353 Fourth Avenue, New York 10, N. Y., by Popular Science Publishing Co., Inc. Godfrey Hammond, President and Treasurer; R. C. Wilson, Raymond J. Brown, Stephen P. Glennon, B. Ray Keefer, Vice-Presidents; F. W. Briggs, Secretary. Entered as second-class matter Dec. 28, 1918, at the Post Office at New York under the act of March 3, 1879; additional entry as second-class matter at Dayton, Ohio. Entered as second-class matter at the Post Office Department, Canada. Printed in U. S. A. Copyright, 1947, by Popular Science Publishing Co., Inc. All rights reserved in the United States, Great Britain, and in all countries participating in the International Copyright Convention and Pan-American Copyright Convention. Yearly subscriptions to United States: its possessions and Canada, \$2.50; foreign countries, \$3.50. Subscribers must notify us of change of address four weeks in advance of the next publication date. Be sure to give both old and new addresses, including zone numbers.



# OPPORTUNITY has a long arm

IT ISN'T even necessary to go half-way to meet Opportunity. It seeks out the man who has prepared himself for advancement.

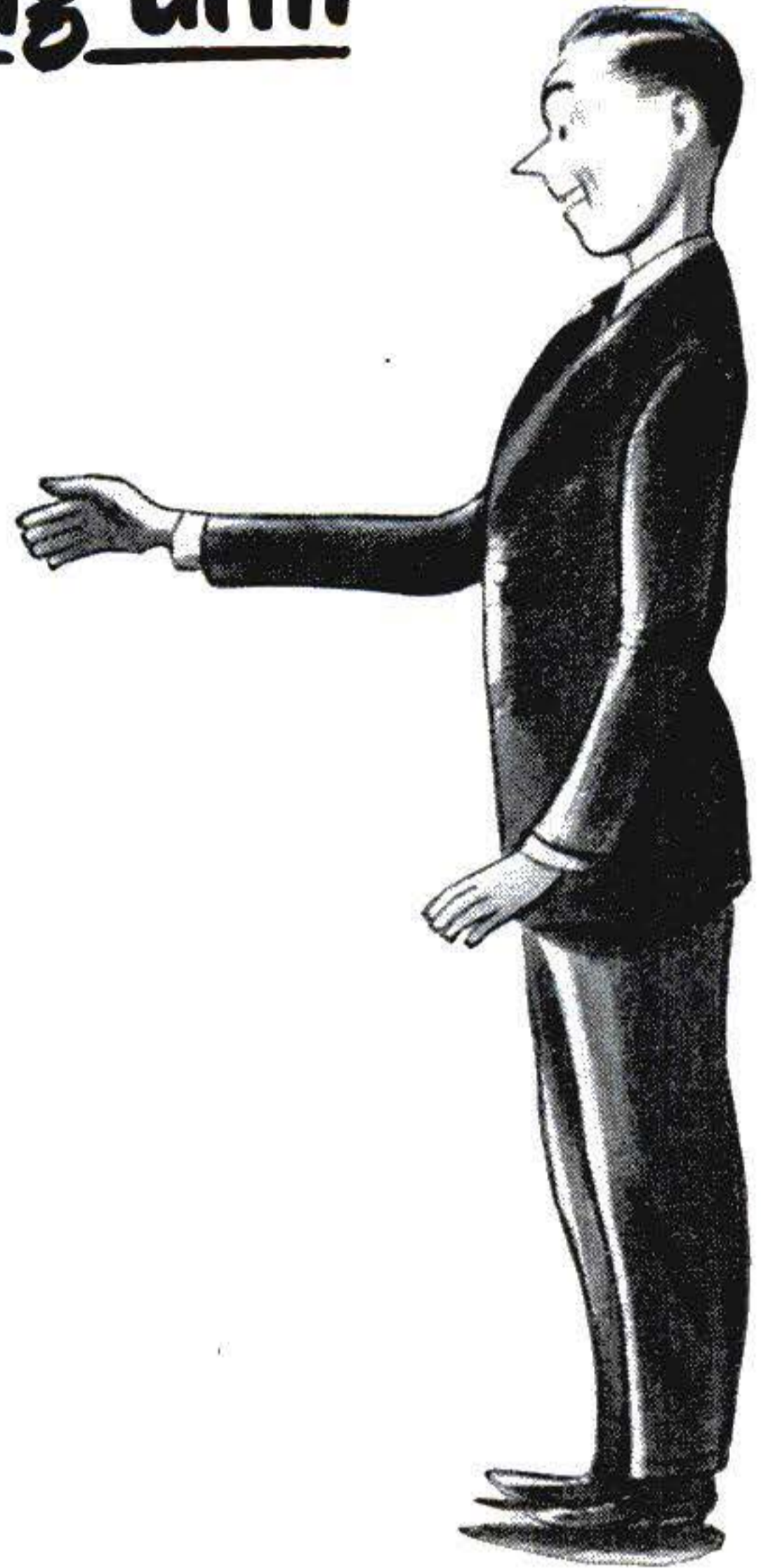
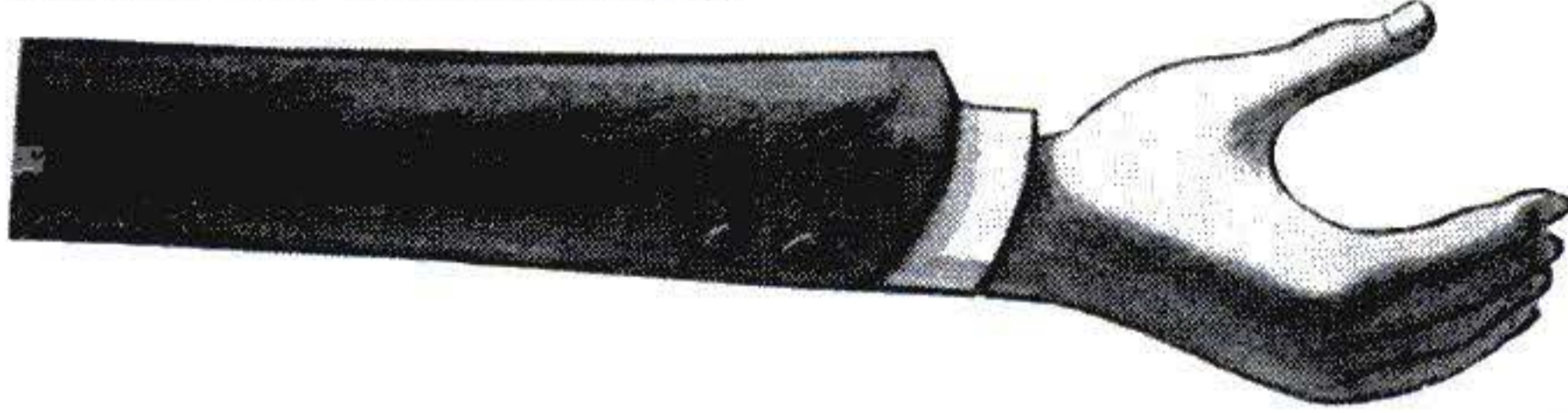

I.C.S. training is one of the effective forms of preparation. When you have mastered an I.C.S. Course, you're ready and able to take on larger responsibilities in your chosen field.

In a single period of four months, I.C.S. has received as many as 1,920 student letters reporting advancement in salary and position. Graduates include the presidents, board chairmen, chief technicians of some of the largest industrial, transportation, publishing and other enterprises in the nation.

You can get ready for Opportunity as they did. Mark and mail the coupon today and be prepared for tomorrow's rewarding openings.

## INTERNATIONAL CORRESPONDENCE SCHOOLS



BOX 7680-L. SCRANTON 9, PENNA.

Without cost or obligation, please send me full particulars about the course *before* which I have marked X:

- |   |   |  |  |
|---|---|--|--|
| <p><b>Air Conditioning and Plumbing Courses</b></p> <input type="checkbox"/> Air Conditioning<br><input type="checkbox"/> Heating <input type="checkbox"/> Plumbing<br><input type="checkbox"/> Refrigeration <input type="checkbox"/> Steam Fitting <p><b>Chemistry Courses</b></p> <input type="checkbox"/> Chemical Engineering<br><input type="checkbox"/> Chemistry, Analytical<br><input type="checkbox"/> Chemistry, Industrial<br><input type="checkbox"/> Chemistry, Mfg. Iron & Steel<br><input type="checkbox"/> Petroleum Refining <input type="checkbox"/> Plastics<br><input type="checkbox"/> Pulp and Paper Making <p><b>Civil Engineering, Architectural and Mining Courses</b></p> <input type="checkbox"/> Architectural Drafting<br><input type="checkbox"/> Architecture<br><input type="checkbox"/> Bridge and Building Foreman<br><input type="checkbox"/> Building Estimating<br><input type="checkbox"/> Civil Engineering<br><input type="checkbox"/> Coal Mining<br><input type="checkbox"/> Contracting and Building<br><input type="checkbox"/> Highway Engineering<br><input type="checkbox"/> Lumber Dealer<br><input type="checkbox"/> Reading Structural Blueprints<br><input type="checkbox"/> Sanitary Engineering<br><input type="checkbox"/> Structural Drafting | <p><input type="checkbox"/> Structural Engineering<br/> <input type="checkbox"/> Surveying and Mapping</p> <p><b>Communications Courses</b></p> <input type="checkbox"/> Electronics<br><input type="checkbox"/> Practical Telephony<br><input type="checkbox"/> Radio, General<br><input type="checkbox"/> Radio Operating<br><input type="checkbox"/> Radio Servicing<br><input type="checkbox"/> Telegraph Engineering <p><b>Electrical Courses</b></p> <input type="checkbox"/> Electrical Drafting<br><input type="checkbox"/> Electrical Engineering<br><input type="checkbox"/> Electric Light and Power<br><input type="checkbox"/> Lighting Technician<br><input type="checkbox"/> Practical Electrician <p><b>Internal Combustion Engines Courses</b></p> <input type="checkbox"/> Auto Technician <input type="checkbox"/> Aviation<br><input type="checkbox"/> Diesel-Electric<br><input type="checkbox"/> Diesel Engines <input type="checkbox"/> Gas Engines <p><b>Mechanical Courses</b></p> <input type="checkbox"/> Aeronautical Engineering<br><input type="checkbox"/> Aircraft Drafting<br><input type="checkbox"/> Flight Engineer<br><input type="checkbox"/> Foundry Work<br><input type="checkbox"/> Heat Treatment of Metals | <p><input type="checkbox"/> Industrial Engineering<br/> <input type="checkbox"/> Industrial Metallurgy<br/> <input type="checkbox"/> Machine Shop<br/> <input type="checkbox"/> Mechanical Drafting<br/> <input type="checkbox"/> Mechanical Engineering<br/> <input type="checkbox"/> Mold-Loft Work<br/> <input type="checkbox"/> Patternmaking—Wood, Metal<br/> <input type="checkbox"/> Reading Shop Blueprints<br/> <input type="checkbox"/> Sheet-Metal Drafting<br/> <input type="checkbox"/> Sheet-Metal Worker<br/> <input type="checkbox"/> Ship Drafting <input type="checkbox"/> Ship Fitting<br/> <input type="checkbox"/> Tool Designing<br/> <input type="checkbox"/> Toolmaking<br/> <input type="checkbox"/> Welding—Gas and Electric</p> <p><b>Railroad Courses</b></p> <input type="checkbox"/> Air Brake <input type="checkbox"/> Car Inspector<br><input type="checkbox"/> Diesel Locomotive<br><input type="checkbox"/> Locomotive Engineer<br><input type="checkbox"/> Locomotive Fireman<br><input type="checkbox"/> Railroad Section Foreman <p><b>Steam Engineering Courses</b></p> <input type="checkbox"/> Boilermaking<br><input type="checkbox"/> Combustion Engineering<br><input type="checkbox"/> Engine Running<br><input type="checkbox"/> Marine Engineering<br><input type="checkbox"/> Steam Electric <input type="checkbox"/> Steam Engines | <p><b>Textile Courses</b></p> <input type="checkbox"/> Cotton Manufacturing<br><input type="checkbox"/> Rayon Weaving<br><input type="checkbox"/> Textile Designing<br><input type="checkbox"/> Woolen Manufacturing <p><b>Business and Academic Courses</b></p> <input type="checkbox"/> Accounting <input type="checkbox"/> Advertising<br><input type="checkbox"/> Arithmetic <input type="checkbox"/> Bookkeeping<br><input type="checkbox"/> Business Correspondence<br><input type="checkbox"/> Business Management<br><input type="checkbox"/> Certified Public Accounting<br><input type="checkbox"/> Commercial<br><input type="checkbox"/> Cost Accounting<br><input type="checkbox"/> Federal Tax<br><input type="checkbox"/> First Year College<br><input type="checkbox"/> Foremanship <input type="checkbox"/> French<br><input type="checkbox"/> Good English <input type="checkbox"/> High School<br><input type="checkbox"/> Higher Mathematics<br><input type="checkbox"/> Illustrating <input type="checkbox"/> Motor Traffic<br><input type="checkbox"/> Postal Service<br><input type="checkbox"/> Salesmanship <input type="checkbox"/> Secretarial<br><input type="checkbox"/> Sign Lettering<br><input type="checkbox"/> Spanish <input type="checkbox"/> Stenography<br><input type="checkbox"/> Traffic Management |
|---|---|--|--|

Name \_\_\_\_\_ Age \_\_\_\_\_ Home Address \_\_\_\_\_

City \_\_\_\_\_ State \_\_\_\_\_ Present Position \_\_\_\_\_

Working Hours \_\_\_\_\_ A.M. to \_\_\_\_\_ P.M. Length of Service in World War II \_\_\_\_\_

Special tuition rates to members of the Armed Forces. Enrollment under the G.I. Bill of Rights approved for War II Veterans.  
 Canadian residents send coupon to International Correspondence Schools Canadian, Ltd., Montreal, Canada.



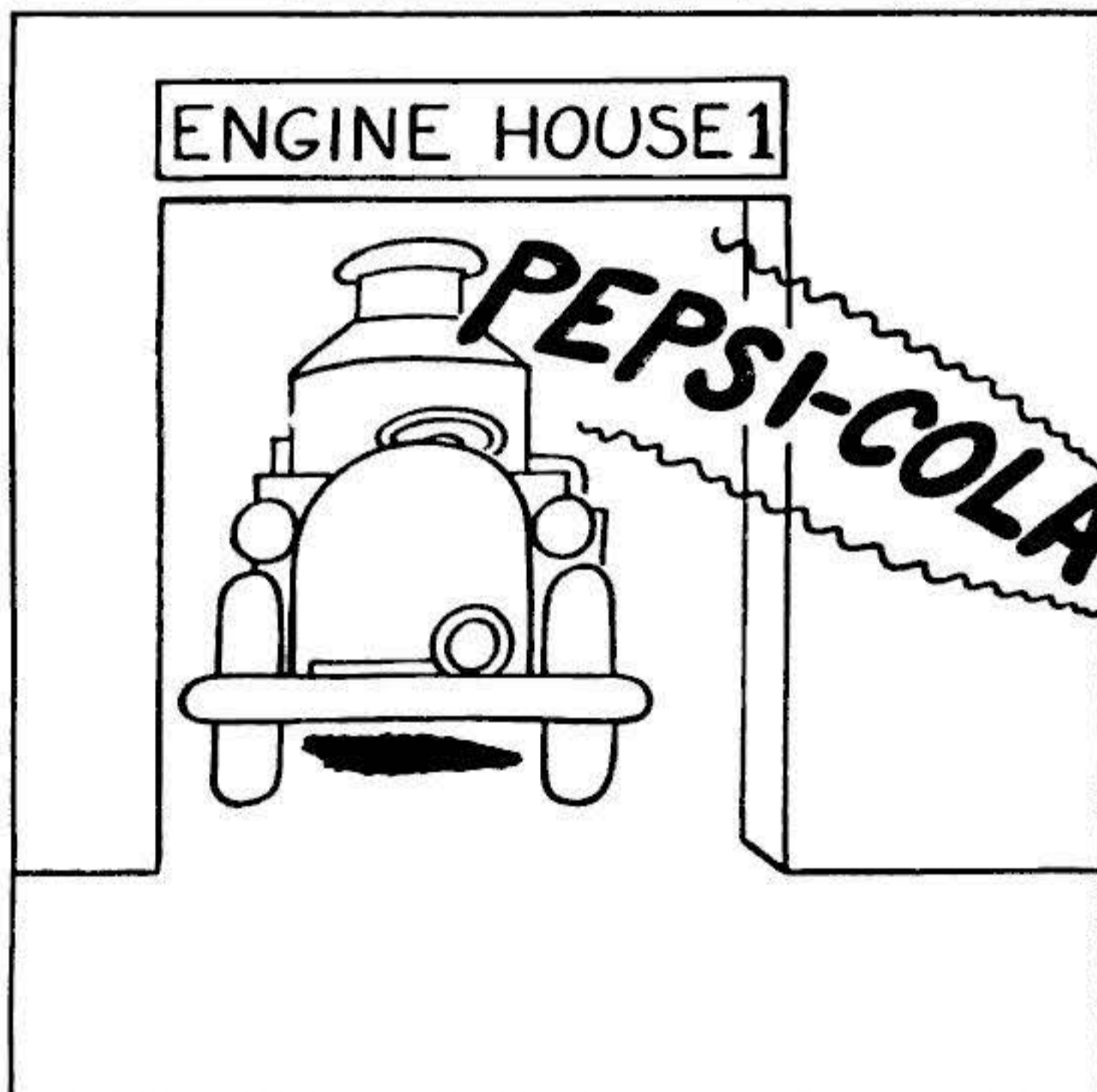
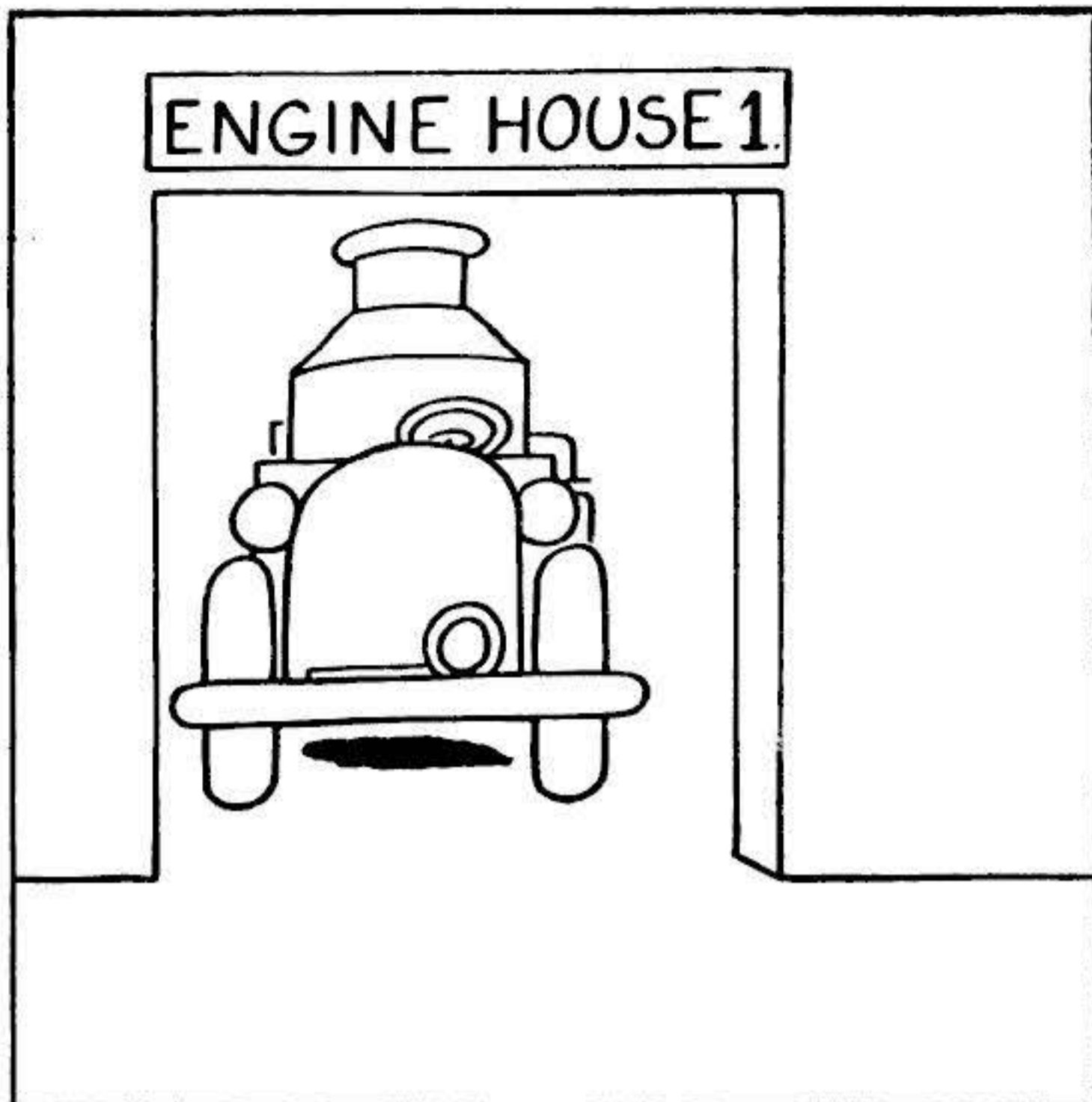

O. SOGLOW

Bending Brake for Metal.....	185
Wedge Screwdriver.....	185
Miniature Socket Wrenches.....	196
Self-heating Solder.....	197
Powder Starts Welding Arc.....	197
Jig for Forming Hinge Gains.....	210
Cotter-pin Tweezers.....	211
Motorized Gluing Machine.....	217

## HOME MECHANICS & HANDICRAFT

Safety Ladder Step.....	152
Electrostatic Air Cleanser.....	153
Four Aluminum-tubing Projects.....	164
Illuminated Corner Cabinet.....	168
Cargo Boom Lamp.....	170
Three-masted Schooner.....	172
Colonial Knickknack Shelf.....	173
Plastic Hat and Coat Rack.....	173
Boxes in a Hurry.....	174
Outdoor Rumpus Room.....	177
Vertical Steam Engine.....	190
Special Drill Holders.....	194
Magnifying-lens Holder.....	198
Lens Mounted in Conduit.....	198
Template for Stamp Sheets.....	211
Mounting Your Prize Fish.....	214
Taking the Sag Out of a Garage Wall.....	217
Garden Stairs.....	218

## RADIO & ELECTRICITY

Recording Rockets' Flight.....	105
Tubes Replace Pipes.....	122
Electronics Gives That Beat.....	122
Storing Sounds on Spools.....	144
Two-band Superhet.....	204
Dry-disk Rectifier.....	208
News in Electronics.....	209

## DEPARTMENTS

Voice of Science.....	7
What's New in Aviation.....	102
Aids to Modern Living.....	152
Auto Ideas.....	159
New Tools.....	167
Craftsmen at Work.....	172
Keeping the Home Shipshape.....	178
What's Your Ingenuity Quotient?.....	184
New Shop Ideas.....	194
Photo Ideas and Equipment.....	202
What's Wrong?.....	210
Home Experiments.....	212
For Easier Farming.....	224



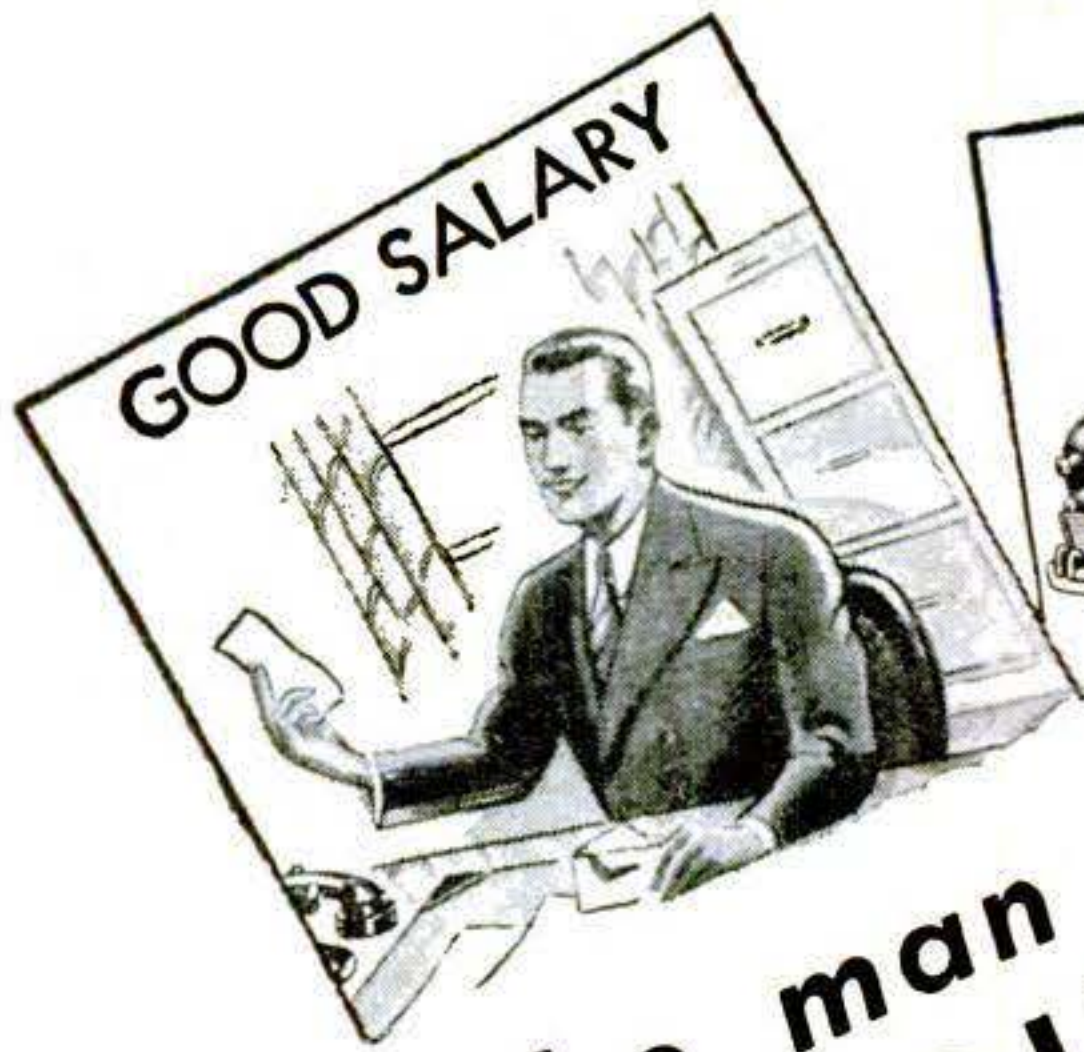

To the man who wants to enjoy  
**an ACCOUNTANT'S**



to enjoy  
**CAREER**



**IF** you're that man, here's something that will interest you.

Not a magic formula—not a get-rich-quick scheme—but something more substantial, more practical.

Of course, you need something more than just the desire to be an accountant. You've got to pay the price—be willing to study earnestly, thoroughly.

Still, wouldn't it be worth your while to sacrifice some of your leisure in favor of interesting home study—over a comparatively brief period in your life? Always provided that the rewards were good—a salary of \$3,000 to \$10,000?

An accountant's duties are interesting, varied and of real worth to his employers. He has *standing!*

Do you feel that such things aren't for you? Well, don't be too sure. Very possibly they *can* be!

Why not, like so many before you, investigate LaSalle's modern Problem Method of training for an accountancy position?

Just suppose you were permitted to work in a large accounting house under the personal supervision of an expert accountant. Suppose, with his aid, you studied accounting principles and solved problems day by day—easy ones at first—then the more difficult ones. If you could do this—and if you could turn to him for advice as the problems became complex—soon you'd master them all.

That's the training you follow in principle under the LaSalle Problem Method.

You cover accountancy from the basic Principles right up through Accountancy Systems and Income Tax Procedure. Then you add C. P. A. Training and prepare for the C. P. A. examinations.

As you go along, you absorb the principles of Auditing, Cost Accounting, Business Law, Statistical Control, Organization, Management and Finance.

Your progress is as speedy as you care to make it—depending on your own eagerness to learn and the time you spend in study.

Will recognition come? The only answer, as you know, is that success *does* come to the man who is really *trained*. It's possible your employers will notice your improvement in a very few weeks or months. Indeed, many LaSalle graduates have paid for their training—with increased earnings—before they have completed it! For accountants, who are trained in organization and management, are the executives of the future.

### Write For This Free Book

For your own good, don't put off investigation of *all* the facts. Write for our free 48-page book, "Accountancy, The Profession That Pays." It'll prove that accountancy offers brilliant futures to those who aren't afraid of serious home study. Send us the coupon *now*.

Over 2300 Certified  
Public Accountants among  
LaSalle alumni

**G. I. APPROVED**

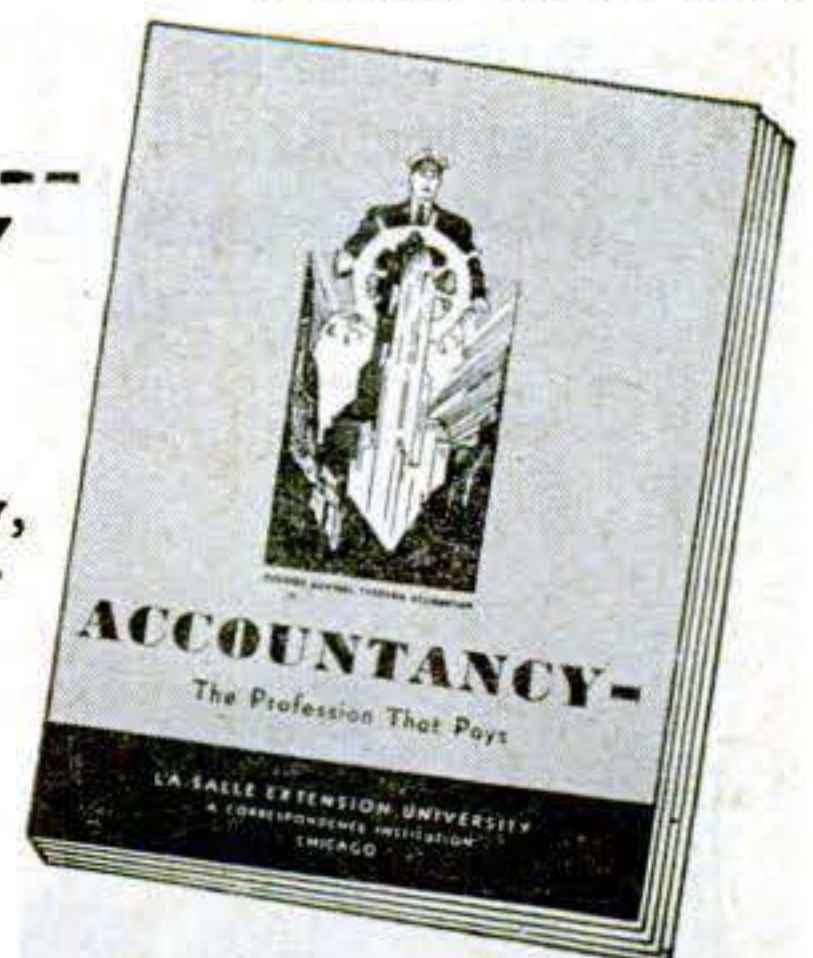

## LASALLE EXTENSION UNIVERSITY

A CORRESPONDENCE INSTITUTION

417 South Dearborn Street, Dept. 483-H Chicago 5, Illinois

I want to be an accountant. Send me, without cost or obligation, the 48-page book, "Accountancy, The Profession That Pays," and full information about your accountancy training program.

Name.....

Address..... City.....

Position..... Age.....

APRIL 5  
1947



You're really  
 "Solid"—when you've got  
 P.A.\*



J. Reynolds Tobacco Co.  
 Winston-Salem, N. C.

**P.A.\* means Pipe Appeal**

Pipe Appeal is that "something extra" that has a real appeal to women. It's the distinctly masculine look of men who smoke pipes!

**P.A. means Prince Albert**



CRIMP CUT P.A. IS  
 GREAT FOR 'MAKIN'S'  
 CIGARETTES. ROLLS  
 EASY—PACKS JUST RIGHT

—that rich-tasting tobacco that's mild and mellow—easy on the tongue. P.A. is specially treated to insure against tongue bite—to give you real smoking joy and comfort. More pipes smoke Prince Albert than any other tobacco. Try it—and see why!



**The National Joy Smoke**





## Why Not a Secretary of Science?

**T**HE Lilienthal Affair underlines the low place of science in the government structure. And it raises the question whether science, which has become politics, should not have political representation "on the Cabinet level."

Might not a Cabinet which includes Secretaries of Agriculture and Commerce, pull up a chair for a Secretary of Science?

The greatest force in the modern machinery of living is now scattered through a dozen departments, bureaus, agencies and White House anterooms. Army and Navy, quite properly from their point of view, control big chunks of cash for research. Agriculture has its Research Administration, its Bureaus of Agricultural and Industrial Chemistry, Animal Industry, Entomology, Human Nutrition, Plant Industry and Soils.

The Commerce Department has the Bureau of Standards, the Civil Aeronautics Administration, the Weather Bureau, the Patent Office, and the Office of Technical Serv-

ices, which publishes a science magazine.

The food and drug laws are administered under the Federal Security Agency. So is the Public Health Service, which is charged with the study of the diseases of mankind as well as enforcement duties. There are pockets of research in Interior's Bureau of Reclamation and Bureau of Mines.

Biggest and most vital, the Atomic Energy Commission itself hooks into the government through the White House family entrance. So does the National Advisory Committee for Aeronautics, which handles aviation research including the supersonic.

If a Secretary of Science did nothing but co-ordinate existing projects, he would have made a valuable contribution. But his office should stand for more than that. It should be concerned with the whole of science and the whole of the people, and their mutual advancement and protection.

*Perry Githeas*

APRIL  
1947 7



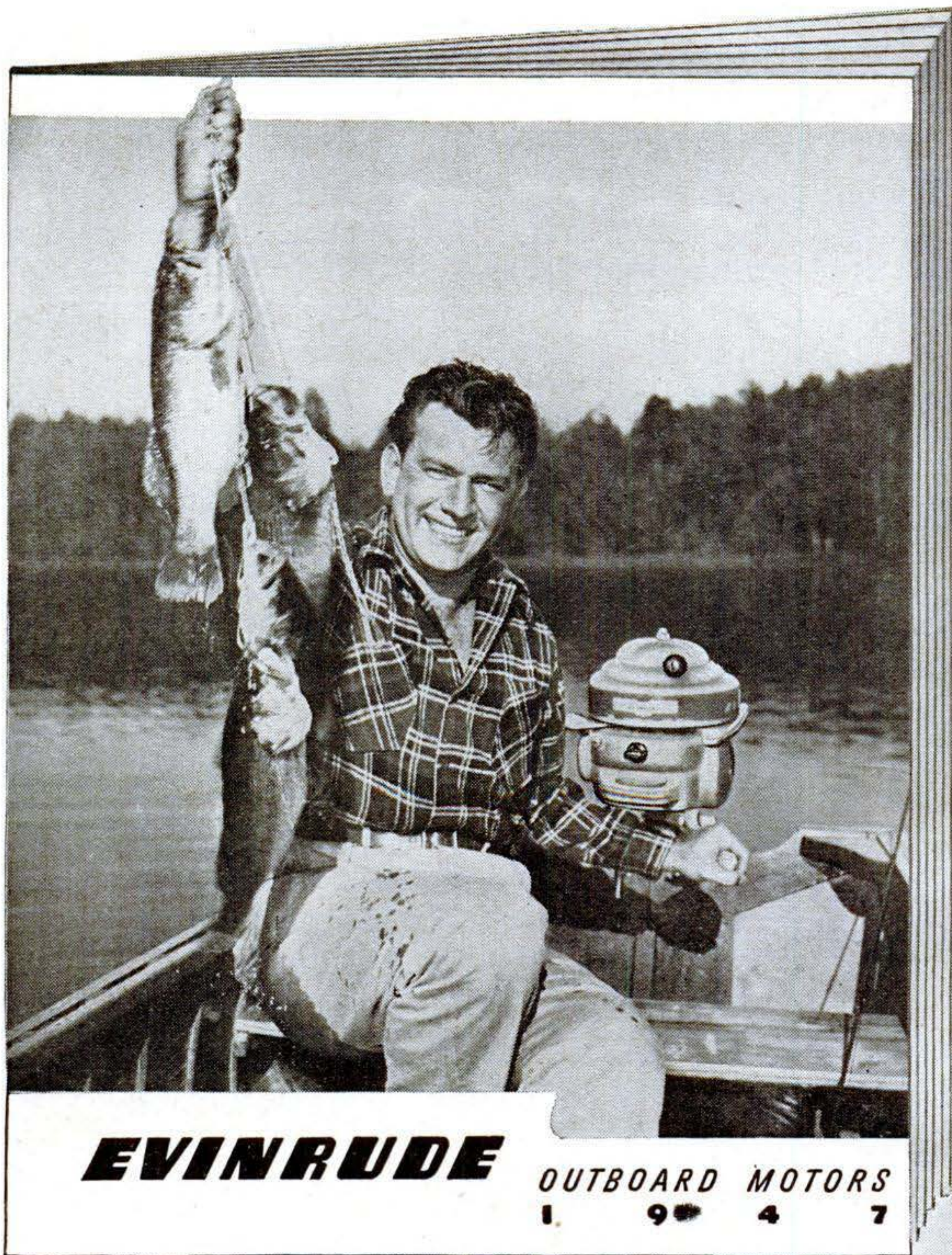

**EVINRUDE**

OUTBOARD MOTORS  
1 9 4 7

- ✓ **COMPLETE LINE**  
7 proved models — the right motor for every boat
- ✓ **THREE THRILLING "FOURS"**  
The last word in fine outboard performance
- ✓ **REVOLUTIONARY WEEDLESS DRIVE**  
A boon to fishermen!
- ✓ **FULL REVERSE**  
— on two favorite fishing models
- ✓ **FAMED STARTING EASE**  
— a "built-in" feature of every model
- ✓ **SIMPLEX STARTERS**  
Standard on 5 models
- ✓ **FLEXIBLE MOTOR MOUNTINGS**  
— for added smoothness
- ✓ **CO-PILOT STEERING**  
For greater handling ease — on every model
- ✓ **CENTRIFUGAL PUMP COOLING**  
Trouble proof for the life of the motor
- ✓ **38 YEARS OF "KNOW HOW"**  
— and how that counts in performance, value, satisfaction!

*"It's full of facts you'll want to know before you buy an outboard motor!"*

Another fishing season coming up fast...plan now to make it the finest ever with the finest outboard ever! Send today for the new Evinrude catalog of 7 great motors for '47...the complete line that offers the right motor for every boat...the right motor for every kind of fishing service...with revolutionary Weedless Drive on two favorite fishing models...and thrilling four-cylinder models for those who want the last word in fishing motors!

Write for the catalog, or visit your Evinrude dealer —

look for his name in your classified phone directory under "Outboard Motors".

EVINRUDE MOTORS, 5485 N. 27th Street, Milwaukee 9, Wisconsin • In Canada: Evinrude Motors, Peterboro, Ontario.



POPULAR SCIENCE



# HOW'S YOUR POST-WAR PROGRESS?

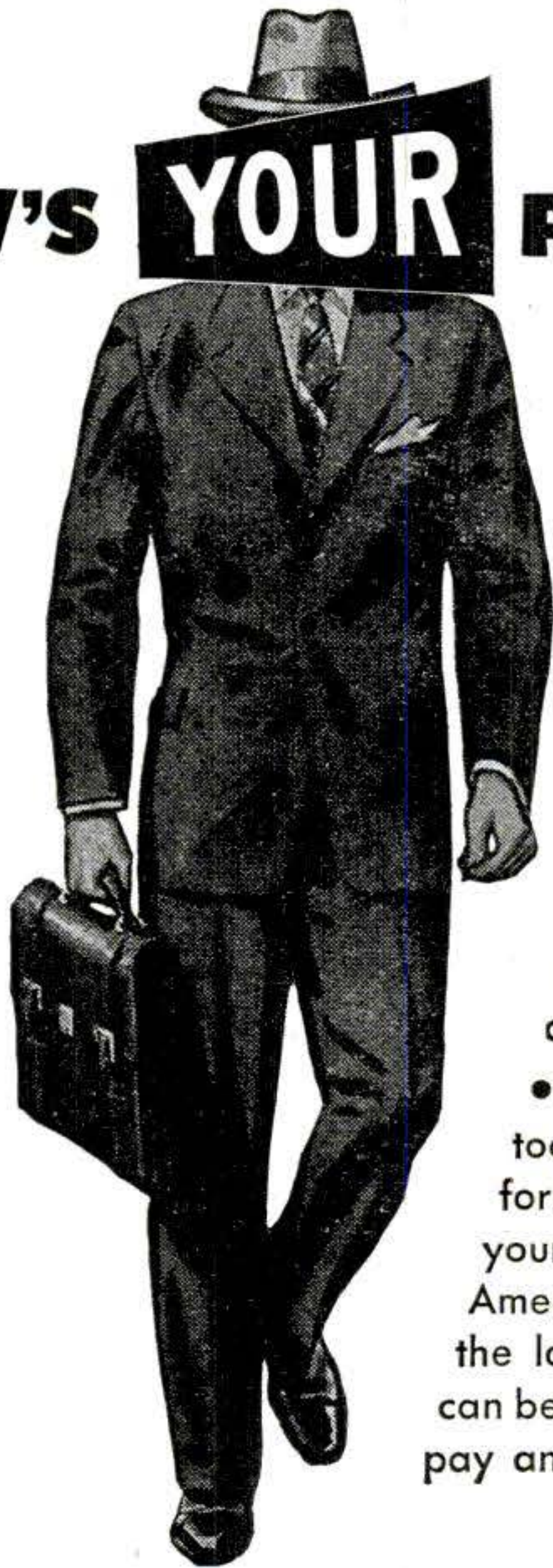

- Remember when you were going to prepare for the period of post-war opportunities? *This is it!* New industries are coming into being, established industries are expanding . . . and there are rewarding openings for *trained* men in all lines.
- If you failed to get ready for them, it isn't too late to do something about it! You don't have to slip back . . . you don't have to content yourself with merely hanging to the same old job. The famous International Correspondence Schools can help you to catch up with the procession.
- But don't delay again . . . or it may be too late. Mail the coupon today for full information on I. C. S. training in the field of your interests. Thousands of leaders in American business and industry started up the ladder of success in just that way. It can be the beginning of your climb to higher pay and a more responsible position.

## INTERNATIONAL CORRESPONDENCE SCHOOLS



BOX 7681-L, SCRANTON 9, PENNA.

Without cost or obligation, please send me full particulars about the course *before* which I have marked X:

- |   |   |   |  |
|---|---|---|--|
| <p><b>Air Conditioning and Plumbing Courses</b></p> <input type="checkbox"/> Air Conditioning<br><input type="checkbox"/> Heating <input type="checkbox"/> Plumbing<br><input type="checkbox"/> Refrigeration <input type="checkbox"/> Steam Fitting <p><b>Chemistry Courses</b></p> <input type="checkbox"/> Chemical Engineering<br><input type="checkbox"/> Chemistry, Analytical<br><input type="checkbox"/> Chemistry, Industrial<br><input type="checkbox"/> Chemistry, Mfg. Iron & Steel<br><input type="checkbox"/> Petroleum Refining <input type="checkbox"/> Plastics<br><input type="checkbox"/> Pulp and Paper Making <p><b>Civil Engineering, Architectural and Mining Courses</b></p> <input type="checkbox"/> Architectural Drafting<br><input type="checkbox"/> Architecture<br><input type="checkbox"/> Bridge and Building Foreman<br><input type="checkbox"/> Building Estimating<br><input type="checkbox"/> Civil Engineering<br><input type="checkbox"/> Coal Mining<br><input type="checkbox"/> Contracting and Building<br><input type="checkbox"/> Highway Engineering<br><input type="checkbox"/> Lumber Dealer<br><input type="checkbox"/> Reading Structural Blueprints<br><input type="checkbox"/> Sanitary Engineering<br><input type="checkbox"/> Structural Drafting | <p><input type="checkbox"/> Structural Engineering<br/> <input type="checkbox"/> Surveying and Mapping</p> <p><b>Communications Courses</b></p> <input type="checkbox"/> Electronics<br><input type="checkbox"/> Practical Telephony<br><input type="checkbox"/> Radio, General<br><input type="checkbox"/> Radio Operating<br><input type="checkbox"/> Radio Servicing<br><input type="checkbox"/> Telegraph Engineering <p><b>Electrical Courses</b></p> <input type="checkbox"/> Electrical Drafting<br><input type="checkbox"/> Electrical Engineering<br><input type="checkbox"/> Electric Light and Power<br><input type="checkbox"/> Lighting Technician<br><input type="checkbox"/> Practical Electrician <p><b>Internal Combustion Engines Courses</b></p> <input type="checkbox"/> Auto Technician <input type="checkbox"/> Aviation<br><input type="checkbox"/> Diesel-Electric<br><input type="checkbox"/> Diesel Engines <input type="checkbox"/> Gas Engines <p><b>Mechanical Courses</b></p> <input type="checkbox"/> Aeronautical Engineering<br><input type="checkbox"/> Aircraft Drafting<br><input type="checkbox"/> Flight Engineer<br><input type="checkbox"/> Foundry Work<br><input type="checkbox"/> Heat Treatment of Metals | <p><input type="checkbox"/> Industrial Engineering<br/> <input type="checkbox"/> Industrial Metallurgy<br/> <input type="checkbox"/> Machine Shop<br/> <input type="checkbox"/> Mechanical Drafting<br/> <input type="checkbox"/> Mechanical Engineering<br/> <input type="checkbox"/> Mold-Loft Work<br/> <input type="checkbox"/> Patternmaking—Wood, Metal<br/> <input type="checkbox"/> Reading Shop Blueprints<br/> <input type="checkbox"/> Sheet-Metal Drafting<br/> <input type="checkbox"/> Sheet-Metal Worker<br/> <input type="checkbox"/> Ship Drafting    <input type="checkbox"/> Ship Fitting<br/> <input type="checkbox"/> Tool Designing<br/> <input type="checkbox"/> Toolmaking<br/> <input type="checkbox"/> Welding—Gas and Electric</p> <p><b>Railroad Courses</b></p> <input type="checkbox"/> Air Brake <input type="checkbox"/> Car Inspector<br><input type="checkbox"/> Diesel Locomotive<br><input type="checkbox"/> Locomotive Engineer<br><input type="checkbox"/> Locomotive Fireman<br><input type="checkbox"/> Railroad Section Foreman <p><b>Steam Engineering Courses</b></p> <input type="checkbox"/> Boilermaking<br><input type="checkbox"/> Combustion Engineering<br><input type="checkbox"/> Engine Running<br><input type="checkbox"/> Marine Engineering<br><input type="checkbox"/> Steam Electric <input type="checkbox"/> Steam Engines | <p><b>Textile Courses</b></p> <input type="checkbox"/> Cotton Manufacturing<br><input type="checkbox"/> Rayon Weaving<br><input type="checkbox"/> Textile Designing<br><input type="checkbox"/> Woolen Manufacturing <p><b>Business and Academic Courses</b></p> <input type="checkbox"/> Accounting <input type="checkbox"/> Advertising<br><input type="checkbox"/> Arithmetic <input type="checkbox"/> Bookkeeping<br><input type="checkbox"/> Business Correspondence<br><input type="checkbox"/> Business Management<br><input type="checkbox"/> Certified Public Accounting<br><input type="checkbox"/> Commercial<br><input type="checkbox"/> Cost Accounting<br><input type="checkbox"/> Federal Tax<br><input type="checkbox"/> First Year College<br><input type="checkbox"/> Foremanship <input type="checkbox"/> French<br><input type="checkbox"/> Good English <input type="checkbox"/> High School<br><input type="checkbox"/> Higher Mathematics<br><input type="checkbox"/> Illustrating <input type="checkbox"/> Motor Traffic<br><input type="checkbox"/> Postal Service<br><input type="checkbox"/> Salesmanship <input type="checkbox"/> Secretarial<br><input type="checkbox"/> Sign Lettering<br><input type="checkbox"/> Spanish <input type="checkbox"/> Stenography<br><input type="checkbox"/> Traffic Management |
|---|---|---|--|

Name \_\_\_\_\_ Age \_\_\_\_\_ Home Address \_\_\_\_\_

City \_\_\_\_\_ State \_\_\_\_\_ Present Position \_\_\_\_\_

Working Hours \_\_\_\_\_ A.M. to \_\_\_\_\_ P.M. Length of Service in World War II \_\_\_\_\_

Special tuition rates to members of the Armed Forces. Enrollment under the G.I. Bill of Rights approved for War II Veterans.  
 Canadian residents send coupon to International Correspondence Schools Canadian, Ltd., Montreal, Canada.



# In your Mind's Eye

## The Secret of MENTAL CREATING

IF you just like to dream, read no further. There comes a time when your fancies *must be* brought into light—and stand the test of every-day, hard realities. Are you one of the thousands—perhaps millions—whose thoughts never get beyond the stage of *wistful wishing*? Do you often come to from a daydream with the sigh, "If only I could bring it about—*make it real*?"

All things begin with thought—it is what follows that may take your life out of the class of those who hope and dream. Thought energy, like anything else, can be dissipated—or it can be made to produce actual effects. *If you know how to place your thoughts* you can stimulate the creative processes within your mind—through them you can assemble things and conditions of your world into a happy life of accomplishment. *Mental creating* does not depend upon a magical process. It consists of *knowing how* to marshal your thoughts into a power that draws, compels and organizes your experiences into a worth-while design of living.

### ACCEPT THIS *Free* BOOK

Let the Rosicrucians tell you how you may accomplish these things. The Rosicrucians (not a religious organization), a world-wide philosophical fraternity, have preserved for centuries the ancients' masterful knowledge of the functioning of the inner mind of man. They have taught men and women how to use this knowledge to *recreate their lives*. They offer you a free copy of the fascinating book, "The Mastery of Life." It tells how you may receive this information for study and use. Use coupon opposite.

*The* ROSICRUCIANS  
(AMORC)

SAN JOSE

CALIFORNIA

SCRIBE: O. T. S.  
The Rosicrucians (AMORC),  
San Jose, California.

Please send free copy of "The Mastery of Life,"  
and I shall read it as directed.

Name.....

Address.....

City.....





**KIT 1** (left) I send you Soldering Equipment and Radio Parts: show you how to do Radio Soldering; how to mount and connect Radio parts; give you practical experience.



**KIT 2** (left) Early in my course I show you how to build this N.R.I. Tester with parts I send. It soon helps you fix neighborhood Radios and earn EXTRA money in spare time.

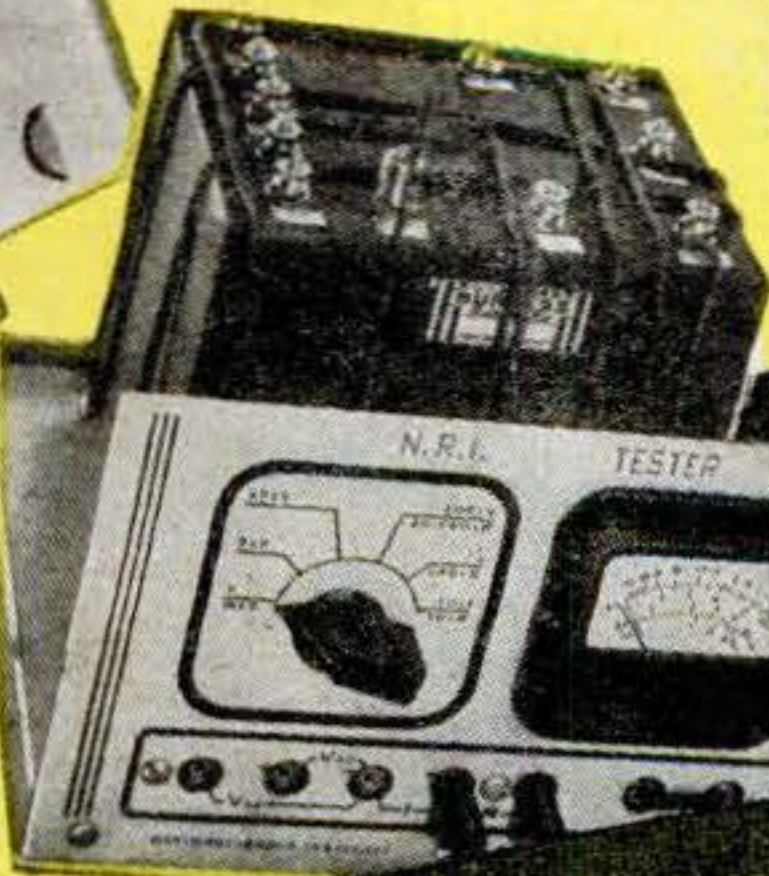

## VETERANS

You can get this training in your own home under G.I. Bill. Mail coupon for full details.

# I will Train You for Success in RADIO with my Big Kits of Radio Parts

## BE A RADIO TECHNICIAN Learn at Home in Spare Time

**KIT 3** You get parts to build Radio Circuits; then test them; see how they work; learn how to design special circuits; how to locate and repair circuit defects.

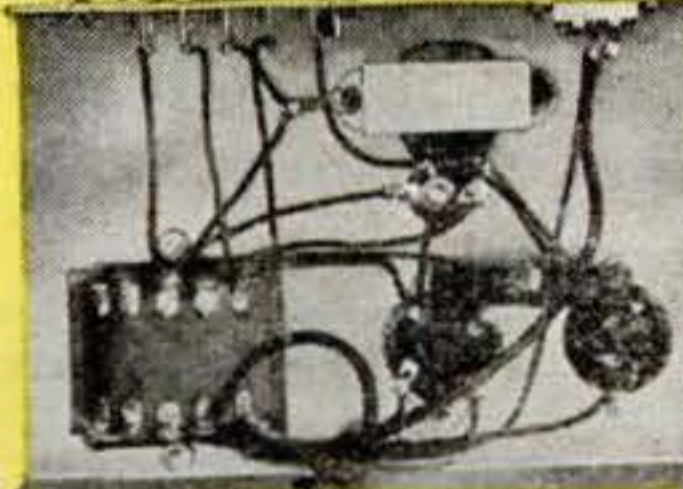
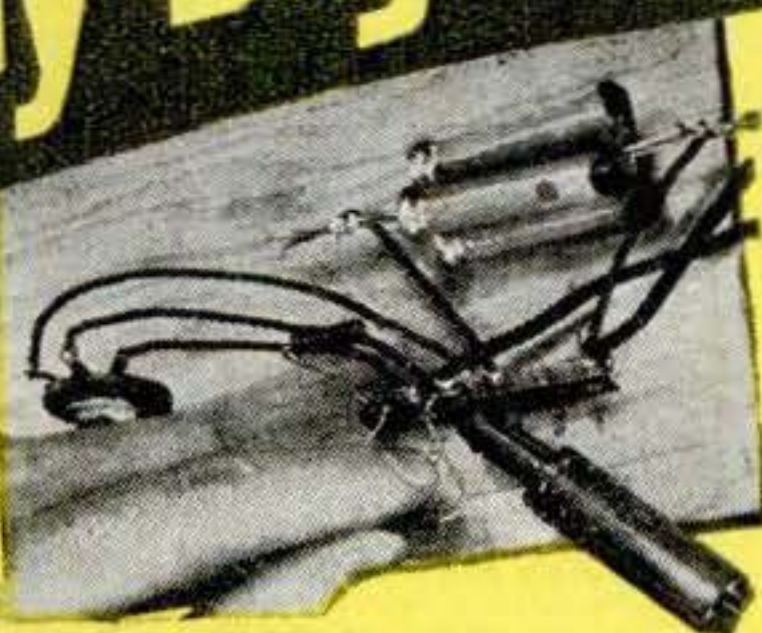

**KIT 4** You get parts to build this Vacuum Tube Power Pack; make changes which give you experience with packs of many kinds; learn to correct power pack troubles.

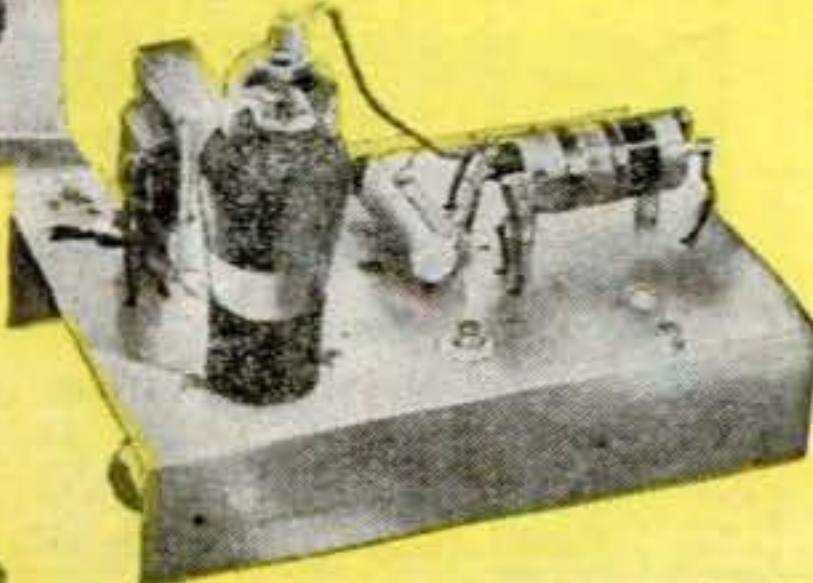

**KIT 5** Building this A. M. Signal Generator gives you more valuable experience. It provides amplitude-modulated signals for many tests and experiments.



**KIT 6** You build this Superheterodyne Receiver which brings in local and distant stations—and gives you more experience to help you win success in Radio.

My Course Includes Training in  
**TELEVISION • ELECTRONICS**  
FREQUENCY MODULATION

Do you want a good-pay job in the fast-growing Radio Industry—or your own Radio Shop? Mail the Coupon for a Sample Lesson and my 64-page book, "How to Be a Success in RADIO—Television, Electronics," both FREE. See how I will train you at home—how you get practical Radio experience building, testing Radio circuits with BIG KITS OF PARTS I send!

**Many Beginners Soon Make Extra Money in Spare Time While Learning**  
The day you enroll I start sending EXTRA MONEY JOB SHEETS that show you how to make EXTRA money fixing neighbors' Radios in spare time while still learning! It's probably easier to get started now than ever before, because the Radio Repair Business is booming. Trained Radio Technicians also find profitable opportunities in Police, Aviation, Marine Radio, Broadcasting, Radio Manufacturing, Public Address work. Think of even greater opportunities as Television, FM, and Electronic devices become available to the public! Send for FREE books now!

**Find Out What NRI Can Do For You**  
Mail Coupon for Sample Lesson and my FREE 64-page book. Read the details about my Course; letters from men I trained; see how quickly, easily you can get started. No obligation! Just MAIL COUPON NOW in envelope or paste on penny postal.  
J. E. SMITH, President, Dept. 7DP3, National Radio Institute, Pioneer Home Study Radio School  
Washington 9, D. C.



Sample Lesson **FREE**  
64 Page Book

Mr. J. E. SMITH, President,  
Dept. 7DP3, National Radio Institute  
Washington 9, D. C.

Mail me FREE, Sample Lesson and 64-page book, (No salesman will call. Please write plainly.)

Age.....

Name.....

Address.....

City..... State.....  
(Please include Post Office Zone number)

Approved for Training under GI Bill





1847 A CENTURY OF PUBLISHING MERRIAM-WEBSTERS 1947

# The Handy-Sized Merriam-Webster

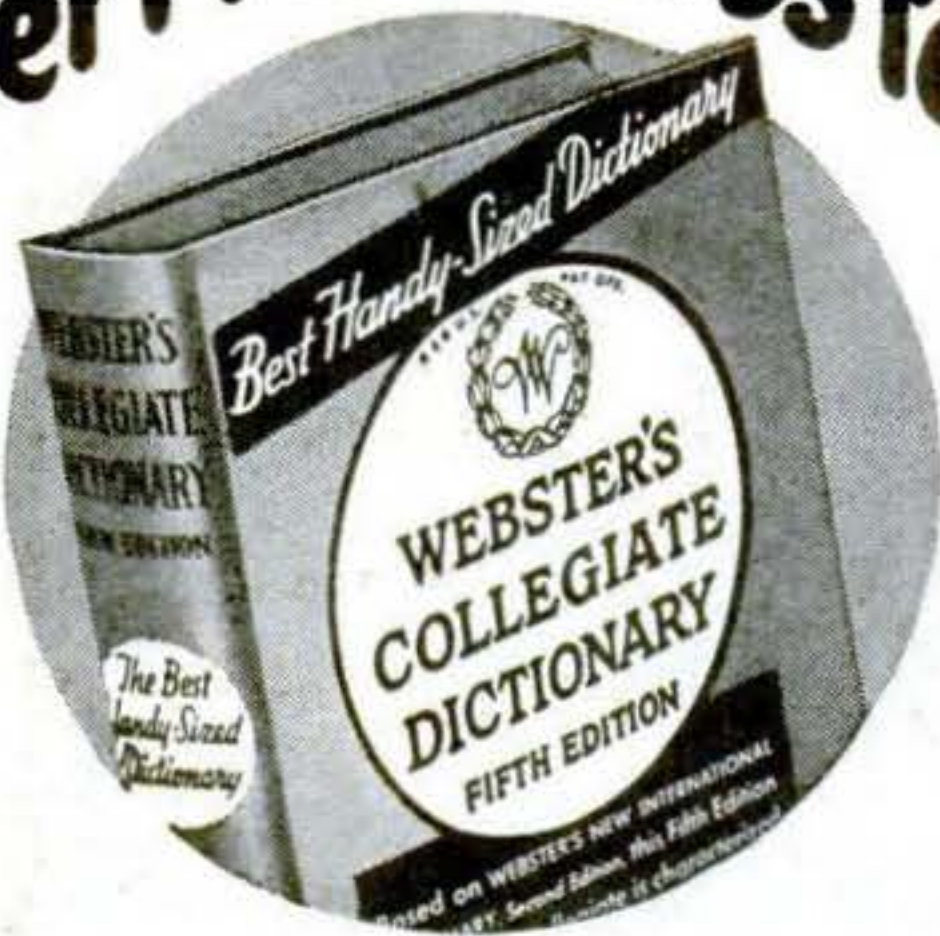

**WEBSTER'S COLLEGIATE** is the most dependable handy dictionary for home and office because it is a compact abridgment of the famous *Webster's New International Dictionary, Second Edition*—“The Supreme Authority.” Defines all the words most commonly used. 1,300 pages; 110,000 entries. \$5 to \$10, depending on binding. Ask your bookdealer.

G. & C. MERRIAM CO., SPRINGFIELD 2, MASS.

## Make Your Own RUBBER MOLDS

*Amazing New Method!....*

Now, an amazing new method to make your own flexible rubber molds to recast sculptured models or subjects. Duplicate singly or in quantity, expensive original subjects at amazing low cost. Reproduce statuettes, plaques or any other models—any surface—with this new liquid rubber material. Hundreds of other uses.

**PROFITABLE HOBBY!**

Start this fascinating hobby that can lead to beginning of your own business. For only a few cents each, make hundreds of castings to resell at big profit prices. Easy to start. Big list of subjects you can reproduce.

**SEND NO MONEY!**

Just your name and address for **BIG INTRODUCTORY KIT** containing 14 different items: everything you need to work with including famous Indian model. Pay postman only \$1.49 plus C.O.D. postage. Money back if not satisfied. Or save C.O.D. by sending \$1.49 with order and we pay postage. Write for **FREE CATALOGUE!**

RUBBER-FOR-MOLDS • 6044 N. Avondale Avenue, Dept. 48-D7 • Chicago 31, Ill.

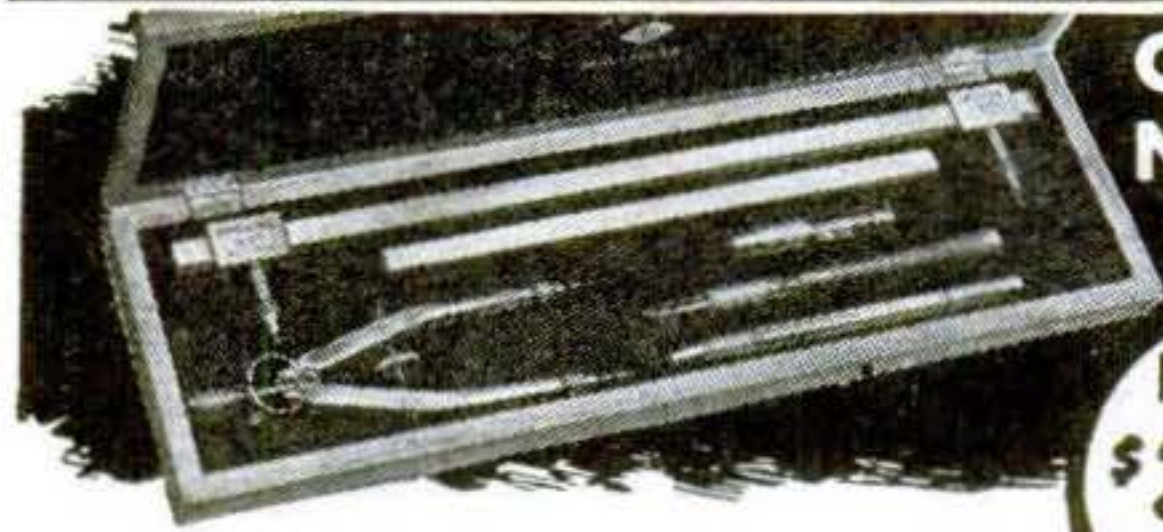

## Own a set with EXCLUSIVE FEATURES—NEW Bruning High Quality Drafting Set!

PRICE \$20<sup>60</sup> NO C. O. D.

**Nowhere Else Can You Get ALL THESE ADVANTAGES!**

**New Type Ruling Pen**—patented calibrated collet adjusts nib opening—easy to reset to maintain uniform width of lines. Mahogany club style handle.

**New Beam Compass**—rapid, simple and positive adjustment. Compass draws circles either in pencil or ink up to 24 inches in diameter.

**New 6-Inch Giant Bow Compass**—for drawing circles either in ink or pencil from 1-16 to 8 inches in diameter. Patented lead propelling device advances lead without soiling fingers.

**New Draftsman's Refillable Pencil**—can be converted to double point, merely by removing screw cap and replacing it with extra tip and chuck furnished.

**Plastic Tube** containing extra leads, needle points, pen part, pencil tip and chuck, completes the set.

The great **SUCCESS** Instruction for men and women now in business . . . or planning to get into **PRODUCTIVE** earnings . . . The **PROFITABLE, EASY, SURE** method . . . Get it **NOW**

# How to Make Money by Mail

Enlarged to 640 pages, 15th edition

Down-to-earth facts, directions (illustrated) for running business profitably, using expertly for **YOUR** good fortune the employees, trains, planes which Gov't places at your disposal **CHEAP**. Get orders by mail, ship by express or freight or mail, get out of the kindergarten . . . 15th edition, enlarged to 640 pages, now selling. It's **YOUR** winner. Make this year and the following years worth more. . . . **THIS** knowledge really **PAYS OFF**.

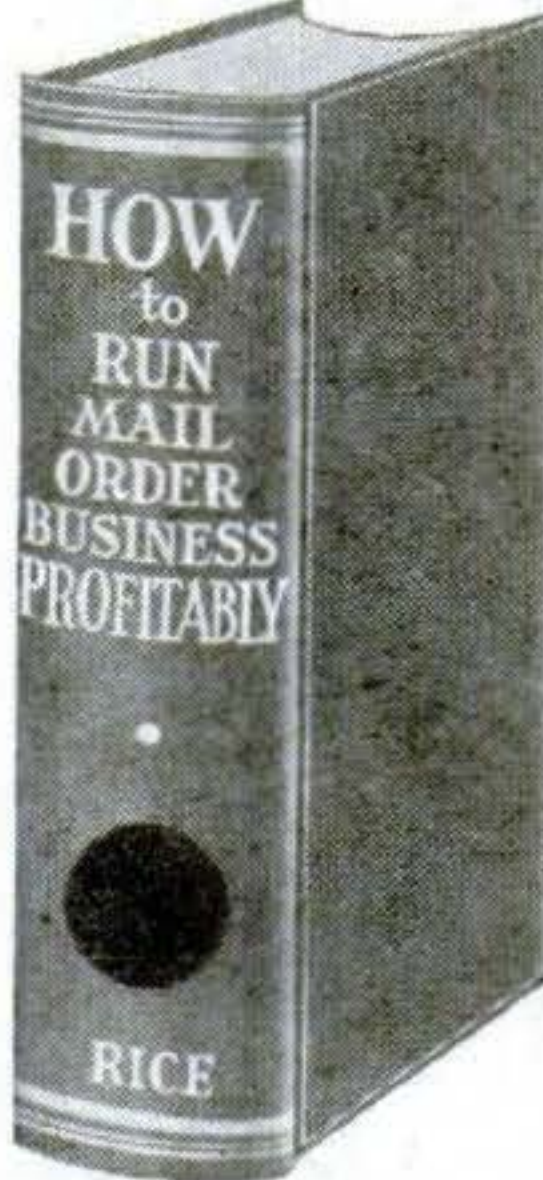

**THE EASY WAY** to start new or expand your present occupation. Do it **NOW**.

Extraordinary plain, simple skill, know-how. **No theory.** Fact story of rich experience of author E. Rice day-by-day. How many times have we heard: "I wish I had some money, this patent would earn me a fortune," or "why can't my crop pay better?" or "I wish I knew how to sell this gadget myself," or "why should my boss alone do this when I too know how the money is made? . . . Listen, You do not need money to start this Rice way. His method automatically pays all bills same day rendered, no bank loans, pay as you go, no borrowing from relatives or friends, no salesmen. Also no worry, quickly a home of your own all paid for. Rice paid off \$5000 in mortgages a year after using this skillful idea.

**46 Years of PROOF**

Sounds fishy? Sure but this has been done steadily for **46 years**, depression or no depression, by the author; that is why he wrote this book, to pass the good word along. Make it go with anything you have which is salable, or with what you are now doing. Rice made his pay plan go from the start when living in one room in a city lodging house. Turn your city or country home, your work, your hobby, into money. How to get orders coming steadily at cost of only \$4 for

each \$100 taken in. The popular error to avoid in trying for sales. Business won free while others have to pay for it. How to conceive the money-getting advertisement . . . Profitable changes from ordinary ideas and methods. Not usual cut-and-dried pattern. 250 adventures, a dictated book in everyday talk by Rice doing day by day what he discloses in his book can be done by his method. No dictionary writing. . . . Read how others are profiting big. Take a chance on this book being worth a fortune to you and yours and send \$2.95. Book mailed same day order is received. Hundreds of buyers whose letters we show you declare emphatically its superlative goodness. Follow its easy pattern for success. Cloth bound. 640 pages, 8 1/2 by 5 1/2. Best seller. 15th edition now selling. Cut out the \$2.95 **HOW BOX** here, pin or stick it to sheet of paper bearing your name and address, mail in envelope with money order or check for \$2.95 to

**HOW** Enlarged 640 pages \$2<sup>95</sup>

**HOWARD ST. HOUSE, Melrose 76E, Massachusetts**

## ARTISTS MAKE MONEY

Do you like to draw? Send name, address, age and occupation for **FREE ART TEST**, to find out your ability.

**ART INSTRUCTION, INC.**

4147 Art Instruction Bldg., Minneapolis 15, Minn.

**GLOWS in the DARK**

**AMAZING LUMINOUS PIGMENT**

**MIXES WITH ANYTHING . . .** Paint, water, plastic, powder, polish, etc. Kit consists of three generous portions of Green, Blue and Orange luminous powders. Postpaid only \$1.00 with directions.

**THE LUMINOUS PRODUCTS COMPANY, 1978 STERLING STREET, PHILADELPHIA 38, PA.**

Nowhere else can you get these patented exclusive features that help make your work easier—neater—more accurate! Set contains four essential, high precision instruments made of satin finish aluminum and chrome-plated steel in flock-lined natural finish mahogany case. Every instrument backed by the famous name Bruning! Get your set now—mail the coupon!

Charles Bruning Co., Inc.

4710-16 Montrose Avenue, Chicago 41, Illinois

Please send me (show number desired).....Bruning Industrial Drafting Set(s). I enclose \$.....

Name.....

Address.....

City..... State.....



# The 97 Pound Weakling

—Who became "The World's Most Perfectly Developed Man"

**"I'll Prove that YOU, too, can be a NEW MAN!"**

—Charles Atlas

I KNOW, myself, what it means to have the kind of body that people pity! Of course, you wouldn't know it to look at me now, but I was once a skinny weakling who weighed only 97 lbs! I was ashamed to strip for sports or undress for a swim. I was such a poor specimen of physical development that I was constantly self-conscious and embarrassed. And I felt only HALF-ALIVE.

Then I discovered "Dynamic Tension." It gave me a body that won for me the title "World's Most Perfectly Developed Man."

When I say I can make you over into a man of giant power and energy, I know what I'm talking about. I've seen my new system, "Dynamic Tension," transform hundreds of weak, puny men into Atlas Champions.

## Only 15 Minutes a Day

Do you want big, broad shoulders—a fine, powerful chest—biceps like steel—arms and legs rippling with muscular strength—a stomach ridged with bands of sinewy muscle—and a build you can be proud of? Then just give me the opportunity to prove that "Dynamic Tension" is what you need.

No "ifs," "ands," or "maybes." Just tell me where you want handsome, powerful muscles. Are you fat and flabby? Or skinny and gawky? Are you short-winded, pepless? Do you hold back and let others walk off with the prettiest girls, best jobs, etc.? Then write for details about "Dynamic Tension" and learn how I can make you a healthy, confident, powerful HE-MAN.

"Dynamic Tension" is an entirely NATURAL method. Only 15 minutes of your spare time daily is enough to show amazing results—and it's actually fun! "Dynamic Tension" does the work.

## Send for FREE BOOK

Mail the coupon right now for full details and I'll send you my illustrated book, "Everlasting Health and Strength." Tells all about my "Dynamic Tension" method. Shows actual photos of men I've made into Atlas Champions. It's a valuable book! And it's FREE. Send for your copy today. Mail the coupon to me personally. CHARLES ATLAS, Dept. 14, 115 East 23rd St., New York 10, N. Y.

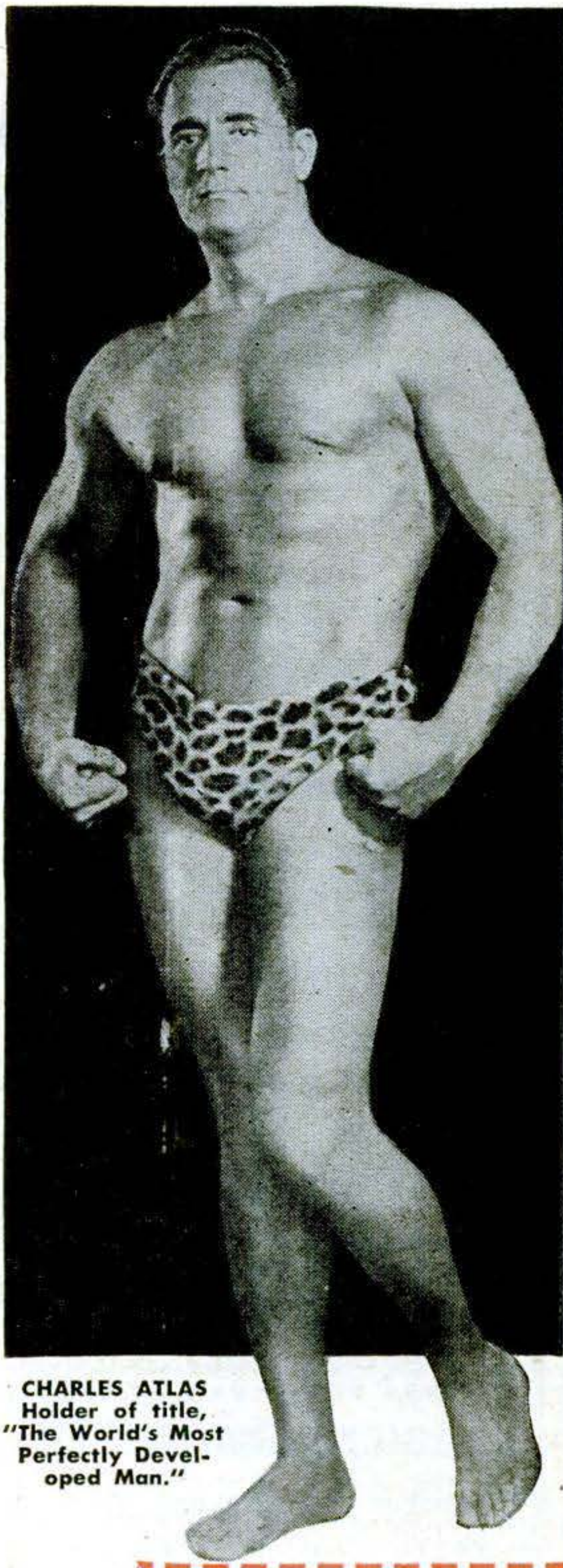

CHARLES ATLAS  
Holder of title,  
"The World's Most  
Perfectly Developed  
Man."

### CHARLES ATLAS,

Dept. 14,  
115 East 23rd Street,  
New York 10, N. Y.

I want the proof that your system of "Dynamic Tension" will help make a New Man of me—give me a healthy, husky body and big muscular development. Send me your free book, "Everlasting Health and Strength."

Name..... Age.....  
(Please print or write plainly.)

Address.....

City..... State.....



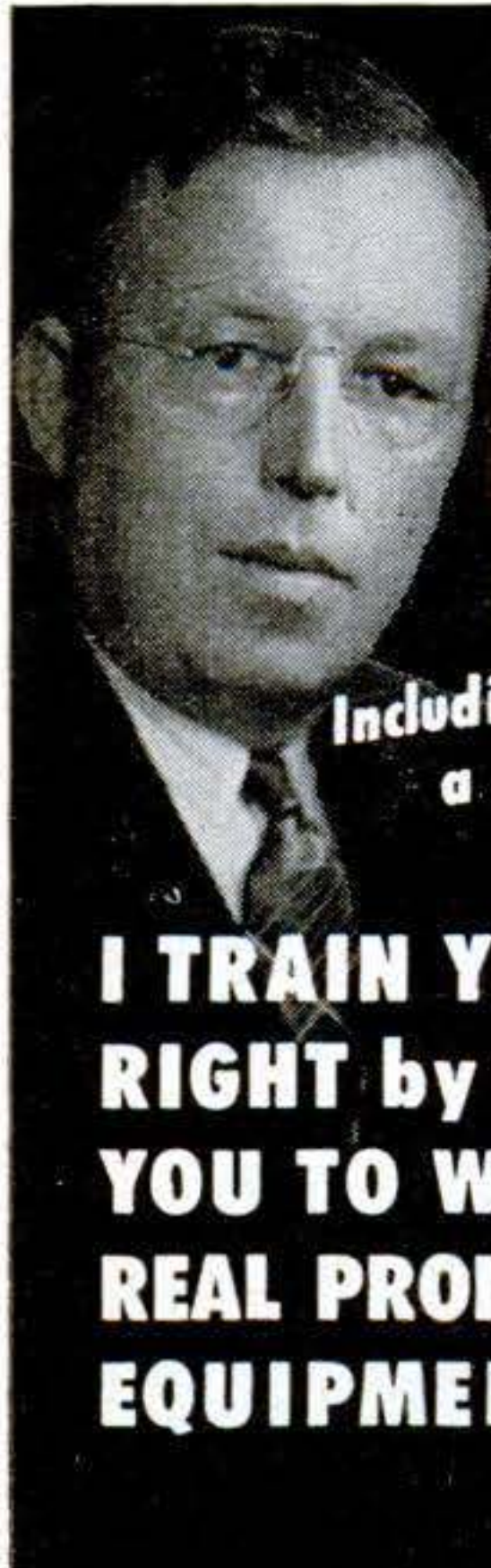

# NOW! An Amazing Opportunity to LEARN RADIO AT HOME

I SEND YOU 8 BIG KITS OF RADIO PARTS

Including a **COMPLETE 6 TUBE SUPER-HETERODYNE RECEIVER**

**I TRAIN YOU RIGHT by PUTTING YOU TO WORK with REAL PROFESSIONAL EQUIPMENT!**

**LEARN HOW TO BUILD CIRCUITS! TEST! REPAIR!**  
YOU DO OVER 175 INSTRUCTIVE EXPERIMENTS

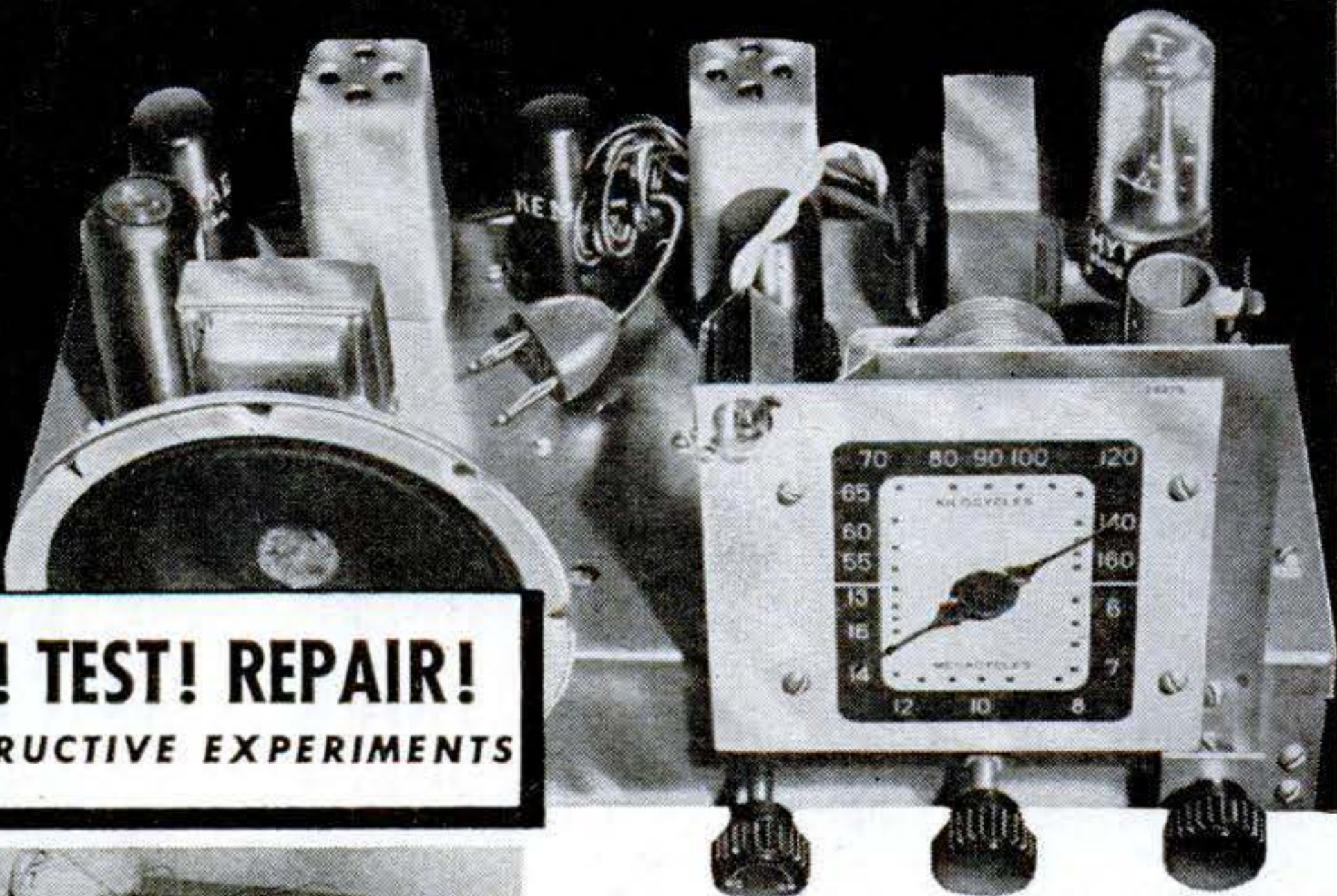

**YOU BUILD THIS USEFUL TEST EQUIPMENT!**

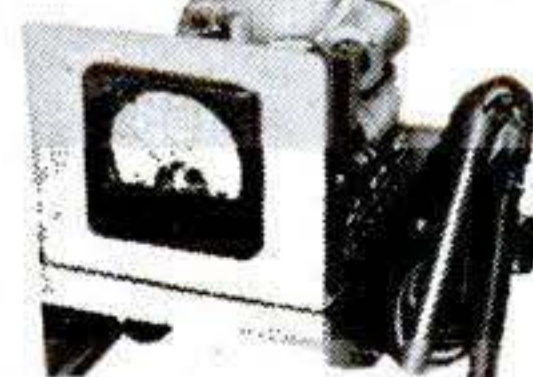

I give you a fine, moving-coil type Meter Instrument on Jewel Bearings — with parts for a complete Analyzer Circuit Continuity Tester. You learn how to check and correct Receiver defects with professional accuracy and speed.

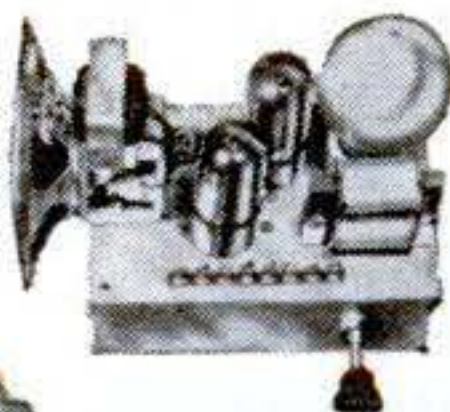

You'll get valuable experience and practice building this Signal Generator and multi-purpose Tester. Makes a breeze out of fixing Radios and you don't have to spend money on outside, ready-made equipment.

Soldering, wiring, connecting Radio parts . . . building circuits — you can't beat this method of learning. When you construct this Rectifier and Filter, Resistor and Condenser Tester, etc. you get a really practical slant on Radio.

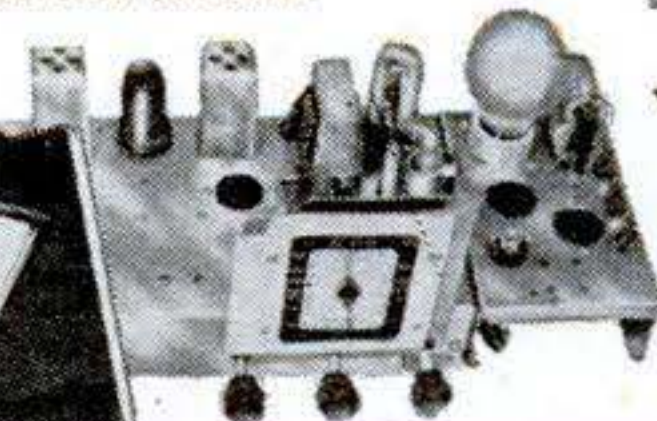

**HERE'S THE EASIEST, MOST PRACTICAL WAY OF ALL TO PREPARE FOR GOOD PAY in RADIO ELECTRONICS and TELEVISION!**

I train your mind by putting you to work with your hands on a big 6-Tube Superheterodyne Receiver. And, believe me, when you get busy with real Radio Parts — 8 big Kits of them — you really LEARN Radio and learn it RIGHT! You get the practical stuff you need to be useful in Radio, and that's what it takes to make money. You don't have to worry about what to do with these 8 Kits of Parts. Step by step, I show you how to build circuits, test, experiment, trouble-shoot. And you don't need any previous experience. The Sprayberry Course starts right at the beginning of Radio! You can't get lost! Simplified lessons, coupled with real "Shop" practice, makes every subject plain and easy to understand and remember. Soon after you begin Sprayberry Training, I'll send you my sensational BUSINESS BUILDERS.

**A BUSINESS OF YOUR OWN . . . OR A GOOD RADIO JOB**  
You'll find out how to get and do neighborhood Radio repair jobs for nice profits and rich experience while learning. This sort of work can easily pave the way for a Radio Service business of your own. But with Sprayberry Training, you're not limited. You can swing into any one of the swiftly expanding branches of Radio-Electronics INCLUDING Radio, Television, FM, Radar, Industrial Electronics. Be wise! Decide now to become a fully qualified RADIO - ELECTRONICIAN. Get full details about my Training at once! Mail coupon below for my 2 big FREE Books.



**GET THESE VALUABLE FREE BOOKS**

*"How to Read Radio Diagrams and Symbols"*

Here's a valuable and wonderfully complete new book which explains in simple English how to read and understand any Radio Set Diagram. Includes translation of all Radio symbols. Send for this volume at once. It's free! Along with it, I will send you another Big Free book describing in detail my Radio-Electronic Training.

**RUSH COUPON!**

**SPRAYBERRY ACADEMY OF RADIO**  
F. L. Sprayberry, President, Room 5547, Pueblo, Colorado  
Please rush my FREE copies of "How to MAKE MONEY in RADIO, ELECTRONICS and TELEVISION," and "HOW to READ RADIO DIAGRAMS and SYMBOLS."

Name ..... Age .....

Address .....

City ..... State .....

(Mail in envelope or paste on penny postcard)



# INVENTORS

The patent laws provide that any new and useful art, machine, article of manufacture, composition of matter, or design, or any new and useful improvement thereof, may be patented if the act of invention is involved. Therefore, every inventor with a valuable invention should take advantage of the patent laws and proceed for patent protection in order to safeguard his rights.

A patent gives the inventor the exclusive right to prevent others from making, using, or selling the invention claimed in the patent for a period of 17 years.

The patent laws were enacted for the benefit of the inventor to give him protection for the features of his invention which are patentable. These features must be properly and concisely set forth and claimed in a formal application for patent in order to comply with the requirements of the U. S. Patent Office. For that reason, the Patent Office advises the inventor to engage a competent registered patent attorney to prepare his application for patent and represent him before the U. S. Patent Office Examiner.

A specially prepared booklet containing detailed information with respect to patent protection and procedure will be forwarded to you without obligation upon request.

**Patents**  
**Trademarks**  
**Copyrights**

**Registered Patent Attorneys**

**CLARENCE A. O'BRIEN**  
**& HARVEY B. JACOBSON**

72-D District National Building + Washington 5, D. C.

CLARENCE A. O'BRIEN & HARVEY B. JACOBSON  
Registered Patent Attorneys  
72-D District National Bldg., Washington 5, D. C.

Please send me booklet containing information regarding patent protection and procedure, and also "Record of Invention" form. This request does not obligate me.

Name \_\_\_\_\_

Address \_\_\_\_\_

City \_\_\_\_\_ State \_\_\_\_\_

(Please write or print plainly.)



# ADD economy, ADD starting ease, ADD miles, ADD PYROIL



When you drive up for gasoline or oil, learn the easy, good-driving habit of saying "add Pyroil." For Pyroil is an "under-the-hood" miracle worker. It prevents sludge and gum formation. It gives oil the property of clinging to cylinder walls even though you have parked it for the night. This is protection from corrosion. This is easy lubricated starting without scoring cylinder walls. This is longer car life—and less repair grief. It's easy—it's economical to say "add Pyroil."

## Pyroil for Aircraft Engines

Use Aircraft Pyroil B for lubricating oil, Aircraft Pyroil A for gasoline.

Manufactured and Guaranteed by Pyroil Company, 212 Main Street, La Crosse, Wisconsin.

### PYROIL COMPANY

212 Main Street, La Crosse, Wisconsin

I want my car to last and run properly. Please tell me more about Pyroil and how it can accomplish this for me.

Name.....

Address.....

City or Town..... State.....



*Jerry, the talking dog, is entertaining hospitalized veterans, by courtesy of the PYROIL Company. Picture of Jerry, sent on request.*

## WAR SURPLUS METERS!

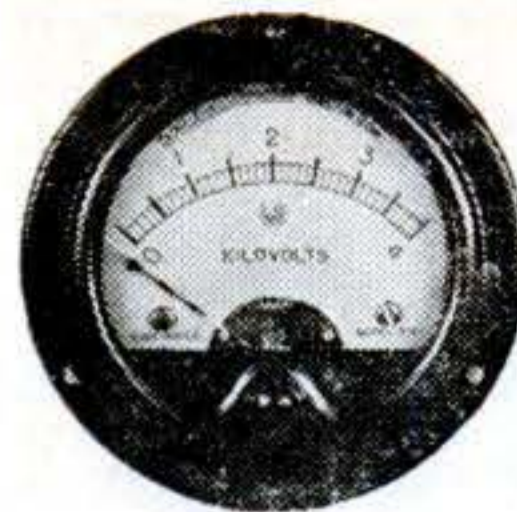

**D.C. Milliammeter** A good basic meter to build your own analyzer. Complete with Circuit Diagram, Volt-Ohm-Milliammeter Scale and list of parts required. Dejur Amsco, 0-1 Milliammeter movement with 0-4 Kilovolt scale (illustrated) 3 1/2", round flush bakelite case. Each \$3.95.

**A.C. Voltmeter** Triplett Model 331 J.P., 3 1/2", round flush bakelite case, white scale, 0-150 volts. Complete with external wire wound precision resistor to increase range to 300 Volts. **A.C. Ammeter** Triplett Model 331 J.P. (same as above) 0-30 Amps A.C. **Special Offer—Both Meters for \$8.95**

**D.C. Ammeter** Beede, 2 1/2", round, flush metal case, 30-0-30 Amperes D.C. Each \$3.00.

### SURPLUS—NEW—GUARANTEED. Gov't Inspected

All orders F.O.B., N.Y., 25% Deposit required on C.O.D.'s. Be sure to include sufficient postage, excess will be refunded. We carry a complete line of all types of Electrical Instruments. Send for our Free Circular

### MARITIME SWITCHBOARD

Dept. PS 3 — 336 Canal Street — New York 13, New York

## ATTENTION AUTO OWNERS!



### New Power, Pickup, Pep!

Amazing TYPHOON SUPER-CHARGER is back again, ready to put new life into old motors, add to power, pickup, pep. 41,000 users find gasoline economy, you will, too. Motor knock vanishes... Grease bath air cleaning keeps dust out. Takes 5 minutes to install with screw driver, fits on carburetor. Order today, mention make and car model. Only \$5.95. Ohio orders add 3% tax, west of Rockies add 10%.

### 10 DAY MONEY BACK GUARANTEE!

**TYPHOON PRODUCTS CO.** 509-D Engineers Bldg., Cleveland 14, Ohio

## GRINDING—POLISHING—HEAD



Immediate Delivery—For Industrial Use and Hobbyist—Height: 7 1/2" Width: 8"—V-Pulley Drive—Split Bronze Bearings—1/2" Shaft—Weight: 7 1/2 lbs. **\$4.45** Post-paid

### GRAND MFG. CO.

158 Grand Street, New York City 13, N. Y.

## GASOLINE ENGINES

Latest type, aircooled Briggs-Stratton and Wisconsin 6 H. P. Immediate delivery. These engines are slightly used government surplus, guaranteed by us to be in excellent mechanical and operating condition. Sale Price..... **\$99.50**

Also new Briggs-Stratton 1 1/2 H. P. ball bearing engines **\$69.50**

### Limited Quantity—Act Quick

No COD Orders. Write for descriptive circular.

### MIDWEST SURPLUS SALES

1520 Locust St.

Kansas City, Mo.



### STRONG 9 Inch METAL STEERING WHEEL

Boys! Build Your Own Junior Auto. Wheel has 1/2 inch diameter lacquered rim, with nickel plated spokes and hub with set screw to take 3/8 inch shaft. (Shaft not included.) Send for list of all parts to build a 56 inch pedal car chassis. **\$2.87** Postpaid USA

**NELSON-PRICE MFG. CO., Box 25, Rockville Centre, N.Y.**

## Lix-Rust



**TRY LIX-RUST!** It removes rust, cleans and polishes auto chrome parts, golf clubs, tools, housewares, hard metal surfaces. If your dealer doesn't stock LIX-RUST ask him to write

DISTRIBUTORS! INQUIRIES INVITED

### MERIT CHEMICAL COMPANY

165 NORTH UNION STREET

AKRON 4, OHIO



# INVENTORS

## Patent Laws Encourage The Development Of Inventions

The Rules of Practice of the U. S. Patent Office advises—unless an inventor is familiar with such matters—that he employ a competent registered attorney, as the value of patents depends largely upon the skillful preparation of the specifications and claims.

The firm of McMorrow, Berman and Davidson is registered to practice before the U. S. Patent Office. Additionally, it maintains a staff of attorneys able to readily understand inventors' disclosures, to advise concerning patentability, and to prepare appropriate specifications and claims for filing with the Patent Office.

If an inventor believes he has an invention, a search of the most pertinent prior U. S. patents should be made and a report obtained relative to its patentability. Where such report indicates that the invention appears patentable, in order to secure protection, diligence should be exercised in making application for a patent.

## McMORROW, BERMAN & DAVIDSON

*Registered Patent Attorneys*

PATENTS — TRADE MARKS — COPYRIGHTS

1423 VICTOR BUILDING, WASHINGTON 1, D. C.

### McMORROW, BERMAN & DAVIDSON

*Registered Patent Attorneys*

1423 Victor Building, Washington 1, D. C.

Send me further particulars as to patent protection and procedure and "Invention Record" form at once. I understand that this request does not obligate me.

Name.....

Address.....

City.....State.....

(WRITE OR PRINT NAME CLEARLY)

APRIL 17  
1947



# Now LEARN ELECTRIC MOTOR REPAIR!



Easily... Quickly...  
**AT HOME \$5**  
for ONLY . . . . . **5**

Based on what you can learn at home from this big book—FOR ONLY \$5 complete—you can train to profitably trouble-shoot, repair and rewind all types of electric motors. Every home, every office, every business and factory is a prospect for electric motor repair work. The field is tremendous, the pay good. Up to now, there has been no easy, practical way to learn the work in spare time study. The field is "wide open"—and ELECTRIC MOTOR REPAIR, the big 580-page book by Robert Rosenberg, helps you cash in on it within a few short weeks!

**TRAIN FOR GOOD PAY IN A FIELD THAT ISN'T CROWDED**

You learn fast! You learn right. ELECTRIC MOTOR REPAIR covers alternating-current motors, direct-current motors and synchronous motors and generators. ALSO, it covers BOTH mechanical and electrical motor control systems. Quick-reference guides show exactly how to handle specific jobs. Every subject is not only written understandably, but further explained VISUALLY by more than 900 easy diagrams. Invaluable for beginners or for bench use in busy shops. Book divides into two sections, enabling BOTH text and related illustrations to be seen AT THE SAME TIME. Lies open flat while you work!

**"BORROW" IT FOR 5 FULL DAYS!**

Send coupon now. Practice from ELECTRIC MOTOR REPAIR for 5 full days. If not more than satisfied with book, return it. Every cent of your money will be cheerfully refunded and absolutely no questions asked. What could be fairer?

**FREE!**

Check coupon for free literature on famous **GHIRARDI RADIO-ELECTRONIC Training Books**



**NO RISK COUPON mail today**

Dept. PS-47, Murray Hill Books, Inc., 232 Madison Ave., New York 16, N. Y.

Enclosed find \$5 (\$5.50 foreign) for my copy of the big ELECTRIC MOTOR REPAIR book; or  send C.O.D. (no foreign C.O.D.'s) for this amount plus postage. In either event, if book is unsatisfactory for any reason, I may return it in 5 days and have my money refunded.

CHECK HERE for free literature on Ghirardi RADIO-ELECTRONIC books.

Name.....  
Address.....  
City & Zone..... State.....

## "YOU ARE UNDER ARREST!"



There's a Thrill in Bringing a Crook to Justice Through Scientific

### CRIME DETECTION!

I have taught thousands this exciting, profitable, pleasant profession. Let me teach you, too, in your own home. Learn Finger Printing, Fire Arms Identification, Police Photography and Criminal Investigation thoroughly, quickly and at small cost.

**Be A FINGER PRINT Expert**

**53% of All American Bureaus** of Identification employ students or graduates of I. A. S. You, too, can fit yourself to fill a responsible crime detection job with good pay and steady employment. But don't delay—get the details now. Let me show you how easily and completely I can prepare you for this fascinating work, during spare time, in your own home. You may pay as you learn. Write today . . . Now . . . Be sure to state age.

**FREE!!!**  
Send for Thrilling "BLUE BOOK OF CRIME"

**INSTITUTE OF APPLIED SCIENCE**  
1920 Sunnyside Ave., Dept. 1364, Chicago 40, Ill.

## LAW

**STUDY AT HOME** Legally trained men win higher positions and bigger success in business and public life. Greater opportunities now than ever before.

**More Ability: More Prestige: More Money** We guide you step by step. You can train at home during spare time. Degree of LL.B. We furnish all text material, including 14-volume Law Library. Low cost, easy terms. Get our valuable 48-page "Law Training for Leadership" and "Evidence" books FREE. Send NOW. G. I. APPROVED. LASALLE EXTENSION UNIVERSITY, 417 South Dearborn Street A Correspondence Institution, Dept. 483-L Chicago 5, Ill.

## PHOTOGRAPHY for PLEASURE or PROFIT

**Qualify at Home!** Learn expert photography as a joy-full hobby, or to qualify for a well-paid position or your own studio. Previous experience unnecessary with N.Y.I.'s success-proved home study training. Details FREE. Also resident courses.

**NEW YORK INSTITUTE OF PHOTOGRAPHY, Dept. 5**  
10 West 33 St., New York 1, N. Y. (37th Year)

## LEARN MONEY-MAKING CARTOONING

**IN SPARE TIME — by Easy Picture Chart Method** Same Simplified Method that has helped train creators of "Terry & Pirates," "Freckles," "Out Our Way," "Winnie Winkle," "Reg'lar Fellers," "Strange As It Seems," "The Neighbors," and many others. Earn while learning. Send 10c for Picture Chart (to test your ability). Samples of successful students, and full details. (State age.)



Landon School of Cartooning, Dept. 472 4, Philadelphia 1, Pa.

## CORRESPONDENCE COURSES IN RADIO and ELECTRICAL ENGINEERING

Tuition \$25

**ELECTRICAL ENGINEERING.** Get good grasp of wide electrical news. Modern. Very understandable. Theory made easy.  
**RADIO ENGINEERING.** Extra fine course in radio, public address, photo-electric work. Trains you to be super-service man, real vacuum tube technician. Tuition ONLY \$25. either course. Deferred payment plan. Servicemen needed badly.

**FREE** Write for free copies of school catalogs, student magazines, etc.  
**LINCOLN ENGINEERING SCHOOL, Box 931-S-100 LINCOLN, NEBR.**

## MARCOT KEY MACHINE



Immediate Delivery

Marcot No. 8 Key Machine Mounted on Cabinet.....	\$ 82.50
Book on Modern Locksmithing....	3.95
Auto Code Book and Auto Depth Keys .....	12.50
162 Doz. Popular Key Blanks....	77.76
Set Key Files, Tools, Pins, Springs, Thimble.....	10.50
	<b>\$187.21</b>

**A. J. MARCOTTE CO.,** 1200 N. KEDZIE AVE. DEPT. PS. CHICAGO 51. ILL.

## What Every Mason Wants

We have Important Masonic books for Blue Lodge, Chapter, Commandery, Scottish Rite, and Shrine.

**OUR RITUALS ARE USED THE WORLD OVER**  
Send for free catalog of books and rituals for Masons, Odd Fellows, Knights of Pythias, Knights of Columbus, etc.  
**EZRA A. COOK, Publisher, P. O. 796, RA Chicago 90, Ill.**



# PATENT PROTECTION *for* INVENTORS

## A PATENT IS A VALUABLE RIGHT

On the basis of a constitutional provision, Congress has established a system under which inventors may secure the exclusive right to prevent the unauthorized use, manufacture and sale of their inventions for periods of seventeen years. The inventor secures this protection by obtaining a patent from the United States Patent Office.

*The United States Patent Office*  
**RECOMMENDS**

in its Rules of Practice that "an applicant is advised, unless familiar with such matters, to employ a competent registered patent attorney or registered patent agent, as the value of patents depends largely upon the skillful preparation of the specifications and claims."

*We*  
**RECOMMEND**

that you authorize us to conduct a search through the U. S. Patents pertinent to your invention and submit a report setting forth our opinion regarding its patentability.

**V**ICTOR J. EVANS & CO., has a staff of experienced registered patent attorneys, available to represent inventors in the preparation and prosecution of their cases before the Patent Office. Detailed information and the steps to be taken in obtaining patent protection will be furnished upon request.

FORM BELOW FOR MAILING CONVENIENCE

**VICTOR J.  
EVANS & Co.**

*Merlin M. Evans*

REGISTERED PATENT ATTORNEY

240-D Merlin Building, Washington 6, D. C.

Please forward to me detailed information regarding procedure to obtain Patent Protection, together with your convenient "Evidence of Invention" form.

Name.....

Address.....

City and State.....

**PATENTS • TRADEMARKS • COPYRIGHTS**

APRIL  
1947 19



**FREE**

**Radio's Greatest  
Buying Guide!**

**ALLIED'S  
NEW RADIO  
CATALOG**

**Send for this Big  
Value Book NOW!**



Send for your **FREE** copy of the leading Buying Guide for Everything in Radio! Here's the handiest catalog for Servicemen, Dealers, Soundmen, Amateurs, Builders and Experimenters. Features the world's largest and most complete stocks of quality radio and electronic supplies—all at lowest prices! Get the equipment, the speedy service, the expert help you want, from **ALLIED**—Radio's Largest Supply House!



**HUGE STOCKS—MORE THAN 10,000 ITEMS**

Everything for every radio use: new model home radios, phono-radios, communications receivers, Ham kits and gear, radio parts, tubes, tools, test instruments, public address equipment, low-cost easy-to-build radio kits, diagrams, instructive radio books, radio's most complete stocks—all at lowest prices!

**HELPFUL RADIO BOOKS!**

- Radio Formulas & Data No. 37-752 . . . 10c
- Dictionary of Radio Terms No. 37-751 . . . 15c
- Radio Circuit Handbook No. 37-753 . . . 25c
- Radio Builders' Handbook No. 37-750 . . . 15c
- Simplified Radio Servicing No. 37-755 . . . 10c
- Radio Data Handbook No. 37-754 . . . 25c
- ALL 6 BOOKS above No. 37-799 . . . \$1.00**
- Parallel-Resistance and Series Capacitance Calculator. No. 37-960 . . . 25c
- R-F Resonance and Coil Winding Calculator. No. 37-955 . . . 25c

**ALLIED RADIO**

**ALLIED RADIO CORP.**  
833 W. Jackson Blvd., Dept. 7-D-7  
Chicago 7, Illinois

**FREE  
CATALOG**

- Rush **FREE** 1947 Catalog
  - Send 6 Books No. 37-799
  - Send Books checked above
  - Send Calculators checked above
- } \$.....enclosed

Name.....

Address.....

City..... Zone..... State.....

**8" BENCH SAW  
14" BAND SAW**

**PRECISION BILT  
FACTORY TO YOU**

**REAL PRODUCTION TOOLS  
BUY BOTH WITH ONE DOWN PAYMENT**

TERMS: \$50.00 with order F.O.B. St. Louis; balance 2 payments \$41.00 each within 60 days. If you prefer to pay cash, deduct 5 per cent. Units will be shipped prepaid.

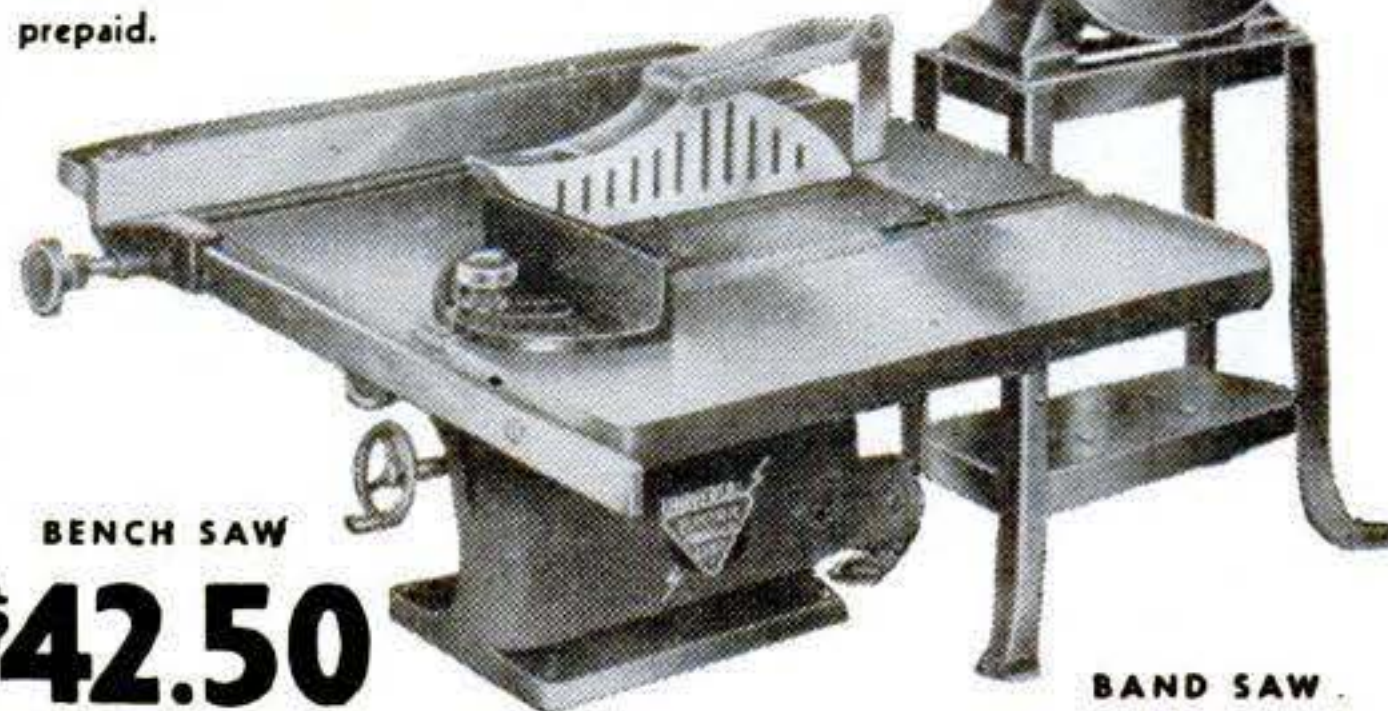

**BENCH SAW  
\$42.50  
LESS MOTOR**

**BAND SAW  
\$89.50  
LESS MOTOR & STAND**

**ON EASY TERMS**

**UNIVERSAL ELECTRIC PRODUCTS CORP.**  
122 N. SEVENTH ST. • SAINT LOUIS 1, MO.

**FIRE  
WORKS**

**WHOLESALE**

**Start a Stand of Your Own  
SPECIAL GET ACQUAINTED OFFER  
SPARKLERS—8 in.**

(8 in box) per gross boxes \$7.25

These sparklers are double dipped for greater brilliancy and longer burning. We carry a complete line of fireworks at the lowest prices. *Write for free catalog.*

**NORMAN NOVELTY CO.** 323 Springbrook Blvd. Dayton 5, Ohio

**WAR SURPLUS BARGAIN SPECIAL**

**BRAND NEW  
VACUUM-AIR  
HYDRAULIC  
FUEL  
PUMP**

**Original Cost  
\$45.00**

**Now Only  
\$9.95**

**Postpaid in U.S.A.**

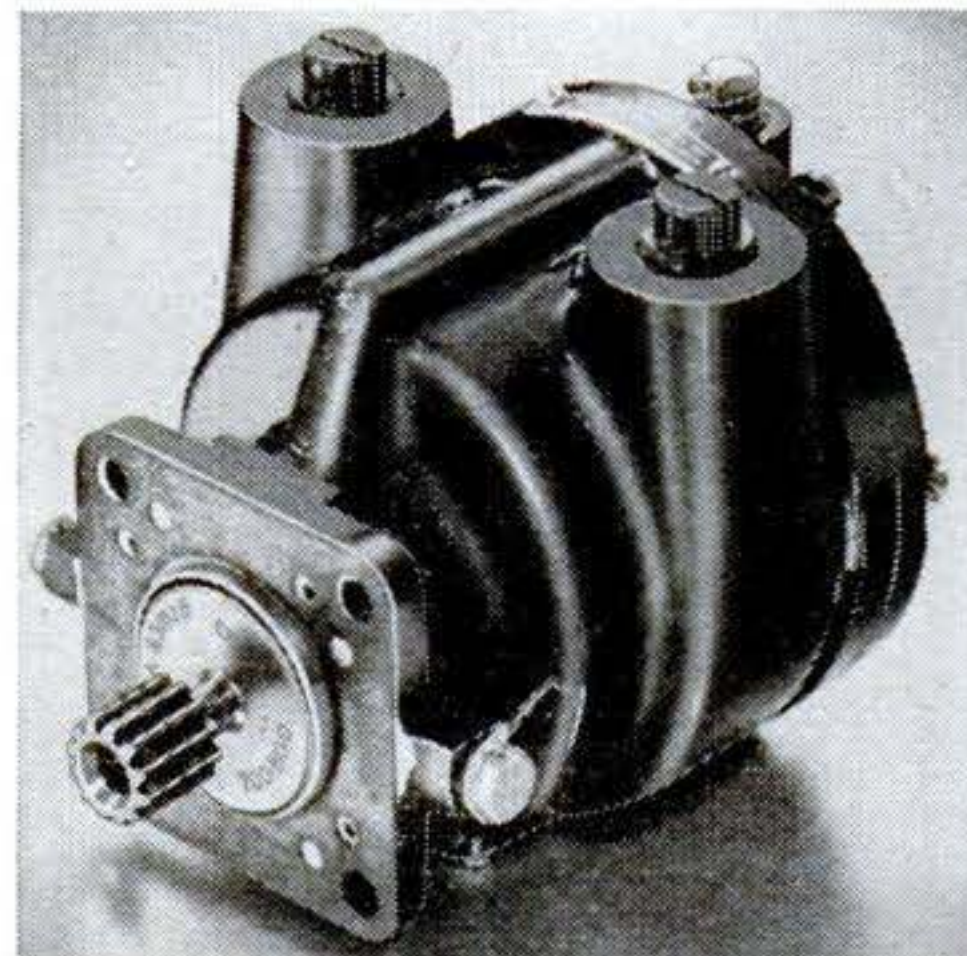

Adaptable for use on Home Oil Burners, Spray Machines, Milking Machines, Compressors, Vacuum Pumps, Hydraulic Systems, Presses, etc. Originally cost \$45.00. Used by the Air Corps to drive bomber de-icer boots, gyroscopes, automatic pilots, etc. May be used as air or fluid pump—for pressure or vacuum. Standard 3/8 inch pipe thread with interchangeable ports. Will pump 7 1/2 gal. SAE 30 oil per minute at 300 RPM. Builds air pressure of 30 lbs. per sq. in. at 1000 RPM. Vacuum will draw 26 inches of mercury at 1750 RPM. Runs forward or reverse. Self aligning shaft. Die cast aluminum housing 6x4x4 inches. Has stainless alloy steel vanes and impeller. Made by Bendix Avia, Corp. Spline terminal for direct drive—readily replaced with a pulley. Recommend a 1/4 H.P. or stronger electric motor as source of power. Rated capacity 1500 RPM with high overload factor. Special price for quantity users. Send check or money order today. Postpaid in U.S.A.

**GROBAN SUPPLY CO.** 1522 So. Michigan Ave. Dept. PS4, Chicago 5, Ill.





# Now Any **AUTO REPAIR JOB** Can Be "Duck Soup" For You!

**MoToR's New AUTO REPAIR MANUAL  
 Shows You How to Service and Repair  
 ANY Part of ANY Car!**

**FREE 7-DAY  
 OFFER!**

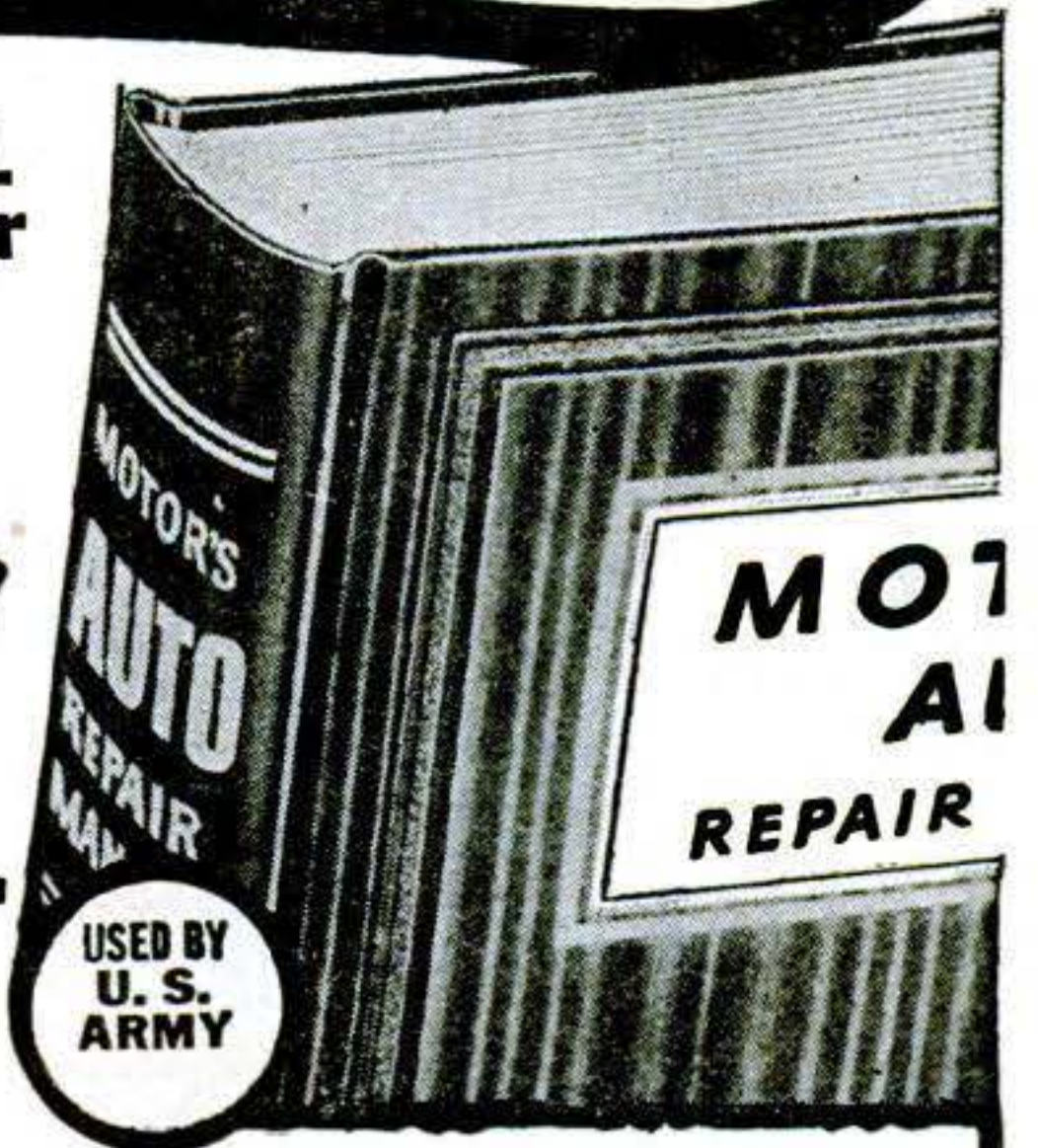

**NOW** you can "polish off" the **HARDEST** jobs the **EASIEST** way! MoToR's **AUTO REPAIR MANUAL** is ready to show you how to repair anything from carburetor to rear end—with the *least* possible amount of time and effort!

Suppose plain-talking car engineers from every auto plant in America got together and showed you all the things you needed to know about repairing and servicing the cars *they* had designed and manufactured! That's really what you get in this big manual! Right at your fingertips, the main "dope"

from **150 Official Factory Shop Manuals**, covering every make car built since 1935!

Easy to use, too! Quick-index leads you to right page in jiffy! Just follow simple instructions step-by-step.

**SEE HOW MUCH YOU GET!**

856 pages, 8½ x 11 inches, bound in sturdy covers. 200,000 service, repair, adjustment, replacement, tune-up facts on all makes and models, built from 1935 through 1946! More than 1000 cut-away photos, diagrams, drawings show you exactly **WHAT** to do and **HOW** to do it. Used by U. S. Army, trade and technical schools everywhere, thousands of auto servicemen.

Now **YOU**—without cost—can see for yourself what a wonderbook MoToR's Auto Repair Manual really is. Try it—**FREE**—for 7 days! Learn first-hand how it can pay for itself the first few times you use it.

**SEND NO MONEY**

**7-Day Free Examination**

Just mail coupon at right, without money! When the postman brings your book, pay him nothing. First make it show you what it's got! Unless you agree this is the greatest time-saver and work-saver you've ever seen—return book in 7 days and pay nothing. Mail coupon today! Address: MoToR Book Dept., Desk 2D, 572 Madison Ave., New York 22, N. Y.

Published by MoToR, The Leading Automotive Business Magazine. MoToR's manuals assure high standards of repair work.

**Covers All These Makes!**

- |           |              |
|-----------|--------------|
| American  | Lincoln      |
| Bantam    | Zephyr       |
| Auburn    | Mercury      |
| Austin    | Nash         |
| Buick     | Overland     |
| Cadillac  | Oldsmobile   |
| Chevrolet | Packard      |
| Chrysler  | Pierce Arrow |
| Cord      | Plymouth     |
| Crosley   | Pontiac      |
| De Soto   | Reo          |
| Dodge     | Studebaker   |
| Ford      | Terraplane   |
| Graham    | Willys       |
| Hudson    |              |
| Hupmobile |              |
| Lafayette |              |
| La Salle  |              |
| Lincoln   |              |

**USED BY U. S. ARMY**

**Clear, Pictured Facts on Every Job on Every Car Built Since 1935!**

Nearly 200,000 service and repair facts on all 31 makes. **856** big pages; including 50 pages of carburetor text, charts, illustrations, covering all models. Over 500 charts, tables; Tune-up Chart; Valve Measurements; Compression Pressure; Torque Wrench Reading; Starting Motor; Engine Clearances; Generator; Clutch & Brake Specifications; Front End Measurements, etc., Engines; Electric, Fuel, Cooling, Lubricating Systems; Transmissions; Universals; Front Ends; Wheels; Rear Ends, etc.

**MAIL COUPON NOW FOR 7-DAY FREE TRIAL**

MoToR Book Dept., Desk 2D, 572 Madison Ave., New York 22, N. Y. Rush to me at once: (check box opposite book you want)

- MoToR's AUTO REPAIR MANUAL.** If O.K., I will remit \$1 in 7 days, (plus 35c delivery charge), then \$2 monthly for 2 months, with a final payment of 95c one month later. (Book's price \$5.95). Otherwise I will return book postpaid in 7 days. (Foreign price, remit \$8 cash with order).
- MoToR's TRUCK REPAIR MANUAL.** (Described at left.) If O.K., I will remit \$2 in 7 days, and \$2 monthly for 3 months, plus 35c delivery charges with final payment (\$8.35 in all). Otherwise I will return book postpaid in 7 days. (Foreign price, remit \$10 cash with order).

Print Name \_\_\_\_\_ Age \_\_\_\_\_

Print Address \_\_\_\_\_

City \_\_\_\_\_ Zone No. \_\_\_\_\_ (if any)

State \_\_\_\_\_ Occupation \_\_\_\_\_

**SAVE 35c!** Check here if enclosing full payt. (check, m.o.) **WITH** Coupon. We pay 35c shipping costs. Same 7-day return-refund privilege.

**Same FREE 7-Day Offer Applies on MoToR's TRUCK REPAIR MANUAL**

For mechanics, truck specialists, service stations, fleet owners. Covers **EVERY** job on **EVERY** truck made since 1936! 1400 pictures, 952 pages, 300,000 facts. Used by Armed Forces.

All types Gasoline Engines, Diesels, Hesselman, Fuel Systems, Governors, Lubrication Systems, Ignition Systems, Starters, Generators, Clutches, Transmissions, Axles, Torque Dividers, Transfer Cases, Brakes, Steering, etc.

**ALSO SERVICES** buses, farm and industrial tractors, contractor and road building equipment, stationary power machinery, etc. (on all parts described in Manual.) Check box in coupon at right.





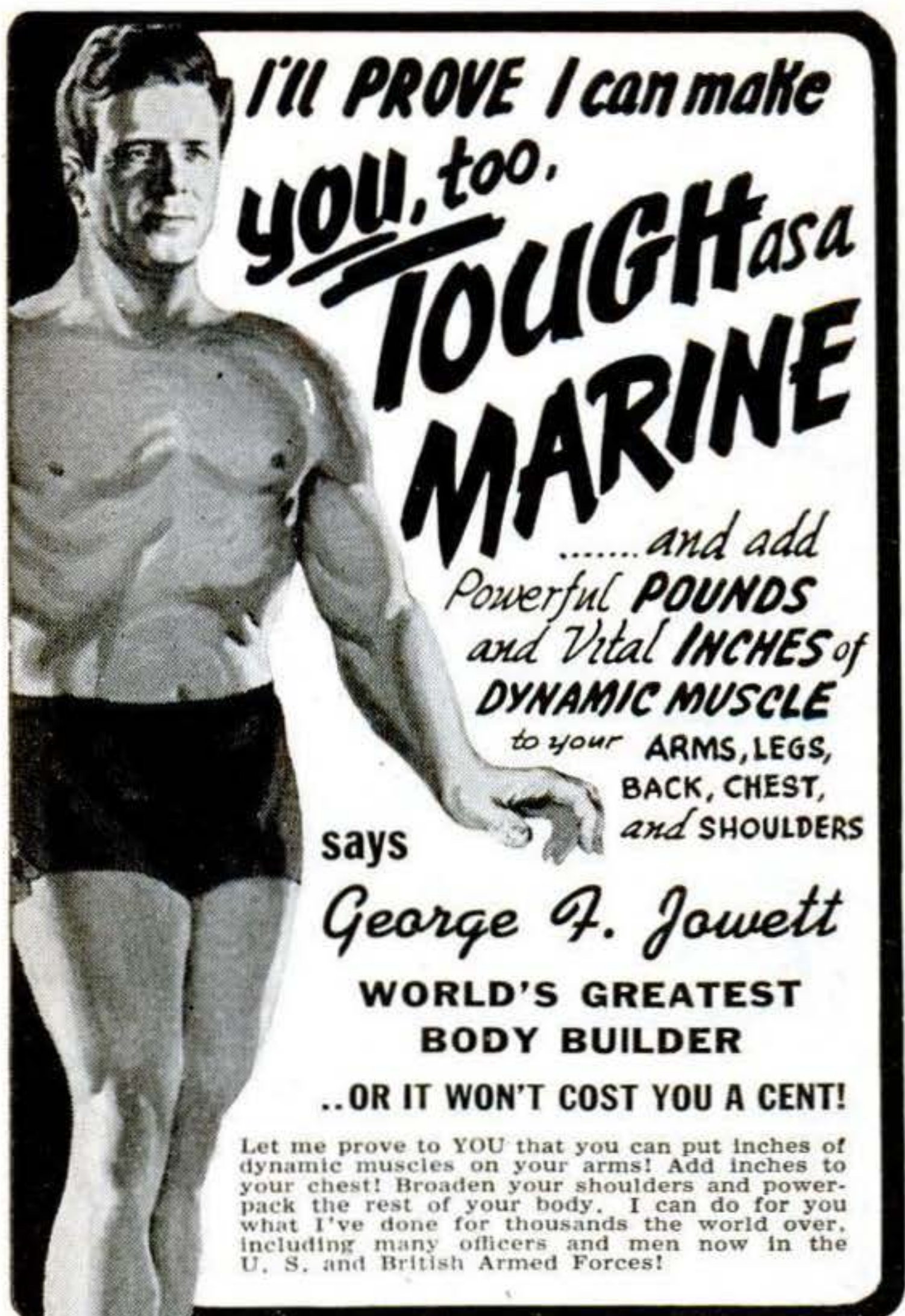

I'll PROVE I can make  
 you, too,  
**TOUGH** as a  
**MARINE**

..... and add  
 Powerful **POUNDS**  
 and Vital **INCHES** of  
**DYNAMIC MUSCLE**  
 to your **ARMS, LEGS,**  
**BACK, CHEST,**  
**and SHOULDERS**

says  
*George F. Jowett*  
**WORLD'S GREATEST**  
**BODY BUILDER**

..OR IT WON'T COST YOU A CENT!

Let me prove to YOU that you can put inches of dynamic muscles on your arms! Add inches to your chest! Broaden your shoulders and power-pack the rest of your body. I can do for you what I've done for thousands the world over, including many officers and men now in the U. S. and British Armed Forces!

**GIVE ME 10 MINUTES A DAY!**

**I'll Show You My Secrets Of Body Building**

I'll help you learn the "Progressive Power Method" through which I rebuilt myself from a physical wreck to the holder of more strength records than any other living athlete or teacher! No matter how skinny or flabby you are, you can learn my methods right in your own home. Through my proved secrets I show you how to develop your power, inside and out, until YOU are fully satisfied that you are the man you want to be, "The Jowett System," says R. F. Kelly, Physical Director of the YMCA, Atlantic City, "is the greatest in the world!"

If you want a physique that will inspire respect from men, and admiration from women . . . **ACT LIKE A HE-MAN!** Decide at once! The famous book, "Nerves of Steel—Muscles Like Iron" will be included FREE! Priceless for the strength fan! Full of photos of marvelous power-bodied men who will show you what Jowett has done for them and how he can do the same for you. Reach out . . . Grasp this Special Offer today!

**PROVE TO YOURSELF IN ONE NIGHT!**

Send only 25c for test Course, "Molding a Mighty Arm." Read it the evening it arrives—learn from experience the thrill you can give your muscles!

**SEND FOR THESE FIVE FAMOUS COURSES IN BOOK FORM ONLY 25c EACH or ALL 5 for \$1.00**

Jowett Institute of Physical Culture  
 230 Fifth Avenue  
 Dept. PS-74A  
 New York 1, N. Y.

*This Book Free!*



**BOOK WITH PHOTOS OF FAMOUS STRONG MEN MAIL COUPON NOW FREE**



Jowett Institute of Physical Culture  
 230 Fifth Avenue, Dept. PS-74A, New York 1, N. Y.  
 George F. Jowett: Your proposition looks good to me. Send by return mail, prepaid, the courses checked below, for which I enclose ( ). Include FREE book of PHOTOS.

- George F. Jowett Champion of Champions
- All 5 courses for . . . \$1
  - Molding a Mighty Arm 25c
  - Molding a Mighty Back 25c
  - Molding a Mighty Grip 25c
  - Molding a Mighty Chest 25c
  - Send all 5 C.O.D. (\$1 plus postage.) No orders less than \$1 sent C.O.D.

NAME ..... Age.....  
 (Please print plainly. Include Zone Number.)

ADDRESS .....

22 POPULAR SCIENCE

YOU MAY BE ABLE TO  
**DOUBLE YOUR INCOME**  
 IN YOUR  
**SPARE TIME!!**

**LEARN SILK SCREEN PROCESS**



Jealously Guarded Trade Secrets NOW Available to You  
 Develop a Profitable Business of Your Own . . . or a Hobby

Prepare yourself for an interesting top paying position. Thousands of jobs open. Silk Screen Process signs, displays, Xmas cards, toys, etc., IN GREAT DEMAND THE WORLD OVER. You may make enough the second week to pay for the entire course. EASY TO DO . . . EASY TO LEARN. No education or mechanical knowledge required. WRITE FOR FREE COLORFUL INTERESTING ILLUSTRATED CATALOG.

**COURSE INCLUDES A COMPLETE KIT OF SUPPLIES**

**CALIFORNIA SCHOOL OF SCREEN PROCESS**  
 Dept. P-47 3740 Overland Avenue, Los Angeles 34, California

**PRINTING PAYS BIG**

"Make your future secure. Prepare for a highly paid position or a print shop of your own. Students throughout the world are enthusiastic in their praise of our training program and the personal attention given each student. Rush name today for free literature and sample lesson. No salesman will call." Write Dept. P-106.

International School of Printing, Box 334, Dayton, Ohio

**Free Book**



**MOUNT BIRDS, ANIMALS, FISH**  
 Yes FREE. Explains Taxidermy. Tells how to learn at home by mail to mount birds, animals, heads . . . to TAN skins and furs. Great for MEN and BOYS. Fun! Also earn money in spare time. WRITE TODAY--NOW--for free book containing 100 game pictures. State AGE. N. W. School of Taxidermy, Dept. 3394, Omaha, Neb.

**LEARN TO WRITE**

The Magazine Institute offers an up-to-the-minute course in writing for magazines which makes it easy to get started in spare time at home. You may concentrate on either fiction or non-fiction. Send for FREE CATALOG describing M. I. method. VETERANS: This course approved for Veterans' training.

**THE MAGAZINE INSTITUTE, INC., Dept. 464-E**  
 50 Rockefeller Plaza, Rockefeller Center, New York 20, N. Y.



Begin today. Write now for our Free Book, "How to Become a Good Penman," it contains specimens and tells how others learned to write in spare time. Enclose 10c for your name beautifully written and a pen point suitable for shaded writing. Write today. **THE TAMBLYN SCHOOL OF PENMANSHIP** N-439 Ridge Building, Kansas City, Mo.

**APTITUDE TESTS**

discover the kind of work or studies best for your success! You get a personal report—a guide for life—more happiness—more prosperity. (for men, women, boys, girls.) Write for complete facts.

**VOCATIONAL COUNSELING INSTITUTE**  
 5057 Woodward Ave., Detroit 2, Michigan

**SELL MERCHANDISE by mail**

**OPERATE** Profitable Lifetime Business Selling Merchandise by Mail. Large Profits on Fast Selling \$1.00 Items. **WRITE TODAY!**

**POWELL CO. DEPT. C** SAMLINER BLDG., CLEVELAND 3, OHIO



*For Your Class or Club*

Pins, rings and emblems. Over 300 designs. Finest quality. Reasonable prices. Pins, 30c up. Write today for free catalog. Dept. O, Metal Arts Co., Rochester, N. Y.

**FUN WITH AMAZING NEW MAGIC DICE**

Here's a special pair of fun dice that certainly can do wonders. It's amazingly easy to predict numbers, perform amusing tricks. No one can guess the hidden "secret" unless you tell them! Display amazing "control" yet the real reason is cleverly concealed from everyone. Fun and fascination! Easy directions explain details. Perform many "magic" tricks! Price only \$2.98. Get a pair today. Send no money. Just name and address. On arrival, pay postman only \$2.98 plus postage. Money back if not delighted. Address Hollister-White Co., Dept. 451-D, 215 N. Michigan Ave., Chicago 1, Ill.





# Prepare for YOUR FUTURE *Now*

You'll Need "ALL-AROUND" Training to Meet New Conditions!

Get Ready QUICK—in 1 of these 2 Opportunity Fields!

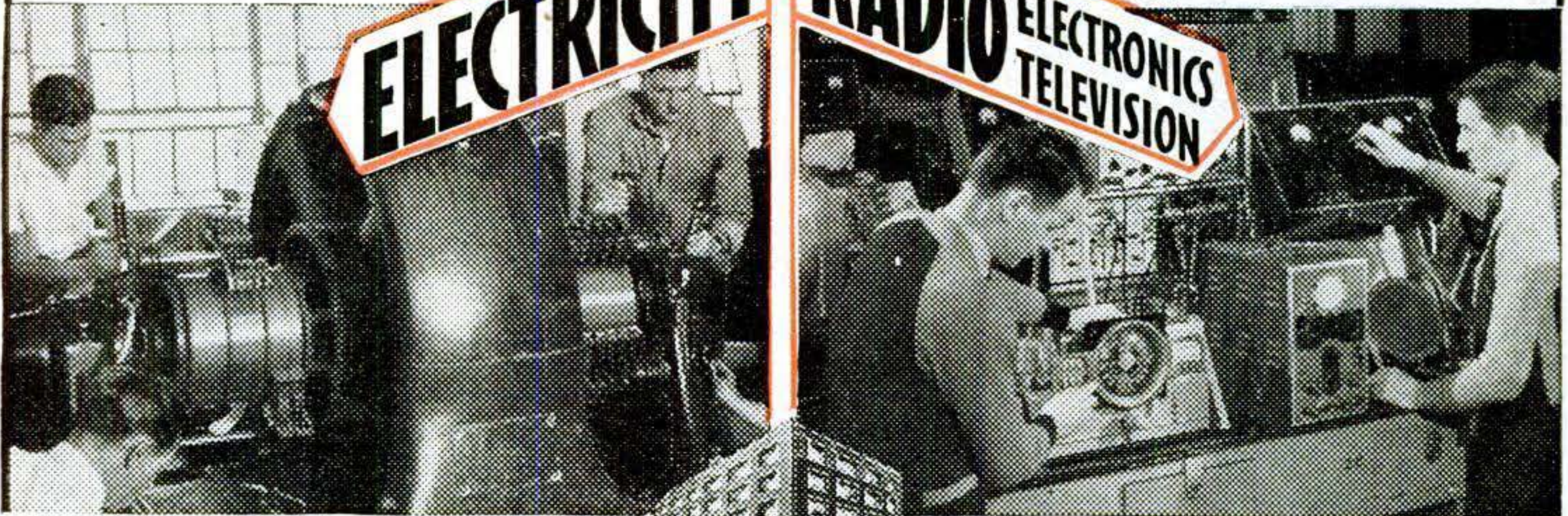

**ELECTRICITY including INDUSTRIAL ELECTRONICS . . .** Prepare for the opportunities in such branches as Power Plant Work, Motors, Armature Winding, Industrial and House Wiring, Maintenance, INDUSTRIAL ELECTRONICS, etc., with COYNE shop training.

This big fire-proof building is occupied entirely by Coyne. FOUNDED 1899

**RADIO . . .** A great field now, even greater growth ahead. Prepare for a real Radio career. Learn construction, trouble-shooting and servicing of Radio Receivers, Public Address Systems, Sound Picture Units. Training includes FM, Photo-Cells, Television—the practical COYNE way.

**“LEARN BY DOING” RIGHT HERE IN THE SHOPS OF COYNE IN A FEW WEEKS**  
**TRAIN FOR A GOOD JOB NOW THAT OFFERS STEADY WORK WITH A REAL FUTURE!**

Conditions today are different. Many “one-operation” jobs that paid well in the past, no longer exist. Do you have a good job with a real future? Plan for steady pay and advancement by training NOW, while there’s still time! Come to the big shops of COYNE in Chicago, for “all-around” training in **Electricity or Radio-Electronics**—the 2 great opportunity fields of today and tomorrow.

## TRAIN ON ACTUAL EQUIPMENT!

Our famous “Learn-by-Doing” method gives you practical experience on full-size equipment. Not by correspondence, but actual shop work plus necessary theory. You are trained right here in the Coyne shops, that has been training men and young men for over 48 years. Men from 16 up to 40, with or without experience, Coyne training is for you.

**Student Finance Plan START NOW—PAY LATER!** **LIFETIME JOB SERVICE TO COYNE GRADUATES**

Don't let lack of money hold you back. Our “Student Finance Plan” has helped thousands to get ahead. Coupon brings details. Many earn while learning, to help take care of living expenses while here.

First we train you for a good job and future, then assist you in getting located. As a Coyne graduate, use this service whenever you need it—no charge. Also FREE review privileges. Get the facts!

**PICK FIELD YOU LIKE—SEND FOR BIG BOOK**

**FREE**



B. W. Cooke



Some men prefer **Electricity**, others **Radio**. Whichever interests you most, we will train you in a few short weeks at Coyne . . . on full-size equipment, by our famous “Learn-by-Doing” method. We have a big, fully illustrated book on each course, and we'll send you the one you want, without the slightest cost or obligation. Simply check below, then **mail coupon in envelope or paste on post-card**. No salesman will call. You are the sole judge. Don't delay. Your future is at stake. Rush coupon to COYNE—TODAY.



## ELECTRIC REFRIGERATION

**Included With Either Course**  
 Added training in the great field of ELECTRIC REFRIGERATION makes you more valuable to employer, leads to opportunities for bigger pay. This valuable TRAINING now included with either our **Electrical or Radio Course**. ANY MAN WITH A PHYSICAL DISABILITY whether a Veteran or not may qualify for Coyne training at no cost to them for tuition or subsistence. Check coupon for details.

## VETERANS—

Coyne is also equipped to train those who qualify for training under G. I. Bill of Rights. Check coupon for our Special G. I. Bulletin.

**COYNE ELECTRICAL SCHOOL**  
 B. W. COOKE, Director Founded 1899  
 500 So. Paulina Street, Dept. 47-73H. CHICAGO 12, ILL.

B. W. COOKE, Director  
 COYNE ELECTRICAL SCHOOL  
 500 S. Paulina St., Dept. 47-73H, Chicago 12, Ill.  
 Send me your BIG FREE BOOK — for the course checked below. Also full details of your “Student Finance Plan.”

ELECTRICITY  RADIO  
 Send special G.I. Bulletin  Physical disability

NAME.....  
 ADDRESS.....  
 CITY..... STATE.....



**TO ALL MEN WHO ARE INTERESTED IN**

# Famous TELEVISION SCHOOL Offers You These 2 PLANS

**PLAN 1** { **YOU CAN BUILD A TELEVISION SET** }  
                  { **RIGHT IN YOUR OWN HOME** }

**I**F you are unable to leave home to go to a resident school, the New York Technical Institute of New Jersey offers you this unusual opportunity. You can get all the parts, including tubes, speaker and 7-inch picture tube, of a television receiver like the one shown below, delivered right to your home.

With the Knockdown Kit will come exactly

the same instructions and directions with which the school's resident students are equipped, when they reach the stage in their training that calls for television set construction.

If you already have a sound radio background, with experience in building radio receivers, you will be surprised to find out how much you can learn about television *at home* by studying the

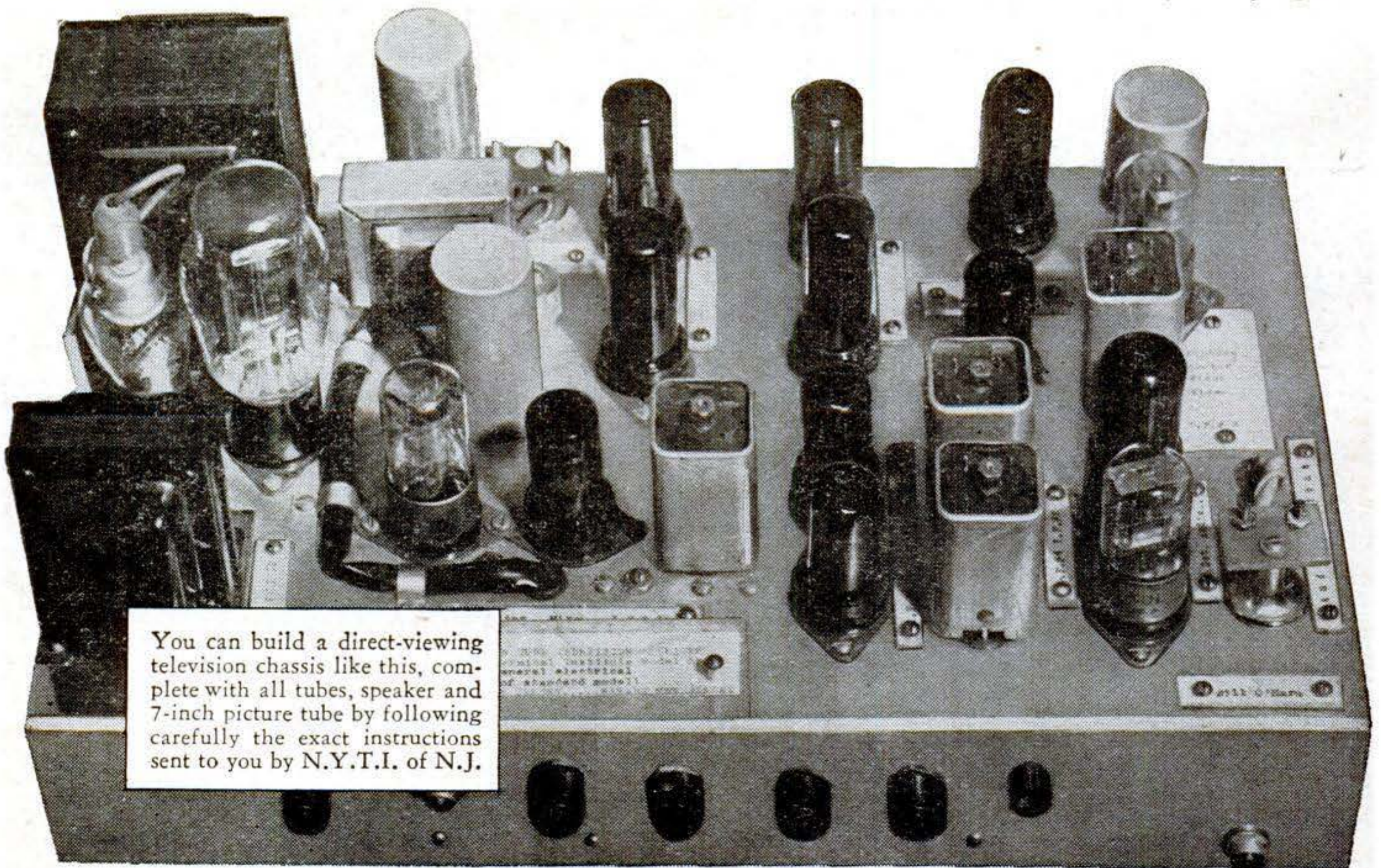

You can build a direct-viewing television chassis like this, complete with all tubes, speaker and 7-inch picture tube by following carefully the exact instructions sent to you by N.Y.T.I. of N.J.



# A HIGH-PAYING CAREER IN TELEVISION

directions and building this set.

The school will be happy to send you complete information about these television kits which are now available. Simply check proper box in coupon below, and mail to the address given.

(Plan 2, described below, not only provides expert instructors to teach resident students television receiver construction: as many as 7 different radio receivers and over 65 electronic educational devices are also constructed as part of practical laboratory training. Resident students may keep the television chassis they build, if they so choose.)

8 of these latest RCA Frequency Sweep Generators are in almost constant use by N.Y.T.I. of N.J. students in Advanced Television.



## PLAN 2

**PREPARE, AT ONCE, TO BECOME A  
RADIO AND TELEVISION EXPERT**

**M**EN seeking thorough, dependable, up-to-the-minute training in radio and television should investigate the schooling offered by N.Y.T.I. of N.J., one of America's great radio and television resident schools.

Students are required to have at least a grammar school education; must be earnest and radio-minded. Students without proper mathematical backgrounds are given special instruction. The school is fully approved by the Veterans Administration for G. I. Training.

N.Y.T.I. of N.J. is just across the river from New York City, in Newark, New Jersey, right

in the heart of America's great radio and television industry. R.C.A., Westinghouse, DuMont, Edison, Western Electric and other leading television equipment manufacturers are nearby. Qualified television and radio instructors are here in abundance. Equipment is easier to get. Television students are therefore offered exceptional advantages in this great electronic center.

Mail the coupon for the special FREE Bulletin—which describes classes, hours, costs, housing, etc.—to New York Technical Institute of N. J., Dept. 34, 158 Market St., Newark, New Jersey.

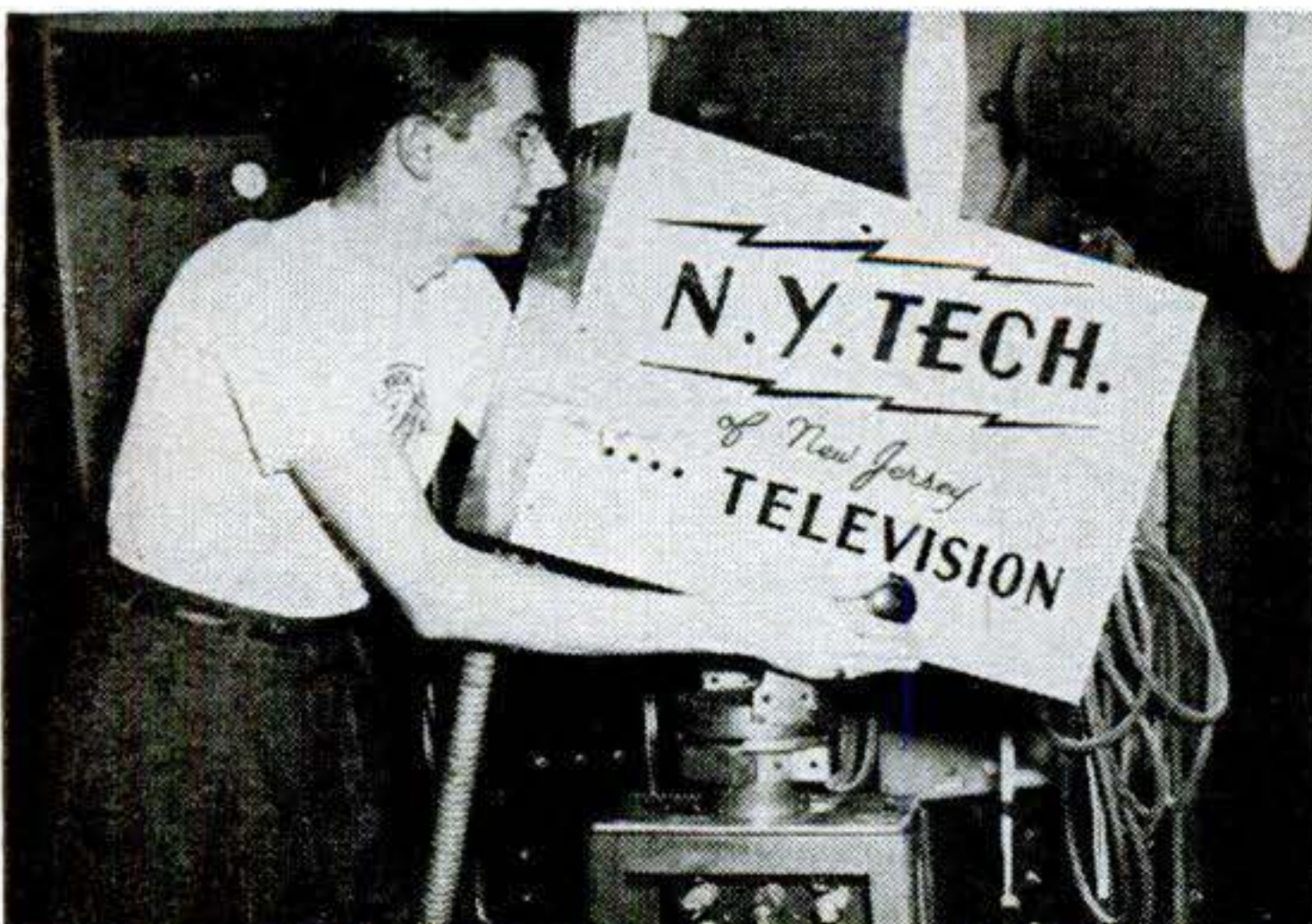

Ex-G.I. taking pictures with N.Y. Tech's Iconoscope Television Camera, which is used in the resident school's course entitled "Transmitters and Camera Technique."

**New York Technical Institute of N. J., Dept. 34  
158 Market Street, Newark, New Jersey**

Check here if you wish to receive the Special FREE Bulletin describing the resident school of the New York Technical Institute of New Jersey located in Newark, N. J.—including its facilities, equipment, courses offered, costs, hours, etc.

Check here if you wish complete information about building a television chassis in your own home.

Check here if you are a War Veteran.

Name.....Age.....

Address.....

City.....<sup>Zone</sup>  
(if any).....State.....

(N.Y.T.I. of N.J. employs no salesmen to call.)



**Pays Good**  
in both these big Branches  
of the Automobile Industry

LEARN IN A FEW  
WEEKS IN OUR  
BIG MODERN  
TRAINING SHOPS

**AUTOMOTIVE  
MECHANICS**

**BODY & FENDER  
REBUILDING**

NOW IS THE TIME  
TO PREPARE FOR  
YOUR PLACE IN A  
GIANT INDUSTRY

Automobile industry making up for lost time! There may never again be such opportunities for men who want better jobs or business of their own to get in on ground floor and go up fast! Yes—FOR MEN WHO ACT FAST, THINGS CAN HAPPEN FAST!

**TRAIN ON ACTUAL EQUIPMENT**

Chicago Motive Trades Institute makes rapid progress possible by Learn-By-Doing SUPERVISED SHOP TRAINING. In motive trades our institute gained nation wide fame training Auto Mechanics for U.S. Army. Same quality training available to you now. CONSULTATION AND PLACEMENT SERVICE WHETHER YOU ARE INTERESTED IN WORTHWHILE JOB OR SETTING UP YOUR OWN BUSINESS.

**AUTOMOTIVE  
MECHANICS**

Practical shop training on all types of equipment. Automotive mechanics needed to keep millions of cars, busses, trucks rolling. Efficient auto mechanics get fine pay. Can service, repair, install all mechanical and electrical parts of autos. Learn to overhaul and repair engines, transmissions, differentials, and other assemblies. Good pay, steady work, excellent opportunities for increased earnings for properly trained auto mechanics.



**BODY AND FENDER REBUILDING**



Body and Fender rebuilding one of best paid fields in automobile industry. Body and Fender Rebuilding makes good profits in garages, service stations. Get practical, all-around Shop Training—welding, aligning, mixing and matching colors, spray painting, power and hand tools.

Values increased when used cars are made to "look like new."

**A NATIONALLY KNOWN INSTITUTION**

Rapid progress possible by supervised learn-by-doing SHOP TRAINING. C.T.I. is an old established school, backed by years of experience—with trained instructors—with completely equipped shops.

VETERANS qualifying under "G.I. Bill" have tuition paid by Government plus monthly subsistence allowance while in school. Just mail coupon, we will handle all details. (LOW TUITION. EASY TERMS if you are not a veteran.)

**CHICAGO MOTIVE TRADES INST.**

Div. of Commercial Trades Inst.

1400 W. Greenleaf Ave., Chicago 26, Ill.

**FREE**—IMPORTANT INFORMATION  
TELLING HOW TO GET STARTED

CUT COUPON ALONG THIS LINE



**Fill Out, Cut Out, Mail Today**

**FACTS FREE for Men Who Want to Get Ahead**

CHICAGO MOTIVE TRADES INSTITUTE, Dept. B-14  
1400 W. Greenleaf, Chicago 26, Ill.

Send free illustrated Brochures and other information about the field I have checked below.

( ) Automotive Mechanics ( ) Body & Fender Rebuilding  
( ) Veteran ( ) Non Veteran

NAME.....

ADDRESS.....

CITY.....STATE.....

**STUDY AT HOME**

With An Educational Institution

Men with specialized training win higher positions, insure larger earnings, and are bigger successes in business and public life. Opportunities NOW greater than ever before. Send for our Catalog.

**ARTS and SCIENCES**

Courses in Philosophy; Education; Letters; Public Health; Medical Jurisprudence; Psychology; Sociology; Physics; Chemistry; Plastics; Geology; Political Science; Theology; Business and Commerce; Accounting; Mathematics; Statistics; Agriculture.

**ENGINEERING**

Courses in Electrical, Civil, Mechanical, Drafting, Architectural, Steam, Aeronautical, Radio, Structural, Mining, Industrial, Petroleum, Marine, Chemical, Diesel, Automobile, Refrigeration, and Air Conditioning Engineering.

**LAW**

Complete Professional Law Course includes 18 Hornbrook Series college grade textbooks. Courses also in Commercial Law, Patent Law and Medical Jurisprudence.

McKinley-Roosevelt Incorporated, 4610-AB, Sheridan Rd., Chicago 40, Ill.

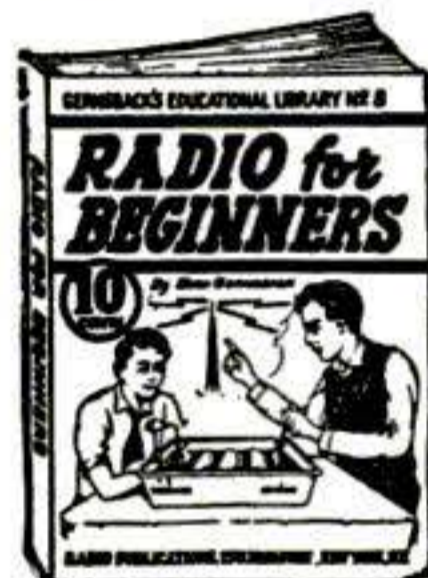

**Get Started in Radio  
TEN "HOW-TO-DO-IT" BOOKS**

Get a solid foundation in radio by means of these 10c timely text books. Each clearly written, profusely illustrated, contains over 15,000 words. You'll be amazed at the wealth of information packed into these handy books. Excellent for reference—ideal for technical library. Your money back if not satisfied.

5 BOOKS FOR 50c—10 BOOKS FOR \$1.00

- No. 1—How To Make Four Doerle Short Wave Sets
- No. 2—How to Make The Most Popular All-Wave 1 and 2 Tube Receivers
- No. 3—Alternating Current for Beginners
- No. 4—All About Aerials
- No. 5—Beginners' Radio Dictionary
- No. 6—How To Have Fun With Radio
- No. 7—How To Read Radio Diagrams
- No. 8—Radio for Beginners
- No. 9—Simple Electrical Experiments
- No. 10—Television

Remit by check or money order—register letter if you send cash or stamps.

RADIO PUBLICATIONS 27-V West Broadway New York (7)



STUDY AT HOME for PERSONAL SUCCESS and LARGER EARNINGS. 38 years expert instruction—over 108,000 students enrolled. LL.B. Degree awarded. All texts furnished. Easy payments. Send for FREE BOOK—"Law and Executive Guidance"

AMERICAN EXTENSION SCHOOL OF LAW  
Dept. 76-S, 646 N. Michigan Ave., Chicago 11, Ill.

**SHORTHAND in  
6 Weeks at Home**

Famous Speedwriting system. No signs or symbols; uses ABC's. Easy to learn; easy to write and transcribe. Fast preparation for a job. Surprisingly low cost. 100,000 taught by mail. Used in leading offices and Civil Services. Also typing. Write for free booklet. Speedwriting, Dept. 2604-7, 55 W. 42 St., N.Y. 18, N.Y.

**"How to Make Money With Simple Cartoons"**

A book everyone who likes to draw should have. It is free; no obligations. Simply address

**CARTOONISTS' EXCHANGE**

Dept. 1444-D Pleasant Hill, Ohio

**REFRIGERATION and  
AIR CONDITIONING**

Mechanical units everywhere need servicing. Be ready with reliable pay-knowledge. Unique home study—actual practice plan. Train now for servicing and installing jobs or business of your own. **Get The Facts FREE Now! Write Today!**

**UTILITIES ENGINEERING INSTITUTE**  
1314 W. Belden Ave., Dept. 347, Chicago 14, Ill.

REFRIGERATION TRAINING Since 1927  
Approved under G.I. Bill



Now IN YOUR OWN HOME Learn

# RADIO ELECTRONICS

The Practical  
"HOME-TESTED"  
Modern "A-B-C" Way



YOU USE ALL OF THESE RADIO PARTS  
TO BUILD  
AND OPERATE  
**7**  
DIFFERENT RADIO  
RECEIVING CIRCUITS

## NO PREVIOUS RADIO OR ELECTRICAL EXPERIENCE NECESSARY

DeForest's Training, Inc. provides every major home study aid to help you learn Radio-Electronics rapidly and thoroughly . . . to give you the *experience* and *confidence* needed for a responsible, Good-Pay Job, or to Start a Business of Your Own! Here is a REAL opportunity field for YOU . . . when you are a trained Radio-Electronics man! Just think of the tremendously exciting future ahead of FM Radio, Aviation and Broadcast Radio, Sound Motion Picture Equipment, Servicing and Sales of Radio Equipment, etc. Put *yourself* in this picture . . . See how you can benefit from a PRACTICAL training in this fascinating work! Think, too, of the coming possibilities ahead of Radar, Facsimile and Television. Send TODAY for the interesting, opportunity-revealing book, "Victory for You!" See how others probably no more talented or ambitious than you, have advanced in earning power after this training . . . how YOU can do it too! Mail the coupon NOW!

16 MM MOVIE PROJECTOR  
YOU USE "LEARN-BY-SEEING" MOVIES



DEFOREST'S TRAINING, INC. INCLUDES INSTRUCTION IN MOTION PICTURE SOUND EQUIPMENT, FM RADIO AND TELEVISION . . . RESIDENTIAL TRAINING IN OUR MODERN CHICAGO LABORATORIES ALSO AVAILABLE—ASK US FOR INFORMATION!

**DeFOREST'S TRAINING, INC.**  
CHICAGO 14, ILLINOIS

### INCLUDING:

1. Simple Receiver
2. Two Tube Receiver
3. Tuned Radio-Frequency Receiver
4. Short Wave Receiver
5. Aviation Band Receiver
6. 4-Tube Superheterodyne
7. 5-Tube Superheterodyne with Magic Tuning Eye

••• PLUS SCORES OF OTHER FASCINATING, INSTRUCTIVE RADIO-ELECTRONIC EXPERIMENTS

#### VETERANS!

Big things are happening at DeForest's Training, Inc. for veterans! See how you can prepare yourself WITHOUT COST for a GOOD JOB or a BUSINESS OF YOUR OWN in the vast Radio-Electronic opportunity field.

### WITH THE HELP OF

**A** EIGHT Big Kits of Actual "Learn-by-Doing" Radio Parts and Assemblies with which you make 133 fascinating SHOP METHOD EXPERIMENTS in your own home! Imagine building 7 different Radio Receivers that operate!

**B** A 16 mm Home Movie Projector and Twelve Reels of "Learn-by-Seeing" Home Movie Films . . . for picture-clear, fast understanding of Radio Fundamentals!

**C** Modern, well-illustrated, Loose-leaf Lessons, prepared in clear, simple, understandable language . . . to guide you throughout your training!

THEN GET THE HELP OF OUR EFFECTIVE EMPLOYMENT SERVICE



E. B. DEVRY, President  
DeFOREST'S TRAINING, INC.  
2535-41 North Ashland Ave., Dept. PS-D4  
Chicago 14, Illinois, U.S.A.

Send FREE "VICTORY FOR YOU!" BOOK, showing how I may make my start in Radio Electronics.

Name \_\_\_\_\_ Age \_\_\_\_\_

Address \_\_\_\_\_ Apt. \_\_\_\_\_

City \_\_\_\_\_ Zone \_\_\_\_\_ State \_\_\_\_\_

If under 16, check here for special information.

If a discharged Veteran of World War II, check here.

APRIL 27 1947



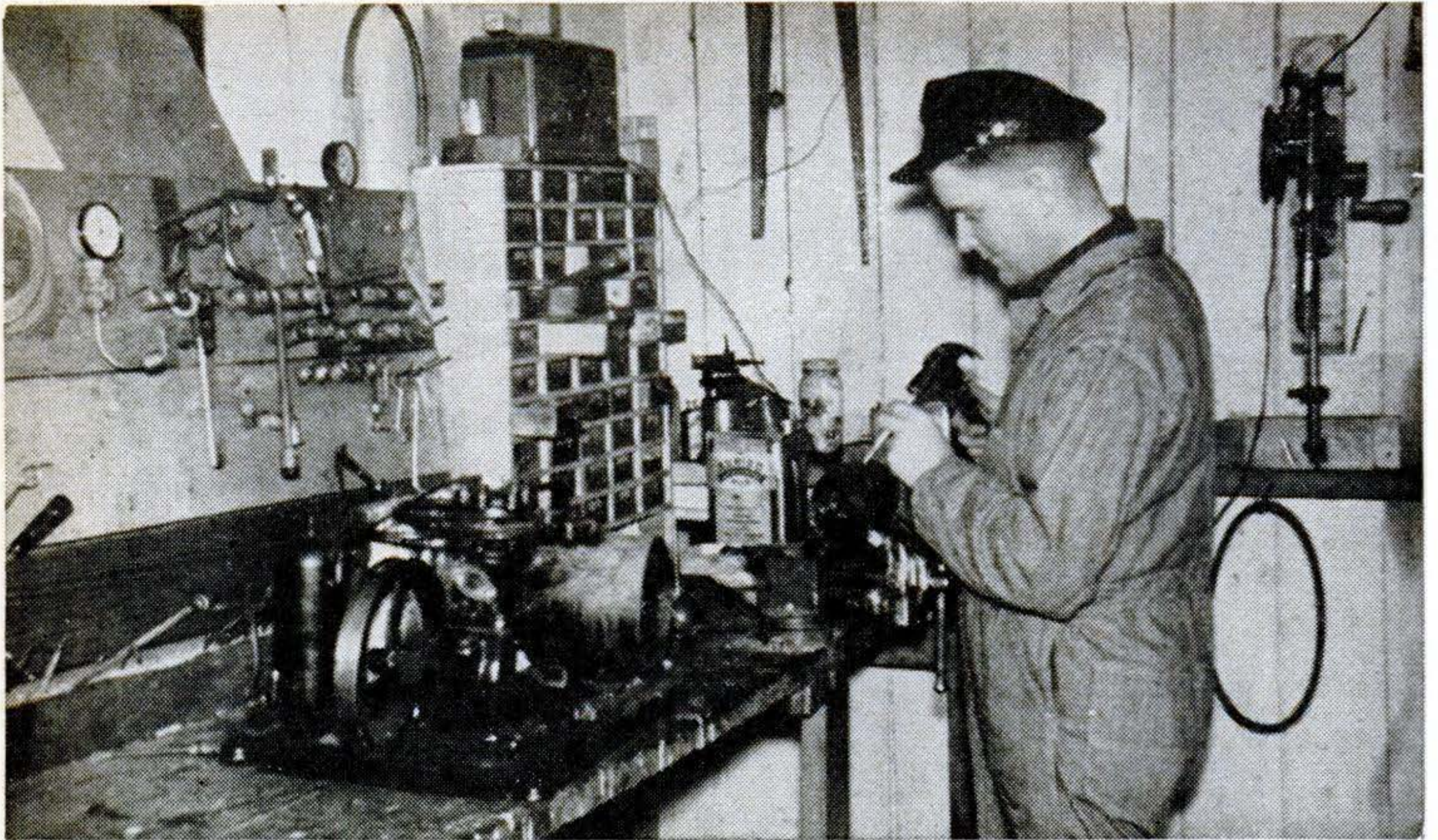

# SO IT NEEDS FIXING

By S. T. CHRISTENSEN

*the "Fix-it-Man"*

"WELL, I guess I'm the fellow to see, for I've repaired thousands of refrigerators (home and commercial both), vacuum cleaners, radios, washing machines, irons, fans, lamps, mangles, motors, etc. In fact, many of my customers call me their "electrical appliance doctor." And "doctoring," I might add has paid me a good substantial income for quite a few years. Funny, in a way, how I got started. Always liked to tinker and by experimenting around I found that most electrical appliances had many things in common. That, regardless of what the appliance was used for, or who the manufacturer was, the basic principles were much the same. From fixing my own appliances to fixing friends' and then for strangers at a fee, seems now to have been but a small step.

## What to Charge?

At first, I let the owner decide the charge and, frankly, I was amazed at what I earned per hour. But then, when one figures what initial costs are involved in buying most electrical appliances, one can readily see that spending extra dollars for repairs is well worth while. Before long I was making more in my spare time repairing than from my regular job. The result . . . I went into business for myself. When war came, business boomed, for new appliances were not available.

For a while, repair parts (needed on some jobs) were a little difficult to get. But that

situation quickly adjusted itself and many repair parts were given the high priority rating of AA2. After all, we had to provide for the health and well-being of our civilian population.

## The Future Offers

Friends ask me about my future. And, I think I've got a grand one. Age is no handicap in repairing. I have in my files enthusiastic letters from repairmen ranging in age from 18 to 79 years. Now the war is over we are certain to see hundreds of new products on the market . . . products that the average person never dreamt of. These new products and our old appliances are all going to need at some time or other "fixing." Well, I'll still be the fellow to do it. The field open for appliance repairmen is unlimited. I don't worry at all about too much competition.

## If You Are Ambitious

To the contrary, I've prepared a complete course, chuck full of simple, easy to understand photos and drawings and written in the same non-technical language as this article. I know the course is good, because I have hundreds of men all over the country writing to me telling me how the course has helped swell their pockets with cash. If you too want to prepare now for your future, I suggest you read the next page and send me the handy coupon."





**BIG MONEY  
INDEPENDENCE**  
*A PROFITABLE  
LIFETIME  
BUSINESS  
OF  
YOUR OWN!*

# LEARN ELECTRICAL APPLIANCE REPAIRING

## PREPARE NOW FOR THE FUTURE

If now employed, start your home appliance repair business NOW in your spare time and be set with a business of your own no matter what happens. You don't need elaborate fixtures or expensive equipment to be a successful repairman. Operate from your garage, basement, vacant store, etc. Work as many hours as you wish—the home appliance repairman is his own boss. It is a profitable occupation for on many types of repairs it is not unusual for a repairman to charge on the basis of \$5.00 to \$6.00 per hour. Don't gamble with your future—learn a trade that will always support you. Remember, as long as electrical appliances are used, there will be a need for electrical appliance repairmen.

If you are at all mechanically inclined—can hold and use tools—then you have all of the qualifications required for becoming a big money earning home appliance repairman. It does not matter if you have not had a great deal of schooling or had previous experience along these lines—**WE WILL TEACH YOU.** Age should be no barrier—nor should any minor physical handicap.

## New Course Tells All

Profusely illustrated, our new course shows you in simple, easy to understand language and drawings how to make each repair on refrigerators, vacuum cleaners, washing machines, motors, etc. Explains and gives you a working knowledge of electricity, welding, nickel plating, etc. Shows you how to build the power tools you need and how to solicit and keep business coming to you. Not a theory course but an honest to goodness course written by and used by repairmen the country over. Price of course is so low that the savings on your own household appliance repairs will quickly pay for it. Act now! Mail the handy coupon below today.

### -----Read What Our Students Say About Course-----

I really believe your course the best investment a mechanically minded man can make.—Claude E. Allen, Indianapolis, Ind.

I have received your Course in Appliance Repairing and I must say I am well pleased with same. I am only sorry I did not have said Course some years ago. I have learned so much more through this course I would not part with it.—Charles Schwarz, Hamilton, Ohio

The Course in Appliance Servicing arrived a few days ago. Want to take out a few minutes of my valuable time to let you know that this is just what I have been looking for ever since I opened up my Fix-It shop. I must admit that you told the truth when you said that it contains quite a bit more information than I bargained for. — P. J. Bretl, Sebring, Ohio.

I am a mechanic for the Western Union Telegraph Co. Three days after receiving the lessons in refrigeration I earned the exact cost of the course.—Henry S. Lee, Washington, D. C.  
i work day times at the shipyard and after 4:00 P.M. I operate from my cellar and garage. I average \$10.00 to \$15.00 clear every day.—Walter Hanhy, Brockton, Mass.

## GET STARTED TODAY — MAIL THIS COUPON

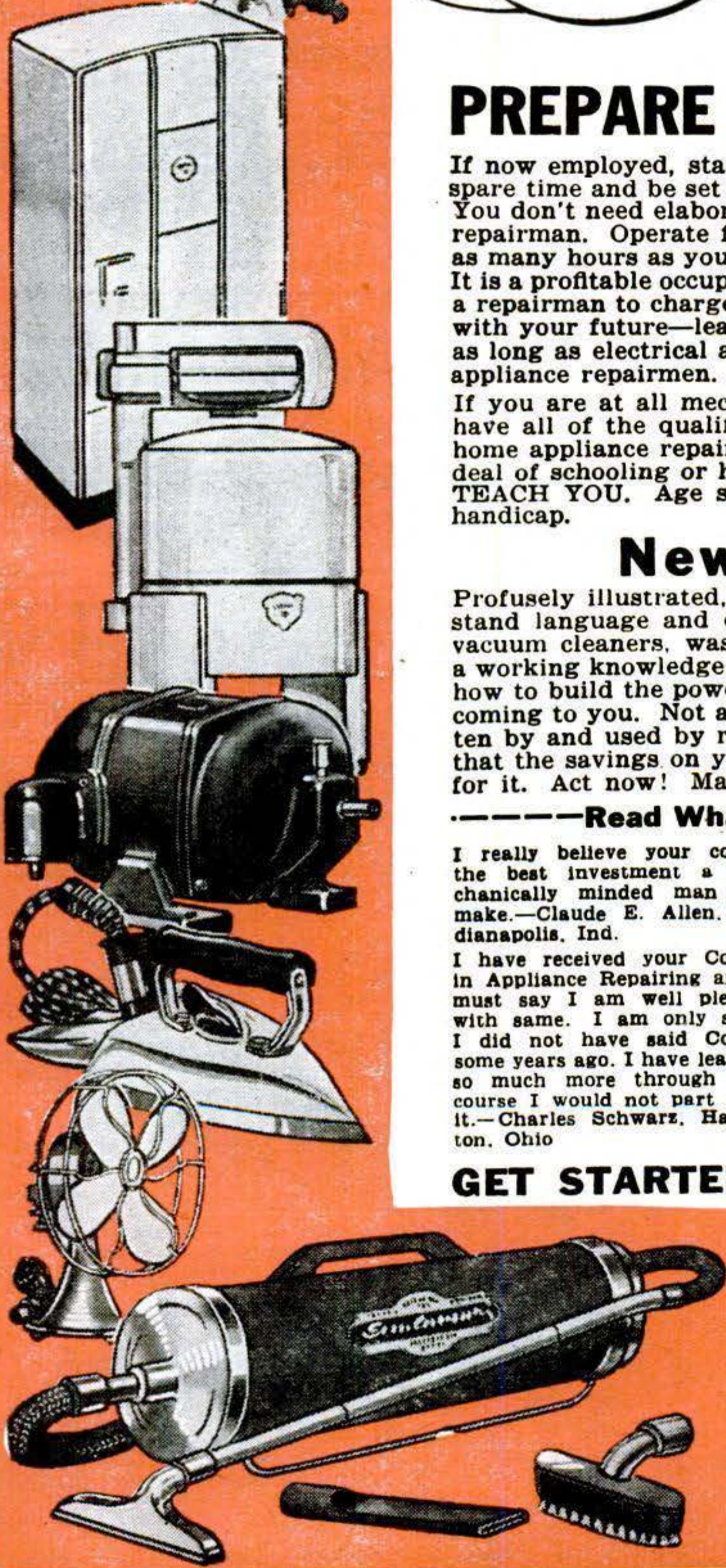

**CHRISTY SUPPLY CO.**  
2835 N. Central Ave., Dept. D-5101  
Chicago 34, Illinois

Please send me free illustrated literature about America's Fastest Growing Industry—**ELECTRICAL APPLIANCE REPAIRING.**

Name.....

Address.....

City.....State.....

APRIL  
1947 29



# ELECTRICIANS! RADIO MEN!

## Valuable BOOK

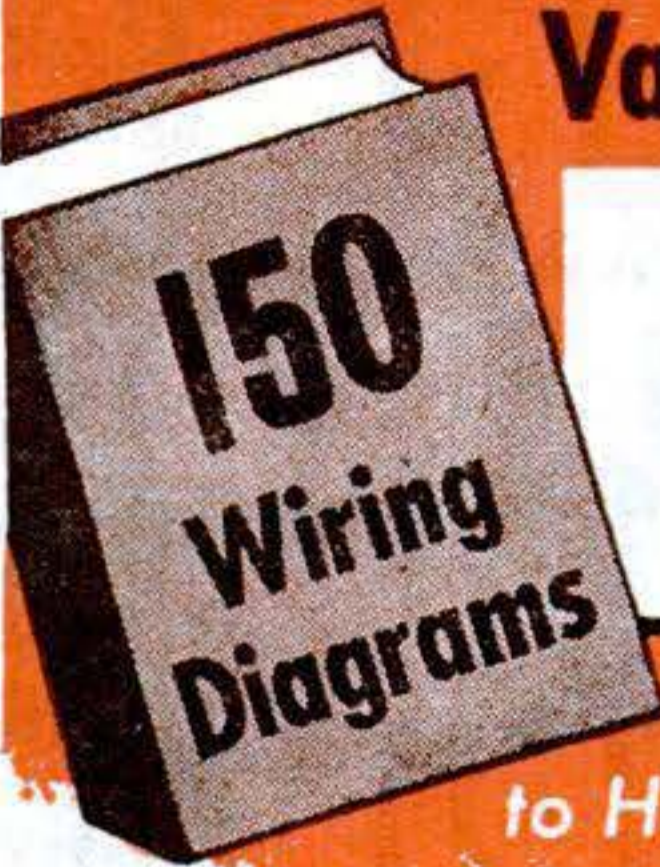

# FREE

It's My Gift  
to Help You Get  
Ahead



B. W. COOKE, Dir.

**5 to 1 Satisfaction  
GUARANTEE**

I personally guarantee that at the end of 1 year from the date you receive these books that they must have earned 5 times their cost or you may return them and I'll refund every cent you paid.

HERE'S one of the greatest "get acquainted" offers ever made. This new book of 150 selected Electrical Shop Prints and Wiring Diagrams is YOURS — absolutely FREE.

This book is 'chuckfull' of valuable charts, diagrams, wiring methods and instructions for reading and using wiring shop prints. All the shop prints are full size 8 1/4" x 11" with full explanatory information. Here's all you have to do to get this free book:

**150 Diagram Book Free  
FOR MERELY EXAMINING  
COYNE'S NEW 7 Volume Set**

To get your FREE copy of this Shop Print Book, all you have to do is to let me send you my complete new 7 volume set of electrical books—COYNE APPLIED PRACTICAL ELECTRICITY for 7 days' FREE examination. Here's a set of books written for the "beginner" or "old-timer" in electrical work who is anxious to get ahead.

This 7 volume set contains thousands of "show how" methods and photos—the latest information in "easy-to-understand language." Electricity from "A" to "Z" presented in new, practical, modern methods of explanation. A leader in electricity today must "know his stuff." To succeed from now on you must know many branches.

**SEND NO MONEY** You have to see this new 7 volume set to really appreciate how much it can mean to you and your future. I'll send you the complete set of 7 volumes (pictured below) at my risk, postpaid for 7 days' FREE Examination. I'll also send you the New Coyne Book of 150 Shop Prints and Motor Diagrams as my FREE gift to you TO KEEP REGARDLESS OF WHETHER OR NOT YOU DECIDE TO KEEP THE 7 VOLUME SET COYNE PRACTICAL APPLIED ELECTRICITY.

**7 AMAZING  
VOLUMES**  
Covers everything  
from home wiring to  
DC - AC Motors and  
Equipment. Over  
3000 subjects — 2000  
illustrations —  
6000 facts.

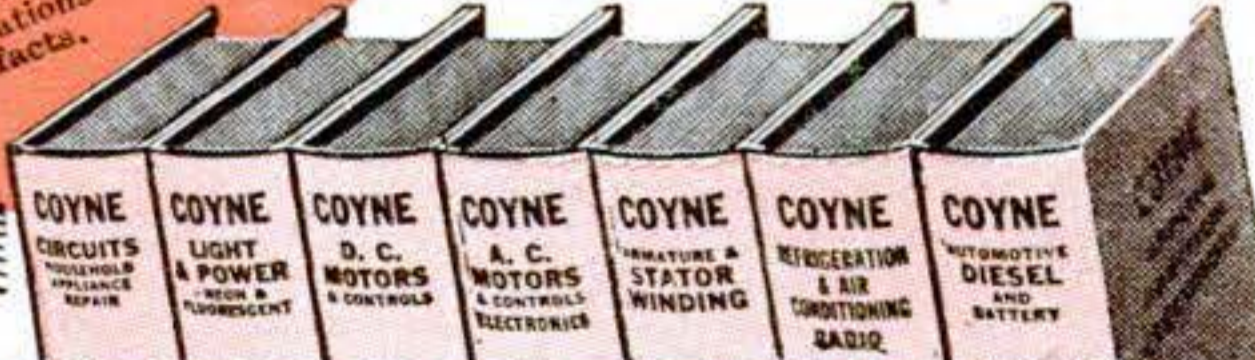

**Coupon is Not an Order**  
Just a Request to See the Books FREE  
YOU ARE NOT BUYING THE 7 VOLUME SET  
WHEN YOU SEND THIS COUPON. You are  
merely asking to see the books free for 7 days.  
The coupon only becomes an order if you decide  
to keep the 7 volume set after 7-Day Free Exam-  
ination. OFFER IS LIMITED—Don't delay!  
Fill in and Mail FREE BOOK COUPON Now!

## FREE BOOK COUPON

B. W. Cooke, Dir., COYNE ELECTRICAL SCHOOL, Dept. 47-R8  
500 S. PAULINA ST., CHICAGO 12, ILLINOIS

Send me the NEW 7 Volume COYNE APPLIED PRACTICAL ELECTRICITY. Also send the Bound Volume of 150 Shop Prints and Diagrams which I am to keep FREE whether I keep the 7 Book Set or not. I'll either return the 7 Book Set in 7 days and owe you nothing or pay \$3 within 7 days and \$3.00 a month until \$21 is paid, or I'll send the cash price of \$19.75. You also include FREE one full year of Consultation service and technical bulletins.

NAME \_\_\_\_\_ Age \_\_\_\_\_

ADDRESS \_\_\_\_\_

TOWN \_\_\_\_\_ Zone \_\_\_\_\_ STATE \_\_\_\_\_

Check here if you want to pay postman cash price of \$19.75 (you save \$1.25) delivered. Same 7 day examination privilege and Money-Back Guarantee.

# LEARN ISOGONIC DRAFTING

## The Drafting of Tomorrow

The first great advancement in Drafting in over 100 years!

INVESTIGATE this NEWEST development in the Drafting and Engineering fields. ISOGONIC Drafting opens up a NEW FRONTIER to those trained in its technique. Fits into EVERY branch of Engineering. ISOGONIC Drafting saves time and money, increases shop efficiency, steps up production. Pays well. Minimum background for success in this lucrative field—two years High School. Men now in drafting, by adding ISOGONIC Drafting to what they know now, become more capable, efficient and valuable. Spare time study at home. All texts and instruments furnished. For full details and descriptive folder. WRITE TODAY—give background of education and experience.

## ISOGONIC INSTITUTE

Dept. "S," 1095 Market Street, San Francisco 3, California

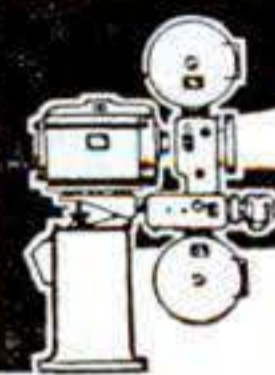

# LEARN MOVIE PROJECTION THEATRE MANAGEMENT

The Motion Picture Theatre Business offers big opportunities for trained men. Get into a fascinating field with a promising future. Train at home in spare time. Free Catalog. Established 20 years.

**THEATRE INSTITUTE** 385 Washington St.,  
Elmira, New York

# ELECTRICAL TRAINING

Intensive 32 weeks residence course in fundamentals of industrial electrical engineering, including radio, electronics. Prepares for technician, engineering aides. Approved for veteran training. 54th year. Write for catalog.

**BLISS ELECTRICAL SCHOOL**  
7606 Takoma Ave., Wash. 12, D.C.



# THERE'S MONEY IN CARTOONS!

RAYE BURNS will teach you HOW to CREATE ORIGINAL CARTOONS at home that you may SELL! Course contains 26 lessons and over 600 illustrations. All for Only... **\$2.85**

Send name and address for free details.

RAYE BURNS SCHOOL, Dept. S, Box 3583, CLEVELAND, OHIO



# MECHANICAL DENTISTRY

A profession offering unlimited opportunities. Most modern and complete course embracing every branch from Plate to Porcelain Work, which prepares you to work for Dentists or start your own business. Individual instruction—practical training in day or night school. No books—no classes. Catalog upon request.

**MCCARRIE SCHOOL OF MECHANICAL DENTISTRY**  
207 N. Broad St. Dept. 861 Philadelphia, Pa.



## THE GEM MAKER

Amateurs or professionals... hobbyists or jewelers... Polish your own gems with a B&I Gem Maker. You will find this a profitable adventure. All necessary lapidary equipment is furnished, including a super-charged diamond blade for sawing, and all wheels for grinding, shaping and polishing, also complete instructions. The complete equipment as shown, less motor and belt, for only \$29.50, f.o.b. Burlington, Wis. Write today for information and literature on the Gem Maker and accessories. **B&I MFG. CO., Dept. M, Burlington, Wis.**

# New Designs in FRANZITE GRIPS

**Modernize Your Gun! Improve Your Score!**  
Most durable grips made. Positively unbreakable! For Colt, Smith & Wesson, Hi-Standard, Orgies, Luger & Mausers in a wide choice of beautiful designs in ivory, pearl, walnut, onyx, etc. Low prices. FREE CATALOG. Dealers Wanted.  
**SPORTS, INC., (Mfrs.) 5501 Broadway, Dept. S-4, Chicago 40, Ill.**



# Men! Bulging Waistlines Flattened in Seconds!

WITHOUT DIET OR EXERCISE

## with THE **MANLY** THE NEW 2-WAY ABDOMINAL SUPPORTER

Now, at once, you no longer need feel embarrassed about being "pot bellied." A trimmer, more athletic-looking appearance can be yours INSTANTLY... look inches slimmer, without strenuous exercise, dangerous dieting or harmful drugs... with MANLY, the revolutionary new abdominal supporter for MEN!

**You Look Streamlined—Clothes Fit Better—You Feel More Alive**

The MANLY abdominal supporter is exclusively designed to support sagging abdomens... give that flat, muscled, athletic appearance to "bay windows". Your suits fit better, look better, and your whole appearance seems more fit and well-proportioned. Friends will be amazed when they notice the startling improvement!

### SCIENTIFIC PRINCIPLES GIVE CONTROL AND PROTECTION

MANLY is a scientifically designed men's two-in-one garment. Provides real stomach support and safeguards vital areas that all athletes know need special protection. MANLY contains NO STEEL RIBS, STRAPS, BUCKLES OR LACES! Made of specially woven elastic cotton-rayon that permits the body to move naturally, easily and comfortably. You'll hardly know you're wearing it... yet the streamlined appearance will be amazingly evident.

### SPECIAL MANLY FEATURES

- MANLY gives you these special features: The DETACHABLE jock-type crotch, made of soft cotton and rayon mesh... quickly snaps into place... easily removed for washing. MANLY provides real protection for athletics, swimming, etc., helps make street clothes look tailored.

### - FREE EXAMINATION COUPON -

THE MANLY CO., Dept. GD-12  
45 East 17th St., New York 3, N. Y.

( ) Send me the MANLY, complete with snap-button crotch, for no-risk 10 day trial. On arrival, I will pay postman \$2.98 plus postage. ( ) Send .....extra crotches at 98c each, C.O.D. Plus postage. If not amazed and delighted, I may return within 10 days for full purchase price refund.

My waist measures.....  
(Send string of waist size if measure is not known)

NAME .....

ADDRESS .....

CITY..... STATE.....

( ) I am enclosing \$2.98. Send MANLY postpaid. I enclose 98c each for..... extra crotches. Send postpaid. Same refund guarantee.

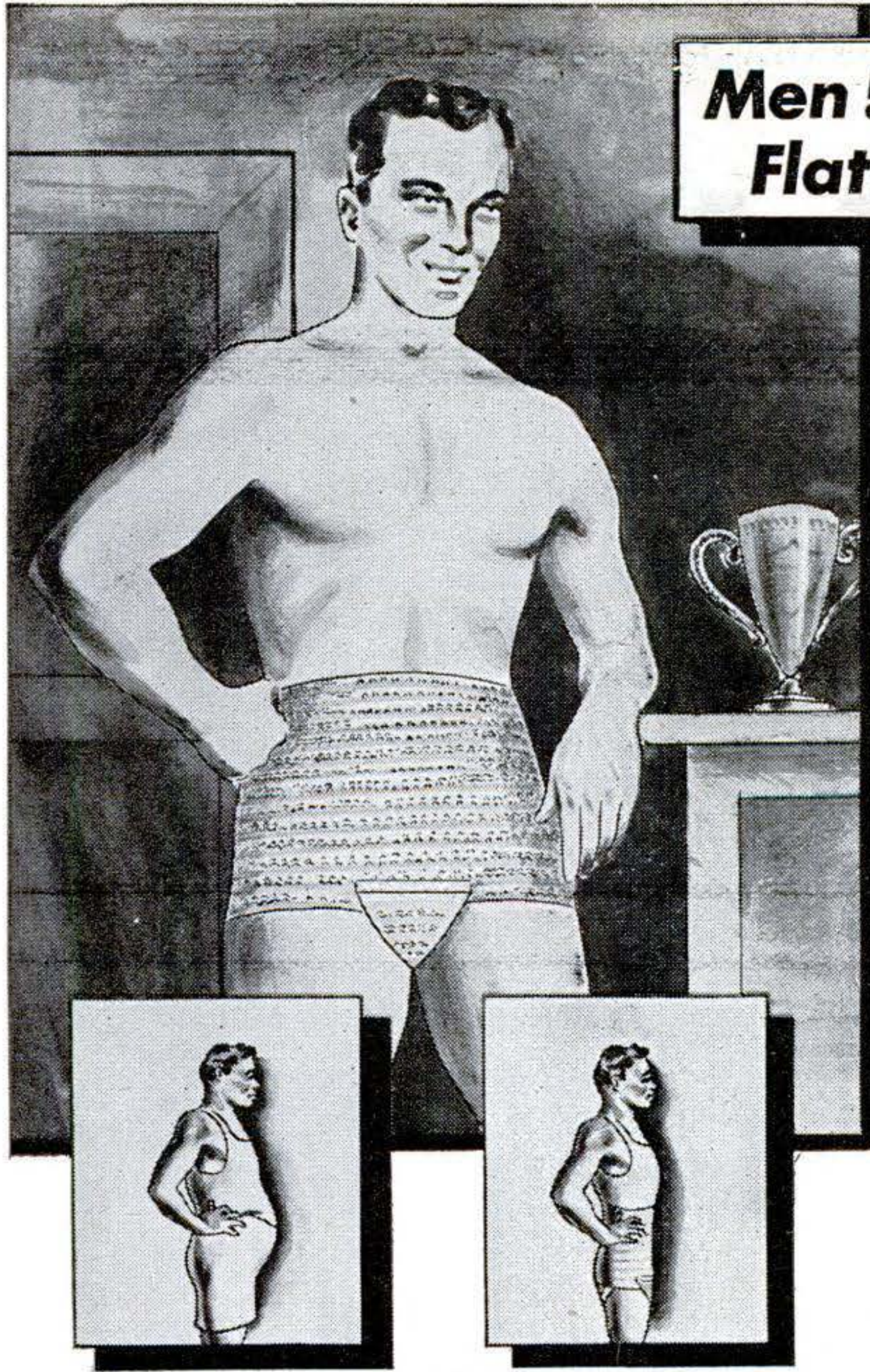

### LET YOUR MIRROR BE THE JUDGE!

This special FREE EXAMINATION offer below tells you how you can examine this amazing abdominal supporter at home, without risk. When your MANLY arrives, make this simple test. Stand sideways before your mirror and note the outline your "corporation" makes. Then put on your MANLY belt. See the difference; If MANLY does not make you appear slimmer by INCHES, then it costs you ABSOLUTELY NOTHING! Order today and see for yourself!

## FREE WEAR FOR 10 DAYS SEND NO MONEY

Wear the MANLY for 10 days. If you are not amazed and delighted by the immediate improvement in the way you feel and look, return it and your purchase price will be immediately refunded.

SIZES 28 to 45

ONLY  
**\$ 2.98**

Special Large Sizes, 46 to 60—\$3.98. Extra snap-button crotches — only 98c each. Makes your MANLY belt last practically twice as long.

Order two or three.

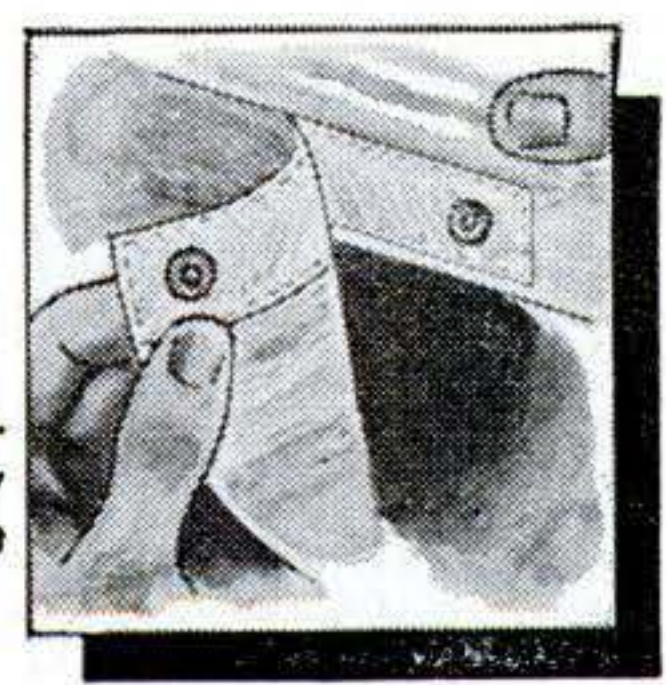



It's YOUR future—Make the most of it!



**Start now to earn the bigger pay in electrical repair**

WAS there ever such an opportunity to get started in electrical maintenance and repair—and at top-notch wages? Are you ready—with experience and ability—to cash in on it? Others are getting just the sort of background needed—quick! practical!—to handle the great variety of electrical maintenance and repair work TODAY—from this well-known electrical library. You can too!

**THE LIBRARY OF ELECTRICAL MAINTENANCE AND REPAIR**

5 vols., 1826 pages, 1724 illustrations

Gives you the "know-how" to tackle any wiring or motor job. Five books show you HOW—to install all types of motor and generator units—to inspect and repair motor starters and generators—to diagnose motor and generator troubles—to figure new windings for old cores—DC and AC windings—to test armature windings—test induction motors, etc., etc. One book is full of trouble-shooting charts that show quickly symptoms, causes, specific remedies, etc.

Take the first step toward improving YOUR future—Mail this coupon TODAY

No money down—special price—easy payments—FREE trial

McGraw-Hill Book Co., 330 W 42 St., New York 18, N. Y.

Send me for ten days' free examination the Electrical Maintenance and Repair Library. If satisfactory I will send you \$1.50 in 10 days and \$3.00 monthly until the price of \$16.50 is paid. If not wanted I will return books postpaid. (To insure prompt shipment write plainly and fill in all lines.)

Name.....  
 Home Address.....  
 City and State.....  
 Company.....  
 Position..... PSM-4-47



**WANT A U.S. Government JOB?**

**START \$1,756 to \$3,021 YEAR**

68,578 appointments from Civil Service Examinations in 1940 fiscal year. Veterans Get Special Preference. Thousands appointments each year. Prepare immediately. 32 Page Book on Civil Service FREE. Mail Coupon Today—SURE.

Franklin Institute  
 Dept. G82  
 Rochester 4, N. Y.

Gentlemen: Rush to me FREE of charge, list of U. S. Government big pay jobs. Send me FREE 32-page book describing salaries, vacations, hours and work. Tell me how to prepare for one of these jobs.

Name.....

Address..... Vet?.....

★ 32 POPULAR SCIENCE

**AVIATION**

Aeronautical University Approved Training meets exacting standards of aviation industry, prepares for key positions, big opportunities.

Courses in:  
**AERONAUTICAL ENGINEERING. B.S. degree.**  
**AERONAUTICAL ENGINEERING DRAFTING**  
**CERTIFIED ENGINE MECHANICS**  
**ADMINISTRATION—including sales**

**PRE-ENGINEERING:** Special course for high school graduates and veterans deficient in math and science.

Also refresher courses for Gov't. Airplane and Engine Mechanics Licenses for those with aviation experience.

Oldest fully approved aviation school. Outstanding faculty, modern equipment, outside employment, placement service. Day, evening. Approved for Veterans. Send today for FREE catalog "Opportunities in Aviation."

**AERONAUTICAL UNIVERSITY**  
 Dept. 87, 116 S. Michigan Avenue, Chicago 3, Illinois

**FOUNDED BY CURTISS-WRIGHT**

**Be A MASTER PLUMBER**

**Earn \$15 To \$50 A Day**

**DON'T ENVY THE PLUMBER—BE ONE**

Every skilled workman will tell you that Plumbers have the best of it. WINTER and SUMMER the Plumber is busy at top wages. No skilled Plumber is ever out of a job—compare his opportunities with any trade, plus the opportunities of having your own shop. We teach you Plumbing with TOOLS (not books) under Licensed Master PLUMBERS in one of the finest equipped schools in America. We make you a Plumber, every branch is taught thoroughly—Lead Work—Blueprint for plan reading—all other tricks.

**LEARN IN 30 WEEKS WITHOUT PREVIOUS EXPERIENCE**

If you like to work with tools you owe it to yourself to investigate. No need to ever work as an apprentice. Get free bulletin. Write now! G.I. APPROVED. Our 24th year.

**UNIVERSAL PLUMBING SCHOOL**  
 819 HOLMES STREET KANSAS CITY, MO.



You can become a good penman right in your own home during spare time by my Simplified Method. Write for my FREE Book, "How to Become an Expert Penman," which shows what others have learned. If desired, send 10c for one of my favorite Pen Points and your name with a beautiful flourished bird written on a card. Write for the Free Book today.

T. M. TEVIS, BOX 25R, CHILLICOTHE, MO.

**RADIO ENGINEERING**, Broadcasting, Servicing, Electronics, Aviation, Marine & Police Radio taught thoroughly. 48 weeks' Engineering course equivalent to 3 years' college radio work. Approved Veteran Training. Co-educational. Catalog upon request.  
**Valparaiso Technical Institute. Dept. 503, Valparaiso, Ind.**

**LEARN MEAT CUTTING**  
**At Home — In Spare Time**

Get into the vital meat industry. Concise, practical Home Training based on 25 years proven instruction methods used at National's famous resident school. Prepares you for bigger pay as Meat Cutter, supervision, market manager or more money in your own store. Go as rapidly as your spare time permits. Diploma. Start NOW to turn your spare hours into money. Send for FREE bulletin today. No obligation.  
**National School of Meat Cutting Inc., Dept. O-53, Toledo 4, Ohio**

**MAKE MONEY AT HOME**

**RUBBER MOLDS** Low as **6¢ EA.**

Amazing rubber mold-making outfit makes perfect flexible molds of plaques, ash trays, book-ends, etc. Molds cost 6c to 25c each. Each mold makes hundreds of novelties and gifts to sell for \$1.00 apiece and more! No experience necessary. Everything furnished. Quick and easy. Start profitable business in your home—sell to stores, gift shops, friends, resorts, road stands, by mail. Full or spare time. Write for complete FREE details and easy instructions.  
**SO-LO WORKS, INC., Dept. T-801, Loveland, Ohio**





# GET INTO THE NEW FIELD OF

# INDUSTRIAL *Electronics*

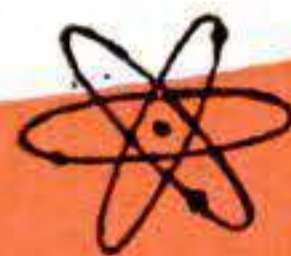

## THRILLING NEW FRONTIER OF OPPORTUNITY



### AMERICA'S FOREMOST SCHOOL OF PRACTICAL TRAINING

Here is a **NEW** Industry—one that points the way to a vast new field of opportunity—Opportunities that beckon alike to men looking for new fields, and to experienced electrical men seeking a way to bigger earnings and a more secure future.

Industrial Electronics is *not* Radio. It has nothing to do with radio transmitters and receivers. It is a totally new application of electric power, applied to modern production by means of the magic of the vacuum tube. Everywhere industrial electronic devices are replacing the old-time electrical controls, and processes. Industrial Electronics is *Modern Industrial Electricity*.

### GET READY NOW!

Now is the time to get into Industrial Electronics, while the field is in its infancy . . . and while it is rapidly developing a need for thousands of trained experts. Tomorrow's leaders are training today.

And here is a School equipped in every way to train *you* for Industrial Electronics work—one of the largest and most completely equipped, and one of the few of its kind in America—a School that already has trained thousands of men for industrial opportunities.

### LEARN AT HOME OR COME TO OUR SCHOOL

Learn Industrial Electronics—now, while the time is ripe. You don't need any advanced schooling or previous experience. If you are at all mechanically inclined and have gone to highschool for at least one year or have an equivalent education, we can teach you Industrial Electronics.

You can take most of your training at home, in your spare time—or you can come to Chicago and take your entire training in our completely equipped shops and laboratories. Either way you quickly acquire the fine points, practical skill, and broad, technical "know how" that makes the expert Industrial Electronics Technician.

**"Every electrician should know — must know — Industrial Electronics."** That's what many Union leaders are telling their members, today. They know that the use of Industrial Electronics devices is growing by leaps and bounds. They know that to install and service this equipment, even the best of present-day electricians must first have had special

### FACTS ABOUT THE I. T. I.

Founded in 1916. Has trained more than 400,000 men for practical work in industrial fields. From 1942 through 1945 trained specialized technicians, exclusively, for the Army, Navy, and Marine Corps. Now training thousands of veterans under the G. I. Bill, both in its Residence Schools and by home-study. Occupies five buildings of its own. Has over \$500,000 invested in training facilities, with an instruction staff of more than 100 men. Known everywhere as America's foremost school of practical training for industry.

training.

Get all the facts about the opportunities in this interesting field of work and about the I.T.I. system of training that has helped so many men into key jobs in industry. Fill out the information, coupon below and mail it **TODAY**. You will be under no obligation whatsoever.

**AUTHORIZED TO ACCEPT VETERANS FOR G. I. TRAINING**



**GET THE FACTS ABOUT AMERICA'S FOREMOST SCHOOL OF PRACTICAL TRAINING**

### REGISTRAR, P2-Q

**INDUSTRIAL TRAINING INSTITUTE,  
2150 LAWRENCE AVE., CHICAGO 25, ILL.**

Please send me, **FREE**, your "Camera Visit" booklet and information about the opportunities for trained men in **INDUSTRIAL ELECTRONICS**. It is understood that I will be under no obligation.

NAME.....

ADDRESS.....

CITY.....STATE.....

ARE YOU A VETERAN?.....





# AUTO BOOKS ON APPROVAL



**SEND NO MONEY.** Just mail the coupon for a complete set of Six Big Auto Books. 20th Edition. Whether you are a mechanic or helper, expert or apprentice, auto owner or driver, take immediate advantage of this **FREE EXAMINATION OFFER.**

### MAKE GOOD MONEY NOW HOLD A PERMANENT JOB

America wants its automobiles kept in good repair. Men with "know how" are in demand, at big pay. These books will help you get and hold an important job, or give you a chance to go into business for yourself now or later. Any man who half tries to improve himself can learn auto servicing and repairing by this quick reference method. Use the **JIFFY INDEX** to find easily understood answer to any auto problem. These wonder books prepared by eleven of America's great automobile engineers. Many hundreds of valuable illustrations. Send the coupon **ODAY.**

**[A year's consulting privileges with our engineers now given with these books without extra charge.]**

*Vocational Publishers Since 1898*

### CAN YOU FIX IT?

These wonder books tell step by step **HOW** to make difficult repairs and adjustments, how to keep a car at maximum efficiency, including latest improvements in car design and operation. Engine troubles and how to correct them well covered.

### 6 BIG VOLUMES

2800 pages, 2000 illustrations, wiring diagrams, etc., including Diesel engines. Beautiful modernistic, washable cloth binding.

**AMERICAN TECHNICAL SOCIETY, Dept. A420, Drexel Ave., at 58th St., Chicago 37, Ill.**

I would like to examine your Six-Volume Set of Auto Books. I will pay the delivery charges only, but if I choose I may return them express collect. If after 10 days' use I prefer to keep them, I will send you \$2 and pay the balance at the rate of only \$3 a month until \$24.80 has been paid. Please include consulting service as offered above.

Name.....

Address.....

City..... State.....

Please attach letter stating age, occupation, employer's name and address, and name and address of at least one business man as reference. Men in service, also please give home address.

# INVENTORS

The inventor who believes he has a new and useful invention, and finds himself in need of advice, should consult a competent registered patent attorney.

The question as to whether a subject matter is patentable can be substantially determined by a search of the U. S. Patent records.

Without obligation, write us for information as to what steps an inventor should take.

## RANDOLPH & BEAVERS

*Registered Patent Attorneys*

905-L Columbian Bldg., Washington 1, D. C.

### RANDOLPH & BEAVERS

905-L Columbian Bldg., Washington 1, D. C.

Please send me full information on how to secure Patents & Trademarks.

Name.....

Street.....

City..... State.....

## NORTHWESTERN GI APPROVED VOCATIONAL INSTITUTE

### MEN AND WOMEN EARN BIG PAY!!

Your opportunity is now. Learn the **NORTHWESTERN** way from skilled, highly trained instructors.

- Radio Maintenance
- Radio Communications
- FM
- Industrial Electronics

Day or night classes. New courses start every 30 days. Study in the heart of the Land O' Lakes. Don't let this opportunity pass. It's up to you! Write for free facts today!!



**NORTHWESTERN VOCATIONAL INSTITUTE**  
Dep't. PS 3  
745 Grand Ave., St. Paul 5, Minn.



### OPPORTUNITIES AHEAD! TRAIN FOR A FUTURE IN

# DIESEL

• Prepare for the big earning power of **Diesel Trained Men.** Start learning at home, in spare time. UEI's easy, practical training covers all phases of **DIESEL** engine operation, fuel systems, auxiliary equipment, repairs and maintenance. When home course is completed, you come to Chicago for actual shop practice on **DIESEL MOTORS** under expert instructors, at UEI's fine, modern school. **BEGIN AT ONCE—GET ALL THE FACTS FREE. WRITE TODAY!**

**DIESEL DIVISION UTILITIES ENGINEERING INSTITUTE**  
1314 Belden Avenue • Dept. 347-D • Chicago 14, Illinois



## A Penny May Bring You HAPPINESS!

Would you gamble a penny to win Happiness, Companionship, Love, Financial Success, through the help of a mysterious International Secret Organization? Then just send name and address on a post-card TODAY for your

**FREE** Copy of great Book "Mayan Mysteries". It can change your whole life! Address Rose Dawn, The Mayan Order, Dep't. 747, P. O. Box 2710, San Antonio, Tex.



**AMAZING DISCOVERY!** Corrects poor penmanship in few days—big improvement in three hours, no failures. Complete Outline Free. Write, C. Ozment, 35-B, St. Louis, Mo. **IMMEDIATELY.**

## STAY HOME AND MAKE MONEY!

—Men! Women! Get into profitable, uncrowded profession you can operate from your home or small office after short home training course. No capital required. No goods to buy. No age limit. Others earn \$50.00 to \$100.00 per week making famous Stephenson corrective foot devices to order. Foot sufferers everywhere pay gladly for relief. Send today for **FREE BOOKLET.** **STEPHENSON METHOD, Established 1894, 5-62 Irvington St., Boston, Mass.**



### Thrilling Work COLORING PHOTOS

Fascinating vocation learned at home by those with aptitude. Thrilling pastime. National method brings out life-like colors. Free booklet.

**NATIONAL PHOTO COLORING SCHOOL**  
1315 S. Michigan, Dept. 1364, Chicago 5

# \$ WINDOW SIGN LETTERS

For Store Fronts and Office Windows. Anyone can put them on. Samples furnished. Genuine gold and silver.  
**METALLIC LETTER CO., 441 N. Clark, Chicago 10**

## DETECTIVES

**TRAINING—SECRET INVESTIGATIONS—FINGERPRINTS**  
Easy Method — Short Time. — Rewards.  
Home—Travel—Secret Code-Booklet **FREE—WRITE**  
**INTERNATIONAL DETECTIVE SYSTEM**  
1701-P Monroe St., N. E., Washington, D. C. 18

# SIGNS EASILY AND EXPERTLY PAINTED WITH LETTER PATTERNS AND SHOWCARDS

**AND MANY SIZES & STYLES WRITE FOR FOLDER!**  
**JOHN F. RAHN**  
1930-33 N. CENTRAL AVE.  
CHICAGO 51, ILL.



# GET INTO RADIO ELECTRONICS & TELEVISION

for Success and Security!

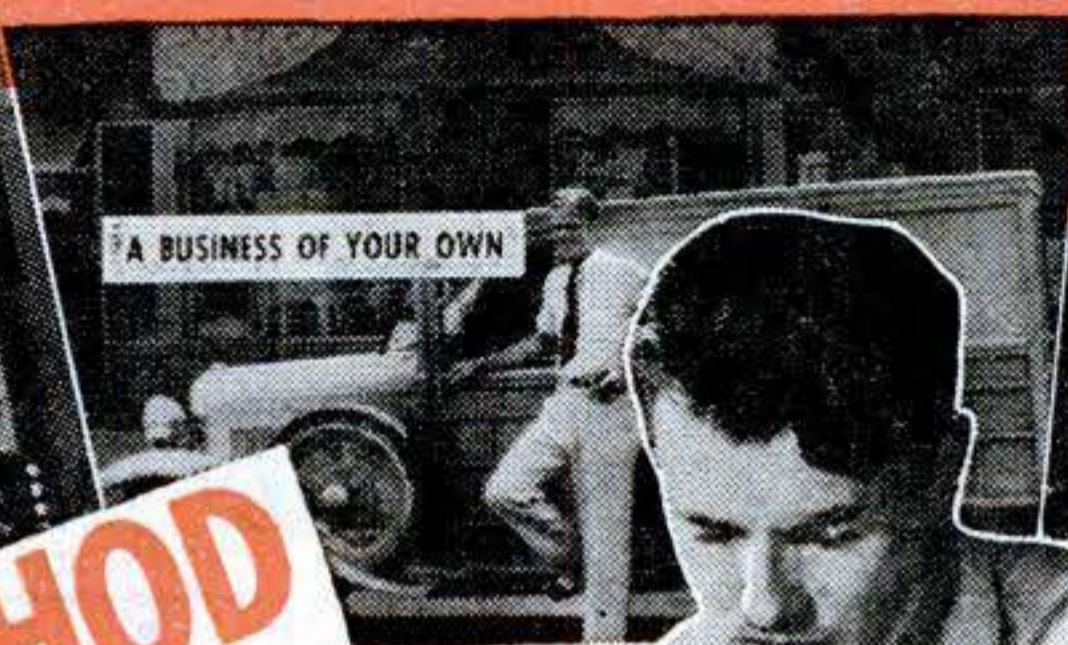
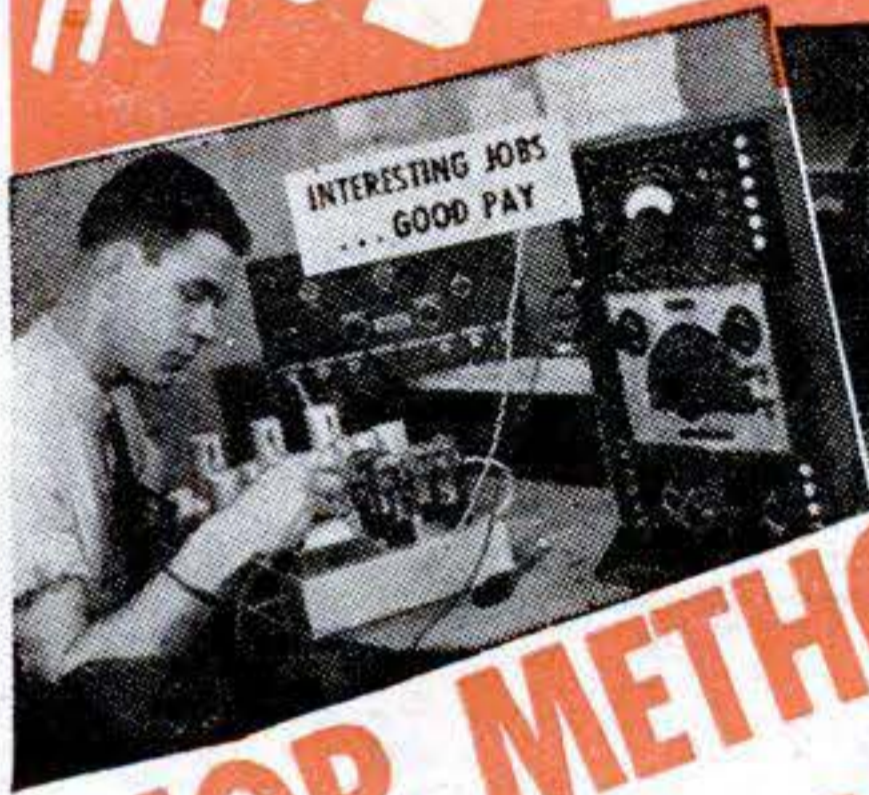

**SHOP METHOD HOME TRAINING**

**BY A REAL ESTABLISHED RESIDENT SCHOOL**

In the Classrooms, Shops and Laboratories of this Established School, improved training methods have been designed for practical Home Study instruction in the great field of Radio—in the rapidly expanding branches of Television and Electronics. National graduates everywhere have qualified through spare time study, for well-paying jobs, success and security. Here is training created BY Practical men FOR Practical men.



You build this powerful super-heterodyne receiver.

phases are constantly absorbing trained men. If you like mechanics—like to work with your hands as well as your head, you too can find your opportunity in industry or in a business of your own.

**LEARN BY DOING RIGHT AT HOME**

## BECOME A RADIO EXPERT IN YOUR SPARE TIME

The Radio, Television and Electronics industries are demanding more and more trained, experienced men as service men, operators and technicians. It is a field with a proved future. Untold Radio sets are in use—they need maintenance or repair. **Radio service organizations, broadcasting, marine and police Radio, public address, and other specialized**

The secret of success of this practical training method is the **EXPERIENCE OF WORKING WITH ACTUAL FULL SIZE, STANDARD EQUIPMENT DURING YOUR TRAINING.** Here's a fully tested and approved method—thorough, complete and easy to put into **PRACTICE!** As you go along, you check **PROGRESS** right on your own equipment! You can see advancement from the start. It will only take a moment to fill out and send the coupon for a sample lesson. **PROVE TO YOURSELF HOW MUCH YOU CAN ACCOMPLISH WITH NATIONAL TRAINING SHOP METHODS.**

**BIG KITS OF EXPERIMENTAL EQUIPMENT ARE INCLUDED WITH YOUR TRAINING**

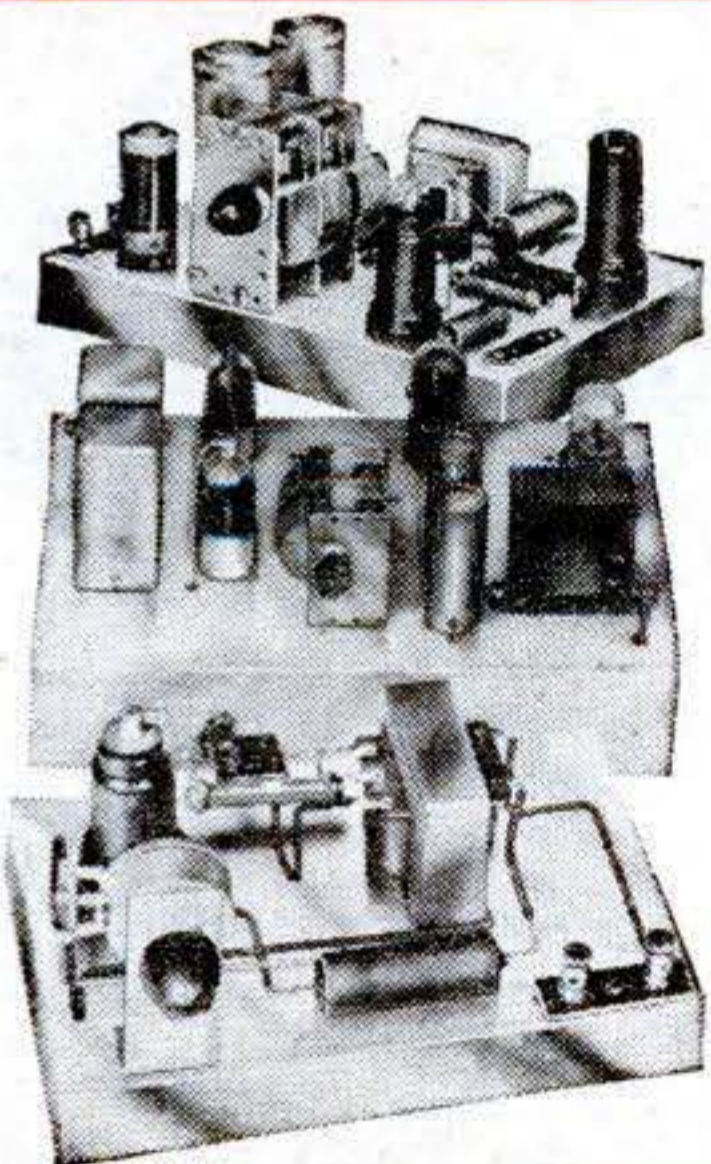

Here are a few of the units of Standard Radio equipment supplied. Build a big, long distance receiver, an audio oscillator, a signal generator and conduct many other experiments.

**BIG OPPORTUNITY BOOK AND SAMPLE LESSON**

*Free*

Learn how National trains you for good-paying jobs—a business of your own. Get this valuable "Modern Radio Servicing" manual without obligation. Send coupon NOW!



### VETERANS

If you qualify for training under G. I. Bill, check the coupon for a Special Bulletin.

## NATIONAL SCHOOLS

LOS ANGELES 37, CALIFORNIA EST. 1905

### MAIL OPPORTUNITY COUPON FOR QUICK ACTION

National Schools, Dept. 4-PS  
4000 South Figueroa Street  
Los Angeles 37, California

(Mail in envelope or paste on penny post card.)

Mail me **FREE** the books mentioned in your ad including a sample lesson of your course. I understand no salesman will call on me.

NAME.....AGE.....

ADDRESS.....

CITY.....ZONE.....STATE.....

Check here if veteran of World War II





SALES ENGINEER    MOLD DESIGNER    RESEARCHER    FABRICATOR    LAMINATOR    PARTS INSPECTOR    MOLDING TECHNICIAN    YOUR OWN BUSINESS

## WHICH CAREER IN PLASTICS DO YOU WANT?

Plastics is one of the fastest growing industries—offering you unusual opportunities for an interesting, successful career and security in the years ahead. Trained men, with plastics know-how will fill the important, well-paying positions. YOU can be one of them. Mail the coupon below for a big, colorful, free catalog on Plastics and complete de-

tails about Plastics Institute, America's oldest and largest plastics school. Resident School located in beautiful Southern California Comprehensive Home Training Courses to prepare you in your spare time at home for a career in plastics. You can enroll immediately!

Write Plastics Institute, Dept. PS7-4, 1601 S. Western Ave., Los Angeles 6, California.



### LEARN BY DOING

To give you practical experience we supply colorful plastics to make useful, attractive creations. You can also make and sell plastics articles to earn while learning.

APPROVED FOR VETERANS

## Plastics INDUSTRIES TECHNICAL INSTITUTE

NEW YORK    CHICAGO    LOS ANGELES



FREE BOOKLET

Plastics Industries Technical Institute  
Dept. PS 7-4, 1601 S. Western Ave., Los Angeles 6, Calif.    Mail in Envelope or paste on penny postcard

Gentlemen: Please send me the booklet "World of Plastics" and information on your Resident School Courses ( ) Home Training Courses. ( ) I understand there is absolutely no obligation

Name (PRINT) \_\_\_\_\_ Occupation \_\_\_\_\_

Street (PRINT) \_\_\_\_\_ Age \_\_\_\_\_

City \_\_\_\_\_ Zone \_\_\_\_\_ State \_\_\_\_\_

Important: Please fill out coupon completely. If Veteran, please check. ( ) If in Armed Services now, please check. ( )

PLASTICS INSTITUTE in the heart of sunny Los Angeles. Here modern laboratories and shops give Resident School students facilities for practice on the finest of industry-type plastics equipment. Also the headquarters for HOME TRAINING.



## AMAZING NEW Pocket or Purse Size RADIO!

Small as a pack of cigarettes! Weighs only a few ounces. Durable and beautiful black chrome plastic cabinets. Uses new pretested war born crystal diode and slide rule dial. REQUIRES NO TUBES—BATTERIES OR ELECTRIC "PLUG-IN". Should play for years.

**GUARANTEED TO PLAY** for you if attached and used according to complete instructions sent with each radio. You can use it at home, in offices, hotels, cabins, in bed, etc. Lots of fun—and real entertainment!

**SEND ONLY \$1.00** (cash, money order, check) and pay postman \$2.99 plus delivery fees on arrival or send \$3.99 for post-paid delivery. Complete as shown ready to play with self-contained personal phone. For Gifts—children will love it—grownups too! An exceptional value—order yours and enjoy the many good radio programs coming! Don't be without your Pakette Radio another day! (All foreign orders \$5.00 U. S. cash.)

PAKETTE ELECTRIC COMPANY    Department PS-4    Kearney, Nebraska

## CHOW PUPS PEDIGREED

hobby. You sell pups for \$50 up. We EVENINGSHADE KENNELS, Box B-2, Helotes, Texas

Raising world's most beautiful pet is world's most fascinating, most profitable hobby. You start you. Write—

## Learn BAKING At Home

Baking is one of America's high industries in wages. Nearly depression-proof. Thorough basic home course lays sound foundation. If you have aptitude, write for FREE BOOKLET, "Opportunities in Commercial Baking." National Baking School, 1315 Mich. Ave., Dept. 1364, Chicago 5



## DRAW for MONEY... Be an ARTIST!

Trained Artists are Capable of Earning \$50-\$60-\$75 OR MORE A WEEK!

You can learn to draw at home in your spare time the well-known WSA way. COMMERCIAL ART. DESIGNING. CARTOONING—all in ONE complete course. No previous art experience necessary—we teach you step-by-step. Prepare now for a fascinating hobby or profitable career. For 33 years WSA graduates have been making good—WHY NOT YOU?

VETERANS! WSA is approved for training under the G. I. Bill

Write today for FREE BOOK, "Art for Pleasure & Profit", it fully describes our well-known course, instruction service, and commercial opportunities for you. TWO ART OUTFITS and other features included with training.

WASHINGTON SCHOOL OF ART, Studio 134-H  
1115—15th St., N.W., Washington 5, D. C.

Please send me full information and your Free Book, "Art for Pleasure and Profit."

Name \_\_\_\_\_ AGE \_\_\_\_\_

Street \_\_\_\_\_

City \_\_\_\_\_ Zone \_\_\_\_\_ State \_\_\_\_\_

I am entitled to training under the G.I. Bill



**WANT TO  
EARN  
MORE  
Money?**  
I Show You How  
at Home

# Start Your Own RADIO

**Business With Little Capital  
or Qualify for a Well Paid Radio Job  
Make Extra Money in Spare Time While Learning**

Find out about the many money-making opportunities Radio offers you. Learn how you can qualify for a good-pay job or start a business of your own without capital. Send coupon below for my big **FREE** book, "Your Opportunities in Radio and Television," which tells of radio's vast opportunities and how **HOLLYWOOD RADIO & TELEVISION INSTITUTE** has been training men for success in Radio for over 17 years, in over 40 different countries, through its proven **2-WAY METHOD-LESSONS PLUS HOME SHOP PRACTICE!**



**ABOVE-** You build this A. C. Power Supply. (Experiment No. 155)  
**LEFT-** You build this Multi-range Voltmeter (Experiment No. 61)

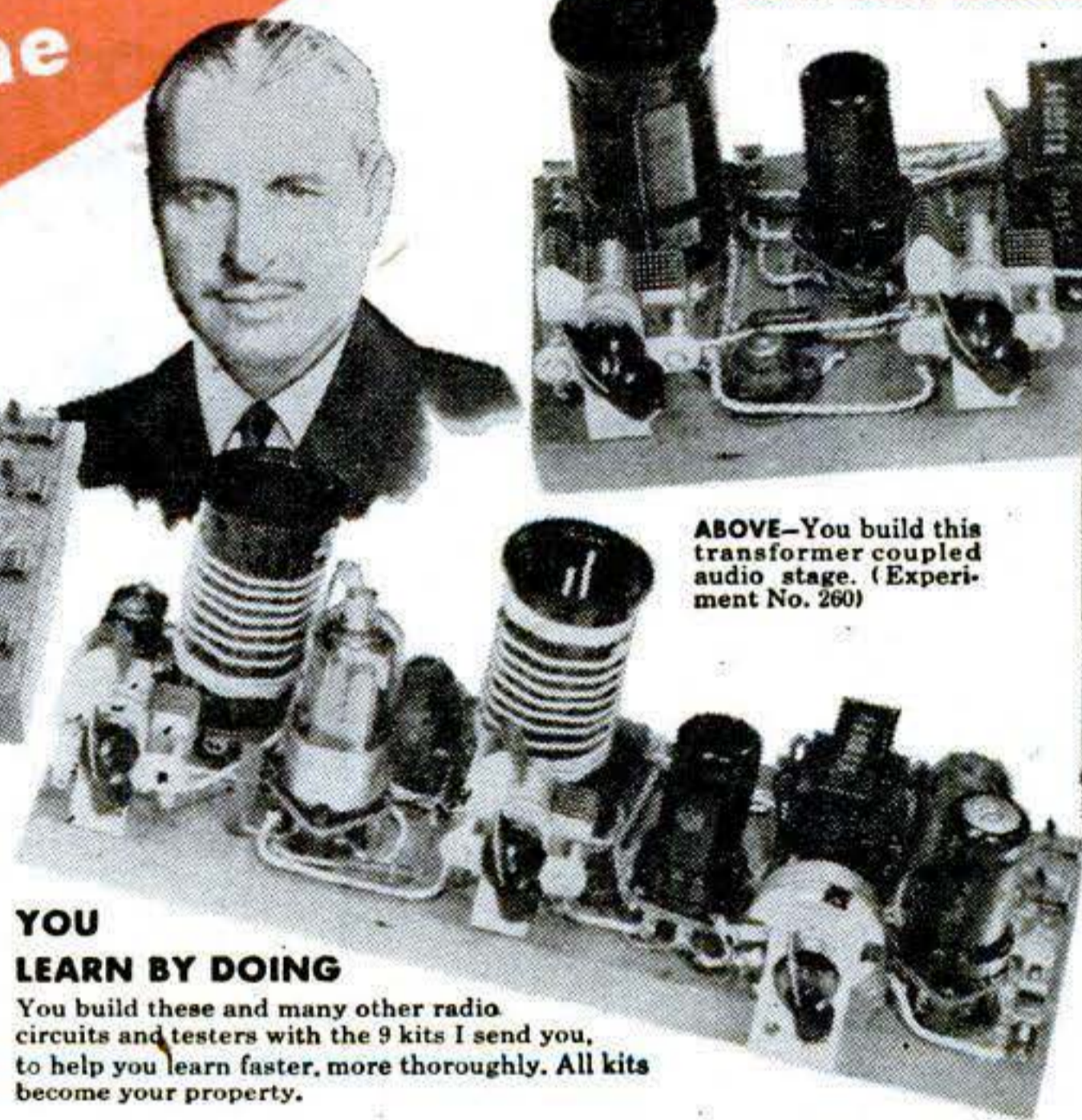

**YOU LEARN BY DOING**  
You build these and many other radio circuits and testers with the 9 kits I send you, to help you learn faster, more thoroughly. All kits become your property.



**ABOVE-** You build this transformer coupled audio stage. (Experiment No. 260)

**ABOVE-** You build this Multi-purpose Shop Test Panel. 5 Test instruments in one.  
**LEFT-** You build this tuned radio stage, regenerative detector and audio amplifier. (Experiment No. 329)

**I Give You 9 KITS OF RADIO PARTS** and Complete Practical Experimental Lessons (All kits remain your own property)

**You Do Over 300 Fascinating Tests ★ Learn This Practical Way**

I send you 9 kits of radio parts with which you make hundreds of interesting, fascinating tests and experiments. You learn the "why and hows" of radio first hand, by doing. Thus, you learn more thoroughly, faster!

**HOLLYWOOD IS A WORLD CENTER**

of radio broadcasting and manufacture-television-motion picture production. Thus, H. R. T. I. is in an excellent location to bring you modern, up-to-the-minute instruction. Before you decide on any course you owe it to your future to find out about H. R. T. I. training. Read what graduates in 40 different countries say about this famous course.

**BIG BOOK FREE**

Just paste coupon on a postcard or send in envelope for **FREE** big fully illustrated book, "Your Opportunities in Radio, Television and Electronics" which explains the advantages of H. R. T. I. training. No salesman will call.



**MANY H. R. T. I. STUDENTS EARN MONEY IN SPARE TIME WHILE LEARNING**

From the very start, through special "Spare Time Work Sheets," I show you how to earn money in spare time by doing good-pay radio jobs that abound in nearly every neighborhood. Many students earn \$5, \$10, and more a week while learning. A mighty good way to lay the foundation for a future radio business of your own.

Now is the time to start preparing for **YOUR** career in this fast-growing industry. Take the first step—send coupon for my big **FREE** Book today.

**MAIL COUPON NOW**

C. H. Mansfield, President, Dept. D-3  
HOLLYWOOD RADIO & TELEVISION INSTITUTE  
810 WEST 6TH ST., LOS ANGELES 14, CALIF.

Send me your **FREE** book, "Your Opportunities in Radio, Television and Electronics" which explains your 2-way training method at home. (No salesman will call.)

Name \_\_\_\_\_ Age \_\_\_\_\_

Address \_\_\_\_\_

City \_\_\_\_\_ Zone \_\_\_\_\_ State \_\_\_\_\_

Air Mail Reaches Me Overnight

**HOLLYWOOD RADIO & TELEVISION INSTITUTE**  
810 West 6th Street, Los Angeles 14, California



No Waiting to LEARN

# START NOW TO EARN!

This BIG BOOK SHOWS HOW



## IF IT'S RESULTS YOU WANT—GET ACTION QUICKLY WITH THESE PRACTICAL IDEAS

Never before has a more helpful book been printed for those planning a business of their own. Gathered in this large illustrated volume are the formulas, recipes, facts and secrets that have contributed so largely to America's great industrial progress. Capitalize on this information for making most any conceivable product without experience, special equipment or previous knowledge of chemistry or manufacturing.

The experts who compiled this book are authorities, and present this information in simple, understandable language. They also give you wholesale supply sources for needed materials, short cuts and methods for the most profitable results.

## START AT HOME—Expand out of profits.

Hundreds of good paying businesses have been built on a product made from a simple recipe. Choose from any of the 162,000 facts and 10,000 formulas of which the following are only a very few: Adhesives, Alloys, Anti-Freeze Solutions, Cosmetics, Beverages and Liquors, Candy, Gum, Casein, Celluloid, Ceramics, Cheese, Cleaning Preparations, Concrete, Copper, Cotton, Dentifrices, Depilatories, Dyes, Embalming Fluids, Enameling, Glass, Glazes, Household Formulas, Inks, Insecticides, Iron, Jewelers' Formulas, Lacquers, Laundry Preparations, Leather, Linoleum, Lubricants, Manicure Preparations, Marble (artificial), Metals, Mirrors, Oils and Ointments, Paints, Paper, Perfumes, Photography, Polishes, Powders, Remedies for Man, Beast or Fowl, Rubber Products, Refrigerants, Soaps, Solder and Soldering, Tooth Cements, Transfers, Varnishes and Thousands of others for making all sorts of profitable and practical things.

### — ALSO —

We include Free —our new book of helpful money-making information:— "The More You Know the More You Can Earn —Easier and Quicker."

## MANY FORTUNES MADE FROM A SINGLE IDEA!

This comprehensive book is an accepted authority by chemists, schools, industry, etc. and is the largest and most comprehensive book of its kind ever issued. Nothing else like it in existence. A single formula has been worth a thousand times this book's small cost to countless owners. Crammed with money-making ideas. Invaluable for reference. Ideal for Factory, Home, Farm, Office or Workshop. As necessary as the dictionary and more useful for manufacturers, chemists and salesmen who put up products for profit.



\$3.98 U. S. Funds. Postpaid anywhere in the world. (C.O.D. in U.S.A. only). Immediate shipment. Safe Delivery Guaranteed.

ADAMS BROWN COMPANY BOOKS OF APPLIED SCIENCE  
Dept. 274 Chestnut Hill 67, Massachusetts, U. S. A.

# Learn this Profitable Profession



IN 90 DAYS AT HOME

## Money-Making Career Open to Men and Women, 18 to 50

Hundreds of men and women between 18 and 50 make \$10 to \$20 in a single day giving scientific Swedish Massage and Hydro-Therapy treatments. There is big demand from doctors, hospitals, sanatoriums and clubs. Graduates earn large full time incomes from these or in private practice in their own offices. Others make good money from home treatments given in spare time. Learn this interesting, money-making profession in your own home, through our home study course. Same instructors as in our nationally known resident school. You can win independence and prepare for future security by qualifying for your Diploma. Course can be completed in 3 to 4 months. Many earn while they learn. Begin your training at once.

## Anatomy Charts & Booklet FREE

Enroll now and we will include, at no extra cost, many needed supplies. Fit yourself to help meet growing demand for Scientific Swedish Massage. Send the coupon at once for complete details, Anatomy Charts and 32-Page Illustrated Booklet, FREE, postpaid.



THE COLLEGE OF SWEDISH MASSAGE  
Dept. 770-D, 100 East Ohio St., Chicago 11, Illinois

Please send me FREE and postpaid, Anatomy Charts, 32-page Booklet and complete details on Home Training.

Name.....

Address.....

City..... State.....

## This Easy Way TEACHES GUITAR to Your Satisfaction in 30 Days Or Money Back



Astounding new Jim Major Home Method teaches you to play guitar easily, quickly, without long hours practicing scales or exercises. *No musical knowledge necessary.* Play many popular songs, hymns in very short time. 30 lessons, complete course for only \$1.69. EXTRA—BIG 53 SONG BOOK included without additional cost. Send no money . . . pay postman \$1.69 plus postage. (Cash with order we pay postage.) Money back guarantee. Send today to Jim Major, Room 48-D, 230 East Ohio, Chicago 11, Ill.

# WALKIE SIREN

Formerly \$15.00—Now Only \$3.95

GOV'T SURPLUS. A precision instrument. Easy turn of crank produces CLEAR, FULL SIREN TONE. Can be heard for great distance. Ideal for Boats, Autos, Schools, Sporting Events, etc. Dimensions 7" x 8" x 5". Wt. 4 1/2 lbs. Price includes shoulder strap and waterproof cover. SEND NO MONEY. Just name and address. We'll ship C.O.D. for \$3.95 plus postage, or send money in advance, we'll ship prepaid. Canadian price \$4.50. ILLINOIS MERCHANTISE MART, Dept. 401-A, 1227 Loyola Ave., Chicago 26, Ill.

## YOU Can Get MOTOR SCOOTER! AS LOW AS \$29.95

Assemble or build it—it's easy! We can furnish factory built parts. 2 speeds up to 45 MPH! 100 M.P. gal. Easy riding—knee action and low gravity spring frame. Large 12" tires. Streamlined. SEND ONLY \$1.00 (cash or money order postpaid) (or pay postman \$1.52 C.O.D. in U.S. only) for complete scale isometric picture blueprints (anyone can read them), 8 pages photo details, lists of factory parts prices for both electric and gas models! FREE with each order—big 48 page color book giving full details on over 100 other new inventions such as JET ENGINES—MIDGET MOTORCYCLES—ELECTRIC WELDERS—MOTORS—MIDGET CARS—BIKE MOTORS AND SIDECARS—MIDGET GARDEN TRACTORS. SAVE HUNDREDS OF DOLLARS WITH THESE PLANS! (Foreign orders \$1.50) MOTOR INDUSTRIES INC. Dept. PS-4 KEARNEY, NEBRASKA



## SUPER YOUR GREATEST ASSET!

FACTS, FIGURES, FACES, STICK LIKE MEMORY with new improved SUPER-MEMORY Course. THOR BOOKS, Y-3 Box 1210, Chicago

## RADIO PARTS GRAB BAG!!

\$25 value assortment of Coils, Condensers, Transformers, Resistors, Controls, etc. An experimenter's dream. Order today! Only \$3.98 MARKO SUPPLY, Dept. PS-4 2924 Logan Blvd. Chicago 47, Ill.

## LIQUID MARBLE COLORED POTTERY

Different! Marvelous! Color-glazed. Brush, spray, mold tiles, table-tops, ornaments! SANITARY COM- POSITION FLOORING—Dustless, noiseless; put on like plaster, plain or tile designs; yielding as cork, lasting as stone. RUBBERLASTIC Mold Compound—For plaster casting, novelties, statuary, toys, plaques, dolls. TILEX Colored Roofing. Build Modern PLASTIC HOMES. Illustrated literature free. RAPID MARBLEIZING SERVICE, Dept. 12-A, Edwardsville, Illinois

## 12 lbs. SURPLUS RADIO PARTS \$2.00

A gold mine of parts for repairmen, amateurs, and experimentors . . . sockets, condensers, resistors, transformers, coils, hardware, wire, etc., etc. An outstanding bargain in usable parts! Send \$2.00 cash, check or M.O. today! (Pay small express charges on receipt.)

ELECTRONIC PARTS, Inc. Dept. S-4, 622 W. Randolph St., Chicago 6, Ill.



# 4 Career Ways to Success

CHOOSE THE ONE THAT FITS YOU BEST

APPROVED FOR TRAINING THE YOUNG MEN OF AMERICA—VETERAN AND NON-VETERAN

## WATCHMAKING— A CAREER FIELD!

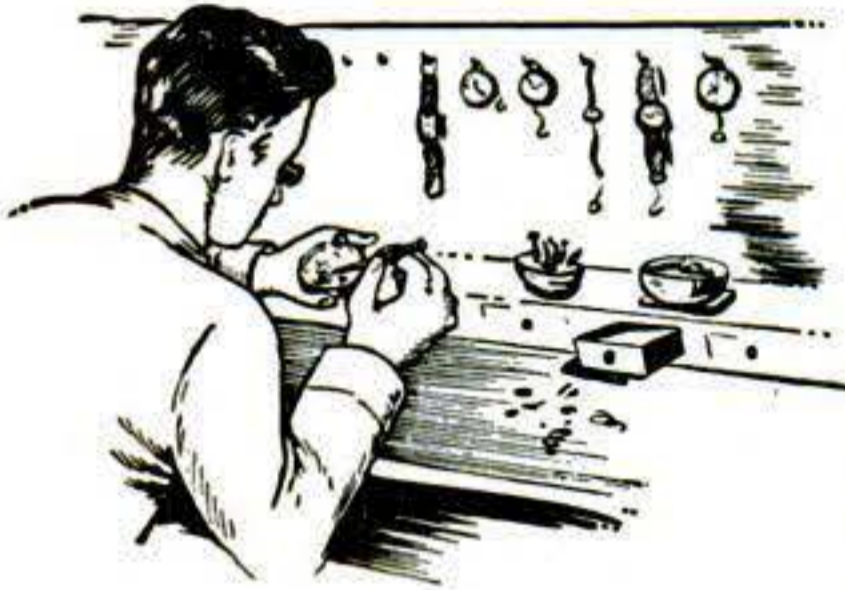

**WORK**—and plenty of it—Millions of watches and clocks need fixing. An interesting and needed service in the top-pay bracket, or start an independent business of your own. The **AMERICAN SCHOOL OF WATCHMAKING**

offers proven training under **QUALIFIED** watchmaker-instructors. Complete information free upon request. Enclose coupon in envelope or paste on penny postcard.

**AMERICAN SCHOOL OF WATCHMAKING,**  
Dept. S-47, 5145 W. San Fernando Rd., Los Angeles 26, Calif.  
Gentlemen: Please send me free booklet and information on your training.

Name (PRINT) .....

Street ..... Age.....

City ..... State.....

Veteran..... Non-Veteran.....

## PLASTICS — MAGIC WORD!

Here at **Plastics Tech** in Los Angeles, men are learning the secrets of this glamorous industry for which the future seems unlimited. Hundreds of new products are being made of plastics requiring trained men to develop and fabricate them. **Plastics Tech** is the pioneer and leader in the field of plastics instruction. Its faculty and directors are leaders in the industry. Write for beautiful four-color catalog today. No obligation. Courses available either residential or study at home. Mail coupon in envelope or paste on penny postcard.

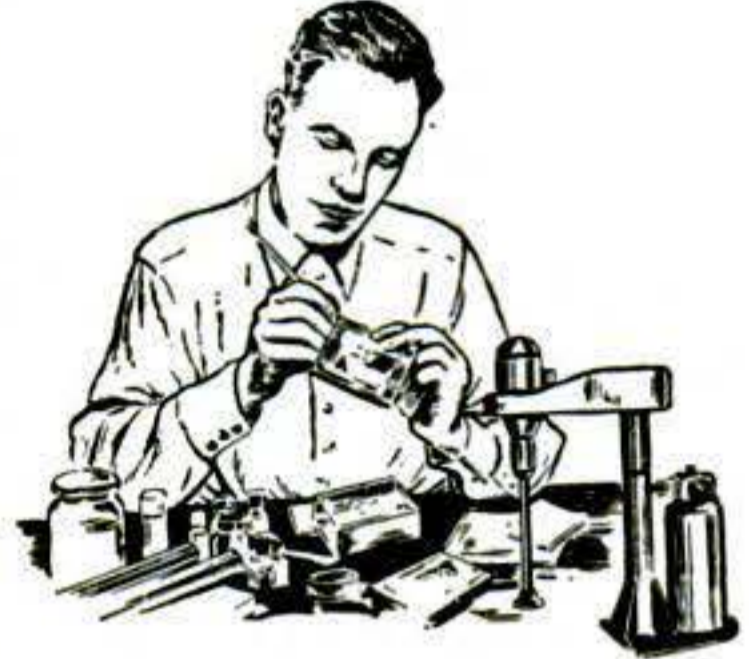

**PLASTICS INDUSTRIES TECHNICAL INSTITUTE,**  
Dept. PS47-1Q, 1601 S. Western Ave., Los Angeles 6, Calif.

Gentlemen: Please send me free booklet "World of Plastics" and information on your training.

Name (PRINT) .....

Street ..... Age.....

City ..... State.....

Veteran..... Non-Veteran.....

Residence School..... Home Study.....



## BE AN AIRCRAFT INSTRUMENT TECHNICIAN

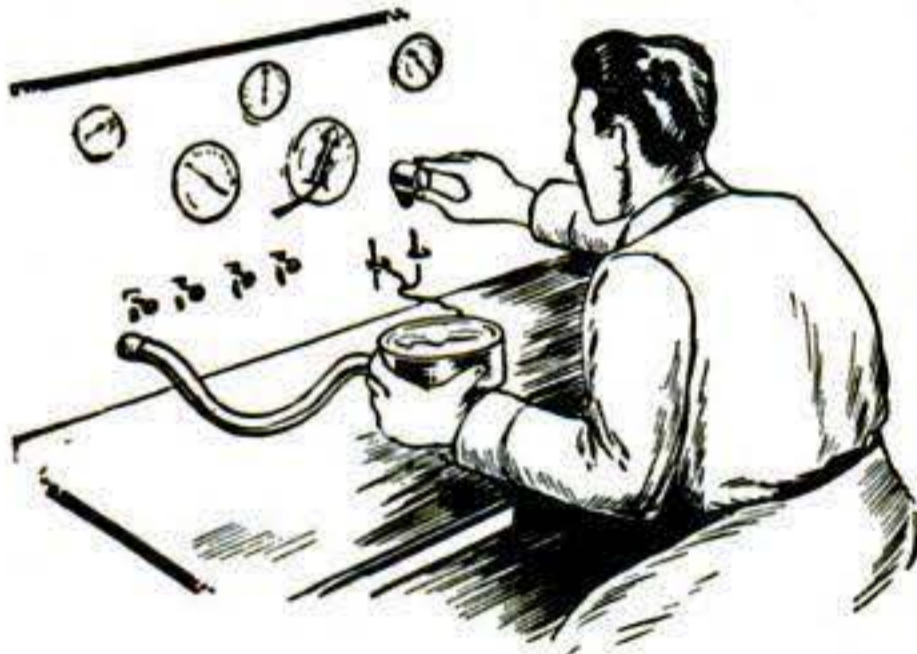

More than 750,000 trained men (CAA survey) will be needed to fill important jobs in the Aviation industry in next 10 years. All planes require delicate instruments. There must be trained men to service, maintain and repair them — Instruments must be right **ALWAYS**. **AMERICAN SCHOOL OF AIRCRAFT INSTRUMENTS** teaches men to perform this important, interesting and well-paid work. The world's future depends on more Aviation—**INSTRUMENTS**. Write today for free booklet. Send coupon in envelope.

**AMERICAN SCHOOLS OF AIRCRAFT INSTRUMENTS,**  
Dept. S-47, 5145 W. San Fernando Rd., Los Angeles 26, Calif.

Name (PRINT) .....

Street ..... Age.....

City ..... State.....

Veteran..... Non-Veteran.....

- **AERONAUTICAL ENGINEERING**
- **MASTER AIRCRAFT MECHANIC**

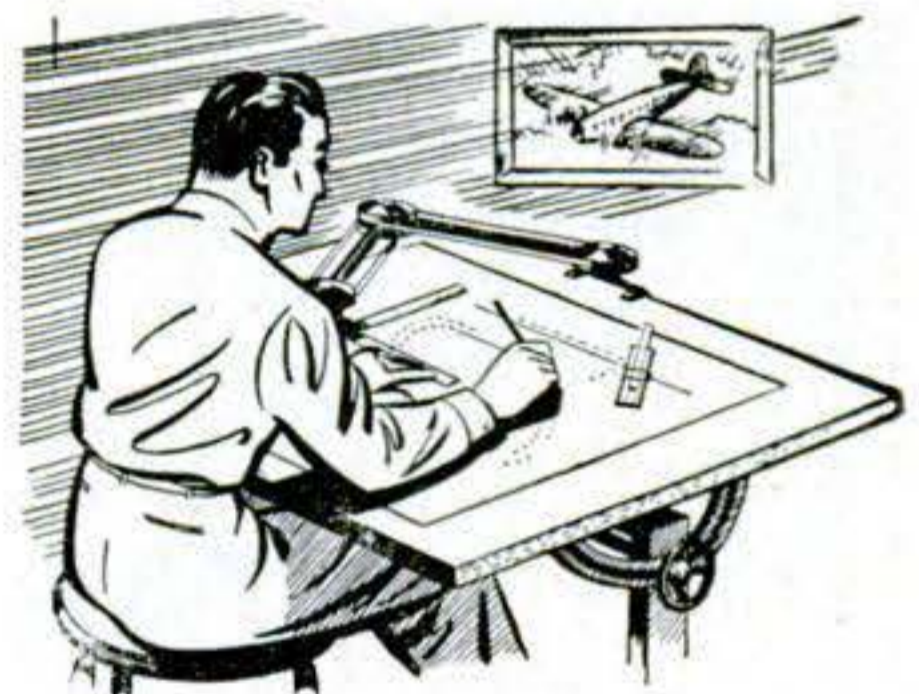

**AERO TECH** training is thorough, specialized, intensive and practical. It assures you of a profitable, interesting career. Independence and financial security. Ideally located on huge Oakland airport—gateway to the Pacific—we are preparing many other ambitious young men for success. Why not join them? The next move is yours. Mail coupon today. Approved for Veterans. Early enrollment possible.

**AERO INDUSTRIES TECHNICAL INSTITUTE,**  
Dept. S-47, Oakland Municipal Airport, Oakland 14, Calif.  
Gentlemen: Please send me free booklet and information on your training.

Name (PRINT) .....

Street ..... Age.....

City ..... State.....

Veteran..... Non-Veteran.....

ALL ARE MEMBERS NATIONAL COUNCIL OF TECHNICAL SCHOOLS

SEND COUPON TODAY



# DIESEL

## Shop Training

**FREE Illustrated Brochure**

### in a Nationally Known School

Diesel engines are used in locomotives, ships, trucks, buses, power plants, tractors. Trained men are needed to repair, rebuild, install, maintain, operate equipment. A big field that promises even bigger things in the years right ahead. Get modern shop training on actual equipment under experienced instructors. Practical training makes rapid progress possible. Get benefits of services and training facilities of nationally known school.

### BETTER JOBS—BETTER PAY

Use of Diesels in automotive and railway industries, other widespread uses all indicate Diesel knowledge means more earning power. Learn Diesel under direction of men who trained Diesel mechanics for U. S. Army. Mail coupon today.



Diesel Division, Motive Trades Institute, Dept. F-14  
1400 Greenleaf, Chicago 26, Illinois

**FREE—Important Information telling how to get started.**  
**CUT OUT COUPON BELOW**



**Fill Out, Cut Out, Mail Today**

**FACTS FREE for Men Who Want to Get Ahead**  
**DIESEL DIVISION, MOTIVE TRADES INSTITUTE, Dept. F-14**  
**1400 Greenleaf, Chicago 26, Illinois**

Send free illustrated Brochures and other information on modern Diesel training.  
( ) Veteran ( ) Non Veteran

Name.....  
Address.....  
City.....  
State.....



## START

**\$1,756 to \$3,021 YEAR**

### MEN—WOMEN

- Postoffice Clerks-Carriers
- Railway Postal Clerks
- Stenographers
- Accountants
- Statistical Clerks
- Typists
- Customs Inspectors
- Many Other Jobs

**VETERANS**  
Get Preference

**MAIL COUPON TODAY SURE**

**Franklin Institute**  
Dept. G81  
Rochester, N. Y.

Gentlemen: Rush to me, FREE of charge, list of U.S. Government big pay jobs. Send FREE 32-page book describing salaries, vacations, hours, work, etc. Tell me how to prepare for one of these jobs.

Name.....

Address..... Vet?.....

## Learn to Speak SPANISH FRENCH, GERMAN OR ITALIAN This Easy Way



**ONLY 15 MINUTES A DAY.** Know a second language for better business or social position; read foreign books; really enjoy travel. Speak like a native just "by listening" to **CORTINA RECORDS**. Learn quickly, easily at home as thousands have! Cortina-phone Method famous for 60 years. Write today for **FREE** book "The Cortina Short-Cut." State language interested in.

**CORTINA ACADEMY (Established 1882)**  
Suite 124 105 West 40th Street New York 18, N. Y.

**DEVELOP THE POWERFUL INFLUENCE**  
**FEUCHTINGER Method Guaranteed**  
**IN YOUR VOICE**  
**DO IT YOURSELF AT HOME**  
*Write for the Voice Book - FREE*  
*Sent only to those over 17yrs of age*  
**PERFECT VOICE STUDIOS**  
Kimball Hall Bldg., 25 E. Jackson, Chicago 4, Studio 1364

### Be Your Own Boss — In Your Own Business

Start at home . . . small capital needed . . . prepare for exciting plastics jobs or Your Own Plastics Business. We teach you Fabrication and Casting right in your own home. All materials furnished. Send ad with name and address for information. **VETERANS:** Eligible for resident training under G. I. bill, Check here

**LEARN PLASTICS**  
**PLASTICS TECH**  
School of America, Inc.  
5200 Euclid Avenue  
Dept. S-4  
Cleveland 3, Ohio

### Learn LANDSCAPE GARDENING

A thorough, interesting, home study course for those who wish to become Landscapers, Gardeners, Designers, etc., for profit or pleasure. Write today for Free Book to

**APPROVED NATIONAL LANDSCAPE INSTITUTE**  
**FOR VETERANS** Dept. PS-4 310 So. Robertson, Los Angeles 36

### TRI-STATE COLLEGE

**B.S. Degree in 27 months** in Engineering (7 branches), Bus. Admin., Acctg. and Sec. Science. **64th year.** School now filled to capacity. No applications can be accepted until further notice. **547 College Ave., Angola, Ind.**

### INDIANA TECHNICAL COLLEGE

**B.S. degree in 27 mos.** Aeronautical, Chemical, Civil, Electrical, Mechanical and Radio Engineering. 2-yr. diploma. Air Conditioning, Refrigeration, GI approved. Low rate. Earn board. Demand for grads. Enter June, Sept., Dec., March. Catalogue. **647 E. Washington Blvd., Ft. Wayne 2, Ind.**

### WATCHES WANTED

**BROKEN OR USABLE**  
All kinds. Highest Prices paid for jewelry, rings, spectacles, gold teeth, diamonds, Sterling Silver, etc. Cash mailed promptly. Write for free shipping container.  
**LOWE'S, Dept. PS, Holland Bldg., St. Louis 1, Missouri**



### REPAIR CRACKED BLOCKS AND HEADS—

External and internal leaks in blocks, cylinders and valve ports quickly and easily with **LUSCO PLASTIC SEAL**. **90 day Service Guaranteed** or your money back. Send money order or check for full pint—more than sufficient for average repair. **\$3.00 Postpaid**

**C. F. LUSK CO., 5916 Bonna Ave., Cleveland, 3 Ohio**

### NEW CHEAP OIL BURNER

**FOR COOKING & HEATING STOVES-FURNACES**  
**HEAT YOUR HOME, COOK YOUR MEALS WITH CHEAP FURNACE OIL**

**NO MORE SHOVELING COAL OR ASHES.** A New Fuelizer Starter Vaporizing System turns Cheap 130 Flash Furnace Oil Distillate, Kerosene, etc. into Oil Gas heat without clogging up. **LIFETIME GUARANTEE** against defects. **\$1.00 Bonus Offer for Testing.** We will let you try it in your own stove or furnace for one month. Get yours for introducing. **Big Profits QUICK.** Be first. Send in your name **TODAY.**  
**NORTHWEST MFG. Co., 562-D 5th. Mitchell, So. Dakota**





**H. T. ARMSTRONG**  
General Manager

**START YOUR OWN  
APPLIANCE REPAIR SHOP  
Be Independent!**



**YOUR JOB IS SAFE  
IF YOU HAVE  
YOUR OWN SHOP**

No new-fangled machine can ever take your place in this work . . . for it takes hands to fix appliances. So you will never be out of a job. Further, everyone needs a repair man from time to time . . . so everyone is literally a potential customer. Yes, and everyone respects and admires a man who can fix things . . . so there is a lot of satisfaction being in this business. But there's even more satisfaction in knowing you and your family will never be out on a limb . . . because you will never be out of a job. Let's talk it over by mail.

**NEW BOOK  
"HOW TO START YOUR  
OWN BUSINESS"  
Sent at No Extra Cost  
If You Act Promptly**

This valuable book covers locating your shop, contains drawings of how to build and wire work-benches, where and how to advertise, what to charge, how to hire solicitors, etc. Sent to students who enroll promptly.

**FREE BOOKLET  
MAIL THIS COUPON  
TODAY**

*Learn* at HOME in  
Your Spare Time  
**How To REPAIR & SERVICE  
ELECTRICAL  
APPLIANCES**

Our practical, thorough course teaches you this interesting, good-paying business AT HOME, DURING YOUR SPARE TIME. A grade school education is all you need. We teach repairing electrical appliances, motors and house wiring. And from long, daily experience we know how to make our lessons understandable and easy to grasp . . . and how to give you the answers to the questions you'll want to ask. For the man who is handy with tools, and likes to work with his hands as well as his head, there is a WIDE OPEN OPPORTUNITY *today*, in this great growing field.

**AN INDUSTRY WITH A FUTURE**

Just think! Despite war, shortages, priorities and restrictions, more than 5,000,000 U. S. homes were wired for electricity for the first time . . . since 1940. It's almost like discovering a new continent filled with customers . . . added to the millions already here. And electrification is in for a big boom with government projects in plan for all over the nation.

**YOU CAN PAY FOR YOUR TRAINING  
WITH JUST ONE GOOD REPAIR JOB**

It's a fact! One good repair job can more than pay the cost of the entire course of training. And here's a business you can start as small as you like, in your basement or garage . . . work when you want to . . . and grow as big as you like. Or, you can take a well paid job most anywhere, to start . . . as the need for service mechanics is tremendous in this field and will grow bigger as more and more appliances are released.

H. T. ARMSTRONG, General Manager,  
**PACIFIC TRAINING SCHOOL, Dept. S-104**  
7217 So. Broadway, Los Angeles 3, Cal.

Dear Sirs: Please send me, without obligation, your FREE BOOKLET, and full details.

Name.....

Address.....

City..... State.....



# How to Write

For Extra Income or Full Time Career,  
Learn At Home To Write Articles,  
Mysteries, Short Stories



## Beginner Credits Success to Palmer Institute

"I had never written a single line before starting your course. Today I am unable to write fast enough to keep up with sales, all of which is entirely due to your coaching." *Hugh G. Jarman, Montreal.*

### Big New Opportunities Now

The public's new interest in technical, mechanical subjects offers big new opportunities for scientific minded writers who are trained to make dry facts interesting and exciting.

You don't have to be a great writer to make good money—using experiences of your own, of friends—or just your imagination. Many beginners start earning early in their training, selling short stories, articles of all kinds, which bring in small but welcome checks of \$25, \$50, \$100 and more. Such material may be turned out quickly once you acquire the proper technique. And now it's easier to learn than you may imagine, through Palmer's unique method of training—for NOT just one field of writing, but for all: Fiction, Article, Radio.

### You Learn To Write By Writing

You receive individual coaching by professional writers who go over your writing, giving you helpful suggestions and showing you how to correct weaknesses, how to capitalize on your good points. Thus your own individual writing style is carefully developed. Study fast or slow. Save time and effort. To find how you too may make money writing—part time or full time—send today for FREE illustrated book, Palmer Institute of Authorship (since 1917), 6362 Hollywood Blvd., Hollywood 28, Calif. Desk U45.

**FREE BOOK** PALMER INSTITUTE OF AUTHORSHIP Since 1917  
6362 Hollywood Blvd., Desk U45, Hollywood 28, Calif.  
Please send me free illustrated book "The Art of Writing Salable Stories," explaining how your training helps new writers get started. This is confidential. No salesman will call.

Mr.  
Mrs.  
Miss

Address \_\_\_\_\_

City \_\_\_\_\_ Zone \_\_\_\_\_ State \_\_\_\_\_

## AIR RIFLES BENJAMIN AIR PISTOLS ARE AVAILABLE

SEND FOR FREE FOLDER OF LATEST MODELS TODAY

If you want a REAL GUN for PRACTICAL USE inside or outdoors get a SAFE-CLEAN-ECONOMICAL-BENJAMIN with Adjustable Power and Amazing Accuracy. Use BENJAMIN H-C PELLETS for BEST RESULTS. WRITE AT ONCE.

BENJAMIN AIR RIFLE CO., 811 MARION ST., ST. LOUIS 4, MO.

# REFRIGERATION AND AIR CONDITIONING

TRAIN FOR YOUR OWN BUSINESS

Now, not "next week," is the time to start training for a top-pay job in this vital field. A drastic shortage of trained service experts exists. Many thousands more will be needed for big post-war expansion caused by new industrial uses. Train NOW to get your pick of best jobs. We will give you the practical training you need. For 2 years we trained men and women for the Army and Navy only, in fine-precision aircraft instrument work. So our methods must be right. Common schooling is all you need. Our unique system makes everything easy to grasp. You can train at home and in our big Chicago shops. Write for full facts TODAY, without obligation. Dept. P7-d

Approved for Veterans' G.I. Training

Millions of Old Units Need Expert Service. Big Building Boom Will Create Even More Opportunities.

## INDUSTRIAL TRAINING INSTITUTE

2150 Lawrence Avenue,

Chicago 25, Illinois

## HOW TO CUT RAFTERS

New vest pocket book gives lengths, Side cuts, Plumb cuts, Deductions. For all rafters for any building from one inch to forty feet wide. Gives numbers to cut on square. Also degrees for same cuts for Radial Saws. All standard pitches from 1/8 to 5/8. Just open book to pitch page and there are your lengths, side cuts, etc. Anyone who knows what a jack rafter is can frame a roof if he has this great book. Price one dollar prepaid. Builders' Topics, Dept. S, Lock Box 828, Seattle, Washington. Original teachers of the square in five easy lessons by mail. SEND FOR FREE LIST OF TECHNICAL BOOKS. Learn to read blueprints, etc.

## EYE-GLASSES by MAIL NEW

Send No Money!

16-Day Trial Offer

NEWEST STYLES

FREE Scientific Sight Test Chart and Catalog. Write today.

U. S. EYE-GLASSES CO. Dept. 4-42, CHICAGO, ILL.



LOW PRICES

## C-THRU-MIRRORS

SEE THRU ONE SIDE

Mirror on other side. Leisurely watch others at close range who imagine themselves unseen. Loads of fun. Lasts a lifetime. 3" x 4" or 2" x 6" sizes only. \$2.95 postpaid. No C.O.D. One day shipment. Beeler Enterprises, Dept. 10-D, North Hollywood, Calif.

## FREE Bikini Crossroads Patch



Send only \$1.00 for our beautiful selection of 20 different Flight Squadron and Shoulder Insignia and receive the RARE BIKINI BOMBER leatherette breast patch absolutely FREE. Tremendous value. Colored insignia book with your order at no cost. Send to-day. Offer limited.

THE INSIGNIA MART DEPT. B-6  
703 Broadway, New York 3, N. Y.



# Now A DYNAMIC Super-charged WELDER

IDEAL FOR AUTO HOME APPLIANCE FARM REPAIRS

DESIGNED TO DO HIGH GRADE WELDING INEXPENSIVELY!

Maintenance Men; Farmers; Mechanics; Machine Shops; Foundries; Auto, General Repair and Job Welding Shops; all using the DYNAMIC find it so indispensable and useful that they cannot afford to be without it. If inexperienced you can easily learn to do a variety of high grade welding jobs by following the practical, simplified operating and welding instructions furnished. Once you see a DYNAMIC in operation, you won't want to be without it. Its simplicity will amaze you. In a year the DYNAMIC only costs you about 6c a day. Helmet, rods, cables, holder and operating instructions, etc., furnished.

SAVES YOU VALUABLE TIME AND MONEY!

This portable industrial transformer type DYNAMIC WELDER easily carried right to the job, can be operated from any convenient, properly wired 110 Volt, 60 Cycle Line — has 8 metallic and carbon arc welding heat stages — does work you would think only possible with a larger more expensive machine. Can also be supplied for 220 volt, 60 cycle operation and other voltages and cycles at slight additional cost. Works on Iron, Steel, Brass, Bronze & other metals. DYNAMIC WELDER CO., 13 East 23rd St., SB, Chicago 16, Ill.

FOR ONLY

\$23.50

COMPLETE... Available Now IMMEDIATE DELIVERIES

Write Today for Particulars

GET DETAILS on our 10 day Trial Offer.

Member Chicago Association of Commerce.





# WAR BARGAINS in LENSES and PRISMS

## Assemble Your Own Binoculars!

Complete Optics! Complete Metal Parts!

Save More Than 1/2 Regular Cost

### ARMY'S 7x50 BINOCULARS



Here's an unusual opportunity to secure a fine set of Binoculars at a substantial saving of money. Offered here are complete sets of Optics and Metal Parts for the Army's M-16 7 x 50 Binoculars (M-16 is not the waterproof model). These components are new and all ready for assembly. We supply full instructions. Limit—1 set of Metal Parts and 1 set of Optics to a customer.

**METAL PARTS**—Set includes all Metal Parts—completely finished—for assembly of 7 x 50 Binoculars. No machining required. Bodies have been factory hinged and covered. A sturdy brown leather Binocular Carrying Case is included with each set of Metal Parts.

Stock #824-N . . . 7 x 50 Metal Parts . . . . . \$35.00 Postpaid

**OPTICS**—Set includes all Lenses and Prisms you need for assembling 7 x 50 Binoculars. These Optics are in excellent condition—perfect or near perfect—and have new low reflection coating.

Stock #5102-N . . . 7 x 50 Optics . . . . . \$25.00 Postpaid

**NOTICE!** If you buy both the Binocular Optics and the Binocular Metal Parts, your purchase becomes subject to 20% Federal Excise Tax. Be sure to add amount covering tax to your remittance or your order cannot be filled.

### ARMY'S 6x30 BINOCULARS

No Carrying Case with any Sets shown below. (None yet available in Surplus Market.) M-13A1 sets are waterproof model. M-3 sets are not waterproof. Limit—1 Set to a Customer on all Sets shown below.

**COMPLETE OPTICS & METAL PARTS**—Model M-13A1, 6 x 30 Binoculars. Everything you need—ready for assembly. When finished will look like a regular factory job costing \$102 to \$120. The Optics are new, in perfect or near-perfect condition. Have new low reflection coating. Metal Parts are new and perfect, all completely finished. No machining required. Bodies factory hinged and covered. Complete assembly instructions included.

Stock #830-N . . . . . \$40.00 Postpaid, plus \$8.00 tax—Total—\$48.00

**COMPLETE OPTICS & METAL PARTS**—Model M-3, 6 x 30 Binoculars. The Optics in this set are new, perfect or near-perfect. Prisms have new low reflection coating. Factory mounted Eye Piece and Objective Assemblies not coated. Metal Parts are perfect, new, ready for assembly. When finished, this will look like a regular factory job, except a name has been filed off a cover plate. No machining required. Bodies factory hinged and covered.

Stock #831-N . . . . . \$35.00 Postpaid, plus \$7.00 tax—Total—\$42.00

**METAL PARTS ONLY**—Model M-13A1, 6 x 30 Binoculars. No Optics. Same Metal Parts as described for Stock #830-N.

Stock #832-N—6 x 30 Metal Parts . . . . . \$25.00 Postpaid

**METAL PARTS ONLY**—Model M-3, 6 x 30 Binoculars. No Optics. Some machining on these Metal Parts required. Bodies hinged and Prism Shelf holes placed, but you must tap them. Prism Shelves have been machined. Six lead spiral focusing threads have been cut. Some less difficult components you must thread and machine yourself, but all material you need is furnished except body covering material and Optics.

Stock #833-N—6 x 30 Metal Parts . . . . . \$12.00 Postpaid

**OPTICS FOR 6 x 30 BINOCULARS** (No Metal Parts.) Slight seconds. Cemented but not coated.

Stock #5123-N . . . . . \$10.00 Postpaid

**SAME OPTICS AS ABOVE** (6 x 30), but coated.

Stock #5124-N . . . . . \$12.75 Postpaid

If you buy both the Binocular Optics and the Binocular Metal Parts, your purchase becomes subject to 20% Federal Excise Tax. Be sure to add amount covering tax to your remittance or your order cannot be filled.

Optics and Metal Parts are Available for Monoculars (1/2 a Binocular). For Complete Details, Write for Bulletin #14-N.

### BATTERY COMMANDER'S PERISCOPE

With Tripod—6 Power Instrument. Excellent condition. Length 27 1/2 inches—diam. 1 1/2 inches. Cost U. S. Govt. approximately \$175.00.

Stock #717-N . . . . . \$20.00 F.O.B. Audubon

SATISFACTION GUARANTEED

**EDMUND SALVAGE CO., P. O. Audubon, New Jersey**

## YOU CAN EASILY MAKE

Telescopes, Magnifiers, Photographic Gadgets and Hundreds of Experiments with these Low Cost Lenses

**23 POWER PRISM SPOTTING TELESCOPE SET**—Optics consist of perfect Achromatic Objective with dia. of 64 mm. and 20 inch F.L. (not a War Surplus item), an Eye Achromat, Field Lens and Prisms from 6 x 30 Binocular. These are slight seconds. All low reflection coated except Objective. Half a covered 6 x 30 Binocular Body, all parts for Eye-Piece end and Prism Shelf section are supplied. You must furnish an extension tube and any parts needed to mount the Objective Lens.

Stock #5127-N . . . . . \$21.00 Postpaid

**SCHMIDT OPTICAL SYSTEM.** Black plastic body, size 3-15/16" by 5-1/2". F.L. 2.4" . . . . . with amazing speed of F.O.9. Used in Navy's Infra-Red Sniperscope and Signaling Units. Govt. cost \$134. Limit—1 to a customer.

Stock #720-N . . . . . \$6.00 Postpaid

**MOUNTED PROJECTING LENS SYSTEM.** F.L. 91.44 mm. (just right for 35 mm. Projectors). Speed of F 1.9. Outside dia. of mount at one end 60 mm. Length of mount 64 mm.

Stock #4033-N . . . . . \$3.00 Postpaid

**MOUNT FOR ABOVE PROJECTING LENS SYSTEM**

Stock #715-N . . . . . \$1.50 Postpaid

**POLARIZING VARIABLE DENSITY ATTACHMENT FOR 7 x 50 BINOCULARS**—An amazingly effective unit for controlling amount of light reaching your eyes. Cuts down glare in sky and overwater observations. Easily snapped on and off over the eye cups of American-made 7 x 50 Binoculars. Govt. cost \$8.30 each.

Stock #20,000-N . . . . . \$2.00 Postpaid

**CONDENSING LENSES for 35 mm Projectors and Enlargers.** Consists of set of 2 Lenses—diam. 2-3/8". F.L. 3" each.

Stock #1077-N . . . . . \$2.00 Postpaid

**MOUNTED KELLNER TELESCOPE EYE PIECE**—Perfect, coated, in Ordnance sealed boxes. F.L. 1-3/4 inches. Outside dia. of steel mount 40 mm.

Stock #6198-N . . . . . \$3.15 Postpaid

**OPTICAL BENCH KIT**—(Not a War Surplus Item) Everything you need, including four Lens Holders for checking Focal Lengths and setting up Lens Systems.

Stock #53-N . . . . . \$8.50 Postpaid

**35 MM KODACHROME PROJECTING LENS SET**—Consists of Achromatic Lens for projecting, plus a Condensing Lens and piece of Heat Absorbing Glass with directions.

Stock #4025-N . . . . . \$1.95 Postpaid

## AIR FORCES GUN SIGHT

With Polarizing Variable Density Attachment



Can be used as Slide Viewer, or take it apart and you can get Polarizing Variable Density Attachment, Mangin Concave Mirror, Reflector Plate, Metal Reticule, Window, Lamp Housing, Ring and Bead Sight. The Polarizing attachment alone is worth many times the price of entire unit. Consists of 2 Polarizing Filters mounted with small handle which rotates one around the other. May be used in Photography, Research, Experiments, as Light Dimmer, etc.

Stock #908-N \$5.00 Postpaid

Same Unit Without

Polarizing Attachment

Stock #916-N \$2.50 Postpaid

**BOMBER SIGHTING STATION**—A double end Periscope Type Instrument of highest precision. Brand new and in perfect condition. 6 ft. tall, shipping wt. 360 lbs. Orig. cost \$9,850. Consists of numerous Lenses, Prisms, Mirrors, Gears, Motors, Metal Parts and Electrical Gadgets.

Stock #914-N . . . . . \$50.00 F.O.B., Oklahoma

**TANK PRISMS**—90-45-45 deg., 5 3/4" long, 2 1/8" wide, finely ground and polished.

Stock #3004-N Silvered Prism (new & perfect) \$2.00 Postpaid

Stock #3005-N Plain Prism (new & perfect) . . \$2.00 Postpaid

Stock #3100-N Silvered Prism (Second) . . . . \$1.00 Postpaid

Stock #3101-N Plain Prism (Second) . . . . . \$1.00 Postpaid

We have literally millions of war surplus lenses and prisms for sale at bargain prices. Write for Catalog "N"—Sent Free!

Order by Stock No.



# 8 BIG BUILDING BOOKS

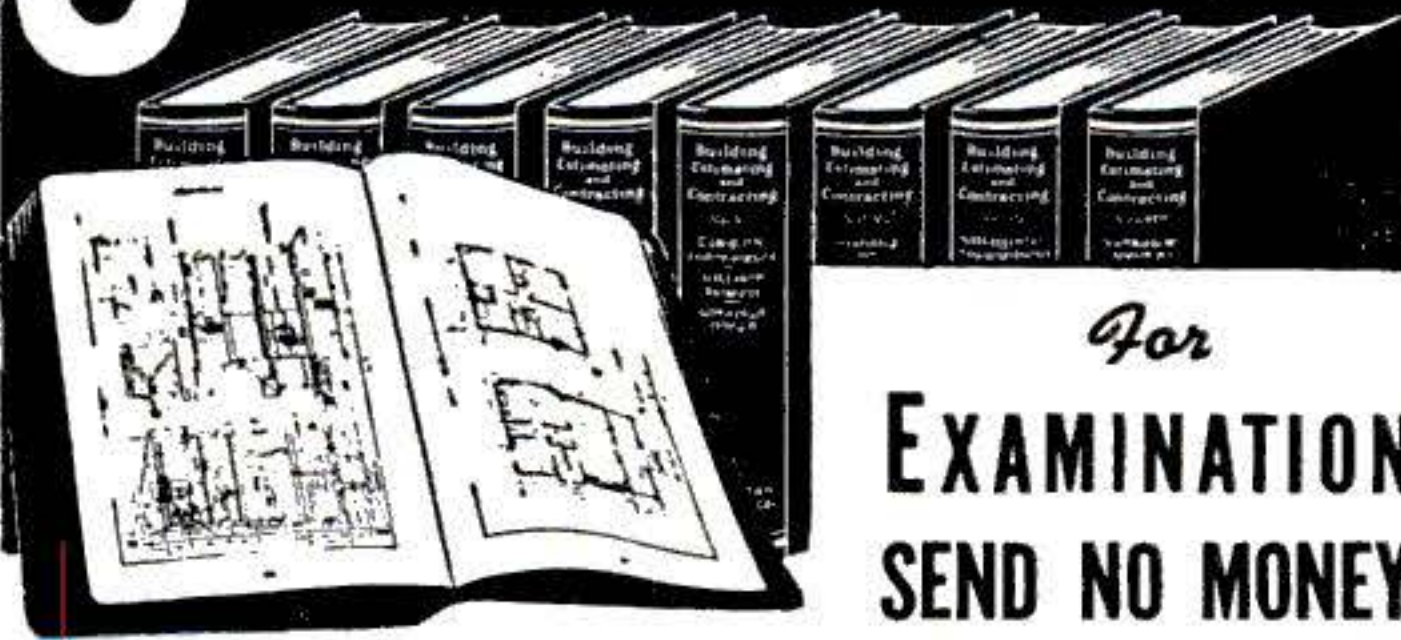

For  
**EXAMINATION  
SEND NO MONEY**

Learn to draw plans, estimate, be a live-wire builder, do remodeling, take contracting jobs. These 8 practical, profusely illustrated books cover subjects that will help you to get more work and make more money. Architectural design and drawing, estimating, steel square, roof framing, construction, painting and decorating, heating, air-conditioning, concrete forms and many other subjects are included.

## BETTER JOBS — BETTER PAY UP-TO-DATE EDITION

The postwar building boom is in full swing and trained men are needed. Big opportunities are always for **MEN WHO KNOW HOW**. These books supply quick, easily understood training and handy, permanent reference information that helps solve building problems.

These books are the most up-to-date and complete we have ever published on these many subjects.

### Coupon Brings Eight Big Books For Examination

**AMERICAN TECHNICAL SOCIETY** Vocational Publishers since 1898  
Dept. G420 Drexel at 58th Street Chicago 37, Ill.

You may ship me the Up-to-Date edition of your eight big books, "Building, Estimating and Contracting," without any obligation to buy. I will pay the delivery charges only, and if fully satisfied in ten days, I will send you \$2.00, and after that only \$3.00 a month, until the total price of only \$34.80 is paid. I am not obligated in any way unless I keep the books.

Name.....  
Address.....

City.....State.....

Please attach a letter stating your age, occupation, employer's name and address, and name and address of at least one business man as a reference. Men in service, also please give home address.

# AVIATION Career

## MAXIMUM TRAINING IN MINIMUM TIME

CAL-AERO TECH TRAINING will add dollars to your pay check all the rest of your life. Specializing in **AERONAUTICAL ENGINEERING** and **MASTER AVIATION MECHANICS** since 1929, Cal-Aero Tech training is carefully designed for just one thing—**TO MAKE MORE MONEY FOR YOU**. An alumni of over 6000 successful graduates proves our career training is unsurpassed.

**VETERANS** —Write us about Aviation Training, as provided under "G.I. Bill of Rights."



**CAL-AERO TECHNICAL INSTITUTE**  
MAJOR C. C. MOSELEY PRES. SINCE 1929  
FORMERLY CURTISS-WRIGHT TECHNICAL INSTITUTE

GRAND CENTRAL AIR TERMINAL  
GLENDALE 1, CALIFORNIA  
LOS ANGELES COUNTY

### MAIL THIS COUPON TODAY!

Cal-Aero Technical Institute, Grand Central Airport, Glendale 1, California  
Please send full information on Aviation Training FREE—without obligation. Dept. PS-4

Name..... Birth Date.....

Street.....

City..... State.....

## ANALYZE HANDWRITING

Qualify for Certified Grapho Analyst Degree at home, spare time. Credit, Employment, Personnel Managers, Business, Professional men, women use **grapho-analysis in their work, earn substantial fees in spare time**. Many study solely for personal benefit, no desire to earn money, find it so fascinating they start using it to add to their incomes. Entertainment field pays well, up to \$100 in a week reported. Others establishing profitable practices as Vocational and Family Problem Counselors, Personality Teachers, and lecturers.



### GROWING—UNCROWDED PROFESSION

More and more police use grapho analysis handling suspects and criminals. They understand how criminals think. Their handwriting tells. Men like Hugh Dunlap, university student, Harry Allen, retired preacher, use it in court, win cases, earn fees even before graduation. **Only school in world devoted to teaching grapho analysis** offers thorough training to earnest, ambitious men and women regardless of where you live, small town, farm or city. Send for **GRAPHO ANALYST**, illustrated lesson, personal handwriting analysis offer, **ALL FREE**. Must be 21 or over. Address **A. I. G. A. Inc., 126, Noel, Missouri**.



Send for **GRAPHO ANALYST**, illustrated lesson, personal handwriting analysis offer, **ALL FREE**. Must be 21 or over. Address **A. I. G. A. Inc., 126, Noel, Missouri**.



## POWERFUL BINOCULARS only \$6.95

All metal type with adjustable focusing wheel. Enjoy indoor, outdoor shows, sporting events, etc. Plated draw tubes extend for sharp instant focusing on distant objects. Low price includes handsome Carrying Case and long adjustable Shoulder Strap. **SEND NO MONEY**. Clip ad and mail. We'll ship C.O.D. for \$8.95 plus tax and postage charges. Address:

ILLINOIS MERCHANDISE MART Dept. 2217 1227 Loyola Ave. Chicago 28, Ill.



Beautiful brass Social Security plates (illustrated 1/2 actual size), priced at only 50c. Please print your name & number plainly.

**ACME**  
Stamping Service  
Box 836  
Davenport, Iowa

## HIGH BLOOD PRESSURE

### A DANGER SIGNAL

Often associated with Hardening of the Arteries, a Stroke, Paralysis, Heart Trouble, Kidney Disease, and other grave complications. Resultful treating methods of the Ball Clinic have proven dependable for nearly a quarter of a century. Send for **FREE Blood Pressure Book** today. No obligations.  
**Ball Clinic, Dept. 36-A, Excelsior Springs, Mo.**

## STUDY TO BE A DOCTOR OF PSYCHOLOGY OR METAPHYSICS

Obtain a Ps.D., Ms.D., D.D., or Ph.D. degree. Be a Teacher, Lecturer or Accredited Practitioner. Teach others how to achieve Health, Happiness and Contentment. Chartered by State. Write today for **FREE** book telling how. **THE NEOTARIAN COLLEGE OF PHILOSOPHY, 1212 Temple Building, Kansas City 6, Mo.**

## If Ruptured



Do What Others Now Do—  
**Wear a Form Fitting MILLER Truss**

which provides natural freedom and comfort in working, walking, playing, horse back riding, dancing, swimming or sleeping. You just cannot afford to be without this protection and convenience.

**Wear two weeks** then consult your physician before deciding to keep it.

Write me today for **FREE** descriptive circular. Sent in plain, sealed envelope.

**FRED B. MILLER** Manufacturer  
Dept. P.S. Hagerstown, Maryland.



**STEADY JOB! GOOD PAY! CLEAN WORK!**

# ELECTRICITY

**NATION'S  
LARGEST  
EXCLUSIVE  
ELECTRICAL  
SCHOOL**

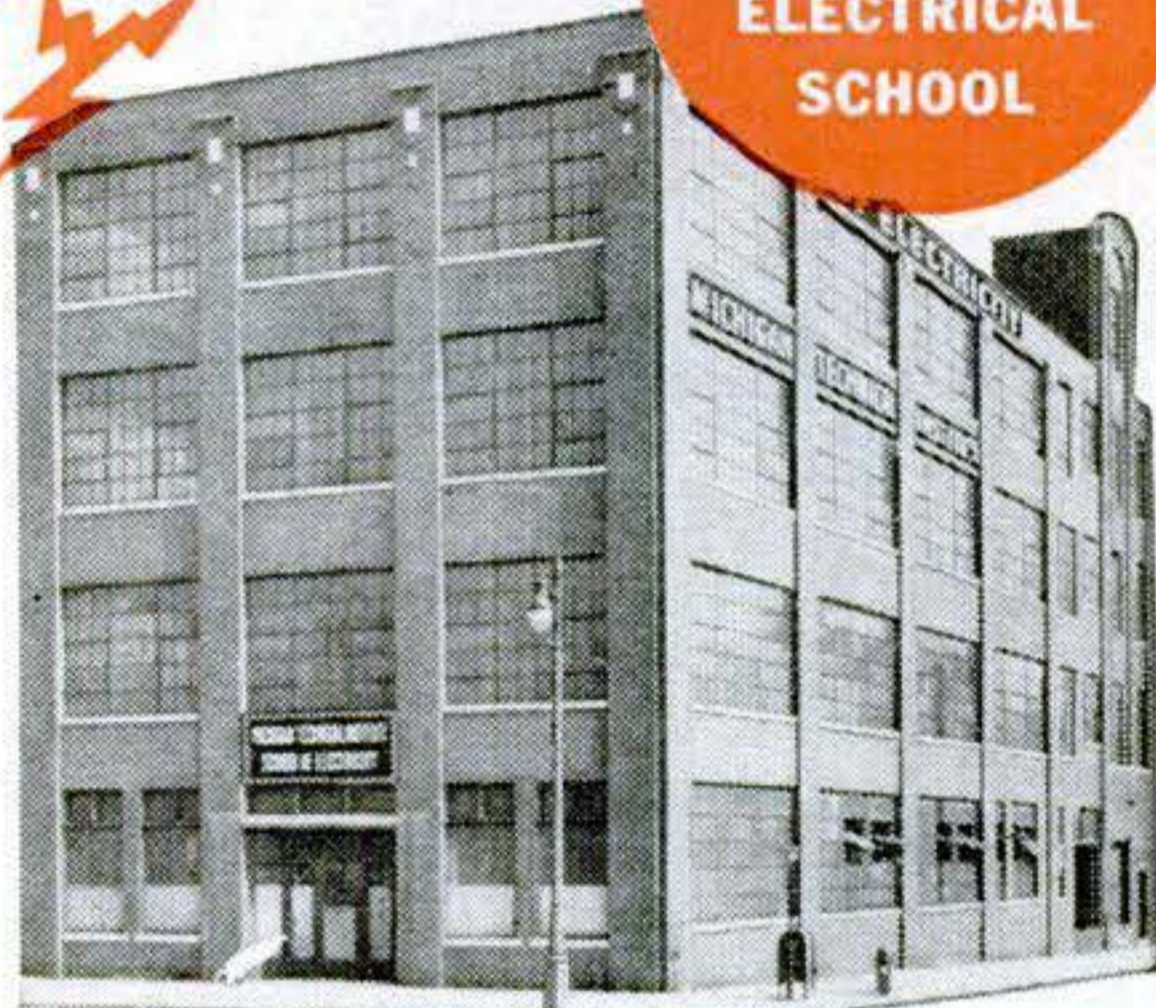

**LEARN QUICKLY AND THOROUGHLY  
LATEST, MOST ADVANCED METHODS**

*Learn Electricity Fast . . . at nation's largest exclusive electrical school . . . in only 19 weeks! Learn Electricity Right . . . topflight instructors help you learn easily, quickly, thoroughly . . . on-the-job, up-to-the-minute methods of training. Qualify yourself for Construction and Industrial Maintenance . . . Operation, Maintenance and Repair of AC and DC Motors, Generators, Controls, other Power Equipment . . . House and Factory Wiring . . . Armature and Motor Rebuilding. Entire building—4 floors devoted exclusively to this one course. Individual attention to students. Living quarters arranged for if desired.*

*Pay after you graduate . . . Lack of money need not hold you back. We will finance your training. Pay later in small monthly payments.*

## MICHIGAN TECHNICAL INSTITUTE

Dept. PS-4 2281 W. Fort St., Detroit 16, Mich.

MICHIGAN TECHNICAL INSTITUTE Dept. PS-4  
2281 W. Fort St., Detroit 16, Michigan

- Send me catalog and complete information.  
 I am a GI. Send special information.

NAME \_\_\_\_\_  
ADDRESS \_\_\_\_\_  
CITY \_\_\_\_\_ STATE \_\_\_\_\_

APPROVED FOR TRAINING UNDER GI BILL

### VETERANS!

Take this course at no cost to you, and receive \$65 to \$90 a month while training. Complete details furnished. **MAIL COUPON TODAY!**

## To those who think LEARNING MUSIC IS HARD

Just strike these notes and you're playing the beginning of the "Merry Widow" Waltz. Look at the diagram. The first note of the music is "D."

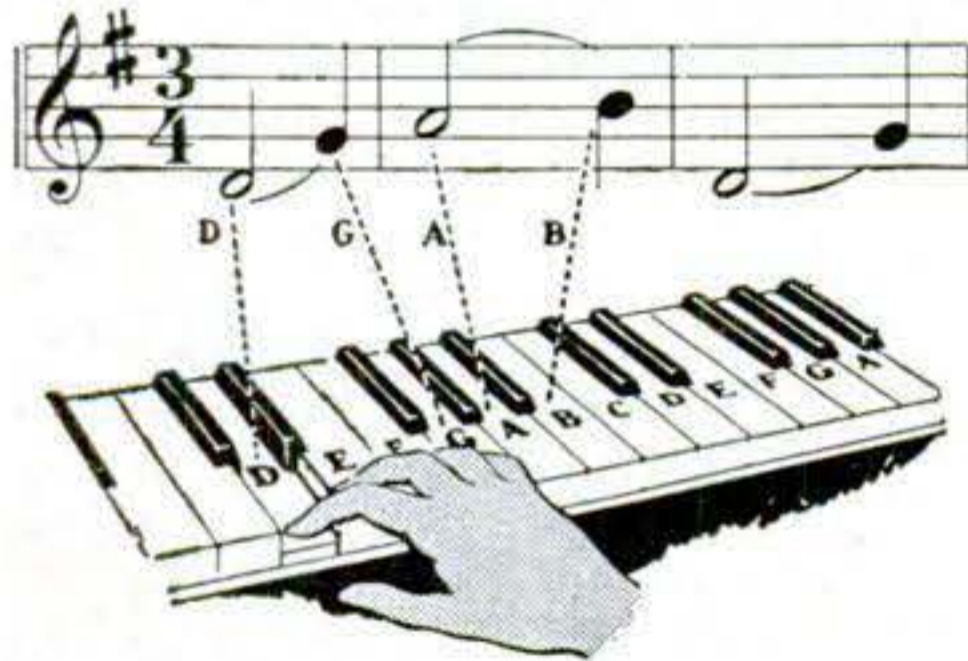

Following the dotted line to the keyboard you'll find "D" is the white key between the two black keys near the middle of the keyboard. Now read below how you can learn to play any instrument quickly and easily.

### Easy as A-B-C—Costs just a few cents a day!

● Perhaps you think learning music is a tedious grind. It isn't any longer! Long hours of practicing scales and monotonous exercise are over.

You have no excuse for not getting started toward musical good times now! For through an easy method you can now learn to play right at home—without a teacher—for a few cents a day.

#### Learn to Play by Playing

The lessons come to you by mail from the famous U.S. School of Music . . . complete instructions, clear diagrams, and all the music you need. You learn to play by playing real tunes by note. First you are told how to do a thing. Then a picture shows you how. Then you do it yourself and hear it. Remember, don't confuse our method with any system claiming to teach music "by ear" or by trick methods. We teach you to play only from real notes!

#### SUCCESS!

Here's what one of our thousands of pupils writes: "I learned more from your course than many of my friends who studied under private teachers have for years. The fact that I've already taken 2 courses and am now enrolling for a third should speak for itself." F. A. S., Indiana.



**Don't delay.** Send now for our illustrated Free Booklet and "Print and Picture" Sample which fully explain this remarkable method. So decide which instrument you want to play and mail the coupon today. U. S. School of Music, 84 Brunswick Bldg., New York 10, N. Y. (Successful 49th Year)

### FREE! Print and Picture Sample

U. S. School of Music  
84 Brunswick Bldg., New York 10, N. Y.

Please send me Free Booklet and Print and Picture Sample. I would like to play instrument checked below.

<input type="checkbox"/> Piano	<input type="checkbox"/> Saxophone	<input type="checkbox"/> Modern Elementary
<input type="checkbox"/> Guitar	<input type="checkbox"/> Trumpet, Cornet	<input type="checkbox"/> Harmony
<input type="checkbox"/> Hawaiian Guitar	<input type="checkbox"/> Reed Organ	<input type="checkbox"/> Mandolin
<input type="checkbox"/> Violin	<input type="checkbox"/> Tenor Banjo	<input type="checkbox"/> Practical Finger
<input type="checkbox"/> Piano Accordion	<input type="checkbox"/> Clarinet	<input type="checkbox"/> Control

Name..... Have You Instrument?.....

Address.....

City..... State.....

Save 2c—Stick Coupon on Penny Postcard

APRIL  
1947 45





## For Men Who are Trained in **AUTO BODY & FENDER WORK**

Men 18 to 60. Want a future with good pay, perhaps a business of your own later? If you are mechanically inclined, start now to learn to become an auto body mechanic and fender repair man. This fast growing field has great possibilities for trained men with experience. U. E. I. spare time, home-study training combined with actual shop practice gives you sound, basic knowledge of latest, best methods so you may get the experience which may bring you big pay. Capable instructors supervise your studies and actual practice. Course includes acetylene welding, spray painting, use of hand and power tools, etc.

### **THOROUGH, RELIABLE TRAINING**

U. E. I. has trained men for new opportunity fields since 1927 and many students are now making good. Auto body and fender repairing is one of the best profit-makers in any garage or service station. Little capital required. . . . placement service, or we will show you how to start your own shop. Get the facts FREE, without obligation. Write today.

*Training approved under G. I. Bill*

## **UTILITIES ENGINEERING INSTITUTE**

**AUTO-CRAFTS DIVISION**

1314 Belden Avenue, Dept. 347-X, Chicago 14, Ill.

Gentlemen: — YES! I want to get into profitable Auto Body and Fender Repair Work. Please send me FREE FACTS at once.

Name \_\_\_\_\_ Age \_\_\_\_\_

Address \_\_\_\_\_

City \_\_\_\_\_ Zone or County \_\_\_\_\_ State \_\_\_\_\_

If veteran of World War II check here  
 Check here for Special Information if under 17.

## **Do you want**

- .. to go to College?
- .. or to enter a Profession?
- .. or get an Office Position?

(Such as Accounting, Architecture, Nursing, Dentistry, Teaching, Social Work, Osteopathy, Beauty Culture, Optometry, Embalming, Chiropody, Law, Medicine, etc.)

To get anywhere, you practically MUST finish High School FIRST. You can complete our simplified High School Course in SPARE time at home, as FAST as your time and abilities permit. Equivalent to resident school work—prepares you for college, pre-professional examinations, business, industry. Standard texts furnished. Diploma. Credit for H.S. subjects already completed. Single subjects if desired. Low tuition, easy terms. American School, Chicago, est. 1897—endorsed by educators. Finish your high school education NOW. Write TODAY!

## **High School Course at Home**

**Many Finish in 2 Years**

American School, Dept. H446, Drexel Ave. at 58th St., Chicago 37

Gentlemen: Send me FREE information covering special training in subjects checked below. No obligation on my part.

- |  |  |
|--|--|
| <input type="checkbox"/> High School Course          | <input type="checkbox"/> Diesel Engineering                    |
| <input type="checkbox"/> Electronics, Industrial     | <input type="checkbox"/> Drafting and Design for Men and Women |
| <input type="checkbox"/> Architecture and Building   | <input type="checkbox"/> Plastics                              |
| <input type="checkbox"/> Automotive Engineering      | <input type="checkbox"/> Private Secretary                     |
| <input type="checkbox"/> Business Management         | <input type="checkbox"/> Mechanical Engineering                |
| <input type="checkbox"/> Electrical Engineering      | <input type="checkbox"/> Aviation                              |
| <input type="checkbox"/> Elec. and Gas Refrigeration | <input type="checkbox"/> Salesmanship                          |
| <input type="checkbox"/> Air Conditioning            | <input type="checkbox"/> Radio                                 |
| <input type="checkbox"/> Railway Training            |  |

Name .....

Address .....

# Get Facts About Fistula — FREE

**NEW BOOK—Explains Causes and Latest Treatment**

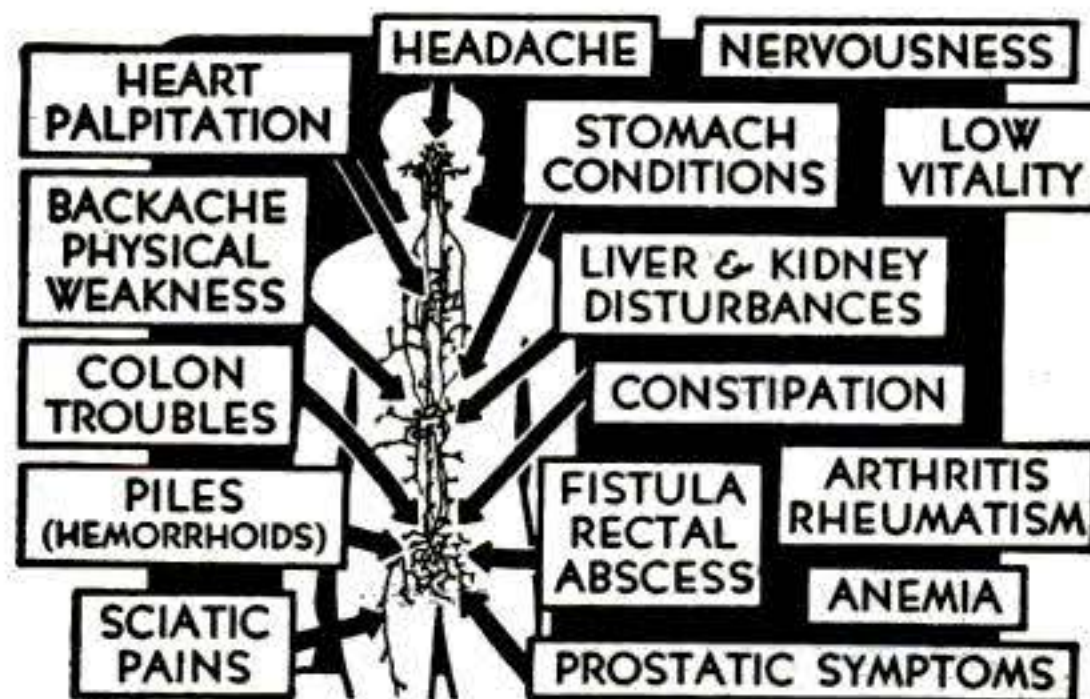

Illustrated, authentic 40-page book on Fistula, Piles (Hemorrhoids), related ailments as shown in diagram and colon disorders is yours FREE. Send postcard to Thornton & Minor Clinic, Suite 449, 926 McGee St., Kansas City, Mo.

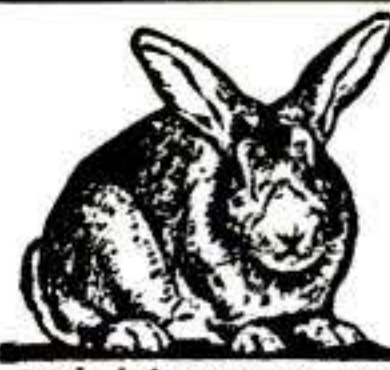

## **RAISE CHIN-CHINS**

No experience needed. Just a few minutes daily and a few feet of backyard, garage or barn space. Several females and a male starts a large, profitable herd. WE FURNISH FREE INSTRUCTIONS. TREMENDOUS DEMAND for breeding and laboratory stock, meat, and world's most beautiful rabbit fur. Brokers, cut off from imported rabbit pelts by world famine, NEED CHIN-CHIN FURS NOW, and for years to come! Write for free illustrated catalog today.

WILLOW BROOK FARM • R-45 SELLERSVILLE, PENNA.

## **Plastics Supplies**

Everything in plastics—Lucite, Plexiglas, Dyes, Rods, Sheets. Lowest prices. Send 3c stamp with name, address and this ad for catalog.

**PLASTICS MFG. & SUPPLY CORP.**

Dept. S-4 4707 Euclid Ave. Cleveland, Ohio

## **HY-SCORE AIR PISTOL**

for ACCURATE SHOOTING

No pumping. Fast. Powerful. Finest made. Single shot. 30½ oz. 10¼" long. \$25.00 with pellets. Extra pellets per 1000 \$2.50 for cal .177, \$3 for cal .22

SEE YOUR DEALER OR ORDER DIRECT  
Send 10c for circular to Dept. P-4

**HIGH-SCORE ARMS CORP. BROOKLYN 1, N. Y.**

## **"MAGIC VANISHING CARD"**

Throw it into the Air. It completely disappears; reproduce it later from spectator's pocket. It amuses and confuses all. Easy to do, 25c with Amazing Catalog of 300 Tricks.

**THE MAGICIAN**

Dept. 6, 2463 Kensington Ave., Phila, 25, Pa.

**ELECTRIC LIGHT PLANTS** Used Government surplus. Guaranteed in good mechanical and operating condition. 110 volt, 3000 watts, powered by Briggs-Stratton or Wisconsin air cooled engines, \$149.50. No COD Orders, Limited quantity, act quick. Send for descriptive circular. **MIDWEST SURPLUS SALES CO., 1520 Locust St., Kansas City, Mo.**

## **FALSE TEETH KLUTCH holds them tighter**

KLUTCH forms a comfort cushion; holds dental plates so much firmer and snugger that one can eat and talk with greater comfort and security; in many cases almost as well as with natural teeth. Klutch lessens the constant fear of a dropping, rocking, chafing plate. 25c and 50c at druggists. . . . If your druggist hasn't it, don't waste money on substitutes, but send us 10c and we will mail you a generous trial box.

**KLUTCH CO., Box 4794-D, ELMIRA, N. Y.**



# Do You STILL CHANGE MOTOR OIL??

If so—you can END this needless waste and expense forever, with "RECLAIMO"

America's Foremost Oil Re-Refining Filter. Continuously re-refines crankcase oil through an ingenious use of motor heat while driving!

1. Removes solids by filtration
2. Removes water-fuel dilution by heat and distillation
3. Prevents acid-sludge formation
4. Maintains stable viscosity
5. ELIMINATES ALL OIL CHANGES!

**CAR—TRUCK—TRACTOR and DIESEL OWNERS!**  
U. S. Bu. of Stds. Bul. 86 states: "Oil Does Not Wear Out Mechanically"—"Reclamo's" re-refining action has fully confirmed that statement. This great oil-saving feature is indeed important, BUT of far greater importance are the savings resulting from "Reclamo's" tremendous reduction of costly motor wear! Again available—also to dealers. Complete details in FREE Book "Oil Facts". Write now! RECLAIMO MFG. CO., 5087 Elston Ave., Dept. 40, Chicago 30, Ill.

GET THE FACTS!



FREE 40 PAGE BOOK



## Satisfied with my JOB and PAY? NOT ME!!

"Some day I'll really get a break and go right on to the top."

That's wishful thinking.

You know that the "breaks" go to the man or woman who is prepared to take advantage of them—to the person who can fill the better job and is worth more money. He makes the "breaks" instead of waiting for them.

You can influence your own future by preparing now for the step forward—so that openings come because you are equipped for them—not as the result of luck.

Why not take the road that thousands of ambitious men and women have taken to help them to better jobs and more money.

Prepare now. Send the coupon below—check the business field of your choice and we'll send you without obligation our FREE 48-page book describing the opportunities and complete information on that field.

Send the coupon Now. It may be the turning point in your life to that better job and more money. G. I. APPROVED.

## LASALLE Extension University A Correspondence Institution

417 S. Dearborn St., Dept. 483-R Chicago 5, Ill.

I want to make my own "breaks" by preparing for a better job. Send me your free 48-page booklet on the subject I have checked below.

- |  |  |
|--|--|
| <input type="checkbox"/> Foremanship           | <input type="checkbox"/> Salesmanship                  |
| <input type="checkbox"/> Accounting            | <input type="checkbox"/> Law: LL.B. degree             |
| <input type="checkbox"/> Bookkeeping           | <input type="checkbox"/> Business English              |
| <input type="checkbox"/> C.P.A. Coaching       | <input type="checkbox"/> Effective Speaking            |
| <input type="checkbox"/> Industrial Management | <input type="checkbox"/> Stenotypy (Machine Shorthand) |
| <input type="checkbox"/> Traffic Management    | <input type="checkbox"/> Executive Management          |

Name.....Age.....

Position.....

Address.....

City.....Zone.....State.....

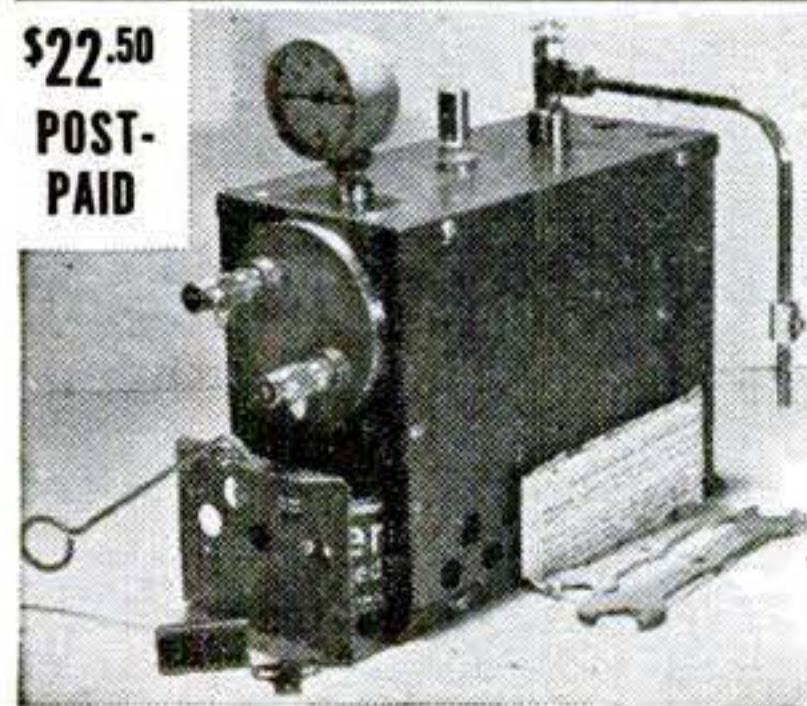

\$22.50  
POST-PAID

## A REAL POWER STEAM BOILER NOT A TOY

Cast bronze ends silver soldered to brass tubing. Withstands 500 lb. pressure. Enclosed in sheet iron housing. Fittings include: safety valve, pressure gauge, throttle, copper connecting steam pipe with oiler, and wrenches. Exceptional value.

HARRY ROSS B 68 West Broadway N. Y. 7, N.Y.

**TALK-SING** thru your own radio with **RADIO MICROPHONE**

Be the life of the party. Put on your own broadcasts at home. Talk-Sing, make announcements from any room. Wonderful voice practice. Microphone easily attached to any radio. Follow enclosed instructions. SEND NO MONEY—pay Postman \$1.98 plus postage. Send Money Order or check and save postage.

**EMPIRE RADIO & TELEVISION CO.** (Dept. R1) 1521 Bedford Ave., Brooklyn 16, N. Y.

## Secret for Inventing FOR THE AMATEUR INVENTOR

The first and only service established exclusively for helping the amateur inventors in testing the commercial value of their inventions and guiding them in the correct course to securing patent and market at the least expense.

Service guaranteed. Full information free on request.

E. C. BARNES, PO Box 85, Attica, Indiana

## FURNACES PROPANE BUTANE

Forced air furnaces for liquefied gases. Gas & Oil Burners, Blowers, Gas & Oil Floor Furnaces. SELL & INSTALL.

PEERLESS SALES 4318 Sheridan Blvd., Lincoln 6, Nebr.

## START A BATTERY FACTORY

—at home; the latest achievement; re-cast junk batteries into new. Complete instructions. We supply everything. Big profits!

THE BATTERY LABORATORIES  
Dept. PS Minneapolis 13, Minn.

EYE-GLASSES BY MAIL  
16 Days Trial

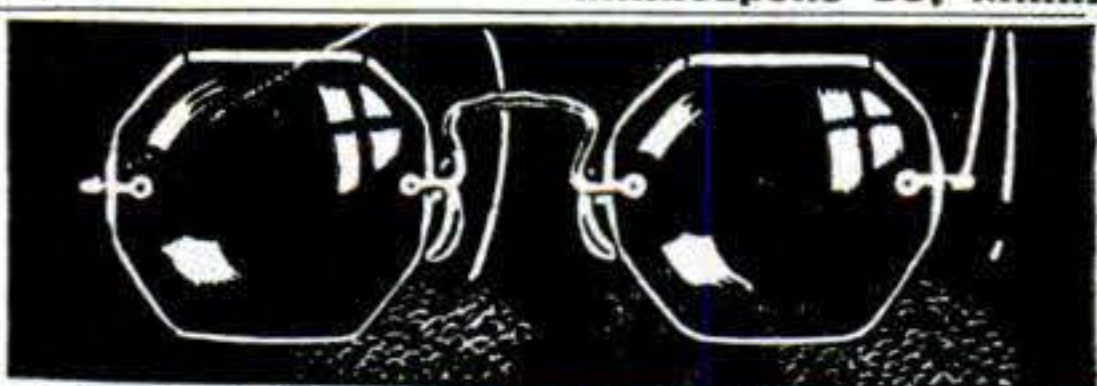

Write Today for Free Catalog. Send no Money

**ADVANCE SPECTACLE COMPANY**  
537 South Dearborn Street, Dept. SPF, Chicago, Illinois



**JUST OUT!**  
**BRAND NEW GOV'T SURPLUS**  
**SOLID BRASS 12 FOOT PORTABLE**  
**RADIO ANTENNA**

**Real \$15 value now only \$4.95 POST PAID**  
**FOR HOMES, BOATS or AUTOS**

Same as used on Army tanks. These telescopic rustproof antenna have a tremendous pickup and eliminate dangerous wiring. Solid Brass throughout practically insures **NOISE FREE RECEPTION.**

**12 exceptionally rugged sections**  
**compress into 1 ft. 4 in.**

**Handy for Camping Trips, also Useful for**  
**Transmitting, FM & Television sets**

*Each antenna comes with clamps, nut, lug, and wire. Easy to install anywhere.*

**QUANTITY LIMITED**

**MAIL ORDER TODAY.** A real \$15 value for only \$4.95 Postpaid. Send check or money order now or mailed C.O.D. plus postage. Money back in 10 days if not satisfied.

**RADIO HOSPITAL**

1113 LEXINGTON AVE., DEPT. B5 NEW YORK 21, N. Y.



**The Modern PLASTIC**  
**for lasting Home Repairs**

**PERMANENTLY** mends cracks or holes in wood, tile, stone or plaster. Sticks and stays put—Does not chip, shrink or fall out. Easy to use. Economical. Mold it, chisel it, polish or paint it. If unobtainable from your lumber, paint or hardware dealer, the big 4-lb. can will be sent you postpaid (in U.S.) for only \$1. Full money-back guarantee, order now.

**DONALD DURHAM CO.**

Box 804-D, Des Moines, Iowa

**Learn to MOUNT BIRDS**



**Tan SKINS, make up FURS**

Be a Taxidermist. Double your hunting fun. We teach you at Home. Mount Birds, Animals, Fish, Heads, common specimens. Fun and profits. Decorate home and den **MAKE MONEY.** Mount game, tan for others. Big profits in spare time. **WRITE TODAY.**

**100 game pictures in FREE BOOK**  
 Hunters, get your copy. It's Now Free. Send post card. State your AGE.

**NORTHWESTERN SCHOOL OF TAXIDERMISTRY**  
 Dept. 3394 Omaha, Nebraska

**FREE BOOK**



**NEW! 2 H.P. BIKE "SIDECAR"**

Attaches to any bike—Motor under as low as sidecar seat. Carries extra passenger or 300 lb. load! Up to 40 MPH 100 gal. gas—plenty of power! Handle bar controls—You can assemble or build it—It's easy—We can furnish parts.

**SEND ONLY \$1.00** (cash or M.O.) postpaid or pay postman \$1.52 C.O.D. (USA only) for complete scale isometric picture blueprints (anyone can read them) 6 page details, lists of parts and prices complete!

**FREE** with each order—big 48 page color book giving full details on over 100 other new inventions such as: **JET ENGINES—SUN MOTORS—MIDGET MOTORCYCLES—CARS AND SCOOTERS—BIKE MOTORS—ELECTRIC WELDERS—REAL AIRPLANES—WALKIE TALKIES, ETC. DON'T PASS UP THIS SUPER VALUE—YOU MAY EARN AND SAVE HUNDREDS OF DOLLARS WITH THESE PLANS!** (All foreign orders \$1.50 U.S. cash with order). **MOTOR INDUSTRIES INC., Dept. PSSC-4 Kearney, Nebraska**

**MASTER MACHINIST • MECHANICAL DRAFTING**  
**TOOL-DIE DESIGNING • TOOL ENGINEERING**

Days, Evenings • Approved for Veteran Training • Bulletin on Request  
**ALLIED SCHOOL OF MECHANICAL TRADES, INC.**  
 44 ALLIED BLDG., 1338 SO. MICHIGAN, CHICAGO 5, ILL.



**LEARN-WATCH REPAIRING**  
**at HOME**

"FREE information write—American Institute of Specialized Watch Repair—P.O. Box 117, Dept. 2, Grand Rapids, Michigan."

**LAW**

**STUDY AT HOME for PERSONAL SUCCESS and LARGER EARNINGS.** 38 years expert instruction—over 108,000 students enrolled, LL.B. Degree awarded. All texts furnished. Easy payments. Send for **FREE BOOK—"Law and Executive Guidance."**

**AMERICAN EXTENSION SCHOOL OF LAW**  
 Dept. 76-S, 646 N. Michigan Ave., Chicago 11, Ill.

**Learn PHOTOGRAPHY at Home**

Splendid opportunities. Prepare in spare time. Practical basic training. Long-established school. Send for free book, "Opportunities in Photography." No obligation.

**American School of Photography, 1315 S. Michigan Ave., Dept. 1364 Chicago 5, Ill.**

**IDEAS**

**AND INVENTIONS WANTED**  
 Cash in on your Ideas, Inventions, Methods Now! Responsible Manufacturer gives complete protection on all Ideas, Methods, Inventions submitted—Costs you nothing. Write to

**MASTERFORM TOOL CO., 2547 Irving Park Rd., Chicago 18, Illinois**

**MAKE MONEY** IN YOUR OWN **SILK SCREEN PRINTING BUSINESS**

Print 100, 50c signs an hour! Build your own press. Start with only \$50, sparetime at home! We tell you HOW! Write today!

**W. E. Wolff Co., 817-A High St., Anderson, Indiana**

★ **GET ON "UNCLE SAM'S" PAYROLL** ★

**\$1,756 TO \$3,021 FIRST YEAR**

**Veterans Get Special Preference**

Railway Postal Clerks—Mail Carriers—Mail Clerks—Patrol Inspectors—Storekeeper Gaugers—Positions at Washington, D.C.—Etc. Mail Coupon immediately—

**32-Page Book on Civil Service—FREE**

**FRANKLIN INST., Dept. G80, Rochester 4, N. Y.**

Gentlemen: Rush to me, without charge, 32 page book with list of U. S. Government big paid positions. Advise me also regarding salaries, hours, work, vacations, etc. Tell me how to prepare for a position.

Name.....  
 Address..... Vet?.....



## CONFIDENTIAL LOAN SERVICE

**Borrow \$50 to \$300<sup>00</sup>**

Need money? No matter where you live you can borrow **BY MAIL** \$50.00 to \$300.00 this easy quick confidential way.

**IT IS EASY TO BORROW BY MAIL!**  
Completely confidential and private  
**CONVENIENT MONTHLY PAYMENTS**

**NO ENDORSERS NEEDED**  
EMPLOYED MEN and women of good character can solve their money problems quickly and in privacy with loans **MADE BY MAIL**. No endorsers or cosigners. We do not contact employers, friends or relatives. Convenient monthly payments. Send us your name and address and we will mail application blank and complete details **FREE** in plain envelope. There is no obligation.

**STATE FINANCE CO.**  
303 Marine Bldg. • Dept. L-13 • New Orleans 12, La.

## BATTERIES FIXED TO WORK LIKE NEW!

with and without new materials. Everything needed supplied. Complete copyrighted course, tool list, etc., only \$10.00. **BATTERY LABORATORY SCHOOL, Dept. C, Minneapolis 13, Minn.**

## MAKE MONEY CASTING AT HOME FREE FACTS SENT



Cast thousands of perfect Plaques, Book Ends, Ash Trays, Etc. Plaster, Liquid Marble, Etc. **ENORMOUS PROFITS.** Start in basement or garage. **LITTLE CAPITAL NEEDED. QUICK, EASY, NO PREVIOUS EXPERIENCE NEEDED.** Rubber molds for speed production. **MAKE YOUR OWN. SAMPLE KIT \$1.00.**  
**PLASTIC ARTS STUDIOS, Route 5, Dept. 45, Muncie, Ind.**

## LAWN ORNAMENT-NOVELTY PATTERNS

28 Lawn Ornament Patterns, 25c. Other patterns: 15-20" high; Dutch Girl, Dutch Boy, Pirate, Bull Terrier, Mexican Girl, Mexican Boy, Dwarf, Penguin, Flower Girl, 10c each. 25 Novelty Patterns, 30c. All 62 Full Size Patterns, \$1.00 Postpaid. **Strother Pattern Service, Dept. 7-P, Box 383, Belington, W. Va.**

## STAMMER?

This new 128-page book, "Stammering, Its Cause and Correction," describes the Bogue Unit Method for scientific correction of stammering and stuttering—successful for 46 years. **Benj. N. Bogue, Dept. 1896, Circle Tower, Indianapolis 4, Ind.**

GET THIS  
**FREE**  
BOOK!

## Big Money for Workers In Home or Shop

Licensed Concrete Specialists wanted. No experience needed. Make **Colorglazed** concrete pottery without molds. New, low cost, patented method. Cemetery products, novelties, tiles, floors, etc. Basement leaksealing. Other big pay projects. Booklet, details free. Men only.  
**NATIONAL POTTERIES COMPANY**  
542 West Lincoln, Fergus Falls, Minnesota



## COMB-A-TRIM THE NEW QUICK TRIMMER

Something New! Trim your hair without any experience. It's easy! The excess hair comes off smoothly and easily by just pulling trimmer through hair like an ordinary comb. Also removes hair from legs—armpits. Save on hair-cut bills. . . . Trim your own hair or the whole family's. Send 59c and your Comb-A-Trim will be sent at once.

59c

**SPECIAL OFFER**  
Send \$1.00 for 2  
Comb-A-Trims  
and save 18c. **2 for \$1**

5 Extra Blades (Year's Supply) 25c  
**COMB-A-TRIM CO.**  
1734 Carew Tower Dept. J-18 Cincinnati, Ohio

## Give yourself the Backing of a GREAT GROWING INDUSTRY



## REFRIGERATION AIR CONDITIONING

• Refrigeration and Air Conditioning have leading place in fast growing fields of our time. Trained men paid well to service, install, maintain, repair, rebuild household and commercial refrigerators. Important new developments such as Frozen Foods and many new industrial uses. Demand for commercial installations in restaurants, butcher shops, taverns, florists, bakeries, etc.—air conditioning in homes, offices, shops.



### START NOW—Full and Part Time Earnings

There may never again be such opportunities for men who want better jobs or business of their own to get in on ground floor and go up fast! Many started with small investment who built good, growing business. If over 17 and under 60 learn how you can get started. **CONSULTATION AND PLACEMENT SERVICE WHETHER YOU ARE INTERESTED IN WORTHWHILE JOB OR SETTING UP YOUR OWN BUSINESS.**



### Begin Training at Home or Come Directly to Shops

Begin your training at home in spare time, finish in our big, modern shops, or come directly to shops. At home you get C.T.I.'s **SHOP PROVED HOME STUDY** instruction—actual shop experience has gone into the practical lesson assignments. That is why it is easy for mechanically inclined men to learn by our Home Study training and start on actual refrigeration work.



### A NATIONALLY KNOWN INSTITUTION

C.T.I. was only civilian school selected by Army to train service men for refrigeration. Same quality training available to you now. The method that has made rapid progress possible. Commercial Trades Institute has established its place in Air Conditioning and Refrigeration Industries, and that is important to you in making your start.

### VETERANS

Veterans qualifying under "G.I. Bill" have tuition paid by Government plus monthly subsistence allowance while in school. Just mail coupon, we will handle all details. (LOW TUITION, EASY TERMS if you are not a veteran.)



Commercial Trades Inst., Dept. A-14  
1400 W. Greenleaf Ave., Chicago 26, Ill.

**FREE**—Important Information Telling How to Get Started  
CUT COUPON ALONG THIS LINE

## Fill Out, Cut Out, Mail Today

**FACTS FREE for Men Who Want to Get Ahead**  
**COMMERCIAL TRADES INSTITUTE, Dept. A-14**  
1400 W. Greenleaf, Chicago 26, Ill.  
Send free illustrated Brochures and other information about Refrigeration and Air Conditioning.

Veteran  Non Veteran

NAME.....

ADDRESS.....

CITY.....STATE.....



# RHEUMATISM YIELDS TO DRUGLESS METHOD OF TREATMENT

Excelsior Springs, Mo., March 30—So successful has a comparatively new, drugless method proven for treating rheumatism and arthritis that an amazing new book will be sent free to any reader of this magazine who will write for it.

This book entitled, "Rheumatism," fully explains why drugs and medicines give only temporary relief and fail to remove the causes of the trouble.

The Ball Clinic, Excelsior Springs, Mo., has perfected a system of drugless treatment for rheumatism and arthritis combined with the world famous mineral waters and baths. This new method of treatment is fully described in the book and tells how it may be possible for you to find freedom from rheumatism.

You incur no obligation in sending for this instructive book. It may be the means of saving you years of untold misery. For writing promptly, the company will also include a free copy of the book entitled, "Good Health, Life's Greatest Blessing." Address your letter to The Ball Clinic, Dept. 36, Excelsior Springs, Mo., but be sure to write today.

**FOR STEREO PICTURES, IT'S STEREO-TACH!**  
**Take Third Dimension Pictures with the STEREO-TACH and your own camera!**  
 There's nothing in photography so startlingly beautiful and lifelike! You can't reproduce a 3-dimension picture in flat 2-dimension printing!

Outfit No. 101—'Tach and Transparency Viewer (for transparencies, with 35MM cameras) **\$22.50\***

Outfit No. 100—'Tach and Print Viewer (for stereo prints, with both 35MM and other size cameras) **\$14.75\***  
 \*Plus Tax.

**The Stereo-Tach**

**Transparency Viewer** For Third-Dimension Projection, the STEREO-FLECTOR! Just Out! See your dealer or write.

**ADVERTISING DISPLAYS, INC. Dept. PS-2, COVINGTON, KENTUCKY**

# EXCITING FILMS



Thrill audiences at your 8-16 mm. screenings! Breath-snatching Bull-fights . . . Movie Stunt Men in life-and-limb action . . . Death Defying Dives.

—o—

GLAMOROUS subjects starring Hollywood's most beautiful daughters. Models selected by artists as the loveliest in all the world in beautiful scenes; sensational dances.

**SPECIAL OFFER:** Send only one dollar for new film short, "Glamorous Exciting Stars" featuring four glorious Beauties. State 8mm. or 16mm. For listings of all Exciting Films free, and this Exciting Film, send only a single dollar, now, to

## EXCITING FILMS

1071 El Centro, Dept. 12, Hollywood, Calif.

**GET INTO CARTOONING!**  
 Learn cartooning from a professional cartoonist! Create original cartoons and ideas. Send for free details about course. Also cartoonists' magazine. Full of lessons, plans, etc. Only 25c coin postpaid.  
**Hartman Studios, 2776 California Court, Lincoln 8, Nebr.**

**ELECTRIC WELDER**  
 AC or DC 110 Volts  
 Pre-war type—All metal—No chemical—5 year written guarantee. Welds 1/8" thick metal or money back. Repairs tanks, tools, fenders, machine parts, etc. Comes complete with rods, unit directions and eye shield. We also manufacture a set you can learn with for only \$3.95 complete. On C.O.D. mailing charges extra.  
**ESSAY MFG. CO., INC., Dept. P.S., Quincy 69, Mass.**

**\$6.45 Complete**

**BOILING HOT WATER IN A JIFFY!!**

Place the Jiffy Electric Water Heater into the water and insert the plug in the nearest electric wall or light plug. You will have hot water in less than five minutes for baby's bath, your washing, shaving and a great many other uses in the home, camping, business, and on the farm. Mailed complete, including six feet of rubber covered wires and plug. One year guarantee.

**JIFFY ELECTRIC COMPANY**  
 21322 Stephenson Highway, Dept. PS-1, Hazel Park, Mich.

**Only \$2.95**  
 plus twenty five cents for postage

**SENDING-RECEIVING SPEED**

Learn to send and receive Radio Code with greater speed. Stop nervous tension. Have confidence. Be proficient. Same system used by radiotelegraph specialists. Thousands of operators needed. Rush name for FREE book.

**CANDLER SYSTEM CO.**  
 Dept. 6-D, Box 928, Denver 1, Colo., U. S. A.

# SIX BAND COMMUNICATION RECEIVER BC-348

Featuring coverage from 200 to 500 KC and 1500 to 18000 KC on a direct reading dial with the finest vernier drive to be found on any radio at any price—extreme sensitivity with a high degree of stability—crystal filter—beat frequency oscillator with variable pitch control—antenna compensation—standard 6 volt tube types. Contains a 24 to 32 volt DC plate supply dynamotor in compartment within the handsome black crackle finish cabinet, the removal of which

leaves plenty of room for installation of a 110 V, 25 or 60 cycle power supply. These receivers, which make any civilian communications receiver priced under \$200.00 look cheap and shabby by comparison, are only \$44.50. Power supply kit for conversion to 110 V, 25 or 60 cycle is only \$8.50 additional.

Aluminum gear box 18x8x7 with 62 matched gears from 1/2 to 4", and 2 powerful electric motors—\$3.00. SEND FOR CATALOGS.  
**BUFFALO RADIO SUPPLY, DEPT. S4, 219-221 GENESEE ST., BUFFALO, N.Y.**





## "JACKPOT"

### Home Model COIN MACHINE

● Great fun maker for Rum-pus Room or Club. Soon pays for itself. Fully automatic payout, three reels, with all the usual winning combinations . . . cherries, lemons, etc. Double jackpot. Rugged lifetime construction. *Guaranteed* to satisfy or money back. Service manual makes it easy to understand how to operate machine successfully. Takes space only 14½ x 11½

in. Ht. 18½ in. Shpg. wt. 47 lbs. CHOICE OF 5c, 10c, or 25c PLAY. Send \$50.00 deposit, balance C.O.D. plus express charges. Immediate delivery.....Each, **\$198.00**

**Webb DISTRIBUTING CO. INC.**

6 SOUTH KEDZIE AVE. • CHICAGO 12, ILLINOIS

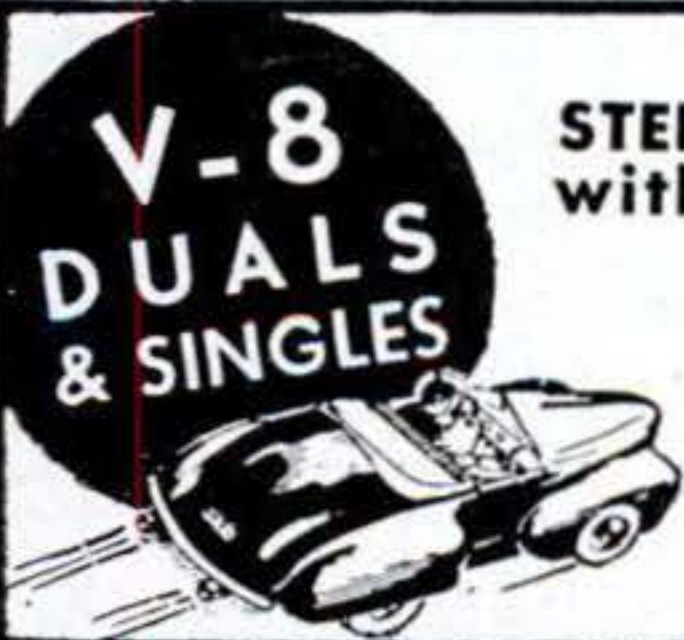

### MUFFLERS

**STEELS and ALUMINUMS**  
with a motorboat tone

SINGLES, Chev, V-8, Plymouth, Steels \$5.50, Aluminum \$6.50, Chry., Olds., Buicks, etc., Steels \$7.50, Aluminum \$8.50. V-8 and MERCURY DUALS, Steel \$17.50, Aluminum \$20.00. Aluminums are guaranteed for life of your car.

**DEALERS WANTED**

**SANDEE MUFFLER CO.**

7523 S. WESTERN AVE., LOS ANGELES 44, CALIF.

### QUICK! "REPAIRING CAR BATTERIES" MONEY

At Home! Easy Too! Free Circulars!  
WRITE, BATTERYMAN Dept. S-1 Grand Junction, Colorado

**HAUCK FLAME GUN KILLS WEEDS**

2000° F controlled heat quickly, easily destroys seeds, roots, brush, poison ivy, wild morning glory, Canada thistle, other unwanted growths. Many uses: splitting rocks, burning stumps, sterilizing poultry houses. Burns kerosene. Does the work of 4 men. Safe, easy to use. 10 day trial. Satisfaction guaranteed. Free catalog.

**HAUCK MFG. CO.**  
122 Tenth St., Brooklyn 15, N. Y.

### Thompson BEATS the World on BOATS

**Safe Boats With Full Length Spray Rails**  
Keep passengers perfectly dry—even at high speeds. Catalog also shows two new models of "Take-Along" Boats. Two big factories—save you freight.

**CATALOG FREE**  
Write for your copy. State kind of boat in which you are interested.  
**THOMPSON BROS. BOAT MFG. CO. (151)**  
219 Ann St. PESHTIGO, WIS. (Write to either place) 119 Elm St. CORTLAND, N. Y.



**Better Built Lower Prices**

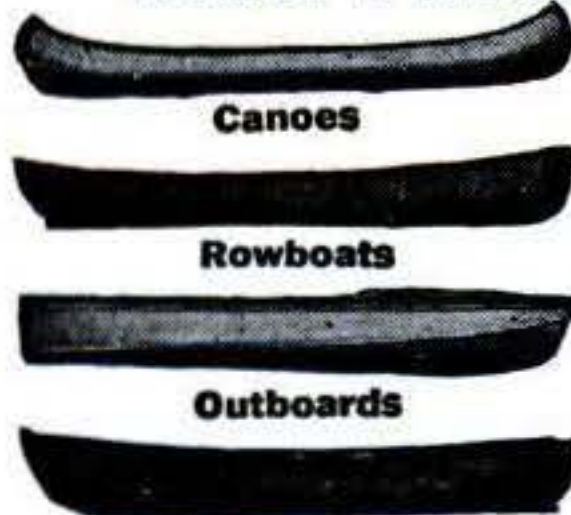

Light Boat for Auto

FIND OUT WHY THE  
**DEAF**  
CALL IT A MIRACLE

THIS ONE  
TINY UNIT  
IS ALL  
YOU  
WEAR

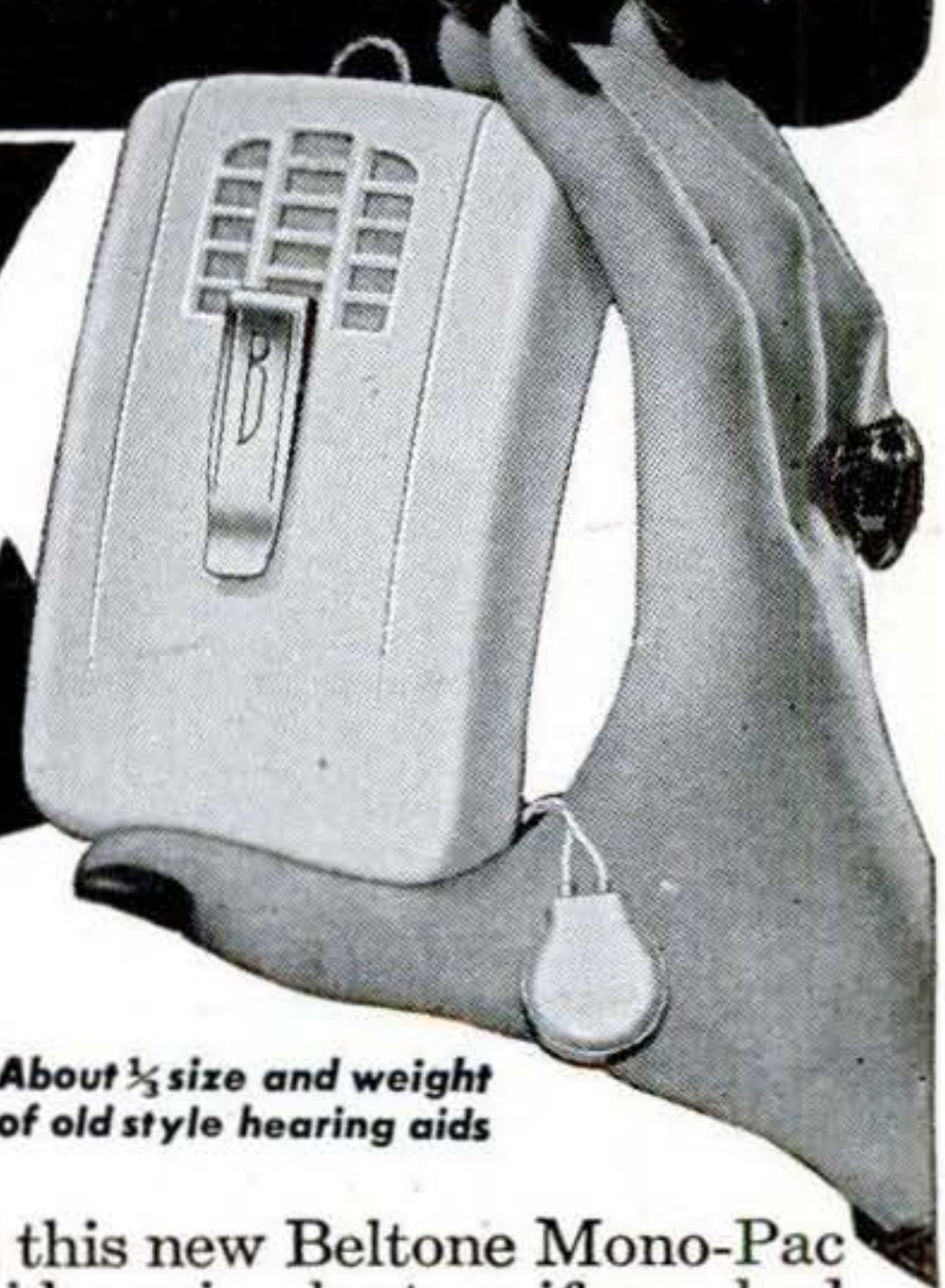

About 1/3 size and weight  
of old style hearing aids

You'd call this new Beltone Mono-Pac Hearing Aid a miracle, too, if you had been wearing a clumsy, annoying, battery pack strapped to your body with entangling wires, and then suddenly found the new Electronic Beltone. It's a single-unit hearing aid—so small you can hide it with the palm of your hand—so light you forget you are wearing it—so thin it is lost from sight—so efficient you bless the day you learned about it.

Those are a few of the reasons why more people are wearing Beltones than all other one-unit hearing aids combined.

**GET FREE BOOK ABOUT HEARING PROBLEMS and about the**

**NEW**  
**Beltone**  
MONO-PAC  
**HEARING AID**



**FREE BOOK—MAIL COUPON**

BELTONE HEARING AID CO., Dept. PS-74  
1450 West 19th Street, Chicago 8, Illinois

Please send me, without obligation, FREE information concerning the new Beltone with the amazing X-Cell which out-performs units 5 times its size.

Name.....

Address.....

Town..... Zone..... State.....

APRIL 1947 51



**Powerful Light**  
Anywhere—Any Time with

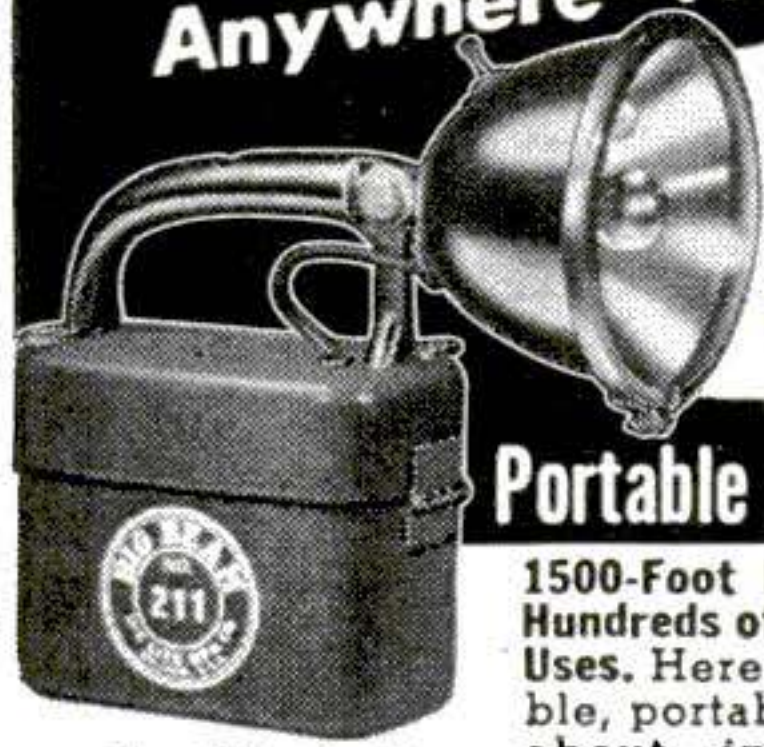

**Big Beam**

Model No. 211

**Portable Electric Hand Lamp**

1500-Foot Beam; Spread Light Control; Hundreds of Sports, Utility or Emergency Uses. Here is the powerful, dependable, portable light everyone's talking about—indispensable for Farmers, Home Owners and Motorists, ideal for Yachting, Hunting, Fishing, Camping

Uses Standard Dry Cell Batteries

and all outdoor uses. Daylight visibility when and where you need it. Built to last for years. Also... other dry cell and storage battery models for police and fire departments, marine, railroad, airport and other industrial uses. Many accessories available—such as colored lens, hold-down bracket for rigid fastening in auto trunks, to prows of boats, etc.

Available Through Better Dealers—or Mail Coupon Today for Complete Descriptive Information.

Canadian Representative—Walters & Marks, Toronto 5.

**U-C LITE MANUFACTURING CO.**

1046 W. Hubbard Street, Chicago 22, Ill.

Please send me without obligation complete information on the following:

BIG BEAM MODEL No. 211  OTHER MODELS

Name \_\_\_\_\_

Street No. \_\_\_\_\_

City \_\_\_\_\_ Zone \_\_\_\_\_ State \_\_\_\_\_

**Now for EVERY WORK SHOP!**

**NEW Invention Electroplates by BRUSH**



**Easy to Plate CHROMIUM GOLD, SILVER, NICKEL, COPPER . . . For Pleasure and Profit!**

If you have a workshop—at home or in business—you need this new Warner Electroplater. At the stroke of an electrified brush, you can electroplate models and projects—you can replate worn articles, faucets, tools, fixtures, silverware, etc. with a durable, sparkling coat of metal . . . Gold, Silver, Chromium, Nickel, Copper or Cadmium. Method is easy, simple, quick. Everything furnished—equipment complete, ready for use. *By doing a bit of work for others, your machine can pay for itself within a week.* So make your shop complete by getting a Warner Electroplater right away. Send today for **FREE SAMPLE** and illustrated literature. **ACT AT ONCE! Mail Coupon.**

**WARNER ELECTRIC CO., DEPT. M-4**  
1512 Jarvis Avenue, Chicago 26, Ill.

**FREE Details & Sample!**

**WARNER ELECTRIC CO., 1512 Jarvis Avenue, Chicago 26, Dept. M-4**

Gentlemen: Send Free Sample and Details to:

Name \_\_\_\_\_

Address \_\_\_\_\_

City \_\_\_\_\_ State \_\_\_\_\_

**OH BOY! FIREWORKS!**

Rich Bros' All-American Pre-war Quality ASSORTMENT. Over 172 pieces including 100-2" Salutes, 20 Cherry Flash Bombs, 25 Flitter Crackers, Comet, 2-shot Repeaters, Whistle Bomb, Red & Green Fire Cones, Whistle Devil, Humdinger, Gyro Flyer, Vesuvius Fountain, Flower Pot, Roman Candles, Aerial Bombs, Sparklers, 6 packages Chinese Firecrackers, **FREE PUNK! RETAIL VALUE \$8.55. YOURS FOR ONLY \$4.95**

**RICH BROS' FIREWORKS CO.**

Dept. 5 Box 514 Sioux Falls, S. D.

Shipped Ry. Express Only. None sent C.O.D.

Enclose Money Order or Check. Name nearest Express Office. Many other assortments and displays. Send for **FREE CATALOG, FREE CAP** and Cap Pistol circular.

**RUPTURED?**

**Get Relief This Proven Way**

Why try to worry along with trusses that gouge your flesh—press heavily on hips and spine—enlarge opening—fail to hold rupture? You need the Cluthe. No leg-straps or cutting belts. Automatic adjustable pad holds at real opening—follows every body movement with instant increased support in case of strain. Cannot slip whether at work or play. Light. Waterproof. Can be worn in bath. Send for amazing **FREE** book, "Advice To Ruptured," and details of liberal truthful 60-day trial offer. Also endorsements from grateful users in your neighborhood. Write:

**Cluthe Sons, Dept. 14, Bloomfield, New Jersey**

**LEARN IMPORT-EXPORT**  
Represent manufacturers. Study at home. Splendid opportunities, uncrowded field, big future. ITP trains you in few weeks. Low tuition. Diploma awarded. **INTERNATIONAL TRADE PROMOTION**  
246-S Fifth Ave. New York 1, N. Y.

**NEW SCIENTIFIC "GUZZLIN CHARLIE"**  
Mystery Drinking Bird with Roly-Poly Eyes  
Complete with glass and stand. No springs, no gadgets, no wires, not mechanical. Amazing "Guzzlin Charlie" drinks and drinks; he is always thirsty. You won't believe your eyes. Young and old go wild over him.  
Dealers write for special prices  
**BERNARD FINE CO.**  
501 6th Ave., Dept. P.S., N. Y. 11, N. Y.

**RADIO PARTS ASSORTMENT**

Experiment with many radio parts. Transformers, Coils, Sockets, Wire, Switches, etc., etc. Bargains like this only once in a lifetime! **Send Cash, Check or Money Order . . . . . 10 lbs. \$1.69**  
**THOR ELECTRONICS, 5051 N. Clark St., Chicago 40, Ill.**

**BUILD YOUR OWN! FAST FREEZER PLANS \$1.00**

It's easy to build this household appliance and profitable to use. Save up to 75%. Operates on 110 or 32 volts. Plans show 5 sizes and are easy to follow. **ENJOY MAKING ONE OF** these freezers from new or used parts. No expert knowledge needed. Mail \$1.00 bill or check for complete plans and catalog.  
**LE JAY MFG., 423 LeJay Bldg., Minneapolis 8, Minn.** 8 to 40 cu. ft.

**Fit-Rite** makes False Teeth **TIGHT**  
Makes loose dental plates fit snugly and comfortably.  
**LASTS for MONTHS!**

Simply squeeze on dental plate and put it in your mouth. Hardens and becomes part of plate. Money-back guarantee.  
**FREE** Generous package of Dental Plate Cleanser with each order. Send \$1.00 or mailed parcel post collect.  
**Fit-Rite Co., 1573 Milwaukee Ave.**  
Dept. 4-42 Chicago, Ill.





# MIRACULOUS OPTICAL GYROSCOPE!

The Famous Mark 18 Gyro-sight...

New—Ready to Run—For Only \$12<sup>95</sup>!

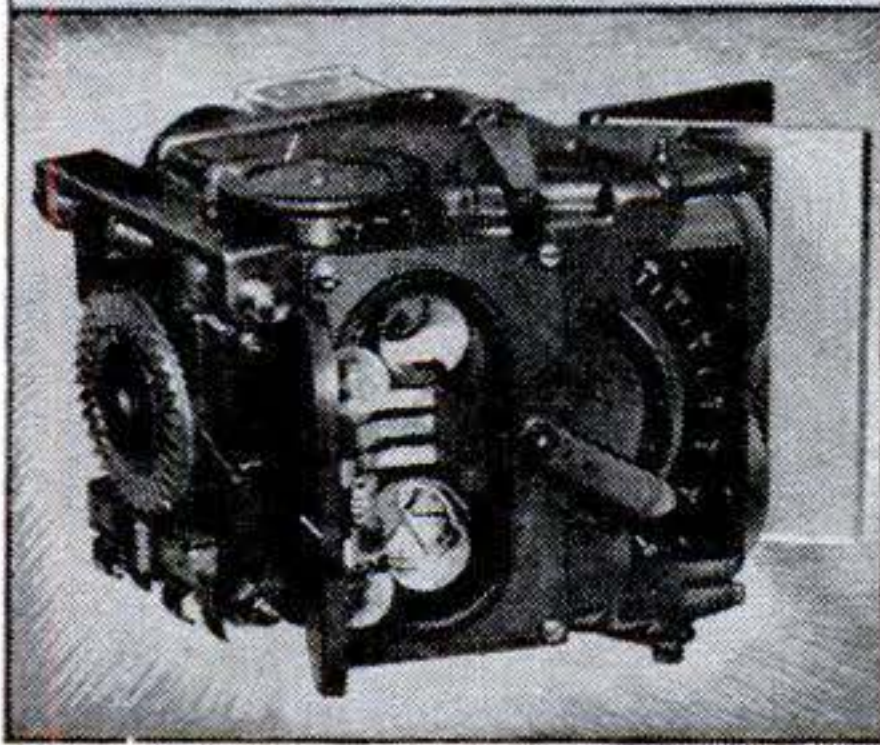
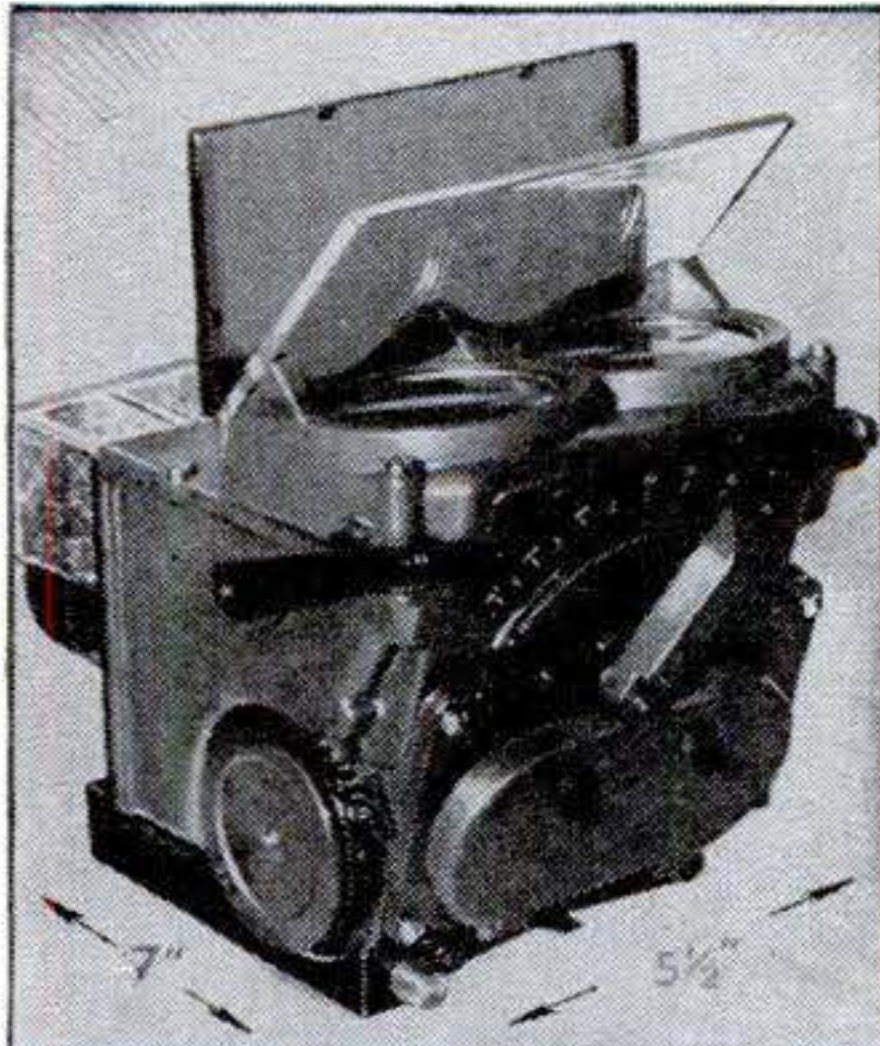

**T**HIS magnificent precision instrument is a triumph of applied Physics. Its breathtaking ingenuity fascinates every engineer who sees it. **IT WORKS!** Operate this inspired aircraft gunsight that measures and computes automatically—see how sheer designing genius made gear-trains and amplifiers unnecessary. **GYRO UNIT COMES OUT** easily with all wires intact. Remove it and see how tiny ball-bearing motor's clever governor maintains constant speed from 14-22 V. at only 1/10th amp. AC or DC (no 3-phase or 400 — stuff!) You'll marvel at the precision-balanced gyro, its beautiful yoke and special bearings. Demonstrate how **GYRO MAINTAINS FIXED POSITION IN SPACE**, and this one has a hand figured **spinning mirror** supporting a perfect optical image at full speed! Energizing 6 electromagnets with DC will show erection rate or compute lead and deflections.

Light up the twin projection systems and see both images fuse into one. One fixed, one moving and variable, demonstrate **virtual** images **TWO SUPERB ACHROMATS** in threaded brass cells, cemented doublets, 2" dia. 7 1/4 e.f.l. tested perfect for telescope objectives! (Unusual—see instructions.) 3 Precision first surface flats, aluminized, in 2 1/4" x 4 1/4". Reflecting glass, sun filter. Two 22v lamps in door, changeable if another voltage is desired, no rewiring. Two reticles, glass enclosed. Stainless gears. **PLASTIC GEL CELL DEHYDRATOR** with tell-tale colored silica gel. Die-cast aluminum case **HERMETICALLY SEALED**. 24" cable, 10 coded wires. Detailed instruction sheets. Detachable recoil shock base. 25-leaf spring, bronze slide on **PRECISION STAINLESS** ground rods, azimuth clamp, bolted to wood shipping base. Elegant padded cover for complete unit—brand new, original package. Cost Navy hundreds of dollars. **What a Buy at Only \$12.95.** Send check or money order, no C.O.D.'s. Ship. wt. 13 lbs. Express Collect.

**COLUMBO TRADING CO., Inc.**  
304 Canal Street, New York 13, N. Y.  
25 years on Canal St.—Five Floors of bargain values.

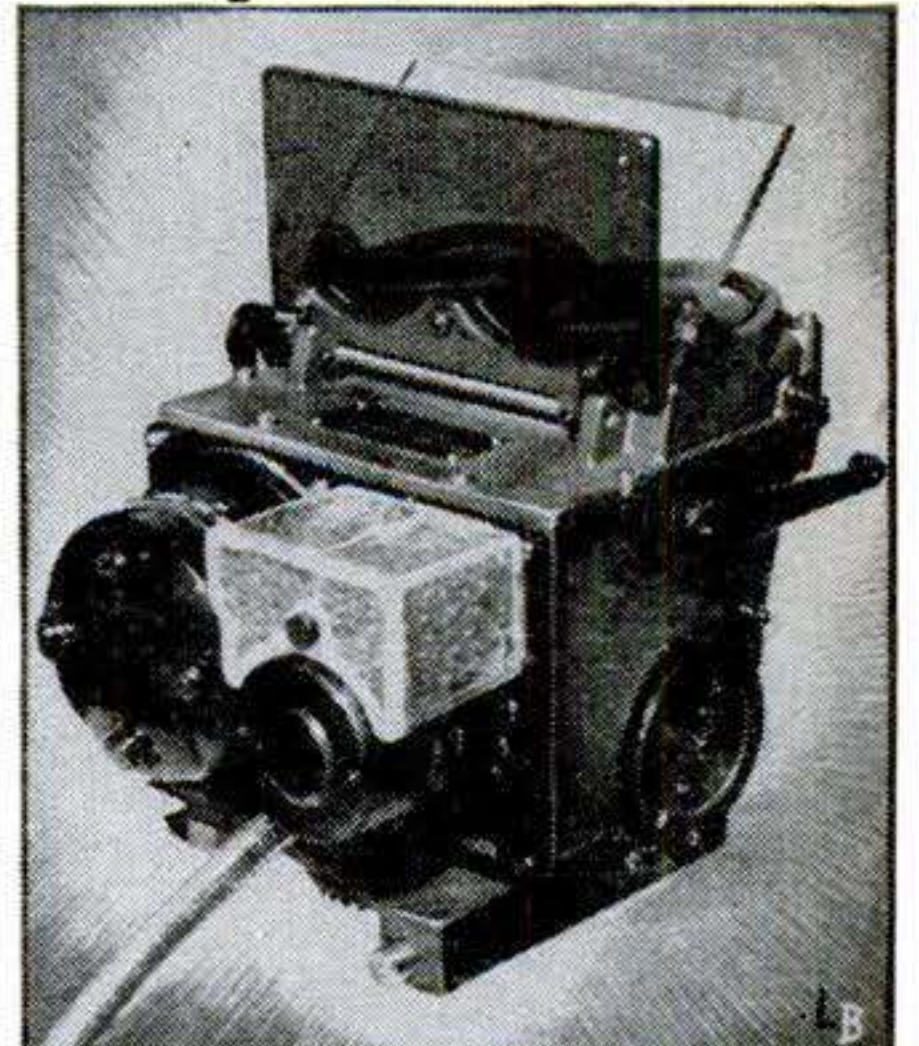

## NEW BIG POWER SAW

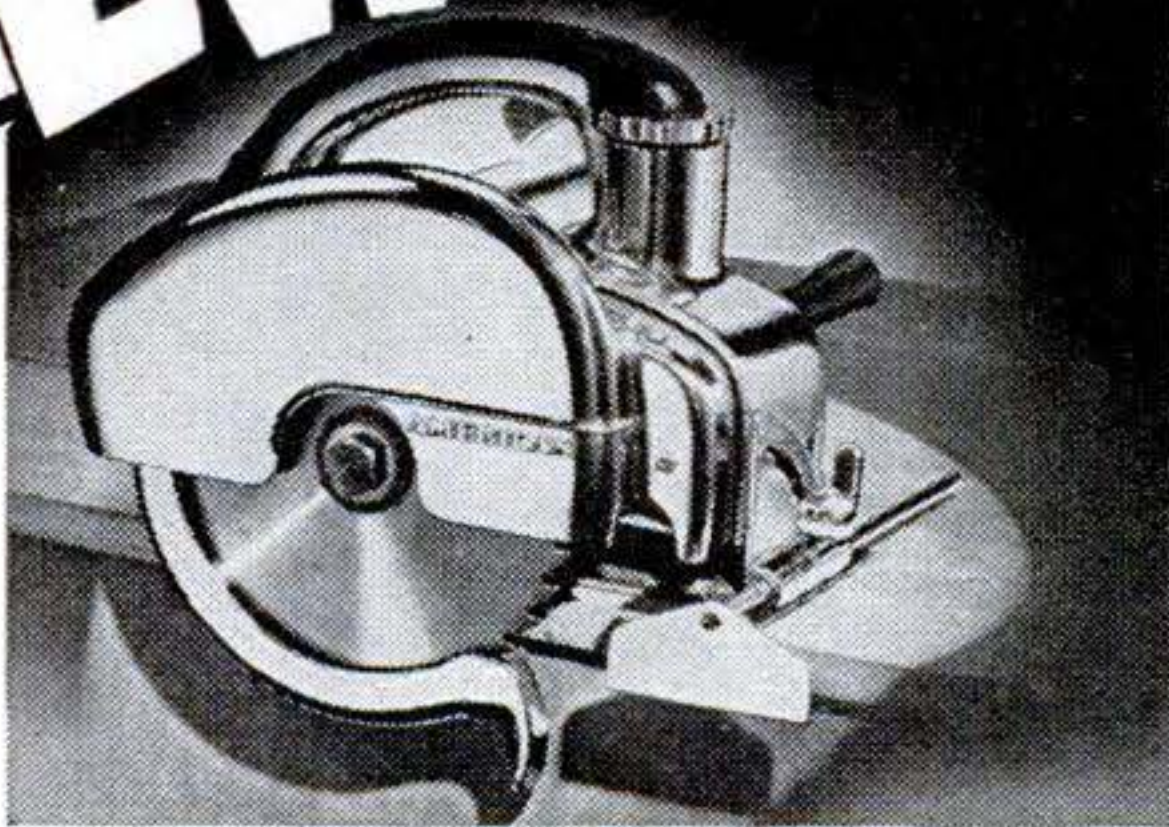

## AMERICAN



Here's the new American Portable Electric Saw—ideal to save time, labor and money in *production work*. Not a hobby tool. Speedy . . . powerful . . . easy for one hand operation. 8" blade. Adjustable. Precision-built, dependable. Write for free details, giving your occupation. The American Floor Surfacing Machine Co., 532 So. St. Clair St., Toledo 3, Ohio.

## Get into ELECTRICITY & INDUSTRIAL ELECTRONICS

Now!

START NOW—BE READY IN FEW WEEKS

**MODERN SHOP TRAINING**

**FOR BIGGER JOB OPPORTUNITIES LEARN ON ACTUAL EQUIPMENT IN NATIONALLY KNOWN SCHOOL**

Get ready for good job or business of your own. Electricity is the heart of modern industry. Electricians are always needed, earn higher pay, work year around. Make rapid progress in step-by-step practical shop training in Electrical Wiring and Circuits; Armature Winding; Electrical Appliance Repairs; Electro Plating and Welding. Rural Electrification, the Building Boom, many new uses of Electricity opening more opportunities in this vast field. Get training under thoroughly experienced instructors, be ready in few short weeks for Job Opportunities in Electricity.



VETERANS qualifying under "G.I. Bill" have tuition paid by Government plus monthly subsistence allowance while in school. Just mail coupon, we will handle all details. (LOW TUITION. EASY TERMS if you are not a veteran.)

**ELECTRICAL DIVISION**  
COMMERCIAL TRADES INSTITUTE, Dept. C-14  
6312 N. Broadway, Chicago 40, Ill.

FREE—Important Information Telling How to Get Started

→ Fill Out, Cut Out, Mail Today ←

**FACTS FREE for Men Who Want to Get Ahead**

**COMMERCIAL TRADES INSTITUTE, Dept. C-14**  
6312 N. Broadway, Chicago 40, Ill.

Send free illustrated Brochures and other information about your training in Electricity.

VETERAN  NON VETERAN

NAME.....

ADDRESS.....

CITY..... STATE.....

APRIL 1947 53



# Harley-Davidson U. S. Gov't Surplus Used Motorcycle Engines

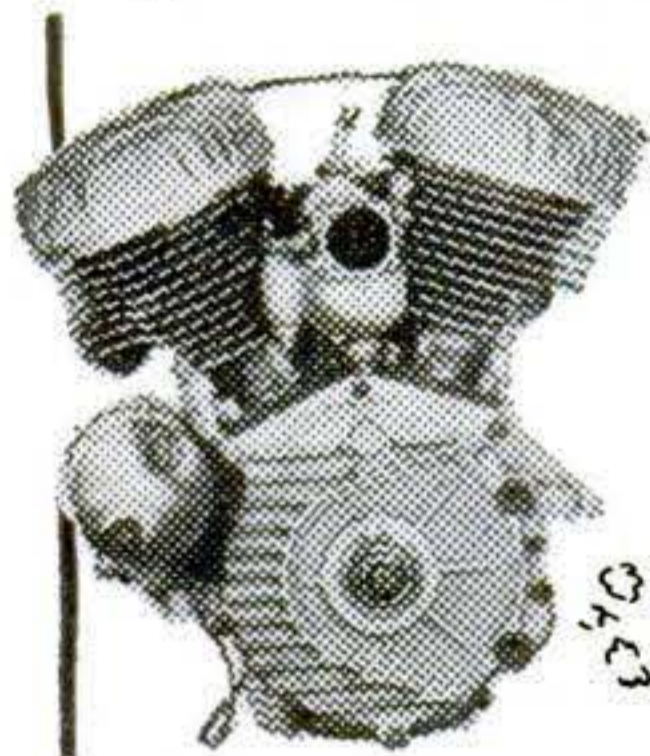

- For '37 to '46 H-D Motorcycles!
- For Economical Portable Power!

## 59<sup>95</sup>



Immediate Delivery  
Write for  
Credit Terms

Worth \$265 when new! Completely inspected and OK'd! The replacement parts alone are worth more than you'll pay for the complete engine! Use it as a motor replacement on your 1937 to 1946 Harley-Davidson motorcycle. Use it on the farm or in the factory as a source of economical portable power or as inboard motor on boats, 2-cylinder, V-type, L-head engine, N.A.C.C. Horsepower rating is 6.05. Mail the coupon TODAY!

# Goldblatt's

-----Clip This Coupon-----

Goldblatt Brothers, 333 S. State St., Chicago 4, Ill.  
State, Jackson, Van Buren Sts., Chicago 4, Ill.

Please Send Me.....Harley-Davidson Used Motorcycle Engines at \$59.95 each.

Name .....

Address .....

City..... State..... Zone.....

Charge  \$10 Deposit on C.O.D.  Money Order

Illinois Residents Add 2% Occupational Tax. Extra Freight Charge for Shipping Outside of Regular Delivery Zone.

# FREE

It's NEW, it's BIG, it's COMPLETE: it's Lafayette's latest, greatest catalog brimming with ALL that you want in Radio and Electronics. Radiomen and servicers, hams and dealers, hobbyists and experimenters. Send for it.

## BIG NEW LAFAYETTE CATALOG



It's crammed with standard as well as new items—they're all in stock—they're ready for super-speed delivery—they're priced for super-economy. If radio's your hobby, if radio's your business, if you're mild about it or wild about it—this is the book for YOU. It's yours, FREE.

# Lafayette Radio

RADIO WIRE TELEVISION INC.

NEW YORK 13  
100 6th Ave.,

BOSTON 10  
110 Federal St.,

NEWARK 2  
24 Central Ave.,

■ LAFAYETTE RADIO, Dept. KD-7  
■ 100 Sixth Avenue, New York 13, N. Y.  
■ RUSH new big radio catalog to:

■ Name.....

■ Address.....

■ City..... State.....

## PRACTICAL TECHNICAL TRAINING FOR YOU

Specialize in Electronics, Radio, Electricity, Refrigeration, Heating and Air Conditioning, or Welding

Prepare in six or twelve months for position as Technician, or in three years secure your B.S. Degree in ELECTRICAL ENGINEERING with a Machinery or Electronics Major.

Write for booklet, "Career Building."

MILWAUKEE  
**SCHOOL of ENGINEERING**  
Institute of Electrotechnics

Dept. PS-447

North Broadway and E. State, Milwaukee, Wis.

### NEW! 12" SHEET METAL BRAKE Only \$10

Fits in bench vise. Quickly, easily forms all kinds of angles in sheet metal, strap iron and aluminum, wire and plastic. Use it to make useful articles, experimental research work, patent models, etc..



simple gages made for quantity duplicating. Now available. Send for details, or order direct. \$10.00 PP. C.O.D. \$2.00 deposit. Wt. 10 lbs.

**WISE IRON BENDER.** Easily bends 1/2" square or round; 1/4" up to 2" wide. Makes hooks, rings, hoops, etc. All steel. Price, \$8.50 PP. Immediate delivery.

**WISE FORMING TOOL.** Makes cylinders, ovals, cones and round corners in sheet metal, wire and 1/8x1 steel strap, 2" to 60" in dia., 16" wide. \$8.50 PP.

**SHEET METAL PLIERS.** Forms angles, channels, and crimps in sheet metal. Jaws 2 1/2" wide. Price, \$2.00. All items guaranteed.

**WISE BRAKE MFG. CO., 1318 So. 30th Ave., Omaha 5, Nebr.**

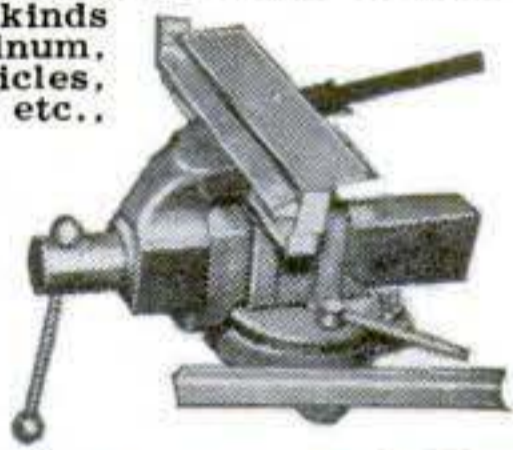

## BURN WATER IN YOUR CAR

### COSTS LESS THAN GAS

More Power, Cleaner Motor.

Mail card for data on \$17.50

Water-injecting Carburetor.

### OCTA-GANE

2425 E. 57TH ST. • LOS ANGELES 11, CAL.

# INVENTING

## —FOR PROFIT!

If you have an inventive turn of mind, write for free 28-page booklet explaining how the Institute of American Inventors is helping inventors pre-test the profit possibilities of proposed devices to fill today's unprecedented demand for new inventions.

INSTITUTE OF AMERICAN INVENTORS  
Dept. 3. 1926 Eye St. NW. Washington 6, D. C.

## INVENTIONS WANTED AT ONCE

Patented or unpatented inventions, all types needed by manufacturers. Write for free booklet "MARKETING YOUR INVENTION" and Protective Disclosure Form. We have a tremendous list of firms who may pay cash or royalties for good inventions. For full particulars, write today.

NATIONAL INVENTION SERVICE  
1404C Mitchell Street Oakland 1, Calif.

### SAVE up to 85% on War Surplus

Hardware — Tools — Machinery. World's largest supply of hydraulic cylinders, valves, fittings, complete systems. Aircraft parts & hardware. Free catalogs.  
Palley Supply Co. Dept. PS-47 6321 San Fernando Road, Burbank, Calif.



# PATENTS AND TRADE MARKS C. A. SNOW & CO.

REGISTERED PATENT ATTORNEYS

WRITE FOR INFORMATION TO

426 SNOW BUILDING,

WASHINGTON 1, D. C.





# AIRPLANE GENERATOR



Can be used on homebuilt Electric Welder, Wind Charger, Battery Charger, Light Plant, etc. Also can be used on boats, trucks, airplanes. Fits nearly any 24 volt airplane system.

Built by Leece-Neville, 24 volt, Model L-3.

### BRAND NEW!

Original cost \$212. **NOW, only \$24.95**

\$2.00 deposit required on CODs. Generators shipped Express charges collect.

**AERO INSTRUMENT COMPANY**  
Municipal Airport, Houston 12, Texas

# APPLIANCE REPAIRMEN

**MONEY SAVING PRICES — IMMEDIATE DELIVERY**

- RENUALL Iron element. Guar. 1 year. Package of 6.....\$3.12
- Toaster element forms. Clear Mica. Fits most toasters. 10 for. 1.80
- Heating element wire 10 ft. coiled 1/4" O.D. =20..... 2.55
- Heating element wire 10 ft. coiled 3/16" O.D. =22..... 1.77
- Christy Electric Heating Element Welding Flux for repairing flat irons, toasters, electric stoves, etc. Enough for 50 elements. 1.00
- Hot Plate bricks 5-3/4" diameter. 6 for..... 1.62
- Appliance cord. Rubber covered. 20 ft. \$1.00; 100 ft..... 4.50
- Electricians Drill Bits. 1/4", 3/8", 1/2", 3/4". Complete set... 6.75
- Ribbon element heating wire. Std. size. 100 ft..... .75
- Percolator elements. Universal. Flat type. 1 yr. guar. 2 for 1.20
- Element cement. Withstand 3000° F. 1 lb. pkg. \$1.00; 5 lb. pkg. 3.50
- Lead wire. Asbestos covered heater hook-up wire. 10 ft..... 1.00
- Iron Cord Sets with complete plug attachments. 10 for..... 5.00
- Carbon brush set. Astd. 104 brushes. 15 springs. Complete set 3.00
- Kerosene to Electric lamp conversion adapters. 5 for only... 1.00
- Nickel Electroplating kit. Complete outfit. Ready to use... 1.50
- Electric Scissor Sharpener. Will handle all sizes. Complete... 9.75

Here is your opportunity to save on repairing your own appliances and to earn extra money repairing appliances for friends and neighbors.

## CHRISTY SUPPLY COMPANY

2835 N. Central Ave. Dept. T-651 Chicago 34, Ill.

## HIGHWAY ENGINEERING

PRACTICAL TRAINING IN HIGHWAY DESIGN AND PRACTICE. HOME STUDY — BY MAIL ONLY — WRITE US NOW!

SCHOOL OF HIGHWAY PRACTICE  
DEPT. C, 2161 SHATTUCK AVE. BERKELEY 4, CALIF.

*Trial offer to*

## PHOTOGRAPHERS

4-35c issues of The Camera Magazine for \$1.00. Each containing over 100 illustrations; 1 how-to-do-it booklet; late color info.; many feature articles. Book-case size. Offer expires August 1. Send \$1.00 now to THE CAMERA, 518-4 Morris Bldg., Balto. 1, Md.

## INVENTORS

**Exhibit and possibly sell**

your invention at the 2nd and greater WORLD'S INVENTION EXPOSITION, Chicago Arena, May 2 to 11. Thousands of mfrs. will see your invention—small rates to display model or drawing. Make reservations now. Write for free folder.

## WORLD'S INVENTION EXPOSITION

Offices—39 South La Salle Street Chicago 3, Illinois

## MAKE YOUR OWN COSTUME JEWELRY

SPLENDID HOBBY OR VOCATION

Sea Shells • Pin Backs • Ear Screws • Screw Eyes  
Plastic Discs • Ear Clips • Floral Stones • Jump Rings  
Chains • Clasps • Wire • Boxes • Bracelets • Parts  
Bow Knots • Catches • Plexiglas • Cements • Dyes

WRITE FOR FREE CATALOGUE • DEPT. E

PHILADELPHIA BADGE CO., 1007 Filbert St., Phila. 7, Pa.

# "I'll show YOU how to make yourself COMMANDO-TOUGH

...in double-quick time

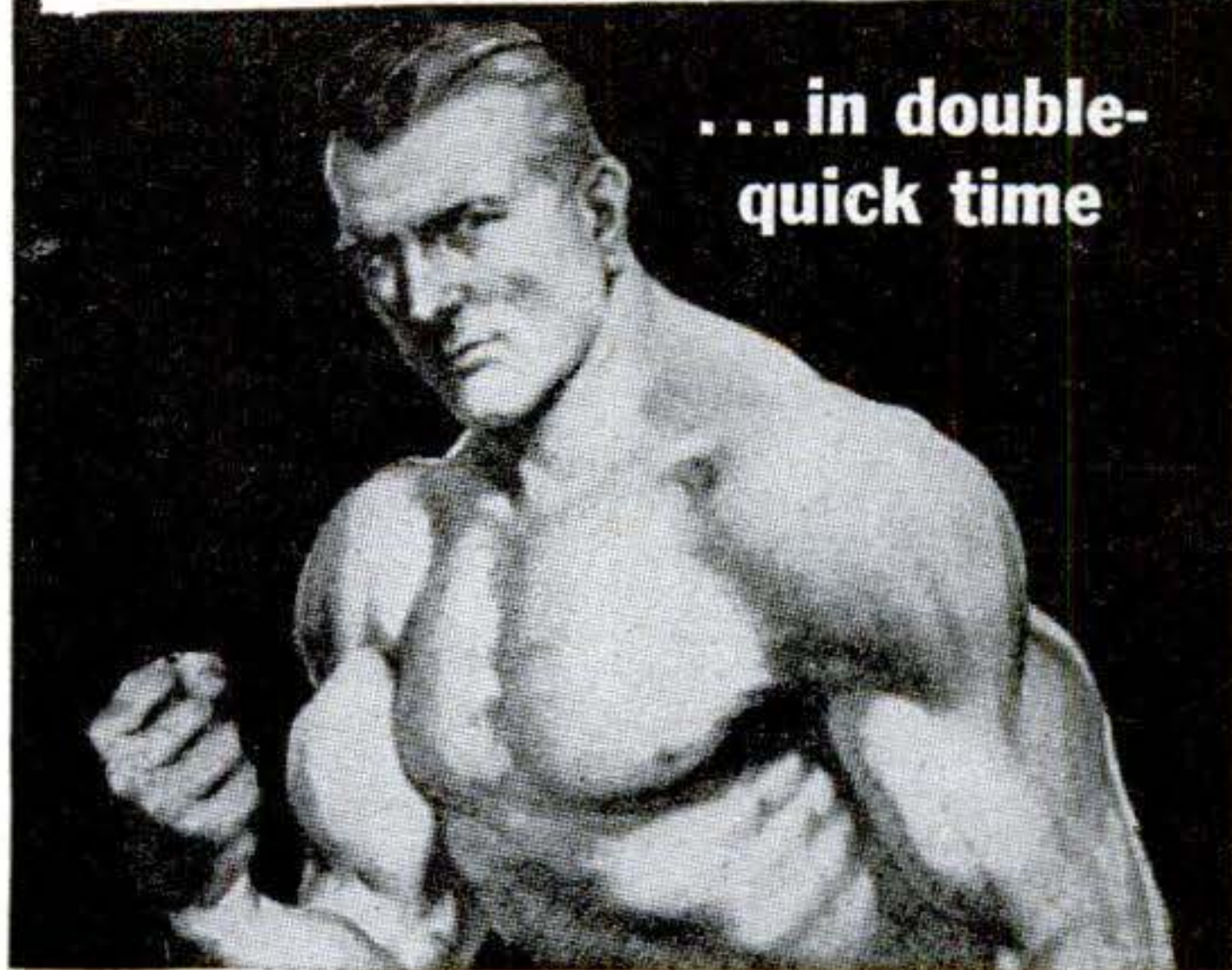

...OR IT WON'T COST YOU A CENT!"

says *George F. Jowett*

## WORLD'S GREATEST BODY BUILDER

Let me prove to YOU that you can put inches of dynamic muscles on your arms! Add inches to your chest! Broaden your shoulders and power-pack the rest of your body. I can do for you what I've done for thousands the world over, including many officers and men now in the U. S. and British Armed Forces!

## GIVE ME 10 MINUTES A DAY!

I'll Show You My Secrets Of Body Building

I'll help you learn the "Progressive Power Method" through which I rebuilt myself from a physical wreck to the holder of more strength records than any other living athlete or teacher! No matter how skinny or flabby you are, you can learn my methods right in your own home. Through my proved secrets I show you how to develop your power, inside and out, until YOU are fully satisfied that you are the man you want to be. "The Jowett System," says R. F. Kelly, Atlantic City, Physical Director, "is the greatest in the world!"

If you want a physique that will inspire respect from men, and admiration from women... ACT LIKE A HE-MAN! Decide at once! The famous book, "Nerves of Steel—Muscles Like Iron" will be included FREE! Priceless for the strength fan! Full of photos of marvelous power-bodied men who will show you what Jowett has done for them and how he can do the same for you. Reach out... Grasp this Special Offer today!

Jowett Institute, Dept. PS-74B  
230 Fifth Avenue  
New York 1, N. Y.

### PROVE TO YOURSELF IN ONE NIGHT!

Send only 25c for test Course, "Molding a Mighty Arm." Read it the evening it arrives—learn from experience the thrill you can give your muscles!

SEND FOR THESE FIVE FAMOUS COURSES IN BOOK FORM

ONLY 25c EACH or ALL 5 for \$1.00

QUICK ACTION BRINGS

THIS BOOK FREE!



BOOK WITH PHOTOS OF FAMOUS STRONG MEN MAIL COUPON NOW

FREE



Jowett Institute of Physical Culture DEPT. PS-74B  
230 Fifth Avenue, New York 1, N. Y.

George F. Jowett: Your proposition looks good to me. Send by return mail, prepaid, the courses checked below, for which I enclose ( ). Include FREE book of PHOTOS.

- All 5 courses for.... \$1
- Molding Mighty Legs 25c
- Molding a Mighty Arm 25c
- Molding a Mighty Grip 25c
- Molding a Mighty Back 25c
- Molding a Mighty Chest 25c
- Send all 5 C.O.D. (\$1 plus postage.) No orders less than \$1 sent C.O.D.

NAME..... Age.....  
(Please print plainly. Include Zone Number.)

ADDRESS.....

APRIL 1947 55



# LOANS *by* MAIL

\$50 to \$300 *IN A HURRY*

## CONFIDENTIAL

Salaried people, men or women, married or single, loans on your own signature, or your own security. NO personal interview. NO co-signers needed. NO wage assignments. You mail the application to us... we mail the money to you.

FOR A LOAN OF	YOU CAN REPAY MONTHLY			
↓	IN 15 PAYMENTS	IN 12 PAYMENTS	IN 9 PAYMENTS	IN 6 PAYMENTS
\$ 50	—	\$ 5.03	\$ 6.43	\$ 9.24
100	8.40	10.07	12.87	18.48
150	12.60	15.10	19.30	27.73
200	16.75	20.09	25.68	36.91
250	20.85	25.02	32.02	46.05
300	24.93	29.94	38.33	55.17

The above payments made at regular monthly intervals will repay the entire loan and all charges in the time indicated. Charges are based on the monthly rate of three per cent on unpaid principal balances to \$150.00 and two and one-half per cent on that portion of unpaid balances in excess of \$150.00 but not exceeding \$300.00. "Loans by Mail" may be repaid in larger amounts, more frequent payments or repaid in full at further savings to you.

## CONVENIENT

Just write us how much money you need and how you wish to repay... there's no charge or obligation. Whatever your needs for cash now or in the future, write for your "Loans by Mail" plan, today.

**MERCHANTS INVESTMENT CO.**  
819-H 1st Nat'l Bldg., Omaha, Nebr.

Without obligation, rush complete details and all papers necessary for a loan of \$ \_\_\_\_\_ to be repaid at \$ \_\_\_\_\_ on the \_\_\_\_\_ day of each month.

Name \_\_\_\_\_

Address \_\_\_\_\_

City \_\_\_\_\_ State \_\_\_\_\_

Occupation \_\_\_\_\_

# How to Start YOUR OWN BUSINESS

Amazing Postwar Development Now Gives You the Opportunity to Make Money Fast! Startling scientific discovery, just now becoming available for general use, will enable you to start your own business and reap great profits!

Plastics, one of the most revolutionizing and rapidly expanding industries, offers a great opportunity to all enterprising men and women. This is one of the few industries in which home manufacturers thrive and prosper. You can start even on a spare time basis in your own home, and expand rapidly into a full time business, paying good profits.

### LIQUID MARBLE

Make LIQUID MARBLE the amazing Plastic, with a thousand uses. LIQUID MARBLE can be poured into FLEXIBLE MOLDS for casting all kinds of artistic and serviceable articles such as: ornaments, novelties, desk sets, paper weights, book-ends, souvenirs, statuary, toys, etc.

### FLEXIBLE MOLDS

Make your own FLEXIBLE MOLDS. The cost is low—in fact, a large sized mold costs but a few cents. Hundreds of casts can be taken from a single mold.

### NO EXPERIENCE NEEDED!

No skill or previous knowledge is necessary. All you do is follow our easy-to-understand instructions.

### UNLIMITED MARKET

The market is literally unlimited. You will find steady year-round demand in your own community. Your problem will not be in selling but in supplying the huge pent-up demand. Moreover, we supply you with names of big buyers for your finished products.

### WRITE TODAY

Bing Products will show you how to start with a small investment and build a permanent, independent, profitable business! Don't fail to grasp this opportunity! Write today for FREE CATALOG.

## BING PRODUCTS

Dept. B-18, 88 Broad Street Boston 10, Mass.

## Ottawa Self-Propelled Buzz Master

**CLEAR LAND FAST!** Powerful 6-HP motor with friction clutch for safe operation. Cuts down timber, brush and hedge; turn blade vertically and saw logs to length. Can be equipped to fell largest trees. Has clutch pulley for belt work. Is fully guaranteed.

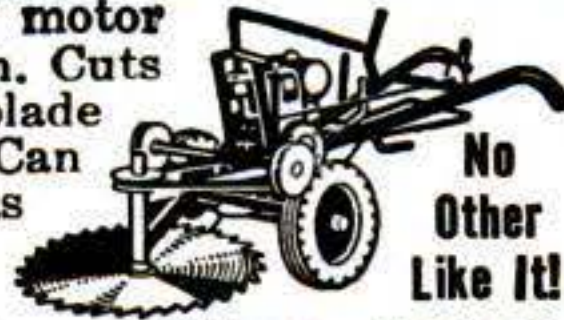

OTTAWA MFG. CO., 401 Brush St. Ottawa, Kansas

## TOOLS—PLASTICS—SUPPLIES—ETC.

New Decorative Plastic Panels for table tops, etc. Also aluminum trim, Plexiglas, Plastic Screws, Cement, Drills, Taps, Dies, Milling Cutters, Torches, Flux, Brazing Wire, Screws, Aluminum, Shafting, Bearings, Pulleys, Mandrels, Machine Handles, Flexible Shaft Tools, Electric Drills, etc. Many other items, 70% in stock. New Illustrated Catalog D-15c. Metiplas Supply Co., 1420 South 16th Avenue, Maywood, Illinois.



## CARTOONING

HAVE FUN! MAKE MONEY! Cash in on your sense of humor at HOME—BY MAIL. No experience needed to start. Write today FOR FREE TRIAL LESSON and full particulars. Moon Gag Cartoon School, Dept. C, Fall Creek, Wis.

## SANBORN DOG WHISTLE NO. 1-G



\$2<sup>00</sup>

Natural Alternating Two Tone Dog Call, Also Human Hailing Call

FACTORY TESTED AT 1 MILE—Pitched just below insect interference tones—a scientific precision-made instrument turned from a special aluminum alloy. Dogs respond without special training. All calls personalized by blower. See your dealer or order direct.

SANBORN PRODUCTS CO.

BOX 132

MENTOR, OHIO

## CARBIDE SCRIBER



HARDEST METAL KNOWN

Used from coast to coast by mechanics, photographers, physicians, tool and die makers. Tungsten carbide tip — carefully ground on diamond laps, brazed into stainless steel 6" handle. For marking steel and other metals — for etching, marking, cutting glass. Non-magnetic. Cuts all directions. Easy to follow any contour. In plastic case with pocket clip.

\$2<sup>00</sup>

Price Post Paid

LUCAS-MILHAUPT ENGINEERING CO.  
5051 SOUTH LAKE DRIVE • CUDAHY, WISCONSIN



## PRICK PUNCH

with Carbide Tip... \$1<sup>50</sup>

Price Post Paid

Newest, most improved prick punch made. Tungsten carbide tip, silver brazed into 3 1/2" heat treated steel body. Longer life — less regrinding — marks harder steels.

COMBINATION OFFER  
SCRIBER & PUNCH \$3<sup>25</sup>

Dealers, Distributors and Salesmen Wanted



# AIRCRAFT SUPERCHARGER LUBE PUMP

Designed for pumping liquids up to 3 G.P.M.

Vacuum: 29½ inches  
of mercury.  
3½" dia., 8½" long

Tandem unit, 5 G.P.M.  
Pressures up to 60  
lbs. per sq. in.



½" shaft.  
Two pump units  
in one housing.  
Precision made of aluminum, cast  
iron, bronze, and steel.  
With test sheet and instructions.  
Check, M.O. or C.O.D.

Original cost: \$24.00  
300 to 3900 R.P.M.

**\$3<sup>95</sup>** postpaid  
in U.S.A.

FISCHER LABS., 1729 N. Mobile, Chicago 39, Ill.

## Have Your Own **ELECTRO-PLATING** Business Profitable-Simple-Pleasant



The VARI-PLATER—110 V. A.C.—plus  
a glass or rubber tank and chemicals,  
which are always available, and accom-  
panying handbook, that is illustrated  
and easy to understand, will give you  
many money making opportunities.

You can **PLATE** Gold—Silver—Chro-  
mium—Nickel—Copper—Cadmium, etc. on  
metals and non-metals with the VARI-  
PLATER.

**FREE** Write today for descriptive literature and  
price list.

LEWIS ELECTRICAL MFG. CO. 1266-S Gun Hill Rd.  
New York 67, N. Y.

## NU-WAY LAWN MOWER

Write for  
FREE Circular

Price **12.50**  
Why Pay More

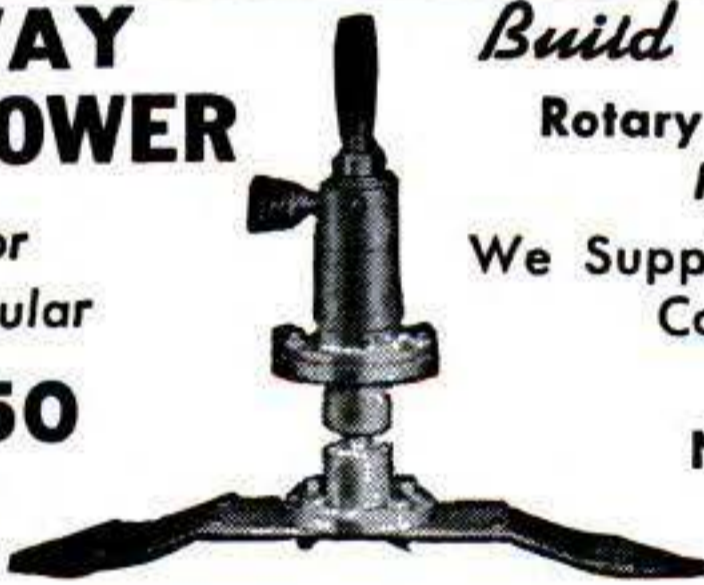

Build Your Own

Rotary Type Lawn  
Mower

We Supply Cutting Unit  
Complete.

**NO INCREASE  
IN PRICE**

TRACTOR-LITE MFG. CO., SPIRIT LAKE, IOWA

## NEW! MINIATURE DUST MASK

Wear DUPOR No. 1 when sanding, grinding, paint spray-  
ing, sweeping, dusting, furnace cleaning, etc. Handy as a  
pair of glasses. Just keep mouth closed and breathe through  
nose is all you do to operate. Protects against nuisance dusts,  
lint, coal, cement, grain dust. Weighs 1 oz. Has 9 sq. in. filter.  
For EYE protection against paint spray, dusts,  
gases, fumes, smoke, order our Fog-Proof Rubber  
GOGGLES.....\$2.00 p.p.

JERRY BRYANT, Dept. PS, 919 N. Michigan Ave., Chicago 11, Ill.



Order  
Today \$1.00  
POST  
PAID

## AT LAST! A HOBBY THAT OFFERS YOU PROFIT AS WELL AS PLEASURE!

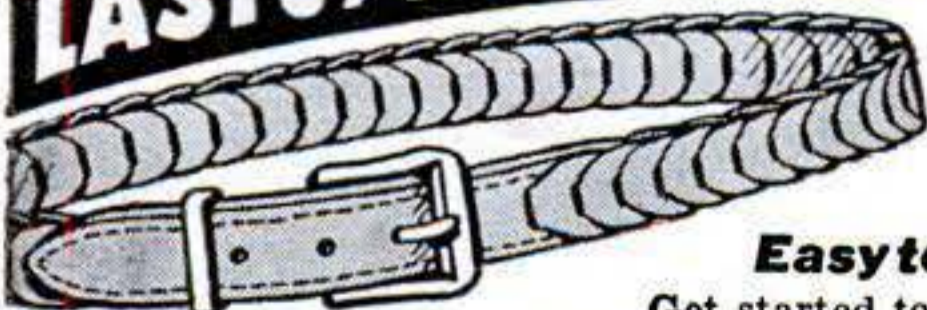

GENUINE LEATHER  
Hand Crafted  
LINK BELT

Easy to Make—Easy to Sell

Get started today on a fascinating hobby  
where you can earn up to \$10 or \$15 a week in  
spare time! Send for your complete profit-producing Handicraft Kit  
with all the material needed to make 6 genuine leather link belts. Sell  
all you make at \$2 each to people expecting to pay far more for genuine  
hand-made belts. Kit for 6 belts costs you only \$3.50—can easily be  
sold for \$12—leaving you a profit of \$8.50. Send \$3.50 for your Kit  
today, or mail only a dollar for sample Kit! Or C.O.D., you pay  
postage. Money back if not delighted.

**FREE**  
WITH YOUR  
ORDER

...IF YOU ACT NOW!

Beautiful Plastic Identification Card Case.  
Value 25c. Yours to keep, even if you return  
belt kit. Also, on request, big new 40-page  
CRAFT CATALOG FREE with or without order.

DWINNELL CRAFT SHOP, Dept. SC-74, Elm Grove, Wheeling, W. Va.

The Champs  
Come out Swingin'

LOUISVILLE  
SLUGGERS

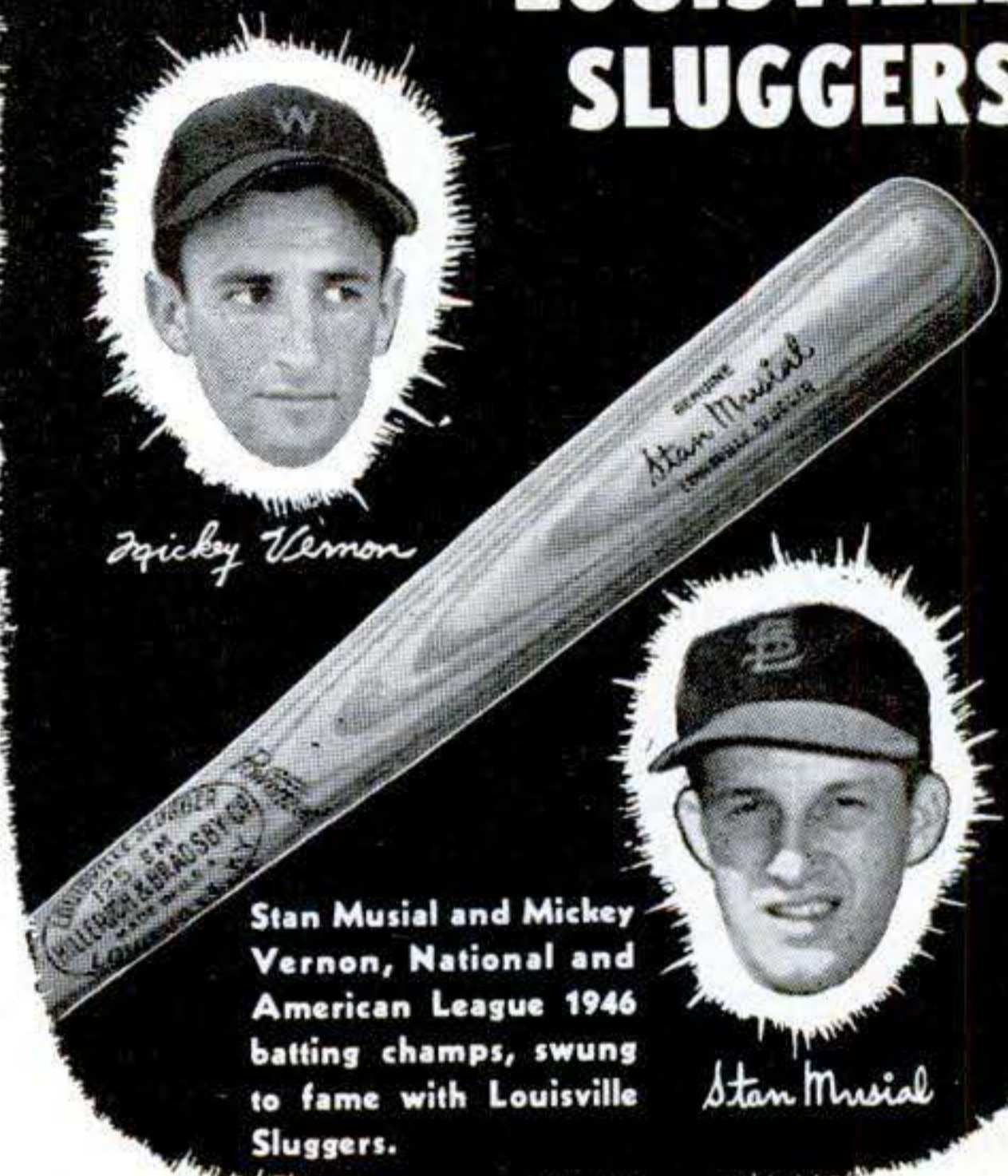

Mickey Vernon

Stan Musial and Mickey  
Vernon, National and  
American League 1946  
batting champs, swung  
to fame with Louisville  
Sluggers.

Stan Musial

When springtime beckons America  
back to her baseball diamonds, you'll  
find all great hitters armed with  
Louisville Slugger Bats. They know  
—from experience—a genuine Slug-  
ger is the thing to swing. It's safe  
to rely on a Louisville Slugger to get  
your base hits, too!



1947 Famous Slugger Year Book

FREE AT YOUR DEALERS

or Send 5 Cents to

Dept. Z-34

Hillerich & Bradsby Co.  
Louisville 2, Kentucky



HILLERICH & BRADSBY CO.  
LOUISVILLE 2, KENTUCKY

Pat. Pend.



Appliance Tester

## SAVES TIME, EFFORT, MONEY IN APPLIANCE REPAIRING!

In the new improved HANLAN APPLIANCE TESTER  
you have all the necessary tests for examining the  
true conditions of any electrical appliance in  
common use today and in one single unit. This  
portable model tests thermostats at the point of  
cut-out and cut-on. Also controls heat on solder-  
ing irons. Tests continuity open circuits and  
grounds. As essential to electrical repairman,  
appliance dealers, shops, and trouble shooters.  
Order today! Only \$10.95 complete postpaid. \$1  
deposit on C.O.D. orders. MONEY BACK GUAR-  
ANTEE.

**FREE** with each Tester. New, Complete Practical Course in  
electrical appliance repairing. WRITE FOR CIRCULAR.  
HANLAN CO., 1419-B, Jefferson Blvd., Los Angeles 7, Calif.



# Portable Paint Sprayers

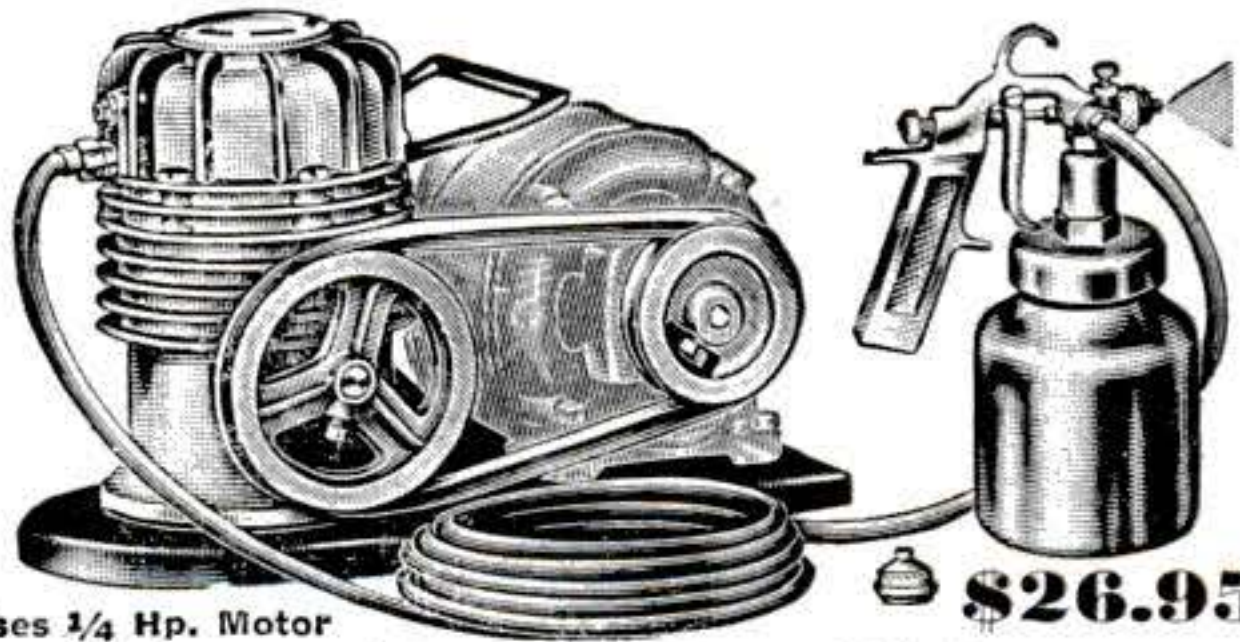

Uses 1/4 Hp. Motor

Complete as illustrated, less motor. Sprays all kind of paint, lacquer, varnish, and etc. Oil-less ball bearing compressor. 2 cu. ft. air per minute. 15 to 50# pressure. Sprays paint 5 times faster than hand brushing.

**No. 890**—Outfit complete as shown, with "V" belt, motor pulley, 15 ft. high test air hose and No. 112 gun, but without motor..... **\$26.95**

**No. 444**—Outfit, twin cyl. 4 cu. ft. production type gun, 15 ft. air hose, reg. and gauge, V belt and motor pulley. Complete less motor..... **\$47.50**

## SPRAY GUNS—LOW PRESSURE

Operate on 15 to 50# pressure

#115—1 pt. cup ..... **\$4.95** #121—Production type **\$7.95**  
 #112—1 qt. cup ..... **\$6.50** #125—External mix. **\$9.50**

Regulator & Gauge Air Hose—25 ft. .... **\$2.75**  
 0 to 160# ..... **\$4.95** 3 Gal. Paint tanks, with hose, reg. and gauge... **\$24.95**  
 Air Filters ..... **\$1.85** Less reg. and gauge... **\$16.50**  
 Air Hose—15 ft. .... **\$1.75**

## BLACK & DECKER ELECTRIC DRILLS

1/4" ..... **\$16.95** 1/2" ..... **\$31.95**

## SUPER-AIR AUTO ENGINE PUMP

Pumps 100# pressure for inflating tires, spray painting, and etc. Complete with hose, pump, gauge, and spark plug adaptors **\$4.75**  
 Less gauge ..... **\$3.75**

\*Air Compressors—Paint Spraying Supplies. Gas engines—1/2 to 1 1/2 hp. \$37.95 up. Hobbycraft supplies, engines and kits 15% discount.

Immediate delivery—check or M. O. shipped prepaid. COD's plus charges.

## INDIANA APPLIANCE CO.

20 East Sycamore Dept. PS-20 Evansville 9, Ind.

## SHARP EDGE in Seconds!



Powerful portable electric grinder gives quick keen beveled edge on any size knife or scissors. Ideal for chisels, plane blades, drill bits, cutters, etc. Anyone can use. Grinds cool. Marvelous time-saver for fix-it shops, model makers, butchers, cafes, barbers, etc. 6000 RPM Delco 115 V AC-DC motor. Plugs in any socket. Norton long-lasting grinding wheel. Users delighted. Guaranteed. Only \$14.95 postpaid. Send check or M. O. Immediate delivery.

Morgan Grinder Mfg. Co., 812 So. 31 St., Omaha 5, Nebr.

## PRESTO! ANYONE CAN MASTER GLAZE

LEAVES HARD GLASS-LIKE FINISH  
 EASY TO APPLY  
 PROTECTS THE SURFACE  
 NO SMEAR OR STREAKS AS WITH WAX  
 LASTS SIX MONTHS TO A YEAR



SEALS THE PORES OF THE SURFACE  
 WILL NOT FINGER-MARK  
 NO OILY FILM AS WITH POLISH  
 SAVES YOU MONEY

Car Owners! Meet Master Glaze—the sensationally different luster for new and used cars! Not a wax—not an oil polish—not a paint!—nothing that "smears" over the surface.

**MASTER GLAZE** is a unique discovery—a creamy liquid—quick and easy to apply! Gives a hard, glass-like surface. Even gasoline cannot dull it! Lasts six months to a year! Amazing luster—beautiful, sparkling clean and brilliant! Doesn't finger-mark—doesn't smear! A match box full glazes an entire car. Seals the pores—protects! **NOTHING LIKE IT!**

**AGENTS**  
 An unusual opportunity! Quick, flashy demonstrator. Big profits. Good territory. Write today!

## FREE SAMPLE

Just send your name and address to  
**MASTER GLAZE CO., 7720-586 W. Harwood Ave., Milwaukee, Wis.**



only \$8.50

## IMPORTED SWISS WATCHES

... for men and women. Sweep second hand and unbreakable crystal. Send no money, wear at our risk. Satisfaction guaranteed or money back in 5 days. Send name and address. Pay postman C. O. D. \$8.50 plus postage and 10% Fed. Tax.

**TECHNOS WATCH CO. DEPT. E**  
**556 BROAD ST., NEWARK 2, NEW JERSEY**

## Easy Self-Instruction In All 25 Branches Of MATHEMATICS

Brought To You By Experts From Leading Colleges in the 4 volumes of the PRACTICAL MATHEMATICS LIBRARY. Helps you qualify for the better jobs in industry. 1300 pages, 600 illustrations. Sent for free examination. Only \$2.00 down, \$2.00 a month; total \$9.80 plus postage. (Cash price \$9.50, postage free. Money-back guarantee.) 160-page 6-Place Logarithm book free with order. National Educational Alliance, Inc., Dept. 804, 37 West 47th St., New York 19, N. Y.

## COLOR YOUR FAVORITE PHOTOS

For pleasure or profit. No artistic ability needed with Marshall's colors. Amateurs turn out professional looking work! Complete sets including easy-to-understand instructions available at your dealer's from \$1.25 up. Or if unobtainable write John G. Marshall, 167 N. 9th St., Brooklyn 11, N. Y. Dept. PS.



*Marshall's Photo Oil Colors*

## AIR LIQUID STORAGE TANKS

Airplane oxygen Tanks (used) good condition. Up to 400 lbs. pressure; non-rusting stainless steel, weighs 18 lbs. 9 gallon capacity, 24" long by 12" diameter, \$4.98. Same specifications 24" long by 6" diameter, weighs 5 lbs., 2 1/4 gallon capacity, \$2.98. Ends tapped 3/8" standard pipe thread. Ideal for compressed air tanks, any bottled gas, any liquids. Perfect for house trailers, compressors and other uses. Limited quantity. Prices FOB Kansas City, No COD orders.

**MIDWEST BUY ANYTHING CO.** 1520 Locust, Kansas City, Mo.



Yes, we're **CALLING ALL BOYS**, and we're calling YOU, too. Tune in on an interesting hobby that pays big returns in fun and interest. Even helps to prepare you for a career in radio. Learn how to make your own simple, tubeless, batteryless crystal radio. Just send 25c. We will send you postpaid by return mail a genuine Melomite crystal with complete illustrated instructions for making your very own set. Then you will enjoy competing with others for long-distant reception. With crystal and instructions we send The Magic Crystal, our own publication chock-full of news, diagrams, questions and answers of interest. Don't delay! Send 25c today!

**ALLEN RADIO, Dept. PSM-4, Clinton, Missouri**



# Special- CAP PISTOL OFFER

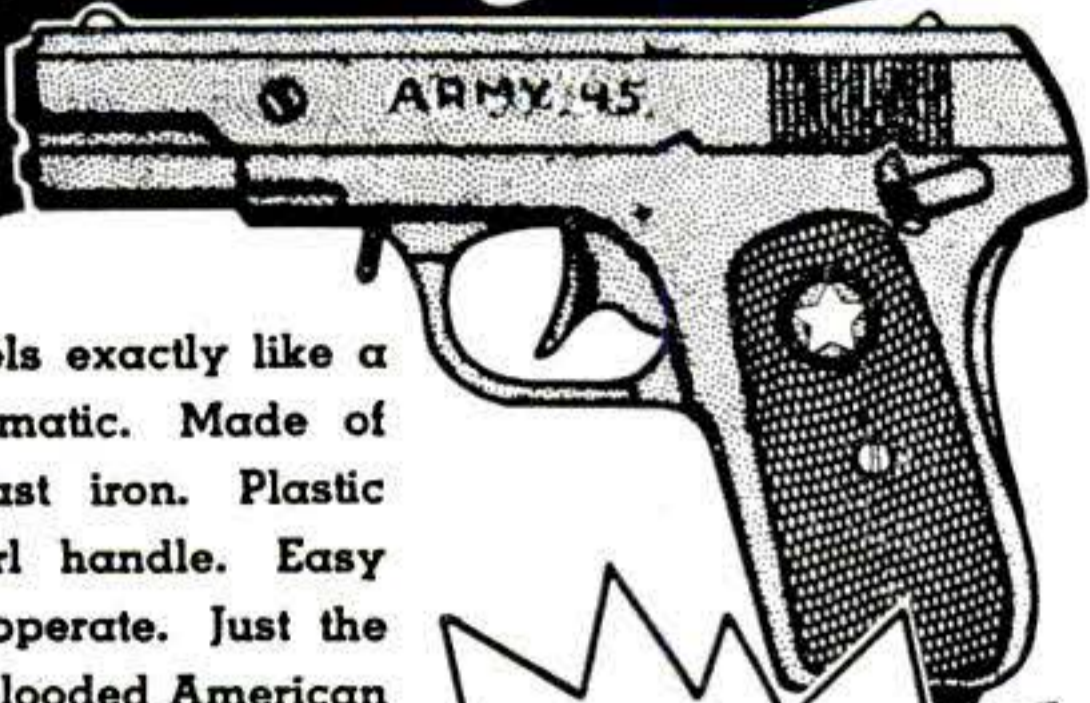

Looks and feels exactly like a real '45 Automatic. Made of heavy die cast iron. Plastic imitation pearl handle. Easy to load and operate. Just the thing for red blooded American Boys.

	RETAIL VALUE
1 Army '45 Pistol .....	\$1.95
20 Boxes Repeating Caps (5,000 shots) .....	2.00
	3.95

Special Offer  
Our Price Only

**\$1.95**

F. O. B. POLK, O.



Also, be sure to send for our new bargain pistol and cap circular. See the new Texas, Silver Pony, Spitfires, Captains, Long Tom's and lots of others. Also Holsters.

**SPENCER FIREWORKS CO.**

151 MAIN STREET, POLK, OHIO

**BUY SHOES DIRECT!**

**SAVE the RETAILERS PROFIT!**

2 MILLION PAIRS SOLD

Famous Sutton Bonded Double Duty Men's Shoes are known to thousands for Amazing Comfort—Longer Wear—Lower Cost! Equally outstanding values in Famous Sutton Shoes for women, boys, girls, tiny tots.

**FREE MONEY SAVING CATALOG**

—showing how Sutton brings you finer shoes for less by saving you the retailer's profit! Valuable Gift Free with each order. Make shoe Dollars Do Extra Duty this modern way, proven best since 1898. For Special Value Catalog and Gift offer, send name and address on post-card to

**SUTTON SHOE CO., DEPT. 1**

32 Sutton St.,

Baltimore, Md.



**SELL ULTRA-BLUE STOCK SIGNS**

To General Stores over 1000 Different Slogans and Sayings. Fine Line of Religious Ultra-Blue Signs for Homes and General Display. Make Money on these Fast Selling Signs, 35c Sellers. 15—Sample Ultra-Blue Store Stock Signs—7x11, \$1.00 ppd. 15—Sample Ultra-Blue Religious Signs—7x11, \$1.00 ppd. 100—Ultra-Blue Stock Signs—7x11, \$6.00. No C.O.D.'s.

L. LOWY, 8 WEST BROADWAY, NEW YORK 7, N. Y.—Department 310

# MIDWEST RADIOS

at Greater-Than-Ever VALUES

**BIG, POWERFUL  
WORLD-  
RANGING  
CHASSIS**

with FM  
(Frequency Modulation)

**5 WAVE BANDS**



SERIES 16

SEPARATE CHASSIS or  
COMPLETE CONSOLES AVAILABLE

**30  
DAYS  
TRIAL**

EASY TERMS



The **SYMPHONY GRAND  
AM-FM RADIO-PHONOGRAPH**

A magnificent radio console and musical instrument that is completely new—from the ground up. Big, powerful Series 16 Chassis brings in long wave, short wave and advanced FM reception. Automatic record-changing phonograph and scores of NEW post-war features including

**TRI-MAGNADYNE  
COIL SYSTEM**

... a sensational, exclusive MIDWEST feature fully described in our new 1947 catalog. Also, other console and table models with Series 16, 12, and 8 Chassis, and portable AC/DC Battery Table Radios.

SEND FOR  
**FREE  
CATALOG**

**BUY DIRECT FROM FACTORY and SAVE!**

FILL IN COUPON AND MAIL TODAY OR JUST  
SEND YOUR NAME AND ADDRESS ON 1c POSTCARD

MIDWEST RADIO CORPORATION

Dept. 24-H, 909 Broadway, Cincinnati 2, Ohio

Please send me your new FREE Catalog.

NAME .....

STREET .....

CITY.....ZONE.....STATE.....

**ARMY-NAVY SURPLUS BY MAIL  
CATALOG FREE**

Now you can buy Genuine Brand New Surplus Clothing by mail at enormous savings. Trousers, jackets, shirts, rain coats, blankets, arctics, shoes, socks, gloves, underwear etc. Mail post card today for your FREE CATALOG sent promptly.

J. R. ADDISON UNIFORM CO. PS-4 CAMBRIDGE, OHIO

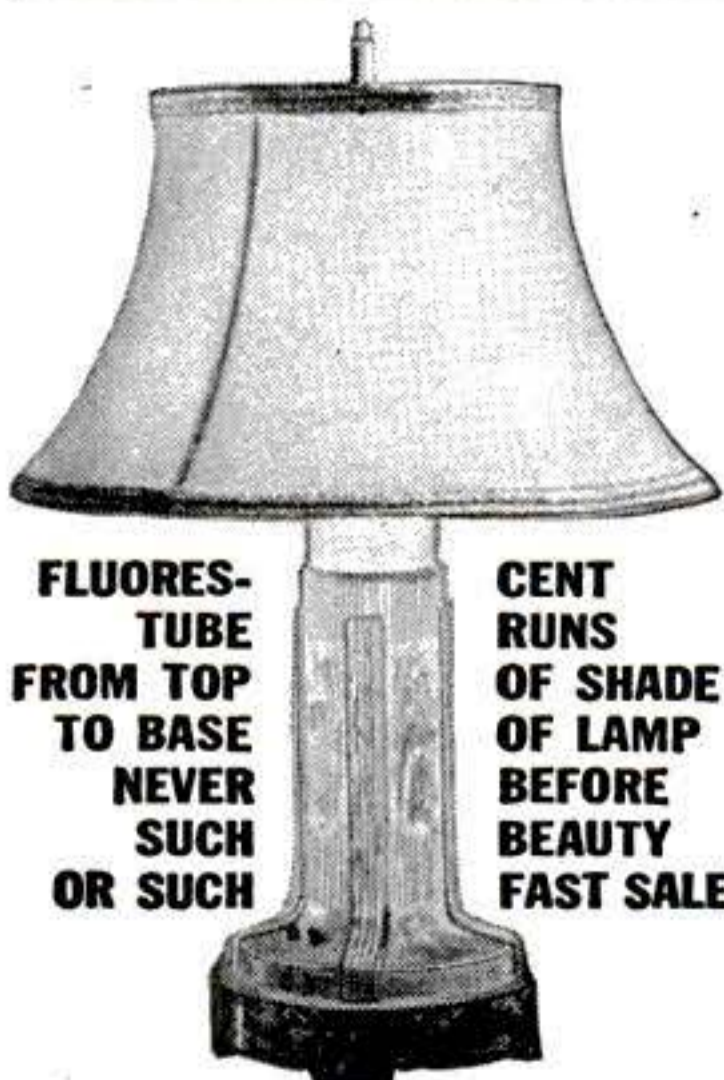

FLUORESCENT  
TUBE  
FROM TOP  
TO BASE  
NEVER  
SUCH  
OR SUCH

CENT  
RUNS  
OF SHADE  
OF LAMP  
BEFORE  
BEAUTY  
FAST SALES

**Agents**

For the First Time—  
**FLUORESCENT  
All-Lite TABLE LAMP!**

**F**IRST to utilize the exclusive feature of UPRIGHT fluorescent illumination, the ALL-LITE gives off a soft, even distribution of light without glare—from shade top to bottom of base.

Selling like mad. Men order sample, show it and reorder in gross lots. Instant appeal. Plug it in and watch them buy. Comes complete with tube and plastic shade.

**FREE** Send name for  
**SAMPLE OFFER**

**D**ON'T send a penny. Sample offer is free. Rush name for selling outfit and make money from the day it arrives. We will show you how to sell to hundreds of homes, restaurants and public places and to stores by the dozens for resale. Also immediate delivery on standard fluorescent fixtures. Get going with the MAXILUME line. It's a winner for others—it can bring big, fast profits to you. Rush name on penny postcard.

**MAXILUME COMPANY** 107 S. CLINTON, Dept. 94  
CHICAGO 6, ILLINOIS

APRIL  
1947 59



**SATCHEL POUCH**

Heavy canvas pouch. Ideal for toting lunches, shopping, books, etc. Has three 11x12 inch pockets.



Brand new, guaranteed perfect. A 113— Each..... **\$1.69**

**ARMY BANDOLEERS**

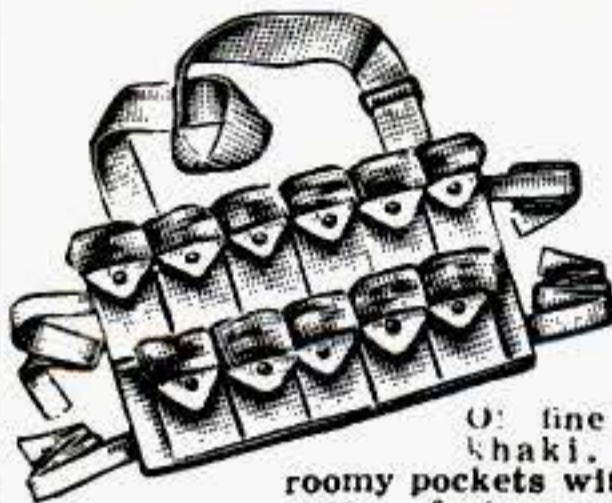

Of fine heavy khaki. Big roomy pockets with snap button fasteners. Fine for hunters, campers, boy scouts, etc. also for shop work in carrying small parts, etc. Material alone is worth this price. 11 Pocket Type No. 129. Each **49c** 5 Pocket Type No. 128. Each **29c**

**BOMB PARACHUTES**

Of fine white rayon fabrics 5 x 8 feet in diameter with split seam for directional dropping. Designed for dropping fragmentation bombs, emergency rations, etc. Each packed in a metal container. Weight 6 lbs.



No. R-162 Each **\$1.95**

**McCLELLAN SADDLE**

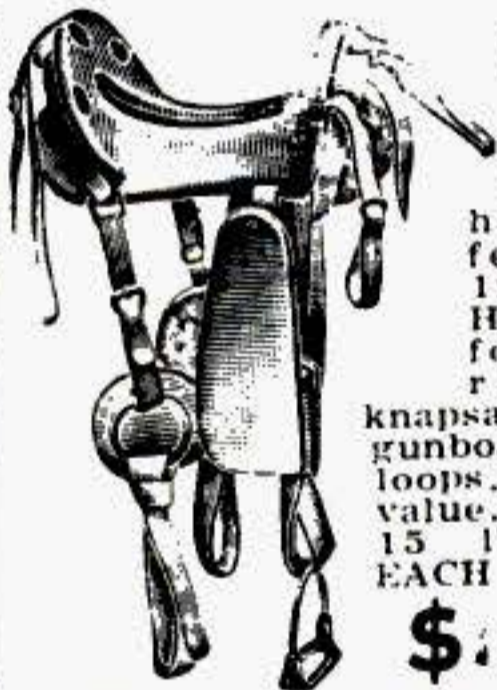

Brand new! McClellan model saddles. Top grade cowhide with hair girth, fender and 12 inch seat. Has straps for blanket roll and knapsack. Buckles, gunboat and sabre loops. A splendid value. Shp. wgt. 15 lbs. **A145. EACH \$6.95**

**CAVALRY SPURS**



Genuine wishbone type cavalry spurs. Nickered brass. **A102, Pair... 98c** **A103** Spur straps per set of four..... **50c**

**2-Pc. Rain Suits**

New 2 piece rain suits. Of durable wear resisting water and wind repellent OD fabric. Bib style pants, zipper fly. Jacket has parka attached. Guaranteed 100% weatherproof. Small, medium and large sizes. Shp. wgt. 3 lbs. No. R549 Each..... **\$4.95**



**CAMERA TRIPOD**

Purchased from Gov't. Used but perfect. For cameras up to 8x10 inches. Folds to 32 inches, extends to 58 inches. Needs adapter to mount camera. Wgt. 5 lbs. Stock No. 190. Each..... **\$4.95**



# WAR SURPLUS AND HUNDREDS OF OTHER BARGAINS



**TELESCOPING BAIT and FLY ROD**

Combination 4 piece telescoping bait and fly casting rod. Screw locking reel seat. Cork grip. Snake guides. Extends to 9 feet, telescopes to 38 inches. Shp. wgt. 1 lb. No. F411. Each..... **\$3.65**



**LEVEL WIND ANTI BACK LASH REEL**

Highest quality with chrome plated frame: 3 piece take down design, 4x gears, bronzed bearings and jeweled spool caps. Spool diameter 1 1/2 ins; pillar lengths 1 1/2 ins. Capacity 100 yard line. Onyx head ring. Shp. wgt. 1 lb. No. 450 F. Each only..... **\$8.55**

**POPULAR RECORD ASSORTMENT**



Fifty records of modern dance, race, blues and hillbilly selections. No two alike. Famous name bands and artists included. Used in juke boxes, but guar. perfect. Shipped exp. collect only—no exchanges or refunds. Wgt. 28 lbs. No. A303— 50 records..... **\$9.64**

**PLASTIC 8-OZ. FLASK**



For hunters, fishermen, scouts. Waterproof and transparent. Use it for liquids, matches, flies, bait, etc. Has screw cap top for liquids, plus full open top. 5 1/2 x 4 1/8 x 1 1/8 ins. Hundreds of uses. Wgt. 1 lb. No. A347. **29c** Each.....

**OXYGEN TANKS**



A shatterproof, welded seam oxygen tank. Fits gauge listed above. Measures 5 1/2 x 8 in. Internal volume 104 cu. in. Square inch pressure 1.4 cu. ft. Has 3/4 inch pipe thread vent. Shp. wgt. 2 lbs. No. 537. **49c** Each.....

**DECORATIVE CHROME STRIPS**



For your car, boat, furniture, etc. Highly polished chrome finished strips with clinched edges for flush mounting to any surface. The 3 pound kit provides approx. 43 pieces in lengths from 4 inches to 3 feet and 1/4 to 3/4 inches wide. Wgt. 4 lbs. No. R-224—3 lb. Assort. only..... **\$2.00**

**7 LB. EXPERIMENTER PARTS ASSORT. KIT**



A "gold mine" for the radio serviceman. Hundreds of valuable radio parts, new radar and electronic parts and sub-assemblies, coils, resistors, trimming condensers—worth many times this low price. **A130R** —7 lbs. .... **\$1.79**

**G.I. PISTOL BELTS**

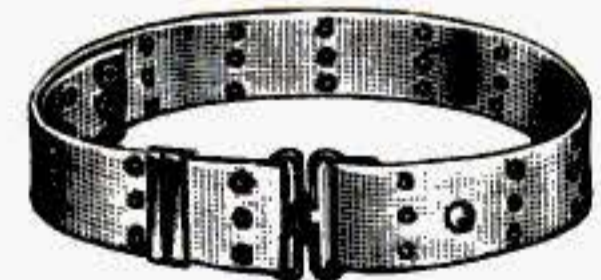

Of heavy canvas webbing. Adjustable. Eyeleted all around. Used but perfect. Wgt. 2 lbs. No. 131. Each..... **98c**

**HAND MICROPHONE**



Top quality hand microphone with control button in handle. Highly sensitive. Has rubber covered cord and tel. plug. Fine for use on home recorders, public address systems, etc. Brand new—perfect. Shp. wgt. 2 lbs. Stock No. 170. Each..... **\$1.95**

**BAYONET BLADE**

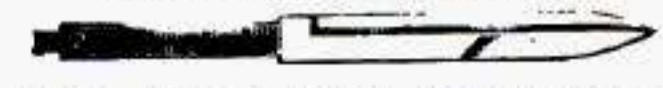

Fine forged steel. Ground but not polished. May be made into throwing or hunting knife or spear. Blade 6 3/4 x 7/8 inches, 11 3/4 inches overall. Will take and hold a fine edge. Shp. wgt. 1 lb. No. 664-R. Each... **49c**

**MESS KITS**



Regulation two piece Army Mess Kits with folding handle. Used, but perfect. Weight 2 lbs. No. A116. Each **69c**

**CANTEENS**

Reg. U.S. issue canteens. Plastic screw top chained to body. Slightly used but perfect. Wgt. 1 lb. No. 117—Metal. No. 118—Plastic. Each..... **69c**



**CANTEEN CUPS**

All metal. Folding handles. Wgt. 1 lb. No. A120. Each..... **25c**

**CANTEEN COVERS**

Heavy canvas. Button fastener. New No. 530. Each..... **69c** Used No. 119. Each..... **35c**

**JUNGLE HAMMOCK**



For back yard, country home and camp use. Has waterproof roof with mosquito-proof nylon netting side.

Lets you sleep outdoors safely. Finest construction. Originally designed for U. S. Army use. Shp. wgt. 7 lbs. No. 134. **\$9.95** Each.....

**2 MAN MOUNTAIN TENT**

Regulation Army type two man mountain tent, complete with poles, guy ropes, etc. Of durable nylon with reinforced seams. Ideal for outdoorsmen, campers, etc. Shp. wgt. 10 lbs. A splendid value. Stock No. 202. Each..... **\$9.95**

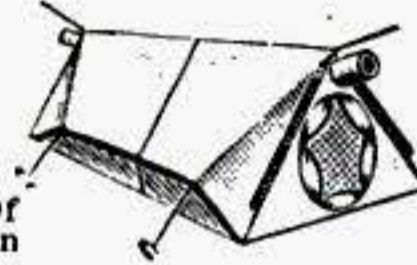

**PUP TENTS**

Regulation Army Pup Tents of durable, brown canvas. Used, but in good condition. Fine for campers, outdoorsmen, boy scouts, etc. Grand Xmas gift for children. Wgt. 5 lbs. **A-100 Tent only..... \$3.95** **A-110 Tent, New..... \$7.95** **A-101 Ropes, wooden poles and stakes for above. Per set..... \$1.00**

**LIFE PRESERVER BELTS**

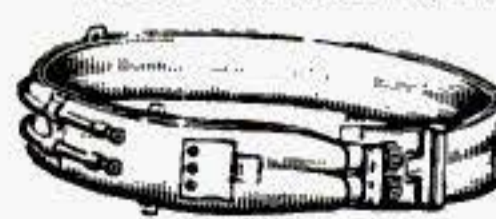

Right from the invasion beaches. Consists of two air chambers. May be inflated automatically with "sparklet" cartridges or manually by attached hose. Adjustable in waist size. One air chamber guaranteed air tight—other may need a tire patch. All belts are used and slightly soiled—but a bargain at this low price. No. 1261. Each..... **\$1.00** No. 254. SPARKLET CARTRIDGES, Box of 10 only... **50c**

**ORDER DIRECT FROM THIS AD**

Values galore! Hundreds of hard-to-find items for home, shop and outdoors. Make remittances by money-order, bank draft or personal check. Send 25% deposit on C.O.D. orders. No C.O.D.'s on orders for less than \$5.00. Include sufficient postage on parcel-post orders—any overage will be promptly refunded. All quotations F.O.B. Chicago. Used items and materials are guaranteed serviceable and as described. Your money back if not more than satisfied.

**BIG ILLUSTRATED CATALOG FREE**

# STARK'S

Dept. PS447  
509 So. State St.  
CHICAGO 5, ILL.



Classified Ads only 60c per word per insertion, payable in advance. Minimum ad 10 words. To be included in May issue, copy should be in our office by March 26. May issue on sale May 1st.

POPULAR SCIENCE MONTHLY—351 FOURTH AVE.—NEW YORK CITY 10

## 12 AUTOMOBILES

**SPEED & Mileage manual.** Easily obtain greater speed, mileage, racing performance from any automobile! Includes simplified methods, speed tuning, gas saving secrets. Instructions on building economizers, speed equipment, superchargers, mufflers, racing fuels, duals, fast conversions, \$1.98. Almqvist Engineering, 447 R, 64 Street, Brooklyn 20.

**CLYMER'S Motor Scrapbooks** (old automobiles) Editions 1, 2, 3, each different, \$1.50 each. Motor History of America, \$3.00. Fastest on Earth racing book, \$2.00. Motor Racing With Mercedes-Benz, \$2.00. Book Steam Automobiles, \$2.00. Power & Speed, \$2.50. Henry Ford, His Life & Work, \$3.00. Midget Automobile racing book, \$1.10. Indianapolis "500" Race History book 1909-1946, \$3.50; 1946 only, \$1.00. All postpaid. Catalog free. See ad motorcycle section. Clymer, Dept. B43, 2125 W. Pico, Los Angeles 6, Calif.

**HIGH Speed engine tuning, Car, Boat, etc.** No gadgets. Do it yourself. Race car mechanic advise each individual job. Information free. George Fawns, D-2552 No. 17th St., Philadelphia 32, Penna.

**PACIFIC Speedway News** auto racing magazine. Complete results, data, large and midget races. Subscribe now, \$6.00 yearly. Clymer, Dept. B40, 2125 W. Pico, Los Angeles 6, Calif.

**RACING Car performance** for all cars. Increase power, speed. Special "Custom built" equipment. Free literature. Write Lee Motorcraft, 1412-B Great Northern Bldg., Chicago 4, Illinois.

**MOTORACES**, new book Grand Prix auto racing. Includes 100 photos famous foreign cars, drivers. \$2.00 postpaid. Clymer, Dept. B41, 2125 W. Pico, Los Angeles 6, Calif.

**AUTOMOBILE Racing Book**. Fifth Edition—Revised. Tells how to build dirt tracks bodies, frames, engines. Records, superchargers, rules, formulas, plans, stock conversions, roadster racing, fast Fords. \$1.00 postpaid; \$1.15 C.O.D. Ray Kuns Department 274, Madisonville, Cincinnati, Ohio.

**"CUSTOM-Styling"** manual — Easily make car look Hollywoodized, custom built, ultra-beautiful! Newest streamlining suggestions, simplified restyling, refinishing, illustrations, plans for accessories, mufflers, model changes—Continental, sport, convertibles, etc. \$2.00. Almqvist Engineering, 447 R, 64 Street, Brooklyn 20.

**DUAL mufflers for B-8's**. Finest obtainable. Beautiful deep tone. Complete with necessary welded pipes, two mufflers, brackets. E-Z installation, \$20.00. Clymer, Dept. B42, W. Pico, Los Angeles 6, Calif.

**HISTORY of Buick**, City of Flint book, now available. Illustrations early, late Buick. Beautiful binding. \$3.00 postpaid. Clymer, Dept. B46, 2125 W. Pico, Los Angeles 6, Calif.

**DUALTONE** Chrystalline packed mufflers. Single or twin mufflers for all cars. Duals priced complete V8's \$23.00. Six cylinders \$33.00. Eight cylinders \$36.00. Large chromed tailpipe extensions \$3.30. Polished carburetor velocity stacks \$1.30. Chromed Station Wagon stacks \$15.00. Request catalogue. Dualtone Mufflers, 2636B India Street, San Diego 1, California.

**HOT-rod and fast stock car equipment.** List 25c 1½ h.p. from older Briggs and Strattons. Instructions \$1.00. Alden Motors, Oakland City, Indiana.

**INDIANAPOLIS Official 1946 Race Program**, 102 pages. Photos, results. Limited supply, 60c each postpaid. Clymer, Dept. B47, 2125 W. Pico, Los Angeles 6, Calif.

**"USED Car Handbook."** Dealers' tricks exposed, buying tips, previous owner clues, simple comprehensive tests. Postpaid \$1.00. Truvalu, Box 723-C, Arcadia, Calif.

**BUILD speedy Midget track racer** from castoff parts! Plans, specifications, construction information, \$1.00. Motor Supply, Box CS-1682, Toledo, Ohio.

**SPEED & Mileage manual**—Easily obtain greater speed, mileage, racing performance from any automobile! Includes simplified methods, speed tuning, gas saving secrets. Instructions on building economizers, speed equipment, dual carburetors, mufflers, superchargers, racing fuels, fast conversions, \$1.98. Almqvist Engineering, 447 (R) 64th Street, Brooklyn 20.

**CUSTOMIZE your automobile.** Illustrated new restyling ideas, instructions, specific model changes by simple methods, \$1. Speed-wheel, Box 723-C, Arcadia, Calif.

**MAKE your Ford fast!** Complete details, photographs. How to construct 120 mph Hotrod. \$1 postpaid. California Bill, Eaglerock Box L-2, Los Angeles 41, Calif.

**SEE our ad under Motorcycles** for midget racer bargains. Midget Motors Directory, Athens, Ohio.

## 13 AUTO SUPPLIES & EQUIPMENT

**HAVING Car Trouble?** New, Used, guaranteed auto, truck parts save money. Transmission specialist. Describe needs; immediate reply. Victory, 2930¼ No. Western, Chicago 18.

**AUTO parts for all autos and trucks.** Trans. motors, differentials, fenders, carburetors. Also Body Parts. Security Auto and Truck Parts, 1941 BP Eddy, Chicago 13.

**BURN water in your car** with the Vanderpoel water injecting carburetor. More power, faster pickup, cleaner, cooler, smoother motor, \$22.50 complete with tank and fittings. State make and year of your car. Ralph A. Shade, 563 Lake Road, Webster, N. Y.

**ATTENTION, Pistons, cast Lynite, Std.** os, semi, 1916 to 1946 cars, trucks and tractors. Also rings, Zrubek Tractor and Supply, 509-11 So. Main St., Pratt, Kans.

**1947 SUPERIGNITIONER \$5.50.** Atomic Starting, pep mileage. EG Mfg. 355B East 149, N. Y. 55.

**NEON warning light** operating with ignition as stop light, before brakes are applied. \$3.00 plus 30c for postage. 26 ft. ignition wire \$1.56 extra. See February Science, P. 119. Automobile Safety Light Co., 858 East 65 St., Chicago.

**INSTANT-Kleen Auto Glaze.** Quick, easy, inexpensive. Cleans & polishes—one application. Pint postpaid 50c or c.o.d. Guaranteed. Write for other products. Agents invited. Three Star Products, 3800 Genessee, Kansas City, Missouri.

**GRILLES for most all cars.** Meyers Auto Parts, 820 Dryades, New Orleans, La.

**CARBURETOR repair kits for Model A Ford** with Zenith carburetor \$1.55 (U.S.A.) Carburetor Service, 600 LaPrairie, Ferndale 20, Mich.

**MUFFLER manual.** Convert easily to Hollywood, Laguna, Westwood, duals, etc. Includes construction details, regulations, diagrams. Postpaid \$1. Mellotone, Box 723C, Arcadia, Calif.

**1000 Motorists Needed** to make gas saving test. Up to 30% savings. For trial test offer write Vacu-matic Carburetor Co., 7617-1307 W. State Street, Wauwatosa, Wisc.

**SCHRADER service station gauge** 10 to 160 lbs. \$1.75. E. Weill, 1650 East 38 St., Brooklyn, N. Y.

## 14 AUTO TRAILERS

**BUILD your own Trailer!** Save Money! Have every feature you want! Plans for House, Sport, Camp and Utility trailers. Catalog describing 9 models 10c. (15c in Canada and overseas). Jim Dandy, Box 125-B, Wausau, Wisconsin.

**TRAILER Travel Monthly Magazine,** Plant City 9, Fla. Twelve issues \$1. Sample 15c.

## 15 MOTORCYCLES, BICYCLES, SUPPLIES

**FACTORY built Motorscooter \$45, 1946 Midget Car \$65, Tires \$1.00!** Send 25c for bargain catalog packed with money saving buys in motorscooters, motorbikes, midget cars, motors, wheels, tires and parts. Gail and Company, 538 Erie, Toledo, Ohio.

**LARGE stock Indian parts.** Expert motor rebuilding. New and rebuilt Chief Motorcycle, motors only. Indian Motorcycle Sales, Kansas City 1, Mo.

**WHEELS, Tires, Tubes for Motor Scooters, Midget Cars, Wheelbarrows, and Industrial equipment.** All sizes. Bicycle Parts, accessories. Largest stock in United States. Send dime for list. Cycle Transport Company, 1241 S. Michigan Ave., Dept. C, Chicago 5, Illinois.

**SCOOTER-CAR Runabout!** Two passenger, three wheeled, motorized, speedy. Simple construction from available second hand parts. Detailed plans \$1.00. Midget "Jeep" plans included free. Universal, 2671 Algonquin, Toledo 6, Ohio.

**"MOTORSCOOTERS 1947 models.** Immediate delivery. Send 10c for illustrated catalogue. Johnson's Motorscooter Sales Co., Milford, Ind."

**WHEELS!** Build wagons, scooters, mowers, trailers, wheelbarrows, grocery carts, baby carts, play pens, baby carriages. 4" to 16". Free list. Trulsen Mfg. Co., 811 E. 31, Kansas City, Mo.

**MOTORBIKE.** Manual contains easy to build motor bike, scooter plans and motor repair information \$1.00. Veco, A247, Box 124, Evansville 5, Ind.

**WHEELS, Steel Disc rubber-tired** for toys, wagons, scooters, etc. Sizes 5", 6", 7", 8", 10" available. United Wheels Mfg. Co., 11727 La Fayette Avenue, Chicago 28, Illinois.

**MOTOR Scooters, bicycle engines.** 120 miles gallon. Dime for catalog. Clymer, Desk B45, 2125 W. Pico, Los Angeles 6, Cal.

**CLYMER'S Motorcycle books.** Speedway Motorcycle Racing, \$2.00. Motorcycle Speedway Annual, \$1.00. How to Manage Motorcycles, \$1.50. Motorcycling Manual, \$2.00. How to Obtain Speed, \$1.50. Motor Scooter Plans, \$2.00. Books on Ariel, BSA, Norton, Triumph, Villiers engines, \$1.50 each. English Motorcycle Magazine, 50c. All postpaid. See our ad automobile section. Catalog free. Clymer, Dept. B44, W. Pico, Los Angeles 6, Calif.

**HARLEY single motorcycle \$50.00, Harley twin \$65.00, complete.** Motorscooters \$9.00 up, midget cars \$10.00 up, motorcycle \$25.00, less motors. Used motors \$3.00 up. Plenty of brand new 2 horsepower motors never taken from factory crates. Over 5000 balloon tires for motorscooters and small cars \$1.00 up, mailorder only. Send 25c for Big War-Bargain catalogue Number 18, just out listing the above and hundreds of other bargains in new and used motors, motorscooters, midget cars, racers, etc. (35c by first class mail.) Midget Motors Directory, Athens, Ohio.

**"PROFESSIONAL Midget Racer, Motor-scooter, Midget Roadster and Midget Motorcycle Plans,** specifications for all four contained in illustrated handbook, 25c. Big list bargain priced used motors, motorscooters, Servicycles, etc., included free! Midwest, 3839 Drummond, Toledo, Ohio."

**"BUILD America's lowest priced motor-scooter speedster!** Complete plans, specifications, \$1.00. Big list bargain priced used motors, etc., included free! Motor Supply, Box 1682-CS, Toledo, Ohio."

**"MOTORSCOOTER \$10, Motor \$3, Tires \$2!** Send 25c for big catalog listing scores of other sensational bargains in motors, wheels, motorscooters, motorbikes, Servicycles, tires, etc. Associated, Box CS-1764, Toledo, Ohio."

**BEAUTIFUL new enameled lapel pins.** Harley-Davidson, Indian, midget or large race car, Daytona Race checkered flag souvenir pin or racing crash helmet pin. \$1.00 Postpaid. Specify choice. Clymer, 2125 W. Pico, Los Angeles 6, Calif.

## 15 AVIATION

**PROPELLERS** — Illustrated literature, correct type, sizes for ice-snow sleds, boats, Airliner 3 blade, also 2 blade. Build your own motor, aircool diagrams 50c. Standard Aircraft, Ft. Worth, Texas.

**AIRLINE employment interest you?** Write for helpful, free information. Air Transport Research, Dept. E, Box 1044, Kansas City 10, Missouri.

**FAMOUS New 1947 Dart—One hundred horse power, two-place full acrobatic low-wing C.A.A. approved airplane.** Can be easily built by you in your spare time at low cost. Send 50c to cover cost of mailing complete information. Dart Aircraft Corp., Quincy, Michigan.

**"CUBS, Wacos, Taylorcrafts, Aeroncas.** Big catalog 25c, lists these and thousands of other sensational airplane bargains. Some are "easy to repair" crack-ups. National, Box 1682-CS, Toledo, Ohio."

**NEW Catalog! Rush name.** Experimenter Supply, Tipp City 7, Ohio.

**MAKE \$100.00 a day with a lightplane.** New stepped-up barnstorming plan. Detailed folio \$1.00 postpaid. Charles Eichhorst, Box 809, Dakota City, Nebr.

**VETERANS: Flight training** under the G.I. Bill. Private, Commercial and Flight Instructor Ratings. Write for information. Gottschalk School of Aeronautics, Adrian, Michigan.



## 49 ELECTRICAL SUPPLIES & EQUIPMENT

**ELECTRIC Pencil:** Writes, Engraves all Metals. \$1.00 postpaid. Beyer Mfg., 4515-C, Cottage Grove, Chicago 15.

**MOTORS,** 110 volt, 60 cycle, 1/6 H.P. \$18.50 1/12 H.P. \$9.00. Sump pumps \$34.50. 16" exhaust fans \$28.50. 20" counter fans \$28.50. Vic's Electric, 208 Niagara, Buffalo, N. Y.

**ELECTRIC Fan.** Assemblies counter models, floor models, attic fans. AAlco Electric, 1430 Franklin, Saint Louis 6, Missouri.

**SUPPLY** going fast: Gov't Inspected Selsyns, 110 volts, 60 cycles, for sale. Quantities up to ten pairs . . . \$10. Pair, 10-100 . . . \$8.00, pair, 100 & over . . . \$6.90 Pair. Also 4mf-600VDC Pyranol condensers . . . \$1.55 each. Small 24VDC motors, 250 rpm . . . \$4.80 each. S. Tanne, 12 East 31st St., New York 16, N. Y.

**LAMPS**—All parts to build or repair. Catalog 10c. Gyro Lamps, 5416 Clark, Chicago 40.

**ELECTRIC Pencil**—writes, engraves all metals. Battery model \$1.00—110 volt model \$2.00 postpaid. Guaranteed 5 years. C.O.D.s accepted. Reb Industries, Dept. 265-Y Elmhurst, Illinois.

**SELSYN** motors, Bendix 3 1/2" x 5 1/2" heavy duty 115 volts, 60 cycles, \$10.25 per pair. J. A. Weber, 150A Maple, Hershey, Pa.

**FLUORESCENT** tubes burned out? You can relight and use indefinitely. Complete instructions \$1.00. Wallingford, 121 Burlington Ave., York, Nebr.

**MAGNETS** Alnico. New Number V stocked. Terry Sales Company, 3726 South Detroit Ave., Toledo 9, Ohio.

**LAMP** sockets brass shell, three-way Mogul sockets cord sets, switches, lamp parts, catalog 10c. Gearon, 4348 Broadway, Chicago 13, Illinois.

**BLOWERS.** Air conditioning supplies. Gas burners. Sell for us. Card for literature. Thuman Equipment Co., 1225 Fifth Ave., St. Joseph, Mo.

**ELECTRIC** fan assemblies. Make your own. Ted Riseman, 425 East Jefferson, Springfield, Illinois.

## 140 WELDING, SOLDERING

**"THUNDERBOLT"**—Transformer welder, dial-control, 3 heats, 60 amps., 110 volts—ac, carrying case, accessories, instructions, \$39.50. Also "Super-Welder", 110 Volts, ac-dc \$19.95. Save 2%, send check. Or order c.o.d. Dealers wanted, liberal proposition. Super-Welder Mfg. Co., 23 E. 20th St., New York 3, N. Y.

**NEW** Model electric welder 110 volt AC-DC; will weld all metals; easy to use, full directions. Complete with power unit, flame and metallic arc attachments, carbons, fluxes, rods, mask; all for \$19.95—Used by the Navy. Magic Welder Mfg. Co., 239-PS—4 Canal St., New York City.

**ACETYLENE** Welding Generator. Easy to build—Plans \$2.00. Weldox, R. 2, Box 264, Phoenix, Ariz.

**BUILD** automatic acetylene welding generator 25 pound carbide capacity. Plans \$1.50. H & B Plan Service, 8981 N. Fortune Ave., Portland, Oregon.

**WELD.** Cut, Braze with gasoline! Amazing new discovery shatters costs. Boosts profits. Important! Write Matthews Mfg. Co., Calgary, Canada.

## 6 AIR CONDITIONING & HEATING

**BLOWERS,** airconditioning units, gas burners, gas & oil furnaces, complete line MH heating controls, plastic roof coatings. Paramount Supply Co., Lincoln 4, Nebr.

## 80 MACHINERY, TOOLS, SUPPLIES

**WAR** Surplus in small tools for machine shop—Send 10c for bulletin. Travers Tool Co., Dept. S, 5 Court Square, Long Island City 1, N. Y.

**ARMY** Surplus 1/4" Drills Runs Off Any Air Compressor Powerful Tool For Mechanics \$15.00 Money Back Guarantee. Send Money Order! Flecks, Warren, Ohio.

**EQUIP** your home workshop quickly, efficiently, economically by building your own Mill, Shaper, Drillpress, Vise, Jointers or other metal and woodworking tools. Lewis Castings and Materials are ready to finish, detailed Blueprints show how. Send 10c to cover cost of mailing new Catalog describing 21 items. Lewis Machine Tool Co., 3217 Union Pacific Ave., Los Angeles 23, California, Dept. S.

**BUILD** Quickchange gear box without castings for \$10.00. Craftsmen, Atlas and other lathes. Complete drawings \$3.75. Stevens Engineering, 2604 Military, Los Angeles 34.

**BUILD** magnetic indicator holder, lifts 25 lbs. magnet 2 keepers and plans \$2.00 postpaid. Peter Andrews, 20 Potomac St., Rochester 11, N. Y.

**NEW** Glass Drill. Free literature. Box R188A, Seal Beach, Calif.

**CARBIDE** Tipped Scriber \$1.00. Penny, 210 Penn., West Chester, Penna.

**DON'T** spend \$50.00 for single purpose sander. New All-Purpose portable machine at fraction of price. For home workshops, cabinet-makers, painters, others. Post card free circular. H. Saltzman, 118-14 83 Ave., Kew Gardens 15, N. Y.

**HANDY**—Handles. For socket-screw wrenches. New invention. Free trial. Witte Manufacturing Co., 1042 Lititz Avenue, Lancaster, Pa.

**FIND** things quickly. 108 hardware and shop labels \$1.00 postpaid, returnable. Hinds, 223 Second, Niagara Falls 2, N. Y.

**SHEBEL** Saw Filer, \$7.50. Files all saws. Free trial. Circular. 730A So. 2nd St., Milwaukee 4, Wis.

**SOCKET** Wrench Sets—9/32-1/2-11/16-13/16-7/8-15/16 5 and 10 inch extension High speed handle \$4.50. A. Friedman, 1514 N. Poinsettia, Hollywood, Calif.

**MAGNETIC** Dial Indicator Bases—\$3.45! Write—Eyrich, Box 849-A, Milwaukee 1.

**MILLING,** shaper attachments fit all lathes, drill presses. Free circular. Corona Tool Co., Dept. S, 107-15 51 Ave., Corona, N. Y.

**TAPS & Dies** direct from manufacturers. Equip your shop at small cost. Write for free price list. King Tap and Tool Co., Inc., North Attleboro, Mass.

**TANKS,** Stainless Steel, 9 gallon capacity. 12" diameter 24" long. Rated strength: 400 lbs. per square inch internal pressure. Ideal for air compressor, rustproof tank for boat or camp. Write for details and "How To Make It" free. Surplus bargain at never-again price of \$8.00, fob Ireland and Vice, 48 Chedel Place, Auburn, N. Y.

**ANGLE** index unit one degree movement for bench layout or machine work \$17.50. Baumtool Co., 1832 Orleans St., Chicago, Ill.

**LATHES**—Atlas, watchmakers, Norton grinder, Millers, chucks, headstocks, compounds. Service, Newfane 1, Vermont.

**JEWELERS** Furnace melts 5 lbs. bronze \$75.00 Folder. Hoover & Strong, Inc., 115 W. Tupper Street, Buffalo 1, N. Y.

**HAND** Grinder and Router—Make your own by adding small chuck to this high speed 110 AC and DC reversible motor. \$3.50. Two for \$6.00. Radico, 1110S Marshall Bldg., Cleveland, Ohio.

**INDEX** Heads for sale. Very inexpensive. Sixty-two different Divisions. Used on lathes up to twenty" swing, drill-presses, milling machines, etc. Make gear, hobbs, cutters, etc. Very accurate and durable used by shops, factories, and machinists. Write for free folders. Long's Index Head, 2117 East B Street, Torrington, Wyoming.

**MAKE** Circular saw; plans 25c; Arbors; Bazuin, 76 Auburn Ave., NE, Grand Rapids 3, Mich.

**WAR** Surplus, Machines, Tools, etc. Free literature. Wayne Engineering, Greenville 2, Ohio.

**GEARS** For inventors, experimenters, model makers, schools, work shops, laboratories, etc. Government surplus made of brass, bronze, dural steel and stainless steel. 12 matched pairs; 24 gears, bevel, spur and ratchet. List price \$12.00, our price \$2.50. 25 matched pairs; 50 gears, includes larger gears, also sets of worm gears. List price \$30.00, our price \$5.00. Limited quantity. Order now. Write for our bulletins on ball bearings, rectifiers, Relays, Selsyns, Horns and government surplus materials. Met Exchange, 323 Canal Street, New York.

**DRILL** Grinder for twist drills \$2.95. See ad on page 265.

## 17 BATTERIES, GENERATORS, ETC.

**MIDGET** Magnetic Motor. (1 by 1 1/2"). Small flashlight cell operates. Parts plus instructions 30c postpaid. Two 55c. Special offer. Send today. Eltro, 171D, Deer Park, N. Y.

## 19 BOATS, OUTBOARD MOTORS, ETC.

**FULL** size, cut to shape boat patterns, blueprints. 7 1/2—38 feet. Illustrated "Build a Boat" catalog, 10c (coin). "How to Build Boats" book, \$1.00. Cleveland Boat Blueprint Co., Dept. A-77, Cleveland, Ohio.

**INBOARD** marine motors, conversions, supplies. Catalog on request. Stokes Marine Supply, Coldwater, Michigan.

**MARINE** Power—Easily convert any Ford and Jeep motor (domestic and foreign) with Osco parts and kits. Complete catalogue 25c (coin). Osco Motors Corp., 2020C E. Orleans St., Phila. 34, Pa.

**WHY** Lug your outboard motor? New carrier \$8.75. Catalog Free. Box 9A, Tahoe Valley, Calif.

**PLYWOOD** Boat Kits! Complete materials for building "Deltacraft," Junior Dinghy." "Tadpole Skiff." Mahogany marine plywood and oak construction! Send 10c today for illustrated folder featuring these Boat Kits and other marine materials and supplies. Carmen-Bronson, Marine Department, Mount Vernon, N. Y.

**ATTENTION** Sportsmen! Go Kayaking! Build yours from complete, easy-construction kits. Literature, Play-acks, Dedham, Mass.

**SAILS,** Sailkits 100 square feet \$21.00. Canvas, all widths for Boats, trailers. Airplane dope, canvas cement. Boat hardware. Catalogue. Alan-Clarke, 96 Chambers, New York City.

**"MARINE** conversions for Ford and Jeep engines. Catalog 10c. Lehman Manufacturing Company, Department A, Newark 2, New Jersey."

**KAYAKS,** Rowboats, Weldwood ready cut kits. Booklet. E. J. Croot Co., #103-E Basking Ridge, N. J.

**PONTOON** dock with swinging basin for children. Plans \$1.00. Lidemark, 226 Potomac, Buffalo 13, N. Y.

## 51 ENGINES, MOTORS, ETC.

**WINDING** Data, listing 225 motors, single and three phase, \$1.00. Motor Data, Box 7631 Kansas City 3, Mo.

**"BUILD** Your Own" gas drive arc welder easily with Hobart Generator. Save \$300 to \$500, and need only add used auto engine and chassis to build portable gas drive welder that goes everywhere after profitable construction and repair jobs. Write for free instruction book, further details. Hobart Brothers Co., Box P-1066, Troy, Ohio.

**150** AMPERE Generators for welding \$47.50. Extra Flexible Cable, 6 ft. lengths \$2.75. Other Bargains. Butler Electric Company, 1885 Milwaukee, Chicago 47.

**MOTOR** winding tester, indicates burned out or partly shorted coils in single or three-phase motors, indispensable for repairmen. Send for bulletin. Motor Industries, Quincy, Illinois.

## 7 AMERICAN POLICE JIU JITSU

**DEADLY** Judo—Fiercest fighting technique. Trick knockouts. (200 photographs—plus illustrations.) Expert instructions—Three volumes. Complete \$2.25. Variety House, Box 46-AP, Wall Station, N.Y.C. 5.

## 20 BODY-BUILDING COURSES

**BAR-BELLS,** Dumbbells, Exercise equipment, Courses, Free booklet. Good Barbell Co., Reading, Penna.

**\$50.00** BODY Building Course with 100# weights \$18.75. EG Elmsford 3, N. Y.

**HE-MAN** muscles make you popular, increase your self-reliance. Write for Free Information. Key Institute of Physical Culture, Dept. D, Miami, Fla.

**BARBELLS!** Catalog! Bur Barbell Co., 319 Orient Way, Lyndhurst, N. J.

## 124 SPORTING GOODS, GUNS, FISHING TACKLE, ARCHERY

**"AMMUNITION"**—"New and Used"—"Shotguns"—"Rifles"—"Revolvers"—"Pistols"—"Fishing Tackle"—List 10c. Rudolph's, Atchison, Kansas.

**2000** BARGAINS, firearms, binoculars, war relics, catalog 40c. Smith Museum, Runnemed, N. J.

**SEND** 10c for list 100 new and used guns. Frayseths, Wilmar, Minnesota.

**CHIGGERS,** Mosquitoes and Biting Flies. Don't let these bothersome, disease carrying insects spoil your outdoor fun or jeopardize your health. Skeeter-Skram cream repels these pests. Smooth on a dab of this easy-to-use repellent and enjoy protection for hours! Safe to use yet amazingly effective. Skeeter-Skram is odorless, invisible and greaseless. Send \$1.00 today for an entire season's supply. The Chapman-Gilbert Company, Inc., 830 West Ivy Street, San Diego 1, Calif.

**FISH** at night with Johnstone Electric Lighted Bobber \$1.00 Prepaid. Circular on request. Dealers Wanted. Johnstone Bobber Co., Aurora, Indiana.

**3,000** BARGAINS:—Antique Firearms, Indian Relics, Coins, Minerals, Flintlocks, Rifles, Pistols, Swords, Cartridges, Fossils, Illustrated Catalog 25c. Heike, Wenona, Ill.



FISHING Poles, Baseball Bats, Bullfrogs, Price list 10c. Vol Brashears, Berryville, Arkansas.

FISHING Poles, Ferrules, Guides, Tips, Clamps, etc., Native Canes, Bamboos, Tonkins, 1-Piece All-purpose rod, guides, top reel-seat, butt, varnished, \$6.60, 3-Piece Native Cane, Painted, \$2.50, 2-Piece Steel Rod, Guides, Tip, Hardwood Handle \$2.50. Dealers write, Bob Pace, Combs, Ark.

### 55 FIELD GLASSES, TELESCOPES, ETC.

REFLECTING Telescope, complete 3 1/2" diameter, equatorially mounted. View planets, stars, \$19.75. Write Skyscope Co., 475-5th Ave., New York.

REFLECTING Telescope Kit, complete optical parts, fully finished: 3" diameter, 44" F. L., mirror and diagonal both hard aluminized, plus 3 lenses for high power eyepieces. Never Again a bargain like this. All \$6.00 Postpaid. Ross, 68 B Broadway, N. Y. 7, N. Y.

BINOCULARS — All Purpose—optically ground lenses, adjustable focus, with shoulder strap attached. Made attractively in black plastic. Ideal for all sports events, theatre, opera. Complete with case. \$3.00 postpaid. Criterion Company, 438 Asylum St., Hartford 3, Conn.

ASTRONOMICAL telescope, 3" by 50" black enameled metal main tube, giant tripod with equatorial mount, 100X (ten thousand area magnification) Clear, sharp vision and full power guaranteed. \$12.50. Carl Jamer, Manorville, N. Y.

60 POWER telescope, \$2.95. 250 power microscope, \$2.45. Send for free catalog of Telescopes, Binoculars and Microscopes. Brownscope Company, 24 West 45th Street, New York.

TELESCOPES, Microscopes, binoculars, barometers, books, photographic equipment; Buy, sell, repair. Lists 10c. Rasmussen & Reece, Amsterdam, N. Y.

BUILD reflecting telescope catalog Free. Instructions 10c. Mayfloor, Katonah, N. Y.

### 43 DOGS, BIRDS, PETS, RABBITS

ANGORAS, Chinchillas, White Giant Rabbits — "Rabbitry Management" tells everything, \$1.00. Self-cleaning Hutch plans \$1.00. Automatic Feeder plans \$1.00. All three \$2.50. Catalog finest Pedigreed Rabbits free! Grinsteads, Dept. 16-D, Edwardsville, Ill.

RAISING Rabbits, Cavies, Hamsters, Chinchillas is a growing and profitable industry. Magazine 10c. Descriptive Book and magazine 25c. Book and magazine (monthly) one year \$1.00. Address Small Stock Farmer, Pearl River 16, N. Y.

GUARANTEED Chin-Chin Giant Chinchilla rabbits. Greatest amount of delicious meat. Largest, finest, most valuable furs. Tremendous demand for breeding stock. We buy youngsters. Contact world's largest breeder, Willow Brook Farm, R16, Sellersville, Pa.

\$2500 EASY raising angora rabbits. We market your output. Contract particulars free. Wilson's, 1065 Shryer, St. Paul 8, Minn.

ST. BERNARD Pups; Champion sired beauties. Franklin Young, R. 3, Riverhead, Long Island, New York.

RABBITS for Fun, Food, and Fur New Zealand White breeding stock. Easy to raise. Instructions free. Hazelbrook, R 5 C, Gettysburg, Pa.

\$250 MONTHLY. Raising Angora Rabbits. Particulars free. White's Rabbitry, Lawrence, Kansas.

REAL Giant Chinchilla Rabbits. Offered by their originator. Free details. Stahl, Pearl River, N. Y.

RAISE Guinea Pigs. Make money at home. Big demand. Booklet free. Taylor, Box 426B, Hapeville, Georgia.

BUY Diamond Seal Rabbits. We pay up to \$50.00 each for the offspring, continuous market. Price guaranteed. Prefabricated Hutches \$5.50 each. Illustrated booklet 25c, with Hutch Plans \$1.00. Completely automatic. Hansens Rabbitry, 1347 Miller Ave., Salt Lake City 5, Utah.

FOR Sale — Coonhounds, combination treehounds and high class foxhounds. Rabbit-hounds a specialty Raccoon Mountain Kennels, Dures Thomas, Rt. 3, Albertville, Ala.

CHINCHILLAS. No Rabbit 3 cents day payments and Booklet on raising \$1.00. Montana Fur Farm, Billings, Montana.

### 83 MILK GOATS

"MONEY from dairy goats!" Booklet free. Introductory 3-month subscription to leading magazine 25c. Dairy Goat Journal, Dept. 768, Columbia, Missouri.

## 52 FARMS, OTHER REAL ESTATE

OZARK Lands for All purposes. Actual river frontages. 5 acres \$90.00 and upwards. Free list and literature. Hubbard, 424H, Minnesota Ave., Kansas City 4, Kans.

GOOD Farms—Ranches. Washington, Minnesota, Montana, Idaho, Oregon, North Dakota. Dependable crops, favorable climate. Write for literature, lists describing typical postwar farm opportunities. Specify which state. J. W. Haw, 120 Northern Pacific Ry., St. Paul 1, Minn.

STROUT'S Green Farm Catalog—Over 2400 Bargains—money-makers—32 states—Coast to Coast. Mailed Free. Tell us what you want—Where? Price? Terms? We will try to save you Time & Money. Strout Realty, 255-ZB 4th Avenue, N. Y. 10, N. Y., 20 W. 9th St., Kansas City 6, Mo., 453 S. Spring, Los Angeles 13, Calif.

WANT A Farm Of Your Own? Good ones are available in Canada at comparatively low prices. Favorable terms. Why not write for information today? Indicate the kind and size of farm, and the province in which you are interested. Address inquiry to H. R. Cresswell, Canadian Pacific, Montreal.

HOMESITES \$450—convenient payments. California's finest garden section. On Morro Bay's scenic shores. Wonderful fishing, hunting, boating, bathing. Fertile soil, softest water, temperate climate, congenial community. Free literature. Richard Otto, 6560-Z, Hollywood Blvd., Hollywood 28, California.

FLORIDA Highlands 200 feet altitude. Above Pensacola—beautiful—100 x 140 feet. \$125. Electricity, Oil Rights. Send \$5.00 monthly payment for maps and literature. Delker-(owner), 2219 Venango, Phila. 40.

ASPARAGUS Plantation Established Market \$4000.00 to \$7400.00. Spring Crop now being harvested \$6500.00. Terms. Machler, Catoosa, Okla.

OZARK Guide, Eureka Springs, Arkansas. For homeseekers, tourists. Year \$1.00.

### 108 POULTRY AND SUPPLIES

RAISE turkeys the new way. Write for free information explaining how to make up to \$3000.00 in your own backyard, address National Turkey Institute, Dept 57, Columbus, Kansas.

YOUR greatest poultry problem will look simple when you read American Poultry Journal regularly. 500,000 poultrymen do, why not you? 2 years 50c. 5 years \$1.00. American Poultry Journal, 551 So. Clark, Chicago.

U. S. Approval Pullorum clean rating. Baby chicks. Free circular. Herm Berry's Hatchery, Dept. P.S., Parkersburg, W. Va.

POULTRY pays. Learn how. Production line methods. More money. Less work. Postcard brings free booklet. "Seven Keys to Poultry Profits." Write Poultry Advisory Service, 1046 So. Olive, Room 109-B, Los Angeles 15, California.

### 111 PROFITABLE OCCUPATIONS

DETECTIVES Earn Big Money. Excellent opportunity. Detective Particulars free. Write, Wagoner, P-125 West 86th, N. Y.

WELDING—Electric Arc. Learn profitable trade quickly through actual practice. Individual welder instructions at bare cost of materials. Full particulars free. Valuable welding lessons book 50c. Hobart Welding School, Box P-1064, Troy, Ohio.

LOCKSMITHING — Profitable Business or Hobby! New course teaches you how to pick locks, fit keys, de-code, masterkey, etc. Easy self-instruction lessons. Bargain price. Fascinating 100-page illustrated catalog Free! Write Nelson Company, Dept. 2-01, Chicago 5.

MUSHROOMS Grown. Boxes, Barrels; Illustrated Instructions, 50c. Spawn \$1.00. Gordons, 553 William, Winnipeg, Manitoba.

\$5.00 FROM Half-Acre Growing Ginseng. Seed Contract supplied. Particulars 10c. Associated Growers, Dept. 12, 340 Furby, Winnipeg, Manitoba.

TRADES that often pay \$50.00 daily completely described and illustrated. "Flagpole Painting and Repairing"—\$2.00. "Smokestack Painting and Repairing"—\$2.00. The Skyline Company, Box 1601-A, Uniontown, Pa.

\$40.00 WEEKLY. Made growing mushrooms. Fresh. Dried. Dominion Patent 331,583, free spawn. North American, 169Y Yonge, Toronto, Canada.

EARN money at home, spare time, interesting mail opportunity. Write Bruno, 3115 Beach Blvd., Jacksonville, Florida.

WHOLESALE Catalogue, business opportunities, plans 10c. Holmes, Box 12S, Oaklandon, Ind.

VETERANS Learn Massage. A dignified and profitable profession. Short courses starting now. Write for free booklet, School of Massage, 96 Union Street, Norwich, Connecticut. Approved by State Board of Education.

BIG Profits! A necessity in every home. Everybody prefers these superior two-way ironing boards, portable or stationary to fit any recess. Great demand. Build them in your basement or garage from our plans only \$1.00. No experience necessary. Be independent! Be your own boss! We guarantee to refund money if dissatisfied so send dollar bill, check or money order today to Home Engineers, Box 391, Claremont, California.

BE a Novelty Manufacturer, fascinating, interesting work. Exceptional profits. No expensive equipment needed, quickly learned. Use garage or basement. Successful manufacturer shows how, orders waiting. Write today. Plastex Products, 127 Clement, San Francisco (18).

SEA Shell Jewelry. Free instruction. Werts, 1429 56th Avenue, Oakland 3, Calif.

MIRRORS from window glass at 3c per foot. Formulas and silvering data \$1.00. Metallize Baby shoes. Several methods \$1.00. Tes-Co., P.O. Box 189-SA, Wilkes Barre, Pa.

MAKE beautiful costume jewelry at home for large profits, hobby or therapy. Free illustrated wholesale catalogue of sea shell, metal and plastic parts contains detailed instructions. Florida Supply House, Bradenton, Florida.

BECOME a Manufacturer's Agent. Be your own boss and earn big profits with little or no capital investment. Send today for the Vimar Plan which provides you in detail with soundly-tested methods on how to become a representative for prominent manufacturers. Learn how to contact concerns, select products and build a successful business for yourself. \$2.00 postpaid. Vimar Co., 210 Loeb Arcade, Dept. A-2, Minneapolis 2, Minn.

### 22 BOOKS, PERIODICALS, ETC.

WHAT Every Mason wants. We have Masonic books for Blue Lodge, Chapter, Commandery Scottish Rite and Shrine. Our rituals are used the world over. Send for our free catalog of books and rituals for Masons, Odd Fellows, Knights of Columbus, etc. Ezra A. Cook, Publisher, Inc., P.O. Box 796-RMY, Chicago 90, Ill.

MAGAZINES (back dated)—foreign, domestic, arts, Books, booklets, subscriptions, pin-ups, etc. Catalog 10c. (refund). Cicerone's, 863 First Ave., New York 17, New York.

BIG Profits Taking Subscriptions For All magazines. Agents' Confidential Catalog listing over 2500 periodicals and complete starting supplies Free. Pines Subscription Agency, Flushing, N. Y.

BOOKFINDERS! (Scarce, out-of-print unusual books.) Quickly supplied. Send wants. Clifton, Box 1377-PS, Beverly Hills, Calif.

GOOD "Used" Self-instruction educational books on all subjects bought, sold, rented, exchanged. Satisfaction guaranteed. Complete information and 100-page illustrated bargain catalog Free! Write—Nelson Company, Chicago 5.

EDUCATIONAL Books sold cheaply or rented for small fee. Books bought. Money-back guarantee. 4,000 Bargains. Catalog Free. (Courses Bought.) Lee Mountain, Pisgah, Alabama.

YES: We are again accepting agents to handle magazine subscriptions, books, greeting cards, complete details 25c (refund). Cassell Publishers Service, Westfield, New Jersey.

NATIONAL Geographic Magazine, 1888-1946. Any issue. Periodical Service, Box 327-S, Swarthmore, Penna.

FREE bargain catalogue for adult book buyers. Kissin, Box 134, Madison Sq. Sta., New York City.

ADULT Books 25c. Five—\$1.00! Free Bookalogues! Hirsch, Spring Valley 3, N. Y.

ARCHITECTURAL—Art Crafts, books, catalog 10 cents. Artcraft, Box 6827, Baltimore 4, Md.

ADULT Books Illustrated—Five. \$1.00. Free Bookalogues. Kogan, 1032-CS, N. Y. 8.

ADULT Books. Catalog and Sample, 10c. Baker Service, Box 1840, Cleveland 6, Ohio.

MAGAZINE subscriptions, technical books, if it's printed we have it! Catalog 10c. Cassell Publishers, Westfield, New Jersey.

MAGAZINE Export Sales Co., 2084 First Ave., New York 29, N. Y. Over-issue popular American Magazines and Pocket-Size Books, Comic, Screens, Fashions Pictorials, Romances, Pulp and many others. Export Only.



**AUTO** driving for learners. Actual course of instruction. Booklet by professional driving instructor, 75c. Bradford's, Box 636, G.P.O. Brooklyn 1, N. Y.

**FREE!**—Send postcard for free list dynamic health books! Strength Culture. Overweight. Problem Drinkers. Social Diseases. Child-Care. Psychology. Philosophy. Daniel Mead, 200 W. 20th (PS), N.Y.C. 11.

**ARTIST'S** Pin-ups. Gorgeous models in tantalizing, breath-taking poses. Set 35 pictures \$1.00. Baker Service, Box 1840 Cleveland 6, Ohio.

**FREE** Bargain catalogue. Correspondence courses. Unusual Books. Baker, 5509-A Winthrop, Chicago 40.

**AMAZING** new book gives instant solutions to 100,000 practical problems. Details free. Columbia Graphs, Columbia 2, Connecticut.

**"LOVE** Ruthbella!" Intimate Diary confessions;—privately published \$5 book now reprinted, price only \$1.00! Make this excitingly beautiful, picturesquely revealing book your secret delight! Confidential listing: "Lonely Hour Books", price 10c. Send Dollar and Dime Today for the book thrill of your life! Poets Corner Press, Box 178, Palisades Park 14, N. J.

**MAGAZINES**—Business, Vocational, Diversion. Current copies. Choice over 800 periodicals. All Fields. Free price-list. Commercial Engraving Publishing Co., 34S North Ritter, Indianapolis 1, Ind.

**WHOLESALE** catalog. Directory 10c 100,000 articles. Latshaw Sales, Sunnyside-C, Indianapolis 44, Indiana.

**POWERFUL** prescription for achieving personal and business success; works without expense or guesswork. You can use it. Send stamp only. G. I. Book Distributor, 126 Lexington Ave., New York City 16, N. Y.

**BOOKS!** (out-of-print, scarce); quickly supplied. Send Wants. Spotlight, 141 Broadway, New York.

**BACK-DATE** Magazines, books. Send wants. Arkell's, Box 744, Tarzana, Calif.

**UNUSUAL** Selfhelp and Educational Books. Literature free. Art Nitzke, Rosendale, Wisc.

**BOOKS** (out-of-print, new, used), quickly supplied, many 35c bargains. Catalog Mid-West Book Service, 18870 Marx Ave., Detroit 2, Michigan.

**RADIO**-electronics books supplied by mail. Servicing, troubleshooting, home study, radio math, electricity, etc. Send postcard for free illustrated catalog. Nephews Publishing Company, 300 Pacific Street, Brooklyn 2, N. Y.

**"WHOLESALE** catalog, directory. 10c" —Stafford Sales, Box 5211, Indianapolis 1, Ind.

### 81 MAGIC TRICKS, PUZZLES, ETC.

**"VENTRILLO"** Professional Voice-Throwing Instrument and Catalog 25c. 2404N15, Philadelphia.

**MAGICIANS'** Gamblers' secrets exposed. Cards, Dice, Punchboards, Slot Machine. Catalog 10c. Book Co., Box 671, St. Louis 1, Mo.

**"MAGIC** Vanishing Card". Throw it into air, it completely disappears, reproduce it later from spectators pocket. Easy to do. Complete 25c with magic catalog. The Magician, 2463-D, Kensington Ave., Philadelphia, 25, Pa.

**WORLD'S** largest professional magic shop, keeps you in touch with latest tricks. To receive mailings, send 35c for new catalog. Holden's, 220-P West 42nd St., N. Y.

**500 TRICKS!** New 1946-7 edition Douglas famous Catalog. Now ready, only 10c. Brand new magic for pocket, parlor, club, stage, professional, amateur. America's fastest service to magicians everywhere for over 25 years. Send 10c Today. Douglas Magicland, Dept. 2, Dallas, Texas.

**VENTRILLOQUISM** laugh. 3c stamp Brings particulars. Smith, Dept. 410, 801 Bigelow, Peoria 5, Ill.

**MAGIC:** Big 160 page Illustrated Catalog, latest Magic Goods, 25c. For over 1/2 century we have supplied Professional as well as Beginner. Chicago Magic Co., 2300 N. Mason, Chicago 39.

**MASTER** Memory Astounding Mystery \$1.00. Frecat, 612 Pine, St. Louis, Mo.

**ILLUSTRATED** Book, "34 Easy-do Magic Tricks" and Magic Catalog; 10c. Lee's, 2231-S McKinley, Berkeley 3, Calif.

**AMAZE** your friends!! "Book of Magic and Party Stunts," (\$1.00 value), and latest newsletter and list, all for only 50 cents postpaid, if you act now!! Ernie Simon's Magic Shop, 116 S. Salina St., Syracuse 2, N. Y.

**THE True Secret** of Ventriloquism. Free booklet. Quackenbush, Big Flats, N. Y.

**FREE!** Large Catalog of magical apparatus if you remit 25c for "MAGIC IS FUN" magazine. Robbins Co., 152-F West 42nd Street, New York.

**READ** the Fakir Monthly Magazine for Magicians. Copy 25c. Subscriptions \$2.00 yearly. Rachun, 114 Grand, Brooklyn 11, N. Y.

**FREE** catalog magic, puzzles, tricks. Scheetz's, 981 Branch, Sellersville, Penn.

**VANISHING** Quarter trick and catalog 25c. Sterling Magic Co., Royal Oak, Mich.

**SNEEZING** Powder, Itching Powder, Eighteen other Tricks. Free with Catalog 25c. "Funmakers", 2404N15, Philadelphia.

**MARVELOUS** magic trick and new magic catalogue 25c. Newman's, Box 1020, Houston, Texas.

**200 ELECTRIC** Stunts, 110 volts, \$1. Cutting Sons, Campbell 3, Calif.

**STARTLING**, Bewildering Hindu Mystic Trick 10c! Postways, Box 5325-Z, Philadelphia 42.

**DOLLAR** Magic Set Free with Mammoth Catalog 25c. Mysto, 4462-E Germantown, Philadelphia.

**BE** a Magician. Large professional magic catalog of latest tricks, 25c. Ireland, F-109 North Dearborn, Chicago.

### 63 GAMES, ENTERTAINMENT

**FASCINATING** Vest Pocket Quoits. Played anywhere; home, camp, traveling. 50c, three for \$1.00. Crawfsales, 540 N. Laramie, Chicago.

### 36 COIN COLLECTING

**100 Diff.** Foreign Coins \$5.00, 2 Small or 1 Large Genuine Roman Coins 2000 years old. \$1.00 Lists approvals. DelMonte 40 W. 18, N. Y. 11.

**FREE!** Foreign coin, banknote and Coin Collectors' Illustrated Catalog to approval service applicants. Send 3c postage. Tatham Coin Co., Springfield-D50, Mass.

**COMMEMORATIVE** \$1/2 — Columbus, Washington, Cleveland, Stone Mountain, \$1.50 en. Illustrated Catalogue 25c. Norman Schultz, Salt Lake 9, Utah.

**FOREIGN** Coin Bargains. List free. Lyle Andrews, Box 677, Summer, Wash.

**COINS**, papermoney, checks, newspapers 1732-1800. Illustrated Catalogue 10c. Nagy, 8-R South 18th, Philadelphia 3, Pa.

**10000000** PENGU note, 25c. Ten other Hungarian inflation bills, \$1.75. Circular free. Beal, 402 Grand, Oakland 10, Calif.

**100 FOREIGN** Coins \$5.00. Parker Fogler 693 Mission, San Francisco 5, Calif.

**LARGE** cents—Indian Heads. Reasonable. Free lists. Hutchinson, 3463 "I" Street, Philadelphia 34, Pa.

**\$2.00 TO \$200** each paid for hundreds of Old or Odd Coins. Indian-Lincoln-Foreign Wanted. Keep all until posted. Send 20 Cents for illustrated Coin Value Book. 4 x 6. Guaranteed Prices. 40 years in business. Coin Exchange (1), Le Roy, N. Y.

**WILL** Pay \$10.00 each for certain Lincoln Pennies! Indianheads \$50.00; Dimes \$1,000.00. Catalogue 10c. Federal Coin Exchange, 5-PS, Columbus, Ohio.

**INDIAN** head cents 22 different \$1.00. Sayers, 219 S. Main, Winston Salem, N. C.

**FREE!** List of U. S. Coins sold at Bargain Prices! Carl Curcio, P.O. Box 11, Middle Village, N. Y.

**\$1500.00** FACE Value guaranteed in each mammoth packet of Japanese Philippine invasion currency. Large assortment. Hard-to-get 1,000 peso included! Price only \$1.00, Stewart Byers, Box 187, Rayville, La.

**3,000 BARGAINS:**—Antique Firearms, Indian Relics, Coins, Minerals, Flintlocks, Rifles, Pistols, Swords, Cartridges, Fossils. Illustrated catalog 25c. Heike, Wenona, Ill.

### 96 OLD STAMPS WANTED

**I WILL** pay \$100.00 each for 1924 1c green Franklin stamps, rotary perforated eleven (up to \$1,000.00 each unused). Send 6c for large illustrated folder showing Amazing prices paid for old stamps, coins, and collections. Vernon Baker, P-74 Elyria, Ohio.

**WHAT** have you to offer? A collection? A "Shoe Box" accumulation? Anything in stamps. We urgently need them. Spot cash paid. Cosmopolitan Stamp Co., 1457 Broadway (Times Square), New York.

**FOR** Sale: 1893 Columbian Half Dollar, 65c; Fifty assorted Indian head cents, \$1.00; Fifty Foreign coins, \$2.00; Large U. S. Catalog, 25c; Foreign catalog listing copper, silver, gold, 50c. Ben's Coin Shop, 72 West Washington, Chicago 2, Ill.

**WORLD** Coins 25 different \$1.00. Harry Elsholz, Box 9014, Pittsburgh 24, Penna.

### 127 STAMP COLLECTING

**WORLD'S** Largest Diamond And Triangle Stamps, Free Stamp Magazine. Stamps from Fighting Free French. 20 stamps from 20 different Countries. Pictorials, Airmails. Big Bargain 5c with approvals. Capital Stamps, Dept. 10, Little Rock, Ark.

**BRITISH** Empire! 55 Different including Batum, Burma, Cyprus, Gwalior, Tasmania. 5c to Approval Buyers. Lyman, 97 Nassau St., New York 7.

**FREE**—Canadian Sets Royal Visit, George VI, George V, Coronation, Jubilee, others, to approval applicants. Ensign, Box 118-P, So. Orange, N. J.

**DEALER'S** Wholesale Catalog. Postage 3c. Franksco, 5031 Queensbury, Baltimore, Maryland.

**WOW!** \$10.00 Worth Of Fun Only 10c. What a treasure hunt! Big package 500 Foreign Stamps—just as received from foreign missions other sources. Includes stamps from Africa, South America, Philippines, Free French, Cape Juby, Palestine, etc., including airmails, commemoratives, and stamps worth up to 50c and 75c. This amazing offer is given for 10c to serious approval applicants only. One to a customer, money back if not more than delighted. Jamestown Stamp Co., Dept. 5, Jamestown, New York.

**AIRMAILS** of World—19 different including Bolivia Triangle, World's Fair, Commemoratives, new issues 5c with approvals. Continental Co., Dept. C, Box 639, New Rochelle, New York.

**50 DIFFERENT** including scarce diamond-shaped airmail 3c to approval service applicants. Avalon Stamp Co., Dept. S, Springfield 8, Mass.

**\$2000** IN Stamps free to Contest Winners. Particulars, entry blank, to approval applicants enclosing only 10c for scarce Roosevelt Mourning Stamps from Nicaragua, Greece & Argentina, plus photograph of "Roosevelt Collecting Stamps." National Stamp Sales, 276 R, West 43rd St., New York 18, N. Y.

**ROUND** The World Colonies, British, Dutch, French, Portuguese, strange little known countries, primitives, cannibals, etc. All for 3c to Approval Buyers. Dixie Stamp Company, Dept. 11, Milwaukee 1, Wisc.

**118** Different Stamps including Commemoratives, Charities, Airmail, surcharges, Sets etc. Only 3c to approval buyers. Badger Stamp Company, Dept. S, Milwaukee 3, Wisc.

**TREMENDOUSLY** Popular, virtually certain to rise to value, is Nicaragua's Roosevelt Memorial Issue, picturing Roosevelt Collecting Stamps, Conferring with Churchill at Atlantic Conference, and Signing Declaration of War against Japan. Three handsome genuine unused stamps (Nos. 695-7) that every collector wants! Special price, with attractive approval selection, only 10c! Garcelon Stamp Company, Box 818, Calais, Maine.

**BRITISH**, Spanish and French Colonies, Vatican, Hitler heads, and airmail packet, free with approvals. Pan-American Stampco, Box 145, New York 33, N. Y.

**FREE**, Irish Commemorative Collection, Including Dramatic Easter Rebellion Issue With Approvals. Raymax, 123-X William St., N. Y. C.

**FINE** Approvals, freshly mounted. Fast, personal service. Tell me what countries you prefer and I'll send their stamps. Milton Skinner, 438 Locust, Long Beach 2, Calif.

**UNITED STATES** Price list. Send Postage. State Stamp Corp., 1225 Park Bldg., Pittsburgh 22, Penna.

**UNITED STATES** approvals complete coverage fine quality, attractive prices. Seminole Stamps, Box 378, Coconut Grove, Florida.

**FREE** U. S. Price list postage 3c. M. Hanna, 335 5th Ave., Pittsburgh 22, Pa.

**FREE!** Negro Triangle; Turks Islands "Cactus"; Dakar; Guinea; Palestine; "Fairy Tale", Pirate Chart, Map, Ship, Sea Lion and Snake stamps; French, British, Portuguese Colonies, etc., Free for 3c postage. Approvals. Potomac Stampco, Washington 10, D. C.

**FREE**—Abyssinia, Cayman Islands, Tuna Triangle, Indochina, Syria, Ivoire, Philippines (Jap "Shame" issue), Turkish Harem, Damascus, Cambodia, African "Beauty," Pirate Islands, Colonials, others —All Free for 3c postage with approvals. Belmont Stampco, Washington 10, D. C.

**50 DIFFERENT** United States 10c. Price list free. No approvals. Seidenberg, Cassopolis, Mich.

**1,000 GRABBAGS**, 15c each. Special Bags 25c. Sandy, 630 Bingaman, Reading, Pennsylvania.



**FREE**—Famous Americans Set, plus Flag Set, plus the National Parks set, plus the Presidential Set to the \$5. A total of 90 stamps absolutely Free to customers for our unsurpassed United States or Foreign selections. Send 3c postage for 15 of the above mentioned stamps and full particulars. Triboro Stamp Company, 145 Nassau Street, Dept. 203, New York.

**FREE**—pick 25c worth of stamps from our first U. S. approval selection. Special illustrated Lists included. S. D. Engel Co., 38 Park Row, New York City.

**POSITIVELY** Greatest free offer—Latest Scott's International \$5.00 stamp album—covering entire world, contains 36,000 illustrated descriptive spaces; Scott's 1947 Standard \$5.00 catalogues "Philately's Encyclopedia"—absolutely free to applicants for foreign approvals becoming customers. Bargain Stamp Service, Palm Springs, California.

**FREE**—Liberia Triangle, set Hitler Stamps, Half-Stamp Triangle, Devils Island, others. Approvals. Postage 3c. Pilgrim, 6404 Old Harford, Baltimore 14, Md.

**31 DIFFERENT** with George Washington Stamps from Brazil and Ecuador; Pirate Island; Victory issue; Medical set; others—all 4c with approvals. Grayson Stamps, Sherman, Texas.

"50 different China, 5c with approvals. Gross Stamp Company, 1330 E. 28th St., Brooklyn 10, N. Y.

**200 DIFFERENT** stamps, 6c, to approval service applicants. Tatham Stamp Company, Springfield 50, Mass.

**GIBRALTAR** Packet Free—Nice collection Gibraltar—New Zealand Centennial—British Uganda—French Colonials—Early British Colonial—West Indies—South American—War stamps plus Philatopic Monthly Magazine. All for 5c postage. Empire Stamp Co., Dept. P R, Toronto 5, Can.

**MAMMOTH** Bargain: Seychelles, Inhambane, Albania, Bolivia, Dominica, British Colonies, Latin American and over 100 different others for 10c to approval applicants. Erhard, Bohemia, N. Y.

**PENNY** Approvals that satisfy. Neil Gronberg, Box 5441S, Philadelphia 43, Pa.

**V-J Day Cover** Free with approvals! Miami Stamp Company, Box 2437, Miami 14, Florida.

**25 DIFFERENT** Stamps 10c. Tunis And Carpenter, Wakeman Ave., Newark 4, N. J.

**OLD** scarce U.S. Seconds on approval. Slightly defective, nice appearance, bargain prices. Hearnfeld, 551 Clinton, Newark 8, N. J.

**RICH** Man's approvals, poor man's prices. Grand value packet containing five Foreign sets. Free with approvals. Stoll Stamp Service, 2632 W. Burnett, Louisville 10, Ky.

**WEEKLY** Philatelic Gossip, Holton 1, Kansas. Stamp collector's magazine, \$2.00 year. Sample 10c. Published since 1915.

**10 DIFFERENT** U. S. Over 40 Years Old, 5c. Foreign, U. S. approvals. Scott, 22 Middle St., Lexington 73, Mass.

\$1.00, \$2.00, \$5.00, U. S., Free with approvals. Alco, Box 57, Miami 35, Fla.

**24c** PRESIDENT Harrison. Don't miss this scarce stamp. Only 5c with United States and foreign approvals. Willet Stamp Co., Box 507 P, Port Chester, N. Y.

**U.S.** \$5. Stamp given free. Approvals sent Bala Stamps, Bala Cynwyd, Pa.

**AIRMAILS**, Hitler Heads, free to approval applicants, Lee Box 1966 Miami, Florida.

**EXCHANGE** your stamps, send 65 different and dime, receive 65 different. Agnes Stamp Exchange, 169-09 116th Avenue, Jamaica 5, N. Y.

**MOZAMBIQUE** Free to serious approval buyers. Write for details, Detroit Postage Stamp Co., Detroit 23, Mich.

**NETHERLANDS** War Set 10c with attractive approvals. Rheume, 8949 Routhier, Montreal 12, Canada.

**STAMPS** from 40 countries including Fiji 10c. Elzea, Bowling Green, Ohio.

**UNITED STATES** Collection 104 Different Commemoratives, including Columbians, Pan-American, Pan-Pacific, Bicentennials, Parks, Famous Americans. Price \$1.00 Approval Applicants only. Fort Orange Stamps, Albany 3, New York.

**UNITED STATES** and Foreign stamps sent on approval; outstanding quality, low prices. Fred Herzberg, PS 168 Oak St., Elmhurst, Ill.

**UNITED STATES**, #283B, #294, #429, #438, #511, #549. Send 50c. Approvals accompany. Whiton-Stamps, Westport 1, Connecticut.

**100 DIFFERENT** U. S. Revenues, only \$1.75. Kaye, Beaumont, Springfield 8, Mass.

**MONTENEGRO** Colorful pictorial set, 10c with approvals. Vargo Stamps, 6044 South Fairfield, Chicago 29, Ill.

**FREE!** Fifteen Beautiful Pictorials to applicants for approvals. Georgian Stamp Shop, Box 1913, Atlanta, Ga.

**FREE!** Amazing "Queer Countries" Assortment! Peachy Approvals! Saxon, Walden, New York.

**BET** You Haven't These! South Georgia, South Orkneys, Grahamland, South Shetlands—Shortlived Falkland Dependencies—Everything 3c with approvals. Viking, 130-PP Clinton St., Brooklyn, N. Y.

**PROTECT** Your Stamps with Crystal-Mount. Send for free samples. Harris & Co., 204 Transit Bldg., Boston 17, Mass.

**TEN** beautiful mint stamps free with approvals. Cornell Stamps, Box 4259, Miami 26, Florida.

**AIRMAILS**, British colonies, free with approvals. Granada Stamps, 4891 S. W. 5th St., Miami, Florida.

**FRENCH**, Portuguese, Spanish colonies, free with approvals. Hill Stamps, Box 732, Woodmere, N. Y.

**AMAZING** offer! 5—5c sets—5c with approvals. Lawrence, Box 1616, Hartford 1, Conn.

**WHOOPIE!** Wowie! 25c worth of U. S. stamps free! No obligations! Write: M & N Co., 742 Sheffield Ave., Brooklyn 7, N. Y.

**FREE** Vatican Cardinal set five values to approval applicants. Wesken Stamp Company, Box 66P, Queens Village, N. Y.

**FREE**—World-wide stamps with first approvals. U. S. want lists Solicited. Peter Nerger, Palisade, N. J.

**U. S.** commemoratives—60 different—25c. Crystal Stamp Co., Racine, Wisc.

**MISSION** Mixtures—U. S., 50c lb.—foreign, \$1.00. Stamps, Box 64, Racine, Wis.

**66 STAMPS** from 33 countries 10c. Garrow, 84 Montevista, Chula Vista, Calif.

"**STAMP** Magazine—World's friendliest! Copy free!! "Stamp Post", Station A, Pasadena, Calif."

**150 DIFFERENT**, 5c. Approvals. Best Stamps, Box 139, Bangor, Maine.

**MAGNIFYING** glass with plastic handle, 10c! To Foreign or United States approval applicants only. Elliott Stamp Company, Box 51, Miami Beach 39, Florida.

**WORLDWIDE** Different: 200-25c; 500-60c; 1000-\$1.50. Beacon Sales, Maynard 3, Mass.

**MEXICO** Mixture—plenty of pictorials, 400 for \$1.00. Biehl, Apartado 2887, Mexico City.

**ABSOLUTELY** Free! Scarce airpost stamp (guaranteed genuine—Catalog Price 50c!) and illustrated "Get-Acquainted Folder" describing other free stamps given with our valuable publications. H. E. Harris & Co., 204 Transit Bldg., Boston 17, Mass.

**VALUABLE** Catalogs 10c each: (1) "United States, Possessions & Brit. N. American" complete with 1000 illustrations; (2) "Airmail Stamps"; (3) "British Empire"; (4) "Modern Europe". Each catalog 128 or more pages, profusely illustrated, wonderfully informative, economical prices. H. E. Harris & Co., 204 Transit Bldg., Boston 17, Mass.

**BOLIVIA** Music set, Greek Occupation of Albania. Air mail packet. Free to approval Applicants. Middleton Stamp Co., Elmhurst, N. Y.

**MINT** National parks \$1.00 approvals sent. Louis Merrill, 1623 5th, Portsmouth, Ohio.

**PENNY** Approvals. Name and address on postcards brings large selection. Franklin Stamp Co., Box 631, Indianapolis 6, Ind.

**ATTRACTIVE** Mint packet free with approvals. Harvey Stamps, 2746 S.W. 15th Street, Miami 35, Florida.

**BEAUTIFUL** French Colony packet free with approvals. Gulfstream, 409 Professional Bldg., Miami 32, Florida.

**50 GERMAN** Hitlers & Swastikas 50c. Buckey, PS-208 Ludlow Bldg., Dayton 2, Ohio.

**FIVE** Vatican City Stamps Free to approval applicants. Florida Stamp Co., Box 807, Miami 5, Fla.

**100 STAMPS**, Album, Hinges—20c. Box 6618, Northeast, Kansas City, Mo.

**BERLIN** Bears Complete set of eight and 100 different stamps only 10c to approval applicants. Reich Stamp Co., 4647 Kenmore, Chicago 40, Ill.

**FREE!** 25 Different Foreign. Mostly pictorials. Approvals. Streiner, 898 East 75, Cleveland 3, Ohio.

**20,000 DIFFERENT** 1c-5c each! Gordon Davison, Box 1019A, Manchester, N. H.

**COLOSSAL** Bargain! Includes Falklands, Fiji, Gilberts, Stratosphere Stamp, 3 different Abyssinia, Airmails, numerous others. Everything 10c to approval applicants. Neal, 1604 Franklin, Cedar Falls, Iowa.

**HIGH** Grade approvals covering many countries are available to serious applicants. Name your favorites. Continental Stamp Co., Box 471, Elizabeth 3, N. J.

**FREE!** San Marino C41-3\*, 1/2c up approvals. Marjay, Box 14, Station B, Brooklyn 16, N. Y.

**BIGGER**, Better, Pleasingly priced Foreign Approvals. Inter-Continental Stamps, Englewood 4, Florida.

"**GOYA** Nude" set, cataloging \$1.05, complete 40c. Approvals. Royal Stamp Company, Tamaqua 2, Penna.

**100 DIFFERENT** world 50c (coin) including airs and new issues. Knopp, Box 1381, Bristol, Conn.

**FINLAND!** 20 different, including several recent commemoratives. Only 10c with approvals. Wollaston Stamps, Wollaston 70, Mass.

**WRITE** today for our better U. S. approvals. Box 488A, Minneapolis.

**EXOTIC** Pictorial collection: Tahiti spearfishing, Melanesian idol, Ingavi battle, Reunion, Madagascar, St. Pierre Miquelon, Djibouti, Wurttemberg, Dutch Indies, Newfoundland, many others. This outstanding offer only 5c. Imperial, Box 1491, Tampa, Florida.

**U. S. Mixture**; 1000 25c, One pound \$1.00. Tarrago, 60 West 66, N. Y. C.

**25 SCANDINAVIA** 10c with approvals. Bjorn Nielsen, Monmouth 1, Maine.

**BEAUTIFUL** Iceland packet free to approval applicants. Everglades Stamps, Box 3222, Station F, Atlanta, Georgia.

**MAGNIFYING** Glass—Fifty different, 10c. Approvals. Buchanan, 307 East 23rd, New York 10.

**SMOKY** Mountain Commemorative Souvenir sheet and 30 different U. S. stamps, including commemoratives, Airmail, etc. (catalog value exceeds 65c) for 10c to approval applicants. Curhan Stamp Co., Dept. 1, Gloucester, Mass.

**U. S.—Foreign** approvals. Monthly Auctions. Riffles, 211 Jefferson, York, Pa.

**YOUR** Money's Worth! Seychelles, Djiboute, Angola, Chinese Hunger Stamps and over 100 different other stamps. Everything 10c to approval applicants. Atlas Stamps, 4220 West 16th., Dept. M, Little Rock, Ark.

**CHINA** 20 Colorful Historical Stamps 10c with approvals. Collins', 71 Coleridge, San Francisco 10, Calif.

**25 DIFFERENT** Switzerland 10c with 1/4-1/2-1c Approvals. Carroll's, 4357-C S. Hoover, Los Angeles 37, Calif.

**55 DIFFERENT** Liberia Triangle, Russian "Berlin Bear", others, 5c. Approvals. Iroquois, Box 53-P, Baltimore 5, Md.

**BIG** packets, all different stamps, 10c each (11 for \$1) 30 Asia; 30 Belgium; 50 British Colonies; 50 Denmark; 50 France; 40 Hungary; 30 India; 50 Italy; 25 Norway; 25 Portugal; 30 South America; 25 Spain; 30 Sweden; 25 Uruguay. Longacre Shop, 100-C West 42nd., New York City 18.

**COSTA** Rica Triangle Diamond-Shaped set 10c with approvals. Arnold Herman, 539F East 54th St., Brooklyn 3, N. Y.

**LIBERAL** Offer, thick packet with Seychelles, Gilberts, Reunion, Inhambane, Mozambique, Inini, Porto Rico, Philippines and multitude others, everything 10c to approval applicants, Burmaster, Box 1910-k, Los Angeles 53, Cal.

## 70 HOBBIES, COLLECTIONS

**JEWELRY** stones removed from rings, etc., 100 assorted \$2.40; 50 large ones \$2.40. B. Lowe, Holland Building, St. Louis 1, Mo.

**EXCHANGE** Your duplicate stamps, match covers, or any hobby, with collectors everywhere! Exchange register listing swappers, 10c. (Mention Hobby). World Hobby House, Box 721-B, Olympia, Wash.

**MAILETEERING!** Brand new hobby complete details 20c. Paradox Service, 7501 Woodhaven Ave., Cleveland 9, Ohio.

**INVENTING** can be an interesting and profitable hobby. Write for complete particulars. Institute of American Inventors, Dept. 30-E, 2926-Eye St., N. W., Washington 6, D. C.

**MATCH** Cover Collectors! Stunning 8 1/2 x 11 album, maroon Spanish-grain leatherette cover. Automatic refillable binder. No paste needed. Slit pages, loose-leaf, interchangeable. Holds 500 match covers. \$2.00 postpaid. Frederick Beach, 200 Fifth Ave., New York 10, N. Y. Copyrighted material



**CAMPAIGN Ribbons—Beginner's Pack-**  
age—Introductory Price—50c. Contains 15  
Assorted Ribbons. L.H.G. Company, 19 E.  
16 St., New York 3.

**KLONDIKE! For Hobby Jewelry Makers!**  
Novelty Jewelry Findings from tables of  
large manufacturers—parts for Bracelets  
—Pins—Earrings, etc.—unfinished. Chains  
—Rings—Pins—Stones—Clips—Beads  
—many other items—1 lb. Bags—\$2.00 Per  
Bag in 5 Bag lots. Sample Bag—\$3.00.  
Prepaid only. Mdse. Distributing Co.,  
Dept. PS, 19 E. 16 St., N. Y. 3.

**LEATHERWORKER'S Bible.** Every  
leatherworker should own one. An illus-  
trated catalogue, combined with valuable  
instructions and information. Actual  
leather samples. Get your order in early.  
\$1.00 postpaid. Satisfaction guaranteed.  
Artcraft Leather of California, 271  
Twelfth St., Oakland 7, Calif.

**TWENTY California Sea Shells \$2.00.**  
Free lists. John Burch, 4206 Halldale,  
Los Angeles (37).

**SELL Rocks!** Let "Mother Nature" fi-  
nance your sparetime enterprises. De-  
tails, other hobby offers, Free! MacCamp-  
bell, Calexico, Calif.

**PUT a Ship into a Bottle.** Anyone can do  
it. Instructions and Material for Hull and  
Spars \$1.00 (No stamps). Capt. Cobb, Box  
825, Hyannis, Mass.

**UNUSED Match Book Covers, 100 all**  
different \$1.00. 35 Royal Flash Covers  
\$1.00. Free list. Charles Edelman, 1311 P  
East 84, Cleveland 3, Ohio.

**SWAPPER? Collector?** Send 25c for  
sample copy, "Hobbyswap Contacts." 1326  
South 27th, Omaha 5, Nebraska.

**SWAPPERS' Hobby Bulletin!** Whatcha  
got? Whatdye Want? Trial two dimes, 128  
Royal Oak, Mich.

**INTRODUCTORY Offers:—10 Officers**  
Insignias 25c; 22 different American or  
15 different foreign—\$1.00. 10 different  
Metal Collar Insignias our choice—\$1.00.  
Illustrated catalog 10c. Hobbyguild, 35X,  
West 32nd St., New York.

**296 COLORED Illustrations;** new book  
"Foreign Medal Ribbons" \$1.00. Foreign  
Campaign Bars, Insignia, lists, samples,  
20c Packets, \$1.00. Insigniacraft, 236 28th  
Ave., N.W. Calgary, Canada.

#### 107A POTTERY & CERAMICS

**ILLUSTRATED instructions, Material**  
and supply sources, send \$1.00. Theron  
Brown Studios, 905 S. W. 9th Terrace,  
Ft. Lauderdale, Florida.

#### 8 ANTIQUES, RELICS, INDIAN GOODS

**EARLY American Indians method of**  
chipping flint arrowheads and spear points.  
Illustrated instructions \$2.00. Glass may be  
used in place of flint. Box 96, Palisade,  
Colo.

**ANTIQUE Firearms, swords, daggers,**  
powder-horns, flasks, tomahawks, cata-  
logue 10c. Nagy, 8-PS South 18th, Phila-  
delphia 3, Pa.

**4 FINE ancient arrowheads \$1.00.** Stone  
Tomahawk \$1.00. List free. Lear's, Box  
569, Galveston, Texas.

**ANTIQUE-modern pistols, revolvers,**  
swords, daggers, armor, 174-page illus-  
trated catalog 50c. Robert Abels, 860 1/2  
Lexington Avenue, New York 21.

**3,000 BARGAINS:—Antique Firearms,**  
Indian Relics, Coins, Minerals, Flintlocks,  
Rifles, Pistols, Swords, Cartridges, Fossils,  
Illustrated Catalog 25c. Heike, Wenona, Ill.

#### 40 CURIOS

**HOBBY Catalogues 10c.** Biological cu-  
rios, Mexican novelties. Quivira Special-  
ties, Topeka, Kansas.

#### 85 MINERALS & PRECIOUS STONES

**METAL Detectors—We have the latest**  
in circuit and mechanical design plus the  
know how. Free Literature. Hedden Metal  
Detectors, 538 North Homewood Avenue,  
Pittsburgh 8, Penna.

**MINERAL and Fossil Collectors! Read**  
The Earth Science Digest. Sample Copy  
25c. Dept. PSM, Box 57, Omaha 3, Nebr.

**GEMS, precious and semi-precious, all**  
genuine from world wide sources. Deal di-  
rect, no overhead, save money. Catalog  
10c. Hill Co., Route 7-K, Salem, Oregon.

**OBSIDIAN small stones 50c, large \$1.00,**  
red and black \$1.00 per pound plus post-  
age. Charles Richards, Box 556, Jackson,  
Wyoming.

**FIFTY mineral specimens, boxed, mount-**  
ed, identified, described. Postpaid \$4.00.  
Old Prospector, A-58, Dutch Flat, Calif.

**MINERALS—Gems, Cutting, specimen.**  
Low prices. Free list. Plummer's, 5068  
Brighton, San Diego 7, Calif.

#### 26 CAMERAS, PHOTO SUPPLIES

**CASH! Spot cash for cameras, lenses,**  
binoculars, movie and still equipment.  
Send full description for prompt cash  
offer. Over 36 years of dependability. Bass  
Camera Co., Dept SP, 179 W. Madison  
St., Chicago 2.

**USED Camera Directory, Box 1031-K,**  
Canton, Ohio—lists hundreds of War-Bar-  
gain Used Cameras—35mm, Speed Graph-  
ics, Kodaks, Rolleiflex—many others. Send  
25c for latest issue.

**BASS Says: Trade Cameras? For 36**  
years Finest equipment available. Always  
Satisfaction Guaranteed Or Your Money  
Back! Bass buy 'em, trades 'em. Bass  
Camera Co., Dept. SP, 179 W. Madison St.,  
Chicago 2.

**PHOTOGRAPHIC Equipment, Terms,**  
Catalogs, Film Rentals, Dayton Film, 2227  
Hepburn, Dayton, Ohio.

**ELECTRONIC Timer Kit—1 to 80 sec-**  
onds—all parts, cabinet, simple instruc-  
tions—2 hour assembly—Mail \$9.95 Now.  
Marcus—15 Ashford St., Brooklyn, N. Y.

**PHOTOGRAPHY for pleasure or profit.**  
Learn at home. Practical basic training.  
Long established school. Write for booklet.  
American School of Photography, 1315  
Michigan, Dept. 1741, Chicago 5.

**CAMERAS—movie projectors—enlargers**  
—free catalog. Cavalier Camera, 1822 Cen-  
ter, Pittsburgh 19, Pa.

**CAMERA Repairing—Shutters, bellows,**  
rangefinders, synchronizers, Ship camera  
for estimate. 48 hour service. COD's ac-  
cepted. Nree Bargain Circular, Jackson  
Laboratories, 27-JA Gore, Webster Groves  
19, Missouri.

**SAVE \$5.00 by assembling Kimac Photo**  
Slide and Stamp Viewer yourself. Finest  
made! Brilliant two-eye, three dimension,  
undistorted image. Dual ground and pol-  
ished 3 1/2" lenses, focusing. All electric.  
All-metal. Retail for \$22.75. You can as-  
semble in a few minutes and save \$5.00.  
Just send \$17.75 (check or money order)  
and we will send you all necessary parts  
and instructions. For 2 x 2 slides, 35 mm  
and 120 film. Satisfaction Guaranteed.  
Offer for limited time only. Address Dept.  
PS-4, Kimac, Old Greenwich, Conn.

**ART Studies of Hollywood's most beau-**  
tiful models! 350 masterpieces of the fe-  
male figure! For adults only! 2x2 Color  
Slides for projector or viewer, 10 for \$3.00,  
100 for \$25.00. 35 mm Fine Grain Neg-  
atives for salon quality enlargements, 10  
for \$1.00, 100 for \$8.00. All Different! Color-  
craft, 1302 Broadway, Burbank, Calif.

#### 102 PHOTO FINISHING

**8 EXPOSURE rolls developed, 1 print**  
each and one enlargement coupon 25c. Two  
each and coupon 35c, 3 each and coupon  
40c. Reprints 3c. Fred A. Eastman, Bode,  
Iowa.

**NEW Color Process makes full color**  
prints from black and white film or  
negatives. Send dime for Sample. We have  
Films. Midwest Photo, Janesville 27, Wis.

**BIGGEST \$1.00 value in 35 MM finish-**  
ing today. 36 exposure fine grain 3 1/4x4 1/2  
enlargements; deckled, embossed margin  
and date. Eighteen exposures 75c; 16 ex-  
posure splits 55c; 36 exposure reloads 50c.  
Special: return this ad with \$2.00 and we  
will send five 36 exposure reloads. Free  
mailers. 8 exposure rolls in beautiful,  
Deckled contact finish with embossed wide  
margin. 25c. Mailbag Film Service, Box  
5440-A, Chicago 80.

**PHOTO statuettes \$1.00.** Send negative,  
money. Suburban, 1410-S Bond, Rock-  
ford, Illinois.

**8 PRINTS, all enlarged to nearly post-**  
card size, from your roll or negatives, 25c.  
Willard's, Box 3506F, Cleveland, Ohio.

**SENSATIONAL Introductory Offer!** Send  
snapshot or negative, this ad and 3c. We'll  
send you a beautiful 7 x 5" enlargement!  
Or, Kodak roll developed and printed  
(with free coupon) only 25c; or 8 Giant  
prints from roll, 30c. Reprints from neg-  
atives—any quantity—regular size, 3c;  
Giant size 4c. Candid rolls—36 exp. 35mm  
developed, vaporated, enlarged to 3 x 4,  
\$1.00, 18 exp. 50c. Free Mailers, Free Pre-  
mium offers sent on request. American  
Studios, Dept. 365, Lacrosse, Wisconsin.

**ANY size roll developed and 4 x 6 or**  
3 1/4 x 4 1/2 oversize glossy Velox prints; 8  
exposure 30c, 12 exposure 45c, 16 exposure  
60c. Clemet Photo Service, 1318 W. Colum-  
bia Ave., Philadelphia 22, Pa.

**ROLLS Dev & Printed Giant size 30c.**  
Reprints 3c. Thrifty, Box 688, Sta. H.,  
Los Angeles, Calif.

**8 BEAUTIFUL Double Size pictures and**  
roll developed 30c. 8 hour service. Free  
Mailers, Pacific Photo Service, Box 666,  
San Francisco, Calif.

**UNIVEX Mercury film finegrain devel-**  
oped, beautifully enlarged 3 1/4 x 4 1/2 glossy,  
65 exposure roll \$2.58, 32 exposure roll  
\$1.31. Fresh 65 exposure film 45c. accesso-  
ries stocked. Spiratone, Dept. (SC), 49 W.  
27 St., N.Y.C.

**PHOTOGRAPHY for pleasure or profit.**  
Learn at home. Practical basic training.  
Long established school. Write for book-  
let. American School of Photography,  
1315 Michigan, Dept. 1722, Chicago 5.

**GORGEOUS 4x6 enlargements complete**  
roll .30. Photo Service, 107 Dewey St.,  
Newark, N. J.

**ROLL developed and 8 prints 30c.** Over-  
night Service. Free Mailers. Tri-Plex Photo  
Service, Box 375, San Francisco, Calif.

**PERSHING Studio-Salon quality en-**  
largements-Tinting-Toning-Copying-Rolls  
developed. All work done personally. Free  
5x7 enlargement with first order. 5503  
Oregon Ave., Baltimore 27, Md.

**16" x 20" ENLARGEMENTS—\$1.00.** Any  
size negative, 35mm up. Matte or glossy  
paper. Cropped, moderately dodged. From  
picture 50c extra. 11 x 4, 14 x 11 "s—\$1.00.  
Postage 25c. Free Bargain Circular. Jack-  
photo, 27-JA Gore, Webster Grove 19, Mo.

**50 REPRINTS \$1.00, 5 new rolls 127,**  
\$1.10, 120—620, \$1.40; 616—116, \$1.60,  
Camera Shop, Albany, Wisconsin.

**YOUR films deserve expert attention.**  
Quality Photo Finishing Deckle Edge Velox  
paper. Any 6 or 8 exposure roll 25c; con-  
tact size 35c jumbo size. Send for free  
mailers. Mail-Back Photo Service, Box  
505, Buffalo, New York.

**8" x 10" HAND colored framed enlarge-**  
ment from negative or photograph \$1.50.  
Rolls developed, 8 prints 25c. Promenade  
Photos, Sta. D., Box 198-A, New York 3.

**ENLARGEMENTS 5 x 7—10c; 8 x 10—**  
25c; National Film Service, 3111 West Tus-  
carawas, Canton, Ohio.

#### 100 MOTION PICTURES, SOUND EQUIPMENT

**FIVE Slide Views—Oldest Convict Ship**  
afloat 25c. Slide Supply Service, 3111  
West Tuscarawas, Canton, Ohio.

**HOLLYWOOD Films! Sample and cata-**  
log 10c. Stone, Lunenburg 10, Mass.

**UNUSUAL home movies: Travel, advent-**  
ure, sports, comedies, Silent-Sound.  
Many film bargains. Big illustrated 1947  
catalog, sample-dime. Audet, Box 6520-  
AG, Philadelphia 38, Pa.

**MOVIE Camera Films, 100' 16mm \$2.50.**  
25' double 8mm, \$1.25. Free Developing.  
Better Films, 742 New Lots, Brooklyn 7,  
N. Y.

**GUARANTEED Fresh anti-halo outdoor**  
movie film! Weston 12 Daylight load-  
ing! Processing free! Three spools Double  
8mm, \$3.45! Six single 8mm for Univex,  
\$4.60! Postpaid! Catalog. ESO-S, 828-A,  
West 39th, Kansas City 2, Missouri.

**8-16mm SILENT-sound films. Complete**  
rental library. All latest subjects. Free  
catalogue, (sample film 10c). Garden Film,  
317 W. 50th. N. Y. 19.

**EXCITING Film.** For artistically pre-  
sented subject, "Exciting Stars in Action",  
starring glamorous girls, send only \$1.  
State 8-16mm. Exciting Films, 1071 El  
Centro, Dept. E, Hollywood, Cal.

**YOUR favorite movie film enlarged**  
beautifully! 5 x 7 Photograph \$1.00 each.  
Artcraft, 1600 Coney Island, Brooklyn 30,  
N. Y.

**DEVELOPING outfit for 8-16mm movie**  
film. Free literature, instructions. Duro  
Movie Products, 1519 Eggert, Eggertsville  
21, N. Y.

**KODACHROME Movies — (8mm-16mm)**  
Travel, glamour Projection length Koda-  
chrome sample. Dollar. Campus Films,  
668-C, Ithaca, N. Y.

**MOVIE Equipment, Terms, Firm Ren-**  
tals, Catalogs, Dayton Film, 2227 Hepburn,  
Dayton, Ohio.

**8-16 35mm Silent Sound Films, Projec-**  
tors. Bedner, 5300 So. Talman, Chicago.

**"KAMIKAZE Attacks!" "Miss America",**  
"Starlet Revue", "Waikiki Hula", many  
others in full color. Projection length, 2  
scene sample, any of above, only \$1.00.  
Big catalog, 25c. Specify 8mm., 16mm.  
World In Color, Box 392-KA, Elmira, N. Y.

**FREE! Six-Months Subscription, Ama-**  
teur Screen Photography, 3021B Narragan-  
sett, Chicago 34.

**SIMPLEX 35mm Sound Projector Com-**  
plete. \$600. Box 163, Shawano, Wisc.

**FREE for the asking, big catalog of**  
Camera Film, Rental Library subjects. If  
you take or show movies you need this  
book. Solar, 4247 South Kedzie, Chicago 32,  
Ill.

**FASCINATING Home Movies. Free Cata-**  
log. Loja, Box 74-G, Station B, Brooklyn 16.



**CHILD Is Born By Caesarean Delivery.** The outstanding home movie production. Project it free. Send postal card immediately. Preferred Movies, Hamilton 10, Ohio.

**UNUSUAL Movie!** "Temptation" featuring beautiful Models. 126 ft. 16 mm \$5. 63 ft. 8mm \$3. C.O.D.'s accepted. Fine Arts Productions, (PS) Box 2084, San Antonio 6, Tex.

**16mm MOTOR Driven Projectors—\$16.00**—Up. Selco Products, Denver, Mass.

**FRESH Movie Film 100' 16mm \$2.25.** three rolls \$6.00. 25' double 8mm \$1.25 developing included. Ambassador, 479-A Quincy St., Brooklyn, N. Y.

**DISTRIBUTORS** wanted. Make big money selling our new 16-mm sound specialties. Send \$10.00 for sample movie and our free wholesale price list. Standard Pictures Corp., Dept. B, Universal City, Calif.

**BARGAINS:** 16mm., 35mm. movie cameras, projectors. Avond, 24 West 46, New York.

**16mm SHOWMEN!** Good sound features \$9.00 weekly. Free catalogue! Popular Pictures, Traverse City, Mich.

**OLD time movies 16mm sound silent comedies, westerns, dramas, Jubilee, 723 7th Ave., New York.**

**FREE, 1947 Movie Catalog, Samples 10c.** Can ship promptly; photographic supplies. Goodwill Company, Jackson, Tenn.

**"THE World's Greatest Passion Play"**. All sizes. Rent or Purchase. Write Hemenway Film, 33 Z Melrose St., Boston 16, Mass.

**HOME Movies, Rent-buy-swap 8/16mm** silent and sound at money-saving rates. Details for a dime. Midland, Box 429, Oak Park 3, Ill.

**SOUND movie projectors immediate** delivery new, used. Gallagher Films, Green Bay, Wisconsin.

**ART model films 16mm rentals** exclusively, adults list. Enclose stamp. Revere Films, Box 1051, Detroit 31, Mich.

**JIU Jitsu movies, How to throw a tough,** 8-16mm. Free list. Stone, Rm. 904-A, 1472 Broadway, N.Y.C.

**LEARN movie projection, management,** Free catalog. Theatre School, Elmira, N.Y.

## 92 MUSIC, MUSICAL INSTRUMENTS

**SONGWRITERS:** Send poem. (Any Subject). For Free Examination and outstanding offer. Write for Free Instructive Booklet outlining opportunities. Recordings Furnished. United Music Service 140, Salem, Indiana.

**WOULD you like to buy a hard to get** Musical Instrument that could not be told from new. For Less? Send for Catalog. Listing Accordions, Guitars, Cornets, Trombones, Clarinets, Saxes, Vibraharp, and many more. Harden's Musical Merchandisers, Marion, Ohio.

**ATTENTION Fine Harmonicas \$2.00,** \$2.90; Double \$5.00, \$7.75, \$9.75, \$14.75; Chromatic \$20.00—Guitars \$12.00, \$18.00, \$25.00, \$45.00—Drums \$15.00, \$25.00, \$45.00—Trumpets \$75.00, \$100.00—Accordions \$75.00, \$100.00, \$175.00, \$250.00—Clarinet, \$95.00—Bass Violin \$195.00. Musician's Shop, 2 E. Centre St., Baltimore 2, Md.

**LEARN Piano Tuning, Prepare for** Career in fascinating profession, \$5000 year easily earned. Real security, pleasant easy work. No profession Paying so well can be mastered so quickly. Natural Aptitude, desire to get ahead chief requirements. Prospectus and full information on request. Harmony School of Piano Tuning, Box 582, Harrisburg, Pa.

**PHONOGRAPH Records Cheap, Catalogue,** Paramount, SB-313 East Market, Wilkes-Barre, Penna.

**AMAZING Plastic Harmonica—Melodious** tone—only one Dollar. Schaffer, Springfield, New Jersey.

**GOOD Used Jukebox Records—Hillbilly,** Western, Popular, Lists Free. Olin Milner, 335 McDaniel St., Atlanta, Ga.

**MUSIC printing \$5—100 Composing** Complete service. Auto-Litho, Jensen, Fla.

## 122 SONG WRITERS

**POEMS Wanted to be set to music, Free** examination. Send poems. McNeil, Master of Music, 510-PS, S. Alexandria, Los Angeles, California.

**POEMS Wanted for musical setting.** Send poem for immediate consideration and Free Rhyming Dictionary. Richard Bros., 46 Woods Bldg., Chicago.

**SONGWRITERS Outstanding Honest,** Music writing offer. Dick Reynolds, Leonard, Texas.

**SONGWRITERS, Songs Published** Monthly. Advance Royalty. Send your songs or poems today for our exciting offer. Hollywood Tunemasters, Dept. 10F-C, 1537 N. Vine, Hollywood 28, Calif.

**SONGWRITERS: \$100 Cash Awarded** Each Month For Best Song or Song Poem. Melodies supplied Without Charge By Hollywood composers. Lead sheets and records furnished. Cinema Song Co., Dept. B-44, Beverly Hills, Calif.

**SONG Poems Wanted, for Musical** settings. Send poems. (Any Subject), for free Examination and Outstanding Offer. United Music, 151, Salem, Indiana.

**POEMS Wanted For Musical Setting.** Send poem for immediate consideration. Five Star Music Masters, 646 Beacon Bldg., Boston.

**SONGWRITERS—Protect your songs.** Get the facts first. Free booklet, attractive offer. Song Service, 331-J West 46th, N. Y.

**DISCOVER Songwriting Facts! Write:** Songwriter's Educational Committee, 1650 S. Broadway, New York.

**REAL Composer of Music will co-operate** with lyric writers in song production. Fine publication proposition. Nationwide distribution of publications. Recordings Made, Copyrights secured. Write Now. C. Isabel Mayer, Box 3896, Portland 8, Ore.

**SONGWRITERS, Submit songs for free** analysis. Only worthy material accepted for development. Tommy Kilbourne, Box 1253 Bakersfield, California.

**YOUR song recorded and placed in juke** boxes. Write. Renown Records, 1314 Jefferson Ave., Buffalo, N. Y.

**POEMS Wanted for new songs. Send** poem for Free examination. Eliot Wright, Master Composer, 206 Rivoli Theater Building, Portland, Oregon.

## 112 RADIOS, SUPPLIES & EQUIPMENT

**MAKE Simple, Tubeless, Batteryless,** Distance-Getting Crystal Radios. Crystal and illustrated instructions 25c postpaid. Allen, 427-S, Clinton, Mo.

**RADIO Service men and experimenters** send stamp for our giant radio catalogue. Save dollars. United Radio Co., (1000-V) Newark 1, N. J.

**RADIO Tubes, parts, for repairmen,** experimenters, Federal Selenium Rectifiers, \$1.09; 6 or more, 99c each; phono motor & turntable \$3.95; one-tube battery kit, \$3.33; (Electric \$5.02). 100 assorted by-pass condensers \$6.95; 5-tube kit with tubes \$18.95; Weller Soldering Gun, \$12.95. Include postage. Free flyer. Variety, 601 Broad St., Newark 2, N. J.

**BUILD "Loudest" Crystal set, Instructions** and Crystal, 25c. Amoroses Radio, Route Four, Richmond, Virginia.

**CRYSTAL Detectors from Bell laboratories,** real microwave detector, fixed—no adjusting. Used in radar long distance microwave. War product, by Western Electric. Cost government originally six dollars, now \$1.29 prepaid. Supreme for crystal sets. Free list. Dept. 5, Radio City Labs, 30 Church St., New York 7, N. Y.

**BUILD "Scottys 4-Way" crystal radio,** using New Radar Crystal, good volume, distance, diagram and instructions—25c. Scotty Bottom, 1305A Monroe, St. Louis, Mo.

**RADIO Tubes—Attention Radio Repair** Service Men. For satisfaction in Radio Tubes. Le-Hi Electrical Co., 660 Broadway, Newark 4, New Jersey. Distributors of guaranteed Radio Tubes.

**25 YEARS Experience in radio repairing** at your fingertips for \$1.00. I've repaired 45,000 radios and have perfected a system which you can follow step by step. My methods are far simpler than any other course on the market and require no calculations. Send \$1.00 to Ross Radio Company, Dept. B, 14615 Grand River, Detroit 27, Michigan.

**LOUD Speaking Crystal Radio, loudest** design. Illustrated plans 30c. Radio Clinic, 10631 A Euclid, Cleveland 6, Ohio.

**1947 REVISED "Plans 18 Crystal Sets"** (SW record 5800 miles), Catalog, "Radio-builder"—25c. Laboratories, Box I-t, San Carlos, Cal.

**WIRERECORDERS—Limited quantity** precision built Navy wire recorder magazines—new and in original boxes. Records ½ hour continuously, has level wind, erasing head, minute and second indicators, automatic stops, etc.—marvelous bargain at \$49.50 FOB Detroit. Photographs on request—Shipped COD. Weight 25#—Richard H. Wann, 3000 East Jefferson Avenue, Detroit 7, Michigan.

**FCC Exam samples; any class commercial** or ham. We send you exam and correct your answers, \$1.00 per element. J. R. Johnson, Mount Arlington, N. J.

**TRANSFORMER—Heavy Duty 110 Volt,** 25 or 60 cycle—Secondary, 6 Volt, 12 Amperes, Ham filament or make soldering outfit with carbon rod, weight five pounds. Price \$3.00, Two for \$5.50, Radioco, 1110 S Marshall Bldg., Cleveland, Ohio.

**WORLD'S Smallest Crystal Radio, Operates** with your headphones and aerial. No electricity necessary. Complete with easy illustrated instructions, only 70c postpaid. Al's Radio Service, Box 1285-S, Sioux City 7, Iowa.

**RADIO Crystals Guaranteed non-technical** formula \$1.00. F. C. Engineers, Box 576, Glendale, Calif.

**ANNOUNCING the "702" The ultimate** in design, efficiency. A 4-tube T.R.F. housed in beautiful table model cabinet. Assembled—\$18.95, Kit—\$15.45. Easily constructed. Free literature. Atkinson Radio Laboratories, Norwood, Penna.

**RADIO Listeners "Don't blow your top!"**—Plug Earsaver remote volume control into your radio; from anywhere in room, fade down Loud Music, Singing Commercials, etc. Only \$4.95 with 15 ft. cord. Circular free. Earsaver, 724 E. Elmwood, Dept. 4, Burbank, Calif.

**RADIO Tubes, parts wholesale retail** large stock. Radio Mail Order Company, 46-13 188th St., Flushing, N. Y.

## 24 BUSINESS OPPORTUNITIES

**GOOD Paying Business Silvering mirrors,** plating autoparts, reflectors, bicycles, bathroom fixtures, etc., by late methods. No tanks or shop required, outfit furnished. Free Booklet. Gunmetal Co., Ave. E, Decatur, Illinois.

**START Home business making statuary,** plaques, art goods, pottery, garden furniture, artificial marble flooring, liquid marble. Make flexible molds yourself. Amazing profits. Folder free. Creative Publishers, Box 236-M, Winnetka, Ill.

**MAKE "DDT" Products, My Ten Master** Formulas shows how. Literature Free. Howard Robinson, Ph.G., 1302-B So. Ohio, Sedalia, Mo.

**\$25 WEEKLY working two hours daily.** No canvassing. No Manufacturing. Lycke, Box 2471, Cleveland 12, Ohio.

**SPECIALTY Manufacturing, the big** money business that can be operated anywhere, start on a very small capital; we supply dependable formulas and complete instructions; get interesting Free booklet, "Money-making Opportunities in Specialty Manufacturing." Howard Robinson, Ph. G., 1300-B S. Ohio St., Sedalia, Mo.

**LIQUID Marble—Colorful, glazed! Molded,** brushed, sprayed! Composition floors, Rubberlastic Molds, Plastic Homes. Particulars free. Marbellizing Service, Edwardsville, Illinois.

**\$565.00 PROFIT from every \$15.00** invested. Standard Service System, La Grange 2, Indiana.

**1947 Gigantic Directory of Opportunities,** Advertisers Supplies, Sources, Trade Information. Mail Order Ideas, Products, Wholesalers. Valuable tips—just published! Descriptive literature Free. Wilkin & Co., 118-CS East Main St., Hillsboro, Ohio.

**OPERATE profitable home business** selling merchandise by mail. Fast sellers. Large profits. Powell Service, 5713 Euclid, Cleveland 3, Ohio.

**HAVE your own office! Learn new profitable** business in uncrowded field. No selling. Many earn up to \$5,000-\$15,000 yearly. Write for Free details. No obligation. No salesman will call. Franklin School, Dept. 203-D, Roanoke 7, Virginia.

**RECAST old batteries into new. Latest** achievements. Battery Laboratories, Minneapolis.

**BIG Pay jobs in welding. Complete** welding lessons and reference books, 516 pages, 41 lessons, \$2.00 copy. Money-back guarantee. Hobartweld, Box P-1065, Troy, Ohio.

**REDUCING Salons make money. Start** at home. We supply automatic equipment. National Products, Portland 2, Oregon.

**WHY Job Worry? Learn Electroplating.** Highly Paid, uncrowded, Interesting Business. Gold, Silver, Nickel, Chromium, etc. Send Postcard for Free booklet and proof. Plater Hyde, Dept. SC P. O. Box 176, National City, Calif.

**MAIL Order Business course shows you** how to make money, spare or fulltime. Teaches professional mail order technique—not penny-snatching schemes. Fascinating 100-page illustrated Success-Catalog Free! Write—Nelson Company, Dept. 4-01, Chicago 5.

**LIQUID Marble—make in any color.** Soundproof Plastic Flooring, Flexible Molds. Cast novelties, plaques, statuary. Big Money—your own business. Catalog Free. Write—Bing Products, 88-B2T Broad Street, Boston 10, Mass.



**LEARN** Shell Jewelry Manufacturing. No tools or experience needed. Learn-earn within a week! Complete home instruction course, beautifully photographed, shows how to make 75 styles of Pins, Earrings, Brooches, Hair Ornaments, Dress Clips, Necklaces, Bracelets, Candy Dishes, Wall Plaques, Ash Trays, Candle Sticks, etc. Includes Pearlizing, Gilding, Dyeing, Luminous methods. Illustrates 55 species of sea shells. Lists hundreds of raw materials with wholesale prices. Complete course \$1.00, postpaid. Beginner's Kit, \$3.00 (\$3.50 in Canada). House of Gifts, Box 4550-AS, Coral Gables, Fla.

**BOOKKEEPERS**—Operate your own simplified "Dollar-A-Week" Bookkeeping & Tax Service. Full or spare time. Details free. Ellis, Box 203, Cedar Grove, N. Car.

**DOLLARS Daily!** Cleared \$1900 in two months. Details. Loeb, 7201 B-4, Montgomery, Cincinnati.

**OPERATE** profitable home business. Levines, Box 15-S, Boulevard Station, New York 59, N. Y.

**START** Mailorder Bookshop—Everything furnished; publisher cooperation. 25c brings booklet, exclusive setup, samples, exciting ideas. General Publications, Ossining 1, New York

**LIQUID** Rubber for making flexible molds. Literature and Sample free. Chaney, 1130 E. 16th St., Jacksonville 6, Fla.

**TYPEWRITER** Repairing instructions, standard typewriters. Webers', Box 1008, Canton, Ohio.

**QUICK** Money! "Repairing Car Batteries." At home! Easy too! Write, Batterymen, Grand Junction 1, Colorado.

**TRAVEL** anywhere or locate permanently. Earn \$85.00 per week up. Be your own boss. No experience necessary. Less than \$5.00 investment required. Literature free. Traveler, La Grange 2, Indiana.

**POPCORN** Machines, all-electric popping units, geared aluminum popping kettles, used Victory Duplex stamp vendors, coin-operated scales. Northsyde Sales Co., Indianola, Iowa.

**ASTOUNDING** modern mail order plans. Brings quick profits. Darrah, Orono 8, Me.

**SWISS** Musical Units, install powder. Cigarette boxes. Lloyd Kelley, Hanover, Mass.

**BATTERY** Repairing, Rebuilding, Plate making plans. L. Wertz, Pekin, Ill.

**MEDICAL** Laboratory Technicians in great demand. We train you in your spare time, in your own home. You can practice while studying. Write for free catalogue. Imperial Technical Institute, Box 973-X, Austin, Texas.

**METALIZE** Baby Shoes! New Field, Big Profits! Learn the right method. Instructions Illustrated. \$3.00 Write Superior, Box 834, Asbury Park, N. J.

**OWN** A Mirror Shop! Resilver Mirrors. Write for information. John Sprinkle, V90, Marion, Indiana.

**UNPAINTED** wall plaques and statues. Variety of designs. Write for free list. Arbo Products Co., Dept. B-232, Aurora, St. Paul 3, Minn.

**GREAT** Opportunities and Profits in Mail Order Business at home. Free Literature. F. Webster, Box 1972D, Hollywood, Calif.

**LEARN** Piano Tuning, Repairing, at home. Tremendous field! Piano parts, tools furnished. Established 1935. Empire School of Piano Tuning, 606-A East University Ave., Champaign, Ill.

**AGENT** or exclusive distributor for cigarette lighter mfg. Box 9W Tahoe Valley, Calif.

**MOULDED** Fruit Plaques Ready Painted Dozen \$1.50. Plastex's, 1001 So. Hampton, Bay City, Michigan.

**IF** you'd like to make \$5,000-\$10,000 yearly in the Collection-Credit Agency business, write us at once. Outstanding opportunity. Cole Associates, Syracuse 2, New York.

**SMALL** Capital. Start your own advertising agency at home in spare time. Complete operation revealed. No stock or equipment. Large earnings and permanent income. Free folder and proof. S. Snyder, Box 4907-A, Philadelphia 19, Penna.

**PROFITABLE** concrete block business. Catalogue, details—10c. Wm. Horne, 206 West Wilder, Tampa, Fla.

**PREPARE** to meet thy God! Delay means disaster. Free Bible course, Voice of Prophecy, Box 55, Los Angeles, Calif.

**CZAR** of Industry! Thru Selling. Magic Formula. Thousands of Agents, Maurival, Mauricetown, New Jersey.

**ATTENTION** Men!! Spicy Cartoon Booklets. Illustrated, 3 x 4 1/2. Distributors wanted. Ten samples \$1.00. Riverdale, Box 34A, Dayton 5, Ohio.

**MIRACLE** Glaze. Amazing discovery puts brilliant glass like surface on automobiles. Free Sample Information Big profits. Miracle Glaze Company, 9714 South Austin Ave., Oaklawn, Ill.

**A FACTORY** in your home garage! Mfg. & sales rights, mechanics' waterless hand cleaner. \$500-\$800 monthly. No special equipment necessary. Western Aircraft, Los Angeles 6, California.

**MAKE** \$6.00 an hour Sharpening Lawnmowers. Details 10c, Angle Slide, Box 582, Binghamton, N. Y.

**PACKAGE**, sell amazing cleaners, under your name. Samples 25c. Linnell, Box 1720B, Cleveland, Ohio.

**MONEY**-Making Opportunities, exclusive supply Sources, personal Guidance, and benefits, etc. Send 25c for full details. Your satisfaction or money returned. E. J. Matteson, 900-A So. Hanford Ave., Hanford, California.

**MAKE** plaster novelties. Special molding rubber. Free sample. Quart \$3.00, Gallon \$10.50. Free instructions. Universal Sales, Box 1076-B, Peoria, Ill.

**SERIOUS** Adults only will be amply repaid by requesting our successfully proved opportunity. Manning, 3259 Decatur, New York 67, N. Y.

**FELLOW** Workers—Down with Bosses—Start own business—Be Independent—Booklet describing 137 Tested Plans, free. P. Padney, 307 York St., Jersey City, N. J.

**METALIZE** Baby Shoes. Correct Modern Method. Information. Stamp. Universal, Box 1076-B, Peoria, Ill.

**CASH** For Common Ashes! Information; Sample Product, 35c. Duffy, V49, Covington, Ky.

**PLANNING** a mail order business? Start right, get the facts, be successful. Investigate Successful Mail Merchandising. Details. Post-Age Industries, 909-F E, 20th St., Indianapolis 2, Ind.

**FLEXIBLE** Molds to order, also originals. Professional course manufacturing molds and cast novelties. Latex, lacquers, flocks, flocking equipment, supplies. Plastics, Box 1574, Boston 4, Mass.

**SUCCEED** in your own business. Big profit domestic service needed everywhere. We show you how, help you start, furnish everything. Fact-crammed booklet free. Opportunity lifetime. Textile Cleaning Service, Inc., 11106-B So. Longwood Drive, Chicago.

**SUPER X** liquid molding rubber. Sample jar 25c, quart \$3.00, Gallon \$10.00. Free instructions. W. Wooley, 115-B, Donald, Peoria, Ill.

**CASTONE**—Hardest coldcasting composition on earth, any mold; White and colors 10 pounds \$2.00. Hundred \$6.00. New Era, 1321-C, Belmont, Chicago.

**RUBBER**-Airflex Makes molds "Overnight." Pint \$1.25, Gallon \$7.00 with instructions. New Era, 1321-C, Belmont, Chicago.

**PLASTIC** Liquid Glass china glazes protects plaster object; Pint \$1.00, Gallon \$3.00. New Era, 1321-C, Belmont, Chicago.

**REDUCING** Salons make money. Start at home. We supply automatic equipment. National Products, Portland 2, Oregon.

**AIR** curing rubber for flexible molds. \$7.00, \$9.75 and \$10.00 gallon. Illustrated mold making instructions. Simple 50c. Advanced \$1.00. Apex Plastic Products, 1915 Lunt, Chicago.

**"PROFITABLE** Mail Order Business. Send \$1.00 for Valuable Instructions." Charles J. Cole, Polebridge Road, Avon, N.Y.

**BRONZING** and Metallizing baby shoes! Gold, Silver, Copper, Nickel, Bronze, Pearl, Ivory and "Luminous glow" colors! Big profits! New Field! Details free! Write R. O. Morgan, Box 349, Long Beach 2, Calif.

**MAKE** Shell Jewelry—Easy, profitable. Illustrated book instructions 75c. Free Catalogue. Florida Shellcraft Co., Box 1840, Sarasota, Florida.

**GOT** \$24,500 Using "Schemes" from "Schemer" Magazine, Alliance, Ohio, 49th year, \$1.00. Three samples 25c.

**200** Money Making Deals. Plans—Rare formulas—Schemes. Folio Free. Formico Prod., Box 572, Dayton, Ohio.

**NEW!** Interesting! Easy! Profitable home enterprise. Maximum income, minimum effort. Men or women. Free literature. Franklin, 22219 Telegraph, Detroit 19, Michigan.

**BE** your own boss—Sell, install Venetian Blinds, full or part time. We tell you how, your investment or ours. Plans and particulars 25c. Ward Products, Capitol Heights, Maryland.

**DO** it with Sea Shells. Big profits. Werts, 1429 56th Avenue, Oakland 3, California.

**PROFITABLE** Home business. Pleasant, interesting \$1.00 starts. Details Free. Crafts, Davison 3, Mich.

**UP To \$15.00 Daily.** Anyone. Anywhere. Anytime. Periodically Resharpening. Butchers', Cooks', Dull, worn, Rat-tail Knife Sharpeners. Hotels, Restaurants, Markets, pay up to \$1.00 each. Takes 15 minutes, by Original Steel Kings' Secret Method and Pocket Tools. Illustrated Instruction Folio, \$2.00. Sample Pages, Details, 25c. Arcay Service, 7601-C Dudley, Cleveland 2, Ohio.

**PADDLE** Balls—Easy to make from plywood. Easy to sell—We make them so can you. Complete plans including sample 25c. Ward's, Capitol Heights, Md.

**"LOS ANGELES Boom"**. Job Opportunities offered in Nation's fastest growing industrial city. Delightful climate. \$1.00 brings copyrighted booklet outlining \$80,000,000 in expansion programs. Lists over 300 firms. Explains how-where to apply. Sample application letter. Los Angeles Research Services, 507 North Windsor Blvd., Los Angeles 4, Calif.

**SALES** Letters, Ads, Folders. That Sell! Your product or Service. Written by—Faultless Advertising, 3439-B Michigan, Chicago 16.

**CORN** Chips—Positively the newest product to hit the market. Sensation everywhere sold. Beats Potato Chips. Cash in on new business. Information and generous sample \$1.00. Ward Products, Capitol Heights, Md.

**DEVELOP** and own permanent mail order business. Crompton, Box 2567, Hollywood 28, Calif.

**MONEY** Making Tips, Ideas, Schemes, opportunities galore in "Tip-Top Magazine". Tipton, Indiana. Year \$1.00, 3 months 25c.

**SYNTHETIC** Latex with Neoprene base for making flexible molds! Quick Drying! Safe! For home, classroom, or industry. Quart \$2.00, Gallon \$5.95. Full instructions. Plastercraft Supply Company, 1406 East 43rd Street, Cleveland 3, Ohio.

**NEW** Publication, thousands of bargains at inside prices. Opportunities, plans, all for 25c, Box 12B, Oaklandon, Ind.

**HANDYMEN**—Earn money home operating Community "Fix-it" Shop. Write, Stafford, 708 Rawlings, Carbondale, Ill.

**"HOW** To Make Simple Molds and Plaster Plaques." Profitable business or hobby! Instructive booklet 25c. Plastercraft Supply Company, 1406 East 43rd Street, Cleveland 3, Ohio.

**HOW** and Where to obtain capital. Particulars free. Star Service, Wapakoneta, O.

**WANTED** unused U. S. Postage Stamps, small discount. Advance Stamp Co., 24 East 23 St., New York.

**MANUFACTURE** Nameplates, House Numbers, Signs, Crabtree, Box 221, Newport News 4, Virginia.

**BABY** Shoes preserved. Formulas, instructions, \$1.00. Novelty Bronzing, Box 56, Hyde Park 36, Mass.

**WASHING** Machines. Parts any make. Old, New. Northeast 1358 H Street, Wash. 2, D. C.

**TYPEWRITER** Repairmen urgently needed. Earn \$40 to \$50 weekly spare time. Our easy to learn home study course teaches how to repair typewriters. Write for free information. Houston Typewriter Repair Service, P.O. Box 5357, Houston 12, Texas.

**START** a clock shop while clock repairing is booming. Our easy to learn home study course with pictures and illustrations teaches you how to repair all kinds of clocks. Information free. Houston Clock Shop, P.O. Box 5086B, Houston 12, Texas.

**INVESTIGATE** Mail Selling! What's the one best thing to sell, happily, honestly, profitably? We know! Get free particulars, free samples. What-To-Do Shop, Box 1082, Tacoma, Washington.

**COLORGLAZED** Concrete Pottery made without molds. New, low cost, patented method. Cemetery products, novelties, tiles, floors, etc. Basement leaksealing. Other money-making projects. Booklet, details free. Men only. National Potteries, Fergus Falls, Minnesota.

**MAKE** flexible molds! Few cents each! Cast plaques, novelties, bookends! Free sample! H. Tooker, Hamilton 7, Ohio.

**\$246.50** MAKING baffling secret device without skill, machinery, from former top priority war material costing \$1.50! Guaranteed simple, revolutionary new discovery, unbelievably profitable. Universal appeal. Frank, illustrated proofs, free! Rolls Enterprises, 115 W. 16th, New York 11.

**UP** to \$1500 yearly selling by mail in spare time interest you? New ideas and plans every month. Details free. Idea of Month Club, 3023-B Greenmount, Baltimore 18, Md.



**THOUSANDS Business Opportunities.** Magic Valley South Texas. Most Prosperous, Fastest Growing Area, Great Southwest. Will represent you. Questions answered. Illustrated literature, \$1.00. McCants, Weslaco, Texas.

**GET Into Mail Order Business,** anywhere: start small, grow fast from profits. "Simplified Selling By Mail", illustrated, fully outlines tested winning methods, for building fascinating, successful business, full or spare time. Complete course in one inexpensive volume; purchase price refunded if not satisfied. Descriptive prospectus free. Frank J. Artz, 1060PS Harding Drive, Toledo 9, Ohio.

**PROFITABLE Home sparetime business.** Making wallets, belts, other fast-selling leather novelties. Simple to make. Tools not necessary. Amazing opportunity. Send for free catalog. Gold Leathercraft, 632 Desplaines Ave., Forest Park, Ill.

**BELTS! Make 'em and make money.** No tools! Sample 50c. Art Leather, 411 Joseph Ave., Rochester 5, N. Y.

**\$46.00 FROM Square Foot Plywood.** Jigsaw necessary; Excellent Home Business. Write, Woodarts, X-46, Bridgewater, Mass.

**ACCOUNTANTS.** Part-time, full-time service. Masterful, result producing letters, 25c. Free description, Box 33, Forest Hills, N. Y.

**OPERATE profitable mail order business.** Splendid Opportunity. For details write, George Radatovich, Box 142, Fairmont, W. Va.

**PUBLISH your own community newspaper!** Big profits and prestige. "Know-How", the complete manual, shows how. Free literature. Success Publications (Dep't-B) 15870 Wisconsin, Detroit 21, Michigan.

**PROFITABLE business of your own.** Local or Mail Order. Write Tes-Co Enterprises, Wilkes Barre, Pa., Box 189-SD.

**HAVE Fine-Paying, Home-Operated, Mail Business!** Others have, you can too! Start small, grow big! Exclusive setups built-to-order by expert. Descriptive booklet free. Coates, 33-B Vassar, Dorchester, Mass.

**6 INTERESTING Mail Trade Magazines** 25c. Containing many wholesale offers and helpful money making information. Send today. Giard, Aurora 12, Missouri.

**BALL Point Pens, Reynolds and others,** Closeout, 97c each. Other values. Times Square Sales, 131-A, West 42nd, New York 18.

**MANUFACTURE costume jewelry at home** for profit, hobby, therapy. Free wholesale supply catalogue. Instructions. Florida Supply House, Bradenton, Florida.

**ATTENTION Ex-G.I.'s.** A business of your own. Sure Fire Aluminum Cleaver. Fast seller, easy to put up. Formula—\$1.00. D. J. Distributors, Post Office Box #4483, St. Louis, Mo.

**YOUR own Plastic business at home.** Produce costume jewelry, novelties, statuettes. Liquid Plastic, Liquid Marble, Flexible Molds. Write for free book. American Trades, Box 1016-B, Peoria, Ill.

**PLASTERCRAFT supplies.** Molds, liquid rubber, plaster. Instructions free. Jayhawk Plasters, Blue Rapids, Kans.

**START profitable business.** Sell herbal remedies under your own name mail. Local Delfa Co., 3956 Avondale, Chicago 41.

**RED Seal Moulding Compound.** DuPont Latex Base! Guaranteed! Made by Experienced Latex Compounds. Free Instructions and literature sent upon request. Dept. 907, Red Seal Rubber Co., 116 Nassau St., New York 7, N. Y.

**MAIL order Business—your opportunity.** Start small—grow big. Literature free. P. Belfort, Engineering Building, Chicago 6.

**OWN A Paper Products business.** Sell envelopes, tags, etc. by mail. No investment. Omaha Envelope Service, Dept. 197, 4721 California, Omaha 3, Nebr.

**BY Now you've surely heard of Colorado's** fabulous oil boom. Take a shot at \$1,000 to \$20,000 on investment of \$160 in 4 monthly installments. Red Bloods of America register in now for your share in this new oil Klondyke. Rocky Mountain states are swarming with new daily opportunities. Big Pay-Offs ahead. More than 160 big new wells in one oil field alone. Write me this very day for details. Dyer, 1835 Champa, Denver, Colorado.

**START home plaster novelty business.** Amazing course tells how. Literature free. W. Belfort, Engineering Bldg., Chicago 6.

**EARN good money at home as I do.** Send stamp for details. Lollar, 678 Emmett, Battle Creek, Mich.

**BECOME a Finance Man.** Particulars free. George Lenhoff, Lincoln 8, Nebr.

**FIREWORKS: Big, Five color Wholesale** Fireworks catalog. 25c coin (Refundable) Earn extra money. Intermountain Fireworks, 2435 South State, Salt Lake City 5, Utah.

**REPAIR Appliances, motors, bicycles,** etc. \$20.00 capital! Illustrated instructions, \$5.50. Repair Service, Janesville, Wisconsin.

**REBUILT standard brank spark plugs,** 1/3 wholesale cost of new. Completely renewed, cadium plated, polished, neatly boxed. Guaranteed 10,000 miles. Service stations, garages, car dealers all heavy repeat buyers. Substantial profit. Permanent business. Exclusive territory to producers. Standard Parts, 3033 Main, Kansas City, Missouri.

**PROTECT Your Car.** Use Chrome Lustre—sensational new transparent, liquid rubber coating. For chrome and other metals. Resists salt, acids, alkali, water; stops corrosion. 1/4 pt., only \$1.00. Send order to: Quality Distributors, 6810 Snow Rd., Parma 9, Ohio. Dealers wanted.

**BIG earnings portable electric lawn** mower grinder, details free. Hopkins, 63 Stewart, Lansdowne, Penn.

**MAKE strange plastics—1c pound.** Makes durable attractive floors, walls. Build with waste—Save half. Bays Laboratory, Oklahoma City 9.

**LATEX for making flexible rubber** moulds. Thoroughly tested. No shrinkage. Complete instructions with each order. Stoneham Rubber Co., Box 244, Stoneham 80, Mass.

**RUBBER Moulds for casting novelties.** Latex for making Molds. Use thoroughly tested and approved products. Eastern Latex Laboratories, Box 153, Mattapan 26, Mass.

**MAIL Order Offers increased income.** Independence. Unlimited Possibilities. Free literature. Manhattan House, 126-S Lexington, New York 16.

**2000 NEW representatives needed,** some sections exclusive territories—Big opportunity small investment. Midwest Drug Company, Inc., Columbus 15, Ohio.

**WOULD you pay 3%—first \$350 made?** Color-illustrated book "505 Odd, Successful Enterprises" free! Some offer occasional "day off." Work home. Expect something odd! Pacific, San Clemente, Cal.

## 88 MONEY MAKING OPPORTUNITIES

**DETECTIVES Earn Big Money.** Experience unnecessary. Particulars free. Waggoner, P-125, West 86th, N. Y., N. Y.

**ELITE Collection describes 137 money-**making plans; local, mail order. Particulars free. Elite Co., 220-A Grand St., N. Y.

**EARN money at home—steady income—**Write Successful Income Builders, 508-B, Hollywood 28, California.

**SEWING Machine Repairmen make Big** Money lifetime. Start neighborhood shop today. Our course repairs all makes. \$2.00 Postpaid. Serviceman, Hamilton 10, Ohio.

**\$25 Weekly Working two hours daily.** No canvassing or manufacturing. Lycke, Box 2411, Cleveland 12, Ohio.

**MAKE Perfume, Make Money.** Free book tells how. Lawson, 21 Joiner, Saint Augustine, Florida.

**START Your own business!** Big money manufacturing novelties, plaques, statuary. Free catalog. Write Bing Products, 88-B2U Broad Street, Boston 10, Mass.

**"THERE'S Big Money In Junk,"** and repairing Car Batteries! Batteryman, Grand Junction, Colorado.

**GET Your Mail Order Start** by joining the National Mail Order Guild. They tell you all the facts. What Sells—who Buys by mail and How to reach them. They help you every step of the way. Write today. A. J. Shutt, Dept. G-2, 506 1/2 S. 15th St., New Castle, Indiana.

**I Made \$1000.00 from 1000 tomatoes** using my unique methods. Detailed instructions \$1.00 (refundable). Alfred Dinsmore, Marlborough, Mass.

**PROFITS for you.** Make "Blowups"! Details Free. Fogarty, 46-A Longview, Farneld, Conn.

**"MAGIC Stone" plastic flooring and** novelty business offers lifetime opportunity. Write, Palmer Company, Station "A", Berkeley, California.

**WIN money on contests advertised in** every magazine and on radio. General Contest Magazine, published monthly, gives hundreds of tips. Lists current contests and rules. Sample 25c. General Contests, 1609-A East 5th, Duluth, Minn.

**OPERATE Profitable Mail Order Business,** \$5.00 starts, Details Free. Crafts, Davison 4, Mich.

**"FIRE Alarm systems for the home.** Fast seller. Every home owner a prospect. Plans \$1.00, or send postcard for further details. Regent Electric, 70 Rockland St., Boston, (Rox.), Mass."

**UNUSUAL mail order opportunity.** For details write, Ray's Supply Co., 1741 Stephens Rd., Kalamazoo 81, Mich.

**MAKE Big Money At Home** preserving baby shoes in Real metal, Pearl, Gold, silver, 1000% profit. Kiktavi Co., 8620 South Ruthelen, Los Angeles 44, Calif.

**UNLIMITED Earnings, create ideas and** business builders for merchants. Copyrighted materials, instructions, \$2.00 Refundable. Keirstead, 3541 North Meridian, Indianapolis 8, Indiana.

**PROFIT 75c or more per dollar.** Postal brings Literature Trader, 216S Degraw, Brooklyn 2, N. Y.

**AT Home—Your own manufacturing** business; making popular \$1.00 novelties. Cost you 3c to 15c. Everything supplied. Write So-Lo Works, Dept. U-6011, Loveland, Ohio.

**HAVE Your Own Business, plenty of it!** Opportunities galore for you! Spare, full time; local, mail order. New magazine shows how! Copy, 25c—six issues, \$1.00—"Opportunities Preferred", 33-C Vassar, Dorchester, Mass.

**GET Dollar Orders by Mail!** You keep 90c profit! Easy, pleasant, home operated business. Just \$5.00 capital starts you! Complete plan, only \$1.00—Interesting details free. Send today! William Redmond, 1216-B Park Row Bldg., New York 7, N. Y.

**MANUFACTURE costume jewelry at** home for profit, hobby, therapy. Free wholesale supply catalogue. Instructions. Florida Supply House, Bradenton, Florida.

**35 TESTED, moneymaking formulas,** 50c (coin). Gordon Reynolds, Whittier Drive, Johnston 9, Rhode Island.

**LIQUID rubber, molds, models four** colored plastic paint that Glows. And complete course in statuary art casting. Dollar brings you sample mold of bear. Robert Fitzpatrick, 15825 Wormer Ave., Detroit 23, Mich.

**YOUR Own Profitable Business.** Spare or full time. Information 10c. Marvett, 211 Hightower Building, Oklahoma City, Oklahoma.

**A Factory in your own home or garage;** Manufacture and sales rignts mechanics waterless hand cleaner; \$500-\$1000 monthly; No Special Equipment Necessary. Schaffner Laboratories, PGH (2), Pa.

**FORMULAS—Money Making Plans.** Literature Free. Jackson, Box 111, Newberg, Ore.

**"TIMELY Tips Magazine,"** Paulding, Ohio, contains promotional plans, ideas, opportunities monthly, 10c. 19th year, \$1.00. Trial four months, 25c.

**UPHOLSTERING Furniture course \$2.65** prepaid. Lyle, Box 385-B, Lombard, Ill.

**FREE Literature describing 20 money-**making plans. Dallis Ruth, Wheelersburg, Ohio.

**EARN Money At Home With Typewriter!** Addressing Envelopes, Circulars, Typing. 25c brings details also 68 Page Book of Moneymaking Opportunities. Ace-8, Box 183, Birmingham, Ala.

**ELECTRIC Clocks are everywhere you** go, buildings, homes, parking-lots, factories. Repairs increasing. Our easy to learn course: with pictures and drawings teach you how to repair these clocks. Electronic Supply Co., Box 2350-B, Houston 1, Texas.

**EARN Money Evenings, copying and** duplicating comic cartoons for advertisers. Aaservice, Argyle (2) Wisc.

**EARN up to \$2,000 year, inventing** simple items for special cash markets. Ideas only. No patents. Hendrickson, Argyle (8) Wisconsin.

**21 POPCORN, Candy Apple, etc. Formu-**las. All money-makers, \$1.00. We can supply equipment. Concession Supply Co., Dept. "B", Box 133 Sta. "B", Toledo, Ohio.

**LEARN Battery repairing, rebuilding.** Engineer offers money making methods. Battery Bureau, 2225 North 44th St., Milwaukee 8, Wisc.

**A \$100-a-month hobby at home!** No soliciting, no mail order, no meeting people. Easy, enjoyable pastime. Details, 25c (refundable) Laura Dickson, 808-PS Elizabeth St., Anderson, S. C.

**MAKE flexible molds! Few cents each!** Cast plaques, novelties, bookends! Free sample! H. Tooker, Hamilton 7, Ohio.

**FREE details, Farm, Lot, Yard can bring** you cash. Johnson, 2062-B East 14th, Brooklyn 29, N. Y.

**PROFITS from plastics formula 25c.** Rochester Hobby Shop, P. O. Box 524, Rochester, Minnesota.



5000 QUARTERS Monthly! Detailed plan only 25c. Schneider, 1038 Holland, Schenectady 3, N. Y.

METALLIZE baby shoes. Start this profitable business now. Send 25c for further information and booklet "Electroplating for Fun and Profit." Metal Crafts, 5501 Suwanee, Tampa, Florida.

SELL Personalized Jewelry, No investment, Big Commission. Bette Lee Jewelry Co., 246 Fifth Avenue, New York 1, N. Y.

### 59 FORMULAS, PLANS, ETC.

137 MONEY-making plans, also formulas for salable products. Descriptive booklet free. Elite Co., 220-A Grand St., N. Y.

NEED Chemists? Formulas? Analyses? Products duplicated, improved? Consulting Scientific Company, Swarthmore, Pa.

127 FORMULAS \$2.00. Literature 10c. W. Huffman, 391 Pleasant Lake, Rives Junction, Mich.

"USE your present alarm clock for automatic control of radio, silex, poultry house, lights, etc. Complete plans and instructions \$1.00. Hills Plans Service, Box 630, Rapid City, So. Dakota."

FORMULAS—Modern, practical. Consultation, Duplicating, Research. Moon, East Broadway, Fulton, N. Y.

FORMULAS — Latest Best. Analysis. Giant formula catalog and chemical instruction sheet 10c. Refunded first order E-Belfort, Engineering Building, Chicago 6.

FORTUNES in Formulas, 900 pages, 10,000 ideas, processes, secrets. Moneyback guarantee. \$2.95 postpaid. Free details. Ray's Supply, 1741 Stephens, Kalamazoo, Michigan.

10,000 Formulas and Trade secrets. Free literature. Stillmans, 555 Kingston Ave., Brooklyn 3, N. Y.

MAKE Products yourself. Free formula Catalogue. Schaffner's Laboratories, Emsworth, Penna.

### 103 PLASTICS

PLEXIGLAS masked sheets 12" x 12" 1/16" \$1.00, 1/8" \$1.25, 3/16" \$1.55, 1/4" \$1.85. Include 10% postage. Dyes, Rods, cements, shells, jewelry findings, tools, buffing compounds, free listings. Craft Plastics, Box 129-S, Somerville, N. J.

PLASTICS—7 colors sheets and rods. Send stamp for price list. Hanson Plastics, 7625 South Parkway, Chicago 19.

NEW liquid plastic. Clear, colors. Cast without heat. Embed flowers, insects, coins, saw, drill, carve, Manual tells how. Send \$3.35 for complete 20 project kit including one pound liquid Castolite. Castolite, Dept. D-24, Box 211, Kenilworth, Ill.

PLASTICS and Supplies; Book on Plastics \$1.10; Kits \$3.00-\$5.00. Internal Carving Drill, \$1.30. FOB St. Louis. List. Plas-Met Sales and Engineering, 4648 Shirley Pl., St. Louis 15, Mo.

FORMALIN, lustrous quick setting liquid plastics. Casting supplies. Free literature. Kit \$3.00 f.o.b. Formalin Works, Box 199, Romeo, Michigan.

PRACTICAL Plexiglas fabricating kit with completely illustrated handbook just off press. Brand new Plexiglas—clear in many colors—and accessories for 15 easy-to-make projects. Complete kit postpaid, \$5.00, U. S. only—Foreign \$6.00. Kosto Plexi-Kits, Washington 7, D. C.

SELF-Training at Home through "Working With Plastics": Covers every step, every material; \$1.25—and Plastic Hobby Kit: 2 lbs. Lucite, Plexiglas, bottle cement, 2 bottles Plastic Dye (red, green). Full instructions; \$3.25 postpaid. (COD plus charges.) Modern Technical Book Co., Dept. MS, 55 West 42nd St., New York 18, N. Y.

PLASTICS, Free List. Swiss Music Box Units \$3.50—New Plexiglas Manual \$1.50. Plastic Supply Co., 2618 St. Louis Ave., St. Louis 6, Mo.

PROJECTS, Ten marvelous plastic, guaranteed, 50c. Plasticplan Co., Box 181, Cincinnati 1, Ohio.

PLEXIGLAS — Dyes, Cement, Jewelry Findings. Free Listings. Novalte Plastic, P.O. Box 106-M, Brooklyn 19, N. Y.

PLASTICS and accessory supplies. Floral carving drills \$1.00 postpaid. List Free. Art Plastics of Calif., 8125 E. 14th St., Oakland 3, Calif.

MONEY In Plastics! Lucite Plastic Hobby Kit 2 pounds Lucite Material, coloring dye, cement. Instructions. Send \$2.50 (plus 40c express charges). Also Swiss Music Movements, \$3.50 each (operatic, popular, ballad tunes, but no specific selection.) Full line of plastic materials. Plastic Specialty Co., Dept. S, 127 East 28th St., N.Y.C.

### 33 CHEMICALS AND APPARATUS

LUMINOUS Paints will glow in dark. Six colors. Fairmount Chemical Co., 136 Liberty St., New York City 6.

THE House of Winn, home of supplies for amateur chemists. See Winn's New Idea chemical kits and apparatus outfits for home experimenting. Send 10c for retail catalog. Established 1931. John H. Winn, Dept. 607, 124 W. 23rd St., New York 11, N. Y.

CHEMICALS-Lab. Supplies New Catalog 10c. Mel-Glo Chemical Co., 258 Fourth Avenue, Brooklyn 15, N. Y.

CHEMICALS and apparatus for industrial, analytical, and private laboratories. Complete supply service for correspondence school students. Send 3c for catalog. Dept. M-26, Biological Supply Co., 1176 Mt. Hope Ave., Rochester 7, N. Y.

FREE Catalog; Chemistry, Mineralogy, Biology, Physics, Tracey Laboratories, Evanston, Illinois.

HIGH quality inexpensive chemicals and apparatus in small quantities. Free catalogue. PK Chemical Co., 3249 Epworth, Cincinnati, Ohio.

CHEMICAL Indicator Kit \$1.75, others. Microkit, Box 324, Jamaica, N. Y.

NEW laboratory Supply Catalog of Chemicals and apparatus. Contains over 5000 items with illustrations, 212 pages. Send 50c. Standard Science Supply Co., 1232 No. Paulina St., Chicago 22, Ill.

HANDBOOK for Chemical Experimenters. Hundreds of experiments; illustrated: 50c. Experiment Booklet, 15c. Supply Catalog, 5c. Reading Scientific Co., Reading, Pa.

HANDBOOK of Chemical Information, 50c postpaid. Catalog Free. Amaco Laboratories, Box 3246 A, Amarillo, Texas.

CHEMICALS, ounce quantities, apparatus, catalog 5c. Fleischer's Laboratories, Everett 49, Mass.

SOMETHING New! Student chemists send 5c for catalog and free copy of "Know Your Chemicals" Met & Co., 160 Hillside Ave., Nutley, New Jersey.

### 68 HELP WANTED

GAS & Oil Furnaces. Conversion burners. Floor furnaces. Blowers. Sell and install. Peerless Sales, 4318 Sheridan, Lincoln 6, Nebr.

### 5 AGENTS WANTED

GOOD Paying Business Silvering mirrors, plating autoparts, reflectors, bicycles, bathroom fixtures, etc., by late method. No tanks or shop required, outfit furnished. Free Booklet. Gunmetal Co., Ave. G, Decatur, Illinois.

LICK After-war layoffs; Start own business; home, office. Booklet describing "Collection of 127 Tester Plans" free. Elite Co., 220 Grand St., New York.

FREE Water and our concentrates makes flavors, lotions, shampoos. 72 products, labels, bottles furnished. Qualco, F-20030 Russell, Detroit.

FREE! Latest issue Opportunity Magazine. Salesman's Guide. Inspiring, constructive. Shows how to earn money selling for others or in your own business. Hundreds postwar opportunities. Send name and describe what you have sold or are selling. Illustrated copy sent Free. Opportunity Magazine, 620 N. Michigan, Dept. 18, Chicago 11, Ill.

AGENTS—300% profit selling genuine gold window letters; stores and offices. Free samples. Metallic Letter Co., 437 N. Clark, Chicago.

EXCELLENT Sideline for printing and advertising salesmen. Decalomania name plates in small quantities. Great demand. Also make money applying initials on automobiles. Free samples. Ralco, XL-Roxbury, Boston 19, Mass.

QUICK Profits with individualized belts, buckles, cap badges, tie holders, uniforms. Choice of thousand emblems. Sure repeat orders. Easy-Selling outfit offer. Write Hook-Fast Company, Dept. 14, Roanoke, Va.

SELL Greeting Cards, Display Signs, Pictures, Books, Novelties, Big Profits. Bulletin Free. Elfco, 432 North Wells, Chicago 10.

HOUSE Numbers that glow in the dark. Luminous pictures, etc. Large mfr. wants factory representative. Wonderful new product. Fast seller. Free samples. Madison Mills, 303 4th Ave., N. Y. C.

SELL Full, Part Time Individualized Belts, Buckles, Cap Badges, Tie Holders, 2,000 emblems to choose. Fast profits. Repeats. Write today special outfit offer. Hookfast Specialties, Box 1425, PS, Providence, Rhode Island.

AMAZING New Zipper Shoe sells on sight. Big profits for salesmen. Leads line 200 splendid styles. Territories open. Get Free Sample Outfit, Write Victor Thomas, Dept. V-783, Chippewa Falls, Wisc.

90c PROFIT Each \$1.00 Sale. Sell Positive mothproofing solution to housewives, stores, agents. Experience unnecessary. Postal brings details. Kinford, Wayne 4, Pa.

AT Last! Something new and sensational in Everyday Cards. Gorgeous Satin and Velour designs never before offered. Get orders fast. Big Profits. 14 assortments for year 'round occasions retail 60c to \$1. Get samples on approval. Puro Co., 2801 Locust, Dept. 741-D, St. Louis 3, Mo.

AT Home—Your own manufacturing business; making popular \$1.00 novelties. Cost you 3c to 15c. Everything supplied. Write So-Lo Works, Dept. S-601, Loveland, Ohio.

SELL New-Used clothing from home, auto, store. Men's suits \$1.17. Leather Jackets 85c. Overcoats 62c. Dresses 17c. Ladies' coats 38c. Other Bargains. Catalog Free. S & N, 565A Roosevelt, Chicago.

SELL Genuine Briar Pipes Direct. All Men Prospects. 100% Profit. Lightweight Sales kit. Write Abbott Pipes, 62 East 87th, New York 28.

SELL Greeting Cards—Everyday, Birthday, Humorous, Easter assortments. Wrappings, Stationery, Correspondence notes. Over 100 Money-Makers. Special Offers. Fast sales, big profits, extra bonus. Experience unnecessary. Request \$1.00 Everyday assortment on approval. Hedenkamp, 343 Broadway, Dept. A-22, New York 13.

\$1. STARTS you in business. Sell DeLuxe ties, 100% wool interlining. Costs you only \$7.00 per dozen, you make \$5.00 Dozen. Send \$1.00 for special introductory offer two DeLuxe ties. Catalog complete line Free. Philip's Neckwear, 20 West 22nd St., Dept. P-10, New York 10.

SELL Personalized soap. Name on every cake. Ideal for gifts. Get sample offer. Dunbar Soap, New Brunswick, N. J.

WE pay you \$25 for selling fifty \$1.00 assortments Birthday, All Occasion cards. Tremendous demand. Sell for \$1.00—your profit 50c. It costs nothing to try. Write for samples. Cheerful Card Co., 81 White Plains, N. Y.

GOLD lacquered Window Sign Letters. Large Sizes Penny Each. New Foils. Absolutely Beautiful. Free Samples. Atlas, 544 W. 79th, Chicago 20.

MAKE money in your spare time! Helps furnished. Easy sales. Voluntary repeat orders. Liberal commissions. Write for Free Wholesale Price List Today! McGregor Magazine Agency, Dept. PS-7, Mount Morris, Ill.

"BIG bargains for big profits. Over 100 sensational values. Men's used suits \$2.00, pants 35c, topcoats \$1.25, Overcoats \$2.00, shoes 20c. Experience unnecessary. Free wholesale catalog. Superior, 1250-A Jefferson, Chicago 7."

MAGIC Cleaner—Hotter than a fire-cracker. Saves Soap—Big Profits—Sample Free. Uco, 5007 Irving Park, Chicago.

\$3 FIRE Extinguisher sells wholesale or direct. "Fire-Killer", 101 Franklin, Syracuse 1, New York.

GREETING Card Agents: "Line Up" with "Pines" for bigger, better and quicker profits. Rush name, address on postcard today. Box 32, Flushing 6, N. Y.

DISTRIBUTORS wanted Minton Improved Corn Salve Removes your corn or callous or your money back. Stops soreness over night. Trial Size 10c. Regular size 35c. Minton, Box 71B, Brighton Station, Rochester, N. Y.

EARNING Less than \$200 weekly? Boost income quickly. Fast selling celluloid price tags, metal moulding, menu covers. Every store, restaurant buys. Pricing Press, Dept. CX, 124 White St., New York.

START Your Own Business on Our Capital. Always your own boss. Hundreds average \$6,000 to \$25,000 annual Sales. We supply stocks, equipment on credit. 200 home necessities. Selling experience unnecessary to start. Wonderful opportunity to own pleasant, profitable business backed by world-wide industry. Write Rawleigh's, Dept. D-U-PSC, Freeport, Ill.

DOUBLE-Duty Shopping Bag. Zips open. Instantly changes from small to large size. Lightning Seller. Samples sent on trial. Kristee 134, Akron, Ohio.

EASY money galore. Up to 100% profit plus bonus. Sell friends complete line greeting card box assortments, gift wrappings, correspondence notes. Experience unnecessary. Special offer. Request peak quality 14 card \$1.00 All Occasion assortment on approval and free personal stationery portfolio. Tom-Wat Studios, Dept. PS, Bridgeport, Conn.



**SHELLCRAFT Instructions—Free!** Make beautiful seashell jewelry! Wholesale Catalogue of complete line shells! Plastic discs! Animal Shapes! Pinbacks! Earrings! Cameos! etc. (Buy Direct). Pace's, Box 279, Bradenton Florida.

**SPARK PLUG factory wants agents—**100 plugs \$19.50. Free catalog—sell dealers. Nation Wide Supply Co., 1716 So. Michigan, Chicago 16, Ill.

**BIG Profits—World's Finest raised lettering signature Embossing Kit.** Fast Seller. Sample kit \$1. Free details, Silvo-gold, Mastic 5, N. Y.

**SENSATIONAL Offer!** New Fluorescent Table Lamp. Selling fast. Commissions advanced. Also complete line fluorescent fixtures. Write for free kit and sample offer. Rose Company, 529 J South Franklin, Chicago.

**NEW, novel way to make money.** Sell 5c and 10c individual greeting cards, \$1.00 and 60c box assortments. Up to 100% profit. Bonus. Special offers. Request free samples personal stationery and special feature \$1.00 All-Occasion assortment on approval. New England Art Publishers, Box C, North Abington, Mass.

**CIGARETTES At Half Cost,** any brand, smoke Fire-Safe way. New Cig-Smoker is world sensation. Millions want it. Free data by Airmail anywhere. Safe-Gard, 22 Perry-Payne Building, Cleveland 13, Ohio.

**SCHOOL Seniors—**Sell classmates America's most beautiful, distinctive Graduation Name Cards. 40% commission. Largest selection. Lowest prices. Free cards and sample kit. Printcraft, 1425 E. Elm St., Scranton 5, Pa.

**AMAZING discovery,** Master Glaze, puts brilliant glass-like surface on cars. Free sample, information. Big commissions. Master Glaze, Dept. 584, 7720 Harwood, Milwaukee, Wisc.

**BOYS, Men, Lawn Mower Sharpening Shops.** It's easy to build your own power mower using our "Handy Dandy Conversion Kit." Write us for details. Le Claire Mfg. Company, Le Claire, Iowa.

**JUST Out!** History of World War II. Huge Volume. Popular price. Authentic text. Official photographs. Big profits. Riverside Book Company, Iowa Falls, Iowa.

**WHOLESALE and Retail,** watches, expansion bracelets, Perfume, Aluminum-ware, Write now . . . Cartier's, Box 272, Pittsfield, Mass.

**POCKET Pal:** The All-Purpose Cutting Tool. 150% profit. Every man and housewife a prospect. 50c seller. Steady repeat item. Sample 25c. Nelson Mfg. Co., 222 W. Kellogg, St. Paul 2, Minn.

**MAKE big profits selling Everyday Greeting Card box assortments.** Fast Sellers. Postcard brings details. Bluebell Art Company, 1059 Avenue C, Bayonne, N. J.

**RELIABLE man with car wanted to call on farmers.** Wonderful opportunity now. \$15-\$20 in a day. No experience or capital required. Permanent. Write today. McNess Co., Dept. 27, Freeport, Illinois.

**AGENTS.** Substantial profits. Repeat order products. Not mere "job" but opportunity establish steady income. Additive lubricant. Limitless field. Factories, autoists, service stations, fleet owners buy in huge quantities. Write Kidder Oil Company, La Crosse 4, Wisc.

**MAKE flexible molds!** Few cents each! Cast plaques, novelties, bookends! Free sample! H. Tooker, Hamilton 7, Ohio.

**NEW Patented Invisible belt,** keeps shirt-tails in, Men, Women, unlimited earnings, sells easily, millions prospects. Free particulars. Invisibelt, PS1 Box 26, Elmwood Station, Omaha 6, Nebraska.

**SELL Stewart's E-Z Silver Detarnisher** to Hotels, Restaurants, Public eating places. Detarnishes, cleans, brightens, in one operation. Takes the place of soap and polish. No rubbing, brushing, polishing or boiling. Saves 100% time, labor, and money. Every demonstration a sale and steady repeat customer. Protected territory. No experience necessary. Factory to you. A postal card will bring you "Once in a lifetime road to fortune," full particulars. F. P. Stewart, Manufacturer, P. O. Box 692, Miami Beach, Florida.

**WHOLESALE and Retail,** watches, expansion bracelets, Perfume, Aluminum-ware, Write now . . . Cartier's, Box 272, Pittsfield, Mass.

**AT Home—Your own business making-selling-popular \$1.00 novelties.** Cost you 3c to 15c. Everything supplied. Write So-Lo Works, Dept. U-6013, Loveland, Ohio.

**AGENTS fortune maker quickmend solder cost 1c sells 50c sample 20c.** Western Chemical, Salem, Oregon.

**IS This My Opportunity?** The NuProcess Products Laboratories, Dept. 287, Aurora, Illinois, is asking for letter inquiries from salespersons who would like to become genuine, exclusive, protected territory Sales-Distributors of their two products in territories where no introductory sales work is being done now. The letter inquiry should come from a man or woman of selling ability and experience, who has a car to work with, and enough funds to finance their first order. Very liberal cash profits should start coming in to them within one hour after they start work. The two products are . . . (1) Silver Plating Liquid (NuSilver and Re-Plate-O patent trademarks) a liquid in \$1.00 glass bottles, also in glass Pints, Quarts and Gallons, which cleans, silverplates and polishes (3 results) from the one application. It is basically a superior quality product for cleaning and preserving silverplated tableware and silverplated pieces of all kinds and sizes. But it also silverplates out onto copper, brass, bronze, zinc and some other new composition metals. It is put on either by being rubbed on with a cloth by hand or by immersion of the piece into the liquid for 1 minute. More uses are being constantly found for this Silver Plating Liquid in stores, offices, shops, factories; and even large Industrial Concerns, Institutions and Universities now purchase it. There is a very large potential market for NuSilver Plating Liquid wherever it is introduced and demonstrated . . . (2) The second product is the Lectrik Silver Kleener Atomic Metal Electrode Plate. This is a metal de-tarnishing plate which, when used as directed, draws the tarnish off silverware, instantly . . . like a magnet will draw tacks to it . . . Restaurants, Hotels, and Eating Places like this de-tarnishing method because it is so quick and simple for the help to do. These 2 products are demonstration sellers. No demonstrations, no sales. Lots of demonstrations, lots of sales. Both products sell wholesale and retail. All sales in your territory are yours as long as you continue to introduce and sell the products. You are expected to secure, appoint and stock-up new selling agents and dealers at all points in your territory. This is a steady, permanent, well-paying job of your own. You are the boss of yourself and of everything in your territory. If this is the kind of a business you are looking for write a letter of full details about yourself to this concern and receive on return mail fuller and more complete details for your further consideration.

**IMMEDIATE Profits!** Take orders for our beautiful Laminated Plastic Reproductions of any picture or negative. Full or part time opportunity for Big Earnings without investment. Free details. Gotham Products Company, Box 5427, Philadelphia 43, Pa.

**OPERATE Profitable business selling Air Deodorant.** Write Salesmanager, 652 Ruthledge, Charleston 20, South Carolina.

**BUILD prosperous, steady business** of your own. No investment, no experience necessary. Wonderful year 'round profits selling everyone quality shoes at exceptional values. Free outfit starts you making cash immediately. Merritt Shoes, Dept. PS, Brockton, Mass.

**WOULD you pay 3%—first \$350 made?** Color-illustrated book "505 Odd Successful Enterprises" free! Proven! Work at home, office. Expect something odd! Pacific, San Clemente, Cal.

#### 47 EDUCATIONAL AND INSTRUCTION

**LEARN Trigonometry better than others.** Master method instructions \$1.00. Guaranteed. J. Ziemba, 6123-B Orchard, Dearborn, Mich.

**MODERN Welding School** gives thorough training for one of industry's best paid jobs. Experienced instructors. Individual attention. Nonprofit institution. Qualified under G. I. Bill. Write for literature and details. Hobart Brothers Co., Box P-1067, Troy, Ohio.

**GOOD "Used" self-instruction educational books** on all subjects bought, sold, rented, exchanged. Satisfaction guaranteed. Complete information and 100-page illustrated bargain catalog Free! Write—Nelson Company, Chicago 5.

**HAVE your own office!** Many earn up to \$5,000-\$15,000 Annually. Learn credit-collection agency business by home study course. Experience unnecessary. Write for Free bulletin. No obligation. Franklin Credit School, Dept. 203-D, Roanoke 7, Va.

**BIG money rebuilding shoes.** Help needed everywhere or start big-income business of your own. Learn practical, sure, easy way in 3 months. Anyone from 18-60 years can learn easily. Approved for G.I. training. Rush postcard today. Modern Shoe Rebuilding School, Est. 1927, 2935 Belmont, Chicago 18, Illinois.

**HYPNOTISM.** "How I Hypnotize" 25c. Dr. Lonk, Hypnotist, D-1619, Palatine, Ill.

**CLINICAL Laboratory Technicians** in great demand. We train you in your spare time, in your own home. You can practice while studying. Write for free catalogue. Imperial Technical Institute, Box 973-B, Austin, Texas.

**PSYCHOLOGY** teaches about mind. Biology teaches about body. Bio-Psychology teaches about powers of mind over body. Use powers subconscious mind. Select proper vocation. If properly placed, increase efficiency. Broaden education. Develop personality. Control emotions. Succeed. Correspondence, Dept. p, Taylor School of Bio-Psychology, Chattanooga, Tenn.

**HERBALISM—Complete Course** in 2 volumes. 1000 recipes. Home Service, Forestville 3, Va.

**BECOME a Christian.** Absolutely free instructive letters. Millard Hart, Rockland, Maine.

**PREPARE for civil service examination.** Lay for course after securing position. Write Free School, Dept. PS-4 Kokomo, Ind.

**BECOME a Doctor of Psychology or Metaphysics.** Teach secret of contentment, happiness. Win degree of PsD or MsD. Solve mental worries. Free book College of Universal Truth, 5153-A N. Clark, Chicago.

**"ART of Gem Cutting" complete book** by Dr. H. C. Dake, covering Gem Cutting and Collecting. \$1.50 postpaid, send check today. B & I Manufacturing Co., Burlington, Wisconsin.

**3800 USED Correspondence courses.** Catalogue 25c. EG Elmsford 3, N. Y.

**MAKE Landscape Oil Paintings.** New method of teaching by mail. Inexpensive course for beginners. Write R. Barton, Box 249, West Haven, Conn.

**DEFEAT boxers.** Secret Jiu-Jitsu course. 36 illustrations complete instructions \$1.00. Sydney Smith, 303 So. Gomez, Tampa, Fla.

**BOOKKEEPING Self-Taught.** Complete Course only \$1.00. Premier Sales Co., 28 Conestee Ave., Greenville 1, S. C.

**TILE setters earn \$400 and up per month.** Learn quickly through my easy low cost home method. Act now, the building boom is on; Gartell Tile Contractor, 15020 Mansel Avenue, Lawndale, California.

**LOCKSMITH Course.** Lock-picking, key-fitting, etc. \$1.00 prepaid. Miller, Box 239, Holdrege, Nebraska.

**URINALYSIS course.** Become technician. \$1.00. Free details. Saur, 127 West 82, New York 24, N. Y.

**ADD with adding machine speed and accuracy.** Use easily mastered, highly efficient method developed by accountant. No groups or tables to memorize. Invaluable to students, adults, math experts . . . Copyrighted instructions \$1.00. Speed-add method, Rt. 1, Box 109-A, Paradise, Calif.

**MASTER Keys, Pick Locks.** Guaranteed Instructions \$1.00. Box 1499, Yale Station, New Haven, Conn.

**MAKE art your profession!** Train at home with New Invention that simulates art-class drawing from three-dimensional life-like models. Free Book. Austin Studios, 121-A Opera Place, Cincinnati 2, O.

**HOME Study course, drugless therapy.** Free Literature. Inst. of Drugless Therapy, Tama, Iowa.

**AMAZE others.** Add faster than adding machine. Free details. Maths Institute, Box 633, Mobile 4, Ala.

**LEARN the profitable jewelry and goldsmithing trade at home.** Simplified Course teaches jewelry designing, manufacture and repairing; gemsetting, etc. Gemcrafters, Kalispell, Montana.

**YOU Can draw—amazing invention.** Professional looking drawings, cartoons, pictures, produced easily. For fun, profit. Artcraft, Box 7, Cincinnati 30, Ohio.

**\$5000. UPWARDS,** annually operating dignified private "Employment Agency" Easily Learned. Free Details, Hunt, Box 308, Burlingame 2, Calif.

**ADD with adding machine speed and accuracy.** Use easily mastered, highly efficient method developed by accountant. No groups or tables to memorize. Invaluable to students, adults, math experts, . . . copyrighted instructions \$1.00. Speed-add method, Rt. 1, Box 109-A, Paradise, Calif.

#### 77 LANGUAGE OUTFITS

**29 LANGUAGES** by Linguaphone, Russian, Spanish, Portuguese—Direct Conversion Method for Mastering any language quickly, easily, correctly at home. Available under GI Bill of Rights. Send for free Book, Linguaphone Institute, 54 RCA Bldg., New York, CI 7-0830.



## 10 AUTHORS SERVICE

I WANT New Writers to cash hundreds of checks for \$1 to \$100, offered each month. The easiest way to write for pay. No previous experience necessary. Send for Free details. No obligation. Saunders M. Cummings, 467-S Independence Bldg., Colorado Springs, Colo.

## 25 BUSINESS SERVICE

GOOD "Used" self-instruction educational books on all subjects bought, sold, rented, exchanged. Satisfaction guaranteed. Complete information and 100-page illustrated bargain catalog Free! Write—Nelson Company, Chicago 5.

CLEARING House. Have you Subcontracting facilities. Engineering Service to spare, production items without plant or outlet? Do you need technical books or accounting assistance? Write P. O. Box 464, El Paso, Texas.

WE do nickel and silver plating. Globe Company, Fitzgerald, Ga.

TO Whom It May Concern: We will represent you in all principal cities of the world. Personal or business assignments \$1 per hour. James W. Farley, Citizens Bldg., Cleveland 14, Ohio. Note: Would appreciate hearing from someone who wishes to enter this business in your city. Will send you assignments immediately. References exchanged. State qualifications.

CHICAGO Trip unnecessary. We become your agent in buying, selling, securing information, collections, expedite business transactions. Chicago Personal Service, Box 145, Chicago 90.

PORTABLE-adding machines \$12.95. One year guarantee. Write for circular. R & M Company, 212 Wyoming Ave., Scranton 3, Pa.

CHICAGO Address, Your Personal Mail. Received and Forwarded, \$1 Monthly. Faultless B-3439 Michigan, Chicago 16.

## 30 CARTOONING, SIGN PAINTING, DRAWING AIDS

"HOW To Make Money With Simple Cartoons"—A book everyone who likes to draw should have. It is Free; no obligation. Simply address Cartoonists' Exchange, Dept. 1444-C, Pleasant Hill, Ohio.

MAKE Signs, 9 complete alphabet pattern sets, 3 complete numeral pattern sets and catalog \$1.00. Sign Letter Distributors, P.O. Box 101, Mineola, N. Y.

CASH for cartoons, hundreds needed now, send yours today. Highest prices paid for your work. Florida Art And Advertising Co., Box 361 Wildwood, Florida.

UNEQUALED Offer! Beginners outfit given away Free with every purchase of our famous showcard writing course. Rush postal for full information. Sherwood Publishing Co., Dept. 102, Irvington, N. J.

754 QUICK Pictures in Modern Poster Art-lettering. Free literature. Art Book Shop, Arnold 5, Mo.

## 31 CHALK TALK STUNTS

CHALK Talks, Laugh Producing Program, \$1.00. Illustrated Catalog 10c. Cartoonist Balda, Oshkosh, Wisconsin.

## 136 TYPEWRITERS

RECONDITIONED Typewriters, Printing Devices, Office Appliances Supplies Dixie-graph, King, N.C.

PORTABLES—Standards immediate delivery. Every machine guaranteed, 30 day refund privilege. All Makes Typewriter Co., Omaha.

## 118 RUBBER STAMPS

RUBBER Stamps. Buy direct from manufacturer. Literature free. Lee-Vall Press, Box 1242, Indianapolis 6, Indiana.

3 LINES 40c; Pads 35c; Signatures \$2.00. Prinrite, Wawatusa, Wis.

## 110 PRINTING OUTFITS, SUPPLIES

CUTS—Make real halftones, linecuts yourself! Samples 25c. Particulars free. Rapid Chemical Service, Edwardsville, Ill.

"PRINTOMATIC" Selffeeding Post Card Stencil Printing Duplicators \$9.50 Up. Office Size Duplicators, Speedoprints, Hilcos, Excellographs \$33.41 Up. Literature Free. Pittsburgh Typewriter Supply, 336 WE Fourth Ave., Pittsburgh 22, Pa.

INEXPENSIVE home-made printing press. Details free. Novelty Shop, Downs-ville, Louisiana.

PRINTING equipment, type and supplies. Send stamp for details or dime for complete illustrated supply book. Kelsey Inc., X-8, Meriden, Conn.

NEW type 44c font. Catalog, dime. Box 123D, Jackson, Michigan.

PERSONAL Stationery—extra quality, 50% rag content white bond. Name, address, beautifully printed, blue ink. 200 letterheads (6 x 9½"), 100 envelopes, postpaid \$2.95. Money back guarantee. Free Samples. Cottage Bookshop, Box 726-S, Lincoln, Nebr.

HOME Made Presses. Write Riegel, 1111 Harrison, Philadelphia 24, Penna.

PRINTERS Galley, quarterly magazine containing valuable information. Copy—10c, Year—25c. Steiner, 27 Rockwell Rd., Danbury, Conn.

PRINT At Home—Send 10c for Catalogue—Type, Presses, Supplies, Barnhard Co., 6 Columbia St., Newark 8, N. J.

PRESSES, cutters, perforators, bindery equipment. Bulletins 3c, Box 918, New York 8.

## 109 PRINTING, MULTIGRAPHING, ETC.

PHOTO Offset, Printing, Multigraphing. Samples free. Mango, 555-B South 20th, Newark 3, N. J.

SEND For our samples Now! Mail Printing. P.S.93, Danvers, Mass.

"CUT printing costs 1,000 offset 8½ x 11 printed \$3.95; 5,000 \$15.75; Larger quantities less, 48 hour service; samples, price list free. Fidelity Company, Parkersburg 10, W. Va."

250 8½ x 11 letterheads and 6¾ envelopes \$2.75. Advance, Strasburg, Ohio.

100—8½x11 HAMMERMILL Letterheads \$1.00 Postpaid. Envelopes, Statements, Business Cards Same. Race Printing, Hudson, New York.

QUALITY Printing: Business, personal stationery. Prepaid delivery. Samples free. Mero Products, 99 Morrison, Punxsutawney, Penna.

SEND 10c Now, for our 36-page 1947 price-list—refunded first order. McCall Press, 1326 S. 27th, Omaha 5, Nebr.

BUSINESS, Personal Stationery, State requirements. Samples. Price Lists Free. How Printing Company, 717-23 Eunice, Webster Groves 19, Missouri.

GUMMED Labels 500—75c, 1000, 75c; List Free. Reed, Spiro, Okla.

## 98 PATENT ATTORNEYS

INVENTORS: Without obligation, write us for information as to what steps an inventor should take to secure a Patent. Randolph & Beavers, Registered Patent Attorneys, 340-A Columbian Bldg., Washington 1, D. C.

INVENTORS: Write for free brochure "Evidence of Invention." Labiner, World Building, New York 7.

INVENTOR'S Guide free on request. Frank Ledermann, Registered Patent Attorney, 154 Nassau St., New York 7, N. Y.

INVENTORS—Patent Laws encourage the development of inventions. The Rules of Practice of the U. S. Patent Office advises—unless an inventor is familiar with such matters—that he employ a competent registered attorney, as the value of patents depends largely upon the skilful preparation of the specifications and claims. Write for further particulars as to patent protection and procedure and "Invention Record" form at once. No obligation. McMorro, Berman & Davidson, Registered Patent Attorneys, 1433 Victor Building, Washington 1, D. C.

PATENTS—Trade marks, Irving L. McCathran, 316 McLachlen Bldg., Washington 1, D. C. Registered Patent Attorney.

REGISTERED Patent Attorney offers services. Sanders, 6430 Evans Ave., Chicago 37, Ill.

PATENT and Trade-Mark Practice before U. S. Patent Office. Validity and Infringement Investigations and Opinions. Booklet and form "Evidence of Conception" forwarded upon request. Lancaster, Allwine & Rommel, Registered Patent Attorneys, Suite 413, 815-15th Street, N.W., Washington 5, D. C.

PATENT—Protection for Inventors—detailed information and steps to take to secure patent protection for your invention will be mailed promptly without obligation. Victor J. Evans & Co., Merlin M. Evans, Registered Patent Attorney, 241-D Merlin Building, Washington 6, D. C.

INVENTORS: Learn how to protect your invention. The patent laws afford the inventor protection for the patentable features of his invention. The United States Patent Office advises the inventor to engage a competent, registered patent attorney to represent him. We offer inventors experienced, confidential service. Specially prepared booklet containing detailed information concerning patent protection and procedure with "Record of Invention" form will be forwarded to you upon request—Without obligation. Clarence A. O'Brien & Harvey Jacobson, Registered Patent Attorneys, 72B-D District National Bldg., Washington, D. C.

C. A. SNOW & CO., S-427 Snow Bldg., Washington 1, D. C. Registered Patent Attorneys. Established 1875. Literature mailed on request.

## 58 FOR INVENTORS

THE Inventor who believes he has a new and useful invention, and needs advice, should consult a competent registered patent attorney. Without obligation, write for full information on how to secure Patents and Trademarks. Randolph & Beavers, Registered Patent Attorneys, 340-E Columbian Bldg., Washington 1, D. C.

"INVENTOR'S Guide" free on request. Frank Ledermann, Registered Patent Attorney, 154 Nassau St., New York 7, N. Y.

INVENTORS: Avoid unnecessary expense. Write for free booklet explaining how our Consulting and Advisory Service can assist you in deriving greatest profit from inventing. Institute of American Inventors, Dept. 30-A, 1926 Eye St., N.W., Washington 6, D. C.

INVENTORS! Have you good patentable ideas? Write Patent Agent Metzler, 11 West 42nd, New York.

PATENTED. Unpatented inventions promoted. M. Joyce Humphries, 1424 Landtitle, Phila 10, Penna.

HIGHEST Royalties and cash for your inventions when we market them. Free particulars without obligation. Universal Marketing Co., Depart. 4C, 126 Lexington Ave., New York 16, N. Y.

HOW to make money from inventions: complete forms, with valuable information on avoiding costly blunders. One dollar. J. O'Brien, Patent, Development Engineer, 132 Nassau St., New York.

INVENTORS' Ideas Developed Exclusively. Models Built to your specifications—in absolute confidence and secrecy. Competent and skilled engineering. Send rough sketch for estimate. P.O. Box 743, San Mateo, California.

INVENTORS: Learn how to protect your invention. The patent laws afford the inventor protection for the patentable features of his invention. The United States Patent Office advises the inventor to engage a competent, registered patent attorney to represent him. We offer inventors experienced, confidential service. Specially prepared booklet containing detailed information concerning patent protection and procedure with "Record of Invention" form will be forwarded to you upon request—without obligation. Clarence A. O'Brien & Harvey Jacobson, Registered Patent Attorneys, 72A-D District National Bldg., Washington, D. C.

HAVE You Ideas, inventions, to sell? We want new products, business ideas. Need New knitting gadgets. Write Ideas, Unlimited, 3009 Naylor Rd., Washington 20, D. C.

INVENTORS—If 5,000 people in America can use or benefit from your idea, I guarantee its sale at your price in less than 60 days. George Pearce, 47S Bartholomew St., Peabody, Mass.

READ Pitfalls For Inventors \$2.00. Inventors Hobby Club, Box 827, St. Louis 1, Missouri.

INVENTORS—Patent Laws encourage the development of inventions. The Rules of Practice of the U. S. Patent Office advises—unless an inventor is familiar with such matters—that he employ a competent registered attorney, as the value of patents depends largely upon the skilful preparation of the specifications and claims. Write for further particulars as to patent protection and procedure and "Invention Record" form at once. No obligation. McMorro, Berman & Davidson, Registered Patent Attorneys, 1434 Victor Building, Washington 1, D. C.

HOW I made Gadget Inventing Pay. Detail booklet, \$1.00. W. C. DeWeese, Del Rio, Texas



WRITE for "Cooperative Combination". Explains patent protection and procedure. Invention sales help if you use my patent application services. Charles R. Morton, 11 West 42nd Street, New York.

## 75 INVENTIONS WANTED

INVENTIONS Promoted. Patented or Unpatented. Write Adam Fisher Company, 183-A Enright, St. Louis, Mo.

WANTED: Practical inventions suitable for sale through 5c-\$1.00 stores, drug-stores, cigar stores; also sportsmen's items of all kinds. Write Matt, 1412-S Great Northern Building, Chicago 4.

WANTED: Practical Inventions by Manufacturers, Patented or Unpatented. John D & Son, Dept. PS-4, Box 3213, 285 Howard Ave., Bridgeport 5, Conn.

INVENTORS: Hundreds of manufacturers have requested our assistance in locating marketable new products. Complete information, free. Institute of American Inventors, Dept. 30C, 1926 Eye St., N.W., Washington 6, D. C.

INVENTIONS Wanted, Patented or Pending. Inventors Exchange, Dept. D, Hartford 1, Connecticut.

PATENTED, unpatented inventions wanted. We have tremendous lists of manufacturers who may pay cash, royalties. Descriptive booklet free. National Invention Service, 1404-D Mitchell Street, Oakland 1, Calif.

## 99 PATENTS

INVENTORS: Test the commercial value of your patented or unpatented inventions, quickly and inexpensively. Write for free information. Institute of American Inventors, Dept. 30-B, 1926 Eye St., N. W., Washington 6, D. C.

INVENTORS: You save up to 300% when dealing with your patent searcher direct. Complete search with patent copies \$6.00. Reports mailed in 5 days. Invention protection forms free. Write Raymond L. Smith, Patent Searcher, 703-S Albee Bldg., Washington 5, D. C.

## 100 PATENTS FOR SALE

PATENT for sale Reclining rocking chair good for porches, hospitals, yachts and lawns with adjustable sun guard, can be produced strong and cheap best of its kind. Joe Haich, 3804 Carey St., E. Chicago, Ind.

## 82 MANUFACTURING

APPARATUS Glass Blowing. Send Drawing and Specifications. We mail no catalogues. Glastube Products, 185 Acacia Ave., Hawthorne, California.

A brand new patentee's service. Write for information. J and M Company, Burlington 2, Kentucky.

MODELS, small lot manufacturing, metals, plastics, etc. Millburn, Burlington, Kentucky.

RUBBER moulds made to order. Stock moulds. Vallance Art Products, 1873 East 70 St., Cleveland 3, Ohio.

## 87 MODELS, MODEL SUPPLIES

MOST complete Illustrated Catalog—"O-HO OO" Model Railroad Parts ever published. Send 5c for mailing. Selly, 1377 Gates Ave., Dept. 836, Brooklyn, N. Y.

SHIP Model and yacht supplies, complete large 64 page catalogue, 30c. Wm. Wild, 510 E. 11th St., New York City.

MODEL Ship Builders! Are you looking for authentic, precision ship models? Send for richly illustrated fully descriptive catalogue in full color of famous ships of all kinds. Only 10c. Halesite Yacht Service Inc., Dept. C-28, Halesite, Long Island, N. Y.

SHIP and Yacht model fittings; blueprints. Send 25c for illustrated catalog No. 20—Listing hundreds of items. A. J. Fisher, 1002-2 Etowah Ave., Royal Oak, Mich.

BUILD Model Ships, Railroads, Catalog 10c. Ideal, 21 West 18th Street, New York 11, N. Y.

RAILWAY models, complete line. Combined HO and O gauge catalogue, 50c. Walthers, 269 Erie, Milwaukee 2, Wisc.

SHIP Model Kits and Fittings, most complete stock in New England. Boucher, Fisher, Marine Model and Model Shipways fittings, blueprints and model yacht equipment at standard prices. Send 25c for new illustrated 1947 Catalog and price list, Dept. S., James Bliss & Co., Inc., 220 State St., Boston, Mass.

SCALE ship model kits and fittings of fine details. Price list 10c. Model Shipways, 476 Main St., Ft. Lee, N. J.

BUILD HO Gauge Wrecking Crane. Complete kit with brass wheel trucks. \$2.15 P.P., Catalog 10c. Ideal, 21 West 18th Street, New York 11, N. Y.

BRASS Gears and model supplies for the inventors. Send 10c for catalog. Pierce Model Works, Tinley Park, Ill.

BIG illustrated Model engine catalog 10c. Active Products & Supply Co., 53 W. Jackson, Chicago 4.

MOTORS — Kits (Aeroplanes, Racing Cars, Boats, Model R.R.)—Tools—Everything for the Hobbyist. Catalog 15c. Westchester Hobbies, Inc., 257 Mamaroneck Ave., White Plains, N. Y.

TRAINS, airplanes, ships, accessories, tools, for hobbyists. Free catalog. Ben's Hobby Shop, 72 West Washington, Chicago 2, Ill.

NEW Illustrated Catalog for Scale and Tinsplate Railroad materials for 25c. Refund coupon, Tri-Lor Hobbyist, Box 260, North Dartmouth, Mass.

STEAM engines—boilers—castings. Catalog 25c. Anton Bohaboy, 2297 Price, Rahway, New Jersey.

DIESEL Model Engine. Displacement .10 cubic inch. For model boats, race cars, airplanes. 4000 to 10,000 r.p.m. Weight 5½ oz. No coil, condenser, spark plug or batteries. \$18.50 C.I.E. 11929 So. Western, L. A. 44.

BUILD Jet Propelled Auto Models described February Popular Science. 12 cylinders \$1.00 postpaid. Amaco Laboratories, Box 3246, Amarillo, Texas.

BALSA Wood Generous Supply \$1.00 Price List Free. Sanlader, Manitowoc, Wis.

RADIO Control. 10 tube unit. Revolutionary Design. Write for details. Box 1097, N. Y. 8, N. Y.

## 71 HOME CRAFTSMEN

WHITTLES supplies, readicut blanks, special woods, knives.—Old Whittler, 1402 Charles, LaCrosse, Wis.

LEATHER Tools Lacing Supplies Wholesale Retail Mail Orders Catalog, National Handicraft Co., 30 Frankfort St., New York City 7.

LEATHERCRAFTERS! Send for catalog listing leathers, kits, supplies. Kit Kraft, 1607 South Western, Los Angeles 6, Calif.

PLYWOOD Cabinet kitchen plans 25c. Playne Cabinets, 4617 Johnson Ave., Western Springs, Ill.

MASONITE Mill ends. 15#—\$1.00. Express charges collect. Roots, 820 So. 7th, Richmond, Ind.

BIGGEST complete shellcraft kits! Cameo brooch, earrings \$1.00. Jewelry, etc. \$3.50. Six animals \$1.00. Instruction book 35c. Wholesale supplies. Shelart, 3027½ 6th St., South, St. Petersburg, Fla.

VENETIAN Blind Cord, .06 yard. Tape .33. Hardware .95 set. Aluminum slats .05 foot. \$50.00 orders 10% discount. "Roberta," Gloversville, New York.

135 DESIGNS for crafts projects in wood, metal, plastics, \$1.00. Contempo, 1467 East 18 St., Bklyn 30, N. Y.

LEATHERCRAFTERS! Send for free catalog on Hand Laced Moccasin Kits and Instructions. Hollywood Mock, 1206 Venice Blvd., Los Angeles 6, Calif.

KNOCKDOWN Cedar Chest Lumber Veneers Free Price List. Giles-Kendall, Box 435, Huntsville, Alabama.

SHELL Jewelry Supplies. Wholesale only. McFarland Plastic Co., Sarasota, Fla.

PERMANENT Molds for casting metal novelties. Write Fritz Foundry & Supply, 622 N. Fulton, Allentown, Penna.

CATALOG: Patterns plywood Novelty Furniture—Letters—Numerals—Plaques—Frames—Weather vanes—Silhouettes—Lawn Ornaments. 100 Books & Booklets on Crafts & Hobbies. Picture Frame Mouldings, Tools. Large line Decal Transfers. Other lines. Hundreds articles finely illustrated. Write Wo-Met Shop, Ashburn, Georgia.

LEATHER Designs. Fifty belts, \$1.00. Twenty billfolds, \$1.00. Ten Handbags, \$1.00. Lampkin Artcrafts, Box 641-S, Culver City, Calif.

LEATHER Designs on plastic eliminate tracing. Introductory offer \$1.00. Sample 10c. Lampkin Artcrafts, Box 641-S, Culver City, Calif.

PIPE kit, Genuine imported Briar. Complete with instructions \$1.00, instruction only 50c. Literature free. Carvapipe, 2829-B Dixie, Hamilton, Ohio.

PLAQUES.—Special Mother's Day Decorated \$1.50. Craft, Box 3447, St. Paul, Minn.

JIG saw patterns. Full size, ready to use. Artistic Gothic wall shelf 20" high; corner shelf 17". Both for 10c. Jig Saw Guild, 117-JS Worth St., New York 13.

EXPERIMENTERS! Interested in Electrical, Mechanical devices from war surplus? List Free. F. Siefke, Box 18, Station E. Buffalo, N. Y.

70 PATTERNS Lawn Ornaments and Novelties, \$1.00. Modern Woodcraft, Saginaw, Mich.

WHITTLERS, easy to finish! Basswood animal Forms—in the Round (not jigsawed Patterns). Skunk .50, Squirrel .50, Beaver .50, Cash with Order. Fieldcraft, Inc., 755 Boylston Street, Boston 16, Mass.

## 18 BLUEPRINTS AND PLANS

FUN or profit. Make own blueprinting and copying device. Plans and instructions \$1.00. Bluebird Novelty, Osceola, Indiana.

DETAIL drawings made of machine parts from your sketches and specifications. G. R. Althen, 1238 Cleveland St., Baltimore 30, Md.

## 23 BUILD IT YOURSELF

BUILD your own Log Cabin home. Richly illustrated book packed with plans, Ideas, Pictures, Instructions. Send \$2 to Otsego Log Homes, Gaylord 2, Mich.

RUBBER Molds 50c up. List Free. Winermolds, 228-S, Grove, St. Paul 1, Minn.

SPEEDY 1 Motor, runs atop flashlight cell! Parts, instructions, 35c. Fonskov, 655-E Amboy, Perth Amboy, N. J.

HOT Water Free—from Sunlight. System efficient any locality year 'round. Standard materials—easily built—low cost. Facts Free. Solar Water Co., Box 175, Dept. F, Coral Gables, Fla.

BUILD Concrete Block Machine. 2 blocks per minute. Easy, inexpensive. Build concrete mixer, automatic electric water heater, stencil duplicator, electroplating outfit. Catalogue, details—10c. Horne, 206 West Wilder, Tampa, Fla.

BUILD Yourself an Outdoor Fireplace that bakes, broils, roasts, fries and barbecues. We supply the unit itself, complete with oven, you add the brick or stonework. You can build any style fireplace, and no chance for error because the unit functions independently of masonry. Many suggested designs sent with each Fireplace Unit. Size: 38" x 18" x 24". Price \$44.50 F.O.B. Hartford. Write Outdoor Oven Fireplace Co., 852 Windsor St., Hartford 6, Conn.

CONCRETE Block Homes. 24 page booklet; drawings, instructions on how to build. \$1.00. H. C. Lightfoot, Civil Engineer, Richboro, Pa.

FRAME Homes. 30 page booklet; drawings, instructions on how to build \$1.00. H. C. Lightfoot, Civil Engineer, Richboro, Pa.

"PUMACRETE buildings. Cheaper. Faster. Better than cement blocks. Build for self and others. Make big money easy. Materials available everywhere. Simple homemade equipment. Nothing complicated. Completely detailed instructions with pictures, \$2.50. Earl Behling, General Contractor, Box 955, Inglewood, Calif."

BUILD real heavy duty Machines, using our production tested plans, 30" Bandsaw, 12" Lathe, Dowel Machine, Portable Sawmill, Planer, Concrete Block Machines. Dozens other Machines for Shop, Farm, Home. Free Lists. Nichols Equipment Co., Purvis, Miss.

COMPLETE, copyrighted plans and instructions for building combined frozen food locker and walkin cooler at home \$1.00. Newman's, Box 1020, Houston, Texas.

BUILD Concrete Block Machine. Vibrator or hand. Easy. Economical. 150 blocks per hour. Build house, shop, garage or other buildings. Save half. Sell blocks. Make Money. Free Details. Clyde Lee, Mountain View, -1, Okla.

AIRPLANE Jettison gasoline tank, streamlined 10' 6" x 2' 4". 165 gallon, twenty gauge terne coated steel. Ideal for making boats, bob sleds, midget auto, etc. Price \$10.00 per tank or \$7.50 per tank quantities of five or more. General Truck Sales, Inc., 205 Market South West, Grand Rapids, Michigan.

MAKE Popular novelties, statues, at home—3c to 15c each. Sell at big profit. Everything Supplied. Write So-Lo Works, Dept. U-6014, Loveland, Ohio.



**BUILD** Electric bike. Relay controlled. No gears; welding. Klauss, 1369 Missouri St., Pittsburgh (6) Pa. Plans \$1.00.

**LANE** oak table, fun for all, felt side cards, wall side dice, easy made, Patented instructions \$1.00. Geo. H. Lane, 62 Edgewood, Md.

**BUILD** your own home. Modern, practical, money saving information, new ideas. Get Builders Guide. Only \$1.00. 1807-B West 73rd Terr., Kansas City, Mo.

**BUILD** Table Circular saw with underslung swinging arbor. Plans \$2.00. Frank Rose, 2222 Alum Rock Ave., San Jose 12, Calif.

**ROTARY** Type lawn mowers. Complete or parts. Free literature. Air-Electric, Lohrville, Iowa.

### 139 WATCHES

**WATCH** and Clock Repairing—complete practical course in modern horology. 66 illustrated self-instruction lessons. Just out! Low price. Fascinating 100-page illustrated catalog Free! Write—Nelson Company, Dept. 3-01, Chicago 5.

**FINE** Watch, Clock, and chronograph repairing at minimum rates. 10 Day service for popular models. The Little Jeweler, Box 17, E. Dedham, Mass. A. R. Ciriello, Watchmaker

**WATCHMAKERS'** Journal containing helpful hints on watch repairing. Send 10c for copy. Dean Watch Co., 116 Nassau St., New York 7, N. Y.

**AMERICAN** Horologist, monthly watchmakers magazine, \$2. year. Kimbell, Plant City, Fla.

**WATCH** and clock repairing increasing, complete home study course with drawings and pictures. Information free. Houston Chronometer and Watch Co., P.O. Box 1140B Houston 12, Texas

**NEW** ladies, gents watches, as low as \$16.50. Best Quality Guaranteed. Write for prices Divers & Son, Box 135, Hertford, N. C.

**YES**, we sell staking tools with adapter for the use of punchers, patent pending. With 40 punchers complete, \$52.95. With 60 Punchers, \$75.50. Adapter alone, \$7.95. F. S. Horological Co., Box 43, Planetarium Station, New York 24, N. Y.

### 95 OLD GOLD, WATCHES, ETC.

**GOLD** \$35.00 Ounce—Mail old gold teeth, diamonds, jewelry, watches—receive cash by return mail. Satisfaction guaranteed. Free information. Dr. Weisberg's Gold Refining Company, 1500-B Hennepin, Minneapolis, Minn.

**CASH** for Old, Broken Jewelry. Highest prices paid immediately. Mail gold teeth, watches, rings, silverware, diamonds, spectacles. Satisfaction guaranteed. Information free. Rose Smelting Co., 29Y East Madison, Chicago.

**20 WATCH** Movements broken for Student Practice work, \$10.00. 3 Pounds Broken Costume Jewelry, \$8.00. 1000 Costume Jewelry Stones, \$3.50. Lowe's, Holland Bldg., St. Louis 1, Mo.

### 76 JEWELRY

**CERAMIC** Jewelry Supplies, Bar Pins, ear screws, for ceramic and woodworkers, also, glass and sea snell assemblers. Free catalog. Philadelphia Badge Co., 1007 Filbert St., Philadelphia, Pa. Dept. E-1.

**MAKE** your own jewelry! Findings in metal and plastics: earwires, pinbacks, cameos, stones, beads, clasps, sprays, combs, hairbars, plastic and metal chains, Hobby Art Corp., Dept. 6, P.O.B. 276, New York 18, N. Y.

**SHELL** Jewelry instruction book with illustrations, plastics, shells, pinback, earbobs, for one set. Send only \$1.00 to Williams Shells, P.O. Box 8635, Sulphur Springs, Fla. Send for free catalogue.

**MAKE** Money. Making Shell jewelry and novelties. Instruction book 75c. Kit \$5.00. Catalogue free. Palm Shellcraft Co., 220 W. 9th St., Sarasota, Fla.

**MANUFACTURE** costume jewelry at home for profit, hobby, therapy. Free wholesale supply catalogue, Instructions. Florida Supply House, Bradenton, Florida.

**EXPANSION** watch bands, stainless steel, adjustable, fits any man's watch \$1.00. Ball Pt. Pens written guarantee, \$1.00. R. Zuckerman, 2709 Ocean Ave., Brooklyn 29, N. Y.

**JEWELRY**, findings. Dime brings latest catalog. George Sassen, 154 Nassau Street, New York 7.

### 132 TOBACCO & PIPES

**CIGARETTES** 5 Cartons \$7.20 postpaid. Check or money order. Sav-on Mailing, Box 92, Jersey City 3, N. J.

**CIGARETTES**—all popular brands, \$1.45 per carton, postpaid. Three cartons, minimum. Send check or money order. No limit. Durham's Mail Order Co., North Branch, N. J.

### 113 RAZOR BLADES, SHAVERS

**"GILLETTE"** type blades! 100—\$1.00. Guaranteed! Kayess, Box 37, Sta. W., Brooklyn, N. Y.

### 86 MISCELLANEOUS

**BOOKFINDERS!** (Scarce, out-of-print unusual books.) Quickly supplied. Send wants. Clifton, Box 1377 PSM, Beverly Hills, Calif

**GOOD "Used"** self-instruction educational books on all subjects bought, sold, rented, exchanged. Satisfaction guaranteed. Complete information and 100-page illustrated bargain catalog Free! Write—Nelson Company, Chicago 5.

**DREAM** Girl Photos—Just For You! Unretouched, actual glossy shots of Hollywood gals in poses you'll like, 12 photos to a set—\$1.00. 30 different sets available. Free brochure chock full of miniature prints with each order. DeLuxe Photo Service, Box 953, Dept. P-5, Church St., Annex, New York 8, New York.

**FREE**—New 42-Page Book Entitled—“How to Become a Successful Direct Salesman,” written by salesmen for those who want to become salesmen and earn up to \$100 and more weekly. Send penny postcard. Specialty Salesman Magazine, Dept. PS-2, 307 N. Michigan, Chicago 1, Ill.

**UNUSUAL** Novelties, samples 10c. Modern, Box 2, Knickerbocker St., New York 2.

**GET** Lots Of Mail: Name Listed Three Directories 25c. Harvey Teeple, Decatur, Ind.

**MEDICAL** Laboratory Technicians in great demand. We train you in your spare time, in your own home. You can practice while studying. Write for free catalogue. Imperial Technical Institute, Box 973-S, Austin, Texas.

**POCKET** Size Can Openers fits on your key ring. Send 25c in coin (no stamps) for trial order of 6. M.B.V. Sales, P.O. Box 1086, Fort Wayne, Indiana.

**LOST** Western Mines. True Stories. Authentic data, landmarks, etc., 22 fabulously rich lost mines. \$1.00. Lost Mines Press, 1047-A Irolo St., Los Angeles 6, Cal.

**RAISE** Earthworms Instructions \$1.00. W. Huffman, 391 Pleasant Lake, Rives Junction, Mich.

**KILLER!** Use a really new, really effective weed killer on your lawn or farm. Slayz-Weed won't harm lawn grass yet it kills most weeds. Up to 5,000 square feet coverage with a one dollar supply. This amazing new product contains 70% 2, 4-D. It's easy. Quick and safe to use. Send \$1.00 today for a generous supply of Slayz-Weed. The Chapman-Gilbert Company, Inc., 830 West Ivy Street, San Diego 1, Cal.

**"HOW To Break And Train Horses"**—A book every farmer and horseman should have. It is free; no obligation. Simply address Beery School of Horsemanship, Dept. 584-C, Pleasant Hill, Ohio.

**FREE**—Samples, Magazines, Catalogues, Literature, Money-making Opportunities! Receive lots of Mail from everywhere! Mails Galore! Your Name Listed in over 15,000 "surefire" mailing directories, \$1.00. 5000 Listings, 50c; 2000, 25c. Stanford, 6220-N 16th, Philadelphia 41, Penna.

**MECHANICAL** Drawing Instruments—Veeco, 4 Piece, compact, precision set, brand new in lined case, value \$12.50. Special \$7.25. Hull Automobile Compass, for accurate road direction, brand new \$2.50. Prisms for 6 x 30 or 8 x 30 Binoculars brand new \$1.50 each. Offset prisms to be attached to 7 x 50 B. & L. Binoculars gives double the field of the ordinary 7 x 50 Binocular. Cost \$98.00. Special \$25.00. Green Sunshades for Binoculars size 6 x 30 and 7 x 50 snap on type, value \$7.50. Special \$1.25 per pair. Forward money order. No C.O.D. shipments. Public Sport Shops, 13 S. 16th St., Philadelphia, Pa.

**NEW** Generators—Surplus—12 Volts D.C. 50 Ampere; Mounting Bracket; Double "V-Belt" Pulley; Cooling Fan. Also: 24-28V-200 Ampere Surplus Aircraft Generators Ideal for Boats; Welders. Bargains at \$14.95 FOB Detroit, Money Orders Only. Wm. Malone, 8136 Forestlawn, Detroit 5, Michigan.

**LARGE** size shoes for men. Sizes 11½ to 16. Most Widths. Satisfaction absolutely guaranteed. Write today. Kingsize, 121, Brockton, Mass.

**SCISSORS** sharpened, reconditioned 50c. Overland's Saw Service P, Independence, Ia.

**RECEIVE** Money-making Opportunities, Samples, Mails, Catalogs, Magazines. Your Name in Thousand Mailing Lists, 25c. Glassminex, 1654-P Amsterdam Avenue, New York 31.

**LOOK!** Standard Guitar with waterproof cover "Home Study" course, tuner, picks.—all for \$17.50—Money order or C.O.D. "Tempo", 718 Broadway, Brooklyn 6, N. Y.

**VISIT** N. Y. by mail, assortment 25 cts. Monthly service \$1.00. Persil, 436 N. Y. Ave., Brooklyn 25, N. Y.

**LEARN** Hypnotism. Few hours home study Ralph Slater famous hypnotist, teaches you his technique, speedy hypnotism. Anyone can learn. Adults only. Complete course \$5.00. Send check or M.O. Today, Ralph Slater, 155 W. 72nd St., N.Y.C., Dept. Z.

**ART** Photos of Beautiful Hollywood models 4 x 5—8 for \$1.00, 32—\$3.50 Prepaid. Visual Slides, 1269 Broadway, New York 1.

**KITE** Fliers—Have fun, make money with the astonishing Paratripper. Automatically releases parachutes any altitude. Send 25c for complete kit and instructions. Lad Ventures, Division A-447, 4815 Newport, San Diego 7, California.

**AMISH** and Hex designs, Authentic, Assortment, 25c. Pennsylvania Dutch designs, authentic, assortment, 25c. Color chart and instructions. Edison, 710 Weiser, Reading, Penna.

**FANNING** Gold. Learn Now. \$60 ounce possible soon. Free illustrated booklet. How To Get Started. Catalogue Mining books, Supplies, Old Prospector, A-57, Dutch Flat, California.

**\$1.00 BRINGS** list of 100 business and job openings in Miami and sample letter of application. EAWentworth Placement Service, 1112 18th Pl., Miami 35, Florida.

**MINERALS**, rocks, drill cuttings, analyzed, \$1.00 up. Also chemical analysis run on drugs, food, soil, metal, paint, etc. Tri-State Laboratories, Grove, Okla.

**GLAMOUR** Photos! Sample set \$1.00. Risque-Pix, Box 699-E, Westfield, N. J.

**MAKE** Your Own Plastoplate printing cuts. Simple, easy process. Plastoservice, Argyle (2) Wisconsin.

**LATEX;** Distributor's Special! \$2.00! Three doz. popular brand & 1 "Super"! Wholesale prices with order only. No C.O.D. Lotz Bros., Dept. 3, 418 Kemper Rd., Rte. 5, Lockland, Ohio.

**SQUARE** Dance Instructions, 25 sets, \$1.00. Rayburne, Eureka Springs, Ark.

**HYPNOTIZE** anyone! Get the most perfect, easily learned, modern scientific course of "Genuine Hypnotism" in the world. Fully illustrated. Only \$1.00. Money back guarantee. Fowler, Soldiers Field, Boston 63, Mass.

**AT** Home—Your own manufacturing business: making popular \$1.00 novelties. Cost you 3c to 15c. Everything supplied. Write So-Lo Works, Dept. U-6012, Loveland, Ohio.

**GLAMOUR** Photographs, 10 for \$1.00. 6 different sets \$5.00. Murray Wilkins, 417 Hill, London, Canada.

**SENSATIONAL** Genuine Ball Point Pen only 50c and stamp. Thomas Pens, Box 3, Station W, Brooklyn 11.

**MERCURY**—Highest prices. Free Containers. Write Mercury Terminal, Norwood, Mass.

**FREE** literature how to locate buried treasure and minerals. Fisher Laboratory, Inc., Palo Alto, Calif.

**JEEP** Hats 10c, meskits 35c, canteens 50c, covers, cups 15c, leggings 25c, holsters 50c, gunslings 75c, pistol cartridge belts 75c, field bags 95c, tool box, steel helmets, raincoats \$1.00, Wading boots \$2.50, training rifles \$2.50, Army tents \$2.95 up, Army canvas 5 & 10c foot. Catalogue, New York Salvage Co., 144 Chambers St., New York City.

**"MURDER"** "Murder" latex—\$1.00-dozen—Guaranteed! Kays, Box 37, Sta. W., Brooklyn, N. Y.

**GIVEN** National Advertised Gifts. Don't miss this. Write To-Day, Mutual Merchandise Co., 1310 N. Wells St., Chicago, Ill.



ART Photos! Spicy; sample .50, 3 for \$1.00, Sandige, Route 1, Box 995, Phoenix, Arizona.

GLAMOUR Photographs! Sample Set \$1.00. Risque-pix, Box 699E, Westfield, N.J.

## 57 FOR THE HOME

ROOFING 100% Fireproof, low cost lasts like slate, insulates better, apply like plaster, Formula \$1, Rav Roofing, Box 98, New Hyde Park, New York.

INEXPENSIVE Home Turkish Bath. Collapsible. Applications cost practically nothing. Information Free. Gordon Brothers, 658 Grand Street, Brooklyn 11, N. Y.

PAINLESS Window Washing. Alter your double-hung wood windows (sashweight type) permanently so that each sash may be readily and quickly reversed for cleaning both sides from inside the room. Reverse Window kit includes parts and complete illustrated instructions easily followed by anyone handy with simple tools. Remit \$2.95 for 5 windows or \$5.00 for 10 or \$7.50 for 15 and 50c each additional shipped postpaid, or COD plus postage. Money-back guarantee. Weather Products Corporation, 18 E. 50 St., New York 22, N. Y.

RID your home of roaches with the sensational new Safe-Way Roach Ribbon. Saturated in 50% DDT Plus 5% Velsicol 1068 which is three to five times more effective. Lasts for several months. Send 25c in coin to Fields Products, Baxter, Tennessee for sample Package containing Three Ribbons.

## 101 PERSONAL

HOW You Can Find Out! Information discreetly developed, any matter, person, problem anywhere. Personal-business assignments, representations, undertaken. Nationwide. Officially Licensed and Bonded Service established 1922. Reasonable. All inquiries confidential. William Herman, 170 Broadway, N. Y.

RUPTURED? Positive comfort, no understraps, no steel, no elastic. Write Smith Manufacturing Co., Preston, Ontario.

PRETEND Visiting Land of Enchantment, Indian or Carlsbad Cavern postcards 3 for 25c. Return for remailing. Letters mailed—20c. Indian Curio Price List—25c. Box 125, NMMI, Roswell, N. M.

PSORIASIS Sufferers: Has everything failed to bring even temporary relief from scales, lesions and itching? Then write today for Free important information. You needn't invest one cent! Pixacol Company, Dept. S, Box 3583, Cleveland, Ohio.

"REGULAR" people swear by Old Mohawk Herb Laxative. Now "Vitamin-Blended." Old Mohawk is Nature's own wonder tonic for people from 8 to 80. Become "regular"—try Old Mohawk, generous super-value sample only 10c—and, by the sign of the tommyhawk, you'll be back for more! Try Old Mohawk "Vitamin-Blended" Herb Laxative today! Old Mohawk, Dept. A, 506½ S. 15th St., New Castle, Ind.

STAMMER? Maybe I Can help. Sauers, Box 139D, Mars, Penna.

WIDOW & Widowers Human Relations Counsel. State problem and age. The Shop of Knowledge, Springfield 3, Missouri.

HAIR Falling? Dandruff? Write Trichologist, 139 Lewis Street, Phillipsburg, N. J.

"REGULAR" people swear by Old Mohawk Herb Laxative. Now "Vitamin-Blended." Old Mohawk is Nature's own wonder tonic for people from 8 to 80. Become "regular"—try Old Mohawk, generous super-value sample only 10c—and, by the sign of the tommyhawk, you'll be back for more! Try Old Mohawk "Vitamin-Blended" Herb Laxative today! Old Mohawk, Dept. B, 506½ S. 15th St., New Castle, Ind.

SAVE your hair. Complete Course by Dr. Malcolm Smith. Treat yourself privately, destroy dandruff. 303 So. Gomez, Tampa, Fla.

PILES, Leg Sores. Money back guarantee. Testimonials. \$1.00 jar, postpaid. Panacea Salve Co., 129 Tepecanoe St., Gary, Ind.

ALL Diseases treated. Worldwide telekinetic theotherapy. Health-Center, Columbia City, Ind.

STOP tobacco, cigarette habit broken quickly, pleasantly. Latest Scientific method. All instructions \$1.00, Psychogenic Science, Dept. A, Box 402, Canton 1, Ohio.

MATRIMONIAL—Sweetheart Magazine, 50c, 6 mos. \$1.00, Yr. \$2.00, Barwood, 2037-E 42nd, Astoria, N. Y.

MYSTERIOUS "Cosmic Key", helps anyone: great leaders discovery—Carnegie! Solomon! Ancients scientific "Healing" psychology. Brings results, Riches! Health! Success! Free "Mystery Message"—Cosmocracy, Box 7-CA, Long Beach, Calif.

LENT and Easter Customs, 25c, Bulletin, Box 87, Station H, New York 25.

THE Case For Creation, 85c, Christian Evidence League, Malverne, N. Y.

BORROW By Mail! Loans \$50.00 to \$1,000.00 to employed men, women. Easy, quick. Completely private, confidential. No endorsers. Up to 18 months to repay. Details Free in plain envelope. Write First Loan Co., World Herald Bldg., Dept. L-15, Omaha, Nebr.

ART-Photos' Exciting assortment of Glamour pics—\$1.00! Box 699-B, Westfield, New Jersey.

SINGLE persons desiring information concerning their future, personal affairs, obtain Free particulars. Write Strone, Box 157, New York 11.

HAIR culturists never grow bald. Why should you? Write James Hilton, 4819 B Fourth Ave., Brooklyn 20, N. Y.

INFORMATION for single people by Human Relation Consultant, University Graduate, Dr. B. Long, Box 375, Los Angeles 53, Calif.

BUY Vitamins Direct. Amazing Savings. Money Back Guarantee. Our 9th year! Postcard, Matoska Products, White Bear Lake, Minn.

"LATEX"! \$1.00-dozen! Name brands—guaranteed! Kaye's, Box 37, Sta. W., Brooklyn, N. Y.

NUDIST Publications—Illustrated Information stamp. Royal, Box 531-A, Waterbury, Conn.

## 1 ADVICE

YOUR Life experiences might make a book! Will discuss your ideas without obligation. E. Jervis Bloomfield, Literary ghost. Present address: Gabriola Island, British Columbia.

PSYCHOANALYTIC advice. All problems solved. Personal—Marital—Domestic. Send Problem and Dollar. Confidential. Box 77, Baldwin Park, Calif.

DRUNKENNESS is a disease which responds to treatment. In 68 Years, the brief, pleasant Keeley Treatment has brought new health, happiness, opportunities to many. Endorsed by thousands of physicians. All correspondence confidential. For free, descriptive booklet in plain wrapper, write P. T. Nelson, Keeley Institute, Dwight, Illinois.

WHY be lonesome, when you can find happiness and good fortune and have hundreds of friends everywhere through my correspondence magazine. Find yourself a good pal and banish loneliness. Send dime for copy of my magazine, you'll never regret it. Address, Jack Wilcox, Publisher, G.P.O. Box 112, New York City 1, New York.

"VITASCIENCE"—The Science of life. Drugless healing through the spoken word. Inexpensive. Details free. Cedric S. Moore, 1313 South Union, Kokomo, Indiana.

## 2 ADVERTISING

ADVERTISE: 24 words, 40 Newspapers \$3.50. Lists Free. Advertising Bureau, 4515-P Cottage Grove, Chicago 15.

ADVERTISERS: Mail order ad covering United States—2,000,000 circulation—\$21.00 inch. Classified ad, 24 words, 20 metropolitan Sunday newspapers—\$25.00. Magazine, newspaper, mailing-list rate-book, advertising assistance—free. Chicago Advertising Agency, 20-PS West Jackson, Chicago 4.

24 WORDS in 64 Weeklies \$4.96. J. Darnell, 730 Hays, Jackson, Tenn.

INCH Display Advertisement Mail-order World, year \$24, Wood's Popular Services, Atlantic City, New Jersey.

## 9 ASTROLOGY

FREE Advice About Your Problem with solar Horoscope. Send birthdate 25c. Eleanor Victor, L-540 Elaine Rd., Columbus, Ohio.

## 66 HANDWRITING ANALYSIS

"HAVE your Handwriting analyzed by a certified Grapho-Analyst. State age and sex. Inquire: Oty Kling, 2240 Selma Avenue, Youngstown 4, Ohio."

ANALYZE Handwriting for Profit! Complete outfit \$1.00. Grapnologists, 2404N15, Philadelphia.

## 45 DRAFTING INSTRUMENTS

SAVE on drafting materials. Free catalog. Draftsmen's Supply Co., 32 North Wells, Chicago 6.

## 129 TATTOOING SUPPLIES

TATTOOING Outfits—engraving Outfits. Circulars Free. Write, Zeis, 728 Lesley, Rockford, Illinois.

BIGGEST Money in tattooing now! No experience required. Complete instructions with outfits. Send for free literature. Tatuco, 651 South State, Chicago.

## 27A CANDY MAKING

MEN—Women—"Everybody Likes Candy". Learn to manufacture professionally at home. (Our 36th Year). Ragsdale Candies, East Orange, N. J.

## 135 TREES, SHRUBS, ROOTS, HERBS

GROW "Tree of Heaven" from seed. Fine ornamental tree, excellent for lawn decoration. Native of China, Hardy; rapid grower (6 feet from seed first summer). Packet 15c. Bird, 2413 Madison, Wilmington 245, Delaware.

## 27 CAMPING

CAMPFIRES easily started even with wet wood with Van's Fire Starter. Year's supply \$1.00 prepaid. Many other uses. Star Mfg. Co., Lincoln, Nebr. Dept. PS.

## 81A MAGNETS

TWENTY Magnets plus 100 experiments; Half are Graduated Alnico V; Remainder novelty Magnets; \$10.00, half quantity \$5.00.—Eljay, Box 891, Newark 1, N. J.

ALNICO Magnet—Lifts Ten pounds! \$1.00. Others available. Ronald Eyrich, Box 849, Milwaukee 1.

## 134 TREASURE FINDERS

MT-SCOPE Metal Locator fully guaranteed and unsurpassed in efficiency. Time payment plan, trade-in and accessories. Free literature. Fisher Research Laboratory, Inc., Palo Alto, Calif.

## 42 DETECTIVES

DETECTIVES—Work home—Travel, Experience unnecessary. Write Wagoner P-125 West 86th, N. Y., N. Y.

BE A Detective—Send for price-list of self-instructional courses at reduced prices. Perkins Publications, 300-C Brandeis Theatre Bldg., Omaha, Nebraska.

DETECTIVE Training. Phillips Secret Service, 1917C, North Kenneth, Chicago 39, Ill.

DETECTIVE training. Department store work, shoplifters, etc. Also general detective procedure. Thirty years diversified detective experience. Free details. Write Shewbridge System, 216 Valdez Avenue, San Francisco 12, Calif.

DETECTIVE Investigator training. New method, Hanna, 3911 Tacon, Tampa 6, Fla.

## 89 MONUMENTS

WRITE For Direct Prices \$14.00 Up. Freight Paid, Guaranteed. Free Catalog. Granite-Marble Factory, A49, Oneco, Fla.

## 67 HEARING AIDS & REPAIRS

ZENITH ear phone cords. New clear plastic. Now ½ price with this advertisement. 2 for \$1.75 save money on batteries and repairs send for list, Chicago Hearing Aid Center, 209 South State.

## 93 NAME LISTS

CHILDREN of Wealthy Parents. \$15.00 per thousand. BMA Company, 5027 Sunderland, Jacksonville 5, Fla.

MAILING list. Good line names, 40 cts. per 100, \$3.00 per 1000. Lloyd Linde, 14147 School, Chicago 27, Ill.

## 84 MILITARY INSIGNIA

COLLECT colorful Army Patches, Pictures. Price and sample patch only 10c. Insignia Mart, 703 Broadway, N. Y.

INSIGNIA collectors our bargain assortment ten army patches. Send fifty cents, Box 228, New York 10, N. Y.

## 123 SOUVENIRS

FREE German War Relics with each purchase. Send 10c for price list of captured Foreign medals, daggers, uniforms and receive 4 German Ration Potato stamps, free. Hobbyguild, S35, West 32nd St., N. Y.



**AL'S A BETTER WORKER SINCE HE GOT A WESTERN ELECTRIC HEARING AID!**



**There is a difference in Hearing Aids**

● That difference can mean better hearing for you, too. Western Electric Hearing Aids are made by the nation's largest producer of communications and electronic equipment. They are the *only* hearing aids designed by Bell Telephone Laboratories, designers of your Bell telephone.

Mail the coupon today for free hearing helps and details on the new Model 64 Hearing Aid.

**Western Electric**

Dept. 380-PS-4, 195 Broadway, New York 7, N. Y.

Please send your free guides to better hearing and information about Model 64.

Name \_\_\_\_\_

Address \_\_\_\_\_

City \_\_\_\_\_ Zone \_\_\_\_\_ State \_\_\_\_\_

Distributed in Canada through Northern Electric Co., Ltd.

**YOU CAN NOW BECOME A PROSPECTOR!**

**HERE IS ONE OF THE WAR'S TOP SECRETS BRAND (NEW) ARMY MINE DETECTORS!**

Portable: Will Detect METALLIC and NON-METALLIC objects; Very Sensitive; using 955 Tube in detecting head; two tube amplifier using two 1N5gt; headset; or microphone; also 150 micro meter; Power supply; 3-45v.; one 6-v.; or 2 3-v. batteries. Complete with instr. Less Batteries; packed in original cases; shpg. wgt. 108 Lbs.

F.O.B. from N. Y. (Less Batteries) **\$17.50** With Batteries F.O.B. N. Y. **\$26.40**

NO C.O.D.

Send order to

**COLUMBO TRADING CO., INC.**  
304 CANAL ST. NEW YORK 13, N. Y.

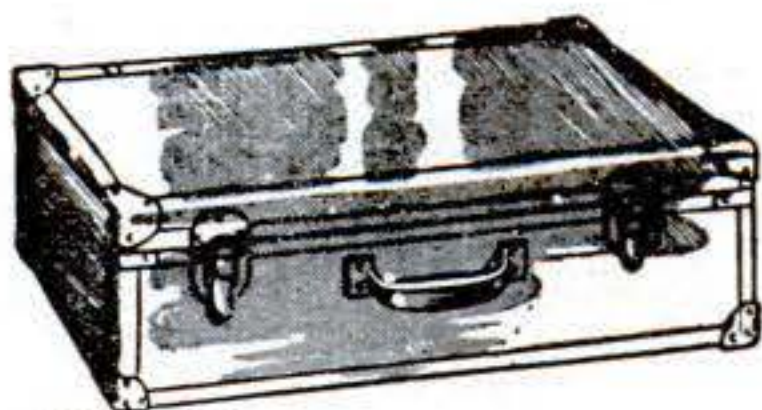

CARRYING CASE  
CY-91/PRS-1



**BABY SHOOTING GALLERY**

COIN OPERATED

Great fun maker for Rumpus Room or Club. Makes money too! Ten shots for 1 coin (1c or 5c). Realistic army type pistol shoots steel balls, one each time trigger is pulled. Ten targets to shoot for.

Scoring device at top registers all hits. Harmless. All action enclosed. Entirely mechanical. Sporty wood and metal cabinet, glass top. Lock and keys protect cash box. Fits any counter or bar. . . . overall size 31 x 11 in. Ht. 16 in. Guaranteed to satisfy or money refunded. Send \$20.00 deposit, balance C.O.D. plus Express charges. Wt. 40lbs. Immediate delivery. Specify 1c or 5c. Each, **\$98.00**

**Webb DISTRIBUTING CO. INC.**

6 SOUTH KEDZIE AVE. • CHICAGO 12, ILLINOIS

**DRAFTO**

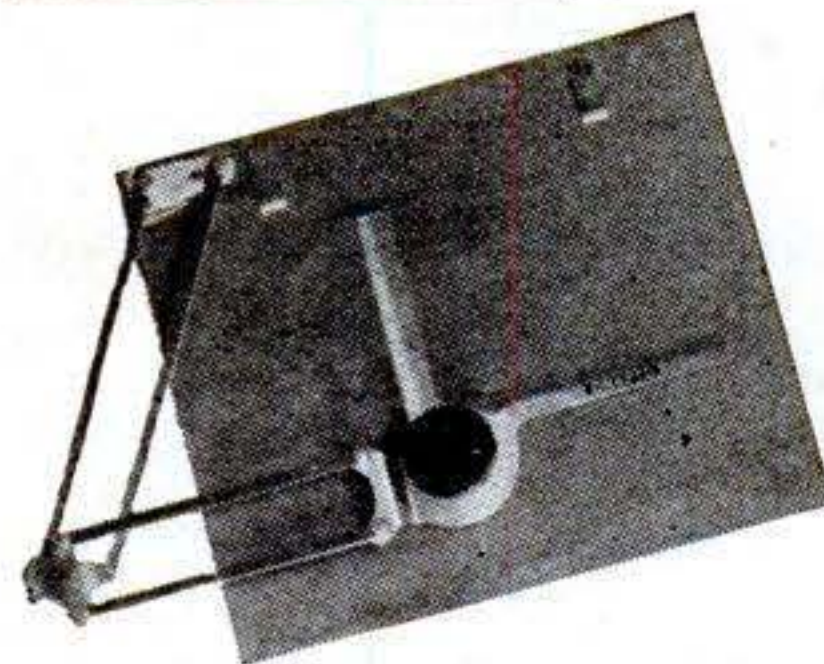

**PORTABLE DRAWING MACHINES**

11 SIZES

for every need

Make Drawings Right on the Job

AT DRAFTSMEN'S SUPPLY HOUSES & BETTER STORES

OR WRITE

DRAFTO CORPORATION, Cochran, Pa.



**GOOD MONEY FOR YOUR SPARE TIME.**

Be our Dealer in your locality for STRONG UNION MADE WORK AND SPORT GARMENTS. No experience necessary. Easy work. Millions of workers buy work uniforms. We supply everything needed. Write immediately for FREE Outfit.

**ROBT. STRONG GARMENT CO., 319-337 W. Van Buren St., Dept. B-4, Chicago, Ill.**

**MAKE MONEY with LARSON Leathercraft**

Send ten cents to Leathercraft Headquarters for 16-page catalog describing all necessary materials for making belts, moccasins, purses, gloves and many other practical items. Easy to assemble. Instructions come with materials.

Send for this Catalog



**J. C. LARSON COMPANY**  
178 N. Wacker Drive • Chicago 6, Illinois



**KAYAKS**  
**AQUA V-18**  
*Easy to Build*

**BOATS for Home Assembly**  
**"U-MAK-IT"**  
 KAYAKS, ROWBOATS, DINGHIES, INBOARDS, OUTBOARDS, RUNABOUTS  
 Cut-To-Fit for Quick Assembly. Everything Complete plus Illustrated Instructions. No Experience Necessary. Simple as A. B. C.

**25¢ COIN FOR ALL THREE**

SEND 25c POSTAGE (COIN) TODAY FOR 3 MONEY SAVING ILLUS. CATALOGS Showing all '47 Models (marine plywood) and construction details.

**AQUAMOBILE V-18**  
 Designed for Auto Engines. Open or with cab. Length 18 ft.  
 Fast VEE Bottom Hull.

**KAYAK BOAT CO., 152R-EAST 129th ST., NEW YORK 35, N. Y.**

**POWER LAWN MOWER**

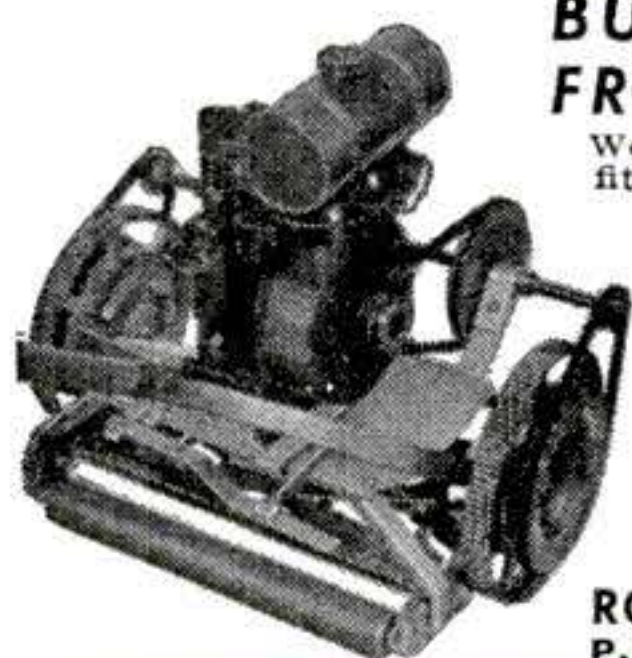

**BUILD ONE YOURSELF FROM YOUR OLD MOWER**

We supply complete attachments that fit any make or size of mower, with or without 1 1/2 H.P. gas engine. Easy to install in less than an hour. No more back breaking mower pushing. Immediate delivery, at low prices, express prepaid.

**MONEY BACK GUARANTEE**  
 You'll be delighted! Complete satisfaction or your money back. Write for

**FREE FOLDER**  
 Dealers Wanted.  
**ROYAL OAK LAWN MOWER SHOP**  
 P.O. Box 48 Royal Oak 1, Mich.

**WAR SURPLUS Close Outs**

- ARMY TRUNKS:** regular size, made of durable Plywood, extra tray, \$9.00 value.....\$3.98
- METAL BOXES:** Extra heavy gauge, well built 14x17x23". Fine for tool box, storage, etc.....\$1.98
- METAL BOX:** (New) 12 1/2 x 18 1/2 x 9 1/2", with 4 lift out trays, fine for tools, valuables, etc. \$12.00 value.....\$5.95
- WHEEL CHAIRS:** New in original crates, \$75.00 value \$24.50
- ROPE:** New 1/2" government specifications, (longer lengths available) 100 feet.....\$2.75
- SCREW JACKS:** Bell Bottom, 12 ton capacity.....\$5.49
- GRINDING & POLISHING Stand,** (New) 1/2" shafts. Up to 6" wheels with pulleys.....\$1.95
- ELEC. DRILLS:** (Used) Chicago Pneumatic, with 1/4" Jacobs Chuck, all tested and in excellent working condition \$19.95
- CHROME PULL HANDLES:** (New) Extra nice, 75c value 24c
- WIRE BUFFING WHEELS:** Genuine Osbornes, 10" (used), like new. State shaft size desired. \$2.20 value.....\$1.19

Prices FOB Kansas City. No COD orders

**MIDWEST BUY ANYTHING CO.**

1520 Locust St. Kansas City, Mo.

**TRIGONOMETRY FORMULAS** for Right and Oblique Angle Triangles

Condensed on 8 1/2 x 11 page with durable plastic cover. Fits 3 ring notebook. Handy reference for STUDENTS—DRAFTSMEN. Send \$1.00 today for your copy—Money Back Guarantee. Diamond's Service, 326 Pa. Ave., S.E., Suite 2, Washington 3, D. C.

**RUN SINGLE PHASE MOTORS ON THREE PHASE POWER**

(OR THREE PHASE MOTORS ON SINGLE PHASE POWER) **WIRING BLUE PRINT TELLS YOU HOW**

**Learn this method—of LIFETIME value, Mail this coupon with \$1.00**

How to run three phase motors on single phase power (or single phase motors on three phase power) is explained so anyone can understand in this valuable *Wiring Blue Print*. Not necessary to change any wiring inside motor. Job can be completed in five minutes. Solves tough power problems for hobbyist, small shops,

**A PROVEN TESTED METHOD**

electricians, mill-wrights, or maintenance men. Guaranteed satisfaction. Complete instructions given. Mail coupon with \$1.00 (one dollar) cash, check or money order. Home Products, Inc., 6801 Compton Ave., Los Angeles 1, Calif.

**HOME PRODUCTS, INC.**  
 6801 Compton Ave.  
 Los Angeles 1, California—Dept. P.S.-1.

Send Wiring Blue print which shows how to run a three phase motor on single phase power (or single phase motor on three phase power)

ENCLOSED \$ 1.00 cash  check  or money order .

Name .....

Address .....

**Electrify YOUR LAWNMOWER**

WITH **BATTERY POWER**

**COMPLETE PLANS**  
**Only \$1.00**  
**SELF-PROPELLED**



We show you how to convert your own lawnmower for use with an ordinary car battery. Save energy, labor and time with this self-propelled unit. Our simplified plans make it easy.

**Makes Grass-Cutting Easy**

Operates quietly on any ordinary auto battery, which is easily charged from house service. Our plans make it simple to convert almost any hand mower to power operation. Be the envy of your neighbors with a quietly propelled mower.

WRITE TODAY FOR PLANS

**LEJAY MFG.CO**

223 LeJay Bldg.  
 MINNEAPOLIS — 8 — MINN.

**Make Your Pocket Coins Pay Big Dividends**

You may have a valuable coin in your pocket right now. Hundreds of dollars are made each year from the sale of old coins. Know what coins are bringing today's high prices. Hanson's Coin Index brings you the latest authentic information. Subscribe now, \$3 a year. Send 25c for trial issue. Money refunded if not satisfied. HANSON'S COIN SHOP—1326 Main, Kansas City 6, Mo



**Send for Free List of LEADING BOOKS**

on Watch Repairing, Clock Repairing, Engraving, Industrial Diamonds, Aircraft Instruments, etc. Dept. 10

**HENRY PAULSON & CO. CHICAGO 3, U.S.A.**



# Opportunities and Advancement Get Started QUICK in DRAFTING



I Will Train You Until You Get  
a GOOD PAY JOB! — *Engineer Dobe*

Act Now! Get ready for a better job, advancement, more pay and security. Drafting is the field of big opportunities and now bigger than ever before. Thousands of draftsmen and designers must come first—before any kind of production can begin. Get into Drafting. Engineer Dobe will train you at home in your spare time. You'll get experience on actual work—the same kind of jobs you will do for the best paying firms. You will be trained until you are competent, experienced, and are actually holding a position that will bring advancement and pay raises as deserved. Write today for details.

**PREVIOUS EXPERIENCE NOT NEEDED**

I train you through practical jobs and give your experience as a reference to employers when you become competent. Lack of starting experience or higher education won't hold you back. Low cost—and monthly payments, if desired. Write today for illustrated book and all details. No salesman will call. Give your age to get reply.

### WORKING TOOLS FURNISHED

Professional instruments, drawing table and other tools included and sent when you start.



**MAIL COUPON FOR VITAL FACTS**

**Engineer Dobe, Div. 24, Libertyville, Ill.**  
Send me the Vital Facts on Drafting and Industrial Designing, your FREE BOOK and advertised list of positions for Draftsmen and Designers wanted.

Name.....Age.....  
Address.....  
City.....Zone.....State.....

**SEND FOR THIS FREE!**

**HOW to BREAK and TRAIN HORSES**

Make money with horses. Every farmer, every lover of horseflesh should have a copy of this booklet. If you want to know how to break, train and make money with horses, write today for full information FREE, together with my special offer of a course in Animal Breeding. If you are interested in Gaiting and Riding the saddle horse check here.  Do it today—now. You'll never regret it.

**BEERY SCHOOL OF HORSEMANSHIP**  
Dept. 584 Pleasant Hill, Ohio

# WRIST WATCH Complete with New Style EXPANSION BAND

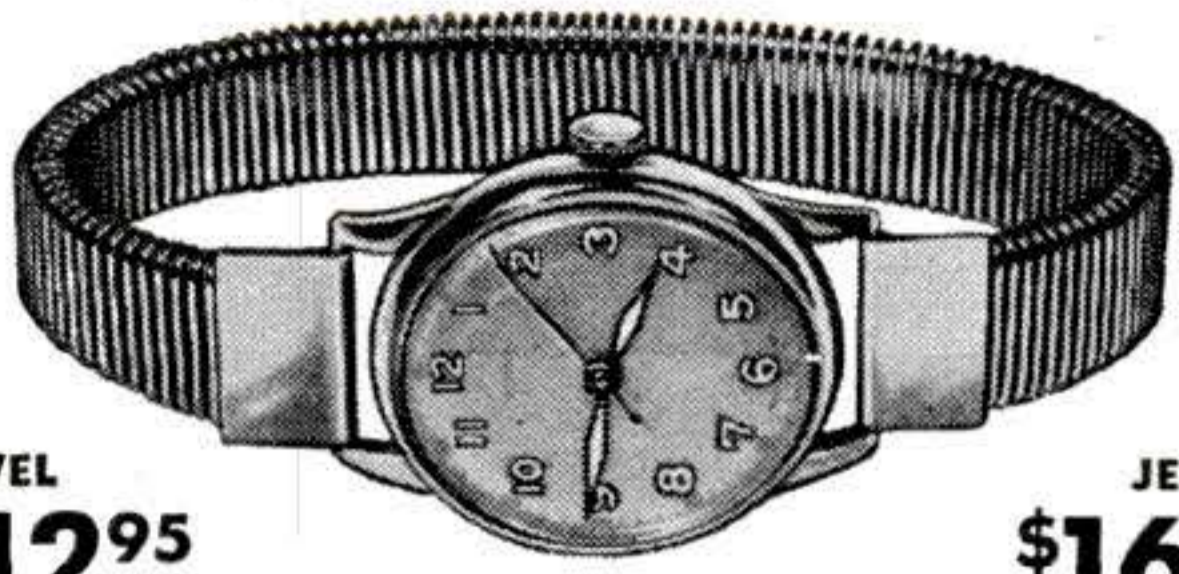

**7 JEWEL \$12.95**

**15 JEWEL \$16.95**

Sensational value! Genuine Military wrist watch precision built, split-second timekeeper, your choice of 15 jewel movement for ONLY \$16.95 plus tax! Or 7 jewel movement for only \$12.95 plus tax. Waterproof, shock-protected, anti-magnetic. Radium dial and hands, easily read in the dark, unbreakable crystal, red sweep second hand. Handsome, non-corrosive stainless steel case. Genuine non-corrosive stainless steel expansion bracelet fits all wrists. Order yours today!

**SEND NO MONEY!** Rush order now stating which watch you want. Pay postman price listed above plus postage and 10% Fed. tax. If not delighted, return within 10 days for refund.

**BURTON SALES COMPANY**  
809 W. MADISON ST. DEPT. D-89 CHICAGO 7, ILL.

**Locksmithing AND KEY MAKING Now Made Easy!**

Practical up-to-date course teaches you how to pick locks, de-code, make masterkeys, repair, install, service, etc. New self-instruction lessons for every handyman, a homeowner, carpenter, mechanic, service station operator, fix-it shop, hardware dealer, gunsmith. 53 easy illustrated lessons. **Low price!** Satisfaction! Free details, write **NELSON CO.** 1139 S. Wabash, Dept. DO-1 Chicago 4

Big Success Catalog yours **FREE**

**BIG MONEY FOR YOU IN PLASTICS**

SEND **10¢** Offer includes 2 books: New Fabrication Manual & Giant Catalog, listing the most complete stock of Plastic Materials, Accessories, Tools.

**BERTON PLASTICS, INC.**  
19 W. 21st St., N. Y. 10, N. Y.

**HORSE MASTERY!**  
A FINE HOBBY — A GREAT VOCATION!

**"The EXPERT HORSEMAN"**

FREE BOOK — Tells how You can learn to: BREAK COLTS, GAIT SHOW HORSES, TRAIN RODEO, STOCK and RACE HORSES, BREAK BAD HABITS, HANDLE ANY HORSE. TRAIN CIRCUS TRICK HORSES. WRITE TODAY!

**ANIMAL LOVERS ASSOCIATION**  
BOX S-157 TARZANA, CALIFORNIA

**SUBSCRIBE TODAY 50¢**  
One Year

**NOW AVAILABLE famous POWER PRODUCTS CORP. DELUXE 1 H.P. LIGHTWEIGHT ALUMINUM GAS ENGINE**

Model 1000-A

- The finest postwar engine on the market
- Compact—weighs less than 20 pounds
- Easy starting—one pull—runs 4 hours on 1/2 gal. of fuel

LAWN MOWERS WATER PUMPS MIDGET CARS  
COMPRESSORS BICYCLES WASHERS  
LIGHT PLANTS SMALL BOATS

**\$69.50**

IMMEDIATE SHIPMENT FOR ONLY  
**ATWATER COMPANY**  
5115 Plankinton Bldg., Milwaukee 3, Wis.

Name.....  
Address.....  
City.....Zone.....State.....  
Enclosed is money order for \$69.50.....  
Please send literature.....

**ATWATER COMPANY**  
5115 Plankinton Bldg.—Milwaukee 3, Wis.



# STUDY NATURE... DO LAB RESEARCH in Your HOME

with this **PROFESSIONAL**  
**50x—300x**  
**FEDERAL MODEL 40**  
**MICROSCOPE only \$59**

- 2 Tapered Clear View Oculars
- Direct Reading Drawtube
- Coarse and Fine Adjustments
- 10x—20x Achromatic Objective
- Standard Society Objective Thread
- Disc Diaphragm Light Control
- Rugged Full Tilting Frame
- Optically Ground Mirror
- Large Size Stage (4" x 4")

At Scientific—Photographic  
& Department Stores

All-metal carrying  
case available \$8.50



**Federal Manufacturing  
and Engineering Corp.**

Makers of Federal Cameras and Enlargers

213 STEUBEN STREET • BROOKLYN 5, N. Y.

## G & E Craftsmen's Bargains

### ELECTRO MAGNETIC LIFT

An important labor-saver every repairman will use in many handy ways. For momentary work. Plug in any AC socket. 110 volt, 60 cycles; size 4 3/4" diam. by 3", with 22" cord and plug attached. Complete with instructions. Ship. Wt. 5 1/2 lbs. No. 7618—only .....



**\$7.35**  
each

### FULFLO HEAVY DUTY FILTERS

Famous Fulflo Filter is ideal for gas, air or oil. Has 1/4" inlet and outlet I.P.T. Heavy bracket attached for mounting. Complete, ready to install. Overall size 3-9/11" diam., 5" high. Ship. Wt. 4 3/4 lbs. No. 4753—only .....



**\$1.95**  
each  
Lots of Ten \$1.85

### HI-POWER ELECTRIC DRILL

Heavy duty 1/4 inch capacity drill. Light weight—hand balanced. Three jaw chuck. Oil bronze bearings. Equipped with 6 feet flexible rubber cord and plug. 900 rpm at full load. Operates at 110 V, AC or DC.



No. 6202  
**\$17.95**  
ea.

Send check or money order, including postage.  
Dealers. Write for quantity discounts.

**G & E EQUIPMENT SUPPLY CO.**

Dept. PS-15 400 N. SANGAMON ST., CHICAGO 22, ILL.

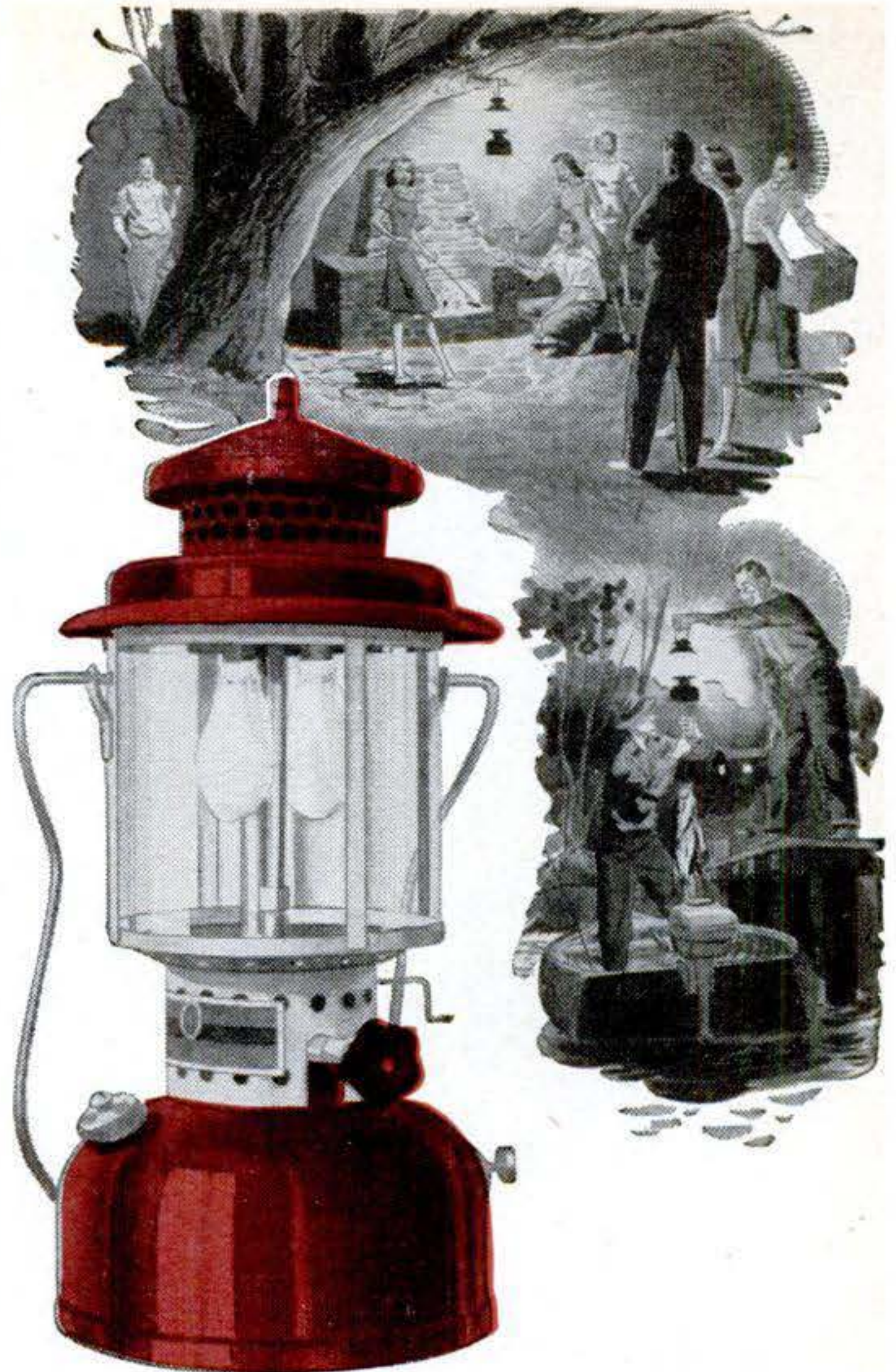

## READY-LITE

**Gives a strong, clear light anywhere, quickly, safely!**

AGM READY-LITE is one of the handiest appliances in the world, for it gives you brilliant, clear light, anywhere—to illuminate your barbecue pit, your cabin, picnics, or any place where portable light is necessary.

Backed by fifty years of gasoline lamp building, READY-LITE is safe and efficient. 8 to 10 hours of steady light on one filling. Can't blow out! One or two mantle models.

**SPEEDIKOOK**—A practical sportsman's portable gasoline stove! 7 inches high—weighs only 5 pounds. Burns for 9 to 10 hours on one filling.



### ... KAMPKOLD

Outdoorsman's portable ice box. Ten pounds of ice lasts 20 hours with temperatures of 80 degrees. Preserves food and game. Only 10 x 10 3/4 x 22 inches.

PRODUCTS OF

**AMERICAN GAS MACHINE COMPANY**

Albert Lea, Minnesota

"Equipment Most Sportsmen Like Best"



APRIL 1947 79



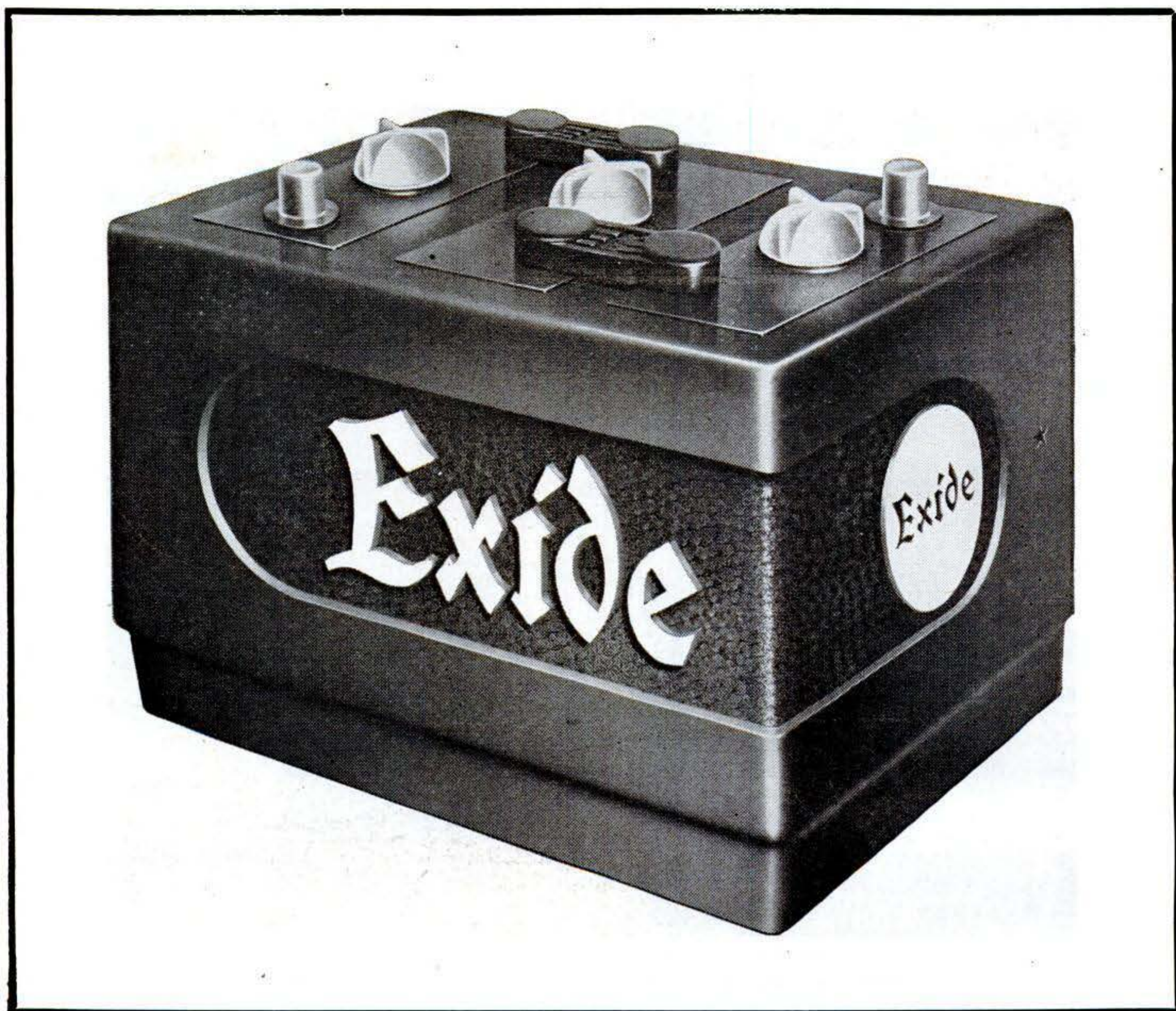

## *Announcing the New Exide Batteries*

In design, construction, performance . . . the NEW Exide BATTERIES excel even Exide's best efforts of the past. A natural result, for with this valuable past experience is combined the new scientific and technical knowledge gained from modern research and severe, wartime service in all climates of the world.

There are many noteworthy improvements and added features:

- Extra-duty capacity—for greater power.
- Heavy, over-size plates—for longer life.
- Double insulation between plates.
- Dirt-proof, non-spitting vent plugs.
- "Bull's-Eye" electrolyte leveling device.
- Heavy, over-size inter-cell connectors.

THE ELECTRIC STORAGE BATTERY COMPANY, Philadelphia 32

Exide Batteries of Canada, Limited, Toronto



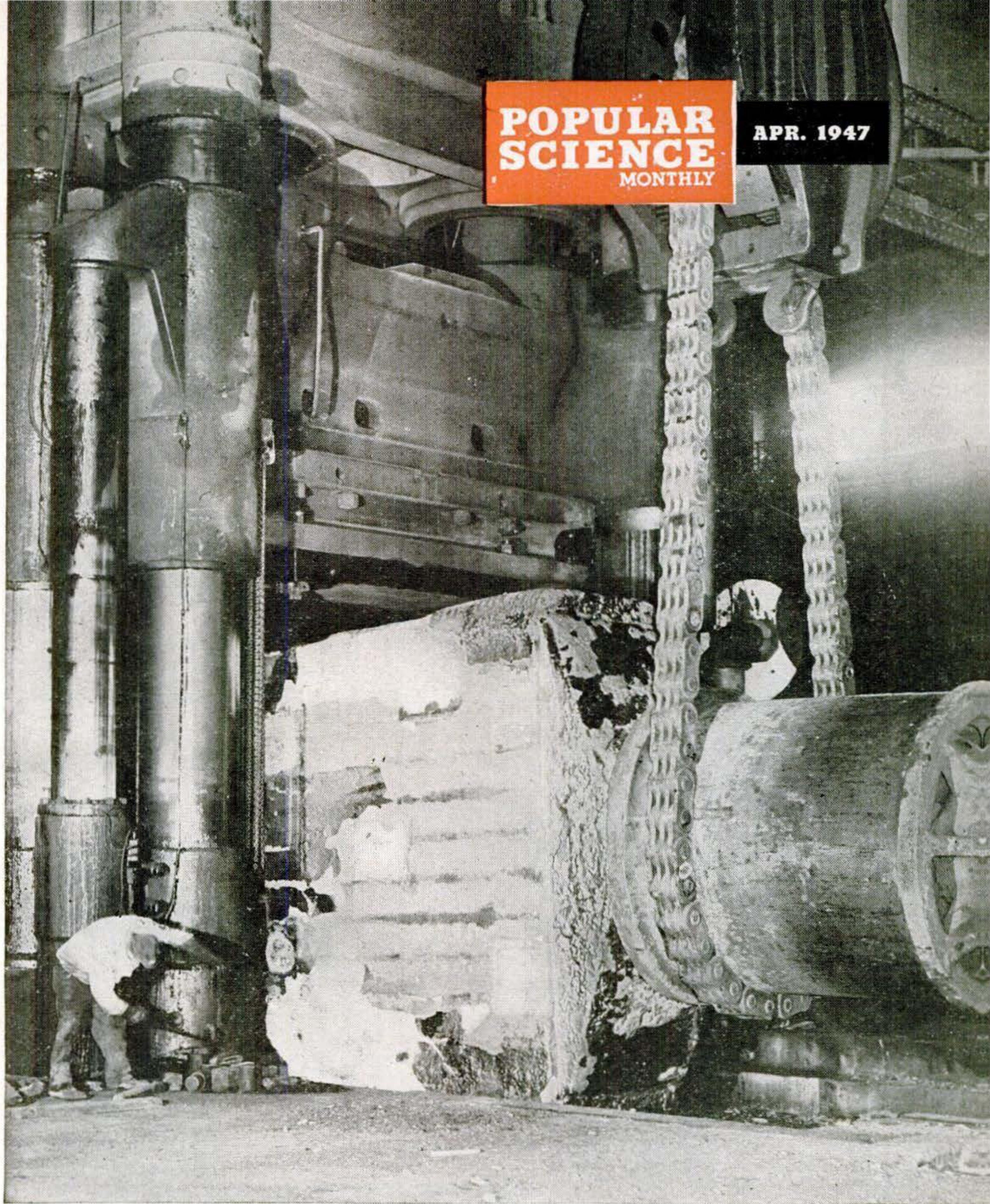

## *Shaping an Atom Smasher*

The jaws of a 7,000-ton Carnegie-Illinois forging press are squeezing this huge steel ingot into a pole piece of an 1,100-ton magnet for the second largest cyclotron in the U. S. Designed to produce particles of more than 200,000,000 electron volts, the atom smasher is being built at the University of Rochester as part of the Navy's radiation research program.





**Automobiles still kill tens of thousands;  
they'll go on doing it until you and the  
rest of the buying public are willing  
to pay the price of safety.**

# Cars Can Be Safer

**By DEVON FRANCIS**

**Y**OU have left the outskirts of town and are rolling on the highway, the speedometer comfortably short of 50. Your car is fresh-tuned for spring; tires are newish, brakes sharp; there is not a squeak or rattle to spoil the purr of the engine. Suddenly, a car comes toward you. It is not going very fast. It veers slightly. It rolls with agonizing slowness across the freshly painted white line, toward you . . . toward you. You jam on the brakes, but you are still doing 15 or 20 when it hits you. . . .

You are washing the car in your driveway. The grade of the driveway is slight, barely enough to make an egg roll. Your kid is playing in the front seat. You bend down to wring out the chamois, look up and realize the car is moving. You scrabble for the doors, but the windows are closed. By the time you get a door opened, the car—moving all of five miles an hour—has

smashed into the corner of the garage. The bumper breaks. The child screams. The doctor bill for hurts suffered by the youngster when he was pitched into assorted knobs on the instrument panel is \$10. The repair bill on your radiator is \$40.

You may be the best driver on the insurance companies' records, but if you don't carry the scars of an accident as you read this, you can thank your good luck as well as your skill.

For in the last 25 years—during which every reader of this magazine has been driving or riding in a motor vehicle—some 500,000 Americans have been shoveled under tombstones because they were involved in automobile accidents. Uncounted millions have been maimed and bruised. Additional millions have had so many close shaves on the highway that they are caloused to the statistics of daily disaster.

This month starts the annual American open season on motorists and pedestrians

---

**EDITOR'S NOTE:** Last year *Popular Science Monthly* warned of the deadly toll to come in the first flush of motoring without fuel rationing. "How To Drive and Stay Alive" (PSM, April '46, p. 66) was a practical examination of what you, the man behind the wheel and the principal ingredient in every automobile acci-

dent statistic, could do to stay out of trouble.

This year PSM considers the car itself, the history of its structure, and its evolution as a safer vehicle for the transportation of human cargo. Out of PSM interviews with safety authorities and automotive engineers have come startling facts about life—and death—on wheels.



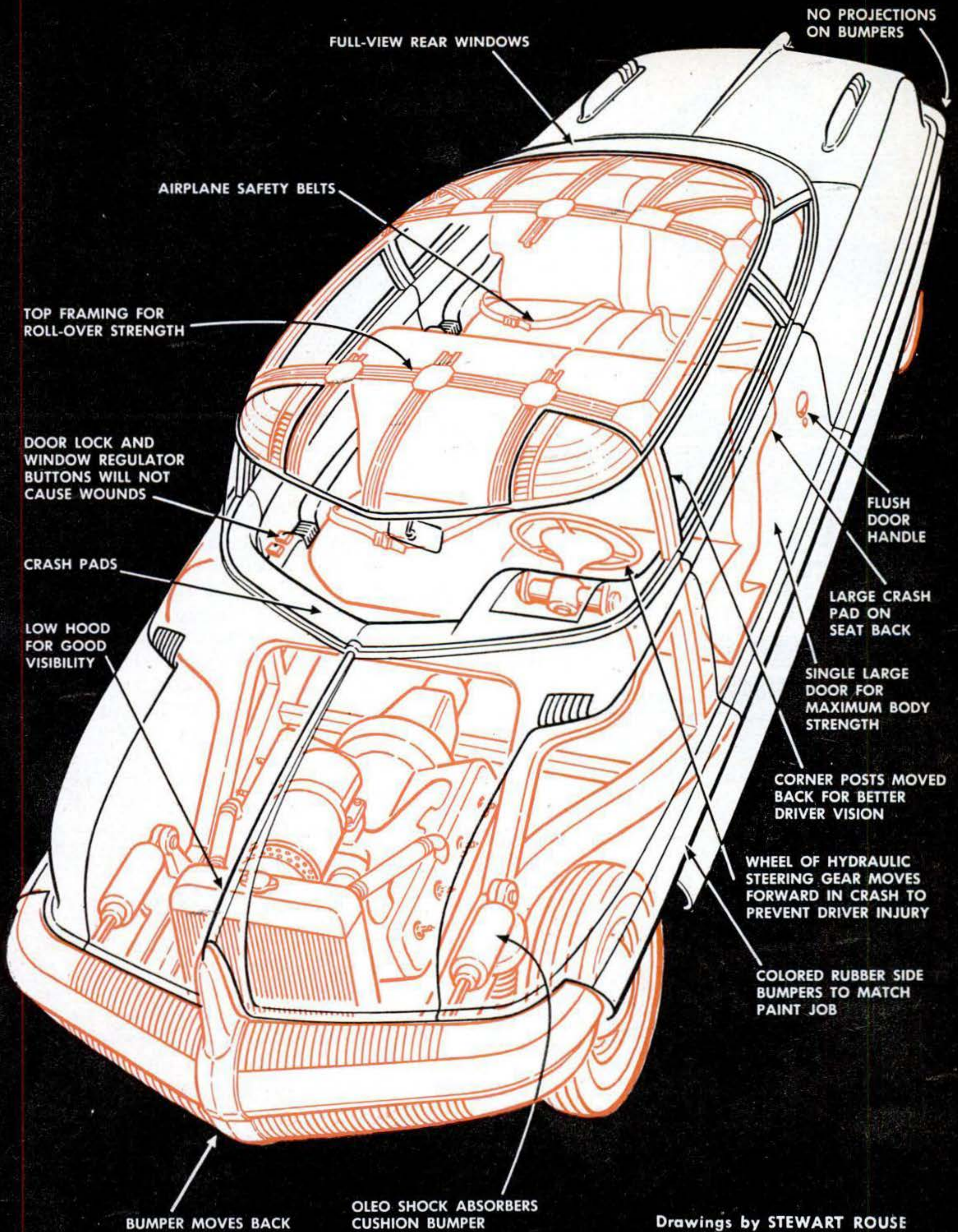

Here is an artist's conception of what a safer car might look like. It's no dream; eventually, automobiles will include many of the items illustrated.

This one could be built now, without waiting for a solution of the problems of weight and balance that make rear-engine design a thing of the future.

APRIL 1947 83



1900

ANGLE OF  
VISIBILITY 40°

1905

ANGLE OF  
VISIBILITY 30°

1920

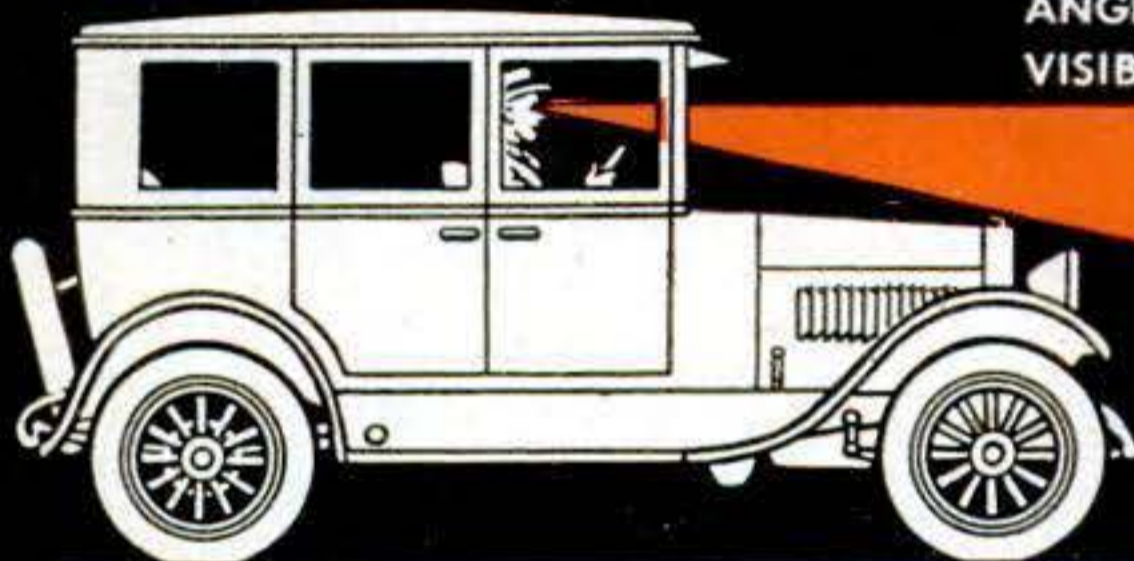
ANGLE OF  
VISIBILITY 12°

1940

ANGLE OF  
VISIBILITY 5°

194-?

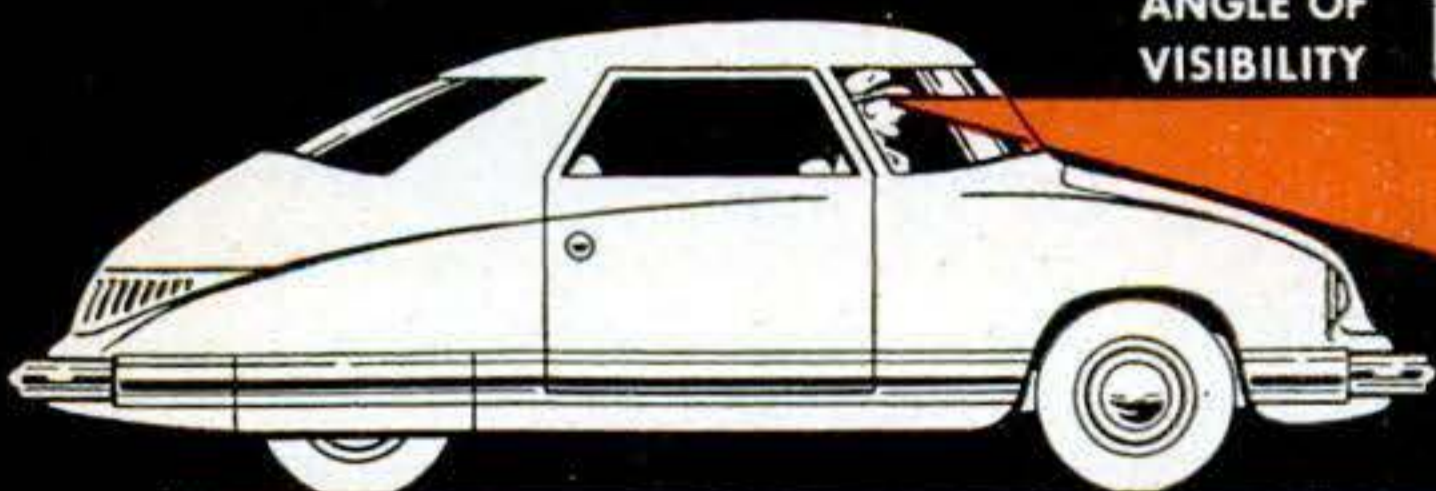
ANGLE OF  
VISIBILITY 17°

R O U S E

A substantial part of the highway accidents that killed 34,000 persons last year could be attributed to poor visibility from the driver's seat. As the drawings above show, visibility has been progressively reduced for years by the longer hoods, lower seats and shallower windshields that found favor with the public. Now visibility is gradually being increased from its hazardous minimum.

alike. Tens of thousands will die in traffic accidents during 1947. *You* may be one of them.

A lot *has* been done to cut down this carnage. More *can* be done. What is it?

I went to Detroit to find out, after some preliminary investigation in Boston, Washington and New York. I knew the automobile makers were sensitive about safety. Making automobiles is a blue-chip business. Any mistake in figuring what you, the motorist, will buy, can mean millions of dollars in losses. Even the most altruistic manufacturer could no more afford to make cars you *ought* to like than Hart, Schaffner & Marx could make suits without lapels. And lapels on a man's suit haven't been used for their original purpose—buttoning up the neck against the weather—for a century.

### *What Price Visibility?*

U. S. buyers have made the auto makers very cautious about safety innovations. One manufacturer reduced the size of the grip on his steering wheel, not so many models back, to give you a better view of the road and of your instrument panel. What happened? You stopped buying that model until the grip had been fattened up by a fraction of an inch. That fraction of an inch didn't increase its strength a particle.

Another courageous pioneer rounded off the hood so you could get a better look at where you were going—and paid for it by losing customers. Another deepened the windshield. Nobody liked it. Drivers complained that they felt "exposed." They were satisfied, though, when the manufacturer blanked out the bottom of the windshield and reduced the visibility.

Nowadays, when you climb into an airplane, you fasten your seat belt as a matter of course. But the motor-car makers are afraid to put seat belts on their vehicles, even though 70 miles an hour is 70 miles an hour, whether you are in a plane or an automobile.

### *The Canvas-topped Killer*

You insist on convertibles, which are a standing order to the undertaker. Even the manufacturers don't like convertibles. Every Detroit big shot I talked with about those canvas-topped killers said, "Not for my boy!" Some said there ought to be a law about them.

So automobiles are what they are for a perfectly logical reason: the collective pur-



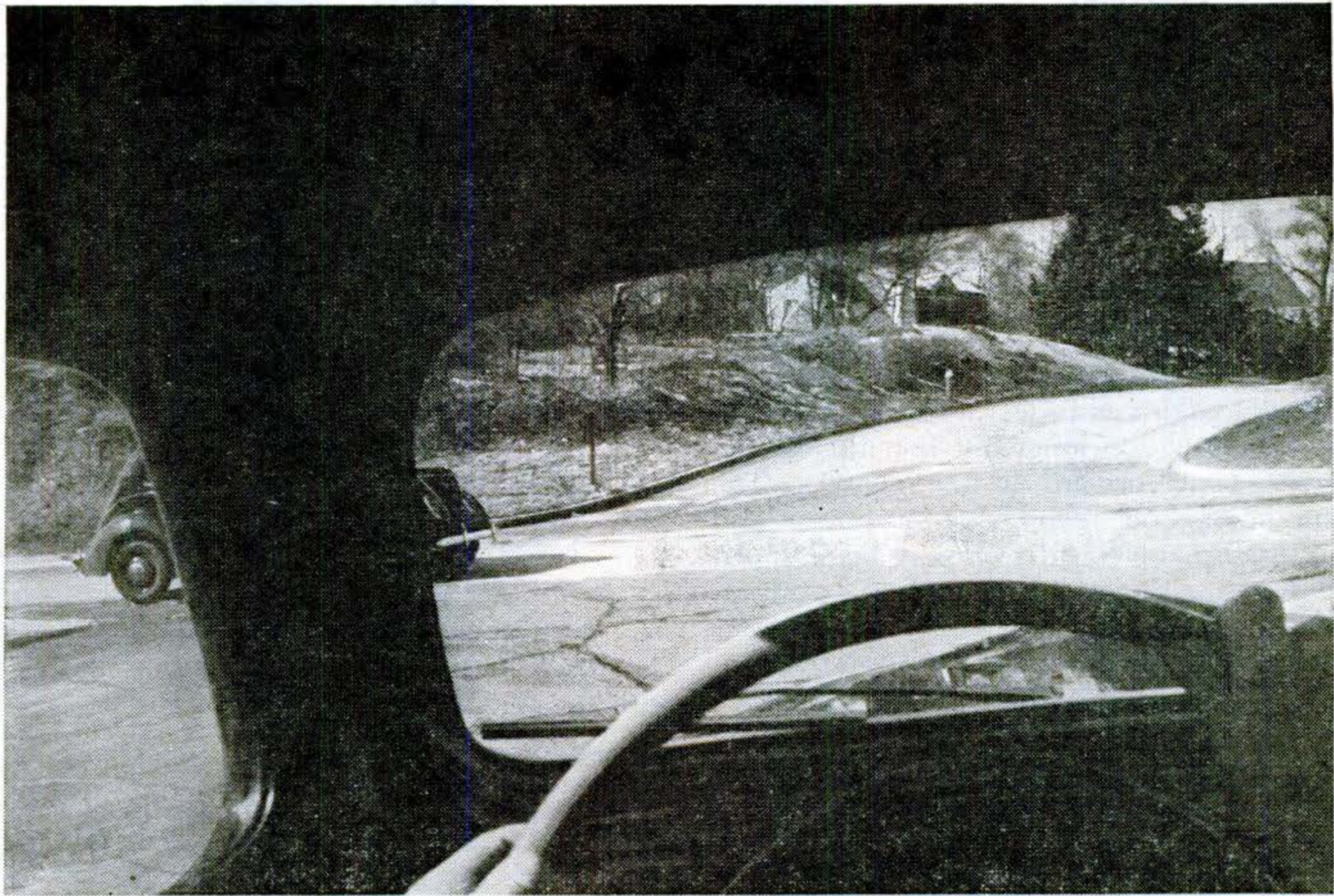

A wide corner post can completely block out another car at a critical moment. The public put the corner post in the driver's eye by crowding three in

front. It's still there, although seats have been widened and corner supports narrowed. A slimmer steering wheel would also increase visibility.

chasing power and *buying desires* of millions of people, you included.

In Detroit I asked a double-barreled question: *What has been done, what can be done, to make automobiles safer containers for people in motion?*

I found out that much had been done—in spite of you, the buyer. Safety glass and solid tops that will take the impact of a roll-over were only two items in a long list of improvements in the last four decades. The self-starter was introduced as early as 1911, the steel frame as early as 1914.

### ***Safety Aids Galore***

Here is an incomplete list of other safety innovations:

Tilt-beam headlights, prism lenses, windshield wipers, stop lights, indirect lighting of instruments, adjustable seats, balloon tires, four-wheel brakes, bumpers front and rear, heaters, hydraulic brakes, synchromesh transmissions, the foot dimmer switch, carburetor silencer and flame arrester, independent front-wheel suspension, the "turret" top, sealed-beam headlights, steering column gear shift and the 50-mile-an-hour warning light on the speedometer.

A lot of these changes were sneaked in by the back door so as not to disturb the customers. Many that were discussed couldn't be made. You have yet to see a car maker put a crash pad on the dash so a passenger wouldn't bash his head on it in a quick stop.

### ***Faults by Inheritance***

The automobile is what it is because it grew from a buggy with a back door. Today's car is a lineal descendant of the old side-winder of the early 1900's, a not-so-horseless carriage. Unlike the helicopter, which had to be engineered fresh and clean, the automobile inherited the ills of its ancestors. People insist, for example, on more doors in their automobiles than in their houses, even though the getting-in and getting-out time is piffling compared with the greater safety of structure that fewer doors would provide.

What would a car be like if the designers didn't have to keep thinking about what the public would and would not buy?

I found in Detroit that it is perfectly possible to build a safer car with existing components, without waiting for rear en-



gines or magic-strength materials. And I discovered, too, that the kind of a car Detroit would *like* to build for you actually is being built—little by little.

Little is the right word: Changes come slowly because the earnest engineers can't start from scratch; they have to begin with innovations that you, your aunt and your next door neighbor think are proper.

### *Advancing the Driver*

Year by year, for a decade, car design has moved the driver forward. Now and then the hood got too long, but nonetheless the driver went forward in the chassis. The long hood, once expressive of power and the egotism of the driver, has been shortened perceptibly. It is going to be shortened more.

Experience with buses and cab-over-engine trucks has shown a decided advantage for this forward position. The driver, key man on the safety team, can see better. Moreover, with his own carcass right out in front, he is a little less likely to rely on the false safety of all that iron between him and disaster.

With the hood rounded down, the much-touted rear engine awaits a new day of lighter, more efficient engines. To transport people, a car must also transport luggage, and today's engines take less room than today's bags. So the best place for the engine is still in front.

What else? Not much, to the eye. But under the sleek roof, frame members will weld body to running gear. This is called "unitized construction." It's in some of today's cars. Whatever footage is ahead of you will be steel, not air under a glamorous hood.

### *Supports May Move*

Corner posts are being thinned down for better visibility. They may be moved back, out of the driver's eye.

Cars also will be engineered to take a punch with less damage to flesh and metal. Today's bumper is only a bar to push a car around. It will fold or snap at anything over four miles an hour. Yet airplanes, engineered for bumps, hit runways every day with foot-pounds of wallop that would make an accordion of a car. My editor tells me he has seen 10-ton Grummans hit a flight deck on one wheel, with the oleos (oil-cushioned shock absorbers) in the landing gear taking up the whole shock. As a



A safety feature would be the inclusion of stopping distances on the speedometer dial, reminding the driver how they shoot up as speed increases. The distances shown are for optimum conditions—halting the car on dry concrete. Slippery pavement or faulty brake action could skyrocket the figures.

flier myself, I know that the oleos absorb the concussion of a lot of pilot error.

So why not have bumpers with oleos? And why not admit, on the drafting tables, that cars must operate in traffic? With bumps inevitable, shock-mounted front and rear bumpers would sop up the abuse. Rubber side bumpers, colored to match the paint job, would save many a wrinkled side panel.

### *Helpful Headlights*

The most dangerous driving, everyone knows, is at dawn, dusk and during the hours of darkness. Sealed-beam headlights already have helped to lessen the danger. Some engineers are thinking about putting the headlights higher, on the roof corners, to afford a greater angle against the road and keep them out of the eyes of the fellow passing you in the opposite direction. The same men who worked out the sealed-beam lights are now experimenting with polarized light. When it comes, the glaring beams that light the whole road will be a couple of dim discs to you.

Death on the road is shocking enough, but there are far more injuries than fatalities. Many of these less-than-fatal accidents have been avoided by better *inside* engineering and design. There are fewer cracked kneecaps because legs have been better



accommodated in the front seat. There are fewer broken noses because the backs of front seats have been padded for the benefit of rear-seat riders.

### *Problems of Impact*

The safer car to come will present a smooth, soft surface to bodies that are involuntarily catapulted forward in sudden stops. That brings up another story which makes you, the customer with the dollar in his pocket and his neck out, look a little foolish. One company actually designed a leather-covered, crash-padded dash. Then the vice-presidents in charge of engineering and profits got cautious. They feared the impact on the market of a car that confessed the realities of danger in driving. So they substituted a nice decalcomania of leather-covered dash right on the steel!

Aside from such reluctance, and the public attitude that causes it, the advantages of crash padding are obvious. A 2,500-pound automobile develops 302,000 foot-pounds of energy at 60 m.p.h.—enough to do a lot of damage if anything gets in its way. A braking action of  $4/5$  gravity, which is common, throws a person forward with a force of  $4/5$  his own weight; if an automobile structure in a collision will withstand an impact of four times gravity, a passenger is bound to get hurt unless there is something in front of him to soften his landing.

The problem of safety in impact is simply one of controlling the rate of deceleration.

Hit a steel plate with your fist and you skin your knuckles; hit a pillow, and your hand is unhurt. For this reason, automobile makers regard the "crumple rate" of fenders, body and framework as a safety factor in collisions.

In terms of impact, because of its sheer weight as a projectile, a heavy car is more dangerous than a light one—so cars are being lightened. Hundreds of pounds are being stripped off with all-welded construction, and further weight reduction is being explored by cutting down mechanical friction.

Even a medium tank cocooned with foam rubber would not be as safe—if it hit another medium tank—as a car on a pedestal, with an empty gas tank, in the Smithsonian Institution. But cars will be made safer as soon as the American people give the manufacturers the green light.

### *Safety Isn't Gratis*

Already an automobile is the second largest collective investment (a home costs more) of the typical American family. Safer cars are likely to cost more. You can't put welds and ribs into a frame for free. And auto makers cannot bet against your whims.

You won't get a really safe car, soundly engineered and sensibly designed for modern traffic, until you are willing to pay the price of safety. That price will mean a few more payments and fewer foolish notions about what a car ought to look like standing still. END

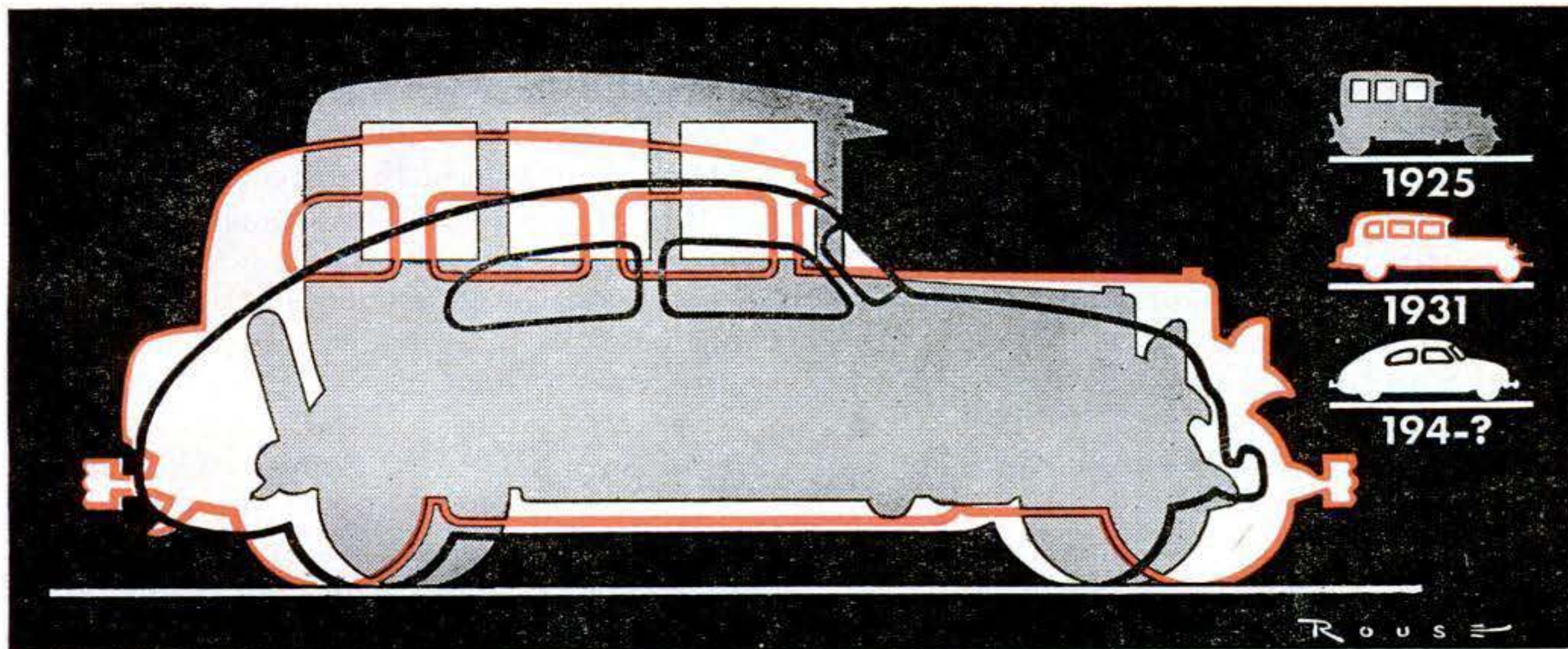

Once high and short, then long, cars are getting more compact and closer to the road. Other changes involve weight, which is being reduced, but engineers are restricted by the rough necessity

of a 50-50 front and rear balance. Incorrect weight distribution could multiply the hazards of applying brakes on a curve, for example, because of "slip-page," or normal side-skid.



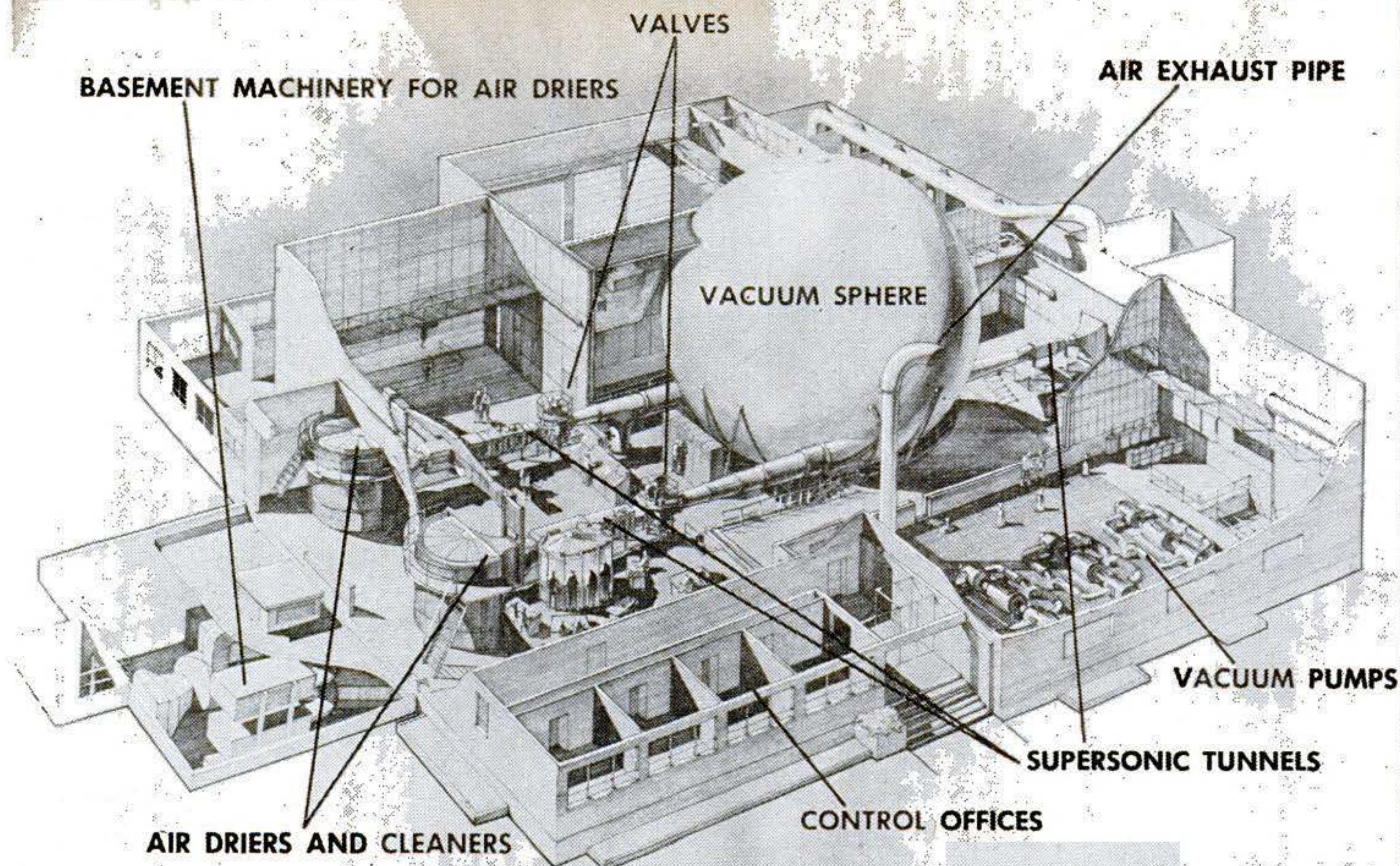

# NAVY Rebuilds V-2'S CRADLE

**I**NCLUDED in the new Naval Ordnance Laboratory being built at White Oak, Md., are three German supersonic wind tunnels that have been transplanted from Kochel, Bavaria. The supersonic German "factory" is described as far ahead of any other apparatus in the world for simulating speeds beyond that of sound. It was in this plant that experimental work was completed on the V-2 rocket used to bombard London in the closing days of the war. The plant was first built at Peenemunde, in Northern Germany, but was moved to Bavaria when Allied bombings got too heavy.

The entire complex of tunnels was disassembled and crated for shipment to the United States after Lyman G. Fisher, assistant director of the mechanics division of the naval laboratory, went to Germany in September 1945 to inspect the captured equipment. "One of the most striking features of the Kochel tunnel design," he reported, "is the economy of operation it achieved. Actually a series of tunnels, the Kochel installation utilizes an ingenious method of intermittent operation, making it possible for the tunnels to be operated with

remarkable efficiency on a fraction of the power required for a continuous tunnel of comparable size."

The tunnels will be used in developing projectiles and rockets for use at speeds beyond that of sound. The tunnels operate at less than atmospheric pressure. Atmospheric air is drawn through the tunnels by suction, created when vacuum pumps exhaust the air from the huge spherical chamber shown in the illustration above. The flow of air starts through two of the three tunnels with the turn of a valve. The tunnel at rear of the sphere has no valve because it was built for velocities that would just match the capacity of the pumps.

Structures in rear of plant contain smaller experimental tunnels. Pipe at top in background supplies such tunnels with air.

German experts achieved tunnel speeds almost  $4\frac{1}{2}$  times that of sound, or roughly 3,350 miles an hour. The only comparable U. S.-built tunnels are at the laboratories of the National Advisory Committee for Aeronautics at Sunnyvale, Calif. (PSM, July '46, p. 66). The entire Naval Ordnance Laboratory project will cost \$15,000,000.



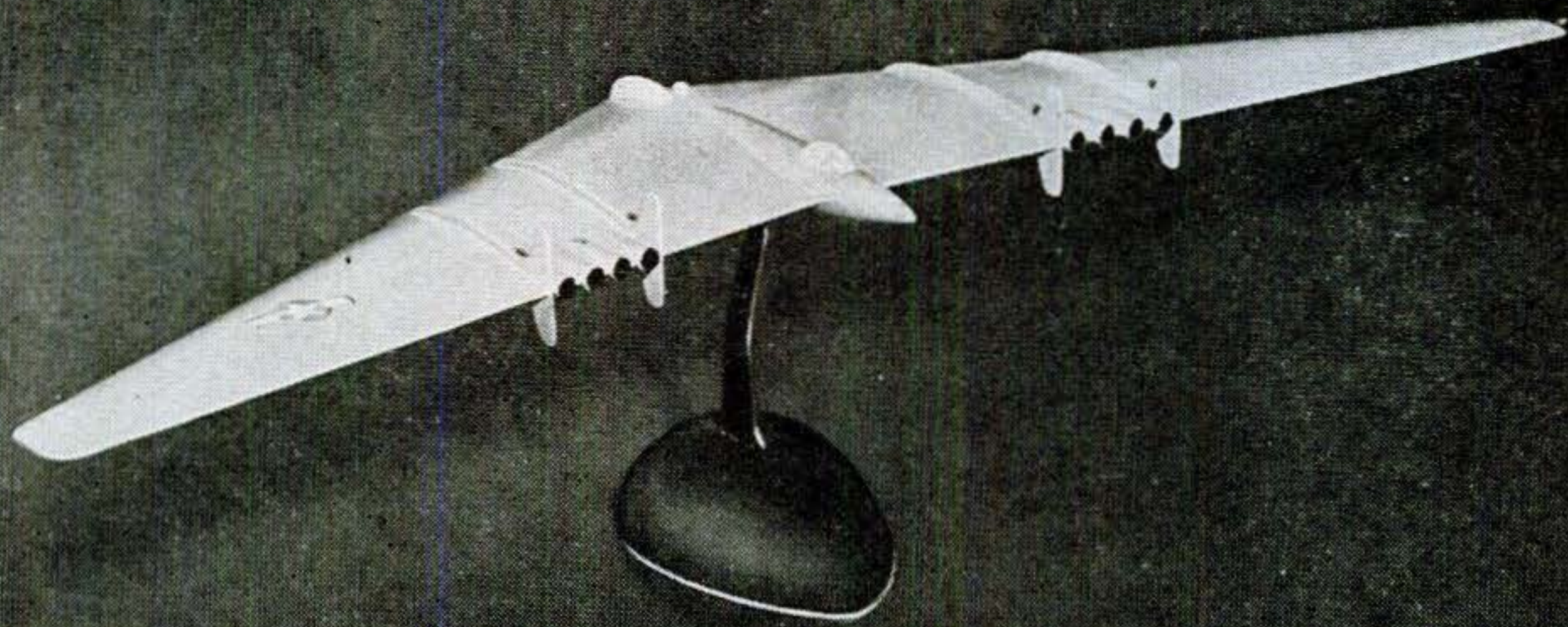

# Flying Wing Goes Jet

**T**HE Northrop YB-49, newest bat-wing bomber for the AAF, is a jet-propelled version of the 172-foot B-35 Flying Wing. A model, above, shows how the eight GE jet engines, delivering a total static thrust of 32,000 pounds, are arranged in two clusters of four each. Closeup below shows one of the clusters of jet exhausts, resembling torpedo launching tubes, being built. Vertical "air separators" give increased stability. The craft is expected to fly this summer.

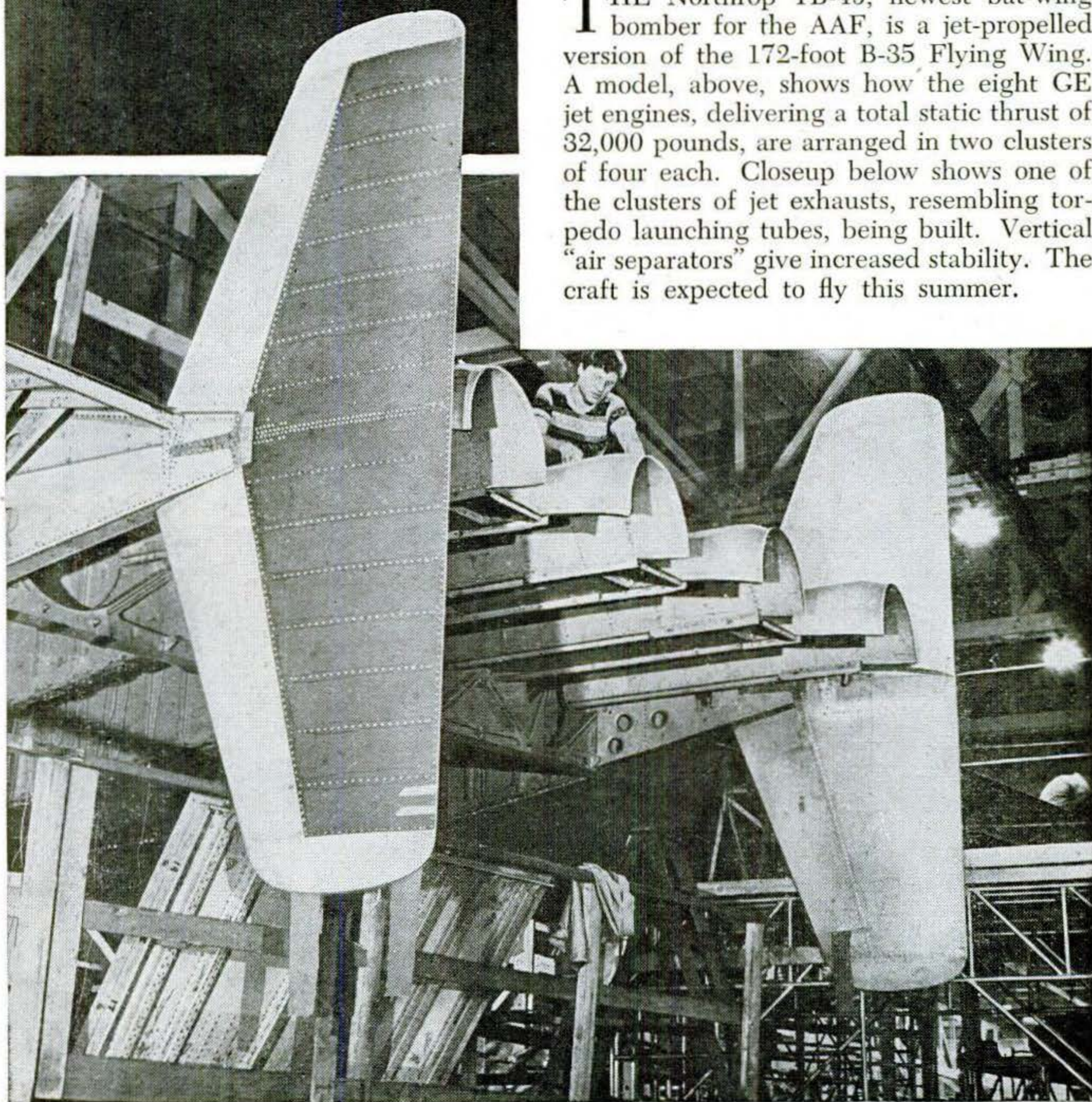

APRIL  
1947 89



# Steering by Electrons

ALREADY overworked electrons have taken on still another job. The Cathotrol, a new compass, uses the magnetic deflection of an electron beam to tell direction.

Developed by the Minneapolis-Honeywell Regulator Co. for aircraft and ship navigation, it is essentially a flashlight-size cathode-

ray tube (at left, below) suspended face down from a universal joint. Instead of a fluorescent screen, however, its downward beam of electrons (at right, below) strikes a four-segment metal target.

A slight but constant westward deflection of the electron beam, caused by the earth's magnetic field, is registered on the target and actuates a compass indicator, corrected to read North instead of West.

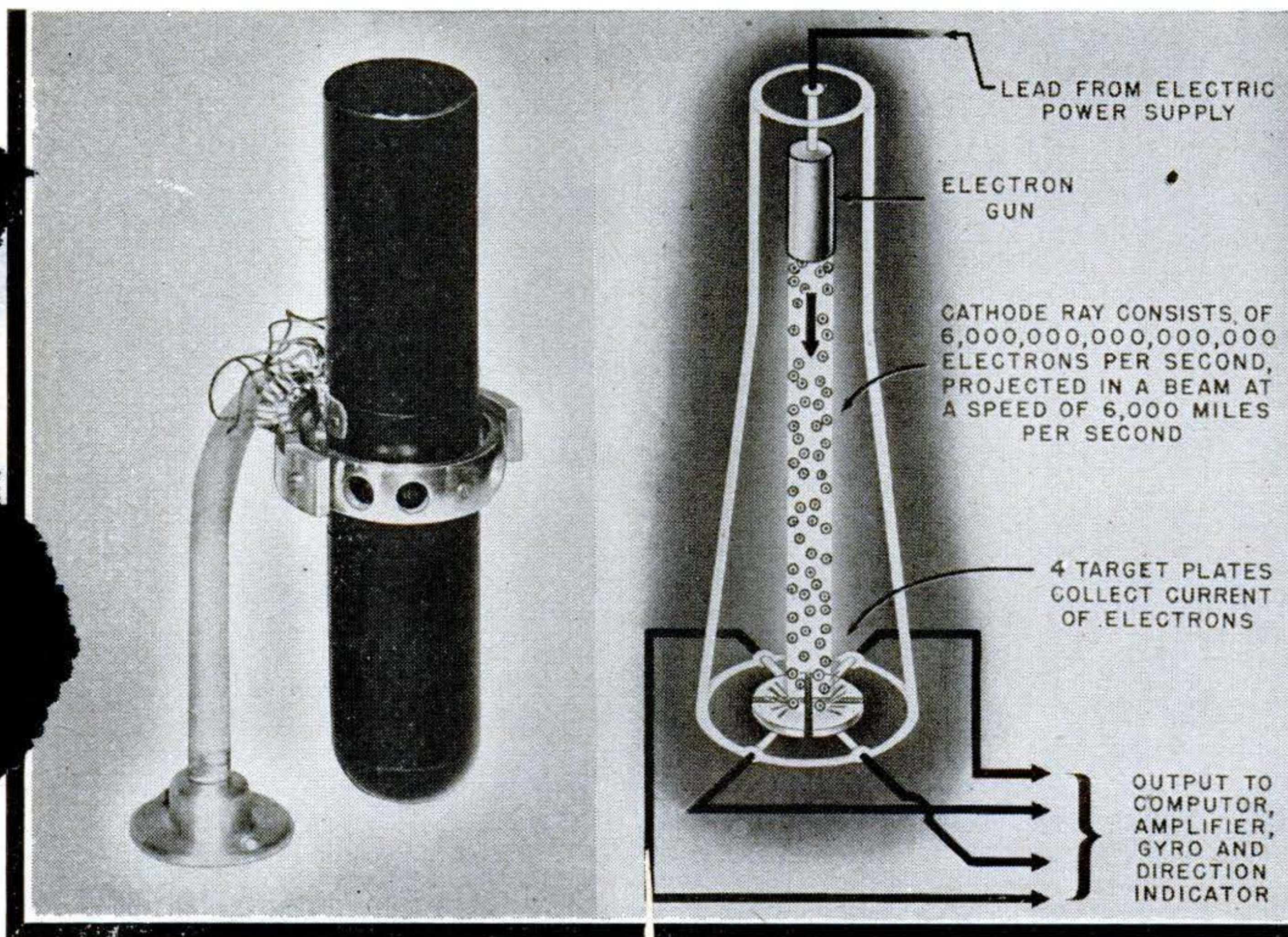

**Pipe Solves Match Problem.** A novel pipe features a built-in lighter and a chamber that precools the smoke and condenses hot tars and fluids. Made by the Birch Regal Co., it requires no filter and is cleaned by moving a pistonlike plunger inside the barrel.





# Pound of Poison

## KILLS 200,000 Rats

**ANTU must be used wisely to destroy whole colony at once.**

By **GEORGE H. WALTZ, JR.**

**S**CIENCE is working from A to Z in its war against disease-carrying pests. A few years ago DDT made its debut as a sure-fire pest weapon for home use. Now a new one—ANTU—has been added to the alphabetical arsenal.

ANTU is to rats what DDT is to insects—a powerful, quick-acting, one-shot poison that is easy to use. But like DDT in its field, ANTU has its limitations as well as its virtues, and to get the most out of its rat-killing powers you must know those limitations, as well as its dangers and the right way of using it.

First of all, ANTU is a specific poison for the brown or Norway rat, which comprises about 90 percent of the rat populations in our towns, cities and farms. Although so deadly that one pound of the fine grey-blue powder is enough to kill 200,000 rats, it has little or no effect on mice and other rodents. It can kill cats, dogs and farm animals if it is not used

properly, but so far as is known at the present it has no bad effects on humans unless taken in large quantities.

ANTU was discovered quite by accident six years ago by Dr. Curt P. Richter at the Johns Hopkins University Hospital, in Baltimore, Md. Dr. Richter, searching for new facts about human diet, was testing his theories on a colony of laboratory rats. At one point in his experiments he decided to test the taste reactions of his rats, as compared to humans, and fed a group of six rats tiny pinches of phenyl thiourea, the bitterest substance known to man and often used without danger in taste-reaction tests on humans. Two surprising things happened—none of the rats seemed to taste the bitterness of the chemical, and by the next morning all six of the rats were dead!

Dr. Richter's thinking shifted quickly from diets to rats. Had he stumbled on a new "safe" rat poison? At the time, "red squill" was the most widely used poison, but the Axis occupation of North Africa had cut off the chief source of supply. The ques-



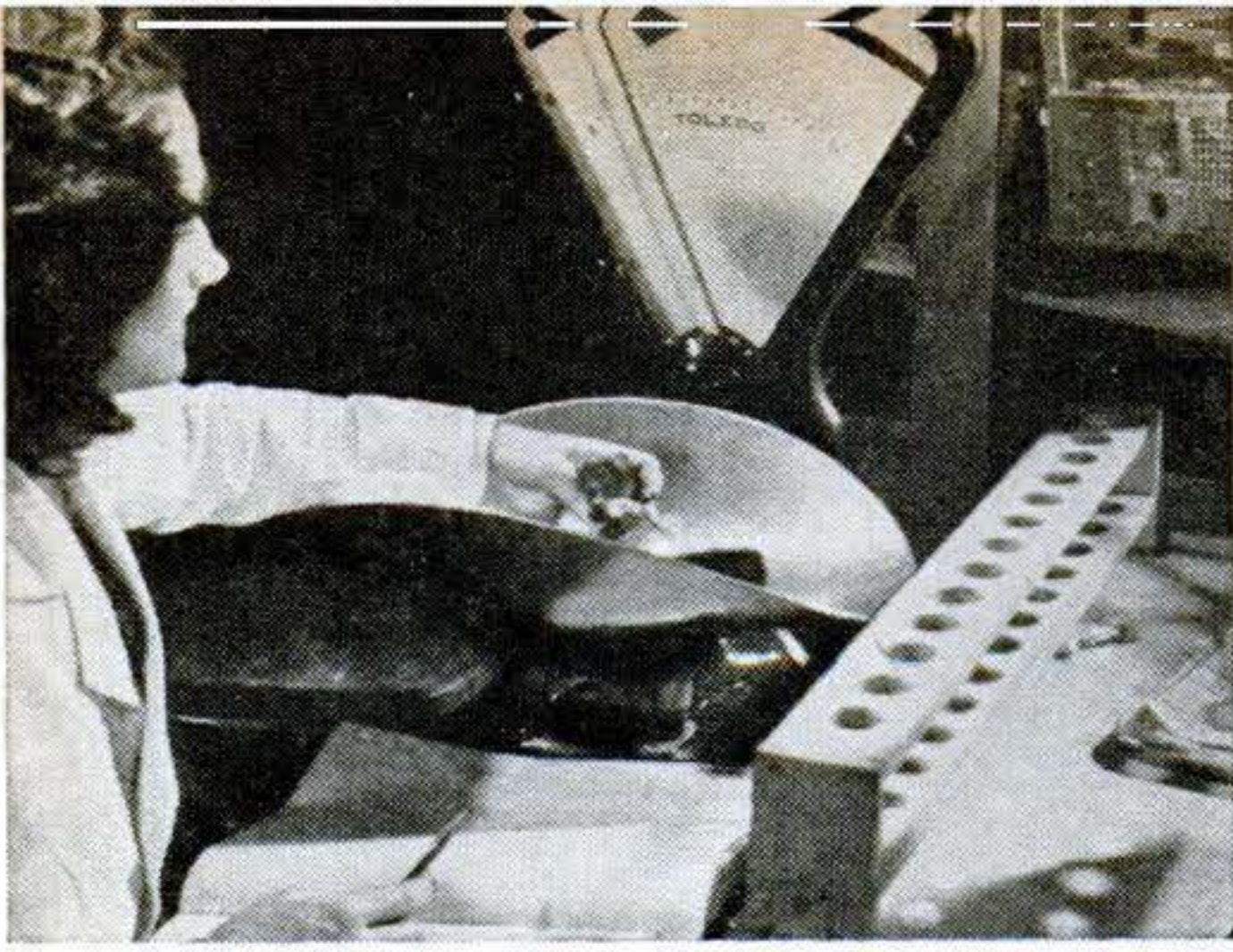

ANTU was discovered during research into the taste reactions of rats in this laboratory at Johns Hopkins University. Here laboratory rat is weighed as part of study of relation of diet to health.

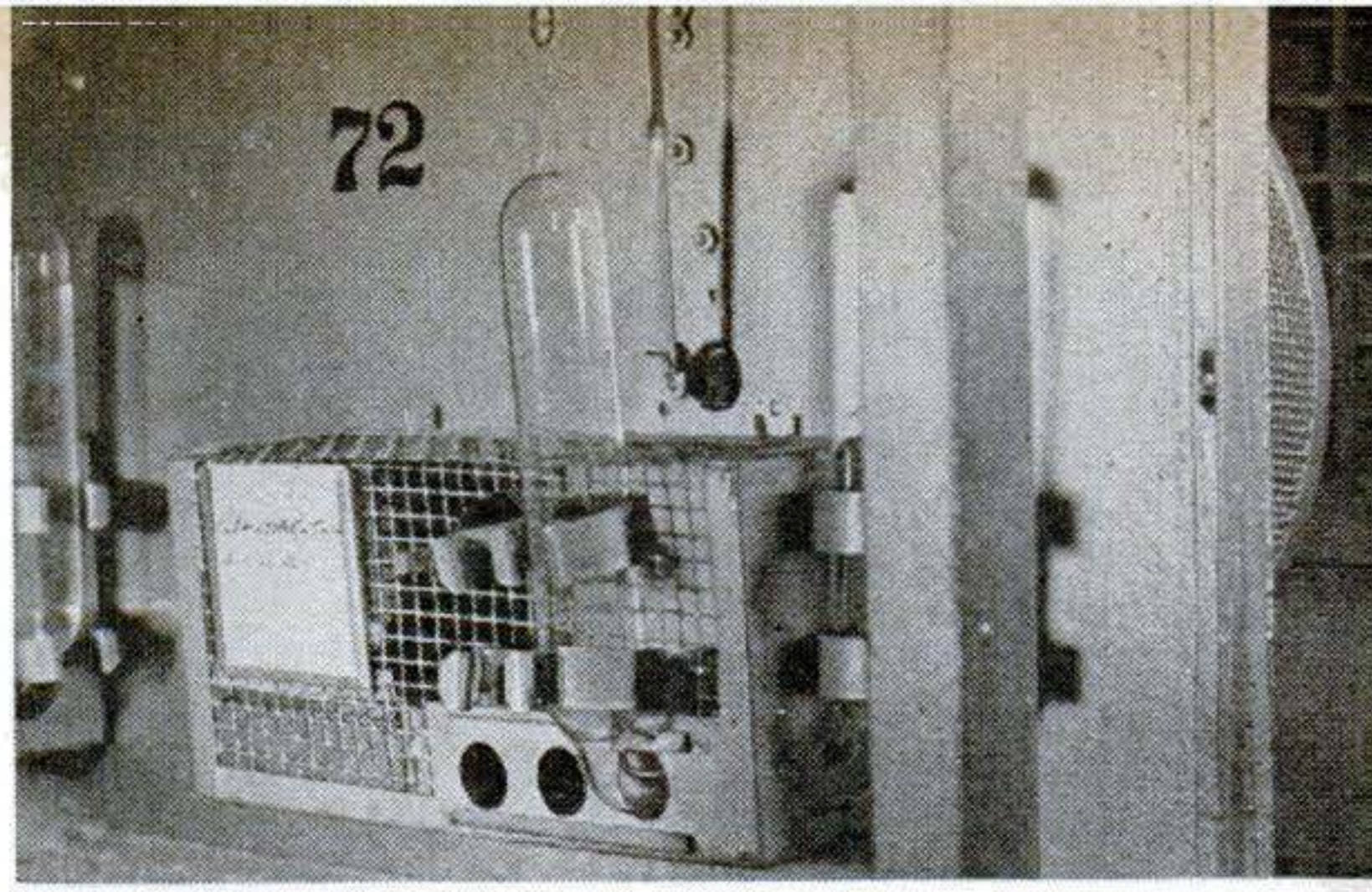

This cage is home sweet home to a Johns Hopkins rat. At far right can be seen edge of revolving drum where he works out. He often runs 40 to 50 miles a day, recorded by counter above the cage.

tion was, would phenyl thiourea kill wild rats as quickly and as thoroughly as it had his laboratory pets?

To find out, Richter trapped a few wild rats on the city dump. Unfortunately, the wild rats proved far wiser in their choice of food than their laboratory relatives. No amount of camouflaging or trickery could get the wild rats to taste the chemical. They turned up their collective noses at even the most attractive bait when it was mixed with the poison. The wild rats could taste the bitterness of the phenyl thiourea where the tame laboratory rats had not.

Richter, however, didn't give up. Perhaps some other similar chemical would do the trick. One by one he tested more than a hundred thiourea compounds in the hope of finding one that would be deadly and that the rats would eat. His search finally led him to the chemical called alpha-naphthyl thiourea, which he shortened to the less tongue-twisting name of ANTU. Wild rats found it palatable—and fatal.

### Baltimore Rats Slaughtered

This was late in 1941, at a time when Baltimore was having more than its share of rat troubles, so Richter had to do little more than step out of his laboratory to find a perfect area for a field test. After an initial trial covering eight square blocks proved highly successful, the city government took over the fight, first with trained volunteers and later with additional regular paid workers. The rat colonies were exterminated systematically, block by block. The rat death rate in many cases was close to 100 percent. It has been estimated that during a one-year period more than 45,000 rats

were killed with ANTU. As a result, Baltimore now has a City Rodent Control Office and more than three-quarters of the densely populated sections of the city have been brought under control.

ANTU is now available to the general public, but before you use it, either in its pure form or in the form of one of the ANTU prepared baits being sold commercially, you will be wise to study your rats as well as the poison.

### Careful Planning Essential

Anti-rat campaigns with ANTU must be carefully planned. ANTU is a one-shot poison; it is not accumulative. Success depends upon getting the rats—and that means all the rats—to eat a good portion of the poison. Their first free meal must be their last. Unfortunately, anything less than a killing dose allows the rats to develop a partial immunity to the poison that lasts about 30 days and an aversion to it that may linger for several months.

Don't attempt poisoning operations on a small scale. The area to be covered is determined by two factors—the location of the building or buildings to be treated and the natural habits of wild rats. Unless they are chased by dogs or cats, or the supply of food is completely removed, rats seldom journey far from home. However, they generally live in one place and eat in another. For this reason, when rats are to be cleared from a farm, or property in the less densely populated portions of a suburb, all out-buildings as well as the main house should be treated with poisoned bait. In sections where the houses are of the so-called "detached" type, groups of neighboring home



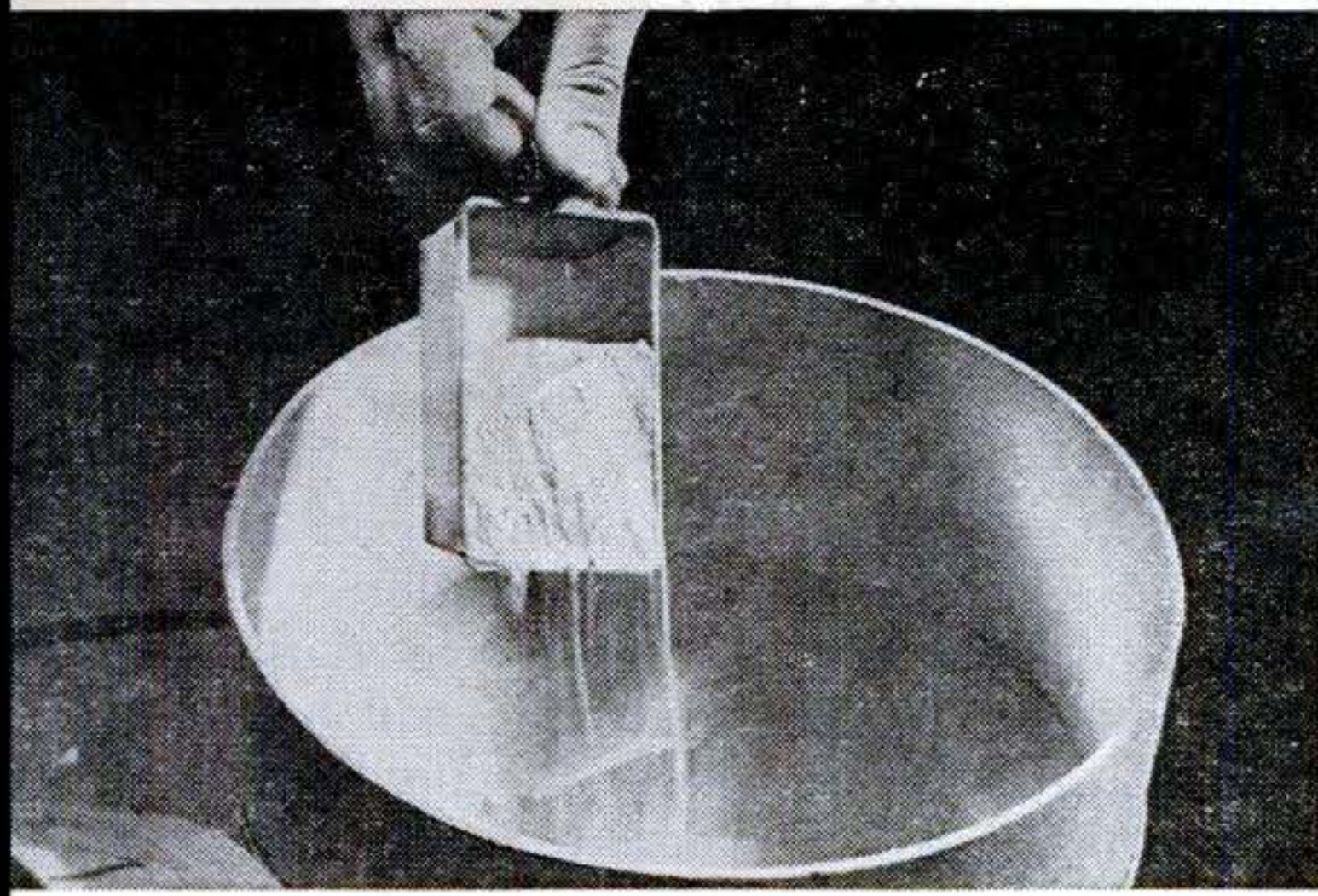

The pure ANTU in this bucket is a fine blue-gray powder. The poison can be used in this pure form, mixed with food or water, or in a commercial bait.



A tablespoonful of the poisoned bait—here a corn-meal mixture—should be placed in a small pile just to one side of a known rat hole or burrow.



Rat burrows can be sprayed with pure poison: The rat will get the powder on his feet and hair and lick it off. ANTU is also spread along rat runs.



owners should co-operate in one general anti-rat campaign. In cities, where the houses are built one against the other, a complete block is the smallest area that should be treated as a unit. Unless a city home is completely ratproofed, there is little sense in attempting to rid it of rats if the surrounding homes remain rat-infested. In crowded districts, rat control should be a community problem.

### Rats Often Unseen Guests

The area to be treated with ANTU first should be carefully surveyed to locate all rat holes and burrows, runways (generally found along walls or fences), possible sources of food, sources of drinking water, and entrance holes leading into homes and outbuildings. These are all good spots to place the poisoned bait. Watch for signs of rats—droppings and telltale teeth marks on soap, food, wood or cardboard boxes. If there are signs of rats but you have never seen one, you are more than likely playing host to from one to 100 of them. If you see them occasionally at night, the colony in your vicinity may number 200. And if you see them during the day as well as at night you are surrounded by an army that may number more than 500.

### Straight or Mixed

Pure ANTU, which costs about \$4 a pound, can be used effectively in a number of ways. A good ground bait can be made by mixing two to three parts of ANTU with 100 parts of finely ground, fresh yellow corn (corn meal). This can be distributed in small shallow piles (about a tablespoonful) where rats are known to be. A good spot for this type of bait is just to one side of the entrance to a known hole or burrow.

Another similar procedure consists of smoothing out a layer of corn meal about one-quarter inch thick and one foot in diameter and dusting it with the ANTU powder from a spray gun or an ordinary kitchen flour shaker. This particular type of bait works well on cellar or outbuilding floors. Small slices of apple, cantaloupe, watermelon, sweet potato and tomato,

One of best methods is to dust an ample layer of ANTU onto a foot-round pile of corn meal spread on the floor in an area rats frequent.

PSM photos  
by W. W. MORRIS

APRIL 1947 93



or ground meat, the white and yolk of eggs, and chicken and fish heads can be dusted with the poison and used in much the same way. When using either of these baiting methods, it is wise to dust an additional area with ANTU around the food for a distance of six or eight inches.

ANTU can also be used without bait. Mixed half and half with ordinary flour it can be pumped into holes and burrows or spread along runways. When the rats get the powder on their feet or hair, they lick it off and get their poison without eating—victims of their personal cleanliness.

In places where food is plentiful and there is no means of conveniently removing the supply, such as in food stores and warehouses, the rats' thirst can be catered to by putting out shallow dishes of water that have been dusted with ANTU. The poison should be dusted on the water until a thin floating layer has formed on the surface.

### **Combined Attack Most Successful**

In any anti-rat campaign it is best to use a combination of these baiting methods and, in any case, it is wise to pre-bait for a short period before applying the poison. Set out *unpoisoned bait* in the same spots for three or four nights in a row, or at least until you are sure that the rats in the vicinity know where the food is. Word of the free lunch will spread rapidly through your rat colony. You can check on the nightly attendance at your rat cafeteria by looking each morning to see how much of the unpoisoned food has been eaten. If the amount consumed increases each night, continue to pre-bait with fresh food; but once the shrinkage of the piles remains constant you can be

pretty sure that the word has spread to the last rat—and remember, it's that last rat that counts. That night you can set out your ANTU bait with fair assurance that you will get close to a 100-percent kill.

Since rats generally eat shortly after dark and early in the morning, put your bait out late in the afternoon. During the pre-baiting and baiting period be sure to remove all other possible sources of food. Then, on the night that you set out the poisoned bait, be sure to keep your children, pets and farm animals away from the poisoned area. After the poisoning operation is completed (the next morning), remove all poisoned bait and dispose of it where humans or animals are not likely to get at it.

### **Block Holes on Third Day**

ANTU-poisoned rats usually die within 10 to 24 hours, so look for dead rats for several days following the poisoning. On the third day close all rat holes with dirt or stones. If any rats remain, the holes will be reopened within a few days.

ANTU kills by affecting the rat's lungs and the production of lymph fluids—in other words, the rat literally drowns in its own body fluids. This is an important feature of ANTU, since by affecting a rat's breathing it usually drives him outdoors to die.

ANTU does not guarantee against reinfestation, so keep a careful watch for rat signs. If necessary, repeat the process within a year.

Rats cost American home owners and farmers \$63,000,000 annually. One rat can eat up to 50 pounds of grain a year. ANTU—plus constant vigilance—may save millions of this tribute to ratdom. END

## **ANTU DON'TS**

**Don't** leave ANTU or poisoned bait around where children, pets or farm animals can get at it.

**Don't** leave poisoned bait out for more than 18 hours. Collect all uneaten bait and dispose of it carefully.

**Don't** throw unused poison or bait into garbage or swill that might be used as food for pigs.

**Don't** use ANTU where there is any likelihood of contaminating food.

**Don't** be stingy with your poison. Give your rats plenty of food and plenty of poison.

**Don't** relax your war on rats after one successful treatment. Repeat your ANTU campaign at least once a year if necessary.

**Don't** use ANTU unless you are sure of covering the entire rat-infested area.

**Don't forget—it's the last rat that counts.**



# Submarines for ATOMIC WAR

## Will be Special Types

**Attack, picket, transport, cargo, aircraft carrier and guided missile ships will supersede all-purpose, fleet-type subs.**

By **LEON SHLOSS**  
*PSM Washington Editor*

ON April 11 the United States Navy celebrates Submarine Day, in honor of all American submariners and especially the 55,000 who helped win World War II. Even while the nation pays tribute to the under-sea fighters' past exploits, however, Navy strategists are studying plans for their future—in a submarine fleet comprising at least six different types of ships that can carry out all the missions of Atom Age warfare while escaping most of its perils.

The Navy high command believes that, as of today, the submarine cannot be consistently detected or continually followed—as, by radar, the surface ship and the airplane can—and that it is the least vulnerable of all types to atom bomb attack. The latter was indicated at Bikini. The former, in the words of Fleet Admiral Chester W. Nimitz, is assured until “electronic waves are able to make reasonable penetration of sea water.”

It is also realized and readily admitted, in the quiet cubicles of the Navy Department where the continued American freedom of the seas is being assiduously planned,

that both Germany and Japan—especially Germany—were way out in front of this country in submarine development at the end of the last war. Considering that the United States escaped the catastrophic potential of such a situation, the planners declare we were lucky because the Navy can now start to build from scratch without having to scrap a lot of valuable equipment. Further, it possesses and is using all the technical knowledge that the late enemy built into its pigboats.

Neither Admiral Nimitz nor his strategists are convinced that the new submarines will eliminate surface navies. They point out that within the last century the architecture of navies has been changed by steam, steel, the screw propeller, the long rifle, the torpedo, the mine, the submarine and the airplane. They know it will be further altered by atomic energy but declare that as long as world commerce moves above, on, or under the oceans there will be need for diversification of ships to protect the sea lanes (“Navy Plans to Go Higher and Deeper,” *PSM*, April '46, p. 82).

Following this philosophy, the Navy intends to overlook no bets if the submarine, as presently indicated, turns out to be *the* warship of the “near future.” Naturally, long-range plans for super-submarines are on the drawing boards. It is not with these that the Navy is so immediately concerned, but with the so-called “fleet type,” which compiled such a diversified record in World War II. Outdistanced technologically as these



ships were at war's end, they nevertheless had:

1. Sunk twice as many Jap cargo vessels as all other American forces.
2. Sunk half as many Jap combat vessels as all other American forces.
3. Landed raiders on enemy islands, bombarded these islands, and recovered the raiders.
4. Rescued more than 500 American aviators from the sea.
5. Laid mines, carried fuel to beleaguered positions when surface ships could not, and performed outstanding feats of reconnaissance.

6. Destroyed 275,000 enemy lives, nearly as many as the entire American Army lost.

All that got the Navy to thinking. If a mutant vessel like the submarine—never recognized as being good for much besides stalking targets of opportunity—could accomplish such varied tasks with such great success, what might not a fleet of undersea craft, broken down into more specialized types to perform specific tasks, do?

The new submarines, by and large, will be about the same size and weight as World War II subs. They can be produced quickly and still incorporate the latest technological advances. This will be the sub-

marine of "tomorrow," not "day after tomorrow," but still built for the first time as a submarine from the keel up, not merely as a surface vessel that can submerge when it becomes necessary.

All the new types will have high speed and long range while submerged, on the principle that, from now on, the surfaced ship is the vulnerable ship. Speed will be limited only by power-plant developments, with atom power the ultimate objective. Range will be governed almost entirely by physical limitations of personnel. These limitations will depend on ability of engineers to provide continually improving air-revitalization systems. The food problem is being solved by development of concentrated foods that will keep crew members well above subsistence levels for long periods, without heavily burdening the submarine with supplies.

The speed factor will be increased by streamlining wherever possible. This streamlining is being accomplished by dispensing with deck armament and other external impedimenta, even by reduction of torpedo capacity and internal load.

The six types of submarines now visualized as components of an Atom Age fleet, along with specifications and missions, are:

**DECK-RECESSED SCHNORKEL TUBE TO BE USED ONLY IN EMERGENCY FOR AIR**

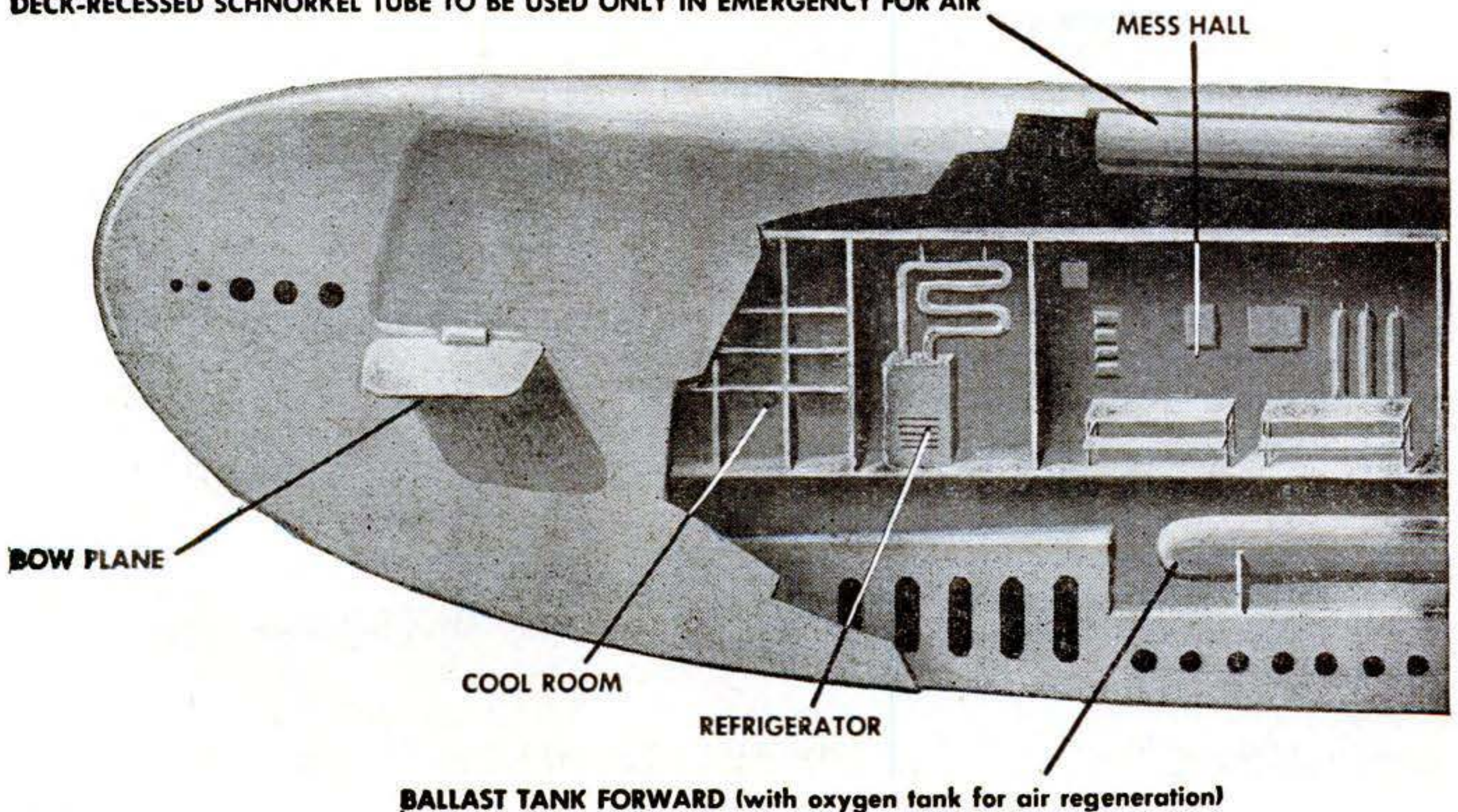



## Attack Type

**Speed:** 26 knots submerged, or highest possible for quick strike and withdrawal.

**Size:** Present submarine size (1,800 tons, 310 feet long) or perhaps slightly smaller for higher maneuverability.

**Shape:** Ultimate in streamlining, for speed and maneuverability.

**Range:** As new power plants emerge, range will be limited only by physical limitations of personnel. Present goal, 25,000 miles.

**Armament:** None topside, all sacrificed for speed. Twelve high-speed, turbo-jet torpedoes with "on-and-off cam" device.

**Special Characteristics:** No torpedo tubes aft, to enhance streamlining; four tubes forward. Projectable radar antennas that can be raised and lowered while submerged.

**Purpose:** Destroy enemy sea power and commerce.

**Comment:** Cam devices on torpedoes cause them, at desired distance from firing point, to "patrol" back and forth, in effect setting up a torpedo screen against enemy vessels.

## Reconnaissance & Picket Type

**Speed:** 15 knots submerged—little more than half that of ATTACK type.

**Size:** Present size or smaller.

**Shape:** Streamlining commensurate with special purpose.

**Range:** As above.

**Armament:** None.

**Special Characteristics:** Room for variety of radar, including long-range, aircraft, surface search. All radar antennas retractable for submerged operation. Good periscope

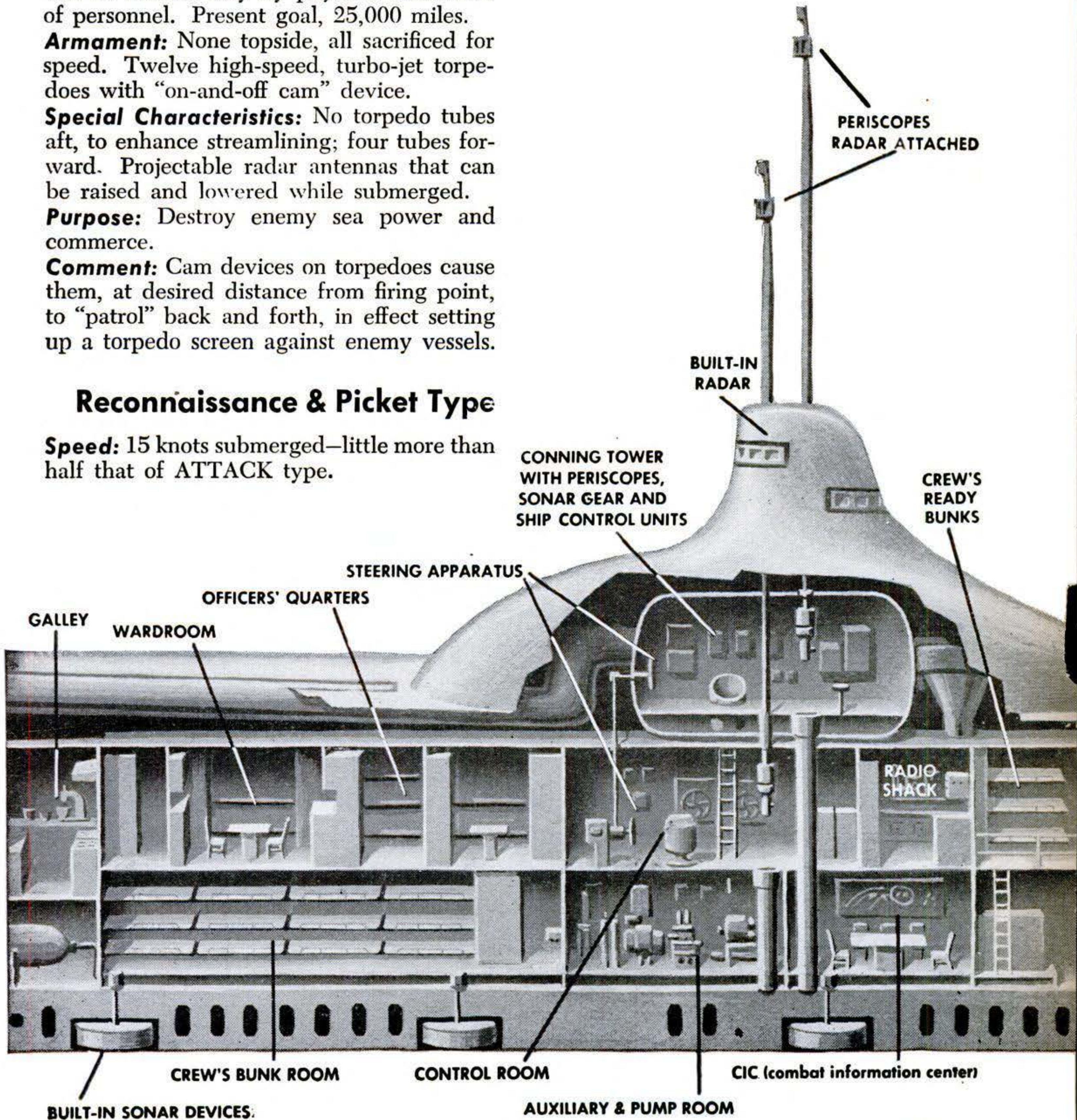



photographic facilities. Good communications facilities, also with retractable antennas for operation while submerged.

**Purpose:** Patrol and spotting, origination of radio reports on enemy dispositions and installations to American attack forces. May work in team with ATTACK and AIRCRAFT-CARRIER types.

**Comment:** On this and other types, all antennas must be retractable for underwater operation to preclude great danger of detection by enemy radar when surfaced. To contain all necessary radar and communications equipment, this type must make a sacrifice in streamlining and therefore in speed. Speed loss can be accepted, because primary function of recco sub is to remain in danger areas indefinitely and report vital information.

### Transport Type

**Speed:** 15 knots submerged.

**Size:** Three times that of present subs, or about 6,000 tons.

**Shape:** As with the transport aircraft, as opposed to the military aircraft, streamlining is sharply reduced to permit increased carrying capacity.

**Range:** As above.

**Armament:** Large rocket launchers and anti-aircraft guns on deck for defense against

enemy attack and before-landing barrages.

**Purpose:** Landing of troops for commando, espionage and other behind-the-lines activities and for evacuation of personnel.

**Comment:** About 600 equipped, special-purpose troops can be carried. Submarines transported as many as 300 Marines per unit in World War II.

### Cargo Type

This type will differ from TRANSPORT type only in compartmentation and purpose. It would be built for adaptation either as a dry-stores carrier or a liquids carrier. It would be used to deliver supplies to besieged garrisons or critical war-production materials to allied powers. Might work in team with TRANSPORT type in following up attack landings with supplies.

### Aircraft-Carrier Type

**Speed:** 15 knots submerged. Higher speed desirable but impractical under load factor.

**Size:** 6,000 tons.

**Shape:** Bulky.

**Range:** As above.

**Armament:** Deck AA guns.

**Special Characteristics:** Hangar space, aircraft maintenance facilities, plane catapult, radar, good communications facilities, ca-

LAUNCHING TUBE CLOSED; MAY BE FIRED EITHER SURFACED OR SUBMERGED

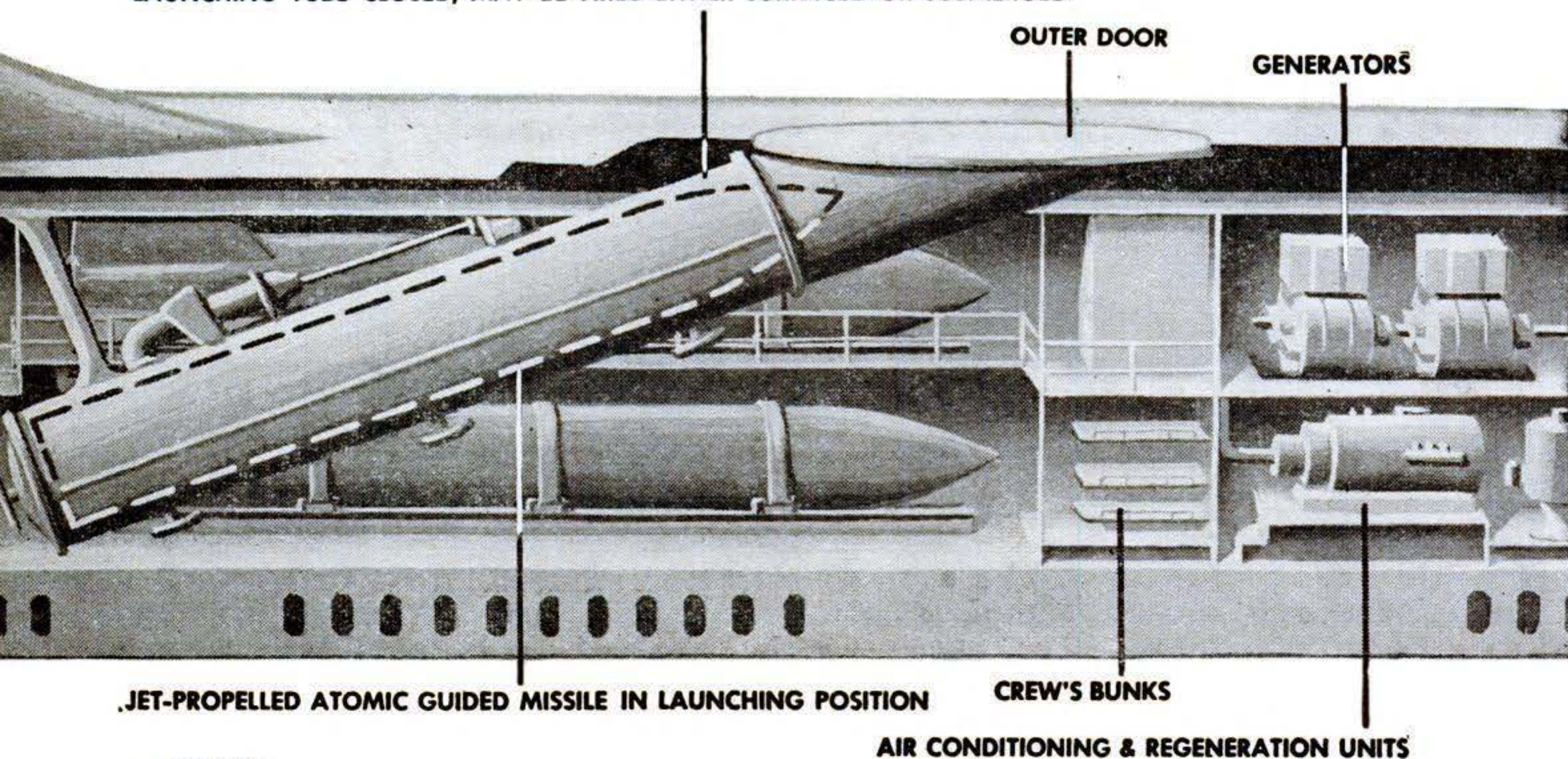

JET-PROPELLED ATOMIC GUIDED MISSILE IN LAUNCHING POSITION

CREW'S BUNKS

AIR CONDITIONING & REGENERATION UNITS



capacity to carry the fuel required by aircraft.

**Purpose:** Extension of scouting range beyond that of recco sub. Aircraft scouts could fly well beyond recco's radar range and report back by radio on enemy naval groupings. Secondary purpose, dropping of atomic bombs.

**Comment:** Bombing value of sub-borne aircraft is depreciated by planners, who foresee development of guided missiles with longer range and greater accuracy. Also low-rated is the possibility of pilot survival and recovery; hence, even scouting missions over land installations, which can usually be more heavily defended than sea forces, are ruled out except in unusual situations. The Japanese at the end of the war had several of the 3,000-ton I-14 class, which carried two planes each, and a couple of the 5,000-ton I-400 class, each of which carried four planes. Each plane could carry only one 1,500-pound bomb. Planners agree that this is not an economical manner in which to mount an effective aerial bombardment force and fail to see the plane-toting pigboat as a successor to the surface aircraft carrier.

### Guided-Missile Type

**Speed:** 24 knots submerged, or highest speed possible to evade coast defenses.

**Size:** Slightly larger than present sub-

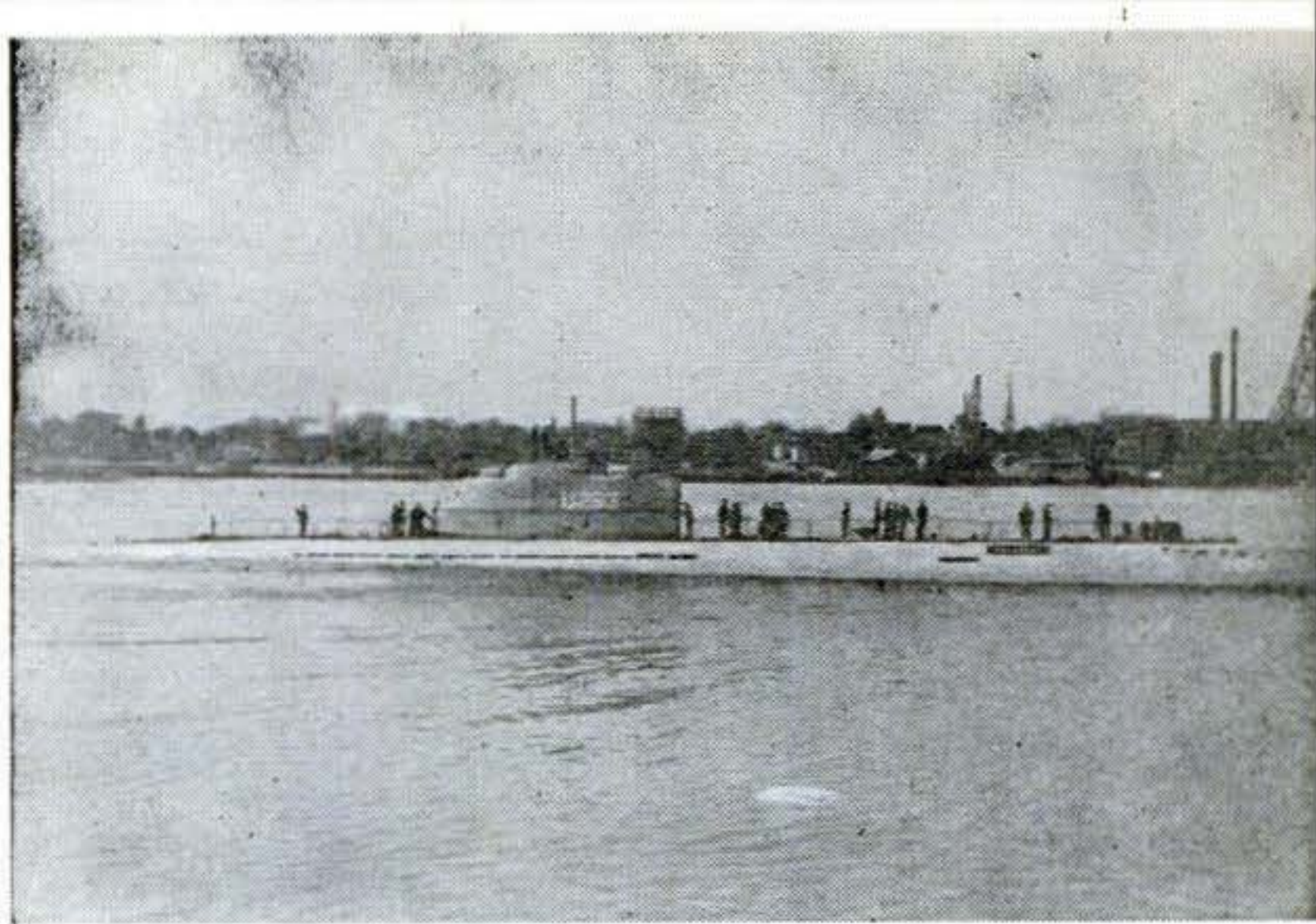

This Type 21 German submarine shows the Nazis' advanced streamlining. All unnecessary gear has been stripped from her deck. Even the guns are gone.

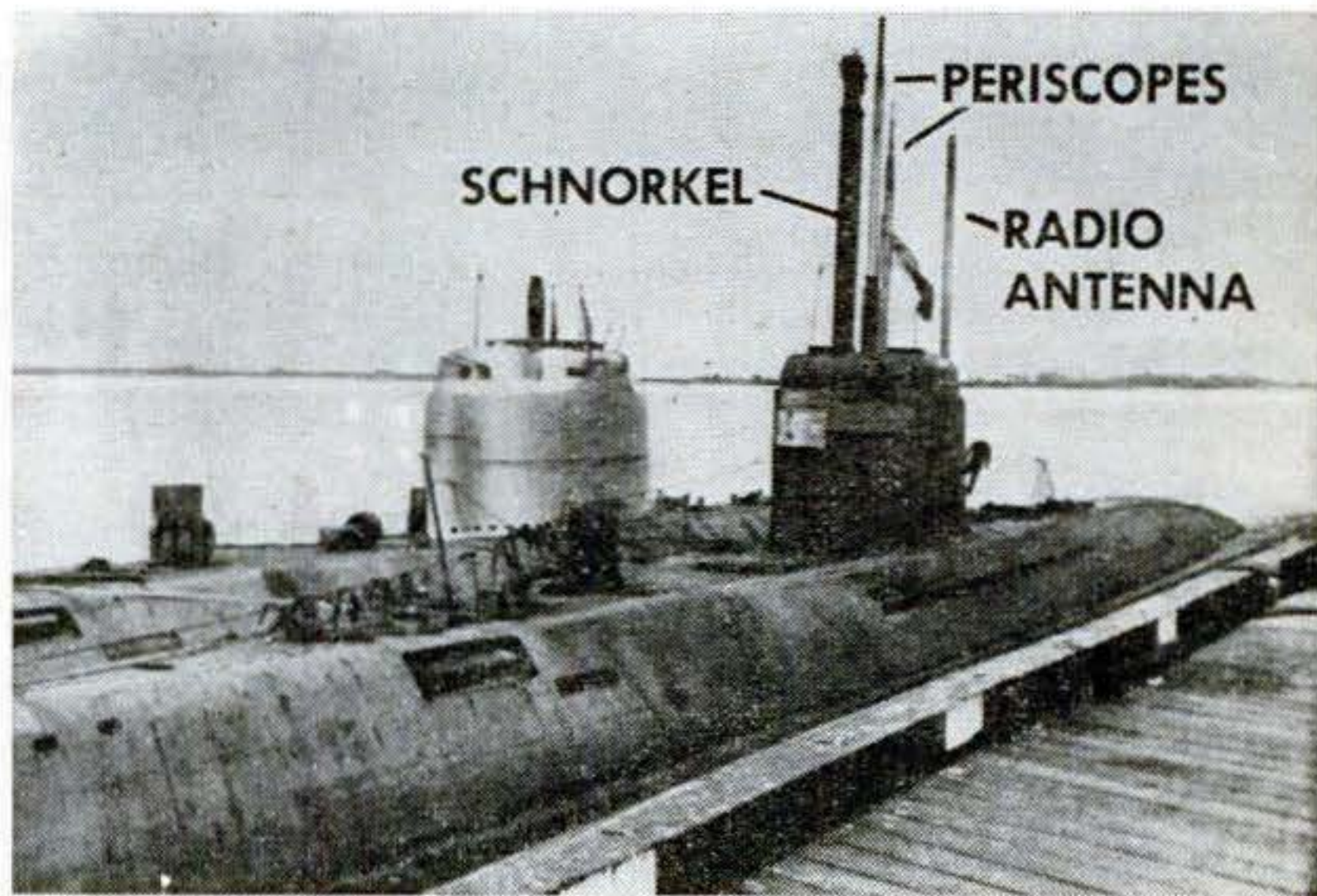

Two captured Type 21s. Schnorkel—breather tube—and elaborate periscopes and radio antennas are extended on sub at right, retracted on craft at left.

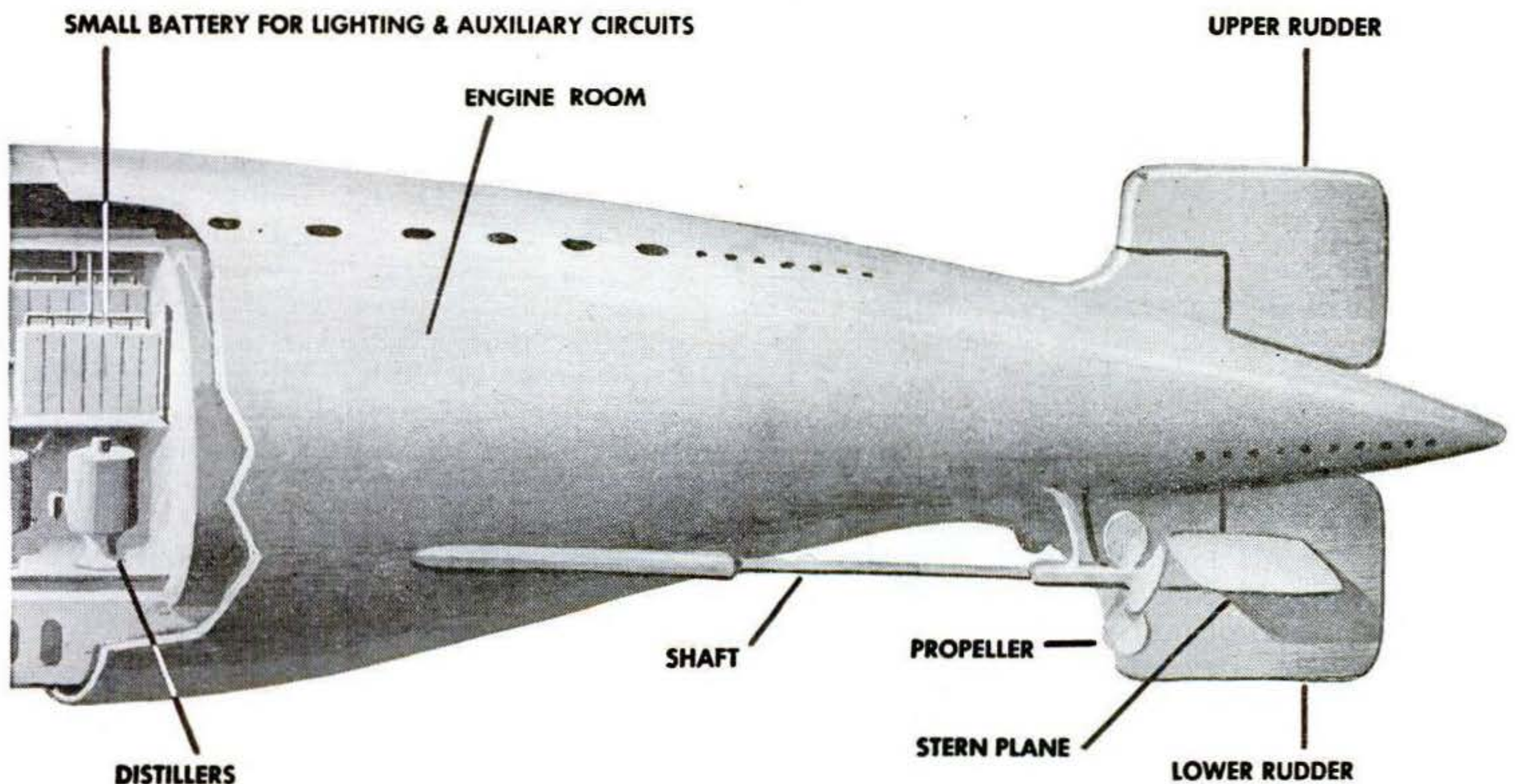



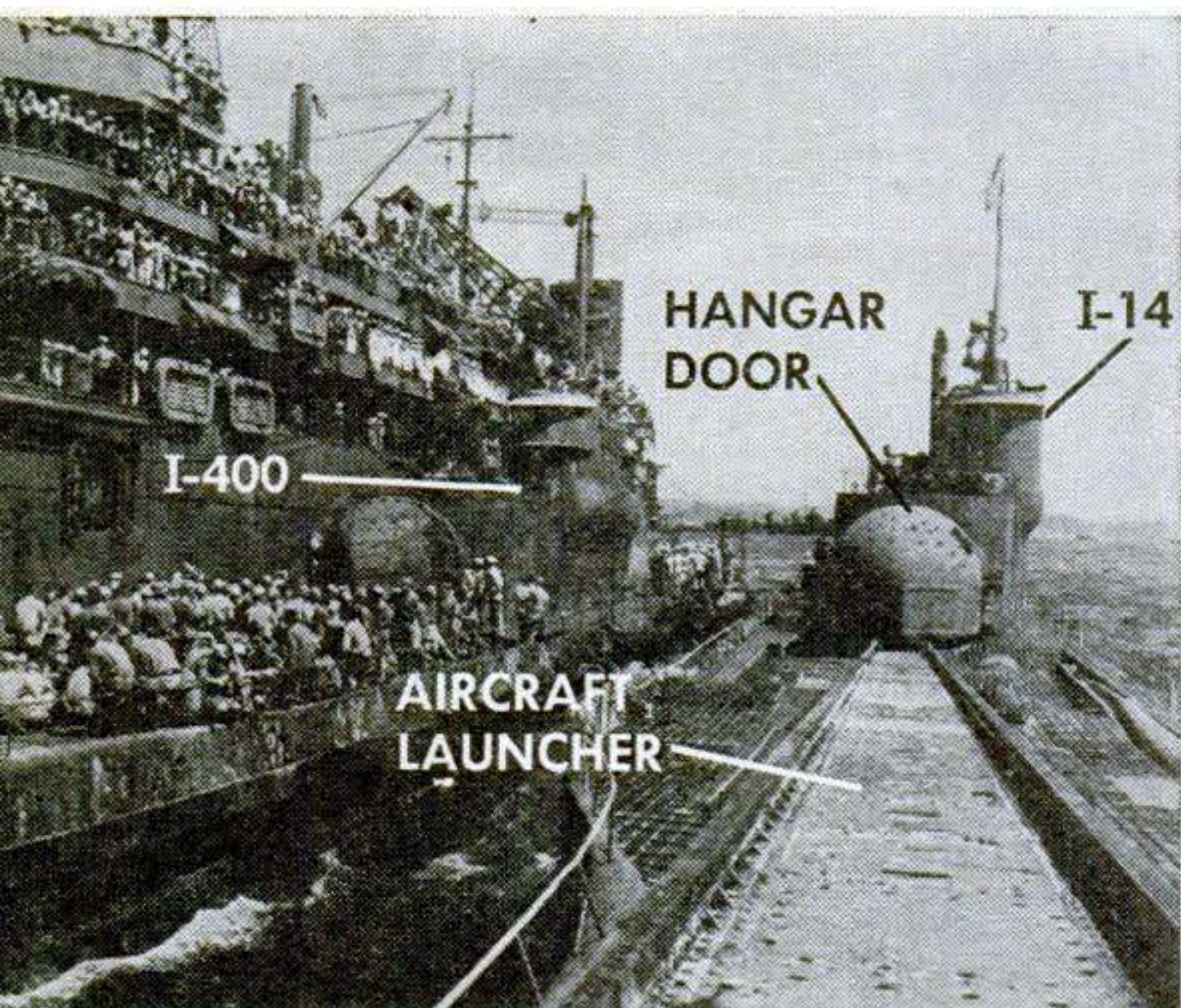

The captured Jap submarine I-400 (left) carried four bombing planes; the I-14 (right), two. The I-14's launching rails can be seen in the foreground.

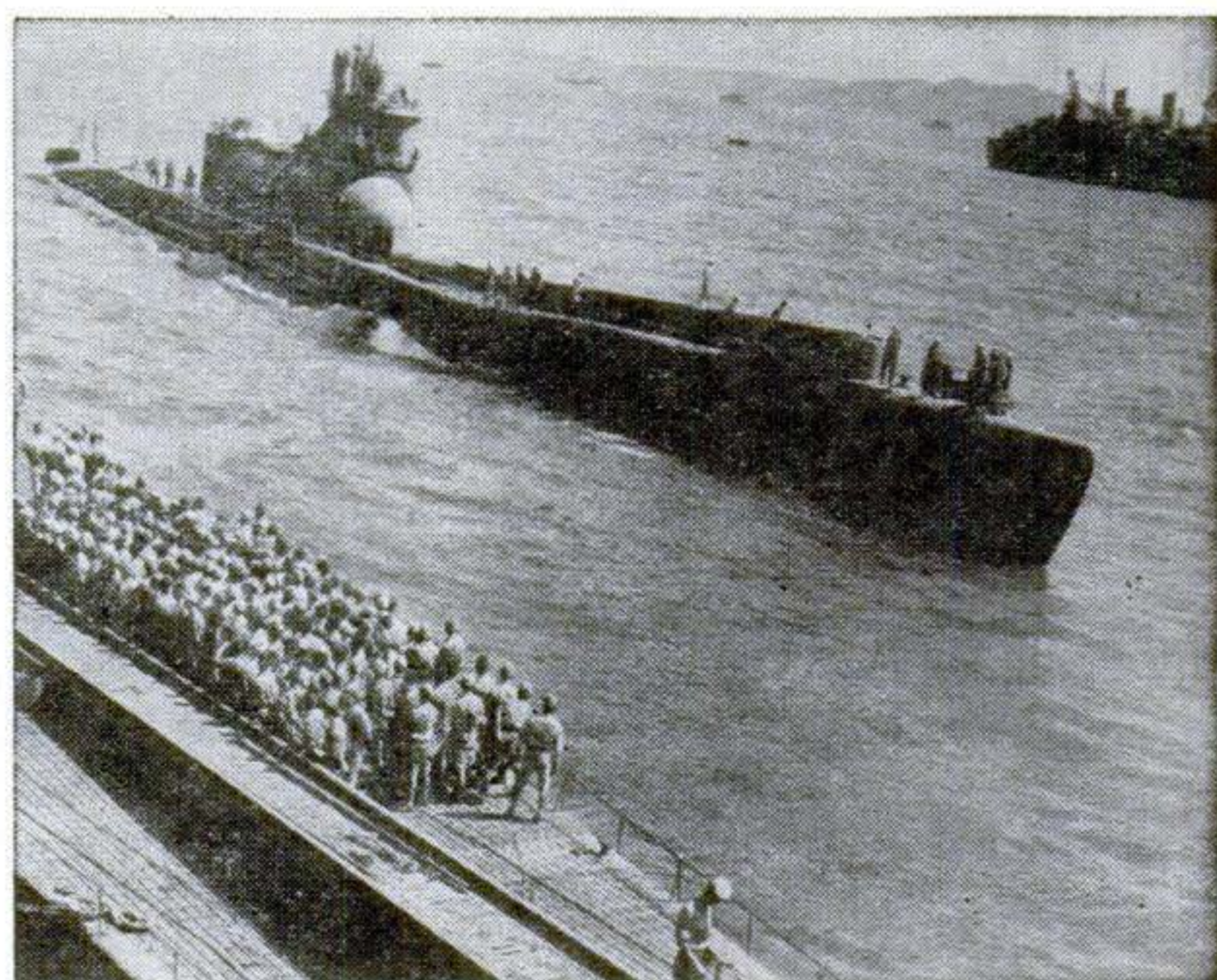

This angle shot of the I-14 gives a clear view of the railed ramp for launching planes carried in the space behind the bulbous hangar doors.

marines, but smaller than CARRIER type.

**Shape:** Moderately streamlined.

**Armament:** No defensive armament.

**Range:** As above.

**Special Characteristics:** Weapon launcher.

**Purpose:** Long-range, total destruction of enemy industrial and military centers.

**Comment:** Where the ATTACK type is the "left jab" of the new submarine Navy, the GUIDED-MISSILE type is the Sunday punch. Long-range, electronically directed missiles of at least 20,000 pounds will be launched, either submerged or surfaced, at ranges up to 500 miles. Submerged launching is the planners' goal because probability of detection and interception of the missile while it is traveling under water is slight.

In planning the new submarine Navy, American experts have the advantage of the German skill that produced Nazi U-boats capable of submerged speeds of more than 20 knots and submerged ranges of more than 20,000 miles. This was accomplished at a time when our best submerged performance was two knots for 40 hours or eight knots for one hour. Admiral Nimitz says that the German Type 21, developed in 1944, might have changed the course of the war had it been available in quantity two years earlier.

One of the developments that gave Germany its lead is the Schnorkel. Borrowed by the Nazis from the Dutch, the Schnorkel is a tube which extends from the

engines to the surface and supplies the power plants with air to permit cruising at periscope depth without using batteries for power. Without this device, American submarines had to use low-voltage, long-life batteries for periscope cruising, as their Diesel engines were useless without air. However, with the Schnorkel, the Germans could use high-voltage, short-life batteries for short bursts of speed when fully submerged. This helped mightily in runs into and out of target areas so fast that depth charges could not be dropped effectively.

At the end of the war, the Germans were building an even better type, the 26. With a small, almost indiscernible conning tower, it had three power sources. At Schnorkel depth, it cruised on Diesels. Fully submerged, it used batteries. For battle speeds, it employed an entirely new type of submarine engine, the Walther gas turbine, which operated thus: Hydrogen peroxide was put through a catalyst and broken into water and oxygen, which gave off heat. Fuel was fed into this hot mix, and the gases expanding from the resulting combination drove the turbine.

The American planners know all about these and many other things, the purpose of which was to attain high submerged speeds, long range and the characteristics that have transformed the submarine into a highly versatile weapon of sea war—and they are doing plenty about it. **END**



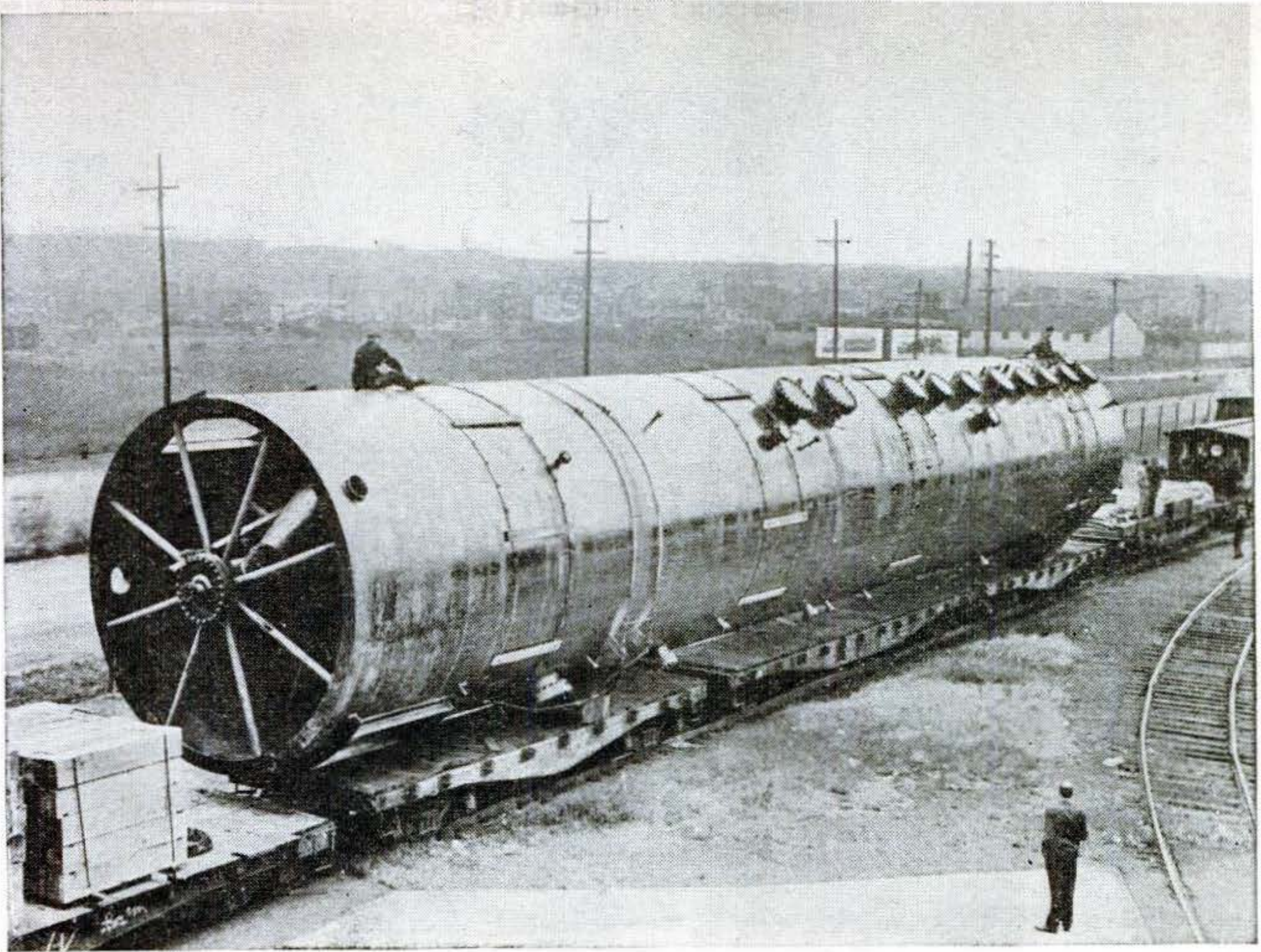

**Big Tower Gets a Long Ride.** It took a tugboat, a barge, and three flatcars to haul this giant 165-ton oil-refining tower from New Jersey to a refinery in Sugar Creek, Mo. The 2,025-mile trip, made largely on water, took 32 days—good time for this traveler.



**Bulldozer Rides the Rails.** A rail-traveling bulldozer (above) is used in a unique method of track-grading devised by Hamer Brothers, Inc., of Detroit. Riding atop earth-piled flatcars, the bulldozer dumps the dirt along the tracks. Steel runways permit the tractor to move between the flatcars.

**Boiler Takes to the Air.** One of two 16,000-lb. steam boilers (below) is raised to the roof of an 18-story building in Dallas, Tex., for a new heating technique.





## WHAT'S NEW in AVIATION



**Twin Engines? Look Again!** The "two-engine" Navy patrol bomber above—the new Martin XP4M-1—really has four power plants to zoom her upward. Allison jets, providing 4,000 pounds of thrust apiece,

are mounted (inset) directly behind each regular 3,000-hp. Pratt & Whitney engine. The plane cruises at 200 m.p.h., can do better than 350 m.p.h., and has a range of more than 3,000 miles.



**One-man Air Control Panel.** This single panel has everything for air traffic control; if need be, one man can run it alone. Flight plans, flight conditions, instrument-

and contact-flight records are all ready in the center of the AAF Control Tower Console, shown undergoing extensive tests at Langley Field, in Virginia.



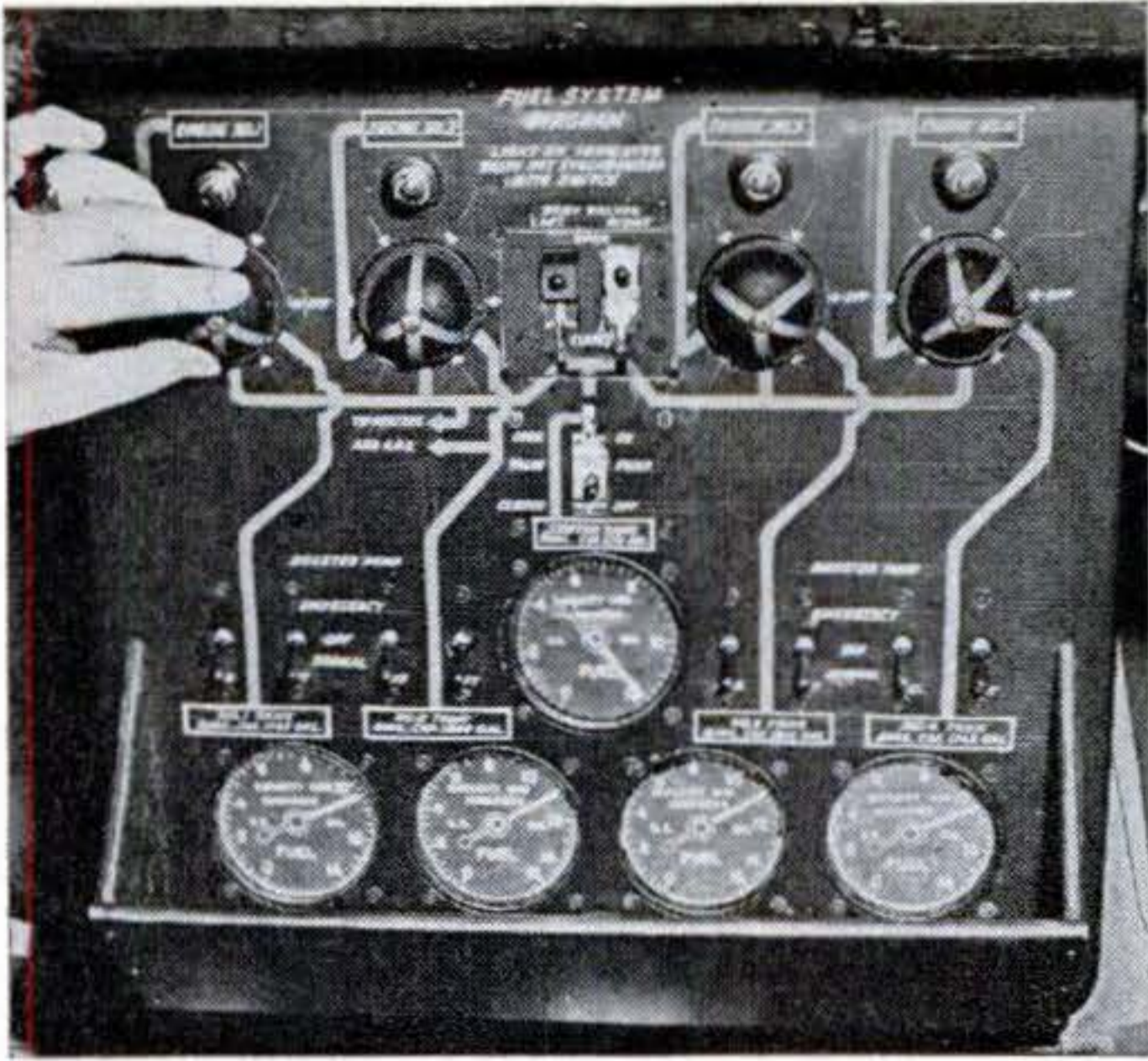

**Panel Shows Fuel Flow.** A pilot sees at a glance how much gas is going where with the fuel control panel used on Boeing Stratocruisers. Bottom dials show supply in each tank, lines mark fuel pipes, knobs control and indicate flow direction.

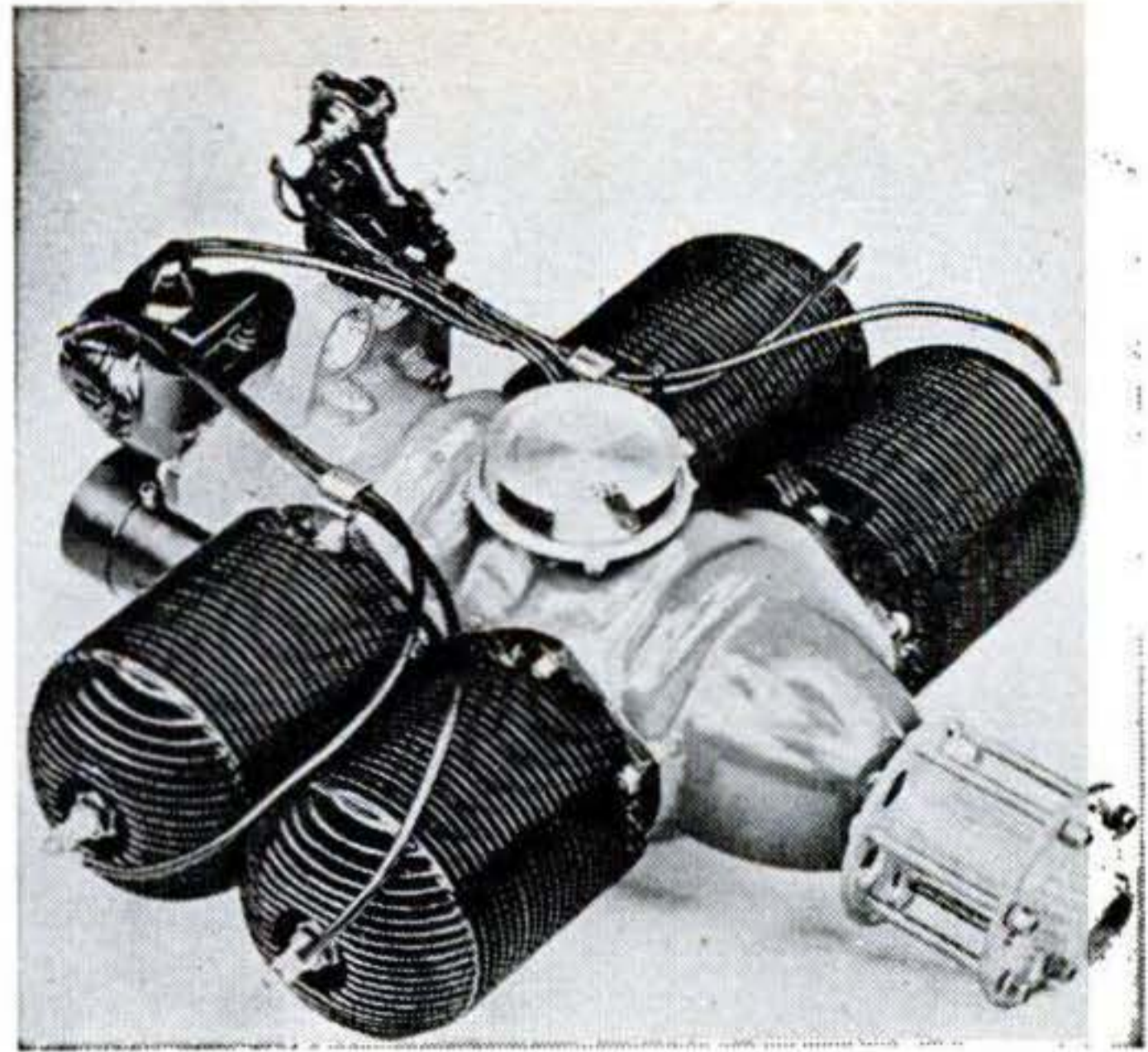

**Baby Engine Speeds Targets.** This McCulloch engine weighs only 74 lb., but its four cylinders produce 60 hp. to fly target aircraft at 200 m.p.h. It has no gears, all accessories being driven from the free end of the crankshaft.

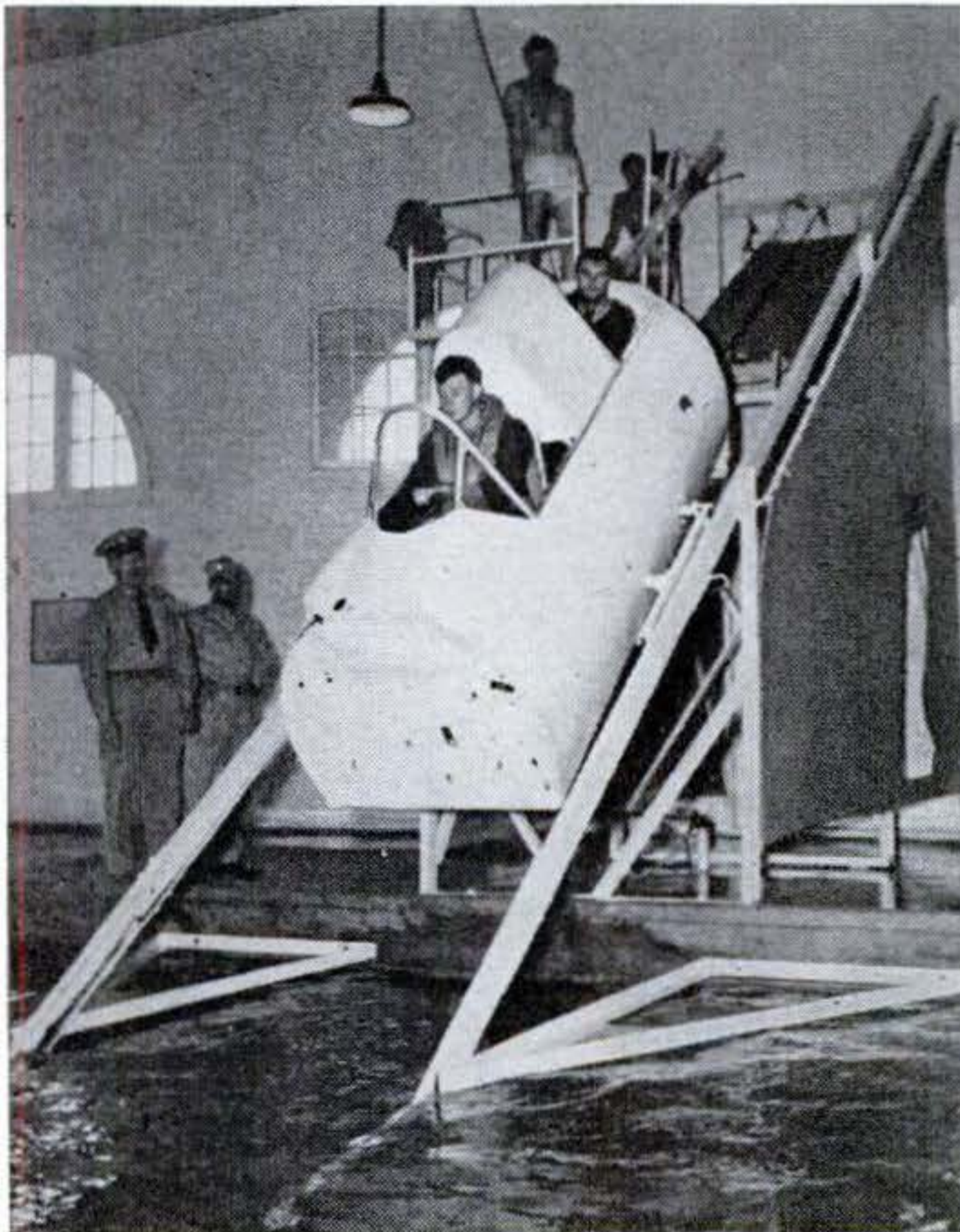

**Crash Landing in a Pool.** Since Naval fliers always face the danger of a crash landing at sea, they are now being trained beforehand, in the safety of a swimming pool, to escape from their sinking plane. Picture at left shows a simulated cockpit, with



pilot and gunner, about to hit the skids. At right the "Dilbert Dunker" crashes into the water. The men must now get out of their safety harness and free their emergency equipment—all in a few seconds while the cockpit is still in motion.



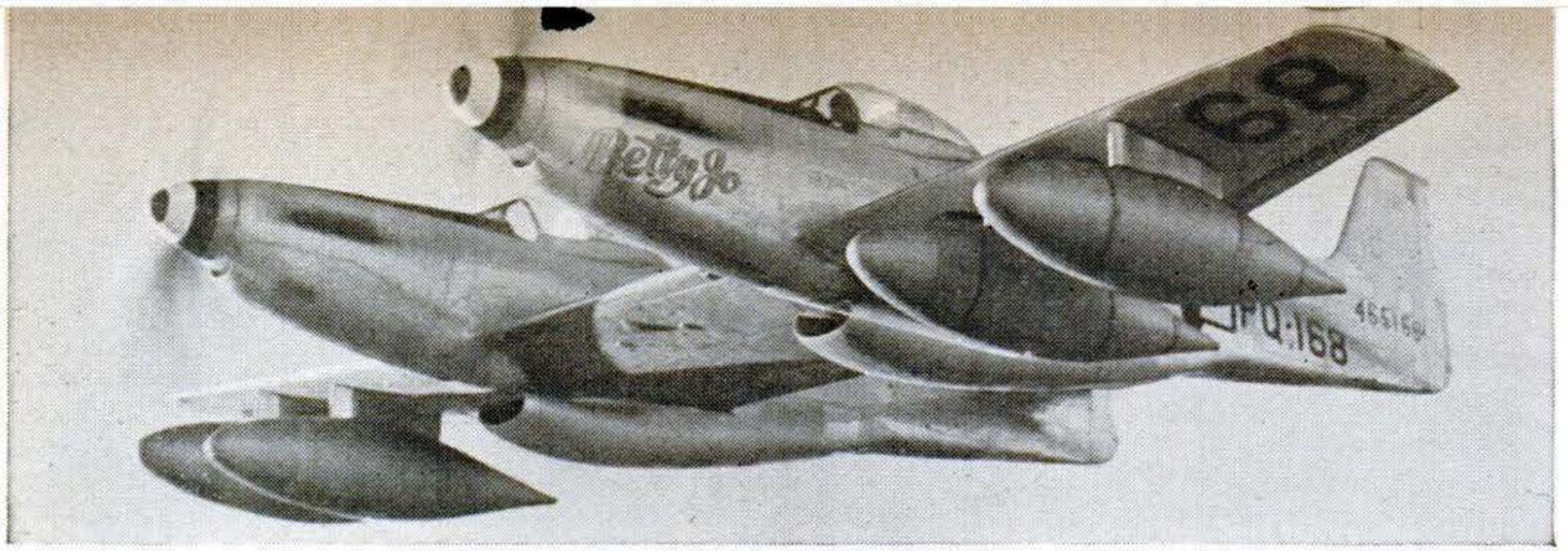

## ***P-82 Sets Distance Record***

**W**ITH perilously little gas left in its tanks, an Army Air Forces P-82 twin Mustang swooped down on New York's LaGuardia Field on Feb. 28 to complete the longest nonstop flight ever made by a fighter plane. It had flown all the way from Honolulu—5,051 miles—in 14 hours and 33 minutes, averaging nearly 350 m.p.h.

The *Betty Jo* (named for the wife of its pilot, Lt. Col. Robert E. Thacker), made the record flight despite a severe handicap. It carried four auxiliary wing tanks, each holding 310 gallons, when it took off. Col. Thacker jettisoned the first one over the Pacific, but as the tank fell free, it damaged the trailing edge of the left wing. Col. Thacker and his co-pilot, Lt. John M. Ard, had to continue on to New York with the remaining three tanks still in place, despite

the increased drag. The tanks are shown, above, during a trial flight.

The flight was not just an attempt to set another record. It had a definite purpose: to test the feasibility of extremely long-range fighter escorts for heavy bombers. The twin-fuselage plane carried special equipment designed to help pilots withstand the strain of such long flights. The seats were of a new pulsating type and the pilots wore a recently developed parachute harness.

The seven-ton plane, powered by two 12-cylinder liquid-cooled engines, carried its weight in gasoline to make the trip. For a time, it appeared that the *Betty Jo* would have to land short of its goal, but the tremendous fuel load proved just adequate to reach New York.

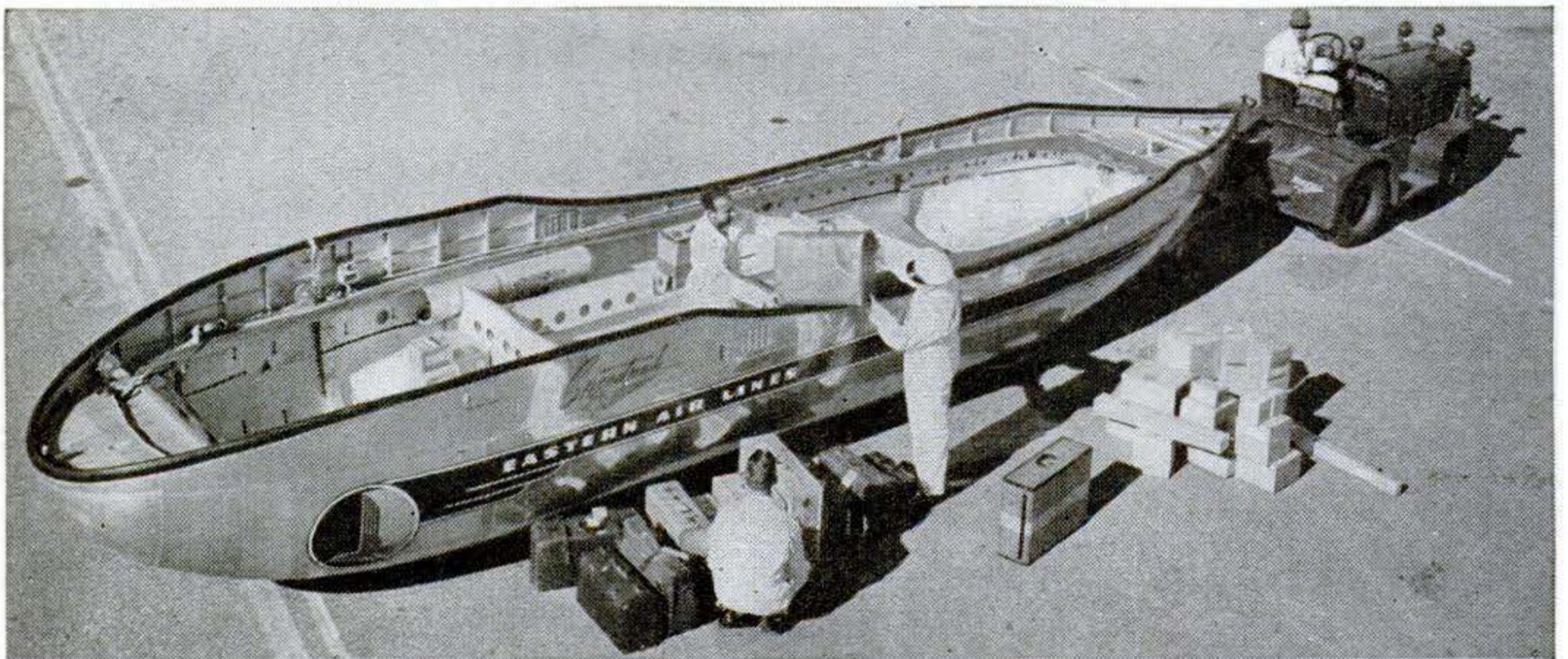

### ***Air-Liner "Cargo Canoe"***

THE gondola-shaped container above is to speed the loading and unloading of baggage and air express on Eastern Air Lines'

new Constellations. It is loaded inside the air terminal, towed to a waiting plane, and hoisted to flight position on bottom of fuselage. Fully loaded, it weighs five tons—four of them pay load.



**Whirling Atoms.** A new "nuclear induction" machine may soon provide a faster, more practical method of chemical analysis. The substance to be analyzed is placed in a magnetic field, and the outer of two surrounding coils (inset) is charged with a high-frequency current. At a certain frequency, different for each element, the nuclear particles begin to spin up to 42,500,000 times a second, inducing a corresponding current in the inner coil. This frequency reveals the presence of an element.

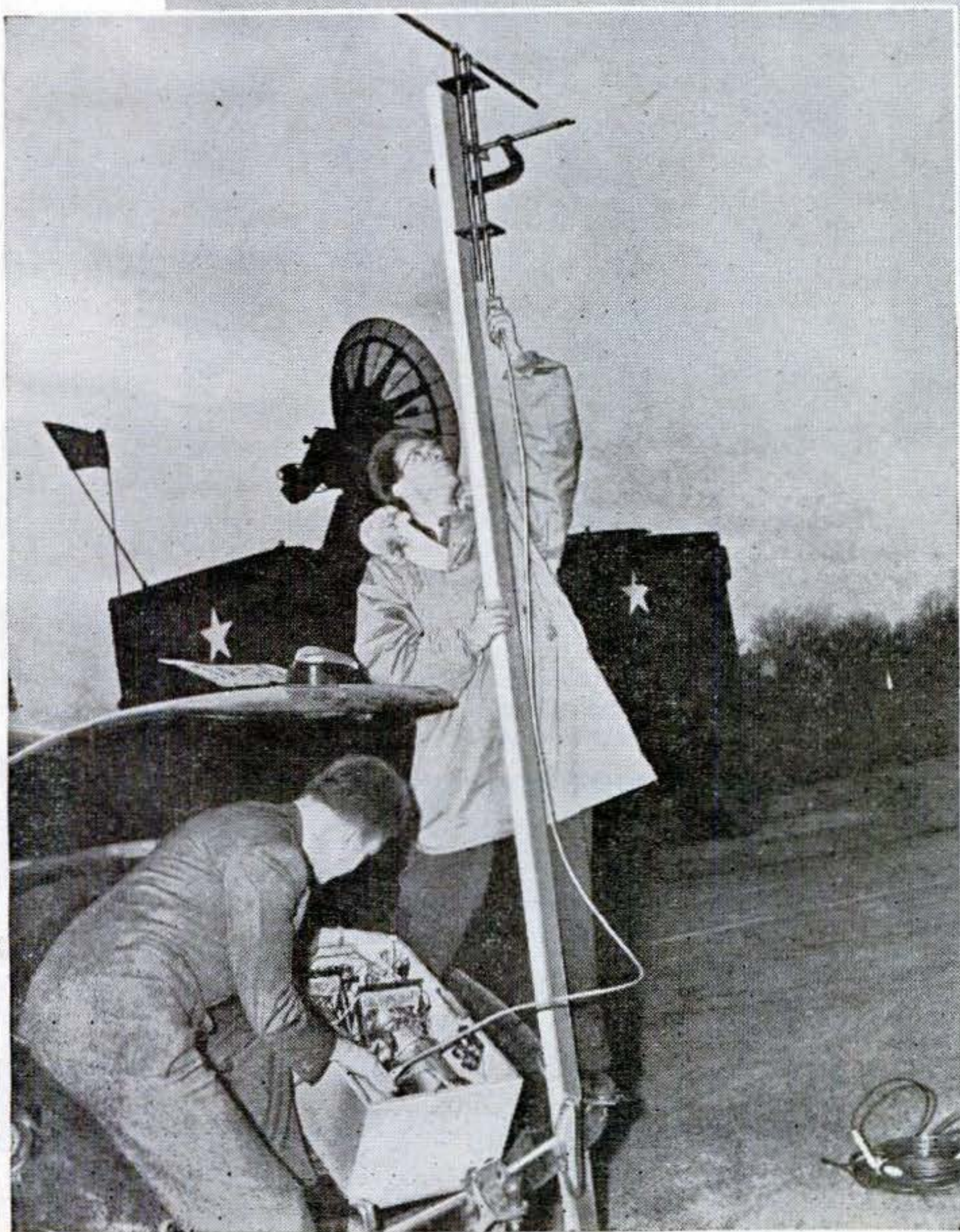
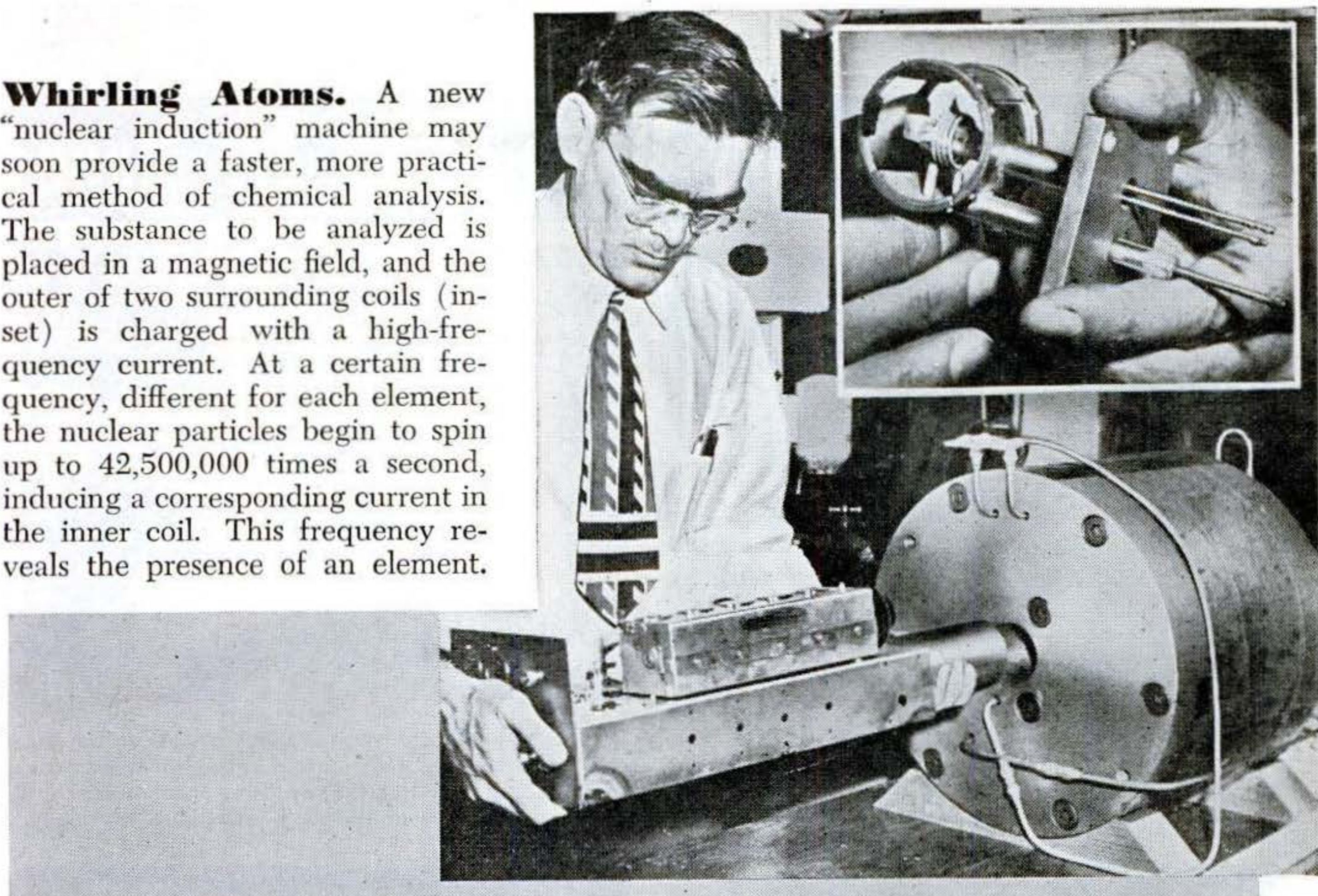

**Recording Rockets' Flight.** To snatch valuable scientific and operating data from speeding rockets before they are dashed to destruction, General Electric has developed a telemetering unit that weighs only 15 pounds and transmits 28 items of information every 1/35 second. Ground equipment records the data permanently on film. Used in recent V-2 tests by the Army at White Sands, N. M., the rocket unit has only 10 tubes, is one-sixth the weight of previous comparable equipment. Shown at left (in box, bottom foreground), the set is being connected to an antenna for a ground test.



# How Men's Shoes Are Made



**1.** First step in the manufacture of shoes is the testing, sorting and selection of skins arriving from the tannery. (These pictures were taken at the Johnston and Murphy shoe factory in Newark, N. J.)

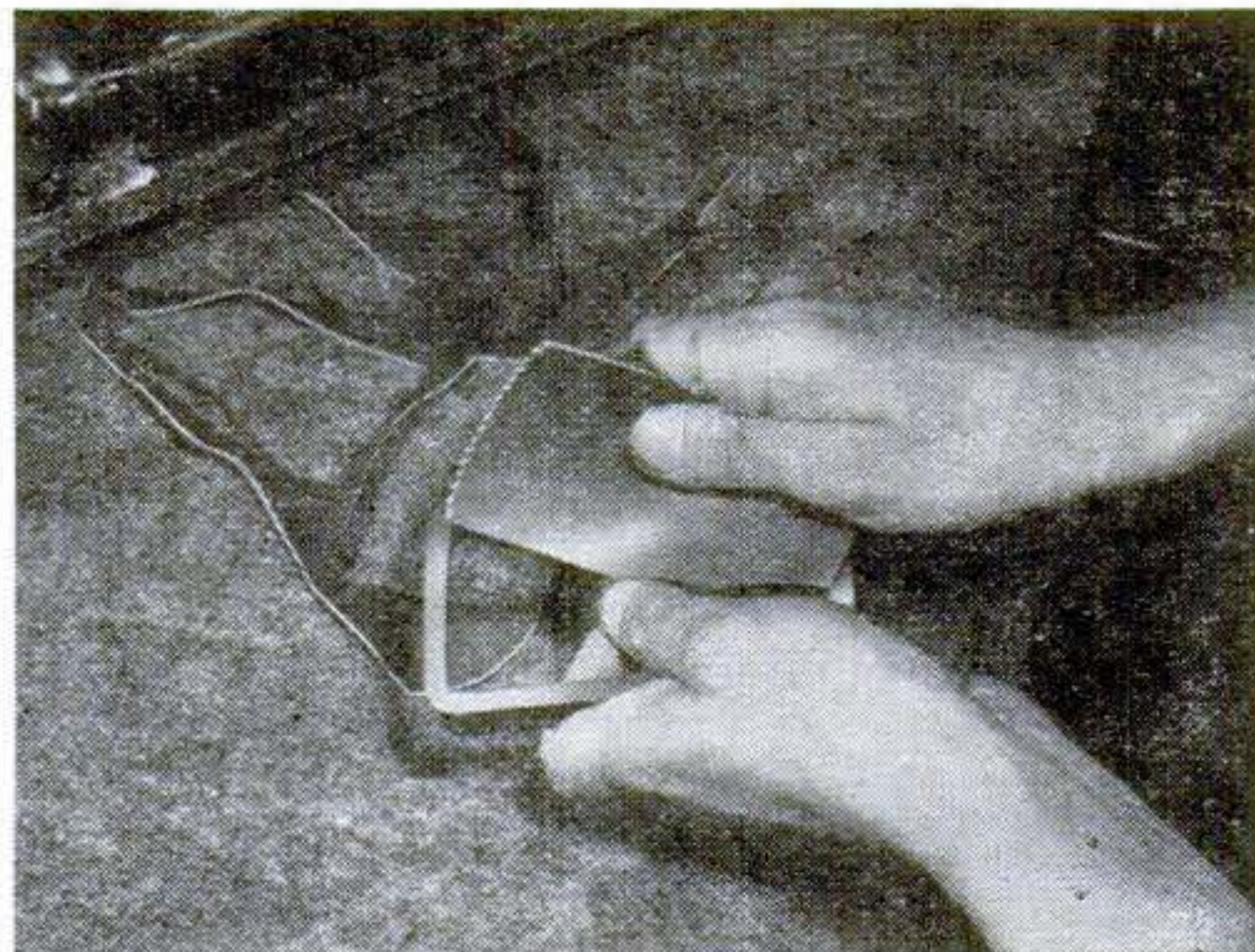

**2.** The tongues are stamped out on an automatic clicking machine, which also finishes them off with scalloped edges along the top. They are then stitched to the upper part of the shoe just below the laces.



**3.** Meanwhile, the vamp, tip and two side pieces, forming the upper body of the shoe, are cut out by hand along brass-rimmed patterns, making possible a more careful selection of cuts and matching of parts.

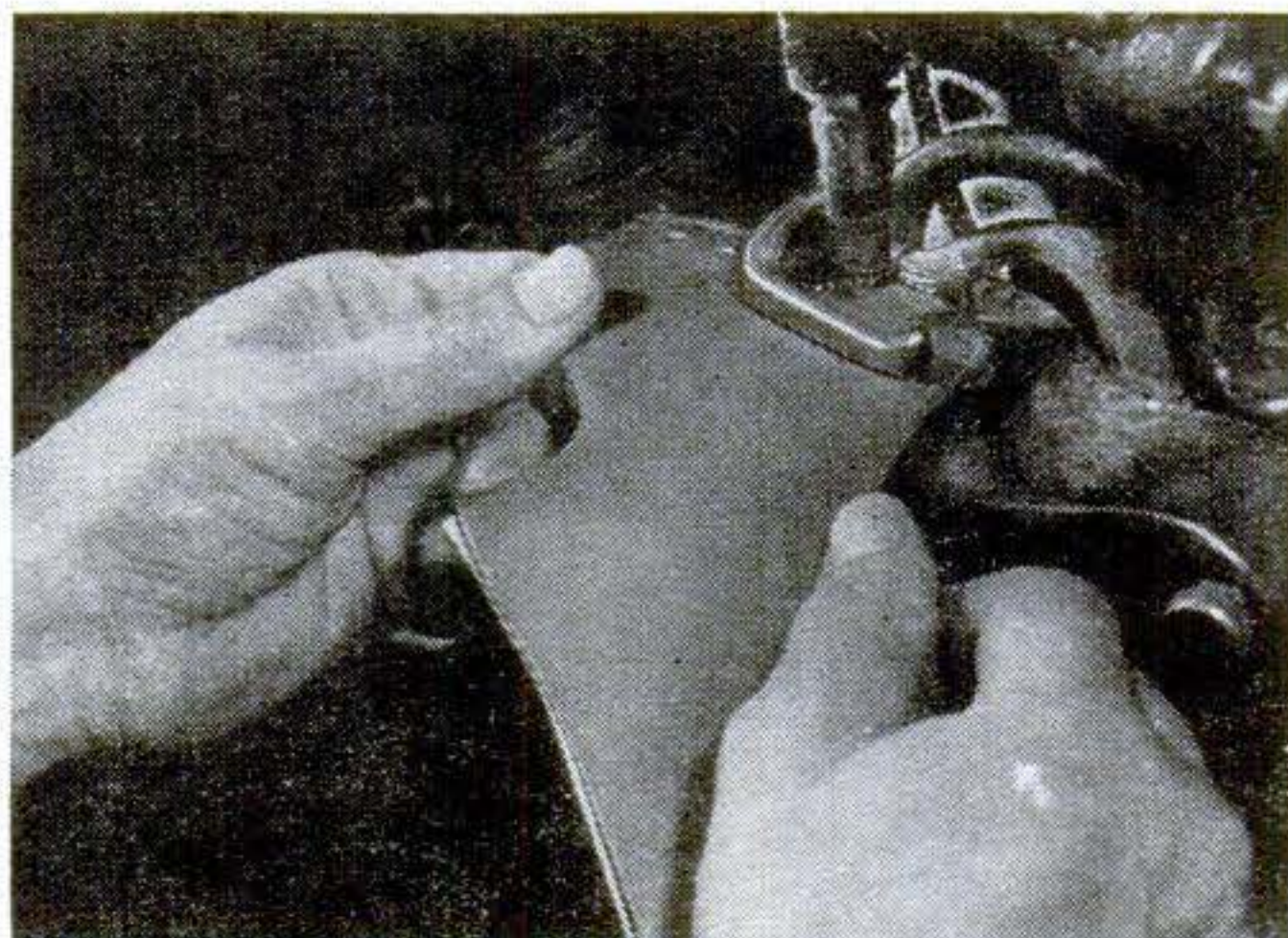

**4.** The eyeleting machine, handling up to 4,000 shoes a day, stamps out two rows of metal-rimmed perforations for the laces. On some shoes, the eyelets are attached on the inside and cannot be seen.

**5.** Silk threads are used for permanent stitching of the upper parts of the shoe, which are first cemented together to insure perfect alignment. Only the center portion of the hide is used for these parts.

**6.** The side-lasting machine pulls the upper part of the shoe down tight over the wooden form, known as a last, around which the shoe is molded. The shoe is then stapled to the last with small metal tacks.

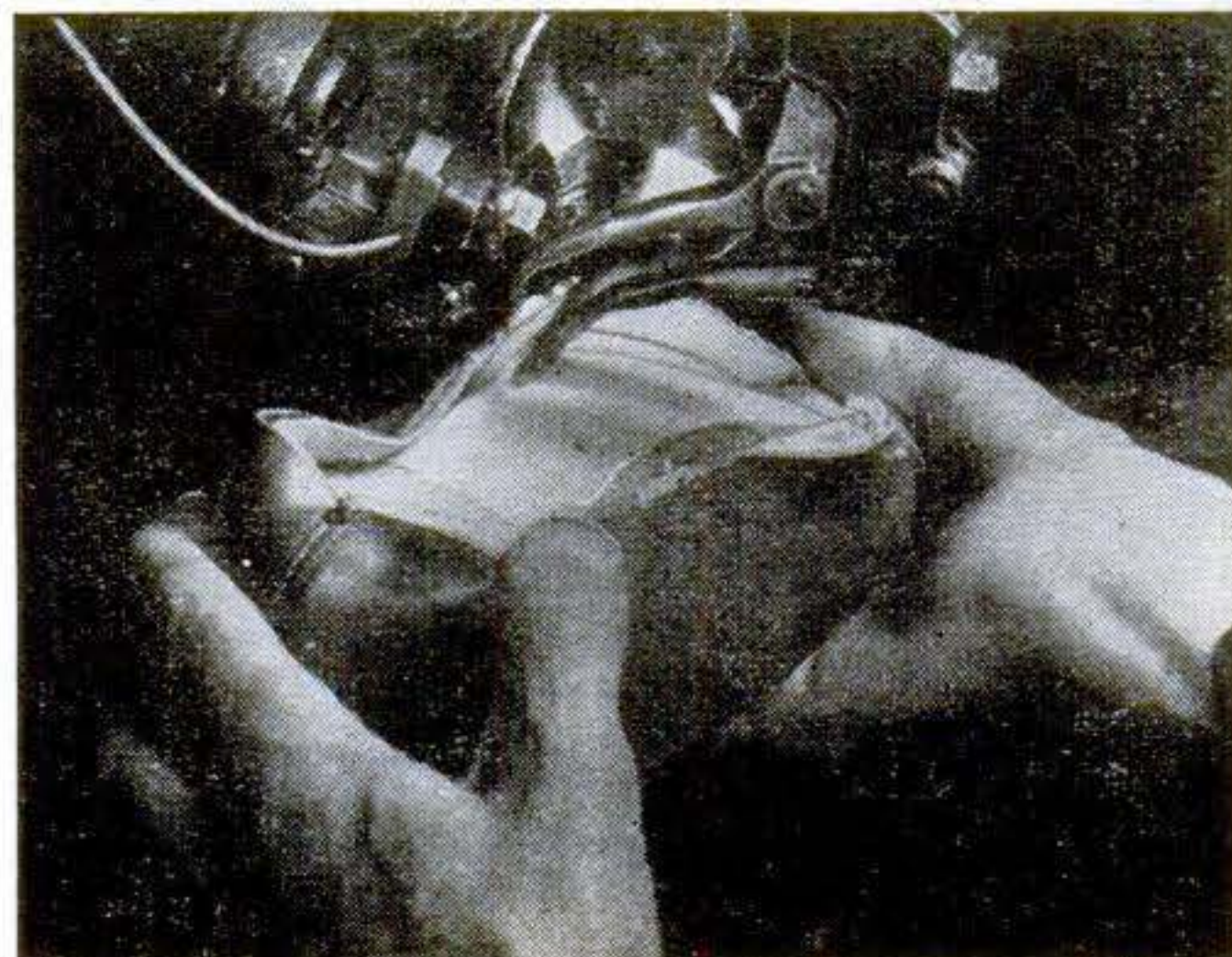
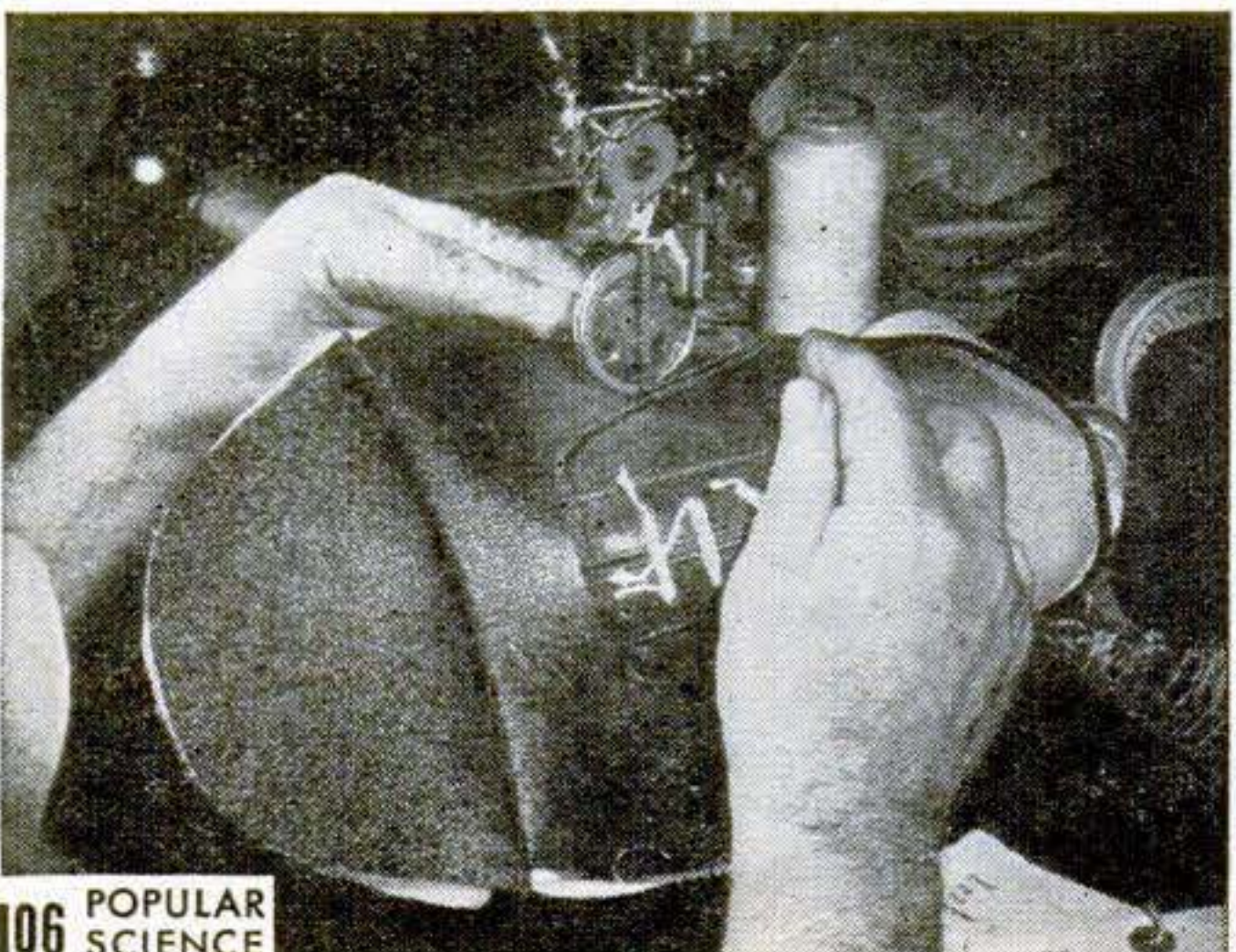



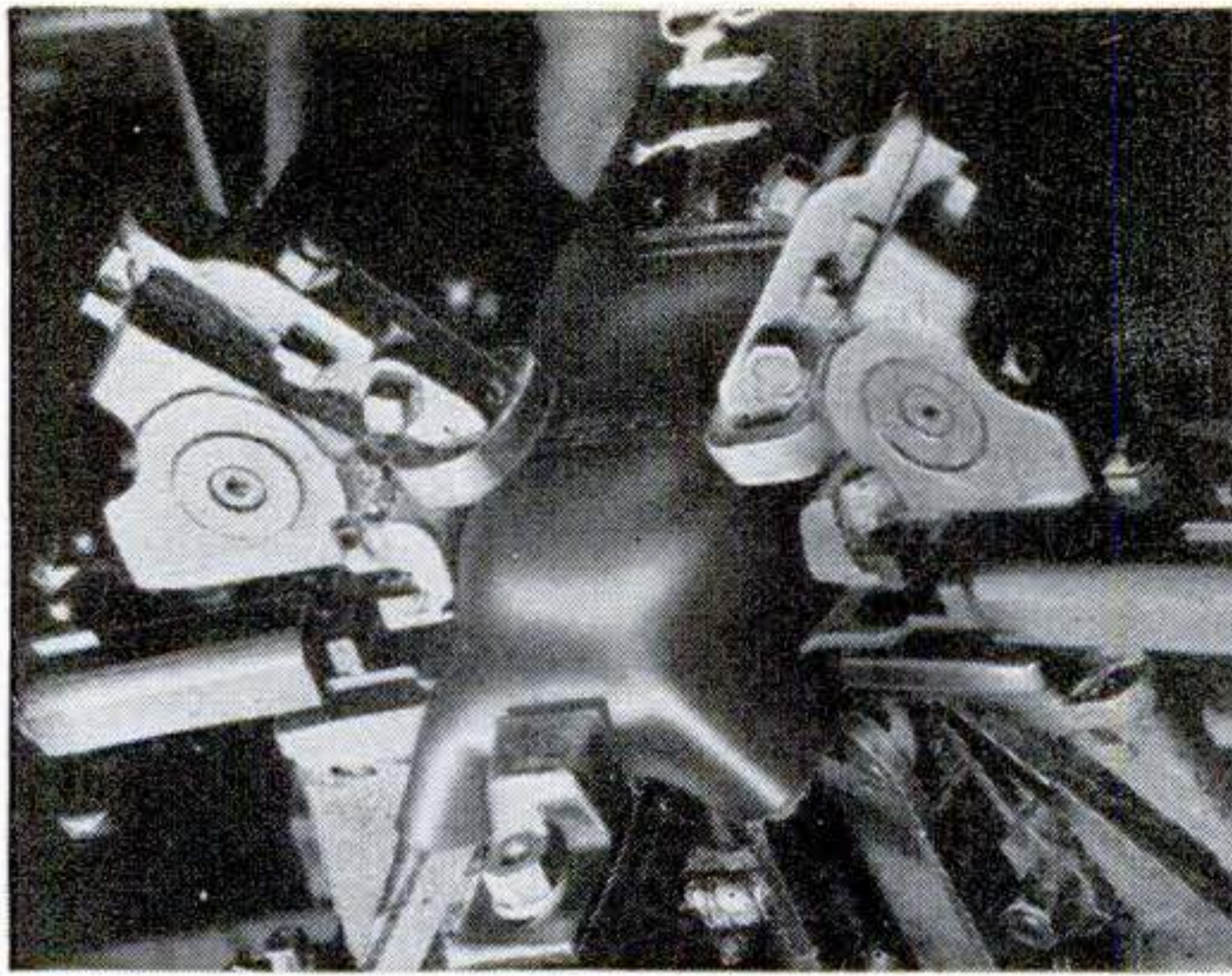

**7.** In the jaws of the bed-lasting machine, the front and rear portions of the shoe are pulled tight, while another part of the mechanism feeds out wire and secures ends of leather at the front of the shoe.

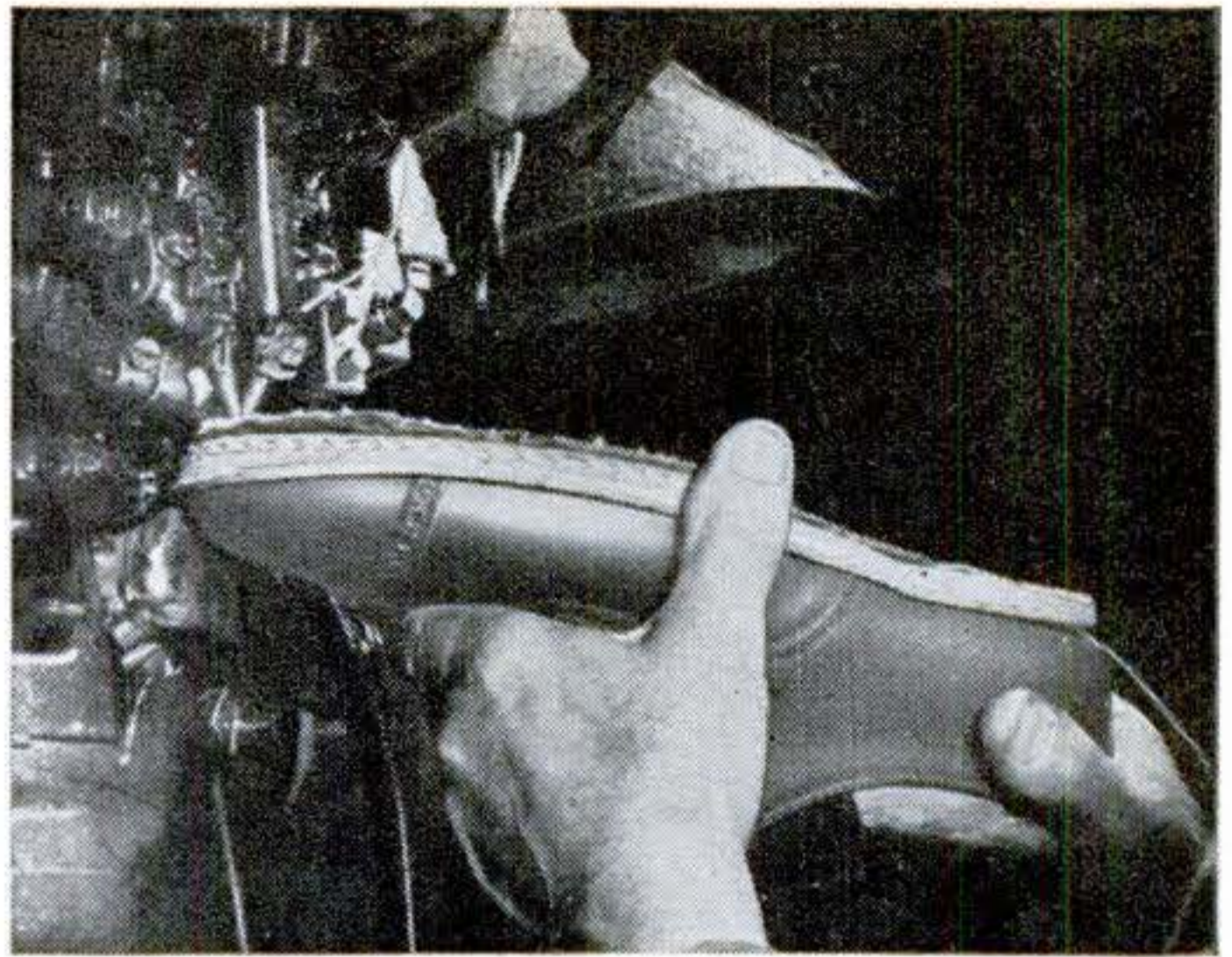

**8.** To form a foundation for the bottom of the shoe, a welt, or leather strip, is sewed around the rim of the shoe with a wax-coated thread. A steel shank is then inserted to form a firm support for the arch.

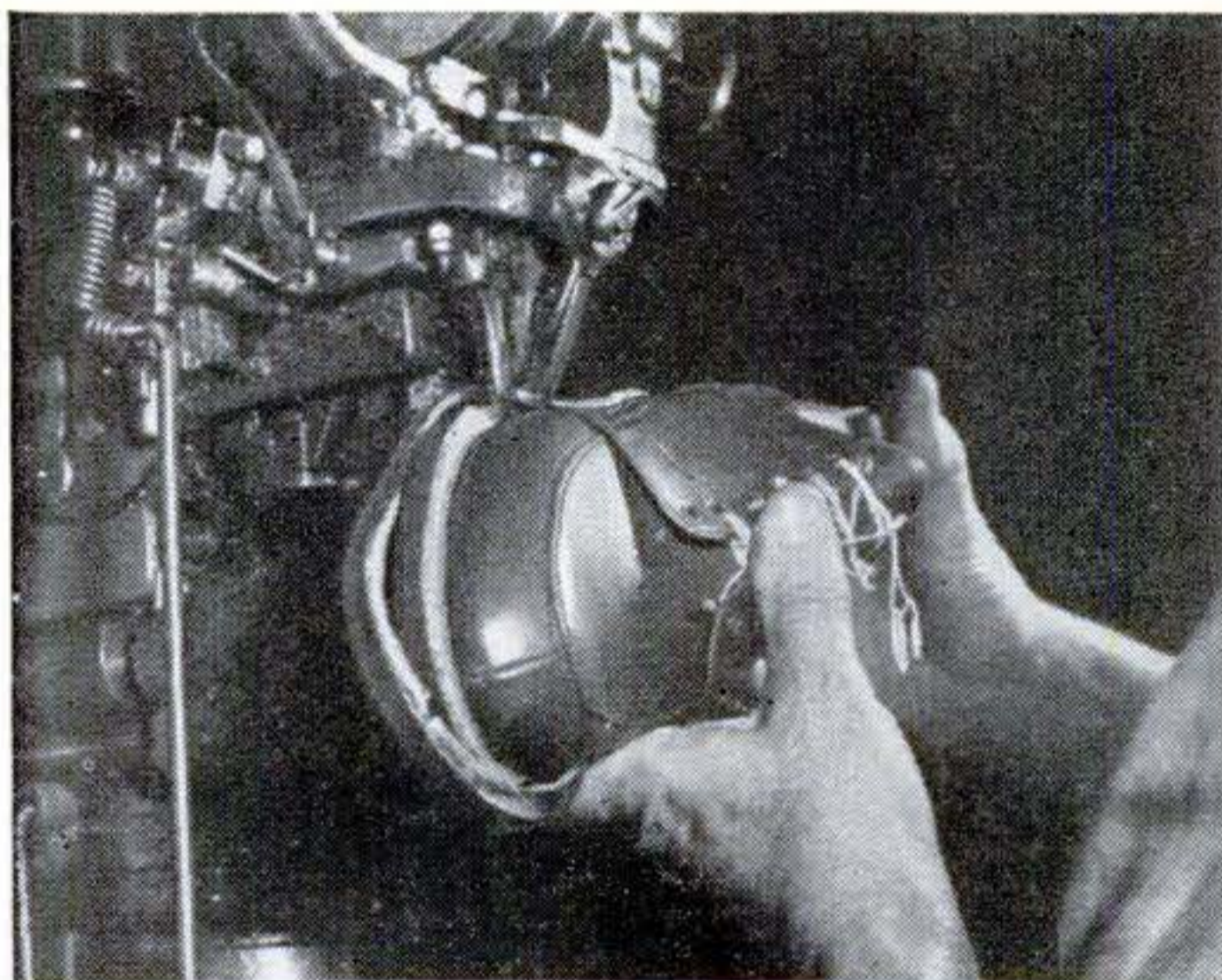

**9.** Of the 49 main operations, one of the most important is the rounding of the sole. This is done on another automatic machine that trims the excess from its edges and determines its final shape.

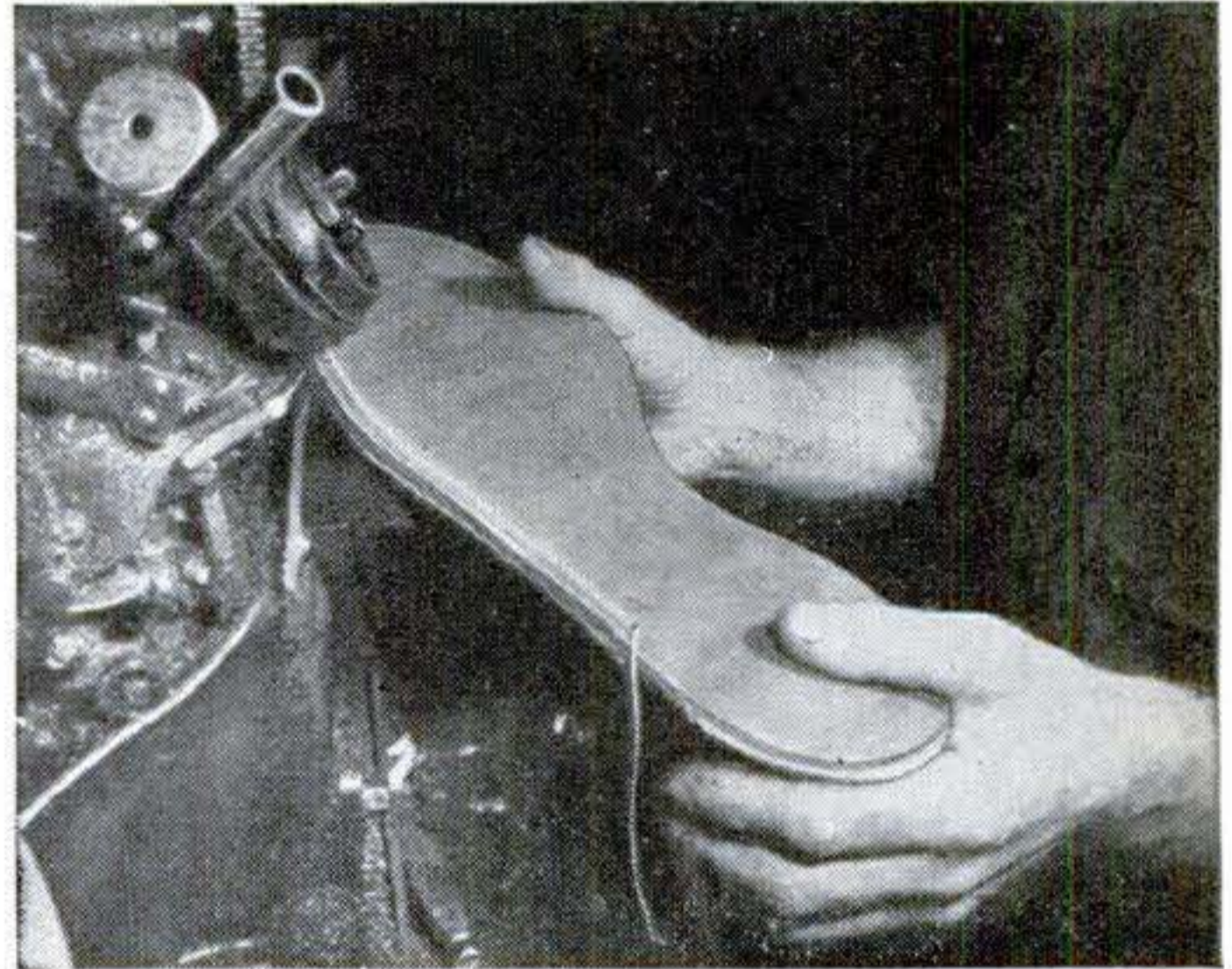

**10.** The sole, cut from the tough kidney portion of South American steer hides, is first cemented and then sewed onto the bottom of the shoe with a fine linen thread that can withstand a pull of 58 pounds.

**11.** A leveling machine, exerting 450 pounds of pressure, smooths the sole into position and insures a proper fit on the bottom of the shoe. It takes a month to six weeks to complete a pair of shoes.



**12.** On the heeling machine, final step in the process, an automatic nailing mechanism fastens on the heel. Waxed, washed, and polished, the finished shoes, with laces added, are now ready for boxing.



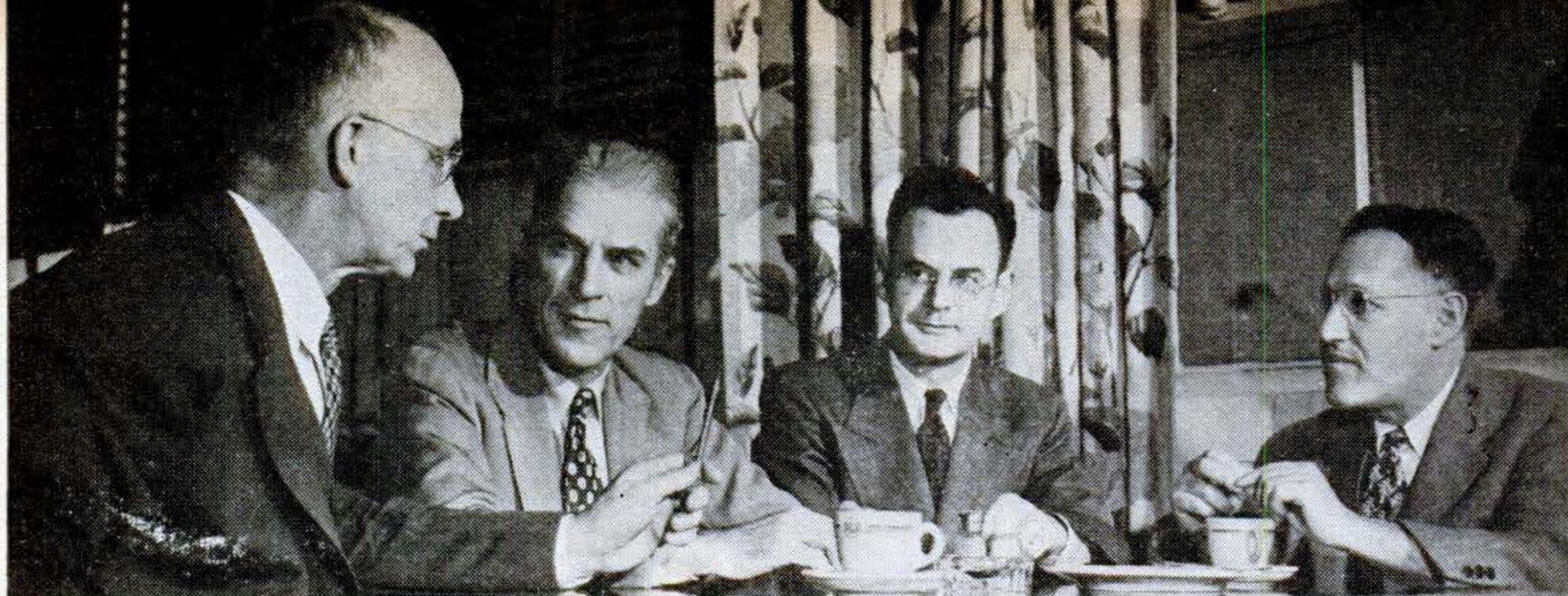

# Carrying the Ball for

**Today's research teams speed creation of new products.**

**S**CIENTISTS play on teams these days. The corny tintype of the long-haired fellow who locks himself into his bleak garret laboratory and emerges with a long beard and a great discovery is as remote from present-day research as the alchemist.

Your searching scientist no longer snoops alone. He can't. The fields of science have grown far too complex and numerous for any one man to cover. It takes a team of experts to tackle a problem of industry.

The modern physicist working on a problem in electronics, for example, no longer can depend entirely on his own knowledge and know-how. In the modern laboratory he can tap the specialized knowledge of chemists, microscopists, glass blowers, metallurgists, engineers, and, in the end, skilled modelmakers, to give his idea the flesh and blood of metal, wires, and glass that make it a reality. As many as a dozen highly trained technicians may have their fingers in even a small industrial pie. A major development may require co-operation among scientists in a single laboratory, collaboration among laboratories within an industry, and, sometimes, teamwork between industries—and nations.

More than 2,000 British and American technologists worked elbow to elbow at M. I. T.'s Radiation Laboratory, for instance, to give us radar and such related



devices as Loran and Shoran. All along the line, it was a pooling of scientific brains that gave us the weapons that were our margin of victory.

A good example of present-day teamwork in research is the work being done in the development of the gas turbine-jet propulsion engine (PSM, Dec. '45, p. 76). While turbine experts in one industry have been battling with design and mechanical problems, metallurgists in the metal industry have been busy devising new and better turbine-blade alloys, tough enough to stand up under the terrific heat of the turbine's exploding gases. Petroleum chemists, meanwhile, have been seeking the ideal gas-turbine fuel, as well as a bearing lubricant that will continue to work when a turbine's shaft



Teamwork does not stop for lunch: The RCA Laboratories' cafeteria provides a congenial forum for busy scientists who seldom have the chance to confer elsewhere. At left (l. to r.) are Igor E. Grosdoff, in charge of research on the electronic counter; Wendell L. Carlson, who directs radio-receiver research; Dr. Albert Rose, who guided the development of the Image Orthicon tube for television; and Dr. Irving Wolff, specialist in radar.

PSM photos by W. W. MORRIS

NEWEST TOOLS aid the scientist in the modern research laboratory. Right, a radio-heat dehydrator.

# SCIENCE



METALLURGISTS are important on research teams. Here, one of RCA's opens a hydrogen furnace.

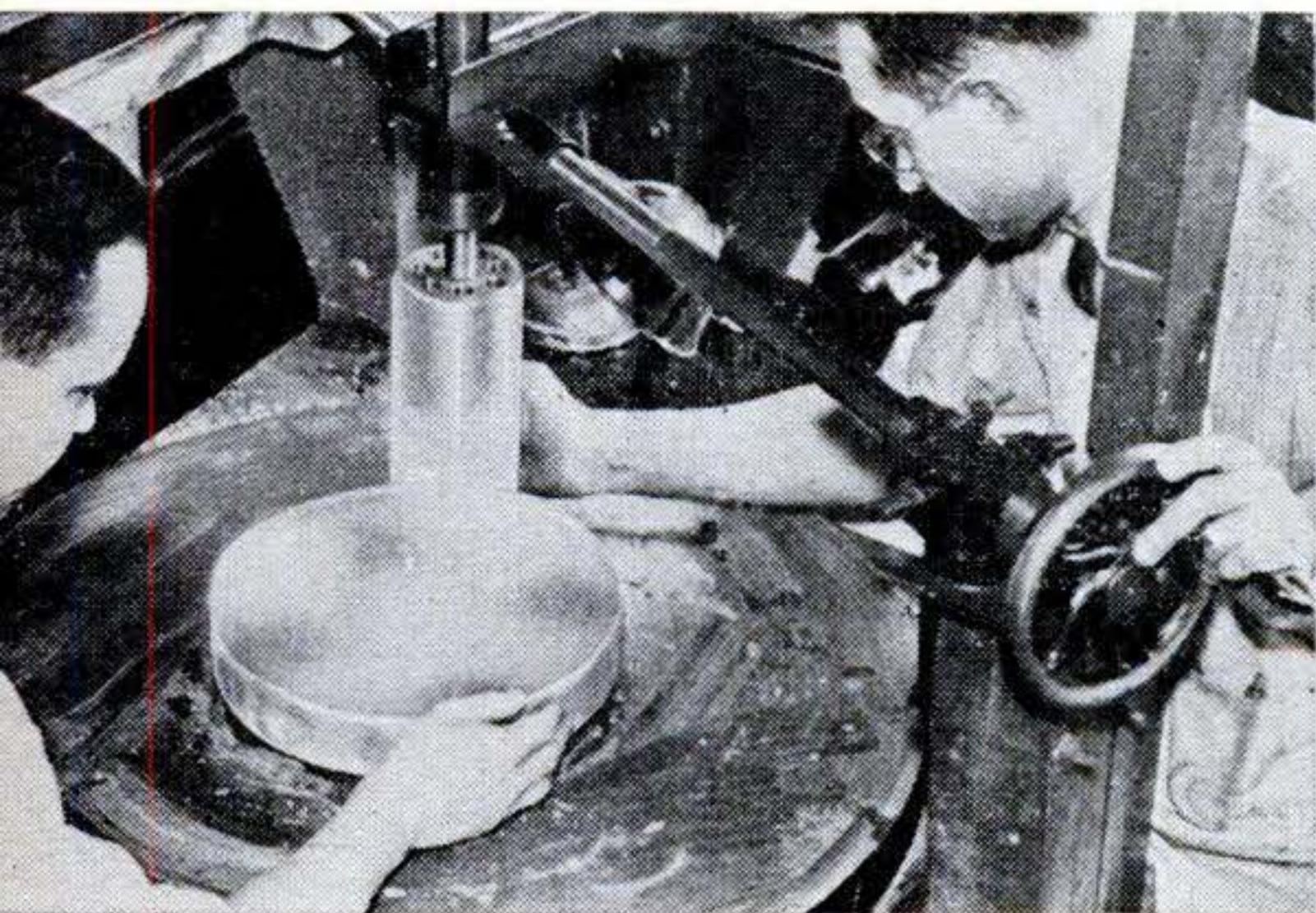

spins at speeds of 15,000 r.p.m. and more. At the same time, experts in other industries are thinking about ways of putting this new power source to work in airplanes, boats, locomotives, trucks and buses.

The physical aspects of the modern industrial laboratory make this speed-up in scientific developments possible. First of all, it is not one laboratory but a group of laboratories housed in one or more roomy, well-lighted buildings, generally set apart

OPTICAL EXPERTS, left, help solve a television problem by grinding a special 12-inch mirror.

APRIL  
1947 109



from any of the company's manufacturing activities. Take a walk through a typical research factory—the new RCA Laboratory at Princeton, N. J., and you would see not just a radio laboratory, but electronics, acoustics, chemistry, physics, mechanics, and optics laboratories, plus a modelmaking shop, a photographer's department, a library, a glass-blowing shop, and, last but not far from least, a cafeteria where the scientists and their workers can relax, and eat. A restaurant plays an important part in the modern research center. Scientists like to talk about their problems while they eat. Many a research nut has been cracked over coffee or cokes, with scribblings on



**GLASS BLOWERS** are a necessary part of the RCA Laboratory team. Like the craftsman shown above, they blow new tube ideas into reality.



**ACOUSTICS ENGINEERS** tackle the problems that arise in radio design and development. At left, an RCA expert uses a stop-motion stroboscope to check on the performance of a loudspeaker.

a paper napkin the proof of the solution.

A research project is born in any one of a number of ways. It may originate in a scientist's mind or at the suggestion of some laboratory helper who runs across an odd fact or curious reaction in his work. It may come as a specific request from an industry, which senses something that you want and need.

Not long ago, the Committee on Sensory Devices of the National Academy of Sciences came to the RCA Laboratory with a typical research problem. They wanted to develop a practical reading aid for the blind—a device as compact as the conventional hearing aid that would allow a blind person to “read” directly from a printed page.

The project's first stop on the RCA idea-assembly line was the desk of L. E. Flory, one of the team of scientists who perfected

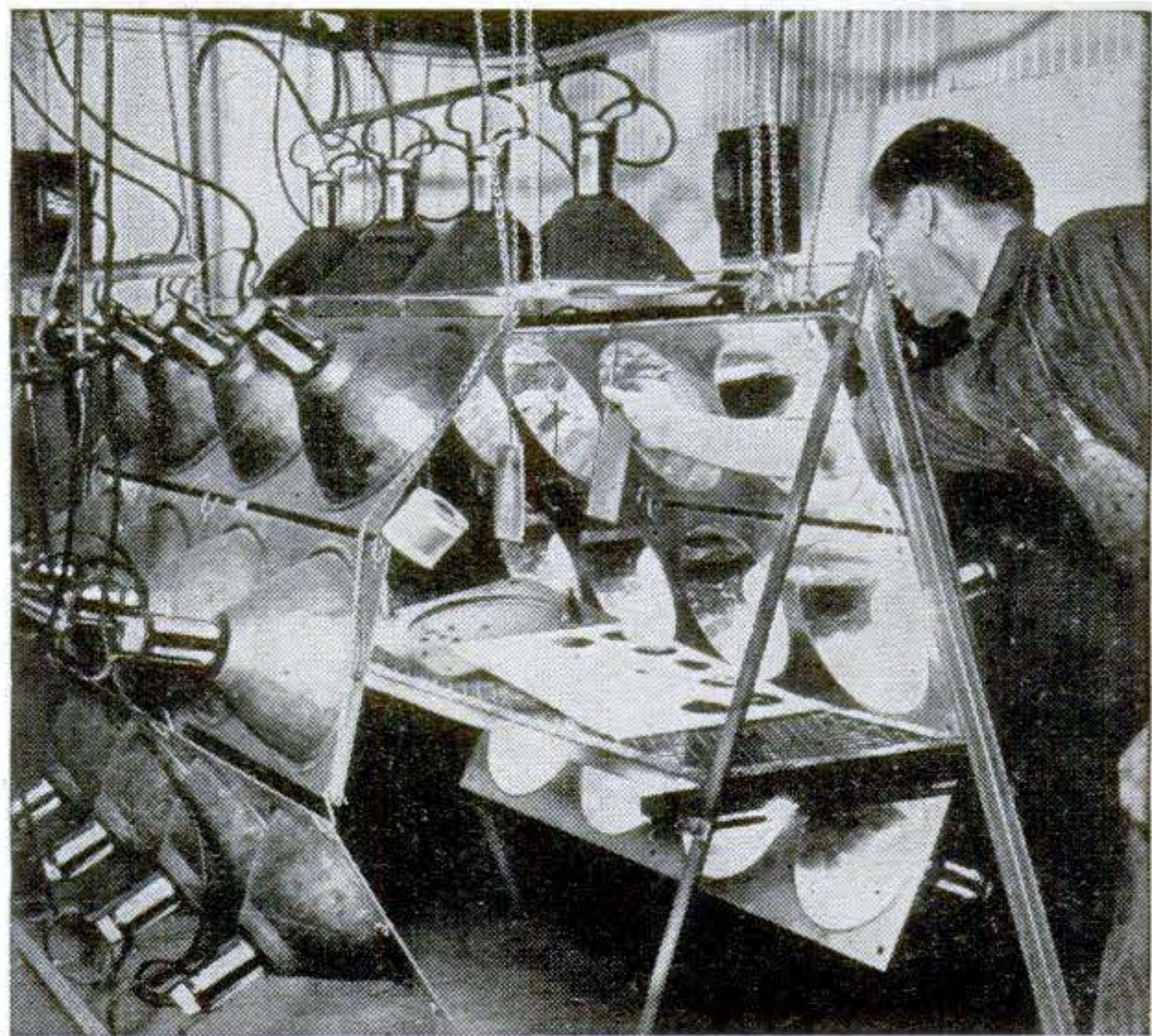

**MODELMAKERS**, working with modern equipment like this infrared drying rack, can turn out just about anything that scientists need in their research.



the "sniperscope" and "snooperscope," used so successfully by our troops in the Pacific (PSM, June '46, p. 73). Flory's first step was to find out what had been done along the same lines by other inventors in the past. Searching through old records he found that an electrical device employing five separate light beams, which transformed the light and dark areas of printed letters into tones that could be heard and "read" by a blind person wearing earphones, had been developed in 1914 by a Frenchman named Fournier D'Albe. It was complicated, however, and could not be adapted to type of varying size.

But here was a starting point. Flory and other RCA scientists, including experts in television, optics, radio and sound, went to work. During the course of their experiments they needed advice on plastics, on batteries, and on the physiology of hearing.

The project was started a year and a

half ago. Today, thanks to research teamwork, Flory and his associates have an experimental model of a reading device that they hope *may* be the answer. It is now being tested by blind subjects. It may be a long time before it or some similar device will be available on the market, but a practical scientific approach has been set up.

Hundreds of such individual research projects have been speeded up and made possible by teamwork research. At present, there are more than 133,000 workers engaged in industrial research—90 percent more than in 1940—and there are more than 2,400 industrial laboratories.

The era of assembly-line research is just beginning. The lone scientist will still be responsible for each original idea, but it takes a team of experts to provide the varied and specialized knowledge, and that friction of minds working together, which speeds ideas toward reality. END

### How Research Teamwork Works

Here is an experimental aid for the blind that research teamwork at RCA is helping to make a reality. Basically, the device is a miniature, mechanical television camera, in a small stylus that can be moved along a printed line. A tiny vibrating mirror causes a spot of light to scan the letters as the stylus is moved. Light reflected from the light and dark areas of the letters is picked up by a rod, which guides it to a peanut-size photoelectric tube. The phototube controls an audio-oscillator, which transforms the reflected light into a warble that can be heard in earphones, and thus can be "read" by a trained listener.

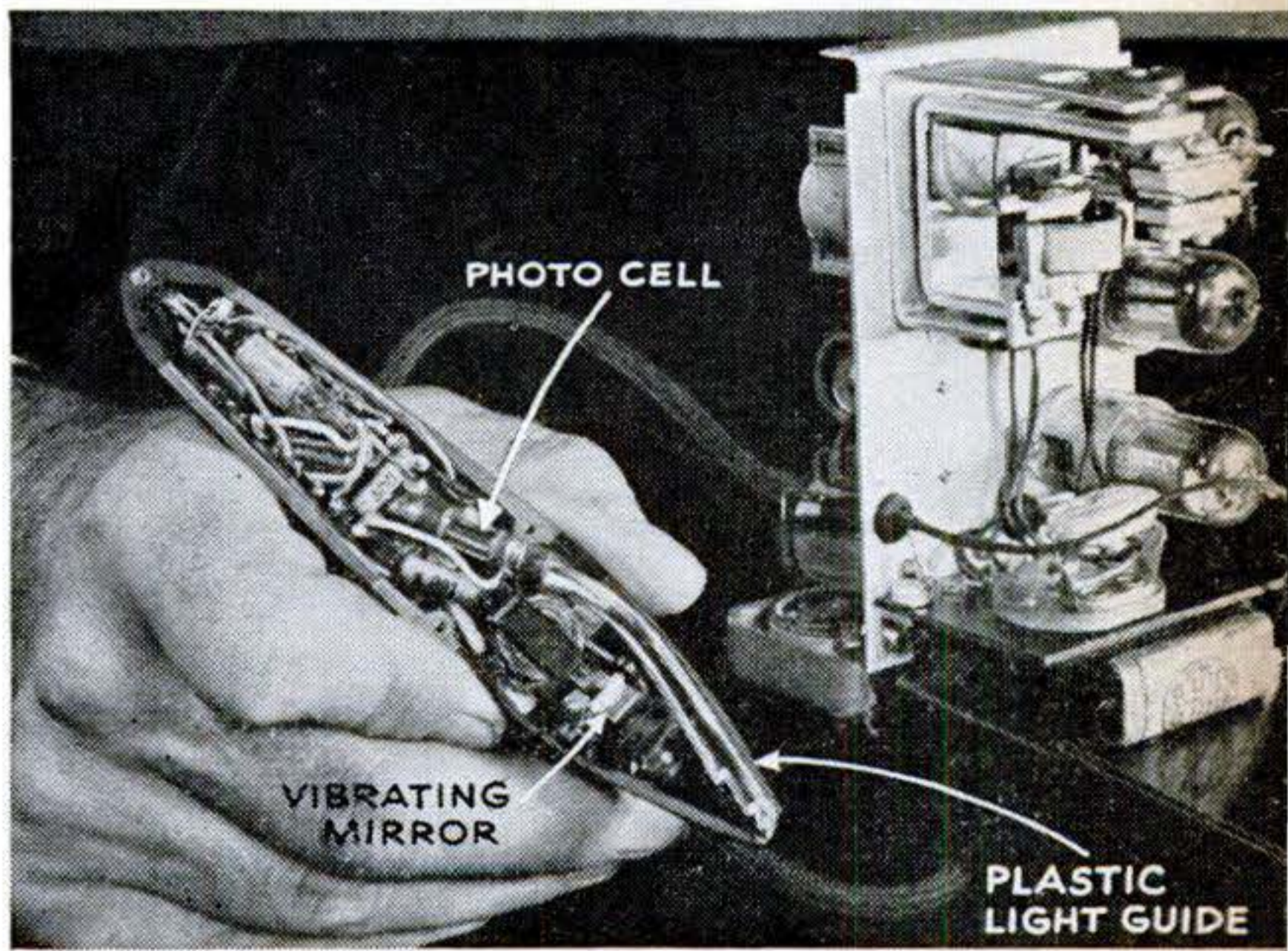
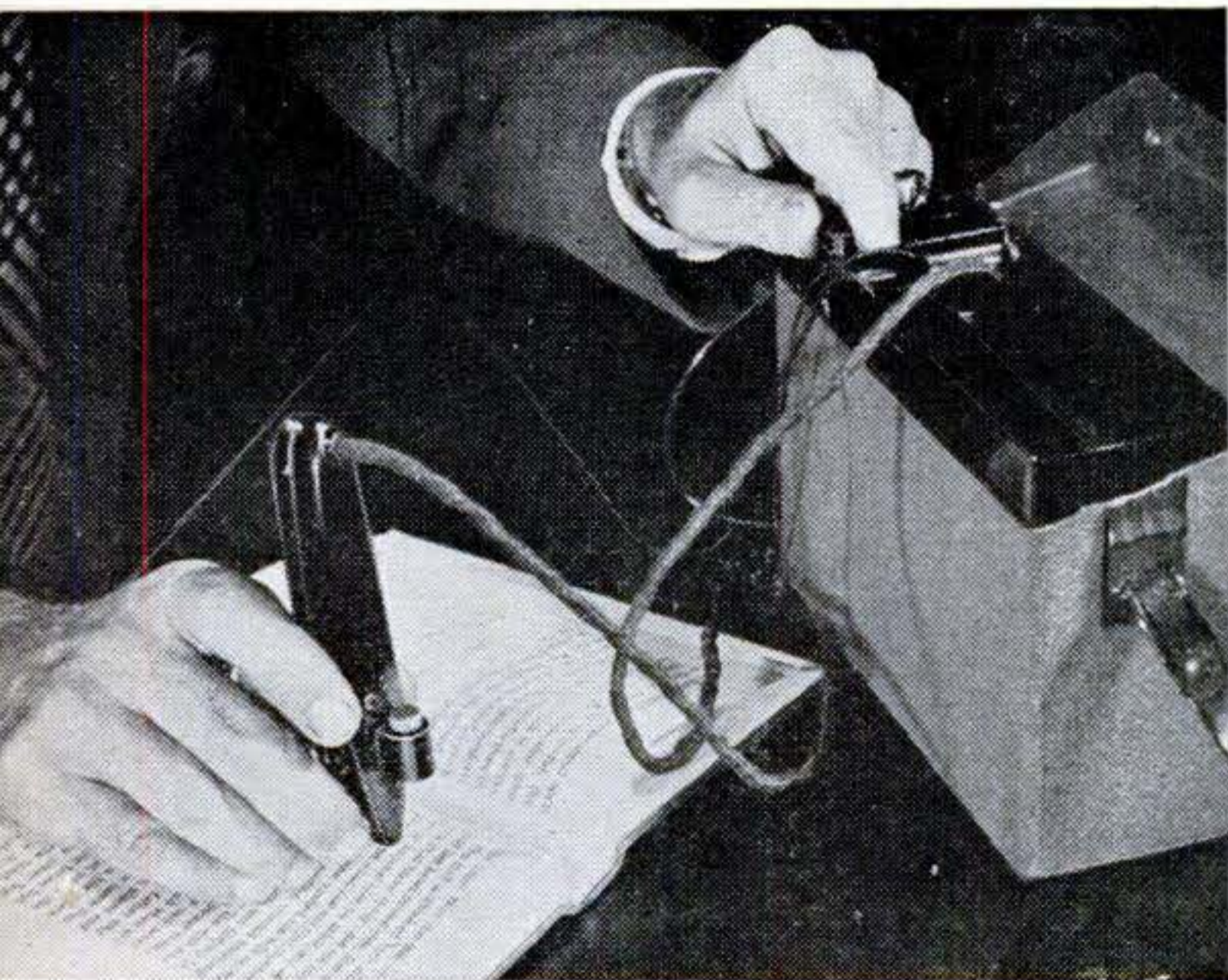

APRIL 1947 III





**Leg Rests Built into Coach Seats.** There's not only room but a place to put your feet up in the Great Northern's new day coaches. A rack drops down from the back of the seat ahead. The seats also swivel around to face the windows or the car's rear. The new coaches are used on the streamliner Empire Builder.

**Lenses Help Television.** The correcting lens, at right, undergoing inspection after polishing, removes aberrations after a mirror has enlarged a television image to five times the prewar size. The American Optical Co. makes both mirrors and lenses.

**Miniature Assembly Line.** Ford engineers see a new plant in three dimensions long before the ground is broken. They put their model makers to work and view the plant scaled  $\frac{1}{4}$  inch to the foot. Below, a worker is placed near a "giant" press.

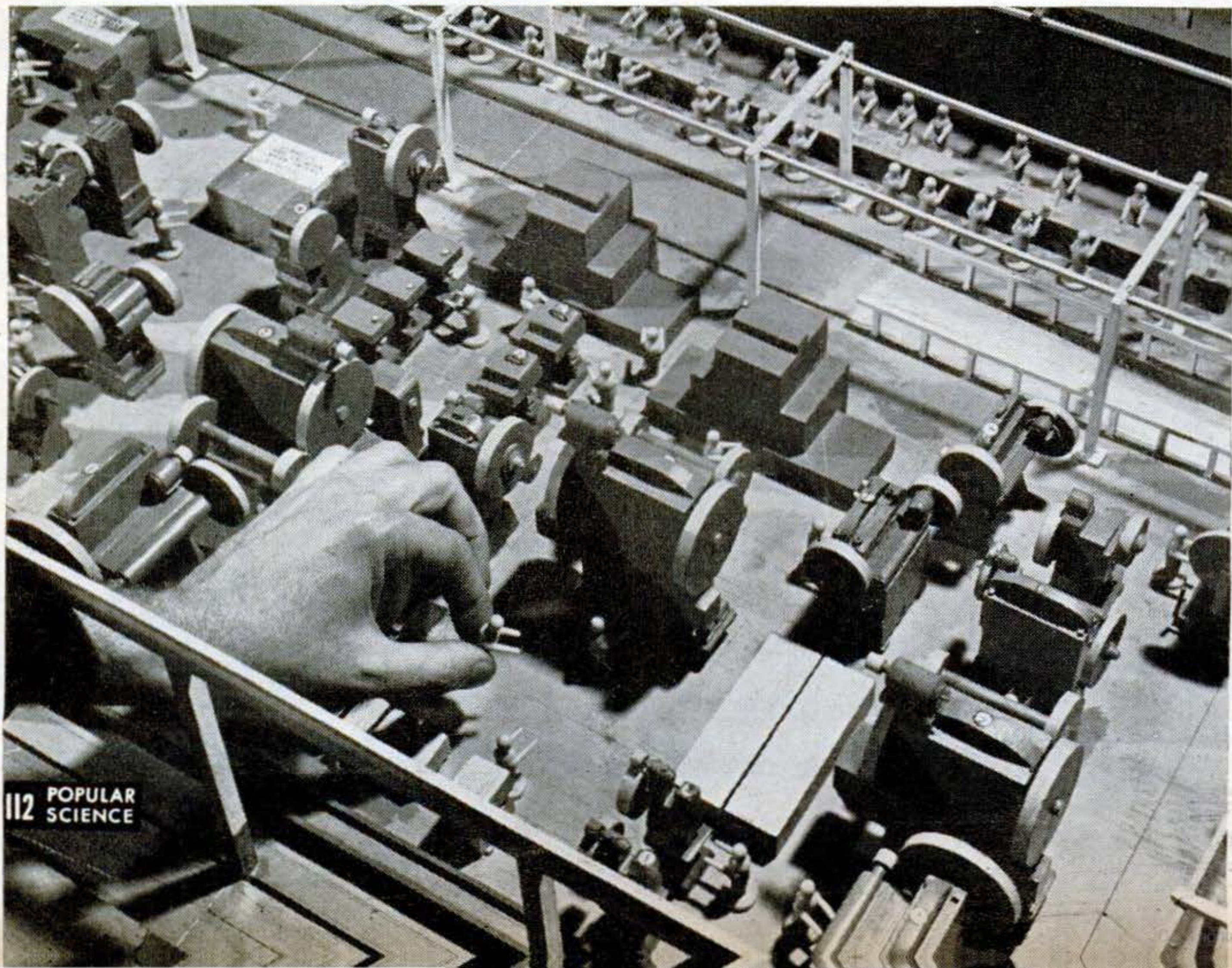



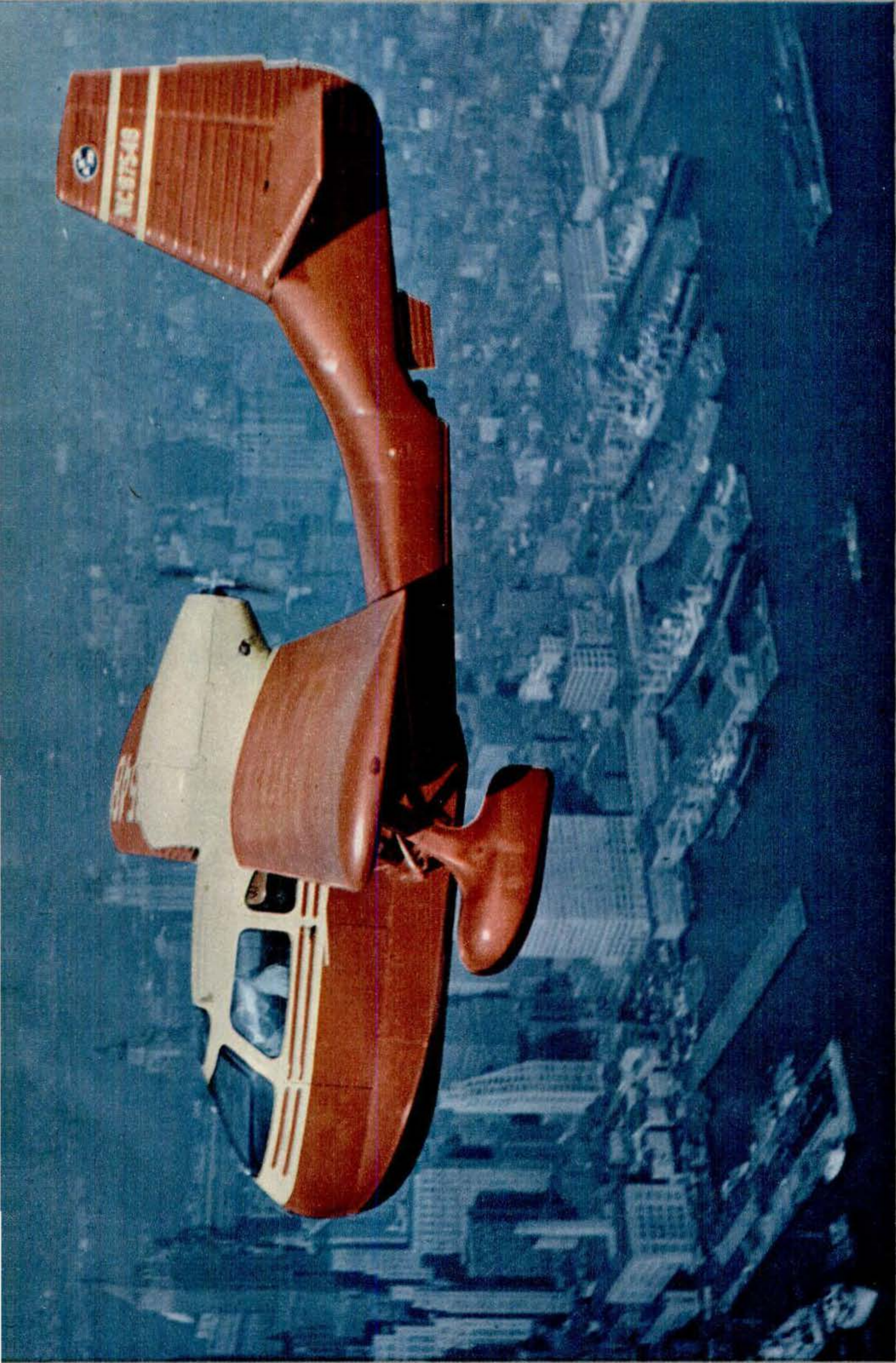

**REPUBLIC SEABEE.** An all-metal, four-place amphibian, the Seabee has a top speed of 120, cruises at 103, takes off in 800 feet on land. Its pusher propeller, set above and behind the cabin, is driven by a 215-HP., air-cooled Franklin engine.

# PIW-UP



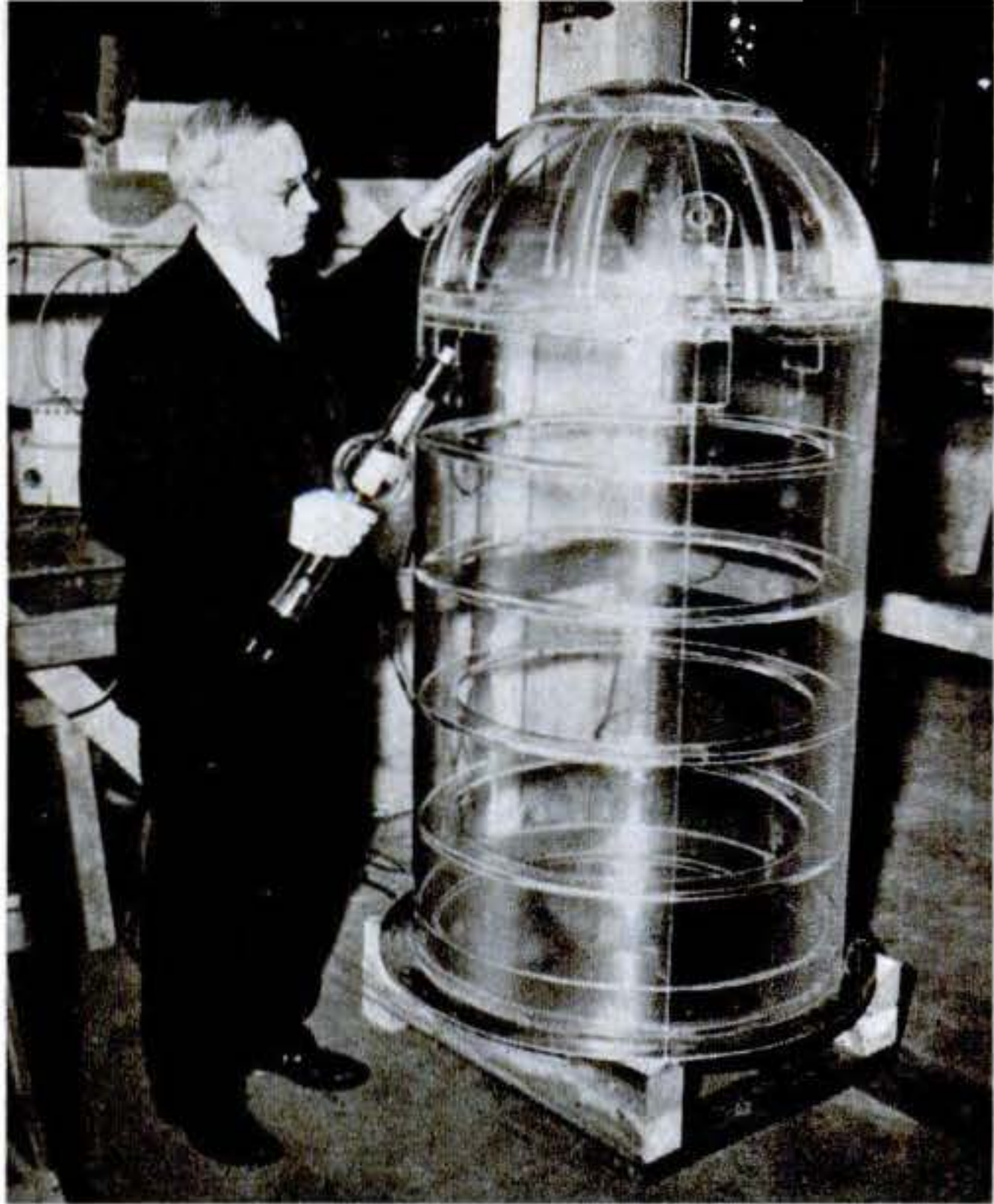

**Huge Bell Jar Aids Research.** Built by the AAF for high-altitude tests, the plastic bell jar above is believed to be the largest ever used for research. Six feet high, it resists 12-ton pressures.

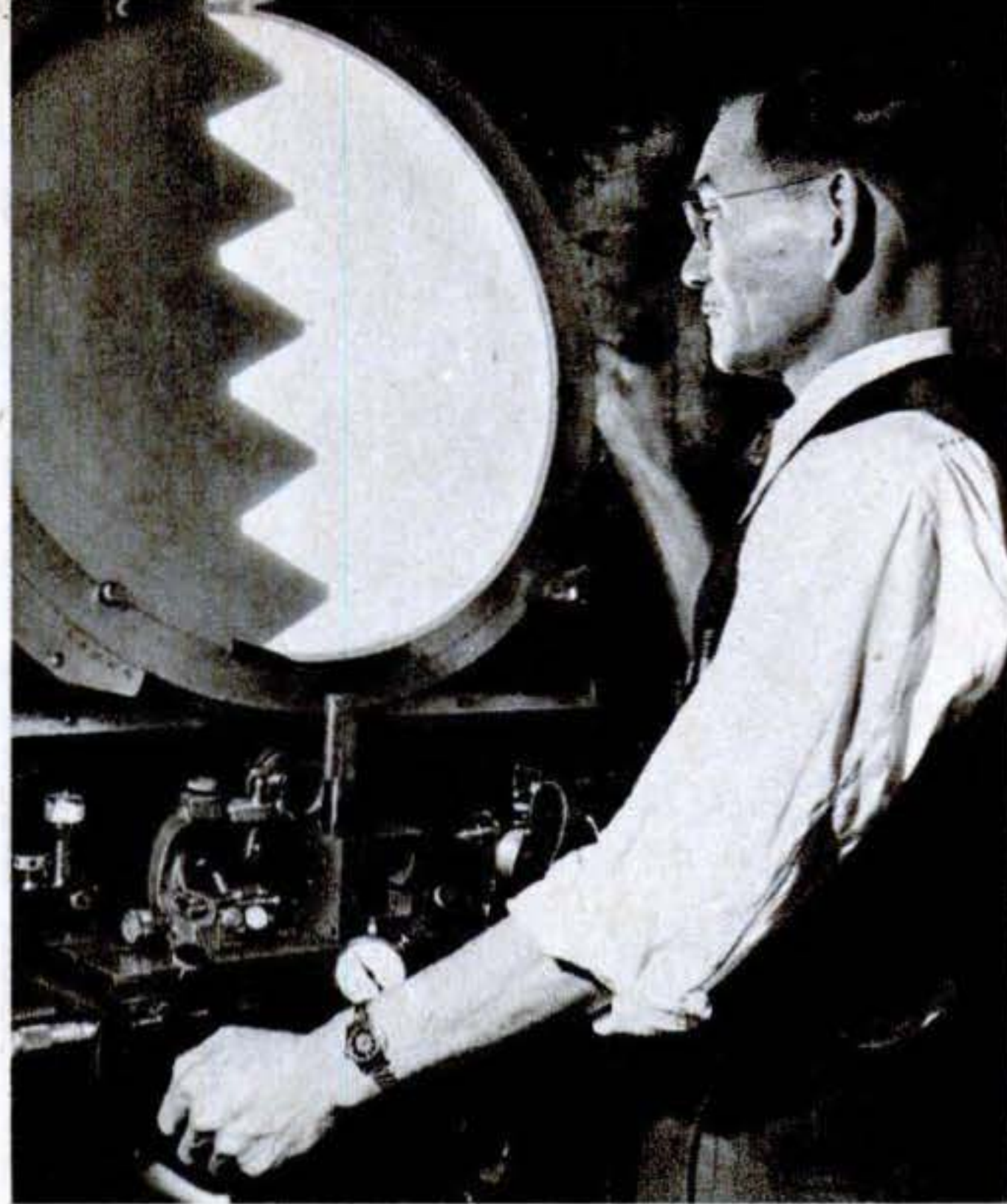

**It Magnifies Mistakes.** The giant teeth shown by this Ford "comparator," used to test precision gauges, are really magnified shadows of screw threads in the gauge visible below the screen.

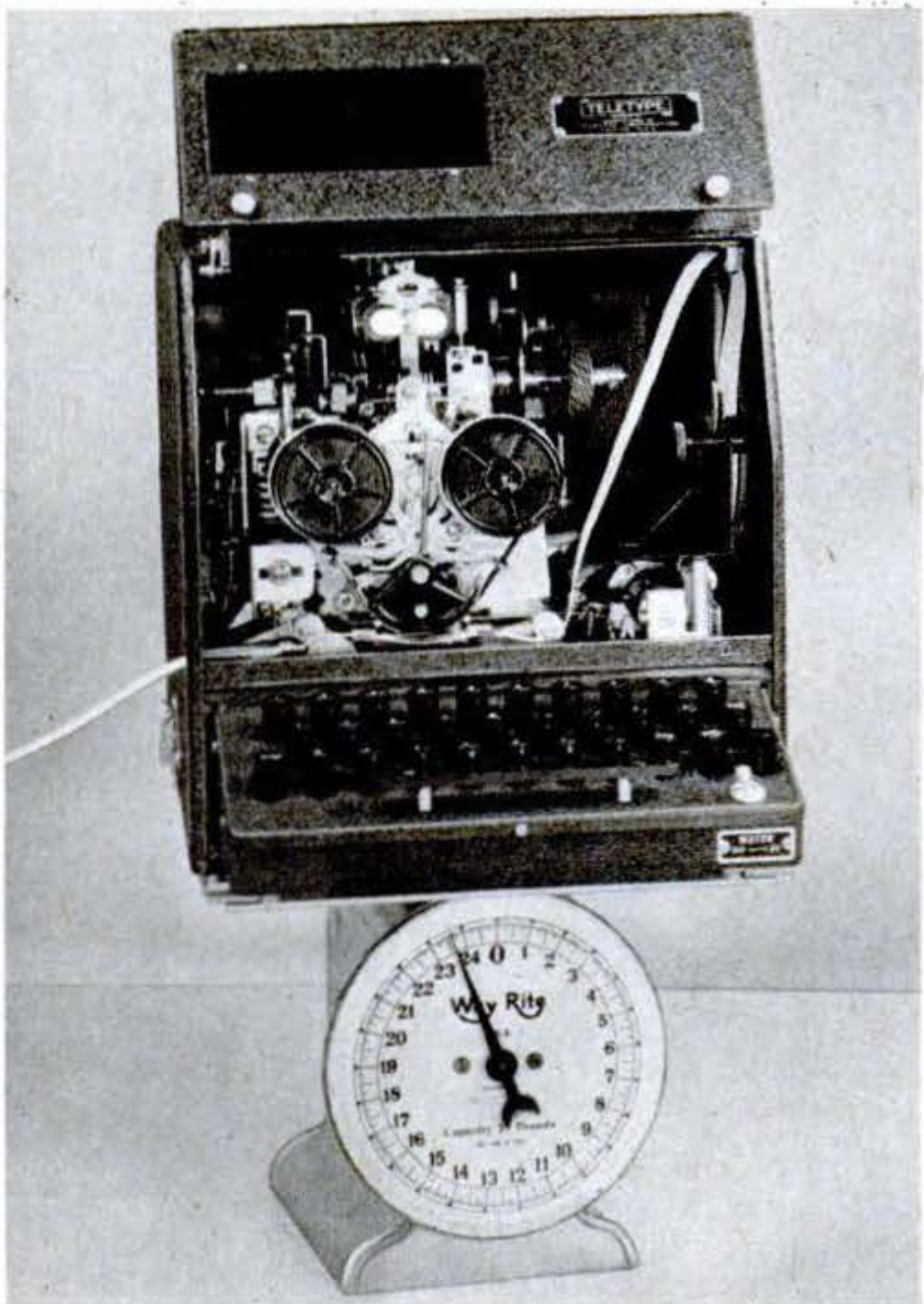

**Teletype Goes Aloft.** To provide printed communications for aircraft in flight, Bell Telephone technicians developed the teletype printer at left. The printer itself weighs less than 24 pounds, and a complete airborne installation adds only about 35 pounds to a plane's load.

**Motorized Spray Gun.** For insect control in large areas, the truck shown below carries a swivel-mounted aircraft engine and propeller. Insecticide fed into the propeller's blast is spread hundreds of feet in any direction.





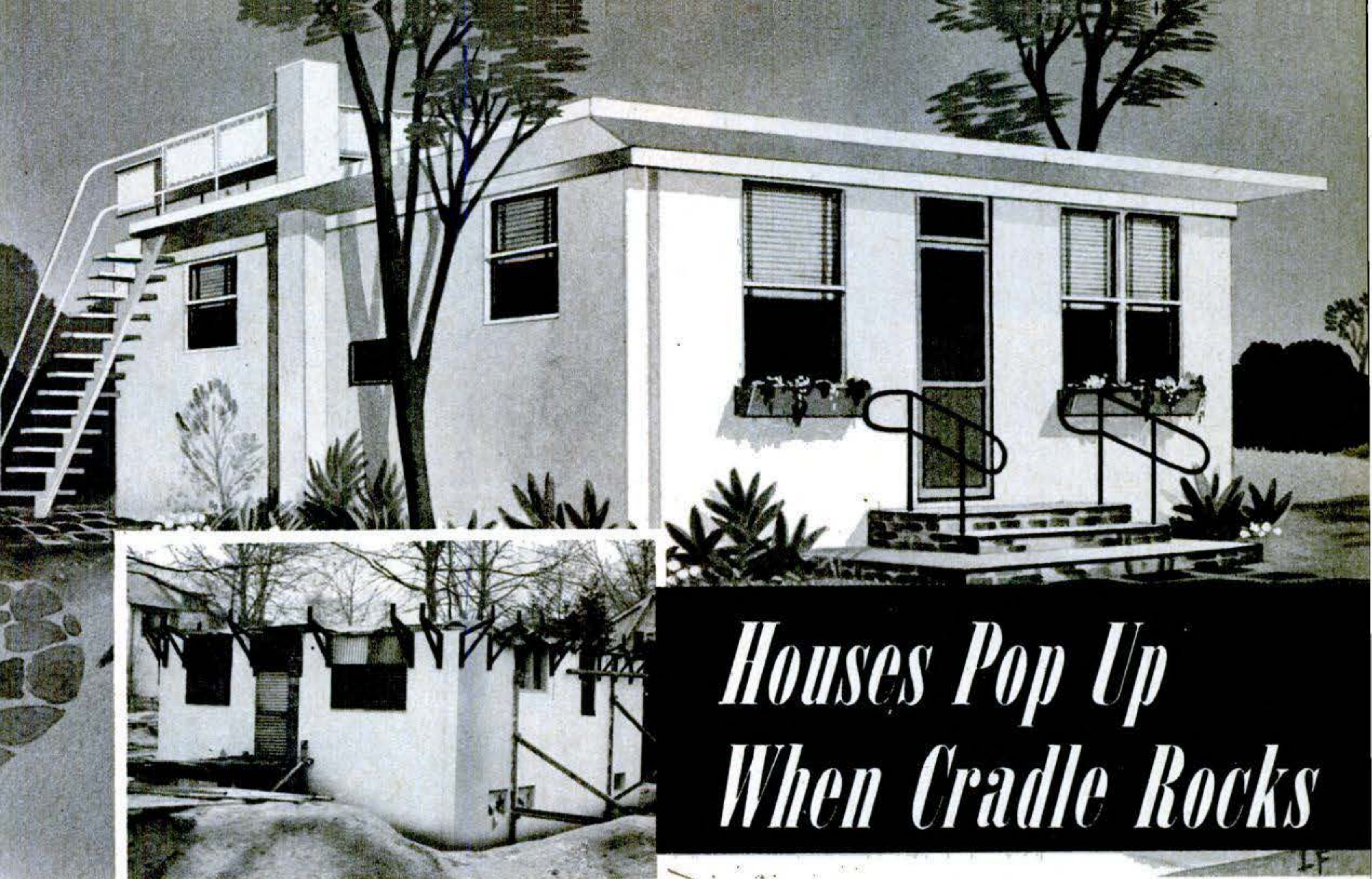

# Houses Pop Up When Cradle Rocks

Drawing above shows how experimental Tyrocrete house, in New York City, will look when finished. Inset shows the structure partially completed, awaiting roof and interior.

By HARTLEY E. HOWE

**Y**OUR new house may be built in a cradle and rocked into place. That's the latest method of mass-producing concrete houses, developed by Charles Tyroler, New York engineer, to help solve the housing shortage.

For an ordinary concrete house, complicated forms must be built or fitted together at the site, or expensive machinery is needed to transport precast walls and lift them into place. Tyroler's "Tyrocrete" method entails pouring the walls flat, in simple open forms laid on top of steel rockers. These are unbalanced by the weight of the concrete so that gravity pulls each wall up into position.

Concrete, Tyroler points out, is not only permanent, fireproof, waterproof and insectproof, but is obtainable almost everywhere. The Peerless Construction Company, of New York, plans to have the rocker forms built locally and either sold or rented to contractors. It estimates that only 100 houses need to be built to pay for a set of rockers. Since no special training is required, local labor can be used entirely. Savings over more conventional methods are estimated to run as high as 50 percent.

The Tyrocrete method can be used for any style of house, although the walls naturally cannot be higher than the width of the cellar on which the rocker rests. The experimental house shown here has five rooms and full basement, will probably cost under \$10,000 with lot.

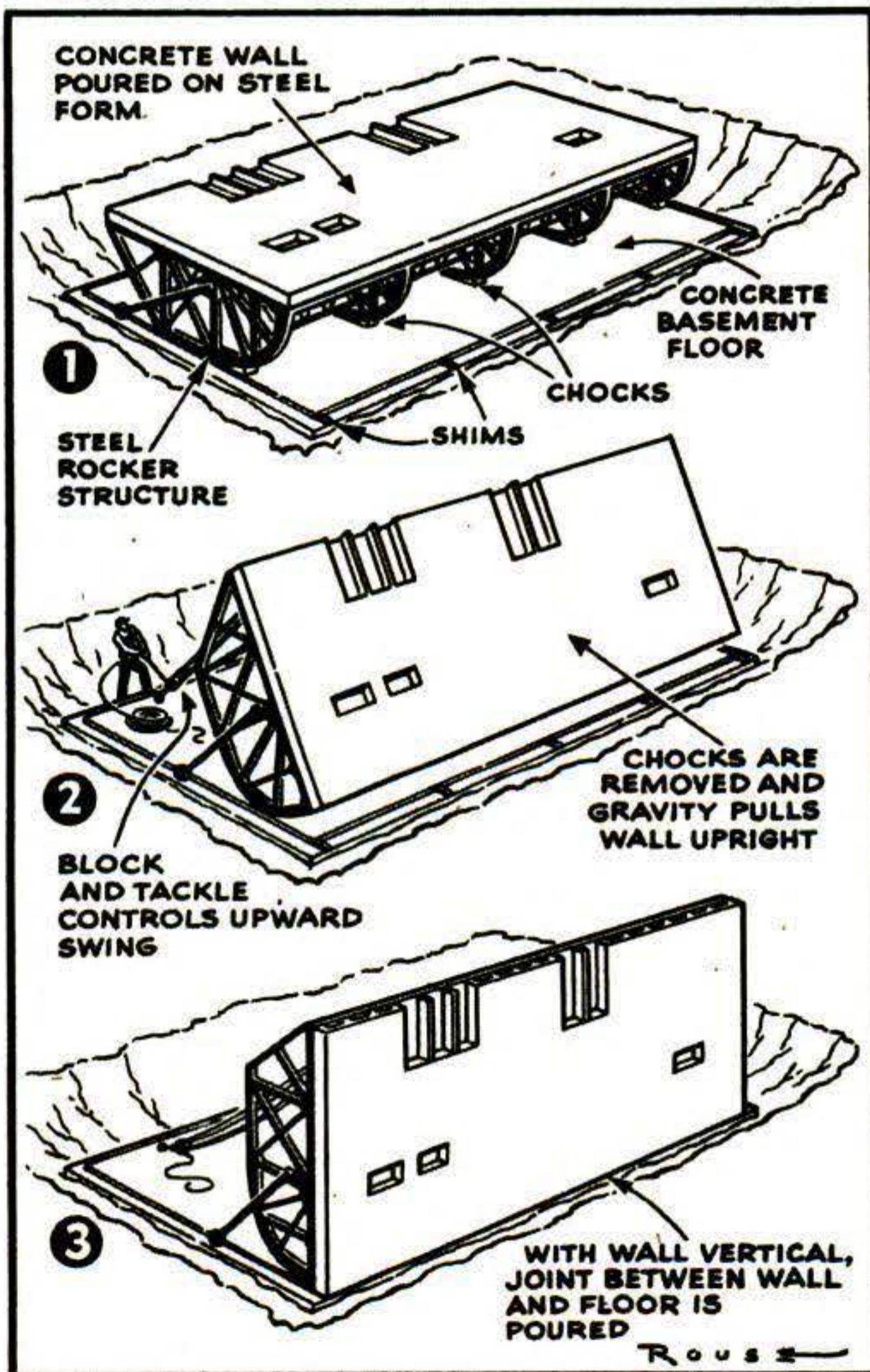





First step is to dig the cellar. Hole is five feet deep; dirt removed is used to raise ground level around house by two feet, improving drainage and permitting seven-foot basement. In the South, the cellar can be eliminated, saving about \$1,500.



Forms for walls and footing are colored to show which side of house they belong on. Tyrocrete system is planned to require a minimum of skilled labor. Supervisor works from manual. The ground layout must be exact so that walls will fit together.



Assembling rockers, which come in sections, usually takes a day. The two-foot metal wall forms are bolted flat across rockers, covered with form oil to keep them from sticking to concrete. Rockers must be accurately set so that wall lands on base.

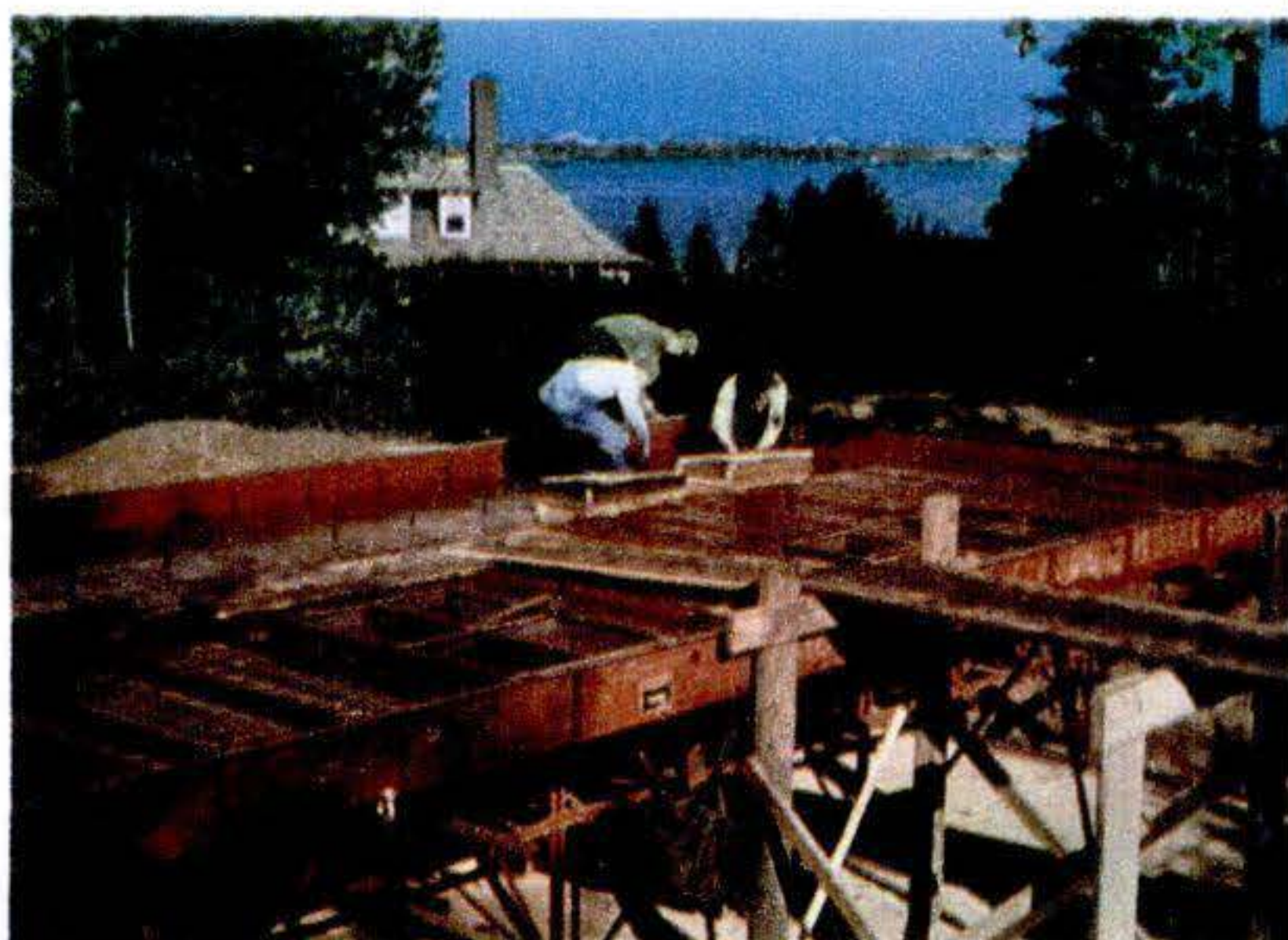

After reinforcing mesh is set into open forms, concrete is poured on. Each wall takes two truckloads of six cubic yards each. Molds are flat for cellar wall, ribbed every two feet for upper wall. Bolts are set in forms to tie them to walls during rocking.



When all is ready, the tackle that keeps the rockers horizontal is loosened and gravity pulls the wall over to the vertical. One man can control the operation, which takes about a minute. Set-in bolts for roof can be seen along upper edge of wall.



The wall rising into place. Once upright, the bolts attaching wall to form will be loosened and gravity will go to work again, pulling the rockers back to the horizontal. Openings left in mold for doors and windows can be seen in face of wall.





Setting up forms for the footing and cellar floor. Footing has trough slightly wider than wall, set with metal shims. When wall's foot rocks into the trough, shims support it so that a narrow opening is left between wall and footing.



Spreading concrete over metal reinforcing of 4 1/2-inch floor of cellar, strong enough to support rockers. Cellar floor takes four truckloads of six cubic yards of concrete each. Bolts are set into floor for the control tackle.

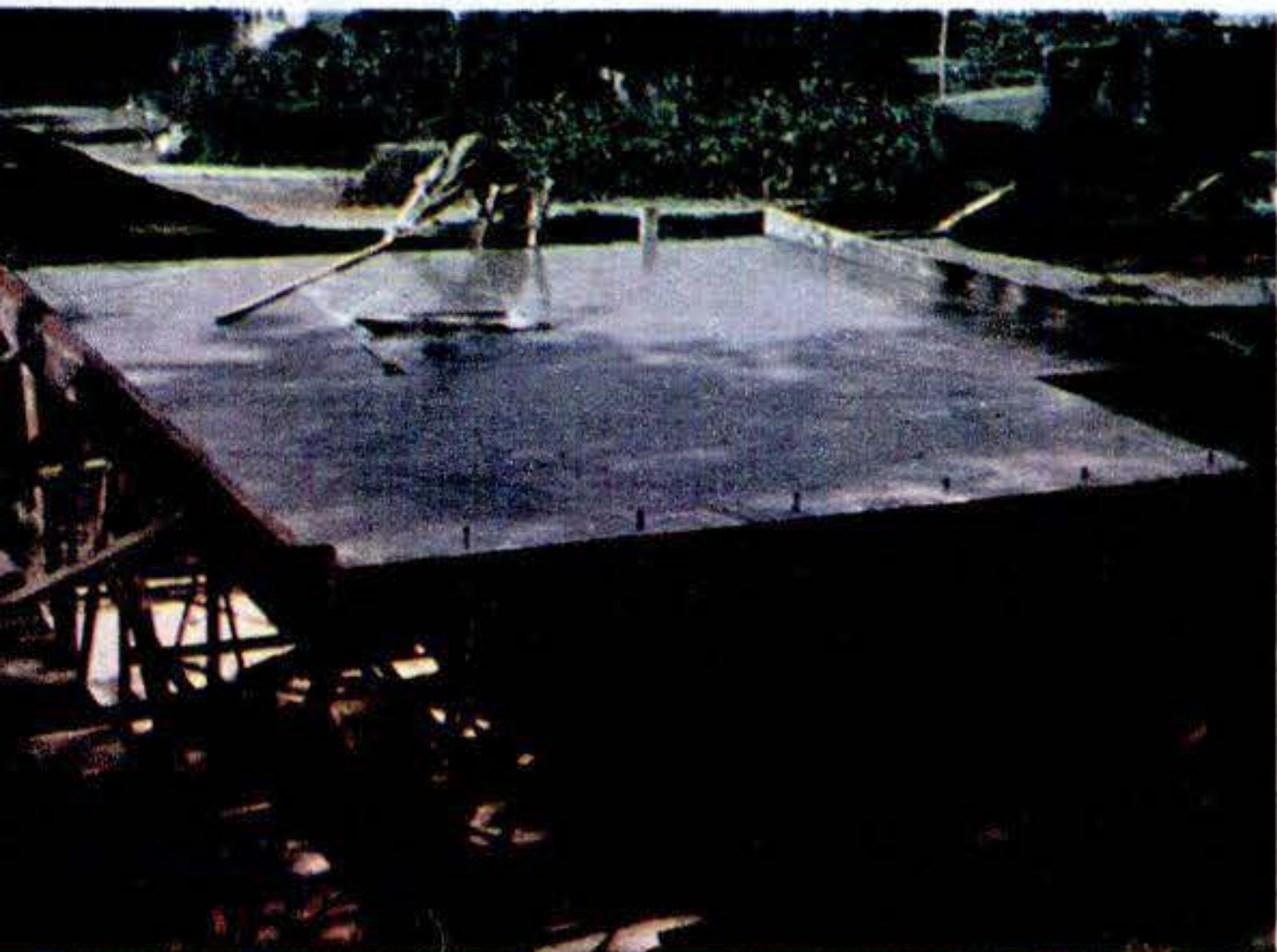

Concrete in forms is smoothed by hand, providing opportunity to give any desired texture. Beams can be set in for old English style, special doorways and pilasters used for colonial, rough stucco finish left for Spanish, block lines used for modern.



During 48-hour curing of 48,000-pound wall, workmen prepare footings. Space between wall and footing will be filled with caulking, covered with cement. Bolts to tie in floors and roof have already been put in molds so that they are set in walls.

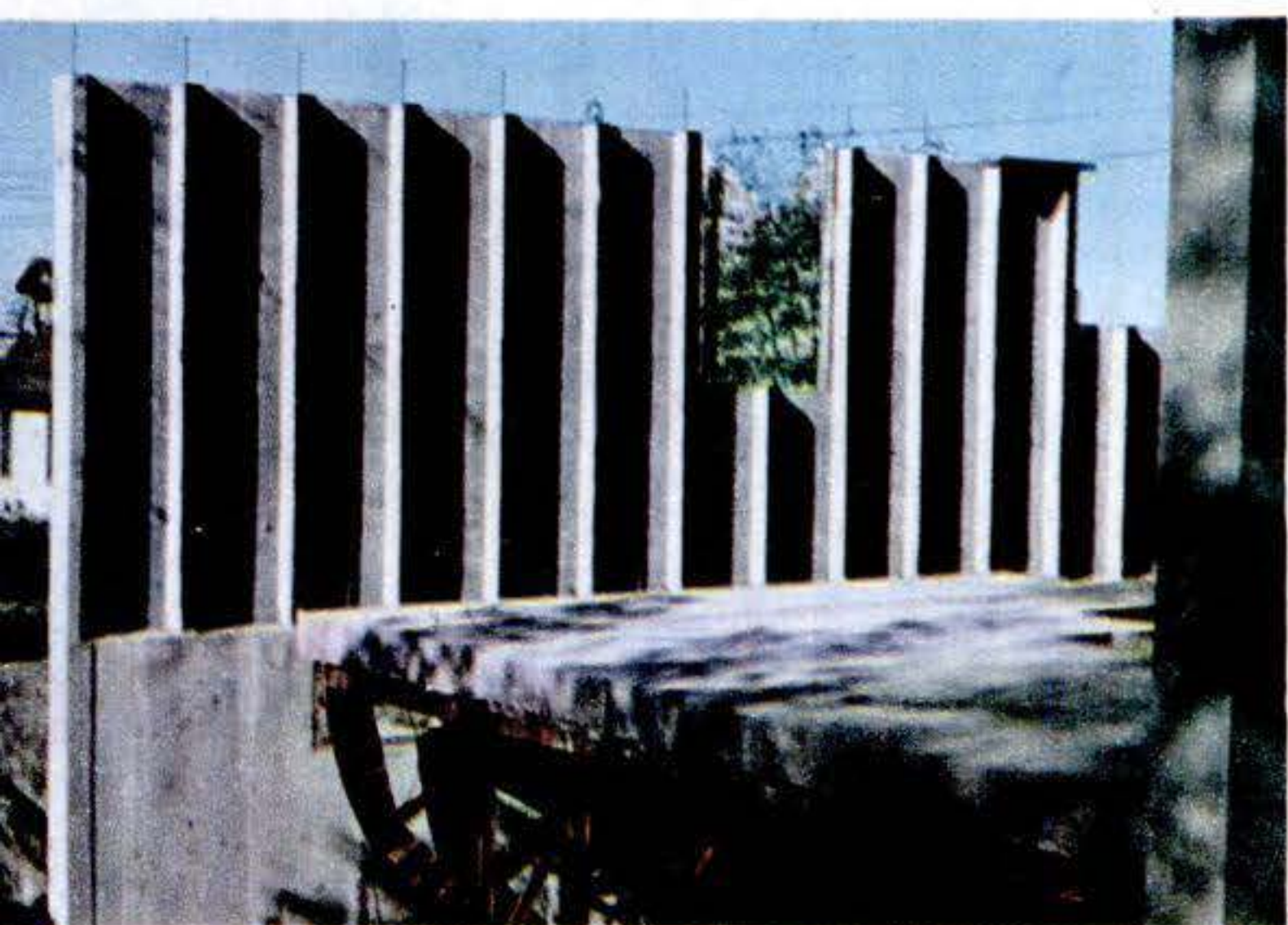

When one wall is up, the rocker is partially disassembled and swung around to prepare the next. Here a second wall, at right angles to the first, is ready to rock into place. Upper wall channels allow for pipes and wiring, provide insulation.

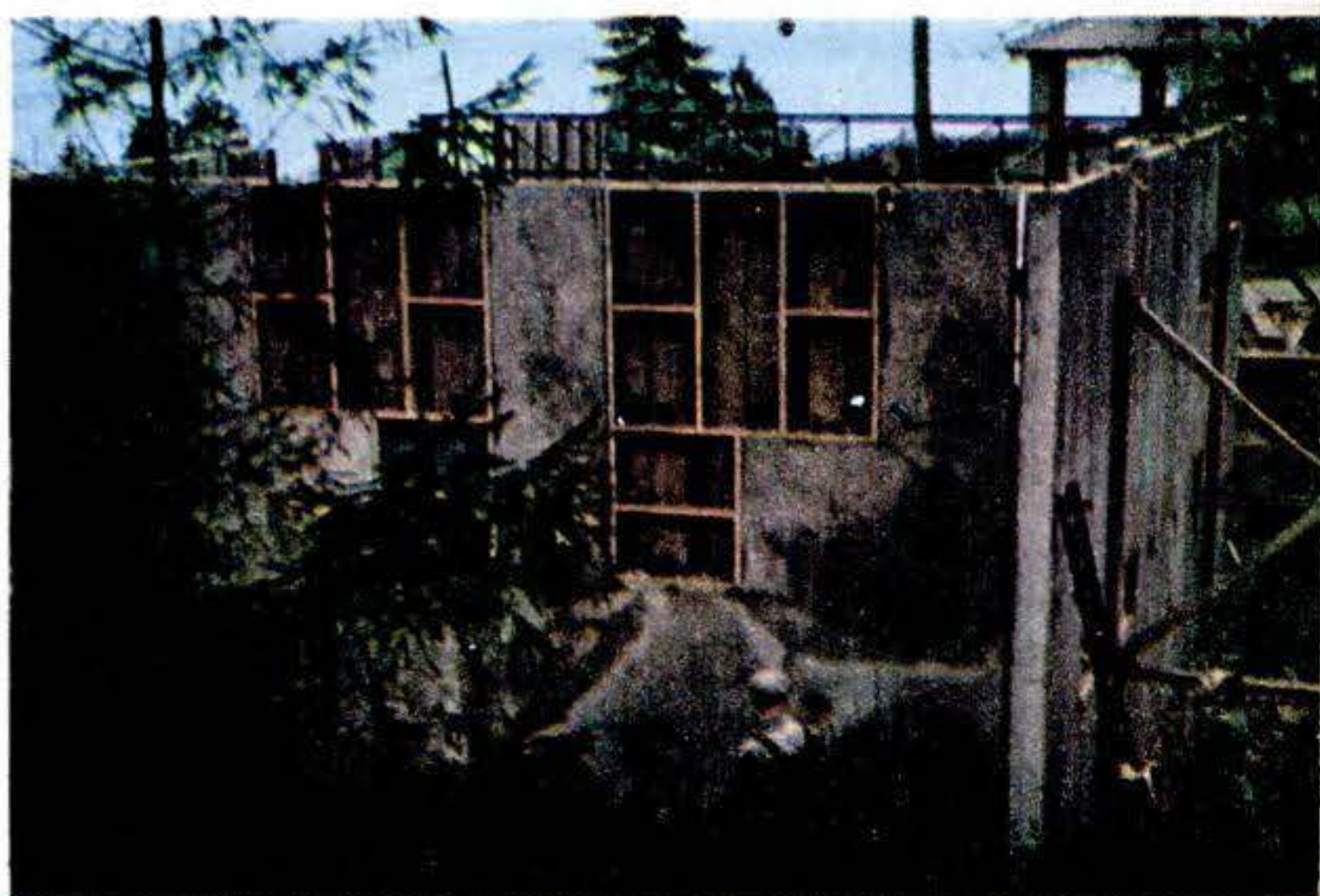

Two walls in place. Corner seam will be made watertight with impregnated fabric, packed with oakum and covered with caulking. Meanwhile, temporary trusses hold walls and support metal forms for casting roof and floor.



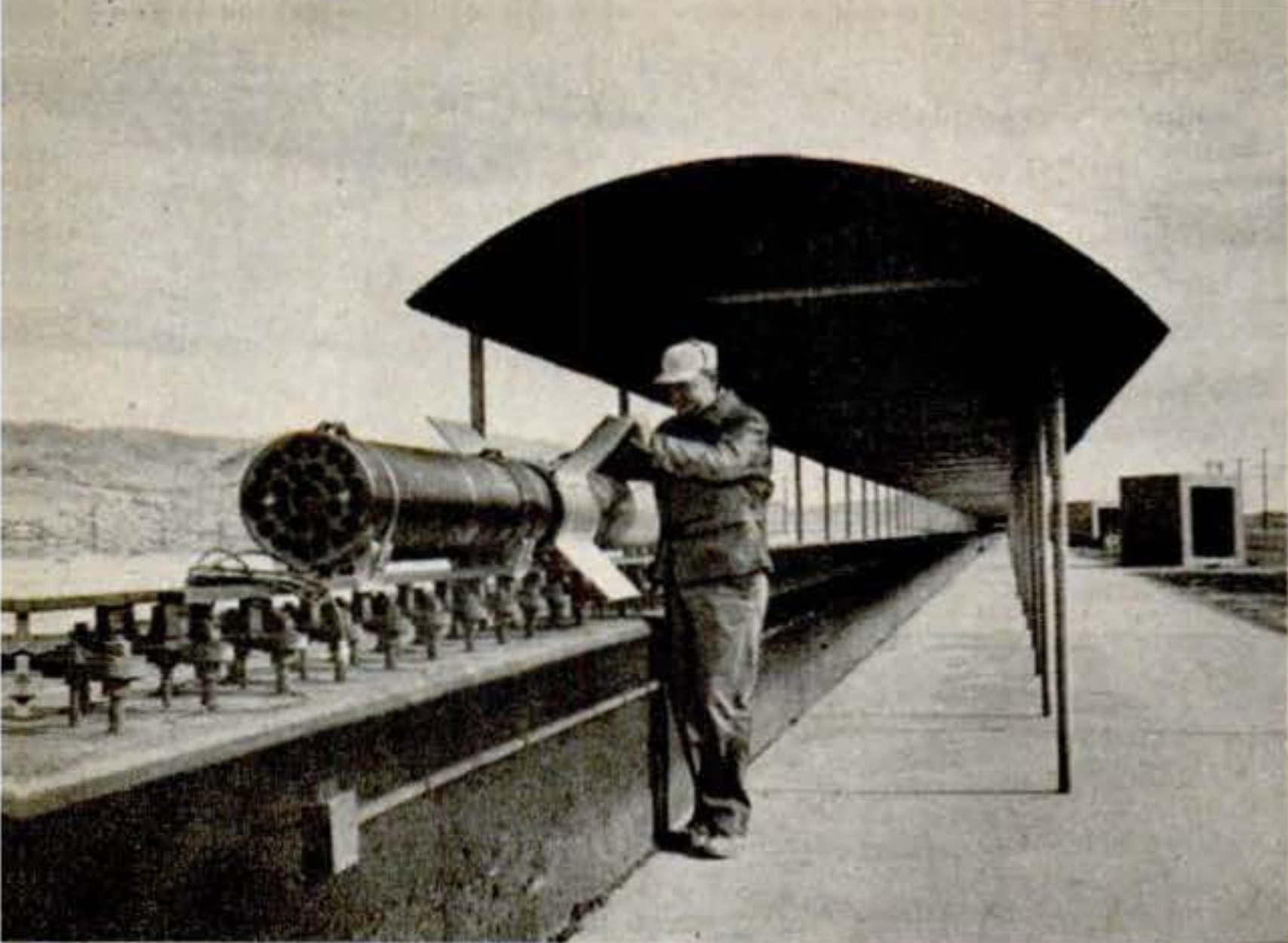

1. Tiny Tim is groomed for a railroad take-off. Its booster, or auxiliary motor, is nearest the camera. Metal roof protects track from heat of desert sun.

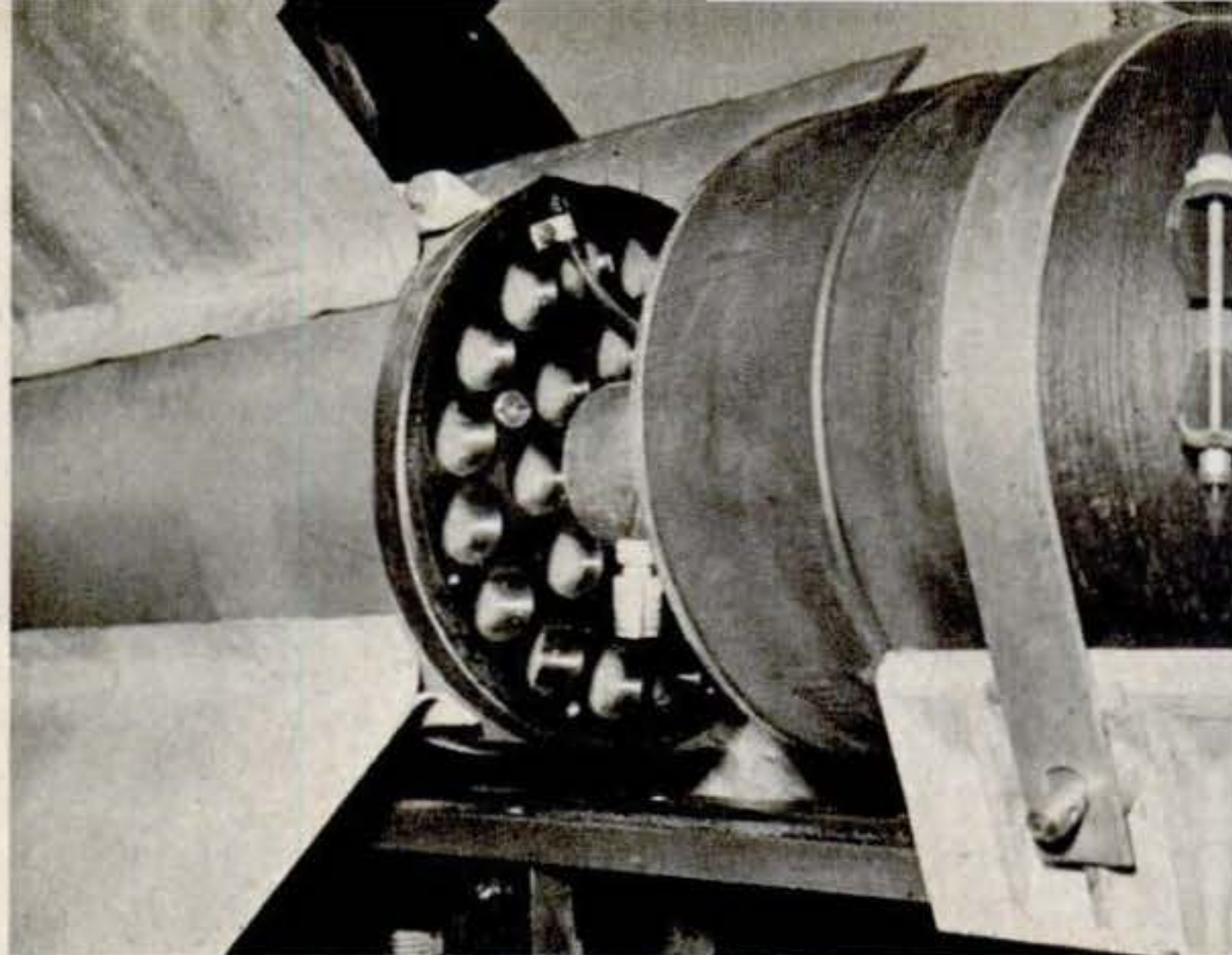

2. A view of the rocket's base. Booster, on the right, is a duplicate of rocket's own motor; it is dropped after 1,000 feet, when rocket motor ignites.

# LOOK OUT FOR THE ROCKET

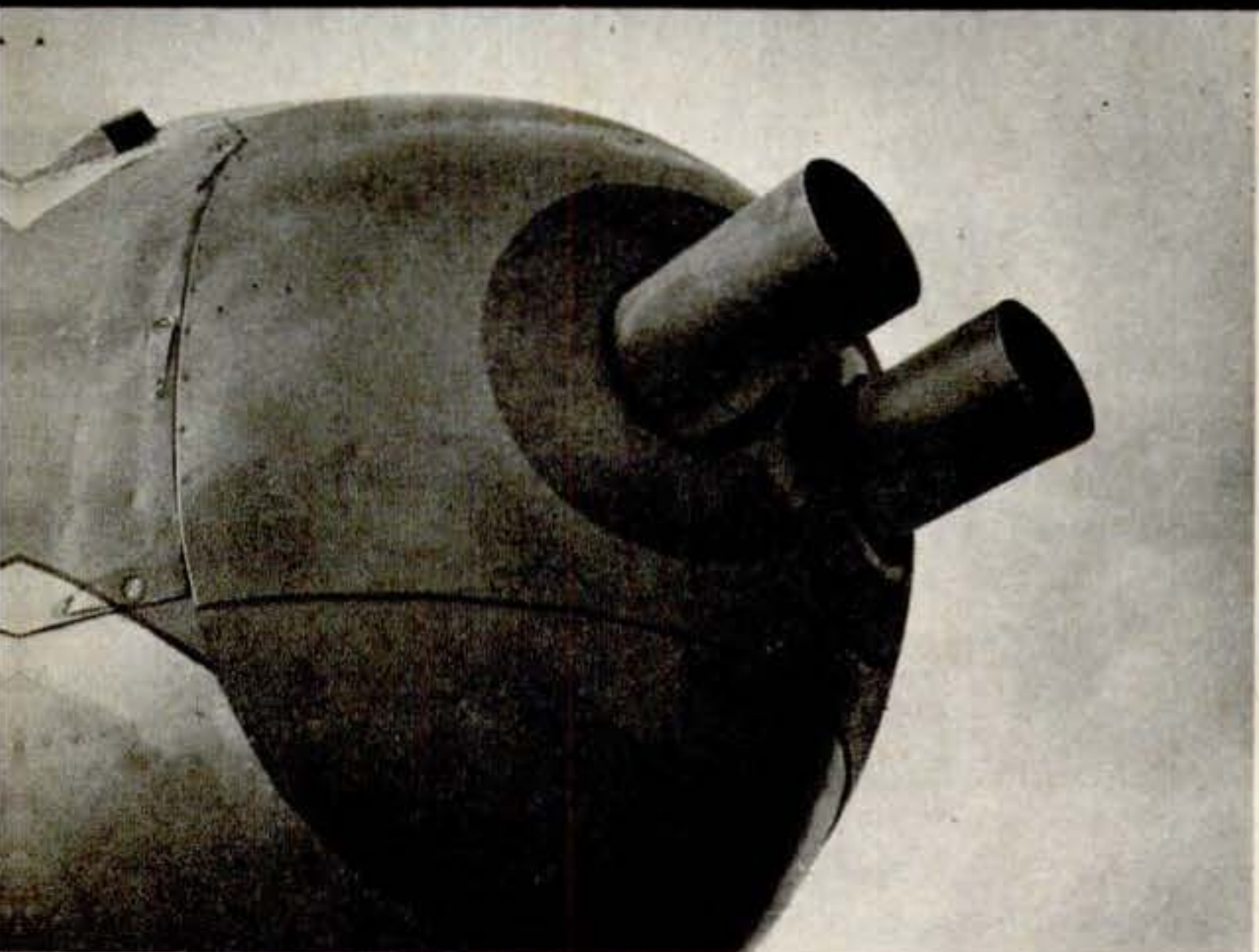

With a new automatic revolving launcher, these twin tubes in a plane's nose fire a whole salvo of five-inch spinner rockets in a matter of seconds.

Biggest U. S. artillery rocket built for aircraft launching is Big Dick, shown below in a ground test. It is 14 inches in diameter, 150 inches long.

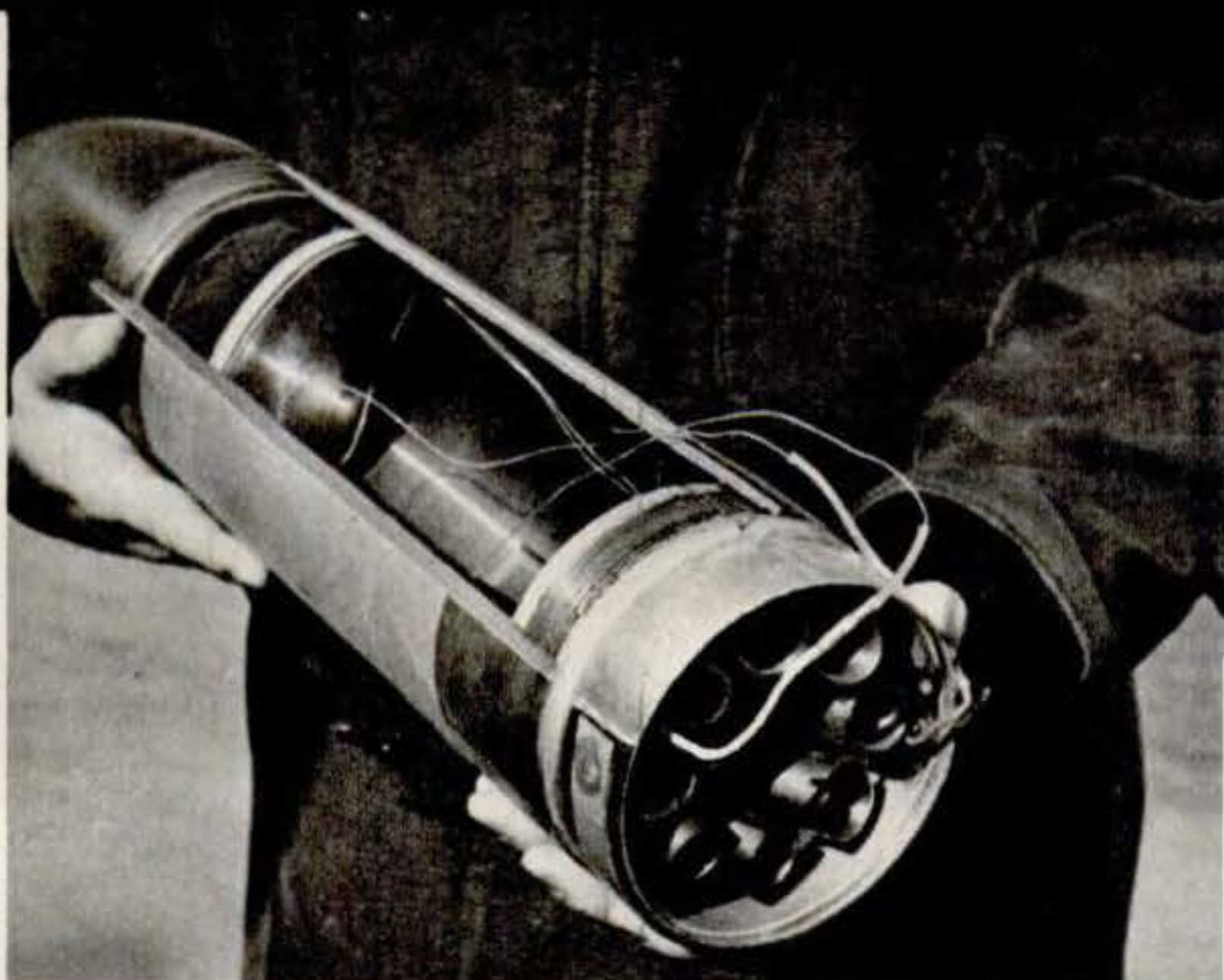

Cutaway of spinner rocket shows angled ports that make it whirl. Rockets are fired from two motor-driven drums, which can be reloaded during flight.

Closeup of Big Dick's nozzle plate shows multiple ports through which burning gas escapes. Electrical contacts are in position, ready for firing.

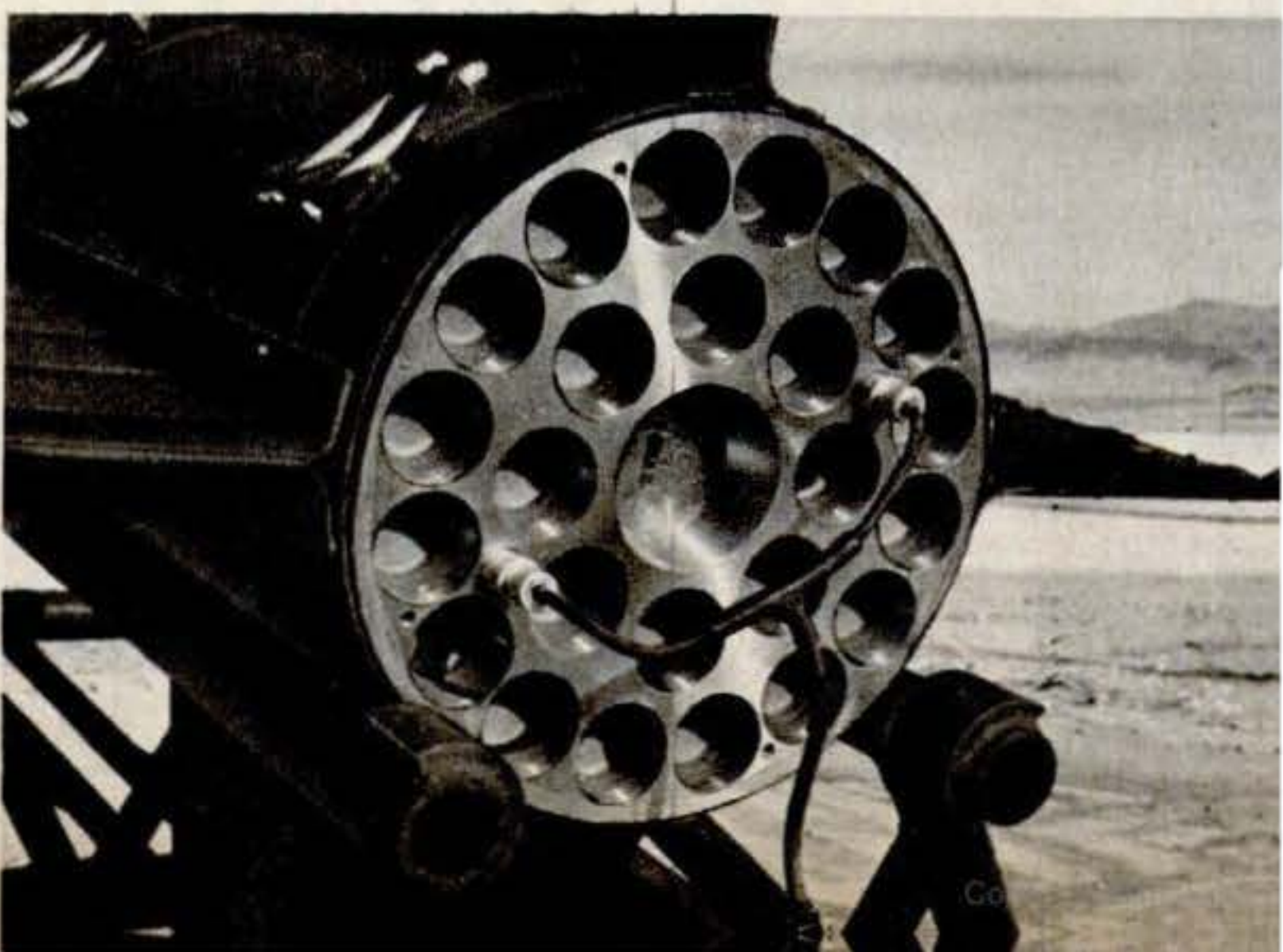



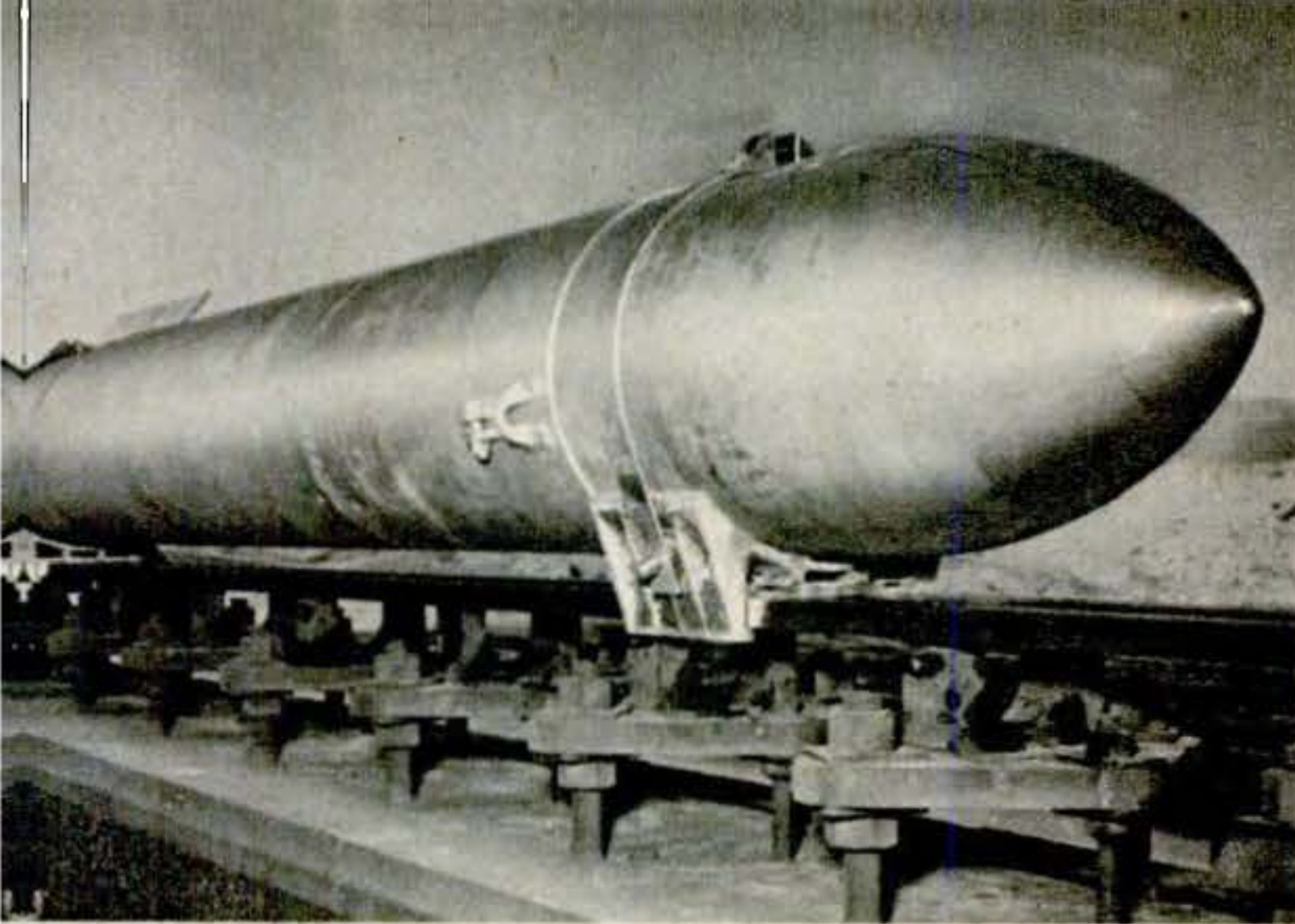

3. Manganese steel grips hold the one-ton projectile to the track. After leaving its 1,500-foot rail, the rocket flies another 500 feet true to the target.

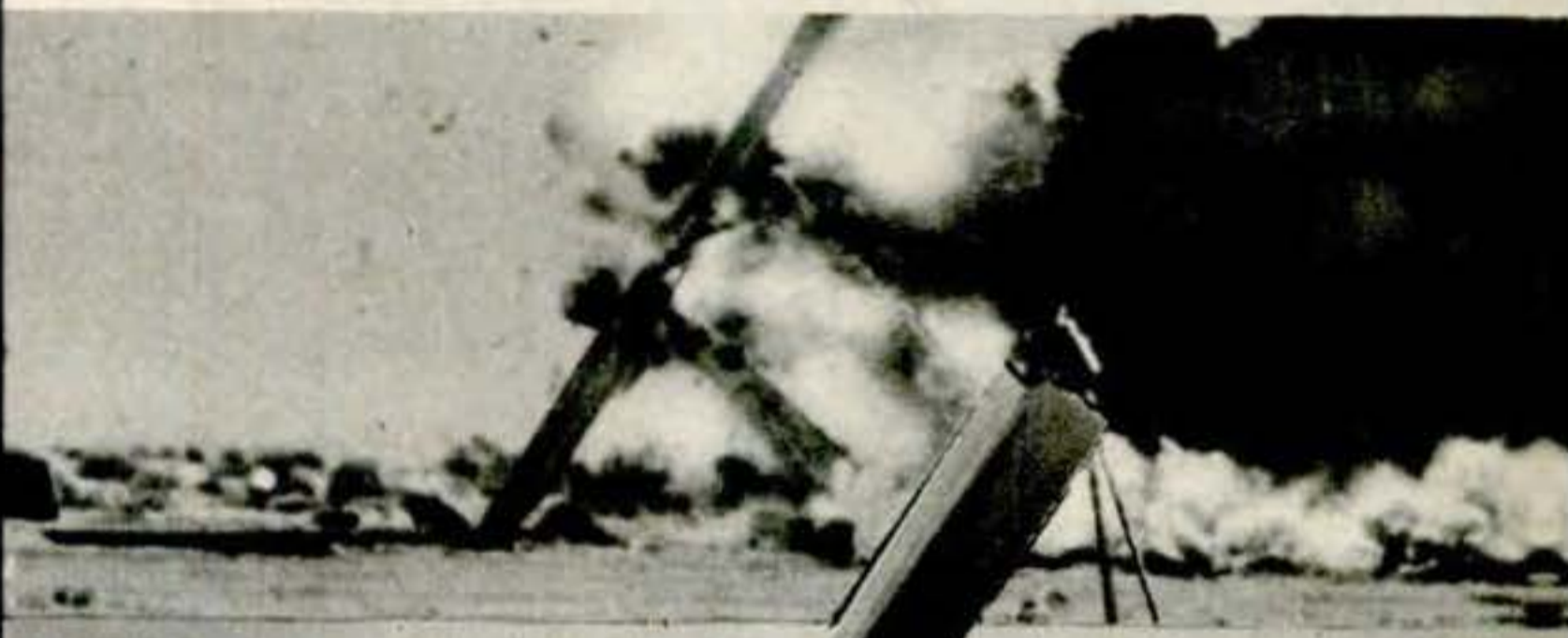
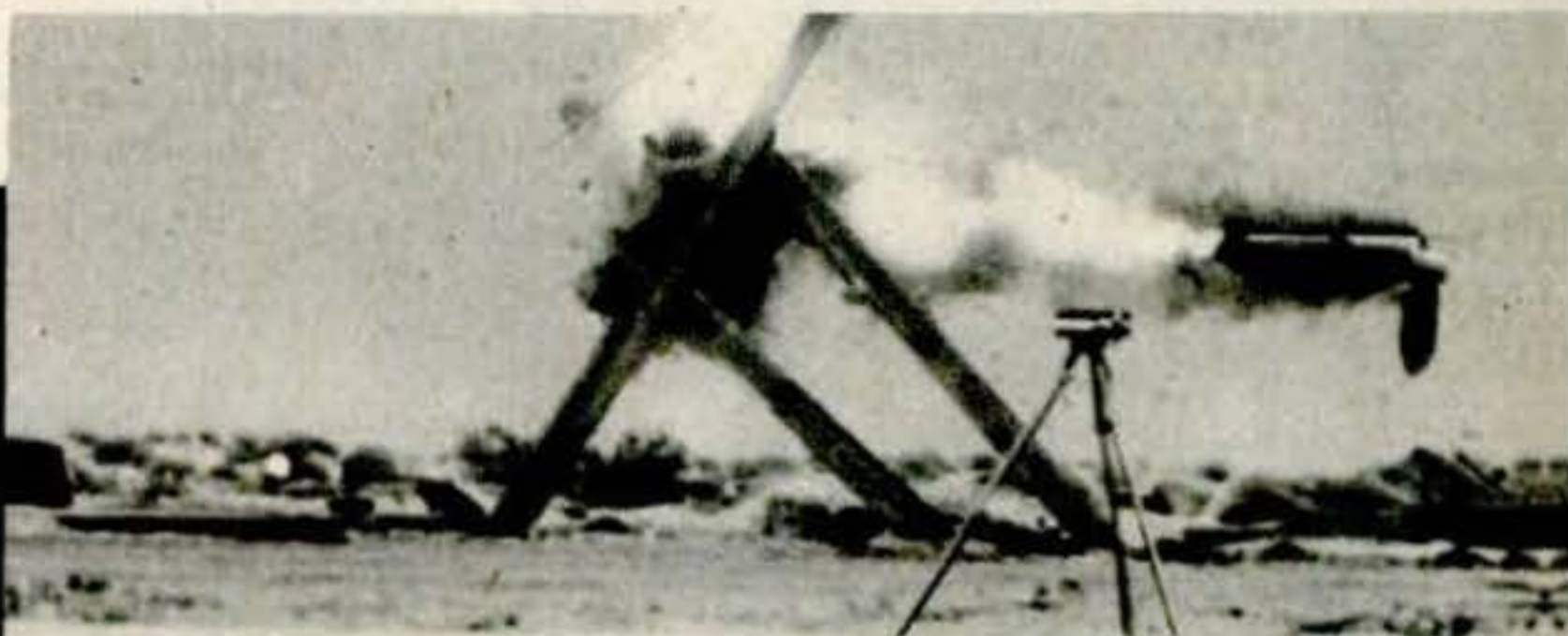
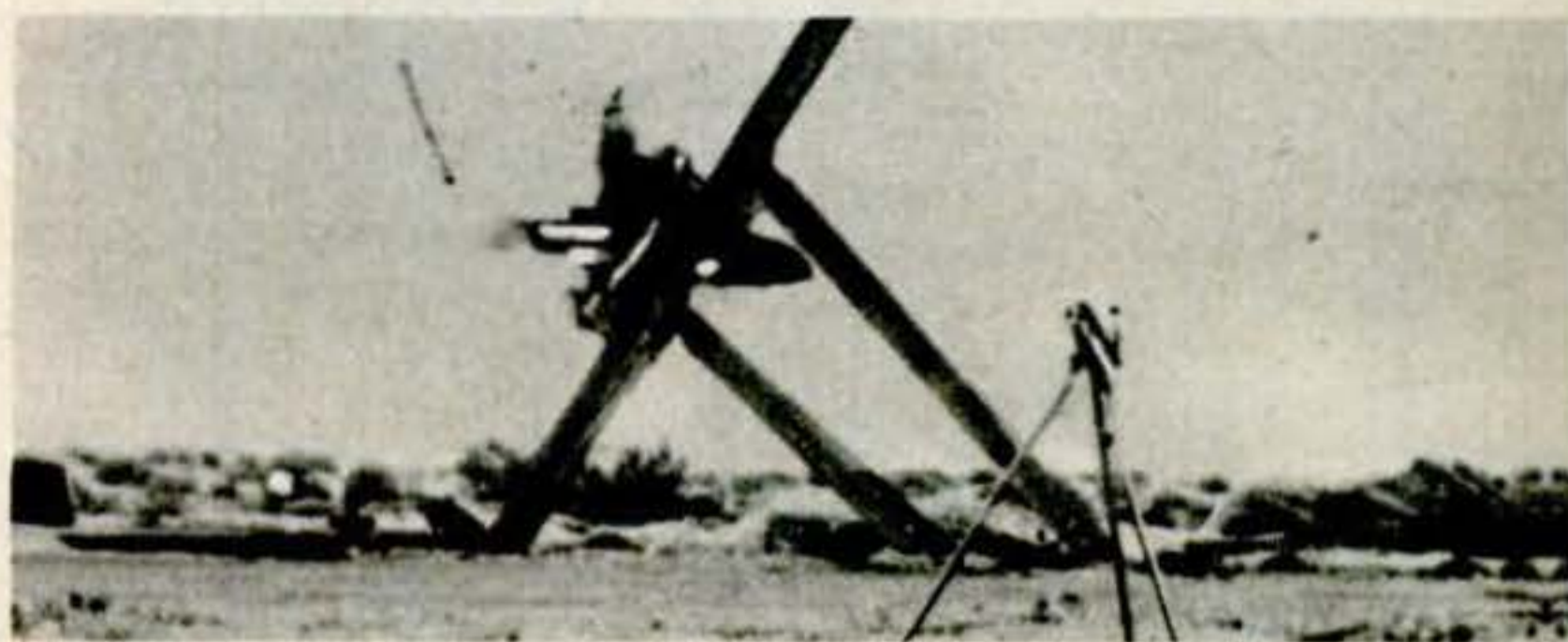

# EXPRESS!

ON THE 1,000-square-mile desert range of the Naval Ordnance Test Station at Inyokern, Calif., rockets are undergoing exhaustive—and spectacular—tests designed to improve their hitting power and destructive force.

From the rockets' fiery performance before high-speed cameras and other precision instruments, Navy scientists learn not only how to make existing types more powerful, but how to design new ones and how to devise new ways of using them.

Two recent developments are shown here, along with a pictorial record of one of the tests, in which a Tiny Tim rocket takes a ride on a railroad to start a 1,000-m.p.h. dash before the camera.

Big Dick on the wing in a low-altitude test. The rocket attains a speed of 1,000 feet a second and holds 250 pounds of TNT—enough to sink a ship.



4. The four top photographs, taken at intervals of about  $2/1,000$  second, show the rocket approaching the target, penetrating it, passing beyond it (with war head broken off and dangling vertically from rocket's body), and exploding. The bottom picture shows what the impact of such a projectile, traveling 1,500 feet a second, can do to the target even without an explosion. The target, pierced and virtually demolished, is  $2\frac{1}{2}$ -inch steel armor plate.



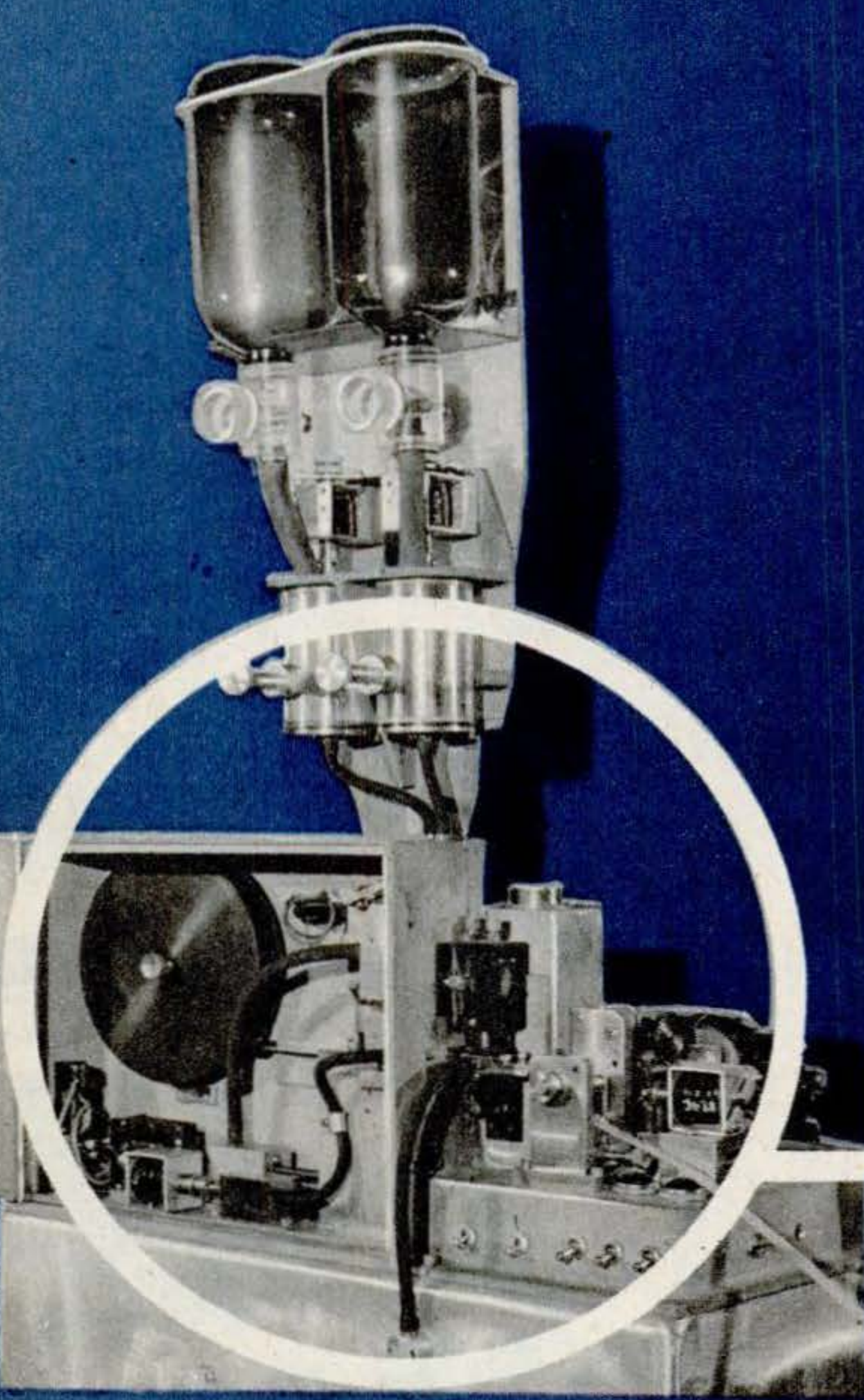

# Souped-up Darkroom Runs Itself

**15 seconds after photo is snapped it's on the screen.**

**F**IFTEEN seconds after the camera above snaps your picture you're looking at yourself on the screen, larger than life. The involved processes of development and projection have been carried out automatically in the time it took you to hang up your hat and coat.

Eastman Kodak developed the machine secretly for such wartime jobs as projecting radar pips a few seconds after they flickered across a 'scope. Now it is being adapted for science and industry. Possible uses include recording oscillograph screens and spectroscopic analyses.

The machine's incredible speed results from the use of highly active chemicals—made even more so by preheating to 140°F. The developer—modified Kodak D82—touches the film only four seconds. Fixing takes 6.5 seconds; washing, another second. The other 3.5 seconds are used for drying and moving the film.

Taking, processing and projecting the picture are a continual, automatic process, run by solenoids controlled by cam-operated switches. The 16-mm. film, emulsion side up, is pulled intermittently from

a reel inside the light-tight camera. The image is thrown on it from below and development to a direct positive begins at once. No negative is made.

Developer and fixer are stored in tanks above the camera and fed through electrically heated lines to a tiny cup, open at both ends. This clamps down on the film at the exposure point, the smooth lower lip making a seal so that the film serves as the bottom of the developing "tank."

To prevent fogging the next exposure, residual hypo must be washed from the cup before the next cycle. Developer is used for this to avoid complicating the plumbing with another feed line. If a permanent record is desired, the film must be given additional treatment later.

After development, the image is advanced five frames into position for immediate projection. A 400-watt lamp shoots light up through the glass-bottomed film track. The f/3 projection lens is mounted vertically above the film and a right-angle prism bends the image beam to the horizontal toward the screen. Meanwhile, another picture is being made.



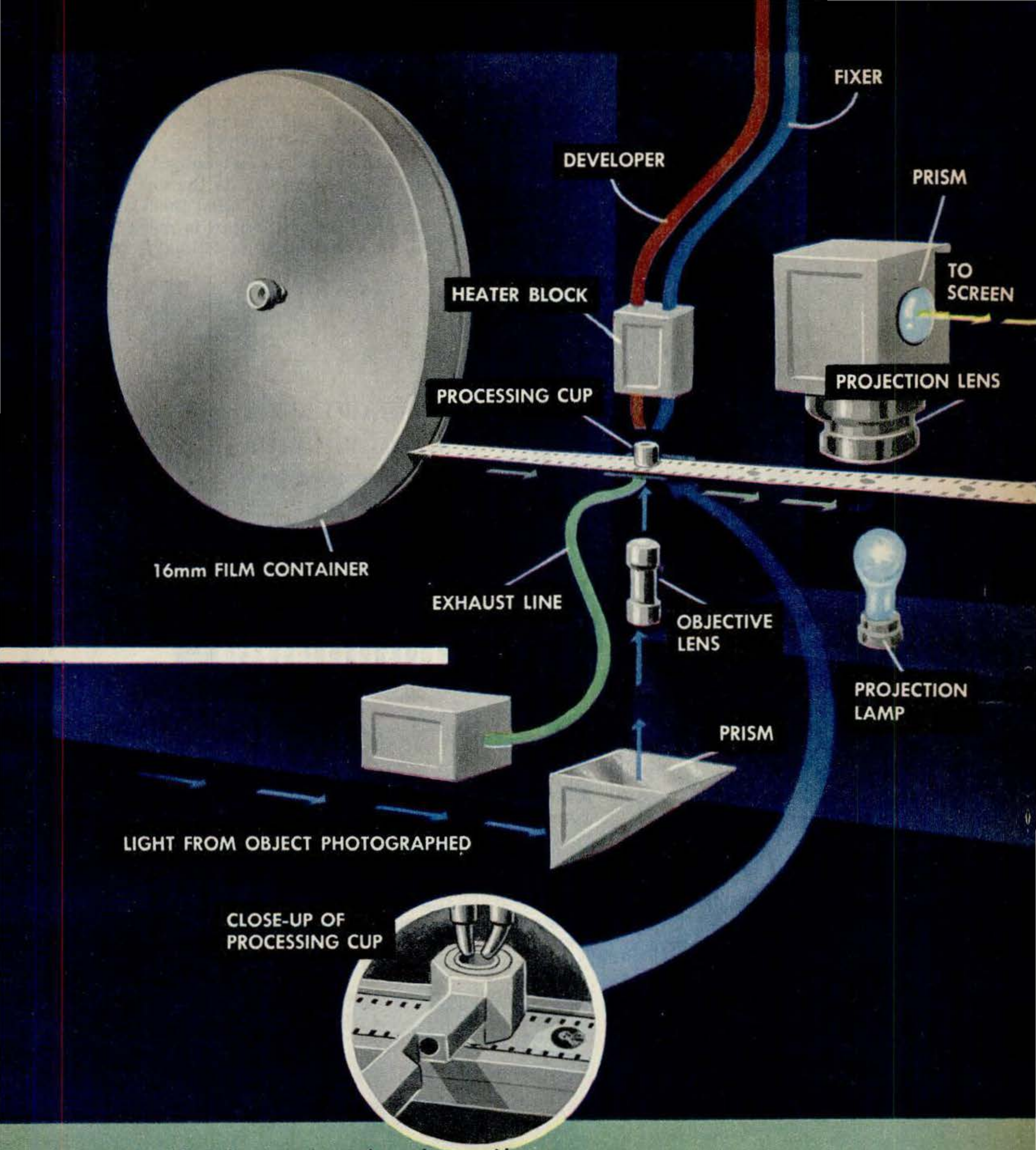

Simplified drawing above shows how rapid processing machine, on opposite page, works. Arrows follow path of image from camera lens. Inset shows details of processing cup, made of two concentric cylinders. Inner diameter is only  $\frac{1}{4}$  inch, same size as image on film, and holds about .3 cc. of liquid. Clawlike nozzles feed in developer and hypo. Cutaway hollow rod raises and lowers cup, also is drain by which used chemicals are sucked away through the air space between cylinders. Same vacuum process dries film. At right, interior of the light-tight camera.



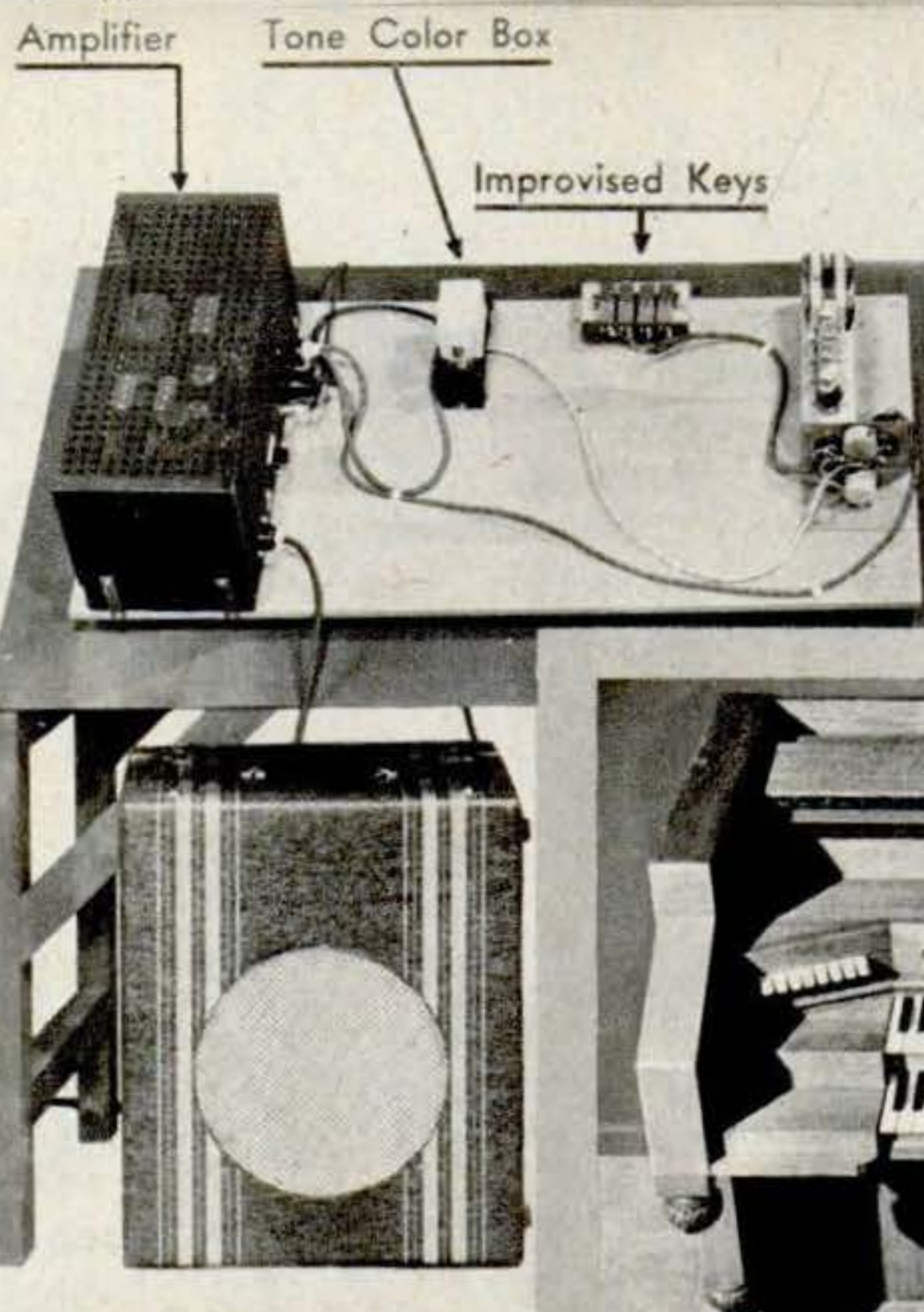

### Tubes Replace Pipes.

This compact organ can produce all the sounds of one with 1,333 pipes—without having any at all. The secret is in electronics: Vacuum-tube oscillators do the work of the usual pipes. Called the Consonata, the new organ is made by C. G. Conn, Ltd., of Elkhart, Ind.



Simplified layout above shows how the Consonata works. Pressing a key sets up electrical impulses, which go through a tone-color box to gain the characteristics of a desired stop, such as diapason or vox humana. After being amplified, the impulses emerge through the loudspeaker.

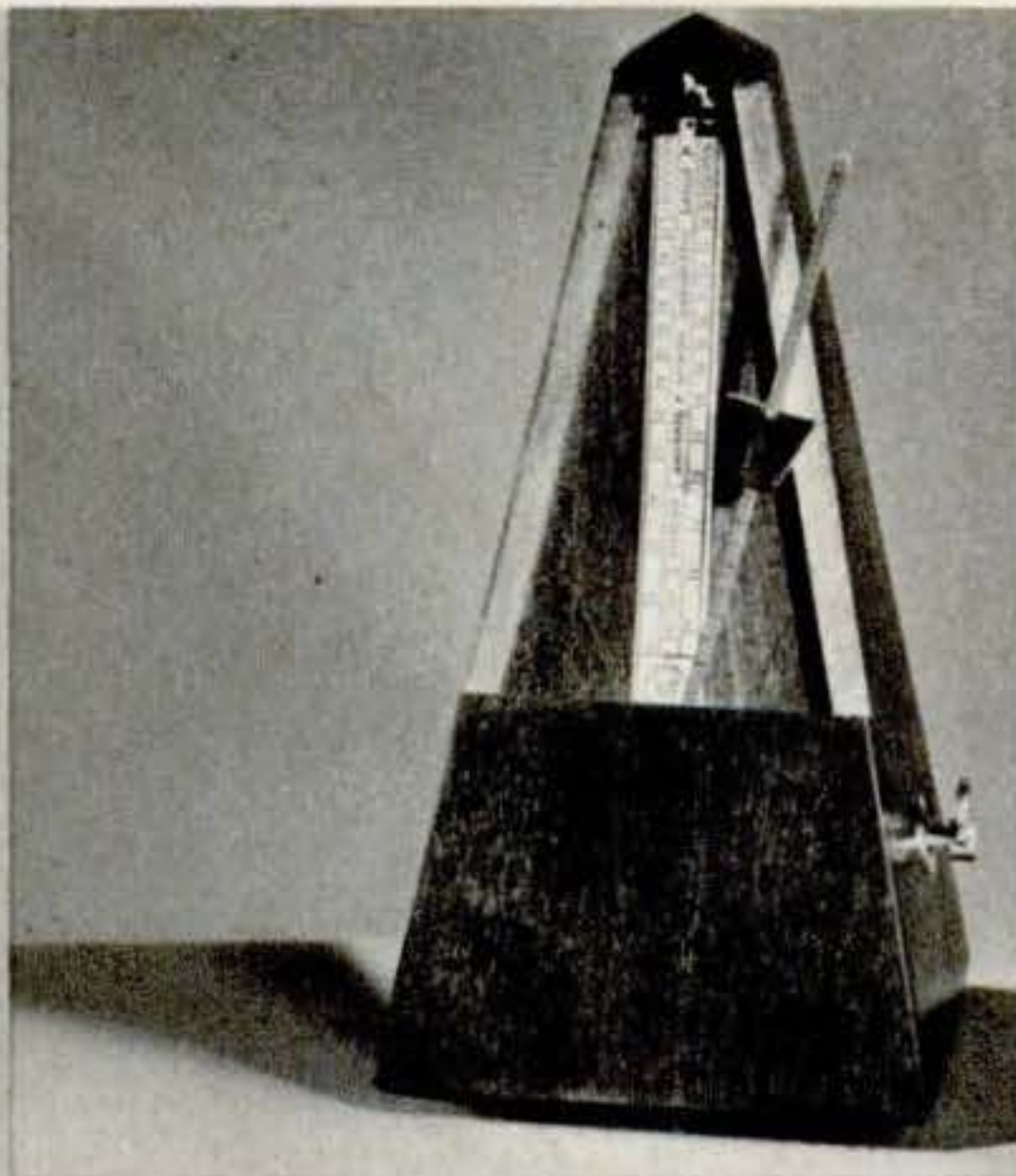

**Electronics Gives That Beat.** After 130 years, the old-fashioned metronome at left has a rival—the Metronoma. Clockwork and pendulum are replaced by a thyratron, or “heartbeat” tube, which produces an electrical impulse anywhere from 40 to 208 times a minute. The current activates a knocker and a neon tube, so that the beat can be seen as well as heard. The Metronoma is made by Crystal Research Laboratories, of Hartford, Conn.

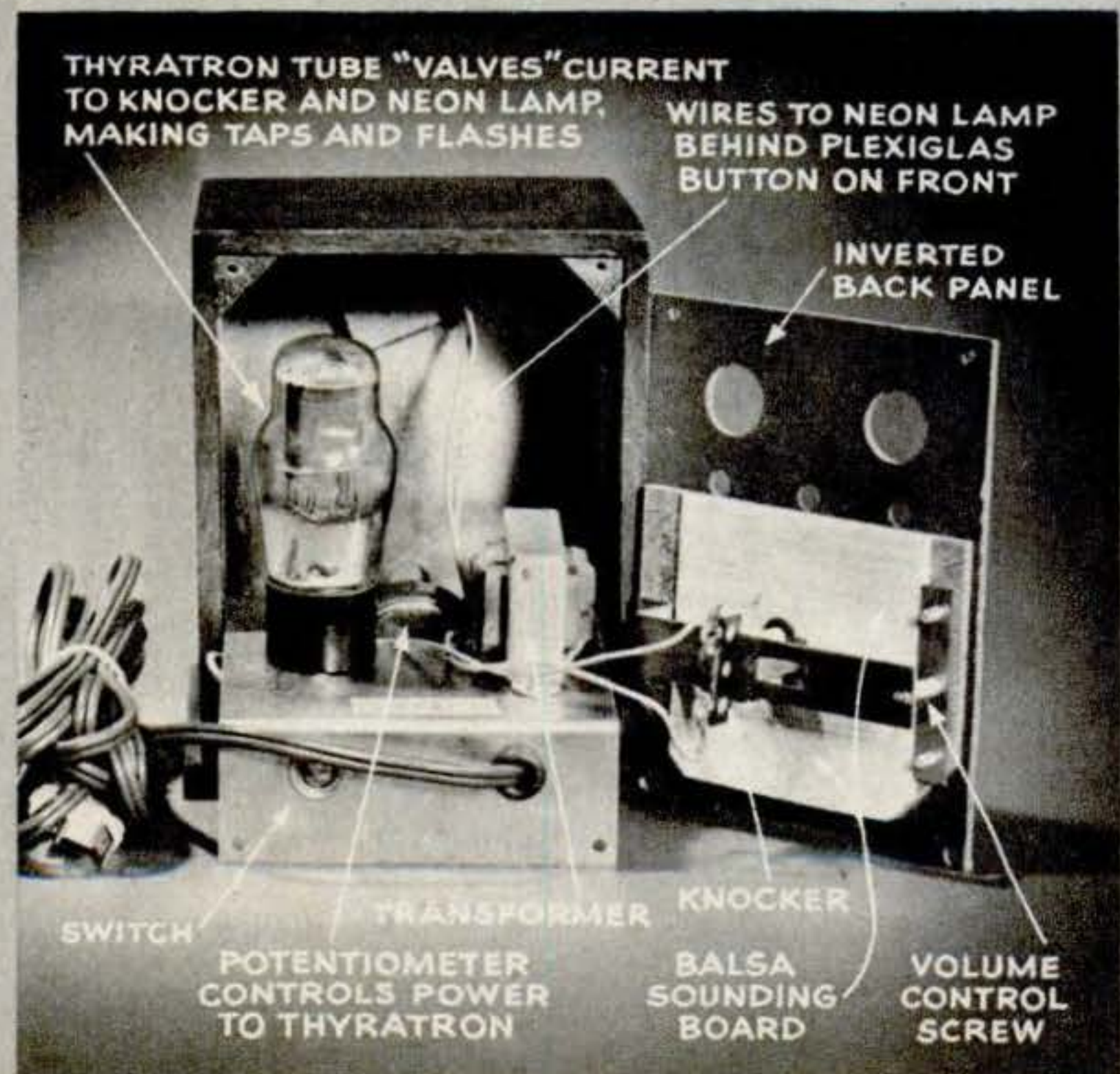
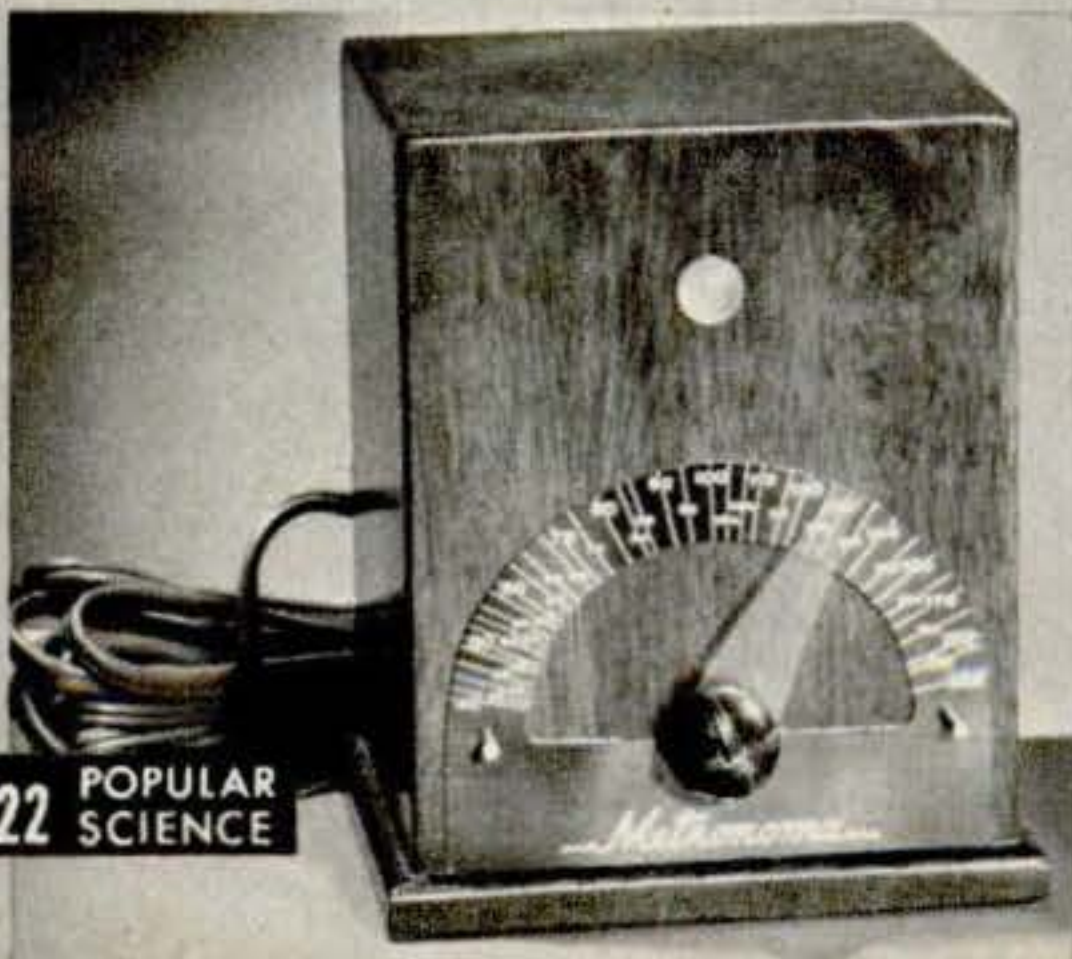



# Plastic Murals Are Painted with Light

By **FRANK ROWSOME, JR.**

**I**F YOU take a sheet of clear plastic, buff the edges to a glasslike finish, and direct light into one edge, the sheet will conduct it much as a pipe carries water. No light will be visible on either face of the sheet, provided the source is shielded and the surfaces are unmarked. But if the surfaces are interrupted in any way, light will spill out at that point as from a leaky pipe. A deep V-shaped groove cut in the plastic produces a bright line of light; a thin scratch makes a delicate line; a few strokes of sandpaper cause a luminous cloud.

Because of this curious "light-piping" characteristic, the acrylic resins known as Plexiglas and Lucite—detoured during the war into such practical applications as bomber noses and fighter "greenhouses"—have emerged as dramatic new materials with which architects, designers and deco-

rators are achieving startling illuminating effects never before possible.

The techniques behind these effects are new and changing, and the men who have developed them admit that much exploratory work remains to be done. It seems certain, though, that the next decade will see the spread of such things as murals that are literally painted in light, table tops and screens that spill a patterned glow from their surfaces, and entire walls that radiate softly to illuminate a room.

Actually, it isn't necessary to cut into the surface to make the light spill out. Anything that comes so close to the plastic as to break the "air seal"—the microscopically thin layer of air between the sheet and whatever is superficially touching it—will modify internal reflection, causing light to show wherever the air seal is broken. If you place your hand lightly against an edge-lighted panel and watch from the other side,

## WAYS TO SECURE COLOR IN EDGE LIGHTING

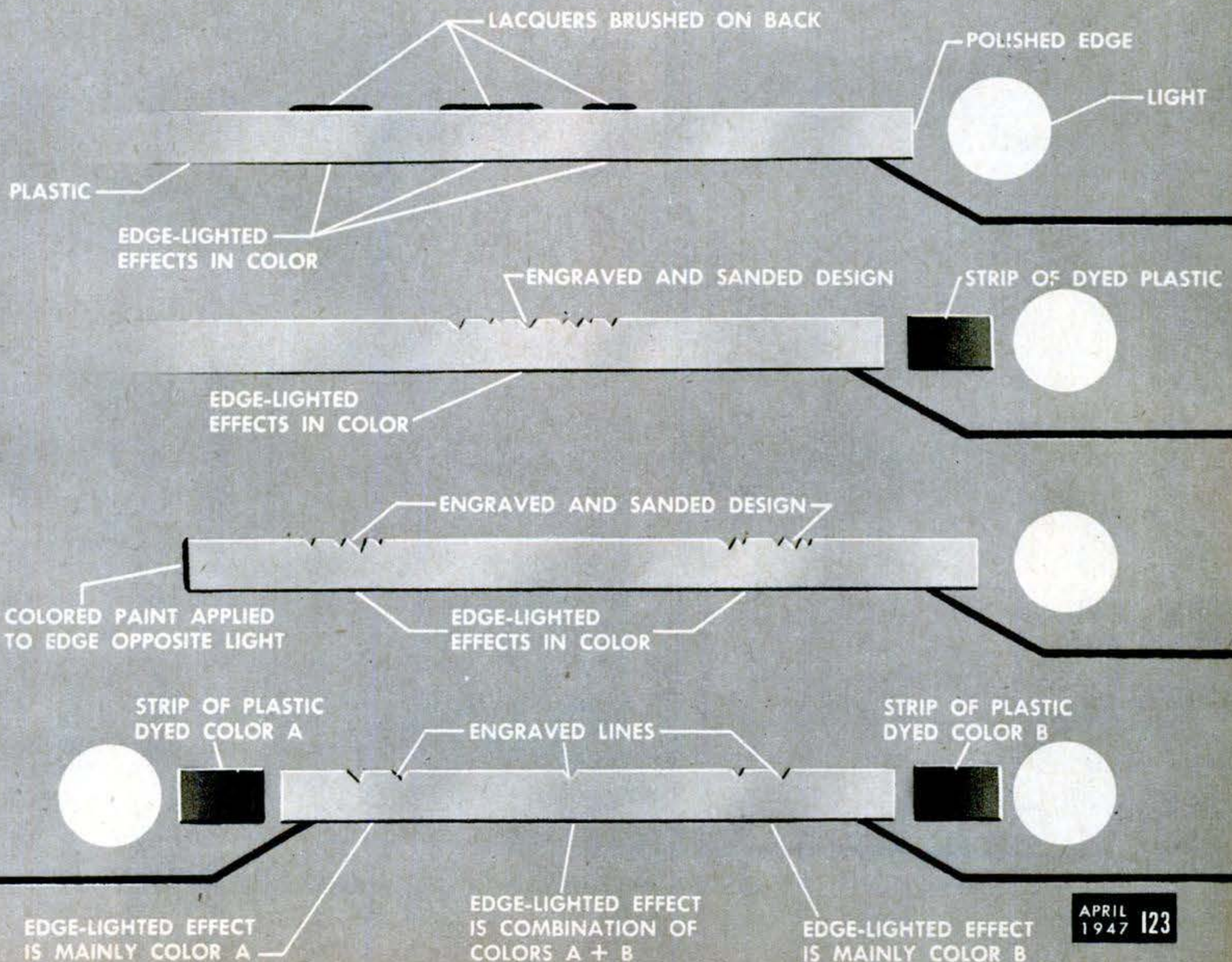





First step in making the plastic mural shown on the opposite page. Designer Jean Perkins, of the Endicott Corp. makes a full-size freehand drawing on tracing paper, using decorator's sketch as a guide.

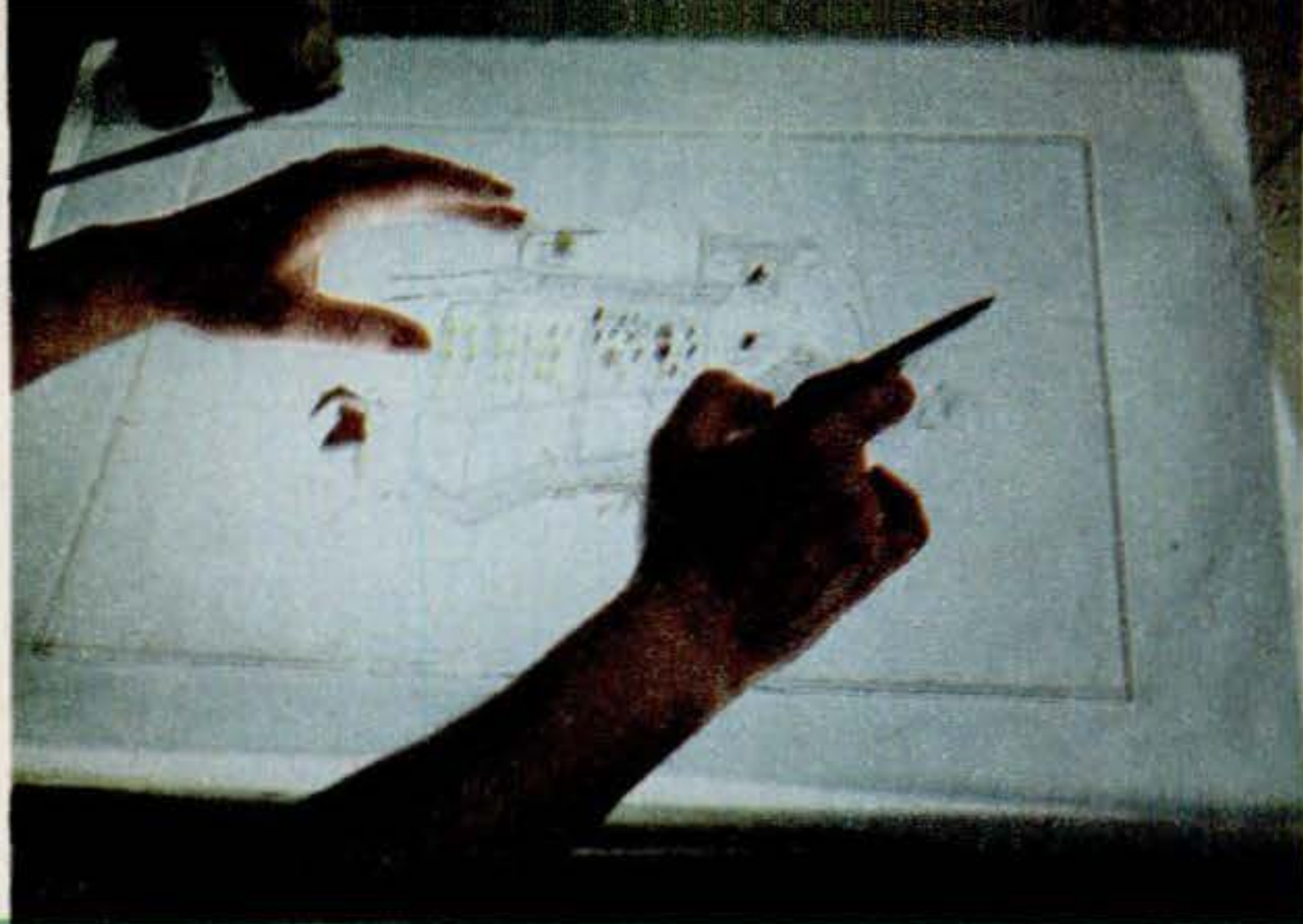

Next, the edges are polished on a sheet of plastic .187 inches thick, the protective paper is peeled off, and the sheet laid over the tracing on a light box. Then several lacquers are lightly brushed on.

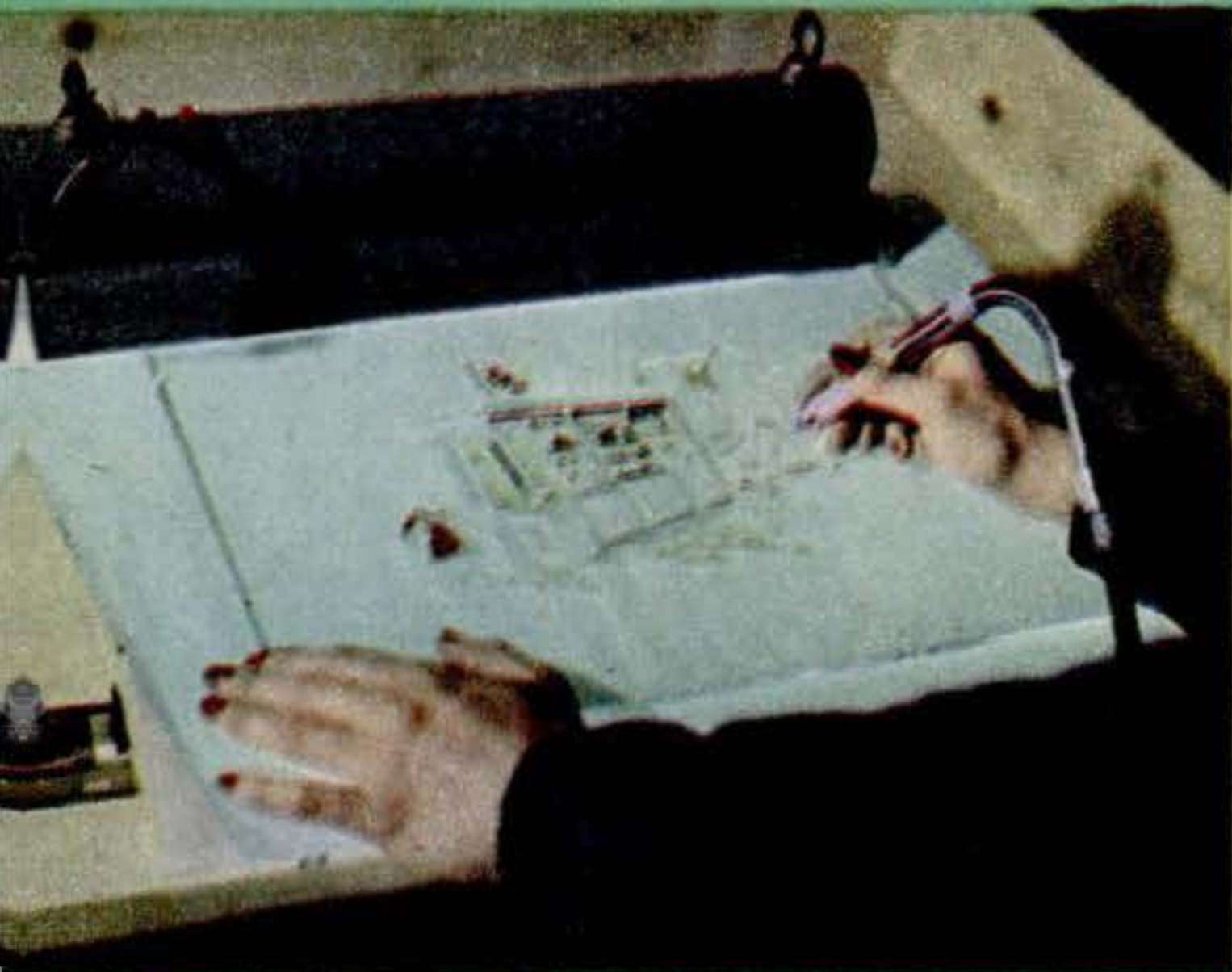

Lines are then engraved with a high-speed flexible-shaft tool, using a steel burr. The tracing serves as a guide. A shaded fluorescent lamp at the top of the sheet partially edge-lights it for this step.



With a small piece of medium-coarse sandpaper, Miss Perkins sands the parts that are to appear as light-toned areas. The panel is placed upon black cloth so that the sanded areas can be easily seen.



Now almost finished, the plastic panel is inspected by Brouning Marean, Jr., head of the Endicott Corp. Flaws of omission are easily corrected, but it is difficult to change what's already done.



After a final touching up, the panel is mounted in a shadow box (see page 126 for details of its construction) in front of another one painted a uniform blue color and also edge-lighted.





gradually increasing pressure against the panel, a point will occur at which this air seal is broken and the outline of your hand will appear in a ghostly glow. Paints and lacquers, or even strokes with a grease pencil, can be used as well as engraving and sanding to produce patterns of light.

This offers one way for designers of plastic murals to employ color. Lacquers can be brushed on the back of a panel, which will then spill light tinted according to the color applied in that area. A second color technique involves using opaque paint on the edge directly opposite the light source. Light then travels through the sheet, is reflected back by the painted edge, and emerges as colored light at the engraved lines. A third way to secure color is to interpose a strip of polished, dyed plastic between the light and the entering edge, a method that, like the second one, gives a single color everywhere light emerges.

Perhaps the trickiest coloring technique calls for the use of two lights and two dyed strips of different colors at opposite edges of the panel. As indicated schematically at the bottom of page 123, this results in a color blend that varies according to the relative distance of an engraved line from each dyed strip.

Depending on the purposes of the designer, various kinds of special backgrounds are used with edge-lighted sheets. The

simplest consists of a panel of smooth-surfaced composition board, painted to harmonize with the design and mounted close behind the plastic. Another background uses a second plastic sheet that is sprayed or silk-screened to an even color. When this background panel is itself edge-lighted, a bright, luminous tone appears behind the main design to emphasize it or set it off. The use of several sheets of plastic in sandwich form gives endless chances for variation, including three-dimensional scenes and pictures in which parts of the whole can be made to appear or vanish at the flick of a switch.

Experiments with edge-lighting show that the best light source is an incandescent bulb with a long filament. However, since very long bulbs of this kind aren't generally available, and since they generate considerable heat, fluorescent lamps are frequently used instead.

Certain special problems confront the designer of an edge-lighted plastic decoration. The acrylic resins have a fairly soft surface and must be handled with great care to escape scratching. (Scratches will of course edge-light as conspicuously as the design.) One advantage of luminous backgrounds is that they tend to drown out the minor scratches that occur almost inevitably in handling. This softness of the plastic also means that in such applications



as table tops, the plastic must have a protective pane of glass over it.

Another limitation springs from the fact that the total light available is necessarily limited—though it should be as bright as possible to avoid being blanketed by light from other sources. The light that can spill from any single engraved line is controlled by the intensity and distance of the light source, the thickness of the plastic (the thicker the better), the squareness of the entering edge, and, particularly, the amount of light that has been taken off the panel elsewhere. A deep V-cut that is half the total thickness of the sheet will approximately halve the amount of light available beyond it. This means that the design must be carefully contrived to deliver enough light to the heavy lines that need it and yet not starve other lines. **END**

The shadow box, a rectangular sheet-metal casing, is used to display the mural in a hotel or restaurant. Below, holes are drilled through a template.

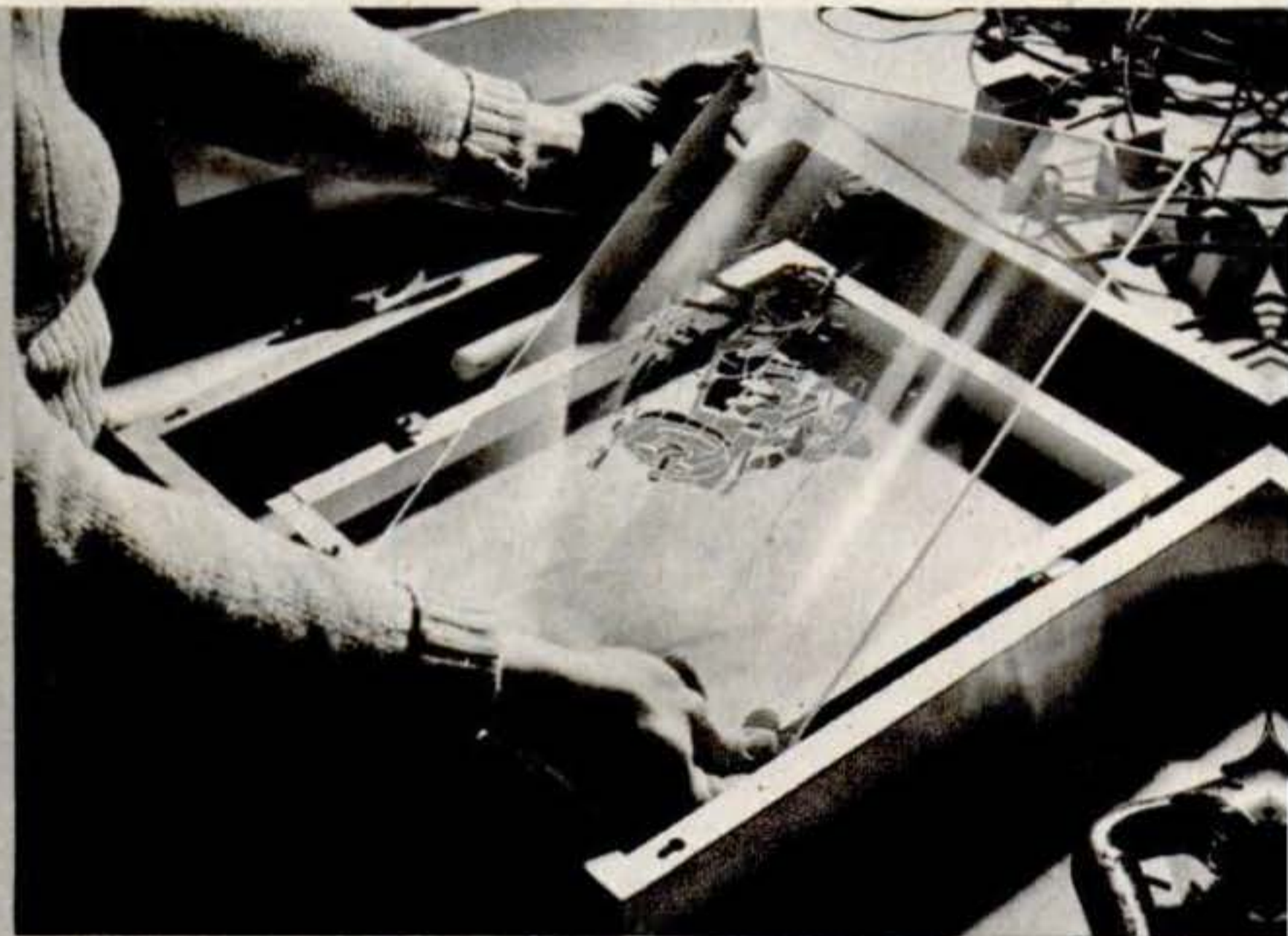
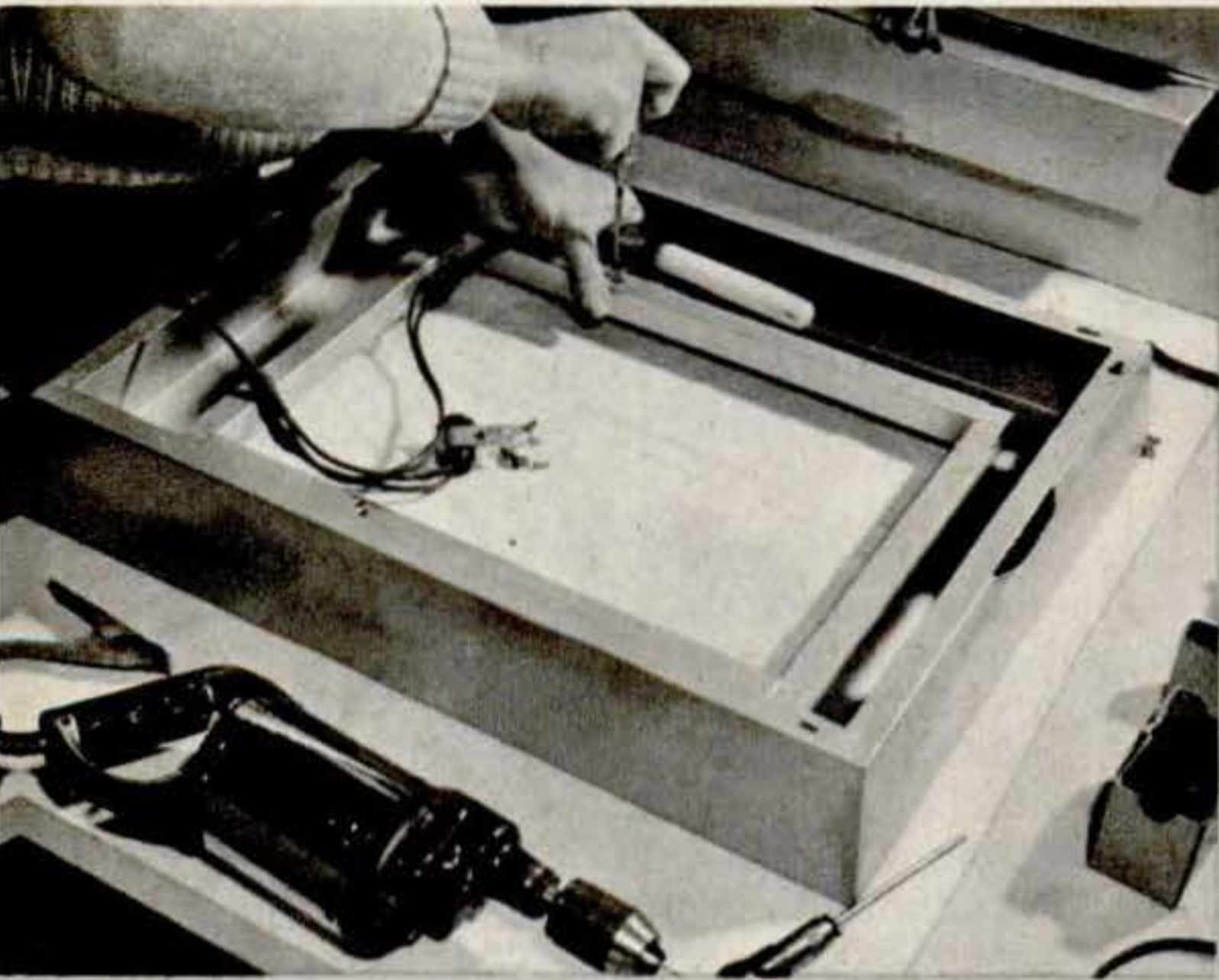
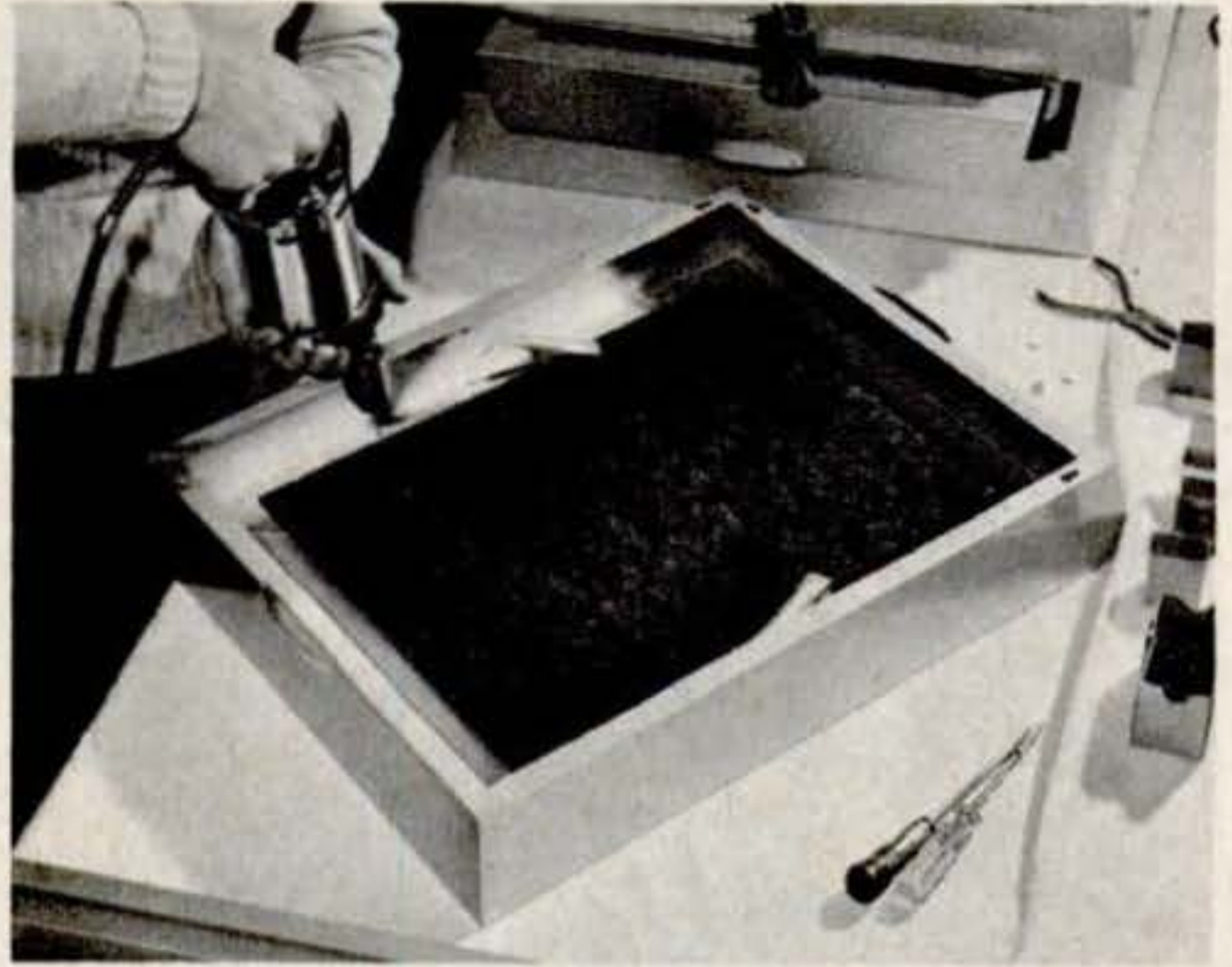

Two tubular incandescent bulbs are sufficient to edge-light the plastic sheet to go in this box. A clip is screwed to the internal lip, left above, so as to hold the socket in the same plane as the edge of the panel. Right, the engraved and painted plastic is slid into place, where it will be held snugly by several U-shaped clips. The engraved side must face to the back to have maximum brilliance of edge-lighting.

A background piece of colored glass fiber is inserted behind the plastic, below left, and the wiring to the two lamps installed. Final step in the assembly is to screw on a backing of sheet dural, right. The two slots at the ends of the shadow box, which are concealed when it is turned over, are to dissipate the heat created by the lamps. If ventilation were not provided, the temperature inside the box might build up to a degree high enough to harm the plastic.

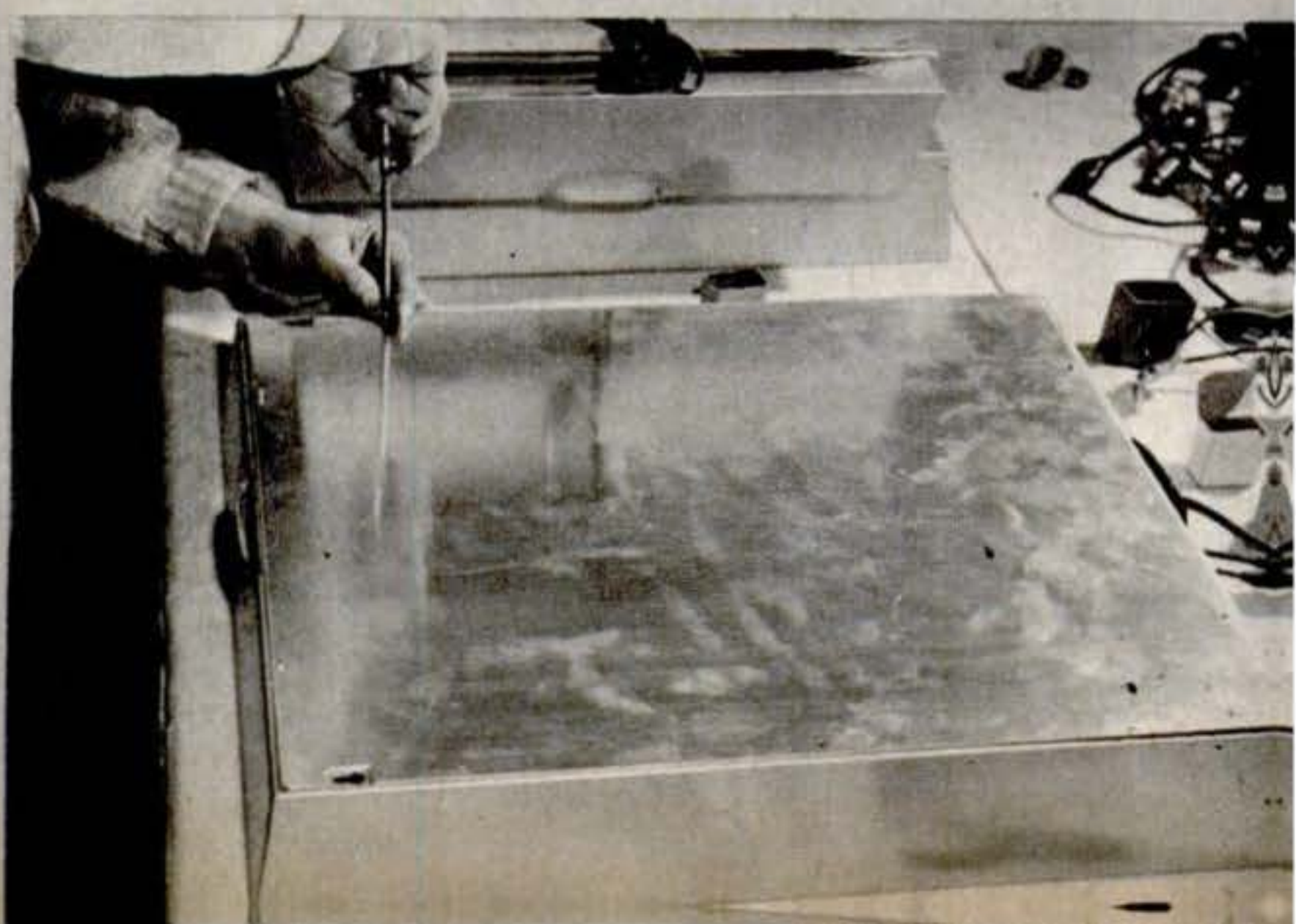



Everybody has his own pet idea of some gadget he would like to see in general use. What is YOURS? *Popular Science Monthly* will pay five dollars for every such suggestion that its editors decide to publish.

# I'd like to see them make

Cartoons by SYD LANDI



**Nose Warmer.** It would be a lot more comfortable if earmuff makers added a puff for the nose, thinks Ann Lindhardt, of San Juan Pueblo, New Mexico.



**Hair Catcher.** An electrically charged plate for barbers that would make hair stand on end and attract all the clippings is the dream of H. W. Bull, of Midland, Mich.



**Great Leveler.** To place everyone on the same level while sipping sodas or eating hamburgers, Lloyd Griep, of Watertown, Wis., wants adjustable counter seats.



**Firefly Print.** For reading after sundown, Joseph Lee Coy, of Danville, Ky., would like to see books printed in ink that would "glow in the dark."



**Hush-Hush Wrappers.** Movies can be spoiled by the crackle of candy bars being unwrapped, so Eugene Anchese, of Dorchester, Mass., wants "silenced" wrappers.



**Juice Trap.** The eyes of the nation would be thankful for a dish with a guard to ward off squirts from grapefruit, says William Howie, of Longview, Wash.





**COMBINE THAT PULLS ITSELF.** This self-propelled McCormick-Deering harvester-thresher can be operated by one man when it is equipped with a grain tank or by two men when equipped, as shown, for bagging the grain. It is driven by a six-cylinder engine and has four speeds forward.

**TRACTOR FITS IN ORCHARDS.** A narrow tractor and offset disk harrow are combined for cultivating between the rows of orchards or vineyards. Plowing and harrowing are done in a single operation, and the two rows of disks leave a smooth surface.





# THREE-HULL BOAT

**T**HRILLING speed and safety are combined in the tri-maran, modernized adaptation of primitive outrigger sailing craft of the South Seas. Designed by Victor Tchetchet, New York artist, the aquatic novelty rides on three floats, instead of the two of a conventional catamaran. pontoons at each side of a canoelike center hull make the boat virtually noncapsizable. A pioneer 24-foot model, easily handled by one or two sailors, attains up to 22 miles an hour in a stiff breeze. Serving as a sailboat or a bathing raft, it accommodates 12 persons. Forty-footers are planned.

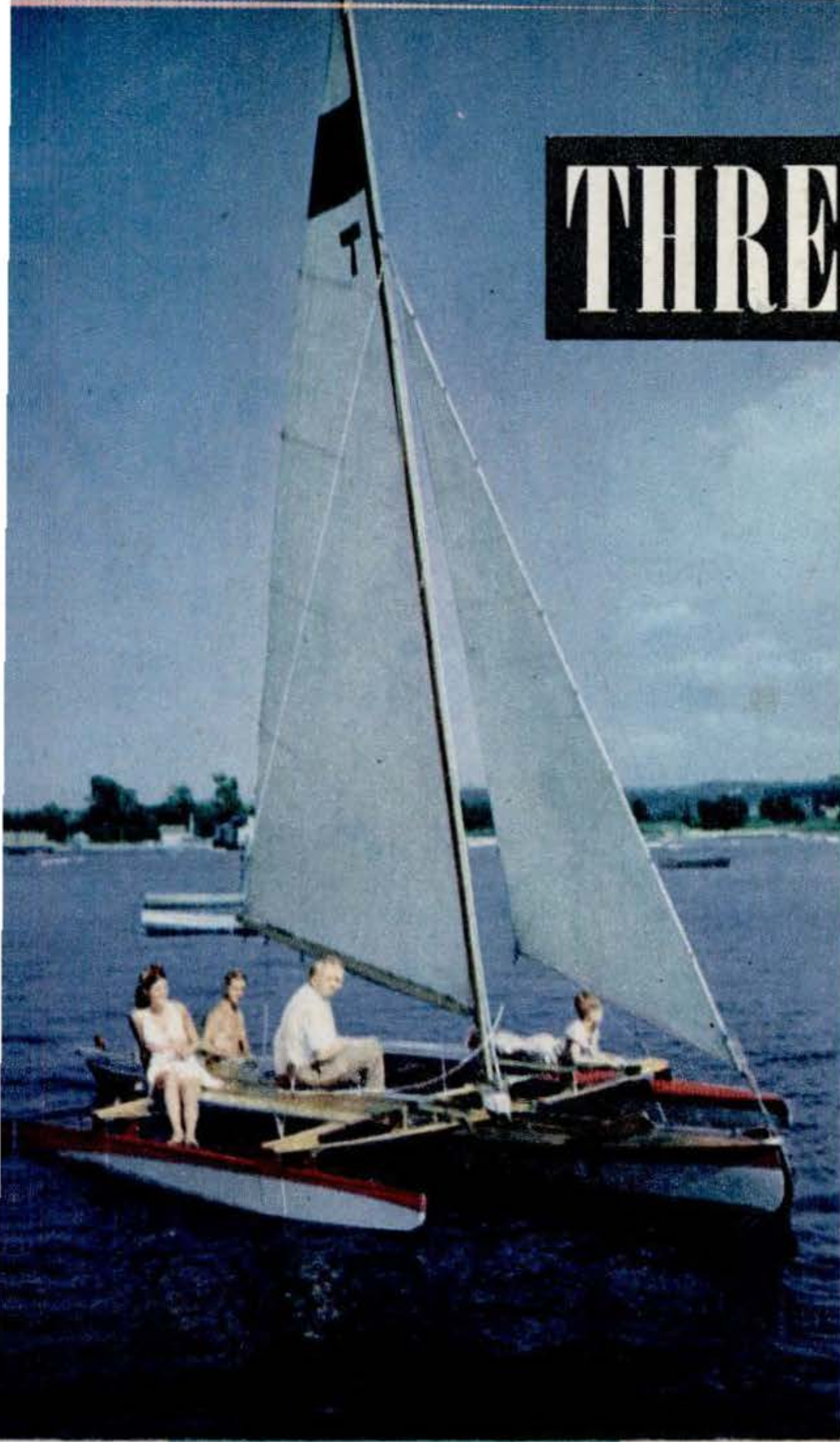

All of the family are safe aboard the tri-maran, above. This 24-foot, V-bottomed model carries 200 square feet of canvas. Light weight and shallow draft make it possible to beach the craft like a canoe after a sail.

Platforms astride the outriggers of the tri-maran, augmenting the passenger capacity of its center hull, serve as decks for sun-bathing or diving. A tiller extension to the outboard rudder permits the boat to be steered from the center hull or from either deck.





**NEW IDEAS**  
from the  
**INVENTORS**

**Blower "Shovels" Grain.** For loading and unloading grain or other granular materials, Milton O. Glessner has invented a combination blower and swivel-connected tube that can be mounted on a truck. The apparatus is connected to the truck's power take-off through a shaft and universal joints. A loading attachment enables the device to transfer material stacked on the ground, or stored in a granary, to the truck.

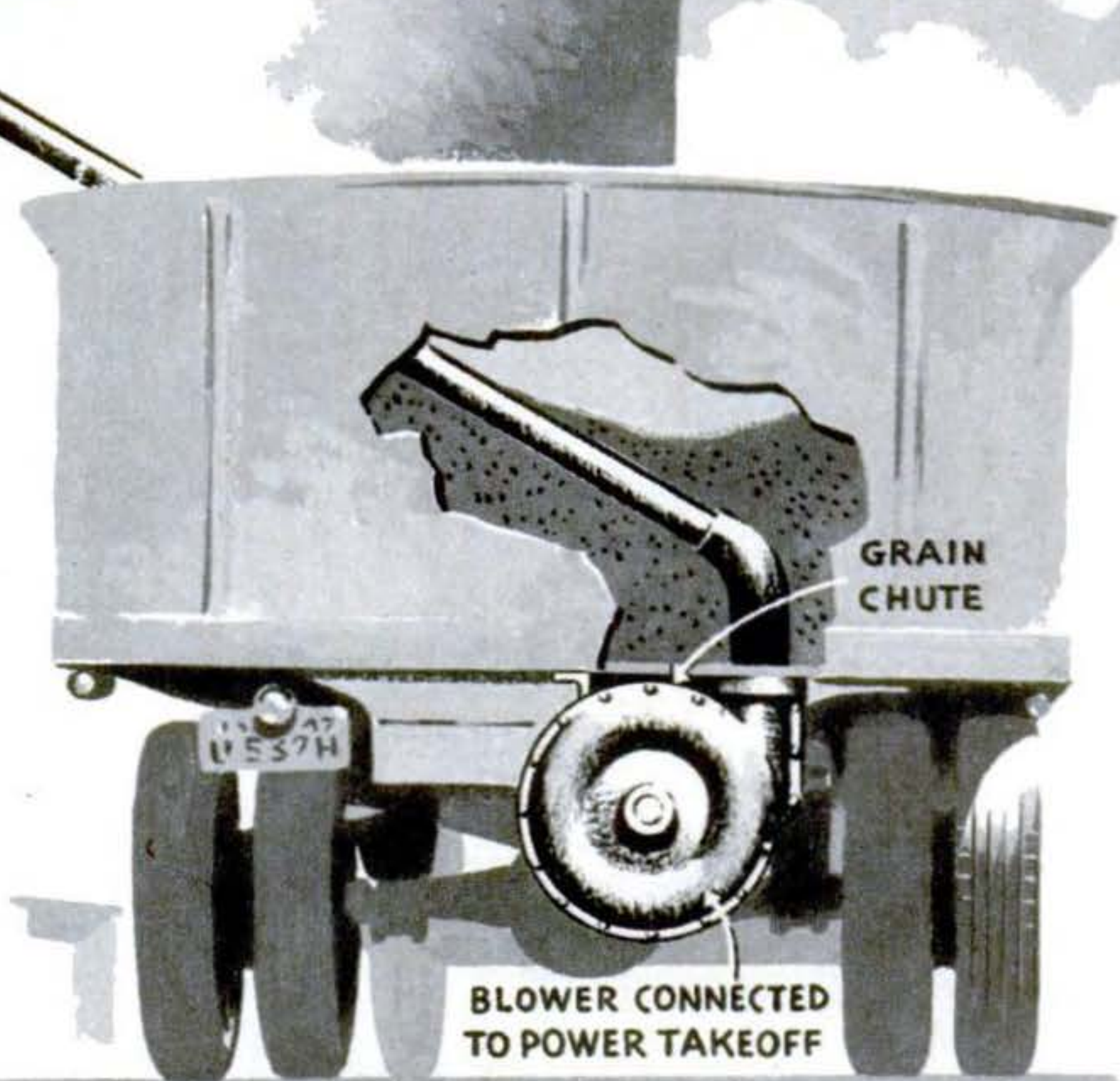

GRAIN CHUTE

BLOWER CONNECTED TO POWER TAKEOFF

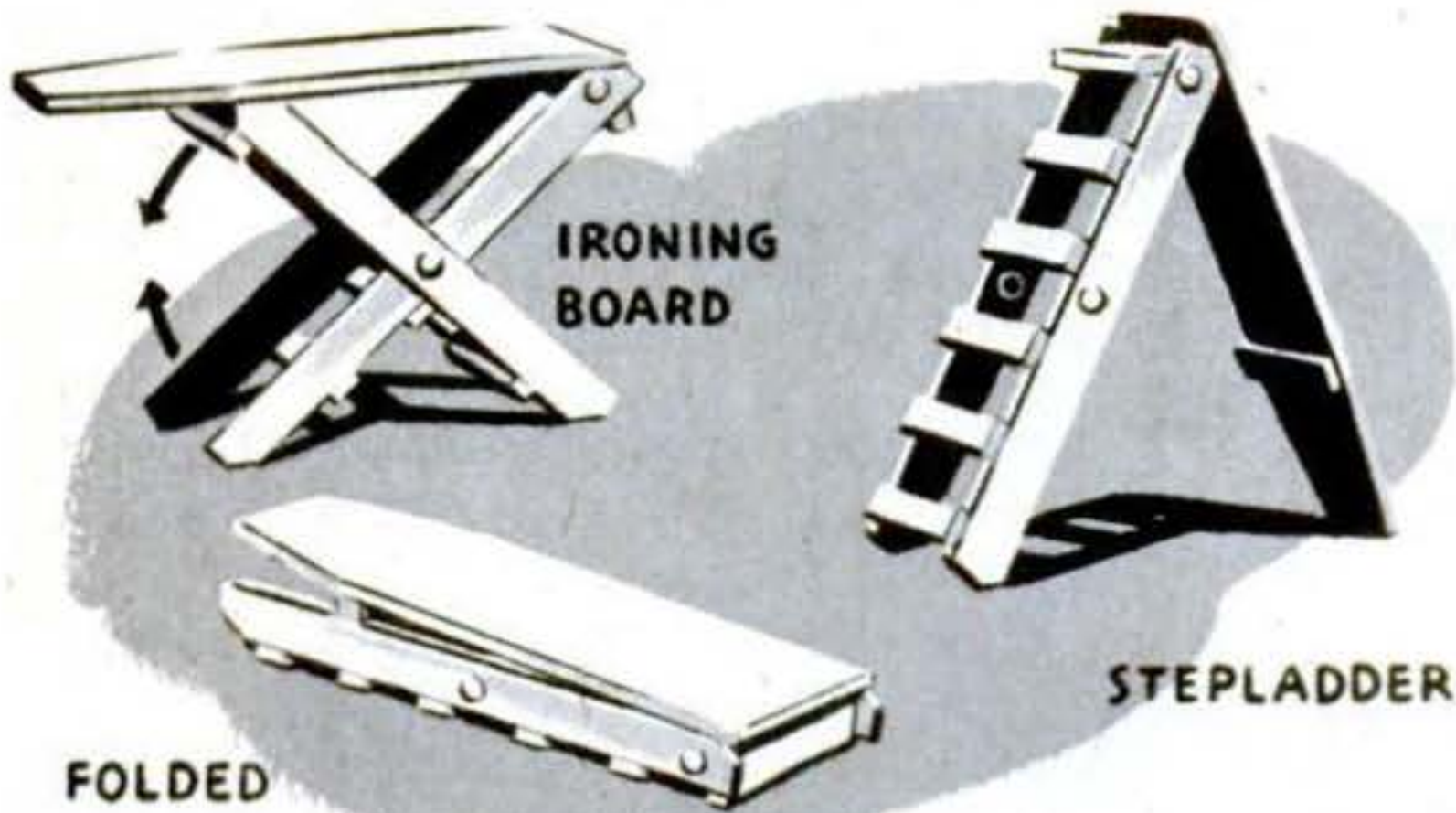

**Ironing-Board Ladder.** When the housewife isn't using the combination at the left as an ironing board, it can be converted into a sturdy stepladder by folding its legs and using the ironing surface as one of the ladder's supports. It can also be completely folded so that it takes up little room when put away. J. W. Mayhugh invented the device.

**Nozzle Caresses Plants.** A nozzle attachment for garden watering cans diffuses the flow of water into a light spray that covers a considerable area and will not harm delicate plants. The nozzle, invented by John Zvolanek, slips over the spout of an ordinary watering can. An angled plate, three times as wide as the can's spout, forces the water to spray upward. The nozzle can be turned to guide the spray in any desired direction.

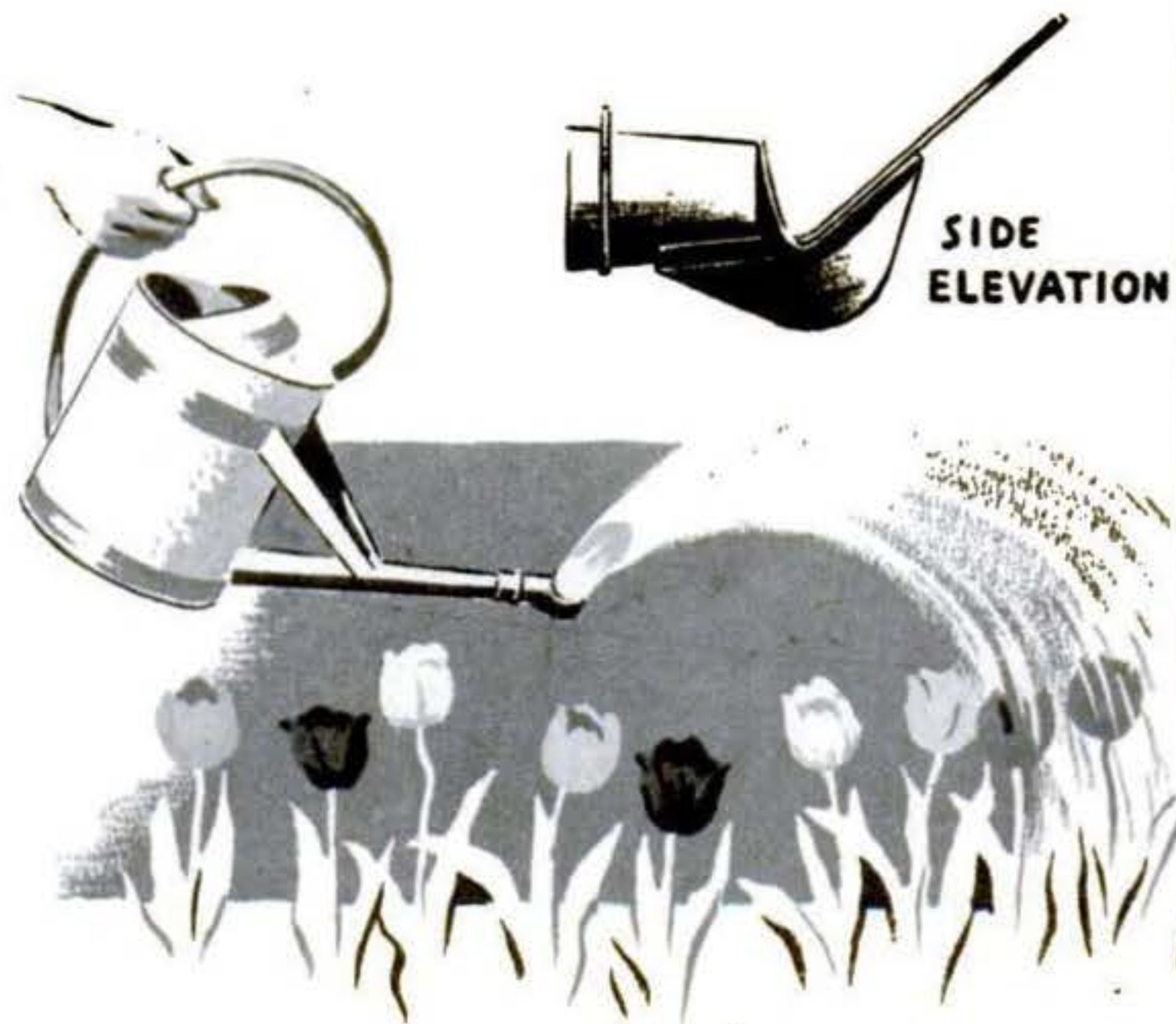



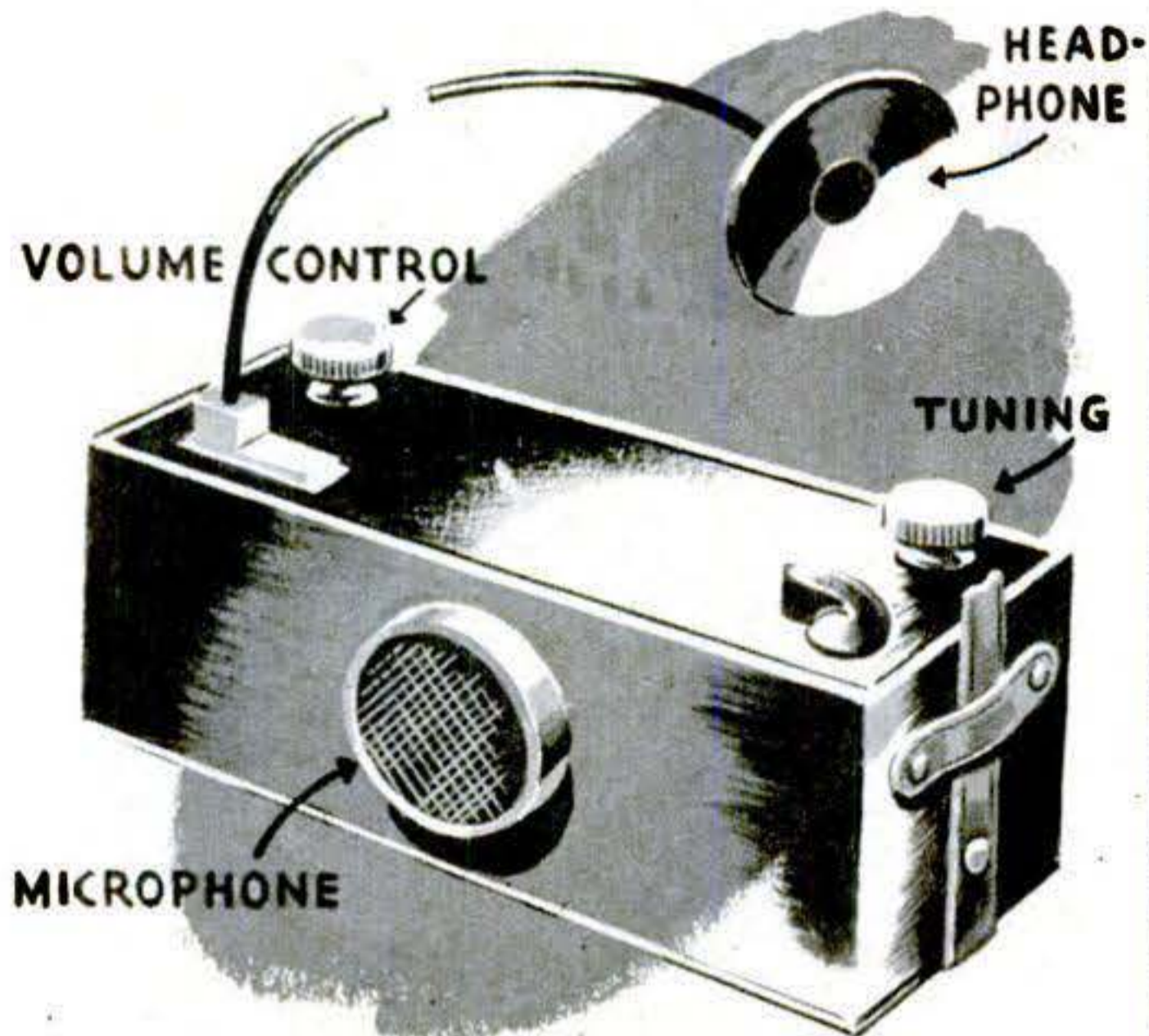

**Radio Is Also Hearing Aid.**

The combination hearing aid and radio receiving set above, invented by Thomas B. Fordham and Thomas W. Moore, has a superheterodyne receiver, a built-in loop antenna, a headphone and a microphone, so that two persons who are hard of hearing may also use it to converse.

**Worktable Refrigerator.**

The refrigerator at the right has a work surface that does not have to be cleared to open any of the four doors of its compartments. The door of the top compartment slides upward and the door of the one underneath it slips downward when a handle on the front of the refrigerator is moved. The other two doors are under the work surface. It was invented by Harold Van Doren.

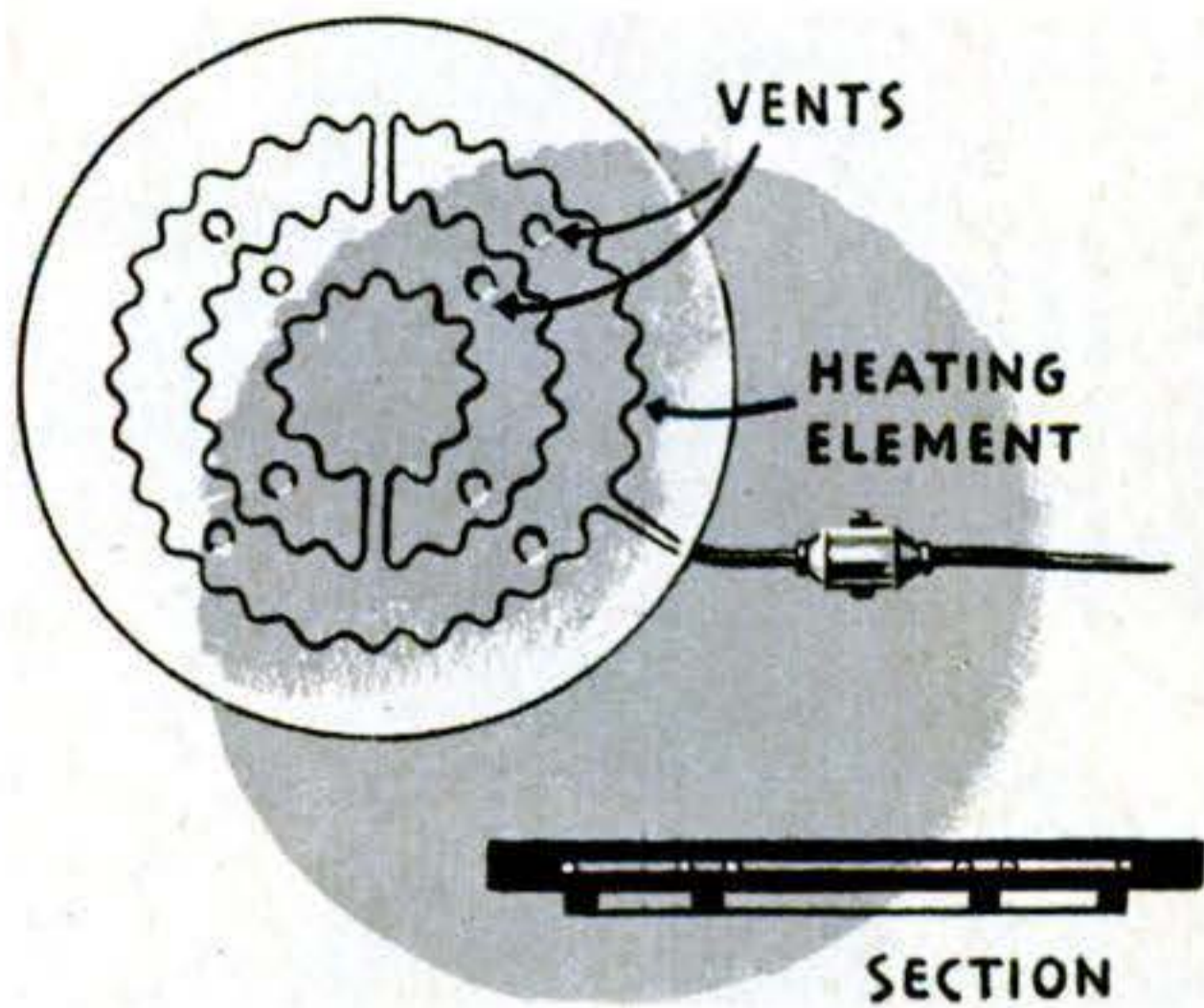

**Hot Plate Made of Glass.** By embedding circularly arranged wire coils in Pyrex glass, inventor John Bilan has devised a novel electric hot plate. The holes in the plate provide draft.

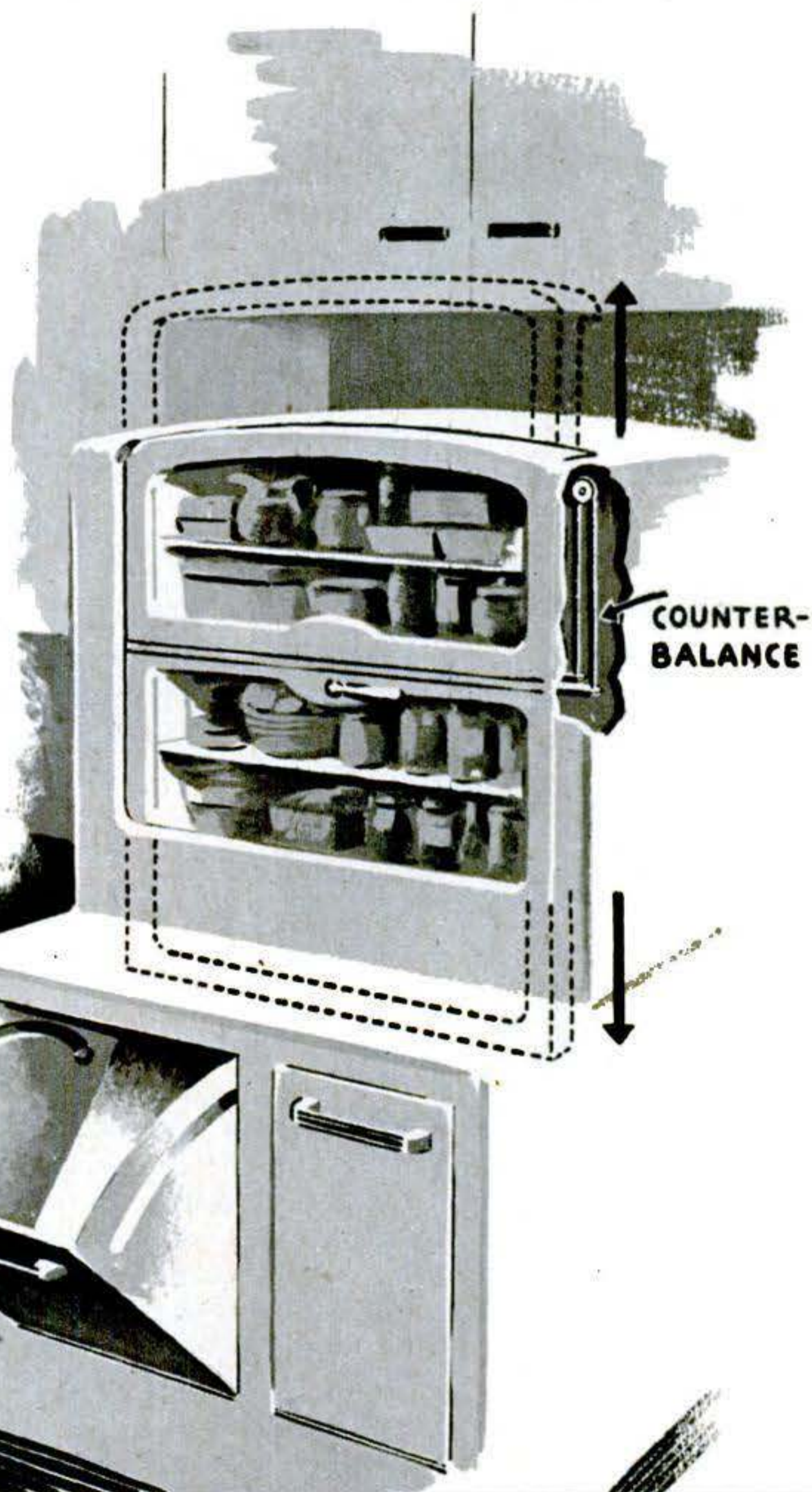





According to historical research, this is how Fort Pitt, situated at the forks of the Allegheny and the Monongahela rivers, appeared in 1763. The buildings painted on the backdrop depict barracks for troops. The miniature-maker is putting a model horseman in position—one of many steps required in planning a particular scene.

# Miniature Fort Guards Movie Budget

**N**OTHING spills dollars out of a movie producer's budget bag quicker than delays on the set after his cameramen have begun shooting the actual picture. So now, borrowing a practice increasingly favored by progressive industrialists, producer Cecil B. DeMille first builds his studio sets to scale in miniature so he can plot definite scenes, action and camera angles long before the cast and the technical staff for a picture go on the pay roll.

Recently DeMille had a scale-model, di-

minutive Fort Pitt built in Hollywood, and he studied it thoroughly before starting to film *Unconquered*. The model of the colonial fort's houses, fortifications and bridge was built 1/24 the size of the actual studio set. Its structures had removable parts that were lifted out for planning interior scenes and shots in the film's version of the 90-day siege of the fort in 1763, during the French and Indian War. Fort Pitt was built on the site of the modern city of Pittsburgh.





One of the scenes that cost less and came off more smoothly because it was first worked out with the aid of a miniature set is shown above. It pictures Seneca chief Guyasuta holding a white flag in his demand for surrender. The drawbridge in right background was built from the model in photo at right. Model is a reproduction of the counter-balanced drawbridge that protected Fort Pitt, constructed according to drafts found in the British Museum. Bridge's weight equals weight of a swing-down inner door. When door swings open, bridge is raised. A watch chain joins door and bridge in model.

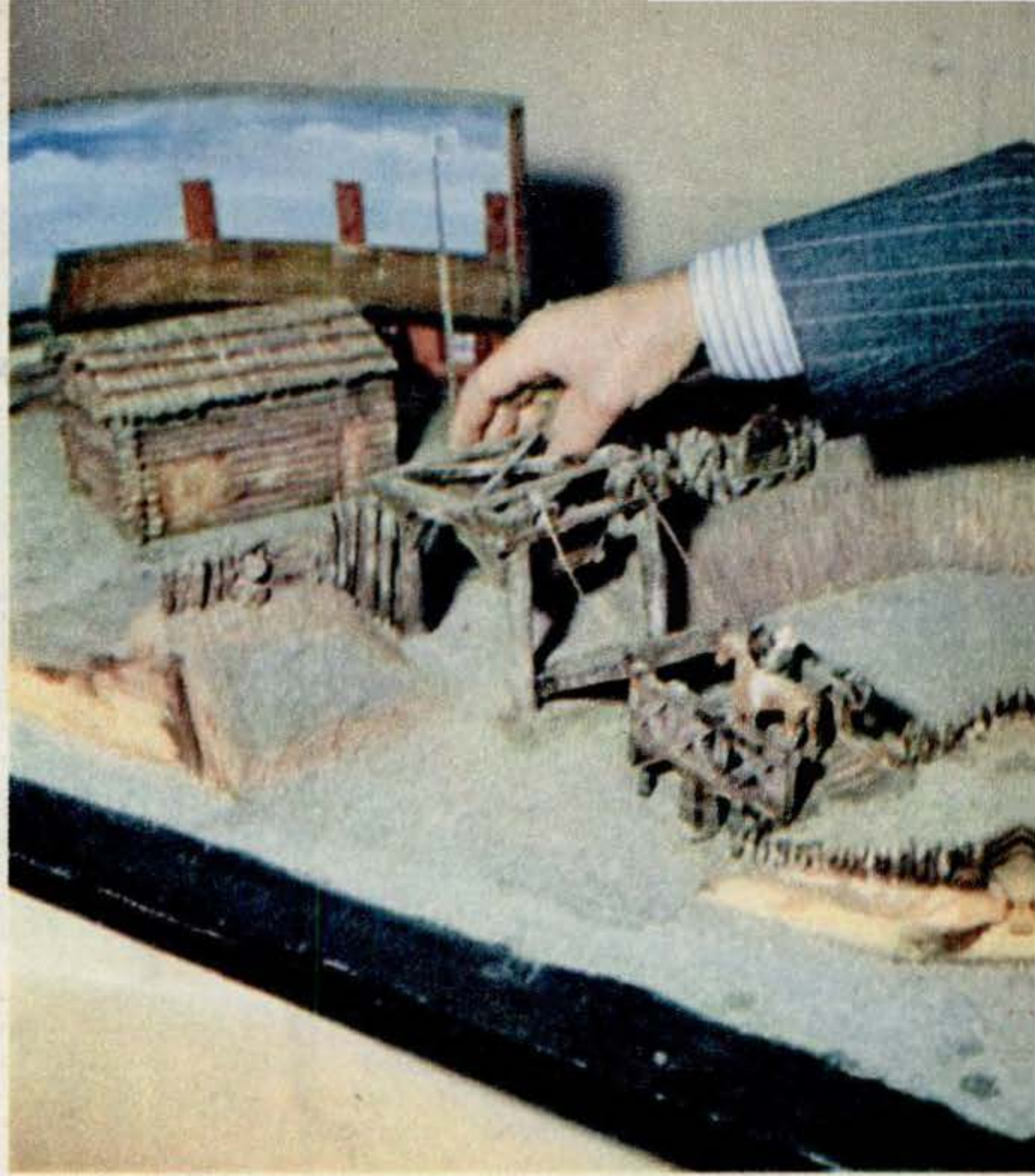

At right: A craftsman lifts one of the removable walls of an inn, called the Gilded Beaver Tavern in the movie. In his left hand are tiny ale casks, one of the interior props used in the picture. Miniatures of goods that were traded to the Indians for furs are glued to the shelves. The come-apart construction reveals how almost any sort of camera shot can be studied. As *Unconquered* is in Technicolor, all parts of the miniature set were painted to resemble the full-size version. Even ocean-going ships and river boats appearing in the film were first mocked up in 1/24-size models. Below: An interior shot of the tavern, as it appears in the film.





# MODELS Help Make Industry Tick

Modelmaker Chesebro working on his most complicated project, a scale model of a 10,000-kw. power plant mounted on two railroad cars. Scale was  $\frac{1}{2}$  inch to the foot. Below is the model, which Chesebro and an assistant worked on for 10 months. Car on left carries boilers to power huge turbine generators in car on right.

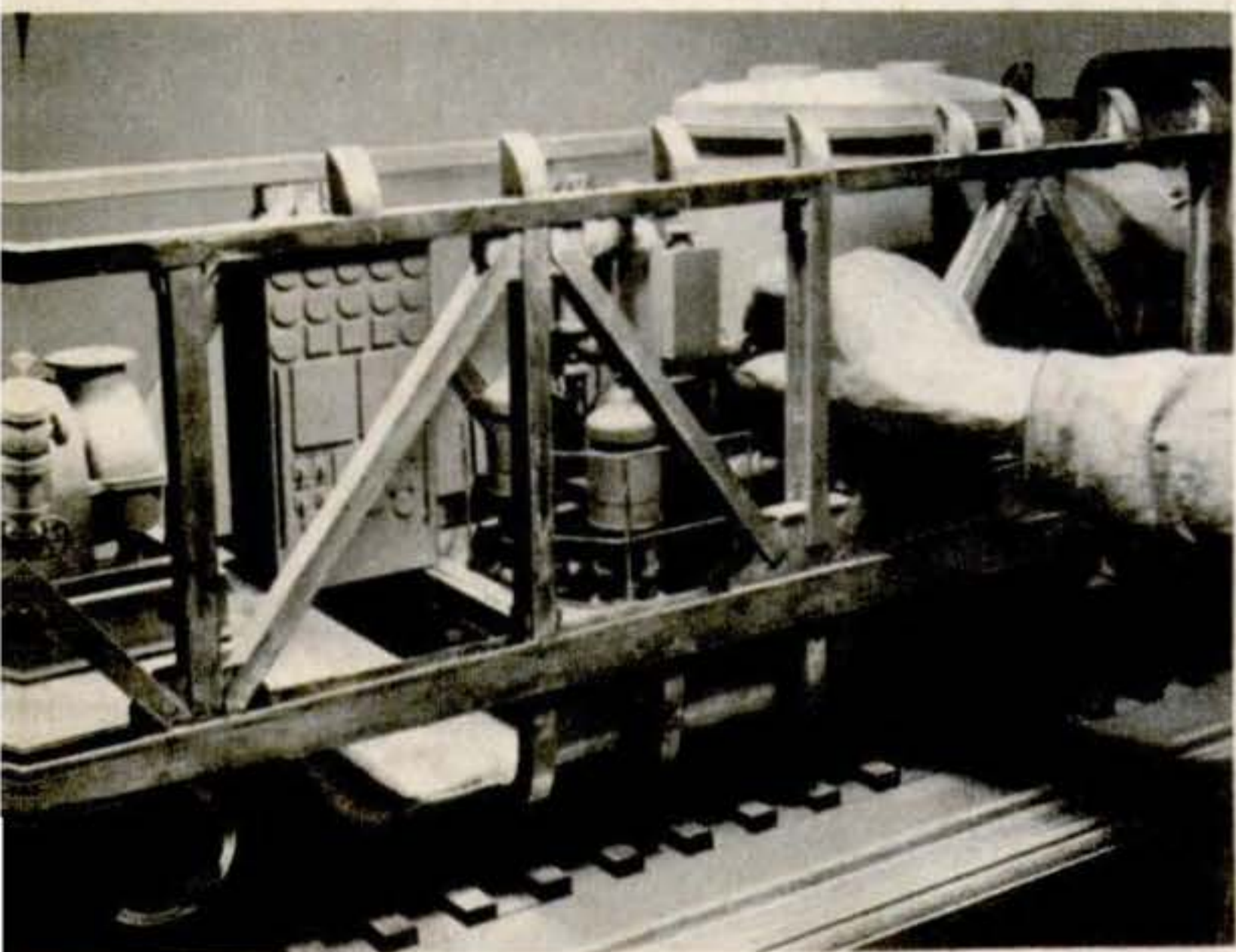
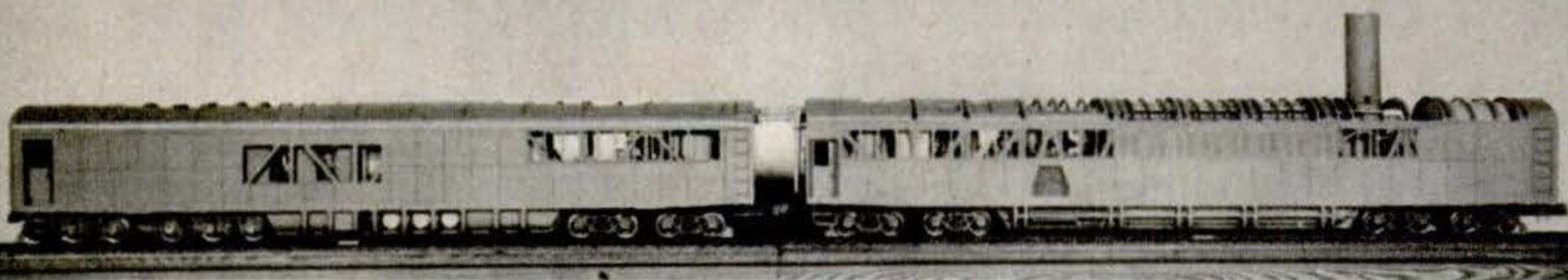

Setting a tiny valve in place on a turbine generator of the mobile power plant model. Built to supply emergency power for bombed-out cities, full-size mobile plant was never needed for original job but powered remote industrial installations.

**H**OWARD E. CHESEBRO'S job is a workshopper's dream: He makes exact scale models of everything from airports to appliance stores—and is paid for his fun. For Chesebro is General Electric's official modelmaker—and GE engineers have found that it saves time and money to have him turn their blueprints into three dimensions before building the real thing.

Chesebro's products range in scale from full size to  $\frac{1}{100}$  inch to the foot. His materials are equally varied: white pine for carvings, maple for wood turnings, brass and galvanized iron for structural members, white metal and aluminum for cast pieces. His outfit includes metal and wood lathes, sanders, circular saws, jointer planers, casting flasks—plus woodworkers' and machinists' finishing tools.

You'll find Chesebro any evening after work in a barn on his farm at Rotterdam, N. Y. But don't look for cows. The barn houses his home workshop. Chesebro spends his spare time making models.



Into the suitcase at right is packed an entire electric substation—Chesebro size. GE builds the big ones and GE's salesmen carry the little ones in their sample cases to show prospective customers. The model comes apart for ease in packing.

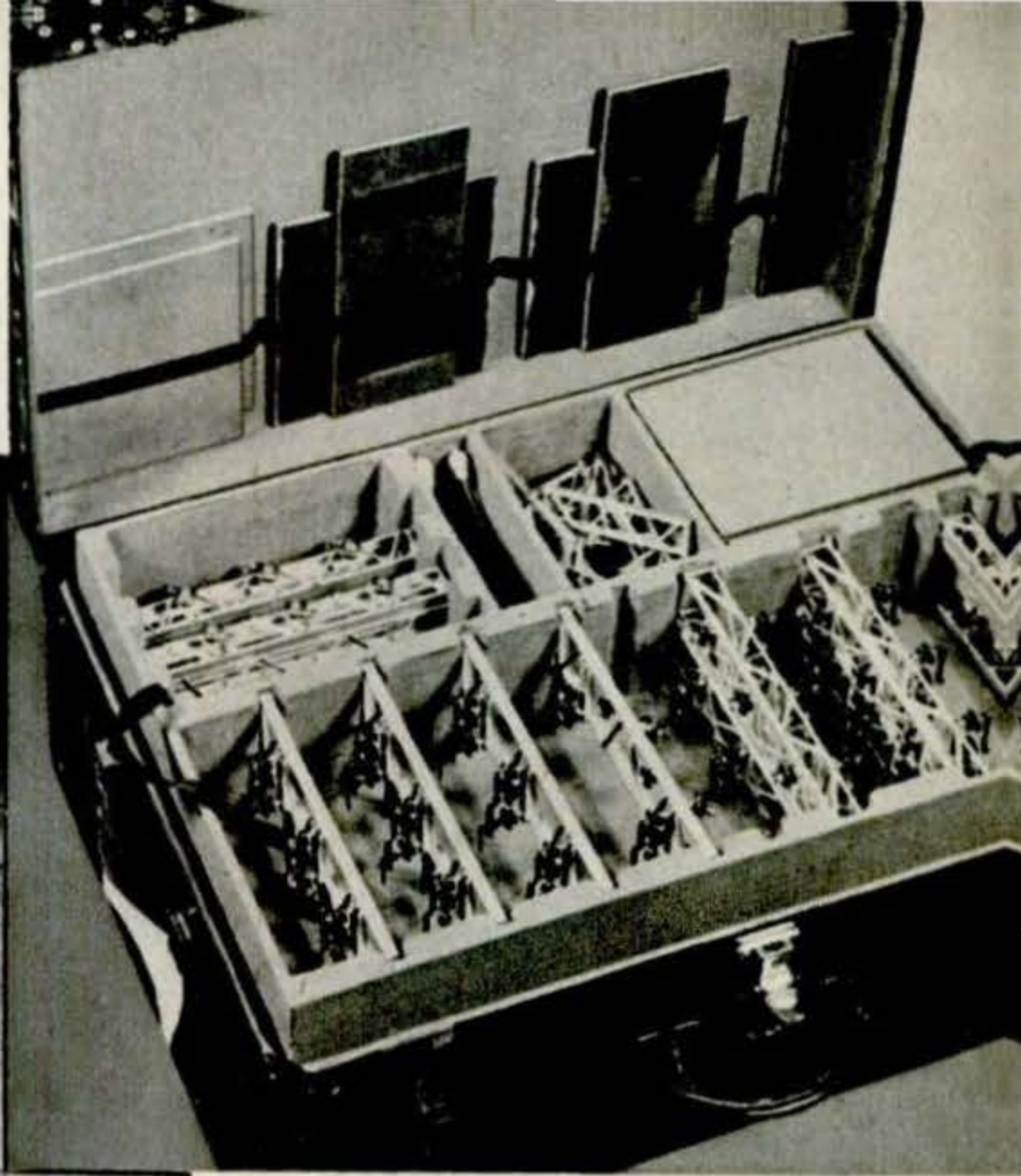
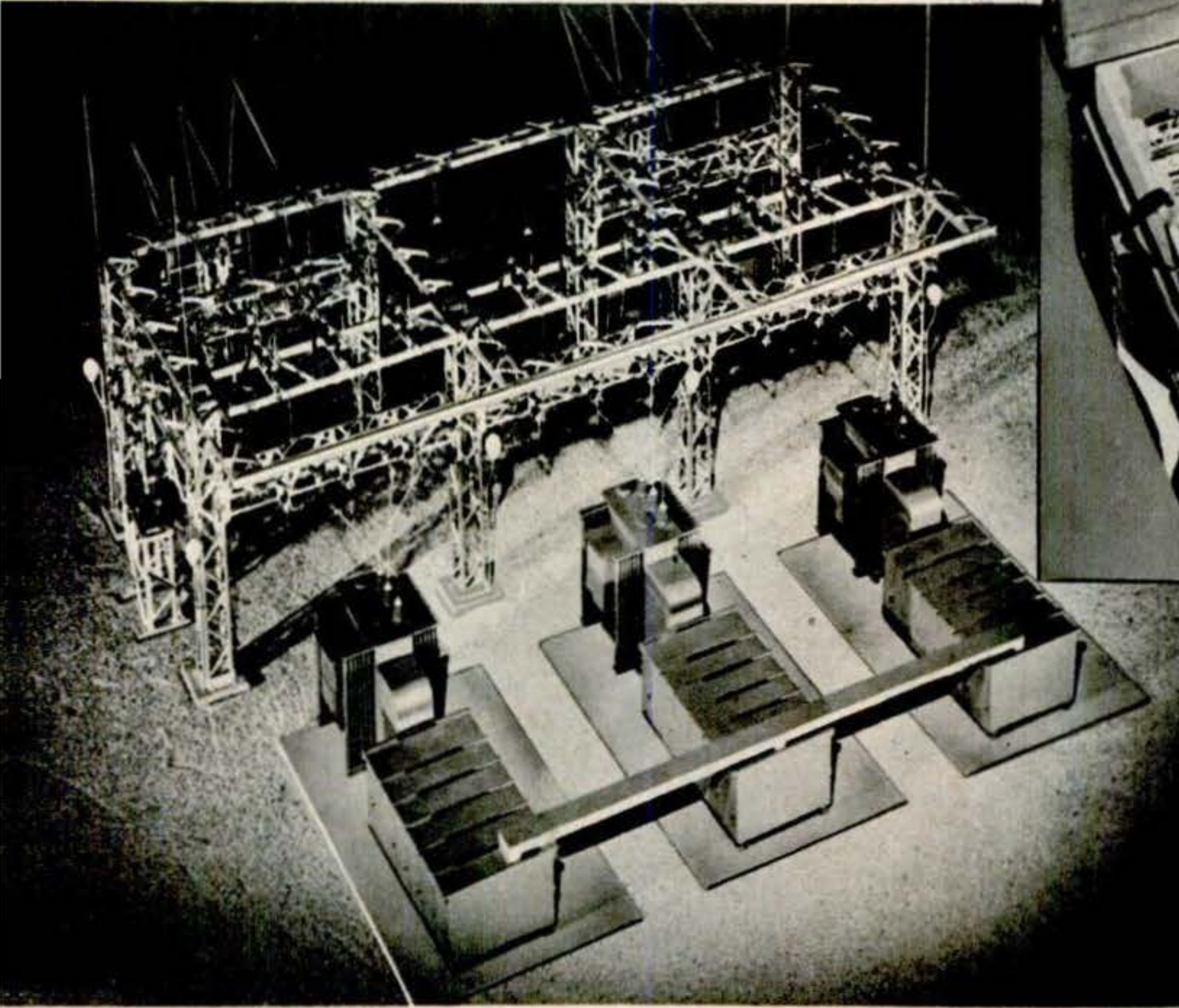

At left is one of the miniature substations set up for display. The transformers and cabinets are made of wood; superstructure rigging and wiring, of brass. The full-size plant, used for multiple subtransmission systems, is a low-voltage selective substation, 9,000-11,700 KVA.

Chesebro was the first person to see what the GE jet engine, built for AAF fighter planes, would actually look like. His model, really a full-size replica (below), was built in secret; the engine parts were locked in a safe every night with the plans. Engine replica was one of Chesebro's favorite jobs in his quarter-century career.

The complicated model below is a turbine room, scaled 1/2 inch to the foot, built by GE for a large Eastern power company. Chesebro took four months to construct the model, which gave customer an exact picture of the proposed plant and a chance to correct errors in the design. Wood, brass, aluminum, lead and Plexiglas went into it.

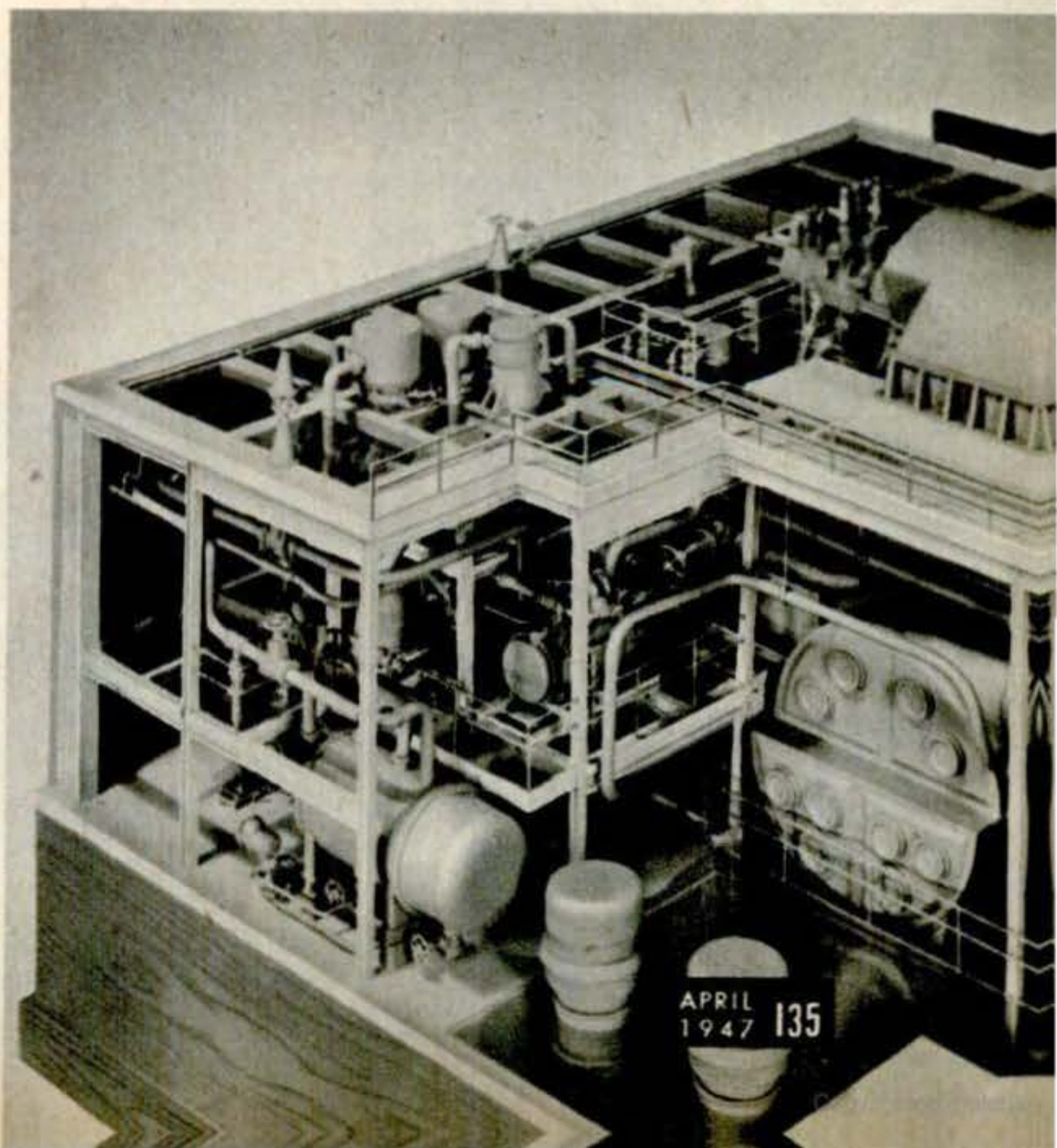
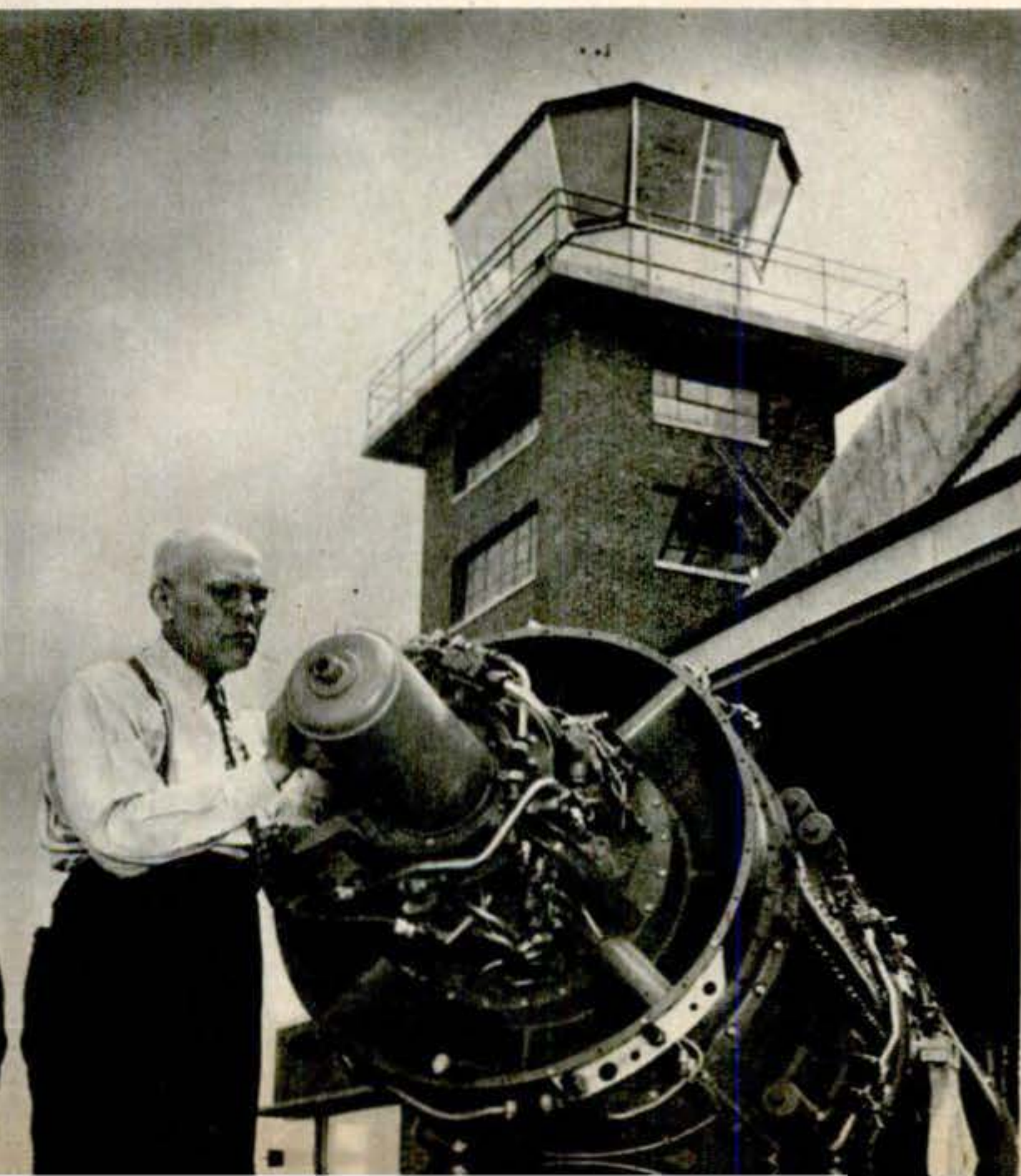



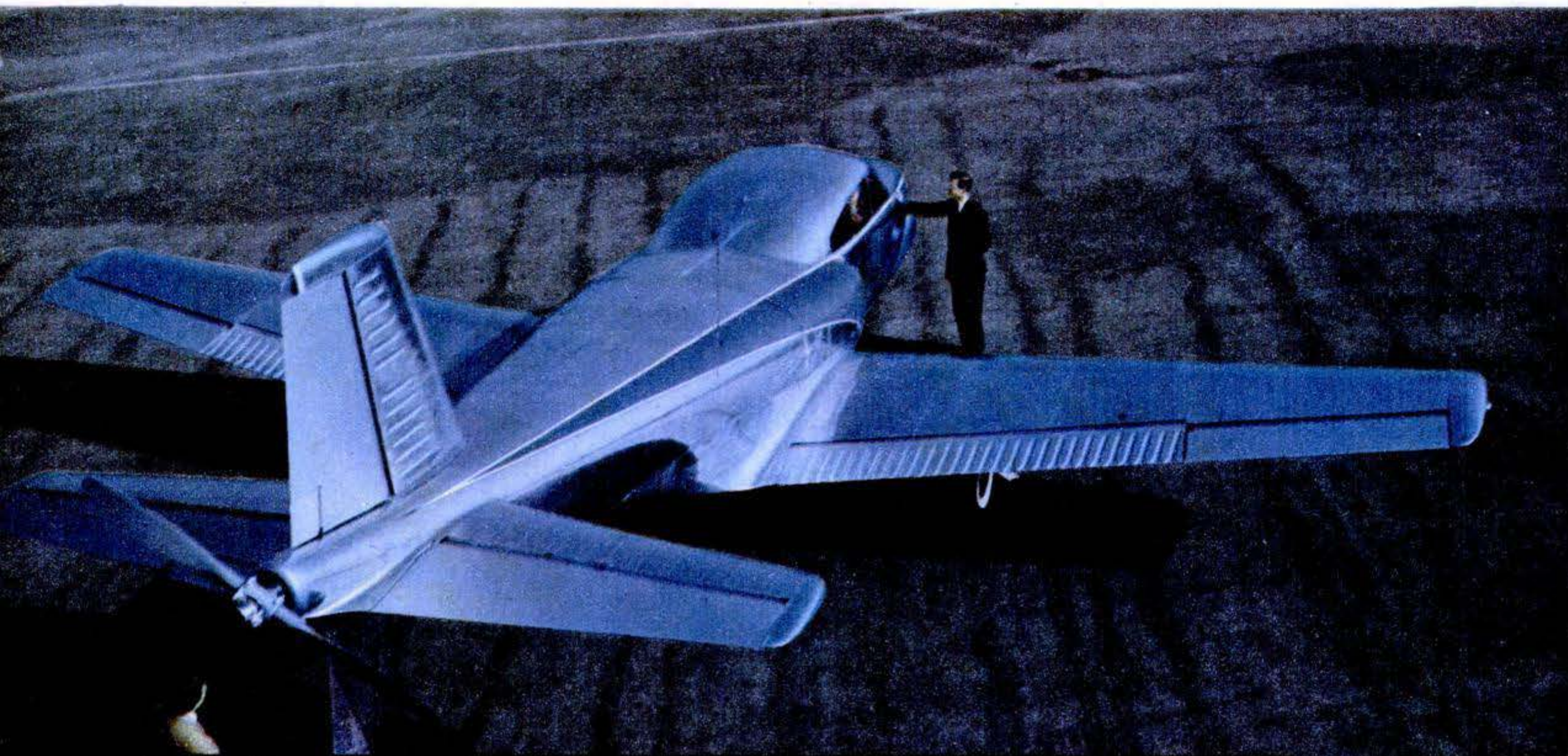

## 5-PASSENGER PUSHER

A rear view of the new Cloudster discloses an unconventional tail construction, with a vertical stabilizer projecting below the fuselage, as well as one above it. The plane is 35 feet long, has a wing span of 40 feet.

One of the two scoops for the air-cooled engines is visible in the wing root, just below the rearmost part of the cabin windows. The deep windshield and the cabin's position, forward of the wing, give good visibility.



**T**AKING the XB-42 Mixmaster as a partial pattern, Douglas Aircraft has produced an all-metal, five-passenger, propeller-in-the-tail airplane for executive use or for charter-operated service.

The Cloudster, as it is called, has two 250-hp. Continental engines housed inside the fuselage, and either or both can be used at will without departing from the center-line-thrust principle. Unlike the Mixmaster, which had counter-rotating propellers, the new plane has a single, eight-foot, two-bladed propeller.

With a service ceiling of 11,800 feet on one engine and 22,200 feet on both, the Cloudster carries its five passengers and 250 pounds of baggage 950 miles at 200 m.p.h. and has a maximum range exceeding 1,100 miles. The passenger compartment, forward of the low wing, affords extremely wide visibility; it seats two forward and three in the rear. The craft has retractable landing gear, with a steerable nose wheel for easy ground handling.

No price has been set for the plane, and Douglas says that no production plans will be made until it has completed an exhaustive flight-test program.



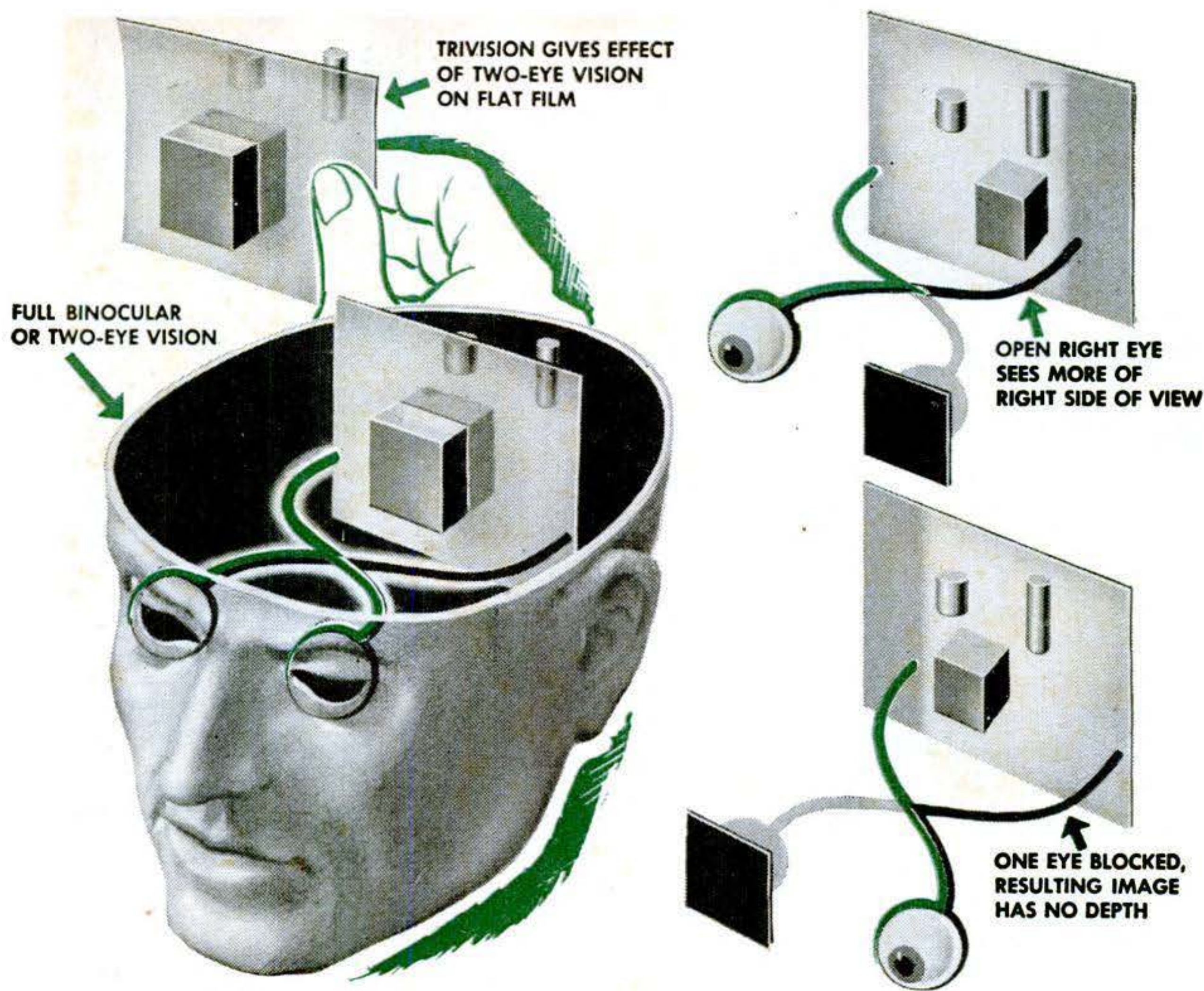

# 3rd Dimension Put Into Photos

By **HERBERT JOHANSEN**

**R**IDING to work on subway or bus some morning you're going to get the surprise of your life. You'll look up from your newspaper at an advertising card across the aisle. The familiar red-bandanna'd mammy—but her arms and the platter of golden-brown hotcakes she is holding will stick right out at you, so lifelike you'll be sure you can reach out and help yourself.

You will almost feel you can look around and see what's behind her. Without thinking, you will move your head to the left, and, by gosh, you can. That pitcher of syrup on the table wasn't there before. You will move your head back and the syrup pitcher will disappear behind mammy's ample form.

Blinking, and slightly befuddled, you will turn to another card, one showing a blond glamour gal sitting cross-legged in a chair,

lipstick poised to her cupid's-bow mouth. Shapely legs will project provocatively. Her boudoir will appear to recede into space out beyond the wall of the car. You will hold back a whistle as you move your head from side to side this time. Then you will whistle, for right in front of your eyes the glamour gal will rub the ruby-red lipstick around her mouth.

Three-dimensional photography, produced on a single surface and seen without a viewing gadget, will be sensational in advertising art. But the new Trivision, with its revolutionary characteristics of "movement perspective" and the ability to "see around" an object, has much more important uses. Already it has proved its value in the production of X-ray and clinical photographs in depth and color (PSM, Sept. '42, p. 88). Three-dimensional aerial photography, when perfected, will be of vast military impor-



tance; as a training aid the process will be invaluable; Trivision movies are on the calendar, and, according to the inventor, you can look forward to three-dimensional television.

Just when the public will be introduced to Trivision, its inventor, Douglas F. Winnek, doesn't say. At the moment, the Navy has priority on the use of his three-dimensional patents under a nonexclusive license. But when Trivision is released to civilian life, you'll see that it has some pretty remarkable characteristics, including:

Depth to such a degree that one can place a pencil point on an object—such as the center of a flower—and the petals will appear to project out and beyond the pencil;

The ability to give the illusion of seeing around and behind objects—that is, objects in the foreground appear to move in relation to objects in the background;

The ability to give the illusion of actual movement in a still photograph.

### Navy Backing Speeded Perfection

Because of the military value of these characteristics of Trivision—plus its simplicity in requiring only one lens and one exposure—the Navy Photographic Service has been working with Winnek on his three-dimensional process for several years. Since 1945, complete Trivision experimental equip-

ment has been under construction at the Aeronautical Photographic Experimental Laboratories at the Philadelphia Navy Yard. Thanks to this intensive war-born research and development, the process has outgrown its swaddling clothes with amazing rapidity. Now Trivision is about ready to make its commercial debut.

So, at 40, Douglas Winnek is within reach of the goal he set for himself 14 years ago. Although the Navy has given Trivision top priority on its photographic development program, and commercial enterprises are seeking licenses to his patents, Winnek, a self-educated man, calls himself a "goofy inventor." He is amused at being referred to in print as "a University of Rochester-trained optical engineer." He did study optics at Rochester—but he had to do it at night because he did not have a high school diploma. As a matter of fact, it was just recently that Winnek, on his way back from a trip to the West Coast, stopped off at the high school he attended in his native Madison, Wis., took some exams, and was finally graduated.

Winnek's process involves no new photographic principle in lens, camera or film processing. What is new is the film itself. Ordinary film does not pick up a three-dimensional image. Winnek's does.

It is ordinary black-and-white or color film—any standard emulsion can be used—

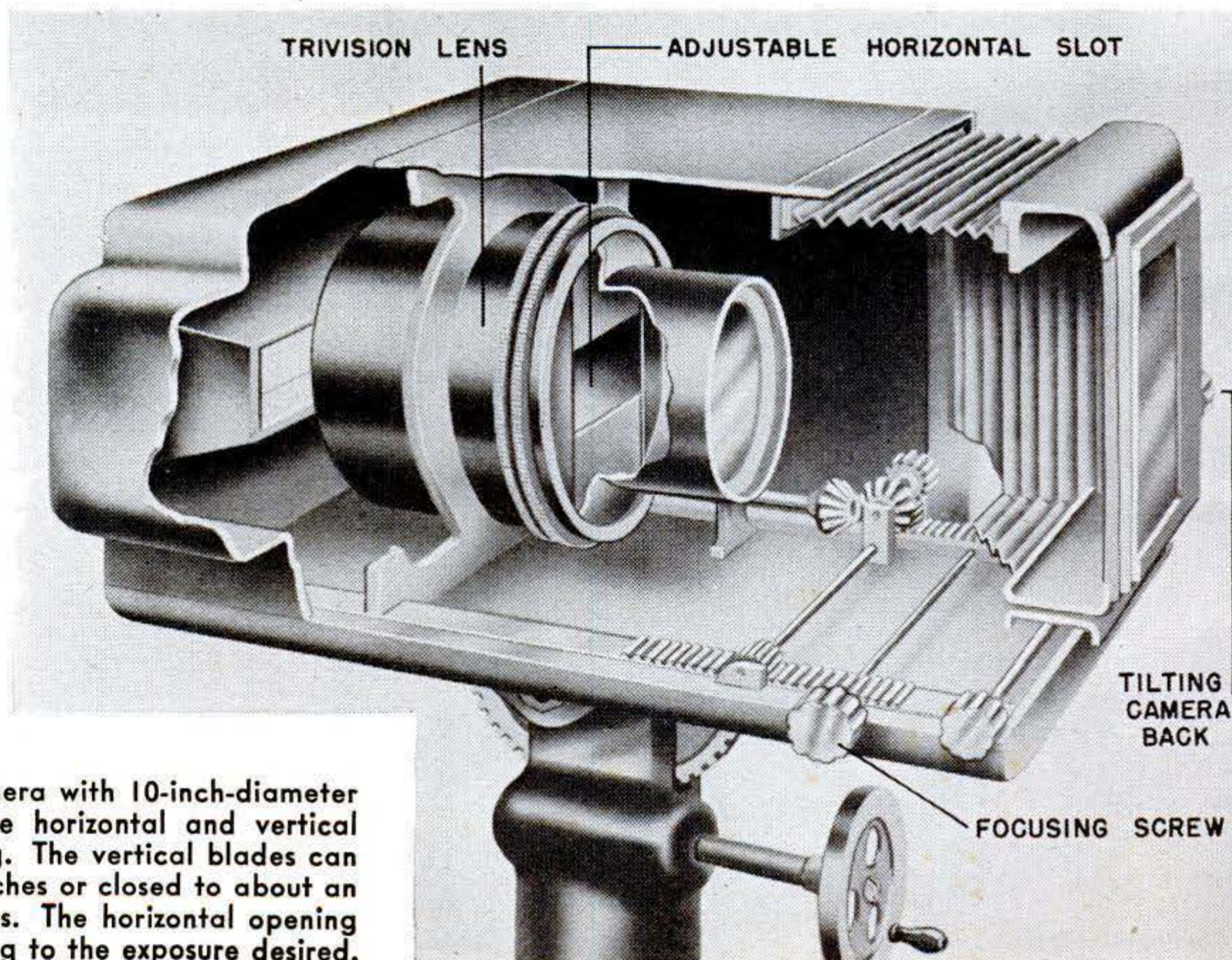

Cutaway of Trivision camera with 10-inch-diameter lens shows the adjustable horizontal and vertical blades that mask opening. The vertical blades can be opened to a full 10 inches or closed to about an inch for focusing purposes. The horizontal opening can be adjusted according to the exposure desired.



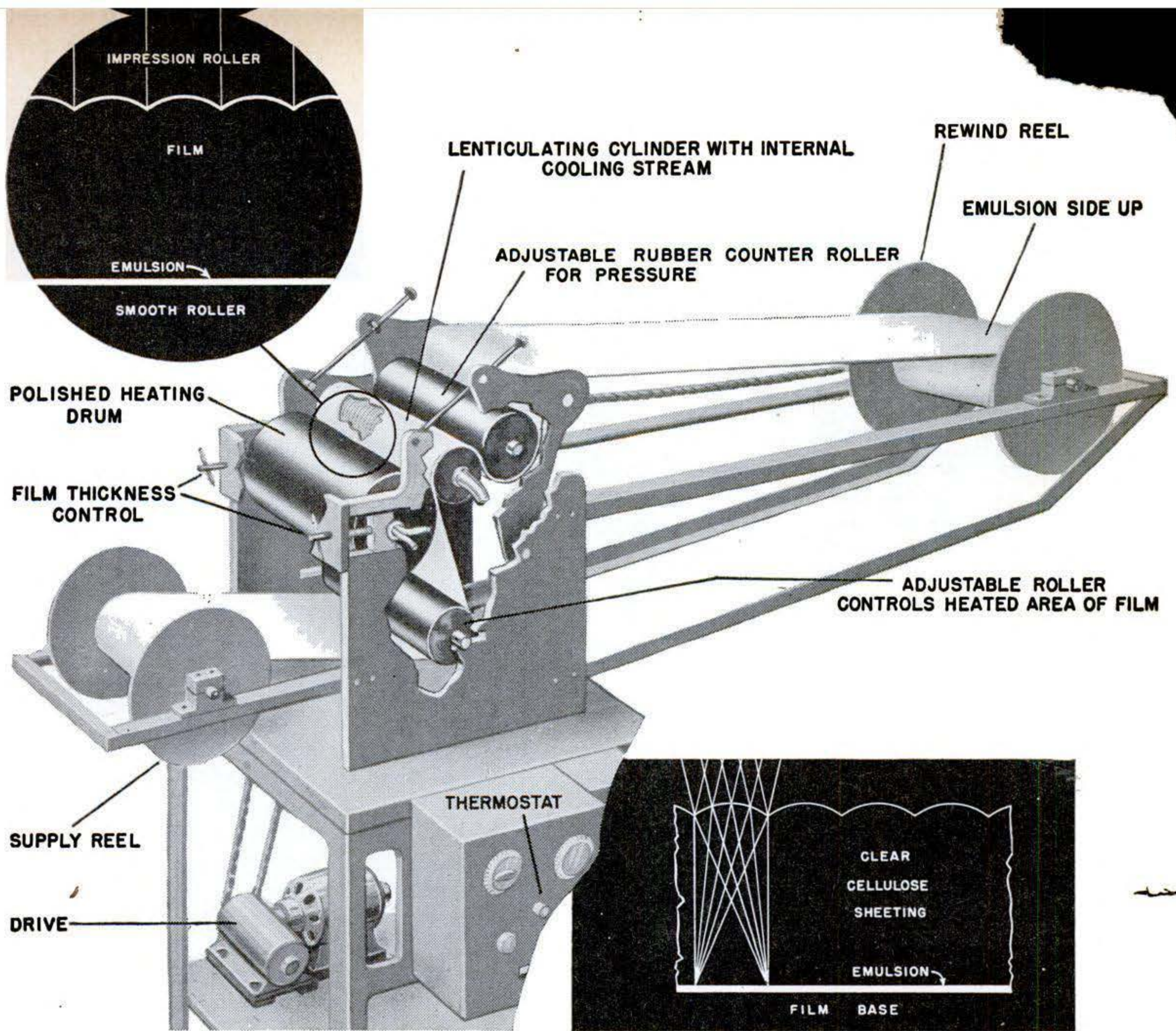

This machine makes the lenticulations, or ridges, on the film. Ordinary film, fed from reel at left, is heated and then embossed by a roller carrying the ridge pattern. Top inset shows how ridges are rolled into section of film: lower right, how light from edges of lens is broken by ridges into separate views.

that has been embossed on its base side, the face opposite the emulsion layer, with microscopic ridges. Each of these ridges serves as a simple semicylindrical lens called a lenticulation. There are about 300 of them to the inch and each one is about three ten-thousandths of an inch deep. They cannot be seen, but you can "hear" them by running your fingernail across a piece of embossed film next to your ear.

These ridges do not alter the speed or thickness of the film. They simply break up the image of the object photographed into a series of picture elements, one element for each ridge. Because of the curved surface of the ridge, these elements are not jumbled on top of each other, but separated, forming a series of stereoscopic pictures all on the same film. When you look at the

picture with the ridge side toward you, the curved surfaces act as a selecting screen, allowing each of your eyes to see one of a stereoscopic pair of images. The rest of the series of panoramic views recorded in the composite picture is screened off by the curves.

The use of lenticulated film in an ordinary camera will give depth but not the movement perspective—"seeing around"—effect essential to realistic three-dimensional vision. One way to obtain this is with the scanning camera, a simple box with an ordinary lens fixed to its front panel and a sliding film carrier on its back. During exposure the camera moves laterally past its subject. As it does so, the mechanized film carrier travels slightly faster to keep the continuous panoramic series of subject



glimpses centered on the lenticulated film.

Because it requires a time exposure, the scanning method has now been abandoned for a camera with an extra-wide-diameter lens. This gives the same viewing range, but permits instantaneous exposure. The Navy is using a new 10-inch diameter lens. Since this is four times as wide as the normal distance between the eyes, the observer of the finished picture can move his head from side to side and see around objects as one would in nature.

This big Navy lens, now being made by several optical concerns, weighs between 135 and 145 lb. Use of plastic lenses may cut its weight to somewhere between 10 and 30 lb. And, since only a rectangular portion of the lens is used in Trivision photography, Winnek hopes to trim both weight and cost still further by having lenses made that are rectangular to begin with.

### **Cold-Light Printer Reverses Image**

The large-diameter lens produces a pseudoscopic negative—the foreground appears where the background should be and vice versa. This is corrected in the new Trivision printer, which resembles an ordinary copying camera except that it also uses a wide-diameter lens, masked to a rectangular opening as in the camera. Cold light passes through a diffusing glass and then through the Trivision transparency, placed with the flat side toward the light source. The wide-diameter lens then projects a reversed or corrected three-dimensional image onto the special printing “paper,” on which the lenticulating process has to be repeated.

This “paper” is really cellulose sheeting, .003 inch thick, coated with an ordinary printing paper emulsion. To make it three-dimensional, the coated cellulose is given the same lens ridges by running it through a lenticulating machine. The print is processed in the normal way; then, while still wet, it is squeegeed against a paper backing having a high reflective surface. The result of the process is a three-dimensional photographic print.

A photomechanical reproduction process for Trivision pictures is now being perfected. Winnek, who has been working on this for some time, is confident that by the addition of a simple lacquering and lenticulating unit to ordinary printing machinery commercial reproduction of three-dimensional magazine covers, window displays, advertising cards,

book jackets, inserts, etc., will be possible within a year. The value of such a process to the Navy in making visual aids for its training program is obvious.

The ability of Trivision to record movement on a single film will make it useful, too, in other fields, especially medicine. Already such actions as the movement of the jaw, the twisting of the wrist, and the tightening of the muscles have been recorded, and the motion studied in three dimensions.

This motion record is made with the new Trivision camera by moving a mask across the lens. A tiny vertical slit in the mask admits an image to successive parts of the film during an exposure of several seconds. When the finished picture is moved before the eyes, the resulting stimulation of successive images along the retina causes an illusion of natural motion.

Used in aerial photography, Trivision has the great advantage of enabling the exact latitude, longitude and height of the terrain to be read directly from the film. This technique is the same as that used in Trivision X-ray photography, using a grid superimposed on the picture. Since the apparent movement of any object on the ground in relation to the grid bears a direct relation to the distance between them, measurement of this movement tells how far the plane was from the ground at this point.

Another attribute of Trivision, valuable for military aerial photography, is its ability to detect and record the direction of movement of ships, waves (the ocean variety), and mobile equipment and troops.

### **Jet Planes May Keep Camera Stable**

A basic problem in using Trivision for aerial photography is keeping the camera stable during the flight. Jet planes may help in this, however, since their speed over the ground is so great that the camera will probably not have time to jar during the exposure.

As for the amateur, Winnek sees no reason why he should have to go on being satisfied with flat, lifeless pictures. The heavy, expensive, 10-inch diameter lens, is of course out of the question. Winnek expects, however, a camera with a 2½-inch or smaller plastic lens, which, while not having the same viewing range, would give all the three-dimensional depth of the large commercial camera. As for the film, the em-



bossing process is so simple that once it is in commercial production it should be within reach of the amateur's pocketbook.

Although it is impossible to reproduce actual Trivision pictures with this article, the writer can attest to their complete effectiveness, both as to three-dimensional quality and movement perspective. He has seen several Trivision color transparencies; in one, a bust of Shakespeare in front of a curtain, the statue projects out in front and the curtain appears to be in space behind it. A pencil point properly placed actually appears to go between the statue

and the curtain. By moving your head from side to side you can "see" around the bust.

Trivision movies, the perfection of which was Winnek's starting point, were necessarily shelved during the war. He is again working on them, but says only that he has definitely proved that the fundamental principles of Trivision will work for the production of motion pictures. He adds, cryptically, that Trivision movies will not need a screen.

How will it be done? Your guess is as good as ours—right now Winnek isn't talking. But you've heard of parabolic mirrors and virtual images, haven't you? END

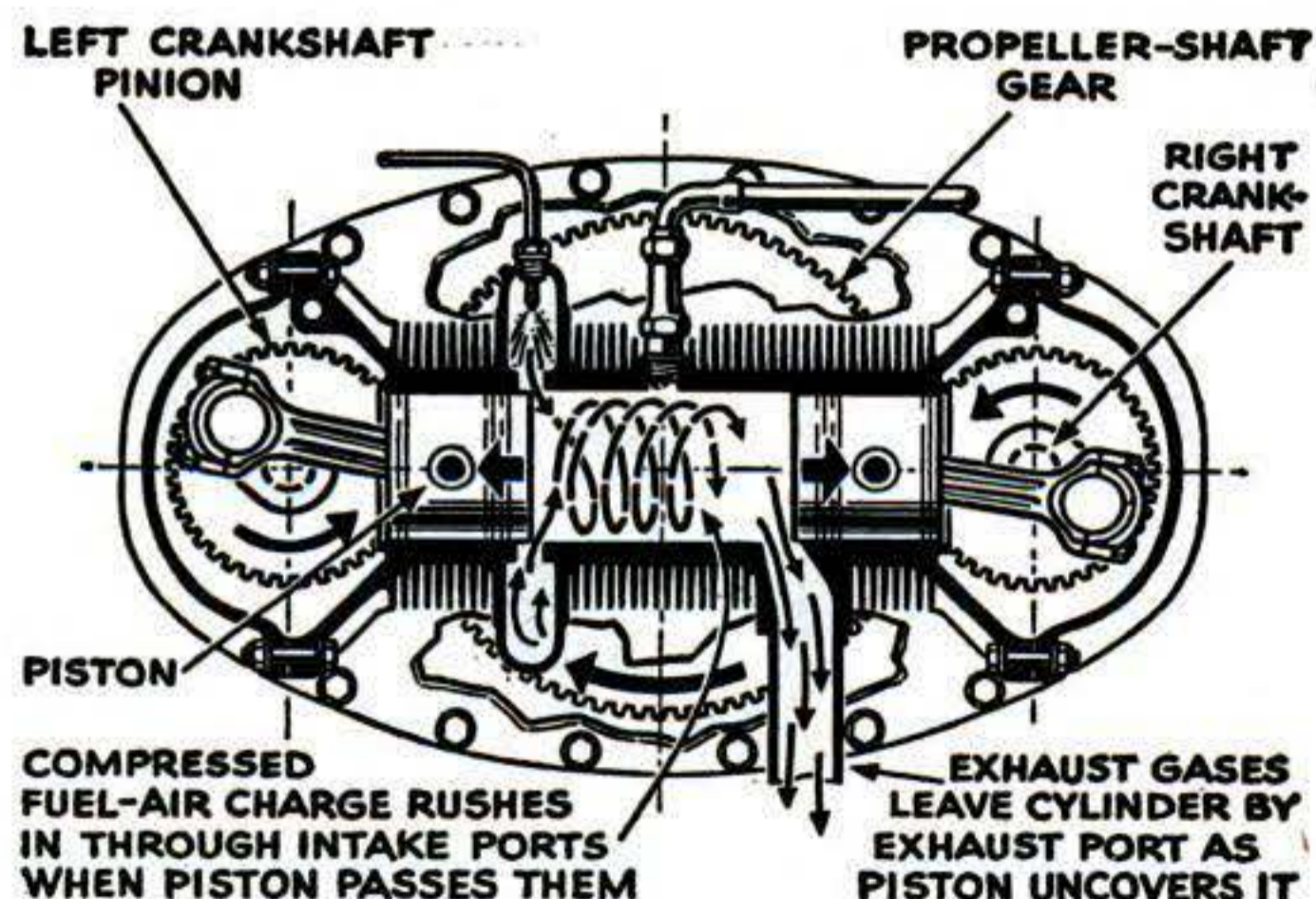
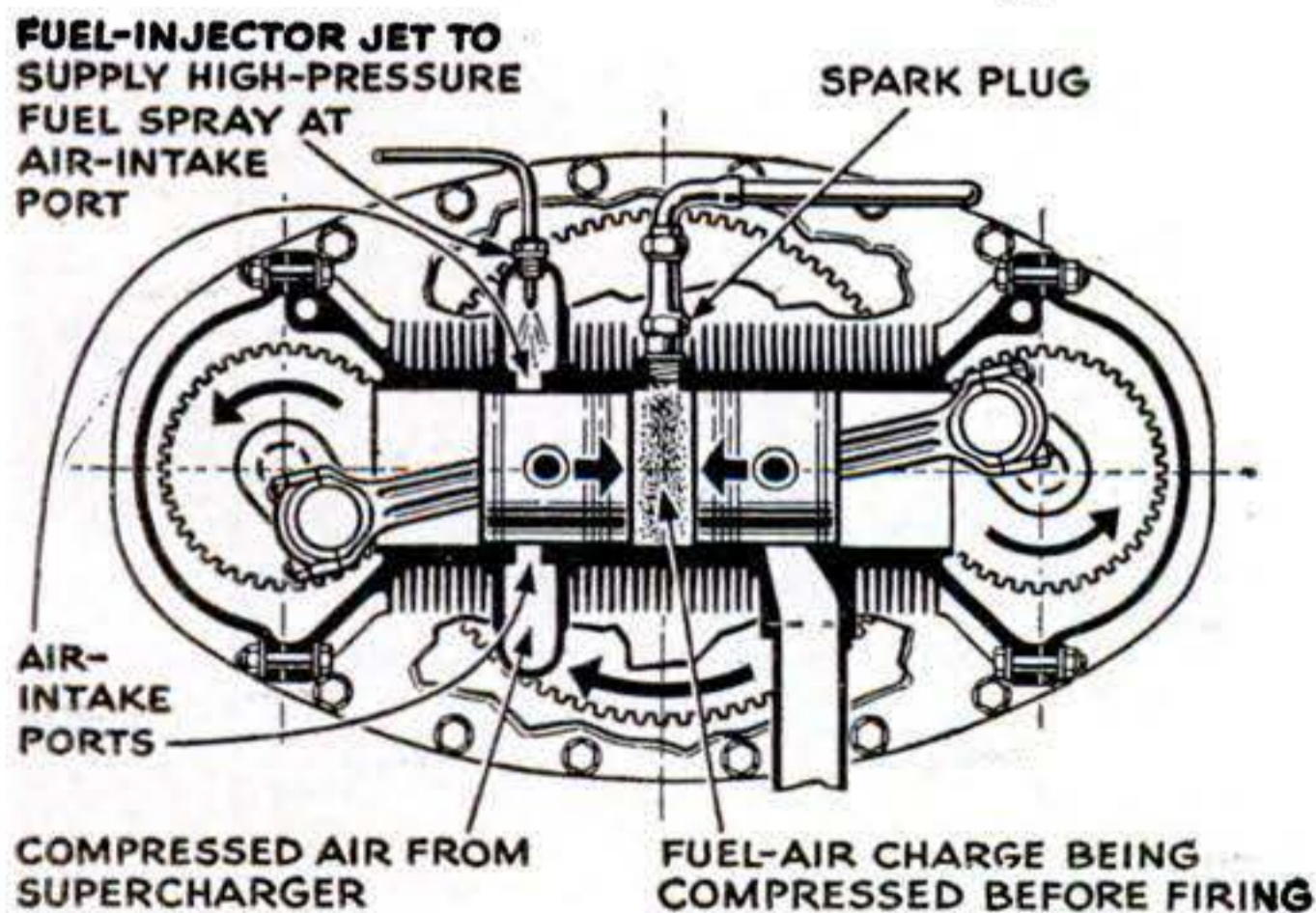
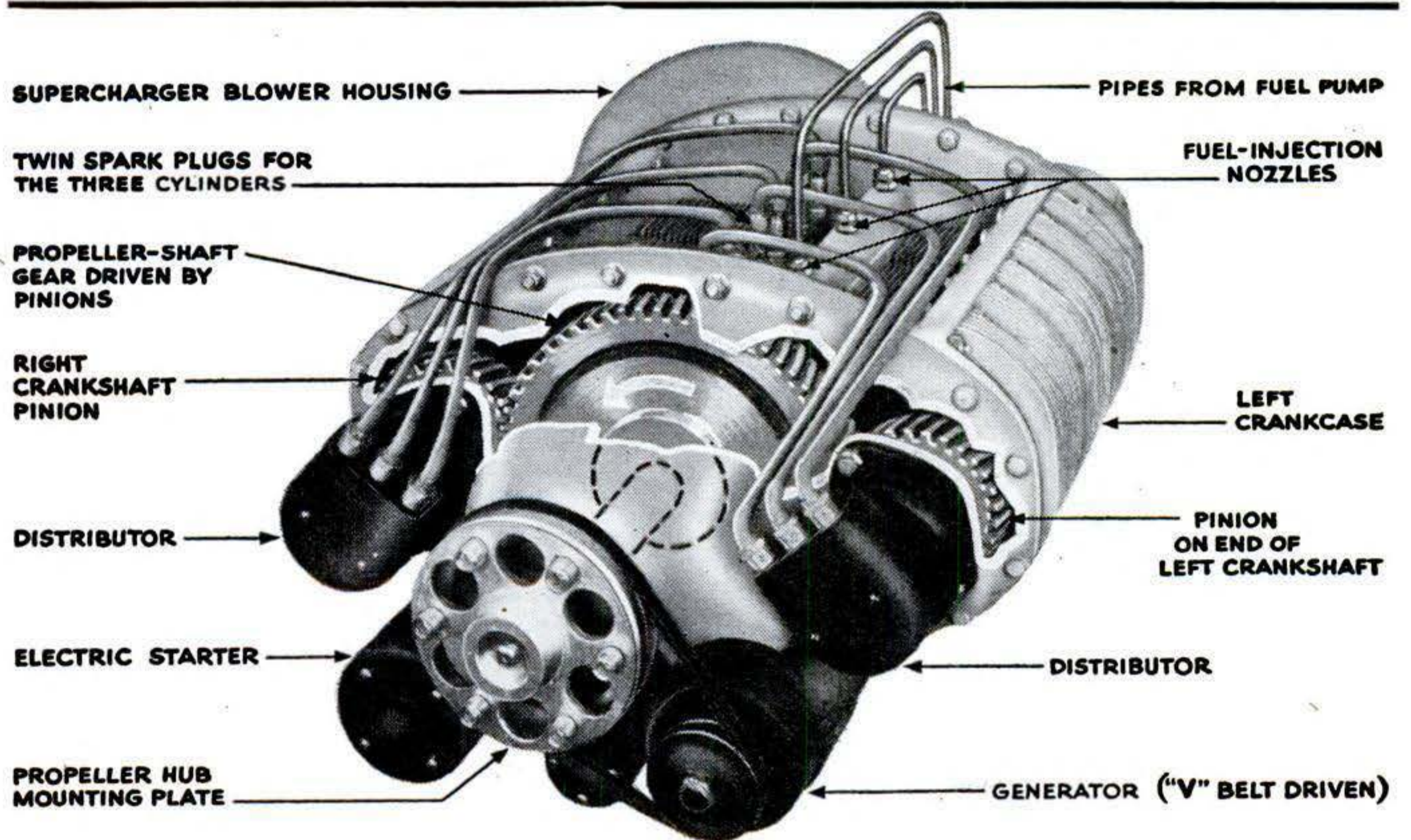

**Three Cylinders, Six Pistons.** This small two-cycle gasoline engine works like a man elbowing through a crowd: Its three cylinders are double-ended; each explosion drives two pistons at once. Intended

for boats or planes, the 120-hp. motor weighs only 150 lb.—100 lb. less than any comparable aircraft engine, says McCulloch Motors, of Los Angeles. Fuel economy equals the best four-cycle engine's.



# How Ionosphere

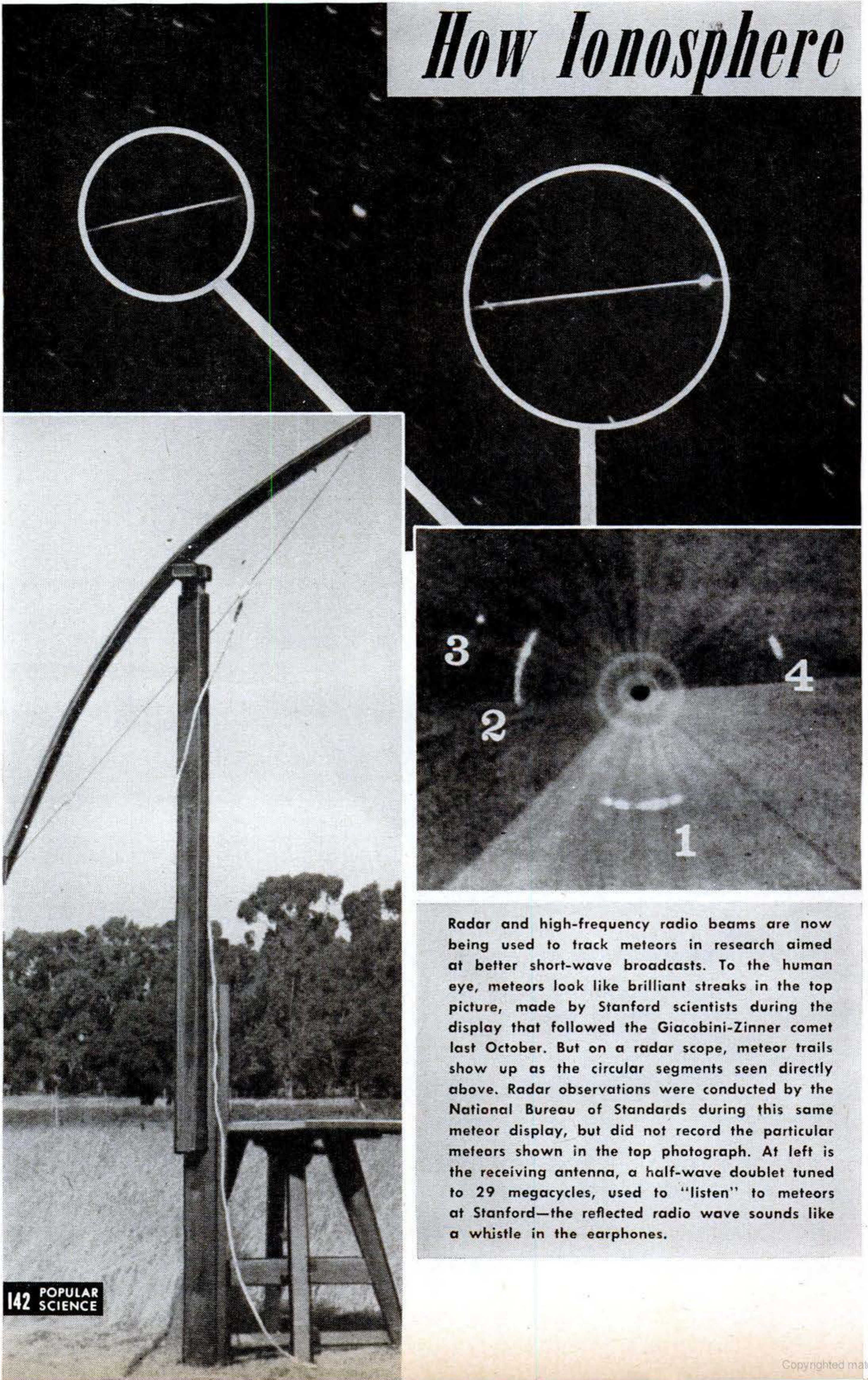

Radar and high-frequency radio beams are now being used to track meteors in research aimed at better short-wave broadcasts. To the human eye, meteors look like brilliant streaks in the top picture, made by Stanford scientists during the display that followed the Giacobini-Zinner comet last October. But on a radar scope, meteor trails show up as the circular segments seen directly above. Radar observations were conducted by the National Bureau of Standards during this same meteor display, but did not record the particular meteors shown in the top photograph. At left is the receiving antenna, a half-wave doublet tuned to 29 megacycles, used to "listen" to meteors at Stanford—the reflected radio wave sounds like a whistle in the earphones.



# Makes Short-wave "Weather"

**R**ADIO broadcasters now get their own "weather reports" predicting clear or cloudy conditions—but they don't tell engineers when to wear their rubbers. The forecasts, prepared from nation-wide observations by the National Bureau of Standards, warn when and where to expect short-wave broadcasting troubles. Thus stations with several frequencies can choose the one most likely to get through.

Basis of the forecasts is study of the ionosphere. This layer of electrically charged particles, 50 to 200 miles above the earth, reflects radio waves and makes long-distance broadcasting possible. It will not reflect all waves, however. Above a top frequency—which varies daily with ionospheric changes—the waves keep right on out into space and are never received on earth. Ionospheric conditions also determine how high a reflected frequency will go before bouncing back. This height tells the distance a radio wave will skip between transmitter and receiver, and thus whether the frequency should be used for long- or short-range communication.

Meteors, too, affect short-wave broad-

casting. Millions of small ones burn up in the earth's atmosphere every day and leave trails of hot gas. These reflect certain radio waves (some radar and old-style, lower-frequency FM particularly) that would ordinarily pass through the ionosphere.

To keep tabs on the peculiarities of the ionosphere, scientists probe it with radio beams. They transmit various frequencies and measure the time it takes for the echo to come back to the receiver. That tells how high each frequency goes before being reflected. With direction-finding equipment, they also follow the route the wave picks in the ionosphere. Meteor trails, more highly ionized than the ionosphere, can be tracked across the sky with certain very-high-frequency beams like radar. Still more information is obtained from V-2 experiments and sunspot studies.

The importance of this radio forecasting was proved during the war. Fifty observing stations all over the world provided day-to-day reports on broadcasting conditions. It was not just coincidence that the Allies started no great battles when ionospheric upheavals were wrecking radio service.

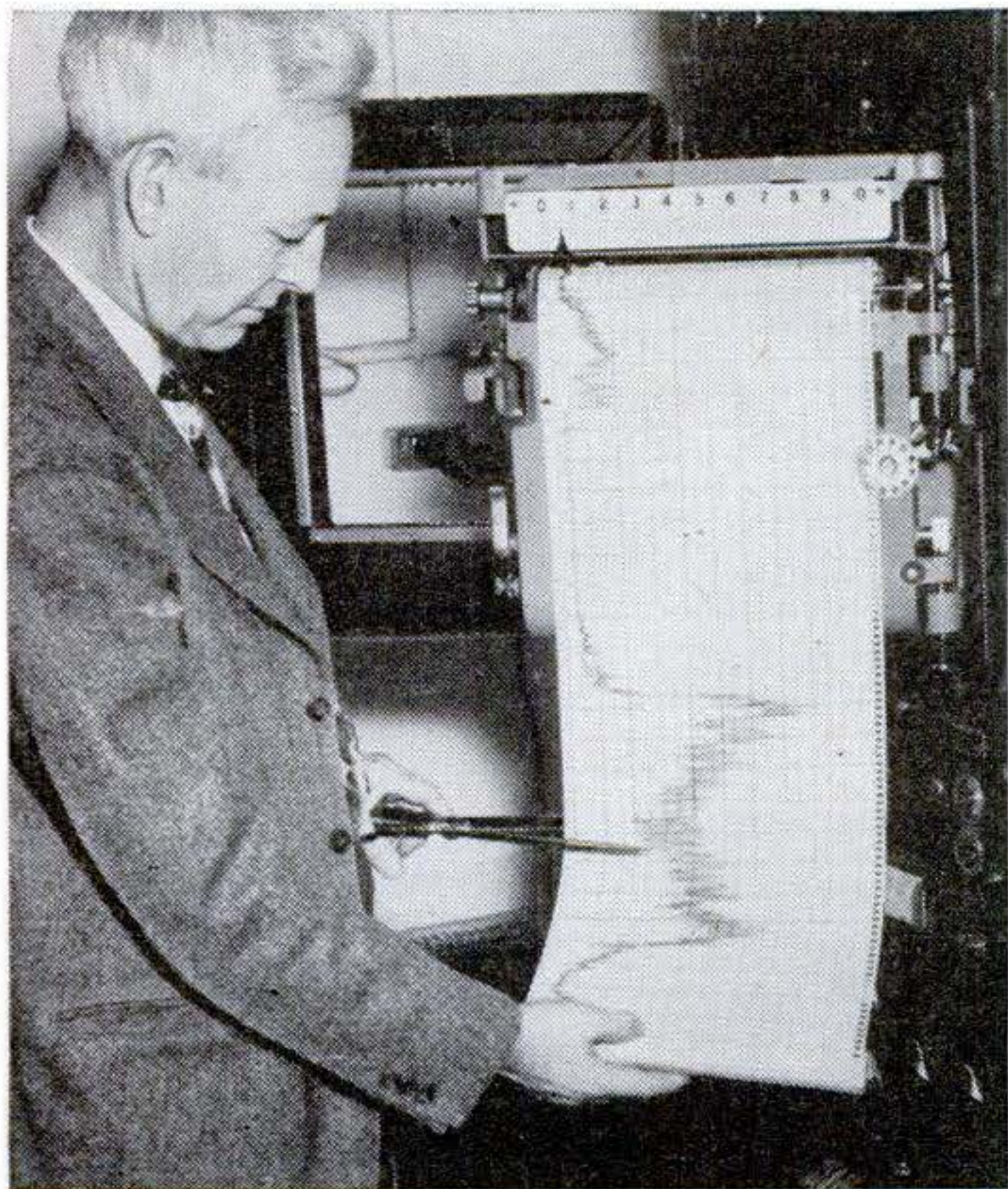

**Ionosphere investigators hope to straighten out the wavy line (left), that represents variations in the signal strength of station JAE3, Tokyo, as heard in California. Ionospheric fluctuations make most of those wiggles. Below, Dr. Robert Helliwell, director of the Stanford project, operates equipment that follows radio waves through the air.**

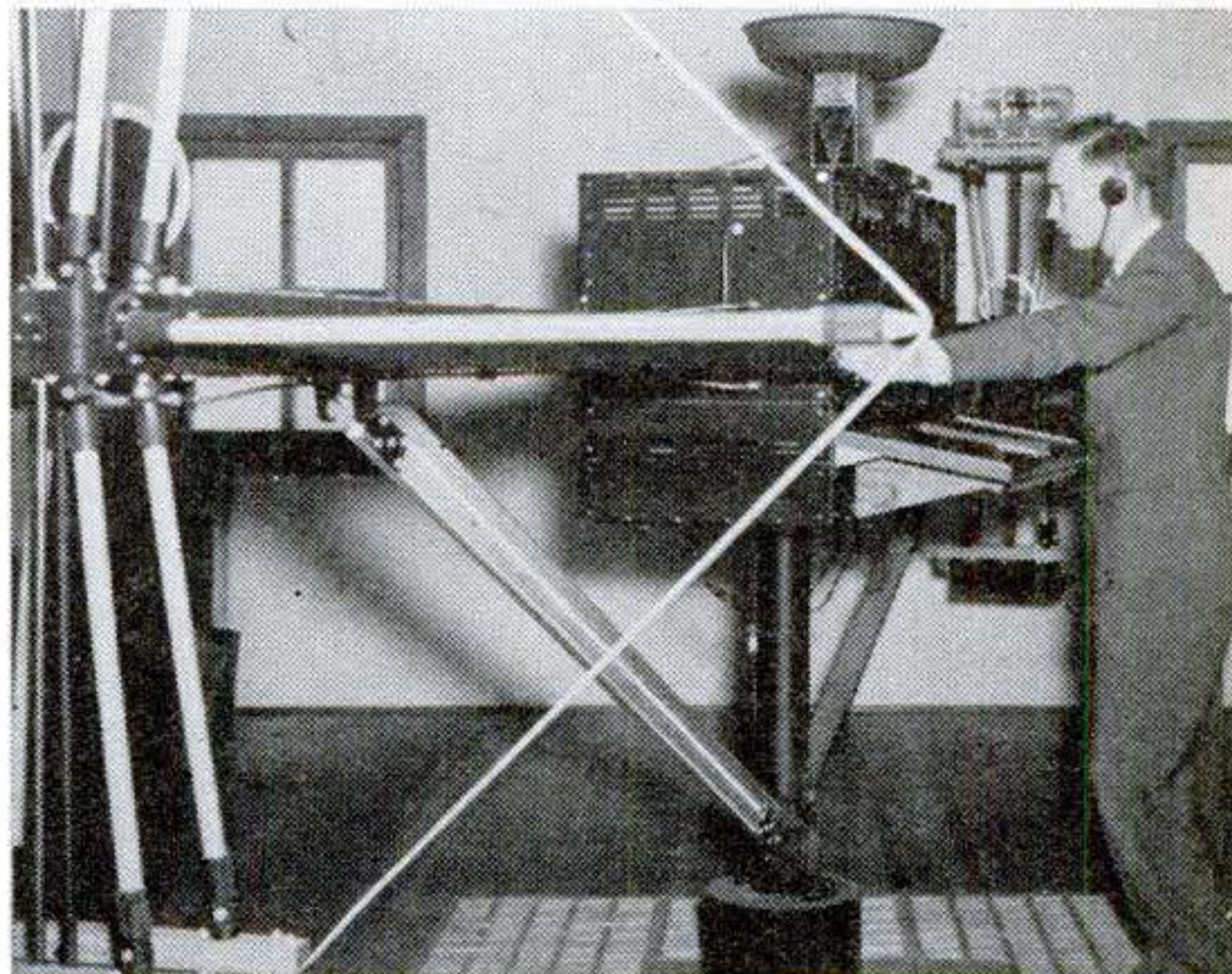



# Storing Sounds on Spools



Norman Corwin records on wire his interview with President Eduard Benes of Czechoslovakia in the Presidential Palace at Prague. Lee Bland, CBS technician, operates the apparatus in the foreground.

The Magnecorder, shown at right, employs a capstan wire drive that keeps the speed constant, has separate erase, record and playback heads. It uses the same wire as other machines but at double speed.

By **ROBERT GORMAN**

**O**F ALL the devices that talked themselves into the history books during the recent war, none talked longer, louder, or clearer than the continuous-strip recorders. They put the voice of battle onto thousands of miles of wire, film, and metalized tape. Now they are ready to make records of Junior's first words, sister's progress on the piano, and your own favorite Saturday night quartet. Business firms, too, will use them for dictating letters, training personnel, recording conferences, and issuing interoffice memos.

The recorders are of two different types: one impresses varying magnetic impulses on wire or metal-coated paper; the other embosses fine lines on film. This film method, incidentally, has nothing in common with the optical sound track used on standard talking pictures.





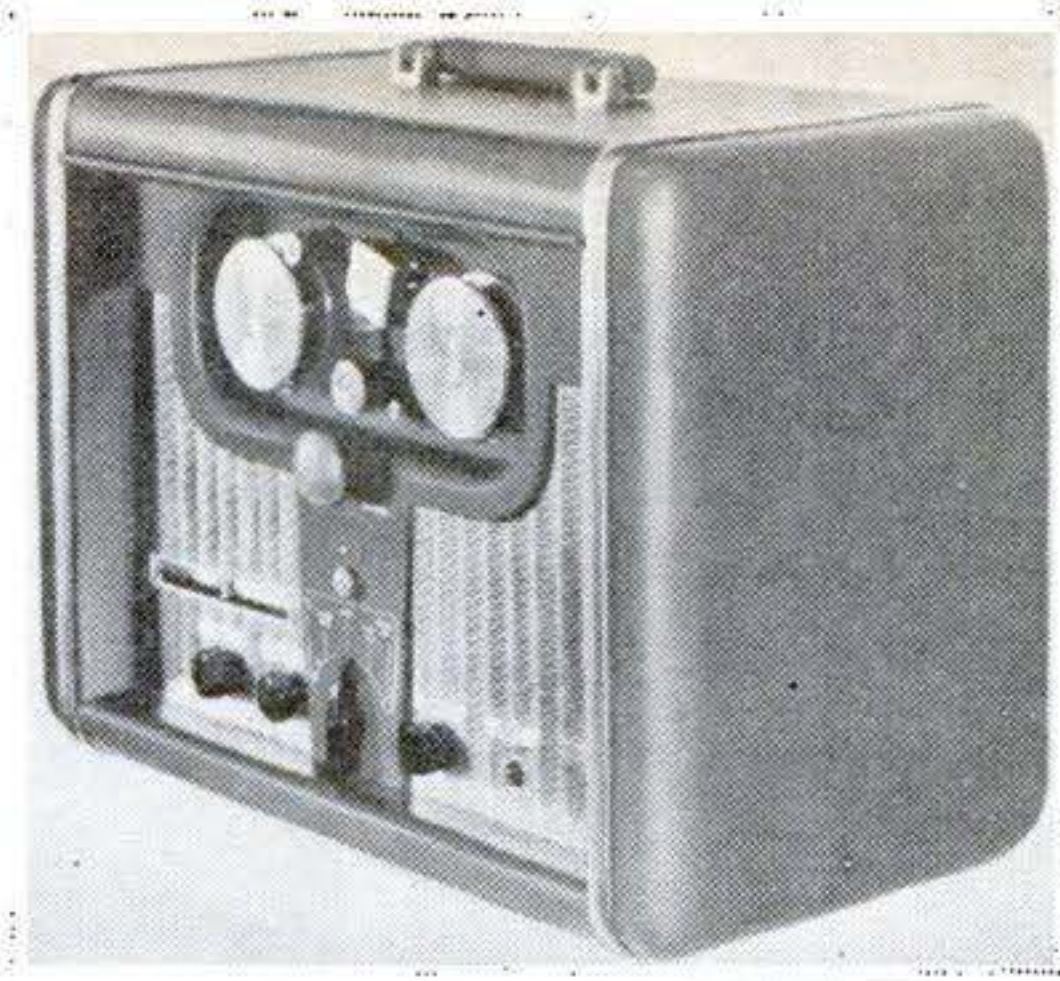

An early combination radio and wire recorder, made by the WiRecorder Corp., is shown at left. Such combinations are indicated for the future.

The pad on which the telephone rests (shown below with the Pierce recorder) is an induction microphone that records on wire both sides of a conversation.

Built by the Armour Research Foundation, the recording unit at left is installed in a combination cabinet.

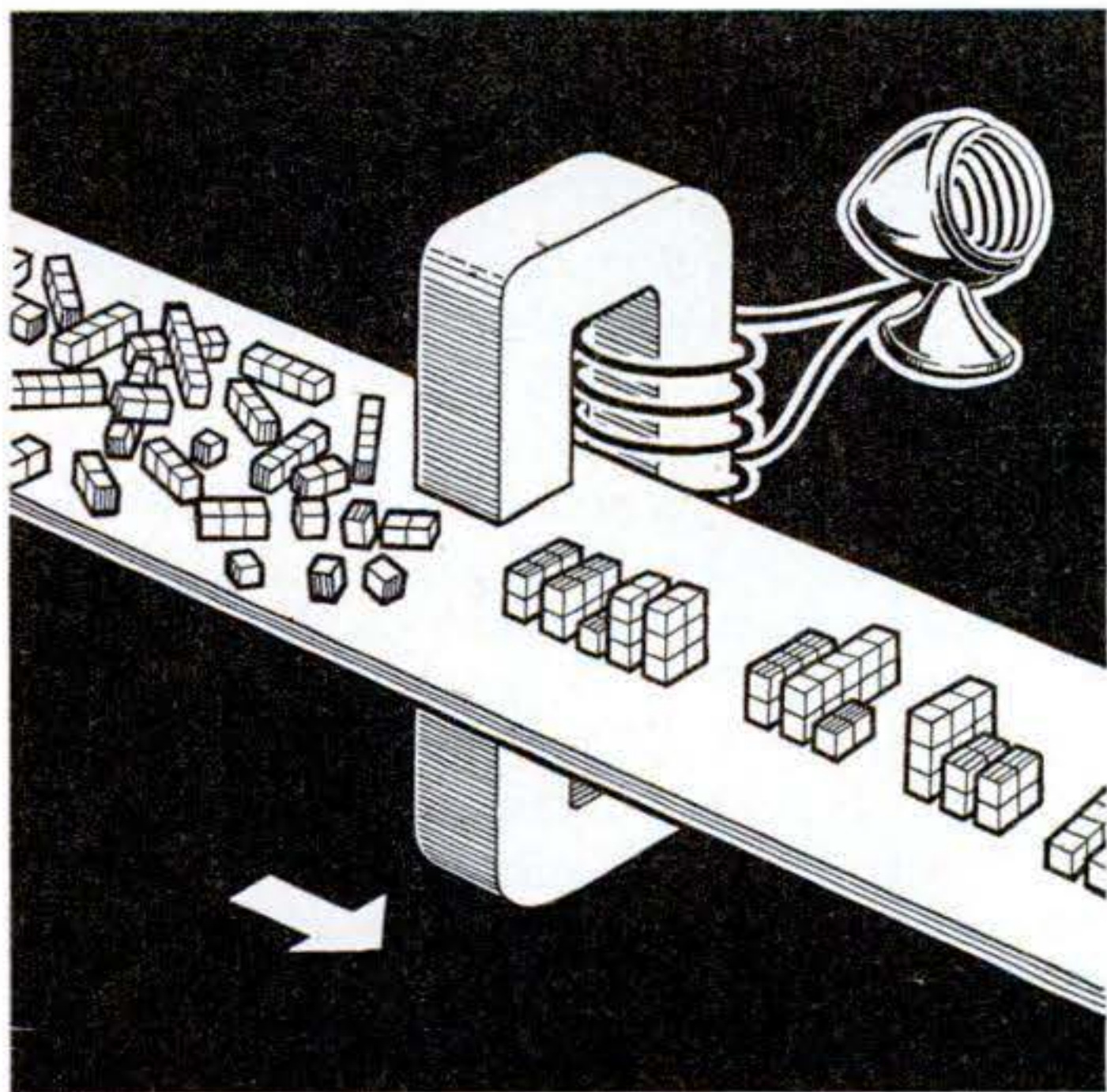

The magnetic molecules in a wire may be compared to tiny bar magnets riding a conveyor belt between the poles of a varying electromagnet. They are arranged with varying polarity, strength, and position corresponding to the current in the coil. Current is actuated by impact of sound waves on mike.

Denmark's Valdemar Poulsen invented the magnetic wire recorder in 1896. Reproduction was poor, the wire was expensive and difficult to manage, and Poulsen's invention was consigned to a "pending file" for future scientists.

In principle, magnetic recording is extremely simple. Its heart is the humble electromagnet. If a wire carrying an electric current is wound around an iron core, the current sets up a field that renders the core magnetic. Every time the direction of the current changes, the polarity of the

magnet changes also. Since, by means of a microphone, sound can be converted into varying electric currents, the current that flows through the coil—and hence the magnetic flux—can be made to vary in accordance with the sound. When a wire is drawn past the poles of the magnet, portions of the wire will be magnetized in the same sequence and intensity as the voice currents fed to the magnet. To reproduce the original sound, the magnetic impulses impressed on the wire are used to induce corresponding voltages in an amplifier system.

High background noise, poor frequency response, and distortion due to the magnetization properties of most materials bothered the early experimenters. A big step over these difficulties, however, was taken with the development of the high-frequency bias technique, in which the varying voice currents are superimposed on a much more rapidly varying electric current. This bias frequency, usually in the supersonic range (30-40 Kc.), effectively "softens up" the wire, making it more responsive to the magnetic variations of the voice frequency. The bias frequency is also used to wipe the wire clean of previous recordings. This can either be



The Hart "Recordgraph" at right, with a 50-foot film reel traveling at 60 feet per minute, is good for about one and a half hours of continuous recording.

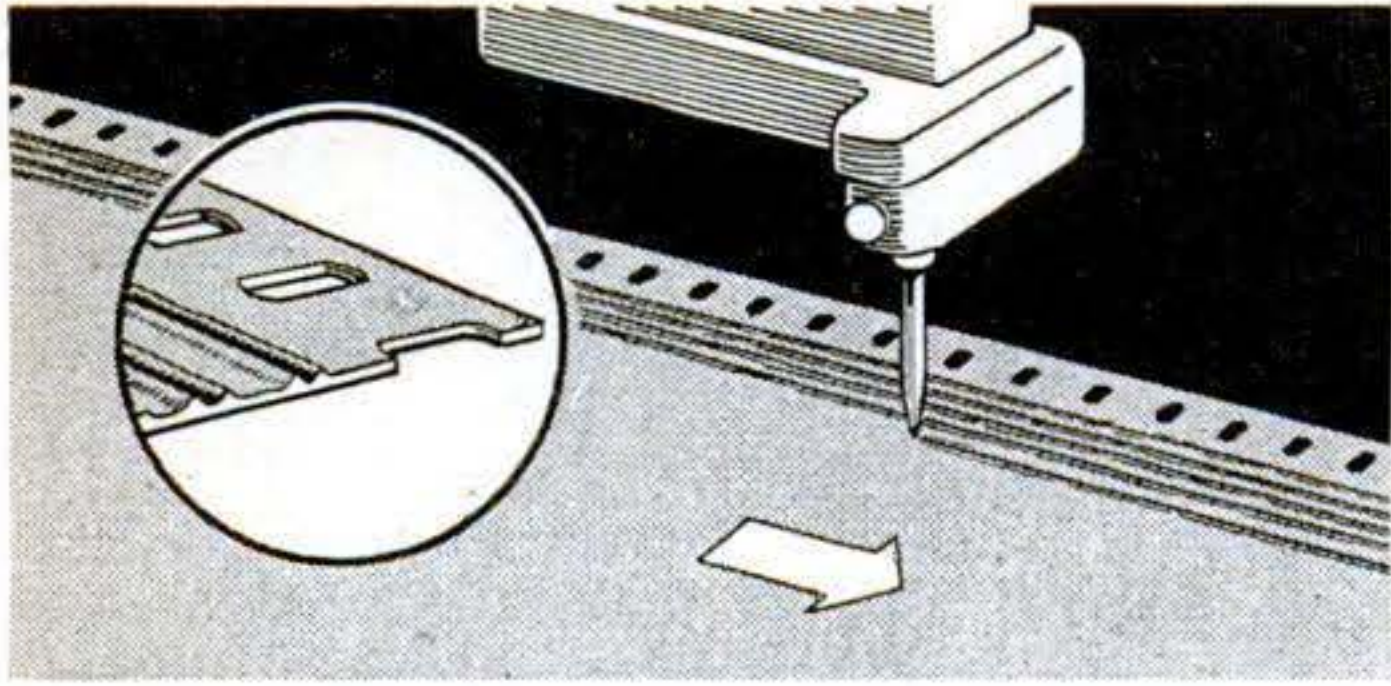

An embossing needle records sound on film in fine wavy lines as it passes below. Another needle traces these lines and reconverts them into sound.

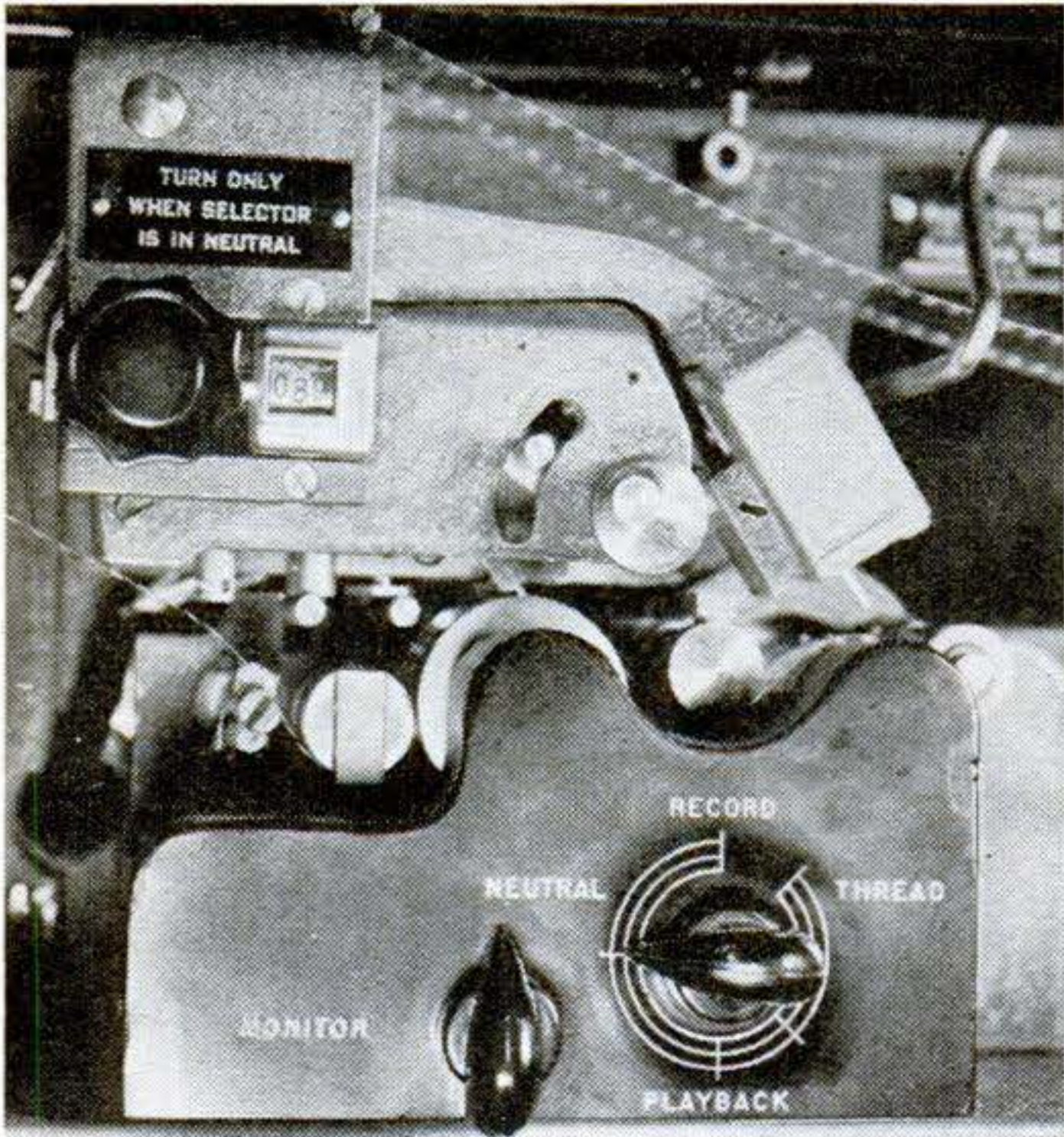
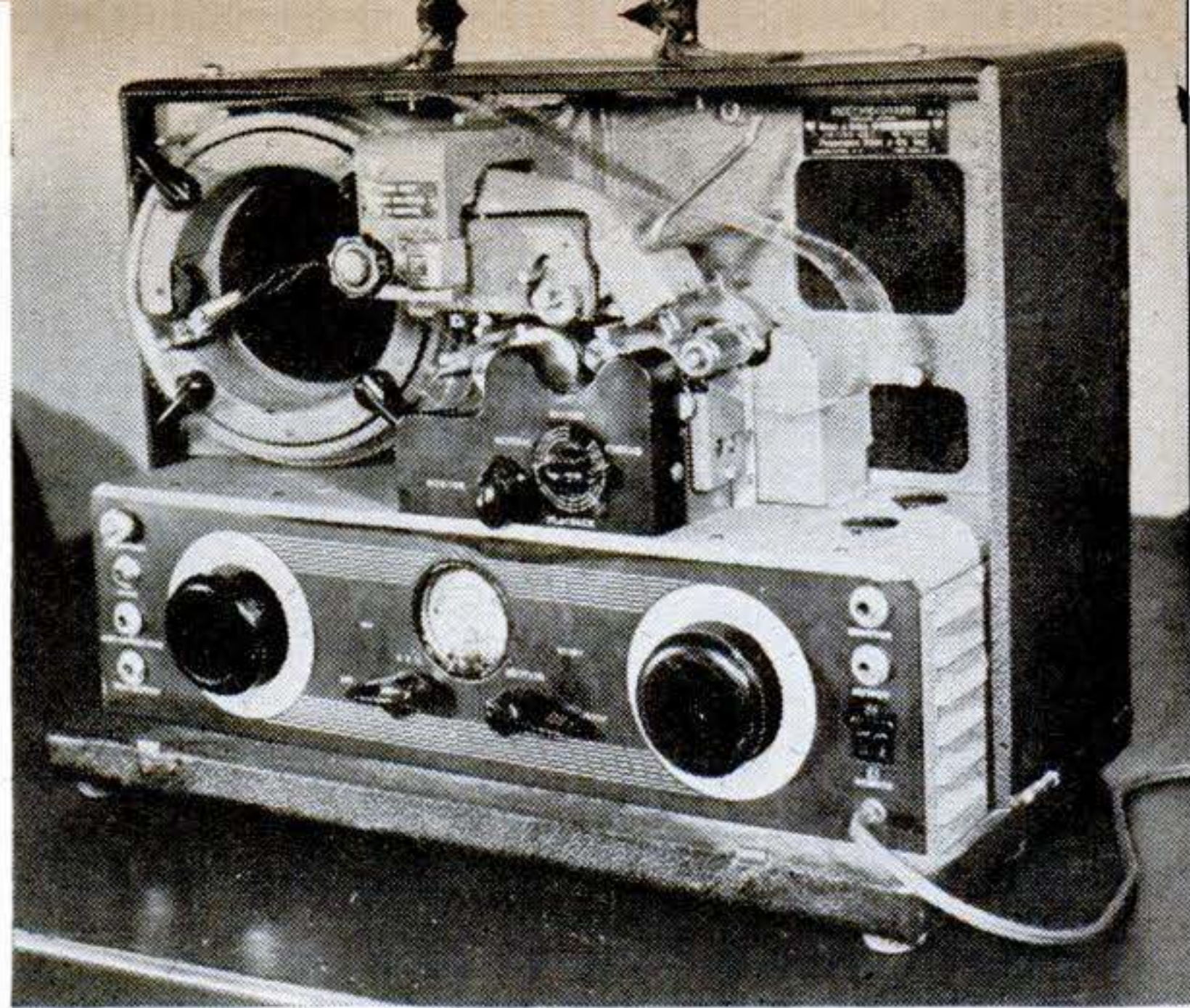

Closeup above shows film recorder's cutting and playback styluses. Automatic counter tells instantly on which of the 115 tracks the machine is working.

done separately or at the same time that a new recording is made. The wire can be reused as often as desired.

War shoved magnetic recorders out of the laboratory and onto the production line before they were quite ready. On some of the machines background noise was extremely high, the wire was liable to break, and some of the metal alloys in use lost their magnetism. The Government wanted recordings that were permanent—and the armed forces began to look with increasing favor on a rival recording method.

The new machine, built by Frederick Hart & Company, was based upon an ingenious adaptation of old-style record cutting. Instead of engraving grooves on a flat disk,

however, it embosses fine tracks on a band of ordinary 35-mm. movie film—without the photographic emulsion. This is drawn lengthwise under a cutting stylus that makes 115 parallel tracks in the 35-mm. width. Each time the stylus moves over to a new track an automatic counter clicks off a number. The film winds continuously from the inside of the reel back to the outside, so it does not have to be separately rewound for playback. In combination, these features make it possible to locate and play back any part of a recording more quickly than by any alternate method.

In a pinch, these machines can operate continuously for nine hours at a stretch. Use of a voice-operated relay that stops the film when no sound hits the microphone allows it to be left in operation, unattended, for even longer periods.

Now magnetic recording has a new development—metallically coated paper tapes. Magnetic recording can be done not only on wire but on any ribbon that will take a magnetic impression. Various types of coatings have been successfully applied to paper tapes. Paper is cheap, uniform, easy to produce, and shows little tendency to snarl. Because of lower cost and ease of handling, tape recorders will be strong competitors for home use.

At last a large number of manufacturers of home and office recorders are tottering on the brink of production. If you pick one for your own use, here are a few points worth remembering.

Frequency range of recorders is important—up to a point. For human speech, a band from about 100 to 3,000 cycles per second is plenty wide. To take radio programs—voice or music—off the air you are not likely to



need any recording frequencies beyond 5,000 cycles since most broadcasting stations are limited to that range. But the highest fundamental note of a piano is over 4,000 cycles, and the audible harmonics that give tone and vitality to music go much higher. Response on most film recorders drops off sharply above 3,500 cycles, but special-purpose machines have raised this to 5,000. Magnetic tapes are in the same class as the better embossed-film recorders. Wire recorders, depending on make, range from 6,000 to as high as 15,000.

The permanence of the recording is another consideration. The old problem of magnetic impressions bleeding off wire has been fairly well licked. Wire made of the now standard stainless steel alloys may be stored for years without noticeable deterioration of the magnetic sound track. In addition, wire is practically indestructible and can be replayed thousands of times. Magnetic tape, while not as durable, is said to be good for at least 1,000 plays. Film, on the other hand, will last indefinitely on the shelf, but is worn out after the playback needle has scratched along it about 30 times.

Film is much cheaper than either of its rivals as a recording medium if all recordings are put in a permanent file. On the other hand, once a sound track has been scratched on film, it is there to stay, while both wire and tape are erasable and the same footage can be used over again and

### Magnetic Strip on Film Promises Low-Cost Sound Movies

In one of the newest applications of magnetic recording, a metallic material is bonded onto movie film to allow for the addition of a magnetic sound track. It is not affected by photographic solutions, and the sound may be erased and altered at will.

Magnetic recording equipment may soon

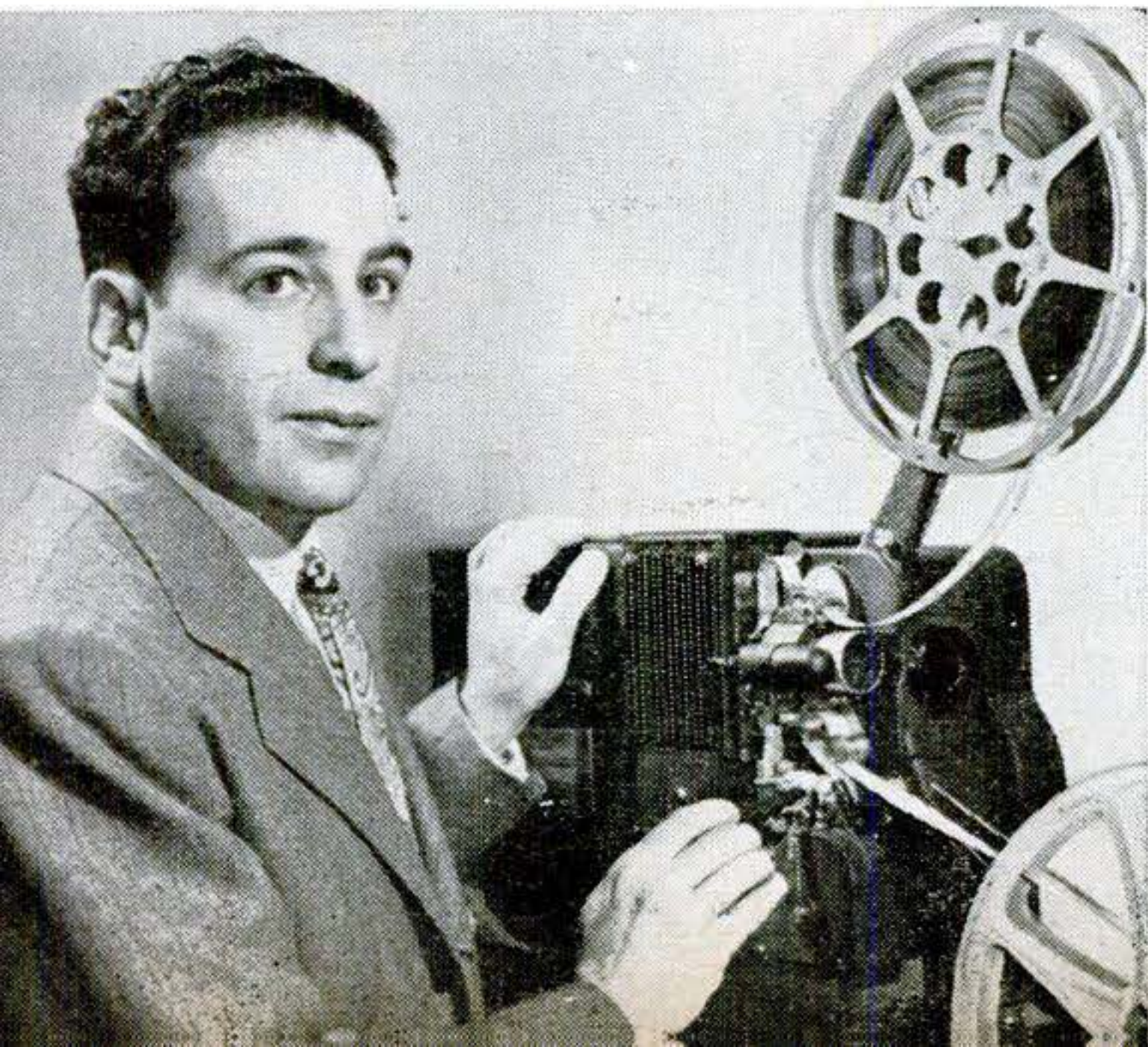

First wire recorder to reach the home market, the St. George unit has a combined erase-record-playback head; uses the windup reel as a turntable.

again. Erasure can also be used to edit wire and tape recordings, or unwanted sections can be cut out and the loose ends tied or pasted together. For all practical purposes, film can't be edited except by retranscription onto another machine.

A typical wire unit that seems slated for mass distribution is the St. George Recorder. It is an attachment only, stripped down to essentials to retail for slightly less than \$100. Its most ingenious feature is a windup reel that doubles as a turntable for ordinary disk recordings. The crystal pickup will play these back through the amplifier or re-record them on wire.

A tape recorder with a built-in amplifier is offered by the Brush Development Company. This machine rewinds the tape at a speed ratio of 30 to one, making it possible to play back a recording almost at once. The tape can also be reeled forward at high speed, to reach a selection at the tag end. 

be added to cameras, so that live sound can be recorded at the time of filming. This promises to bring the cost of sound recording far below present levels.

On 16-mm. film, a frequency range of 50 to 5,000 cycles is obtained; slower-moving 8-mm. film gives about half this range.

Marvin Camras, of the Armour Foundation, shows how a standard sound projector has been modified to take the new sound film. Closeup shows the enlarged flywheel stabilizer (lower center) on which the film travels. The small black oblong brushing against it contains the magnetic head.

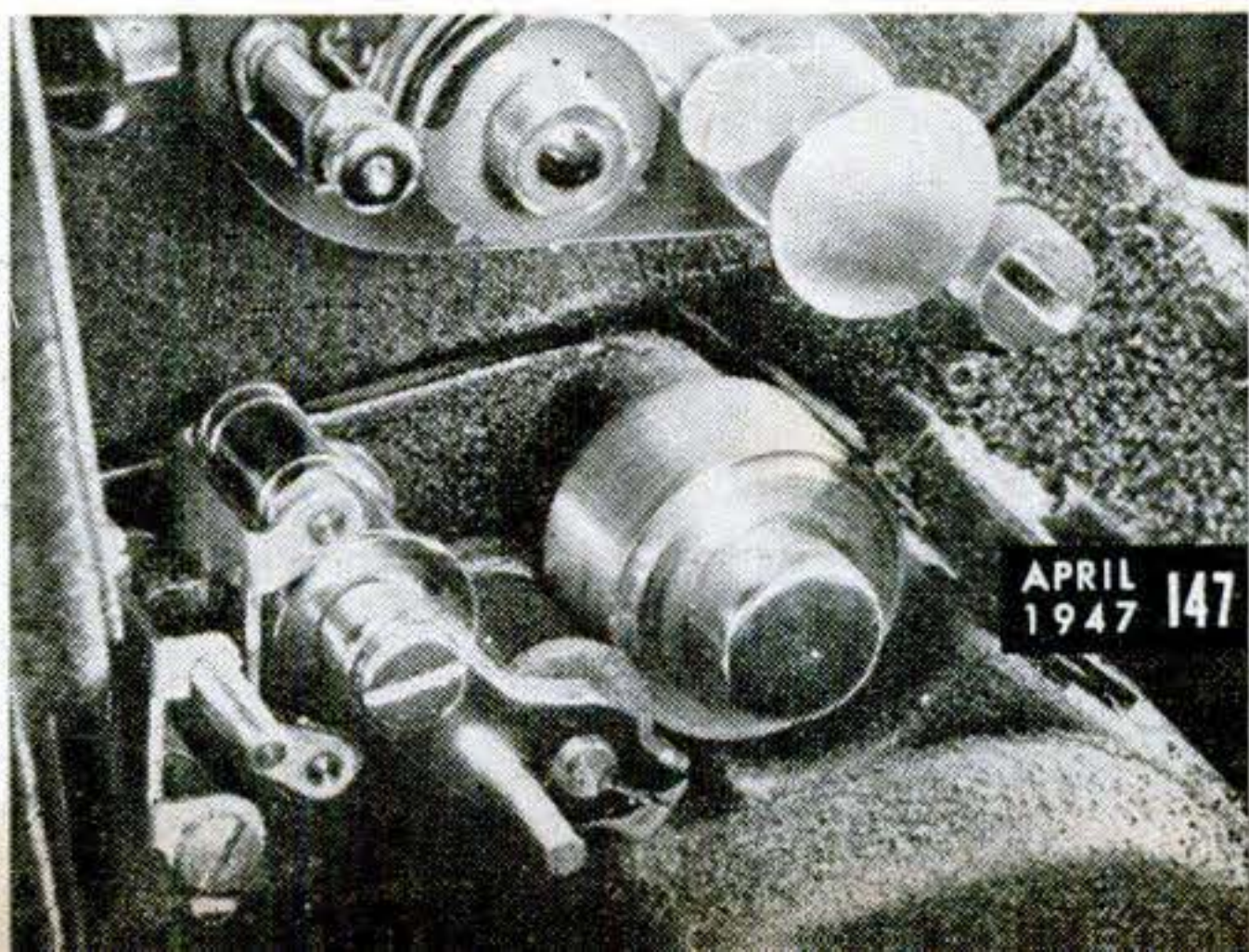





The tape recorder at left for home or office use is made by the Brush Development Co. It can be connected to a radio to record broadcasts.

The Brush "Mail-A-Voice" makes records magnetically on finely coated paper disks, thin enough to be folded and mailed. Same machine plays disks.



Many more elaborate combination models—most of them using wire—are planned. These will be integral radio-recording units with such refinements as automatic logging timers for locating short selections on a long spool, and high-speed forward drives.

Business and office applications are a promising field for magnetic recording development. The Pierce dictating unit is one well adapted to commercial uses. For transcription the machine plays back through either loudspeaker or headphones. A foot-operated switch helps a typist to rewind, back-space, or move forward with ease. A mixer permits up to four microphones to be used simultaneously for recording conferences, and the orderly executive who likes to keep records of important phone calls need only place a small padlike microphone near the induction coil of his phone to get a transcription of the conversation.

The Magnecorder, priced out of reach of most home-recording enthusiasts (\$1,500 without accessories), has engineering refinements for professional and broadcast use. The wire, not the spool, is driven by a

precision-timed capstan to keep flutter and "wow"—the dissonant effect due to poor speed regulation—to a minimum. The wire travels at four feet per second (twice as fast as in other models), and has a 50- to 12,000-cycle frequency range.

So far, very little has been done to provide commercial libraries of wire-recorded music. In anticipation, however, wire speed and sizes are being standardized although the multiple-recording problem has not yet been satisfactorily solved. Unlike wax disks that are pressed from a master, each reel of wire has to be individually run through a recording head. While one master reproducer can be made to feed many individual heads, high-speed mass production is still in the future.

Also in the future, although widely heralded for some time, is a truly portable machine that can be carried easily by reporters and others in search of on-the-spot transcriptions. The size of the equipment used overseas by Norman Corwin, shown on page 144, suggests how much improvement is still possible. END

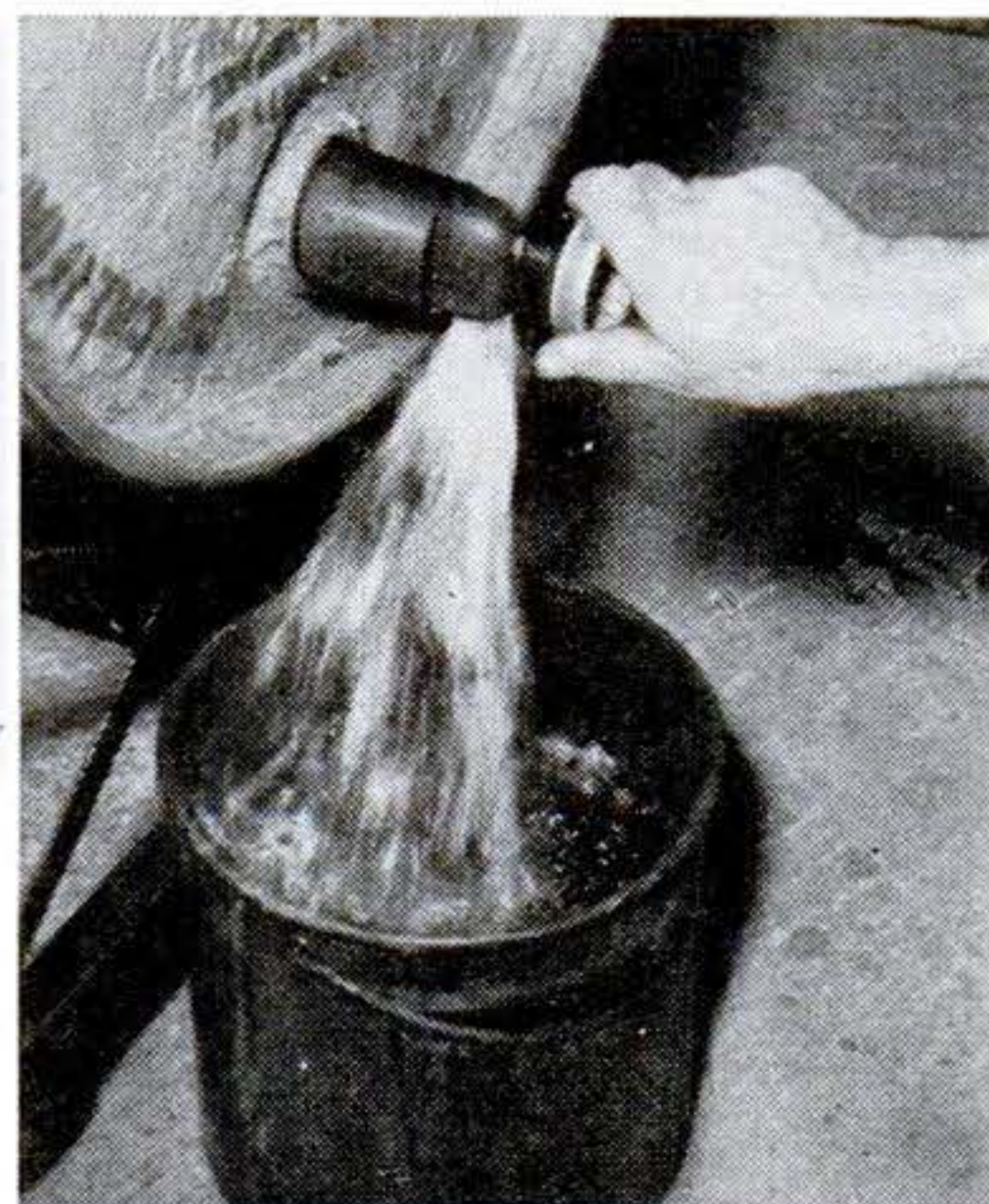

**Speed Spout.** No threading is needed for this synthetic rubber plug. Made by Meco, Inc., of Portland, Ore., it can be fitted to drum by folding (above left) or stored inside (above right). Moving plug in and out (right) adjusts flow.



# SUN BIN SAVES FUEL

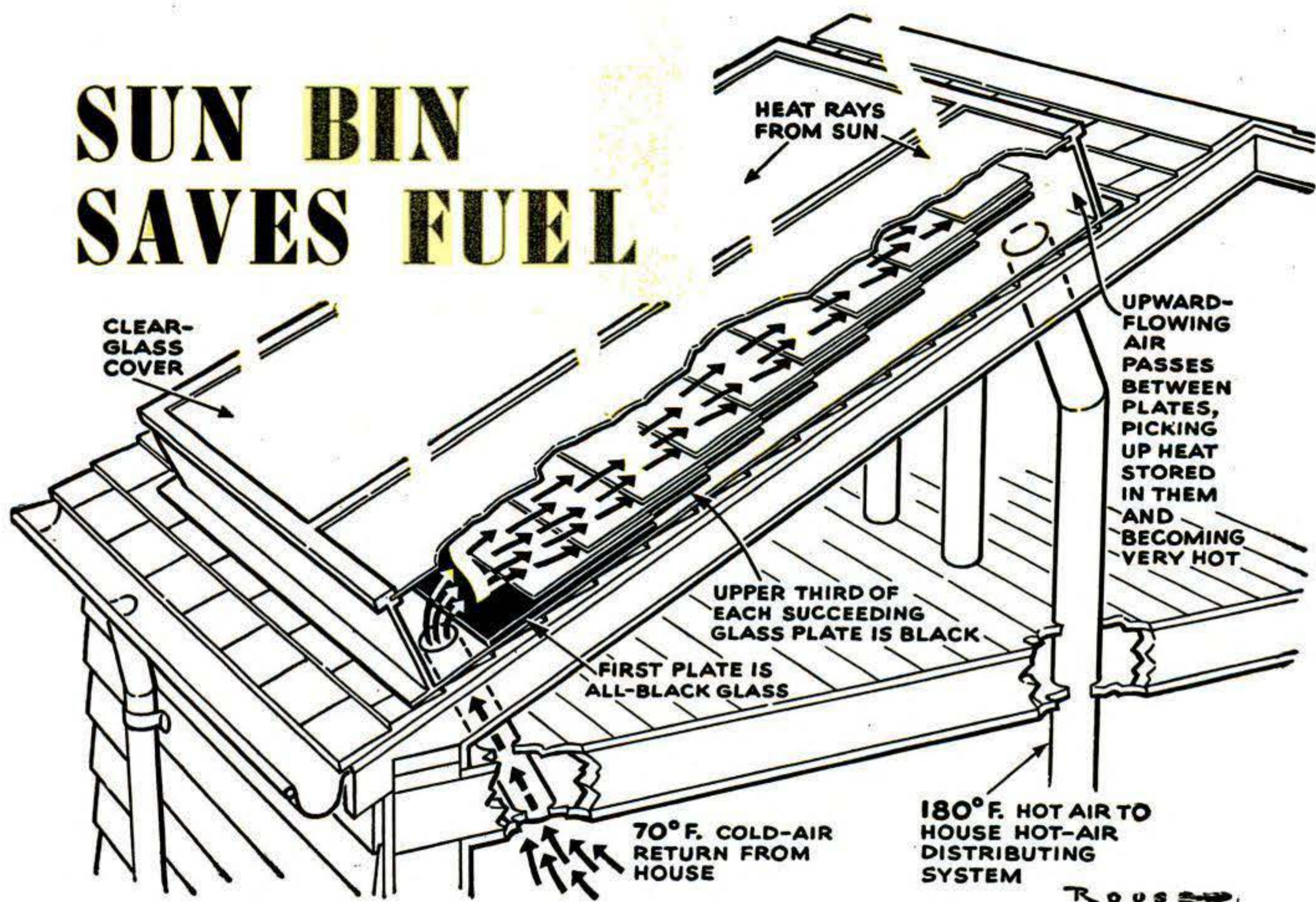

**T**HE ancient warning to people living in glass houses assumes literal significance at the University of Colorado, where glass roofs are being used to catch energy from the sun. One small house, its roof covered with beds of glass panes arranged shingle-fashion, is completely heated by this system so long as the sun shines. Although the furnace must take over at night and on cloudy days, warmth from the sun-trap reduces the annual fuel bill 20 to 30 percent.

The Colorado experimental unit uses the principle employed in greenhouses. Radiant heat from the sun—mostly of short wave length—penetrates the glass top of the roof box, then the clear part of the glass shingles inside the box, and is absorbed by the painted end of the glass shingles on the very bottom. The painted glass reradiates this heat, but at a longer wave length that will not go through clear glass and so is trapped inside the box.

Cold air from the house, passing between

Dr. George Lof, head of the solar energy project at the University of Colorado, closes the door on his sun-heated home. The beds of glass visible on the roof keep the house at a pleasant 70° F. even in Colorado winters . . . as long as the sun shines.

the glass shingles, is warmed by the trapped heat waves and is then distributed through a standard hot-air heating system. Although this solar heater can provide air as hot as 200° F., it has two disadvantages: The glass shingles shatter from the constant expansion and contraction, and there is no easy way to store the heat for use when the sun does not shine. If an efficient storage system can be developed, experts figure the fuel saving may climb to 60 percent.

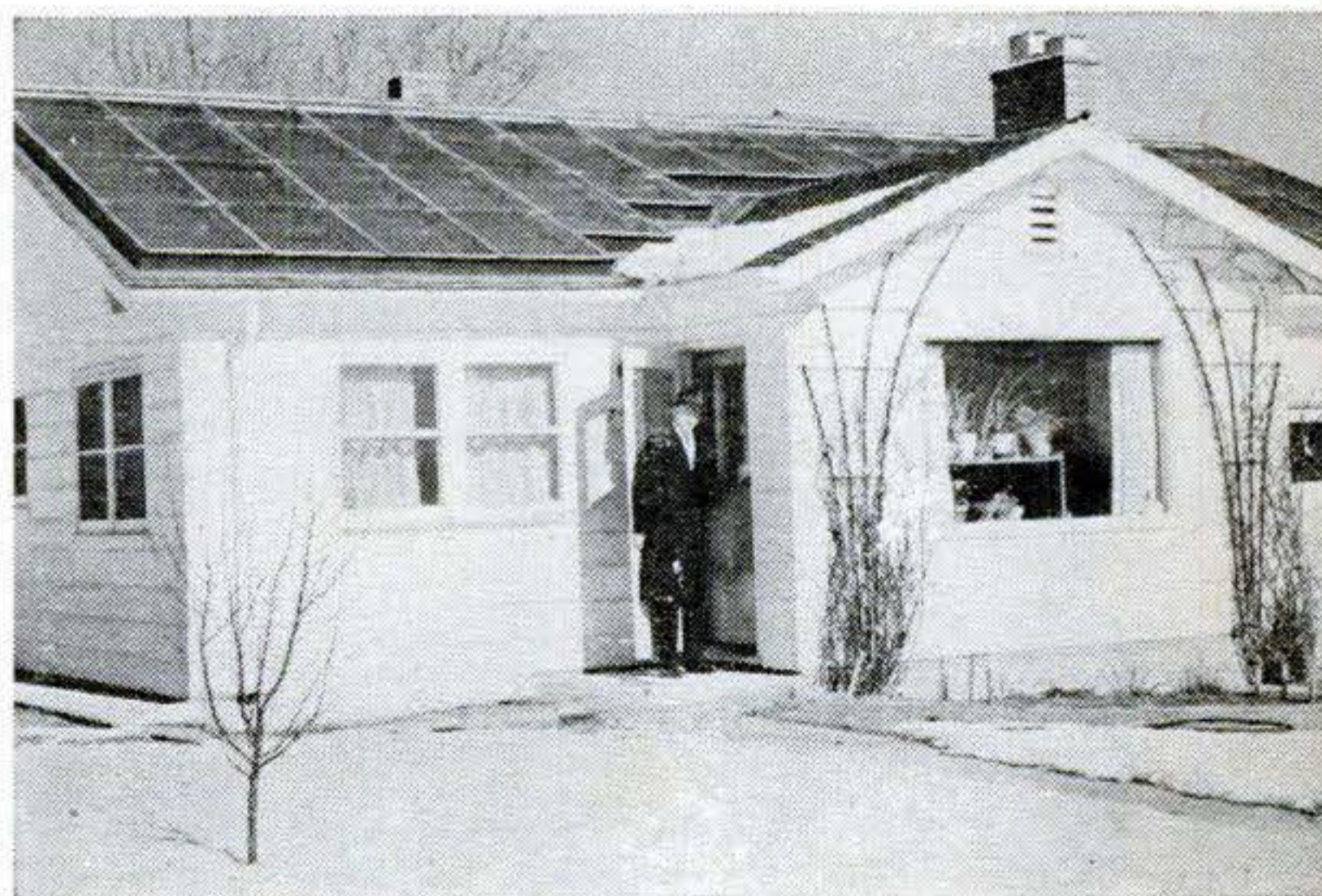



# CORN TURNED INTO FUEL

THAT old farmer who refused to replace his horses with a tractor because it wouldn't give fertilizer may be converted to the machine age yet. A new small distilling unit that processes farm crops into alcohol for tractor fuel also makes fertilizer or feed as a by-product.

With the new still designed by Joseph E. Seagram and Sons, Louisville, Ky., farmers can produce their own fuel from surplus or spoiled produce of practically any kind—grain, sugar beets, potatoes, fruits, sugar cane, wood products, and many others. The still, no bigger than a kitchen stove, is almost entirely automatic. Once the hopper is filled with the raw carbohydrate material, only occasional attention is necessary before 95% ethyl alcohol can be taken out. Five gallons of alcohol are made from two bushels of grain in less than 11 hours. And the stillage left over is a nutritious wet feed for poultry and livestock—or a high nitrogen-content fertilizer.

Although alcohol does not burn efficiently in engines made for gasoline, many motors are easily converted to the new fuel. But two obstacles still stand in the way of home-

- ① GRAIN IS GROUND INTO COARSE FLOUR BY MILL
- ② FLOUR IS BLOWN BY AIR STREAM TO CYCLONE SEPARATOR
- ③ FLOUR FALLS INTO GLASS VESSEL, AND IS MIXED WITH WATER AND SULPHURIC ACID, TO MAKE A WATERY PASTE OR MASH

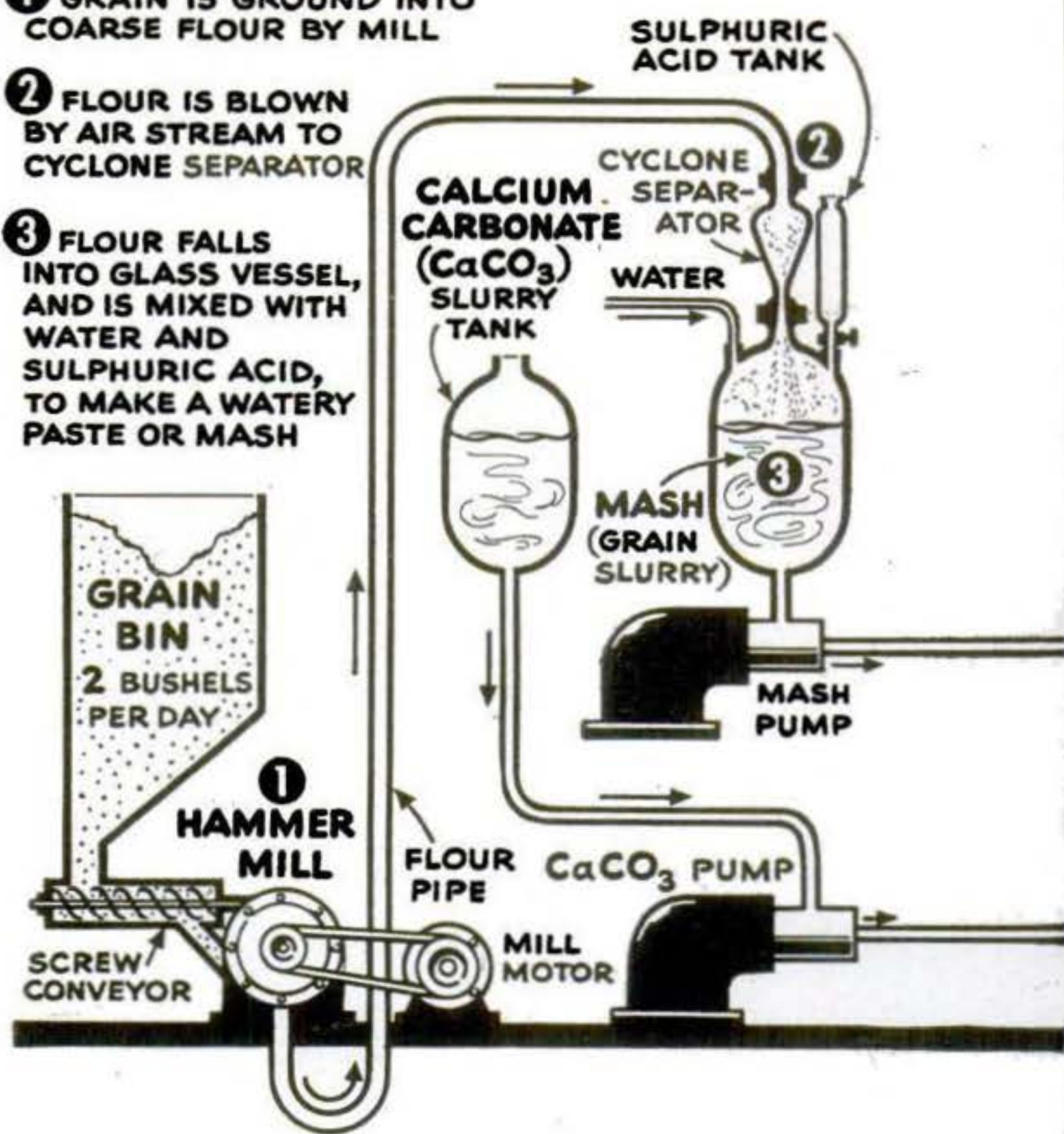

grown fuel. One is cost: the alcohol produced by the still costs more than gasoline. Improvements in techniques—or possibly raised gasoline prices—could change this situation, however. The other difficulty is legal, restricting the use of the unit—the product is highly potent moonshine!

Working parts of the model still shown below are diagrammed in reverse order in the drawing above.

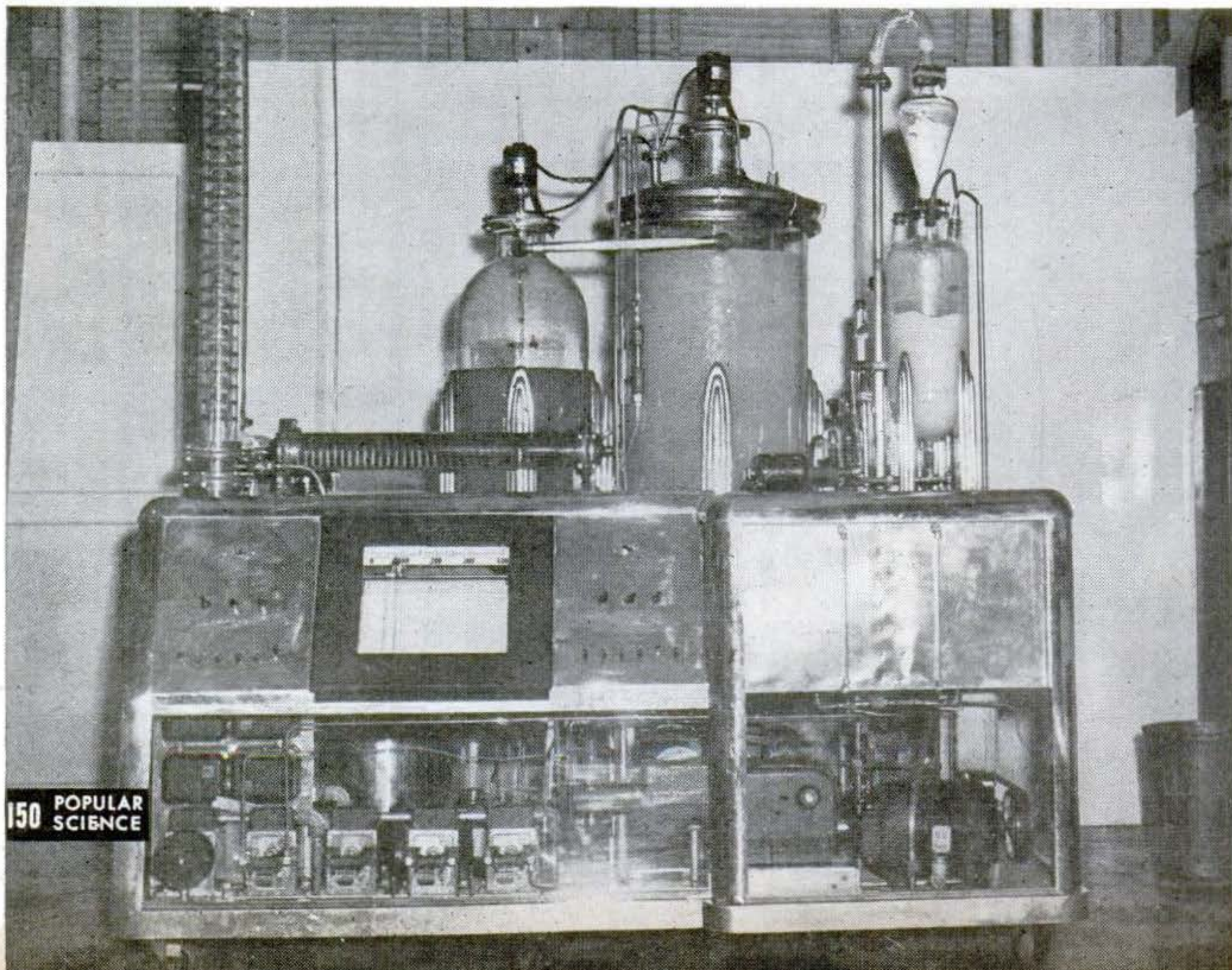



- ④ MASH IS PUMPED TO STEAM-JET MASH COOKER, WHERE STARCH IS CONVERTED TO FERMENTABLE SUGAR
- ⑤ CONVERTED MASH IS NEUTRALIZED WITH  $\text{CaCO}_3$  AS IT LEAVES COOKER
- ⑥ MASH IS WATER-COOLED TO 89°F.
- ⑦ MASH PASSES TO FERMENTER, YEAST IS ADDED, AND LATER IT BEGINS TO OVERFLOW AS BEER INTO BEER WELL
- ⑧ REMAINING SUGAR FERMENTS IN WELL

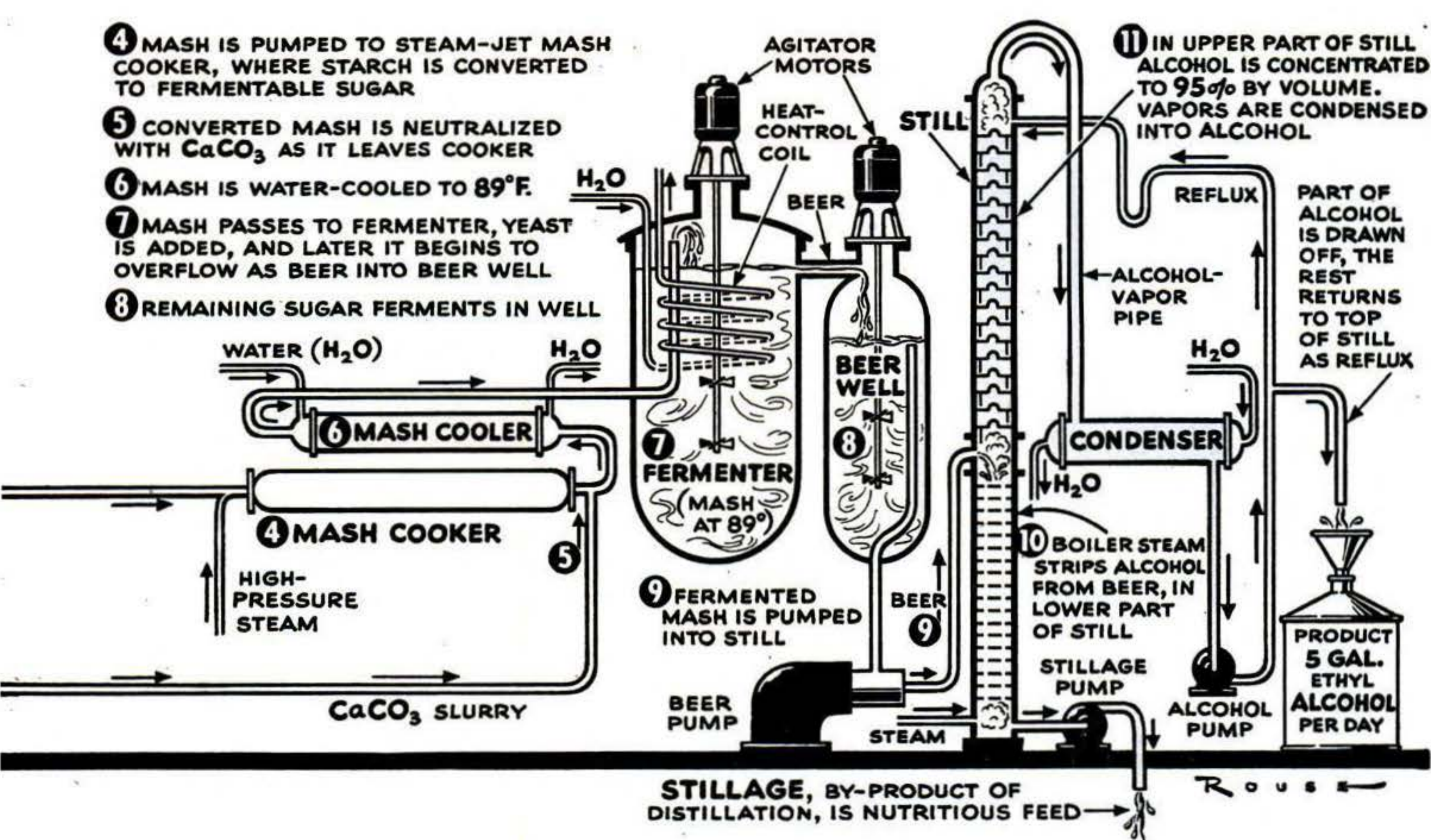

**Gear in a Goldfish Bowl.** You can see how the spiral bevel gear, right, works without taking it apart. It is enclosed in a boxlike case, bolted together of thick, machined pieces of Plexiglas. Turning an exterior rod operates the gear. The demonstration model was made by M. L. Bayard & Co., Inc., of Philadelphia.

### Silver Shields Superpyrometer.

To test new gas-turbine and jet engines, the Navy needs an accurate temperature measure. Ordinary pyrometers have shields—to protect the thermocouples from radiant heat—that are too bulky, slow response to heat changes, and block gas flow. So the Navy and the Bureau of Standards have evolved the new type below, with a small, light, silver shield, accurate to 5° F.

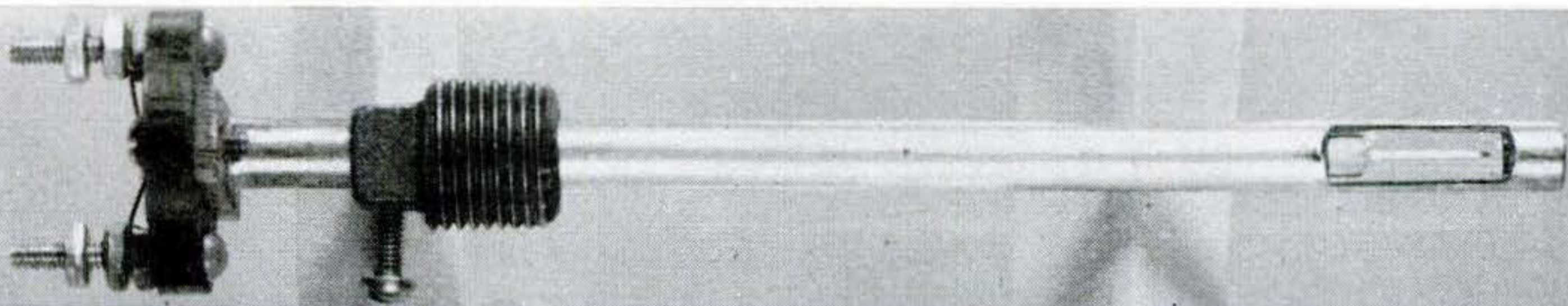
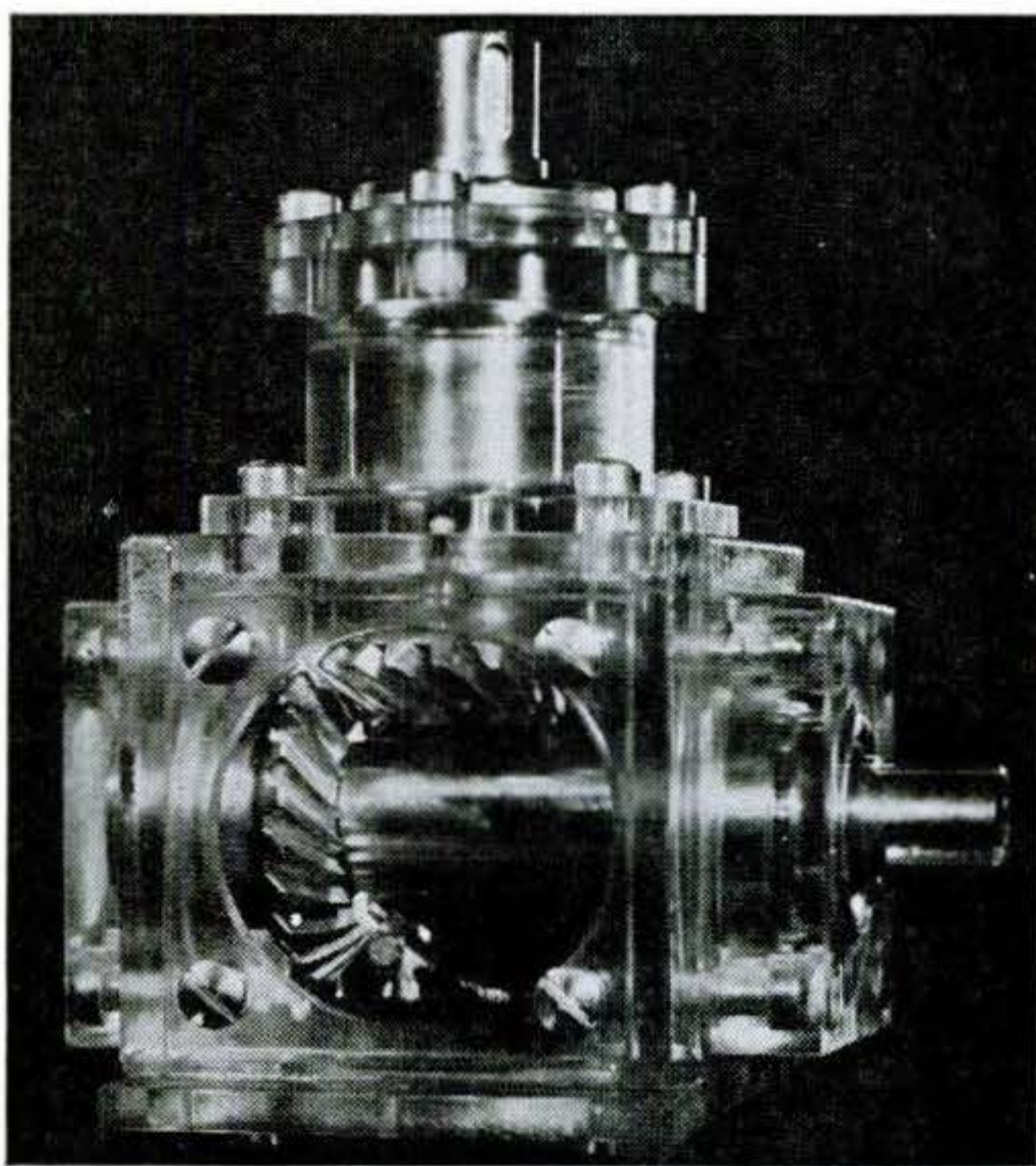



## AIDS TO MODERN LIVING

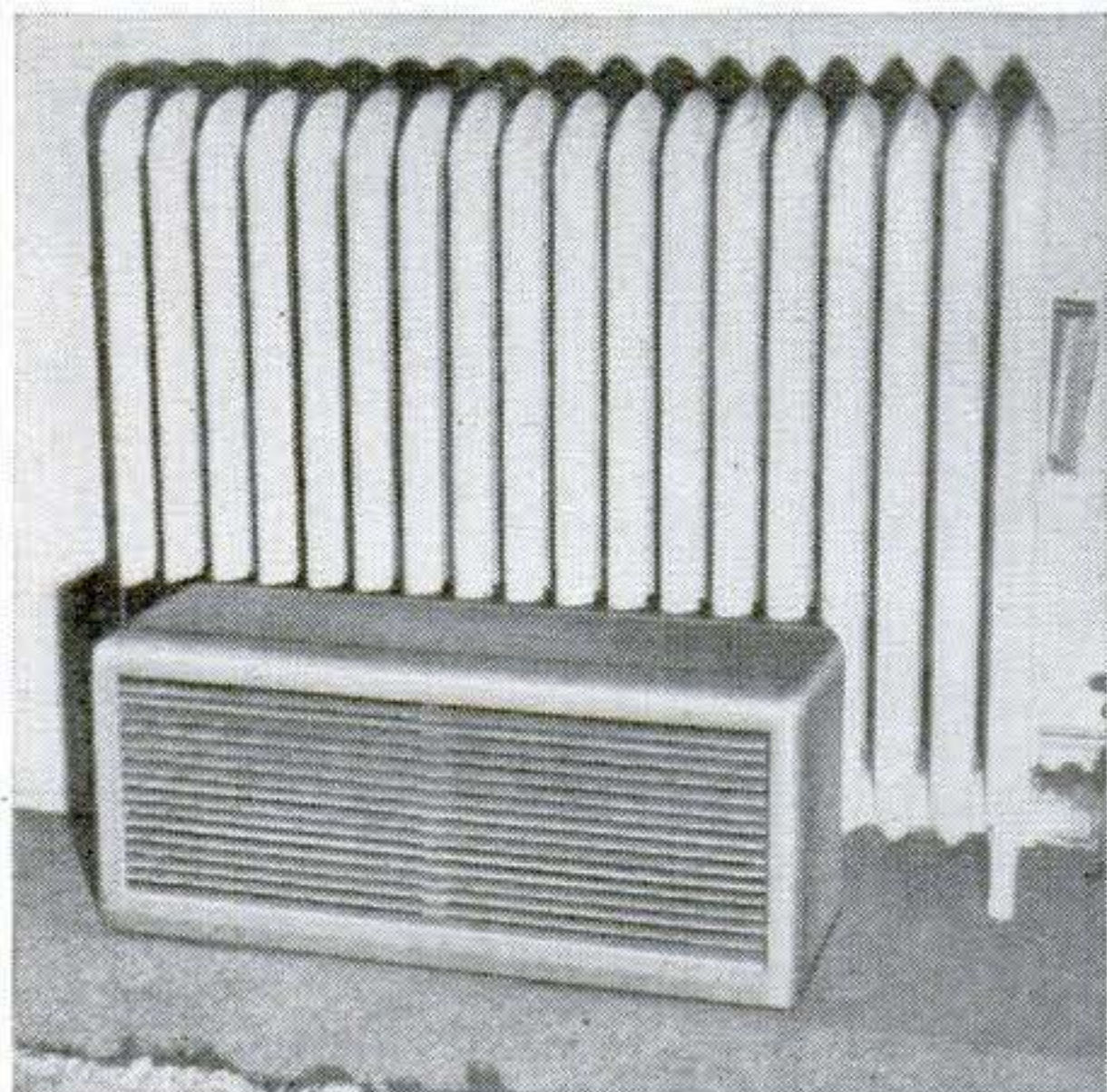

How the midget furnace compares in size with a radiator. The new gas-burning unit heats an average of two and a half rooms and can be installed in the walls. At top, a view of the furnace with the cover off.

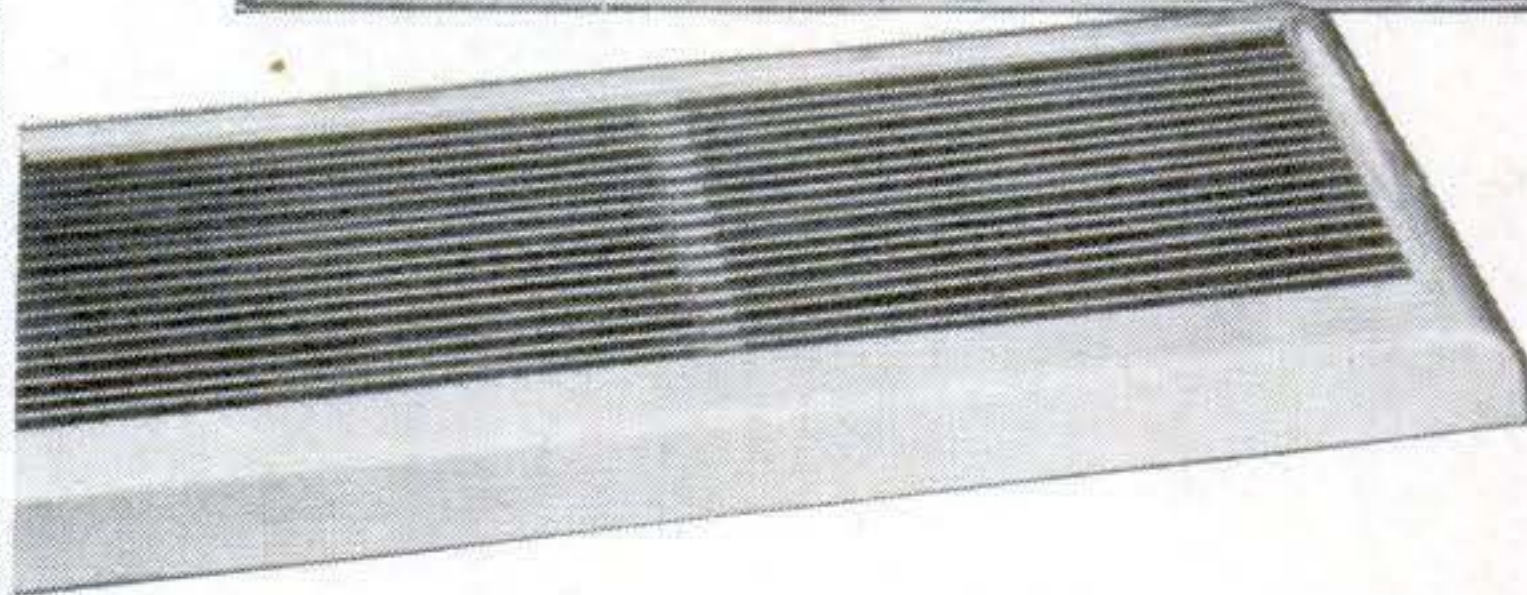
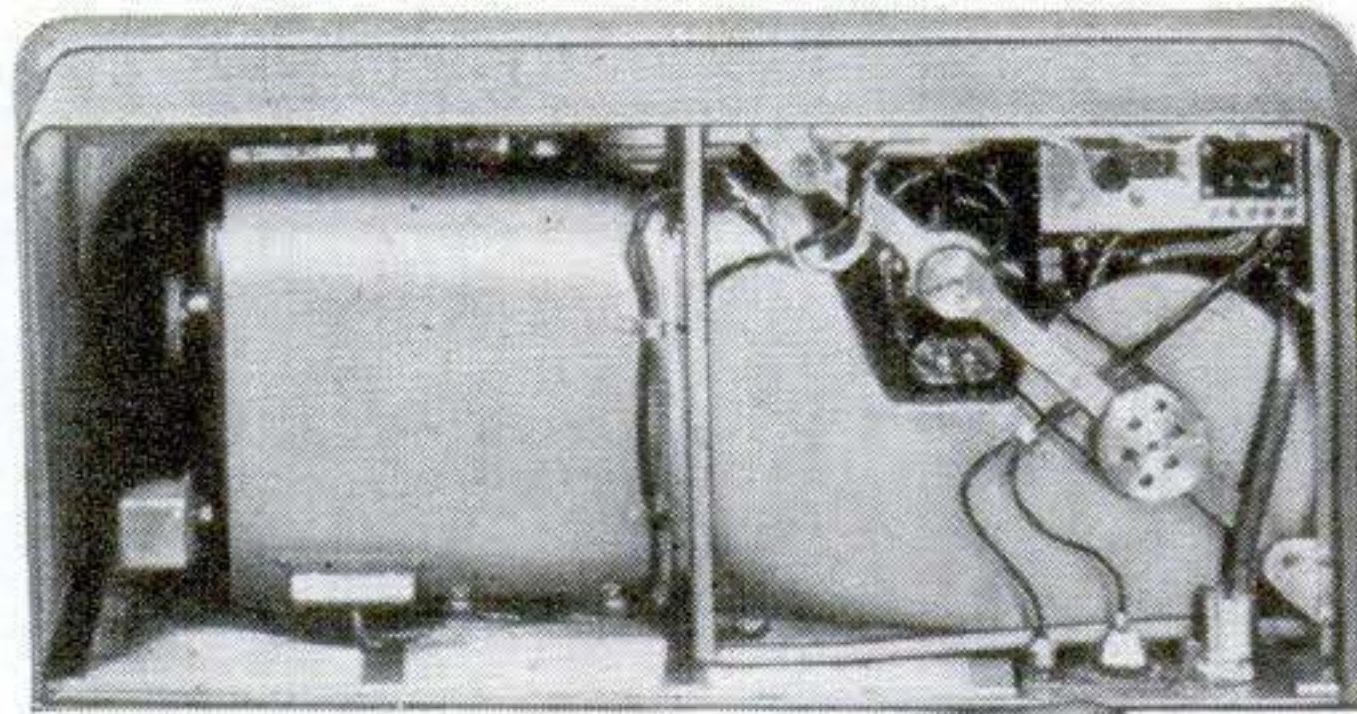

**SUITCASE-SIZE GAS FURNACE.** The new Stewart-Warner South Wind, based on the principle of an airplane heater, is now becoming available for home use. A sealed-flame system, forced-draft blower, and vents to the outside, combined with small size, make installation possible between wall studs or in floors or ceilings. One unit is needed for each zone where different temperatures may be required, and each unit is individually and automatically controlled. Cost is comparable to that of central heating plants.

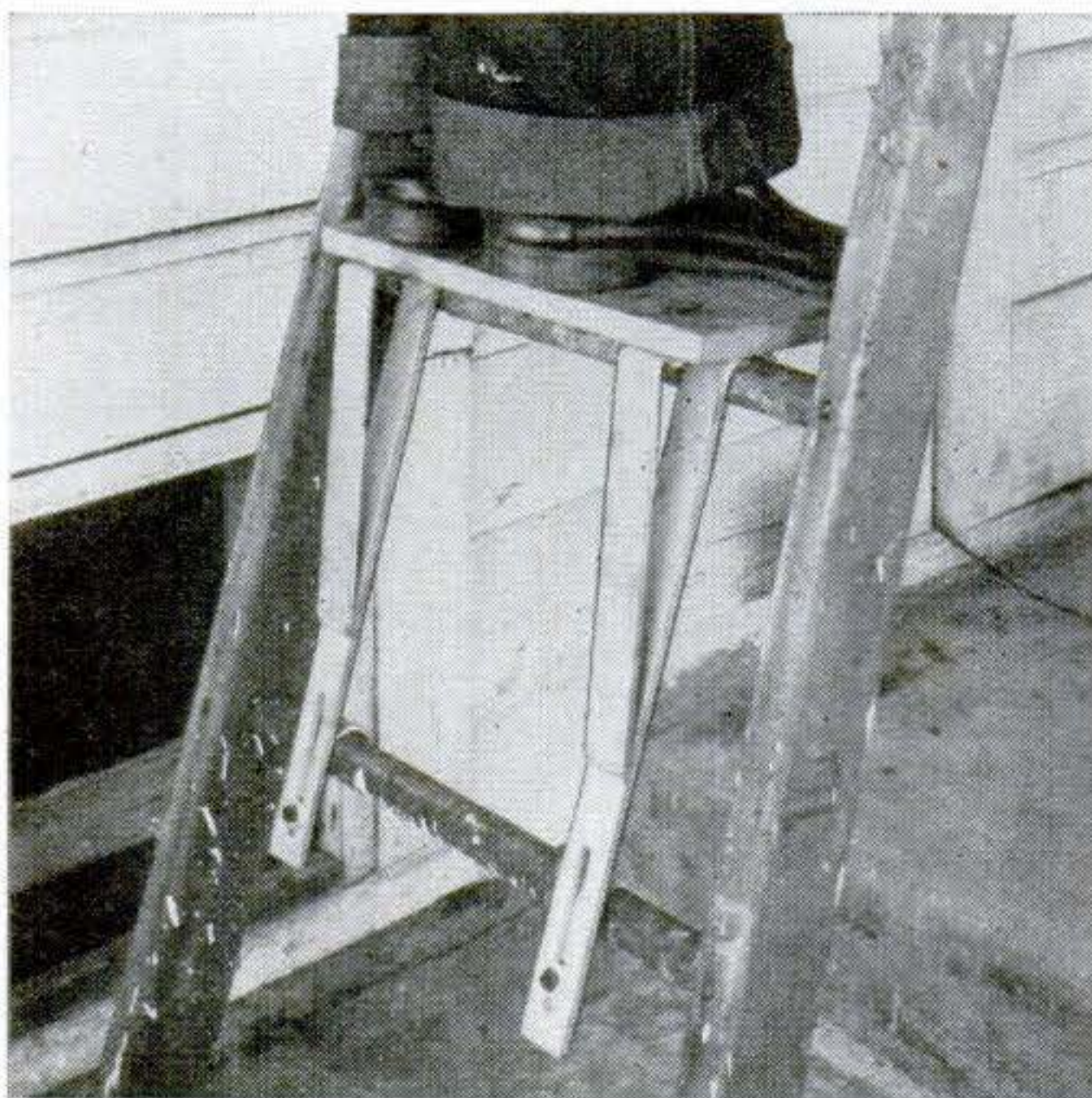

**SAFETY LADDER STEP.** Clamped on a rung ladder, this device provides a firm, steplike footing. The clamps are affixed to the rung from which work is to be done and to the one below, and then tightened with wing nuts. Made by the Tara Manufacturing Co., of Chicago, the ladder step is listed to sell at retail for about \$3.

**HASSOCK AND RECORD CABINET.** Known as the Has-o-Rak, this space saver serves as a low seat beside the phonograph and also as a storage case for 50 records. A drop-front door provides easy access to the disks. The finish is simulated leather. Peerless Album Co., Inc., of New York, offers it for under \$25.

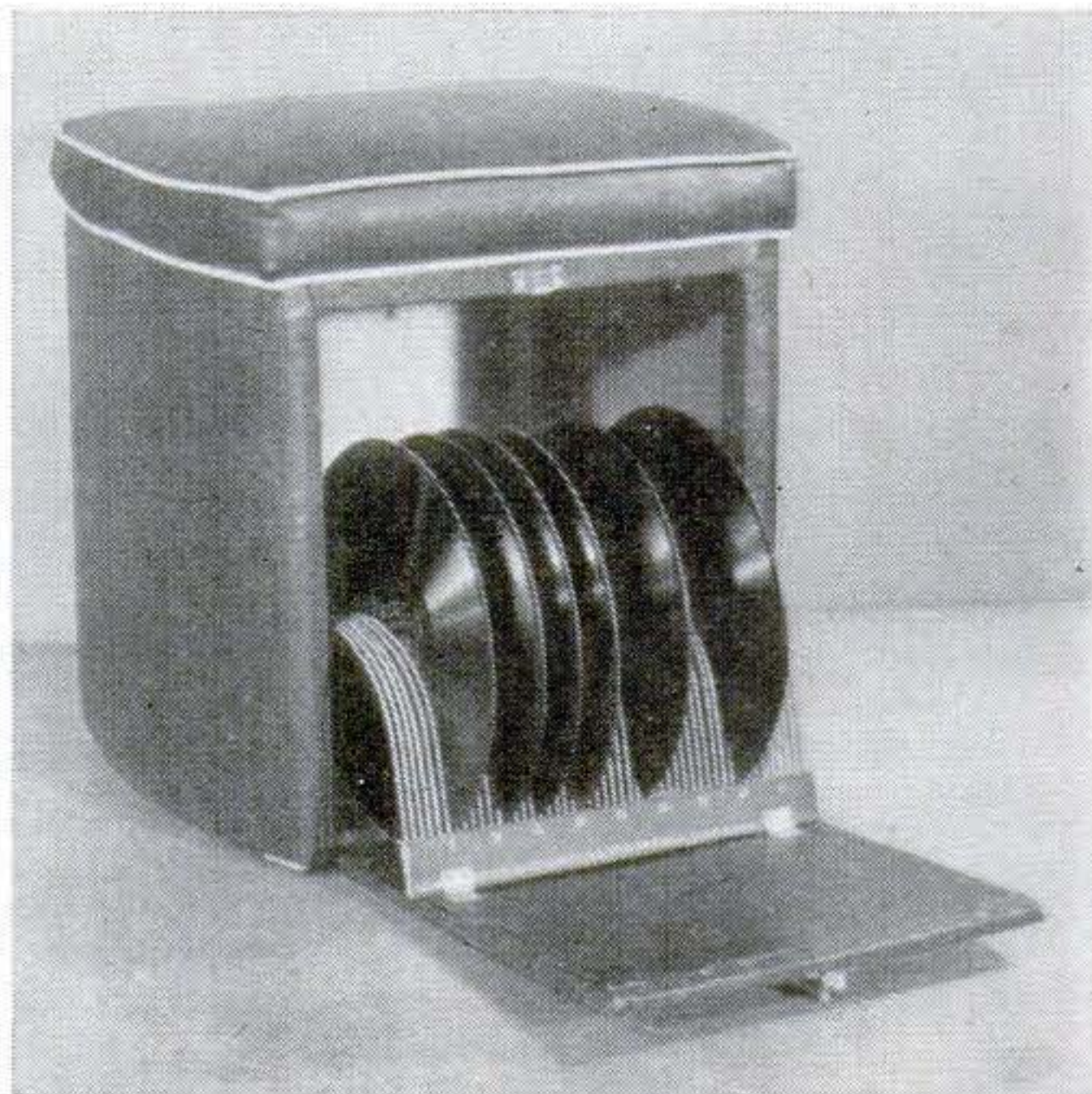



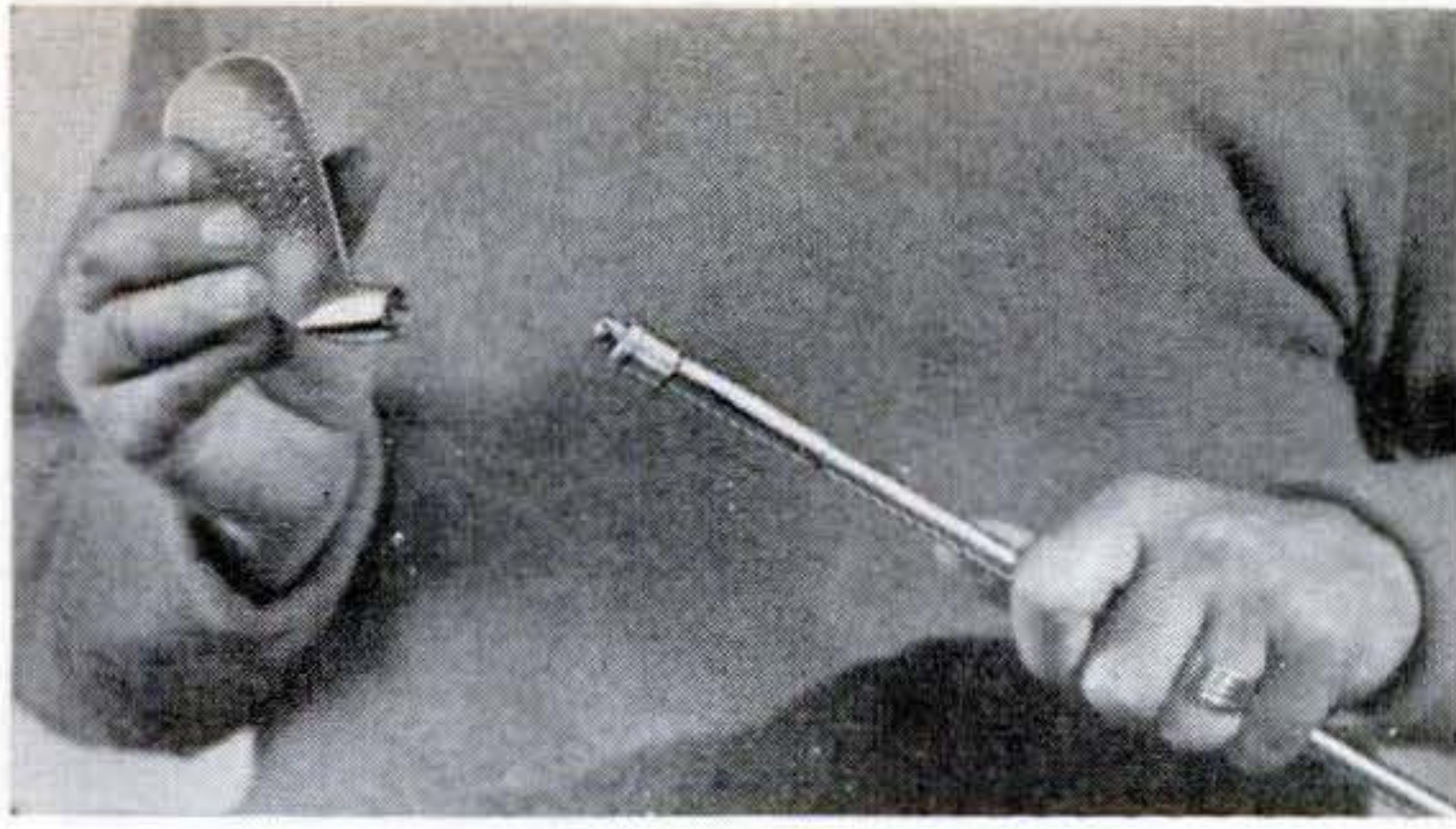

**TIRED OF LUGGING A GOLF BAG?** Here's a complete set of six clubs made up of only two heads and a single, adjustable-length shaft. The set is made by Jakosky Co., of Los Angeles, to retail for about \$25. A second model that folds down to traveling-bag size is priced at under \$40.



**HOME CHERRY PITTER.** Seeds are removed from olives, too, by this kitchen gadget. The fruit rests on a cushioned holder that protects it from bruises. Pits drop into the jar on which the plunger is mounted. R. Krasberg & Sons Mfg. Co., of Chicago, price it at \$1.

**POWER DRIVE FOR OLD MOWERS.** The Silver Creek electric power unit attaches to standard hand-pushed lawn mowers. It is adjustable to fit various widths, power is controlled by a switch at the handle, and a lever raises the unit off the wheels to permit easy backing. Current from any 115-volt outlet recharges the battery on which the motor in the device operates.



**ELECTROSTATIC AIR CLEANSER.** Designed for cleaning conditioned and warm air, Westinghouse's Precipitron works on the principle of ionization. Air enters through a duct and passes through a screen of air-turning vanes to an electrostatic field where the dust particles receive a positive electric charge. Negatively charged dust-collector plates attract and hold the charged particles, permitting only clean air to pass through into the house. Efficiency of 85 to 90 percent is claimed. Collected dust in the unit is flushed out by a water spray when cleaning of the unit becomes necessary. Installed in an air-conditioning or heating system, the Precipitron has an air-cleaning capacity of 1,200 cubic per minute, enough for an eight-room house.

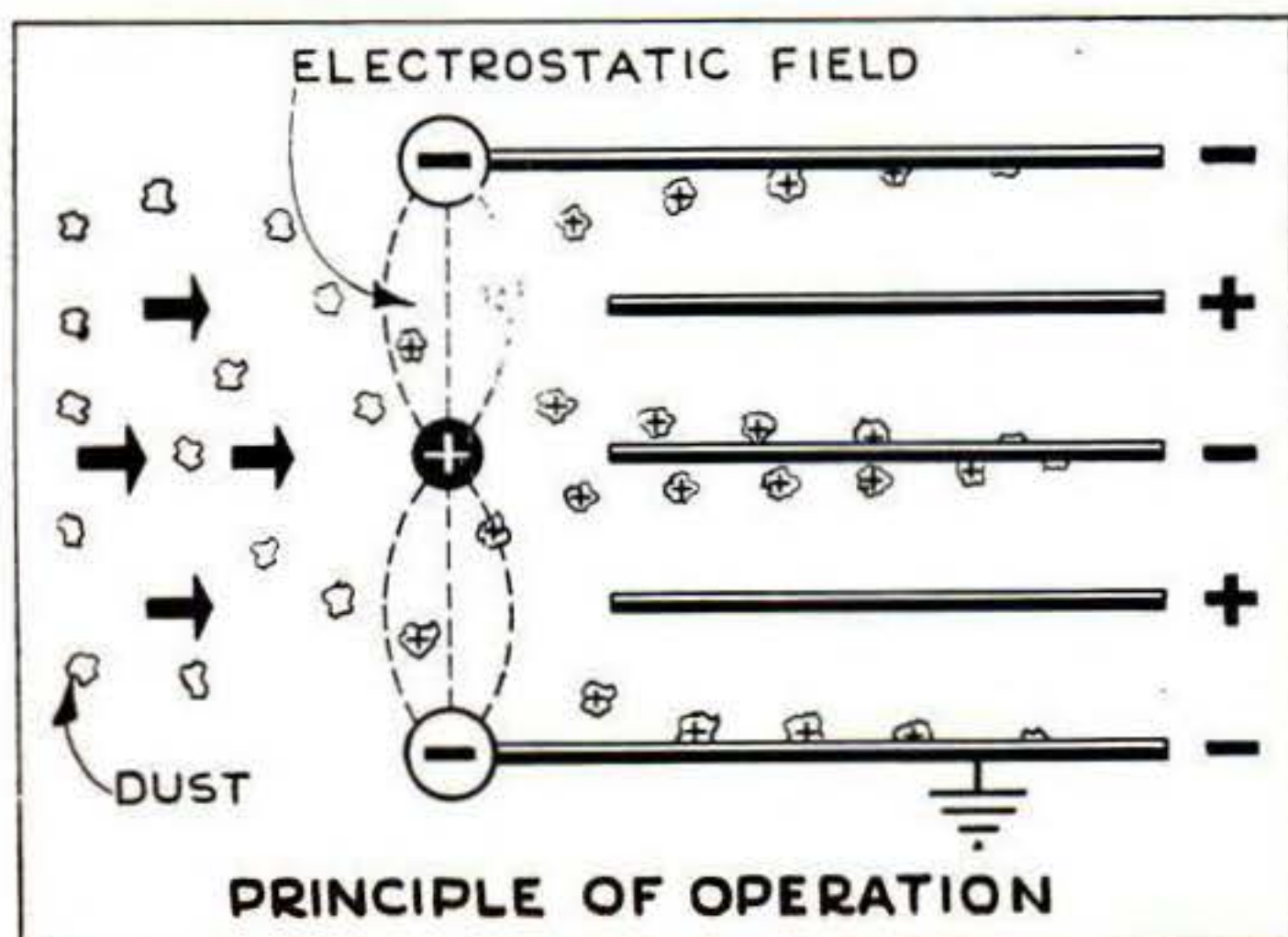
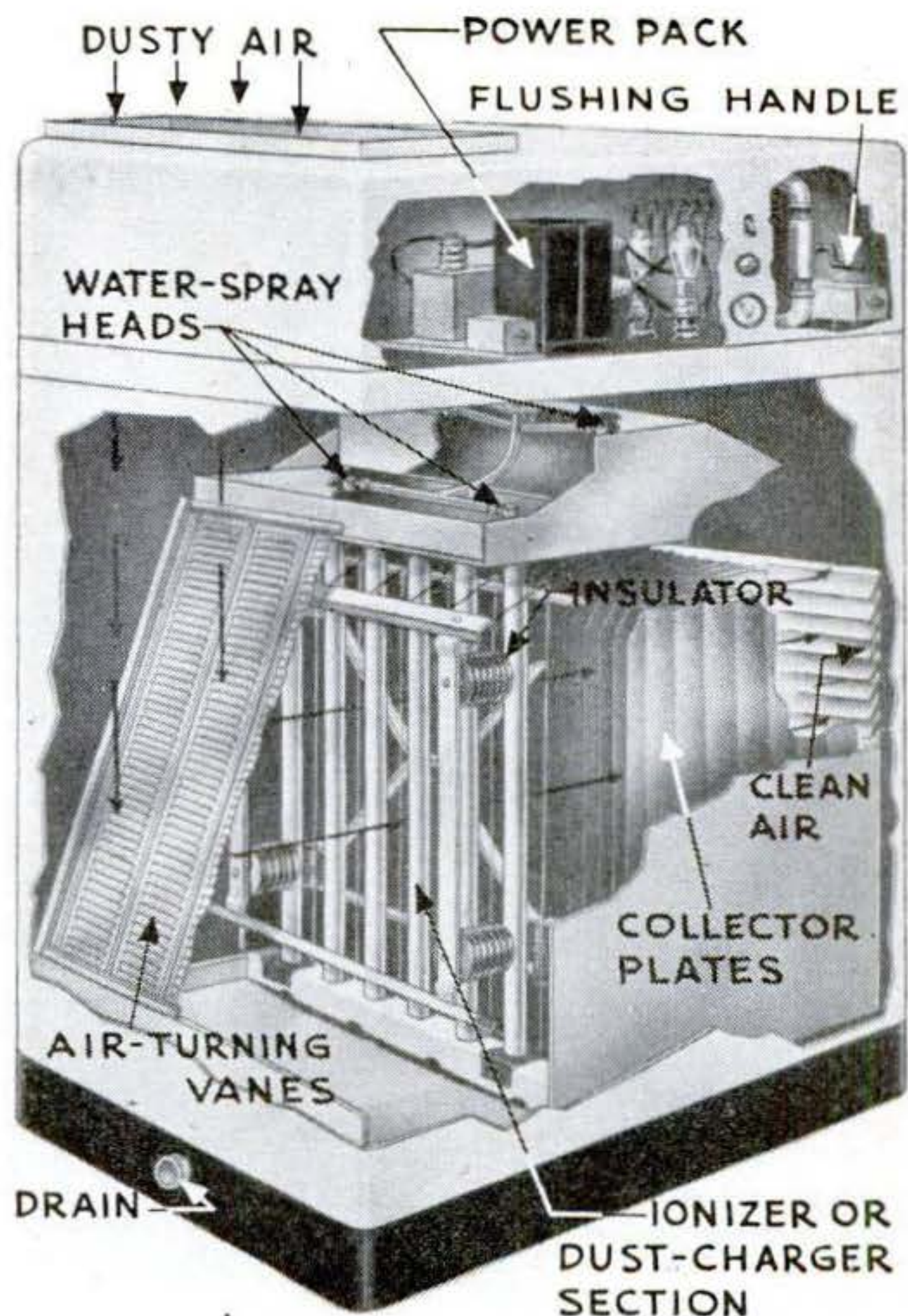



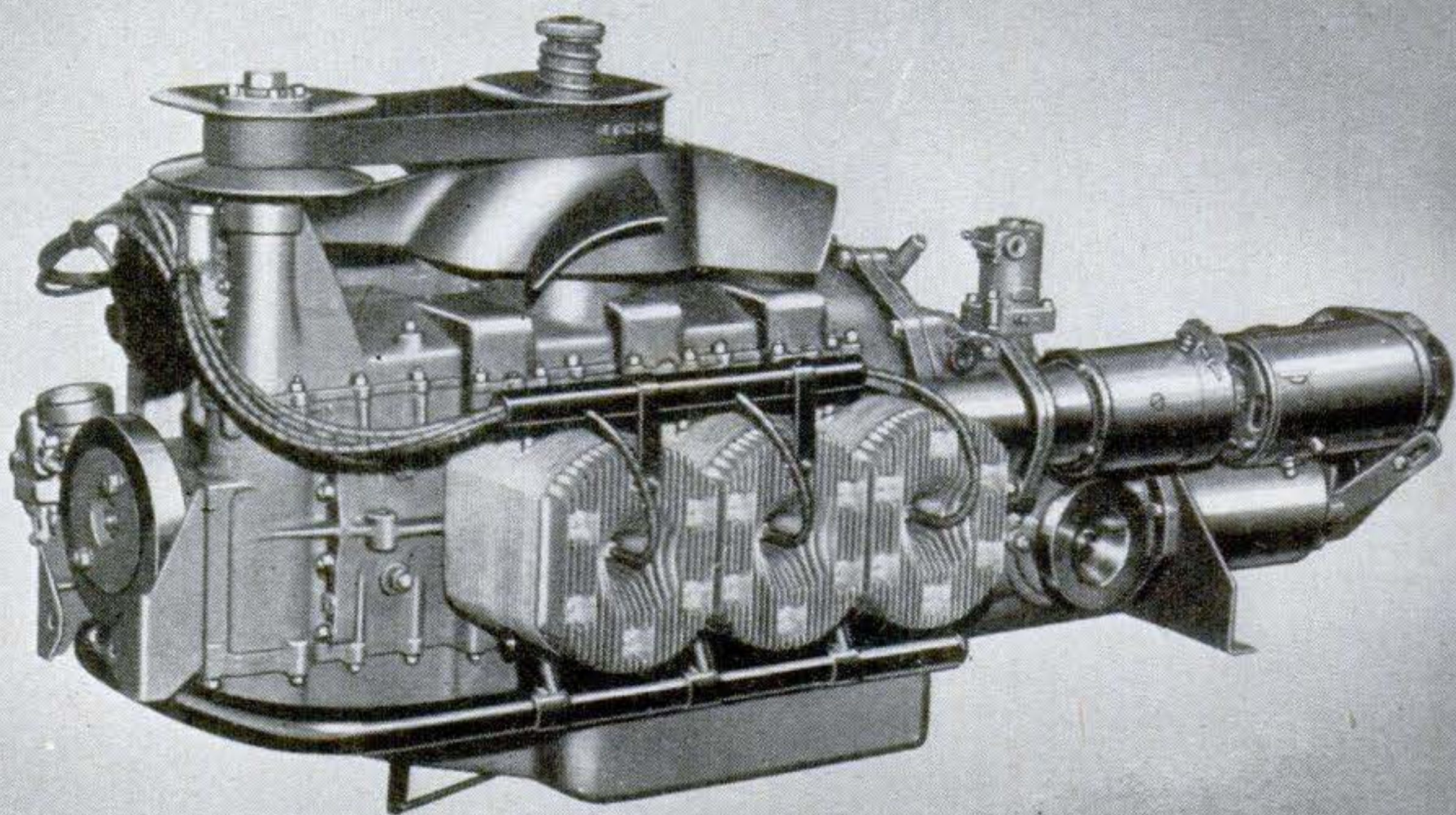

# PANCAKE ENGINE

## Has Slide Valves

**W**HAT the future holds for this six-cylinder horizontally opposed engine is not yet clear, but there's a chance you may find it in some of the really new postwar cars still to come out of Detroit. Air-cooled, light, and efficient, it is said to be suitable for either front or rear drive.

Developed in its present form to power either an automobile or lightplane, the engine first was built during the war to drive a generator in a long-distance bomber. Jack & Heintz Precision Industries, Inc., of Cleveland, produces it under license from the Skinner Motor Co., of Detroit, designer of the original engine from which this was adapted.

The valves are a variation of the sleeve valves previously employed in other engines. But, whereas the sliding sleeves used in the old Willys-Knight and other cars fully encircled the cylinder, these are split into two segments, one for the intake and one for the exhaust, and are more exactly known as slide valves. The rotary motion of a pair of eccentrics is translated into the reciprocating

action of the valves by a connecting rod attached near the center of the valve lever, a ball on one end of the latter fitting into a socket on the valve and the other end operating on a fixed pivot. By eliminating the "hot spots" associated with poppet valves, the design permits the use of comparatively low-octane fuels.

A horizontal fan driven by a thermostatically controlled variable-speed pulley cools the engine. This makes it possible to increase fan speed under conditions of low engine speed and heavy load. A built-up crankshaft permits the use of one-piece connecting rods; bearing surfaces of the rods are hardened, and the bearing metal is applied to the pins.

The engine has 126 cu. in. displacement, delivers a peak of 95 hp., and will turn up as high as 7,000 r.p.m. Fuel consumption is said to be 25 percent less than that of comparable conventional engines. The die-cast components in the engine should cut down manufacturing costs once the original expense of the dies is recovered.



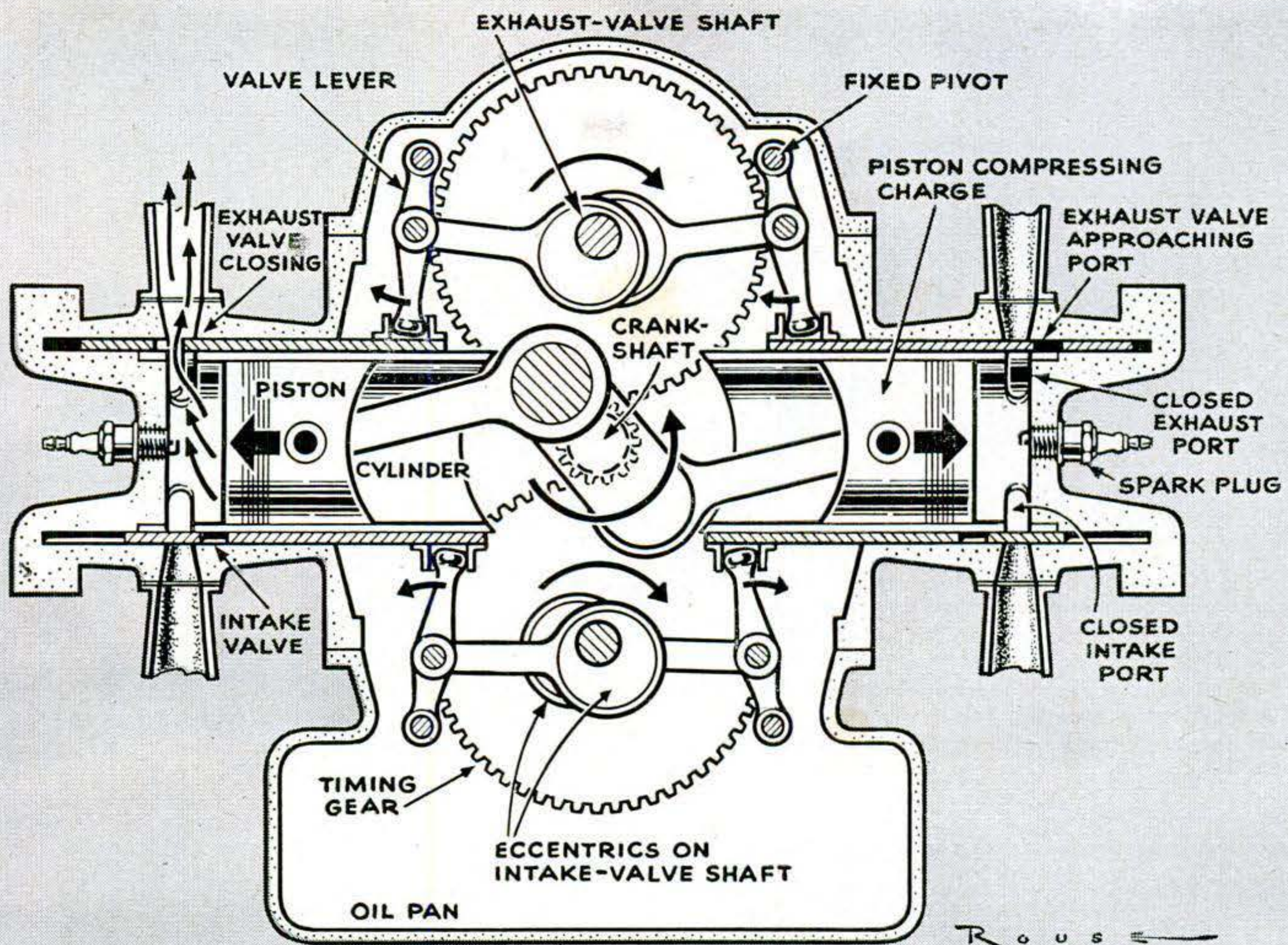

Rous

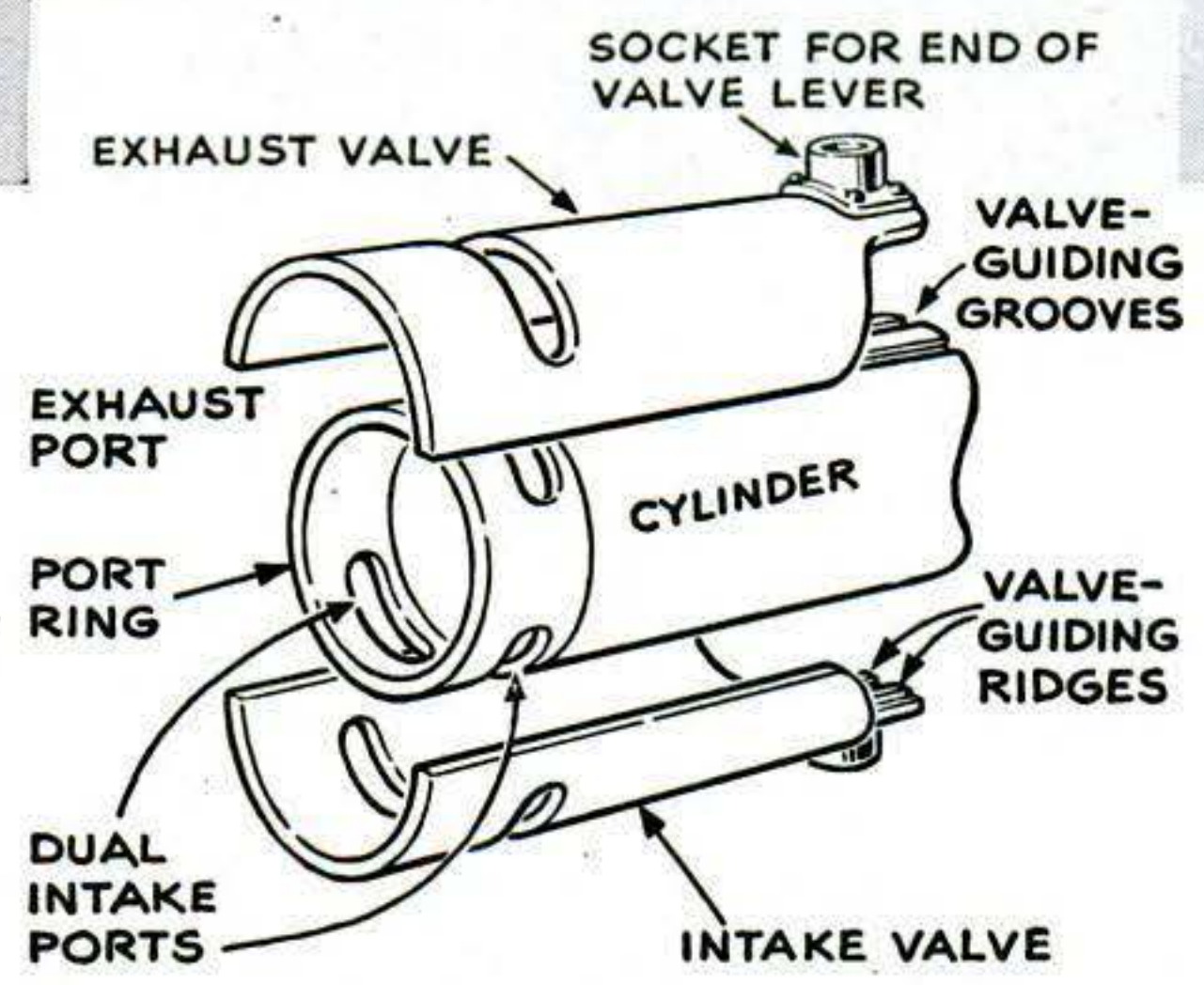

Each valve consists of a slotted segment outside the cylinder liner; together, intake and exhaust valves extend around the liner. The ports are opened on both the outward and the return strokes of every valve segment.

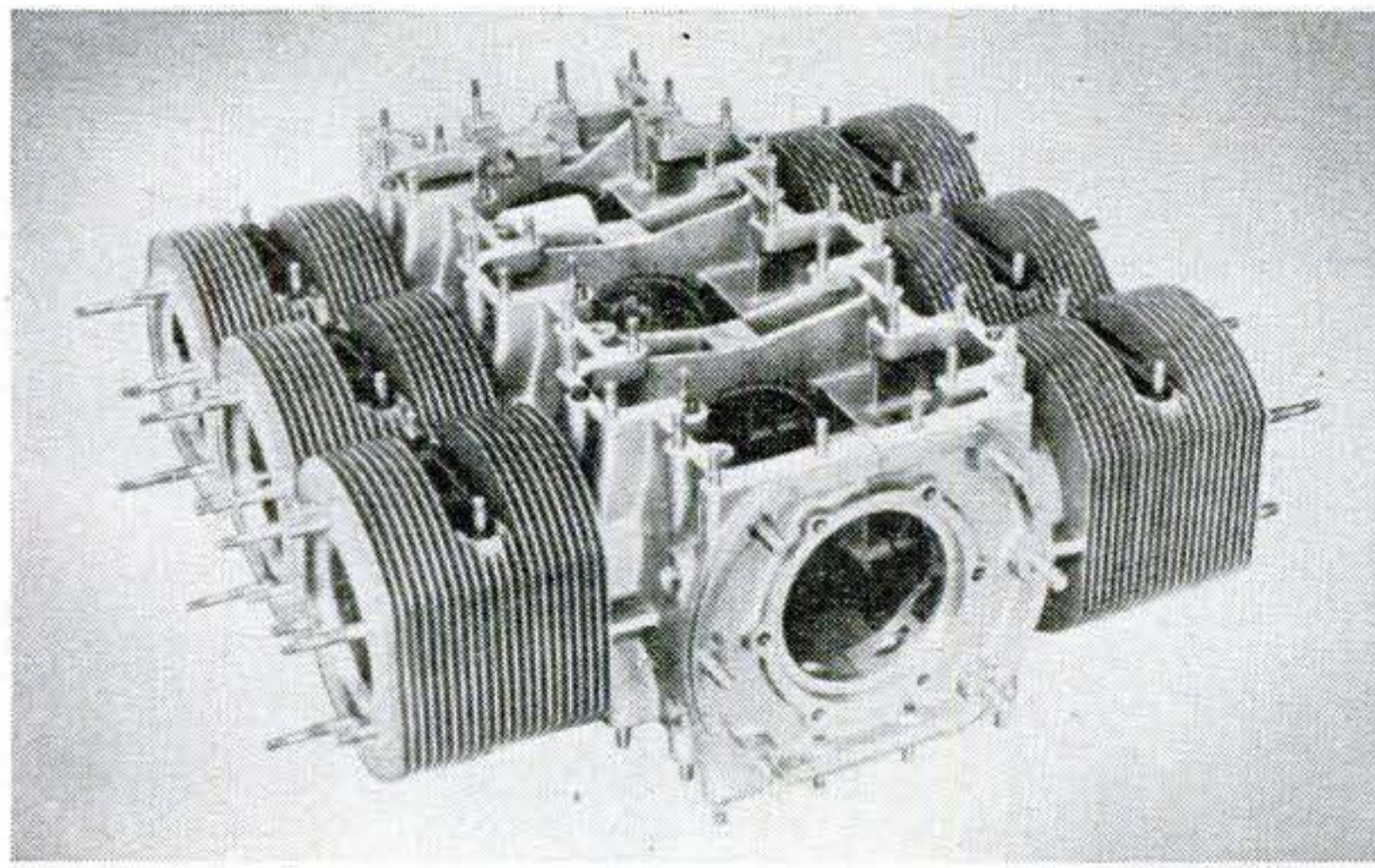

Die-casting keeps down the cost of the cylinders and crankcase, and the use of light alloys reduces the weight. Here are the cylinder barrels and block.

Two valve-shaft assemblies are used, one driving the exhaust valves and oil pump and the other the intake valves. Each shaft is driven at one fourth the engine speed, eccentrics and a pivoted lever carrying the action to the valves. At right is one valve-shaft assembly.

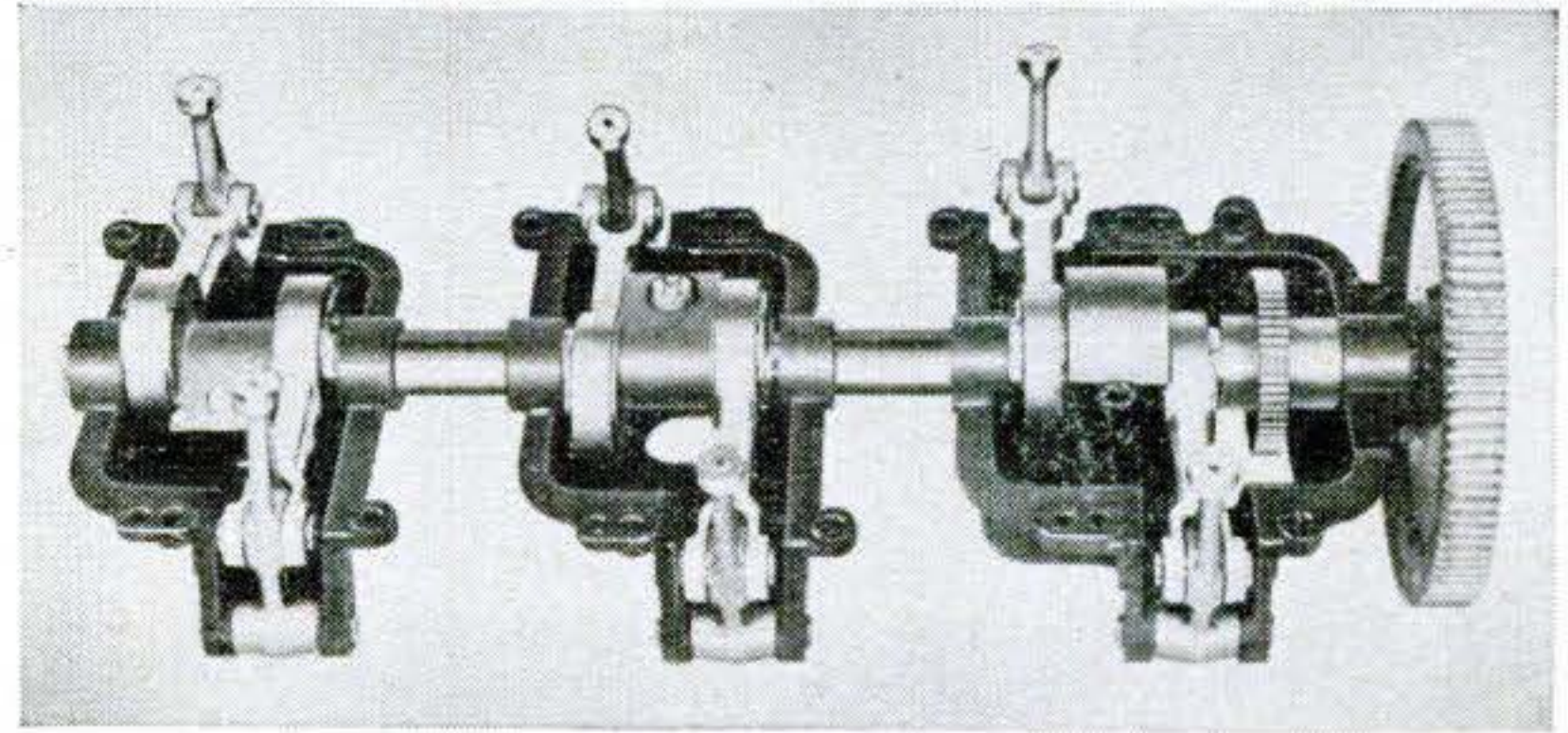



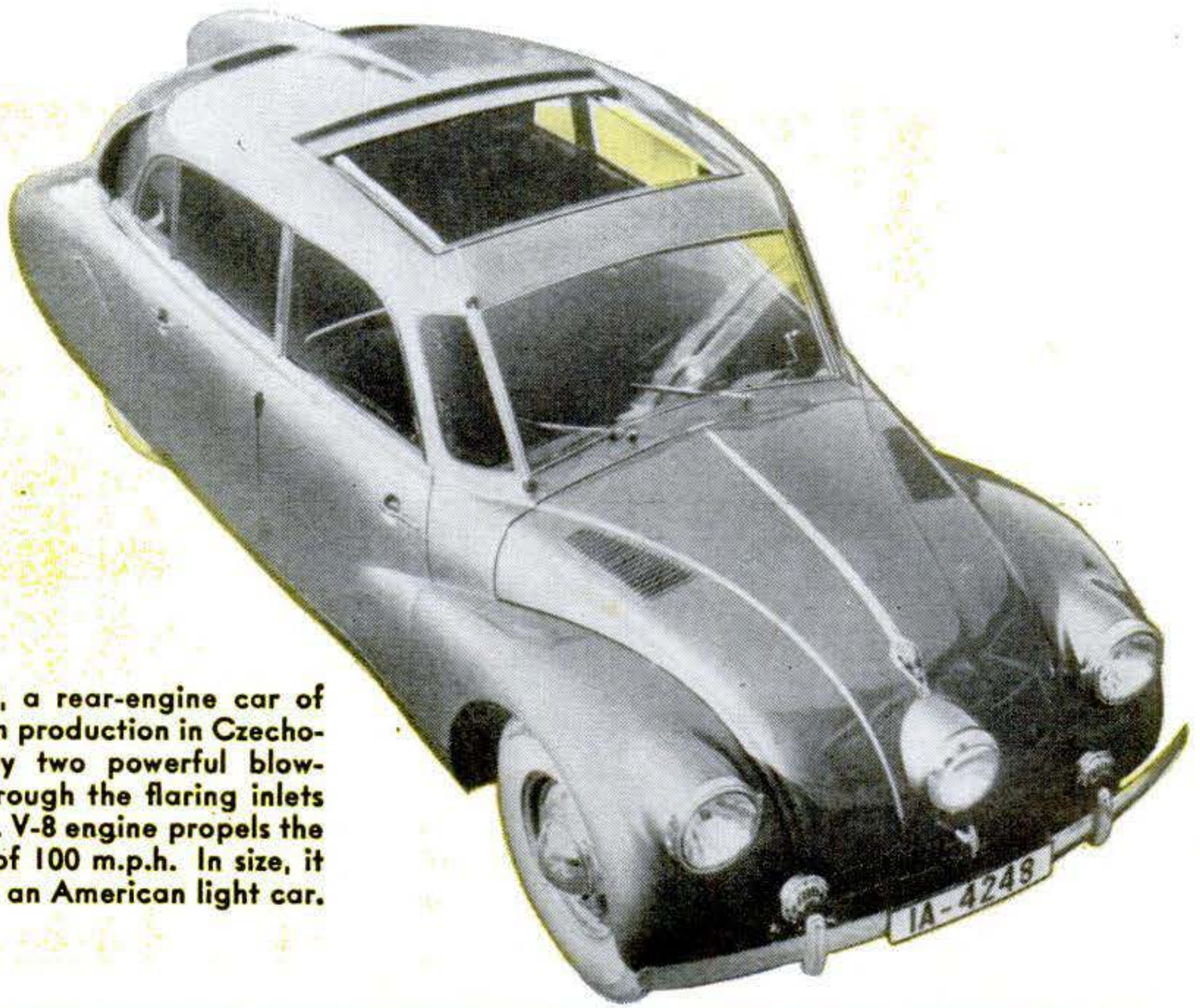

This is the Tatra 87, a rear-engine car of unusual design now in production in Czechoslovakia. Cooled by two powerful blowers that draw air through the flaring inlets at the back, a 75-hp. V-8 engine propels the car at a top speed of 100 m.p.h. In size, it is about the same as an American light car.

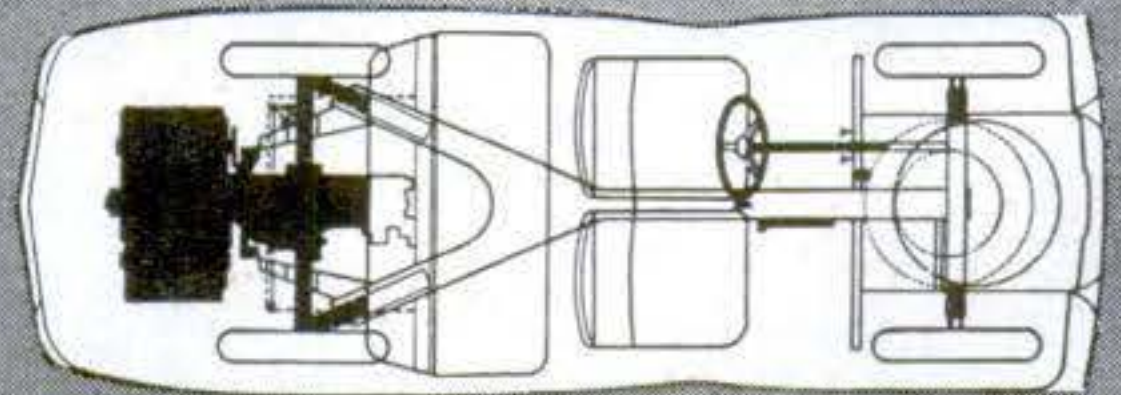
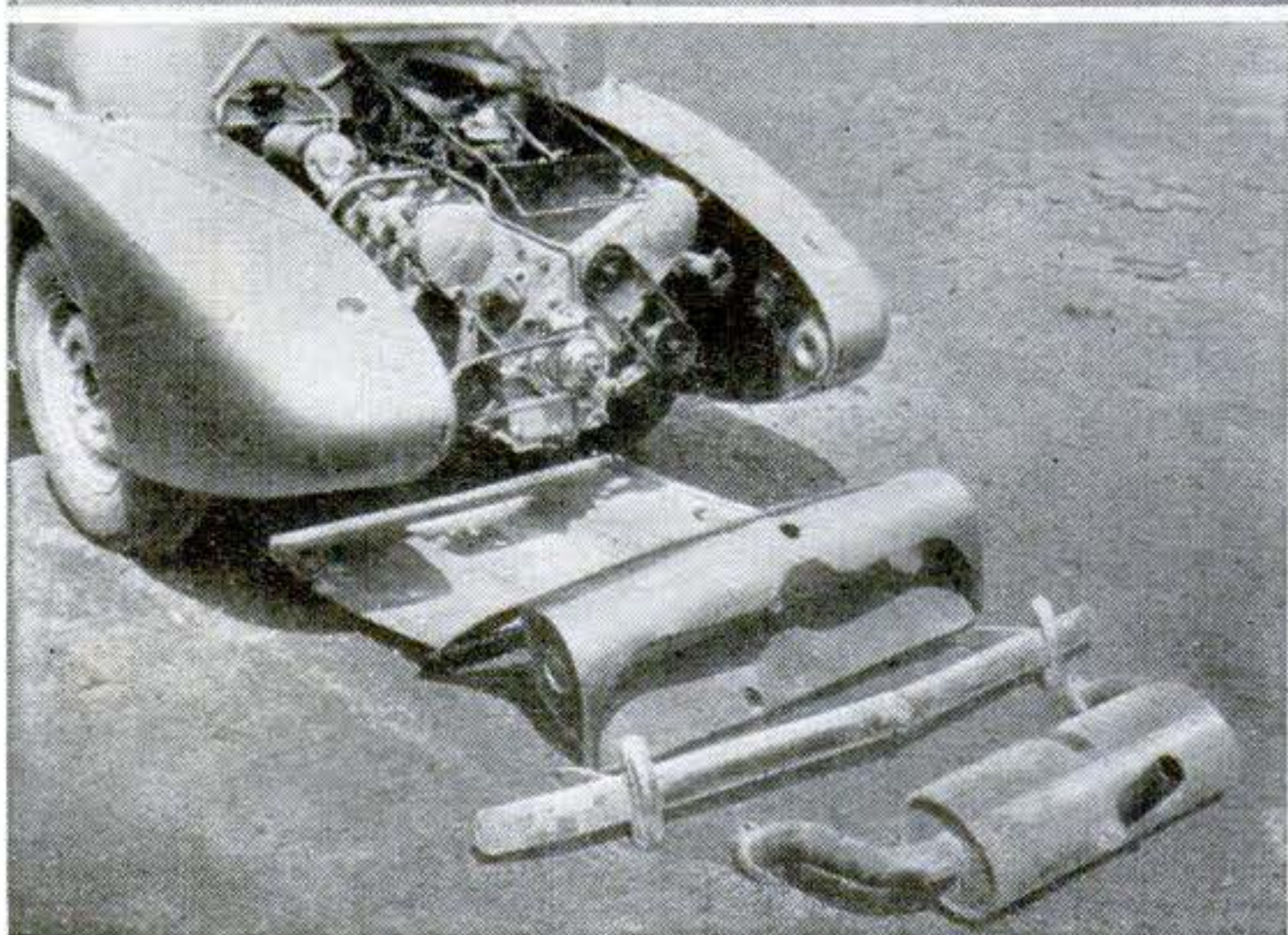
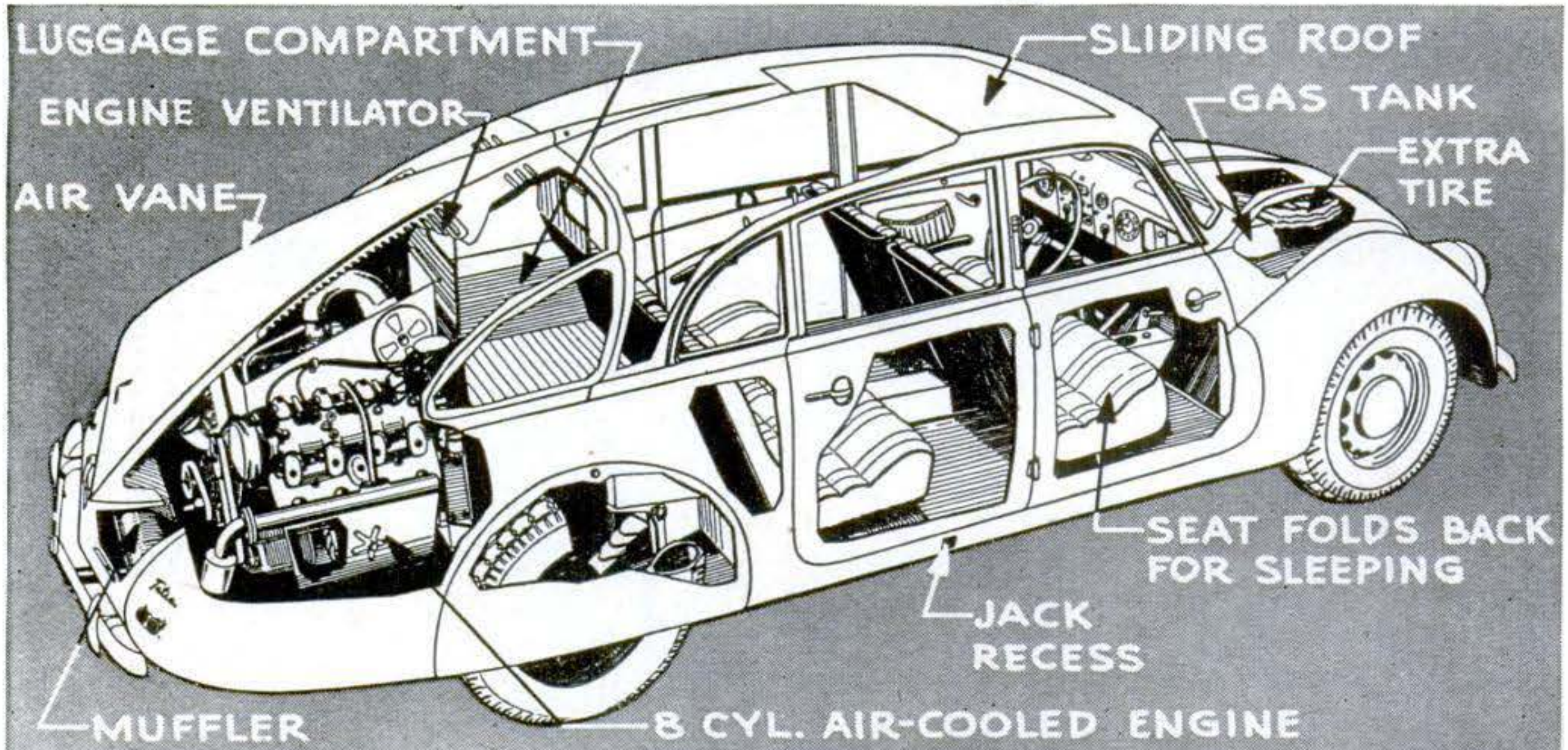

Built of light materials, the Tatra engine adds little more weight than is usually found at the rear of a car. Shown in black above, the entire power unit readily rolls free for servicing after the engine cover, bumper, and muffler are detached and the rear of the car is jacked up. As illustrated directly above, the Tatra rests on a Y-shaped steel backbone.





Although small, this rear-engine Renault carries four persons. Now being tested in France, it is built for economy, having a 4-cylinder water-cooled engine that is said to give 47 miles on a gallon of fuel, with a maximum speed of 56 m.p.h.

## Czech and French DREAM CARS

**Supermodern models designed by two long-established auto manufacturers in Europe have removable rear engines.**

By R. P. STEVENSON

**I**MAGINATIVE artists for years have been sketching cars of the future as sleek vehicles with superstreamlining. Now in production in Czechoslovakia is a car that approaches these dream cars in appearance about as closely as anything yet produced on either side of the Atlantic. It is the Tatra 87, a sedan with smooth, sweeping lines, a rudderlike air vane at the back, an air-cooled engine located at the rear, and other unconventional features.

The Tatra, a product of the Tatra Works, Limited, is one of two rear-engine models now attracting interest in Europe. The other

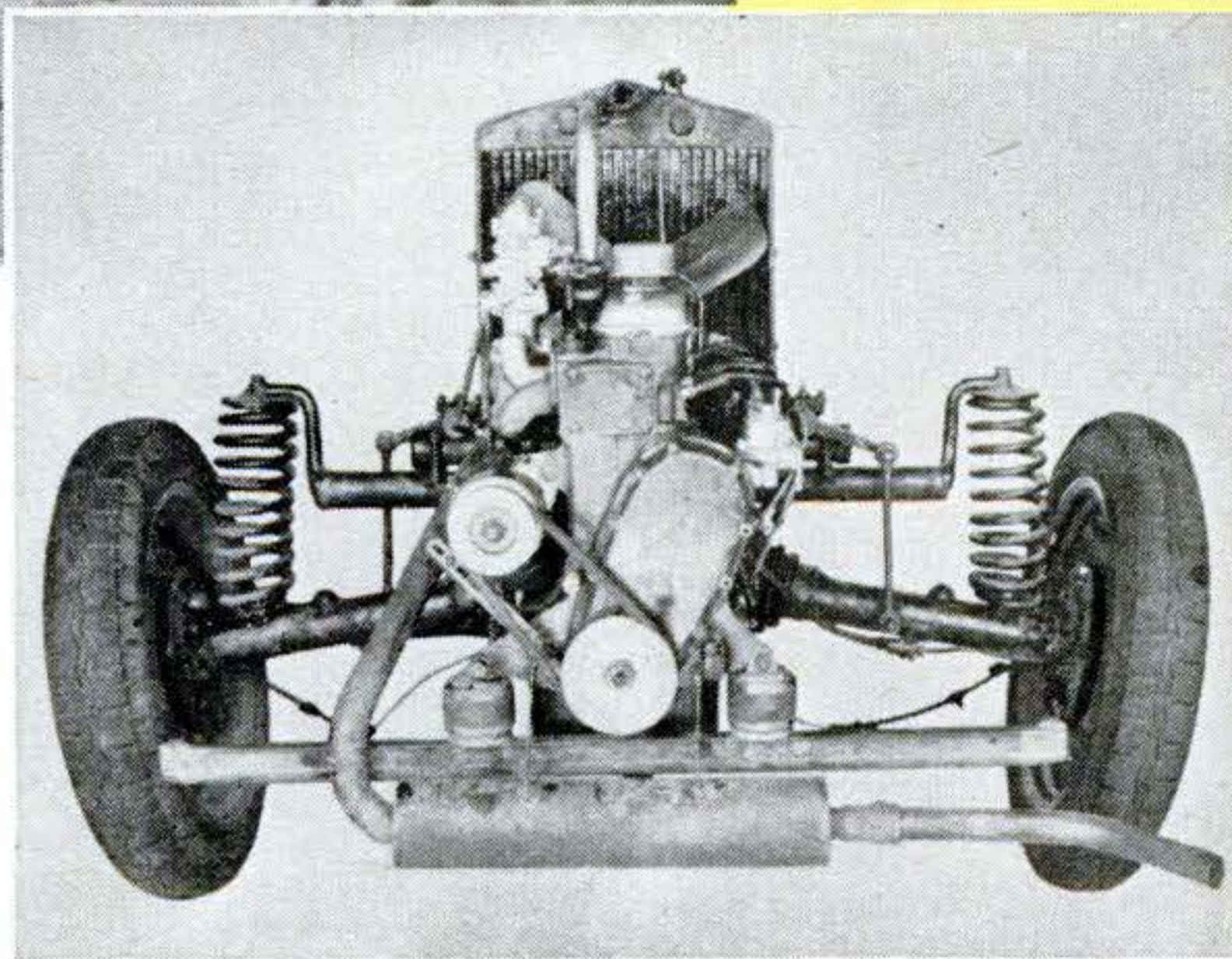

is an experimental four-seater midget, announced last year by the Renault company of France but at last report not yet in production. Both the Tatra Works and the Renault company are long-established manufacturers with a reputation for successful production of cars of traditional design. In addition, the Czech company was producing rear-engine cars before the war.

Whether these vehicles represent an evolutionary step that might eventually help lead some of the major American manufacturers into the rear-engine field remains to be seen, but two leading Detroit firms some time ago each imported a Tatra, apparently for study and testing. When produced, the rear-engine Renault probably will be seen in limited numbers in the United States, for this company has been sending part of its output here for more than a year.

In both cars, the engine, transmission, and



rear suspension form a single unit that is readily removable for servicing, making it possible to install another engine and keep the car in operation while the regular power unit is being overhauled.

Equipped with a 75-hp. 8-cylinder engine, the Tatra has a maximum speed of around 100 m.p.h. and a comfortable cruising speed of about 75, the gasoline mileage averaging better than 30 miles per gallon. To cool the V-8 engine, two powerful blowers drive air in large volume over the two rows of four cylinders, air being swept into the engine compartment through forward-facing inlets.

Like most other European cars, the Tatra has four forward speeds, the two upper ratios being synchronized. In size, it approximates the average American light car. The weight is 3,015 lb., wheelbase 110", overall length 187", width 66", tread 49" front and back, ground clearance 9", and height 59".

In deference to tradition, the Tatra retains a front hood but, instead of an engine, this covers the gasoline tank and the vertically mounted spare wheel and tire, with room to spare for any luggage that will not go into the big luggage compartment back of the rear seat. A searchlight, equal in size and similar in appearance to the regular headlights, is centered at the front. In the early Tatra models, this light turned with the front wheels, but this feature has now been abandoned. Two grilles in the hood carry air into the interior of the car when ventilation is needed.

Inside, the four-door Tatra is roomy enough to seat five persons comfortably. The front seat folds back, providing sleeping

space in the car for two. A low center of gravity gives the car excellent stability, knee action provides a greater degree of comfort, and hydraulic brakes for all four wheels increase the margin of safety.

A variation of the steel backbone that supports another Czech car, the little Jawa-Minor (PSM, Aug. '46, p. 136), is employed in the Tatra. But instead of a single steel support running the length of the car, as in the Jawa-Minor, the Tatra backbone is Y-shaped, two arms swinging away laterally toward the rear wheels from a position under the rear edge of the front seat. The body itself is of all-steel construction. When the car must be raised to change a tire or for other work, a reinforced recess in the body just below the rear door provides an accessible place to locate the jack.

Like the majority of European cars, the rear-engine Renault is tiny by American standards, but it seats four comfortably. Weighing only 1,146 lb., it has a wheelbase of 83", the overall length is 142", the tread 47", and the overall width 56". Independent suspension is employed on all four wheels.

Engineered for high operating economy, its 4-cylinder, overhead-valve engine develops about 16 hp. at a maximum speed of 56 m.p.h., and gives around 47 miles per gallon of gasoline. A radiator is located directly over the rear axle, a belt from the camshaft driving both the water pump and fan. The fan draws in air through grilles located just ahead of the rear fenders. Mounted immediately behind the rear wheels, the engine delivers power through a single-plate clutch and three-speed transmission, with synchromesh engagement of the two upper ratios. END

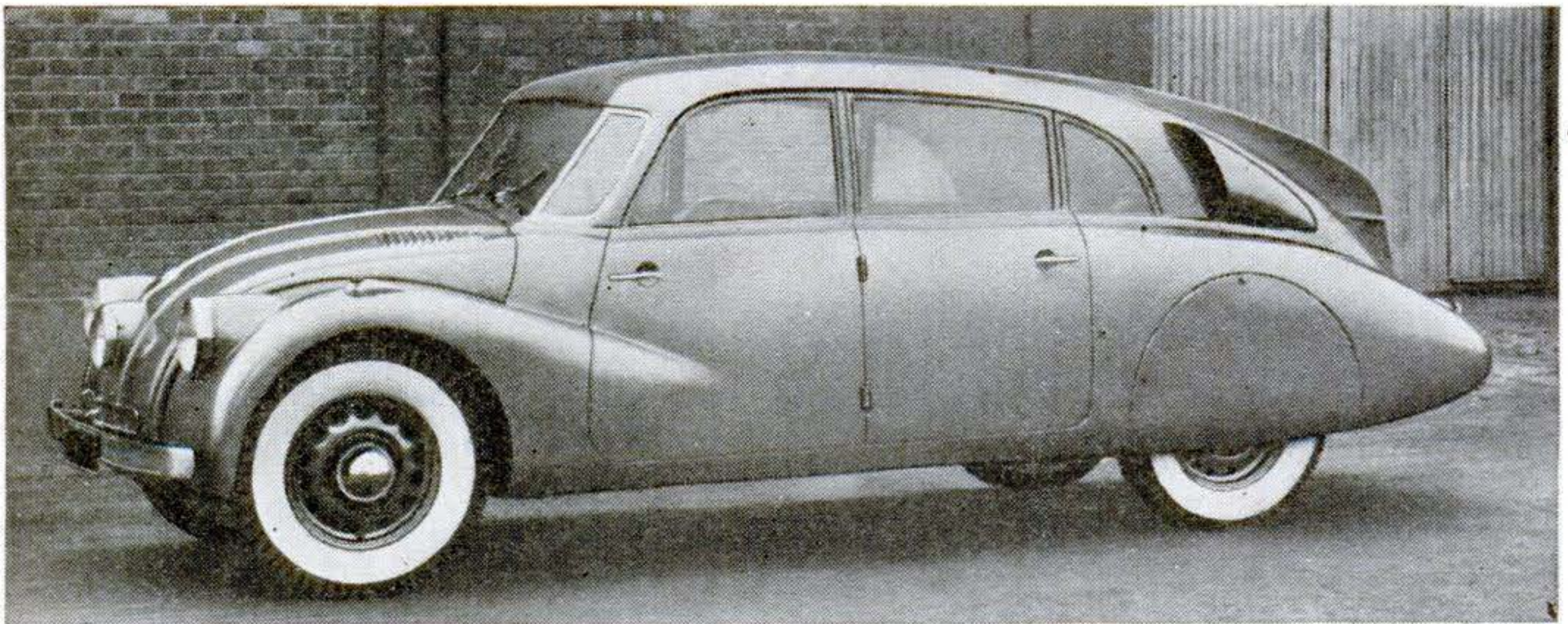

A down-curving hood allows the Tatra driver a better view ahead and increases the streamlining effect.



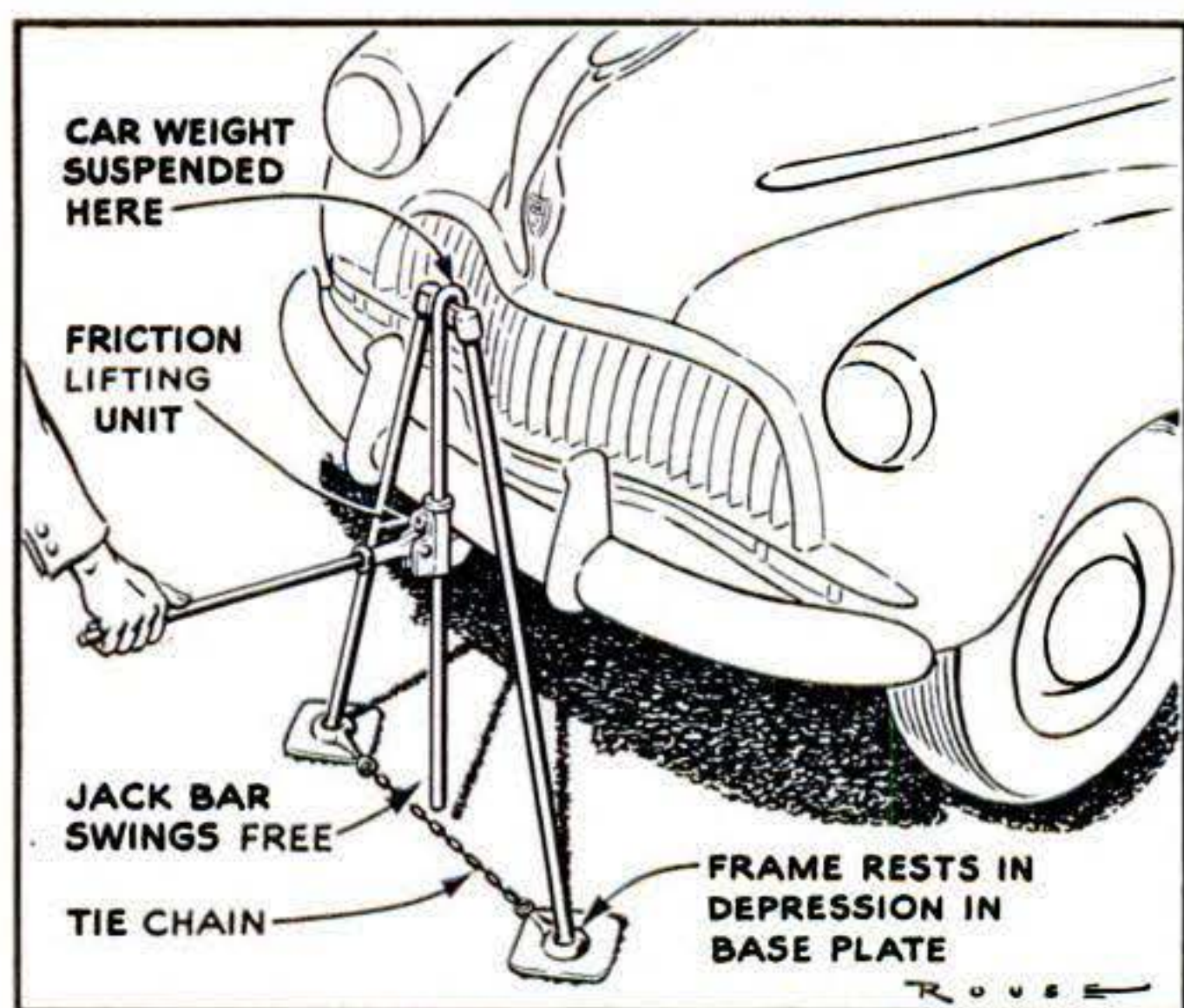

**NEW BUMPER JACK.** Using a suspension point that is substantially higher than the point of contact with the car, a bumper jack produced by the Johns Manufacturing Corp., of Dunellen, N. J., consists of a steel A-frame on which rests a free-swinging jack bar with a friction lifting unit. This construction is said to give excellent stability, since the bar is free to swing in any direction and compensate for any lateral movement of the car due to changes in the spring suspension while the car is being lifted.



**MOP FLOWS WATER ON CAR.** The advantages of a mop and a hose are combined in a new device, the "Jack Robinson" continuous-flow car cleaner, now being marketed by Corbett Patents, of Altrincham, England. Water from a tap flows through 20' of hose, a metal pipe that serves as a handle, and sprays from the detachable mop.



**MAP HOLDER FITS ON VISOR.** Attached to the car visor with a strong elastic cord, the holder shown above makes it possible to keep road maps, guide books, and other reference material within easy reach and sight while driving. Produced by Visor-Ads, of West Hartford, Conn., the device is made with a clear plastic front, reinforced with steel wire to increase its durability.

**WARNING REFLECTORS.** Intended for use by disabled trucks, this new device employs four red plastic reflecting lenses mounted on a set of swivel-type metal legs. When the unit is set up on a highway, approaching automobile headlights are said to reflect a warning signal visible from half a mile away. Sold in sets of three and easily carried, "Reflector Flares" are produced by the Grote Manufacturing Company, of Bellevue, Ky. They meet interstate trucking regulations.

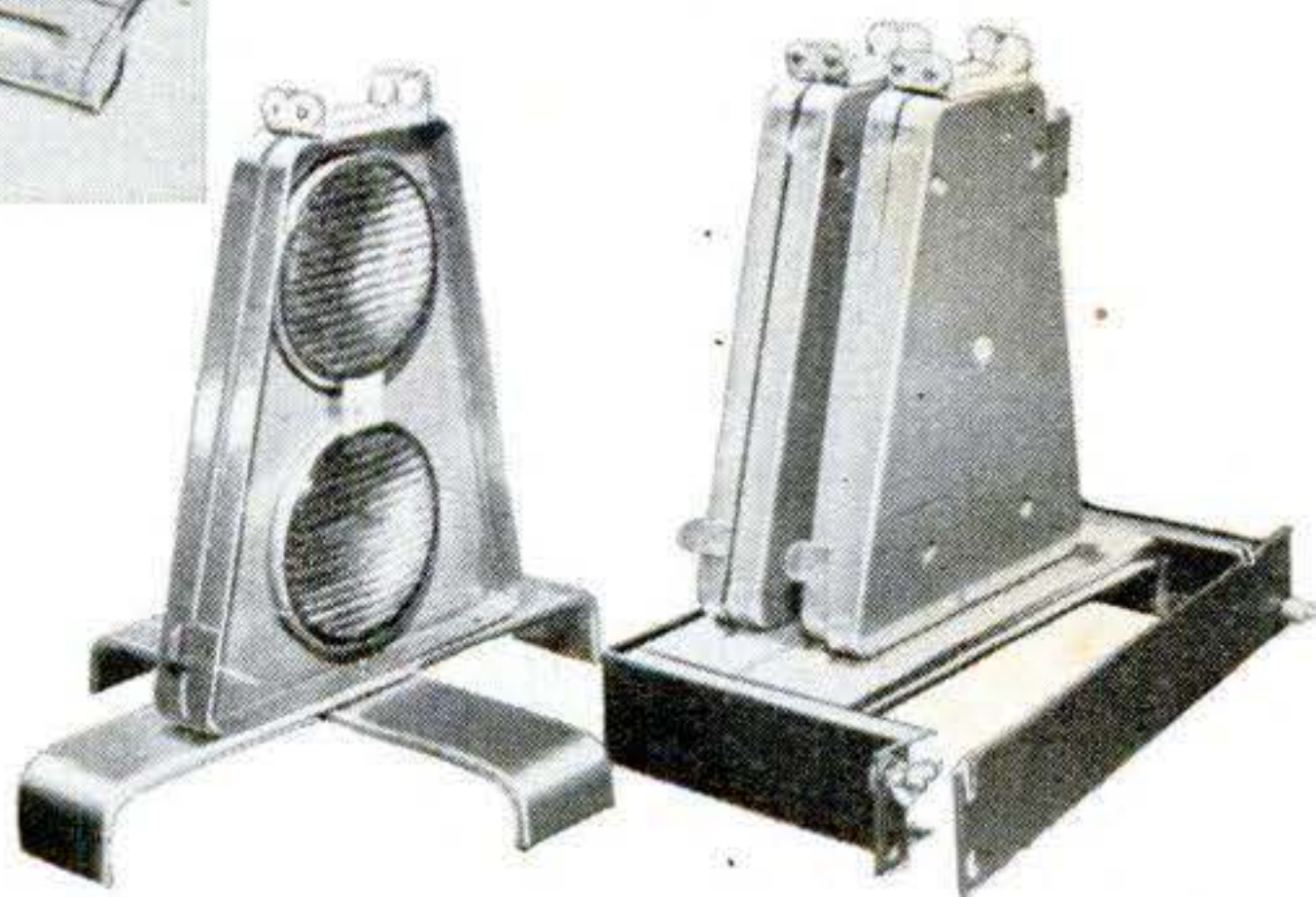





# GUS Tames a Bucking Flivver

By MARTIN BUNN

STAN HICKS was on the phone a long time. From where Gus Wilson was working he could see an earnest expression on his young helper's face.

"Probably making a date," Gus grumbled, "but he's sure taking his time about it." With some annoyance he began scraping the carbon from a cylinder head.

Stan finally emerged from the office, looking thoughtful. Gus tossed the scraper onto the bench with a clatter and growled:

"Hop to it, youngster. Scraping out this head is your job."

"Huh? Oh—sorry!" Stan trotted briskly over and took up where his employer had left off. After a few seconds his young face again took on a preoccupied expression. In a suspiciously offhand voice, he inquired: "Bad carburetor adjustment can cause bucking, can't it?"

"Uh huh."

"And maybe if the plugs aren't right or a valve is stuck?"

"Yup. Or if the head gasket's blown. Bring the light over here."

"Sure. What else could do it?"

"Is this a quiz, kid?" Gus grinned at his feeble joke. "What's up? We don't have any buckers in the shop."

"Oh, nothing. Just curious."

The subject was dropped, and a short while later Gus and his helper got ready to leave for the night. Joe Clark had come in and was checking over sales slips with Gus while Stan washed up.

A horn sounded in front of the garage. "I hope that's not a last-minute job," Gus said anxiously. He looked out the window and saw an aging roadster pull up to the curb. Henry Weeks, a boy whom he liked but



knew only casually, flipped open the door to let Stan Hicks hop in. Gus noticed as the car moved off that it quivered and bucked like someone skating through a gravel pit.

**H**ELLO, Stan," Henry said with a trace of shyness. "Hope I'm not interrupting anything important."

"Heck, no." Stan tried not to notice the embarrassing bucking of the car. Because it would have been awkward either to mention it or remain silent, he cast around for something to say. "Do you still see Peggy?" he asked finally.

"You bet. She's practically my steady."

Peggy Graham was the leading belle of the high-school set. Actually Henry was overstating his claim, but she did seem to like him.

"She's one of the reasons why I called you. Though it's mostly this old bus of mine. I've tinkered with cars a good bit, but sometimes a fellow likes to consult with—er—another expert."

"Of course," Stan agreed modestly. "Why, even Mr. Wilson discusses his tough cases. I know how it is, old man."

"Anyway, this is Thursday, and the big Country Club dance is Saturday. I have a date with Peggy, only she says she won't go unless the car acts better. That doesn't leave me much time to get the old crate running right."

"I should say not, Henry." Stan tried to recall how Gus would go about a diagnosis. "Has it been bucking long?"

"Began the day before yesterday. I went to call for Peggy and her girl friend to take them for a drive. We got bounced around so much Evelyn started making nasty cracks and Peggy got mad at me and made me take her home right away quick."

They arrived in front of Henry's house, parked under a street light, and lifted the hood. An expensive new sedan coasted alongside. Turning, the two boys looked up into the face of Sumner Craven, a chubby youth of about their own age. Seated next to Sumner was lovely Peggy Graham.

"What's the matter, fellows?" Sumner asked. "Having trouble with your jalopy?"

"Hmf! Listen to him," scoffed Henry. "Just because his old man lets him use his new car he thinks he can sneer at his betters."

"Bosh!" Sumner pulled his head in huffily. "I'll bet you can't fix that car!" Then he began to laugh, let in the clutch, and glided

smoothly away. Stan and Henry returned to their examination of the motor. Suddenly Stan stopped and pointed at the spark-plug wires. "Hey!" he shouted. "What's that?"

Henry stared. "The wires of those two plugs are switched!"

"Exactly." Stan tried to imitate Gus's manner. "That's why it's been bucking."

Stroking his beardless chin, Henry announced, "They were okay the last time I checked. I know enough about cars not to make *that* mistake."

"You mean you smell a mouse in the cabbage?" asked Stan.

"Putting two smells together, I get worse than a mouse. I get Sumner."

It was the work of seconds to reverse the crossed wires. Henry started the motor, and let the car move slowly forward. It picked up briskly, then gasped, rocked forward, coughed, and lost speed. The roadster was bucking as badly as ever!

**S**UMNER CRAVEN opened the front door of the Graham house and stepped out.

"Good night, Sumner." Peggy's slim young figure was framed in the light from the house.

"Should I call for you Saturday?"

"I can't ask you to do that," the girl replied. "I have sort of a date with Henry. Of course, I told him I wouldn't go with him if his car's going to shake out my hair-do."

"Ha ha!" Sumner started down the steps. "I'll call for you at eight on Saturday. Good night!" He climbed behind the wheel of his father's new car, snapped the switch, and pressed the starter. The engine turned over but didn't start.

"Holy smoke!" he whispered. "Something's wrong!" Nervously he tried again, with the same results. "If anything's happened to the car, Pa will have my hide." Hopping out, he lifted the hood and looked helplessly at the engine.

"Having trouble, chum?" A familiar voice drifted over his shoulder. Sumner whirled to find Stan and Henry, looking as casual as they could manage, standing behind him.

"You've done something to my car," Sumner yelled. "If you've hurt it I'll have both of you thrown in jail!"

"Do you know what he's talking about?" Stan asked Henry with an expression of exaggerated puzzlement.

"That's a guilty conscience talking,"



Henry rejoined. "The kind of stinker who'd cross someone else's spark-plug wires probably thinks honest people would stoop to the same tricks."

Sumner glared at him.

"See?" Henry went on triumphantly. "He admits it!"

"It was just a gag," growled the chubby youth. "Anyway, you found it. What have you done to my fa—my car?"

"Tsk—tsk. D'ya still think we did something to it? Of course that distributor rotor we found up the street might. . . ."

"Give it back!"

"Funny thing, it got lost," said Stan.

"But we might be able to find it," Henry added quickly, "if you could remember what else you did to my car."

"I crossed the plug wires. That's all. Honest!"

"Quit kidding." Henry dropped his flip-pant tone and stepped in close to Sumner. "We fixed that and the car still bucks."

There was no mistaking the expression on Sumner's face. He was honestly puzzled. A few more questions showed he had nothing further to reveal. The hand Stan had been holding behind his back came forward. It held the rotor from the sedan's distributor.

The two friends made their way back toward the roadster. Grimly Stan rolled up his sleeves. "Looks like there's no way out," he said. "We got to take off the head."

Working with few tools and little light, the two boys took even longer on the job than they had expected. Worse, they could find nothing wrong—no valves were stuck and the gasket bore up under scrutiny.

"There's only one thing left," Stan confessed wearily, as they began to reassemble the engine. "Bring the bus around to the shop tomorrow and let my boss look at it. Boy! How he'll rib me!"

**G**US WILSON knew when to leave well enough alone. Despite Stan's fears, he tactfully refrained from rubbing salt on the young mechanic's wounded pride.

"We tried everything we could think of," said Stan.

"In that case," Gus replied, "the trouble must be some place you didn't think of. Let's go over it step by step."

"How about the crossed plug wires?" asked Henry.

"That might have done it easily enough, and whatever the trouble turns out to be, crossing the wires may have helped to bring



"We got bounced around so much that Peggy got mad and made me take her home right away quick."

it on. You checked the valves and the head gasket. Although they don't seem to be the answer, you may still have been on the right track." He raised the hood and instructed Henry to start the motor. It rumbled unevenly and coughed through the carburetor. Gus checked the vacuum at the carburetor and found it low. "That could happen," he said, "if the exhaust and intake were getting together."

"But we examined the valves," Stan protested.

"How about the ports at the side?"

"The ports . . . ?"

"Sure. Where the gas goes in and the exhaust comes out." Gus showed Stan where to back off the nuts that held the manifold to the block. As it came loose, slivers of blackened copper fell out.

"There's your trouble." Gus pointed to a gap that had been burned in the gasket between an intake and exhaust port. "Put on a new manifold gasket and try it."

The boys set to work. When Gus strolled by a half hour later, the motor was purring.

"Okay now?" asked Gus.

"Like a dream," Henry affirmed, "I can't tell you how much I . . ."

Gus waved his hand. "Forget it. But wait until I see that Craven kid. I don't say this couldn't have happened if the wires hadn't been crossed, but I'll bet a peach to a pumpkin it helped bring it on."

Henry scraped his foot shyly along the grease-blackened floor. "Please don't say anything to him right away," he said. "If he finds out that my car's been fixed before Saturday night, he'll be able to make another date. I'd like to see that double-crosser get hung up at the last minute. It would serve him right if he had to go dancing with his father's sedan!"



# MECHANICS AND HANDICRAFT

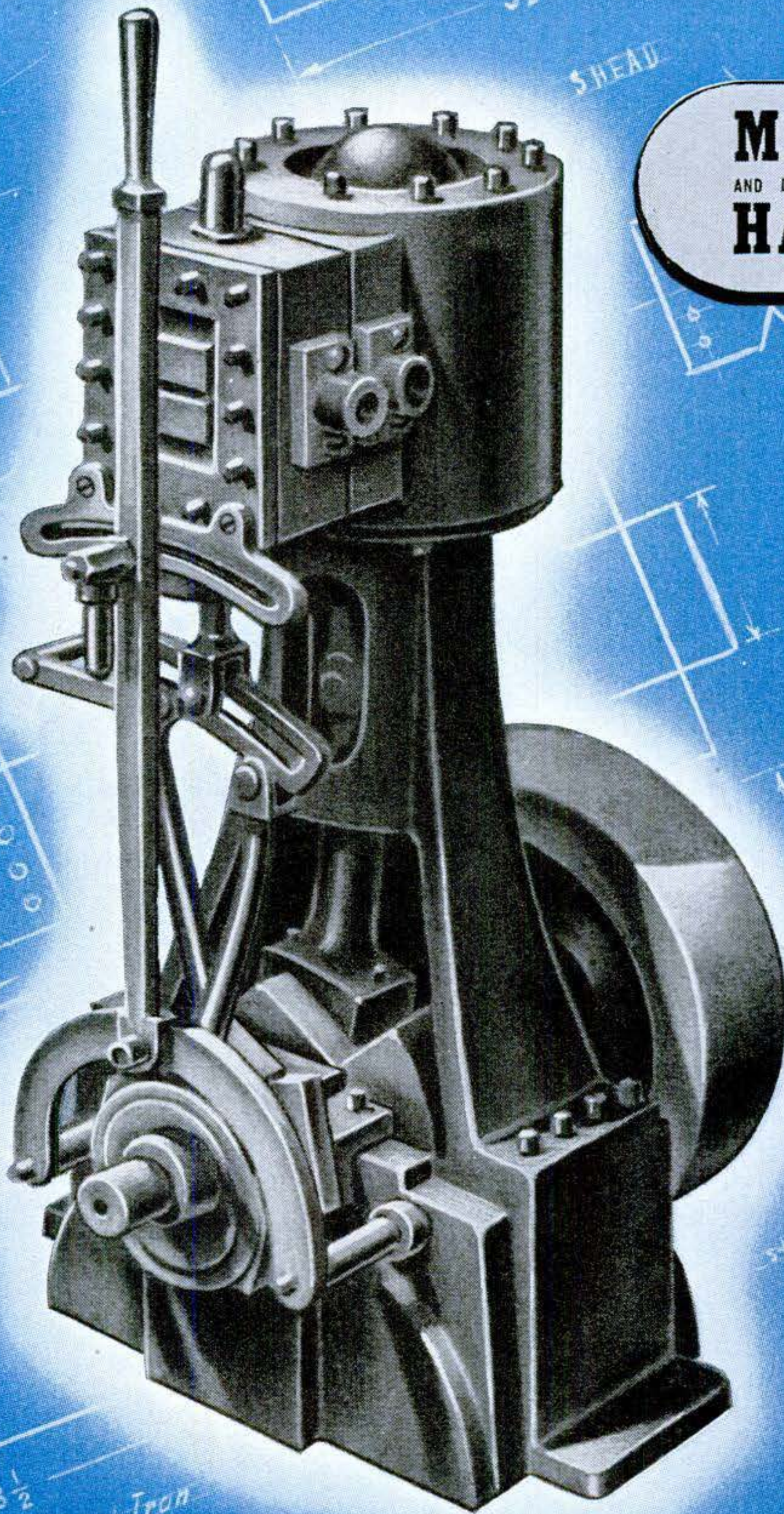

- Steam Engine with Reverse Gear
- Projects from Scrap Aluminum
- Building Outdoor Stairs
- Two-Band Superhet Receiver
- Your Own Water-Power Plant

APRIL  
1947 163



Two vases in aluminum—one 2" by 6½" in a table stand set on a rivet-studded micarta base, and the other 1" by 4½", held in a studded wall bracket. Both are made from lengths of ordinary aluminum tubing spot-polished in a regular pattern.

Thin wood or fiber screwed to the back of the bracket with a projecting lip, as shown below, provides a means of attaching the vase to the wall. If the hole bored in the bracket is a tight fit for the tubing, the vase can be pressed in and held at any desired position.

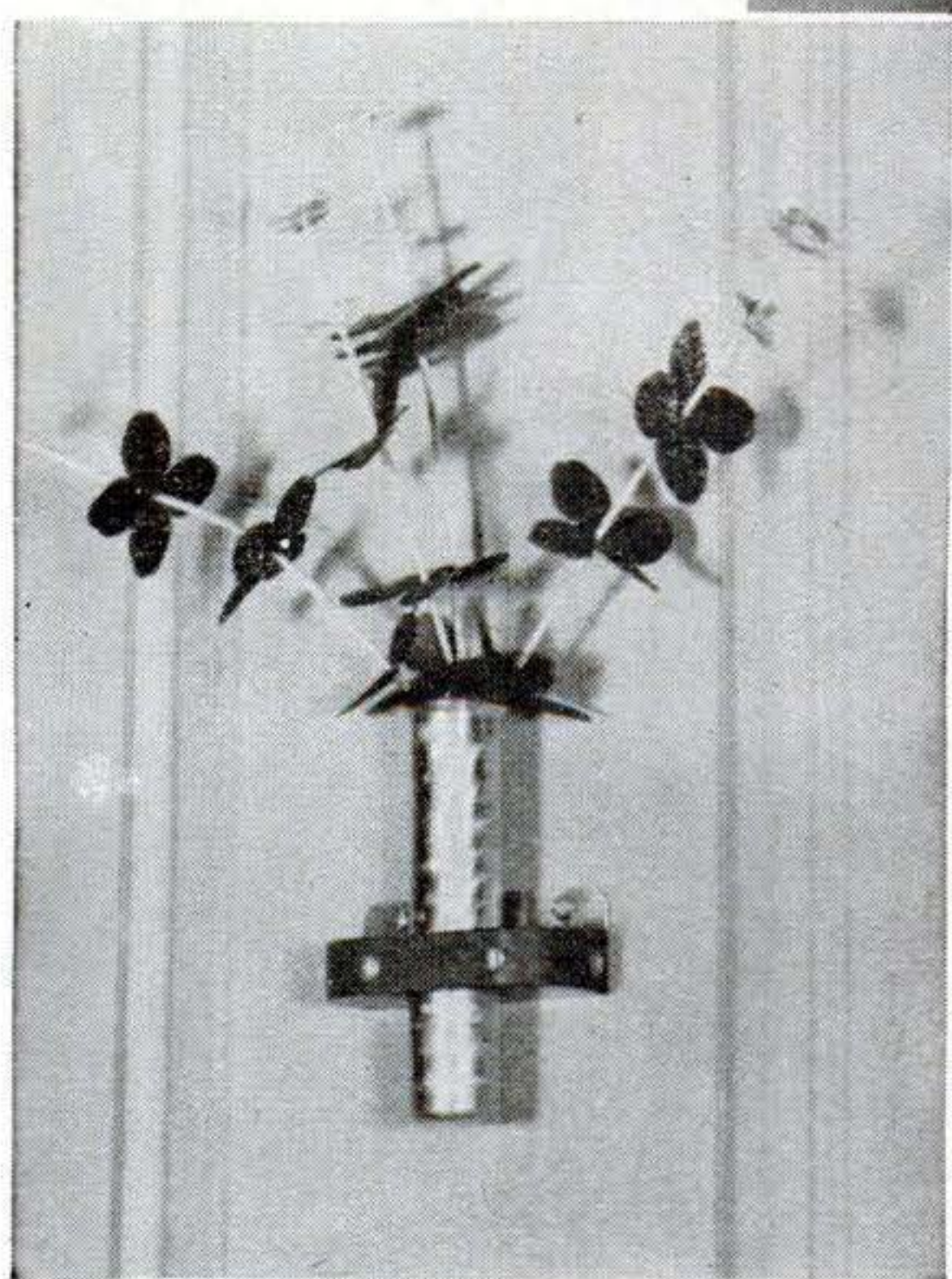
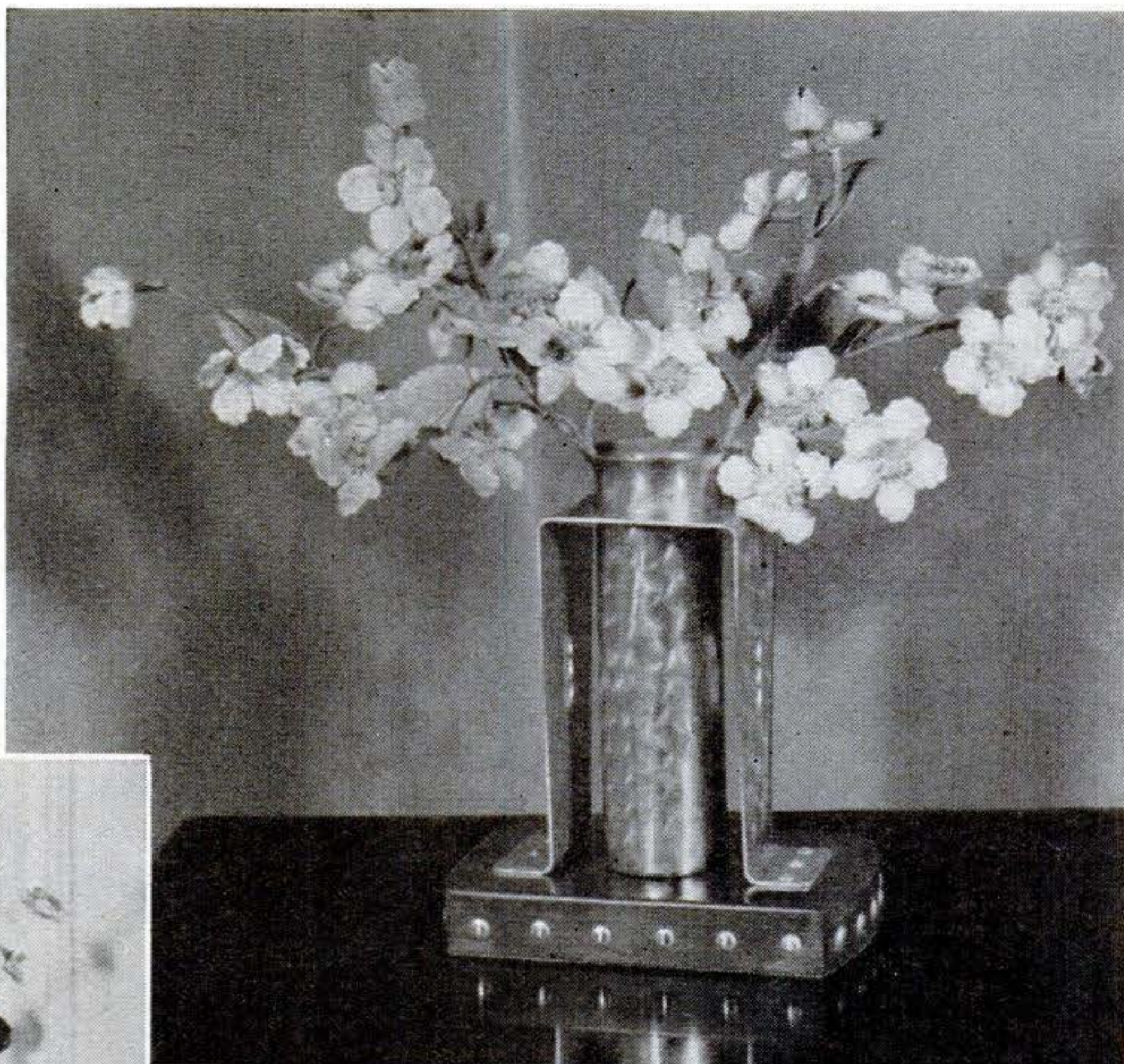

## For the Metalworker... Four Projects

By R. J. DECRISTOFORO

**C**RAFTSMEN who like working in aluminum will find tubing 1" and 2" in diameter an extremely satisfactory medium. Such projects as the vase with an ornamental stand shown above, the wall vase at left, and the pair of matching vases and dinner bell illustrated on page 166 can be made with it.

In general, the same procedure is followed for all four projects. One end of the tube is first sealed with a disk of sheet aluminum cut slightly larger than the inside diameter of the tubing. The disk is forced into the tubing, which is then held on a hard surface or anvil while the edge is hammered all around. Filing a radius and sanding smooth will leave the joint watertight and practically invisible. Soldering can, of course, be tried, but requires special solder and considerable patience. Welding can be done

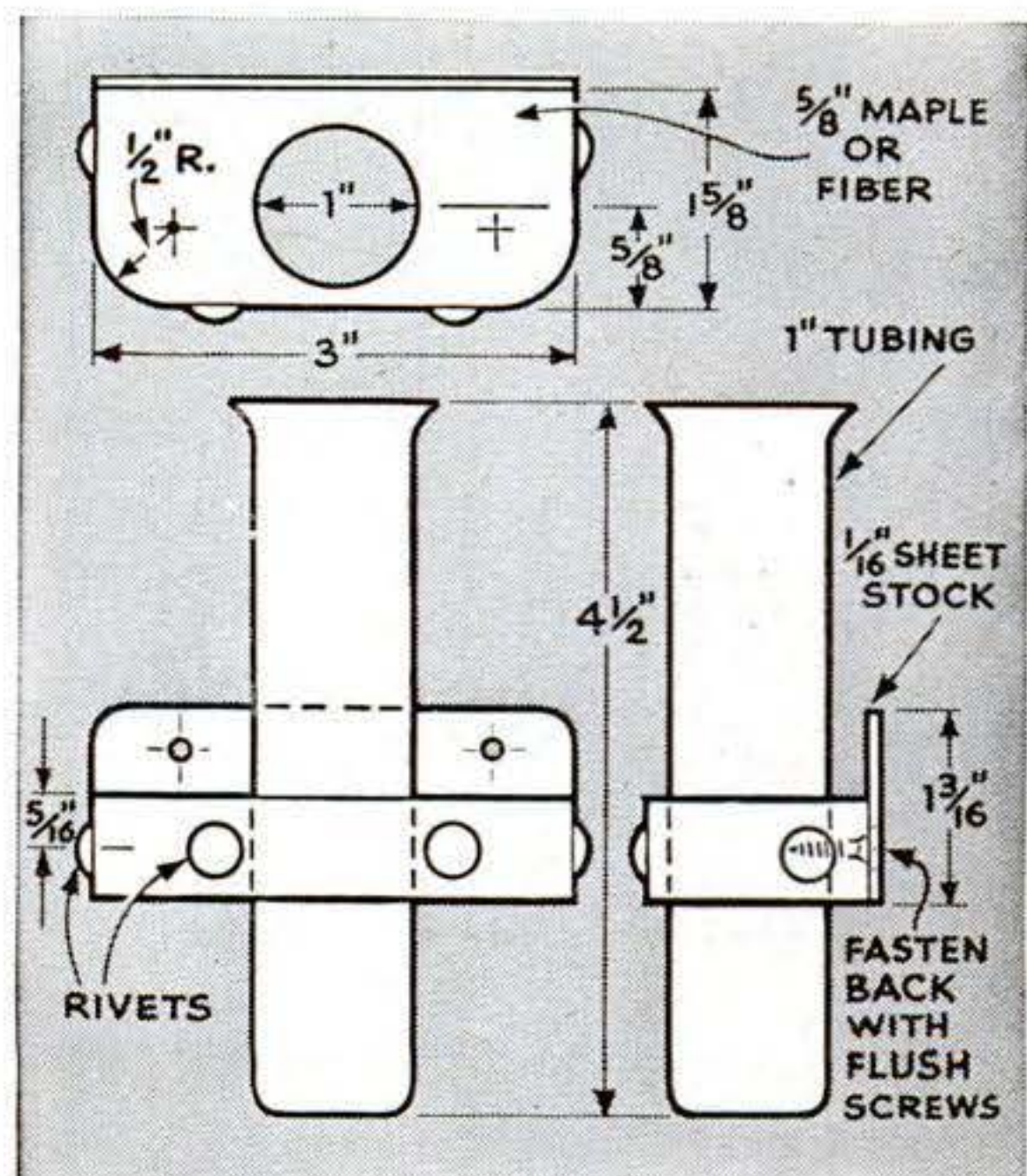



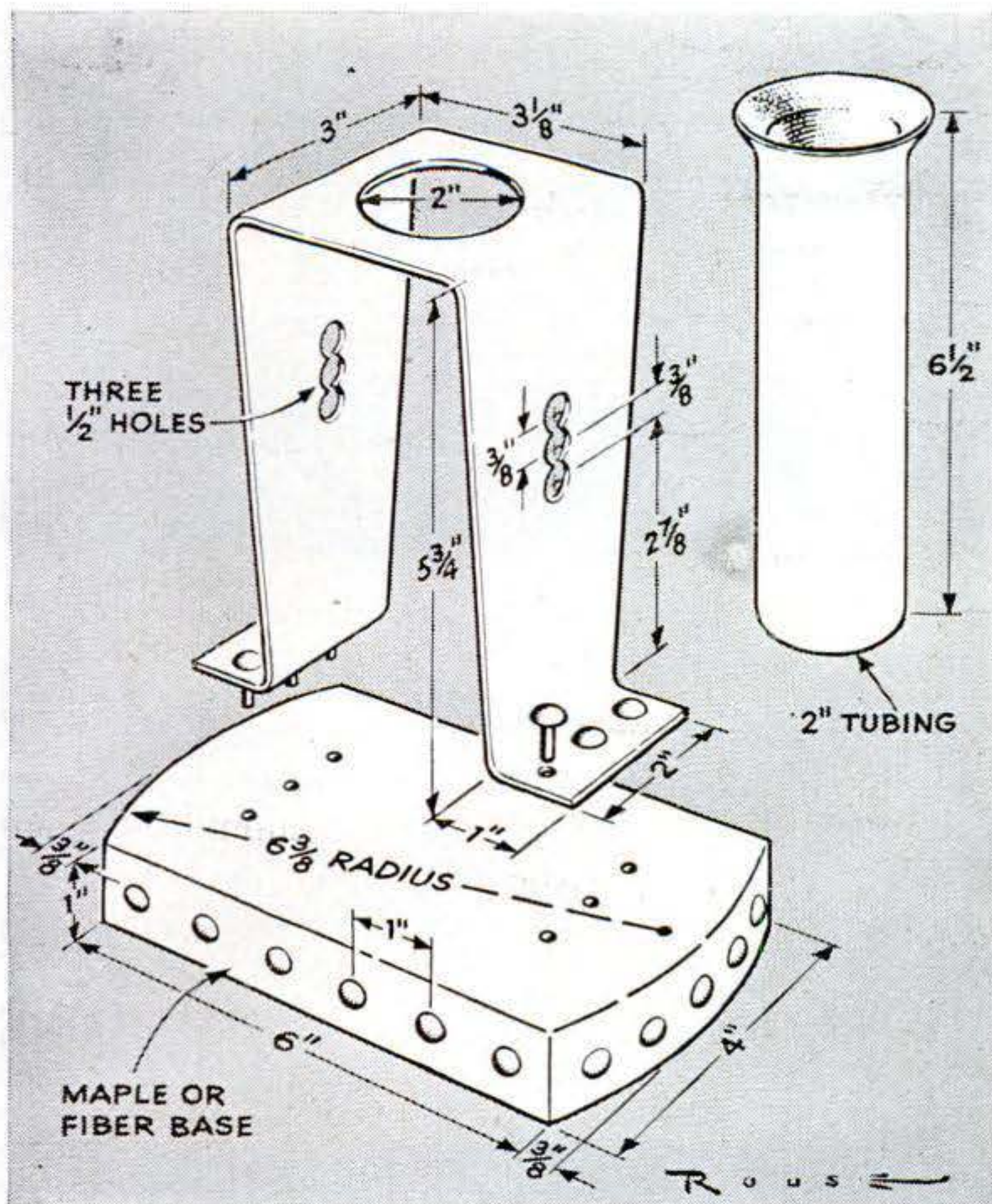

All parts of the table vase are shown in the drawing. The vase is a loose fit in the stand to permit removal for filling. Felt is glued to the bottom of the base.

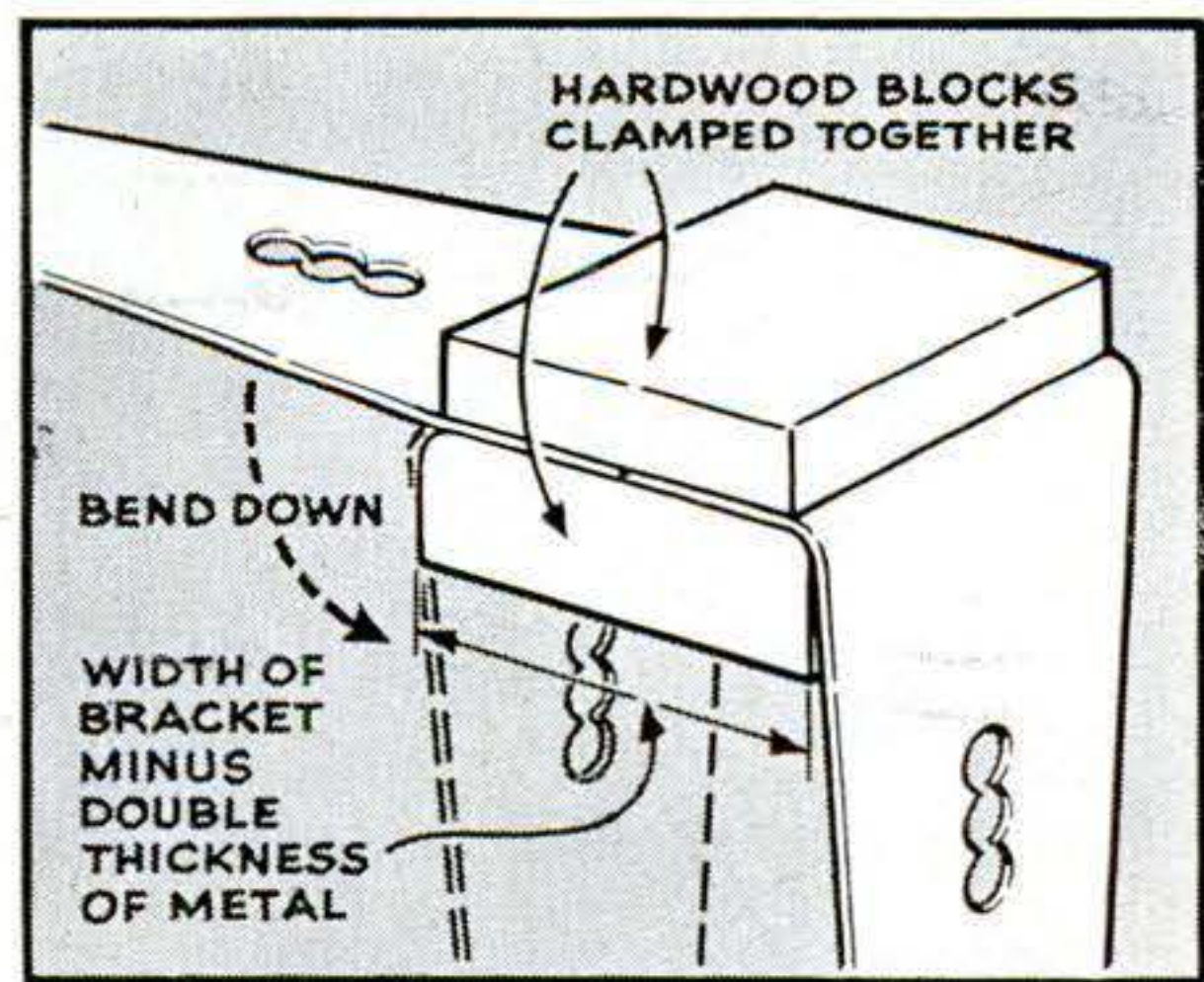

Use clamped blocks as a form to bend the stand. Top edges of the lower one are rounded.

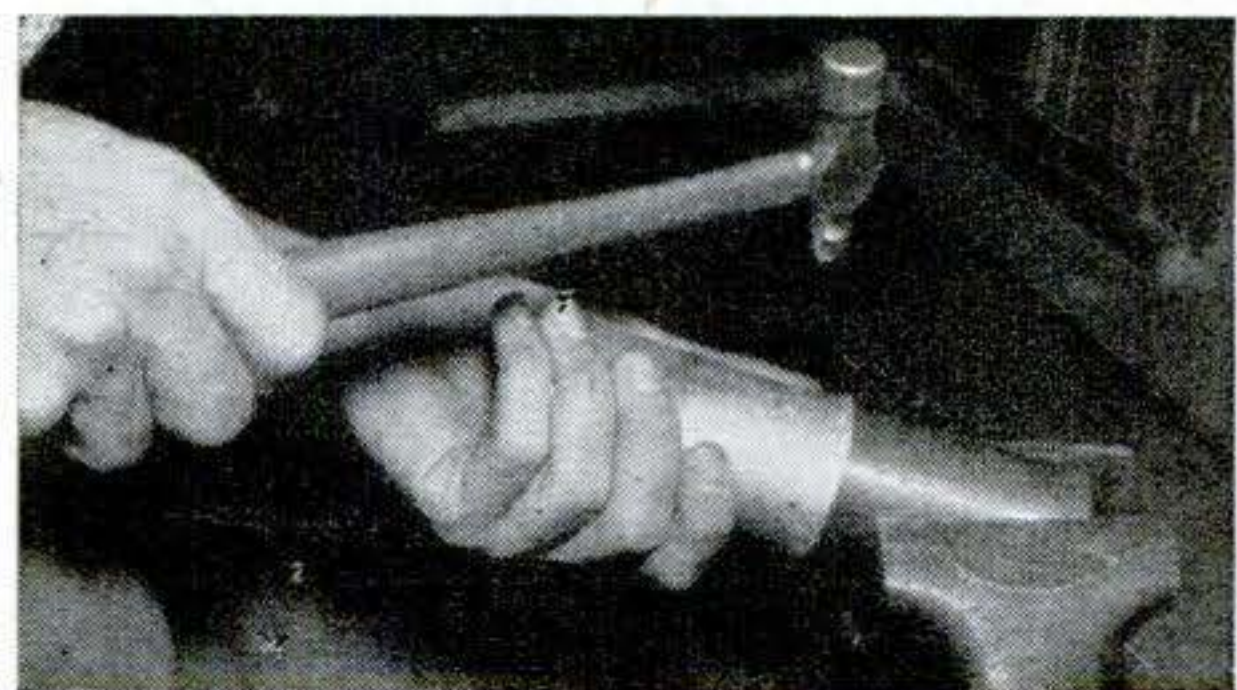

Instead of spot-polishing, a hammered effect can be obtained by peening the entire surface of the tubing with a ball-peen hammer.

## from ALUMINUM TUBING

only on certain types of aluminum, some of which are too hard for easy working.

A soft aluminum, such as 24SO or 52SO, is required if the open end is to be flanged for a nice finished effect. This is done by holding the tubing at an angle over the end of a round bar or piece of pipe clamped tightly in the vise and tapping lightly with the edge of a mallet as in the photo on page 166. The bar or anvil should, of course, be somewhat smaller in diameter than the tubing. Tap about  $\frac{3}{8}$ " from the end while rotating the tubing slowly.

Both hammered and spot-polished finishes are possible. The former is obtained by peening the entire surface with a ball-peen hammer while holding the piece on a round bar, as shown above. There is no need to try for a uniform pattern. Rub down with fine steel wool and light oil; then, if you

want a high polish, dry the oil off thoroughly and buff with a wheel and jeweler's rouge.

Spot-polishing can be done with a hand grinder or electric drill. Hold a bolt in the chuck and wrap fine steel wool around the bolt head tight enough for it not to turn on the bolt. Circles will appear on metal parts held against the spinning abrasive. A definite pattern is best in this case, and the metal should be finished smooth before spot-polishing is begun.

For different effects, experiment on scrap pieces of aluminum with various grades of steel wool and abrasive cloth. The angle at which the work is held, the kind of abrasive used, and the diameter of the spinning abrasive all have a bearing on the result obtained. A round brass brush will also give a variety of finishes.

The stand for the table vase was laid out



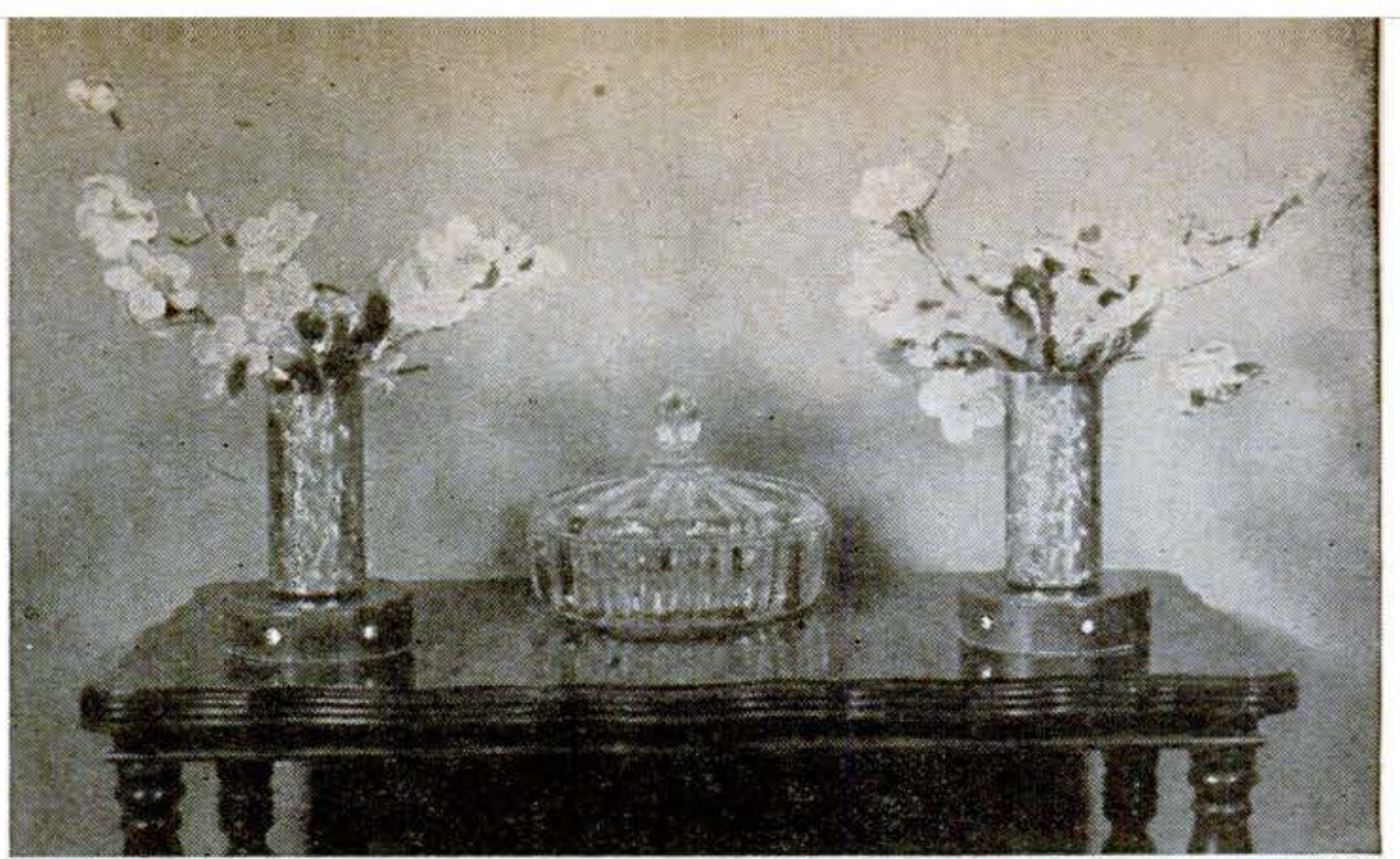
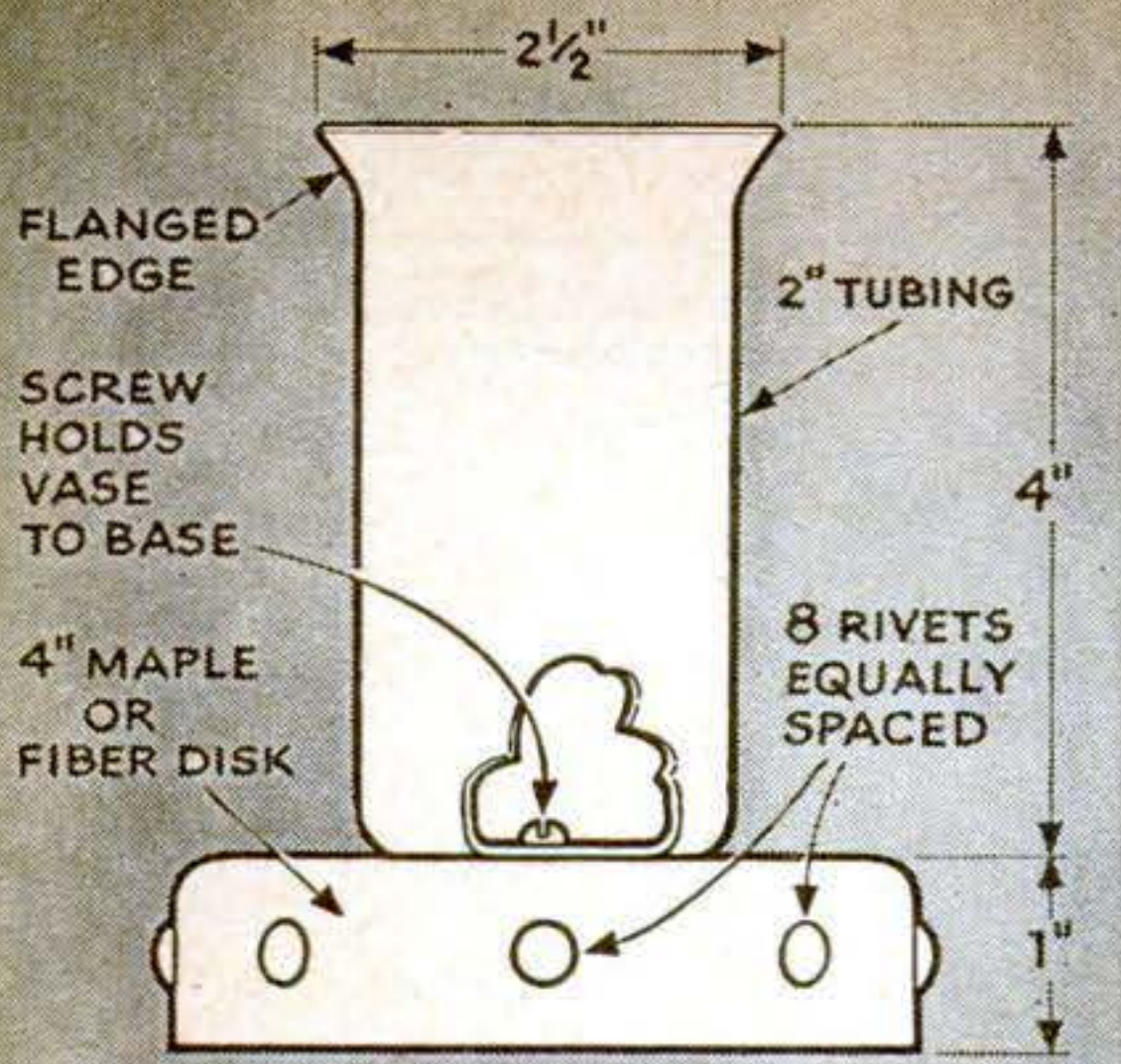

Matching vases are mounted on disk bases of wood or fiber. A screw through the bottom holds them.

and cut from 24ST aluminum sheet .064" thick (any reasonably stiff stock will serve). It was drilled and then bent between two hardwood form blocks. Some length is gained in the bends, and compensation must be made for this by shortening the length of the flat pattern. As a rule, deduction equal to the thickness of the metal at each bend will serve. Always bend metal more than the required angle to allow for a tendency to spring back. Smooth all cut and filed edges with emery and steel wool.

Bases, brackets, and the stand for the bell may all be made of maple, black walnut, mahogany, or other hardwood. Phenolic fiber or micarta can be substituted for wood in the vase bases and brackets. These materials, used in aircraft work, are rather expensive, but only small scrap pieces will be needed. When finished smooth and waxed, they often have a leathery appearance that

goes especially well with maple furniture.

For decoration and for holding the vase stand to the base you can use 1/8" aluminum rivets with brazier heads. They may be filed sharp like nails or broadened at the end with hammer blows, and then tapped with a mallet into undersize holes. Don't polish the heads. END

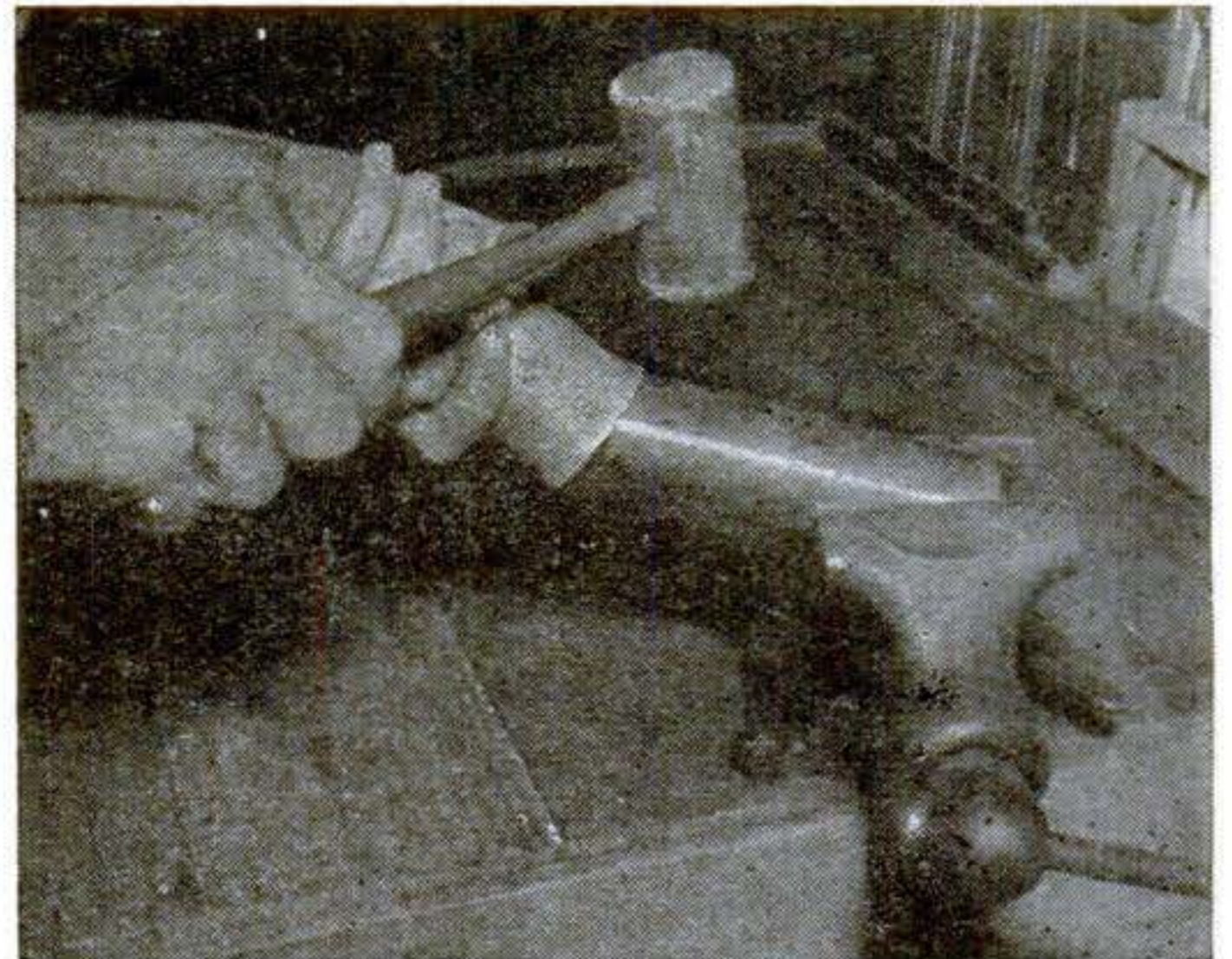

Flanging is done with the edge of a mallet while the tubing is revolved on a round bar. The hammer head and handle shown were turned on a lathe.

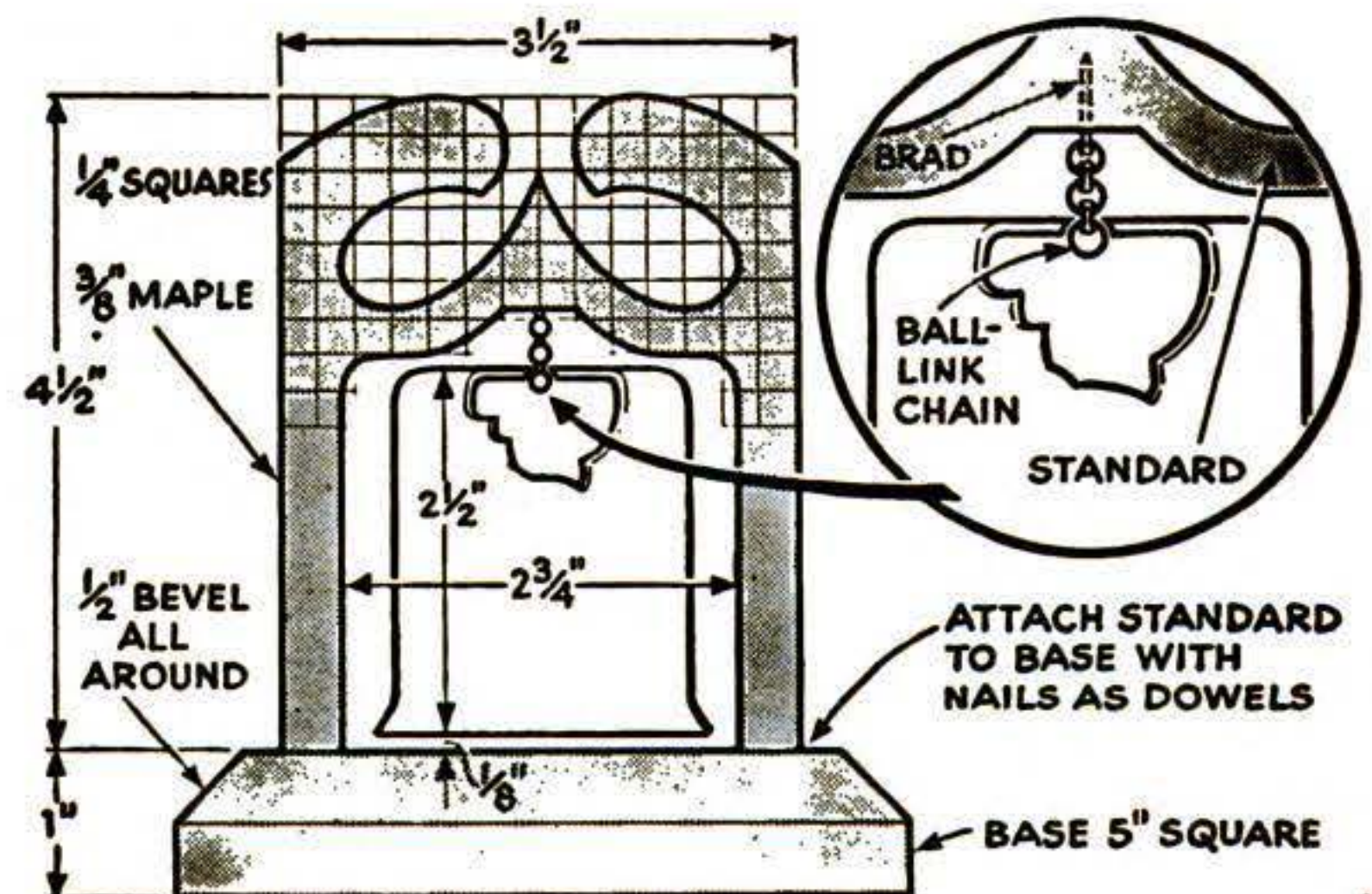



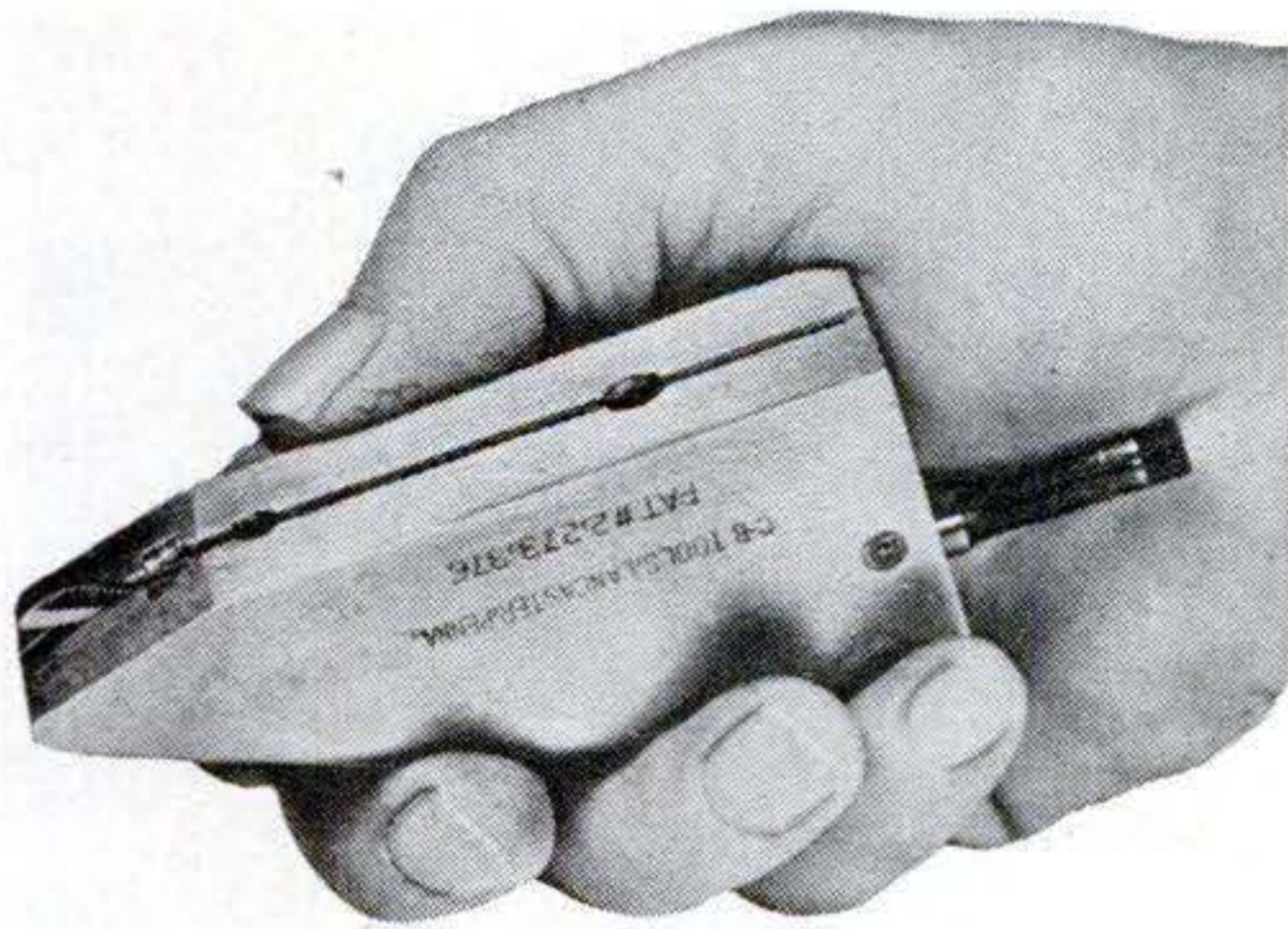

**METAL CUTTER.** Chucked into a  $\frac{1}{4}$ " electric or pneumatic drill, the Royal Clipper Metal Cutter produced by the C-B Tool Company, of Lancaster, Pa., leaves a smooth edge that requires no grinding or filing. The regular model cuts light metals up to .040" while the heavier-duty model will handle average sheet metal as heavy as .055". The tool also can be used to cut plywood, plastics, cardboard, and linoleum.

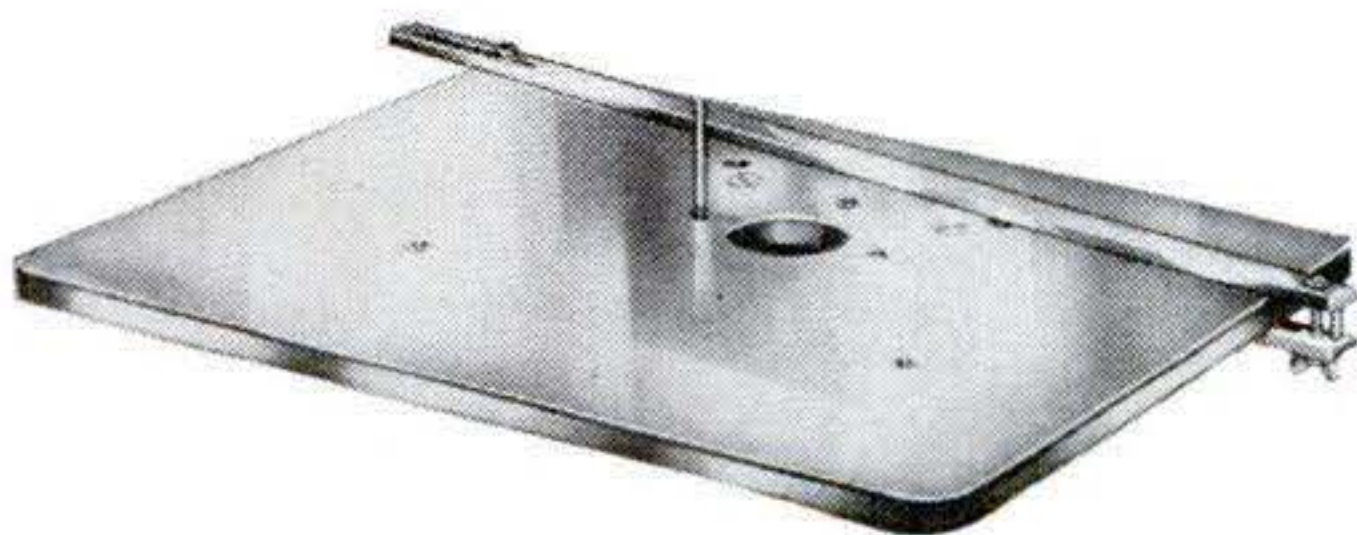

**DRILL-PRESS TABLE.** Cast of aluminum alloy and equipped with a cadmium-plated steel fence, this auxiliary 13" by 18" drill-press table offers an enlarged and true working surface for many drill-press operations. Manufactured by the Barron Tool Company, of Detroit, it comes supplied with an irregular shaping pin, anchor bolts, fence, and fence-clamp assembly. It sells at around \$10.

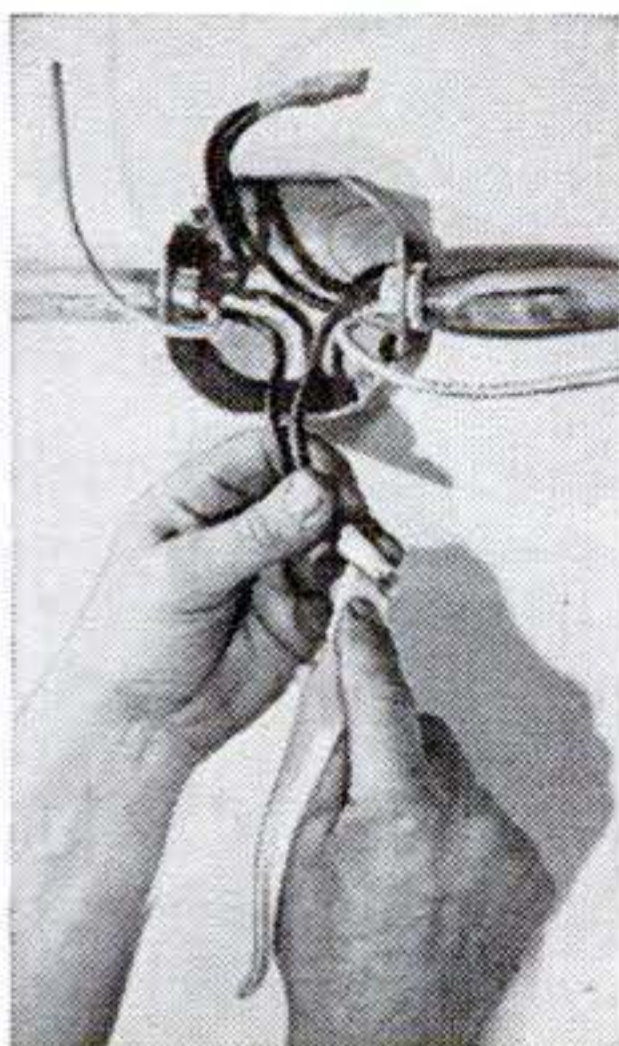

**PLASTIC TAPE.** Thinner and less bulky in use than ordinary tape, plastic electrician's tape made by the Minnesota Mining and Manufacturing Co., of Saint Paul, Minn., has an elastic, rubberlike vinyl backing, coated on one side with adhesive. The backing has high dielectric strength.

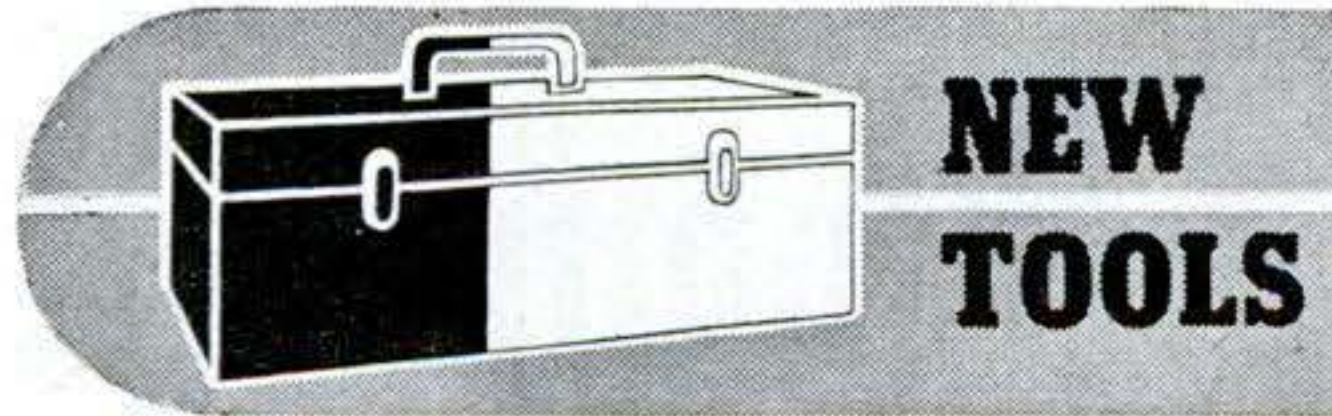

**SMALL HAND DRILL.** Compact and sturdy, the British-produced hand drill below has ribs on the inside of the handle to prevent the hand from slipping while the tool is in use. First shown in London at a display of new British products, the drill is manufactured by the Leytonston Jig & Tool Co.



**FINISHING HAMMER.** Although designed for flattening, smoothing, and dent-removing operations in automotive shops, a finishing hammer produced by M. F. Robertson Sons Co., Darby, Pa., also has a practical value for home tool chests. Each hammer is supplied with a felt-lined metal cover to protect the face when not in use.

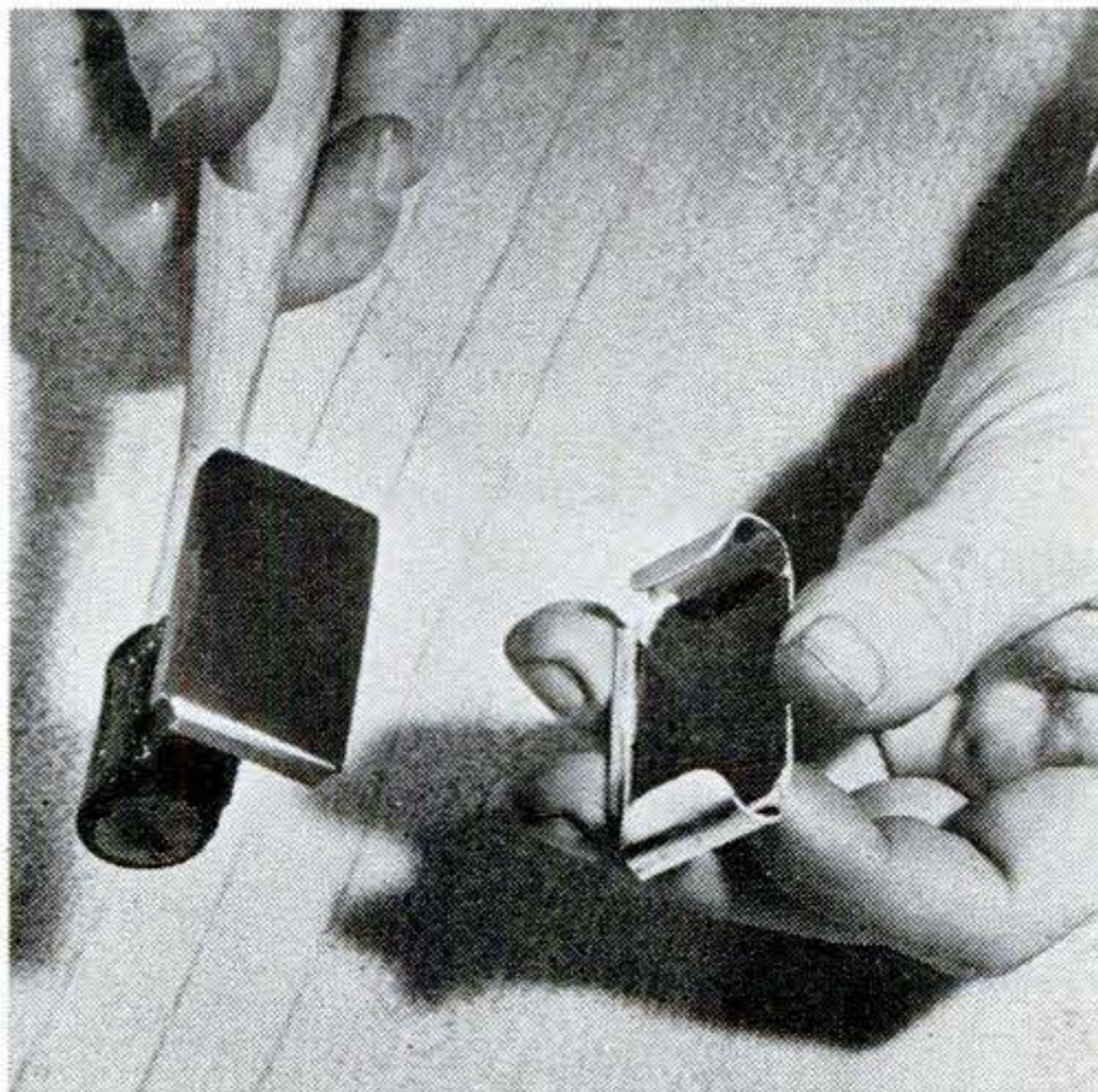



# Illuminated Corner Shelf

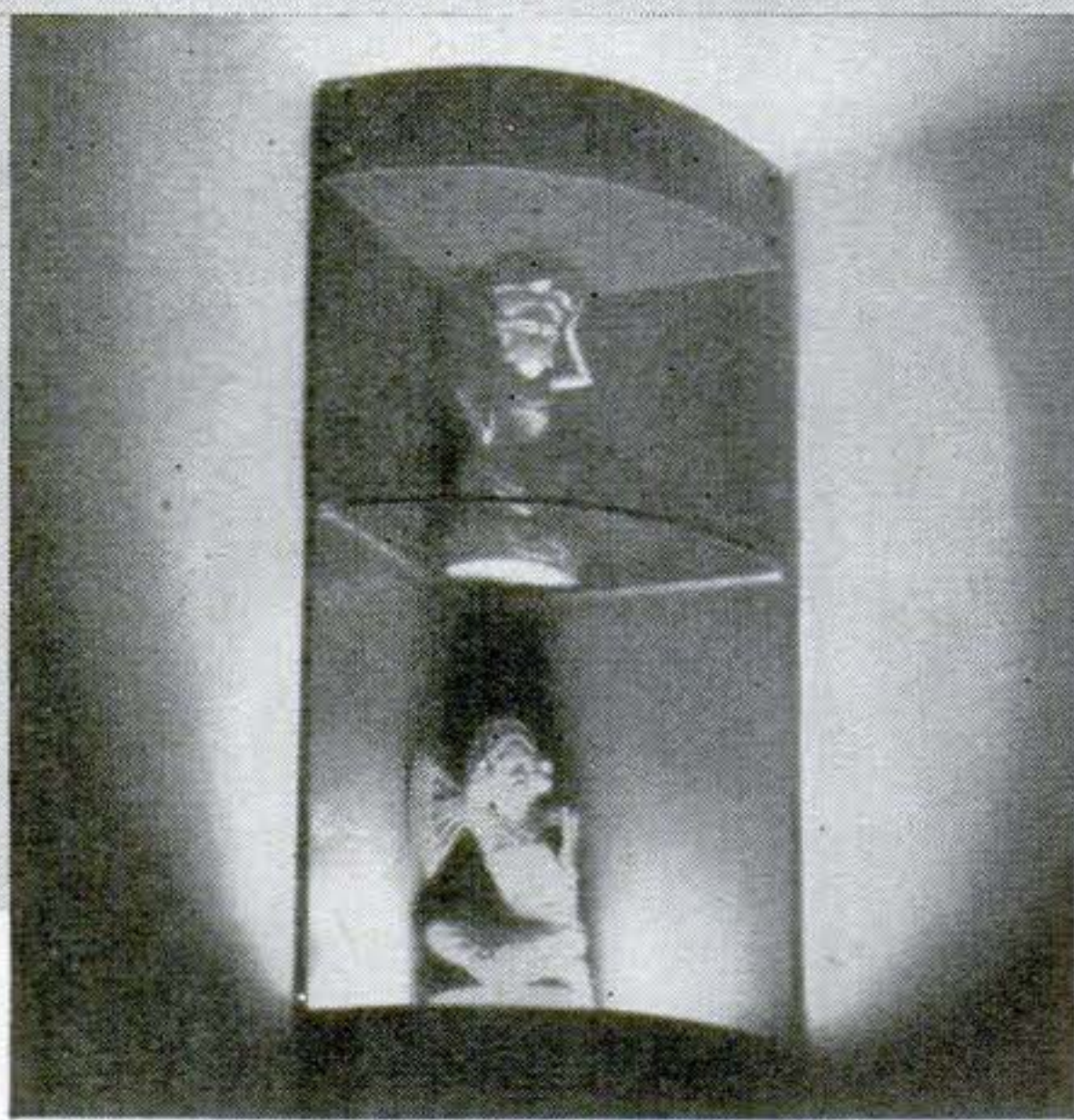

Light from the base of the cabinet illuminates the objects displayed on its glass shelves, while that from the top provides a soft glow for the room.

By **JAMES S. HARTZELL**

**H**ERE is something different in knick-knack shelves. This self-illuminated corner cabinet not only lights up the objects on its shelves but provides also a mild indirect room light—enough to give a soft glow in a small hall or to brighten the corner of a large room.

The piece is made up of two  $\frac{1}{4}$ " plywood sides, two curved fronts, two  $\frac{1}{4}$ " plywood members cut to an  $11\frac{5}{8}$ " radius, and three glass shelves, two frosted and one clear. Sheet plastic, sheet metal, veneer, or thin solid wood can be used for the curved fronts.

Build a form of  $\frac{3}{4}$ " lumber, as in Fig. 1, if you wish to use solid stock. Across the middle of each of two 12" wide pieces lay out a 90-deg. arc having a radius of  $11\frac{5}{8}$ " and saw through cleanly with a jigsaw or scroll saw. Build up the two concave pieces with two extra pieces of  $\frac{3}{4}$ " stock, and nail all firmly to a base. Then assemble the convex sides similarly, but do not nail to the base.

Dress two pieces of clear pine  $3\frac{1}{2}$ " by  $18\frac{3}{8}$ " to a thickness of  $\frac{5}{32}$ " and sand

smooth. It will take two days to curve the strips in a single form since each must remain in it 24 hours. First soak a strip overnight in water, dry by pressing between the folds of a towel, and then clamp in the jig. Finish by drilling the ends for  $\frac{1}{4}$ " bolts.

Though the fronts of the shelves are 90-deg. arcs, the shelves themselves are not exactly 90-deg. sectors, as Fig. 2 will show, since a slice must be taken out of one side to allow a  $\frac{1}{4}$ " space for wiring. This in no way affects the fit in a square room corner, and the joint still appears as a right angle when seen from the front. The glass as well as the plywood members is cut according to this pattern. Ready-cut corner glass shelves available in hardware stores have plastic mountings that afford enough support to make trimming the shelves unnecessary.

Assemble the plywood sides with nails, nail in the plywood bottom, and nail in the upper plywood piece  $3\frac{1}{2}$ " from the top edge. Bolt the curved front strips to the angle braces, drawing them up just enough to touch the curved fronts of the platforms but not enough to touch the braces. Then brad the strips to the platforms, putting the holes. Mount the glasses on cleats, the clear



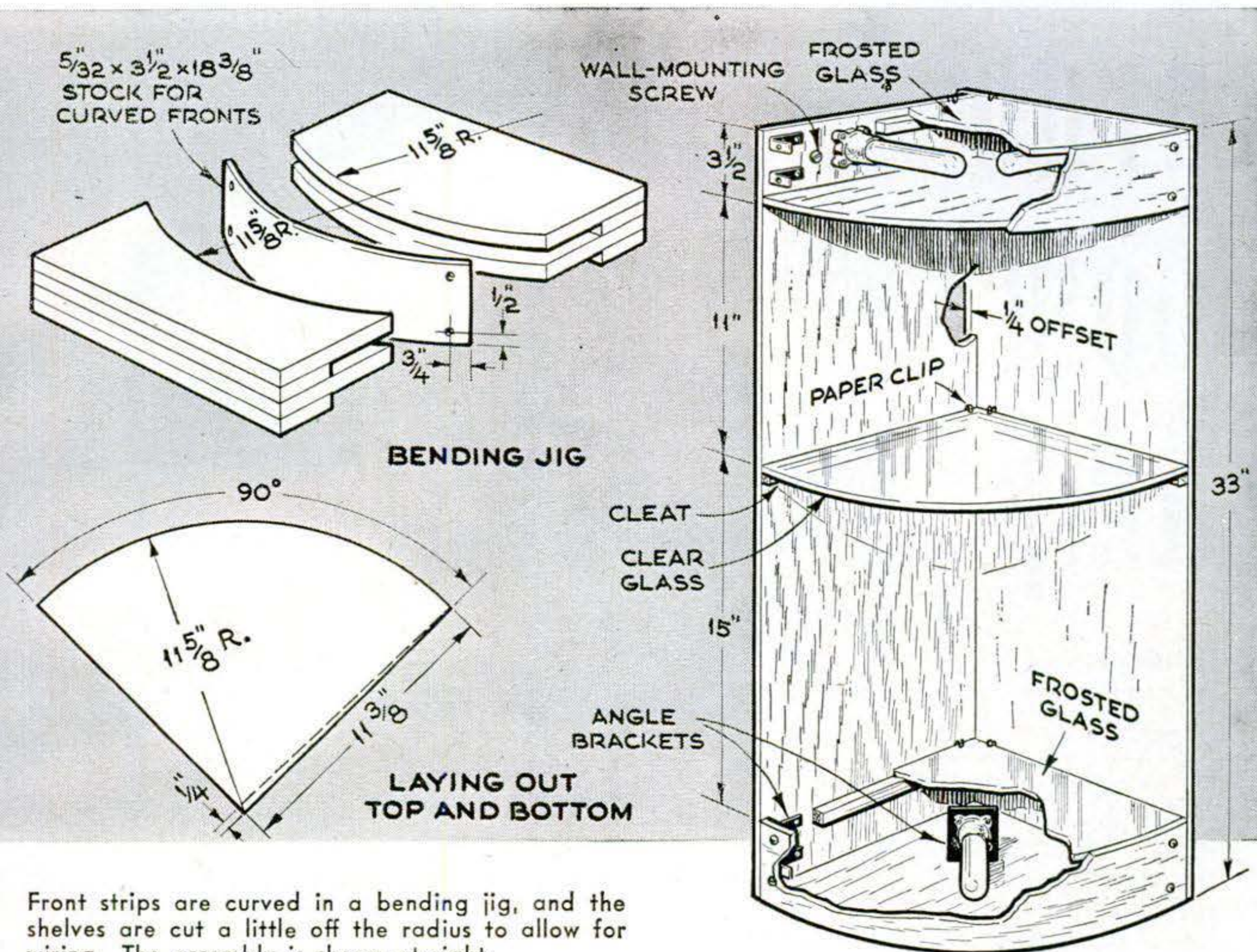

Front strips are curved in a bending jig, and the shelves are cut a little off the radius to allow for wiring. The assembly is shown at right.

one in the center, holding them with bent wire clips driven behind the cleats.

Line the light pockets with sheet asbestos and wire sockets for two showcase bulbs in the upper and one in the lower. Put in a toggle switch on the underside of the

bottom where it will not be noticeable.

Particular pains must be taken with the finish, using both undercoat and high-grade enamel, since the light will show up blemishes. Jade green or brick red will go well with silver and other objects.

## RINGS OF ANNUAL GROWTH

[WOODWORKING]

Each of the concentric rings in a cross section of a tree represents growth made during one year—from the time active growth begins in spring until the tree becomes dormant in fall. The age of a tree can be determined by counting these rings, but only approximately, for drought often causes two rings in one year. Widths of the annual rings vary according to the growth conditions.

In many woods, each annual ring is made up of two parts—inner light-colored springwood and outer, darker summerwood. Springwood is made up of relatively large, thin-walled cells formed during the early part of each growing season. Summerwood is formed later and consists of cells with thicker walls and smaller openings. It therefore contains more solid wood substance than springwood. A change from springwood to summerwood is less noticeable in hardwoods than in soft.

The proportion of springwood and summerwood present in softwood lumber has an important effect upon its strength properties and physical characteristics, according to the National Lumber Manufacturers Association. In the softwoods commonly used for structural purposes, the rate at which trees grow has an important effect on their strength. A measure of this strength is provided by the relative width and the character in each ring. Pieces with medium to narrow rings have generally higher strength than those with wide rings. In addition, in certain woods, pieces in which a considerable part of each annual ring is made up of the dense, darker summerwood are recognized as having still higher strength. Therefore, when structural material is being graded for use under known loads, the number of rings per inch radially and the proportion of summerwood are both considered. Material with a specified minimum number of annual rings per inch is termed "close grained" and that which in addition consists of at least one-third summerwood is termed "dense."

POPULAR SCIENCE MONTHLY SHOP DATA



# Cargo Boom Lamp

By CHARLES S. JEGLINSKI



SEAGOING accessories are always popular in a den or game room for their note of outdoors and adventure. This wall lamp is built to represent a ship's cargo boom, with the mast against the wall and the lamp and shade suspended from the boom.

If the room is large, a pair or more may be wanted. At any rate, the mast, base, and truck should be made up as split turnings with paper glued in the joint to simplify the work. Then, if the second half is not needed, it can be discarded.

Make up the wooden parts from pine, whitewood, mahogany, maple, or any good turning stock. Note that the mast tapers from a  $1\frac{1}{4}$ " diameter at the base to  $1\frac{1}{4}$ " at the truck. Both the base and truck are turned round, and then split at the paper joint. Round off the lower edge of the truck only. All three pieces should be sanded smooth before removal from the lathe.

Cross-drill the mast to a depth of about  $\frac{1}{2}$ " for a  $\frac{3}{8}$ " brass grommet; then drill a  $\frac{3}{8}$ " hole up from the bottom to meet and also drill the base. The hole thus formed takes the light cord. Glue the base and truck in place, reinforcing the former with a short length of  $\frac{1}{8}$ " pipe nipple and the latter with a screw. The nipple cuts its own thread.

Jigsaw the crosstree to shape; the semi-circular cutout should be performed as a separate operation with the saw table tilted to a 2-deg. angle so the cutout will fit the pitch of the mast. Glue in place and fasten

with screws or light finishing nails driven in at an angle from the back.

Brass screw eyes in the crosstree and truck hold the stays, which are picture wire. The wire is unstranded at the ends and all but two strands cut off there. These are put through the eyes, bound around the thicker part of the wire to look like seizing, and soldered. Picture hangers on the back of the crosstree are for hanging the lamp.

Turn the boom from  $1\frac{1}{8}$ " stock to  $1\frac{1}{16}$ " at the center and tapering to 1" at the top end and  $\frac{7}{8}$ " at the other. A  $\frac{3}{4}$ " tenon  $\frac{5}{16}$ " long is turned at the small end to take the boom socket. The top end is trimmed to a  $\frac{3}{8}$ " by 1" flattened oval.

One of the ferrules from a renewable-type cartridge fuse (250 volt, 35 to 60 amp., or 600 volt, 1 to 30 amp.) supplies the socket. It will cut its own threads. Drill it  $\frac{3}{16}$ " for a tight fit for the stud on the end of the filed brass coupling. The gooseneck is rough-cut with a hacksaw from a  $\frac{7}{16}$ " by  $\frac{17}{32}$ " by  $1\frac{7}{16}$ " brass block, drilled, and finished with a file.

Blocks can be obtained at a hobby shop, but it is not too difficult to jigsaw a pair from maple or ash and to turn brass sheaves. They are attached to the mast and boom with screw eyes opened to receive the end of the brass fitting and then pinched shut again. File the cleat from brass and drill and countersink. The lamp socket and wiring are standard.



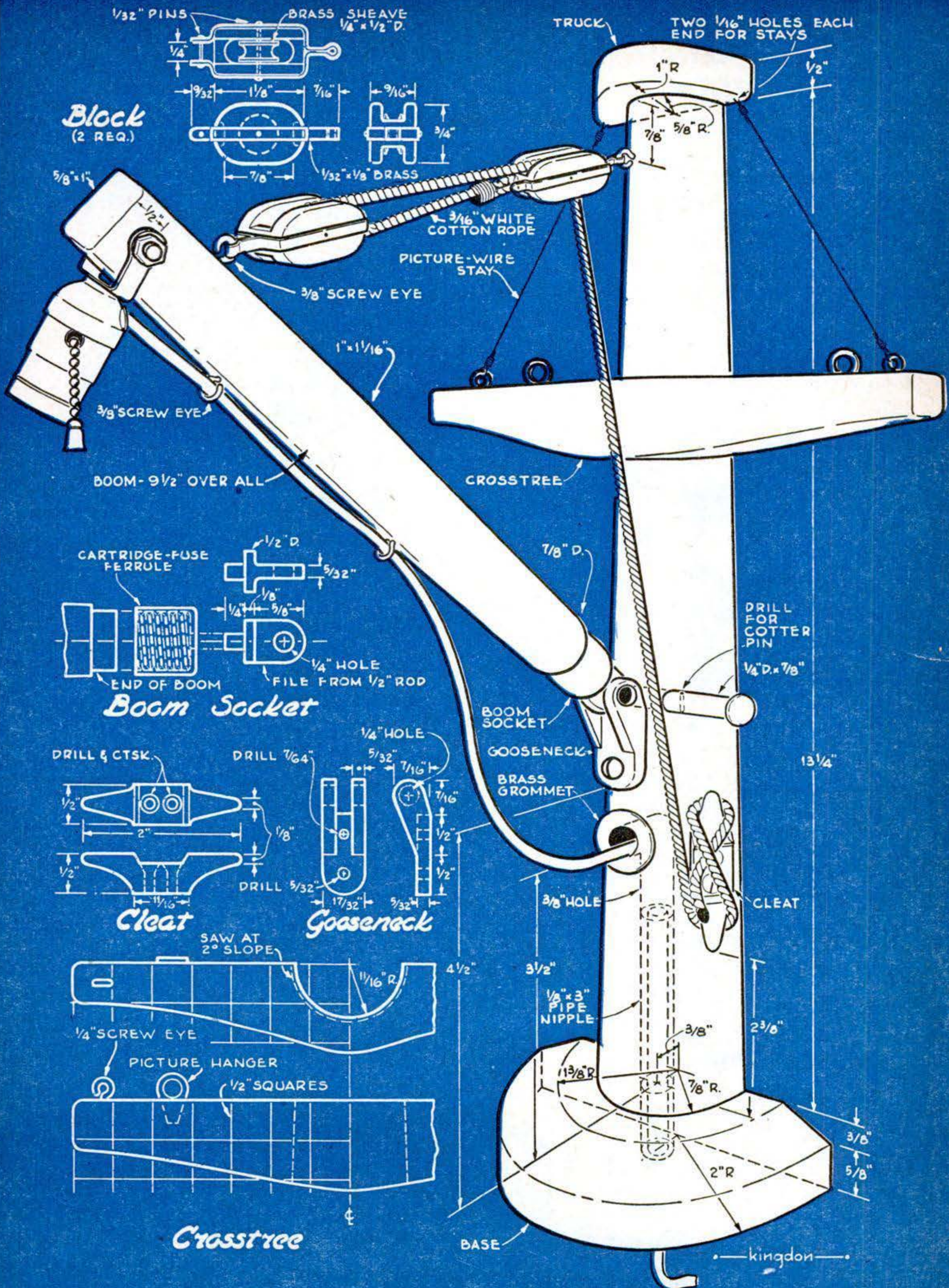



## CRAFTSMEN at WORK



**HOME-BUILT HYDRAULIC PRESS.** Using surplus airplane parts, Wat Slee, of Seattle, built a two-way hydraulic press for inserting and removing bearings, bushings, and the like and for straightening and bending jobs in his home workshop. With 4 sq. in. of piston surface in his cylinder, he has a 4-ton press using 2,000 lb. of oil pressure from a 1" bore hand pump.

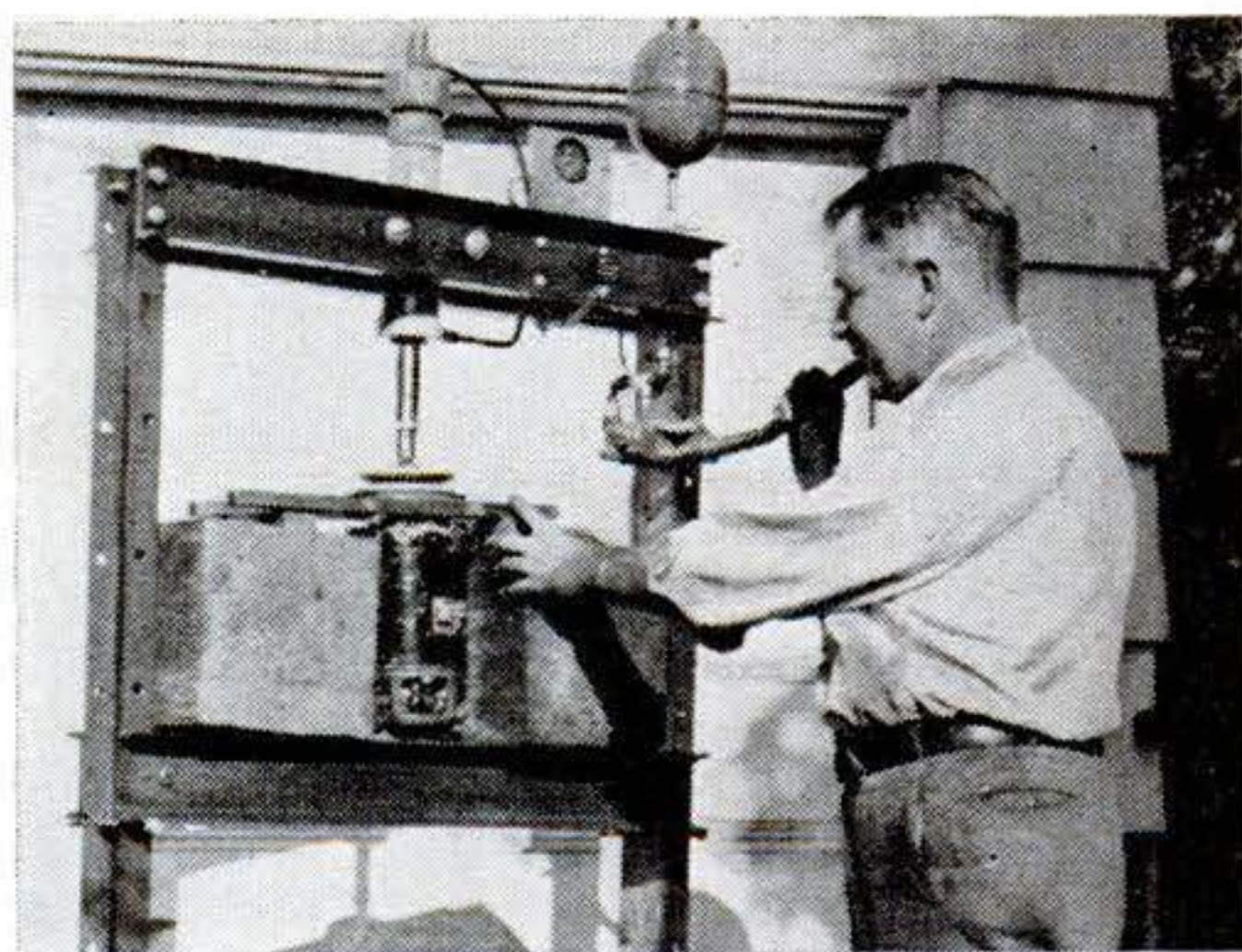

**MODEL CABOOSE.** Like the postman who hiked in his spare time, Engineer Jack M. Fesco, of the Southern Pacific, worked on his model caboose. Made on a scale of  $\frac{3}{4}$ " to 1', it is complete in every detail including inside fittings. Parts were put together with 3,000 rivets and 1,000 screws. The job took 4,850 hours. Fesco plans to work on a locomotive next.

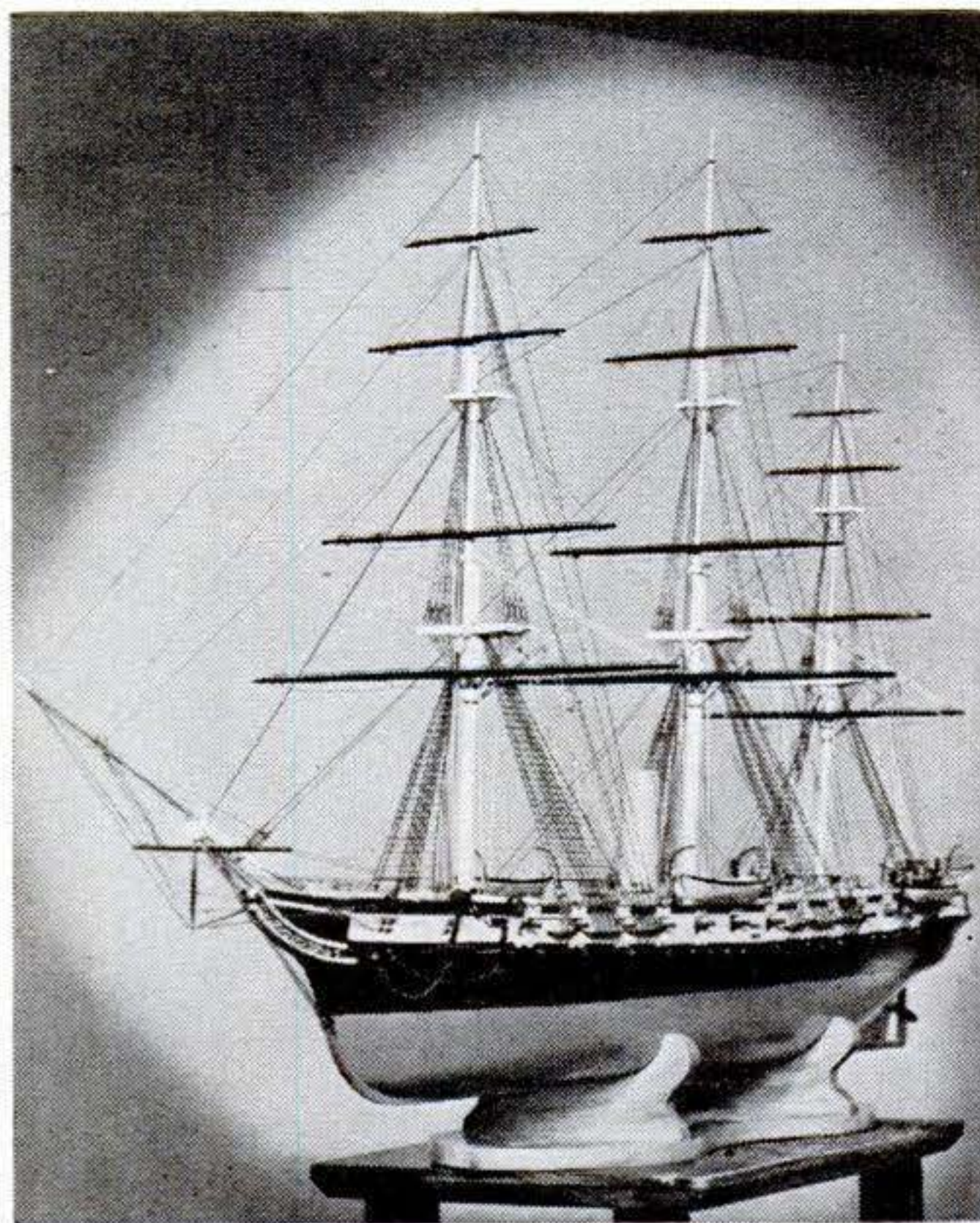
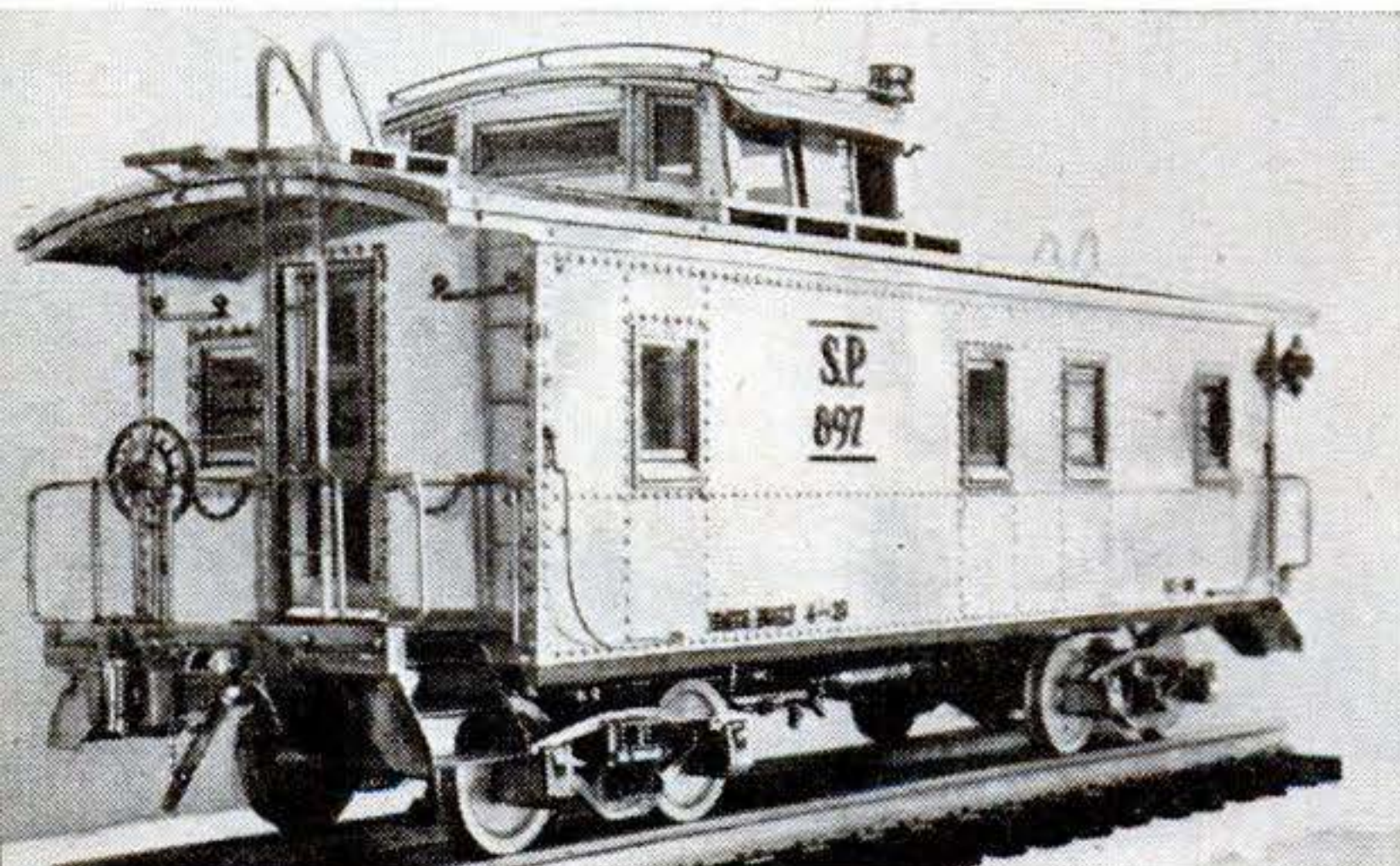

**THREE-MASTED SCHOONER.** This model of the old *Hartford* was made by Paul Chamberlin, of Alhambra, Calif., from PSM plans. Work was almost entirely by hand, the only fittings purchased being the dead-eyes, blocks, anchors, and belaying pins. The guns were turned from brass and electroplated black for a realistic appearance.

**GEARLESS SCOOTER.** Hydraulic linkage between the  $\frac{3}{8}$ -hp. engine and the drive wheel makes gears unnecessary on this scooter built by Cpl. E. C. Cole, of Lost Hills, Calif. The scooter has two speeds, gets 70 miles out of a gallon of gas, and will carry three men, with sidecar, at 35 m.p.h. It will speed up to 45 m.p.h. when not taking the two passengers.





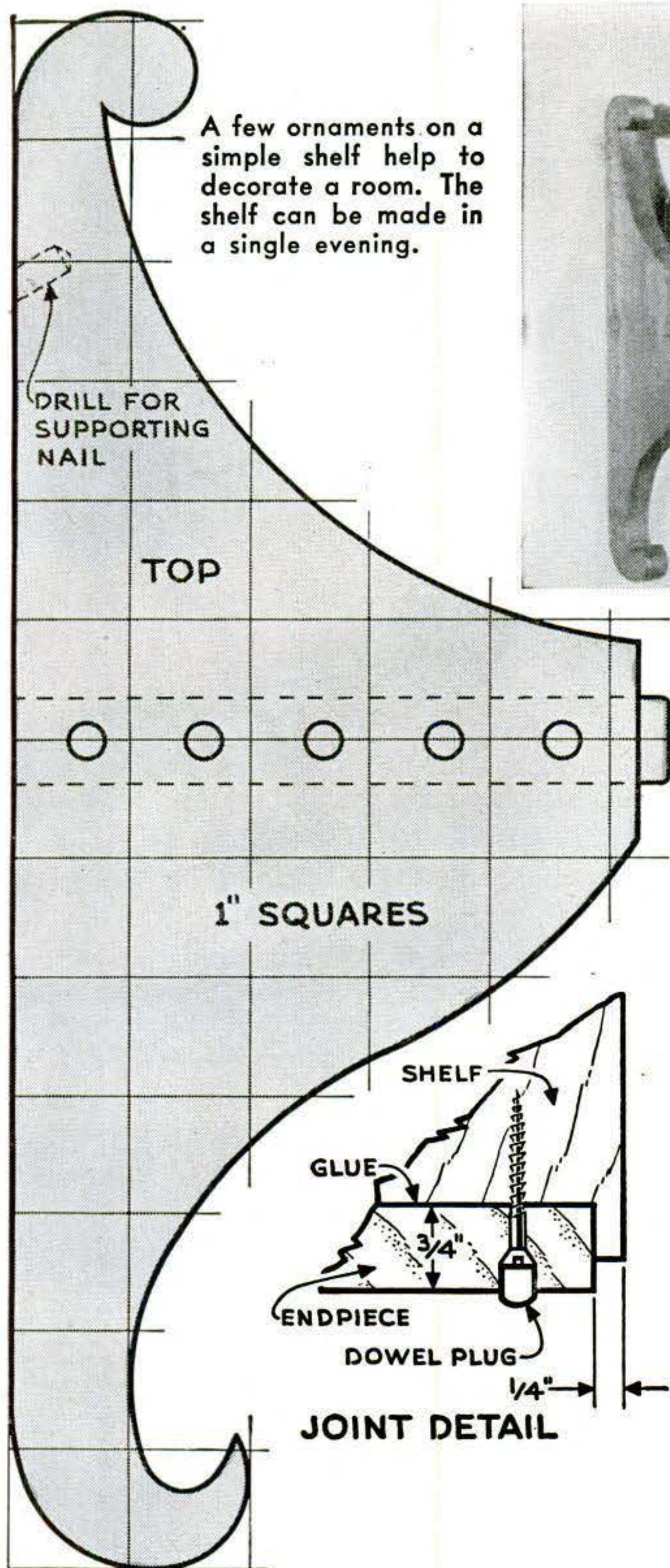

A few ornaments on a simple shelf help to decorate a room. The shelf can be made in a single evening.

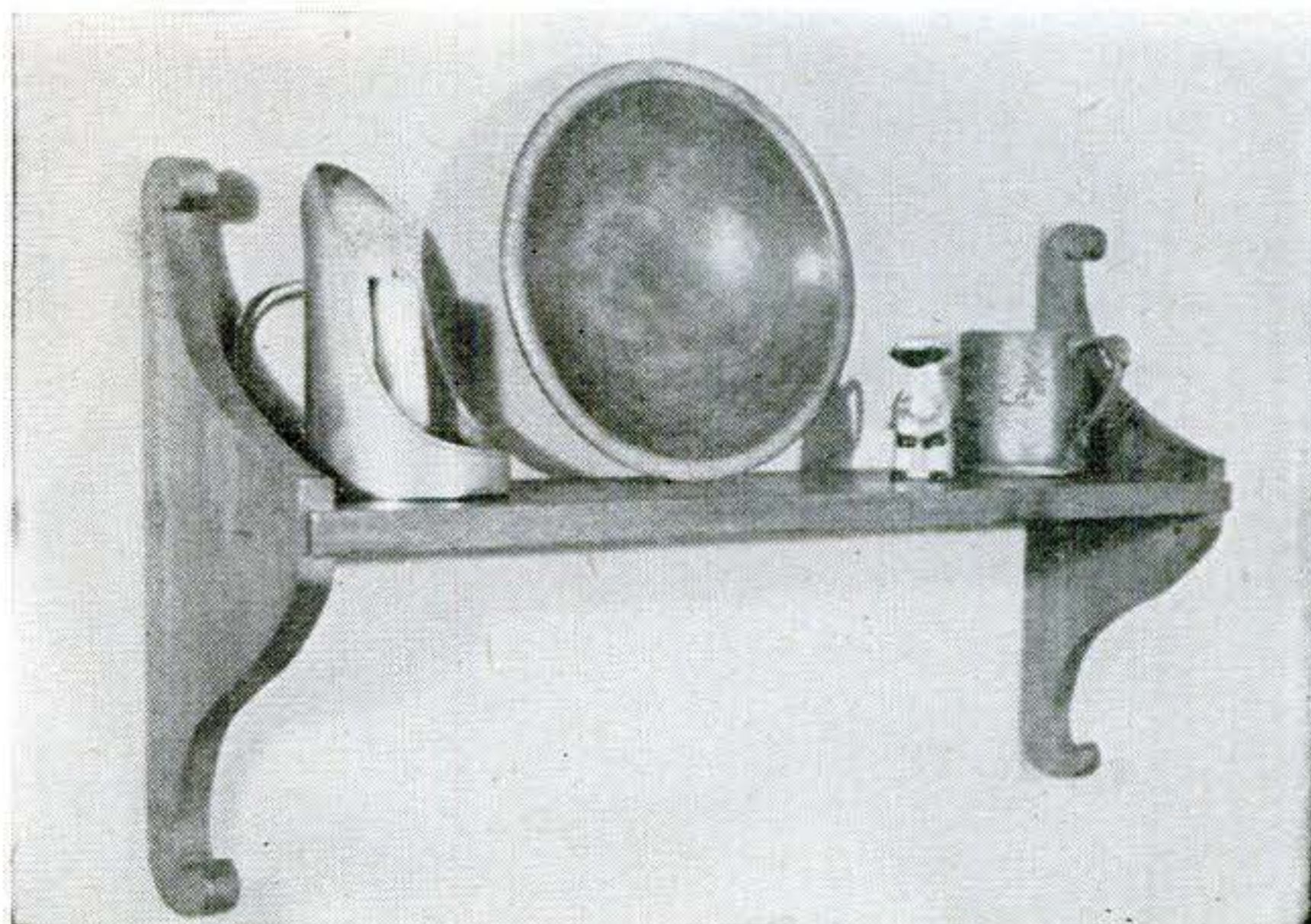

## Wall Shelf for Knickknacks in Colonial Style

FOR a home with early American furnishings and old-time knickknacks to display, this simple shelf will add an authentic note. Centered over a low bookcase or other furniture, it takes the place of a picture.

Choose good wood, such as nicely grained pine. Clamp or tack two pieces together, lay out the end pattern, and bandsaw identical endpieces at one time. The 5½" by 24" shelf is cut to fit over the front edge of the endpieces and simulate dado joints, although the pieces are actually butt-joined.

A ¼" hole ½" deep is drilled on an upward slant near the top of each endpiece as a means of supporting the shelf. The supporting nails require exact placing in the wall, but this can be done by measuring with the shelf itself.

Sand the entire piece well. A first coat of linseed oil will impart a golden tone, if you like, or two coats of white shellac sanded and then waxed will do the job.

## Hat and Coat Rack Bent From Plastic

HEATED in the kitchen oven, a ⅛" by 1¼" by 10" length of clear plastic can be bent to shape for a modern hat and coat rack that can be attached to the inside of a closet door.

First, using a coping saw, taper one end of the coat hook, and smooth all edges with fine sandpaper. Then heat the piece in the oven at 250 deg. until it is pliable, take it out, and bend to shape with gloved hands. If the curves are not satisfactory, reheat and bend again. No jig should be necessary.

Finish by drilling and countersinking the piece for two wood screws to mount it by.

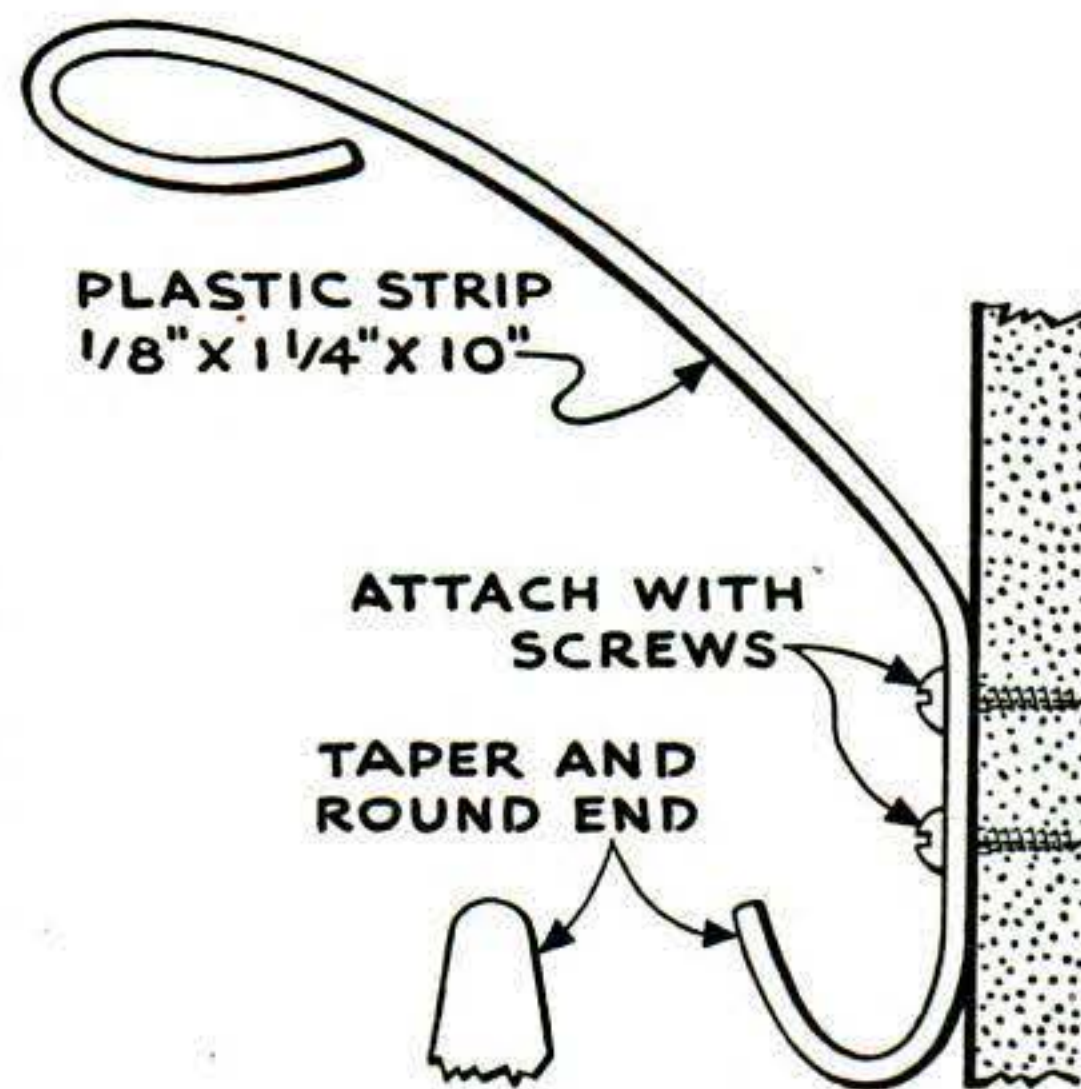



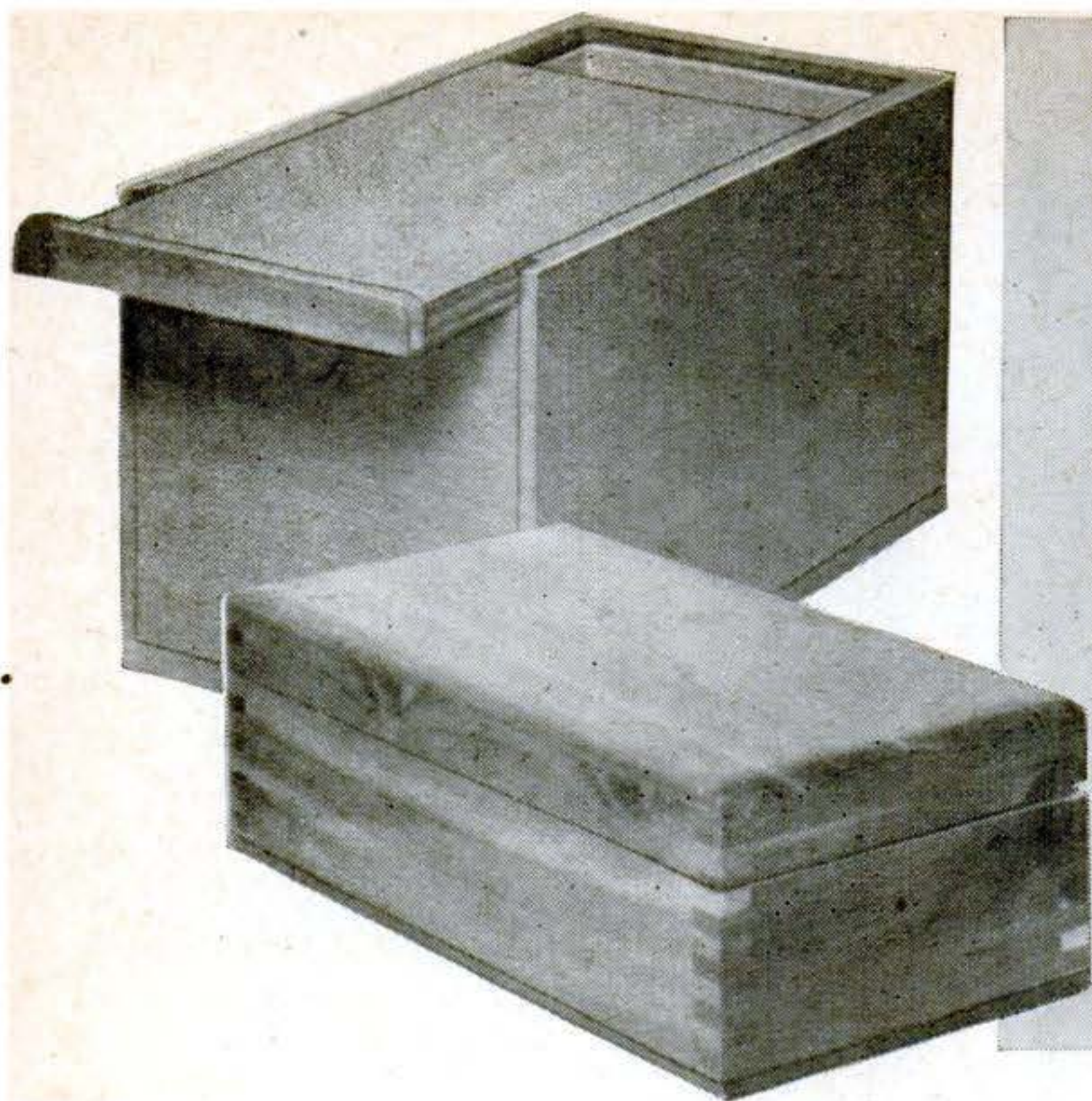

## in a Hurry

**Not simple to make, but still basic to many a project, boxes call for woodworking skill.**

By **JOHN P. ARNOLD**

**B**OXMAKING on a production scale is a highly specialized branch of woodworking, and yet boxes are a basic form of so many projects that the home craftsman is often called upon to make them. Applications of the box structure range from hope chests to jewelry cases, and to such divergent things as newel posts, plywood suitcases, bookcases, cabinets, and other furniture. So if your hobby is woodworking, a look at small shop production methods may afford a valuable tip or two—particularly if you're interested in earning money in your shop, or in turning out projects in quantity for your gift list.

The machines usually available for the work are circular saws, jointers, shapers, and sanders. Dovetailing and lock-cornering machines of the kind used in box factories are too specialized and costly for the small shop, but their work can be duplicated on a limited scale with common power tools.

In quantity work, it takes about five times as long to assemble a box as it does to make parts. Whether a box can be assembled readily depends largely on the kind of joints. Those commonly used are butt, miter, rabbet, rabbet-and-dado, dovetail, and lock-corner. Butt joints are for rough work, such as packing cases, and can be assembled rapidly only in jigs devised to hold the parts for nailing. Miter joints, plain, locked, or splined, are excellent in

appearance, but even when made with precision, they can't be put together in a hurry.

Rabbet and dado-and-rabbet joints require special forms to hold the parts while the glue is setting. Dovetail and lock-corner boxes need only be squared up, for their joints will stay in place without clamping if properly made. When the number of boxes being built is limited and gluing forms are not available, rabbet joints can be assembled with fair speed by using brads or nails with or without glue.

There are also three general styles of boxes classified according to their lids: the slide-cover or unhinged box; the cut-apart lid, which is separated from the body after assembly; and the box with a separately built hinged top. Details can be combined or varied to suit most jobs.

A box with a slide cover and rabbet joints is shown above. This type of construction is suitable for instrument cases and the like where nice appearance is not the main thing. Its chief virtues are the avoidance of hinging and a dustproof lid.

Stock for the sides and ends is ripped to width and grooved to take the slide cover. The stock is next cut to length, thus leaving each piece grooved right across from edge to edge. One endpiece is cut down to the bottom of the groove to take the lid. Then the sidepieces are rabbeted with a sharp dado head to the same depth as the groove. It is usually advisable to cut the rabbets a trifle wider than the thickness of the end stock and to sand them flush after assembly.



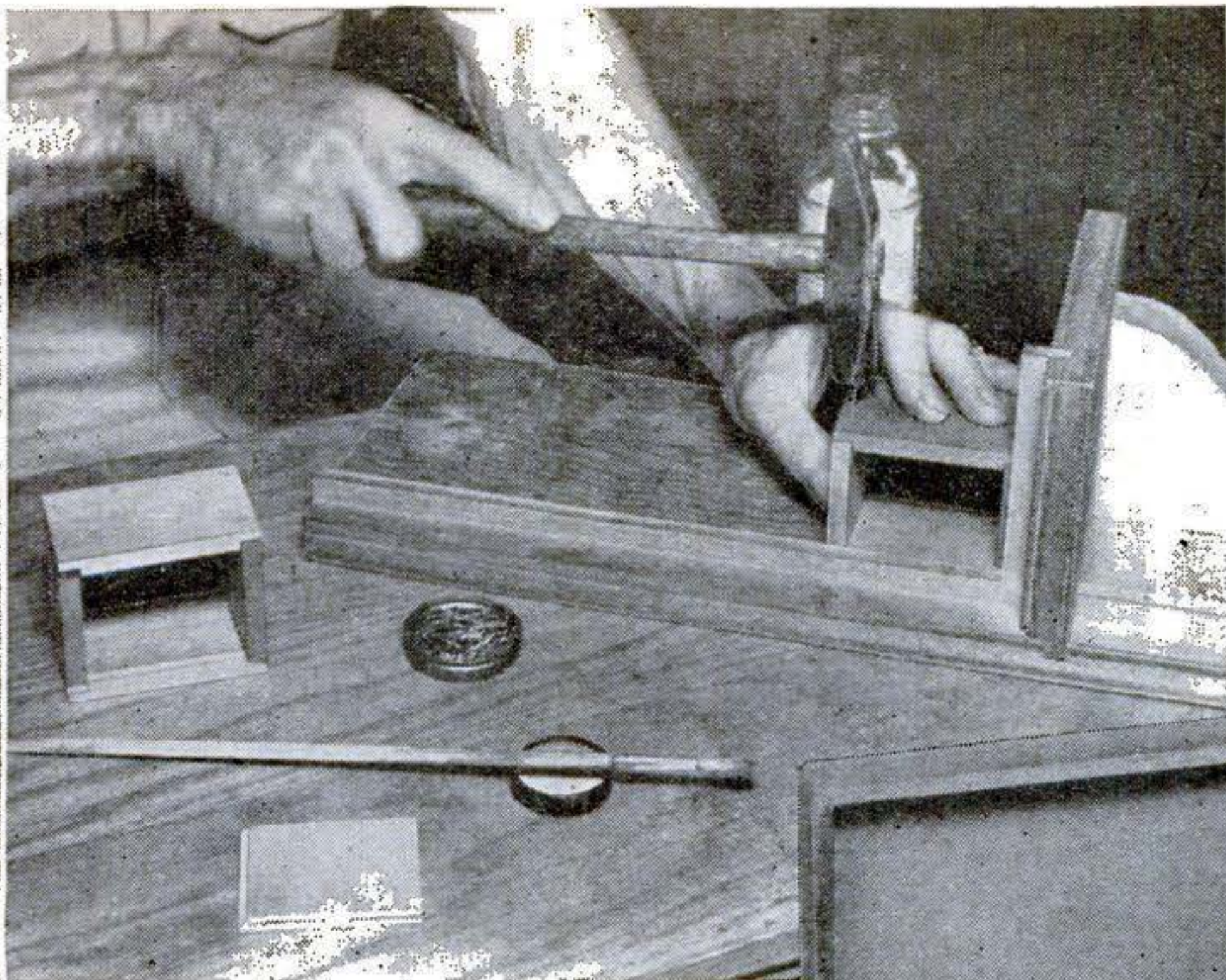

Squareness of assembly is assured when the sides and ends are glued up and nailed while held in a jig consisting of a braced upright at right angles to a flat base. The brads hold rabbeted corner joints and eliminate the need for clamps.

Boxes with tops like that below are made as closed units and then sawed apart to form body and lid. This construction along with a dado-and-rabbit joint, also shown below, makes fine-looking boxes.

If the quantity of boxes is limited and gluing forms are not available in the right size, the parts can be assembled with glue and light brads. A convenient jig for holding the parts square when nailing is shown in use above. Particular care must be taken to get the lid grooves in alignment.

The lid treatment shown on the facing page is somewhat elaborate. Though rabbeting the three sides of the lid that go in the grooves presents a neat appearance, it is simpler to make the grooves wide enough to take the full thickness of the lid. Instead of the raised cleat at the end for opening, a notch cut in the upper surface will serve as a finger catch. The bottom of boxes like this, incidentally, can also be inserted in grooves cut as for the lid, or else simply butt-nailed to sides and ends with or without gluing.

An all-glued box having dado-and-rabbit joints and a cut-apart hinged lid is shown at center above. This is the best construction for novelty boxes of fine appearance when the quantity is sufficient to justify preparing special gluing jigs of the kind illustrated just under the box.

The joints are cut in the usual manner on the circular saw or shaper, or the saw may be set up to cut the dado and the shaper to form the rabbit. Make the dado

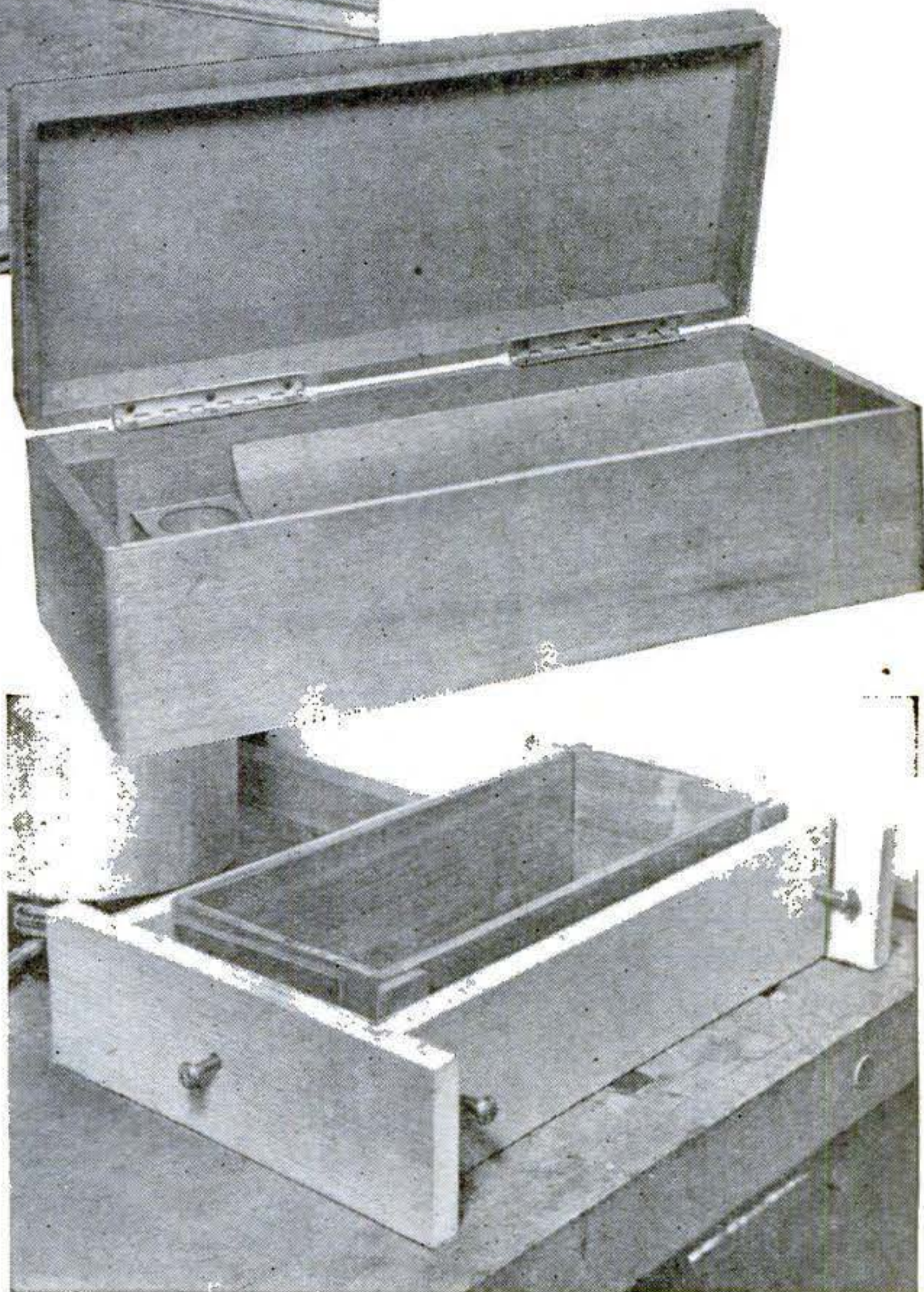

An efficient clamp for gluing dado-and-rabbit joints applies pressure at the corners and ends. Wedges or screws are used.

one third the thickness of the side stock so rounding of the corners after assembly will not weaken the joint. Dado-and-rabbit joints are ideal not so much for the additional gluing surface they provide as for making clamping more convenient. They are not suitable, however, for boxes having bottoms inserted in grooves, as the grooves would have to be end-stopped on the



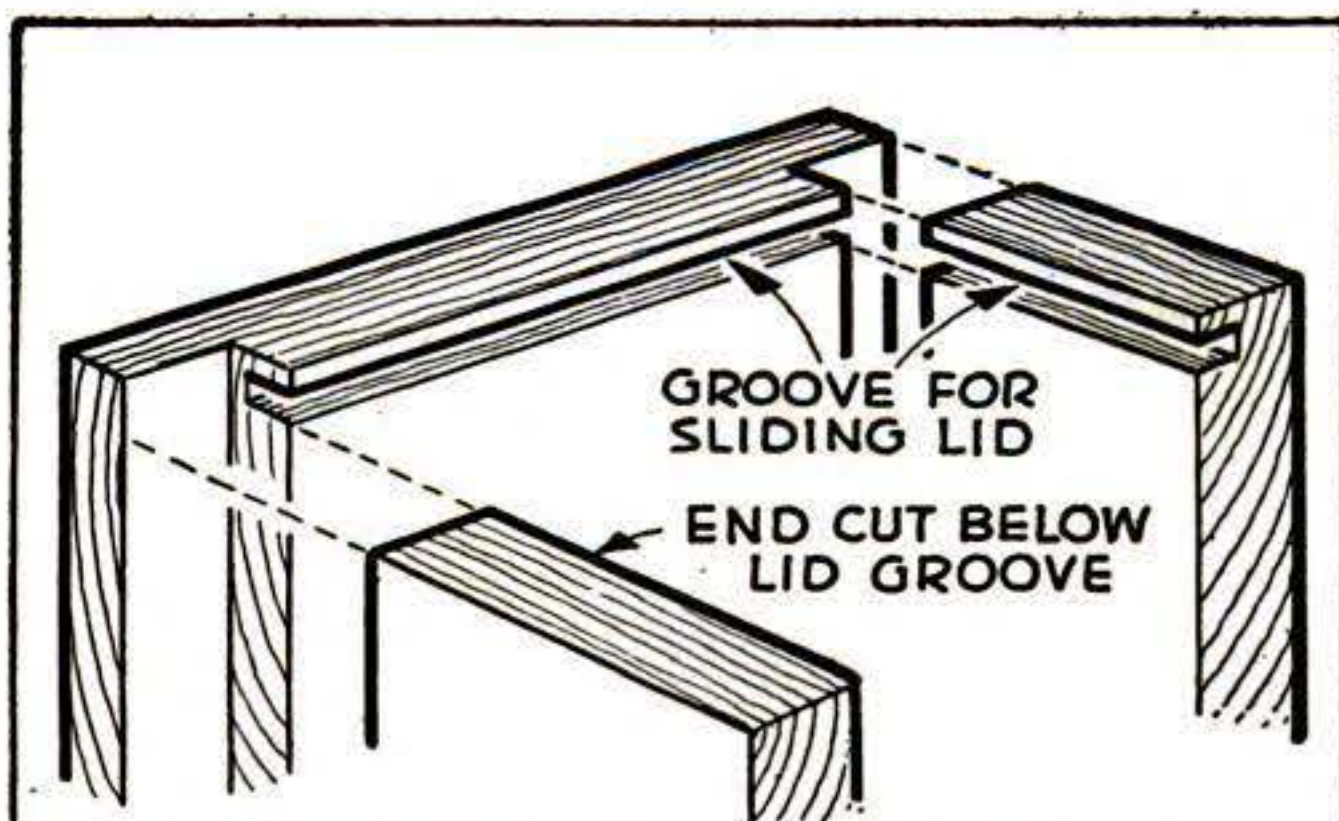

RABBETED CONSTRUCTION

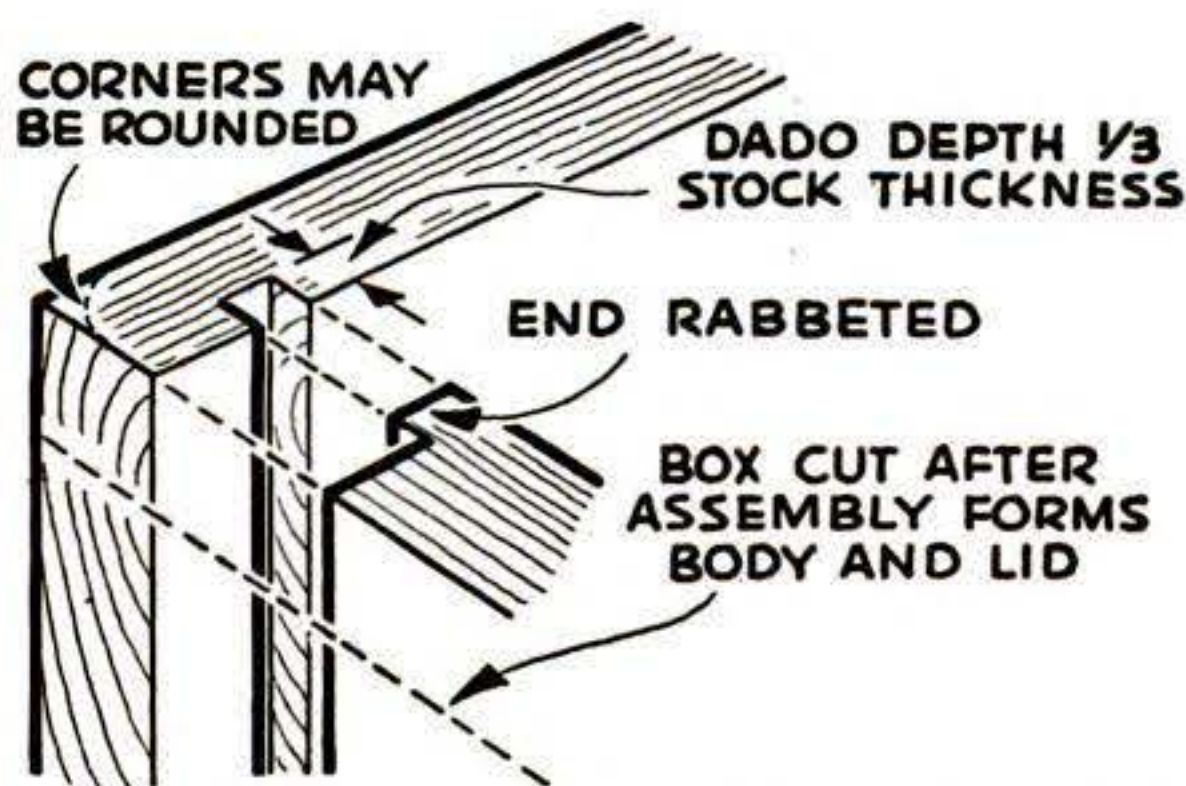

RABBET-AND-DADO CONSTRUCTION

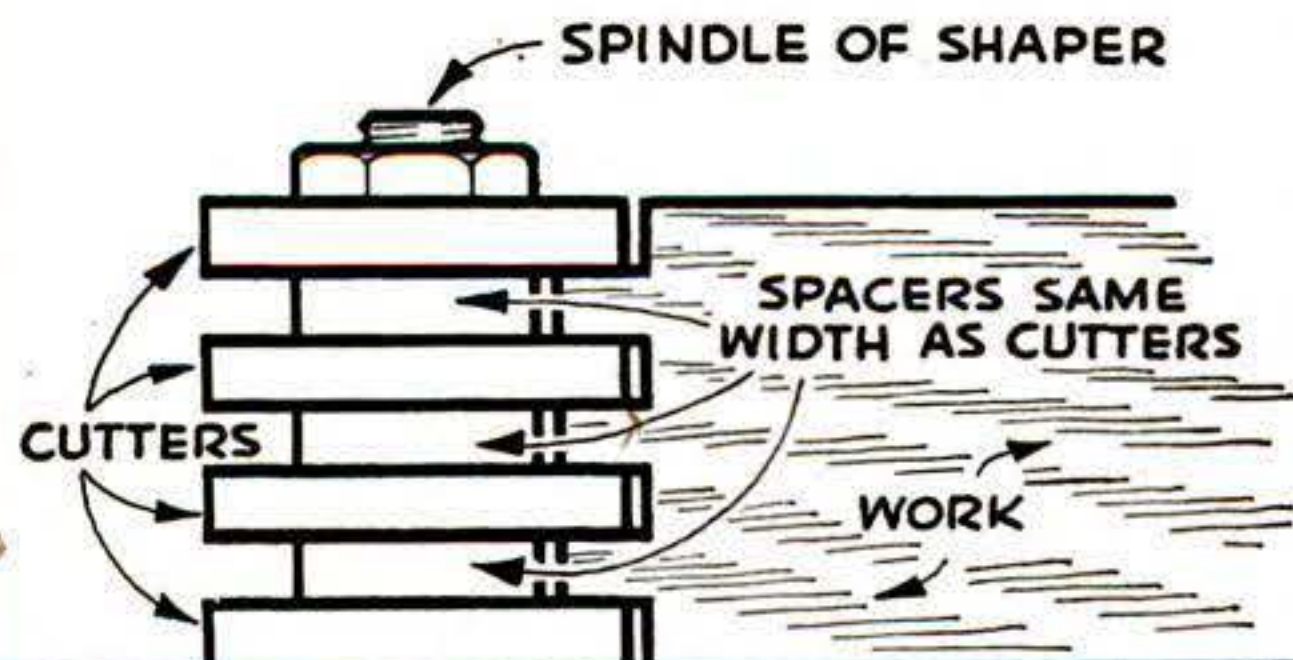

LOCK-CORNER CONSTRUCTION

dadoed pieces so as not to show. The simple rabbet joint with the groove cut to the depth of the rabbet as described before is by far the best for inserted bottoms.

Glue up the sides and ends in jigs made of hardwood, accurately squared, and used on a flat surface. These forms should be sufficiently oversize to take wedges or screws (thumbscrews are best) to clamp the joints.

How long the boxes should remain in the forms varies with the material, its freedom from warping, and the kind of glue used. With fast-setting hot glues under favorable conditions, the jigs can be removed in 15 minutes and the boxes set aside for further drying. Squareness and intimate contact of the gluing surfaces, rather than great pres-

sure, should be sought. Mahogany and other nonwarping woods require minimum clamping; oak, walnut, and the like take a little longer. Filler blocks of suitable size may be inserted in big forms for clamping smaller boxes.

Tops and bottoms are cut 1/16" oversize to allow for possible slipping under the clamps. They may be glued to the boxes and the latter stacked and held under weights or clamped several together with bar clamps.

Dovetail joints can be made with reasonable efficiency in limited quantities. A high-speed router with a dovetailing attachment will cut both members of a joint in one operation. The setup, shown below, requires careful adjustment for thickness, but once it is made, no skill and little effort is needed in cutting either open or blind lapped dovetails. The stock may be 1/4" to 3/4" thick and up to 8" wide. With systematic laying out, the four joints of a box 6" deep can be cut in about six minutes.

Lock joints 2" or 3" in width can be cut on a shaper by loading the spindle alternately with cutters and spacers of identical width. The fence is set at a point where the cutters will work to a depth equal to the thickness of the stock. Ten to 15 or more box sides may be clamped together or held in an open-box jig for cutting joints at either end with one passage.

The endpieces are cut the same way, but the spindle is raised or lowered so the grooves and pins mate perfectly with those of the sides and still allow the bottom and top edges to be flush all around. **END**

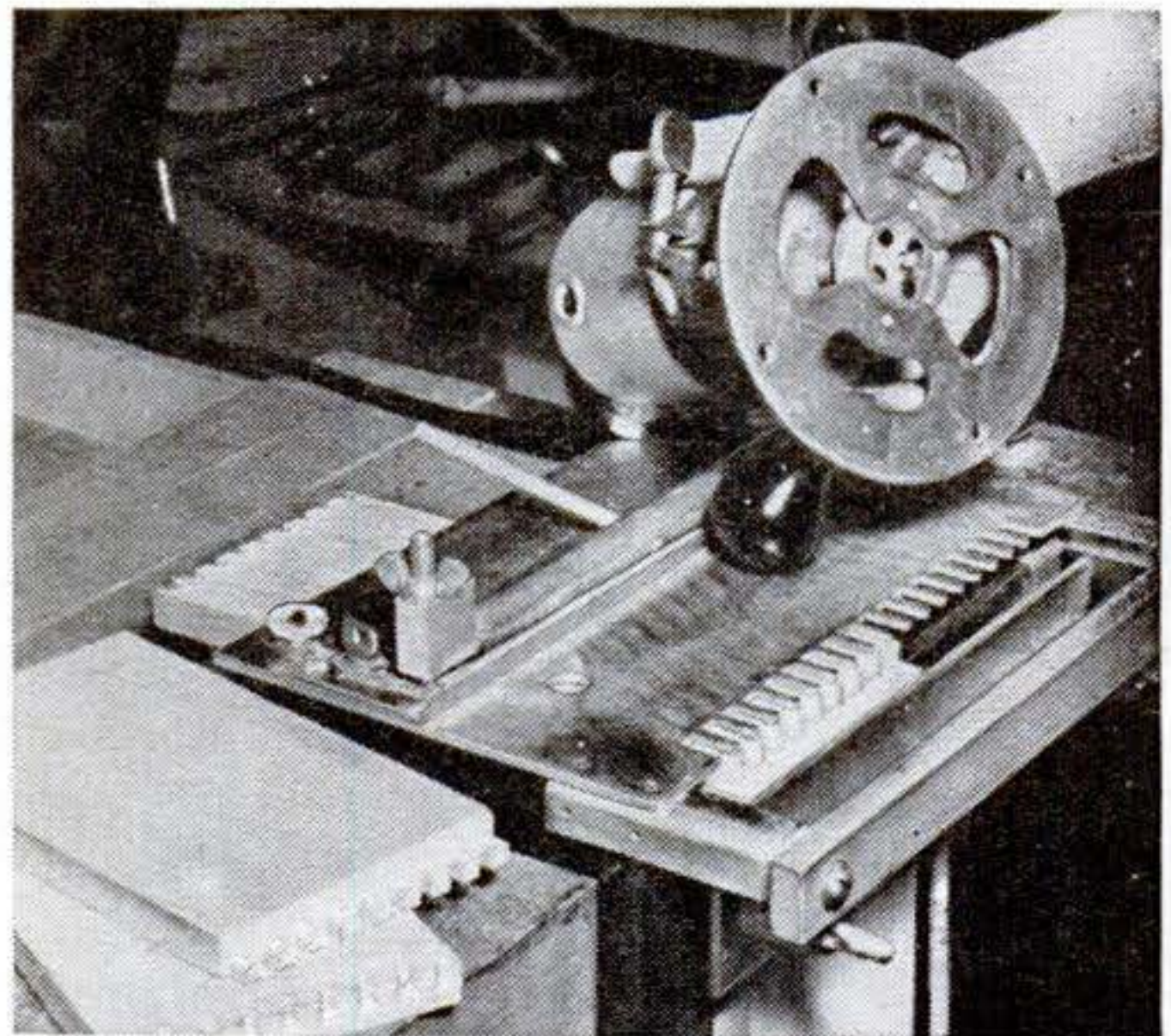

Once the setup is made on the router, either open or blind lapped dovetails can be cut with little effort. Both members are cut in one operation.



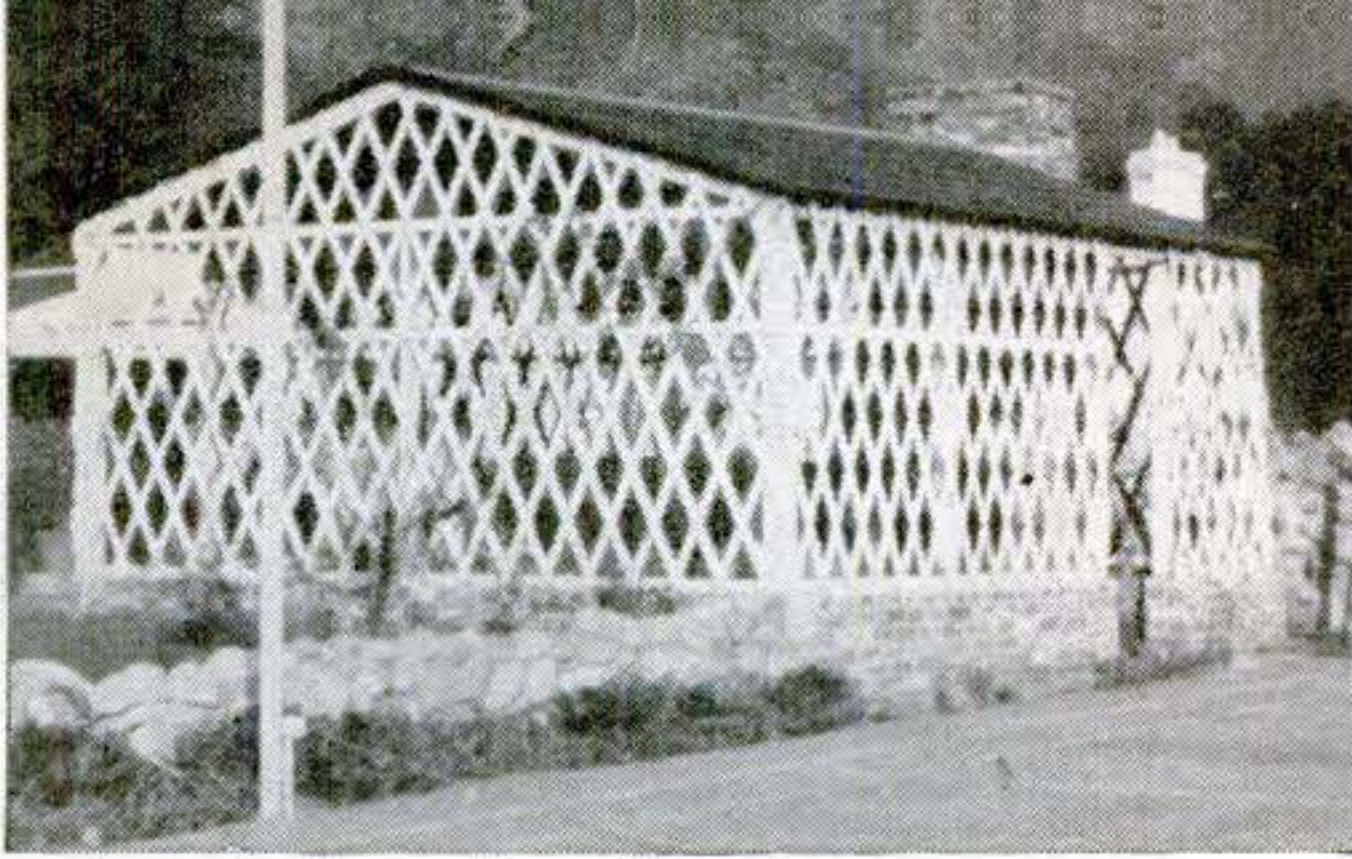

# Outdoor RUMPUS ROOM

**I**F YOUR outdoor stove is put under a roof along with an airy playroom, neither hot sun nor rain can spoil your back-yard or lawn parties. Lattice provides a cool, open finish, strengthens the structure, and serves also as a trellis for growing vines. If mosquitoes or insects are a problem, screened frames may be installed also and the gable ends closed.

Field stone, brick, or concrete may be used for the floor and low foundation. Excavate below the frost line for the footings and barbecue foundation. Sills are held by anchor bolts set in concrete.

The brick barbecue is built conventionally with angle bars supporting the grates and hot plate or grill. One grate is for charcoal and a lower one for wood or coal. The chimney is built on the outside.

Shingles or roll roofing may be used. With the former, open sheathing prevents dampness and rotting.—HI SIBLEY.

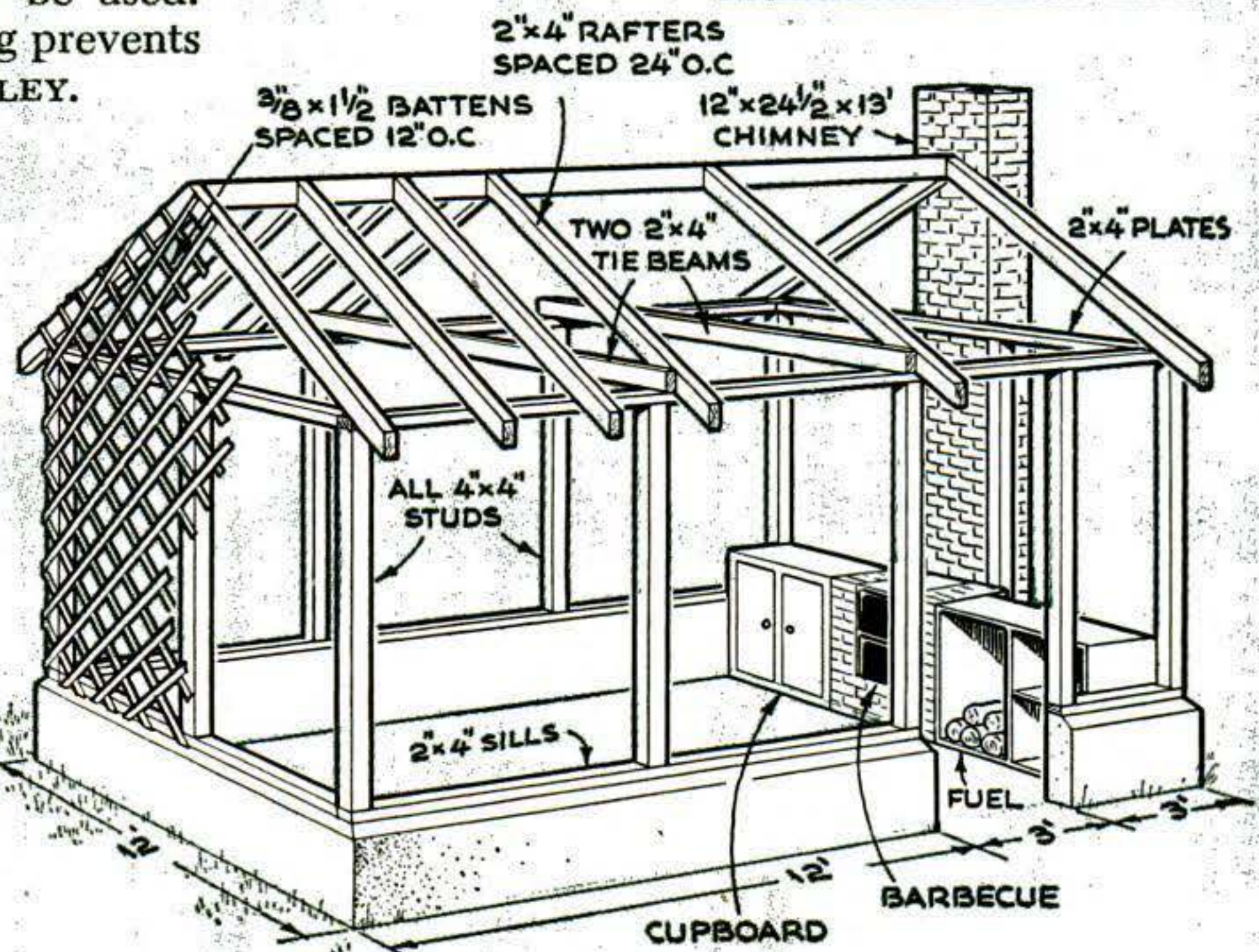
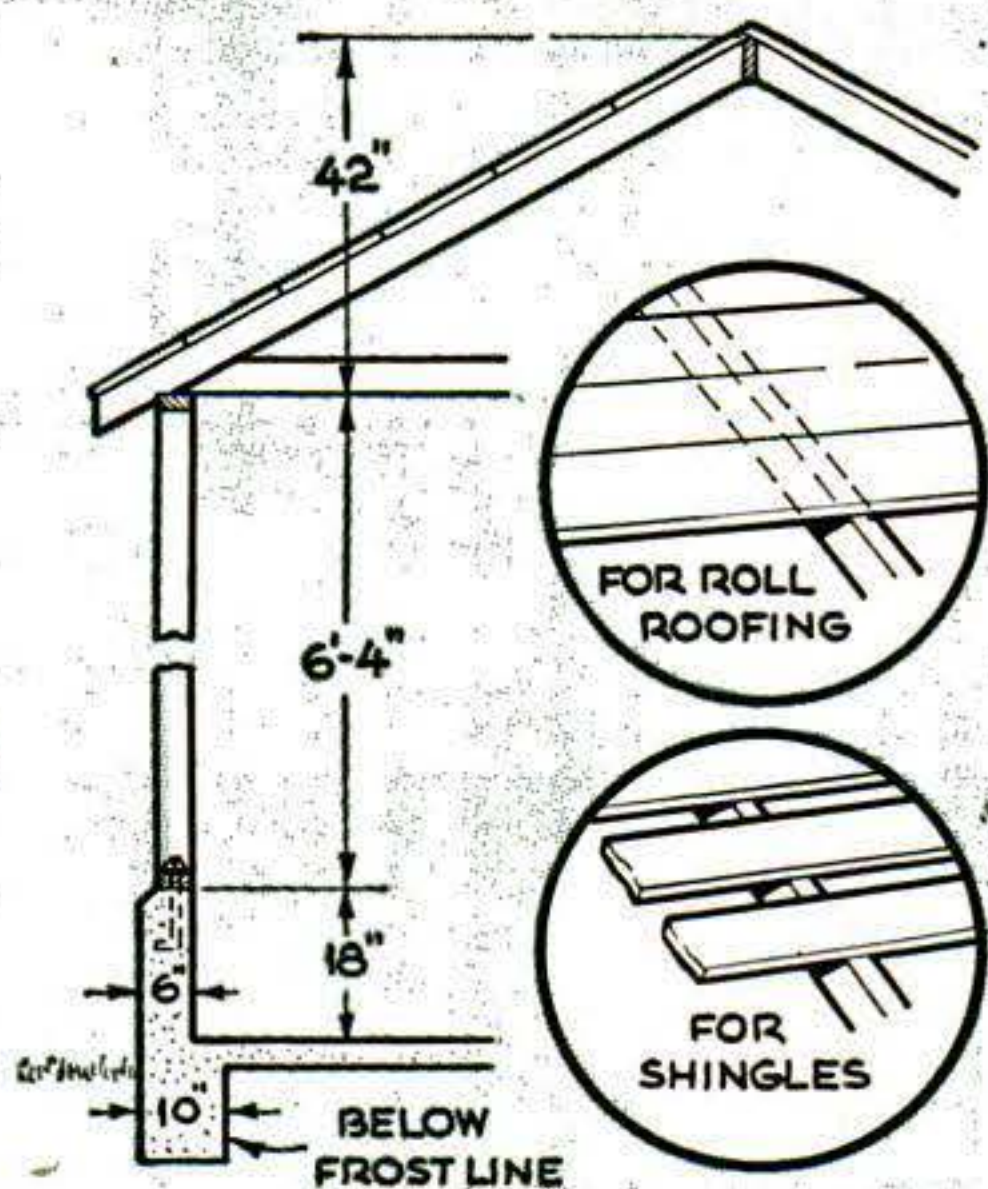
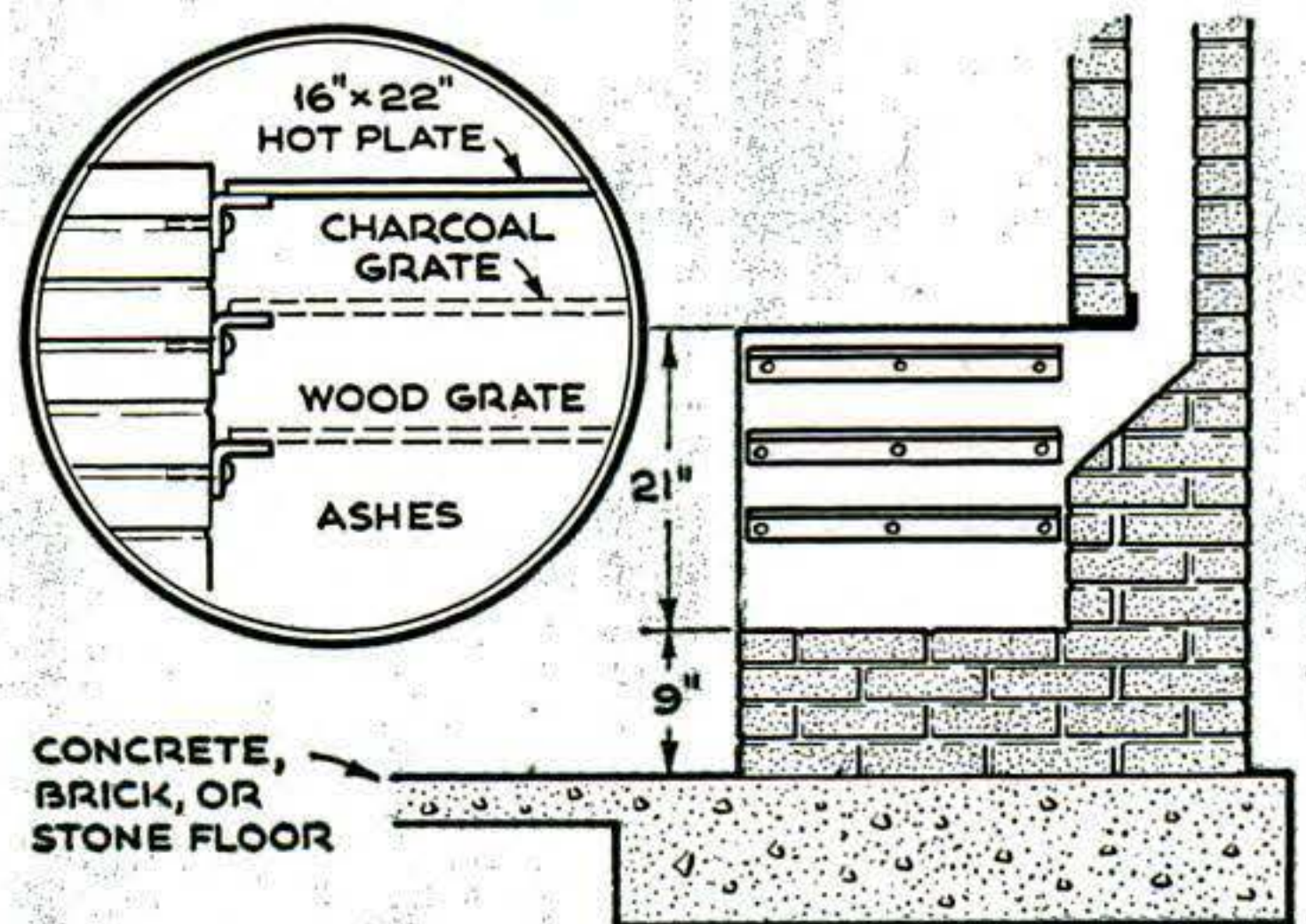
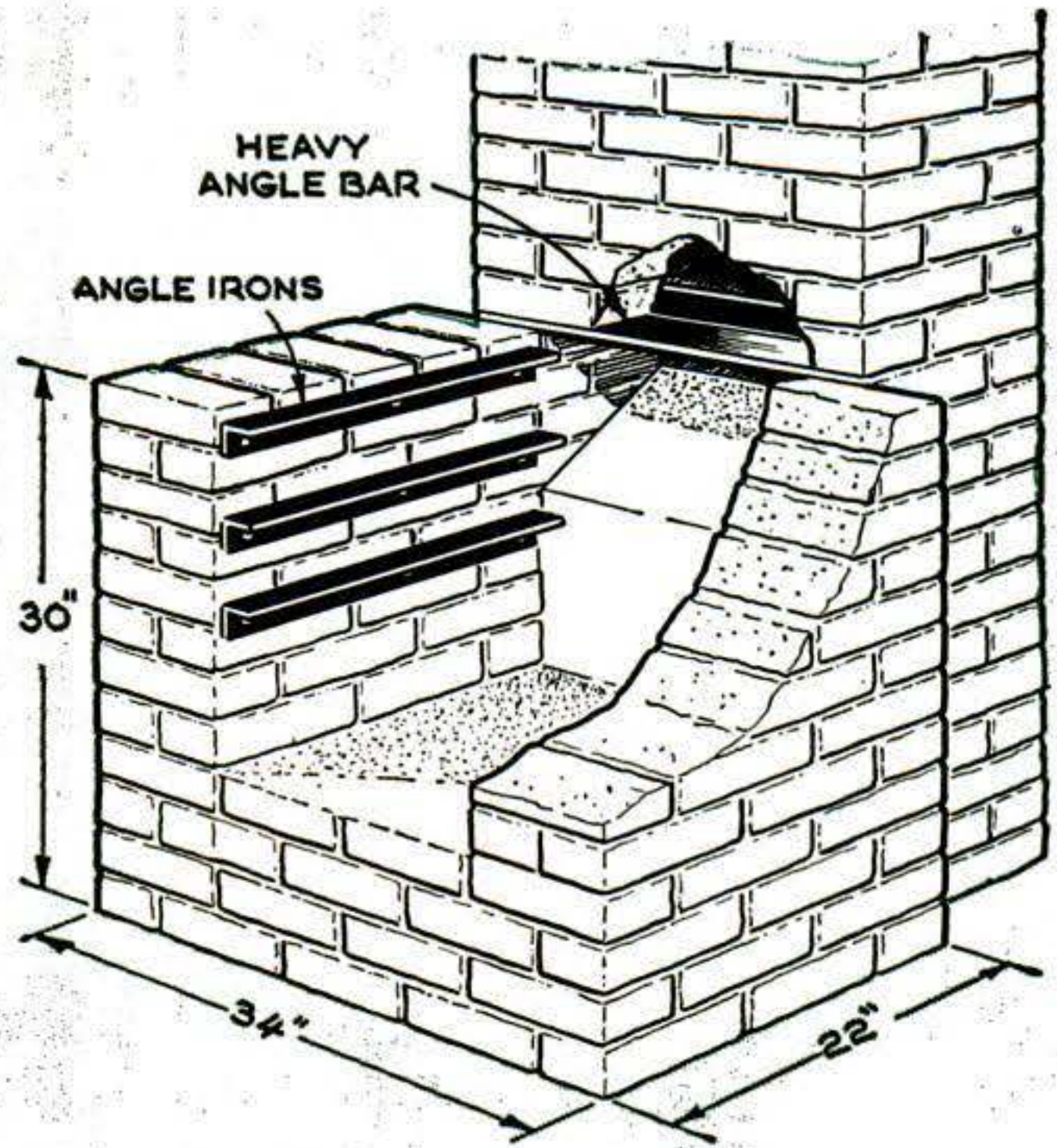



## KEEPING the HOME SHIPSHAPE

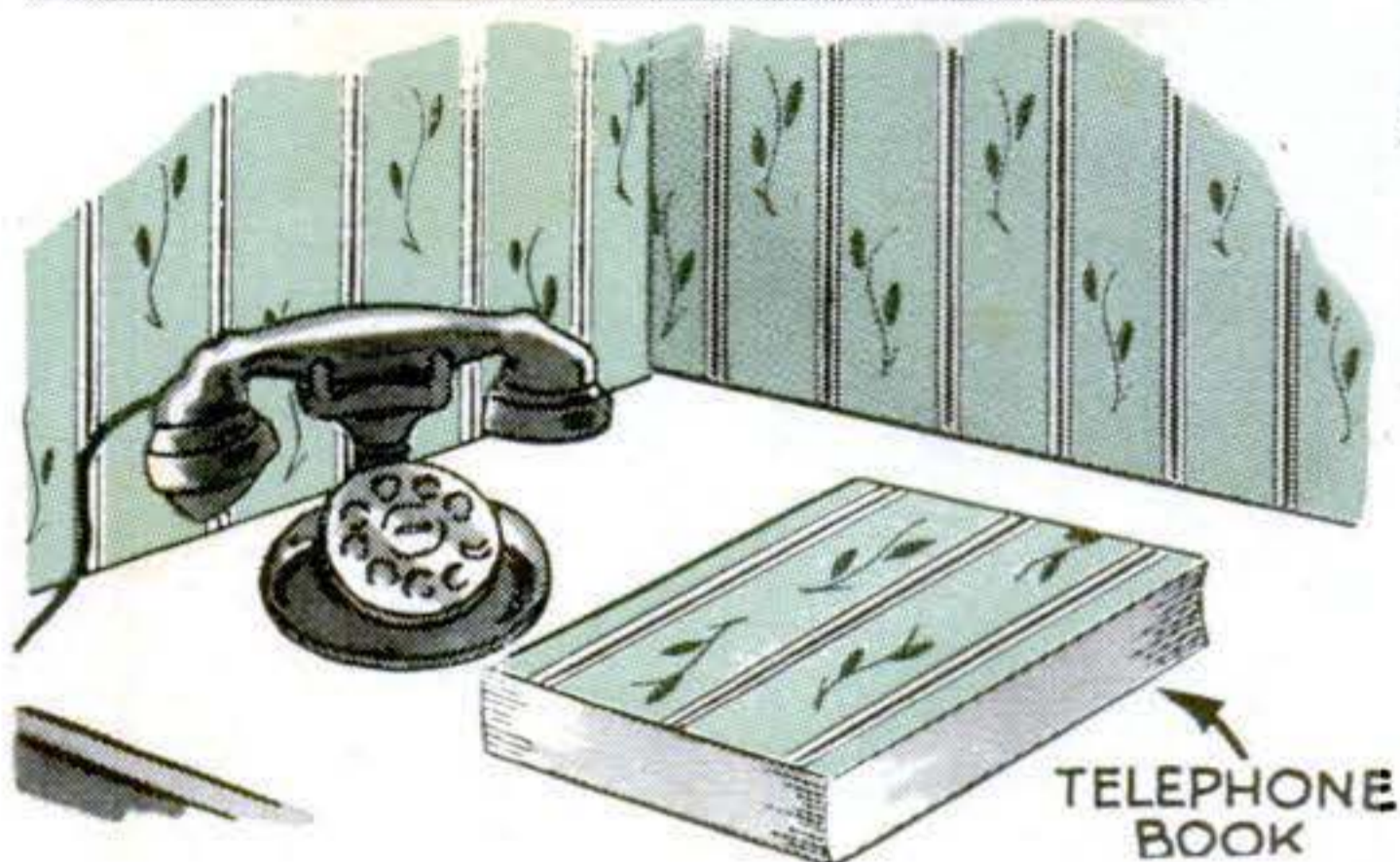

After papering the room in which your telephone is located, use scraps of the wallpaper to cover the telephone book, front and back. This will protect the book and give it a more pleasing appearance.

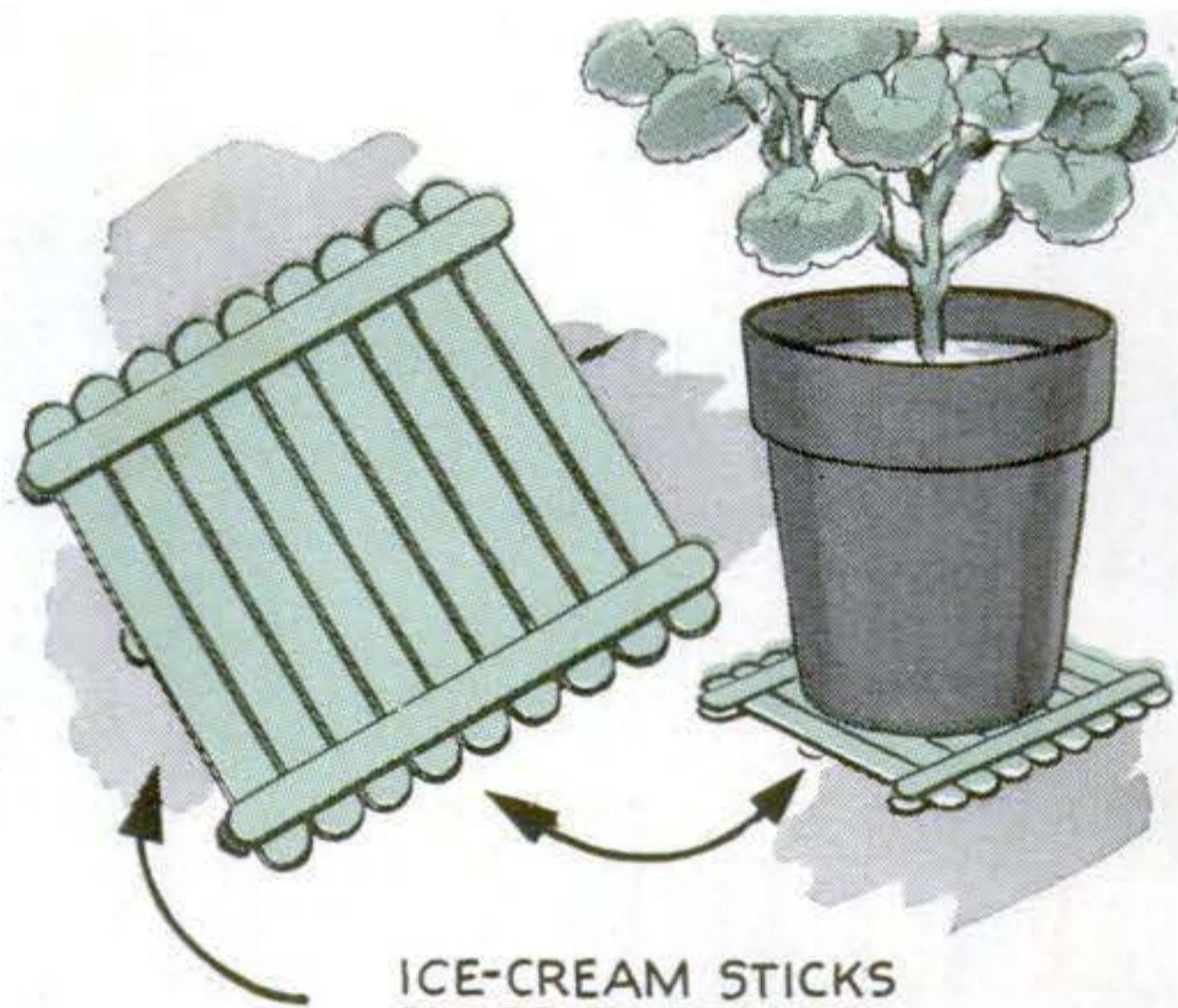

Ice-cream sticks carefully glued together as seen above will give you a convenient flower-pot stand or a coaster for a hot plate. After the glue has dried, stain or paint the stand as desired. Small brads may be used in place of glue if you wish.

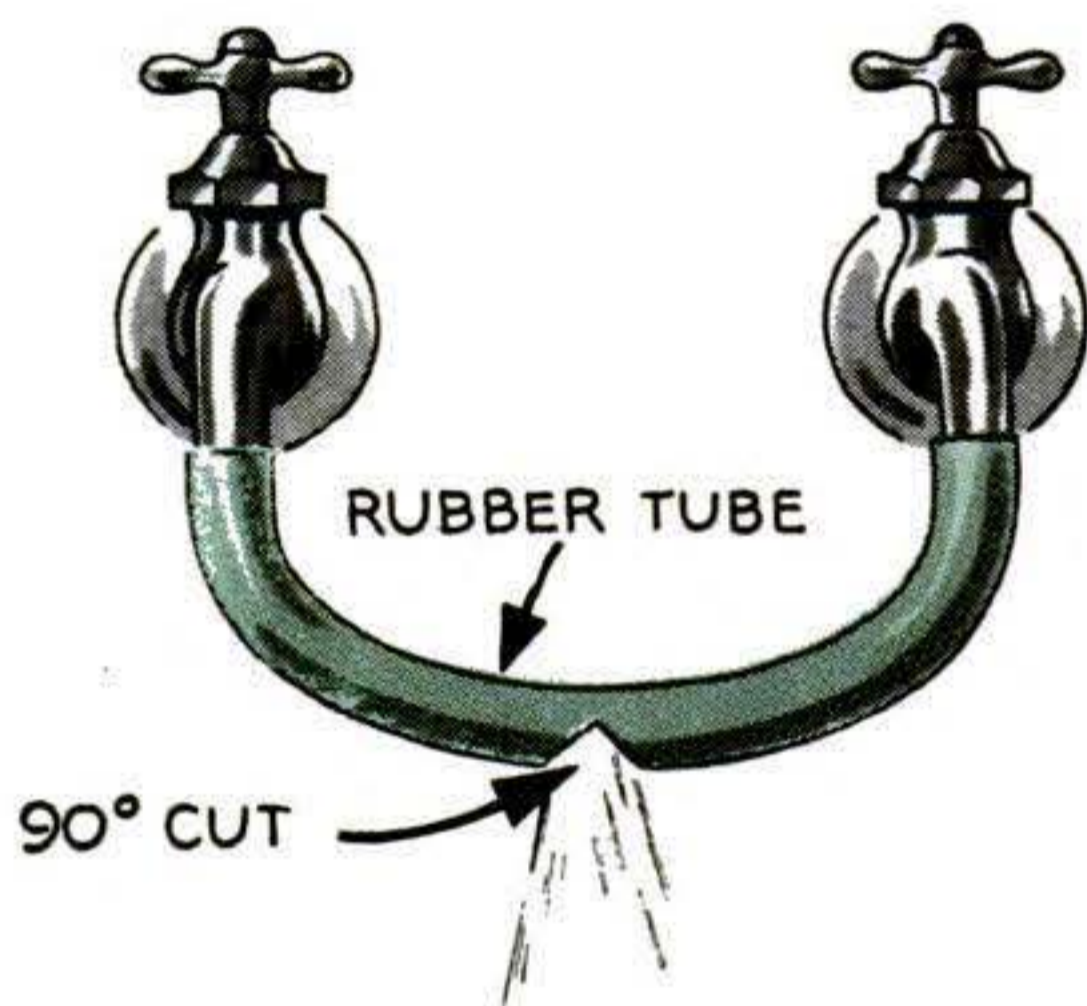

When no mixer is available to give you water at the temperature you desire, slip a short piece of rubber tubing over the hot and cold faucets, cut an opening in the tubing at the middle, and adjust the faucets as necessary.

A pane of window glass placed on a cook-book will keep it open at the desired page, allow full visibility for reading the recipe, and save the book from any harmful splatterings.

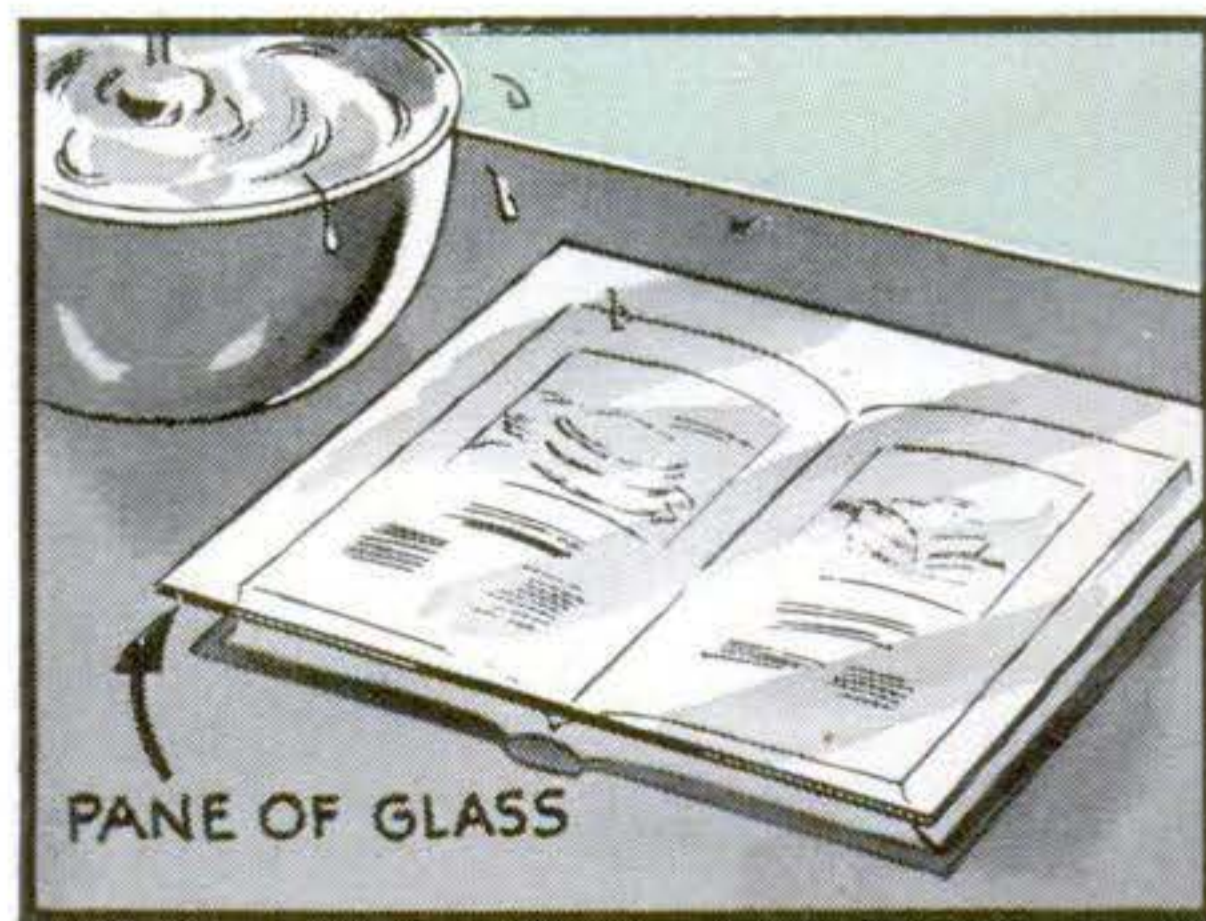





Small leaves or stones often slip through the teeth of an ordinary rake. You may catch them by attaching a strip of 1/4" hardware cloth, allowing the teeth to project about 1/2".

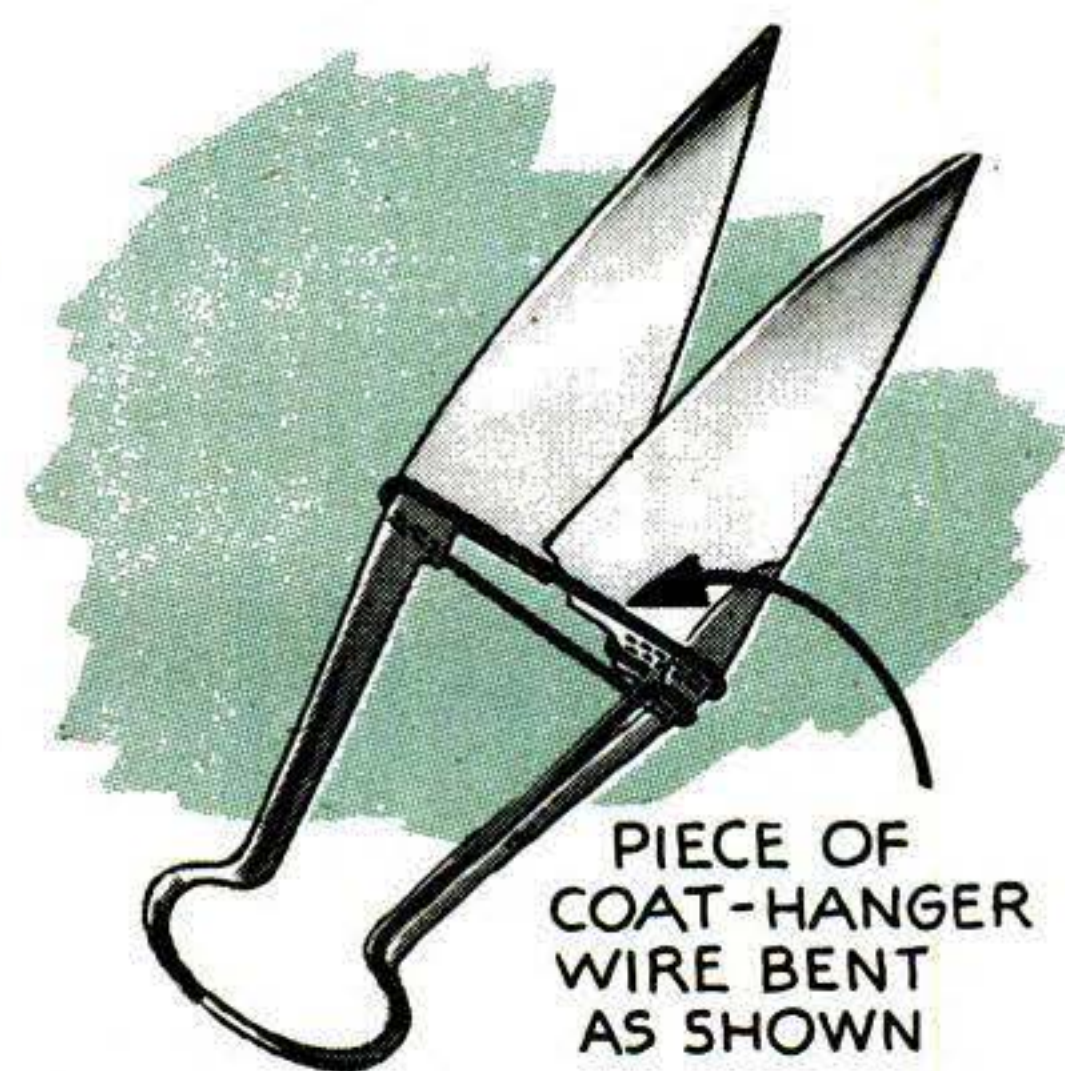

Most grass-cutting shears spread too far apart when pressure is released. The outward travel of the blades can be restricted by looping coat-hanger wire around them as illustrated here. One blade moves freely inside the loop.

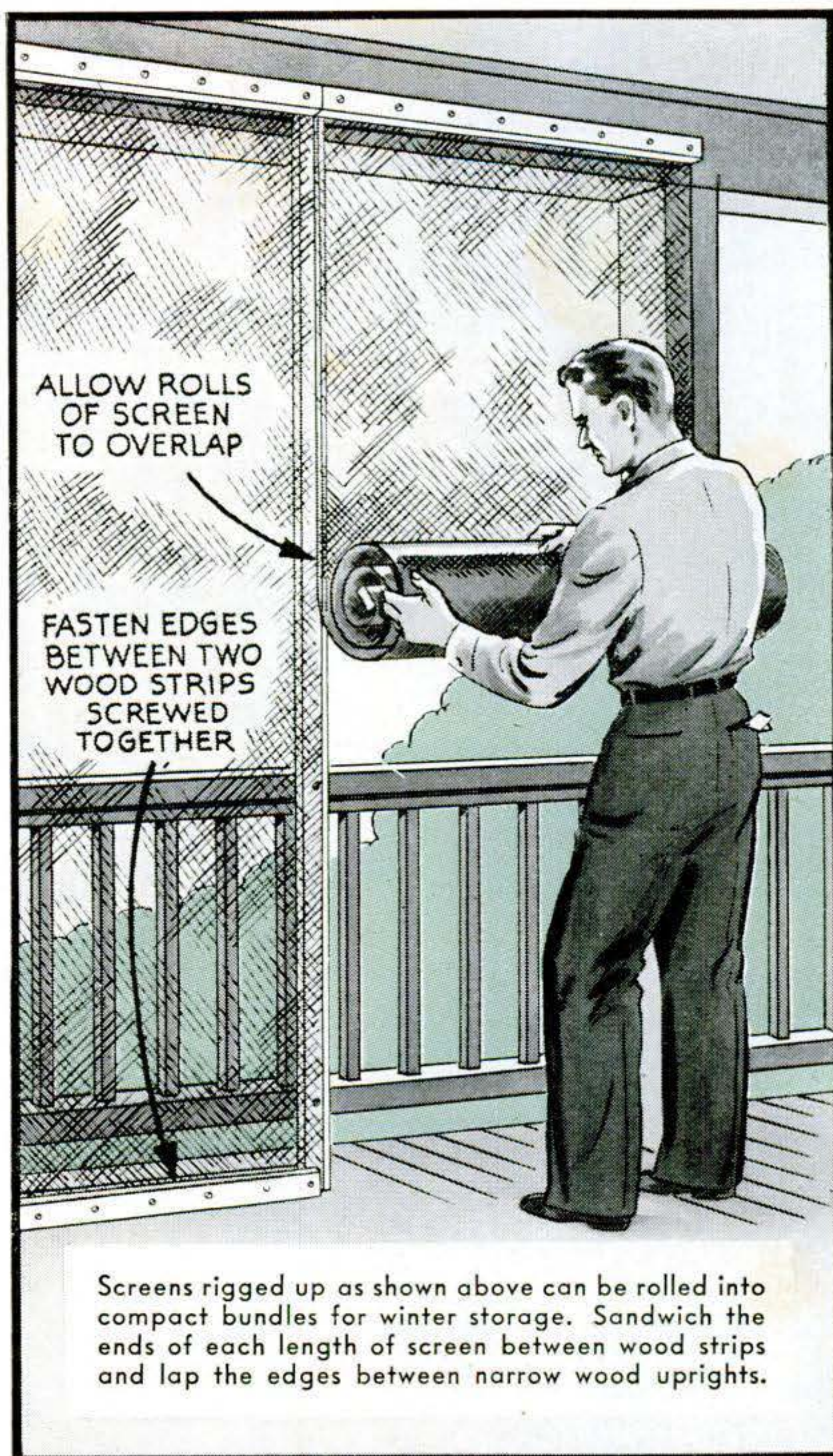

If a concrete floor, driveway, or sidewalk needs cleaning, a garden hose wired to the handle of a push broom will enable you to accomplish the job with about half the effort. To clean out cracks, turn the nozzle to give a high-pressure stream.

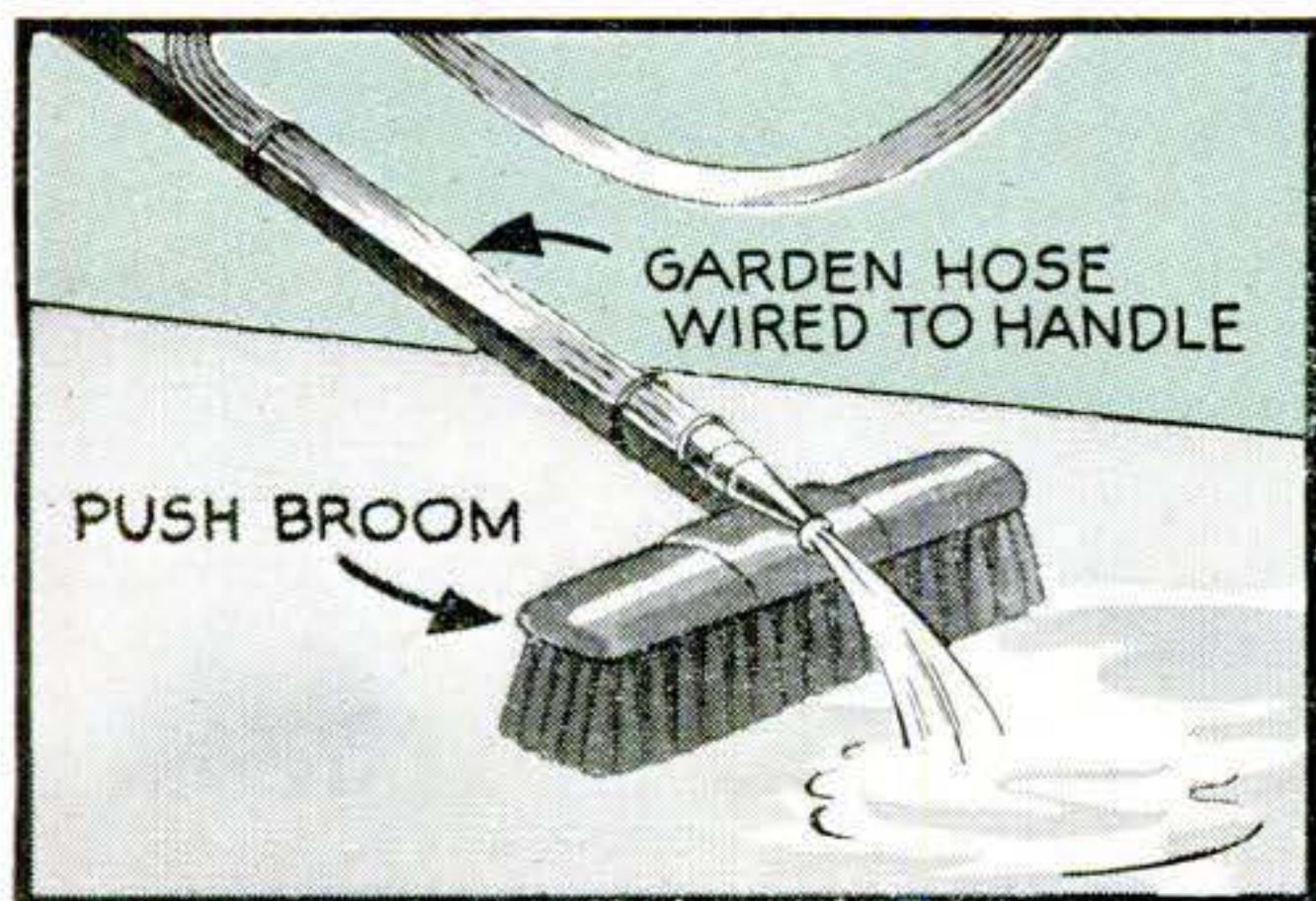

Rubber boots with flexible tops that collapse when the boots are not being worn can be properly dried and ventilated by suspending them upside down on a special hanger formed by bending two loops in an ordinary wire hanger. This allows air circulation.

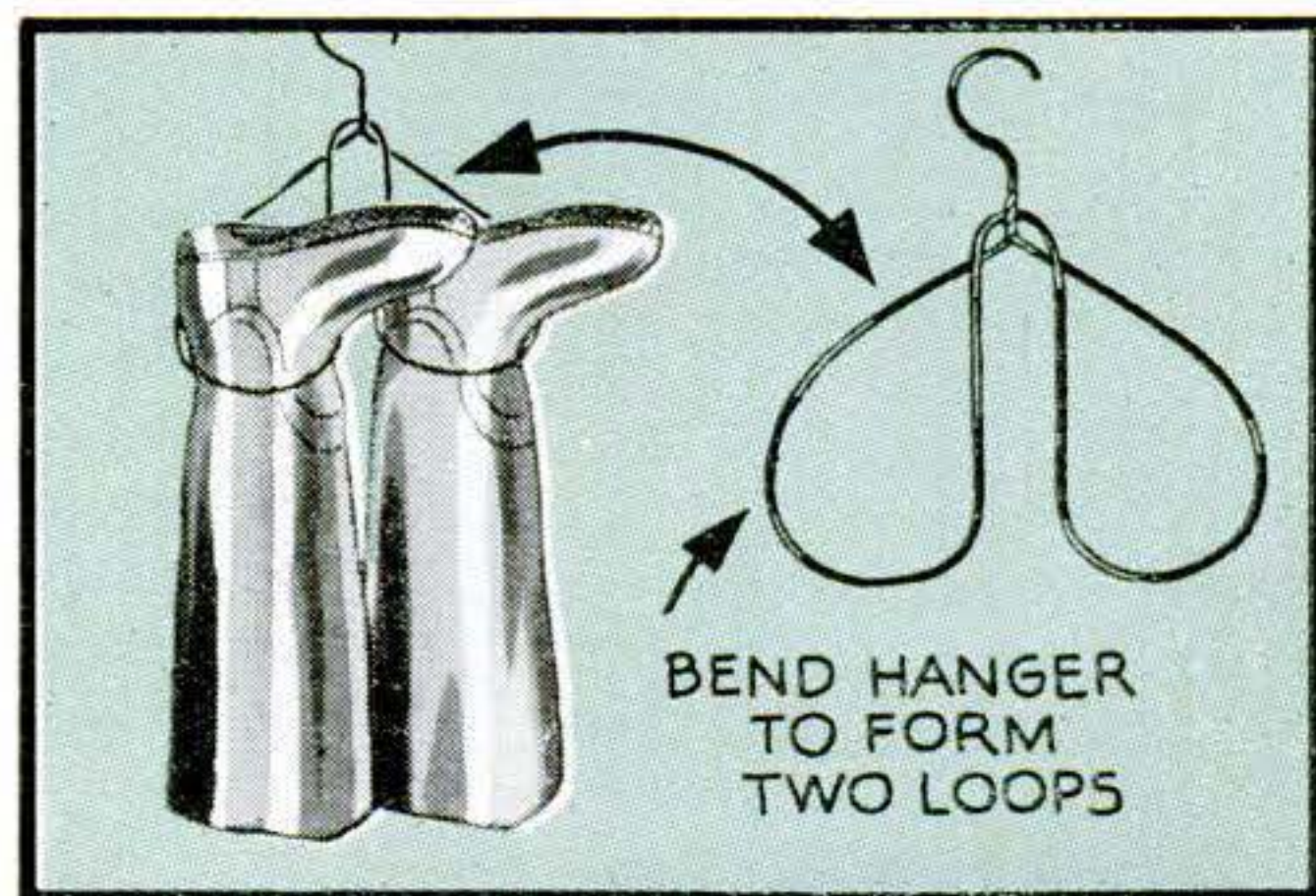





Held in a jack, a door is easily planed or otherwise worked. Put the door in place and lower it  $\frac{1}{4}$ " to scribe the top, as below.

# Fitting DOORS

By EDWIN M. LOVE

**O**N HOW doors are hung depends the service they will give—whether they will bind at the edges, have draft-inducing gaps, or fit snugly and open and close easily. The same is true of window sash.

Select the best doors for the best rooms, carry them to their locations, and stand them on blocks. In preparation for hanging, sight along the stiles for spring. If there is an outward-sprung corner, make it the latch side so that it will be held in position by the latch. If the door frame does not have a rabbeted jamb, nail up blocks for temporary stops.

Make a jack like that in Fig. 1 to hold the door while it is being worked. The weight pinches the blocks against the door, holding it steady. Joint the hinge stile first, straight and square or very slightly beveled toward the stop to prevent binding.

Then stand the door in the opening, hinge stile against the stop, with the top held against the top of the frame by means of a large chisel on a fulcrum at the bottom. An auto-spring leaf is also handy for this since the ends will rock. Inspect the fit of the hinge stile against the jamb, and scribe for irregularities. Have a helper run a

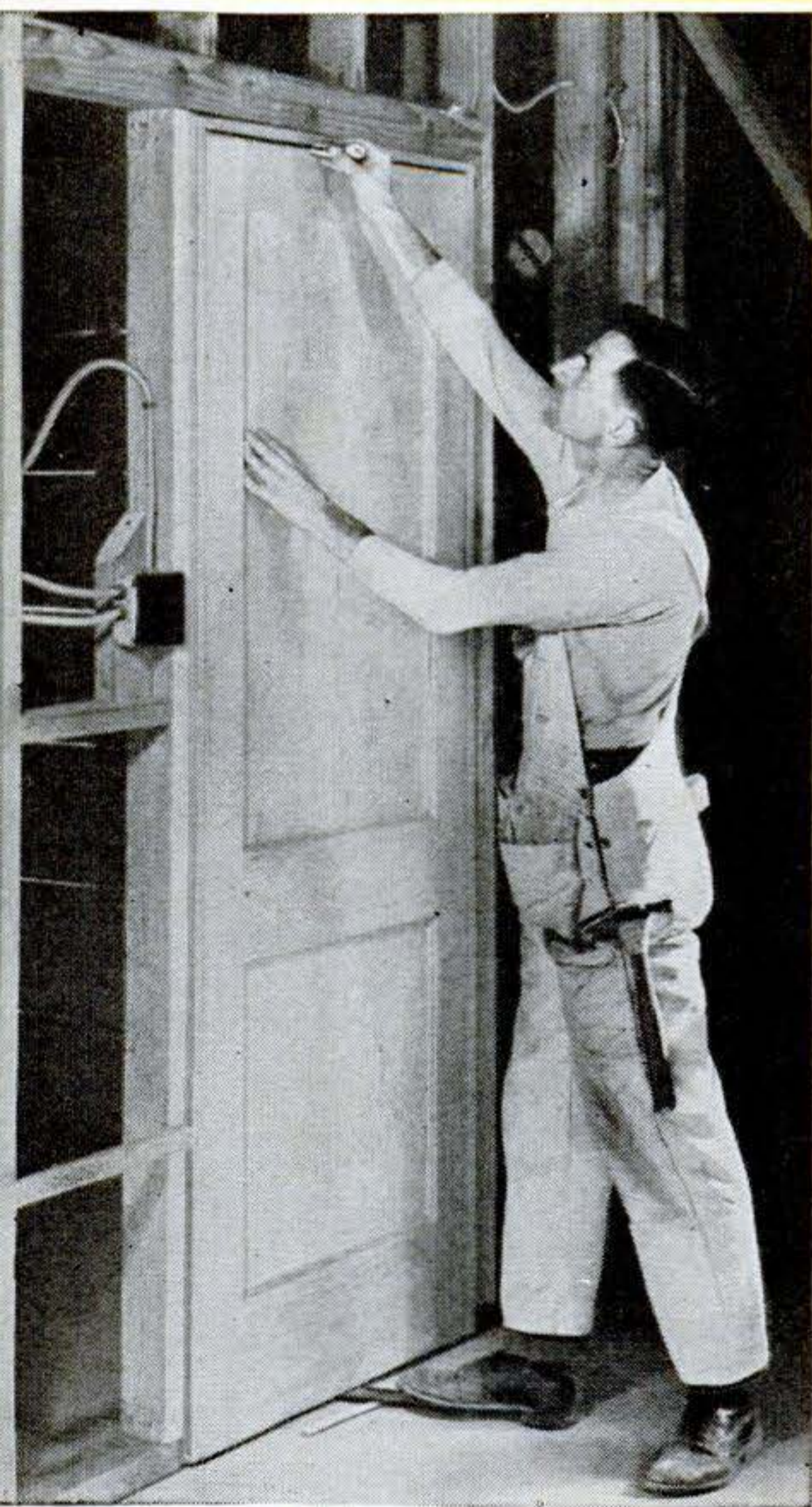



Fig. 1

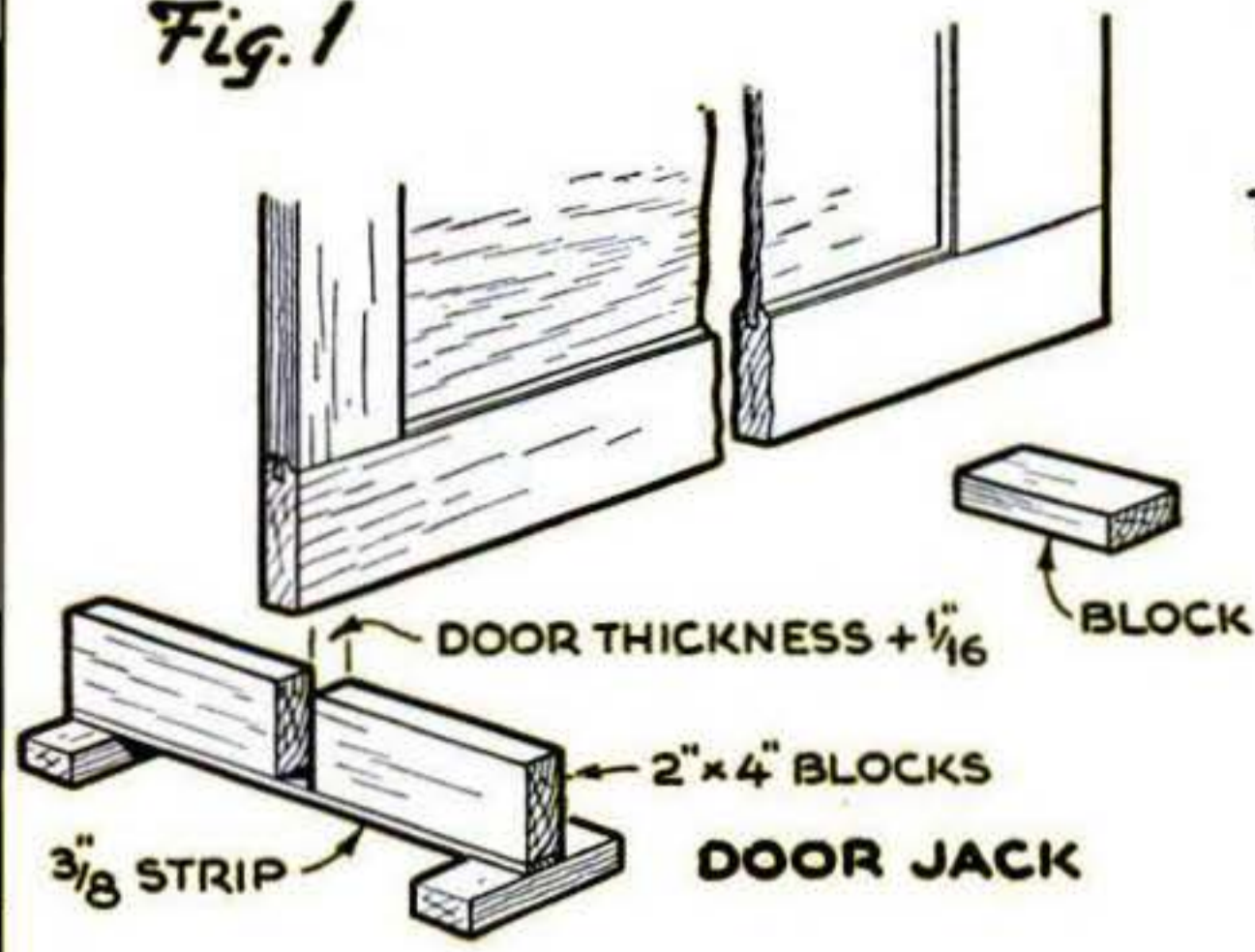

Fig. 2

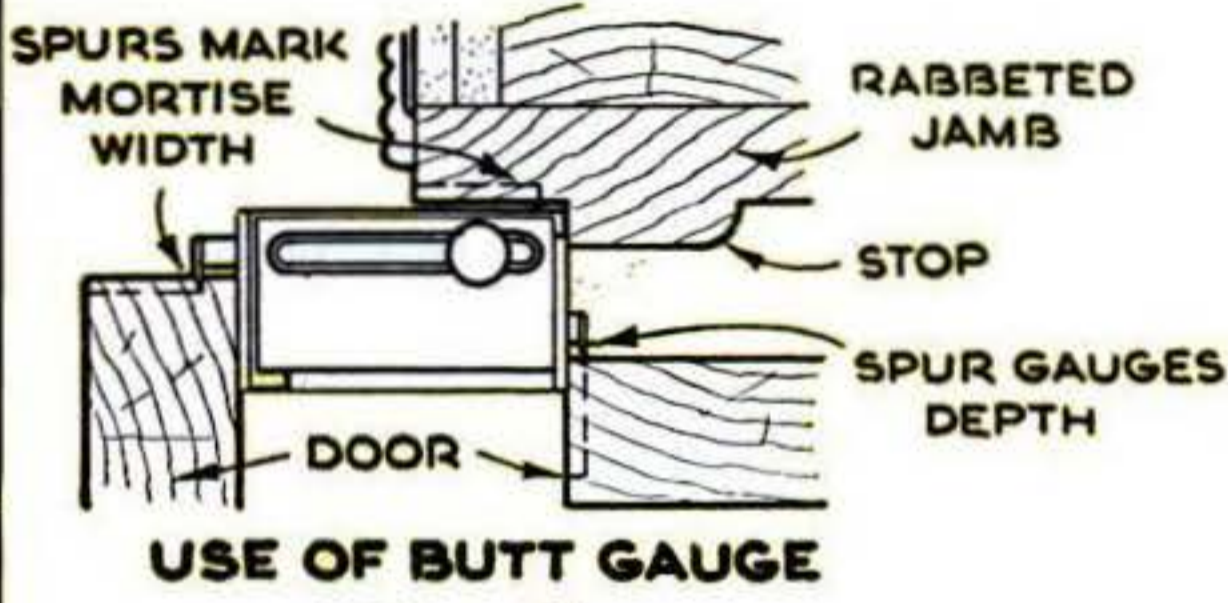
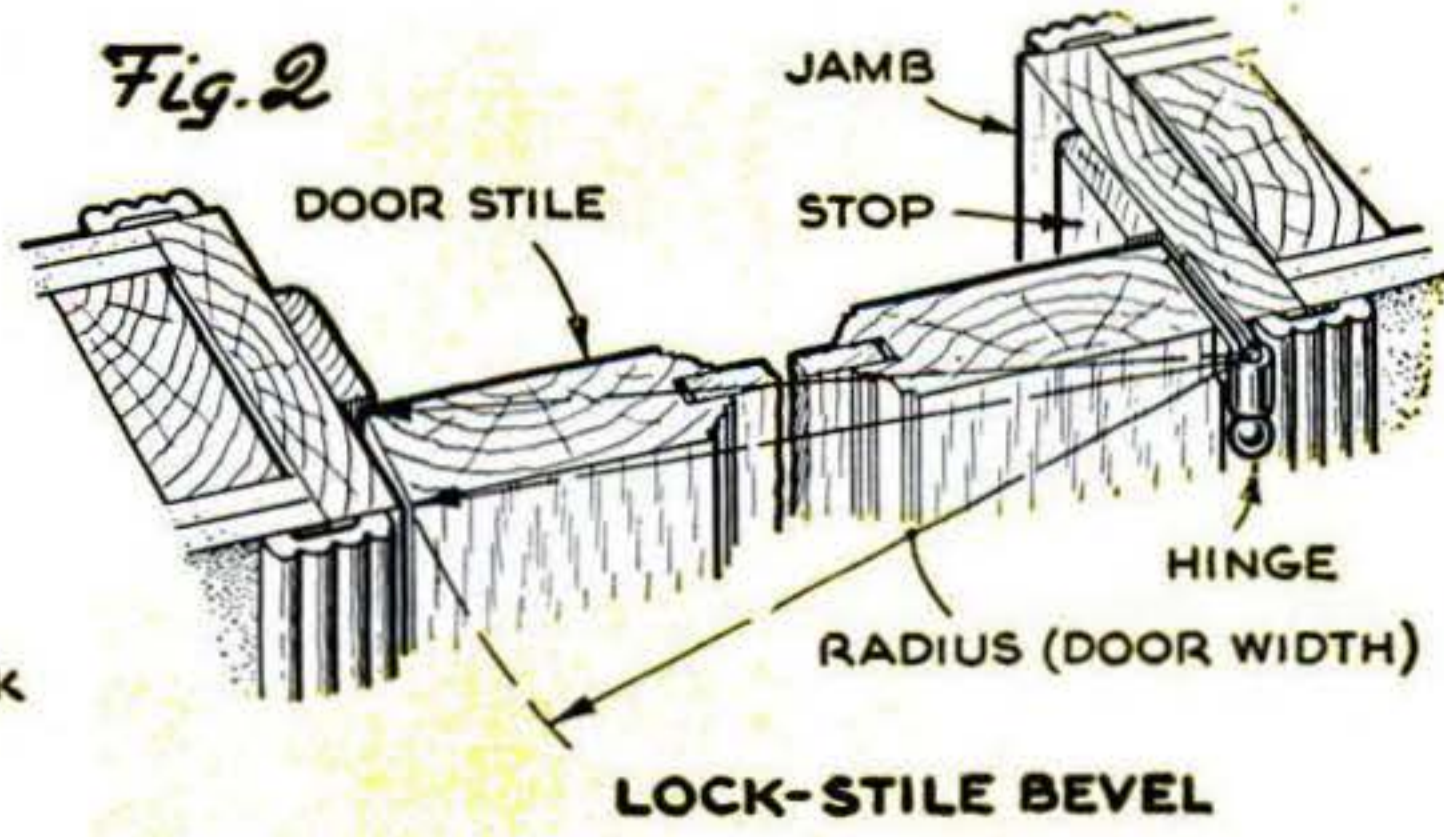

Fig. 3

# and WINDOWS

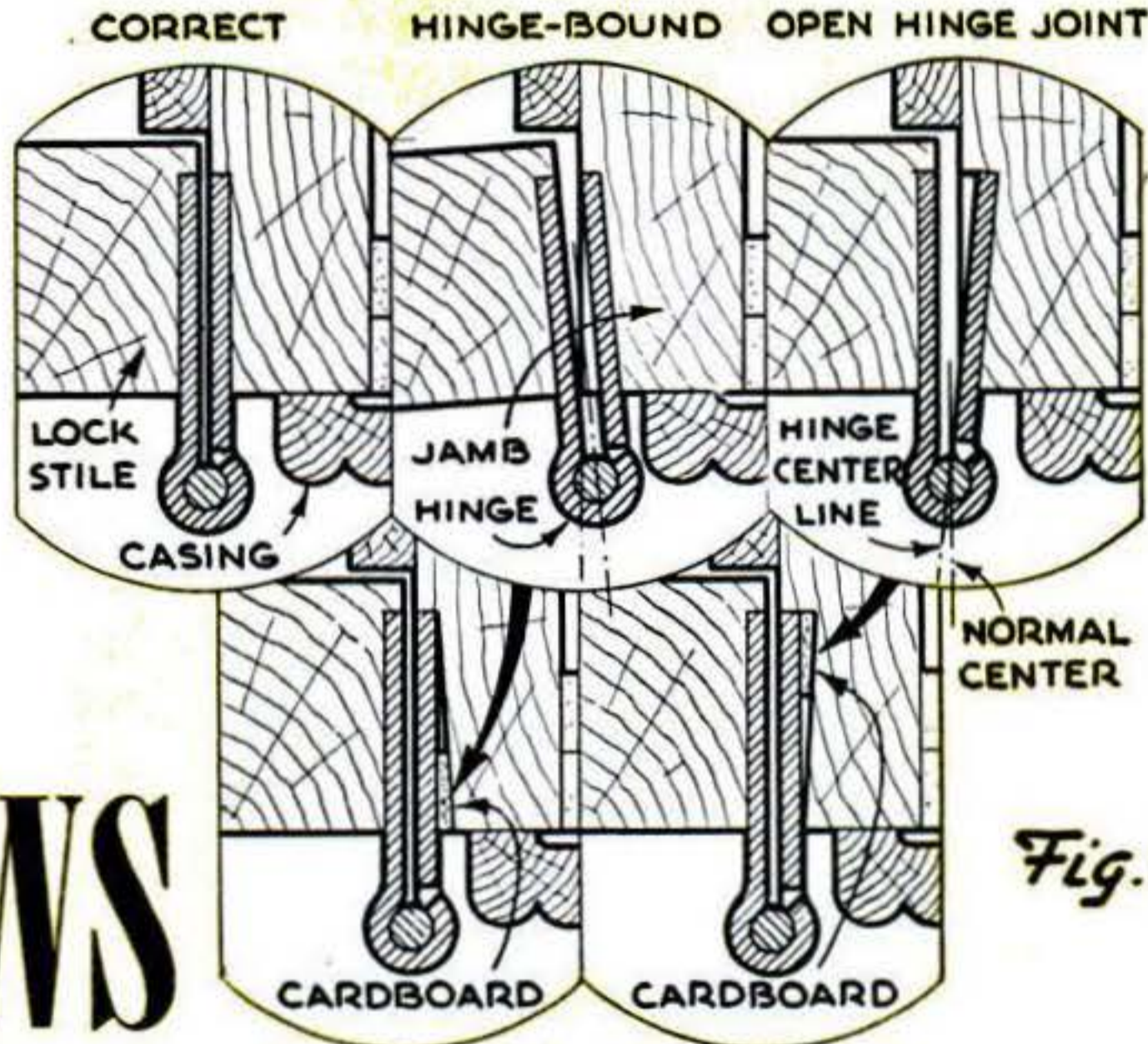

Fig. 4

FAULT CORRECTION

Mortise length is gauged with a leaf from the hinge, but width and depth are best marked with a butt gauge, which is used on the jamb at the same settings.

Begin making the mortise with chisel cuts about  $\frac{3}{8}$ " apart. Work inside the lines. Clean out the chips with the chisel lowered and its beveled side up.

Drive the hinges in from the edge. Punch screw holes with a nail set, locating them toward the back of the leaf holes to draw the hinge back when the screws are driven.

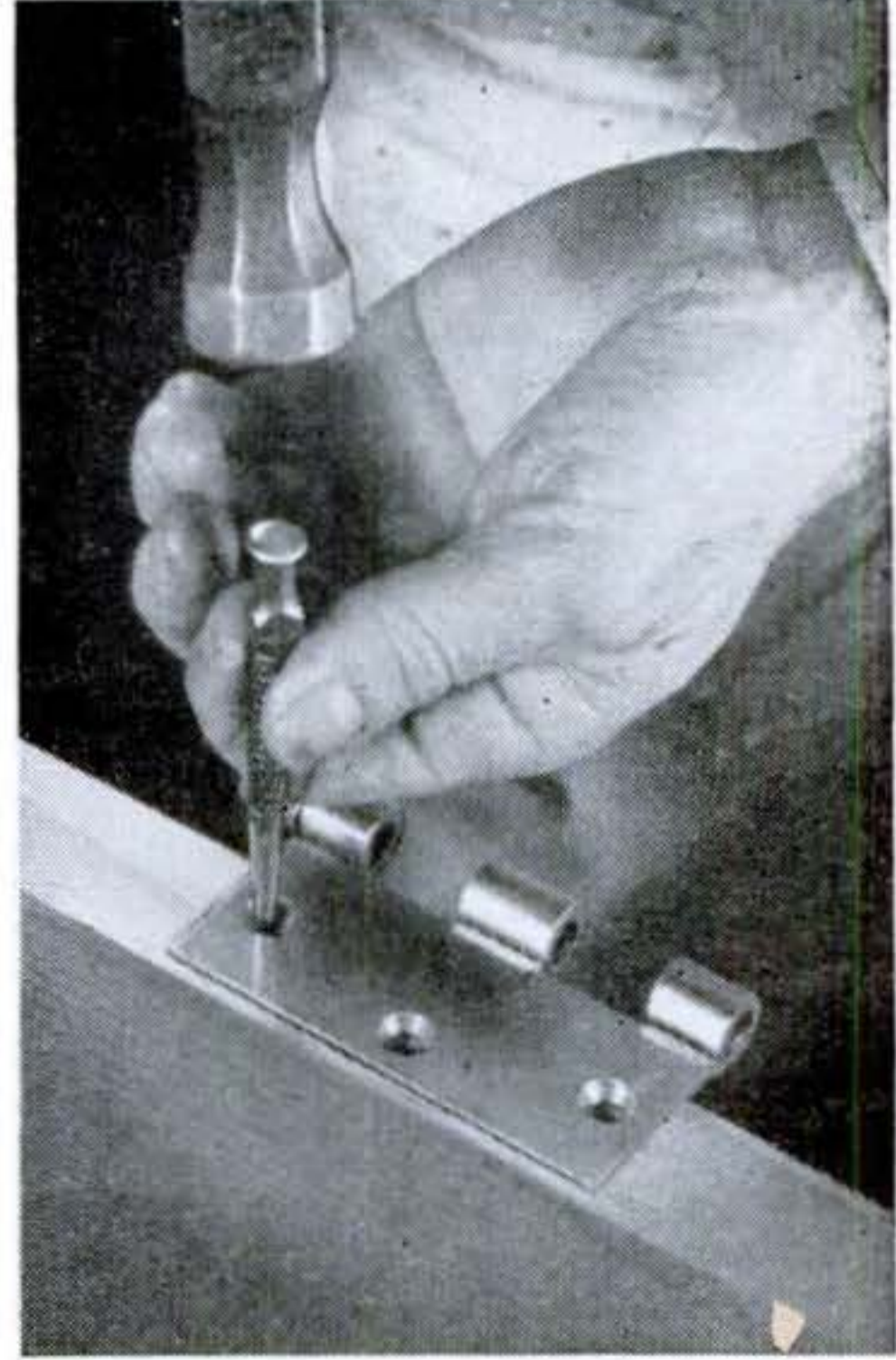



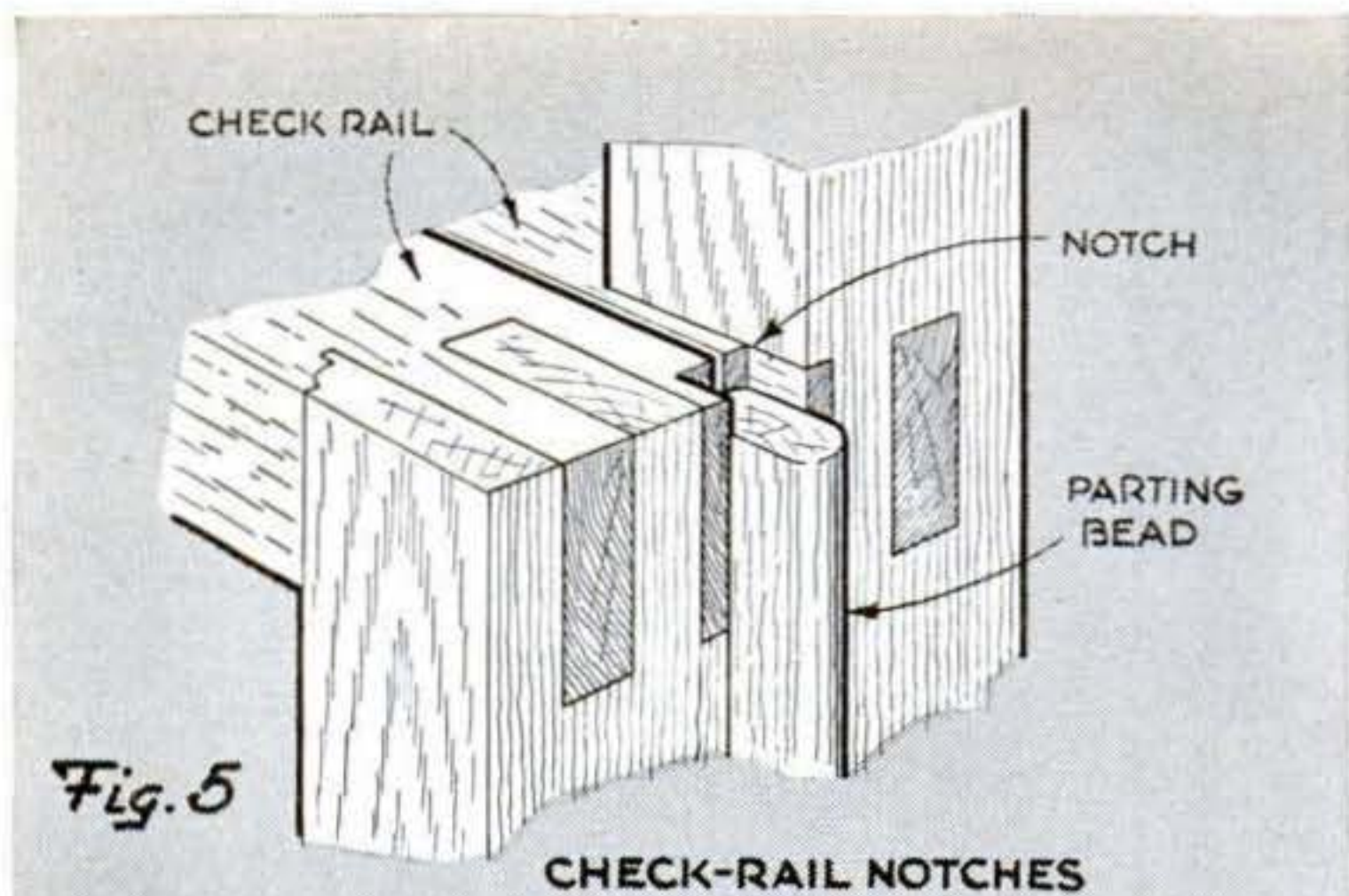

Fig. 5

CHECK-RAIL NOTCHES

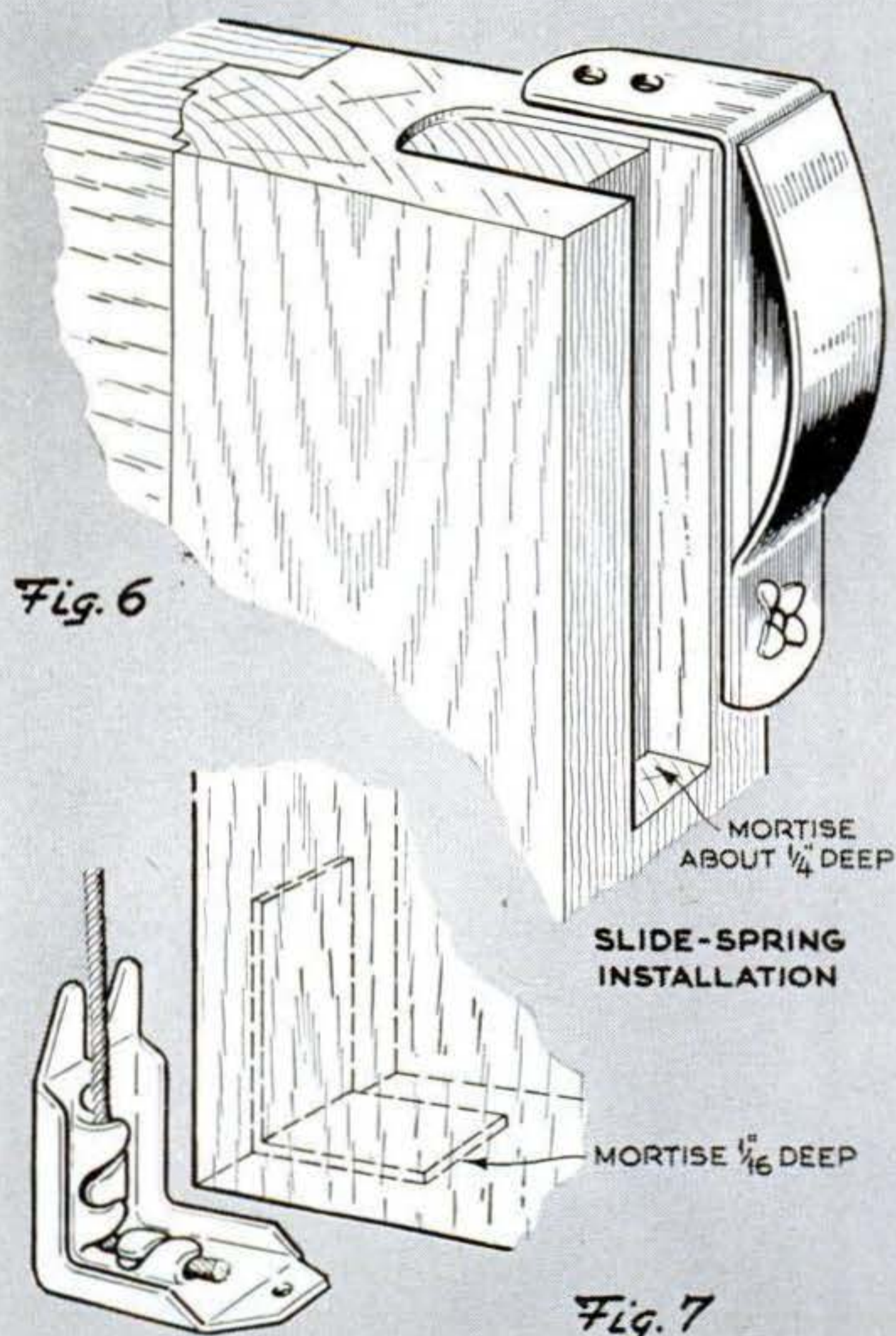

Fig. 6

SLIDE-SPRING  
INSTALLATION

MORTISE  $\frac{1}{16}$  DEEP

Fig. 7

CABLE-HOOK INSTALLATION



Nail the slide spring in its mortise, but leave the nail heads projecting to permit removal if the spring needs adjusting.

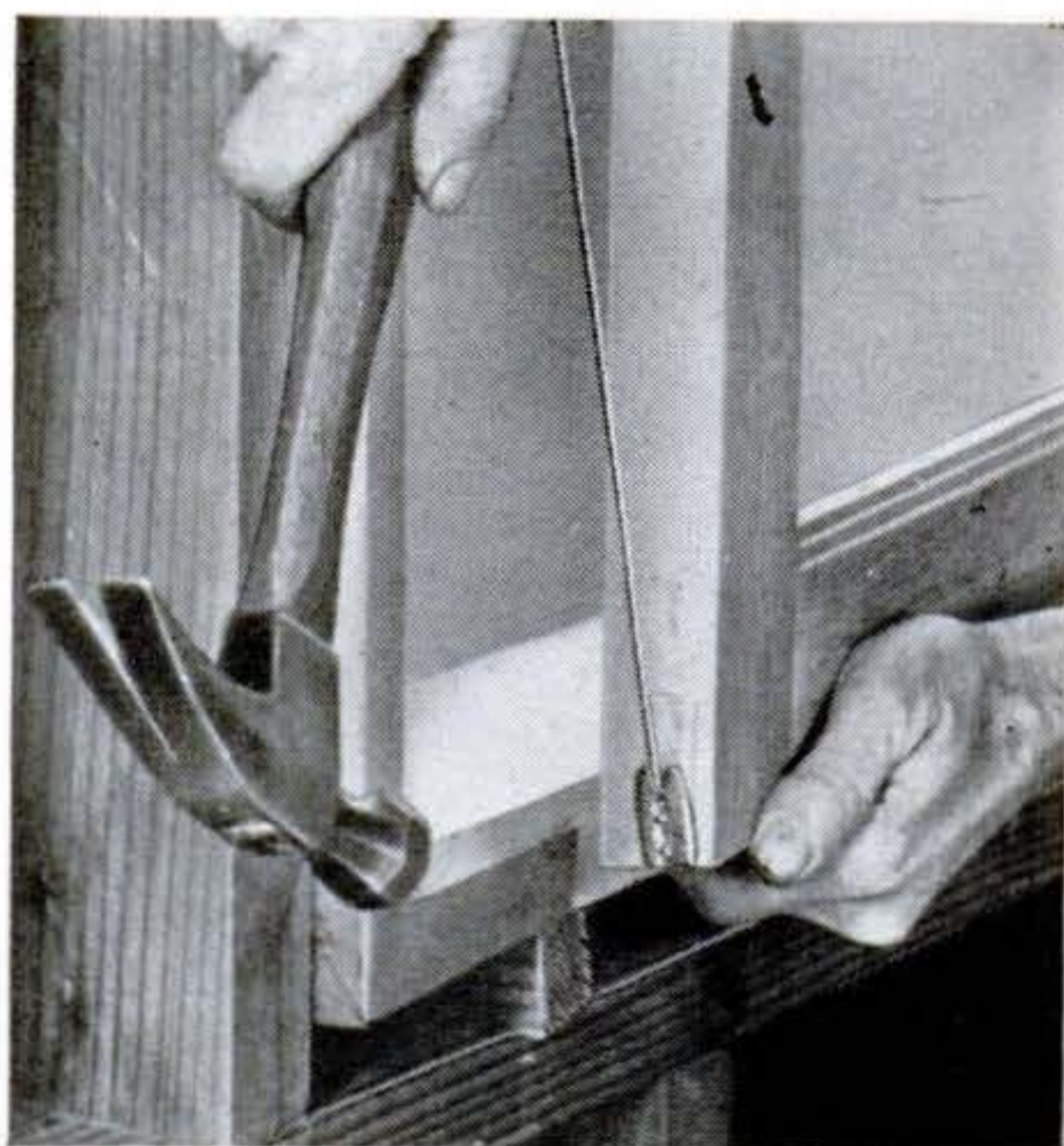

Drive the cable hook into its mortise from the side of the sash to sink the flanges, and then put the nail in from below.

pencil along the lock jamb on the other side to scribe the lock stile.

Plane to the lines so the door will have about  $\frac{1}{16}$ " clearance at the edges and top. Give the lock stile a bevel toward the stop side (Fig. 2). Stand the door in the frame again and inspect the top fit, dropping it about  $\frac{1}{4}$ " for convenience in scribing.

Mark the hinge positions in pencil on the jamb 7" below the top of the door and

11" above the floor. Then stand the door in place, raising the top against a clearance gauge such as a cabinet scraper, and mark the hinge positions on the door and jamb at the same time with stabs of a knife.

Gauge the ends of the mortises with a hinge leaf, but use a butt gauge for width since it automatically allows for clearance against the stop of a rabbeted jamb, as in Fig. 3. Mark also for hinge thickness. Drive



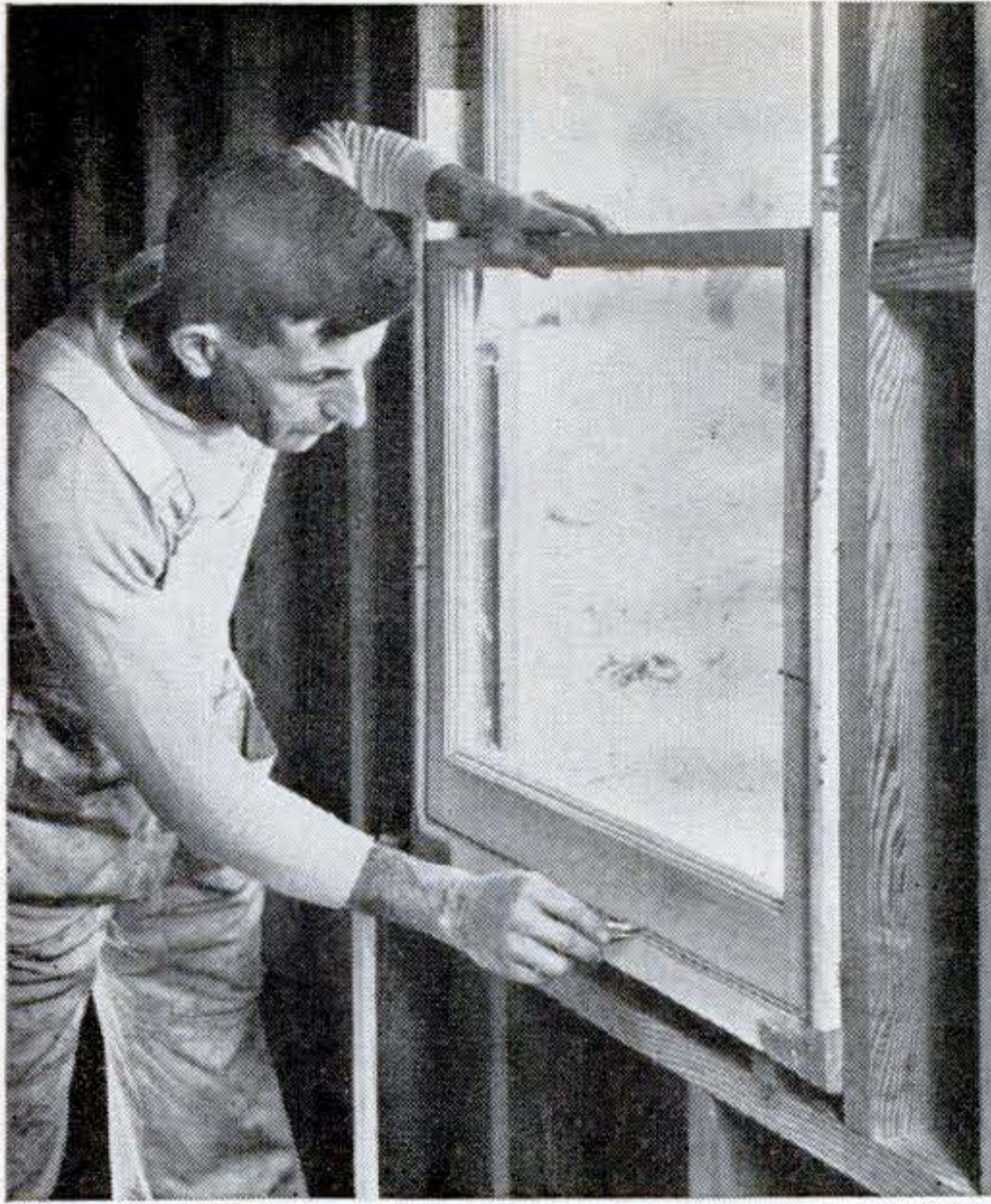

With dividers set, the bottom of the lower sash is scribed to the sill. Mark the edges with a bevel at a slightly greater angle than the sill slope.

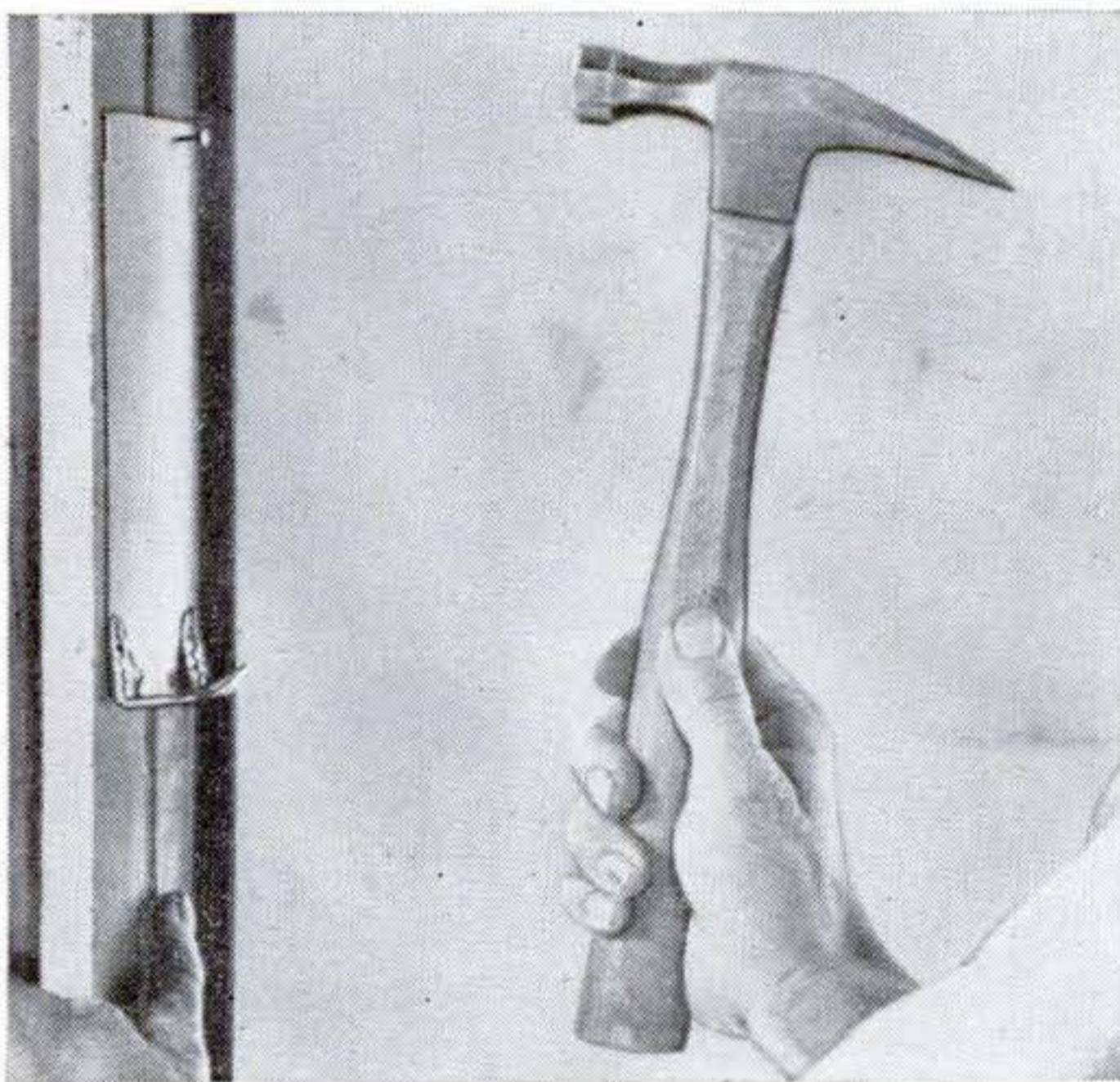

Notch the parting bead to clear the spring balance and nail the balance in the pulley-stile opening with four nails driven in cleanly.

the hinges in the mortises from the edges if they fit snugly. Punch screw holes with a nail set placed a little to the back of the hinge-leaf holes.

To swing the door, mesh the halves of the lower hinge, start the pin, and then engage the halves of the upper hinge. If they are slightly offset, tap them up or down with a hammer. With the hinge stile properly jointed and the hinges set flush, the door

should close perfectly. If it is hinge-bound, place cardboard behind the leaves mortised too deep, as in Fig. 4. A striking lock stile is sometimes remedied by jointing while the door is on the hinges, but only if hinge-stile clearance is correct.

Customarily the lower end of the door is cut  $\frac{1}{2}$ " above the finish floor, an operation usually deferred until the finish floor is laid and the door can be scribed.

When hanging windows, install upper parting beads permanently, but only fit the side beads and leave them out for the time being. Joint the sash stiles, reducing the width of the sash to about  $\frac{3}{16}$ " less than that of the window frame. Notch the check rails, as in Fig. 5, to clear the parting beads, and insert the slide springs temporarily in the upper corners (Fig. 6) opposite the sash balance. If necessary, joint the check-rail faces for clearance.

Set the upper sash in the frame and hoist it to the top to check and fit the top rail. Lower it to the bottom and install the side parting beads by slipping the lower ends into the grooves past the check-rail notches while springing the upper ends to clear the top of the frame. When the ends touch the sill, the beads can be forced full-length into the grooves. Try the sash for bead clearance and hold it at the top with a nail.

Next, set the lower sash in place, wedging the bottom, if necessary, to parallel the check rail with that of the upper sash. The projection above the upper-sash check rail equals the strip to be cut from the bottom rail of the lower sash. Set scribes or dividers to this amount and mark at the sill.

Remove the sashes and mortise the lower end of the stiles to receive the balance cable hooks, as in Fig. 7. When the spring sash balance is taken from the package, the cable hooks will be reversed. Pull them down slightly and turn them out before nailing.

Put the upper sash back in the frame and swing the cable edge out. Pull down the balance hook, insert it in the mortise, and swing the sash back against the blind stop. Hoist it and try the action. Binding may be due to too much slide-spring projection, while sagging of the opposite side may indicate the slide-spring mortise is too deep. The former is remedied by deepening the mortise, the latter by cardboard shims. Since the spring balance closes the parting-bead slot, the bead must be notched to clear.

Hang the lower sash in the same way. Prime sashes soon after hanging. END.



**WHAT'S YOUR  
INGENUITY QUOTIENT?**

**IQ**

**IT'S AN ART** to quiet a bawling baby. When the kid I was watching yowled, I soothed him by taping cut-outs to a phonograph and projecting moving pictures onto the opposite wall with the beam of a flashlight.—**HOWARD JOHNSTON, JR.**



**THE NOSE KNOWS** when the water pan of a hot-air furnace runs dry. I kept forgetting to fill the pan until I hit on the idea of placing one or two moth balls in the pan. When the water evaporates, the moth balls start to do likewise. The scent is sent up the register, sending me trotting down with a bucket.—**RONALD EYRICH.**



**Have you pulled off a smart one lately? We will pay for acceptable contributions showing ingenious solutions of problems in the home, shop, garage, or camp. It doesn't matter if it's wacky—if it works.**

**WATER, WATER, EVERYWHERE**, but nothing with which to pour it into our car's hot and thirsty radiator. I pried off a hub cap that had just been coming along for the ride, scooped up all the water old rubberneck could drink, then cleaned the cap and took a good, long swig myself.—**ROBERT M. KAHN.**



**I FOUND THE \$64 ANSWER** to the question that's been bothering everyone. After locating a puncture by holding an inner tube under water, I mark the spot with my new underwater ball-point pen so that I can find it again when I come up for air and a tire patch.—**KENNETH MURRAY.**





## Homemade Brake Makes Accurate Bends for Metalwork Projects

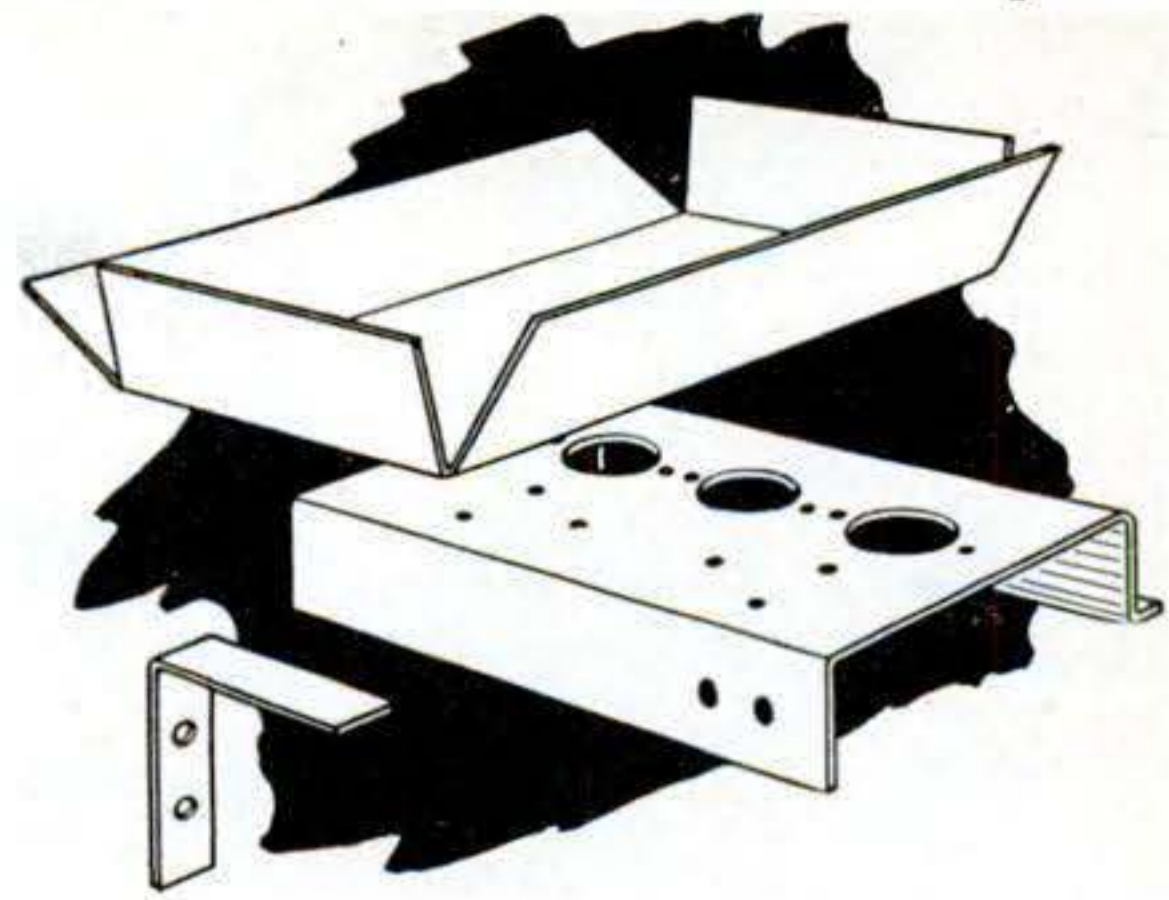
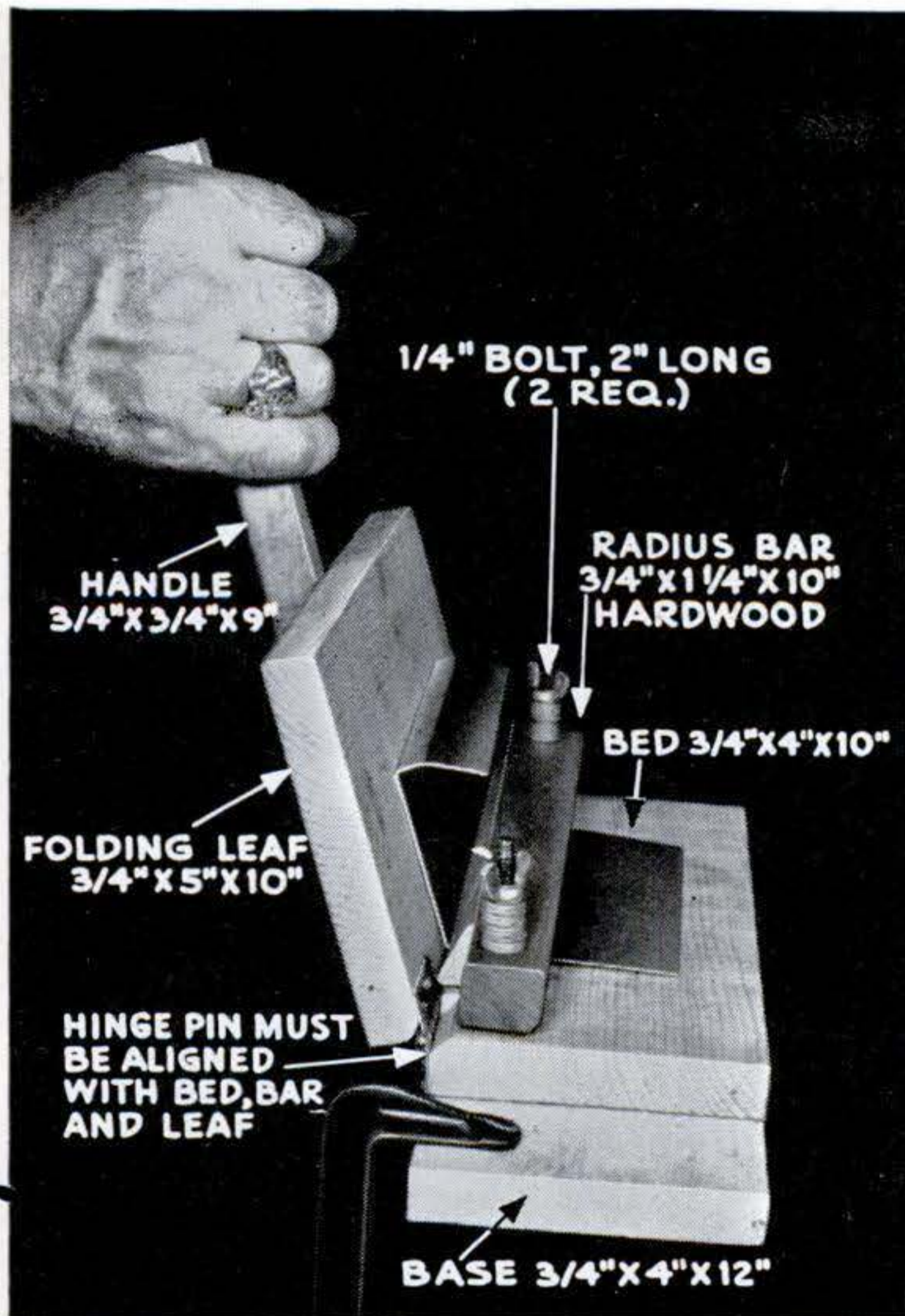

hour from scrap wood knocked from an orange crate—all but the radius bar, which is oak. An old table leaf might furnish that. It handles aluminum up to 7" wide and .040" thick, and if you make it entirely of oak, it will handle heavier stock.

The base is clamped to a bench or bolted in a permanent setup, so be sure to countersink the radius-bar bolts on the underside. To use, simply clamp the metal under the radius bar and fold the leaf up and over. Make several trial bends on scrap first, noting how near the layout mark the bend actually comes. The radius bar should be beveled to compensate for springing back of the metal, which may be as much as 10 deg. for a right-angle bend. A separate 30-deg. bar will come in handy for special bends.

A great deal depends on the sturdiness of the hinges, so be sure to use a strong pair and attach them firmly. They must also be properly aligned to assure a free, swinging action of the folding leaf.

CRAFTSMEN who work with sheet metal know how stubbornly it can refuse to take a clean, sharp bend where the layout line demands it. A bending brake is the answer, of course, but they're usually thought to be difficult to make or expensive to buy. This one is neither. It was built in less than an

## Wedge Screwdriver Grips Screw

WHEN a screw must be threaded into a tapped hole that can't be reached by hand, time will be saved if it is fastened to the screwdriver. This can be done by grinding down the blade of a long-handled screwdriver until it is about

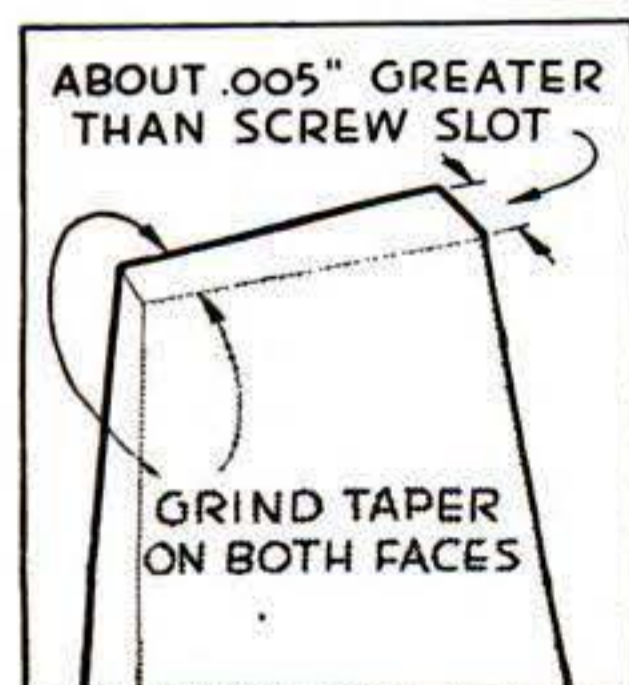

.005" thicker than the width of the screw slot, and then grinding a slight taper to form a wedge. Jam the blade in from the end of the slot so it will get a firm grip.—F. E. AVERILL, JR.

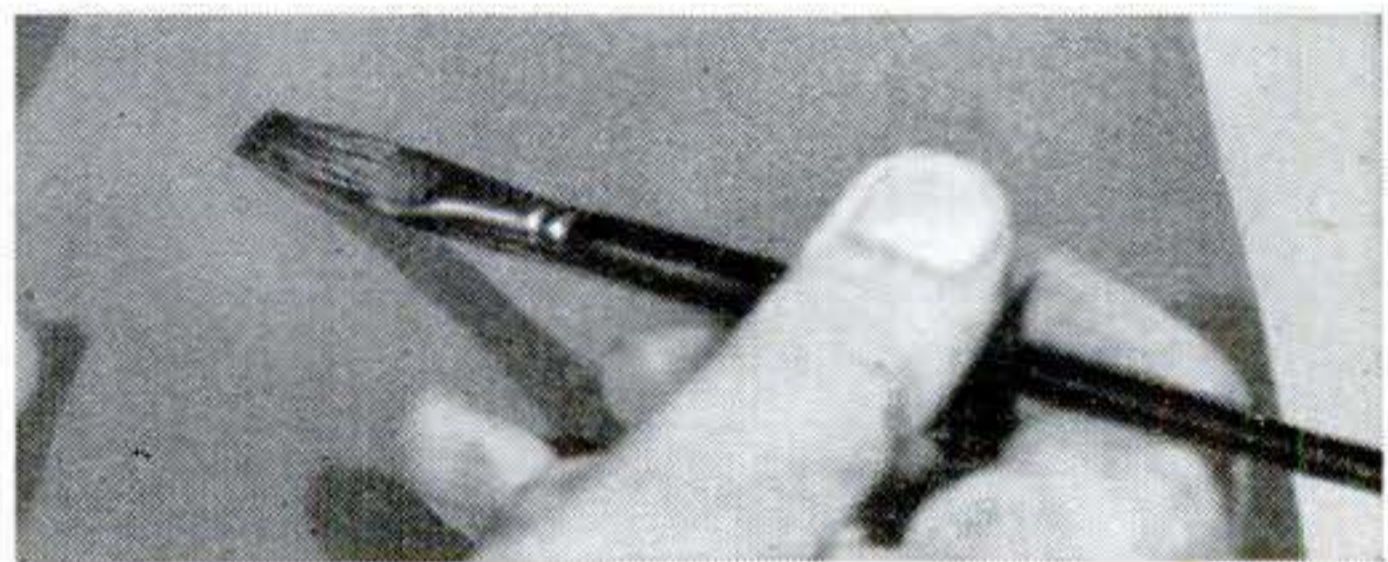

## Shaping Brushes on Sandpaper

WORN brushes can be reshaped or special ones made to suit the job. Soak the bristles in water-soluble glue, shape to a compact mass, and let dry. Then rub on coarse abrasive paper to the form desired. Remove the glue in hot water.—WILL THOMAS.



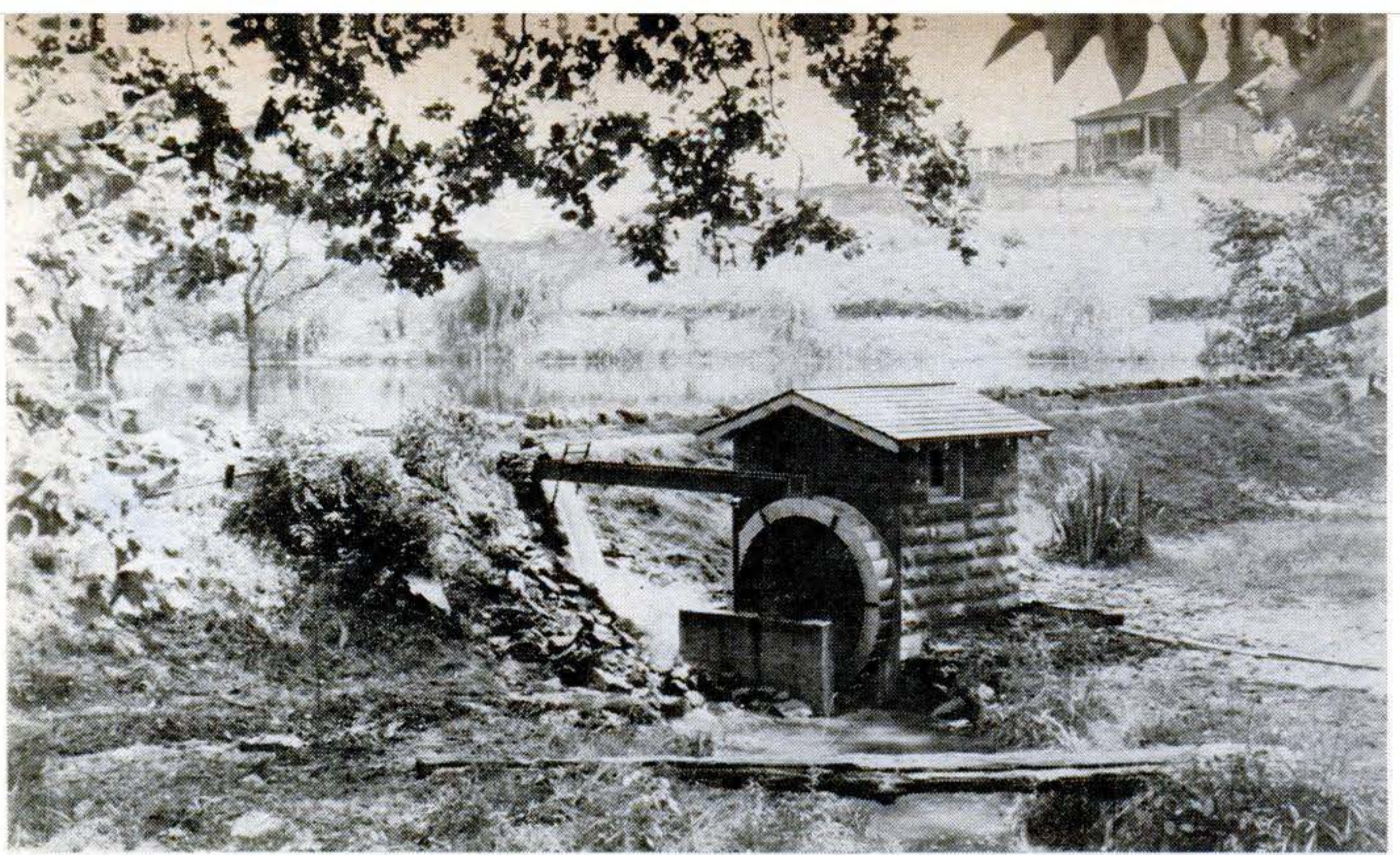

Fitz Water Wheel Co.

Impounded by an earth-fill dam, water here drives an 8' overshot wheel connected to a pump. Sufficient power is secured, even during low water, to supply three homes with water pumped against a 258' head.

# Your Own WATER-POWER PLANT

**Want to put that brook to work?  
Here's the first of a series on how  
and where to engineer your own  
back-yard Boulder Dams**

## **PART ONE**

**By C. D. BASSETT**

**M**ANY farms, ranches, and other fair-sized tracts of land embrace at least one brook within their limits. In most cases, the idea that a small stream can provide a useful source of power has never occurred to the property owner or, if it did, has been rejected as silly. The fact remains, nevertheless, that impressive advantages can spring from small water-power installations.

Electricity can be generated for general use, for pumping water, and for stand-by or emergency purposes; and the pond that is usually created can serve additionally as a means for watering livestock in dry times, for fire-fighting, as a swimming pool, as a place to raise fish for sport or as a "crop," and for landscaping or scenic purposes.

Power can be obtained from any flowing stream, no matter how small. Whether it is desirable to harness this power depends on two factors. First, does water flow all the year round, even in the late summer months? Second, does enough water flow to make the harnessing of it economically sound? The first factor is, of course, known to the property owner by observation; the second may be determined by simple measurements.

What's the least amount of power that is worth developing? There is in this country at least one water-wheel manufacturer who makes a line of small-capacity units, and this company's smallest hydroelectric unit develops  $\frac{1}{2}$  kilowatt. From this it can be inferred that, in this company's experience, it is not economically wise to harness a stream that will not develop at least 500 watts dependably at the switchboard. Half a kilowatt will light 10 fair-sized lamps or supply  $\frac{3}{8}$  hp. to operate, say, a deep-well pump. With this figure in mind as a criterion, the reader can make a preliminary reconnaissance of the water power available on his property. The chances are he will be surprised; even a seemingly insignificant



stream can deliver many times this minimum.

The power available at the site of a water wheel (that is, before deductions for inefficiencies in the wheel and generator) is expressed in this formula:

$$H_p = \frac{62.4 \times Q \times H}{33,000}$$

Here Q is the cubic feet of water passing through the wheel in one minute; H is the "head" or vertical distance in feet through which the water falls; 62.4 is the weight in pounds of 1 cu. ft. of water; and 33,000 the number of foot-pounds per minute in 1 hp. A number of methods exist by which the variables Q and H can be determined, but before considering them, it's well to examine first the possible sites for the dam and wheel, since they will necessarily affect the amount of head secured.

The location of the dam, as suggested in Fig. 1, should be governed by two principles. It should be placed where the greatest useful head is obtainable, that is, where the greatest

If located at a waterfall, right, a dam will often be small and inexpensive and the total head fairly large.

A wide valley calls for a long dam, as high as possible to provide the maximum head.

Swampy meadowland indicates the presence of a natural reservoir. Place the dam at the narrowest point where the brook leaves.

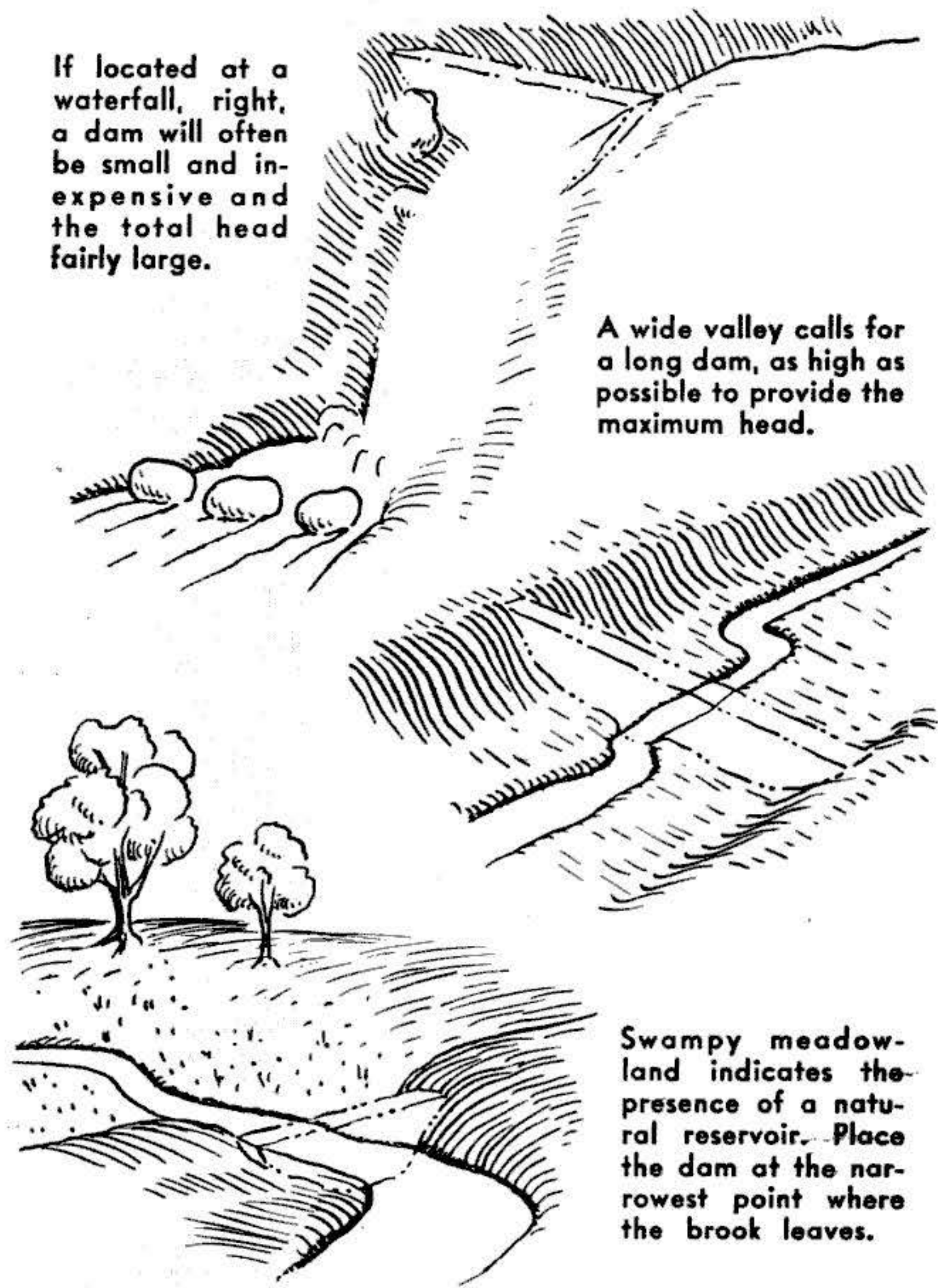
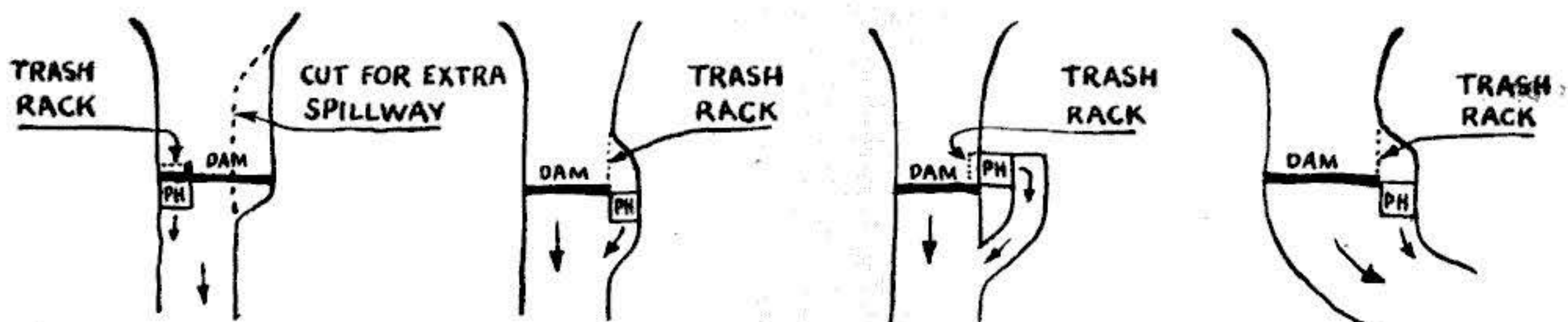
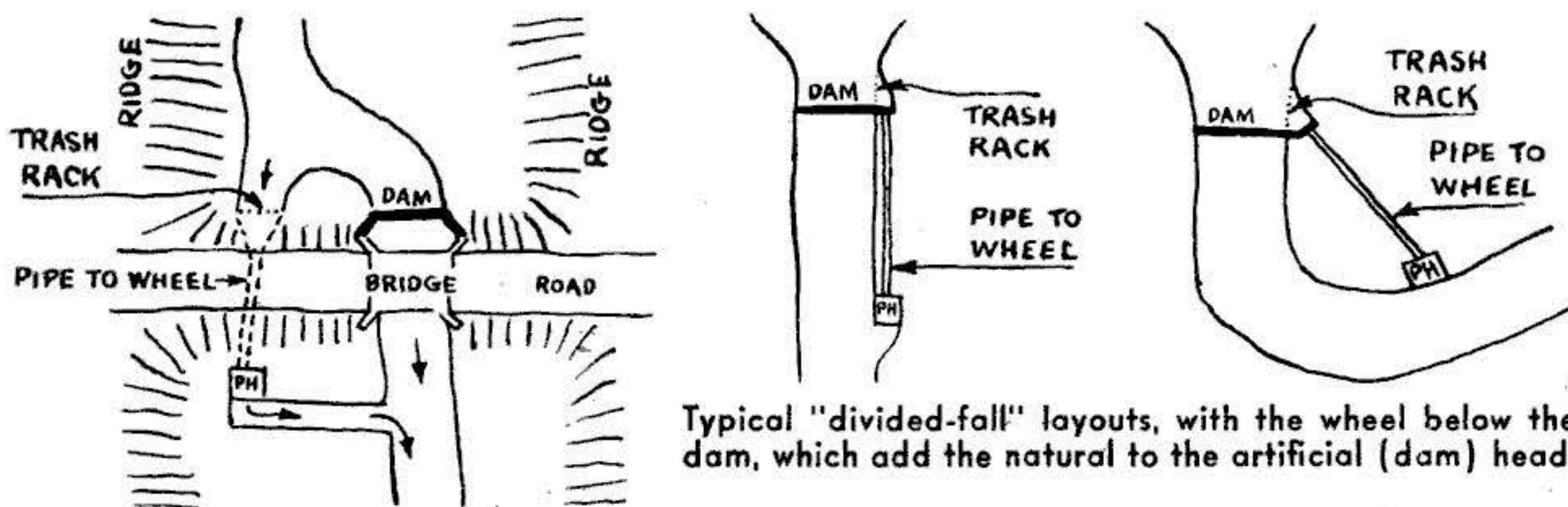

FIG. 1. LOCATING THE DAM

FIG. 2. LOCATING THE WHEEL



Typical layouts with the powerhouse at the dam, a location that uses only the artificial head.



Typical "divided-fall" layouts, with the wheel below the dam, which add the natural to the artificial (dam) head.



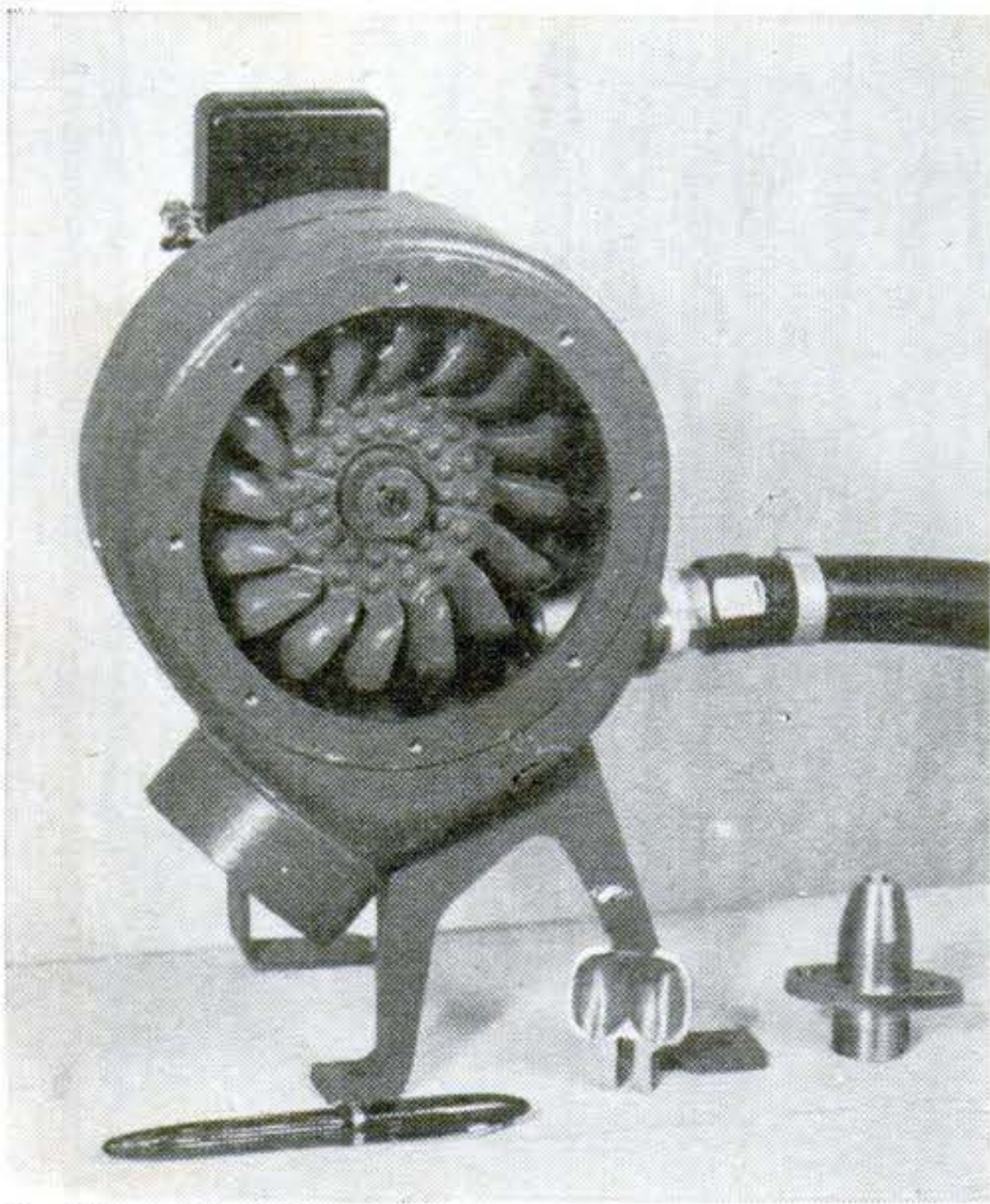

Fitz Water Wheel Co.

This 4" impulse wheel, built for war requirements, was direct-connected to a small generator. It can be run off an ordinary water faucet. Note the removable nozzle and the tiny bucket, lower right.

fall occurs in the shortest length of stream. Such a site is often indicated by a natural waterfall, by a conspicuously steep slope, or by the swiftness of the current. The second locating principle is a simple matter of cost: a dam should be placed where it can be smallest and still impound the most water. This means, in general, that it should be placed where the stream valley or cut is narrowest.

The site of the water wheel, Fig. 2, may be either at the dam or some distance below it. The former location is the more common, being simpler to build and eliminating the need for a pipe or penstock to deliver water to the wheel. Disadvantages include the fact that the spillway must be of ample capacity to protect the powerhouse in time of high water, and the fact that only the "artificial head"—that created by the dam itself—is available. In cases where the ground falls away abruptly below the dam site, the "divided-flow" layout may be desirable, for it greatly increases the head.

Another preliminary calculation should be made as to the height of the proposed dam. This is restricted, as a rule, only by the height of the valley walls at the site, and by the materials, equipment, and money available for building it. The higher it is, the greater the head and the larger the

pond that will be created. "Pondage"—water stored for use in times of peak demand—is an important factor in water-power calculations. Power is rarely needed 24 hours a day, and construction of a dam of sufficient height to provide water storage will greatly increase the power available at the time of day required.

If, for example, a wheel is to be run for 16 hours a day, and if a dam is built that will impound all water flowing into the pond during the idle eight hours, the power capacity will be increased by 50 percent. Don't neglect to distinguish between "live storage"—the volume of water represented by the difference in height of the spillway flash boards and the wheel intake—and "dead storage"—the volume of water below the level of the wheel intake. The former is power banked against a time of need; the latter is worthless, powerwise.

Once the dam and powerhouse are tentatively sited, and the height of the first is provisionally set, it is time to measure the power available. Assume that all water flowing in the stream can be made to flow through the wheel, which is a fair assumption on small installations. This flow ( $Q$  in the power formula) can be determined by the "weir method," which involves constructing a temporary dam of controlled proportions and which will be detailed in a subsequent installment, or by the "float method," which is theoretically a trifle less accurate, though still quite satisfactory.

The float method (Fig. 3) involves the formula:

$$Q = A \times V \times 60$$

in which  $Q$  is the volume of water flowing in cubic feet per minute,  $A$  is the cross-sectional area of the stream in square feet at the site, and  $V$  is the average velocity of the stream at this point, expressed in feet per second.

Select a length of the stream that is fairly straight, with sides approximately parallel, and unobstructed by rocks or shoals for a distance of about 100'. Stretch a taut wire squarely across the stream near the middle of this length and measure the width of the stream here in inches. Mark this width off on the wire and divide it into ten equal divisions. From the center point of each division, measure the depth of the water in inches. Then average the depth figure by adding each value and dividing by 10. The cross-sectional area of the stream,  $A$ ,



is now secured by multiplying this average depth by the width, and dividing the result by 144 to obtain the answer in square feet.

Your next step in determining  $Q$  is to measure the rate of flow. Using a steel tape, mark off a course along the bank that is 100' long; the mid-point of this course should be at the line where the cross section was measured. Stretch wires or rope tautly across the stream at each end of the course, and make a float by filling a bottle so that it rides awash. Provide it with a pennant so that you can follow it easily. Then set the float adrift in the middle of the stream, timing its progress over the course with a stop watch, beginning just when the pennant passes the first wire and stopping just as it passes the second.

Make a series of runs, averaging the results. The speed of the float in feet per second is then the length of the course divided by the average time. This result is not, however, suitable for immediate use in the flow formula, since not all the water in a stream flows as rapidly as that in the center and near the top. If you multiply the float speed by the coefficient 0.83, the resultant value will serve as  $V$  in the flow formula.

Given an estimate of the amount of head to be present at the wheel, you can now make a rough determination of the horsepower your stream can provide. It's worth emphasizing, though, that this figure is necessarily only as accurate as the measurements that produced it, and that the power indicated is that present *at the time of measuring*. A single stream-flow value is not of itself particularly useful unless it is

obtained at the time of lowest water, usually in the late summer months. Moreover, even if you have measured the flow at slack-water time, the figures should if possible be supplemented by others secured during maximum springtime flow, so that you can calculate the size of spillway needed to prevent damage to your installation in times of high water.

It's a good practice, for back-yard engineers as well as for professionals, to refine, cross-check, and test your measurements by all means at your disposal. Such checks will not only reduce the chance of disappointment in the final result, but will also permit calculated economies in construction and greater efficiency in operation.

Your estimate of the head present at the wheel, for instance, should be carefully checked, since head is a vital element in the efficiency of any water-power project. Several methods for determining the head rather precisely will be given in the next installment, together with the weir method for measuring flow. Subsequent installments will consider types of dams, methods of construction, wheels best suited to small plants, and plans for building them.

Before you begin even a preliminary reconnaissance of water power on your property, the writer suggests you secure a loose-leaf notebook to be devoted solely to the project. Develop the habit of neatly entering all data as it is obtained, not forgetting to note dates and stream conditions at the time measurements are made. Such a record is a great help in performing sound calculations and producing excellent results.

TO BE CONTINUED.

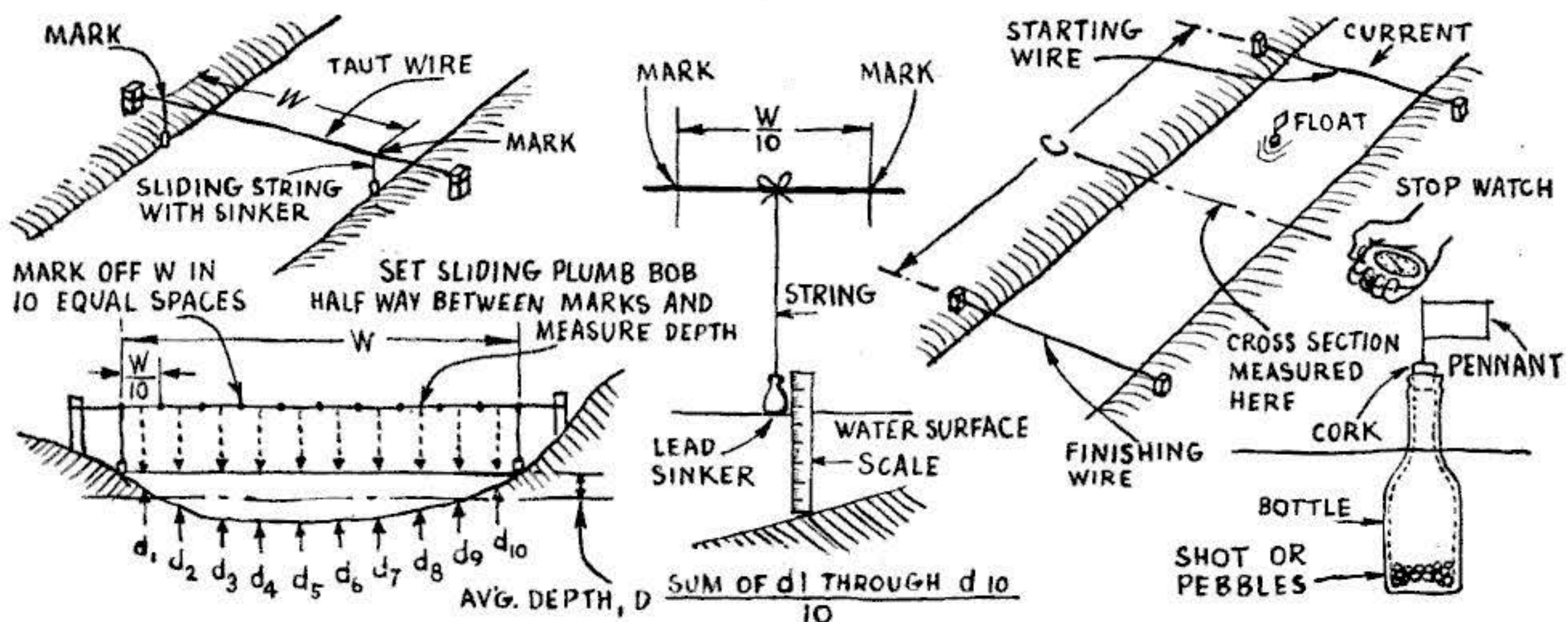
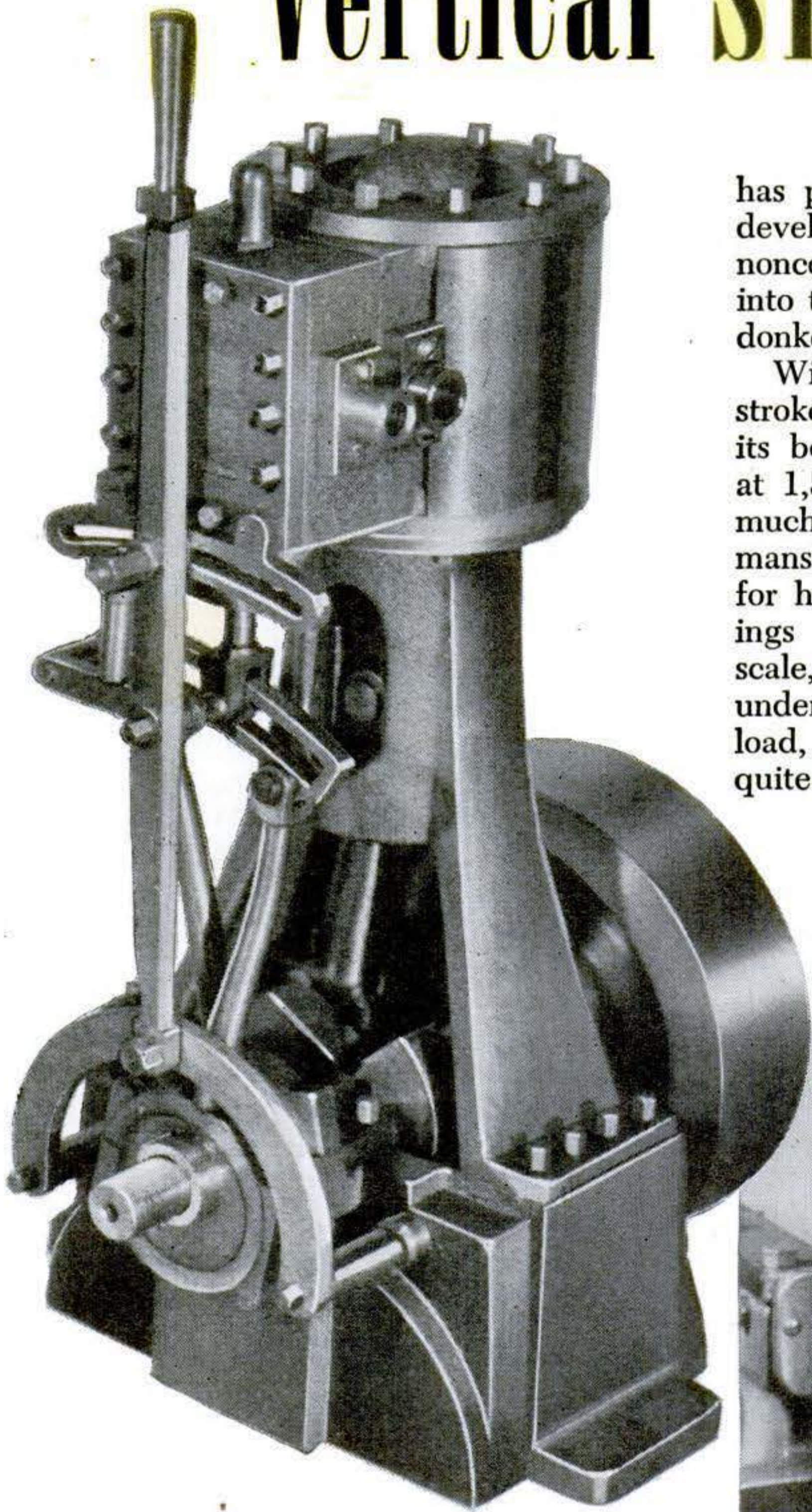

FIG. 3. FLOAT METHOD OF MEASURING FLOW



# Vertical STEAM ENGINE



**A**MATEUR machinists who run the models they build will get double pleasure from this miniature vertical steam engine. Although it is not a scale reproduction of any particular engine, it has the same general appearance and eye-taking appeal of the picturesque old-timers so hard at work about the turn of the century.

The model is equipped with the link-motion reverse gear perfected by George Stephenson for his famous locomotive, *The Rocket*, in the 1830s. This valve action, which also provides a variable steam cutoff,

has played a historic role in steam-power development. The engine is a double-acting noncondensing one that exhausts directly into the air with the familiar *puff-puff* of a donkey engine or steam shovel.

With its 1¼" cylinder bore and 1" piston stroke, and with 75 or 80 lb. of steam in its boiler, the little engine will turn over at 1,500 r.p.m. Actual power will depend much on the boiler used and on the workmanship in the engine itself. The design is for heavy duty, however, with main bearings and other working parts larger than scale, and the engine will stand up well under hard, continuous runs at full working load, developing enough power to drive a quite large model boat, a small dynamo, an air fan, or other light equipment of fractional-horsepower rating.

Much exacting work is required in building an engine of this type, espe-

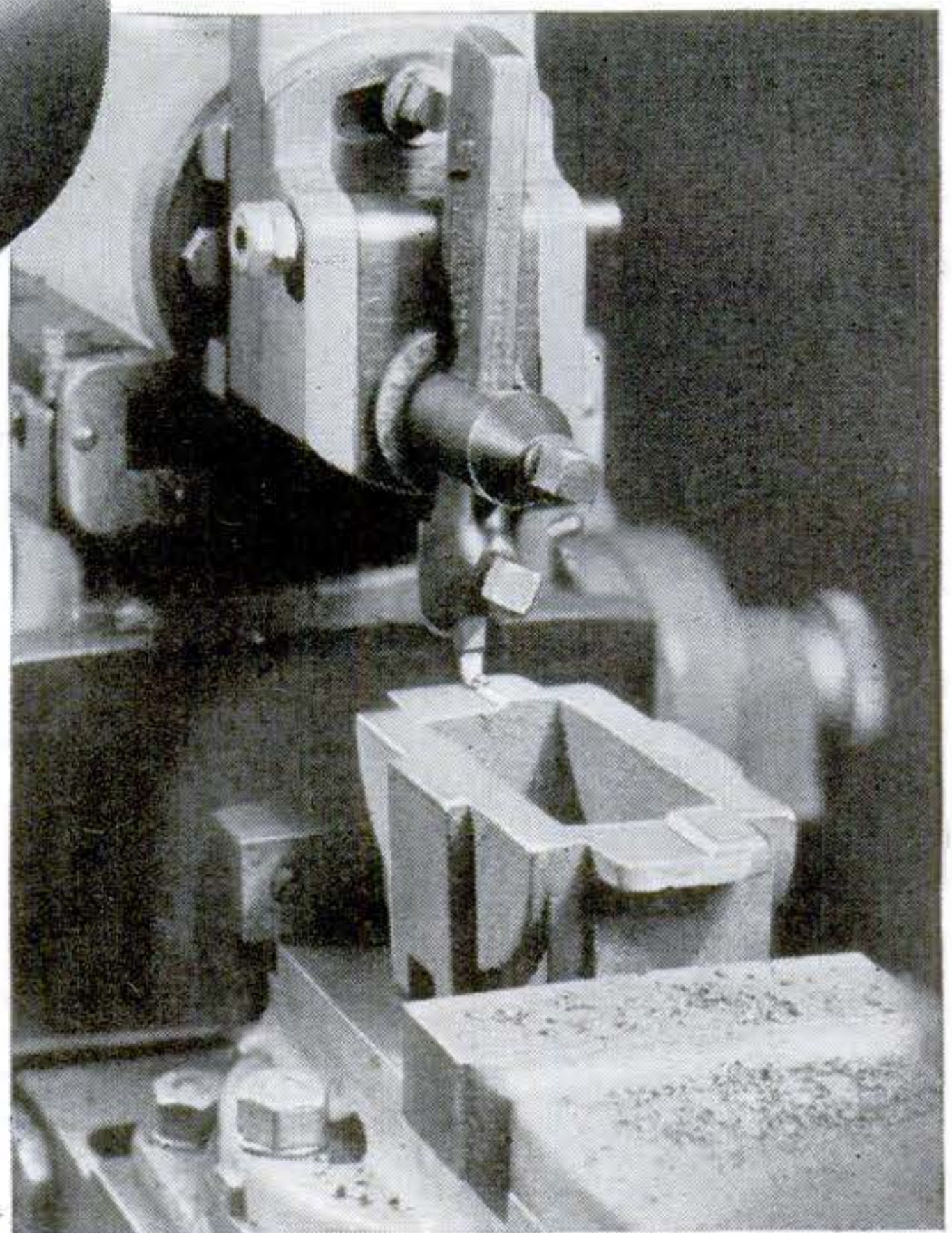

Machining the bottom of the casting for the base. The operation can be done in a lathe as well as a shaper, with the work clamped to the faceplate.







cially since the reverse gear and crankshaft, to be described in a later installment, and other small parts must be machined from steel. However, it is enjoyable work for the modelmaker, and it is of a kind well within the scope of anyone who has become proficient in the use of a screw-cutting lathe.

If you are experienced in woodworking, you can build the necessary patterns and have iron or bronze castings made at your local foundry for the base, standard, cylinder, cylinder head, steam chest, and fly-wheel. Or you can even make up the sand molds and pour bronze castings yourself. The pattern work, however, is by no means a one-evening project, and castings can be supplied for those who want to get right at the machining. Dimensions shown in the drawings are for the finished parts. If patterns are made, an allowance of  $3/32$ " must be added to surfaces to be machined. Shrinkage allowance need not be considered.

Machining operations are possibly best begun on the base since many of the parts can be fitted on it and temporarily assembled as the work proceeds. The casting is easily handled in a shaper, but if your shop boasts only a lathe, the facing can be done with the work clamped to the faceplate and the milling can be done with the lathe milling attachment. Since the casting is open at the center, only the bottom and top need be faced and slots milled for the bearings, after which the pin holes are drilled and the piece cleaned up with a file. Drilling and tapping the screw holes should wait until the mating parts are fitted, when both can be drilled at the same time.

Two identical main bearings are made up from  $3/8$ " by  $3/4$ " brass bar stock cut to length and soldered together in pairs. Mounted in the four-jaw chuck, each bearing is drilled and reamed to size for the crankshaft and the ends faced smooth. The halves are then melted apart and the parts filed to shape and to a good snug fit in the base. Save drilling them and the base for screws until the crankshaft can be set in place.

The standard or main column is held in the three-jaw chuck, and the solid body is bored smoothly and accurately to take the crosshead. With the piece on a mandrel, the head is faced square with the bore and turned to diameter; then the work is reversed on the mandrel and the feet are trued. Screw holes are next drilled in the head to hold the cylinder in place and in the feet for mounting on the base. The tapped holes in

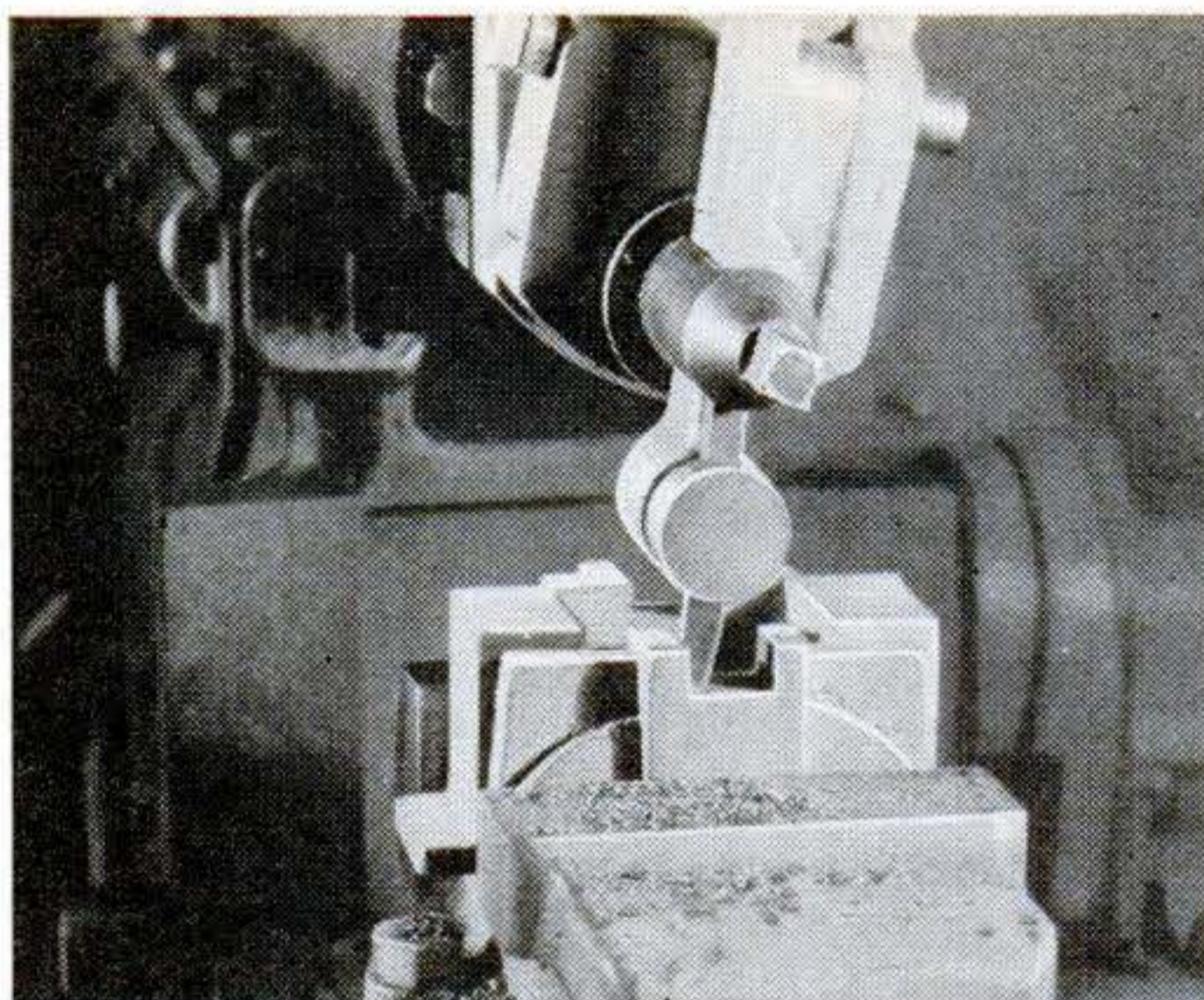

Slots are machined across the top of the base to take the main bearings, which will be made a snug fit. If a shaper is not available, the work can be done on a lathe with a milling attachment.

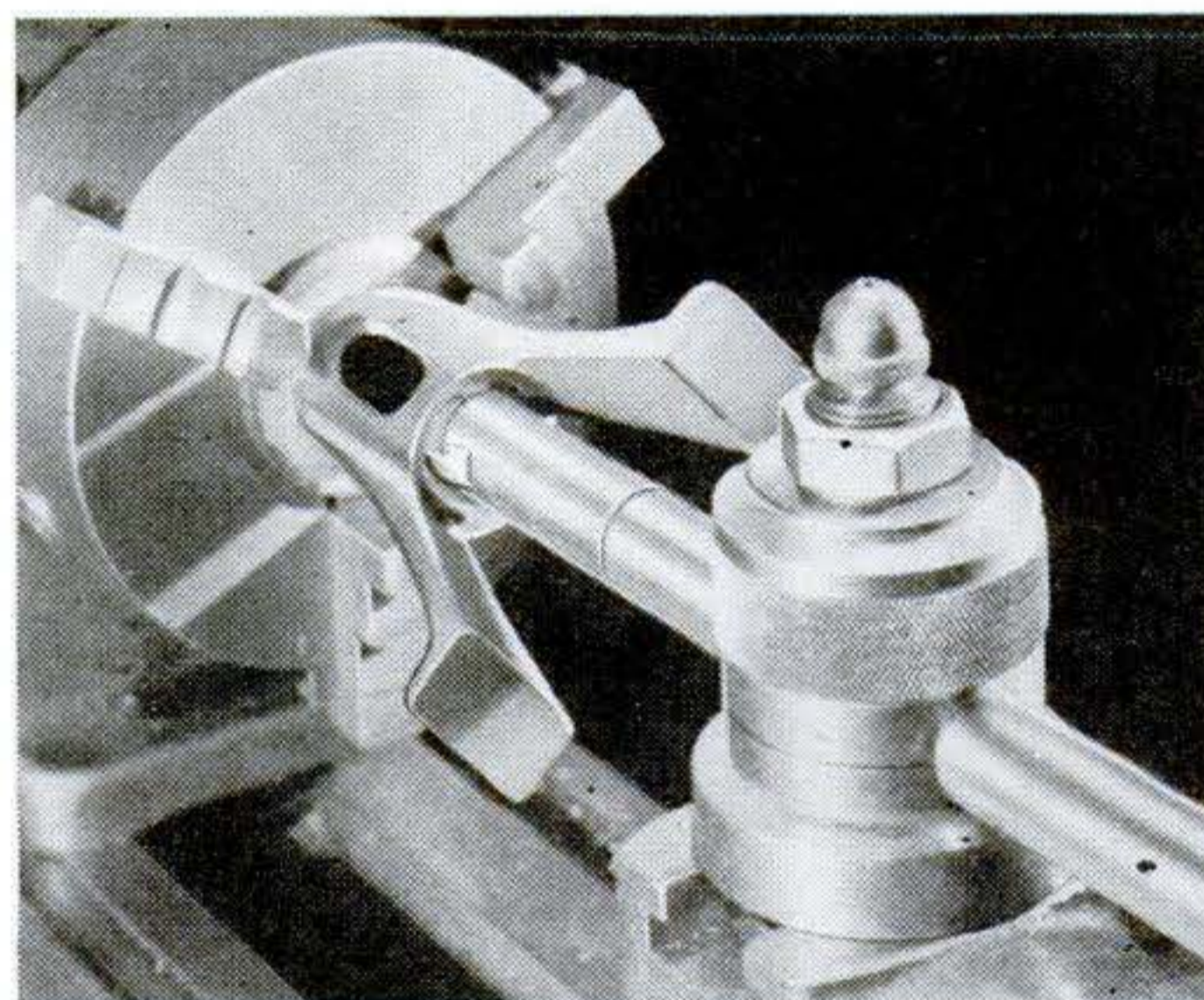

Since the top part of the standard or main column is cast solid, it must be drilled and bored out to take the crosshead. The operation is performed in the lathe with the work in the three-jaw chuck.

the base are spotted from those drilled in the feet.

In making the crosshead, a short piece of cold-rolled steel or bronze is held in the three-jaw chuck and turned to a nice sliding fit in the main-column bore. Next, the upper end is recessed and turned to shape, and it is also drilled and tapped for the piston rod while still chucked so the outer diameter and the piston-rod hole will be concentric. The part is then cut off and the opposite end faced smooth.

Grooves are cut on both sides in the shaper or with the milling attachment, leaving a  $3/8$ " thick web to take the forked end of the connecting rod. The hole for the connecting-rod pin is then cross-drilled in the lower end.

TO BE CONTINUED.



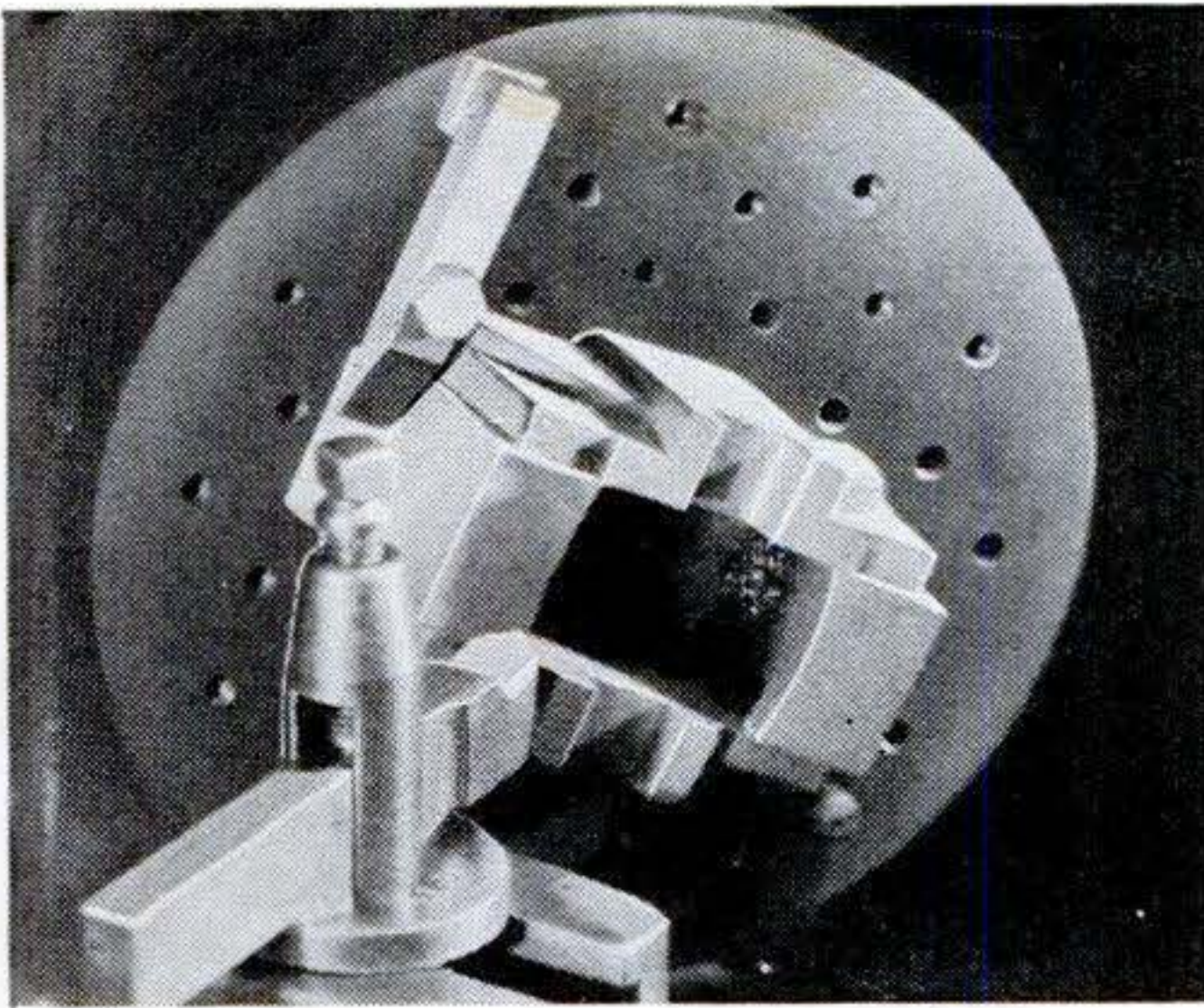

Here the base casting is clamped to the faceplate of the lathe, and the top is machined smooth and to height. A heavy cemented carbide tool is used. Any rough spots are cleaned up with a file.

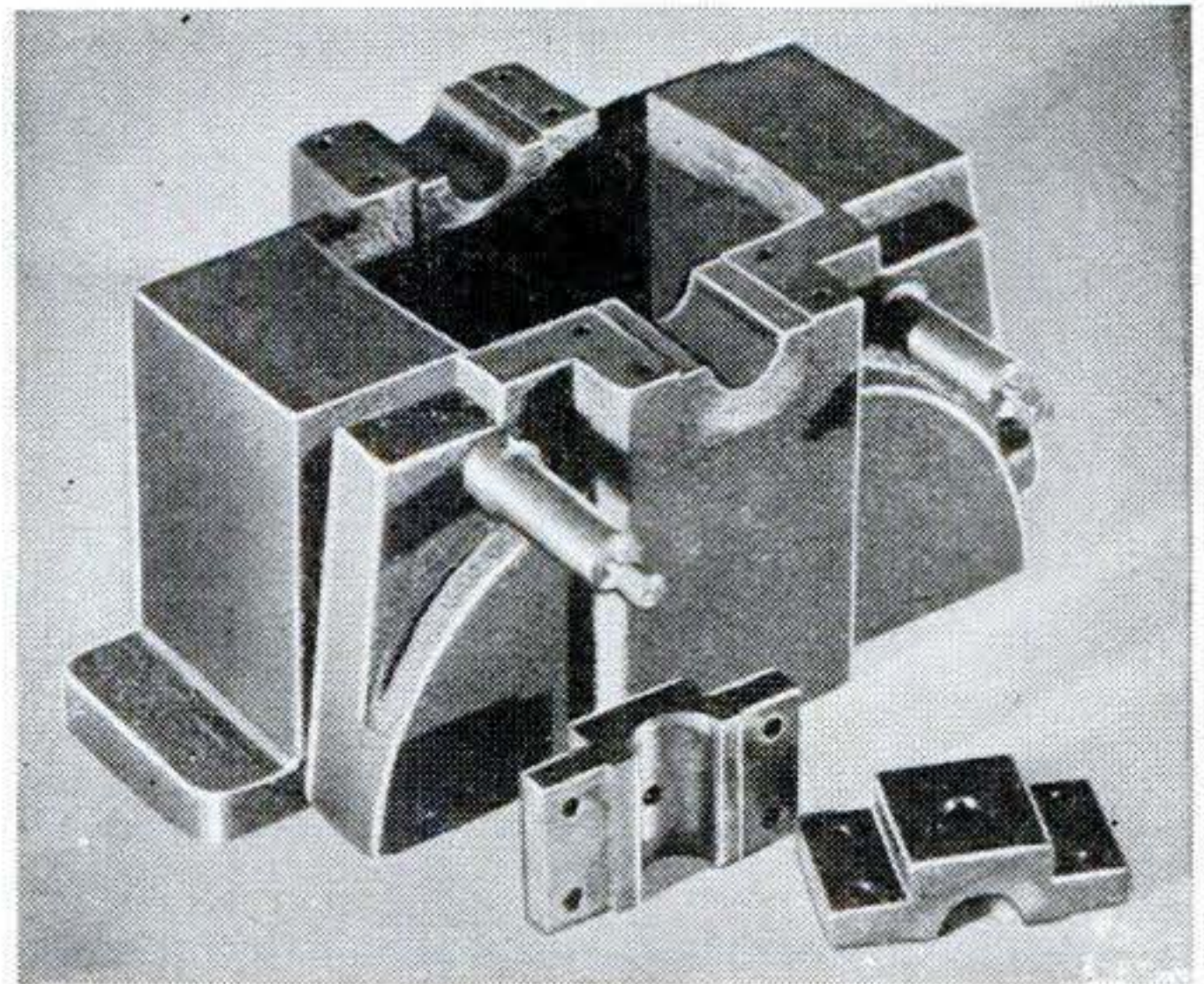

Halves for the main bearings are drilled and reamed while soldered together, then split apart and each half filed to shape. Here the lower halves are in their slots, the upper ones beside the base.

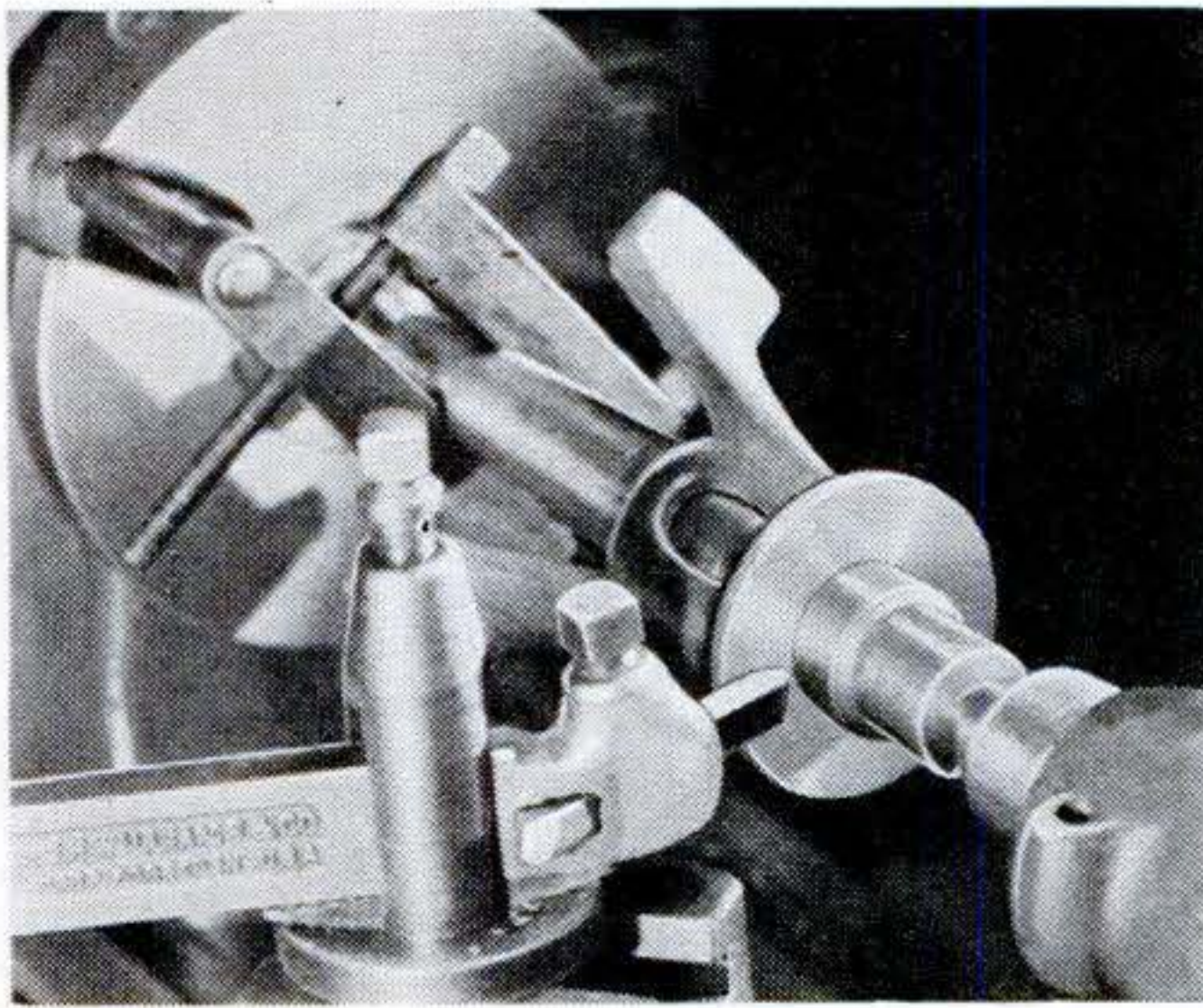

The column is then mounted on a mandrel held between centers for facing the head square with the bore and turning to diameter. It is next reversed on the mandrel and the feet faced smooth and true.

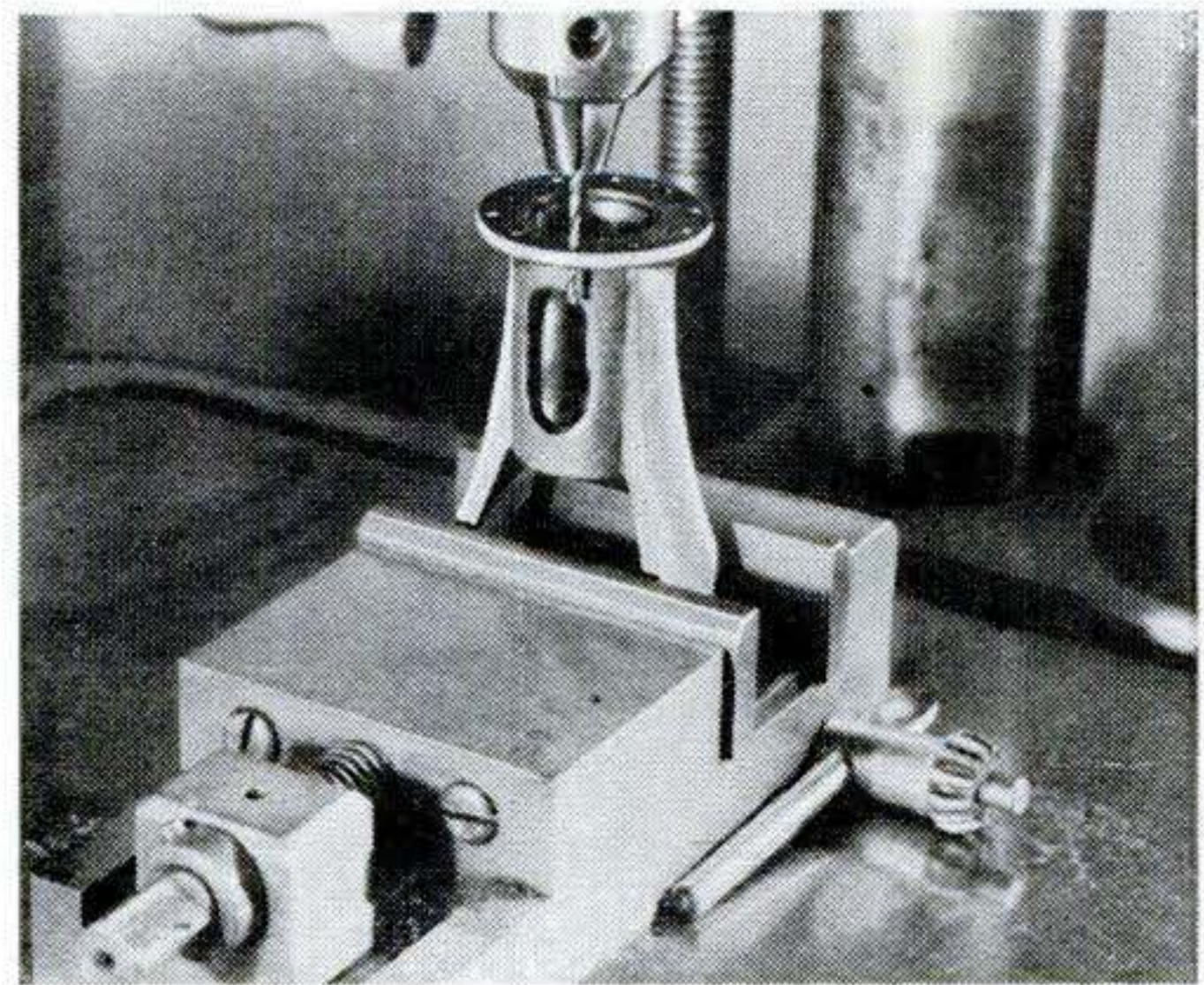

Drilling the head for screws to hold the cylinder in place, and the feet for four mounting screws apiece, completes the standard. Tapped holes in the base are spotted from those drilled in the feet.

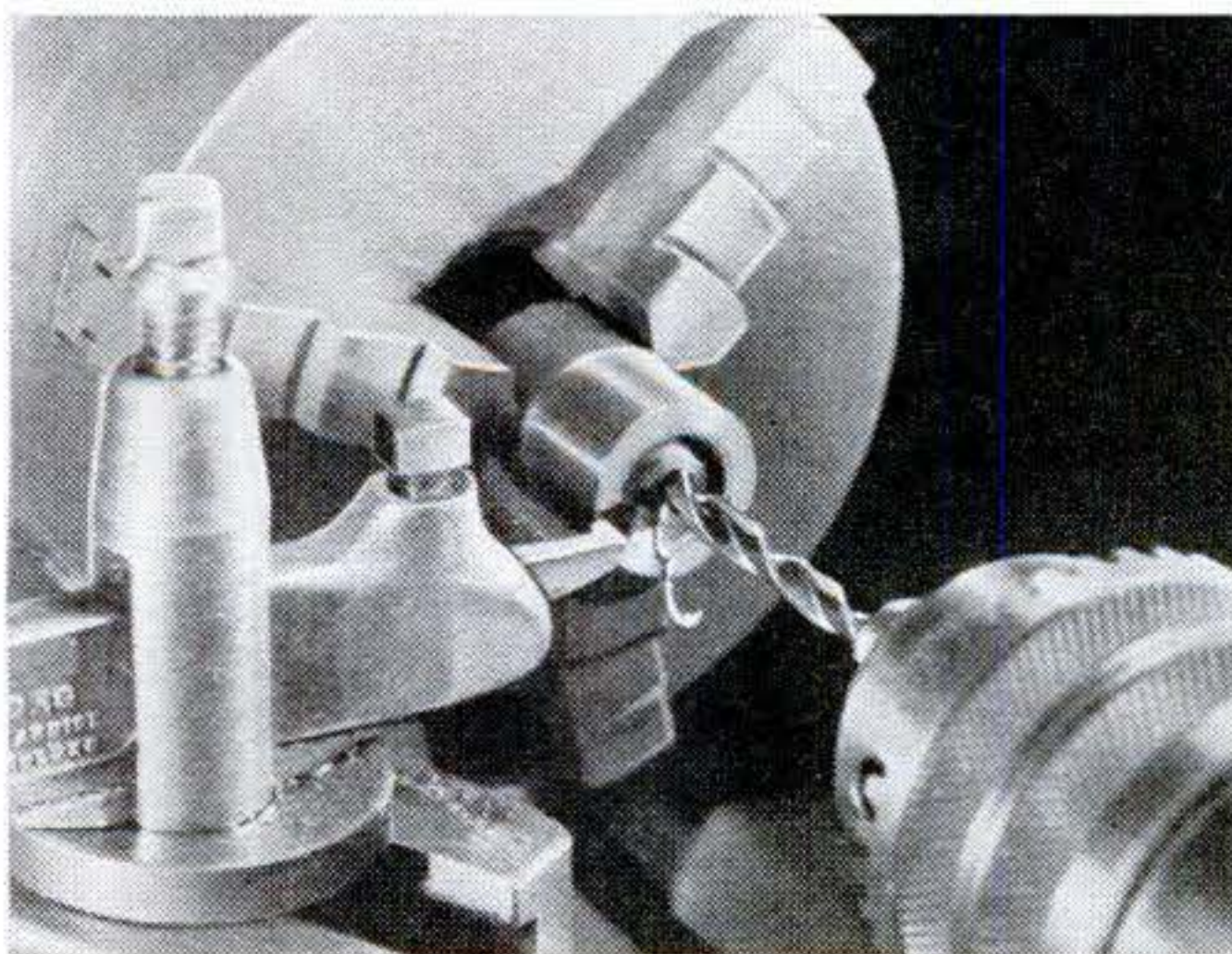

Stock for the crosshead is turned to a sliding fit in the main-column bore; then one end is recessed and turned to shape. The piece is also drilled and tapped for the piston rod while chucked.

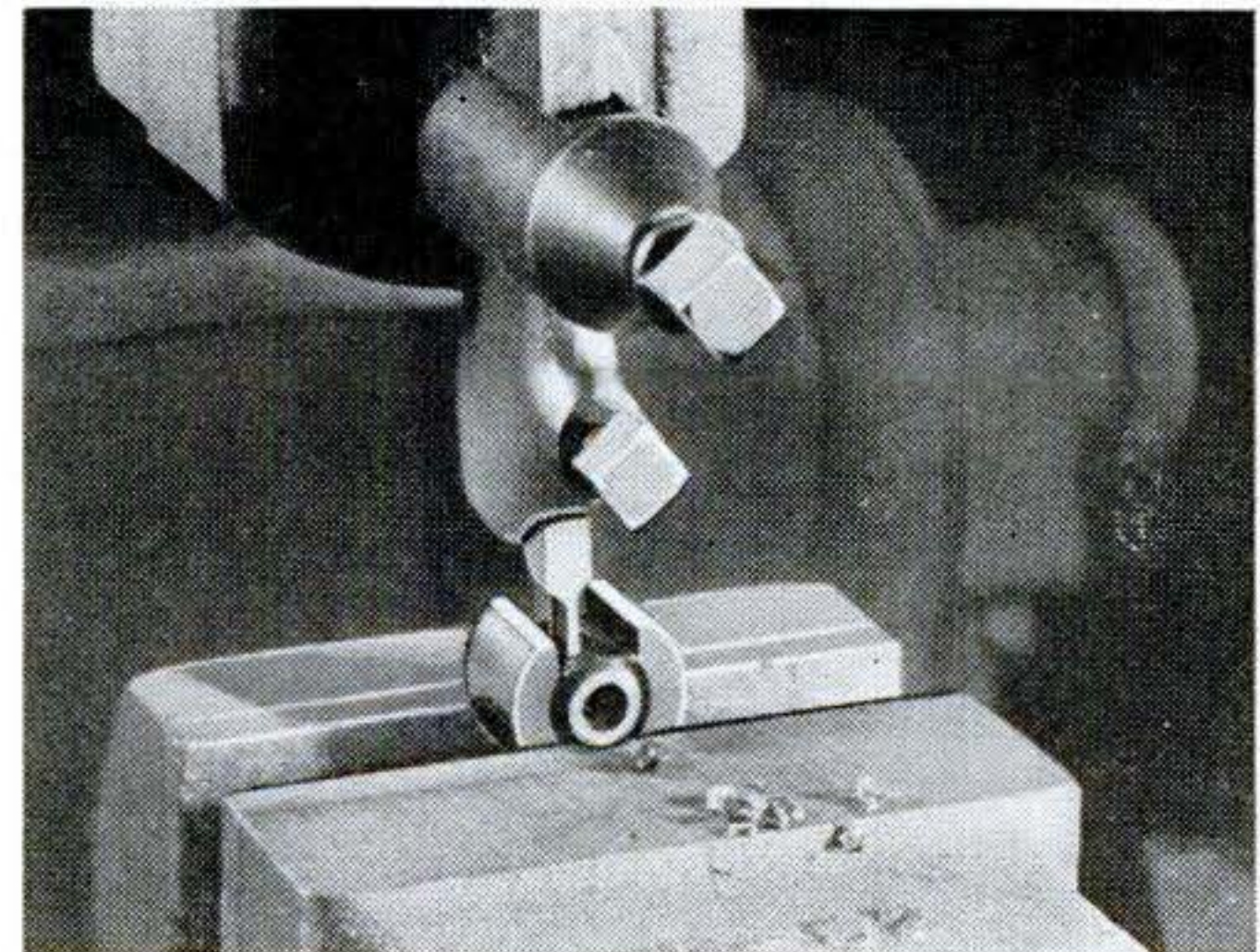

Grooves milled in opposite sides of the crosshead take the forked end of the connecting rod. This operation may be done in a shaper, as shown here, or with a lathe milling attachment.



# NEW SHOP IDEAS



**SPECIAL DRILL HOLDERS.** Here are two easily made devices to help keep your drills in order. The circular container below serves both as a storage place and as a selector for drills between Nos. 61 and 80. At the right, a gauge is used as a stand for that extra set of high-speed precision drills which you want to give special care.

For the circular container, turn a piece of stock to a diameter of 2½" and drill a small center hole. Then cut off a ⅜" piece for the cover and enlarge the hole in it for a 1" roundhead wood screw. In the container, locate the radial holes exactly as indicated and drill 2" deep. They should be big enough to enable you to store several drills of each number.

To make the gauge stand, cut a block of maple 1½" by 3½" by 7½" and slice off

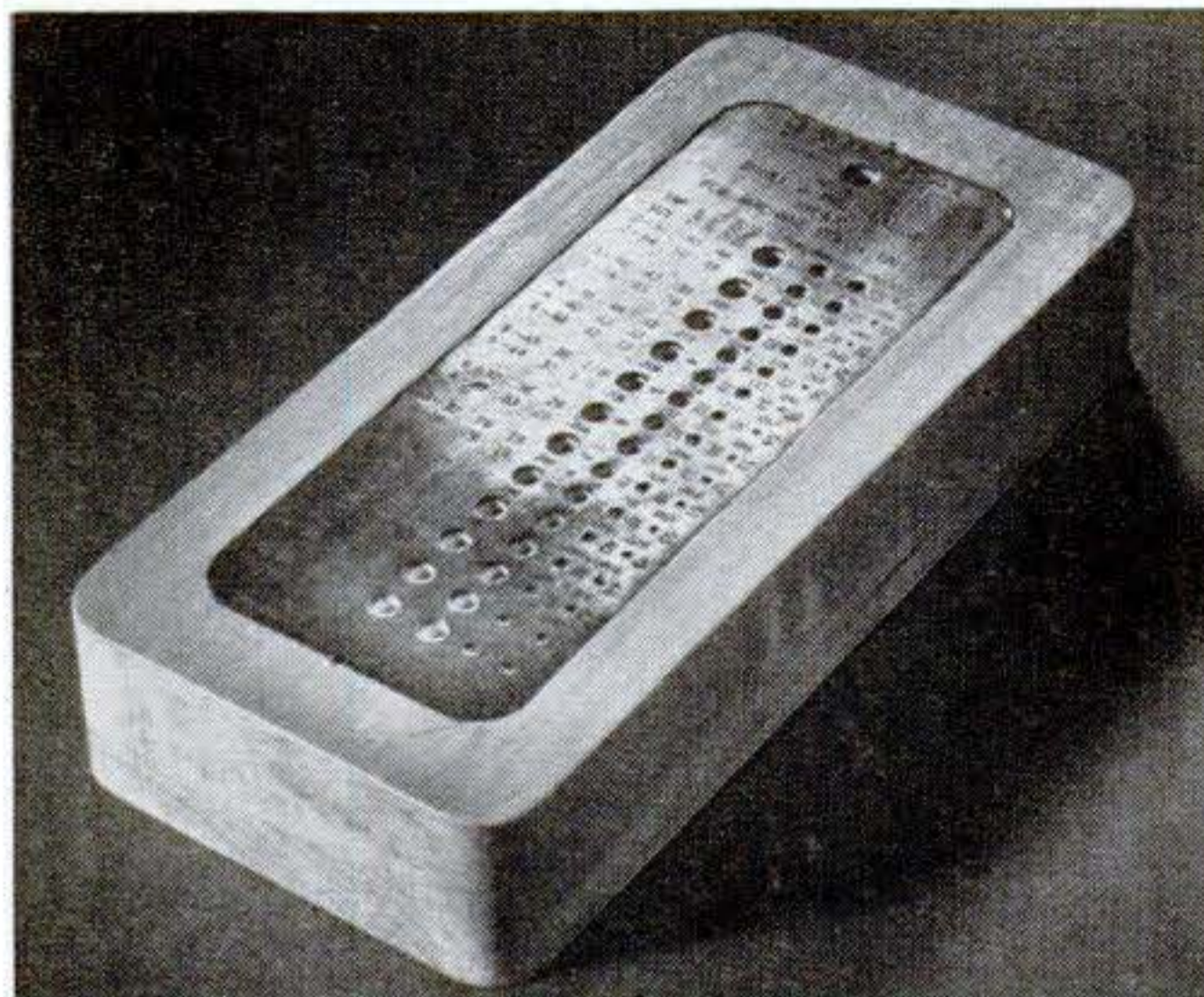

This holder, a drill gauge set in a wood block, provides storage for an extra set of precision drills.

a ½"-thick piece for the bottom. Rout out the top to receive the gauge. Then, with the gauge in place, spot each of the 60 holes through the top. Next, remove the gauge and drill each hole oversize. After attaching the base, fasten the gauge to the block with two escutcheon pins.—H. R. PFISTER.

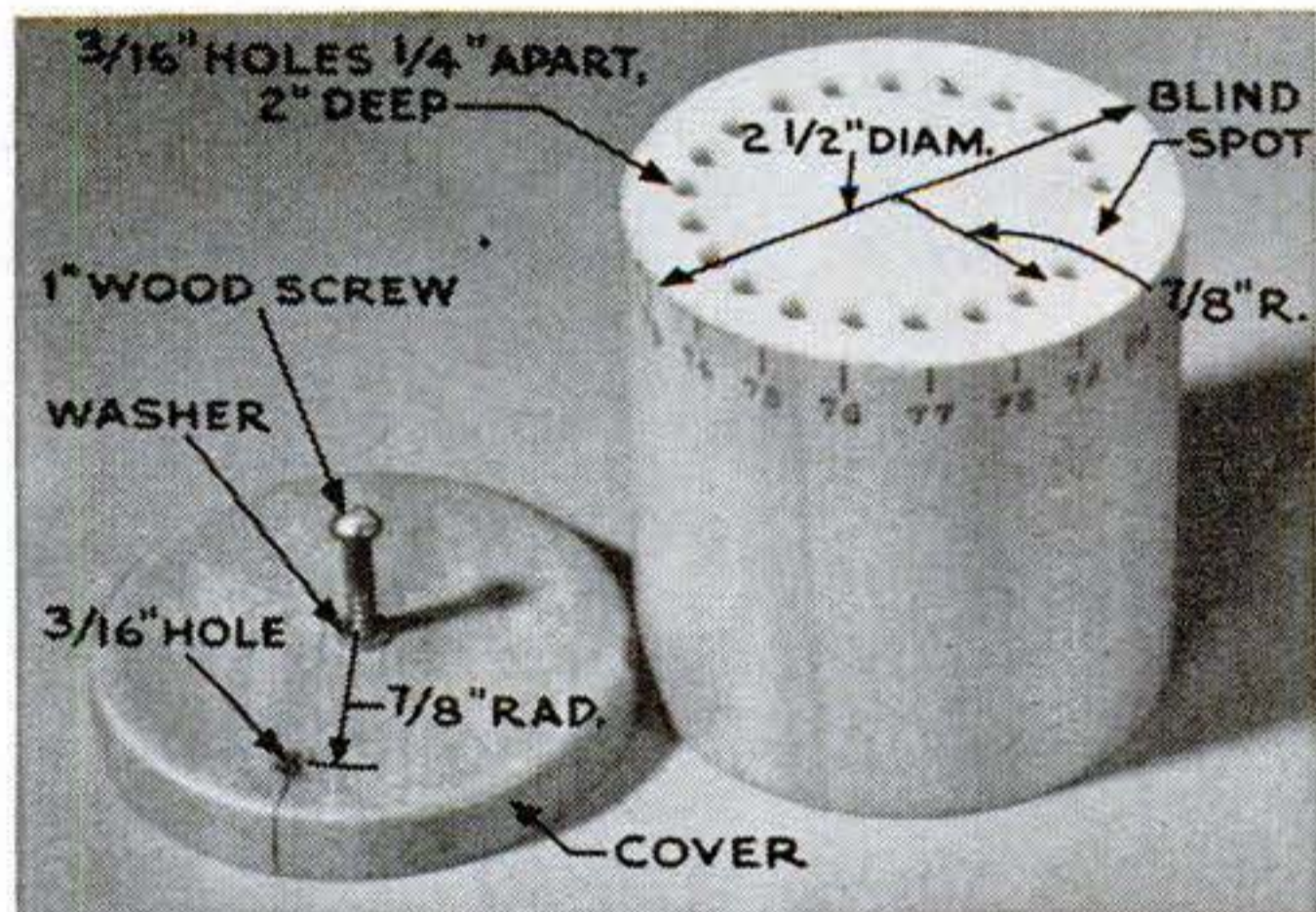

The 3/16" holes let you store several drills of each size in this container. To get a particular drill, turn the cover hole to the size you want.

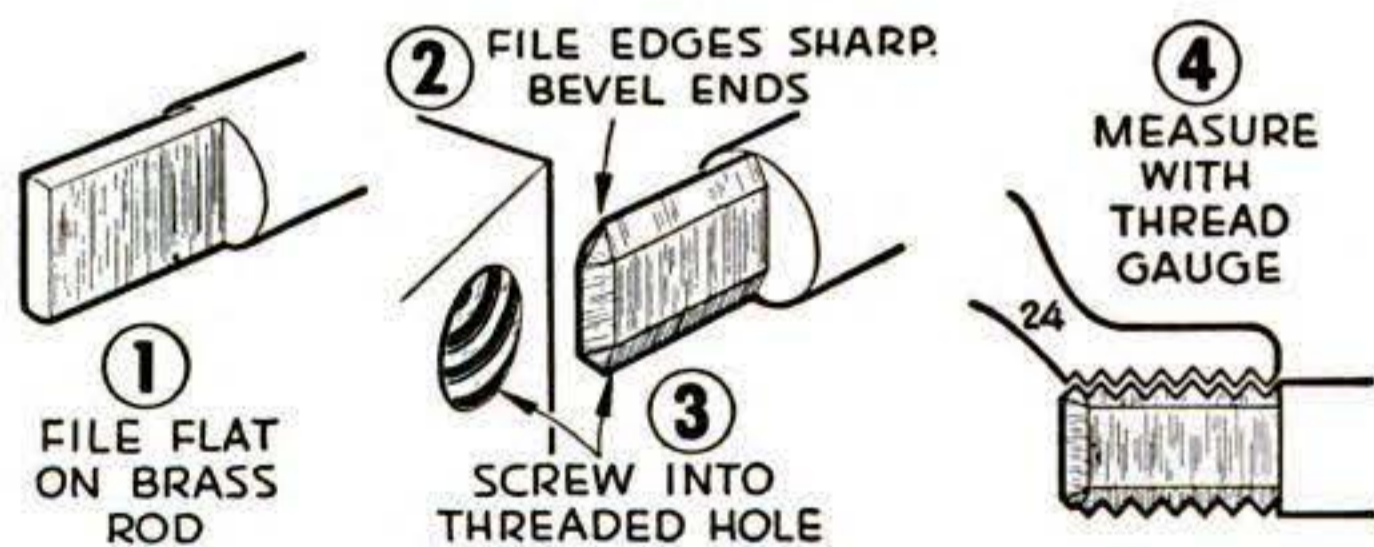

**MEASURING A TAPPED HOLE.** When a tapped hole is too small for accurate use of a thread gauge, obtain a brass rod about the estimated diameter of the required screw, file as shown above, and turn into the hole. This will cut threads into the sharp edges. Measure these with a gauge and refer to a screw-thread table for the hole size.

**BROKEN SETSCREW REMOVED.** A set-screw that has been twisted off in its socket may be removed by drilling a small hole in the broken part remaining in the socket, and then driving an Allen wrench into this hole. Drill the hole just a trifle smaller than the wrench. After the wrench has been firmly lodged in the hole, the broken part may be turned out in the same way that you would use the wrench normally. The wrench will not be damaged if care is used when forcing it into the hole.

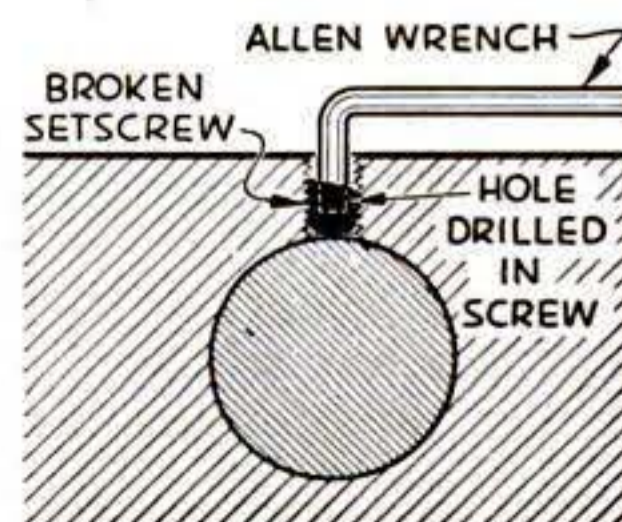



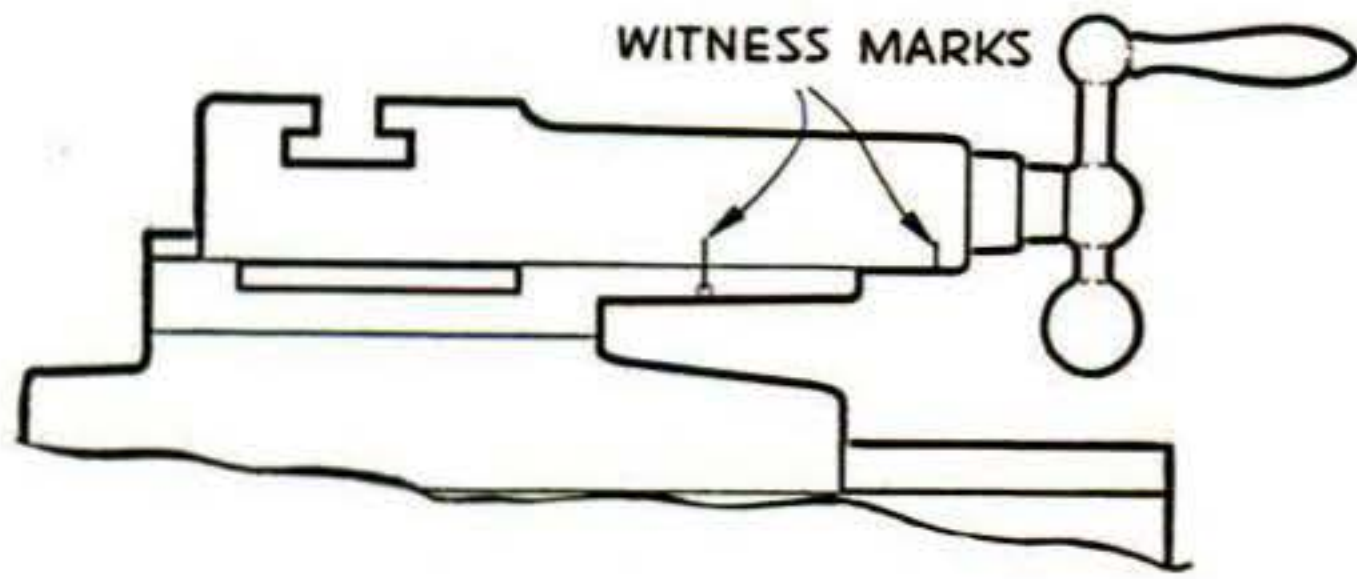

**MARK COMPOUND-REST TRAVEL.** Witness marks placed to indicate the extreme travel of a compound rest, as at left, will tell you if the rest should be moved before starting a new cut. This will save you the annoyance of "running out of travel" in making an important cut—EARL R. GODDARD.

**IMPROVED BORING BAR.** With this boring bar, the cutter may be set quickly and accurately to bore an exact diameter. Center up the bar and turn down a section at the cutter location, enough to run true. Drill the cutter hole at an angle of about 70 degrees, and only about three quarters through the bar. Drill the rest with a tap drill and tap to receive a short headless setscrew of a diameter less than the cutter to be used. Then drill and tap a second hole at right angles to the first to receive another setscrew for pinching the cutter in place.

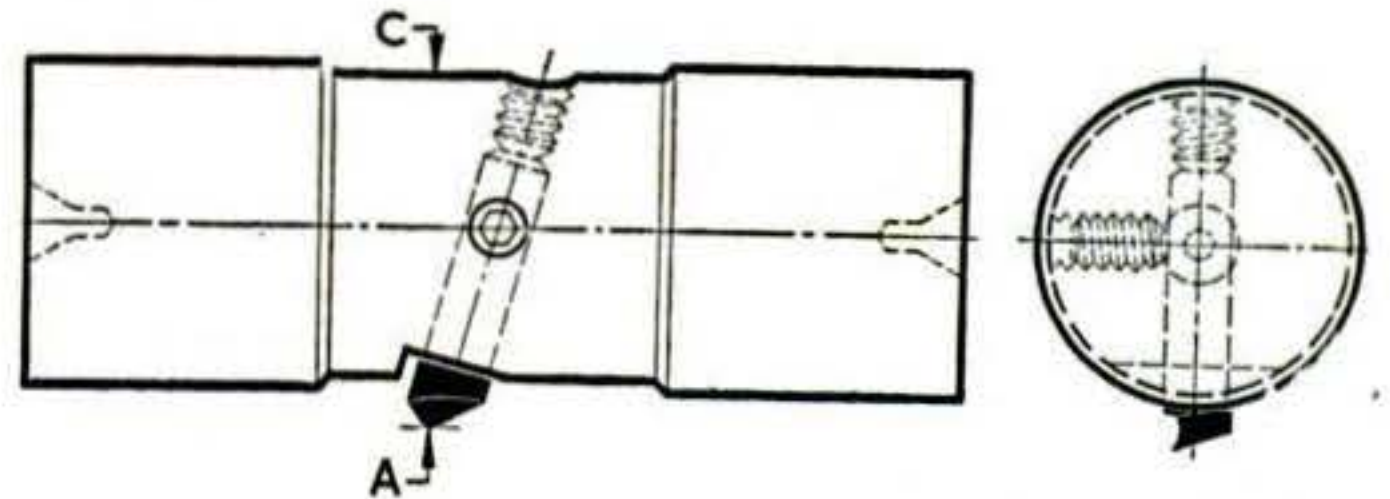

To set the cutter, add the diameter of the turned-down section and the diameter to be bored. Then adjust the cutter so that a measurement taken over the bar and the cutter point, across A-C in the drawing, equals half the sum obtained.—J. S. MORREL.

**CIRCLE CUTTER.** Constructed of drill rod, this tool will enable you to cut disks or rout circular grooves with a drill press or an electric hand drill, using either a routing bit or an end mill as the cutter. On the drill press, the work is rotated; with the hand drill, the cutter moves, the work being firmly fastened to the workbench. Collars can be used to regulate routing depth.

After a  $\frac{3}{8}$ " hole has been made in the 1" bushing case, drill a  $\frac{1}{4}$ " hole for the  $5\frac{1}{2}$ " long arm and tap the hole for threads cut on the arm. Then press-fit the hardened bushing by pushing it home in a vise as seen below. Drill a  $\frac{1}{4}$ " center hole in the slide—a  $\frac{1}{4}$ " section of  $\frac{3}{8}$ " drill rod—and drill and tap a  $\frac{1}{8}$ "-diameter hole for the 1" pivot. Tap this hole only part way so the pivot will not bear on the arm. On the opposite side, drill and tap a hole for the setscrew. Lubricate the inside of the bushing so friction will not bind the cutter or burn it.

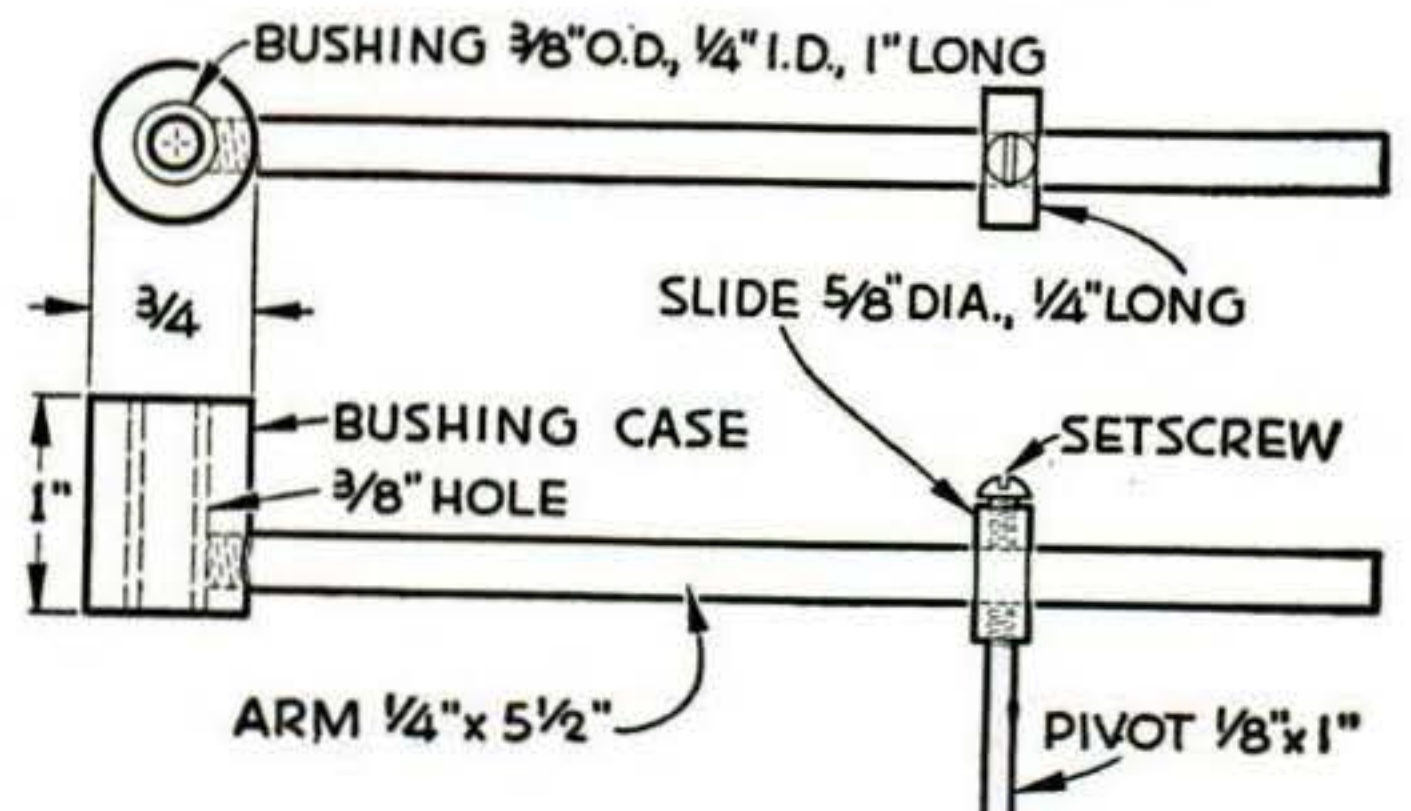
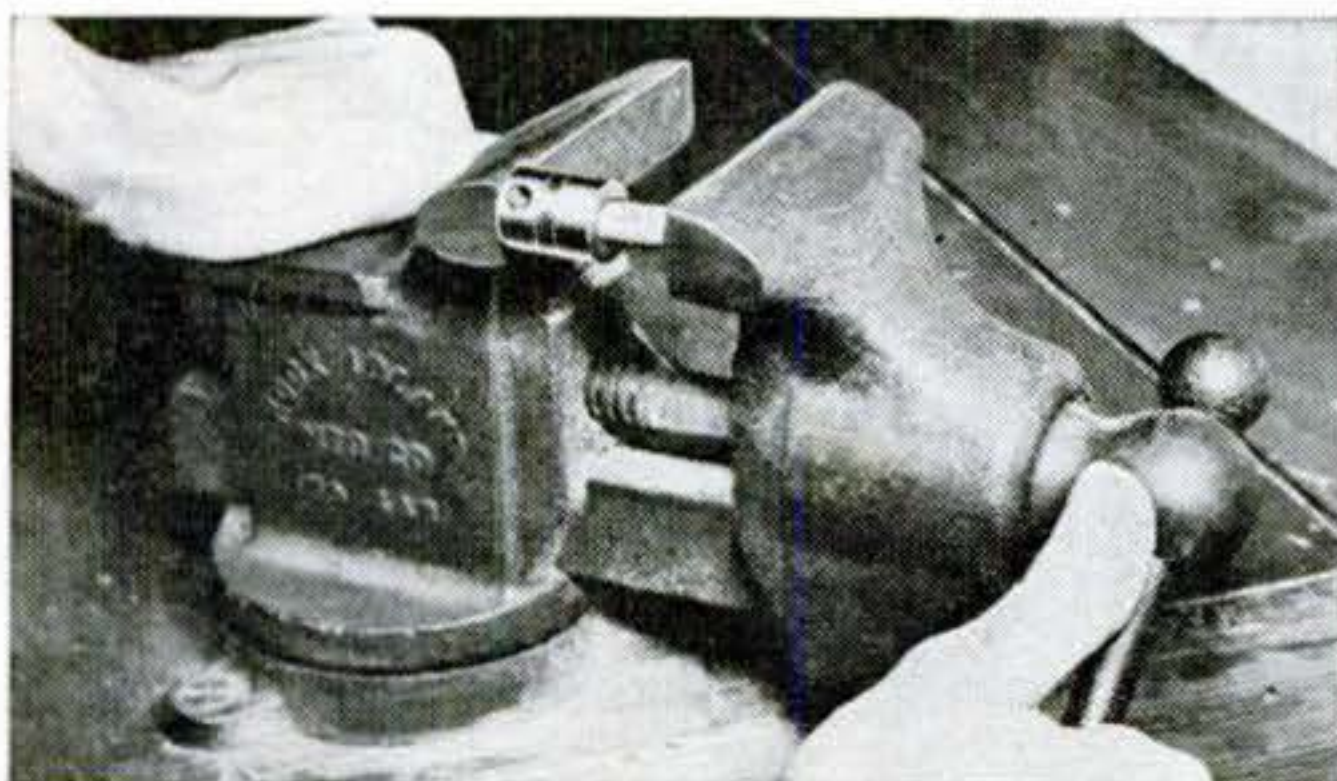
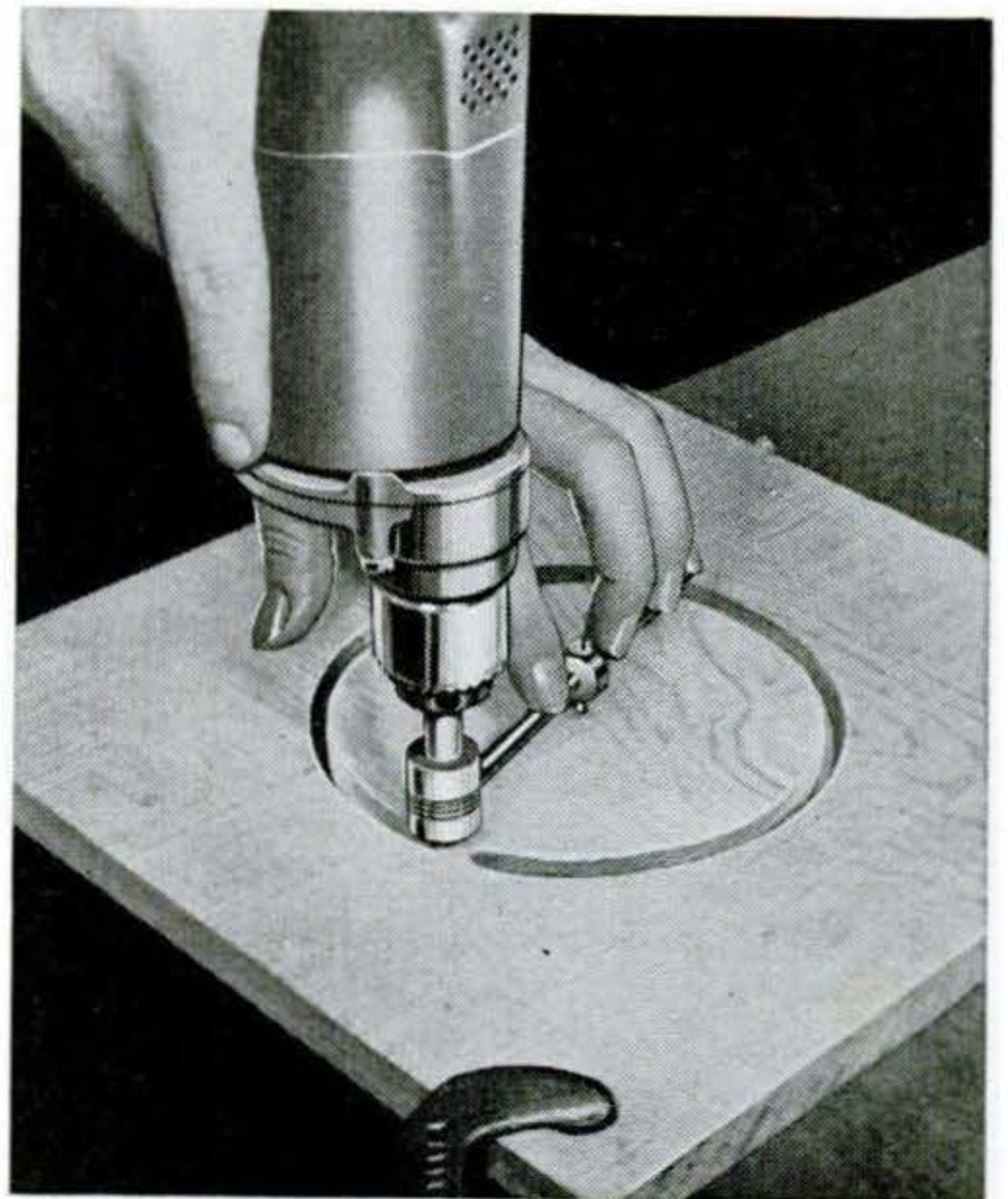



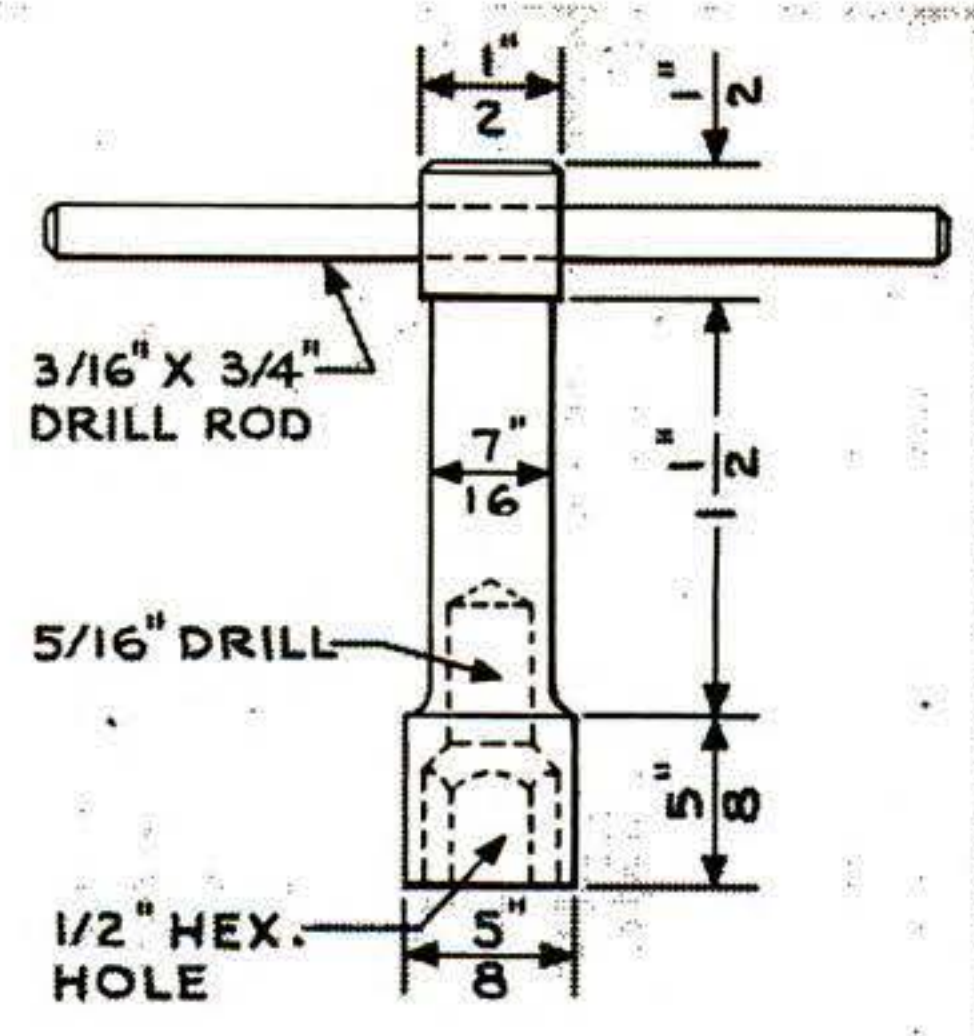
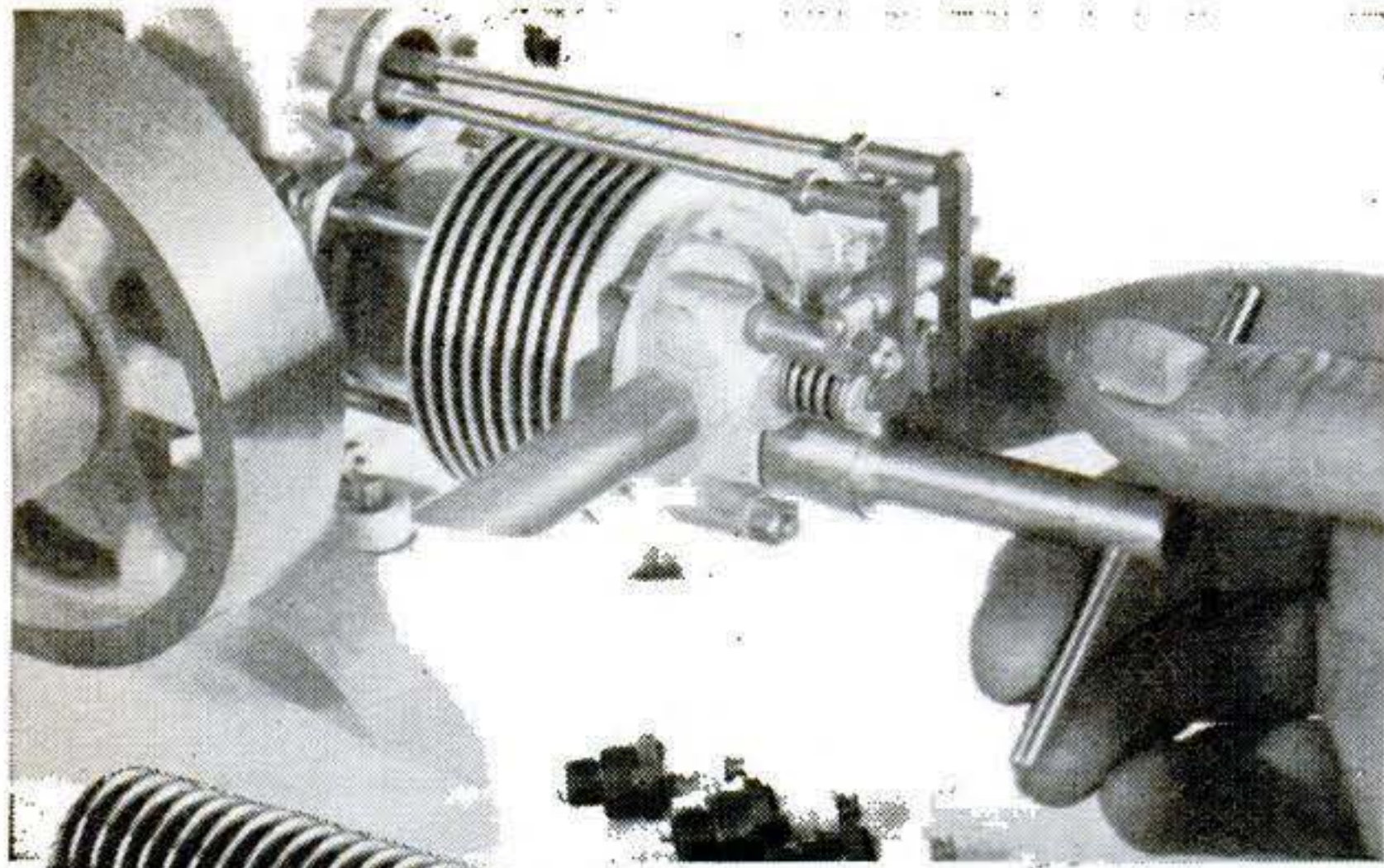

From a screw like this a wrench can be made for use, as at top, on model-engine spark plugs.

# Miniature SOCKET WRENCHES

**M**ODELMAKERS who need small socket wrenches for assembling their projects might try using standard hollow-head screws. These screws are usually of good steel and fairly hard, but not so hard that they can't be turned in the lathe without annealing.

The large screw shown above has a hexagon hole  $\frac{1}{2}$ " across flats and makes up to fit model-engine spark plugs of the V-plug size. Wrenches can be made the same way for  $\frac{3}{8}$ " V-2 and  $\frac{5}{16}$ " V-3 spark plugs.

Chuck the head of the screw true so the outboard end will show no wobble, drill a center hole, and support the drilled end with the tailstock center. Then turn down the threads and turn the shank to the shape shown in the drawing. Reverse the work, turn the head to size, and drill a  $\frac{5}{16}$ " clearance hole for the top of the spark plug to a depth not less than 1" from the outer edge of the head. Cross-drill the opposite end next and drive in tightly a short length of  $\frac{3}{16}$ " drill rod for a handle.

Still smaller socket wrenches for model-size cap screws can be made similarly, but

Here is how the model spark-plug wrench is made. The shank is turned to shape; then the work . . .

with the shank turned the same diameter from head to end. They may then be used in a tap wrench, thus requiring no handle.

Threads on very small hollow-head screws are best left on and screwed into a short length of steel rod tapped to fit. A crossbar handle can be added. In this way even the smallest hollow-head setscrews can be made up into socket wrenches for tiny hexagon-head screws.

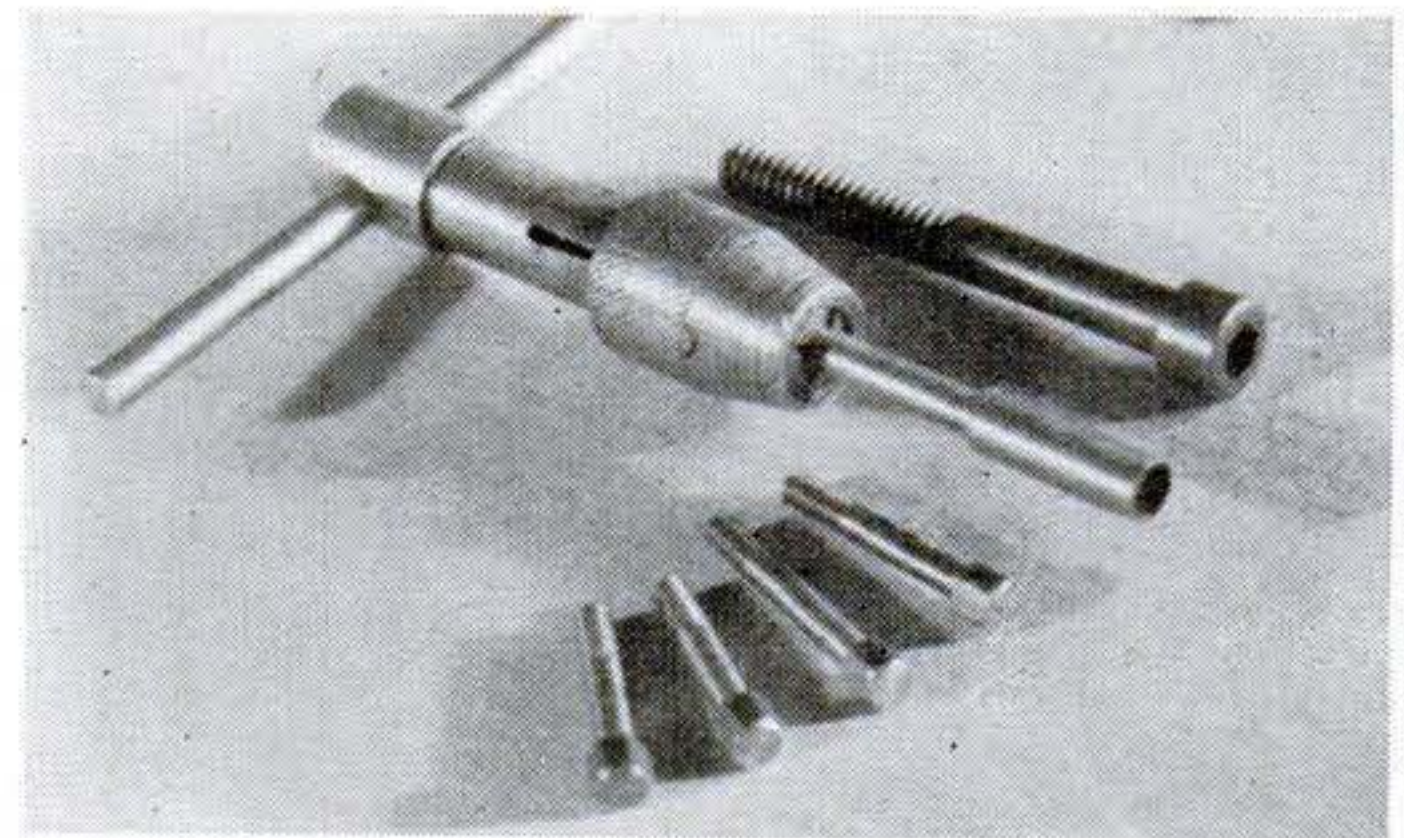

Socket wrenches for model cap screws can be made up with straight shanks and used in a tap wrench.

. . . is reversed in the chuck and the head shaped. Finally, it is cross-drilled to receive the handle.

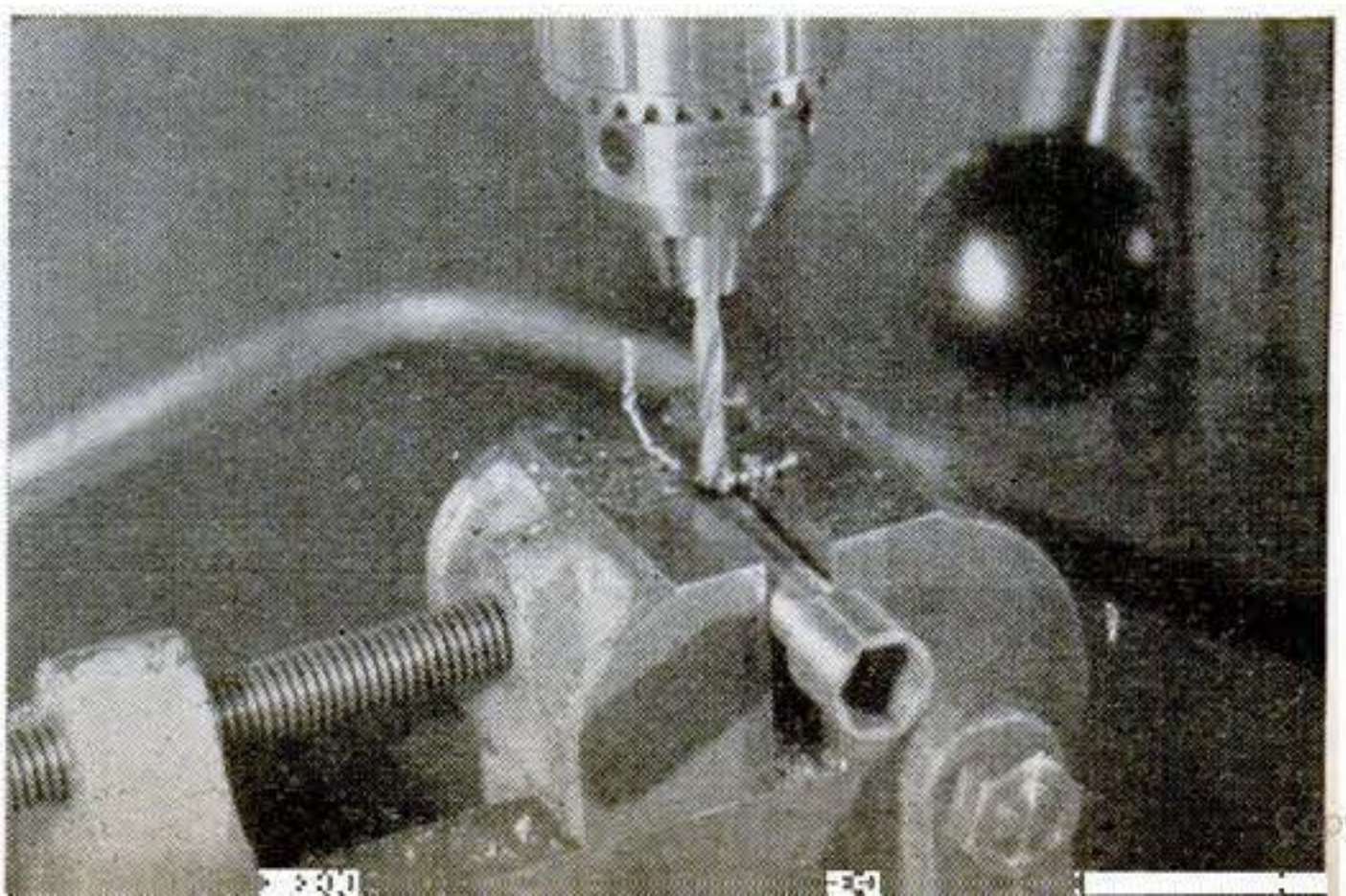
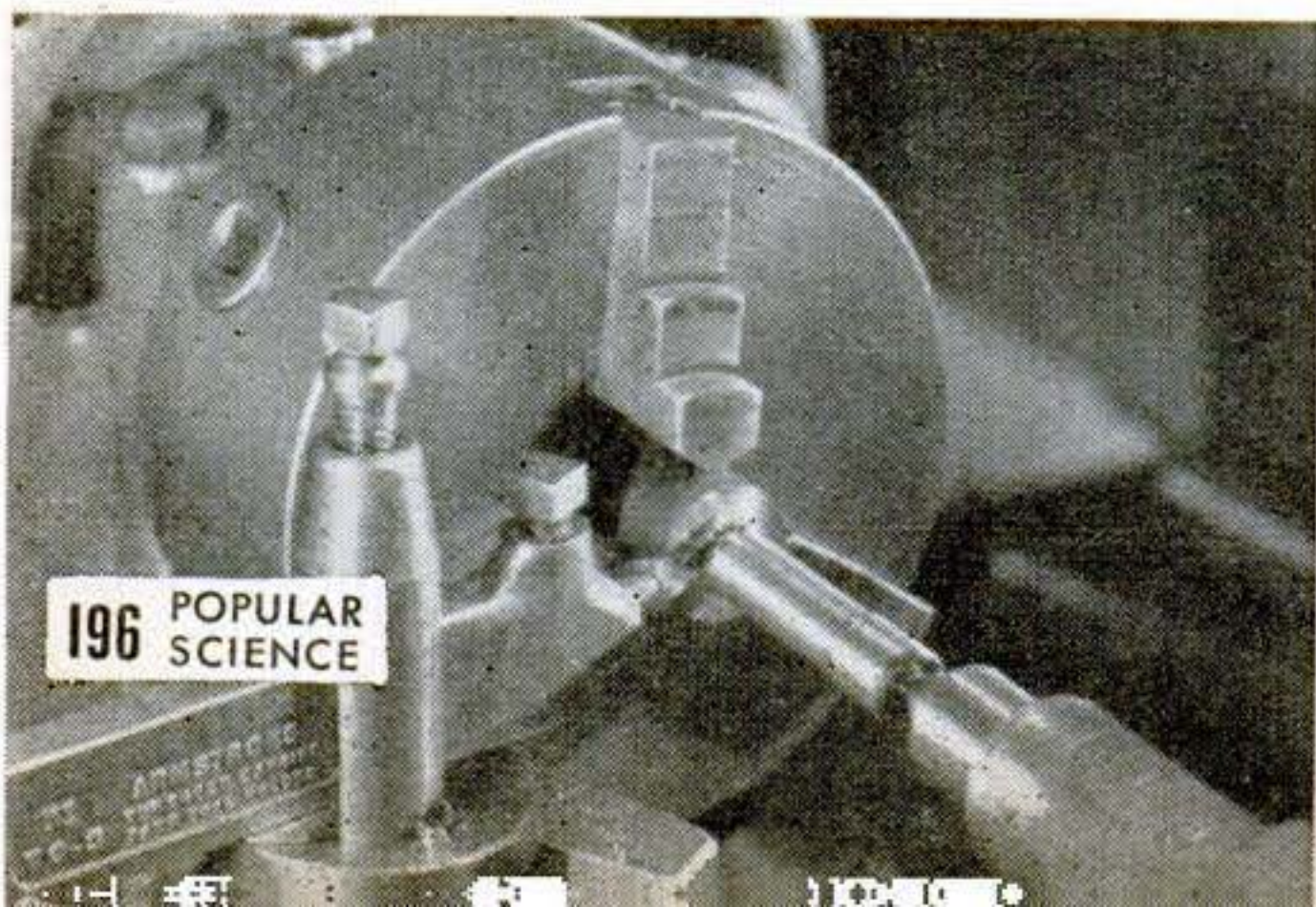





Paste flux from the kit is applied to the spliced wires, and soldering tape is twisted tightly around the splice.

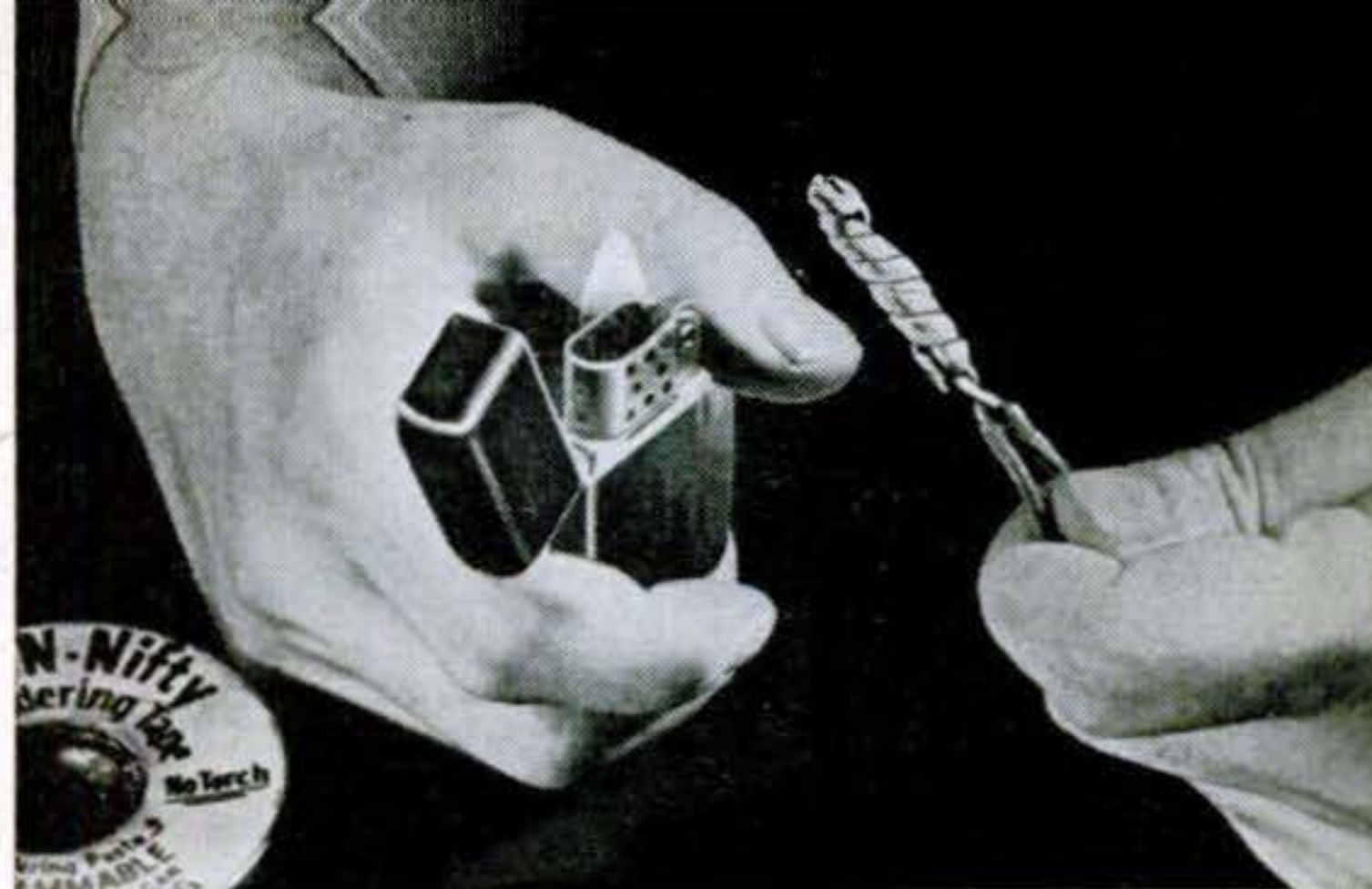

Unused tape is then put safely away—it is highly inflammable—and the twist is fired.

Flame and sparks follow the twist along the splice. Take precautions to protect clothing and woodwork from damage.

The surplus of melted solder is wiped off, and the soldered connection is left clean.

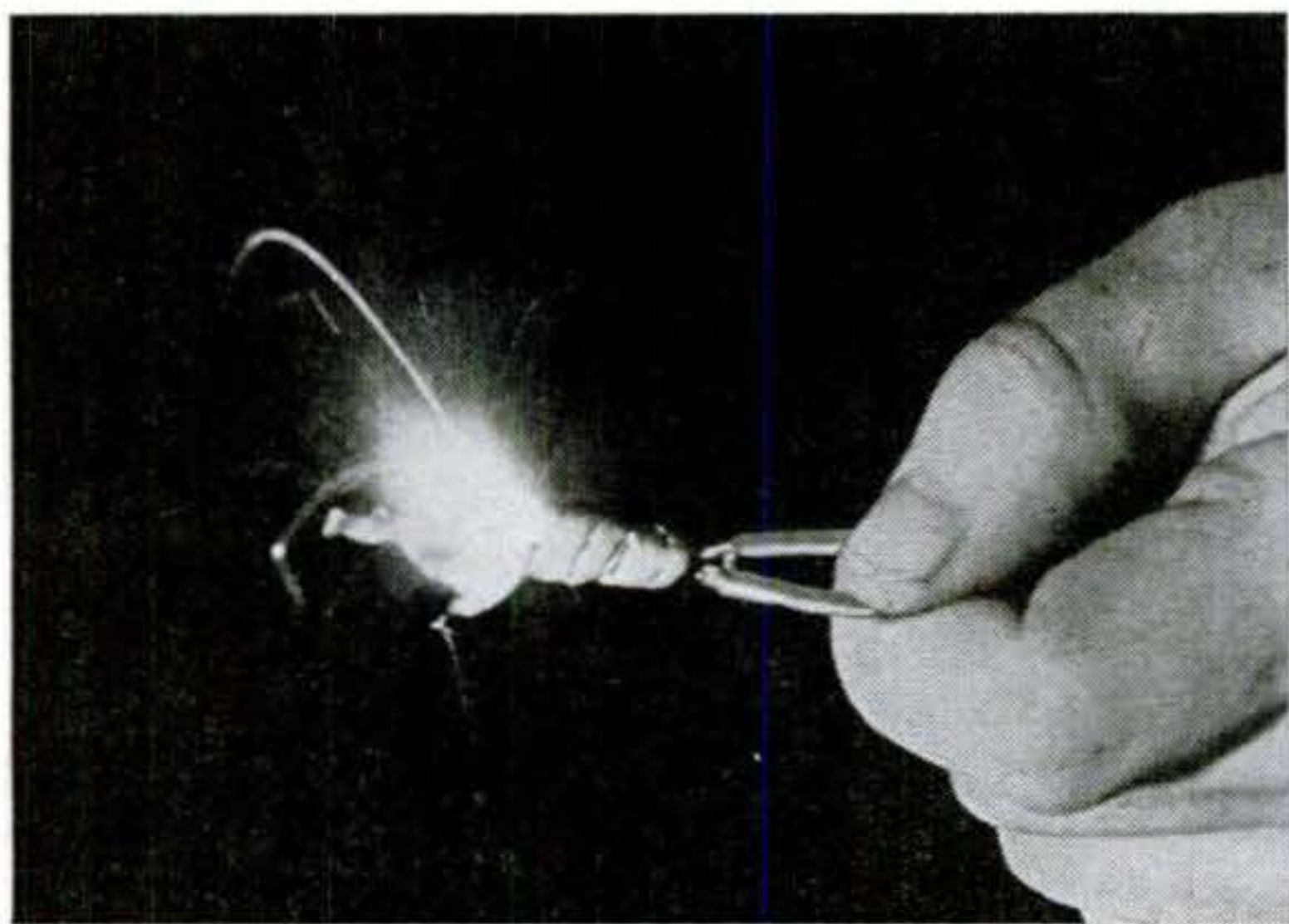

## Self-Heating Solder Does Job Without Use of Iron or Torch

MANY soldering jobs can be simplified by the use of a new soldering tape that carries its own heat and is ignited with a match or cigarette lighter. The tape is made up of solder on one side and plastic containing a chemical fuel on the other. Twisted solder-side down on spliced wires, or laid over a hole to be plugged or between two metal surfaces to be joined, the solder can be flowed onto the work in less time than it

takes to heat a torch or soldering iron.

Paste flux to be used with the self-soldering tape comes in the kit. The tape can be used like any ordinary solder on tin, copper, and brass. Surfaces to be joined have to be scraped clean, as usual, in order to make the solder stick.

The product is made by W. B. Franklin Company, of San Fernando, Calif., in 75-cent and \$1.50 kits.

## Powder Starts Arc for Welding

AN ARC-WELDING starter that eliminates contact between the electrode and the work and prevents blown fuses caused by the electrode freezing to the work is offered by the Electrical Engineering Company, of Indianapolis, for both A.C. and D.C. welding.

Illustrated is a test with a pinch of starting powder on a  $\frac{1}{4}$ " square of .020" cold-rolled steel unclamped on the work table. At 15-amp. welding heat, the arc starts before the electrode touches the work.





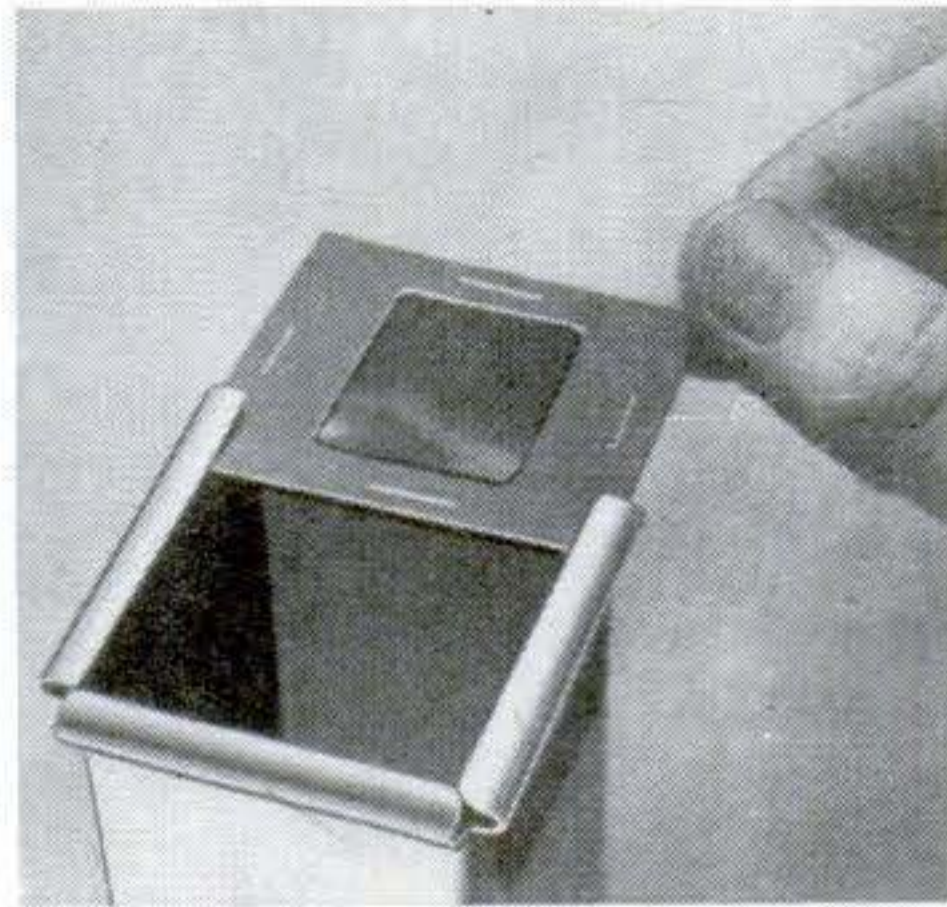
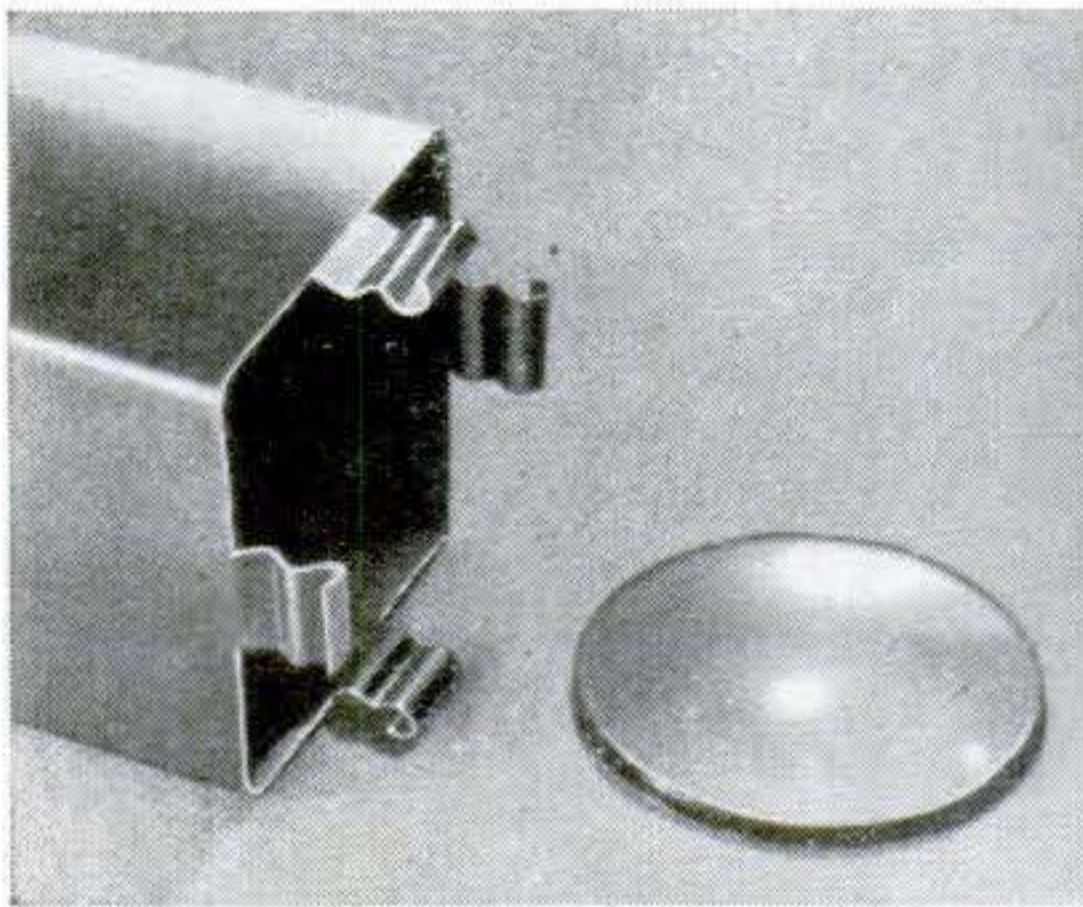

To use the viewer at a desk or table, direct a light toward a sheet of white paper at close range and view slides against the paper.

Tabs  $\frac{3}{8}$ " wide and  $\frac{7}{8}$ " long are left on one end and shaped into clips to hold the lens in place. To protect the lens, bind a narrow strip of tape around its edge.

On the opposite end, tabs are bent outward in a U-shape on three of the edges to receive the 2" by 2" slides.

### Simple Slide Viewer Shaped from Tin

METAL cut from a large tin can will provide the material for the body of this convenient slide viewer. The only soldering required is where the edges are fitted together into a seam at one corner.

Before cutting the metal, determine the working distance of the lens by experiment, for this will determine the length of the viewer. The model shown is  $3\frac{1}{2}$ " long and  $1\frac{13}{16}$ " square. At one end, tabs on three edges are bent into a U-shape to receive the slides, and at the other tabs on all four edges are formed into clips to hold the lens. The viewer will be more efficient if the inside is coated with dull black photographic paint. In use the device is of course directed toward a window or other light source.—ROBERT SCOTT.

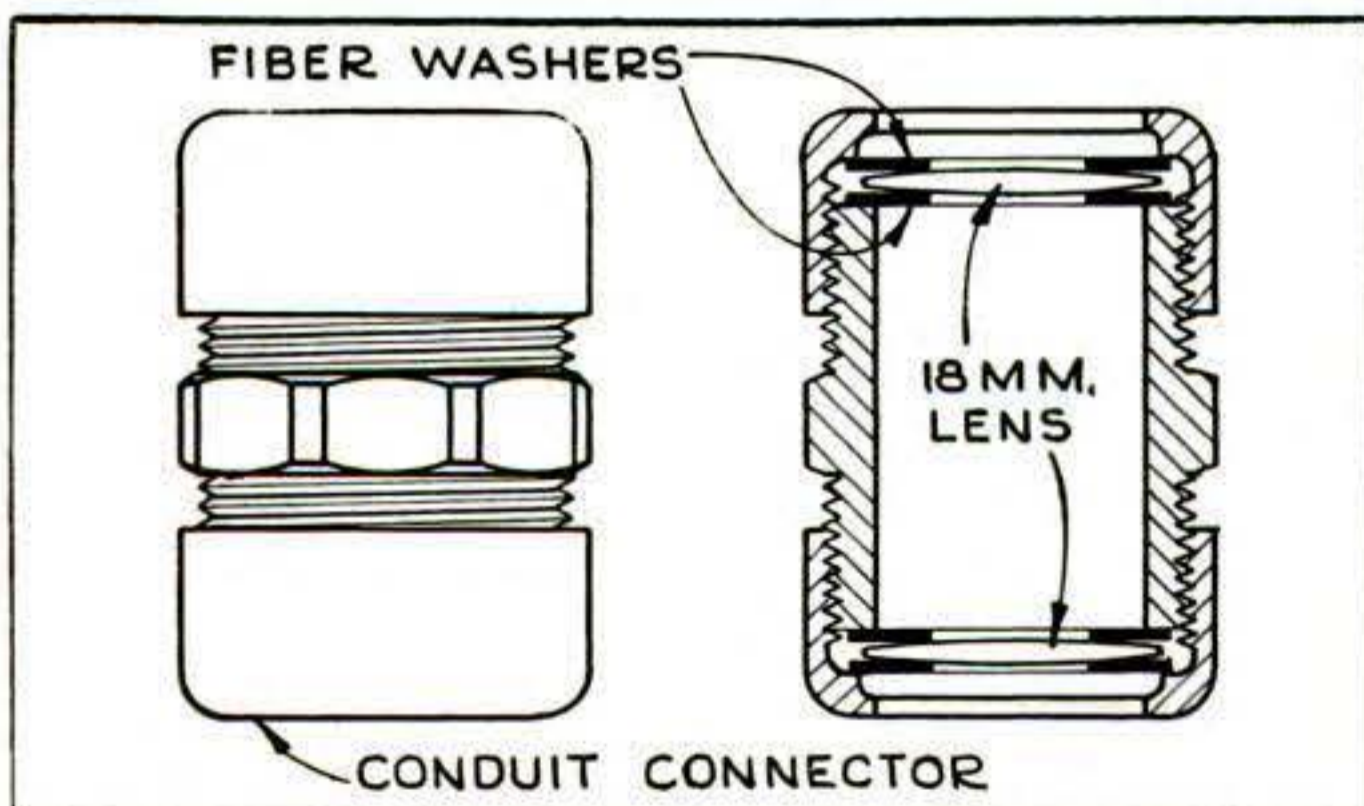

### Lens Set in Plastic Handle

MOUNTED in this plastic holder, a magnifying lens is less likely to be damaged when you put it down. Cut a groove  $\frac{1}{16}$ " deep equal in length to the circumference of the lens, using a V-shaped chisel or a routing tool. Smooth and round off the edges with sandpaper, heat the plastic in an oven until soft, remove with gloved hands, and bend around a suitable form. Insert the lens and cement the handle.—FRANK SHORE.

### Conduit Fitting Holds Lenses

Two 18-mm. lenses, each having a focal length of 50 mm., can be mounted in a standard electrical conduit connector to make a convenient hand magnifier. The conduit connector comes apart in three pieces. In each end piece, sandwich a lens between two fiber washers,  $\frac{3}{4}$ " in diameter with a  $\frac{3}{8}$ " hole. Then screw the parts of the connector back together.—ALFRED BLAKER.

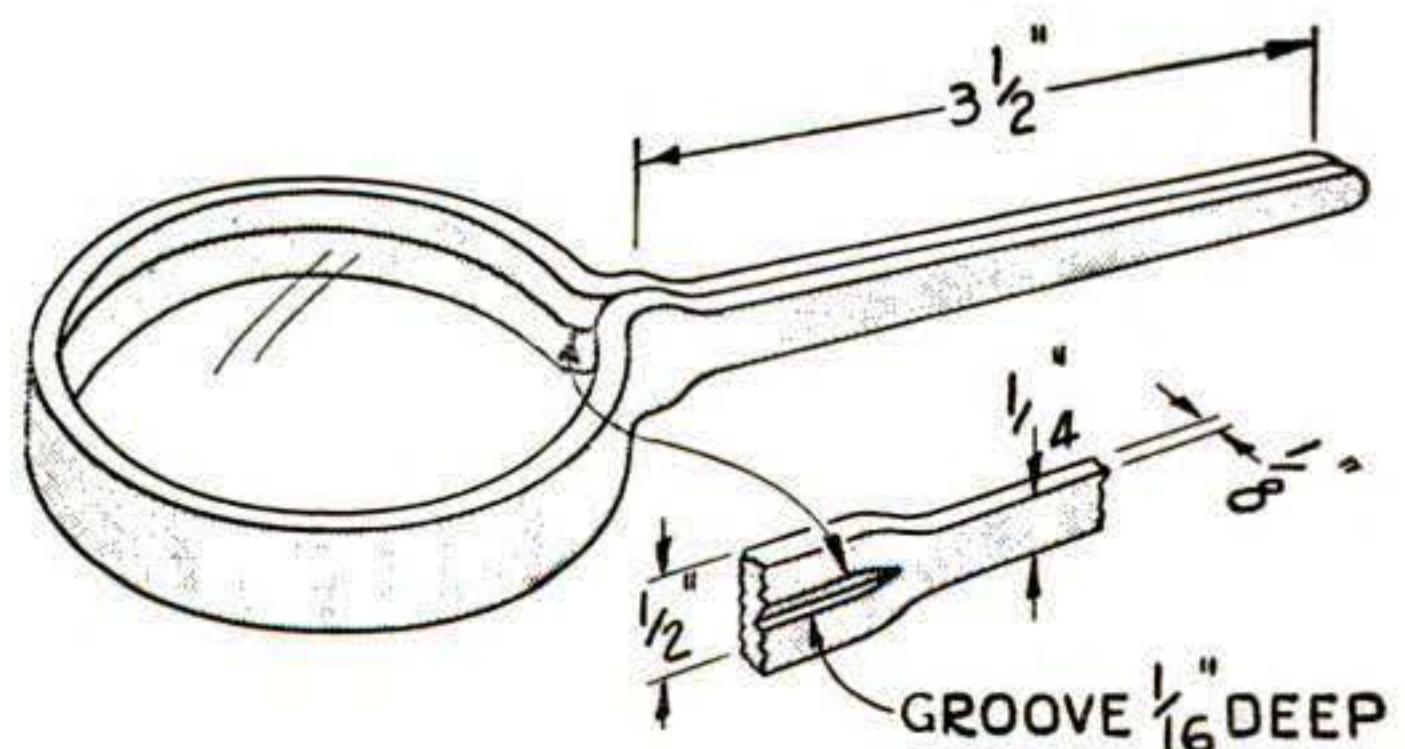





# Shoot LESS Show MORE

By FRITZ W. NEUGASS

THERE is a Latin proverb, "*De gustibus non est disputandum*," that means, "You can't argue about taste"—but the Romans didn't know anything about cameras. We photographers can't help arguing about taste, and we even get something out of it.

Recently I went with my Rolleiflex, my tripod, and my friend Dick to a meeting place of photo fans—the catacombs under the highway along the Hudson River at 79th Street. The view hunters find ample opportunity there to shoot the river and the Jersey shore through arches and vaults. Now

Actually less space is encompassed by the camera in the photo above than in that below, but which picture would you say shows more? By taking his stand closer to the bridge, the photographer has achieved a sense of distance that the foreground expanse of river in the lower photo dwarfs, and he has captured detail even on the distant shore.

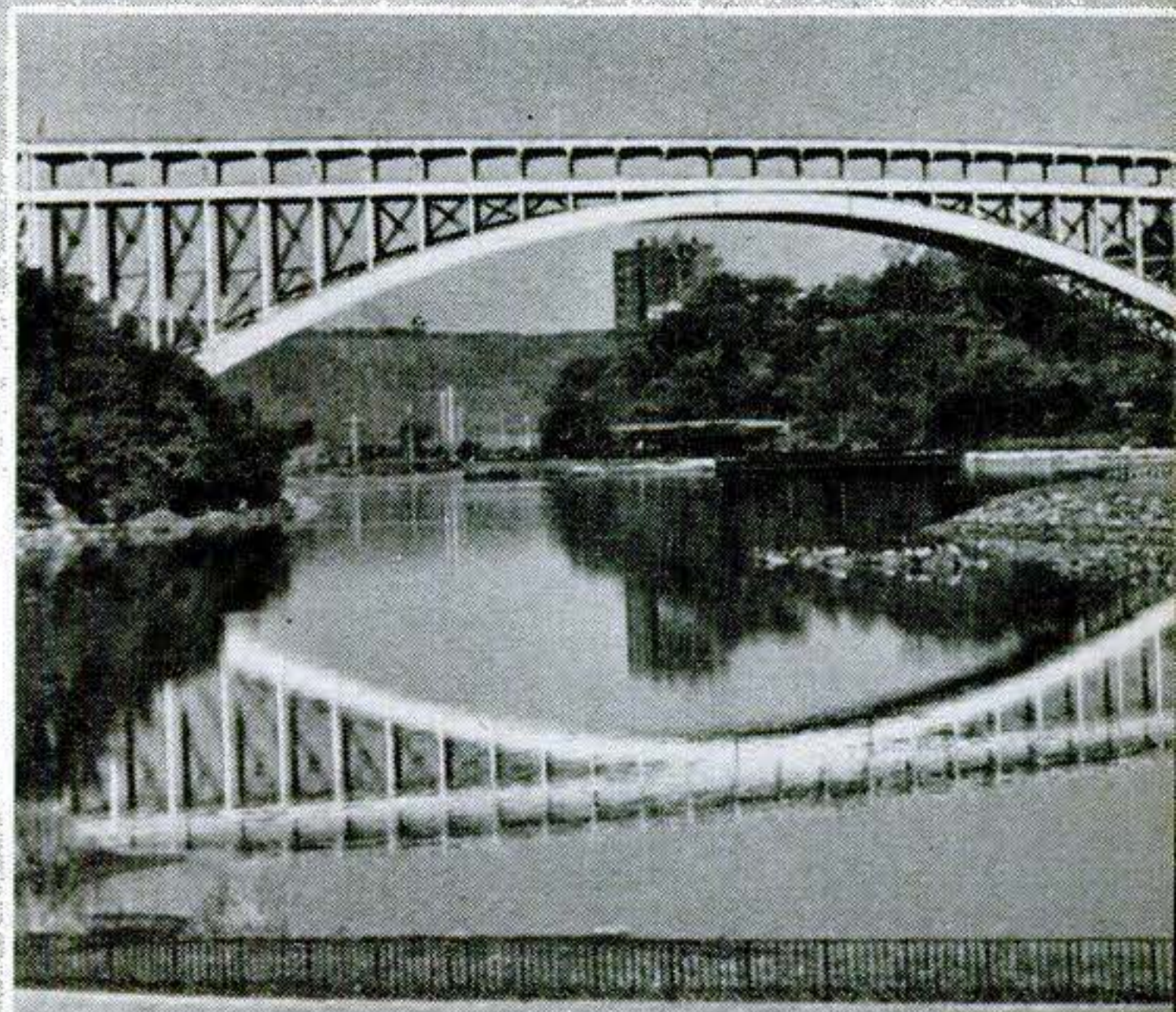

APRIL  
1947 199



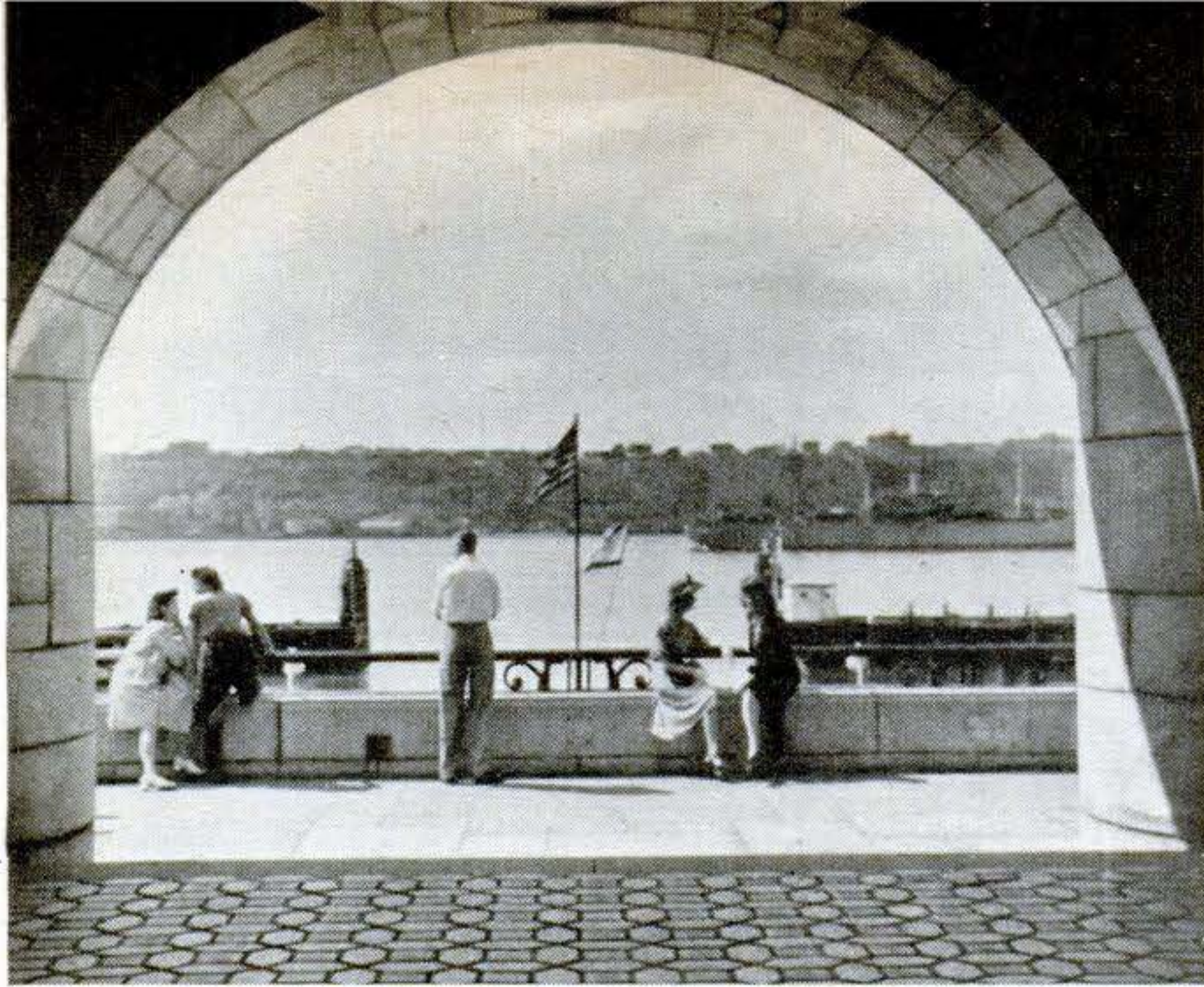

Snapped head-on under an arch, the photo above includes so much that no basic theme stands out. Pictorially it's dull because of parallel lines and symmetry. The view below sacrifices details for dominating architectural lines and diagonals that accentuate depth.



Dick is a fellow who is usually pretty sure that he's right. This time I gave in and followed his suggestions.

Dick liked the wide arch spanning almost a half circle; he liked the people sitting and standing in the foreground; he liked the flag in the center; and, recently discharged from the Navy, he didn't want to miss the warship at anchor.

My conception, however, was quite different. The symmetry in his composition, the heavy vault, and the many parallel horizontal lines impressed me less than the picture that was waiting only a few feet away, at an angle that transformed the arch into almost a Gothic point. I discarded the foreground figures, concentrating upon the massively constructed arch and upon the strong diagonal patterns. Later, in the darkroom, Dick found my conception of the scene empty and unappealing, just as I had found his conception cluttered and a little obvious.

The sight of downtown New York thrilled Dick. He saw the skyscrapers stretching toward the sky; he was enchanted by the elevated and by the traffic on the street. His only regret when I snapped the lower picture on the facing page was that no train was passing by.

But only a few steps forward, I discovered a new approach to this same photographic subject. Attempting to bring some order into this pell-mell scene, I concentrated my composition within the heavy frame of the elevated with its curved shape and strong black tone. Dick agreed that the picture had something, but





Two ways of looking at New York. At right, the confusion of street, elevated, and skyscrapers is true to life, but hardly a picture. Above, the distracting multitude of motifs is suppressed in favor of one — the cluster of buildings framed by the "E".

he couldn't forgive me for cutting out the people and cars.

Again, along a stream, Dick picked a spot that would show almost the entire arch of a graceful bridge and its full reflection in the clear water. We walked a little distance along the bank, and I stopped at a point where we could look up at the bridge to make it appear higher, where we could find detail in the rocks and foliage of the near shore and not be so far away that contrast would be lost in the background.

The result pleased even Dick. He was willing at last to admit that often the camera can capture more while aiming at less, that the whole may be clearer through detail of a part. END





## PHOTO IDEAS and EQUIPMENT

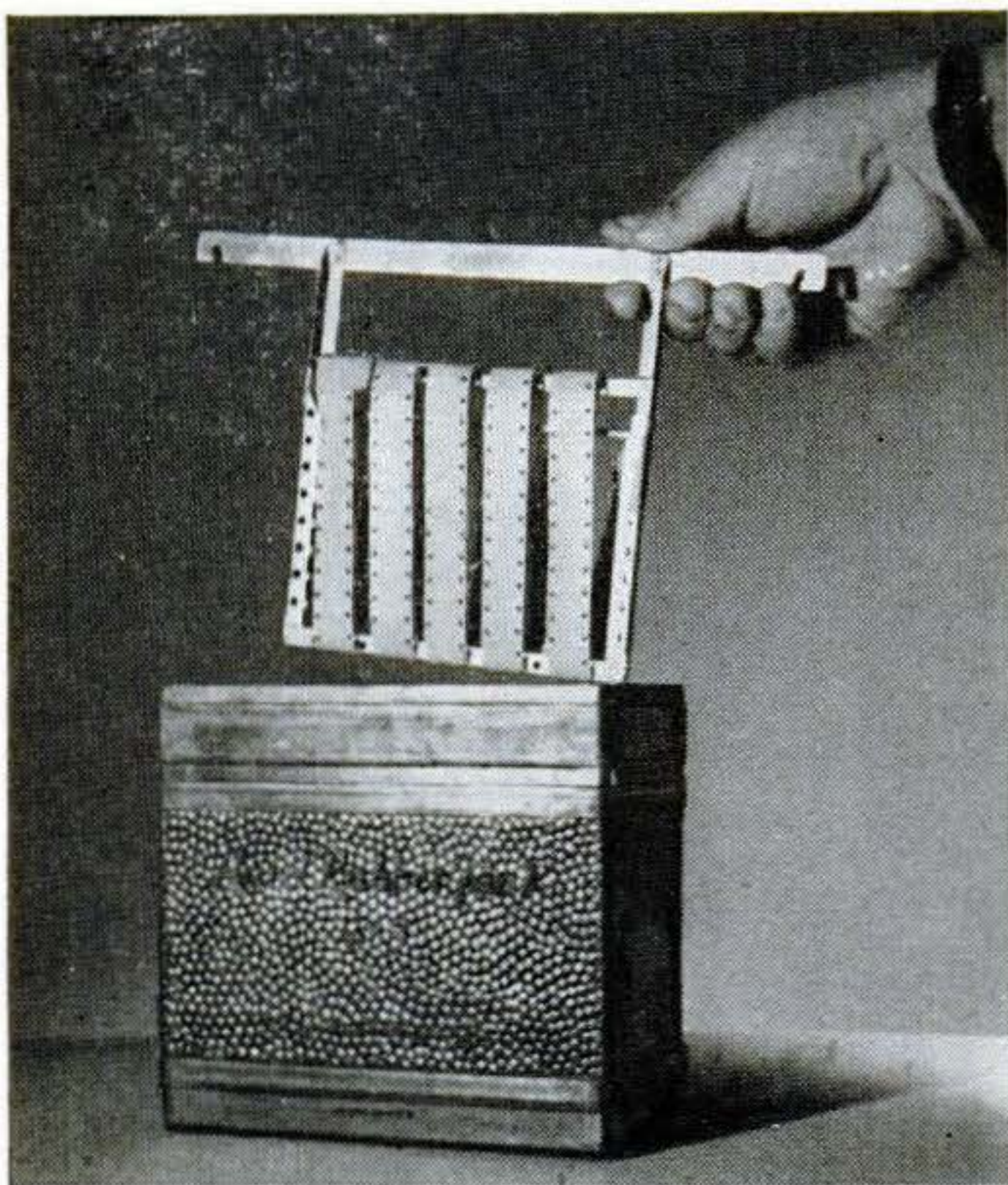
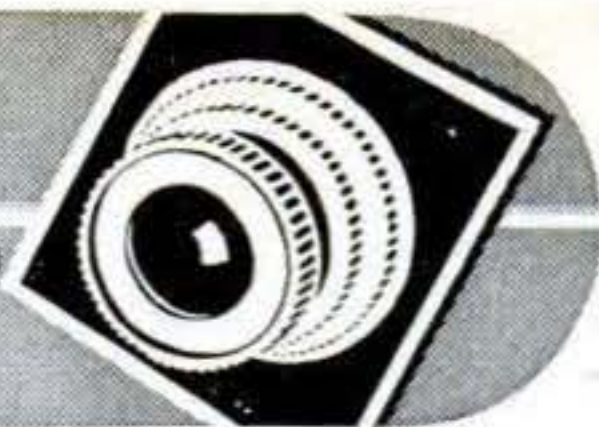

**PROCESSING MOVIE FILM.** Amateurs who shoot their own movie titles on positive stock can develop lengths up to 36" on cut-film hangers. Tape one end of the film to the upper corner of the hanger, wind the film around the frame as shown, and tape the other end also.—LOUIS HOCHMAN.

**BRUSH USEFUL IN DARKROOM.** Shoe-polish applicators of the type shown below have many uses in a darkroom. Their soft sponge daubers won't hurt prints or negatives. Here, one is being used to apply Farmer's reducer.—H. LEEPER.

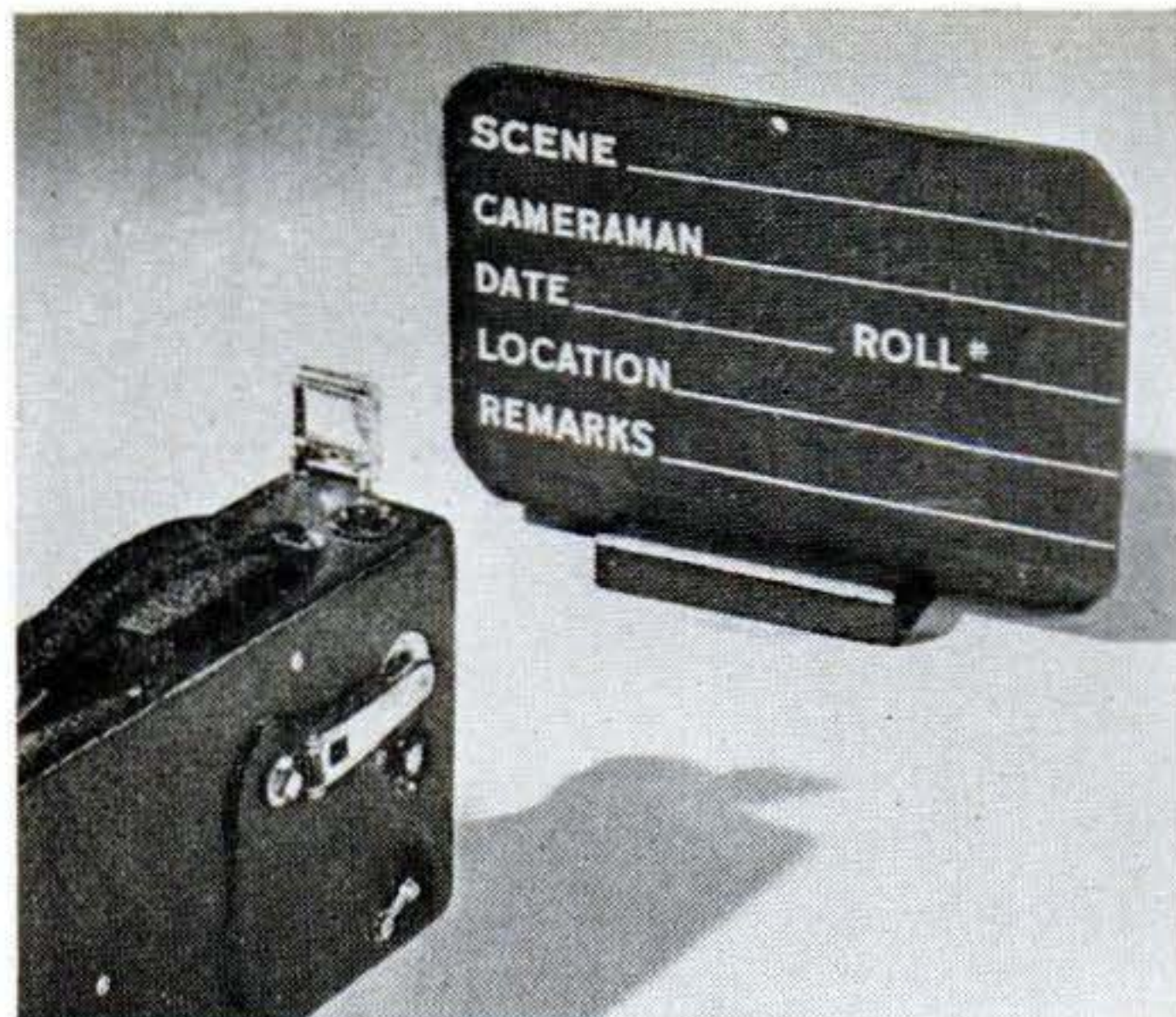

**SLATE IDENTIFIES MOVIES.** For amateur movie makers, the Cine-Slate above offers a means of identifying each roll, scene, date, cameraman, and location in the same way that is used in Hollywood. Marketed by the Sherwood Products Company, of Forest Hills, N. Y., it measures only 6" by 9", making it convenient to carry.



**FOCO-SPOT CONTROLS LIGHT.** Designed for use with the Bardwell & McAlister Baby Keg-Lite, the new B & M Foco-Spot shown above enables a photographer to confine light to any given area or shape of spot and to vary the focus and intensity at will. Four mats for rectangular effects and a revolving disk with apertures of various sizes offer a wide choice of light shapes. In addition, designs may be painted on glass slides and projected on a background, while the lenses mounted in the tube give easy focusing.





Despite its cumbersome appearance, this studio stand is readily maneuverable. One wing nut loosens the camera shelf for quick adjustment to any level. The base slides on dome gliders.

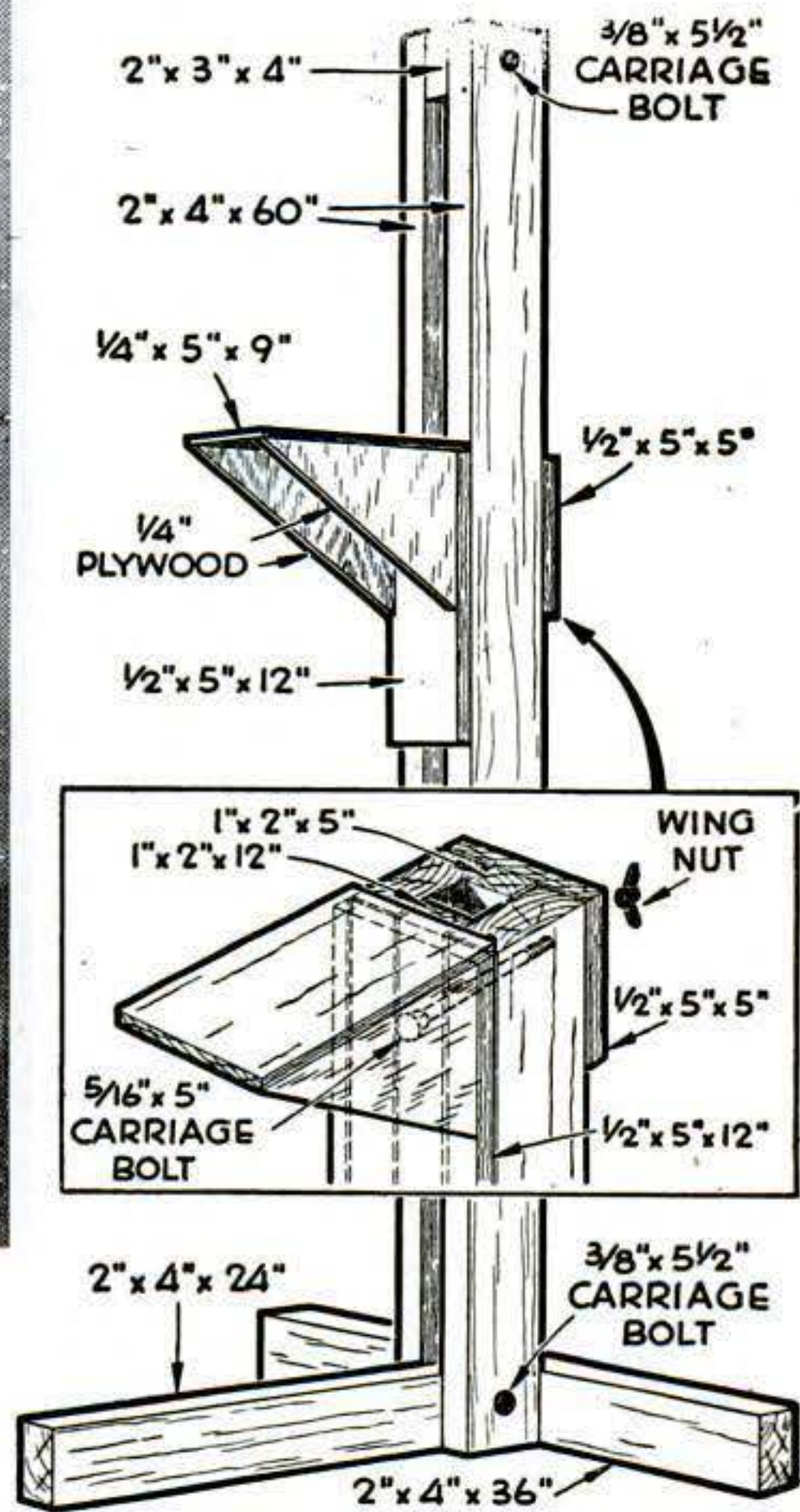

**STUDIO STAND ADJUSTS EASILY.** In a home studio, a camera stand such as this is more convenient than the ordinary tripod. It is set more quickly to different levels and is less likely to be upset.

Although supporting members of this particular stand are cut from two-by-fours, you can use lumber of smaller size if you wish—and still retain rigidity. In addition to two  $\frac{3}{8}$ " by  $5\frac{1}{2}$ " carriage bolts, 20d. nails are used to hold together the five pieces of the

base and standard so as to assure rigidity.

Brad and glue together the plywood parts of the camera shelf, and attach the  $\frac{1}{2}$ " by 5" by 12" facing member to the 1" by 2" by 12" inside slide in the same way. The  $\frac{1}{2}$ " by 5" by 5" piece at the back also is bradded and glued to its sliding guide. These front and back clamping members separate when the wing nut is loosened. Give all sliding faces a thin coat of melted paraffin for easy action.—CHARLES KIMBALL.

**FAIRYTALE STUDIO.** As every photographer knows, it often is difficult to get a good expression and pose when taking a portrait of a child. In his studio at Bronxville, N. Y., Pat Candido has eliminated this difficulty. While the youngsters watch a movie, a remote-controlled camera, aimed at them through an opening beneath the small screen, catches their changing expressions. Disguised as sunflowers, high-speed electric repeater flash lamps operate almost unnoticed by the children. The studio is decorated with fairytale murals.

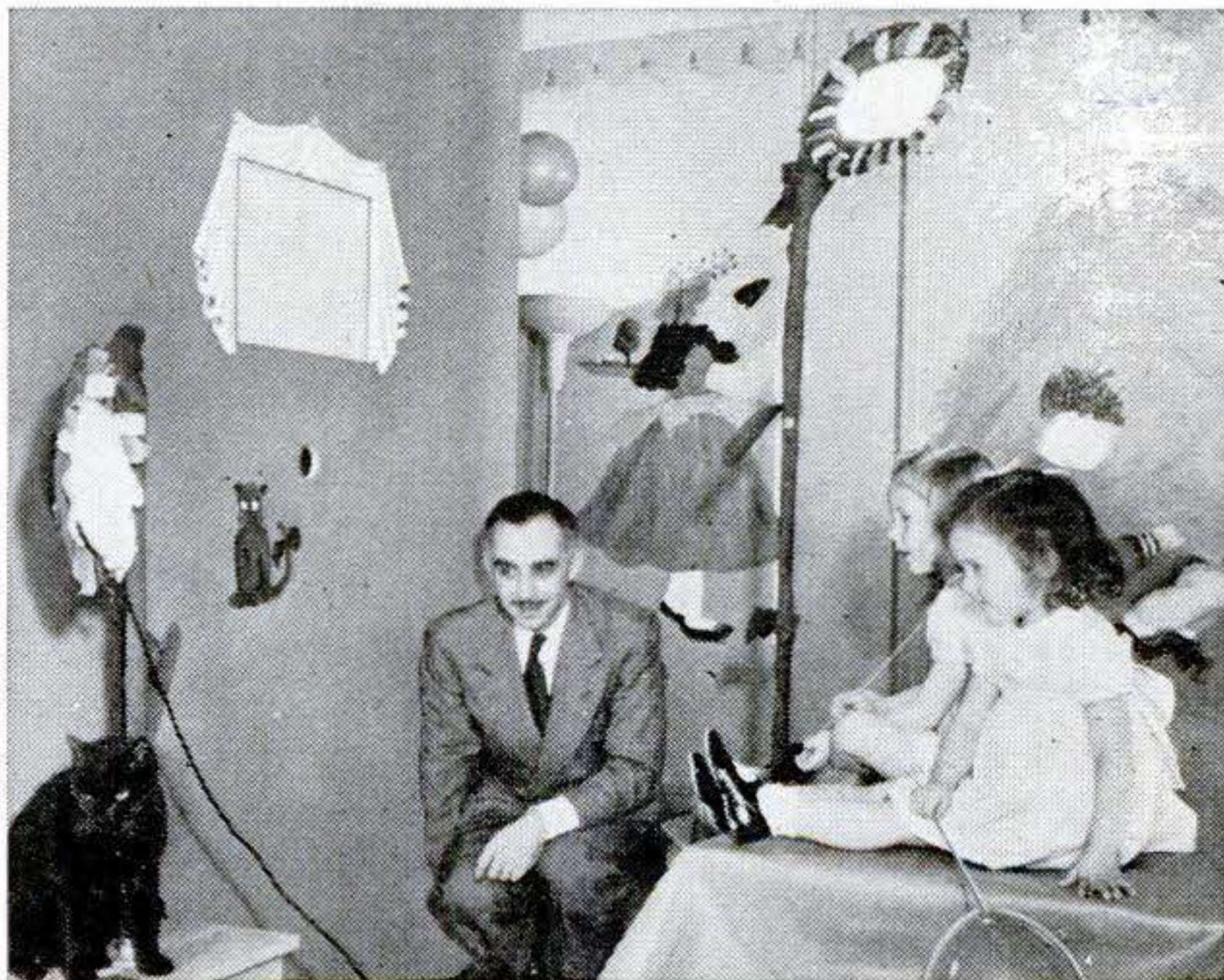





Elusive short-wave signals often come in best at night, so headphones are built into this two-band superheterodyne for midnight DX listening. Flicking a couple of switches, however, brings in the full broadcast band at loudspeaker volume.

By **FRANK TOBIN**

**T**HREE tubes for a two-band superhet doesn't suggest much power, but there's plenty of pickup and drive in this circuit to pull in the 20 and 40-meter ham-band transmitters as well as short-wave broadcasts from Europe and Australia. Reception on the broadcast band is clear and loud; a 10-foot hank of antenna wire strung out along the floor will usually be sufficient to get local stations at full loudspeaker volume, and an external ground can be omitted altogether. For remote locations or good DX listening, of course, you'll want a more substantial antenna and a good ground.

Being battery operated, this set is ideal for camp, hunting lodge, or week-end cabin as well as for the den. The use of only three tubes allows economical operation on dry batteries.

Considerations of size played practically no part in the selection of the midget 3S4 power tube; what is important about the

tube is that it will maintain good and undistorted output at plate potentials down to 65 volts. Most battery-operated power pentodes work well enough with a fresh battery supply, but when the cells age and voltage starts to drop, considerable distortion occurs at normal output levels. The 3S4, however, is built to work in personal radios that normally use 67½-volt batteries, and is therefore capable of distortion-free performance from 90 volts down to 65.

But even this allowance for a sliding plate voltage would do little good if the grid bias were fixed. To insure smooth operation throughout the entire effective life of the battery, a voltage is applied to the control grid of the pentode through an automatic bias circuit as described below, thus keeping the grid and plate voltages in operating harmony.

Within the limits of the circuit's sensitivity, the automatic volume control regulates volume at both the converter and I.F. stages. Fading on distant stations is dimin-



# Two-Band SUPERHET

**THREE-TUBE CIRCUIT PERMITS  
COMMUNICATIONS RECEIVER  
TO OPERATE UP TO 1,000 HOURS  
ON BATTERY PACK**

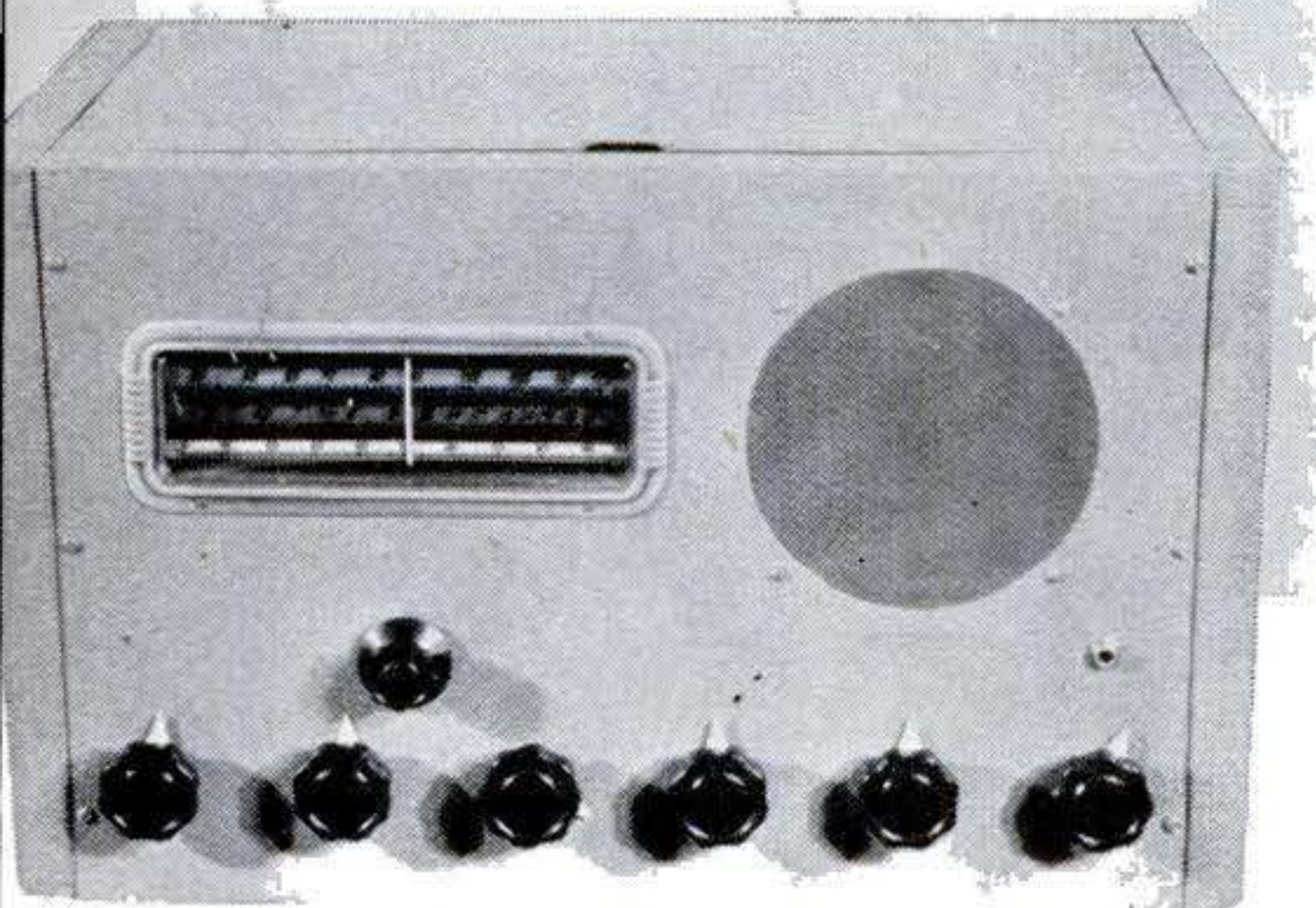

ished by A.V.C., which also prevents blasting when the set is tuned through the frequencies of local or strong transmitters. Automatic control of volume is obtained by impressing on the grids of the 1A7 and the pentode section of the 3A8 a bias voltage that varies with the strength of the incoming signal. A strong signal increases the bias voltage, thereby reducing the sensitivity of the tubes and decreasing their amplification; a weak signal reverses the process. Bias voltage is fed back from the diode detector section of the 3A8 through a resistance-condenser network.

For night-time listening or when signals are weak, a headphone jack has been included. By taking the phone-jack connections from the voice-coil winding of the output transformer, the phones can be switched in at any time, regardless of volume, without danger of blasting or overloading. Use the transformer tap that gives the most comfortable volume, and be sure that the grounded side of the phones cor-

responds to the grounded side of the speaker. This connection is shockproof since none of the high voltage flows through the phone circuit.

A variable tone control, consisting of a .1-mfd. tubular condenser (C12) in series with R10, a 75,000-ohm potentiometer, operates on both speaker and phones. By reducing the audibility of higher sound frequencies, this control serves to relieve heavy static conditions. High-pitched code signals can also be changed to more pleasing notes by means of the tone control, and musical programs can be tuned to suit the ear.

When a signal is picked up by the antenna, it is fed into the fourth grid of the 1A7 converter, where it is mixed with a signal generated by the local oscillator to create an intermediate frequency of 456 kc. After passing through the I.F. amplifier, this signal is rectified by the diode detector, then further amplified by the first audio tube. All three functions—I.F. amplifier, diode detector, and first audio—are performed by the single 3A8 tube. Building a pentode amplifier, diode rectifier, and high-mu triode into one glass envelope not only saves space, parts and work for the builder, but also cuts down filament current drain.

The output of the 3A8 amplifier triode is resistance coupled to the control grid of the 3S4 power pentode through a 75,000-ohm plate resistor, a .05-mfd. coupling condenser, and a 1-meg. grid resistor. A mica condenser of 100-mmfd. capacity in the plate circuit of the first audio stage by-passes any unrectified R.F. current to ground, preventing it from weakening or distorting the desired signal.

Through an output transformer, the audio-frequency currents flowing in the plate circuit of the 3S4 are fed into a 6" P.M. speaker. Load resistance of the tube is about 5,000 ohms; a selection of taps on the secondary of the transformer permits matching of this resistance to the speaker's voice-coil impedance.

Grid bias for the 3S4 is obtained by means of a 600-ohm resistor, R9, in series with the negative 90-volt lead and ground. The voltage drop across this resistor is impressed on the grid of the tube through the 1-meg. grid leak, R8. As the B voltage drops, so does the negative bias on the tube, resulting in a compensating increase in amplification. Automatically regulated bias permits the power tube to function efficiently even though the output voltage of the B battery



falls by as much as a third.

To protect the loudspeaker cone from damage, a wire screen is placed over the speaker frame. The screen is covered by a grille cloth before the speaker is bolted to the front panel.

The number of knobs in use could have been reduced if space had demanded, but it will probably prove convenient to have the full number. From left to right, these knobs control: sensitivity (R1, for local-distance tuning), wave band (S1), volume (R6), tone (R10), power (S3, on-off switch), and speaker or headphone output (S2).

Although the volume control and power switch might easily have been combined, the latter is also useful as a quick-action stand-by switch because the battery circuit requires practically no warm-up time. When the set is played through the loudspeaker, the speaker-headphone switch will provide even more instantaneous stand-by control.

Three-scale slide-rule dials of the type shown may be obtained with all the neces-

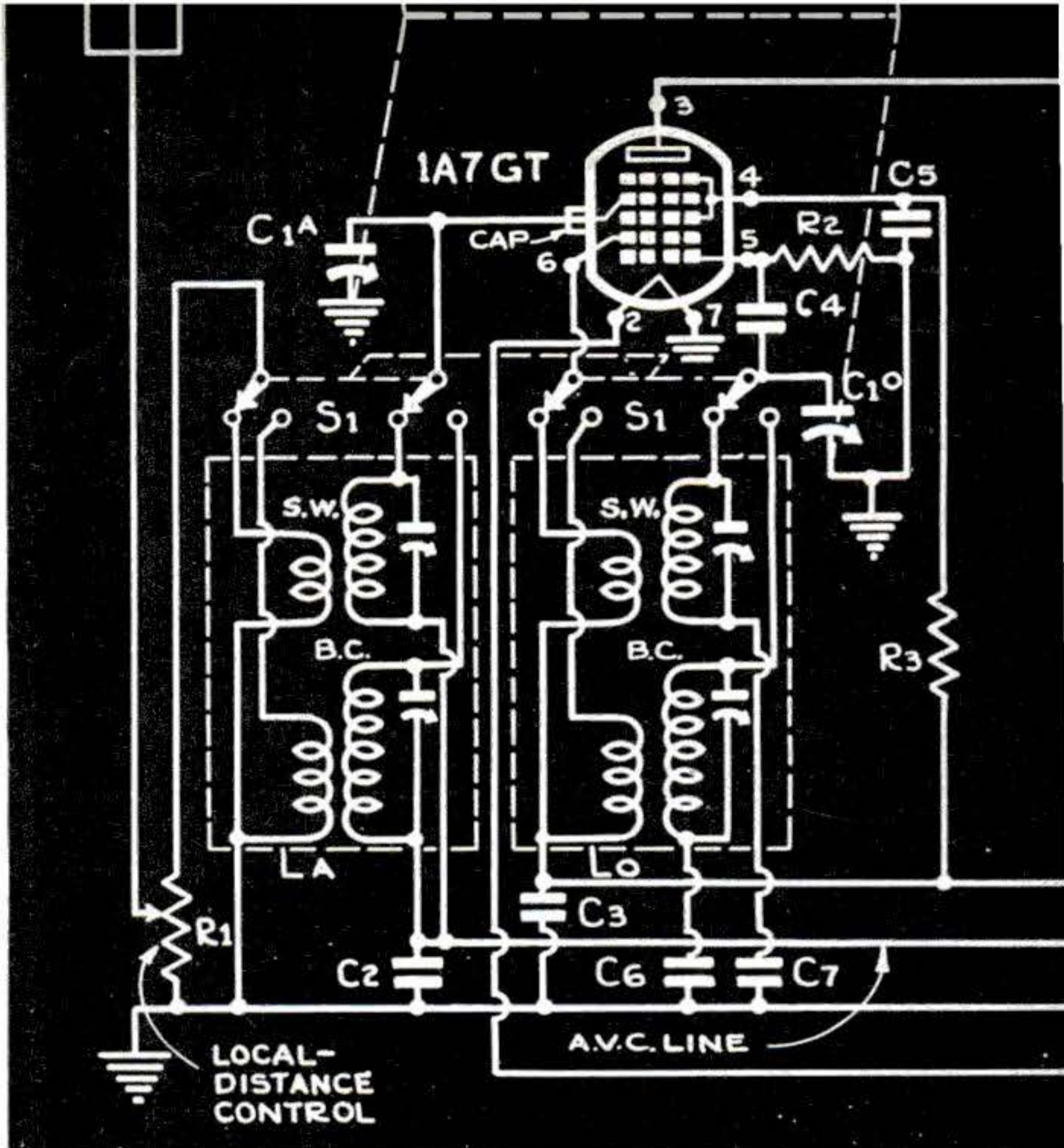

#### LIST OF PARTS

- C1: 360-mmf. two-gang tuning condenser.
- C2, C3, C5, C12: .1-mfd., 600-volt paper tubular.
- C4: 250-mmf. mica.
- C6: 400-mmf. mica, close tolerance.
- C7: .01-mfd. mica, close tolerance.
- C8, C10: 100-mmf. mica.
- C9, C11: .05-mfd., 600-volt paper tubular.
- C13: 16 mfd., 200-volt electrolytic.
- R1: 250,000-ohm potentiometer.
- R2: 50,000-ohm, 1/2-watt carbon.
- R3: 10,000-ohm, 1-watt carbon.
- R4, R5: 2-meg., 1-watt carbon.
- R6: 1-meg. pot.
- R7: 75,000-ohm, 1/2-watt carbon.
- R8: 1-meg., 1-watt carbon.
- R9: 600-ohm, 1-watt carbon.
- R10: 75,000-ohm pot.
- S1: 4-pole D.T. rotary band switch.
- S2: D.P.D.T. rotary.
- S3: D.P.S.T. rotary.
- LA: Shielded antenna coil, 540-1,500 kc., and 5,500-18,000 kc.
- LO: Shielded oscillator coil, same bands.
- I.F.1: Iron-core I.F. input transformer, 456 kc.
- I.F.2: Iron-core I.F. output transformer, 456 kc.
- T: Universal output transformer.
- J: Headphone jack and plug.
- Tubes, chassis, cabinet, 6" P.M. speaker, sockets, knobs, hardware, etc.

sary calibrations for both broadcast and short-wave bands, plus a 0-100 scale for logging purposes.

To align the set a modulated signal generator is, of course, desirable. If one is available, ground the shielded cable to the chassis and clip the live conductor to the grid of the 3A8 pentode. Tune the generator to 456 kc. and adjust the secondary and then the primary of I.F.2 for maximum sound at the speaker. Work backward through the first I.F. transformer. Tune the R.F. stage by removing the screws on the condenser (C1) trimmer and aligning the trimmers first on the oscillator and then on the antenna coils. Broadcast and short-wave bands will have to be tuned separately. Use a 1,500-kc. R.F. signal for the former and 15 or 16 mc. for the latter.

If you don't have a signal generator, you can tune by ear by first getting the strongest station you can find, and working backward in the sequence described above until the signal comes through with the greatest volume. It may be necessary to do the aligning of the short-wave band at night when strong stations are easier to find. Most I.F. transformers are factory tuned with sufficient precision to allow a strong signal to get through.

Cabinet size will depend largely on your individual requirements. The one shown was



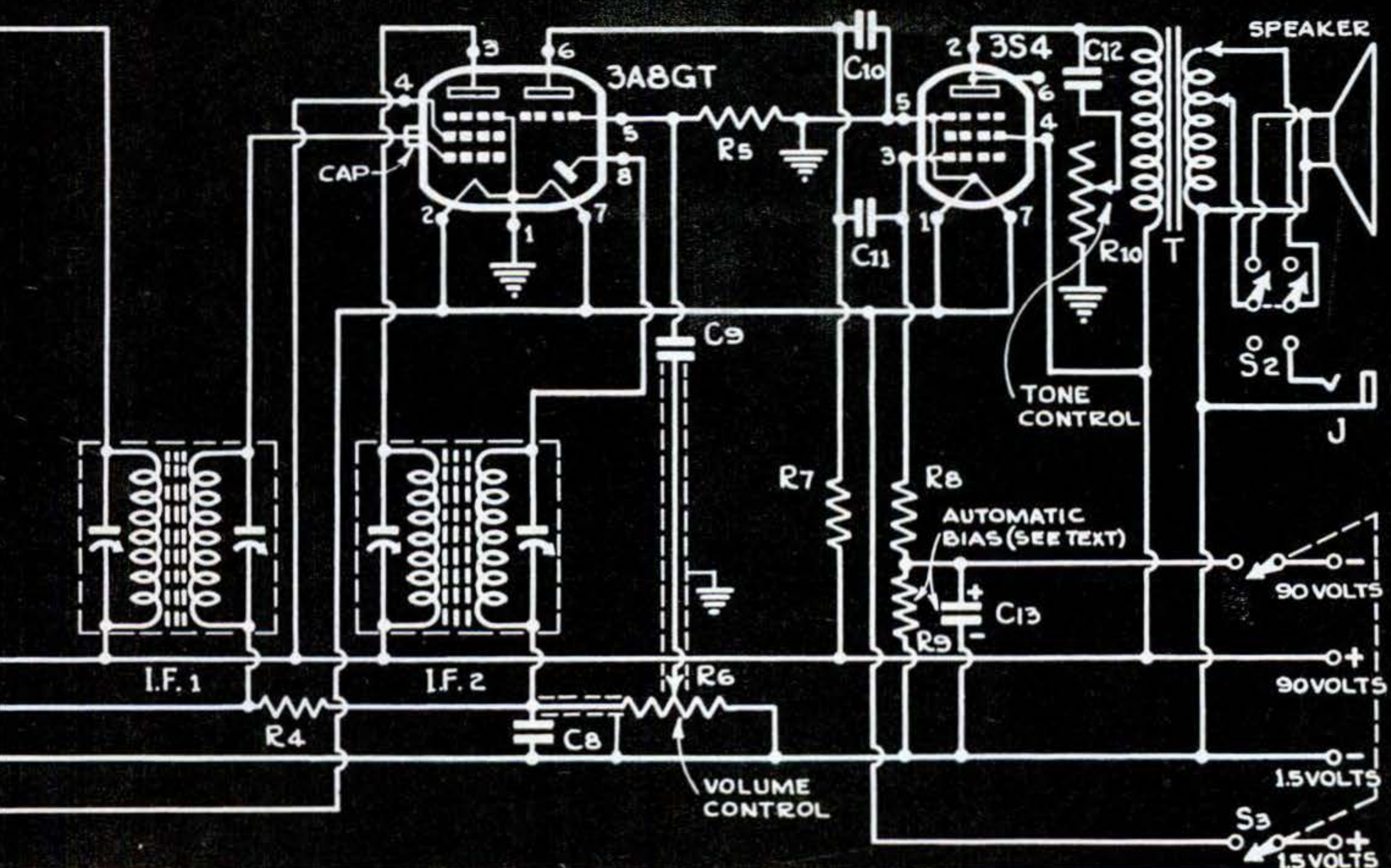

selected because it has room for a 1,000-hour power supply. Battery packs that deliver 1.5 volts for the filaments and 90 volts for the plates are now available in a variety of sizes and shapes. Where portability is a factor, a small pack may be used, in which case the cabinet can be much reduced in size. The larger of the so-called "farm" packs are estimated to be good for a full year of service with this low-drain circuit, based on average daily use of about three hours.

For extra usefulness the set may be readily converted to 115-volt A.C. or D.C. operation. A forthcoming article will describe a suitable dry-disk rectifier unit that will enable the builder to install a complete three-way power supply.

END

APRIL 1947 207

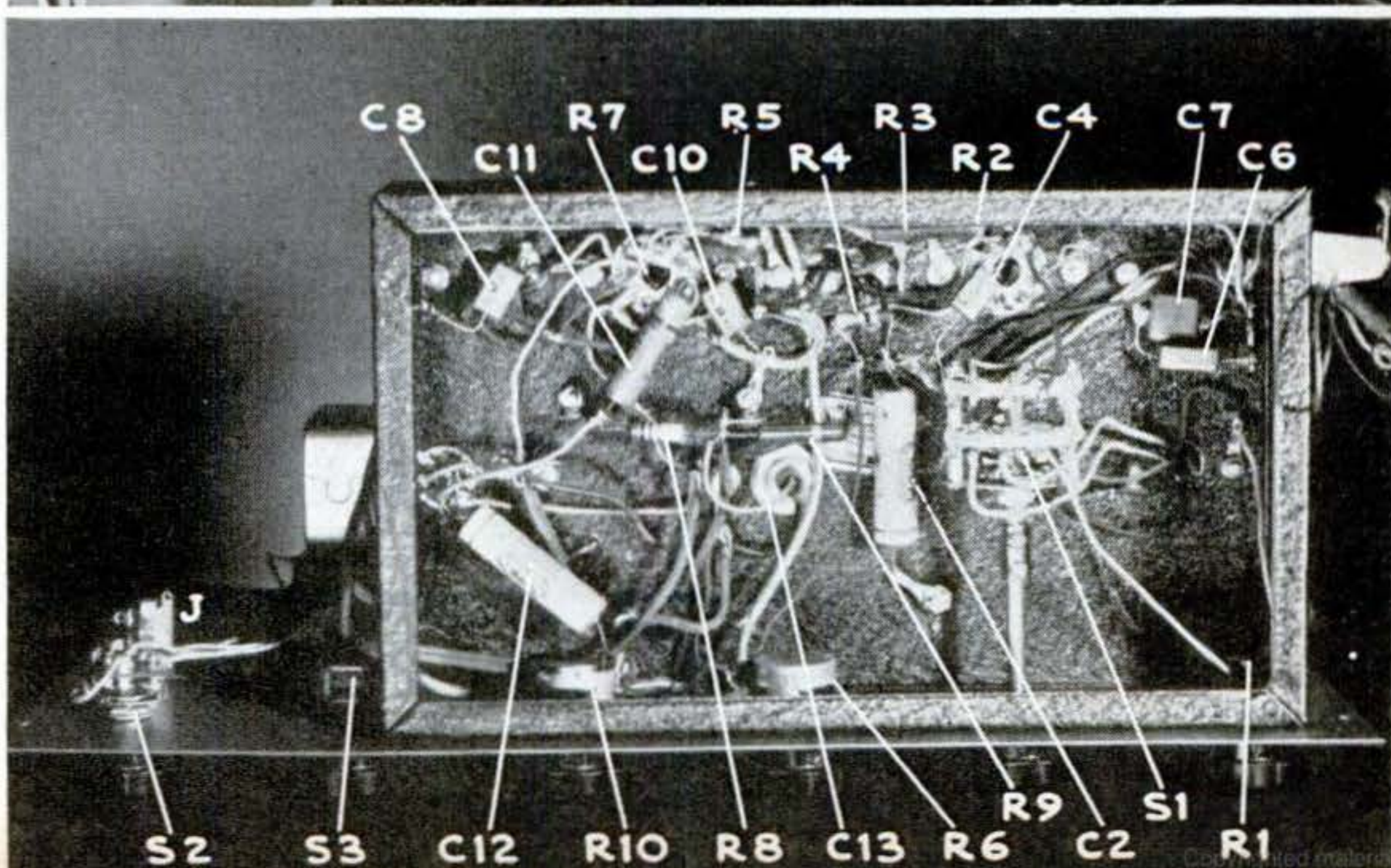
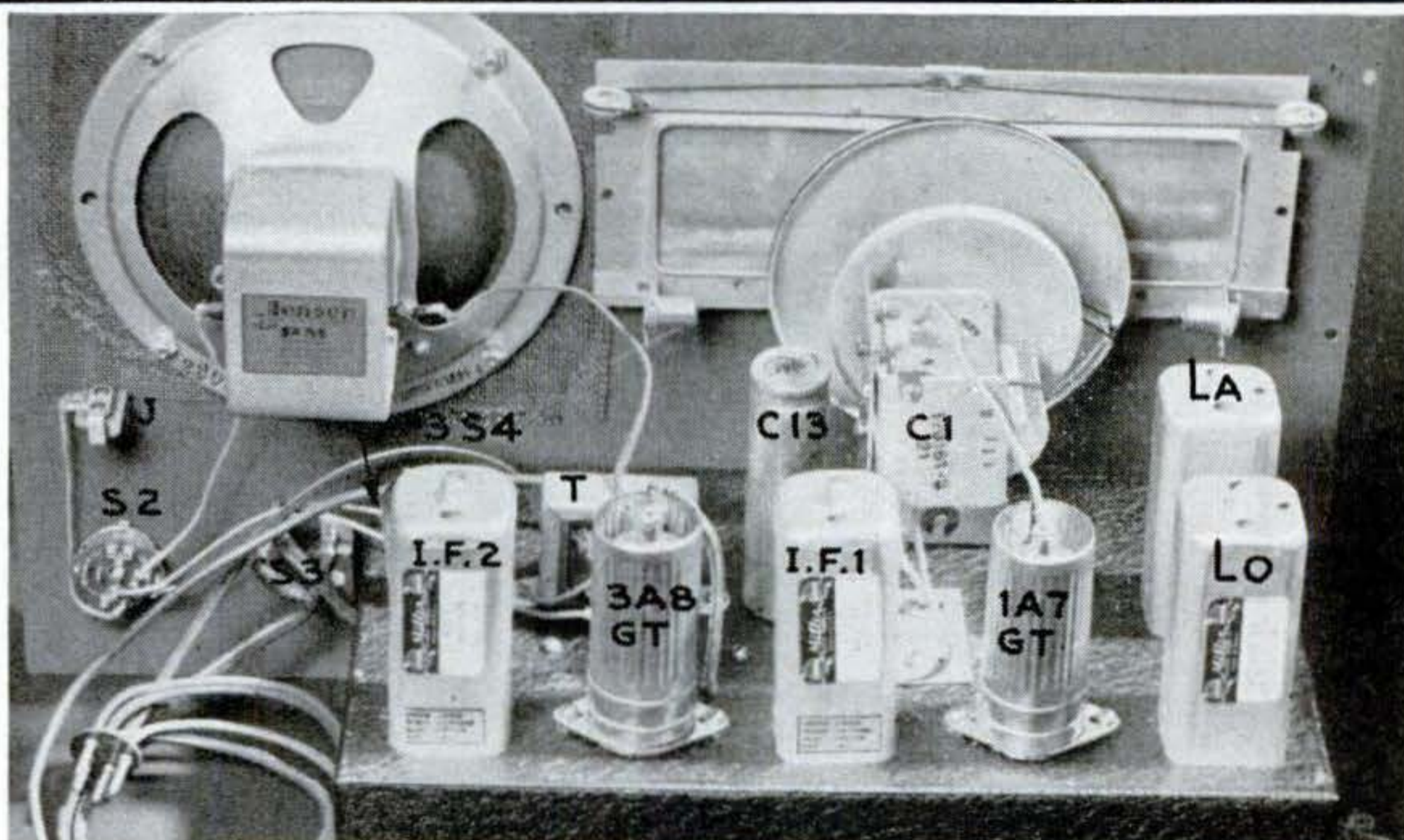



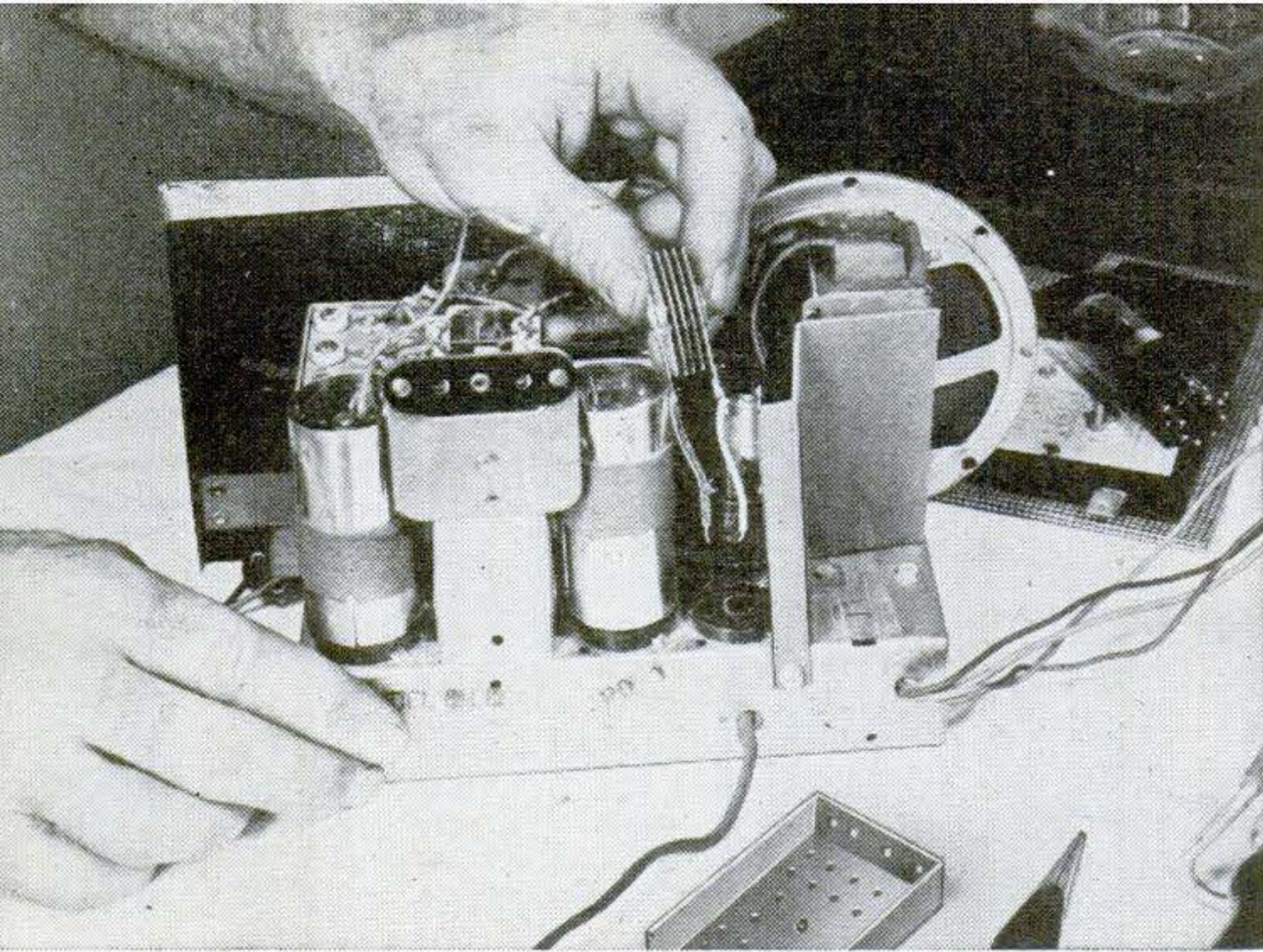

# Dry-Disk RECTIFIER

REPLACES  
BURNED-OUT TUBES

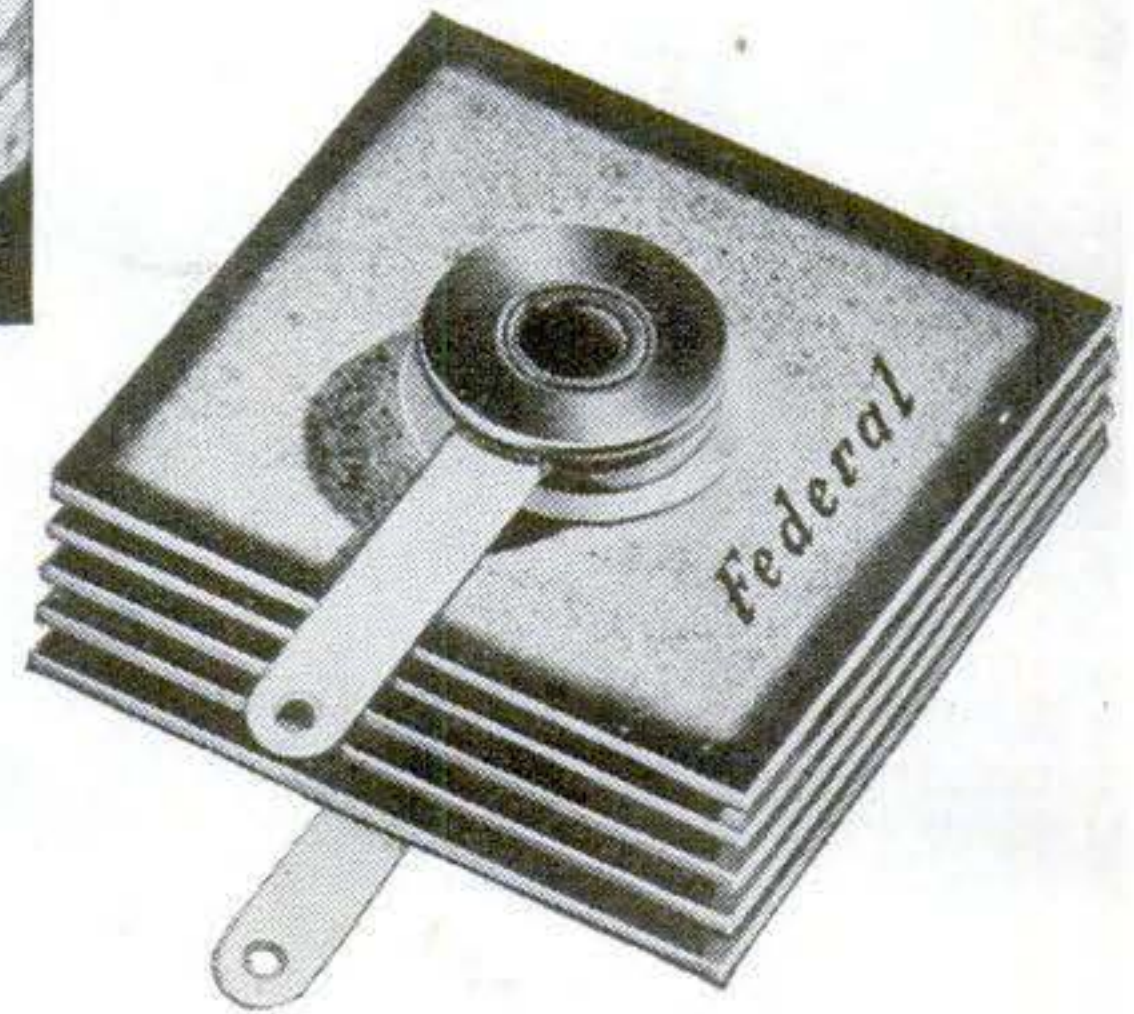

If the rectifier stack doesn't fit conveniently beneath the chassis, solder two extension leads to its terminals and install the disk over the empty tube socket.

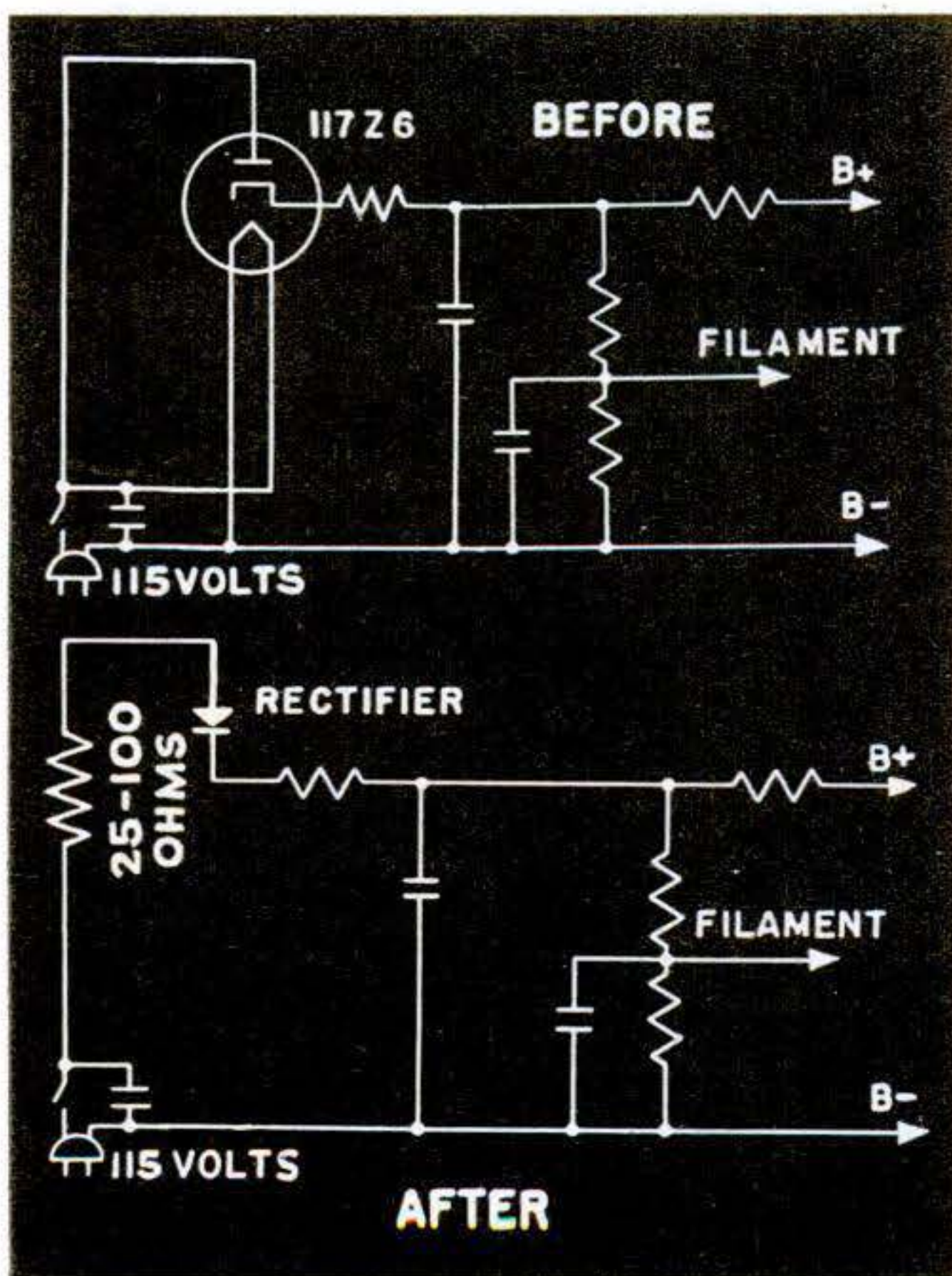
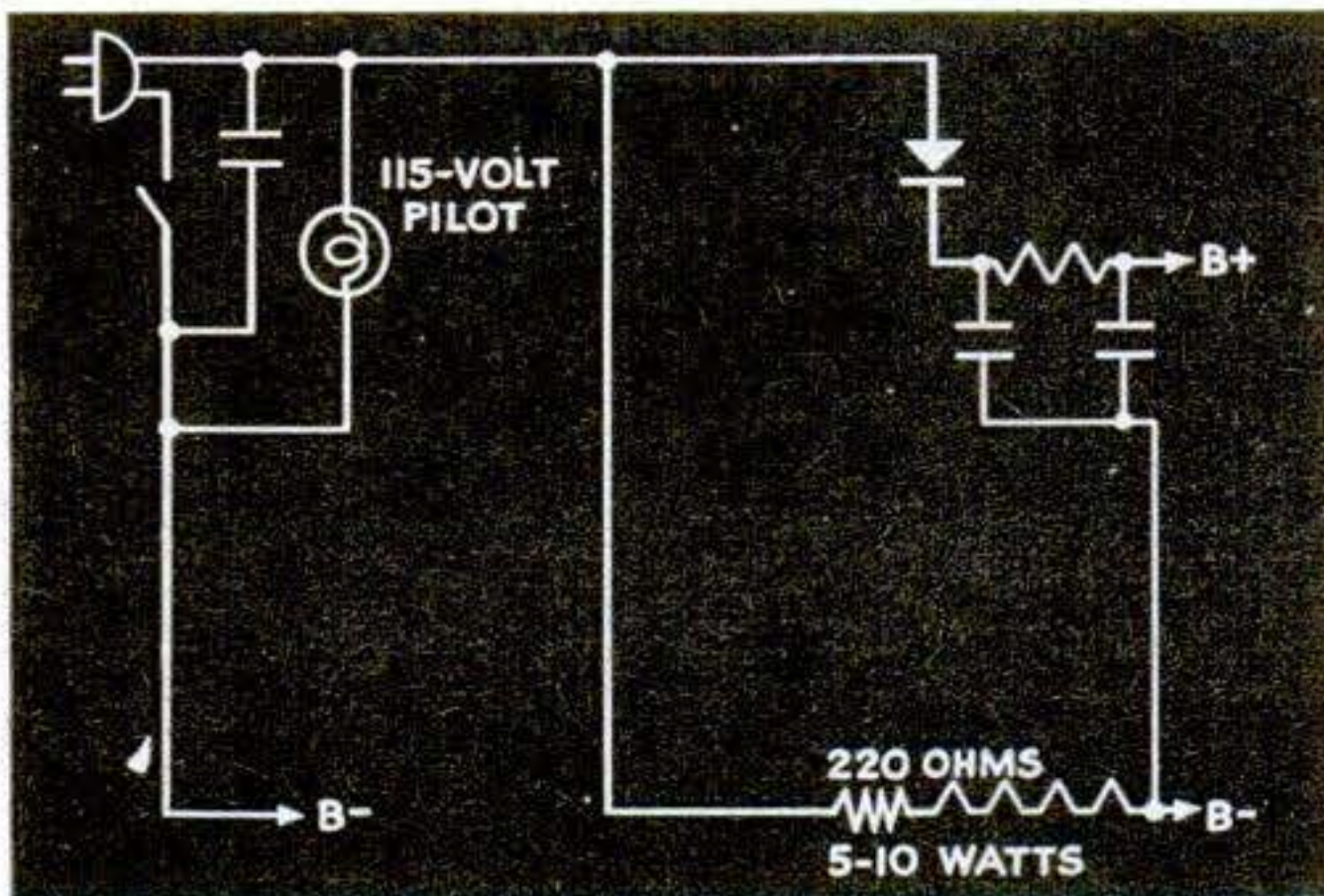

**P**RACTICALLY all commonly used rectifier tubes are now replaceable by dry-disk selenium rectifiers. They not only take the place of hard-to-get tubes, but are also smaller, cooler and quicker in operation (because they have no filaments to warm up), and they won't burn out or break under conditions that generally damage tubes.

Details of the replacement vary from set to set; the diagrams on this page show two typical installations. One involves a 35Z5 tube and the other a 117Z6. In the former case tube filaments are in series, requiring a 200-ohm, 5- to 10-watt resistor to be inserted in the line to provide continuity for the other heaters. Since the pilot light is generally operated off the center tap of the 35Z5, some changes are called for in that circuit as well. One of the simpler solutions to the pilot-light problem is shown at the upper left. The original pilot connections are shunted, and a 115-volt bulb is connected between the cold side of the power switch and the old tube's plate prong.

Where a tube of the 117-volt type is being replaced, a series resistor of between 25 and 100 ohms is needed (as shown in the bottom drawing) to compensate for the lower internal resistance of the dry disk. The filament connections, however, may be removed without affecting the other tubes.



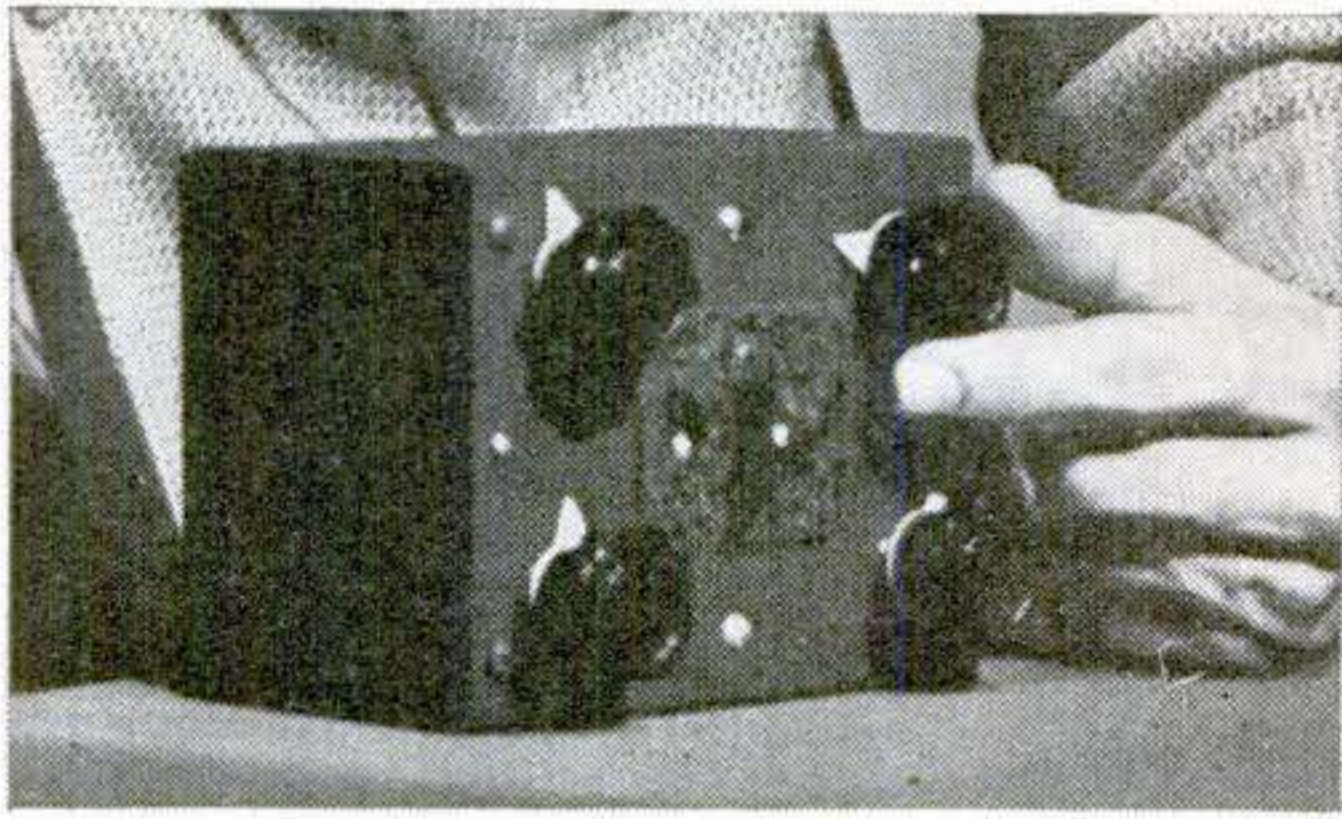

**DX BOOSTER.** For hams who have trouble picking weak signals out of the crowded, noisy airways, General Electric has designed the broad-band preamplifier and impedance-matching unit shown above. The combination of matching antenna to receiver and adding an extra RF stage is said to increase gain up to 60 db. The device, known as the "R-9'er" will be made by the James Millen Mfg. Co., of Malden, Mass.

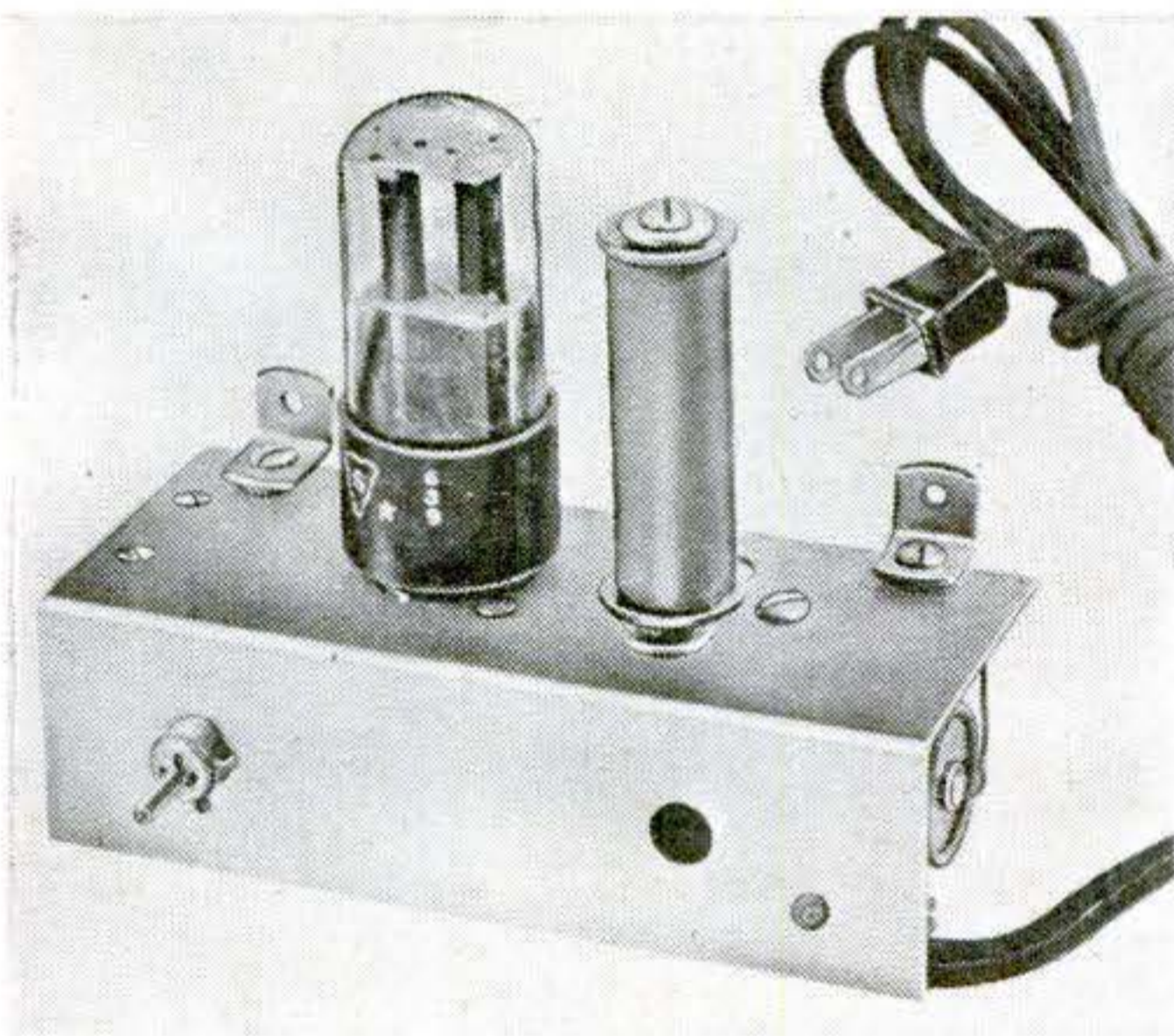

**PHONO OSCILLATOR.** Exceptional signal strength is claimed for this permeability-tuned oscillator that will play any phonograph through any radio. It is made by the D & M Mfg. Co., of Midland Park, N. J., and is tunable from 550 to 1,500 kc.

**EXTENDING LINE-OF-SIGHT.** In a recent test jointly arranged by the American Radio Relay League and the Radio Society of Great Britain, a 50-mc. broadcast from West Hartford, Conn., was received by two British amateurs. Highest frequency ever to be beamed across the ocean, the experiment was a step in extending the reliable service area of high-frequency transmitters, now thought to be limited to about 100 miles.



## NEWS IN ELECTRONICS

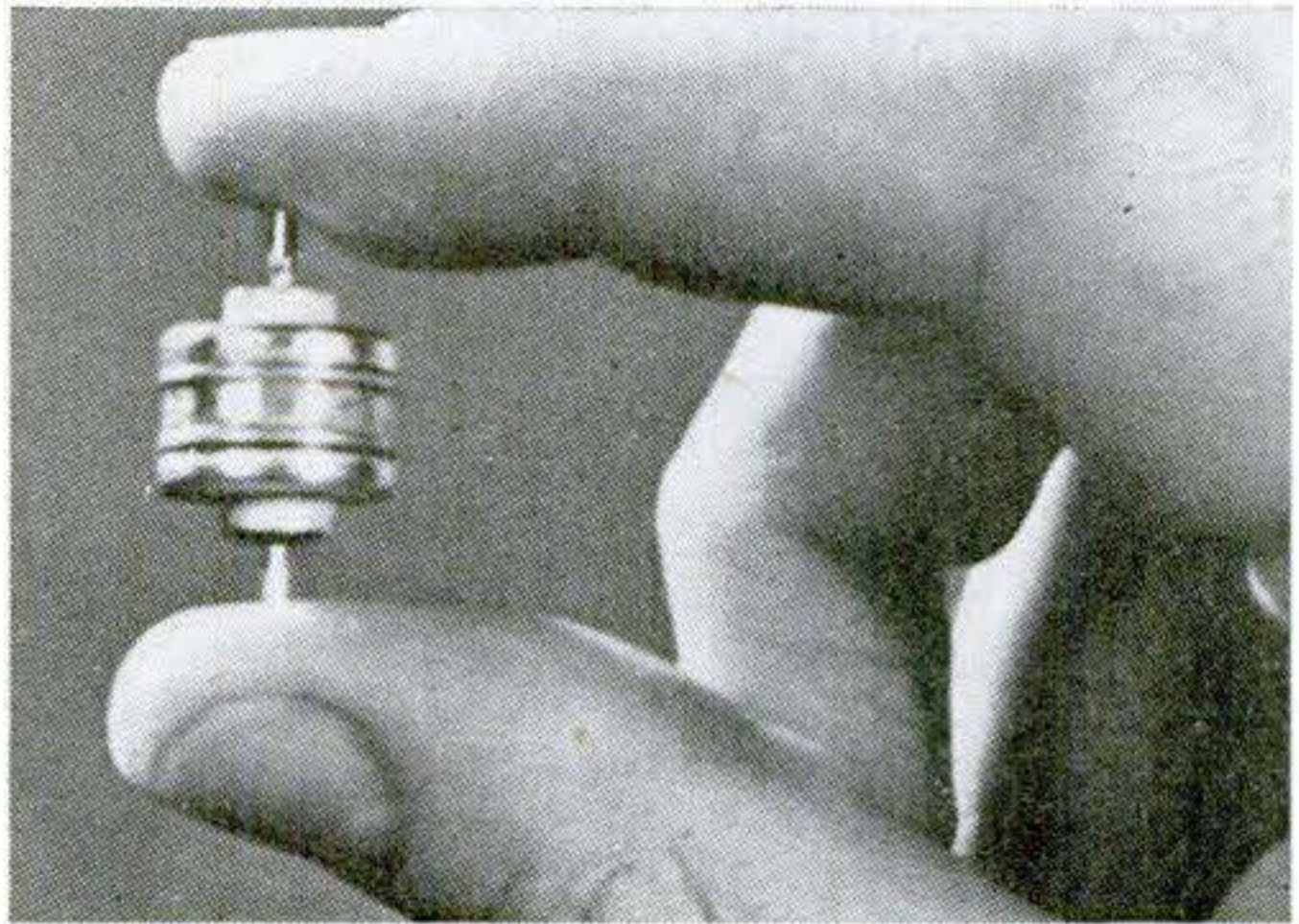

**CRYSTAL CONTROL AT 50 MC.** A new unit developed by Western Electric provides direct crystal control from 15 to 50 mc., thereby eliminating the need for multiplier stages used in most previous VHF equipment. The development will permit high-frequency transmitters to be made smaller and lighter, and employ fewer components. By reducing the number of undesirable frequency responses present, it will also allow greater scope in the choice of intermediate frequencies and increase the efficiency of new equipment.

**TOM THUMB'S THUMB.** To meet the need for quality volume controls for midget hearing aids and receivers, Centralab has announced a complete new line of dime-size potentiometers said to be the smallest practical for low-noise, long-life operation. The tiny controls will be available in sizes ranging from 500 ohms to 5 meg. Dust shielding and a selection of mounting positions are also provided.

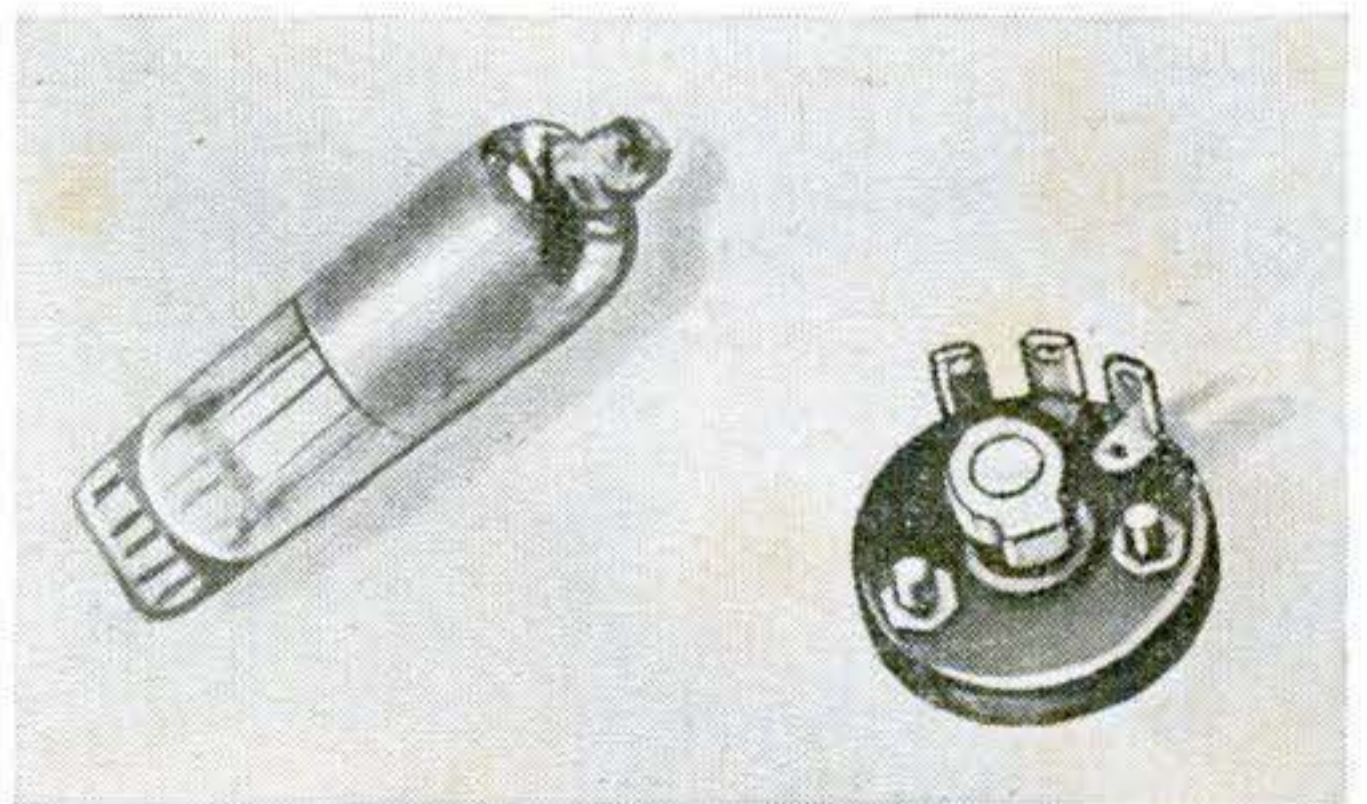



# WHAT'S WRONG

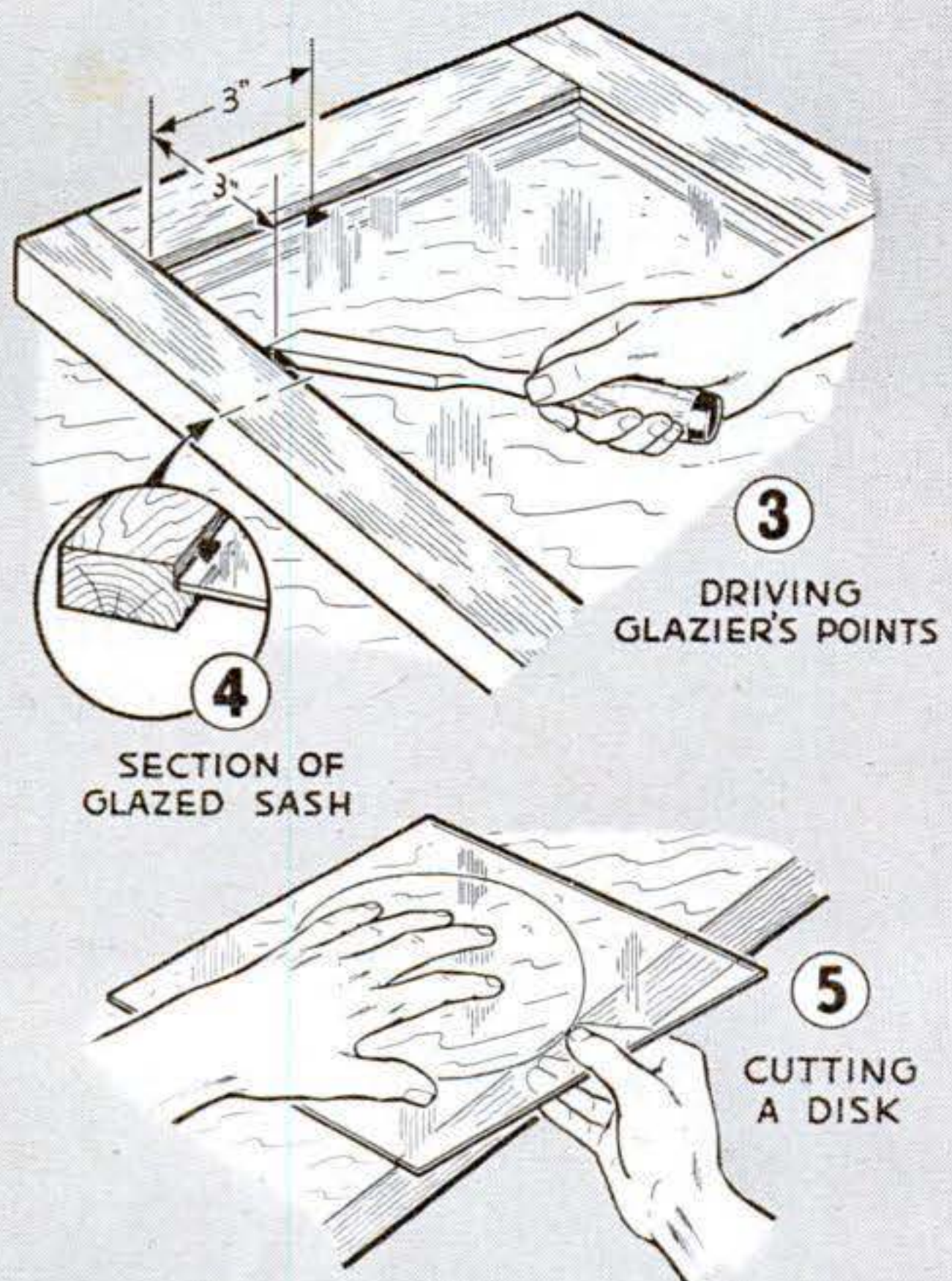
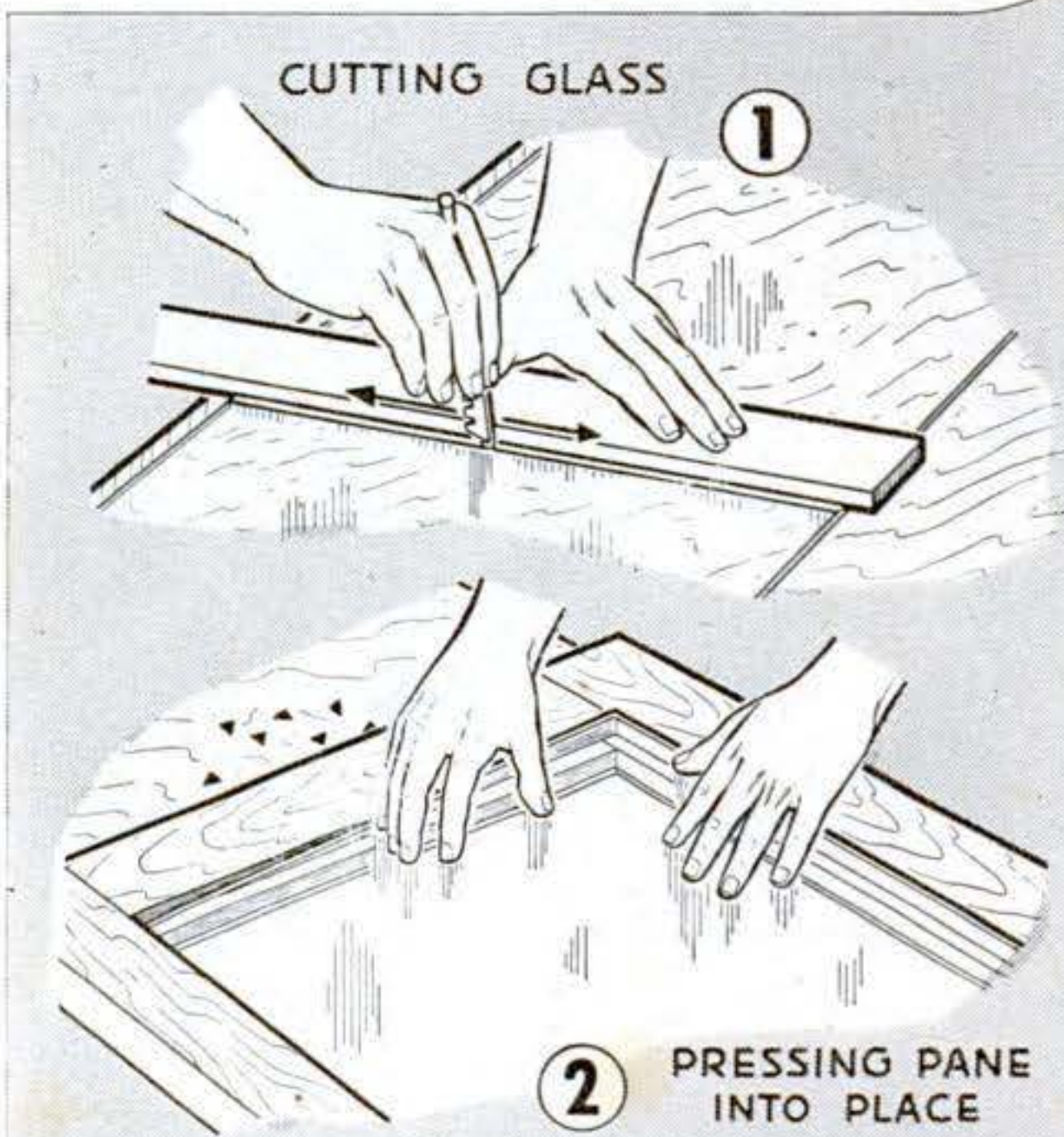

MISTAKES in glazing usually carry a cash penalty. Can you find the five errors shown here?

4. In the best work, and in old work especially, the glass should be bedded in a thin layer of putty spread in the rabbet.  
5. Score radial lines outward from the scored circle. It will then be easy to break out a small section at a time.

1. Never run the cutter twice over the same line. This dulls and eventually ruins the wheel. A single pass with firm, even pressure is required.  
2. The pane should be a close fit, but not so close it has to be forced into the rabbet. Cut the glass  $\frac{1}{8}$ " short each way, allowing a clearance of  $\frac{1}{16}$ " all around.  
3. Points should be unequal distances from the corners, say one at 3" and the other at 7". Equal distances create a diagonal strain that may crack the glass.

## ANSWERS

## Jig for Forming Hinge Gains Speeds Box Production

WHEN a jointer or small shaper is available, an auxiliary fence with four stops spaced to limit cutting simplifies quantity production of identical hinge-knuckle gains. The stops are so placed that the cuts will be at equal distances from both ends.

A straight cutter is used, being adjusted to project half the thickness of the hinge knuckle beyond the outer face of the fence. If only one section of the box is to carry the "pocket," the cutter is set for full hinge depth. About 100 boxes an hour can be handled.—JOHN P. ARNOLD.

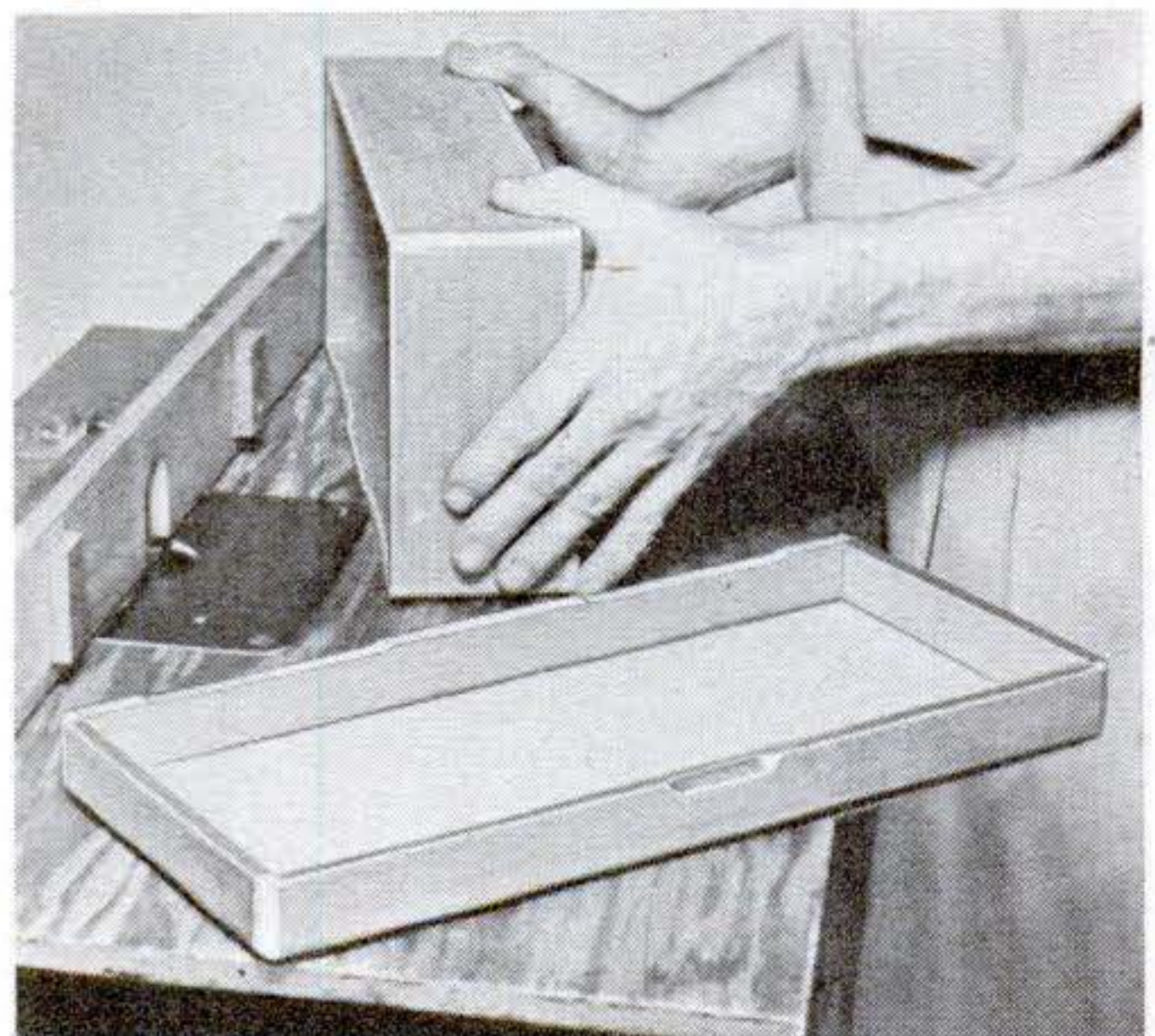



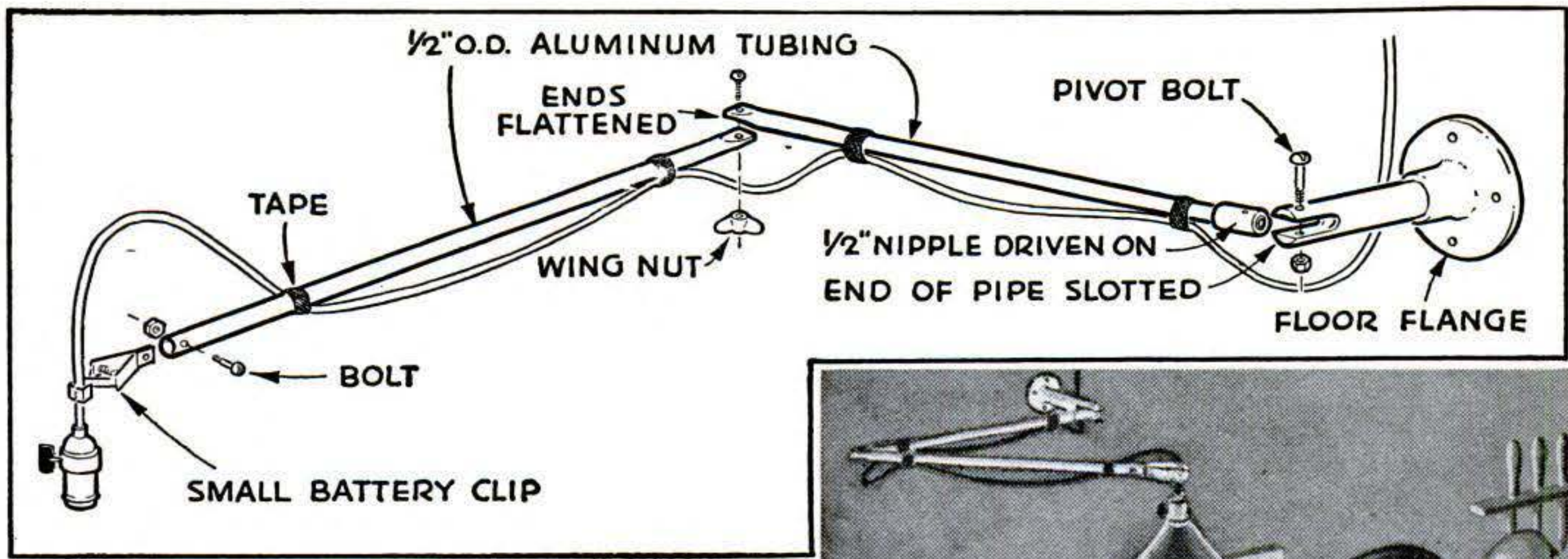

## Fully Adjustable Bench Light Will Cover Wide Range

As my workbench is a long one, I needed a good light that would really get around. This one does. The wall mounting is a  $\frac{3}{4}$ " floor flange with a 7" length of  $\frac{3}{4}$ " pipe slotted to fit a  $\frac{1}{2}$ " nipple snugly. Lengths of  $\frac{1}{2}$ " o.d. aluminum tubing, 30" long for the rear, 21" long for the front, form the arms. The inner one is reinforced with a short  $\frac{1}{2}$ " pipe nipple on one end to pivot in the slot. Its other end is hammered flat and bolted to a flat end of the second tube.

A hole crosswise near the other end of

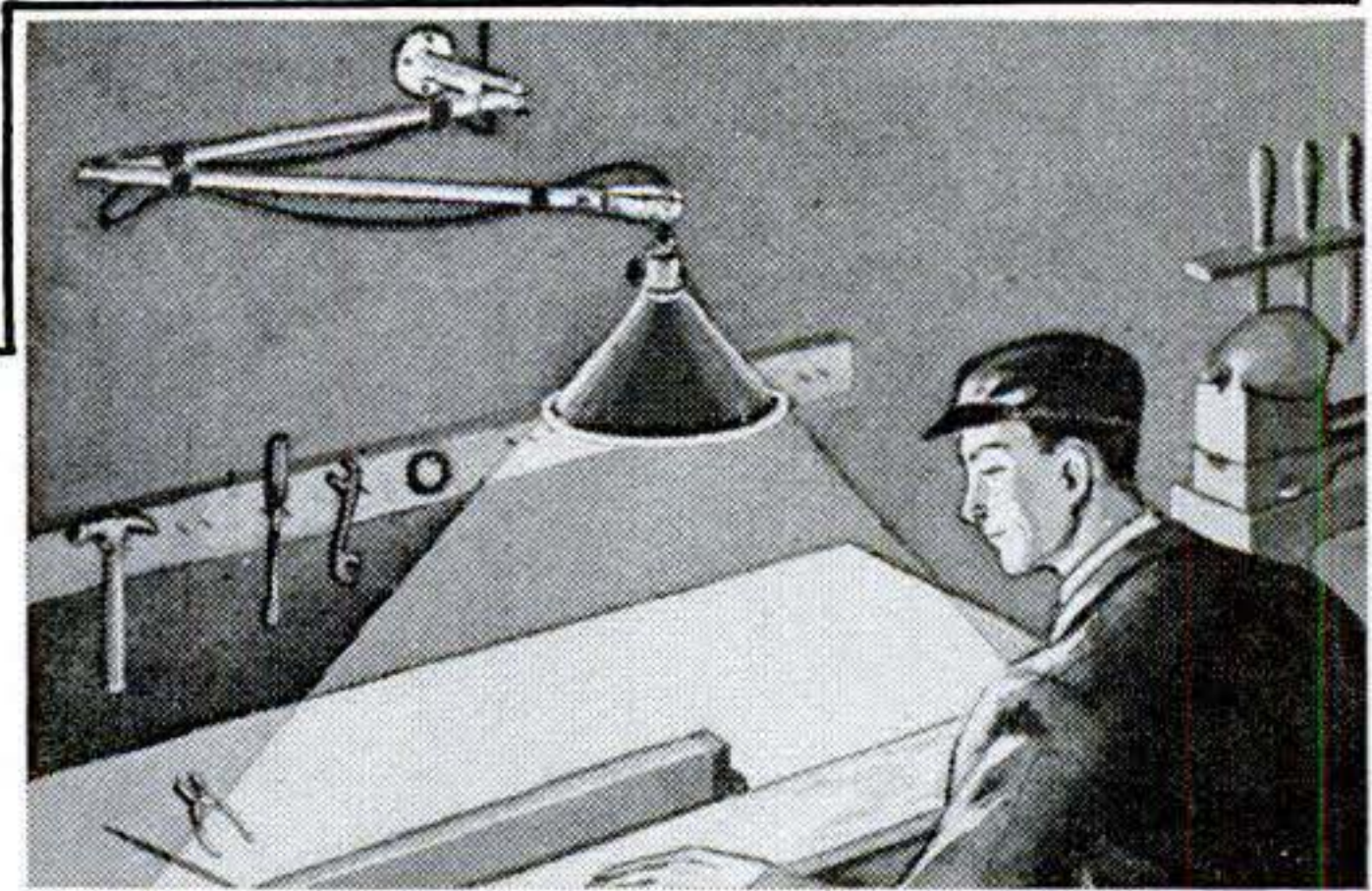

this piece takes a bolt to hold a small battery clip. The lamp cord runs through the clip jaws (behind the teeth, not across them); there's friction enough to hold the socket at any height. Then the cord is taped to the tubing with loops to leave slack at joints. Two loose turns near the socket permit height adjustment.—HERBERT SPOHN.

## Tweezers Made from Cotter Pin

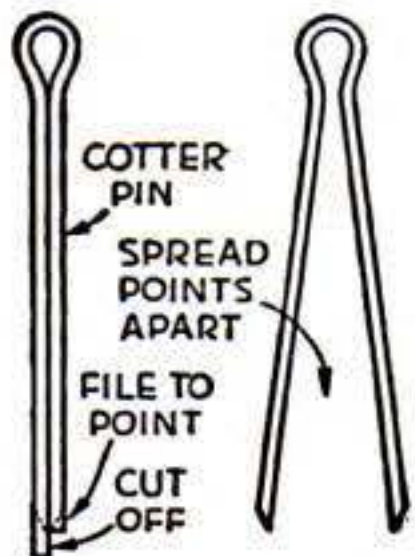

MINIATURE tweezers for handling small objects can be improvised from a cotter pin. Cut the legs even and spread them so they'll grasp the work. They have just enough natural spring.



## Cultivator Disks Form Anchor

A LIGHT mushroom anchor can be made by bolting a cultivator disk to a length of rod and fitting a shackle to the other end. Use several disks for a heavy anchor.

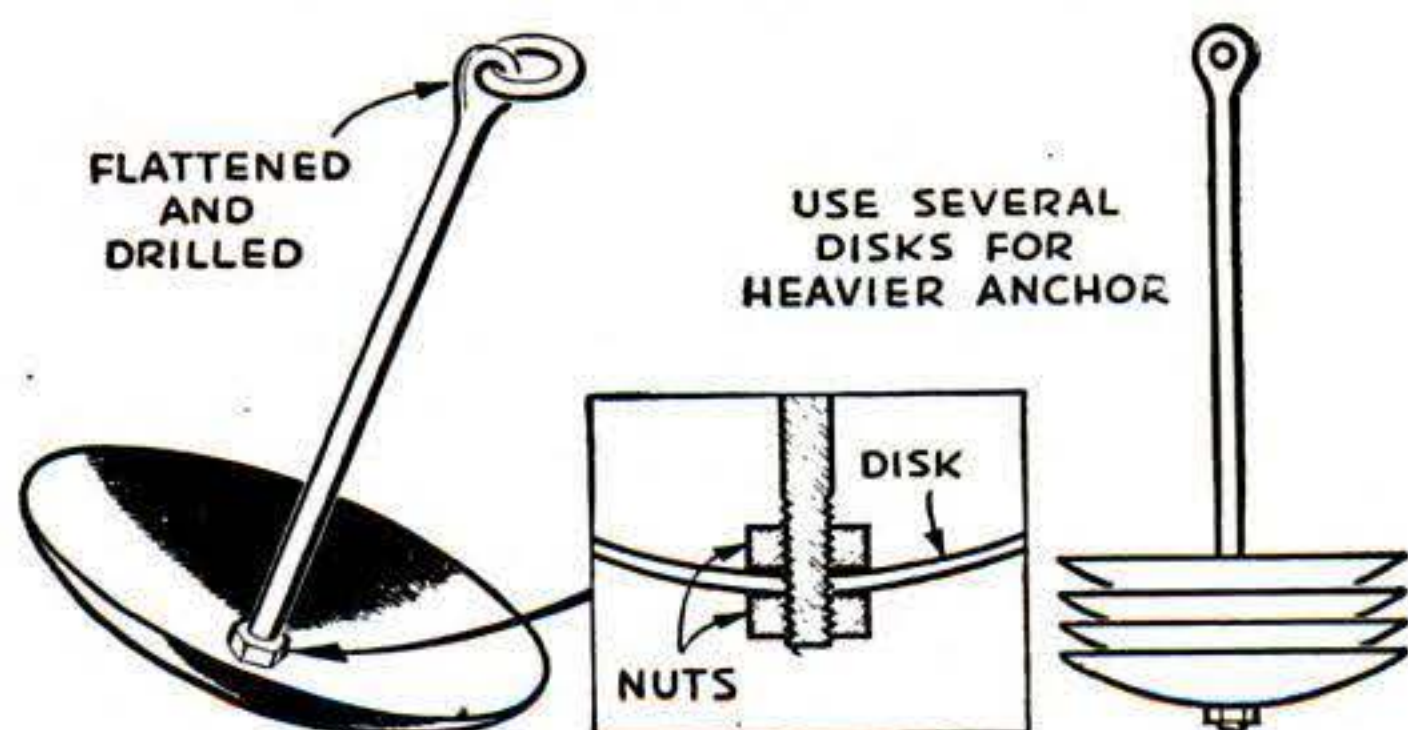

## Template for Mounting Stamps

WHEN extra sheets have to be added to a stamp album, they are usually in blank form except for border lines. A template cut from stiff cardboard or thin plastic will help get even spacing. The sheet should be the same size as the album page. Rule and cut with a sharp knife along a straightedge two or three rows of rectangles for average-size stamps and a row or two additional for over-size ones.—E. A. RERUCHA.



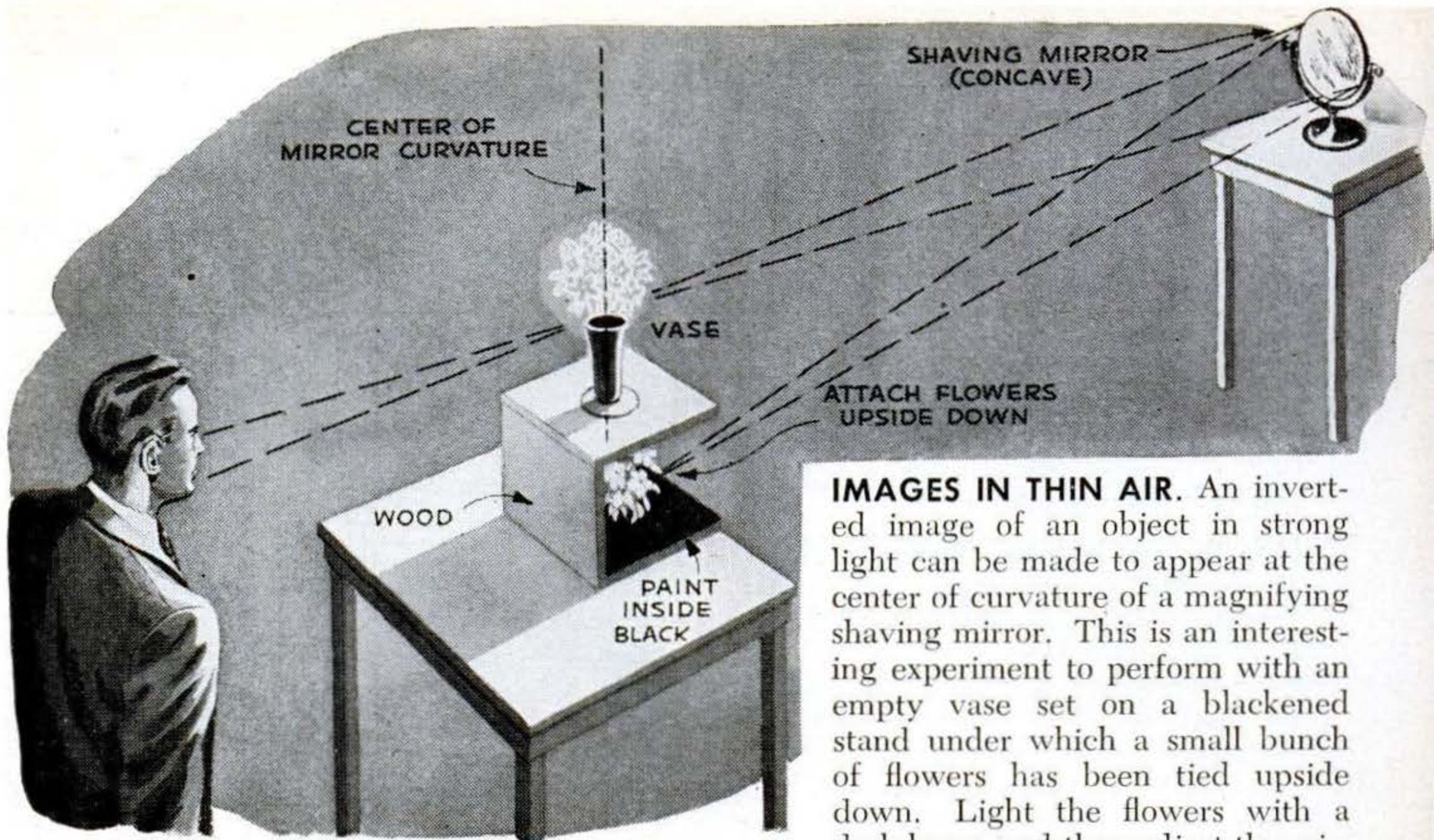

**IMAGES IN THIN AIR.** An inverted image of an object in strong light can be made to appear at the center of curvature of a magnifying shaving mirror. This is an interesting experiment to perform with an empty vase set on a blackened stand under which a small bunch of flowers has been tied upside down. Light the flowers with a desk lamp, and then adjust the mirror until the flowers appear to be in the vase. The point where the image appears natural size is the center of curvature of the mirror and of an imaginary sphere of which the mirror can be considered a small surface area.

**HOME EXPERIMENTS**

# Odd Facts About PHYSICS

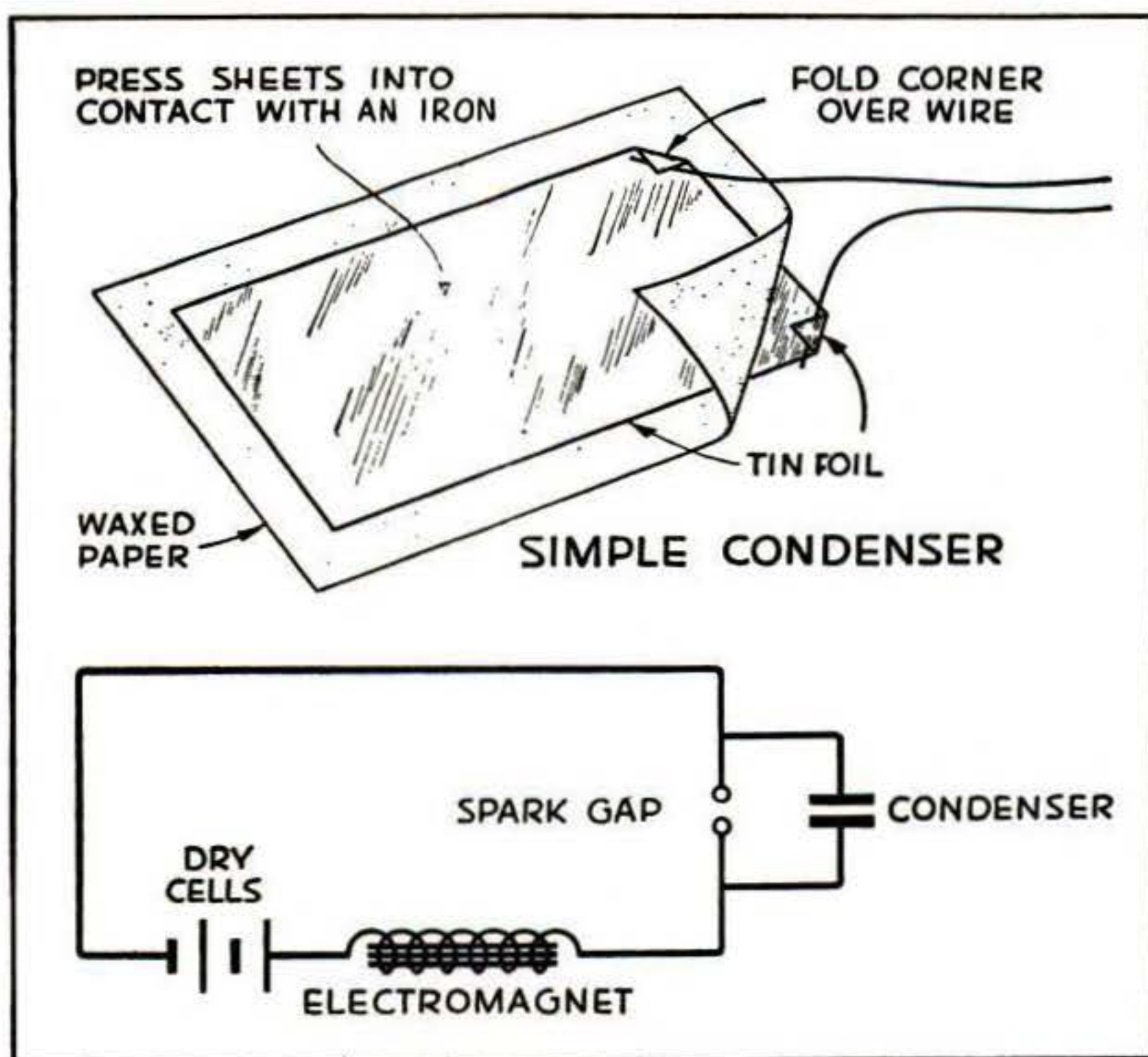

**WHY CARS NEED CONDENSERS.** If you connect an electromagnet in series with several dry cells and break the circuit, a hot spark will jump the break because of extra voltage produced by the collapse of the magnetic field about the magnet. But connect in the circuit a radio filter condenser, an automobile condenser, or even one made by sandwiching a sheet of waxed paper between two pieces of tin foil, again break the circuit, and you will find the spark greatly diminished. On a car timer, this diminishing of the spark not only makes the contact points last longer, but it also causes a stronger and more accurately timed spark at the plugs where it is needed.



**ACTION OF CENTRIFUGAL PUMP.** With a volute casing made from waxed cardboard and an impeller wheel bent from tin, the discharge action of a centrifugal pump can be shown. Bend two strips of tin at right angles and curve each half in the same direction. Clamp both bent pieces between washers on a bolt by drawing the nut down tight, and chuck in a hand drill. Place the casing in a pan of water, center the bolt head in a hole in the bottom of the casing, and rotate the wheel clockwise. Water will be drawn into the hole and forced out at the end of the spiral. A pennant at the opening will show the movement.

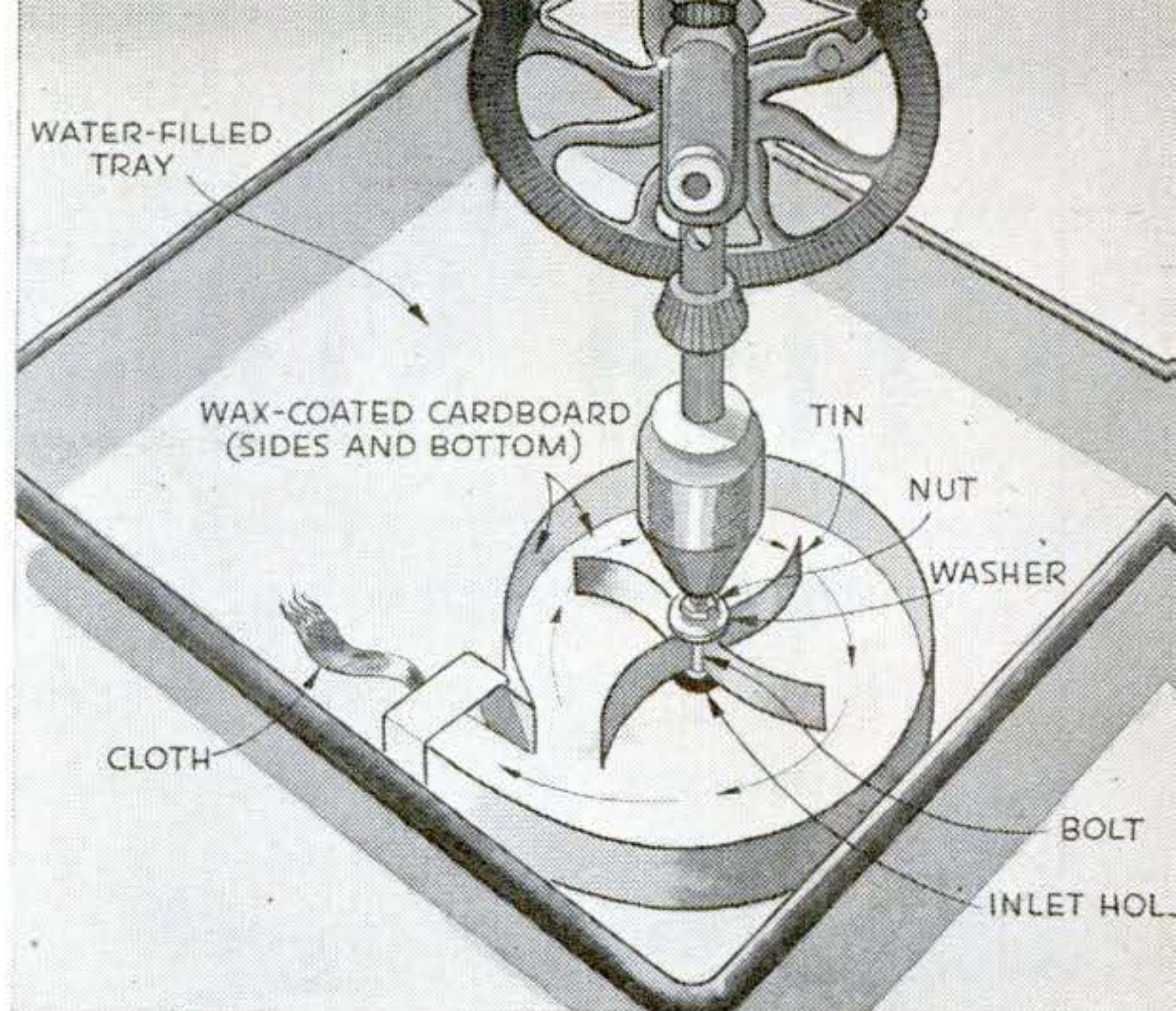

**HOT LIQUID FLOATS.** That hot water is lighter than cold can be shown by an experiment with hot coffee. Half fill a tumbler with cold water, float a small piece of cardboard on it, and pour in hot coffee slowly through a funnel held close to the cardboard. The two fluids will mix only slowly. Use a thin glass to prevent cracking by temperature change.



**WATER EXPANDS AS IT FREEZES.** Many householders have had this demonstrated for them by bursting water pipes. You can show this characteristic with a tumbler of ice and a test tube of colored water. Put a thin glass tube through a hole in a cork, press the cork into the test tube until the liquid rises in the tube, and mark the temperature on a paper scale behind the tube. Mark the lowest point on the scale as the water grows cold, which would be about 40 deg. F. if you could take the temperature of the water, and mark the high point as the water again rises. This will be 32 deg. Actual freezing of the water probably will force the cork out.

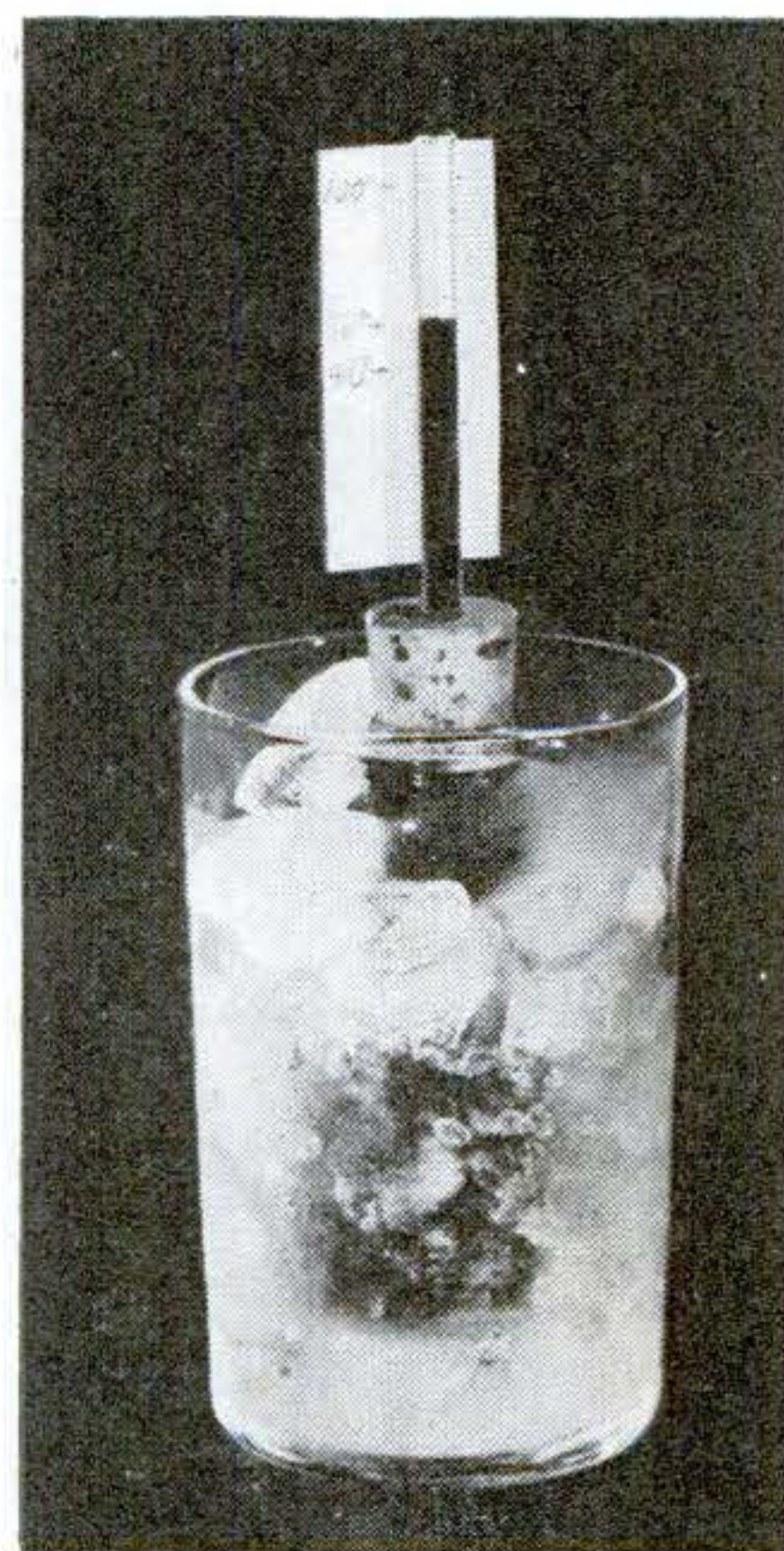
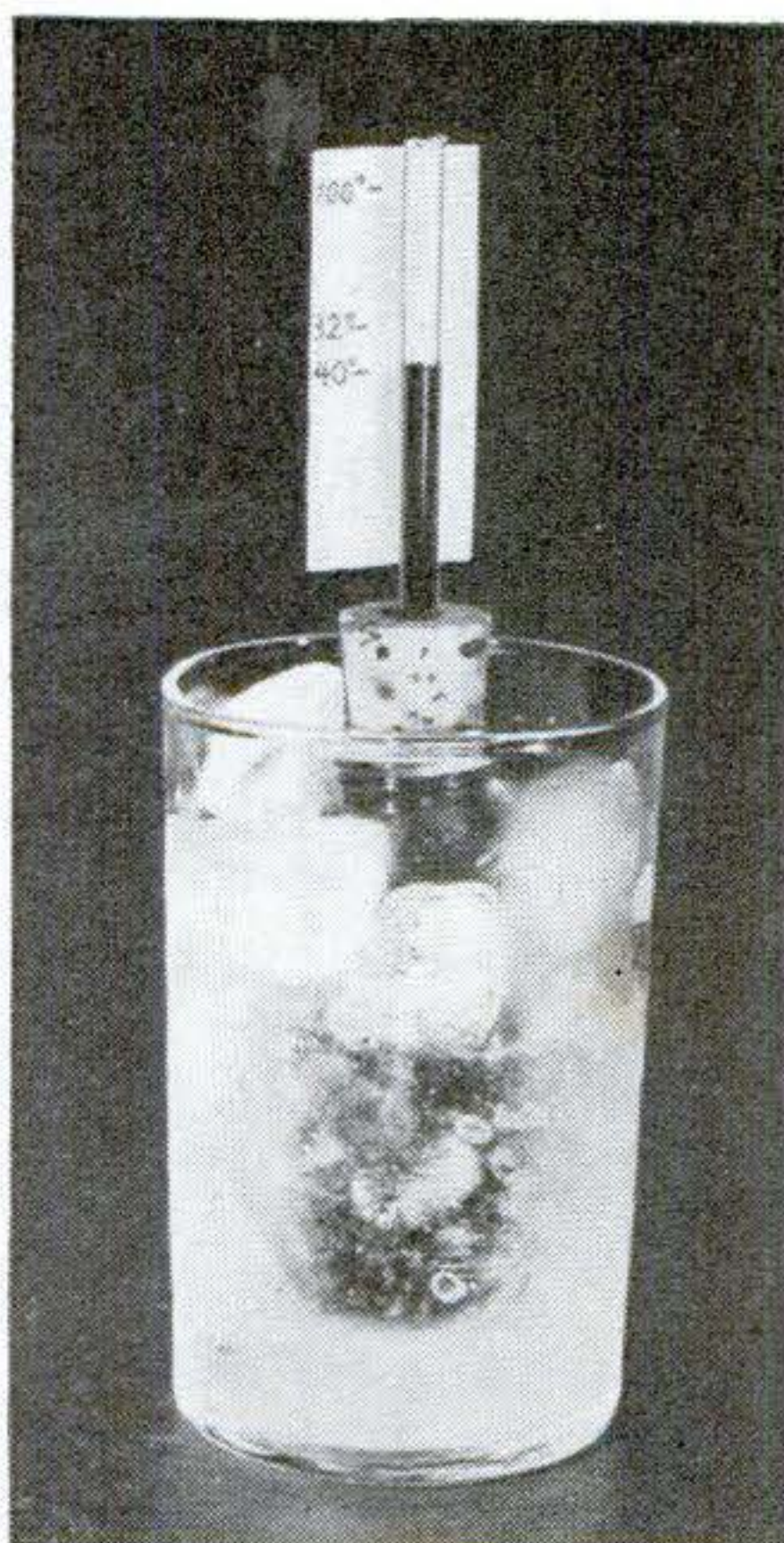
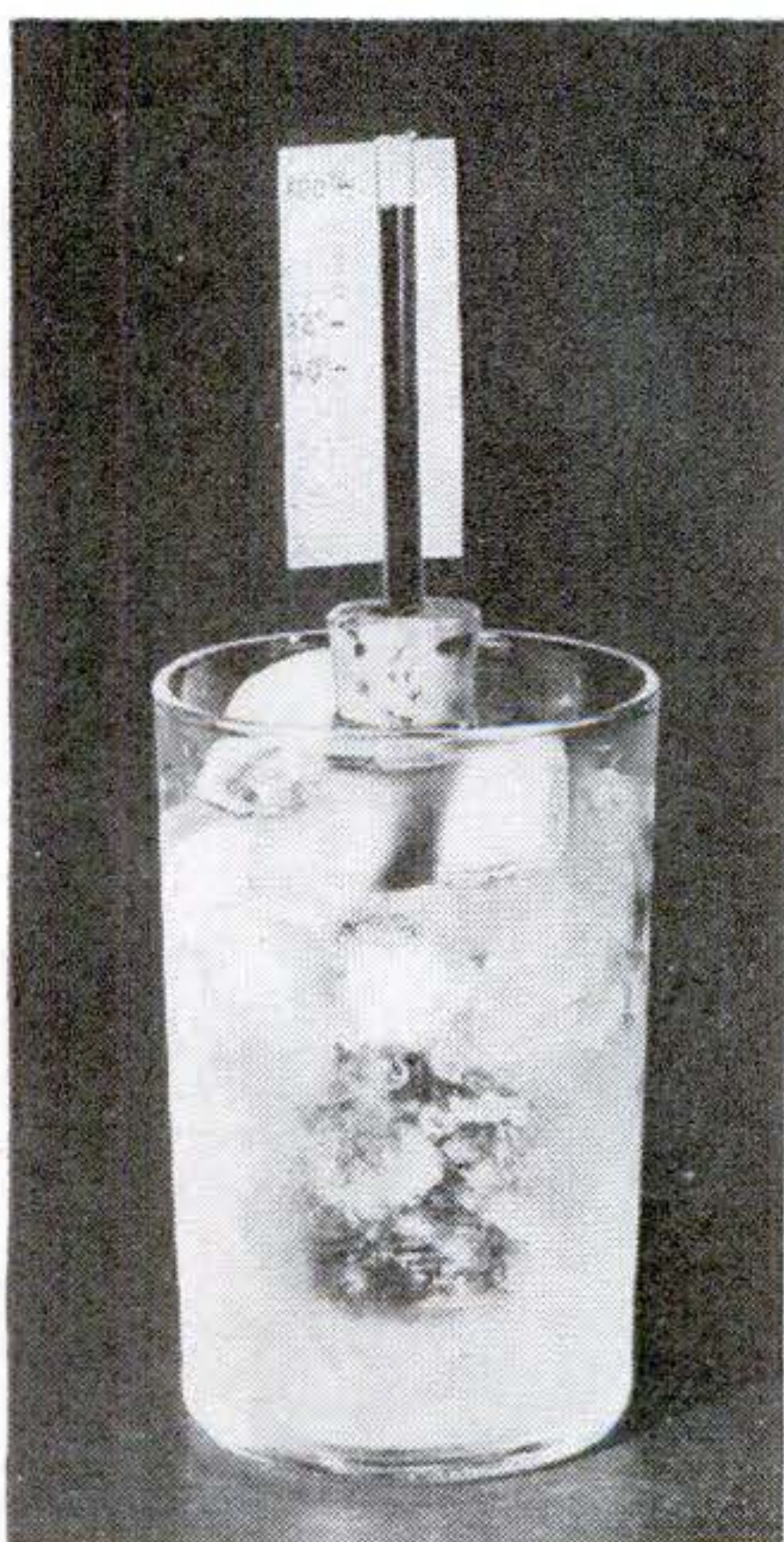



# FISH STORY on a Plaque

How to mount the big one that didn't get away. A taxidermist describes a quick home method.

By BERLEN DIEHM

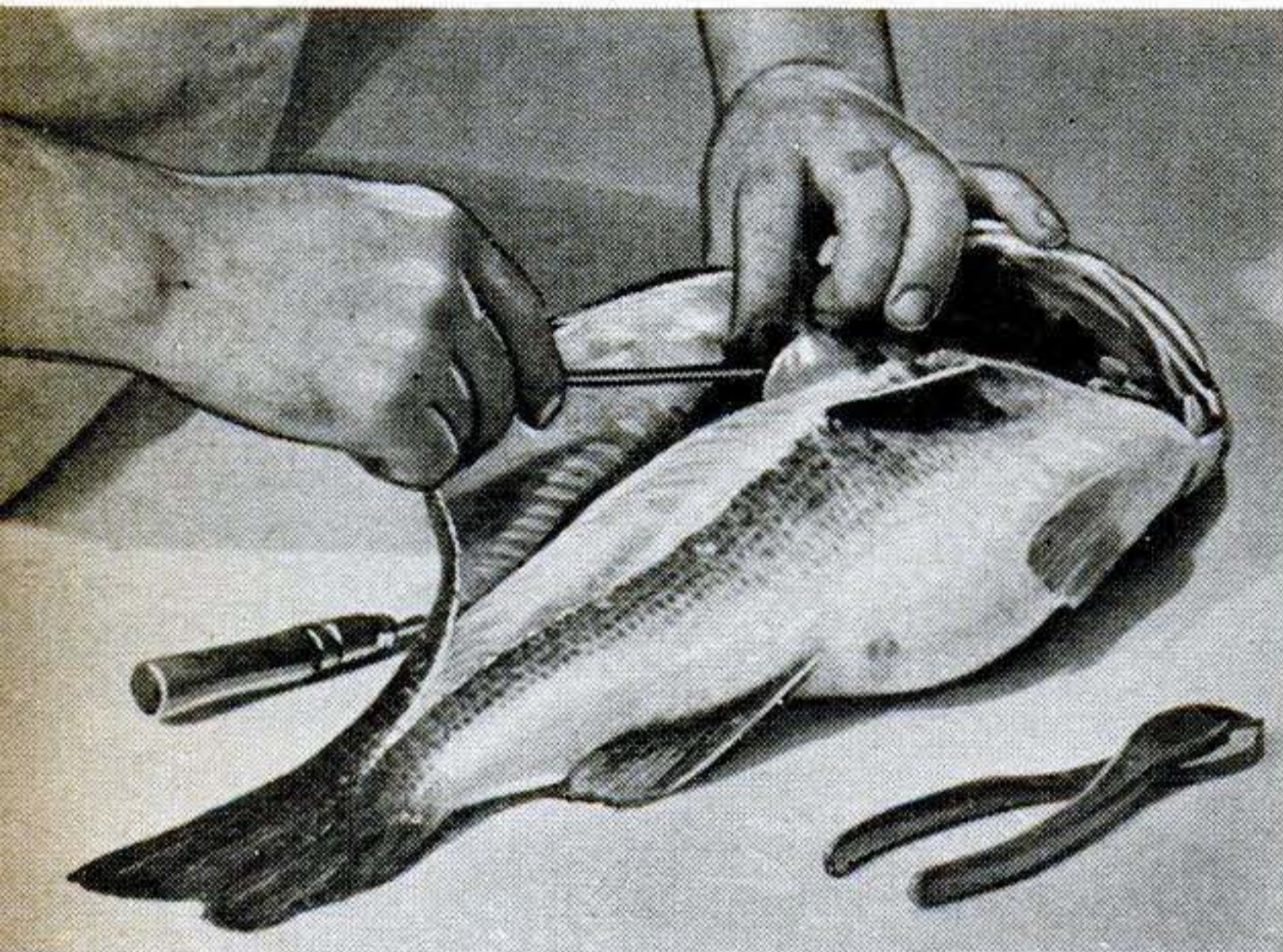

Select the best side to show, turn to the other side, and split from gill to tail. Skin out the meat with a fish skinner or hacksaw blade.

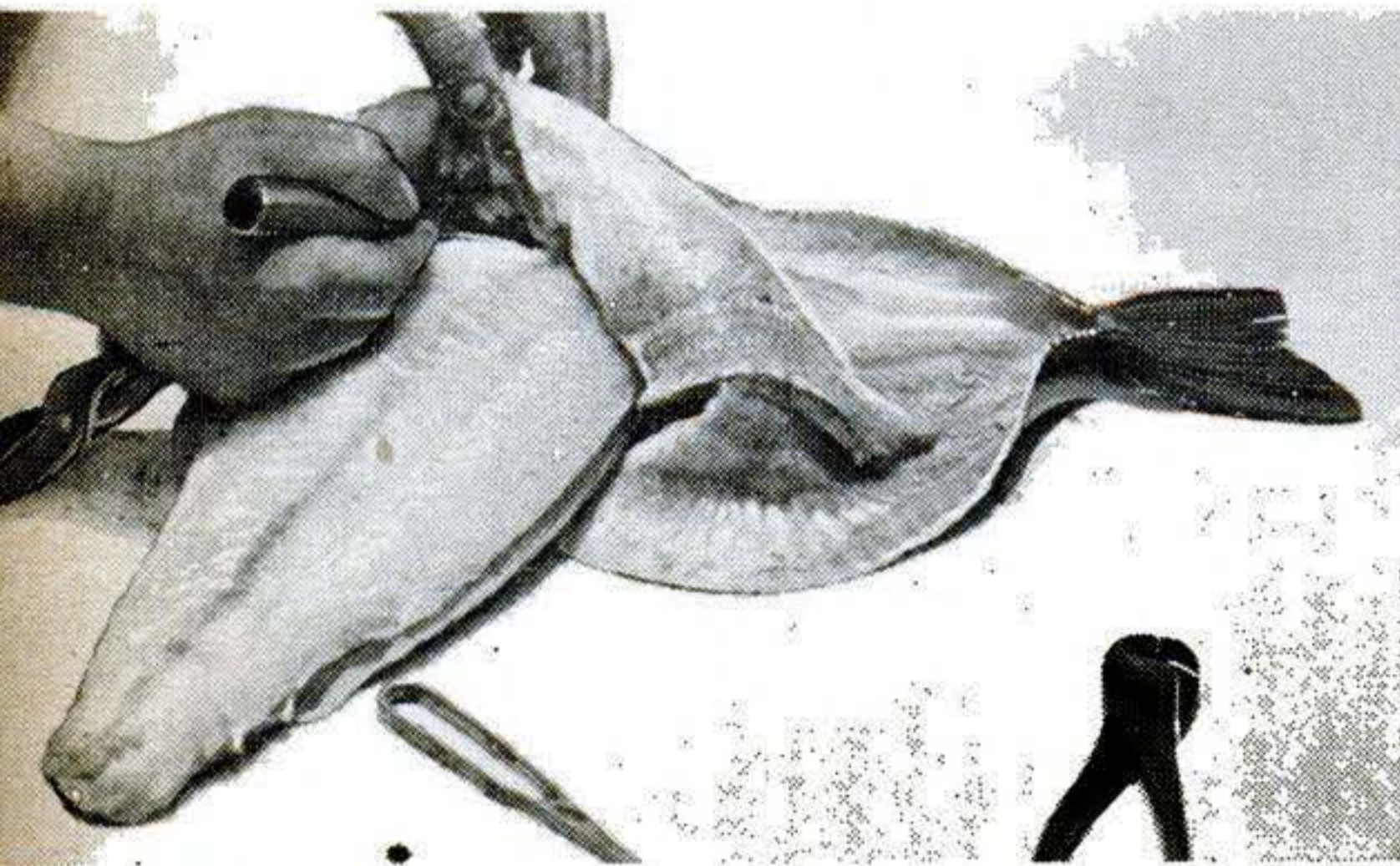

Then cut the body (meat) from the head. It can be consigned to the frying pan. The head is next cleaned thoroughly with a pair of pliers.

Scraping with a hacksaw blade removes all traces of meat from the skin, which is then rinsed with water and submerged in alcohol to tan.

WOULD you like to save that prize catch as proof of your favorite fish story? You can easily mount it on a plaque to confound all doubters. By a new method using a plaster of Paris core, the old tedious carving of a balsa-wood form for the skin is dispensed with entirely, and actual work-time on the job is cut from seven hours to 30 minutes. An extra eight hours must still be allowed for tanning, of course, and another seven to 10 days for the mounted fish to dry, but these are merely waiting periods and involve no work on the part of the taxidermist.

The fish ought to be well cared for immediately after catching, that is, not exposed to the sun. When you get it on the workbench, select the best side to be shown and slit the opposite side for its entire length from gill to tail. Skin out the meat with a fish skinner (knife) or hacksaw blade and cut it from the head; then clean inside the head thoroughly with pliers and scrape inside the body skin with a hacksaw blade until it is perfectly clean.

Rinse the skin with water, and then submerge it in alcohol for eight hours to tan it, following with another water rinse when it is removed from the tanning bath. Sew up the cut side and pour the skin full of a mixture of plaster of Paris and zonolite in just enough water for good pouring consistency. If a helper will hold the skin up for you, the plaster mixture can be poured in easily.

Lay the fish on a board and shape it immediately before the plaster can set. Fill the head with the plaster mixture next and shape it properly. The fins are then fastened in position with pins, and the filled fish is left on the board to dry, a matter of seven to 10 days, after which it is affixed to the

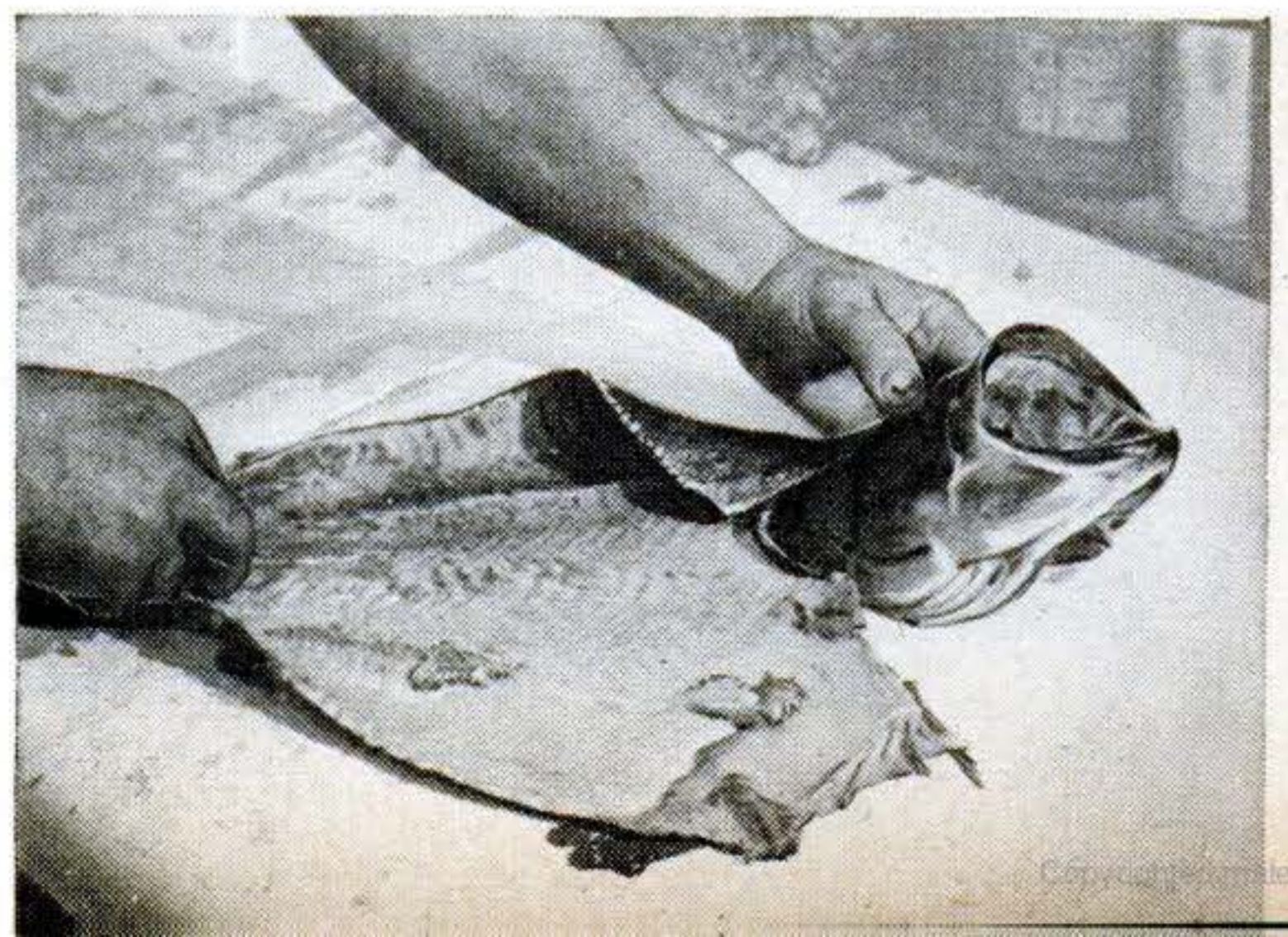



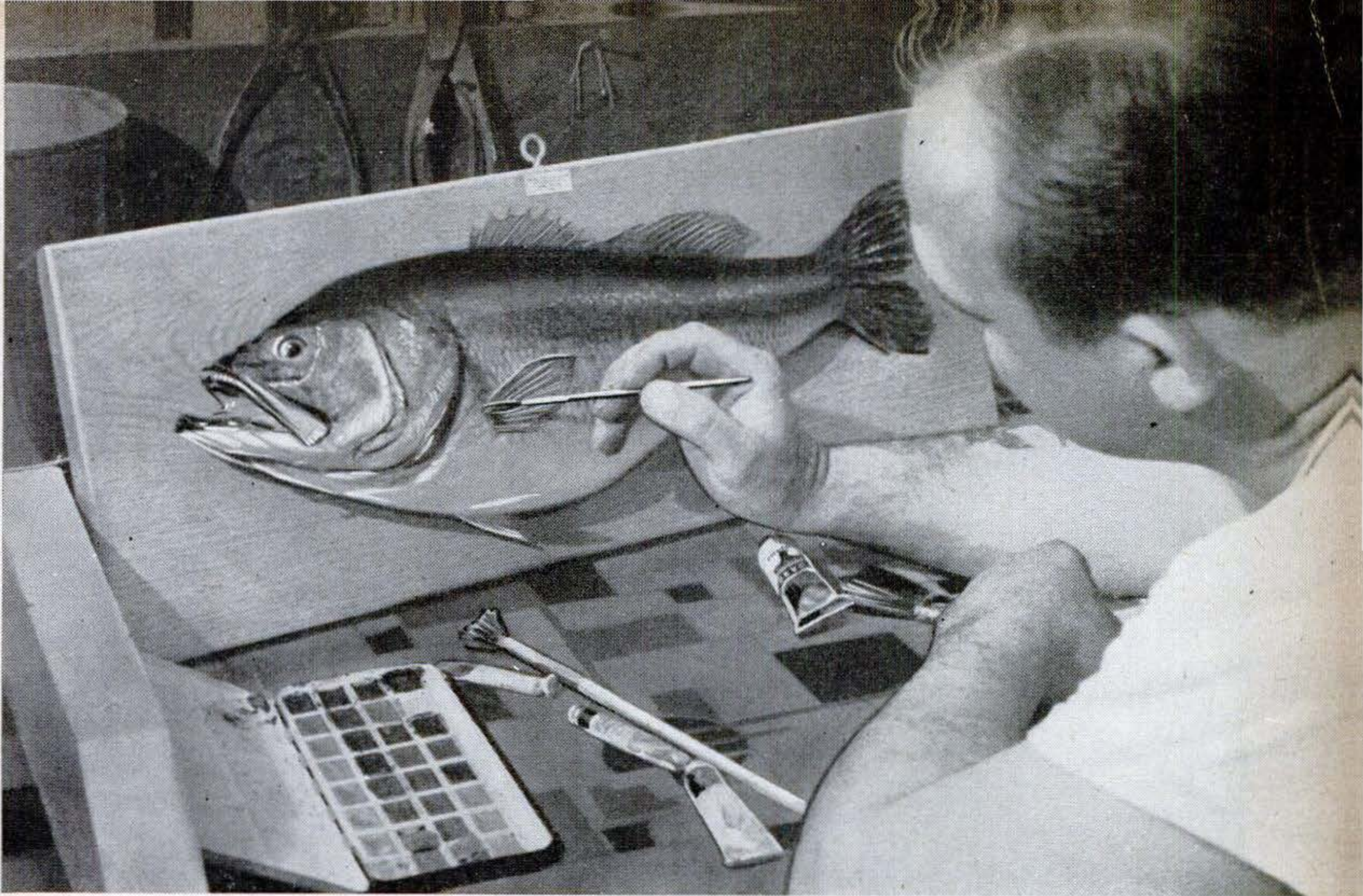

Natural coloring is restored to the mounted and dried fish with water colors, and a coat of varnish is then applied to the entire surface. Color restoration is necessary since mounting turns the fish white.

mounting board or plaque with wood screws through the plaque into the plaster core.

Take careful note of the coloring of the fish before mounting, for the plaster mixture will turn the skin white as it dries and the coloring will have to be restored. This

can best be done with water colors, which will bring out the natural coloring if properly used. The job is then completed with a coat of varnish over the entire fish and the wood plaque to protect them from dust and to preserve the color.

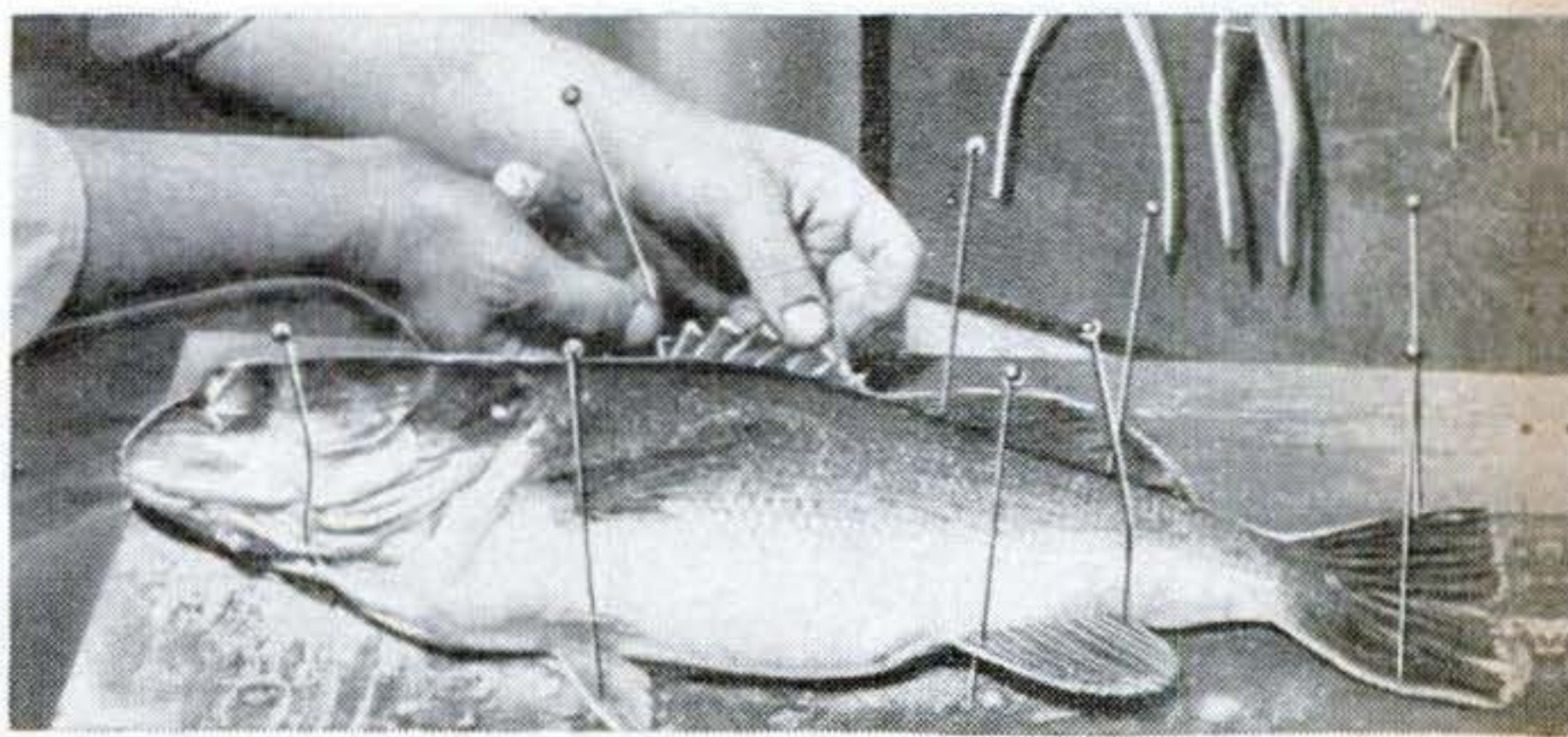

After tanning, the skin is rinsed again, the cut sewed up, and the cavity filled with a mixture of plaster of Paris and zonalite, a mica insulating material available at building supply dealers. Plaster and zonalite are used in half and half proportions. As soon as filling is completed, the fish is laid on a board and shaped, and the fins are held in position with pins, as above, until it has dried. This takes about a week.



# RADIANT ENERGY

## Nips Jack Frost

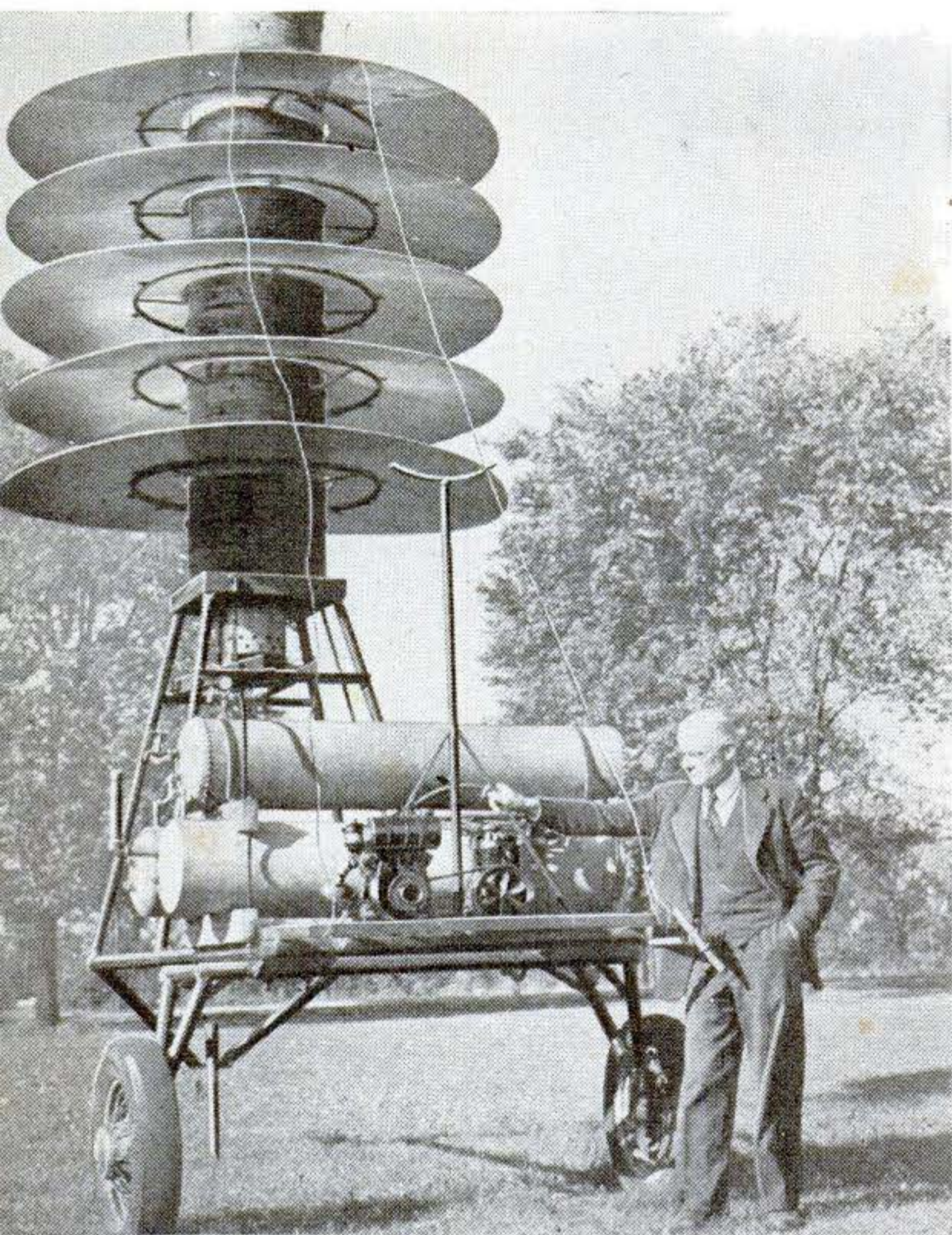

Experimenters at Michigan State College developed this huge oil burner to determine whether radiant heat would protect farm crops from frost damage.

EXPERIMENTS conducted at Michigan State College hold a promise that fruit growers and truck farmers eventually may be able to use radiant heat to prevent frost damage. In the tests, a huge oil burner and an electrical unit both were successfully employed to direct radiant heat on the vegetation and keep it above the frost point without using the air itself as the medium of heat transfer.

The electrical unit consists of aluminum reflectors with rod-type electric heating elements placed 10' above the ground and connected to a 440-volt A.C. line, the reflectors being shaped to distribute the infrared radiant energy over an area 40' square. Even on the coldest night the apparatus was in use, it gave effective frost protection.

Because the cost of electrical energy would make this method impracticable for many growers, the Michigan experimenters also developed and are testing an oil-heated radiation unit. This consists of a large heater tube that operates at low red heat and circular reflectors to direct the heat down against the crop. Kerosene is stored in three 30-gal. hot-water tanks. After further development, it is hoped that a single oil unit will protect an acre of crops.

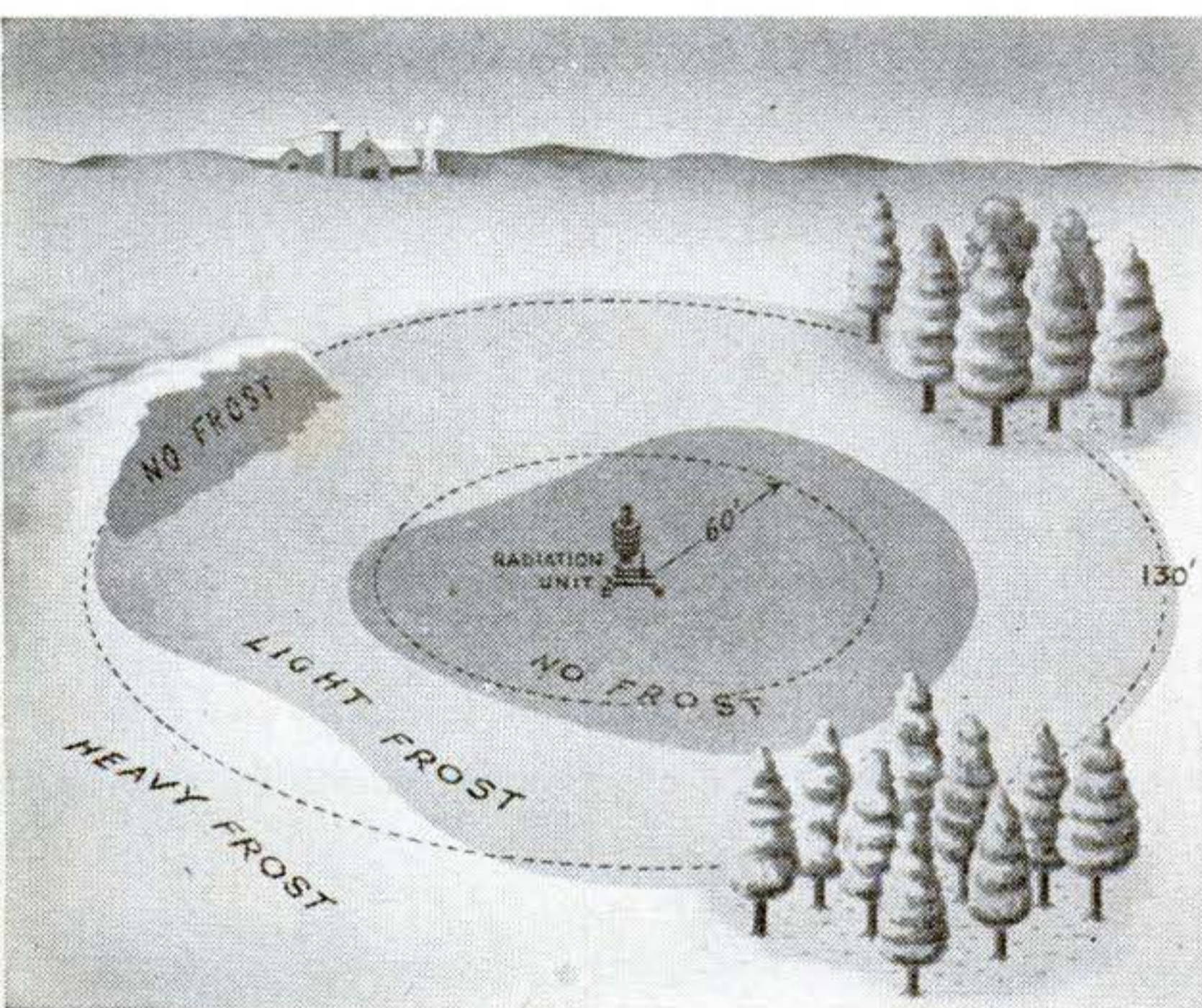

On one night, the experimental oil burner gave the results sketched above. It prevented frost within a radius of 60' to 100', as well as at a distant spot that sloped toward the unit. Although the air temperature was 31 deg. F., the vegetation within the heavily shaded area dropped only to 37 deg.

Infrared radiant energy from this experimental electrical unit also prevented frost from forming.

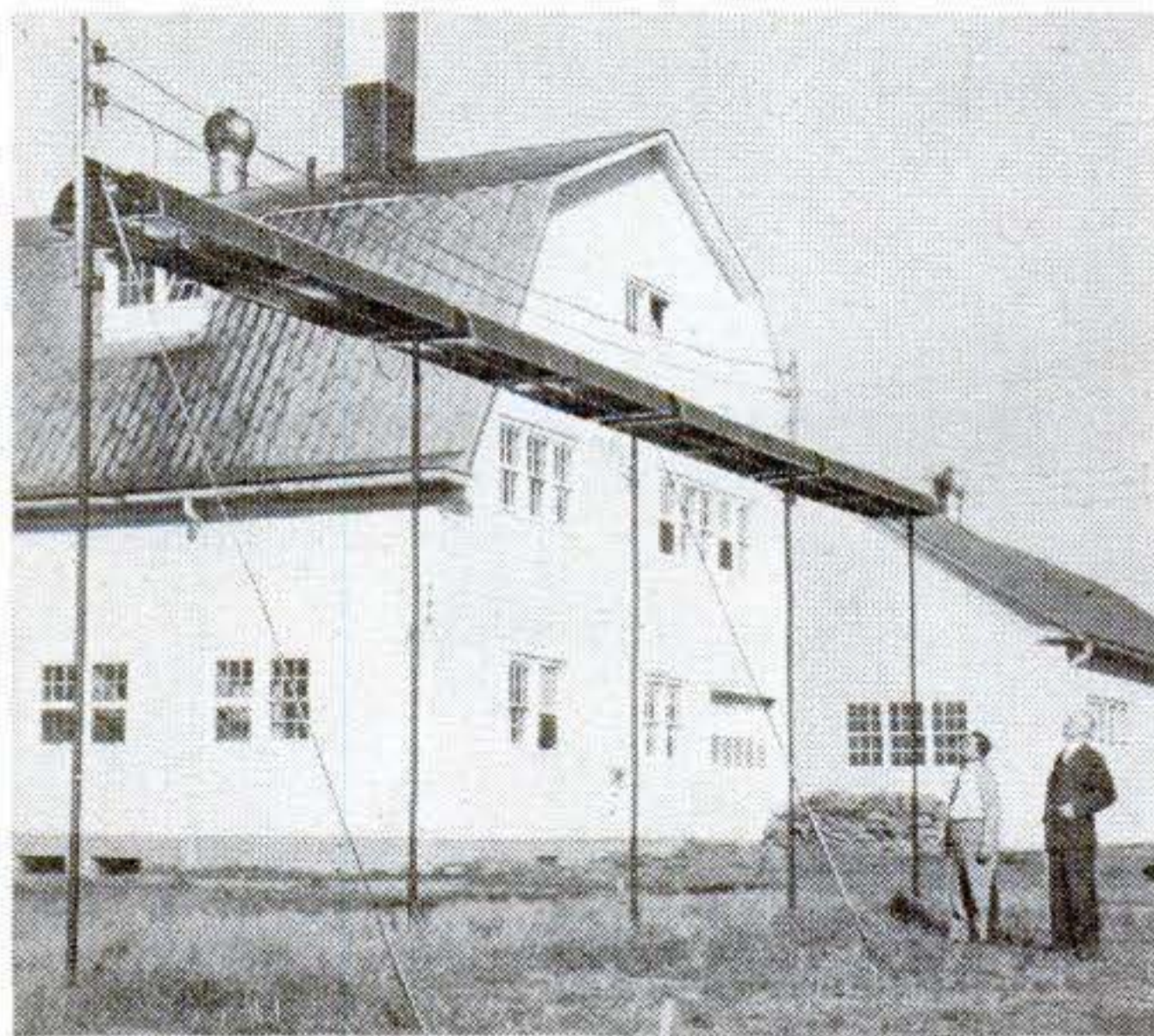



## Motorized Drum Gluing Machine Coats Work Swiftly and Evenly

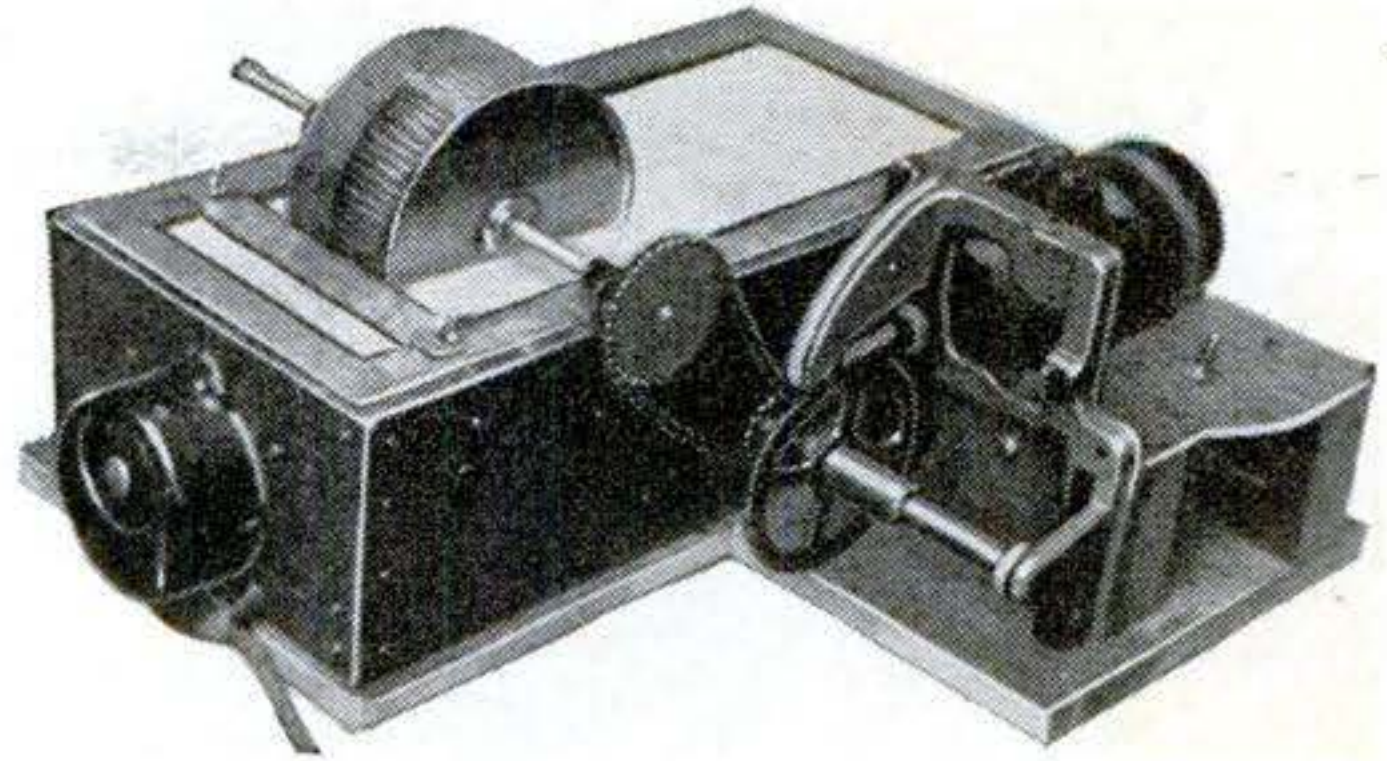
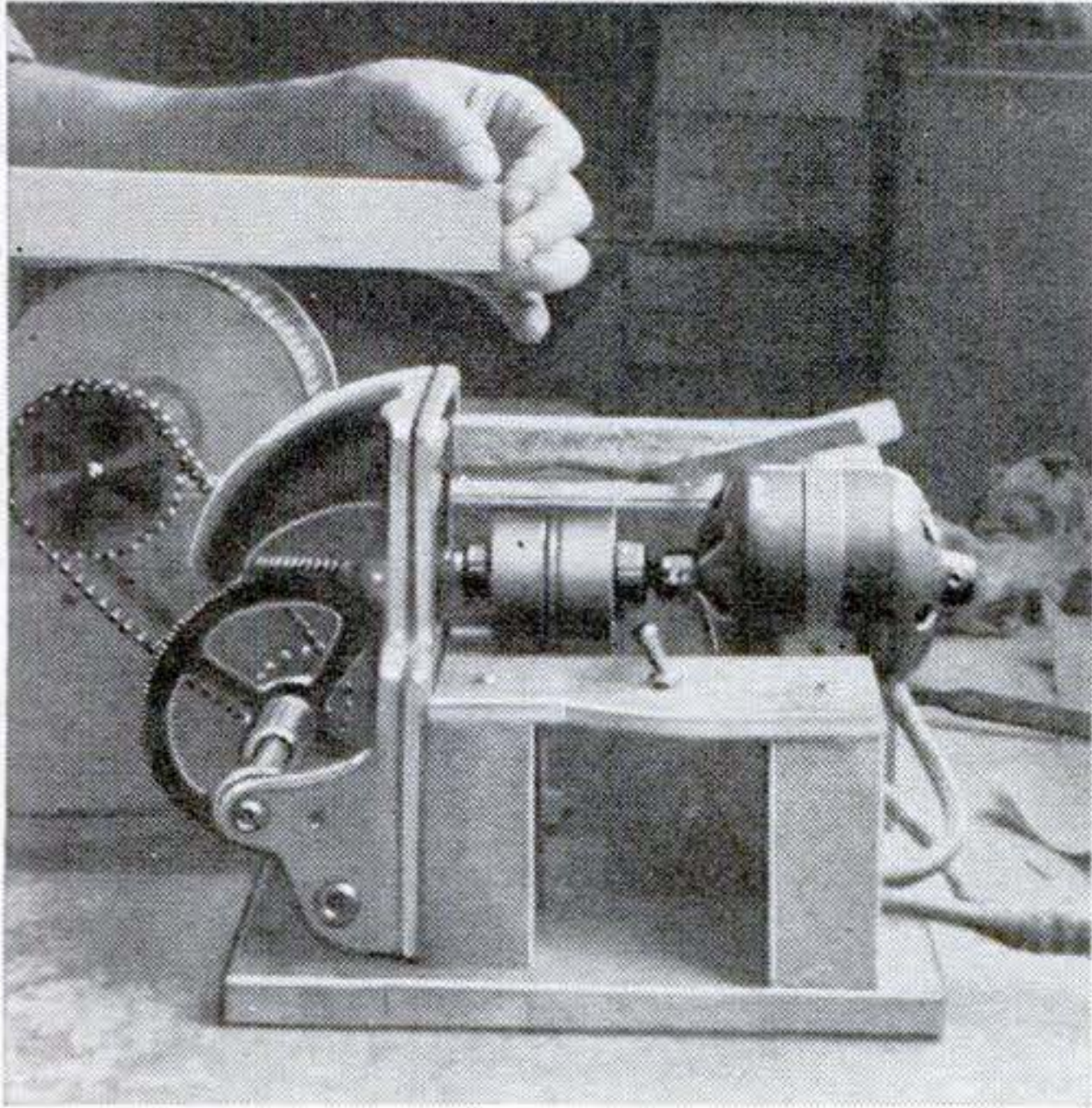

WHEN Russell Jackson, of Angola, Ind., expanded his home workshop for the production of instrument cases, he built this drum gluing machine to speed the job.

A 5-qt. stainless-steel glue tank is flanged so it can be set into a 6" by 8" by 17" sheet-brass casing with 1/4" clearance all

around. The casing is lined with 1/4" corrugated asbestos paper. Two 500-watt strip heaters connected in series are placed in the bottom. They are thermostatically regulated to maintain an even 160-deg. temperature.

The drum, a 5 1/2" coffee tin with crimped strips soldered on, is driven at 24 r.p.m. by a fan motor geared through an old phonograph mechanism. An adjustable space bar keeps an even film of glue on the drum. Work is applied in the direction of rotation. Between jobs the heater is disconnected and the glue allowed to harden. It can be brought to working temperature in an hour.

## Permanent Concrete Support Takes Sag Out of Old Garage Wall

SAG in a garage wall traced to a rotten mudsill can be permanently repaired by replacing the old sill with a concrete foundation. At several points along the wall, jack the sinking studs with a hydraulic or heavy screw jack. Wedge two-by-fours under the plate at each of the jacked-up points until the wall is level.

Next dig a 2' deep, 8" wide trench flush with the inside of the studs and running the length of the wall. Remove the sills and any old foundation posts; then build a form flush with the outside of the studs. For the inside form use 6" boards braced 2" from the studs. About 4" from the bottom of each stud, bore a hole for a short length of reinforcing 1" pipe.

Pour concrete level with the inside form. Tamp the concrete around the pipe inserts, and when it has set remove the forms and braces from around the work.—ALEXANDER BURK.

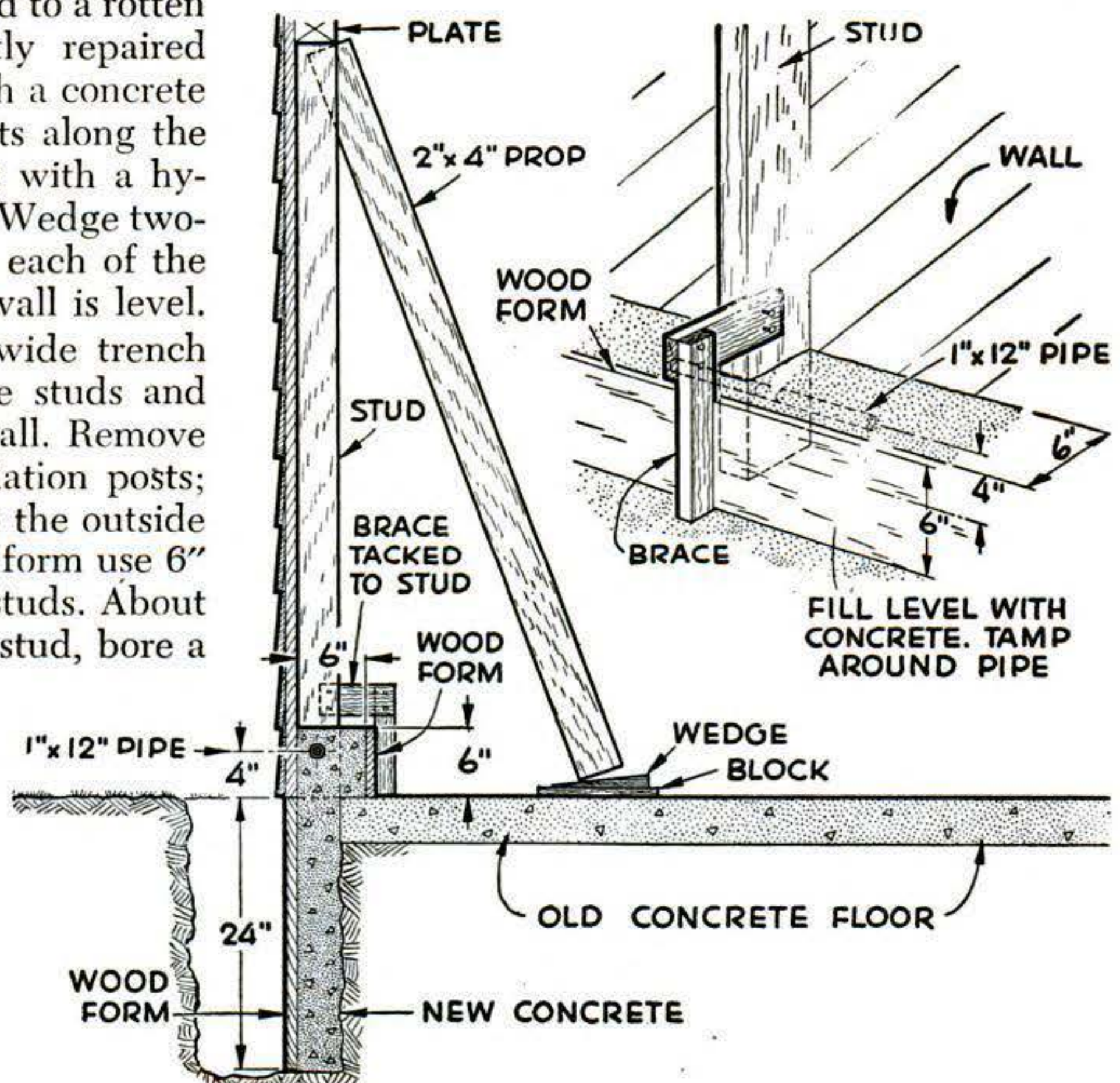



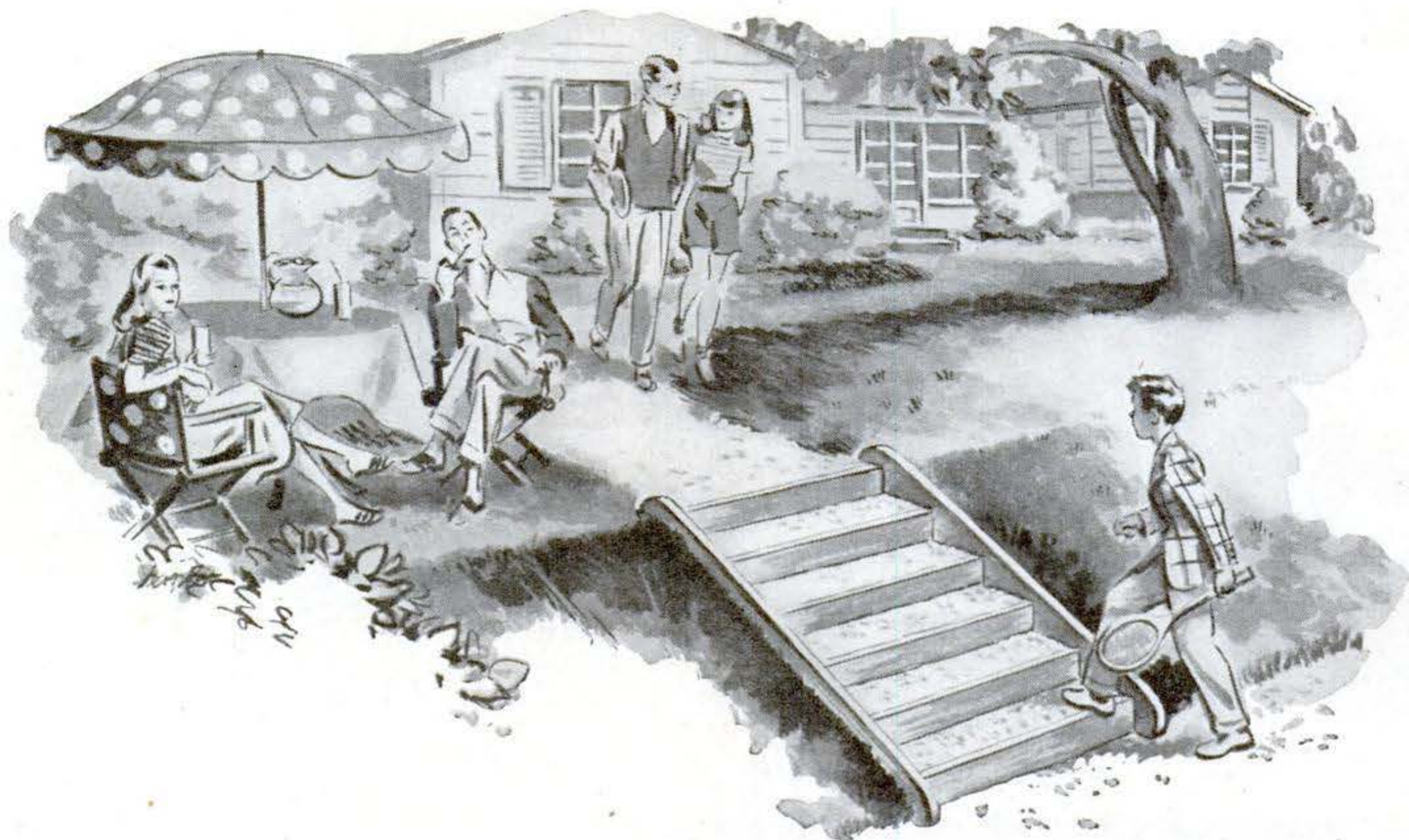

# STAIRS for Your Terrace Garden

By H. L. KETCHAM

WHEN an informal garden or a lawn requires terracing, concrete stairs connecting the various levels are frequently too formal to carry out the landscaping scheme. The set of stairs shown here has a charm of unconventionality that is impossible to attain with cement or bricks. Stringers and risers are wood, and the treads are rock dust, also known as quarry waste, laid 1" deep on dirt fill and sprinkled and tamped.

Redwood is by far the best stock for outdoor use, but locust, red cedar, longleaf

yellow pine, and oak also weather well in most climates. Creosoting or other preservative treatment is hardly necessary for redwood. Any other stock should be treated according to local custom for best results. All wood used is 2" rough lumber.

In laying out the stringers, work by the formula in the table on the facing page. The rise and run,  $AB$  and  $BC$  in Fig. 1, must first be measured so the number of steps required can be determined. One way is to weight the end of a long board on the upper level and mark the point  $C$  at the head of the flight. Then raise the outboard

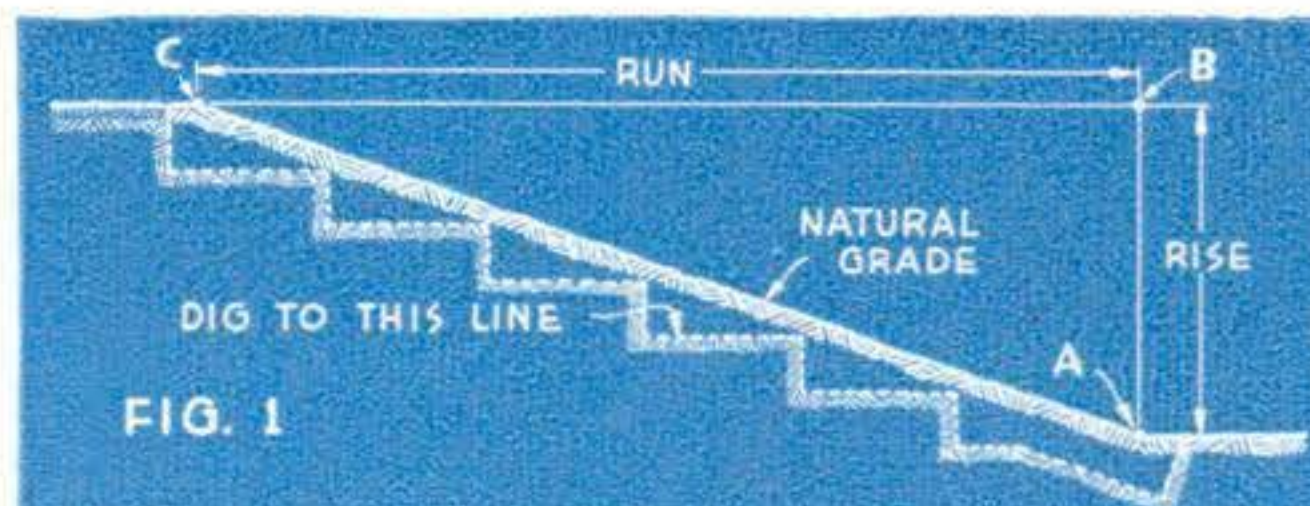

FIG. 1

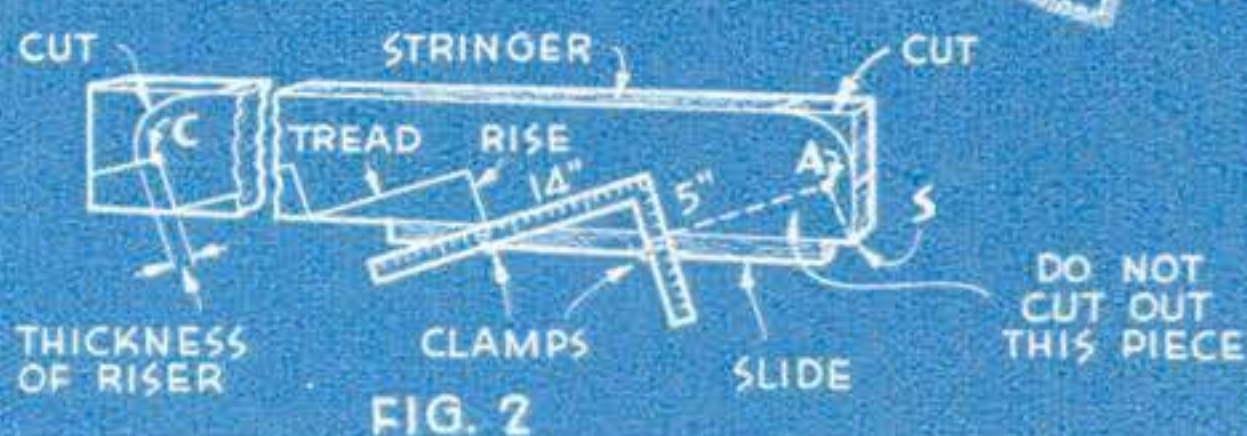

FIG. 2

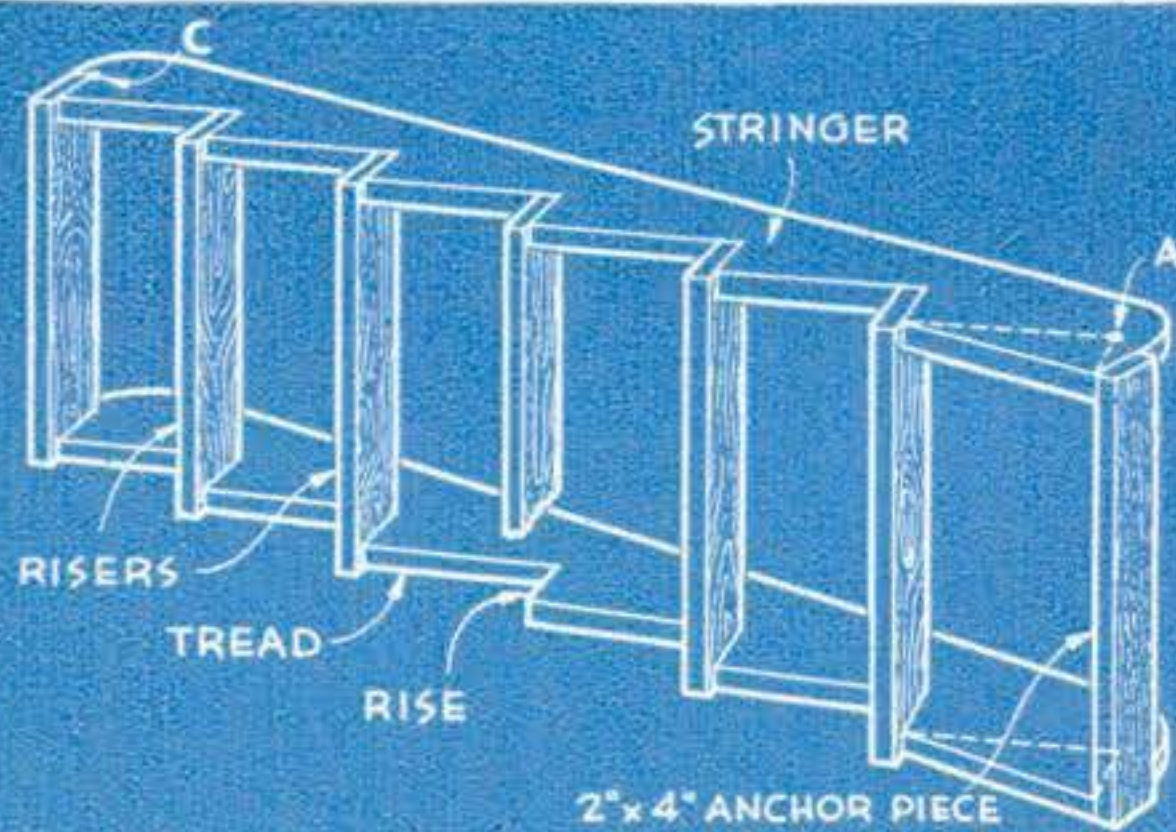
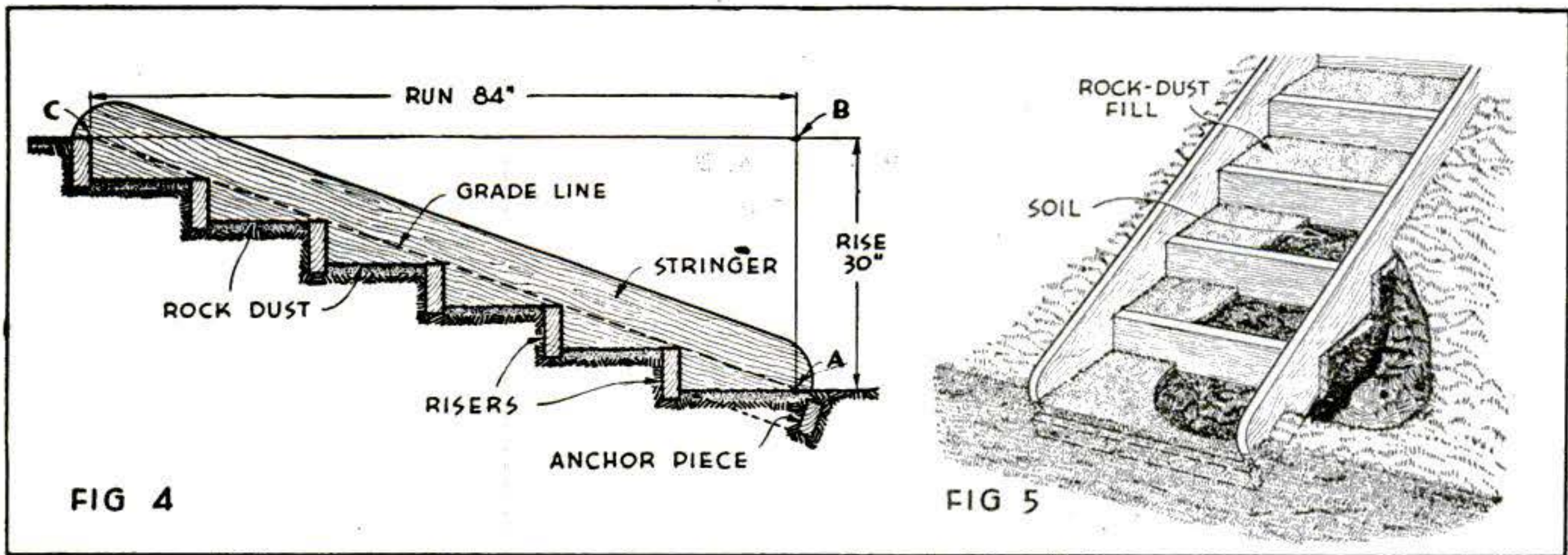

FIG. 3





end by hand until a carpenter's level shows it to be horizontal, and with a plumb bob at A locate and mark B.

Choose for stringers lumber that is free from knots or with knots only in waste wood. Lay out one stringer with the aid of a carpenter's square, as shown in Fig. 2. Saw the ends to shape and saw out the notches between risers and treads with the exception of that at end A. Then use this stringer as a template to lay out its mate.

The width of the steps is a matter of choice, but from 30" to 40" between stringers will be found practical. Cut the risers and anchor piece to size and spike them to the stringers, as in Fig. 3. It is good practice in building outdoor stairs to have the risers about 1" higher than called for. Then this extra 1" can be buried below the surface of the treads, and dirt will not come out from under the edge.

Tack diagonals across the tops of the

stringers to keep them from racking out of square. Set the assembly on the previously excavated slope, as indicated in Fig. 4, and level it up. If the ground is very loose, it may be necessary to set 2" by 4" or 4" by 4" posts outside the stringers at the lower corners. In this event, be sure to spike the posts to the stringers before the postholes are filled. Painting is usually unnecessary, but if it is desired, the assembly should, of course, be painted before it is set in the ground. Since wear will be hard, only the best outdoor paint should be used.

Backfill and tamp in the treads to within 1" of the top level, and then fill to the top with rock dust (Fig. 5), sprinkle, and tamp. In use, the tread surface will sink somewhat, but it can be built up again easily, and after several such rebuildings little further trouble should be experienced. If bricks are used in the treads, save mortaring until they have finally settled.

## BUILDING OUTDOOR STAIRS [SHIPSHAPE HOME]

The rule almost universally observed in stair building is that the height of two risers plus the length of one tread is equal to 24" to 25". A riser is a vertical strip that separates successive steps, and a tread is a horizontal footboard. To accommodate the longer stride most people use out of doors, outside stairs are generally built with relatively shorter risers and longer treads. As against a standard of 7<sup>5</sup>/<sub>8</sub>" for indoor stairs, garden risers vary only about 1" on either side of the 5<sup>1</sup>/<sub>2</sub>" mark. If the slope is so steep that risers greater than 6<sup>3</sup>/<sub>4</sub>" are required, build ladder-type steps; if treads of more than 16" will be needed for 4<sup>1</sup>/<sub>2</sub>" risers, abandon the idea of steps and use a ramp instead.

Assume that you are going to use an equal number of treads and risers for a rise of 30" and a run of 84". Rise is always fixed by circumstances, but since it is not necessary to consider headroom, run can be quite variable on outdoor stairs. Dividing 30" by 5<sup>1</sup>/<sub>2</sub>", to obtain the number of steps needed, indicates a choice of five or six. Five steps require risers of 6" and treads of 16<sup>4</sup>/<sub>5</sub>" to cover the two dimensions. But two of these plus a 16<sup>4</sup>/<sub>5</sub>" tread would equal 28<sup>4</sup>/<sub>5</sub>", considerably more than the 24" to 25" check measurement. The alternative of six steps calls

for 5" risers and 14" treads, totaling up to a check measurement of 24". If the total run were 90" instead of 84", treads of 15" could be used and still conform to the formula.

The following table is given as a means of quickly checking calculations; best results are obtained by keeping to these standards.

Riser	Tread	Twice Riser	Check Measure
4 <sup>1</sup> / <sub>2</sub>	15	9	24
4 <sup>1</sup> / <sub>2</sub>	16	9	25
4 <sup>3</sup> / <sub>4</sub>	14 <sup>1</sup> / <sub>2</sub>	9 <sup>1</sup> / <sub>2</sub>	24
4 <sup>3</sup> / <sub>4</sub>	15 <sup>1</sup> / <sub>2</sub>	9 <sup>1</sup> / <sub>2</sub>	25
5	14	10	24
5	15	10	25
5 <sup>1</sup> / <sub>4</sub>	13 <sup>1</sup> / <sub>2</sub>	10 <sup>1</sup> / <sub>2</sub>	24
5 <sup>1</sup> / <sub>4</sub>	14 <sup>1</sup> / <sub>2</sub>	10 <sup>1</sup> / <sub>2</sub>	25
5 <sup>1</sup> / <sub>2</sub>	13	11	24
5 <sup>1</sup> / <sub>2</sub>	14	11	25
5 <sup>3</sup> / <sub>4</sub>	12 <sup>1</sup> / <sub>2</sub>	11 <sup>1</sup> / <sub>2</sub>	24
5 <sup>3</sup> / <sub>4</sub>	13 <sup>1</sup> / <sub>2</sub>	11 <sup>1</sup> / <sub>2</sub>	25
6	12	12	24
6	13	12	25
6 <sup>1</sup> / <sub>4</sub>	11 <sup>1</sup> / <sub>2</sub>	12 <sup>1</sup> / <sub>2</sub>	24
6 <sup>1</sup> / <sub>4</sub>	12 <sup>1</sup> / <sub>2</sub>	12 <sup>1</sup> / <sub>2</sub>	25
6 <sup>1</sup> / <sub>2</sub>	11	13	24
6 <sup>1</sup> / <sub>2</sub>	12	13	25
6 <sup>3</sup> / <sub>4</sub>	10 <sup>1</sup> / <sub>2</sub>	13 <sup>1</sup> / <sub>2</sub>	24
6 <sup>3</sup> / <sub>4</sub>	11 <sup>1</sup> / <sub>2</sub>	13 <sup>1</sup> / <sub>2</sub>	25

POPULAR SCIENCE MONTHLY SHOP DATA



Deadly methyl or "wood" alcohol can be ferreted out, if present in a liquid, by adding salicylic acid or aspirin and concentrated sulphuric acid to the solution and standing the container in a beaker of warm water. Any wood alcohol in the solution will be disclosed by the odor of methyl salicylate (synthetic oil of wintergreen).

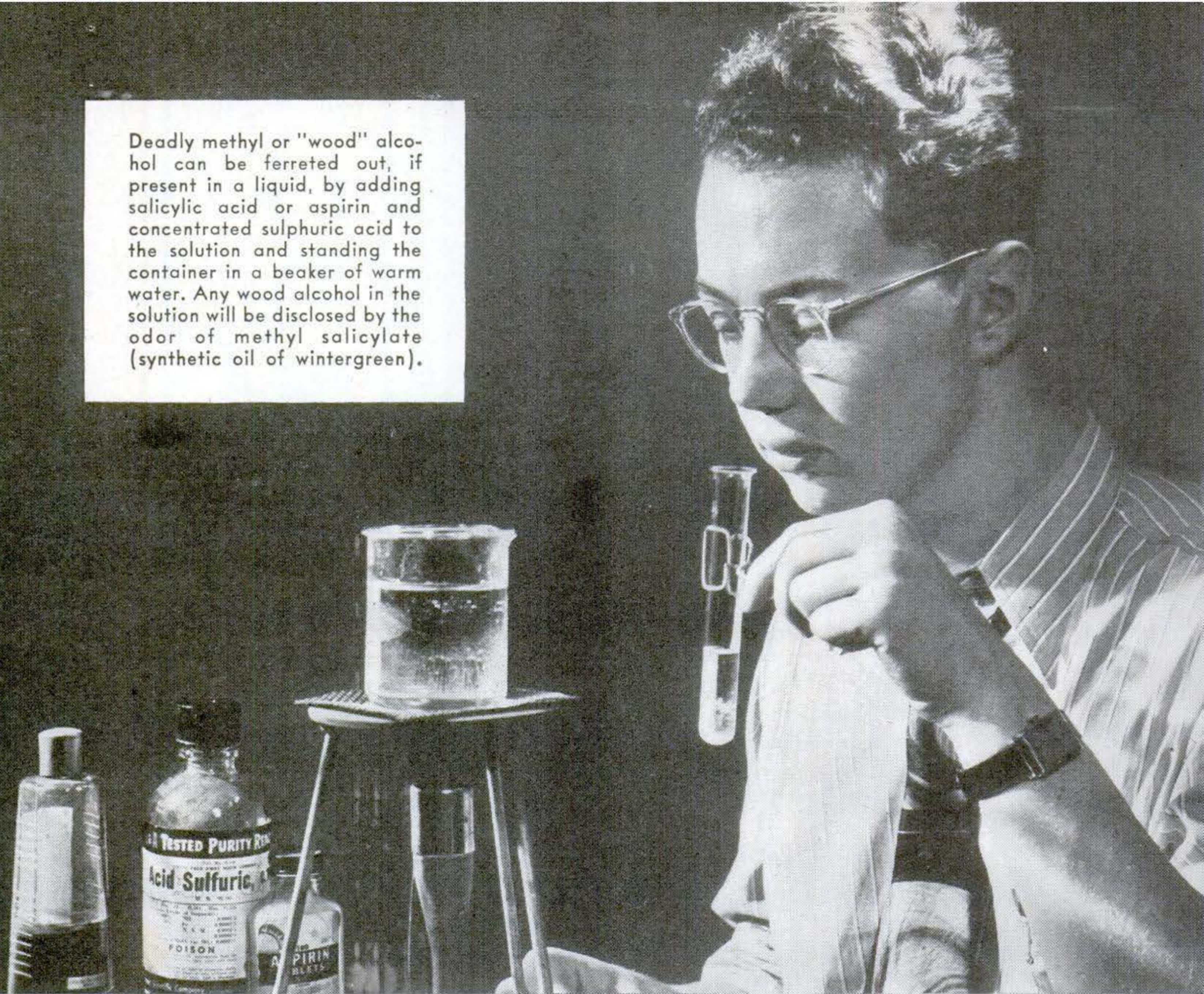

# CHEMISTRY...

## Household Detective

**Simple tests in your own kitchen or home lab give you the low-down on what's in the common articles you use every day.**

By  
**KENNETH M. SWEZEY**



**H**AVE you ever wondered if you were getting the ingredients you paid for in your packaged foods, cosmetics, and medicines? The chances are that most of them, at least, contain just what is claimed, for the Food and Drug Administration of the Federal Government keeps a close check and, besides, no reputable manufacturer would care to risk loss of good will for the sake of unfair profit.

How easy it is to detect substitutes and adulterations can be shown with a few



simple chemical tests. For your "suspect" samples, you can deliberately introduce foreign elements into several familiar household and table items, and then proceed with your chemical detecting.

A little methyl or "wood" alcohol, for instance, may be added to some bay rum, witch hazel, hair tonic, or toilet water for one experiment. Be careful not to use the adulterated liquid for any other purpose, however, for methyl alcohol is a dangerous poison and only ethyl alcohol is present in the legitimate products. Margarine mixed in butter, commercial glucose put in honey, and olive oil diluted with some cheaper oil will do for still other tests. Traces of arsenical and lead insecticides clinging to the skin of fruit can also be discovered if present, but in practice, of course, thorough washing removes these poisons.

One quick, easy method of detecting the presence of methyl alcohol is to plunge a red-hot copper wire into a little of the suspected solution held in a test tube. If a considerable amount of methyl alcohol is present, formaldehyde will be evolved. This gas can be readily recognized by its pungent, irritating odor.

Another method is to convert the methyl alcohol into methyl salicylate, which is synthetic "oil of wintergreen"

and has a familiar smell. Into about 5 ml. of the solution stir 5 grams of salicylic acid or a few crushed aspirin tablets (acetylsalicylic acid) and add carefully while stirring 3 ml. of concentrated sulphuric acid. The sulphuric acid absorbs water formed during the reaction and acts as a catalyst. Plug the mouth of the tube loosely with cotton and stand the tube in warm water for 10 or 15 minutes to give the odor a chance to rise.

Methyl alcohol is a potent poison that can cause blindness or death. Be careful when

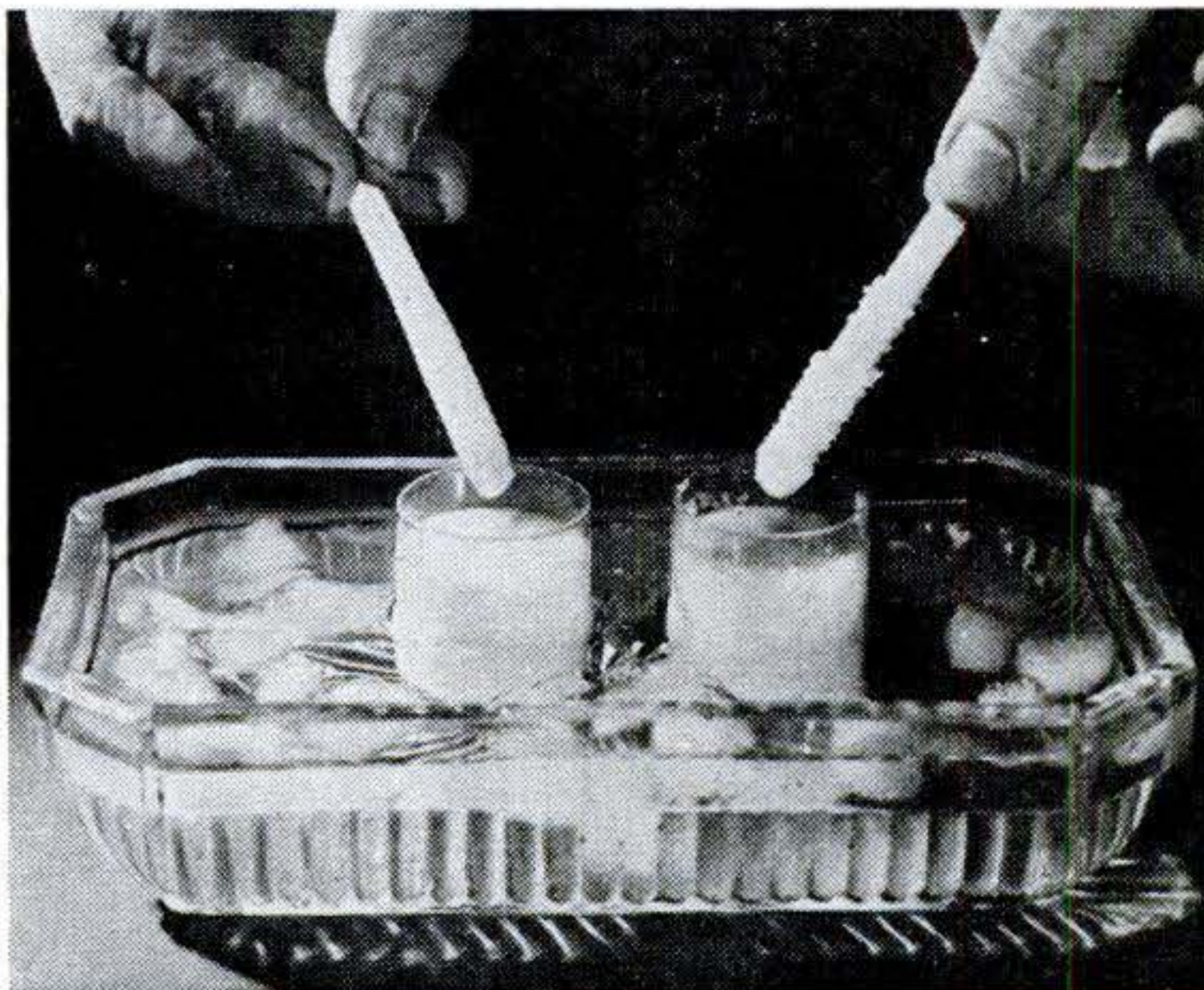

Butter and margarine act differently when melted in hot milk and then cooled. The former remains emulsified, but margarine separates and collects on the stirrer.

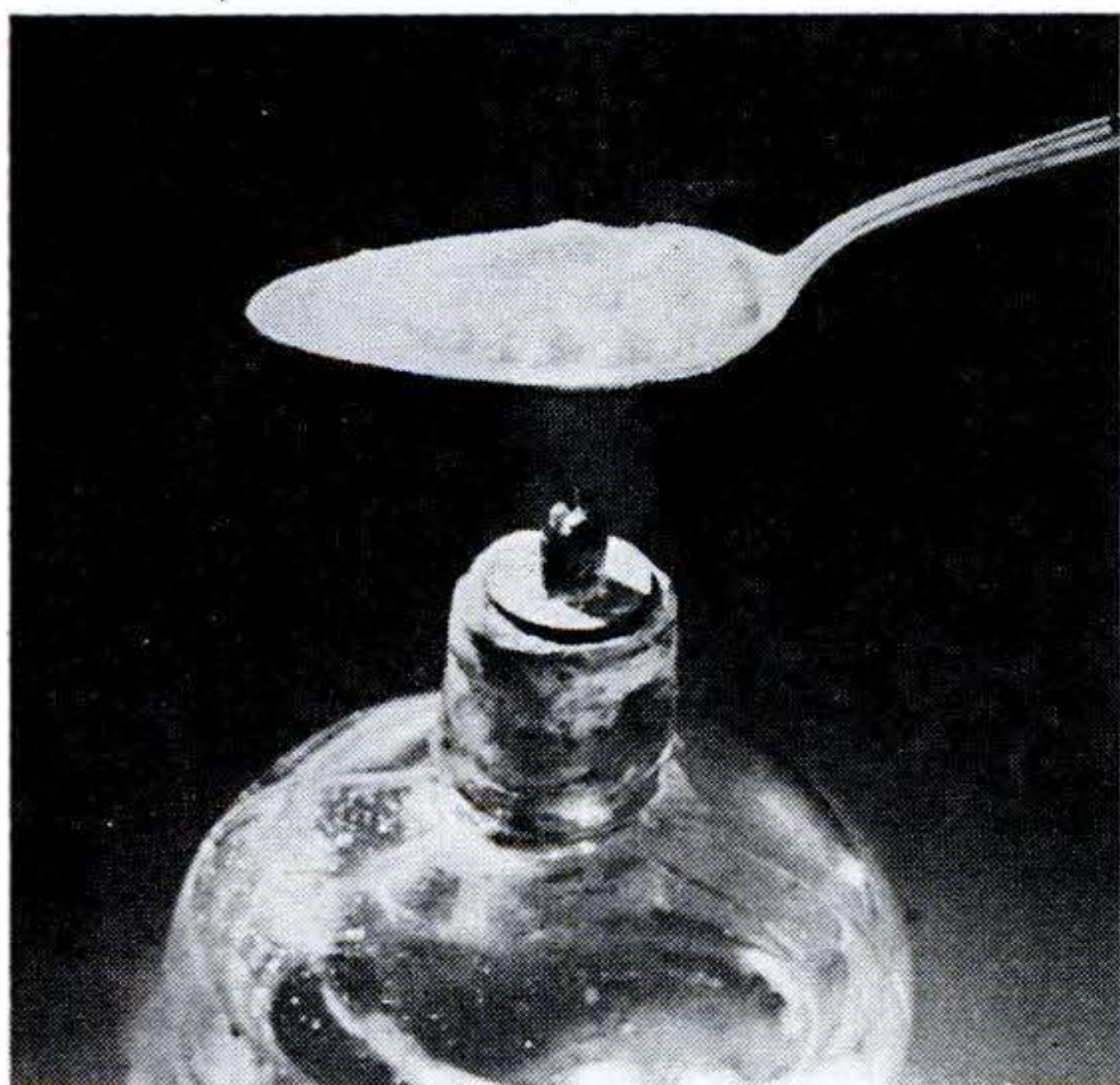

One quick test for distinguishing butter from margarine is to heat a little of each in the bowl of a spoon over a small flame. Butter will foam smoothly and copiously, while . . .

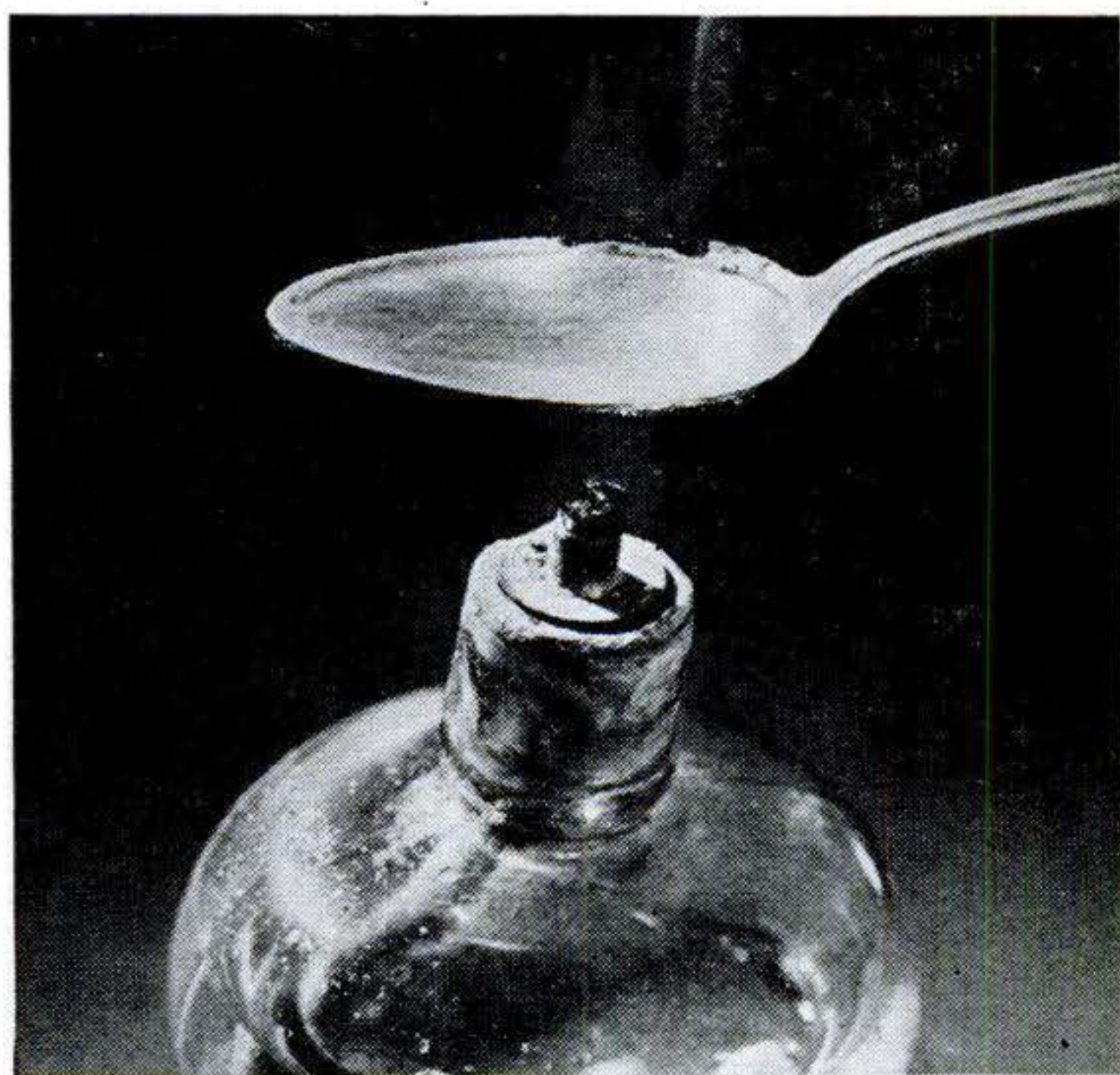

. . . margarine, or butter containing margarine, will foam but little or not at all when subjected to the same test. Instead, the heat will cause it to smoke and sputter in the spoon as hot grease does in a frying pan.



handling it because it may take effect not only through the mouth but also through the nose and skin.

Butter can be distinguished from margarine by the way it reacts when heated. Put a little butter in a spoon, heat it over a small flame, and it will foam smoothly and copiously. Margarine or butter containing it will foam little or not at all and will sputter like hot grease.

The two products also act differently when melted in hot milk and then cooled. Both become somewhat emulsified when stirred into the hot milk, but butter fat remains in that state when the milk is cooled, while margarine separates from the milk and collects as a lump or lumps on the stirrer. A small wooden paddle is best for the test.

If commercial glucose is added to honey, an iodine test will disclose its presence. Dilute a small sample of the mixture with an equal amount of water and add a few drops of a solution of 1 gram of iodine and 3 grams of potassium iodide in 50 ml. of water. When commercial glucose is contained in the mixture, the color will turn red or violet because of erythrodextrins ("red" dextrins) that are almost always found in the artificially manufactured product.

Corn, cottonseed, peanut, and other

If commercial glucose is added to honey, it can be detected with a few drops of a solution of iodine and potassium iodide. Commercial glucose contains erythrodextrin, which turns red or violet.



cheaper oils can be detected in olive oil by a simple color test with nitric acid. Shake up 5 ml. of pure olive oil with an equal volume of concentrated nitric acid in a test tube—but be careful of the acid. After two minutes, allow the mixture to stand. The olive oil may darken, but it will remain yellow. Try the same experiment with olive oil containing another oil, and the mixture will turn brown or red.

Although modern farmers and fruitgrowers use great care in removing the last traces of arsenical and lead insecticides from their products, occasionally a little of these poisonous metals may remain. That is one reason why housewives should wash vegetables and fruit thoroughly before preparing or serving them. At any rate, it makes an interesting project in analysis to test for these poisons. As contamination would be chiefly on the surface, peelings are all that are needed for the tests.

When testing for arsenic, all organic matter that might interfere should first be destroyed by treatment with nitric and sulphuric acids. The fumes given off during this process are poisonous and corrosive, so this preliminary part of the experiment must be performed either outdoors or under a chemical hood. Care should also be taken to prevent spattering of the hot acids on

Impurities in olive oil can also be determined by a color test. The oil remains virtually unchanged when shaken up with a little concentrated nitric acid. Cheaper oils become brown or red.





either your bare hands or your clothing.

To about 10 grams of peelings in a porcelain evaporating dish add 5 ml. of concentrated nitric acid and then, carefully, 2 ml. of concentrated sulphuric acid. Heat cautiously to avoid foaming and spattering. Press the peelings under the solution with a glass rod and add nitric acid, a few drops at a time, until all the organic matter is destroyed. This occurs when the solution will not darken further after it has become clear and has given off copious white fumes of sulphur trioxide. Cool and add 8 ml. of water and 3 ml. of a saturated ammonium oxalate solution. Evaporate once more until sulphur trioxide fumes appear again.

The residue may then be tested for arsenic in a homemade Gutzeit generator like the one shown in the photo at right below. This generator consists of a 250-ml. Erlenmeyer flask closed with a one-hole stopper into which the small tip of a conventional drying tube has been pushed. A small wad of glass wool is placed in the constricted end of the drying tube, and the remainder of the tube is loosely filled with crumpled filter paper moistened with a 10-percent solution of lead acetate to absorb hydrogen sulphide fumes that may be generated. Close the upper end of the drying tube with a one-hole stopper fitted with a 5" or 6" narrow glass tube. In

To test fruits and vegetables for arsenic from sprays, first destroy the organic material by heating with nitric and sulphuric acids, as at left. Put the residue in a Gutzeit generator with hydrochloric acid and zinc. The gas arsine, if formed, will discolor the paper in the top tube.

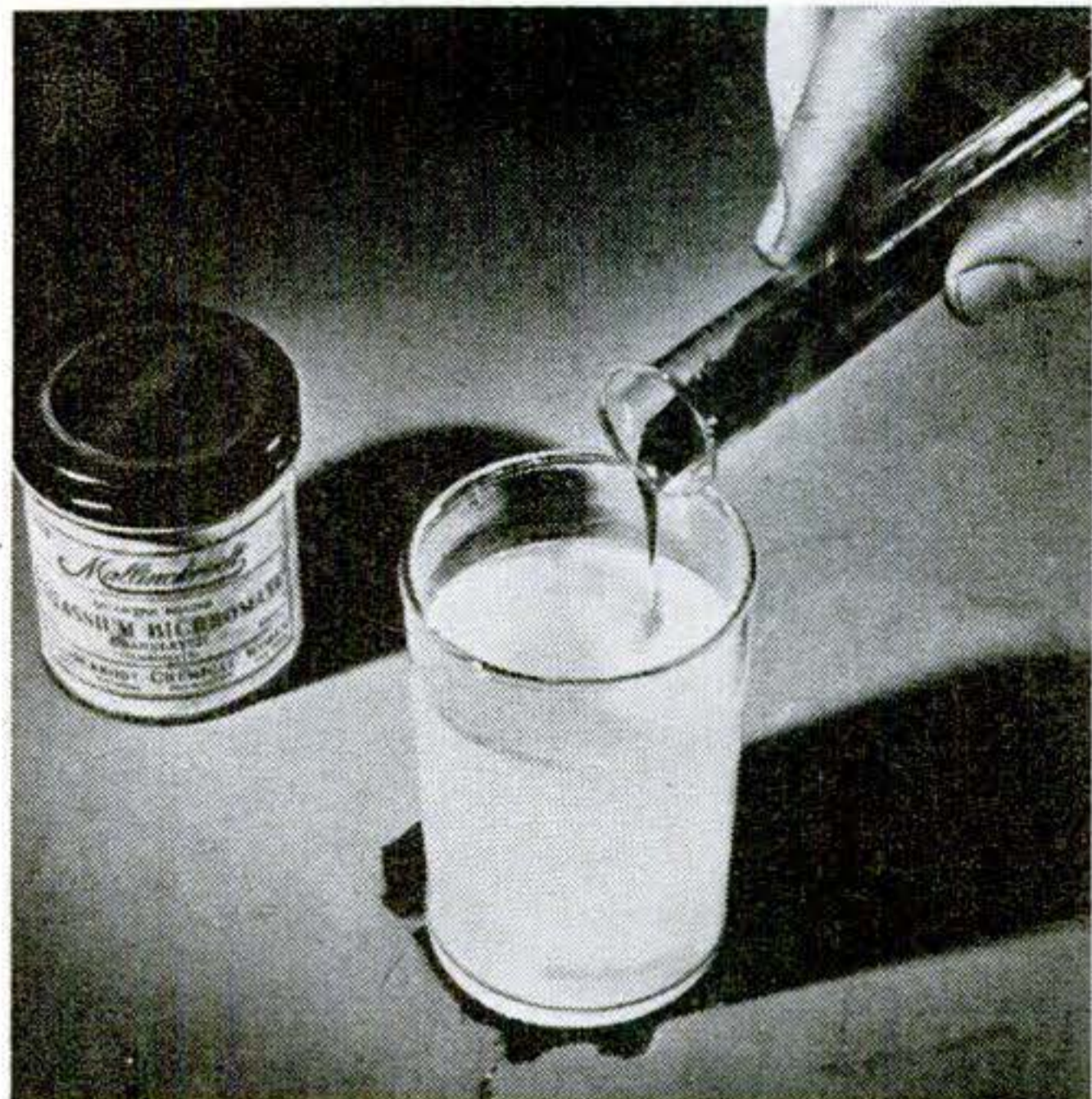

Poisonous lead can be detected easily by adding a solution of potassium chromate to a solution that contains it. A yellow precipitate is formed.

this put a thin strip of filter paper freshly soaked in a concentrated solution of mercuric chloride and dried.

Place a few small pieces of arsenic-free zinc in the bottom of the flask, add the solution to be tested, and add also 10 ml. of concentrated hydrochloric acid. A few drops of a 10-percent solution of copper chloride

will promote the reaction between the acid and zinc. After a half hour, any arsenic present will react with the hydrochloric acid to form the gas arsine. This in turn will discolor the strip of mercuric chloride paper in the upper tube, changing it from a pale yellow to a deep orange, depending on the amount of arsenic present.

A test for lead, either from insecticide residue or from water pipes, is much simpler. Merely add a solution of potassium chromate or dichromate to the solution being tested. The formation of a yellow precipitate of lead chromate will indicate the presence of lead. END

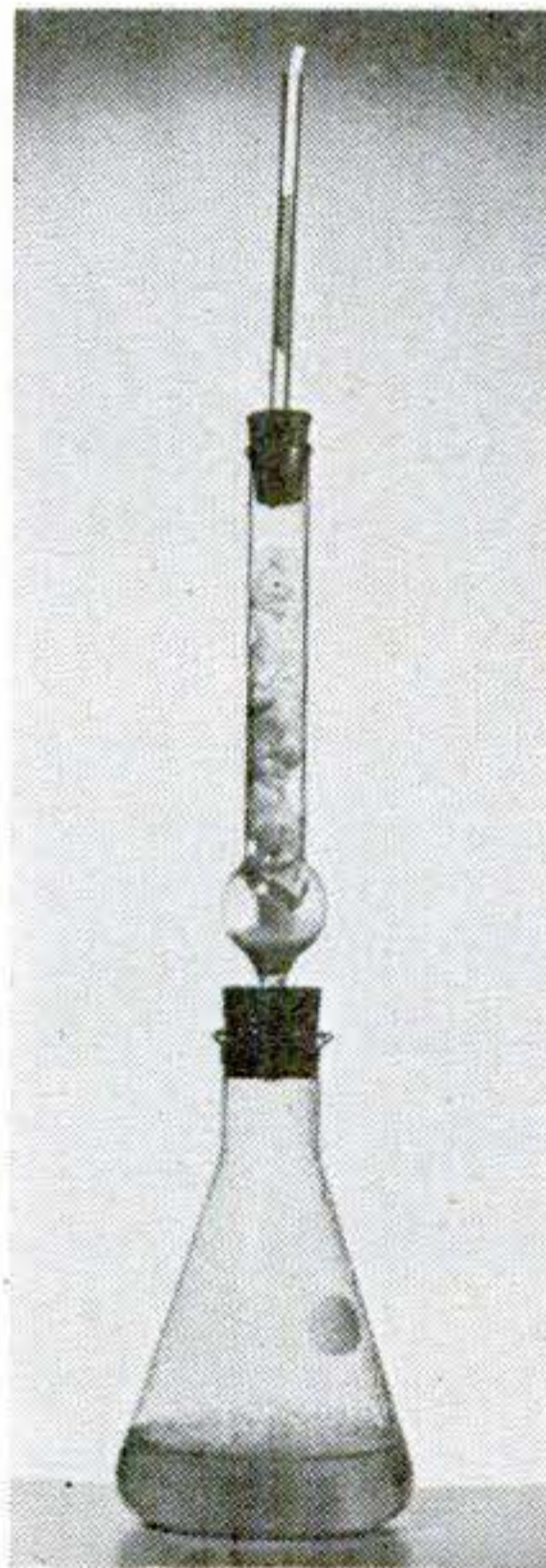



## FOR EASIER FARMING



**PREFAB FARM BUILDINGS.** To reduce the cost, several firms now are producing various farm buildings and structures in prefabricated form. Many already are in use in the West. Here, workmen are seen piecing together a large prefabricated corn crib on an Illinois farm. Looking more like a small airplane hangar than a storage building for grain, it has a capacity of 5,500 bushels of ear corn, plus 2,700 bushels of small grain.

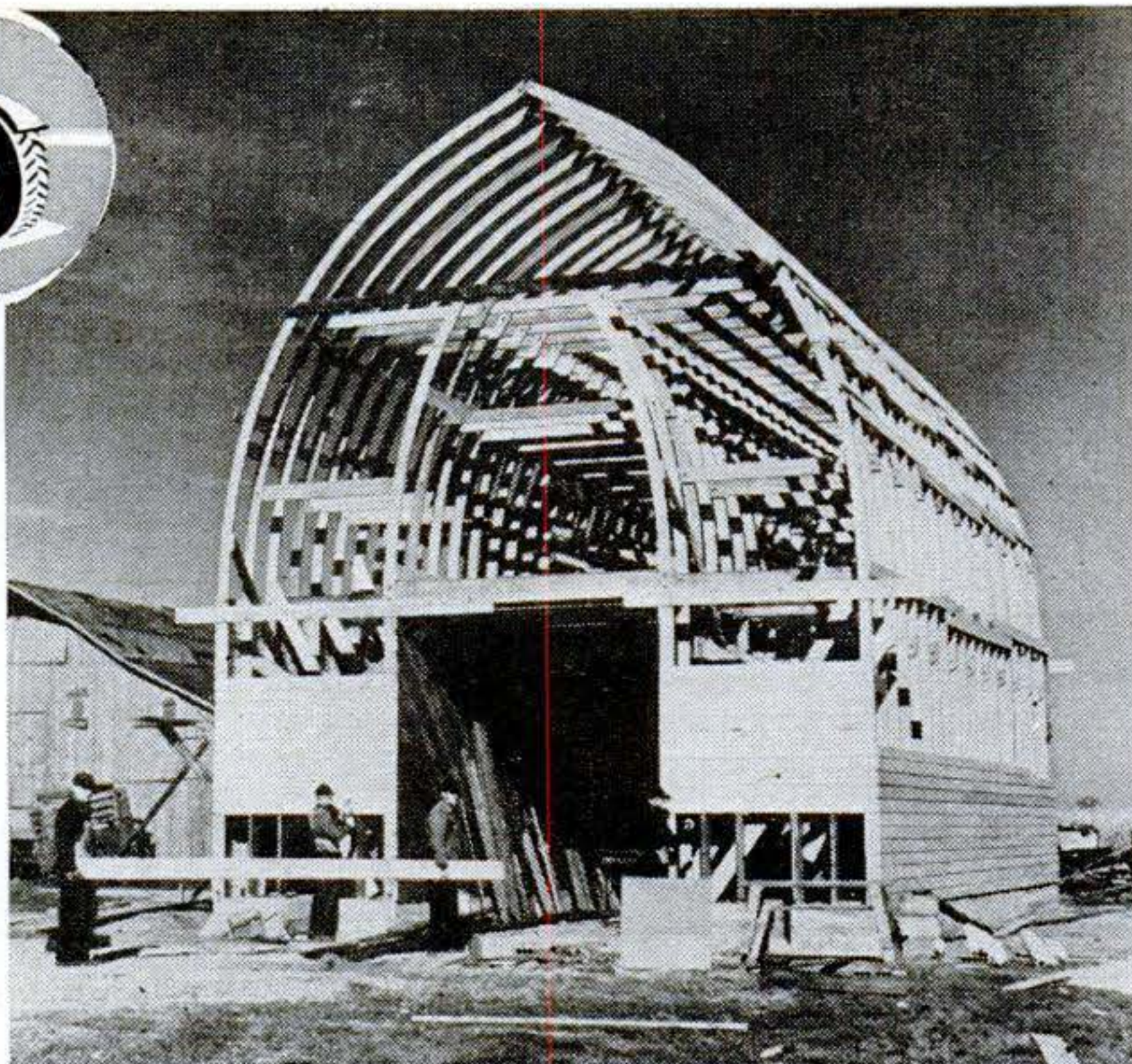

**ALARM WARNS OF FIRE.** Farmers can obtain quick warning of the outbreak of fire in any of their buildings by using a new electrically operated warning system manufactured by Lord-Taber Company, of Canandaigua, N. Y. The standard equipment includes a control unit for installation in the farm home and 15 thermostats to be placed in various buildings. When fire causes a rise in temperature in any of the thermostat areas, the control unit rings a bell, switches on a red light, and designates the fire location on a dial. In addition to warning of fires, the system may be used to give notice of plant-killing drops in temperature.

**NEW BASKET.** A rubber-covered egg basket has been developed by the United States Rubber Company to lessen the possibility of breakage during collection of eggs. The rubber is coated on light steel wire. The open construction facilitates cleaning of the basket.

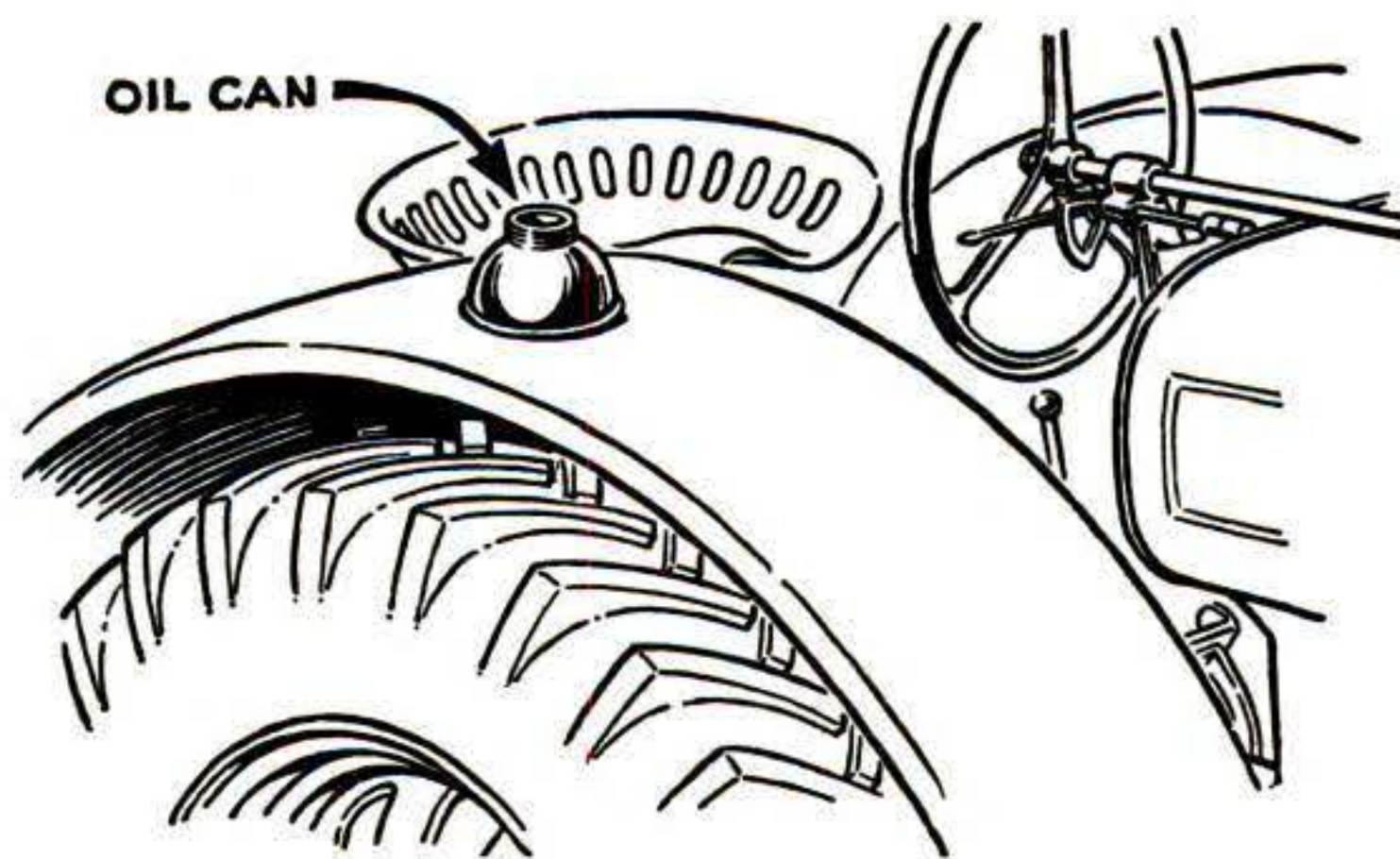
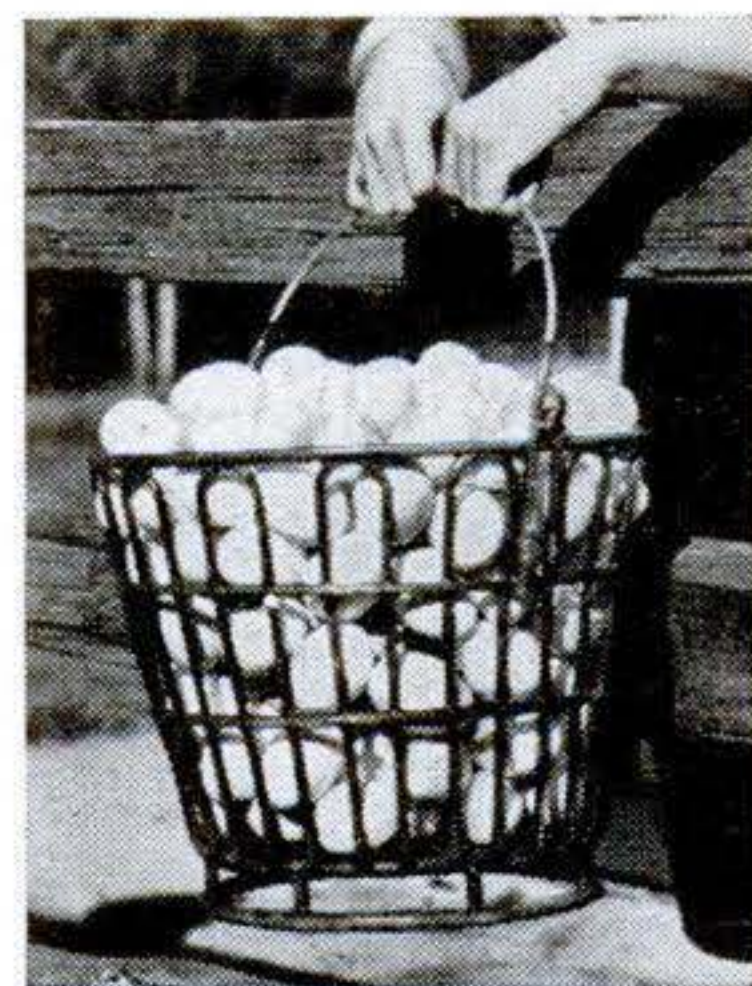

**ASH TRAY ON TRACTOR.** The possibility of cigarette butts setting a fire in your fields can be lessened by attaching the base of an old oil can to your tractor as an ash tray. A little sand placed in the can and moistened occasionally with a little water will put out any live butts.—RAY HARRISON.



# New Lightweight Tripod



**... makes your camera steady and light on its feet**

*Kodak Eye-Level Tripod* is light in weight, quick to set up . . . and built to last for years. It gives rigid, dependable support to movie and still cameras and helps you get pictures free from accidental camera movement. Extends from 22½ inches to 60 inches. \$16.75 plus tax.



**Kodak Turn-Tilt Tripod Head angles your shots expertly**

Easier panning with your movie camera, a versatile accessory support for still shots. New smoothness in performance with a minimum of adjustments. Fits your present tripod or *Kodak Eye-Level Tripod*. \$13.25 plus tax.



**ENLARGING EASEL speeds making of album prints from miniature negatives**

*Kodak Miniature Enlarging Easel* for 2¼ x 3¼ album prints (with ⅛-inch white margins) from miniature negatives. Makes a

rapid succession of record prints from which choice shots may be selected for further enlargement. With its white Tenite base insert, there's no need to use photographic paper while focusing. Two built-in bins hold your papers. It rests on the baseboard of your enlarger. \$6 plus tax.



Optipod  
\$1.50 plus  
tax



Kodapod  
\$2 plus  
tax

**These clamp-on "tripods" are convenient and steady**

*Optipod* (left) and *Kodapod* (right) are pocket-size and easy to carry—yet give you tripod steadiness. *Optipod* is felt-lined, fastens to chairs, tables, desks—*Kodapod's* teeth bite firmly into fences, tree branches, etc.

Eastman Kodak Company  
Rochester 4, N. Y.

**Kodak**



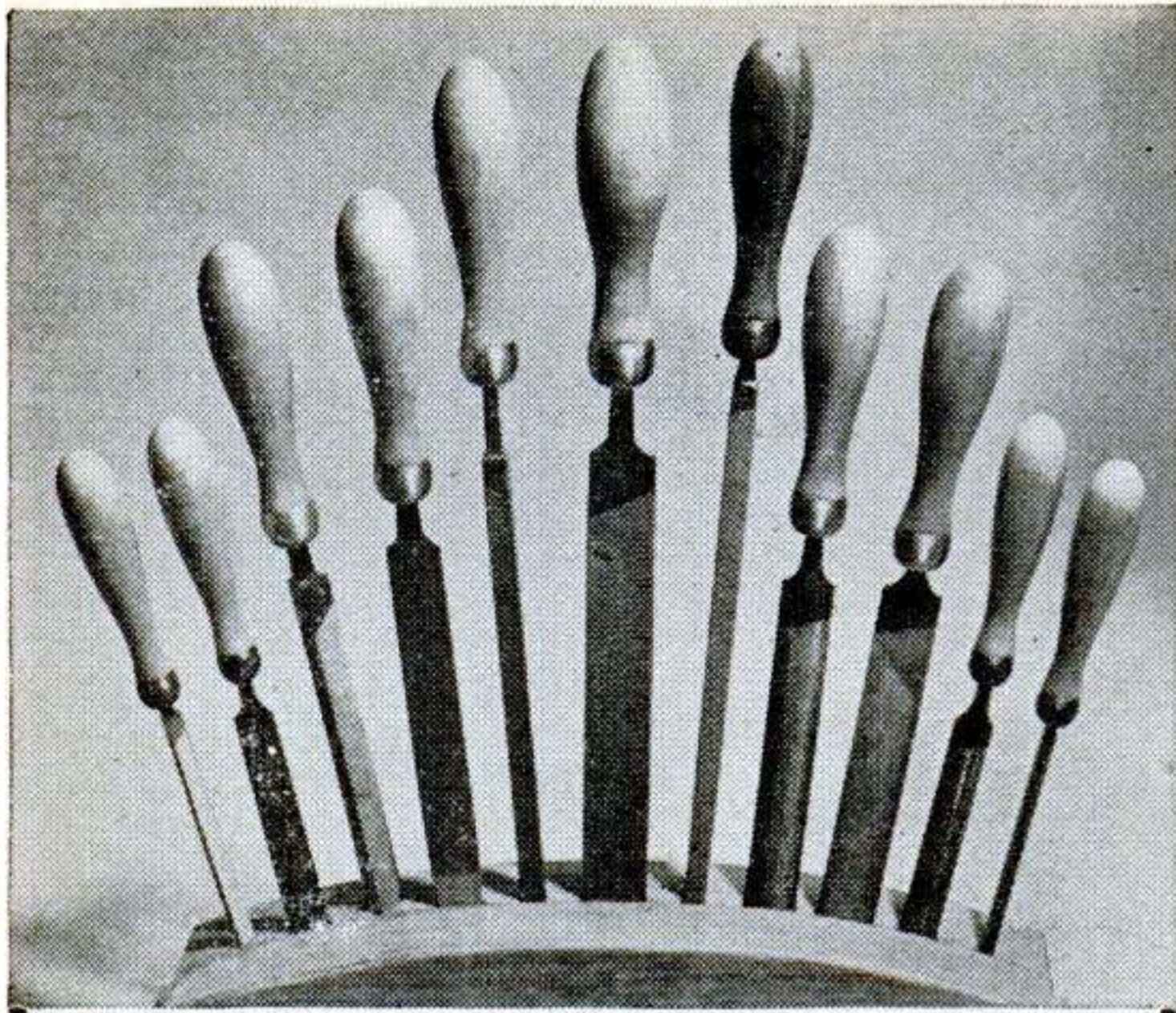

## Invitation to craftsmanship

There's nothing like fine tools to awaken the latent skill in a man—to inspire him to use his talents to advantage. You'll find it especially true of Nicholson and Black Diamond files. Their recognized quality . . . their sure, keen bite . . . their wide variety of shapes, cuts and sizes make them the over-all favorite in home and industrial workshops. Equipped with a well-rounded assortment, you can be sure of having *The right file for the job.* Available through the better hardware stores.

**NICHOLSON FILE CO.**  
19 Acorn Street, Providence 1, R. I.  
(In Canada, Port Hope, Ont.)

NICHOLSON  
U.S.A.

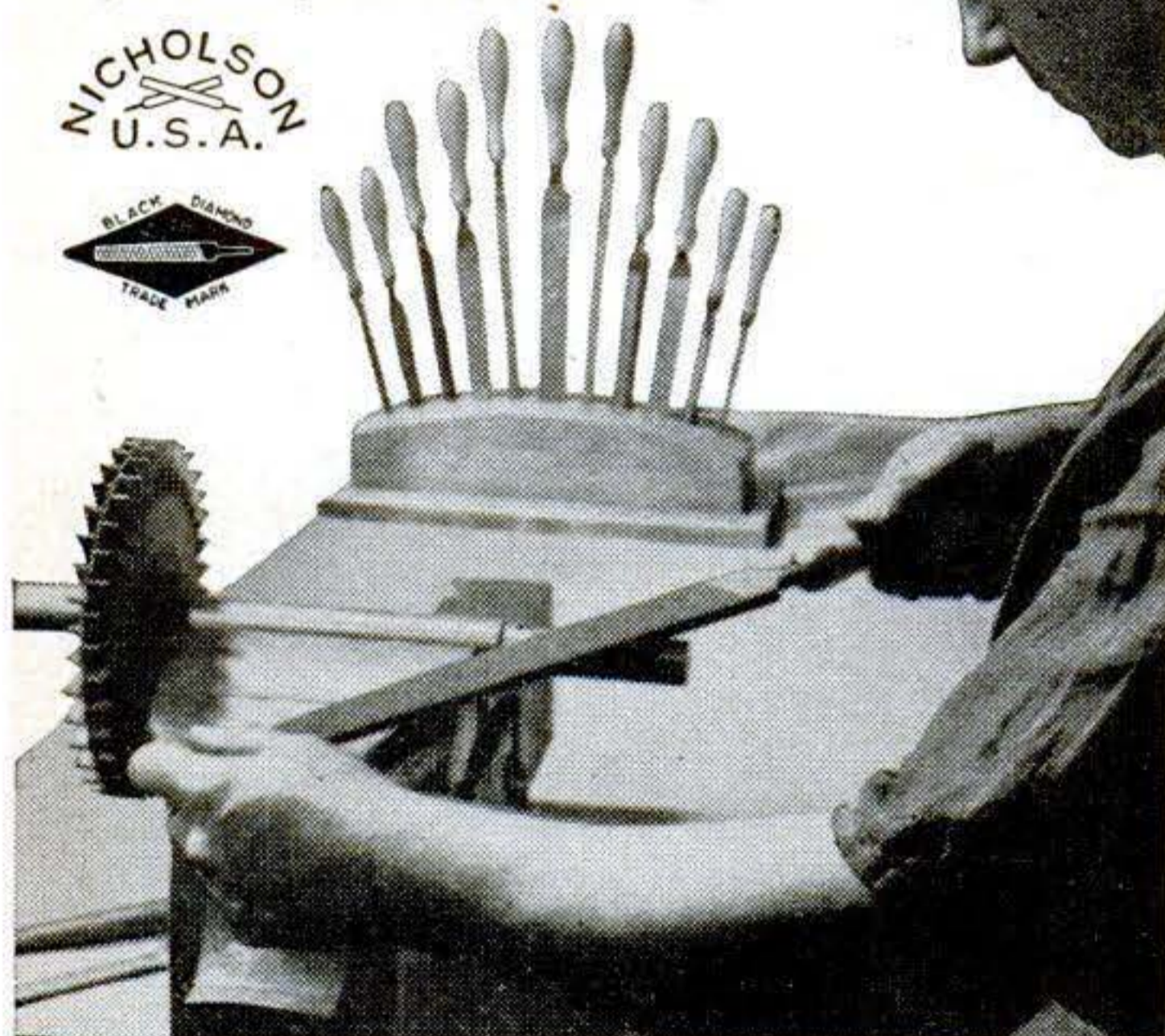

# NICHOLSON FILES

FOR EVERY PURPOSE

# New!

## MODEL 151M .22 Caliber MOSSBERG AUTOMATIC

Tops in beauty, mechanical perfection and value. Embodies many new features. Shoots 15 shots as fast as you can pull the trigger. Equipped with all Mossberg's finest sighting devices and many other Mossberg conveniences. See it at your dealers..

Write for  
free catalog  
No sales at  
factory

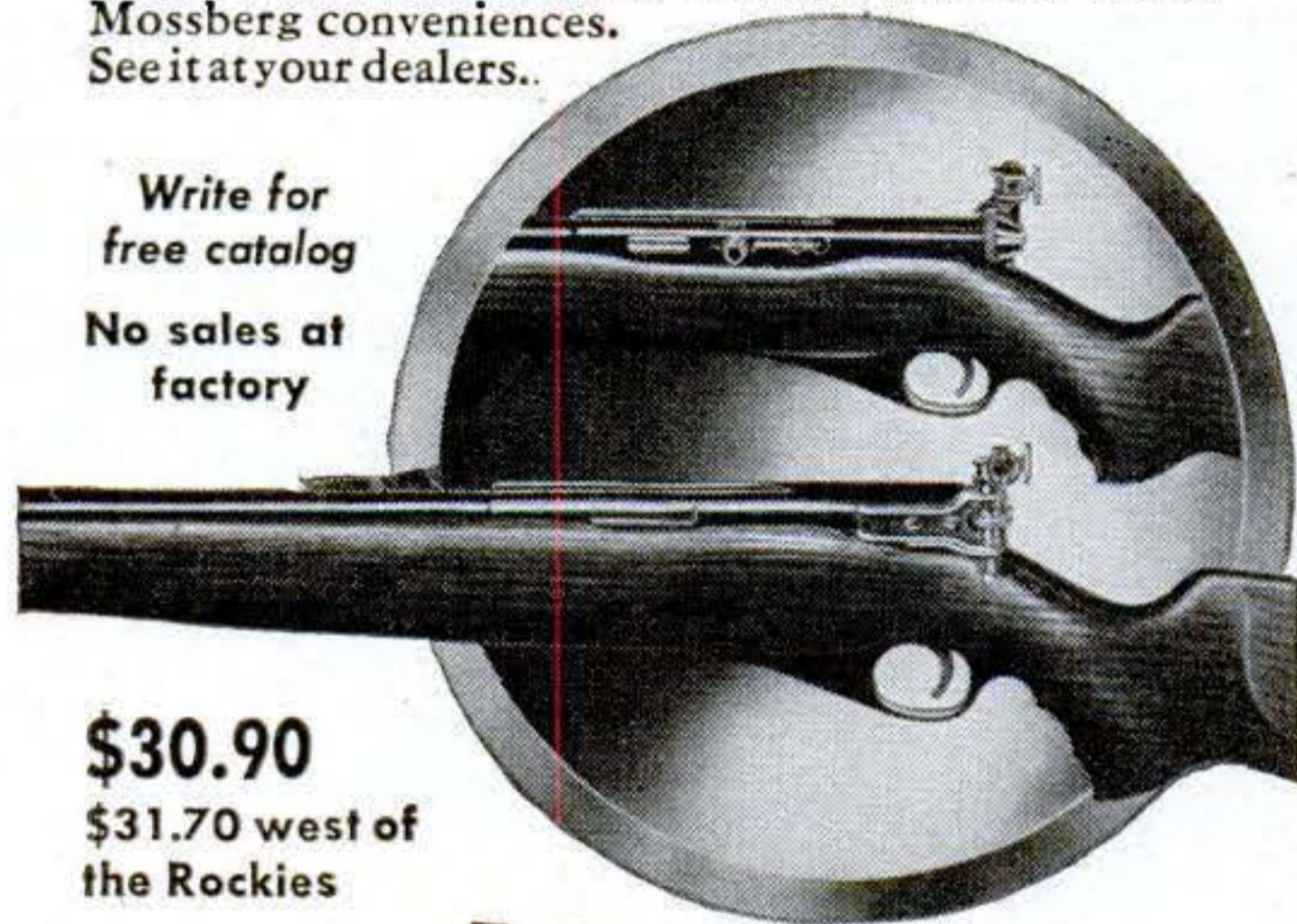

\$30.90  
\$31.70 west of  
the Rockies

# O.F. Mossberg

& SONS, INC.

79704 St. John Street • New Haven 5, Conn.

IT'S EASY TO MAKE  
YOUR OWN "BLOW-UPS"

And grand fun too, with a

**FEDERAL**

"America's Fastest Selling Enlarger"

Picture-taking's a pleasure, but the real thrill comes when you make your own enlargements. It's really easy to turn out top-notch prints, and *inexpensive*, too, when you use a Federal. Advanced principles of illumination and optics make this the finest Federal ever built. And for *extra value*—A TESTED, ANASTIGMAT LENS IS INCLUDED in the modest price of every Federal.

"ENLARGING IS THRILLING"

don herold's wisdom-packed book  
— tells you all you need to know.  
25c at Camera Stores, Everywhere  
or send coin (no stamps, please) to Federal



**FEDERAL MANUFACTURING & ENGINEERING CORP.**  
Makers of Photographic & Electronic Devices  
213 Steuben Street • Brooklyn 5, N. Y.



# A CHAMPION WITHOUT EQUAL by FRANK WILLIAMS

THE GRAND LITTLE MAN OF BILLIARDS

## WILLIE HOPPE

...FOR 43 YEARS A WORLD'S TITLEHOLDER? TRY TO MATCH THAT RECORD IN ANY OTHER SPORT!

...IN 1906 HE DEFEATED VIGNAUX IN PARIS FOR THE WORLD'S 18.1 BALKLINE TITLE. SINCE THEN HE'S WON EVERY WORLD'S CHAMPIONSHIP... AT 59 HE STILL HOLDS MOST OF THEM!

WILLIE FIRST LEARNED TO HANDLE A CUE AT EIGHT...



...AT 16 HE WON THE JUNIOR MASTERS' TOURNAMENT.

HE LOOKS **SHARP!**

...CALMLY AND CONFIDENTLY SCORING A SPECTACULAR SHOT... HE HAS RUN MORE THAN 15 MILLION POINTS IN BILLIARDS DURING HIS LIFETIME!

HE FEELS **SHARP!**

...TRAVELLING CROSS-COUNTRY TO GIVE COUNTLESS EXHIBITIONS OF HIS SKILL... DURING THE WAR HOPPE TOURED USO CAMPS ...OFTEN MAKING 8 TO 10 APPEARANCES DAILY!

look **SHARP**  
feel **SHARP**  
be **SHARP**

use

**Gillette Blue Blades**

with the **SHARPEST** edges ever honed!

● You *look* sharp for you enjoy the swellest shaves ever. You *feel* sharp because they're refreshing and give you a lift. You *are* sharp for you get far more shaves per blade and save money. Ask for Gillette Blue Blades.



5 for 25¢

ENJOY BOXING

FRIDAYS AT 10 PM EST OVER ABC NETWORK. GILLETTE'S CAVALCADE OF SPORTS ALSO AIRS WORLD SERIES AND OTHER CLASSICS YEAR'ROUND.

HE IS **SHARP!**

...WILLIE HOPPE TAKES NO CHANCE ON MISFIT BLADES OR FAULTY SHAVING METHODS. HE WANTS THE CLEANEST, MOST REFRESHING SHAVES IN THE BOOK, SO HE ALWAYS USES **GILLETTE BLUE BLADES**. SURE HE KNOWS THAT **DOUBLE EDGES MEAN DOUBLE ECONOMY!**

Gillette Safety Razor Company, Boston 6, Mass.

Copyright, 1947, by Gillette Safety Razor Company

APRIL 1947 227



# "HULA DANCER DANCER Fools the Big Ones!"

*Writes C. W. "Duke" Mead,  
Memphis Angler*



"Dear Fred:

"Have discovered it takes a Hula Dancer with your invisible bait casting leader to fool the big ones, especially in the colder months when they are down deep. I caught this 9-lb. bass and several others from Storm Creek Lake near Helena, Ark. — which isn't virgin waters.

"I have used your Hawaiian Wigglers and Jitterbugs for years. They have proved their worth time and again on numerous fishing trips. Previous to this 9-lb. bass, the largest I had ever caught was a 6½-lb. largemouth on a No. 2 Hawaiian Wiggler. If the boys want action and bass, I recommend that they try your lures." — C. H. "Duke" Mead, Memphis, Tenn.

## Write for Free Catalog

Beautifully illustrated in colors, it tells all about Hawaiian Wigglers, Jitterbug, my famous surface bait, and Hula Dancers. Copy free on request.

## Colored Movies Available

We have 8 reels of colored movies taken of bass fishing in Canada, Michigan and Florida. These are available without cost for showing to clubs. Advise what club and when you would like to use them.

FRED ARBOGAST & CO., 1704 North St., Akron 3, Ohio



\$1.21 ea.

Choice of 6 Colors



# LEAK PROOFS

**sealed against corrosion...  
sealed against power loss!**

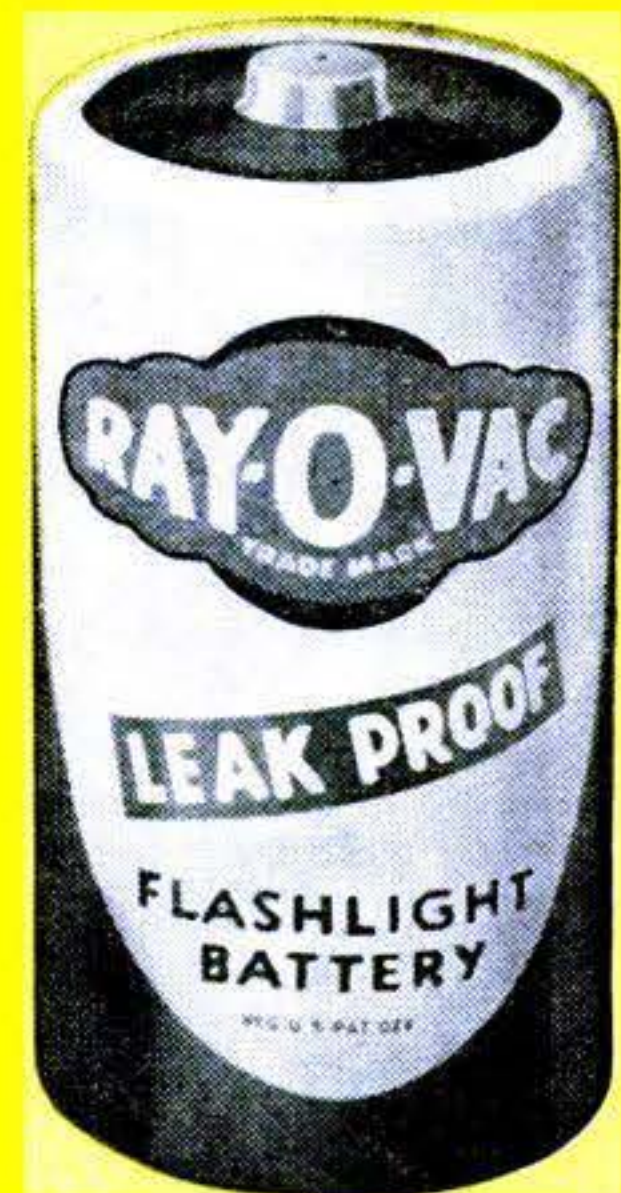

Ray-O-Vac LEAK PROOFS keep your flashlight *safe* from corrosion—they're insulated and sealed-in-steel to keep corrosive battery materials from damaging your flashlight. This same patented construction prevents loss of battery energy. LEAK PROOFS *stay fresh* 'til you need them! For FREE helpful "Flashlight Service Guide" write Dept. PS-1, Ray-O-Vac Co., Madison 3, Wis.

*Read this Guarantee*

## AGAINST FLASHLIGHT DAMAGE

If your flashlight is damaged by corrosion, leakage, or swelling of this battery, send it to us with the batteries and we will give you FREE a new comparable flashlight with batteries.

**BUY SPARES... THEY STAY FRESH!**

**ONLY LEAK PROOFS  
GIVE YOU THE "ADDED 4"**

START WITH A  
POWERFUL BATTERY

ADD STEEL BOTTOM

ADD STEEL TOP

ADD INSULATION

ADD STEEL JACKET

FINISH WITH  
RAY-O-VAC LEAK PROOF  
BETTER 4 WAYS





## 110 POWER TELESCOPE

Explore the LAND, SEA and HEAVENS

with this super power precision built instrument. 110 power astronomical eyepiece. 45 power terrestrial eyepiece. Rigidly constructed alt-azimuth tripod over 5 feet high. Price complete with eyepieces and tripod

**\$135**

Length of telescope 3½ ft.  
Weight with tripod 11 lbs.



Highest quality 2½" dia. achromatic lenses fluoride hard-coated for maximum brilliance. Duraluminum tubing finished in black aluminite and chromium plate. A knurled knob at the eyepiece provides easy yet accurate spiral-thread focussing.

This professional instrument built to scientific perfection and lifetime durability will provide you with a delightful and never ending source of pleasure and information. Turn the telescope toward the heavens and it will show you the moons of Jupiter, phases of Venus, rings of Saturn, double stars, hundreds of mountains and valleys on the moon, etc. At the seashore, in the mountains, on the farm, observing from an apartment house window, the back yard, or front lawn, you will be fascinated as distant people, houses, ships, airplanes, and other objects invisible to the naked eye are brought amazingly close in great detail. The price complete with all accessories is only \$135. It is fully guaranteed, ready for immediate delivery, and the shipping charges are paid by us to anywhere in the United States. It is available in limited quantities only.

## 8 x 32 FEATHERWEIGHT BINOCULAR

Check These Features:



**\$53.40**  
Postpaid

- HIGH MAGNIFICATION
- COMPLETELY COLOR CORRECTED
- LARGE BRIGHT OBJECTIVE LENSES
- NEEDLE-SHARP CLARITY
- QUICK FOCUSING
- WIDE FIELD OF VIEW
- LIGHTWEIGHT YET STRONG
- BROWNSCOPE MONEY-BACK GUARANTEE

Constructed of special lightweight aluminum alloy, these high-powered prism binoculars are rigid as steel yet weigh only 16 ounces. Central focussing wheel for easy adjustment. The eyepiece lenses as well as the objective lenses are achromatic, a feature found only in the best binoculars. 8 power, 32 mm lenses. This fine glass is unexcelled for hunting, sports, marine use, and general long-range observation. Sold with a guarantee of complete satisfaction or money refunded. Leather carrying case and straps included. Only \$53.40 including all tax and shipping charges.

## LABORATORY MICROSCOPE

**600 POWER \$25.50**

3 Objectives—75X, 300X, 600X



A professional type microscope priced within the reach of the amateur. For school, laboratory, physician, and student. Color corrected achromatic lenses. Professional size eyepiece and objective interchangeable with all standard professional makes. Height 14 inches. Weight 5¼ lbs. Stage 4" x 4". 2 wheel focussing. Body tilts any angle. Microscope complete with 3 objectives, prepared specimen slide, and 96 page book on microscopy, only \$25.50 postpaid.

Immediate Delivery

Money Back Guarantee

**BROWNSCOPE CO.**

Dept. 4P 24 West 45th St., New York 19, N. Y.

**IMMEDIATE DELIVERY!**

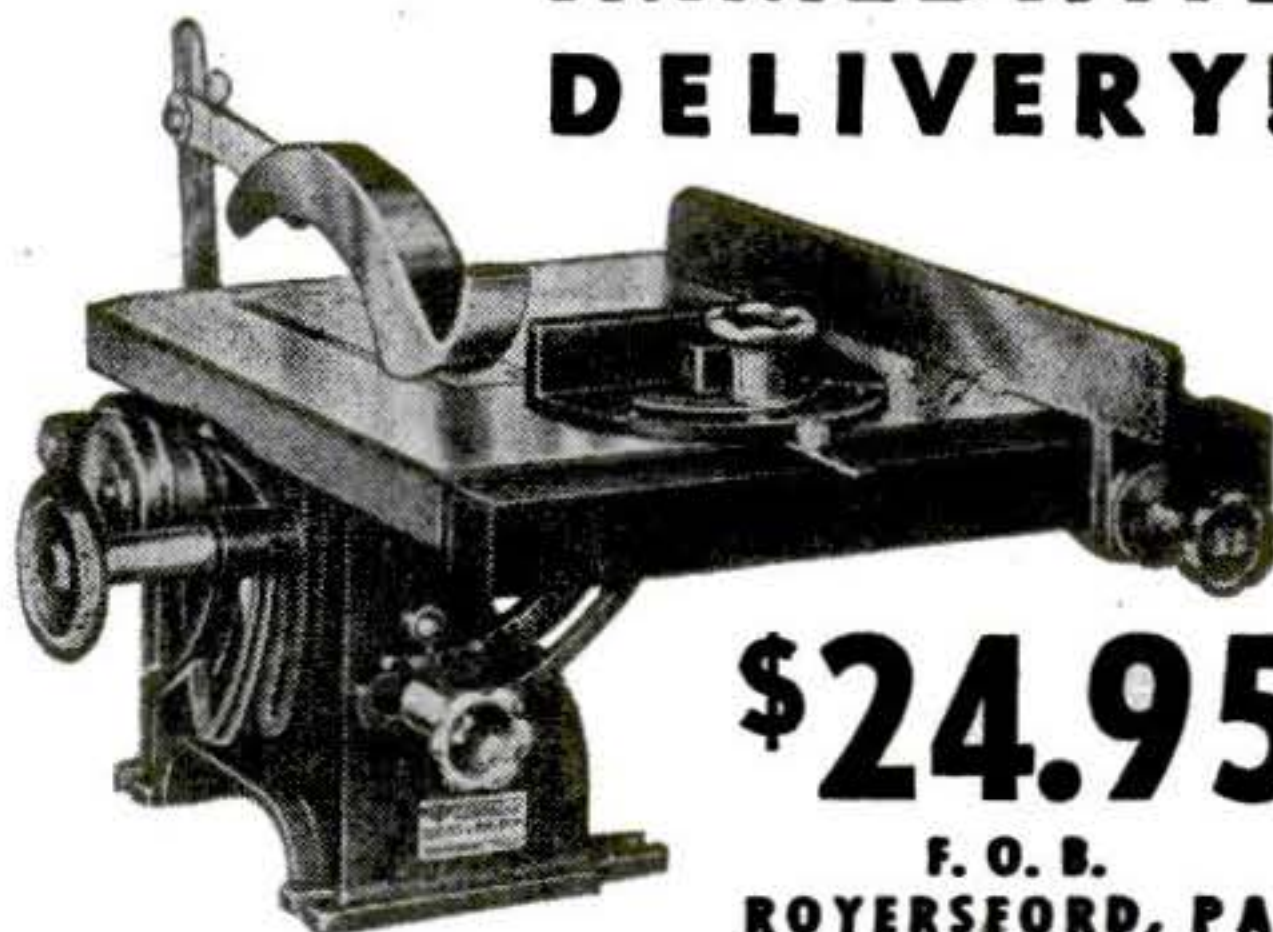

**\$24.95**

F. O. B. ROYERSFORD, PA.

## 8 in. BENCH SAW

COMPLETE AS SHOWN

**TABLE SEGMENT**—Shows degree of table tilt—graduated. **SPLITTER**—Hard temper cold rolled steel. **GUARD**—Aluminum. **MITER GAUGE**—Aluminum. Accurately graduated 45° each side of center. **BEARINGS**—(2) Oilite bronze. **CAPACITY**—0 to 2¼". **TABLE**—12"x14". **SHIPPING WEIGHT**—44 lbs.

**AMERICAN MACHINE & TOOL CO., Inc.**

DEPARTMENT 200 • ROYERSFORD, PA.

**\$2.95**



## TORNADO GAS TORCH

*The Modern Way of Soldering*

Ideal for hard and soft soldering. Will heat quickly; solder will flow freely and smoothly. No compressed air required. Nothing to pump. Self-adjusting. Safe. Economical. Can be used for annealing small parts and bending metal parts. Generates a heat of 1700° Fahrenheit. Simply connect to any illuminating gas jet with a rubber hose and operate.

Tornado Torch No. 119 comes with three (3) tips, (½", ¼", ⅜" blast).

The Tornado Gas Torch No. 119, complete with three tips, is \$2.95. See your dealer or order direct. Send check or money order—post paid.

Robco Corporation, 204 E. 44th Street, New York 17, N. Y.



**Model Builders Attention!**

	V	V-2	V-3
Hex	½"	⅜"	⅝"
Thread	⅜"-24	¼"-32	¼"-32
Thread Length	7/32	7/32	5/32
Weight, Grams	8	3½	2½

Actual Size V-Plug

Champion spark plugs for model gas engines give the same dependable performance as regular Champions. Sillment sealed. Sillimanite insulator. Alloy needlepoint electrodes for easy starting. One piece construction.

**CHAMPION**

SPARK PLUG COMPANY • TOLEDO 1, OHIO



Dependable

# CHAMPION

AMERICA'S FAVORITE SPARK PLUG



Outstanding example of the dependability of Champions is the recent world's record, non-stop, non-refueled flight of the Navy Airship XM-1. Champion equipped engines kept her in sustained flight for over 170 hours, a record for any type of aircraft. Such dependability is inherent in every Champion Spark Plug for every engine and operating condition. Champion Spark Plug Company, Toledo 1, Ohio.



***FOLLOW THE EXPERTS***

**DEMAND DEPENDABLE CHAMPIONS FOR YOUR CAR**

Listen to the CHAMPION ROLL CALL,  
Harry Wismer's fast sportscast every Friday night,  
9:55 EST over the ABC network.

APRIL 1947 231



# FLOODLIGHT

## the Night

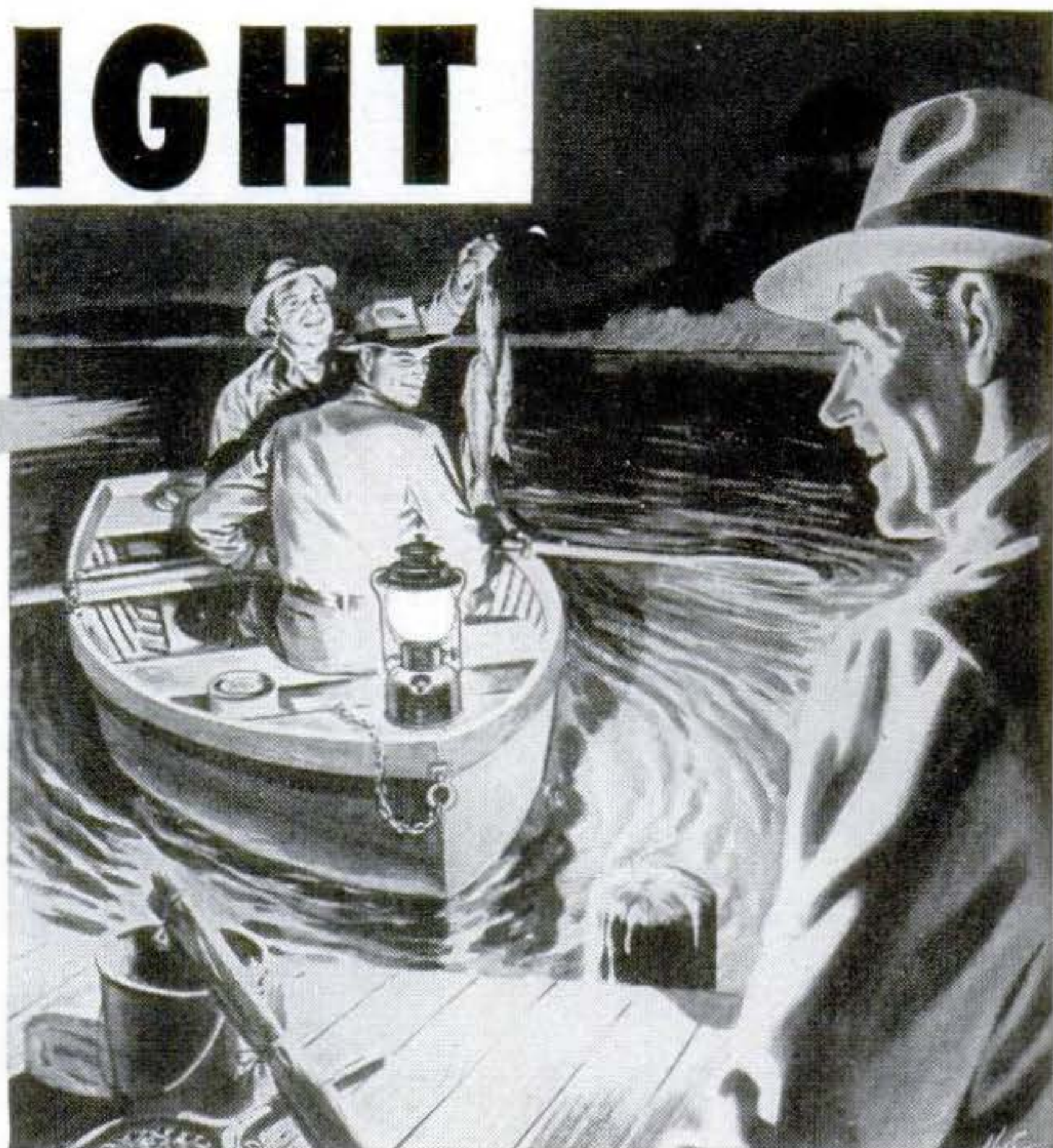

**For Plenty of Light** on every fishing, hunting and camping trip, take along a Coleman Floodlight Lantern. It floodlights your whole camp with light so bright you can read a newspaper 50 feet away. Instant lighting. Storm proof. Safety sealed fount can't spill fuel. Gives 40 hours of floodlight service per gallon of fuel. Pyrex glass globe protects mantles.

**Lights Up the Whole Camp.** Coleman Floodlight Lanterns are used and endorsed by famous guides and sportsmen as the perfect light for all outing trips. See a free demonstration at your Coleman dealer's now.

**FREE**— Write for illustrated book telling all about Coleman Lanterns, Stoves and other Coleman Appliances. Address nearest office.

**THE COLEMAN COMPANY, INC.**, Dept. 106-PS, Wichita 1, Kans.; 401 N. Broad St., Philadelphia 8, Pa.; Los Angeles 54, Calif.; Honolulu, T. H.; Toronto, Can.

# Coleman

# FLOODLIGHT LANTERN

## Coleman

### Folding CAMP STOVE

A favorite for years for quickly and easily cooking big meals. Cooks like city gas. Carries like a suitcase. Two burners. Instant lighting. See it at your Coleman dealer's now.



## Coleman

### POCKET STOVE

**3 lbs.—8½ in. high—Take it anywhere**  
The handiest little sport stove you ever saw; for cooking, heating drinks, boiling water. Burns any kind of gasoline; white or leaded. Aluminum case makes 2 cooking utensils. Get one from your dealer. Ask him to demonstrate it for you.

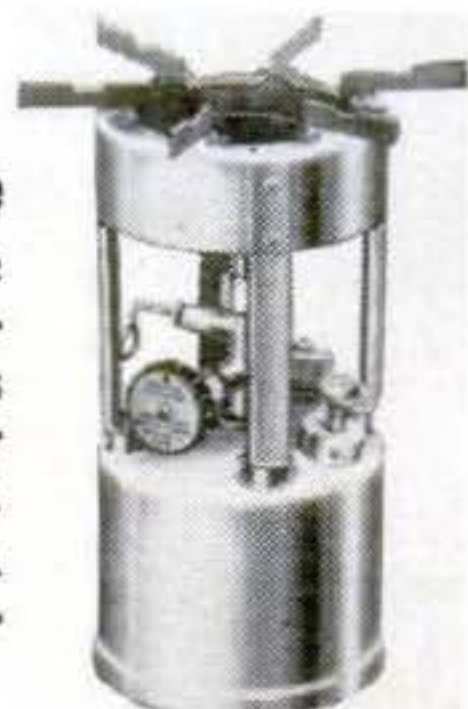





## A full day's hunting on one loading with Marlin's dependable tubular magazine .22

● Shooting efficiency, with the least fuss and bother, is what you get in the 81-DL. Tubular magazine holds a load for a full day's hunting of small game. And this man-sized Marlin is light enough to carry all day without tiring.

### CHECK THESE SPECIFICATIONS —FOR VALUE AND FOR SPORT!

One-piece buttstock, with fluted comb and semi-beavertail forearm.

Quick-release trigger; self-cocking action; side ejection; On and Off safety.

24" tapered blued steel barrel; Ballard type rifling; crowned muzzle.

Unique, patented feeding mechanism; magazine capacity 25 - .22 short, 18 long rifle cartridges.

Shoots .22 short, long and long rifle—regular and high speed—without adjustment.

Removable, plated bolt assembly; flush takedown screw.

Equipped with peep sight, ramp front sight and hood; sling strap swivels. Also available with open rear sights, bead front sights, no swivels.

Outstanding for rugged construction, reliability and accuracy.

**Marlin 81-DL**  
25-Shot Tubular Magazine .22 Cal. Repeating Rifle

**\$25.55.** Price Slightly Higher West of the Rockies.

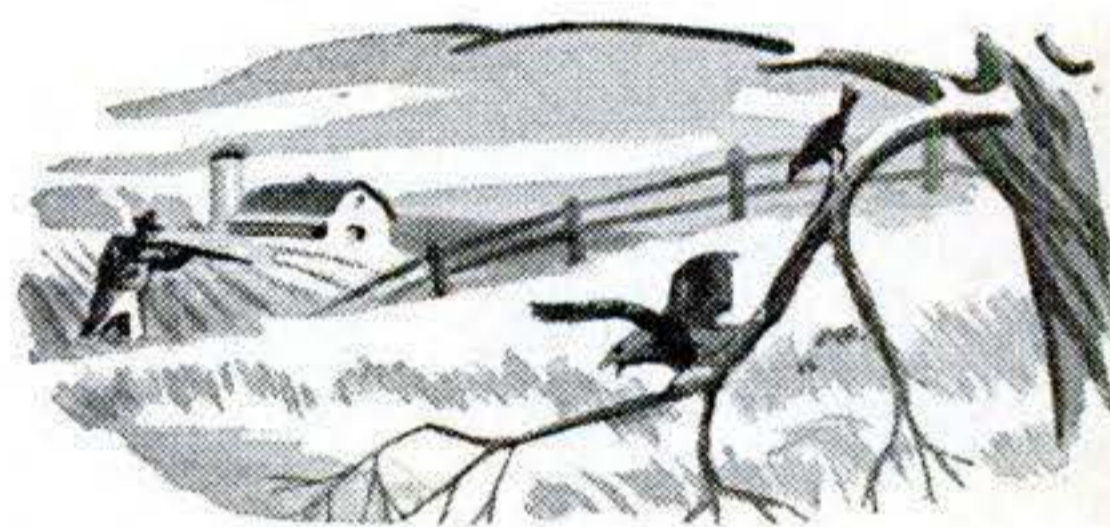

Unbeatable for pests and vermin...owls, rats, hawks and crows, the 81-DL carries up to 25 shots.



Marlin's 81-DL is a sure getter of woodchuck, raccoons, rabbits and other fur-bearing small game.



Finely balanced for plinking and general target work, the 81-DL is also an ideal "learning gun."

SEE THE MARLIN 81-DL AT YOUR DEALER'S TODAY.

THE MARLIN FIREARMS CO., NEW HAVEN, CONN. • Fine Guns Since 1870

APRIL  
1947 233



# BRIGHT STAR

## BATTERIES

**GIVE MORE  
BRIGHT LIGHT  
LONGER  
FOR YOUR 10¢**



**HERE IS PROOF! BASED ON TESTS CONDUCTED UNDER GOVERNMENT STANDARDS**

THREE LEADING BRANDS TESTED	BRIGHT STAR	BATTERY A	BATTERY B
<b>VERY BRIGHT LIGHT</b>			
<b>GOOD LIGHT</b>			
<b>FAIR LIGHT</b>			

Each column adds up to 10 cents, but BRIGHT STAR leads the field with 70% VERY BRIGHT LIGHT.

And that's not all... Bright Star batteries give 150% of the Light Industrial Test requirements as specified by the U. S. Gov't Bureau of Standards.

*and there are more  
BRIGHT STAR FLASHLIGHTS  
sold than any other make.  
they, too, have been  
best since 1909!*



BRIGHT STAR BATTERY CO.  
CLIFTON, N. J.

MARGIE



**DIRT and DUST  
YOUR DOUBLE-TROUBLE?**



Fix it with **Mortite**  
a household friend

Shut out dirt and dust! Press pliable Mortite around windows, doors, baseboards, etc. It's done in a jiffy. Keeps out ants, insects; fine for calking, stops rattles; the ideal weather-stripping. Roll covers about 80 ft. At Hdwe., Paint, Dept. Stores, Lumberyards.

**\$1.25** Higher West of Rockies and Canada

WRITE FOR FREE BOOKLET.

J. W. MORTELL CO., 534 Burch St., Kankakee, Ill.

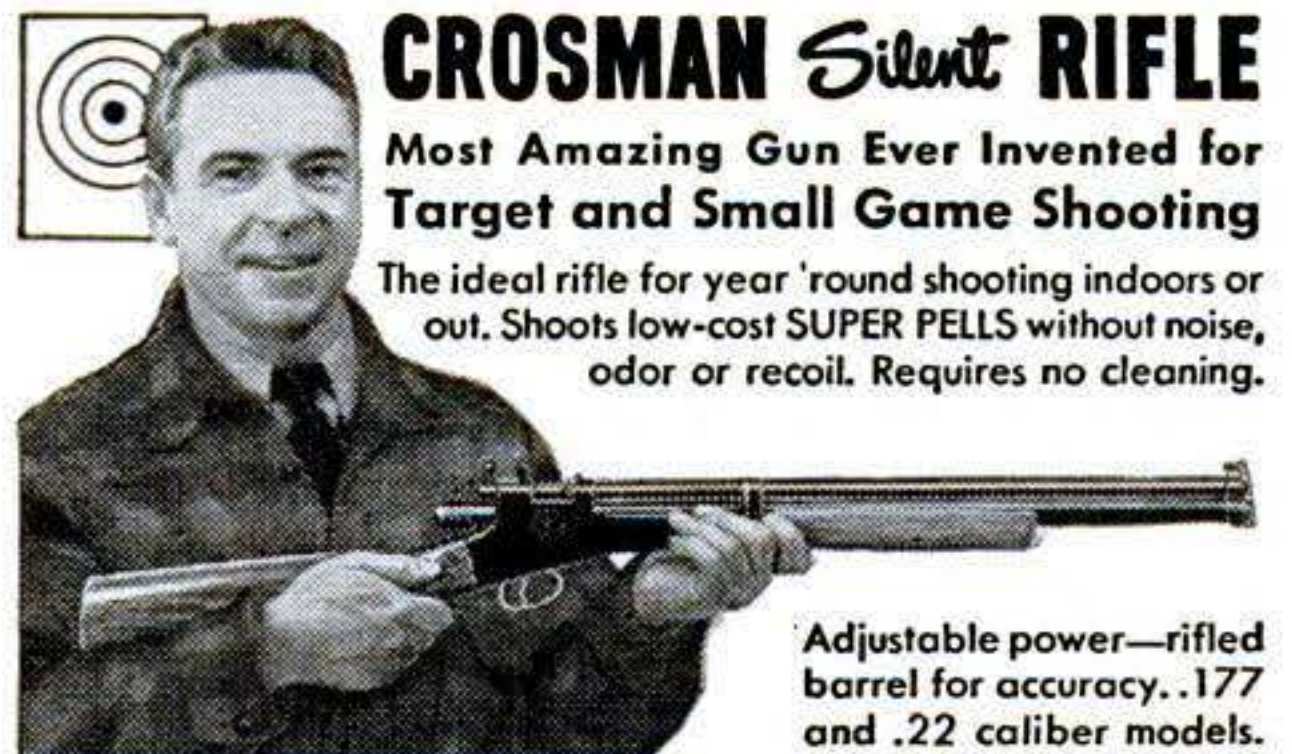

## CROSMAN Silent RIFLE

**Most Amazing Gun Ever Invented for Target and Small Game Shooting**

The ideal rifle for year 'round shooting indoors or out. Shoots low-cost SUPER PELLETS without noise, odor or recoil. Requires no cleaning.

Adjustable power—rifled barrel for accuracy. .177 and .22 caliber models. Write for information.

CROSMAN ARMS CO., INC.  
9 HENRIETTA ST., ROCHESTER 7, N. Y.

## AUTOMATIC RETOOTHER

Makes  
New Profits

Cuts new teeth in 50 seconds! Any size tooth 4 to 16 points. Old teeth fall off as chips. Simple to operate. A perfect job.

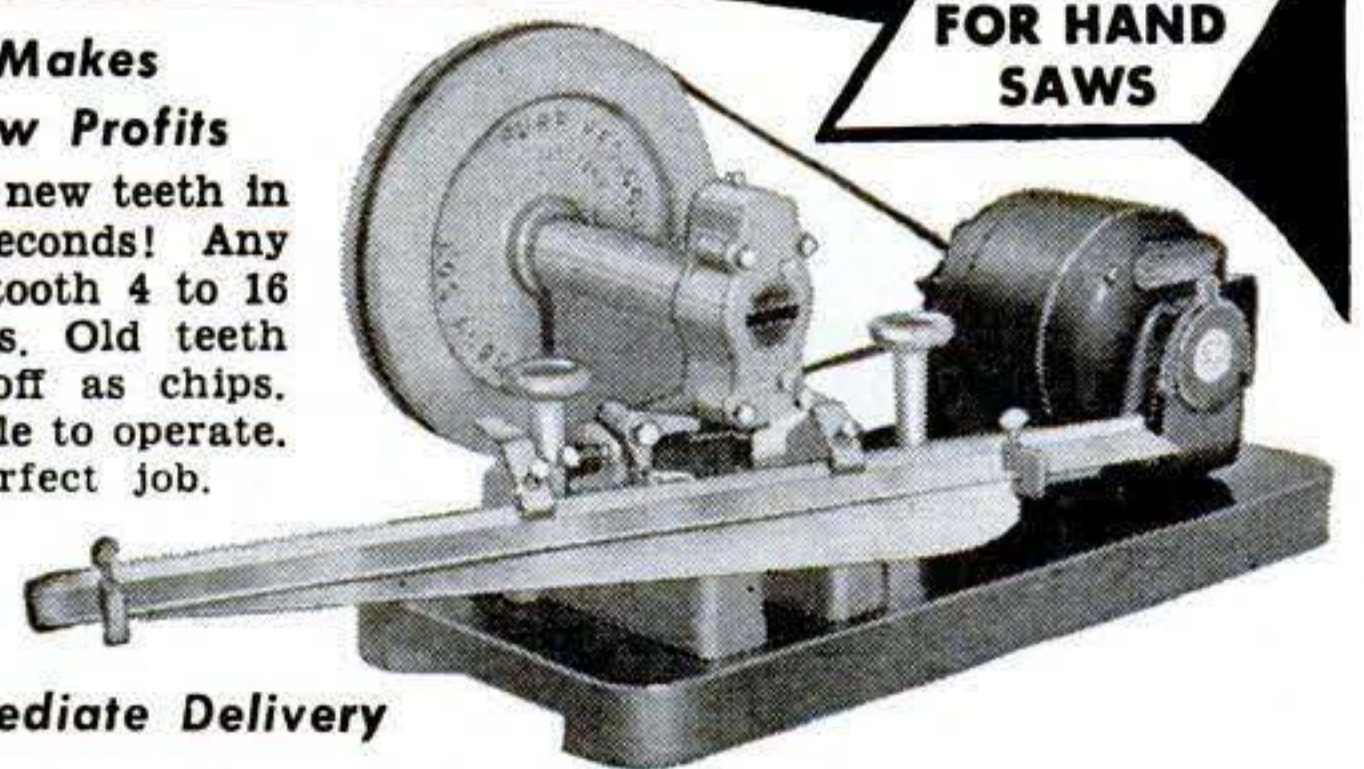

Immediate Delivery

**BURR MFG. COMPANY** 8931-C Venice Blvd.  
Los Angeles 34, Calif.





*Frequency-Modulation radio reception is virtually free from natural static—even thunderstorms do not interrupt.*

## ***FM Radio—another world in listening pleasure!***

It's as though the orchestra were right in the room with you—and the room suspended in the silence of space. When you listen to music over RCA Victor FM, you hear FM at its finest.

Natural static interference ordinarily caused by thunderstorms does not mar FM radio reception. You are in a world of utter quiet where you hear only the lifelike music. Moreover, you enjoy the same perfect reception day or night.

The vast experience, research and skills at RCA Laboratories, such as aided in the development of RCA

Victor FM, are constantly applied to all RCA products, so each one is at the top of its field.

And when you buy anything bearing the RCA or RCA Victor name—a radio (standard or FM, or both), a television receiver, Victrola radio-phonograph, a phonograph record or a radio tube, you know you are getting one of the finest science has yet achieved. "Victrola" T. M. Reg. U. S. Pat. Off.

*Radio Corporation of America, RCA Building, Radio City, New York 20. Listen to The RCA Victor Show, Sundays, 2:00 P.M., Eastern Standard Time, over the NBC Network.*



With the new RCA Victor AM-FM sets you'll hear FM radio—and standard AM radio too, at their finest. Ask your RCA Victor dealer to show you the new Crestwood Victrola radio-phonographs.



**RADIO CORPORATION of AMERICA**



**Hobart**  
helps you  
**SUCCEED**



**in ARC WELDING**



The HOBART "Build Your Own" (Generator Only)

**A Big Pay Business**—and it's all yours! It's so easy to start your own job welding shop and reap the big dividends that Hobart Arc Welders bring you. There's plenty of arc welding repair and construction work everywhere, customers even bring it to you.

**Hobarts Weld Better**—that's because of exclusive operation features that save you time and money. The exact welding heat is easy to get, for Hobart lets you select from 1000 volt-amp combinations. Hobart's Remote Control saves valuable time by allowing you to adjust welding heat at the work. Hobarts last longer because they're built better!

**"Build Your Own"**—and save hundreds of dollars! Make your own gas drive portable arc welder using the Hobart "Build Your Own," a reconditioned motor and chassis. Free booklet gives complete instructions.

**Send the Coupon**—for complete details on the Hobart Arc Welder you desire—there's no obligation.

**HOBART BROTHERS COMPANY**

BOX P-471, TROY, OHIO. "One of the World's Largest Builders of Arc Welders"

HOBART Jr. Electric 150 Ampere Welder



The HOBART A. C. Welder for single phase lines

**The HOBART SCHOOL of ARC WELDING**—

It's a modern trade school in which students learn by doing. Expert instructors give individual attention. Each student has own welding booth and welder. Fully accredited under G. I. Bill of Rights. Send coupon.



**HOBART**

HOBART BROS. CO., BOX P-471, Troy, Ohio

Send me the Free Book, and also information on items I've checked below:

- Electric Drive       A. C. Welder  
 "Build Your Own"     Welding School

NAME \_\_\_\_\_

ADDRESS \_\_\_\_\_

**Free!**

Art Welder's Vest Pocket Guide contains tables, equations, charts, etc.



**GARDENING IS A CINCH**  
with a  
**BREADY!**



All-Purpose Attachments

Plow, Cultivator, Disc, Cutter-Bar, Harrow, Snow Plow

You simply *guide* the BREADY Garden Tractor through the toughest gardening jobs. BREADY's big 1½ H.P. motor plus patented "front-hitch" gives power and traction to spare. Attachments hitched on in a jiffy. Turns "on a dime." Uses only 1 gallon of gas in 5 hours.

» Write for free folder.

**GARDEN TRACTOR SALES CO.**  
BOX No. 213      SOLON, OHIO

**Practical Shop Training in AIR CONDITIONING**

• Domestic • Commercial • Industrial  
**REFRIGERATION**

Service Maintenance Installation

Write for Details

**COMMERCIAL TRADES INSTITUTE**

202 So. 20th St., Birmingham, Ala.

• Train in the Magic City of the South. •

Approved for G. I. Training

**5 POWER Spy Glass AND CASE**

SEE IT  
5 Times Closer  
5 Times Larger

**\$1.25**

STURDILY BUILT FOR LASTING USEFULNESS

NOT A TOY



Easy to carry on your belt

**TaVEL'S JEWELRY CO.** 4 West Market Street Indianapolis 4, Indiana

Please send me  5 POWER Spy Glasses with Case at \$1.25 for both. No C. O. D.

NAME \_\_\_\_\_

ADDRESS \_\_\_\_\_

Merchandise fully guaranteed —  M. O.  Check





# AUTO-LITE

## Plug Tips

**M**AKE SURE you have the right spark plug for the type of driving you give your car. Your Auto-Lite Spark Plug Dealer can tell you when plugs are lazy or faulty and when plugs of a different heat range\* will give better results. Let your friendly neighborhood Auto-Lite Spark Plug Dealer give you a complete Auto-Lite "Plug-Chek" regularly, at least once every 5,000 miles.

### TOO HOT



If the firing tips on your spark plugs are fused or blistered, the spark plugs are operating too hot and may be causing costly loss of power and harmful spark knock.

### HOT PLUG

The longer firing tip of this plug dissipates heat slowly and operates at a relatively high temperature. Stop-and-go driving and slow speeds require this type of plug.

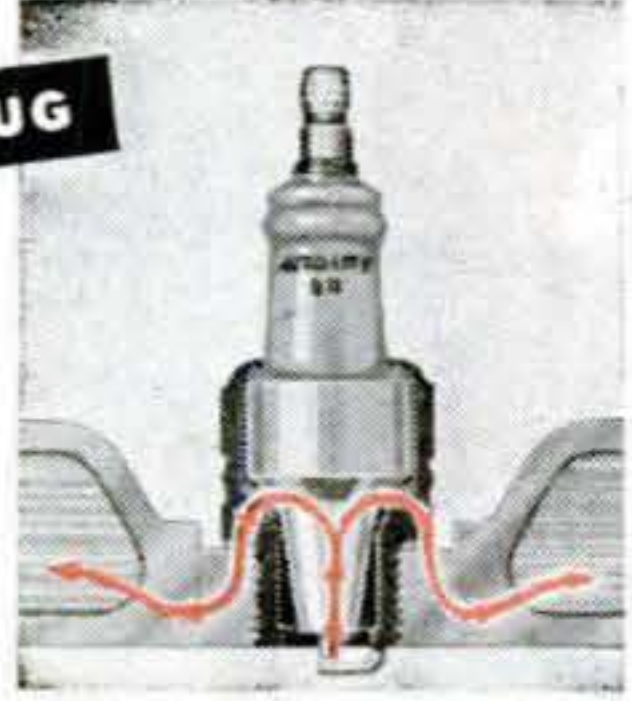

\*Even though Auto-Lite Spark Plugs are wide range spark plugs, it is still necessary for best results to select the plug whose heat range will be most suitable for the speed and loads required.

### TOO COLD



If the firing tips on your spark plugs show deposits of carbon or are wet with oil, the spark plugs are too cold and may be causing slow, difficult starting and high gas consumption.

### COLD PLUG

The shorter firing tip of this spark plug dissipates heat rapidly and operates at a relatively low temperature. High speeds and wide open throttle operation require this type of spark plug.

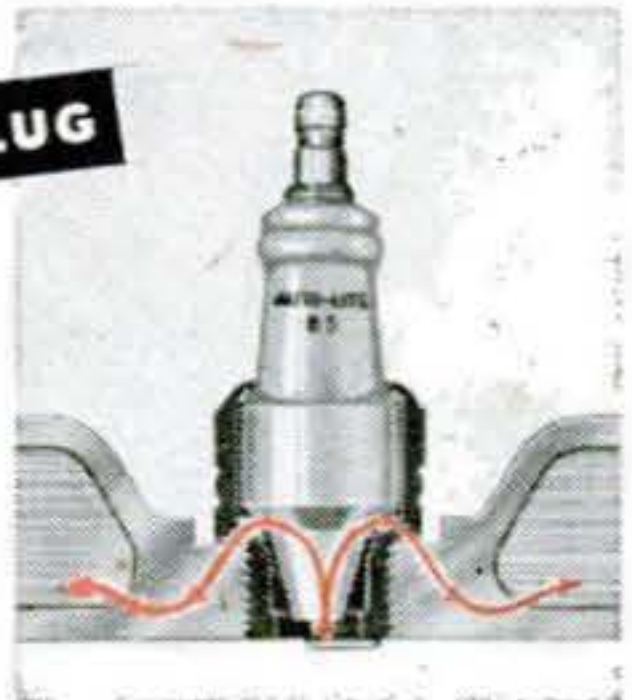

# Switch to AUTO-LITE SPARK PLUGS



"Say," he exclaims, "this GRIZZLY brake lining still stops on a dime!"

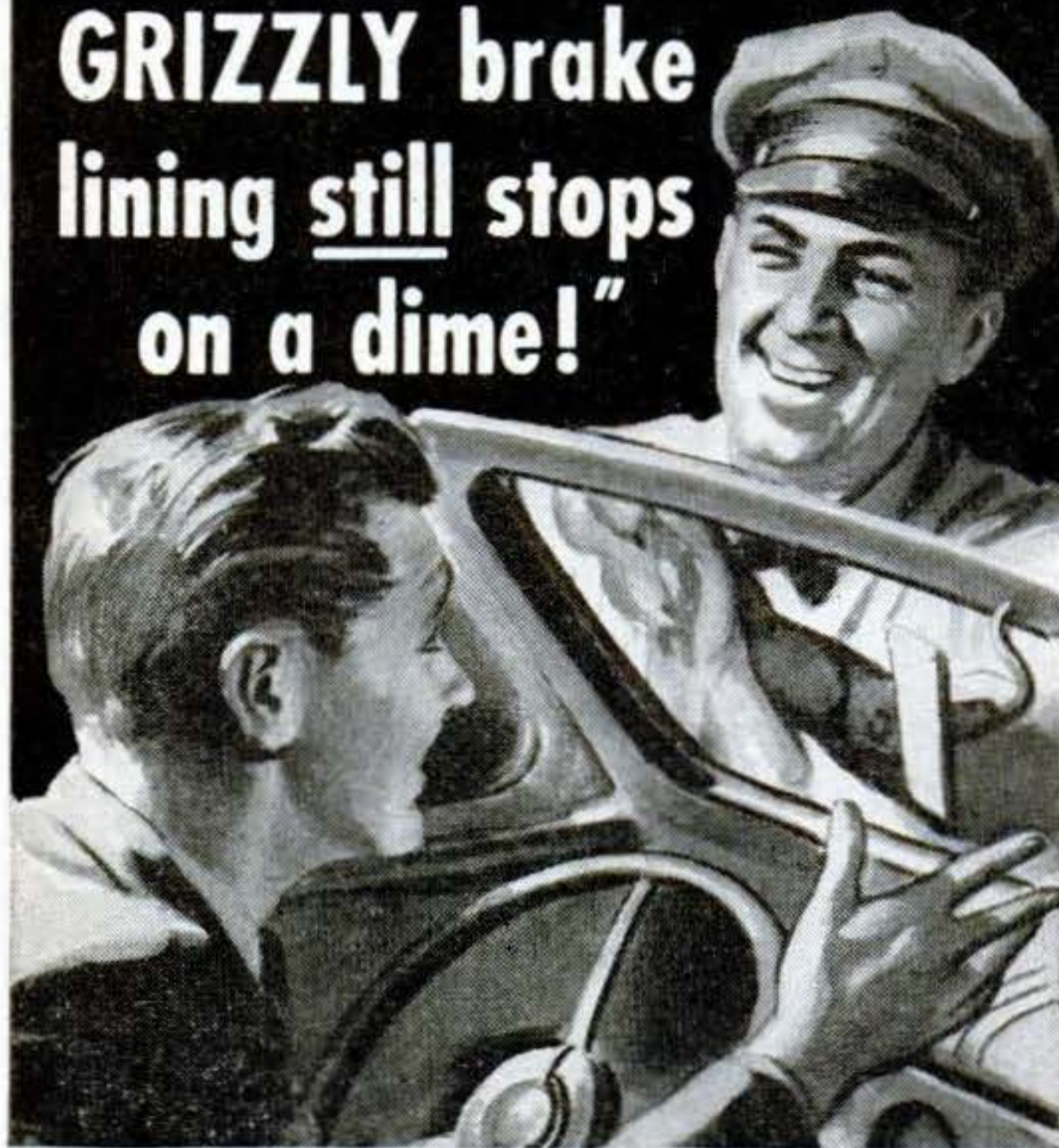

"Naturally," I grin, "but is that all you can say for my reline job?"

"No," he adds quickly, "through all these months I've found that just easy pressure on my brake pedal brings smooth, quick stops. Ann mentions that a lot."

"That," I emphasize, "is what we call a 'soft' pedal—it's a major feature of Grizzly Brake Lining! Sure, you get extra long life and hardly ever need an adjustment, but on top of that, you also get smooth, sure stops with that 'soft' pedal. That's what makes Grizzly the safe lining for both men and women. 'Big Foot' or 'Little Foot'—driving is easier for both."

"You're right," he agrees. "The wife and I will back you up on that!"



**BIG FOOT . . . LITTLE FOOT**  
Grizzly Brake Lining is engineered for both. Next time you reline, reline with Grizzly. Grizzly Manufacturing Company, Paulding, Ohio.

"Bear in Mind" . . . ask for

**GRIZZLY**  
REG. U.S. PAT. OFF.  
**BRAKE LINING**

**WHEREVER BRAKES ARE SERVICED**

**NEW PORTABLE METAL BRAKE**  
BENDS-FORMS ANGLES CHANNELS, Etc.

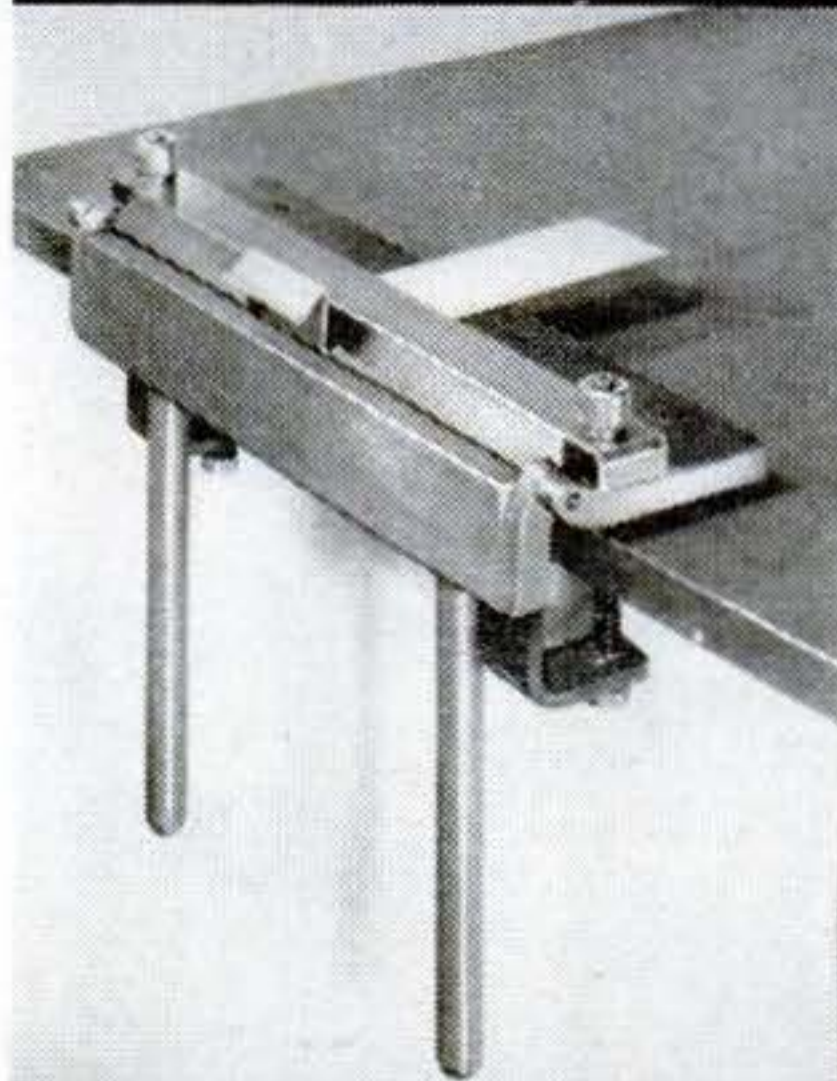

Quickly Fastens to Any Work Bench

Very versatile tool—maximum capacity 22 gage thickness—10" wide. Sturdy—well balanced—easy to operate.

Ideal for mechanics, model builders, hobbyists—clamps on bench with 2 screw clamps or take it with you on the job. Order today.

Larger sizes up to 18" available upon inquiry.

ONLY \$20<sup>00</sup> F.O.B. DETROIT

SEND CHECK OR MONEY ORDER—NO C.O.D.'S

**G & S MACHINE SHOP**  
8700 GRINNELL  
DETROIT 13, MICHIGAN

**A SEAMAN TILLER**  
*is Your Best Crop Insurance . . .*

Because this farm-size Rotary Tiller pulverizes the soil thoroughly; mixes fertilizer and humus into the growing area of the seedbed; conserves moisture; aerates soil; promotes earlier and more complete germination of seed; helps to destroy many crop pests; provides effective weed control . . . all with ONE machine!

Write for "Questions and Answers" booklet that tells you all about it! There is no obligation.



Motorized models . . . 4 to 6-ft tillage widths.



Power Take-Off Models . . . 3 to 6-ft. tillage widths.

**SEAMAN MOTORS, Inc.** 365 No. 25th Street Milwaukee, Wis.

**NEW Liquid Casting Plastic**

**CRAFTSMEN, HOBBYISTS!**

Here is a new craft, a fine hobby, or profitable home business. **CASTOLITE**, Liquid Casting Plastic that pours without heat or pressure, sets at low temperature. Make beautiful crystal clear objects—lamp bases, book ends, candle holders, novelty jewelry. Drill, saw or carve. Other novel effects obtained by embedding real flowers, butterflies, coins, photos. Ordinary jars, glasses, tubes serve as molds. Easy, fascinating to use!

**SPECIAL CASTOLITE-KIT ONLY \$3.35**

Get our new professional experimental Casto-Kit now at special low price of only \$3.35. Make lovely objects very first day. Kit contains materials for 20 projects. Contains 1 lb. liquid **CAS-TOLITE**, bottle hardener, buffing compound, measuring dropper, abrasive sheets, vial, flowers for embedding and Instruction Manual showing simple step-by-step method. Send \$3.35 for Kit prepaid or order C.O.D. Instruction Manual only, 25c (stamps or coin.)

**THE CASTOLITE COMPANY**  
Dept. D-4, Box 211, Kenilworth, Ill.  
DEALERS write for literature and prices.

**Castolite**  
LIQUID PLASTIC  
TRADE MARK

Makes 1001 OBJECTS



FERN IN LAMPBASE



NOVELTY JEWELRY

20-Project  
**KIT**  
\$3<sup>35</sup>  
PREPAID





# Piston rings wear out, too

**P**iston rings are designed to "take" the wear . . . to protect your engine. When they wear out they waste oil, cause loss of power and lead to excessive cylinder wear. Fortunately, piston rings can be replaced—again and again—renewing engine protection—restoring engine performance.

So, when your car first begins to smoke, waste oil, or lose power, install Hastings Piston Rings at once. They *stop* oil-pumping, *check* cylinder wear, *restore* performance. It's the best money you can spend on your car.

**HASTINGS MANUFACTURING COMPANY**  
Hastings, Michigan • Hastings Ltd., Toronto

LISTEN TO: "I DEAL IN CRIME"  
SATURDAY NIGHTS • ABC

TOUGH BUT OH SO GENTLE



# HASTINGS

**STEEL-VENT PISTON RINGS**

**TOUGH** on oil-pumping  
**GENTLE** on Cylinder Walls

APRIL 1947 239





## DRILL PRESSES

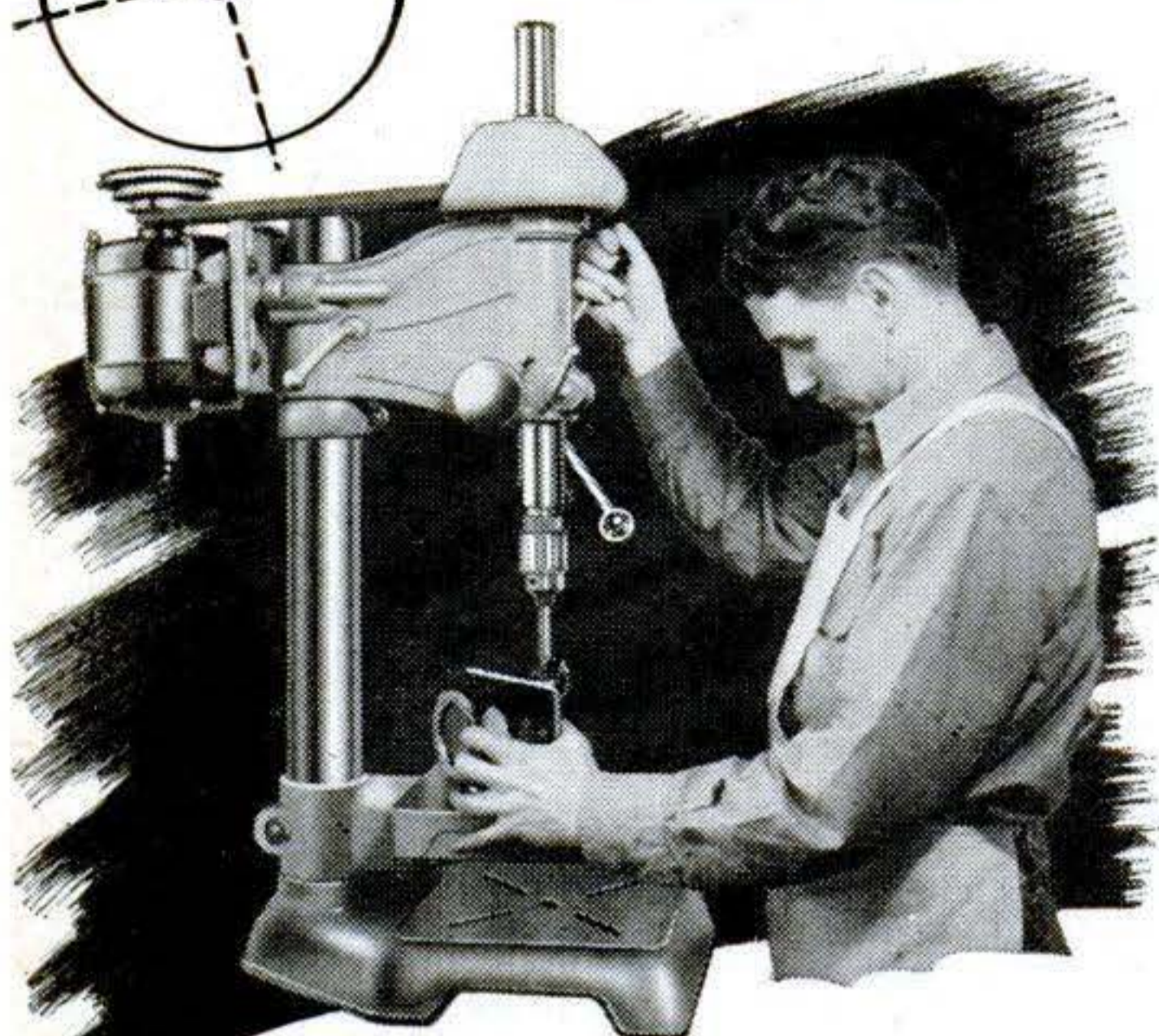

# Industrial Precision for Your Home Shop

From its finely balanced pulleys to its solid, heavy base an Atlas drill press is built to give you absolute rigidity, smoothness, and lasting accuracy. It's the kind of a tool you'll enjoy working with every minute—quality through and through.

Important features are the extra size and weight of the grey iron castings for base, table, and head, and column. The table is accurately ground, tilts 90° right or left. Power is transmitted by the exclusive Atlas "floating drive" spindle design—with deep-grooved ball bearings—that keep the precision-ground spindle solidly and accurately aligned for maximum smoothness.

Three sizes are available: 15-inch floor or bench type, and 12¾" bench type. Get all the facts about these drills that will give you a lifetime of industrial precision on your home shop work. Ask your Atlas distributor to show them to you, or send for the latest catalog.

**FREE**

*Atlas*



### ATLAS PRESS CO.

455 N. PITCHER ST.

KALAMAZOO 13, MICHIGAN

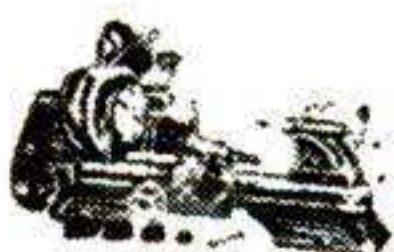

6"-10" Lathes

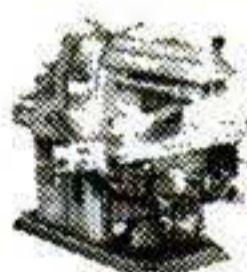

Milling Machines



Shapers



Drill Presses

## ATLAS 4 TOOL TEAM

I'm an un-handy man - BUT -

by don herold

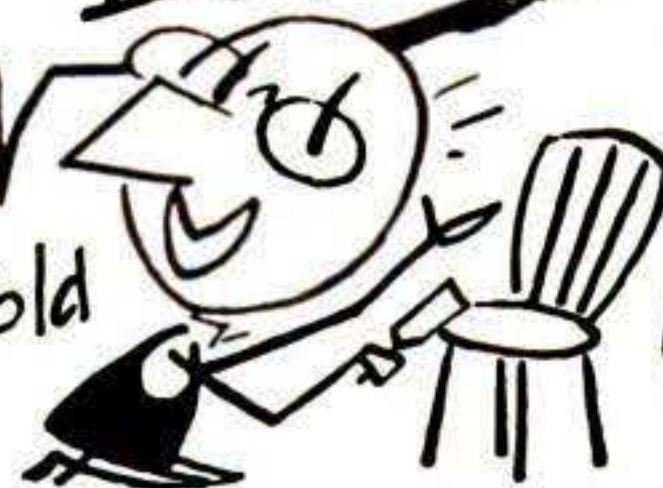

... but here is something that even an all-thumbs guy like me can use to plug holes and cracks around the house.

Reardon's Water Putty—a powder you mix with water as needed. No waste, no caking in the can. Dries hard and can be painted over. Does not shrink or loosen. Good for re-seating screws, repairing furniture. Works on wood, metal, plaster, tile. Good, good, good!

Get a can at your hardware, paint, variety or department store. **25c** Lb. Can

Made by The Reardon Co.

St. Louis—Montreal

Makers of BONDEX Cement Paint



REARDON'S

# WATER PUTTY

- Four Interchangeable Tips
- Replaceable Heating Element

Easily and Quickly Installed



IT'S THE NEW  
*Flash* FC-110

THE PERFECT BALANCE—PISTOL GRIP—SOLDERING GUN THAT WEIGHS

**ONLY 6 OUNCES!**

There is nothing else like the Flash FC-110—a 100-watt iron with 5/16" tip for direct operation from 110 V AC or DC line. Heats up in 60 seconds. The natural wrist position, perfect balance, cool pistol grip and light weight make a Flash your best buy. Four interchangeable tips for general utility service. REPLACEABLE HEATING ELEMENT—a feature that prolongs life of tool and assures uninterrupted service. **PRICE \$9.95.** Ask your dealer for a Flash FC-110, or send coupon for literature or a Flash FC-110 shipped postpaid direct to you.

BAKER-PHILLIPS CO.

2816-7 Aldrich Avenue So., Minneapolis 8, Minnesota

Send circular on Flash FC-110.

Enclosed is.....for.....Flash FC-110 Soldering Guns at \$9.95 each, postpaid.

Name.....

Address.....



*No rust  
for the  
wary!*



*Clean rust out of your radiator with*  
**DU PONT Cooling System CLEANSER**

Drain out your anti-freeze, and clean out winter's accumulation of scum, scale, and rust. Neglect now may mean trouble and costly repairs later. Just pour a can of DU PONT COOLING SYSTEM CLEANSER into your radiator, run the engine 30 minutes or more, and drain. It dissolves rust—cleans thoroughly—improves engine performance. It's safe, sure, and easy to use.

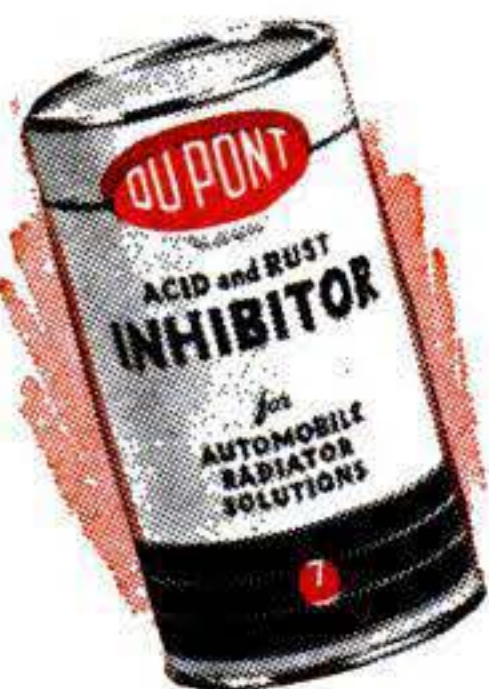

*Keep out rust with*  
**DU PONT Acid and Rust INHIBITOR**

After cleaning out the radiator, you can keep it free from rust all season by pouring in a can of DU PONT ACID AND RUST INHIBITOR. It prevents rust forming, and keeps out acid, too.



*Avoid radiator leaks with*  
**DU PONT Cooling System SEALER**

Stop leaks quickly and securely—and make the cooling system LEAKPROOF—by pouring in DU PONT COOLING SYSTEM SEALER. It will not clog the radiator.

**DU PONT**

REG. U.S. PAT. OFF.

BETTER THINGS FOR BETTER LIVING  
... THROUGH CHEMISTRY

APRIL 1947 241



# Sweeping the Country



**Speed Sweep**  
**THE BRUSH WITH  
THE STEEL BACK**

Speed Sweep brushes are replacing old style brushes in thousands of factories, warehouses, and stores because they sweep faster, cleaner and easier. Speed Sweep brushes also outlast ordinary brushes 3 to 1. There is a Speed Sweep to meet every requirement. Write for styles, sizes and prices today.

Milwaukee Dustless Brush Co.  
530 North 22nd Street.  
Milwaukee 3, Wis.

Please send me complete information about Speed Sweep brushes.

Name \_\_\_\_\_

Address \_\_\_\_\_

City \_\_\_\_\_ State \_\_\_\_\_

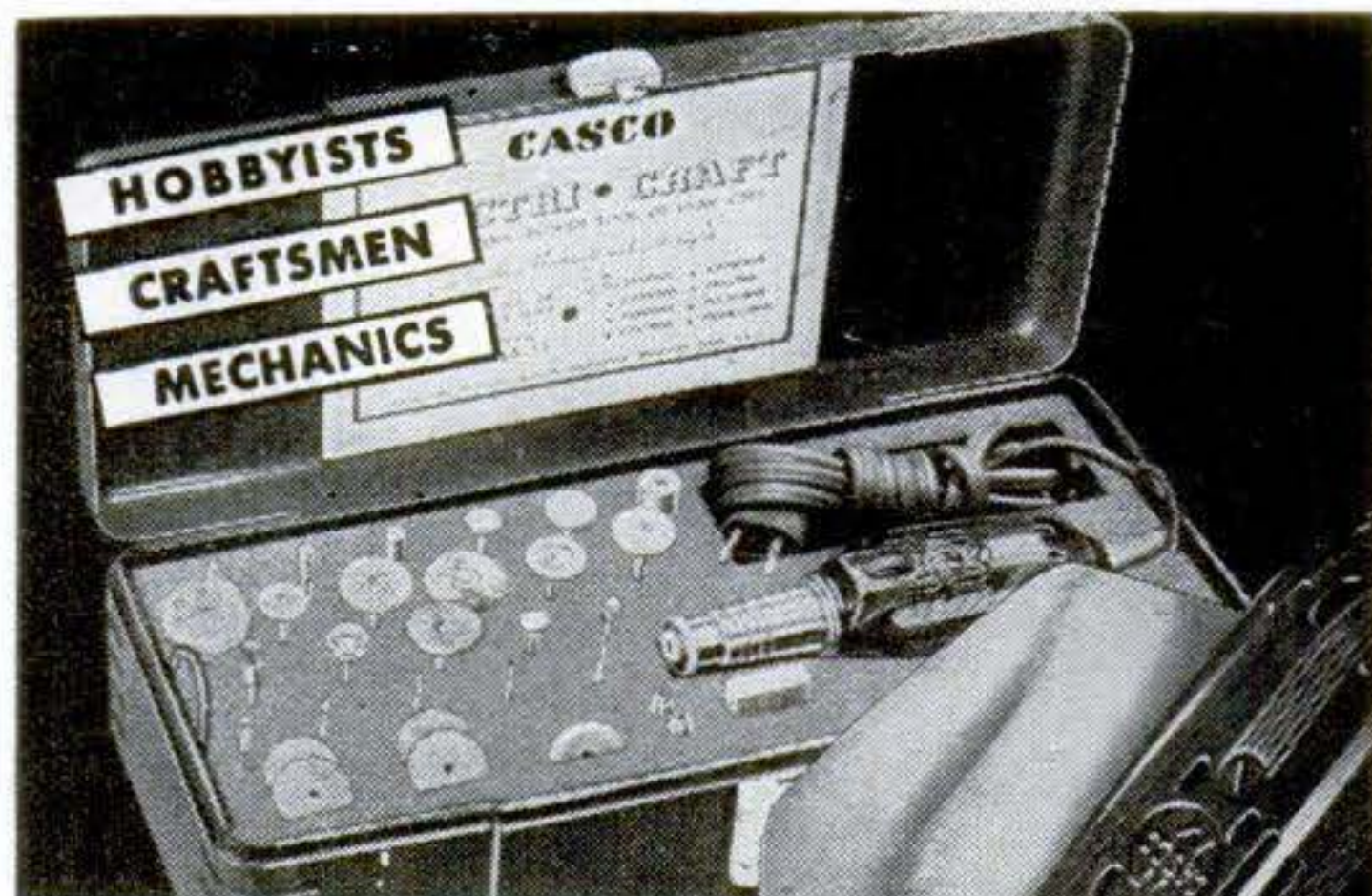

**A WHOLE SHOP  
FULL OF TOOLS  
IN ONE!**

Use it for grinding, routing, drilling, sawing, polishing, carving, sanding and 9,994 other uses. Increases your skill and your scope. Precision-engineered, AC-DC. More exclusive features than any other tool.

Exclusive  
Safety  
Fingergrip  
for fine  
detail work

**\$2250**

**COMPLETE WITH 36 ACCESSORIES  
IN FITTED STEEL CASE**

\$31.75 Value if  
Purchased Separately

Works **Wood, Metal,  
Glass, Plastics**

**CASCO ELECTRI-CRAFT TOOL KIT**

CASCO PRODUCTS CORPORATION, BRIDGEPORT 2, CONN.



**AMBROID**

**THE UNIVERSAL  
LIQUID CEMENT**

*The "Mr. Fix-it"  
for "a million things"*

Tops in quality for 37 years. Uses unlimited . . . sticks and mends permanently. Waterproof . . . quick drying. Keep a tube on hand always. Extra quality . . . extra strength. Ready to use. **LOOK!** Get acquainted with Ambroid quality. At your dealers or send 25c for big 2-oz. tube postpaid (U.S.A. **25¢** only). Money back guarantee.

**AMBROID CO.**

307 Franklin St., Boston 10, Mass.

Also 50c 4-oz. tube.  
Pts., qts., gals. for  
industrial use.

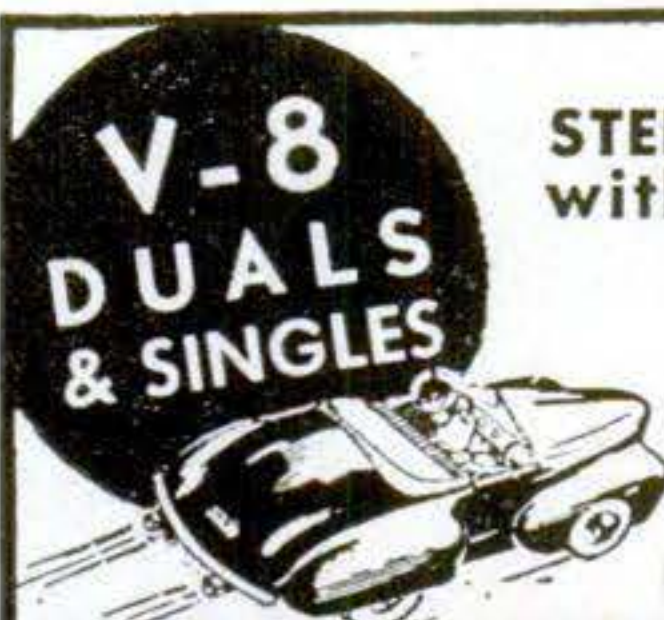

**V-8  
DUALS  
& SINGLES**

**MUFFLERS**

**STEELS and ALUMINUMS  
with a motorboat tone**

SINGLES, Chev, V-8, Plymouth, Steels \$5.50, Aluminum \$6.50. Chry., Olds., Buicks, etc., Steels \$7.50, Aluminum \$8.50. V-8 and MERCURY DUALS, Steel \$17.50, Aluminum \$20.00. Aluminums are guaranteed for life of your car.

**DEALERS WANTED**

**SANDEE MUFFLER CO.**

7523 S. WESTERN AVE., LOS ANGELES 44, CALIF.



IT'S A GRAND FEELING,  
TO CAPTURE A PICTURE  
IN A FLASH!



IT'S A GRAND FEELING, TOO,  
WHEN YOUR CAR IS  
CUSHIONED WITH MARFAK  
CHASSIS LUBRICATION

THAT CUSHIONY FEELING LASTS LONGER WITH **MARFAK!**

It's a grand feeling to snap good pictures of friends or family with a flash . . . the same grand feeling you get from your smooth riding, *Marfak* lubricated car.

*Marfak* is scientifically designed to cling to bearing surfaces, resist wash-out, jar-out and squeeze-out and stick to the job a thousand miles and more. See your Texaco Man today, and say: "*Marfak*, please!"

**THE TEXAS COMPANY**

**TEXACO DEALERS IN ALL 48 STATES**



Tune in: TEXACO STAR THEATRE every Sunday night. See newspapers for time and stations.

APRIL  
1947 243



# You'll Save Money and Oil!

When your service station makes this Free AC Oil Test and the AC Test Pad shows this



YOU TELL THE SERVICE MAN TO PUT IN THIS

OR PUT IN THIS

Dirty oil wastes gasoline, as well as oil, and clogs vital oil slots in the piston rings. Then, carbon forms faster, valves gum, power is lost. Overhaul expense soon follows. So, get the FREE AC Oil Test, regularly, wherever you see the yellow - and - black

official AC Sign. Keep your oil clean with AC replacement Elements and AC Oil Filters.

AC SPARK PLUG DIVISION • GENERAL MOTORS CORPORATION



# OIL FILTERS

# MORE PROFITS

with

## MODERN LAWN MOWER SHARPENER



SHARPEN ANY LAWN MOWER from 5-inch Edger to 36-inch Power Mower in ten to twenty minutes with a MODERN LAWN MOWER SHARPENER because dismantling is unnecessary — neither handle, roller, wheels nor motor need be removed when sharpening any mower. . . . the MODERN SHARPENER eliminates all hand filing; it precision grinds to the extreme ends of both left or right reel blades. Bottom knife is held in same brackets for sharpening. NO EXTRA ATTACHMENTS! Order today! Price \$241.50 (less motor) f.o.b. Pasadena (1/3 or 1/4 H.P. single phase motor recommended.)

Modern Mfg. Co., 160 N. Fair Oaks, Pasadena 1, Calif.

## WOODWORKERS ... Get this

CONSTANTINE MASTER MANUAL

Get the Most Fun From Your Hobby

Indispensable to woodworkers. Newest, biggest edition, more pages, more color, helpful how-to-do-it articles, pre-war and new items, more bargains. Send 25c today and we will include FREE! FULL YRS. SUBSCRIPTION to Chips and Chats, published bi-monthly. Keeps you up-to-date on everything in woodworking, offers big money-saving bargains. Send now.

ALBERT CONSTANTINE & SON, Inc. 793-D 135th Street. New York 54, N. Y.



ONLY 60c

## ELECTRIC MOTOR

CONSTRUCTION KIT

EASY TO ASSEMBLE  
FUN-EDUCATIONAL

IDEAL GIFT

RUNS ON A SINGLE DRY CELL (not included) USE IT TO RUN TOYS-PUMPS-PULLEYS-Etc.

SEND CHECK—MONEY ORDER or CASH (at your own risk) to

THE HAYDN CHEMICAL CO., Dept. A2, Box 27, Kenmore 17, N.Y.

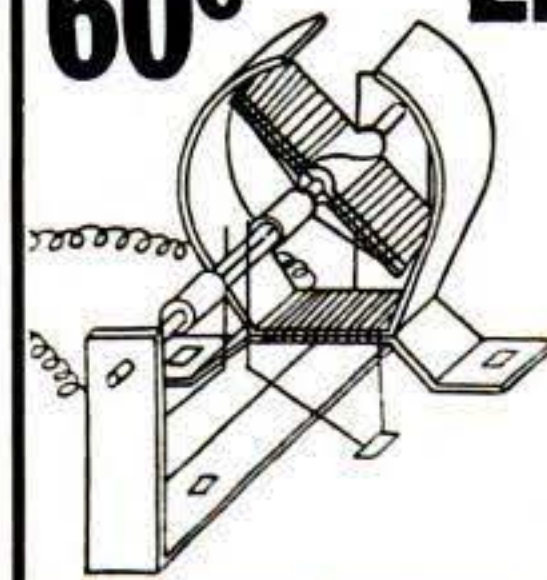

## ELECTRICITY Anywhere

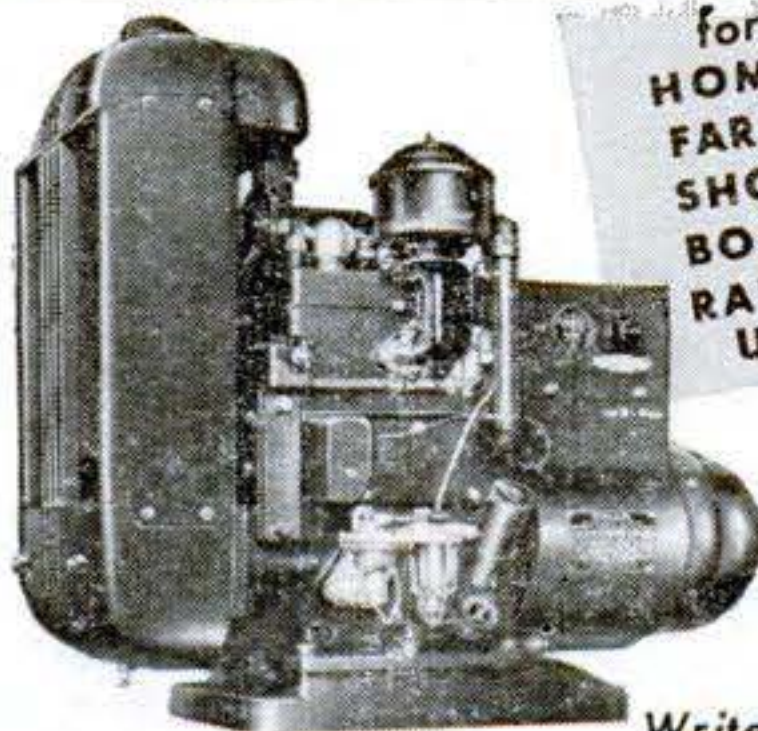

for HOMES FARMS SHOPS BOATS RADIO USE

Onan gasoline-engine-driven Electric Plants supply reliable, economical electric service for any use. Portable, stationary or standby models. Water or air-cooled, compact and rugged.

A.C.: 350 to 35,000 watts in all standard voltages and frequencies. D.C.: 600 to 10,000 watts. 115 and 230 volts. BATTERY CHARGERS: 500 to 3,500 watts; 6, 12, 24, 32 volts.

Write for folder

D. W. ONAN & SONS INC.

1850 Royalston Ave., Minneapolis 5, Minn.







**Snap-on**

**Vacuum Grip**  
REG. U.S. PAT. OFF.  
**Pliers**

A complete line . . . engineered for performance

Pliers are basic tools in an extremely wide and varied range of operations. The *right pliers for the job* can make a tremendous difference in speed and workmanship. The Snap-on pliers illustrated are typical of the many types of Vacuum Grip pliers . . . each type *job-engineered* for peak performance on the work for which it is designed. Snap-on builds Vacuum Grip pliers in a modern plant devoted exclusively to the production of the finest, most efficient pliers that can be produced. Vacuum Grip pliers are hammer forged

from special high carbon chrome-silico-manganese alloy tool steel, hardened and tempered through and through. Light in weight, perfectly balanced. Smooth, easy riding joints, sharp, deeply milled teeth. Hand filed, perfectly aligned cutters. Spring-tempered, "Vacuum Grip", non-slip handles.

A famed name in Snap-on's complete line of tools for production and service, Vacuum Grip pliers are available through Snap-on's nationwide direct-to-user tool service. Write for free catalog.

**SNAP-ON TOOLS CORPORATION**  
 8060-D 28th AVENUE                      KENOSHA, WISCONSIN

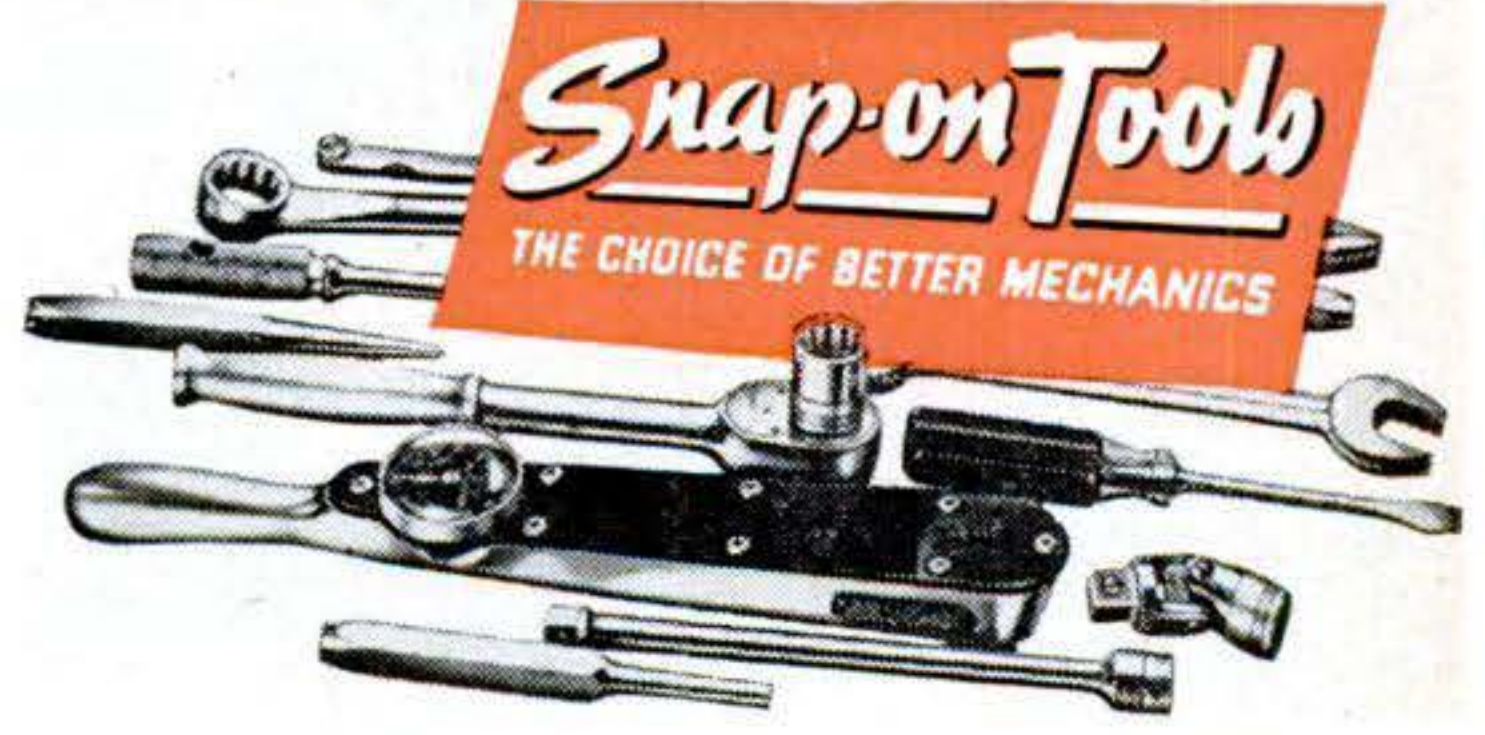





## HOW TO MAKE ANY CAR START QUICKER—RUN BETTER

● Eliminating the leakage around intake valve guides steps up compression, improves combustion. The careful mechanic uses Burd Valve Packing. Installed on top of valve guides, it keeps oil in, crank-case vapors out, lubricates valve stems. Its soft tension spring does not hinder valve action. The next time the head is off your engine, put in Burd Valve Packing . . . get a lot of satisfaction for just a few extra dollars. Mail the coupon for two FREE booklets described below.



**BURD PISTON RING CO.**  
Dept. PS • Rockford, Ill.

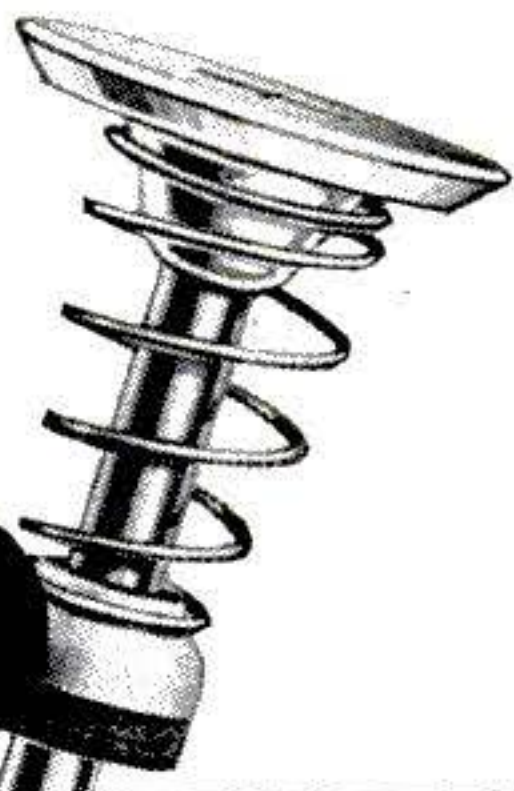

# BURD VALVE PACKING

### THIS COUPON BRINGS FREE BOOKS

**BURD PISTON RING CO., DEPT. PS**  
Rockford, Illinois

Gentlemen:

Please send me folder "Little Leaks That Run Into Big Money." Also, include FREE a copy of your "Serviceman's Handy Handbook."

Name.....

Address.....

City.....State.....



## NEW MIDGET ELECTRIC ARC WELDER

**FULLY GUARANTEED** **RETAILS ONLY \$3.95**

**Plugs into Light Socket AC or DC**

It's new! It's handy! It's efficient! Use the Midget Electric Arc Welder for hundreds of light-metal jobs. Does comparable welding work with a 1/16 inch welding rod on thin metal as that of larger and higher priced welders. Operates on 15 ampere fuse, 110 volt 60 cycle A.C. or D.C. current, by use of our special standard-coated 1/16-inch welding rods. Generous supply of rods supplied with machine. Recommended for all light welding like automobile fenders, etc. Take the Midget Arc anywhere to the job. Sturdily built and fully guaranteed. Comes complete—ready to use. Nothing else to buy. No previous welding experience needed to strike an arc. In a short time, anyone mechanically inclined can learn to weld with this machine.

You'll find hundreds of money-saving, time-saving uses for the Midget Arc around your home, garage, or workshop. Also in garages, factories, repair shops, tin shops, mechanics, farmers, inventors, etc. Order a Midget Electric Arc Welder now! **SEND NO MONEY.** We'll rush one to you, complete with rods and helmet (equipped with APPROVED welding glass). Pay postman only \$3.95 plus postage charges. If not satisfied, return Midget Arc in 5 days from receipt and we'll refund your money immediately. **RUSH YOUR ORDER NOW.**

**MIDGET ARC WELDER CO., Strader Ave., Dept. W-205, Cincinnati 26, Ohio**

## MOTORCYCLISTS

**★ ★ ★ ★ ATTENTION!**

The B & H Footshift for all Harley's eliminates hand gear shift, gives fast getaway, greater maneuverability, maximum driving safety. Improved clutch lever booster. Easy to install. Write for details, prices.

**SCIENTIFIC RESEARCH CO.** 1618 N. Vancouver Portland 12, Ore.

### Arc Welded Design "Know-How"

Only \$3.50 each      Each volume contains over  
3 different volumes      100 welding designs. Write  
\$10.00, postpaid      Hobart Bros. Co. Box P-561, Troy, O.

## LAW

STUDY AT HOME for PERSONAL SUCCESS and LARGER EARNINGS. 38 years expert instruction—over 108,000 students enrolled. LL.B. Degree awarded. All texts furnished. Easy payments. Send for FREE BOOK—"Law and Executive Guidance"

**AMERICAN EXTENSION SCHOOL OF LAW**  
Dept. 76-S, 646 N. Michigan Ave., Chicago 11, Ill.

## REPAIR FURNITURE

WITH THE GLUE THAT MANUFACTURERS USE

# FRANKLIN GLUE

GENUINE LIQUID HIDE GLUE  
**READY-TO-USE**

Makes joints stronger than the wood itself. No mixing—No heating—No unpleasant odor—No chilled joints.

**THE FRANKLIN GLUE CO., COLUMBUS 15, OHIO**  
**AT YOUR HARDWARE DEALER**



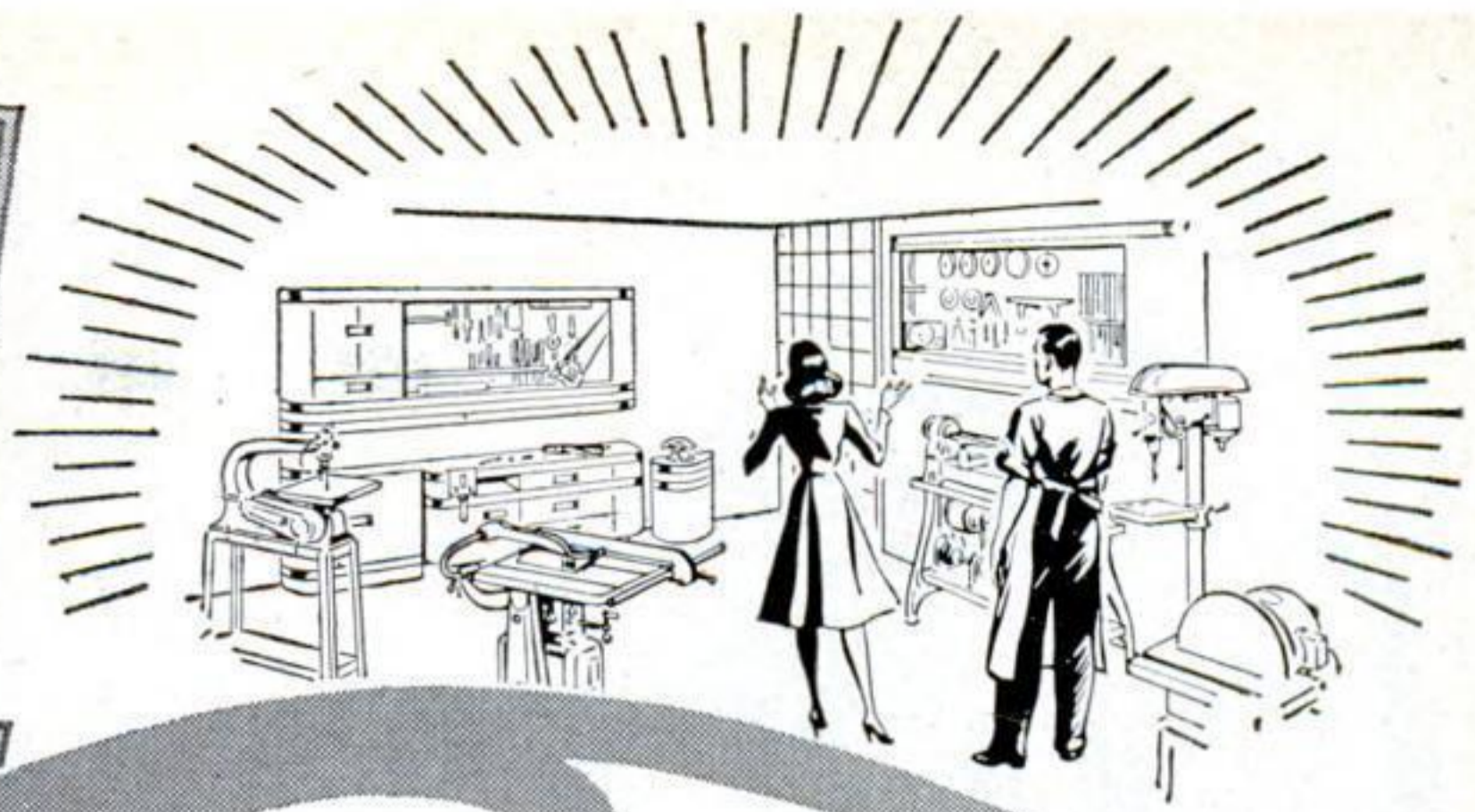

# A book of ideas to bring you greater homecraft happiness!

## New Delta\* book . . . "21 Home Workshop Floor Plans," helps you plan a hobby room that's fun to work in

What a bargain! 32 pages of home workshop ideas: Ideas you can add to your own—to help make your dreams come true!

Whether you expect to build a homecraft shop "from scratch" or to modernize your old one . . . whether your shop is to be large or small — there's lots of worthwhile material here for you.

### The Finest Plans Available!

These plans are the "cream of the crop". They are the ingenious ideas of top-notch woodworking hobbyists — selected from thousands of shop plans gathered by Delta.

### Use This Help!

Combine this experience of others with your own ingenuity. Let this book help you plan a homecraft

shop that is the envy of your friends—one you're proud of and happy to work in, an attractive place where the whole family can enjoy close companionship as they join in your wholesome fun.

Send for your copy of Delta's new, big book, "21 Home Workshop Floor Plans." Use the coupon below. Mail it today with your check, money order, or dollar bill.

There's a store near you that handles Delta Homecraft\* Power Tools. It is listed under "Tools" in the classified section of your telephone directory. The people there are glad to give you advice on planning and equipping your shop. Ask them about Delta Homecraft Power Tools — the popular tools with a reputation for *quality*.

**\$1**  
Postpaid

**Tear out coupon and mail today!**

DELTA MANUFACTURING DIVISION  
Rockwell Manufacturing Company  
682D E. Vienna Ave., Milwaukee 1, Wisconsin

Enclosed is one dollar {  cash  
 check  
 money order } as payment in full  
for the new Delta book, "21 Home Workshop Floor Plans."

Name.....

Address.....

City.....(.....) State.....

- Look at all the helpful information you get:**
- Floor plans for almost any size shop — to fit almost any size budget!
  - Scale drawings of the base dimensions of Delta Homecraft Power Tools — helpful in estimating the floor space you need!
  - Practical suggestions on the arrangement of tools, storage of lumber, etc.
  - Page after page of useful ideas for convenience, economy, and safety!
  - Pictures of interesting workshops where other hobbyists find happiness!



\*Trade Mark Reg. U.S. Pat. Off.

HM-48





## PROTECT YOUR ENGINE!

Prevent overheating the **WHIZ** way!

Burned out bearings, warped valves, blown gaskets, frozen rings—*this, so often, is the toll of overheating!* But cooling system trouble won't trouble you, if you use WHIZ cooling system chemicals.

Among the many WHIZ favorites are these popular cooling system products: KLEEN FLUSH to clean out the rust, scale, corrosion, and sludge that clog the system and cause overheating...COMMANDORUSTPREVENTIVE to guard against the formation of new deposits and to lubricate sealed water pumps ... INSTANT SEALER to quickly stop all leaks.

Keep your car, truck, or tractor out of trouble! Have your cooling system serviced the WHIZ way now! You'll find WHIZ products at your service station, garage, or implement dealer

—in fact, wherever automotive products are sold. R. M. Hollingshead Corp., Camden, N. J.; Toronto, Can.



PRODUCTS OF

*Hollingshead*

LEADER IN MAINTENANCE CHEMICALS

Get This Book on Fishing

**FREE!**



Back after 5 years! New "Fishing—What Tackle and When" shows South Bend and Oreno items. Color pictures of fishes. Casting instructions. Stories by famous writers. Every fisherman needs a copy. Sent free! A postal gets it!

**FAMOUS BASS-ORENO No. 973**



The unbeatable fish-getter that should be in every tackle box. Available in 6 finishes, 5 sizes. . . **\$1.10**

SOUTH BEND BAIT CO., 892 High St., South Bend 23, Ind.

**SOUTH BEND** *A Name Famous in Fishing*

**LUCY**

**NEW DRAWING DEVICE**

Draw any object, scenery, profile, portrait or reduce copy with LUCY. Optical illusion in LUCY makes phantom view of subject to be drawn appear on drawing paper. Drawing, even from nature, becomes simple tracing. No talent needed. Used by artists and children alike. Educational, amusing, practical, durable. Guaranteed.

\$6.95 cash, check or Money Order brings LUCY promptly postpaid, complete and ready to attach to any table or drawing board. No. C.O.D. Calif. residents add 17c tax.

BEELER ENTERPRISES, Dept. 10D, North Hollywood, Calif.

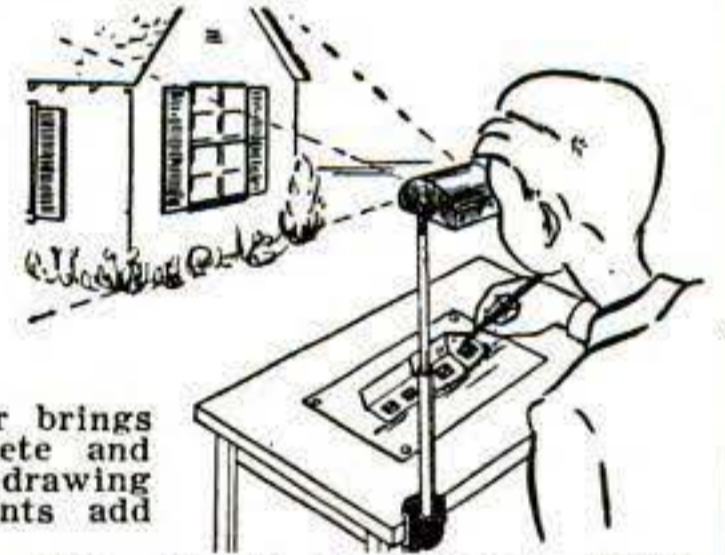

**SHAW GARDEN TRACTORS and MOWERS**



**Get FREE FOLDER NOW!**

Get details on 1 to 9 H. P. walking and riding tractors. Do 1000 jobs on small farms, estates, orchards, gardens. Low-priced. Send postcard!

**SHAW MFG. CO.**

5704 Front St., Galesburg, Kans. 668 PS No. 4th St., Columbus, Ohio

**Today's Best PLANER VALUE**

A Lifetime-Tool at Low Cost

**\$119.50**

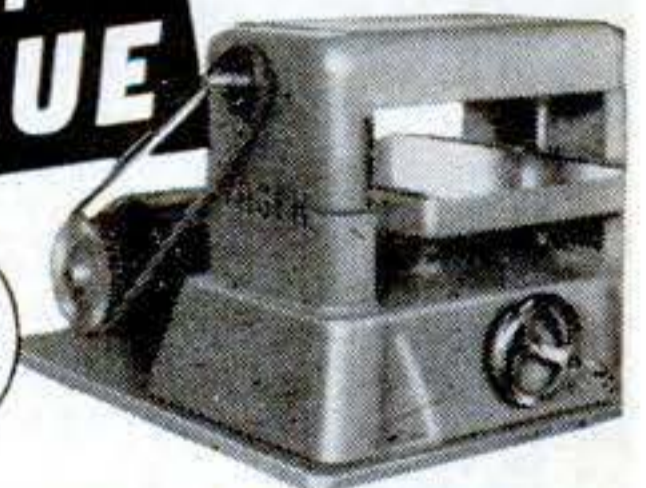

**The "YAGER"** —Thickness Planer—not a jointer, for home-craftsmen, or auxiliary tool for large shops. A marvel of efficiency, precision performance —at an amazingly low cost. Dependable for constant, uninterrupted, trouble-free service. Works any stock from soft balsa to hard ebony. Produces smooth, polished surfaces. Takes stock up to 10 in. wide, 2 3/4 in. thick or down to a thinness of 1/16 in. Handles light work with 1/3 H. P. motor and hand crank feed or heavy cuts up to 1/8 in. with 3/4 H. P. Sealed ball bearing arbor requires no lubricant. Feed gears packed in oil seldom need repacking. Now ready for immediate delivery. Write for prices and startling facts.

**THE KNEISLEY ELECTRIC COMPANY**

495 S. St. Clair St.

Dept. 47-A

Toledo 3, Ohio



Motorcycling is **TOPS**  
for **FUN** and **THRILLS!**

## Own a **HARLEY- DAVIDSON**

No wonder motorcycling is the favorite sport of so many fun-loving, vigorous, red-blooded young men and women! There's a thrill to riding a new 1947 Harley-Davidson that beats anything else on wheels. Owners have grand times — they belong to clubs—make new friends — compete in endurance runs, race meets and hillclimbs. They get out on the open road and tour the country — even tour other lands. Don't merely *wish* for good times — when you can roll up so many pleasure-filled miles on your own Harley-Davidson! Get set for the happiest evenings, weekends and vacations of your life — see your Harley-Davidson dealer **NOW** — and mail the coupon today.



**HARLEY-  
DAVIDSON**  
*Motorcycles*

**HARLEY-DAVIDSON MOTOR CO.**  
Department PS, Milwaukee 1, Wisconsin

Please send free copy of 24-page "ENTHUSIAST" Magazine, filled with motorcycle action pictures and thrilling stories.

Name.....

Address.....

City..... State.....

APRIL  
1947 249



What's Missing in this Picture?

*Not a thing!*

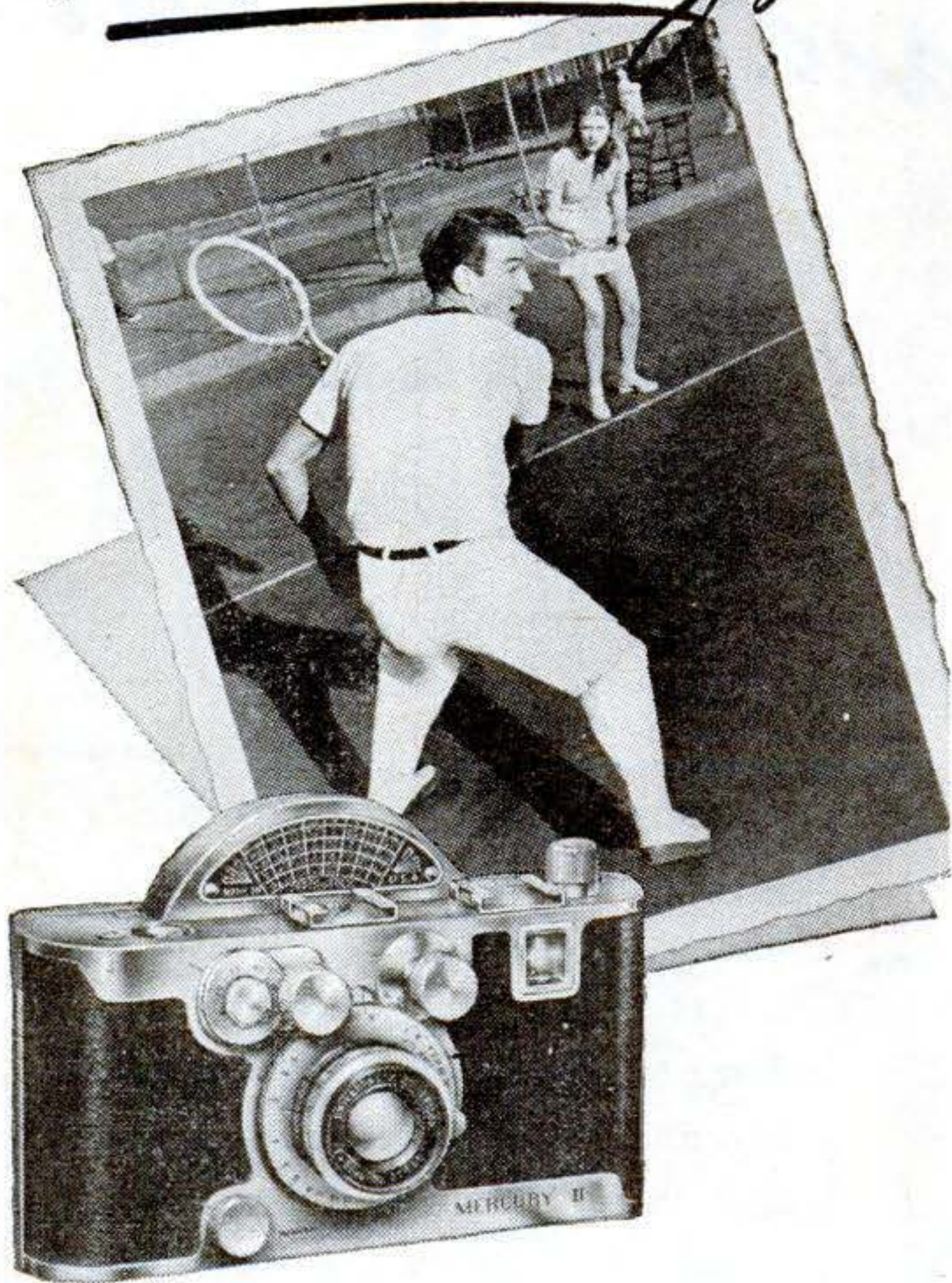

You, too, can get everything with

## MERCURY II

*It's a UNIVERSAL*

Shoot *everything* with Mercury II — candid, split-second action, portrait, still-life — and you get *everything* with a maximum of ease.

**COLOR!** The only minicamera especially designed for color, gets pictures as fresh and vivid as new paint.

**ACTION!** Lightning-like shutter freezes rapid action.

**LOOK-ALIVE DEPTH!** Three-dimensional depth of focus guarantees clear focus even when you misjudge distances up to 50%.

**FUSSPROOF SIMPLICITY!** Extreme ease-of-operation leaves you free to concentrate on your subject.

**FILM ECONOMY!** Shoots *more* pictures — 36 exposures on a standard 20-exposure cartridge.

See the Mercury II at your dealer's today!

Shoot Pictures like the "Pros" with Mercury II

**UNIVERSAL CAMERA CORPORATION**

NEW YORK

CHICAGO

HOLLYWOOD

Manufacturers of Cinémaster and Mercury Cameras and other Photographic Equipment

250 POPULAR SCIENCE



## CONGRESS PULLEYS

No matter what kind of a pulley you need, your hardware dealer—who displays the sign below—has it for you. He has pulleys to drive your bench saw, lathe, grinder—or to drive the refrigerator, washing machine or furnace blower. Highest quality, perfect balance, long pulley life are yours with CONGRESS DRIVES.



Sign of an Authorized Congress Dealer

**CONGRESS DIAMOND-BORED DRIVES**  
3750 EAST OUTER DRIVE DETROIT 12, MICHIGAN

.297 CU. IN. DISPL.

Class 'B'

Delivers 2-12,000 r.p.m.

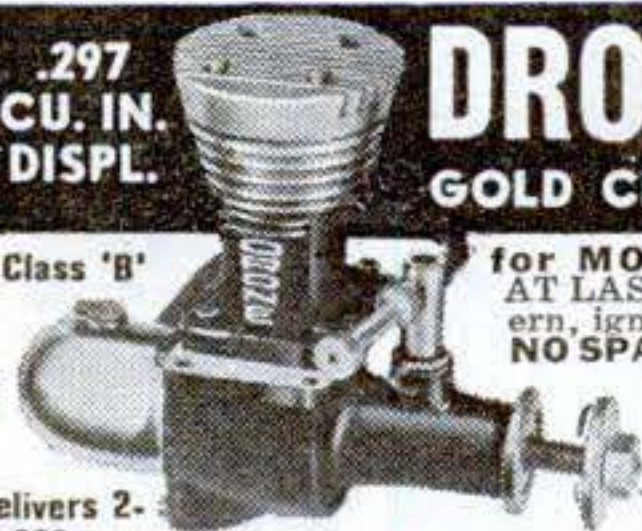

**DRONE** *diesel*  
GOLD CROWN

for MODEL PLANES—BOATS—RACE CARS  
AT LAST! America's first—America's finest modern, ignitionless DIESEL miniature power plant.  
**NO SPARK PLUG! NO COIL! NO BATTERIES!**  
Sure, quick start—dependable run every-time! Wiring-ignition complications eliminated. Bore 21/32; Comp. Ratio (fixed) 18/1. Ready-to-run \$21.50 at dealers, or write direct.  
DRONE Eng. Co., 125 Broad, Elizabeth, N. J.

## TRAILER AXLES, HITCHES, AND PARTS

● If you are interested in purchasing trailer axles, hitches, and other trailer parts, contact us promptly.

Write for free literature

HAMMER BLOW TOOL COMPANY, Dept. D-20, WAUSAU, WIS.



**HOLD-E-ZEE**  
*Automatic Grip*

### SCREWDRIVERS

... not only tools of finest quality, with chrome-vanadium blades, hand-ground bits, insulating, unbreakable handles ... but possessing the exclusive Gripper which holds, starts, and sets up screws in unhandy places. At leading dealers everywhere. Upson Bros., Inc., 86 Exchange St., Rochester, N.Y.

QUALITY UNSURPASSED • CONVENIENCE UNEQUALLED



**new** . . . for wood, linoleum,  
plastics, etc.



## NO. 77 X-ACTO WOODCARVING SET

Contains: 6 different chisel and gouge blades, scalpel-sharp, high carbon surgical steel. Flat, "U" and "V" shapes.  
4 assorted regular X-acto blades.  
2 3-inch blades.  
1 specially designed X-acto handle.

Gouge and chisel blades are designed with architectural rib, for rigidity and control in cutting. At hobby, hardware and gift shops. Only \$3.00

Other X-acto Knives, Blades & Tools, 25c to \$45.00

**X-ACTO CRESCENT PRODUCTS CO., INC.**

440 Fourth Ave., New York 16, N. Y.

In Canada: Handicraft Tools, Ltd., Hermant Bldg., Toronto

**ANYONE CAN DO THIS IF THEY HAVE OUR CHART**

**SPECIAL OFFER FOR AGENTS**

Blue print 27 x 36" now printed on both sides showing squares full size. Shows how to find the length of any rafter, find any angle, in degrees, frame any polygon three to sixteen sides, read the board foot and braceable, octagon scale, rafter tables, many other uses, can be scaled down for model work as well as full scale framing. Also chart changing pitches to degrees. For use with radial saws. About 13 square feet of printed copy sent post paid for \$1.00. No checks or stamps. MASON ENGINEERING SERVICE, 2032 N. Burdick St., Division 4, Kalamazoo 81, Mich.

## Wagemaker WOLVERINE BOATS



### THE SPORTSMAN'S CHOICE

Choosing your favorite Wolverine Outboard Boat is simple with nearly 60 models to select from. Wolverine Boats have proven themselves for sportsmen and pleasure seekers throughout the United States and Canada for their top performance. Featuring Standard, De Luxe, and Super De Luxe Molded Plywood Models in 12'-14'-16', and many others. Be Wise—Choose Wolverine for your next boat. Free literature on request.

**WAGEMAKER COMPANY**  
DEPT. 26 GRAND RAPIDS, MICH.



**FREE**

*get*

## ALLIED'S NEW RADIO CATALOG

SEND FOR IT  
NOW

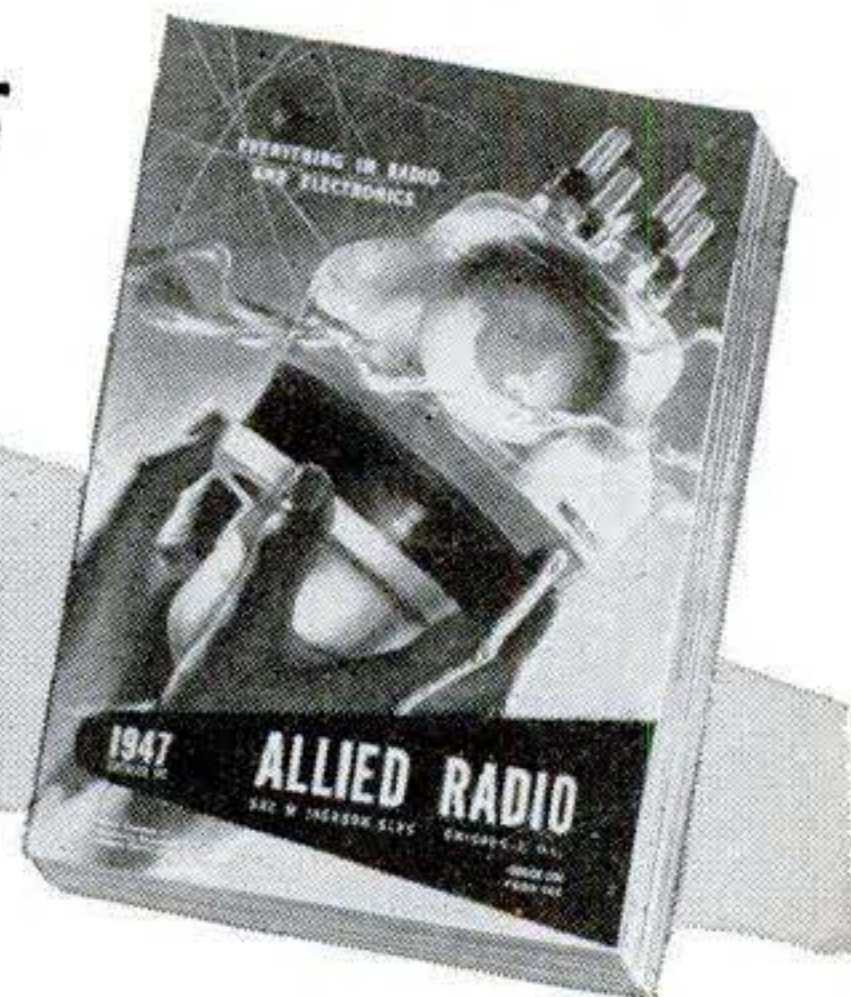

FOR  
EVERYTHING  
IN RADIO!



NEW HOME RADIOS



SERVICE SUPPLIES  
BUILDERS' SUPPLIES



AMATEUR GEAR



SOUND SYSTEMS

**164 Value-Packed Pages**

Send for your FREE copy of the most complete Buying Guide for Everything in Radio! Here's the Catalog for Servicemen, Dealers, Soundmen, Amateurs, Builders and Experimenters. Features the world's largest and most complete stocks of radio and electronic supplies—quality equipment at lowest prices! Get the speedy service and expert help you want from ALLIED—Radio's Largest Supply House. Depend on ALLIED!

**MORE THAN 10,000 ITEMS**

Get everything for every radio use: New 1947 home model radios, phono-radios, recorders, communications receivers, Ham kits, and gear, code apparatus, radio parts, tubes, tools, test instruments, public address equipment, low-cost easy-to-build radio kits, diagrams and matched parts lists, largest selection of instructive radio books—all at lowest prices!

## ALLIED RADIO

ALLIED RADIO CORP.  
833 W. Jackson Blvd., Dept. 7-DD-7  
Chicago 7, Illinois



Rush new FREE 1947 Catalog

Name.....

Address.....

City..... Zone..... State.....



# BY DEMAND

# OF THE EXPERTS

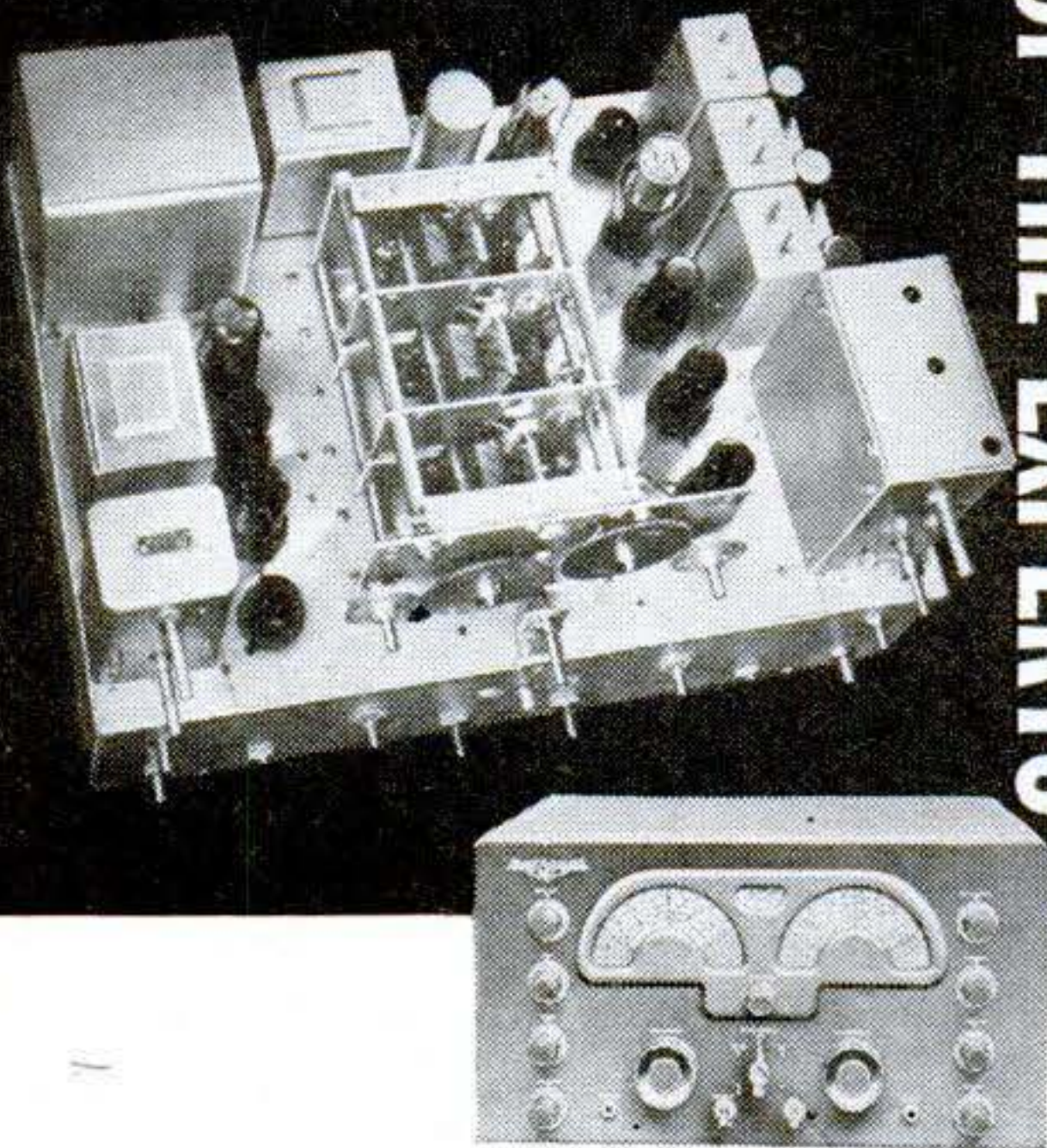

## THE GREAT NEW NC-173

Now you can enjoy the radio that was built to suit the world's most exacting radio fans—the amateurs who run their own stations. The new National NC-173 is the product of hundreds of their suggestions, plus five years of intensive research. Turn its dials and the world comes in... with marvelous clarity, pin-point sensitivity. Yet its cost is surprisingly moderate.

- 13-tube superheterodyne circuit.
- Standard and short-wave bands, 540 to 31,000, 48,000 to 56,000 KC. (Includes amateur bands.)
- AM reception, phone and code.
- AC-powered. Can also be operated on battery for portable or emergency use — 110/120 or 220/240 volts, 50/60 cycle.
- Distinctive streamlined styling.

Write for name of your nearest dealer today.

EST. 1914



MALDEN, MASS.

# NATIONAL

COMPANY, INCORPORATED

THE MOST DISTINCTIVE NAME IN RADIO COMMUNICATIONS

252 POPULAR SCIENCE

## An Easier, Quicker Way to CUT GRASS and WEEDS

Get a MOW-MASTER... the Rotary Mower built to do a hard job the easy way. Plenty of power from famous air-cooled, 2 H. P. gasoline motor with muffler. Easily adjustable rotary blade.

### LOW PRICED

Modern methods of volume production make MOW MASTER low priced.

### SEE YOUR DEALER

or write us for Free Folder.

Adjustable handle, handle-bar control, precision built of quality materials.

Lightweight — a woman can run it. Cuts thru high grass and weeds. Keeps lawn velvety smooth.



The PROPULSION ENGINE CORP. Dept. 300

7<sup>th</sup> and White Eagle Rd. Kansas City, Kansas

POWERED BY 2 H. P. POWER-PAK GASOLINE ENGINE with MUFFLER.

## MOW-MASTER

Rotary Mower

## MACHINE SHOP EQUIPMENT



Just off the press!—Every man who owns a workshop should have a copy of our new, up-to-the-minute, 200 page catalog of Machine Shop Equipment—the latest tools made by the biggest manufacturers in the U. S. Replete with illustrations, descriptions, prices. Prompt delivery on most tools listed in this book. Available at cost of printing—50c a copy—get yours today! **Price of Catalog Refunded on First Order over \$5.00.** Send Check or Money Order to

CENTER TOOL CO., 153 Centre St., Dept. D, N. Y. C. 13

## USE YOUR BENCH SAW

FOR JOINTING & CUTTING MOULDINGS



With our six inch tool steel cutters make mouldings, casings, drop-leaf tables, grooves beading and jointing. Moulding cutters, A 1 in. wide \$1.50. 1 1/2 in. \$2.00. Jointing cutters, B 1 in. \$1.50. 1 1/2 in. \$2.00. E 1 in. for drop-leaf tables, \$1.50, E 1 1/2 in. Makes 3/4 in. cove & Quarter. \$2.00. Postpaid. Guaranteed. State size hole. List & Folder free.

JOHN A. SANDSTROM  
Rt. 1-P. Clearwater, Fla.



## SAVES MANY ELECTRIC APPLIANCES



NICHROCITE REPAIRS HEATING ELEMENTS IN A JIFFY . . .

Simply overlap ends, apply Nichrocite Paste and turn on current. Used by large utility companies. Trial order, \$1.00; 4 oz., \$2.50; 1 pound, \$8.00.

ARROWHEAD SALES & DIST. CO. Dept. G  
1325 4th St. N., Minneapolis 11, Minn.



## SPEEDY! 2 H. P. BIKE MOTOR

Makes a fast-powerful motorbike out of any bike. Up to 50 MPH—100 mile gal. gas. "Vari-matic drive." You can convert it easily from standard motors or parts we can supply. It's simple. **As low as \$19.95**

**SEND ONLY \$1.00** (cash or M.O.) postpaid or pay postman \$1.52 C.O.D. (USA only) for complete scale isometric picture blueprints (anyone can read them) 6 page details, lists of parts and prices complete!

**FREE** with each order—big 48 page color book giving full details on over 100 other new inventions such as: JET ENGINES—MIDGET MOTORCYCLES—CARS AND SCOOTERS—ELECTRIC BOATS—OUTBOARD MOTORS—BIKE RADIOS—WALKIE TALKIES, ETC. **DON'T PASS UP THIS SUPER VALUE—YOU MAY EARN AND SAVE HUNDREDS OF DOLLARS WITH THESE PLANS!** (All foreign orders \$1.50 U.S. cash with order).

MOTOR INDUSTRIES INC., Dept. PSBM-4 Kearney, Nebraska

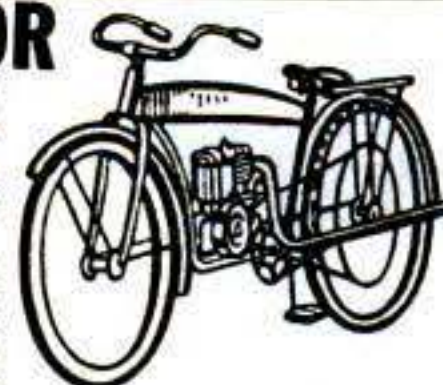



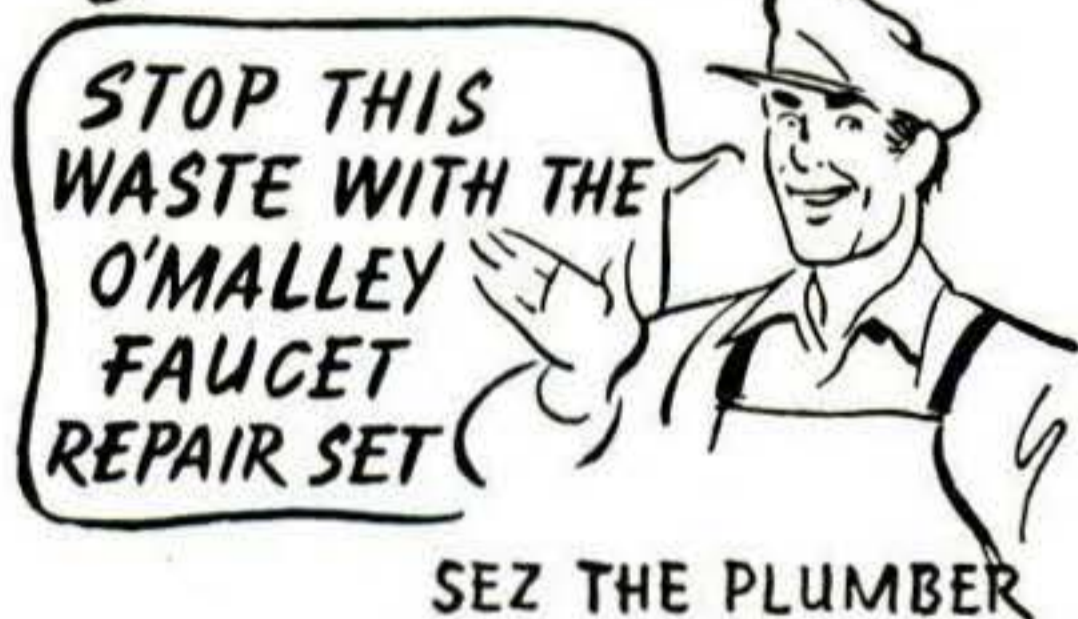
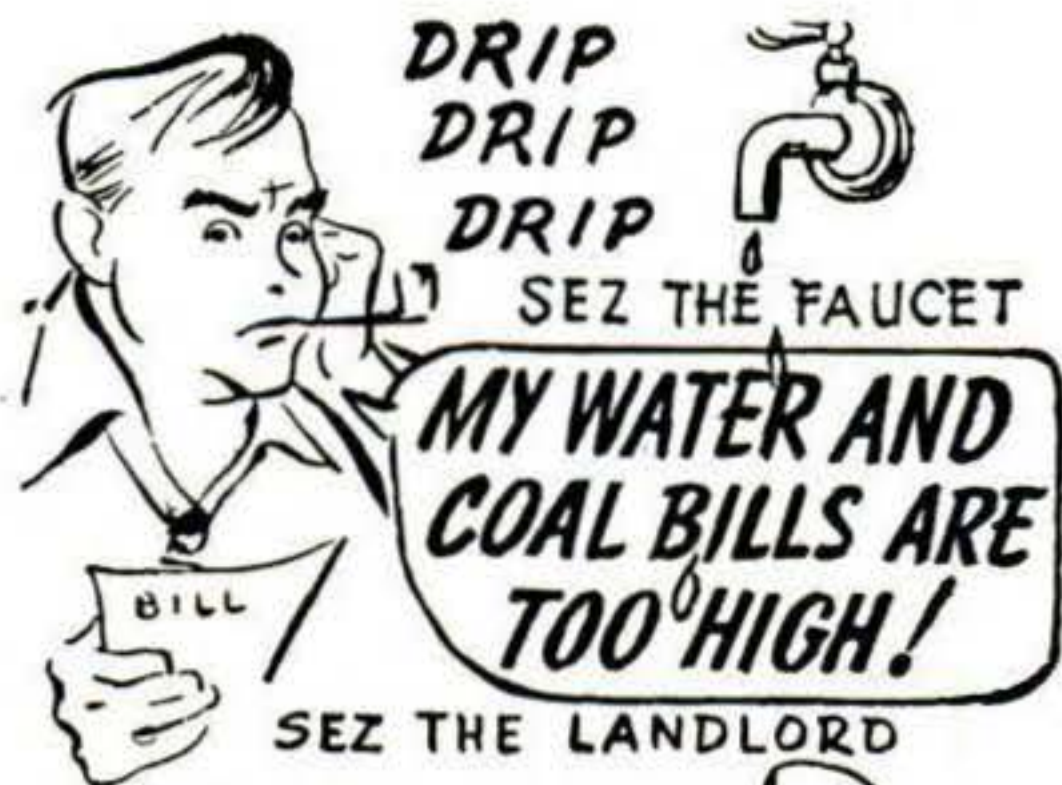

### FIX IT YOURSELF!

Stop those high water bills... just get an O'MALLEY FAUCET REPAIR SET... read the simple directions... and in a few minutes you can fix your faucet and stop its messy, water-wasting, nerve-devastating Drip-Drip-Drip. Costs less than a dollar, depending on the size you require, wherever hardware is sold.

EDWARD O'MALLEY VALVE CO. — CHICAGO 19

**O'MALLEY FAUCET REPAIR SET**

**FIREWORKS**  
**OH-BOY!**

Banner has always been right there with the newest and best in fireworks. Now we offer you sensational new creations you never heard of before. Thrills galore. You'll be the envy of your friends and neighbors when you start celebrating with BANNER FIREWORKS... always rock bottom in price.

**BIG SPECIAL DEAL—ONLY \$4.95**

Big giant assortment of over 150 pieces including Salutes, Roman Candles, Sky Screammers, Chinese Firecrackers, Sparklers, Vesuvius Fountains, Aerial Bombs and many others... regular \$10.05, retail value for only \$4.95. Rush your order. Supply limited. Catalog FREE.

**BANNER FIREWORKS MFG. CO., INC., DEPT. 245**  
446 Capistrano Toledo 12, Ohio

**UTICA TOOLS**

**PLIERS FOR EVERY NEED**

**Ask Your Dealer**

UTICA

**UTICA DROP FORGE & TOOL CORP.**  
UTICA 4, NEW YORK



make your  
**TALLEST**  
wish come true  
instantly in  
**ELEVATORS\***  
TRADE MARK  
HEIGHT-INCREASING SHOES  
"YOUR PERSONAL PEDESTAL"  
\*TRADE MARK OF STONE-TARLOW CO., INC.

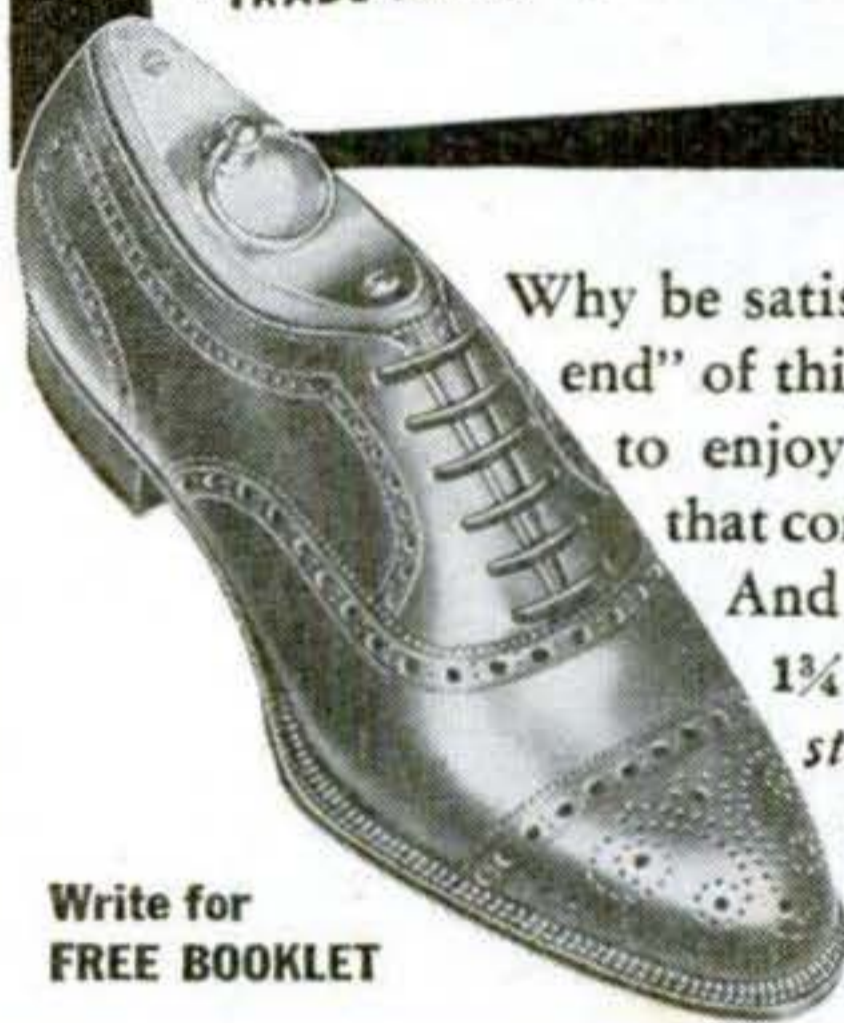

Why be satisfied with the "short end" of things when it's so easy to enjoy all the advantages that come from being taller. And you can be almost 1 1/4 inches TALLER the instant you step into a pair of "ELEVATORS". Secretly, too, for the heels are no higher.

Write for  
FREE BOOKLET

**STONE-TARLOW CO., Inc.** Dept. PS 4-47  
Brockton 68, Mass.

Please send me Free Booklet  
and name of nearest dealer.

Name \_\_\_\_\_ (Please Print)

Address \_\_\_\_\_

City \_\_\_\_\_ State \_\_\_\_\_

The Original and Genuine "ELEVATORS"  
Manufactured Exclusively by Stone-Tarlow Co., Inc.



## A GALLON OF GAS



Think of it—a six-mile ride for just one cent! With a WHIZZER Motor on your bike, you'll enjoy America's thriftiest power transportation. 2½ rugged horsepower . . . modern 4-cycle design . . . speeds up to 35 miles an hour . . . precision engineered for trouble-free performance. Fits any man's balloon tire bike. Join the WHIZZER parade now!

## TAKES YOU 125 MILES

RIDE ONE  
AND YOU'LL  
BUY ONE!

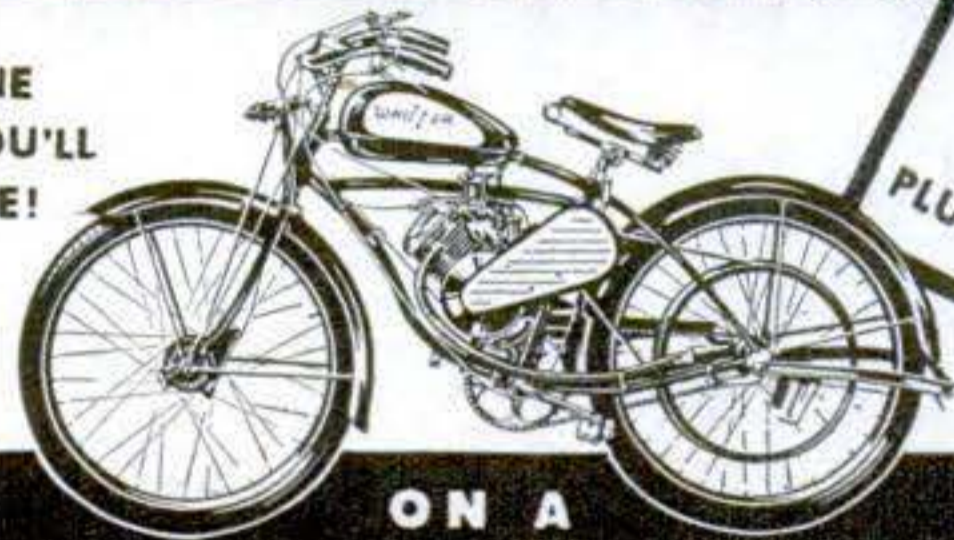

ONLY  
\$97.55  
PLUS TAX

FOB Pontiac,  
Mich.

ON A

# WHIZZER

Whizzer Motor Company, Dept. 534, Pontiac, Michigan.

I enclose \$99.97, which includes \$2.42 Federal Excise Tax ( ) check or ( ) money order. Send me one WHIZZER Motor complete, ready for installation. If descriptive literature only is desired, check here ( ).

Name \_\_\_\_\_ City \_\_\_\_\_  
Street \_\_\_\_\_ State \_\_\_\_\_

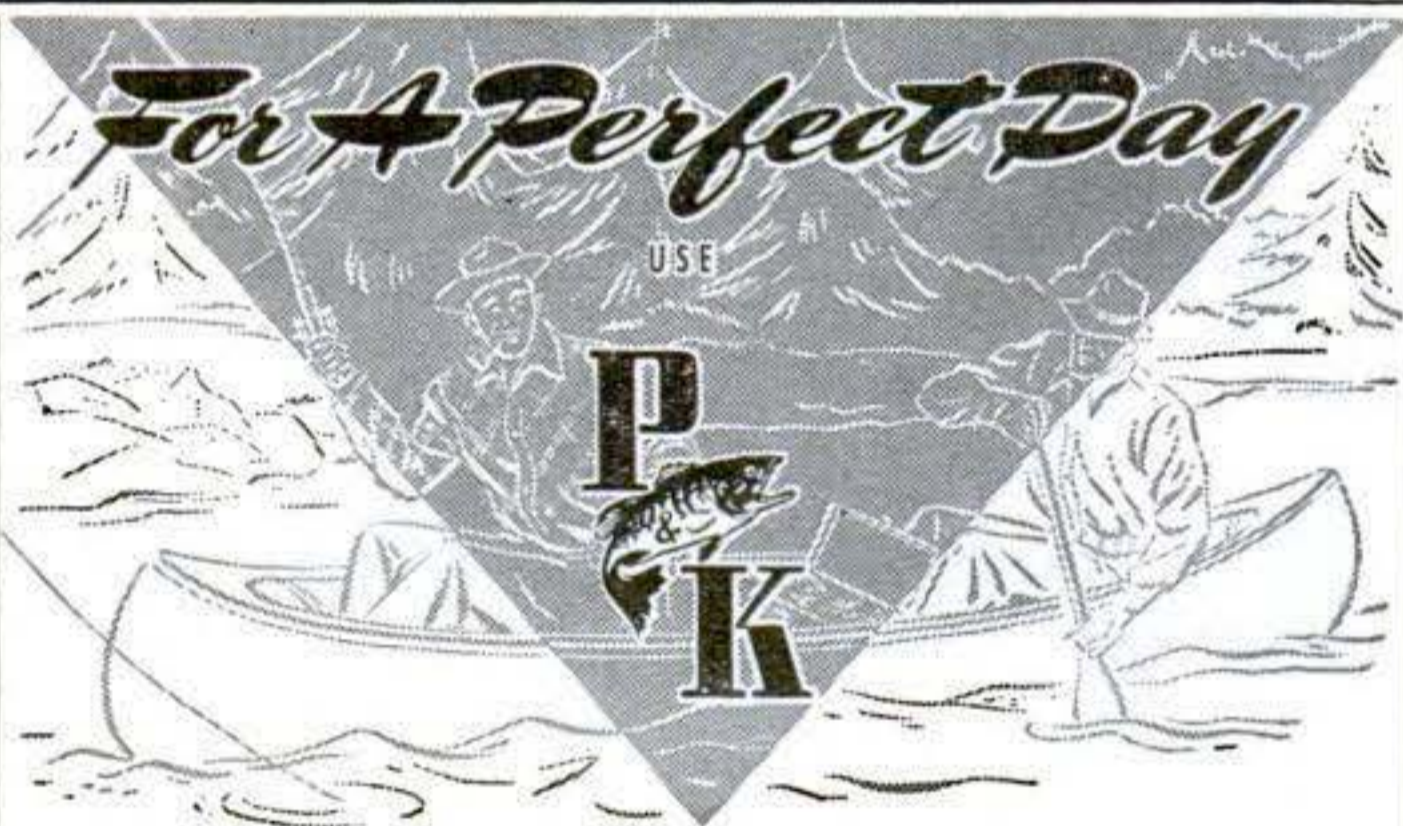

## AMAZIN' MAIZIE

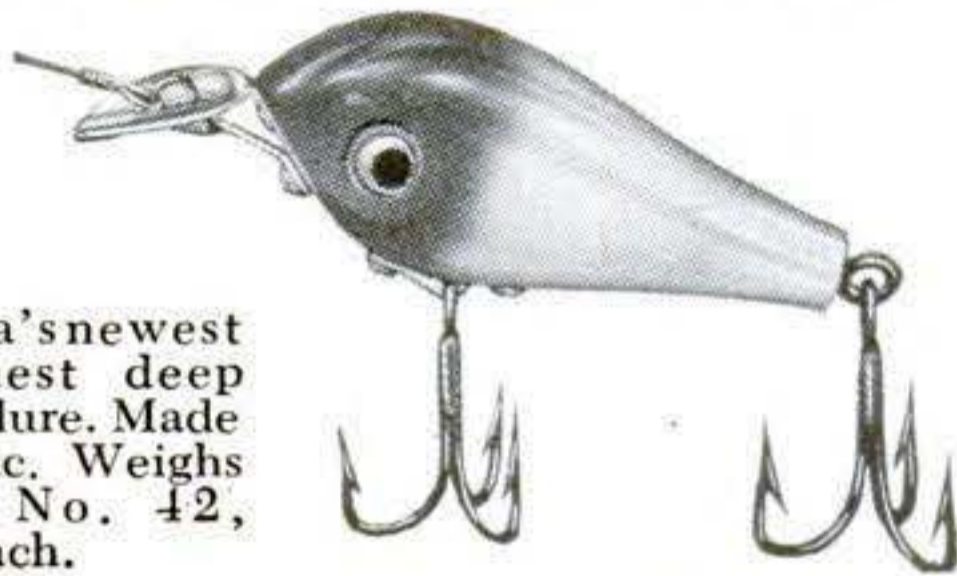

America's newest and finest deep running lure. Made of Plastic. Weighs 5/8 oz. No. 42, \$1.35 each.

### "Adventures in Fishing"

48 pages in four colors; pictures, fishing stories, secret hints, etc., with regular 10c package of Raparound, invisible ribbon sinker, both for only 10c. Send your dime today.

## P & K INCORPORATED

(Pachner & Koller, Inc.)

3454 Archer Avenue Chicago 8, Illinois  
Canadian Distributors: Central Purchasing Agency, Ltd., Toronto, Ont.

TESTED AND PROVED LURES AND FISHING ACCESSORIES

254 POPULAR SCIENCE

## Do a Better Job WITH ONE OF THESE EMPIRE LEVELS

Smallest, most handy and accurate Level made. "Cigar-shaped"—no sharp corners to tear pocket. Aluminum stock. Only 3 oz. wgt. 9" long. Has Level, Plumb, 45° Vials.  
No. 26 .....\$1.75



### ALUMINUM LEVEL — No. 151

Cast and Machined, a Beautiful Tool, with Patented, Removable Level and Vial.  
With 2 Plumb, 2 Levels, 2 — 45° Vials. 18".....\$6.00  
24".....\$6.00 28".....\$7.00

Order EMPIRE LEVELS from your local dealer.  
Write direct for literature.

EMPIRE LEVEL MFG. CO.  
707 S. 6th St. Milwaukee 4, Wis.

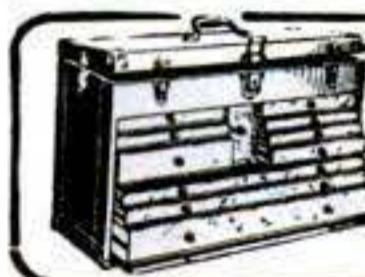

Machinists, Tool, Die and Pattern Makers will want genuine Gerstner High Grade Tool Chests. Free Catalog.

GERSTNER TOOL CHESTS  
547 Columbia St., Dayton 7, Ohio

## LEARN ELECTROPLATING

Highly Paid, Uncrowded, Interesting Business. Part or Full Time, Common School Education Sufficient. Gold, Silver, Nickel, Chromium; etc. Money Making Secrets, Processes. Send postcard for FREE Electroplating Booklet and proof. PLATER HYDE, Dept. 5, P. O. Box 176, National City, California.

## HULL AUTOMOBILE COMPASS



A travel companion that shows directions anywhere, any time. Write for Circular. At your dealer's. Price \$3.95.



HULL MFG. CO., P. O. Box 246-E2, Warren, Ohio

## No More Bother Solving Problems

100,000 problems solved instantly. Greatest mathematical aid since the invention of the slide-rule. Details free. COLUMBIA GRAPHS, Columbia 6, Connecticut

## Now She Shops "Cash And Carry"

### Without Painful Backache

Many sufferers relieve nagging backache quickly, once they discover that the real cause of their trouble may be tired kidneys.

The kidneys are Nature's chief way of taking the excess acids and waste out of the blood. They help most people pass about 3 pints a day.

When disorder of kidney function permits poisonous matter to remain in your blood, it may cause nagging backache, rheumatic pains, leg pains, loss of pep and energy, getting up nights, swelling, puffiness under the eyes, headaches and dizziness.

Don't wait! Ask your druggist for Doan's Pills, a stimulant diuretic, used successfully by millions for over 50 years. Doan's give happy relief and will help the 15 miles of kidney tubes flush out poisonous waste from your blood. Get Doan's Pills.



# Keep Brushes like New

**BEFORE**

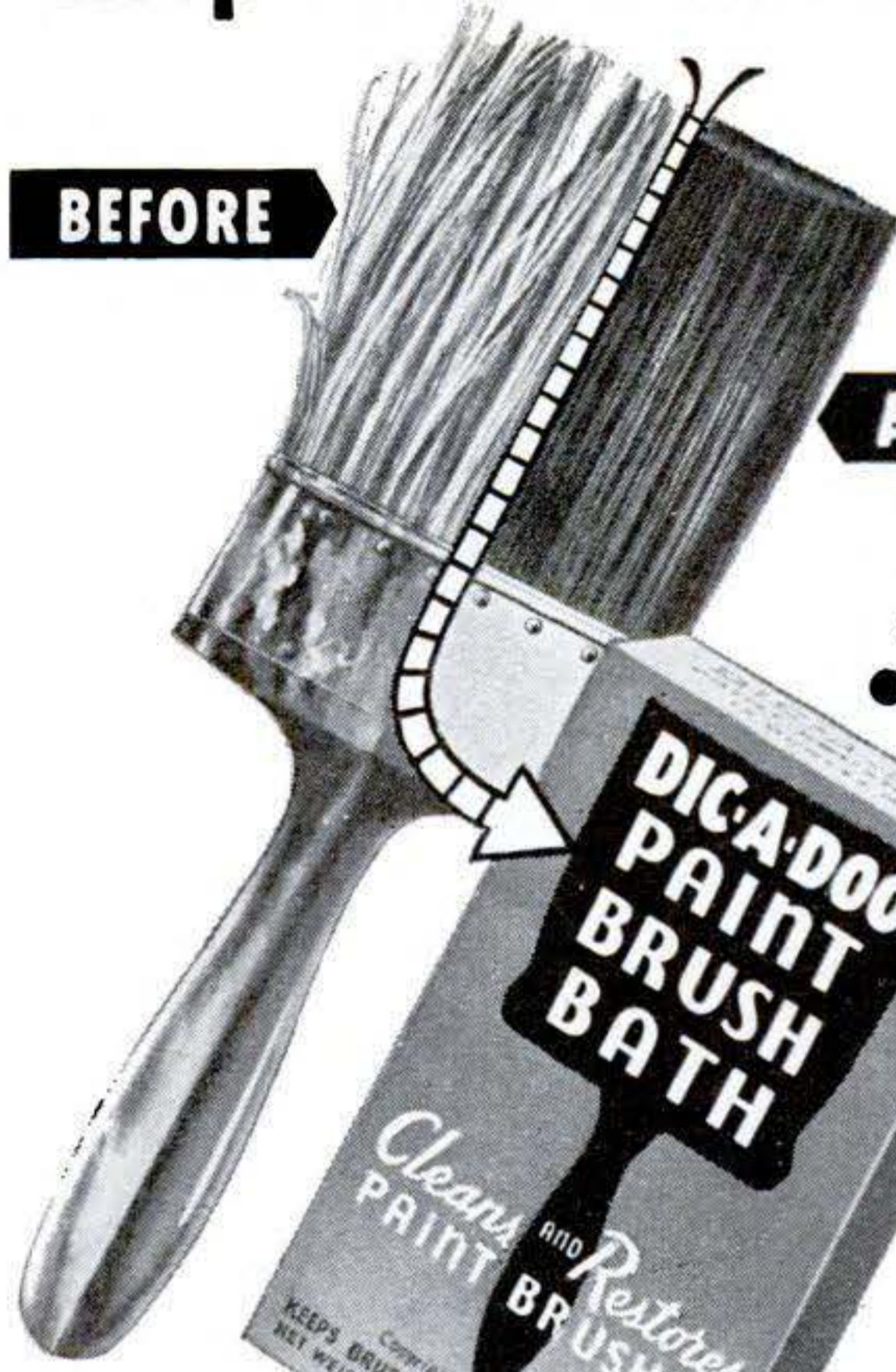

**AFTER**

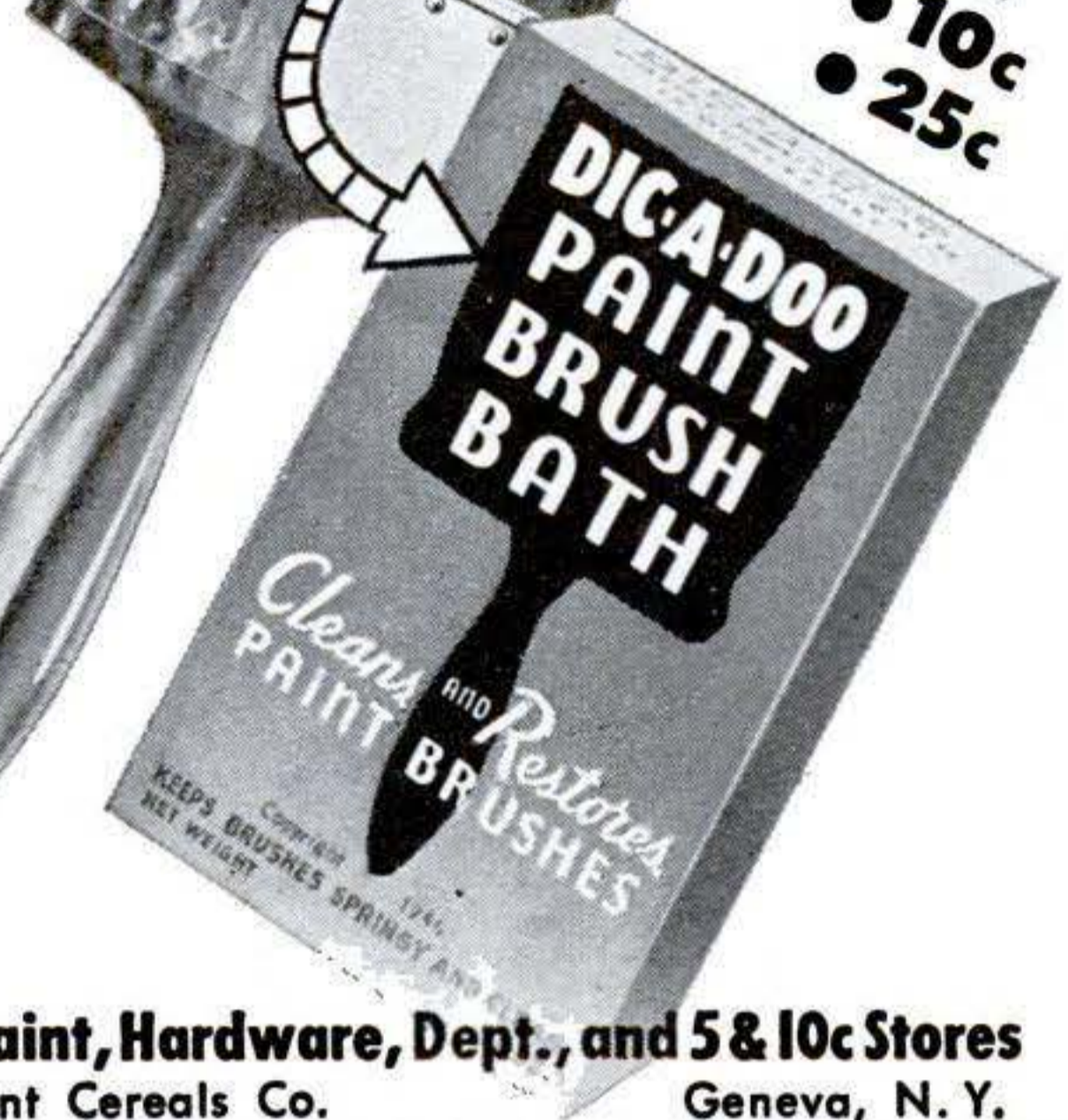

**DICA-DOO  
PAINT  
BRUSH  
BATH**

Clean and Restore  
PAINT BRUSHES

KEEPS BRUSHES SPRING AND CLEAN

Copyright 1947  
NET WEIGHT

- 5c
- 10c
- 25c

**At Paint, Hardware, Dept., and 5 & 10c Stores**  
Patent Cereals Co. Geneva, N. Y.

## A BIG 25¢ WORTH OF TOOL TIPS



● Everything about tools . . . at a glance. More than 2000 views of boring and cutting tools, squares, gauges, jigs, etc. Years of tool experience in one, low-priced book . . . 25¢ postpaid. Write today. Stanley Tools 247 Elm St., New Britain, Connecticut.

**STANLEY**

Trade Mark

# Repair Storm Windows and Screens with **PLASTIC WOOD**

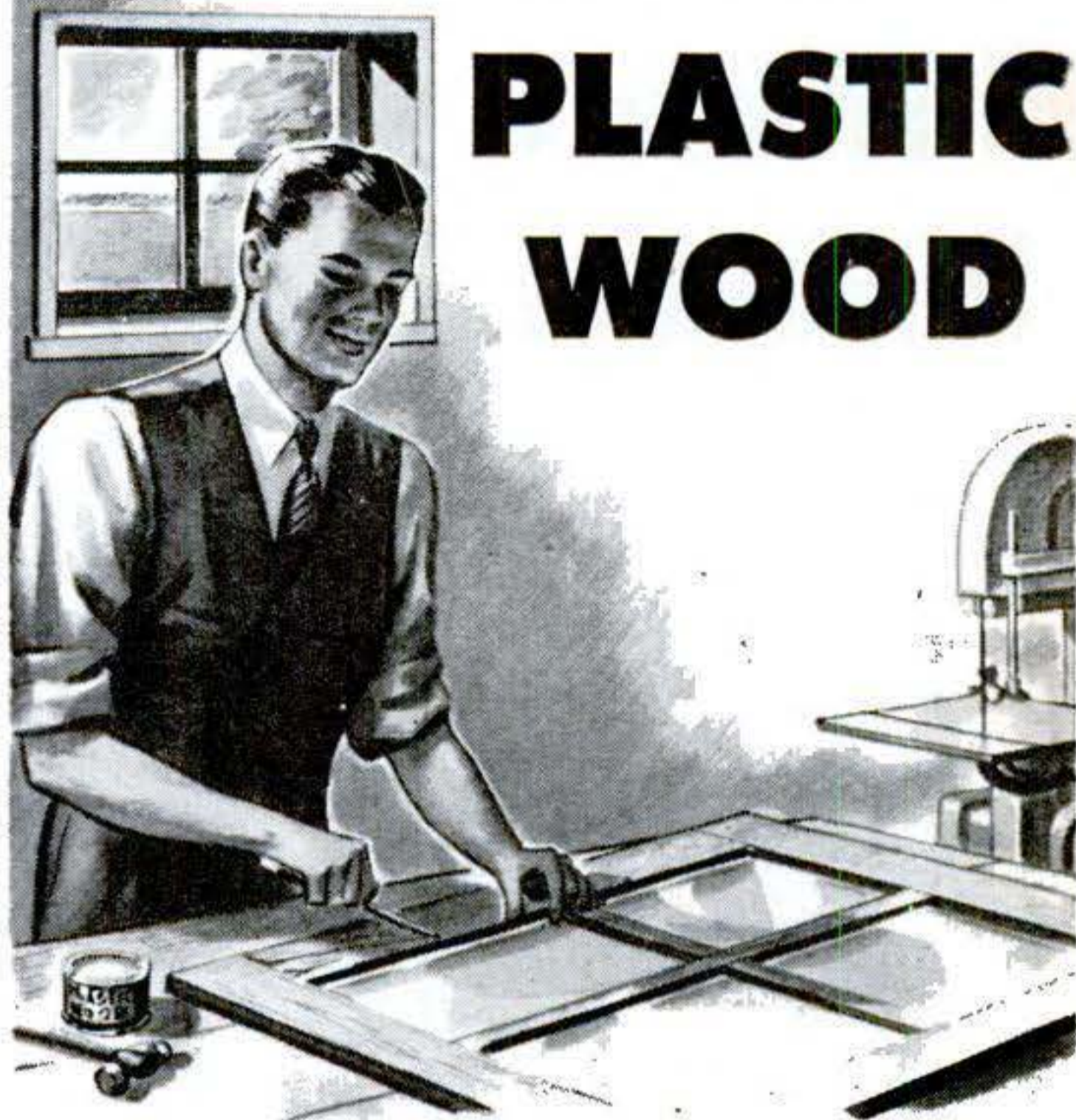

**When making new screens,** or replacing old rusted screen, apply thin layer of **PLASTIC WOOD** around frame after tacking down screen. This gives greater strength to the frame. **PLASTIC WOOD** can be easily shaped to match broken molding. Valuable in replacing rotted wood in storm windows.

. . . dozens of other uses

### FOR FILLING . . .

- Cracks in floors
- Countersunk screws
- Chipped furniture
- Nail and screw holes

### FOR REPAIRING . . .

- Loose tiles
- Loose casters
- Broken balusters
- Broken furniture

- **PLASTIC WOOD SOLVENT** is indispensable to the home workshop hobbyist for controlling the consistency of Plastic Wood and removing dried Plastic Wood from hands and tools.

T. M. Reg. U. S. Pat. Off.

At all Hardware,  
Paint and 10c Stores



# PLASTIC WOOD

Tube or Can

A CELLULOSE FIBRE FILLER

## PAINTERS' STRIPING TOOL

NOW you can do your own expert striping on furniture, bikes, model planes, bulletins, autos, toys, signs, linoleum, wall board . . . make plain walls look like tile! It's easy to paint straight, curved, circular, even parallel lines with any color. Handiest paint tool in your workshop! Type "M" Master Painters' Striping Tool complete with tip for 1/16" stripe, \$1.00. Extra tips 1/64", 1/32", 3/64", 1/16", 5/64", 3/32", 1/8"—75c each. Tool with complete set of 7 tips \$5.00. (C.O.D. orders 25c extra.) WENDELL MFG. CO., 4234—A Lincoln Ave., Chicago 18, Ill.

**A TOOL . . .  
NOT A BRUSH**

**STRIPE  
WITH  
PAINT  
EASY  
AS  
USING  
A  
PENCIL**

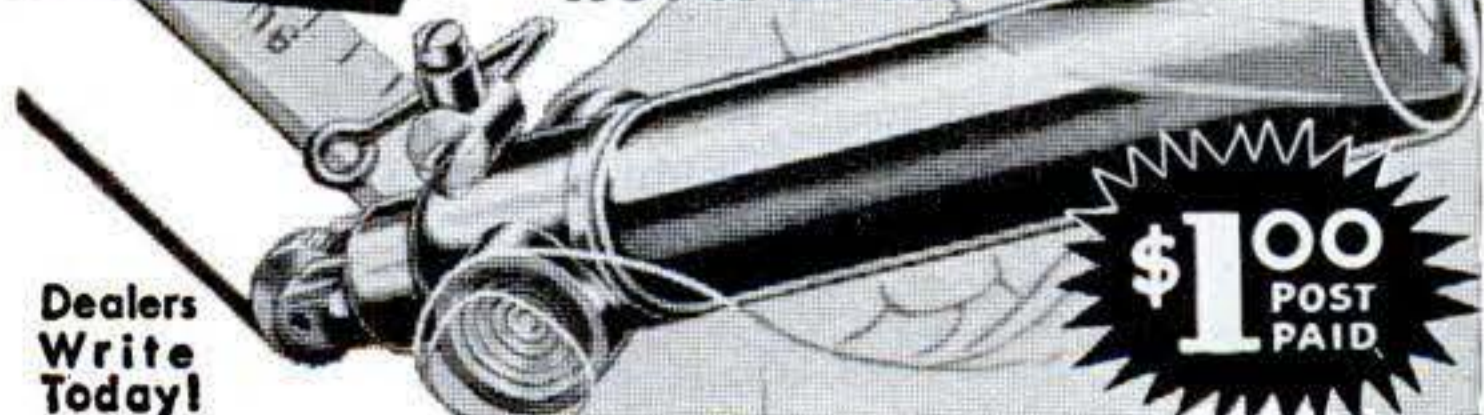

**\$1.00  
POST  
PAID**

Dealers  
Write  
Today!



**FINEST BLADES  
MONEY CAN BUY  
OR YOUR MONEY BACK**



DOUBLE OR  
SINGLE EDGE  
12 for 25¢

**America's Big Shaving Buy**

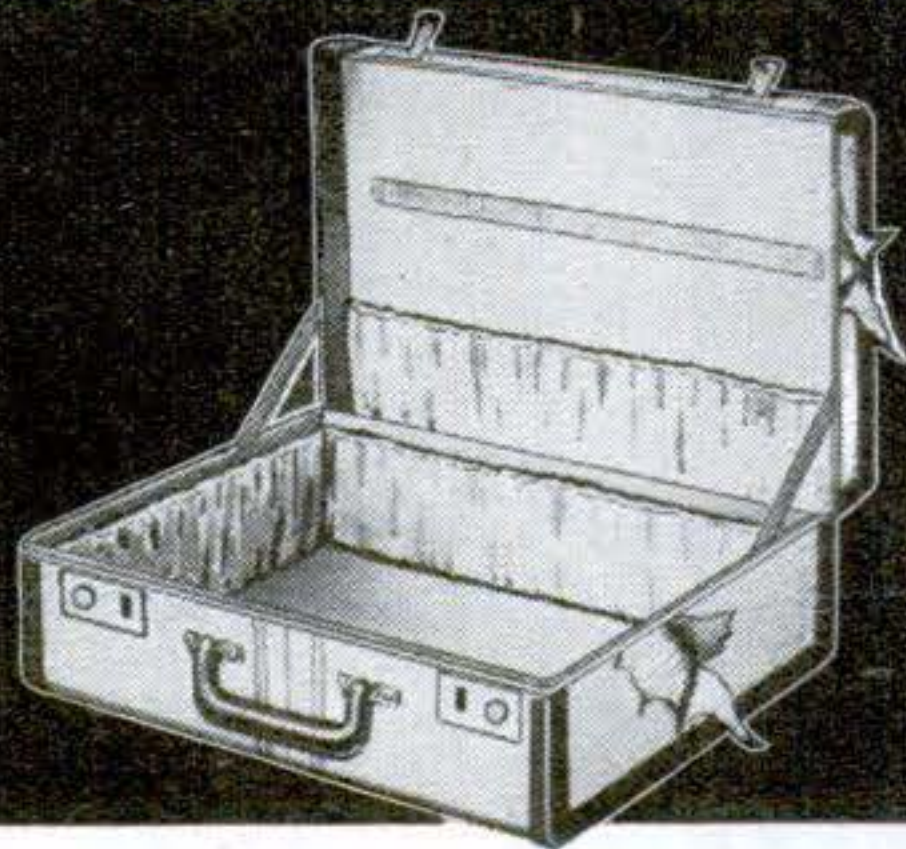

**FIXES** LUGGAGE, FURNITURE,  
DISHES, TOYS,  
AND BOOKS

It's transparent, water-  
proof, flexible and  
durable. Get a  
tube today.

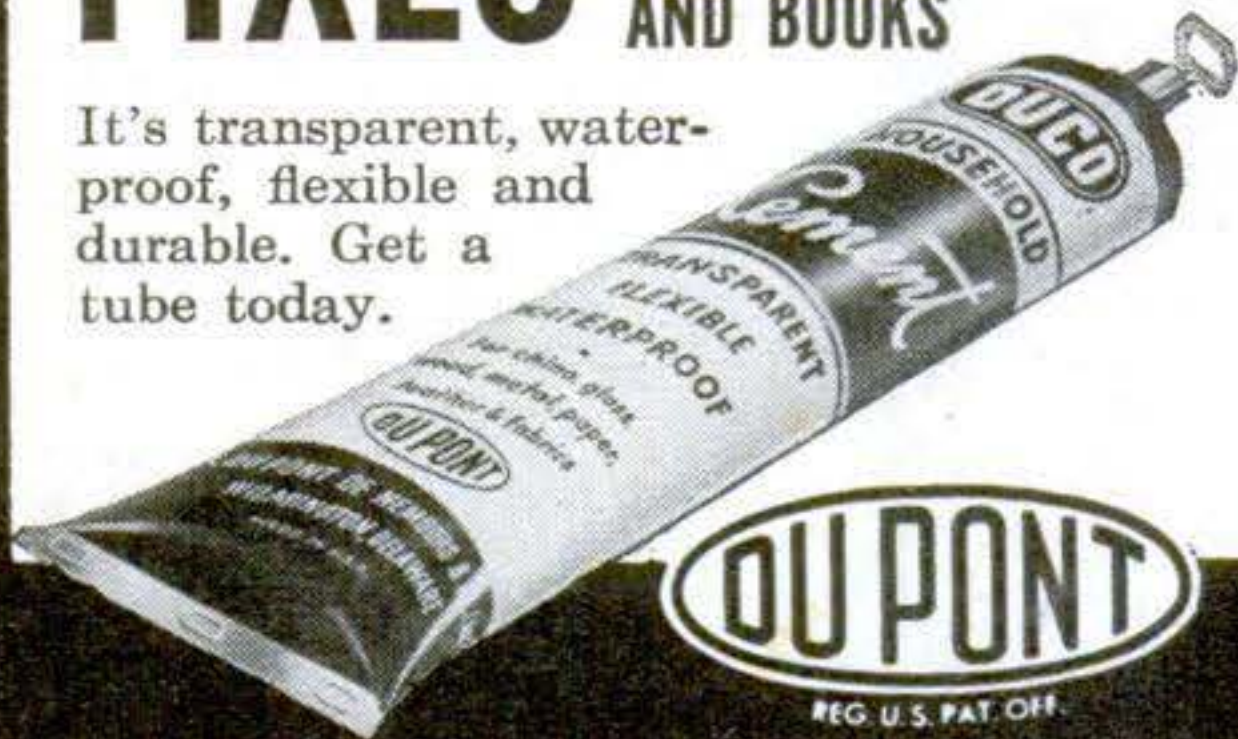

**DU PONT**  
REG. U.S. PAT. OFF.  
**DUCO CEMENT**

REG. U. S. PAT. OFF.

256 POPULAR  
SCIENCE

## Mows and Trims Lawns



**In One Simple  
Easy Operation**

**8 1/4 Lbs.**



**Save Time  
and Labor with a  
MONTAMOWER**

New model. New type metal handle has special device to adjust cutting height. Drive shaft now mounted on free rolling, factory lubricated, and sealed ball bearings. No tired backs or aching arms. 8 1/4 lbs. of live precision made mechanism that first gathers, then cuts smoothly a clean 16" swath through grass, dandelions, spike grass and weeds. No noise or clatter. As modern and efficient as your electric razor. Cuts right up to walls, fences, trees or posts; leaves no fringes to be trimmed by hand. Cutters are self-sharpening. Built to last many years. Many thousands in use. Sold direct from factory. Costs little. Write at once for guarantee information and literature.

**MONTAMOWER DISTRIBUTING CO.**  
830 Keeler Bldg. GRAND RAPIDS 2, MICHIGAN

## BUILD YOUR OWN POWER LAWN MOWER

**WHY BREAK YOUR BACK  
MOWING FIELD OR LAWN?**

WRITE  
FOR  
**FREE**  
LITERATURE  
The Rite-Way  
Mower  
Attachment  
Ball Bearing



**SAVE MONEY  
SAVE TIME**

Now anyone can save time and effort mowing field or lawn by building their own whirl type power mower. Build according to your own ideas and needs at small cost. Cut close to fences, walks, buildings, etc. Build in short time with parts and instructions we furnish. Save hours of time and back breaking labor. Write today for FREE information.



IT'S FUN TO BUILD

**T & H MFG. CO., Dept. S-2**  
811 E. 31, Kan. City 3, Mo.

## ITS EASY PICKING from a Huot DRILL INDEX

A handy container for indexing and filing twist drills. All steel—ten sizes. Correct drill always at your fingertips. SEND \$1. for No. 13—holds drills from 1/16" to 1/4" by 64s. (Or see dealer.) Order Today.

**HUOT MFG. CO.**  
436 FOOT, SCHULTZ BLDG.,

ST. PAUL 1, MINN.

**NOW**

**CHANITE SELF-WELDING FLUX—REPAIRS** all ELECTRIC HEATING ELEMENTS. So simple anyone can make repairs in your broken or burnt-out electrical appliances—irons, toasters, stoves & etc. Guaranteed nothing like it. From our mines to your appliances. \$1.00 per package. \$7.50 per doz. Stick form 25c. \$2.00 per doz.

**CHANITE SALES COMPANY, 914 South Main, Fort Worth 4, Texas**



## CORROSION and FRICTION

Use Fiendoil on tools, electrical appliances, household devices. It actively

Lubricates·Cleans·Prevents Rust

**FIENDOIL**

"The Enemy of Corrosion and Friction"

3-oz.  
Spoon  
Can  
**40c**



Something new!

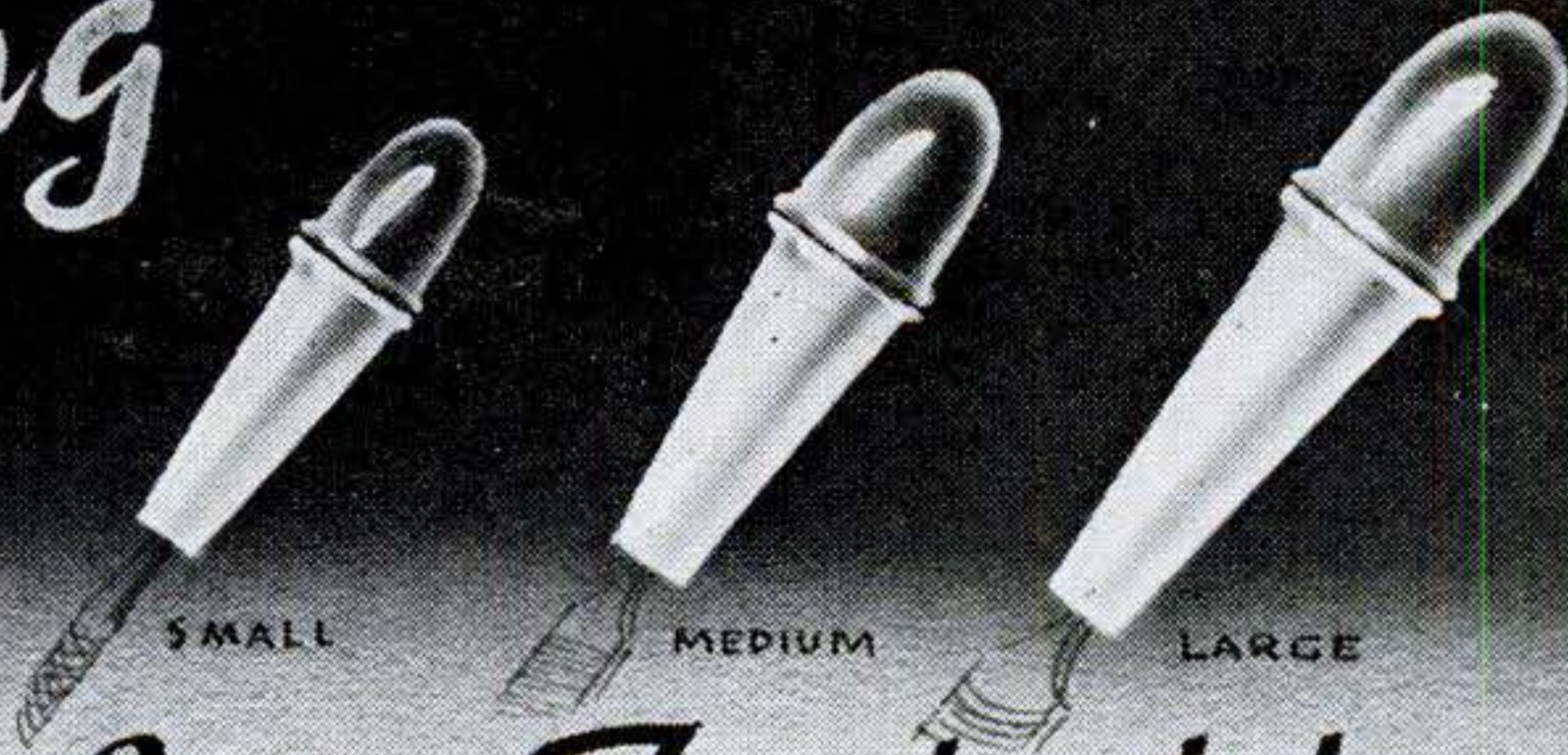

You need the new Ross - Frederick  
**FILE HANDLE**  
 IN YOUR WORKSHOP!

- Palm fitted
- Will not chip
- Can be reused
- Will not break
- Light in weight
- Permanent colors
- Form fits to any shank
- Will not loosen from file
- Non inflammable

See your dealer or write direct.

ROSS-FREDERICK CORP., Box 429, Mineola, N. Y.

Please send me the following:—small size @ \$.25 ea.—medium size @ \$.30 ea.—large size @ \$.35 ea. I am enclosing check or money order for.....

Name.....

Address.....

My dealers name.....

Here they are! **WORLD WAR 2** PRECISION INSTRUMENTS

**NOW**

**ALL-IN-ONE UNIT!**

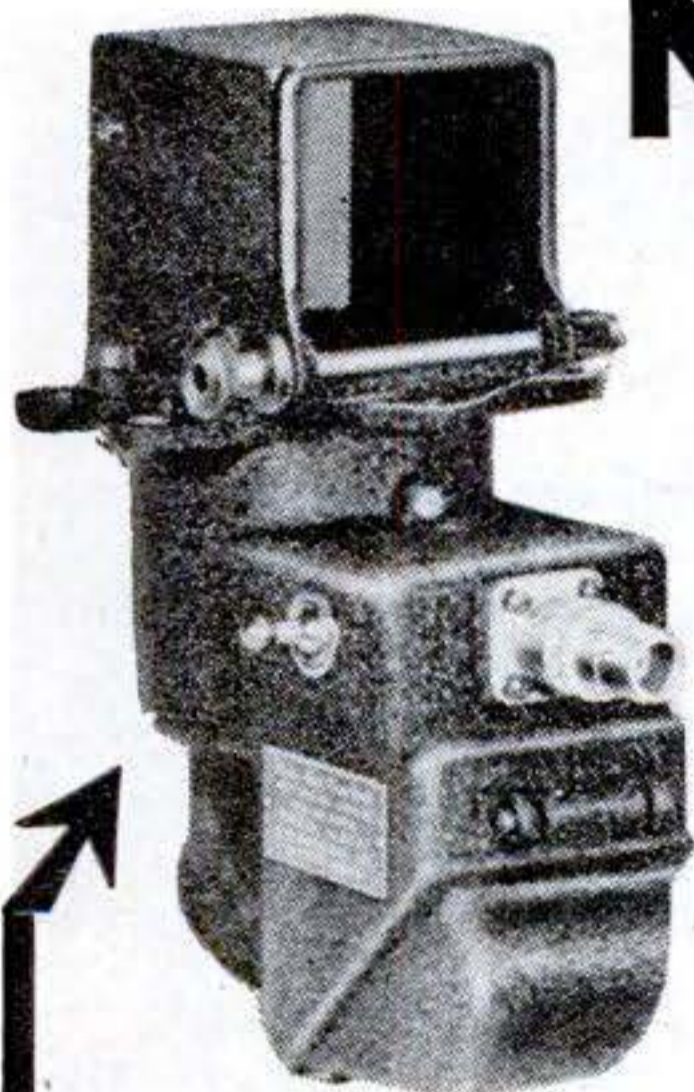

**ONLY \$8.50**

Postpaid in U. S. A.

- Colimeter
- Slide Viewer
- Baby Spot
- Slide Projector
- Fixed Focus Microscope

**A "Treasure Chest"**  
 GYRO GUN STABILIZER

- Two Motors
- Perfect for Reconverting
- All Parts are Precision Made

This marvelous BRAND NEW-GYRO GUN STABILIZER is perfect for reconverting. All NEW valuable precision made parts in Metal Case. Consists of TWO 1/50 H.P. 12 Volt Motors high speed to 10,000 r.p.m. removable for separate use. Variable resistor assembly. Vibrator dampener. Small Condenser. Coils. Springs. Suspension System. Made by Westinghouse for government use, costing hundreds of dollars. With these valuable parts you can power your home workshop machine . . . build an engine for model trains . . . make many motored parts.

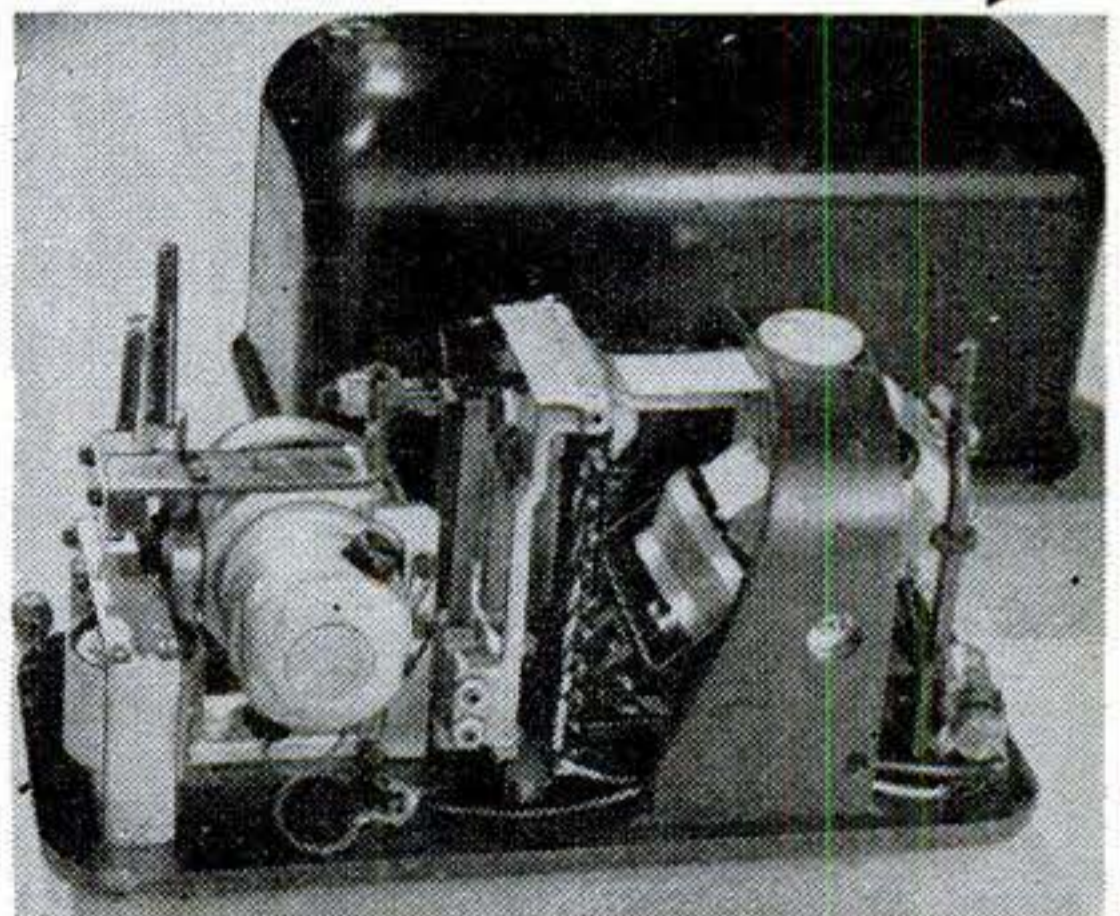

Priced at only 1/10th original cost to government

**ONLY \$12.50**

F. O. B. Chicago

With the valuable parts found in this Famous B-29 Air Force GUN SIGHT you can build all these items plus many more. Composed of more than 25 expensive parts . . . All top quality construction, precision made for Finest Accuracy and Dependability . . . Possible adaptations are endless and fascinating . . . Free conversion sheet with each order . . . All NEW in original cartons . . . Worth many times our LOW PRICE.

Remit With Order • SEND FOR FREE CATALOG

RUSH YOUR ORDER **B & B PRODUCTS CO., 111 W. Jackson Blvd., Dept. PS-4, Chicago 4**



*It will LAST  
a LIFETIME*

**—Because It's a PLUMB**

A Plumb hand tool is made for permanence. The scientifically tempered head is built for years and years of service. The second growth hickory handle is shaped for a comfort grip and tested for strength. For almost a century master craftsmen have been combining these exclusive Plumb features into perfectly balanced tools. You can be certain it will last a lifetime—because it's a Plumb. Fayette R. Plumb, Inc. Phila. 37, Pa.

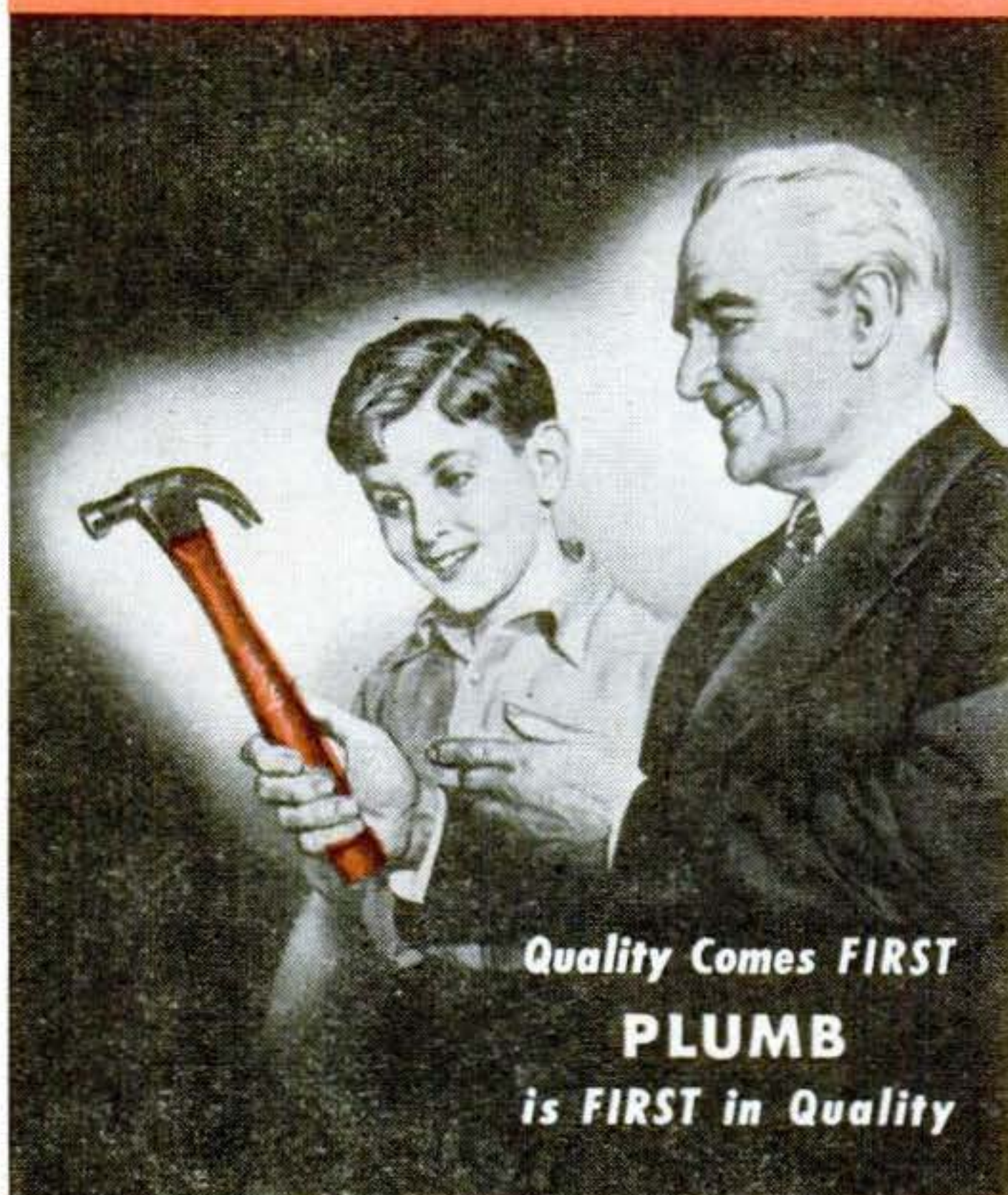

Quality Comes **FIRST**  
**PLUMB**  
is **FIRST** in Quality

**PLUMB**

HAMMERS • HATCHETS • AXES • SLEDGES

**PRESSURE QUEEN**

FOUR CYLINDER  
PORTABLE AIR COMPRESSOR  
SPRAY PAINTING OUTFIT

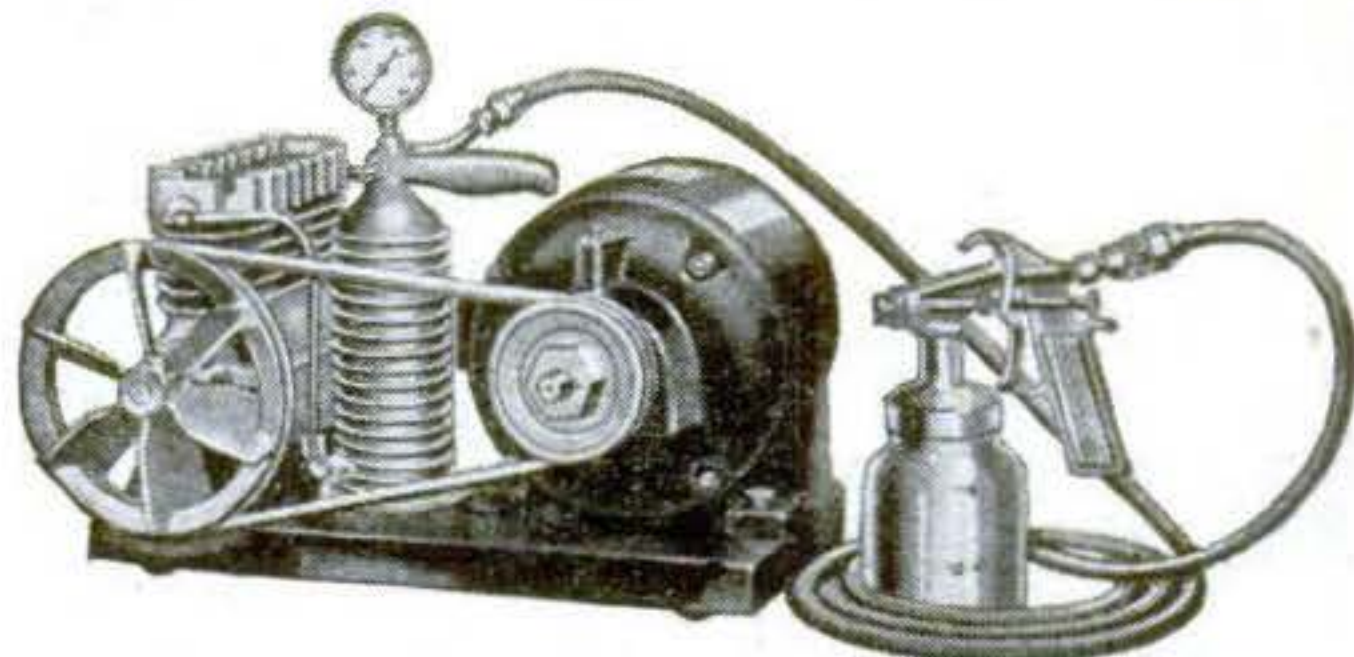

COMPACT • RUGGED • POWERFUL

The ideal air supply for home and farm workshop, machine shop, garage and contracting painter; for product finishing, inflating tires, painting automobiles, trucks, machinery, etc. Indispensable for building maintenance, interior and exterior. Handles any paint, insecticide or disinfectant.

This 4 cylinder compressor has drop forged crankshaft, stainless steel, heat treated valves; bronze bearings and positive forced feed lubrication. Maximum pressure 50-60 lbs., free from pulsation. Standard equipment includes the compressor mounted on steel base with carrying handle, belt, compressor pulley, air chamber, air gauge, 15-ft. hose, spray gun. Requires 1/2 or 2/3 h.p. motor or gas engine, not included.

If your dealer does not sell Pressure Queen write direct

**THE CAMPBELL-HAUSFELD CO.**

151 RAILROAD AVE.,

HARRISON, OHIO

Sand Casting—Forging—Heat Treating—Case Hardening

**BRONZE FOUNDRY**



is again available in limited quantity without priority. Orders filled in sequence as received. INVENTORS-SCHOOLS-CRAFTSMEN use FOUNDRYETTE for making castings quickly for new inventions, for instruction, and general purpose. Order now for early delivery. Three sizes are available capable of making bronze castings of 1 1/2, 3, and 8 pounds weight, aluminum, copper, brass, etc. Domestic gas supply and 110 volt AC or DC energy required for operation. Write for circular.

**KANSAS CITY SPECIALTIES CO.**

Box 6022, Dept. S-77

Kansas City, Mo.

**FINE TOOLS  
NEED  
FINE OIL!**



• Lubricates



• Prevents Rust

• Cleans • Polishes

SOLD EVERYWHERE

**3-IN-ONE Oil**



# SPEED LINER

Fishing Boats and Runabouts

## Your DREAM BOAT!

The boat you've dreamed of owning... a SPEED LINER. And you have seven super models from which to choose... for fishing, fun and family pleasure. Precision-built, streamlined design... for attractive appearance, durability, maneuverability and seaworthiness.

Place your order with your dealer now to be assured of delivery in 1947. If no dealer near you, write us.



"TROPHY" MODEL

**GENERAL MARINE COMPANY**  
ST. JOSEPH 25, MISSOURI

## ATTENTION HOMECRAFTSMEN!

**PLANS** For Dutch Windmills, Lighthouses, Bird Houses, Lawn Chairs, Arbors, Trellises, many kinds of fine furniture, also a great variety of Lawn Figure patterns. SEND 10c FOR CATALOG ILLUSTRATING OVER 100 PRACTICAL PROJECTS  
Craftsman's Model Co., 2030 N. 41st St., Dept. K16, Milwaukee, Wis.

## GOLD TEETH WANTED

Dental gold teeth, plates and bridges with metal attached. Any broken pieces of gold jewelry. Immediate payment and free mailing container to you or your friends upon request.  
**LOWES, DEPT. PS, Holland Bldg., St. Louis 1, Mo.**

**FREE!**  
FAMOUS  
BLUE BOOK  
CATALOG

### GAME SUPPLIES

Club Furniture - Counter Games - Punchboards - Magic Cards Readers, Read the backs - Inks - Daubs - Poker Chips - Tops Flats - Layouts - Game Boxes.



K.C. CARD CO., 838 South Wabash Ave., Chicago 3, Ill.

## 75 MILES Per Gallon



**Cushman**  
MOTOR SCOOTER

The two wheel Cushman Motor Scooter, when equipped with tandem seat, will safely and comfortably carry two people. When equipped with SIDE KAR a third person or a 200 lb. payload can also be carried. Side Kar quickly and easily detachable.

For City or Highway - factory, farm or commercial use!

DEALERS from Coast to Coast. Write today for name of your dealer and **FREE FOLDER** describing our two and three wheel models.  
**CUSHMAN MOTOR WORKS, INC., Dept. S-400 Lincoln, Nebr.**

# A TOOLSHOP IN YOUR HAND!



• GRIND • DRILL • ROUT  
• POLISH • ENGRAVE  
• CUT • SAND • SAW • etc.  
MAKE THINGS FROM WOOD  
PLASTICS—METALS—GLASS  
LINOLEUM—LEATHER  
ALLOYS—HORN—STONE  
BONE, etc.

**HANDEE**

**TOOL OF 1001 USES**

Smooth, steady power at your fingertips! Perform precision operations not possible with any other portable tool! With a Handee you can turn out professional looking projects for pleasure or profit—ship, plane and train models, costume jewelry, wood carvings, puppets, initialed tumblers, etc. AC or DC. 25,000 r.p.m. Wt. 12 oz.

**USE THE RIGHT ACCESSORIES!** Choose them from the most complete line... more than 500 made right in the Handee plant.

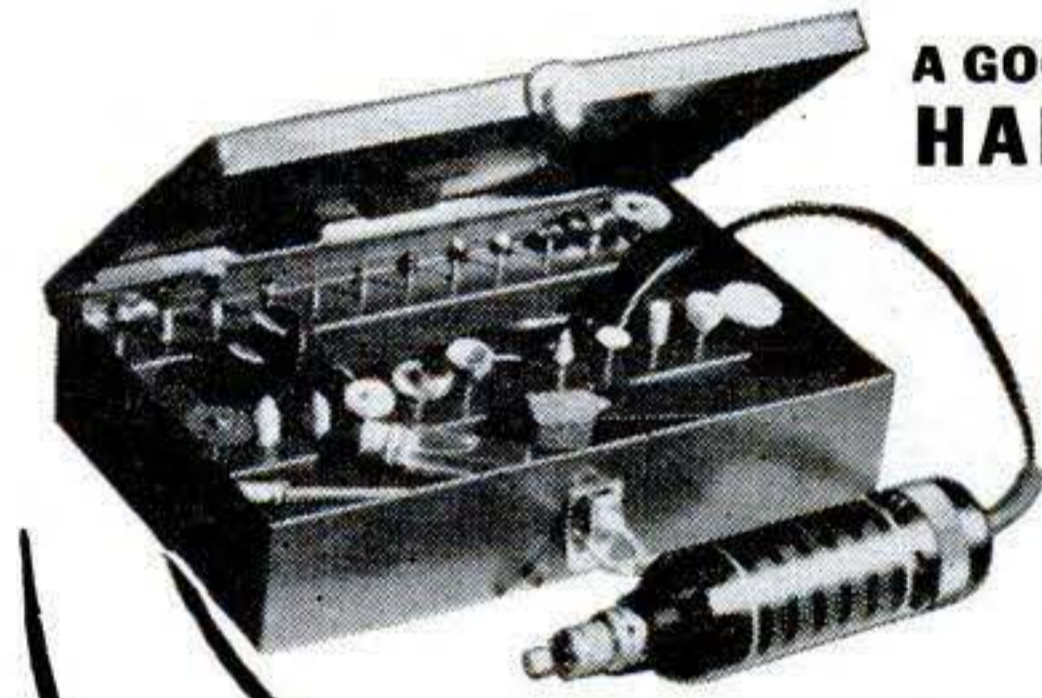

### A GOOD START—THE HANDEE KIT

HANDEE Tool and 40 most popular accessories packed in compact steel carrying case. You'll be amazed at what you can accomplish! Complete, postpaid.

**\$27.50**

Handee only, with 7 accessories, \$20.50

FOR YOURSELF OR A FRIEND...  
THE GIFT OF A LIFETIME!

### NEW PRECISION ATTACHMENTS

Fit Handee only, enable novice or craftsman to do perfect work. Magically, easily, your offhand carving, routing, shaping will be exact as to depth of cut, accuracy of line. Set of 6 attachments with instructions, postpaid

**\$7.95**

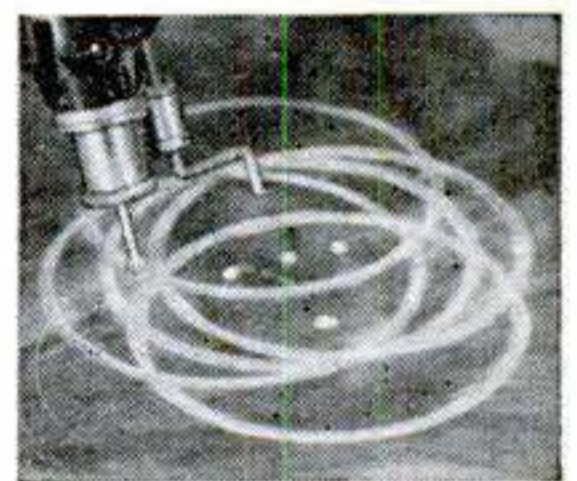

**ORDER NOW! SATISFACTION GUARANTEED!**

**FREE! NEW 52-PAGE MANUAL**

### CHICAGO WHEEL & MFG. CO.

1101 W. Monroe St. Dept. PO, Chicago 7, Ill.

Send  Handee Kit  Handee Tool  Precision Attachments  C.O.D.  Remittance enclosed  Send Manual

Name.....

Address.....

APRIL  
1947 259



# ANCO RAIN-MASTER

"Dead-Locker"

WINDSHIELD WIPER  
ARMS and BLADES

BLADE SNAPS ON...  
STAYS PUT

FINGER-  
TIP  
RELEASE

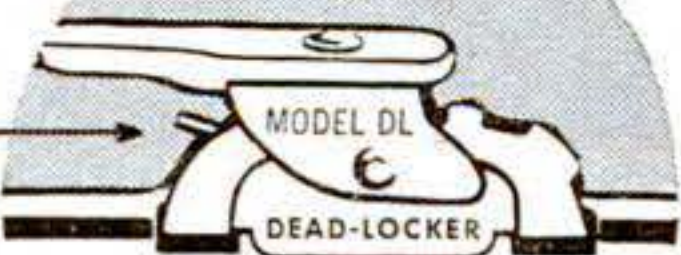

CAN'T FALL OFF  
CAN'T BLOW OFF

(A war-born invention—by ANCO—first)  
for military aircraft—now for your car.)

## DON'T SHOOT YOUR GAS-PUMP MAN!

He's doing the best he can. Sure, he knows how dangerous it is for you to drive your car... in stormy weather... with your dull old windshield wipers that smear and smear. He'd gladly put on for you quickly a pair of keen new ANCO RAIN-MASTER Wiper Blades and Arms. He has them—Newest Models! But he forgets to remind you? Too busy? You can't shoot him for that!

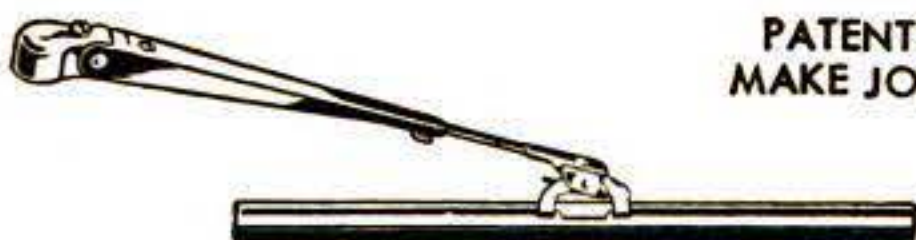

After all, it's *your* car to protect. So *you* remind *him*. Get RAIN-MASTERS... patented features... original equipment on many makes of high grade cars and trucks... used in war—on our fighting tanks and trucks and ships and bombers too... because ANCO RAIN-MASTERS clean quicker, clean cleaner... last longer. May save you a costly smashup.

Ask for RAIN-MASTER Windshield Wiper  
Arms and Blades next time you buy gas.

THE ANDERSON COMPANY  
Established 1918  
GARY, INDIANA



It's new! Expands as it sets. You never before saw a household repair cement like X-Pandotite. Just add a little water, then apply with a putty knife, or table knife. It's the permanent fixer for cracks, joints, loose fixtures, tile, tools and 1001 other things around the household. For anchoring and molding purposes; X-Pandotite can be colored before using; stained or painted after hardening.

X-Pandotite is sold at leading hardware and paint stores at 35¢ for a ½ lb. can—60¢ for a one lb. can.

If your dealer can't supply, send 50¢ for a ½ lb. or \$1.00 for 1½ lbs. to the X-Pando Corp., 43-13 Thirty-Sixth St., Long Island City, N. Y. The X-Pandotite will be sent prepaid.

# X-PANDOTITE



Send for Complete  
Price List No. 102

MEIER BRASS & COPPER CO.  
1155 Bellevue, Detroit 7, Mich.

## BRASS RODS For Home Work Shops

Free Cutting Rods  
3/32-3" Round & Hex  
Naval Brass Rods  
1/8-2 1/4" Round  
Brass & Copper Tubing  
1/4-3/4" Outside Diam.

\$\$\$ if trained in **arc welding**

Big income jobs await you. Learn quickly and thoroughly. Enroll under G. I. Bill. Write today. Hobart Trade School, Inc., Box P-563, Troy, O.



## New MILLING ATTACHMENT

Sizes for 8" to 16" metal lathes  
BUILD IT YOURSELF from our sets of semi-machined castings and save \$\$\$. Can be finished on your lathe alone. Complete working drawings and step-by-step machining instructions furnished with castings.

Mill keyways, slots, splines, dove-tails, flutes in reamers, taps, hobs, and special cutters; produce spur, bevel, mitre and worm gears, ratchets and racks; mill flat surfaces, square shafts, mill hexes, spot face, drill spaced holes, bore, etc. on your lathe with this precision attachment. It has a T-slotted table, a vise which swivels for angular milling, a gear cutting fixture and dividing centers.

**FREE!** Illustrated folder and price list. Mention your lathe. Write today.  
HURON MACHINE AND TOOL CO.  
YALE 2, MICHIGAN





**5 POWER TOOLS IN 1**

**\$34<sup>95</sup>**



**COMPLETE HOME WORKSHOP**  
 Here is power tool pleasure and profit in a ruggedly built, HEAVY steel unit—the Emrick Universal Woodworker. Handles big work. Drill press pulls 1/2" drill in steel. Saw takes 6" to 8" blade. Lathe 10" swing, 30" centers, spindle dia. 3/4". Takes all standard accessories. Sander 8" dia. Emery wheel 5". Bronze bearings, replaceable throughout. Price does not include motor and saw blade. Order today.

**10 DAY TRIAL**

1754 CLINTON STREET  
**EMRICK, Inc. KALAMAZOO 24, MICH.**  
 Ship on 10 Days Trial. I am enclosing \$17.50, balance C.O.D.  Send free literature.  
 Name \_\_\_\_\_  
 Address \_\_\_\_\_ City \_\_\_\_\_

**LIVE STEAMERS**

Blue Prints and Castings in 3/4" Scale for Six Engines  
 Tom Thumb — Pacific 4-6-2 — Atlantic 4-4-2  
 Tanker 4-6-6-T — New York Central Hudson  
 4-6-4 — Union Pacific Articulated 4-6-6-4

Write for Price List  
**YANKEE SHOP, Machinists**  
 88 High Street, Danvers, Mass.



**FREE NEW HOBBY HANDBOOK**

A Gold Mine of Information on Newest Equipment, Materials, Tools for HOME CRAFTSMEN AND MECHANICS  
 IF you work in metals, woods, plastics or glass, you need this Big, FREE Source Book of equipment, tools, parts and materials . . . including dozens of hard-to-get items you can't find in stores. Many things you must have for your home hobby or shop. Just loaded with ideas and illustrations.

**A WAREHOUSE OF THINGS YOU WANT**

More than 100 items including: Portable Welder; Bench Tools; Plastic Molder; Telephone System; Chemical Sets; Spray Guns; Electroplater; Drills; Grinders; Tool Chests; Model Tools; Key Maker . . . everything you need for your hobby or craft. Send for this Big, FREE Book TODAY. Mail postcard or coupon below.

**WARNER ELECTRIC CO., 1512 Jarvis, Chicago 26, Dept. M-66**

**WARNER ELECTRIC CO., 1512 Jarvis, Chicago 26, Dept. M-66**  
 PLEASE SEND BIG, FREE BOOK  
 NAME.....  
 ADDRESS.....  
 CITY..... ZONE..... STATE.....

**USE AC's FOR  
 UTMOST  
 RELIABILITY**

Factory-recommended AC's, of correct Heat Range for today's fuels and driving speeds, help millions to be punctual. Have your plugs checked to be sure that you have the right plugs for today's driving and fuels.

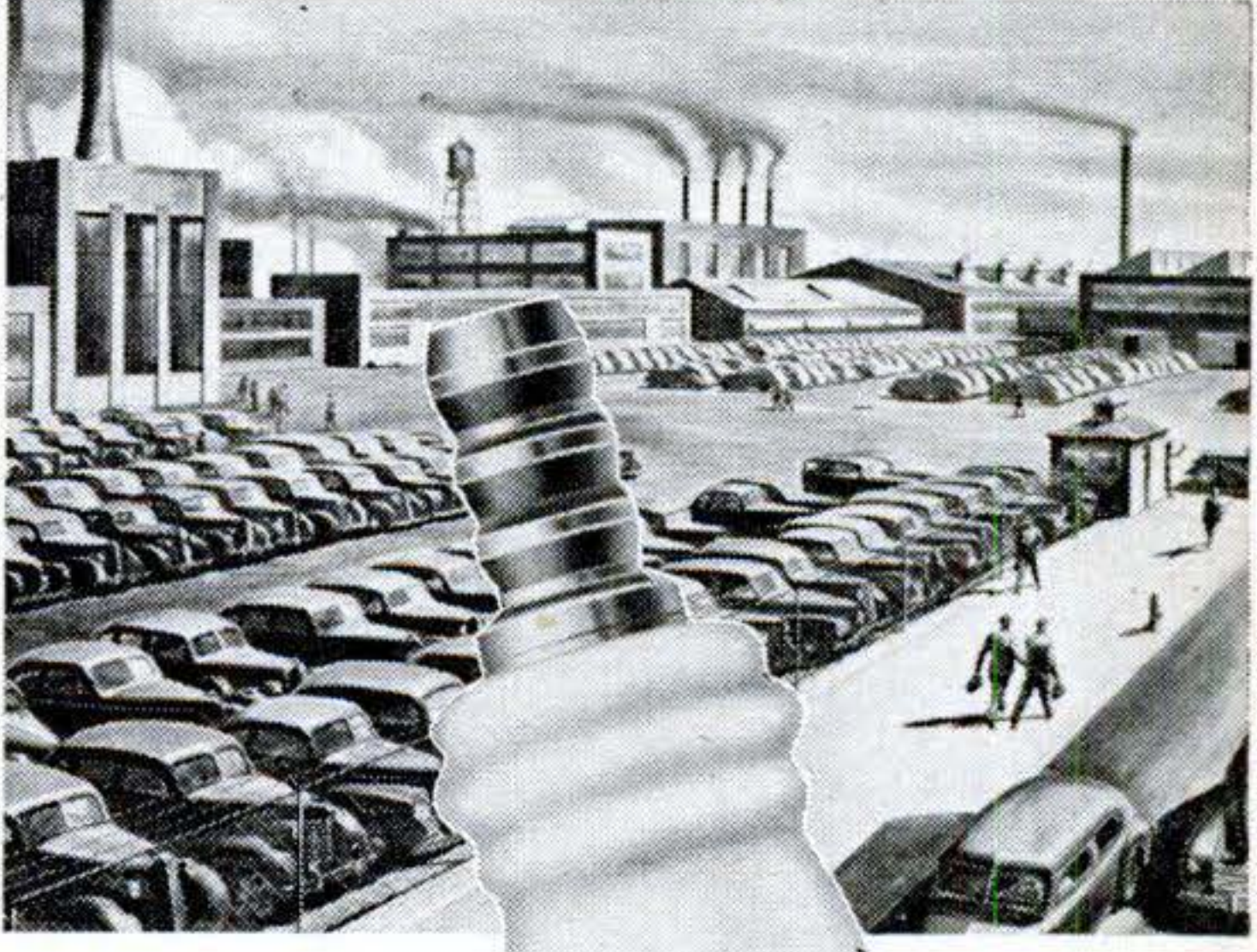

Look for this sign

**AC**



Spark Plugs cleaned and adjusted "By the AC Method" may save as much gas as 1 gallon in 10



**AC**

**SPARK PLUGS**

AC SPARK PLUG DIVISION • GENERAL MOTORS CORPORATION



*Only*  
Toggle-Lever Wrench  
with this Feature!



JAWS always  
PARALLEL  
when  
they grip

**PRESSURE  
LOCK  
WRENCH**

**No Slipping!  
No Skinned Knuckles!  
No Rounded Edges!**

The BMC Pressure Lock Wrench will grab hold of any shape piece and lock on . . . until released with the flick of a finger. That's because the jaws are always parallel at any opening. They give a uniform grip to the very tip, due to an exclusive, patented device found in no other wrench. Pressure as great as 1½ tons, or as light as you desire, applied with almost equal ease. There's no slipping, no skinned knuckles, no rounded edges or ruined tempers.

Grips All These Shapes  
... and Others  
Too!

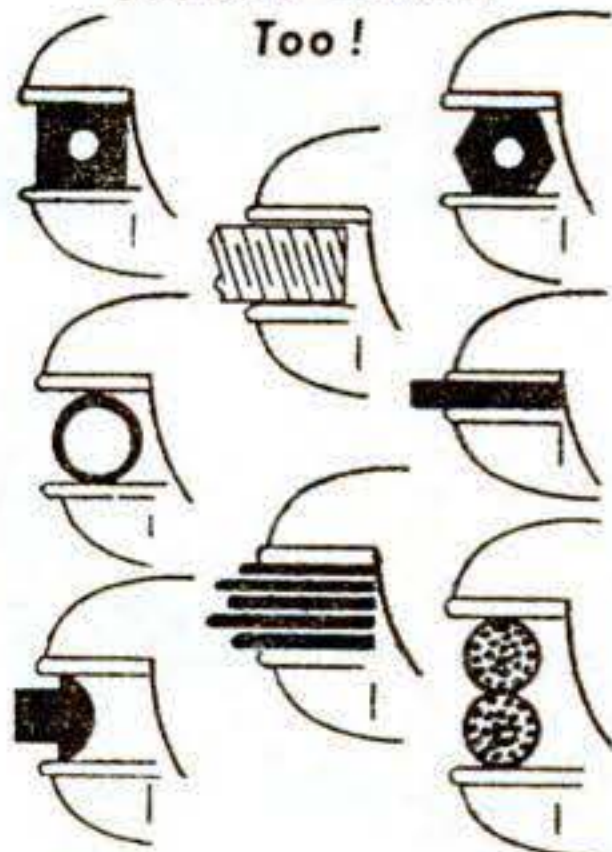

*Only*

Wrench Adjustable  
with One Hand

The BMC Pressure Lock Wrench is a true, one-hand tool. Jaws can be adjusted to desired indexed opening with the thumb. Needs no fussy trial settings because it fits as it grips . . . and it holds. It is actually six tools in one . . . an adjustable end wrench . . . a pipe wrench . . . a gripping tool . . . a multi-leverage pliers . . . a hand vise . . . and a locking clamp.

**3 HANDY SIZES:**

- No. 7—Max. jaw opening, ¾" . . . \$2.29
- No. 9—Max. jaw opening, 1" . . . 2.59
- No. 11—Max. jaw opening, 1½" . . . 4.89

For sale at leading hardware, auto equipment, mill supply, plumbing and electrical stores and departments.

**BMC MANUFACTURING CORP.**  
Binghamton, New York

Manufacturers of Offset Screwdrivers for Regular and Phillips Head Screws, Charge-A-Blade Scissors, and Ready-Ray Auto Trouble Lights.

**SMALL EFFICIENT  
SPEED REDUCER**

Just the thing for the Home Work Shop, Hobby Shop, Bench Work, Animated Displays, Light Production work. Used daily in thousands of homes and shops. Sturdy, compact, (see dimensions). Case of aluminum. Gears, SAE 65 (British) Gear Bronze. Worm of case hardened steel. Timken Bearings throughout. Torque capacity 100 inch pounds. Available in 4 different assemblies (shown below) and in these standard ratios:



**\$18.56**  
NET - POSTPAID

4-1	25-1	64-1	200-1
8-1	30-1	75-1	200-1
10-1	40-1	80-1	400-1
16-1	50-1	100-1	600-1
20-1	60-1	150-1	800-1

When ordering be sure to specify assembly and ratio required. Shipping weight in carton, 8 lbs. Full money back guarantee. Prompt deliveries.

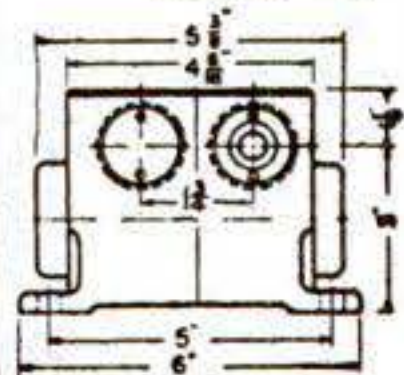
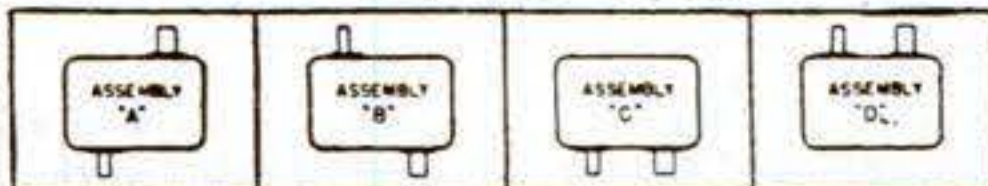
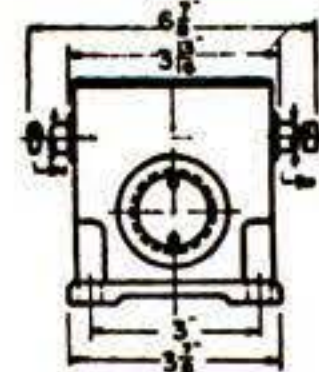

**THE OHIO GEAR CO.**  
1424 EAST 179th ST. - CLEVELAND 10, OHIO

**A.C. CURRENT ANYWHERE!**

WITH  
**KATOLIGHT PLANTS AND GENERATORS**

Furnish the same kind of Current as the highlines. Sizes 500 watts to 100 KW. Also Manufacturers of Rotary Converters, Frequency Changers, 32 and 110 Volt D.C. Motors in ¼, ½ & 1½ H.P. A.C. Motors, single phase in 1½ and 2 H.P. only.

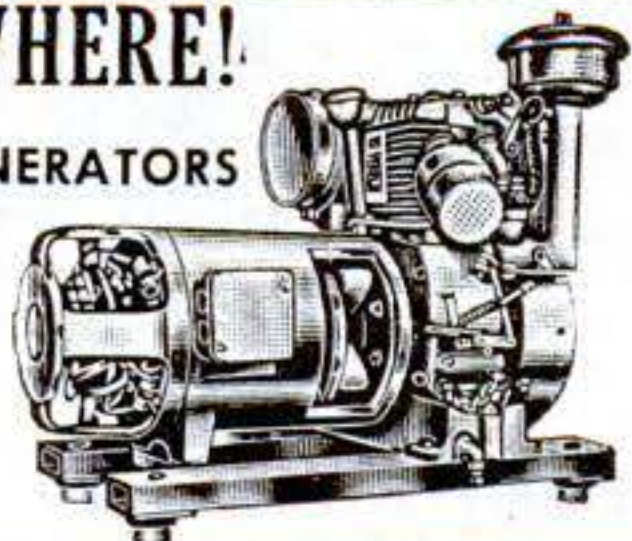

**KATOLIGHT** 1401 First Avenue,  
MANKATO, MINN.

**BUILD YOUR OWN MACHINE TOOLS!**  
Blueprints \$1.00 - Catalog FREE

Detail construction Blueprints on 6 Lewis metal and wood-working tools postpaid for \$1.00. Includes prints for Lewis 10" Shaper, Milling Machine, Drill Press, Vise, 8" Circular Saw, 6" Jointer. Costings for these tools save up to 80% of comparable new tool cost. Illustrated 32-page Catalog—sent free with Blueprint Order—describes 21 Lewis tools. WRITE TODAY!



**LEWIS MACHINE TOOL CO.**

P. O. Box 7446, Sta. L, Dept. S, Los Angeles 23, Calif.

**MIDGET AUTO RACING BOOK \$1.10**



45 FOTOS, History 1946 Calif. Racing, \$1.10. 1946 Indianapolis "500" Race Book, \$1.00. Mercedes-Benz book \$2.00. See our ad (Autos) Classified Section. Catalog free. CLYMER, Dept. B-4, 2125 W. Pico, Los Angeles 6, Calif.

**NEW PLASTICS  
Fabricating MANUAL**



Make beautiful objects of Plexiglas, Lucite, Catalin, Polystyrene at home. Jewelry, novelties, accessories. Send for new 10,000 word manual on how to fabricate, weld and form latest plastic materials in home workshop. Hundreds of practical suggestions. Written by leading plastics engineer. Price prepaid 25c (stamps or coin). Or get FREE information and price list covering transparent plastic sheets, rod, tubing cut to your size. Write today!

**HOUSE BEAUTIFUL PLASTICS.**  
Dept. 40, 5534 W. Harrison St., Chicago 44, Ill.



**STUDY AT HOME for PERSONAL SUCCESS and LARGER EARNINGS.** 38 years expert instruction—over 108,000 students enrolled. LL.B. Degree awarded. All texts furnished. Easy payments. Send for FREE BOOK—"Law and Executive Guidance"

**AMERICAN EXTENSION SCHOOL OF LAW.**  
Dept. 76-S, 646 N. Michigan Ave., Chicago 11, Ill.

**Everything in Radio!**

Make Radolek your buying headquarters for Radio-Electronic repair and replacement needs. Large stocks assure finest, most complete selections of all available items at lowest prices. Your orders receive special attention for fastest delivery. Send today for FREE Radolek Buying Guide.

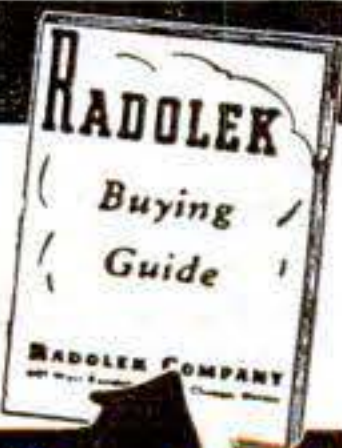

**RADOLEK CO., Dept. A-124, 601 W. Randolph St., Chicago 6, Ill.**

**FREE RADIO BUYING GUIDE**



**BOYS!**  
Fly your own plane  
**REAL  
GAS ENGINE**  
Complete with  
**MODEL  
AIRPLANE KIT**

**ONLY \$11<sup>95</sup>**



All ready to build and fly  
... and anyone can do it!

More than a toy—a real gas-powered model plane that you'll get a kick out of building and flying. This little beauty will really perform in the sky! You'll be the envy of your pals! Fully detailed instructions provided. Complete outfit, including: 1/6 H.P. engine, coil and condenser; beautiful trim airplane; propeller, wheels, etc.

**SEND ONLY \$1.** We'll ship C.O.D. for balance. Don't delay, order NOW and be the first fellow in your neighborhood to fly this swell plane! Have you our FREE catalog? Send for it!

**AMERICA'S HOBBY CENTER, Inc.**  
DEPT. SN-47, 156 W. 22ND ST., N. Y. 11, N. Y.

**EXHAUST  
BLOWERS**

WORTH \$50

**\$15<sup>85</sup>**

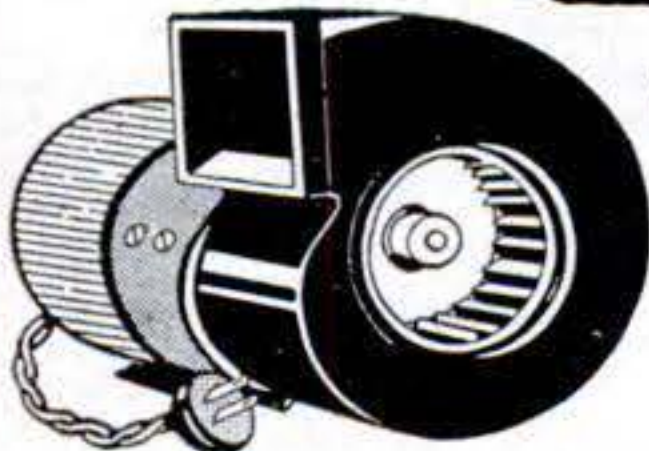

For PHOTOGRAPHERS • HOSPITALS • LABORATORIES • WORK SHOPS • LAUNDRIES • OFFICES • RESTAURANTS • PRINTERS • PLAYROOMS

**100 CU. FEET FRESH AIR EVERY MINUTE!**

Solve your ventilation problems with this rugged, built-for-service blower and exhaust. Quick and simple to install. Anyone can do it with ordinary household tools.

110 Volt, A.C., 50-60 cycles. Continuous duty, ball bearing motor assures quiet, trouble free operation.

Send Check, Money Order, No C.O.D.'s. West of Mississippi add \$1.00 for mailing, handling.

**Immediate Delivery!**

**UNIVERSAL YONKERS CORP.**

(Dept. S-4) 41 Locust St.

Yonkers 2, N. Y.

**FREE RADIO CATALOG**

Latest radio and electronic parts and devices, newest ham gear, gadgets, war surplus items. All in this new FREE catalog. Don't delay,

**BURSTEIN-APPLEBEE CO.**  
1014 McGee, Kansas City 6, Mo.



**STEEL RUBBER-TIRED WHEELS**

For Toys and Many Industrial Uses. Send for Catalog.

**CIRCLE METAL MANUFACTURING COMPANY**  
4272 E. PACIFIC WAY, LOS ANGELES 23, CAL.

Save Filing Time With  
**FOLEY RETOOTHER**

Cuts **NEW TEETH**  
on all Hand Saws  
in 2 to 3 Minutes.

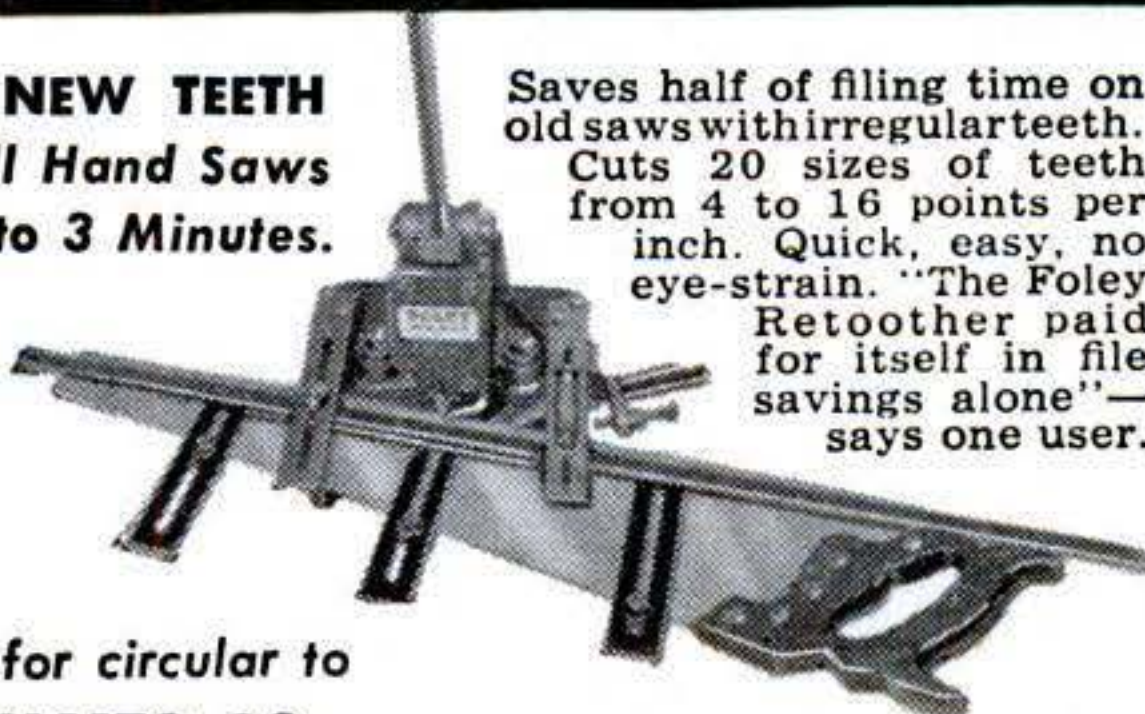

Saves half of filing time on old saws with irregular teeth. Cuts 20 sizes of teeth from 4 to 16 points per inch. Quick, easy, no eye-strain. "The Foley Retoother paid for itself in file savings alone"—says one user.

Write for circular to

**FOLEY MFG. CO.,** 491-7 Foley Bldg., Minneapolis 13, Minn.

**SOLVES WOODWORKING  
PROBLEMS FAST!**

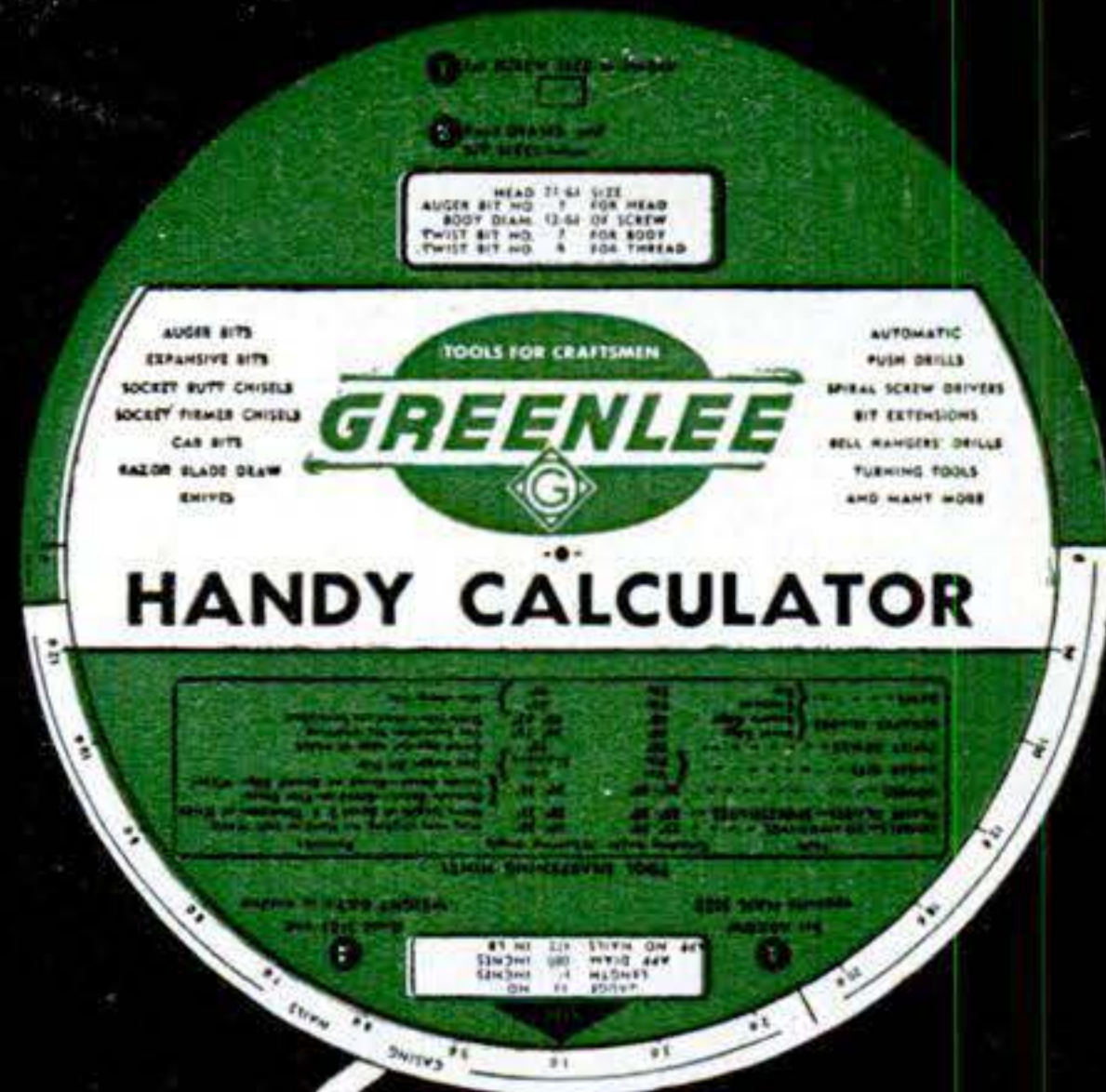

*Only 10¢*  
**SPECIAL OFFER**

• This easy-reading **GREENLEE HANDY CALCULATOR** swiftly solves your wood-working problems. Just set the dial: convert linear feet to board feet; get slope per foot in degrees; compare hardness, weights, shrinkage, warping and working ease of various woods. More, too: bit sizes for head, body, thread of screws; nail specifications; tool sharpening hints; protractor. 6" diameter, fits your tool kit. Heavily varnished cardboard. Special offer. Order now, send 10¢ (not stamps) in next mail. Greenlee Tool Co., 2124 Columbia Ave., Rockford, Ill.

TOOLS FOR CRAFTSMEN  
**GREENLEE**







Master II

# WESTON

## EXPOSURE METER

Most picture failures are caused by incorrect exposure. With a WESTON, you can be sure of every exposure — in black-and-white or color — with still or movie camera. Easy-to-use, it gives exact camera settings for any scene. Ask your photographic dealer for a demonstration, or write . . . Weston Electrical Instrument Corporation, 622 Frelinghuysen Avenue, Newark 5, New Jersey.

The meter most photographers use

MODEL 350-B (11 boring heads) \$5.95

**FASTER, EASIER WOOD-BORING**  
with this  
**BRUNO AUGER BIT SET** **\$3.95**

Complete with 6 boring heads (5/8" to 1-1/4") in plastic case



**BORES AT ANGLE**  
**FINGER TIP PRESSURE**

**CUTS FAST AND CLEAN**

Now you can bore many different size holes with one auger bit... exclusive Bruno Quick-Change Boring Heads cut tool costs in half! Boring heads of finest high carbon tool steel have special extra long cutting edge... require no forward pressure, turn easily in toughest woods. No flutes to bind or clog, bores all the way without cleaning. **MONEY BACK GUARANTEE.**

SEE YOUR DEALER OR WRITE DIRECT. Dept. PS-4

Tool No.	Boring Heads	Cutting Diameters	Shank Length	Price
340-B*	6	5/8" to 1-1/4" by 8ths	8-1/16"	\$3.95
350-B*	11	5/8" to 1-1/4" by 16ths	8-1/16"	5.95

\*Square shanks for use in hand brace. Nos. 340, 350 straight shanks for use in bench drill, drill press, or portable drill.

**BRUNO** The **BIG BUY** in TOOLS

**BRUNO TOOLS** 9330 SANTA MONICA BLVD. BEVERLY HILLS, CALIFORNIA

## CUTTING TOOLS

A catalog of cutting tools and supplies made available for the first time—is yours for the asking. Hard-to-get cutting tools and supplies—hundreds of them—are in our available stock. Send 35c and receive this wonderful catalog immediately by return mail.

Write **EASTERN TOOL & SUPPLY COMPANY**  
or Phone **176 Grand Street, New York 12, N. Y.**  
**Canal 6-3749**

## ONE-MAN SAWMILL LESS THAN \$200<sup>00</sup>

Easy To Turn Trees Into Money

Makes Lumber ties, shingles, crates, lath, studding, siding.



**BELSAW MODELS**

in 10 to 24 foot sawing lengths. **MECHANICAL FEED**, accurate set works and positive dogs. Use tractor or old auto engine for low cost power. Thousands used for commercial sawing. Pays for itself quickly. Send post card today for **FREE** booklet, "How To Make Lumber" and Catalog of Woodworking Equipment.

**BELSAW MACHINERY COMPANY**  
1846W Field Bldg., 315 Westport Rd., Kansas City 2, Mo.

**NOW 93% MORE ENERGY, LONGER LIFE**

Get the **New "Eveready"** Flashlight Batteries

The word "Eveready" is a registered trade-mark of **National Carbon Co., Inc.**

"I'LL TAKE THE WHITE ONE EVERY TIME!"

**WYTEFACE**  
TRADE MARK  
**STEEL MEASURING TAPES**



**KEUFFEL & ESSER CO.**



## Quick, Easy, Lasting REPAIRS!



Cracks, holes, dents in wood, plaster, concrete, metal, etc. — loose handles, rungs, knobs, screws — mistakes in carpentry, etc. — fix them *all* with Savogran Crack Filler (hard as stone) or Savogran Wood Putty (easily tooled). Just mix with water, press into place. Stays put, hardens quickly, will not shrink! Can be painted pre-colored. Ideal for models, inlays, etc. Patented! Big 1-lb. can only 30c at hardware and paint stores.

### FREE CIRCULAR

Describes these and other Savogran Products: Heavy Duty Cleaner, Remover & Bleacher (renews floors), Paint Brush Cleaner, Strypeeze (removes all finishes), Coldfoam Soapless Soap Powder.

**THE SAVOGRAN CO.**

Dept. 43, Boston 10, Mass.



# SAVOGRAN

Reg. U. S. Pat. Off.

## CRACK FILLER • WOOD PUTTY

IN EVERY WELL-EQUIPPED HOME WORKSHOP

## arc welding manual and text book...\$2.00

Teaches you how to become an arc welding operator — one of highest paid trades today. Write today!

**Hobart Bros. Co., Troy, Ohio** Box P-562

**NONE BETTER!**

## SUPER DRILL GRINDER

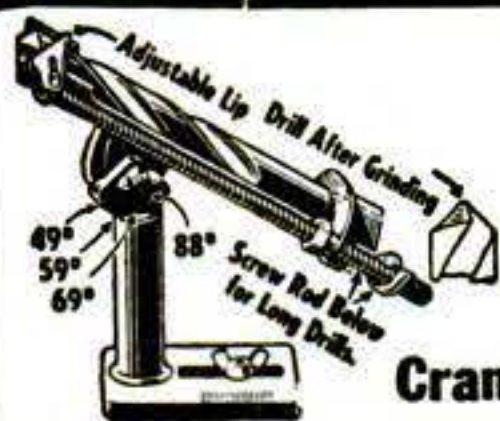

Sharpens round shank drills from 3/32" to 1 1/16" in diameter, up to 11" long. Grinds old drills like new in 4 different point angles, using hand or power grinding wheels. Money-back guarantee.

**Price only \$2.95**

At Dealers or Postpaid

**Crandall Mfg. Co.** 1512 W. Slauson, Dept. FB-16 Los Angeles 44, Calif.

## CUTS INTRICATE DESIGNS never before possible



Sharp spiral blade saws in *any* direction. Cuts wood, plastics, or light metals without binding or breaking. Sturdy steel frame, with new lever adjustment, keeps tension right. Complete saw with 3 extra blades, 95¢. Blades only, 3 for 25¢. Get yours—today. AT YOUR NEAREST HARDWARE STORE, or send \$1 direct for sample to

**TYLER MANUFACTURING COMPANY**  
938 Pico Boulevard — Santa Monica, California



ENLARGED SECTION OF BLADE

# AMAZING NEW MAGNETIC SAW

READY for PROMPT DELIVERY!

## SYNGRO DELUXE JIG SAW

WORLD'S SAFEST SAW!

SOLD ON 10 DAYS MONEY BACK TRIAL... Send Coupon for Details



COMPLETE WITH CORD. 3 BLADES

**NO MOTOR NEEDED—JUST PLUG IN! PORTABLE—SAFE—CUTS CLEAN and SMOOTH—NO SANDING NECESSARY!**

ANNOUNCING SYNCRO... new, remarkable, patented magnetic jig saw! Needs no belts, no motor, no gears, no oiling! Just plug into any 60 cycle A. C. 110-130 volt outlet—and saw! Portable. Use anywhere, kitchen, basement, attic, etc. Cuts clean, smooth... no sanding necessary! Perfect for models, displays, inlays, silhouettes, etc. Ideal for hobbyists, craftsmen, light production. Cuts intricate designs on 3/4" soft wood, 1/2" plywood and thinner hardwoods, metals, plastics. Leaves NO ragged undersides on plywood or heavy cardboard. Cuts to center of 27" circle. This rugged, powerful power tool is NOT for ordinary lumber cutting but is unsurpassed for intricate and fancy scroll work, etc. Special magnetic safety stroke feature permits even small children to use. Nothing else like it! Sold on 10 Days Moneyback Trial. Prompt delivery guaranteed—if you hurry!



**HURRY! SEND COUPON! CIRCULAR FREE!**

Rush Coupon pasted on post-card for Free Circular, details of 10 Days Moneyback Trial Offer. 1947 production limited... so act promptly... now! Don't gamble—get your jig saw from SYNCRO—world's largest makers of electric jig saws!

### FREE SYNGRO INFORMATION!

**SYNGRO SAW CORP., Dept. B-47, Rochester, Michigan**

Gentlemen: Rush me, without obligations, free, complete details on Syncro Saw, your 10 Days Moneyback Trial Offer, amazing low saw price.

NAME.....

ST. & NO.....

CITY.....ZONE NO.....STATE.....

APRIL 1947 265



# WHAT TO DO FOR LOOSENEED SCREWS

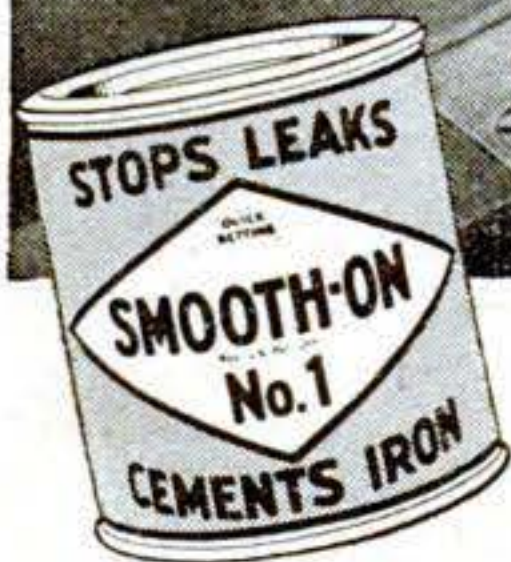

Wood screws that refuse to stay put obey promptly when anchored with SMOOTH-

ON No. 1 Iron Cement. You simply apply a little Smooth-On and insert the screw. As Smooth-On hardens, it fills in the open spaces, insuring a tight fit that *stays* tight.

This quickly-made little repair job is typical of many useful things you can do around the house and in the garage when you have a container of Smooth-On handy. You can seal cracks, stop leaks, tighten loose hinges, bathroom fixtures, knobs, casters, tool and cutlery handles. Get Smooth-On from your neighborhood hardware store in inexpensive 1 $\frac{3}{4}$ -oz., 7-oz. or larger size. If they haven't it, write us.

## FREE HANDBOOK OF REPAIRS

40 pages. 170 diagrams. Clear, short-cut directions for many tested household repair jobs. You'll be glad you sent for this book. Just clip the coupon and paste it on a postcard—that's all.

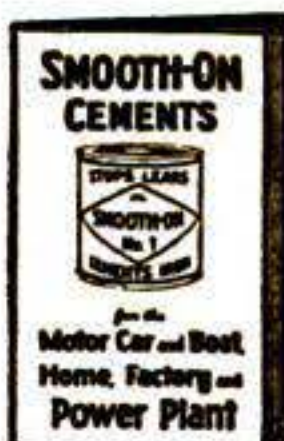

— — — Sign and Mail NOW — — —

SMOOTH-ON MFG. CO., Dept. 58D  
570 Communipaw Ave., Jersey City 4, N. J.  
Yes — I'd like my free Smooth-On Handbook.

Name.....

Address.....

4-47.....

Do it with **SMOOTH-ON**  
Iron Cement of 1000 Uses

# LOOK AT THESE RADIO BARGAINS



### T-17B MICROPHONE

A perfect carbon hand mike for every Radio Enthusiast. Fine quality, light weight, sturdy. 200 ohm, Single Button, press-to-talk switch.

With 5 ft. rubber cord, plug and dust cover. **\$1.69**  
A real bargain at only.....



### TELEGRAPH KEY

What a buy! A professional quality Signal Corps key. Bakelite base 4 $\frac{3}{4}$ " x 3", 2 sets of binding posts, circuit closing

switch. Solid silver contacts. Don't miss it at only... **49c**

### SIGNAL CORPS PHONES

Brand New and Guaranteed. You never saw better value! Light weight phones have bakelite shells and caps, adjustable headband, rubber cushions. 8,000 ohms impeded. Limited quantity, Rush Your Order. Only... **\$1.95**



Send for Bargain Bulletins with Terrific Values. Visit any of our 3 Great Stores and see for yourself. Mail Orders Filled from Either New York or Chicago.

NEW YORK  
Offices & Warehouse  
242 W. 55th St., N.Y. 19

**NEWARK**  
ELECTRIC COMPANY, INC.

CHICAGO  
323 W. Madison St.  
Chicago 6, Ill.

New York City Stores: 115-17 W. 45th St. & 212 Fulton St.

## New THOR "B" ENGINE - \$6.95

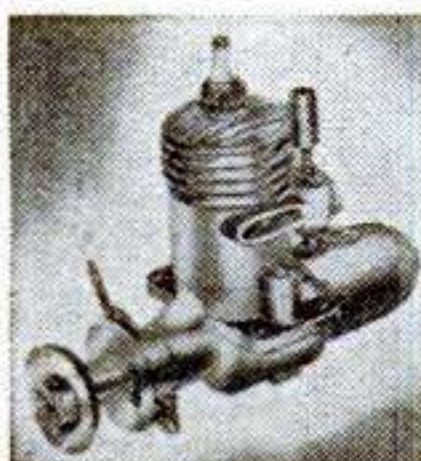

The new THOR "B"—Sensational miniature gasoline engine that really works. Super-power performance. Smooth, velvety power that roars into action with a "twist of the wrist." Over 20,000 already sold. 1/6 H.P. Complete with coil, condenser, and fully illustrated instructions, ready to run, only \$9.95. In KIT form, fully machined, 5 minutes to assemble, \$6.95, without coil and condenser. Powers all models. Send \$1.00—shipped collect same day C.O.D. or send full price plus 25c extra and we ship parcel post insured.

FREE. SEND FOR 32-PAGE ILLUSTRATED HOBBY CATALOG.  
AMERICA'S HOBBY CENTER, INC.  
DEPT. S47, 156 WEST 22ND STREET, NEW YORK 11, NEW YORK

## GREAT NEW TOOL!

QUICKLY SHAPES, SANDS, CARVES, PROFILES, GRINDS, BEVELS, SMOOTHS, POLISHES, CLEANS!

War industry's most versatile machine—now available to hobbyists, craftsmen, model makers, pattern makers, home workshops—cuts fast and clean on wood, metal, plastics! Works equally well on inside cut-out openings or irregular outside edges, on intricate scrolls, curves, saves hours of tiresome hand work—does better job. Nothing else like it. IDEAL TO GIVE OR GET FOR WORKSHOP! Sold on 5 Days' Trial, money back GUARANTEE.

Bandsander

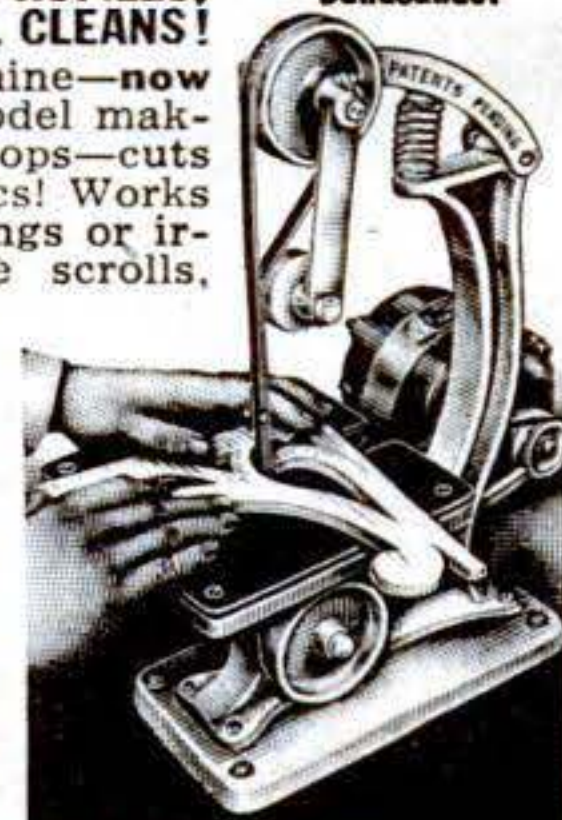

### FREE!

Write for Free, lavishly illustrated Circular describing how Bandsander—the machine that amazed the experts—saves time, money, trouble. Write now—a post card will do!

MEAD SPECIALTIES CO.  
4114 North Knox Ave., Dept. 247, Chicago, 41, Ill





# OWN A "POCKET SIZE" MACHINE SHOP

## IMPROVED MOTO-TOOL

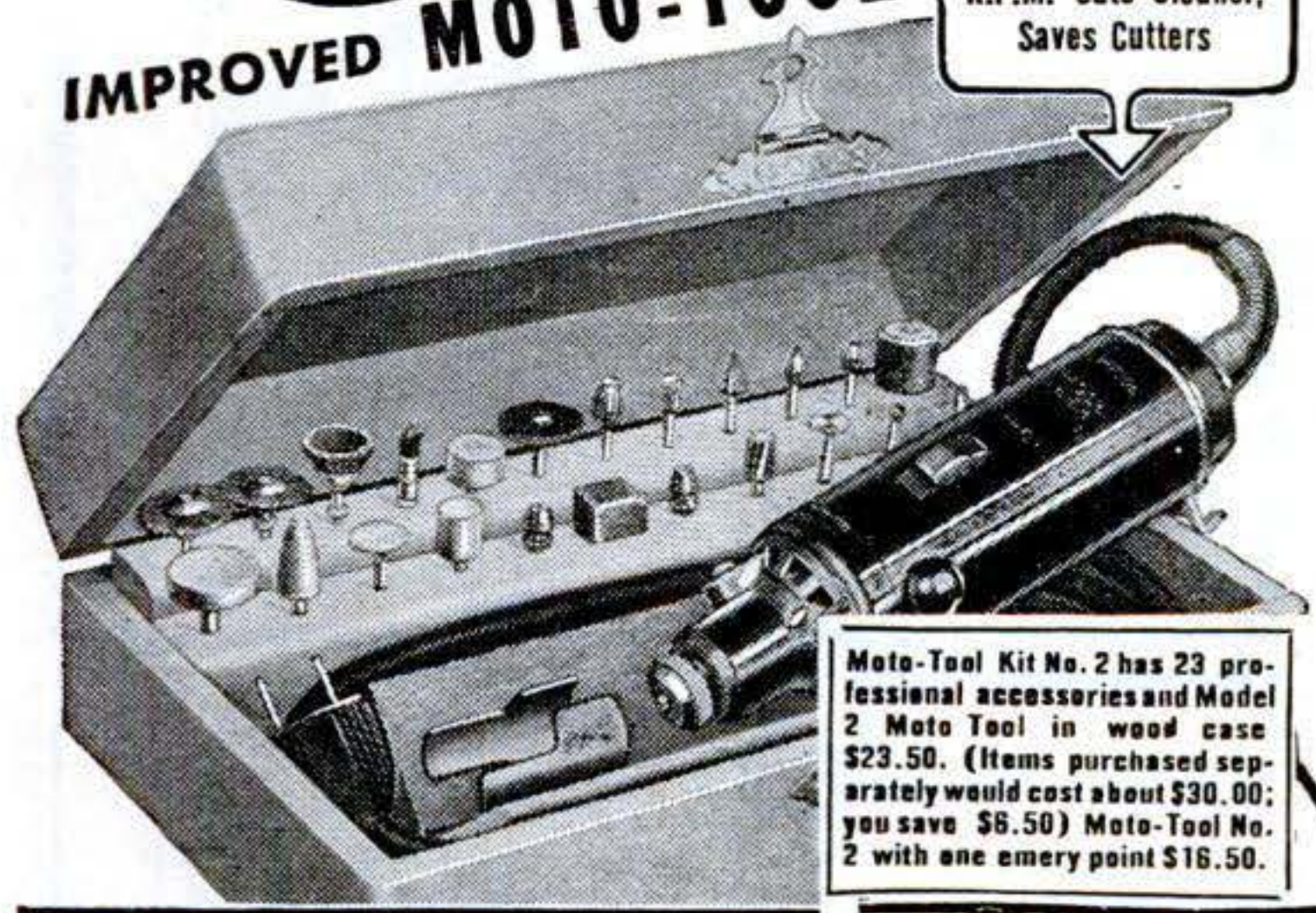

Approximately 27,000 R.P.M. Cuts Cleaner; Saves Cutters

Moto-Tool Kit No. 2 has 23 professional accessories and Model 2 Moto Tool in wood case \$23.50. (Items purchased separately would cost about \$30.00; you save \$6.50) Moto-Tool No. 2 with one emery point \$16.50.

### "MAN... WHAT A POWERHOUSE!" A TOOL THAT PACKS YEARS OF PLEASURE

Here's a tool to please a man's heart. A gleaming "powerhouse" that holds promise of endless creative hours. This "pocket-size machine shop" is a war veteran... used by all branches of the armed forces in far flung repair bases... and it helped set production records at General Electric, Westinghouse, Remington Arms, Ford and other plants. Hobby enthusiast or expert craftsman... first choice is model 2 Moto-Tool kit, with its handsome, felt-lined, highly finished wood case... with rows of tools begging to be put to work. The usefulness of Moto-Tool for precision work is increased by two versatile attachments now available at slight additional cost (see below).



#### Look for These Features

Housing has "pencil-type" finger-grip; instant-action, wrenchless chuck; oil-less (sealed) bearings; patented automatic chuck-lock pin; oversize armature shaft, hardened, ground and polished; 110 volt universal type motor; easily replaced commutator brushes; sliding, snap-type switch; handy hanger hook; cord protector; sturdy, shock-proof bakelite housing; dust-filtered, air-cooling system; weighs only 13 oz; shaped to fit the hand; dynamically balanced for vibrationless operation.

**MONEY BACK GUARANTEE**  
Buy Moto-Tool and Accessories from your dealer; or order direct from factory on 10 day trial, money back guarantee.

**DREMEL MFG. CO.**  
Dept. 127-D, Racine, Wis.

### Free Both Hands With Moto-Tool Attachments

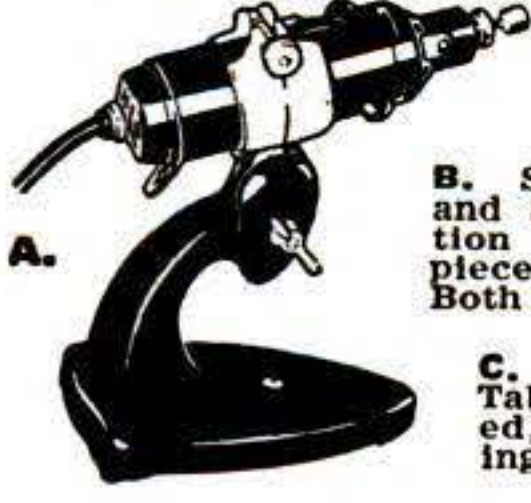

A. Moto-Tool Universal Stand holds Moto-Tool at any angle. \$4.50



B. Shaping Table and Stand in position to grind flat pieces to any shape. Both \$7.00



C. Shaping Table, inverted, for routing—\$2.50

- Do These Better—Faster**
- Brushing
  - Dressing
  - Burring
  - Grinding
  - Routing
  - Sanding
  - Drilling
  - Inlaying
  - Sawing
  - Scoring
  - Cutting
  - Carving
  - Sharpening
  - Burnishing
  - Engraving
  - Touching Up
  - Mortising
  - Polishing
  - Finishing
  - Cleaning
  - Rasping

## MECHANICAL SURPLUS BARGAINS



### 1. BROWNING GUN SIGHT

A fine precision instrument used by Air Force on Browning machine guns for distance sighting. Incorporates a powerful lens with vertical and horizontal correction calibrations. Adaptable to any precision sighting use. Shipping weight, 2 lbs. Limited quantity! **\$9.95**

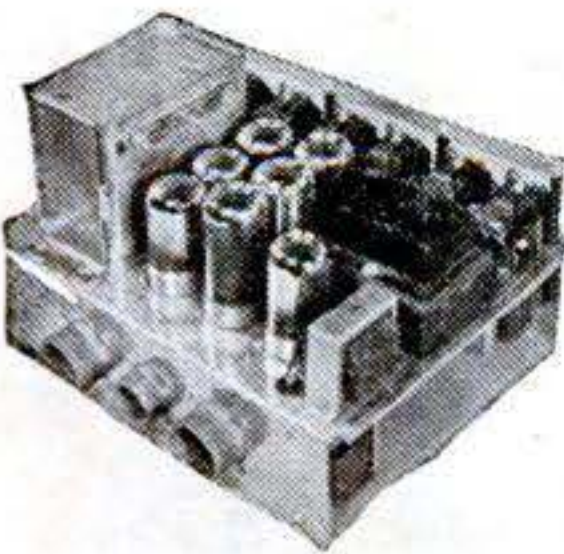

### 2. AMPLIFIER, POWER

Manufactured by Minneapolis-Honeywell, type GI024A20A1. A gold mine of electronic parts for the experimenter. Partial list of components: 7 tubes including 7N7-7F7-7Y4, transformers, relays condensers, capacitors, tube sockets, variable condensers and many other valuable parts. Shipping weight, ten lbs. Used. Limited! **\$8.95**

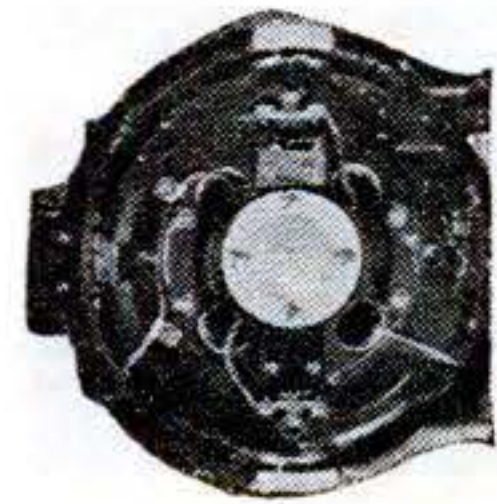

### 3. GYROSCOPE, ELECTRIC

A high rpm electric gyro, formerly used in bomb sights. Runs on any DC voltage up to 24 volts. Ideal for experiments, testing, etc. Used condition. Shipping weight, 15 lbs. Limited quantity! **\$2.59**

- 4. MICROPHONE, HAND TYPE—Air Force hand mike, used, good condition. With cord and plug. **\$1.49**
- 5. HEADPHONES—Air Force type headphones with ear cushions, headbands, plug, etc. Used. Ideal for crystal sets. **\$1.19**
- 6. MICROPHONE, THROAT TYPE—Air Force throat mike, used; leaves hands free. **\$0.89**
- 7. PERISCOPES, TANK TYPE—90 degree reflection; adaptable as a periscope by use of two units. Look around corners, over crowds, etc. Used condition, per pair. **\$1.79**
- 8. GUN TURRET HANDLES—Handle used on guns in turret; has thumb microswitch, etc. used. **\$0.99**
- 9. AVIATOR'S HELMET—Type A-9 gabardine Aviator's helmet. With sherling ear pads and chin strap. Size. **\$0.89**
- 10. GAS MASK BAGS—Canvas bag with shoulder straps. Ideal for school, hunting, fishing bag; general utility carryall, hiking, etc. **\$0.89**
- 11. CHEMICAL WATER TESTING SET—Used by Army for testing drinking water contamination, etc. Consists of 15 pieces of chemicals and apparatus in plastic utility carrying case! Instructions! Overseas packaged, prepaid **\$1.49**
- 12. ARMY FOX HOLE SHOVELS—Brand new, two for only, **\$1.98**
- 13. AIRPLANE COMPASS—Removed from Bombers & Fighters, panel mounting, magnetic type, only, **\$9.95**
- 14. AMP-METER, 0-150, 0-300. Uses external shunt; state type desired. Used. **\$1.49**

ATTENTION: Minimum order \$2.00. All COD orders must be accompanied by 20% deposit. Include postage or we ship collect via Express or mail.

**SOUTHWEST AERO SUPPLY, P. O. Drawer 488, South Houston, Texas**





**STOP LOOKING...  
START LIVING!**



**SCHULT OFFERS FULL VALUE IN A FURNISHED HOME**

● The Schult Luxury Liner built to quality standards by pioneers of the trailer coach industry offers you an unbeatable combination of living comfort and value, *available right now!*

In one package you get well heated, well insulated mobile housing, ingeniously designed furniture, a kitchen equipped with refrigerator, oven range and double sink.

**EVERY FACILITY OF A 3-ROOM HOME**

The Luxury Liner contains three separate rooms... sleeps four comfortably... provides all the wardrobe, closet, and drawer space you need... is luxuriously furnished and decorated, includes vanity with built-in lavatory or toilet room.

See a Schult! Write today for dealer's name; we'll send latest catalog, too.

**SCHULT CORPORATION**  
DEPT. 3104 • ELKHART, INDIANA  
In Canada, John Inglis Co., Ltd., Toronto



**TWO LUXURIOUS MODELS!**  
Schult Luxury Liner, and new sparkling Deluxe Commodore for economical Luxury Travel.

**SCHULT Trailer Coaches**

**B A R G A I N**

Original Cost \$150.00



**3X Army Telescope**

**ALL COATED LENSES—BRAND NEW**

An ideal gift for viewing objects, landscapes, seashores, etc. The high resolving power of the six coated lenses, five of them achromats will bring out great details. For the experimenter it can be dismantled and used for hundreds of projects. Length 22½ inches, 36° Field, Postpaid \$7.50.

**500,000 Lenses and Prisms.** Send 3 cent stamp for "BARGAIN" List.

**A. JAEGER, BOX 84B, SO. OZONE PARK 20, N. Y.**



**Build it Yourself**

... of Cemadobe brick. Durable, attractive, fireproof, soundproof and dirt cheap. Make them yourself of earth and cement at low cost. Practical in all climates. Amazing discovery in soil stabilization. Acceptable to loan agencies. Complete instructions in attractive, easy-to-understand "Cemadobe" Handbook, 60 illustrations and 40 chapters. Money back guarantee of satisfaction. Now selling **Enlarged Second Edition**. Send \$2.00 to **CEM-ADOBE CO., Box 81, Dept. PS-47 West Los Angeles Station, Los Angeles 25, Calif.**

**Build Your Power Tools With OUR BALL BEARING ARBORS**



New Departure Self Lubricating Bearings

10,000 rpm



(No extra charge for left hand threads)

C5-5/8 pictured

- B33—\$4.95 PP
- 5/8x4 1/2 Spindle
- B15 Plain Spindle \$3.45
- C4-1/2x12 1/2 Spindle, Housing 2x8 \$8.25 PP.
- C5-5/8x12 1/2 spindle, housing 2x8 \$8.25 PP.
- C6-3/4x12 1/2 spindle, housing 2 1/4x8 \$9.25 PP.
- D8-1x17 1/2 spindle, housing 2 5/8x11 \$16.95 PP.
- 1 INCH BETWEEN WASHER AND COLLAR
- Shaper Arbors, C4, 6 or 8, 3 inches between collars, add \$6.00.
- Heavy Saw Arbors with four Multi-drive pulleys, f.o.b. factory.
- D9-1 1/8x20 spindle \$37.30, D10-1 1/4x20 spindle \$39.50.
- Full stock of V belts and pulleys for immediate delivery PP.
- V BELTS \$.03 per inch PP.

POLY PRODUCTS, 406 S. Chester Ave., Ct. 1, Dept. S2, Pasadena 5, Calif

**WRITE FOR YOUR FREE COPY OF THE NEW KRW HYDRAULIC PRESS BOOK**

Describes all manner of Production and Shop Work on KRW Hydraulic and Bench Type Arbor Presses. 32 pages illustrating the new KRW Hand-operated, Electric-operated and Air-operated Hydraulic Presses. Write for your copy today.

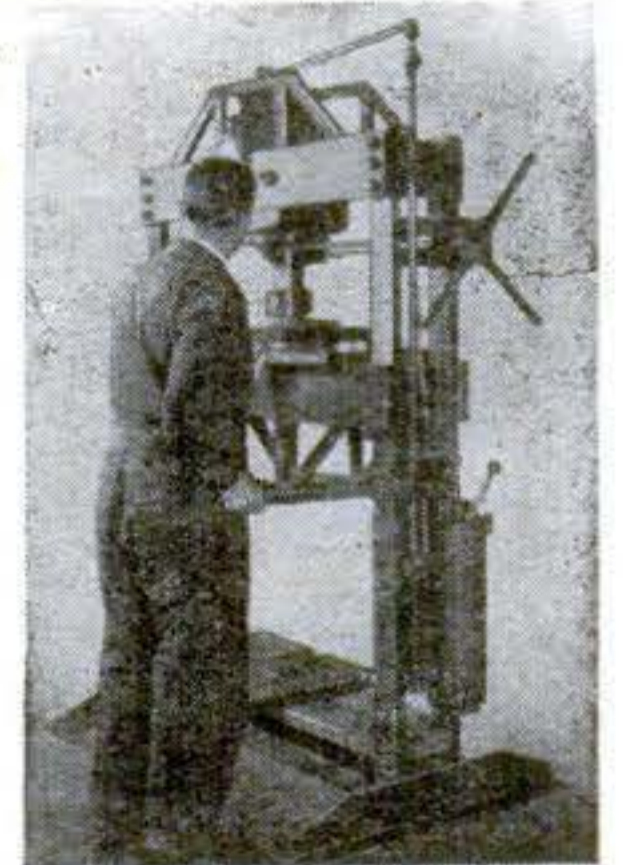

**K. R. WILSON, DEPT. 54, 215 MAIN ST., BUFFALO 3, N. Y.**



# THESE ARE JOHNSON DEVELOPMENTS

FULL PIVOT  
REVERSE

DUAL  
CARBURETION

ALTERNATE  
FIRING

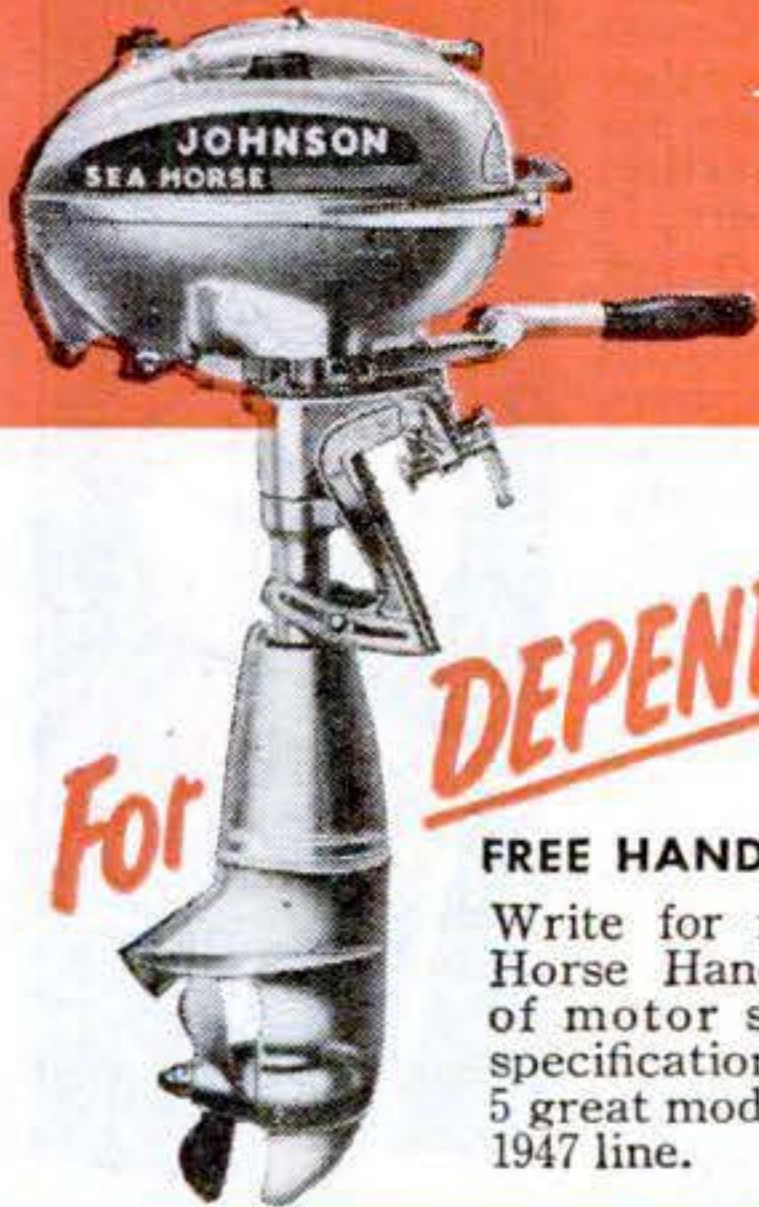

For **DEPENDABILITY**

**FREE HANDY CHART**

Write for new Sea-Horse Handy Chart of motor sizes and specifications on the 5 great models of the 1947 line.

Reverse is a *Johnson* feature. So is Alternate Firing. So is Dual Carburetion—and there are many others. When you look for quality features, look for them in the motor where they were developed—and perfected. Consult your Johnson dealer about delivery. Look for his name under "Outboard Motors" in your classified phone book.

JOHNSON MOTORS, 500 PERSHING ROAD, WAUKEGAN, ILLINOIS  
*Johnson Motors of Canada, Peterboro, Canada*

## JOHNSON SEA-HORSES

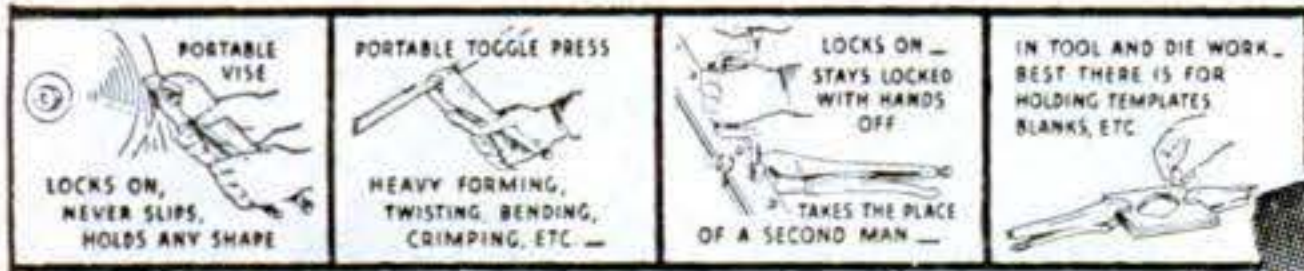

### World's Finest Hand Tool Has Never Been Duplicated

Gripping power exceeds a ton! Does more things—easier and quicker—than any other tool. Remains locked to work with hands removed. Adjusts to super-plier action (handle opens automatically when grasp is released.) Greater range of jaw-adjustment than any other type of toggle-wrench.

There is only one Vise-Grip—it's the original toggle-wrench and has never been duplicated in strength or utility. Ask for Vise-Grip by name. Don't accept an imitation.

Built of fine alloy steel. Nickel plated.  
Invented, Developed and Made World Famous by  
**PETERSEN MFG. CO. Dept. 34 DeWitt, Nebr.**



**INSIST  
On The Genuine**

**UTMOST VALUE:**

7", \$1.65  
10", \$1.95

Sold through  
TOOL JOBBERS  
and DEALERS

# VISE-GRIP

The Original Toggle Wrench

Double Lever  
Action  
Gives 1 Hand  
Ton-Grip

APRIL 1947 269







# ★ PAINT NEWS ★

## War Brings Sensational NEW PAINT Discovery!



**Extra High Gloss—for Any Surface  
Anywhere—ONE COAT DOES THE JOB!**

Now a new wonder paint, made from resins developed and used by the Army and Navy during the war, is available to paint users everywhere. Made of finest resins and chinawood oil. Good for indoor and outdoor painting. Dries quickly; leaves no brush marks; gives hard high-gloss finish; will not chip or crack. Definitely superior in every respect. Available in colors. Withstands salt air, salt water, rain, sleet, snow, sun, alcohol and road tar.

**SPECIAL SAVINGS OFFER!** RESINITE is now being made available to dealers. If the dealer in your town has not yet stocked RESINITE, order direct from our factory at only \$2.95 per qt. F.O.B. Chicago. For a limited time we will allow you a 25c reduction on each quart of RESINITE if, with your order, you also send us the name and address of your paint dealer and the store manager's name. RESINITE goes farther, lasts longer; and gives a superbly superior finish. Think! One quart is enough to paint an automobile. Get RESINITE at your dealer's or order direct from Factory—today. RESINITE CHEMICAL CORPORATION, Dept. D-3, 322 S. Michigan Ave., Chicago 4, Ill. DEALERS write for prices and literature.



**only PER  
\$2.95 QT.**

**RESINITE** FOR ANY SURFACE ANYWHERE

### RISCO RECORD PLAYERS \$9.95



**\$2.15**  
ASTATIC—L-70  
Crystal Pickups.

**\$3.50** Alliance Phono Motors

**\$16.50** V. M. MIXER CHANGER Plays 10" & 12" records at same time.

Walnut Cabinet Plays 10" & 12" records. Both easily attached to any radio. Or—Complete 3-tube amplifier & 5" speaker for above—\$8.00  
Ideal Music for Home Movies  
DETROLA RECORD Changers \$15.50—MAGUIRE 2-Post Changers \$15.  
25% on COD orders—24 hour service—FREE CATALOG—Order From This Ad.  
Wholesale Distributors RISCO ELECTRONICS, 22 WARREN ST. N. Y. 7, N. Y.

## WORLD'S LOWEST PRICED ADDING MACHINE

**VEST POCKET SIZE  
IDEAL FOR BUSINESS OR PERSONAL USE**

**FREE TRIAL  
ONLY \$2.50  
TOTAL COST**

**SEND NO MONEY**

Each Baby Calculator in Beautiful, rich-looking Leatherette case—at no extra cost.  
**FREE!!**



Fits vest pocket or purse. Guaranteed accurate. Operated as easily, and as reliable, as machines costing many times as much. Not a toy. Substantially made of 28-gauge steel—guaranteed for life against defects in construction. You positively can't buy a calculator of equal quality for as little money. **ACCEPTED AS THE FINEST LOW PRICED CALCULATOR FOR OVER 30 YEARS!** Operates with a flick of your finger. Adds, subtracts, multiplies, divides—counts up to ten million. Pays for itself over and over in mistakes avoided, and time saved. **MAKES IDEAL GIFT.**

Sold on a positive money back guarantee. Send only \$2.50. Calculator sent postpaid, or send name and address and pay postman \$2.50 plus postage. **MONEY BACK IN 10 DAYS IF NOT DELIGHTED!** (If outside U. S., send \$3.00.) **AGENTS WANTED.**

**CALCULATOR MACHINE CO., (Mfrs.)**

Dept. 477 P.O. Box 248, Glenview, Illinois



# A Bigger Cash Income

*can be yours with  
this new...*

## HOBART arc WELDER

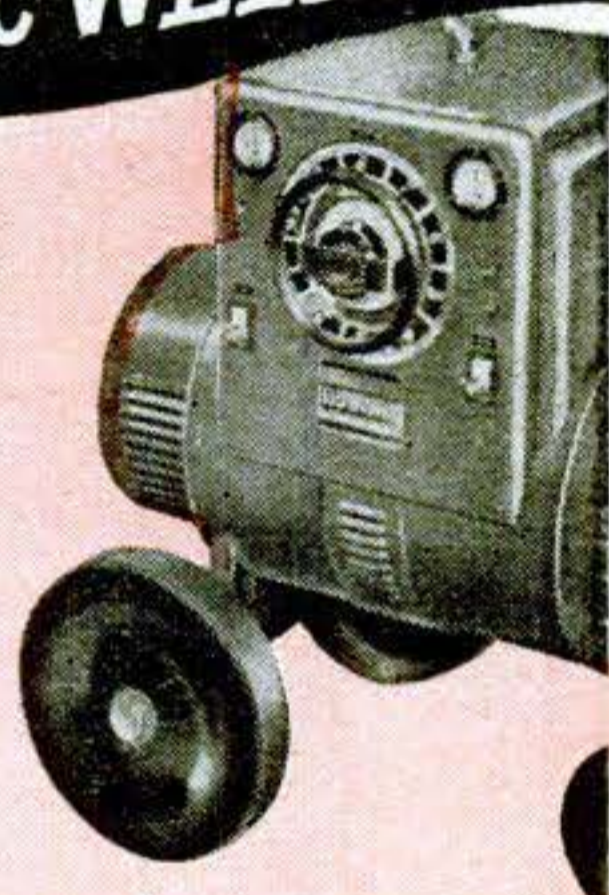

Own a profitable business with a minimum investment? It's easy if you start a welding shop with Hobart Arc Welders. People bring repair work to you—automotive, farm equipment, etc. There is profit in every job—and plenty of jobs to keep you busy the year round.

**WELDING WITH HOBART IS EASIER!** Only with Hobart do you get operation and convenience features that let you complete a job faster while producing better quality, more profitable welds.

**"BUILD YOUR OWN" AND SAVE!** With the Hobart Generator, a used auto engine and chassis, you can build your own portable gasoline drive arc welder and save hundreds of dollars. Go everywhere for welding jobs. Send coupon.

HOBART BROTHERS CO., BOX P-47, TROY, OHIO

"One of the World's Largest Builders of

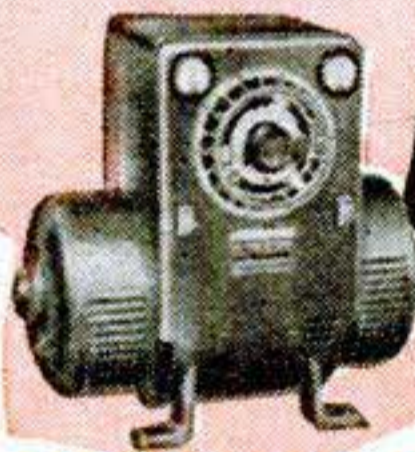

**Hobart**

arc welders"

You'll find every type and size of arc welder in the Hobart line—electric or gasoline drive, stationary or portable, AC or DC.



Attend the **HOBART WELDING SCHOOL**

Instruction in all phases of welding. Individual instruction. Qualified under G. I. Bill. A non-profit institution.



**I'm Interested** in the profit-

making possibilities of Hobart Arc Welders. Send me free book, and details on items checked.

- |   |   |
|---|---|
| <input type="checkbox"/> Electric Drive   | <input type="checkbox"/> A. C. Welder   |
| <input type="checkbox"/> "Build Your Own" | <input type="checkbox"/> Welding School |
| <input type="checkbox"/> Gas Drive        | <input type="checkbox"/> Catalog        |

HOBART BROTHERS CO., BOX P-47, TROY, OHIO

NAME \_\_\_\_\_

ADDRESS \_\_\_\_\_





**Customer:**  
"That's a beautiful job, Pete."

**Pete:** "Yes, you can't beat the Foley for turning out a perfect cutting saw."

**SAW FILING**

**is a Good Business**

With the Foley Automatic Saw Filer you can put yourself into a fine cash business with steady customers and make a good living. The Foley automatically joints the saw, making all teeth even in size, shape, spacing. The Foley is the only machine that files all hand saws, also band and cross-cut circular saws. **SEND FOR FREE PLAN**—Shows how to start a saw repair shop. No canvassing. Send coupon today.

**FOLEY Automatic SAW FILER**

**FOLEY MANUFACTURING CO.**  
419-7 Foley Bldg., Minneapolis 13, Minnesota  
Send Free Plan on Saw Filing business, no obligation

Name \_\_\_\_\_

Address \_\_\_\_\_



**WAKE UP YOUR Scalp**

**BE FAIR TO YOUR HAIR** Want better-looking hair? Embarrassed by falling dandruff, itching scalp? Then try VITABRUSH, new electric driven scalp brush that gives your scalp a vigorous and invigorating "workout" in just three minutes of fun. Cleans scalp. Stimulates blood supply. Restful. Pleasant. Write *today* for complete information and satisfaction-guaranteed offer. Hershey Mfg. Co., 3799 Field Bldg., Chicago 3.

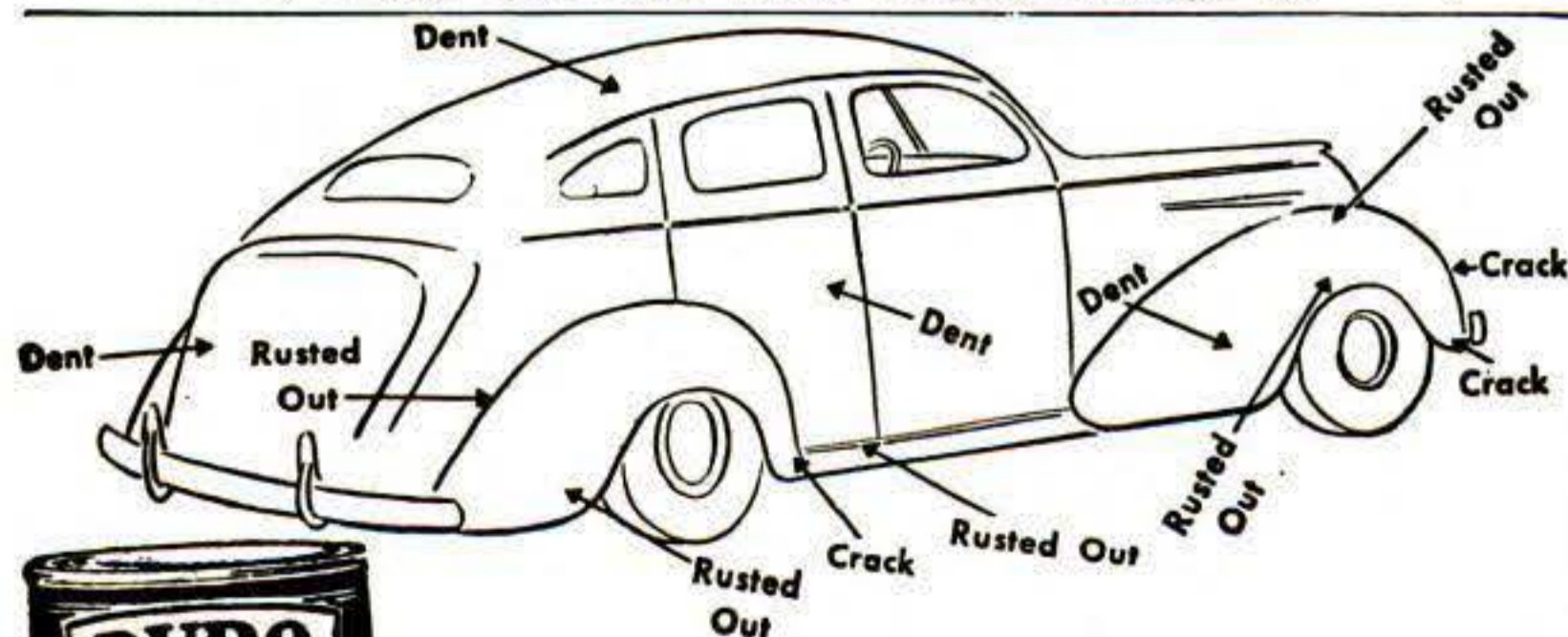

**EASY TO USE! Adheres to All Bare Metal Surfaces!**

Simple as eating pie. Just apply cold, right out of can with putty knife, knife blade or spatula. It dries to metallic hardness overnight—and there you are—GOOD AS NEW!

**McAleer SIDE CAR CARRIERS** THOUSANDS NOW IN USE **\$ 4 50**

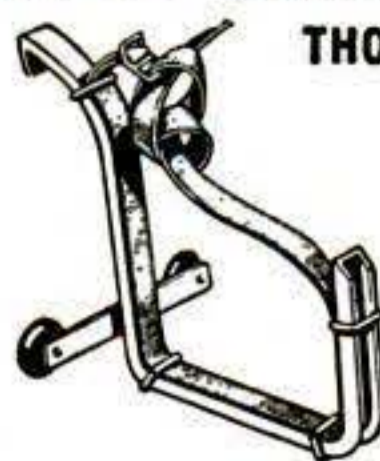

Slips on or off any car in a jiffy

Will carry anything too big for the inside of your car

PER PAIR COMPLETE

● Indispensable for carpenters, painters, plumbers, farmers, window washers, gardeners, campers, hunters, fishermen, home owners, salesmen, etc. Carries tent poles, lumber, pipe, oars, ladders, garden tools, fish poles, skis, etc., securely and conveniently. Guaranteed not to damage car finish. Instantly removable. Fully patented. Exclusive design.

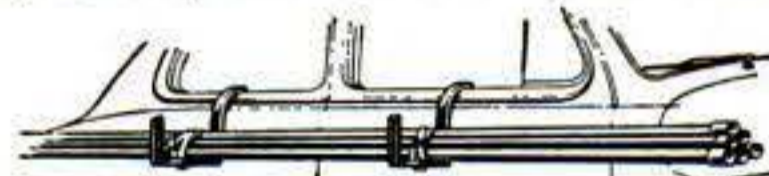

Shipped prepaid on receipt of check, money order . . . or C.O.D. Or at your nearest dealer. Write Dept. 10.

SOLD ON 5 DAY MONEY BACK GUARANTEE

Makers of McAleer Automotive Cleaners, Polishes, Home Buffing Compounds, Waxes, Rust Removers

**McALEER MFG. CO.** Rochester, Michigan

**AIRBORNE 17th AIRBORNE DIVISION STORY** "Thunder from Heaven"

19,000 men who fought with 17th listed plus complete history of the division and many action photos. Men of the TALON Division, this is your golden record. Order today, receipt sent, postpaid . . . \$5.00  
**BOOTS, 15 Ravine St., Birmingham, Mich.**

**OTTAWA LOG SAW** Write For FREE BOOK



Put this OTTAWA to work for you. MAKE MONEY! Wood is bringing highest prices ever known. Ottawa does more than 10 men. Easily operated. Falls trees—SAWS LIMBS. Use 5-hp. engine for other work.  
**OTTAWA MFG. CO., 401 Wood St., Ottawa, Kans.**

**PROFESSIONAL FINISHES**

Every Craftsman should have our catalog of hard to get materials: Electroplating and shop supplies; chemicals; novelty and industrial finishes for wood, metal, plastics and other materials.  
**CRAFTS FINISHES, Box S-467, Arlington, Virginia**

**Fenders Rusted Out?**

● Has your car taken a beating? Are there rust spots, cracks, dents or holes in fenders or on the body? You can patch them easily—at home at low cost—this easy "do-it-yourself" way.

**USE DURO PLASTIC METAL BODY SOLDER**

Duro is foolproof. It sticks to any metallic surface like glue to paper, can be filed down smooth, sanded to the same finish as the metal, and painted. You never know it's there. Friends will marvel. Perfect for any household repair job. Just name it. Duro will do it.

**\$1.50 lb.**  
**50¢ ¼ lb.**

ON SALE AT MOST GOOD AUTO SUPPLY, HARDWARE, PAINT, DRUG & DEPT. STORES or write for dealer's name **WOODHILL CHEMICAL CO., 1391 E 33rd St. Cleveland, Ohio**





*"In the new 4-passenger Crosley convertible I think we've struck a note in harmony with the youthful heart!"*

*Powell Crosley Jr.*

PRESIDENT, CROSLY MOTORS, Inc.

Have you a flair for youth and beauty? Then the new fine CROSLY Convertible is the car of your dreams! One ride will prove it.

Here's big-car roominess, ample for 4 husky 6-footers, plus baggage. An easy-to-manage top that snaps into a snug weather-proof in a jiffy. Real CROSLY economy that won the fine CROSLY Sedan a place in America's warm heart! CROSLY COBRA (Copper BRAzed) steel engine, of course—that 59 lb. 4-cylinder, valve-in-head powerhouse that gives 35-50 miles on a gallon of ordinary gasoline; speeds up to 60-plus. And typical CROSLY maneuverability, pick-up, sure-footed nimbleness! The new fine CROSLY Convertible is The Youth-Car-Of-The-Year. Clever new type convertible cloth top. See it today!



**EXAMINE THESE FEATURES.** ALL STEEL body, low center of gravity, great safety factors. MODERN Streamlining, "the Aircraft Flavor" gives extraordinary beauty • CAR WEIGHS only 1110 lbs., curb-side; perfectly balanced, weight-to-power • EASY DRIVING, virtually "parks on a dime"; oversize shock absorbers • MORE MANEUVERABLE in traffic; 20 inches narrower than most cars • ECONOMY that's almost unbelievable; speeds to 60-plus.

For information and literature write: Crosley Motors, 2530-I Spring Grove Ave., Cin'ti 14, O.

## PERFECT DOWELS ... easily made



**ON YOUR LATHE OR DRILL PRESS**  
Use a SPEE-DOWL and you can work wonders with wood. Quickly and easily you'll make dowels of any wood . . . perfect burnished dowels for furniture, toys and thousands of other projects. You merely push

SPEE-DOWL on wood—the lathe or drill press does the work! Cast body, tool steel blade. SIZES: 2, 3, 4, 5, 6, 7 and 8/16" (illustrated at left). Only \$1. ea. Special—any 4 of above for \$3.50; complete set of 7 for \$6. Also individual sizes 9 to 20/16" (illustrated at right) \$2.65 each. SPEE-DOWL is Unconditionally Guaranteed. Send postal note or check—we pay postage in North America. **FREE Literature.**

JOHNS MFG. CORP. DEPT. B-7 DUNELLEN, N. J.

# a float

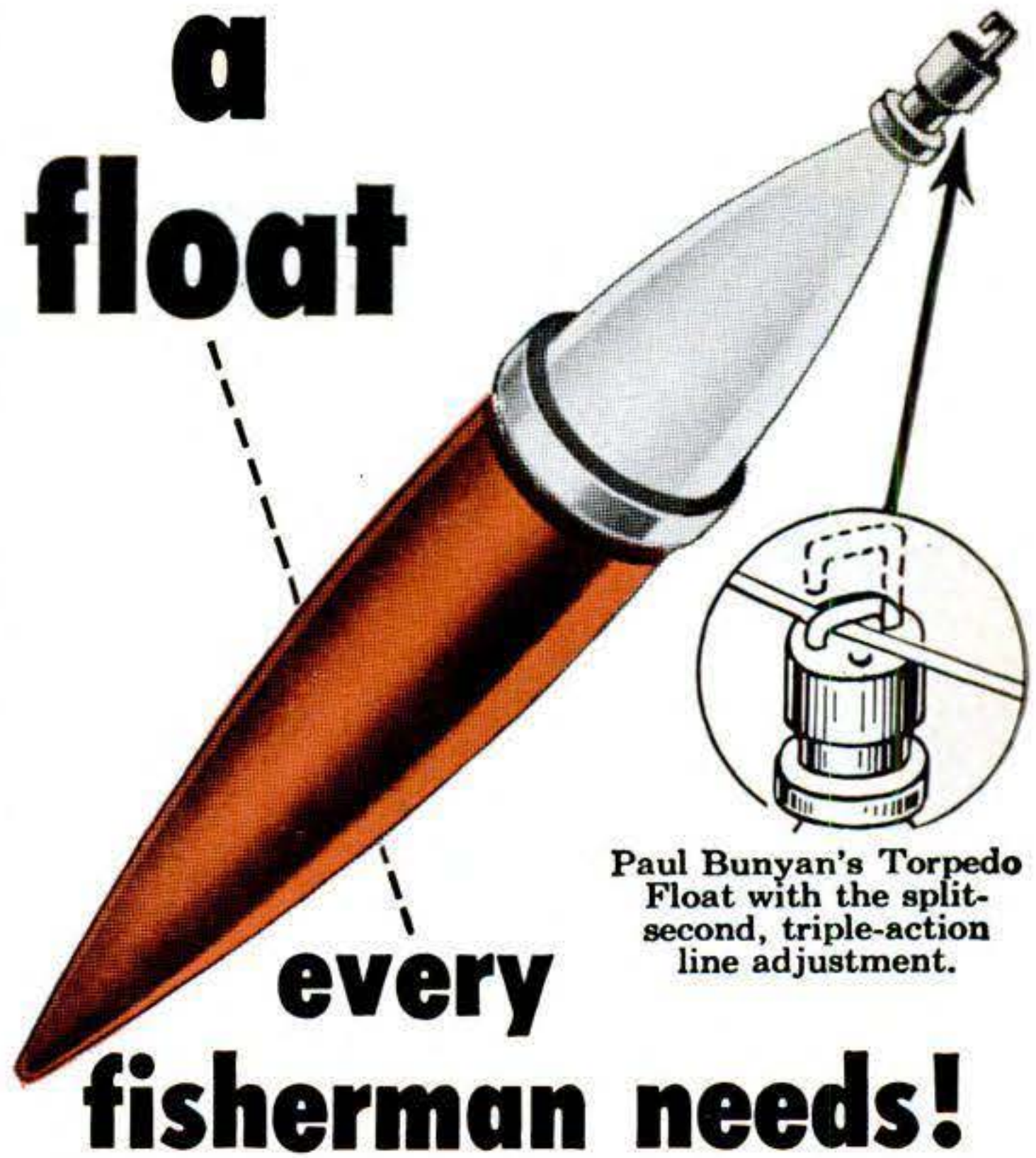

Paul Bunyan's Torpedo Float with the split-second, triple-action line adjustment.

# every fisherman needs!

**YOU'LL WANT** this truly modern Torpedo Float with its triple-action head that enables you, *in a split second*, to attach or detach your line—to lock your line firmly in position desired—or to release as a free-running line for casting. And the spring-lock action is always positive, yet unharmed to the line. Its added buoyancy helps to set the hook when a fish strikes. Perfect for casting, trolling or still fishing. Designed by fishermen for fishermen. Price 75¢.

### PAUL BUNYAN FLASH EYE!



Here's the old reliable "fish getter" that always gets results—Paul Bunyan's Flash Eye! Flashing transparent eyes that attract Northerns, Lake Trout, Wall-Eyes, Muskies, etc. The Flash Eye spoon comes in two finishes: copper for dark days, nickel for bright days.

Thousands of guides and men who know fishing go all out for this tantalizing killer that attracts the big ones. In two sizes priced at \$1.00 and \$1.10.

PAUL BUNYAN BAIT CO.  
Department P577  
Minneapolis 5, Minn.



# PAUL BUNYAN BAITS



If your dealer can't supply you, write us.

APRIL 1947 273



**KEEP SHARP THINGS  
SHARP!**

with the  
**NEW**  
**JET ACTION  
SPEED GRINDER**



Another Quality Product  
from the House of Hudson

**SHARPENS  
EVERYTHING**

**FOR HOME AND SHOP**

*The* **HUDSON  
TURBO GRINDER**

End the annoyance of dull knives and blunt tools. The amazing new Hudson Turbo-jet Grinder sharpens knives, scissors, lawn mowers, wood planes, drills, chisels and all edged tools quickly and easily. Polishes silverware and metal.

Simplest operation imaginable...just attach to ordinary faucet, turn on the water and the patented Hudson Turbo-jet impeller spins the grinding wheel at 3000 to 10,000 revolutions per minute.

Precision built, quality throughout. Wheel, super-hard silicon carbide; Shaft, stainless steel; Bearings, Chrysler oilite (never need oiling). All metal parts gleaming chrome. Colorful Vinylite tubing.

**ONLY  
\$8.95**

Ideal for the handyman, housewife, hobbyist, mechanic and everyone who uses knives and tools.

**FULL MONEY BACK GUARANTEE**  
See your hardware dealer

**HUDSON PRODUCTS CO.**  
4424 ST. AUBIN AVE.  
DETROIT 7, MICHIGAN

**IF YOUR DEALER DOESN'T  
HAVE THE HUDSON TURBO  
GRINDER SEND COUPON  
TODAY**

**HUDSON PRODUCTS CO.**  
4424 St. Aubin Ave., Detroit 7, Michigan

Enclosed is a \$8.95 ( ) check ( ) money order for which rush to me, postpaid, one Hudson Turbo Grinder with full instructions for use. I understand the Grinder carries a full, money back guarantee.

Name.....

Address.....

City.....State.....

Name of Hardware Dealer.....

Address.....



**MORE  
POWER!**

**MORE  
CAPACITY!**

**MORE  
FLEXIBILITY!**

... than any other  
**homeshop handgrinder**



Now you can have the handgrinder you've always wanted for your workshop! Its full 1/14 HP motor has the extra power for "heavy" jobs. Its extra-capacity chuck takes all 3 tool sizes - 1/4", 1/8", 3/32". Attachments convert it instantly for bench, lathe, and flexible-shaft work!

Think what you can do with the extra power, capacity, and versatility of the Duplex. Work in wood, metal, and plastics is faster, easier—and twice the fun!

**Tear out this coupon and mail today!**

The Dumore Company, Dept. D-52, Racine, Wisconsin

Please send complete information on Duplex Grinder

Send me Deluxe Duplex Kit (27 accessories). \$27.50 enclosed

Send me Standard Duplex Kit (9 accessories). \$19.75 enclosed

Shipping charges C.O.D.

Name.....

Address.....

City.....(.....) State.....

**GENUINE  
WIRELESS RECORD COILS  
PLAYER**

With 600 k c trimmers. Latest type diagram and parts list uses miniature rectifier stack and instantaneous heat-up tube fine for automatics. Price includes coil, trimmer, diagram, parts list!

**\$1.75**  
Postpaid

**OSCAR'S**

937 So. Soto Los Angeles 23, Cal.



**SHALLOW WATER DIVING UNIT**

For salvage, rescue, exploration dives and pool cleaning. Comfortable and efficient; seals absolutely. Low cost with long life. Also, complete line deep-diving gear. Write for details.

- Mask
- Weighted Belt
- Air Hose
- Portable Compressor

**DIVING EQUIPMENT & SUPPLY CO.**  
1121 N. Water Street, Milwaukee 2, Wis.



**SURPLUS BARGAIN  
COMPLETE METAL  
STAMPING DIE SET**

Stamp metal, wood, leather, plastics, etc. with your name. Stamp your tools for identification. Use it in the shop—on the farm—anywhere! Will pay for itself over and over again.

**LETTERS A TO Z  
NUMERALS 0 TO 9**

Kit includes letters from A to Z etc. 43 pieces in all. Letters approx. 1/8 inch high. All in solid drilled box 3 1/4 x 8 x 4 inches. Will last a lifetime. Sets are used but guaranteed perfect. Original cost to government approx. \$20.00 You'll find hundreds of uses for a die stamping set like this.

**\$3.95**

- OUTFIT  
INCLUDES**
- Letters A to Z
  - Numbers 0 to 9
  - Hammer • Jig
  - Guides • Box

**POSTPAID IN U. S. A. . . . .**  
**GROBAN SUPPLY CO., Dept. PS4**  
1522 So. Michigan Ave. Chicago, Ill.



## EDGE-GETTER... MAKES YOUR MOWER A TRIMMER!

*Now*... you can trim usually missed lawn edges with ease and speed. Mow around tree wells, in trenches and troughs with this *easy-to-use, permanent* attachment. Adjustable to varied depths. Swings easily into position when needed. *Eliminates tiresome hand clipping!!! Makes hard work a cinch!!! Light but sturdy!!! EASILY INSTALLED ON ANY MOWER!! ORDER YOURS TODAY!!*  
Only \$3.95—postpaid. Literature on request.



**BARTON CO.**  
Box 442, Dept. P, Montrose, Calif.

### Extra! JUST OUT Extra! INSTANT NICKEL NO CURRENT-OR-BATTERIES USED

U. S. PAT. PEND.  
NO. 702581

Iron, Steel, Aluminum, Brass, Bronze, Copper and practically all Industrial Metals can now be HEAVILY nickel-plated WITHOUT equipment, vessels, electricity or previous copper plating, a blessing to Hobbyists, Doctors, Hospitals, Restaurants, Bar and Beauty shop owners. Recommended for Auto, Bicycle and Machinery parts and accessories, Musical Instruments, Electrical appliances, Coffee Urns, and practically anything made of metal.

IN THIS MARVELOUS NEW PROCESS the principles of the battery and electroplating have been harnessed in the INSTANT NICKEL formula, so when it is applied with a wet applicator on a clean metallic object, a bright nickelplate instantly appears! Thickness of plating is regulated by number of applications.

JUMBO SHOP SIZE (nickelplates 50 sq. ft.) only \$6.75 postpaid. Sample offer \$2.00 postpaid. Applicator sent free. Send check or money order today!

INSTANT PLATING PRODUCTS, 3439 Michigan Ave., Chicago 16, Ill.

COMPLETE  
**\$2.00** POST PAID  
COVERS 10 FT.  
NO C.O.D.  
PLEASE

**PAINT IT YOURSELF...  
WITH  
Plasti-Kote**

**The Plastic Finish for  
AUTOS, BOATS, FLOORS  
FURNITURE & WOODWORK**

Use Plasti-Kote wherever you want a gleaming, lasting and durable finish. Plasti-Kote leaves a cellophane-like surface that resists hot or cold water, alcohol, dirt, oil, vibration and changing weather. Dries in 3 hours—leaves no brush marks. Easy to apply. 36 beautiful colors. \$2.95 quart.

**Plasti-Kote**  
TRANSPORTATION  
FINISH  
48 NAVY BLUE  
ONE QUART

**PLASTI-KOTE, INC.** 425 LAKESIDE AVENUE N. W.  
CLEVELAND 13, OHIO

Send new color folder and descriptive literature:

Name .....

Address .....

City..... Zone..... State.....

\*  
Only *Martin* gives you  
mechanically-controlled  
poppet valves!

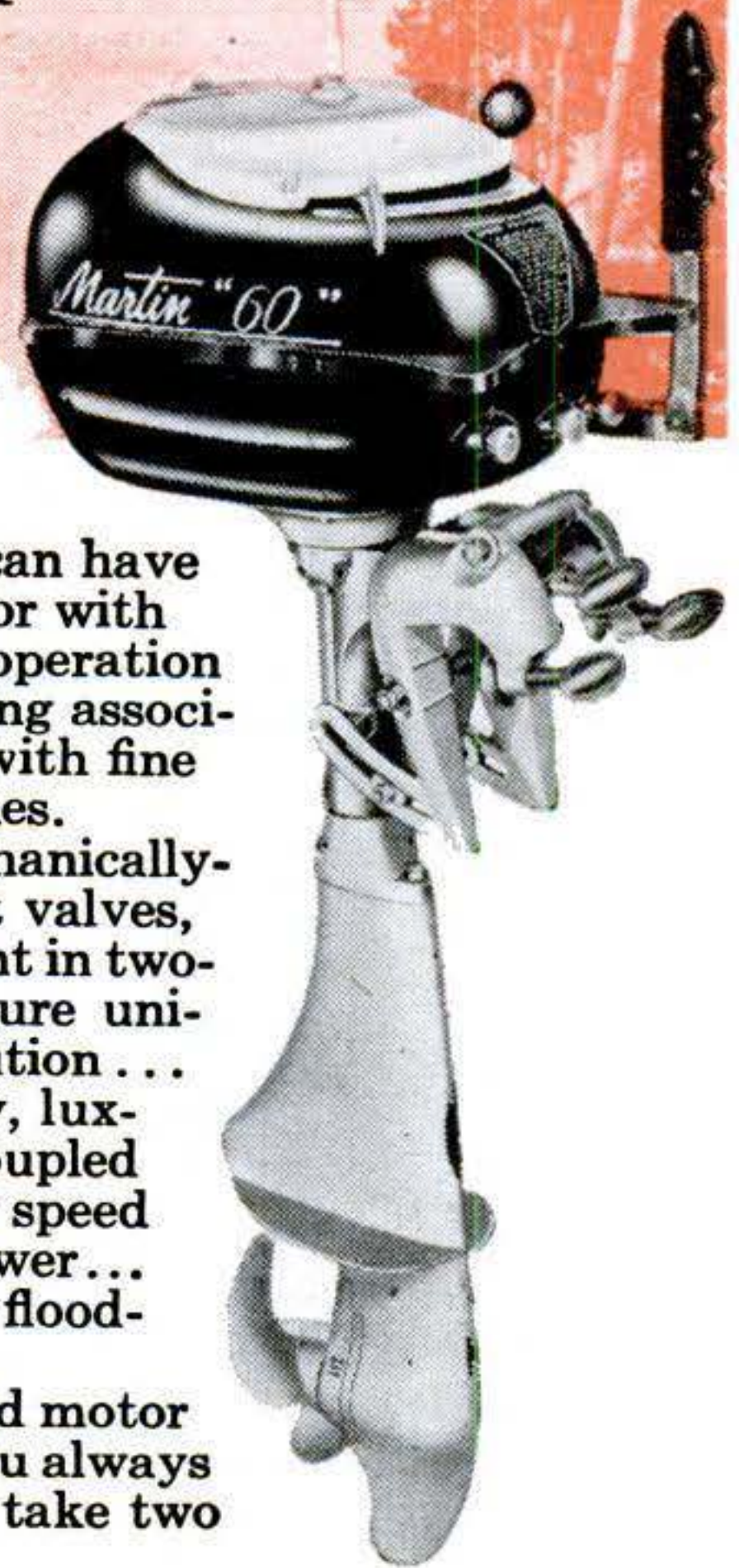

**NOW** sportsmen can have an outboard motor with the flexibility of operation and ease of starting associated in the past with fine automotive engines.

MARTIN'S mechanically-controlled poppet valves, an exclusive patent in two-cycle motors, insure uniform fuel distribution... unbelievably slow, luxurious cruising coupled with exhilarating speed and maximum power... instant, virtually flood-proof starting...

It's the outboard motor that does what you always thought it would take two motors to do!

**MARTIN** gives you all you'd expect in a fine outboard, **PLUS** many exclusive features—

- ★ **Power-head swivel, 360°** (patented)—Swings lower unit into boat, facilitates checking.
- ★ **New Martin Vertical Stern Adjustment** (patent pending)—Enables easy adjustment while underway.
- ★ **New Streamlined, Leak-proof Filler Cap**—Combines vent and spare shear pin clip.

Other highly desirable features: Full reverse steering • Steering stabilizer • Propeller clutch • Depend-a-pull starter • Easy grip stern bracket handles • Synchronized and centralized controls • Resiliently mounted handles and power head • Quiet underwater exhaust • Positive rotor water pump • Long-life sintered bronze rust-proof bearings • Positive oil and grease seals • Alternate firing.

See the new MARTIN at your dealer's, or write for free booklet to: MARTIN MOTORS, Dept. PS 473, Eau Claire, Wisconsin.

*Martin*

\*The New Standard of Performance in

**Outboard Motors**



# Drill Press

WORK SHOP TOOLS BY

## Barron



**5-in-1 ROTARY DRILL PRESS  
PLANNER** — PLANES, PANELS,  
RABBETS, ROUTS, TENONS, GROOVES

Over 60 000 now in use by pattern and cabinet makers, carpenters, hobbyists, etc. Fits any drill press. Lightening fast, accurate, safe, easy to use. Complete. No special blades needed. No shop complete without it. Fully guaranteed. For all woods and plastics.

**\$7.50**

### New Style MORTISING and ROUTER BITS

Range in size from 1/8" to 1/2". Priced in individual sizes or by the set. Provides entirely new spiral flute cutting principle for faster chip clearance, smoother, accurate routing, carving, veining, grooving, round-end mortising. Extra long cutting flutes. Finest hi-speed tool steel—Super for woods and plastics.

**\$9.50**

SET  
OF 6  
SIZES



### NEW! 4' Rotary Surface SANDER



New larger Barron Sander with live sponge rubber pad bonded to metal. Sanding discs changed instantly. For use on any drill press, flexible shaft or motor. Guarantees a dead-true, agate smooth surface. No ridges, waves, ripples, or striations. Fully guaranteed. Complete with 20 sanding discs.

**\$5.95**

### ANNOUNCING

New Dovetail Cutting Tool for Drill Press \$1.85 each. All Metal 13" x 18" Auxiliary Drill Press Table \$9.85. Tapered and Threaded Drill Press Adapters \$1.00 and \$1.50 each.

Liberal 10 Day Money Back Guarantee

Workshop Guide FREE



**BARRON TOOL CO.**

570 Architects Bldg., Detroit 1, Mich.

## AIRPORT MANAGEMENT

Learn full fundamentals of airport operation, salesmanship, flight instruction, bookkeeping, and all phases of a successful career in aviation. Full year's instruction with flight in the modern \$125,000 Brayton School. Write for Free Catalog.

**BRAYTON AERONAUTICAL SCHOOL**

Lambert Field

St. Louis 21, Missouri

## NEW CONCORD RADIO Bargain Catalog



Brand new—48 exciting pages of radio parts, equipment, and supplies for experimenting, building, testing, repair, maintenance—Big feature sections of Ham Gear, Radio Sets, Communications Receivers, Amplifiers, Record Players and Portables, Record Changers, complete Sound Systems. Pages and pages of top-quality standard-make radio and electronic parts—plus scores of special value bargains. Thousands of items NOW IN STOCK and ready for IMMEDIATE SHIPMENT! Write TODAY for your FREE COPY. Please address Dept. PS-47

**CONCORD RADIO CORP.**

LAFAYETTE RADIO CORPORATION

**CHICAGO 7**  
901 W. Jackson Blvd.

**ATLANTA 3**  
265 Peachtree Street

## Electrically Welded Endless

# Paramount

## BAND SAW BLADES



Made in widths from 1/8" to 1-3/4"

Make your band saw do more work for you. The proper width of blade will extend the scope of this important machine. Burrill's Paramount Blades are made from tough Nickel Alloy Steel properly tempered. Teeth accurately set and filed, and all saws carefully straightened. Send order and check today. Delivery will be made as promptly as conditions permit, from a few days to a week or two. You can obtain these saws at the following prices:

1/8"-3/16"-1/4"-3/8" wide, 5'6" long.....\$ .90 each  
1/8"-3/16"-1/4"-3/8" wide, 6'6" long..... .95 each  
1/8"-3/16"-1/4"-3/8" wide, 7'6" long..... 1.10 each

Other sizes at proportional prices

**NO C.O.D. SHIPMENTS ACCEPTED**

State Make of Machine

Your satisfaction is guaranteed

**BURRILL SAW & TOOL WORKS**

405 E. Main St., Ilion, N.Y.

GUNSIGHTS AND MECHANICAL EQUIPMENT  
Write for list of War Surplus bargains

**WARSHAWSKY & LAZAR**

2126 S. Michigan Ave. Chicago 16, Ill.

## PULVEX FLEA POWDER

DDT

now also contains

Guaranteed by  
Good Housekeeping  
IF DEFECTIVE OR  
NOT AS ADVERTISED THEREIN

Kills the fleas  
QUICKLY!

Keeps others off  
for days!

Still 25¢ and 50¢



## MAKE UP TO \$5.00 AN HOUR In Your Own YEAR ROUND Business!

ONLY A FEW  
DOLLARS  
PUTS YOU IN  
BUSINESS!

Many Clearing as High as \$20 to \$30 a Day NET Renewing Rugs, Carpets, Upholstery. New Method Now Used for Auto Upholstery. Write for Facts About Quick, Easy Way to Get Started

Here is the chance you've been looking for to step into a pleasant, dignified, big-pay business of your own that offers you a steady, year 'round income. Start on "a shoestring," full or spare time, right from your own home. Equal opportunities for men and women, young or old, in small towns or big cities. No experience needed. Many making big money with new American System just cleaning auto upholstery. Easy to learn. We send you complete instructions and quick-cleaning supplies so you can start making money the very first day! Quick method cleans upholstery, rugs and carpets like new without taking off floor! Tremendous demand in homes, apartments, hotels, stores, office and public buildings. Steady repeat business. Territories going fast. Write today for full FREE facts. No cost or obligation. Rush letter or postcard now to  
**AMERICLEAN CO., Inc.**  
Dept. H-4; 211 North 7 St., St. Louis 1, Mo.

WRITE  
FOR FREE  
DETAILS  
NOW!



# WOODWORKERS! *Send for My* Greatest Book of Wood Bargains



**HAROLD F. HUNT**  
"I Can Deliver the  
Woodworking  
Supplies You  
Want!"



World's Finest Selection of IMPORTED and DOMESTIC Woods at Money-Saving Prices  
There's no hobby like working in wood—for relaxation, for enjoyment and pride of workmanship. And it's a real pleasure to be able to select ALL your needs . . . from a rare piece of ebony to a tiny brass hinge . . . from this great new 148-page catalog of Wood Craftsmen's supplies.

### NO OTHER BOOK LIKE IT!

Packed with top-notch values, new hints and projects for making beautiful articles of wood. Many pages in NATURAL COLORS showing the beautiful grains of fine domestic and imported woods. Hundreds of unusual scroll saw patterns—for beautiful articles you will be proud to make and own. And dozens of pages of supplies, equipment and hard-to-find hardware accessories.

### SEND COUPON TODAY

Expert or beginner, you need my big new 1947 Bargain Catalog for the amazing selection of woods and supplies and the valuable ideas it contains. Use the coupon today for your copy while they last. Your 15c is refunded on first order. Act now!

### Here You'll Find—

- ★ Rare and Seasoned Lumber
- ★ Stanley Tools and Routers
- ★ Paint Spraying Equipment
- ★ Electric Hand Grinders
- ★ Carving Tools
- ★ New Colored Plastics

**VENEERS  
PLYWOODS  
INLAYS  
BANDINGS  
HARDWARE  
TOOLS  
PATTERNS**

**HAROLD F. HUNT, President**  
Craftsman Wood Service Co.  
2729 S. Mary St., Dept. B-80, Chicago 8, Ill.

Enclosed find 15c (refundable on my first order) for which please send me your new 1947 Catalog No. 15A.

NAME.....

ADDRESS.....

CITY.....STATE.....

**CRAFTSMAN WOOD SERVICE CO.**  
2729 S. Mary St., Dept. B-80, Chicago 8, Ill.

**THRILLS  
GALORE**



## New GIANT Glider-Kite

Tows Auto or Lifts Light Person. Lifting Wing Area Equal to Small Plane

Cost Government \$108.00  
Yours for Only **\$34<sup>50</sup>**

Not a toy for youngsters. Men with scientific or aeronautical turn of mind get thrill of lifetime with this genuine Barrage Glider-Kite. A "natural" for sky advertising. Took 12 years to perfect. Hundreds used during the war to shield convoys. 134 sq. ft. special aircraft fabric. 10' long x 14' wide double wing and tail. Gives enough pull to move car on level ground. Act quick if you mean business. Cost Government \$108. You send only \$34.50 and we ship F.O.B. complete with spare parts and repair material. Ready made. Assembles easily in 15 minutes. Dismantle in 5 minutes. Or send \$10 and we ship C.O.D. for balance.

Write or Send card for Additional Information:

**GREAT NORTHERN MART, North Adams, Mass.**  
Dealers letterhead inquiries invited.

## Now a DYNAMIC Super-charged WELDER

IDEAL FOR AUTO HOME APPLIANCE FARM REPAIRS

**FOR ONLY  
\$23<sup>50</sup>**

COMPLETE...

**Available Now  
IMMEDIATE  
DELIVERIES**

Write Today for  
Particulars  
**GET DETAILS  
on our 10 day  
Trial Offer.**

Member Chicago  
Association of  
Commerce.

### DESIGNED TO DO HIGH GRADE WELDING INEXPENSIVELY!

Maintenance Men; Farmers; Mechanics; Machine Shops; Foundries; Auto, General Repair and Job Welding Shops; all using the DYNAMIC find it so indispensable and useful that they cannot afford to be without it. If inexperienced you can easily learn to do a variety of high grade welding jobs by following the practical, simplified operating and welding instructions furnished. Once you see a DYNAMIC in operation, you won't want to be without it. Its simplicity will amaze you. In a year the DYNAMIC only costs you about 6c a day. Helmet, rods, cables, holder and operating instructions, etc., furnished.

### SAVES YOU VALUABLE TIME AND MONEY!

This portable industrial transformer type DYNAMIC WELDER easily carried right to the job, can be operated from any convenient, properly wired 110 Volt, 60 Cycle Line—has 8 metallic and carbon arc welding heat stages—does work you would think only possible with a larger more expensive machine. Can also be supplied for 220 volt, 60 cycle operation and other voltages and cycles at slight additional cost. Works on Iron, Steel, Brass, Bronze & other metals.

**DYNAMIC WELDER CO., 13 East 23rd St., SC, Chicago 16, Ill.**







**FARTHER?**

**FASTER?**

**HIGHER?**

**HOTTER?**

**COLDER?**

**LEAVE IT TO  
AAF RESEARCH!**

**N**EVER in history has aviation research advanced so swiftly. Never have ambitious young men had such a glorious opportunity to take part in it! The aircraft of tomorrow are being designed to fly farther, faster and higher than the average person can comprehend.

At testing grounds of the Army Air Forces, enlisted technicians share with test pilots and leading aeronautical engineers the thrills of probing the unknown. How cold is it at 80,000 feet? Will supersonic speeds "burn up" plane fuselage? What should an airman wear when he bails out at 600 miles an hour? At 1500 miles an hour?

AAF men are helping to design and construct a huge supersonic wind tunnel. They

are studying the use of atomic power for aircraft. They are participating in the development of electronic systems for all-weather flying precision navigation, automatic blind landing devices, radar traffic control systems, guided missiles.

This is the type of work which appeals to the wide-awake young men of the AAF. Naturally the standards are high and only qualified men will be assigned to the jobs which are open. Eligible men who enlist for three years can choose the Air Forces. See your nearest Army Recruiting Officer for full details.

**A GOOD JOB FOR YOU**  
**U. S. Army**  
**CHOOSE THIS**  
**FINE PROFESSION NOW!**





## "Me... a magician?"

"Honest, I'm not. I'm only a mechanic, a Doctor of Motors, perhaps *your* Doctor of Motors.

"Most of my 'patients' are broken down jalopies that have been neglected for three or four years straight. Yet, the owners expect me to wave a magic wrench and make their cars purr like next year's models!

"No, I'm not a magician but I *do* bring those cars back to life. We mechanics have had to specialize in old cars since '41. And we have learned how to make motors last—and last—and last."

### **Notice to Car Owners!**

You can help your Doctor of Motors help your car last, merely by taking it in to him for regular care. That way he can spot troubles in advance, keep all those little troubles from becoming big ones, save you money, probably save you your car.

So see him soon and regularly. Your favorite mechanic—*your* Doctor of Motors—recommends Perfect Circle Piston Rings. They are available at every automotive repair shop.

The Perfect Circle Companies, Hagerstown, Indiana, U.S.A. and Toronto, Ontario, Canada.

Your Doctor of Motors  
restores power... saves gas  
... saves oil with...

**PERFECT  
CIRCLE** PISTON  
RINGS



# SOUTH BEND LATHES

**FOR PRECISION WORK**

Built for precision machining, South Bend Lathes are ideal for all kinds of fine work. Their dependability has been proved in every type of shop—from the smallest to the big toolrooms, laboratories, and production lines of large industries.

They give you the best of everything. Accuracy that is more than adequate for exacting jobs. A versatility for efficient machining on all types of operations. And the ease of operation and rugged durability that have made South Bend Lathes favorites of craftsmen everywhere.

Prices are only slightly higher than pre-war—and improvements developed to meet exacting war production requirements give you greater dollar value. Write for catalog, stating size of lathe in which you are interested: 9", 10", 13", 14½", or 16" swing.



**SOUTH BEND LATHE WORKS**

BUILDING BETTER LATHES SINCE 1906

456 EAST MADISON STREET • SOUTH BEND 22, INDIANA

## COLLET ATTACHMENT

One of more than 60 attachments and tools available for South Bend Lathes that provide greater versatility. Write for Catalog 77 which illustrates and describes all of them in detail.

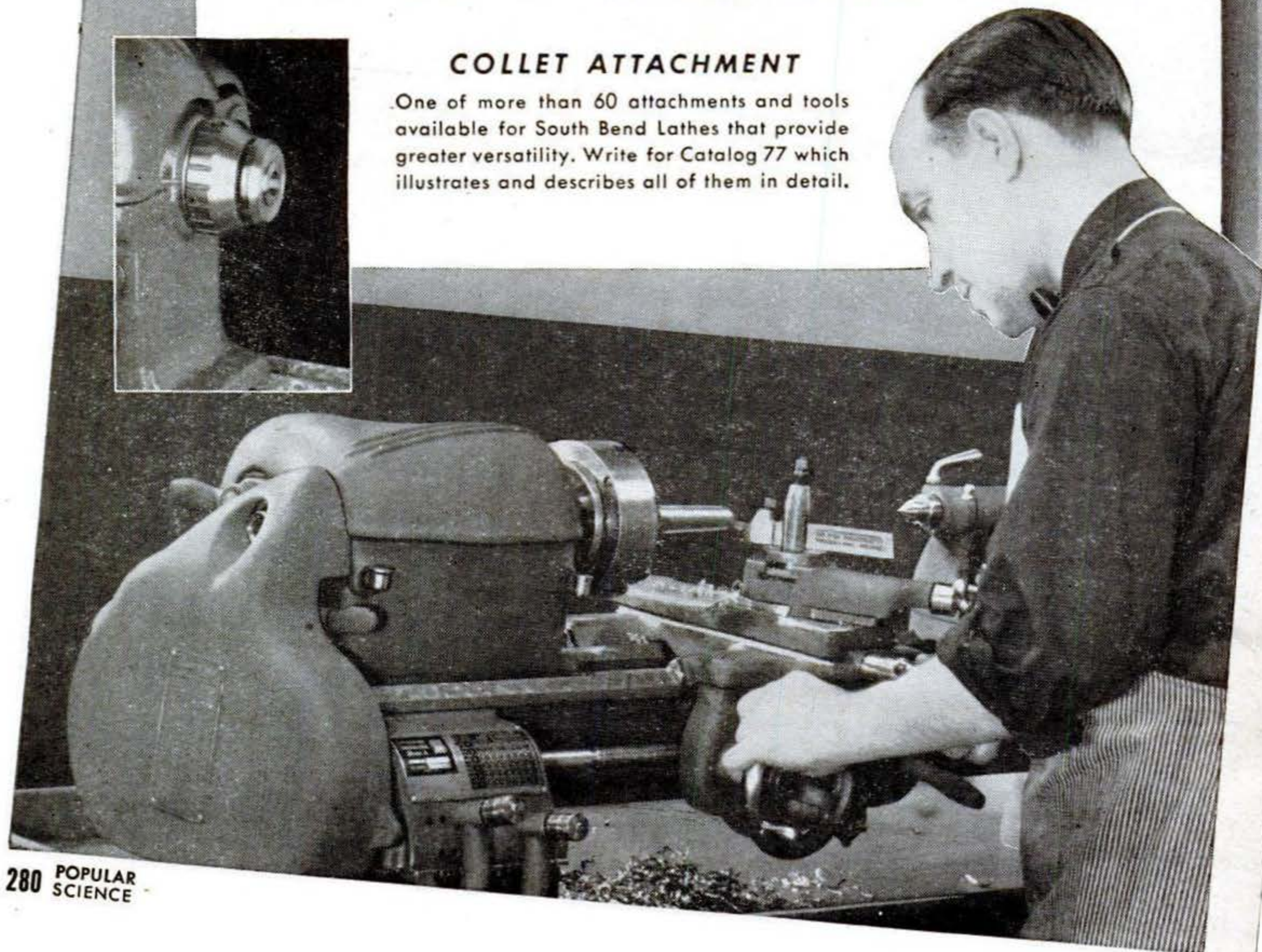



## AUDELS REFRIGERATION & AIR CONDITIONING GUIDE.....\$4

New from Cover to Cover—1280 Pages, Fully Illus. Covering basic principles, servicing, operation & repair of household, commercial & industrial refrigeration & air conditioning. A gold mine of essential important facts for engineers, servicemen, users.

## AUDELS CARPENTERS & BUILDERS GUIDES—4 Vols. ....\$6

A practical illustrated trade assistant on modern construction for carpenters, joiners, builders, mechanics and all woodworkers. 4 vols., 1600 pages, 3700 illustrations, flexible covers. Pocket size. Each volume sold separately \$1.50 a vol.

## AUDELS AUTOMOBILE GUIDE.....\$4

A practical quick ready reference book for auto mechanics, service men, operators & owners. Explains theory, construction & servicing of modern motor cars, trucks, buses & auto type Diesel engines. 1540 pages, fully illustrated. 55 chapters. Indexed. A standard book for mechanics. New fluid drive covered.

## AUDELS DIESEL ENGINE MANUAL.\$2

A practical, concise treatise with questions and answers on the theory, operation and maintenance of modern diesel engines including General Motors 2 cycle Diesel. 384 pages, fully illus., flexible binding, pocket size. All details plainly brought out, this book is of extreme value to engineers, operators & students.

## AUDELS WIRING DIAGRAMS.....\$1

210 Pages. Illustrated. Gives practical facts on wiring of electrical apparatus. It shows clearly how to wire apparatus for practically all fields of electricity. Each diagram is complete & self-explanatory. Highly Endorsed Pocket Companion.

## AUDELS PLUMBERS & STEAMFITTERS GUIDES—4 Vols. ....\$6

A Practical Trade Assistant & Ready Reference. Explains in plain language & by clear illustrations, diagrams, charts, graphs, pictures principles of modern plumbing practice including Marine Pipe Fitting and Air Conditioning. 4 Vols.—1670 Pages—3642 Diagrams. Pocket size. Each Vol. Sold Separately \$1.50 a Vol.

## AUDELS SHEETMETAL WORKERS HANDY BOOK.....\$1

Practical inside information. Fundamentals of Sheet Metal Work. 388 pages. Illustrated. 11 sections. Clearly written. Essential & important facts, figures, pointers in everyday language. Ref. Index.

## AUDELS SHEETMETAL PATTERN LAYOUTS.....\$4

Developed by Experts for Sheet Metal Workers, Layout Men & Mechanics. A Practical Encyclopedia in 10 Sections, size 7 x 10 x 2—1125 Pages—350 Layouts—1600 Illustrations. 1001 Key Facts. Fully indexed for ready reference in answering your layout problems. Covers all phases of sheet metal work including Pattern Cutting, Pattern Development & Shop Procedure.

## AUDELS ANSWERS ON BLUE PRINT READING.....\$2

For Mechanics & Builders. Covers all types of blue print reading including ship & airplane. 376 pages, fully illustrated.

## AUDELS NEW MACHINIST & TOOLMAKERS HANDY BOOK...\$4

Covers modern machine shop practice in all its branches. 5 practical books in 1. New from cover to cover. Tells how to set up & operate lathes, screw and milling machines, shapers, drill presses and all other machine tools. 1600 pages, fully illustrated, 5 x 6 1/2 x 2. Indexed. 5 sections. 1—Modern Machine Shop Practice. 2—Blue Print Reading & How to Draw. 3—Calculations & Mathematics for Machinists. 4—Shop Physics. 5—How to Use the Slide Rule. 60 chapters. Easy to read and understand. A shop companion that answers your questions.

## AUDELS MATHEMATICS & CALCULATIONS FOR MECHANICS \$2

Mathematics for home study or reference. 700 pages, 550 illus. Practical mathematics from beginning. How to figure correctly. Easy, correct methods covering a complete review. Ill. & Indexed.

## AUDELS HANDY BOOK OF PRACTICAL ELECTRICITY.....\$4

For maintenance engineers, electricians & all electrical workers. 1440 Pages, 2600 illus. Covers important electrical information in handy form—including Marine Wiring, Radio Principles, Welding. Indexed. A Key to a practical understanding of electricity.

## AUDELS RADIOMANS GUIDE.....\$4

A key to the practical understanding of radio including Frequency Modulation, Television, etc., Aircraft & Marine Radio. For radio engineers, servicemen, amateurs. 772 pages. 400 Illustrations & Diagrams. Photos. Review Questions & Answers, Reference Index. Authentic, clear, concise.

## AUDELS ELECTRONIC DEVICES...\$2

Tells What You Want to Know About Electric Eye. Easily Understood. Covers photo-electric cells & their applications. Amplifiers, illumination, frequencies, voltage, photocell, tubes, Ohm's Law, wiring diagrams, etc.

## AUDELS WELDERS GUIDE.....\$1

A concise, practical text on operation & maintenance of all welding machines for all mechanics. Over 400 pages, illustrated. Covers all methods of electric and acetylene welding including airplane work.

**AUDEL, Publishers, 49 W. 23 St., N. Y. 10**

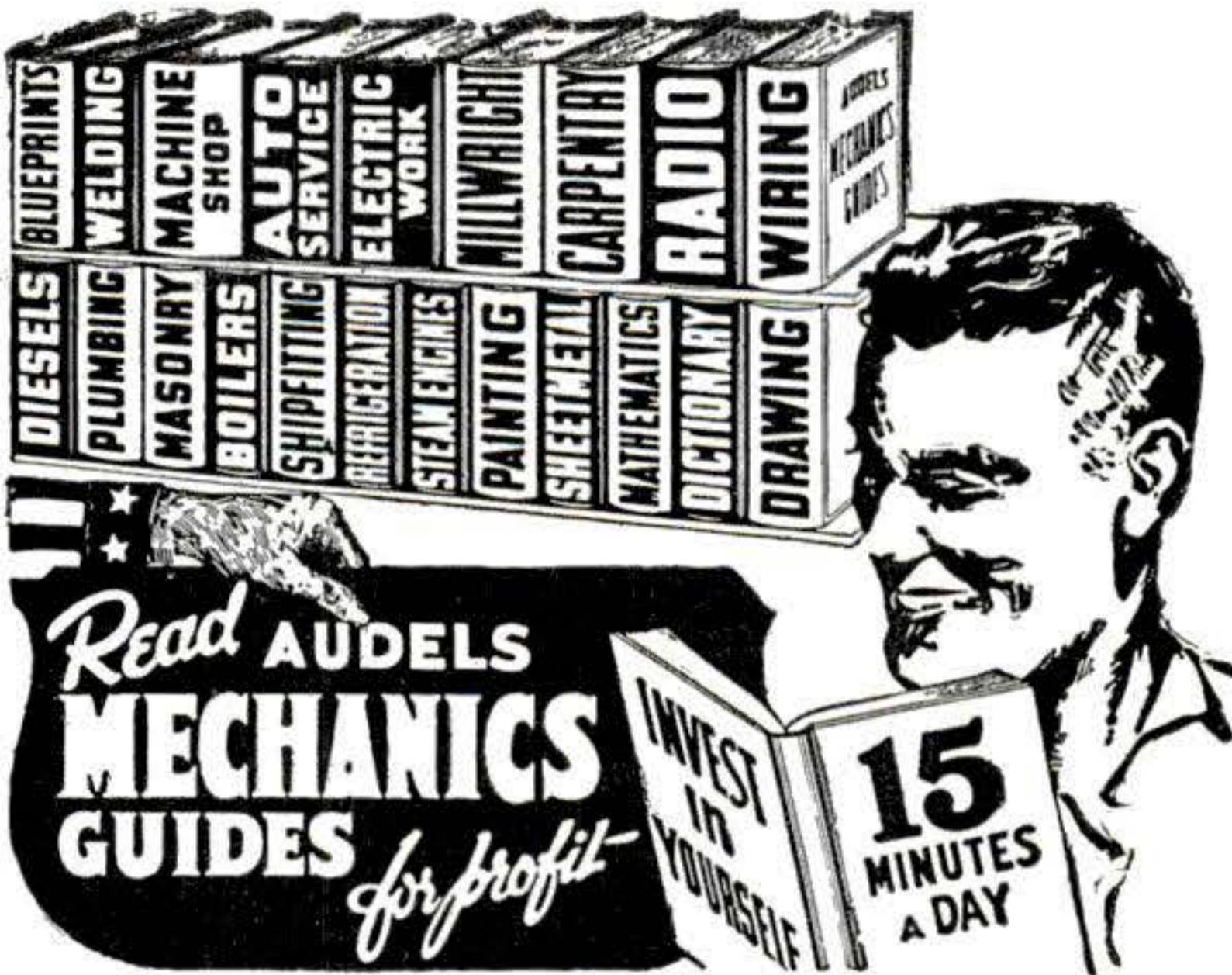

## AN AUDEL GUIDE IS A GOOD FRIEND!

Use the brains and experience of others in these Guides of the Trades. Save time and money with right methods, short cuts, labor saving ideas. CHECK NOW! You can look over any Audel Guide in your home. Start the Easy Payments if satisfied.

# CUT HERE MAIL ORDER

THEO. AUDEL & CO., 49 W. 23 St., New York 10, N. Y.

Please mail me for 7 days' free examination the books marked (X) below. I agree to mail \$1 in 7 days on each book or set ordered, and to further mail \$1 a month on each book or set ordered until I have paid purchase price.

If I am not satisfied with Guides I will return them.

- Audels OIL BURNER GUIDE . . . . . \$1.
- Audels REFRIGERATION & Air Conditioning Guide. 4.
- Audels POWER PLANT ENGINEERS GUIDE . . . . . 4.
- Audels PUMPS, HYDRAULICS & AIR COMPRESSORS . . . . . 4.
- Audels WELDERS GUIDE . . . . . 1.
- Audels BLUE PRINT READING . . . . . 2.
- Audels SHEET METAL WORKERS Handy Book . . . . . 1.
- Audels SHEET METAL PATTERN LAYOUTS . . . . . 4.
- Audels AIRCRAFT WORKER . . . . . 1.
- Audels MATHEMATICS and CALCULATIONS . . . . . 2.
- Audels MACHINISTS & TOOLMAKERS Handy Book . . . . . 4.
- Audels MECHANICAL Dictionary . . . . . 4.
- Audels AUTOMOBILE GUIDE . . . . . 4.
- Audels DIESEL ENGINE MANUAL . . . . . 2.
- Audels MARINE ENGINEERS Handy Book . . . . . 4.
- Audels SHIPFITTERS Handy Book . . . . . 1.
- Gueths MECHANICAL DRAWING COURSE . . . . . 1.
- Rogers DRAWING and DESIGN . . . . . 2.
- Audels MILLWRIGHTS and Mechanics Guide . . . . . 4.
- Audels CARPENTERS and Builders Guides (4 vols.) . . . . . 6.
- Audels PLUMBERS and Steamfitters Guides (4 vols.) . . . . . 6.
- Audels MASONS and Builders Guides (4 vols.) . . . . . 6.
- Master PAINTER and DECORATOR . . . . . 2.
- Audels GARDENERS & GROWERS GUIDES (4 vols.) . . . . . 6.
- Audels ENGINEERS & FIREMANS EXAMINATIONS . . . . . 1.
- Audels ENGINEERS and Mechanics Guides . . . . . 12.
- Nos. 1, 2, 3, 4, 5, 6, 7 and 8 complete . . . . . 12.
- Audels Answers on Practical ENGINEERING . . . . . 1.
- Audels ELECTRICIANS EXAMINATIONS . . . . . 1.
- Audels WIRING DIAGRAMS . . . . . 1.
- Audels Handy Book of PRACTICAL ELECTRICITY . . . . . 4.
- Audels ELECTRICAL POWER CALCULATIONS . . . . . 2.
- Audels ELECTRONIC DEVICES . . . . . 2.
- Audels ELECTRIC Dictionary . . . . . 2.
- Audels RADIOMANS GUIDE . . . . . 4.
- Audels NEW ELECTRIC LIBRARY at \$1.50 a Volume . . . . . 4.
- Vols. I, II, III, IV, V, VI, VII, VIII, IX, X, XI, XII

Name \_\_\_\_\_

Address \_\_\_\_\_

Occupation \_\_\_\_\_

Employed by \_\_\_\_\_ PSM



**EXPERIENCE  
IS THE BEST  
TEACHER!**

Mrs. Dorothy Newstead  
has followed the  
trail of game fish  
to the Atlantic  
and Pacific.

*Mrs. Dorothy Allan  
Newstead*

Holder of the  
International  
Women's All-  
Tackle Record  
for Cobia

A record catch!  
The rare yellow-  
bellied cobia  
landed by  
Mrs. Dorothy  
Newstead.

**EXPERIENCE IS  
THE BEST TEACHER...  
IN DEEP-SEA FISHING...  
IN CIGARETTES TOO!  
CAMELS SUIT ME TO A T**

More people are smoking CAMELS today than ever before in history!

**M**RS. DOROTHY NEWSTEAD speaking:  
"During the war shortage, I smoked many dif-  
ferent brands. And that's when I found that Camels  
suit my 'T-Zone' best!"

You and millions of other smokers, Mrs. Newstead.

Result: *Today more people are smoking Camels  
than ever before.* But, no matter how great the  
demand:

*Camel quality is not to be tampered with.  
Only choice tobaccos, properly aged, and  
blended in the time-honored Camel way,  
are used in Camels.*

*According to a recent Nationwide survey:*

**MORE DOCTORS  
SMOKE CAMELS**  
*than any other cigarette*

Three nationally known independent research organiza-  
tions asked 113,597 doctors to name the cigarette they  
smoked. More doctors named Camel than any other brand.

**YOUR 'T-ZONE'  
WILL TELL YOU...**

**T for Taste...**

**T for Throat...**

That's your proving ground for any  
cigarette. See if Camels don't  
suit your 'T-Zone' to a 'T'



R. J. Reynolds Tobacco Co.  
Winston-Salem, N. C.