

POPULAR SCIENCE

75TH ANNIVERSARY
ISSUE

MAY 30 1947

MAY 1947
25 CENTS

MONTHLY

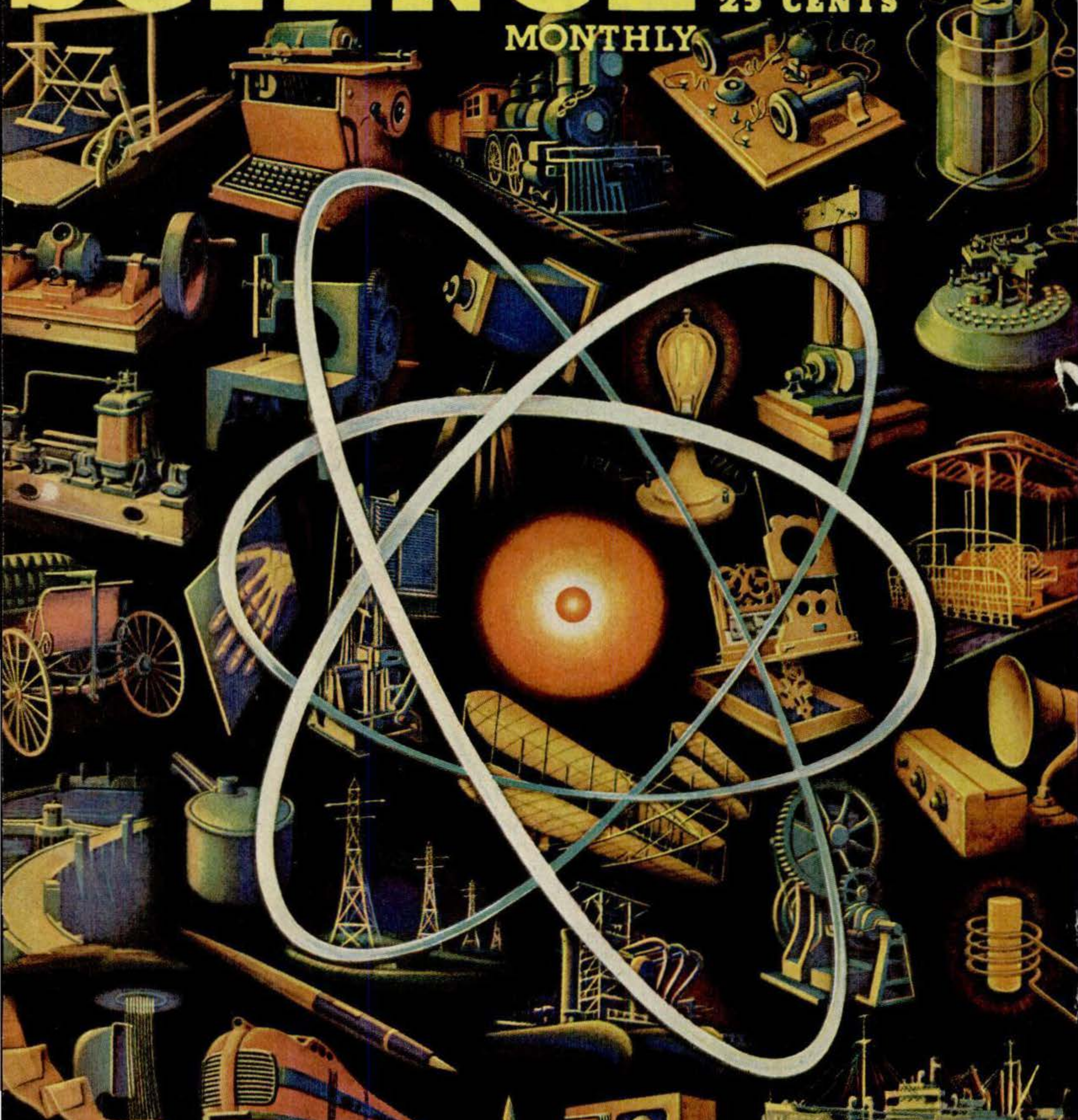

Science Never Stops

p. 82

FOR
**EASIER-TO-TAKE
 BETTER PICTURES**

The
KALART
 MASTER AUTOMATIC
Speed Flash

GIVES YOU THE THRILL OF
 PROPERLY EXPOSED, CLEAR,
 SHARP BRILLIANT PICTURES
 . . . INDOORS OR OUTDOORS

- Synchronizes "Between-the-Lens" shutters at all speeds with all flash bulbs including SM and SF.
- Does not drain batteries — opens shutter mechanically, using battery only for bulb flash!
- Easy "on-and-off" attachment by owner! No holes, or permanent brackets to mar camera!

**PLACE
 YOUR
 CAMERA
 HERE!**



\$24.60
 COMPLETE
 INC. FED. TAX

OTHER KALART
 SPEED FLASH
 MODELS \$8.95 UP

THERE'S A **KALART Speed Flash** FOR ALMOST EVERY CAMERA



Free!

Address KALART, Dept. PS-5 Stamford, Conn. for free booklet, "How To Take Speed Flash Pictures of Baby." Packed with ideas. Simple, easy instructions! Write today!



KALART

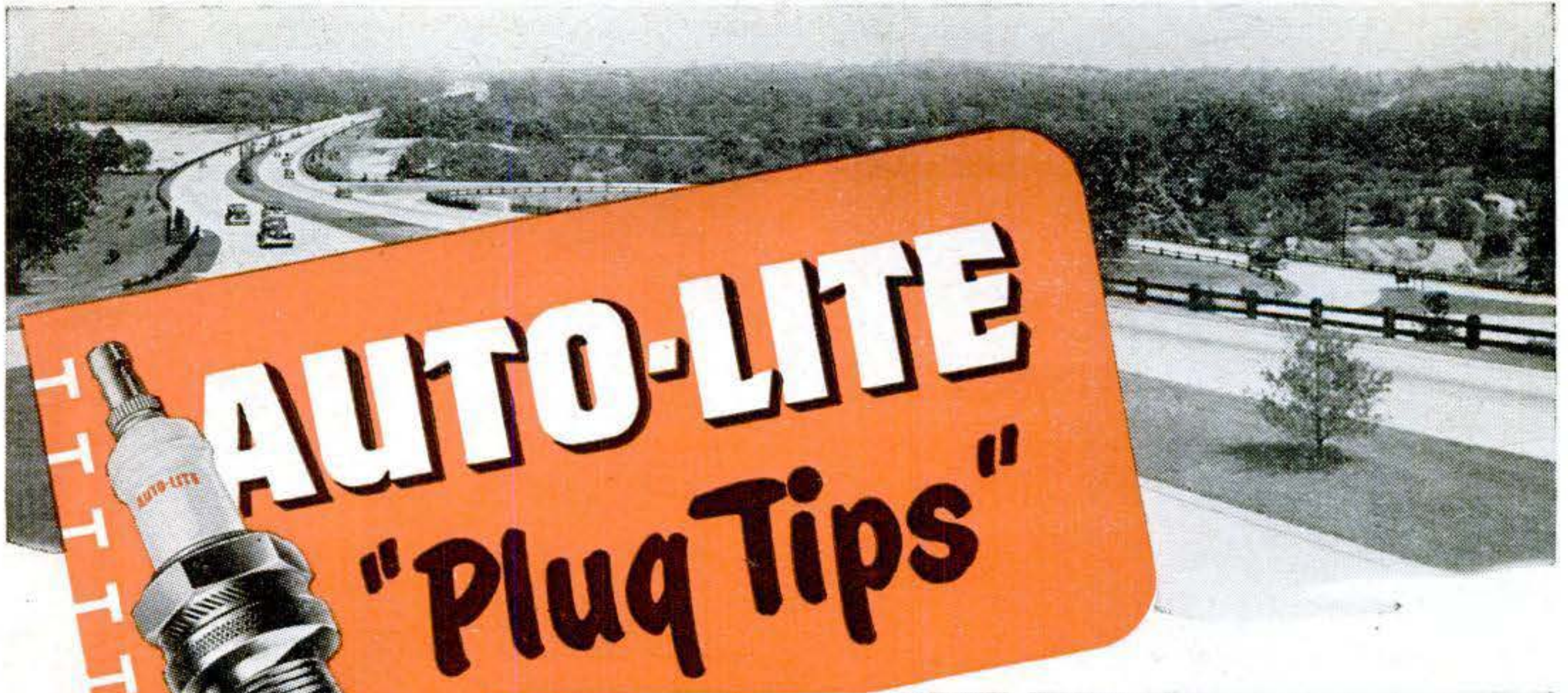

AUTO-LITE "Plug Tips"

Are your plugs wasting time and money?

The right type of spark plug will save you time and money. Plugs which are faulty and mis-fire waste as high as 10 per cent of your fuel, according to experts. And hard-to-start engines can lose valuable time. Check all your spark plugs regularly to make sure you have the right plugs for your engines.

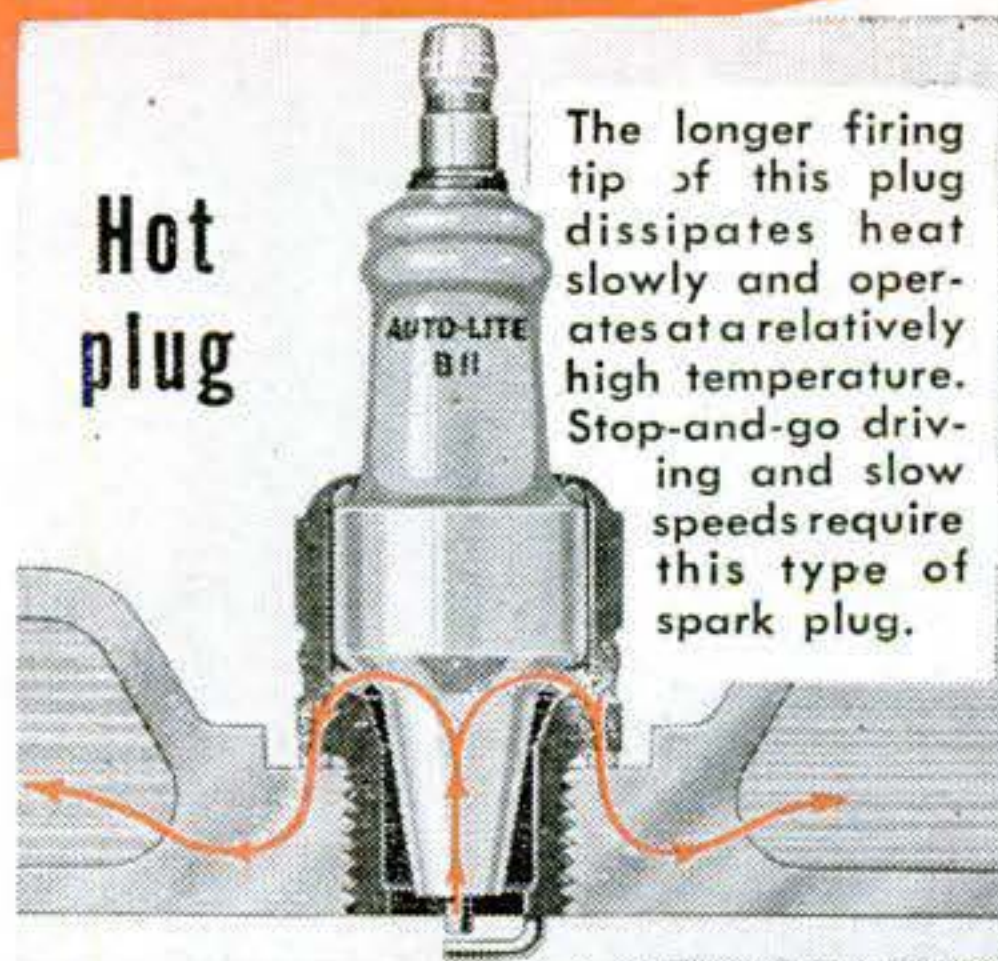

Hot plug

The longer firing tip of this plug dissipates heat slowly and operates at a relatively high temperature. Stop-and-go driving and slow speeds require this type of spark plug.

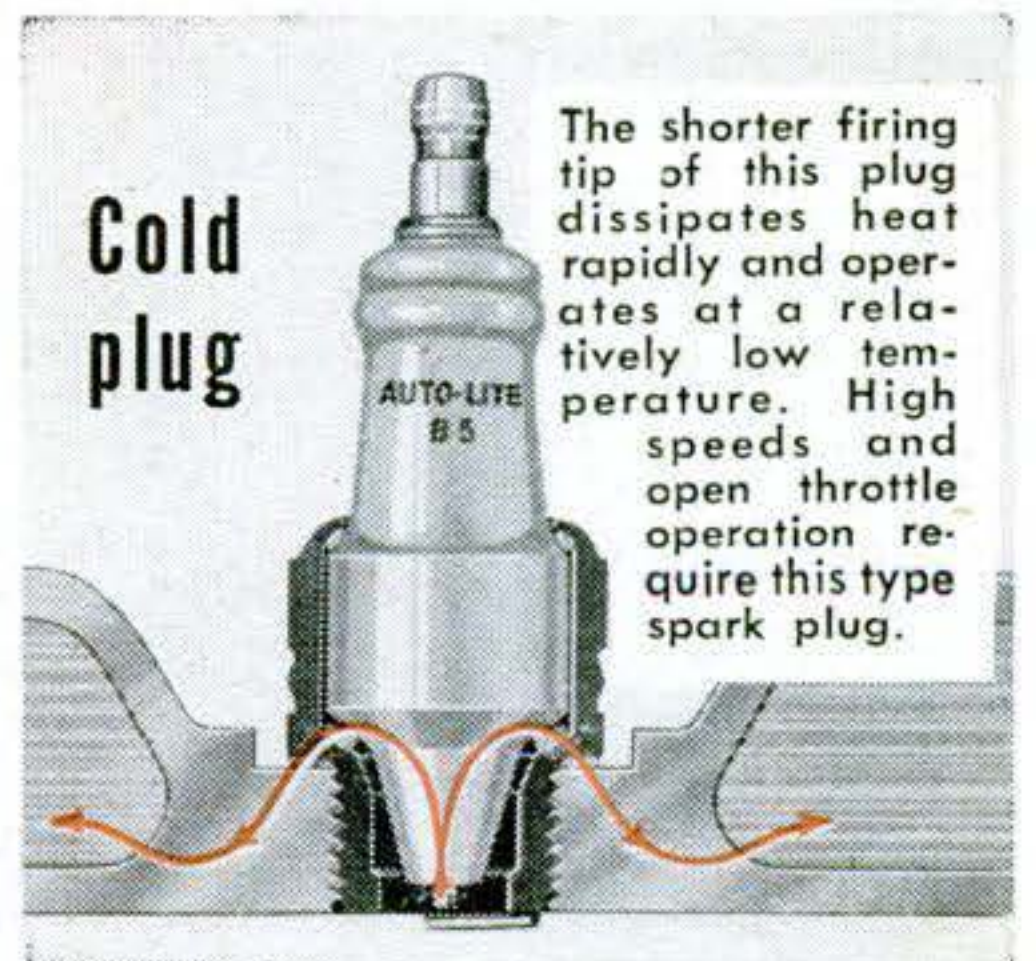

Cold plug

The shorter firing tip of this plug dissipates heat rapidly and operates at a relatively low temperature. High speeds and open throttle operation require this type spark plug.

Send for Auto-Lite "Plug-Chek" kit...only 10¢!



Too Hot *

If spark plug firing tips are fused or blistered, plugs are operating too hot and may be causing loss of power and damaging spark knock.



Normal *

If spark plugs look like this, they are of correct heat range. Get your Auto-Lite "Plug-Chek" Kit right now and check your spark plugs.



Too Cold *

If spark plug firing tips show deposits of carbon or are wet with oil, plugs are too cold, may cause poor starting and waste dollars in costly gas.

This Auto-Lite "Plug-Chek" Kit quickly helps you find spark plugs that are causing trouble. All you do is match plugs with pictures on the "Plug-Chek" Indicator—each example refers to a page in the "Plug-Chek" Data Book that shows you what to do.



* Because these illustrations are not in full color, they do not accurately reproduce the actual firing tip appearance. For accurate, full color reproduction, mail the coupon.

Switch to
AUTO-LITE
SPARK PLUGS

THE ELECTRIC AUTO-LITE COMPANY
Department P52, Toledo 1, Ohio

Enclosed find ten cents for the Auto-Lite "Plug-Chek" Kit that includes both the "Plug-Chek" Indicator and Data Book.

Name _____

Address _____

City _____

POPULAR SCIENCE

Mechanics & Handicraft MONTHLY
REG. U. S. PAT. OFF.

EDITOR:
Perry Githens

MANAGING EDITORS: Fred O. Newman, Volta Torrey

ART EDITOR: Howard C. Jensen

HOME & WORKSHOP EDITOR:
Harry Walton

ASSOCIATE EDITORS: Devon Francis, Robert Gorman,
Hartley E. Howe, Herbert Johansen, Martin Mann,
Frank Rowsome, Jr., John F. Stearns, R. P. Stevenson

WASHINGTON EDITOR: Leon Shloss

WESTERN EDITOR: Andrew R. Boone (Los Angeles, Cal.)

ART DIRECTORS: Harry Samuels, Francis Sweeney

ART ASSOCIATES: Eric Karminski, Jr., Stewart Rouse,
Frances Cooper (Production)

STAFF PHOTOGRAPHERS: W. W. Morris, Hubert Lockett,
Robert F. Smith

EDITORIAL ASSISTANTS: Mae G. Dyer (Chief), Carol Ennis,
Sheldon Gallager, Saverio Rada, Lillian Thalenfeld,
Ruth Westphal

PUBLISHER:
Godfrey Hammond

MAY 1947

SCIENCE AT WORK

Testers "Hug" New Cars..... 91
Chicken-wire Ocean Tests Navy's Eyes 92
Davy Jones's Party Line.....148

PSM FEATURES

How Fast Is 3,000 m.p.h.?.....119
Mower Wheel Gets the Edges.....146
How to Fire Up a Live Steamer.....166
Putting Water to Work (Part II).....180
Spontaneous Combustion.....212
Seen in a Candle Flame.....218

AVIATION

One-ton Howitzer Hits the Silk..... 94
Tests Tires Visually.....102
Eagle-eyed Radar.....103
Spokes Test Planes.....104
AAF Tests First Four-jet Bomber.....105
Ryan XF2R-1 (Pin-up).....113
Looking into the XB-35.....117
"Pioneer" for Frontier Flying.....120
Who's Who in Foreign Air.....121

75th ANNIVERSARY FEATURES

Picture of the Month..... 81
Science Never Stops..... 82
Educating a Scientist..... 88
"Young Men of Science"..... 90
The Growing Years of Science.....122
Measurements Unlimited.....124
Science in 1872.....127
Covers That Came True.....132
These Men Helped Popularize Science....134
America's First Evangelist of Science....137
Like to See Edison's Laboratory?.....142

SCIENCE NEWS

Inside the Biggest Man-made Brain..... 95
Televising Surgery.....100
Maxwell's Demon Comes to Life.....144
Fuse Looks for Target.....147

AUTOMOBILES

Mechanics Win the Races.....107
Auto Ideas.....154
Land Cruiser.....155
Tune Your Car for Vacation.....156
Gus Settles an Incident.....160

INVENTIONS

New Ideas from the Inventors.....114
I'd Like to See Them Make.....118
Timber Rides Skyhook.....147

PHOTOGRAPHY

Camera Coughs Out Finished Prints.....150
Shadow Backgrounds Set Moods.....198
Darkroom in a Box.....201
Photo Ideas and Equipment.....202

(CONTINUED ON PAGE 4)

Published monthly at 353 Fourth Avenue, New York 10, N. Y., by Popular Science Publishing Co., Inc. Godfrey Hammond, President and Treasurer; R. C. Wilson, Raymond J. Brown, Stephen P. Glennon, B. Ray Keefer, Vice-Presidents; F. W. Briggs, Secretary. Entered as second-class matter Dec. 28, 1918, at the Post Office at New York under the act of March 3, 1879; additional entry as second-class matter at Dayton, Ohio. Entered as second-class matter at the Post Office Department, Canada. Printed in U. S. A. Copyright, 1947, by Popular Science Publishing Co., Inc. All rights reserved in the United States, Great Britain, and in all countries participating in the International Copyright Convention and Pan-American Copyright Convention. Yearly subscriptions to United States, its possessions and Canada, \$2.50; foreign countries, \$3.50. Subscribers must notify us of change of address four weeks in advance of the next publication date. Be sure to give both old and new addresses, including zone numbers.

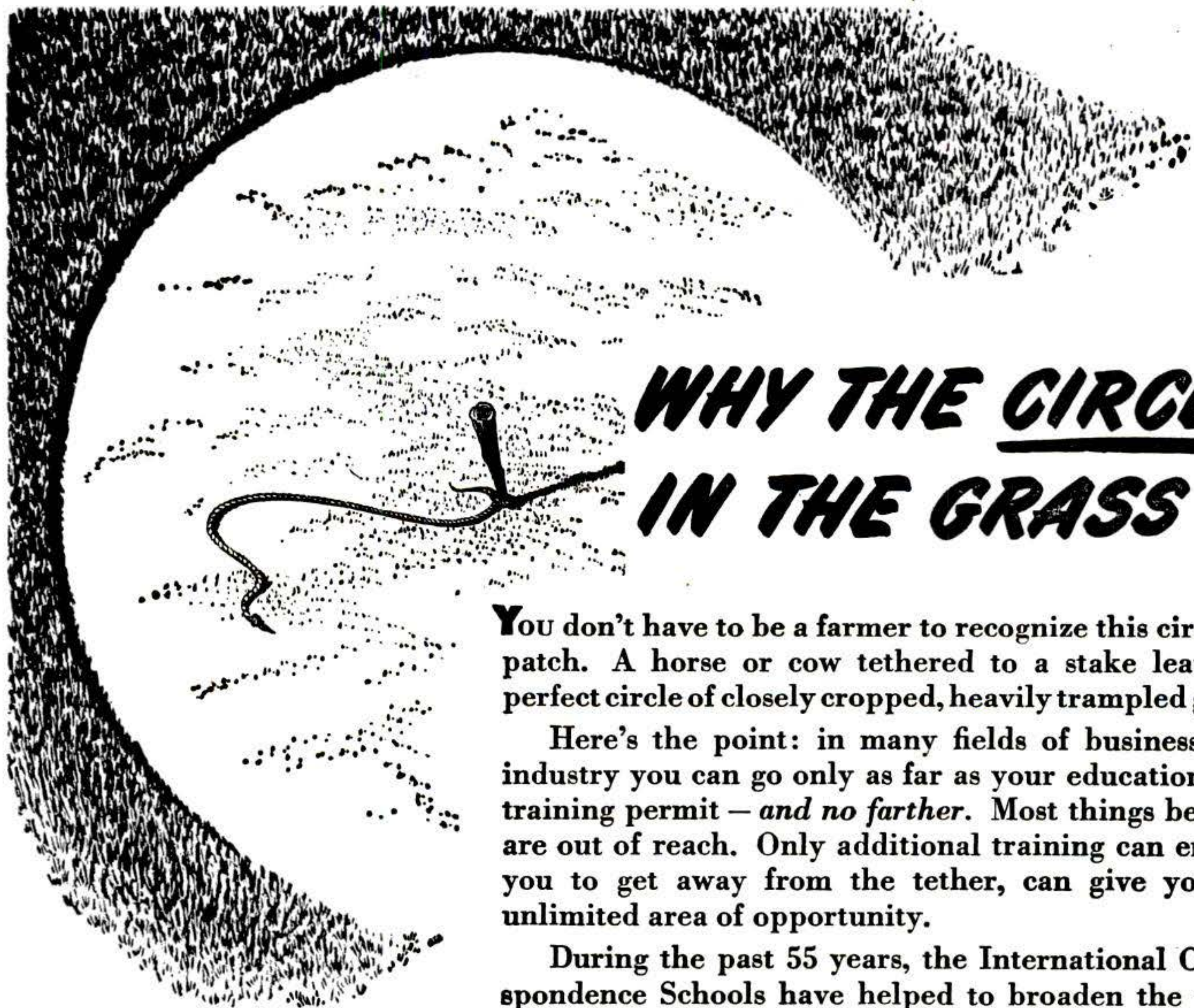

WHY THE CIRCLE IN THE GRASS?

You don't have to be a farmer to recognize this circular patch. A horse or cow tethered to a stake leaves a perfect circle of closely cropped, heavily trampled grass.

Here's the point: in many fields of business and industry you can go only as far as your education and training permit — *and no farther*. Most things beyond are out of reach. Only additional training can enable you to get away from the tether, can give you an unlimited area of opportunity.

During the past 55 years, the International Correspondence Schools have helped to broaden the vocational scope for more than 5,000,000 men like yourself.

INTERNATIONAL CORRESPONDENCE SCHOOLS



BOX 7682-L, SCRANTON 9, PENNA.

Without cost or obligation, please send me full particulars about the course *before* which I have marked X:

- | | | | |
|---|---|---|--|
| <p>Air Conditioning and Plumbing Courses</p> <input type="checkbox"/> Air Conditioning
<input type="checkbox"/> Heating <input type="checkbox"/> Plumbing
<input type="checkbox"/> Refrigeration <input type="checkbox"/> Steam Fitting <p>Chemistry Courses</p> <input type="checkbox"/> Chemical Engineering
<input type="checkbox"/> Chemistry, Analytical
<input type="checkbox"/> Chemistry, Industrial
<input type="checkbox"/> Chemistry, Mfg. Iron & Steel
<input type="checkbox"/> Petroleum Refining <input type="checkbox"/> Plastics
<input type="checkbox"/> Pulp and Paper Making <p>Civil Engineering, Architectural and Mining Courses</p> <input type="checkbox"/> Architectural Drafting
<input type="checkbox"/> Architecture
<input type="checkbox"/> Bridge and Building Foreman
<input type="checkbox"/> Building Estimating
<input type="checkbox"/> Civil Engineering
<input type="checkbox"/> Coal Mining
<input type="checkbox"/> Contracting and Building
<input type="checkbox"/> Highway Engineering
<input type="checkbox"/> Lumber Dealer
<input type="checkbox"/> Reading Structural Blueprints
<input type="checkbox"/> Sanitary Engineering
<input type="checkbox"/> Structural Drafting | <p><input type="checkbox"/> Structural Engineering
 <input type="checkbox"/> Surveying and Mapping</p> <p>Communications Courses</p> <input type="checkbox"/> Electronics
<input type="checkbox"/> Practical Telephony
<input type="checkbox"/> Radio, General
<input type="checkbox"/> Radio Operating
<input type="checkbox"/> Radio Servicing
<input type="checkbox"/> Telegraph Engineering <p>Electrical Courses</p> <input type="checkbox"/> Electrical Drafting
<input type="checkbox"/> Electrical Engineering
<input type="checkbox"/> Electric Light and Power
<input type="checkbox"/> Lighting Technician
<input type="checkbox"/> Practical Electrician <p>Internal Combustion Engines Courses</p> <input type="checkbox"/> Auto Technician <input type="checkbox"/> Aviation
<input type="checkbox"/> Diesel-Electric
<input type="checkbox"/> Diesel Engines <input type="checkbox"/> Gas Engines <p>Mechanical Courses</p> <input type="checkbox"/> Aeronautical Engineering
<input type="checkbox"/> Aircraft Drafting
<input type="checkbox"/> Flight Engineer
<input type="checkbox"/> Foundry Work
<input type="checkbox"/> Heat Treatment of Metals | <p><input type="checkbox"/> Industrial Engineering
 <input type="checkbox"/> Industrial Metallurgy
 <input type="checkbox"/> Machine Shop
 <input type="checkbox"/> Mechanical Drafting
 <input type="checkbox"/> Mechanical Engineering
 <input type="checkbox"/> Mold-Loft Work
 <input type="checkbox"/> Patternmaking—Wood, Metal
 <input type="checkbox"/> Reading Shop Blueprints
 <input type="checkbox"/> Sheet-Metal Drafting
 <input type="checkbox"/> Sheet-Metal Worker
 <input type="checkbox"/> Ship Drafting <input type="checkbox"/> Ship Fitting
 <input type="checkbox"/> Tool Designing
 <input type="checkbox"/> Toolmaking
 <input type="checkbox"/> Welding—Gas and Electric</p> <p>Railroad Courses</p> <input type="checkbox"/> Air Brake <input type="checkbox"/> Car Inspector
<input type="checkbox"/> Diesel Locomotive
<input type="checkbox"/> Locomotive Engineer
<input type="checkbox"/> Locomotive Fireman
<input type="checkbox"/> Railroad Section Foreman <p>Steam Engineering Courses</p> <input type="checkbox"/> Boilermaking
<input type="checkbox"/> Combustion Engineering
<input type="checkbox"/> Engine Running
<input type="checkbox"/> Marine Engineering
<input type="checkbox"/> Steam Electric <input type="checkbox"/> Steam Engines | <p>Textile Courses</p> <input type="checkbox"/> Cotton Manufacturing
<input type="checkbox"/> Rayon Weaving
<input type="checkbox"/> Textile Designing
<input type="checkbox"/> Woolen Manufacturing <p>Business and Academic Courses</p> <input type="checkbox"/> Accounting <input type="checkbox"/> Advertising
<input type="checkbox"/> Arithmetic <input type="checkbox"/> Bookkeeping
<input type="checkbox"/> Business Correspondence
<input type="checkbox"/> Business Management
<input type="checkbox"/> Certified Public Accounting
<input type="checkbox"/> Commercial
<input type="checkbox"/> Cost Accounting
<input type="checkbox"/> Federal Tax
<input type="checkbox"/> First Year College
<input type="checkbox"/> Foremanship <input type="checkbox"/> French
<input type="checkbox"/> Good English <input type="checkbox"/> High School
<input type="checkbox"/> Higher Mathematics
<input type="checkbox"/> Illustrating <input type="checkbox"/> Motor Traffic
<input type="checkbox"/> Postal Service
<input type="checkbox"/> Salesmanship <input type="checkbox"/> Secretarial
<input type="checkbox"/> Sign Lettering
<input type="checkbox"/> Spanish <input type="checkbox"/> Stenography
<input type="checkbox"/> Traffic Management |
|---|---|---|--|

Name _____ Age _____ Home Address _____

City _____ State _____ Present Position _____

Working Hours _____ A.M. to _____ P.M. Length of Service in World War II _____

Special tuition rates to members of the Armed Forces. Enrollment under the G.I. Bill of Rights approved for War II Veterans.
 Canadian residents send coupon to International Correspondence Schools Canadian, Ltd., Montreal, Canada.

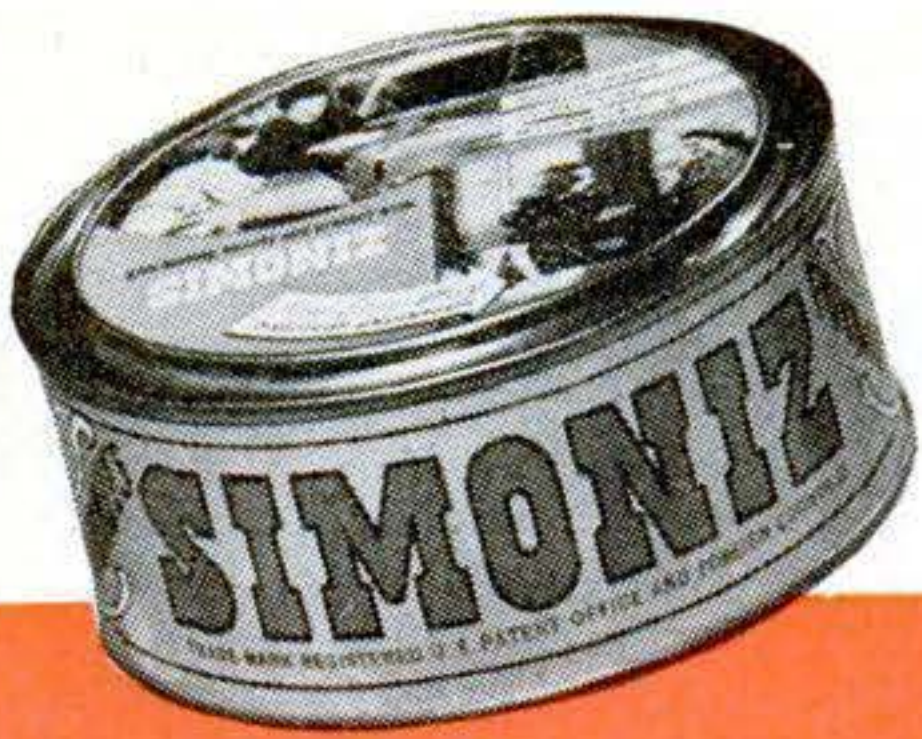

Simoniz Gives Your Car Lasting Glamour

First step before vacation travel—SIMONIZ! It starts you off with a car more beautiful than ever . . . and keeps it that way mile after mile. The finish is protected against ultra violet rays, corrosive airborne chemicals and road grit that dull and destroy. Then, at the trip's end, dust and dirt are whisked away with a dry cloth . . . and the finish sparkles brighter than ever. Insist on SIMONIZ—your car deserves it!

TO RESTORE NEW BEAUTY to dull finishes . . . use the Simoniz Kleeners—*liquid* when it's in average condition . . . *paste* when the finish is exceptionally dull. Then apply SIMONIZ to make that sparkling finish last years longer. Sold everywhere.

THE SIMONIZ COMPANY, Chicago 16, Ill.

"SIMONIZ". . . Trade Mark Reg.
U. S. Pat. Off. and Foreign Countries



Motorists Wise
SIMONIZ

MECHANICS & SHOPCRAFT

Abrasive Sheet Torn for Sander.....	171
New Shop Ideas.....	190
Vertical Steam Engine (Part II).....	192
Arbor for Turning Wheels.....	196
Rubber Washers Made in Lathe.....	197
Concrete Aggregate.....	197
Brad Spreads Split Rivet.....	217
Screen Disks Form Wire Brush.....	217

HOME MECHANICS & HANDICRAFT

Dry-cell Lamp Goes Anywhere.....	164
All-metal Matchbook Case.....	168
Steamboat Race Game.....	169
Two-tone Veneered Bowl.....	170
Tennis-court Brush from Brooms.....	171
Nontip Chair Tray.....	172
Tools Carried in Glass Case.....	172
Installing Mortise Door Locks.....	176
Plywood Screw Fastenings.....	178
Roller Runway for Launching Boat.....	179
Garden Hints.....	184
Stressed-paper Control-line Plane.....	186
Paint for Frosting Windows.....	196
Cardboard Guards Piano Finish.....	197
Freeing Broken Shovel Handle.....	197
Bird House of Packing-case Wood.....	216
Clothes Separator in Laundry Chute....	217
Build True to Sail True.....	220
Lawn-mower Sharpener.....	224

RADIO & ELECTRICITY

Transmitters Shrink to Lipstick Size.....	101
300 Volts in the Palm of Your Hand.....	106
Blowing Big Bubbles.....	151
Businessman's Radio Fits Briefcase.....	204
FM Converter.....	208
FM Antennas.....	209
Output Meter Uses 1½-volt Tube.....	210
Underwriters' Knot	211

DEPARTMENTS

Voice of Science.....	7
Letters.....	16
Aids to Modern Living.....	152
New Tools.....	173
Keeping the Home Shipshape.....	174
What's Your Ingenuity Quotient?.....	185
News in Electronics.....	208
Garden Gadgets.....	224
Editorial Memo.....	286

**"What's he got
that I haven't got?"**

LOOK at the successful men you know. "What have they got" that you haven't?

Very little, probably. In most ways these men are no brighter or naturally more capable than average. Many of them probably have no more formal education or better natural aptitudes than you.

But that little extra they have is important. They have the special knowledge and ability for which business is glad to pay well—they know the what, why and how of business. They have also the confidence and aggressiveness which come from knowing that they know and can apply their knowledge.

You may add that extra—may get that same profitable knowledge and ability—that same confidence and aggressiveness—if you are willing to pay the price in earnest, necessary study. For LaSalle has spent 38 years developing, testing and proving, with over a million student members, spare-time success training in certain specialized business fields. What scores of thousands of men and women—many just like you—have done, you should be able to do.

You need not leave your home or interrupt your job; you need pay comparatively little money. But you must be ambitious and willing to study seriously. And soon after you start training, the results will begin to show up in your own confidence and in your work. For what you learn at home tonight is so practical that often you can apply it on the job tomorrow.

How much do you want success—more money, a promotion or a new job, prestige and responsibility? If you really want it, you will use the coupon below to find out what LaSalle training can do for you. It costs only a postage stamp, but a coupon like it has been the starting point to real success for scores of thousands—and can be for you.



G. I. APPROVED

LA SALLE Extension University
A Correspondence Institution

Dept. 583-R • 417 S. Dearborn • Chicago 5, Ill.

I want to know how LaSalle can help me win success in the field I have checked below. Please send me your free 48-page booklet about that field and your success training in it.

- | | |
|--|--|
| <input type="checkbox"/> Accountancy | <input type="checkbox"/> Salesmanship |
| <input type="checkbox"/> Bookkeeping | <input type="checkbox"/> Effective Speaking |
| <input type="checkbox"/> C.P.A. Coaching | <input type="checkbox"/> Executive Management |
| <input type="checkbox"/> Business English | <input type="checkbox"/> Industrial Management |
| <input type="checkbox"/> Law: LL.B. degree | <input type="checkbox"/> Traffic Management |
| <input type="checkbox"/> Foremanship | <input type="checkbox"/> Stenotypy (Machine Shorthand) |

Name.....Age.....

Position.....

Address.....

City, Zone and State.....

LA SALLE EXTENSION UNIVERSITY
A Correspondence Institution

MAY 5
1947

Long-distance Television is twenty years old



At the 1927 demonstration, Dr. Herbert E. Ives explained the television system developed in Bell Telephone Laboratories.

APRIL 7 is a notable day in communication history, for on that day in 1927 was the first demonstration of television over long distances. Large-scale images were flashed from Washington, D. C., by wire and from Whippany, N. J., by radio to a demonstration in New York City. "It was," said a newspaper, "as if a photograph had suddenly come to life and begun to smile, talk, nod its head and look this way and that."

That was the first of many public demonstrations, each to mark an advance in the television art. In 1929 came color television, and in 1930 a two-way system between the headquarters buildings of A. T. & T. and Bell Laboratories. When

the first coaxial cable was installed in 1937, television signals for 240-line pictures were transmitted between Philadelphia and New York and three years later 441-line signals were transmitted. By May, 1941, successful experiments had been made on an 800-mile circuit.

End of the war brought a heightened tempo of development. Early in 1946 began the regular experimental use of coaxial cable for television between New York and Washington, and a few months later a microwave system for television transmission was demonstrated in California.

Transmission facilities will keep pace as a great art advances to wide public usefulness.

BELL TELEPHONE LABORATORIES



Exploring and inventing, devising and perfecting, for continued improvements and economies in telephone service

6 POPULAR
SCIENCE

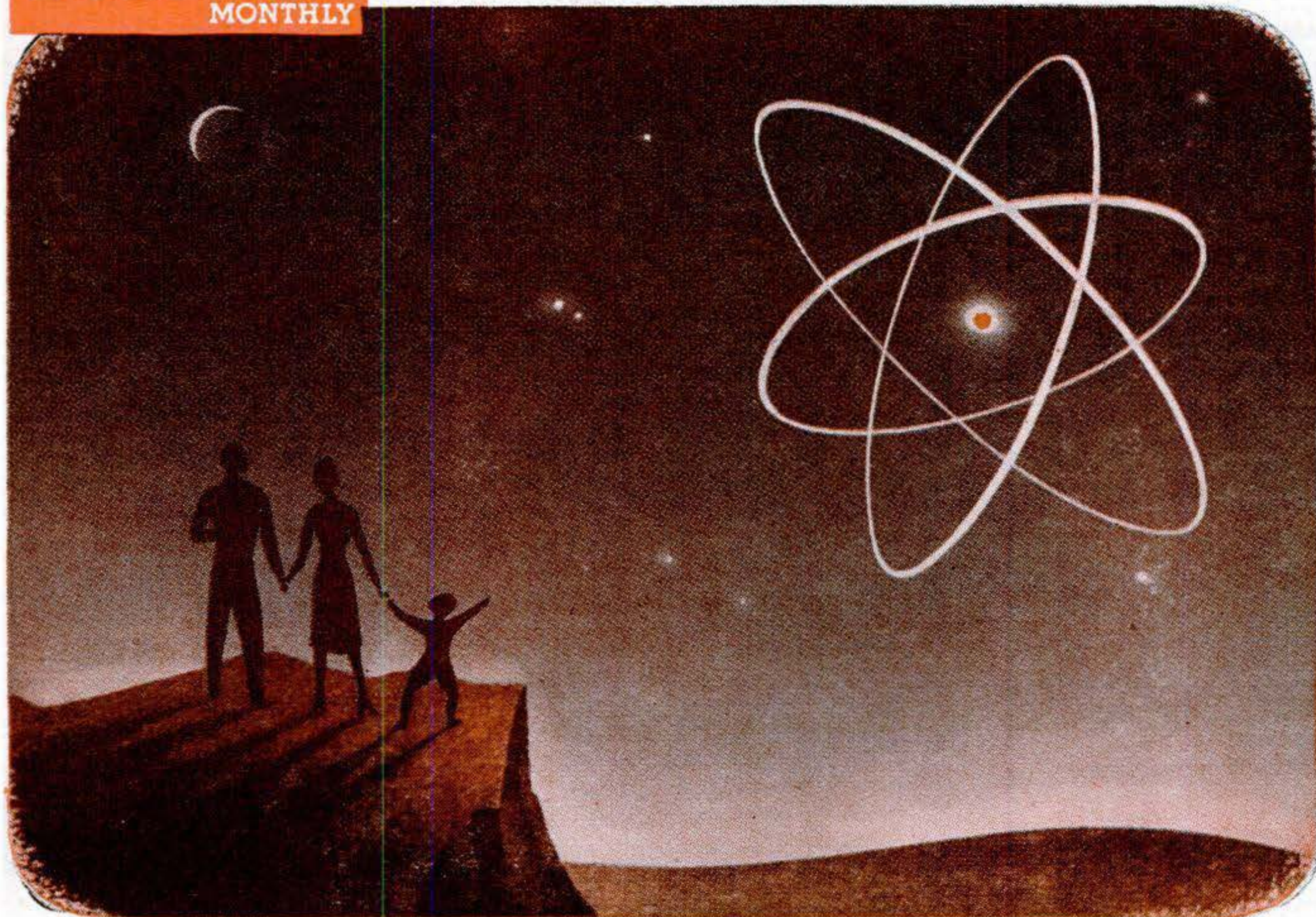

The Size of Science

THE increasing interest in science, in its facts and principles, its practical applications, and its bearings upon opinion, is undeniable. With this interest, there is growing up a new and enlarged meaning of the term.

By science is now meant the most accurate knowledge that can be obtained of the order of the universe by which man is surrounded, and of which he is a part. Science is now regarded as not applying to this or that class of objects, but to the whole of nature—as being, in fact, a method of the mind. What some call the progress of science, and others its encroachments, is undoubtedly the great fact of modern thought.

Many subjects once widely separated from the recognized sciences have been brought nearer to them. Intellect, feeling, human action, morals, all social relations—each has its basis of fact, which is the legitimate subject matter of scientific inquiry.

Those who consider that observatory watching, laboratory work, or the dredging of the sea for specimens to be classified, is all there is to science, make a serious mistake. Science truly means continuous intelligent observation of the characters of men as well as of the characters of insects. It means the analysis of mind as well as chemical substances. It means the scrutiny of evidence in regard to political theories as inexorable as that applied to theories of comets. It means the tracing of cause and effect in the sequences of human conduct as well as in the sequences of atmospheric changes.

Telegraphs, steam engines, and the thousands of devices to which science has led, are great things. But what, after all, is their value compared with the emancipation of the human spirit?

E. L. Yarnall

Editor's Note: These lines, which might have been written today, are digested from the editor's introduction to the first issue of POPULAR SCIENCE MONTHLY, May, 1872.

(P₆)

MAY 7
1947



GRANDSON- OF-A-GUN

THAT cavernous muzzle staring at you is the business end of the Army Ground Forces' new 75-mm. recoilless rifle. It fires a 14-pound projectile—with sniper accuracy—at targets four miles away. Two infantrymen can carry it. One can fire it.

This weapon is a grandson of the old 75-mm. Field Artillery piece, mainstay of World War I, which weighed over 3000 pounds and required a crew of six to nine men.

The 75-mm. recoilless rifle, by contrast, weighs 110 pounds, and its tripod is the same used for the Army's caliber .30 machine gun!

Increasing firepower per man is only one among hundreds of new, pace-setting developments now under way in Army laboratories all over the country. The job of keeping our Ground Forces ahead in equipment and training calls for the efforts of thousands of high-caliber, conscientious young men.

Your new Regular Army is advancing the frontiers of science, and many of its projects, now in the exploratory stage, will find their way into vital peacetime uses. There's a place here for inventive genius and mechanical skill.

Today, many of America's finest young men are launching interesting and useful careers with the Regular Army. If you can measure up to high enlistment standards, you become a part of an organization that offers the best available training in a wide range of trades and skills. New pay increases enable you to begin your service at \$75 a month, with food, clothing, housing and other expenses paid. Get full details at your nearest U. S. Army Recruiting Station.

- Listen to "Sound Off," "Warriors of Peace," "Voice of the Army" and "Proudly We Hail" on your radio.

A GOOD JOB FOR YOU
U. S. Army
CHOOSE THIS
FINE PROFESSION NOW!



Reports on



"Conscientious study of I. C. S. Courses proves their value beyond doubt."

R. D. CHARLES
Maintenance Superintendent
Africa-Orient Division
Pan American World Airways

RECORDS of Pan American World Airways tell you plenty about the value of I. C. S. Aviation Courses. They show that hundreds of Pan American pilots, co-pilots, flight engineers and maintenance men have taken I. C. S. Courses.

Now flying for just one division of the airline—Latin American—are 336 pilots and co-pilots who are holders of I. C. S. diplomas.

What better endorsement could there be of any institution offering training for Aviation careers?

If you are planning for a place in Aviation, you owe it to yourself to mail the coupon today for full information on the famous I. C. S. Courses. Do it now!

INTERNATIONAL CORRESPONDENCE SCHOOLS



BOX 7683-L, SCRANTON 9, PENNA.

Without cost or obligation, please send me full particulars about the course *before* which I have marked X:

- | | | | |
|--|--|---|---|
| <ul style="list-style-type: none"> <input type="checkbox"/> AIRCRAFT ENGINE MECHANICS <input type="checkbox"/> PRIVATE PILOT <input type="checkbox"/> COMMERCIAL PILOT <input type="checkbox"/> FLIGHT ENGINEER <input type="checkbox"/> AERONAUTICAL ENGINEERING <input type="checkbox"/> AIRCRAFT DRAFTING <input type="checkbox"/> WEATHER OBSERVING <input type="checkbox"/> ELECTRONICS <input type="checkbox"/> RADIO <input type="checkbox"/> TRAFFIC MANAGEMENT Air Conditioning and Plumbing Courses <input type="checkbox"/> Air Conditioning <input type="checkbox"/> Heating <input type="checkbox"/> Plumbing <input type="checkbox"/> Refrigeration <input type="checkbox"/> Steam Fitting Chemistry Courses <input type="checkbox"/> Chemical Engineering <input type="checkbox"/> Chemistry, Analytical <input type="checkbox"/> Chemistry, Industrial <input type="checkbox"/> Chemistry, Mfg. Iron & Steel <input type="checkbox"/> Petroleum Refining <input type="checkbox"/> Plastics <input type="checkbox"/> Pulp and Paper Making | <ul style="list-style-type: none"> Civil Engineering, Architectural and Mining Courses <input type="checkbox"/> Architectural Drafting <input type="checkbox"/> Architecture <input type="checkbox"/> Bridge and Building Foreman <input type="checkbox"/> Building Estimating <input type="checkbox"/> Civil Engineering <input type="checkbox"/> Coal Mining <input type="checkbox"/> Contracting and Building <input type="checkbox"/> Highway Engineering <input type="checkbox"/> Lumber Dealer <input type="checkbox"/> Reading Structural Blueprints <input type="checkbox"/> Sanitary Engineering <input type="checkbox"/> Structural Drafting <input type="checkbox"/> Structural Engineering <input type="checkbox"/> Surveying and Mapping Electrical Courses <input type="checkbox"/> Electrical Drafting <input type="checkbox"/> Electrical Engineering <input type="checkbox"/> Electric Light and Power <input type="checkbox"/> Lighting Technician <input type="checkbox"/> Practical Electrician Internal Combustion Engines Courses <input type="checkbox"/> Auto Technician <input type="checkbox"/> Aviation <input type="checkbox"/> Diesel-Electric <input type="checkbox"/> Diesel Engines <input type="checkbox"/> Gas Engines | <ul style="list-style-type: none"> Mechanical Courses <input type="checkbox"/> Foundry Work <input type="checkbox"/> Heat Treatment of Metals <input type="checkbox"/> Industrial Engineering <input type="checkbox"/> Industrial Metallurgy <input type="checkbox"/> Machine Shop <input type="checkbox"/> Mechanical Drafting <input type="checkbox"/> Mechanical Engineering <input type="checkbox"/> Mold-Loft Work <input type="checkbox"/> Patternmaking—Wood, Metal <input type="checkbox"/> Reading Shop Blueprints <input type="checkbox"/> Sheet-Metal Drafting <input type="checkbox"/> Sheet-Metal Worker <input type="checkbox"/> Ship Drafting <input type="checkbox"/> Ship Fitting <input type="checkbox"/> Tool Designing <input type="checkbox"/> Toolmaking <input type="checkbox"/> Welding—Gas and Electric Railroad Courses <input type="checkbox"/> Air Brake <input type="checkbox"/> Car Inspector <input type="checkbox"/> Diesel Locomotive <input type="checkbox"/> Locomotive Engineer <input type="checkbox"/> Locomotive Fireman <input type="checkbox"/> Railroad Section Foreman Steam Engineering Courses <input type="checkbox"/> Boilermaking <input type="checkbox"/> Combustion Engineering <input type="checkbox"/> Engine Running | <ul style="list-style-type: none"> <input type="checkbox"/> Marine Engineering <input type="checkbox"/> Steam Electric <input type="checkbox"/> Steam Engines Textile Courses <input type="checkbox"/> Cotton Manufacturing <input type="checkbox"/> Rayon Weaving <input type="checkbox"/> Textile Designing <input type="checkbox"/> Woolen Manufacturing Business and Academic Courses <input type="checkbox"/> Accounting <input type="checkbox"/> Advertising <input type="checkbox"/> Arithmetic <input type="checkbox"/> Bookkeeping <input type="checkbox"/> Business Correspondence <input type="checkbox"/> Business Management <input type="checkbox"/> Certified Public Accounting <input type="checkbox"/> Commercial <input type="checkbox"/> Cost Accounting <input type="checkbox"/> Federal Tax <input type="checkbox"/> First Year College <input type="checkbox"/> Foremanship <input type="checkbox"/> French <input type="checkbox"/> Good English <input type="checkbox"/> High School <input type="checkbox"/> Higher Mathematics <input type="checkbox"/> Illustrating <input type="checkbox"/> Motor Traffic <input type="checkbox"/> Postal Service <input type="checkbox"/> Salesmanship <input type="checkbox"/> Secretarial <input type="checkbox"/> Sign Lettering <input type="checkbox"/> Spanish <input type="checkbox"/> Stenography |
|--|--|---|---|

Name _____ Age _____ Home Address _____

City _____ State _____ Present Position _____

Working Hours _____ A.M. to _____ P.M. Length of Service in World War II _____

Special tuition rates to members of the Armed Forces. Enrollment under the G.I. Bill of Rights approved for War II Veterans. Canadian residents send coupon to International Correspondence Schools Canadian, Ltd., Montreal, Canada.

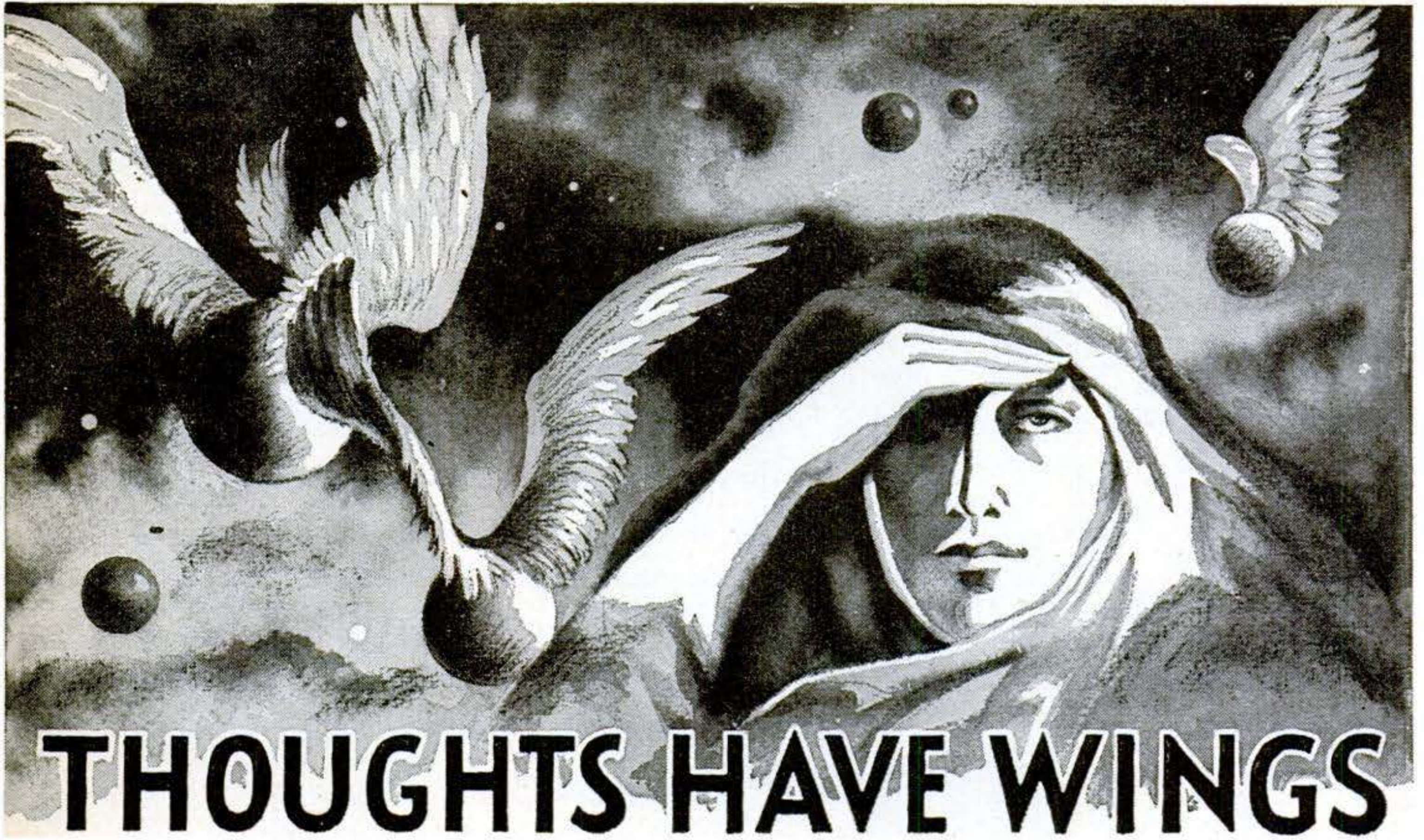

THOUGHTS HAVE WINGS

You Can Influence Others With Your Thinking!

TRY IT SOME TIME. Concentrate intently upon another person seated in a room with you, without his noticing it. Observe him gradually become restless and finally turn and look in your direction. Simple—yet it is a *positive demonstration* that thought generates a mental energy which can be projected from your mind to the consciousness of another. Do you realize how much of your success and happiness in life depend upon your influencing others? Is it not important to you to have others understand your point of view—to be receptive to your proposals?

Demonstrable Facts

How many times have you wished there were some way you could impress another favorably—*get across to him or her your ideas*? That thoughts can be transmitted, received, and understood by others is now scientifically demonstrable. The tales of miraculous accomplishments of mind by the ancients are now known to be fact—not fable. The method whereby these things can be *intentionally*, not accidentally, accomplished has been a secret long cherished by the Rosicrucians—one of the schools of ancient wisdom existing throughout the world. To thousands everywhere, for centuries, the Rosicrucians have

privately taught this nearly-lost art of the practical use of mind power.

This Free Book Points Out the Way

The Rosicrucians (not a religious organization) invite you to explore the powers of your mind. Their sensible, simple suggestions have caused intelligent men and women to soar to new heights of accomplishment. *They will show you how to use your natural forces and talents to do things you now think are beyond your ability. Use the coupon below and send for a copy of the fascinating sealed free book, "The Mastery of Life," which explains how you may receive this unique wisdom and benefit by its application to your daily affairs.*

The ROSICRUCIANS (AMORC)

Scribe K.K.W. The Rosicrucians, AMORC,
Rosicrucian Park, San Jose, California.

Kindly send me a free copy of the book, "The Mastery of Life." I am interested in learning how I may receive instructions about the full use of my natural powers.

Name.....

Address..... State.....



I Will Show You How to Learn RADIO by Practicing in Spare Time

I Send You Big Kits of Radio Parts

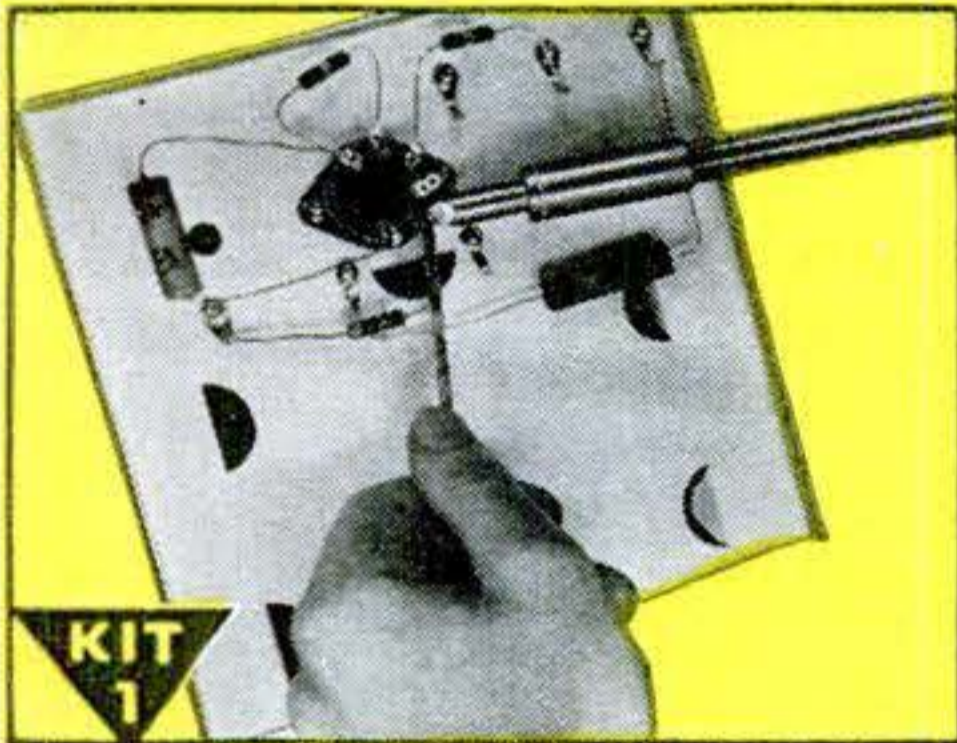

KIT 1

I send you Soldering Equipment and Radio Parts; show you how to do Radio soldering; how to mount and connect Radio parts; give you practical experience.

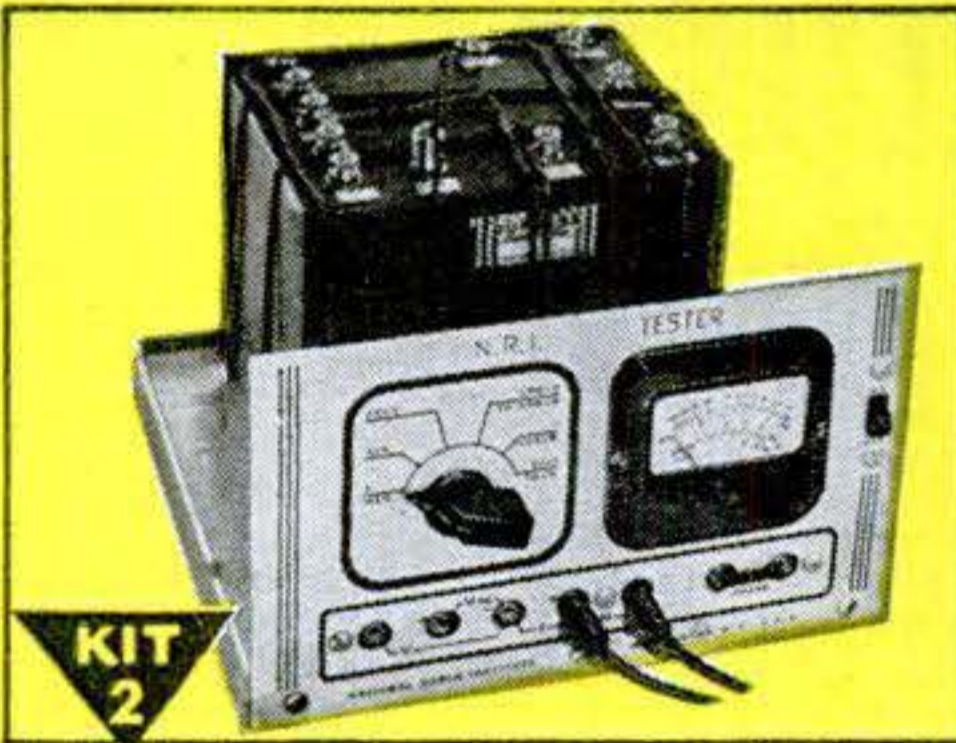

KIT 2

Early in my course I show you how to build this N.R.I. Tester with parts I send. It soon helps you fix neighborhood Radios and earn EXTRA money in spare time.

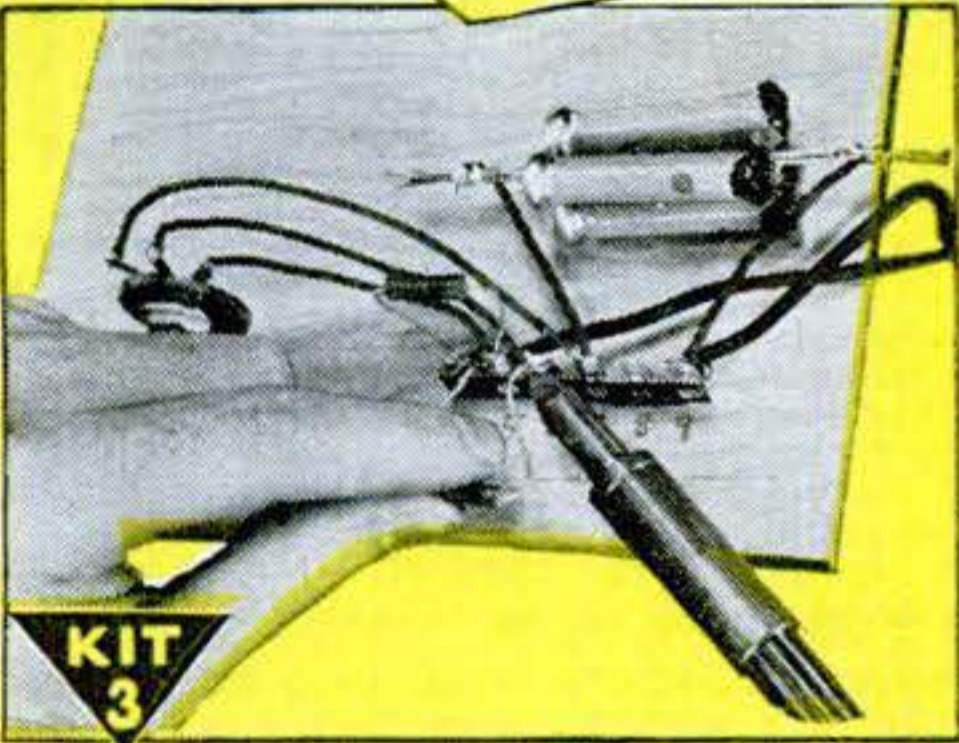

KIT 3

You get parts to build Radio Circuits; then test them; see how they work; learn how to design special circuits; how to locate and repair circuit defects.

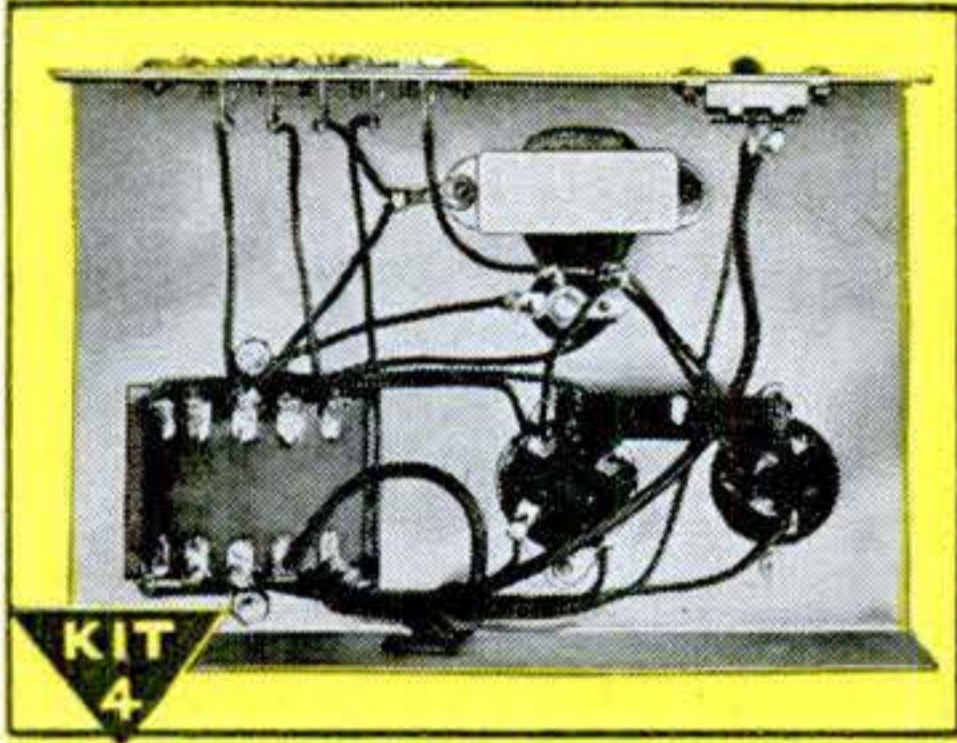

KIT 4

You get parts to build this Vacuum Tube Power Pack; make changes which give you experience with packs of many kinds; learn to correct power pack troubles.

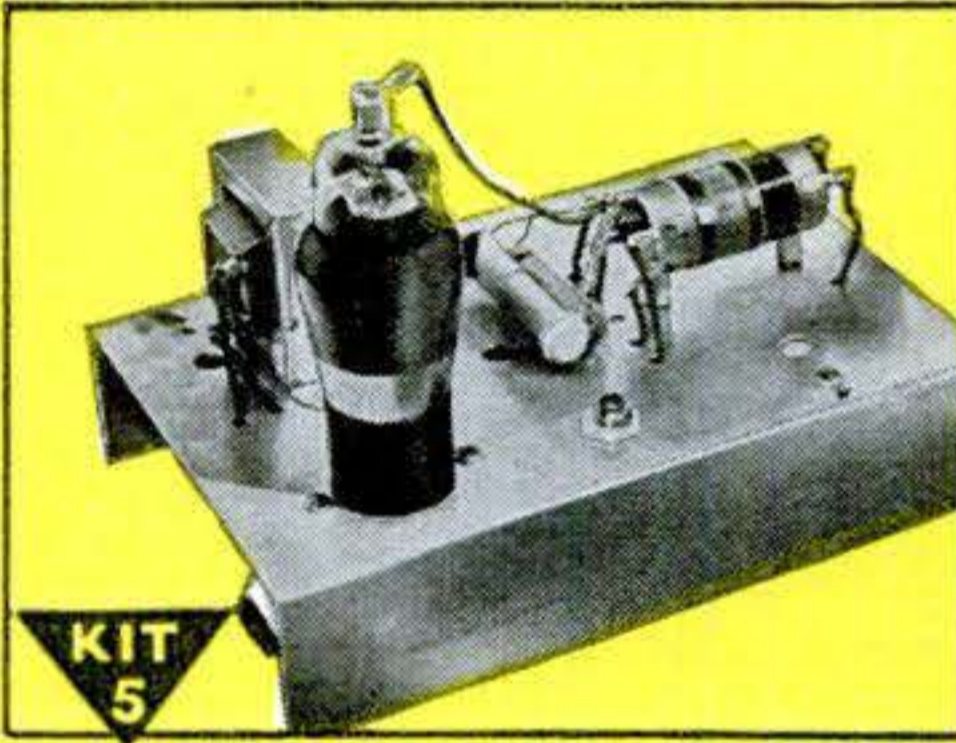

KIT 5

Building this A. M. Signal Generator gives you more valuable experience. It provides amplitude-modulated signals for many tests and experiments.



KIT 6

You build this Superheterodyne Receiver which brings in local and distant stations—and gives you more experience to help you win success in Radio.

KNOW RADIO - Win Success I Will Train You at Home - SAMPLE LESSON FREE

Do you want a good-pay job in the fast-growing Radio Industry—or your own Radio Shop? Mail the Coupon for a Sample Lesson and my 64-page book, "How to Be a Success in RADIO—Television, Electronics," both FREE. See how I will train you at home—how you get practical Radio experience building, testing Radio circuits with BIG KITS OF PARTS I send!

to get started now than ever before, because the Radio Repair Business is booming. Trained Radio Technicians also find profitable opportunities in Police, Aviation, Marine Radio, Broadcasting, Radio Manufacturing, Public Address work. Think of even greater opportunities as Television, FM, and Electronic devices become available to the public! Send for FREE books now!

Find Out What NRI Can Do For-You
Mail Coupon for Sample Lesson and my FREE 64-page book. Read the details about my Course; letters from men I trained; see how quickly, easily you can get started. No obligation! Just MAIL COUPON NOW in envelope or paste on penny postal. J. E. SMITH, President, Dept. 7EP3, National Radio Institute, Pioneer Home Study Radio School, Washington 9, D. C.

Many Beginners Soon Make Extra Money in Spare Time While Learning

The day you enroll I start sending EXTRA MONEY JOB SHEETS that show how to make EXTRA money fixing neighbors' Radios in spare time while still learning! It's probably easier

Approved for Training under GI Bill

Good for Both - FREE

Mr. J. E. SMITH, President, Dept. 7EP3 National Radio Institute, Washington 9, D. C. Mail me FREE, your sample lesson and 64-page book. (No salesman will call. Please write plainly.)



VETERANS
You can get this training right in your own home under G. I. Bill. Mail coupon for full details.

Name.....Age.....
Address.....
City.....Zone...State.....

HOW TO EFFECT ANY KIND OF MOTION or MOVEMENT

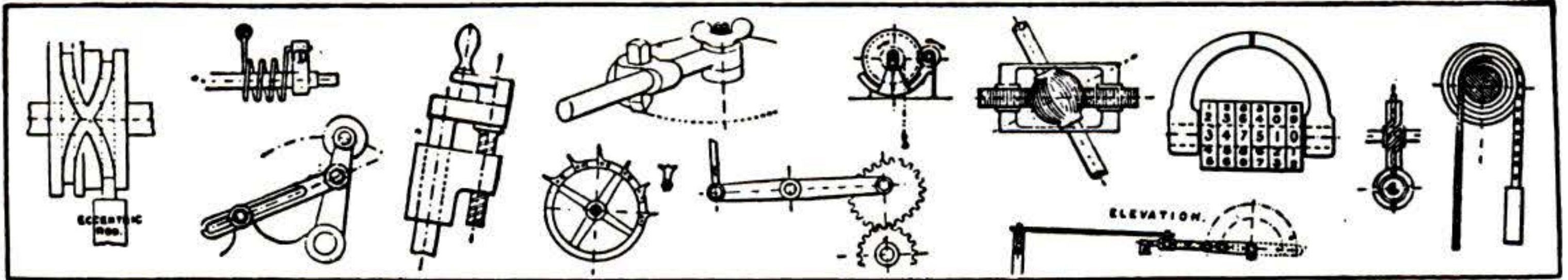

A Book That Shows You

3000 ILLUSTRATIONS and DESIGNS of Mechanical Movements, Devices, Contrivances & Details!

Every conceivable kind of mechanical motion and work is explained and illustrated in this unusually helpful book. As far as known, the only work in existence which aims to provide side by side suggested sketches of the various methods in use for accomplishing any particular mechanical movement or work, in a form easily referred to. Every engineer, inventor or mechanic finds the need of devising, simplifying or improving

some mechanical process or method. In doing this he has to rely on memory or experience. Here is a reference book of nearly 3000 MEANS AND METHODS for producing any kind of movement or work, classified and arranged for easy reference!

SUCH AS: Accumulators, Anti-friction, Ball and Socket, Bearings, Blowings, Brakes, Cams, Chain Gear, Chopping, Chucks, Circular Motions, Clutches, Conveying, Cranes, Cranks, Cutting, Doors, Drilling, Eccentrics, Engines, Expanding, Filtering, Gears, Governors, Grips, Grinds, Heating, Hinges, Hydraulics, Indicators, Journals, Levers, Links, Lowerings, Lubricators, Measuring and Weighing, Mixing, Nozzles, Parallel Motions, Pipes, Pivots, Power, Propulsion, Raising, Ratchets, Rotary Engines, Safety Appliances, Shafting, Signals, Slides, Sounds, Speed, Spindles, Springs, Starting, Striking, Swivels, Tanks, Traps, Turbines, Valves, Water Wheels, Winding, Wipers, etc.

If you work with machinery of any kind, you need this ENGINEERS' SKETCH BOOK by Thomas W. Barber—355 pages, durably printed and bound in cloth. Mailed postpaid if you send order with \$2.98 or sent C.O.D. if preferred plus postage. Money back guarantee if not exactly as described or if not satisfied.

**KNICKERBOCKER PUB. CO., Dept. M-27,
120 Greenwich St., New York 6, N. Y.**

Send me a copy of ENGINEERS' SKETCH BOOK. If I am not satisfied, I can return book and my money will be refunded.

- I enclose \$2.98; send book postpaid.
 Send book C.O.D. for \$2.98 plus postage.

Name.....

Address.....

City & Zone..... State.....

"The Supreme Authority"

in courts, schools, homes, newspapers
and Government offices

The Merriam- WEBSTER

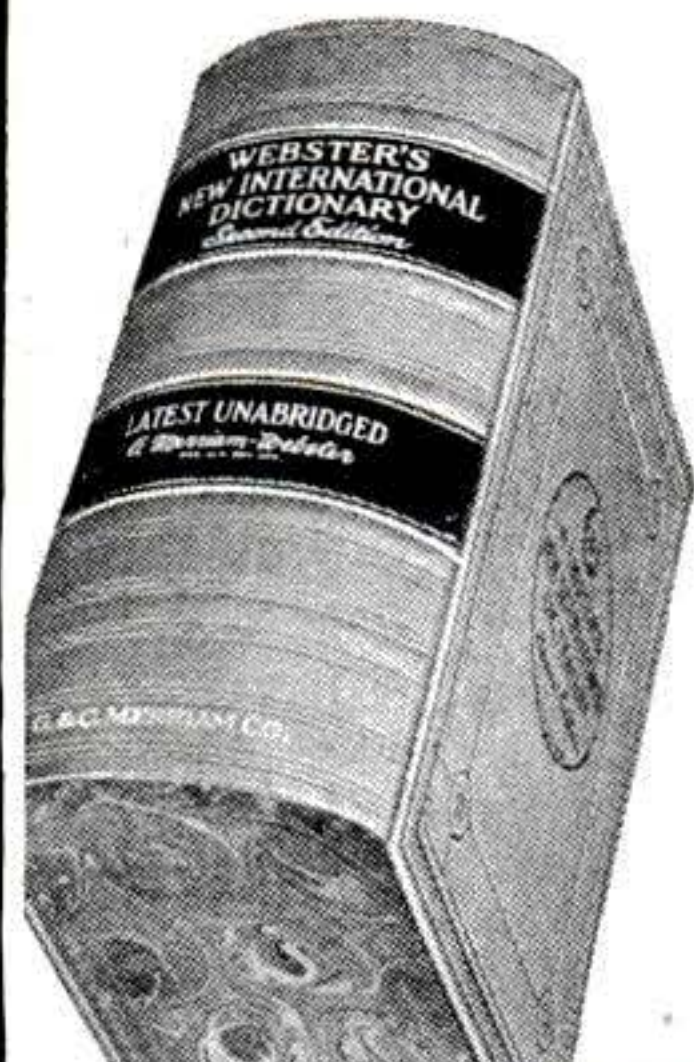

YOU may have had to wait for a copy of WEBSTER'S NEW INTERNATIONAL DICTIONARY, Second Edition. However, more and more copies are reaching your dealer. See him now. The MERRIAM-Webster contains 3,350 pages, illustrations for 12,000 terms, and a total of 600,000 entries—122,000 more than any other dictionary. It is the only unabridged dictionary completely revised and rewritten in three decades. G. & C. Merriam Co., Springfield 2, Mass.

1847 A CENTURY OF PUBLISHING
MERRIAM-WEBSTERS **1947**

**WEBSTER'S NEW INTERNATIONAL
DICTIONARY • Second Edition**

LEARN MONEY- MAKING CARTOONING

IN SPARE TIME — by Easy Picture Chart Method
Same Simplified Method that has helped train creators of "Terry & Pirates," "Freckles," "Out Our Way," "Winnie Winkle," "Reg'lar Fellers," "Strange As It Seems," "The Neighbors," and many others. Earn while learning. Send 10c for Picture Chart (to test your ability). Samples of successful students, and full details. (State age.)
Landon School of Cartooning, Dept. 4725, Philadelphia 1, Pa.



Electric Heating Element

FLUX

Repair burned out electric elements of coffee urns, electric stoves, flat irons, toasters, and other electrical appliances. Simply apply Christy Electric Heating Element Flux to the break, turn on the current and PRESTO the job is done and your appliance is ready again for years of satisfactory service. Generous size package (enough to repair 50 elements) sent postpaid for only \$1.00.

ELECTRICAL APPLIANCE REPAIR PARTS

Renual Iron element. Guar. 1 year. Package of 6.....	\$3.12
Toaster element forms. Clear Mica. Fits most toasters. 10 for....	1.80
Heating element wire. 10 ft. coiled 1/4" O.D. #20.....	2.55
Heating element wire. 10 ft. coiled 3/16" O.D. #22.....	1.77
Hot Plate bricks 5/8" diameter. 6 for.....	1.62
Appliance cord. Rubber covered. 20 ft. \$1.00: 100 ft.....	4.50
Electricians Drill Bits. 1/4", 3/8", 1/2", 3/4". Complete set.....	6.75
Ribbon element heating wire. Std. size. 100 ft.....	.75
Percolator elements. Universal. Flat type. 1 yr. guar. 2 for.....	1.20
Element cement. Withstand 3000° F. 1 lb. pkg. \$1.00. 5 lb. pkg...	3.50
Lead wire. Asbestos covered heater hook-up wire. 10 ft.....	1.00
Iron Cord Sets with complete plug attachments. 10 for.....	5.00
Carbon brush set. Assorted. 104 brushes. 15 springs. Complete set	3.00
Kerosene to Electric lamp conversion adapters. 5 for only.....	1.00
Nickel Electroplating Kit. Complete outfit. Ready for use.....	1.50
Electric Scissor Sharpener. Will handle all sizes. Complete.....	9.75

Here is your opportunity to save on repairing your own appliances and to earn extra money repairing appliances for friends and neighbors.

CHRISTY SUPPLY COMPANY

2835 N. Central Ave., Dept. T-751, Chicago 34, Ill.

Are You Satisfied with YOUR BODY?

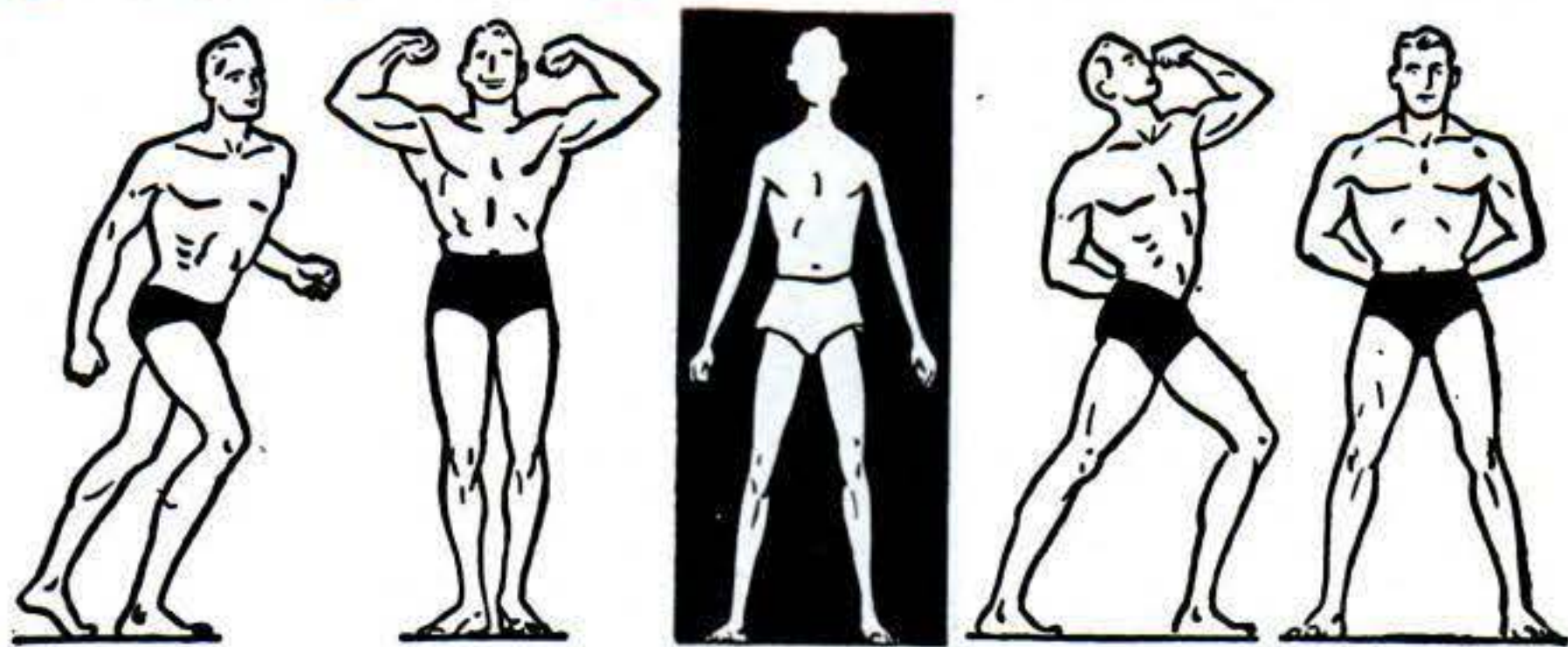

Let Me PROVE I Can Make You a NEW MAN in Only 15 Minutes a Day!

HOW do YOU look *stripped*—in locker-room or gym? Skinny, scrawny, sparrow-chested, self-conscious, HALF ALIVE?

How do you feel when people notice *your physique*? Can you stand their gaze? If you're not satisfied with your present physical development, let me prove I can make you a New Man—in only 15 minutes a day, right in the privacy of your own home! I'll give you biceps like iron and a fine, deep chest. I'll broaden your shoulders, add ridges of solid muscle to your stomach, fill out your arms and legs. If you are fat and flabby, I'll streamline you into a picture of radiant manhood.

What "Dynamic Tension" Can Do For You

"Dynamic Tension" changed me from a flat-chested 97-lb. weakling into the red-blooded **HE-MAN** that I am today. That's how I'm turning thousands of fellows **LIKE YOURSELF** into New Men—with husky, handsome body and tireless endurance. I can do the same for YOU! Let me **PROVE** it!

"Dynamic Tension" is a **PRACTICAL** and **NATURAL** method. You use no tiring apparatus, no muscle-straining gadgets. My method is actually **FUN!** In only 15 minutes a day, you will actually see your muscles increase into powerful bulges of brawn and strength. You'll enjoy new stamina, a glad-to-be-alive feeling. Before you know it, you'll have a rugged, handsome body, a rough-and-ready ambition surging out of you that the world can't lick! I'll show you how it really feels to **LIVE!**

SEND FOR FREE BOOK

All I ask is that you mail the coupon **NOW** for my illustrated **FREE** book, "Everlasting Health and Strength." It shows actual photos of pupils I've changed from weaklings into remarkable specimens of manhood. If you want a body that men respect and women admire, then get this coupon into the mails as fast as you can. Address me personally: **CHARLES ATLAS, Dept. 15, 115 E. 23rd St., New York 10, N. Y.**



Charles Atlas

An untouched photo of Charles Atlas, twice winner and holder of the title, "The World's Most Perfectly Developed Man."

CHARLES ATLAS, Dept. 15, 115 E. 23rd Street, New York 10, N. Y.

I want the proof that your system of "Dynamic Tension" will help make a New Man of me—give me a healthy, husky body and big muscle development. Send me your free book, "Everlasting Health and Strength."

NAME.....Age.....
(Please print or write plainly)

ADDRESS.....

CITY.....Zone No. STATE.....
(if any)

MAY 1947 13



NOW! An Amazing Opportunity to LEARN RADIO AT HOME

I SEND YOU 8 BIG KITS OF RADIO PARTS
Including a **COMPLETE 6 TUBE SUPER-HETERODYNE RECEIVER**

I TRAIN YOU RIGHT by PUTTING YOU TO WORK with REAL PROFESSIONAL EQUIPMENT!

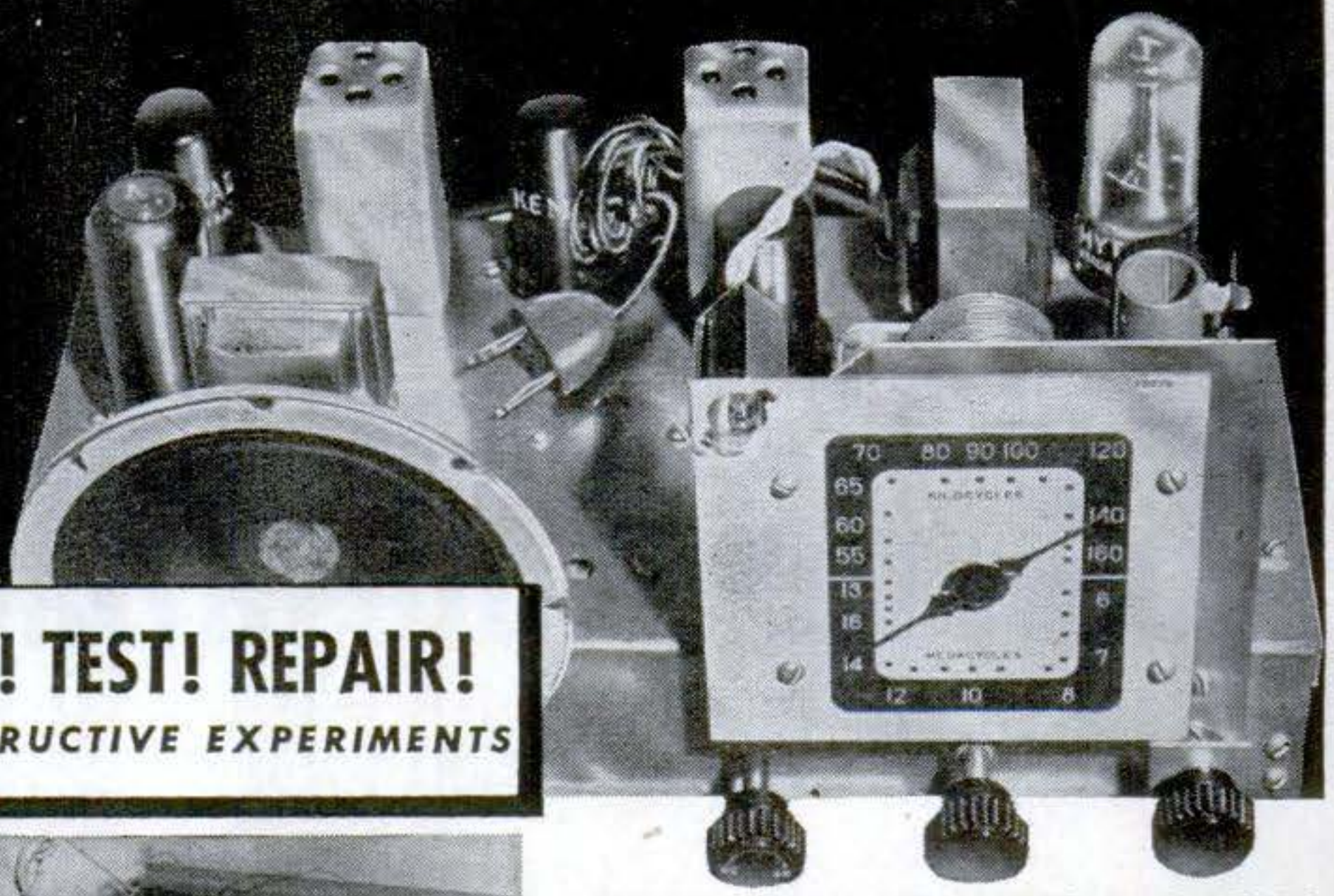

LEARN HOW TO BUILD CIRCUITS! TEST! REPAIR!
YOU DO OVER 175 INSTRUCTIVE EXPERIMENTS

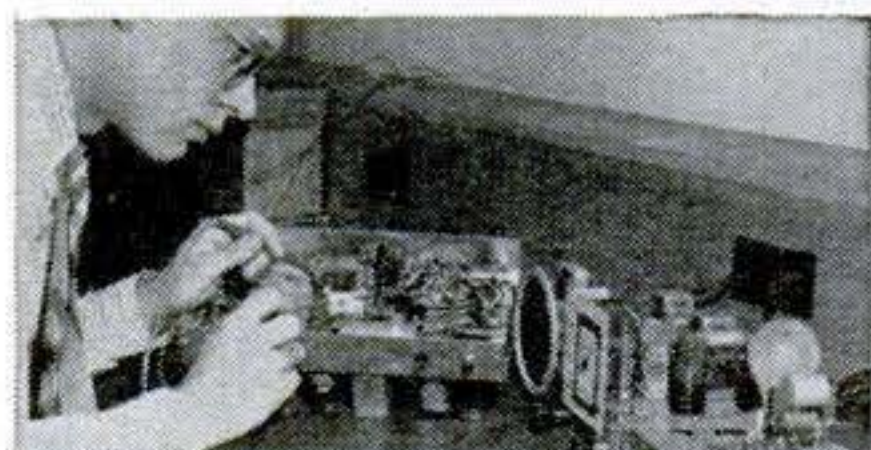

YOU BUILD THIS USEFUL TEST EQUIPMENT!

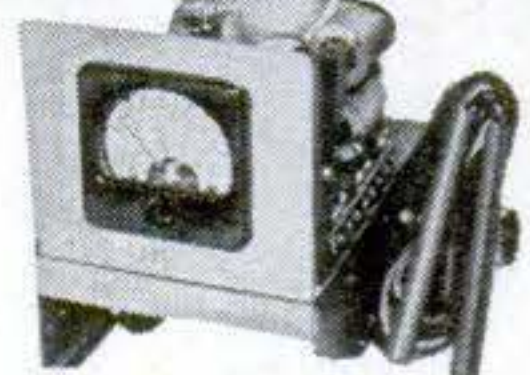

I give you a fine, moving-coil type Meter Instrument on Jewel Bearings — with parts for a complete Analyzer Circuit Continuity Tester. You learn how to check and correct Receiver defects with professional accuracy and speed.

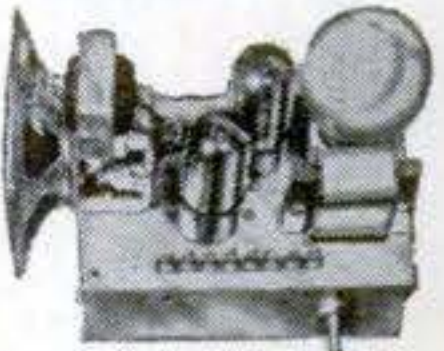

Soldering, wiring, connecting Radio parts . . . building circuits — you can't beat this method of learning. When you construct this Rectifier and Filter, Resistor and Condenser Tester, etc., you get a really practical slant on Radio.

HERE'S THE EASIEST, MOST PRACTICAL WAY OF ALL TO PREPARE FOR GOOD PAY in RADIO ELECTRONICS and TELEVISION!

I train your mind by putting you to work with your hands on a big 6-Tube Superheterodyne Receiver. And, believe me, when you get busy with real Radio Parts — 8 big Kits of them — you really LEARN Radio and learn it RIGHT! You get the practical stuff you need to be useful in Radio, and that's what it takes to make money. You don't have to worry about what to do with these 8 Kits of Parts. Step by step, I show you how to build circuits, test, experiment, trouble-shoot. And you don't need any previous experience. The Sprayberry Course starts right at the beginning of Radio! You can't get lost! Simplified lessons, coupled with real "Shop" practice, makes every subject plain and easy to understand and remember. Soon after you begin Sprayberry Training, I'll send you my sensational BUSINESS BUILDERS.

A BUSINESS OF YOUR OWN . . . OR A GOOD RADIO JOB
You'll find out how to get and do neighborhood Radio repair jobs for nice profits and rich experience while learning. This sort of work can easily pave the way for a Radio Service business of your own. But with Sprayberry Training, you're not limited. You can swing into any one of the swiftly expanding branches of Radio-Electronics INCLUDING Radio, Television, FM, Radar, Industrial Electronics. Be wise! Decide now to become a fully qualified RADIO - ELECTRONICIAN. Get full details about my Training at once! Mail coupon below for my 2 big FREE Books.



You'll get valuable experience and practice building this Signal Generator and multi-purpose Tester. Makes a breeze out of fixing Radios and you don't have to spend money on outside, ready-made equipment.

GET THESE VALUABLE FREE BOOKS

"How to Read Radio Diagrams and Symbols"

Here's a valuable and wonderfully complete new book which explains in simple English how to read and understand any Radio Set Diagram. Includes translation of all Radio symbols. Send for this volume at once. It's free! Along with it, I will send you another Big Free book describing in detail my Radio-Electronic Training.

RUSH COUPON!

SPRAYBERRY ACADEMY OF RADIO
F. L. Sprayberry, President, Room 5557, Pueblo, Colorado
Please rush my FREE copies of "How to MAKE MONEY in RADIO, ELECTRONICS and TELEVISION," and "HOW to READ RADIO DIAGRAMS and SYMBOLS."

Name Age

Address

City State

(Mail in envelope or paste on penny postcard)



INVENTORS



The patent laws provide that any new and useful art, machine, article of manufacture, composition of matter, or design, or any new and useful improvement thereof, may be patented if the act of invention is involved. Therefore, every inventor with a valuable invention should take advantage of the patent laws and proceed for patent protection in order to safeguard his rights.

A patent gives the inventor the exclusive right to prevent others from making, using, or selling the invention claimed in the patent for a period of 17 years.

The patent laws were enacted for the benefit of the inventor to give him protection for the features of his invention which are patentable. These features must be properly and concisely set forth and claimed in a formal application for patent in order to comply with the requirements of the U. S. Patent Office. For that reason, the Patent Office advises the inventor to engage a competent registered patent attorney to prepare his application for patent and represent him before the U. S. Patent Office Examiner.

A specially prepared booklet containing detailed information with respect to patent protection and procedure will be forwarded to you without obligation upon request.

Patents
Trademarks
Copyrights

Registered Patent Attorneys

CLARENCE A. O'BRIEN
& HARVEY B. JACOBSON

72-E District National Building + Washington 5, D. C.

CLARENCE A. O'BRIEN & HARVEY B. JACOBSON
Registered Patent Attorneys
72-E District National Bldg., Washington 5, D. C.

Please send me booklet containing information regarding patent protection and procedure, and also "Record of Invention" form. This request does not obligate me.

Name _____

Address _____

City _____ State _____

(Please write or print plainly.)

MAY 15

Subtract
 wear, corrosion
 carbon, sludge...

Add
PYROIL
Add
MILES



The thoughtful thing to say when you drive up for gasoline or oil is "add Pyroil." Pyroil gives oil the property of adhering to cylinder walls, providing an ever-ready film of lubrication for easy, low friction starting. The protective film also prevents corrosion. The thoughtful—the economical thing to say is "add Pyroil."

Pyroil for Aircraft Engines

Use Aircraft Pyroil B for lubricating oil, Aircraft Pyroil A for gasoline.

Manufactured and Guaranteed by Pyroil Company, 219 Main Street, La Crosse, Wisconsin.



PYROIL COMPANY
 219 Main Street,
 La Crosse, Wisconsin

I want my car to last and run properly. Please tell me more about Pyroil and how it can accomplish this for me.

Name.....

Address.....

City or Town.....State.....



Jerry, the talking dog, is entertaining hospitalized veterans, by courtesy of the PYROIL Company. Picture of Jerry, sent on request.

LETTERS

How Not to Drive

Sir:

That was an interesting story on how to drive tractor trailers (Mar. '47, p. 132), but I wouldn't want to ride with Champ Smith if he is going to pass a truck with another car coming, as he is doing in picture No. 5.

H. G. CRAGON

Ruston, La.

Reader Cragon, and the many others who chided Edson Smith, should give him credit for better sense. (If he didn't have it, he'd be dead, not a safety champion.) It isn't his fault that the caption writer's phrase, "about to 'take' the truck ahead," was misunderstood to mean that he was already doing it.

Treating Magnesium Lightly

Sir:

In your March article on magnesium, you state that a cubic mile of sea water contains 10 million pounds of magnesium. . . . Our physics book says there are nine billion pounds. I questioned our physics teacher about this, and he said they approximate the amounts. Did you ever hear of approximations being 8,990,000,000 pounds off?

JOHN LAWRENCE

Hazleton, Pa.

PSM wishes it could dodge as easily as the teacher did, but the Dow Chemical Co. says that the misstated approximation is even farther off than that. The figure should be 12 billion pounds.

Fumbles

Sir:

In your February article, "Edison's Magnificent Fumble," (p. 130), you mentioned that radar, using the klystron, has bounced signals against "even the moon." According to my information, the tubes used in the transmitter for Operation Diana for supply-

INVENTORS

Patent Laws Encourage The Development Of Inventions

The Rules of Practice of the U. S. Patent Office advises—unless an inventor is familiar with such matters—that he employ a competent registered attorney, as the value of patents depends largely upon the skillful preparation of the specifications and claims.

The firm of McMorrow, Berman and Davidson is registered to practice before the U. S. Patent Office. Additionally, it maintains a staff of attorneys able to readily understand inventors' disclosures, to advise concerning patentability, and to prepare appropriate specifications and claims for filing with the Patent Office.

If an inventor believes he has an invention, a search of the most pertinent prior U. S. patents should be made and a report obtained relative to its patentability. Where such report indicates that the invention appears patentable, in order to secure protection, diligence should be exercised in making application for a patent.

McMORROW, BERMAN & DAVIDSON

Registered Patent Attorneys

PATENTS — TRADE MARKS — COPYRIGHTS

1424 VICTOR BUILDING, WASHINGTON 1, D. C.

McMORROW, BERMAN & DAVIDSON

Registered Patent Attorneys

1424 Victor Building, Washington 1, D. C.

Send me further particulars as to patent protection and procedure and "Invention Record" form at once. I understand that this request does not obligate me.

Name.....

Address.....

City..... State.....

(WRITE OR PRINT NAME CLEARLY)

MAY
1947 17

FREE Radio's Greatest Buying Guide!

ALLIED'S NEW RADIO CATALOG

Send for this Big Value Book NOW!



Send for your FREE copy of the leading Buying Guide for Everything in Radio! Here's the handiest catalog for Servicemen, Dealers, Soundmen, Amateurs, Builders and Experimenters. Features the world's largest and most complete stocks of quality radio and electronic supplies—all at lowest prices! Get the equipment, the speedy service, the expert help you want, from ALLIED—Radio's Largest Supply House!

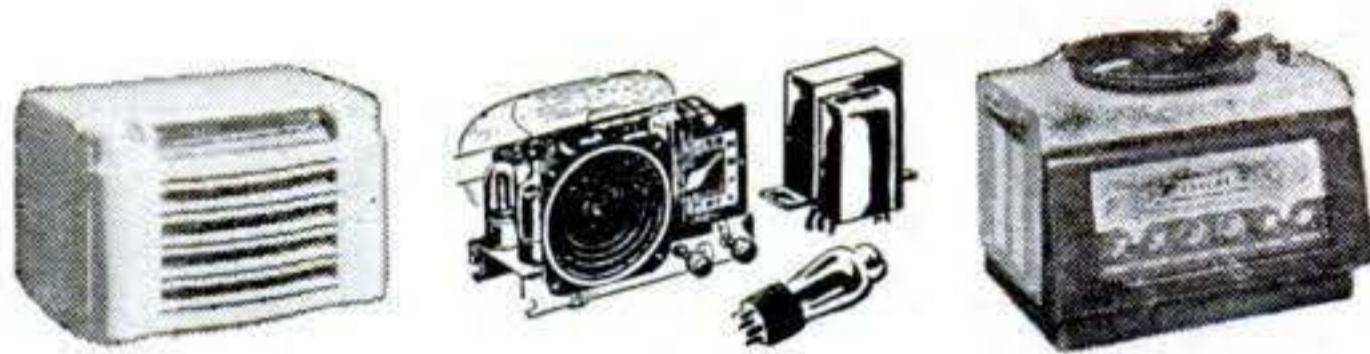

HUGE STOCKS—MORE THAN 10,000 ITEMS

Everything for every radio use: new model home radios, phono-radios, communications receivers, Ham kits and gear, radio parts, tubes, tools, test instruments, public address equipment, low-cost easy-to-build radio kits, diagrams, instructive radio books, radio's most complete stocks—all at lowest prices!

HELPFUL RADIO BOOKS!

- Radio Formulas & Data No. 37-752 . . . 10c
- Dictionary of Radio Terms No. 37-751 . 15c
- Radio Circuit Handbook No. 37-753 . . 25c
- Radio Builders' Handbook No. 37-750 . 15c
- Simplified Radio Servicing No. 37-755 . 10c
- Radio Data Handbook No. 37-754 . . . 25c
- ALL 6 BOOKS above No. 37-799 . . \$1.00
- Parallel-Resistance and Series Capacitance Calculator. No. 37-960 . 25c
- R-F Resonance and Coil Winding Calculator. No. 37-955 . . 25c



ALLIED RADIO

ALLIED RADIO CORP.
833 W. Jackson Blvd., Dept. 7-E-7
Chicago 7, Illinois

- Rush FREE 1947 Catalog
 - Send 6 Books No. 37-799
 - Send Books checked above
 - Send Calculators checked above
- \$.....enclosed

Name.....

Address.....

City.....Zone.....State.....

FREE CATALOG

ing power to the antenna were a pair of 1000-T's, which are not klystrons, but transmitting triodes.

SHERMAN RIGBY

Brooklyn, N. Y.

Reader Rigby scooped up PSM's nonmagnificent fumble for a touchdown. Klystrons produce too little power to reach the moon, and are used chiefly as local oscillators in radar receivers. For the record, the Signal Corps reports that 1000-Ts were used as the transmitting tubes in the original moon contact; subsequent higher-powered transmissions were achieved by using WL530s.

Seeing Double

Sir:

I noted with interest your March article concerning the cable fire escape from burning hotels (p. 81), for which the inventor received considerable publicity. . . . Being quite a fan of your magazine, this was nothing new to me, for if you will dig back in your files 26 years (to the March 1921 issue, p. 42, to be exact) you will find a similar article concerning a very similar device, with a photograph of its inventor. . . .

Now just what is the story on this "revolutionary" new idea of Mr. Bassett's? (Or is that Mr. Bassett as he looked in 1921, and you're running so short of material you have to print the same article twice over a period of time?)

MONROE STARK

(No address given)



1921



1947

At this late date, only Mr. Bassett, on the right, knows if that is Mr. Bassett on the left, too. PSM is as curious as Reader Stark.

Those New Fire Engines

Sir:

. . . In your January article on new fire engines, I would say that you belittle the present-day fireman, and infer: that he has

AUDELS REFRIGERATION & AIR CONDITIONING GUIDE.....\$4

New from Cover to Cover—1280 Pages, Fully Illus. Covering basic principles, servicing, operation & repair of household, commercial & industrial refrigeration & air conditioning. A gold mine of essential important facts for engineers, servicemen, users.

AUDELS CARPENTERS & BUILDERS GUIDES—4 Vols.\$6

A practical illustrated trade assistant on modern construction for carpenters, joiners, builders, mechanics and all woodworkers. 4 vols., 1600 pages, 3700 illustrations, flexible covers. Pocket size. Each volume sold separately \$1.50 a vol.

AUDELS AUTOMOBILE GUIDE.....\$4

A practical quick ready reference book for auto mechanics, service men, operators & owners. Explains theory, construction & servicing of modern motor cars, trucks, buses & auto type Diesel engines. 1540 pages, fully illustrated. 55 chapters. Indexed. A standard book for mechanics. New fluid drive covered.

AUDELS DIESEL ENGINE MANUAL.\$2

A practical, concise treatise with questions and answers on the theory, operation and maintenance of modern diesel engines including General Motors 2 cycle Diesel. 384 pages, fully illus., flexible binding, pocket size. All details plainly brought out, this book is of extreme value to engineers, operators & students.

AUDELS WIRING DIAGRAMS.....\$1

210 Pages. Illustrated. Gives practical facts on wiring of electrical apparatus. It shows clearly how to wire apparatus for practically all fields of electricity. Each diagram is complete & self-explanatory. Highly Endorsed Pocket Companion.

AUDELS PLUMBERS & STEAMFITTERS GUIDES—4 Vols.\$6

A Practical Trade Assistant & Ready Reference. Explains in plain language & by clear illustrations, diagrams, charts, graphs, pictures principles of modern plumbing practice including Marine Pipe Fitting and Air Conditioning. 4 Vols.—1670 Pages—3642 Diagrams. Pocket size. Each Vol. Sold Separately \$1.50 a Vol.

AUDELS SHEETMETAL WORKERS HANDY BOOK.....\$1

Practical inside information. Fundamentals of Sheet Metal Work. 388 pages. Illustrated. 11 sections. Clearly written. Essential & important facts, figures, pointers in everyday language. Ref. Index.

AUDELS SHEETMETAL PATTERN LAYOUTS.....\$4

Developed by Experts for Sheet Metal Workers, Layout Men & Mechanics. A Practical Encyclopedia in 10 Sections, size 7 x 10 x 2—1125 Pages—350 Layouts—1600 Illustrations. 1001 Key Facts. Fully indexed for ready reference in answering your layout problems. Covers all phases of sheet metal work including Pattern Cutting, Pattern Development & Shop Procedure.

AUDELS ANSWERS ON BLUE PRINT READING.....\$2

For Mechanics & Builders. Covers all types of blue print reading including ship & airplane. 376 pages, fully illustrated.

AUDELS NEW MACHINIST & TOOLMAKERS HANDY BOOK...\$4

Covers modern machine shop practice in all its branches. 5 practical books in 1. New from cover to cover. Tells how to set up & operate lathes, screw and milling machines, shapers, drill presses and all other machine tools. 1600 pages, fully illustrated, 5 x 6 1/2 x 2. Indexed. 5 sections. 1—Modern Machine Shop Practice. 2—Blue Print Reading & How to Draw. 3—Calculations & Mathematics for Machinists. 4—Shop Physics. 5—How to Use the Slide Rule. 60 chapters. Easy to read and understand. A shop companion that answers your questions.

AUDELS MATHEMATICS & CALCULATIONS FOR MECHANICS \$2

Mathematics for home study or reference. 700 pages, 550 illus. Practical mathematics from beginning. How to figure correctly. Easy, correct methods covering a complete review. Ill. & Indexed.

AUDELS HANDY BOOK OF PRACTICAL ELECTRICITY\$4

For maintenance engineers, electricians & all electrical workers. 1440 Pages, 2600 Illus. Covers important electrical information in handy form—including Marine Wiring, Radio Principles, Welding. Indexed. A Key to a practical understanding of electricity.

AUDELS RADIOMANS GUIDE.....\$4

A key to the practical understanding of radio including Frequency Modulation, Television, etc., Aircraft & Marine Radio. For radio engineers, servicemen, amateurs. 772 pages. 400 Illustrations & Diagrams. Photos. Review Questions & Answers, Reference Index. Authentic, clear, concise.

AUDELS ELECTRONIC DEVICES...\$2

Tells What You Want to Know About Electric Eye. Easily Understood. Covers photo-electric cells & their applications. Amplifiers, illumination, frequencies, voltage, photocell, tubes, Ohm's Law, wiring diagrams, etc.

AUDELS WELDERS GUIDE.....\$1

A concise, practical text on operation & maintenance of all welding machines for all mechanics. Over 400 pages, illustrated. Covers all methods of electric and acetylene welding including airplane work.

AUDEL, Publishers, 49 W. 23 St., N. Y. 10

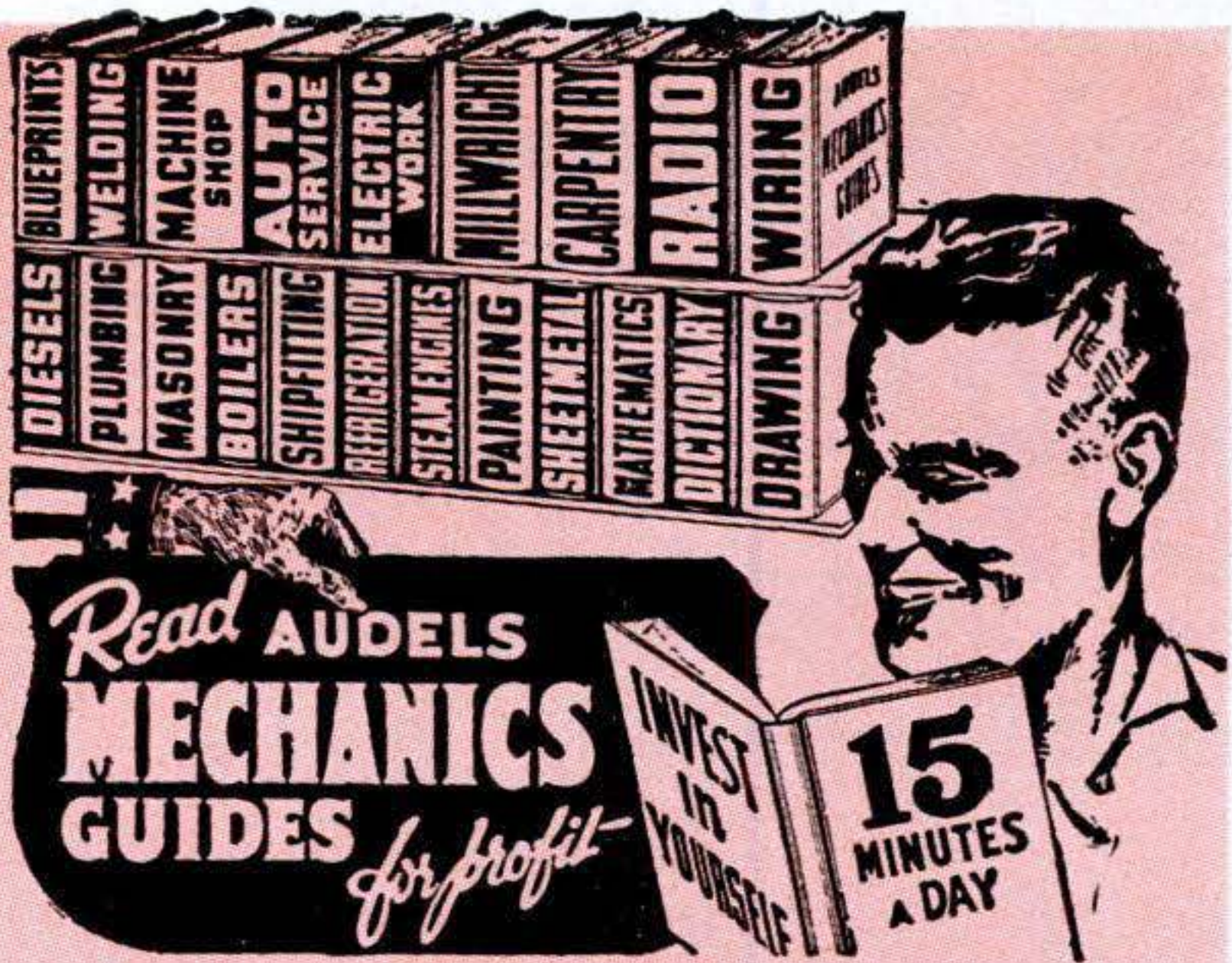

AN AUDEL GUIDE IS A GOOD FRIEND!

Use the brains and experience of others in these Guides of the Trades. Save time and money with right methods, short cuts, labor saving ideas. CHECK NOW! You can look over any Audel Guide in your home. Start the Easy Payments if satisfied.

CUT HERE MAIL ORDER

THEO. AUDEL & CO., 49 W. 23 St., New York 10, N.Y.

Please mail me for 7 days' free examination the books marked (X) below. I agree to mail \$1 in 7 days on each book or set ordered, and to further mail \$1 a month on each book or set ordered until I have paid purchase price.

If I am not satisfied with Guides I will return them.

- Audels **ELECTRIC MOTOR GUIDE** \$4.
- Audels **OIL BURNER GUIDE** 1.
- Audels **REFRIGERATION & Air Conditioning Guide** 4.
- Audels **POWER PLANT ENGINEERS GUIDE** 4.
- Audels **PUMPS, HYDRAULICS & AIR COMPRESSORS** 4.
- Audels **WELDERS GUIDE** 1.
- Audels **BLUE PRINT READING** 2.
- Audels **SHEET METAL WORKERS Handy Book** 1.
- Audels **SHEET METAL PATTERN LAYOUTS** 4.
- Audels **AIRCRAFT WORKER** 1.
- Audels **MATHEMATICS and CALCULATIONS** 2.
- Audels **MACHINISTS & TOOLMAKERS Handy Book** 4.
- Audels **MECHANICAL Dictionary** 4.
- Audels **AUTOMOBILE GUIDE** 4.
- Audels **DIESEL ENGINE MANUAL** 2.
- Audels **MARINE ENGINEERS Handy Book** 4.
- Audels **MECHANICAL DRAWING GUIDE** 1.
- Rogers **MECHANICAL DRAWING and DESIGN** 2.
- Audels **MILLWRIGHTS and Mechanics Guide** 4.
- Audels **CARPENTERS and Builders Guides (4 vols.)** 6.
- Audels **PLUMBERS and Steamfitters Guides (4 vols.)** 6.
- Audels **MASONS and Builders Guides (4 vols.)** 6.
- Master **PAINTER and DECORATOR** 2.
- Audels **GARDENERS & GROWERS GUIDES (4 vols.)** 6.
- Audels **ENGINEERS & FIREMANS EXAMINATIONS** 1.
- Audels **ENGINEERS and Mechanics Guides** 12.
- Nos. 1, 2, 3, 4, 5, 6, 7 and 8 complete 12.
- Audels **Answers on Practical ENGINEERING** 1.
- Audels **ELECTRICIANS EXAMINATIONS** 1.
- Audels **WIRING DIAGRAMS** 1.
- Audels **Handy Book of PRACTICAL ELECTRICITY** 4.
- Audels **ELECTRICAL POWER CALCULATIONS** 2.
- Audels **ELECTRONIC DEVICES** 2.
- Audels **ELECTRIC Dictionary** 2.
- Audels **RADIOMANS GUIDE** 4.
- Audels **NEW ELECTRIC LIBRARY at \$1.50 a Volume** 4.

Name _____
 Address _____
 Occupation _____
 Employed by _____ PSM

MAY 1947 19

Now LEARN ELECTRIC MOTOR REPAIR!



**Easily... Quickly...
AT HOME \$5
for ONLY . . . \$5**

Based on what you can learn *at home* from this big book—FOR ONLY \$5 complete—you can train to profitably trouble-shoot, repair and rewind all types of electric motors. Every home, every office, every business and factory is a prospect for electric motor repair work. The field is tremendous, the pay good. Up to now, there has been no easy, practical way to learn the work in spare time study. The field is "wide open"—and **ELECTRIC MOTOR REPAIR**, the big 580-page book by Robert Rosenberg, helps you cash in on it within a few short weeks!

**TRAIN FOR GOOD PAY
IN A FIELD THAT
ISN'T CROWDED**

You learn fast! You learn right. **ELECTRIC MOTOR REPAIR** covers alternating-current motors, direct-current motors and synchronous motors and generators. ALSO, it covers BOTH mechanical and electrical motor control systems. Quick-reference guides show exactly how to handle specific jobs. Every subject is not only written understandably, but further explained **VISUALLY** by more than 900 easy diagrams. Invaluable for beginners or for bench use in busy shops. Book divides into two sections, enabling BOTH text and related illustrations to be seen **AT THE SAME TIME**. Lies open flat while you work!

"BORROW" IT FOR 5 FULL DAYS!

Send coupon now. Practice from **ELECTRIC MOTOR REPAIR** for 5 full days. If not more than satisfied with book, return it. Every cent of your money will be cheerfully refunded and absolutely no questions asked. What could be fairer?



FREE!

Check coupon for free literature on famous **GHIRARDI RADIO-ELECTRONIC Training Books**

NO RISK COUPON mail today

Dept. PS-57, Murray Hill Books, Inc.,
232 Madison Ave., New York 16, N. Y.

Enclosed find \$5 (\$5.50 foreign) for my copy of the big **ELECTRIC MOTOR REPAIR** book; or send C.O.D. (no foreign C.O.D.'s) for this amount plus postage. In either event, if book is unsatisfactory for any reason, I may return it in 5 days and have my money refunded.

CHECK HERE for free literature on Ghirardi **RADIO-ELECTRONIC** books.

Name

Address

City & Zone State

been asleep all these years and knows nothing of the improvements in fire apparatus; he resents being disturbed when a new improvement comes about . . . he doesn't like to do his work unless he has an audience; he always travels recklessly through the streets at 50 m.p.h. or greater. . . .

It seems to me that in writing this article with the co-operation of the New York Fire Department, which incidentally has a well-organized department and a good drill school and officers' college, that the modern fire department could have been presented in a much better light. . . .

WALTER A. ROSSMEISL
Captain, Fire Department

Springfield, Mass.

Capt. Rossmeisl's criticism is welcomed, but he infers more than PSM said. Apparently he missed the references to aged equipment and to the vollies, who constitute 90 percent of U. S. fire-fighting personnel.

Bringing Up the Rear

Your article on "How Electric Meters Work" (Mar. '47, p. 107) is very interesting . . . but the picture shows the pointer driven directly by the worm gear on the left side. It should be on the right, and the other pointers should follow.

CLINTON SNOW, JR.

Chicago, Ill.

Right, except that the dials were shown over the rear of the meter. If you imagine the dials swung around to the front, where they always are, the gear train is in the right order. PSM's artist did it on purpose, for pictorial clarity, and carefully omitted numbers from the dials.

Deep Freezing

Sir:

I was always of the opinion that water froze at temperatures below 32°, yet you mention (ocean) temperatures of near zero 600 feet down ("Television on the Job," Feb. '47, p. 66). I would appreciate it if you would explain this.

ALBERT KRONSNABLE

Kenosha, Wis.

The temperatures referred to were Centigrade—in other words, near freezing.

PATENT PROTECTION *for* INVENTORS

A PATENT IS A VALUABLE RIGHT

On the basis of a provision in the Constitution of the United States, Congress has established a system under which inventors may secure the exclusive right to prevent the unauthorized use, manufacture and sale of their inventions for periods of seven-teen years. The inventor secures this protection by obtaining a patent from the United States Patent Office.

VICTOR J. EVANS & CO., has a staff of experi-
enced registered patent attorneys, available to
represent inventors in the preparation and prose-
cution of their cases before the Patent Office.
Detailed information and the steps to be taken in
obtaining patent protection will be furnished
upon request.

FORM BELOW FOR MAILING CONVENIENCE

**VICTOR J.
EVANS & Co.**

Merlin M. Evans

REGISTERED PATENT ATTORNEY

240-E Merlin Building, Washington 6, D. C.

Please forward to me detailed information regarding procedure to obtain Patent Protection,
together with your convenient "Evidence of Invention" form.

Name.....

Address.....

City and State.....

PATENTS • TRADEMARKS • COPYRIGHTS

MAY
1947 21

**Big
News!**

America's Famous 150 Openings for

Many Thousands of Dollars Worth of New Equipment Enables Us to Increase Our Enrollment Quota—Personal Instruction by Expert Teachers on Big, Modern Television Equipment—Students May Keep the Television Receivers They Build.

Students are here checking alignment of television sets they are building.



The latest test equipment is available in volume to all students at N.Y.T.I. of N.J. Just learning how to use the latest types of television test equipment is an important part of your training.

IF YOU are interested in a big-money career in TELEVISION—here is good news! We have just purchased more thousands of dollars of up-to-the-minute television equipment. This enables us to accept 150 *additional* students in May, June and July. *New classes begin every 2 weeks.*

Television is a highly technical subject. You can't expect to make the best progress unless you get expert, PERSONAL instruction and study with the *right apparatus*. You've actually got to *handle* the big, technical equipment YOURSELF. You've got to be in daily PERSONAL contact with your teachers. You've actually got to BUILD television receivers to understand them—and don't let anybody tell you differently!

Here's The Best Way To Learn Television

At the New York Technical Institute of New Jersey—one of America's great technical schools—you can do all that. The school is located right



Here you see one of the television laboratories in full swing. The class is building television receivers, using many advanced types of test devices.

Television School Will Have May, June & July

in Newark, N. J.—smack in the heart of the television industry. It is lavishly equipped with the very latest television test equipment. It maintains a large staff of expert instructors—many of whom are also actively associated with the television industry.

Here you "live" right WITH these experts. They are all regular fellows who have come up "through the mill." They know your problems and they also *know* Television. Working with these men makes it easier to understand even the most technical side of Television. They help you with the 77 different electronic experiments which each student must complete before he starts to build his very own television receiver—which he may keep as his own property—if he chooses.

School Approved for G.I. Training

N.Y.T.I. of N.J. is approved for training under the G.I. Bill of Rights. The government pays up to \$500 a year for a veteran's educational expenses and pays \$90 a month to veterans with dependents and \$65 a month to those without dependents for their living expenses. (Of course, you *don't* have to be a veteran to attend the school.)

We Will Teach You the Mathematics You Need

N.Y.T.I. of N.J. is ideally located for Television Training—right in Newark, in the heart of the country's great radio and electronics industry, just 20 minutes from N. Y. City. The school is near such leading television, radio and electronics man-



Eight of these latest RCA High-Frequency Sweep Generators are in almost constant use by students in Advanced Television.

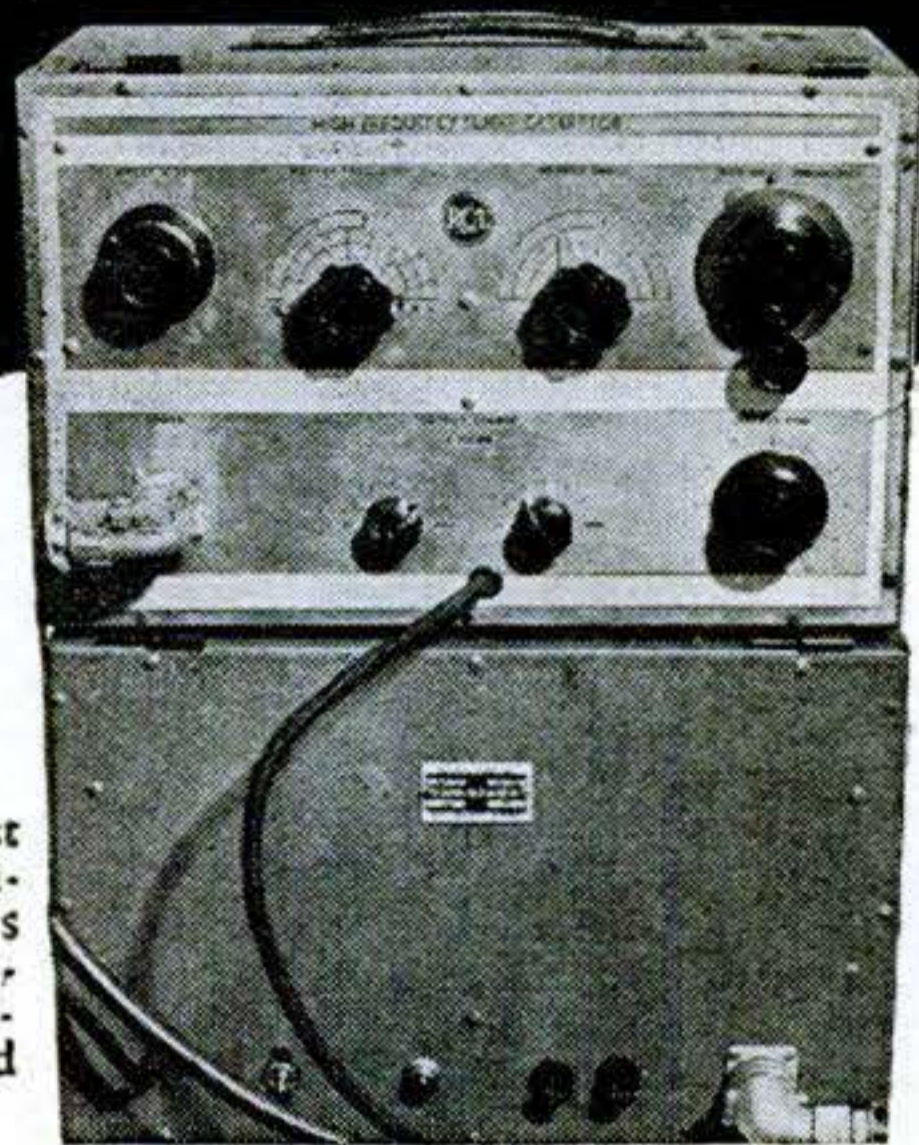

ufacturers as R.C.A., Western Electric, General Electric, DuMont, Federal, Westinghouse and Edison. It is also near some of the biggest television transmitting stations.

Here at the N.Y.T.I. of N.J.—you can really start from scratch and become a television expert. No high school diploma is required. All you need is a grammar school education and a sincere desire to learn, plus a willingness to make an all-out effort. If you are rusty in mathematics, we can teach you the radio and television math you will need.

Send for our Special FREE Bulletin

The school issues a Special Bulletin, which describes and illustrates its facilities and equipment. The FREE Bulletin also describes classes which may be attended, housing conditions, costs, hours, etc. You can have it by mailing the coupon below to—*New York Technical Institute of New Jersey, (Dept. 35) 158 Market Street, Newark, N. J.*

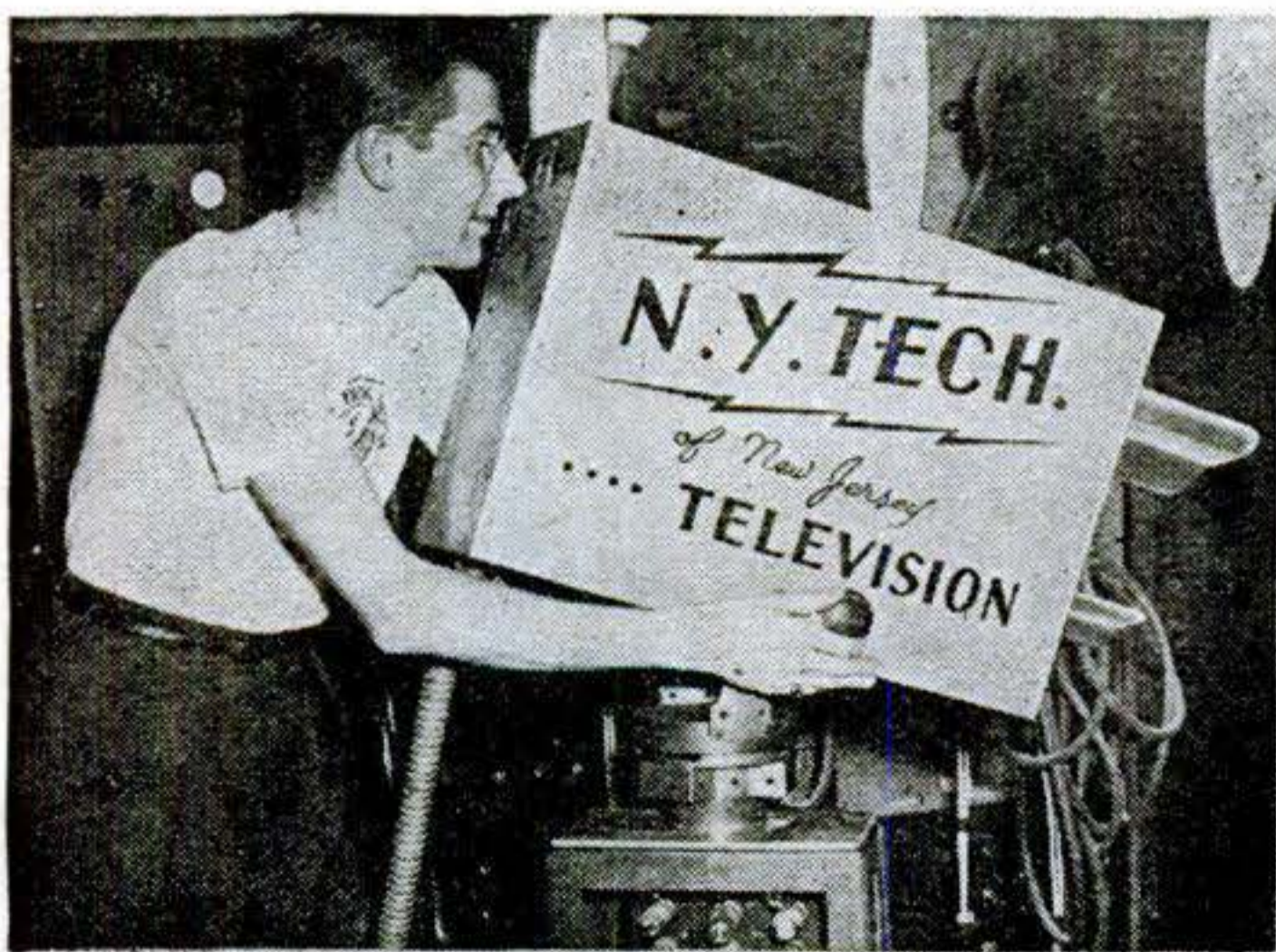

Here an Ex-G.I. is shown taking pictures with N.Y. Tech's Iconoscope Television Camera. When it comes to television—you can't beat N.Y.T.I. of N. J.

**New York Technical Institute of N. J., Dept. 35,
158 Market Street, Newark, New Jersey**

Please send me your FREE Bulletin describing the famous Resident School of the New York Technical Institute of New Jersey located in Newark, N. J.—including its facilities, equipment, courses offered, costs, hours, etc.

Check here if you are a Veteran of World War II.

Name.....Age.....

Address.....

City.....(if any).....State.....

(N.Y.T.I. of N.J. employs no salesmen to call.)

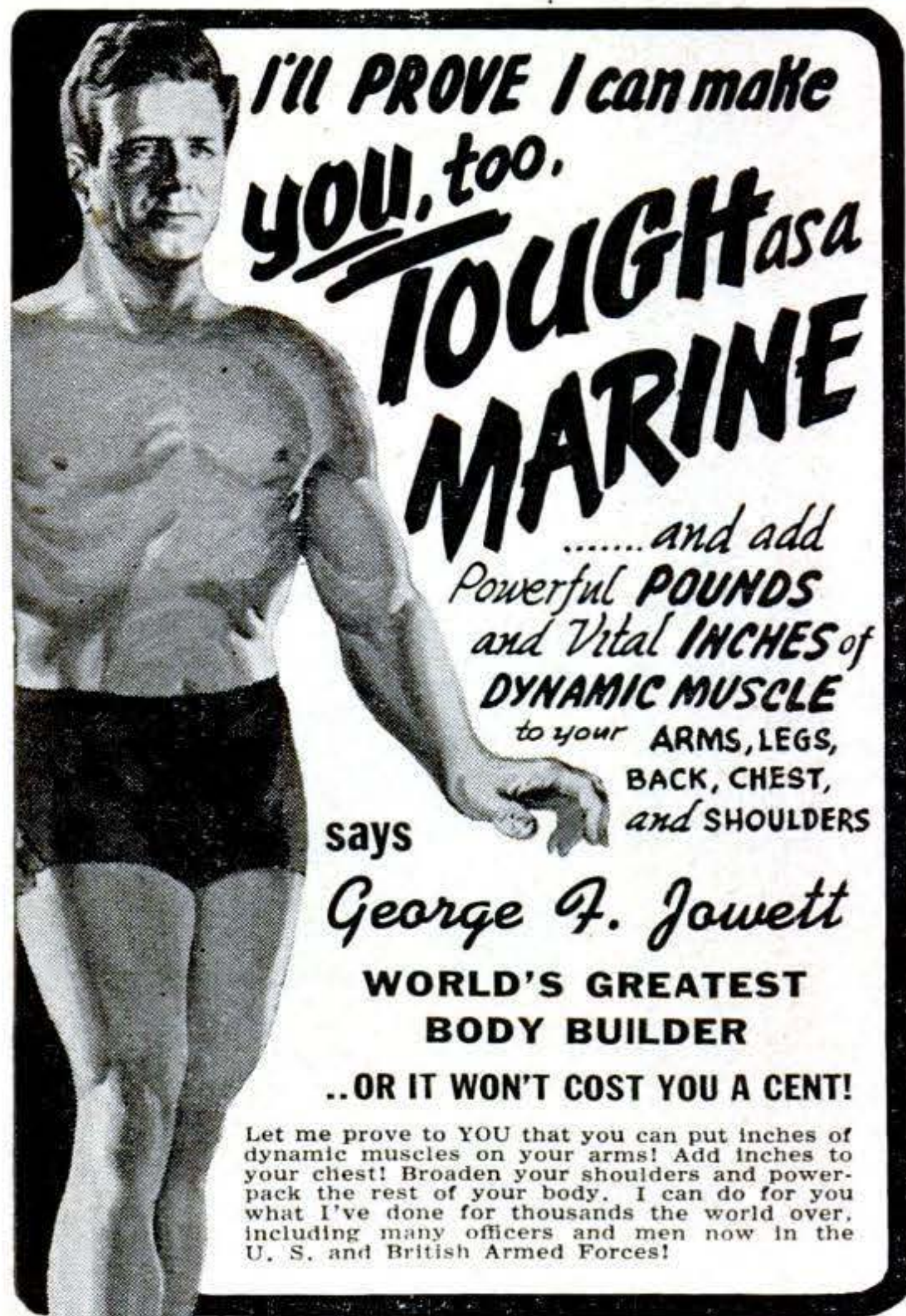

I'll PROVE I can make
you, too.
**TOUGH as a
MARINE**

..... and add
Powerful **POUNDS**
and Vital **INCHES** of
DYNAMIC MUSCLE
to your **ARMS, LEGS,**
BACK, CHEST,
and **SHOULDERS**

says
George F. Jowett
**WORLD'S GREATEST
BODY BUILDER**

..OR IT WON'T COST YOU A CENT!

Let me prove to YOU that you can put inches of dynamic muscles on your arms! Add inches to your chest! Broaden your shoulders and power-pack the rest of your body. I can do for you what I've done for thousands the world over, including many officers and men now in the U. S. and British Armed Forces!

GIVE ME 10 MINUTES A DAY!

I'll Show You My Secrets Of Body Building

I'll help you learn the "Progressive Power Method" through which I rebuilt myself from a physical wreck to the holder of more strength records than any other living athlete or teacher! No matter how skinny or flabby you are, you can learn my methods right in your own home. Through my proved secrets I show you how to develop your power, inside and out, until YOU are fully satisfied that you are the man you want to be. "The Jowett System," says R. F. Kelly, Physical Director of the YMCA, Atlantic City, "is the greatest in the world!"

If you want a physique that will inspire respect from men, and admiration from women... **ACT LIKE A HE-MAN!** Decide at once! The famous book, "Nerves of Steel—Muscles Like Iron" will be included **FREE!** Priceless for the strength fan! Full of photos of marvelous power-bodied men who will show you what Jowett has done for them and how he can do the same for you. Reach out... Grasp this Special Offer today!

**PROVE TO YOURSELF
IN ONE NIGHT!**

Send only 25c for test Course, "Molding a Mighty Arm." Read it the evening it arrives—learn from experience the thrill you can give your muscles!

**SEND FOR THESE FIVE FAMOUS
COURSES IN BOOK FORM**

**ONLY 25c EACH
or ALL 5 for \$1.00**

Jowett Institute of Physical
Culture
230 Fifth Avenue
Dept. PS-74A
New York 1, N. Y.

*This
Book
Free!*



**BOOK WITH PHOTOS OF FAMOUS STRONG MEN
MAIL COUPON NOW**

FREE



**JOWETT INSTITUTE OF PHYSICAL CULTURE Dept. PS-75
230 FIFTH AVENUE • NEW YORK 1, N. Y.**

George F. Jowett: Your proposition looks good to me. Send by return mail, prepaid, the courses checked below, for which I enclose (). Include **FREE** book of PHOTOS.

- George F. Jowett
Champion of
Champions
- All 5 courses for . . . \$1
 - Molding a Mighty Arm 25c
 - Molding a Mighty Back 25c
 - Molding a Mighty Grip 25c
 - Molding a Mighty Chest 25c
 - Molding Mighty Legs 25c
 - Send all 5 C.O.D. (\$1 plus postage.) No orders less than \$1 sent C.O.D.

NAME..... **Age**.....
(Please print plainly. Include Zone Number.)

ADDRESS

**24 POPULAR
SCIENCE**

Get into Good Paying AUTO BODY and FENDER WORK



Men 18 to 60. If you are mechanically inclined, start now to learn to become an auto body mechanic and fender repair man. U. E. I. spare time, home-study training combined with actual shop practice gives you sound, basic knowledge of practical methods so you may get the experience which may bring you big pay. Course includes acetylene welding, spray painting, use of hand and power tools.

THOROUGH, RELIABLE TRAINING

Auto body and fender repairing is one of the best profit-makers in any garage or service station. Employment placement service included, or we'll show you how to go about to get started in your own shop. Get the facts **FREE** today!

Approved for
training under
G. I. Bill

**AUTO-CRAFTS
DIVISION • UTILITIES ENGINEERING INSTITUTE**
1314 BELDEN AVENUE, DEPT. 357-X CHICAGO 14, ILLINOIS

MAKE MONEY CASTING AT HOME FREE FACTS SENT



Cast thousands of perfect Plaques, Book Ends, Ash Trays, Etc. Plaster, Liquid Marble, Etc. **ENORMOUS PROFITS.** Start in basement or garage. **LITTLE CAPITAL NEEDED. QUICK, EASY, NO PREVIOUS EXPERIENCE NEEDED.** Rubber molds for speed production. **MAKE YOUR OWN. SAMPLE KIT \$1.00.**
PLASTIC ARTS STUDIOS, Route 5, Dept. 45, Muncie, Ind.

LAW...

STUDY AT HOME Legally trained men win higher positions and bigger success in business and public life. Greater opportunities now than ever before.

More Ability: More Prestige: More Money We guide you step by step. You can train at home during spare time. Degree of LL.B. We furnish all text material, including 14-volume Law Library. Low cost, easy terms. Get our valuable 48-page "Law Training for Leadership" and "Evidence" books **FREE.** Send **NOW, G. I. APPROVED.**
LASALLE EXTENSION UNIVERSITY, 417 South Dearborn Street
A Correspondence Institution, Dept. 583-L Chicago 5, Ill.

Big Money for Workers In Home or Shop



Licensed Concrete Specialists wanted. No experience needed. Make **Colorglazed** concrete pottery without molds. New, low cost, patented method. Cemetery products, novelties, tiles, floors, etc. Basement leaksealing. Other big pay projects. Booklet, details free. Men only.

NATIONAL POTTERIES COMPANY
542 West Lincoln, Fergus Falls, Minnesota



**\$5, \$10, \$15
FOR ONE
DRAWING**

Be an ARTIST!

—Train at Home In Your Spare Time

Trained Artists are capable of earning \$50, \$60, \$75 a week. The fascinating field of Art offers commercial opportunities to men and women. **COMMERCIAL ART, CARTOONING, DESIGNING** all in one complete course. **TWO ART OUTFITS** furnished. Learn to draw step-by-step. Write today for full information in **FREE BOOK.** "Art for Pleasure and Profit." Course available under G.I. Bill.

FREE BOOK gives details!

Washington School of Art, Studio 135H
1115—15th St., N. W., Washington 5, D. C.

Name..... **AGE**.....
Street.....
City..... **Zone**..... **State**.....



Choose one of these **2 GREAT FIELDS**

- Get Ready **QUICK** at **COYNE!**

ELECTRICITY OR **RADIO-ELECTRONICS TELEVISION**

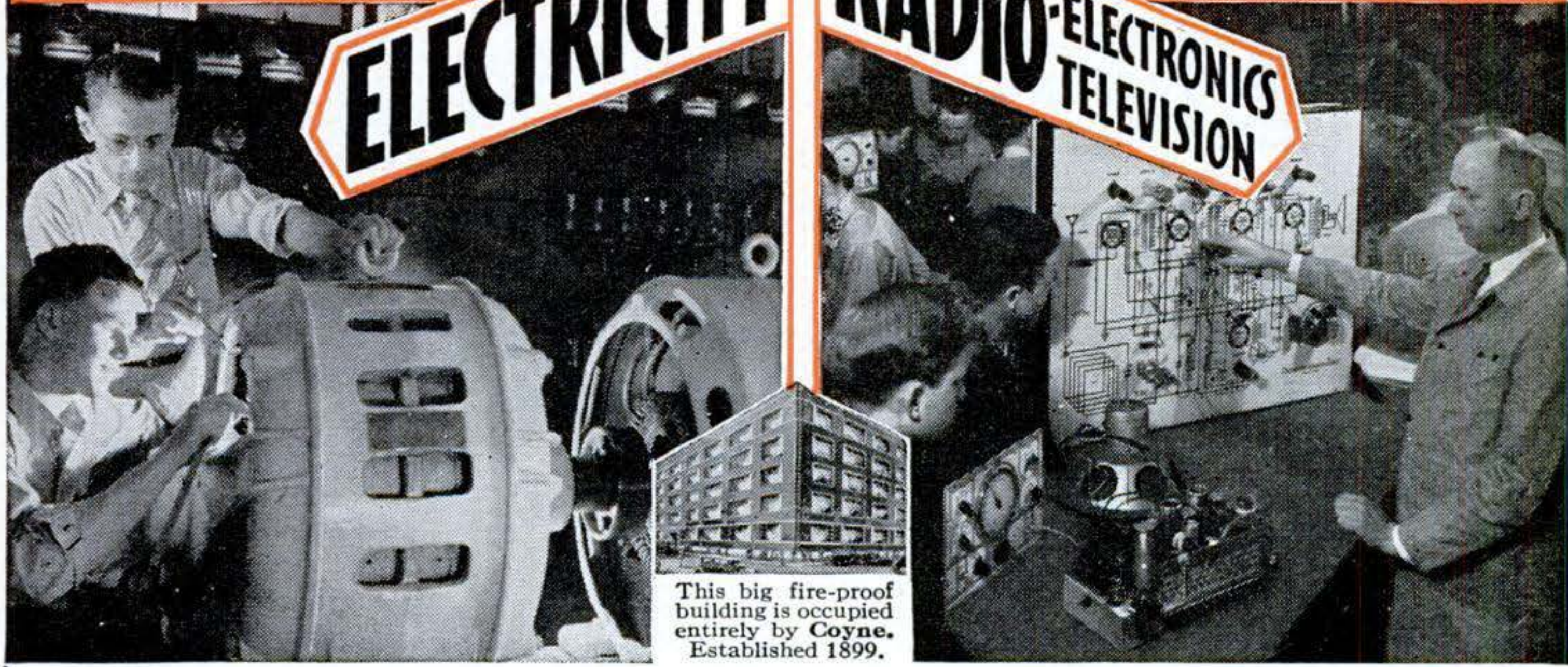

This big fire-proof building is occupied entirely by Coyne. Established 1899.

Prepare for Success in a few short weeks... in the

GREAT SHOPS OF COYNE

Conditions today are different. Many "one-operation" jobs that pay well will not last. Plan for steady pay and advancement by training NOW. Come to the great shops of COYNE in Chicago, for "all-around" training in Electricity or Radio—the 2 great opportunity fields.

NOT A "HOME-STUDY" COURSE

Our famous "Learn-by-Doing" method gives you practical experience on full-size equipment. Not by correspondence, but actual shop work plus necessary theory. You are trained right here in the great Coyne shops that has been training men and young men for over 48 years.

ELECTRICITY RADIO ELECTRONICS TELEVISION

INCLUDING INDUSTRIAL ELECTRONICS

Big future in Power Plant Work, Motors, Armature Winding, Home and Factory Wiring, Appliances, Refrigeration, Maintenance, Illumination, etc. Electricians are in demand everywhere—lifetime job service. Send for BIG FREE BOOK.

A great field now, even greater growth ahead. Here at COYNE you're trained for Construction, Testing, Trouble-Shooting on Radio, Public Address, Sound Picture Units, Training includes FM, Photo-cells, Television, etc. Our training is quick, easy, practical. Many Coyne trained men own well-paying radio businesses of their own.

PICK FIELD YOU LIKE—
SEND FOR BIG BOOK

FREE

—MAIL COUPON



B. W. Cooke

Whether you prefer Electricity, or Radio, train in a few short weeks at Coyne. We have a big, fully illustrated book on each course, and we'll send you the one you want, without obligation. Mail coupon — TODAY.



ELECTRIC REFRIGERATION

Added training in Electric Refrigeration now included with either our Electrical or Radio Course—no extra tuition cost.

Any Man With a Physical Disability whether a Veteran or not may qualify for Coyne training at no cost to them for tuition or subsistence. Check coupon.

VETERANS

COYNE is authorized to train those who qualify for training under G. I. Bill of Rights. Check coupon for our Special G. I. Bulletin.

Non-veterans who are short of cash can finance most of their tuition and pay it in easy monthly payments after graduation.

B. W. COOKE, Director
COYNE ELECTRICAL SCHOOL

500 So. Paulina Street, Dept. 57-73H, Chicago 12, Ill.

B. W. COOKE, Director
COYNE ELECTRICAL SCHOOL
500 S. Paulina St., Dept. 57-73H, Chicago 12, Ill.

Send me your BIG FREE BOOK — for the course checked below, also details of your "Student Finance" plan. This does not obligate me.

ELECTRICITY RADIO
 Send special G. I. Bulletin Physical disability

NAME.....

ADDRESS.....

CITY.....STATE.....

MAY 1947 25

**NEW peacetime
production plans
mean**



BIGGER PAY FOR MACHINISTS

Master shop work quickly with these books

This big home-study and reference course gives you the practical facts on machines and methods you need to advance in machine shop work. Take advantage of the other man's experience as found in books, to solve your problems, increase your efficiency, with

**The AMERICAN
MACHINISTS' LIBRARY**

**6 volumes—2368 pages—2516 illustrations
(A combined home-study course and reference library)**

This library of machine shop practice was written for practical men. It gives you the best methods for every kind of machine shop work. It fully explains lathes, drills, and other machine tools and their operation, automatic screw machines, speeds and feeds, gear design and production, jigs and fixtures, punch and die work, metal surfacing, etc., etc. Plainly written—completely illustrated—the best kind of help to the machine shop man who wants to advance himself.

No money down—special price—easy payments.

EXAMINATION COUPON

McGRAW-HILL BOOK CO., 330 W. 42nd St., N. Y. C. 18

Send me for ten days' examination the American Machinists' Library. If satisfactory I will send you \$4.00 in 10 days and \$4.00 monthly until the price of \$20.00 is paid. If not wanted, I will return the books postpaid. (To insure prompt shipment write plainly and fill in all lines.)

Name.....
Home Address.....
City and State.....
Company.....
Position..... **PSM, 5-47**

**AVIATION
Career**

MAXIMUM TRAINING IN MINIMUM TIME

CAL-AERO TECH TRAINING will add dollars to your pay check all the rest of your life. Specializing in AERONAUTICAL ENGINEERING and MASTER AVIATION MECHANICS since 1929, Cal-Aero Tech training is carefully designed for just one thing—TO MAKE MORE MONEY FOR YOU. An alumni of over 6000 successful graduates proves our career training is unsurpassed.

VETERANS —Write us about Aviation Training, as provided under "G.I. Bill of Rights."



**CAL-ACRO
TECHNICAL INSTITUTE**
MAJOR C. C. MOSELEY PRES. SINCE 1929
FORMERLY CURTISS-WRIGHT TECHNICAL INSTITUTE

**GRAND CENTRAL AIR TERMINAL
GLENDALE 1, CALIFORNIA
LOS ANGELES COUNTY**

MAIL THIS COUPON TODAY!

Cal-Aero Technical Institute, Grand Central Airport, Glendale 1, California
Please send full information on Aviation Training FREE—without obligation. Dept PS-5

Name..... Birth Date.....
Street.....
City..... State.....

STUDY AT HOME

With An Educational Institution

Men with specialized training win higher positions, insure larger earnings, and are bigger successes in business and public life. Opportunities NOW greater than ever before. Send for our Catalog.

ARTS and SCIENCES

Courses in Philosophy; Education; Letters; Public Health; Medical Jurisprudence; Psychology; Sociology; Physics; Chemistry; Plastics; Geology; Political Science; Theology; Business and Commerce; Accounting; Mathematics; Statistics; Agriculture.

ENGINEERING

Courses in Electrical, Civil, Mechanical, Drafting, Architectural, Steam, Aeronautical, Radio, Structural, Mining, Industrial, Petroleum, Marine, Chemical, Diesel, Automobile, Refrigeration, and Air Conditioning Engineering.

LAW

Complete Professional Law Course includes 18 Hornbrook Series college grade textbooks. Courses also in Commercial Law, Patent Law and Medical Jurisprudence.

McKinley-Roosevelt Incorporated, 4610-AB, Sheridan Rd., Chicago 40, Ill.

**RADIO
10¢
BOOKS**

Get Started in Radio

TEN "HOW-TO-DO-IT" BOOKS

Get a solid foundation in radio by means of these 10c timely text books. Each clearly written, profusely illustrated, contains over 15,000 words. You'll be amazed at the wealth of information packed into these handy books. Excellent for reference—ideal for technical library. Your money back if not satisfied.

5 Books for 50c- 10 Books for \$1

We cannot send less than 5 books.

SENT TO YOU POSTPAID

- No. 1—How To Make Four Doerle Short Wave Sets
- No. 2—How To Make The Most Popular All-Wave 1 and 2 Tube Receivers
- No. 3—Alternating Current for Beginners
- No. 4—All About Aerials
- No. 5—Beginners' Radio Dictionary
- No. 6—How To Have Fun With Radio
- No. 7—How To Read Radio Diagrams
- No. 8—Radio for Beginners
- No. 9—Simple Electrical Experiments
- No. 10—Television

Remit by check or money order—register letter if you send cash or stamps.
RADIO PUBLICATIONS, 27X West Broadway, New York (7)

PSYCHO-POWER
DYNAMIC MENTAL FORCE
Success—Health—Happiness
OBTAIN YOUR DESIRES
Priceless Secrets of Success, Happiness, Personality, Wealth and Health revealed! Revolutionize your Life!
FREE BOOKLET, entitled, "An Amazing Secret", 24 pages, sent to you upon request. No obligation.
PATY CO., 618 South Western, DT 88, Los Angeles.

AN AMAZING Secret

Good Handwriting
HELPS YOU WIN SUCCESS!
It's so important to write a good hand for business and social advancement. Poor illegible penmanship often causes costly errors and marks you for failure. Why write a poor hand? It's so easy to learn at home in spare time. Write for our new free booklet today. If you wish, send 10c for a penpoint suitable for shaded writing and your name beautifully written.
In Business Since 1895
The TAMBLYN SCHOOL OF PENMANSHIP
H-439 Ridge Bldg., Kansas City, Mo., U.S.A.

What Every Mason Wants

We have Important Masonic books for Blue Lodge, Chapter, Commandery, Scottish Rite, and Shrine.
OUR RITUALS ARE USED THE WORLD OVER
Send for free catalog of books and rituals for Masons, Odd Fellows, Knights of Pythias, Knights of Columbus, etc.
EZRA A. COOK, Publisher, P. O. 796, RMY Chicago 90, Ill.

**Store Route Plan
PAYS BIG MONEY**

SELL COUNTER CARD PRODUCTS
Build a good-paying business of your own: Call on dealers of all kinds; show nationally-advertised Aspirin, Vitamins, Cosmetics and 200 other necessities. Big 5c and 10c retail packages, high quality. Attractive counter displays sell goods fast. Free book gives amazing facts. Write!
World's Products Co., Dept. 83-M, Spencer, Ind.



RADIO ELECTRONICS

DeFOREST'S
TRAINING, INC.
CHICAGO, ILLINOIS

IT IS THE **WELL TRAINED** MAN WHO **WINS**

In the prize ring, as in the bigger contest of making a livelihood for ourselves and families, *training* makes the champion . . . brings the real **PAY OFF!**

You can prepare for bigger winnings, too, by training for one of America's great championship fields—**RADIO and ELECTRONICS**—the billion dollar opportunity-packed industry that is *on the march*.

Mail coupon below right now, for late facts about the exciting events in F.M. Radio, Broadcast Radio, Motion Picture Sound, Electronics, Sound Recording, the future developments in Television, Radar and other branches. See, too, how you may score a *knockout* against low pay, uninteresting work, an uneventful future.

You don't have to know a thing about Radio and Electronics at present. Over a period of 15 years, DeFOREST'S TRAINING, INC. has perfected a championship method of home training that **GETS RESULTS QUICKLY!**

We provide you, for use in your own home, with a **BIG FOUR** training method that includes

(1) commercial type Radio-Electronic parts and assemblies for valuable "LEARN-BY-DOING" experience, (2) a 16 mm Motion Picture Projector and 12 reels of action-packed "LEARN-BY-SEEING" instructive movies to speed your understanding of important principles, (3) many easy-to-read loose-leaf lessons illustrated with handy fold-out diagrams, and (4) an effective **FREE EMPLOYMENT SERVICE** to help you get started toward a good Radio Job when trained—or to assist you in starting your own Radio Business where you can be your own boss.

This championship method has started many men toward Real Pay, Fascinating Work, and a Grand Future—see **HOW** it may do the same for you. Mail coupon today for big free book that shows you the way.

YOU CAN BUILD **133** FASCINATING EXPERIMENTS

You use 8 Big Kits of Radio-Electronic parts and assemblies. Build and operate **SEVEN** different Radio Receiver Circuits, Electric Eye Devices, Radio Telephone, Wireless Microphone and dozens of other fascinating projects.

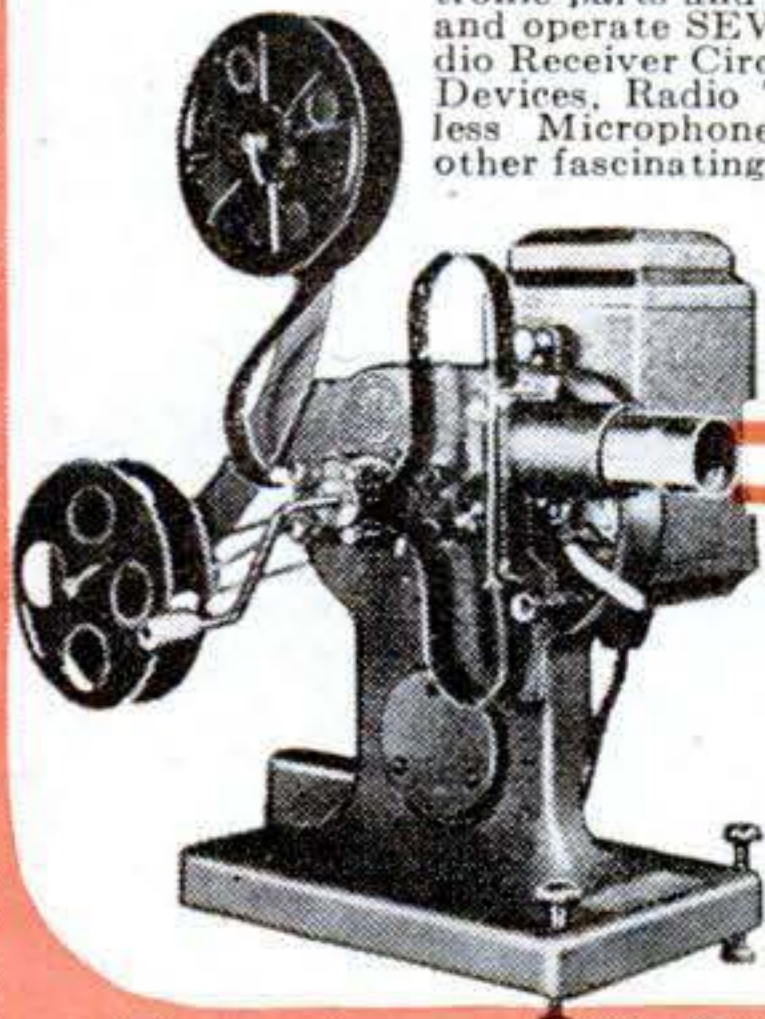

YOU USE A 16 MM. MOTION PICTURE PROJECTOR with 12 reels of instructive movies to help you grasp important fundamentals faster, easier. You enjoy one of today's most modern, effective training aids, **right in your own home.**



LEARN FASTER AT HOME WITH MOVIES

Without obligation, send for our valuable, information-packed book, "VICTORY FOR YOU"
MAIL COUPON TODAY!



DeFOREST'S TRAINING, INC.
2533-41 N. Ashland Ave., Dept. P.S.-D5
Chicago 14, Illinois, U. S. A.

Send me both your big book "VICTORY FOR YOU" and Kit Supplement, showing how I may make my start in Radio-Electronics with your modern home training plan. No obligation.

Name..... Age.....

Address..... Apt.....

City..... Zone..... State.....

If under 16, check here for special information.

If a discharged veteran of World War II, check here.

VETERANS!!!

Both the Home Study and Chicago Laboratory courses of DeForest's Training, Inc. are approved for your training. If you qualify under the "G. I. Law", you can obtain this training without cost.

MAY 27
1947

Do you want

- ➔ .. to go to College?
- ➔ .. or to enter a Profession?
- ➔ .. or get an Office Position?

(Such as Accounting, Architecture, Nursing, Dentistry, Teaching, Social Work, Osteopathy, Beauty Culture, Optometry, Embalming, Chiropody, Law, Medicine, etc.)

To get anywhere, you practically MUST finish High School FIRST. You can complete our simplified High School Course in SPARE time at home, as FAST as your time and abilities permit. Equivalent to resident school work—prepares you for college, pre-professional examinations, business, industry. Standard texts furnished. Diploma. Credit for H.S. subjects already completed. Single subjects if desired. Low tuition, easy terms. American School, Chicago, est. 1897—endorsed by educators. Finish your high school education NOW. Write TODAY!

High School Course at Home

Many Finish in 2 Years

American School, Dept. H546, Drexel Ave. at 58th St., Chicago 37

Gentlemen: Send me FREE information covering special training in subjects checked below. No obligation on my part.

- | | |
|--|--|
| <input type="checkbox"/> High School Course | <input type="checkbox"/> Diesel Engineering |
| <input type="checkbox"/> Electronics, Industrial | <input type="checkbox"/> Drafting and Design for Men and Women |
| <input type="checkbox"/> Architecture and Building | <input type="checkbox"/> Plastics |
| <input type="checkbox"/> Automotive Engineering | <input type="checkbox"/> Private Secretary |
| <input type="checkbox"/> Business Management | <input type="checkbox"/> Mechanical Engineering |
| <input type="checkbox"/> Electrical Engineering | <input type="checkbox"/> Aviation |
| <input type="checkbox"/> Elec. and Gas Refrigeration | <input type="checkbox"/> Salesmanship |
| <input type="checkbox"/> Air Conditioning | <input type="checkbox"/> Radio |
| <input type="checkbox"/> Railway Training | |

Name.....

Address.....



WANT A GOVERNMENT JOB?

START \$1,756 to \$3,021 Year

Prepare NOW for Early Examinations

VETERANS GET SPECIAL PREFERENCE

Railway Postal Clerks
City Mail Carriers
City Postoffice Clerks
Rural Mail Carriers
3rd & 4th Class
Postmasters

32-Page Book on Civil Service
FREE

Mail Coupon today—**SURE**

FRANKLIN INSTITUTE
Dept. H81
Rochester 4, N. Y.

Rush to me, entirely free of charge, 32 page book with: (1) A full description of U. S. Government jobs; (2) A list of U. S. Government jobs; (3) Tell me how to prepare for a job.

Name.....

Address.....

..... Vet?.....

OPPORTUNITIES AHEAD! TRAIN FOR A FUTURE IN **DIESEL**

● Prepare for the big earning power of Diesel Trained Men. Start learning at home, in spare time. UEI's easy, practical training covers all phases of DIESEL engine operation, fuel systems, auxiliary equipment, repairs and maintenance. When home course is completed, you come to Chicago for actual shop practice on DIESEL MOTORS under expert instructors, at UEI's fine, modern school. **BEGIN AT ONCE—GET ALL THE FACTS FREE. WRITE TODAY!**
DIESEL UTILITIES ENGINEERING INSTITUTE
1314 Belden Avenue • Dept. 357-D • Chicago 14, Illinois

Learn to MOUNT BIRDS



Tan SKINS, Make Up FURS

Be a Taxidermist. We teach you at Home. Mount Birds, Animals, Pets, Game Heads, Fish. Save your hunting trophies; decorate home and den. **MAKE MONEY.** Mount and Krome-tan for others. Big spare-time profits.

FREE BOOK 100 game pictures 48 pages - Hunters, get this wonderful book. It's Now Free. Send post card TODAY. State your AGE. **NORTHWEST SCHOOL OF TAXIDERMISTRY** Dept. 3395 Omaha, Nebraska

TRI-STATE COLLEGE

B.S. Degree in 27 months in Engineering (7 branches), Bus. Admin., Acctg. and Sec. Science. 64th year. School now filled to capacity. No applications can be accepted until further notice. 557 College Ave., Angola, Ind.

The REAL ESTATE BUSINESS

Taught by an easy, home study method by nationally known school. G.I. Approved. Prepare for LIFETIME CAREER. Many earn up to \$500 monthly. Sell while you learn. Write for FREE book.

FREE BOOK

WEAVER SCHOOL of REAL ESTATE, Dept. PC 15 E, Pershing Rd., Kansas City 6, Mo.

THERE'S MONEY IN CARTOONS!

RAYE BURNS will teach you HOW to CREATE ORIGINAL CARTOONS at home that you may SELL! Course contains 26 lessons and over 600 illustrations. All for Only... **\$2.85**

Send name and address for free details.
RAYE BURNS SCHOOL, Dept. S, Box 3583, CLEVELAND, OHIO

CORRESPONDENCE COURSES IN RADIO and ELECTRICAL ENGINEERING

Tuition \$25

ELECTRICAL ENGINEERING. Get good grasp of wide electrical field. Modern. Very understandable. Theory made easy.
RADIO ENGINEERING. Extra fine course in radio, public address, photo-electric work. Trains you to be super-service man, real vacuum tube technician. Tuition ONLY \$25. either course. Deferred payment plan. Servicemen needed badly.
FREE Write for free copies of school catalogs, student magazines, etc
LINCOLN ENGINEERING SCHOOL, Box 931-S-101 LINCOLN, NEBR.

STUDY TO BE A DOCTOR OF PSYCHOLOGY OR METAPHYSICS

Obtain a Ps.D., Ms.D., D.D., or Ph.D. degree. Be a Teacher, Lecturer or Accredited Practitioner. Teach others how to achieve Health, Happiness and Contentment. Chartered by State. Write today for FREE book telling how. **THE NEOTARIAN COLLEGE OF PHILOSOPHY, 1212 Temple Building, Kansas City 6, Mo.**



A Penny May Bring You HAPPINESS!

Would you gamble a penny to win Happiness, Companionship, Love, Financial Success, through the help of a mysterious International Secret Organization? Then just send name and address on a post-card TODAY for your

FREE Copy of great Book "Mayan Mysteries". It can change your whole life! Address Rose Dawn, The Mayan Order, Dep't. 757, P.O. Box 2710, San Antonio, Tex.



makes False Teeth TIGHT

Makes loose dental plates fit snugly and comfortably. **LASTS for MONTHS!**

Simply squeeze on dental plate and put it in your mouth. Hardens and becomes part of plate. Money-back guarantee.
FREE Generous package of Dental Plate Cleanser with each order. Send \$1.00 or mailed parcel post collect.
Fit-Rite Co., 1573 Milwaukee Ave. Dept. 5-42 Chicago, Ill.



Now Any AUTO REPAIR JOB Can Be a "Push-Over" for You!

**IN LESS TIME —
WITH LESS WORK —
AND MORE PROFITS!**

MoToR's new AUTO REPAIR MANUAL shows you how to service and repair ANY part of ANY car! Now you can lick even the toughest jobs when you have this amazing Manual to make your work easier!

Every job on every car built since 1935 is explained as simply as A-B-C. Clear, illustrated instructions lead you step by step. NOW you can tackle ANY job from carburetor to rear end—and do it quick, easy, right, the FIRST time! Just look up make, model, and the job in the quick index of MoToR's AUTO REPAIR MANUAL—and go to work!

ONLY Manual of Its Kind

No wonder this manual is used by the U. S. Army, Navy, trade and technical schools everywhere, and thousands of successful auto servicemen!

To make this great book possible, the engineer-editors of MoToR Magazine condensed all the meat from 150 official factory manuals for you. They dug out all the information you need; made sure every word is crystal-clear; and put "the whole works" into this one great, handy book!

MoToR's AUTO REPAIR MANUAL is a big book: 856 large pages, 8½ x 11 inches, bound in sturdy covers. Nearly 200,000 ser-

vice, repair, adjustment, replacement, tune-up facts on every car built from 1935 through 1946!

Over 1,000 Pictures!

More than 1,000 cutaway photos, diagrams, drawings, charts, SHOW you what the clear text TELLS you! No wonder thousands of men call this amazing book their Auto Repair "Bible"! No wonder it will save YOU countless hours of work—and help you make MORE MONEY from auto repairs!

See for yourself—without cost!—what a work-saver, time-saver, and "life-saver" MoToR's AUTO REPAIR MANUAL will be for you! TRY it FREE—for 7 days. Learn first-hand how it can pay for itself the first few times you use it!

**FREE
7-DAY OFFER
SEND NO MONEY**

Just mail coupon below—without money! When the postman brings your book, examine it thoroughly. Make it show you what it's got! Unless you agree this is the greatest time-saver and work-saver you've ever seen—return book in 7 days and pay nothing. Mail coupon today! Address: MoToR Book Department, Desk 2-E, 572 Madison Ave., New York 22, New York.



Same FREE 7-Day Offer Applies on MoToR's Truck Repair Manual

For mechanics, truck specialists, service stations, fleet owners. Covers EVERY job on EVERY truck made since 1936! 1400 pictures, 952 pages, 300,000 facts. Used by Armed Forces. Warranted to contain every essential fact you need to know. Strong binding, size 8½x11.

Covers all types Gasoline Engines; Diesels and Hesselmans. Fuel Systems, Governors, Lubrication Systems, Ignition Systems, Starters, Generators, Clutches, Transmissions, Axles, Torque Dividers, Transfer Cases.

Brakes, Steering, etc., etc. Also services buses, farm and industrial tractors, contractor and road building equipment, stationary power machinery, etc. (on all parts described in Manual.)

Offered on same FREE 7-Day examination as Auto Repair Manual. Check box in coupon at right.



Published by MoToR, The Leading Automotive Business Magazine. MoToR's manuals assure high standards of repair work.



Clear, Pictured Facts on Every Job on Every Car Built Since 1935!

Nearly 200,000 service and repair facts on all these makes:

American	Crosley	La Salle	Packard
Bantam	De Soto	Lincoln	Pierce
Auburn	Dodge	Lincoln	Arrow
Austin	Ford	Zephyr	Plymouth
Buick	Graham	Mercury	Pontiac
Cadillac	Hudson	Nash	Reo
Chevrolet	Hupmobile	Oldsmobile	Studebaker
Chrysler	Lafayette	Overland	Terraplane
Cord			Willys

856 big pages; including 50 pages of carburetor text, charts, illustrations covering all models. Over 500 charts, tables: Tune-up Chart; Valve Measurements; Compression Pressure; Torque Wrench Reading; Starting Motor; Engine Clearances; Generator; Clutch & Brake Specifications; Front End Measurements, etc.; Engines; Electric, Fuel, Cooling, Lubricating Systems; Transmissions; Universals; Front Ends; Wheels; Rear Ends, etc.



MoToR Book Dept., Desk 2-E, 572 Madison Ave., N. Y. 22
Rush to me at once: (Check box opposite book you want)

MoToR's AUTO REPAIR MANUAL. If O.K. I will remit \$1 in 7 days, (plus 35c delivery charge;) \$2 monthly for 2 months and a final payment of 95c a month later. (Book's price \$5.95.) Otherwise I will return book postpaid in 7 days. (Foreign price, remit \$8 cash with order).

MoToR's TRUCK REPAIR MANUAL. (Described at left.) If O.K. I will remit \$2 in 7 days, and \$2 monthly for 3 months, plus 35c delivery charge with final payment (\$8.35 in all). Otherwise I will return book postpaid in 7 days. (Foreign price, remit \$10 cash with order.)

Print Name..... Age.....

Print Address

City..... Zone No. (if any).....

State..... Occupation.....

SAVE 35c SHIPPING CHARGE! ENCLOSE full payment (check, m. o. or postal note) and we pay postage. Same 7-day return-refund privilege.



Become an Expert Accountant

The Profession That Pays

The demand for skilled accountants—men who really know their business—is increasing. National and state legislation is requiring of business—both big and small—much more in matters relating to Auditing, Cost Accounting, Business Law, Organization, Management, Finance. Men who prove their qualifications in this important field are promoted to responsible executive positions—given an opportunity to earn real salaries. The range is from \$3,000 to \$10,000 a year, even to higher income figures.

Send for Free Book—

“Accountancy, the Profession That Pays”

Why let the other fellow walk away with the better job, when right in your own home you may equip yourself for a splendid future in this profitable, growing profession?

Knowledge of bookkeeping unnecessary. Our free book on accountancy fully explains how we train you from ground up, or according to your individual needs. Low cost; easy terms.

The facts about the new LaSalle training in Accountancy and the opportunities in this highly profitable field are clearly outlined in a 48-page book which LaSalle will send you free.

The man in earnest to get ahead will find this coupon a most profitable aid to progress. If you have the urge and the will to increase your income, clip and mail the coupon NOW.

G. I. APPROVED

LASALLE EXTENSION UNIVERSITY

A CORRESPONDENCE INSTITUTION

Dept. 583-HR, 417 So. Dearborn St., Chicago 5

I would welcome details of opportunities in accounting, together with copy of “Accountancy, the Profession That Pays,” without obligation.



Higher Accountancy

Other LaSalle Opportunities:

LaSalle opens the way to success in every important field of business. If interested in one of the fields below, check and mail.

- | | |
|--|---|
| <input type="checkbox"/> Business Management | <input type="checkbox"/> Law—Degree of LL.B. |
| <input type="checkbox"/> Modern Salesmanship | <input type="checkbox"/> Commercial Law |
| <input type="checkbox"/> Traffic Management | <input type="checkbox"/> Modern Business Correspondence |
| <input type="checkbox"/> Foremanship | <input type="checkbox"/> Expert Bookkeeping |
| <input type="checkbox"/> Industrial Management | <input type="checkbox"/> C. P. A. Coaching |
| <input type="checkbox"/> Stenotypy (Machine Shorthand) | |

Name.....

Present Position.....

Address.....

AVIATION

Aeronautical University Approved Training meets exacting standards of aviation industry, prepares for key positions, big opportunities.

Courses in:

AERONAUTICAL ENGINEERING. B.S. degree.
AERONAUTICAL ENGINEERING DRAFTING
CERTIFIED ENGINE MECHANICS
ADMINISTRATION—including sales

PRE-ENGINEERING: Special course for high school graduates and veterans deficient in math and science.

Also refresher courses for Gov't. Airplane and Engine Mechanics Licenses for those with aviation experience.

Oldest fully approved aviation school. Outstanding faculty, modern equipment, outside employment, placement service. Day, evening. Approved for Veterans. Send today for FREE catalog “Opportunities in Aviation.”

AERONAUTICAL UNIVERSITY

Dept. 87, 116 S. Michigan Avenue, Chicago 3, Illinois

FOUNDED BY CURTISS-WRIGHT

REFRIGERATION and AIR CONDITIONING

REFRIGERATION TRAINING
Since 1927

Mechanical units everywhere need servicing. Be ready with reliable pay-knowledge. Unique home study—actual practice plan. Train now for servicing and installing jobs or business of your own.

Get The Facts FREE Now! Write Today!

Approved under G. I. Bill

UTILITIES ENGINEERING INSTITUTE
1314 W. Belden Ave., Dept. 357, Chicago 14, Ill.

“How to Make Money With Simple Cartoons”

A book everyone who likes to draw should have. It is free; no obligations. Simply address

CARTOONISTS' EXCHANGE

Dept. 1445-D

Pleasant Hill, Ohio



Learn Profitable Profession in 90 days at Home

MEN AND WOMEN. 18 TO 50—Many Swedish Massage graduates make \$50, \$75 or even more per week. Large full time incomes from doctors, hospitals, sanatoriums, clubs or private practice. Others make good money in spare time. You can win independence and prepare for future security by training at home and qualifying for Diploma. Anatomy Charts and 32-page Illustrated Book FREE—Now! THE College of Swedish Massage, Dept. 770E, 100 E. Ohio St., Chicago 11, Ill.



MECHANICAL DENTISTRY AT HOME!

To make Crowns, Plates, Bridgework, etc., for Dentists. Easy practical way to learn mechanical dentistry at home in spare time. FULL EQUIPMENT OF TOOLS AND MATERIALS INCLUDED WITH COURSE. Low tuition. Easy terms. Write for FREE BOOK about this money making profession that is not affected by the machine age.

MCCARRIE SCHOOL OF MECHANICAL DENTISTRY
207 N. Broad St. Dept. 862 Philadelphia, Pa.

CODE SPEED SHORT CUT

Be an expert. Learn to be a Telegraph or Radio Operator. Thousands of men needed. Intensely interesting work—good pay. Learn at home or wherever you are, quickly, easily with the famous Candler Speed System. Book of particulars Free. **CANDLER SYSTEM CO., Dept. 6-E, Box 928, Denver 1, Colo. U.S.A.**



GOOD MONEY FOR YOUR SPARE TIME.

Be our Dealer in your locality for **STRONG UNION MADE WORK AND SPORT GARMENTS.** No experience necessary. Easy work. Millions of workers buy work uniforms. We supply everything needed. Write immediately for FREE Outfit.
ROBT. STRONG GARMENT CO., 319-337 W. Van Buren St., Dept. B-5, Chicago, Ill.

GET INTO RADIO

TELEVISION ELECTRONICS NOW!



You build this complete, modern superheterodyne receiver with the equipment that comes with your National Training at no cost.

This practical shop instruction system gives you actual experience with a Home Radio Laboratory — part of the

SHOP METHOD HOME TRAINING

FOR YOU—A REAL HOME LABORATORY IN MODERN RADIO

from one of the world's Oldest and Largest Technical Trade Schools

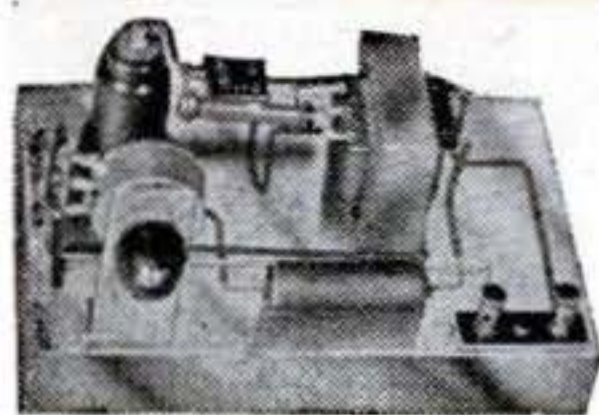

Your National Training Kits include equipment for over a hundred practical electronic experiments in your own home. You

get standard radio parts for this audio oscillator which you get to understand by building it yourself.

You learn modulation, beat frequencies, signal generation by actually building this small radio transmitter with your National shop parts.

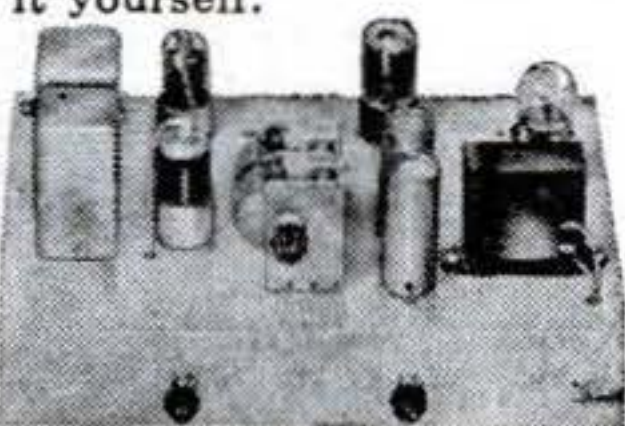

Your training outfits from National are made up of the most modern radio equipment —

much of it just out of the experimental laboratory. You learn new ways of handling equipment by modern methods. Get the details by mailing the coupon.

ern methods. Get the details by mailing the coupon.

NATIONAL TRAINING WINS BIG JOBS

You, too, can share the success of National graduates. Clifford Hannah, Portage La Prairie, Manitoba, Canada, writes: "My training has brought results as I'm in line for another raise, thanks to National's encouragement and thorough training. You can count on me as a real National booster and I am glad I used such good judgment in getting into a live and growing field."

While still a student of National training, I. Wilson of Vallejo, California, writes: "My pay has jumped from \$52.18 a week to \$72.65, and the end is not in sight. I am proud of my National Course."

Joseph Michel, Jr., Granite City, Illinois, writes: "I am enthused with National training. I am now earning \$225 a month as a radio operator and technician and \$20 a week more in my shop at home."

Send the coupon below immediately. Learn how this improved practical training can fit you for the GREAT BUSINESS OF RADIO—for the NEW AND RAPIDLY EXPANDING FIELD OF FREQUENCY MODULATION (F.M.), TELEVISION AND ELECTRONICS.

This is the thoroughly proved method used so extensively in wartime training—endorsed by the success of National men everywhere—a system by which you study in spare time—off hours, even minutes right in your home and yet have the ADVANTAGE OF REAL SHOP EXPERIENCE behind you.

Trained Radio Men Wanted

The man who really knows modern Radio is in greater demand today than ever before—not only in Radio proper but in Television and Electronics—in Aviation, Transportation, Manufacturing, Communications. Good jobs await the

trained man, in the production, operation and maintenance of modern electronic equipment—in radio stations, in hundreds of industries—in homes, theatres and studios. Good sound training in this important field is absolutely necessary. And now, National Schools brings such training to you no matter where you live or what you may be doing—not only the fundamental theory but the actual experience that comes with knowing shop practice and working with real equipment—demonstrating each step with first-hand knowledge. This is true "learning by doing"—direct from the great shops and laboratories of National Schools where new developments in methods, equipment and applications are constantly going forward.

National offers you such practical training and National has the facilities. Sample this training yourself. MAIL THE COUPON FOR A FREE LESSON.

SUCCESS and SECURITY FOR YOU

Radio is a Well-Established Business. Television and allied fields are just on the threshold of limitless expansion. Would you like to profit from these developments? An excellent job or perhaps into a business of your own? Answer these questions by reading the catalog sent you FREE from National Schools. Get the facts.

Check the Job You Now Have With These Opportunities in RADIO

1. Financial Security Radio has grown from \$100 million to \$5 billion in past few years.
2. Limitless Future predicted by over 1,800 manufacturers of equipment.
3. Television promises unrealized opportunity.
4. Electronics opens wide new fields in home and industrial use.
5. Your Own Business with little capital.

Get the details. Use the coupon!

FREE GET THESE 2 BIG BOOKS



NATIONAL SCHOOLS

LOS ANGELES 37, CALIFORNIA EST. 1905

MAIL OPPORTUNITY COUPON FOR QUICK ACTION

National Schools, Dept. 5-PS
4000 South Figueroa Street
Los Angeles 37, California

(Mail in envelope or paste on penny postcard.)

Mail me FREE the books mentioned in your ad including a sample lesson of your course. I understand no salesman will call on me.

NAME..... AGE.....

ADDRESS.....

CITY..... ZONE..... STATE.....

Check here if veteran of World War II

MAY 31 1947

EVEN IF YOU DON'T KNOW A NOTE OF MUSIC NOW...

YOU CAN LEARN YOUR FAVORITE
INSTRUMENT THIS EASY A-B-C WAY

• No special talent, no previous training needed. This U. S. School home-study method is so successful because you learn to play by playing real tunes by note, right from the start. And just think, you can learn your favorite instrument for only a few cents a day!

If interested, mail coupon for FREE Booklet and Print and Picture Sample. See

for yourself how easy it is to learn any instrument, right at home, in spare time,

without a private teacher. U.S. SCHOOL OF MUSIC, 85 Brunswick Bldg., New York 10, N.Y.



FREE! Print and Picture Sample

U. S. School of Music, 85 Brunswick Bldg., New York 10, N. Y. Please send me FREE Print and Picture Sample and Illustrated Booklet. I am interested in the instrument checked below.

<input type="checkbox"/> Piano	<input type="checkbox"/> Piano Accordion	<input type="checkbox"/> Tenor Banjo
<input type="checkbox"/> Guitar	<input type="checkbox"/> Saxophone	<input type="checkbox"/> Modern Elementary Harmony
<input type="checkbox"/> Violin	<input type="checkbox"/> Trumpet, Cornet	<input type="checkbox"/> Other Instrument

Name.....
(Please Print)

Street.....

City..... State.....

No Waiting to LEARN

START NOW TO EARN!

This BIG BOOK SHOWS HOW



IF IT'S RESULTS YOU WANT—GET ACTION QUICKLY WITH THESE PRACTICAL IDEAS

Never before has a more helpful book been printed for those planning a business of their own. Gathered in this large illustrated volume are the formulas, recipes, facts and secrets that have contributed so largely to America's great industrial progress. Capitalize on this information for making most any conceivable product without experience, special equipment or previous knowledge of chemistry or manufacturing.

The experts who compiled this book are authorities, and present this information in simple, understandable language. They also give you wholesale supply sources for needed materials, short cuts and methods for the most profitable results.

START AT HOME—Expand out of profits.

Hundreds of good paying businesses have been built on a product made from a simple recipe. Choose from any of the 162,000 facts and 10,000 formulas of which the following are only a very few: Adhesives, Alloys, Anti-Freeze Solutions, Cosmetics, Beverages and Liquors, Candy, Gum, Casein, Celluloid, Ceramics, Cheese, Cleaning Preparations, Concrete, Copper, Cotton, Dentifrices, Depilatories, Dyes, Embalming Fluids, Enameling, Glass, Glazes, Household Formulas, Inks, Insecticides, Iron, Jewelers' Formulas, Lacquers, Laundry Preparations, Leather, Linoleum, Lubricants, Manicure Preparations, Marble (artificial), Metals, Mirrors.

ALSO

We include Free—our new book of helpful money-making information:—
"The More You Know the More You Can Earn—Easier and Quicker."

Paints, Paper, Perfumes, Photography, Polishes, Powders, Remedies for Man, Beast or Fowl, Rubber Products, Refrigerants, Soaps, Solder and Soldering, Tooth Cements, Transfers, Transparencies, Varnishes and Thousands of others for making all sorts of profitable and practical things.

MANY FORTUNES MADE FROM A SINGLE IDEA!

This comprehensive book is an accepted authority by chemists, schools, industry, etc. and is the largest and most comprehensive book of its kind ever issued. Nothing else like it in existence. A single formula has been worth a thousand times this book's small cost to countless owners. Crammed with money-making ideas. Invaluable for reference. Ideal for Factory, Home, Farm, Office or Workshop. As necessary as the dictionary and more useful for manufacturers, chemists and salesmen who put up products for profit.

\$3.98 U. S. Funds. Postpaid anywhere in the world. (C.O.D. in U.S.A. only). Immediate shipment. Safe Delivery Guaranteed.

ADAMS BROWN COMPANY BOOKS OF APPLIED SCIENCE
Dept. 275 Chestnut Hill 67, Massachusetts, U. S. A.

POSTPAID
\$3.98
ANYWHERE IN THE WORLD

FREE! 32-PAGE ILLUSTRATED BOOKLET ABOUT WORLD'S MOST FASCINATING HOBBY



You're invited to hours of satisfaction with skilled tradesmen, business and professional men. Build your own scale model railroad—easy, inexpensive—looks and performs like the real thing. Get started now! Send for our FREE illustrated booklet—"Model Railroading For You." Send us your name and address TODAY!

MODEL RAILROADER MAGAZINE
DEPT. 723-E • MILWAUKEE 3, WISCONSIN

ELECTRICAL TRAINING

Intensive 32 weeks residence course in fundamentals of industrial electrical engineering, including radio, electronics. Prepares for technician, engineering aides. Approved for veteran training. 54th year. Write for catalog.

BLISS ELECTRICAL SCHOOL
7608 Takoma Ave., Wash. 12, D. C.



"YOU ARE UNDER ARREST!"



Help Bring Crooks to Justice Through Scientific
CRIME DETECTION!

I have taught thousands this exciting, profitable, pleasant profession. Let me teach you in your own home. Learn Finger Printing, Firearms Identification, Police Photography, Secret Service Methods thoroughly, quickly, at small cost. 58% of all American Bureaus of Identification employ I. A. S. students or graduates. I can prepare you for this fascinating work, during spare time. Write today, stating age, for "Blue Book of Crime."

INSTITUTE OF APPLIED SCIENCE, 1820 Sunnyside Ave., Dept. 1365, Chicago 40, Ill

FREE 5 INCH GENUINE LEATHER Jolly Rogers Patch



Join the Jolly Rogers Club of Insignia Collectors. Send only \$1.00 and get this Genuine Leather Jolly Roger Breast Patch Free with 25 all different Air Force Wings and Officers Collar Insignia. (List Price \$5.00.) Colored Insignia Book FREE with order.

The Insignia Mart, Dept. B-10,
703 Broadway New York 3, N. Y.



WINDOW SIGN LETTERS

For Store Fronts and Office Windows. Anyone can put them on. Samples furnished. Genuine gold and silver.

METALLIC LETTER CO., 441 N. Clark, Chicago 10

SELL MERCHANDISE by mail

OPERATE Profitable Lifetime Business Selling Merchandise by Mail. Large Profits on Fast Selling \$1.00 Items. WRITE TODAY!

POWELL CO. DEPT. C SAMLINER BLDG., CLEVELAND 3, OHIO



TALK-SING thru your own radio
with
RADIO MICROPHONE



Be the life of the party. Put on your own broadcasts at home. Talk-Sing, make announcements from any room. Wonderful voice practice. Microphone easily attached to any radio. Follow enclosed instructions. SEND NO MONEY—pay Postman \$1.98 plus postage. Send Money Order or check and save postage.

EMPIRE RADIO & TELEVISION CO. (Dept. R1) 1521 Bedford Ave., Brooklyn 16, N. Y.

HY-SCORE AIR PISTOL for ACCURATE SHOOTING



No pumping. Fast. Powerful. Finest made. Single shot. 30½ oz. 10¼" long.
\$25.00 with pellets. Extra pellets per 1000
\$2.50 for cal. .177. \$3 for cal. .22

SEE YOUR DEALER OR ORDER DIRECT
Send 10c for circular to Dept. P-5

HY-SCORE ARMS Corp. BROOKLYN, I. N. Y.

SHOOTS
CAL. 177
or .22
LEAD
PELLETS

Want to be in
BUSINESS
For
YOURSELF
Prepare at Home--
in Spare Time

Learn **RADIO**

**Qualify For a Good Pay Job-or Start
Your Own Business Without Capital**

Find out about the many money-making opportunities Radio offers you. Learn how you can qualify for a good-pay job or start a business of your own without capital. Send coupon below for my big **FREE** book, "Your Opportunities in Radio and Television," which tells of radio's vast opportunities and how **HOLLYWOOD RADIO & TELEVISION INSTITUTE** has been training men for success in Radio through home study, for over 17 years, in over 40 countries, through its proven **2-WAY METHOD—LESSONS PLUS HOME SHOP PRACTICE!**

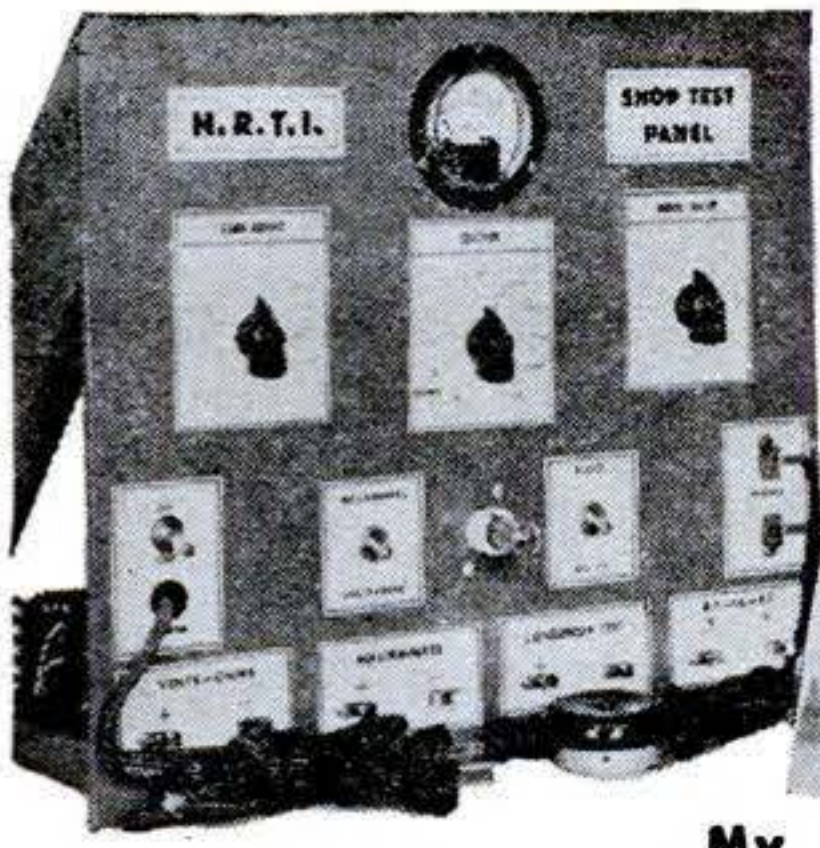

ABOVE — You build this Multi-purpose Shop Test Panel. 5 Test instruments in one.



My 2-Way Method (Lessons plus practical experience) helps you get into Radio Quicker.



BELOW You build this A.C. Power Supply. (Experiment No. 155)

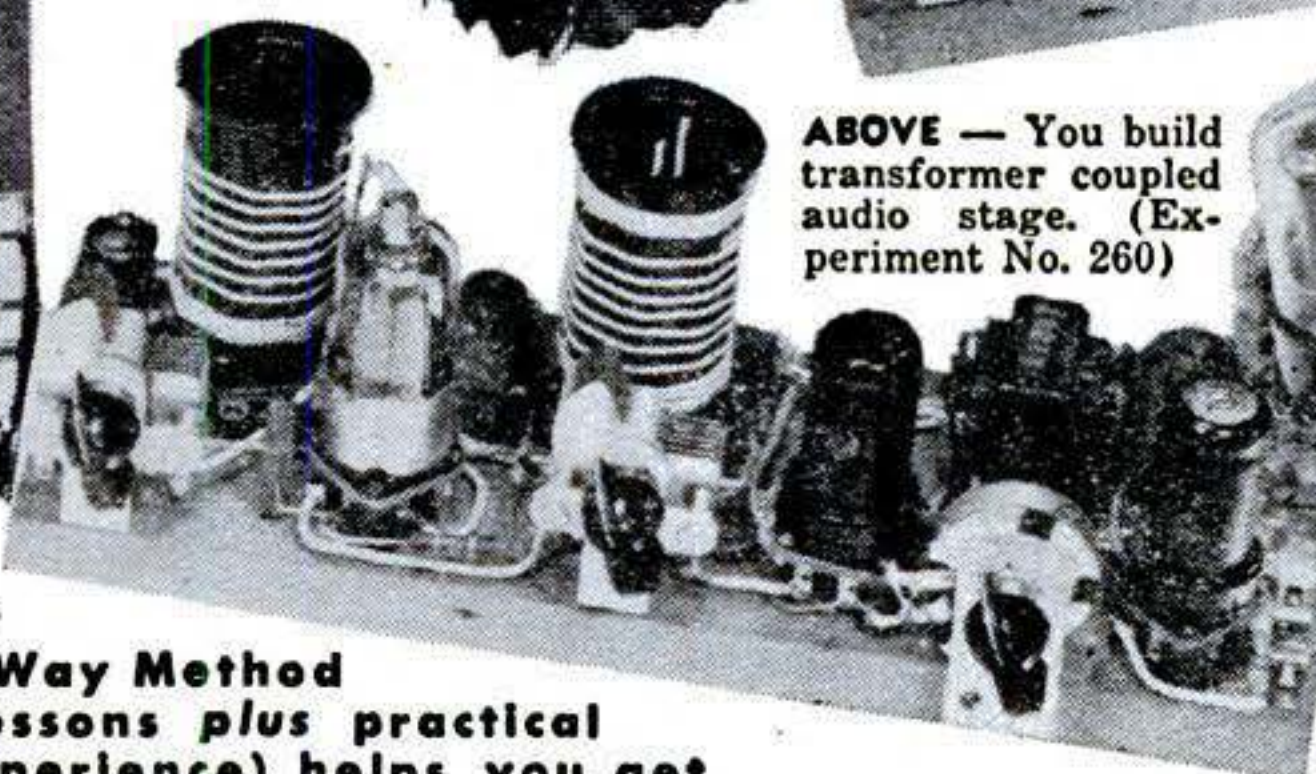

ABOVE — You build transformer coupled audio stage. (Experiment No. 260)

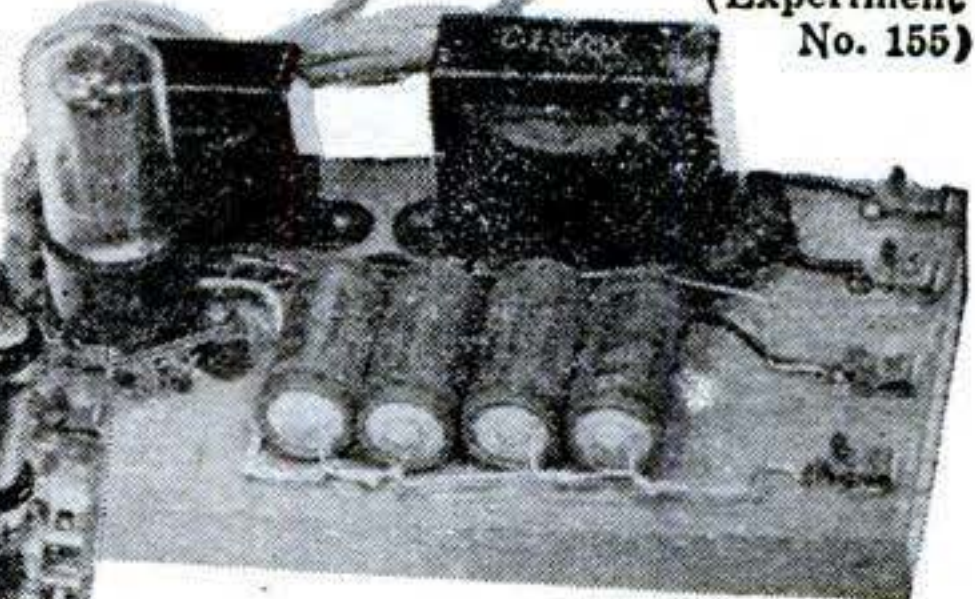

LEFT—You build this tuned radio stage, regenerative detector and audio amplifier. (Experiment No. 329)

**You Get 9 KITS OF RADIO PARTS * You Learn By Doing
You Do Over 300 Fascinating Tests * You Keep All Kits!**

My regular course shows you the "Whys" of radio. My Home Work Shop Experimental Course shows you the "Hows" of radio, first hand—by doing. Thus you learn more thoroughly—quicker.

HOLLYWOOD IS A WORLD CENTER

of radio broadcasting and manufacture-television-motion picture production. Thus, H. R. T. I. is in an excellent location to bring you modern, up-to-the-minute instruction. Before you decide on any course you owe it to your future to find out about H. R. T. I. training. Read what graduates in 40 different countries say about this famous course.

BIG BOOK FREE

Just paste coupon on a postcard or send in envelope for free big fully illustrated book "Your Opportunities in Radio, Television and Electronics" and explaining the advantages of HRTI training. No salesman will call.



MANY H.R.T.I. STUDENTS EARN MONEY IN SPARE TIME WHILE LEARNING

From the very start, through special "Spare Time Work Sheets," I show you how to earn money in spare time by doing good-pay radio jobs that abound in nearly every neighborhood. Many students earn \$5, \$10, and more a week while learning. A mighty good way to lay the foundation for a future radio business of your own. Now is the time to start preparing for YOUR career in this fast-growing industry. Take the first step—send coupon for my big **FREE** Book today.

MAIL COUPON NOW

C. H. Mansfield, President, Dept. D4
HOLLYWOOD RADIO & TELEVISION INSTITUTE
810 WEST 6TH ST., LOS ANGELES 14, CALIF.

Send me your **FREE** book, "Your Opportunities in Radio, Television and Electronics" which explains your 2-way home study training method. (No salesman will call.)

Name _____ Age _____
Address _____
City _____ Zone _____ State _____

Air Mail Reaches Me Overnight

HOLLYWOOD RADIO & TELEVISION INSTITUTE
810 West 6th Street, Los Angeles 14, California

MAY 1947 33

Be A Writer

of Short Stories, Mysteries, Novels, Articles, Radio Scripts

Learn at Home in Spare Time



"A Failure" Succeeds As Writer

"I tried to write but no success until I enrolled with you. Before I was half-way through your course I sold one story—and numerous other writings since."

Stephen Kerro, Cleveland, Ohio

Big New Opportunities Now

The public's new interest in technical, mechanical subjects offers big new opportunities for scientific minded writers who are trained to make dry facts interesting and exciting.

You don't have to be a great writer to make good money—using experiences of your own, of friends—or just your imagination. Many beginners start earning early in their training, selling short stories, articles of all kinds, which bring in small but welcome checks of \$25, \$50, \$100 and more. Such material may be turned out quickly once you acquire the proper technique. And now it's easier to learn than you may imagine, through Palmer's unique method of training—for NOT just one field of writing, but for all: Fiction, Article, Radio.

You Learn To Write By Writing

You receive individual coaching by professional writers who go over your writing, giving you helpful suggestions and showing you how to correct weaknesses, how to capitalize on your good points. Thus your own individual writing style is carefully developed. Study fast or slow. Save time and effort. To find how you too may make money writing—part time or full time—send today for FREE illustrated book. Palmer Institute of Authorship (since 1917), 6362 Hollywood Blvd., Hollywood 28, Calif. Desk U57.

FREE BOOK PALMER INSTITUTE OF AUTHORSHIP Since 1917
6362 Hollywood Blvd., Desk U57, Hollywood 28, Calif.

Please send me free illustrated book "The Art of Writing Salable Stories," explaining how your training helps new writers get started. This is confidential. No salesman will call.

Mr. _____
Mrs. _____
Miss _____

Address _____

City _____ Zone _____ State _____

AIR RIFLES BENJAMIN AIR PISTOLS ARE AVAILABLE

SEND FOR FREE FOLDER OF LATEST MODELS TODAY

If you want a REAL GUN for PRACTICAL USE inside or outdoors get a SAFE-CLEAN-ECONOMICAL-BENJAMIN with Adjustable Power and Amazing Accuracy. Use BENJAMIN H-C PELLETS for BEST RESULTS. WRITE AT ONCE.

BENJAMIN AIR RIFLE CO., 811 MARION ST., ST. LOUIS 4, MO.

ARTISTS MAKE MONEY

Do you like to draw? Send name, address, age and occupation for FREE ART TEST, to find out your ability.

ART INSTRUCTION, INC.

5147 Art Instruction Bldg., Minneapolis 15, Minn.

ANALYZE HANDWRITING

Qualify for Certified Grapho Analyst Degree at home, spare time. Credit, Employment, Personnel Managers, Business, Professional men, women use grapho-analysis in their work, earn substantial fees in spare time. Many study solely for personal benefit, no desire to earn money, find it so fascinating they start using it to add to their incomes. Entertainment field pays well, up to \$100 in a week reported. Others establishing profitable practices as Vocational and Family Problem Counselors, Personality Teachers, and lecturers.



GROWING—UNCROWDED PROFESSION

More and more police use grapho analysis handling suspects and criminals. They understand how criminals think. Their handwriting tells. Men like Hugh Dunlap, university student, Harry Allen, retired preacher, use it in court, win cases, earn fees even before graduation. Only school in world devoted to teaching grapho analysis offers thorough training to earnest, ambitious men and women regardless of where you live, small town, farm or city. Send for GRAPHO ANALYST, illustrated lesson, personal handwriting analysis offer, ALL FREE. Must be 21 or over. Address A. I. G. A. Inc., 126, Noel, Missouri.



Learn Penmanship

You can become a good penman right in your own home during spare time by my Simplified Method. Write for my FREE Book, "How to Become an Expert Penman," which shows what others have learned. If desired, send 10c for one of my favorite Pen Points and your name with a beautiful flourished bird written on a card. Write for the Free Book today.

T. M. TEVIS, BOX 25R, CHILLICOTHE, MO.

FIREWORKS WHOLESALE

Start a Stand of Your Own

SPECIAL GET ACQUAINTED OFFER

SPARKLERS—8 in.

(8 in box) per gross boxes \$7.25
These sparklers are double dipped for greater brilliancy and longer burning. We carry a complete line of fireworks at the lowest prices. Write for free catalog.

NORMAN NOVELTY CO. 323 Springbrook Blvd. Dayton 5, Ohio

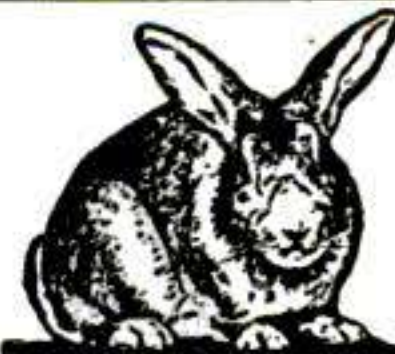

RAISE CHIN-CHINS

No experience needed. Just a few minutes daily and a few feet of backyard, garage or barn space. Several females and a male starts a large, profitable herd. WE FURNISH FREE INSTRUCTIONS. TREMENDOUS DEMAND for breeding and laboratory stock, meat, and world's most beautiful rabbit fur. Brokers, cut off from imported rabbit pelts by world famine, NEED CHIN-CHIN FURS NOW, and for years to come! Write for free illustrated catalog today.

WILLOW BROOK FARM • R-45 SELLERSVILLE, PENNA.

RADIO PARTS GRAB BAG!!

\$25 value assortment of Coils, Condensers, Transformers, Resistors, Controls, etc. An experimenter's dream. Order today! Only.....

\$3.98

MARKO SUPPLY, Dept. PS-5
2924 Logan Blvd. Chicago 47, Ill.

GOLD TEETH WANTED

Dental gold teeth, plates and bridges with metal attached. Any broken pieces of gold jewelry. Immediate payment and free mailing container to you or your friends upon request. LOWES, DEPT. PS, Holland Bldg., St. Louis 1, Mo.

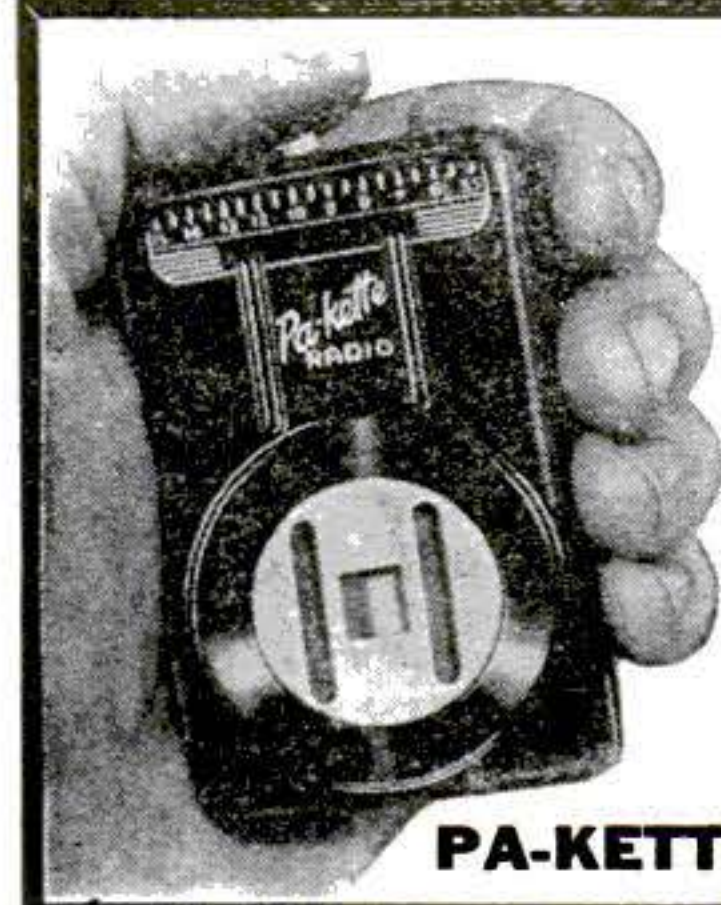

AMAZING NEW Pocket or Purse Size RADIO!

Small as a pack of cigarettes! Weighs only a few ounces. Durable and beautiful black chrome plastic cabinets. Uses new pretested war born crystal diode. SLIDE RULE DIAL! REQUIRES NO TUBES—BATTERIES OR ELECTRIC "PLUG-IN" and should last for years. Many times you can receive local broadcasts simply by snapping to metal trim of phones, floor lamps, bed springs, etc.!

GUARANTEED TO PLAY for you if regular AG system used. Complete instructions sent with each radio. You can use it at home, in many offices, hotels, cabins, in bed or most anywhere! Lots of fun—and real entertainment!

SEND ONLY \$1.00 (cash, money order, check) and pay postman \$2.99 plus delivery fees on arrival or send \$3.99 for postpaid delivery. Complete as shown ready to play with self-contained personal earphone. For gifts—children will love it—grownups too! An exceptional value—order yours and enjoy the many good radio programs coming! Don't be without your Pa-Kette Radio another day! (All foreign orders \$5.00 U. S. cash.)

PA-KETTE ELECTRIC COMPANY Department PS-5 Kearney, Nebraska

SAVE UP TO 85% in WAR SURPLUS

SENSATIONAL VALUES at GADGETEER'S HEAVEN

IN MANY ITEMS WE HAVE THE WORLD'S LARGEST SUPPLY

New Hydraulic Cylinders

VALVES, PUMPS, FITTINGS, HOSE & TANKS

The World's Largest Supply. 1001 Labor Saving Adaptations for pulling, pushing, lifting operations.

Finest precision workmanship and materials. Liquid and/or air operation, developing terrific power.

15% OF GOVERNMENT COST! Write for Catalogue



A Real Buy!

A 1001 USES! WINCH HOIST

Capacity 2500 lbs. Controlled worm gear drive winch, with 19 ft. 1/4" diam. alloyed steel cable. Ideal for garages, truck loading, machine shops, boat building, etc.

#100 \$10.75
#100 With handle \$12.50



Dry Cell BATTERIES

NEW! FULL STRENGTH For portable Radios, Signal Lamps, Boats, Electric Trains, etc.

#515 #516
#516 9 Volt 8 1/2 x 6 x 4 in. 3 run, 24 Volt Motor 79c
#515 90, 45 & 1 1/2 Volt all in one 4" x 4" x 7" Battery... 99c
#517 67 1/2 & 1 1/2 Volt Battery 69c



PNEUMATIC GUNS

RIVET #180
Gooseneck #181
Pistol #186

PNEUMATIC ALLIGATOR SQUEEZER #186

Pistol & Goose-neck Type Chipping, Riveting and Hammering Cement. Chicago Pneumatic, Cleco, Ingersoll Rand Makes. E3, E2, 3X, 2X, OY \$55 Value \$8.95

\$80 Value \$15.95



MESS TRAY

6 COMPARTMENTS Rustless, Stainless Steel. Can be used for cooking as well Ideal for restaurants. The perfect companion for that vacation trip, barbecue picnics! Saves dishwashing.

#311 69c ea.



PLEXIGLASS DOMES

15"x19 1/2"x6" deep. 1/4" thick.

Can be used for home hot-house, fish bowl, washbowl, ornamental light. Can be flattened in oven and will make flat sheet, 15"x19 1/2" x 1/4". Weight 3 1/4 lbs.

#700 \$1.69

Also 200,000 lbs. of other plexi-glass sizes and shapes.



NEW Amplidyne Motor-Generator

With 24 volt current, it gives 60 volt output. This unit has been adapted to independent and rural lighting power.

Welding and many other uses. Weight 29 lbs. Gov't. Cost Approximately \$237.00!

A Steal at \$8.95



LEATHER FLEECE-LINED BOOT INSERTS

For hunting or around house as slipper. sizes: medium, large.

\$7.00 Value \$1.89 pr.



WINDSHIELD WIPER KIT

1/6 H. P., 24 volt, D. C. series wound motor, with 30" flexible shaft, switch circuit breaker, 10,000 forward or 5,000 reverse R. P. M. Wiper & wiper bracket, arm blade & switch.

only \$7.95



Electric GYRO PILOT Assembly Part

2 solenoids for reverse and forward motor control. 2 solenoids throw clutch to engage drive. With brake assembly. Can be used as boat rudder control, converted for lathe tapping and slow speed motor tool. wt. 29 lbs. Finest precision workmanship

Cost Gov't. Thousands! Your Cost \$8.95



OPTICAL GYROSCOPE!

MARK 18 GYRO-SIGHT

An engineering marvel worth hundreds of dollars! - Our Price \$8.35

Airforces Gun-Sight, #103 N8A, with polarizing variable density \$2.95
L3 Type, #102, Triple Lense \$1.95



LIQUIDOMETER

\$10 value in parts alone! Used for any type of gasoline tank, with any automobile gage. A sensational value!

Elect. jet. box w/2 Magnets \$1.95



COMPASSES

#151 Marching, lensite, with luminous dial \$1.69
#152 Matchbox, both jewel & liquid floating dial 39c
#153 Jeweled Pocket Watch Compass #153 \$1.19
#154 Wrist strap Compass 69c



COMPARE THESE PRICES

#301 CANTEEN, 1 qt., alum., plastic top 29c
#302 MESS KITS, 2 pc. alum. 39c
#304 FISHING KITS - Excellent fishing knife, hook & line, mackerel & feather jig, pork rind bait, abrasive stone, hooks, triple hook jig, dip net, sm. harpoon \$3.95
#400 WORK HELMET, Alum., 12 oz. 59c
#510 & 511 Amp. & Volt Meters ea. \$2.50
#303 SLEEPING BAGS, New, 100% wool Mummy type, heavy 30" zipper \$4.95
Water Repellent Cover \$1.00 Extra.
#305 GOGGLES, New colored flexible lens. Shatterproof. 59c
Sponge Rubber Frame

Air Corp Fleece Lined Leather Jacket, used \$6.95



HOBBYISTS! An Unequaled Value!

GADGET MIX

Rivets, spacers, Clamps, bolts, nuts, Radio parts, gears, etc.

A gold mine 5 lbs. \$1.19

#120 Aero-Seal #120 CLAMPS Adel #121 Adel Alum. rubber lined. Mixed 4 doz. 89c
#121 Aero-Seal, Rust Resistant. Slotted with screw gear top. 1/2" to 3". Reg. 27c NOW 10c \$1. doz.



PRESSURE TANKS

Stainless steel, shatter proof. 400 lbs. /sq. in. G-1 2100 cu. in. 26 x 12 in #105 \$4.75
D-2 500 cu." #104 2.25

Valuable GEARS Bargains!

8 to 1 ratio, spindle drive #110 \$2.98
4 to 1 with screw shaft #111 4.95
85 to 1 (can be used for radio antennae, etc.) #112 \$3.95
2 to 1. Box geartype #113 4.95
1 to 1 #114 3.95
Flexible gear shaft with end drives 30" #115 1.00



All Purpose HAMMER

Ax & hammer combination for wood & metal work. 3 1/2 lbs. 14 1/2" hardwood handle, hard steel cutting edge. 69c

Compound METAL SNIPS Action

Hard steel blades. Expansion spring. Locking device. Both lefts and rights. Now \$2.59



BOAT FENDER-21 in. long, 5 in. diam. Protection against docks for small boats.

\$6.50 VALUE A STEAL AT \$1.95

9/16" JUTE ROPE 3 Thread Strand. Right Lay. 50 Ft. 79c
7/8 SISAL ROPE 50 Ft. \$3.59
5 lb. Ball 3/16" Hemp Twine Treated \$1.49

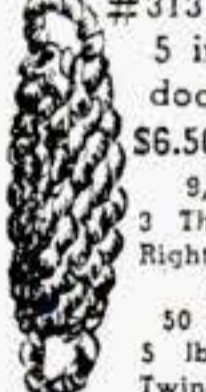

SPRING MIX

Torsion, compression and tension springs. Assorted sizes

2 lbs. 89c

A shelf treasure for emergencies!



RUBBER GOODS

RUBBER PAD 24 x 24 in. 1/2" thick. \$1.95 Soft & springy. Ideal foot-mat for workers who stand on their feet - Cashiers, Demonstrators, machinists, etc.

NEOPRENE SHEET RUBBER

Thick-ness	approx. Width	Price per sq. yd.
#323 .015"	1/64 36"	\$.50
#324 .017"	1/64 36"	.60
#325 .020"	1/64 36"	.65
#326 .037"	1/32 36"	.85
#327 .064"	1/16 36"	1.25
#328 .175"	3/16 42"	6.00



COMPRESSOR complete with tank and fittings.

G. E. 2-stage, A.C. or D.C. 1/3 h. p. 1000 lbs./sq. in. Spraying, laboratory use, inflating. NOW #506 \$17.95

Compressor and 24 volt motors can be adapted to 110 A.C. with transformers or 4 1000 heating elements. We stock both.

ELECTRIC MOTORS

New 1/2 H. P. 27 Volt D. C., 24 Volt A. C. #500 \$5.45
Used 1/2 H. P. 27 Volt D. C., 24 Volt A. C. #502 \$3.95

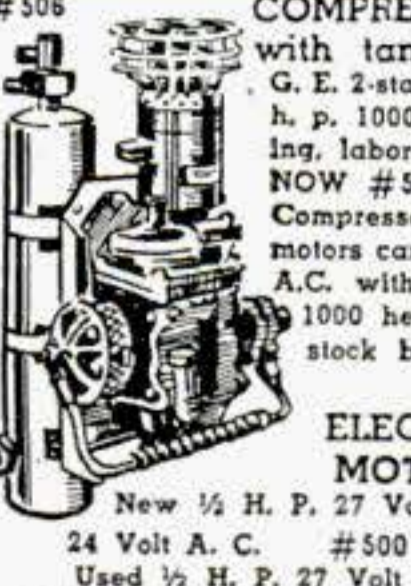

JEEP CAN Perfect Condition #331

Perfect on motor trips, camping, etc. Easily carried, fits into narrow space, sturdily built.

5 Gal. 89c

Flexible spouts available with order of 39c ea.



We Maintain Large Stocks of: AVIATION SUPPLIES, AIRCRAFT COMPONENT PARTS, A & N FITTINGS, RIVETS, BOLTS, HARDWARE, ALUMINUM, BRASS, COPPER, STAINLESS STEEL, ANGLE ENTRUSIONS TEES, SHEETS HARDWARE

Write US YOUR REQUIREMENTS



SELSYN MOTOR TRANSFORMERS

For Remote Control G. E. Model 2J1G.1 57.5 volts, 400 cycle #514

COST \$60.00 OUR PRICE \$3.95 Each



ORDER DIRECT FROM THIS AD

All sales final. Make remittances by money-order, bank draft or personal check. Purchase orders acceptable from D & B firms. All quotations F.O.B. Los Angeles. BIG ILLUSTRATED CATALOGUE AVAILABLE

Send 25% deposit with C.O.D. orders. Also Aircraft Supply Catalogue

AUDELS ELECTRIC MOTOR GUIDE

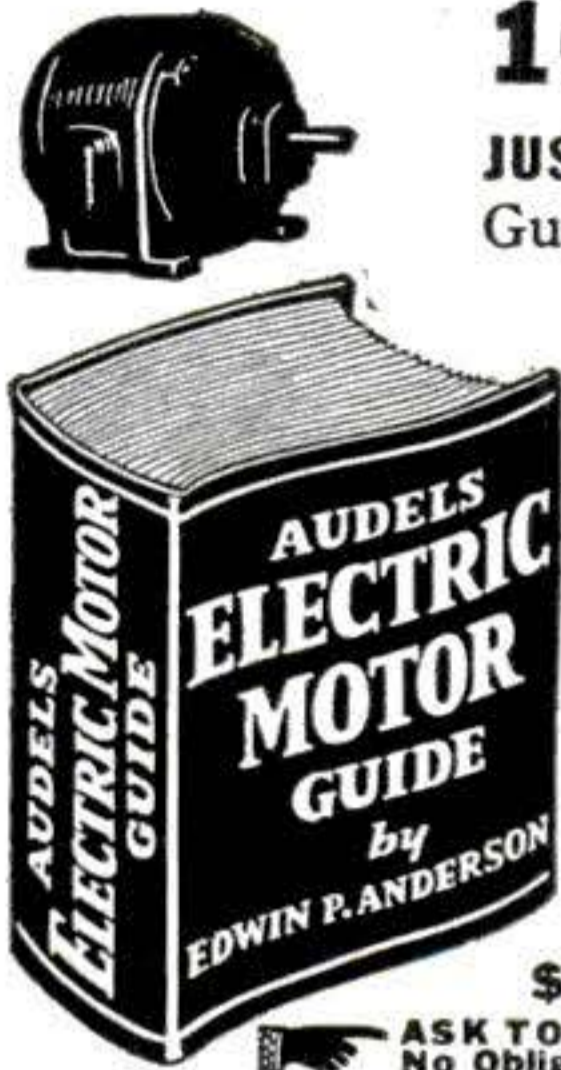

1000 PAGES OF PRACTICAL MOTOR INFORMATION

JUST OUT! Audels Electric Motor Guide covering the construction, hook-ups, control, maintenance and trouble shooting of all types of motors including armature winding. Explains entire subject in every detail. 31 Chapters, 617 Illustrations and Diagrams. A Handy Guide Fully Indexed for Electricians and all Electrical Workers.

\$4 COMPLETE • PAY \$1 A MO.

ASK TO SEE IT!—Get This Information for Yourself No Obligation Unless Satisfied.

MAIL ORDER

AUDEL, Publishers, 49 W. 23rd St., New York 10, N. Y.
MAIL AUDELS ELECTRIC MOTOR GUIDE for free examination. If O. K. I will send you \$1 in 7 days; then remit \$1 monthly until price of \$4 is paid. Otherwise, I will return it.

Name _____
Address _____
Occupation _____
Employed by _____ PSM

G & E Craftsmen's Bargains

ELECTRO MAGNETIC LIFT

An important labor-saver every repairman will use in many handy ways. For momentary work. Plug in any AC socket. 110 volt, 60 cycles; size 4 3/4" diam. by 3", with 22" cord and plug attached. Complete with instructions. Ship. Wt. 5 1/2 lbs. No. 7618—only



\$7.35
each

FULFLO HEAVY DUTY FILTERS

Famous Fulflo Filter is ideal for gas, air or oil. Has 1/4" inlet and outlet I.P.T. Heavy bracket attached for mounting. Complete, ready to install. Overall size 3-9/11" diam., 5" high. Ship. Wt. 4 3/4 lbs. No. 4753—only



\$1.95
each
Lots of Ten \$1.85

HI-POWER ELECTRIC DRILL

Heavy duty 1/4 inch capacity drill. Light weight—hand balanced. Three jaw chuck. Oil bronze bearings. Equipped with 6 feet flexible rubber cord and plug. 900 rpm at full load. Operates at 110 V, AC or DC.



No. 6202
\$17.95
ea.

Send check or money order, including postage.
Dealers. Write for quantity discounts.

G & E EQUIPMENT SUPPLY CO.

Dept. PS-15 400 N. SANGAMON ST., CHICAGO 22, ILL.

36 POPULAR SCIENCE

YOU MAY BE ABLE TO
DOUBLE YOUR INCOME
IN YOUR
SPARE TIME!!

LEARN SILK SCREEN PROCESS

Jealous? Guarded Trade Secrets NOW Available to You

Develop a Profitable Business of Your Own... or a Hobby

Prepare yourself for an interesting top paying position. Thousands of jobs open. Silk Screen Process signs, displays, Xmas cards, toys, etc., IN GREAT DEMAND THE WORLD OVER. You may make enough the second week to pay for the entire course. EASY TO DO... EASY TO LEARN. No education or mechanical knowledge required.

WRITE FOR FREE COLORFUL INTERESTING ILLUSTRATED CATALOG.

CALIFORNIA SCHOOL OF SCREEN PROCESS
Dept. P-57 3740 Overland Avenue, Los Angeles 34, California



COURSE INCLUDES A COMPLETE KIT OF SUPPLIES

Play in One Hour by Ear and Note

NEWLY INVENTED SLIDE-CHORD DEVICE. Fits piano. Play any chord at once. Plink out tunes by ear and note and add chords to play beautiful 2-hand professional radio style at one sitting! Complete course in one package—no extras needed. Fun! A game! No exercise or drills. Startle your friends. **PLAY 27 COMPLETE SONGS WITH 4 CHORDS (SEND NO MONEY) (JUST 1c CARD).** 25 lessons ABC METHOD, including many POPULAR SONGS and SLIDE CHORD DEVICE. ALL for \$2 plus C.O.D. Save C.O.D. and send \$2 cash, check, money order. MONEY BACK GUARANTEE. No C.O.D. in Canada.



DALE SHEAR'S SCHOOL OF MUSIC

Studio 4105

Struthers 3, Ohio

INVENTORS

The question as to whether a subject matter is patentable can be substantially determined by a search of the U. S. Patent records. Without obligation, write us for full information on what steps an inventor should take to secure a Patent or Trademarks.

RANDOLPH & BEAVERS

Registered Patent Attorneys

905-L Columbian Building, Washington 1, D. C.

INVENTING

—FOR PROFIT!

If you have an inventive turn of mind, write for free 28-page booklet explaining how the Institute of American Inventors is helping inventors pre-test the profit possibilities of proposed devices to fill today's unprecedented demand for new inventions.

INSTITUTE OF AMERICAN INVENTORS

Dept. 3.

1926 Eye St. NW.

Washington 6, D. C.

PATENTS AND TRADE MARKS

C. A. SNOW & CO.

REGISTERED PATENT ATTORNEYS

WRITE FOR INFORMATION TO

426 SNOW BUILDING, WASHINGTON 1, D. C.

INVENTIONS WANTED AT ONCE

Patented or unpatented inventions, all types needed by manufacturers. Write for free booklet "MARKETING YOUR INVENTION" and Protective Disclosure Form. We have a tremendous list of firms who may pay cash or royalties for good inventions. For full particulars, write today.

NATIONAL INVENTION SERVICE

1404J Mitchell Street

Oakland 1, Calif.

Learn REFRIGERATION AND AIR CONDITIONING FROM THE INDUSTRIAL TRAINING INSTITUTE

America's Foremost School of **PRACTICAL TRAINING!**



ADMINISTRATION BUILDING



DEMONSTRATION LABORATORY



ELECTRONICS LABORATORY



REFRIGERATION LABORATORY



EXPERIMENTAL HOME

*Industrial
Training
Institute*

Here is an industry that offers every opportunity you could ask for. Good jobs—security—plenty of chance for advancement—a business of your own.

And here is a school equipped in every way to train you for Refrigeration and Air Conditioning work—one of the largest and most completely equipped schools of its kind in America—a school that already has trained thousands of men for just such opportunities.

GET READY NOW!

Learn Refrigeration and Air Conditioning—now, while the time is ripe! You don't need any advanced schooling or previous experience. If you are at all mechanically inclined and have gone to high school for at least one year or have an equivalent education, we can teach you Refrigeration and Air Conditioning.

**LEARN AT HOME
OR COME TO OUR SCHOOL**

You can take most of your training at home, in your spare time—or you can come to Chicago and take your entire training in our completely equipped shops and laboratories. Either way you quickly acquire the fine points, practical skill, and broad, tech-

nical "know how" that makes the expert Refrigeration and Air Conditioning Technician.

**FACTS ABOUT THE
INDUSTRIAL TRAINING INSTITUTE**

Founded in 1916. Has trained more than 400,000 men for practical work in industrial fields. From 1942 through 1945 trained specialized technicians, exclusively, for the Army, Navy and Marine Corps. Now training thousands of veterans under the G.I. Bill, both in its Residence Schools and by home-study. Occupies five buildings of its own. Has over \$500,000 invested in training facilities, with an instruction staff of more than 100 men. Known everywhere as America's foremost school of practical training for industry.

Get all of the facts about the opportunities in this interesting field of work, and about the I.T.I. system of training that has helped so many men into key jobs in this industry. Fill out the information coupon below and mail it TODAY. You will be under no obligation whatsoever.

**AUTHORIZED TO ACCEPT
VETERANS FOR G. I. TRAINING**



GET THE FACTS MAIL THIS
COUPON

TODAY

**REGISTRAR P2R
INDUSTRIAL TRAINING INSTITUTE
2150 Lawrence Ave., • Chicago, 25, Ill.**

Please send me, FREE, your "Camera Visit" booklet and information about the opportunities for trained men in Refrigeration and Air Conditioning. It is understood that I will be under no obligation.

Name.....

Address.....

City..... State.....

Are you a veteran?.....

MAY
1947 37

LOANS *by* MAIL

\$50 to \$300 *IN A HURRY*

CONFIDENTIAL

Salaried people, men or women, married or single, loans on your own signature, or your own security. NO personal interview. NO co-signers needed. NO wage assignments. You mail the application to us... we mail the money to you.

FOR A LOAN OF	YOU CAN REPAY MONTHLY			
	IN 15 PAYMENTS	IN 12 PAYMENTS	IN 9 PAYMENTS	IN 6 PAYMENTS
\$ 50	—	\$ 5.03	\$ 6.43	\$ 9.24
100	8.40	10.07	12.87	18.48
150	12.60	15.10	19.30	27.73
200	16.75	20.09	25.68	36.91
250	20.85	25.02	32.02	46.05
300	24.93	29.94	38.33	55.17

The above payments made at regular monthly intervals will repay the entire loan and all charges in the time indicated. Charges are based on the monthly rate of three per cent on unpaid principal balances to \$150.00 and two and one-half per cent on that portion of unpaid balances in excess of \$150.00 but not exceeding \$300.00. "Loans by Mail" may be repaid in larger amounts, more frequent payments or repaid in full at further savings to you.

CONVENIENT

Just write us how much money you need and how you wish to repay... there's no charge or obligation. Whatever your needs for cash now or in the future, write for your "Loans by Mail" plan, today.

MERCHANTS INVESTMENT CO.

819-H 1st Nat'l Bldg., Omaha, Nebr.

Without obligation, rush complete details and all papers necessary for a loan of \$_____ to be repaid at \$_____ on the _____ day of each month.

Name _____

Address _____

City _____ State _____

Occupation _____

INVENTORS

IF YOU WISH TO PROTECT YOUR INVENTION, You should take steps to protect it by a U. S. Patent. Write me for "Record of Invention" form.

CARL MILLER

REGISTERED PATENT ATTORNEY

Woolworth Bldg., 35th Floor, Dept. 57C, New York City
Please send me "Record of Invention" form.

NAME.....

ADDRESS.....

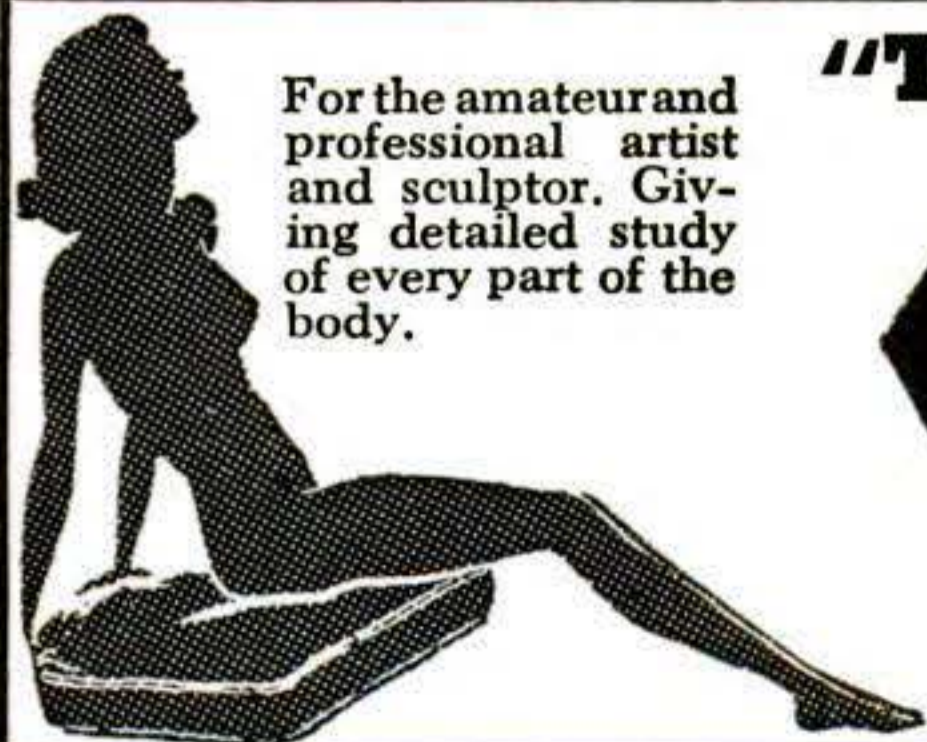

For the amateur and professional artist and sculptor. Giving detailed study of every part of the body.

"The Book They're Talking About"

Contains over 300 illustrations, charts and notes

ART ANATOMY OF THE HUMAN FIGURE

MALE AND FEMALE, POSED AND IN ACTION

(Sent in plain wrapper.) Outside of U. S. A. Send \$1.25

MAJOR BOOK CO., DEPT. 54-D, LYNBROOK, NEW YORK

ONLY
\$1.00

Tells How You Can Learn to



Learn At Home

Men, Boys, Hunters, Fishermen, mount and save your lovely wild-game trophies. Be a Taxidermist. Mount Birds, Animals, Heads, Fish, Tan skins. YOU learn easily, quickly in spare time. Have a grand home-museum. The finest and the greatest hobby known, for sportsmen. Fun, real profits.

FREE BOOK

Yes. FREE. Beautiful strange, valuable Book, telling all about Taxidermy. Contains over 100 beautiful game-pictures. And it's yours FREE, if you rush your request. You can mount all kinds of wild-game, and common specimens too. We can positively TEACH YOU. So GRASP this opportunity. RUSH letter or postal for this amazing FREE BOOK. Don't delay. State your AGE. N. W. SCHOOL OF TAXIDERMY, 3395 Elwood Bldg., Omaha 2, Neb.

Learn BAKING At Home

Baking is one of America's high industries in wages. Nearly depression-proof. Thorough basic home course lays sound foundation. If you have aptitude, write for FREE BOOKLET, "Opportunities in Commercial Baking." National Baking School, 1315 Mich. Ave., Dept. 1365, Chicago 5



QUICK! "REPAIRING CAR BATTERIES" MONEY

At Home! Easy Too! Free Circulars! WRITE, BATTERYMAN Dept. S-1 Grand Junction, Colorado

MARCOT KEY MACHINE

Immediate Delivery



Marcot No. 8 Key Machine Mounted on Cabinet.....\$ 82.50
Book on Modern Locksmithing.... 3.95
Auto Code Book and Auto Depth Keys 12.50
162 Doz. Popular Key Blanks.... 77.76
Set Key Files, Tools, Pins, Springs, Thimble..... 10.50
\$187.21

A. J. MARCOTTE CO., 1200 N. KEDZIE AVE. DEPT. PS. CHICAGO 51, ILL.



BUILDING HUMAN STATURE

"I grew 6 inches during a year I followed instructions given in "BUILDING HUMAN STATURE" says the younger man at left. "Now I am a head taller than my father."

If you wonder why you are short send for FREE outline of this remarkable book loaded with practical information.

CARILLON BOOKS, Dept. 104, Boerne, Tex.



Begin today. Write now for our Free Book, "How to Become a Good Penman." It contains specimens and tells how others learned to write in spare time. Enclose 10c for your name beautifully written and a pen point suitable for shaded writing. Write today. THE TAMBLYN SCHOOL OF PENMANSHIP N-439 Ridge Building, Kansas City, Mo.

DETECTIVES

TRAINING—SECRET INVESTIGATIONS—FINGERPRINTS
Easy Method — Short Time. — Rewards.
Home—Travel—Secret Code-Booklet FREE—WRITE
INTERNATIONAL DETECTIVE SYSTEM
1701-P Monroe St., N. E., Washington, D. C. 18



**BIG MONEY
INDEPENDENCE**

*A PROFITABLE
LIFETIME
BUSINESS
OF
YOUR OWN!*

LEARN ELECTRICAL APPLIANCE REPAIRING

PREPARE NOW FOR THE FUTURE

If now employed, start your home appliance repair business NOW in your spare time and be set with a business of your own no matter what happens. You don't need elaborate fixtures or expensive equipment to be a successful repairman. Operate from your garage, basement, vacant store, etc. Work as many hours as you wish—the home appliance repairman is his own boss. It is a profitable occupation for on many types of repairs it is not unusual for a repairman to charge on the basis of \$5.00 to \$6.00 per hour. Don't gamble with your future—learn a trade that will always support you. Remember, as long as electrical appliances are used, there will be a need for electrical appliance repairmen.

If you are at all mechanically inclined—can hold and use tools—then you have all of the qualifications required for becoming a big money earning home appliance repairman. It does not matter if you have not had a great deal of schooling or had previous experience along these lines—**WE WILL TEACH YOU.** Age should be no barrier—nor should any minor physical handicap.

New Course Tells All

Profusely illustrated, our new course shows you in simple, easy to understand language and drawings how to make each repair on refrigerators, vacuum cleaners, washing machines, motors, etc. Explains and gives you a working knowledge of electricity, welding, nickel plating, etc. Shows you how to build the power tools you need and how to solicit and keep business coming to you. Not a theory course but an honest to goodness course written by and used by repairmen the country over. Price of course is so low that the savings on your own household appliance repairs will quickly pay for it. Act now! Mail the handy coupon below today.

-----Read What Our Students Say About Course-----

I really believe your course the best investment a mechanically minded man can make.—Claude E. Allen, Indianapolis, Ind.

I have received your Course in Appliance Repairing and I must say I am well pleased with same. I am only sorry I did not have said Course some years ago. I have learned so much more through this course I would not part with it.—Charles Schwarz, Hamilton, Ohio.

The Course in Appliance Servicing arrived a few days ago. Want to take out a few minutes of my valuable time to let you know that this is just what I have been looking for ever since I opened up my Fix-It shop. I must admit that you told the truth when you said that it contains quite a bit more information than I bargained for. — P. J. Bretl, Sebring, Ohio.

I am a mechanic for the Western Union Telegraph Co. Three days after receiving the lessons in refrigeration I earned the exact cost of the course.—Henry S. Lee, Washington, D. C.

I work day times at the shipyard and after 4:00 P.M. I operate from my cellar and garage. I average \$10.00 to \$15.00 clear every day.—Walter Hanhy, Brockton, Mass.

GET STARTED TODAY — MAIL THIS COUPON

CHRISTY SUPPLY CO.
2835 N. Central Ave., Dept. D-5201
Chicago 34, Illinois

Please send me free illustrated literature about America's Fastest Growing Industry—**ELECTRICAL APPLIANCE REPAIRING.**

Name.....

Address.....

City.....State.....

MAY
1947 39

BAUSCH AND LOMB 7x50 NAVY BINOCULARS



Mfgd. to U.S. Navy Standards! (Alignment guaranteed to .001") Brand new glasses. Dust proof! Climate proof! Individual eye adjustment. Instant focusing. Coated optics insure sharp, clear images! Ideal for long range hunting, yachting, watching planes, etc. This magnificent 7 power 50 mm. Navy Binocular gives better detail, heightening image contrast. Complete with carrying case only \$135.00 plus 20% Federal tax.

BAUSCH AND LOMB 6x30 Binoculars \$37.50

6 Power Binoculars made to rigid Army specifications by BAUSCH AND LOMB. Used in good condition. Sturdily constructed of genuine brass, leather covered. Ideal for hunting, sports, etc. These fine Bausch and Lomb glasses come complete with case and straps, ready to use. Similar to picture. \$37.50 plus 20% tax. WHILE THEY LAST!

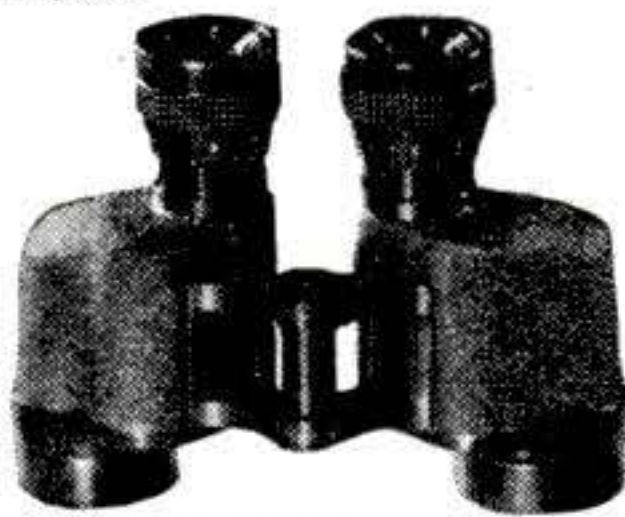

OTHER BINOCULARS (3 to 16 POWER!)

12x40 Carl Zeiss. Like new.	\$200.00
16x40 French. No case. Used	125.00
16x45 French Monte Carlo. New	135.00
12x38 French Monte Carlo. New	100.00
10x32 French Monte Carlo. New	79.00
10x50 German Dienstglass. Used	140.00
8x30 French Monte Carlo. New	62.00
8x25 French Monte Carlo. New	57.00
8x25 French Monte Carlo. Used	45.00
8x24 Busch. Lightweight. Used	65.00
7x50 German Dienstglass. Used	130.00
8x30 Carl Zeiss. Used	90.00
6x30 Carl Zeiss. Used	75.00
6x30 Universal. Navy. Lightweight. Used	38.50
6x25 Ross. London. Used	60.00
6x30 Heesch. Used	55.00
6x24 USN. Turner Reich. Lightweight. Used	60.00
5x40 Nat'l. Field Glass. Coated Optics. New	29.75
4x50 Super Eye Field Glass. No Case. New	15.00
4x40 Fee & Stenwedel Field Glass. New	20.00
5x40 Fee & Stenwedel Field Glass. New	22.00
4x40 Wollensack Field Glass. New	16.25
3x30 Fee & Stenwedel Field Glass. New	4.25
10x, 20x, 30x, 40x Variable Telescope. New	42.50

Add 20% For Federal Excise Tax. Carrying case and straps included. Supply limited. Give second choice.

MONEY BACK GUARANTEE! Use for 20 days at our risk and expense. If not fully satisfied, return for full refund of your money. **ORDER TODAY!** Send \$2.00 deposit and we will ship C.O.D. for balance. Cash orders sent postpaid.

UNITED PRODUCTS CO.

7941 S. Halsted Dept. ARF-116 Chicago 20, Ill.
(Reference Dun & Bradstreet)

Say You Saw
It In Popular Science

PHOTOGRAPHY

for Today's—and Tomorrow's
Better Opportunities

Ever-increasing demand for trained photographers in advertising, industry, science, publishing. N. Y. I.'s success-proved home study training qualifies you. Previous experience unnecessary. Details FREE! Also resident courses.

NEW YORK INSTITUTE OF PHOTOGRAPHY Dept. 5 10 West 33 St. New York 1, N. Y.

MINERALS

IDENTIFICATION AND QUALITATIVE CHEMICAL ANALYSIS
OF MINERALS—By Orsino C. Smith, A. B., A. M.

The most complete handbook on the subject ever published; with every step in identification and analysis clearly explained and illustrated in full color.

At last, all the facts about all minerals between the covers of one great book! More than 2,000 minerals listed and classified by specific gravity and hardness. Hundreds of beautiful, full-color photographs and illustrations. Complete directions for determining any known mineral from its physical properties—index of refraction, color, streak, lustre, cleavage, fracture, fusibility, etc.—all organized for instant practical use. **\$6.50**

D. VAN NOSTRAND COMPANY, INC. EXAMINE THIS
250 Fourth Avenue, New York 3, N. Y. GREAT BOOK FREE
Please send me a copy of "Identification and Qualitative Chemical Analysis of Minerals". Within 10 days, I will either return the book or send you \$6.50 plus a few cents postage.

Name.....
Address.....
City..... Zone..... State.....
Pop Sci.—May 1947

FIREWORKS

OH-BOY!

Banner has always been right there with the newest and best in fireworks. Now we offer you sensational new creations you never heard of before. Thrills galore. You'll be the envy of your friends and neighbors when you start celebrating with BANNER FIREWORKS... always rock bottom in price.

BIG SPECIAL DEAL—ONLY \$4.95

Big giant assortment of over 150 pieces including Salutes, Roman Candles, Sky Screammers, Chinese Firecrackers, Sparklers, Vesuvius Fountains, Aerial Bombs and many others... regular \$10.05, retail value for only \$4.95. Rush your order. Supply limited. Catalog FREE.

BANNER FIREWORKS MFG. CO., INC., DEPT. 246
446 Capistrano Toledo 12, Ohio

REPAIR ELECTRICAL APPLIANCES, SEWING MACHINES, MOTORS, BICYCLES, LAWN MOWERS, ETC.

Start on \$20.00 and common tools! Earn up to \$6.00 an hour! Build low cost equipment. Learn from illustrated instruction course. Only \$5.50 Free Details

REPAIRMAN'S SERVICE, 222 4th Ave., Janesville, Wis.

HORSE MASTERY!

A FINE HOBBY — A GREAT VOCATION!

"The EXPERT HORSEMAN"

SUBSCRIBE TODAY 50¢
One Year

FREE BOOK — Tells how You can learn to:
BREAK COLTS, GAIT SHOW HORSES, TRAIN RODEO, STOCK and RACE HORSES, BREAK BAD HABITS, HANDLE ANY HORSE, TRAIN CIRCUS TRICK HORSES. WRITE TODAY!

ANIMAL LOVERS ASSOCIATION
BOX S-157 TARZANA, CALIFORNIA

12 lbs. SURPLUS RADIO PARTS \$2.00

A gold mine of parts for repairmen, amateurs, and experimentors... sockets, condensers, resistors, transformers, coils, hardware, wire, etc., etc. An outstanding bargain in usable parts! Send \$2.00 cash, check or M.O. today! (Pay small express charges on receipt.)

ELECTRONIC PARTS, Inc. Dept. S-5, 622 W. Randolph St., Chicago 6, Ill.

BATTERIES FIXED TO WORK LIKE NEW!

with and without new materials. Everything needed supplied. Complete copyrighted course, tool list, etc., only \$10.00.

BATTERY LABORATORY SCHOOL, Dept. C, Minneapolis 13, Minn.

CARTOONING

HAVE FUN! MAKE MONEY! Cash in on your sense of humor at HOME—BY MAIL. No experience needed to start. Write today FOR FREE TRIAL LESSON and full particulars.

MOON Gag Cartoon School, Dept. C, Fall Creek, Wis.

RADIO ENGINEERING, Broadcasting, Servicing, Electronics, Aviation, Marine & Police Radio taught thoroughly.

48 weeks' Engineering course equivalent to 3 years' college radio work. Approved Veteran Training. Co-educational. Catalog upon request.

Valparaiso Technical Institute, Dept. 503, Valparaiso, Ind.

LEARN-WATCH REPAIRING at HOME

"FREE information write—American Institute of Specialized Watch Repair—P.O. Box 117, Dept. 2, Grand Rapids, Michigan.

MAKE MONEY AT HOME

RUBBER MOLDS

Low as 6¢ EA.

Amazing rubber mold-making outfit makes perfect flexible molds of plaques, ash trays, bookends, etc. Molds cost 6c to 25c each. Each mold makes hundreds of novelties and gifts to sell for \$1.00 apiece and more! No experience necessary. Everything furnished. Quick and easy. Start profitable business in your home—sell to stores, gift shops, friends, resorts, road stands by mail. Full or spare time. Write for complete FREE details and easy instructions.

SO-LO WORKS, INC., Dept. U-801, Loveland, Ohio

You Can Grow With PLASTICS!

Plastics is one of the fastest growing industries—offering you unusual opportunities for an interesting, successful career and security in the years ahead. Trained men, with plastics know-how will fill the important, well-paying positions. YOU can be one of them. Mail the coupon below for a big, colorful, free catalog on Plastics and complete details

about Plastics Institute, America's oldest and largest plastics school. Resident School located in beautiful Southern California. Comprehensive Home Training Courses to prepare you in your spare time at home for a career in plastics. You can enroll immediately! Write Plastics Institute, Dept. PS7-5, 1601 S. Western Ave., Los Angeles 6, Calif.

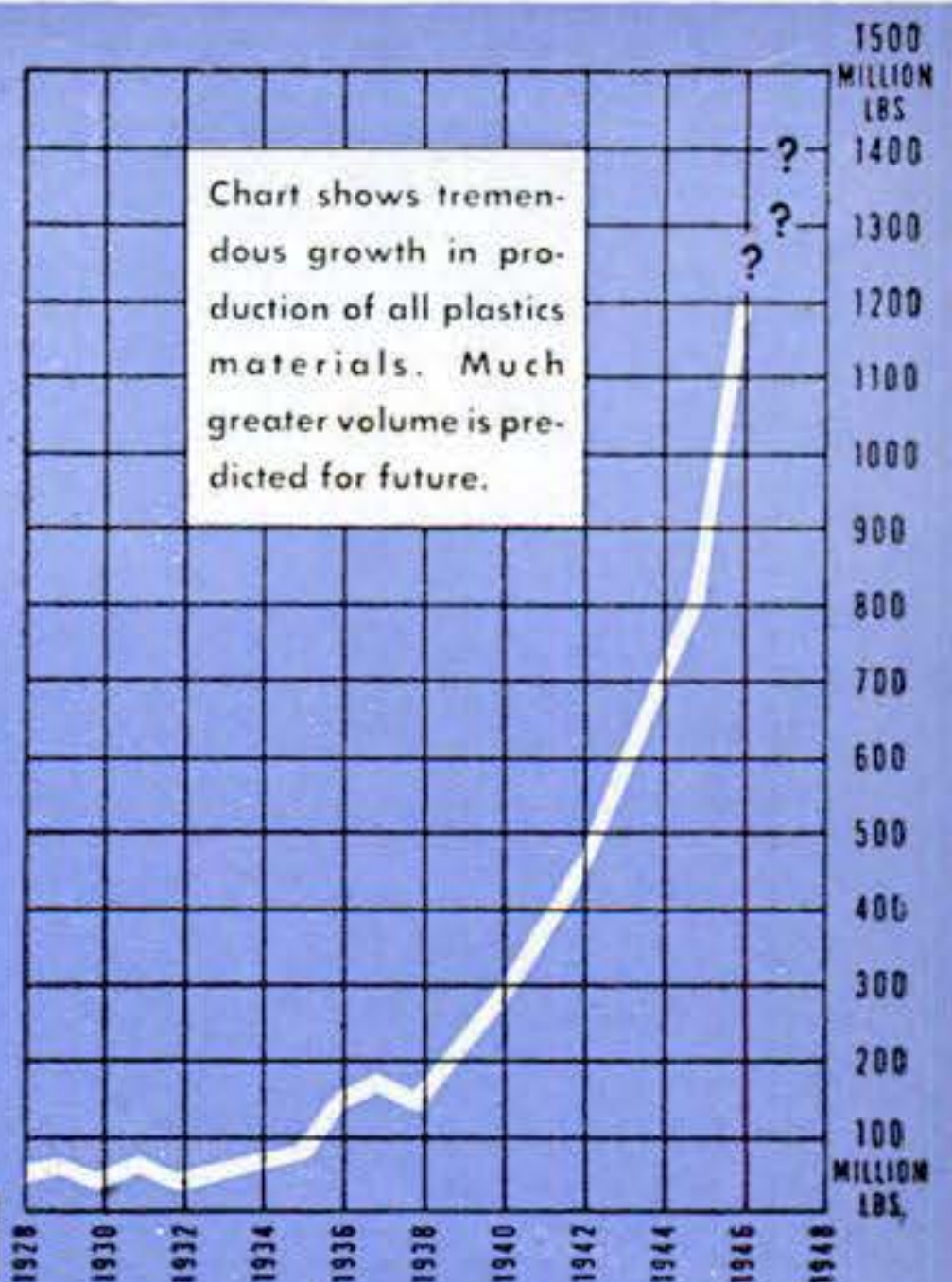

LEARN BY DOING

To give you practical experience we supply colorful plastics to make useful, attractive creations. You can also make and sell plastics articles to earn while learning.

APPROVED FOR VETERANS

FREE BOOKLET

Plastics Industries Technical Institute
Dept. PS 7-5, 1601 S. Western Ave., Los Angeles 6, Calif.

Gentlemen: Please send me the booklet "World of Plastics" and information on your Resident School Courses () Home Training Courses. () I understand there is absolutely no obligation.

Name (PRINT)..... Occupation.....

Street (PRINT)..... Age.....

City..... Zone..... State.....

Important: Please fill out coupon Completely. If Veteran, please check. () If in Armed Services now, please check. ()

Mail in Envelope or paste on penny postcard



PLASTICS INSTITUTE in the heart of sunny Los Angeles. Here modern laboratories and shops give Resident School students facilities for practice on the finest of industry-type plastics equipment. Also the headquarters for HOME TRAINING.

LAW

STUDY AT HOME for PERSONAL SUCCESS and LARGER EARNINGS. 38 years expert instruction—over 108,000 students enrolled. LL.B. Degree awarded. All texts furnished. Easy payments. Send for FREE BOOK—"Law and Executive Guidance"

AMERICAN EXTENSION SCHOOL OF LAW
Dept. 77-S, 646 N. Michigan Ave., Chicago 11, Ill.



Make Your Pocket Coins Pay Big Dividends

You may have a valuable coin in your pocket right now. Hundreds of dollars are made each year from the sale of old coins. Know what coins are bringing today's high prices. Hanson's Coin Index brings you the latest authentic information. Subscribe now. \$3 a year. Send 25c for trial issue. Money refunded if not satisfied. HANSON'S COIN SHOP—1326 Main, Kansas City 6, Mo.

LEARN MEAT CUTTING EASILY - QUICKLY At Home-In Spare Time



The steady, dependable trade of Meat Cutting taught easily, quickly by improved HOME METHOD. National School, established over 25 years, has organized its famous "Learn By Doing" Classroom, Cutting room and Retail Market training system into sound, practical HOME STUDY form.

Now, by the miracle of this EXTENSION TRAINING you can prepare in Your Spare Time At Home, for a better job, bigger responsibilities or success and security in a store of your own. Remember, PEOPLE MUST EAT!

Buying, cutting, percentage, pricing, advertising, selling—a complete meat education. For beginner or men with ex-

perience. Thousands of successful graduates. Send coupon for FREE Bulletin NOW!

MAIL THIS COUPON TODAY FOR FREE BULLETIN

National School of Meat Cutting Dept. 054, Toledo 4, Ohio

Send me your FREE Bulletin on Meat Cutting and Meat Merchandising. No obligation. No Salesman will call.

Name.....

Street.....

City..... State.....

MAY 1947 41

Learn to Repair ELECTRIC APPLIANCES

AT HOME in your SPARE TIME

Prepare now for a permanent future, independence and security with a business of your own. Our practical, easy-to-learn home course teaches you, during your spare time, how to repair washing machines, vacuum cleaners, electric ranges, lamps, motors, irons, etc., and do house wiring.



WRITE TODAY for FREE BOOK

OPEN YOUR OWN SHOP Have a Secure Future

For the man who is handy with tools, and likes to work with his hands as well as his head, there is a WIDE OPEN OPPORTUNITY today, in this great growing field. If you own your own shop you can depend on making more money in good times . . . and not losing your job in a depression. You can start a business of your own in your garage or basement with \$20.00 worth of tools. One good repair job can pay for the cost of the entire course. Write today for further information, without obligation.

PACIFIC TRAINING SCHOOL

7217 So. Broadway, Dept. S-105, Los Angeles 3, Calif.

Dear Sirs: Please send me, without obligation, your free catalog and free details.

Name

Address

City..... State.....

Make Your Decision for a BETTER JOB OR A BUSINESS OF YOUR OWN

AIM high—pick one of these big fields. May never again be such opportunities to get in on ground floor and go up fast. REFRIGERATION & AIR CONDITIONING growing fast—frozen foods, commercial installations, many other developments. ELECTRICITY & INDUSTRIAL ELECTRONICS offers good pay to trained men. BODY & FENDER REBUILDING bringing many big money. AUTO MECHANICS in demand. DIESEL a rapidly expanding field. Pick one of these fields now—for men who ACT FAST things can happen fast. CONSULTATION AND PLACEMENT SERVICE whether you are interested in worthwhile job or setting up your own business. YOU CAN START TRAINING AT HOME IN SPARE TIME AND THEN COME TO BIG TRAINING SHOPS LATER. A few short weeks can make all the difference.



VETERANS ENROLLED UNDER "G. I." BILL. COMMERCIAL TRADES INSTITUTE, a nationally known school, only civilian school selected by Army to train service men for refrigeration. FACTS FREE. MAIL COUPON TODAY. NO OBLIGATION.

Fill Out, Cut Out, Mail Today

COMMERCIAL TRADES INSTITUTE, Dept. E15
1400 W. Greenleaf, Chicago 26, Ill.

Send FREE illustrated Brochures and other information about the field I have checked below.

- Refrigeration and Air Conditioning Auto Mechanics
 Electricity & Industrial Electronics Diesel
 Body & Fender Rebuilding

Name.....

Address.....

City..... State.....

Veteran Non-Veteran

PRACTICAL TECHNICAL TRAINING FOR YOU

Specialize in Electronics, Radio, Electricity, Refrigeration, Heating and Air Conditioning, or Welding

Prepare in six or twelve months for position as Technician, or in three years secure your B.S. Degree in ELECTRICAL ENGINEERING with a Machinery or Electronics Major.

Write for booklet, "Career Building."

MILWAUKEE SCHOOL of ENGINEERING Institute of Electrotechnics

Dept. PS-547 North Broadway and E. State, Milwaukee, Wis.

INDIANA TECHNICAL COLLEGE

B.S. degree in 27 mos. Aeronautical, Chemical, Civil, Electrical, Mechanical and Radio Engineering. 2-yr. diploma. Air Conditioning, Refrigeration, GI approved. Low rate. Earn board. Demand for grads. Enter June, Sept., Dec., March. Catalogue. 657 E. Washington Blvd., Ft. Wayne 2, Ind.

STAMMER?

This new 128-page book, "Stammering, Its Cause and Correction," describes the Bogue Unit Method for scientific correction of stammering and stuttering—successful for 46 years. Benj. N. Bogue, Dept. 1897, Circle Tower, Indianapolis 4, Ind.



MASTER MACHINIST • MECHANICAL DRAFTING TOOL-DIE DESIGNING • TOOL ENGINEERING

Days, Evenings • Approved for Veteran Training • Bulletin on Request
ALLIED SCHOOL OF MECHANICAL TRADES, INC.
44 ALLIED BLDG., 1338 SO. MICHIGAN, CHICAGO 5, ILL.



THE GEM MAKER

Amateurs or professionals . . . hobbyists or jewelers . . . Polish your own gems with a B&I Gem Maker. You will find this a profitable adventure. All necessary lapidary equipment is furnished, including a super-charged diamond blade for sawing, and all wheels for grinding, shaping and polishing, also complete instructions. The complete equipment as shown, less motor and belt, for only \$29.50, f.o.b. Burlington, Wis. Write today for information and literature on the Gem Maker and accessories. B&I MFG. CO., Dept. M, Burlington, Wis.

AIR LIQUID STORAGE TANKS

Airplane Oxygen tanks; non-rusting, stainless steel, (used). Good condition. Tested for 400 lbs. safe pressure. 9 gallons capacity, 12x24 inches, weighs 16 lbs., both ends tapped 3/8" standard pipe thread, \$4.98. 24x6 inch, 2 1/4 gal. size \$2.98. Ideal for compressed air, any liquids, bottled gas, house trailers, buoys, floating rafts and other uses. Limited quantity. Order now. No COD orders, send money orders or cashiers checks for faster delivery.

MIDWEST BUY ANYTHING CO. 1520 Locust St., Kansas City, Mo.

EYE-GLASSES by MAIL NEW

Send No Money!

16-Day Trial Offer
NEWEST STYLES



LOW PRICES

FREE Scientific Sight Test Chart and Catalog. Write today.
U.S. EYE-GLASSES CO. 1557 MILWAUKEE AVENUE
Dept. 5-42, CHICAGO, ILL.

If Ruptured



Do What Others Now Do—
Wear a Form Fitting
MILLER Truss

which provides natural freedom and comfort in working, walking, playing, horse back riding, dancing, swimming or sleeping. You just cannot afford to be without this protection and convenience.

Wear two weeks then consult your physician before deciding to keep it.

Write me today for FREE descriptive circular. Sent in plain, sealed envelope.

FRED B. MILLER Manufacturer
Dept. P.S. Hagerstown, Maryland.

Be A MASTER PLUMBER

Earn \$15 To \$50 A Day

DON'T ENVY THE PLUMBER—BE ONE

Every skilled workman will tell you that Plumbers have the best of it. WINTER and SUMMER the Plumber is busy at top wages. No skilled Plumber is ever out of a job—compare his opportunities with any trade, plus the opportunities of having your own shop.

We teach you Plumbing with TOOLS (not books) under Licensed Master PLUMBERS in one of the finest equipped schools in America. We make you a Plumber, every branch is taught thoroughly—Lead Work—Blueprint for plan reading—all other tricks.

LEARN IN 30 WEEKS WITHOUT PREVIOUS EXPERIENCE

If you like to work with tools you owe it to yourself to investigate. No need to ever work as an apprentice. Get free bulletin. Write now! G.I. APPROVED. Our 24th year.

UNIVERSAL PLUMBING SCHOOL
819 HOLMES STREET KANSAS CITY, MO.

ELECTRICIANS' SCHOOL

PRACTICAL RESIDENT TRAINING IN

HOUSE AND COMMERCIAL WIRING • MOTOR REPAIR AND REWINDING • ELECTRIC REFRIGERATION, COMMERCIAL AND DOMESTIC.

Approved for Veterans Training

PENNSYLVANIA INSTITUTE SCHOOL OF ELECTRICITY

42nd and SPRUCE STS. PHILADELPHIA 4, PENNA.

DEVELOP THE POWERFUL INFLUENCE

FEUCHTINGER Method Guaranteed

IN YOUR VOICE

DO IT YOURSELF AT HOME

Write for the Voice Book FREE

Sent only to those over 17yrs of age

PERFECT VOICE STUDIOS

Kimball Hall Bldg., 25 E. Jackson, Chicago 4, Studio 1365

STAY HOME AND MAKE MONEY!

—Men! Women! Get into profitable, uncrowded profession you can operate from your home or small office after short home training course. No capital required. No goods to buy. No age limit. Others earn \$50.00 to \$100.00 per week making famous Stephenson corrective foot devices to order. Foot sufferers everywhere pay gladly for relief. Send today for FREE BOOKLET.

STEPHENSON METHOD, Established 1894, 35-62 Chatham St., Boston, Mass.

NEW CHEAP OIL BURNER

FOR COOKING & HEATING STOVES-FURNACES
HEAT YOUR HOME, COOK YOUR MEALS
WITH CHEAP FURNACE OIL



NO MORE SHOVELING COAL OR ASHES. A New Fuelizer Starter Vaporizing System turns Cheap 130 Flash Furnace Oil Distillate, Kerosene, etc. into Oil Gas heat without clogging up. LIFETIME GUARANTEE against defects. \$1.00 Bonus Offer for Testing. We will let you try it in your own stove or furnace for one month. Get yours for introducing.

Big Profits QUICK. Be first. Send in your name TODAY.
NORTHWEST MFG. CO., 562-E 5th, Mitchell, So. Dakota

WALKIE SIREN

Formerly \$15.00—Now Only \$3.95



GOV'T SURPLUS. A precision instrument. Easy turn of crank produces CLEAR, FULL SIREN TONE. Can be heard for great distance. Ideal for Boats, Autos, Schools, Sporting Events, etc. Dimensions 7" x 8" x 5". Wt. 4 1/2 lbs. Price includes shoulder strap and waterproof cover. SEND NO MONEY. Just name and address. We'll ship C.O.D. for \$3.95 plus postage, or send money in advance, we'll ship prepaid. Canadian price \$4.50. ILLINOIS MERCHANT-DISE MART, Dept. 401-A, 1227 Loyola Ave., Chicago 26, Ill.

HAUCK FLAME GUN KILLS WEEDS



2000° F controlled heat quickly, easily destroys seeds, roots, brush, poison ivy, wild morning glory, Canada thistle, other unwanted growths. Many uses: splitting rocks, burning stumps, sterilizing poultry houses. Burns kerosene. Does the work of 4 men. Safe, easy to use. 10 day trial. Satisfaction guaranteed. Free catalog.

HAUCK MFG. CO.
122 Tenth St., Brooklyn 15, N. Y.

ELECTRICIANS! RADIO MEN!

Valuable BOOK

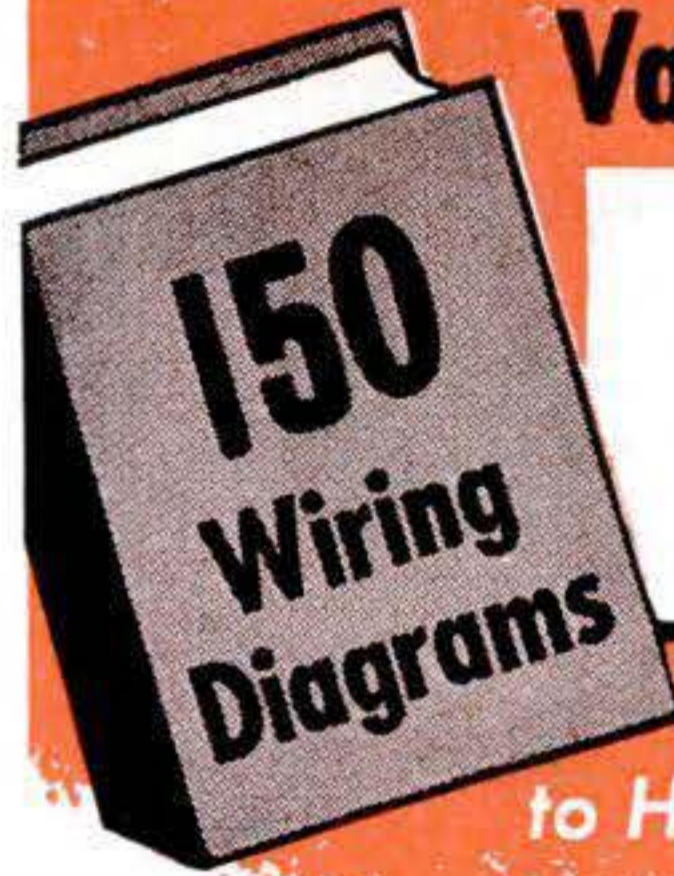

FREE

It's My Gift to Help You Get Ahead



B. W. COOKE, Dir.

5 to 1 Satisfaction GUARANTEE

I personally guarantee that at the end of 1 year from the date you receive these books that they must have earned 5 times their cost or you may return them and I'll refund every cent you paid.

HERE'S one of the greatest "get acquainted" offers ever made. This new book of 150 selected Electrical Shop Prints and Wiring Diagrams is YOURS — absolutely FREE.

This book is 'chuckfull' of valuable charts, diagrams, wiring methods and instructions for reading and using wiring shop prints. All the shop prints are full size 8 1/2" x 11" with full explanatory information. Here's all you have to do to get this free book:

150 Diagram Book Free FOR MERELY EXAMINING COYNE'S NEW 7 Volume Set

To get your FREE copy of this Shop Print Book, all you have to do is to let me send you my complete new 7 volume set of electrical books—COYNE APPLIED PRACTICAL ELECTRICITY for 7 days' FREE examination. Here's a set of books written for the "beginner" or "old-timer" in electrical work who is anxious to get ahead.

This 7 volume set contains thousands of "show how" methods and photos—the latest information in "easy-to-understand language." Electricity from "A" to "Z" presented in new, practical, modern methods of explanation. A leader in electricity today must "know his stuff." To succeed from now on you must know many branches.

SEND NO MONEY You have to see this new 7 volume set to really appreciate how much it can mean to you and your future. I'll send you the complete set of 7 volumes (pictured below) at my risk, postpaid for 7 days' FREE Examination. I'll also send you the New Coyne Book of 150 Shop Prints and Motor Diagrams as my FREE gift to you TO KEEP REGARDLESS OF WHETHER OR NOT YOU DECIDE TO KEEP THE 7 VOLUME SET COYNE PRACTICAL APPLIED ELECTRICITY.



Coupon is Not an Order

Just a Request to See the Books FREE YOU ARE NOT BUYING THE 7 VOLUME SET WHEN YOU SEND THIS COUPON. You are merely asking to see the books free for 7 days. The coupon only becomes an order if you decide to keep the 7 volume set after 7-Day Free Examination. OFFER IS LIMITED—Don't delay! Fill in and Mail FREE BOOK COUPON Now!

FREE BOOK COUPON

B. W. Cooke, Dir., COYNE ELECTRICAL SCHOOL, Dept. 57-R8
500 S. PAULINA ST., CHICAGO 12, ILLINOIS

Send me the NEW 7 Volume COYNE APPLIED PRACTICAL ELECTRICITY. Also send the Bound Volume of 150 Shop Prints and Diagrams which I am to keep FREE whether I keep the 7 Book Set or not. I'll either return the 7 Book Set in 7 days and owe you nothing or pay \$3 within 7 days and \$3.00 a month until \$21 is paid, or I'll send the cash price of \$19.75. You also include FREE one full year of Consultation service and technical bulletins.

NAME _____ Age _____

ADDRESS _____

TOWN _____ Zone _____ STATE _____

Check here if you want to pay postman cash price of \$19.75 (you save \$1.25) delivered. Same 7 day examination privilege and Money-Back Guarantee.

MAY 1947 43

RHEUMATISM YIELDS TO DRUGLESS METHOD OF TREATMENT

Excelsior Springs, Mo., March 30—So successful has a comparatively new, drugless method proven for treating rheumatism and arthritis that an amazing new book will be sent free to any reader of this magazine who will write for it.

This book entitled, "Rheumatism," fully explains why drugs and medicines give only temporary relief and fail to remove the causes of the trouble.

The Ball Clinic, Excelsior Springs, Mo., has perfected a system of drugless treatment for rheumatism and arthritis combined with the world famous mineral waters and baths. This new method of treatment is fully described in the book and tells how it may be possible for you to find freedom from rheumatism.

You incur no obligation in sending for this instructive book. It may be the means of saving you years of untold misery. For writing promptly, the company will also include a free copy of the book entitled, "Good Health, Life's Greatest Blessing." Address your letter to The Ball Clinic, Dept. 36, Excelsior Springs, Mo., but be sure to write today.

BECOME A MANUFACTURER'S AGENT

Be your own boss and earn big profits with little or no capital investment. Send today for the VIMAR PLAN which provides you in detail with soundly-tested methods on how to become a representative for prominent manufacturers. Learn how to contact concerns, select products and build a successful business for yourself. \$2.00 postpaid.

VIMAR CO. 210 LOEB ARCADE, Dept. A-21
MINNEAPOLIS 2, MINN.



FREE RADIO CATALOG

Lafayette—world's largest radio supply house—presents the world's greatest radio catalog. 144 value-packed pages. Over 10,000 items. Everything handsomely illustrated—fully described—economy priced. Send for FREE copy AT ONCE.

LAFAYETTE RADIO

100 SIXTH AVE., NEW YORK 13

110 Federal St., Boston 10 • 24 Central Ave., Newark 2, N.J.

LAFAYETTE RADIO, Dept. KE-7 • 100 Sixth Avenue, N. Y. 13, N. Y.
RUSH new Lafayette Catalog to:

Name.....
Address.....
City.....Zone.....State.....

**MAIL
COUPON
NOW**



BABY SHOOTING GALLERY

COIN OPERATED

Great fun maker for Rumpus Room or Club. Makes money too! Ten shots for 1 coin (1c or 5c). Realistic army type pistol shoots steel balls, one each time trigger is pulled. Ten targets to shoot for.

Scoring device at top registers all hits. Harmless. All action enclosed. Entirely mechanical. Sporty wood and metal cabinet, glass top. Lock and keys protect cash box. Fits any counter or bar... overall size 31 x 11 in. Ht. 16 in. Guaranteed to satisfy or money refunded. Send \$20.00 deposit, balance C.O.D. plus Express charges. Wt. 40lbs. Immediate delivery. Specify 1c or 5c, Each, **\$98.00**

Webb DISTRIBUTING CO. INC.

6 SOUTH KEDZIE AVE. • CHICAGO 12, ILLINOIS

AMAZING NEW TRAP CATCHES ANIMALS ALIVE!

CAN'T HARM CHILDREN, PETS, BIRDS, POULTRY

It's amazing how the new HAVAHART catches rats, rabbits, squirrels and other animals, yet it's harmless to children and pets. Simple to set, rustproof. No springs! No jaws! Animal walks in to get bait, and the doors close! Send postal for free booklet.

HAVAHART,
476 Water Street
Ossining, N.Y.

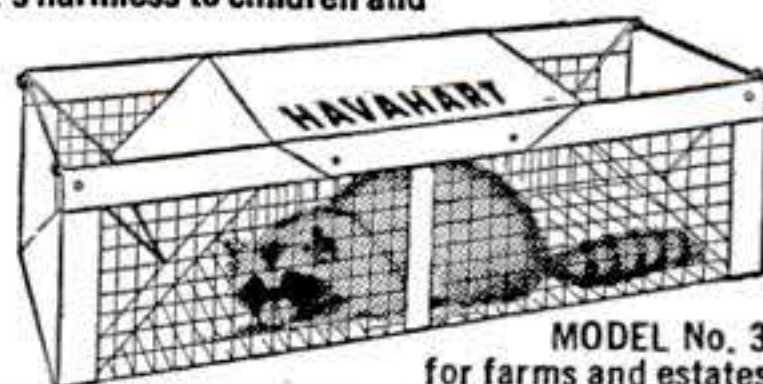

MODEL No. 3
for farms and estates

BUILD THIS CONCRETE BLOCK MACHINE

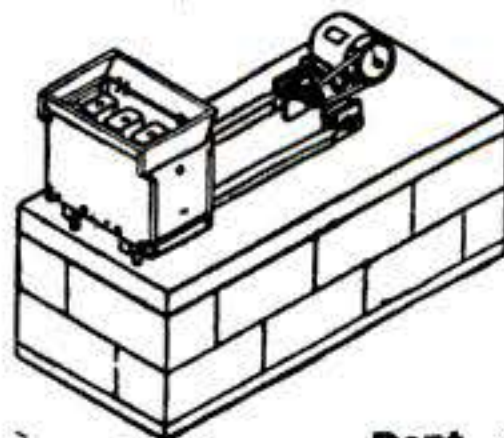

Sell blocks; or build your home, garage, barn, or filling station at 1/3 cost by making and laying your own blocks.

This simple machine which you can build yourself at a cost of \$15 (excluding motor) will make a block in 30 seconds using only one form. Mass production can be achieved by a new simple method of removing blocks which allows two to four forms to one vibrator. Power driven concrete mixer plans also. Send dime for details and "How to Make and Lay Blocks" folder.

U-BUILD-IT SERVICE

Dept. 4-A, 206 West Wilder St., Tampa 3, Florida

C-THRU-MIRRORS

SEE THRU ONE SIDE

Mirror on other side. Leisurely watch others at close range who imagine themselves unseen. Loads of fun. Lasts a lifetime. 3" x 4" or 2" x 6" sizes only. \$2.95 postpaid. No C.O.D. One day shipment. **Bealer Enterprises, Dept. 10-E, North Hollywood, Calif.**

**BURN
WATER
IN YOUR CAR**

COSTS LESS THAN GAS

More Power, Cleaner Motor.

Mail card for data on \$17.50

Water-injecting Carburetor.

OCTA-GANE

2425 E. 57TH ST. • LOS ANGELES 11, CAL.

**MAKE YOUR OWN
COSTUME JEWELRY
SPLENDID HOBBY OR VOCATION**

Sea Shells • Pin Backs • Ear Screws • Screw Eyes
Plastic Discs • Ear Clips • Floral Stones • Jump Rings
Chains • Clasps • Wire • Boxes • Bracelets • Parts
Bow Knots • Catches • Plexiglas • Cements • Dyes

WRITE FOR FREE CATALOGUE • DEPT. E

PHILADELPHIA BADGE CO., 1007 Filbert St., Phila. 7, Pa.

STEADY JOB! GOOD PAY! CLEAN WORK!

ELECTRICITY

**NATION'S
LARGEST
EXCLUSIVE
ELECTRICAL
SCHOOL**

**LEARN QUICKLY AND THOROUGHLY
LATEST, MOST ADVANCED METHODS**

Learn Electricity Fast . . . at nation's largest exclusive electrical school . . . in only 19 weeks! Learn Electricity Right . . . topflight instructors help you learn easily, quickly, thoroughly . . . on-the-job, up-to-the-minute methods of training. Qualify yourself for Construction and Industrial Maintenance . . . Operation, Maintenance and Repair of AC and DC Motors, Generators, Controls, other Power Equipment . . . House and Factory Wiring . . . Armature and Motor Rebuilding. Entire building—4 floors devoted exclusively to this one course. Individual attention to students. Living quarters arranged for if desired.

Pay after you graduate . . . Lack of money need not hold you back. We will finance your training. Pay later in small monthly payments.

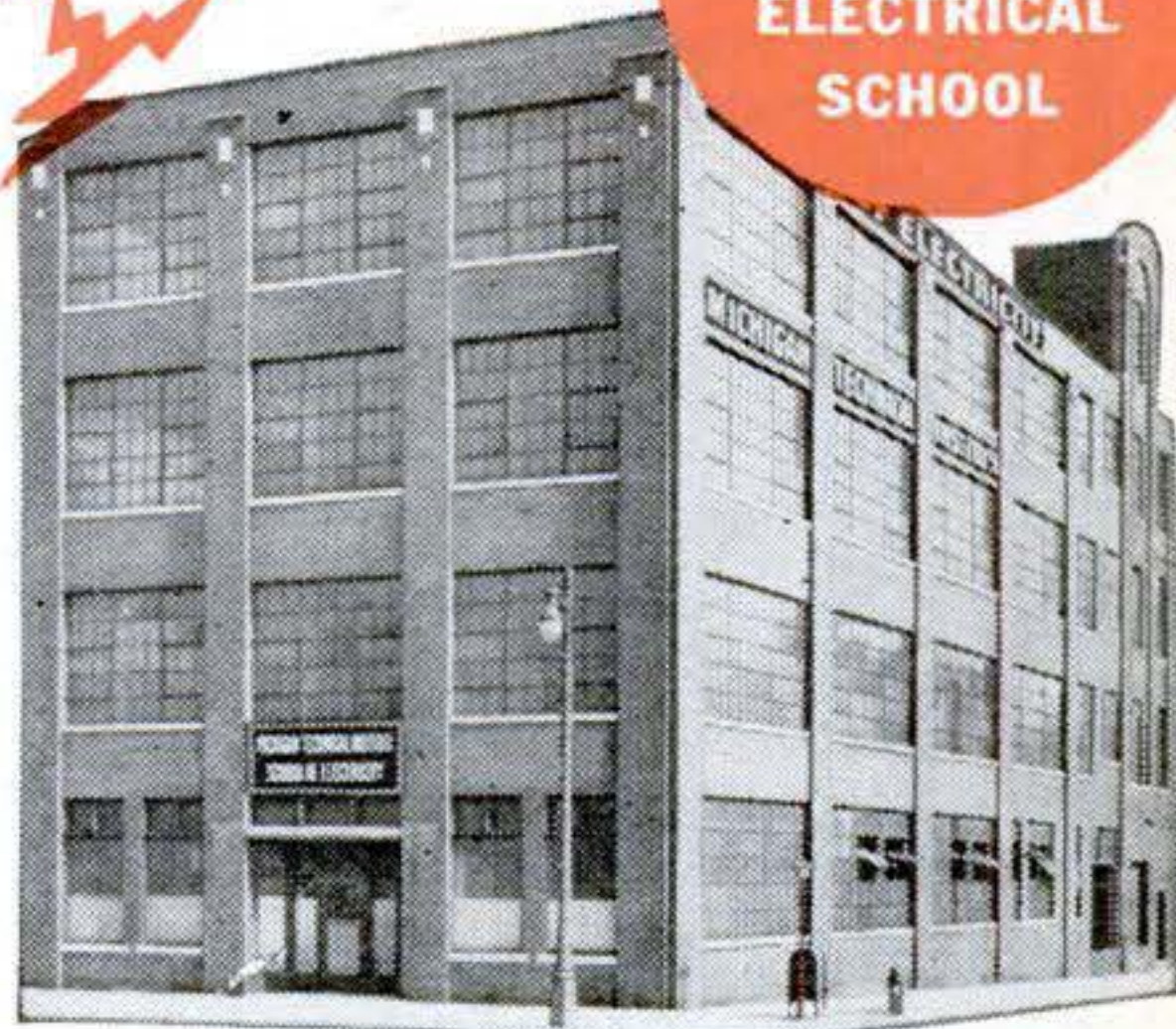

MICHIGAN TECHNICAL INSTITUTE

Dept. PS-5 2281 W. Fort St., Detroit 16, Mich.

APPROVED FOR TRAINING UNDER GI BILL

VETERANS!

Take this course at no cost to you, and receive \$65 to \$90 a month while training. Complete details furnished. **MAIL COUPON TODAY!**

**MICHIGAN TECHNICAL INSTITUTE Dept. PS-5
2281 W. Fort St., Detroit 16, Michigan**

Send me catalog and complete information.

I am a GI. Send special information.

NAME

ADDRESS

CITY STATE

WANT \$1,756 to \$3,021 A YEAR?

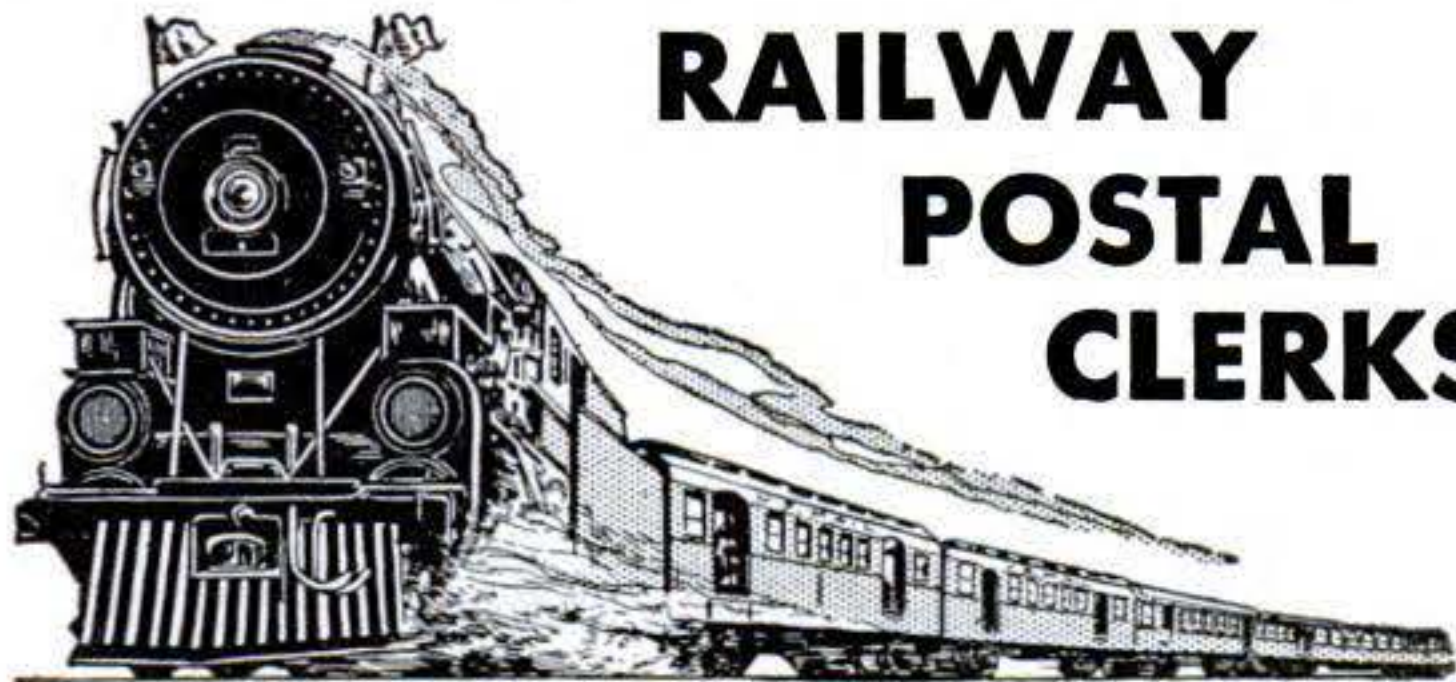

**RAILWAY
POSTAL
CLERKS**

City and Rural Carriers—Postoffice Clerks—
Inspectors—Accountants—Clerks at Washington
—Many other Government Jobs

TRAVEL FOR "UNCLE SAM"

Prepare Now for Many Coming Examinations
Veterans Get Special Preference

FRANKLIN INSTITUTE, Dept. H80, Rochester 4, N. Y.

Sirs: Rush to me, without charge, copy of 32-page book, "How to get a U. S. Government Job," list of positions, and full particulars telling how to prepare for them.

Name.....

Address..... Vet?.....

NORTHWESTERN GI APPROVED
VOCATIONAL INSTITUTE

**STUDY in
SCENIC
MINNESOTA**



MEN and WOMEN Earn Big Pay

Learn the **NORTHWESTERN** way! Train under the skilled and highly qualified **NORTHWESTERN** instructors. Study in the nation's beautiful, resort capitol! Scenic Minnesota's 10,000 lakes await you. Sports and recreations the year round! Fishing, boating, swimming in the summer. Skating, skiing, snow-shoeing and hunting in the winter. Train in this restful atmosphere the **NORTHWESTERN** way. Excellent opportunities in the BIG PAY fields of

• Radio Maintenance • FM • Radio Communications • Industrial Electronics

Practical Course of Instruction in Television, including Receiver & Transmitter Laboratory Training.

Day or night classes. New classes start every thirty days. Don't miss this opportunity. Study in vacation land! It's up to you. Don't delay! Write for the interesting free facts, today!!

NORTHWESTERN VOCATIONAL INSTITUTE

DEPT. PS 5
745 GRAND AVE.
ST. PAUL 5, MINN.

CUT OUT THIS BAND TO FIND RING SIZE

AUTHENTIC WESTERN

SADDLE RING

PURE STERLING SILVER

FOR MEN WOMEN or CHILDREN

Only \$4.95

POSTPAID We Pay Tax

First time at anywhere near this low price! Authentic replica of romantic western saddle. Handsomely formed from solid Sterling Silver by expert silver craftsmen. Massive style for men, dainty style for women and children. A gift of distinction. A pleasure to wear. Sent on approval.

SEND NO MONEY! Just clip this ad and mail with your name and address. Pay postman only \$4.95 plus few cents postage on arrival; or send cash and we pay postage. Wear this sensational ring for 10 days. If not delighted, return for full refund. Specify for **MAN, WOMAN or CHILD** and **RING SIZE**. Use cut-out band to determine size.

ARIZONA CRAFTSMEN

ROOM 696A
1904 FARNAM
OMAHA 2, NEBR.

How to Start YOUR OWN BUSINESS

Make Flexible Molds, Composition Flooring

NO EXPERIENCE—UNLIMITED MARKET

Start your own business at home in your spare time. Tremendous money-making opportunities for both men and women.

FLEXIBLE MOLDS

Make your own FLEXIBLE MOLDS. Cast novelties, statuary, desk sets, book ends, etc. Hundreds of casts made from single mold. Large size mold costs but a few cents. No experience necessary. Steady year-round demand.

COMPOSITION FLOORING

Make floors that last a lifetime with amazing COMPOSITION FLOORING! New discovery now enables you to lay artistic floors, in beautiful patterns in most colors and shades. Can be laid over wood, concrete, brick, steel, etc. This composition flooring offers unlimited money-making possibilities.

Free Catalog!

For FREE information about these and many other profitable business opportunities, WRITE TODAY!

BING PRODUCTS

Dept. B-19, 88 Broad Street Boston 10, Mass.

HAVE YOU AN APTITUDE FOR WRITING?

Storycrafters Guild determines your writing potentialities with a FREE APTITUDE TEST, then teaches you fundamentals of ALL creative writing. You study current material editors have bought and published. You learn how to write Stories, Articles, Radio, Motion-Picture, Novels, "Fillers"; specialty writing of all kinds under personal direction of Frederick Palmer. **EARN WHILE YOU LEARN** through Storycrafters Guild Manuscript Sales Service. Send for FREE APTITUDE TEST today!

STORYCRAFTERS GUILD, Dept. 34
5617 Hollywood Blvd., Hollywood 28, Calif.
Send FREE APTITUDE TEST and details of Home-Study Course in Creative Writing.

Mr. Mrs. Miss _____
Address _____
City _____ State _____

Thompson
BEATS
the World
on BOATS



Better Built Lower Prices



Safe Boats With Full Length Spray Rails
Keep passengers perfectly dry—even at high speeds. Catalog also shows two new models of "Take-Along" Boats. Two big factories—save you freight.

CATALOG FREE
Write for your copy. State kind of boat in which you are interested.
THOMPSON BROS. BOAT MFG. CO. (151)
219 Ann St. (Write to either place)
PESHIGO, Wis. 119 Elm St. CORTLAND, N.Y.

Light Boat for Auto

SPEEDY! 2 H. P. BIKE MOTOR

Makes a fast-powerful motorbike out of any bike. Up to 50 MPH—100 mile gal. gas. "Vari-matic drive." You can convert it easily from standard motors or parts we can supply. It's simple.



As low as \$19.95
SEND ONLY \$1.00 (cash or M.O.) postpaid or pay postman \$1.52 C.O.D. (USA only) for complete scale isometric picture blueprints (anyone can read them) 6 page details, lists of parts and prices complete!

FREE with each order—big 48 page color book giving full details on over 100 other new inventions such as: JET ENGINES—MIDGET MOTORCYCLES—CARS AND SCOOTERS—ELECTRIC BOATS—OUTBOARD MOTORS—BIKE RADIOS—WALKIE TALKIES, ETC. **DON'T PASS UP THIS SUPER VALUE—YOU MAY EARN AND SAVE HUNDREDS OF DOLLARS WITH THESE PLANS!** (All foreign orders \$1.50 U.S. cash with order).

MOTOR INDUSTRIES INC., Dept. PSBC-5 Kearney, Nebr.

POWERFUL BINOCULARS **only \$6.95**



All metal type with adjustable focusing wheel. Enjoy indoor, outdoor shows, sporting events, etc. Plated draw tubes extend for sharp instant focusing on distant objects. Low price includes handsome Carrying Case and long adjustable Shoulder Strap. **SEND NO MONEY.** Clip ad and mail. We'll ship C.O.D. for \$6.95 plus tax and postage charges. Address:

ILLINOIS MERCHANDISE MART Dept. 2217 1227 Loyola Ave. Chicago 28, Ill.

Send for Free List of LEADING BOOKS



on Watch Repairing, Clock Repairing, Engraving, Industrial Diamonds, Aircraft Instruments, etc. Dept. 10

HENRY PAULSON & CO. CHICAGO 3, U.S.A.

KIDNEYS MUST REMOVE EXCESS ACIDS

Help 15 Miles of Kidney Tubes Flush Out Poisonous Waste

If you have an excess of acids in your blood, your 15 miles of kidney tubes may be over-worked. These tiny filters and tubes are working day and night to help Nature rid your system of excess acids and poisonous waste.

When disorder of kidney function permits poisonous matter to remain in your blood, it may cause nagging backache, rheumatic pains, leg pains, loss of pep and energy, getting up nights, swelling, puffiness under the eyes, headaches and dizziness.

Kidneys may need help the same as bowels, so ask your druggist for Doan's Pills, a stimulant diuretic, used successfully by millions for over 50 years. Doan's give happy relief and will help the 15 miles of kidney tubes flush out poisonous waste from your blood. Get Doan's Pills.

Do You STILL CHANGE MOTOR OIL??

If so—you can END this needless waste and expense forever, with "RECLAIMO"

America's Foremost Oil Re-Refining Filter. Continuously re-refines crankcase oil through an ingenious use of motor heat while driving!

1. Removes solids by filtration
2. (Removes water-fuel dilution by heat and distillation)
3. Prevents acid-sludge formation
4. Maintains stable viscosity
5. ELIMINATES ALL OIL CHANGES!

CAR—TRUCK—TRACTOR and DIESEL OWNERS!
U. S. Bu. of Stds. Bul. 86 states: "Oil Does Not Wear Out Mechanically"—"Reclaimo's" re-refining action has fully confirmed that statement. This great oil-saving feature is indeed important, BUT of far greater importance are the savings resulting from "Reclaimo's" tremendous reduction of costly motor wear! Again available—also to dealers. Complete details in FREE Book "Oil Facts". Write now! RECLAIMO MFG. CO., 5087 Elston Ave., Dept. 45, Chicago 30, Ill.

GET THE FACTS!



FREE 40 PAGE BOOK



NEW! 2 H.P. BIKE "SIDECAR"

Attaches to any bike—Motor under as low as sidecar seat. Carries extra passenger or 300 lb. load! Up to 40 MPH 100 gal. gas—plenty of power! Handle bar controls—You can assemble or build it—It's easy—We can furnish parts.

SEND ONLY \$1.00 (cash or M.O.) postpaid or pay postman \$1.52 C.O.D. (USA only) for complete scale isometric picture blueprints (anyone can read them) 6 page details, lists of parts and prices complete!

FREE with each order—big 48 page color book giving full details on over 100 other new inventions such as: JET ENGINES—SUN MOTORS—MIDGET MOTORCYCLES—CARS AND SCOOTERS—BIKE MOTORS—ELECTRIC WELDERS—REAL AIRPLANES—WALKIE TALKIES, ETC. DON'T PASS UP THIS SUPER VALUE—YOU MAY EARN AND SAVE HUNDREDS OF DOLLARS WITH THESE PLANS! (All foreign orders \$1.50 U.S. cash with order).

MOTOR INDUSTRIES INC., Dept. PSSC-5 Kearney, Nebraska

KUT RITE

LAWN MOWER SHARPENER
IT'S SAFE—QUICK—SIMPLE

Patented. 3 popular sizes. Retail prices: 14" \$1.40; 16" \$1.50; 18" \$1.60. Mailing charges .20.

ACCURATE SHARPENER MFG. CO.
Dept. PS2 Milwaukee 12, Wis.

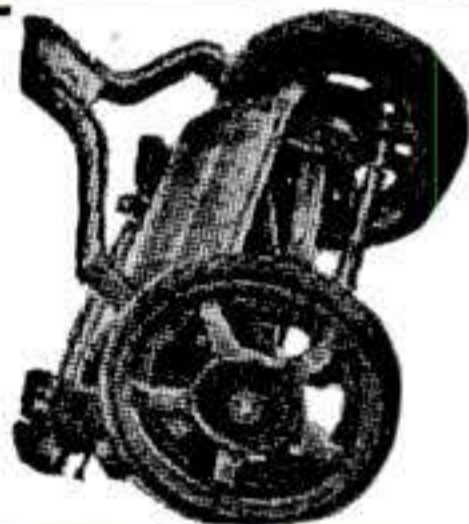

Plastics Supplies

Everything in plastics—Lucite, Plexiglas, Dyes, Rods, Sheets. Lowest prices. Send 3c stamp with name, address and this ad for catalog.

PLASTICS MFG. & SUPPLY CORP.
Dept. S-5 4707 Euclid Ave. Cleveland, Ohio

ARMY TARGET BALLOONS

Giant size balloons that inflate to 3½ feet in diameter. Flies better than a kite. Children love them. 29c each postpaid.

HARRY FREEDMAN, Box 68, Revere 51, Mass.

NOW! The ONE-UNIT HEARING AID

Thousands Have Waited for

The New ONE-UNIT
Beltone
MONO-PAC
HEARING AID



THIS IS ALL YOU WEAR

No Separate Battery Pack
No Dangling Battery Cords

The tiny new BELTONE Mono-Pac is about ½ size and weight of old-style hearing aids, yet so powerful you hear even *whispers!* Get helpful facts about this new

"MIRACLE" aid in valuable FREE book about deafness.

BELTONE HEARING AID CO.
1450 W. 19th St., Dept. PS-75, Chicago 8, Ill.

FREE BOOKLET

Beltone Hearing Aid Co.

Dept. PS-75, 1450 W. 19th St., Chicago 8, Ill.

Please send me FREE booklet about deafness and what can be done to overcome it.

Name _____

Address _____

Town _____ Zone _____ State _____

PEPSI-COLA ... Tops For Quality

Now a 10-inch WEATHERPROOF BRUNING All-Plastic Slide Rule



PRICE \$8.25

Here's the slide rule you've been wanting—an all-plastic precision instrument! This rule operates smoothly and accurately under any atmospheric conditions. Precision graduations are not affected by weather or temperature changes. Backed by the famous name Bruning, this new rule has numerals and graduations of the CI scale in RED to provide easier reading. A, B, CI, C, D, K, S, L and T scales provide widest possible range of service. Beveled edges of rule are graduated in inches and centimeters. Glass indicator is enclosed in a stainless steel frame that holds it firmly in place—tension of slide easily adjusted by four screws on back of rule. Instruction manual furnished with each rule at no extra cost.

Includes sturdy leatherette case and instruction manual. Price with genuine leather case and manual, \$10.50.

No C. O. D. Orders

Charles Bruning Co., Inc.

4710-18 Montrose Avenue, Chicago 41, Illinois

Please send me (show number desired) _____ Bruning 10-Inch Slide Rule(s) _____ with leatherette case \$8.25 each _____ with genuine leather case \$10.50 each I enclose \$_____

Name _____

Address _____

City _____ State _____

MAY 1947 47

New Sensational RADIO

Special Bargain

ONLY \$7.98

COMPLETE with Earphone



SLIDE RULE DIAL

Developed by Army Radar Branch

At last, the sensational post-war midget radio, known as RADARADIO. Small, superbly superior in quality. Recent radar developments make this set unique. Enjoy your favorite radio broadcasts without disturbing others. Smart streamlined design. Cabinet made of durable, colorful plastic. Comes complete with earphone for individual reception.

SEND NO MONEY—LIMITED SUPPLY
Order today. Limited number available at special low price of only \$7.98, postpaid, complete with earphone. **SEND NO MONEY.** Upon delivery pay postman only \$7.98 plus postage. C.O.D. charges. Or send \$7.98 with order for postpaid delivery. Return in 10 days (untampered) for refund if not delighted. **RUSH order NOW!**

AMERICAN MERCHANDISING CO., Inc.
12 Adams Avenue, Dept. PSR-2, Montgomery 4, Alabama.



FEATURES

Conventional slide rule dial. **USES NO** electricity, battery, tubes. Perfect lifetime pleasure. **GUARANTEED** reception when used as directed. Nothing to assemble—comes ready to use! Order now!

LEARN MASONRY

Get in on the biggest building boom in history. Prepare for a long and profitable career as a big-pay building tradesman. Actual shop training under expert instructors. Write for big free catalog today.

MIDWEST SCHOOL OF BUILDING TRADES
Dept. M25, 411 N. Center Street, Bloomington, Ill.

VETERANS ASK FOR GI PLAN

Free FACTS

TRIGONOMETRY FORMULAS for Right and Oblique Angle Triangles

Condensed on 8½ x 11 page with durable plastic cover. Fits 3 ring notebook. Handy reference for **STUDENTS—DRAFTSMEN**. Send \$1.00 today for your copy—Money Back Guarantee. Diamond's Service, 326 Pa. Ave., S.E., Suite 2, Washington 3, D. C.

Mows and Trims Lawns



In One Simple Easy Operation

8¼ Lbs.

Save Time and Labor with a MONTAMOWER

New model. New type metal handle has special device to adjust cutting height. Drive shaft now mounted on free rolling, factory lubricated, and sealed ball bearings. No tired backs or aching arms. 8¼ lbs. of live precision made mechanism that first gathers, then cuts smoothly a clean 16" swath through grass, dandelions, spike grass and weeds. No noise or clatter. As modern and efficient as your electric razor. Cuts right up to walls, fences, trees or posts; leaves no fringes to be trimmed by hand. Cutters are self-sharpening. Built to last many years. Many thousands in use. Sold direct from factory. Costs little. Write at once for guarantee information and literature.

MONTAMOWER DISTRIBUTING CO.
831 Keeler Bldg. GRAND RAPIDS 2, MICHIGAN

RUPTURED?

Get Relief This Proven Way

Why try to worry along with trusses that gouge your flesh—press heavily on hips and spine—enlarge opening—fail to hold rupture? You need the Cluthe. No leg-straps or cutting belts. Automatic adjustable pad holds at real opening—follows every body movement with instant increased support in case of strain. Cannot slip whether at work or play. Light. Waterproof. Can be worn in bath. Send for amazing **FREE** book, "Advice To Ruptured," and details of liberal truthful 60-day trial offer. Also endorsements from grateful users in your neighborhood. Write:

Cluthe Sons, Dept. 14, Bloomfield, New Jersey

Easy Self-Instruction In All 25 Branches Of

MATHEMATICS

Brought To You By Experts From Leading Colleges

in the 4 volumes of the PRACTICAL MATHEMATICS LIBRARY. Helps you qualify for the better jobs in industry. 1300 pages, 600 illustrations. Sent for free examination. Only \$2.00 down. \$2.00 a month; total \$9.80 plus postage. (Cash price \$9.50, postage free. Money-back guarantee.) 160-page 6-Place Logarithm book free with order. **National Educational Alliance, Inc., Dept. 805, 37 West 47th St., New York 19, N. Y.**

GET INTO CARTOONING!

Learn cartooning from a professional cartoonist! Create original cartoons and ideas. Send for free details about course. Also cartoonists' magazine. Full of lessons, plans, etc. Only 25c coin postpaid.

Hartman Studios, 2776 California Court, Lincoln 8, Nebr.

START A BATTERY FACTORY

—at home; the latest achievement; re-cast junk batteries into new. Complete instructions. We supply everything. Big profits!

THE BATTERY LABORATORIES
Dept. PS Minneapolis 13, Minn.

Learn PHOTOGRAPHY at Home

Splendid opportunities. Prepare in spare time. Practical basic training. Long-established school. Send for free book, "Opportunities in Photography." No obligation.

American School of Photography, 1315 S. Michigan Ave., Dept. 1365 Chicago 5, Ill.

NOW **CHANITE SELF-WELDING FLUX—REPAIRS all ELECTRIC HEATING ELEMENTS.** So simple anyone can make repairs in your broken or burnt-out electrical appliances—irons, toasters, stoves, etc. Guaranteed nothing like it. From our mines to your appliances. **\$1.00** per package. **\$7.50** per doz. Stick form 25c. \$2.00 per doz.

CHANITE SALES COMPANY, 914 South Main, Fort Worth 4, Texas

No More Bother Solving Problems

100,000 problems solved instantly. Greatest mathematical aid since the invention of the slide-rule. Details free.

COLUMBIA GRAPHS, Columbia 6, Connecticut

Giffy ELECTRIC HEATER

HOT WATER IN FIVE MINUTES

For baby's bath, your washing, shaving and many other uses in the home, camping business or on the farm.

One Year Guarantee
See your local Dealer or order direct . . .

AMBORY CORPORATION
Dept. S-2 Hazel Park, Michigan

"MAGIC VANISHING CARD"

Throw it into the Air. It completely disappears; reproduce it later from spectator's pocket. It amuses and confuses all. Easy to do, 25c with Amazing Catalog of 300 Tricks.

THE MAGICIAN
Dept. 6, 2463 Kensington Ave., Phila, 25, Pa.

MICROSCOPES SUPPLIES-ACCESSORIES & SCIENTIFIC INSTRUMENTS

NEW & USED

BEI SPENCER BOUGHT-SOLD-EXCHANGED-REPAIRED LEITZ ZEISS

Send for **FREE LIST**

NATIONAL SCIENTIFIC INSTRUMENT CO. 119 CHAMBERS ST NY 7

MEDICAL INDUSTRIAL AMATEUR

Ask For
the
Genuine

ZIPPO
Windproof
LIGHTER

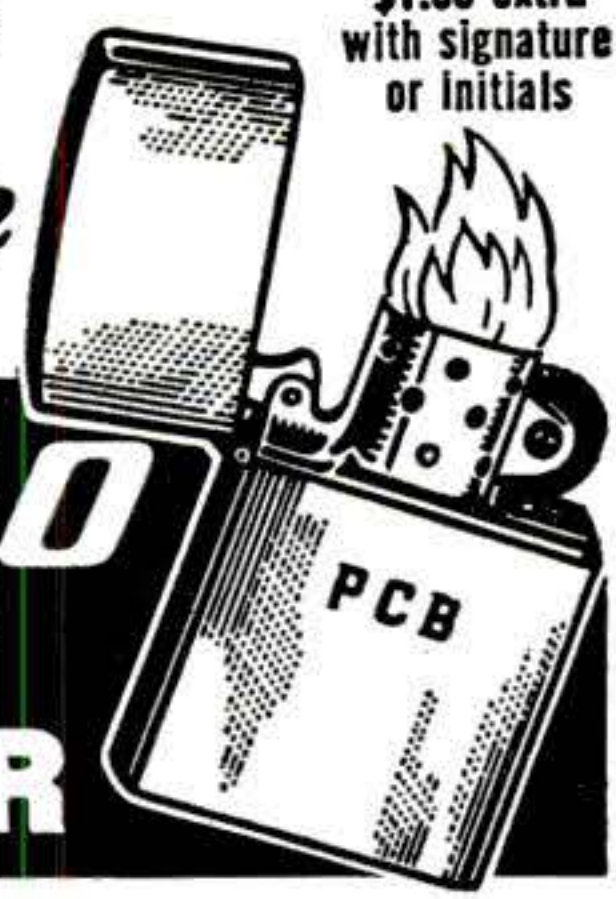

\$2.50
\$1.00 extra
with signature
or initials

LIFETIME GUARANTEED BY ZIPPO MFG. CO., BRADFORD, PA.

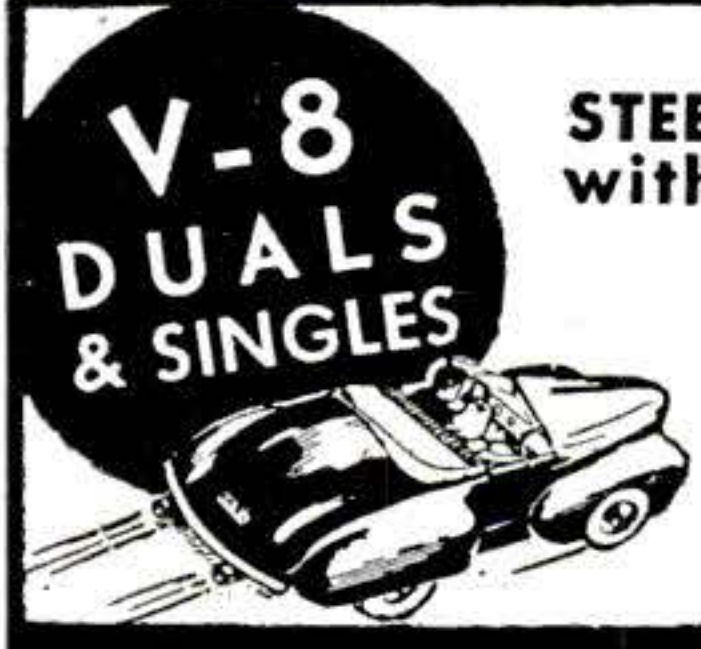

MUFFLERS
STEELS and ALUMINUMS
with a motorboat tone
SINGLES, Chev, V-8, Plymouth,
Steels \$5.50, Aluminum \$6.50,
Chry., Olds., Buicks, etc., Steels
\$7.50, Aluminum \$8.50. V-8 and
MERCURY DUALS, Steel \$17.50,
Aluminum \$20.00. Aluminums are
guaranteed for life of your car.
DEALERS WANTED

SANDEE MUFFLER CO.
7523 S. WESTERN AVE., LOS ANGELES 44, CALIF.

CHOW PUPS Raising world's most beautiful pet is world's most fascinating, most profitable hobby. **PEDIGREED** Sell pups \$50 up. Start home kennel. Low upkeep, big returns. We start you. Write—**EVENINGSHADE KENNELS, Box B-3, Helotes, Texas**

START YOUR OWN PHOTO COPY BUSINESS!
SMALL investment . . . BIG profits. No darkroom needed. EASY work. Write immediately for FREE 4 page folder and price list.
GENERAL PHOTO PRODUCTS COMPANY
15 Summit Avenue Dept. PS Chatham, New Jersey

Become a Doctor of PSYCHOLOGY
Win the degree of Ps.D. Teach the secret of contentment, happiness. Solve mental worries. Experience the revelation of truth. Chartered college. Individual help. Write for FREE book. **COLLEGE OF UNIVERSAL TRUTH 5153-A North Clark St., Chicago.**

HOW TO CUT RAFTERS

New vest pocket book gives lengths, Side cuts, Plumb cuts, Deductions. For all rafters for any building from one inch to forty feet wide. Gives numbers to cut on square. Also degrees for same cuts for Radial Saws. All standard pitches from 1/8 to 5/8. Just open book to pitch page and there are your lengths, side cuts, etc. Anyone who knows what a jack rafter is can frame a roof if he has this great book. Price one dollar pre-paid. **Builders' Topics, Dept. S, Lock Box 828, Seattle, Washington.** Original teachers of the square in five easy lessons by mail. **SEND FOR FREE LIST OF TECHNICAL BOOKS.** Learn to read blueprints, etc.

PULVEX
"DDT"
FLEA POWDER



Kills the fleas
Quickly!
Keeps others off
for Days.

Pulvex also comes with ROTENONE, the original formula. BEST FOR CATS.

Either Kind
25¢ & 50¢

WAR BARGAINS in LENSES and PRISMS

ASSEMBLE YOUR OWN BINOCULARS!

Complete Optics! Complete Metal Parts!
Save More Than 1/2 Regular Cost

ARMY'S 7x50 BINOCULARS

Here's an unusual opportunity to secure a fine set of Binoculars at a substantial saving of money. Offered here are complete sets of Optics and Metal Parts for the Army's M-16 7 x 50 Binoculars (M-16 is not the waterproof model). These components are new and all ready for assembly. We supply full instructions. Limit—1 set of Metal Parts and 1 set of Optics to a customer.

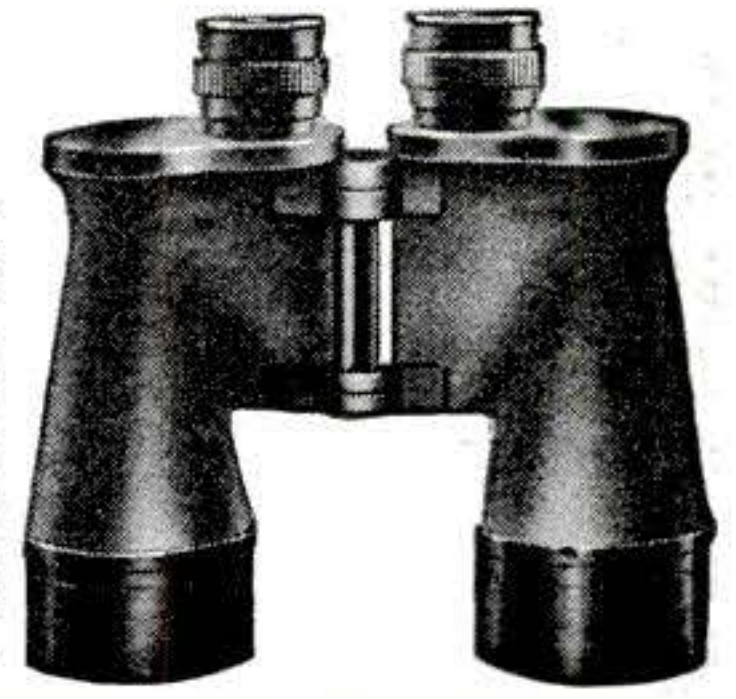

METAL PARTS—Set includes all Metal Parts—completely finished—for assembly of 7 x 50 Binoculars. No machining required. Bodies have been factory hinged and covered. A sturdy Binocular Carrying Case is included with each set of Metal Parts.

Stock #824-N . . . 7 x 50 Metal Parts . . . \$35.00 Postpaid

OPTICS—Set includes all Lenses and Prisms you need for assembling 7 x 50 Binoculars. These Optics are in excellent condition—perfect or near perfect—and have new low reflection coating.

Stock #5102-N . . . 7 x 50 Optics . . . \$25.00 Postpaid

NOTICE! If you buy both the Binocular Optics and the Binocular Metal Parts, your purchase becomes subject to 20% Federal Excise Tax. Be sure to add amount covering tax to your remittance or your order cannot be filled.

ARMY'S 6x30 BINOCULARS

COMPLETE OPTICS & METAL PARTS—Model M-13A1, (Waterproof Model) 6 x 30 Binoculars. Everything you need—ready for assembly. When finished will look like a regular factory job costing \$102 to \$120. The Optics are new, in perfect or near-perfect condition. Have new low reflection coating. Metal Parts are new and perfect, all completely finished. No machining required. Bodies factory hinged and covered. Complete assembly instructions included.

Stock #830-N . . . \$40.00 Postpaid, plus \$8.00 tax—Total—\$48.00

METAL PARTS ONLY—Model M-13A1, 6 x 30 Binoculars. No Optics. Same Metal Parts as described for Stock #830-N.

Stock #832-N—6 x 30 Metal Parts . . . \$25.00 Postpaid

OPTICS FOR 6 x 30 BINOCULARS (No Metal Parts) Slight Seconds. Cemented and coated.

Stock #5124-N . . . \$12.75 Postpaid

If you buy both the Binocular Optics and the Binocular Metal Parts, your purchase becomes subject to 20% Federal Excise Tax. Be sure to add amount covering tax to your remittance or your order cannot be filled.

Optics and Metal Parts are Available for Monoculars (1/2 a Binocular). For Complete Details, Write for Bulletin #14-N.

BATTERY COMMANDER'S PERISCOPE With Tripod—6 Power Instrument. Excellent condition. Length 27 1/2 inches—diam. 1 1/2 inches. Cost U. S. Govt. approximately \$175.00.

Stock #717-N . . . \$20.00 F.O.B. Audubon

MOUNTED KELLNER TELESCOPE EYE PIECE—Perfect coated, in Ordnance sealed boxes. F.L. 1 3/4 inches. Outside dia. of steel mount 40 mm.

Stock #6198-N . . . \$3.15 Postpaid

35 MM KODACHROME PROJECTING LENS SET—Consists of Achromatic Lens for projecting, plus a Condensing Lens and piece of Heat Absorbing Glass with directions.

Stock #4025-N . . . \$1.95 Postpaid

SCHMIDT OPTICAL SYSTEM. Black plastic body, size 3-15/16" by 5-1/2". F.L. 2.4" . . . with amazing speed of F.O.9. Used in Navy's Infra-Red Sniperscope and Signaling Units. Govt. cost \$134. Limit—1 to a customer.

Stock #720-N . . . \$6.00 Postpaid

MOUNTED PROJECTING LENS SYSTEM. F.L. 91.44 mm. (just right for 35 mm. Projectors). Speed of F 1.9. Outside dia. of mount at one end 60 mm. Length of mount 64 mm.

Stock #4033-N . . . \$3.00 Postpaid

MOUNT FOR ABOVE PROJECTING LENS SYSTEM

Stock #715-N . . . \$1.50 Postpaid

CONDENSING LENSES for 35 mm Projectors and Enlargers. Consists of set of 2 Lenses—diam. 2-3/8". F.L. 3" each.

Stock #1077-N . . . \$2.00 Postpaid

We have literally millions of war surplus lenses and prisms for sale at bargain prices. Write for Catalog "N"—Sent Free!

Satisfaction Guaranteed • Order by Stock No.

EDMUND SALVAGE COMPANY
P. O. AUDUBON NEW JERSEY

MAY 1947 49

CIGARETTES

"THROUGH THE YEARS
... FAITHFUL SERVICE
TO THOUSANDS"



POPULAR BRANDS

- REGENTS
 - OLD GOLD
 - PHILIP MORRIS
 - CHESTERFIELD
 - LUCKY STRIKE
 - CAMEL
 - RALEIGH and others
- \$4.23 FOR 3 CARTONS**

\$1.24
per Carton
MARVEL WINGS

Minimum Order 3 Cartons

OTHER CIGARETTE VALUES

	(Per Carton)
PARLIAMENT	\$2.30
MARLBORO (Plain or Tip)	\$1.81
VIRGINIA ROUNDS (Plain or Tip)	\$1.81

For Shipping & Insured Delivery within 300 miles of N. Y. City

- For 3 items add only 16c
- Up to 6 items add only 22c
- Up to 10 items add only 30c

In FURTHER areas add ONLY 2c more per item for each 400 miles

Price list includes popular brands of candy, playing cards, razor blades, etc. Send for your copy today.

GLOBE

Dept. P 6
631 Newark Ave. JERSEY CITY, N. J.

Practical Shop Training in AIR CONDITIONING

- Domestic
 - Commercial
 - Industrial
- ### REFRIGERATION

Service Maintenance Installation

Write for Details

**COMMERCIAL
TRADES INSTITUTE**

202 So. 20th St., Birmingham, Ala.

• • Train in the Magic City of the South. • •

Approved
for
G. I.
Training

**5 POWER
Spy Glass**
AND CASE

\$1.25

SEE IT
5 Times Closer
5 Times Larger

Easy to carry
on your belt

STURDILY BUILT
FOR LASTING
USEFULNESS

NOT A TOY

TaVEL'S JEWELRY CO. 4 West Market Street
Indianapolis 4, Indiana

Please send me 5 POWER Spy Glasses with Case at \$1.25 for both postpaid. No C.O.D.

NAME.....
ADDRESS.....
Merchandise fully guaranteed — M. O. Check

50 POPULAR SCIENCE

DRAFTO

PORTABLE DRAWING
MACHINES

for MECHANICS and ENGINEERS

Make the
drawings
you need
on the
job!

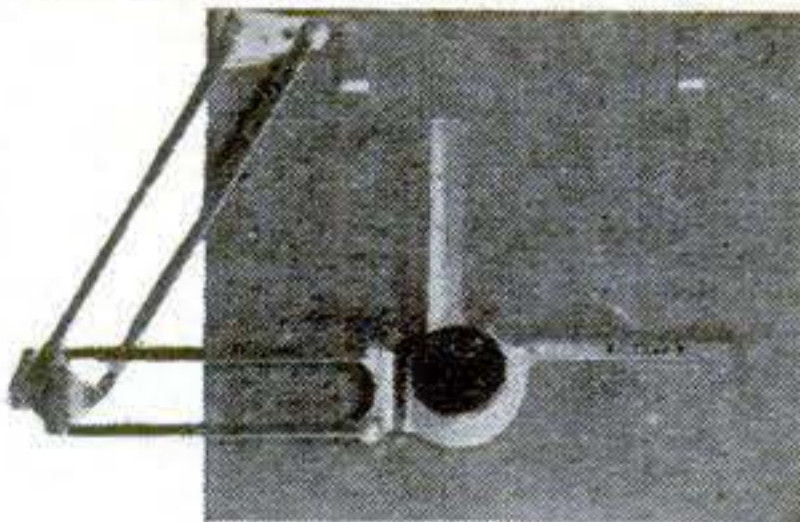

Save
time
and
energy

AT DRAFTSMEN'S SUPPLY HOUSES

OR WRITE

DRAFTO CORPORATION, Cochran, Pa.

Do I smell pretty?

**Q-W PINE BAR
REMOVES
DOG ODOR
EASILY**



MAIL ORDER SIZE \$1.00 SENT POSTPAID

Q-W LABORATORIES, PLAINFIELD, N. J., DEPT. 9
"SUCCESS WITH DOGS" FREE BOOK INCLUDED WITH ORDER

Opportunity Knocks

With TRADIO... the radio FUNCTIONALLY DESIGNED for coin operation in Hotels, Motels, Stopovers, Clubs, Hospitals, Stations, Etc. Big Earnings... Steady Income

- No Clock To Punch... Full Or Part Time!
- QUANTITY DELIVERIES DAILY... ONLY SMALL INVESTMENT Grow With A Young Industry! Get In On The Ground Floor and Be Independent For Life. It's Easy!

Send for Complete Information TODAY... No Routes Sold

WRITE TO **TRADIO, INC.** DEPT. PS ASBURY PARK, N. J. Right Now!

PANTS - SHIRTS
TO MATCH - FREE CIRCULAR

Also other work and sport garments including WAR SURPLUS merchandise. Suitable for indoor, outdoor work and sports. Sold by mail at money saving prices. Write for FREE Illustrated circular, order blank.

J. R. ADDISON UNIFORM CO. Dept. PS-5C CAMBRIDGE, OHIO

New Designs in

FRANZITE GRIPS



Modernize Your Gun! Improve Your Score!

Most durable grips made. Positively unbreakable! For Colt, Smith & Wesson, Hi-Standard, Ortgies, Luger & Mausers in a wide choice of beautiful designs in ivory, pearl, walnut, onyx, etc. Low prices. FREE CATALOG. Dealers Wanted.

SPORTS, INC., (Mfrs.) 5501 Broadway, Dept. S-5, Chicago 40, Ill.

CONFIDENTIAL LOAN SERVICE

Borrow \$50 to \$300⁰⁰

Need money? No matter where you live you can borrow BY MAIL \$50.00 to \$300.00 this easy quick confidential way.

BY MAIL

IT IS EASY TO
**BORROW
BY MAIL!**

Completely confidential and private
**CONVENIENT
MONTHLY
PAYMENTS**

NO ENDORSERS NEEDED
EMPLOYED MEN and women of good character can solve their money problems quickly and in privacy with loans **MADE BY MAIL**. No endorsers or co-signers. We do not contact employers, friends or relatives. Convenient monthly payments. Send us your name and address and we will mail application blank and complete details **FREE** in plain envelope. There is no obligation.

STATE FINANCE CO.
303 Marine Bldg. • Dept. M-13 • New Orleans 12, La.

Test-O-Lite the MODERN TROUBLE SHOOTER



← THE NEON GLOW

... LOCATES TROUBLE INSTANTLY in electric circuits, fuses, cut-outs, motors, radios, appliances. Tests everything electrical from 100 to 550 volts. Indicates hot or grounded wires. Tells AC from DC. Engineers prefer it because it has patented safety features.

↑ PUTS "FINGER" ON THE TROUBLE SPOT -- QUICKLY

Far superior to ordinary clumsy test bulb. Saves precious time. Indispensable in shop or home. Vest pocket size. Lifetime guarantee. (Pat. No. 1,778,883) Purchase through regular electrical dealers.

L. S. BRACH MFG. CORP.

200 Central Ave. Newark, N.J.

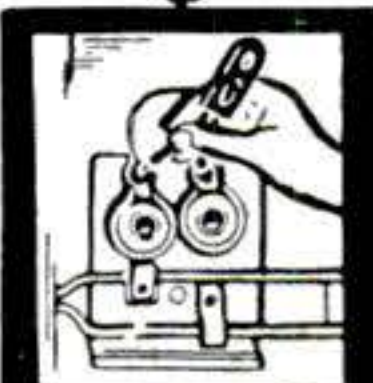

FUSES

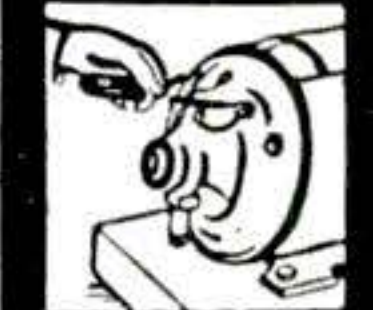

MOTORS



OUTLETS

FOG-PROOF! AIR-TIGHT!

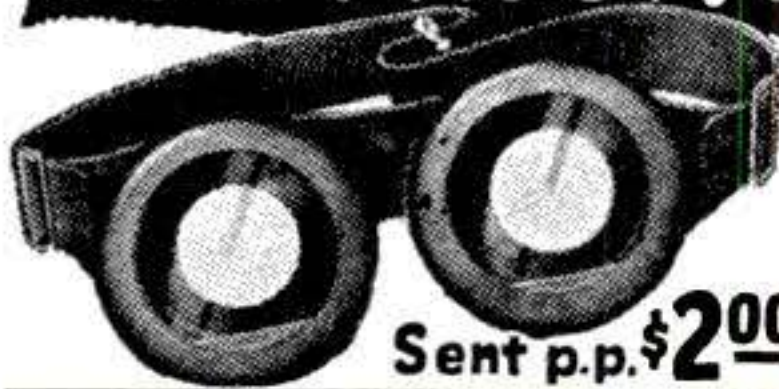

Sent p.p. \$2.00

RUBBER GOGGLES

protect against dusts - gases - fumes - smoke! Ordinary air-tight goggles fog instantly, but patented water chamber keeps lenses of these goggles clear indefinitely! Order today! JERRY BRYANT, Dept. PS, 919 N. Michigan, Chicago 11, Ill.

IDEAS AND INVENTIONS WANTED

Cash in on your Ideas, Inventions, Methods Now! Responsible Manufacturer gives complete protection on all Ideas, Methods, Inventions submitted—Costs you nothing. Write to
MASTERFORM TOOL CO., 2547 Irving Park Rd., Chicago 18, Illinois

AMAZING OFFERS!

INVENTORS
. . . EXPERIMENTALISTS
SURPLUS B-29 PEDESTAL
GUN-SIGHTS



Contains sighting station with lens, polaroid filter. Four Selsyn generators with caps. Two gyroscope motors, 10,000 r.p.m.—adaptable for tachometers. Adjustable double swivel mounting—excellent for telescope mounting or photographic work. Gear reduction assembly with right angle drives. Switches—knobs—dials—bearings—connecting cables. Hundreds of useful, accurately-machined parts. Thousands of practical uses. Shipping weight 50 lbs. Cost U.S. Government over \$2,000. You pay only \$39.50. Cash with order. No COD.

ing—excellent for telescope mounting or photographic work. Gear reduction assembly with right angle drives. Switches—knobs—dials—bearings—connecting cables. Hundreds of useful, accurately-machined parts. Thousands of practical uses. Shipping weight 50 lbs. Cost U.S. Government over \$2,000. You pay only \$39.50. Cash with order. No COD.

27-VOLT DC MOTOR

Geared for 120 r.p.m. operates on AC transformer or power supply. Can be used for Model Railroads, Counter or Window Displays, countless other purposes! A MUST for the home workshop. Original cost \$30. Now only \$7.50. Cash in advance. No COD. Order today while they last!

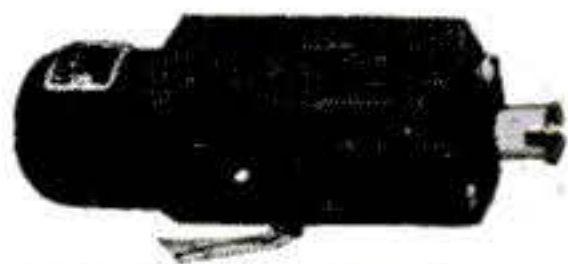

"BACHMAN'S IS AMAZING"

23-31 Herman St. Department C Rochester 5, N. Y.



AMAZING DISCOVERY! Corrects poor penmanship in few days—big improvement in three hours, no failures. Complete Outline Free. Write, C. Ozment, 35-B, St. Louis, Mo. IMMEDIATELY.

COMPRESSED AIR INSTANTLY, Anywhere!!

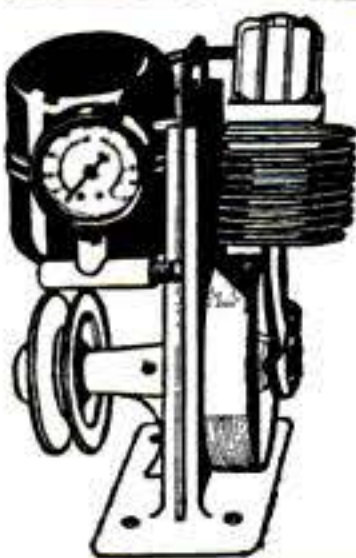

Portable Air Compressor and storage tank. Ruggedly built of best materials using lifetime lubricated ball-bearing on connecting rod and oil impregnated main bearing on shaft. Unusual design forever eliminates valve trouble, the most common fault in air compressors. PATENTED unique air intake system increases efficiency tremendously over other compressors so that air output is much greater than that from larger compressors powered by heavier motors. Will deliver approximately 3500 cu. inches of air per minute at maintained pressure of 30 lbs., or will inflate a 90 lb. truck tire in less than one minute. Comes complete with 100 lb.

gauge, although finger-tip adjustment allows setting of output pressure at any value, which will automatically be maintained. Works from any 1/4 H.P. motor. Useful for spraying paints or lacquers, disinfectants, insecticides, annealing or brazing with natural gas, inflating tires, etc. Price \$14.50 postage prepaid anywhere in the U. S. Efficient, completely adjustable syphon type spray gun complete with 12 ft. of 100 lb. tested hose available for only \$7.75 with pint container, also prepaid. 25% required on all C.O.D. orders. Send for free catalogs of radio parts and surplus items.

BUFFALO RADIO SUPPLY; 219-221 GENESEE ST., DEPT. S5, BUFFALO, N. Y.

Now A DYNAMIC Super-charged WELDER

IDEAL FOR AUTO • HOME APPLIANCE • FARM REPAIRS

DESIGNED TO DO HIGH GRADE WELDING INEXPENSIVELY!

Maintenance Men; Farmers; Mechanics; Machine Shops; Foundries; Auto, General Repair and Job Welding Shops; all using the DYNAMIC find it so indispensable and useful that they cannot afford to be without it. If inexperienced you can easily learn to do a variety of high grade welding jobs by following the practical, simplified operating and welding instructions furnished. Once you see a DYNAMIC in operation, you won't want to be without it. Its simplicity will amaze you. In a year the DYNAMIC only costs you about 6c a day. Helmet, rods, cables, holder and operating instructions, etc., furnished.

SAVES YOU VALUABLE TIME AND MONEY!

This portable industrial transformer type DYNAMIC WELDER easily carried right to the job, can be operated from any convenient, properly wired 110 Volt, 60 Cycle Line—has 8 metallic and carbon arc welding heat stages—does work you would think only possible with a larger more expensive machine. Can also be supplied for 220 volt, 60 cycle operation and other voltages and cycles at slight additional cost. Works on Iron, Steel, Brass, Bronze & other metals.

DYNAMIC WELDER CO., 13 East 23rd St., SD, Chicago 16, Ill.

ONLY \$28.50

COMPLETE Available Now IMMEDIATE DELIVERIES

Write Today for Particulars

GET DETAILS on our 10 day Trial Offer. Member Chicago Association of Commerce.

BICYCLE REPAIRS

FARM IMPLEMENTS

SHOP WORK

HOME APPLIANCES

AUTOMOBILE REPAIRS

MAY 1947 51

Get one
for your
Boy

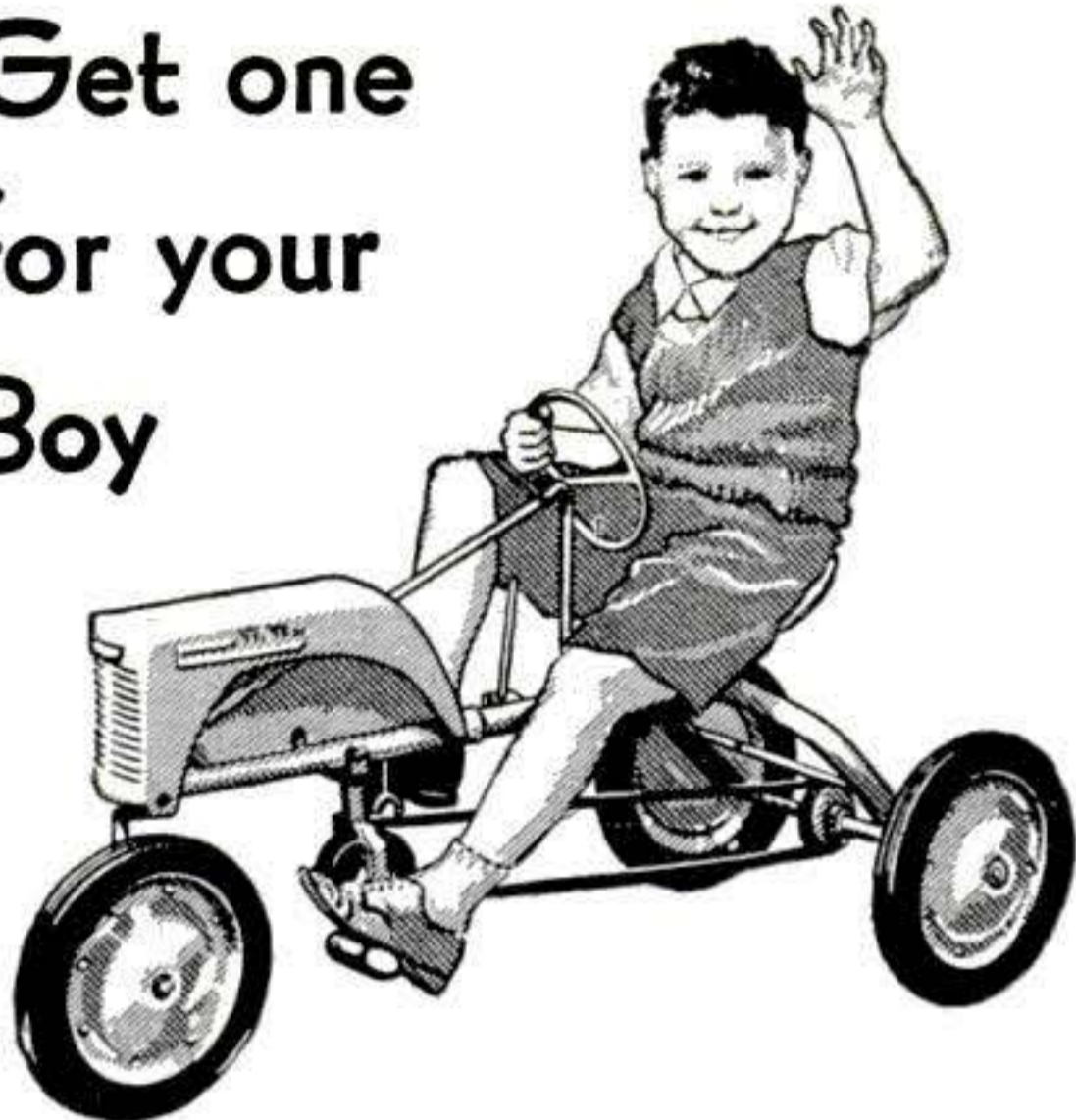

The Sensational Inland TRACTALL

The Greatest thing on wheels
for Boys and Girls 4 to 8

Cast aluminum and steel throughout, finished in red baked enamel. Big rubber tires on ball-bearing disk wheels. Pedal driven, non-slip V belt. Bucket seat, mock four-way gear shift lever and throttle just like a real tractor.

A toy that makes a boy happy, useful and teaches him to do things.

SOLD DIRECT FROM FACTORY

In no other way is this low price possible. Sent Express charges collect and guaranteed on a money-back basis if it does not satisfy upon its arrival.

Give your full address and enclose check or money-order for

\$26⁷⁵

INLAND MFG. CORP.

158-164 ELLICOTT ST.
Buffalo 3, N. Y. Dept. No. B



NEW B-M POWER MOWERS

- For Modern Lawn Care Newest type three-wheel rotary blade mower. Prompt shipment with 1 1/2 h.p. Clinton engine. Choose from two models of assembled mowers or Build-it-yourself kit of parts. Guaranteed. Write for Free literature.

At
LOW
FACTORY
COST

**B-M MOWER CO., Box 66-S
Blue Mound Kansas**

ONE & TWO MAN

RUBBER BOATS

Brand New Aviator's Model
Bought Direct from Gov't
SURPLUS

Bright yellow color.
Easily inflated by
mouth or hand
pump.

Packed in handy
water proofed
carrying case.



\$16.50

Complete with Repair Kit and Hand Paddles

EDWARD LAWRENCE CO., INC. 396 BROADWAY
NEW YORK 13, N. Y.

SENSATIONAL BARGAIN OFFER!
LOTS OF NOISE AND BEAUTY



FIREWORKS

Here they are! Big combination assortment! Plenty of "Bang" for the day... gorgeous, vari-colored display for after-dark thrills! Giant Salutes... Whistling Chasing Bombs... Flare Bombs... Roman Candles, Flitter Bombs and many other noise and beauty pieces! **\$4.98**

\$9.95 VALUE FOR ONLY

Think of it! Giant assortment... 241 pieces for phenomenal low price of \$4.98! You save 50%!

OTHER AMAZING BARGAINS! WRITE TODAY! FREE

F. O. B. FT. WORTH. NO C. O. D. SALES. WRITE DEPT. F. CATALOG

STARS & STRIPES FIREWORKS CO. Box 6206
Fl. Worth, Tex.

GET
INTO

REFRIGERATION AND AIR-CONDITIONING

Build your future in fast-growing industry. Prepare for high pay jobs or get into your own business. Resident classes only.

Send ad with name and address for information.

VETERANS
Eligible for training under G. I. Bill, Check here

BOSTON TECHNICAL INSTITUTE
School of Refrigeration, 4707 Euclid Ave., Cleveland 3, Ohio

I. GOLDBERG & CO.

Camping Supplies Gov't Surplus
429 Market Street Philadelphia 6, Pa.

NEW REGULATION G. I. PUP TENT \$6.75 P.P. 35c

2-3-piece poles & 8 stakes
New GI Mountain Ruck Sack.....\$3.95 P.P. 35c

New Nylon Mountain Tent
Aluminum Stakes & 2-3 Piece Poles.....\$12.00 P.P. 50c

New GI Canteen Cover & Cup.....\$1.95 P.P. 30c

New U.S.M.C. Camouflage Poncho.....\$1.95 P.P. 25c

New Army Blanket.....\$6.50 P.P. 30c

Write For New Free Catalog. Mail Orders Promptly Filled.

GOOD LUCK

Remarkable disclosure reveals how Happiness, Good Fortune and Success may easily be yours by applying a few simple, though little known rules that lead to the **MASTERY OF LIFE!** Good Luck Key included free! Both sent postpaid for \$1.00. Money back if not satisfied. Belle Haven. P. O. Box 987-A, Palo Alto, California

VETERANS!

Be financially independent. New booklet describes changes in Loan Guaranty not generally understood which provide not only opportunity for a home but also offer amazing possibilities for income and profit. For your copy mail \$1.00 today.

H. B. SMITH Box 747 Dept. S Youngstown, Ohio

New. Scientific Drinking Bird

"TOP HAT BOBBY" complete with Colored High Hat, Attractive Lucite Stand & Glass

ONLY
\$2.95

Top Hat Bobby is a new screw-ball drinking bird that will fascinate young and old with his antics. Perched on his STAND he will drink and drink for hours at a time. **NO SPRINGS, NO MOTOR, NO ELECTRICITY.** He is new, novel, different. Wonderful as a gift, or for the home.

Mail Your Order Today
BERNARD FINE CO.

501 Sixth Ave., Dept. P.S. 3, N.Y. 11, N.Y.

BUILD ARC WELDER PLANS 35c

We Show You How to build this new powerful welder without rewinding. For light or heavy work. Uses coils taken from old auto generators. Works on 110 or 220 volts A. C. Has 20 different heats. Send 35c for complete PLANS and valuable Catalog. Write today. **LEJAY MFG. CO., 1323 LeJay Bldg., Minneapolis 8, Minn.**



PLASTIC HOMES



New Building Material! Resurface old homes; build new ones. Colorful, beautiful! **LIQUID MARBLE**-Color-glazed! Molded, brushed, sprayed. **SANITARY FLOORING**-Dustless, noiseless; put on like plaster; resilient-yeilding as cork; lasts like stone; plain or marked in tile design. **RUBBERLATIC Mold Compound**-Mold novelties, statuary, toys, gifts, plaques, plaster animals. **COLORED POTTERY**-Birdbaths, garden furniture, vases. **TILEX** colored roofing. Illustrated literature **FREE.**

RAPID MARBLEIZING SERVICE, Dept. 12-B, Edwardsville, Ill.

SELL FLUORESCENT FIXTURES

SEND FOR
BIG FREE
MONEY MAKING KIT



Full or
Part Time

NO EXPERIENCE
NECESSARY—WE SHOW YOU HOW!

National Lighting Products offers you an opportunity to become affiliated with one of America's fastest growing and most profitable industries. Modern fluorescent lighting is ideal for everyone and sells quickly. It is easily installed. Perfect for stores, theatres and hotel lobbies as well as professional waiting rooms—display rooms—hospitals—churches—farms and homes. It is a "sales getter". National Lighting Products backed by extensive advertising including brochures, magazine ads, mailing pieces. No samples to buy or other strings. Investigate today by writing to

NATIONAL LIGHTING PRODUCTS, INC.
4217 West Harrison St., Chicago 24, Ill.

OSCEOLA

ARTHRITIS SANATORIUM

DAYTONA BEACH, FLORIDA

In this ideal year around climate our staff of Doctors make a comprehensive search for the body dysfunction causing rheumatoid disease. All diagnostic findings are correlated and treatment is applied accordingly.

Write for free booklet

Dept. 6, Dr. C. K. Heberle, Daytona Beach, Florida

BUILD YOUR OWN ZEOLITE WATER SOFTENER

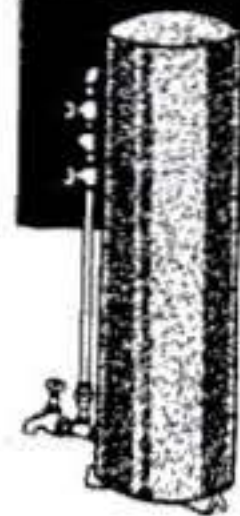

Save up to 50%. Pays for itself. Fun to build. Only a wrench required. All materials available. Send \$1.00 check or money order for simple and complete plans and operating instructions.

BOX 2732-S LAR MFG. CO. MINNEAPOLIS 7, MINN.

LOOKING FOR SOMETHING?

Why go crazy? We'll find it for you! Save your valuable time. Any hard-to-get item located for just \$1! We advise, locate, guarantee our service. Send your request to

Eddie DuPuy, P. O. Box 267, North Hollywood, Calif.

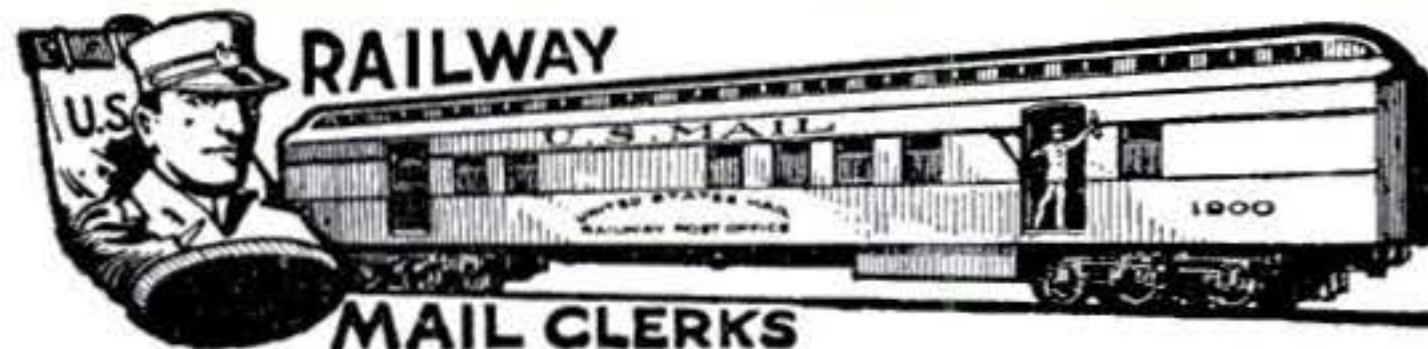

MAIL CLERKS

\$2,300 a Year—To Commence!

Railway Mail Clerks, Mail Carriers—Clerks, Storekeeper, Gauger, etc. \$1,756 to \$3,021 first year. Write IMMEDIATELY for list of jobs and pointers on how to get one.

FRANKLIN INSTITUTE, Dept. H82, Rochester 4, N. Y.

COMB-A-TRIM THE NEW QUICK TRIMMER

Something New! Trim your hair without any experience. It's easy! The excess hair comes off smoothly and easily by just pulling trimmer through hair like an ordinary comb. Also removes hair from legs—armpits. Save on hair-cut bills . . . Trim your own hair or the whole family's. Send 59c and your Comb-A-Trim will be sent at once.



59c



5 Extra Blades
(Year's Supply) 25c

SPECIAL OFFER
Send \$1.00 for 2
Comb-A-Trims
and save 18c. **2 for \$1**

COMB-A-TRIM CO.

1734 Carew Tower Dept. J-19 Cincinnati, Ohio

FACTORY REJECTS (UNPOLISHED)

FULL SIZED PIPES OF GENUINE
IMPORTED BRIAR

Below
Manu-
facturing
Cost —
(To Make
New
Friends)

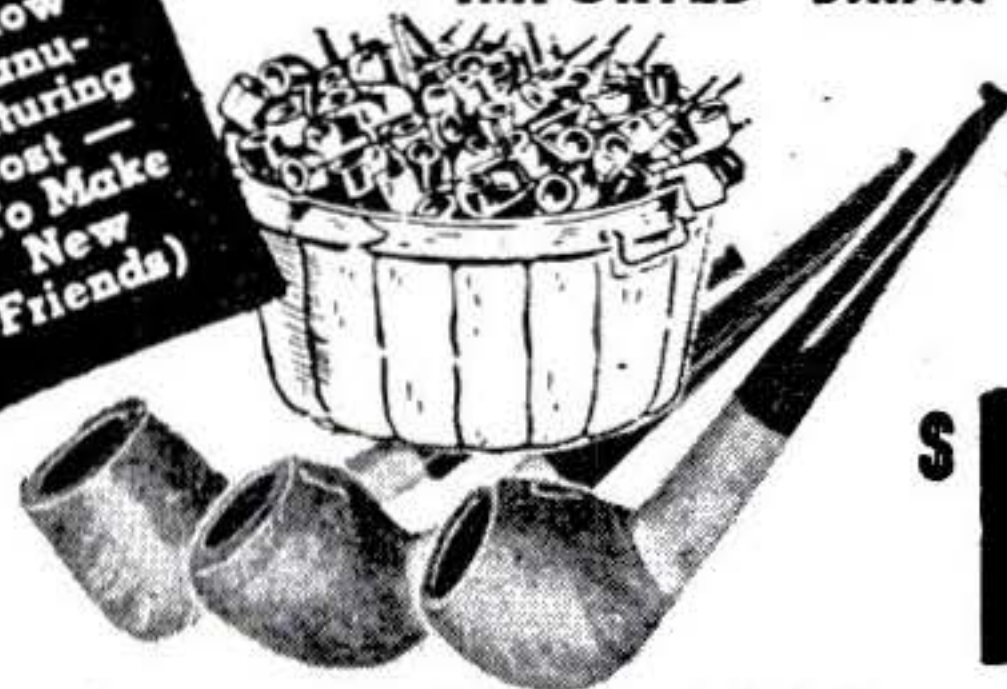

3
PIPES
FOR
ONLY—
\$1.00
POST-
PAID

These pipes of genuine imported briar were taken out of the factory production line of \$3.50 to \$5.00 pipes before final smoothing and polishing due to defects which do not impair their smoking quality. Smoke them "as is" or fill the defects with wood filler, then smooth and polish. Limited supply. Act Today.

5 NEW YORK CITY STORES

10 E. 45th ST. • 3 W. 51st ST. • 157 B'way
1789 B'way cor. 58 ST. • 93 Nassau cor. Fulton ST.

Send Mail Orders to—

WALLY FRANK, Ltd.

150 NASSAU STREET, NEW YORK 7, N. Y., Dept. 330

Enclosed find \$1.00. Send postpaid 3 pipes described above. If, upon examination, I am not satisfied, I will return pipes for full refund. (Sorry . . . no C.O.D.'s).

PRINT NAME AND ADDRESS BELOW

Say You Saw
It In Popular Science

Here's the Point!

The ball point . . . of course! Universal, nationally known pen maker for over thirty years presents the famous BUCK-BALL. BUCK, because it's a dollar, BALL because it writes on a miniature sphere. Three months to three years at a stretch with no time out for refills. Feeds evenly, dries instantly, and writes under water. BUCK-BALL has a polished plastic surface, crowned with a silvery metal cap, and deep pocket clip. BUCK-BALL is streamlined for beauty. **Guaranteed satisfaction.**

\$1

Ball Point
Actual Size



DOLLAR DISTRIBUTORS

P. O. Box 26, Morris Heights Station, New York 53, N. Y.

Enclosed find check , money order , for which send me . . . pens at \$1.00 each. Check color desired.
Grey Maroon Black

Name
Address
City State Zone No

MAY
1947 53

PRESTO! ANYONE CAN MASTER GLAZE



LEAVES HARD GLASS-LIKE FINISH
EASY TO APPLY
PROTECTS THE SURFACE
NO SMEAR OR STREAKS AS WITH WAX
LASTS SIX MONTHS TO A YEAR

SEALS THE PORES OF THE SURFACE
WILL NOT FINGER-MARK
NO OILY FILM AS WITH POLISH
SAVES YOU MONEY

Car Owners! Meet Master Glaze—the sensationally different luster for new and used cars! Not a wax—not an oil polish—not a paint!—nothing that “smears” over the surface.

MASTER GLAZE is a unique discovery—a creamy liquid—quick and easy to apply! Gives a hard, glass-like surface. Even gasoline cannot dull it! Lasts six months to a year! Amazing luster—beautiful, sparkling clean and brilliant! Doesn't finger-mark—doesn't smear! A match box full glazes an entire car. Seals the pores—protects! **NOTHING LIKE IT!**

AGENTS
An unusual opportunity! Quick, flashy demonstrator. Big profits. Good territory. Write today!

FREE SAMPLE

Just send your name and address to

MASTER GLAZE CO., 7720-594 W. Harwood Ave., Milwaukee, Wis.

OH BOY! FIREWORKS!

Rich Bros' All-American Pre-war Quality ASSORTMENT. Over 172 pieces including 100-2" Salutes, 20 Cherry Flash Bombs, 25 Flitter Crackers, Comet, 2-shot Repeaters, Whistle Bomb, Red & Green Fire Cones, Whistle Devil, Humdinger, Gyro Flyer, Vesuvius Fountain, Flower Pot, Roman Candles, Aerial Bombs, Sparklers, 6 packages Chinese Firecrackers, FREE PUNK! RETAIL VALUE \$8.55. **\$4.95** YOURS FOR ONLY.....

RICH BROS' FIREWORKS CO.

Dept. 5 Box 514 Sioux Falls, S. D.

Shipped Ry. Express Only. None sent C.O.D.

Enclose Money Order or Check. Name nearest Express Office. Many other assortments and displays. Send for FREE CATALOG, FREE CAP and Cap Pistol circular.



SOCIAL SECURITY
AS REGISTERED WITH U.S. GOVERNMENT
No

Beautiful brass Social Security plates (illustrated 1/2 actual size), priced at only 50c. Please print your name & number plainly.

ACME
Stamping Service
Box 838
Davenport, Iowa

New! Easy-to-Use Invention TRIMS your HAIR as it Combs



Save Money!
Save Time!

Anyone in the family can use it at home! Less than 2c Now you can look more handsome by always keeping your HAIR NEAT with this simple amazing invention! Give yourself a BARBER-LIKE TRIM OR A TRIM HAIRCUT by running it through your hair as a comb. Easy as combing! Absolutely safe for men, women, children! Also excellent for underarms, legs. More than pays for itself with the first few hair trims.

Send No Money Don't send a penny! Just pay postage for 1 "Hair Trimmer" plus 15 EXTRA BLADES with FREE "KLEAN HAIR-CUT COVER-ALL"! Tie it around neck, whether dressed or in underwear before trimming hair. Helps cover your shirt, suit or body from the cut hair. If you wish to save postage, send only \$1 with order. Money back guaranteed if not satisfied. Order now! TESTED SALES, Dept. T-4403, 20 Vesey St., New York City

FREE!
"KLEAN HAIR-CUT COVER-ALL"
Keeps Cut Hair Off Clothes, Body

Start Your own BUSINESS

★ Molding Toys and Novelties At Home in Spare Time



Now anyone can be an expert molder! Mold Art Kit is both a fascinating hobby and a money-making business... molding statuettes, book ends, toy animals, novelties, etc. Ideal for gifts, bridge prizes, church bazaars, etc. Free 50c Mold Art book tells you (1) How to make a rubber mold (2) How to mold plaster models (3) How to color and finish. Send for this free book today. Better still, order a trial set (\$1.49) on money-back guarantee. **SEND NO MONEY.** When package arrives, pay postman \$1.49 plus COD postage. (No COD outside U.S.). Write today.

MOLD ART (Rubber-For-Molds, Inc.)
Dept. 48-E, 6044 North Avondale Ave.
Chicago 31, Illinois

NEW! METAL FORMING TOOLS



WISE IRON BENDER. Easily bends 1/2" square or round: 1/4" up to 2" wide. Makes hooks, rings, hoops, eyelets, etc. Screw adjustment for accurate work. All steel. Price \$8.50 PP. Immediate delivery.

WISE FORMING TOOL. Makes cylinders, ovals, cones and round corners in sheet metal, wire and 1/8x2 steel strap, 2" to 60" in dia., 18" wide. \$8.50 PP.

12" BRAKE. Fits in vise, or bolts to bench. Forms angles, channels, boxes and crimps in sheet metal and strap iron. \$14.50 PP.

SHEET METAL PLIERS. Forms any length angles. Jaws 2 1/2" wide. Price \$2.50. All items guaranteed. Instruction book, 50c.

WISE BRAKE MFG. CO., 1318 So. 30th Ave., Omaha 5, Nebr.

SHALLOW WATER DIVING UNIT



For salvage, rescue, exploration dives and pool cleaning. Comfortable and efficient; seals absolutely. Low cost with long life. Also, complete line deep-diving gear. Write for details.

- Mask
- Weighted Belt
- Air Hose
- Portable Compressor

DIVING EQUIPMENT & SUPPLY CO.
1121 N. Water Street, Milwaukee 2, Wis.

WHEELS FOR JUVENILE AND INDUSTRIAL USE

MANUFACTURER'S AND DEALER'S INQUIRIES INVITED.

CIRCLE METAL MFG. CO. * 4266 E. Pacific Way-Los Angeles 23, Cal.

LEARN IMPORT-EXPORT

Represent manufacturers. Study at home. Splendid opportunities, uncrowded field, big future. ITP trains you in few weeks. Low tuition. Diploma awarded.

INTERNATIONAL TRADE PROMOTION
246-S Fifth Ave. New York 1, N. Y.

MAKE THIS SUIT YOURS NEW PLAN

EARN CASH SHOWING TO FRIENDS!

Write at once if you want this fine made-to-measure suit! You can get it by taking a few orders from friends, and earn up to \$10, \$12 in a day. Your bonus suit helps you take more orders with latest style, made-to-measure guaranteed suits at amazingly low prices. Also complete line of Ladies' Tailored Suits. No experience, no money needed. Write TODAY for FREE SAMPLES—telling about yourself—age, etc. No obligation!

PIONEER TAILORING CO. Congress and Throop Streets, Dept. 5-1120, Chicago 7, Ill.

WIN with MAGIC CARDS



This special deck of playing cards with secret code on back of each card tells YOU what each card is when lying face down. Easy directions explain code and how to do many kinds of "Magic" tricks. Use same deck for usual card games, such as poker, bridge, etc. Only \$1.49. Get a deck today. **SEND NO MONEY.** Send Name and Address. Pay postman on arrival only \$1.49 plus postage. Money back if not delighted. Address **Hollister-White Co., Dept. 452-M** 215 N. Michigan Ave. Chicago 1, Illinois

WAR SURPLUS BARGAINS!

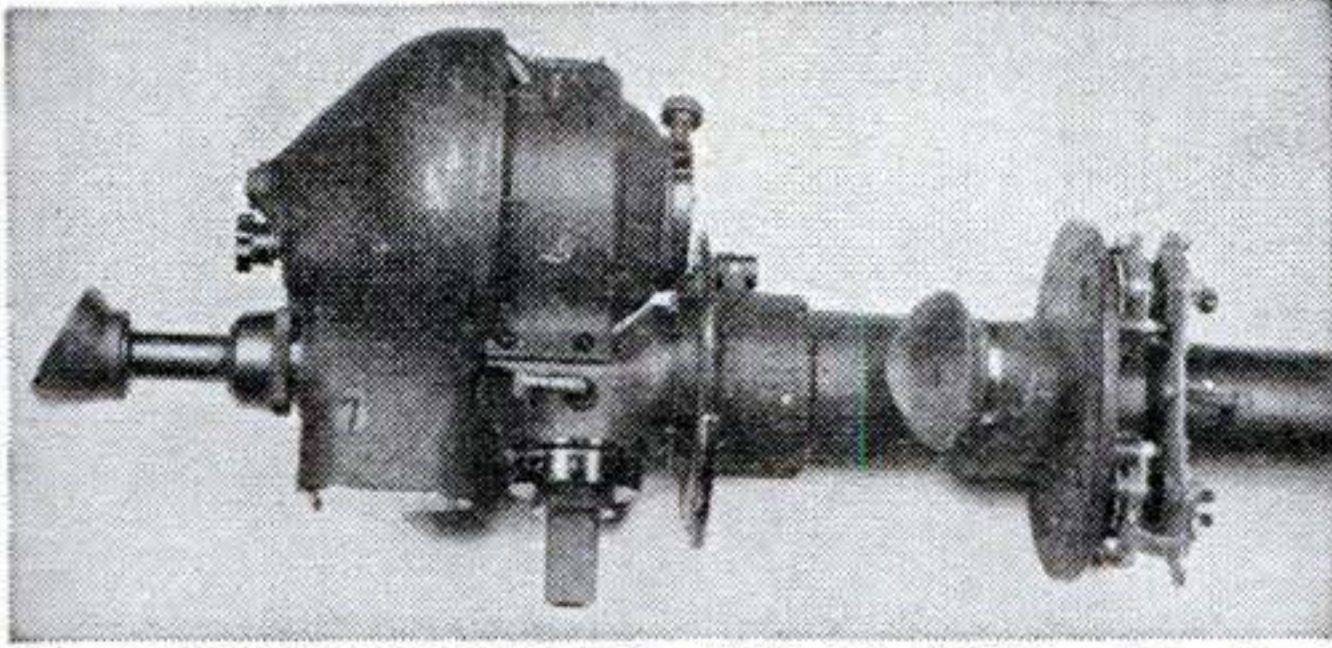

101. AIRFORCE DRIFT METER, TYPE B-3. Built to close precision tolerance by Bendix for Bombers. Overall length 47" Net weight 24 lbs. Contains many valuable unreplacable items such as precision lenses, eyepieces, switches, electric gyroscope, filters, prisms, scales, etc. Invaluable to the experimenter. Used to determine drift of aircraft in flight. Cost many hundreds of dollars! Shipping weight app. 40 lbs. Slightly used. **\$19.95** A bargain at only.

102. AIRPLANE GENERATOR, TYPE L-3. Mfg. for Air force by Leece-Neville. 24 volt. Has been used for light welders, lite plants; as generators on airplanes, boats, etc. 24 volt type. BRAND NEW! Cost \$212. NOW only **\$24.95**

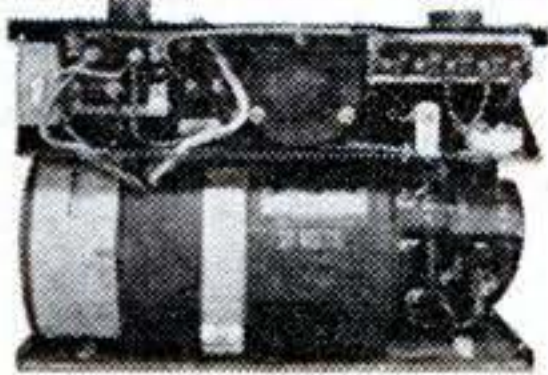

103. Triple Output Dynamotor
Input voltage 12 or 24 volts! Output is 300, 150 and 14.5 volts DC. RPM 6000, continuous duty, temperature rise 50 deg. C. Built by Bendix Radio. Has voltage regulator and fan for cooling. Weight approximately 18 lbs. Closing out at less than one percent of cost..... **\$6.50**



104. Gas Powered Light Plant
HOMelite model HRU. Powered by 2 1/2 HP gasoline engine, one cylinder, two cycle. Generator attached; output 24 volts, 2000 watts, 70 amps. Used but reconditioned. Can be used as portable lite plant for farm, boat, camp, etc. Also usable for battery chargers, light arc welders, etc. Crated, shipping weight approximately 115 lbs. Original cost over \$500 Now **\$75.00** (State method of transit. Express or Freight)

105. AIRCRAFT MACHINE SCREW and RIVET ASSORTMENT. Treasure box of at least ten sizes of screws and ten sizes or types of aluminum rivets. Not mixed but in separate containers; contains well over 15,000 separate pieces of screws and rivets. Shipped in free metal mechanics tool box. Shipping weight app. 30 lbs. NOW only **\$9.95**

106. MINIATURE ULTRA-HIGH FREQUENCY RADIO RECEIVER. Was used by Airforce as marker beacon receiver. 75 meg. Contains tubes, coils, tuning capacitors, RF amplification, leak condensers, many many more valuable parts. Circuits furnished. Shipping weight app. 5 lbs. Only **\$9.95**

107. RADIO INTERPHONE AMPLIFIER TYPE RL-7. Fine interphone for experimenters, etc. Contains many valuable radio parts as well as tubes, 24 volt dynamotor (250 vt out-put), etc. Shipping weight 10 lbs. **\$9.95**

108. RL-7 interphone control box. with switches, etc. **\$1.29**

109. RADIO HEADPHONES, fine for hams, crystal, etc. Used but good condition, only **\$1.10**

110. THROAT MICROPHONE, used condition, only **\$1.00**

111. SOLENOID ELECTRIC VALVE, Type G102AY16CAL, Stewart-Warner, 24 volt, Shipping weight 3 lbs. only **\$1.49**

112. DUAL CYLINDER HEAD TEMP. GAGE, 0 to 350 deg. Cent. 8 ohm lead type, iron constantan, Type 76AT3. When properly wired can be used to record temperature of water, oil, cylinder heads, etc. Two sensitive micro amp jeweled movements! Brand new. Shipping weight 3 lbs. **\$6.95**

113. ELECTRIC THERMOMETER, by Weston, Type 20L. Used on aircraft to record Free Air temperature, plus or minus 50 deg. Cent. Has sensitive micro-amp jeweled movement; used 24 volt current. Shipping weight app. 3 lbs. Brand new. Only **\$5.95**

114. ELECTRIC GYROSCOPE, from famous bombsight. For experimenters, practical jokesters, etc. Cost hundreds of dollars; from Uncle Sam's best bombsight. Precision bearing mounted; runs on DC power. Shipping weight app. 12 lbs. Only **\$2.49**

115. ELECTRIC FUEL QUANTITY GAGE, Has four scales, Misc. electronic parts, etc. Used condition, minor damage. Shipping weight 5 lbs. Now only **\$1.29**

116. TOGGLE SWITCHES. Double pole double throw... \$.49
Single pole single throw... \$.39

117. INTERPHONE AMPLIFIER BC347A, 24 volt interphone 6" x 14". Without tube. Shipping weight 3 lbs. Only **\$2.49**

118. MALLORY RADIO NOISE FILTER, Size 2 1/2"x3"x3 1/4", metal box. For cutting noise between radio and motor, etc. Brand new. Shipping weight app. 3 lbs. Only **\$1.29**

IMPORTANT: We pay no shipping charges! Include adequate on cash orders to pay charges or we will ship collect charges. No orders accepted for less than \$2.00. No C.O.D.'s shipped unless 20% deposit made in advance. App. shipping weight of each item is listed. Canadian orders, add \$2.00 extra charge per order.

AERO INSTRUMENT COMPANY, Municipal Airport, Houston 12, Texas

SUPER YOUR GREATEST ASSET!
MEMORY Facts, figures, faces, **STICK LIKE BURRS** with new improved **SUPER-MEMORY** Course.
THOR BOOKS, Y-3 Box 1210. Chicago

Have an OFFICE of YOUR OWN!

LEARN NEW PROFITABLE PROFESSION
At Home in 60 Days, Men & Women, 18 to 70!

Be Your Own Boss and the Boss of Others. Be Respected. Meet Interesting People.



Earnings of men and women in this profession run as high as \$5,000-\$15,000 yearly. Others make good money in spare time. Little money needed to start. A business where your earnings begin sooner. Easy to learn. No selling or goods to buy. No experience necessary. A depression-proof business. A course of action to guide you step by step as you earn. All 53 lessons sent at once to use as operating manuals. Easy terms. Diploma. Money-back agreement. Write for **FREE BULLETIN.**

FRANKLIN CREDIT SCHOOL
Dept. 999 ROANOKE 7, VIRGINIA

BY MAIL in Easy Lessons



WITH SPEED CONTROL
Just the Thing to—
• Electrify your **SEWING MACHINE**
• Run Small Lathes • Turn Small Blowers and many other jobs
5-speed control, 1/4" double shaft, 5000 R. P. M. **\$21.95**
1/20 HP. AC-DC.
Electrify your sewing machine this easy way! All necessary parts, motor, foot control, bracket, screws, pulley. Takes but a few minutes to turn your old foot power sewing machine into a modern, electric machine. The hobby enthusiast will find 1000 and one uses for this kit!
Money back guarantee. Order today! Kit sent by return mail. C.O.D. or you may enclose your check. Send your name and address to **American Appliance Co., 12427 Superior Ave., Cleveland 6, Ohio**

Now you get **2 PIPES IN 1** NO EXTRA COST

Thoro-Kleen

AIR COOLED ALUMINUM PIPE WITH INNER AND OUTER BOWLS OF GENUINE IMPORTED BRIAR

Ask Your Dealer for the Genuine Thoro-Kleen



\$2.50 COMPLETE

NATIONALLY FAIR TRADED

2 INTERCHANGEABLE SCREW-ON BOWLS
FEATHERLIGHT • ALL PARTS REPLACEABLE
INSIDE FILTERS • SPIC AND SPAN CLEAN
VULCANITE RUBBER BIT BEVELLED FOR COMFORT

GREENWICH HOUSE CORP.

939-K 8th AVENUE, N. Y. 19, N. Y.

Territories Open. Jobber Inquiry Invited.

War Surplus Bargain Special

Brand New! Vacuum-Air

HYDRAULIC

FUEL PUMP

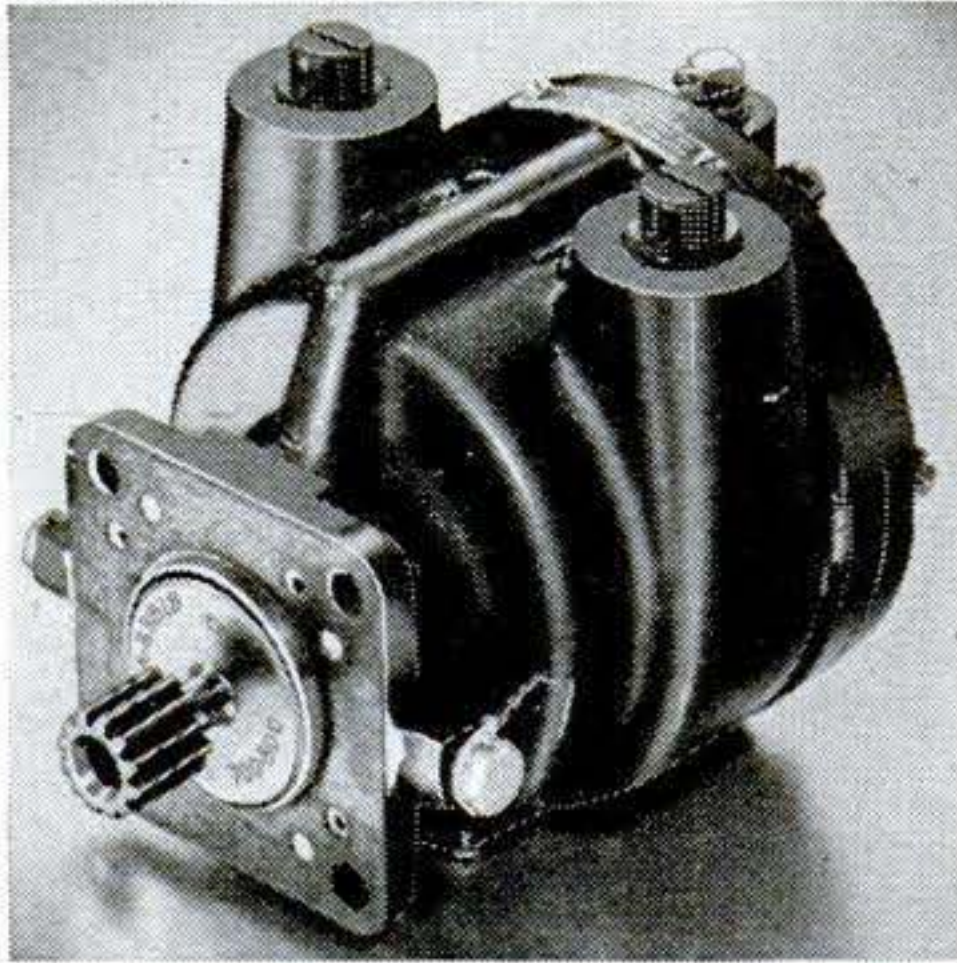

Original Cost \$45.00—Now Only **\$9.95** POSTPAID
In U.S.A.

WORTH MANY TIMES THIS LOW PRICE

USE THEM
ON

OIL BURNERS

SPRAYING
MACHINES

MILKING
MACHINES

COMPRESSORS

VACUUM
PUMPS

HYDRAULIC
SYSTEMS

MANURE
LOADERS

PRESSES, etc.

Originally cost \$45.00. Used by the Air Corps to drive bomber de-icer boots, gyroscopes, automatic pilots, etc. May be used as air or fluid pump—for pressure or vacuum. Standard 3/8 inch pipe thread with interchangeable ports. Will pump 7 1/2 gal. SAE 30 oil per minute at 300 RPM. Builds air pressure of 30 lbs. per sq. in. at 1000 RPM. Vacuum will draw 26 inches of mercury at 1750 RPM. Will develop up to 120 lbs. per sq. inch of hydraulic pressure which, in conjunction with the 3 inch hydraulic cylinder, will lift 840 lbs. minimum. Runs forward or reverse. Self aligning shaft. Die cast aluminum housing 6x4x4 inches. Has stainless alloy steel vanes and impeller. Made by Bendix Avia. Corp. Spline terminal for direct drive—readily replaced with a pulley. Recommend a 1/4 H. P. or stronger electric motor as source of power. Rated capacity 1500 RPM with high overload factor. Special price for quantity users. Send check or money order today. Complete illustrated report and instruction booklet FREE with every pump. **\$9.95** Postpaid in U.S.A.

GROBAN SUPPLY CO.

1522 So. Michigan Ave., Dept. PS5, Chicago 5, Ill.



SHAW DU-ALL GARDEN TRACTORS and MOWERS

Get FREE FOLDER NOW!

Get details on 1 to 9 H. P. walking and riding tractors. Do 1000 jobs on small farms, estates, orchards, gardens. Low-priced. Send postcard!

SHAW MFG. CO.

5705 Front St., Galesburg, Kans. 668 PS No. 4th St., Columbus, Ohio

New! 6 in 1 CIG-SMOKER



A WORLD SENSATION. Now for the FIRST TIME in smoking history, smoke cigarettes without Fire and Burning hazards to Person, Home, Clothes, etc.—and also SAVE HALF on your cigaret expense. A scientific invention of beautiful, durable design, made of miracle war-born fireproof SILVERGLAS (won't burn out) and Silvery Aluminum Alloy. Relax and enjoy long, cool smokes SAFELY, anywhere—even in bed. No sparks fly, no ashes fall. Has safety self-snuffer and nicotine tar filter.

Tested, approved, exclusive, it is now ready for world distribution. Try it. A smoking thrill for men and women. Shipped prepaid promptly—GUARANTEED.
1 Cig-Smoker—filter supply, boxed. Send \$2.00
3 Cig-Smokers—filter supply, boxed. Send \$5.00
Cig-Smokers pay for themselves in few days.

Dealers, Importers
Write Airmail

Pat. & Mfr., **SAFE-GARD MFG. CO.**
22 Perry-Payne Bldg., Cleveland 13, Ohio

EXCITING FILMS



Thrill audiences at your 8-16 mm. screenings! Breath-snatching Bull-fights . . . Movie Stunt Men in life-and-limb action . . . Death Defying Dives.

—o—

GLAMOROUS subjects starring Hollywood's most beautiful daughters. Models selected by artists as the loveliest in all the world in beautiful scenes; sensational dances.

SPECIAL OFFER: Send only one dollar for new film short, "Glamorous Exciting Stars" featuring four glorious Beauties. State 8mm. or 16mm. For listings of all Exciting Films free, and this Exciting Film, send only a single dollar, now, to

EXCITING FILMS

1071 El Centro, Dept. 12, Hollywood, Calif.

LEARN PIANO IN ONLY 10 EASY LESSONS

FIRST LESSON STARTS YOU PLAYING SONGS

LOW
COST

NO
RISK

SEND
NO
MONEY

• Amazing! So Easy! So Practical! Here is the World's only piano course using this new perfected method. You learn Faster, Easier thru exclusive aids never before available. First lesson starts you playing actual pieces with both hands. Stop Wishing. Start Playing. For complete information Kit FREE, Send Your Name and Address to **TRACY INSTITUTE OF MUSIC**, Dept. PS-1, 54 Holmehurst Ave., Baltimore 28, Md.



LOCKSMITHING & KEY MAKING COMPLETE UP-TO-DATE COURSE

How to pick locks, decode, make master-keys, repair, install, service, etc. 53 easy illustrated self-instruction lessons for every handy man, homeowner, carpenter, mechanic, hardw're dealers, maintenance men, etc. Satisfaction guaranteed. Send for Success-Catalog Free. Address below.

WATCH AND CLOCK REPAIRING

LEARN at HOME in Your Spare Time Prepare for a happy future of prosperity and security—and get a good job Now. A fascinating, thorough self-instruction training in American and Swiss watches, clocks. Special section on alarm clock repairs. Fast-growing field. Success-Catalog Free. **NELSON CO.**, 1139 S. Wabash Av., Dept. E01 Chicago 5, Ill.



Good News To Fistula Suffers

Interesting FREE BOOK on
Dangers of Delay

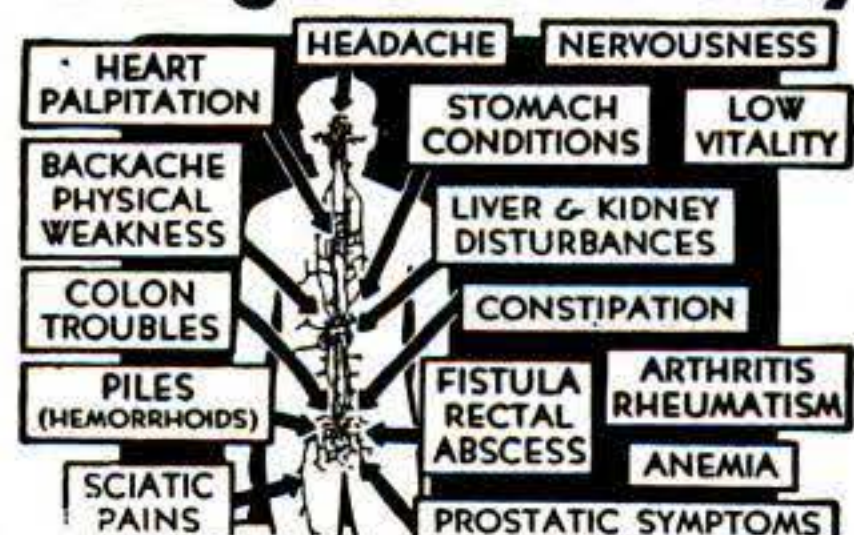

Illustrated, authentic 40-page book on Fistula, Piles (Hemorrhoids), related ailments and colon disorders is yours FREE. Write today. Thornton & Minor Clinic, Suite 549, 926 McGee St., Kansas City, Mo.

ARMY RADIO PHONES



They're Weather — Water and Shock Proof

When we say they are made to Army specifications, that's enough assurance they must be of best quality. These Army Radio Phones are perfect and were O.K.'d by Signal Corps Inspectors. These Dynamic Mikes and Receivers, were used on aircraft and tank inter communication systems. Use them for recording, for battery-less phone, for pocket size set loud

speaker or talk through your radio set. We bought a good many of these Radio Phones, they are brand new, and cost a great deal more than you can get them for. A complete dynamic hand mike, 2 earphones, headband, cord set. A wonderful buy for only **\$3.45**

Send check or Money Order. FOB warehouse

LEEDS RADIO CO.

75 Vesey St.

Dept. PS5

New York City 7

Learn LANDSCAPE GARDENING

A thorough, interesting, home study course for those who wish to become Landscapers, Gardeners, Designers, etc., for profit or pleasure. Write today for Free Book to

APPROVED NATIONAL LANDSCAPE INSTITUTE FOR VETERANS Dept. PS-5, 310 So. Robertson, Los Angeles 36

HIGHWAY ENGINEERING

PRACTICAL TRAINING IN HIGHWAY DESIGN AND PRACTICE. HOME STUDY — BY MAIL ONLY — WRITE US NOW!

SCHOOL OF HIGHWAY PRACTICE DEPT. C, 2161 SHATTUCK AVE. BERKELEY 4, CALIF.

Get this New RADIO RULE!

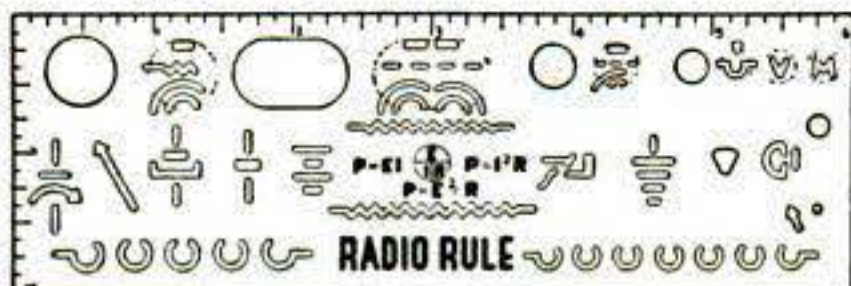

Needed by all radio engineers, draftsmen and technicians. This accurate 6 inch symbol rule saves you time and money. Sent immediately upon receipt of \$1.00.

ORDER YOURS TODAY

413 FOX BLDG. DETROIT 1, MICH.

COLETTE PRODUCTS CO.,

MAKE MONEY IN YOUR OWN SILK SCREEN PRINTING BUSINESS

Print 100, 50c signs an hour! Build your own press. Start with only \$50, sparetime at home! We tell you HOW! Write today!

W. E. Wolf Co., 817-A High St., Anderson, Indiana

THANK YOU CALL AGAIN

SELL ULTRA-BLUE STOCK SIGNS

To General Stores over 1000 Different Slogans and Sayings. Fine Line of Religious Ultra-Blue Signs for Homes and General Display. Make Money on these Fast Selling Signs, 35c Sellers. 15-Sample Ultra-Blue Store Stock Signs-7x11, \$1.00 ppd. 15-Sample Ultra-Blue Religious Signs-7x11, \$1.00 ppd. 100-Ultra-Blue Stock Signs-7x11, \$6.00. No C.O.D.'s.

L. LOWY, 8 WEST BROADWAY, NEW YORK 7, N. Y. — Department 319

LAWN ORNAMENT-NOVELTY PATTERNS

28 Lawn Ornament Patterns, 25c. Other patterns: 15-20" high; Dutch Girl, Dutch Boy, Pirate, Bull Terrier, Mexican Girl, Mexican Boy, Dwarf, Penguin, Flower Girl, 10c each. 25 Novelty Patterns, 30c. All 62 Full Size Patterns, \$1.00 Postpaid. Strother Pattern Service, Dept. 7-R, Box 383, Belington, W. Va.

Make Your Own RUBBER MOLDS

with **RED LATEX MOLDING COMPOUND**

Earn money, have fun; make your own molds for plaster objects. Produce novelties and gifts for home and to sell to friends. RED LATEX MOLDING COMPOUND (60% density) now available in quart and gallon quantities. Gives perfect results, easy to apply. Send for complete information and prices.

FRANCIS SUPPLY CO., Dept. E-3, 1836 E. Fulton St., Columbus 9, Ohio

EYE-GLASSES BY MAIL

16 Days Trial

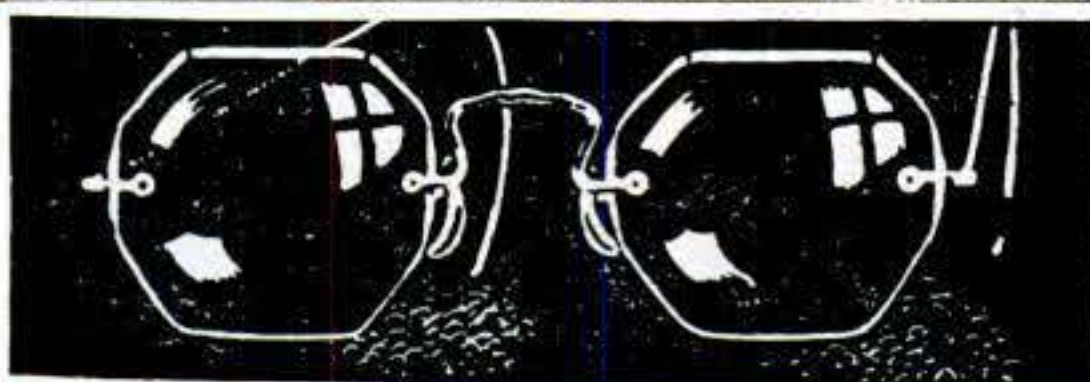

Write Today for Free Catalog. Send no Money

ADVANCE SPECTACLE COMPANY

537 South Dearborn Street, Dept. SP5, Chicago, Illinois

Time & Date AT A GLANCE

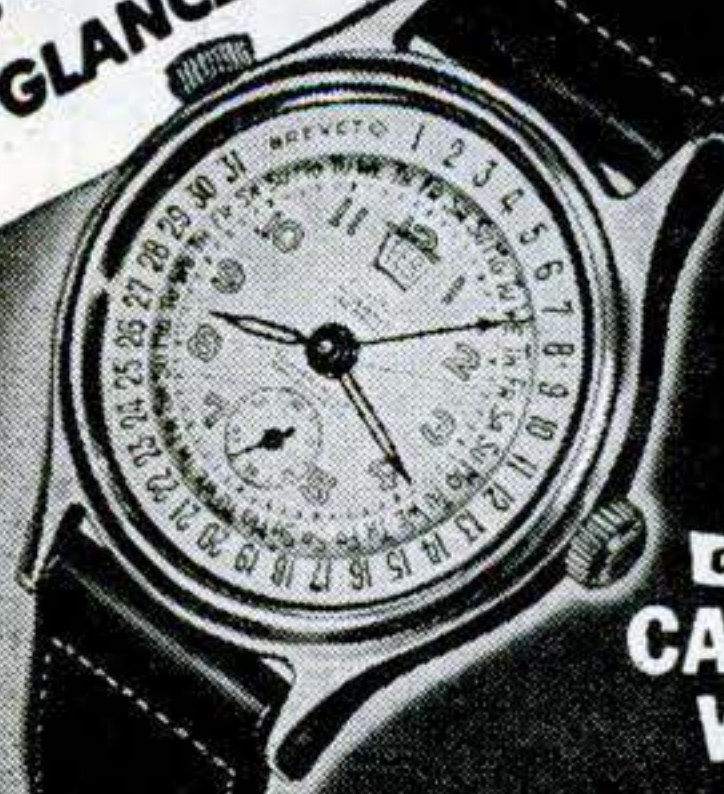

BELL
GUARANTEED
CALENDAR WATCH

Tells time, name of day and date. Day name changes automatically.

No. SF 382 — Calendar watch, 17 jewels waterproof, shockproof, anti-magnetic, radium dial and hands, stainless steel back. **\$49.75**

OTHER SPORTS WATCHES WATERPROOF SHOCKPROOF

NOW AT RECORD LOW PRICES

Precision tested, guaranteed. 17 jewels, anti-magnetic, radium dial and hands, unbreakable crystal, sweep second hand.

No. SF 196 — Stainless Steel Back..... **\$24.75**

No. SF 220 — ALL STAINLESS STEEL CASE... **\$29.95**

ORDER BY MAIL: Send check, money order or pay postman C.O.D. Prices Incl. Fed. Tax and Postage. Write for FREE Booklet "SF"

REPAIR SERVICE: All types and makes of quality watches. FREE estimate on request.

BELL WATCH COMPANY, INC.

Time and Life Bldg., Rockefeller Center, New York 20, N. Y.

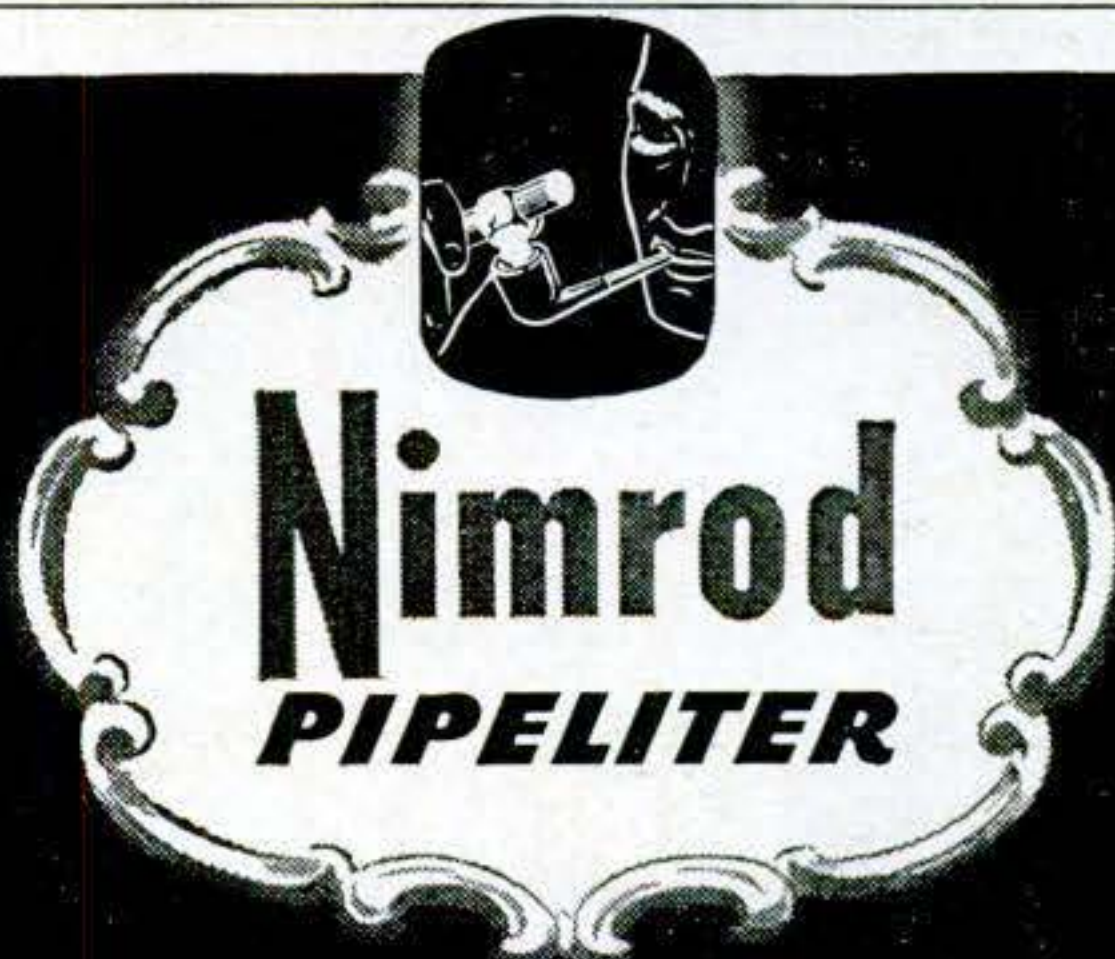

THE ONLY DOWN-DRAFT CHIMNEY-ACTION LIGHTER MADE. DESIGNED EXCLUSIVELY FOR PIPE SMOKERS.

\$3.50 AT YOUR DEALER

- WINDPROOF
- LIGHTWEIGHT
- LARGE FLAME

A perfect lighter for pipes, cigarettes or cigars too. Unconditionally guaranteed. If your dealer cannot supply you, send \$3.50 direct to us. Include your dealer's name.

WARD-NIMROD COMPANY

Dept. 36-B, 2968 Jessamine St., Cincinnati 25, Ohio



MAY 1947 57

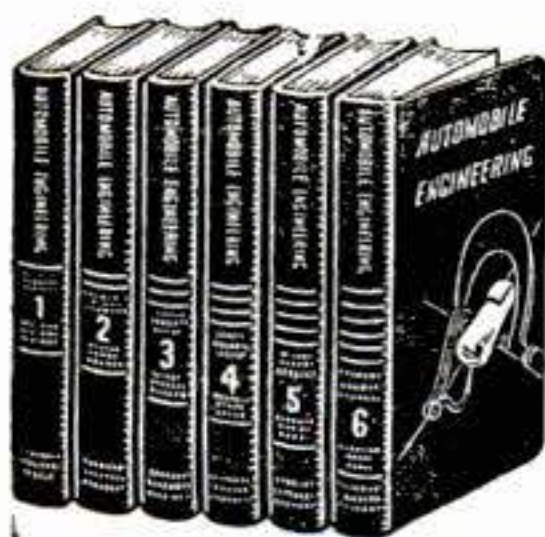

AUTO BOOKS ON APPROVAL



CAN YOU FIX IT?

These wonder books tell step by step HOW to make difficult repairs and adjustments, how to keep a car at maximum efficiency, including latest improvements in car design and operation. Engine troubles and how to correct them well covered.

6 BIG VOLUMES
2800 pages, 2000 illustrations, wiring diagrams, etc., including Diesel engines. Beautiful modernistic, washable cloth binding.

SEND NO MONEY. Just mail the coupon for a complete set of Six Big Auto Books. 20th Edition. Whether you are a mechanic or helper, expert or apprentice, auto owner or driver, take immediate advantage of this FREE EXAMINATION OFFER.

MAKE GOOD MONEY NOW. HOLD A PERMANENT JOB

America wants its automobiles kept in good repair. Men with "know how" are in demand, at big pay. These books will help you get and hold an important job, or give you a chance to go into business for yourself now or later. Any man who half tries to improve himself can learn auto servicing and repairing by this quick reference method. Use the JIFFY INDEX to find easily understood answer to any auto problem. These wonder books prepared by eleven of America's great automobile engineers. Many hundreds of valuable illustrations. Send the coupon TODAY.

A year's consulting privileges with our engineers now given with these books without extra charge.
Vocational Publishers Since 1898

AMERICAN TECHNICAL SOCIETY, Dept. A520, Drexel Ave. at 58th St., Chicago 37, Ill.

I would like to examine your Six-Volume Set of Auto Books. I will pay the delivery charges only, but if I choose I may return them express collect. If after 10 days' use I prefer to keep them, I will send you \$2 and pay the balance at the rate of only \$3 a month until \$24.80 has been paid. Please include consulting service as offered above

Name.....
Address.....
City..... State.....
Please attach letter stating age, occupation, employer's name and address, and name and address of at least one business man as reference. Men in service, also please give home address.



MY DOBE TRAINING WAS ALL PRACTICAL EXPERIENCE!

I WILL TRAIN YOU AT HOME UNTIL YOU GET A GOOD PAY JOB!

Get Started NOW in DRAFTING

EXPERIENCE WHILE LEARNING

Your training will be experience because I give you practical jobs to do. And I list your experience and send it to employers as a reference when you are ready. All Dobe trained men start out with experience. You will too, because I will train you until you get a good pay job in drafting.

Take the first step now and step into Drafting—the big opportunity field—as an experienced, well paid draftsman. Act now for a better job, better pay and better working conditions. The field for draftsmen is bigger now than ever before for all new products, machines, construction start with the draftsman. Get into drafting now. I will train you at home in your spare time, and give you actual experience on actual work—the same kind of jobs you will do with the best paying firms. I will train you until you are competent, fully experienced, and holding a position that will bring advancement and pay raises. Write me today.

WORKING TOOLS SENT WHEN YOU START

All drafting instruments and table and other needed equipment sent when you start. Nothing to buy. Act today. Mail coupon to me now and be sure to give age.



MAIL COUPON FOR VITAL FACTS

Engineer Dobe, Div. 25 Libertyville, Ill.

Send me the Vital Facts on Drafting and Industrial Designing, your Free Book and advertised list of positions for Draftsmen and Designers wanted.

Name..... Age.....
Address.....
City..... Zone..... State.....

REFRIGERATION AND AIR CONDITIONING

BECOME A SERVICE EXPERT

Now, not "next week," is the time to start training for a top-pay job in this vital field. A drastic shortage of trained service experts exists. Many thousands more will be needed for big post-war expansion caused by new industrial uses. Train NOW to get your pick of best jobs. We will give you the practical training you need. For 2 years we trained men and women for the Army and Navy only, in fine-precision aircraft instrument work. So our methods must be right. Common schooling is all you need. Our unique system makes everything easy to grasp. You can train at home and in our big Chicago shops. Write for full facts TODAY, without obligation. Dept. P7E

Approved for Veterans' G.I. Training
Millions of Old Units Need Expert Service. Big Building Boom Will Create Even More Opportunities.

INDUSTRIAL TRAINING INSTITUTE
2150 Lawrence Avenue Chicago 25, Illinois

LAW

STUDY AT HOME for PERSONAL SUCCESS and LARGER EARNINGS. 38 years expert instruction—over 108,000 students enrolled. LL.B. Degree awarded. All texts furnished. Easy payments. Send for FREE BOOK—"Law and Executive Guidance"

AMERICAN EXTENSION SCHOOL OF LAW
Dept. 77-S, 646 N. Michigan Ave., Chicago 11, Ill.

LEARN MOVIE THEATRE MANAGEMENT

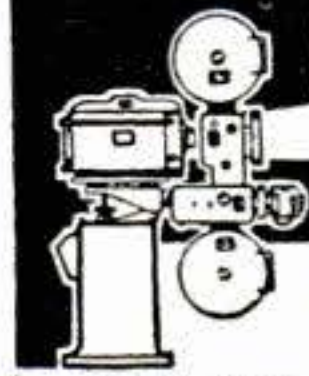

The Motion Picture Theatre Business offers big opportunities for trained men. Get into a fascinating field with a promising future. Train at home in spare time. Free Catalog. Established 20 years.

THEATRE INSTITUTE 385 Washington St., Elmira, New York

APTITUDE TESTS

discover the kind of work or studies best for your success!

You get a personal report—a guide for life—more happiness—more prosperity. (for men, women, boys, girls.) Write for complete facts.

VOCATIONAL COUNSELING INSTITUTE
5057 Woodward Ave., Detroit 2, Michigan

ELECTRIC LIGHT PLANTS

Used Government surplus. Guaranteed in good mechanical and operating condition. 110 volt, 3000 watts, powered by Briggs-Stratton or Wisconsin air cooled engines, \$149.50. No COD Orders. Limited quantity, act quick. Send for descriptive circular.

MIDWEST SURPLUS SALES CO., 1520 Locust St., Kansas City, Mo.

MAGIC LIQUID MAKES PHOTOS APPEAR

Amazing discovery permits you to print pictures from any of your snapshot negatives on wood, cloth, leather or paper. Like magic your pictures will show on ties, handkerchiefs, purses, cards and letterheads. Takes only a few minutes in broad daylight. Won't rub off or harm negative. An attractive set with enough material for over 100 pictures. ORDER TODAY. Send \$2.49 postpaid. C.O.D. pay postman a few cents more in addition. (Foreign \$2.60 money order only.)

STYLE-ARTS, Inc. Dept. 2-C, 4649 Broadway, Chicago 40, Ill.

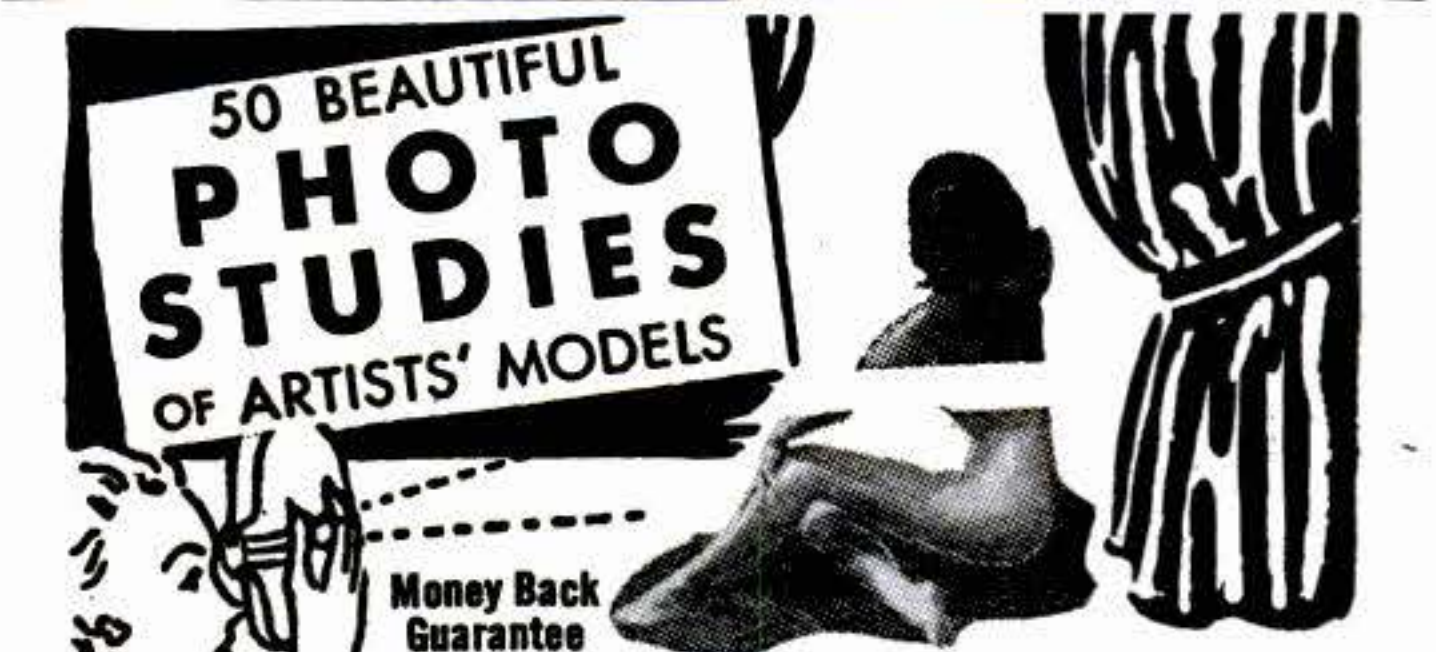

On 16mm film complete with movie viewer that fully encloses and protects the film. Lovely models in charming poses... with lighting data for photographers... an aid to artists and sculptors. Extra reel (series 3-4-5-6, all different poses) of studies for 25c.

PARISIAN ART STUDIOS, Dept. PS 545 5th Avenue New York, N. Y.

Ball-Bearing

SPEED WHEELS

with semi-pneumatic Tires



12" x 1.75" wheel....\$3.25
 10" x 1.75" wheel....\$2.75
 8" x 2" wheel.....\$2.00
 10" or 12" wheels with V-pulley.
 Low Price Derby Steering Wheel.
 Write Us

—AXLES—

24" Steel axle.....75c

—Solid Tire WHEELS— (no bearings)

7" wheel.....60c
 6" wheel.....50c
 4" wheel.....30c

ORDER NOW FOR
 PROMPT DELIVERY

10% REQUIRED
 WITH C.O.D.'S

JIM BROWN TOY COMPANY

1093 Home Ave.

Akron 10, Ohio

MAGIC LIQUID CASTS PLASTICS

A NEW LIQUID PLASTIC! Just pour **PLASTICAST** into any kind of mold or pan and it hardens in a few minutes to a solid, smooth, clear as glass plastic! No machinery or tools required. There is **NO END** to the fascinating, brilliant, sparkling and colored plastic articles you can easily make because **PLASTICAST** has **UNLIMITED POSSIBILITIES**. Being transparent it is ideal for imbedding flowers, coins, photos, souvenirs, etc. Can also be cast into rods, sheets, or any shape. Make **Plasticasting** A Thrilling New Hobby or A Profitable Business! Full instructions and accessories provided.

Complete Master Outfit, will make over 200 articles.....\$3.00

PLASTICAST CO.

(Send order to nearest office)

5961 Madison St.,
 Chicago, Ill.

Dept. A.

P. O. Box 987,
 Palo Alto, Calif.



METALLIZE BABY SHOES

Learn this easy, money making business from nationally recognized consultant. Perpetual market, small investment, interesting work. Get know how from outstanding authority. For free details write **JOSEPH B. KUSHNER, Metal Finishing Engineer, RD3F, STROUDSBURG, PA.**

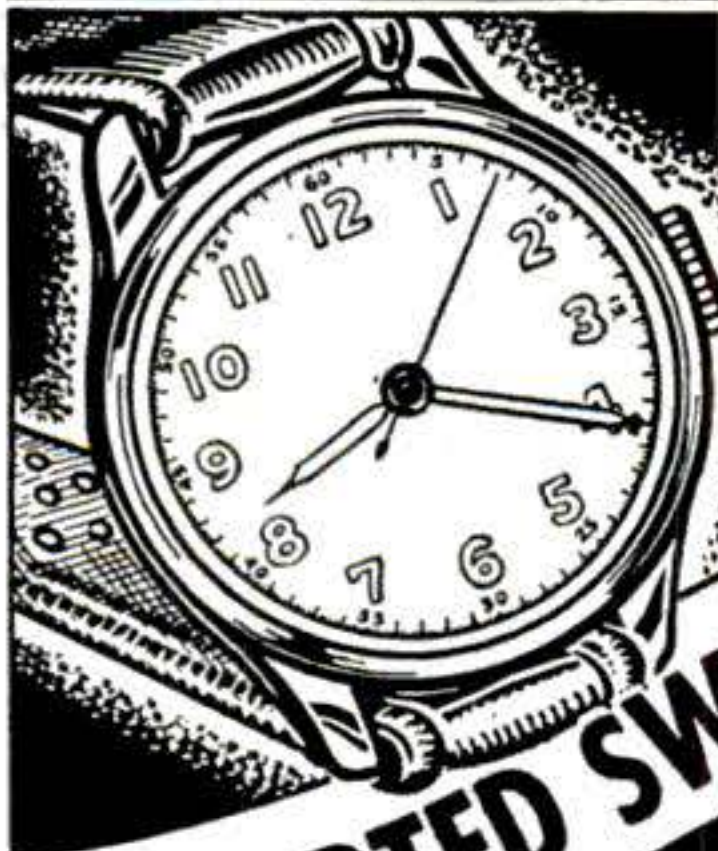

only
\$8.50

IMPORTED SWISS WATCHES

... for men and women. Sweep second hand and unbreakable crystal. Send no money, wear at our risk. Satisfaction guaranteed or money back in 5 days. Send name and address. Pay postman C. O. D. \$8.50 plus postage and 10% Fed. Tax.

TECHNOS WATCH CO. DEPT. E
 556 BROAD ST., NEWARK 2, NEW JERSEY

RUNNING HOT WATER INSTANTLY!

From
 Your
 Cold
 Water
 Faucet

with ROLEY Instant Hot Water Heater



Here's one of the greatest household inventions of all time . . . back again for the first time in many years. Now you can actually have all the hot water you need the instant you need it . . . FROM YOUR COLD WATER FAUCET! This new postwar type heater quickly attaches to any cold water faucet . . . in the basement for extra hot laundry work . . . in the bathroom for bathing needs . . . in the kitchen for dishes, cooking and cleaning. You regulate the temperature and quantity with your faucet handle. Just plug the cord in any electric outlet (AC or DC 110-120 volts), turn the faucet and PRESTO—Hot Water, anytime of day or night, as much and as hot as you want. Easy to install, complete with 6-foot extension cord. Order one or more TODAY.

\$8.49

Hot water as fast as
 it flows from your
 cold water faucet.

SEND
 NO MONEY

Just write today . . . order your Rokey electric Water Heater and pay the postman \$8.49 plus postage when delivered, or send \$8.49 and we will pay the postage. Try for 5 days and if not completely satisfied return to us and we will gladly refund full purchase price. No C.O.D.'s outside U. S. A.

ROLEY SALES CO., INC. Dept. FE-70 15 Spruce St. New York 7, N. Y.

Name.....

Address.....

City & Zone..... State.....

Personalized Playing Cards



EACH CARD GOLD STAMPED WITH
 YOUR NAME OR INITIALS

\$1.00
 Per Deck

OR

6 decks \$5.00

Postpaid

Here is a new idea in games and gifts—your name or initials gold-stamped on each card of the deck—to give it that **PERSONAL TOUCH!** Each deck attractively boxed and mailed to you promptly upon receipt of order.

ORDER TODAY! (Limit name to 20 letters)

HERBERT CO., 143 Am. Red Cross Bldg., Detroit 1, Mich.

Enclosed is..... Please mail.....decks
 playing cards, personalized as follows:

Mail To:.....

Address.....

City..... State.....

Write for free bulletin of personalized gifts.

MAY
 1947 59

HUNDREDS OF THOUSANDS OF MEN



Appear

SLIMMER..

FEEL BETTER, LOOK YOUNGER

with **COMMANDER**

The Amazing New Abdominal Supporter

Yes, instantly, you, too, can begin to feel ALIVE... ON TOP OF THE WORLD by joining the Parade of Men who are marching up the highway of happier living with the COMMANDER, the amazing new Men's Abdominal Supporter.

GET "IN SHAPE" INSTANTLY AND ENJOY A HAPPY STREAMLINED APPEARANCE

The COMMANDER presents the exclusively designed "INTERLOCKING HANDS" principle for extra support where you need it most. It flattens the burdensome sagging "corporation" and restores to the body the zestful invigorating feeling that comes with firm, sure "bay window" control. Order this new belt today and begin enjoying the pleasure of feeling "in shape" at once.

BREATHE EASIER—TAKE WEIGHT OFF TIRED FEET

The helpful uplifting EXTRA SUPPORTING power of the COMMANDER firmly supports abdominal sag. The instant you pull on the belt you breathe easier... your wind is longer... you feel better!

YOUR BACK IS BRACED—

YOUR CLOTHES FIT BETTER—YOU APPEAR TALLER

The COMMANDER braces your figure... you look and feel slimmer... your clothes fit you better. Your friends will notice the improvement immediately.

COMMANDER IS NEW AND MODERN!

The absence of gouging steel ribs, dangling buckles and bothersome laces will prove a joy. COMMANDER has a real man's jock type pouch. IT GIVES GENUINE MALE PROTECTION. Try this amazing new belt with full confidence... and at our risk. SEND FOR IT NOW!

Above and to left are just a few of the many unsolicited testimonials for the Commander that we receive regularly. Originals of these and others are on file.



BEFORE



AFTER

FREE 10 DAY TRIAL!

If it fails to do all we say, send it back and the purchase price will be promptly refunded.

Only \$2.98

Special Large Sizes, 48 to 60. \$3.98

SIZES 28 to 47

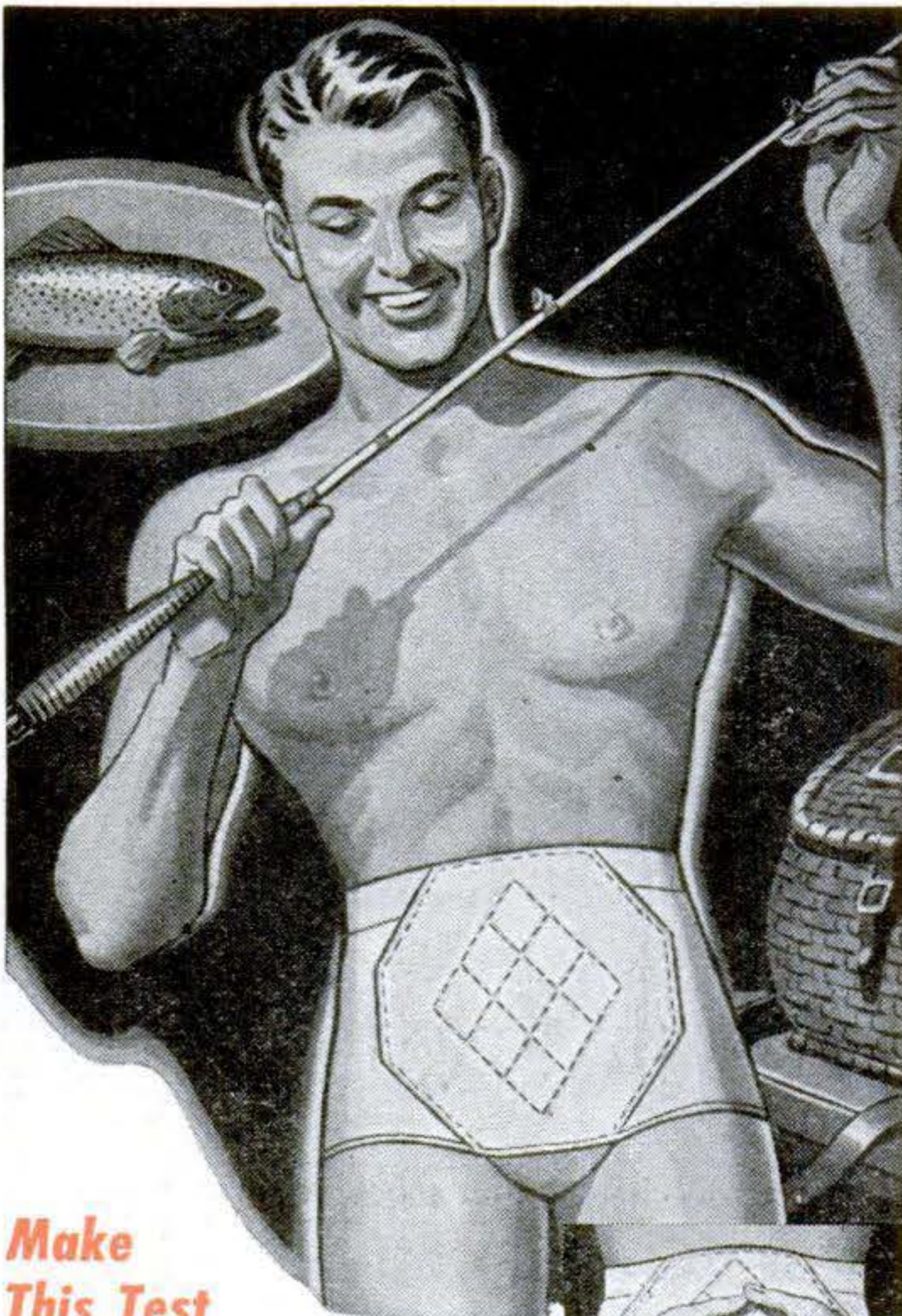

Make This Test

with your own hands and feel what we mean The Secret of the "Interlocking Hands"

Only COMMANDER contains this New principle. A porous non-stretch material is built into the special stretchy body of the COMMANDER... In the outline of two interlocking hands for EXTRA DOUBLE SUPPORT where you need it most. No BUCKLES, LACES or STRAPS.

Commander Wearers All Over America Say—

"I am sure you will be pleased to know that it is by far the best and most practical supporter I have ever had. I have been pleased to show it to several of my friends and they are likewise impressed with it. You shall probably hear from some of them in the future."
—Dr. A. M. S. Standish, Mich.

"Enclosed find order for another belt. I wouldn't be without this

supporter for ten times what it costs."
—Dr. G. C. S., St. Charles, Ill.

"I recommend the Commander for what it is made for. It sure has been a great help to me. I want to thank you for what it has done. I might add it has helped me more than anything I have ever tried."
P. N., Fort Knox, Ky.

MAIL THIS COUPON TODAY

INTRODUCTORY TEN-DAY TRIAL OFFER

**WARD GREEN CO., DEPT. T-915
113 WEST 57TH STREET, NEW YORK 19, N. Y.**

Send me the "COMMANDER" for ten days Trial. I will pay postman the special price of \$2.98 plus postage. If not satisfied after wearing it ten days, I may return it and the purchase price will be promptly refunded.

My waist measure is.....My height is.....

NAME

ADDRESS

CITY..... STATE.....

Check here if you enclose \$2.98 with this order and we will pay postage charges. The same refund offer holds.

POPULAR
SCIENCE

Classified Opportunities

Save time - Save Money



Classified Ads only 60c per word per insertion, payable in advance. Minimum ad 10 words. To be included in June issue copy should be in our office by April 28th. June issue on sale June 1st.

POPULAR SCIENCE MONTHLY—351 FOURTH AVE.—NEW YORK CITY 10

12 AUTOMOBILES

"CUSTOM-Styling" manual — Easily make car look Hollywoodized. Custom built, ultra-beautiful! New, simplified customizing illustrations. Plans for accessories, refinishing, mufflers—model changes for new and old cars. \$2. Almquist Engineering, 447-A 64 Street, Brooklyn 20.

RACING Car performance for all cars. Increase power, speed. Special "Custom built" equipment. Free literature. Write Lee Motorcraft, 1412-B Great Northern Bldg., Chicago 4, Illinois.

AUTOMOBILE Racing Book. Fifth Edition—Revised. Tells how to build dirt tracks bodies, frames, engines. Records, superchargers, rules, formulas, plans, stock conversions, roadster racing. fast Fords. \$1.00 postpaid; \$1.15 C.O.D. Ray Kuns Department 274, Madisonville, Cincinnati, Ohio.

BUILD your Midget Racer complete plans Blueprints Parts buying guide, etc. 50c. Arthur Sibley, Mendon, Mass.

HOT-rod and fast stock car equipment. List 25c 1½ h.p. from older Briggs and Strattons. Instructions \$1.00. Alden Motors, Oakland City, Indiana.

CUSTOMIZE your automobile. Illustrated new restyling ideas, instructions, specific model changes by simple methods. \$1. Speed-wheel, Box 723-C, Arcadia, Calif.

MAKE your Ford fast! Complete details, photographs. How to construct 120 mph Hotrod. \$1 postpaid. California Bill, Box L-2, Eaglerock, Los Angeles 41, Calif.

DUALTONE Chrystalline packed mufflers. Single or twin mufflers for all cars. Duals priced complete V8's \$23.00. Six cylinders \$33.00. Eight cylinders \$36.00. Large chromed tailpipe extensions \$3.30. Polished carburetor velocity stacks \$1.30. Chromed Station Wagon stacks \$15.00. Request catalogue. Dualtone Mufflers, 2636B India Street, San Diego 1, California.

SEE our ad under Motorcycles for midget racer bargains. Midget Motors Directory, Athens, Ohio.

HISTORY of Buick, City of Flint book, now available. Illustrations early, late Buick. Beautiful binding. \$3.00 postpaid. Clymer, Dept. B-56, 2125 W. Pico, Los Angeles 6, Calif.

INDIANAPOLIS Official 1946 Race Program, 102 pages. Photos, results. Limited supply, 60c each postpaid. Clymer, Dept. B-57, 2125 W. Pico, Los Angeles 6, Calif.

MOTORACES, new book Grand Prix auto racing. Includes 100 photos famous foreign cars, drivers. \$2.00 postpaid. Clymer, Dept. B-51, 2125 W. Pico, Los Angeles 6, Calif.

RACING Auto Lapel Pins. Non-Tarnishing colorful chromed. Identifies your favorite sport. Specify Midget, Indianapolis car, Indian or Harley Motorcycle, or Indianapolis souvenir crossed flags. \$1.00 each postpaid. Clymer, Dept. B-58, 2125 W. Pico, Los Angeles 6, Calif.

"STREAMLINED Roadster"—America's lowest priced car! Small, speedy two passenger sportster! Amazingly easy to build from inexpensive material—small motor. Complete instructions, drawings \$1.98. Almquist Engineering, 447-A 64 Street, Brooklyn 20.

CLYMER'S Motor Scrapbooks (old automobiles) Editions 1, 2, 3, each different, \$1.50 each. Motor History of America, \$3.00. Fastest on Earth racing book, \$2.00. Motor Racing With Mercedes-Benz, \$2.00. Book Steam Automobiles, \$2.00. Power & Speed, \$2.50. Henry Ford, His Life & Work, \$3.00. Midget Automobile racing book, \$1.10. Indianapolis "500" Race History book 1909-1946, \$3.50; 1946 only, \$1.00. All postpaid. Catalog free. See ad motorcycle section. Clymer, Dept. B-53, 2125 W. Pico, Los Angeles 6, Calif.

USED-Car Handbook, "Judging the Used Car." Dealers' tricks exposed, comprehensive simple tests, photographs. Postpaid \$1. Truvalu, Box 723-C, Arcadia, Calif.

AUTO racing magazine subscriptions. Pacific Speedway News, \$6.00 yearly. National Speed Sport, \$4.00 yearly. Illustrated Speedway News, \$4.00 yearly. All give complete data midget, big car race results. Sample copy each 50c. Specify publication wanted. Clymer, Dept. B-50, 2125 W. Pico, Los Angeles 6, Calif.

SPARKRITE Electronic Coil gives 25% more power, pep, & miles per gallon. Cures Hard Starting. No more dead batteries. One minute to install. Thirty day double your money back guarantee. \$5.00 postpaid. Send today! State make, year automobile. Pacific Engineering Enterprises, Box 3030, Los Angeles, California. Dealers wanted. Send for particulars.

"BUILD speedy Midget Track Racer from castoff parts! Plans, specifications, construction information, \$1.00. Motor Supply, Box CS-1682, Toledo, Ohio."

SPEED & Mileage manual—Obtain greater speed, mileage, racing performance from any automobile! Includes simplified methods, speed tuning, gas saving secrets—Instructions on building economizers, speed equipment, duals, mufflers, superchargers, racing fuels, fast conversions. \$1.98. Almquist Engineering, 447-A 64 Street, Brooklyn 20.

13 AUTO SUPPLIES & EQUIPMENT

HAVING Car Trouble? New, Used, guaranteed auto, truck parts save money. Transmission specialist. Describe needs: immediate reply. Victory, 2930¼ No. Western, Chicago 18.

AUTO parts for all autos and trucks. Trans. motors, differentials, fenders, carburetors. Also Body Parts. Security Auto and Truck Parts, 1941 BP Eddy, Chicago 13.

WANTED: complete overhead valve head—Ford-A. C. Curtiss, Box 108, Shelton, Conn.

GLAZE your car twice—50c! Guaranteed! New concentrated quick, easy-to-use powder. Just mix with water. No hard rubbing. Postpaid 50c. Write for other products. 3 Star Products, 3800 Genessee, Kansas City 2, Mo.

BURN water in your car with the Vanderpoel water injecting carburetor. More power, faster pickup, cleaner, cooler, smoother motor, \$22.50 complete with tank and fittings. State make and year of your car. Ralph A. Shade, 563 Lake Road, Webster, N. Y.

MANIFOLD Whistle—Imitates "Wolf Whistle", Barking Dog, Siren, Etc. Connects to any car manifold. Complete installing instructions. Send \$6.00 to Pro-tecturod Company, 4033 Windsor #5, Youngstown 7, Ohio.

MUFFLER manual. Convert easily to Hollywood, Laguna, Westwood, duals, etc. Includes construction details, regulations, diagrams. Postpaid \$1. Mellotone, Box 723C, Arcadia, Calif.

GRILLES for most all cars. Meyers Auto Parts, 820 Dryades, New Orleans, La.

CLYMERTONE Twin Muffler Sets, beautiful sound, complete with necessary welded pipes, E-Z installation. Ford V-8, \$20.00. Chevrolet set with split exhaust manifolds, \$37.50. Specify car model. Clymer, Dept. B-52, 2125 W. Pico, Los Angeles 6, Calif.

SPEEDY Piston Ringer, amazing new tool. Instantly removes, replaces any size ring. Saves time, eliminates breakage. \$3.00 postpaid. Clymer, Dept. B-511, 2125 W. Pico, Los Angeles 6, Calif.

NEON warning light operating with ignition as stop light, before brakes are applied. \$3.00 plus 30c for postage. 26 ft. ignition wire \$1.56 extra. See February Science, P. 119. Automobile Safety Light Co., 858 East 65 St., Chicago.

RACING Equipment. Cylinder Heads with Single or Dual Ignition, Camshaft grinding. Camshafts duplicated. Dual Manifolds. 180 degree 60v8 Crankshafts, wheels, etc. Knepper Manufacturing Co., 504 S. Alnegany, Tulsa 4, Okla.

NEED Auto Parts? We have them. New and Rebuilt. Prompt Shipment. Write Requirements. Save Money. Buy Direct. Factory Warehouse, Mechanics Auto Parts, 3807-A North Ashland, Chicago 13.

ATTENTION! Stations, Garages Air Gun 35c; chucks 50c; deflators 10c postpaid. Box 136, Galveston, Ind.

OIL Pumping Motors—brought back to normal without ring job. Send address on Post Card for Free details. Mullner Co., Box 3102, St. Paul 1, Minn.

CARBURETOR repair kits, gasket sets, needle and seat assemblies for most popular carburetors. State requirements. Carburetor Service, 600 LaPrairie, Ferndale 20, Mich.

MAY
1947 61

POPULAR SCIENCE OPPORTUNITIES

14 AUTO TRAILERS

BUILD your own Trailer! Save Money! Have every feature you want! Plans for House, Sport, Camp and Utility trailers. Catalog describing 9 models 10c. (15c in Canada and overseas). Jim Dandy, Box 125-B, Wausau, Wisconsin.

TRAILER Travel Monthly Magazine, Plant City 9, Fla. Twelve issues \$1. Sample 15c.

91 MOTORCYCLES, BICYCLES, SUPPLIES

LARGE stock Indian parts. Expert motor rebuilding. New and rebuilt Chief Motorcycle, motors only. Indian Motorcycle Sales, Kansas City 1, Mo.

WHEELS, Tires, Tubes for Motor Scooters, Midget Cars, Wheelbarrows, and Industrial equipment. All sizes. Bicycle Parts, accessories. Largest stock in United States. Send dime for list. Cycle Transport Company, 1241 S. Michigan Ave., Dept. C, Chicago 5, Illinois.

WHEELS! Build wagons, scooters, mowers, trailers, wheelbarrows, grocery carts, baby carts, play pens, baby carriages. 4" to 16". Free list. Trulsen Mfg. Co., 811 E. 31, Kansas City, Mo.

MOTORCYCLE Illustrated Magazine. \$1.00 year. Anniversary Edition featuring Movie Star Motorcyclists 25c. Buzzzz, 5424-B Sawyer, Chicago 25.

BICYCLE Bargain! Brand new 1947 Schwinn or Roadmaster full size 26" balloon boys or girls only \$36.75. Send check or money order to Holterman's Bicycle Store, 308 E. Walnut St., Kalamazoo, Michigan.

CHROME plating on motorcycle and all other parts. Silver, Gold, Brass, Bronze and Tin plating on all metals. Send parts or description for prices. Master Silverplaters, 2031 Caniff, Detroit 12, Michigan.

CLYMER'S Motorcycle books. Speedway Motorcycle Racing, \$2.00. Motorcycle Speedway Annual, \$1.00. How to Manage Motorcycles, \$1.50. Motorcycling Manual, \$2.00. How to Obtain Speed, \$1.50. Motor Scooter Plans, \$2.00. Books on Ariel, BSA, Norton, Triumph, Villiers engines, \$1.50 each. English Motorcycle Magazine, 50c. All postpaid. See our ad automobile section. Catalog free. Clymer, Dept. B-54, 2125 W. Pico, Los Angeles 6, Calif.

HARLEY single motorcycle \$50.00, Harley twin \$65.00, complete. Motorscooters \$9.00 up, midget cars \$10.00 up, motorcycle \$25.00, less motors. Used motors \$3.00 up. Plenty of brand new 2 horsepower motors never taken from factory crates. Over 5000 balloon tires for motorscooters and small cars \$1.00 up, mailorder only. Send 25c for Big War-Bargain catalogue Number 18, just out listing the above and hundreds of other bargains in new and used motors, motorscooters, midget cars, racers, etc. (35c by first class mail.) Midget Motors Directory, Athens, Ohio.

SCOOTER-CAR Runabout! Two passenger, three wheeled, motorized, speedy. Simple construction from available second hand parts. Detailed plans \$1.00. Midget "Jeep" plans included free. Universal, 2671 Algonquin, Toledo 6, Ohio.

MOTOR Scooters, bicycle engines. 120 miles gallon. Dime for catalog. Clymer, Desk B-55, 2125 W. Pico, Los Angeles 6, Cal.

MOTORCYCLE (miniature) lapel pins. Exact duplicates favorite 1947 model. Chromed, colorful, non-tarnishing. Specify Harley, Indian, BSA, Norton, Triumph or Ariel, or Daytona race souvenir crossed flags. \$1.00 each, postpaid. Midget or Indianapolis racer same price. Any above pins on attractive tie-clasp. \$1.25; tie-holder, \$1.75. Postpaid. Clymer, Dept. B-59, 2125 W. Pico, Los Angeles 6, Calif.

BEAUTIFUL new bicycles also tricycles all makes all sizes. Reduced price list free. Atlas Cycle Co., 3002 B. Broadway, Chicago 14, Ill.

62 POPULAR SCIENCE

MOTORCRAFT Manual complete motorbike, motorscooter, midget car plans, instructions, other information. 75c Details free. Reed Motorcraft Co., 215 No. First Avenue, Maywood, Illinois.

"**BUILD** America's lowest priced motor-scooter speedster! Complete plans, specifications, \$1.00. Big list bargain priced used motors, etc., included free! Motor Supply, Box 1682-CS, Toledo, Ohio."

"**PROFESSIONAL** Midget Racer, Motor-scooter, Midget Roadster, and Midget Motorcycle. Plans, specifications for all four contained in illustrated handbook, 25c. Big list bargain priced used motors, motorscooters, Servicycles, etc., included free! Midwest, 3839 Drummond, Toledo, Ohio."

"**CUSHMAN** motorscooter \$15, Shaw bicycle motor \$15, Harley-Davidson Motorcycle \$35! Send 25c for bargain catalog #8, just off the press, packed with money saving buys in motorscooters, motorbikes, midget cars, motors, wheels, tires and parts. Gail and Company, 538 Erie, Toledo, Ohio."

"**CUSHMAN** Motorscooter \$20 (includes motor and extra tires), Midget Racer \$15! Send 25c for big Summer catalog #938, just printed, listing these and scores of other sensational bargains in motors, wheels, motorscooters, motorbikes, Servicycles, tires, etc. Associated, Box CS-1764, Toledo, Ohio."

WHEELS, Steel Disc rubber-tired for toys, wagons, scooters, etc. Sizes 5", 6", 7", 8", 10" available. United Wheels Mfg. Co., 11727 La Fayette Ave., Chicago 28, Ill.

SERVOCYCLES no more oil and gas mizing. Write for details, new lubrication system. Kalamazoo Tool Design, 337 South Burdick, Kalamazoo, Michigan.

"**MOTORSCOOTERS** 1947 models. Immediate delivery. Send 10c for illustrated catalogue. Johnson's Motorscooter Sales Co., Milford, Ind."

15 AVIATION

AIRLINE employment interest you? Write for helpful, free information. Air Transport Research, Dept. E, Box 1044, Kansas City 10, Missouri.

PROPELLERS—Especially designed, Air-liner 3 Blade for ice-snow sleds, boats. Also 2 Blade. Aluminum castings Ford A air-cooled conversion. Free literature. Standard Aero Craft, Ft. Worth, Texas.

VETERANS: Flight training under the G.I. Bill. Private, Commercial and Flight Instructor Ratings. Write for information. Gottschalk School of Aeronautics, Adrian, Michigan.

CAREER Counselor. Guidance for beginners. 23 years aviation experience. George Miller, 1333-18th Street, Santa Monica, Calif.

"**CUBS**, Wacos, Taylorcrafts, Aeroncas. Big catalog 25c, lists these and thousands of other sensational airplane bargains. Some are "easy to repair" crackups. National, Box 1682-CS, Toledo, Ohio."

4 AVIATION INSTRUCTION

TRAIN For Aviation Mechanics High Salaries. This famous school approved for veterans. Immediate enrollment. For information write California Flyers, Inglewood, California.

49 ELECTRICAL SUPPLIES & EQUIPMENT

ELECTRIC Fan. Assemblies counter models, floor models, attic fans. AALCO Electric, 1430 Franklin, Saint Louis 6, Missouri.

ELECTRIC Pencil—writes, engraves all metals. Battery model \$1.00—110 volt model \$2.00 postpaid. Guaranteed 5 years. C.O.D.s accepted. Reb Industries, Dept. 265-Y Elmhurst, Illinois.

BLOWERS, Air conditioning supplies. Gas burners. Sell for us. Card for literature. Thuman Equipment Co., 1225 Fifth Ave., St. Joseph, Mo.

ELECTRIC Pencil: Writes, Engraves all Metals. \$1.00 postpaid. Beyer Mfg., 229-C Dixon Blvd., Uniontown, Penna.

MOTORS, electric, new, 1/25 H.P., 110 volts, immediate delivery, write for specifications. J. Fisher, 126 Richland, Pittsburgh 8, Penna.

LAMPS—All parts to build or repair, Catalog 10c. Gyro Lamps, 5416 Clark, Chicago 40.

SELSYN motors, Bendix 3 1/2" x 5 1/2" heavy duty 115 volts, 60 cycles, \$10.25 per pair. J. A. Weber, 150A Maple, Hershey, Pa.

FANS, irons, clocks, motors, toasters, radios, etc. Jeanette Electric, 159 West 23rd St., N. Y. 11, N. Y.

HOUSEHOLDERS Attention: Repair your own electrical equipment. Detailed instructions on motors, fluorescent lamps, etc. 50 cents E. W. Lutz, 182 W. Como Ave., Columbus 2, Ohio.

WASHING Machines. Parts all makes. Northeast Burner, 1358 H Street, Washington 2, D. C.

"**GAS-MIZER**"—America's finest hot water system. Dealership opportunities available. Safety Control Company, 2519 Wilson, Arlington, Virginia.

MAGNETS Alnico. New Number V stocked. Terry Sales Company, 3726 South Detroit Ave., Toledo 9, Ohio.

MANUAL On multispeed three phase induction motors \$2.00 free literature. Electric Generator Mfg. Co., 1333 N. Dale St., St. Paul 3, Minn.

ELEMENTS, Irons, Toasters, 55 cents each. Claudio, 67 West 101 Street, New York 25, N. Y.

ELECTRIC fan assemblies. Assemble your own. Ted Riseman, 207 North Fifth, Springfield, Ill.

WIRE Recorder Magazine—Sixty minutes of recording voice, radio or music, reproduces and erases. Brush Laboratory made, completely assembled, chassis mounted, enclosed unit with wire spools and 10,000 feet of stainless steel wire, level-wind and brake control mechanism, elapsed time indicator, warning and stop switches, brand new. Add your amplifier and motor drive for complete recorder. Price \$54.50. McCoy Sales Company, P. O. Box 335, Berea, Ohio.

140 WELDING, SOLDERING

MYRTLEWOOD Lumber 60c Bd. Ft. for turning or Furniture. Box 1, Agate Beach, Oregon.

ACETYLENE Generator. Easy to build—Plans. Instructions \$2.00. Weldox—R. 2, Box 264, Phoenix, Arizona.

NEW Model electric welder 110 volt AC-DC; will weld all metals; easy to use, full directions. Complete with power unit, flame and metallic arc attachments, carbons, fluxes, rods, mask; all for \$19.95—Used by the Navy. Magic Welder Mfg. Co., 239-PS—4 Canal St., New York City.

WELD, Cut, Braze with gasoline! Amazing new discovery shatters costs, Boosts profits. Important! Write Matthews Mfg. Co., Calgary, Canada.

GUARANTEED 20 to 160 amperes output welder, uses 1/16" to 3/16" rods, with complete supplies \$135.00. New, heavy-duty industrial portable. Others, \$35.00 to \$245.00. Free illustrated literature. Williams Co., Box 4100, Portland 8, Oregon.

80 MACHINERY, TOOLS, SUPPLIES

WAR Surplus in small tools for machine shop—Send 10c for bulletin. Travers Tool Co., Dept. S, 5 Court Square, Long Island City 1, N. Y.

BUILD Quickchange gear box without castings for \$10.00. Craftsmen, Atlas and other lathes. Complete drawings \$3.75. Stevens Engineering, 2604 Military, Los Angeles 34.

SHEBEL Saw Filer, \$7.50. Files all saws. Free trial, Circular, 730A So. 2nd St., Milwaukee 4, Wis.

POPULAR SCIENCE OPPORTUNITIES

SOCKET Wrench Sets—9/32-1/2-11/16-13/16-7/8-15/16 5 and 10 inch extension High speed handle \$4.50. A. Friedman, 1514 N. Poinsettia, Hollywood, Calif.

GEARS For inventors, experimenters, model makers, schools, work shops, laboratories, etc. Government surplus made of brass, bronze, dural steel and stainless steel. 12 matched pairs; 24 gears, bevel, spur and ratchet. List price \$12.00, our price \$2.50. 25 matched pairs; 50 gears, includes larger gears, also sets of worm gears. List price \$30.00, our price \$5.00. Limited quantity. Order now. Write for our bulletins on ball bearings, rectifiers, Relays, Selsyns, Horns and government surplus materials. Met Exchange, 323 Canal Street, New York.

BRASS parts made to order on automatic Lathe. Send pencil sketch for price and delivery. G. K. Keller Company, Baltimore 23.

WORK wanted for hand Turretlathe. Glenbern Machine Co., Youngwood, Pa.

DRILL GRINDER—Grinds drills to factory accuracy. Calipers with direct reading scales. Circle cutters. New Tool grinder. Lowest prices. Free literature. Factory, 811-A East 31st, Kansas City 3, Mo.

MENDALL Metal. Permanent repairs for leaks, cracks, splits, holes, in all pipe and fittings, right through rust, corrosion, paint. Also motors, cylinder heads, water gaskets, etc. Easy to use with blowtorch flame. Fuses with any metal at only 250 degrees of heat—less than red heat. Contains own flux. Permanently mends in ten minutes. Any part accessible to blow torch can be mended in place. Money back guarantee. Used nationally for 30 years. Send \$5.00 for 6-bar package, prepaid to you. Immediate delivery. 4 A Manufacturing Co., Dept. 12, Littleton, Colo.

TANKS, Stainless Steel, 9 gallon capacity. 12" diameter 24" long. Rated strength: 400 lbs. per square inch internal pressure. Ideal for air compressor, rustproof tank for boat or camp. Write for details and "How To Make It" free. Surplus bargain at never-again price of \$8.00, fob Ireland and Vice, 48 Chedel Place, Auburn, N. Y.

AIR Compressors, Electric, 3 Stage. Value over \$200.00. New 27 Volt AC-DC. Convert Easily with Transformer or 4 1000 Watts Heating Elements. Weight 28 lbs.—instructions Free. A real buy \$15.00. Immediate Delivery. Write For Quantity Prices—General Vacuum Co., 1439 Grand Ave., Kansas City 6, Mo.

AT last—a wire brush that really whisks off rust, paint or slag in a hurry. Heavy, powerful bristles. 6" Diameter. Fits any 1/2" shaft. Send for one or more of these wonder brushes today. \$1.00 each or 6 for \$5.00 postpaid. Enclose check or Money Order. Penn Electric Co., 222 Lafayette St., New York 12, N. Y.

WAR Surplus, Machines, Tools, etc. Free literature. Wayne Engineering, Greenville 2, Ohio.

MAGNETIC Dial Indicator Bases—\$3.45! Write—Eyrich, Box 849-A, Milwaukee 1.

TAPS & Dies direct from manufacturers. Equip your shop at small cost. Write for free price list. King Tap and Tool Co., Inc., North Attleboro, Mass.

HOBBYISTS! You can equip your workshop at a fraction usual cost by building your own Mill, Shaper, Drillpress, Bandsaw and other shop tools for metal and woodworking from Lewis Castings. Materials and Blueprints. Easy to complete, and ideal for home use. Send 10c to cover cost of mailing latest Catalog describing 23 items. Lewis Machine Tool Co., 3217-S Union Pacific Ave., Los Angeles 23, Calif.

HOISTS, surplus Spur Gear Hand Hoist will lift 500 pounds 20 feet. Made by famous manufacturer to lift bombs into aircraft. Easy to install and operate. New... unused. Shipped postpaid anywhere in U.S.A. for \$10.00, or write for illustrated details and dozen uses. Hurry! Ireland and Vice, 48 Chedel Place, Auburn, N. Y.

FILES—New 6" to 18". Assorted shapes \$1.00 Dozen. D & H, 1362 College Ave., Bronx, N. Y.

MACHINE shop tools released for private industry; 14" Loose Change Lathes \$150; 16"—\$180; Vertical Miller \$410; 16" Quick Change Lathe \$440; Gould & Eberhart Gear Cutter \$430; 18" lathe \$340; #2 Cincinnati miller \$660; floor type sensitive drill \$40; small hand miller \$130; Plain milling machine \$180; Medium sized \$250; Conversion Parts Co., 277 Adams Street, Boston 22, Mass.

DRILL Grinder for twist drills \$2.95. See ad on page 272.

79 MACHINERY FOR SALE

ACETYLENE Welding Outfits, new, consisting of 2 gauge Regulators, torch, 3 tips, hose, connections, clamps, lighter, \$54.50. Eagle Welding, Dept. 42, 5085 Broadway, Chicago 40, Ill.

17 BATTERIES, GENERATORS, ETC.

MIDGET Magnetic Motor. Small flashlight cell operates. Parts plus instructions 30c. Eltro, Deer Park, N. Y.

19 BOATS, OUTBOARD MOTORS, ETC.

FULL size, cut to shape boat patterns, blueprints, 7 1/2—38 feet. Illustrated "Build a Boat" catalog, 10c (coin). "How to Build Boats" book, \$1.00. Cleveland Boat Blueprint Co., Dept. A-77, Cleveland, Ohio.

INBOARD marine motors, conversions, supplies. Catalog on request, Stokes Marine Supply, Coldwater, Michigan.

MARINE Power—Easily convert any Ford and Jeep motor (domestic and foreign) with Osco parts and kits. Complete catalogue 25c (coin). Osco Motors Corp., 2020C E. Orleans St., Phila. 34, Pa.

ATTENTION Sportsmen! Go Kayaking! Build yours from complete, easy-construction kits. Literature. Play-acks, Dedham, Mass.

KAYAKS, Rowboats, Weldwood ready cut kits. Booklet, E. J. Croot Co., #103-E Basking Ridge, N. J.

WHY lug your outboard motor? New easy carrier \$8.75. Catalog free. Sportsman's Pal, Tahoe Valley 4, Calif.

ANCHORS navy type, sizes 10-15-20-25-30 lb. Semi-steel, aluminum finish. Recommended size, 1 lb. per ft. Price 20c lb. f.o.b. Wilson Patterns, Coffeyville, Kansas U.S.A. Discount to dealers.

CANVAS for boats. Sailcloth, winddope, canvas cement, paints. Sails for sailboats, canoes, etc. Catalogue. Alan-Clarke, 96 Chambers, New York City.

"**MARINE** conversions for Ford and Jeep engines. Catalog 10c. Lehman Manufacturing Company, Department A, Newark 2, New Jersey."

RUBBER Boats—Holds 1 to 5 men; weigh 5 to 40 lbs. Ideal for fishermen, duck-hunters, yachtsmen, seashores. Made to rigid government specifications. Price \$14.81 to \$69.75 depending upon size and condition. Write for circular. Karl Ort, Dept. PS-2, York, Pa.

KAYAK Blueprints, Deluxe Models—catalogue 10c. Viking Kanoes, Merrick, N. Y.

PRACTICAL, light, folding Kayak. Specify 10 1/2' or 15'. Rush \$1.00 for plans. Hoosier House, Dept. A, P.O. Box 1264, Indianapolis 6, Ind.

51 ENGINES, MOTORS, ETC.

"**BUILD** Your Own" gas drive arc welder easily with Hobart Generator. Save \$300 to \$500, and need only add used auto engine and chassis to build portable gas drive welder that goes everywhere after profitable construction and repair jobs. Write for free instruction book, further details. Hobart Brothers Co., Box P-1066, Troy, Ohio.

MOTOR winding tester, indicates burned out or partly shorted coils in single or three-phase motors, indispensable for repairmen. Send for bulletin. Motor Industries, Quincy, Illinois.

150 AMPERE Generators for welding \$47.50. Extra Flexible Cable, 6 ft, lengths \$2.75. Other Bargains. Butler Electric Company, 1885 Milwaukee, Chicago 47.

ELECTRIC Motors 110 Volt AC-DC 1/8 horsepower 8000 R.P.M. (Reconditioned) Marvelous Value \$6.50. Limited Quantity. B. Price, 1394 Fulton Avenue, Bronx 56, New York.

WINDING Data, listing 225 motors, single and three phase, \$1.00. Motor Data, Box 7631 Kansas City 3, Mo.

7 AMERICAN POLICE JIU JITSU

DEADLY Judo—Fiercest fighting technique. Trick knockouts. (200 photographs—plus illustrations.) Expert instructions—Three volumes. Complete \$2.25. Variety House, Box 46-AR, Wall Station, N.Y.C. 5.

20 BODY-BUILDING COURSES

BAR-BELLS, Dumbbells, Exercise equipment, Courses, Free booklet. Good Barbell Co., Reading, Penna.

BARGAIN sales, Barbell Equipment, Muscle Courses. Free Strongmen Physique Circular. Write Sid's System, (C P S M 10) 8421 1/2 Evergreen, South Gate, California.

1947 NEW Low Prices. Burgo Barbells, 405 Martinique, Dallas 10, Texas.

124 SPORTING GOODS, GUNS, FISHING TACKLE, ARCHERY

"**AMMUNITION**"—"New and Used"—"Shotguns"—"Rifles"—"Revolvers"—"Pistols"—"Fishing Tackle"—List 10c. Rudolph's, Atchison, Kansas.

2000 BARGAINS, firearms, binoculars, war relics, catalog 40c. Smith Museum, Runnemedde, N. J.

SEND 10c for list 100 used guns. Frayseth's, Willmar, Minnesota.

BOWS—Arrows. Write headquarters for Archery equipment. Quality products. Popular prices. Catalog 10c. Large illustrated Hand Book Instructions, making and shooting, 50c. Archery, 617-A So. State, Chicago 5.

"**GLO** Lite" Bobber Release—allows bobber to slide free on line when the fish bites—35c postpaid. Glo Lite Bobbers, 2111 Woodward Avenue, Detroit 1, Michigan.

FISHING Poles, Ferrules, Guides, Tips, Clamps, etc., Native Canes, Bamboos, Tonkins. 1-Piece All-purpose rod, guides, top, reel-seat, butt, varnished, \$6.60. 3-Piece Native Cane, Painted, \$2.50. 2-Piece Steel Rod, Guides, Tip, Hardwood Handle \$2.50. Dealers write. Bob Pace, Combs, Ark.

SPORTS Bassrod Sensational Design. Lifetime Guarantee. Catalog Free. National Distributor Goff, 5017-19 Cermak, Cicero 50, Illinois.

WAR Surplus—Repair Kits. For repairing Guns, Fishing Rods, Reels, Radios, Electrical Appliances. Over 100 items. \$2.70. No C.O.D. shipments. Turley Sporting Goods, Brigham, Utah.

SPECIAL Sale: Hunting Knives \$1.00; Telescopes \$1.00; Compasses 35c. Folder "S" Sporting, Police Goods, Badges etc. Nassau Sales Co., Floral Park, N. Y.

3,000 BARGAINS—Antique Firearms, Indian Relics, Coins, Minerals, Flintlocks, Rifles, Pistols, Swords, Cartridges, Fossils, Illustrated Catalog 25c. Heike, Wenona, Ill.

AMERICA'S most fascinating hobby. Collect famous American and foreign insignia emblems. 77 selections. Airlines, Railroads, Steamships, Hotels. See page 112 March Popular Science. Introductory package, plus Free Baseball sticker, 25c. Samples 10c. "Traveler" c/o Vogue Specialties, Carnegie Hall, Cleveland 15, Ohio.

POPULAR SCIENCE OPPORTUNITIES

55

FIELD GLASSES, TELESCOPES, ETC.

REFLECTING Telescope, complete 3½" diameter, equatorially mounted. View planets, stars, \$19.75. Write Skyscope Co., 475-5th Ave., New York.

60 POWER telescope, \$2.95. 250 power microscope, \$2.45. Send for free catalog of Telescopes, Binoculars and Microscopes. Brownscope Company, 24 West 45th Street, New York.

FOR Sale: 6 x 30 and 7 x 50 Binocular optics. Fine quality. Cemented doublets. All optics coated. 6 x 30 . . . \$6.50 complete set, 7 x 50 . . . \$12.50 complete set. Mail Your Orders Today. Mitchell Optical Co., 236 East Monroe, Kirkwood 22, Mo.

INFRA-RED filters glass 1¼" (40 mil) diameter, mounted. Snap on binocular or camera. \$1.00 per set. Ross, B68 West Broadway, New York, N. Y.

GENUINE polaroid glass—2⅞" (72 mil) diameter. \$1.25 each, 2 for \$2.00. Ross, B68 West Broadway, New York, N. Y.

MAKE high power reflecting telescope. complete kit of precision optical parts. fully finished: 3" diameter, 44" focal length, mirror and diagonal both hard aluminized, plus 3 lenses for high power eyepieces. The buy of the year. All \$6.00. Ross, B68 W. Broadway, New York 7, N. Y.

TELESCOPES, Microscopes, binoculars, barometers, books, photographic equipment; Buy, sell, repair. Lists 10c. Rasmussen & Reece, Amsterdam, N. Y.

MAKE your own powerful, efficient astronomical telescope. Lenses and instructions 100X \$2.50. 200X \$3.50. 400X \$5.50. Instructions alone 10c. Carl Jamer, Manorville, N. Y.

MAKE your own efficient compound microscope. Lenses and instructions 50X \$1.00. 200X \$2.00. 400X \$3.00. Instructions alone 10c. Carl Jamer, Manorville, N. Y.

43

DOGS, BIRDS, PETS, RABBITS

ANGORAS, Chinchillas, White Giant Rabbits — "Rabbitry Management" tells everything, \$1.00. Self-cleaning Hutch plans \$1.00. Automatic Feeder plans \$1.00. All three \$2.50. Catalog finest Pedigreed Rabbits free! Grinsteads, Dept. 16-D, Edwardsville, Ill.

RAISING Rabbits, Cavies, Hamsters, Chinchillas is a growing and profitable industry. Magazine 10c. Descriptive Book and magazine 25c. Book and magazine (monthly) one year \$1.00. Address Small Stock Farmer, Pearl River 16, N. Y.

GUARANTEED Chin-Chin Giant Chinchilla rabbits. Greatest amount of delicious meat. Largest, finest, most valuable furs. Tremendous demand for breeding stock. We buy youngsters. Contact world's largest breeder, Willow Brook Farm, R16, Sellersville, Pa.

RABBITS for Fun, Food, and Fur. New Zealand White breeding stock. Easy to raise. Instructions free. Hazelbrook, R 5 C, Gettysburg, Pa.

\$250 MONTHLY. Raising Angora Rabbits. Particulars free. White's Rabbitry, Lawrence, Kansas.

REAL Giant Chinchilla Rabbits. Offered by their originator. Free details. Stahl, Pearl River, N. Y.

FOR Sale — Coonhounds, combination treehounds and high class foxhounds. Rabbit-hounds a specialty. Raccoon Mountain Kennels, Dures Thomas, Rt. 3, Albertville, Ala.

\$2,500.00 YEARLY raising Angoras year round market. Wilsons, 1065 Shryer, St. Paul 8, Minn.

RAISE Angora Wool Rabbits, very profitable, wool \$14 a pound, shear four times a year. Also good for meat, easy to raise, we teach you in 20 lessons. Details free. International Angora Institute, 200 Burrell Bldg., San Jose, California.

RAISE Guinea Pigs. Make money at home. Big demand. Booklet free. Taylor, Box 426B, Hapeville, Georgia.

ST. BERNARD Pups: Champion sired beauties. Franklin Young, R. 3, Riverhead, Long Island, New York.

83

MILK GOATS

"MONEY from dairy goats!" Booklet free. Introductory 3-month subscription to leading magazine 25c. Dairy Goat Journal, Dept. 768, Columbia, Missouri.

52

FARMS, OTHER REAL ESTATE

HOMESITES \$450—convenient payments. California's finest garden section. On Morro Bay's scenic shores. Wonderful fishing, hunting, boating, bathing. Fertile soil, softest water, temperate climate, congenial community. Free literature. Richard Otto, 6560-Z, Hollywood Blvd., Hollywood 28, California.

OZARK Lands for All purposes. Actual river frontages, 5 acres \$90.00 and upwards. Free list and literature. Hubbard, 424H, Minnesota Ave., Kansas City 4, Kans.

GOOD Farms—Ranches, Washington, Minnesota, Montana, Idaho, Oregon, North Dakota. Dependable crops, favorable climate. Write for literature, lists describing typical postwar farm opportunities. Specify which state. J. W. Haw, 120 Northern Pacific Ry., St. Paul 1, Minn.

STROUT'S Green Farm Catalog—Over 2400 Bargains—money-makers—32 states—Coast to Coast. Mailed Free. Tell us what you want—Where? Price? Terms? We will try to save you Time & Money. Strout Realty, 255-ZB 4th Avenue, N. Y. 10, N. Y., 20 W. 9th St., Kansas City 6, Mo., 453 S. Spring, Los Angeles 13, Calif.

WANT To Be Your Own Boss? A good farm in Canada is your answer. Low prices. Favorable terms. Drop a postal today, giving your preferences as to size and kind of farm, and province in which you are interested. Address H. R. Cresswell, Canadian Pacific, Montreal.

GET up to 120 acres of Land Free, for your own Fur Farm, Resort, Etc. In United States, or Alaska. Send \$1.00. Info. P. O. Box 373, New Holstein, Wisc.

CHEAP Homes, Stock Ranches. Free stock range, lovely climate in healthful, fertile, beautiful Ozarks. Free literature. Write Barnsley, Ozone, Ark.

FARMS free list Dairy Chicken Muskrat, Timber Lands, R. J. Sheehe, Broker, Arcade, N. Y.

FILE now! Government accepting application 5 acre sites this area. Information and maps \$1.98. T. Ray, Palm Springs, Cal.

108 POULTRY AND SUPPLIES

RAISE turkeys the new way, write for free information explaining how to make up to \$3000.00 in your own backyard, address National Turkey Institute, Dept 57, Columbus, Kansas.

POULTRY Pays. Learn how Post Card brings free booklet "7 Keys to Poultry Profits." Information—Factual write Poultry Guild, 1046 South Olive Street, Room 109, Los Angeles 15, Cal.

111 PROFITABLE OCCUPATIONS

DETECTIVES Earn Big Money. Excellent opportunity. Detective Particulars free. Write, Wagoner, P-125 West 86th, N. Y.

WELDING—Electric Arc. Learn profitable trade quickly through actual practice. Individual welder instructions at bare cost of materials. Full particulars free. Valuable welding lessons book 50c. Hobart Welding School, Box P-1064, Troy, Ohio.

LOCKSMITHING — Profitable Business or Hobby! New course teaches you how to pick locks, fit keys, de-code, masterkey, etc. Easy self-instruction lessons. Bargain price. Fascinating 100-page illustrated catalog Free! Write Nelson Company, Dept. 2-01, Chicago 5.

MUSHROOMS Grown, Boxes, Barrels; Illustrated Instructions, 50c. Spawn \$1.00. Gordons, 553 William, Winnipeg, Manitoba.

\$5000. FROM Half-Acre Growing Ginseng. Seed Contract supplied. Particulars 10c. Associated Growers, Dept. 12, 340 Furby, Winnipeg, Manitoba.

\$40.00 WEEKLY. Made growing mushrooms. Fresh, Dried, Dominion Patent 331,583, free spawn. North American, 169Y Yonge, Toronto, Canada.

MAKE beautiful costume jewelry at home for large profits, hobby or therapy. Free illustrated wholesale catalogue of sea shell, metal and plastic parts contains detailed instructions. Florida Supply House, Bradenton, Florida.

CUSTOM Made jewelry, profitable hobby or business. Copyrighted laboratory manual starts you working with precious metals. Designing, pattern making, casting by proven methods using simple equipment. \$1.00 refundable in seven days if dissatisfied. Hobby Craft Research Bureau, Suite 312-B, Guaranty Bldg., 6331 Hollywood Blvd., Hollywood 28, Calif.

"CASH in on hard water in your community. Complete instructions \$1.00. Mr. Clevenger, 6342 S. Loomis Blvd., Chicago 36, Ill."

BE a Novelty Manufacturer, fascinating, interesting work. Exceptional profits. No expensive equipment needed. Quickly learned. Use garage or basement, successful manufacturer shows you how to start on limited capital. Plastex Products, 711 Laguna, San Francisco 2, California.

START Back Yard, Perennial Plant Business much more Profitable than Ginseng. Instructions \$1.00. Richland Gardens, Martin, Tennessee.

EARN Money At Home With Typewriter! Addressing Envelopes, Circulars, Typing. 25c brings details also 68-Page Book of Money-making Opportunities. Ace-9, Box 183, Birmingham, Ala.

MAKE beautiful mirrors from inexpensive window glass. No special equipment required. Details Free. Tes-Co., Box 189-SE, Wilkes Barre, Penna.

METALLIZE Baby shoes for big profits. Several methods \$1.00. Tes-Co., Box 189-SF, Wilkes Barre, Penna.

SCRAP Metal costing 5c pound brings Dollars in finished castings. Information, Fritz Foundry & Supply, 622 N. Fulton, Allentown, Penna.

MONEY from Wood Scraps. Details Stamp, Woodcraft, Lovers Lane, Gainesville, Tex.

SEA Shell Jewelry. Free instruction. Werts, 1429 56th Avenue, Oakland 3, Calif.

TRADES that often pay \$50.00 daily completely described and illustrated. "Flagpole Painting and Repairing"—\$2.00. "Smokestack Painting and Repairing"—\$2.00. The Skyline Company, Box 1601-A, Uniontown, Pa.

22

BOOKS, PERIODICALS, ETC.

WHAT Every Mason wants. We have Masonic books for Blue Lodge, Chapter, Commandery Scottish Rite and Shrine. Our rituals are used the world over. Send for our free catalog of books and rituals for Masons, Odd Fellows, Knights of Columbus, etc. Ezra A. Cook, Publisher, Inc., P.O. Box 796-RMY, Chicago 90, Ill.

MAGAZINES (back dated)—foreign, domestic, arts, Books, booklets, subscriptions, pin-ups, etc. Catalog 10c. (refunded). Cicerone's, 863 First Ave., New York 17, New York.

BIG Profits Taking Subscriptions For All magazines. Agents' Confidential Catalog listing over 2500 periodicals and complete starting supplies Free. Pines Subscription Agency, Flushing, N. Y.

BOOKFINDERS! (Scarce, out-of-print unusual books.) Quickly supplied. Send wants. Clifton, Box 1377-PS, Beverly Hills, Calif.

POPULAR SCIENCE OPPORTUNITIES

GOOD "Used" Self-instruction educational books on all subjects bought, sold, rented, exchanged. Satisfaction guaranteed. Complete information and 100-page illustrated bargain catalog Free! Write—Nelson Company, Chicago 5.

EDUCATIONAL Books sold cheaply or rented for small fee. Books bought. Money-back guarantee. 4,000 Bargains. Catalog Free. (Courses Bought.) Lee Mountain, Pisgah, Alabama.

NATIONAL Geographic Magazine, 1888-1946. Any issue. Periodical Service, Box 327-S, Swarthmore, Penna.

FREE bargain catalogue for adult book buyers. Kissin, Box 134, Madison Sq. Sta., New York City.

ADULT Books 25c. Five—\$1.00! Free Bookalogues! Hirsch, Spring Valley 3, N. Y.

MAGAZINE Export Sales Co., 2084 First Ave., New York 29, N. Y. Over-issue popular American Magazines and Pocket-Size Books, Comic, Screens, Fashions Pictorials, Romances, Pulps and many others. Export Only.

BACK issue magazines. Prices catalogue for \$1.00. Credited on first order. Kovach, 712 So. Hoover, Los Angeles 5, Calif.

AUTO driving for learners. Actual course of instruction. Booklet by professional driving instructor. 75c. Bradford's, Box 636, G.P.O. Brooklyn 1, N. Y.

ADULT Book. Revealing Sex Truths. "Illustrated." 50c. Kogan, 1032-SF, N.Y. 8.

RADIO-electronics books supplied by mail. Servicing, troubleshooting, home study, radio math, electricity, etc. Send postcard for free illustrated catalog. Nephews Publishing Company, 300 Pacific Street, Brooklyn 2, N. Y.

1947 WHOLESALE catalog and Directory 10c. Latshaw Sales, Sunnyside-C, Indianapolis 44, Indiana.

SECRETS and Tricks of Hypnotism exposed in "Confessions Of A Hypnotist" \$1.00. William-Frederick Press, 313 West 35th Street, N. Y. 1.

ARTIST'S Pin-ups. Gorgeous models in tantalizing, breath-taking poses. Set 35 pictures \$1.00. Baker Service, Box 1840 Cleveland 6, Ohio.

ADULT Books, Catalog and Sample, 10c. Baker Service, Box 1840, Cleveland 6, Ohio.

BOOKS! (out-of-print, scarce); quickly supplied. Send Wants. Spotlight, 141 Broadway, New York.

MAGAZINES—Business, Vocational, Diversion. Current single copies. Choice over 850 periodicals. All fields. Free price-list. Commercial Engraving Publishing Co., 34S North Ritter, Indianapolis 19, Indiana.

BACK-Date Magazines. Books. Specific issues—years. Arkell's, Tarzana, Calif.

BACK issues magazines, reasonable. Reedmor, 841 Intervale Ave., N. Y., N. Y.

"RADIO For The Millions"—practical book. Complete instructions for building 78 radios, phonographs, other sets. 192 pages. 648 pictures. Regular Edition \$1.49. Popular Science, Dept. 57-C, 353 4th Avenue, New York 10, N. Y.

"FIX It Yourself"—home repair book. How to fix appliances, furniture, plumbing, etc. 256 pages, 163 pictures, \$1.49. Popular Science, Dept. 57-C, 353 4th Avenue, New York 10, N. Y.

"WHOLESALE Catalog. Directory 10c" Big 8 1/2 x 11 Catalog. Stafford Sales, Box 5211, Indianapolis 1, Indiana.

ANY Back Number Magazines quickly supplied. Books all subjects. American Book Mart, 20 West Jackson, Chicago 4, Ill.

AMAZING new book gives instant solutions to 100,000 practical problems. Details free. Columbia Graphs, Columbia 2, Connecticut.

81 MAGIC TRICKS, PUZZLES, ETC.

FREE catalog magic, puzzles, tricks. Scheetz's, 981 Branch, Sellersville, Penn.

MAGICIANS', Gamblers' secrets exposed. Cards, Dice, Punchboards, Slot Machine. Catalog 10c. Book Co., Box 671, St. Louis 1, Mo.

"MAGIC Vanishing Card". Throw it into air, it completely disappears, reproduce it later from spectators pocket. Easy to do. Complete 25c with magic catalog. The Magician, 2463-D, Kensington Ave., Philadelphia, 25, Pa.

WORLD'S largest professional magic shop, keeps you in touch with latest tricks. To receive mailings, send 35c for new catalog. Holden's, 220-P West 42nd St., N. Y.

500 TRICKS! New 1946-7 edition Douglas famous Catalog. Now ready, only 10c. Brand new magic for pocket, parlor, club, stage, professional, amateur. America's fastest service to magicians everywhere for over 25 years. Send 10c Today. Douglas Magiland, Dept. 2, Dallas, Texas.

THE True Secret of Ventriloquism. Free booklet. Quackenbush, Big Flats, N. Y.

FREE! Large Catalog of magical apparatus if you remit 25c for "MAGIC IS FUN" magazine. Robbins Co., 152-F West 42nd Street, New York.

READ the Fakir Monthly Magazine for Magicians. Copy 25c. Subscriptions \$2.00 yearly. Rachun, 114 Grand, Brooklyn 11, N.Y.

VANISHING Quarter trick and catalog 25c. Sterling Magic Co., Royal Oak, Mich.

200 ELECTRIC Stunts, 110 volts, \$1. Cutting Sons, Campbell 3, Calif.

STARTLING, Bewildering Hindu Mystic Trick 10c! Postways, Box 5325-Z, Philadelphia 42.

BUBBLE Gum: 25c brings 25 pieces and latest list magic, novelties, useful articles. etc. Lion Sales—Box 822—Fond du Lac, Wisconsin.

INSTRUCTIONS—279 tricks (illustrated)—50c. Steiner's, 33 Rockwell Road, Danbury, Conn.

VENTRILOQUISM Taught. 3c stamp brings particulars. Smith, Dept. 410, 801 Bigelow, Peoria 5, Ill.

EXPLODING Booby Trap; Joy Buzzer; 50c. Catalogue included. Box 99, Brookline 46, Mass.

JOIN Trick Of The Month Club. Mystify friends throughout the year. 12 months membership only \$1.00. Trick Of The Month Club, Box 710, Roseville, Calif.

HYPNOTISM! 25 Lesson Course, \$1.00. Monarch, 38-S Jefferson, Auburn, New York.

BE a Magician. Large professional magic catalog of latest tricks, 25c. Ireland, F-109 North Dearborn, Chicago.

MAGNETIC Tricky dogs amusing, unusual instructive, terrific novelty on powerful magnets, four pair \$1.00. Gross \$21.00. Auerbach, 14 East 34th, New York.

GUARANTEED Magic tricks! High quality, low prices, and fast service. Big, illustrated catalog and five good tricks explained, only 25c. Satisfaction guaranteed! Bargain! Act now! Newton Magic Company, 121-B Main, Bonham, Texas.

63 GAMES, ENTERTAINMENT

PHONOGRAPH Records Cheap. Catalogue. Paramount, S-313 East Market, Wilkes-Barre, Penna.

36 COIN COLLECTING

FREE! Foreign coin, banknote and Coin Collectors' Illustrated Catalog to approval service applicants. Send 3c postage. Tatham Coin Co., Springfield-D50, Mass.

COMMEMORATIVE \$1 1/2 — Columbus, Washington, Cleveland, Stone Mountain, \$1.50 en. Illustrated Catalogue 25c. Norman Schultz, Salt Lake 9, Utah.

FOREIGN Coins on Approval on Request. Del Monte, 40 W. 18, N. Y. 11.

2,000 YEARS old! Ancient coins, \$1.00 for assortment. Allyn Roberts, 1018 Third, Marquette, Mich.

INDIAN head cents 22 different \$1.00. Sayers, 219 S. Main, Winston Salem, N. C.

"GREEK Drachma Currency—Authentic issue during German Occupation. 20c each while they last—Send coins or Stamps. Meisner Supply Service, 1816 Griswold St., Port Huron, Mich."

\$2.00 TO \$200 each paid for hundreds of Old or Odd Coins, Indian-Lincoln-Foreign Wanted. Keep all until posted. Send 20 Cents for illustrated Coin Value Book. 4 x 6. Guaranteed Prices. 40 years in business. Coin Exchange (1), Le Roy, N. Y.

WILL Pay \$10.00 each for certain Lincoln Pennies! Indianheads \$50.00; Dimes \$1,000.00. Catalogue 10c. Federal Coin Exchange, 6-PS, Columbus, Ohio.

WORLD Coins 25 different \$1.00. Harry Elsholz, Box 9014, Pittsburgh 24, Penna.

FREE Coin Bill and Catalog to Future Approval Accounts, Nassau Hobby Center, Freeport, New York.

FREE! Stamp and Coin Collector's Catalogue. Box 418, Beverly Hills, California.

20 DIFFERENT Indian Head cents, \$1.00. Price list 5c. E. Walton, 7 Water, Boston 9, Mass.

JAPANESE invasion currency. Dutch East Indies and Philippines. Large assortment including scarce denominations. Only \$1. Stewart Byers, Box 187, Rayville, La.

3,000 BARGAINS:—Antique Firearms, Indian Relics, Coins, Minerals, Flintlocks, Rifles, Pistols, Swords, Cartridges, Fossils, Illustrated catalog 25c. Heike, Wenona, Ill.

NEW Half Dollars—Iowa \$3.50; Booker T. Washington Set (3) \$4.00; Stone Mountain Memorial \$1.25. Lincoln Cent Bargains; 1909 SVDB \$10.00; 1914-D \$2.25; 1909-S 60c; 1922-P \$1.75; 1931-S 65c. Other Lincolns, 10 Different \$1.00. Twenty Different Indian Cents \$1.00. Whitman Folders 25c. Minimum Order \$1.00. Beebe Coin Co., 1180 East 63rd, Chicago 37, Ill.

96 OLD STAMPS WANTED

WHAT have you to offer? A collection? A "Shoe Box" accumulation? Anything in stamps. We urgently need them. Spot cash paid. Cosmopolitan Stamp Co., 1457 Broadway (Times Square), New York.

127 STAMP COLLECTING

WORLD'S Largest Diamond And Triangle Stamps, Free Stamp Magazine. Stamps from Fighting Free French, 20 stamps from 20 different Countries, Pictorials, Airmails, Big Bargain 5c with approvals. Capital Stamps, Dept. 10, Little Rock, Ark.

BRITISH Empire! 55 Different including Batum, Burma, Cyprus, Gwalior, Tasmania. 5c to Approval Buyers. Lyman, 97 Nassau St., New York 7.

FREE—Canadian Sets Royal Visit, George VI, George V, Coronation, Jubilee, others, to approval applicants. Ensign, Box 118-P, So. Orange, N. J.

DEALER'S Wholesale Catalog, Postage 3c. Franksco, 5031 Queensbury, Baltimore, Maryland.

WOW! \$10.00 Worth Of Fun Only 10c. What a treasure hunt! Big package 500 Foreign Stamps—just as received from foreign missions other sources. Includes stamps from Africa, South America, Philippines, Free French, Cape Juby, Palestine, etc., including airmails, commemoratives, and stamps worth up to 50c and 75c. This amazing offer is given for 10c to serious approval applicants only. One to a customer, money back if not more than delighted. Jamestown Stamp Co., Dept. 5, Jamestown, New York.

50 DIFFERENT including scarce diamond-shaped airmail 3c to approval service applicants. Avalon Stamp Co., Dept. S, Springfield 8, Mass.

\$2000 IN Stamps free to Contest Winners. Particulars, entry blank, to approval applicants enclosing only 10c for scarce Roosevelt Mourning Stamps from Nicaragua, Greece & Argentina, plus photograph of "Roosevelt Collecting Stamps." National Stamp Sales, 276 R, West 43rd St., New York 18, N. Y.

POPULAR SCIENCE OPPORTUNITIES

ROUND The World Colonies, British, Dutch, French, Portuguese, strange little known countries, primitives, cannibals, etc. All for 3c to Approval Buyers, Dixie Stamp Company, Dept. 11, Milwaukee 1, Wisc.

118 Different Stamps including Commemoratives, Charities, Airmail, surcharges, Sets etc. Only 3c to approval buyers. Badger Stamp Company, Dept. S, Milwaukee 3, Wisc.

TREMENDOUSLY Popular, virtually certain to rise to value, is Nicaragua's Roosevelt Memorial Issue, picturing Roosevelt Collecting Stamps, Conferring with Churchill at Atlantic Conference, and Signing Declaration of War against Japan. Three handsome genuine unused stamps (Nos. 695-7) that every collector wants! Special price, with attractive approval selection, only 10c! Garcelon Stamp Company, Box 818, Calais, Maine.

BRITISH, Spanish and French Colonies, Vatican, Hitler heads, and airmail packet, free with approvals. Pan-American Stampco, Box 145, New York 33, N. Y.

FREE, Irish Commemorative Collection, including Dramatic Easter Rebellion Issue With Approvals. Raymax, 123-X William St., N. Y. C.

FINE Approvals, freshly mounted. Fast, personal service. Tell me what countries you prefer and I'll send their stamps. Milton Skinner, 438 Locust, Long Beach 2, Calif.

UNITED STATES Price list. Send Postage. State Stamp Corp., 1225 Park Bldg., Pittsburgh 22, Penna.

UNITED STATES approvals complete coverage fine quality, attractive prices. Seminole Stamps, Box 378, Coconut Grove, Florida.

FREE U. S. Price list postage 3c. M. Hanna, 335 5th Ave., Pittsburgh 22, Pa.

FREE! Negro Triangle; Turks Islands "Cactus"; Dakar; Guinea; Palestine; "Fairy Tale"; Pirate Chart, Map, Ship, Sea Lion and Snake stamps; French, British, Portuguese Colonies, etc., Free for 3c postage. Approvals. Potomac Stampco, Washington 10, D. C.

FREE—Abyssinia, Cayman Islands, Tuna Triangle, Indochina, Syria, Ivoire, Philippines (Jap "Shame" issue), Turkish Harem, Damascus, Cambodia, African "Beauty," Pirate Islands, Colonials, others—All Free for 3c postage with approvals. Belmont Stampco, Washington 10, D. C.

FREE—Famous Americans Set, plus Flag Set, plus the National Parks set, plus the Presidential Set to the \$5. A total of 90 stamps absolutely Free to customers for our unsurpassed United States or Foreign selections. Send 3c postage for 15 of the above mentioned stamps and full particulars. Triboro Stamp Company, 145 Nassau Street, Dept. 203, New York.

FREE—pick 25c worth of stamps from our first U. S. approval selection. Special illustrated Lists included. S. D. Engel Co., 38 Park Row, New York City.

200 DIFFERENT stamps, 6c, to approval service applicants. Tatham Stamp Company, Springfield 50, Mass.

U.S. \$5. Stamp given free. Approvals sent Bala Stamps, Bala Cynwyd, Pa.

BET You Haven't These! South Georgia, South Orkneys, Grahamsland, South Shetlands—Shortlived Falkland Dependencies—Everything 3c with approvals. Viking, 130-PP Clinton St., Brooklyn, N. Y.

PROTECT Your Stamps with Crystal-Mount. Send for free samples. Harris & Co., 204 Transit Bldg., Boston 17, Mass.

TEN beautiful mint stamps free with approvals. Cornell Stamps, Box 4259, Miami 26, Florida.

AIRMAILS, British colonies, free with approvals. Granada Stamps, 4891 S. W. 5th St., Miami, Florida.

FRENCH, Portuguese, Spanish colonies, free with approvals. Hill Stamps, Box 732, Woodmere, N. Y.

ABSOLUTELY Free! Scarce airmail stamp (guaranteed genuine—Catalog Price 50c!) and illustrated "Get-Acquainted Folder" describing other free stamps given with our valuable publications. H. E. Harris & Co., 204 Transit Bldg., Boston 17, Mass.

50 GERMAN Hitlers & Swastikas 50c. Buckey, PS-208 Ludlow Bldg., Dayton 2, Ohio.

25 SCANDINAVIA 10c with approvals. Bjorn Nielsen, Monmouth 1, Maine.

BIG packets, all different stamps, 10c each (11 for \$1) 30 Asia; 30 Belgium; 50 British Colonies; 50 Denmark; 50 France; 40 Hungary; 30 India; 50 Italy; 25 Norway; 25 Portugal; 30 South America; 25 Spain; 30 Sweden; 25 Uruguay. Longacre Shop, 100-C West 42nd., New York City 18.

"MINT French Coat-of-Arms, Vatican, Hitler Heads, Airmails, Free with approvals. Gulfstream, Drawer 71, Miami, Fla."

PHILIPPINE Occupation stamps Free with approvals! Miami Stamp Company, Box 2437, Miami 14, Florida.

EGYPT—15 different, 5c to approval applicants. Bohemia Stamp Service-2, Bohemia, N. Y.

FREE! Rhodesian Bi-colored Waterfall; old El Salvador issues;—plus 25 different worldwide stamps. All free to approval applicants. Pladon Stamps, 1717-S Idaho, Toledo 5, Ohio.

POSITIVELY Greatest free offer—Latest Scott's International \$6.00 stamp album—covering entire world, contains 36,000 illustrated descriptive spaces; Scott's 1947 Standard \$6.00 catalogues "Philately's Encyclopedia"—absolutely free to applicants for foreign approvals becoming customers. Plymouth Specialty Company, Dept. A3, Bell, California.

300 DIFFERENT given free with approvals. Postage 3c. Windsor Stamps, 1435 E. 67th Place, Chicago 37.

U. S. 797 SPA Sheet only 5c to applicants for U. S. approvals. M. Haycock, 61 O'Brien Pl., Brooklyn, N. Y.

PORTUGUESE Colonies 25 different 5c with approvals. Loran Brown, Marion, Mich.

CUBA'S Latest Retirement Set shows aged couple receiving pension check. This set sent to approval applicants for only 5c. Bryson Stamp Company, Drawer F-1, Rossford, Ohio.

ALL different 100 25c, 200 40c, 300 60c, 1000 \$2.00. Leventhal, 831 Lafayette Ave., Brooklyn 21, N. Y.

FREE! Tiny Chinese "Midget" War set Approvals. Seminole, Elliston 10, Va.

UNITED States Bargain. Here's an offer so stupendous that it is almost unbelievable: 50 different U. S. Stamps ranging in age as far back as over sixty years and in face value as high as the dollar value composed entirely of face different postage, airmail and commemorative stamps, nothing else. In addition, we include 2 Japanese stamps of the Philippines. We will send all these for only 10c, but only for sincere approval applicants. In asking for approvals, please state whether you are interested in United States or foreign stamps, or both. Approval Headquarters, Globus Stamp Company, 268 Fourth Avenue, New York City 10, Dept. 217.

PROFIT in stamps. Cover every angle with the new book "How To Gain Pleasure and Profit from Stamp Collecting." \$2.75. Funk & Wagnalls, Dept. PS, New York 10.

20,000 DIFFERENT 1c-5c each! Gordon Davison, Box 1019A, Manchester, N. H.

PENNY Approvals that satisfy. Neil Gronberg, Box 5441S, Philadelphia 43, Pa.

MEXICO Mixture—plenty of pictorials, 400 for \$1.00. Biehl, Apartado 2887, Mexico City.

FREE! 25 Different Foreign, Mostly pictorials. Approvals. Streiner, 898 East 75, Cleveland 3, Ohio.

54 DIFFERENT Argentine "Roosevelt"; Libia, Ukraine "Hitler-Mussolini" stamps; others—5c. Maryland Stamps, Arlington-P, Baltimore 15, Maryland.

50 DIFFERENT United States 10c. Price list free. No approvals. Seidenberg, Cassopolis, Mich.

10 DIFFERENT U. S. Over 40 Years Old, 5c. Foreign, U. S. approvals. Scott, 22 Middle St., Lexington 73, Mass.

MAGNIFYING Glass — Fifty different, 10c. Approvals. Buchanan, 307 East 23rd, New York 10.

UNITED States and Foreign stamps sent on approval; outstanding quality, low prices. Fred Herzberg, PS 168 Oak St., Elmhurst, Ill.

ASSORTMENT each Airmails, U.S. Commemoratives, Spanish Colonies, Hyderabad, Triangles, Portuguese Colonies, etc. Everything 10c to approval applicants. Kay Stamps, Box 216, Great Neck, N. Y.

100 DIFFERENT world 50c (coin) including airm and new issues. Knopp, Box 1381, Bristol, Conn.

25 DIFFERENT Stamps 10c. Tunis And Carpenter, Wakeman Ave., Newark 4, N. J.

WORLDWIDE Different: 200-25c; 500-60c; 1000-\$1.50. Beacon Sales, Maynard 3, Mass.

BERLIN Bears Complete set of eight and 100 different stamps only 10c to approval applicants. Reich Stamp Co., 4647 Kenmore, Chicago 40, Ill.

BEAUTIFUL Iceland packet free to approval applicants. Everglades Stamps, Box 3222, Station F, Atlanta, Georgia.

OLD scarce U.S. Seconds on approval. Slightly defective, nice appearance, bargain prices. Hearnfeld, 551 Clinton, Newark 8, N. J.

MAGNIFYING glass with plastic handle, 10c! To Foreign or United States approval applicants only. Elliott Stamp Company, Box 51, Miami Beach 39, Florida.

COLOSSAL Bargain! Includes Falklands, Fiji, Gilberts, Stratosphere Stamp, 3 different Abyssinia, Airmails, numerous others. Everything 10c to approval applicants. Neal, 1604 Franklin, Cedar Falls, Iowa.

EXOTIC Pictorial collection: Tahiti spearfishing, Melanesian idol, Ingavi battle, Reunion, Madagascar, St. Pierre Miquelon, Djibouti, Wurttemberg, Dutch Indies, Newfoundland, many others. This outstanding offer only 5c. Imperial, Box 1491, Tampa, Florida.

BIGGER, Better, Pleasingly priced Foreign Approvals Inter-Continental Stamps, Englewood 4, Florida.

FIVE Vatican City Stamps Free to approval applicants. Florida Stamp Co., Box 807, Miami 5, Fla.

UNITED STATES. #303, #304, #305, #306, #307, #367, Used, #656 (Mint). Only 50c. Approvals accompany. Whiton-Stamps, Westport 1, Connecticut.

FREE! 25c worth from Du-luxe approvals. Williams Deems, Ravenswood, W. Va.

FLAG stamp free with U. S. Approvals. E. Wenigman, 929 Oakdale, Chicago.

MISSION Mixture 500 stamps 25c. Garrow, 84 Montevista, Chula Vista, Calif.

UNITED STATES Collection—Thirty-seven fine unused commemoratives before 1943 including Columbians, Bicentennials, Parks. Price \$1.03 approval applicants only. Orange Stamp Co., Albany 3, N. Y.

UNITED STATES Approvals—Largest varieties, Americas lowest selling prices. Stamp Company, Albany 3, N. Y.

PICTORIAL Packet! Philippines, Panama, Palestine, Paraguay, Portugal, Porto Rico, Poland, Peru, Persia, Free to Approval Applicants. Eliot Stamps, 86-31 Eliot Avenue, Rego Park, N. Y.

PENNY Approvals that more than satisfy. Royal Stamp Co., Tamaqua 2, Penna.

POPULAR SCIENCE OPPORTUNITIES

UNUSUAL! 25 unusual mint stamps only 10c to approval applicants. Bamboo Stamp Co., Box 605, Los Angeles 25, Calif.

FREE—Unusual. Italian Social Republic Set with Approvals. Want Lists Filled at Lowest Prices! Home Hobby-Craft, 3322 Decatur, Phila., 36, Penna.

FINLAND! 20 different, including several recent commemoratives. Only 10c with approvals. Wollaston Stamps, Wollaston 70, Mass.

1,000 GRABBAGS, 15c each. Special Bags 25c. Sandy, 630 Bingham, Reading, Pennsylvania.

RICH Man's approvals, poor man's prices. Grand value packet containing five Foreign sets. Free with approvals. Stoll Stamp Service, 2632 W. Burnett, Louisville 10, Ky.

UNPICKED: 5000 U. S. \$2.00; 3000 Foreign \$2.00. Satisfaction guaranteed. Kuhn, 3315 80th, Jackson Heights, N. Y.

ATTENTION! 5—5c sets—5c with approvals that satisfy—Lawrence, Box 1616, Hartford 1, Conn.

DOLLAR Each: 1500 Foreign; 750 Australia; 2000 Canada; Seiden, 1331-S Intervale, N. Y. 59.

1000 MIXED United States 18c. Two pounds \$1.25. Halay, 132 West 63rd, New York 23.

SMOKY Mountain Commemorative Souvenir sheet and 30 different U. S. stamps, including commemoratives, Airmail, etc. (catalog value exceeds 65c) for 10c to approval applicants. Curhan Stamp Co., Dept. 1, Gloucester, Mass.

FREE Vatican Cardinal set five values to approval applicants. Wesken Stamp Company, Box 66P, Queens Village, N. Y.

BOLIVIA Music set, Greek Occupation of Albania. Air mail packet. Free to approval Applicants, Middleton Stamp Co., Elmhurst, N. Y.

CHINA 20 Colorful Historical Stamps 10c with approvals. Collins', 71 Coleridge, San Francisco 10, Calif.

25 DIFFERENT Switzerland 10c with 1/4-1/2-1c Approvals. Carroll's, 4357-C S. Hoover, Los Angeles 37, Calif.

WORLD'S Largest Diamond And Triangle Stamps. Free Stamp Magazine. Stamps from Fighting Free French. 20 stamps from 20 different Countries. Pictorials, Airmails. Big Bargain 5c with approvals. Capital Stamps, Dept. 10, Little Rock, Ark.

FREE! Western Hemisphere Packet. Postage 3c. Owens, 801 Welshblgd., Bay-city, Michigan.

FREE! Pony Express set (facsimiles). Postage 3c. Roberts, 401 Shearerblgd., Baycity, Michigan.

SCARCE U.S. Stamps Nearly 100 Years Old. 1893 Commemorative. \$5-\$10 stamps. Armed Services Pictorials complete. Roosevelt set, large Allegorical Figure of Commerce. Old Revenues, everything 5c to serious approval applicants. Metropolitan, 140 Nassau, New York 7.

300 COMMEMORATIVES. Pictorials, etc., plus surprise packet \$1.00. Schneider, Box 1012, Chicago 90.

2000 MIXED U.S., \$1.00; 5000, \$2.00. Kaye, Beaumont, Springfield 8, Mass.

MINT Hitlers. 15 different 25c; Approvals. Philatelic Corner, 175 Stratford Rd., Buffalo 16, N. Y.

SPECTACULAR Beginner's Packet. Bantoland—Newfoundland—Kathiri—Pitcairns—Falklands—Rhodesia—Commemoratives—Triangle. Everything 10c. Approvals. Royal, Box 531-S, Waterbury, Conn.

100 DIFFERENT 10c with Approvals. Jacobsen, 59 Nagle Ave., New York 34.

BRAZIL Diamond Shaped Set 10c, with approvals. Vargo Stamps, 6044 South Fairfield, Chicago 29, Ill.

\$27.00 CHINESE Airmail and 50 others 10c to approval applicants. Burmaster, Box 1910-P, Los Angeles 53.

AIRMAILS of World—19 different including Bolivia Triangle, World's Fair, Commemoratives, new issues 5c with approvals. Continental Co., Dept. C, Box 639, New Rochelle, New York.

VATICAN City! Four varieties of Vatican City (world's smallest country) including portrait of Pope Pius! Also stamps from Afghanistan, Cape Juby, Libya, Macao, Palestine, Syria, Liechtenstein, San Marino, and many other interesting countries. All together 48 different stamps, total catalog price over \$2.50!—only 10c to approval applicants! Methuen Stamp Service, Inc., Dept. 210, Lawrence, Mass.

HISTORY'S International Criminals. Hitler and Mussolini, learned too late crime doesn't pay. Both are on set of six Italian stamps, worth \$1.45 in 1947 catalog, which we offer for only 10c with approvals. Detroit Stamp, 10304 Dexter, Detroit 6, Michigan.

5,000 MIXED U.S., \$2.00 postpaid, good value. William Waugh, 2140 N. NW, Washington 7, D. C.

25 SCANDINAVIA 10c with approvals. Bjorn Nielsen, Monmouth 1, Maine.

WHOOPIE! Wow! 25c worth of U. S. stamps free! No obligations! Write: M & N Co., 742 Sheffield Ave., Brooklyn 7, N. Y.

600 MIXED 10c! Australia, China, Ecuador, Fine Bank Mixtures From Many Lands. (One to a Customer) Approvals Included. Limited supply so write today! Brady, Cheswick, Penna.

600 U.S. MIXTURE 10c to approval applicants. Barrett, 975 Wells Street, Cincinnati 5, Ohio.

70 HOBBIES, COLLECTIONS

JEWELRY stones removed from rings, etc., 100 assorted \$2.40; 50 large ones \$2.40. B. Lowe, Holland Building, St. Louis 1, Mo.

INVENTING can be an interesting and profitable hobby. Write for complete particulars. Institute of American Inventors, Dept. 30-E, 2926-Eye St., N. W., Washington 6, D. C.

UNUSED Match Book Covers, 100 all different \$1.00. 35 Royal Flash Covers \$1.00. Free catalog. Charles Edelman, 1311 P East 84, Cleveland 3, Ohio.

INTRODUCTORY Offers:—10 Officers Insignias 25c; 22 different American or 15 different foreign—\$1.00. 10 different Metal Collar Insignias our choice—\$1.00. Illustrated catalog 10c. Hobbyguild, 35X, West 32nd St., New York.

296 COLORED Illustrations; new book "Foreign Medal Ribbons" \$1.00. Foreign Campaign Bars, Insignia, lists, samples, 20c Packets, \$1.00. Insigniacraft, 236 28th Ave., N.W. Calgary, Canada.

EXCHANGE Your duplicate stamps, match covers, or any hobby, with collectors everywhere! Directory listing swappers. 10c. (Mention hobby). World Hobby House, Box 721-B, Olympia, Wash.

"GEM Cutting." Interesting Hobby. Instructive Illustrated Booklet. One Dollar. Mineral Specimens Company, Box 1191, Santa Monica, California.

SWAPPER? Collector? Send 25c for sample copy, "Hobbyswap Contacts." 1326 South 27th, Omaha 5, Nebraska.

LEATHERWORKER'S Bible. Every leatherworker should own this completely illustrated catalogue combined with valuable instructions and information. Largest in this field. Actual leather samples. \$1.00 postpaid. Satisfaction guaranteed. Artcraft Leather of California, 271 Twelfth St., Oakland 7, Calif.

MILITARY Insignia; Metal Regimental Crests; 12 assorted Officer Insignia \$1; 1001 Collectors Items. Send 25c for Sample Crest. Catalogue. Bon-Lee Company, 5801-15th Ave., Brooklyn 19, N. Y.

8 ANTIQUES, RELICS, INDIAN GOODS

WAR point, scraper, Lists 25c. Williams, 405 S. Monroe, Green Bay, Wisc.

ANTIQUE-modern pistols, revolvers, swords, daggers, armor. 174-page illustrated catalog 50c. Robert Abels, 860 1/2 Lexington Avenue, New York 21.

3,000 BARGAINS:—Antique Firearms, Indian Relics, Coins, Minerals, Flintlocks, Rifles, Pistols, Swords, Cartridges, Fossils, Illustrated Catalog 25c. Heike, Wenona, Ill.

4 FINE ancient arrowheads \$1.00. Stone Tomahawk \$1.00. List free. Lear's, Box 569, Galveston, Texas.

85 MINERALS & PRECIOUS STONES

"GENUINE" Arizona Rubies (Garnets). Send quarter for packet. Mineral Specimens Company, Box 2651, Phoenix, Ariz.

OBSIDIAN small stones 50c, large \$1.00, red and black \$1.00 per pound plus postage. Charles Richards, Box 556, Jackson, Wyoming.

GEMS, precious and semi-precious, all genuine from world wide sources. Deal direct, no overhead, save money. Catalog 10c. Hill Co., Route 7-K, Salem, Oregon.

FIFTY mineral specimens, boxed, mounted, identified, described. Postpaid \$4.00. Old Prospector, A-73, Dutch Flat, Calif.

MINERALS—Gems, Cutting, specimen. Low prices. Free list. Plummer's, 5068 Brighton, San Diego 7, Calif.

"GENUINE" French Rhinestones Packet Assortment 50c. Herber, 1360 Hicks, N.Y.C. 67.

26 CAMERAS, PHOTO SUPPLIES

CASH! Spot cash for cameras, lenses, binoculars, movie and still equipment. Send full description for prompt cash offer. Over 36 years of dependability. Bass Camera Co., Dept. SP, 179 W. Madison St., Chicago 2.

USED Camera Directory, Box 1031-K, Canton, Ohio—lists hundreds of War-Bargain Used Cameras—35mm. Speed Graphics, Kodaks, Rolleiflex—many others. Send 25c for latest issue.

BASS Says: Trade Cameras? For 36 years Finest equipment available. Always Satisfaction Guaranteed Or Your Money Back! Bass buy 'em, trades 'em. Bass Camera Co., Dept. SP, 179 W. Madison St., Chicago 2.

PHOTOGRAPHY for pleasure or profit. Learn at home. Practical basic training. Long established school. Write for booklet. American School of Photography, 1315 Michigan, Dept. 1741, Chicago 5.

INFRA-RED filters glass 1 1/4" (40 mil) diameter, mounted. Snap on camera or binocular. \$1.00 per set. Ross, B68 West Broadway, New York, N. Y.

SPEED-O-COPY Groundglass focusing attachment for Leica. Contax Argus C-2 and C-3. Send for Literature. D. Paul Shull, 240 S. Union, Dept. PS-4, Los Angeles, California.

COMPLETE camera repair service, we buy foreign cameras damaged beyond repair. Northwest Camera Repair, 209 Loeb Arcade, Minneapolis 2, Minn.

CAMERAS—movie projectors—enlargers—free catalog. Cavalier Camera, 1822 Center, Pittsburgh 19, Pa.

ART Studies of Hollywood's most beautiful models! 350 masterpieces of the female figure! For adults only! 2x2 Color Slides for projector or viewer, 10 for \$3.00, 100 for \$25.00. 35 mm Fine Grain Negatives for salon quality enlargements, 10 for \$1.00, 100 for \$8.00. All Different! Colorcraft, 1302 Broadway, Burbank, Calif.

MICRO 16. New sensational pocket precision camera. 2 1/2x3 1/4 prints. Smaller than package cigarettes. \$29.95 postpaid. Clymer Motors, Dept. B-522, 2125 W. Pico, Los Angeles 6, Calif.

200 POWER telephoto camera easily made. Objects miles away photograph close up. Telephoto lens and instruction \$3.00. Instructions alone 10c. Carl Jamer, Manorville, N. Y.

MAY 1947 67

POPULAR SCIENCE OPPORTUNITIES

CONCORD Camera—(formerly Lafayette Camera) pays top dollars for used cameras and all type photographic equipment. Write Concord Camera, Dept. CE-11, 901 West Jackson Blvd., Chicago 7, Ill.

40 INCH lens adaptable to most cameras. Cost \$3 to install. Instructions—\$1. Delareuelle, 1136 E. 33 Street, Oakland 10, Cal.

102 PHOTO FINISHING

8 EXPOSURE rolls developed, 1 print each and one enlargement coupon 25c. Two each and coupon 35c. 3 each and coupon 40c. Reprints 3c. Fred A. Eastman, Bode, Iowa.

NEW Color Process makes full color prints from black and white film or negatives. Send dime for Sample. We have Films. Midwest Photo, Janesville 27, Wis.

BIGGEST \$1.00 value in 35 MM finishing today. 36 exposure fine grain 3¼x4½ enlargements; deckled, embossed margin and date. Eighteen exposures 75c; 16 exposure splits 55c; 36 exposure reloads 50c. Special: return this ad with \$2.00 and we will send five 36 exposure reloads. Free mailers. 8 exposure rolls in beautiful. Deckled contact finish with embossed wide margin. 25c. Mailbag Film Service, Box 5440-A, Chicago 80.

SENSATIONAL Introductory Offer! Send snapshot or negative, this ad and 3c. We'll send you a beautiful 7 x 5" enlargement! Or Kodak roll developed and printed (with free coupon) only 25c; or 8 Giant prints from roll, 30c. Reprints from negatives—any quantity—regular size, 3c; Giant size 4c. Candid rolls—36 exp. 35mm developed, vaporated, enlarged to 3 x 4. \$1.00, 18 exp. 50c. Free Mailers, Free Premium offers sent on request. American Studios, Dept. 365, Lacrosse, Wisconsin.

PHOTOGRAPHY for pleasure or profit. Learn at home. Practical basic training. Long established school. Write for booklet. American School of Photography, 1315 Michigan, Dept. 1722, Chicago 5.

50 REPRINTS \$1.00, 5 new rolls 127, \$1.10, 120—620, \$1.40; 616—116, \$1.60, Camera Shop, Albany, Wisconsin.

LARGA-PIC—We have only one offer, but it's an outstanding one! Your roll developed and 8 prints made into brilliant Larga-Pic photos for 30c. Reprints from your negatives 4c each. Write for Free mailers. Larga-Pic, Box Z-4, Brookline 46, Mass.

EVERY Picture an enlargement... Bigger and Better Snapshots than you have ever seen before! New Electronic developments give you improved lifetime deckled-edge enlargements at our same low prices. Any 8 exposure roll developed and printed Enlarge size 25c; Reprints 3c each. Fast. Accurate Service Guaranteed! Send for free mailers, today! Enlarge Photo Service, Box 791L, Boston, Mass.

ENLARGEMENTS 5 x 7—10c; 8 x 10—25c; National Film Service, 3111 West Tuscarawas, Canton, Ohio.

BEAUTIFUL enlargement from each picture on roll 25c. Cut Rate Photos, Dept. A-6, Janesville, Wis.

TWO beautiful prints from each picture on roll 25c. Twenty five years of satisfied customers. Quick Service. Lens Photos, Dept. J-9, Janesville, Wis.

UNIVEX Mercury film finegrain developed, beautifully enlarged 3¼ x 4½ glossy, 65 exposure roll \$2.58, 32 exposure roll \$1.31. Fresh 65 exposure film 45c, accessories stocked. Spiratone, Dept. (SC), 49 W. 27 St., N.Y.C.

"SALON Enlargements: 8 x 10 expertly colored. Framed \$2.00. Klossart, Loudonville, Ohio."

ROLL Developed and 8 prints 25c or 8 enlargements 30c. Reprints 3c. Enlargements 4c. Young Photo Service, 406-C, Albany 2, N. Y.

4 ACTUAL Photographs 15c. Four 5x7 Enlargements \$1.00, Movie-Film Enlarged 3 Wallet-Size Photographs 75c. 100 Photo-stamps \$1.50. Artcraft, 1600 Coney Island, Brooklyn 30, N. Y.

PHOTO copied, 25 prints \$1., Suburban, 1410-S Bond, Rockford, Illinois.

YOUR photograph reproduced, enlarged or restored. Write for details. Promenade Photos, Cooper Station, Box 198-W, N. Y. 3.

ROLL developed and 8 prints 30c. Overnight Service. Free Mailers. Tri-Flex Photo Service, Box 375, San Francisco, Calif.

8 BEAUTIFUL Double Size pictures and roll developed 30c, 8 hour service. Free Mailers. Pacific Photo Service, Box 666, San Francisco, Calif.

90 MOTION PICTURES, SOUND EQUIPMENT

HOLLYWOOD Films! Sample and catalog 10c. Stone, Lunenburg 10, Mass.

UNUSUAL home movies: Travel, adventure, sports, comedies, Silent-Sound. Many film bargains. Big illustrated 1947 catalog, sample-dime. Audet, Box 6520-AG, Philadelphia 38, Pa.

MOVIE Camera Films, 100' 16mm \$2.50. 25' double 8mm, \$1.25. Free Developing. Better Films, 742 New Lots, Brooklyn 7, N. Y.

GUARANTEED Fresh anti-halo outdoor movie film! Weston 12 Daylight loading! Processing free! Three spools Double 8mm, \$3.45! Six single 8mm for Univex, \$4.60! Postpaid! Catalog. ESO-S, 828-A, West 39th, Kansas City 2, Missouri.

8-16mm SILENT-sound films. Complete rental library. All latest subjects. Free catalogue, (sample film 10c). Garden Film, 317 W. 50th, N. Y. 19.

EXCITING Film. For artistically presented subject, "Exciting Stars in Action", starring glamorous girls, send only \$1. State 8-16mm, Exciting Films, 1071 El Centro, Dept. E, Hollywood, Cal.

16mm MOTOR Driven Projectors—\$16.00—Up. Selco Products, Denver, Mass.

LEARN movie projection, management. Free catalog. Theatre School, Elmira, N.Y.

HOLLYWOOD Home Movie Headquarters. Free Catalog. Bailey Films, Dept. PS, P. O. Box 2528, Hollywood 28.

"MISS America, 1946". Projection length test film, \$1.00. Complete editions. 8mm, 50 ft. Kodachrome, \$7.50, black-white, \$2.00. 16mm, 100 ft. Kodachrome, \$14.75, black-white, \$4.00. 43 subject color catalog. 25c. World In Color, Box 392-A, Elmira, N. Y.

LATEST subject including the sensational hit of the year "The Anniversary Waltz". Complete 16mm sound only. Approximately 400'. Immediate delivery. \$17.50. "Parade of Stars" Approximately 400' Kodachrome sound, \$67.50. Garden Film Service, 317 West 50, New York 19.

16-35mm Silent, Sound films, projectors, Bedner, 5300 So. Talman, Chicago.

SELECTED Films, Photos, Slides, List 10c. Thomas Productions, 2709 West Ave. 34, Los Angeles 41, California.

MOVIE Cameras, Projectors, Films. Silent-Sound. Catalogs 10c. Richardson, Wyoming, Pa.

FASCINATING Home Movies. Free Catalog. Loja, Box 74-G, Station B, Brooklyn 16.

IMMEDIATE delivery of 16mm Sound projectors. Large stock of Castle, Official, Nu-Art and Pictorial films. Soundies, Comedies, 16mm Anscocolor film. Used 8mm, 16mm Sound. List Titlers, Splicers, Editors, Rewinders. (Home Movies, 41 South Fourth Street, Allentown, Penna.)

DEVELOPING units for movie film with instructions. Literature. Duro Movie Products, 1519 Eggert, Eggertsville 21, N. Y.

FILM Movetone is back. It's Weston 12 nonhalation. Free processing 100 ft. 16mm \$3.25, 25 ft. double 8mm \$1.50. Bulk film without processing 100 ft. 16mm \$2.25, double 8mm \$2.45. Free circulars. Fromader Genera, Davenport 5, Iowa.

SEND stamp for 16mm, 8mm lists. Sterling's, 679 Northampton, Easton, Penna.

CHILD Is Born By Caesarean Delivery. The outstanding home movie production. Project it free. Send postal card immediately. Preferred Movies, Hamilton 10, Ohio.

HOME Movies. Rent-buy-swap 8/16mm silent and sound at money-saving rates. Details for a dime. Midland, Box 429, Oak Park 3, Ill.

TALKIES: Convert your silent 16mm Projector into sound with our guaranteed parts kit. Plays all 16mm sound films. Quickly assembled at home. Special introductory offer: Send this ad now with \$19.95, check or money order, and we will include sound test film, instruction manual and full information on how to use with your radio. Kit includes photocell, exciter lamp, optic, which makes a sound head complete. Or send \$1.50 for complete blue prints showing how to make adapter yourself. Sound Tech, Box 3071, Hollywood 28, California.

UNUSUAL movie. "Temptation" featuring beautiful models. 100 ft. 16mm \$5. 50 ft. 8mm \$3. COD's accepted. Catalog free. Fine Arts, Box 2084, San Antonio 5, Tex.

BEAUTIFUL Kodachrome Slide and Lists 25c. Slide Supply Service, 3111 West Tuscarawas, Canton, Ohio.

PANCHROMATIC Movie Film Indoor-Outdoor. Top Quality—not Surplus! Extra speed—Weston 32. Fine Grain. Anti-Halo. Spooled, ready for Camera. Dalite loading. Processing included! 25 ft. Double 8—\$1.65. 100 ft. 16mm—\$3.95. Fast Service! Postpaid! Order Now! Satisfaction guaranteed or money back. Chromex Films, Dept. E, Rutherford, N. J.

EXCEPTIONAL Entertainment; Instructionals. Free Catalogues. Meginnis, 115-J Anchor, Oceanside, N. Y.

RARE 8-16mm. Silent-sound films. International, 2120 Strauss, Brooklyn, N. Y.

FREE, Movie Catalog; sample film 10c. Cameras, Projectors. Goodwill Company, Jackson, Tennessee.

JOIN World's largest Movie Society. Many advantages. Details Free. International Cinematographers, 6770 Hollywood Blvd., Suite 218, Hollywood 28, Calif.

FREE—Movie Titles. Dime brings details, samples, etc. Peerless Service, 6411 Hollywood Blvd., Suite 218, Hollywood 28, California.

FRESH Movie Camera Films—100'—16mm \$2.25 three rolls \$6.00 25' double 8mm \$1.25. Ambassador, 479 A Quincy St., Brooklyn 21, N. Y.

NEW Da-Brite 16 mm projector. AC Motor! 400' capacity! 120 Watts! \$17.95 complete! Case \$3.95. Satisfaction Guaranteed. Stone, Lunenburg 40, Mass.

ART model films 16mm rentals exclusively, adults list. Enclose stamp. Revere Films, Box 1051, Detroit 31, Mich.

92 MUSIC, MUSICAL INSTRUMENTS

RECORD Collectors—Send Me Your "Want-List" Today. Olin Milner, 335 McDaniel, Atlanta, Ga.

PIANISTS Popular Music Chord Chart: shows names; symbols; readings; enharmonics; notations; 648 treble, 180 bass positions. Sensational! Desirable! Practicable! Only \$1.00. Carol Music Chart Co., Box 21-PS, Lefferts, Brooklyn 25, N. Y.

CHORD Chart: (364 popular, including modern chords) 25c. Calculator, Box 1-PS, Station A, Brooklyn 6, N. Y.

WHOLESALE—Good Used Jukebox Records. \$15.00 per 100. Olin Milner, 335 McDaniel St., Atlanta, Ga.

"SONGWRITERS, Send Poem For Free Examination. Outstanding Offer, and Free Instructive Booklet. United Music, 108, Salem, Indiana"

POPULAR SCIENCE OPPORTUNITIES

122 SONG WRITERS

POEMS Wanted to be set to music. Free examination. Send poems. McNeil, Master of Music, 510-PS, S. Alexandria, Los Angeles, California.

SONGWRITERS. Songs Published Monthly. Advance Royalty. Send your songs or poems today for our exciting offer. Hollywood Tunersmiths, Dept. 10F-C, 1537 N. Vine, Hollywood 28, Calif.

POEMS Wanted For Musical Setting. Send poem for immediate consideration. Five Star Music Masters, 646 Beacon Bldg., Boston.

SONGWRITERS—Protect your songs. Get the facts first. Free booklet, attractive offer. Song Service, 331-J West 46th, N. Y.

POEMS wanted for musical setting. Send Poem for immediate consideration. Hamann Service, 626 Manhattan Bldg., Milwaukee, Wisc.

SONGWRITERS Outstanding Honest, Music writing offer. Dick Reynolds, Leonard, Texas.

POEMS Wanted for new songs. Send poem for Free examination. Elliot Wright, Master Composer, 206 Rivoli Theater Building, Portland, Oregon.

"**POEMS** Wanted For Musical Setting! Send Poem For Free Examination. Outstanding Offer and Free Instructive Booklet. United Music, 107, Salem, Indiana"

SONGWRITERS: \$100 Cash Awarded Each Month For Best Song or Song Poem. Melodies supplied Without Charge By Hollywood composers. Lead sheets and records furnished. Cinema Song Co., Dept. B-45, Beverly Hills, Calif.

CATCHY Melodies. Arrangements Written. Sholl, 2217 Penn. St., Harrisburg, Pa.

112 RADIOS, SUPPLIES & EQUIPMENT

MAKE Simple, Tubeless, Batteryless, Distance-Getting Crystal Radios. Crystal and illustrated instructions 25c postpaid. Allen, 427-S, Clinton, Mo.

RADIO Service men and experimenters send stamp for our giant radio catalogue. Save dollars. United Radio Co., (1000-V) Newark 1, N. J.

BUILD "Scottys 4-Way" crystal radio, using New Radar Crystal, good volume, distance, diagram and instructions—25c. Scotty Bottom, 1305A Monroe, St. Louis, Mo.

BUILD "Loudest" Crystal Radio. Instructions and Crystal. 25c. Amoroses—Route Four, Richmond, Virginia.

SPECIALS: Assorted guaranteed Filter Condensers \$8.75; 100 assorted Bypass \$6.95; 100 assorted Resistors \$3.95; 10 20-20 Filters \$4.95; Radio Tubes. Parts. Wholesale. Free Flyer. Variety. 601 Broad St., Newark 2, N. J.

1947 REVISED "Plans 18 Crystal Sets" (SW record 5800 miles). Catalog. "Radio-builder"—25c. 3 issues "Radiobuilder"—25c. Laboratories. Box Eye-T, San Carlos, California.

FREE New Radio Catalog Is Ready! Radionic's catalog lists hard-to-get radio parts, books, amateur, test and P.A. Equipment. All available for immediate shipment. Send today to: Radionic Equipment Co., 155, 170 Nassau St., New York 7, N.Y.

FREE crystal radio diagram send post card. Pierce Radio, McAlester, Okla.

RADIO Crystals Guaranteed non-technical formula \$1.00. F. C. Engineers, Box 576, Glendale, Calif.

BUILD Radio, Phonograph, Combinations. Complete Kits. Catalog. Radion, 6922E, 21st Ave., Brooklyn 4, N. Y.

RADIO Tubes 29c up. Free Bargain lists. Potter, 1314 McGee, Kansas City 6, Mo.

WESTERN Electric fixed detector—no adjusting—excellent for crystal sets, scarce, cost Govt. over \$5.00—Special 99c prepaid. Free Radio List—8—Radio City Labs, 30 Church St., New York 7, N. Y.

"25 YEARS Experience in radio repairing at your fingertips for \$1.00. I've repaired 45,000 radios and have perfected system you can follow step by step. My methods are far simpler than any other course published. Requires no calculations. Total price \$1.00 postpaid or COD. Money-back guarantee. Ross Radio Company, 14615-B Grand River, Detroit 27, Michigan."

PARATROOP All metal folding antenna, used by landing troops. New-real sensation—expands to 128 in. with flick of the wrist. Good for boats, radios, auto. Worth \$10.00. prepaid \$1.98. Free list 9. John Barron, Box 128, Ft. Hamilton Sta., Brooklyn 9, N. Y.

NEW RCA Philco radios, combinations. Refrigerators. Washers. Fans. Immediate delivery. Discounts. Gravlee Company, Kennedy, Alabama.

RADIO Tubes, parts wholesale retail large stock. Radio Mail Order Company, 46-13 188th St., Flushing, N. Y.

RADIO book—"Everybody's Radio Manual." Tells how to service all radios at home. 256 pages, 216 pictures. DeLuxe edition. \$1.49. Popular Science, Dept. 57-C, 353 4th Avenue, New York 10, N. Y.

RADAR Crystals. Super-Sensitive. Free details. Hayes, Box 636, Santa Barbara, California.

IN Stock—No Waiting—Hallicrafters Short Wave Radios. S-38 \$47.50; S-40A \$89.50. Covers Broadcast and all short Wave Bands. Ideal for Short Wave Listeners. Send \$5.00 deposit and we will ship COD for balance. Henry Radio, 11240 W. Olympic, Los Angeles 25, Cal. and Butler, Mo.

COMPLETELY assembled crystal radio plus 100 foot antenna. Postpaid \$1.00. J. Kennedy, Box 653, Boston, Mass.

HIGH Fidelity 14 watt amplifier! Complete schematic and electrical parts list—50c. J. R. Johnson, Mount Arlington, N. J.

FCC Exam samples; any class commercial or ham. We send you exam and correct your answers, \$1.00 per element. J. R. Johnson, Mount Arlington, N. J.

RADIO crystal detector kit. Easily assembled and ready to get reception with your headphones and aerial. Complete with crystal, parts, base, illustrated instructions. 40-page radio beginners booklet, extra crystal and crystal set building diagram, all for only \$1.00. Al's Radio Service, Box 1285-S, Sioux City 7, Iowa.

RAZOR Blade Radio. Make one. We supply headphones \$1.75. Complete plans 25c. Send check or money. Nico Supply Co., 1700 Walnut, Phila. 3, Pa.

24 BUSINESS OPPORTUNITIES

GOOD Paying Business Silvering mirrors, plating autoparts, reflectors, bicycles, bathroom fixtures, etc., by late methods. No tanks or shop required. outfit furnished. Free Booklet. Gunmetal Co., Ave. E, Decatur, Illinois.

START Home business making statuary, plaques, art goods, pottery, garden furniture, artificial marble flooring, liquid marble. Make flexible molds yourself. Amazing profits. Folder free. Creative Publishers, Box 236-M, Winnetka, Ill.

\$25 WEEKLY working two hours daily. No canvassing. No Manufacturing. Lycke, Box 2471, Cleveland 12, Ohio.

OPERATE profitable home business selling merchandise by mail. Fast sellers. Large profits. Powell Service, 5713 Euclid, Cleveland 3, Ohio.

RECAST old batteries into new. Latest achievements. Battery Laboratories, Minneapolis.

BIG Pay jobs in welding. Complete welding lessons and reference books, 516 pages, 41 lessons. \$2.00 copy. Money-back guarantee. Hobartweld, Box P-1065, Troy, Ohio.

BOOKKEEPERS—Operate your own simplified "Dollar-A-Week" Bookkeeping & Tax Service. Full or spare time. Details free. Ellis, Box 203, Cedar Grove, N. Car.

MAIL Order Business course shows you how to make money, spare or fulltime. Teaches professional mail order technique—not penny-snatching schemes. Fascinating 100-page illustrated Success-Catalog Free! Write—Nelson Company, Dept. 4-01, Chicago 5.

LEARN Shell Jewelry Manufacturing. No tools or experience needed. Learn-earn within a week! Complete home instruction course, beautifully photographed, shows how to make 75 styles of Pins, Earrings, Brooches, Hair Ornaments, Dress Clips, Necklaces, Bracelets, Candy Dishes, Wall Plaques, Ash Trays, Candle Sticks, etc. Includes Pearlizing, Golding, Dyeing, Luminous methods. Illustrates 55 species of sea shells. Lists hundreds of raw materials with wholesale prices. Complete course \$1.00, postpaid. Beginner's Kit, \$3.00 (\$3.50 in Canada). House of Gifts, Box 4550-AS, Coral Gables, Fla.

DOLLARS Daily! Cleared \$1900 in two months. Details. Loeb, 7201 B-5, Montgomery, Cincinnati.

START Mailorder Bookshop—Everything furnished; publisher cooperation. 25c brings booklet, exclusive setup, samples, exciting ideas. General Publications, Ossining 1, New York.

POPCORN Machines, all-electric popping units, geared aluminum popping kettles, used Victory Duplex stamp vendors, coin-operated scales. Northsyde Sales Co., Indianola, Iowa.

ASTOUNDING modern mail order plans. Brings quick profits. Darrah, Orono 8, Me.

LEARN Piano Tuning, Repairing, at home. Tremendous field! Piano parts, tools furnished. Established 1935. Empire School of Piano Tuning, 606-A East University Ave., Champaign, Ill.

IF you'd like to make \$5,000-\$10,000 yearly in the Collection-Credit Agency business, write us at once. Outstanding opportunity. Cole Associates, Syracuse 2, New York.

FELLOW Workers—Down with Bosses—Start own business—Be Independent—Booklet describing 137 Tested Plans, free. P. Padney, 307 York St., Jersey City, N. J.

GOT \$24,500 Using "Schemes" from "Schemer" Magazine, Alliance, Ohio, 49th year, \$1.00. Three samples 25c.

WANTED unused U. S. Postage Stamps, small discount. Advance Stamp Co., 24 East 23 St., New York.

COLORGLAZED Concrete Pottery made without molds. New, low cost, patented method. Cemetery products, novelties, tiles, floors, etc. Basement leaksealing. Other money-making projects. Booklet, details free. Men only. National Potteries, Fergus Falls, Minnesota.

MANUFACTURE costume jewelry at home for profit, hobby, therapy. Free wholesale supply catalogue. Instructions. Florida Supply House, Bradenton, Florida.

YOUR own Plastic business at home. Produce costume jewelry, novelties, statuettes. Liquid Plastic, Liquid Marble, Flexible Molds. Write for free book. American Trades, Box 1016-B, Peoria, Ill.

PUBLISH community newspaper. Share big profits, prestige. "Know How" will help you launch, operate, fascinating business. Reveals practical methods of newspaperman whose popular weekly grossed \$41,000 advertising in 18 months. Illustrated. Free literature. Success Publications, (Dept. B), 15870 Wisconsin, Detroit 21, Mich.

AGENT or exclusive distributor for cigarette lighter Mfg. MacGregor, Tahoe Valley 15, Calif.

COLOR Concrete with chemicals. Make Hollywood style pottery; home or shop. Marbling, water-paints. 10c brings sample, pictures. Hollywood Cementcraft, 8530 Wonderland, Hollywood 46, Calif.

BUYERS Wanted for plaster novelties. Painted—Unpainted. Retail—Wholesale. Write today for free information. Bing Products, 88-XB Broad, Boston 10, Mass.

POPULAR SCIENCE OPPORTUNITIES

NEW Batteries from Junks. Card for Details. L. Wertz, Pekin, Illinois.

MONEY In "Bobby-Jo" Baby Shoes. Complete, tested Mail Order Plan and sample pair 50c. No-Co-Ro, Oakland 6, Calif.

PROFITABLE mail order business. Free details. Fosler, 1328 N. Newkirk St., Philadelphia 21, Penna.

MOLD-MAKING. Plaster casting. Money-making Business. Literature Free. Kemico, Park Ridge, Illinois.

RED latex for making rubber molds! Cast plaques, novelties, bookends! Free sample! H. Tooker, Hamilton 21, Ohio.

START selling costume jewelry. \$1-\$5 sellers order assortment \$12.00 Dozen. Double your money. A. & S. Jewelry, 31-49 12th St., Astoria, N. Y. Dept. S 1.

COMPOSITION Flooring—made in most colors. Lifelong. Soundproof. Resilient. Flexible Molds. Cast novelties, plaques, statuary. Big money—your own business. Catalog Free. Write—Bing Products, 88B2W Broad Street, Boston 10, Mass.

OWN A Mirror Shop! Resilver Mirrors. Write for information, John Sprinkle, V90, Marion, Indiana.

OPERATE profitable mail order business. Splendid Opportunity. For details write, George Radatovich, Box 142, Fairmont, W. Va.

SPECIALTY Manufacturing, the big money business that can be operated anywhere, start on a very small capital; we supply dependable formulas and complete instructions; get interesting Free booklet, "Money-making Opportunities in Specialty Manufacturing," Howard Robinson, Ph. G., 1300-B S. Ohio St., Sedalia, Mo.

MEDICAL Laboratory Technicians in great demand. We train you in your spare time, in your own home. You can practice while studying. Write for free catalogue. Imperial Technical Institute, Box 973-X, Austin, Texas.

SMALL Capital. Start your own advertising agency at home in spare time. Complete operation revealed. No stock or equipment. Large earnings and permanent income. Free folder and proof. S. Snyder, Box 4907-A, Philadelphia 19, Penna.

QUICK Money! "Repairing Car Batteries." At home! Easy too! Write, Batterymen, Grand Junction 1, Colorado.

TYPEWRITER Repairing instructions, standard typewriters. Webers', Box 1008, Canton, Ohio.

137 PLANS to make money local, mail order. Particulars free. Elite Co., 220-A Grand St., N. Y.

I MAKE big money in the mail-order business. You can do the same at home with copyrighted system. Write me I'll tell you how. F. Little, Glenshaw, Box 8, Pa.

BE your own boss, small investment, large income. Write, Russells Camp, R.D. 1, Box 55, Oak Ridge, N. J.

START Mail Order Business—Our plan proven successful—Send \$1.00 for complete plans. Satisfaction Guaranteed or Money refunded. Service Bureau, Box 172, Kokomo, Indiana.

FLEXIBLE Molds to order, also originals. Professional course manufacturing molds and cast novelties. Latex, lacquers, flocks, flocking equipment, supplies. Plastics, Box 1574, Boston 4, Mass.

UP to \$1500 yearly selling by mail in spare time interest you? New ideas and plans every month. Details free. Idea of Month Club, 3023-D Greenmount, Baltimore 18, Md.

200 Money Making Deals. Plans—Rare formulas—Schemes. Folio Free. Formico Prod., Box 572, Dayton, Ohio.

VITAMINS! Big Sellers! Guaranteed Finest! Your labels. Dr. Swearingen, 9128S, Station S, Los Angeles.

DISTRIBUTORS. Insecticide spraying equipment. Vital Sales Company, 408 Walton Building, Atlanta, Georgia.

HOW and Where to obtain capital. Particulars free. Star Service, Wapakoneta, O.

BABY Shoes preserved. Formulas, instructions, \$1.00. Novelty Bronzing, Box 56, Hyde Park 36, Mass.

REDUCING Salons make money. Start at home. We supply automatic equipment. National Products, Portland 2, Oregon.

START profitable business. Sell herbal remedies under your own name mail—Local Delfa Co., 3956 Avondale, Chicago 41.

TYPEWRITER Repairmen urgently needed. Earn \$40 to \$50 weekly spare time. Our easy to learn home study course teaches how to repair typewriters. Write for free information. Houston Typewriter Repair Service, P.O. Box 5357, Houston 12, Texas.

START a clock shop while clock repairing is booming. Our easy to learn home study course with pictures and illustrations teaches you how to repair all kinds of clocks. Information free. Houston Clock Shop, P.O. Box 5086B, Houston 12, Texas.

MAKE Shell Jewelry—Easy, profitable. Illustrated book instructions 75c. Free Catalogue. Florida Shellcraft Co., Box 1840, Sarasota, Florida.

BRONZING and Metallizing baby shoes! Gold, Silver, Copper, Nickel, Bronze, Pearl, Ivory and "Luminous glow" colors! Big profits! New Field! Details free! Write R. O. Morgan, Box 349, Long Beach 2, Calif.

OPERATE profitable mail order business. Write, Walter Service, B-4159 East 112th, Cleveland 5, Ohio.

EARN \$20-\$30 daily "Textra-Cleaning" upholstery, rugs; demand everywhere. We start you, furnishing everything. Booklet free. Textile Cleaners, Inc., 11106-B So. Longwood, Chicago.

OPERATE profitable Mail Order business \$5. Capital. Write Crafts' Pursuit, Davison 2, Mich.

START your own Business Rug Carpet and Upholstery Cleaning and Rejuvenating all kinds all makes household and automotive products to distribute \$875 to \$1000 for Merchandise and Equipment exclusive territory. Write Hinson and Company Inc., Richmond, Indiana.

SYNTHETIC Latex with Neoprene base for making flexible molds! Quick Drying! Safe! For home, classroom, or industry. Quart \$2.00, Gallon \$5.95. Full instructions. Plastercraft Supply Company, 1406 East 43rd Street, Cleveland 3, Ohio.

HANDYMEN—Earn money home operating Community "Fix-it" Shop. Write, Stafford, 708 Rawlings, Carbondale, Ill.

MAKE \$6.00 an hour Sharpening Lawnmowers. Details 10c, Angle Slide, Box 582, Binghamton, N. Y.

MANUFACTURE Nameplates, House Numbers, Signs. Crabtree, Box 221, Newport News 4, Virginia.

REPAIR Appliances, motors, bicycles, etc. \$20.00 capital! Illustrated instructions. \$5.50. Repair Service, Janesville, Wis.

UNPAINTED plaster plaques and statuettes. Free illustrated catalog. Edison, 710 Weiser, Reading, Penna.

SPECIAL Liquid Molding Rubber. Free Sample. Quart \$3.00, Gallon \$10.50. Free instructions. Universal Sales, Box 1076-B, Peoria, Ill.

WHOLESALE Distributor. Amazing screw holding screw drivers! Removes holds, inserts screws hard-to-get places! Stores, mechanics, factories buy quantities. Counter displays furnished. Also Staple Driver for all wiring purposes! Fast sales, big profits, repeats, tremendous domestic & foreign market. Refundable trial offer! Millen Mfg., 519 Miller Bldg., Boston, Mass.

SOAPMAKING. Learn at home. No machinery needed. Posera, DN-4545 Bartlett, Milwaukee 11, Wisconsin.

SUPER X liquid molding rubber. Sample jar 25c, quart \$3.00, gallon \$10.00. Free sample. W. Wooley, 115-A Donald, Peoria, Ill.

SILVERPLATE Mirrors—Make Mirror Novelties \$1.00. Universal, Box 1076-B, Peoria, Ill.

START profitable Mail Order business. Write Tes-Co, Box 189-SH, Wilkes Barre, Pa.

\$46 FROM Square Foot Plywood: Jigsaw necessary. Write, Woodarts, X-47, Bridgewater, Mass.

DON'T throw it away! There could be a fortune in your attic or cellar. Research Enterprises, P.O. Box 5296, Baltimore 24, Md.

BELTS! Make'm and make money. No tools! Sample 50c. Art Leather, 411 Joseph Ave., Rochester 5, N. Y.

6 INTERESTING Mail Trade Magazines 25c. Containing many wholesale offers and helpful money making information. Send today. Giard, Aurora 12, Missouri.

BY Now you've surely heard of Colorado's fabulous oil boom. Take a shot at \$1,000 to \$20,000 on investment of \$160 in 4 monthly installments. Red Bloods of America register in now for your share in this new oil Klondyke. Rocky Mountain states are swarming with new daily opportunities. Big Pay-Offs ahead. More than 160 big new wells in one oil field alone. Write me this very day for details. Dyer, 1835 Champa, Denver, Colorado.

START home plaster novelty business. Amazing course tells how. Literature free. W. Belfort, Engineering Bldg., Chicago 6, Calif.

MAKE strange plastics—1c pound. Makes durable attractive floors, walls. Build with waste—Save half. Bays Laboratory, Oklahoma City 9.

CASH For Common Ashes! Information; Sample Product, 35c. Duffy, V49, Covington, Ky.

DO it with Sea Shells. Big profits. Werts, 1429 56th Avenue, Oakland 3, California.

BOOKKEEPERS: General ledger and tax report experience operate permanent, profitable accounting service for the smaller business. Part or full time. Simplified method. Write now! L. A. Bell, 1402 West 25th St., Cleveland 13, Ohio.

INVESTIGATE Wall-Cote Franchise profit opportunities your territory. Wall-Cote protects, beautifies concrete masonry, stucco. Tremendous demand. Your profits exceptional. Wall-Cote Company, Elmdale Court, Holland 2, Mich.

INTERESTED in a new field with growing opportunities? If so ask for information on our Oil Burner for Kitchen Stove—"read what folks like yourself say about it"—Oil Burner Supply, Box 327, Cambridge, Massachusetts.

YOUR own Hustling Business with 75c profit on every dollar merchandise sale, plenty of repeats. Work locally or by mail. New complete plan tells all. Write: Einert Sales, 150-23 115 Ave., Jamaica 4, N. Y.

MEN! Spicy Cartoon Booklets. Vest Pocket Size. Distributors wanted. Melvin's Studio, Box 34-F, Riverdale, Dayton 5, Ohio.

2000 NEW representatives needed, some sections exclusive territories—Big opportunity small investment. Midwest Drug Company, Inc., Columbus 15, Ohio.

25c BRINGS you lots of Mail Catalogs, magazines, opportunities for one full year. James "E" Summerson Agency, 621 E. Church St., Lock Haven, Penna.

SILVERING Mirrors—profitable home spare time business. Formula 25c. Charles, 12 EA, Norwood, Ohio.

WE sell the Wholesaler for you. Do detail selling for wholesaler insuring active accounts full coverage Drug, Gift Trade. South California Rector Sales Company, Twenty Six Sixteen Three Quarters Redondo Blvd., Los Angeles 16, California.

START Manufacturing now. Own your own business, big profits, good instructing chemists, 25 years experience. Reliable Silver Cleaner Formula. Manufacturing instructions. Samples, other particulars, complete for \$3.00. Kimia Testing Laboratory, Box 262, South Bend, Ind.

POPULAR SCIENCE OPPORTUNITIES

INVESTIGATE Mail Selling! What's the one best thing to sell, happily, honestly, profitably? We know! Get free particulars, free samples. What-To-Do Shop, Box 1082, Tacoma, Washington.

PLASTIC—Wood-cast Bookends, Ashtrays, Statuettes; 12 assorted samples with big list models \$1.00. Plastic Artcraft Products, 3151-7, Southport, Chicago.

AVAILABLE exclusive territory, distribute Travel and Sports Insignia Emblems. See page 112, March Popular Science. 25c brings samples, full details. Vogue Specialties Corp., Carnegie Hall, Cleveland 15, O.

WOULD you pay 3%—first \$350 made? Color-illustrated book "505 Odd, Successful Enterprises" free! Some offer occasional "day off." Work home. Expect something odd! Pacific, San Clemente, Cal.

POWER lawn mowers. Drop shipment prepaid. Agents-dealers. Rotacut M-2014. Ex. Springs, Mo.

88 MONEY MAKING OPPORTUNITIES

DETECTIVES Earn Big Money. Experience unnecessary. Particulars free. Waggoner, P-125, West 86th, N. Y., N. Y.

ELITE Collection describes 137 money-making plans; local, mail order. Particulars free. Elite Co., 220-A Grand St., N. Y.

EARN money at home—steady income—Write Successful Income Builders, 508-B, Hollywood 28, California.

\$25 WEEKLY Working two hours daily. No canvassing or manufacturing. Lycke, Box 2471, Cleveland 12, Ohio.

MAKE Perfume. Make Money. Free book tells how. Lawson, 21 Joiner, Saint Augustine, Florida.

START Your own business! Big money manufacturing novelties, plaques, statuary. Free catalog. Write Bing Products, 88-B2X Broad Street, Boston 10, Mass.

AT Home—Your own manufacturing business; making popular \$1.00 novelties. Cost you 3c to 15c. Everything supplied. Write So-Lo Works, Dept. T-6011, Loveland, Ohio.

GET Dollar Orders by Mail! You keep 90c profit! Easy, pleasant, home operated business. Just \$5.00 capital starts you! Complete plan, only \$1.00—Interesting details free. Send today! William Redmond, 1216-B Park Row Bldg., New York 7, N. Y.

MANUFACTURE costume jewelry at home for profit, hobby, therapy. Free wholesale supply catalogue. Instructions. Florida Supply House, Bradenton, Florida.

A Factory in your own home or garage; Manufacture and sales rights mechanics waterless hand cleaner; \$500-\$1000 monthly; No Special Equipment Necessary. Schaffner Laboratories, Pittsburgh (2), Pa.

FREE Literature describing 20 money-making plans. Dallis Ruth, Wheelersburg, Ohio.

5000 QUARTERS Monthly! Detailed plan only 25c. Schneider, 1038 Holland, Schenectady 3, N. Y.

\$246.50 MAKING baffling secret device without skill, machinery, from former top priority war material costing \$1.50! Guaranteed simple, revolutionary new discovery, unbelievably profitable. Universal appeal. Frank, illustrated proofs, free! Rolls Enterprises, 115 W. 16th., New York 11.

RUBBER moulds made to order. Stock moulds. Vallance Art Products, 1873 East 70 St., Cleveland 3, Ohio.

"THERE'S Big Money In Junk," and repairing Car Batteries! Batteryman, Grand Junction, Colorado.

SHELLCRAFT Instructions—Free! Make beautiful seashell jewelry! Wholesale Catalogue of complete line shells! Plastic discs! Animal Shapes! Pinbacks! Earrings! Cameos! etc. (Buy Direct). Pace's, Box 279, Bradenton, Florida.

25c INSTRUCTIONS and drawings for manufacturing Gamepuzzle. Mason, Box 86, Lynwood, Calif.

FREE literature describing 137 tested money making plans. Sars Sales, Hatch, N. Mex.

CASH In on one of today's fastest money makers. Make up to \$200 weekly refinishing leatherette and leather stools, seats, chairs, booths, etc. with Leathercote Plastic. Simply brush it on; dries almost instantly, leaving beautiful, scuff-proof, leatherlike finish. Eliminates necessity of expensive upholstering. Refinishing quickly done on customer's premises without disrupting business routine. Refinish plain stools for \$1.00 each. Average tavern job brings \$20.00 in two hours. Every tavern, restaurant, hotel, beauty parlor, picture show, etc. a prospect. No competition. Leathercote Company, Inc., Dept. 30, 713-A Linwood Blvd., Kansas City, Mo.

UNLIMITED Earnings, create ideas and business builders for merchants. Copyrighted materials, instructions, \$2.00 Refundable. Keirstead, 3541 North Meridian, Indianapolis 8, Indiana.

YOUR town is ripe for a profitable collection agency. \$5000 first year easily possible. We train you, coach you, get you started and help develop your business. Send \$1.00 for starter course, or ask for facts. American Collection Associates, 226 State St., Schenectady 5, N. Y., Dept. S.

LEARN Battery repairing, rebuilding. Engineer offers money making methods. Battery Bureau, 2225 North 44th St., Milwaukee 8, Wisc.

GET Your Mail Order Start by joining the National Mail Order Guild. They tell you all the facts. What Sells—who Buys by mail and How to reach them. They help you every step of the way. Write today. A. J. Shutt, Dept. G-4, 506½ S. 15th St., New Castle, Indiana.

FORMULAS—Money Making Plans. Literature Free. Jackson, Box 111, Newberg, Ore.

WIN money on contests advertised in every magazine and on radio. General Contest Magazine, published monthly, gives hundreds of tips. Lists current contests and rules. Sample 25c. General Contests, 1609-A East 5th, Duluth, Minn.

500%-1000% profit and up. Your own interesting service business. Tremendous demand everywhere. Experience unnecessary. We teach, help, supply everything. Practically no capital needed. Resistal, Inc., 1757-A Sunnyside, Chicago 40.

WHOLESALE Directory \$2.00. Racetrack Systems \$1.00. Business Opportunities \$1.00. Reimer, T-1119 Chestnut, Saginaw, Michigan.

SEWING Machine Repairmen make big money lifetime. Start neighborhood shop. Complete repair manual, covering all makes, \$1.98 postpaid. Money Back Guarantee. Sewmachine Serviceman, Hamilton 10-A, Ohio.

ELECTRIC Clocks are everywhere you go, buildings, homes, parking-lots, factories. Repairs increasing. Our easy to learn course with pictures and drawings teach You how to repair these clocks. Electronic Supply Co., Box 2350-B, Houston 1, Texas.

UNUSUAL mail order opportunity. For details write, Ray's Supply Co., 1741 Stephens Rd., Kalamazoo 81, Mich.

YOUR Own Profitable Business. Spare or full time. Information 10c. Marvett, 211 Hightower Building, Oklahoma City, Oklahoma.

A \$100-A-MONTH hobby at home! No soliciting, no mail order, no meeting people. Easy, enjoyable pastime. Details, 25c (refundable) Laura Dickson, 808-PS Elizabeth St., Anderson, S. C.

MAKE flexible molds! Few cents each! Cast plaques, novelties, bookends! Free sample! H. Tooker, Hamilton 7, Ohio.

"FIRE Alarm systems for the home. Fast seller. Every home owner a prospect. Plans \$1.00, or send postcard for further details. Regent Electric, 70 Rockland St., Boston, (Rox.), Mass."

EXCELLENT profits raising mink. Details furnished. Franklin Young, Riverhead, N. Y.

PRIZE Contest Fans Reap Rich Rewards. Enclose 3c stamp. National Contest Bulletin, Box 2685-S, Miami 31, Fla.

EARN \$25-\$100 weekly. Complete Details, 25c. S. Goldstein, 6324 Bay Parkway, Brooklyn 4, N. Y.

METAL Eagle foot scrapers, etc. Paint per instructions. Great demand by homes and antique shops. Literature. Sheldon Fisher, Fishers, N. Y.

LADIES. Want independent income? Write for particulars about The Very Thing to do. No selling. Spare time work. West Agency, Box 2115, Pueblo, Colo.

VETERANS Only. Earn money, spare time. No selling. Disabled welcomed. Veterans Cooperative, LaGrange, Georgia.

A Business of your own! Go into business for yourself. Start at home in your spare time. We can help you! Details free. Rennolet, 1022-B 9th Street, Rock Island, Ill.

AMAZING Profits in Home operated distinctive exclusive. Art-Gifts Specialty Business. Write for starting ideas. Valvick, Warba, Minnesota.

"TIMELY Tips Magazine." Paulding, Ohio Prints Promotional Plans. Ideas Opportunities Galore! 19th Year. \$1.00. Three Months, 25c.

WHOLESALE Catalogue and home profits 10c. Holm Sales, Box 12B, Oaklandon, Indiana.

\$100.00 WEEKLY Easy, as our Agent. Rush \$2.50 for Sample. Information. Valley Sales Company, Weslaco, Tex.

RECONDITION Motors without new rings. Instructions 25c. Charles, 12 EB, Norwood, Ohio.

\$50-\$100 WEEKLY! Almost no Capital, no selling or manufacturing. Instructions \$1.00. Pamats, Brooklyn 21, N. Y.

\$1,000.00 REWARD For A Bible Text!! Complete details of this remarkable late offer absolutely free with our "20th Century Bible Course" with 30 lessons, consultation and lesson grading service, diploma and three beautiful volumes from "Timely Topics Library". A \$25.00 course for only \$4.95—Refunded with your diploma making course virtually free! Paul M. Jenkins, 1719 Larrabee, Chicago 14.

VETERANS! Loan Guaranty offers amazing opportunity for financial security. See Page 52.

59 FORMULAS, PLANS, ETC.

137 MONEY-making plans, also formulas for salable products. Descriptive booklet free. Elite Co., 220-A Grand St., N. Y.

MAKE Products yourself. Free formula Catalogue. Schaffner's Laboratories, Emsworth, Penna.

FORMULAS—All kinds. Latest money-makers; literature Free. Kemi-Kal, Park Ridge, Ill.

"NEED Chemists? Products duplicated? Formulas? Analyses? Consulting Scientific Company, Swarthmore, Pennsylvania."

APPROACHING person operates electronic switch. Illustrated plans \$1.00. Tie-man, 4425 Redmont Ave., Deer Park 13, Ohio.

10,000 FORMULAS and Trade secrets. Free Literature. Stillmans, 555 Kingston Ave., Brooklyn 3, N. Y.

FORTUNES in Formulas, 900 pages, 10,000 ideas, processes, secrets, Moneyback guarantee. \$2.95 postpaid. Free details. Ray's Supply, 1741 Stephens, Kalamazoo, Michigan.

100 SINGLE ingredient formulas 25c. Tes-Co, Box 189-SG, Wilkes Barre, Pa.

FORMULAS—Modern, practical, Consultation, Duplicating, Research, Moon, East Broadway, Fulton, N. Y.

FORMULAS—Latest Best. Analysis. Giant formula catalog and chemical Instruction Sheet 10c. Refunded first order. E-Belfort, Engineering Building, Chicago 6.

POPULAR SCIENCE OPPORTUNITIES

106

PLASTICS

PLASTICS—7 colors sheets and rods. Send stamp for price list. Hanson Plastics, 7625 South Parkway, Chicago 19.

NEW liquid plastic, Clear, colors. Cast without heat. Embed flowers, insects, coins. Saw, drill, carve. Manual tells how. Send \$3.35 for complete 20 project kit including one pound liquid Castolite, Castolite, Dept. E-24, Box 211, Kenilworth, Ill.

SPECIAL—One Pound Lucite, Cement. Instructions. Diagrams. Only \$1.00 C.O.D. Novalte Plastic, P. O. Box 106-S, Brooklyn 19, N. Y.

PROJECTS. Ten Marvelous Plastic. Guaranteed. \$1. Plasticplan Co., Box 181, Cincinnati 1, Ohio.

GUARANTEED: We are America's lowest priced plastic supply house. Write for free price lists: Allcraft Products, Hempstead, New York.

HOME Crafters! Plastic formula-moulding instructions \$1.00. Box 84, Station K, Toronto, Canada.

HOME Training through "Working With Plastics," covering every step, every material. \$1.25.—Plastic Hobby Kit: 2 lbs. Lucite, Plexiglas, bottle cement, 2 bottles plastic dye (red, green) \$3.25 postpaid. (Includes instructions.) Modern Technical Book Co., Dept. MS, 55 West 42nd St., New York 18, N. Y.

MAKE money assembling our pre-fabricated plastic kits. Sample Kit 50c. Catalog free. Fabros, Box 156, Station F-2, Buffalo 12, N. Y.

PLASTICS and supplies; book on Plastics \$1.50; kits \$3.00—\$5.00. Special internal carving drill \$1.30. FOB St. Louis. List. Plas-Met Sales and Engineering, 4648 Shirley Pl., St. Louis 15, Mo.

PLEXIGLAS masked sheets 12" x 12" 1/16" \$1.00, 1/8" \$1.25, 3/16" \$1.55, 1/4" \$1.85. Include 10% postage. Dyes, Rods, cements, shells, jewelry findings, tools, buffing compounds, free listings, Craft Plastics, Box 129-S, Somerville, N. J.

PLASTICS, Free List, Swiss Music Box Units \$3.50—New Plexiglas Manual \$1.50. Plastic Supply Co., 2618 St. Louis Ave., Dept. PS52, St. Louis 6, Mo.

MAKE perfect copper molds for plastics. Complete instructions \$2.50. A. Manning, Box 165, Tuckahoe, N. Y.

INJECTION Molded Plastic Parts for 4" Baby Ball—Gyro Singing Top—Three Compartment Tray. Red, Blue, Ivory, and Pink colors. Tenite and Polystyrene materials. Easy to assemble. Complete kit \$1.00 postpaid. Quantity prices included. Economy Precision Products Co., 10 Main Street, Germantown, Wisconsin.

GOLD Imprinter \$3.25. Samples .10. G.P.E., 8 Walden, Cambridge 40, Mass.

MAKE Plastic Novelties with Hollywood kit containing 2 lbs. of Lucite and Plexiglas; 3 colors of dye, bottle of cement and complete instructions. Postpaid \$3.25. Hollywood Items Co., Dept. PS, Box 1151, Hollywood 28, California.

NOW we are able to offer a complete line of plastics casting supplies. Complete instructions. Free literature. Sample kit \$3.00 F.O.B. Plasticast Industries, Box 199, Romeo, Michigan.

ATTENTION! Hobbyists and Experimenters—You cannot miss on a buy like this: Sample Kit—Lucite and Plexiglas odds and ends. Makes many useful things: rings, tie pins, pencil holders, earrings, etc. Price . . . 98c. DeLuxe Master Kit—Makes cigarette boxes, jewel boxes, earring stands, picture frame, jewelry pieces, etc. Price . . . \$2.98. Fairyland Plastic Products Co., 2316-18 Third Ave., New York 35, N. Y.

PLASTIC Tablecloth Covers, Curtains, Drapes, Baby Pants, Bowl Covers and other Plastic Articles selling like wildfire! Make big money now! Free Details. Write Plastics, Dept. 59-E, 206 N. Fourth, St. Louis, Mo.

33

CHEMICALS AND APPARATUS

LUMINOUS Paints will glow in dark. Six colors. Fairmount Chemical Co., 136 Liberty St., New York City 6.

THE House of Winn, home of supplies for amateur chemists. See Winn's New Idea chemical kits and apparatus outfits for home experimenting. Send 10c for retail catalog. Established 1931. John H. Winn, Dept. 607, 124 W. 23rd St., New York 11, N. Y.

CHEMICALS-Lab. Supplies New Catalog 10c. Mel-Glo Chemical Co., 258 Fourth Avenue, Brooklyn 15, N. Y.

CHEMICALS and apparatus for industrial, analytical, and private laboratories. Complete supply service for correspondence school students. Send 3c for catalog. Dept. M-26, Biological Supply Co., 1176 Mt. Hope Ave., Rochester 7, N. Y.

FREE Catalog; Chemistry, Mineralogy, Biology, Physics, Tracey Laboratories, Evanston, Illinois.

NEW laboratory Supply Catalog of Chemicals and apparatus. Contains over 5000 items with illustrations, 212 pages. Send 50c. Standard Science Supply Co., 1232 No. Paulina St., Chicago 22, Ill.

HANDBOOK for Chemical Experimenters. Hundreds of experiments; illustrated: 50c. Experiment Booklet, 15c. Supply Catalog, 5c. Reading Scientific Co., Reading, Pa.

CHEMICALS, ounce quantities, apparatus, catalog 5c. Fleischer's Laboratories, Everett 49, Mass.

CHEMICAL Indicator Kit \$1.75, others. Microkit, Box 324, Jamaica, N. Y.

SOMETHING New! Student chemists send 5c for catalog and free copy of "Know Your Chemicals" Met & Co., 160 Hillside Ave., Nutley, New Jersey.

"CHEMICALS—Ten pure samples; valuable information. Send \$1.00. Zahler, Rt. 1, Clackamas, Ore."

HANDBOOK of Chemical Information, 50c postpaid. Catalog Free. Amaco Laboratories, Box 3246 A, Amarillo, Texas.

68 HELP WANTED

CONSTRUCTION workers attention! In Philippines, Hawaii, Okinawa, Alaska, South America, large construction contracts. Excellent opportunity. Send \$1.00 for details. Personnel Service, Box 949-B, Knoxville, Tenn.

MAKE More Money selling individualized buckles, belts, tie holders, cap badges: Choice of 2000 emblems. Quick profits—repeats. Special Outfit Offer. Write Hook-Fast Products, Dept. B, Columbus 6, Ohio.

5 AGENTS WANTED

GOOD Paying Business Silvering mirrors, plating autoparts, reflectors, bicycles, bathroom fixtures, etc., by late method. No tanks or shop required, outfit furnished. Free Booklet. Gunmetal Co., Ave. G, Decatur, Illinois.

LICK After-war layoffs; Start own business; home, office. Booklet describing "Collection of 127 Tester Plans" free. Elite Co., 220 Grand St., New York.

FREE Water and our concentrates makes flavors, lotions, shampoos. 72 products, labels, bottles furnished. Qualco, F-20030 Russell, Detroit.

FREE! Latest issue Opportunity Magazine, Salesman's Guide. Inspiring, constructive. Shows how to earn money selling for others or in your own business. Hundreds postwar opportunities. Send name and describe what you have sold or are selling. Illustrated copy sent Free. Opportunity Magazine, 620 N. Michigan, Dept. 18, Chicago 11, Ill.

AGENTS—300% profit selling genuine gold window letters; stores and offices. Free samples. Metallic Letter Co., 437 N. Clark, Chicago.

SELL Greeting Cards, Display Signs, Pictures, Books, Novelties, Big Profits. Bulletin Free. Elfco, 432 North Wells, Chicago 10.

SELL Personal Initialed Individualized Belts, Buckles, Cap Badges, Tie Holders, 2,000 emblems to choose. Fast profits. Repeats. Write today special outfit offer. Hookfast Specialties, Box 1425, PS, Providence, Rhode Island.

AMAZING New Zipper Shoe sells on sight. Big profits for salesmen. Leads line 200 splendid styles. Territories open. Get Free Sample Outfit, Write Victor Thomas, Dept. V-784, Chippewa Falls, Wisc.

90c PROFIT Each \$1.00 Sale. Sell Positive mothproofing solution to housewives, stores, agents. Experience unnecessary. Postal brings details. Kinford, Wayne 4, Pa.

AT Home—Your own manufacturing business; making popular \$1.00 novelties. Cost you 3c to 15c. Everything supplied. Write So-Lo Works, Dept. T-601, Loveland, Ohio.

\$1. STARTS you in business. Sell DeLuxe ties, 100% wool interlining. Costs you only \$7.00 per dozen, you make \$5.00 Dozen. Send \$1.00 for special introductory offer two DeLuxe ties. Catalog complete line Free. Philip's Neckwear, 20 West 22nd St., Dept. P-11, New York 10.

SELL Personalized soap. Name on every cake. Ideal for gifts. Get sample offer. Dunbar Soap, New Brunswick, N. J.

GOLD lacquered Window Sign Letters. Large Sizes Penny Each. New Foils. Absolutely Beautiful. Free Samples. Atlas, 544 W. 79th, Chicago 20.

MAKE money in your spare time! Helps furnished. Easy sales. Voluntary repeat orders. Liberal commissions. Write for Free Wholesale Price List Today! McGregor Magazine Agency, Dept. PS-7, Mount Morris, Ill.

"BIG bargains for big profits. Over 100 sensational values. Men's used suits \$2.00, pants 35c, topcoats \$1.25, Overcoats \$2.00, shoes 20c. Experience unnecessary. Free wholesale catalog. Superior, 1250-A Jefferson, Chicago 7."

MAGIC Cleaner—Hotter than a fire-cracker. Saves Soap—Big Profits—Sample Free. Uco, 5007 Irving Park, Chicago.

GREETING Card Agents: "Line Up" with "Pines" for bigger, better and quicker profits. Rush name, address on postcard today. Box 32, Flushing 6, N. Y.

EARNING Less than \$200 weekly? Boost income quickly. Fast selling celluloid price tags, metal moulding, menu covers. Every store, restaurant buys. Pricing Press, Dept. CX, 124 White St., New York.

START Your Own Business on Our Capital. Always your own boss. Hundreds average \$6,000 to \$25,000 annual Sales. We supply stocks, equipment on credit. 200 home necessities. Selling experience unnecessary to start. Wonderful opportunity to own pleasant, profitable business backed by world-wide industry. Write Rawleigh's, Dept. E-U-PSC, Freeport, Ill.

DOUBLE-Duty Shopping Bag, Zips open. Instantly changes from small to large size. Lightning Seller. Samples sent on trial. Kristee 135, Akron, Ohio.

JUST Out! History of World War II. Huge Volume. Popular price. Authentic text. Official photographs. Big profits. Riverside Book Company, Iowa Falls, Iowa.

NEW Patented Invisible belt, keeps shirt-tails in. Men, Women, unlimited earnings, sells easily, millions prospects. Free particulars, Invisibelt, PS1 Box 26, Elmwood Station, Omaha 6, Nebraska.

AT Home—Your own business making-selling-popular \$1.00 novelties. Cost you 3c to 15c. Everything supplied. Write So-Lo Works, Dept. T-6013, Loveland, Ohio.

ENJOY lifetime security recommending best life and disability insurance. Write Reliance Life & Casualty Co., Dept. 1070, Phoenix 3, Arizona.

POPULAR SCIENCE OPPORTUNITIES

NUPROCESS Products Laboratories, Dept. 279, Aurora, Illinois, have some choice Distributorships open. Exclusive territory franchise. Big Profits. Wholesale and Retail. Age no barrier. Men and women eligible. Cash profits start first hour. Two products (1) Silver Plating Liquid (NuSilver Trademark Patent No. 245,336, and Re-Plate-O Trademark Patent No. 367,355), and (2) Lectrik Silver Kleaner Plate for quick de-tarnishing of silverware. Full details free. Write them today.

EXCELLENT Sideline for printing and advertising salesmen. Decalcomania name plates in small quantities. Great demand. Also, make money with our line of Automobile Initials and Sign Letters. Free Samples. "Ralco", XL-Roxbury, Boston 19, Mass.

FREE—New 42-Page Book Entitled—"How to Become a Successful Direct Salesman," written by salesmen for those who want to become salesmen and earn up to \$100 and more weekly. Send penny postcard. Specialty Salesman Magazine, Dept. PS-3, 307 N. Michigan, Chicago 1, Ill.

IMMEDIATE Profits! Take orders for our beautiful Laminated Plastic Reproductions of any picture or negative. Full or part time opportunity for Big Earnings without investment. Free details, Gotham Products Company, Box 5427, Philadelphia 43, Pa.

SELL Stewart's E-Z Silver Detarnisher to Hotels, Restaurants, Public eating places. Detarnishes, cleans, brightens, in one operation. Takes the place of soap and polish. No rubbing, brushing, polishing or boiling. Saves 100% time, labor, and money. Every demonstration a sale and steady repeat customer. Protected territory. No experience necessary. Factory to you. A postal card will bring you "Once in a lifetime road to fortune," full particulars. F. P. Stewart, Manufacturer, P. O. Box 692, Miami Beach, Florida.

200 Money Making Deals. Plans—Rare formulas—Schemes—Folio Free. Formico Company, Box 572, Dayton, Ohio.

100% PROFIT or more. No investment. Unusually steady business. Handle Photo Stamps. Amazing Stamp size gummed-back, glossy photographs. 100 Retail for only \$2.00. Free samples and information. American Foto Stamp Co., 103 East 125th Street, Dept. (401), New York 35, N. Y.

EARN Money With Handmade Jewelry. Assemble original creations for gifts, resale. We supply the necessary parts. Dollar starts you! Free—Wholesale proposition. Hughes Plastic Works, 712 Kimball, Danville 2, Ill.

SELL Men's Latex. Large Profits. Send \$2 for samples, details. Peerless Sales, 913-H Main, Kansas City, Mo.

BOYS, Men, Lawn Mower Sharpening Shops. It's easy to build your own power mower using our "Handy Dandy Conversion Kit." Write us for details, Le Claire Mfg. Company, Le Claire, Iowa.

QUICK Profits selling full or part time, individualized buckles, belts, cap badges, tie holders, uniform shirts, caps, ties. Choice of thousand emblems. Sure repeat orders. Easy-selling outfit offer. Write Hook-Fast Co., Dept. 14, Roanoke, Va.

WHERE To Buy 800,000 articles direct from manufacturers; save middleman's profit; folder free. Glass Pub. Co., Ellwood City 5, Penna.

SELL Delicious Candies, Nuts, Gum. Immediate delivery. Write Casterline, 2031-PS Sunnyside, Chicago 25, Ill.

\$3 FIRE Extinguisher sells wholesale or direct. "Fire-Killer", 101 Franklin, Syracuse 1, New York.

MAKE flexible molds! Few cents each! Cast plaques, novelties, bookends! Free sample! H. Tooker, Hamilton 7, Ohio.

AMAZING discovery, Master Glaze, puts brilliant glass-like surface on cars. Free sample, information, Big commissions. Master Glaze, Dept. 584, 7720 Harwood, Milwaukee, Wisc.

MILLIONS want foot comfort! Amazing daily profits. Sensational new arch support body-balancer for men, women selling like hotcakes. Experience unnecessary. Complete outfit free. Special deal to distributors, crew managers. Write: Colt Shoe Company, 244-C5 Purchase, Boston 10, Mass.

BIG Profits. Sell hand colored Photo enlargements. Rich, 215 W. 98, New York C.

AGENTS. Substantial profits. Repeat order products. Not mere "job" but opportunity establish steady income. Additive lubricant. Limitless field. Factories, autoists, service stations, fleet owners buy in huge quantities. Write Kidder Oil Company, La Crosse 4, Wisc.

SALESMEN Collect, Keep \$1.00 each \$3.50 Sale. We collect balance. A-1 Fire Extinguisher. Easy Sales. Flame-Killer, Box 27, Flint, Michigan.

GREETING Cards, Gift Wrappings, Novelties, Personalized Papeteries, Raum, 4154 Fifth Street, Philadelphia 40.

PLASTONE—Amazing new polishes for floors, furniture, autos. Beautifully packaged. Low priced. Whirlwind seller to stores, gas stations, homes, fast repeater. Big profits. Unconditional money back guarantee. Write for free samples offer now! Plastone Company, 2207, PS-5, West Chicago Ave., Chicago 22, Ill.

COLLEGE Students! 100% Profits selling Costume Jewelry. W. Morris, Maywood, N.J.

BIG Cash year 'round profits. Show friends sensational value 14 card All-Occasion Box assortment. Wildfire \$1.00 seller. Your profit up to 50c per box. Also quick money making Birthday, Get Well, Correspondence Notes, Gift Wrapping boxes. Extensive Personalized Stationery line. No experience needed. Special Offers. Request \$1.00 Everyday box on approval and Free Stationery Samples. Holiday Card Co., 463 Congress St., Dept. E, Portland, Me.

SELL Everyday Greeting cards, stationery, Notes. Large assortments. Free Catalog. Atlantic Card, 3525 Reisterstown Road, Baltimore 15, Md.

WOULD you pay 3%—first \$350 made? Color-illustrated book "505 Odd Successful Enterprises" free! Proven! Work at home, office. Expect something odd! Pacific, San Clemente, Cal.

NEED Money? Start your own business! 137 Different detailed plans. Sparetime, home, office. Small investment, immediate returns. Free booklet. Twin Park Co., Box 4696, Dallas, Texas.

AMAZING daily profits. Big repeat business. Sell top-quality, lowest-priced men's, women's hosiery, full, part-time. Experience unnecessary. Take orders. We deliver. Complete outfit free. Write Colt Shoe Co., 242-C5 Purchase, Boston 10, Mass.

69 HIGHGRADE SALESMEN

AMAZING daily profits, steady repeat business selling Colt's famous Foot-Balance Shoes direct. Exclusive features make selling easy. 216 styles! Experience unnecessary. Patented Foot-O-Graph assures accurate fitting. Free Selling outfit. Colt Shoes, 601-C5 Atlantic, Boston 10, Mass.

POCKET Pal: The All-Purpose Cutting Tool. Wagon Jobbers—Salesmen. Sell to retailers and jobbers. 50c seller. Steady repeat item. Exceptional profit. Sample 25c. Nelson Manufacturing Company, 222 W. Kellogg, St. Paul 2, Minn.

50 EMPLOYMENT SERVICE

TEACHERS Needed Central, Rocky Mt., Pacific states. Vacancies: Grades, H.S., College. Free Enrollment. Western Teachers Exchange, 215 Plymouth Bldg., Minneapolis 2, Minn.

HOW to get the job you want. Free information. Dee Enterprises, 3360 Sims, Overland 14, Mo.

\$1.00 BRINGS list of 100 firms with Latin American projects or branches including job requirements and simple letter of application. Foreign Service Training Institute, Box 1897, Riverside Station, Miami 35.

LOS ANGELES Area—Our brochure gives latest employment demand by trades; housing possibilities; present & future industrial expansions. Postpaid \$1.00. H. R. Brown, Box 1315, Santa Ana, Calif.

47 EDUCATIONAL AND INSTRUCTION

MODERN Welding School gives thorough training for one of industry's best paid jobs. Experienced instructors. Individual attention. Nonprofit institution. Qualified under G. I. Bill. Write for literature and details, Hobart Brothers Co., Box P-1067, Troy, Ohio.

GOOD "Used" self-instruction educational books on all subjects bought, sold, rented, exchanged. Satisfaction guaranteed. Complete information and 100-page illustrated bargain catalog Free! Write—Nelson Company, Chicago 5.

HAVE your own office! Many earn up to \$5,000-\$15,000 Annually. Learn credit-collection agency business by home study course. Experience unnecessary. Write for Free bulletin. No obligation. Franklin Credit School, Dept. 203-E, Roanoke 7, Va.

BIG money rebuilding shoes. Help needed everywhere or start big-income business of your own. Learn practical, sure, easy way in 3 months. Anyone from 18-60 years can learn easily. Approved for G.I. training. Rush postcard today. Modern Shoe Rebuilding School, Est. 1927, 2935 Belmont, Chicago 18, Illinois.

HYPNOTISM. "How I Hypnotize" 25c. Dr. Lonk, Hypnotist, D-1619, Palatine, Ill.

PREPARE for civil service examination. Pay for course after securing position. Write Free School, Dept. PS-5 Kokomo, Ind.

HOME Study course, drugless therapy. Free Literature. Inst. of Drugless Therapy, Tama, Iowa.

"UNCLE Sam" Jobs! \$1756-\$3021 year. Men-Women. Prepare for next examinations. Veterans get preference. 32 page Booklet on Civil Service Free. Write Franklin Institute, Dept. H-23, Rochester, N. Y.

WHY Don't You Write? Writing short stories, articles, etc., will enable you to earn extra money. In your spare time we teach you to write the way newspaper men learn—by writing. Free "Writing Aptitude Test" tells whether you possess the fundamental qualities essential to successful writing. Veterans: This course approved for Veterans' Training. Write today! Newspaper Institute Of America, Suite 566-A, One Park Avenue, New York 16, New York.

CLINICAL Laboratory Technicians in great demand. We train you in your spare time, in your own home. You can practice while studying. Write for free catalogue. Imperial Technical Institute, Box 973-B, Austin, Texas.

LEARN Trigonometry better than others. Master method instructions \$1.00. Guaranteed. J. Ziembra, 6123-B Orchard, Dearborn, Mich.

HERBALISM—Complete Course in 2 volumes, 1000 recipes. Home Service, Forestville 3, Va.

BUILDING boom is here. Free particulars about most lucrative trade. Lidemark, 226 Potomac, Buffalo 13, N. Y.

HYPNOTIZE anyone. Secrets revealed. Exciting experiments. \$1. Mohr, 810, 75 Kneeland, Boston 11, Mass.

LEARN To "Speak in Public". Overcome fear. Speak fluently with confidence. New Simplified method. Easily mastered. Absolutely guaranteed. Amazingly low cost! Write for free details. Trissel-Heymann, Publishers, Mason City 3, Iowa.

OPERATE commercial Employment Agency. Many more needed Nationally. Earn \$5000. upwards annually. Experienced Director has low-cost full instruction course. Information free. Hunt, Box 308, Burlingame 22, Calif.

POPULAR SCIENCE OPPORTUNITIES

LEARN Photo-Retouching. One of the most profitable fields of commercial art. Positions always open. Experts earn \$5000 a year. Practical and easily mastered course. Personal instructions. No special ability needed. Write at once for full particulars. School of Commercial Illustrating, 3720 N. Penn St. #40, Indianapolis, Ind.

LOCKSMITH Course. Lock-picking, key-fitting, etc. \$1.00 prepaid. Miller, Box 239, Holdrege, Nebraska.

USED Correspondence Courses and Educational Books Bought, Sold, Rented. Catalog Free. Educational Exchange, Hensgar, Alabama.

OCCUPATIONAL Success Chart. How to Study Guide. Free. Prepared by college authorities. Learn how to make your own practical Home Study Course of every text in big educational catalogue. Send for free Chart and Guide today. Central Educational Service, Dept. B-34, 6009 Belmont Avenue, Chicago, Illinois.

BETTER your conditions through nerve force. Development. Instructions reveal all, tells how to overcome fear, nerves, worry, obstacles, free details. O'Leary, Box 594-B3, Baltimore 3, Md.

AMAZING discovery: Review Touch Typewriting develop terrific Typewriting speed. 25c coin. Walker, Box 394, Union, N. J.

SAVE money! Enjoy interesting hobby brewing beer at home. New manual furnishes instructions. Send \$1.00. Scientific Publications, 274 Brookline Avenue, Boston, Mass.

77 LANGUAGE OUTFITS

29 LANGUAGES by Linguaphone, Russian, Spanish, Portuguese—Direct Conversational Method for Mastering any language quickly, easily, correctly at home. Available under GI Bill of Rights. Send for free Book, Linguaphone Institute, 54 RCA Bldg., New York, CI 7-0830.

10 AUTHORS SERVICE

I WANT New Writers to cash hundreds of checks for \$1 to \$100, offered each month. The easiest way to write for pay. No previous experience necessary. Send for Free details. No obligation. Saunders M. Cummings, 467-S Independence Bldg., Colorado Springs, Colo.

NEW Writers Needed. Nonfiction material demand is booming. Many magazine editors buy features and "fillers" from new writers. Our Earn As You Learn lessons prepare you to meet their requirements. Experience unnecessary. Reasonable price, unexcelled service. Details, sample lesson free on request. Use postcard. No obligation. Comfort Writer's Service, 210RN S. 7th St., St. Louis 2, Mo.

25 BUSINESS SERVICE

GOOD "Used" self-instruction educational books on all subjects bought, sold, rented, exchanged. Satisfaction guaranteed. Complete information and 100-page illustrated bargain catalog Free! Write—Nelson Company, Chicago 5.

SAVE—Buy direct from manufacturers. Any article. Guaranteed lists. Pittshire Research, Box 90, Pittsfield 4, Mass.

TO Whom It May Concern: We will represent you in all principal cities of the world. Personal or business assignments \$1 per hour. James W. Farley, Citizens Bldg., Cleveland 14, Ohio. Note: Would appreciate hearing from someone who wishes to enter this business in your city. Will send you assignments immediately. References exchanged. State qualifications.

ENJOY Big Mail Sales. Your Ads, Letters, Folders, etc. That Sell! Written by Faultless Advertising, 3439-S, Michigan, Chicago 16.

30 CARTOONING, SIGN PAINTING, DRAWING AIDS

CARTOONS drawn to order. Jagoda, 79 St. Alphonsus St., Roxbury 20, Mass.

74 POPULAR SCIENCE

"HOW To Make Money With Simple Cartoons"—A book everyone who likes to draw should have. It is Free; no obligation. Simply address Cartoonists' Exchange, Dept. 1445-C, Pleasant Hill, Ohio.

ADS, letterheads illustrations, trademarks, cartoons, etc. Free literature. Hal Barbo, O'Fallon, Mo.

LEARN sign painting, be independent. Signways, 4933 W. Erie St., Chicago 44.

LEARN Showcard writing at home, in spare time. Fascinating lifetime business of your own. No special skill needed. Free information. Sherwood Publishing Co., Irvington 56, N. J.

MAKE Signs, 9 complete alphabet pattern sets, 3 complete numeral pattern sets and catalog \$1.00. Sign Letter Distributors, P.O. Box 101, Mineola, N. Y.

EARN Money Evenings, copying and duplicating comic cartoons for advertisers. Adservice, Argyle 2-B Wisc.

ARTISTS—Turn talent into Cash. Send for Portfolio of Stencil Prints. Heath Filmed Stencil Products, Lawndale, Calif.

31 CHALK TALK STUNTS

CHALK Talks, Laugh Producing Program, \$1.00. Illustrated Catalog 10c. Cartoonist Balda, Oshkosh, Wisconsin.

136 TYPEWRITERS

RECONDITIONED Typewriters, Printing Devices, Office Appliances Supplies Dixiegraph, King, N.C.

PORTABLES—Standards immediate delivery. Every machine guaranteed. 30 day refund privilege. All Makes Typewriter Co., Omaha.

118 RUBBER STAMPS

3 LINES 40c; Pads 35c; Signatures \$2.00. Prinrite, Wawatusa, Wis.

RUBBER Stamps Buy direct from manufacturer. Literature free. Lee-Vall Press, Box 1242, Indianapolis 6, Indiana.

110 PRINTING OUTFITS, SUPPLIES

"PRINTOMATIC" Selffeeding Post Card Stencil Printing Duplicators \$9.50 Up. Office Size Duplicators, Speedoprints, Hilcos, Excellographs \$33.41 Up. Literature Free. Pittsburgh Typewriter Supply, 336 WE Fourth Ave., Pittsburgh 22, Pa.

HOME Made Presses. Write Riegel, 1111 Harrison, Philadelphia 24, Penna.

HAND Presses, Cutters, Bindery equipment, Jobbers. Your requirements? Box 918, New York 8.

MAKE Your Own Plastoplate printing cuts. Simple easy process. Plastoservice, Argyle (2-A) Wisconsin.

109 PRINTING, MULTIGRAPHING, ETC.

FIFTY sheets, fifty envelopes, printed your name, address. 75c postpaid. Atlantic, Box 653-P, Rock Hill, S. C.

QUALITY Printing: Business, personal stationery. Prepaid delivery. Samples free. Mero Products, 99 Morrison, Punxsutawney, Penna.

SEND 10c Now, for our 36-page 1947 price-list—refunded first order. McCall Press, 1326 S. 27th, Omaha 5, Nebr.

1000 GUMMED Labels 75c. Stationery, etc. List free. Hugh Reed, Spiro, Okla.

CUT Printing Costs; 1,000 offset 8½ x 11 printed \$3.95. 5,000, \$15.75; larger quantities less; 48 hour service; samples, price list free. Fidelity Company, Parkersburg 12, W. Va.

MAY Special, 500 8½ x 11 letterheads, 500 6¾ envelopes printed, \$4.00. H. J. Vrazel, Yoakum 2, Texas.

2,000—4½x6 Circulars—\$4.25 postpaid. 150 word limit. Schultheis; Box 449; Irwin, Pennsylvania.

78 PATENT ATTORNEYS

INVENTORS: Without obligation, write us for information as to what steps an inventor should take to secure a Patent. Randolph & Beavers, Registered Patent Attorneys, 340-A Columbian Bldg., Washington 1, D. C.

INVENTORS: Write for free brochure "Evidence of Invention." Labiner, World Building, New York 7.

INVENTOR'S Guide free on request. Frank Ledermann, Registered Patent Attorney, 154 Nassau St., New York 7, N. Y.

INVENTORS—Patent Laws encourage the development of inventions. The Rules of Practice of the U. S. Patent Office advises—unless an inventor is familiar with such matters—that he employ a competent registered attorney, as the value of patents depends largely upon the skilful preparation of the specifications and claims. Write for further particulars as to patent protection and procedure and "Invention Record" form at once. No Obligation. McMorro, Berman & Davidson, Registered Patent Attorneys, 1437 Victor Building, Washington 1, D. C.

PATENT and Trade-Mark Practice before U. S. Patent Office. Validity and Infringement Investigations and Opinions. Booklet and form "Evidence of Conception" forwarded upon request. Lancaster, Allwine & Rommel, Registered Patent Attorneys, Suite 413, 815-15th Street, N.W., Washington 5, D. C.

INVENTORS: Learn how to protect your invention. The patent laws afford the inventor protection for the patentable features of his invention. The United States Patent Office advises the inventor to engage a competent, registered patent attorney to represent him. We offer inventors experienced, confidential service. Specially prepared booklet containing detailed information concerning patent protection and procedure with "Record of Invention" form will be forwarded to you upon request—Without obligation. Clarence A. O'Brien & Harvey Jacobson, Registered Patent Attorneys, 72B-D District National Bldg., Washington, D. C.

C. A. SNOW & CO., S-427 Snow Bldg., Washington 1, D. C. Registered Patent Attorneys. Established 1875. Literature mailed on request.

INVENTORS—Send today for "Detailed Patent Information" outlining preliminary steps to be taken toward Patent Protection. Also convenient "Evidence of Invention" form. Victor J. Evans & Co., 241-E Merlin Bldg., Washington 6, D. C.

INVENTORS. For "Record of Invention" form, contact Carl Miller, Registered Patent Attorney, Woolworth Building, New York.

PATENTS—Trade marks. Irving L. McCathran, 316 McLachlen Bldg., Washington 1, D. C. Registered Patent Attorney.

58 FOR INVENTORS

THE Inventor who believes he has a new and useful invention, and needs advice, should consult a competent registered patent attorney. Without obligation, write for full information on how to secure Patents and Trademarks. Randolph & Beavers, Registered Patent Attorneys, 340-E Columbian Bldg., Washington 1, D. C.

"INVENTOR'S Guide" free on request. Frank Ledermann, Registered Patent Attorney, 154 Nassau St., New York 7, N. Y.

INVENTORS: Avoid unnecessary expense. Write for free booklet explaining how our Consulting and Advisory Service can assist you in deriving greatest profit from inventing. Institute of American Inventors, Dept. 30-A, 1926 Eye St., N.W., Washington 6, D. C.

INVENTORS! Have you good patentable ideas? Write Patent Agent Metzler, 11 West 42nd, New York.

PATENTED, Unpatented inventions promoted. M. Joyce Humphries, 1424 Landtitle, Phila 10, Penna.

POPULAR SCIENCE OPPORTUNITIES

HIGHEST Royalties and cash for your inventions when we market them. Free particulars without obligation. Universal Marketing Co., Depart. 4C, 126 Lexington Ave., New York 16, N. Y.

HOW to make money from inventions: complete forms, with valuable information on avoiding costly blunders. One dollar. J. O'Brien, Patent, Development Engineer, 132 Nassau St., New York.

INVENTORS: Learn how to protect your invention. The patent laws afford the inventor protection for the patentable features of his invention. The United States Patent Office advises the inventor to engage a competent, registered patent attorney to represent him. We offer inventors experienced, confidential service. Specially prepared booklet containing detailed information concerning patent protection and procedure with "Record of Invention" form will be forwarded to you upon request—without obligation. Clarence A. O'Brien & Harvey Jacobson, Registered Patent Attorneys, 72A-D District National Bldg., Washington, D. C.

INVENTORS—Patent Laws encourage the development of inventions. The Rules of Practice of the U. S. Patent Office advises—unless an inventor is familiar with such matters—that he employ a competent registered attorney, as the value of patents depends largely upon the skilful preparation of the specifications and claims. Write for further particulars as to patent protection and procedure and "Invention Record" form at once. No obligation. McMorro, Berman & Davidson, Registered Patent Attorneys, 1436 Victor Building, Washington 1, D. C.

INVENTORS—Send today for "Detailed Patent Information" outlining preliminary steps to be taken toward Patent Protection, also convenient "Evidence of Invention" form. Victor J. Evans & Co., 242-E Merlin Bldg., Washington 6, D. C.

IF 5,000 people in America can use or benefit from your idea, I guarantee its sale at your price in less than sixty days. Don't show your idea to me or anyone else. Write for free information. George Pearce, 47V Bartholomew Street, Peabody, Mass.

SCALE Models Inc., Consultant Engineers development and construction of Mechanical, Electrical, Electronic and Decorational models for patent and industrial purposes. 104 Penn Street, Brooklyn 11, New York.

INVENTORS . . . There is absolutely no legal way to protect an invention without a Patent. Learn how to protect yours and receive selling help. Buyers waiting. I save you considerable in Patent Application cost. Invention Record Free. Charles R. Morton, Patent Broker, 11 West 42nd Street, New York.

HOW I made Gadget Inventing Pay. Detail booklet, \$1.00. W. C. DeWeese, Del Rio, Texas.

INVENTORS: You save up to 300% when dealing with your patent searcher direct. Complete search with patent copies \$6.00. Reports mailed in 5 days. Invention protection forms free. Write Raymond L. Smith, Patent Searcher, 703-S Albee Bldg., Washington 5, D. C.

75 INVENTIONS WANTED

INVENTIONS Promoted. Patented or Unpatented. Write Adam Fisher Company, 183-A Enright, St. Louis, Mo.

WANTED: Practical inventions suitable for sale through 5c-\$1.00 stores, drug-stores, cigar stores; also sportsmen's items of all kinds. Write Matt, 1412-S Great Northern Building, Chicago 4.

INVENTORS: Hundreds of manufacturers have requested our assistance in locating marketable new products. Complete information, free. Institute of American Inventors, Dept. 30C, 1926 Eye St., N.W., Washington 6, D. C.

INVENTIONS Wanted. Patented or Pending. Inventors Exchange, Dept. D, Hartford 1, Connecticut.

PATENTED, unpatented inventions wanted. We have tremendous lists of manufacturers who may pay cash, royalties. Descriptive booklet free. National Invention Service, 1404-D Mitchell Street, Oakland 1, Calif.

FREE Service: Descriptions of your inventions sent to 1000 manufacturers. National Industrial Chamber, 107 Washington Street, New York 6.

WANTED: Practical Inventions by Manufacturers, Patented or Unpatented. John D & Son, Dept. PS-5, Box 3213, 285 Howard Ave., Bridgeport 5, Conn.

EARN up to \$2,000 year. inventing simple items for special cash markets. Ideas only. No patents. Hendrickson, Argyle 8, Wis.

89 PATENTS

INVENTORS: Test the commercial value of your patented or unpatented inventions, quickly and inexpensively. Write for free information. Institute of American Inventors, Dept. 30-B, 1926 Eye St., N. W., Washington 6, D. C.

100 PATENTS FOR SALE

PATENT No. 2149816 Air cooled rubber Sanding Drum Pad. F. S. Mitchell, 4674 Ohio St., San Diego 4, Calif.

"DENTIFRICE containing, Dispensing Toothbrush" "automatic." Seibel, 6467 Wanda, St. Louis, Mo.

82 MANUFACTURING

MODELS, small lot manufacturing, metals, plastics, etc. Millburn, Burlington, Kentucky.

87 MODELS, MODEL SUPPLIES

MOST complete Illustrated Catalog—"O-HO OO" Model Railroad Parts ever published. Send 5c for mailing. Selly, 1377 Gates Ave., Dept. 836, Brooklyn, N. Y.

SHIP Model and yacht supplies, complete large 64 page catalogue, 30c. Wm. Wild, 510 E. 11th St., New York City.

MODEL Ship Builders! Are you looking for authentic, precision ship models? Send for richly illustrated fully descriptive catalogue in full color of famous ships of all kinds. Only 10c. Halesite Yacht Service Inc., Dept. C-28, Halesite, Long Island, N. Y.

SHIP and Yacht model fittings; blueprints. Send 25c for illustrated catalog No. 20—Listing hundreds of items. A. J. Fisher, 1002-2 Etowah Ave., Royal Oak, Mich.

BUILD Model Ships, Railroads, Catalog 10c. Ideal, 21 West 18th Street, New York 11, N. Y.

RAILWAY models, complete line. Combined HO and O gauge, catalogue, 35c. Walthers, 269 Erie, Milwaukee 2, Wisc.

SHIP Model Kits and Fittings . . . most complete stock in New England. Boucher, Fisher, Marine Model and Model Shipways fittings, blueprints and model yacht equipment at standard prices. Send 25c for new illustrated 1947 Catalog and price list, Dept. S., James Bliss & Co., Inc., 220 State St., Boston, Mass.

BUILD HO Gauge Wrecking Crane. Complete kit with brass wheel trucks, \$2.15 P.P., Catalog 10c. Ideal, 21 West 18th Street, New York 11, N. Y.

MOTORS — Kits (Aeroplanes, Racing Cars, Boats, Model R.R.)—Tools—Everything for the Hobbyist. Catalog 15c. Westchester Hobbies, Inc., 257 Mamaroneck Ave., White Plains, N. Y.

STEAM engine, precision made to scale from brass and bronze. A practical working model that performs like its full size brother. Complete, fully assembled—ready for steam. Overall size 6" by 3"; weight 2 1/4 lb. \$17.50 postpaid. Ross, B68 West Broadway, New York, N. Y.

STEAM boiler for model engines, withstands 500 lb. pressure. Complete with pressure gauge and all fittings. Postpaid \$22.50. Ross, B68 West Broadway, New York, N. Y.

BRASS Gears and model supplies for the inventors. Send 10c for catalog. Pierce Model Works, Tinley Park, Ill.

SCALE ship model kits and fittings of fine details. Price list 10c. Model Shipways, 476 Main St., Ft. Lee, N. J.

GET your Lionel Equipment while the choice is good and all items available. Send for list. Our Scale Illustrated Catalog 25c. Refund coupon first order. Factory Authorized Sales and Service for Lionel and American Flyer. Tri-Lor Hobbyist, Box 260, North Dartmouth, Mass.

BUILD Jet Propelled Auto Models described February Popular Science. 12 cylinders \$1.00 postpaid. Amaco Laboratories, Box 3246, Amarillo, Texas.

BIG illustrated Model engine catalog 10c. Active Products & Supply Co., 53 W. Jackson, Chicago 4.

BALSA Wood Generous Supply \$1.00 Price List Free. Sanlader, Manitowoc, Wis.

STEAM Engine unique valve gear. Build it yourself from stock items—without castings. Send only \$3 for expert blueprints of completed job. Steam Projects Co., 1616 Walnut Street, PS1, Phila., 3, Penna.

RADIO Control, 10 tube unit. Revolutionary Design. Write for details. Box 1097, N. Y. 8, N. Y.

87A MOLDS AND MOLDING MATERIALS

LIQUID Rubber for making flexible molds. Literature and Sample free. Chaney, 1130 E. 16th St., Jacksonville 6, Fla.

PLASTERCRAFT supplies. Molds, liquid rubber, plaster. Instructions free. Jayhawk Plasters, Blue Rapids, Kans.

MECHANICALLY Inclined Men—Own and operate general Appliance Repair Shop. Complete, illustrated course shows you how. Welding Refrigeration. Motor repair. How to get business, etc., all phases covered. Free literature. Christy Supply, Dept. 775, 2835 N. Central Ave., Chicago.

EARN \$126 weekly at home. \$1 brings samples, details. Moneyback guarantee. Box 72, N.Y.C. 16.

\$300 MONTH, sparetime. \$10 starts you. Guaranteed plan 15c. Cue, Box 256, Batavia, N. Y.

OPERATE home mailorder business. Full or spare time. Fascinating. Profitable. Learn how. Literature free. Dallis Ruth, Wheelersburg, Ohio.

LIQUID rubber for flexible molds. Instructions. Advanced \$1.00. Simple 50c. Apex Plastic Products, 1915 Lunt, Chicago.

"HOW To Make Simple Molds and Plaster Plaques." Profitable business or hobby! Instructive booklet 25c. Plastercraft Supply Company, 1406 East 43rd Street, Cleveland 3, Ohio.

MAKE flexible molds! Few cents each! Cast plaques, novelties, bookends! Free sample! H. Tooker, Hamilton 19, Ohio.

RED Seal Moulding Compound, DuPont Latex Base! Guaranteed! Made by Experienced Latex Compounds. Free Instructions and literature sent upon request. Dept. 907, Red Seal Rubber Co., 116 Nassau St., New York 7, N. Y.

LIQUID rubber, molds, models four colored plastic paint that Glows. And complete course in statuary art casting. Dollar brings you sample mold of bear. Robert Fitzpatrick, 15825 Wormer Ave., Detroit 23, Mich.

71 HOME CRAFTSMEN

PLYWOOD Cabinet kitchen plans 25c. Playne Cabinets, 4617 Johnson Ave., Western Springs, Ill.

SHELL Jewelry Supplies, Wholesale only. McFarland Plastic Co., Sarasota, Fla.

TOY patterns. Circus wagons, trucks, carts, pull toys, etc. 35 patterns \$1.00. Continental Homecrafter, 907 Birch, Eau Claire, Wisconsin.

MAY 1947 75

POPULAR SCIENCE OPPORTUNITIES

JEWELRY made in your own home, economically. We supply findings, imitation gems, small Lucite and Plexiglas squares, chemicals, ideas. Send for the Big illustrated Craftsman's Catalog. Only 25c (Refunded on First Order) Pittshire Plastics, Box 90, Pittsfield 4, Mass.

LEATHERCRAFTERS! Send for free catalog listing leathers, tools, supplies. Kit Kraft, 1607 South Western, Los Angeles 6, California.

ELECTROPLATING service: Chrome, Silver, Gold, Bronze, Brass and Tin plating on all metals. Send Article or description we will quote prices. Master Silverplaters, 2031 Caniff, Detroit 12, Michigan.

LEATHER Designs. Fifty belts, \$1.00. Twenty billfolds, \$1.00. Ten Handbags, \$1.00. Lampkin Artcrafts, Box 641-S, Culver City, Calif.

EXPERIMENTERS! Interested in Electrical, Mechanical devices from war surplus? List Free. F. Siefke, Box 18, Station E. Buffalo, N. Y.

KNOCKDOWN Cedar Chest Lumber Veneers Free Price List. Giles-Kendall, Box 435, Huntsville, Alabama.

JIG saw patterns, Full size, ready to use. Artistic Gothic wall shelf 20" high; corner shelf 17". Both for 10c. Jig Saw Guild, 117-JS Worth St., New York 13.

WHITTLERS. Carve six amusing animals. Plans, redicut w.m. blanks, \$1.75. Free list expert kits. Wm. Rackham, 7122 Ingleside, Chicago 19, Ill.

WHITTLERS, easy to finish! Basswood animal forms—in the Round (not jigsawed Patterns). Skunk .50, Squirrel .50, Beaver .50, Cash with Order. Fieldcraft, Inc., 755 Boylston Street, Boston 16, Mass.

"SEA Shells and all parts for making pins, earrings, novelties. Instructions Free with \$2.00 Kit. Free Catalogue. Herbert Diamond Co., Box 4619, Miami 28, Fla."

NEW! Money Making Shellcraft Kits! Violet Corsage \$1. Cameo Brooch, Earrings \$1. Chateau Gardenias \$1. Instruction Booklet 35c. Wholesale Supplies. Shelart, 3027½ 6 St. S. St. Petersburg, Fla.

PAINT Beautiful Pictures quickly, easily, inexpensively. Free literature. Art Book Shop, Arnold 6, Mo.

WHITTLES' supplies, redicut blanks, special woods, knives.—Old Whittler, 1402 Charles, LaCrosse, Wis.

PANTOGRAPH. Indispensable home-craft instrument eliminates enlargement headaches. Details dime. Pantographs, Munising 2, Michigan.

REDWOOD Burl sample Block \$1.00 postpaid 3 for \$2.00. E. McLean, 1325 Bryant, Eureka, Calif.

70 PATTERNS Lawn Ornaments and Novelties, \$1.00. Modern Woodcraft, Saginaw, Mich.

PIRATE treasure chest plans, inexpensive, easily built, 25c postpaid. Henry Morgan, North End Station, Box 127, Detroit 2, Michigan.

LEATHER Designs on plastic eliminate tracing. Introductory offer \$1.00. Sample 10c. Lampkin Artcrafts, Box 641-S, Culver City, Calif.

18 BLUEPRINTS AND PLANS

"BLUEPRINT Reading Made Easy"—ready reference book for reading any type blueprint. 596 pages. 463 pictures. Formerly \$8.95, now only \$1.98. Popular Science, Dept. 57-C, 353 4th Ave., New York 10, N. Y.

23 BUILD IT YOURSELF

BUILD your own Log Cabin home. Richly illustrated book packed with plans, Ideas, Pictures, Instructions. Send \$2 to Otsego Log Homes, Gaylord 2, Mich.

MIDGET 1" Motor, runs atop flashlight cell! Parts, instructions, 35c. Fonskov, 655-E Amboy, Perth Amboy, N. J.

GARDEN Chair. Full size jig saw pattern postpaid 10c. Masterprint Company, White Building, Buffalo 2, New York.

HOT Water Free—from Sunlight. System efficient any locality year 'round. Standard materials—easily built—low cost. Facts Free. Solar Water Co., Box 175, Dept. K, Coral Gables, Fla.

MAKE Popular novelties, statues, at home—3c to 15c each. Sell at big profit. Everything Supplied. Write So-Lo Works, Dept. T-6014, Loveland, Ohio.

BUILD concrete block machine. 2 blocks per minute. Build concrete mixer. Easy, inexpensive. Details free. Horne, 206 West Wilder, Tampa, Florida.

MAKE your own Fluorescent Lighting. Modern, economical, simple. Fascinating possibilities for special designs in every home, shop. All electrical parts for 20-watt fixture—\$2.00 postpaid. Complete instructions. Fluorokit, 332 E. Reservoir, Milwaukee, Wis.

CONCRETE Block Homes. 24 page booklet; drawings, instructions on how to build. \$1.00. H. C. Lightfoot, Civil Engineer, Richboro, Pa.

"BUILD Your House as a Hobby." Save 50%. No rent. No Mortgage. 24 page booklet; drawings, instructions on how to build. \$1.00. H. C. Lightfoot, Civil Engineer, Richboro, Penna.

LANE oak table, fun for all, felt side cards, wall side dice, easy made, Patented instructions \$1.00. Geo. H. Lane, 62 Edgewood, Md.

"LAY Cement Block Faster, more accurately! Kingsley Bonder guarantees uniform joints by providing adjustable slot for mortar. Place Bonder on top of block, trowel mortar into slot, sweep clean, remove Bonder. Neat, accurate bond remains, without waste of material. \$2.00 postpaid—Kingsley Shop, Inc., P.O. Box 1832, Atlanta, Ga.

"BUILD Cabins"—book offers complete instructions and plans for building your own cabin, lodge, tourist home, or wayside stand. 251 Pages, 200 plans and pictures. \$2.48 Deluxe. Popular Science, Dept. 57-C, 353 4th Ave., New York 10, N. Y.

BUILD real heavy duty machines using our production tested plans. 30" Bandsaw, 12" Lathe, Dowel Machine, Portable sawmill, Planer, Concrete Block Machines, Mixers, 70 machines for shop, farm, home. Catalog—Handbook Free. Nichols Equipment Co., Dept. PS, Purviss, Miss.

AIR Plane Jettison Tanks streamlined, 10½ foot tear drop shaped, 165 gallon of Light weight lead, coated steel weighs 75 pounds floats over 1200 pounds. Ideal for making trim, inexpensive boats, canoes, Kayaks, Dinghys, Duck Boats, Powered Catamarans and Runabouts, prices \$12.50 complete, \$9.75 each for three or more US Freight prepaid. General Sales, 205 Market, Grand Rapids 3, Mich.

139 WATCH REPAIRING

WATCH and Clock Repairing—complete practical course in modern horology. 66 illustrated self-instruction lessons. Just out! Low price. Fascinating 100-page illustrated catalog Free! Write—Nelson Company, Dept. 3-01, Chicago 5.

FINE Watch, Clock, and chronograph repairing at minimum rates, 10 Day service for popular models. The Little Jeweler, Box 17, E. Dedham, Mass. A. R. Ciriello, Watchmaker.

EXPERT Watch repairing Reasonable. Send by insured mail for free estimate. Ernest Parigan, P. O. Box 2866, Miami, Florida.

WATCH and clock repairing increasing, complete home study course with drawings and pictures. Information free. Houston Chronometer and Watch Co., P.O. Box 1140B Houston 12, Texas.

95 OLD GOLD, WATCHES, ETC.

CASH for Old, Broken Jewelry, Highest prices paid immediately. Mail gold teeth, watches, rings, silverware, diamonds, spectacles. Satisfaction guaranteed. Information free. Rose Smelting Co., 29Y East Madison, Chicago.

GOLD \$35.00 Ounce—Mail old gold teeth, diamonds, jewelry, watches—receive cash by return mail. Satisfaction guaranteed. Free information. Dr. Weisberg's Gold Refining Company, 1500-B Hennepin, Minneapolis, Minn.

WATCHES—Broken or Usable: All kinds. Highest prices paid for jewelry, rings, spectacles, gold teeth, diamonds, sterling silver, etc. Cash mailed promptly. Write for free shipping container. Lowe's, Holland Building, St. Louis, Mo.

76 JEWELRY

CERAMIC Jewelry Supplies, Bar Pins, ear screws, for ceramic and woodworkers, also, glass and sea shell assemblers. Free catalog. Philadelphia Badge Co., 1007 Filbert St., Philadelphia, Pa. Dept. E-1.

MAKE your own jewelry! Findings in metal and plastics; earwires, pinbacks, cameos, stones, beads, clasps, sprays, combs, hairbars, plastic and metal chains, Hobby Art Corp., Dept. 6, P.O.B. 276, New York 18, N. Y.

MANUFACTURE costume jewelry at home for profit, hobby, therapy. Free wholesale supply catalogue. Instructions. Florida Supply House, Bradenton, Florida.

TIGER Eye Cameos — Rectangulars 12 x 16 M.M. \$4.50 each. Any quantity. Creative Shops, Inc., 2916 North Oakland Avenue, Milwaukee 11, Wisconsin.

JEWELRY Findings, supplies. Catalogue 10c. George Sassen, 154 Nassau St., N. Y. C. 7.

MAKE Money. Making Shell jewelry and novelties. Instruction book 75c. Kit \$5.00. Catalogue free. Palm Shellcraft Co., 220 W. 9th St., Sarasota, Fla.

SHELL Jewelry—easy to make—Instructions and materials for making six colorful pin and earring sets, sent postpaid, only \$3. Price list free. Don-Dee Shellcraft Industries, Box 1183-C, Orlando, Florida.

SEND dime for Cameo Samples included Rhinestone and Findings Pricelist. Perry Metros, 34-37 100 St., Corona, N. Y.

132 TOBACCO & PIPES

PIPE Sale; custom Built—79c, 3 for \$2.25; Genuine Briar; Super grains; Aluminum Filter; Hard rubber filters; All shapes; Guaranteed satisfaction or money refunded. Pipes Repaired reasonable price. Metropolitan, 2020 E. 41 St., Bklyn. N. Y.

CIGARETTES—all popular brands, \$1.45 per carton, postpaid. Three cartons, minimum. Send check or money order. No limit. Durham's Mail Order Co., North Branch, N. J.

CIGAR Smokers—Free Trial Offer. S. Kelley, 2302 Ontario St., Ft. Wayne 6, Ind.

NATIONAL Brand Cigar. List Free. 50 Mild Coronas \$3.20. Continental Cigars, Corning, New York.

86 MISCELLANEOUS

BOOKFINDERS! (Scarce, out-of-print unusual books.) Quickly supplied. Send wants. Clifton, Box 1377 PSM, Beverly Hills, Calif.

GOOD "Used" self-instruction educational books on all subjects bought, sold, rented, exchanged. Satisfaction guaranteed. Complete information and 100-page illustrated bargain catalog Free! Write—Nelson Company, Chicago 5.

UNUSUAL Novelties, samples 10c. Modern, Box 2, Knickerbocker St., New York 2.

GET Lots Of Mail: Name Listed Three Directories 25c. Harvey Teeple, Decatur, Ind.

LOST Western Mines. True Stories. Authentic data, landmarks, etc., 22 fabulously rich lost mines, \$1.00. Lost Mines Press, 1047-A Irolo St., Los Angeles 6, Cal.

"HOW To Break And Train Horses"—A book every farmer and horseman should have. It is free; no obligation. Simply address Beery School of Horsemanship, Dept. 585-C, Pleasant Hill, Ohio.

POPULAR SCIENCE OPPORTUNITIES

MECHANICAL Drawing Instruments—Veeco, 4 Piece, compact, precision set, brand new in lined case, value \$12.50, Special \$7.25. Hull Automobile Compass, for accurate road direction, brand new \$2.50. Prisms for 6 x 30 or 8 x 30 Binoculars brand new \$1.50 each. Offset prisms to be attached to 7 x 50 B. & L. Binoculars gives double the field of the ordinary 7 x 50 Binocular. Cost \$98.00, Special \$25.00. Green Sunshades for Binoculars size 6 x 30 and 7 x 50 snap on type, value \$7.50, Special \$1.25 per pair. Forward money order. No C.O.D. shipments. Public Sport Shops, 13 S. 16th St., Philadelphia, Pa.

ART Photos of Beautiful Hollywood models 4 x 5—8 for \$1.00, 32—\$3.50 Prepaid. Visual Slides, 1269 Broadway, New York 1.

AT Home—Your own manufacturing business; making popular \$1.00 novelties. Cost you 3c to 15c. Everything supplied. Write So-Lo Works, Dept. T-6012, Loveland, Ohio.

YES, Men's shoes in Sizes 11½ to 16. Widths AA to EEE. Finest Quality, moderate price. Free Circulars. Write Kingsize 135, Brockton, Mass.

MEDICAL Laboratory Technicians in great demand. We train you in your spare time, in your own home. You can practice while studying. Write for free catalogue. Imperial Technical Institute, Box 973-S, Austin, Texas.

VISIT N. Y. by mail, assortment 25 cts. Monthly service \$1.00. Persil, 436 N. Y. Ave., Brooklyn 25, N. Y.

SHIPPING Room supplies Gummed Tape. Labels, Tags, Twine, etc. Price list free. Fountainhead Supplies, 1049 Bluff, Beloit, Wisconsin.

PLASTIC Letters 2 inch, 4 for \$1.00 additional 20c each. House Numbers, 4 inch Shine in any light never fade out 29c postpaid. Midwest Plastic's, 217 Bates, St. Paul 6, Minn.

PERFUME Oils—Perfume's price list Stamp. G & W Supply Co., 217 E. State St., Trenton, N. J.

MEN! Six daring Glamour photographs—\$1.00. Box 699-Q, Westfield, N. J.

ART Photos! Spicy; sample .50, 3 for \$1.00, Sandige, Route 1, Box 995, Phoenix, Arizona.

PANNING Gold. Learn Now, \$60 ounce possible soon. Free illustrated booklet, How To Get Started, Catalogue Mining books, Supplies. Old Prospector, A-72, Dutch Flat, California.

FREE literature how to locate buried treasure and minerals. Fisher Laboratory, Inc., Palo Alto, Calif.

PLAY Postal Chess. Partner, Details Furnished, \$1.00. Nowlin, Box 164, Alameda, New Mexico.

MEXICAN Law General Practice Attorney, 1203 Arizona St., El Paso, Texas.

COMBINATION mimeographed letterhead and letter, 100—\$1.35. Samples free. Martin Mimeo, 3212 Harper, St. Louis 7, Mo.

ARMY Blankets—All wool, used, minor defects, special, \$3.33 postpaid. Send 3c stamp for circular. Midwest War Surplus Division, 54-J South 3rd Street, Minneapolis, Minn.

HYPNOTIZE anyone! Get the most perfect, easily learned, modern scientific course of "Genuine Hypnotism" in the world. Fully illustrated. Only \$1.00. Money back guarantee. Fowler, Box 1284, Boston 4, Massachusetts.

"FANS—Save \$100.00 on 42-inch Attic Fan. Cools 6 room house. Build your own. All parts, including 42-inch hi-capacity aluminum blade, rubber mounted bearings, shaft, pulleys, V-belt, etc., for only \$29.95. Other sizes priced accordingly, while they last. Rush M.O. or check to Sedco, 1313 Silver St., Houston 10, Texas. Motors not included, but any ¼ H.P. or larger motor will work. Complete instructions furnished. All parts guaranteed 5 years. Dealers solicited."

GLAMOR Girls. Real Photographs. Captivating Poses, 10 for \$1.00. Wilkins, 417 Hill Street, London, Canada.

FREE—Samples, Magazines, Catalogs, Literature, Moneymaking Opportunities! Receive lots of Mail from Everywhere! Mails Galore! Your Name Listed in over 15,000 "Surefire" Mailing Directories, \$1.00. Smaller, More Select listing—same price. Here's your chance to receive plenty of interesting mail! Act Now! Stanford, 6220-N 16th St., Philadelphia 41, Penna.

FREE Details—Cash in your spare time. Charles, 12 EC, Norwood, Ohio.

RECEIVE Moneymaking Opportunities, Samples, Mails, Catalogs, Magazines. Your Name in Thousand Mailing Lists, 25c. Glassminex, 1654-P Amsterdam Avenue, New York 31.

SAFES New \$25.00. Delivered Free anywhere in U.S.A. Send for our Catalog Showing complete line. United Safe Manufacturing Co., 23 S. High Street, Baltimore 2, Md.

250 GUMMED Shipping Labels, 2½x3½, blue ink, \$1.75; 500, \$2.50; 1,000, \$3.25. 4 lines your copy. Other sizes. Stock Labels. Ad-Man, 305 Liberty Bldg., Indianapolis, Ind.

101 PERSONAL

HOW You Can Find Out! Information discreetly developed, any matter, person, problem anywhere. Personal-business assignments, representations, undertaken. Nationwide. Officially Licensed and Bonded Service established 1922. Reasonable. All inquiries confidential. William Herman, 170 Broadway, N. Y.

PSORIASIS Sufferers: Has everything failed to bring even temporary relief from scales, lesions and itching? Then write today for Free important information. You needn't invest one cent! Pixacol Company, Dept. S, Box 3583, Cleveland, Ohio.

STAMMER? Maybe I Can help. Sauers, Box 139E, Mars, Penna.

ALL Diseases treated. Worldwide telekinetic theotherapy. Health-Center, Columbia City, Ind.

PIMPLES? Send for latest Report, Free. Harmel Co. (Dept. D) 4718—18th Ave., Brooklyn 4, N. Y.

PROBLEMS counseled send dollar. Suite 1, 54 Clark Ave., Chelsea, Mass.

MEN: Don't forget important dates. We will remind you. Send \$1.00 fee. Your Date Reminder Service, Box 64, Jamaica 1, N. Y.

MATRIMONIAL—Sweetheart Magazine, 50c, 6 mos, \$1.00, Yr, \$2.00. Barwood, 2037-E 42nd, Astoria, N. Y.

I Don't Care What Laxative You Now use for constipation. Test genuine Old Mohawk Herb Laxative and you'll never use anything else again. It works. Generous sample 10c. Write today. A. J. Shutt, Dept. L-4, 506½ S. 15th St., New Castle, Ind.

MEN Only! Six daring Glamour photographs—\$1.00. Box 699-R, Westfield, N. J.

BORROW By Mail! Loans \$50.00 to \$1,000.00 to employed men and women. Easy, quick. Completely private, confidential. No endorsers. Repay in convenient monthly payments. Details Free in plain envelope. Write First Loan Co., World Herald Bldg., Dept. M-15, Omaha, Nebr.

SINGLE Persons desiring information concerning future, personal affairs, request Free particulars. Strone, Box 157, New York 11.

TOBACCO Habit Broken Quickly Pleasantly. Quit Cigarettes like Magic. Latest Scientific Method. Booklet Formula-Details \$1.00. Psychogenic Science, Dept. A, Box 402, Canton 1, Ohio.

PRETEND Visiting Atlantic City. Post Card Views mailed, 25c ea., Address, Return for mailing. Letters 50c. Bernard Weinsaft, 280 So. Congress Ave., Atlantic City, N. J.

"THE Case For Creation," 85c. Christian Evidence League, Malverne, N. Y.

RUPTURED? Positive comfort, no understraps, no steel, no elastic. Write Smith Manufacturing Co., Preston, Ontario.

HAIR Falling? Dandruff? Write Trichologist, 139 Lewis Street, Phillipsburg, N. J.

TURKEY In Prophecy, 5c. Bulletin, Box 87, Station H, New York 25.

YOU Can Find happiness and good fortune and have friends everywhere through My Magazine of "Friendship" you're really missing plenty, if you do not send dime to cover cost for sample copy—you'll never regret it. Address, Jack Wilcox, Editor, G.P.O. Box 112, New York 1, New York.

STUTTER? Stammer? Literature sent free. Frank Teurfs, 25 E. Jackson, Chicago, Illinois.

PICTURE Post Cards from Photograph, 1000 \$9.75. Raum, 4154 Fifth Street, Philadelphia 40.

BUY Vitamins Direct. Amazing Savings. Money Back Guarantee. Our 9th year! Postcard, Matoska Products, White Bear Lake, Minn.

THINK! Mysterious "Cosmic Key" brings results—Health! Money! Success! Great leaders amazing discovery—Carnegie! Napoleon! Psychology that works: healing science—helps anyone. Cosmocracy, Box 7-DZ, Long Beach, Calif. Mystery Message Free.

PRETEND visiting California or Reno, Nevada. 3 postcard views 25c write message, address, return to me for remailing. Letters mailed 25c each. Free Information, Smith, Box 4685, San Francisco 2, Calif.

SEND \$1.00 and I will tell you how cheaply I stopped my hair from falling out. Hartley, 1014 Dakin, Chicago 13.

ATHLETE'S foot remedy. Guaranteed \$1.00 bottle. Dr. Renz, Room Three, Chavanne Building—Lake Charles, La.

1 ADVICE

YOUR Life experiences might make a book! Will discuss your ideas without obligation. E. Jervis Bloomfield, Literary ghost, Present address: Gabriola Island, British Columbia.

"VITASCIENCE"—The Science of life. Drugless healing through the spoken word. Inexpensive. Details free. Cedric S. Moore, 1313 South Union, Kokomo, Indiana.

DRUNKENNESS is a disease which responds to treatment. In 68 Years, the brief, pleasant Keeley Treatment has brought new health, happiness, opportunities to many. Endorsed by thousands of physicians. All correspondence confidential. For free, descriptive booklet in plain wrapper, write P. T. Nelson, Keeley Institute, Dwight, Illinois.

2 ADVERTISING

ADVERTISERS: Mail order ad covering United States—2,000,000 circulation—\$21.00 inch. Classified ad, 24 words, 20 metropolitan Sunday newspapers—\$25.00. Magazine, newspaper, mailing-list rate-book, advertising assistance—free. Chicago Advertising Agency, 20-PS West Jackson, Chicago 4.

ADVERTISE: 24 words, 40 Newspapers \$3.50. Lists Free. Advertising Bureau, 229-P Dixon Blvd., Uniontown, Penna.

ADVERTISERS: Mail order ad covering United States—2,000,000 circulation—\$21.00 inch. Classified ad, 24 words, 20 metropolitan Sunday newspapers—\$25.00. Magazine, newspaper, mailing-list rate-book, advertising assistance—free. Chicago Advertising Agency, 20-PS West Jackson, Chicago 4.

"GET Results! Inch display ad Midwest Mail Directory \$2. F. A. Priebe, Box 90, Kearney, Nebr."

24 WORDS in 64 Weeklies \$4.96. J. Darnell, 730 Hays, Jackson, Tenn.

17 WORDS 60,000 Readers 3 months \$3.00. Renick, Holland 3, N. Y.

MAY 1947 77

POPULAR SCIENCE OPPORTUNITIES

9 ASTROLOGY

FREE Advice About Your Problem with solar Horoscope. Send birthdate 25c. Eleanor Victor, L-540 Elaine Rd., Columbus, Ohio.

66 HANDWRITING ANALYSIS

YOUR handwriting reveals your personality. Are you generous, affectionate, sensitive? Send 75c for personal character analysis. Any two for \$1.00. Frank Konick, Oak Hill 2, W. Va.

45 DRAFTING INSTRUMENTS

SAVE on drafting materials. Free catalog. Draftsmen's Supply Co., 32 North Wells, Chicago 6.

128 SURVEYING INSTRUMENTS

TAYLOR Precision Compasses. Oil filled, luminous, adjustable directional dial. Wrist attachment. Send \$2.95, prepaid. Hahn-Masten, 50 South Broadway, Denver, Colo.

129 TATTOOING SUPPLIES

TATTOOING Outfits—engraving Outfits. Circulars Free. Write, Zeis, 728 Lesley, Rockford, Illinois.

BIGGEST Money in tattooing now! No experience required. Complete instructions with outfits. Send for free literature. Tatuco, 651 South State, Chicago.

27 A CANDY MAKING

MEN—Women—“Everybody Likes Candy”. Learn to manufacture professionally at home. (Our 36th Year). Ragsdale Candies, East Orange, N. J.

29 CARNIVAL OUTFITS

KIDDIE Auto Ride Plans \$5; Brill, 228-A North University, Peoria, Ill.

81 A MAGNETS

“ALNICO” Magnet—Lifts 10 pounds — \$1.00. Five assorted smaller magnets—\$1.00. Ronald Eyrich, Box 849, Milwaukee 1, Wisconsin.

SPECIAL, 12 Alnico Magnets plus 100 experiments, \$3.00. 100 experiments only, 25c. War surplus, extra powerful 1" Disc Alnicov magnets—fascinating; pair \$2.00. G. E. Midget precision switches, 110V. 10A—2 circuit; each \$1.00; six \$5.00. Eljay, Box 891, Newark 1, N. J.

PERFORM astounding stunts with Alnico. Defy gravity. Mystify your friends. Two bar magnets, (4 oz.), instructions, \$.60 Postpaid. Ross, B68 West Broadway, New York, N. Y.

134 TREASURE FINDERS

MT-SCOPE Metal Locator fully guaranteed and unsurpassed in efficiency. Time payment plan, trade-in and accessories. Free literature. Fisher Research Laboratory, Inc., Palo Alto, Calif.

METAL Detectors. The Very Latest Circuit. Free Literature. Hedden Metal Detectors, 538 North Homewood Avenue, Pittsburgh 8, Penna.

42 DETECTIVES

DETECTIVES—Work home—Travel, Experience unnecessary. Write Wagoner P-125 West 86th, N. Y., N. Y.

DETECTIVE Training. Phillips Secret Service, 1917C, N. Kenneth, Chicago 39, Ill.

BE A Detective—Send for price-list of self-instructional courses at reduced prices. Perkins Publications, 300-C Brandeis Theatre Bldg., Omaha, Nebraska.

DETECTIVE training. Department store work, shoplifters, etc. Also general detective procedure. Thirty years diversified detective experience. Free details. Write Shewbridge System, 216 Valdez Avenue, San Francisco 12, Calif.

89 MONUMENTS

WRITE For Direct Prices \$14.00 Up. Freight Paid, Guaranteed, Free Catalog. Granite-Marble Factory, A49, Oneco, Fla.

93 NAME LISTS

WANT Mail? Your name listed three directories 25c. 841 Belmont, Dayton 5, Ohio.

“MANUFACTURERS” addresses 3, 50c, additional 20c each. J. Ragno, Berwick, Pa.

WHOLESALE anything imaginable. New guaranteed list 10c. Refundable. La Salle Novelties, Box 2172, Waterloo, Iowa.

500 WORKING Peoples names and addresses \$2.00. A. Reeves, College Station, Box 184, New York City.

SEND for prices of mailing lists. 1412-B Great Northern Building, Chicago, Ill.

84 MILITARY INSIGNIA

COLLECT colorful Army Patches, Pictures, Price and sample patch only 10c. Insignia Mart, 703 Broadway, N. Y.

123 SOUVENIRS

FREE German War Relics with each purchase. Send 10c for price list of captured Foreign medals, daggers, uniforms and receive 4 German Ration Potato stamps, free. Hobbyguild, S35, West 32nd St., N. Y.

USE THIS ORDER FORM TO INCREASE YOUR MAIL ORDER BUSINESS

LOOK AT THESE LOW RATES

60c

Per Word, Per Insertion
WHITE SPACE—\$3.60 Per Line.
Minimum Ad—10 Words—\$6.00
CASH WITH ORDER

If You Sell A Product or Service To Men, Use This Easy Means To Get More Sales

CLASSIFIED ADVERTISING ORDER

Popular Science Monthly • 353 Fourth Avenue • New York

Please insert the ad below in your.....issue.

Heading.....

Enclosed is \$..... Word Count.....

.....

.....

.....

Name.....

Address.....City & State.....

To be inserted in the June issue, this order must reach us by April 28th.

SACHEL POUCH

Heavy canvas pouch. Ideal for toting lunches, shopping, books, etc. Has 11 x 12 inch pockets.



Brand new, guaranteed perf A 11 - Each..... **\$1.69**

ARMY BANDOLEERS

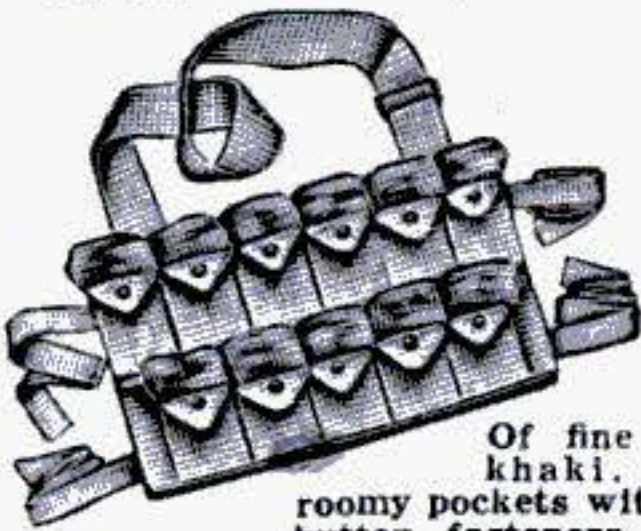

Of fine heavy khaki. Big roomy pockets with snap button fasteners. Fine for hunters, campers, boy scouts, etc., also for shop work in carrying small parts, etc. Material alone is worth this price. 11 Pocket Type No. **49c** 5 Pocket Type No. **29c** 129. EACH 128. Each.



AVIATORS GOGGLES

Heavy rubber frame, chamoisskin lined. Made by Polaroid. Complete with 8 extra lenses, 3 green, 3 ruby, 2 clear. Shatterproof. Ventilated. Adjustable head band. Protect eyes from glare, dust, dirt, wind, etc. Use at work and play. Brand new. Shp. wgt. 1 lb. No. 329. Each only **98c**

BERNARD WIRE PLIERS

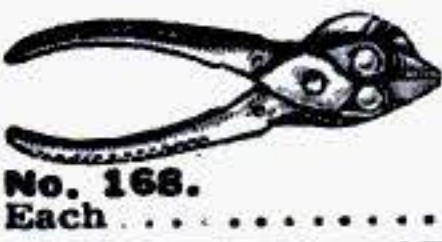

Parallel acting jaws. Wire cutter at top. Brand new. Wgt. 2 lbs. No. 168. Each..... **\$1.29**

McCLELLAN SADDLE



Brand new! Top grade cowhide. 12 inch seat. Hair girth. Has straps for blanket roll and knapsack. Gun boot and sabre loops. A real buy for any horseman. Worth much more. Shipping weight 15 lbs. Stock No. A145. Each..... **\$16.95**



CAVALRY SPURS

Genuine wishbone type cavalry spurs. Nickered brass. A102, Pair **98c** A103 Spur straps per set of four..... **50c**

2-Pc. Rain Suits

New 2 piece rain suits. Of durable wear resisting water and wind repellent OD fabric. Bib style pants, zipper fly. Jacket has parka attached. Guaranteed 100% weatherproof. Small, medium and large sizes. Shp. wgt. 3 lbs. No. R549 Each.... **\$4.95**



Officers Watch Compass



Brand new gov't. surplus. Army-Navy model. Single jewel mounted needle. Silver colored dial. A splendid value. Shp. wgt. 1 lb. A174-EACH **98c**



CAMERA TRIPOD

Purchased from Gov't. Used but perfect. For cameras up to 8x10 inches. Folds to 32 inches, extends to 58 inches. Needs adapter to mount camera. Wgt. 5 lbs. Stock No. **\$4.95** 190. Each

WAR SURPLUS AND HUNDREDS OF OTHER BARGAINS



TELESCOPING BAIT and FLY ROD

Combination 4 piece telescoping bait and fly casting rod. Screw locking reel seat. Cork grip. Snake guides. Extends to 9 feet, telescopes to 38 inches. Shp. wgt. 1 lb. No. F411. Each..... **\$3.65**

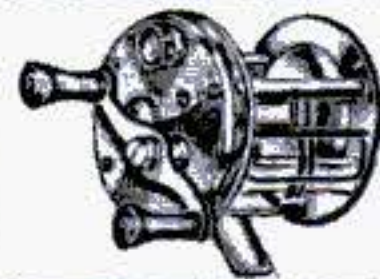

LEVEL WIND ANTI BACK LASH REEL

Highest quality with chrome plated frame: 3 piece take down design, 4x gears, bronzed bearings and jeweled spool caps. Spool diameter 1 1/2 ins; pillar lengths 1 1/2 ins. Capacity 100 yard line. Onyx head ring. Shp. wgt. 1 lb. No. 450 F. Each only..... **\$8.55**

POPULAR RECORD ASSORTMENT



Fifty records of modern dance, race, blues and hillbilly selections. No two alike. Famous name bands and artists included. Used in juke boxes, but guar. perfect. Shipped exp. collect only-no exchanges or refunds. Wgt. 28 lbs. No. A303-50 records..... **\$9.64**

PLASTIC 8-OZ. FLASK



For hunters, fishermen, scouts. Waterproof and transparent. Use it for liquids, matches, files, bait, etc. Has screw cap top for liquids, plus full open top. 5 1/2 x 4 1/8 x 1 1/8 ins. Hundreds of uses. Wgt. 1 lb. No. A347. Each..... **29c**

OXYGEN TANKS



A shatterproof, welded seam oxygen tank. Fits gauge listed above. Measures 5 1/2 x 8 in. Internal volume 104 cu. in. Square inch pressure 1.4 cu. ft. Has 3/8 inch pipe thread vent. Shp. wgt. 2 lbs. No. 537. Each..... **49c**

DECORATIVE CHROME STRIPS



For your car, boat, furniture, etc. Highly polished chrome finished strips with clinched edges for flush mounting to any surface. The 3 pound kit provides approx. 43 pieces in lengths from 4 inches to 3 feet and 1/4 to 3/4 inches wide. Wgt. 4 lbs. No. R-224-3 lb. Assort. only..... **\$2.00**

7 LB. EXPERIMENTER PARTS ASSORT. KIT



A "gold mine" for the radio serviceman. Hundreds of valuable radio parts, new radar and electronic parts and sub-assemblies, coils, resistors, trimming condensers-worth many times this low price. A130R -7 lbs. **\$1.79**

G.I. PISTOL BELTS



Of heavy canvas webbing. Adjustable. Eyeleted all around. Used but perfect. Wgt. 2 lbs. No. 131. Each..... **98c**

HAND MICROPHONE



Top quality hand microphone with control button in handle. Highly sensitive. Has rubber covered cord and tel. plug. Fine for use on home recorders, public address systems, etc. Brand new - perfect. Shp. wgt. 2 lbs. Stock No. 170. Each..... **\$1.95**

BAYONET BLADE



Fine forged steel. Ground but not polished. May be made into throwing or hunting knife or spear. Blade 6 3/4 x 7/8 inches, 1 3/4 inches overall. Will take and hold a fine edge. Shp. wgt. 1 lb. No. 664-R. Each... **49c**

MESS KITS



Regulation two piece Army Mess Kits with folding handle. Used, but perfect. Weight 2 lbs. No. A116. Each **69c**

CANTEENS

Reg. U.S. issue canteens. Plastic screw top chained to body. Slightly used but perfect. Wgt. 1 lb. No. 117-Metal. No. 118-Plastic. Each..... **69c**



CANTEEN CUPS

All metal. Folding handles. Wgt. 1 lb. No. A120. Each..... **25c**

CANTEEN COVERS

Heavy canvas. Button fastener. New No. 530. Each..... **69c** Used No. 119. Each..... **35c**



JUNGLE HAMMOCK

For back yard, country home and camp use. Has waterproof roof with mosquito-netting side.

Lets you sleep outdoors safely. Finest construction. Originally designed for U. S. Army use. Shp. wgt. 7 lbs. No. 134. Each..... **\$5.95**

2 MAN MOUNTAIN TENT

Regulation Army type two man mountain tent, complete with poles, guy ropes, etc. Of durable nylon with reinforced seams. Ideal for outdoorsmen, campers, etc. Shp. wgt. 10 lbs. A splendid value. Stock No. 202. Each..... **\$9.95**

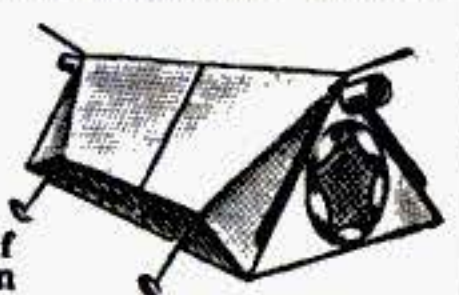

PUP TENTS

Regulation Army Pup Tents of durable, brown canvas. Used, but in good condition. Fine for campers, outdoorsmen, boy scouts, etc. Worthwhile gift for children. Wgt. 5 lbs. A-100 Tent only..... **\$3.95** A-110 Tent, New..... **\$7.95** A-101 Ropes, wooden poles and stakes for above. Per set..... **\$1.00**

LIFE PRESERVER BELTS

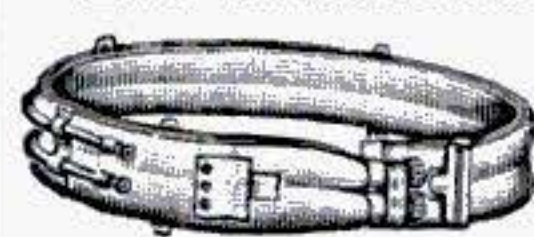

Right from the invasion beaches. Consists of two air chambers. May be inflated automatically with "sparklet" cartridges or manually by attached hose. Adjustable in waist size. One air chamber guaranteed air tight—other may need a tire patch. All belts are used and slightly soiled—but a bargain at this low price. No. 1261. Each..... **\$1.00**

ORDER DIRECT FROM THIS AD

Values galore! Hundreds of hard-to-find items for home, shop and outdoors. Make remittances by money-order, bank draft or personal check. Send 25% deposit on C.O.D. orders. No C.O.D.'s on orders for less than \$5.00. Include sufficient postage on parcel-post orders—any overage will be promptly refunded. All quotations F.O.B. Chicago. Used items and materials are guaranteed serviceable and as described. Your money back if not more than satisfied.

BIG ILLUSTRATED CATALOG FREE

STARK'S

Dept. P5547
509 So. State St.
CHICAGO 5, ILL.



Television gives you a choice seat at the game.

Television—a Season Pass to Baseball!

Every home game—day or night—played by the New York Giants, Yankees and Brooklyn Dodgers will be seen over television this season!

Owning a television receiver in the New York area will be like having a season pass for *all three ball clubs*. And in other cities, preparations for the future telecasting of baseball are being made.

When more than one home game is on the air, baseball fans can switch from one to the other—see the most exciting moments of each!

Those who own RCA Victor television receivers will enjoy *brighter, clearer, steadier* pictures through the exclusive RCA Victor Eye-Witness

picture synchronizer that “locks” the receiver in tune with the sending station. For television at its finest, you’ll want the receiver that bears the most famous name in television today—RCA Victor.

When you buy an RCA Victor television receiver or radio, or Victrola radio-phonograph, or an RCA Victor phonograph record or a radio tube, you know you are getting one of the finest products of its kind science has yet achieved.

Radio Corporation of America, RCA Building, Radio City, New York 20. Listen to the RCA Victor Show, Sundays, 2:00 P.M., Daylight Saving Time, NBC Network. “Victrola” T. M., Reg. U. S. Pat. Off.



Several television cameras bring you a close-up of the action wherever it occurs. Here are two RCA Image Orthicon television cameras used by NBC's New York station WNBT in televising home games of the New York Giants.



RADIO CORPORATION of AMERICA



**POPULAR
SCIENCE**
MONTHLY

EDWARD L. YOUMANS

The Editor's Job

1872...1947

*A statement by the publisher
of Popular Science Monthly.*

WHEN Edward Livingston Youmans was the editor of this magazine, there were no such things as the long-distance calls, linotypes, half tones, high-speed color presses, airplanes and teletypes that fill the days of Perry Githens. But the present editor shares with the first editor the same conviction: that science is not only the concern of star-watchers and laboratory hermits. Today, in fact, science is more than ever what Youmans called it: everybody's business. In the past 75 years science has emerged from the library, through the laboratory, into daily use in our houses and industry. And it is this basic belief, I think, which has kept *Popular Science Monthly* growing for three-quarters of a century.

Seventy-five years have changed PSM physically from a magazine of words to a magazine that delivers its message with a liberal use of illustrations as well as articles from authorities in their fields; nine hundred issues published have sharpened it editorially. Youmans solicited his manuscripts from the scientists, pleading with them to put their ideas into plain people's language. Nowadays, science has become an important subject in every kind of magazine and news-



PERRY GITHENS

paper. There has evolved a whole new body of scientific journalism.

Today, with a circulation of more than a million, Githens arouses his readers to awareness and understanding of the complex world about them. He must anticipate their timely interests with a journalistic approach almost as breathless as the morning paper. He must take his readers inside the things and situations, big and small, which affect their living.

To do this more complex job, today's editor has a large permanent staff of professional writers, artists and photographers, plus a corps of specialist contributors. For everything that goes into this magazine must be specially fitted to the needs of its readers.

But the purpose of PSM has never changed. And the techniques of idea-presentation originated by Youmans are still used, with the added force of modern methods for the speedy and colorful dissemination of ideas on paper.

Godfrey Hammond

MAY
1947 81

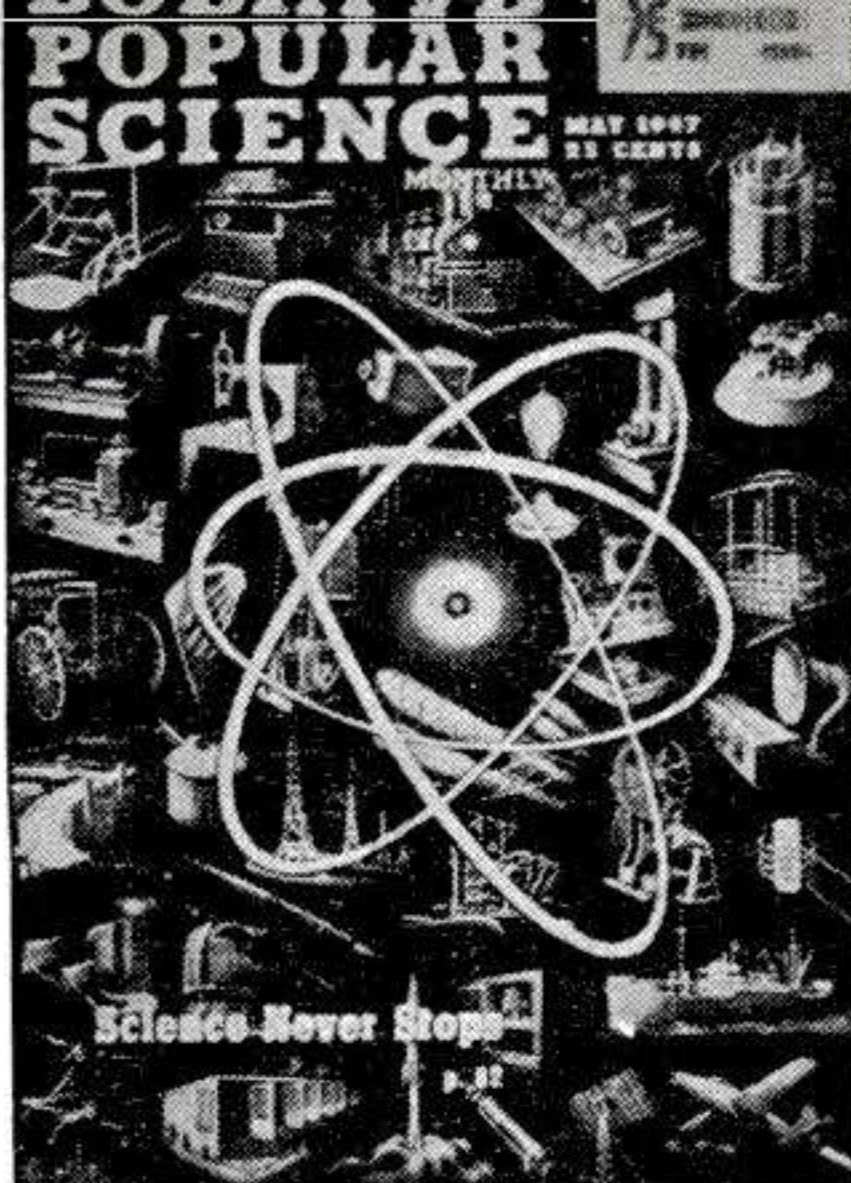

Painting by Ray Ploch

*The world has made vast strides
in the last 75 years; even greater
triumphs lie ahead if mankind has
the courage to go on with the job.*

Science Never Stops

By Harland Manchester

Illustrations by John Gaydos

MAN, standing upon the eminence of 1947 and gazing into the future, may well be dazzled and also perplexed by the promise of science to redeem his world. New discoveries and improved techniques on a hundred fronts present golden chances for a richer and fairer existence—if man has the sense, the honesty and the guts to seize and exploit them for the good of all.

Science is a blank check, and this is no time to be niggardly in filling it out. There are, of course, the doubters, like the 19th-century patent commissioner who wanted to close his office because nothing remained to be invented. If these timid souls look about them, they will see men and women who were living when there were no telephones, electric lights, automobiles, airplanes, radios, motion pictures, antitoxin serums or anti-septic surgery, to mention a few advances of the last 75 years.

Modern techniques have shortened the time lag between the original idea and its practical application. Today's machines and methods, which amaze oldsters, may be nothing compared with the parade of triumphs soon to come.

There will be many discoveries and feats of engineering that we cannot foresee, but if we consider the significant projects now under way and the world's most obvious needs, we can reasonably make an informed guess as to the shape of things to come.

AT THE top of anyone's "future list" stands the great question of atomic energy. Will the splitting atom bring a millenium of cheap power, supplanting oil and coal? At present there are two answers: a short-range program based on actual knowledge, and distant possibilities based on audacious hopes.

Many corporations, aided by the country's leading scientists and engineers, are now working on projects to apply the energy of the splitting atom to stationary power plants,

THE COVER: *Left to right, top to bottom—early McCormick harvester; Remington Type-Writer; wood-burning locomotive; early telephone; "wet" battery; Edison tinfoil phonograph; Singer sewing machine; early camera; Edison incandescent lamp; dynamo; telegraph printer; steam turbine generator; Duryea auto; X-ray; first linotype; stereoscope; streetcar; Boulder*

Dam; pressure cooker (symbol of light metals); high-voltage power line; Wright airplane; early radio; nylon; Diesel streamliner; fountain pen; petroleum cracking plant; machine tool; induction heating; helicopter; prefab house; V-2; television; steamship; hypodermic needle (symbol of vaccines, sulfas, penicillin); radar; jet plane; over all: the symbol of atomic energy.

ships, guided missiles and planes. Atomic power plants at Hanford and Oak Ridge will be in operation within a year or so. That project is simple. Heat and power are interchangeable, and every hour the Hanford pile turns out heat equal to that obtained from burning 7,100 gallons of fuel oil or 38.5 tons of coal. This heat can be used to make steam to drive turbines, or, more efficiently, to heat mercury vapor that will drive a turbine and then make steam to drive a second turbine. This mercury-steam combination (now used in coal-fired plants in Kearney, N. J., Hartford, Conn., and Schenectady, N. Y.) is the only prime mover known that gets as much power from its fuel as the Diesel, long the yardstick of superior efficiency. It may be still better to use the heated air from the pile to drive a gas turbine of the closed-cycle type, in which the hot air constantly recirculates, and heat wasted through the exhaust in the open-type gas turbine is used to make more power. Since radioactive air may eat away the turbine blades, helium, which cannot be "poisoned," may be used in this efficient engine.

That brings us to one of the greatest problems of atomic power—radiations that cause falling hair, sterility, wrecked red corpuscles and often lingering death. A wad of paper will stop all the charged particles caused by nuclear fission, but two uncharged criminals—gamma rays (akin to X-rays) and neutrons—must be caged by heavy shields of lead, concrete or other dense material. Nuclear physicists all over the world are seeking a lighter, more compact shield. We can reflect heat radiations with a thin sheet of aluminum instead of absorbing them with bulky insulation, and we can bend light rays in a lucite pipe and send them back where they came from. If these facts offer any clues, we can be sure that they are not being neglected.

Until lighter shields are discovered, atomic power as we now know it can be used only in stationary power plants, ships, locomotives, rockets and pilotless planes. There is no evidence yet that it will be much more economical than power methods now used, but it might bring all the blessings of a TVA to a region without coal or water power, and it might enable an aircraft carrier to circle the world a few times without refueling.

But if we persist in harnessing the atom to our present engines, we will copy the

early motorcar makers who mounted gasoline engines in buggies. A great goal seen by scientists is the direct conversion of atomic energy into electric power without routing it through the cumbersome heat cycle. How about some method of inserting metal terminals in a uranium pile and drawing electric power as you would from a

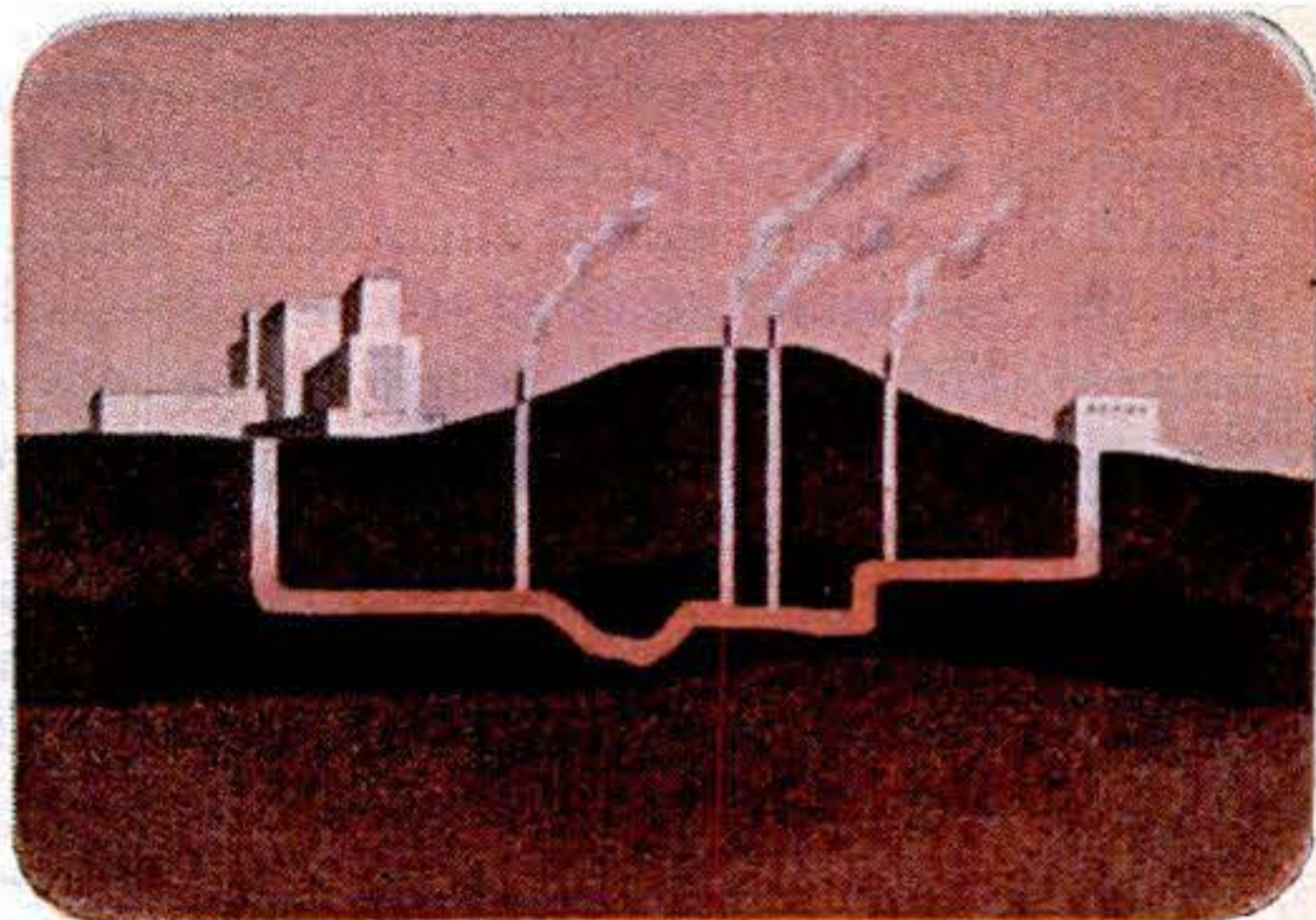

battery? (Forecast by Dr. J. A. Hutcheson, Westinghouse Research Laboratories.) Can we use high-vacuum insulation to build small electrostatic generators like the giant Van De Graaff atom-smasher, enabling us to use directly and conveniently the energy of nuclear fission? (Suggested by Prof. John G. Trump, of MIT.)

So far, our atomic power has come from smashing the heavy atoms U-235 and plutonium, but the sun gets its power by combining little atoms of hydrogen into bigger ones of helium. Man may learn to do this, with an increase in power of about 1,000 percent. Or scientists now investigating the cosmic ray in this country and in Russia may learn its trick of disintegrating hydrogen atoms. No one can scoff at the notion that some day the world's work may be done by atomic-power engines of sizes suitable for every job, fueled by elements that are abundant and cheap. In any event, science will press toward that goal. We have entered the lair of the atom, God help us, and the door is locked behind us. There is only one way to go.

WHILE we are waiting for atomic power, scientists and engineers will have their hands full perfecting new fuels for our present motors as the oil wells run dry. The world's petroleum supply is definitely dwindling, and new deposits will be increasingly expensive to work. But we have enough coal for an estimated 2,500 years, and from

coal and natural gas, as the Germans have shown, we can obtain gasoline and Diesel oil, as well as by-products of fuel gas and alcohols. Coal, the orphan of research, will soon come into its own at the hands of the "long-haired professors" whom the short-sighted mine operators long disdained.

For several years a toy refinery has been operating in the laboratories of the Bureau of Mines in Pittsburgh. Coal goes in at the top and gasoline trickles out at the bottom. Now two full-scale plants are being built in Texas for making motor fuels from natural gas by the more efficient Fischer-Tropsch process. The next step is to use coal to make the gas to make the gasoline, and several big oil companies are spending large sums in research to have this method ready when it is needed. The cost of gasoline from coal abroad has always been high compared with U. S. filling station prices, but improved methods of making cheap oxygen (developed by Dr. Kapitza, of Russia; MIT, and M. W. Kellogg and Co.) will help in making synthetic fuels at prices we can pay.

You don't have to turn coal into oil to provide a convenient fluidlike fuel. You can pulverize it as fine as face powder and blow it into the combustion chamber of a gas turbine. Perhaps tomorrow's Iron Horse will grind up any cheap coal, burn it, remove the fly ash, and spin a turbine with the hot gas, getting three or four times as much power out of the coal as does today's steam loco-



otive. (Built experimentally by John I. Yellott of the Locomotive Development Committee, Baltimore.) There is no reason why this engine can't be used to drive ship propellers and factory wheels.

But why mine coal, haul it to factories, pollute the air and run up laundry bills? Why not burn it where it lies, pumping air down a pipe to keep the fire going, and collecting

the fuel gas as it comes up another pipe? (Now done experimentally by the Alabama Power Co.) If oxygen becomes cheap enough, it could feed the fire to make richer gas, which might be distributed through pipe lines like oil, or burned at the surface and converted into electric power.

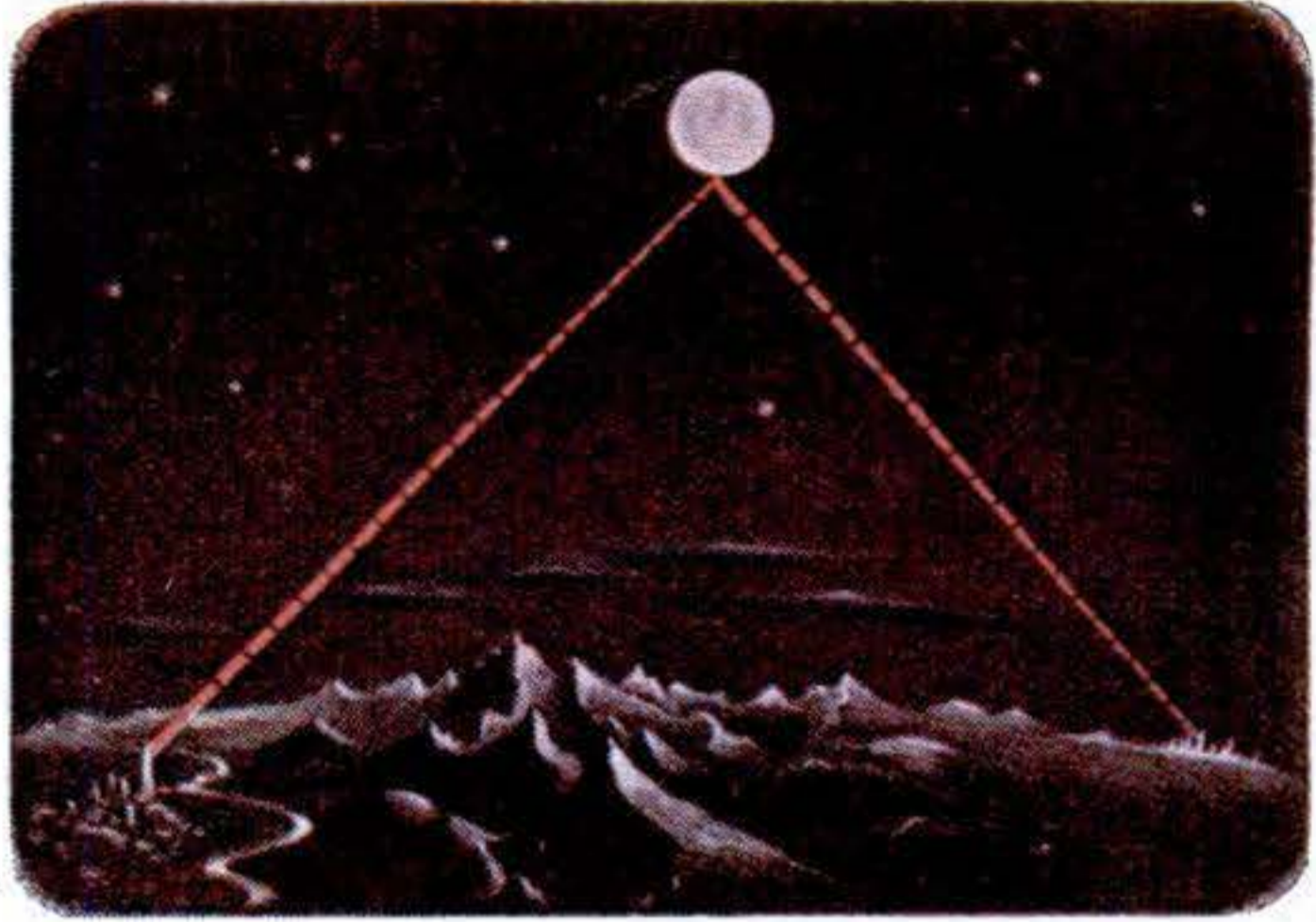

That brings us to another great need—an efficient method of transmitting electric power over a thousand miles. However it may be arrived at, power decentralization is one of America's most important goals. Aside from a military value that we hope will not be tested, it should contribute immeasurably toward promoting freer competition and providing more living space and recreational opportunities for everyone.

THE man of 40 will live to be flabbergasted by new strides in transportation. Before long, robot planes with recording instruments will probably penetrate the transonic speed barrier, that mysterious region lying between 650 and 950 m. p. h. Will these pioneers pave the way for human flight at 1,000 m. p. h. or better, and if so, what motors and airfoils will be used and how will they behave at a slowpoke 400 m. p. h.? Planes have already reached speeds that rival the pace of their own bullets, and pilots who bail out have to be blown from their seats by explosives. There will come a time, determined by the length of the average journey between points on earth, when further speed will not pay. If you're going on a quarter-mile errand, you don't step up your car to 80, and we can apply such a formula to air distances and speeds.

The future of really fast travel lies in the waste spaces of the heavens. A V-2 rocket has already been sent up 114 miles (White Sands Proving Ground, Dec. 18, '46), and as Dr. Fritz Zwicky puts it: "We first throw

a little something into the skies, then a little more, then a shipload of instruments—then ourselves.” Restless man will probably throw himself at the moon, at Mars, and at other chunks of matter and return to write books about it. Experts report that it’s only a matter of mathematics, but first a few problems must be solved. While man’s body can safely travel at any known speed, with too sudden a change in speed or direction his more easily detachable components, like blood and entrails, proceed in an opposite, or tangential, line of march. The more efficient a rocket is, the more likely it is to annoy its crew in this manner, since it must lighten its fuel load by quickly turning it into driving energy. This may cause acceleration too rapid for health. A compromise is indicated, and research toward creating new fuels that will give more power per pound. If lightweight shields against radiation are discovered, atomic power may bring about interplanetary travel.

To serve man best, earth-bound aviation will concentrate on economy, convenience and safety, with safety first. We have an array of tools—Ground Control Approach, Instrument Landing System, Loran, fog-dispersal methods, to name a few—that in some combination should make blind flying about as safe as taking a bath. For convenience, we need among other things a reliable low-priced helicopter. Maybe it will be driven by jets mounted on the tips of the rotors. Such a machine may sometime supplant taxicabs, ambulances, fire engines, cow ponies and crop sprayers.

NEWLY developed tools for communication, when fully applied, will match comic-book dreams. Just now we are beginning to move radio broadcasting from the noisy, crowded, low-fidelity AM band upstairs to FM, where music sounds the way it’s made and there is room enough on the air for thousands of stations instead of hundreds. The transition should be virtually complete in a few years. Beyond that lies a time when telephone and telegraph poles will be sold for firewood, and microwave relay networks (used experimentally by A. T. & T., I. T. & T., Western Union, General Electric and Raytheon) will cover the country, using wave lengths a few inches long to carry all oral and visual intelligence, including FM broadcasting, phone calls, telegrams, television and facsimile.

By means of such a co-ordinated system,

a general in the Pentagon could throw on his office screen radar scopes in any part of the country and see what planes are in the air, and the telephone band could be so wide that every house in a city of 10,000 could have its own radiophone wave length. (Predicted by Dr. M. H. White, of Princeton, formerly of the Radiation Lab.) The networks may be extended throughout the world by putting relay stations in planes that spell one another in the stratosphere, (proposed by Westinghouse) or by bouncing the microwaves off the moon. (Planned by Federal Telephone and Radio Corp.)

Tiny radio receivers and transmitters, with circuits printed instead of wired (see p. 101), will be as common in pockets as fountain pens, with great savings in time, gasoline and shoe leather. In short, everyone may soon become accessible to everyone else, and that, too, is something for the thoughtful scientist to brood about.

PERHAPS the most ambitious goal of science is the duplication of the process of photosynthesis, by which plants, with the catalytic aid of their green chlorophyll, utilize the sun’s energy in the production of sugar, starch, proteins, fats and cellu-

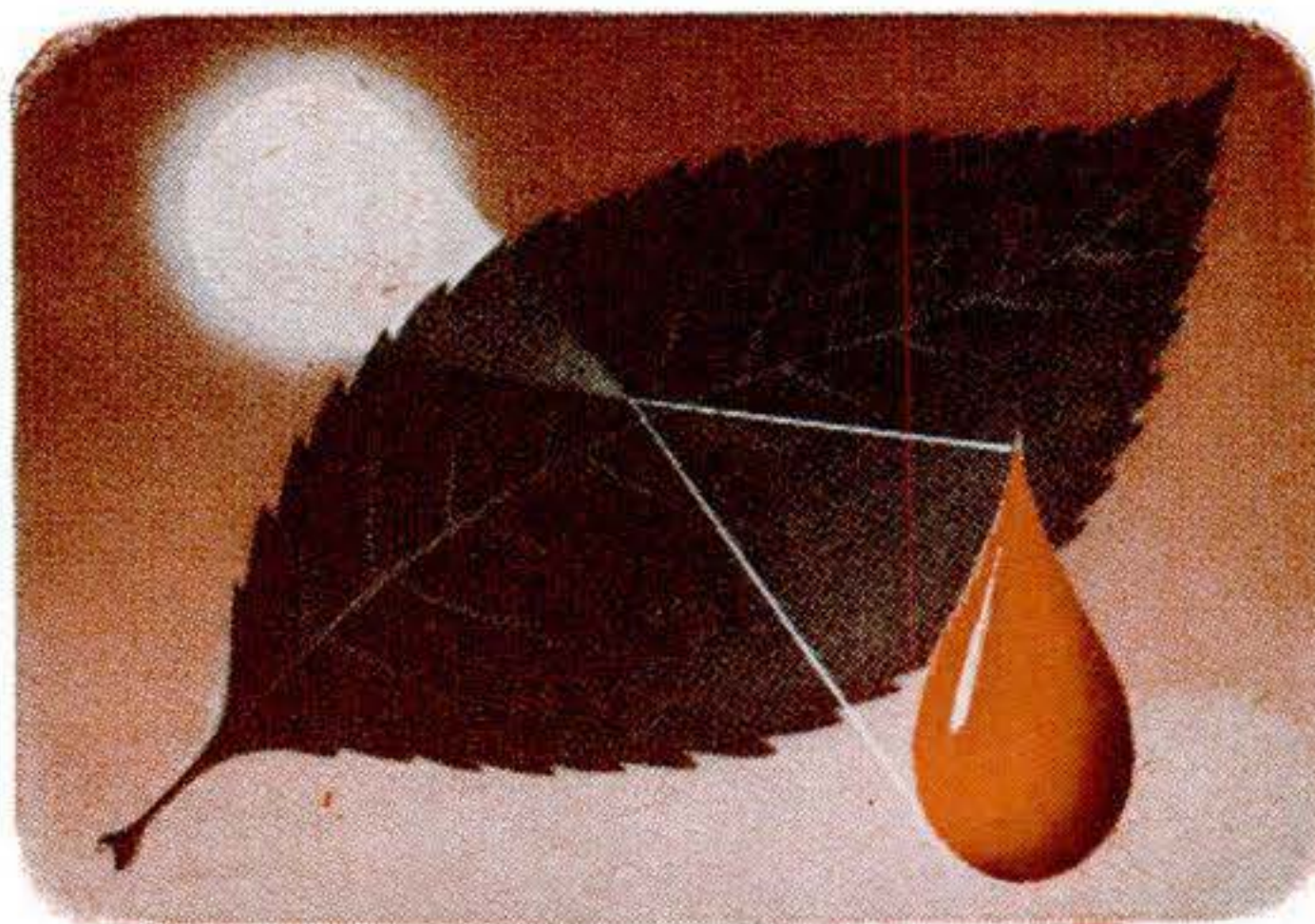

lose—without which life on earth would end. If the efforts of many brilliant research men (like Dr. Eugene Rabinowitch, of MIT) should bear fruit, there might ensue a golden age of plenty for all mankind.

Many developments may be expected in the field of nutrition. Will a protein-deficient world eat cheap “beefsteaks” made from yeast? (Developed by Anheuser-Busch.) Will we feed our animals proteins made from wood scraps (pilot plant at University of New Hampshire), or on cheap synthetic urea made from coal? (Feeding tests at Wisconsin Agricultural Experiment Station.)

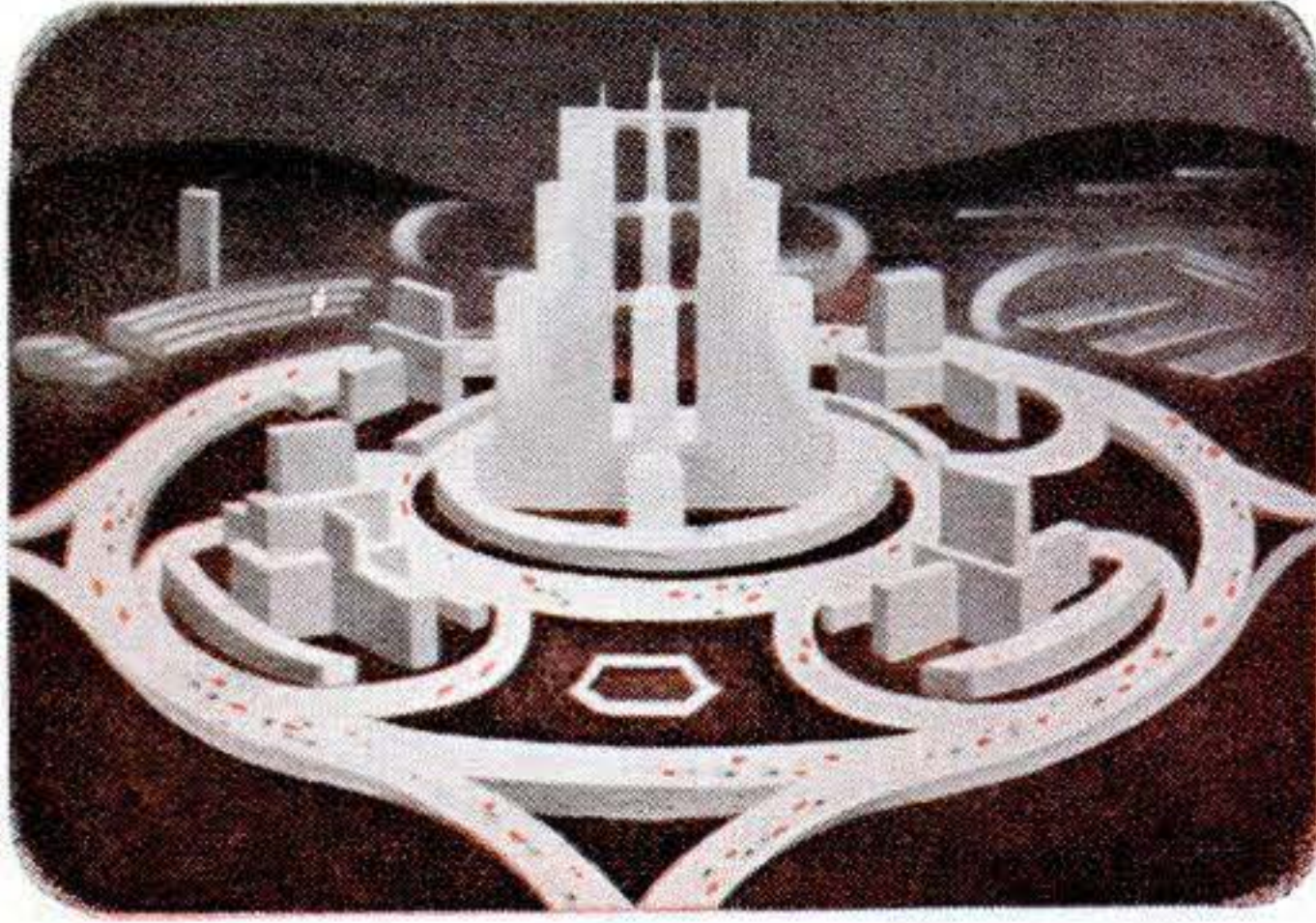

Will our descendants have everlasting teeth from drinking water containing fluorine?

Man may hope for the conquest of his cruelest diseases—cancer, rheumatic fever, arthritis and polio—if he really wants it. But not while he spends two billions for a weapon and passes the hat for health. Fund-raising drives may warm the heart, but they are no match for carcinoma, which is not sentimental.

THE huge industrial metropolis, a fairly new development in man's history, is one of his worst mistakes. The pattern of degradation is familiar: Real estate owners chop up dwelling units and create congestion, then those who can afford it move to the suburbs, leaving behind them run-down areas that yield low taxes. Then the city tries to stave off bankruptcy by floating bond issues, underpaying teachers and levying sales taxes. All the while, radial superhighway approaches are being built to jam the streets from curb to curb with transient vehicles. As a result, the place isn't fit to live in, and even its millionaires cannot buy the sunlight, clean air and recreation space that the village handyman gets for nothing. But cities can be excellent places for living, if we will heed scientific "visionaries" who are concerned with the needs of human beings.

If we select a number of ideas that have been proposed by advanced architects and planners, the city of the future may look like this: It will be surrounded by a multilevel belt highway near which industry will be relocated to isolate much heavy traffic. Within this great circle, the city is divided into self-contained sections, each circled by a one-way "ring street" to prevent through traffic and to restore to residential streets the character of additional "living space" that they had in the horse-and-buggy days. (Proposed for New York by architect Her-

mann Herrey.) Since it has been shown that the building of more and wider streets and more parking places simply lures more cars into town to fill the vacuum, all incoming private cars, with few exceptions, would park in lots provided at the city limits, where the occupants would receive free bus tickets to the center of the city. (Plan now being tested in Baltimore.)

METEOROLOGISTS would aid in city planning, breaking up streets to check cold winds. Walls of city gardens and courtyards and walls lining streets would have large louvres, like outdoor Venetian blinds, set to catch the sun's heat rays in summer and bounce them back into the sky. (Proposed by Dr. Albert E. Parr, Director, American Museum of Natural History.)

All heavily traveled sidewalks would have awnings or roofs to protect pedestrians from the elements (proposed by Edward Bellamy in *Looking Backward*), and snow would be melted on midtown streets by radiant heat from pipes imbedded in the pavement. (Now used on a road in Belmont, Mass.) Better still, snowstorms over cities may be prevented by sending planes to "seed" the clouds with dry-ice pellets, making them dump their cargo in the country. (Done experimentally by Vincent J. Schaefer, General Electric Co.)

These may not be the answers, but cities will adopt plans equally revolutionary, or slide further into their morass of fiscal and architectural bankruptcy.

WE MUST lessen the gap between the scientist and the rest of the world. The scientist is not a mysterious genius. He is an ordinary man with a highly developed respect for provable facts, who has learned accurate methods for sifting those facts from the chaff of conjecture, legend and wishful



half-beliefs. The man who masters a balky furnace and the woman who bakes a better muffin are often unconscious scientists.

People must come to a better understanding of laboratory men and their methods, for science plans our future and sends us the bills. When we don't know how to read them, we sometimes get stuck. And that's not all. History shows that it's dangerous for members of a small, powerful minority to consider themselves universally misunderstood. If we don't knock on their lucite towers and ask them to the clambake, a few ingrown fanatics may try to run the world on their own, and there will be a loud and final bang.

The responsible scientist of the future will be increasingly concerned with social problems. When people say that a certain human dilemma lies beyond the scope of science, it is often more accurate to say that scientific analysis has not yet been successfully applied to it. Race prejudice is one of the most challenging fields for tomorrow's scientists, and no one knows what physician, psychiatrist, anthropologist, ecologist or economist may discover facts that will help to end lynchings and ghettos. To what extent is race hatred a function of the income, occupation, nutritional status, dental condition and folk habits of the hater and the hated? Nobody knows. Science should explore the dark problem.

Juvenile delinquency, venereal disease and assorted neuroses present more jobs for enlightened scientists. It is not enough to treat these maladies after they occur. What would be the preventive effect of subsidized early marriages? Animals mate blamelessly when they reach biological maturity. *Homo sapiens* is expected to wait until he gets a raise or a house to live in. What ills derive from his abstention, or from his guilt at violation of the social code? If a billion-dollar research project established facts leading to

a 10% improvement, it would be the greatest bargain of the ages. Also, manufacturers might sell more refrigerators.

The organization of our industry and agriculture has made us into a nation of movers. Trends in population movements should be anticipated, and practical methods should be adopted to ease the shocks of a family's readjustment to the new locale.

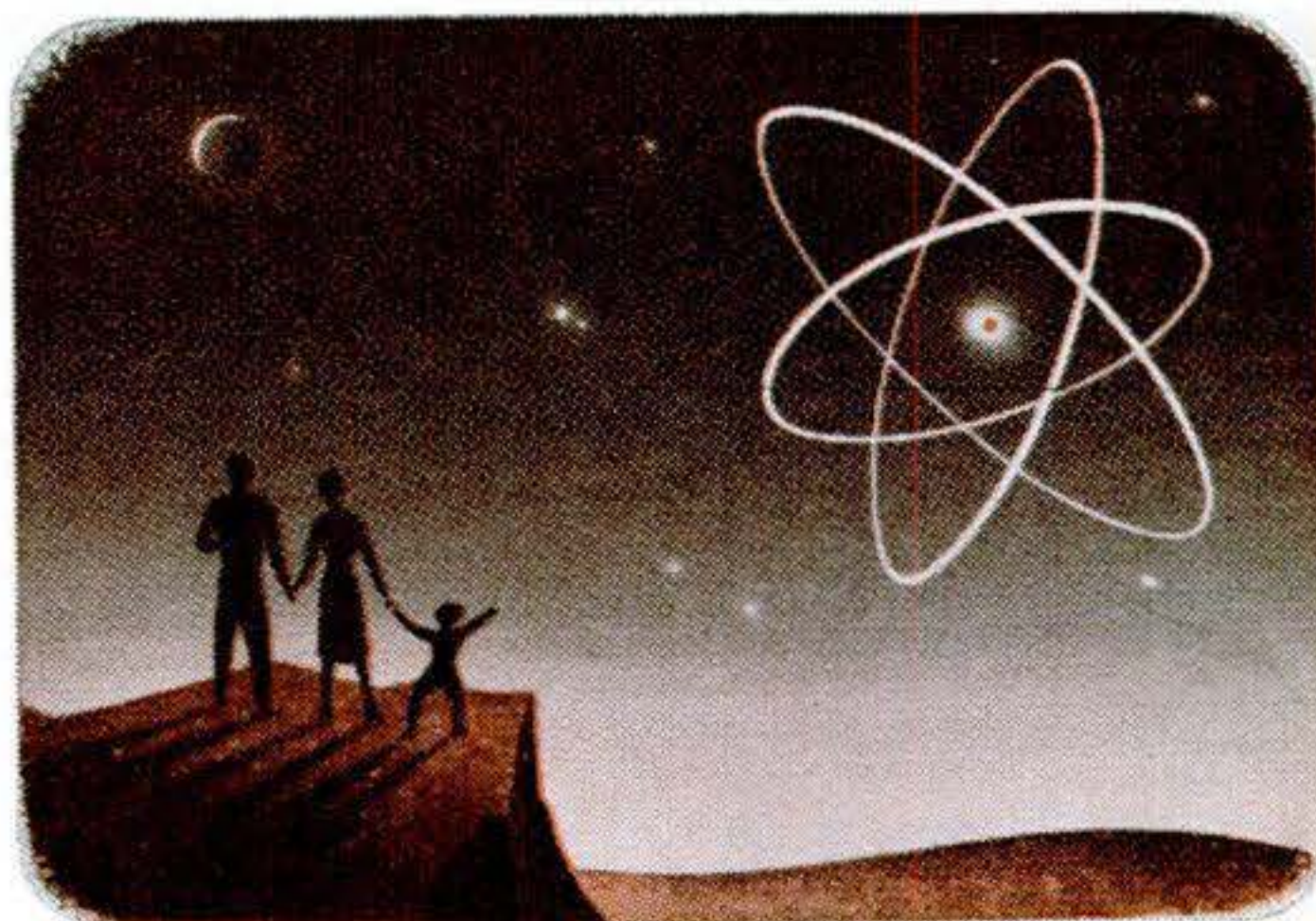

Today no enlightened corporation builds a big plant without considering the housing and transportation facilities available to its employees. What happens to the employee and his family when the plant shuts down or moves somewhere else is of equal importance to society.

Today, scores of eminent scientists, horrified at the killing power of the splitting atom, are earnestly working to unite all peoples in a master plan to harness it in the service of life. We'd better help them, and do it fast. Once we have jailed this bloodthirsty outlaw, the same plan can be used to control other scourges, both man-made and natural. Man will then have a chance to fulfill his destiny through science. Until then, we live by the skin of our teeth, awaiting the White Pillar of Doom. **END**

HARLAND MANCHESTER, the author of "Science Never Stops," has written about scientific and technical developments for many leading magazines. As a roving editor of Reader's Digest, he spends much of his time in research centers and production plants throughout the United States, observing new machines and new methods and interviewing the scientists and technicians who use them. A native of New England and a veteran of the Marine Corps, Mr. Manchester is a former newspaperman and radio commentator. He is the author of New World of Machines.



***A message to
young men interested
in science, from
the President of
Harvard University***



Dr. James B. Conant, chemist and educator; chairman of National Defense Research Committee, 1941; president of the American Association for the Advancement of Science, 1946; member of the General Advisory Committee for the U. S. Atomic Energy Commission.

Educating a Scientist

By Dr. James B. Conant

IN APPLIED science, there is only one thing that can outmatch young men with good ideas, and that is still younger men with better ideas.

During the war, many scientists and engineers labored in what were to them new and untried fields. Indeed, I am inclined to think that a detailed analysis of the work of scientists in the National Defense Research Committee would reveal that some of the most important work was done by able scientists who came to a technical problem with no previous experience in the matter. Nuclear physicists working on radio fuses and radar; chemists and physicists dealing with subsurface warfare; physicists, chemists and engineers who had never heard of rockets before 1940 developing and manufacturing rockets in 1942—all these and many other cases demonstrate the point I have in mind. If the success of the hitherto uninitiated seems a paradox, it has its parallel in the history of more than one industry.

Well-trained men with capacity and imagination, when brought into a new field, often make startling advances. Why is this so? I think that the answer is to be found, not in

the great store of knowledge about specific things which these men have accumulated, but in their understanding of the strategy and tactics of science. Since our civilization is now so largely determined by advances in science, both scientists and nonscientists need to understand both the possibilities and the limitations of experimental and theoretical science.

Strategy and Tactics

The best way to get an understanding of science is to study important experiments that men have made in the past. You will find examples of such experiments in a little book, *On Understanding Science* (Yale University Press), based on some lectures I gave at Yale University last spring. One can see recurring certain basic principles of the strategy and tactics of science in the stories of such men as Galileo, Copernicus, Newton or in the less well-known accounts of men like Torricelli, Pascal and Boyle. I am inclined to prefer the latter. For the reader of the history of science should be warned against overemphasizing the role of the few brilliant generalizations that from time to time in the last 300 years have played so important a part in the advancement of

science. In my book I have tried to direct attention primarily to observation and experiment and the less spectacular and less known advances in the sciences.

In studying the history of science, a person will find certain points that have a wide application to science in general. Among these points are:

1. The influence of new techniques of experimentation and their connection with the practical arts. (Men could not study the behavior of materials in a vacuum until a convenient method of producing a vacuum had been invented.)

2. The evolution of new concepts from experiment. (Through experiment, men were able to discard the ancient idea that "nature abhors a vacuum" for the concept of an atmosphere of a weighable material air, the pressure of this atmosphere varying with the height above the bottom of the "sea of air.")

3. The difficulties of experiment, and the need for eternal vigilance in interpreting experiments. While the inherent "cussedness" of inanimate nature is something that only a man who has spent years in experimentation can fully understand, some appreciation of the pitfalls that surround the experimentalist can be acquired by the proper study of the history of science. (The study of the transmission of sound in air and in a vacuum is a good example of these difficulties.) In this connection, attention should be called to the importance of the controlled experiment. The essence of the controlled experiment is, of course, control of the relevant variables, such as temperature, pressure, light and presence of other materials. There is always a question of the necessary degree of control, and ways of estimating the effect of lack of control are of first importance. Progress in a given field often depends on recognizing what are in fact the relevant variables and devising methods of measuring and controlling them in the experiment. Errors frequently spring from overlooking important variable factors.

4. The development of science as an organized social activity. Science has always been related to the economic, political and cultural life of its times. In some cases, the channels in which scientific inquiry flowed were conditioned by political events and forces. The history of science has been influenced by such general events as the founding of the famous scientific societies in the 17th century. Any reader of science also should get at least a glimpse of the vast

literature of science that exists in the 20th century. The layman should know something of the methods of indexing and compiling this literature and gain some understanding of how, in spite of the volume of material, scientific news now travels faster than ever before.

So much for the understanding of science by nonscientists. Now let us consider what is necessary to make a well-rounded scientist in the present day.

Breadth of Vision

No man can properly serve the nation as a scientist today without a good grounding in what I call general education, which may be described as education for broadening a man's horizon. No man can be considered educated these days who does not have a share in the common core of man's knowledge, "the wisdom of the ages."

No one wishes to disparage the importance of being "well informed." But even a good grounding in mathematics and the physical and biological sciences, combined with an ability to read and write several foreign languages, does not provide a sufficient educational background for the scientists of a free nation. For such learning lacks contact with both man's emotional experience as an individual and his practical experience as a social being. It includes no history, no art, no literature, no philosophy. A person, *at every stage of his life*, must be concerned, in part at least, with the words "right" and "wrong" in both the ethical and the mathematical sense.

The good citizen of today will know something of the political and economic history of the past, and be able to relate this to the political and economic problems of the present. He will understand the evolution of science as part of the whole cultural history of the world. And he will read the literature and philosophy of the past as a help in meeting the problems of modern man and modern society.

Unless he feels the import of those general ideas and aspirations that have been a deep moving force in the lives of men, he runs the risk of partial blindness. In an age characterized by the terrifying potentialities of science and a highly contracted world, men cannot afford even partial blindness. **END**

Do You Know These "Young Men of Science?"

PSM's artist has portrayed them as they were when they made their early contributions to science, and as they might look in modern dress. Check clues under pictures, then turn page upside down for answers.



1. He was a mere 26 when he published his report on relativity.



2. He was only 28 years old when he invented the cotton gin.



3. He was Director of the Harvard Observatory at the age of 36.



4. He was granted the first patent on his wireless when he was only 22.



5. He made first powered-plane flight when he was 32 years old.



6. He was only 38 when he proved that the steam-boat was practical.



7. He was 24 when he built the first multi-engined plane.



8. He was 24 years old when he discovered the law of gravity.



9. He invented the self-starter for automobiles when he was 34.

9. Charles Kettering
8. Isaac Newton
7. Igor Sikorsky

6. Robert Fulton
5. Orville Wright
4. Guglielmo Marconi

3. Harlow Shapley
2. Eli Whitney
1. Albert Einstein

Testers "Hug" New Cars

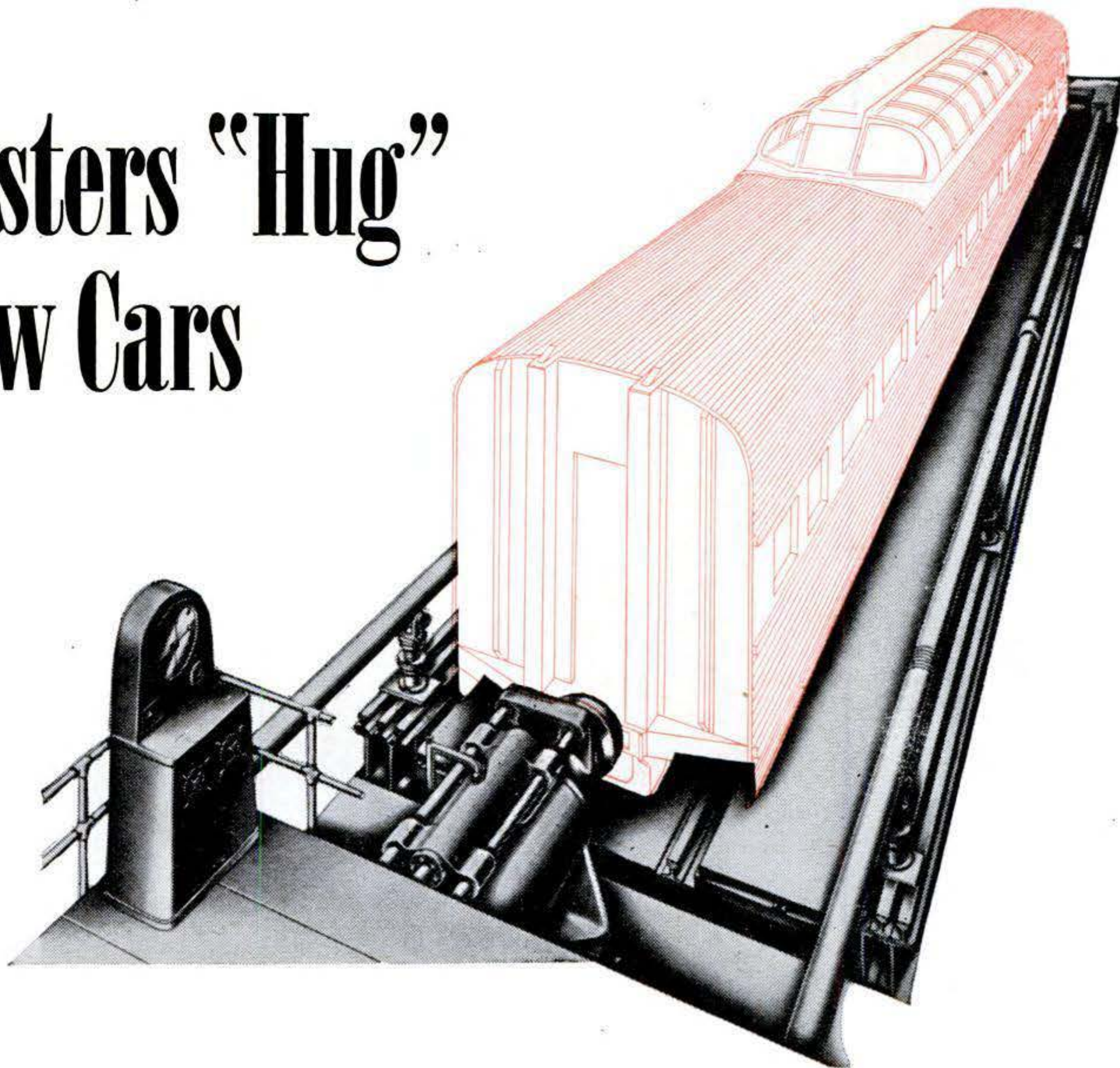

NEW railway cars are being given tests tough enough to make their hair—or their framing—curl. Pictured above in Budd's Railway Structural Test Laboratory, the new Vista-Dome is getting the works in a 2,000,000-pound horizontal testing machine, which can accommodate cars up to 95 feet in length. A huge ram gave the new observation car an 850,000-pound squeeze along the center line of the coupler. A wire

stretched alongside recorded the original length, and the difference after the squeeze told the deformation. The Vista-Dome took the squeeze with no permanent deformation; the windows didn't even break. The same results were obtained when 550,000 pounds were applied a foot higher on the center line of the buffer. These loads were 50,000 pounds greater than the requirements of the American Association of Railroads.



Taking readings of vertical deflection during the test of Budd's new Vista-Dome car. Gauge measures the car's contraction under a compressive load.

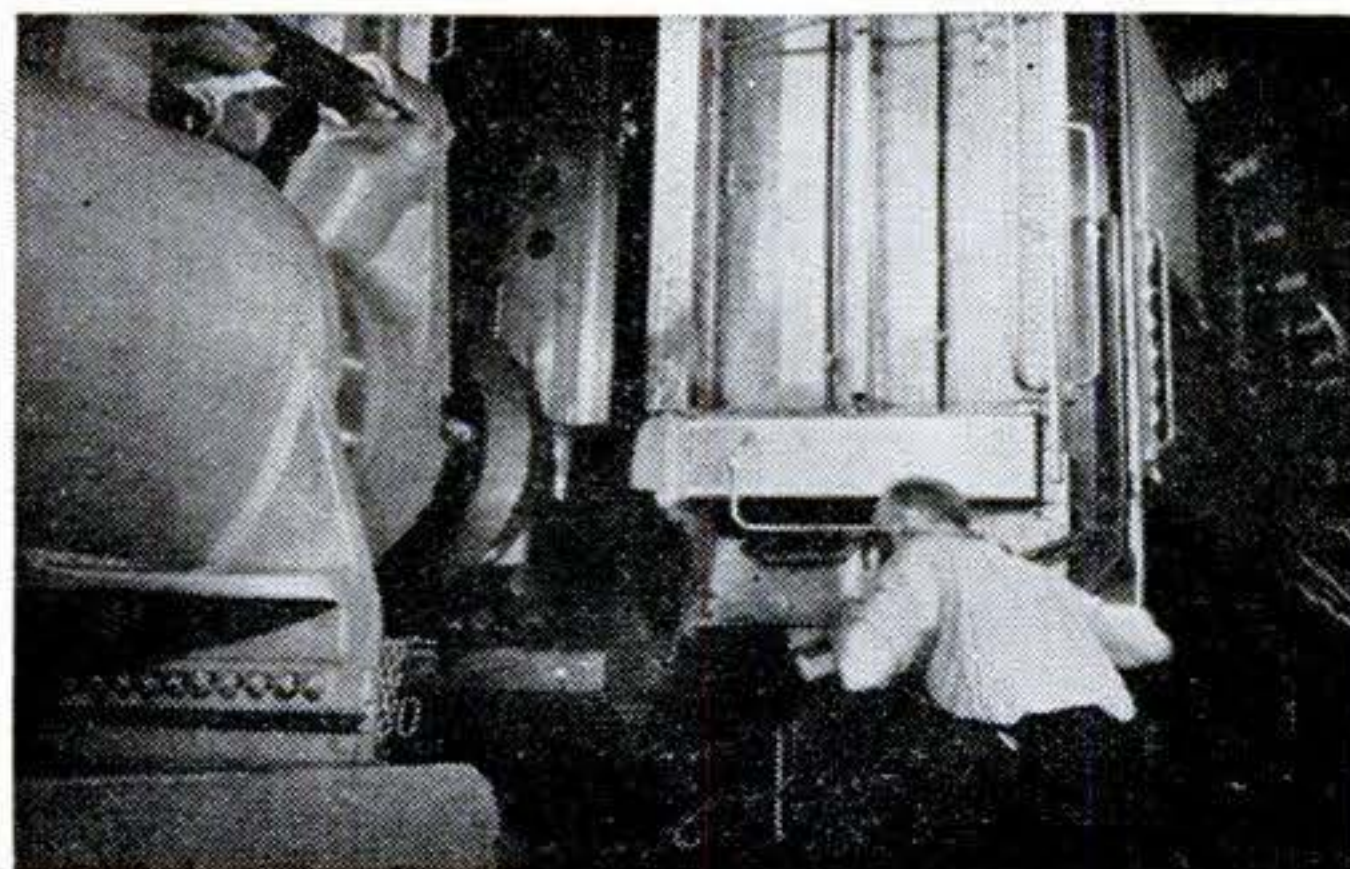

This huge ram, at left of picture, can supply up to 2,000,000 pounds pressure to test railroad cars. Jacks check body rigidity under torsion loading.

MAY
1947 91

Chicken-wire Ocean Tests

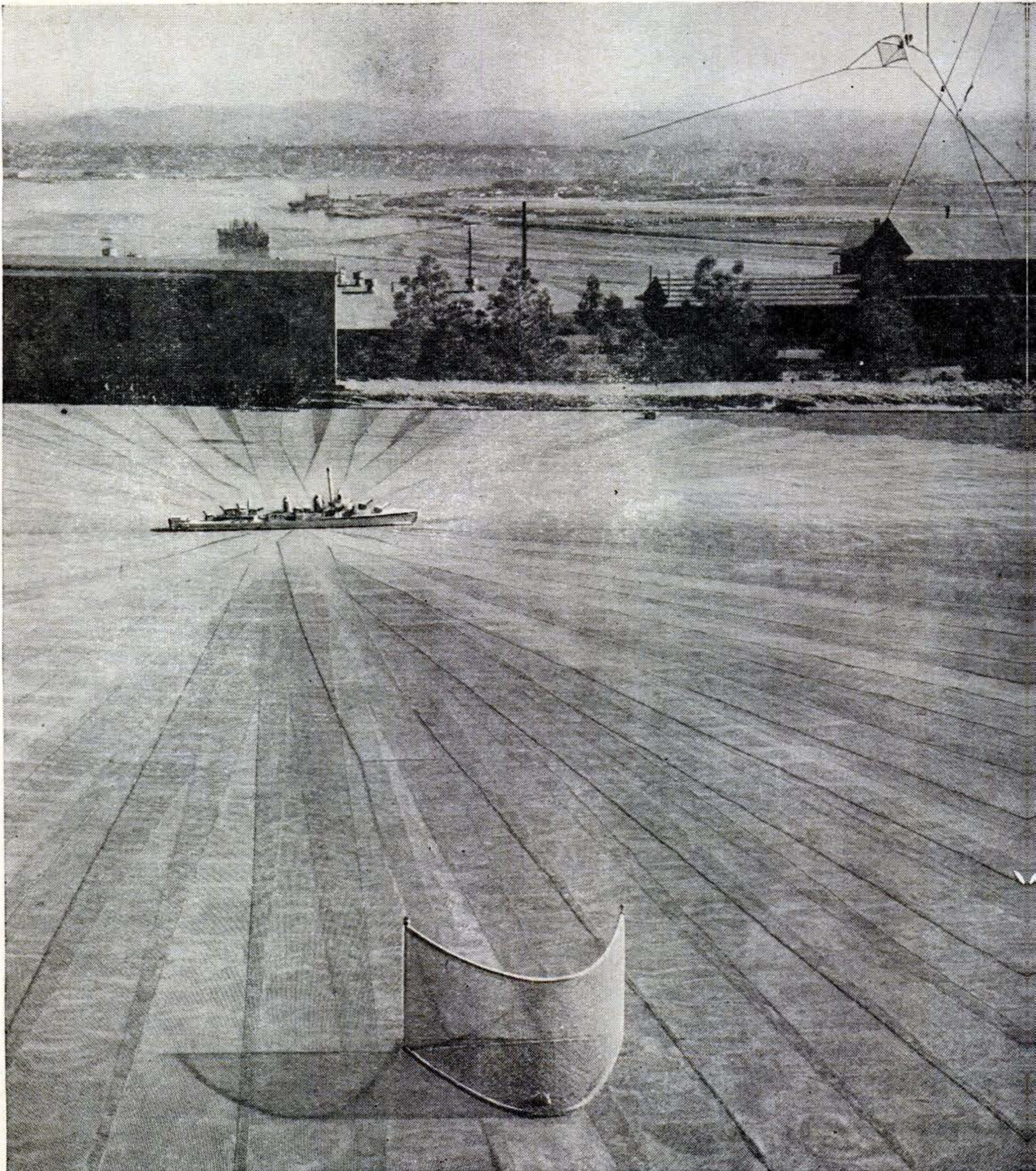

This destroyer model is being tested atop Pt. Loma, near San Diego, by the Navy Electronics Laboratory. The antenna in the air at right and the parabolic reflector at "sea level" in the foreground are used in conjunction with apparatus aboard the model. Both vertical and horizontal measurements can thus be made.

Navy's Eyes

MINIATURE ships of brass, sailing on seas of hardware cloth and chicken wire, are helping the Navy improve its communications. Both radar and radio are affected by the shape of a ship's superstructure and its relation to the antennas. Testing these effects on big ships involves swinging them through a tight circle while the signal strength of their transmissions is measured ashore. By building exact models and testing them with multiplied frequencies, distortions can be studied and better designs can be made far more easily.

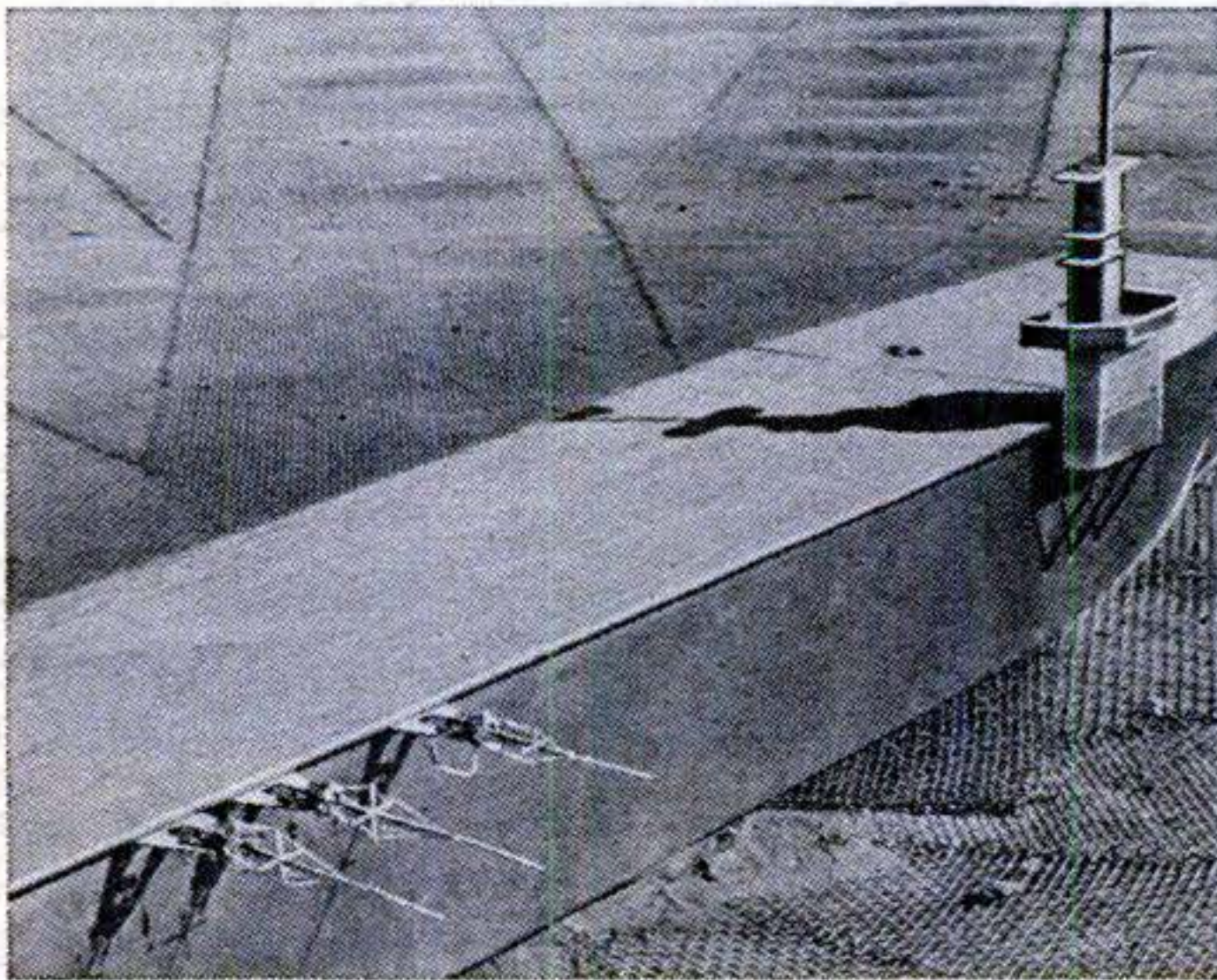

The whip antennas (lower left) on this 1/24 scale model of a baby flat-top are being checked in the horizontal position they would be in when planes take off or land. Each transmits on a separate band, from 2 to 18 megacycles.

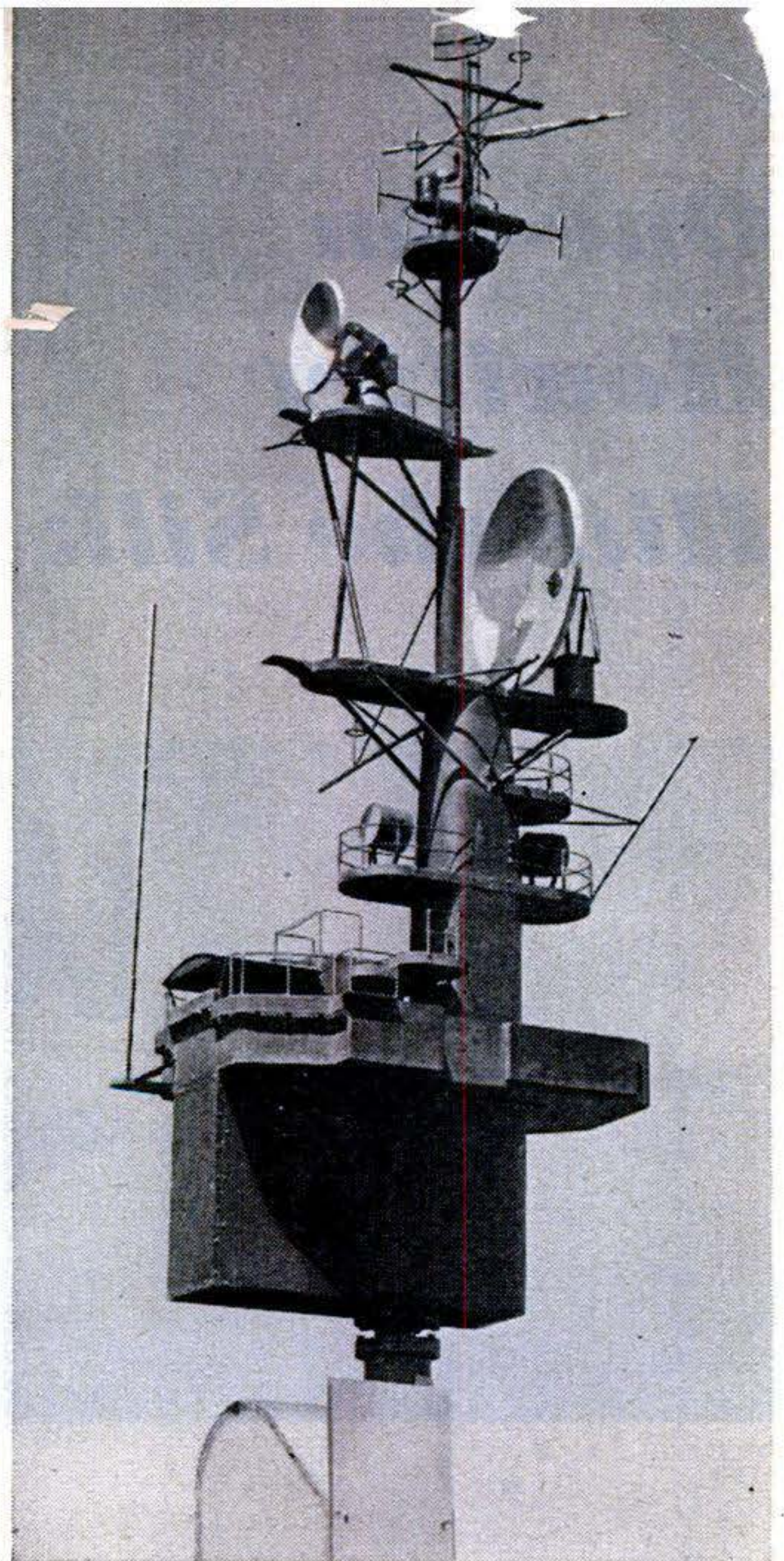

This model of a carrier's "island" is twice the scale of the one on the left. Radio antennas and radar beacon are at the top, SK radar parabola at the center, and TDE communication antenna below. Model is built of 1/16-inch sheet brass.

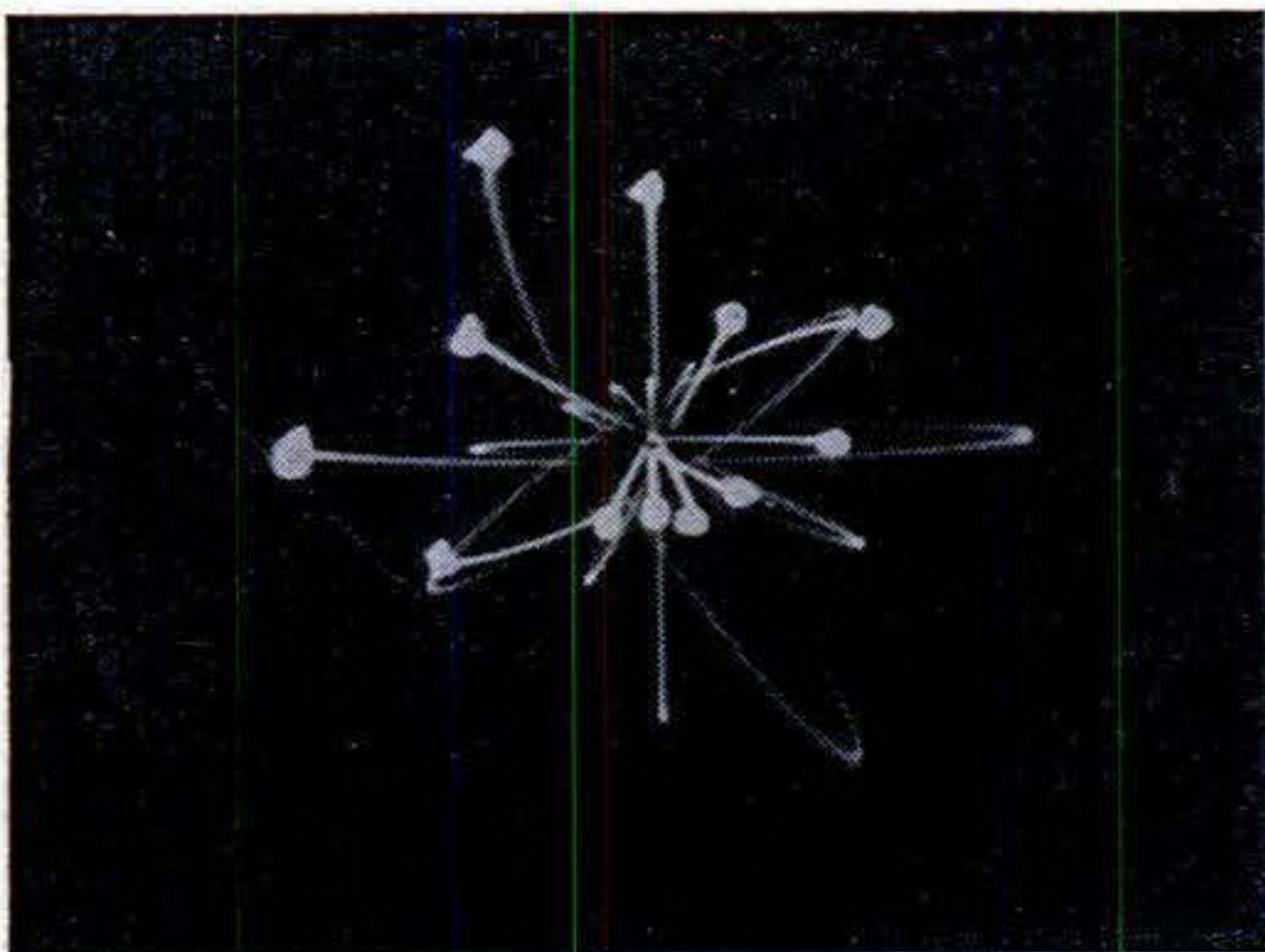

View of oscilloscope shows a sweep being made in several directions: The signals appear as blobs at the ends of the sweep lines. If the blobs were connected, they would form a pattern like that shown in the next picture.

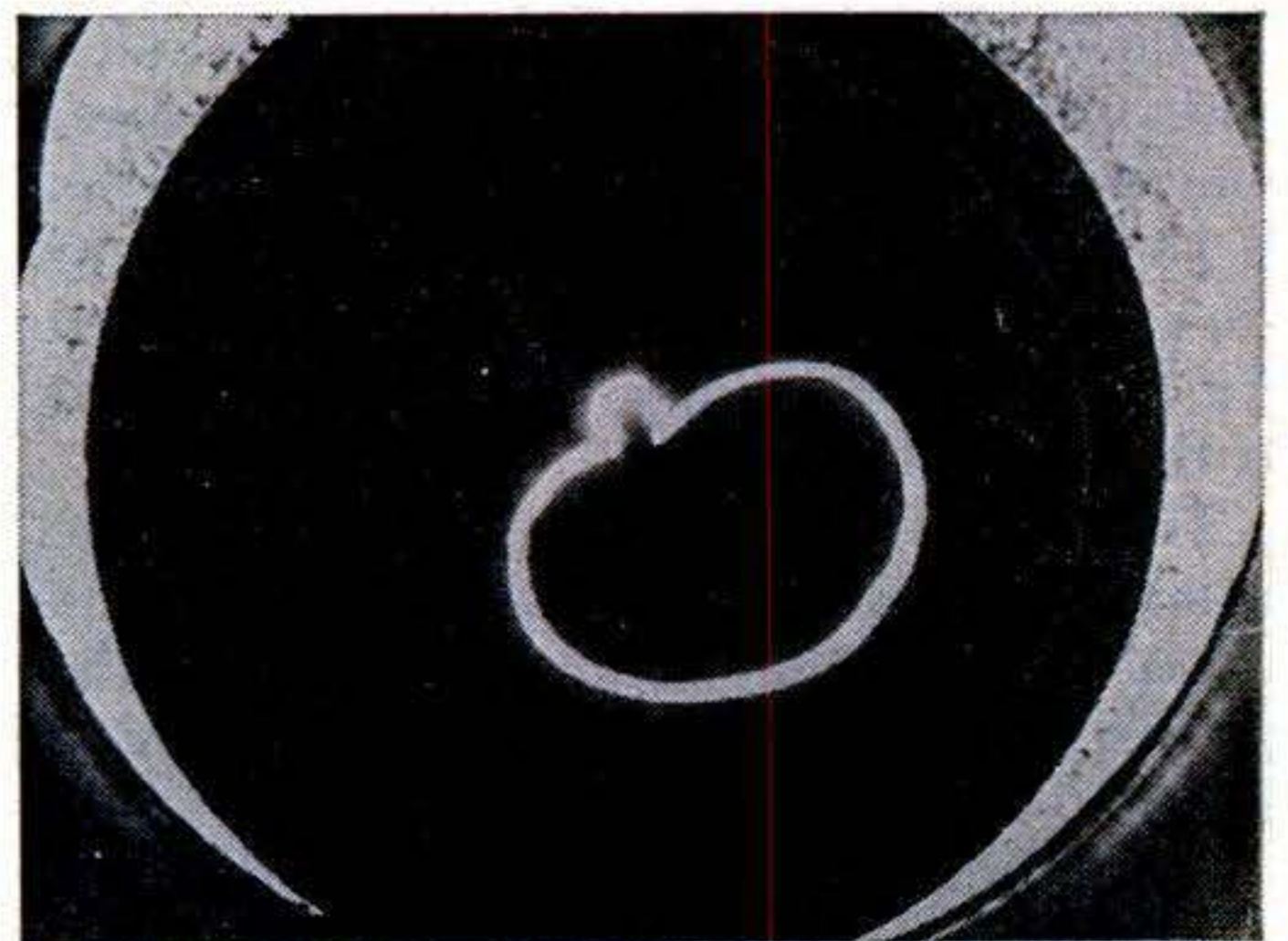

This is the oscilloscope's report on a continuous, around-the-compass signal from a cruiser at 3.0 megacycles. The foremast suppresses forward and reflects rearward radiations. Investigation of such distortions is the object of the Navy's tests.

One-ton Howitzer Hits the Silk



The 2,240-lb. howitzer is loaded into the rear door of a C-82 Fairchild cargo plane. Packed on skids beforehand, it can be put aboard in 15 minutes.

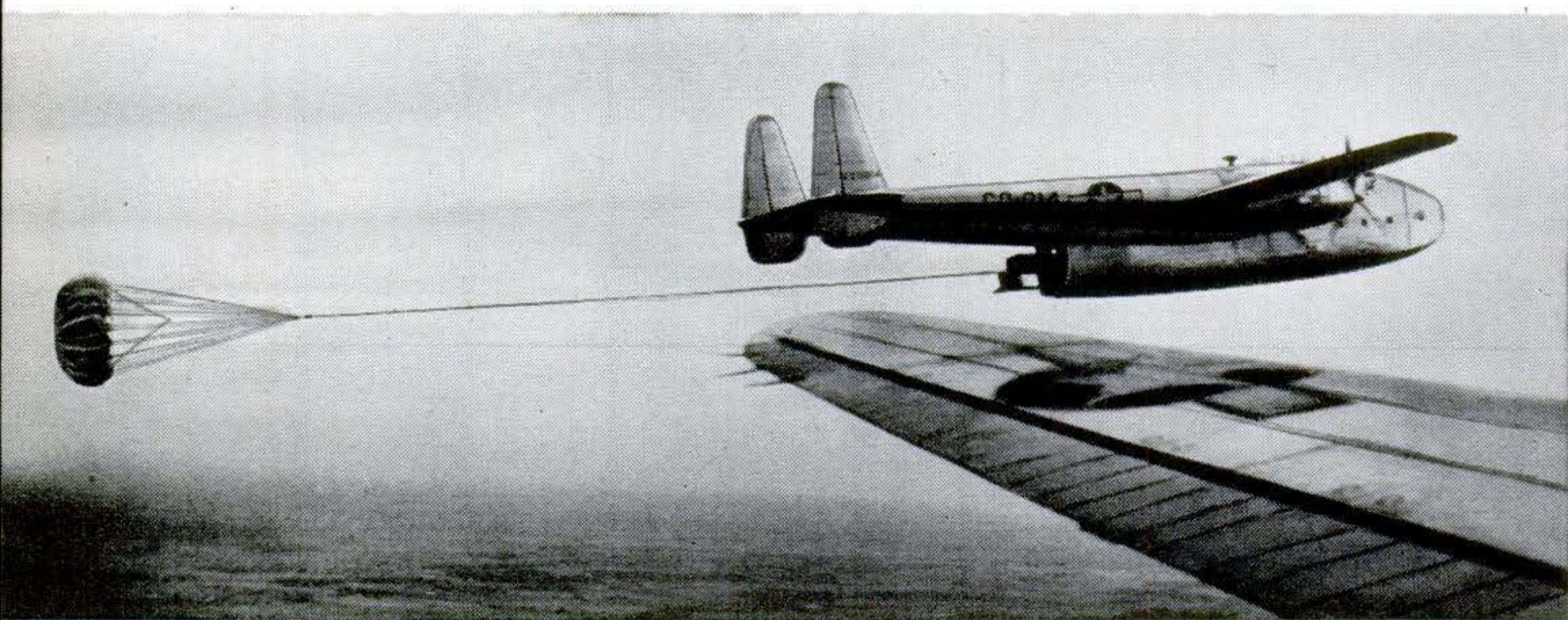

A small ribbon 'chute, folded, was released as plane neared target area. Now, at the drop point, it has been tripped and fills, left, to pull out cargo.

MILES up, a ton of howitzer slides out of a plane into space—and floats gently to the ground. That's the latest trick AAF engineers have pulled with their improved version of the German ribbon parachute.

The 75-mm. howitzer is carried on wooden skids and loaded on a ball-bearing wheel conveyer located on the floor of the plane. A 14-foot ribbon parachute drags it out of the plane, and as the cargo falls it pulls open the big 90-foot canopy 'chute that eases it to the ground.

The ribbon parachute eliminates both the usual opening shock and the tumbling of the cargo as it hits the slipstream. Because the cargo's forward motion is reduced, it is more likely to land where aimed.

The ribbon parachutes are also proving their worth in dropping instruments out of V-2 rockets 70 miles up in space. Now the 'chutes are even bringing the whole rocket back to earth after its upward impulse has been exhausted, permitting it to be re-used.

Once out, the cargo is floated down by a large 90-foot canopy parachute. The extraction 'chute stays open alongside to stabilize against swings.

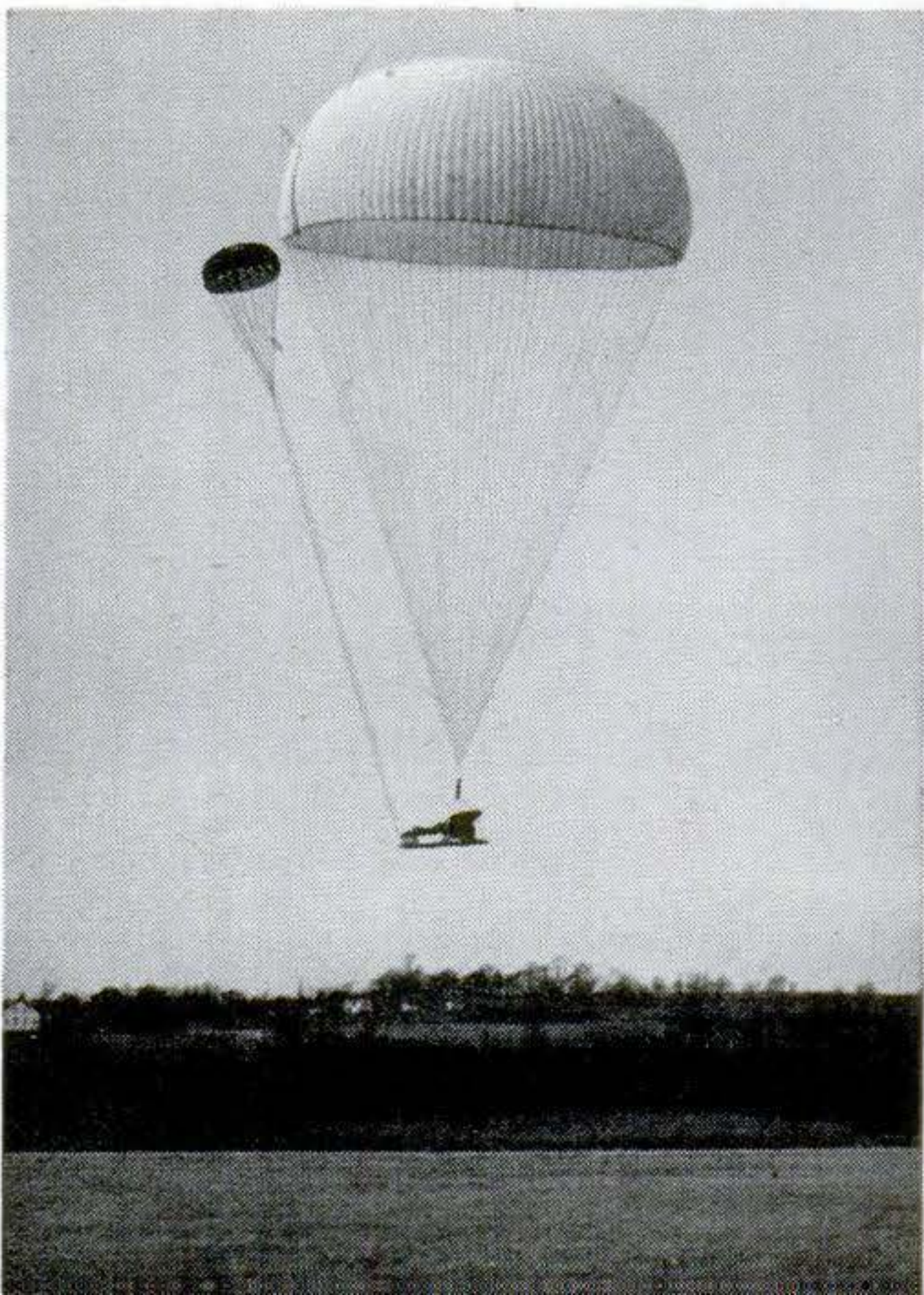

Inside the Biggest Man-made Brain

*Navy's new calculator
has steel bones,
silver nerves,
paper impulses, and
can make mistakes.*

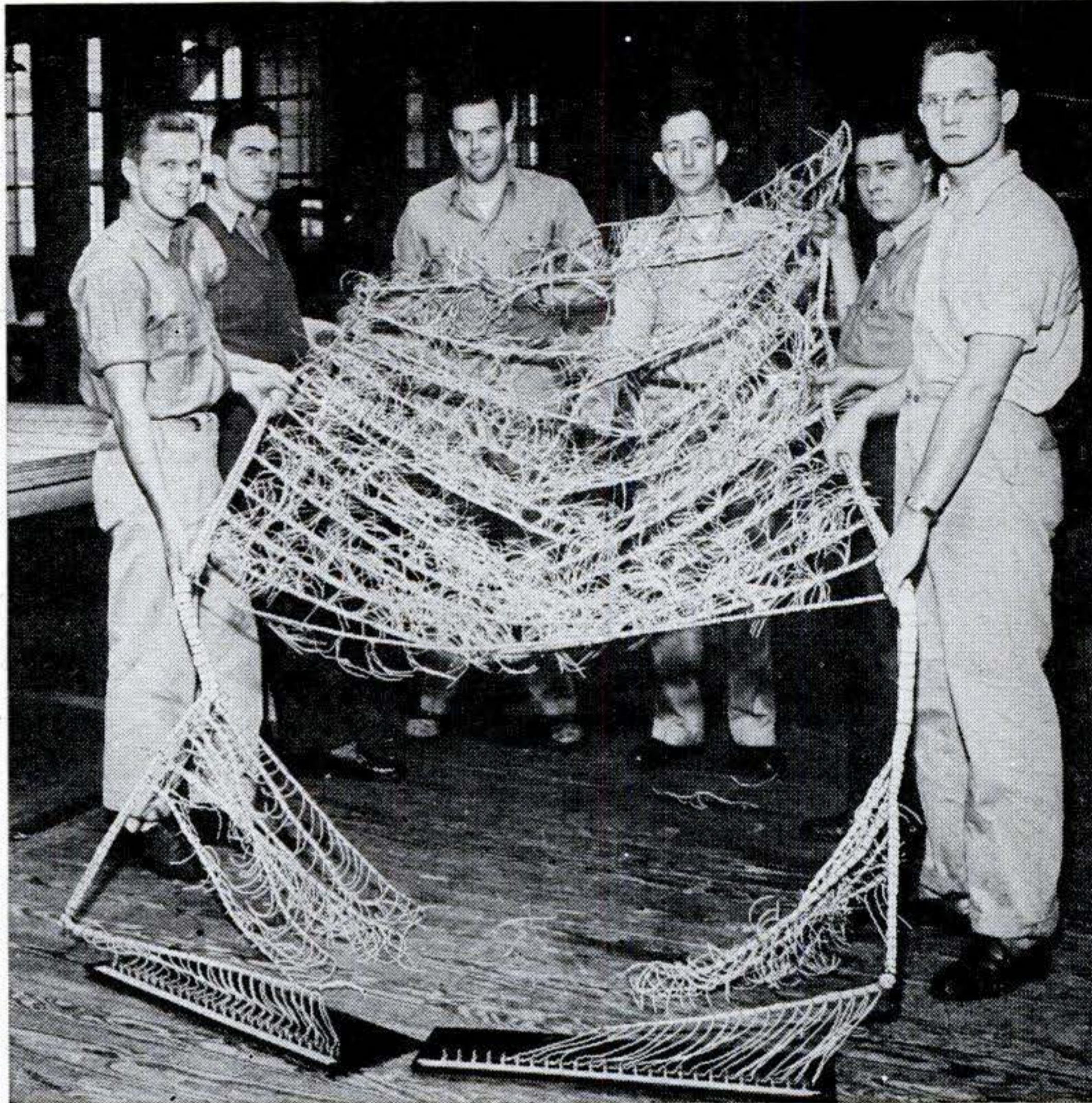

This intricate, bedspringlike maze of wiring shows the complexity of the giant "brain." All panel wiring was done first on jigs, laced for identification.

By Stephen L. Freeland

THE LARGEST brain in the world today is a mammoth electrical mathematician being built at Harvard's Computation Laboratory for the U. S. Navy Proving Grounds at Dahlgren, Va. But its reign as king of the robots will be brief.

Work already has begun on faster, better calculators based on the lessons learned in creating this machine, known as the Dahlgren Calculator, or Mark II, just as this one was designed to be the big, tough brother of Mark I, which was built for Harvard during the war by the International Business Machines Corp. (PSM, Oct. '44, p. 86).

Mark II, however, will not be retired. Even Mark I has many years of useful labor ahead. There is plenty of work waiting for all the big calculators now in existence and on the drawing boards. Mark I is still churning out answers to abstruse mathematical problems 24 hours a day, and Mark II will be taken to Virginia next month to begin an equally strenuous career.

Mark II is simply larger, faster, more

versatile and more flexible than Mark I. The difference between the two machines, however, starts right at the eight-foot-high front panel, which is 60 feet long and shaped like a shallow "U" in Mark II, 51 feet long and straight in Mark I. Adders, multipliers, interpolators and instruction mechanisms are all let into this front panel like drawers in a bureau in Mark II. Two men can handle them easily, and if one unit goes haywire, it can be removed and a spare one slid into place with no waste of time. In Mark I no such substitution is possible.

Answers Roll Out on Ribbons

There are other differences, too. Long strips of paper tape run on aluminum spools across four panels of Mark II, and one entire section is devoted to printing and storing these tapes. Punched in code, they pass through delicate fingering devices on the panel; depending on how they are punched and where they go, they tell the calculator what numbers to use and how

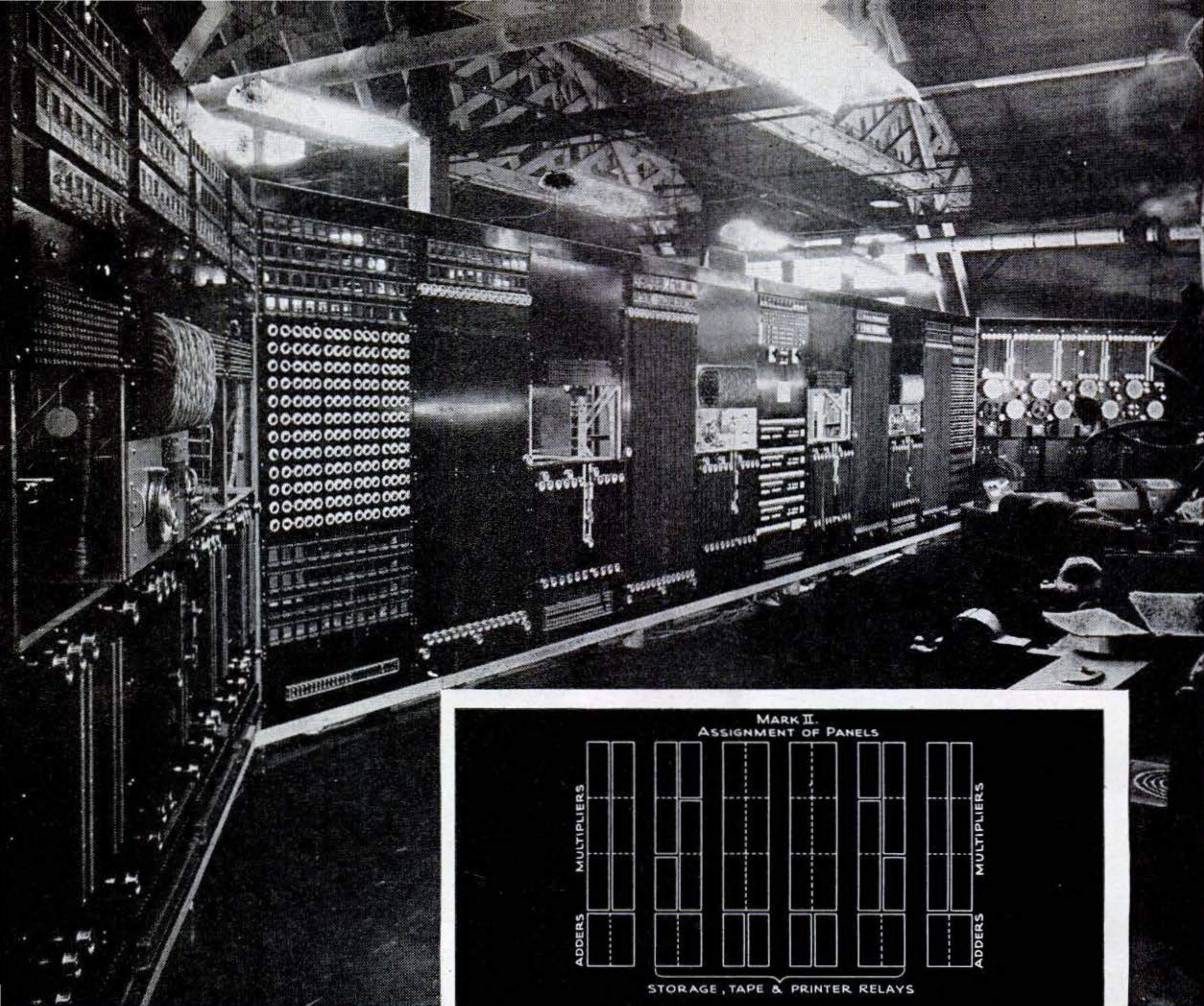

The long main panel board of the Mark II Calculator, shaped like a shallow "U," is shown in the angled view above. The diagram at right is a floor plan of the computing machine showing the arrangement of the main board, the control desk in front of the board, and the six relay cubicles behind it.

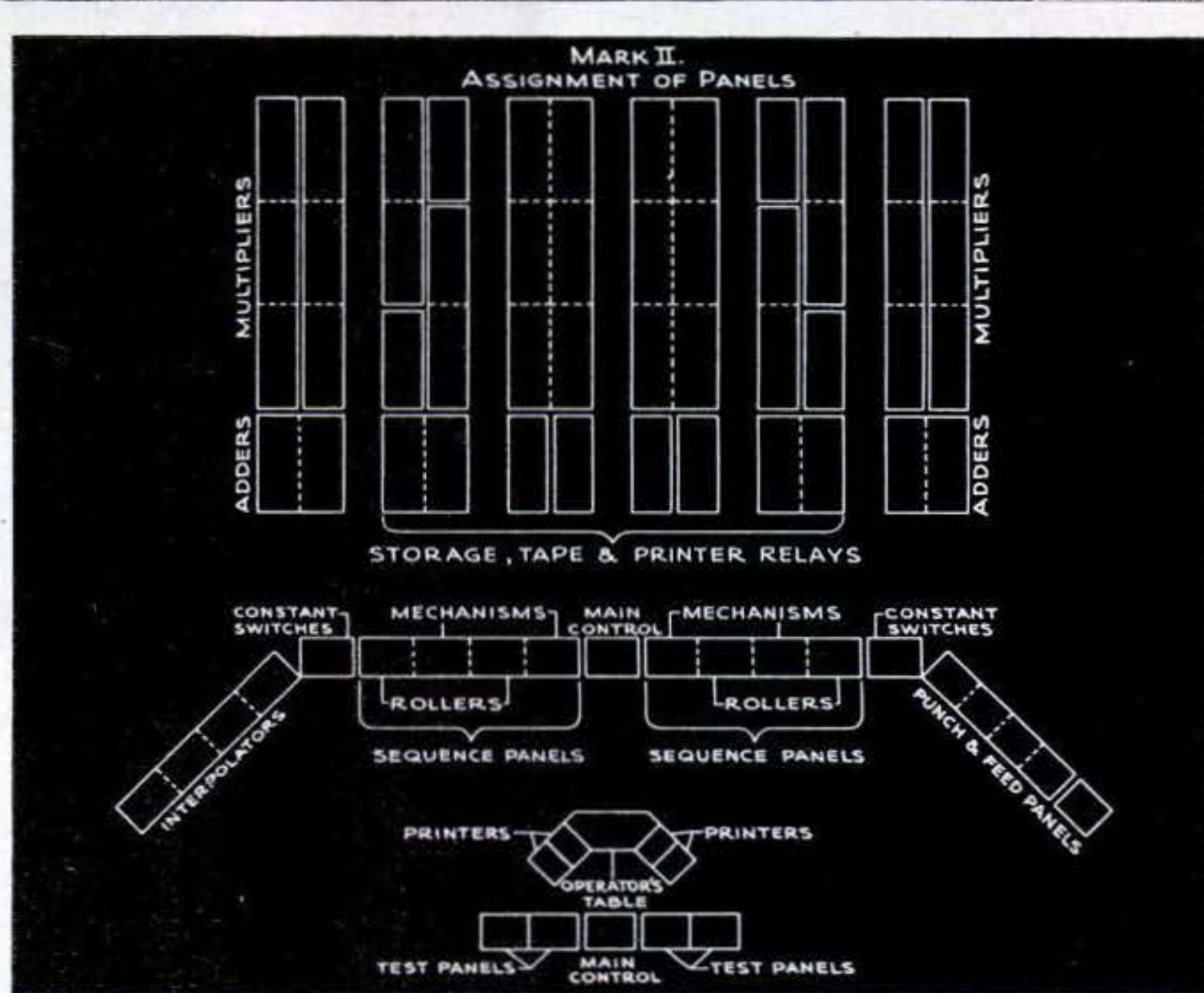

to use them. Mark I also uses tapes, along with punch cards, but the tape is broad and heavy and forms a complicated and bulky maze behind the panel, where it is hard to get at. On Mark II a tape can be changed in a minute.

Mark II is hooked up to a battery of four teletypewriters, with a fifth as a standby, while Mark I has only two. Mark I displays a 30-foot stretch of glass window behind which the spinning gears of the counters may be observed, whereas Mark II has no visible moving parts except for the spools of tape.

Unlike as the two machines are in appearance, it is not until one goes behind the panels that their real difference is seen. While Mark I performs its functions almost noiselessly by a combination of mechanical gears and electrical relays, Mark II's calculations are all done in a whirling clatter of relays. There are 13,000 of them in place now, and positions are available for 2,000 more if needed.

Actually, Mark II uses three kinds of relays: a single coil, a double coil, and a double coil with a latch. All were designed and developed by the staff of the Harvard

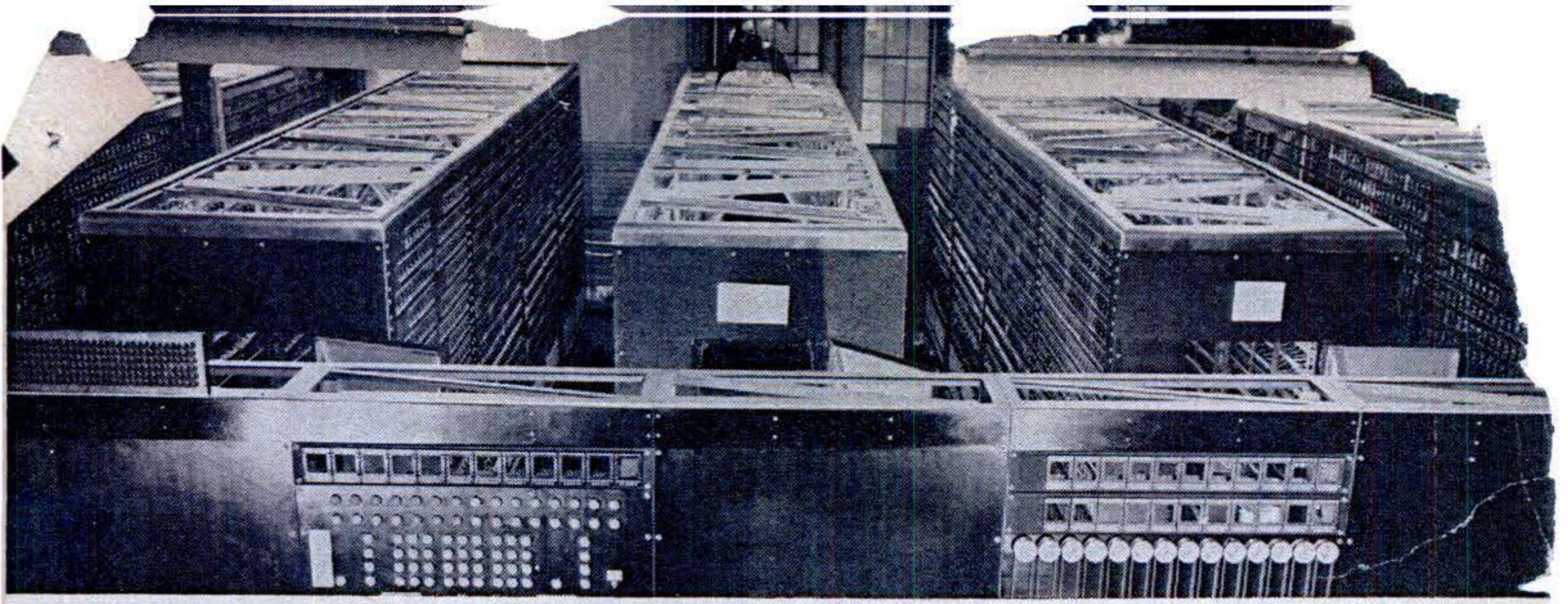

Visible over the top of the main board, above, are several of the six big relay cubicles where all of the actual calculations are performed. At the low control desk shown at left, one man can operate the entire machine. Facing the main board, he is surrounded by five teletype machines, four for normal operation and a spare for emergency use. At his back is the operating control board.

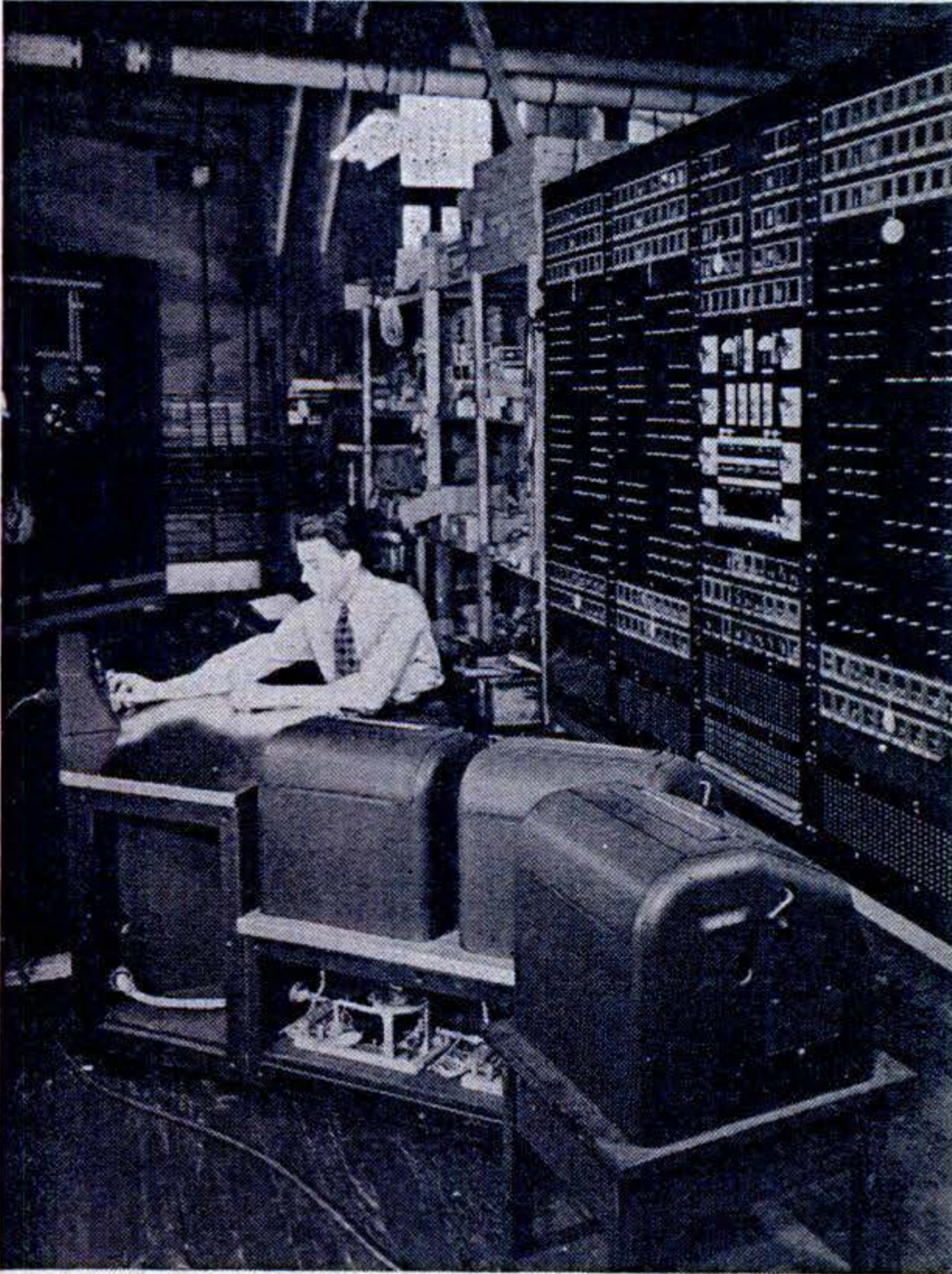

latch, will hold a number indefinitely until it receives a special signal to put it into the calculation.

Mark II can perform in less than one second multiplication that takes Mark I nearly six seconds. And since Mark II has four multiplier units, compared to only one in Mark I, it can do four such operations at the same time. All the other jobs are speeded up in like degree, and frequently the Mark II will get answers faster than the one-per-second rate at which the printer can record them.

Faster Recorders Are Needed

The business of speeding up recording, incidentally, is bothering the builders of big calculators right now. The Army's ENIAC (Electronic Numerical Integrator and Computer) and EDVAC (Electronic Discrete Variable Computer) are perhaps 1,000 times faster in getting answers than Mark II (PSM, Apr. '46, p. 83). They hit the same bottleneck of printer speed, however, when it comes to writing them down.

The not-yet-completed EDVAC, for example, uses a series of mercury tanks capable of "memorizing" up to 1,000 10-digit numbers and referring to any of them in an average time of 1/5,000 second. Also, its system of magnetic tapes, upon which problems are coded and their results obtained, is similar in purpose but superior in speed of operation to that of Mark II's perforated paper tapes. Its actual over-all speed, however, is still dependent upon the rate at

Computation Laboratory in co-operation with the Autocall Company, of Shelby, Ohio. Their contacts are made of a special silver alloy that enables them to operate at least 100,000,000 times at a pulse rate of five milliseconds.

Each type of relay has a different job to perform. The single coil simply acts as an immediate transfer agent for a number, shooting it right into a computation; the double-coil relay can take a number and hold it for a certain predetermined number of pulses—carry the number in its head, in effect; the third type, the double coil with

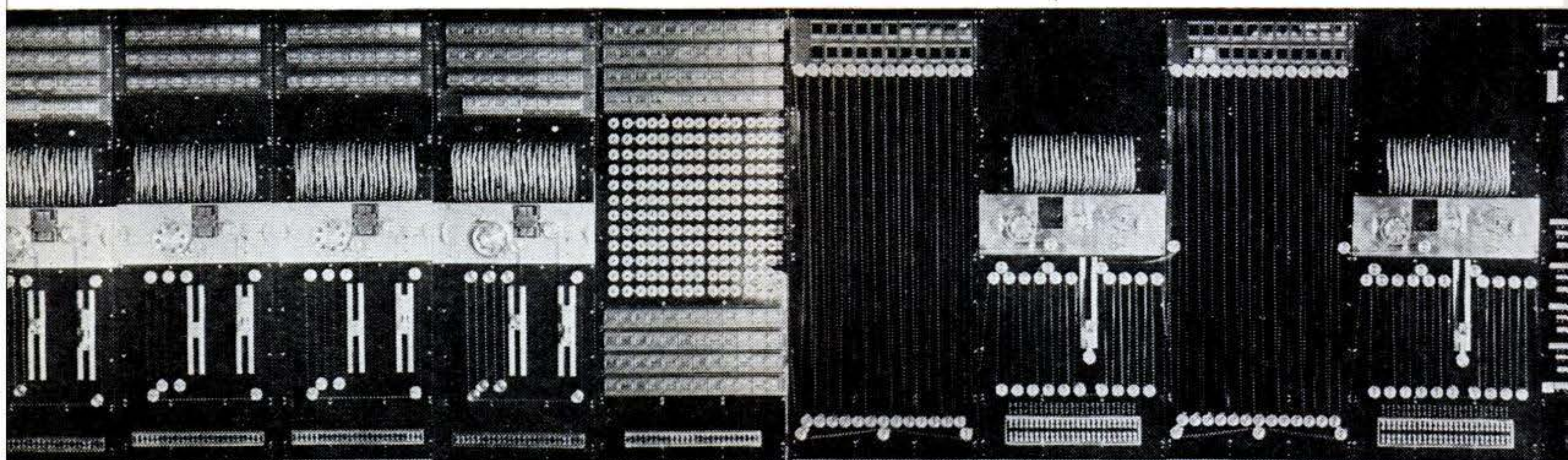

The eight-foot-high, 60-foot-long main panel board is shown above as it would appear if laid out flat. Indicative of its simplicity are the plug-and-jack connections that make all wiring installations possible in a matter of seconds. Sliding spools, famili-

arly known as "yo-yos," permit variations in the length of the paper tapes and their almost instant removal. A system of lights across the top of the sub-main control panel (center panel) reveals intermediate calculations prior to the final answer.

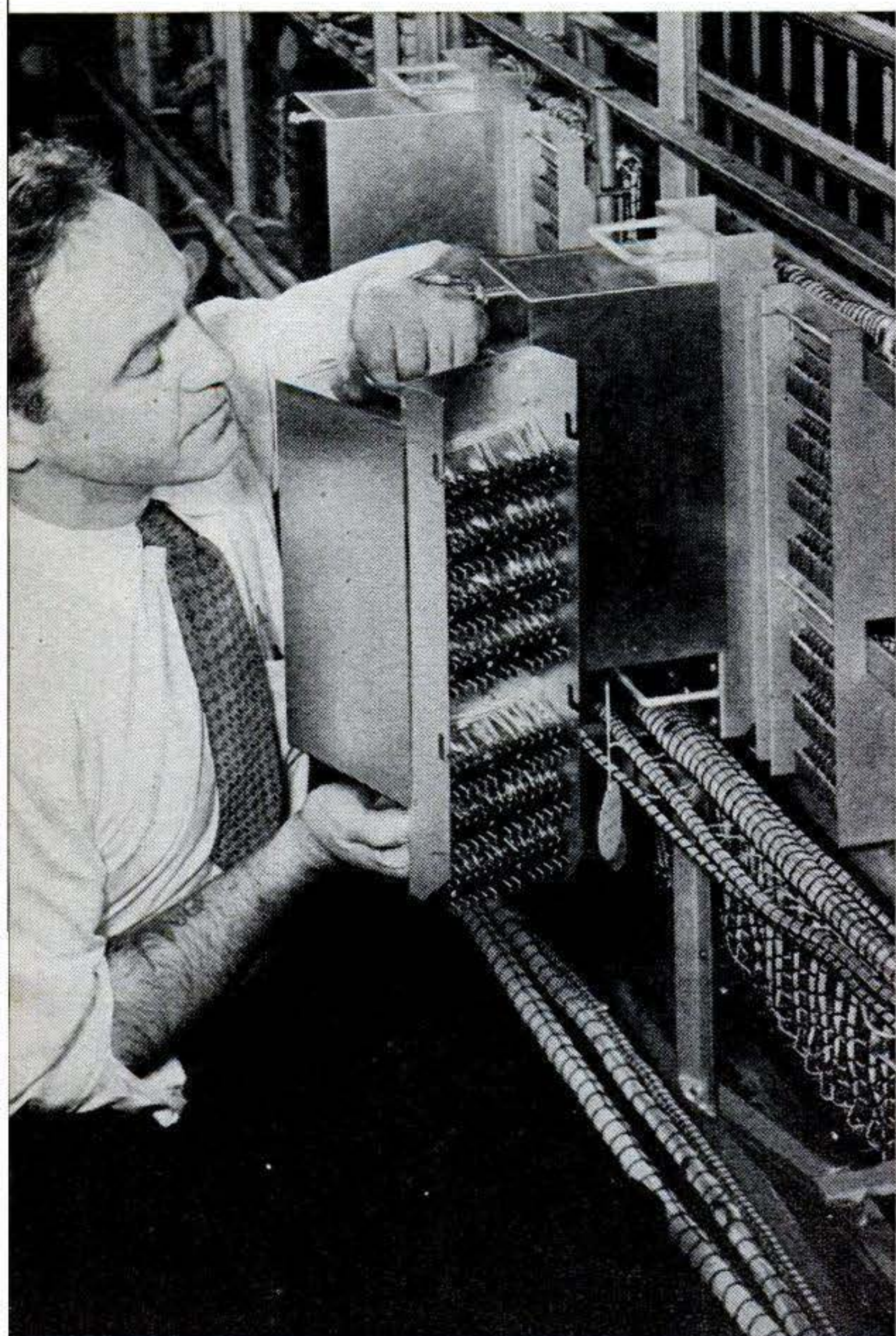

Accessibility is an important achievement in the construction of Mark II. The ease with which the entire mechanism of this rotating stepping switch can be removed is characteristic of its design.

which its conclusions can be written down.

A possible solution to the problem of printer speed has been suggested by the development at Harvard of the "numeroscope," a cathode tube that would flash an actual number when energized. A battery of these tubes would, of course, permit the calculator to write any number it wanted as quickly as it got the number. At present, however, there is no film fast enough and of sufficiently fine grain to get clear photographs of numbers flashing so swiftly.

Simplicity Speeds Assembly

Mere speed, even when its full use is made possible, is only one of the advantages obtained by using relays in Mark II. Equally important is their greater accessibility for maintenance and repair. Ranged in banks along the exteriors of six 15-foot-long cubicles, the relays are easy to get at.

They are, moreover, interchangeable with others of the same type; to make replacement completely foolproof, each type of relay has its own color on its case and on the blank into which it should go. A man would have to be color-blind to try to jam a black double-coil latch relay, for instance, into the place belonging to a red single-coil relay.

The wiring of Mark II is also a masterpiece of accessibility and mobility. Every panel can be moved without touching any but external wires. These external wires, like the wires on the panel itself, are clearly identified. Panel wiring was completely laid out, laced on jigs and brought to the panel itself as a unit before a single connection was made.

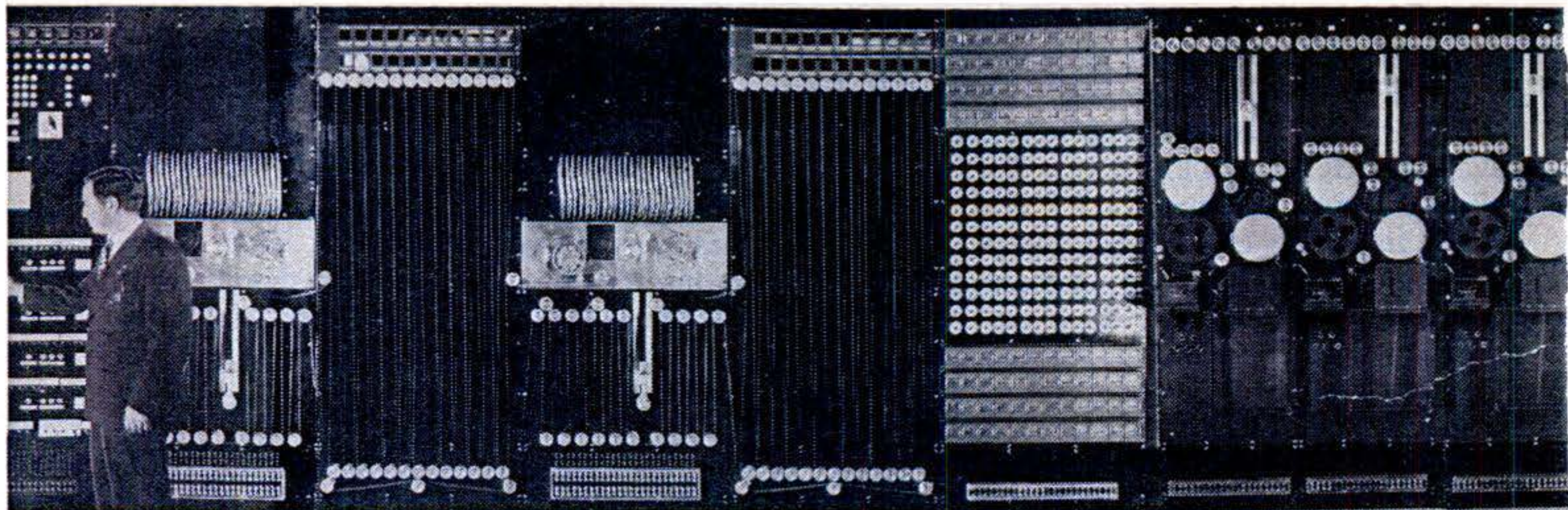

The sub-main control panel, operated by the technician above, co-ordinates the two separate but substantially identical sections of the board. Each section consists of five panels similarly arranged on either side of the sub-main control panel—two

for sequence mechanisms, two for tape storage, and one of mathematical constants. In addition, each section is connected to two of the four tape punch and feed panels at the extreme right and two of the four interpolator panels at the extreme left.

When Mark II goes from the computing lab in Cambridge, Mass., to the Proving Grounds at Dahlgren sometime in June, only 15,000 out of some 300,000 connections for over 1,000,000 feet of wire will have to be broken and remade. The bolted angle-iron construction of the machine's framework makes it simple to take apart and move.

Convoy Will Move It

Moving will be done by a 25-trailer-truck convoy, with one whole truckload devoted to testing equipment. Once the machine gets to Dahlgren, it will take two to three months to set it up and test it. The boss on the job will be a graduate engineer from Cornell, Mr. Frederick G. Miller, who has worked on Mark II from the blueprint stage.

Mr. Miller, with a staff of five mathematicians and a crew of 12 maintenance and repair men, all trained under the supervision of Dr. Howard H. Aiken, head of the Computation Laboratory at Harvard and a leading authority on large-scale calculators, will stay with Mark II as civilian employees of the Navy. They will keep the machine running 24 hours a day, every day in the year.

Testing a big calculator is like training a mule—the man has to know more than the mule. There will be the arduous matter of checking all contacts, then every circuit, then groups of circuits (there is a special machine for this, built at Harvard, which acts like a baby calculator itself) and then of making trial runs of problems.

Because Mark II is built in two halves, like the two lobes of the human brain, it will be possible to check one half against the

other. Finally, the entire machine will be given a problem for which the answers are known—perhaps something Mark I has done already. If it pulls through that, Mark II will be ready to roll for the Navy.

Even after it gets into operation, however, Mark II can make mistakes, and one of the biggest jobs Mr. Miller and his team will have will be guarding against them. The machine itself will help in this. It has 30 "check circuits" built into it, and the mathematician who sets up a problem punches instructions into the tape that brings these checks into operation.

If a result fails to pass the check circuit, bells ring, lights flash, and the whole computer stops like a tilted pinball machine. Then the trouble-shooters go to work, tracking down the source of error by the same process of progressive isolation a radio repairman uses in fixing a balky set.

Six Twelves vs. Twelve Sixes

A simple example of how a check circuit is used is in multiplication. Whether done with paper or pencil or by relays, multiplication is, after all, only a way of adding. Six times 12, for instance, is 72, whether one gets the answer by grade-school methods or by adding a column of 12 sixes. Mark II, like most calculators, does it the hard way, taking 12 separate sixes out of 12 separate relays and adding them.

To check that, the machine is also asked to take six twelves out of their relays and add them. Then both results are passed through the check circuit: if they agree, fine; if not, the machine stops. In much the

same way, checks are put in for using trigonometric functions to establish mathematical identities. These check circuits were developed by the Computation Laboratory and are found both on Mark I and II, but not on any other existing machines.

Sometimes these check answers are not absolutely the same, but they can still get past the check circuit at the mathematician's discretion. The difference comes about because Mark II is correct only to 10 significant figures (Mark I works out to 23 figures and can be rigged to go to 46), and in "rounding off" two series of numbers from a problem done two different ways a discrepancy may pop up in the last figure.

There is a special "tolerance" control in the check circuit to take care of this. The mathematician may decide that a difference of one in the 10th significant figure is okay for his purposes, so he sets that in the circuit, and if the two answers differ by one or less, they go right on; if they differ by more, the machine stops.

Obviously, much depends on the mathematician. He has to know what the machine can do and just how it does it. That is why those in the laboratory, who even now are engaged in building Mark III and planning Mark IV, look forward to the day when they will turn away from constructing machines and get to work on the even more important task of training mathematicians and engineers to handle them.

Large-scale computers like Mark II are

not put to work to find *one* answer to *one* equation, any more than a pressure cooker is used to boil *one* three-minute egg. They are used, instead, to get a long series of answers to the same equation where the variable factors change a little bit each time. A gradual change in a variable should produce a gradual change in answers, which, if charted, would show up as a nice smooth curve.

A mathematician can sense this curve without charting it, just as an old fisherman can tell when his boat is drifting without taking bearings. Any sudden departure from the smooth curve shows that the calculator is making mistakes. Occasionally, though, there are some surprises.

Some of the people at Harvard got a surprise during the war. One day they received from Washington a formula to run on Mark I, with no further information than orders to do the job right away. They put it in the machine, and for a while the answers built up slowly in a nice, normal curve. All of a sudden they went completely haywire; the curve stopped being a curve and became a mountain peak. Then the peak itself got higher and higher.

The watchers tested the machine up and down, but it looked all right. They thought that the machine had gone crazy but couldn't prove it.

Months later an atomic bomb burst on Hiroshima. That made the astounding answer to the problem plausible. END

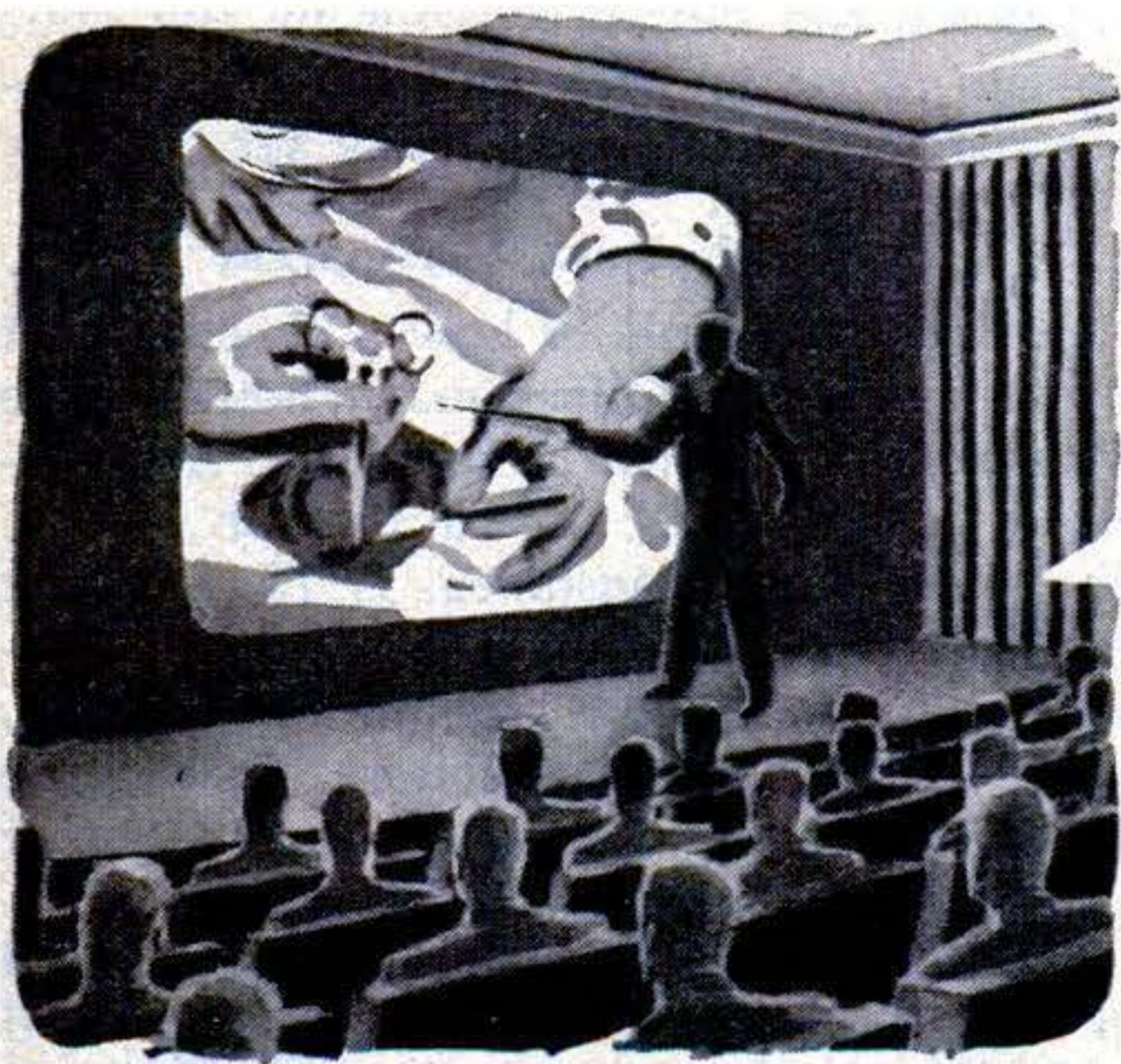

PSM's February conception of televised surgery (above) envisioned the use of auditoriums. The Johns Hopkins test promises such a development.

Televising Surgery

CLOSE on the heels of prophecy, the first television broadcast of an actual operation was made late in February as a test to determine its practicability for surgical education (PSM, Feb. '47, p. 66).

Presented by Johns Hopkins in co-operation with RCA, the experiment enabled 300 doctors to witness the so-called "blue" baby operation (delicate heart surgery to correct an oxygen deficiency).

Two transmitters, one directly above the operating table and the other in the gallery with a telephoto lens, provided a view of the operation as clear and inclusive as that of the surgeon himself. A microphone above the table permitted the surgeon to comment during the operation.

Transmitters Shrink to Lipstick Size

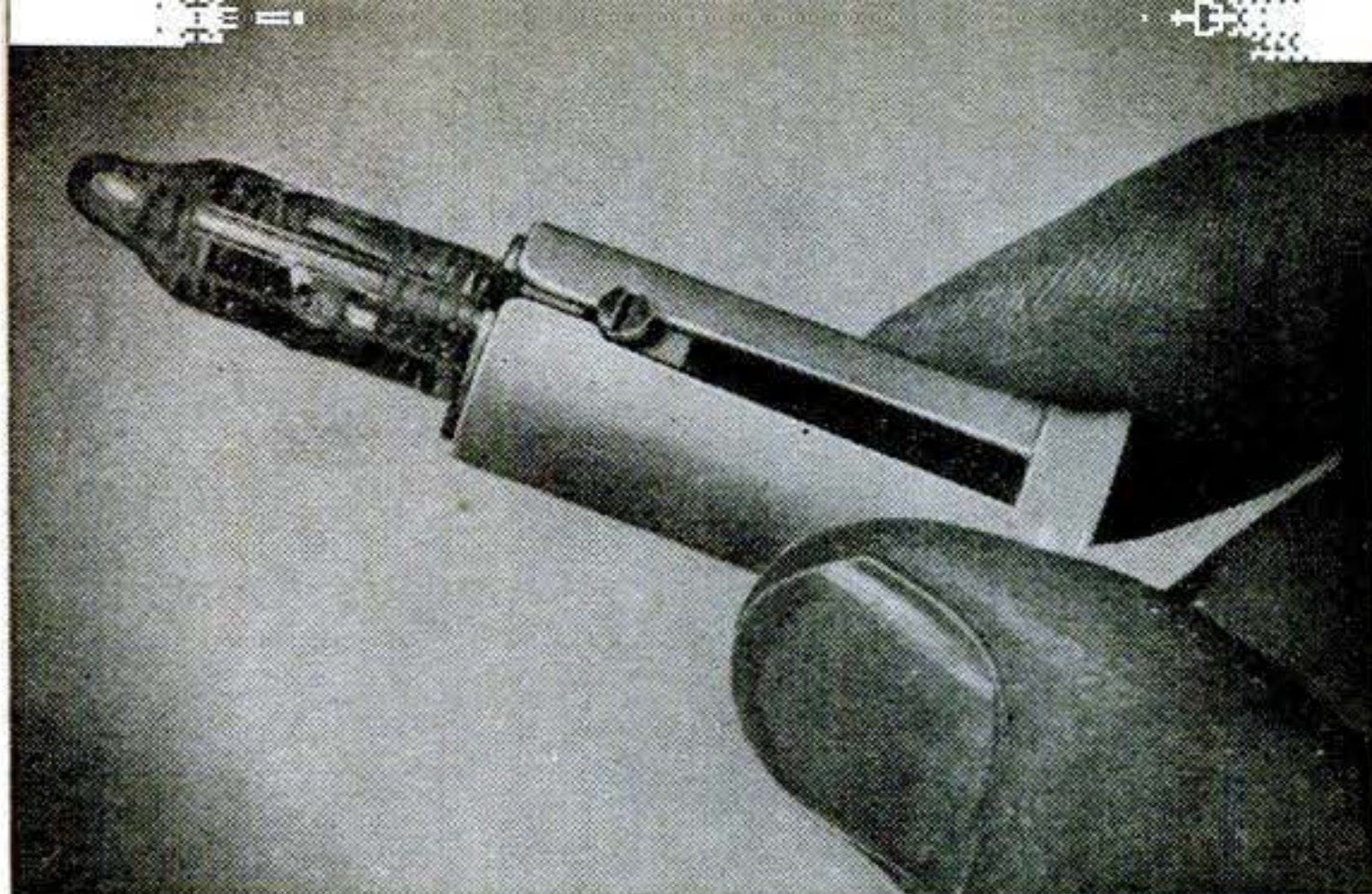

THE guy who tells you that you'll soon be talking through your hat may not be talking through his. For now your hat is plenty big enough to hold a complete broadcasting station. The printed, or painted, radio circuits developed for the proximity fuse, already used for receivers (PSM, May '46, p. 131), have been applied to transmitters.

These laboratory models, no bigger than a lipstick, are the after-hours work of Dr. Cleo Brunetti and fellow experts at the National Bureau of Standards. Tiny transmitting circuits are painted on the outside of subminiature tubes. Only microphone and batteries are needed to complete the units.

Combination of the new transmitters with the printed-circuit receivers opens the door to personal, two-way communicators. Special FCC permission was obtained to test the transmitters on the two-meter ham band, but

the miniature "transceivers" will probably be most used in the 460- to 470-megacycle Citizens' Radiocommunications Service that the FCC has set aside for unlicensed civilians. Broadcast range under ideal conditions might be 40 to 50 miles, but surveys show that demand is centered on very short-range communications. For this, both battery and antenna can be kept small enough for easy portability.

Wide interest has been aroused by the miniatures. A chain store would like to use them for taking inventories—the lister would just name each item on the shelf and a checker in the office would hear and record it. Police propose to link their individual patrolmen to headquarters. Farmers hope to talk across the fields. Waiters can whisper orders into the kitchen. And mothers see a fine way to keep tabs on what little Johnny is up to when playing outdoors.

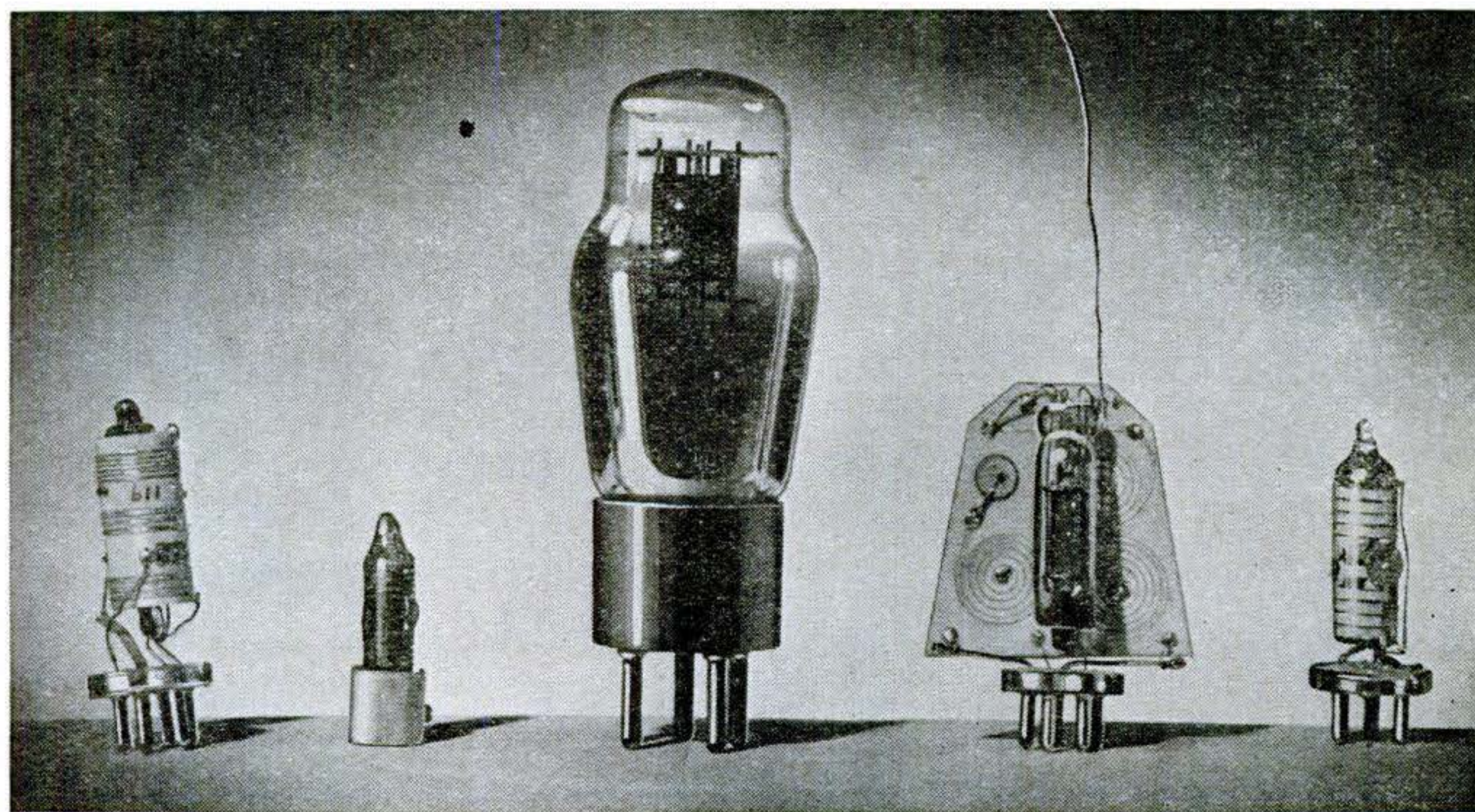

Four models of painted-circuit transmitters are lined up beside an ordinary radio tube to show comparative size. Type mounted in lipstick holder in top picture is only $\frac{1}{4}$ inch in diameter and one inch long.

MAY
1947 101

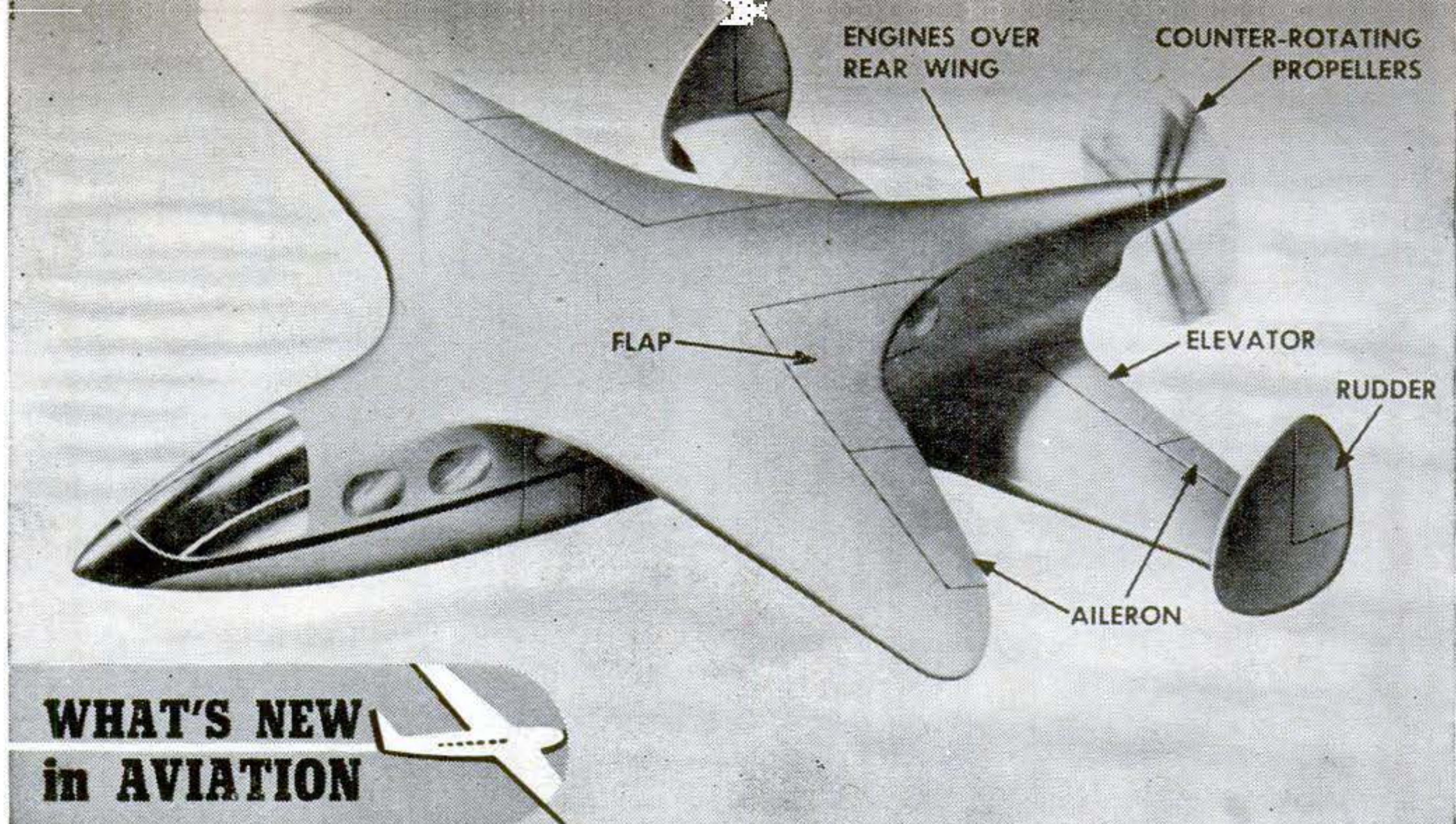

Germans Wanted It

THIS odd plane cost its designer three years in a Nazi prison. With a 300-m.p.h. top speed, it can mush down to a nose-up landing at 47 m.p.h. The Germans wanted details for a new attack plane—and Frenchman Maurice Delanne refused. Now he plans

a U. S.-built, 10-passenger transport (above). The low wing replacing the tail gives so much extra surface that the plane, instead of stalling, is said to drift down at 12 feet per second. The 35-percent extra lift also permits the load center to be far from the center of gravity, so the two 500-hp. engines are tail-mounted without a long shaft.

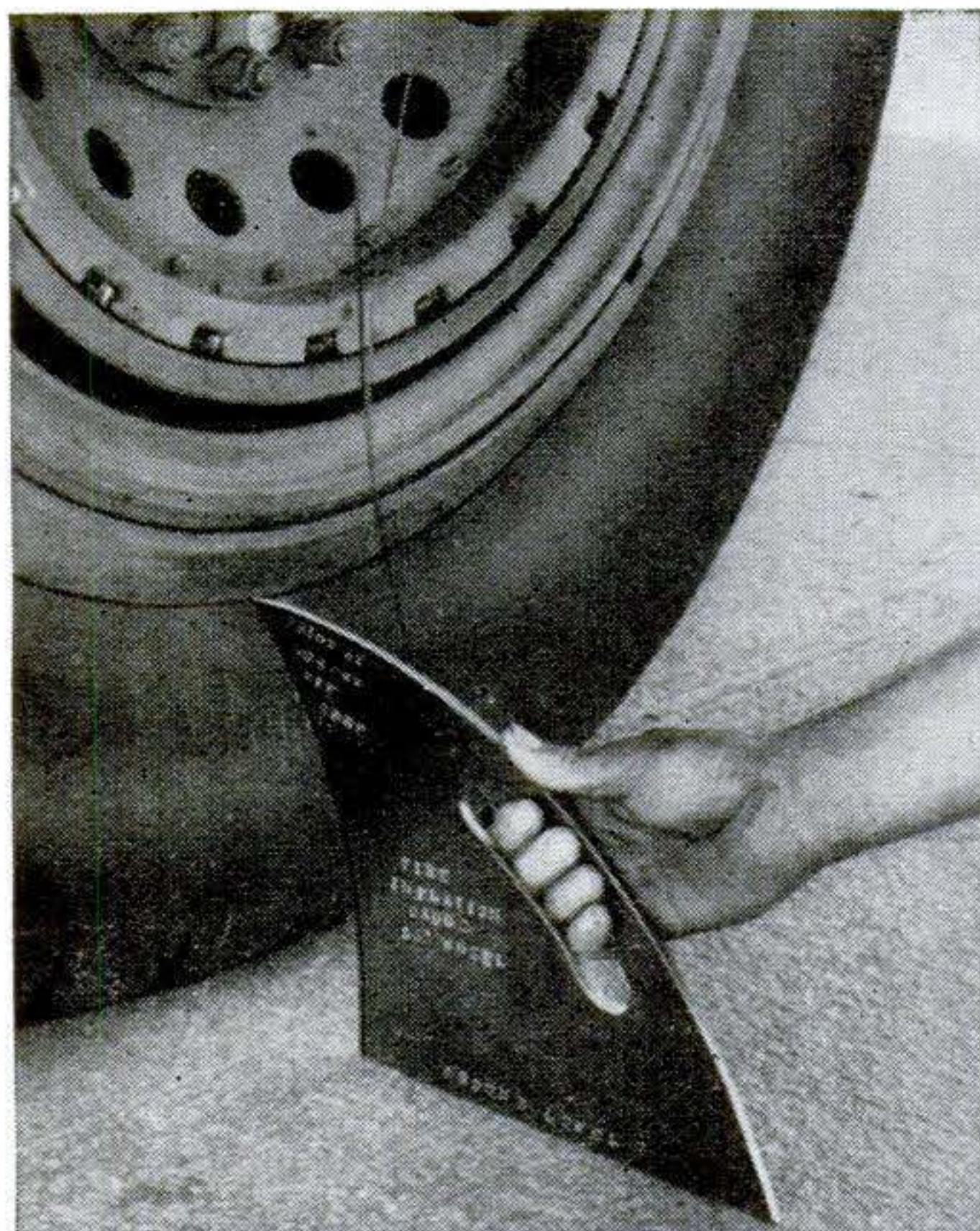

Tests Tires Visually

PLANE tire pressures can be tested by eye alone with this simple Consolidated Vultee gadget. The measure is set on the ground beside the tire: if the upper point just touches the rim, the pressure is okay.

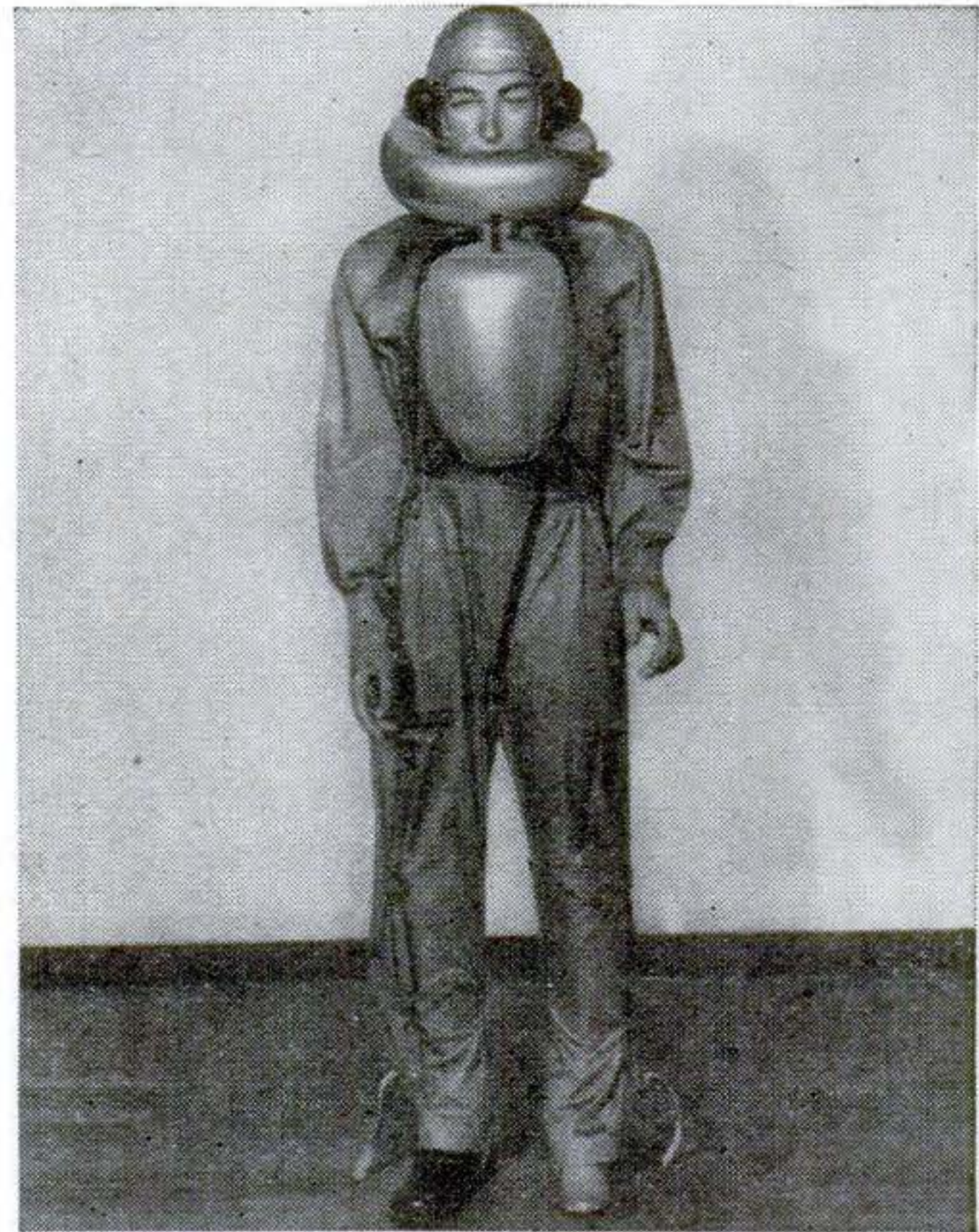

Three-in-One Suit

THIS AAF cotton-twill suit combines a life jacket that floats its wearer face up, a light flying suit, and an emergency sustenance vest. It cuts the weight of flying clothes by about two pounds.

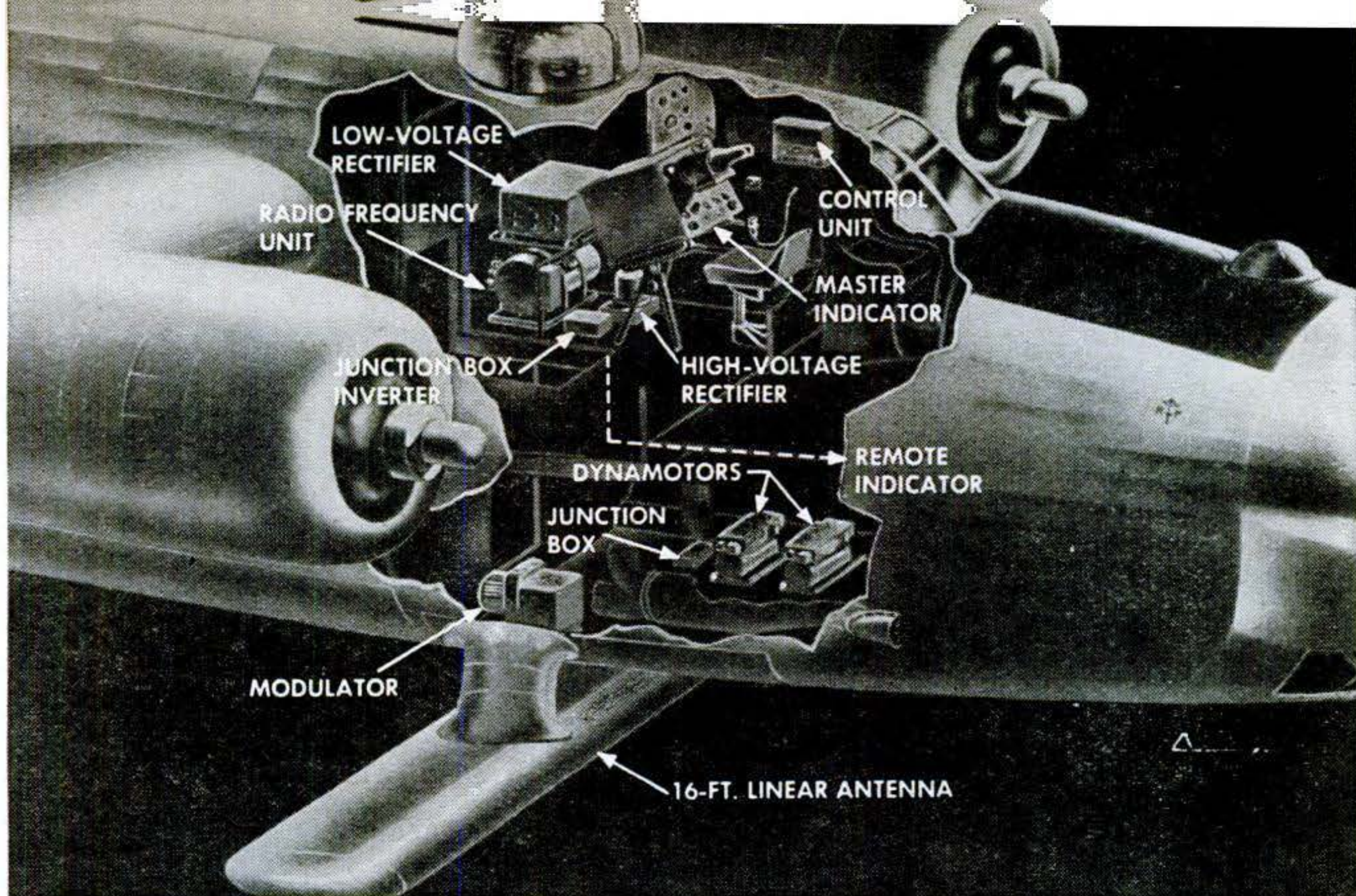

Eagle-eyed Radar

THIS 16-foot Eagle radar antenna structure, a wartime secret, is really 250 individual antennas. They replace the usual rotary disk

or spinner to provide greater resolution and thus more scope detail. The Eagle meant more accurate B-29 bombing at night or through overcast. Now it is being used for GCA and MEW air-traffic control systems.



One-stop Service Station

TIRED of running out on the line to diagnose electrical troubles on aircraft and then running back for tools and equipment, two AAF civilian employees have designed and built a portable shop. Used at the Clinton

County Army Air Field, Wilmington, Ohio, it can be taken to any plane needing electrical service, checking, maintenance or installation. It is estimated that 50 percent more work can be done with the unit, which is contained in a three-wheel cart and weighs less than 600 pounds.



Trainer Is Missing Link

A NEW North American trainer, the XSN2J-1, fills a gap in the Navy's training program. Fast enough to give the feel of tricky, high-speed fighters, it is simple

enough for intermediate students to fly. The all-metal, two-place trainer is unusual in putting the student in the forward seat to get the feeling of flying alone. A Wright nine-cylinder engine gives a 270-m.p.h. top speed. Service ceiling is 30,000 feet.

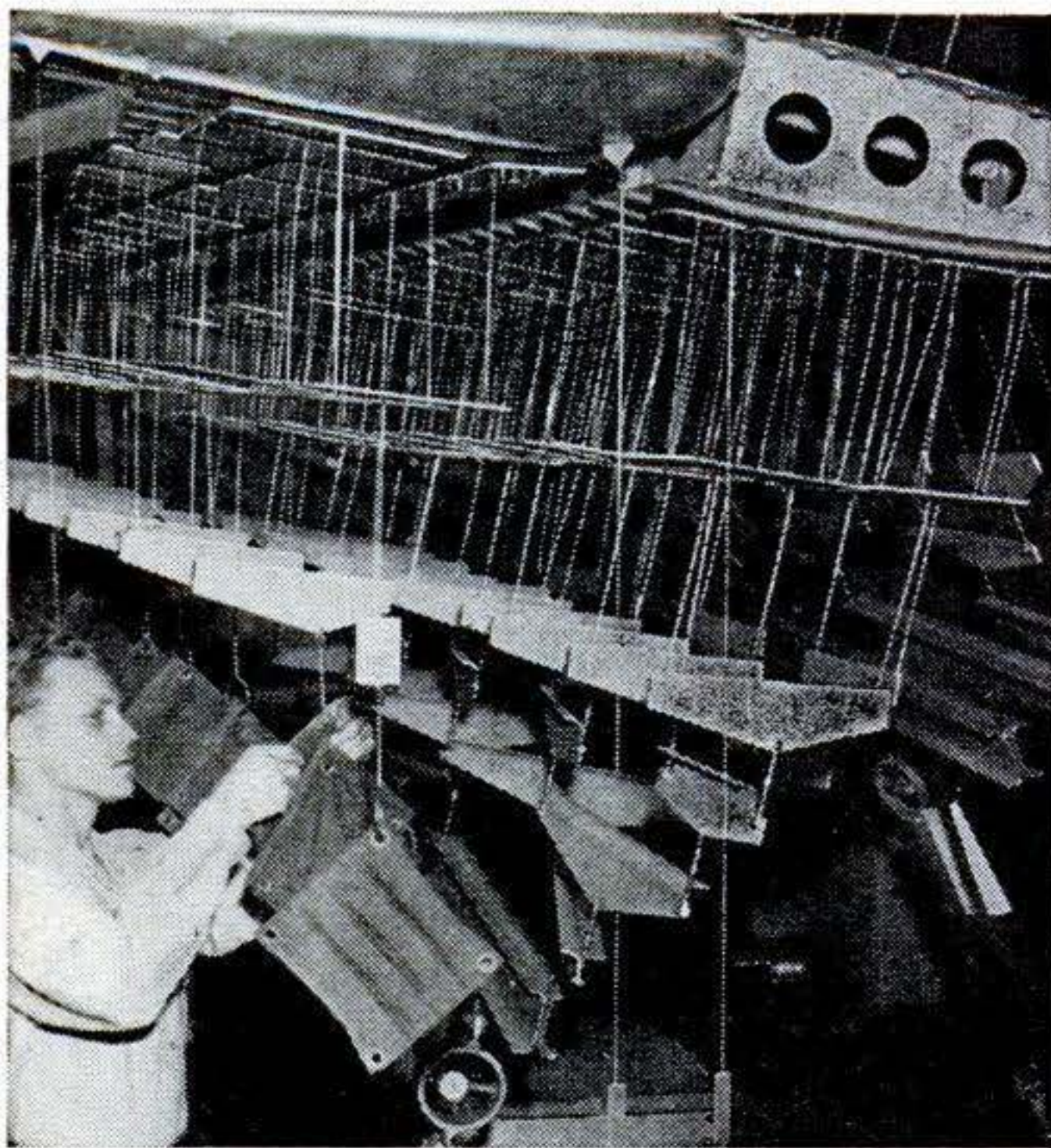

Spokes Test Planes

THIS maze of bicycle spokes can exert all the stresses that a plane meets in flight. Each link the skin of the aircraft to a hydraulic jack. Here engineers use it to test Northrop's new transport, the Pioneer. Shot bags in foreground apply minor loads.

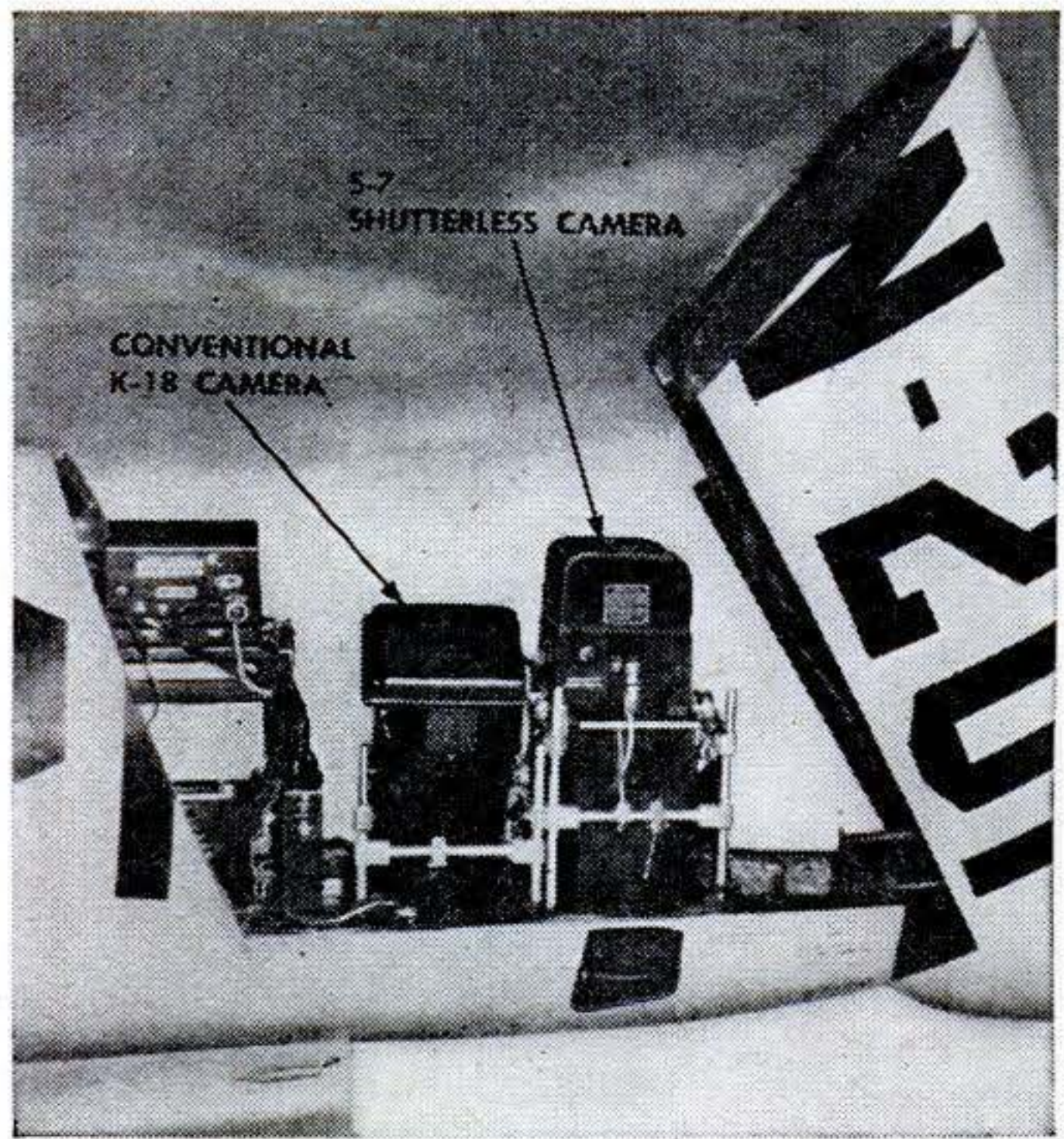

Camera Scorns Shutter

THIS AAF camera, the S-7, has no shutter—and doesn't need one. It is used by fast planes for treetop photography. Motor keeps film moving past lens as fast as objects on ground move on camera's focal plane, so image is motionless on film.

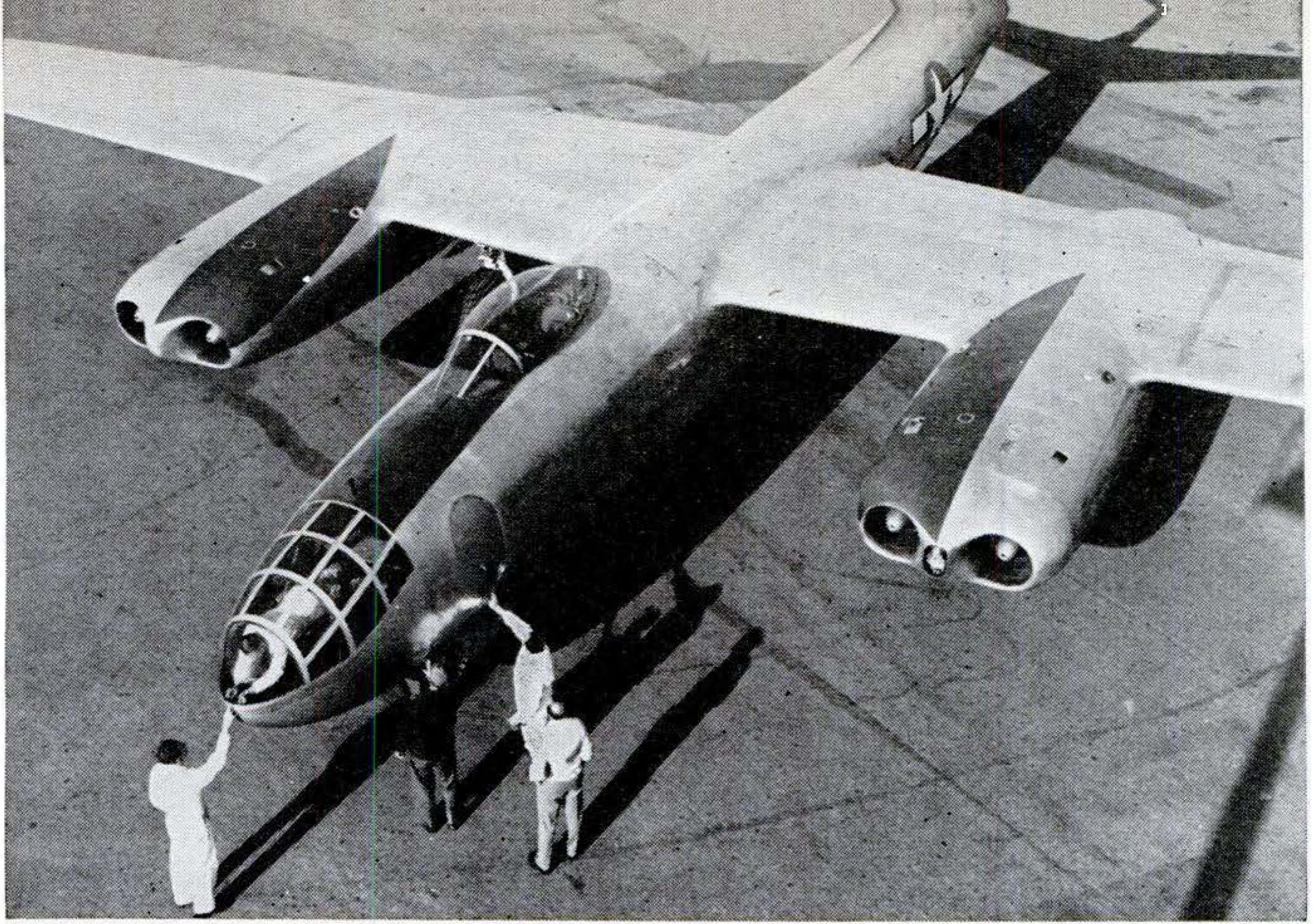

The XB-45 boasts a slender, fighterlike fuselage, but it can carry more bombs than the wartime "heavies."

AAF Tests First Four-Jet Bomber

NORTH American's XB-45, undergoing tests at Muroc Army Air Base, Calif., is the first four-jet bomber to fly in the U. S. Its engines—General Electric J-35s set in pairs in two nacelles—are said to give it an "exceedingly high" speed. Gun turrets have been eliminated for streamlining, and the

only protuberance is the "bubble" in which pilot and co-pilot sit in tandem. Although the XB-45 compares in size and range with the heavy bombers of World War II, it is classed as a medium. It has a wing span of 89½ feet, is 74 feet long, and accommodates a crew of four men.

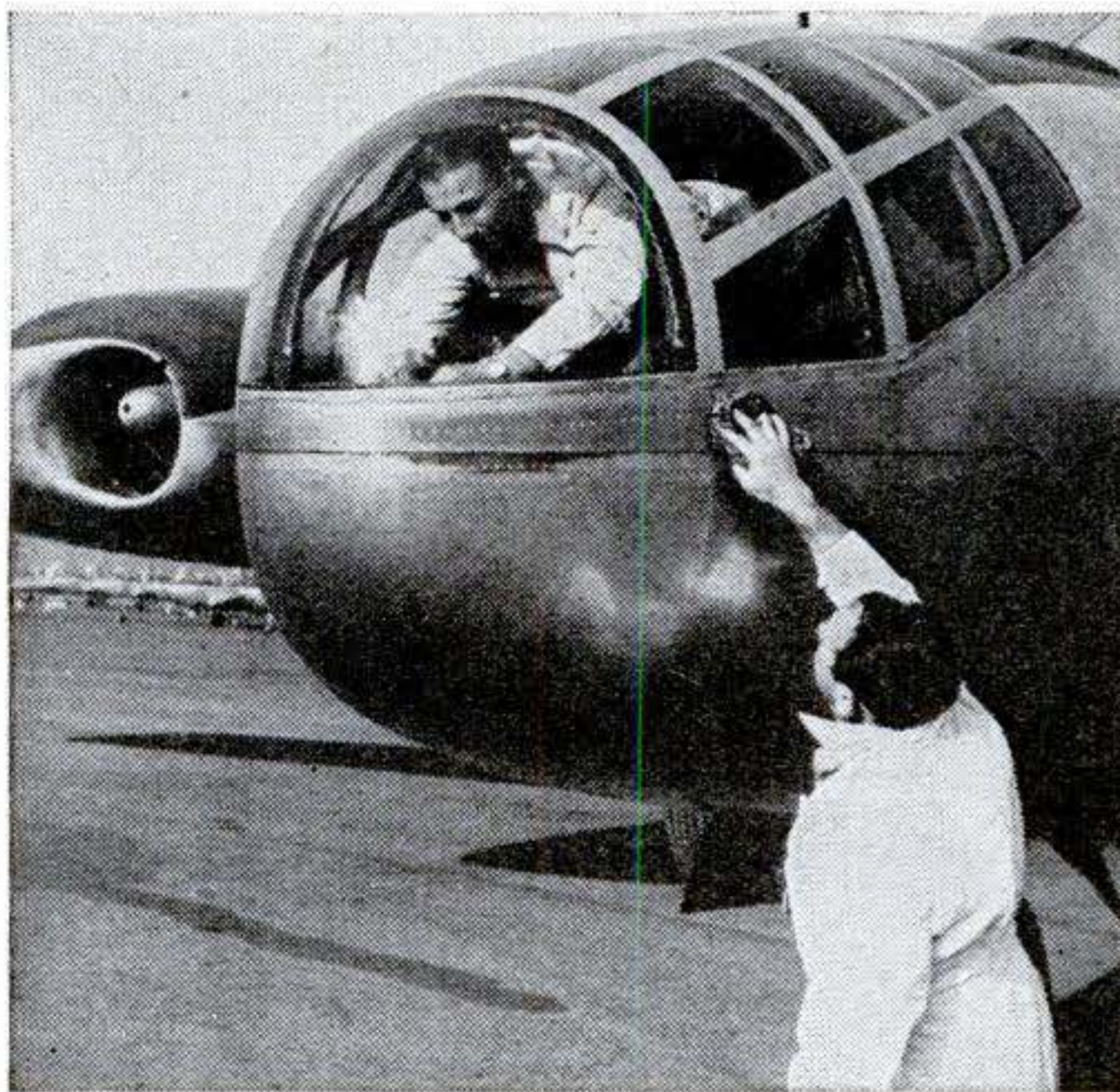

Streamlined bombardier's nose is reinforced to withstand stress of high-speed flight. The plane has a refrigeration system to offset frictional heat.



Twin-jet nacelles are ahead of wing's leading edge for easy accessibility. The new high-pressure tire was specially developed to fit into the thin wing.

300 Volts in the Palm of Your Hand

TWO hundred 1½-volt cells have been crammed into a one-pound package by engineers of the National Carbon Company to produce a small fistful of high voltage. At approximately 300 volts a pound, these Eveready batteries can deliver several thousand volts without adding greatly to the size or weight of portable equipment.

One immediate application for the new batteries is in completely self-contained Geiger counters used to detect the presence of radioactive substances. Portable Geiger counters are finding increasing use in such fields as medicine, metallurgy and geology—not to mention nuclear physics. One of the smallest radioactive detectors produced up to the present, only 11 inches long, is pictured at the upper right. Three batteries in series provide the 900 trigger volts needed to make the counter tube and amplifier tick off the presence of particles from radioactive elements.

Repeating photoflash tubes of the gas-discharge type also need high voltages but little current. Six or seven series-connected batteries have enough electrical energy for 2,500 flashes—plenty to keep a news photographer clicking for many months.



Close-up shows compactness of 300-volt battery made of 10 stacks of flat cells. It is slightly less than three inches square, just under four inches high.



This Geiger counter, made by Instrument Development Laboratories, Chicago, weighs only 10 lb. complete with case, probe and batteries.

Compact battery construction has largely been made possible by new techniques for sealing in sandwich form the carbon-electrolyte-zinc cell invented nearly 60 years ago. Plasticized sealing materials have reduced the nonproductive space by eliminating the metal cans and other bulky liners that were formerly needed to prevent the semifluid electrolytes from intermixing and short-circuiting. Flat squares, moreover, may be stacked with much more economy of space than the rounded or cylindrical cells. Ten wax-impregnated stacks, each containing 20 individual cells, make up this latest addition to industry's stockpile of portable power.

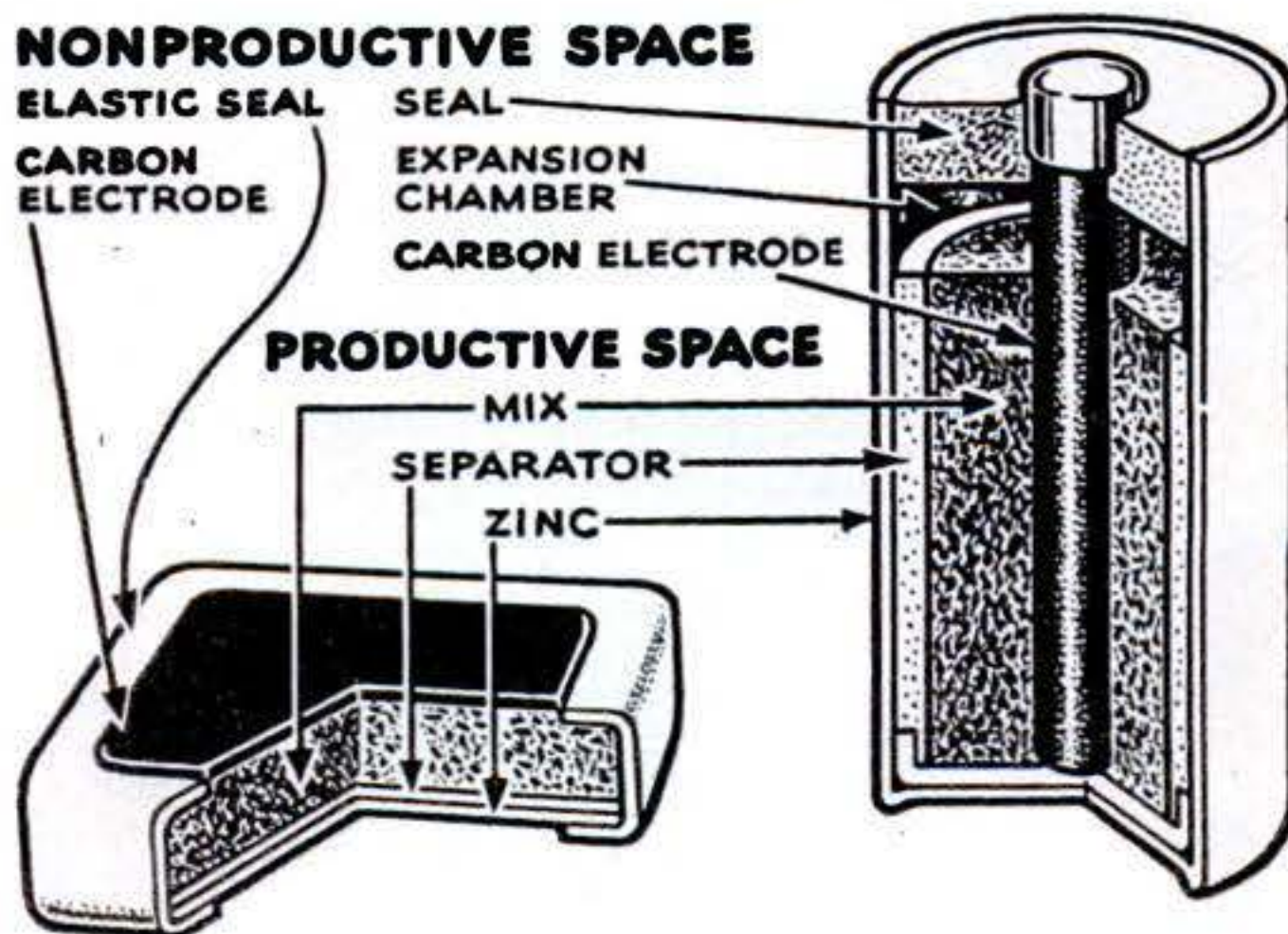

Cutaway diagram shows how flat cell construction cuts nonproductive space by eliminating thick seal, heavy carbon electrode and expansion chamber.



Mechanics Win the Races

Speedway drivers and cars alike depend on skill of men in the pits.

By Devon Francis

WHEN the winner of the annual Indianapolis Speedway 500-mile race streaks across the finish line late this month to the thunder of applause, a man in the pits, ignored by the crowd, will relax his grip on a grimy stop watch, grin to himself and start collecting his tools.

His name won't be in the headlines. When the cameras click, he will be only a face in a sea of faces. But to those who know automobile racing he will be the hero of the day. For he will be the winning car's chief mechanic.

It's largely the mechanics who win the races. They are the nursemaids of the delicate and temperamental machines that for hours on end pound around the world's greatest closed raceway for wheeled vehicles. They are far more than that, though. They are practical engineers, surgeons on call for emergencies, father confessors to racing drivers, coaches who call their signals from the bench.

A good mechanic is a Jimmy Valentine in overalls. By feel, by ear, he can perform a

diagnosis on his racer in a matter of seconds. Last year Ted Horn, at the wheel of an Italian-made Maserati Grand Prix car, coasted into his pit on the seventh lap with a dead engine.

"What happened?" asked Harry W. ("Cotton") Henning, dean of all the Indianapolis race mechanics, even before the wheels had stopped rolling.

"It began to pop," said Horn. "Then it quit."

Henning's practiced fingers already had the hood up.

"Did it get rough?" he called from the bowels of the racer.

"Yes."

Seven-minute Surgery

Henning ripped out the magneto. In six minutes and 45 seconds he had replaced it with another. He recognized the engine roughness as a timing ailment in the ignition system. The magneto rotor had, in fact, sheared. The Maserati, tailing the field, rolled back on the track and went on to take third place.

Mechanics have to be fast. Seconds count. Riley Brett, of Los Angeles, once changed a wheel for Wilbur Shaw in 7 2/10 seconds, probably a world's record. Shaw, president and general manager of the Indianapolis

Motor Speedway Corp., retired from racing now, is a former mechanic, by the way.

The mechanics are a breed by themselves, living with their noses on their engine blocks. Some of them follow the seasonal sun to automobile races all over the United States. The consuming ambition of each of them is to have a winner of the Indianapolis 500.

Planning Starts from Scratch

Planning for this race, richest in prize money in the United States, starts practically on May 31, the day after the current year's race is over. The mechanics tinker, tear down, rebuild. They examine every part of their cars. The machines have to clock as high as 170 miles an hour on the straight-aways to get a net of 115 or so, and a defect can lose a race or cost a life.

In the springtime the work accelerates. All last month the mechanics who hope to place their cars among the 33 qualified starters on Memorial Day were having the drivers feel out the machines. The feel is important. Like any roadway, the track is full of imperfections. As Shaw puts it, "No matter how fast you go, it's the longest 500 miles in the world." A car must cruise as smoothly as possible so a man will take no more of a beating than he has to; the seat must be adjusted to a perfect fit.

Diagnosis by Touch

After each test run, a car goes back into the shop. Here the mechanic turns the engine over by hand, slowly, waiting for his ears and fingertips to tell him if anything is wrong. Almost any good mechanic can make a car go fast. The problem is to make it go fast for 500 miles. That's about equal to the highway distance between Denver and Salt Lake City.

As one step toward long-distance speed, the master mechanic experiments with the fuel mixture. And don't ever ask a racing car mechanic what his fuel mixture is. Some cars use an alcohol blend, some a gasoline blend. The blends are top secret with the individual mechanics and are varied to fit the temperature and humidity of the day.

Since racing engines turn at twice the rate ever asked of a stock-car engine, mechanics deliberately allow for five times the clearance between piston and cylinder wall that is manufactured into a stock engine—as much as 15/1,000 inch. That's to reduce friction and keep down heat.

Entries in the 500 customarily are torn

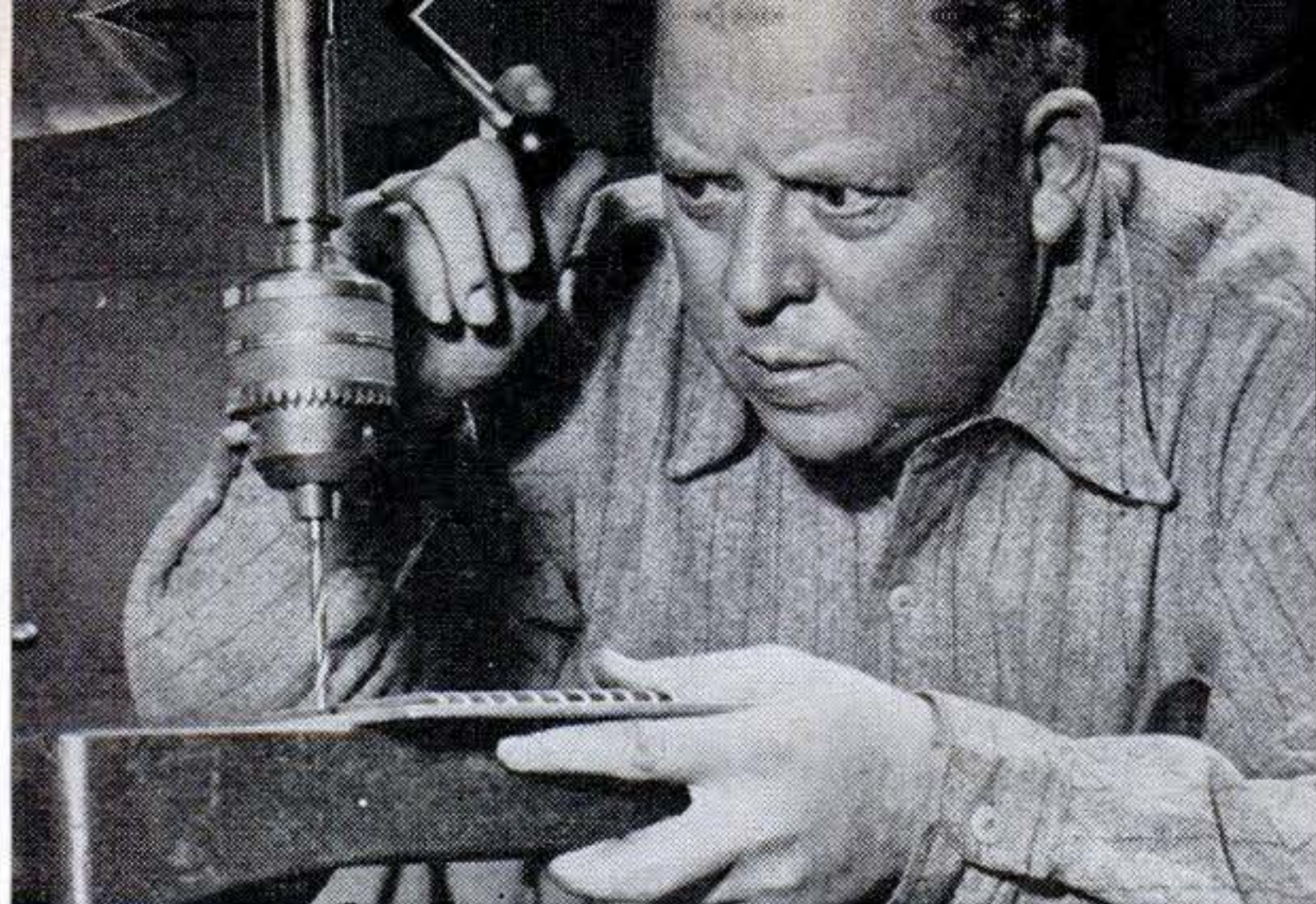

Cotton Henning, master mechanic, has played nurse to four Speedway winners: 1925, 1934, 1939 and 1940. This year he is an owner as well.

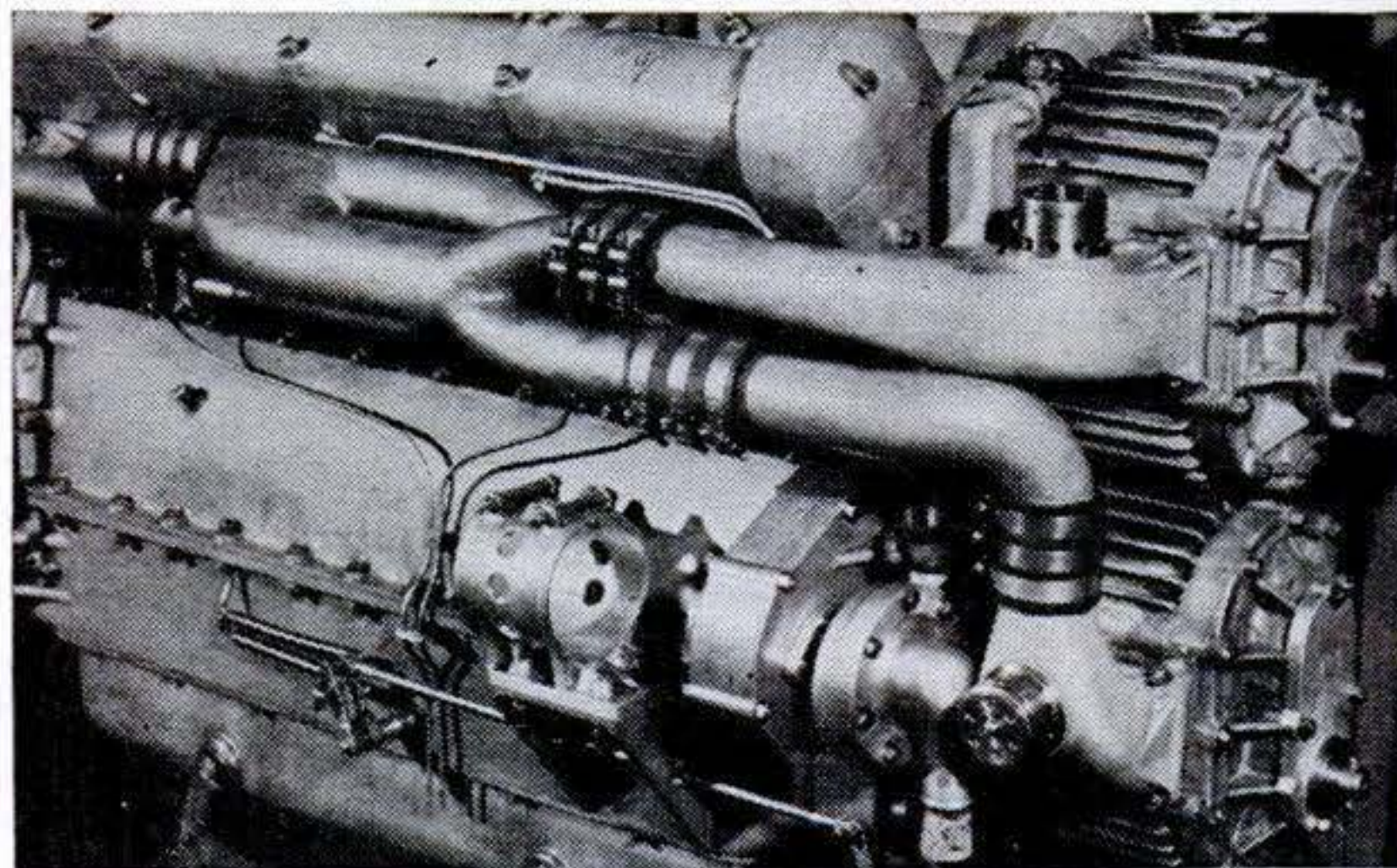

Two Rootes-type blowers (extreme right), fed from two carburetors, turn at engine speed to produce 14 pounds of manifold pressure on Henning's Maserati. Piston displacement is 179.2 cubic inches. Some mechanics prefer centrifugal blowers, which supply greater pressure but have to turn faster.

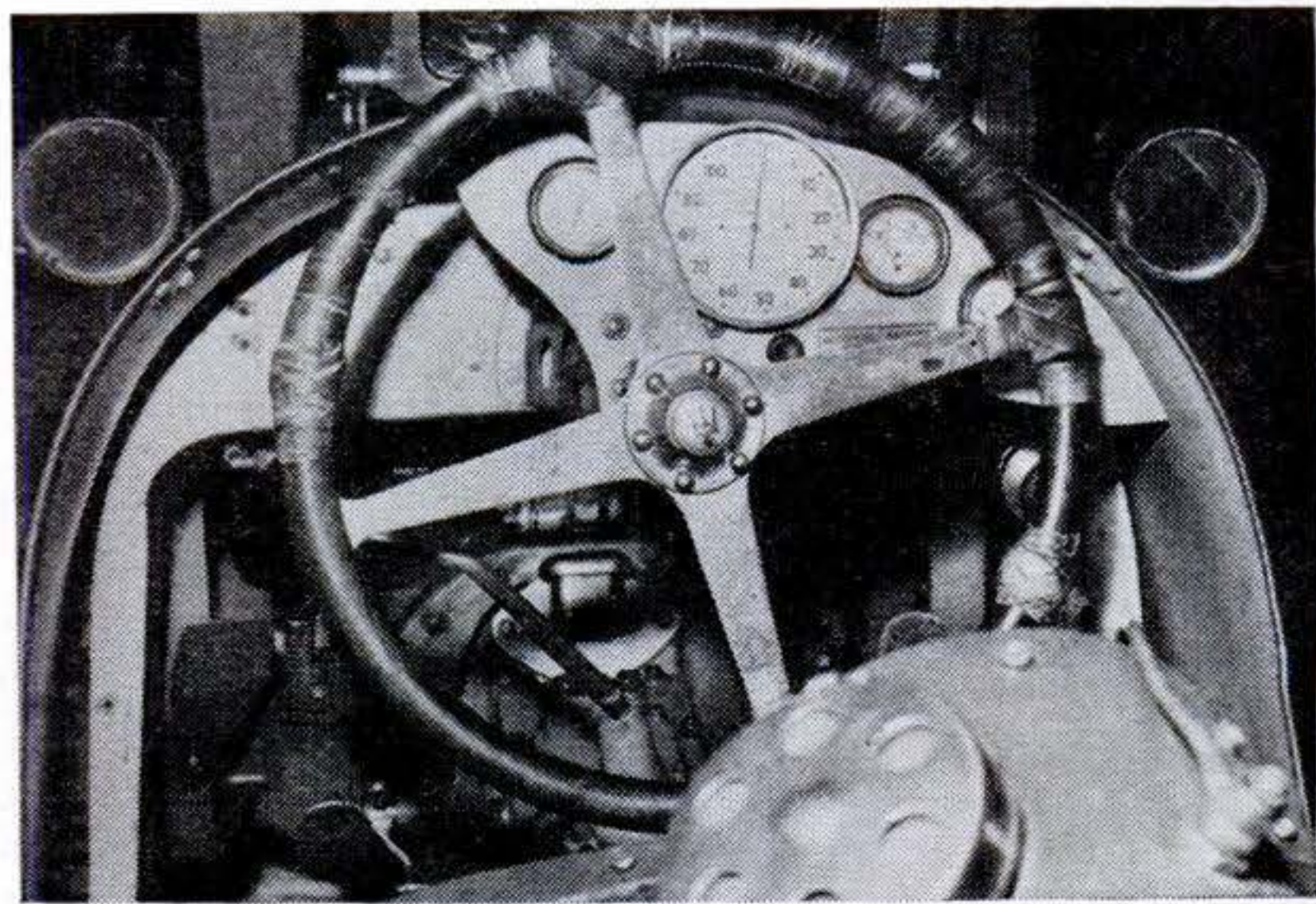

Dials on Maserati (l. to r.) tell water temperature, engine speed, oil pressure and air pressure on fuel. Cap of 52-gallon fuel tank is in foreground. Wheel is gauged and knob-taped to give driver a firm grip.

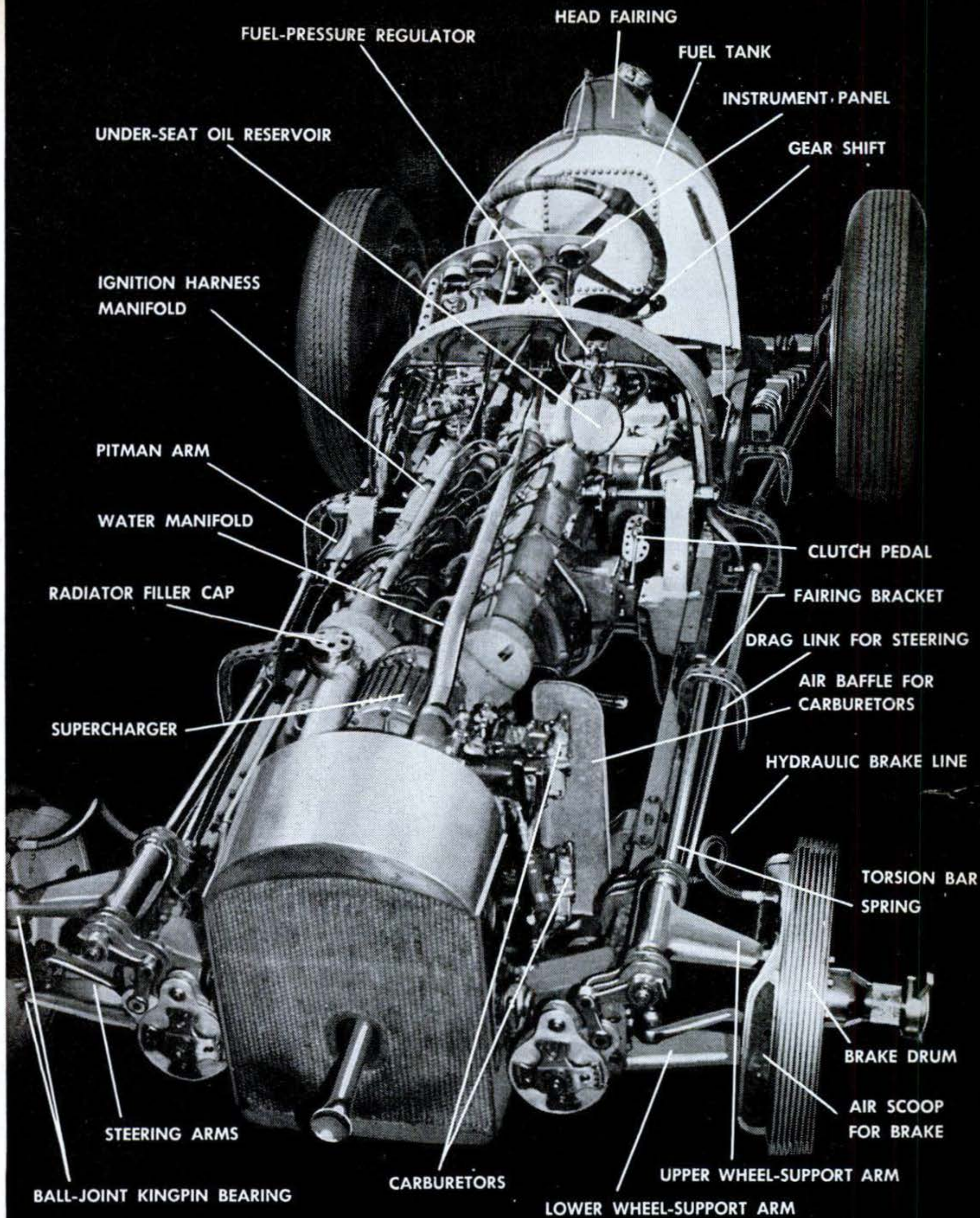

The Maserati has a "dry weight" of 1,920 pounds, but weighs 600 pounds more, including its driver, on the starting line. Its wheel base is 108 inches; tread, 55 inches. Most racers have three speeds forward, but the Maserati has four



The figures on a pit blackboard tell driver "Ted" that car No. 5 is only 12 seconds ahead of him, and position of the board tells him to overtake it. Such codes must be simple, but in the pinches competing drivers should not be able to read the message.

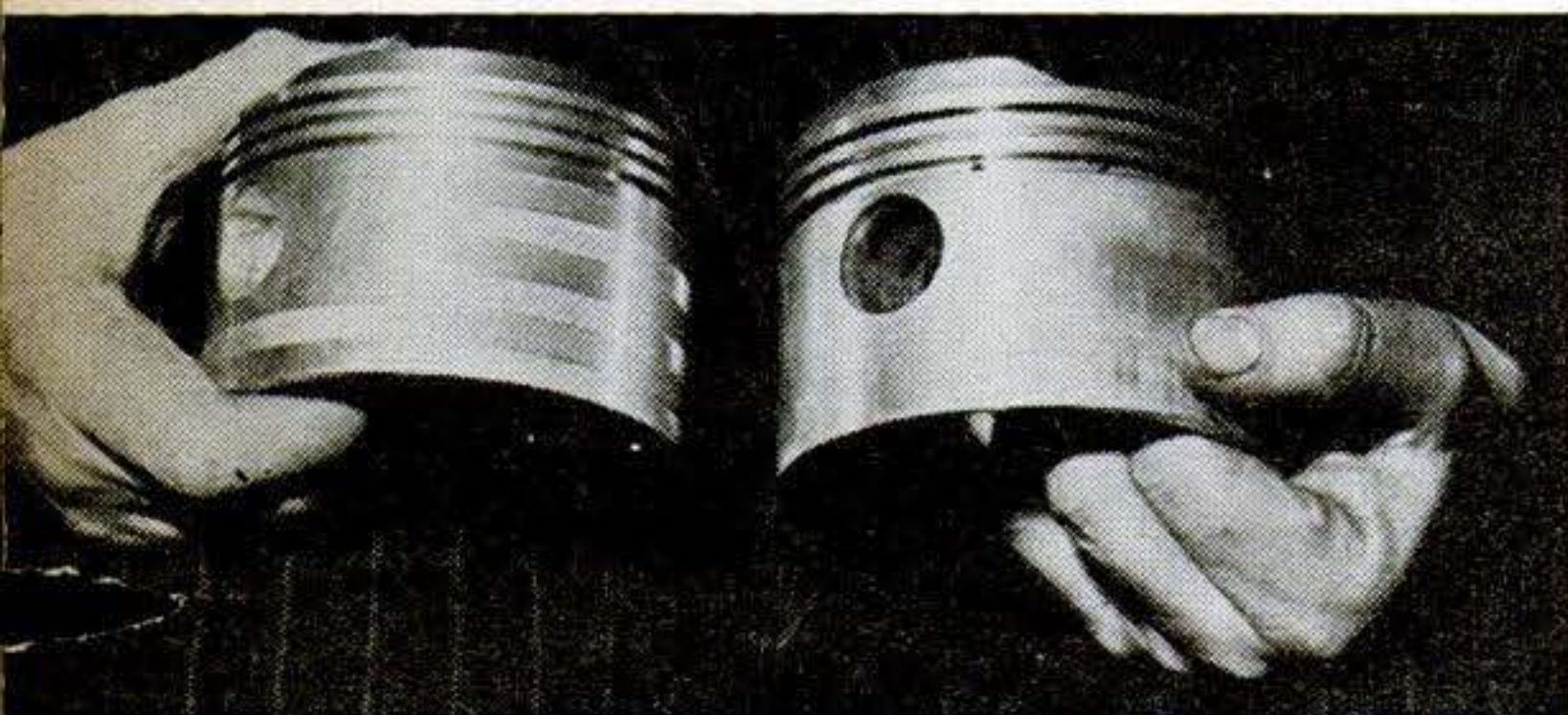

Herringbone grooving on piston walls (shown on the left) is a new wrinkle on engines for the 1947 race. It is designed to retain oil longer than does the smooth-walled piston on the right.



New Firestone tires with half-tread will be tried this year to even tire wear when rubber is scraped off on turns. The track is abrasive to begin with, but gets coated with so much rubber in the first 100 miles that tire wear decreases thereafter.

down for final inspection a few days before the race. Occasionally the reassembling isn't completed until the last frantic hours before the cars start the pacing lap.

On race day, with a single car's mathematically possible winnings upward of \$40,000, the master mechanic and his crew of three or four men have completed only the preliminaries of their job. Now the real work starts.

Tips to the Tyros

Master mechanics have given the inexperienced eager beavers among the drivers their final instructions:

"Don't get into traffic"—don't get into a swarm of cars. Only the older hands can take such chances.

"Don't get in over your head"—don't get beyond a speed that you can control.

"Watch your pit. We'll tell you if there's a chance to pick up the car ahead"—if there's a chance to overtake him.

"Feather it on the turns"—ease off speed leaving the straightaway and take the turns with just enough throttle to get maximum performance on each lap.

"Don't stand on it unless you're clear"—don't open up unless you have room to pass.

"Above all, don't lose it"—don't lose control of the car, particularly on the turns.

Driver and master mechanic have set up a code for chalking messages on a hand-held blackboard that can be read as the car flashes by. Stop watches are calibrated. The pit must keep tabs on the relative positions of 10 or 12 cars in the elapsed-time vicinity of its own car.

The race is run from the pits. Once a driver has made a few laps and the cars are strung out around the saucer, he hasn't the foggiest notion what his relative position is. He has to depend on his chief mechanic for information. He is also beholden to his crew for fuel, water and repairs—but not for oil. He can't take on oil, once the race is under way. That rule was made to keep the track from getting sodden with oil from leaky engines.

Lost Seconds Lose Races

Governing the speed of its car is a split-second business for the pit. It is done on a basis of seconds gained or lost on laps. A gain or loss of one second on a lap can spell the difference between prize money and a total loss for a year's work. The pit must keep an eye on the lap prizes, too. Money

for the best speed for single laps aggregates \$20,000 or more.

Typical of smart pit work was that in 1934 when Wild Bill Cummings was 30 seconds behind Mauri Rose, with only 50 of the 200 laps to go. Thirty seconds is a long time in an automobile race.

At lap 160—25 miles later—Cummings, coached from his pit, had gained three seconds. At lap 170 he had gained 14 more to increase his rate of gain by $1\frac{1}{10}$ second a lap. In the next five laps he boosted his gain to $2\frac{6}{10}$ seconds a lap. At that point he picked up Rose, and his margin of victory was 27 seconds at an average speed of 104.865 m. p. h.

Shaw, who is the only man besides Lou Meyer to win the race three times, almost lost second place in 1938 after he had it in the bag because of that lap-seconds-gain bugaboo. The pit crew of Chet Miller, cruising behind him, sensed that Shaw's pit had gone to sleep and signaled its man for a speedup. Shaw, pounding along at a respectable 115-m. p. h. average, had no inkling of trouble until Miller had picked him up. It was too close to the finish for Shaw to make up the time. Then, suddenly, Miller had to refuel. Shaw, grinning, saluted both crews as he roared by.

Henning Was Right

Shaw almost got into trouble the following year because he didn't heed Cotton Henning's admonitions. He made his first scheduled refueling stop at lap 69. His next and last, Henning said, was to be at lap 140. On lap 107 a three-car smashup occurred and the yellow caution flag went up. When the racers are circling under a yellow flag because of wreckage, they must reduce speed and maintain their relative positions. Shaw thought this was a golden opportunity to refuel. He rolled to his pit on lap 127.

Henning shook his head. "You'll never make it," he protested as the fuel, propelled through its hose by compressed air, gushed into the tank. "You'll run dry."

"I'll make it," replied Shaw confidently.

On lap 191 his engine sputtered. He saw \$20,000 in first-prize money dribbling through his fingers. But Henning, the fox, had installed a one-gallon auxiliary fuel tank before the race for just such a contingency. With it Shaw managed to make his pit.

Ordinarily the refueling stop would have taken 30 seconds. With the carburetors dry, it took a minute and a quarter to get Shaw

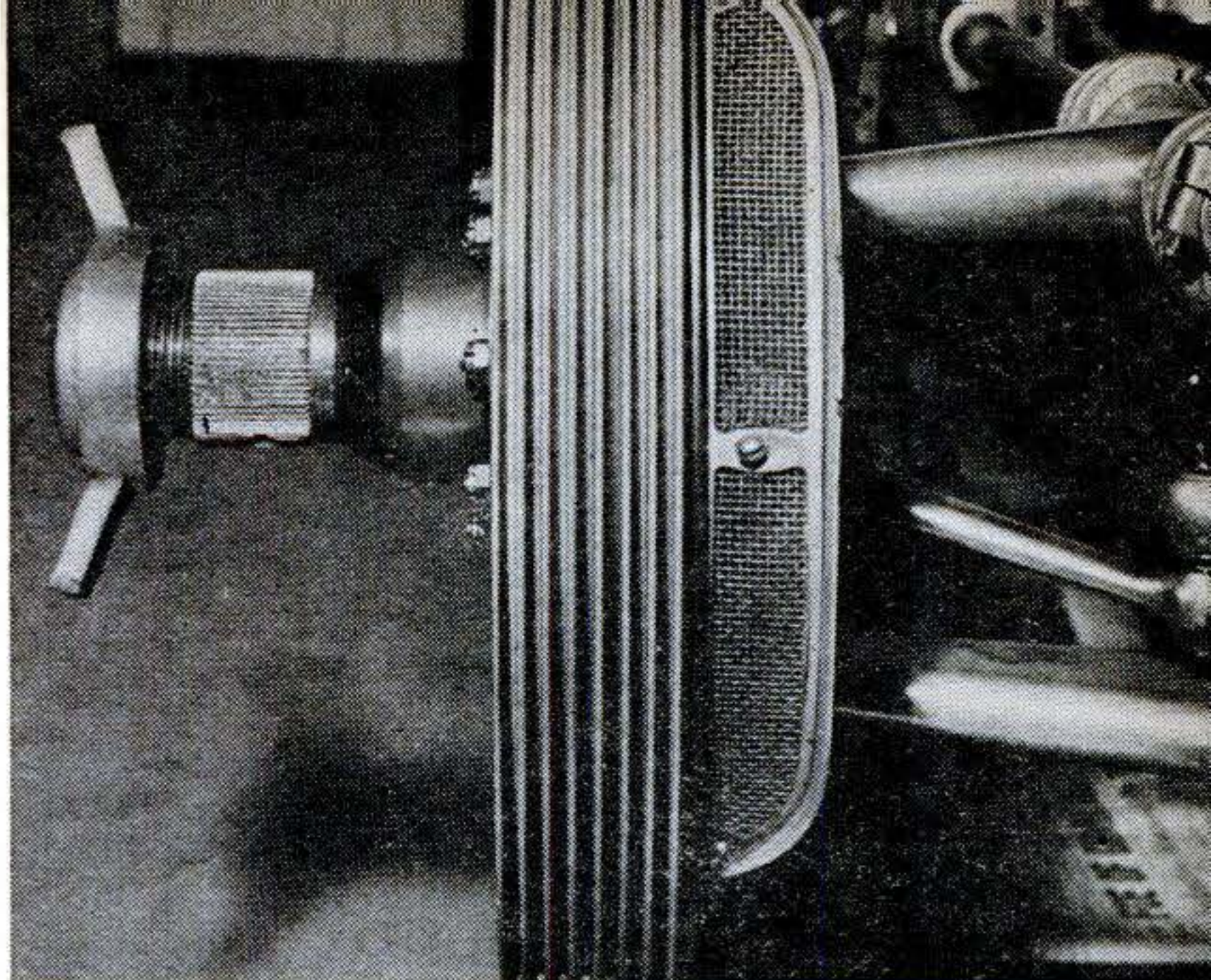

Rapid-fire tire changing is made possible by the single wing nut and the hub serrations onto which the wheel slips. Screened scoop at right of finned brake drum supplies cooling air to the drum.

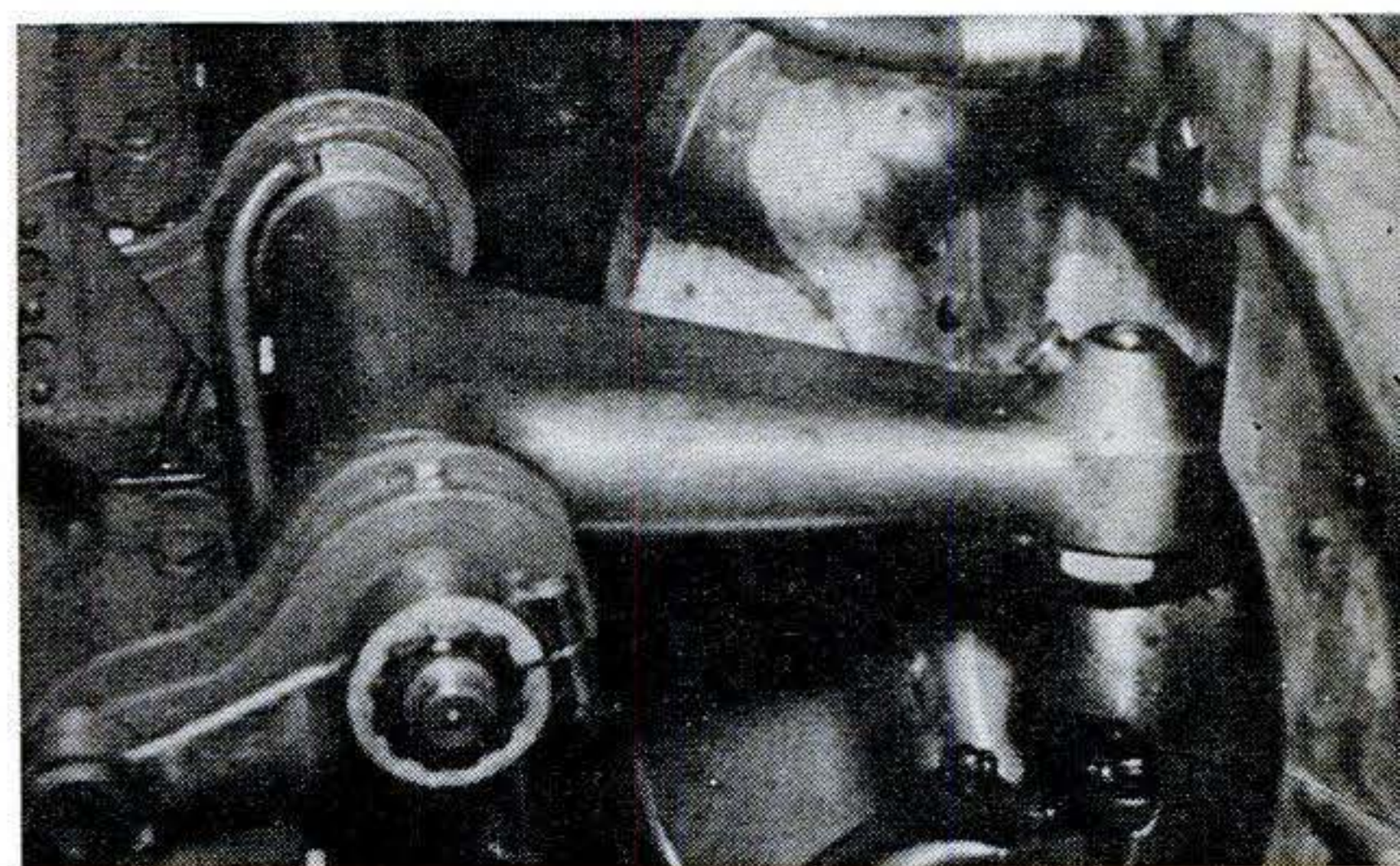

A torsion bar replaces springs for racer's front wheels, each of which has independent drag links. Steering wheels have no play and are geared seven or eight to one; stock cars run about 12 to one.



Duraluminum wheels weigh only 16 to 18 pounds without tires, about half as much as steel wheels. The $5\frac{1}{2}$ -inch-wide rim would support a 4,000-lb. car.

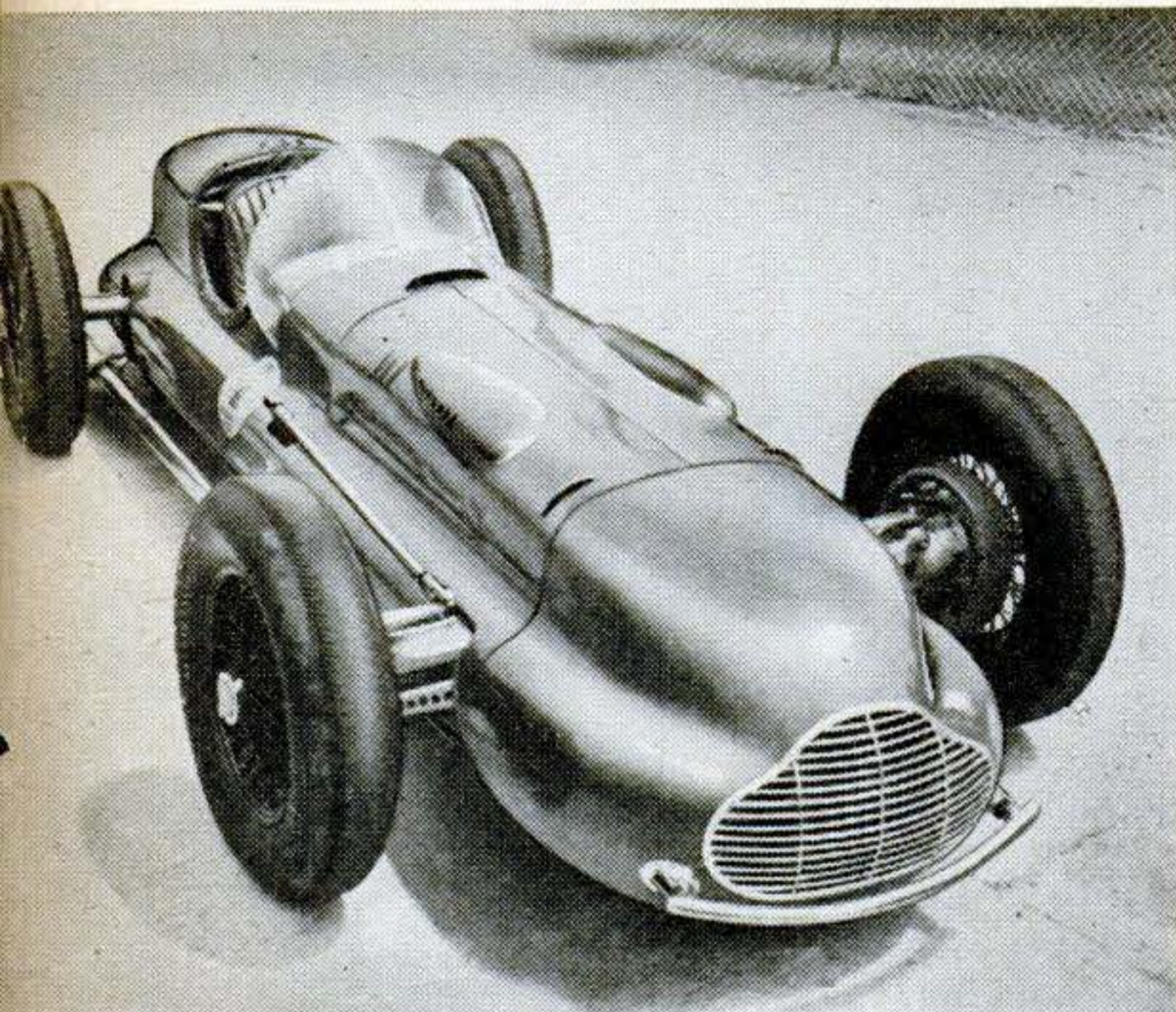

Ralph Hepburn's 500-hp. car, reportedly capable of 250 m.p.h., set new records in trials for the 1946 race and ran laps at better than 130 m.p.h. before it was forced out of the race. The all-time Speedway track record is 117.2 m.p.h., set by Floyd Roberts in 1938 in a car powered with a four-cylinder Offenhauser engine. Roberts was killed in 1939.

rolling again. He promptly stood on it. His margin of victory was only one minute and 48 seconds. Even so, that was a bit more comfortable than his two-second victory in 1937.

Bad Breaks and Good Ones

Nobody, of course, can foresee the bad breaks, not even the smartest of the master mechanics. Cars collide. Drivers lose them on turns and smash into the concrete retaining wall. Etched on the Speedway's north turn are the broadside wheel marks of a racer, the calling card left by Mauri Rose's mount last year. Ralph Hepburn set a new one-lap record of 134.446 m. p. h. and a new four-lap record of 133.944 in his qualifying trials, only to have a broken crankshaft in the actual race.

Then, of course, sometimes men make their own breaks. In the first revival of the 500 since the war there was a severe shortage of good babbitt metal for bearings. The engines of the racers obviously were going to suffer as a result. But not Cotton Henning's machine.

"Lemme see," mused Henning. "Didn't I have some babbitt put away around here someplace before the war?"

That's right, he did.

Cotton Henning is more than a master mechanic. He is a symbol. With the wisdom of 22 years at the Speedway, he stands for the men who win the races.

From Mechanic to Owner

Henning began coming to the Speedway back in 1921, and in the two-man-car days rode in the 500 as a mechanic. He has raced at the side of Peter DePaolo, Joe Thomas and Frank Elliott, all names in the Speedway firmament. He has nursed the mounts of Al Miller, Chet Miller, Russ Snowberger, George Connor, Meyer, Horn and Shaw and has produced four Speedway winners. This is an important year for Cotton Henning. Now he is the owner of a racer. He bought the Maserati that carried Shaw to victory on two successive years. But he is still his own master mechanic.

"Once a mechanic," he says, "always a mechanic."

It must be true. Last year a visitor at the Speedway the day before the race asked, "Who's the fellow in the business suit over there with his head under the hood of that racer?"

"Oh, him?" was the noncommittal reply. "Man named Shaw. Wilbur Shaw." **END**



Edward Stomper Memorial Trophy for the winning car's nursemaid, established in 1946, was the first formal recognition of master mechanics' role.



RYAN XF2R-1. The Navy's newest Fireball is another hybrid—it has a General Electric TG-100 prop-jet gas turbine in front of the pilot and a J-16 thermal jet behind him. The shark-nosed plane is expected to reach the 500-m.p.h. range.

PIW-UP

NEW IDEAS from the INVENTORS

Camera Holds a Darkroom.

For the convenience of photographers who have neither time nor space for a darkroom, Clifton V. Berry, of West Haven, Conn., has patented a small, snapshot-type camera that features its own built-in developing tank. Shown in the cutaway view at right, the tank is a separate unit mounted on the floor of the camera and opening at its rear. After the roll of exposed film has been removed from the top, the camera is turned lens downward. This puts the tank in an upright position, ready to receive the film. Protected from the light by a sliding shield, the exposed film is then inserted in the tank.

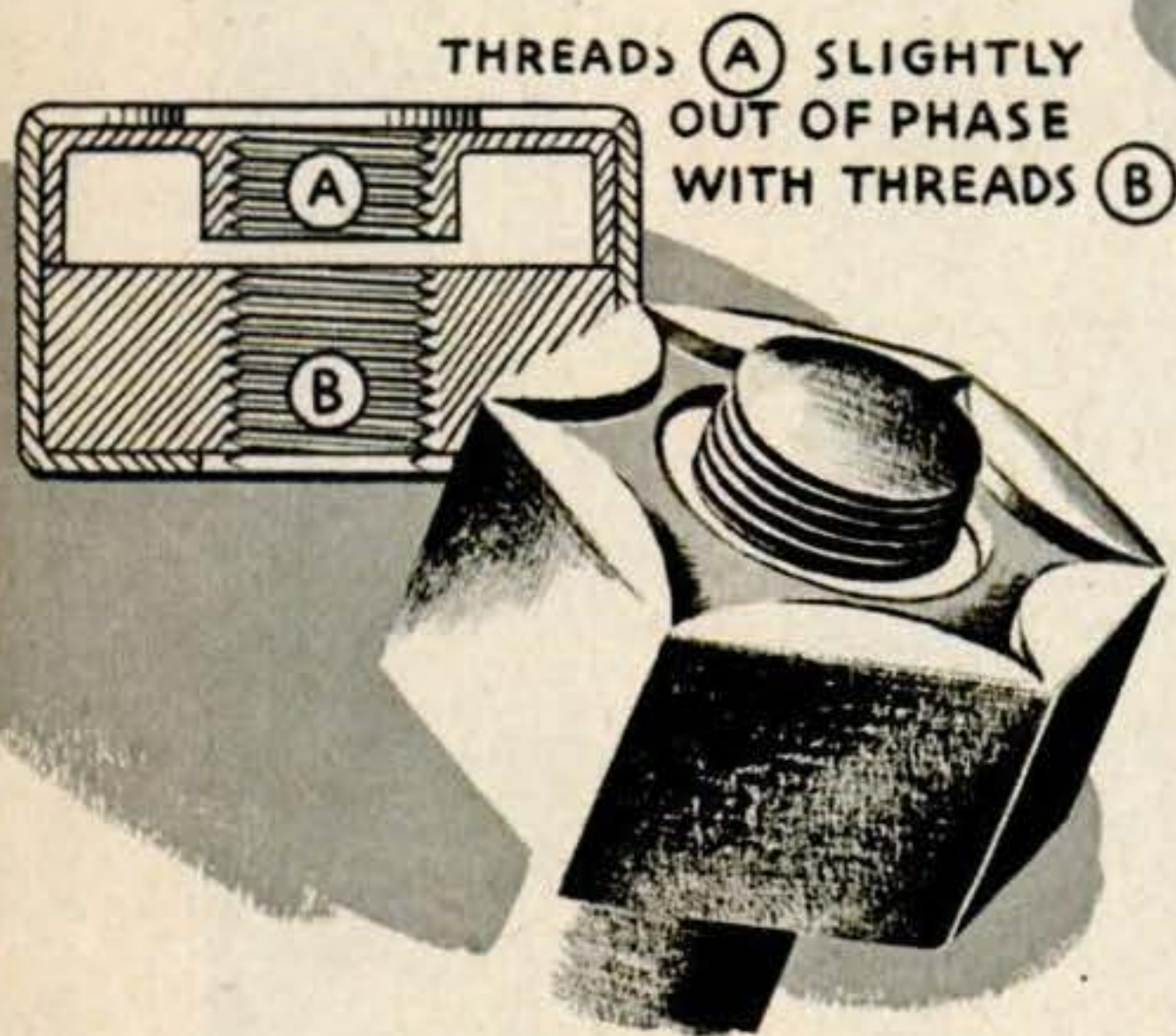
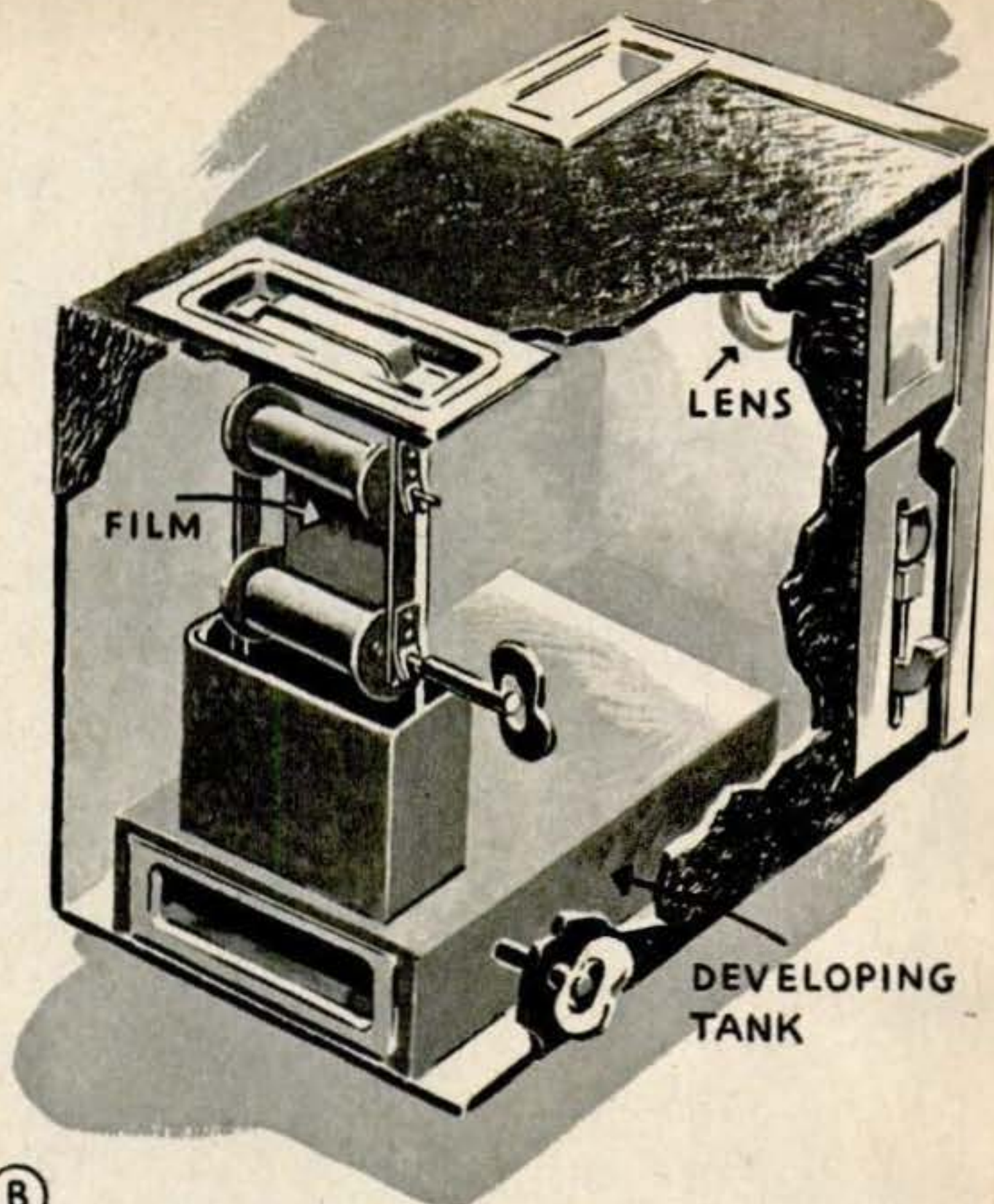

Nut Locks Itself on Bolt.

Designed not to work loose, a nut invented by the late Albert C. Lusher, of Waterbury, Conn., is composed of two identically threaded but slightly out-of-phase parts. The friction set up by the two parts, which press against the bolt's threads like two separate nuts forced together on a single bolt, is sufficient to prevent the nut from loosening.

Prefabs for Dogs. Not to be outdone by his master, Fido will enjoy the convenience of a prefabricated doghouse if an invention of John J. Latura, of Memphis, Tenn., is put into use. Shown in finished form at right, it is constructed of six one-piece, prefabricated floor, roof and wall sections, easily assembled with few tools. Interlocking metal joints in all of the parts, designed to slide together, prevent the wood from warping and make nails, screws or other fasteners unnecessary.

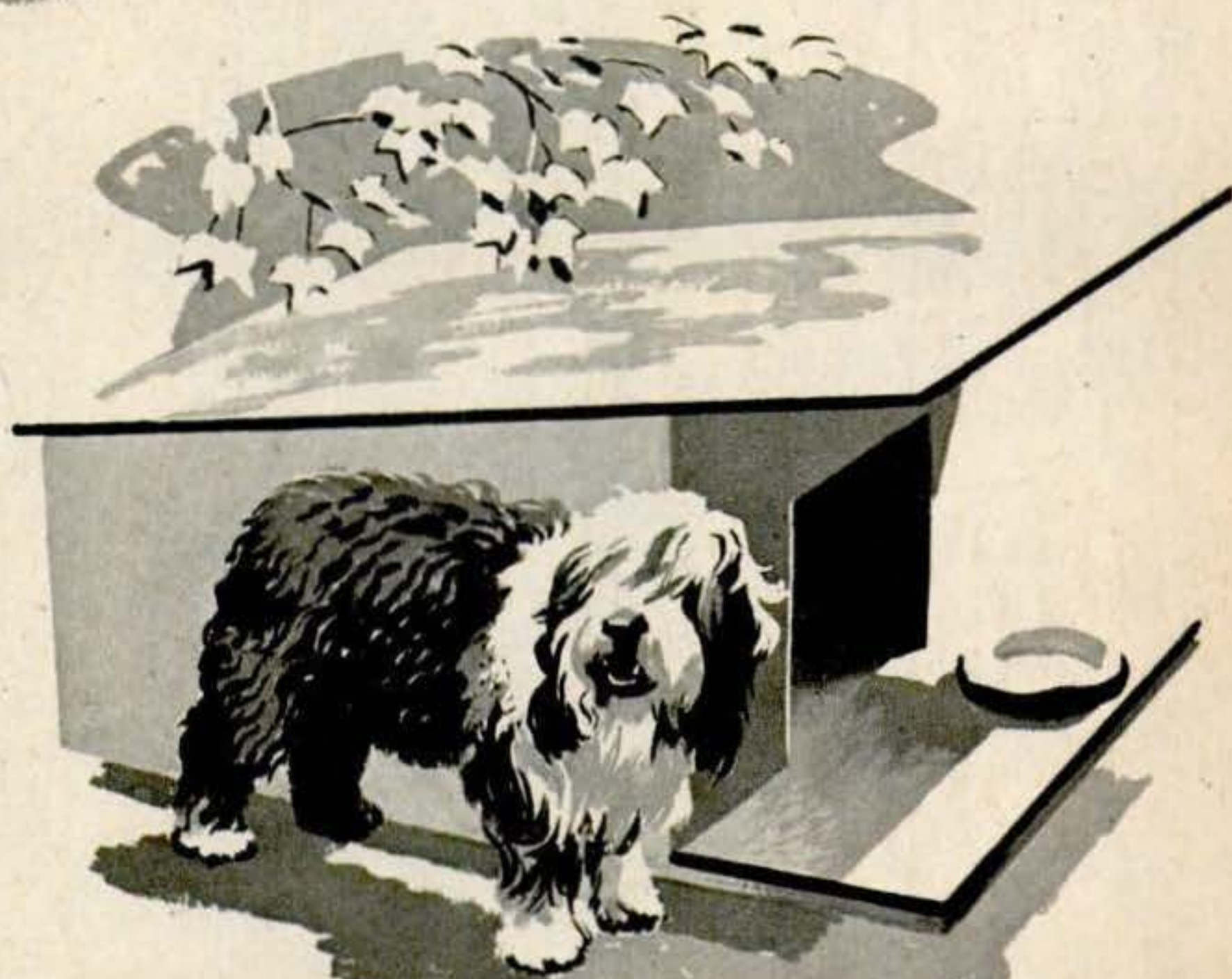

Pocket Eye Aid. Foreign particles are removed from the eye by a replaceable loop of delicate hair in the instrument pictured at right, patented by Clara Andrzejewski, of Chicago, Ill. Looking like a fountain pen, it also has a container that releases eye lotion directly into the eye when desired and an adjustable magnifying glass to help locate the foreign particles.

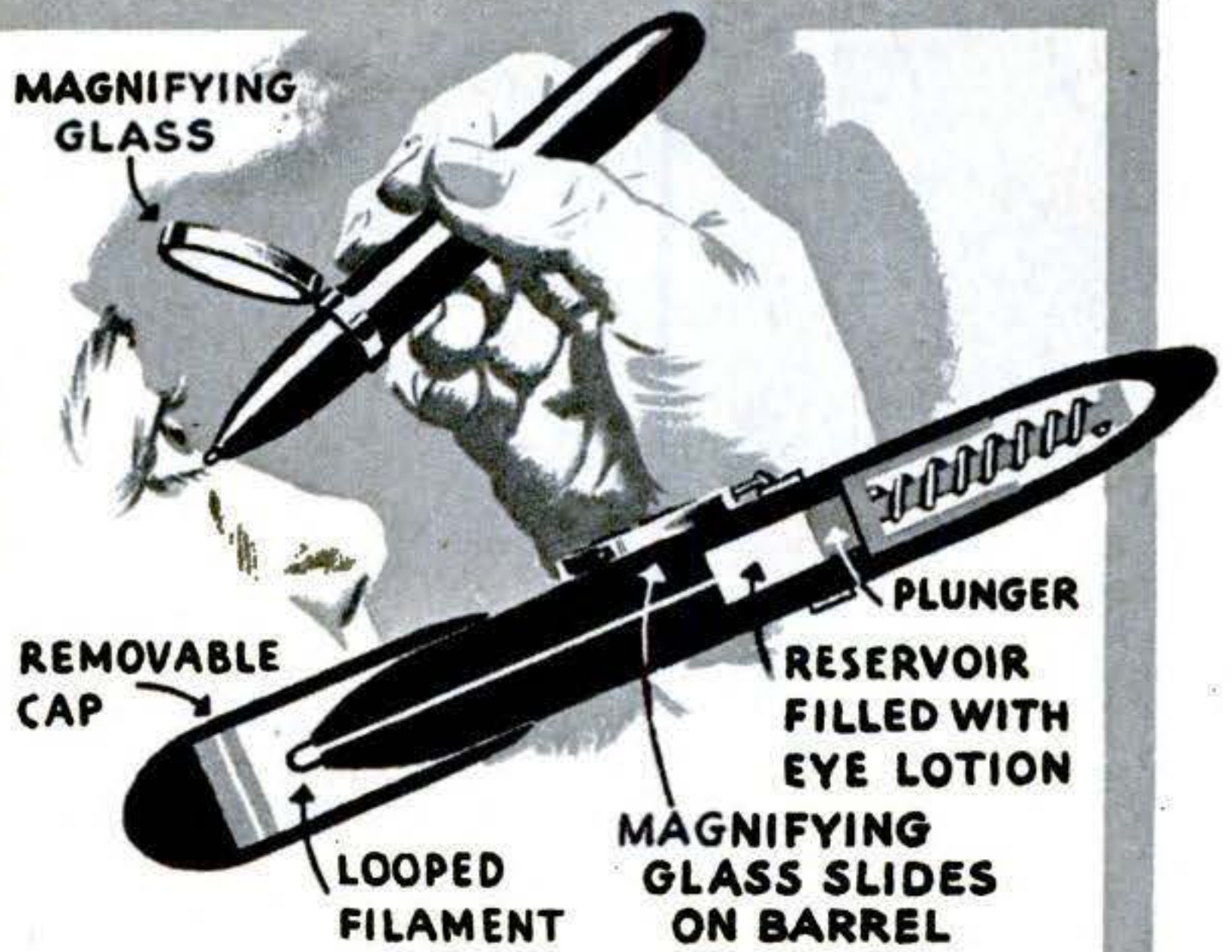

Wristband Cigarette Case. A cigarette and match are made instantly available in the wrist container for cigarettes shown at left. Invented by William E. Celestin, of New York City, it is composed of two layers of individually sealed, waterproof cylindrical pockets mounted on an elastic wristband. Each of the pockets, which may be opened one at a time by individual tear strings protruding from the top, contains one cigarette and a match. The container can be made to hold up to 40 cigarettes.

Wing Changes Its Camber. An airplane wing that can be adjusted in airfoil thickness to meet changing lift requirements has been invented by Jacque Fresco, of Hollywood, Calif. A hublike hydraulic jack unit, joining a number of flexible spars from points along the wing's edges, increases or decreases the space between the wing's surfaces, thus giving the pilot constant control over the wing's performance.

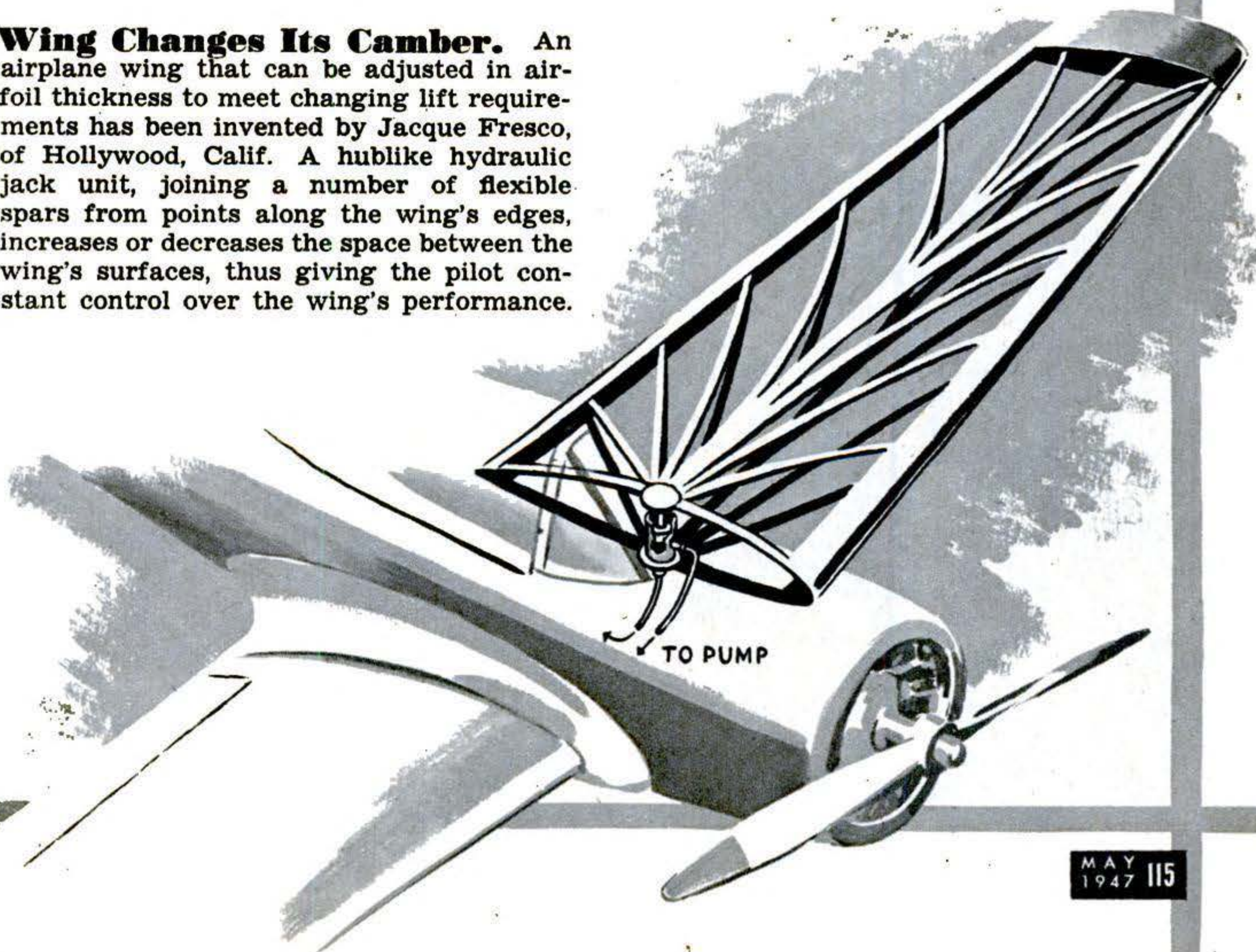



TINY TIM TAKES OFF. High above the vast Naval Ordnance Test Station at Inyokern, Calif., this Corsair fighter is being left behind by one of its 12-inch Tiny Tim rockets, fired a moment before.

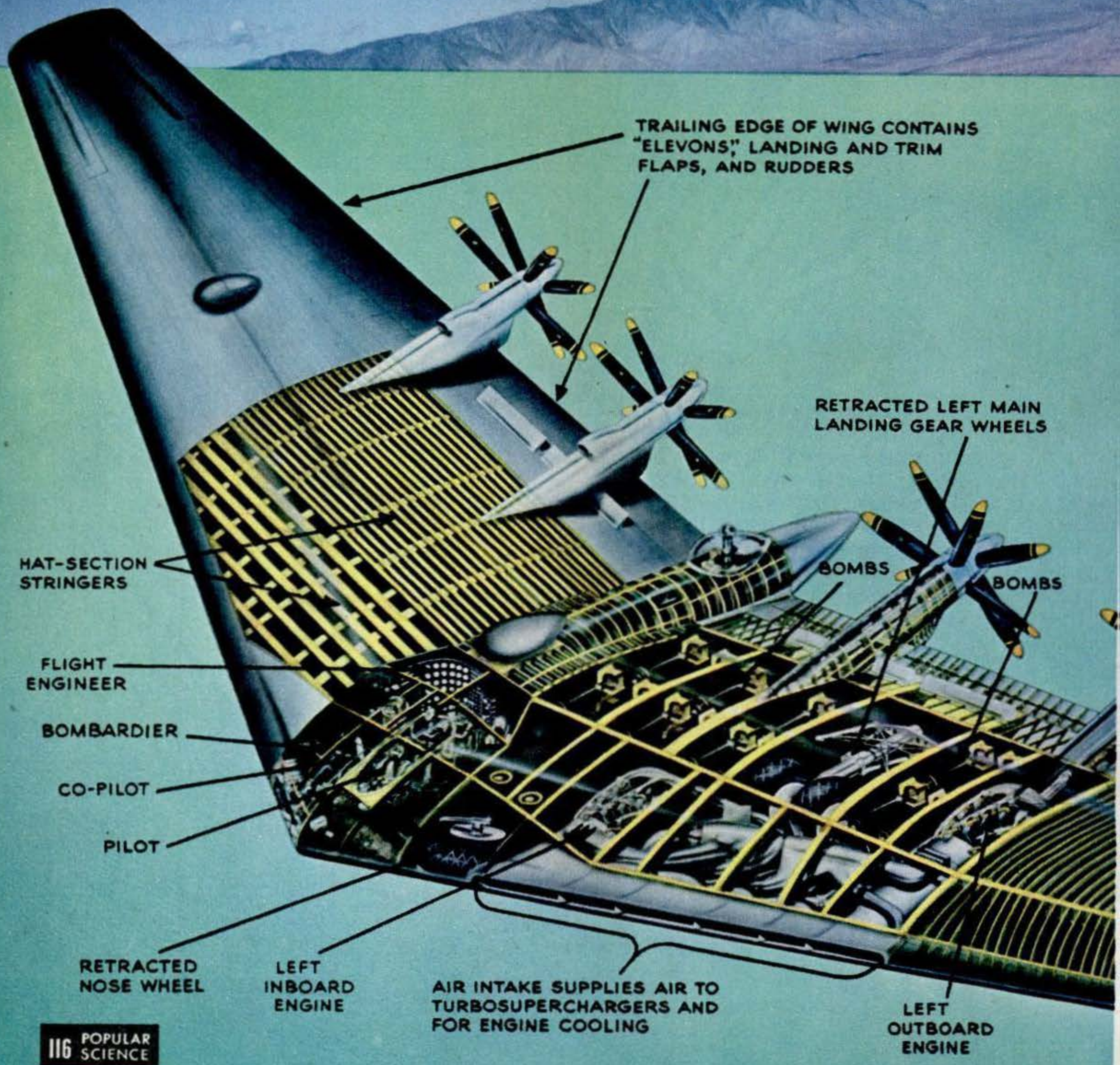

TRAILING EDGE OF WING CONTAINS "ELEVONS," LANDING AND TRIM FLAPS, AND RUDDERS

RETRACTED LEFT MAIN LANDING GEAR WHEELS

BOMBS

BOMBS

HAT-SECTION STRINGERS

FLIGHT ENGINEER

BOMBARDIER

CO-PILOT

PILOT

RETRACTED NOSE WHEEL

LEFT INBOARD ENGINE

AIR INTAKE SUPPLIES AIR TO TURBOSUPERCHARGERS AND FOR ENGINE COOLING

LEFT OUTBOARD ENGINE

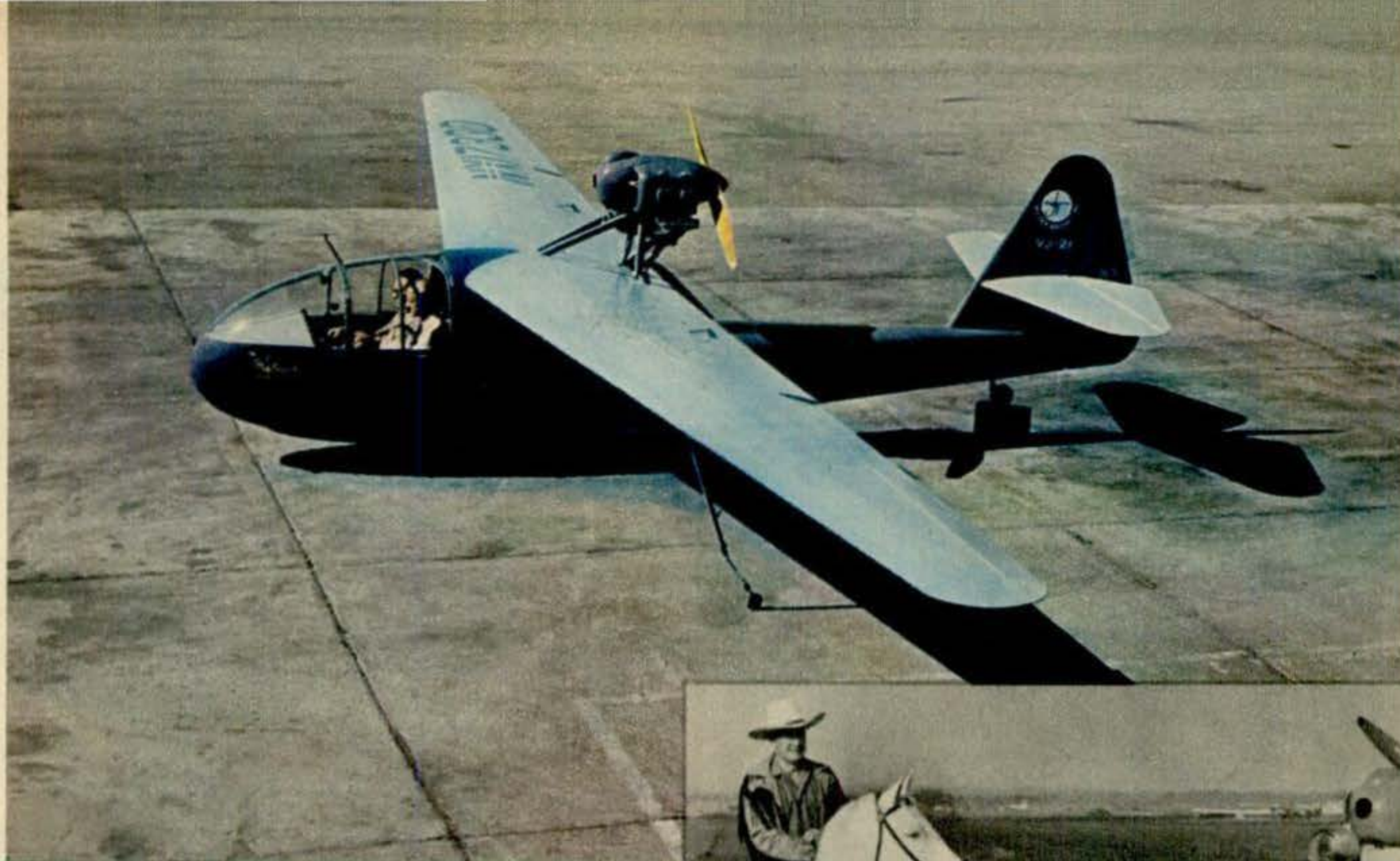

VJ-21 MAKES ITS BOW. With a 75-hp. engine atop its wing, the Volmer Aircraft Company's new three-place personal plane has a cruising speed of 110 m.p.h. and a 500-mile range. Prototype has a single main wheel and small retractable wing wheels (one of which is visible in top photo), but production models will have fixed tricycle gear. Lower photo shows the designer, Volmer Jensen, entering cockpit of the 1,350-pound craft.

HOUSING FOR COAXIAL SHAFTS OF
CONTRA-ROTATING PROPELLERS

RIBS

AUTOMATIC SLOT DOOR
CLOSES AT HIGH SPEEDS,
OPENS AT LOW TO GIVE
BETTER CONTROL

LOOKING INTO THE XB-35. Northrop's engineers faced a complex problem when it came to stowing a huge bomb load, a mass of operating mechanisms and 15 men inside the Army's Flying Wing. The cutaway drawing at the left indicates how difficult the job was—and how the engineers tackled it. Some of the crew positions are shown; other stations, plus sleeping quarters, are also in the center nacelle (PSM, Jan. '47, p. 95).

Everybody has his own pet idea of some gadget he would like to see in general use. What is YOURS? *Popular Science Monthly* will pay five dollars for every such suggestion that its editors decide to publish. Suggestions cannot be acknowledged or returned.

I'd like to see them make

Cartoons by SYD LANDI



Photographic Guns. A camera attachment for rifles and shotguns would give the hunter evidence for doubting friends, declares John Mantta, of Pelkie, Mich.



Calorie Calculator. A device for counting the calories in a meal would insure a proper diet and also spare the figure, says Mrs. T. M. Edwards, of San Mateo, Calif.



Winding Bed Covers. Separate blankets that roll up at the foot of the bed would satisfy both husband and wife, thinks Frank Kelley, of Fairfield, Conn.



Keyless Locks for Cars. To avoid the nuisance of lost or forgotten keys, Joseph Marymont, of Elizabeth, N. J., suggests combination locks for the doors of cars.



Adjustable Steering Wheel. To make getting in and out of the driver's seat easier, M. Garson, of Brooklyn, wants a steering wheel that will bend out of the way.



Rubber Shampoo Bottle. Soap-blinded shampooers could drop it on the floor without hunting for a place to put it, says Walter Bartlett, of West Creek, N. J.

HOW FAST IS 3,000 m.p.h.?

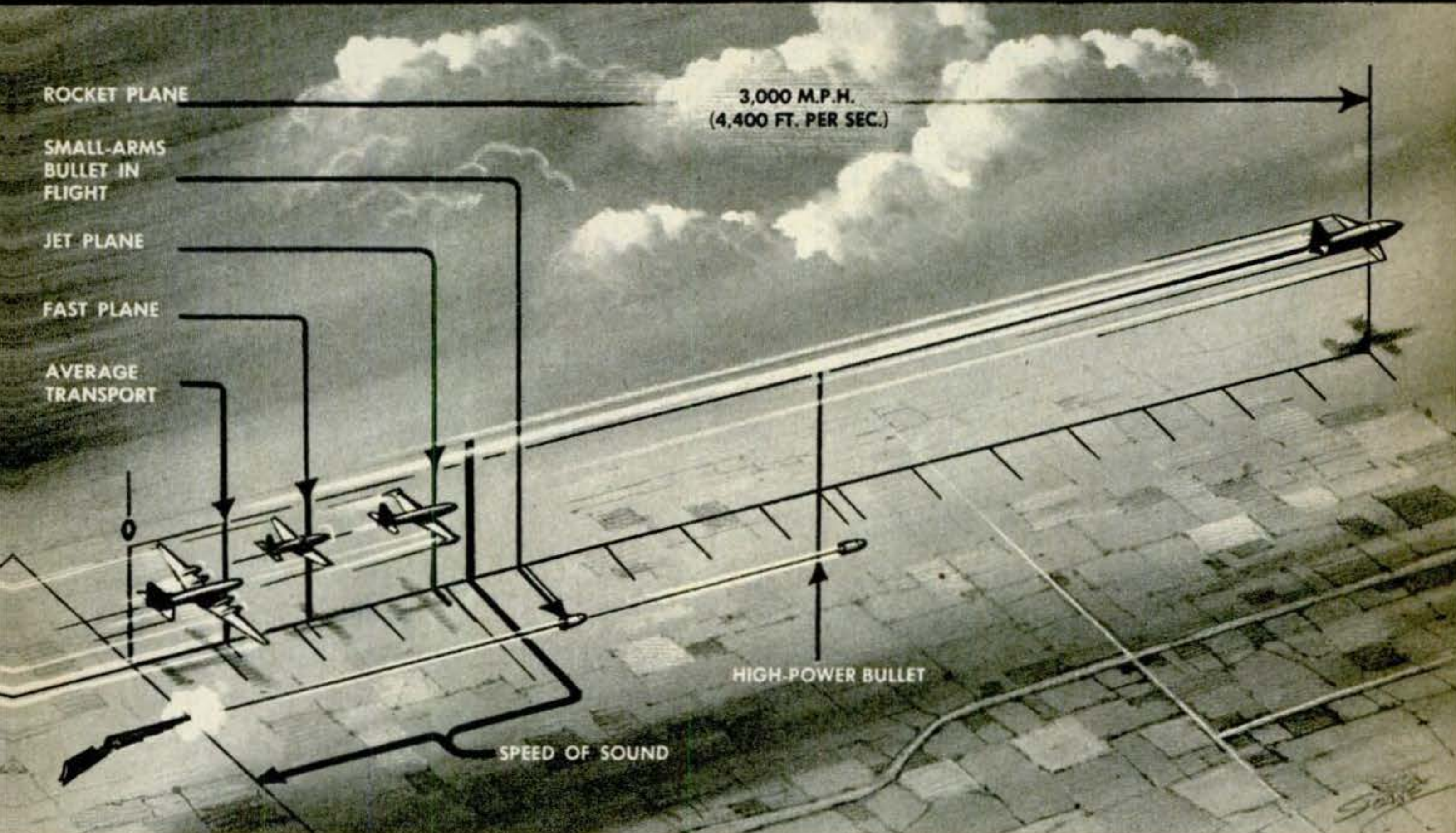

A CENTURY ago, "a mile a minute" was just a phrase that meant high speed; few people could visualize exactly how fast it really was. Today, almost every driver knows what 60 m.p.h. is like. We have "conceived" that speed. Perhaps in the near future we shall be able to conceive 200 or 300 m.p.h., but the speeds of stratospheric rockets will for a long time be nothing but figures. Two, three and four thousand m.p.h. are too fantastic to be grasped by most

Shown below are maximum fuel-reaction speeds in a total vacuum. Note how fastest plane with reciprocating gas engine would be left far behind.

Jet planes are nearing the 900 f.p.s. pace of small-arms bullets. Jet rockets are much faster; present ones could circle earth in less than seven hours.

men's minds today. Look at the drawing above and see how a mere 3,000 m.p.h.—the average lower speed for a coasting V-2 rocket at its peak altitude—compares with some with which we are more familiar.

All the speeds we know best are limited by atmospheric resistance; even the V-2 is retarded by air. Without air, speeds become almost unlimited, as shown in the diagram below, giving theoretical speeds for rockets and airplanes. The fastest—17,000 feet per second—would be about 11,000 m.p.h.!

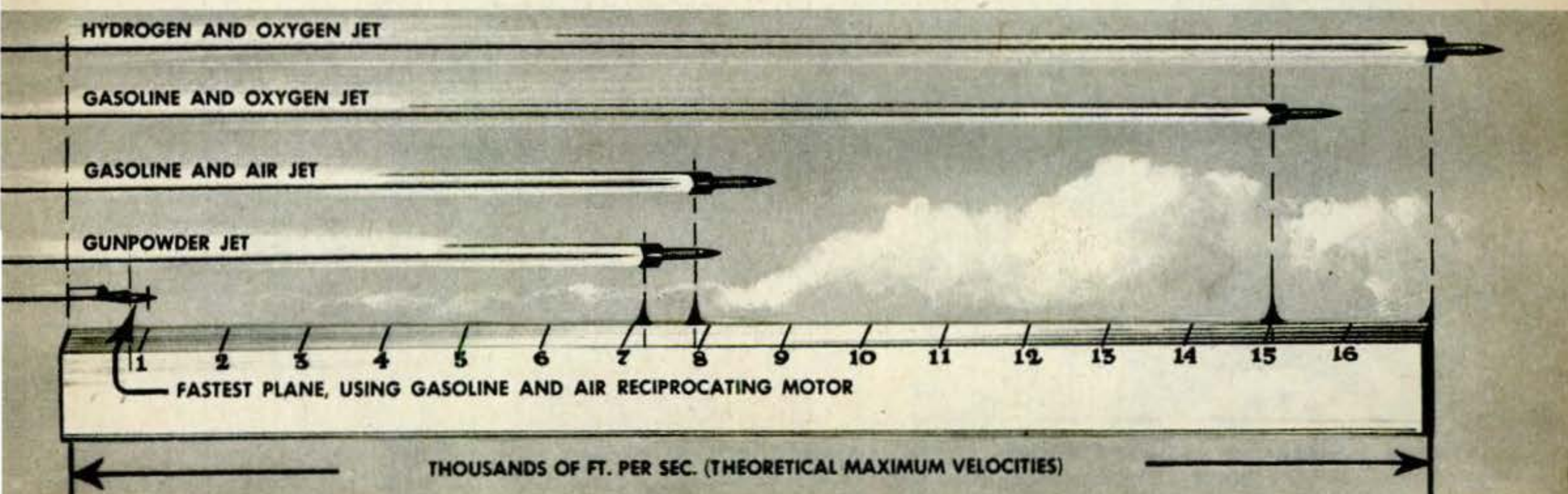



'Pioneer' for Frontier Flying

The new Northrop Pioneer, first new tri-motor plane in many years, is a flying workhorse built for rugged frontiers with small fields and few repair shops. It takes off in 700 feet with full 10,600-lb. useful load and needs a minimum of servicing. Range is 1,750 miles and top cruising speed, at 10,000 feet, is 185 m.p.h.

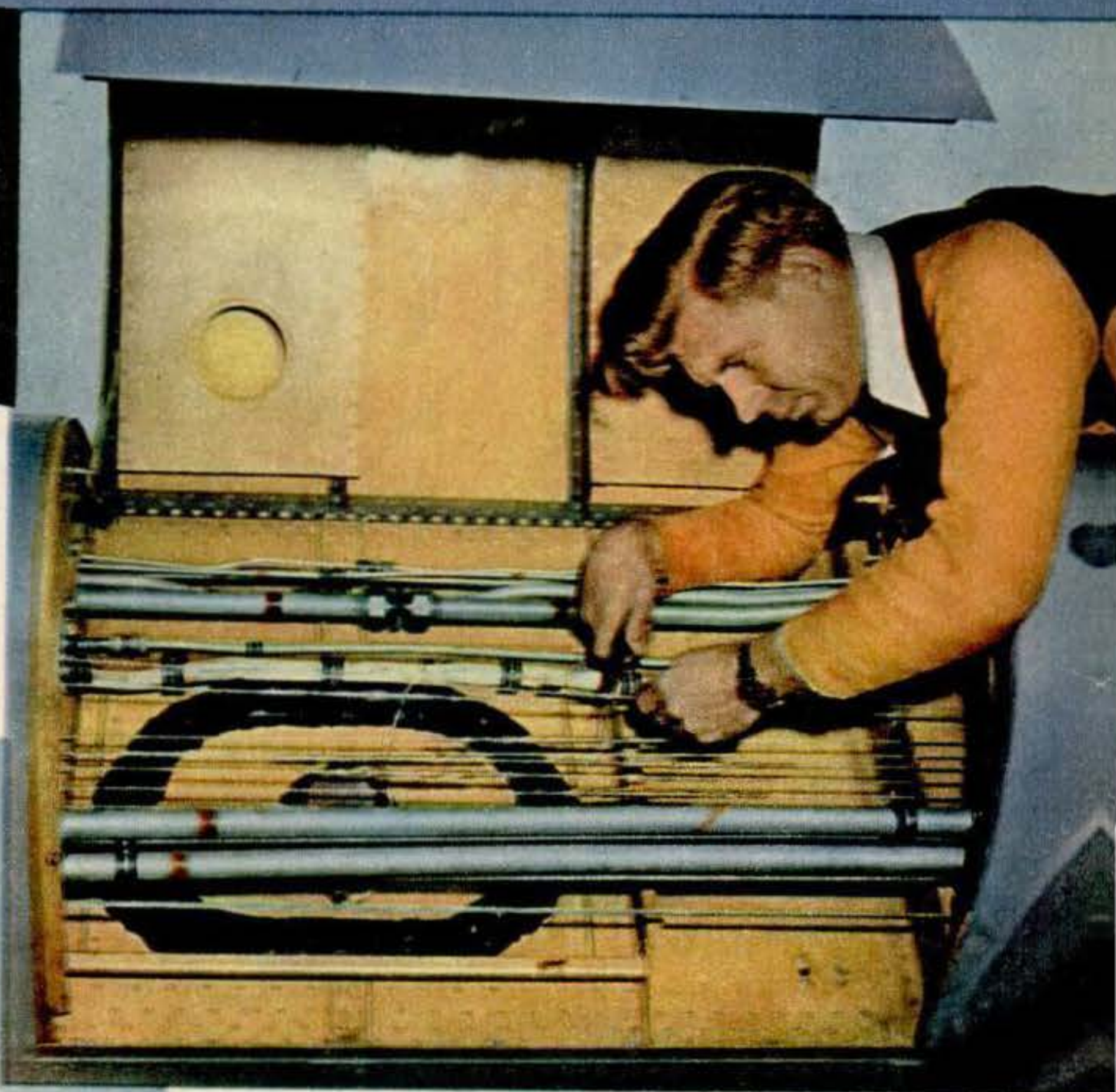

To simplify repairs, the wing's leading edge is hinged in sections to expose color-coded wires, fuel lines and control cables.

Fueling through right landing strut (at left) simplifies servicing. The fixed landing gear lowers speed but saves 400 lbs.

Bulky freight or 30 passengers can be carried in the cabin shown below. Even 36-foot pipe can be loaded through nose.

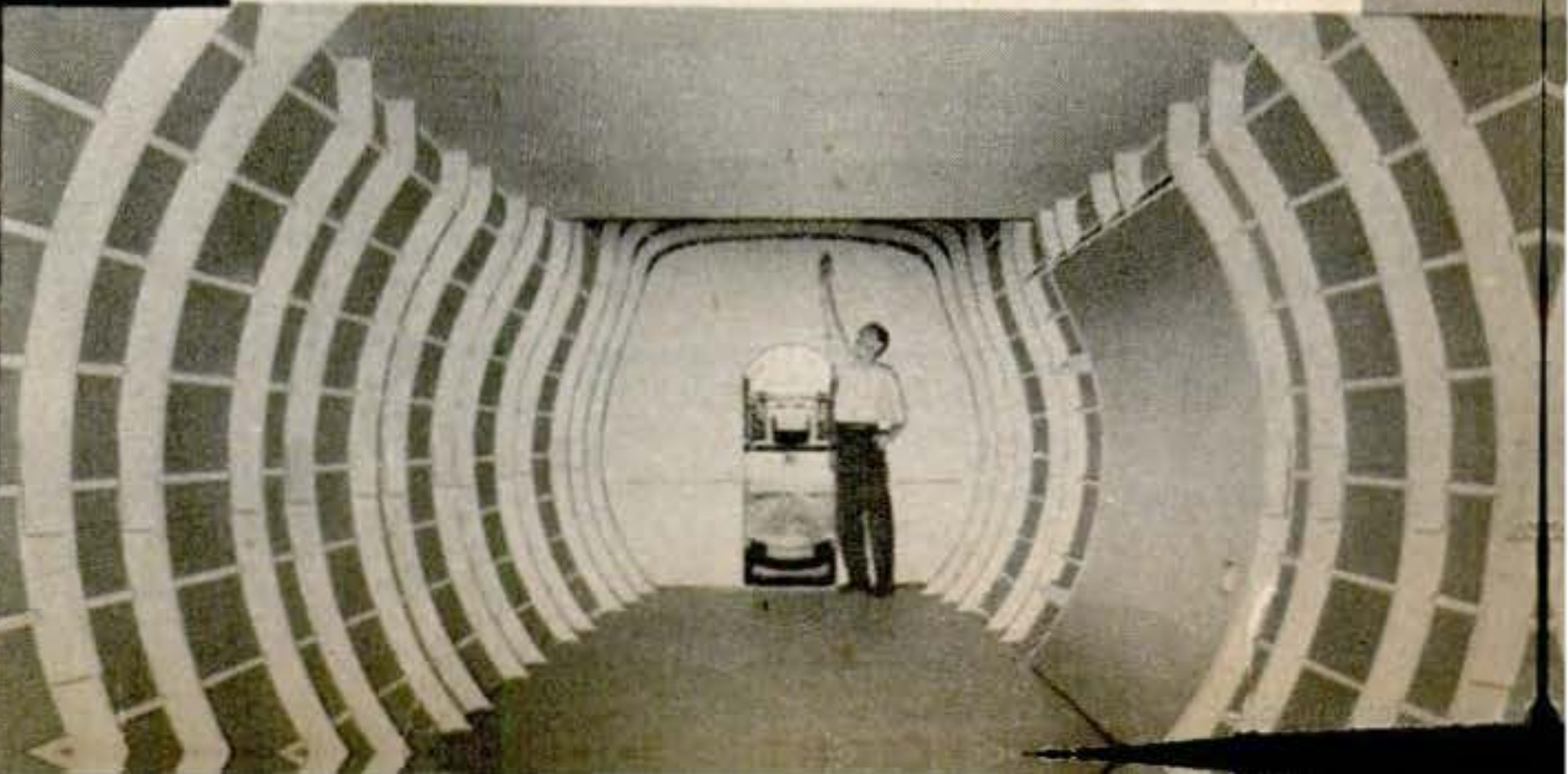

Who's Who in Foreign Air

YOU'LL find these insignia on air liners all over the globe. Representing some of the outstanding foreign air carriers,

their colorful symbols portray maps, birds and beasts, reflect national pride and confidence in the air age.



Mexico's eagle totes a map on the insignia of CMA—Compania Mexicana de Aviacion.

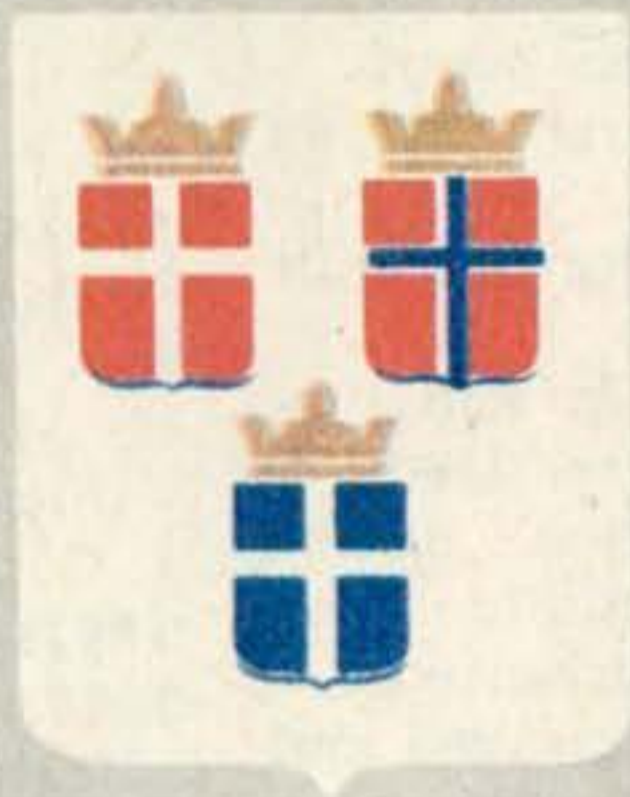

Norway, Sweden and Denmark share Scandinavian Airways Systems—hence, three shields.



Sabena emphasizes the colors of the Belgian flag. Shield has star over a Belgian cross.



The kangaroo is, of course, Australian—the device of Trans Australian Airlines.



KLM—Royal Netherlands Air Lines—serves in Europe beneath a blue crown.



Serving Dutch colonies and countries outside of Europe, KNILM is a branch of KLM.



Also Down Under, Australian National Airways indicates its operations area in red.



Iberian Airlines uses the colors of old Spain, plus a symbol of present Spanish government.



The winged sea horse of Air France flies over the North Atlantic and French possessions.



Swissair has the familiar white cross on red of national flag, dating from the Middle Ages.



Called "The Springbok Line," South African Airways naturally sports a flying springbok.



With different lettering, this bird doubles for ABA, inside Sweden, and SILA, overseas.

The GROWING YEARS

- 1872:** *H.M.S. Challenger*, during oceanic exploration, was first steamship to cross Antarctic Circle. Oleomargarine produced in France.
- 1873:** Remington built first practical typewriter. Ammonia refrigeration begun.
- 1874:** Soundings made for first Pacific cable. DDT synthesized.
- 1876:** Bell invented telephone. Edison built his first phonograph.
- 1877:** Presence of oxygen gas in sun discovered. Electric welding introduced.
- 1878:** Edison invented a practical incandescent lamp. Calculating machine that solved differential equations invented.
- 1879:** Benz's two-cycle engine appeared and cathode rays were discovered. Lockyer, accomplishing first transmutation of metals, obtained calcium from copper.



A crawl tread installed on his son's bicycle tested the traction wheel patented by Henry Stith in 1880.

- 1880:** Pasteur presented serum theory.
- 1881:** Kelvin estimated size of atoms.
- 1882:** Koch discovered tubercle bacillus.
- 1883:** Antipyrine, first synthetic drug, developed. Rayon produced in England.
- 1884:** Inventions: Mergenthaler linotype and smokeless powder. Waterman pen.
- 1885:** Color photography introduced.
- 1886:** Hertz created radio waves. Alternating-current system devised.
- 1887:** Tesla invented split-phase induction motor. Burroughs adding machine introduced.
- 1888:** First portable roll-film camera marketed. Dunlop's pneumatic tire patented.
- 1890:** First four-cylinder automobile constructed in France.
- 1891:** Telephone line laid: London to Paris.
- 1893:** First Ford car built. Edison produced motion-picture machine.
- 1894:** Lake constructed an even-keel submarine. Argon and helium discovered.
- 1895:** Roentgen discovered X-rays. First Diesel engine built. Oxygen extracted from liquid air.
- 1896:** Marconi established wireless commu-



The Maxim, invented about 1885, was the first true machine gun. Firing and ejection were automatic.

- nication between England and France. Curtis steam turbine invented.
- 1897:** Electrons discovered by Thomson.
- 1898:** Radium discovered. First sensitized photographic paper produced.
- 1899:** Two faint satellites of Saturn discovered by photographic method.
- 1900:** First Zeppelin flew 17.8 m.p.h. Munroe reported "curious effects produced with explosive substances" that later made bazookas possible.
- 1901:** Adrenalin isolated from suprarenal gland. Theory of mutation in biology announced, and research on proteins begun.
- 1902:** Continuous-wave system for radio transmission invented.
- 1903:** Wright brothers made first flight at Kitty Hawk. Cosmic rays discovered.
- 1904:** A bulb detecting radio waves, forerunner of vacuum tube, invented.
- 1905:** Einstein announced theory of relativity. Sperry gyroscope compass and stabilizer invented.
- 1906:** First actual radio broadcast took place at Brant Rock, Mass.
- 1908:** Novocain discovered.
- 1909:** Peary discovered North Pole.
- 1910:** Wireless message received in plane.
- 1911:** U. S. air-mail service started. Rogers flew from New York to Pasadena in 82 hours. Amundsen discovered South Pole.
- 1912:** Wilson cloud chamber used for nuclear-particle detection.
- 1913:** Isotopes of elements discovered.
- 1914:** Commercial radiotelegraphy inaugurated between San Francisco—Hawaii.
- 1915:** Fokker invented mechanism for firing

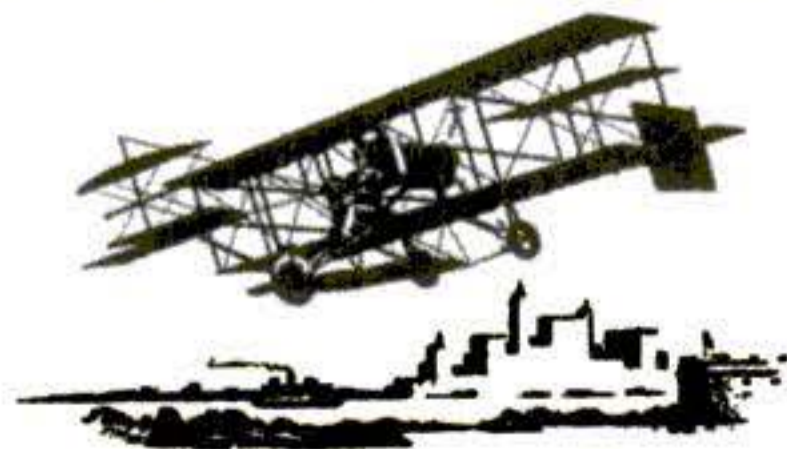

Glenn Curtiss arriving at New York, May 29, 1910, on his flight from Albany that won \$10,000 prize.

of SCIENCE

A chronology of significant developments and discoveries during the last 75 years.

- a machine gun through plane propellers.
- 1916:** X-ray tube invented by Coolidge. Stainless steel produced.
- 1917:** Supercharger for airplane engines invented by Moss.
- 1918:** Sperry applied for patent on a gyroscope robot plane.
- 1919:** Alcock and Brown made first nonstop transatlantic flight. First parachute jump from a plane.
- 1920:** De la Cierva built the autogyro. Election-returns program marked first radio broadcasting of spoken words and music.



"Hot Shot" robot plane of 1919 depended on timing gears to fly it over target and drop bombs.

- 1921:** Using principle of interferometry, Michelson measured diameters of the stars Betelgeuse and Antares.
- 1922:** Using facsimile system, pictures were sent from London to New York via Atlantic cable. Insulin isolated for medicinal purposes.
- 1923:** Synthetic rubber first obtained from butadiene. First nonstop transcontinental flight, New York to San Diego.
- 1924:** U. S. Air Service completed first around-the-world air tour (26,345 miles in 363 hours flying time).
- 1925:** Black-and-white caricatures sent during television experiments in Washington.
- 1926:** Plasmochin, a synthetic drug more powerful than quinine, discovered. Byrd flew over North Pole.
- 1927:** Lindbergh made solo flight across the Atlantic. Michelson clocked the speed of light at 186,284 miles per second.
- 1928:** Penicillin discovered. Radio beacon invented. Geiger-Muller counter for ionization developed.
- 1929:** Byrd accomplished first flight over South Pole. Zeppelin flew around world.
- 1930:** Nylon, Neoprene and high-octane gasoline produced. Planet Pluto discovered.
- 1931:** First photos showing curvature of earth made. Radar put to first practical use. Cyclotron invented.
- 1932:** Neutron and positron (positive electron) discovered.

- 1934:** Curie and Joliot created artificial radioactivity.
- 1935:** Therapeutic use of sulfanilamide discovered. World's record balloon ascent of 72,934 feet made.
- 1936:** Multiple telephone plugs attached to seats enabled delegates to Third World Power Conference in Washington to hear speeches in any of official languages.
- 1937:** Whittle's first jet-propulsion engine operated successfully.
- 1938:** Uranium fission discovered. The *Queen Mary* made record Atlantic crossing in three days, 20 hours, 42 minutes.
- 1939:** First controllable-pitch propeller installed on Army P-36. DDT saved Swiss potato crop.
- 1940:** Sikorsky's helicopter made first successful flight. Omnidirectional radio beacon for planes perfected. First permanent U. S. radar installation on battleship *New York* tested in maneuvers.
- 1941:** Electron microscope used successfully after Pearl Harbor raid to locate metal splinters.
- 1942:** First self-maintaining nuclear chain-reaction pile begun at Stagg Field, Chicago. First U. S. jet plane flown. Sea-search radar accounted for more than half of U-boats sunk after mid-1942.
- 1943:** Work begun on Oak Ridge and Han-

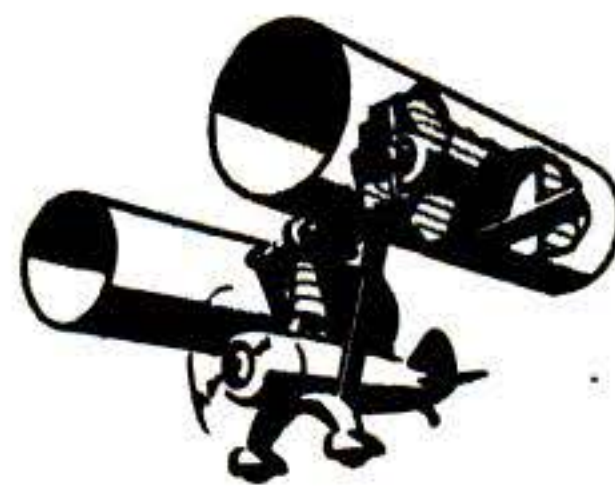

A wingless "cylinder" plane, driven by jets of air, was suggested in the February 1934 issue of PSM.

- ford atomic-bomb plants. Skip-bombing technique used successfully by Allies.
- 1944:** Nazis dropped winged bombs (V-1s) on England, followed by rockets (V-2s). Streptomycin identified.
- 1945:** Atomic bomb dropped on Hiroshima, August 6. A new star, the Eagle, 80,000 times brighter than sun, discovered.
- 1946:** Atomic bombs dropped in Bikini tests. Radar signal sent to the moon and back. Artificially created snow fell on Massachusetts.
- END

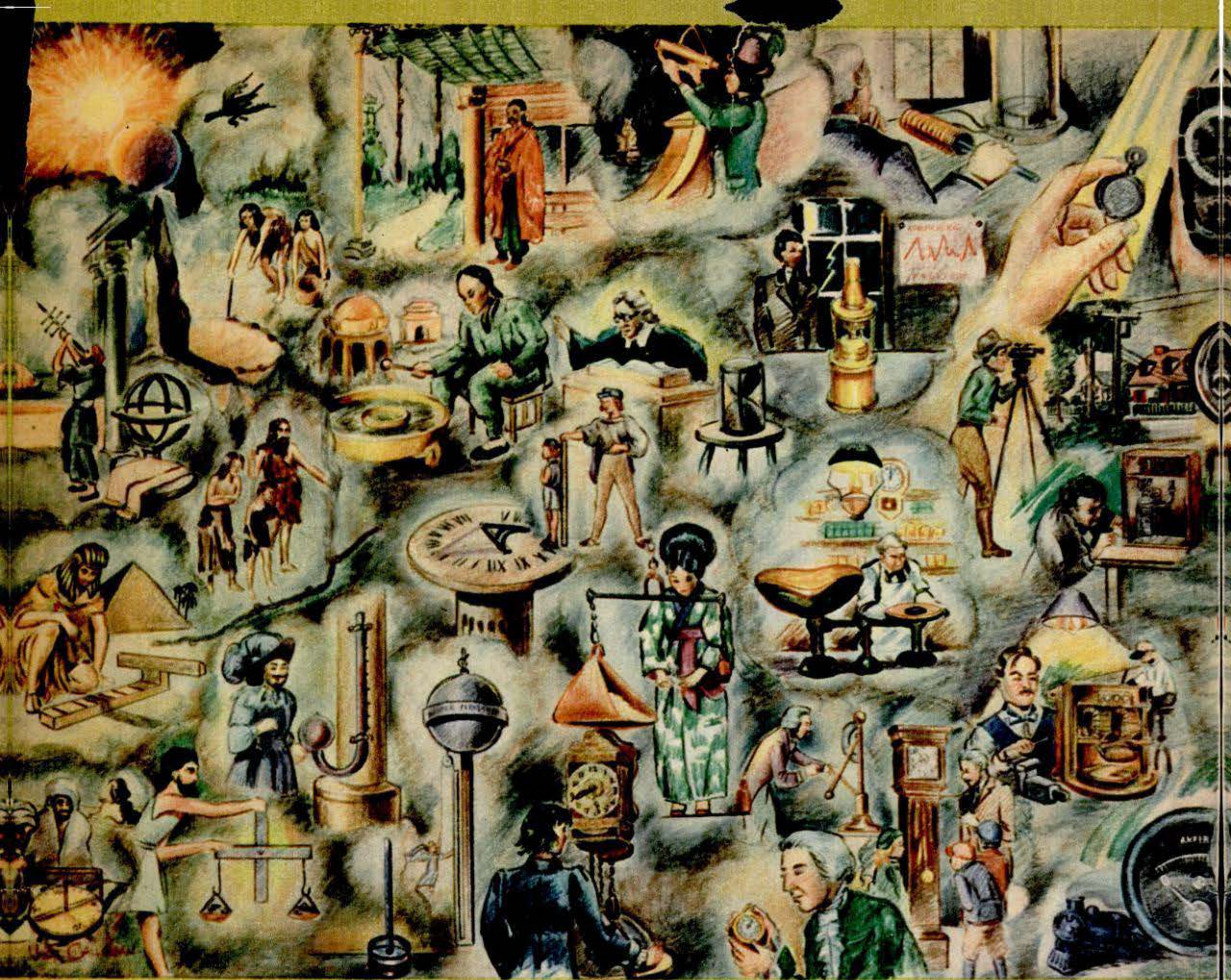

M

Measurements

SINCE that day many thousand years ago when some fussy cave dweller decided he wanted all his arrowheads the same size, man has been measuring things—and measuring them in nearly the same way. The slow improvement in tools and methods is illustrated above in Frank Gianascol's sketch for a mural planned for the General Electric plant at West Lynn, Mass.

The Stone Age armorer who made the first uniform arrowheads probably used a sample as his guide. But before long he changed to a marked stick. The marked stick is still the measure of length we use every day, although now that it is called a rule it is smoother and far more accurate.

Even the butcher-shop scale that weighs

your steak works on exactly the same principle as the balance owned by a merchant in Biblical times. To measure volume, we still use a standardized container.

Yet improvements did come. Astronomers, unable to pace off the height of the stars, invented about 150 B.C. the astrolabe, forerunner of the mariner's sextant and the surveyor's theodolite. The sextant and theodolite, themselves hundreds of years old, remained unchanged and unchallenged in their fields until World War II produced Loran for navigation (PSM Feb. '46, p. 78) and tri-metrogon aerial mapping for surveying (PSM Jan. '44, p. 68).

Primitive man divided up his days into hours by burning a piece of rope having

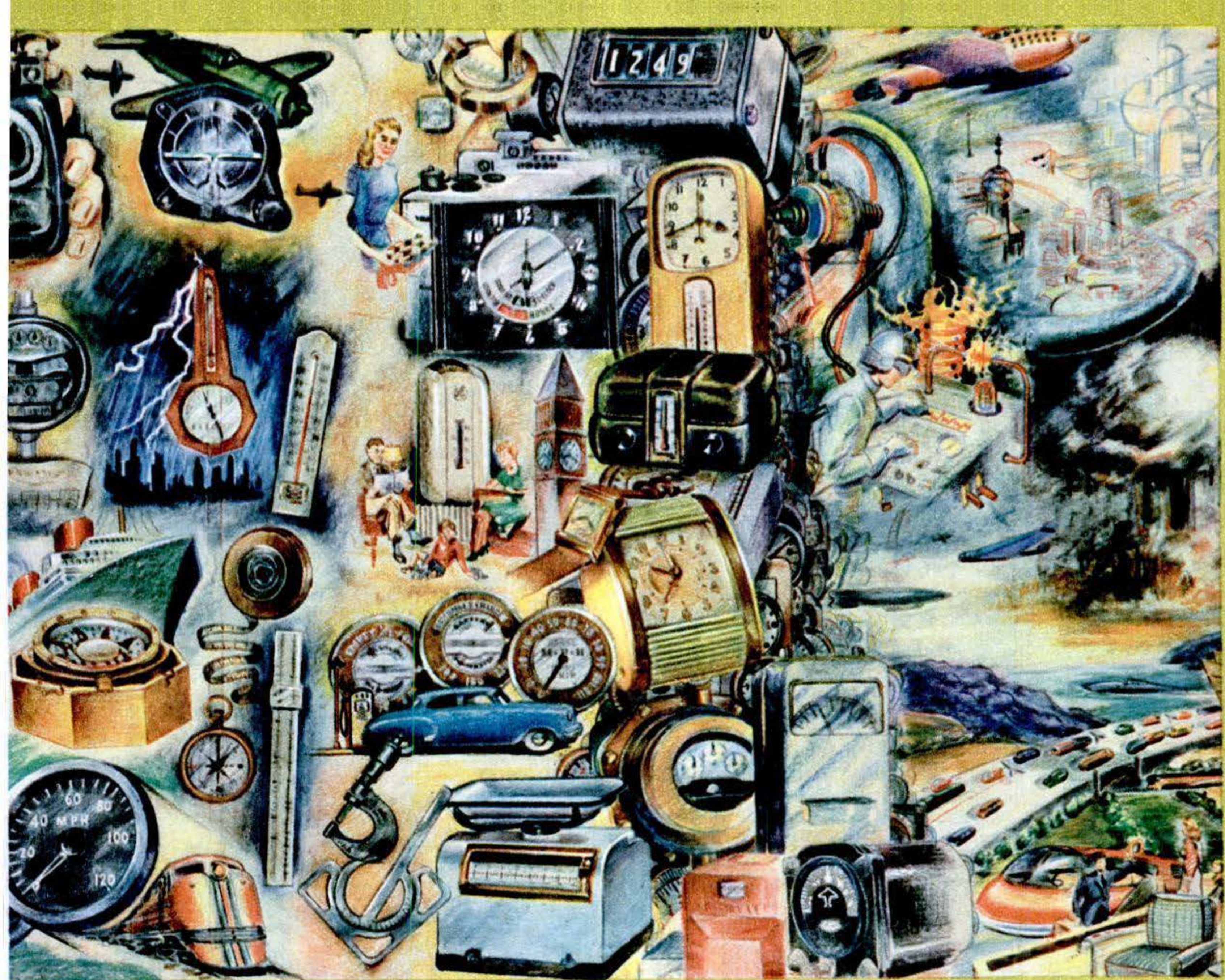

Unlimited PSM ANNIVERSARY FEATURE 75

equally spaced knots. Galileo's discovery of the pendulum in the 16th century made possible precise timekeepers—about as accurate as could be built until the recent development of electrically controlled quartz-crystal clocks. Now there are electronic stop watches that time differences of a billionth of a second!

The biggest advances in measurement have come in the past two centuries—partly because that period produced a host of new things to measure and to measure with. The discovery of electricity resulted in voltmeters, ammeters and similar devices. It also gave us the electron, which inside a vacuum tube performs all kinds of measuring no rule or scale could attempt.

The rise of industry in the same era also called for improved measuring devices. Invention of the vernier caliper and the micrometer about 100 years ago made mass production of interchangeable parts possible. Even then, mass production was generally limited to individual plants, for micrometers varied in adjustment—pistons

More than 50 measuring instruments—ancient and modern—are depicted in the mural planned by General Electric (above). How many of them can you identify? Check with the keyed drawing and answer list on the next page to see how good you are.

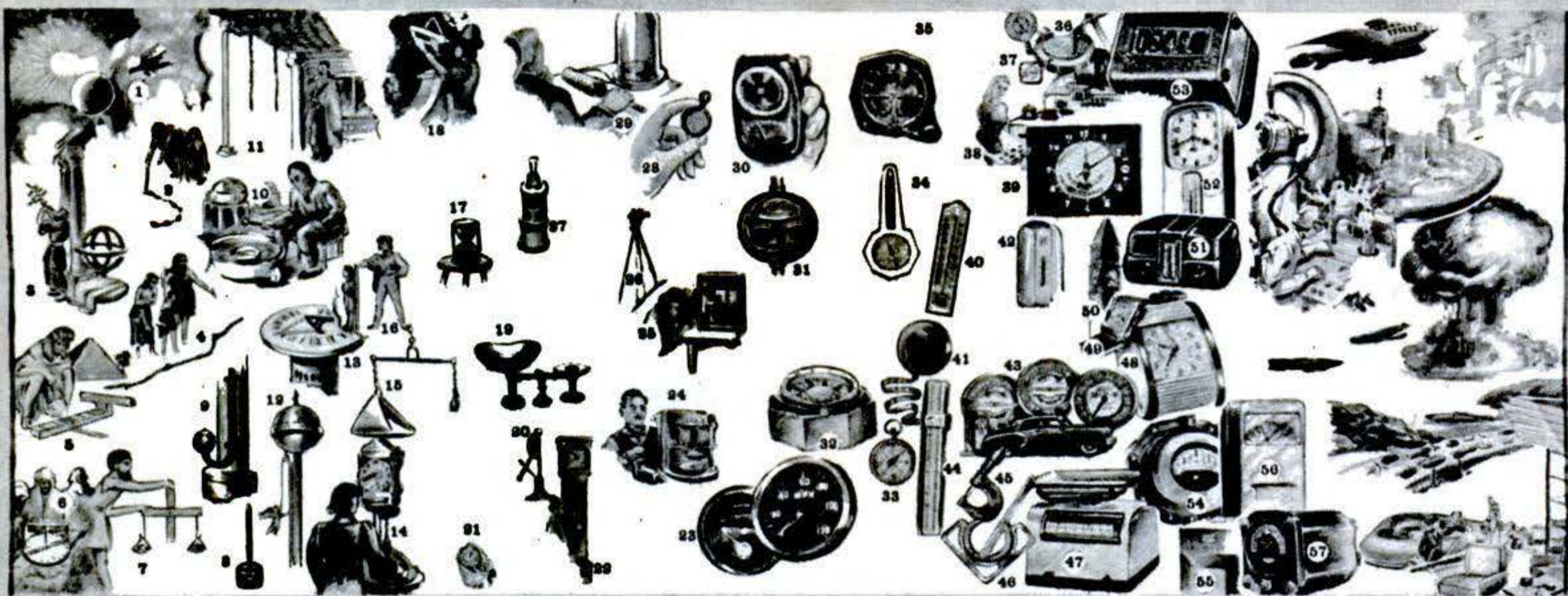

1 Sun and earth at the beginning of time. . . . 2 Primitive man telling time by the shadow cast by a rock. . . . 3 Early astronomical instrument. . . . 4 Stone Age men dividing the time by means of burning rope. Knots on rope indicate intervals of time. . . . 5 Early sun dial, Egypt. . . . 6 Early compass, Egypt. . . . 7 First scale for weighing solids. . . . 8 Cistern type of barometer, 15th century. . . . 9 Original thermometer, 15th century. . . . 10 Chinese water clock. When small dish fills with water, causing it to sink, the watch-boy strikes a gong. . . . 11 Chinese burning-rope clock protected from the weather. . . . 12 Later type of thermometer. Angel indicated temperature. . . . 13 Sun dial. . . . 14 First all-mechanical clock, 13th century. . . . 15 Chinese scale. . . . 16 First English yardstick. . . . 17 Hourglass. . . . 18 Astrolabe, an early version of the modern sextant. . . . 19 Early 19th century scale. . . . 20 Henley's electroscope (1772) for measuring electrical charge. . . . 21 The Nuremberg Egg, the first pocket watch. . . . 22 Grandfather clock. . . . 23 Railroad engine instruments. . . .

24 Professor Thomson and the first AC meter. . . . 25 Thomas Edison and the first DC meter. . . . 26 Surveyor's level. 27 Barometer. . . . 28 Early English exposure meter (1905). . . . 29 Faraday generating electricity from magnetism (1831). . . . 30 Modern photoelectric exposure meter. . . . 31 Home electric meter. . . . 32 Modern marine compass. . . . 33 Pocket compass. . . . 34 Modern barometer and thermometer. . . . 35 Aircraft horizon indicator. . . . 36 Several industrial measuring instruments. . . . 37 Modern kitchen electric clock. . . . 38 Modern kitchen stove with time switch controls. . . . 39 Modern time switch for domestic use. . . . 40 Modern thermometer. . . . 41 Measuring tape. . . . 42 Thermostat for heat control. . . . 43 Automobile instruments. . . . 44 Slide rule. . . . 45 Micrometer. . . . 46 Protractor. . . . 47 Modern scale. . . . 48 Clock. . . . 49 Wrist watch. . . . 50 Tower clock. . . . 51 Radio. . . . 52 Thermostat, electric clock and thermometer. . . . 53 Cyclometer clock. . . . 54 Old-type electric meter. . . . 55 Gas meter. . . . 56 Time switch for industrial use. . . . 57 Aircraft direction indicator.

made in one factory might not fit cylinders built somewhere else because they were measured with different tools.

C. E. Johansson solved this problem in 1897 when he made sets of steel blocks that varied from their specified sizes by less than 2/1,000,000 inch. Using "Jo" blocks to check the accuracy of gauges, many complicated machines are now as-

sembled, without hand fitting, from parts made in dozens of scattered plants.

Jo blocks are a big step ahead of the Stone Age mechanic's marked stick. But still the search for greater accuracy continues. Measurements are unlimited, yes—if you're satisfied with a millionth of an inch or a billionth of a second. The scientists are not.

END

Science in 1872

By HAL BORLAND

PSM **75** ANNIVERSARY
FEATURE

Its Growing Importance Brought About the Publication of Popular Science Monthly

IN 1872, the year *Popular Science Monthly* was founded, Thomas Alva Edison and Alexander Graham Bell were 25 years old. Edison had already improved the telegraph and was experimenting, in his Newark laboratory, with other uses for electricity. Bell was teaching phonetics for deaf pupils in Boston. Samuel F. B. Morse died that year, and in the first issue of *The Popular Science Monthly* an editorial note said that "his name and work will help to save our age from oblivion in the distant future."

In England, James Clerk Maxwell, professor of experimental physics at Cambridge University, was completing his major work on electricity and magnetism. Herbert Spencer was completing the second section of his system of fundamental philosophy, which brought order into the world of scientific philosophy and thought. Charles Darwin was a tired 63; Thomas Huxley, 47.

In France, Louis Pasteur, who gave us serum immunity, was 50 years old and ranting vigorously at medical superstitions. In Austria, Gregor Mendel was virtually unknown, though he had published his master study of heredity six years before. In Russia, Dmitri Mendeleev, at 38, had published his statement of the Periodic Law governing chemical atoms two years before. In Germany, Julius Sachs, the botanist, was a 40-year-old fanatic trying to convince his elders that his observations three years before proved implicitly that plants absorbed carbon dioxide and gave off oxygen both day and night—contradicting the venerable notion that at night the plants reversed themselves and absorbed oxygen and gave off carbon dioxide. In Italy, Guglielmo Marconi was not yet born.

Here in the United States, the first transcontinental railroad had been in use only three years. The country's population totaled about 40,000,000, and New York City had a population of 1,500,000. Ulysses S. Grant was about to be elected to his second

term as President. Europe was two weeks away from New York by fast steamship. A farmer living five miles out was an hour from town. Henry Ford was a nine-year-old schoolboy in rural Michigan.

A ferment was working. There was energy and the spirit of inquiry and development. Men were restless, both physically and mentally. Farmers were moving out toward the New West, and scientists were reaching into the unknown.

Many forays had been made into it, and information had been brought back. Few people had undertaken to organize this scattered information, however, and still fewer had pieced even related sections together into a usable whole. But the urge was there. Prof. W. Kingdon Clifford, of University College, London, was saying in

Breech of Sharp's breech-loading rifle, the "Old Reliable" of 1870s.



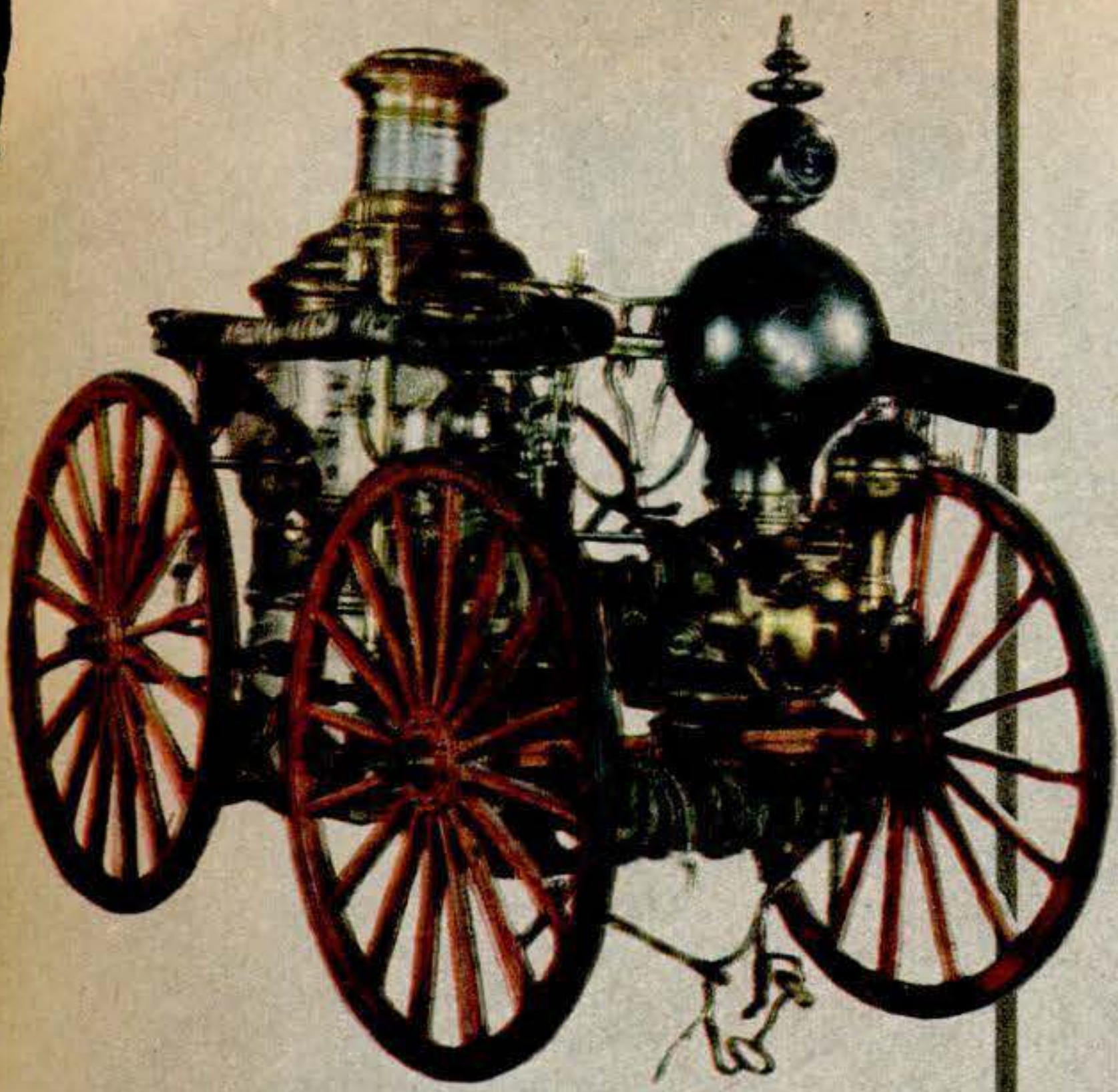

Hand-drawn steam fire engine: 1876.



Stereo-camera.



Graphoscope and stereoscope.

1872: "The subject of science is the human universe; that is to say, everything that is, or has been, or may be, related to man" (PSM, Nov. '72, p. 94).

The 19th century brought a rush of discovery. Dalton published the first table of atomic weights and founded the atomic theory. Prout theorized that all elements were built of the same ultimate material. Berzelius set forth the electrochemical theory. Oersted discovered magnetism, and Ampere related it to electricity; Faraday discovered electromagnetic induction—the foundation of the dynamo—and Daniell and Grove invented the electric battery. Cook, Wheatstone and Morse put electricity to work in the telegraph.

Liebig applied chemistry to physiology and agriculture. Helmholtz formulated the first law of thermodynamics. Simpson used chloroform as an anesthetic. Wallace and Darwin propounded the theory of evolution. Huggins photographed stellar spectra. Lister revolutionized hospital and surgical techniques by antiseptics. Stas made accurate atomic-weight measurements.

In almost every field of science we had new and swiftly increasing knowledge. We had developed a scientific method of inquiry and investigation. Pure science, the accumulation of factual knowledge and scientific speculation, was pretty well advanced. We were ready to put it to wide use.

First of all, we had power. Man's first source of power outside himself was in domesticated animals. Then he developed the water wheel, which was his major source of power until the 18th century, when steam was put to work pumping water from mines. Watt put steam pressure

PSM ANNIVERSARY
75 FEATURE



Remington Type-Writer: 1873-74.

behind the piston; and steam wrought the Industrial Revolution. It was still the principal source of power in 1872. The principles of the electric generator were known, but it was Thomas Edison who was to apply those principles efficiently and make ours an age of electric power.

Power made it possible for man to develop tools, machines that could do heavier work and more of it than could be done by hand. Basic machine tools were in use before 1872—the lathe, the drill, the grinder, the milling machine, the die press, and the jig. And we had good steel in quantity. Bessemer in England and Kelly in America had invented in 1857 what is now known as the Bessemer process, and the Siemens brothers had invented the open-hearth method nine years later. We were beginning to make and use alloy steels.

We had compact high-power steam engines in locomotives, and we had thousands of miles of railroads. The telegraph had been in use since 1844. Steamships plied the oceans. We had the basis of an excellent system of communication. We had the camera, the telescope, the microscope.

Industrially, we had petroleum—but limited uses for it—illuminating gas, machines for making lead pencils and screws and horseshoes, the typewriter, the sewing machine, the rock drill, the rotary printing press, the electroplating process, and the knowledge of how to vulcanize rubber. We had the carbon arc lamp, and an inefficient electric locomotive had been built and run.

We had an industrial system and a market for its products, a swiftly increasing population, a rapidly expanding country, and new wealth from gold and silver mines,

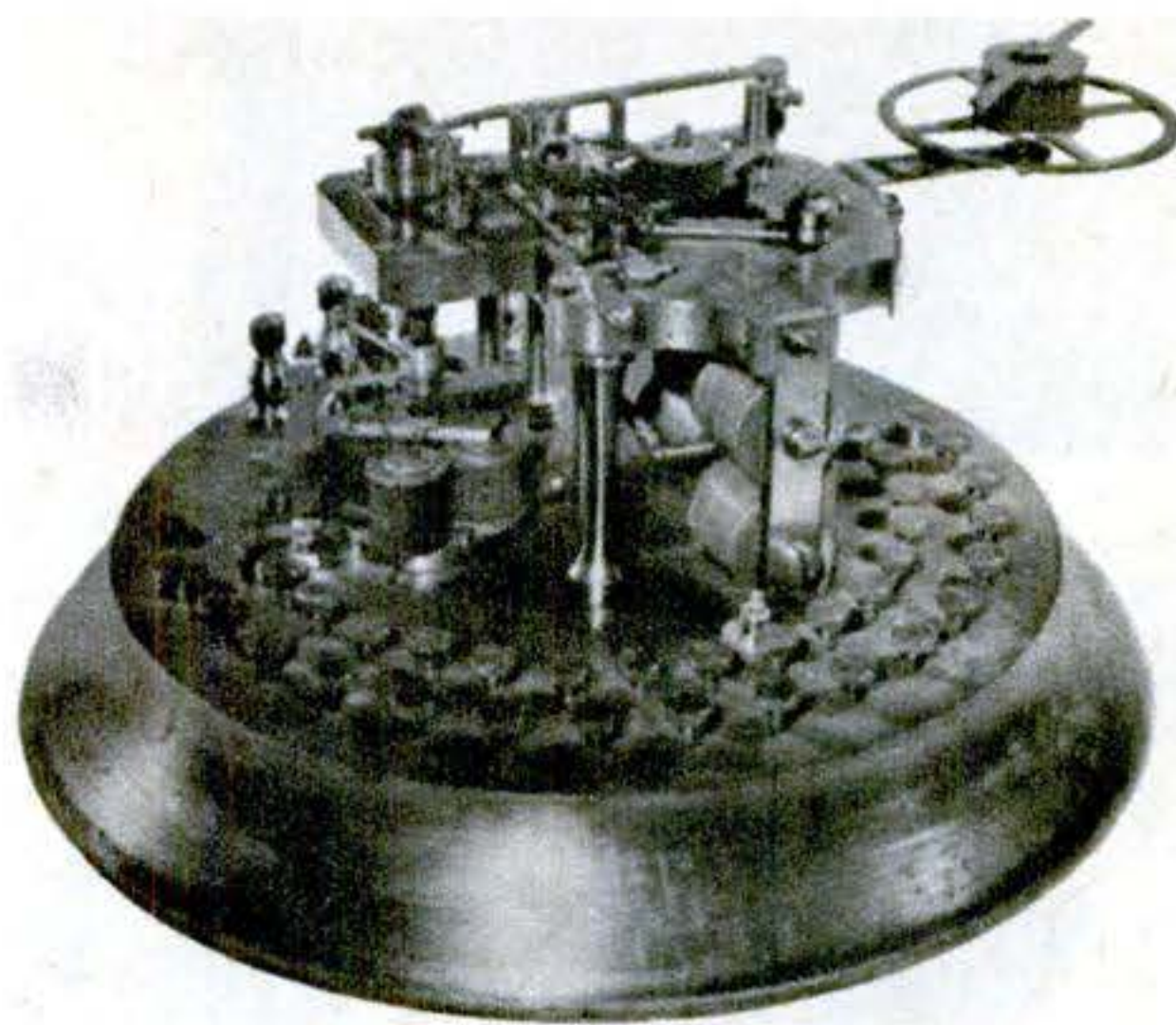

Printing telegraph apparatus: 1872.

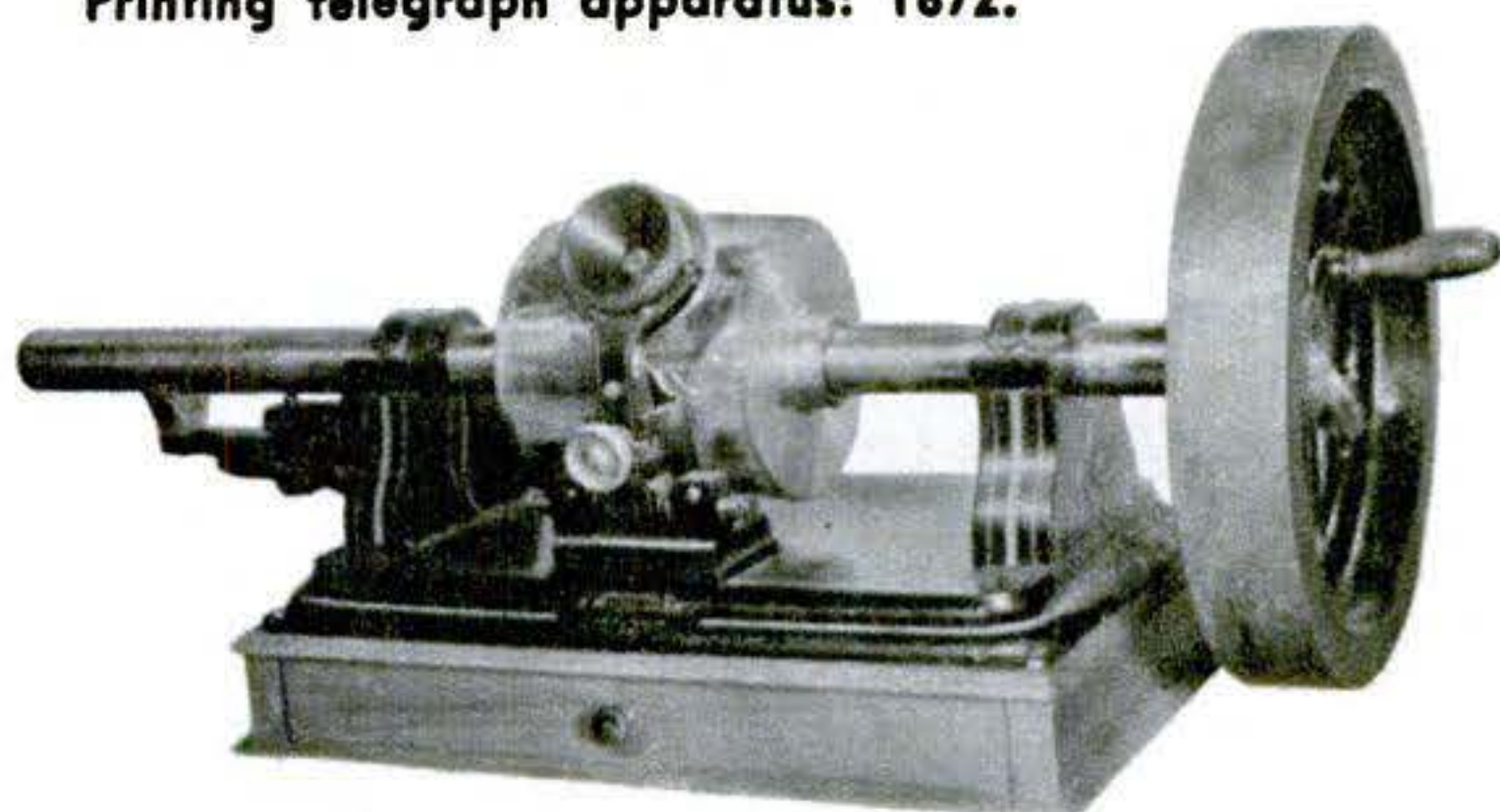

Edison tin-foil phonograph: 1878.



Singer sewing machine.



Edison dynamo: 1880.

PSM photos taken by
W. W. MORRIS at the
Smithsonian Institution

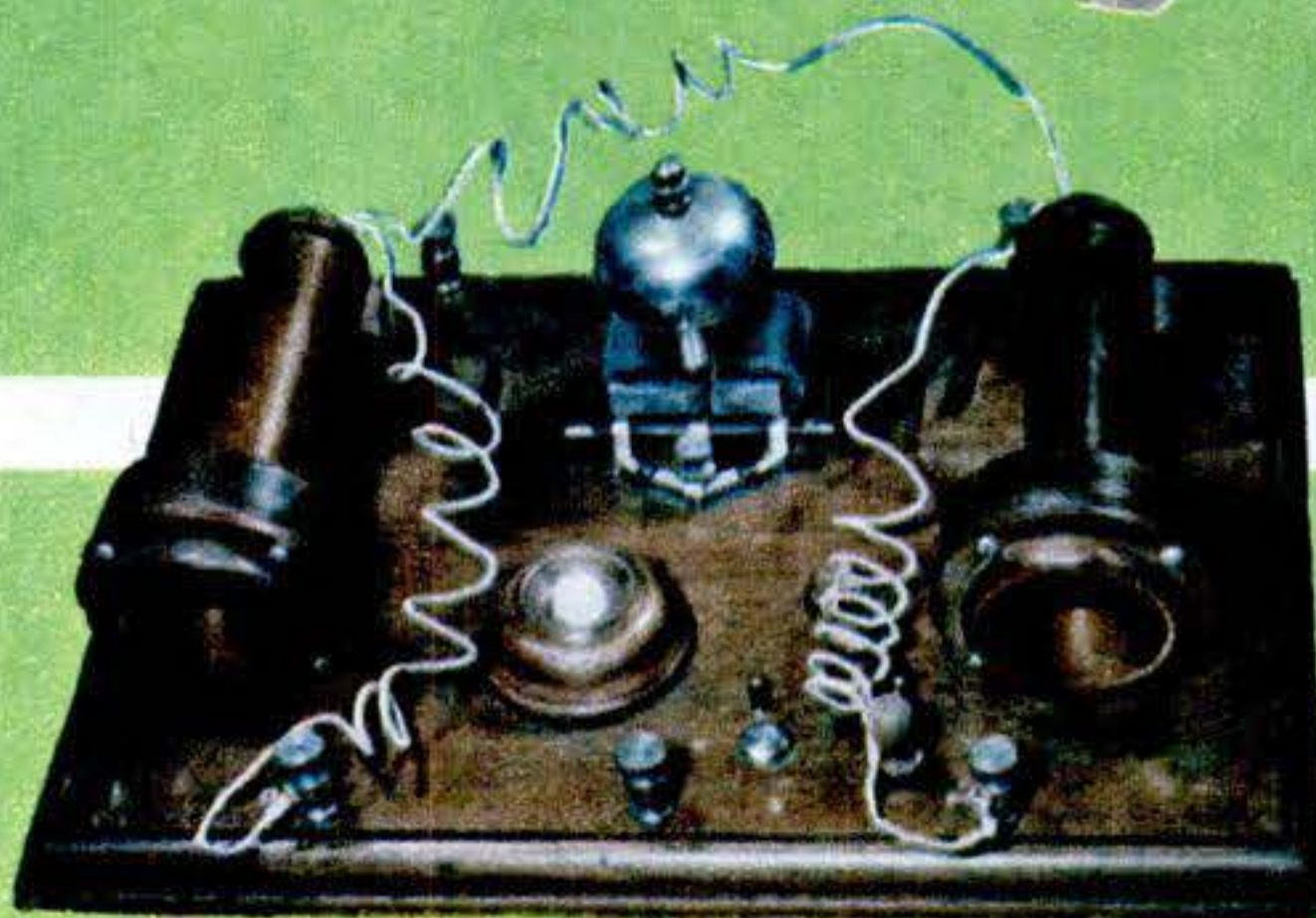

Pioneer desk telephone set: 1877.

MAY
1947 129

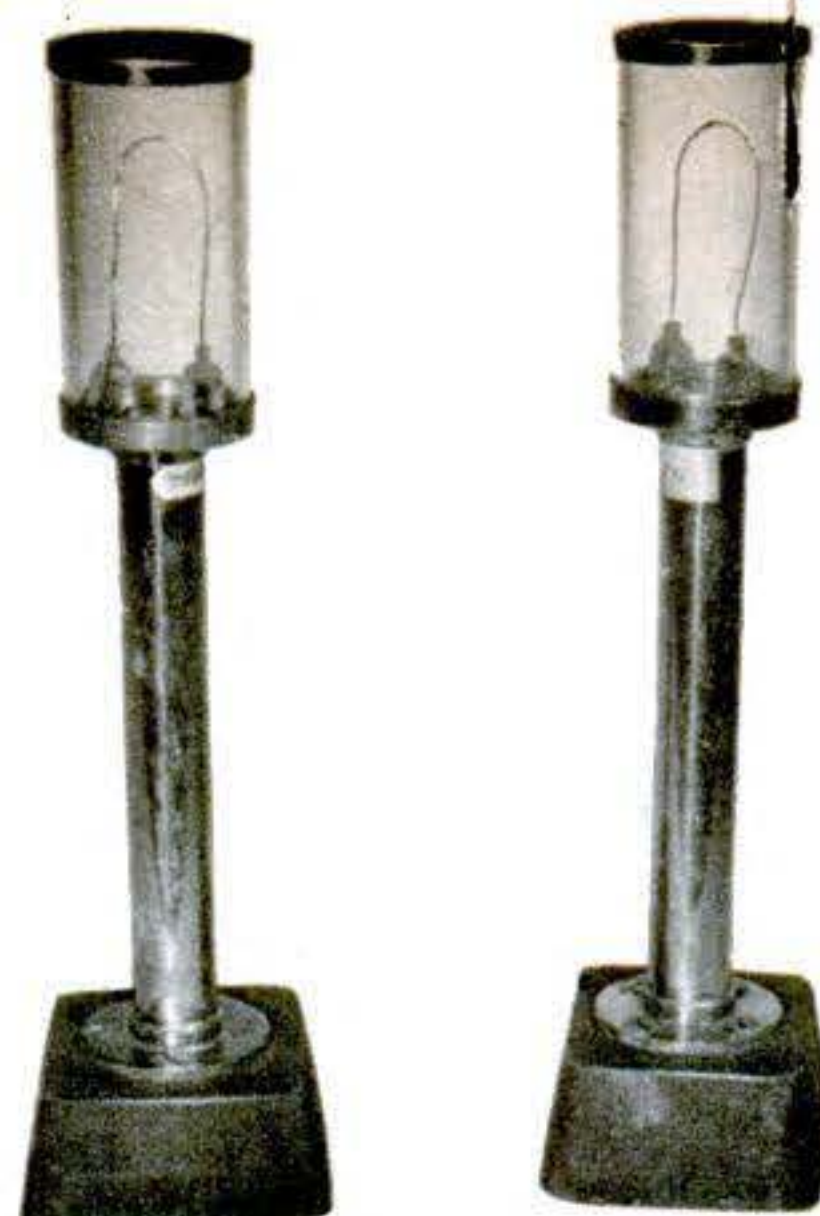
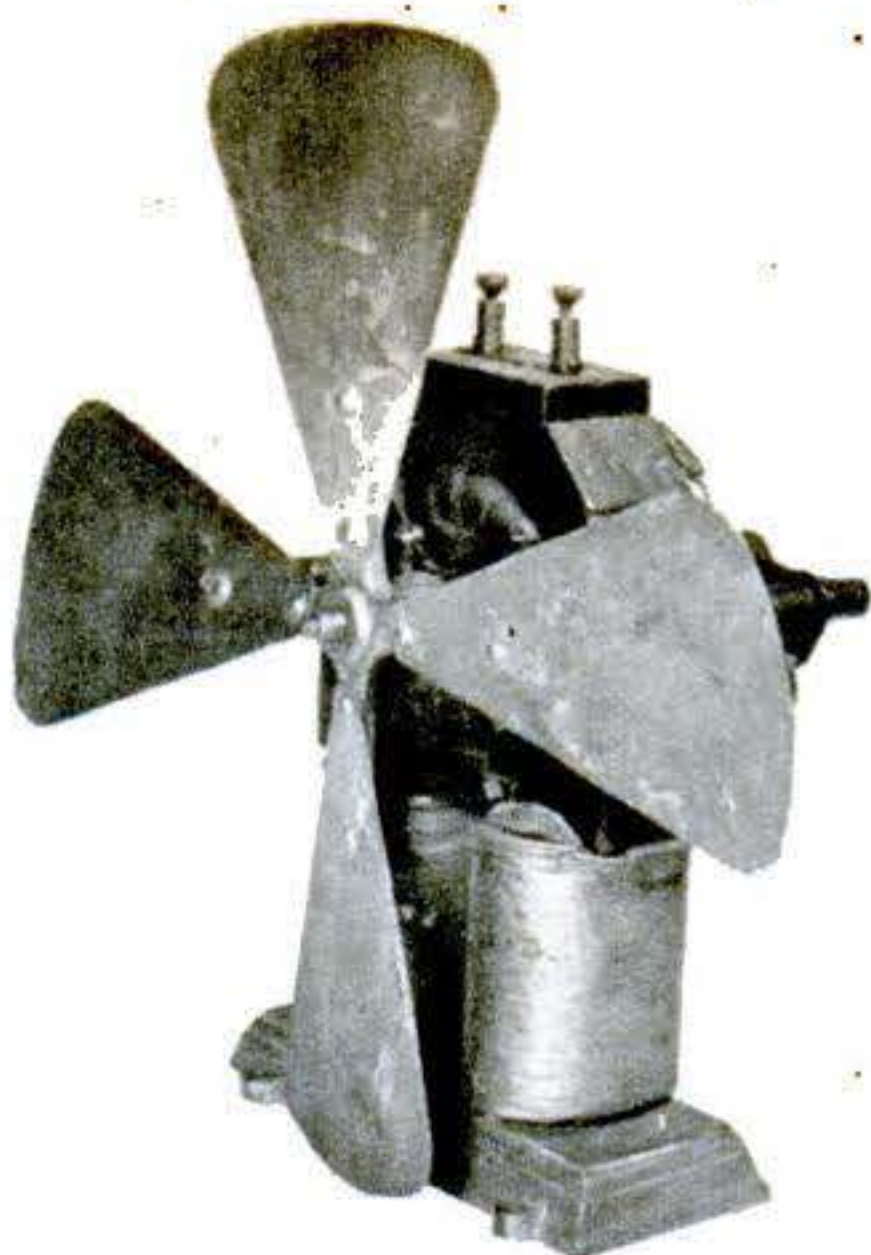

Edison bamboo-filament lamp: 1880.

Daft electric fan: 1885.

Farmer platinum-filament lamps: 1859.

from timber, from industry itself. The Civil War so recently ended had marked the turn from an essentially rural economy to an urban industrial economy, from slave labor in the fields to paid labor in the factories. Industry needed science and all the practical knowledge science could muster. Science itself was ready to come out of the cloisters and take its place in the world.

In 1872, we had reached that point in time and development when a reservoir of knowledge was ready to pour its stream over the spillway onto the water wheel of practical application.

From this point on it would be impossible ever again completely to separate pure science from applied science. Back of applied science always would stand pure science, the search for fundamental truth and the establishment of scientific principles; but that truth and those principles would be interlocked henceforth. For man now had the most important tool of all—the scientific approach to his problems. From here on he would question, investi-

gate, and base his answer on honest inquiry.

Herbert Spencer was the philosopher-prophet of this new era. He saw, with more clarity than any other man writing at the time, the scope of science and the necessity of organizing scientific knowledge and applying it to all phases of life. He knew and followed the work of the major scientists of the day. He had practical experience as an engineer and an economist. He had written a book on education that laid the foundations for modern schooling. In the 1860s he began the series of scientific-philosophical works that mark a turning point in science itself. Darwin challenged venerable ideas and offered new ones. Spencer, starting from Darwin's theories, integrated the sciences, pointed out the common goal of all scientists, and pioneered the modern scientific approach to life and its problems. More, he made scientific knowledge and the scientific method understandable to the layman.

Three volumes of Spencer's major work had been published by 1872. The fourth

Parsons steam turbine generator: 1885.

Zoetrope, or "movies" with mirrors: c.1867.

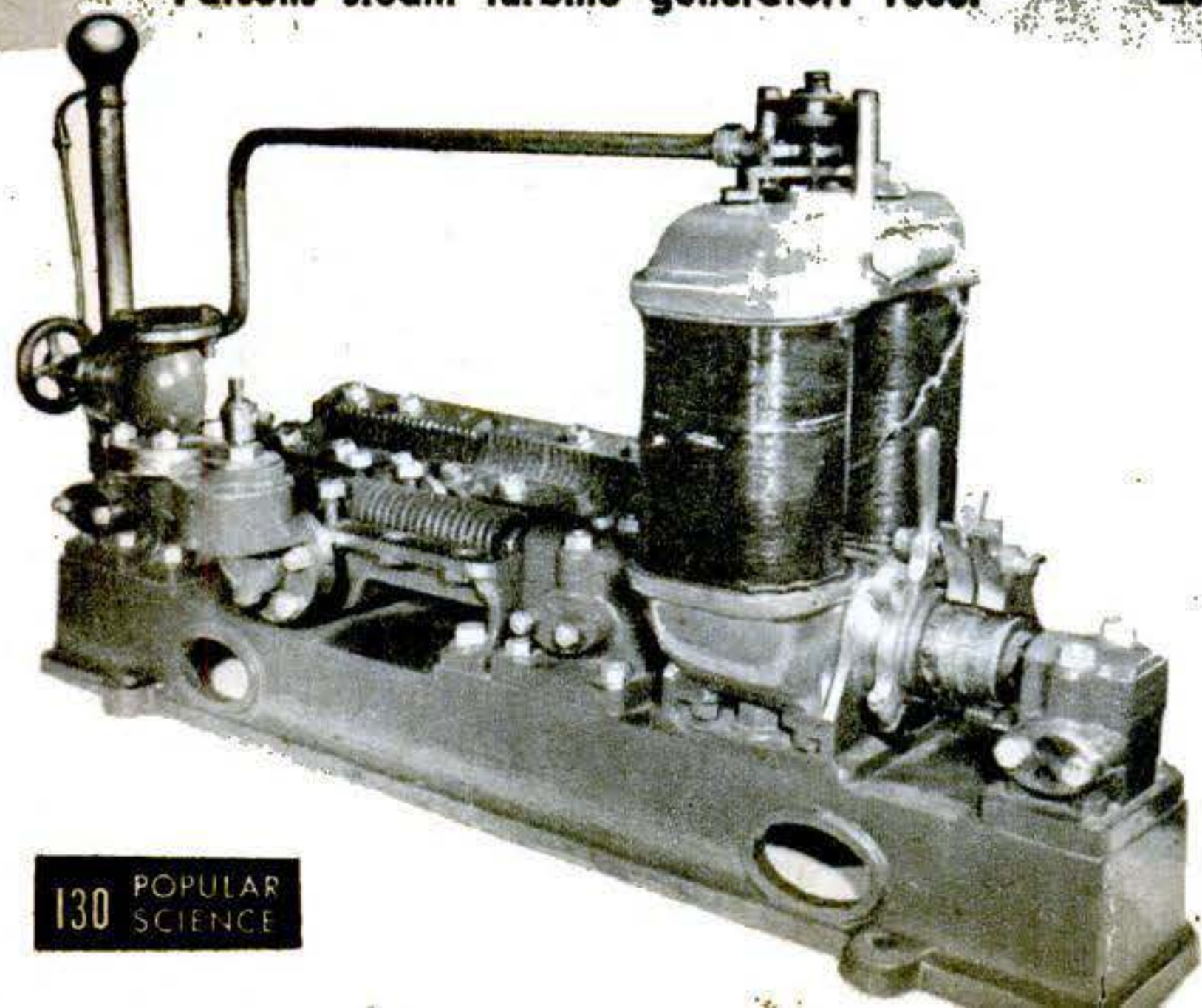



Beeston-Humber racing bicycle: 1886.

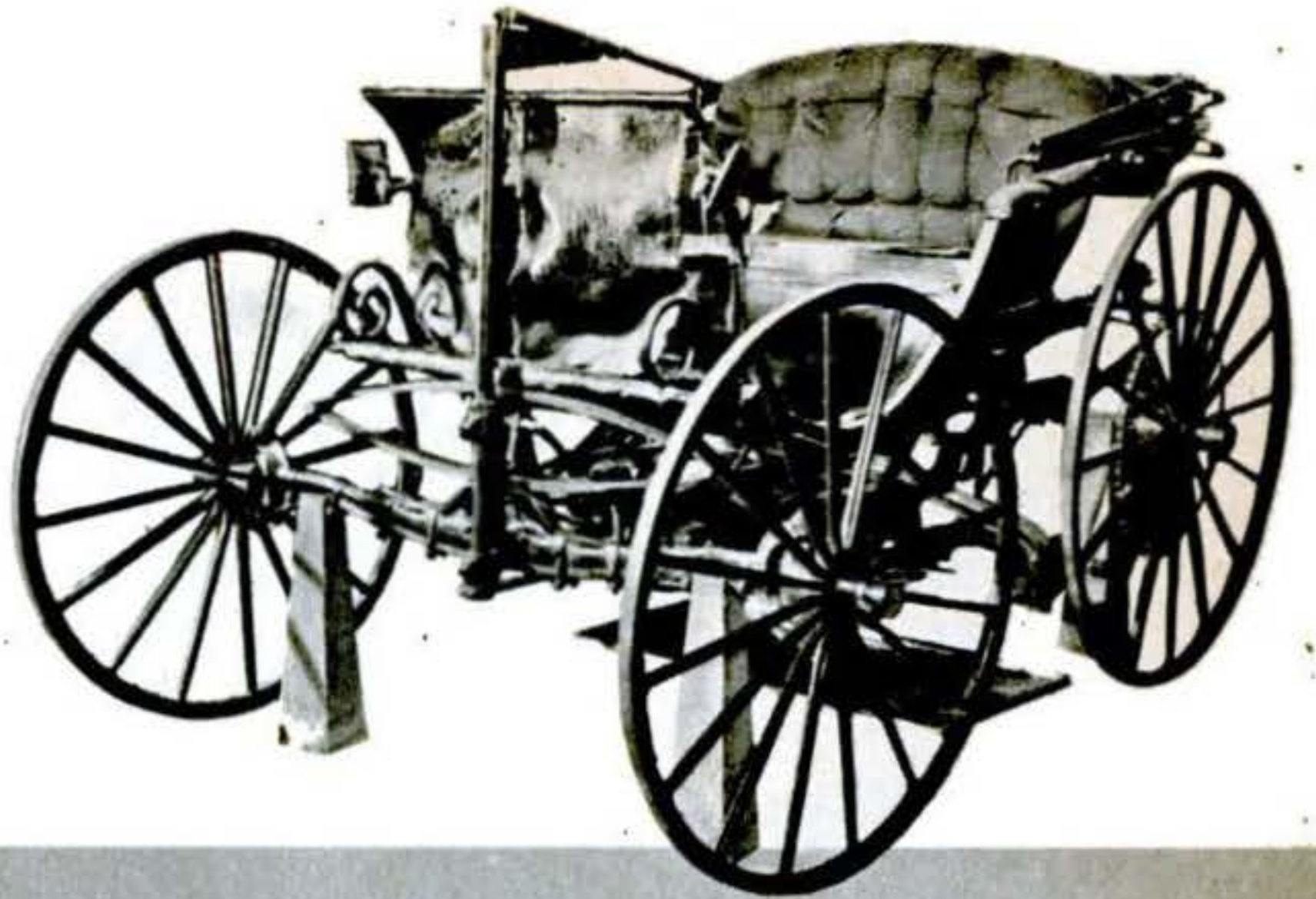

Duryea automobile: 1892.

volume, "Principles of Sociology," was published in America in *The Popular Science Monthly*. This publicity gave Spencer's philosophy of universal science its first widespread public. It stirred bitter controversy, being Darwinian. But it brought science out of the musty laboratories.

Rereading Spencer now is like reviewing well-known fundamentals, so completely have his ideas been accepted and woven into our basic knowledge. As recently as December 1946, James B. Conant restated one of Spencer's principles in his address to the American Association for the Advancement of Science, when he said, "The test of a new idea is not only its success in correlating the then-known facts, but much more its success or failure in stimulating further experimentation or observation which in turn is fruitful. This dynamic quality of science viewed not as a practical undertaking but as development of conceptual schemes seems to me to be close to the heart of the best definition (of science.)" END

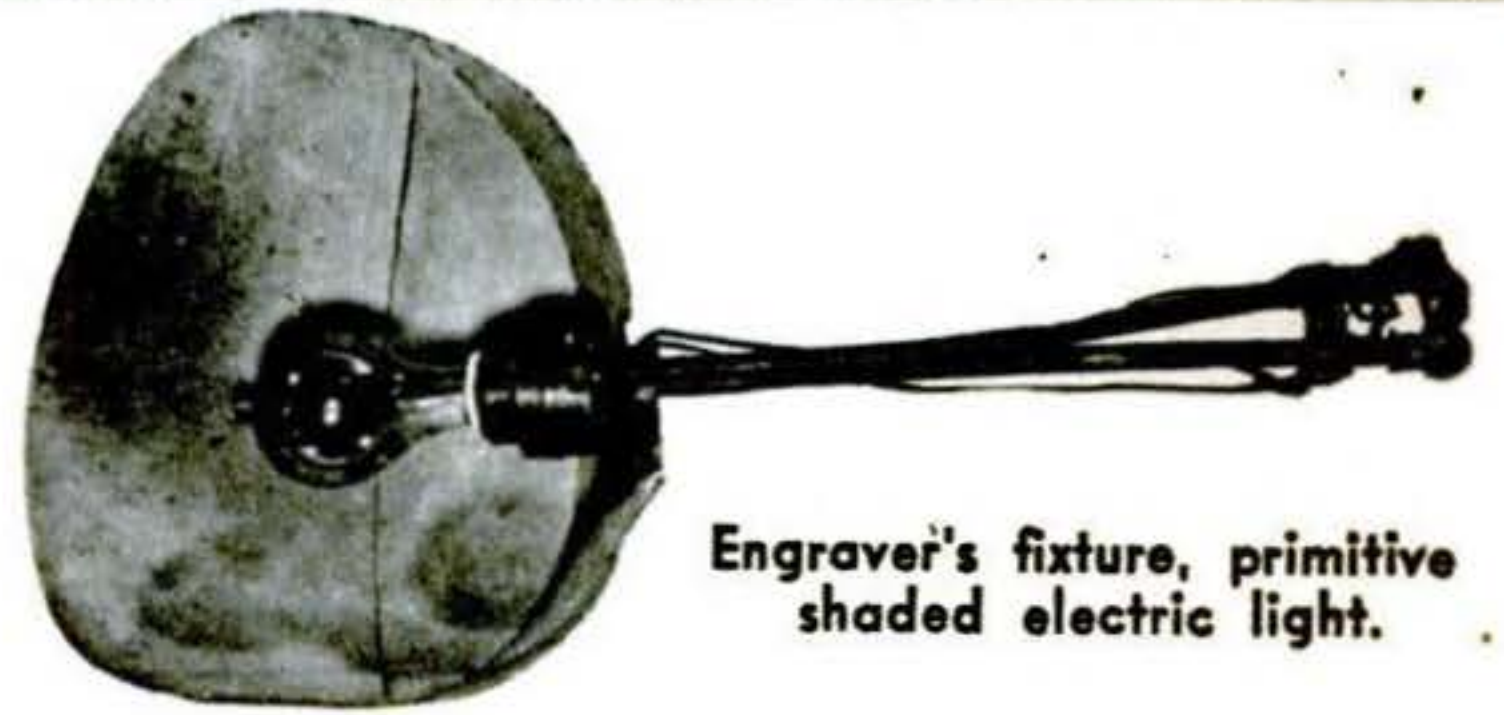

Engraver's fixture, primitive shaded electric light.

Mergenthaler linotype: 1884.

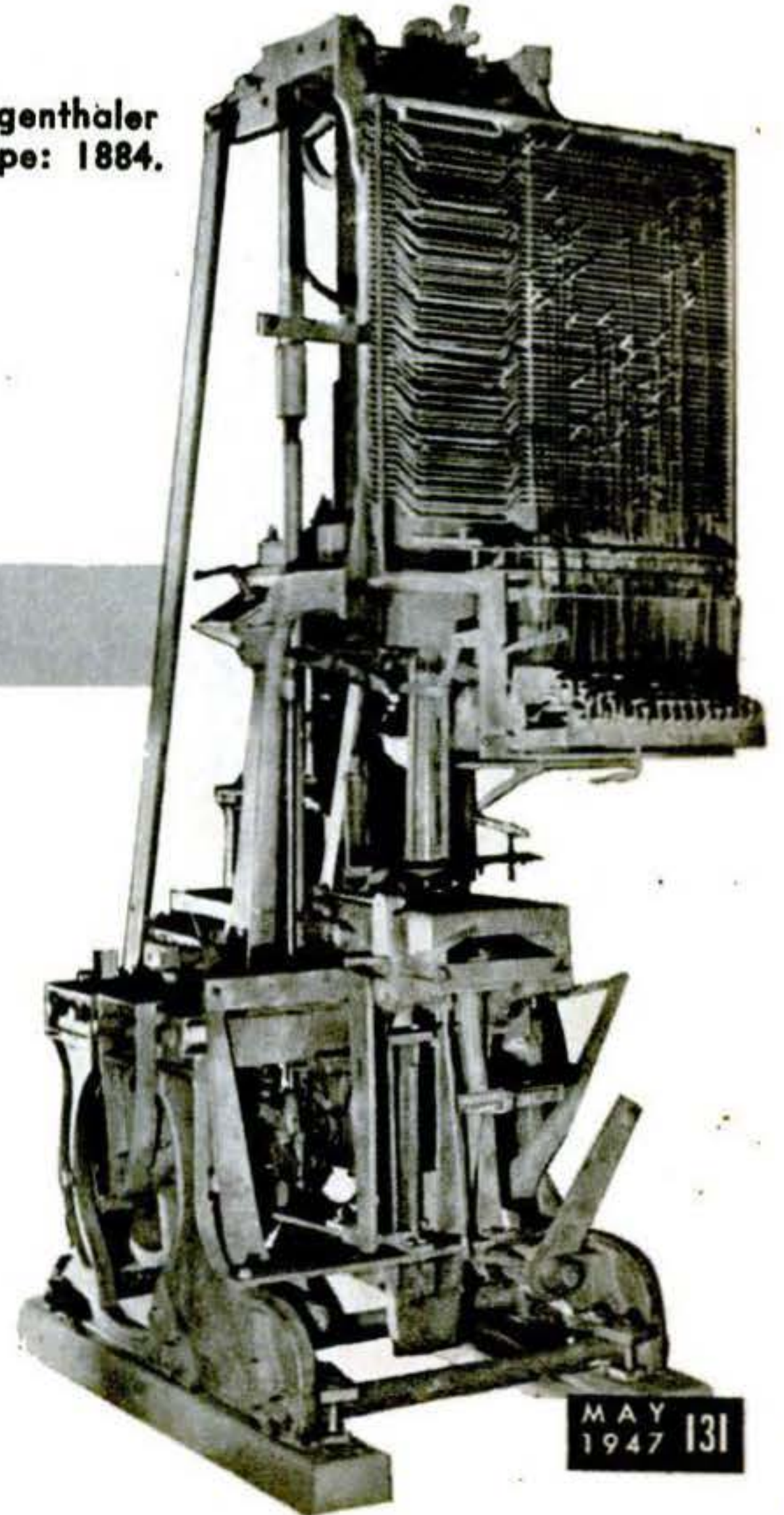

Edison chemical meter: 1882-85.

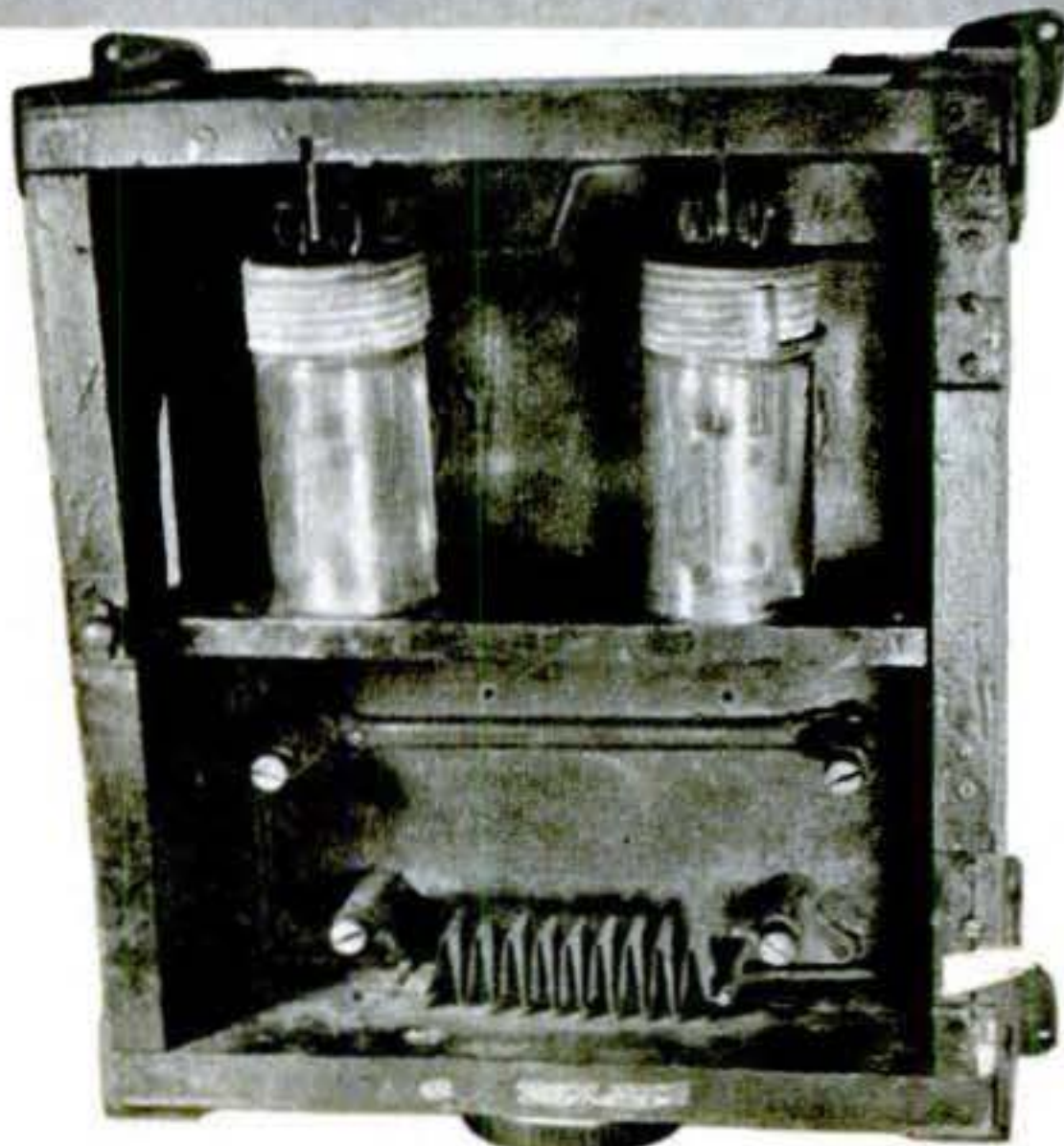

COVERS that came TRUE



This amphibious auto made a beachhead on PSM's cover in March 1916. Grown up into the famous DUKW—or Duck—it was used by the thousand in World War II, as described in PSM for April 1944.



This tremendous rivet squeezer was a good idea when it was shown on the cover for June 1920. In February 1947, PSM showed a hydraulic riveter that puts a 50-ton squeeze on railroad cars.

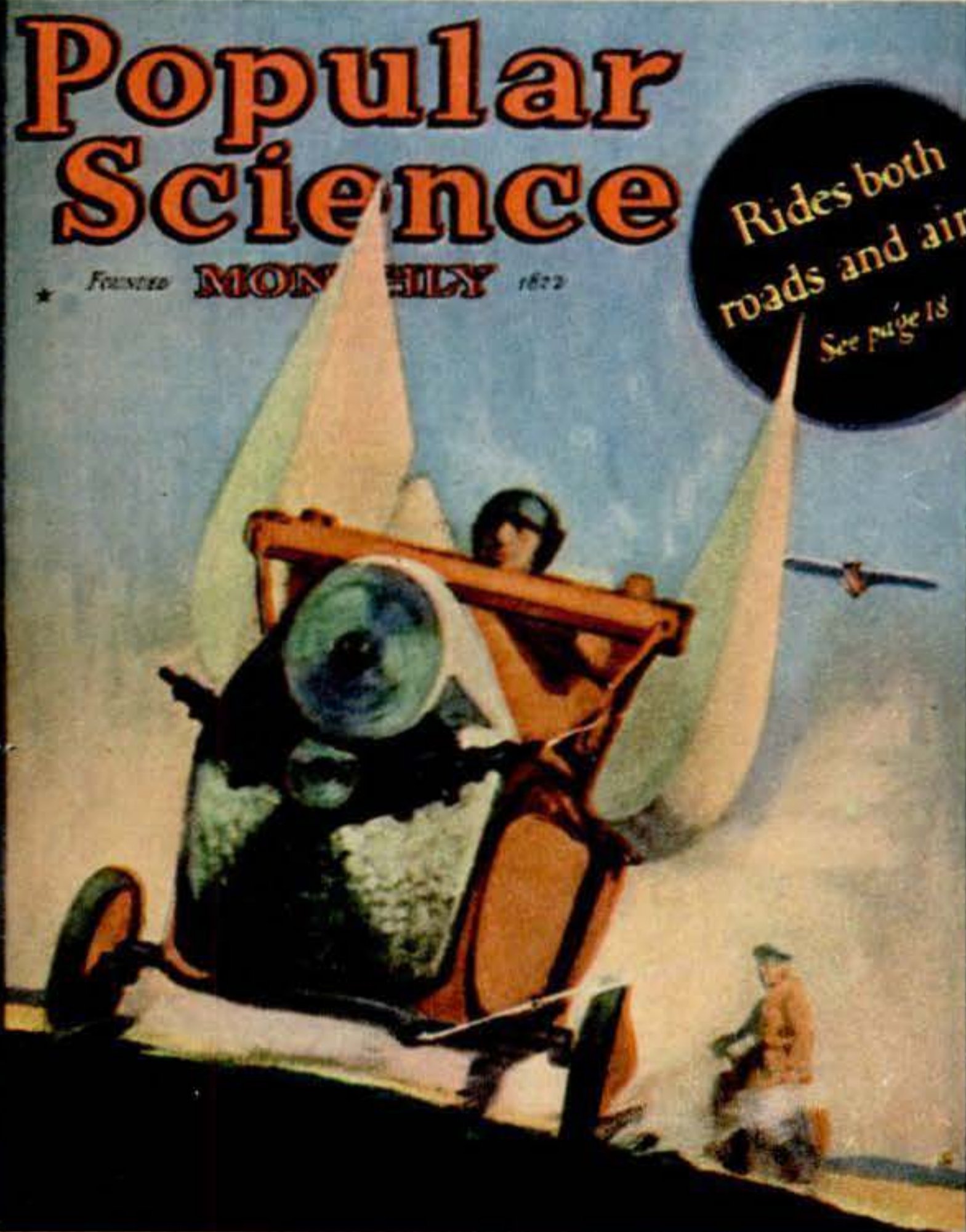

This concept of the roadable plane goes back to the cover for March 1926. Southern Aircraft and the Fulton "Airphibian" are making it a reality—see PSM for April 1946 and February 1947.



Learning to fly indoors may have seemed a crazy idea when PSM featured it on its March 1932 cover. World War II saw Army and Navy fliers do just this—PSM for April 1944 and October 1946.

Popular Science

FOUNDED MONTHLY 1872

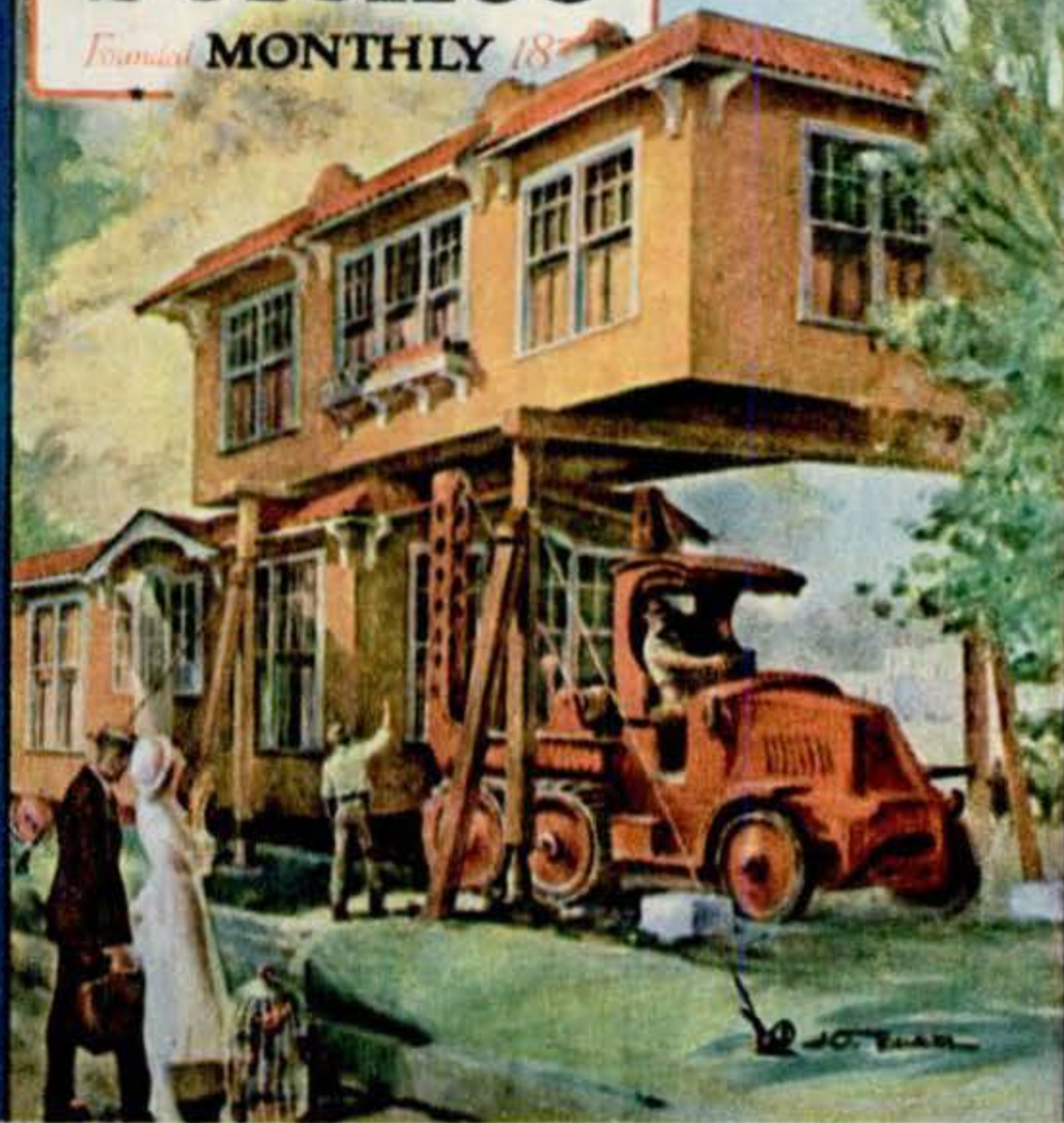

When this appeared on the cover back in August 1921, prefabs were really dream houses. The August 1946 issue gave the picture a quarter-century later—with houses delivered in one piece, as above.

Popular Science

FOUNDED MONTHLY 1872

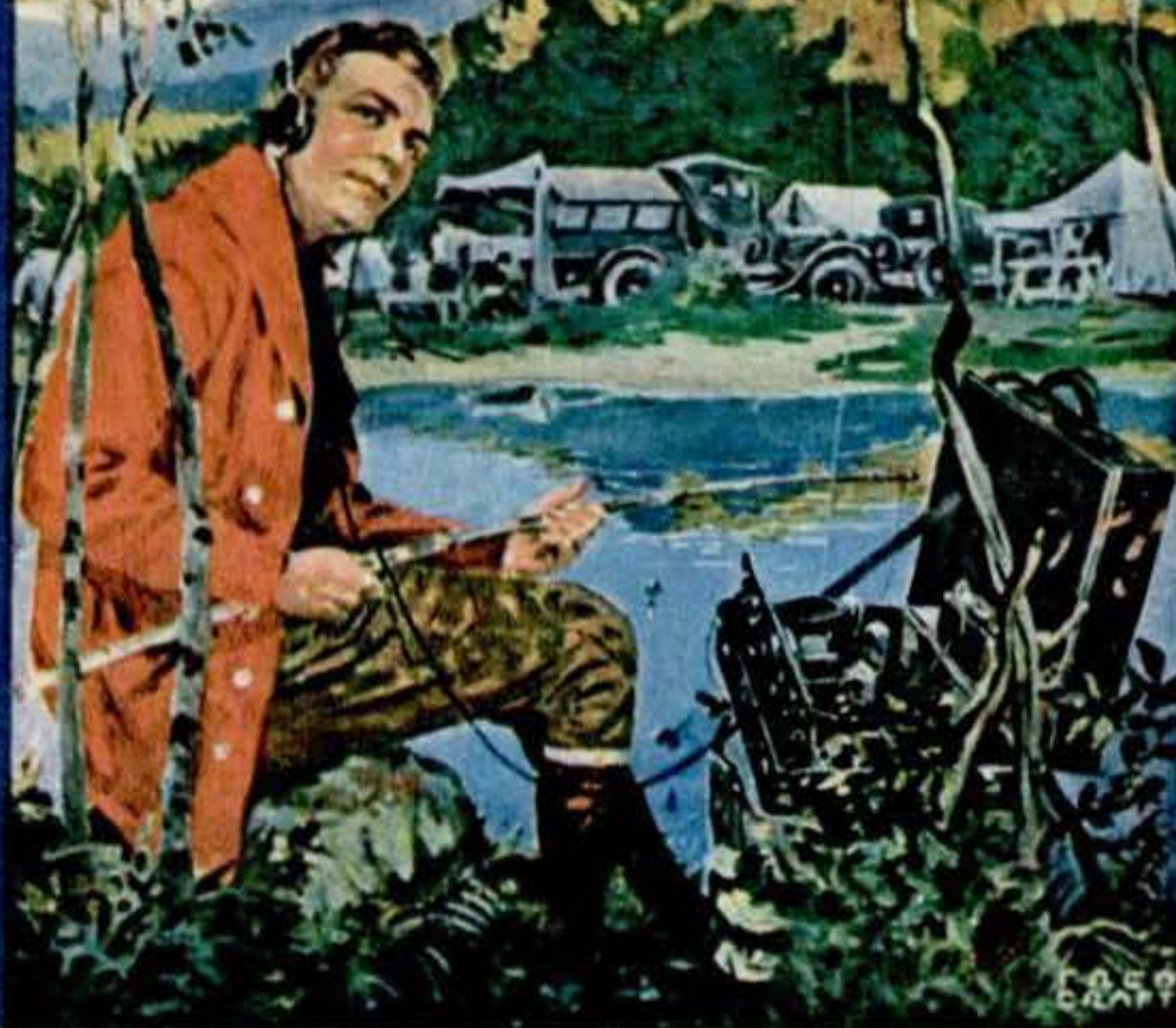

Radio fans and hams long dreamed of a really portable radio—as witness the cover of the June 1924 issue. PSM told how to make a walkie-talkie for licensed operators in September 1946.

POPULAR SCIENCE

JUNE

FOUNDED MONTHLY 1872



SEE PAGE 41

The flying wing may be one of the newest things in aviation, but PSM readers got an advance look at it in June 1933. In May 1946, PSMers read about a flying wing that really flies—the Northrop.

POPULAR SCIENCE

JUNE

MONTHLY

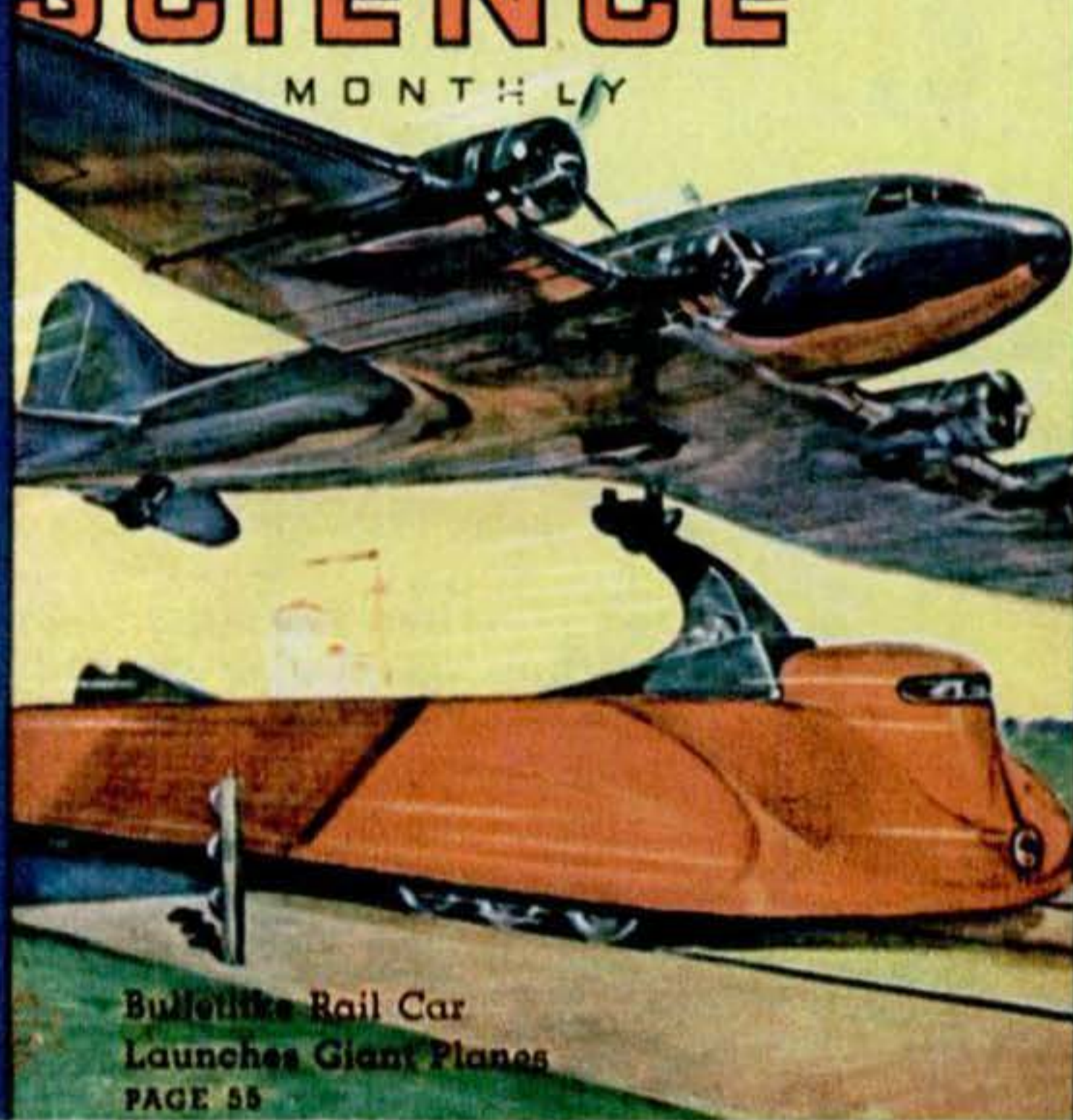

Bullet Train Rail Car
Launches Giant Planes
PAGE 55

Back in June 1937, somebody had a bright idea about using a car on rails to launch aircraft. It took nearly 10 years and a world war for the idea to develop—reported by PSM in November 1946.

MAY 1947 133

These men helped Popularize Science



JAMES CLERK MAXWELL (1831-1879), British physicist, performed his greatest work in the field of electricity. An article entitled "The Theory of Molecules" appeared in the June 1874 issue, when he was at the height of his career. It was about this time that he ex-

pounded the law of distribution of velocities of the molecule. He also made valuable studies of color perception.

T. H. HUXLEY (1825-1895), although he never fully accepted the Darwinian principle of the modification of species, was a staunch supporter of Charles Darwin in the controversy that followed publication of "The Origin of Species." Among his contributions to PSM was

an article "What Are Species?" in August 1876. He made many contributions in the fields of biology and medicine.



LOUIS PASTEUR (1822-1895), French chemist, is best known for the development of a curative and preventive treatment of hydrophobia, a subject treated in the July 1884 issue of PSM. He developed an anthrax serum, and his experiments with fermentation not only

led to the pasteurization of milk, but helped pave the way for Lord Lister's use of carbolic acid to exclude atmospheric germs.

ALEXANDER GRAHAM BELL (1847-1922) was born in Scotland. In 1872 he settled in Boston, where he opened a school for training teachers of the deaf. In 1876 he demonstrated an apparatus that was the prototype of the modern telephone. His PSM contributions in 1880-81 dealt with the production of sound by light and radiant energy. His later scientific efforts included studies of mechanical flight.



SAMUEL P. LANGLEY (1834-1906) first demonstrated the practicability of mechanical flight. In 1874 and 1885, articles by him dealing with another subject, infrared rays from the sun, appeared in PSM. His experiments with an "aerodrome" in 1903 failed, leaving the honor of the first powered

airplane flight to the Wright brothers, but eight years after his death the Langley machine was flown.

HUDSON MAXIM (1853-1927), American inventor and experimenter with explosives. Curiously enough, he wrote an article in the October 1918 issue of PSM describing a ship he had invented that would be immune to explosives. He developed the first smokeless powder used by the U. S.

Among his other inventions was "maximite," a high explosive enabling torpedoes to pierce armor before exploding.





THOMAS ALVA EDISON (1847-1931), American inventor who became one of the best customers of the U. S. Patent Office, taking out more than 1,000 patents. In a PSM article in May 1922, he expressed doubt about freeing atomic energy. "I just can't see that yet," he said. "Nevertheless, some fellow may come along tomorrow and do it."

atomic energy. "I just can't see that yet," he said. "Nevertheless, some fellow may come along tomorrow and do it."



HERBERT HOOVER (1874-), 31st president of the United States, was originally a mining engineer and technical expert, but after World War I he devoted his efforts to a career in public life. As Secretary of Commerce, he predicted in an article written for PSM in July 1922 that speech,

not music, would eventually become one of the most popular features of radio broadcasting.



CHARLES STEINMETZ (1865-1923), the German-born electrical genius, was associated with the General Electric Company during most of his life in this country. He considered his three greatest scientific contributions to be: investigations of magnetism, alternating current and lightning. It was on the

last of these that he wrote for PSM in 1922; his article dealt particularly with lightning's effect on radio reception.



NIKOLA TESLA (1856-1943), American inventor born in Yugoslavia. Specializing in electricity, he wrote an article for the 50th anniversary issue of PSM (May 1922) forecasting the future of wireless communication. "It will soon be possible," he wrote, "to see as well as hear by means of electricity.

'Television' will be employed as generally as telephoning." Tesla achieved many major electrical advances.



LUTHER BURBANK (1849-1926) conducted hundreds of thousands of experiments with all kinds of plants, producing a series of "new creations." In the April 1923 issue of PSM, he compared his work to improving "human plants." "In the development of plant life," he wrote, "lies a great, if not the greatest, object lesson for human beings."

HENRY FORD (1863-), father of the light, low-priced car and the assembly line that made it possible, turned out his first Model T in 1908. Although it took seven years to produce the first million cars, by 1926 his company was making two million cars a year. In an article for the July 1922 issue of PSM, Ford discussed one of his favorite subjects: agricultural-industrial communities.



OTHER CONTRIBUTORS TO POPULAR SCIENCE

Among the other noted men who wrote for PSM during the past 75 years are:

Herbert Spencer, Charles Darwin, Charles F. Kettering, Admiral Richard Byrd, "Eddie" Rickenbacker, Vilhjalmur Stefansson, William Beebe, Camille Flammarion, John W. Draper, Norman Lockyer, Simon Newcomb, Henry George, John Tyndall, John Lubbock, James G. Frazer, William Huggins, William Gladstone, John Dewey, John Burroughs, William James, William Thomson, Frank Chapman, Thorstein Veblen, Fridtjof Nansen, Cesare Lombroso, Flinders Petrie, Havelock Ellis, Edward Pickering, Alfred Russell Wallace, Percival Lowell, Simon Lake, Gen. "Billy" Mitchell, Glenn Curtiss, William Jennings Bryan, and William Coolidge.



E. L. Youmans

EDWARD LIVINGSTON YOUNG, 1821-1887

Founder, First Editor of Popular Science Monthly

America's First Evangelist of Science

He founded Popular Science Monthly to bring science to the American people.

By Roger Burlingame

IN THE winter of 1842, a young man of twenty-one walked dangerously in New York City. Others crossed the streets thoughtlessly enough through the slow, horse-drawn traffic, and were not greatly disturbed if they lost their way on a street ending in a river. But to Edward Livingston Youmans, even in the bright New York noon, every step was perilous for he moved in perpetual twilight. He could see dark objects dimly; he was aware of reflections of sharp light, and his senses of touch, hearing and smell were keen. But for all normal purposes he was blind.

He strayed from his course this day and his combined senses told him he had come to the waterfront. As he felt his way along it, he heard a splash and a cry for help. Instantly, Youmans groped about until his hand met a chain that was fastened to a wharf post. Gripping it, he lowered himself into the icy water and held up the drowning man until help came.

The exposure sent him to the hospital. When he began to recover, he found that the shock had robbed him even of the twilight; he was totally blind.

This incident—almost incredible as we first meet it in John Fiske's biography of Youmans—fits plausibly into the complete

picture of an almost incredible man. For Youmans' whole story is one of courage in the dark—not the darkness obscuring his eyes, but the darkness of ignorance, superstition, traditional prejudice. He was the missionary of science in the world to which he was born.

It is difficult now to reconstruct that world. A stone's throw from New York State's Route 50, where a stream of fast-moving cars runs today between Schenectady and Saratoga Springs, Vincent Youmans had a wagon shop. It was a center of news, gossip, political and religious debate in the 1830s. To it the outlying farmers brought their slow wagons with wheels and axles distorted by the rutted roads, and talked to the accompaniment of a hammer ringing on the anvil.

A Youthful Individualist

Edward, a normal child with an exceptionally strong physique, was something of a phenomenon in this community. He rebelled against the crude discipline of parrot-memory in school. He took the side of a pastor ostracized in the village because he had voted in a state election. He listened eagerly to the talk of a "free thinker" who was sinful enough to doubt the story of Genesis. At 10 he attached himself to a school outside the town because the teacher,

"Uncle Good," taught as Socrates had taught regarding the human mind: as Youmans later put it, not as "a tank to be filled," but rather "an organism to be quickened." His curious, independent mind seized on chemistry, "natural philosophy," the persistent "why" of common things. He read in every spare moment, carried his books with him about the farm. At night he fought sleep, reading and writing notes and comments on what he read.

Candlelight Study Ruined His Eyes

This incessant study held other dangers than the theological ones his Calvinistic mother feared. In the long winter evenings light on the farm came from the fire or from a dim candle. He kept at his books in spite of eyestrain. At 14 his whole life was a violent conflict between this and what Herbert Spencer later called his "work-drunkenness." At 17, still trying to ignore his suffering, he entered Galway Academy, paying his way by teaching on the side. In six weeks he broke down, was treated with caustics and calomel by an ignorant doctor—and lost, forever, the sight of one eye.

Youmans' spirit met his blindness without despair. It introduced important factors into his life. One was a capacity for reflection, an important balance to his impulsiveness. Another was the help of his sister Eliza. She was an able critic and analyst, a tireless worker. In the weeks following his disastrous treatment, she read aloud to him. Among other things she read, secretly, a book Edward told her it was not prudent to leave "lying about the house." The book was *Vestiges of Creation*—so heretical that the author dared not sign it. Full of errors and half-truths, as Youmans later knew, it was his curtain-raiser to the drama of evolution that absorbed his life.

For 10 years the case of his eyes seemed hopeless. He went to New York, went from one oculist to another, steadily draining the small family funds. In these years there were periods of "twilight"—times even when he could read and write—and stretches of complete darkness. A Doctor Elliott kept up his morale by his confidence in an eventual cure. Meanwhile, he lived in cheap boarding houses, attached himself to a group of other blind men, charmed them by his talk, his humor, his astonishing knowledge. He paid his way by composing advertisements for a druggist, supervising men working on Dr. Elliott's home, teaching a mem-

ory course. He invented a device to guide his hand in writing; some of the work he did with its aid, he sold.

Twice when he had a book ready for publication, a book by another author appeared with almost precisely the same scope and content. It was like finding that one's inventions had been patented only yesterday by someone else—a common occurrence in a time when all the best minds were groping in the same direction.

It was not an improvement in his eyes that brought Youmans success; it was success that brought the eyesight. That, anyway, was the doctor's belief, and in the light of modern "somatic" medicine this is understandable.

The thing that brought him money and fame was a chemical chart. Eliza had helped him construct it. His old distaste for crude teaching had inspired it. He wanted, too, to fill the gap left in schools by lack of laboratory equipment. The chart, five feet long and four wide, contained some thousand diagrams in 16 colors. The common elements were represented by variously sized and tinted squares; lines from them joined in graphic representations of compounds. It rolled like a map and, when hung on the wall, was visible to a large class. This graphic method with charts, diagrams, pictures, was basic in all Youmans' thinking "So," as he told Eliza, "that the whole could be learned in the quickest possible way and without reference to text, which loses time."

Linking Chemistry to Life

With his energy renewed, he followed the chart with the *Class-Book of Chemistry*. Contrary to the pattern of current education, with emphasis on disciplinary dullness, it made the subject interesting, connected it with the common experiences of life. Its introduction committed the heresy of suggesting that the study of nature is congenial to the young mind and "one of the purest sources of pleasure." Fiske speaks of the *Class-Book* as Youmans' germinal book. "Its reception showed him his strength and his true field. Thenceforth his career was that of breaking the bread of science to the multitude."

Its quick success ended the darker phase of Youmans' life. It had been a bootstrap-lifting phase, a lonely fight against the threat of total moral annihilation, but it had taught him a great deal. He had felt the ignorance

of science in hard impact upon his own body. He had been thrown constantly with people such as the blind men at the boarding house, to whom he had explained what he knew in the simplest, universal terms. He had learned to be tolerant of prejudice—not to hurt people and thus close their minds against him. His earliest environment had showed him the breadth of the gap between Calvinism and evolution. This was why he so often approached the popular teaching of science *in religious terms*. In combination, these things made Youmans a great teacher of the people.

Science Remote from People

Science in the mid-century was a snobbish business. Important English physicists, including Newton, Davy and Faraday, had told their achievements only to the Royal Society. Scientists generally distrusted the masses (partly because of religious opposition) and liked to protect the aristocracy of their studies from vulgarization.

In England, Herbert Spencer was working in this rarefied atmosphere when his extraordinary theory of evolution first came to Edward Youmans' attention. To Spencer, not only had physical life evolved, but so had all the sciences, all knowledge, human society—all according to a similar scheme. From the simple nebular, homogeneous state (as astronomers imagine the once-gaseous earth) into diverse, compact and complex entities, everything had moved and was continuously and forever moving. So, too, the human studies of philosophy, psychology, biology and sociology, had evolved out of vague and simple forms. A certain realm was forever unknowable; on First Causes, for instance, Spencer thought we must all remain agnostics.

When Youmans came upon a review of one of Spencer's books in an obscure London periodical, he saw the immense possibilities such a scheme held for popular education. Here, for example, was something which need not conflict with true religion. Did we not all confess the unknowableness of God? Then, in a scheme which correlated all the forces, physical, psychological, social—each dependent on some other—he saw a break in the deadly categorical plan of current education in which mathematics, physics, chemistry, economics, ethics, government and political economy were taught as separate matters hanging in the air, so to speak, as if they bore no relation to one

another. But all this integration of physical and social science, which modern students take in their stride, was locked up in a little circle of English scholars. How to unlock it, how to spread it broadcast among the American people? The question, from that moment, obsessed Edward Youmans.

First he got Spencer's published books from England. The new principle stood out; it must be introduced to Americans and made a permanent part of American education. The books *must* be published here.

He wrote Herbert Spencer, a bold thing for any "Yankee" (as he called himself in the letter) to do in those days. Spencer replied with the cordiality of a man who intuitively recognizes a kindred, sympathetic mind. The books were published by subscription, Youmans doing much of the advance salesmanship.

Youmans' eyesight was partially restored, the "chart" spread his reputation, and in the meantime he had also begun lecturing. Traveling in the winter from one small town to another in the primitive trains of the day, driving through blizzards in sleighs, he went as far west as Minnesota. His lectures on "The Masquerade of the Elements," the "Chemistry of the Sunbeam," "Ancient Philosophy," "Modern Science," and the "New Philosophy of Forces" were packed with illustrations from everyday experience.

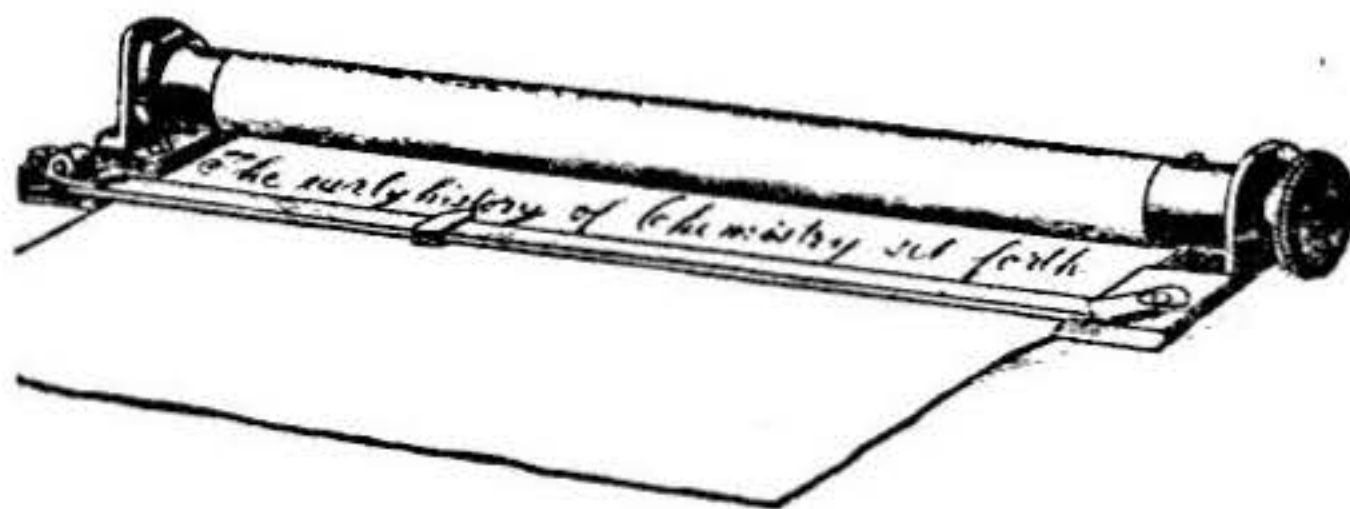

While blind, Youmans devised this "writing machine." Roller separated lines; bar guided the pencil.

Youmans got \$50, occasionally \$75 an evening, but paid his own expenses. One wild night he talked after the lecture to a young man who had driven 10 miles to get there. Youmans "commiserated his folly" in braving the storm.

"I would not," said the boy, "take \$500 for what I have learned this night."

We may imagine the audiences, the young absorbed faces, out in the new country hearing for the first time of the world of science beyond the horizon—remembering, as we must, that these people grew into the

generation that transformed the nation and brought it through science to industrial leadership. Lost in excitement, Youmans sometimes fell off the platform, made immense gestures, his voice rising to great volume—"a combination," Fiske called it, "of explosive animal spirits and eagerness with perfect grace and gentleness."

Sometimes a pastor would deliberately call a church meeting at the precise time

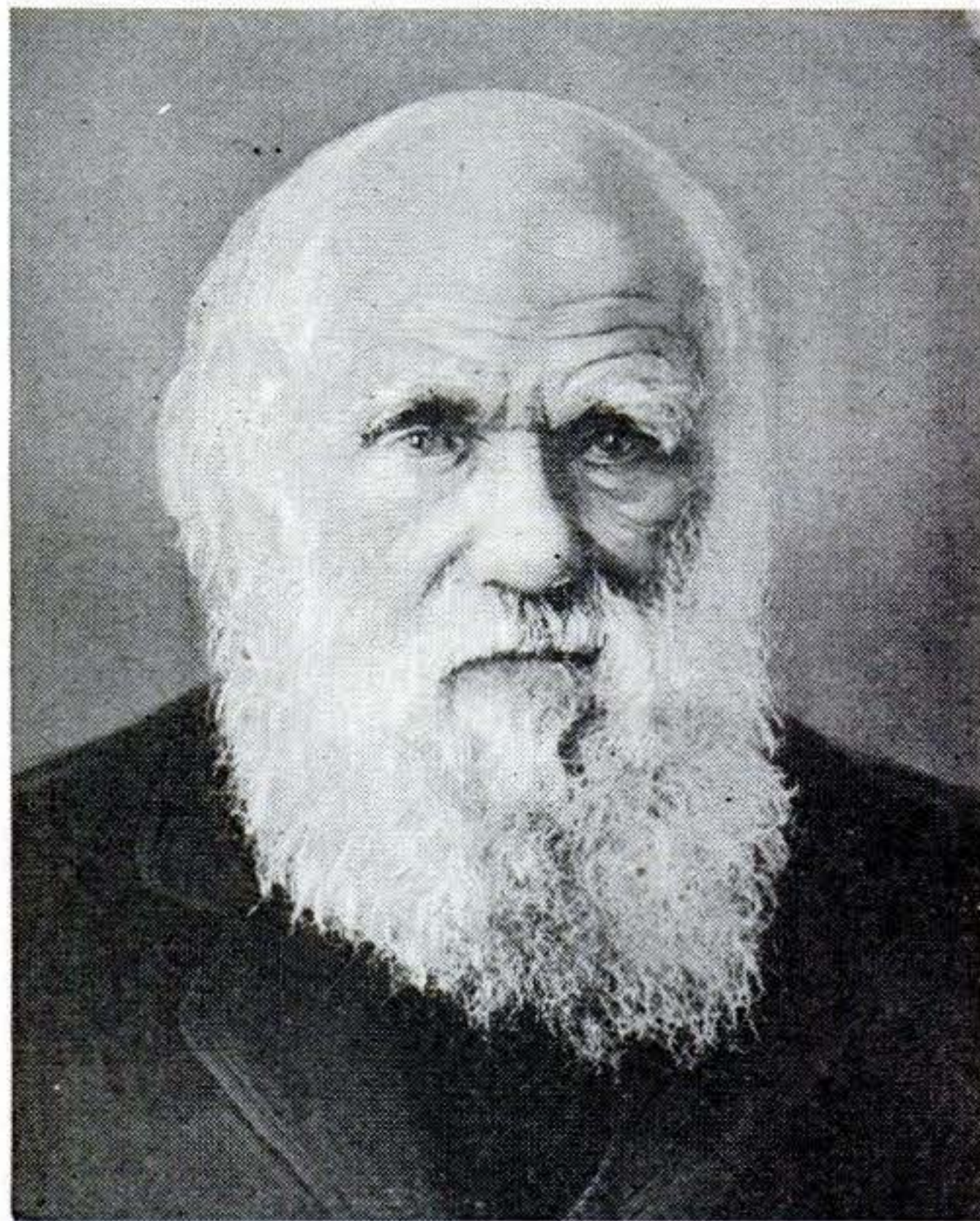

Charles Darwin upset concepts of man's origin, focused public attention on science as PSM was born.

of the lecture and angrily harangue his congregation about the "sin" of those who "preferred science to Christ." When, after Youmans had met Spencer, he introduced the "horrors" of evolution that (even before Darwin) suggested man's kinship with the monkeys and the "survival of the fittest," the fight grew hotter and the press joined the clergy. Youmans met this conflict in the end by his insistence on Spencer's own belief that religion and evolution were reconcilable and by the persuasive argument that evolution was quite as beautiful a manifestation of Divine Will as the story of Adam and Eve.

Eventually, the lecturing told on his health. Every severe cold, every moment of exhaustion threatened his eyes. So he turned at last to the quieter pursuits of edi-

torial and literary work. Even these were strenuous enough. Trips to Europe, and long office hours, laid a tax on his strength that only the fire of his zeal could combat.

In these pursuits Edward Youmans was pre-eminent as an editor. He had written several books, to be sure, and many articles. Perhaps the most popular of all was the *Handbook of Household Science*. This was not a collection of recipes and practical hints, but a revelation of the scientific facts behind ventilation, heating, sanitation, cleaning, artificial light, food. It expressed convictions that the farm and home of his childhood had bred in him.

Aid for Spencer

The Spencer books that he edited moved slowly. Once, when Spencer became discouraged to the point of announcing that he could not go on with his life's work, Youmans got up a subscription among Spencer's American disciples and took to England a fund of \$7,000 in securities, together with a Waltham watch, as a token of their admiration. It was a delicate mission. Spencer was sensitive to such approaches; he had already declined an offer by John Stuart Mill to finance his projects. Youmans explained the securities as a fund that would lie idle unless Spencer used it, and so persuaded him. But when American papers played this up as a national gesture, Youmans answered the editorials, saying that science was international, that the subscribers were individuals and should not be tagged as an "American" group. With the revival resulting from Youmans' efforts, Spencer's works moved into a sale of more than 130,000 copies.

The two enduring monuments to Youmans' editorial career were the *International Scientific Series* of books and *Popular Science Monthly*. The Series began in that era of literary piracy, before the International Copyright Act, when anyone was legally free to bring out an American edition of a foreign book without paying a cent of royalty to its author. Youmans attacked the ethics of this widespread practice, and royalties were scrupulously paid. Thus he was able to break down much of the general overseas distrust of American publishers. He arranged for volumes by Tyndall, Huxley, Darwin, Liebig, Helmholtz and many others to be published simultaneously in America, England, France and Germany. During Youmans' life, 57 volumes of the

Herbert Spencer might well be called the co-founder of *Popular Science Monthly*; indeed, in 1908 the editor of PSM referred to the magazine as "one of the by-products of his (Spencer's) genius."

The first part of Spencer's series on "The Study of Sociology" opened PSM's first issue, in May, 1872. Youmans' reaction is recounted in Spencer's autobiography, which quotes this letter from the founder of PSM:

"A thousand thanks for your favour of March 13th, with article on 'Study of Sociology' enclosed . . . You did wisely in sending it, and I decided upon our course in 10 minutes after getting it. I determined to have a monthly at once and in time to open with this article. . . We have started a monthly of 128 pages . . . I am utterly glad that things have taken the course they have. I have wanted a medium of speech that I can control, and now I shall have it."

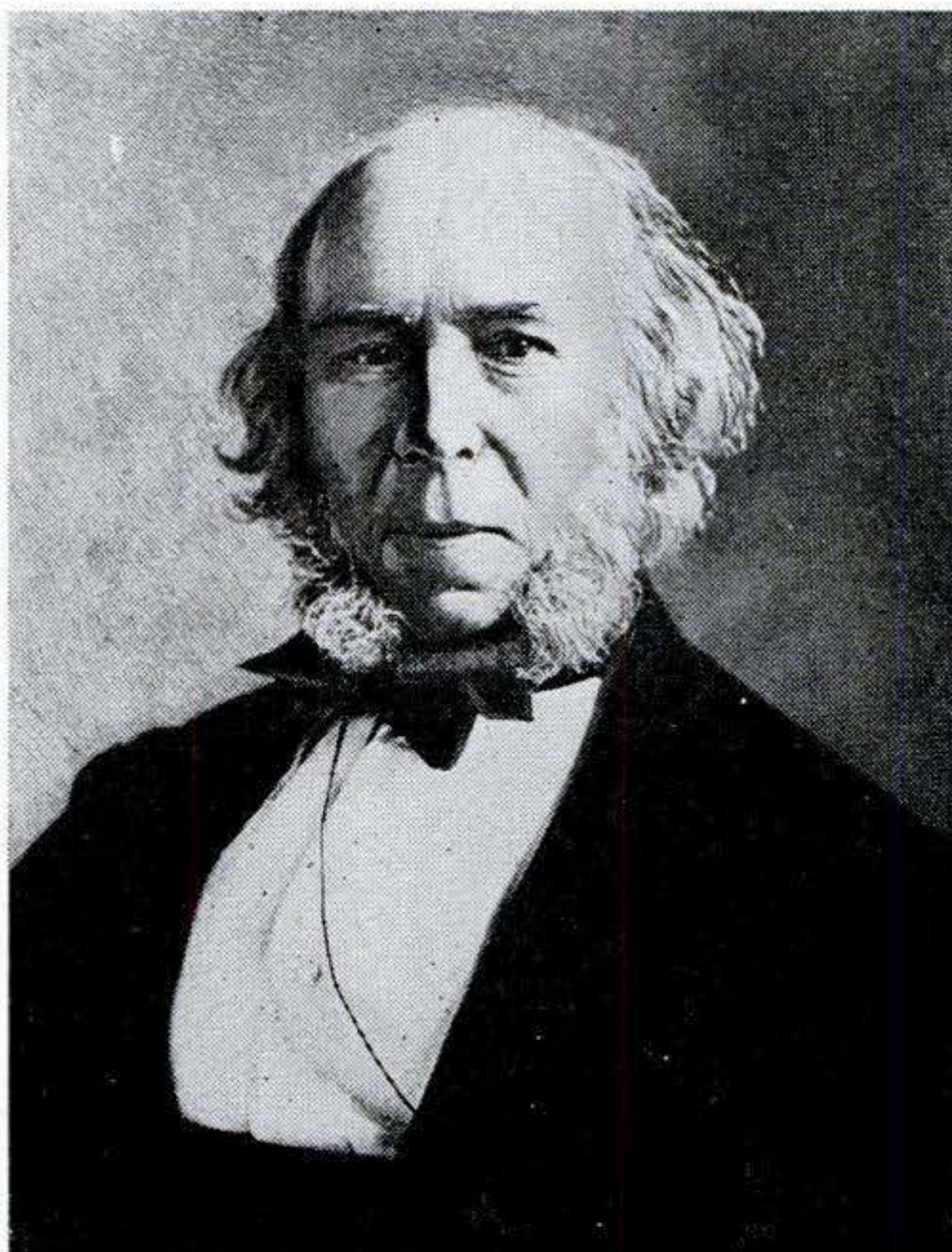

Herbert Spencer

International Scientific Series were published. Under his direction, they were all as popular presentations as their scientist authors could contrive.

A magazine had long been one of Youmans' dominant ambitions. For a time he worked as scientific editor of *Appleton's Journal*, a weekly with general circulation. It would not do. Subscribers objected to scientific articles in a paper they bought for literature and art. Youmans saw that he must attract a special public and work through it to the general reader. He persuaded the Appletons to publish *Popular Science Monthly*. "The work of creating science," he wrote in the first issue, "has been organized for centuries . . . The work of diffusing science . . . is clearly the next great task of civilization."

PSM Fought Prejudice—and Won

The magazine, which opened with a Spencer article, met the angry prejudice of the time. Its publishers were branded in the press as "infidels." Letters poured in from readers who confused agnosticism with

militant atheism. Yet the little paper continued. The increase in its circulation in three-quarters of a century from 12,000 to more than a million is evidence of the distance of Youmans' thought ahead of his own time.

Three Generations Ahead

And this is the overwhelming sense that comes from the review of his life. Youmans' mind moved on a level that was some three generations away. His concept of the "universality" of science belongs in today's laboratories. His ideas of the social sciences are incorporated in modern university study. His rebellion against "mental discipline" as an end in itself in secondary education is the basis of the progressive school. He anticipated international copyright by many years. But most vital of all to the American people, he made science democratic.

"Among professed worshipers of humanity" wrote Spencer in his autobiography, "I have not yet heard of one whose sacrifices on behalf of humanity will bear comparison with these of my friend."

END

MAY
1947 141

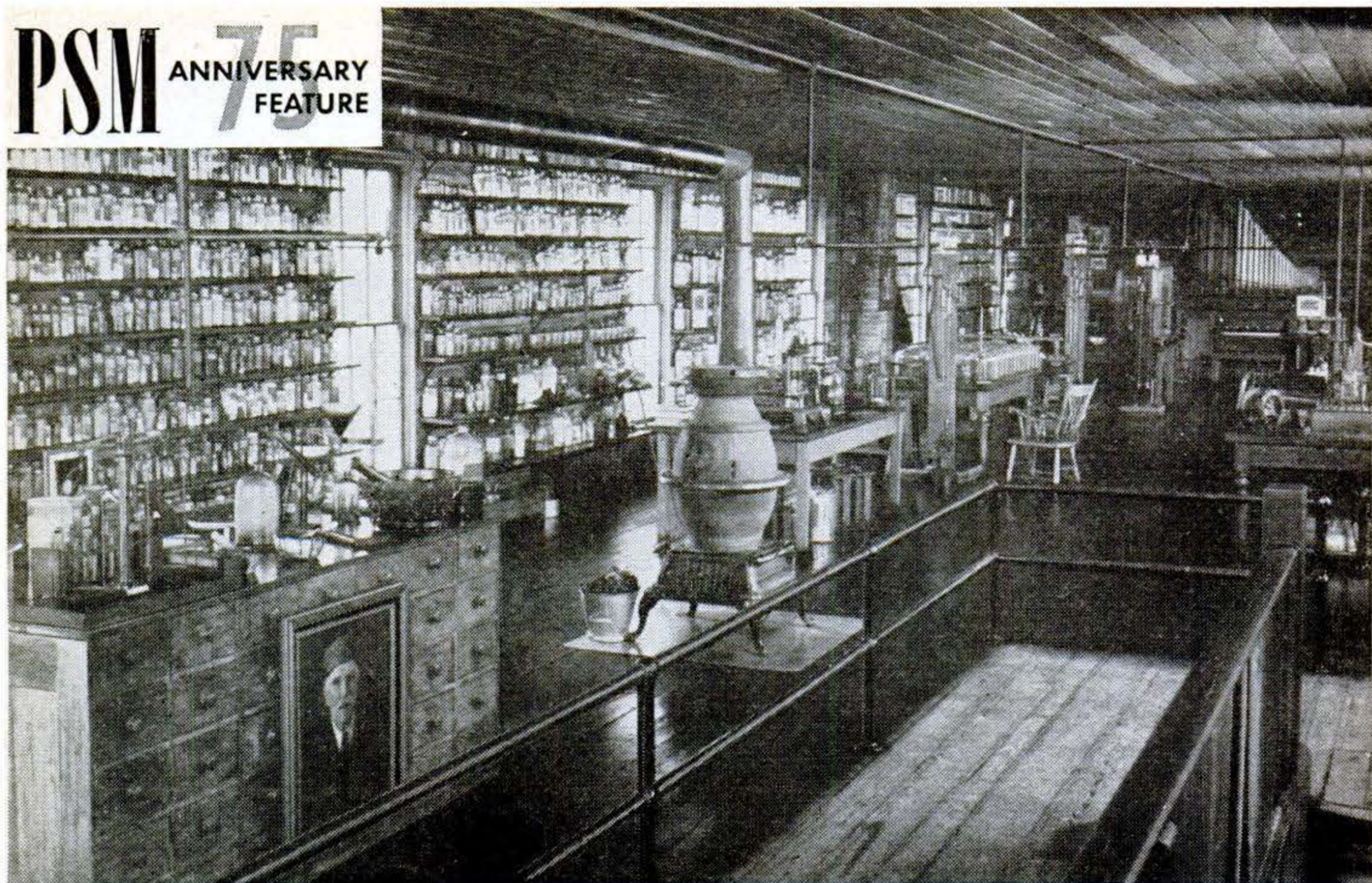

Like to See Edison's Laboratory?

This is where Genius labored when PSM was young.



Henry Ford reconstructed the Menlo Park laboratory, the exterior of which is shown above. At the 1929 dedication Edison called it a true replica of the original he built in New Jersey in 1876.

The battery of smoking kerosene lamps at right produced the carbon for the Edison carbon-button telephone transmitter, which made the Bell telephone a practical success. Today, this transmitter is used almost unchanged, along with the Bell receiver.

PSM photos by HUBERT LUCKETT

Thomas Edison's historic Menlo Park workshop has been reconstructed as part of the Edison Institute at Dearborn, Mich. Second floor interior, above, has original equipment with which Edison carried out experiments. Shelves are filled with every conceivable substance, from horsehair to precious metals, including bound volumes of PSM.





The Edison Electric Pen, shown at left, was a forerunner of the mimeograph. The inventor first manufactured it at Menlo Park. The pen is powered by a small electric motor that draws current from the wet-battery cells at the left of the picture. The stencil made with the pen is placed in the frame at right and ink forced through the perforations with a roller, making copies. Popular in big business offices, more than 60,000 of the pens were once in use.

The stock ticker at right was Edison's third invention. With all its original parts, it still works as smoothly as when the inventor applied for his patent in 1869. The crude and undependable stock tickers then in use were soon replaced by the new machine, and money from the sale of stock-ticker inventions enabled Edison to open his own laboratory. At one time the inventor himself kept the tickers working.

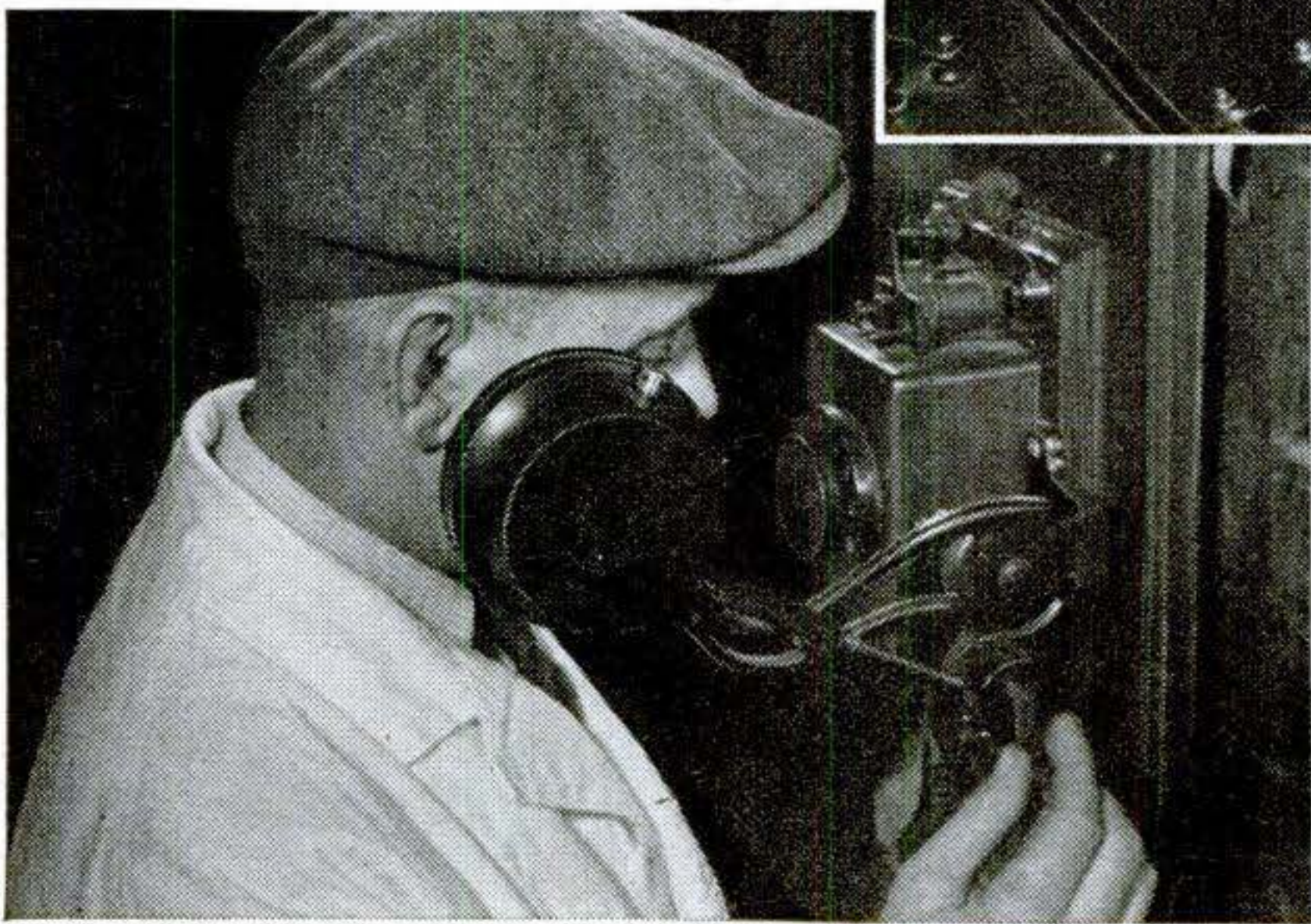

Edison devised the Motograph Telephone Receiver, left, to get around patents on the Bell magnetic type. The transmitting current is fed into a revolving chalk drum. This pushes against a spring with pressure varying according to the intensity of the current. The spring activates a sound-producing diaphragm.

This bell jar and hand-operated vacuum pump were used by Edison during his early search for a suitable material for an incandescent light filament. It took thousands of experiments before he hit on a successful carbon filament. Although Edison did not invent the incandescent lamp, his high-resistance carbon filament, all-glass fused-sealed chamber, high vacuum, and sealed platinum lead-in wires combined to provide the world with a practical and efficient electrical lighting system.

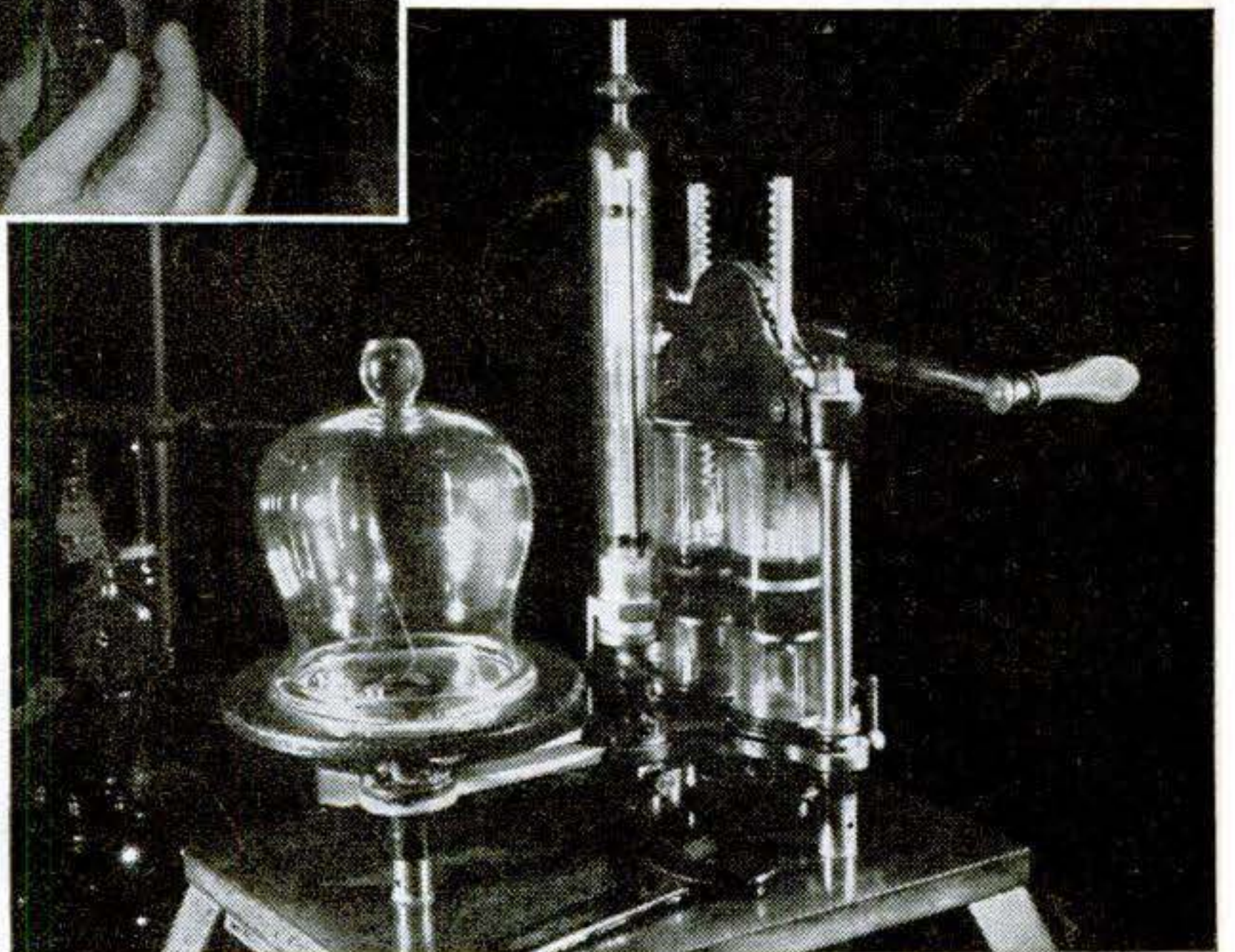

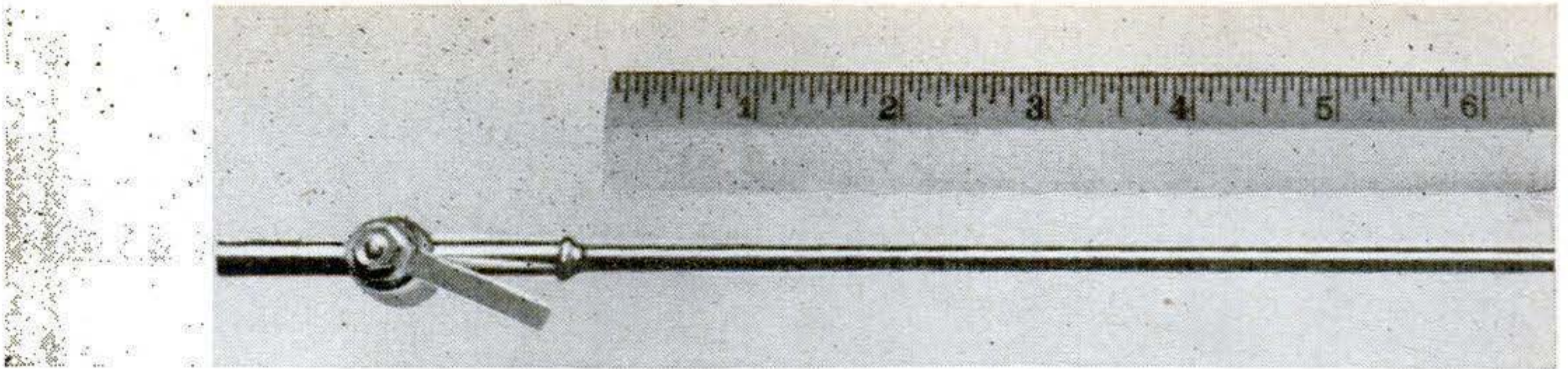

The mysterious Hilsch tube in its original form as developed in Germany is about 20 inches long.

Maxwell's Demon Comes to Life

THE world lifted an eyebrow in the 1870s when James Clerk Maxwell, eminent British scientist, suggested the possibility of hot and cold running air from the same faucet. It took three-quarters of a century and an obscure German physicist to turn Maxwell's idea into reality. Success, however, has bred a minor laboratory tempest over exactly what has been wrought and for what it can be used.

Maxwell's hint followed his development of "Maxwell's Law," which proved that the molecules in gases follow a pattern of arrangement and action. Some circulate at considerable speed and are hot; others remain relatively static and cold. Maxwell suggested that if they could be separated, an unusually simple method of producing hot and cold air simultaneously would be available. Facetiously, he recommended stationing "an intelligent demon" at a trap door to route the molecules along their proper paths.

Considerable comment was evoked. The editor of *Popular Science Monthly*, in the issue for July 1879, somewhat ponderously

commented: "This looks to us like a somewhat ridiculous way of evading the real difficulties in the explanation of molecular motions and their effects. . . . When men like Maxwell lend their sanction to such a crude hypothetical fancy as that of little devils knocking and kicking the atoms this way and that, in order to explain the observed changes of natural phenomena, we may well ask, 'What next?'"

The editor would have had a 65-year wait for his answer. It came when the Navy sent Dr. Robert Milton, a physicist, to Ger-

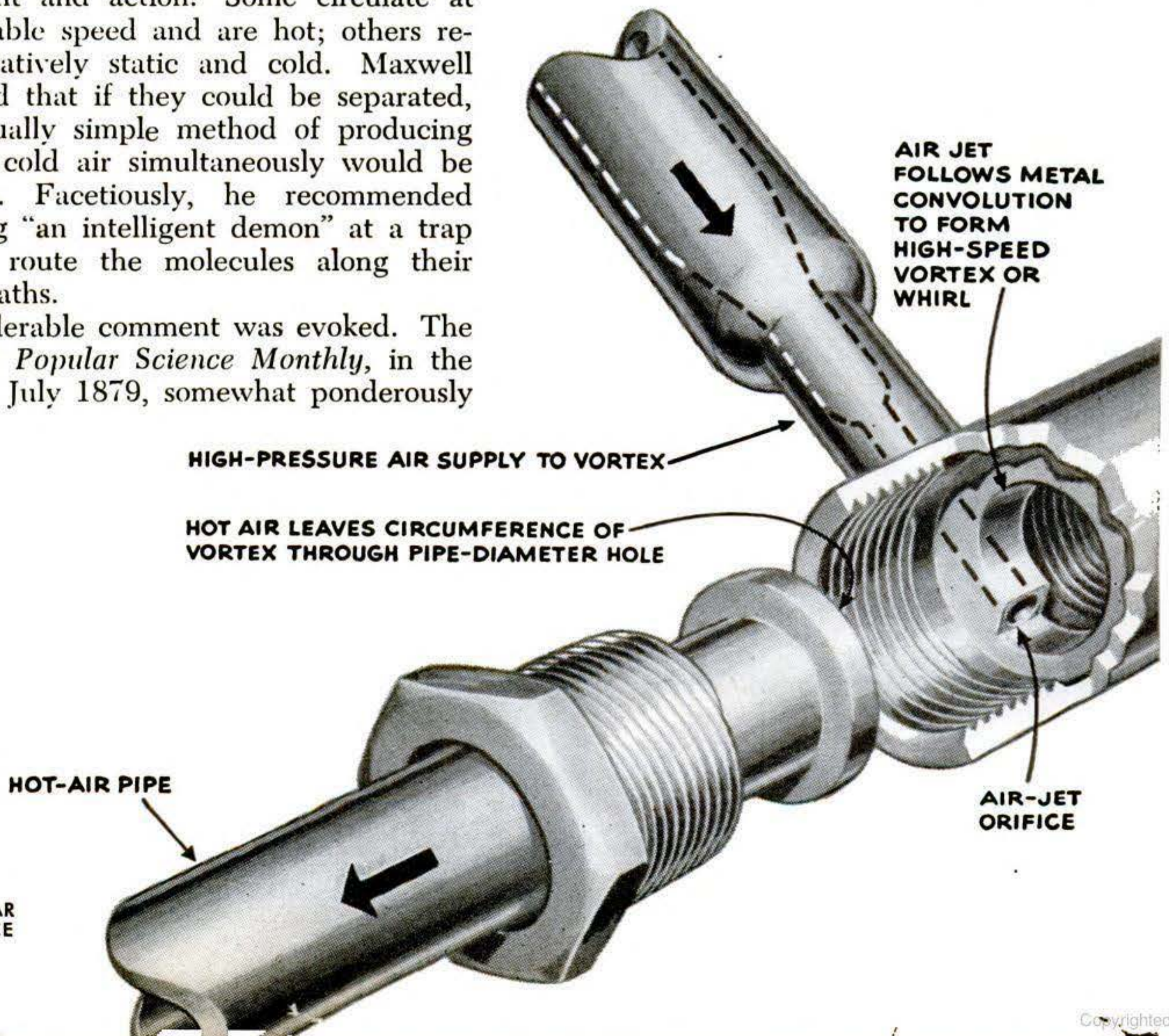

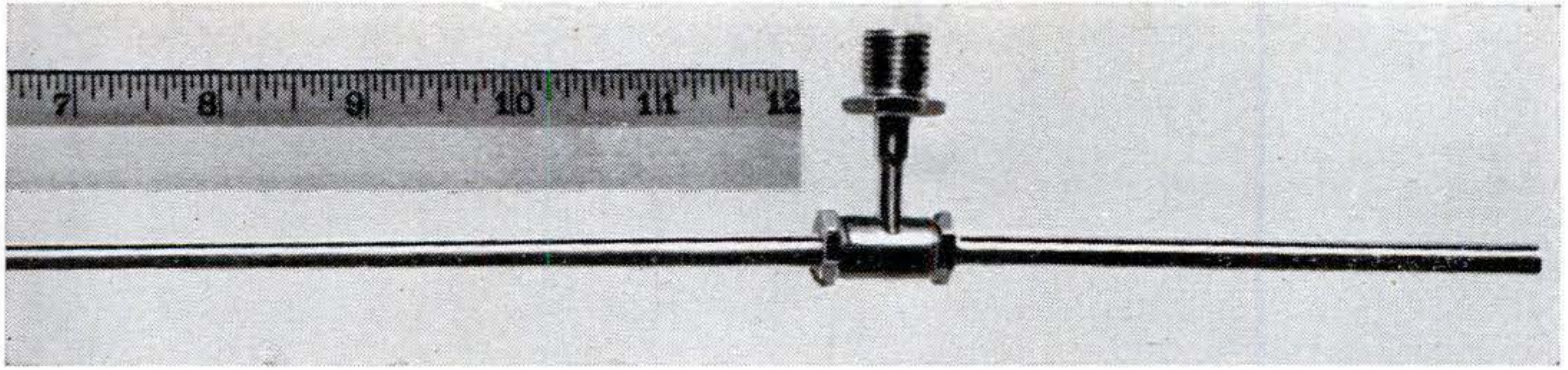

In operation, hot air flows through the long left arm of the tube, cold air through the short right arm.

many to investigate a report that the Germans possessed radically new equipment for cooling gases to within a few degrees of absolute zero. Dr. Milton set out prepared to bring back at least a ton of equipment to the United States. He found what he was looking for in a tiny laboratory in Erlangen. It was a tube about 20 inches long, less than half an inch in diameter and a few ounces in weight! Dr. Milton brought it home.

The tube, it was learned, had been perfected by Rudolph Hilsch, a bush-league German low-temperature physicist. Hilsch, who was integrated into the Nazi war effort, credits an unidentified Frenchman with discovery of the principle.

Here the muddle begins. Scientists themselves cannot agree on just how the tube works. Thousands of words seeking to re-

duce the mystery to formulas have been printed, along with detailed drawings of the tube. These are simple enough: The tube is divided into two arms of unequal length and width by a perpendicular, off-center jet.

There is a certain amount of agreement, however, on the tube's principle. William J. Taylor, of the National Bureau of Standards, offers this general explanation: Compressed air entering the jet, passes through a nozzle, speeding up and losing heat—the gain in velocity energy being made at the expense of the lost heat energy.

This fast, cold air is then slowed up by the spiral core of the tube. Some molecules drop toward the center. Instead of heating up as they lose speed, however, they pass along some of their energy to their next outer neighbor, and remain cool.

An additional cooling effect comes from the centrifugal force of the whirlpool itself. This force throws air molecules out to the edge of the spiral so that there are fewer molecules—and therefore lower pressure—in the inner layers than in the outer ones. When air moves from the high-pressure outer layers to the low-pressure inner layers, it naturally cools.

The result is a core of cold air at the center of the whirlpool and a border of hot air at the periphery. The shorter, smaller-

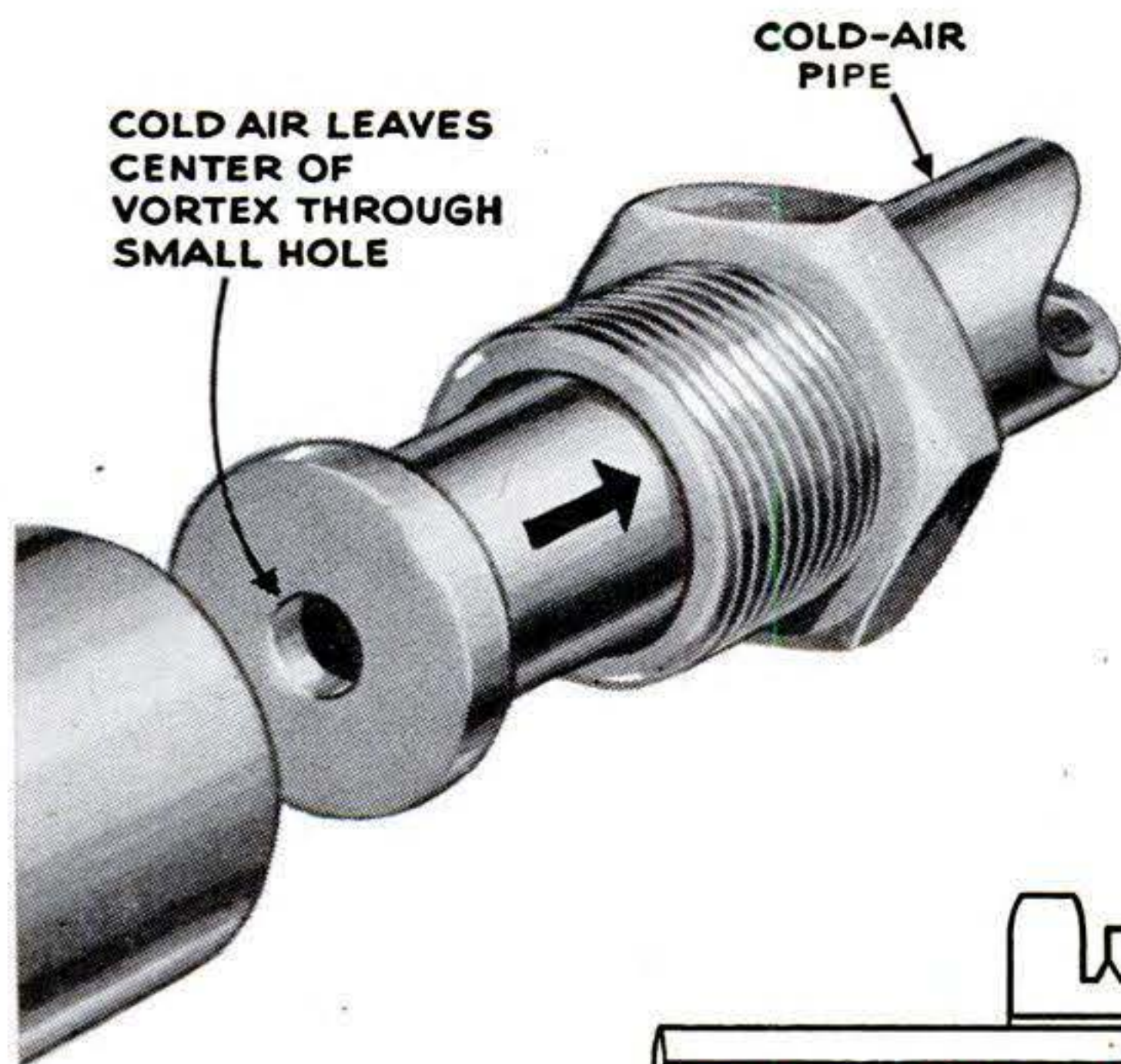

Cross section of the tube, below, shows how the air jet enters through hole, bottom center, and is spiraled by the shape of the tube. Drawing at left illustrates the tube's essentially simple construction.

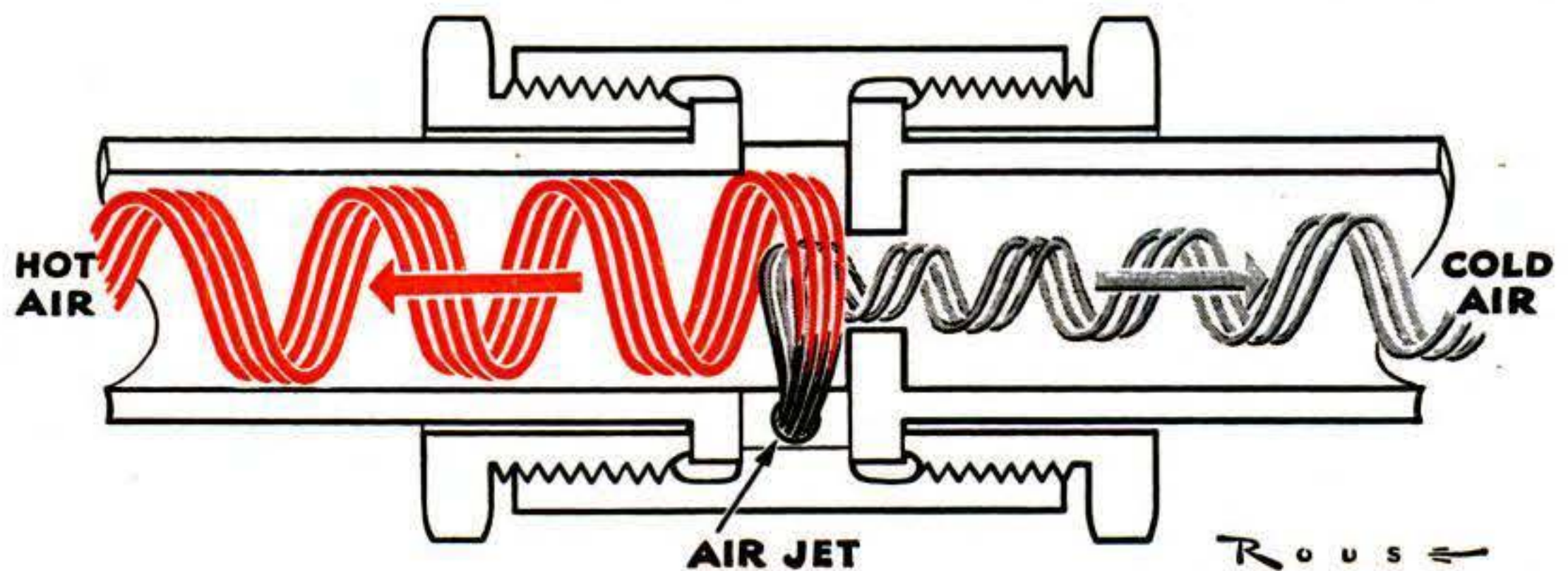

R o u s
MAY 1947 145

bore arm of the tube communicates only with the center of the whirlpool and therefore draws off the cold air. The longer, larger-bore arm draws off the rest of the air—the hot molecules left at the periphery of the whirlpool.

Varying ratios of hot and cold air can be obtained by adjusting the stopcock at the warm-air end. The tube is capable of simultaneous temperatures of plus 106° and minus 56° F. At “hot” adjustment it can produce up to 350° F.

While the fundamental scientists have been arguing, the applied scientists of the refrigerating industry have been doing some experimenting of their own. Industry overlooks no bets that may involve discarding methods laboriously and expensively developed. At least three big concerns have had a look at the tube. At Westinghouse, Gaylord W. Penney, manager of the Electrophysics Department, has built a model three times the diameter of the original tube. He reports:

“Not efficient for refrigeration. The tube’s

highest utility is as a laboratory device. For instance, it could be used as a cold trap for mercury. It could also be used to cool gases, such as helium, prior to liquefaction.”

Physicists of other companies, together with those of the National Bureau of Standards, generally agree that the Hilsch tube has no particularly rosy industrial future for the time being. They point out that while the tube gives 15 to 20 times more cooling than the ordinary laboratory method—expansion of gas through a nozzle under the Joule-Thomson principle—it has refrigerating efficiency of only 20 percent, as against 70 percent in household refrigerators and close to 90 in larger cooling installations.

They are loath, however, to disregard the provocative commercial possibilities of the tube. A more highly refined model might attain the thermodynamicists’ dream of a double-purpose unit, on which one switch produces heat; another, cold.

Maxwell and his intelligent demon are probably smiling quietly at some astral laboratory bench. END

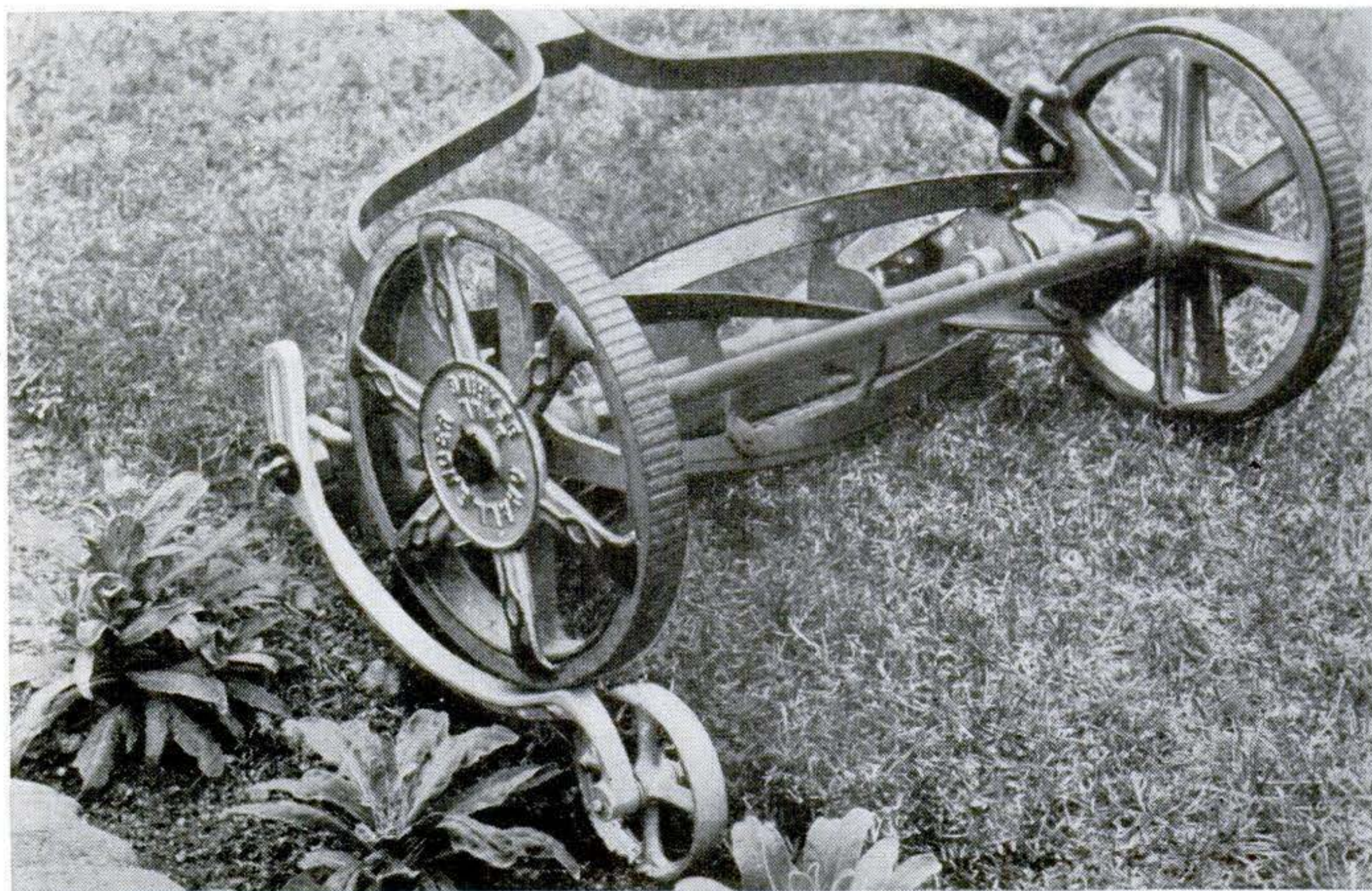

Mower Wheel Gets the Edges

LAWNS can be trimmed evenly right up to the edge of a flower bed with this one-pound aluminum edge-getter. It drops down to carry the wheel that ordinarily would hang

over the edge, thus keeping the mower level and its blades clear of the ground. When not in use, the attachment rides upright, being attached to a bolt supporting the roller. The device is made by the Barton Company, of Montrose, Calif.

Timber Rides Skyhook

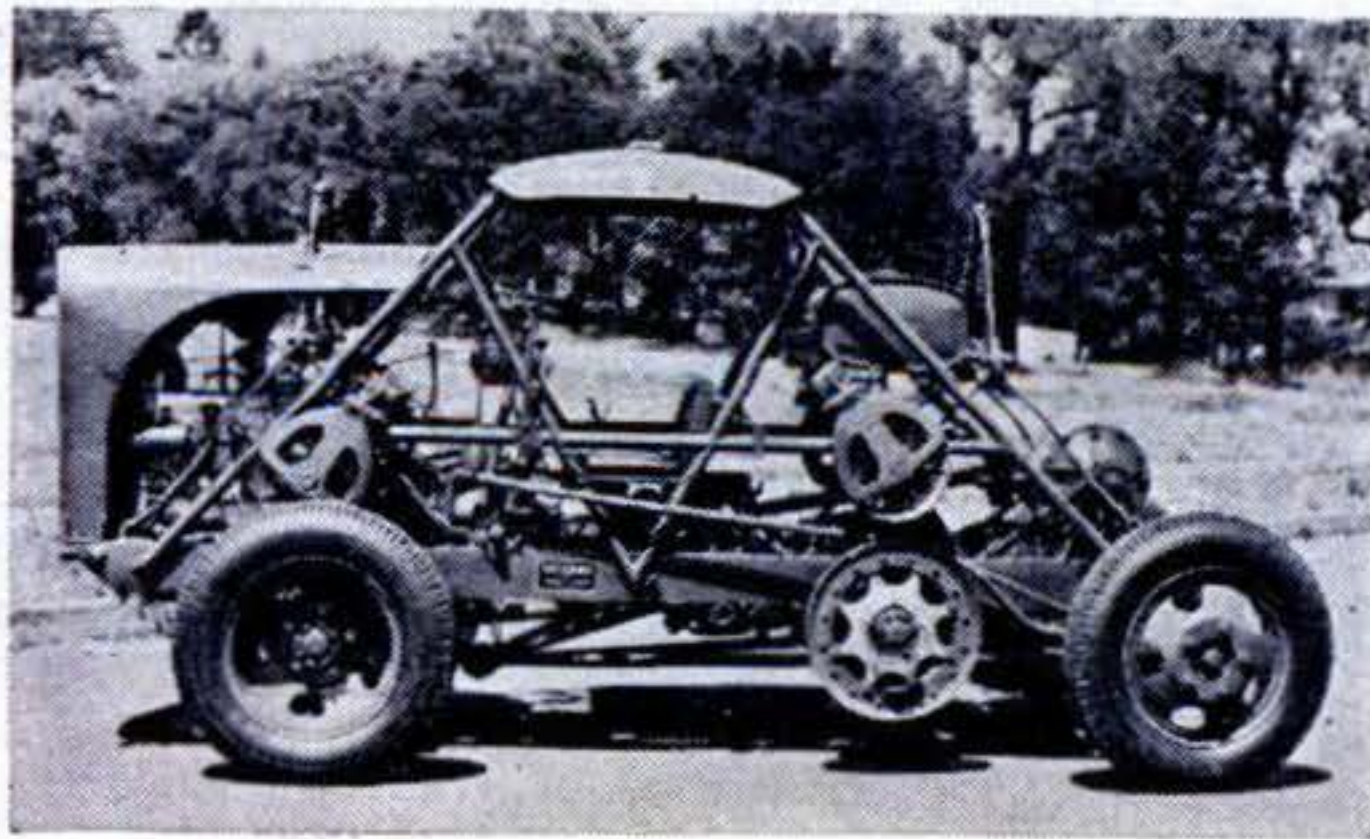

TRIED out in the Oregon woods and now hard at work in North Carolina, a woodsman's invention is simplifying big logging operations. Appropriately called the Skyhook, the device rides on two large cables supported by pole trees about 500 feet apart and pulls itself along (right) on roller-bearing sheaves by means of two smaller traction cables. Fitted with tires (above), it can travel from one job to another at speeds up to 50 m.p.h.

The North Carolina installation is a 4,000-foot cableway along which the Skyhook carries average loads of 10 tons. It can do 35 m.p.h. on open spans, but has to slow down to 15 m.p.h. to pass the tree supports that hold the two 1½-inch cables. A 10,000-foot cableway is planned.

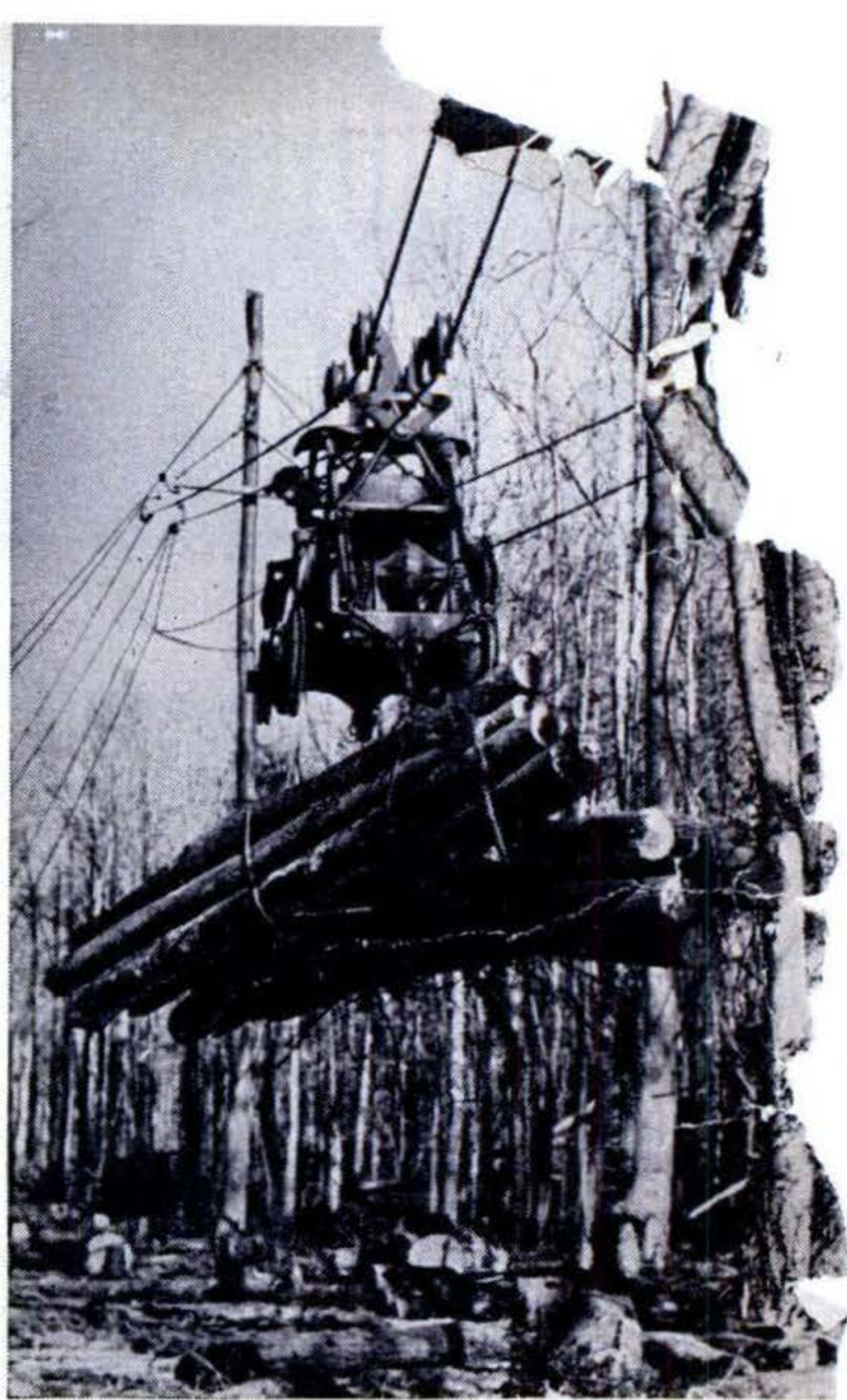

Fuse Looks for Target

ANTI-AIRCRAFT shells can actually look for their targets when guided by the optical proximity fuse that waits until it "sees" a plane before exploding the shell. This wartime development, recently revealed by the Bell Telephone Laboratories, uses a ringlike plastic lens near the tip of the fuse to focus light from the sky on a photoelectric cell in the center of the fuse. When the amount of light hitting the lens changes suddenly—that is, when the shell nears the target and is shaded by it—the resulting impulse explodes the shell.

Shown at the right are: (A) an optical proximity fuse assembled in its container; (B) the photo cell, on top of the amplifier housing, at the left, and the fuse cap with its ring lens, on the right; (C) the amplifier, left, and the protective wooden block that holds it; (D) the assembled amplifier unit, left, and the housing into which it fits.



Wavy Jones's Party Line



A NATURAL speaking tube thousands of feet below the sea will soon summon help for air and ship survivors from shore stations more than 3,000 miles away. Through this ocean "party line" the new Sofar system can detect the explosion of a single distress bomb thousands of miles distant and spot the position of castaways within a mile. Combined with Raser (PSM, Oct. '46, p. 134), it is expected to direct rescue ships to within a few feet of a bobbing life raft.

The long-distance yelp for help is plugged in with a three-pound TNT bomb, dropped overboard by the survivors of an abandoned airplane or ship. Water pressure automatically sets the bomb off at a depth of 3,000 to 4,000 feet. Because of the recently discovered speaking-tube effect at this level, the sound of the blast travels tremendous distances to hydrophones (underwater telephones) set offshore at the speaking-tube depth. Comparison of the times at which the explosion's sound arrives at several listening stations enables the operators to plot the exact location of the underwater bomb burst.

Pacific Stations Begun

The first installation of sofar (for Sound Fixing and Ranging) is already under construction. Four shore stations, at Kaneohe Bay and Hilo in the Hawaiian Islands, and Monterey and Point Arena on the California coast, will cover the wide, empty stretches of the Pacific that have claimed many victims from our busy air and sea traffic to South Sea bases and the Orient.

Sofar is the result of some ingenious reasoning back in 1937 by Dr. Maurice Ewing, associate in submarine geology at the famed Woods Hole Oceanographic Institute, Woods Hole, Mass., and professor of geology at Columbia University. Dr. Ewing was aboard the Woods Hole research ship *Atlantis*, investigating the sedimentary and

rock layers on the ocean bed three miles below by setting off small bombs on the bottom and measuring the resulting vibrations with a seismograph. One day he listened for the bomb burst by pressing his ear to the ship's rail. To his surprise, he heard the explosion and three echoes, the last of which must have bounced up and down seven times, traveling 21 miles.

Speed Varies with Depth

This observation led Dr. Ewing to wonder just how far an underwater blast could be heard in a horizontal direction with sensitive receiving and amplifying equipment. Knowing that the speed of sound in water increases with rising temperature and rising pressure, he calculated that sound would travel slower as the depth increased to 4,000 feet, because the temperature drops with depth. But below that level sound speed would increase again, since the temperature remains the same while the pressure increases. This meant that sound waves originating at the level of slowest speed, 4,000 feet, would always be bent back toward this level as their velocity was increased by warmer water or higher pressure above or below—just like the refraction of light rays as their speed is changed by a glass lens.

Further computation disclosed an even more interesting fact. Sound waves leaving the 4,000-foot axis at an angle smaller than 12° from the horizontal would never reach the surface or the bottom. They would be refracted back and forth across the axis and travel zig-zag fashion in a horizontal direction. In other words, the zone around 4,000 feet acts as a channel, directing a large percentage of all sound originating there along a horizontal "tube."

This channeling effect is so great that, theoretically, an explosion on the sound axis

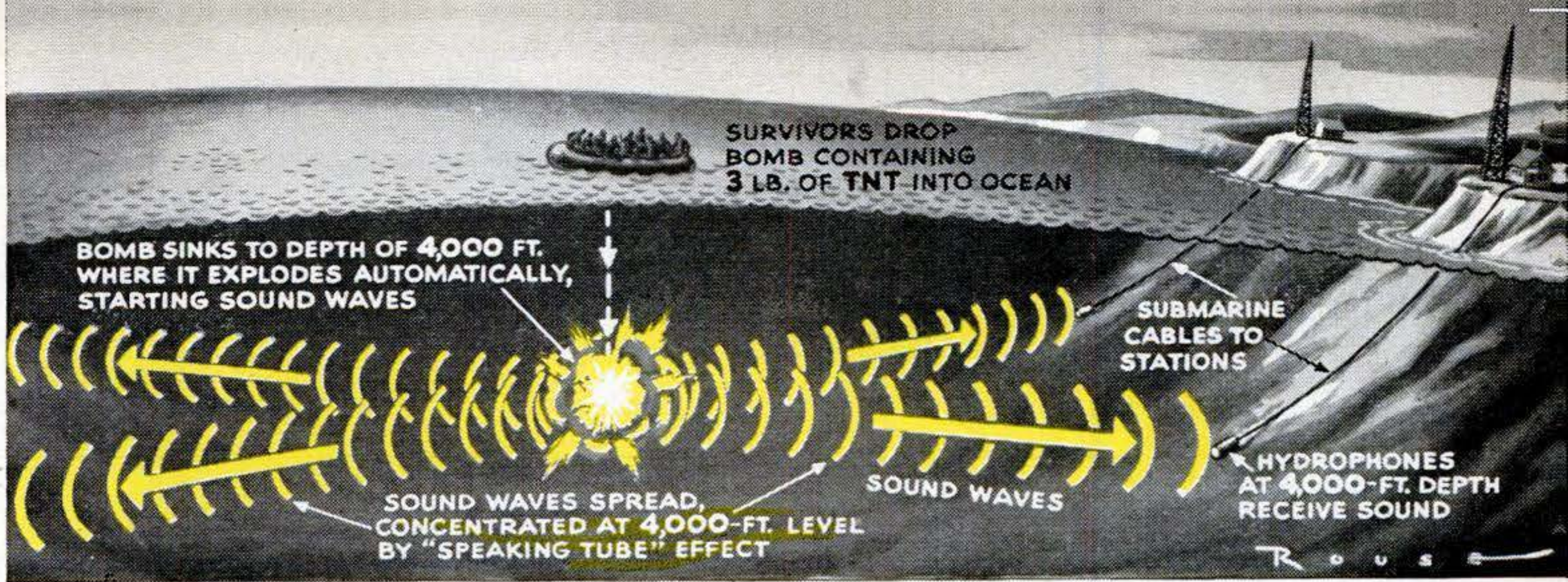

might be heard 25,000 miles away if no land masses interfered. In actual test, a bomb set off near Dakar, French West Africa, was easily heard in the Bahamas, 3,100 miles across the Atlantic.

A bomb bursting within the channel produces an unusual, characteristic sound in the hydrophone. The fast rays making the widest zig-zags around the axis are heard first, even though they travel the longest route. Their intermittent beats build up gradually to a sharply ending boom—the slow sound ray that goes straight along the axis. The complete effect sounds like a kettle drum, slowly rising in tempo and volume to the finale of a cymbal clash. Because of this sharp cutoff, time measurements precise to 1/10 second are possible, permitting accurate location of the distress bomb—and the survivors.

Accidental false alarms from everyday underwater blasting are unlikely, since the characteristics of sound originating inside the channel are so different from those made outside it. Only an improbable coincidence

These Navy technicians, using information gained by bottom sampling and shoran positioning, are plotting an ocean-bed survey for sofar operations.

could produce an explosion at 4,000-foot depth that was not a distress call.

The sound channel remained little more than a scientific curiosity until World War II brought the need for better sea-rescue devices. Then the Navy assigned its Underwater Sound Laboratory in New London, Conn., to co-operate with Woods Hole in the development of sofar.

The instruments now being used are similar to those designed for sonic depth-finding and ranging (PSM, Nov. '45, p. 84).

With construction of the first sofar stations already under way, Coast Guard monitors will soon be listening in on Davy Jones's party line. Yet research continues. The system has been tested in tropic and temperate zones, but not in the polar regions, where future air routes may be busiest. Water in the Arctic and Antarctic is almost the same temperature all the way down from surface to bottom, and many authorities predict that there will be no sound channel there. No one knows for sure—but the Navy intends to find out. END

Nansen bottles are lowered to obtain salinity samples at varying depths, as part of the process of determining the best zones for sound transmission.

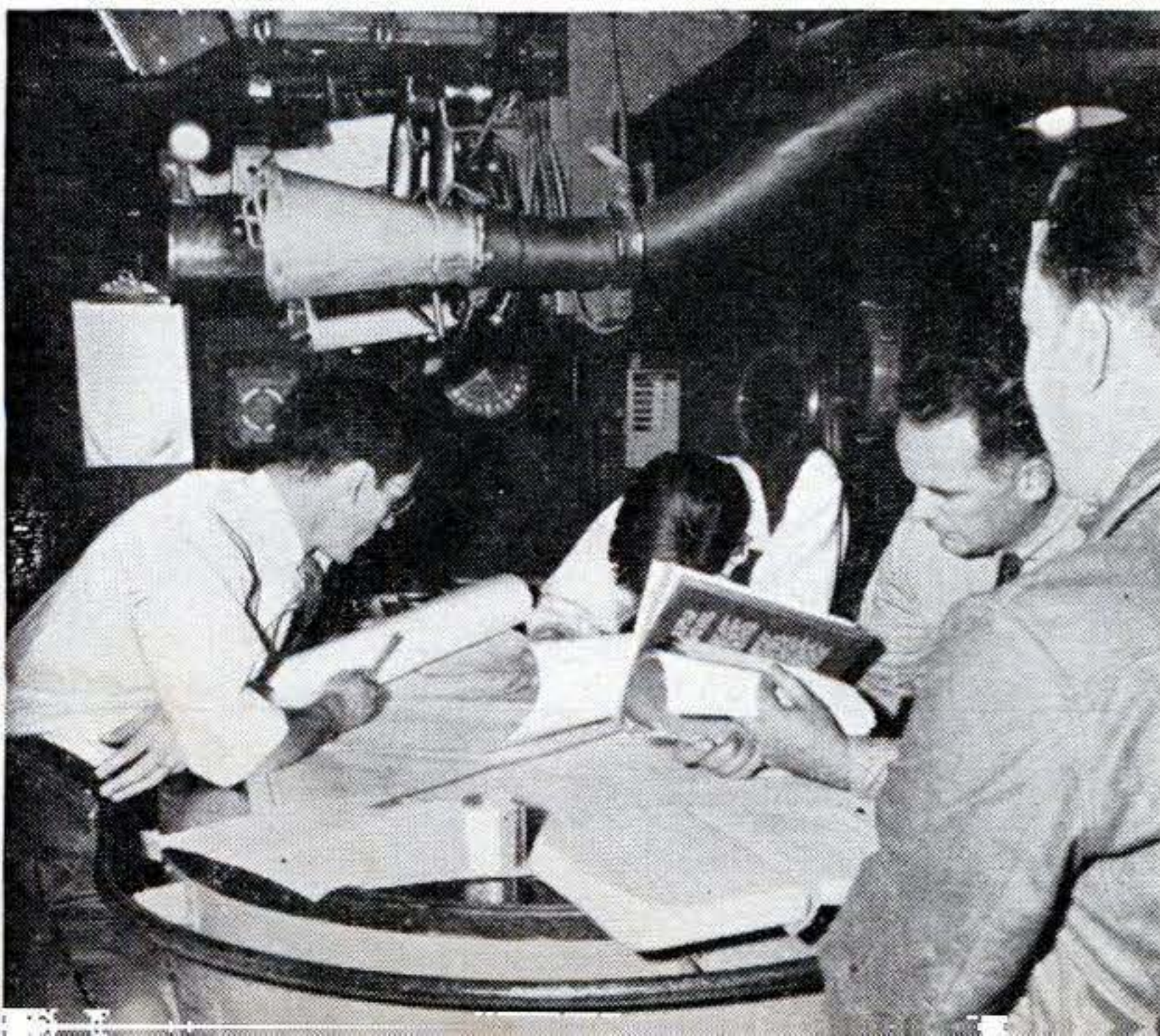

Camera Coughs Out Finished Prints

YOUR present camera performs only one of many steps—developing, fixing, printing, and so on—involved in making a photograph. Edwin H. Land, 38-year-old president of the Polaroid Corporation, has invented a one-step process in which the camera does everything. With his camera, you snap the shutter and turn a knob; 60 seconds later you have a finished, dry print.

The Land camera takes its pictures in the conventional way, but inside it, in addition to the film roll, there is a roll of positive paper with a pod of developing chemicals at the top of each frame. Turning the knob forces the exposed negative and the paper together through rollers, breaking the pod and spreading the reagents evenly between the two layers as they emerge from the rear of the camera. Clipped off, they can be peeled apart a minute later.

Ordinary chemicals are used, but the negative is not transparent and light is not

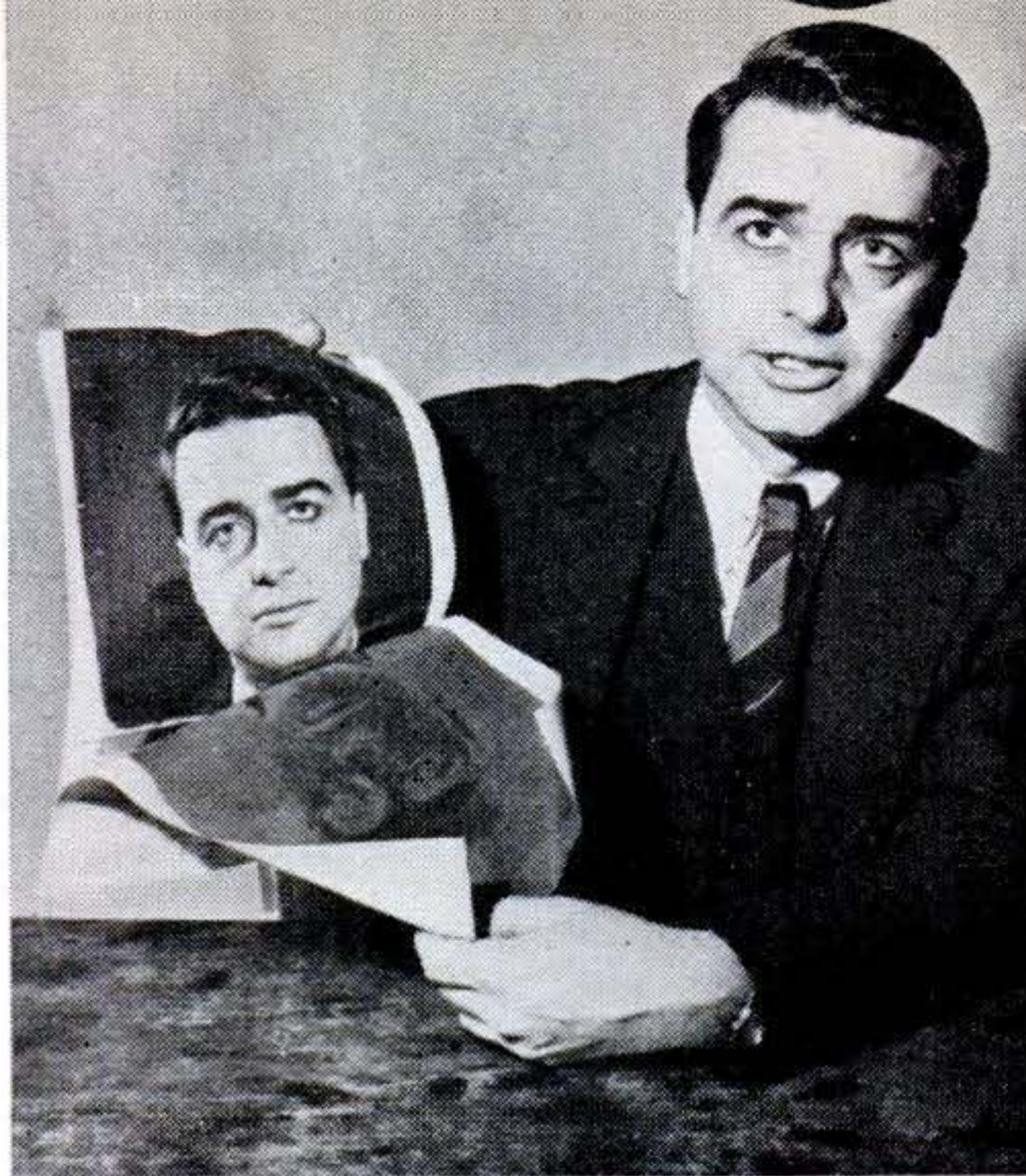

Land displays a one-minute photograph of himself. A model of his camera has been designed for large-scale production, but plans for it are undisclosed.

required for printing. The unexposed portions of silver halide are transferred from the negative to form the positive image.

Land says that ordinary transparent film can be adapted to one-step photography, but he sees no need for it. If additional prints are desired, the easiest way is to make additional exposures. If necessary, the original print can be rephotographed.

An artist's conception of a conventional model of Land's camera. Opacity of negative and printing paper prevents light from interfering with developing process.

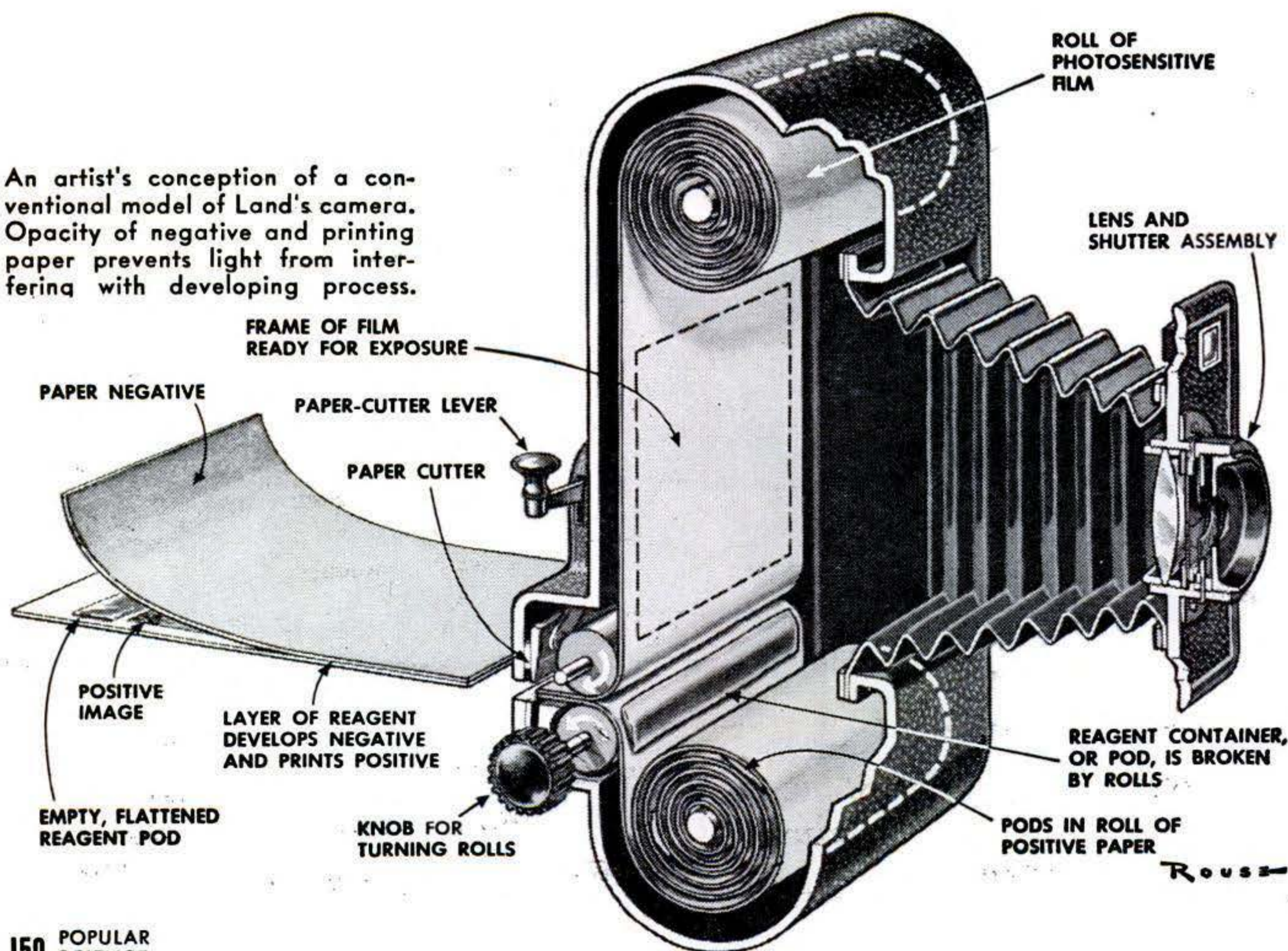

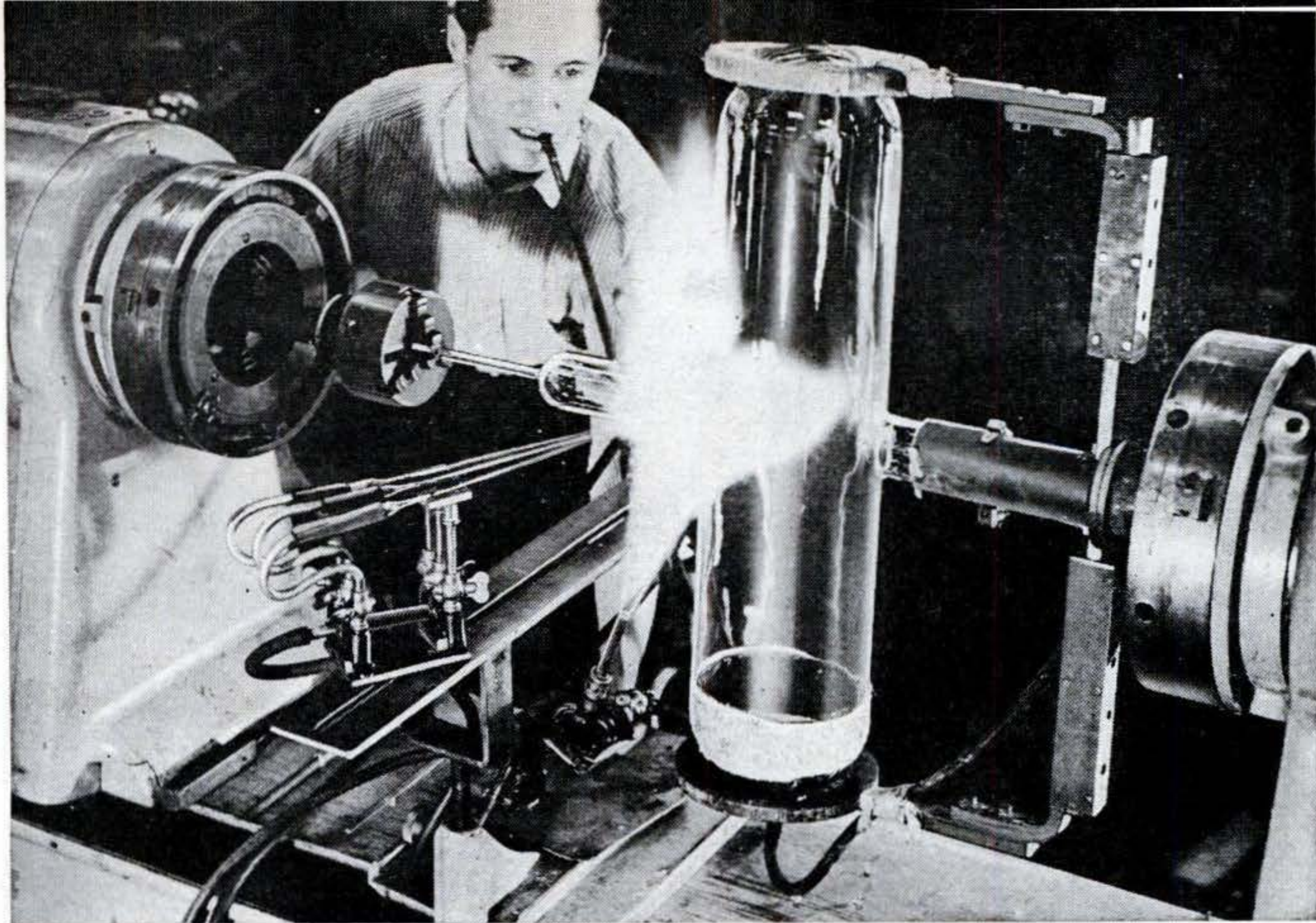

Blowing Big Bubbles. A glass blower (above) puts the finishing touches on the glass envelope for a giant 100,000-watt General Electric transmitting tube. The blowing keeps the glass from burning and maintains a constant air pressure within the tube.

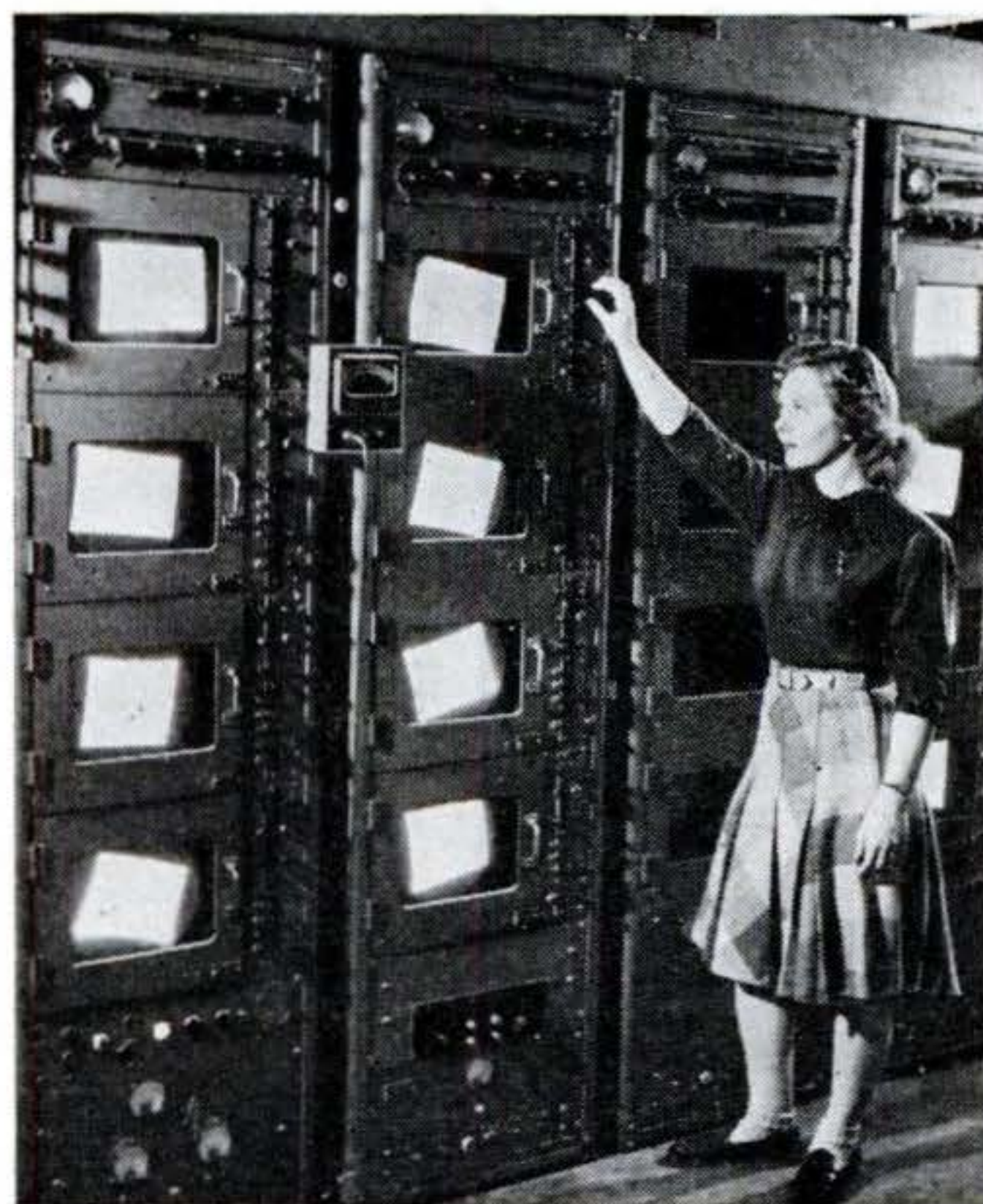

Testing Television Tubes. Allowed to burn nearly 24 hours a day, these cathode-ray tubes (above) will last only two to four months, but their performance will provide GE engineers with valuable data.

Glass Spray Seals Tubes. Pulverized glass is sprayed on the metal base of an electronic tube (at left) in a new Westinghouse process. When baked and cooled, a thin, hard, airtight coating is formed.

AIDS TO MODERN LIVING



KNOTTY FURNITURE.

Carrying the decorative features of paneled living-room and den walls to the furniture itself, designers have now brought out chairs, tables, and other pieces in knotty pine. This wood takes a variety of attractive finishes. The room shown at right was a display at the International Home-Furnishings Mart, Chicago.



STEEL-AND-COPPER COOKER. This new pressure cooker is made of acid-resisting stainless steel and has a bottom covered with a thick sheet of copper to increase heat conduction. A hinged gauge lifts automatically at 15-lb. pressure. The cooker is in the copper-clad line put out by Revere Copper and Brass, Inc. About \$16.

CLEAR-PLASTIC RIVETS. Both solid and hollow fastenings are made up in colorless and tinted Plexiglas for use with light metals, leather, cardboard, rubber, upholstery, and sheet plastics. The rivets, shown at the right, are expanded and headed by heat rather than by hammering. Douglas Aircraft Company developed the rivets and two rivet guns for handling them.

RUNG SAVERS. Socket clips of heavy-gauge steel screwed or nailed to the sides of a ladder to support the rungs will add safe extra life to an old ladder, even if the rungs have rotted in their sockets. A curved lip is fitted under the rung to provide a saddle or socket extension reaching to sound wood.

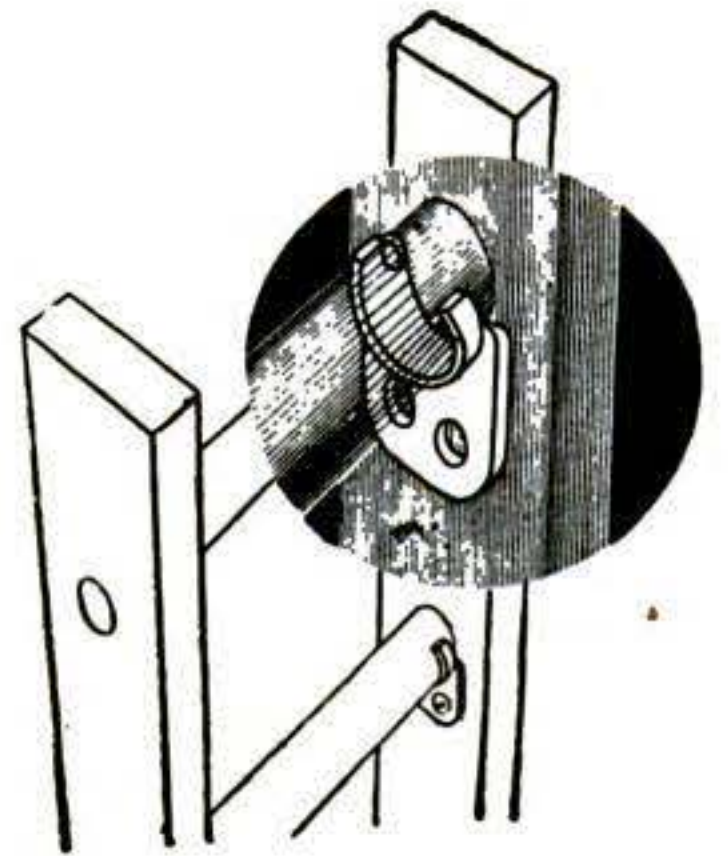

The rung reinforcements are manufactured by Reimann and Georger, of Buffalo, N. Y. They are made of a heavy-gauge sheet steel and are cadmium-plated to resist rust.

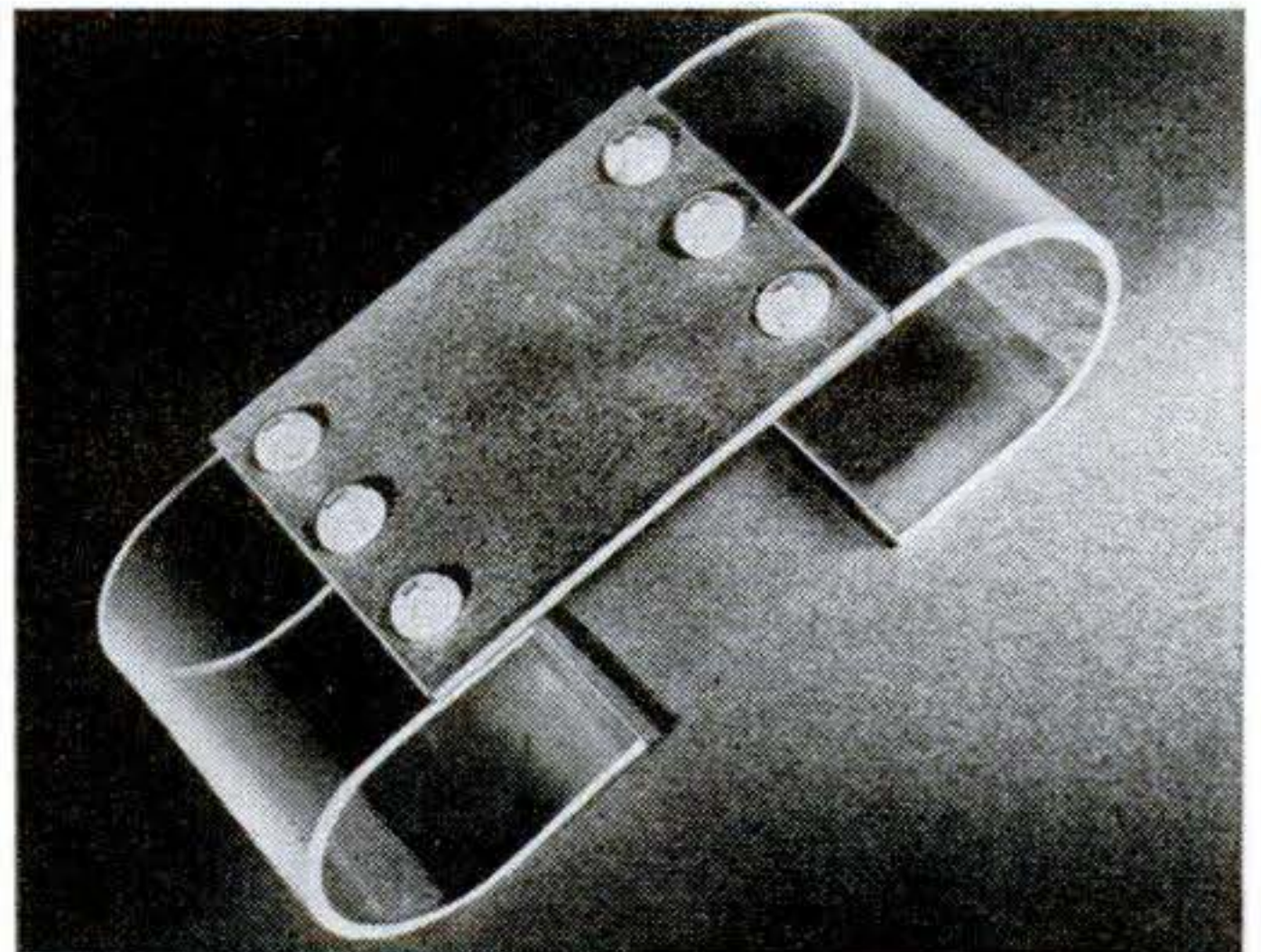

CASTERS LEVEL FURNITURE. Plastic casters, made in two parts, will level up chairs and other pieces having uneven legs and also steady furniture used on uneven floors. One section fitted with a screw is attached permanently to the leg, and a screw cap adjusts height. Levelor Corp., of White Plains, N. Y., manufactures the casters from Tenite.

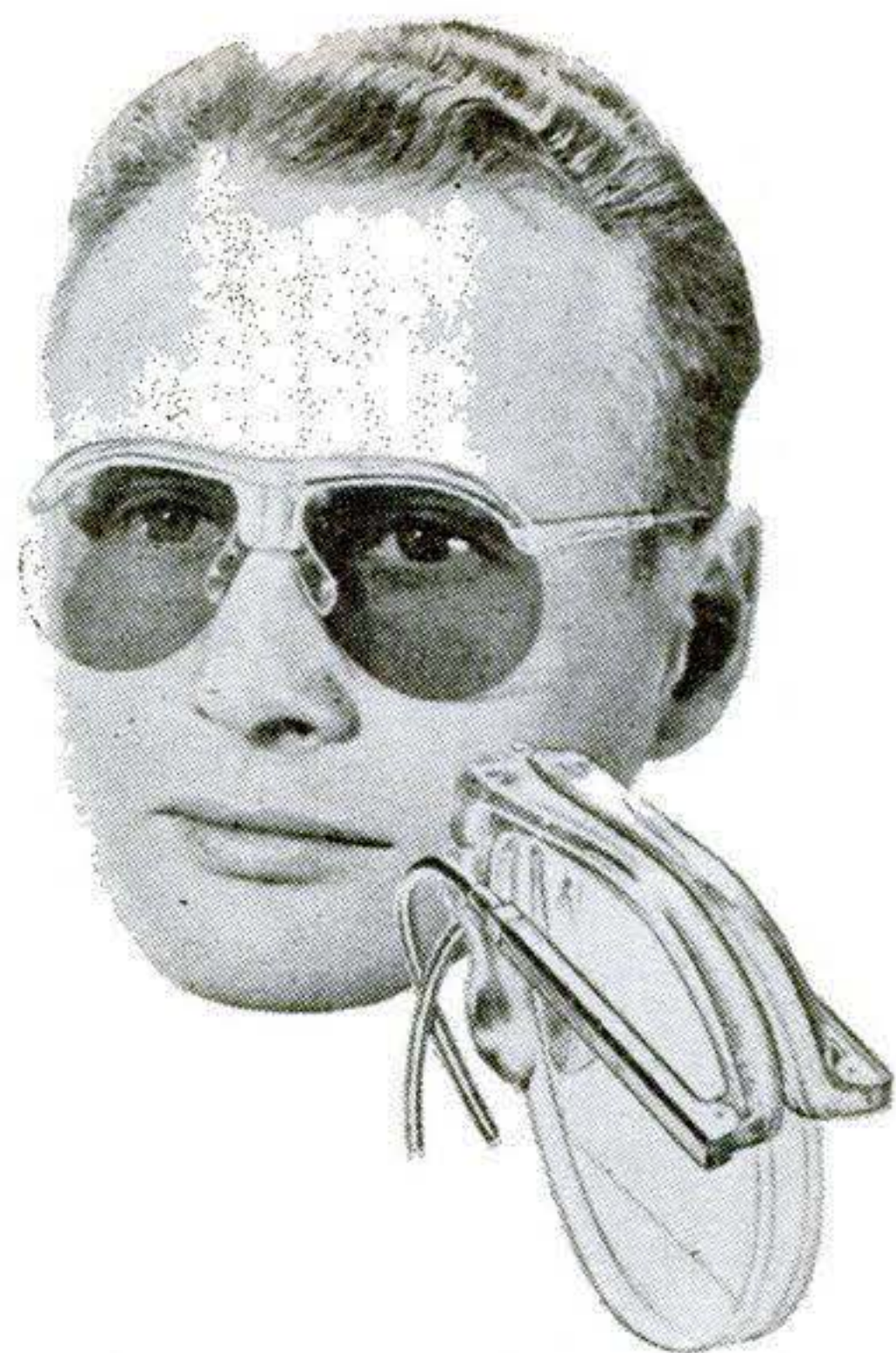
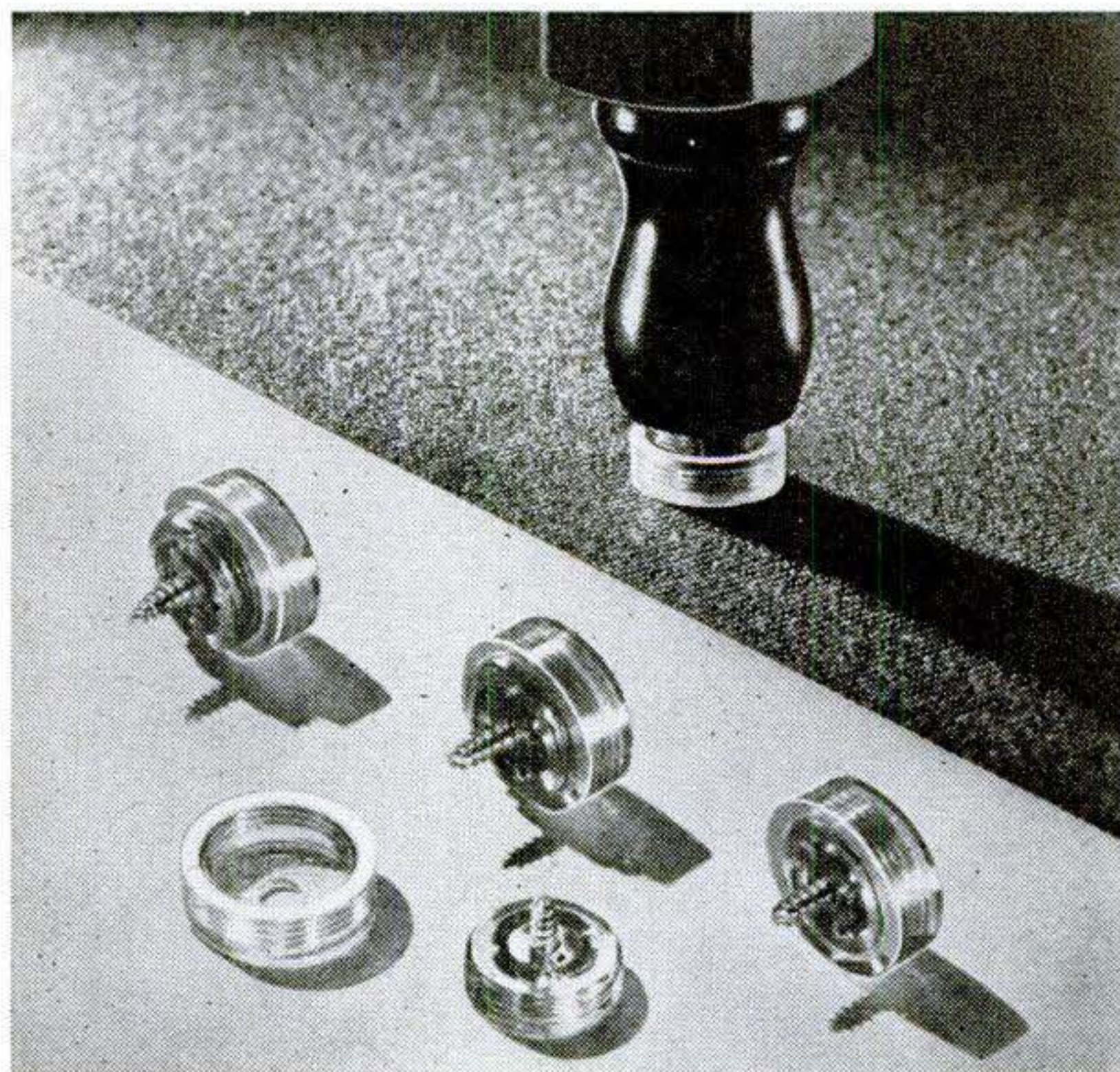

FOLDING GOGGLES. Hinged at the bridge, new shatter-resistant plastic-lens goggles fold to less than the size of a cigarette pack. A stainless-steel rim extends across the top. Lenses are green. Watchemoket Optical Co., Inc., of Providence, R. I., is the maker.

EIGHT OUTLETS IN ONE BOX. This electrical unit, equipped with 12' of cord, is designed to provide extra outlets for the home or shop. In addition to conveniently spaced receptacles, it has a 1/25-watt neon pilot light that distinguishes between A.C. and D.C., a double-pole toggle switch, and a pair of 15-amp. fuses to guard against shorts and overloading. The box is enclosed in a 3" by 4" by 5" metal casing and weighs 1½ lb. It is a product of Allied Laboratory Instrument, Inc., of New York. Models are available for 115 and 230-volt use.

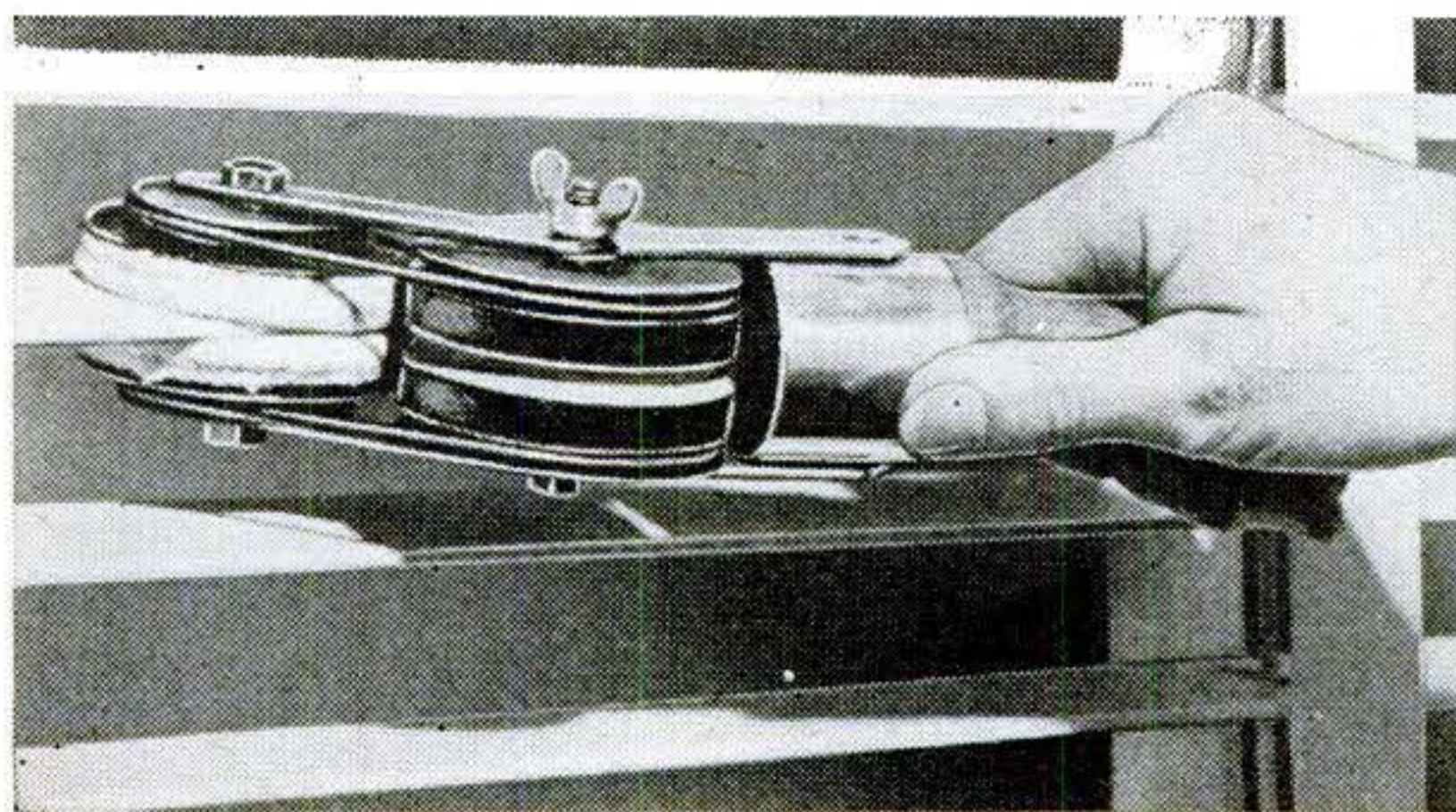
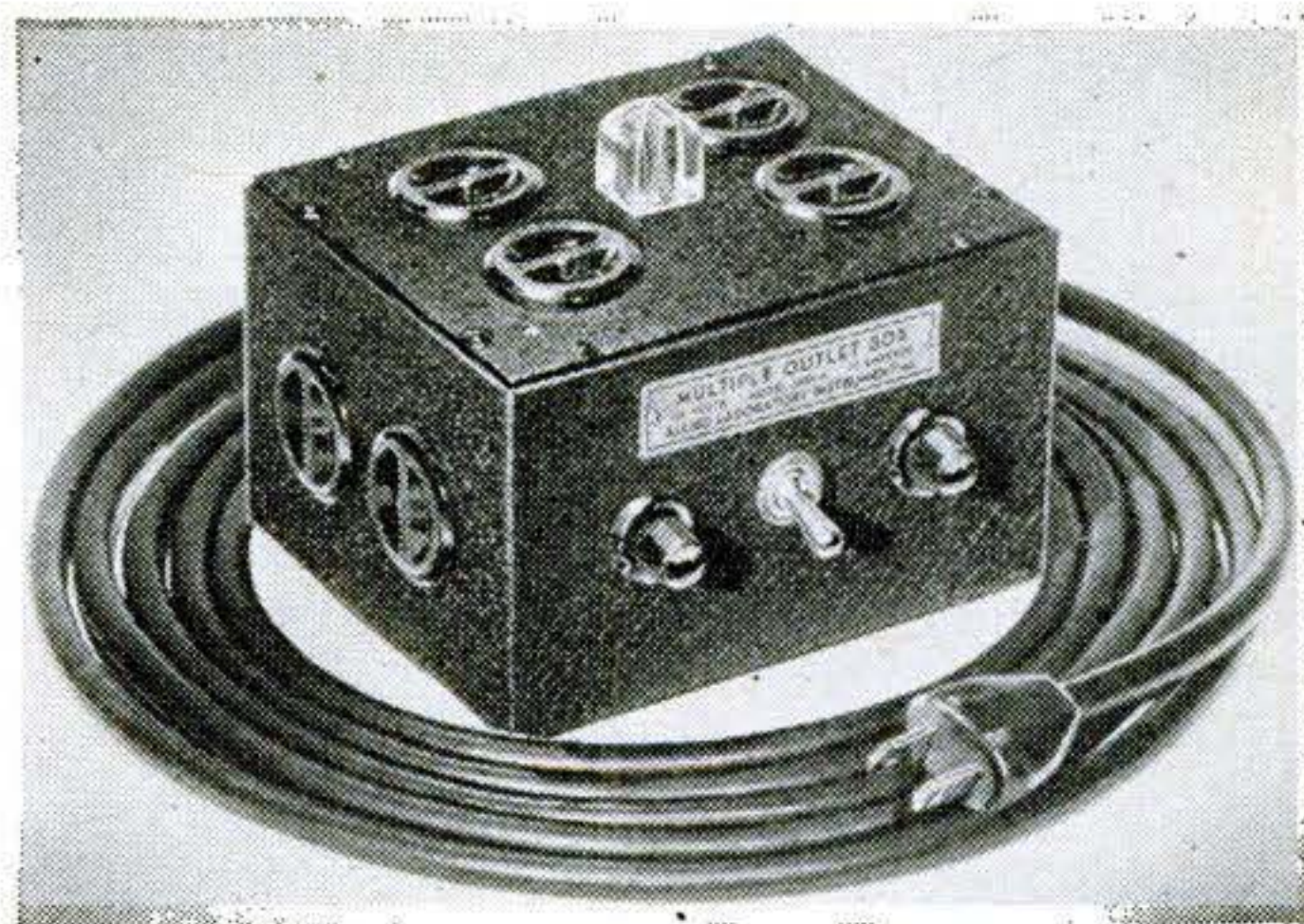

QUICK BLIND CLEANING. A set of pads on revolving disks cleans both surfaces of Venetian blind slats in one operation. Three sets of pads come with the roller—one for use with cleaning fluid, one for waxing, and one simply for dusting. They are of washable cotton. Warren Venetian Blind Cleaner Co., of Pittsburg, Kans., supplies the roller and pads along with a special cleaning fluid for the blinds.

AUTO IDEAS

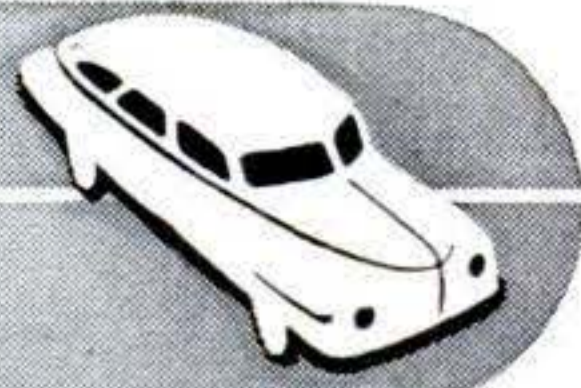

VENT DEFROSTS WINDSHIELD. Slipped neatly under the hood, this flat aluminum vent channels engine heat against the windshield and dispels frost and sleet. Although flared at each end, the vent narrows to just a slight aperture at the point where the hood pins it down. It is manufactured by the Johnson Ladder Shoe Co., Eau Claire, Wis.

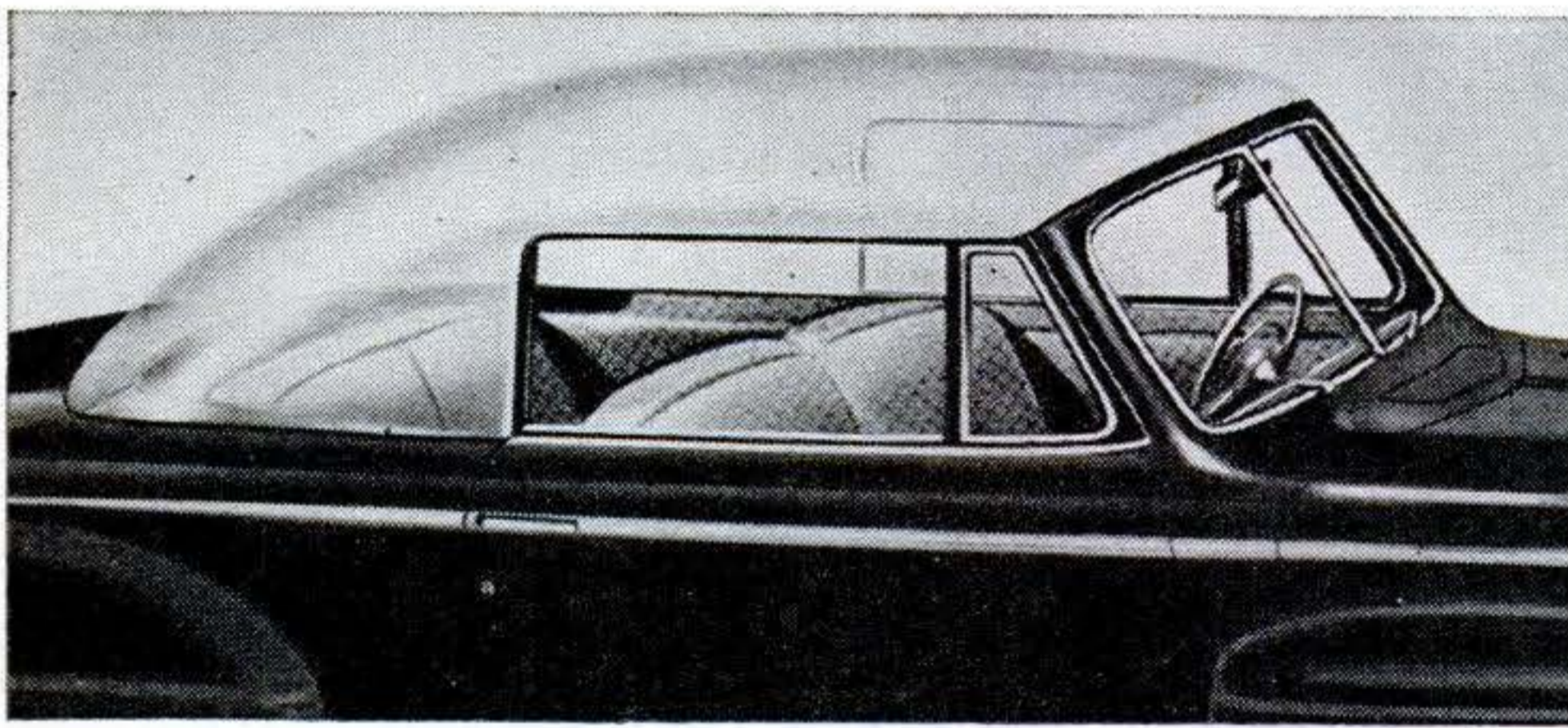

With this plastic top, you can get the same amount of sunshine as in an open car—but without the breezes. Windows raise and lower normally.

PLASTIC TOP. Vision in all directions is permitted by a clear plastic top manufactured for convertibles by the Wright-Austin Company, of Detroit. The Plexi-Top is held by four toggle clamps and does not necessitate removal of the regular canvas top. It has a roll shade to shut out the sun when desired. The top weighs 50 lb.



SPOTLIGHT ON ROOF. A streamlined movable spotlight for mounting on the roof of a car instead of through the corner post has been introduced by the Trippe Manufacturing Co., of Chicago. Operated by a control knob on the ceiling of the car, the light turns through a field of 270 deg. A switch on the knob turns the light on and off.

TWIN JETS WASH WINDSHIELD. With an automatic washer produced by the Trico Products Corp., of Buffalo, N. Y., you can keep your windshield clean while you drive. Vacuum-operated, the washer squirts twin jets of water or washing solvent on the windshield when you touch a dashboard button. The wiper then clears the shield. A 2-qt. reservoir is located under the hood.





Land Cruiser

IS DE LUXE HOME ON WHEELS

At home abroad. This 30' traveling home has all the comforts of a four-room house.

It gets its power from a front-wheel-drive motor built as a removable unit with the clutch, axle, and transmission.

WHEN it comes to vacations, this land cruiser with a strong resemblance to a cross-country bus combines the speed of motor travel with the comforts of yachting. It will accommodate eight persons with such conveniences as a galley, lounging rooms, observation tower, sleeping quarters, shower, and intercommunication phones.

The de luxe home on wheels was built to specifications for Dr. H. J. Sealey, of Dumont, N. J., by the Linn Coach & Truck Corp., of Oneonta, N. Y. Its 125-hp. Hercules engine was put into a Linn front-wheel-drive unit and is accessible from inside, as in the Linn trucks, when an interior hoodlike covering is lifted.

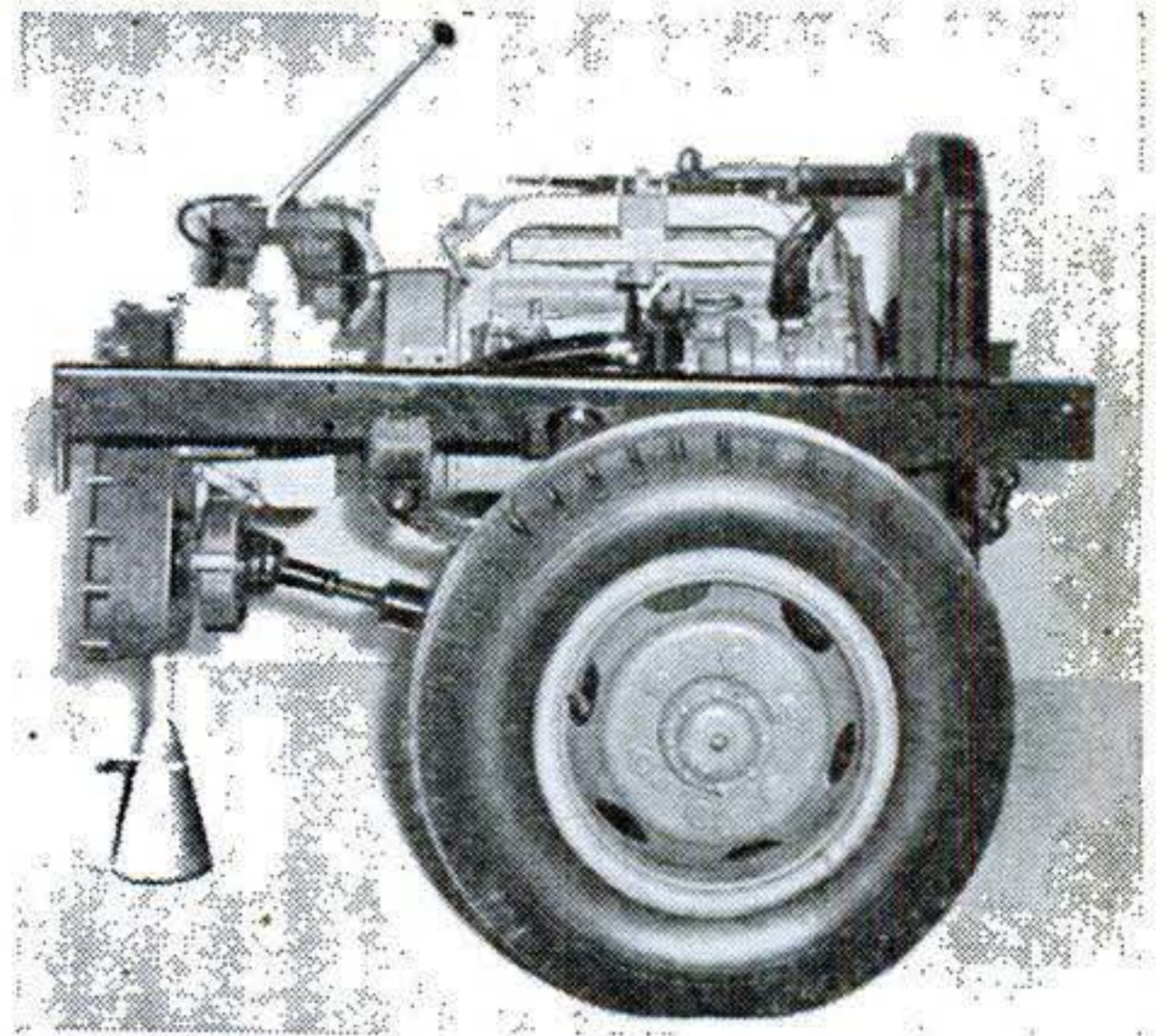

Accessible from within the driver's cab, the engine is exposed for minor repairs and adjustments by lifting the inside hood.

Beds for two persons can be made up in the main living room, and there are sleeping quarters for six more. A shower, galley, and observation tower are included.

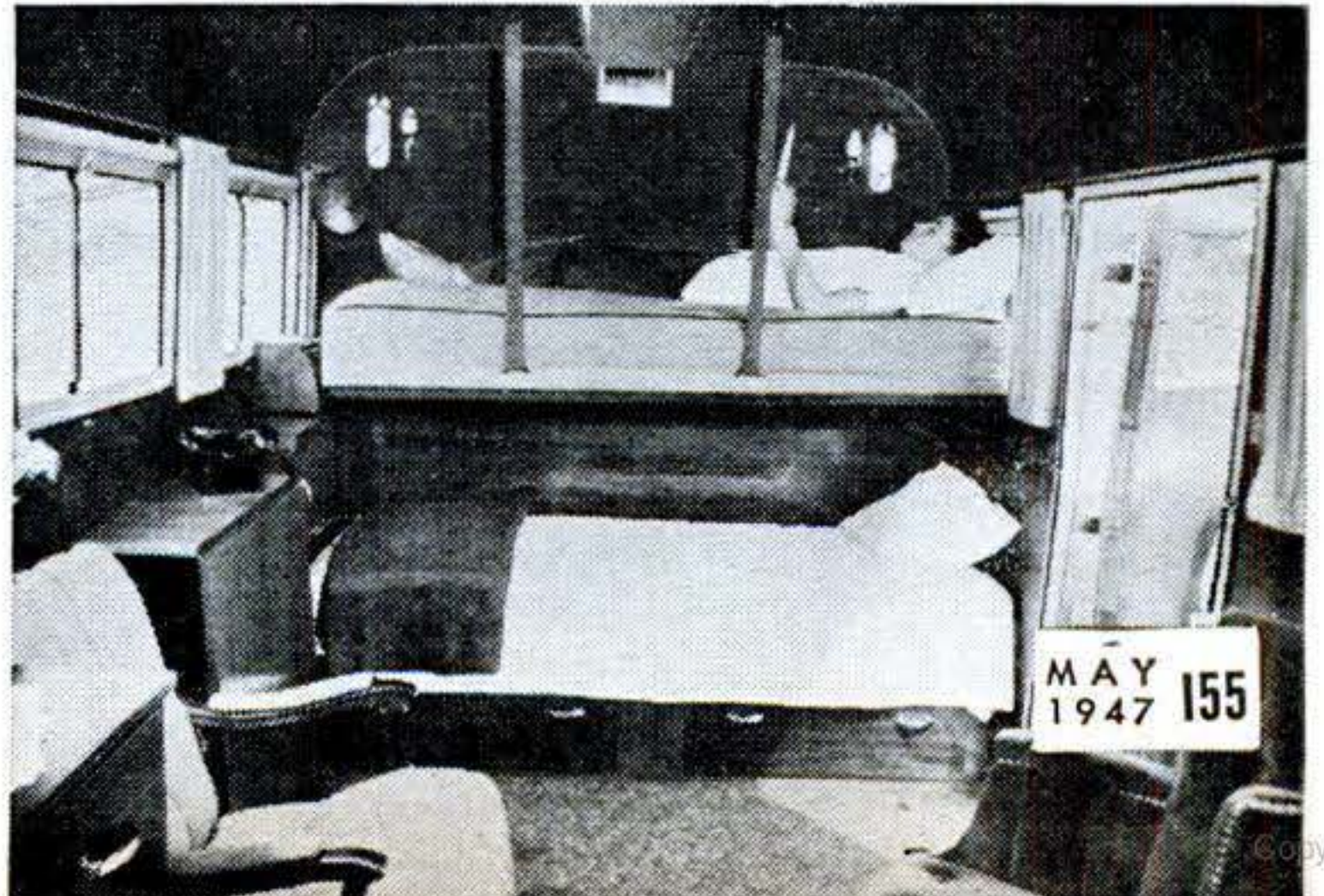

Tune Your Car for a Carefree Vacation

By R. P. STEVENSON

PSM Photos by ROBERT F. SMITH

VACATIONS always are more restful and interesting if free of the cares of your everyday life. For this reason, it will pay you to become a worry wart for a week or two ahead of time, if you are planning a motor trip this summer, and check over your car to see that it is in the best possible condition. For some of the more difficult jobs, you probably will want to take it to your serviceman, but there are many things you can do yourself, some of them minor and routine but all adding up to greater effi-

ciency for your car and more travel comfort for yourself.

Such a pre-vacation checkup is particularly advisable if you are planning several days of steady driving, for minor defects that may not amount to much in short trips around home are apt to turn into major repair jobs under the stress of long runs. For example, you may have been getting along with brakes that are not quite equalized, or a grabbing clutch. On a long trip, bad brakes may damage your tires and it is possible that a grabbing clutch could magnify itself into a smashed transmission, rear end, or universal joint.

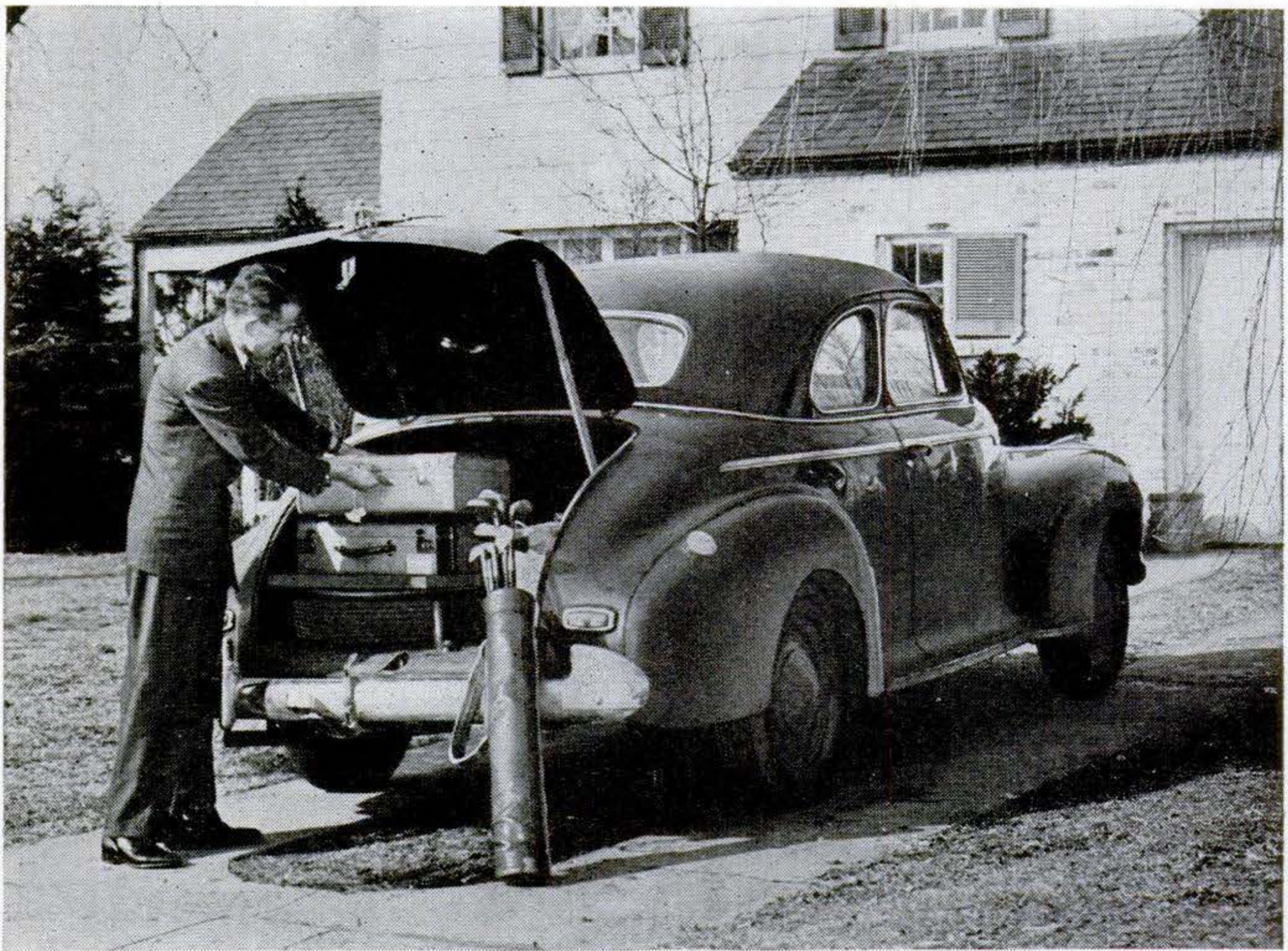

Before you set out, check the car thoroughly so it will not turn your trip into a series of garage stopovers. A can of motor oil stored with the luggage will help guard against burned-out bearings.

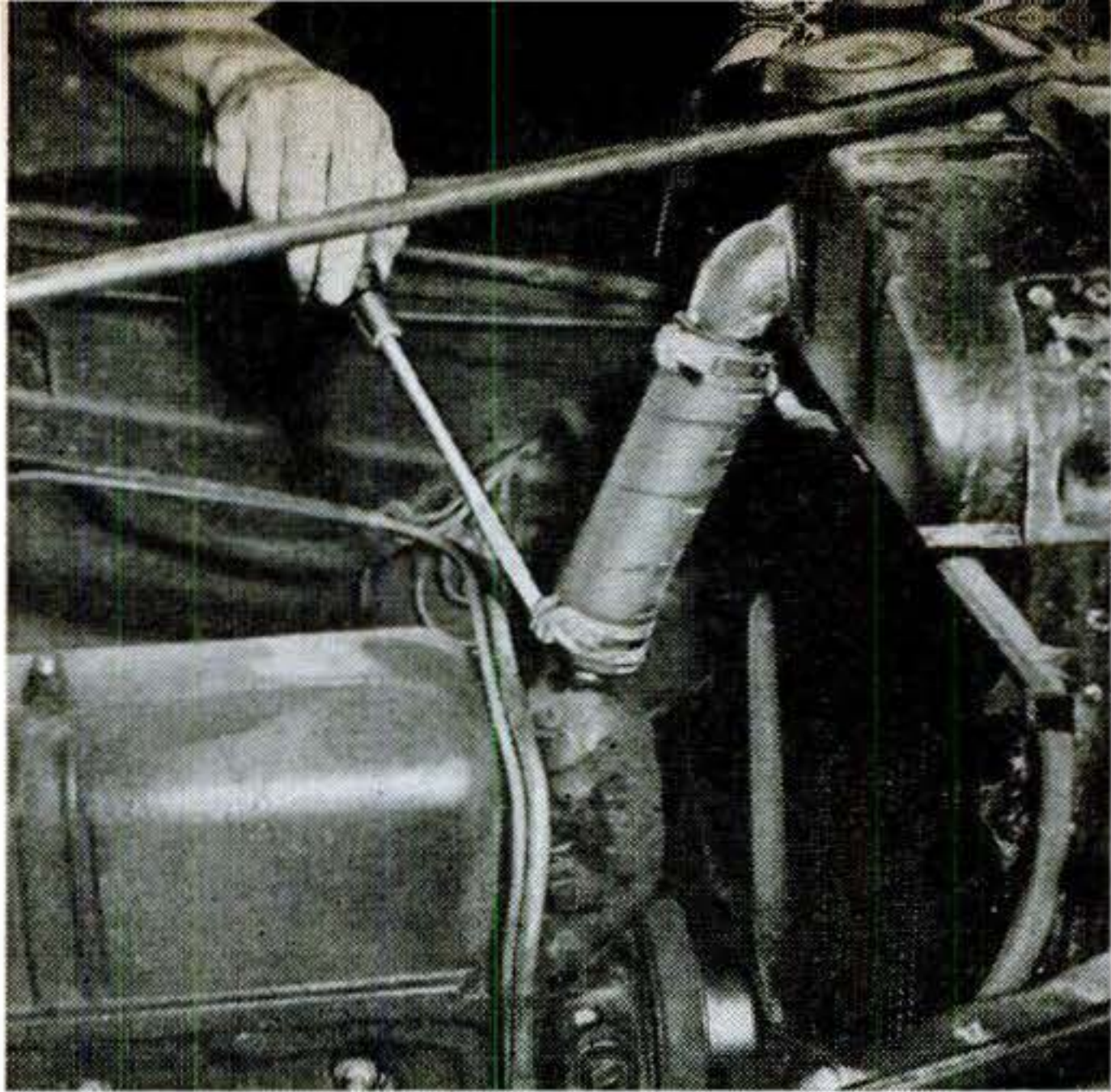

Hot weather and fast driving place a heavy burden on the cooling system. So tighten the hose clamps and adjust the fan belt, or replace it if frayed.



Also flush out the cooling system. Reverse flushing is more effective in cleaning out the corrosion, but a hose used in the old way will help a great deal.

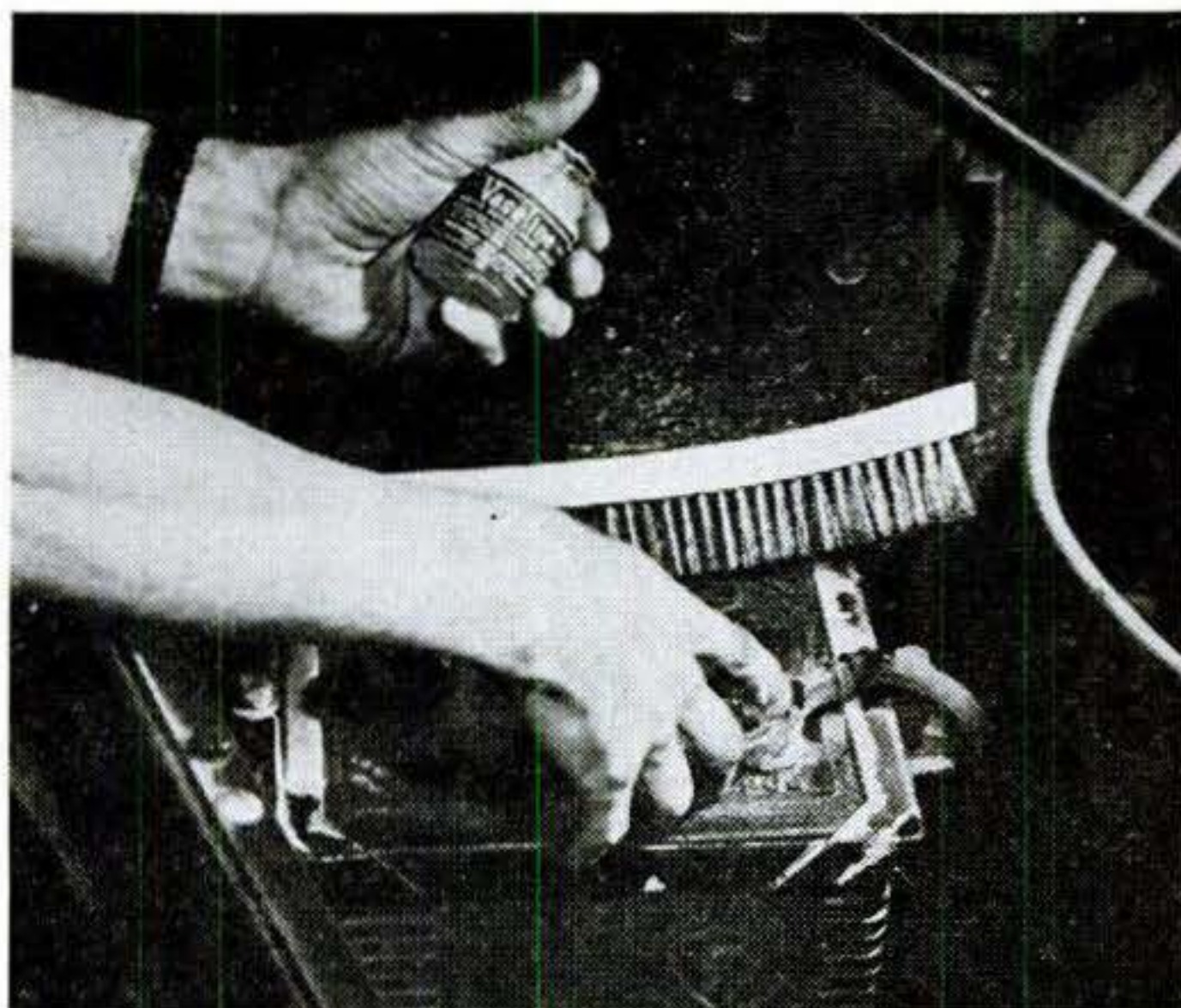

With a wire brush, clean off the corrosion from the battery terminals. Then apply a light coating of petroleum jelly. Also check over the cables and be certain each one is making good contact.



Remove the mesh filter from the air cleaner and wash the dirt from the filter with gasoline. Then dip it into a container of light oil and allow to drain for some time before returning to its place.

Before settling down to a consideration of the more serious jobs, like checking the brakes, adjusting the carburetor to give the best mixture for summer driving, cleaning the spark plugs, flushing the cooling system, and inspecting the tires, it would be well to give a thought to a few things that are so obvious that they could easily be overlooked.

You may *think* you are adequately prepared to handle a task such as changing a tire on the road—but are you? Check to be sure you actually have a jack, tire pump, lug wrench, tire iron, and tube-repairing kit in the car. Such equipment has a habit of getting left in the garage or cellar after being used for other jobs. Even at the last moment, you better take a look at the tire pump again, since Junior may have bor-

rowed it to inflate his bike tires or football.

While you are making sure of your tools, think about storing a gallon can of motor oil in the luggage compartment. It's sometimes a long distance between service stations—and that oil reserve could easily be the means of preventing your bearings from burning out. Incidentally, keep a close watch on the oil consumption for the first few hundred miles driven at good speed, for the car may have developed into an oil hog since your last long trip without showing it in routine day-to-day driving.

Before you set out, give your battery the same kind of check that you should anyway about every two weeks. See that the water level in each cell is at least $\frac{3}{8}$ " above the plates, adding distilled water if necessary;

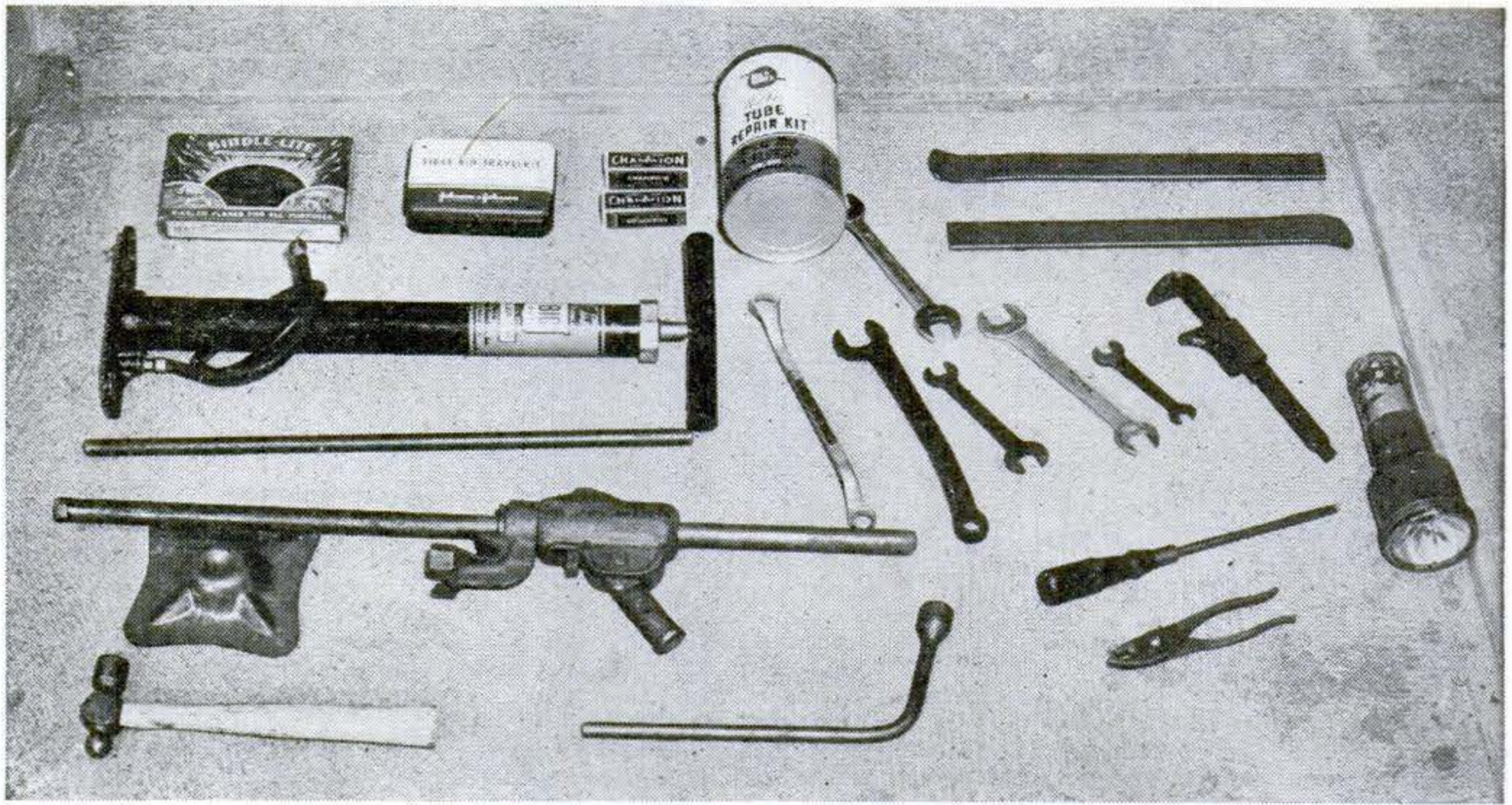

Are you prepared for any emergency that might arise on the trip? Spread out your tools and equipment on the driveway and check them over to see that nothing essential is missing. In addition to the items seen here, a provident driver will take along chains, spare fuses, and extra bulbs for the accessory lights.

and take a hydrometer reading of each cell. Fully charged, the battery should have a specific gravity reading of 1.280 to 1.300. If the reading is below 1.250, have the battery recharged.

At the same time, clean any corrosion from the battery terminals with a wire brush, wash the posts and lugs with baking soda and water, and rinse with fresh water. A coating of petroleum jelly will help keep them clean. Go over the cables and be sure that they are in good condition, and that they make firm, low-resistance connections.

Unless you have done so quite recently, it would be well to change the crankcase oil and the transmission and rear-end lubricants, and have the car lubricated throughout. It's a good plan to refill the shock absorbers, too, and to replace any defective links. At the same time this is being done, make a painstaking inspection of the brakes, looking particularly for leaks in the hydraulic system. Have the linings replaced if you suspect they are worn to, or almost to, the rivets.

Go over each tire carefully for cuts, bruises, nails, and worn spots that may indicate unbalanced wheels, uneven brake action, or shimmy. Make this tire inspection after removing the wheels, and then transfer each to another position to get more even wear. On your pre-vacation visit to the service station be sure to have the wheels

checked for alignment, for there is nothing that will ruin your tires more quickly than improper front-end alignment.

On a long trip at high speed, the cooling system must work at its best. Hence, the radiator should be flushed thoroughly to remove any corrosive deposits that might eventually work loose and clog the system. There is a difference of opinion whether the permanent antifreeze mixtures should be removed during the summer, but even if you want to leave the mixture in, it is a good idea to remove it temporarily, flush the system, and replace the mixture. While working on the cooling system, also adjust the fan belt to the proper tension. Replace the belt if it shows any sign of raggedness or is oil soaked.

While it may be best to have an expert set the carburetor for the most economical performance, there is one seasonal adjustment on many carburetors that anyone can make with ease. This is an adjustment that in winter causes the acceleration pump to shoot an extra charge of gasoline to your cylinders when you step on the gas. For summer, this should be set to pump a smaller amount.

If your car has an automatic choke, as it probably has, you will find a tiny wire-mesh air filter inside the choke housing. Remove this and clean with carbon tetrachloride—or if it looks hopeless, throw it away and get a

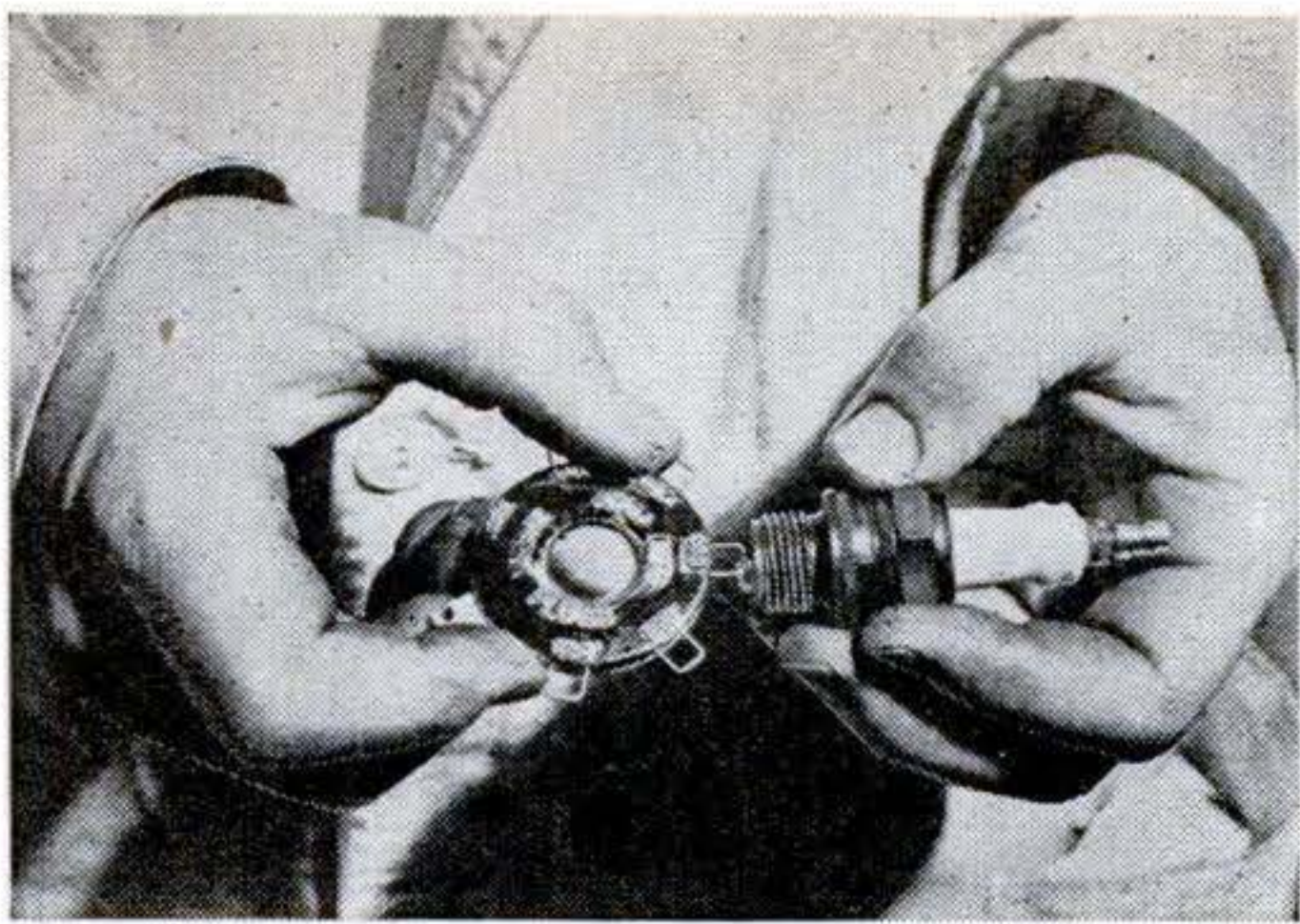

After scraping carbon from the spark plugs, check the gap on each with a wire gauge. If adjustment is necessary, bend only the side electrode.

new one. Also remove the filter from the air cleaner, wash out the dirt with gasoline, dip the filter in light oil, and drain before replacing. Clean the oil-filler cap in the same way. The sediment bowl in the fuel pump is still another cleaning job you should take care of.

Spark plugs are deserving of special attention. Before touching them, however, carefully brush away all dirt so it will not fall into the cylinders when the plugs are removed. If a plug is found to be cracked, badly worn, or oxidized, replace it. If it's still in good condition, scrape the accumulated carbon from the electrodes and check the gap with a wire gauge, bending the side electrode only if any adjustment is needed.

Next, turn to the distributor, inspecting the housing for cracks. If the points are pitted, smooth them with a coil file or replace, remembering that an accurate setting is required for smooth functioning of the engine. It is essential, too, that the timing (that is, the distributor vacuum-advance) be exactly right since this is a prime factor in good performance, and good performance will be especially important to your peace of mind during a vacation.

On a long trip, it is remarkable how annoying you may find a little squeak that you scarcely notice while driving around home. So locate it if you can—and tighten up the joint or apply a little oil. In any case, apply a little graphite lubricant to the wedge-plate and dovetail assemblies of the doors. You may be surprised at what a difference this makes in giving you a quieter ride.

In addition to the tools and equipment previously mentioned, consider taking along

a good set of chains—for on side trips in some rural areas you still may get bogged down in mud or sand. And speaking of weather, you undoubtedly are hoping that the sun will shine throughout the trip. However, it may not. So why not check the windshield-wiper hose for leaks right now—and be prepared?

A provident driver, especially if the trip is to be in lonely country, also would have on hand such things as flares, duplicate fuses, and spare bulbs for the taillight, backup light, and dash light. A duplicate set of keys—door and trunk or spare—is another good idea, but don't carry them yourself. Give them to a companion—or wire them to some inconspicuous place on the car that's accessible from the outside to someone who knows where to look.

Lastly, if you are like most other people, your glove compartment probably could stand some attention. Clean out the mixture of bobbie pins, gum drops, old envelopes, and other debris that probably finds a haven there, and replace with insurance papers, several up-to-date maps, a flashlight, some spare matches and cigarettes, and any other personal items that will help bring you back alive and in good spirits. END

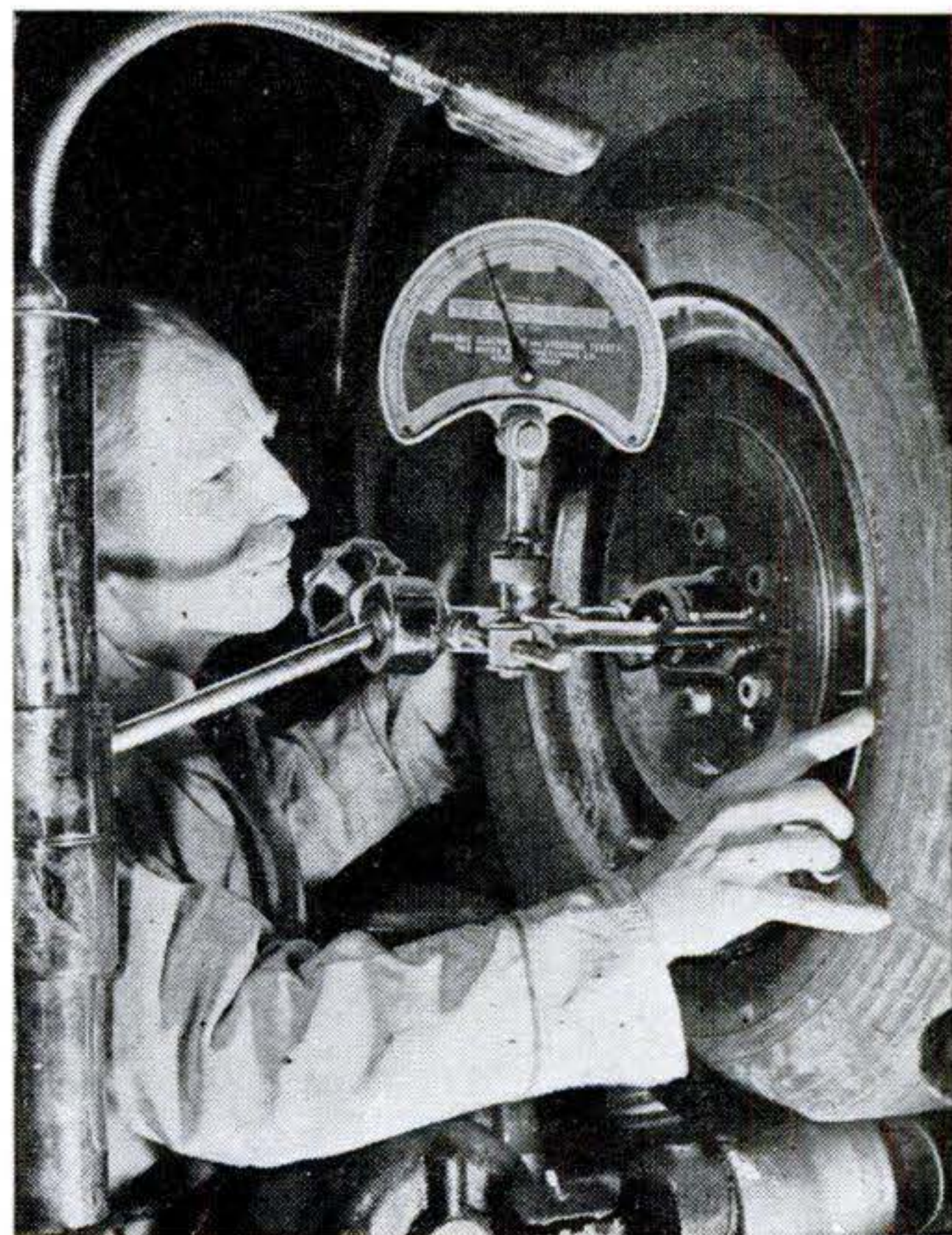

On a pre-vacation visit to your service station, have the wheels aligned. It is estimated that a tire $\frac{1}{2}$ " out of line is dragged sideways 87' each mile, reducing life of the tire 20 to 50 percent.

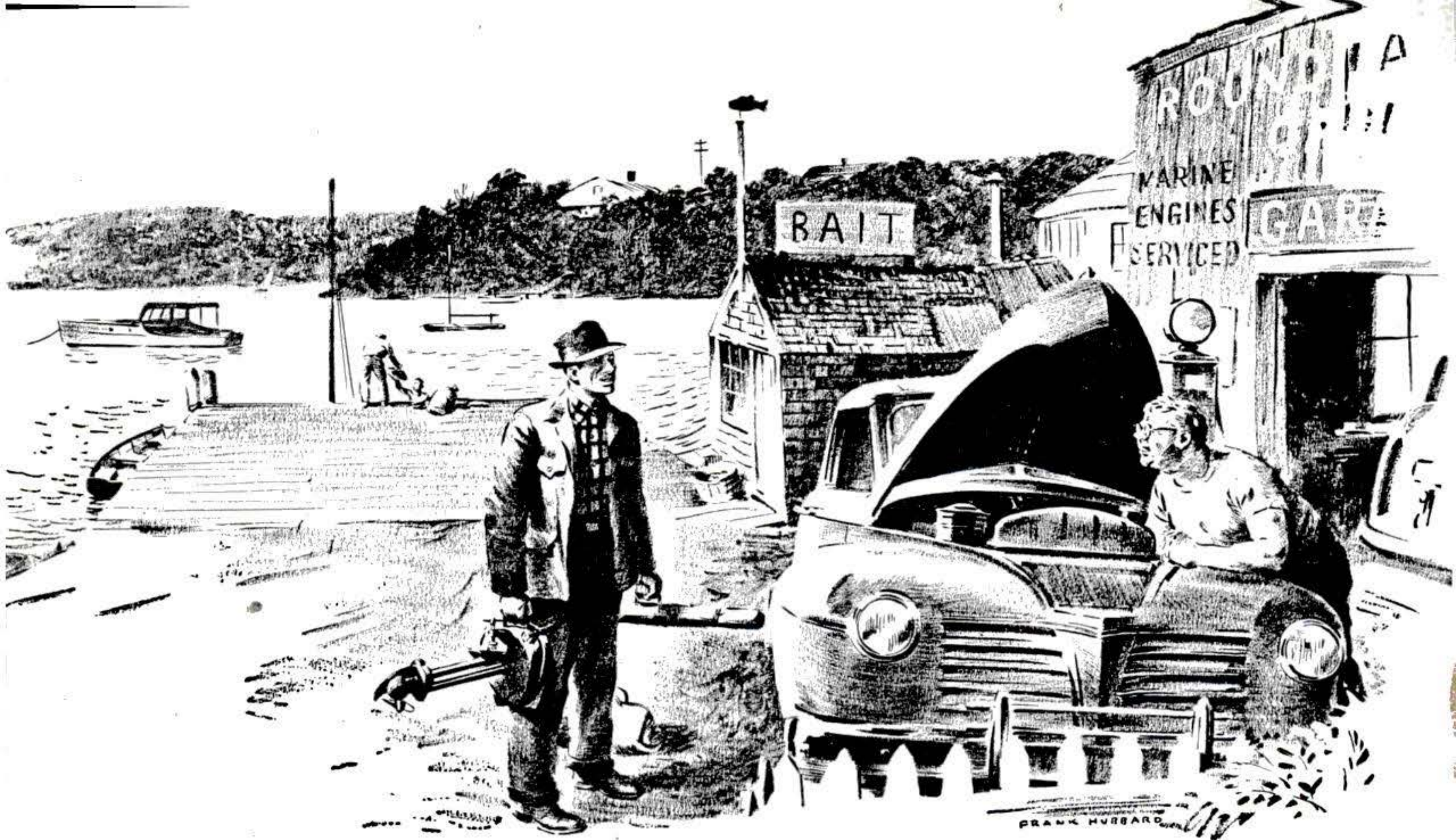

GUS Settles an International Incident

By MARTIN BUNN

STAN HICKS has a habit of acting first and thinking afterward. That's what he did late one afternoon when a convertible with its horn blowing continuously was driven up to the Model Garage. He dashed to the shop door, opened it, and motioned in the sheepish young man at the wheel.

Gus Wilson, intent at the workbench, looked up startled as the continuously blasting horn echoed in the garage. Then he hurried over, raised the hood, and deftly disconnected the horn relay. Quiet returned to the shop.

The driver climbed out—Paul Tarlin, a young man who's been going right up the ladder at our town's bank. It was the opening day of the bass season and his clothes told Gus that he'd been fishing. "Hello, Paul," Gus greeted him. "Get any bass?"

Paul shook his head. "They wouldn't

touch a thing," he said dourly. "Say, that's the second time the horn's done that. The first time my wife was with me, and did she raise the roof! She always blames me if anything happens to the car—and you ought to see what *she* does to it!"

Gus bent over to examine the wiring so he wouldn't have to answer that one.

"Short in the relay," he diagnosed after a moment. "If the owner of a '39 bus hasn't anything worse than that to worry about, he ought to be a happy man."

Paul grunted. "As a matter of fact, there is something else. The engine's begun making a queer sort of noise—it sounds as if there's something wrong with a bearing. I noticed it driving up to Round Lake this morning. It kept getting louder and louder, especially when I went over 40."

"There's a one-man garage at the boat landing, and I told the man there to take a look at the engine while I was fishing. The

bass wouldn't bite, so after an hour I decided to drive over to Clear Pond. Back at the landing the garageman told me the trouble was that the oil was too thin. It sounded reasonable because I was still using winter oil, so I had him drain the crankcase and put in No. 30."

"Did that help any?" Gus queried.

"For a while it seemed to," Paul went on. "But before I got to Clear Pond the noise was back as loud as ever. I parked the car and fished for a couple of hours, but I couldn't get a single strike, so I thought I'd call it a day. On the way back the engine ran quietly for a few miles and then it started making the same racket.

"At the Coatsville Garage the mechanic told me that the trouble was in the connecting-rod bearings. He said I could make it home all right if I went slow. I kept under 35 all the way and didn't have any trouble, though the noise was there all the time. It must be made by a bearing that's quiet when the oil is cool and thick, but gets noisy when the oil thins out."

He started the engine. Gus's trained ear immediately picked up the sound, a regular thudding knock that speeded up as Paul opened the throttle. After a moment he signaled Paul to cut the switch.

"It could be a con-rod bearing, and it could be something else," Gus mused. "Anything I told you now would be just a guess. Suppose you let me do a job of checking and we'll know for sure."

Paul looked at his watch. "I've got to get home now," he said. "Agatha has to use the car tonight, and she'll be madder than a wet cat that I'm this late. How'd it be if I bring it in before work tomorrow so you can give it a good going over?"

"Make it day after tomorrow," Gus amended. "Tomorrow I'm going fishing."

"They won't bite," Paul predicted glumly.

THE NEXT day, with Gus fishing and Joe Clark busy in the office, Stan Hicks was feeling comfortably important when a blonde young woman brought a convertible to a rubbery stop at the gas pump. "Fill it up with petrol," she directed in clipped accents.

"Huh?" Stan demanded.

"I said," the young woman repeated, "fill it up with pet—I mean, gasoline."

"I getcha," said Stan. "Switch the engine off, please—no, wait a moment." He listened intently. "Hear that noise?"

She listened. "I do rather hear a thump,"

she admitted. "Where does it come from?"

Stan raised the hood, looked as wise as he could, and listened again. "Loose connecting-rod bearings," he announced.

"Oh, bother!" said the young woman.

"You better have it fixed right away," Stan told her. "Otherwise your crankshaft might be scored, and then you *would* be in trouble."

"Bother!" she repeated. "It must have happened since I took Paul down to the bank this morning. If there'd been a thump then he would have noticed it—he's such a fuss!" Her pretty face hardened. "Now he'll say I've ruined his blawsted motor car! How long will it take to tighten those things?"

"Can't tighten them—have to put in new bearings." Stan hesitated because it was really too big a job for him to tackle alone. Then he yielded to the temptation to show Gus how good he was. "I'll have it done by four o'clock," he promised.

"Cheers!" she said, and climbed out.

In the next few hours Stan hung up a new personal record for sustained effort. At quarter to four, when he had the oil pan back on, Gus Wilson drove into the shop. The bass hadn't bitten and he had quit in disgust. "What's all this?" he asked Stan as he eyed the discarded bearing shells.

Stan tried hard to be nonchalant. "Con-rod bearing job for Mrs. Tarlin," he said. "I was just going to road-test her car."

Gus looked surprised. "You mean *Mr.* Tarlin, don't you?"

"Nope—Missus."

"Oh," said Gus. "I see. . . . I'll go with you." Stan drove the convertible out of the shop and up the highway. It purred as contentedly as a cat that sees the top taken off the cream bottle. After a mile Stan started back. "Keep going," Gus told him.

Stan drove on. After another mile Gus's quick ears picked up a noise from the engine—the same muffled knock that he had listened to the day before. He watched a crimson flush spread from Stan's cheeks to his ears and to the nape of his neck. After a minute, his eyes still on the road, Stan muttered, "Go ahead, boss—say it!"

Gus laughed and gave his deflated assistant a friendly poke in the ribs. "You're not the only mechanic in this car who's made a good job of fixing the wrong thing," he said. "Let's get back to the shop."

When they got there, Agatha Tarlin was waiting. "Is my motor car all right now?"

Stan, in the throes of another hot flash,

muttered unintelligibly. Gus went to his rescue. "I'm afraid it isn't," he said. "You see, that noise that Paul noticed yesterday—"

Agatha's lips tightened and her blue eyes flashed. "Oh," she interrupted grimly, "so Paul did something to the car yesterday, and didn't say anything about it so he could blame it on me! That was simply caddish! And I'm going right over to the bank to tell him so!"

"Well, now," Gus mollified, "I wouldn't—" But Agatha was already out the door.

Gus shrugged helplessly. Then he got a steel rod, placed one end of it on the cylinder head, and put his ear against the fist holding the other end. The engine was still running, and with his improvised listening rod he could hear the knock better. "It might be the wrist pins," he said, "but it sounds more like—Stan! Help me get this cylinder head off!"

THEY were ready to lift the head-free when the shop's quiet was shattered by the sound of high-voiced contention. Paul and Agatha arrived together, both talking at the same time. "What do you mean, it isn't my car—just lend-lease?" she shrieked. "I've listened to just about enough such talk, Paul Tarlin!"

By then Stan was carrying the head to the workbench. Gus took one look at the pistons, and quelled the riot by pounding on an oil can with a wrench. "If you kids will quiet down for a moment, I'll show you that you're scrapping about nothing at all," he announced. He pointed to the exposed pistons. "The normal clearance between the pistons and the head on this engine is about an eighth of an inch. See how the carbon has built up on these pistons until it practically

fills the clearance space? Look at these flat spots—that's where the carbon has been hitting the head and making the noise that started all the trouble.

"As soon as we get the carbon scraped off, the engine will run as smoothly as ever. Neither of you is to blame for this—it's just the result of easy-carbonizing wartime gasoline."

Paul looked at Agatha, but she wouldn't look at him. "That's extraordinarily interesting," she told Gus coldly. "Nevertheless, the beastly car must have been thumping when I drove Paul downtown this morning. Knowing that I can't tell if it makes odd sounds, he didn't say anything about it so he could say later that *I* was to blame!"

Gus grinned. "The engine wasn't making that noise when you started out this morning. You see, when it's cool the pistons and rods contract sufficiently to clear the head. So there isn't any noise until the car has been driven a few miles."

Now Agatha looked at Paul, and after a moment they both laughed. "I say, Mr. Wilson," she said with a grin, "it rawther looks as if *I*'d been the fuss this time, doesn't it? I'm most dreadfully sorry."

"Skip it," said Gus cheerfully. "If an Englishwoman driving in this country can keep on the righthand side of the road, she's doing well." Agatha made him a graceful mock curtsy.

"And as for the new bearings Stan put in," Gus went on, "your old ones don't seem to have been in bad shape. So you'll have a new set free, and Stan here will have learned not to jump at conclusions. Something which," he finished with a twinkle as Agatha took Paul's arm, "seems to have caught on generally."



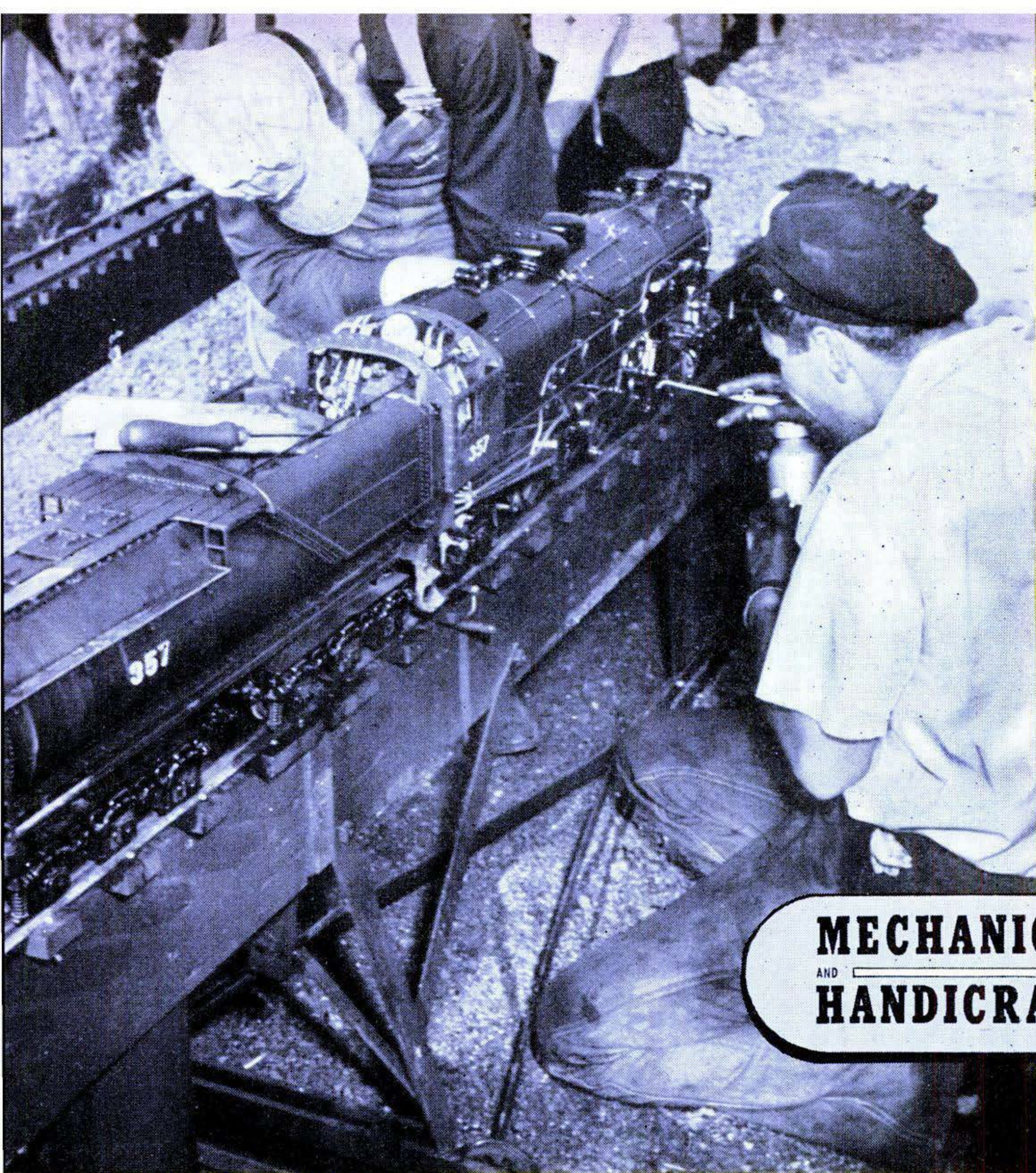

MECHANICS AND **HANDICRAFT**

- **Highballing on Live Steam**
- **Paper Control-Line Plane**
- **Briefcase Radio**
- **Installing Mortise Locks**
- **Spontaneous Combustion**

MAY
1947 163



Dry-Cell Lamp Goes Anywhere

By JACK MELLINGER

FLASHLIGHTS have uncounted uses, but even their most enthusiastic admirers have never suggested that they make attractive table fixtures. This colorful lamp is essentially an unfocused flashlight, but it also deserves a prominent place in your home. Because it will be left out in the open, it will be easier to find and use than the ordinary light that is hidden in a drawer or hung under the back steps.

Since all the wood parts will be painted—in contrasting or matching colors—any soft wood can be used. If necessary, small pieces can be glued up to size. The shape and dimensions given in the drawings are guides; they are not critical and can be altered to

suit your material or your taste. Turn the wood parts first, starting with the cover. In the top of the cover bore a hole large and deep enough to conceal the cap of a mayonnaise or similar jar. The jar itself, when screwed into the cap, will become the globe. Make the lid or shade next, and cut a hole that will fit snugly over the other end of the glass. Turn the outside of the base; then bore out a compartment large enough for three flashlight cells.

For the light itself, use a miniature socket and a three-cell bulb. Solder a long bolt or a rod, threaded at the other end, to the bottom of the socket. Alternatively, you can use a radio pilot-light socket set in a piece of dowel as shown. Drill a hole in the metal jar lid large enough to assure am-

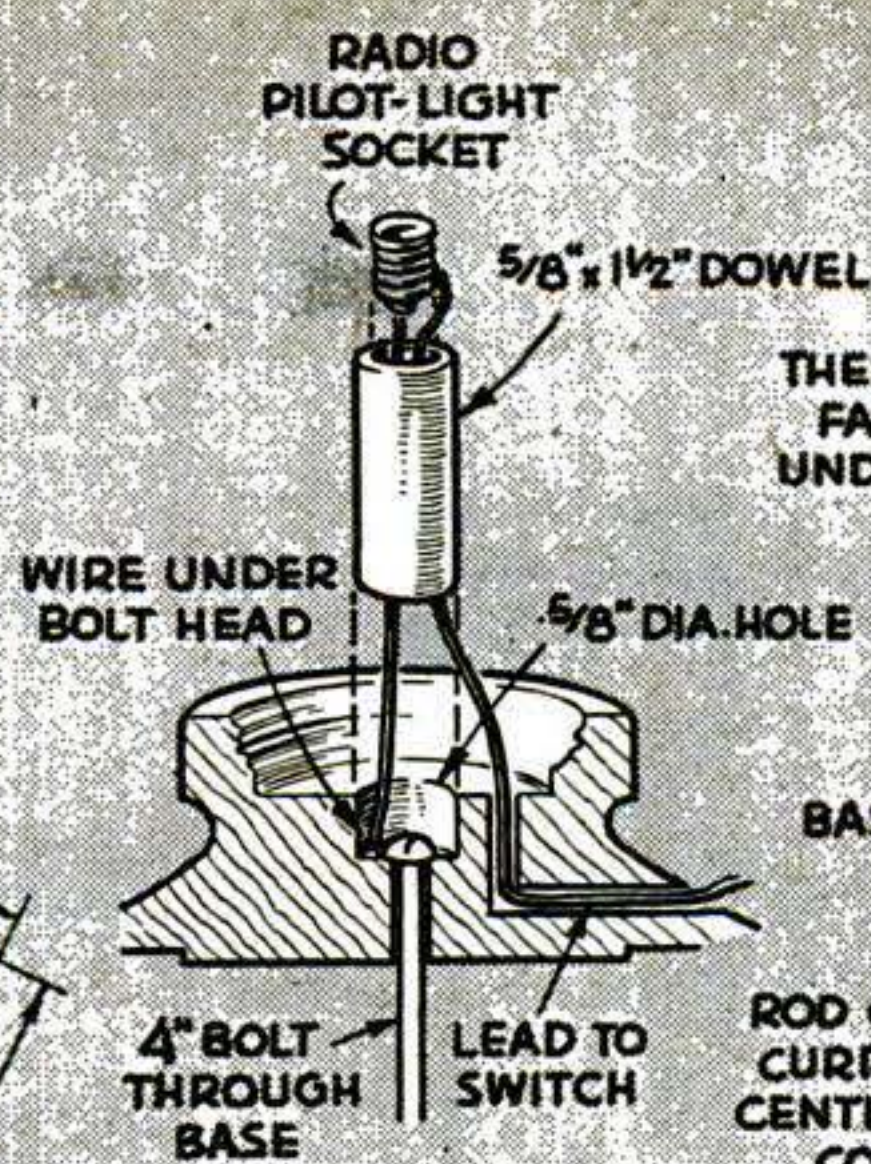
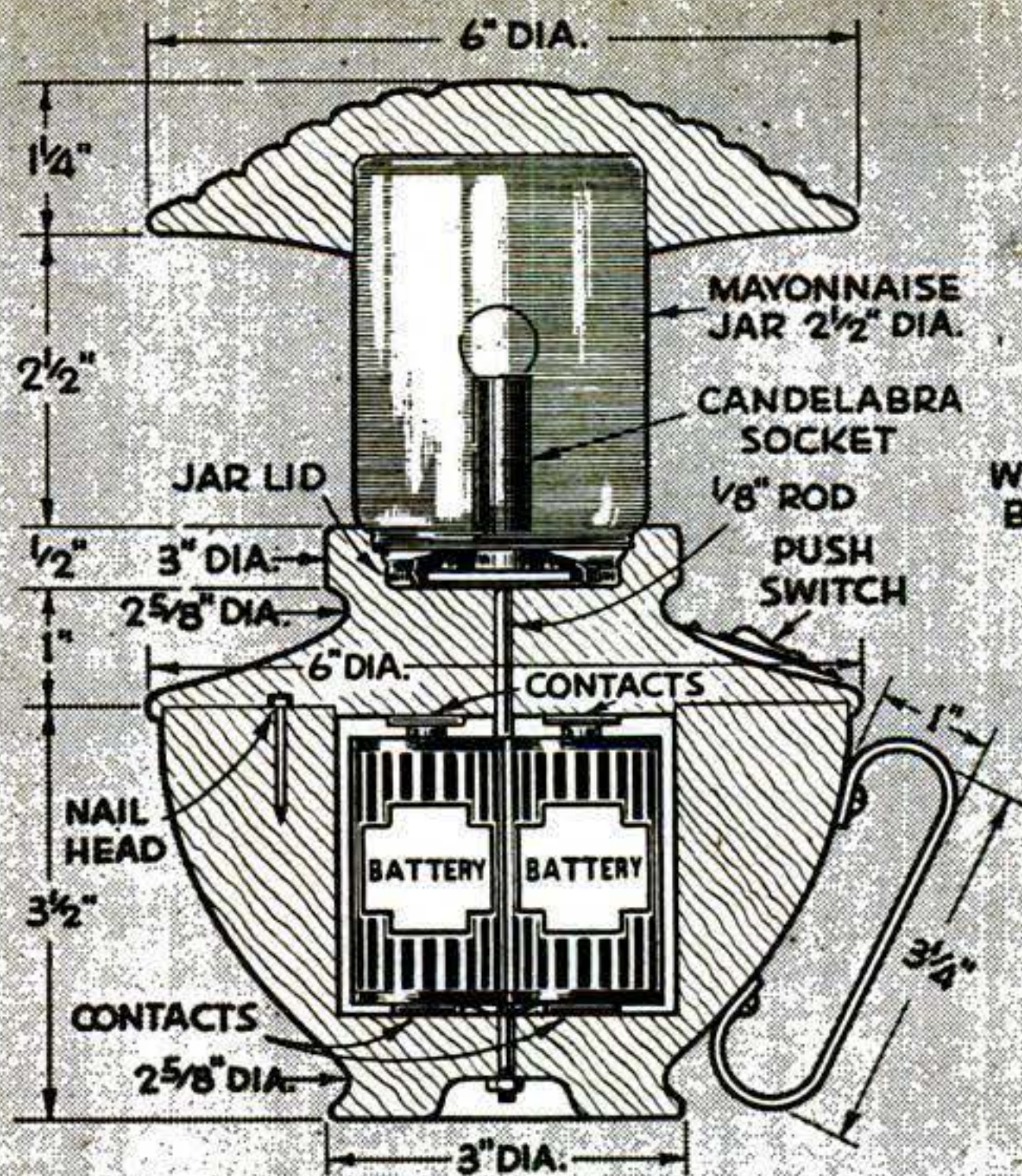

ALTERNATE SOCKET DETAIL

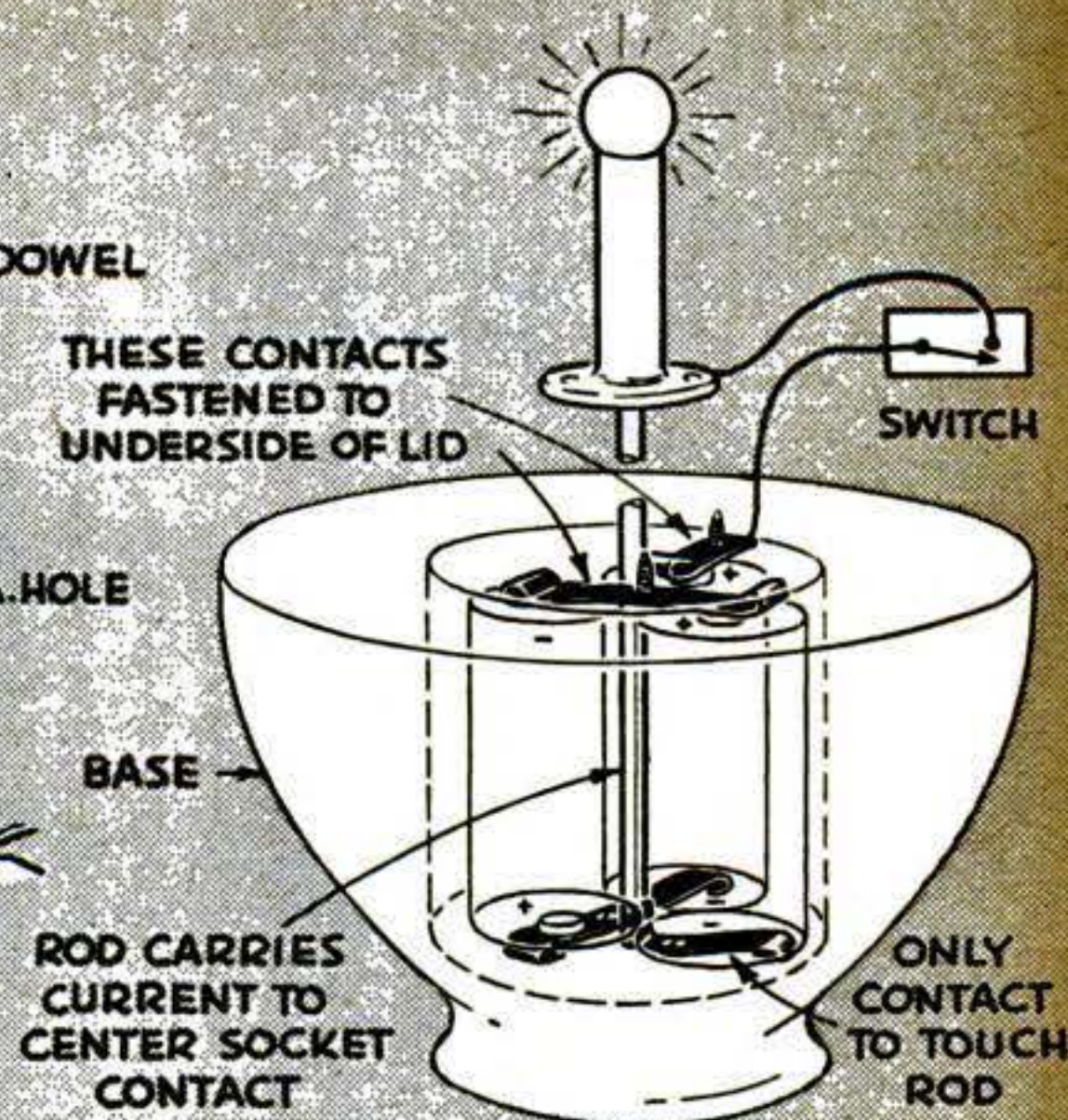

WIRING DIAGRAM



One end of the glass jar is cemented to the wooden shade; the other end screws into the metal lid which is fastened into a recess in the cover.

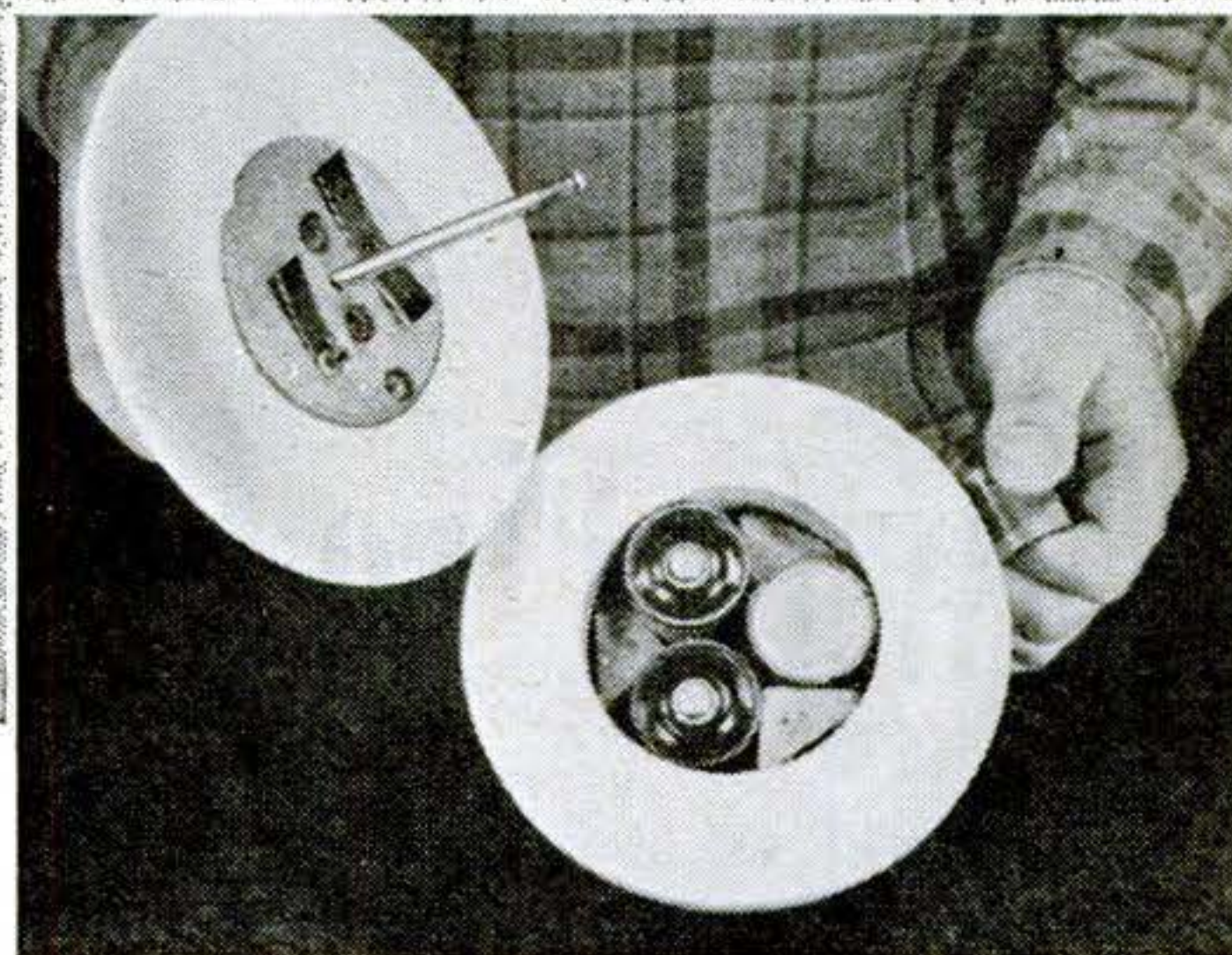

Open view of the lamp. Note the copper contacts in the cover. These must touch the cells and the center rod as shown in the drawing above.

ple clearance for the rod or bolt. Affix the jar lid and socket with wood screws.

A switch taken from an old metal flashlight is ideal; it is flat, inconspicuous, and has a hold and a lock position. Leaving a narrow flange of metal around the switch makes it possible to attach it to the cover with two wood screws.

The three batteries must be connected in series, which means that two will face in one direction and the third in another. Thin strips of spring brass are screwed down to the wood and bent up to make good electrical contact with the ends of the cells. Solder on fairly fine wire leads to the switch and socket, running them through small, inconspicuous drilled holes.

Once the batteries have been put in

place, it is necessary to secure the parts against any movement that will change or interrupt the contact. If the cells fit too loosely in their compartment, wrap them with tape or paper to provide a friction hold on the walls of the compartment. Then, to prevent misalignment of the cover and base, drive a small finishing nail into the base, allowing the head to project slightly. A corresponding hole in the cover will fit over this projecting stud and keep the two parts in the same relative positions regardless of movement or handling of the lamp.

The handle can be made out of a strip of flat brass, a curtain rod, or any similar metal bent to shape and screwed to the base. Attach the top of the jar to the shade with colorless cellulose cement.

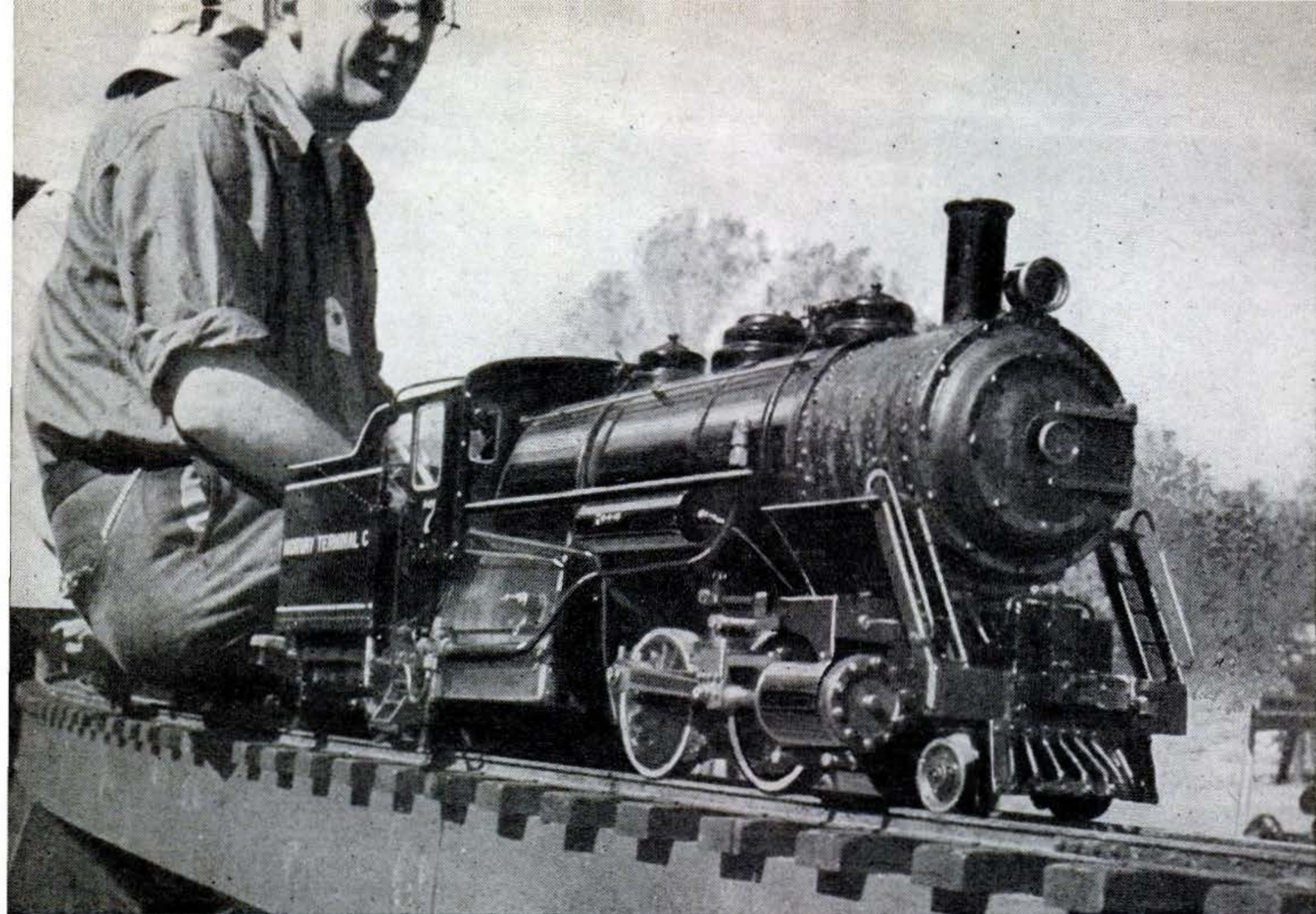

How to Fire Up a LIVE STEAMER

A LIVE-STEAM model locomotive, king of home shop projects, is essentially several hundred pounds of steel and bronze, accurately scaled and painstakingly engineered. Construction time is often several thousand hours. With boiler pressures of 100 lb. or more, it will easily draw six or

eight adults. Such an engine is usually coal-fired and has the familiar coal-smoke-and-hot-oil smell and the familiar (if slightly soprano) *chuff-chuff* of its big brothers. These pictures, taken at a meet of the New England Live Steamers, show steps in preparing for a run on the 3½"-gauge track.

1 The water tank at the back of the tender is filled. Boiler-water level is checked on the glass; if low, a few strokes of the hand feed-water pump quickly bring it up.

2 A few spoon-size scoops of kerosene-soaked coal are now shoveled into the firebox and lighted by a match. The tiny fire door is left open at first to improve the draft. More pea-size anthracite is added as the fire catches hold.

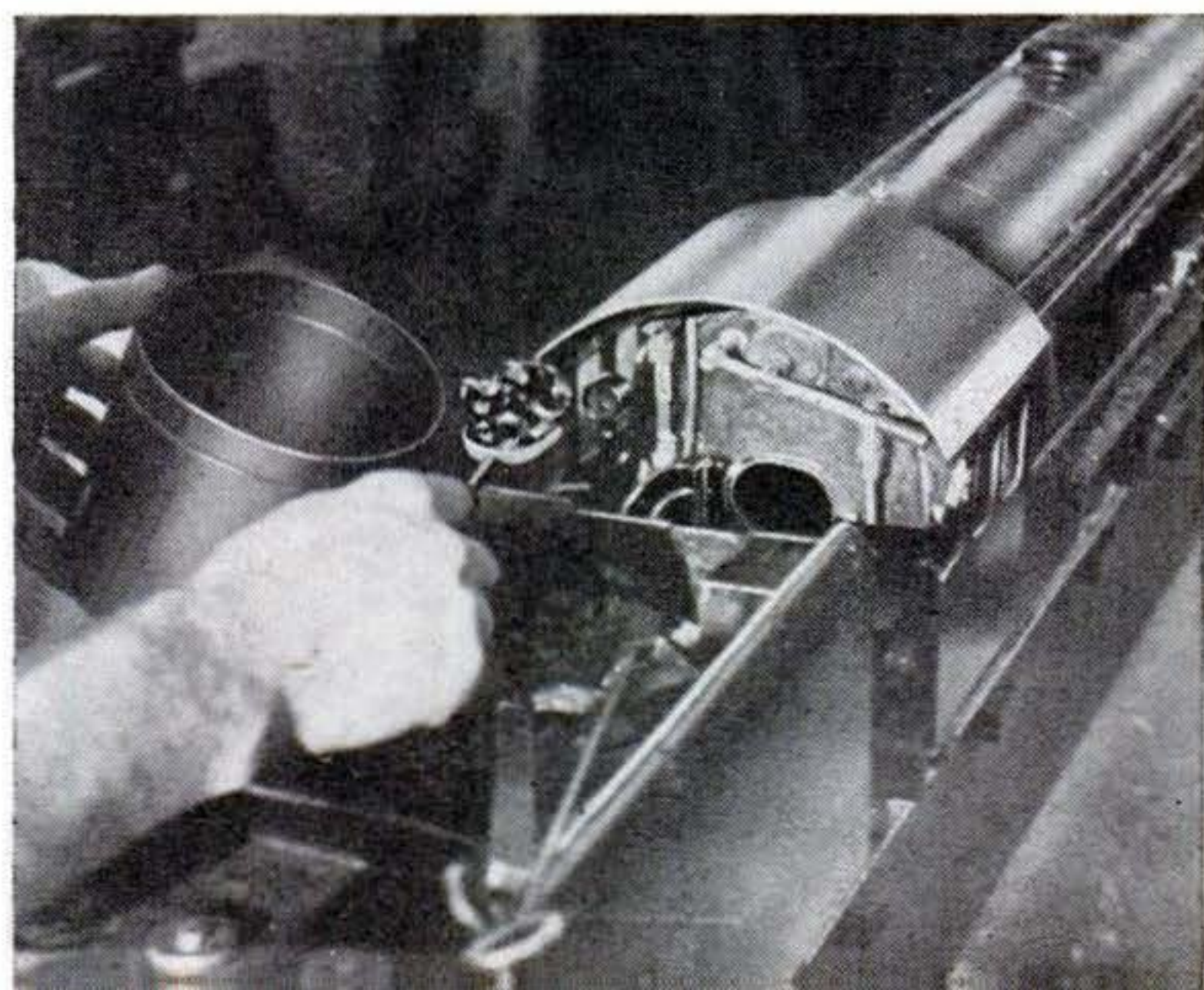
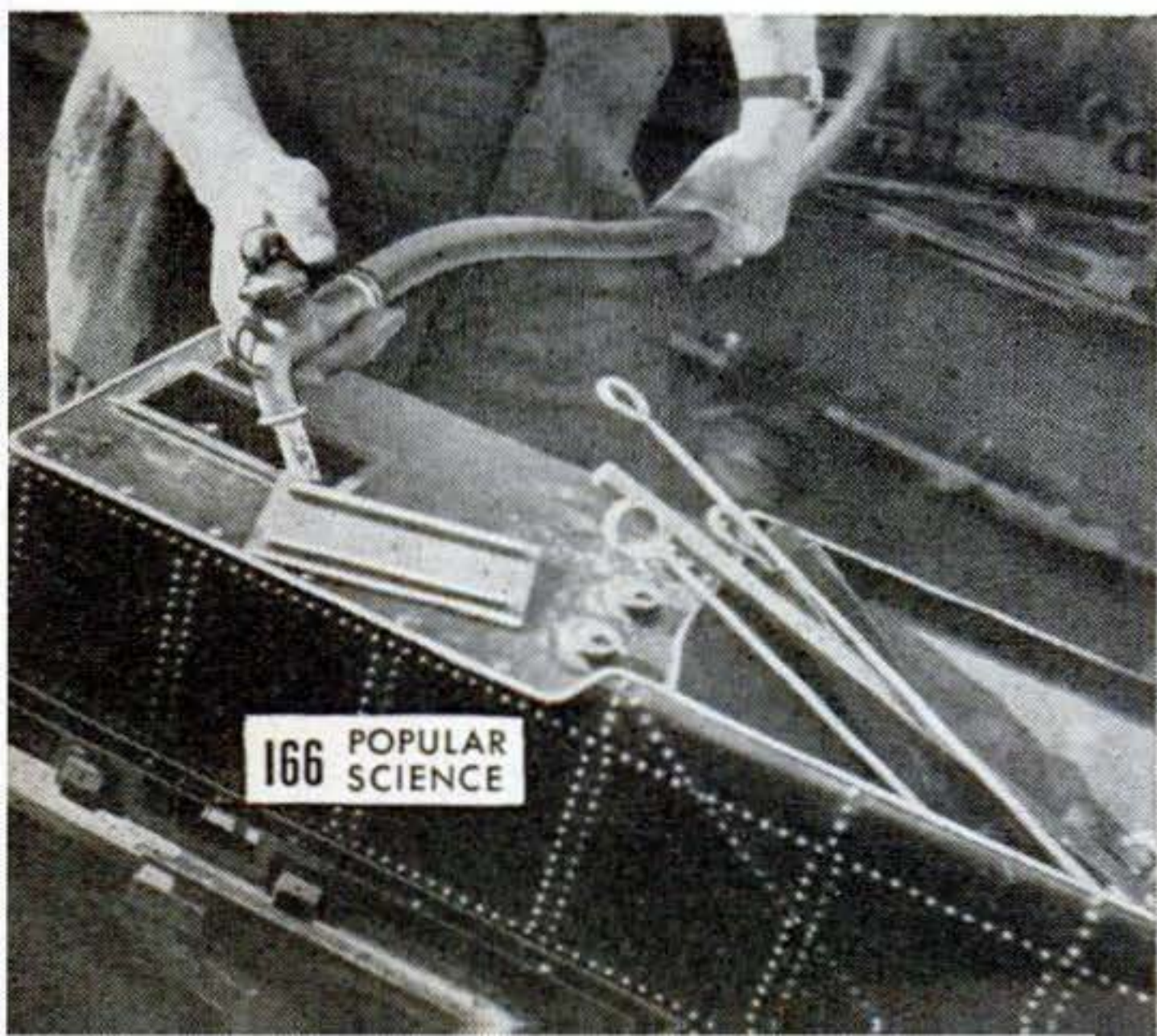

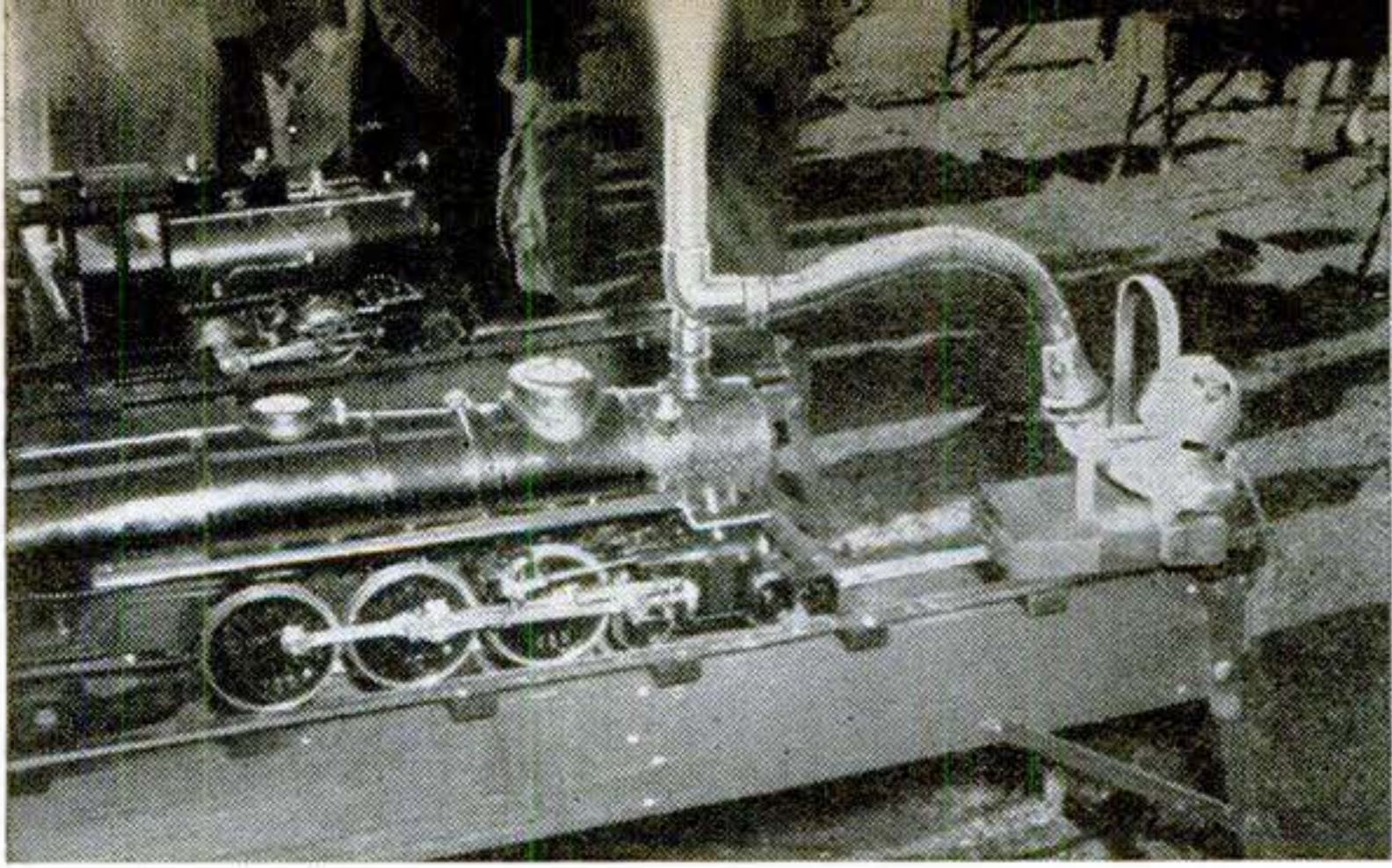

3 A starting blower, consisting of an old vacuum-cleaner motor and jet tube, is connected to the stack to draw air through the fire and get up steam faster. During runs, exhaust steam shooting up the stack performs the same job.

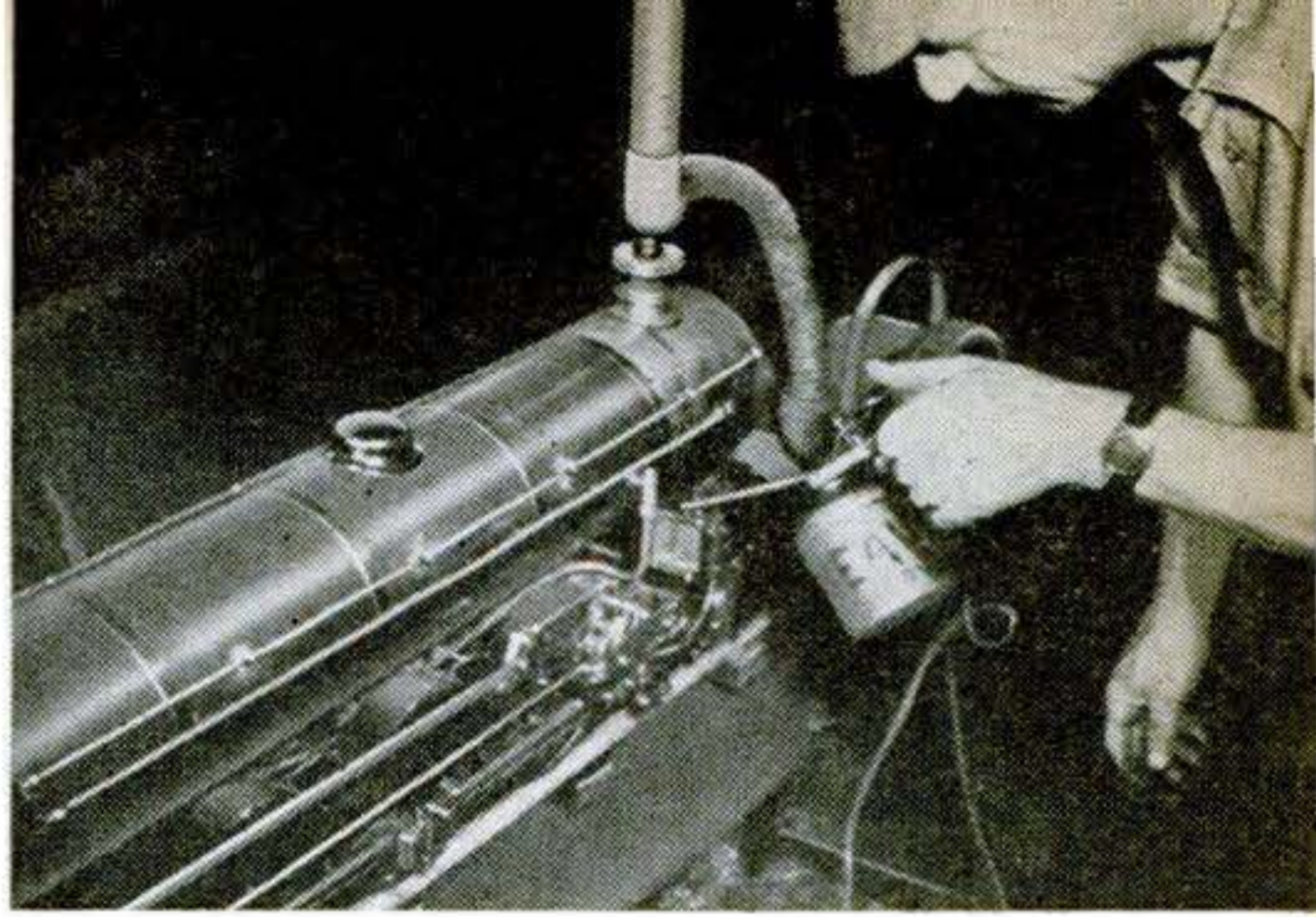

4 While steam pressure builds up, some moments are spent in filling the lubricator and applying oil to the crosshead, valve gear, and the main driver bearings.

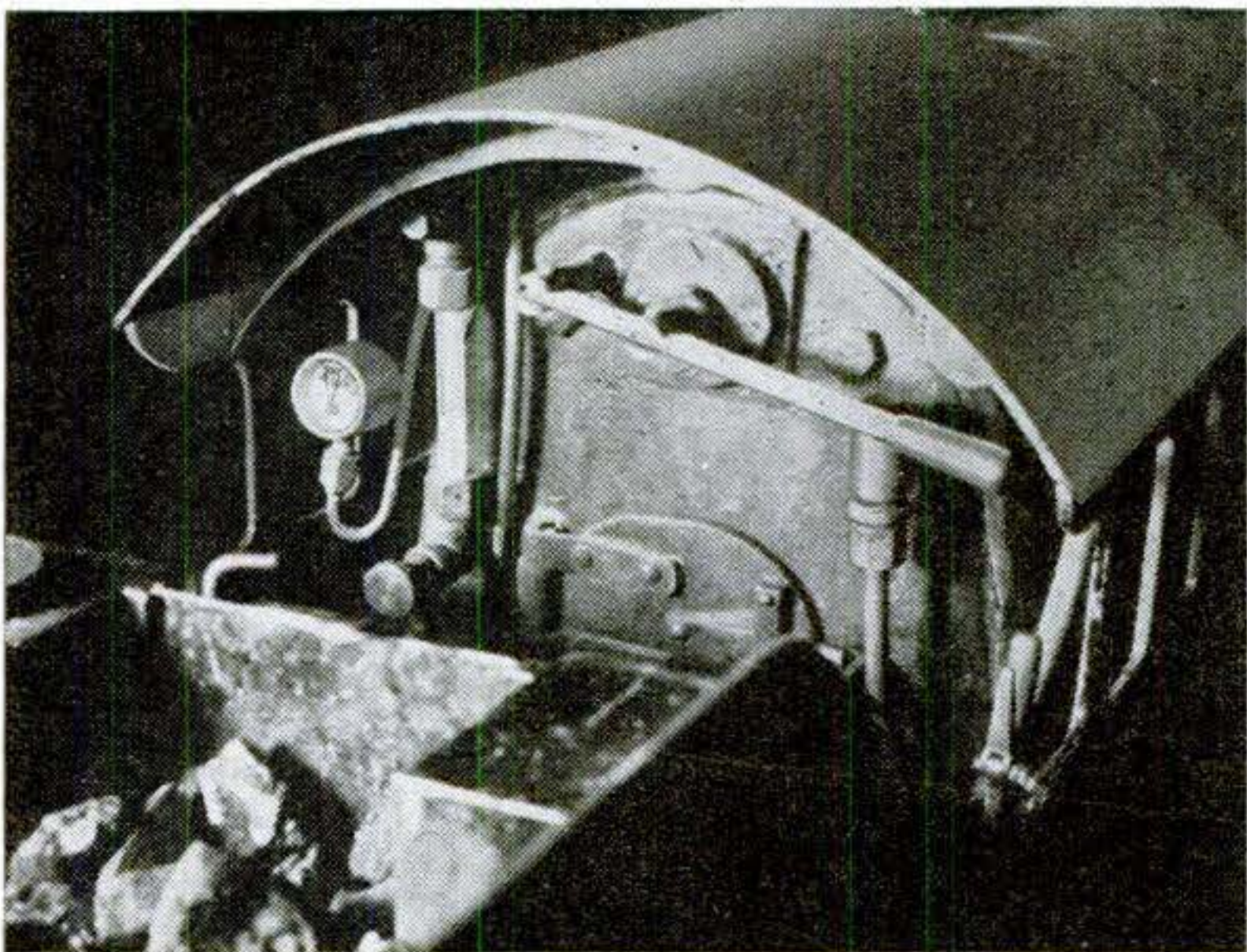

5 With the needle on the gauge climbing up toward 80 lb., and with ample water showing on the glass, the little engine is almost ready to roll. The horizontal lever above the fire door is the throttle; reverse gear is on the right.

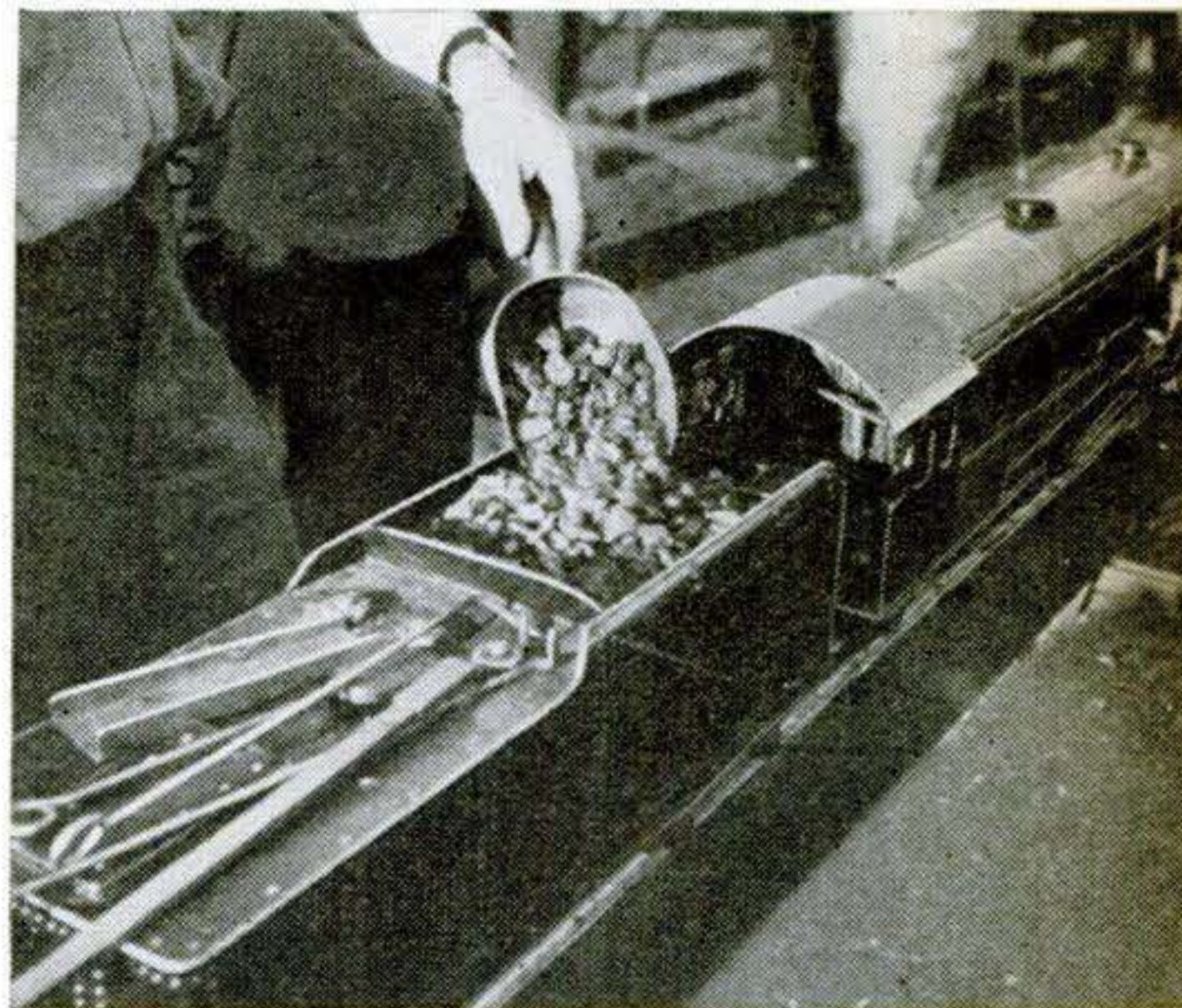

6 By now the boiler has reached full working pressure; notice the plume of steam from the pop valve. The auxiliary blower is taken off and coal is added to the tender.

7 After a touch of the throttle has moved the engine forward to a sliding section of track, the engineer-builder, Norman Robinson, of Celeron, N. Y., rolls the track to join the main line. His next step is to couple on a flat car.

8 Seated precariously on the flat car, he cracks the throttle and chuffs off. Here he is highballing around a curve at perhaps 15 m.p.h., much faster than top scale speed.

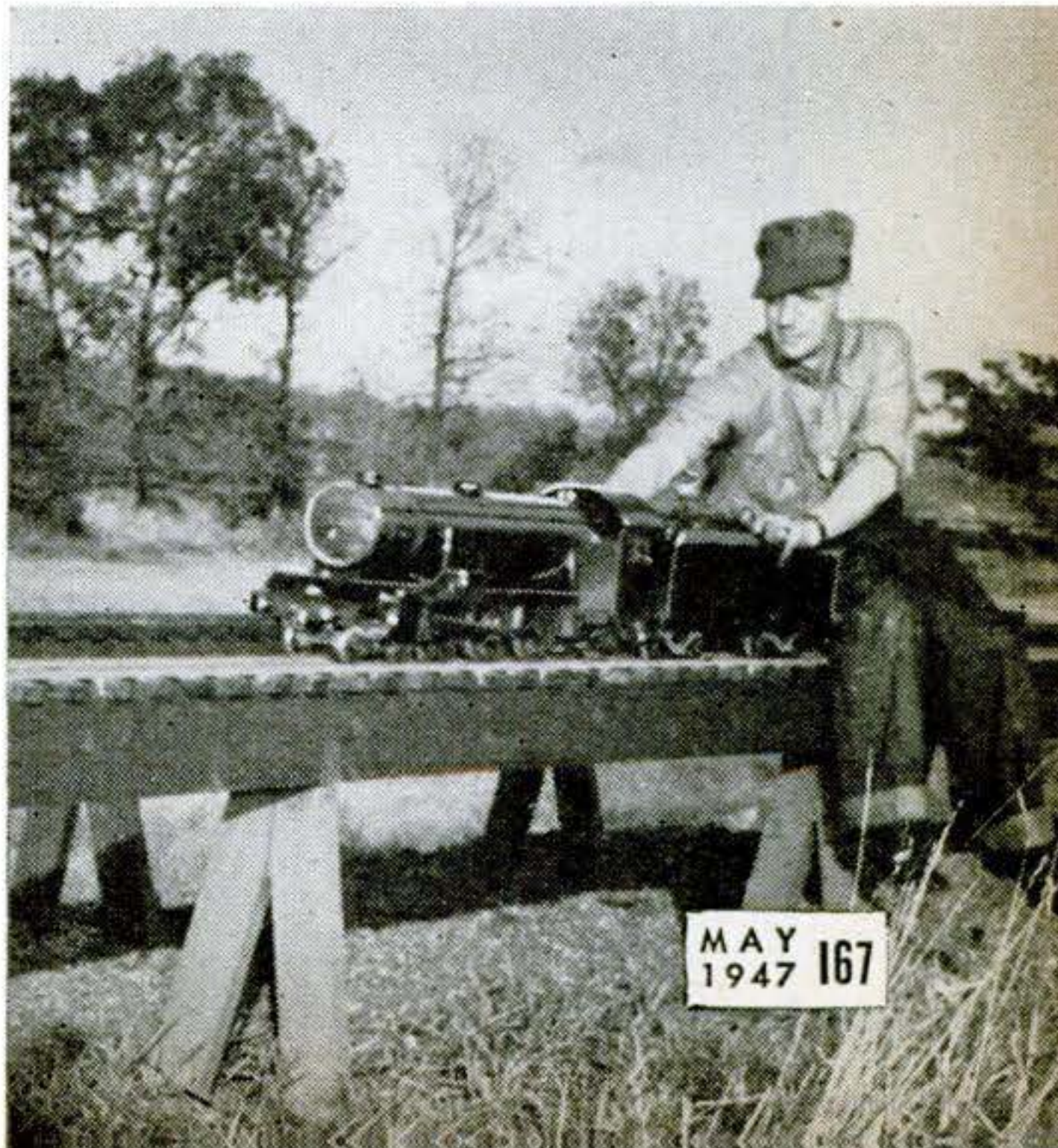
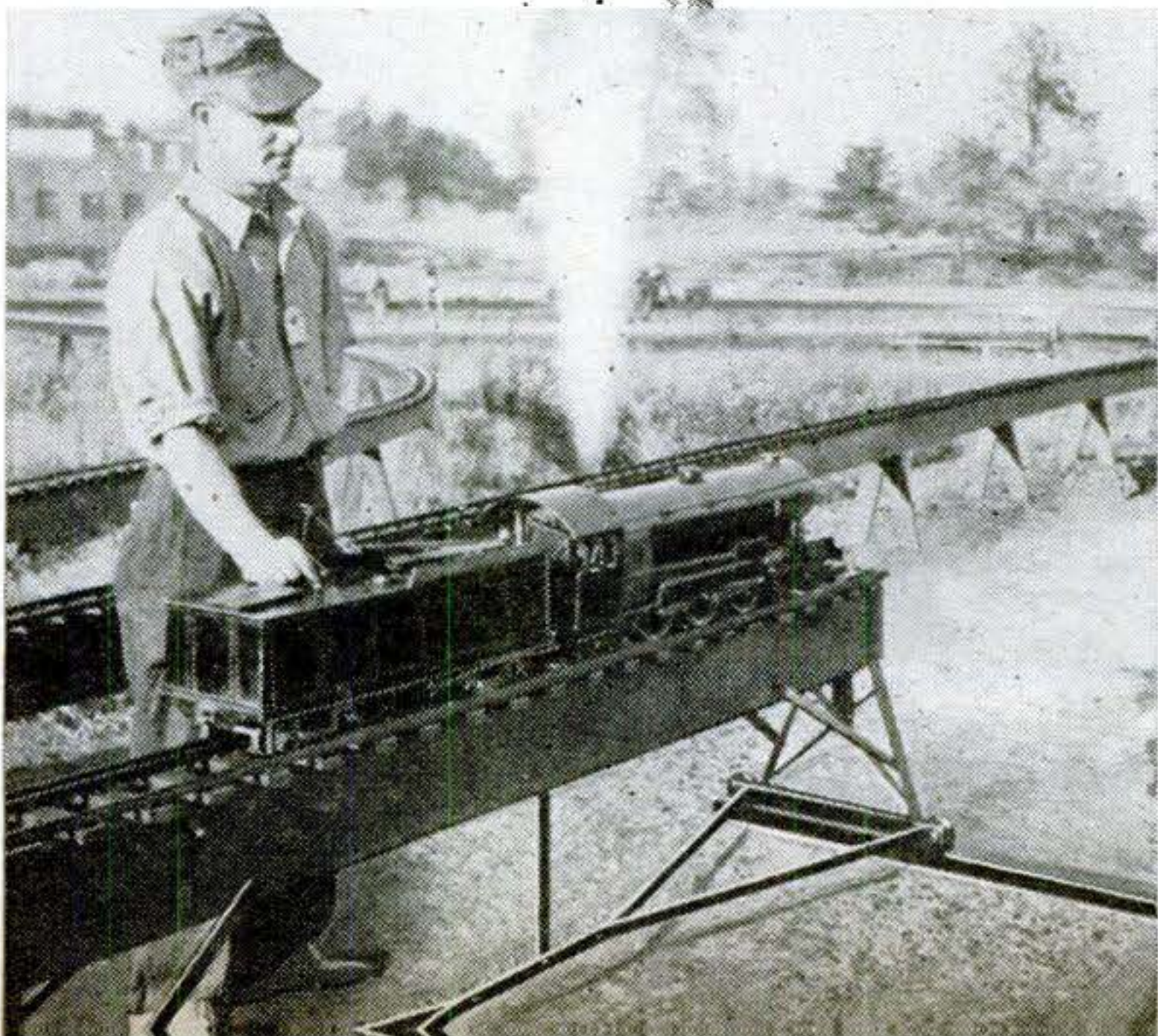

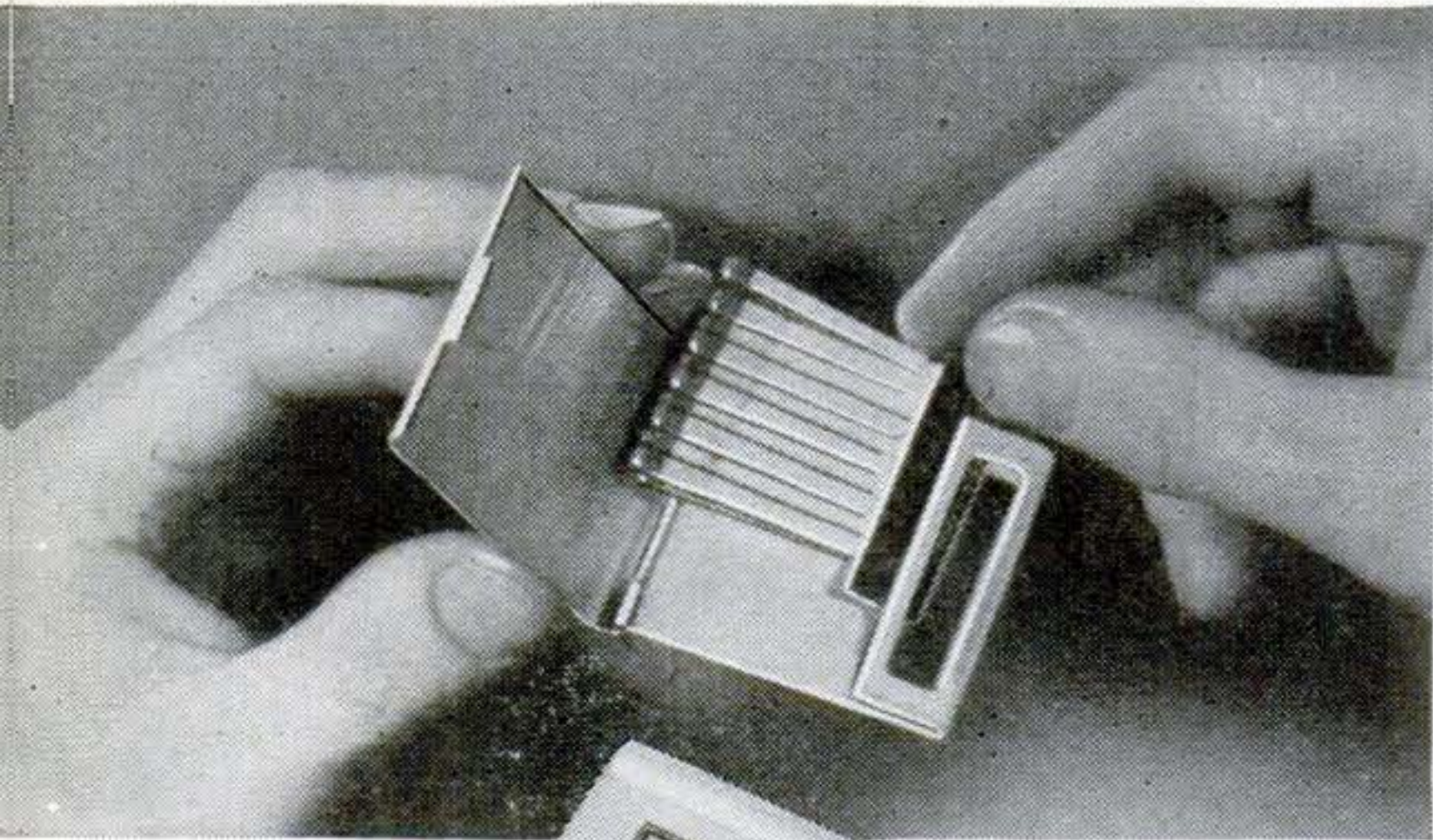

Match-Book Case for Smoker Is All-Metal Craft Project

BRASS, aluminum, dural, or hard copper works up nicely into a pocket case for book matches, an accessory any smoker will be glad to have.

Use 16-gauge metal and cut blanks a little long for the cover and back. Shape the hinge ends first by filing; then hammer the edges around a length of thin wire. Insert the wire as a hinge pin. The big curve of the cover can be formed around a $\frac{3}{8}$ " dowel or rod. Bend the projection at the end as a clip to snap the case closed. Drill striking slots through with a wood strip between, and file smooth.

If you prefer only one slot, in the back, cut it before bending. Either a hammered or polished finish is pleasing, but aluminum can be frosted in a lye solution and brass may be plated. Spot-polishing and wire-brush satin finishes are possible if they are put on before bending. Initials are engraved or enameled.—HENRY HANSCOM.

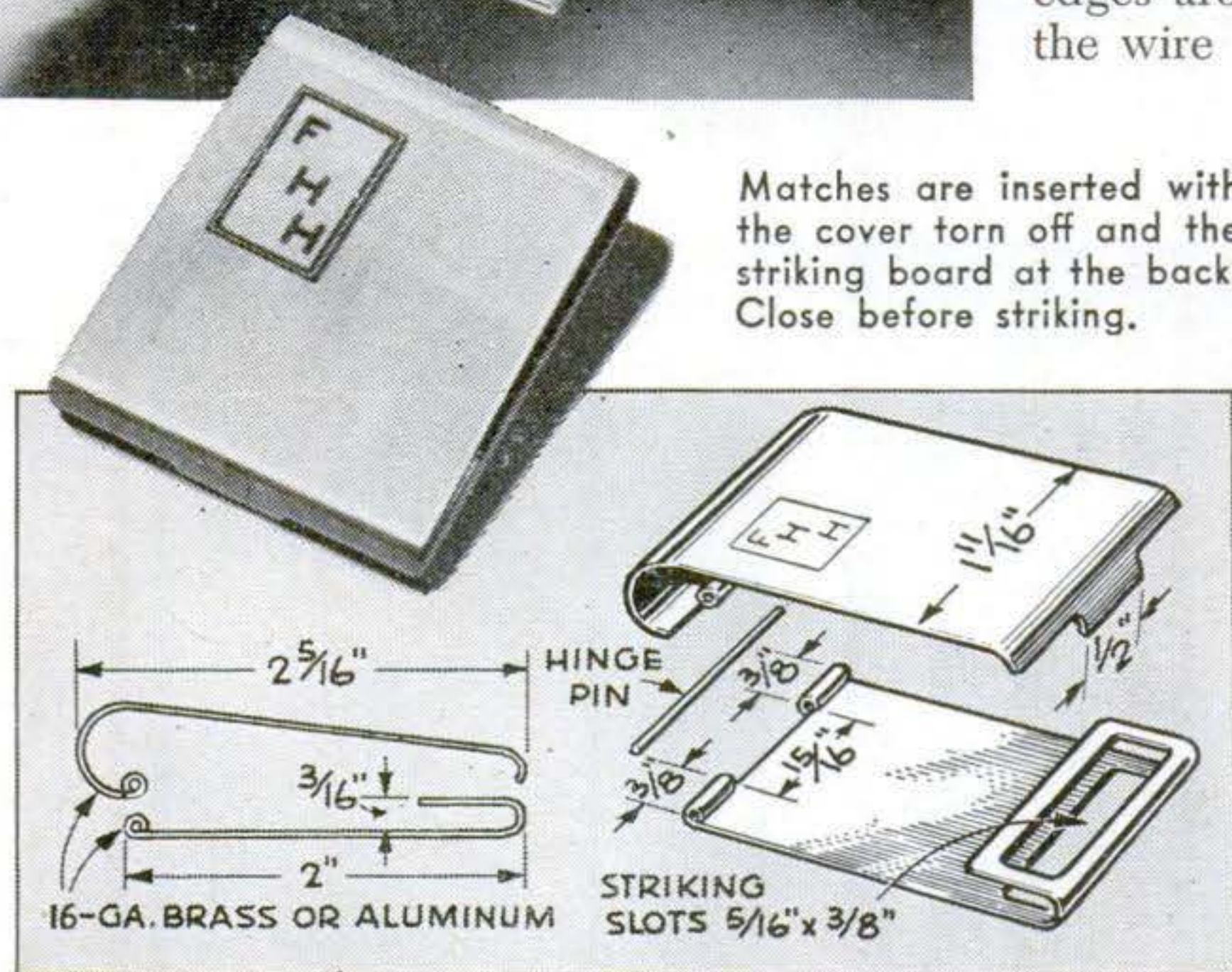

Matches are inserted with the cover torn off and the striking board at the back. Close before striking.

Indoor-Garden Watering Pot from Flat Tin Can

A FLAT pint can—the kind floor wax and solvents come in—can be converted into an attractive watering pot. Begin by carefully cutting out about half of the top, including the screw-cap opening. If the remaining edge is sharp, bend it under to form a safe, smooth edge. Then wash out the inside thoroughly with hot water.

Near the bottom of the can punch a $\frac{1}{4}$ " hole and solder in a 6" length of copper tubing (old automobile gas line will do). Make the spout retainer and handle of tin plate cut from another can. Fold over the two long edges of a $1\frac{1}{8}$ " by 14" strip for the handle and shape it over a pattern drawn on 1" squares. Solder it inside the top opening and to the body of the can.

Fold both edges of a $\frac{7}{8}$ " by $8\frac{1}{4}$ " strip for the spout retainer, punch a $\frac{1}{4}$ " hole in one end, and solder to the front of the can and to the spout. The inside of the can may be coated with spar varnish or asphaltum to prevent rusting, and the outside finished with enamel and a decal.

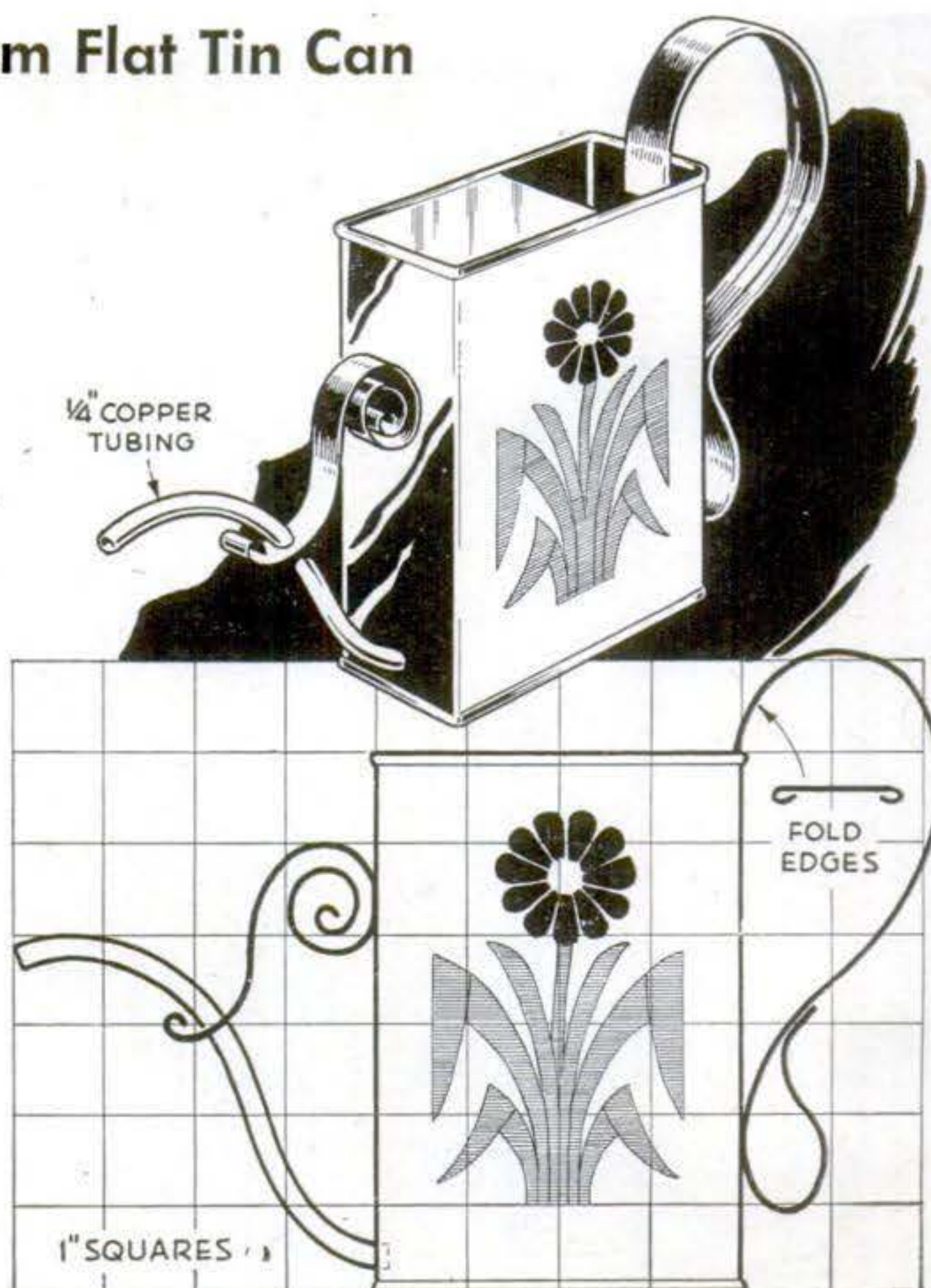

River Pilots Race in New Table Game

By HI SIBLEY



THRILLS reminiscent of the river-boat races of Mark Twain's day are provided by this spinning game. From two to four may play; more may crowd traffic in the "Mississippi" channels. Make a steamboat counter for each player and paint all counters the same except for distinguishing roofs. The board is painted on 18" by 18" showcard stock in contrasting colors, such as green land, yellow water, and red cities. Poster colors will do if coated with clear varnish or shellac.

Players each get one spin in turn unless penalized, as directed on the board, when their counters stop on obstacles. They also lose one turn for loading and unloading if

they stop at cities. When the arrow comes to rest at "Engine Repair" or "Man Overboard," the player loses that move.

The full number of spaces called for in the spin must be taken unless the last space is occupied by a rival, in which case the counter stops one space behind. When a counter is stopped at the entrance to alternative routes, it proceeds on that indicated by an arrow when the next turn comes. It can go into the bayou before "New Orleans" and back out again without loss unless it is stopped in the longer branch.

CITIES RED, RIVER YELLOW, AND LAND GREEN

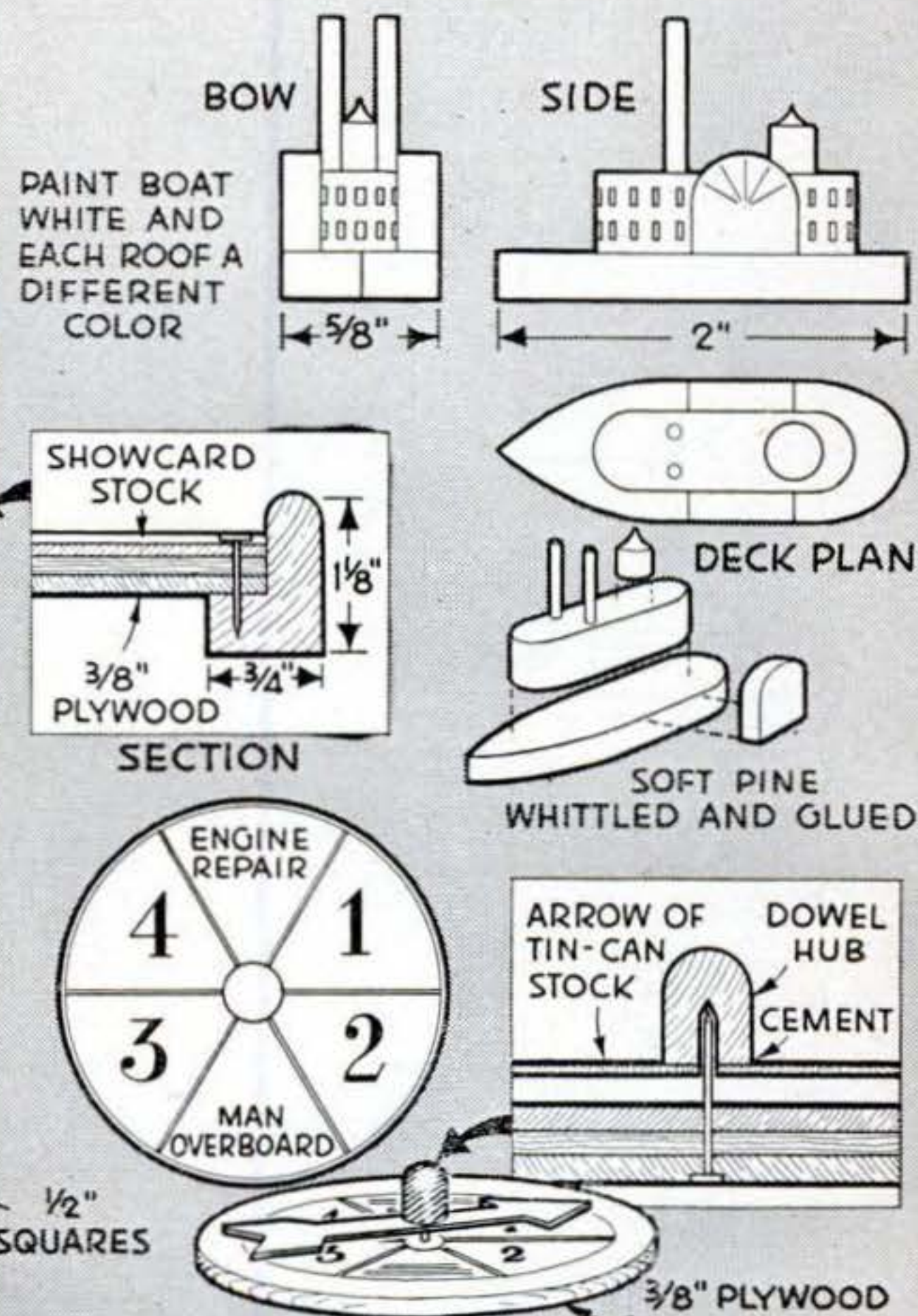
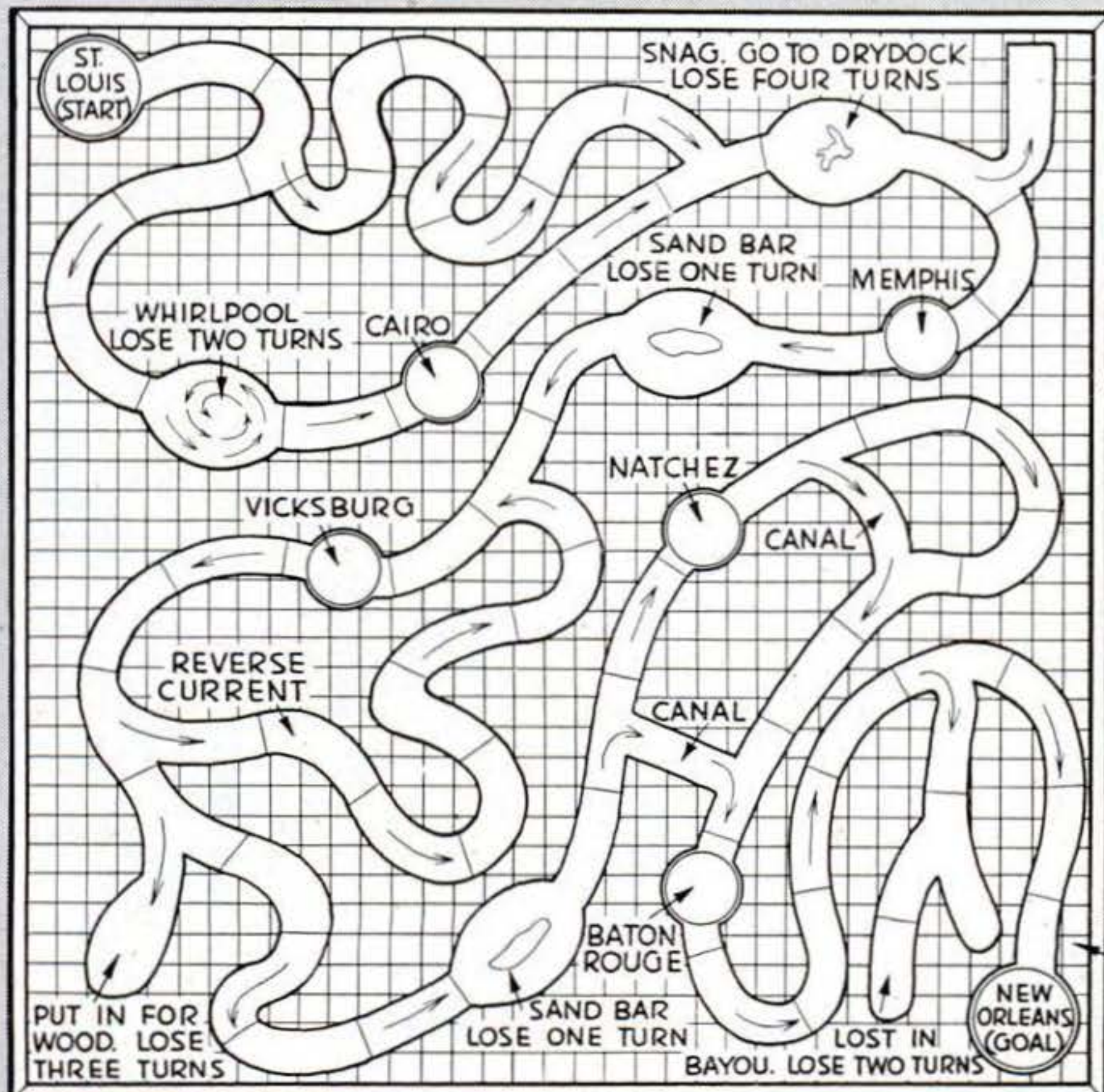

Bowl Veneered in Two Tones



For flowers or rock plants, the bowl can be fitted with a glass container. The veneer is put on as a ribbon joined to give a spiral effect.

CONTRASTING veneers glued around this bowl in a spiral pattern make it a striking tablepiece. The bowl is turned from a 3" by 8" maple or birch block, and the veneer is cut from two 1 $\frac{7}{8}$ " by 12 $\frac{1}{2}$ " strips, one dark wood and the other light.

On one veneer strip, run a diagonal from a point 2" from one end to another 2" from the opposite end, curving the ends of the line to fair them into the edges. Cut with a sharp-pointed knife. Then use one of the halves as a template for cutting the other strip so the joints will be true.

In turning the bowl, first surface one face and scribe on it an 8" circle, marking the center with a nail set. Then saw roughly to shape to reduce turning time. Rather than mar the bottom with screw holes, bandsaw a disk from 1" lumber, bore a small hole in the center, and glue it to the turning block with paper in the joint.

Rough-turn the piece at the lowest lathe speed, cutting in from the face with the point of a skew chisel to reduce chipping. Then face off the block, rough the inside, and scrape a recess for the veneer.

Now, leaving the work in the lathe, join the veneer pieces in a ribbon with veneer

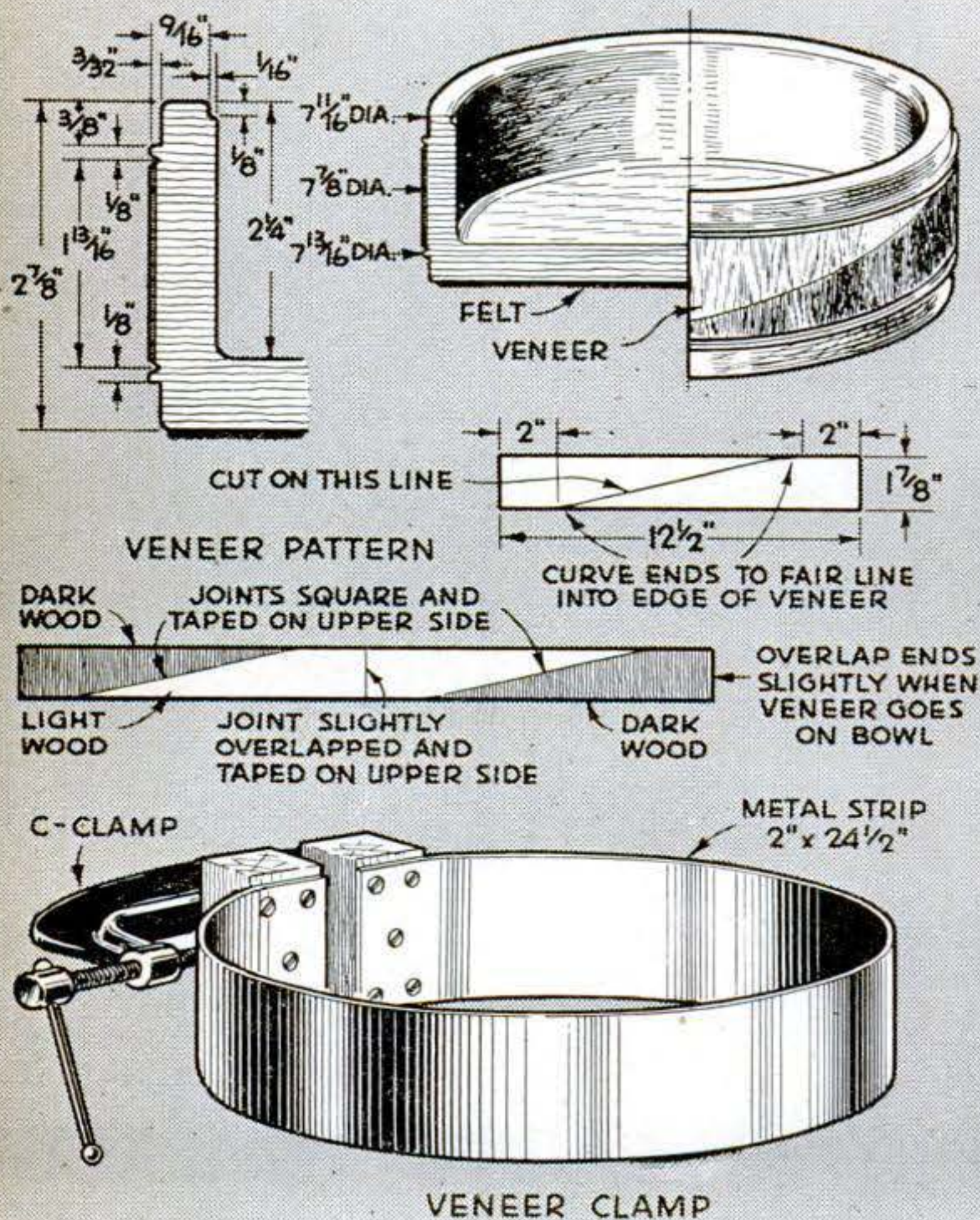

Half of one veneer strip is used as a template in cutting the other to assure trueness of the joint.



tape or strong paper reinforced with cloth, letting the square ends overlap slightly. Apply waterproof plastic glue to the veneer to within about 1" of each side of the square joints and to the corresponding area of the bowl recess. Pad the veneer with cardboard and clamp it to the bowl. When the glue has dried, trim and fit the loose ends and glue them down.

Then complete the turning, trimming the edge of the veneer first with the point of a skew chisel. True the surface of the veneer, if necessary, with light scraping cuts, and sand all over.

Before applying filler to the dark veneer, protect the light wood with shellac, or with clear lacquer if a lacquer finish is intended.



In finishing the bowl inside, projection of the tool rest into the hollow shortens tool overhang.

Scribed Abrasive Sheet Is Easily Torn to Fit Sanding Disk

WHEN cutting garnet paper to shape for a power sanding disk, don't dull your scissors or tin snips. Simply lay the paper face down, place the metal disk on top, and scribe

around it with a sharp point. A sharpened nail or an ordinary scriber will serve. The paper can then be torn easily along the scribed line.

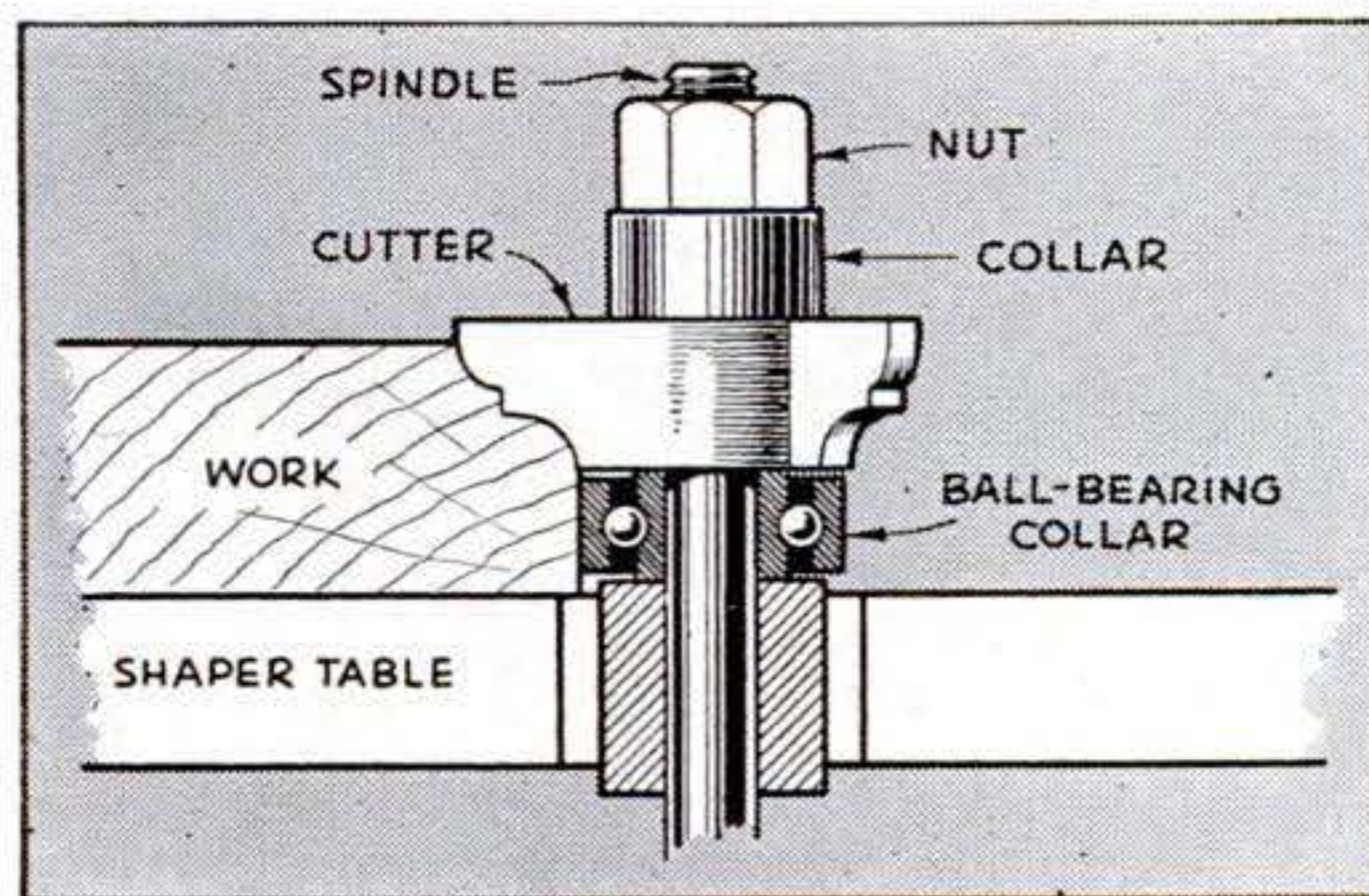

Ball-Bearing Collar for Shaper

IF A cutter is to be raised above the table of a small shaper, a ball bearing of the grease-packed, preloaded type will make an excellent free collar. Its outer race idles when curved work is run against it and thus prevents friction burns. The inside diameter should be slightly larger than the spindle. Such bearings can be obtained in sizes to fit loosely over spindles of $\frac{1}{2}$ ", $\frac{5}{8}$ ", and $\frac{3}{4}$ " diameter.—CHARLES LINCOLN, JR.

Wide Brush Made of Three Push Brooms Smooths Tennis Court

DRAGGED over a tennis court before wetting and rolling, a stiff brush will distribute loose clay evenly. A wide brush made by joining three push brooms with a strip of wood screwed across the tops will cut down the work considerably. The handle of the center broom is taken from its socket and fastened across the outer ones for a crossbar.—H. K. FITTS.



Nontip Chair Tray Won't Spill Ashes, Drinks, or Tobacco

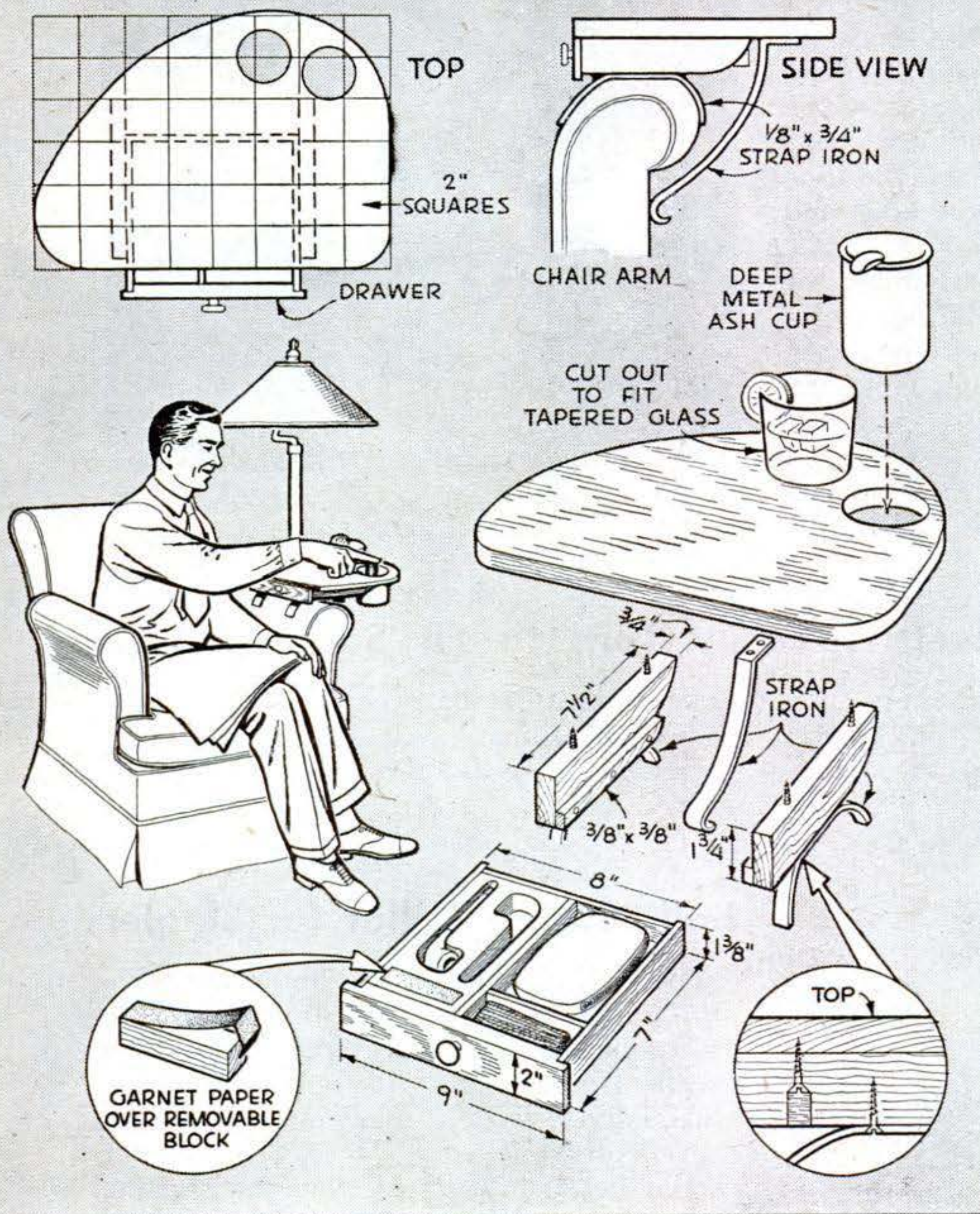

BOTH the housewife and her pipe-smoking husband ought to welcome this arm-chair smoking set, because it can't tip over and it has a securely held ash cup big enough to hold all the burnt matches and ashes likely to accumulate in an evening. Pipes, tobacco pouch, or cigarettes are stored in the little drawer; a strip of emery cloth discourages the use of polished surfaces for striking matches.

Walnut or mahogany will make a handsome top. Whatever wood you select, it should blend with the color of your room or furniture. Holes are cut out to hold a tapered glass and a deep metal ash cup. Wooden cleats on the underside support drawer rails and also the strap-iron brackets that curve over the chair arm. Paint the iron to match the chair on which the set is to be used.

Tools Carried in Glass Case

HAVING daily need for small tools, I use an ordinary spectacle case as a pocket kit for carrying such essential equipment as a neon test light, wrench, screwdrivers, and tweezers.—KARL J. GREIF, JR.



Removable Cover for Glue Jar

NEXT time you have to loosen the cap of a glue jar or can with a wrench, throw it away and seal the container with strips of cellulose tape, which can be removed in a jiffy.—WILL THOMAS.

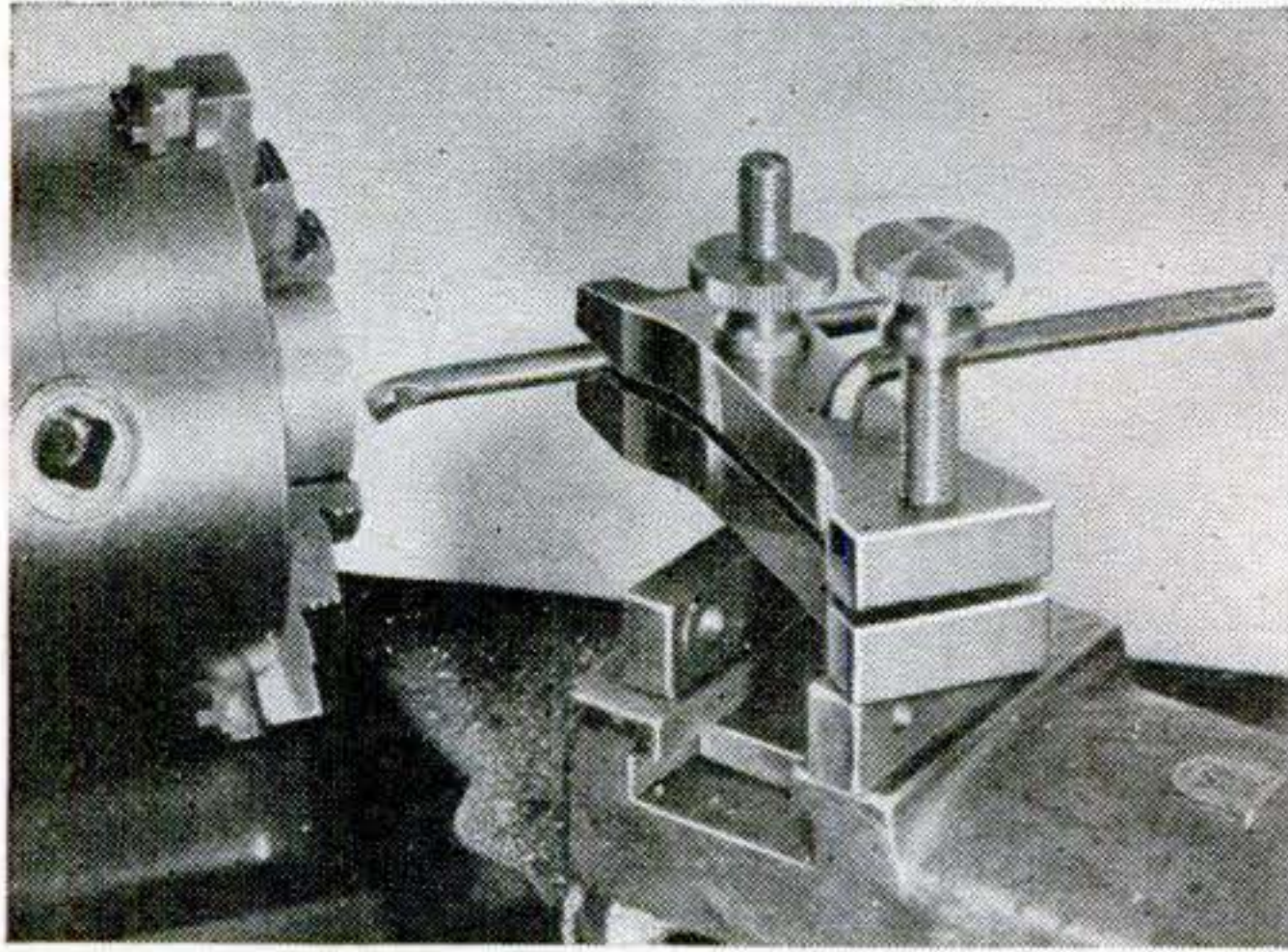

UNIVERSAL WORK HOLDER. A new work holder produced by the Wright Mfg. Co., of Elgin, Ill., lies flat on any surface (as at right). Among its many uses in industry and the home workshop are as a bench vise, parallel clamp, and as a lathe tool holder (above). Large thumbscrews permit quick, easy adjustment. The holders sell for \$4.75 each or \$9 in pairs.

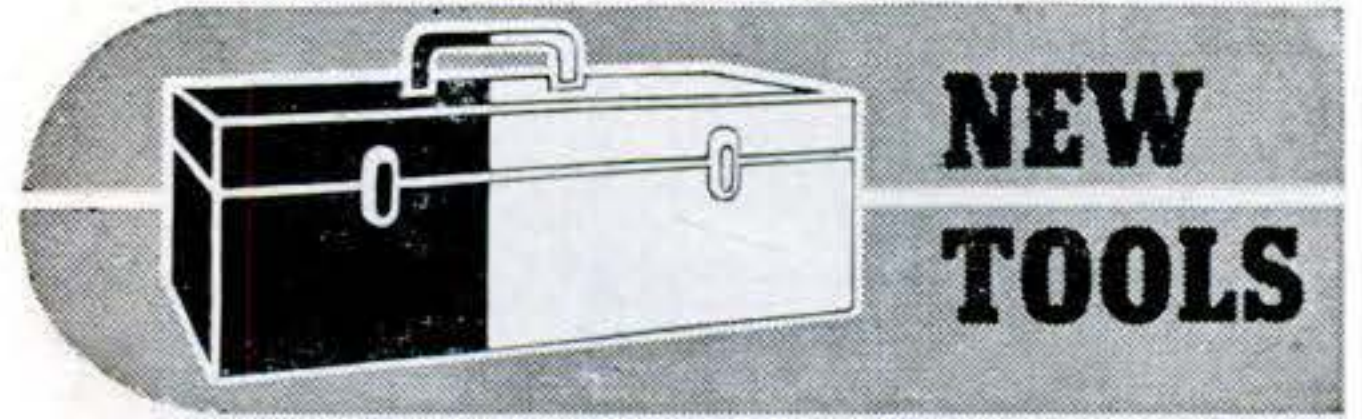

**NEW
TOOLS**

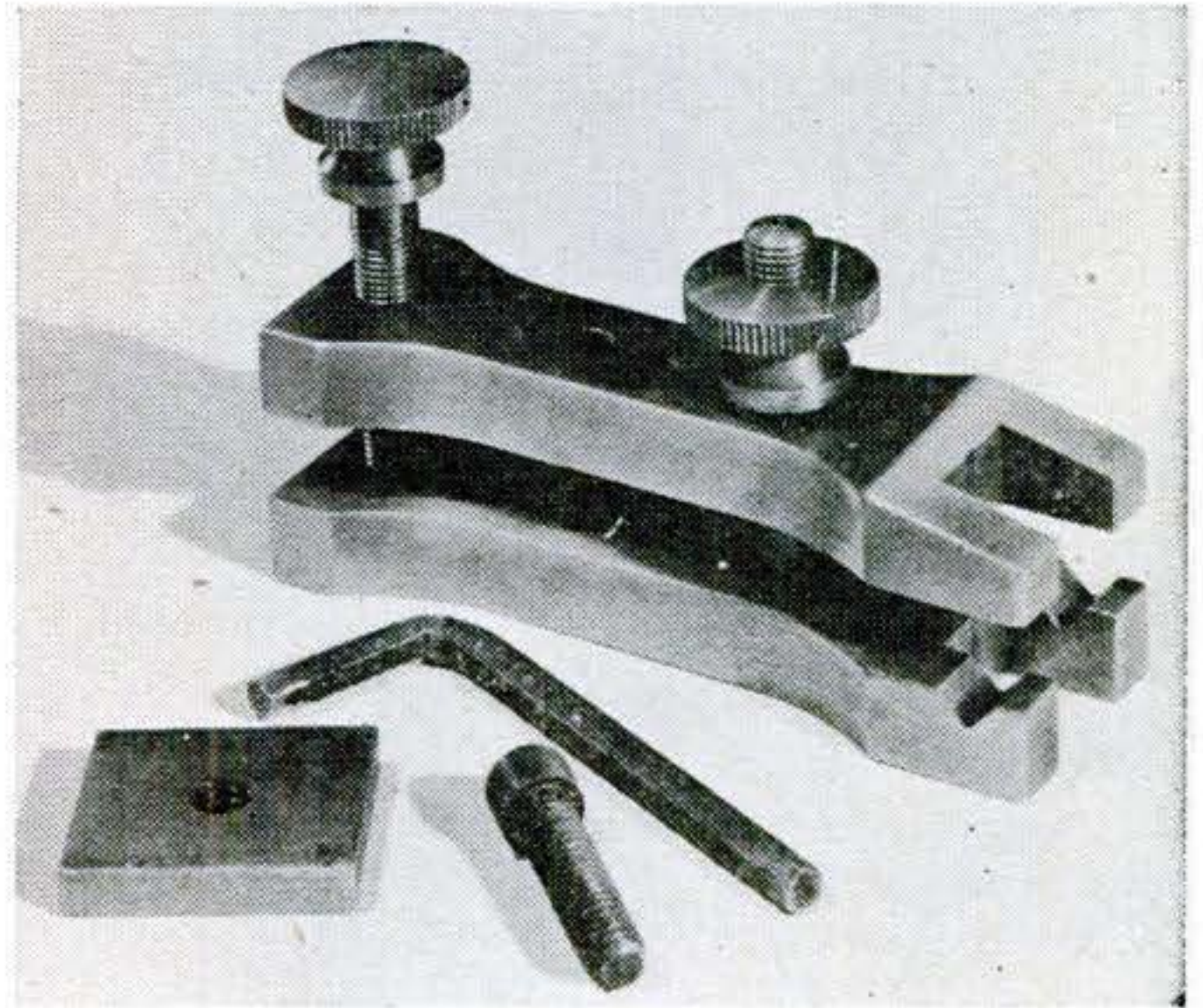

AUGER-BIT SET. For faster wood boring, Bruno Tools, of Beverly Hills, Calif., now offers auger-bit sets consisting of one $8\frac{1}{4}$ " shank with interchangeable heads. This makes it possible to bore holes of many sizes simply by changing the head. One set has six heads ranging from $\frac{5}{8}$ " to $1\frac{1}{4}$ " by eighths. Another covers the same range by sixteenths.

PUMPLESS BLOWTORCH. Generating its own pressure when heat vaporizes gasoline in the tank, this small blowtorch operates without the pump normally associated with such torches. Light in weight and economical to use, it is produced by the National Pumpless Blowtorch Company, Cleveland.

NEW GRINDER. An electric grinder announced by the Dumore Company, of Racine, Wis., is a dual-purpose tool for use either as a hand grinder or with an attachment that converts it to a flexible-shaft tool. Other attachments adapt the grinder to bench and lathe-mounted operations. It is powered by a $1/14$ -hp. motor.

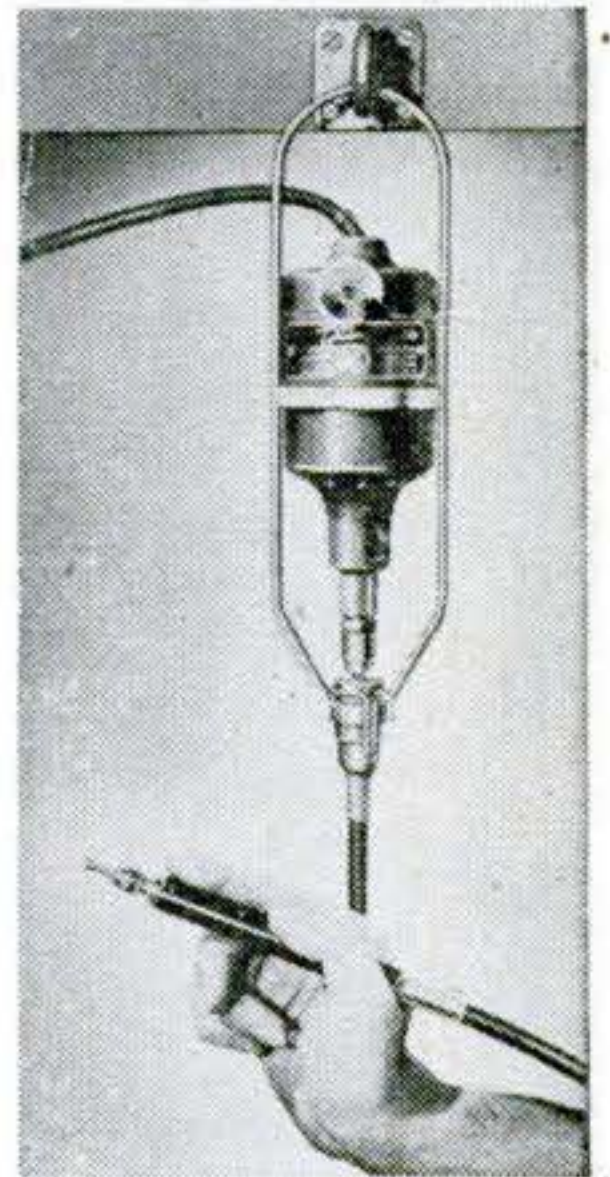

KEEPING the HOME SHIPSHAPE

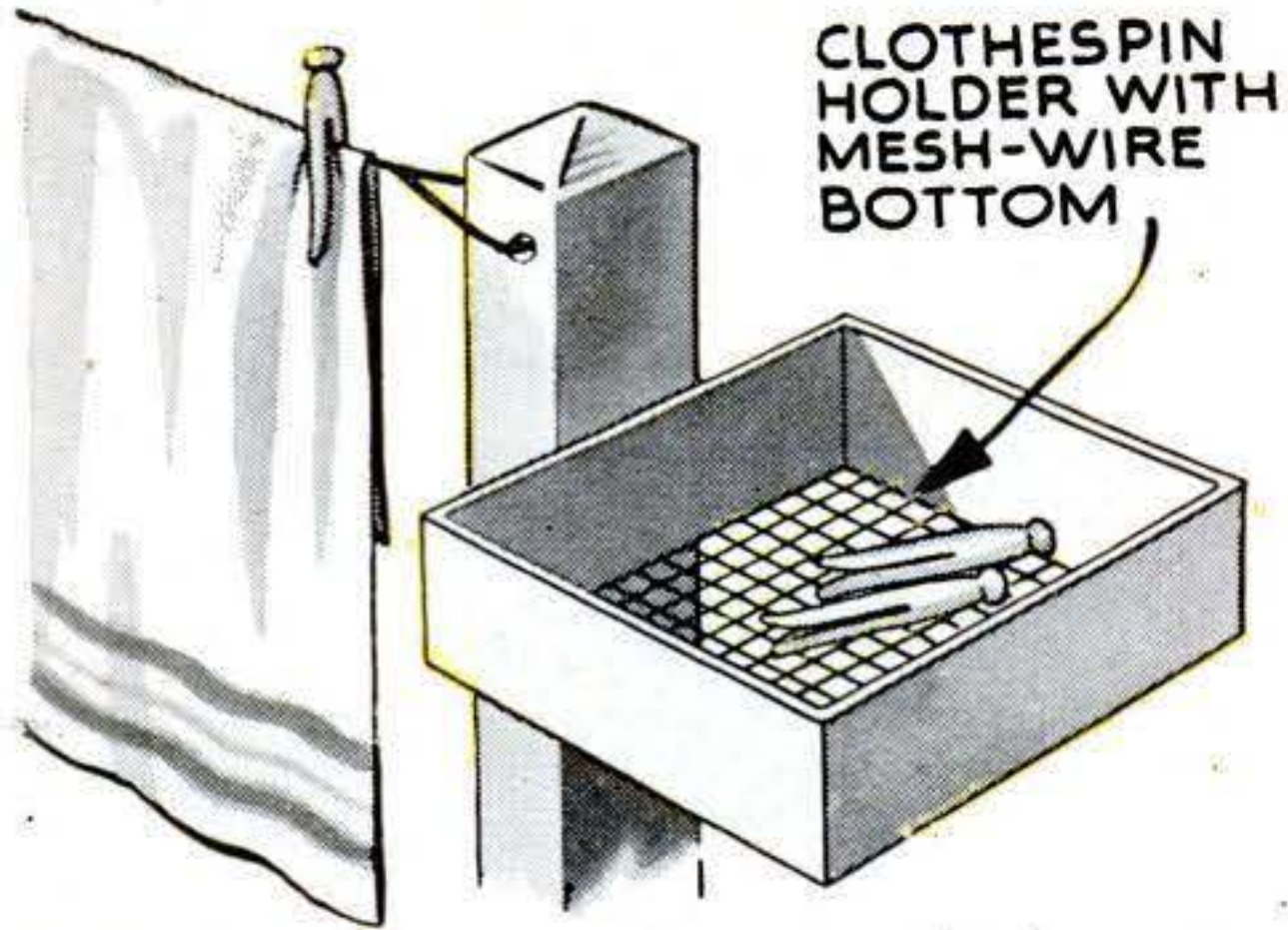

CLOTHESPIN HOLDER WITH MESH-WIRE BOTTOM

Clothespins won't get dirty from collected dust and rainwater, and soil clean laundry, if the bottom is removed from the box in which they are kept and a piece of galvanized $\frac{1}{4}$ " wire mesh put in its place.

Buttons can be replaced the minute they're missed—at the ironing board—if an assortment is strung on a large safety pin stuck into a pincushion hung in the ironing-board recess. Keep needles in the pincushion, too, and spools of thread on finishing nails.



IRONING-BOARD CABINET

NAILS TO HOLD SPOOLS

PIN CUSHION

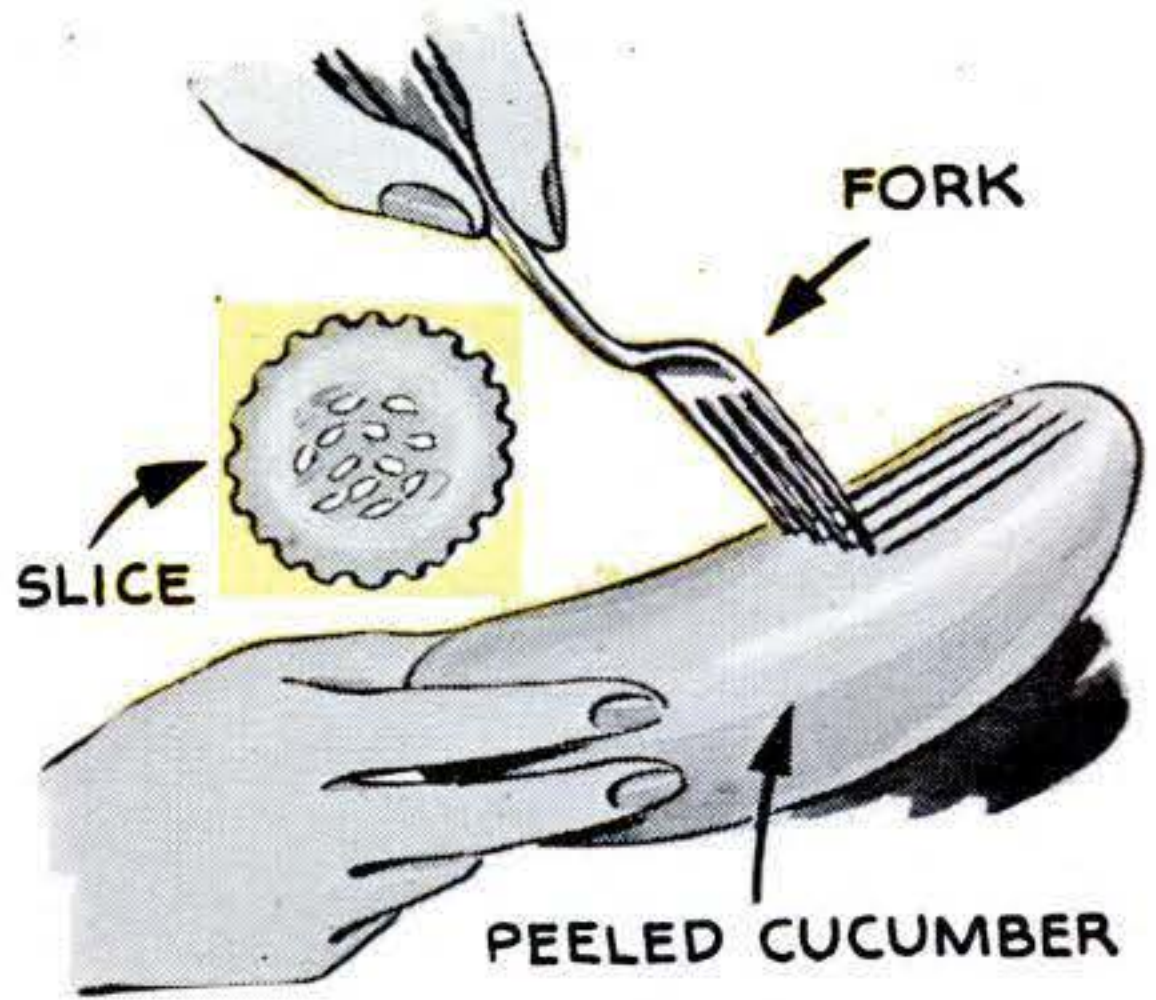

SLICE

FORK

PEELED CUCUMBER

Scalloped edges on thin cucumber slices help make an attractive dish. The scalloping is easy; just run the tines of a fork lengthwise over the peeled cucumber, and then slice.



PILLOW TICK TIED TO CLEANER TUBE

FEATHERS

Feathers can be stuffed into a pillow quickly and neatly with the help of a vacuum cleaner. Substitute the tick for the cleaner bag, dump the feathers on a paper, and draw them in.

More comfort for the goldfish and less danger of fire result if you put aquatic plants in the fish bowl. Because of the burning-glass effect, bowls shouldn't be left in sunny spots.



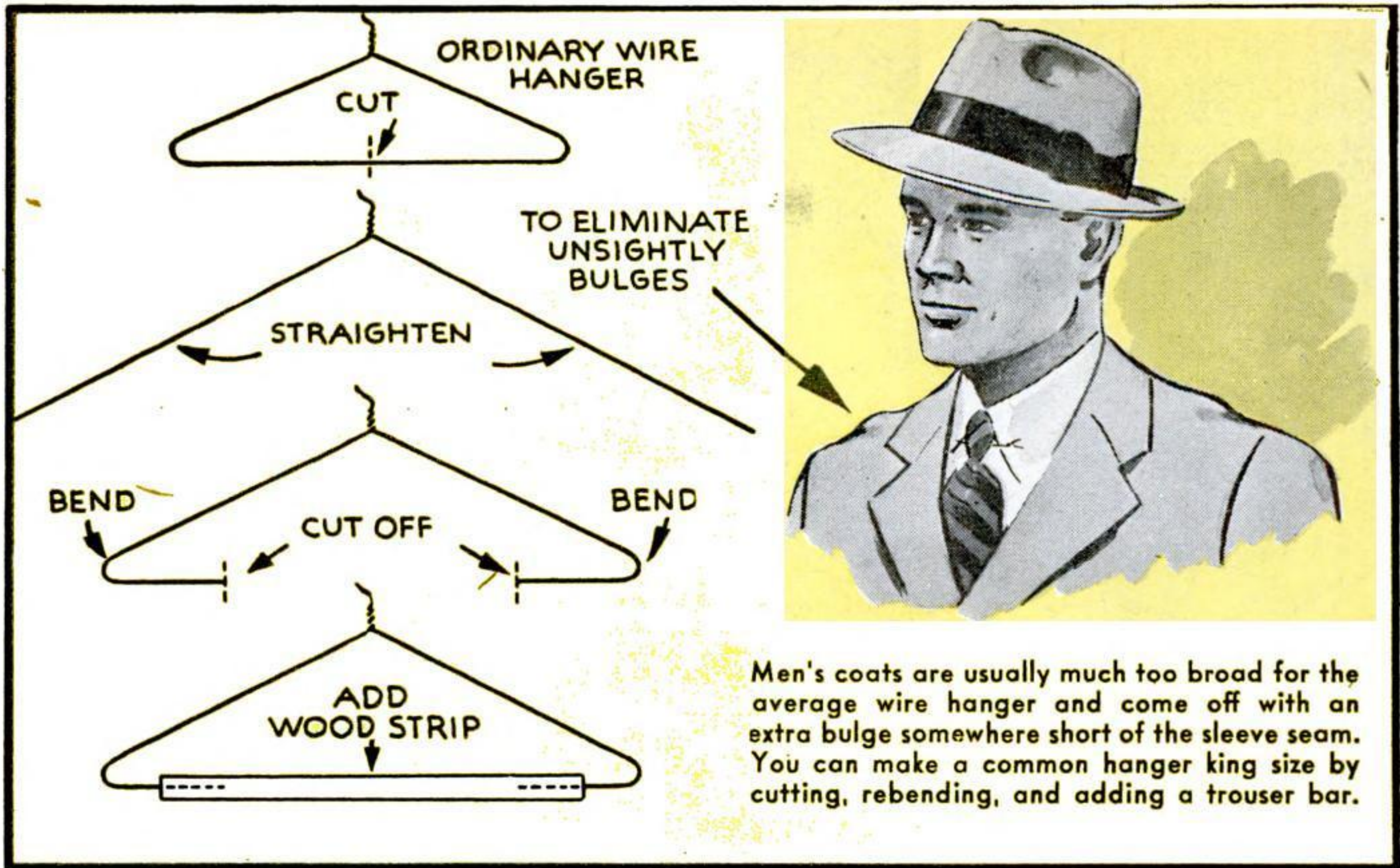

Men's coats are usually much too broad for the average wire hanger and come off with an extra bulge somewhere short of the sleeve seam. You can make a common hanger king size by cutting, rebending, and adding a trouser bar.

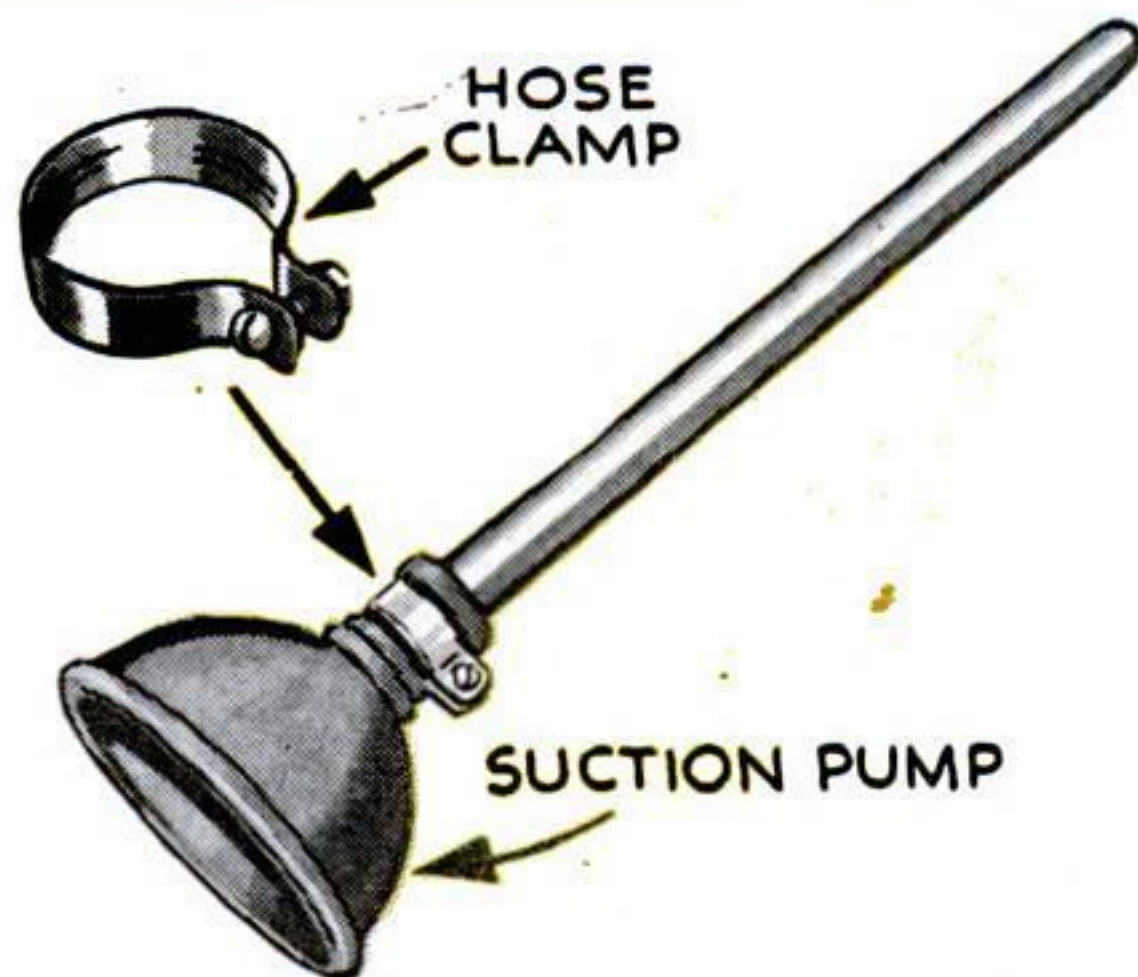

If a suction-pump cup won't stay on the end of a handle, an effective anchor can be made from an ordinary hose clamp, a radio-ground clamp, or a length of strap metal drilled and bolted.

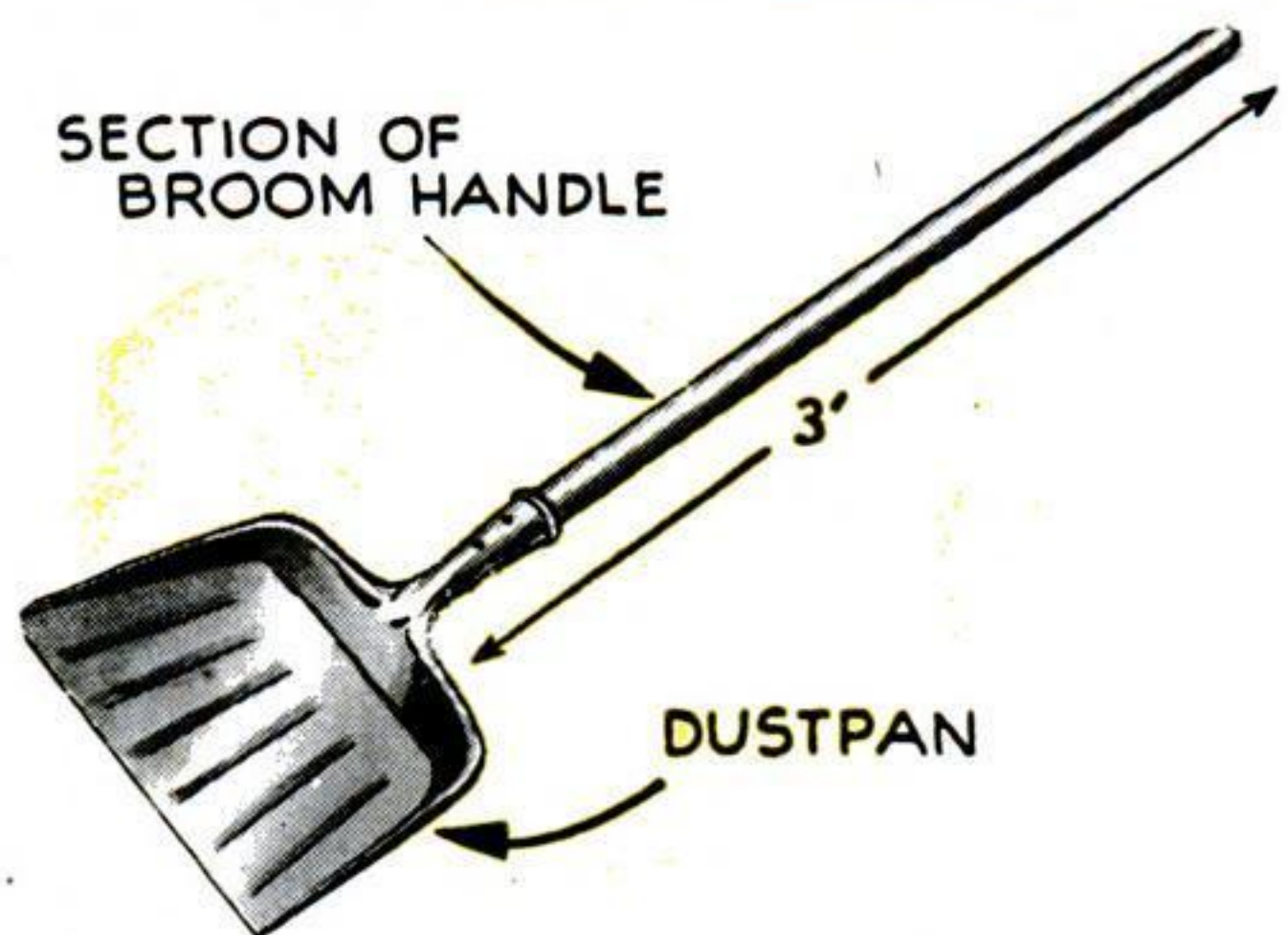

Admittedly not as good looking as the shovel of a brass fireplace set, a dustpan with its wide scoop nevertheless makes short work of removing fireplace ashes. It is easily fitted with a handle.

Run-down rubber heels, cuts, and other worn spots on shoes can be built up at home with a tube of rubber-base tire-cut filler. This is self-adhesive and self-vulcanizing, and it dries overnight.

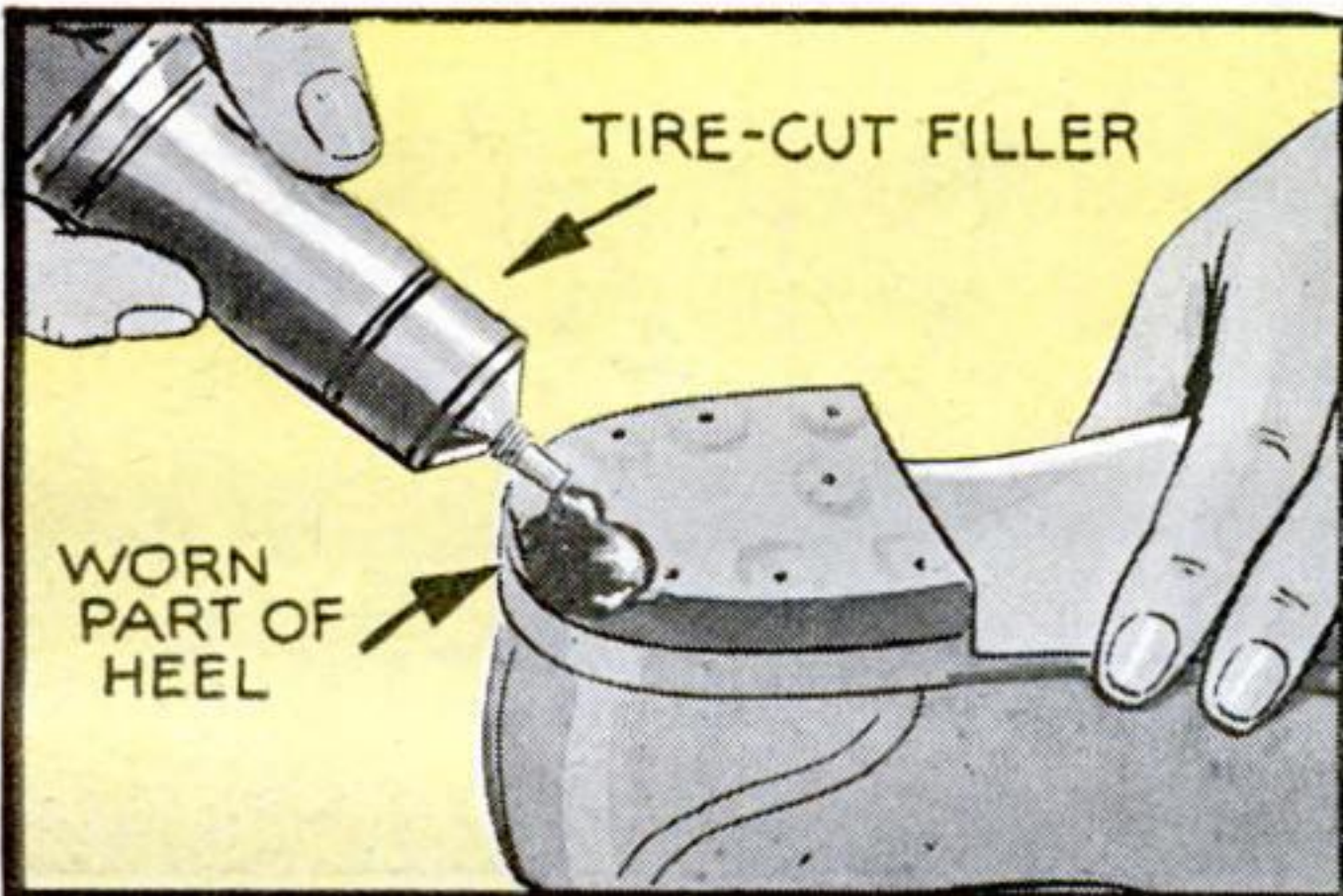

When a quantity of gummed labels must be affixed and no moistener is at hand, moisten them on an electric-light bulb in a bowl of water. The bulb rotates at a touch and is thus kept wet.

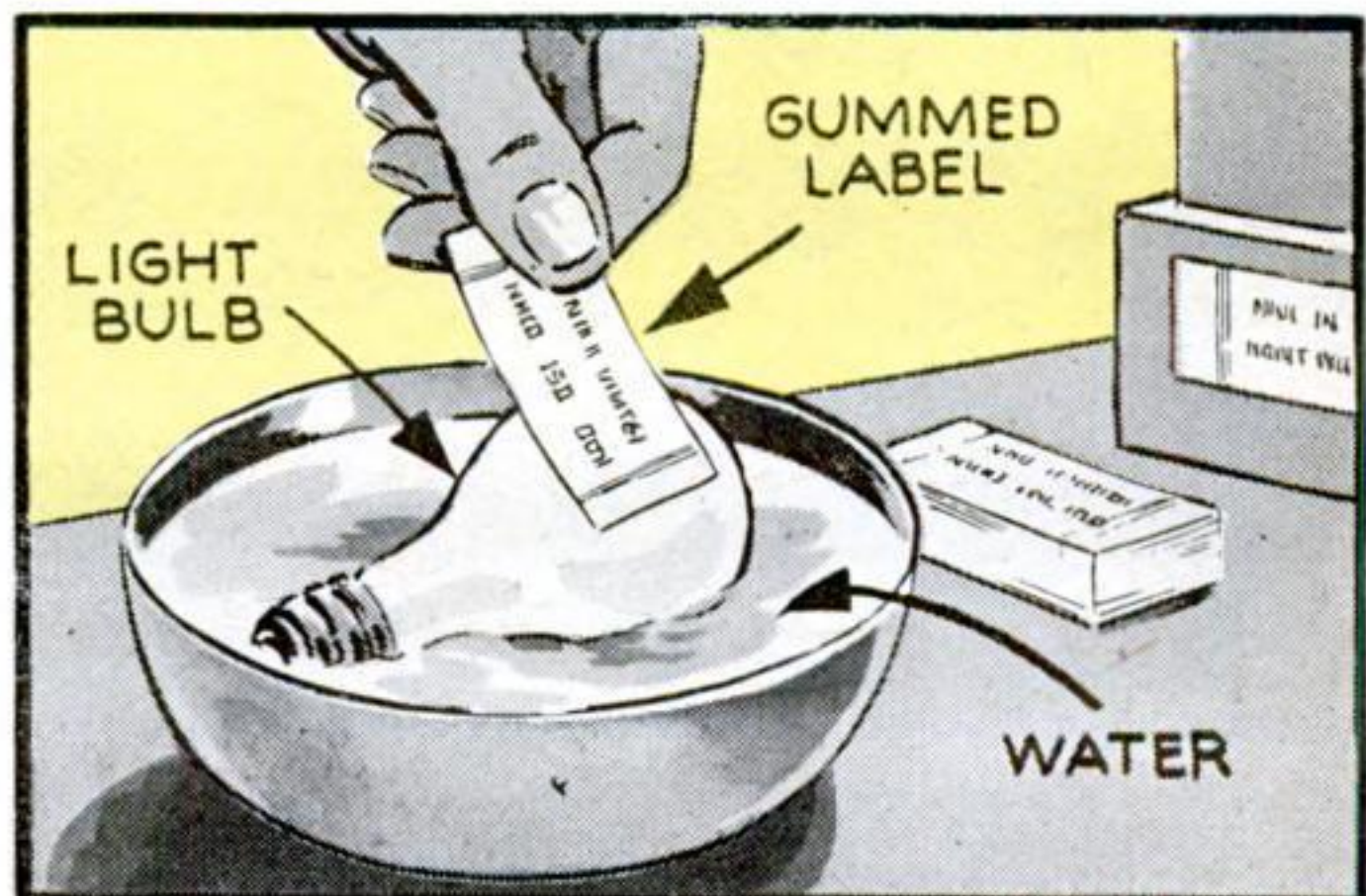

Installing

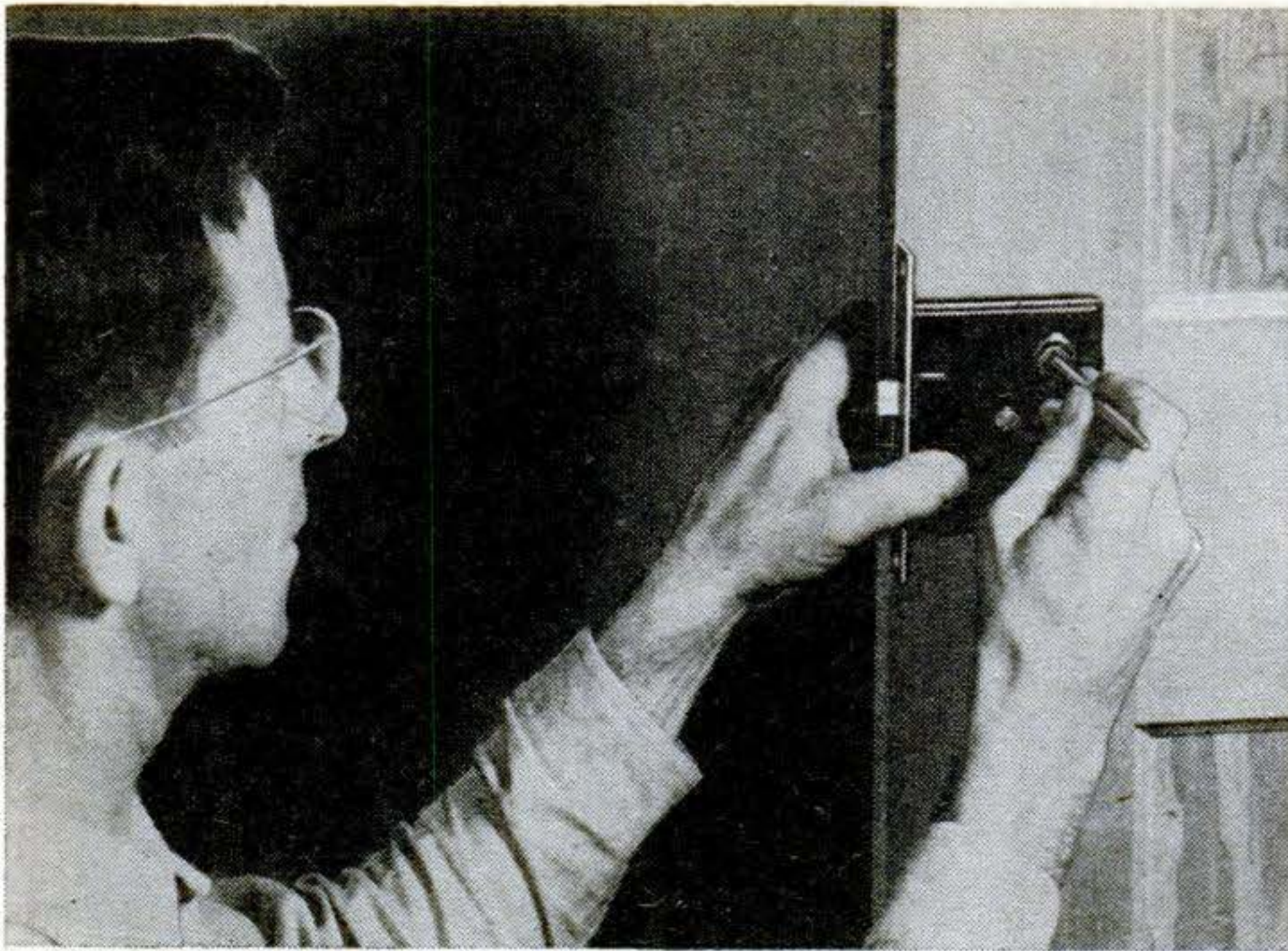

With the height of the knob spindle gauged 3' above the finish floor, the lock is held against the stile, and the key and spindle holes are scribed. The selvage is held flush or 1/16" in from the edge.

By **EDWIN M. LOVE**

MORTISE locks are most practical for inside doors but are also used extensively as auxiliary locks on outside doors. They are inexpensive, are easy to install, and serve as latches when locking with a key is not required. The mortises to receive them need not be cut any too neatly, and if the key and spindle holes aren't perfect,

Scribing for the selvage mortise. Holes are first bored for the spindle and key, and then the lock mortise is bored and chiseled out. If one end of the selvage sinks too far, put a shim under it.

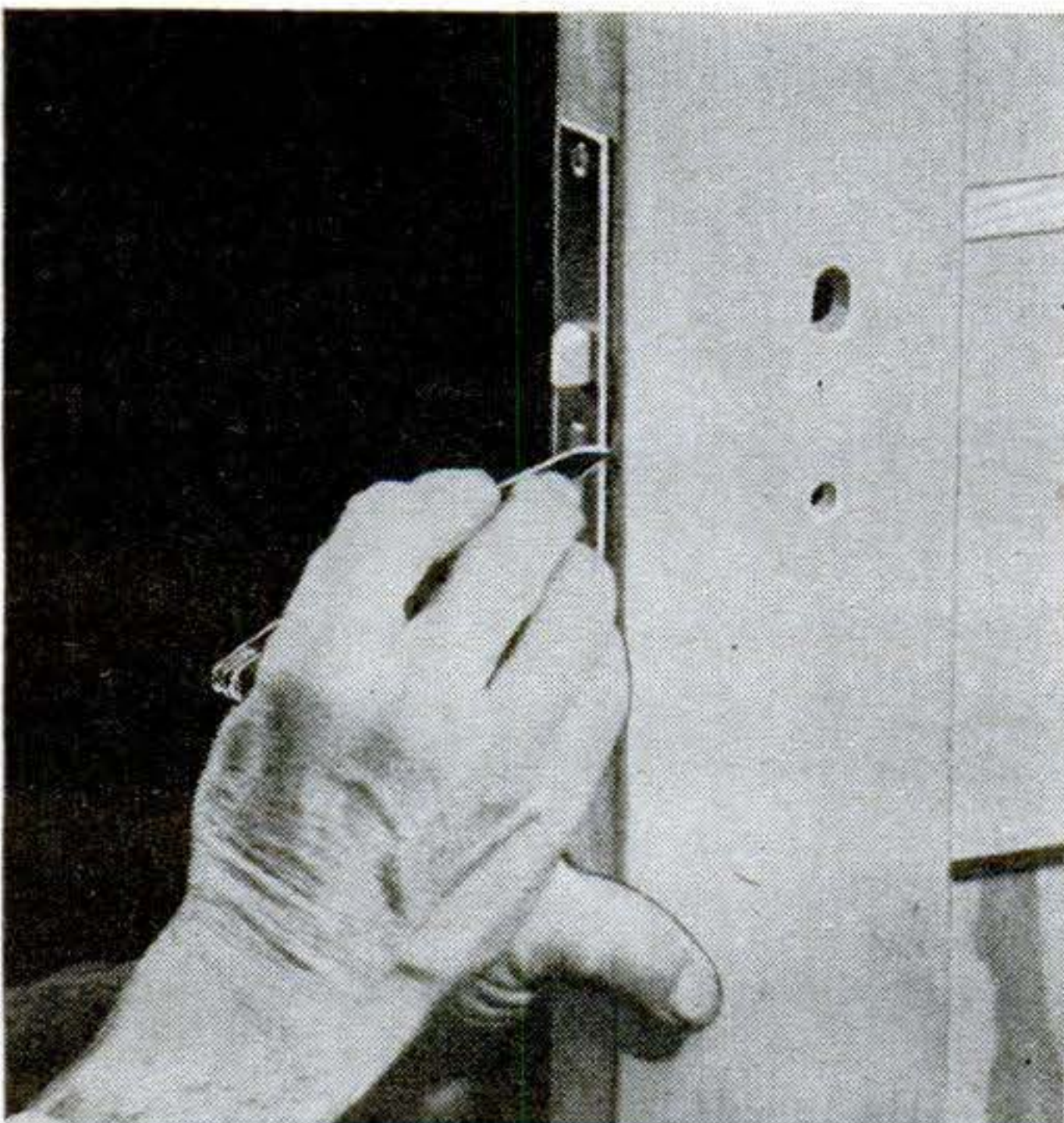

no harm is done as they will be concealed behind escutcheon plates. Locks of this kind come assembled for right-hand doors, but they can be reassembled quickly to operate on doors swinging in the opposite direction. If the flat side of the latch faces the strike, lay the lock on the bench and remove the cover. Lift the inner end of the latch bolt to take it out and turn it over before replacing it. Be sure to slip the bolt spring over the prong in the slot when putting it back.

When preparing to install the lock, hold the door open with a pair of wedges driven under the lock stile. Mark the height of the knob spindle—customarily 3' above the finish floor—and, holding the lock against the door with the latch plate or "selvage" flush with the edge, scribe through the key and

Here the jamb is scribed to width for the strike. Its position is found by closing the door until the latch touches and marking above and below it. Center the striking lip between these marks.

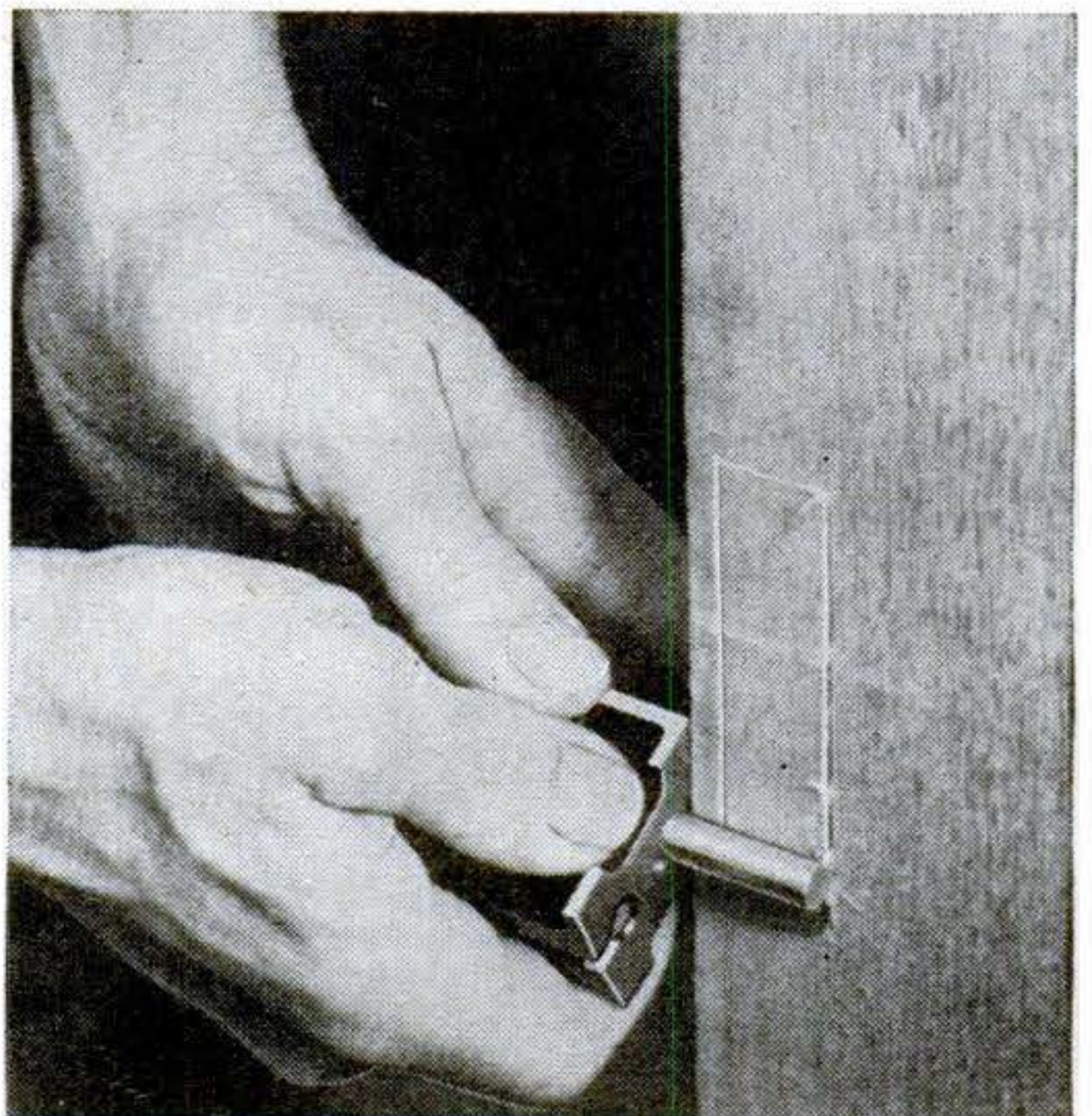

MORTISE DOOR LOCKS

spindle hole to locate their centers. Draw a line also along the top of the lock to guide in laying out the mortise. Some carpenters prefer to set the face of the selvage $1/16$ " behind the edge of the lock stile to permit dressing down without removing the lock if the door swells and binds.

Next, bore the spindle hole with a $1/2$ " bit and the keyhole with a $3/4$ " bit, stopping when the point pricks the opposite side of the door. Finish boring from the other side to avoid splintering. Then elongate the keyhole on both sides with a $3/16$ " or $1/4$ " chisel.

Lay out for the mortise by squaring across the edge of the door from the top line drawn on the side of the stile. Draw a bottom line also, and gauge a center line. Bore $3/4$ " holes $1 1/4$ " apart and overlap with holes between them. Put the end ones beyond the end lines to clear out the corners and save time in chiseling. Sight along both sides of the door when boring to assure alignment. Regulate depth with a bit gauge or a chalk mark on the bit.

Trim the sides of the mortise with a wide chisel, trying

the lock from time to time until it enters properly. Then punch screw holes with a nail set and screw the selvage to the edge of the door. Scribe around the selvage with a knife point, remove the lock, and mortise the edge to take the selvage, making cross cuts as in dapping for a hinge and trimming to the outline after removing the waste.

Screw the lock back in place, and if one end of the selvage sinks too far, shim with cardboard or sandpaper. Insert the spindle and try the lock with the knob and key.

Locate the position of the strike, also known as the keeper, on the door jamb by

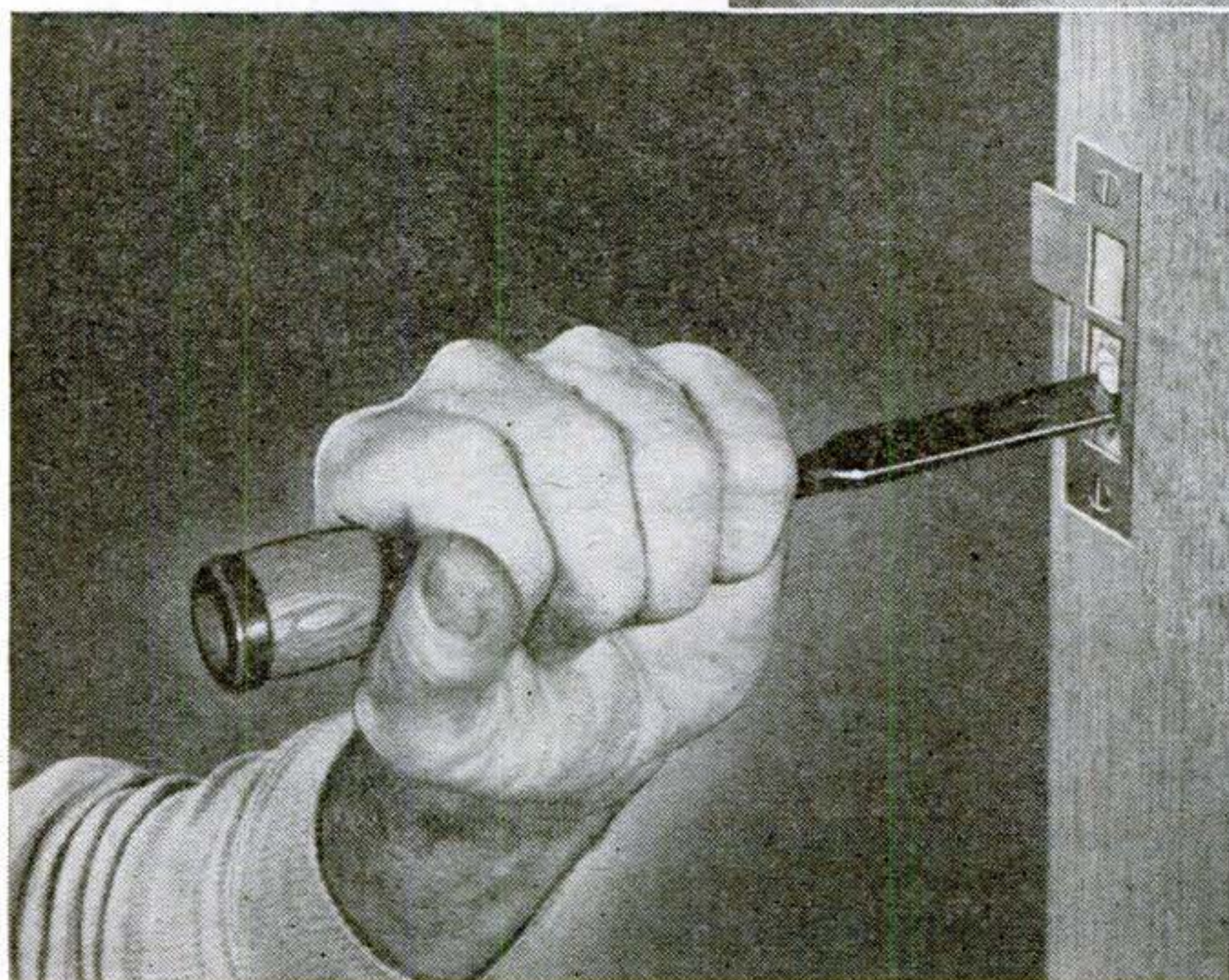
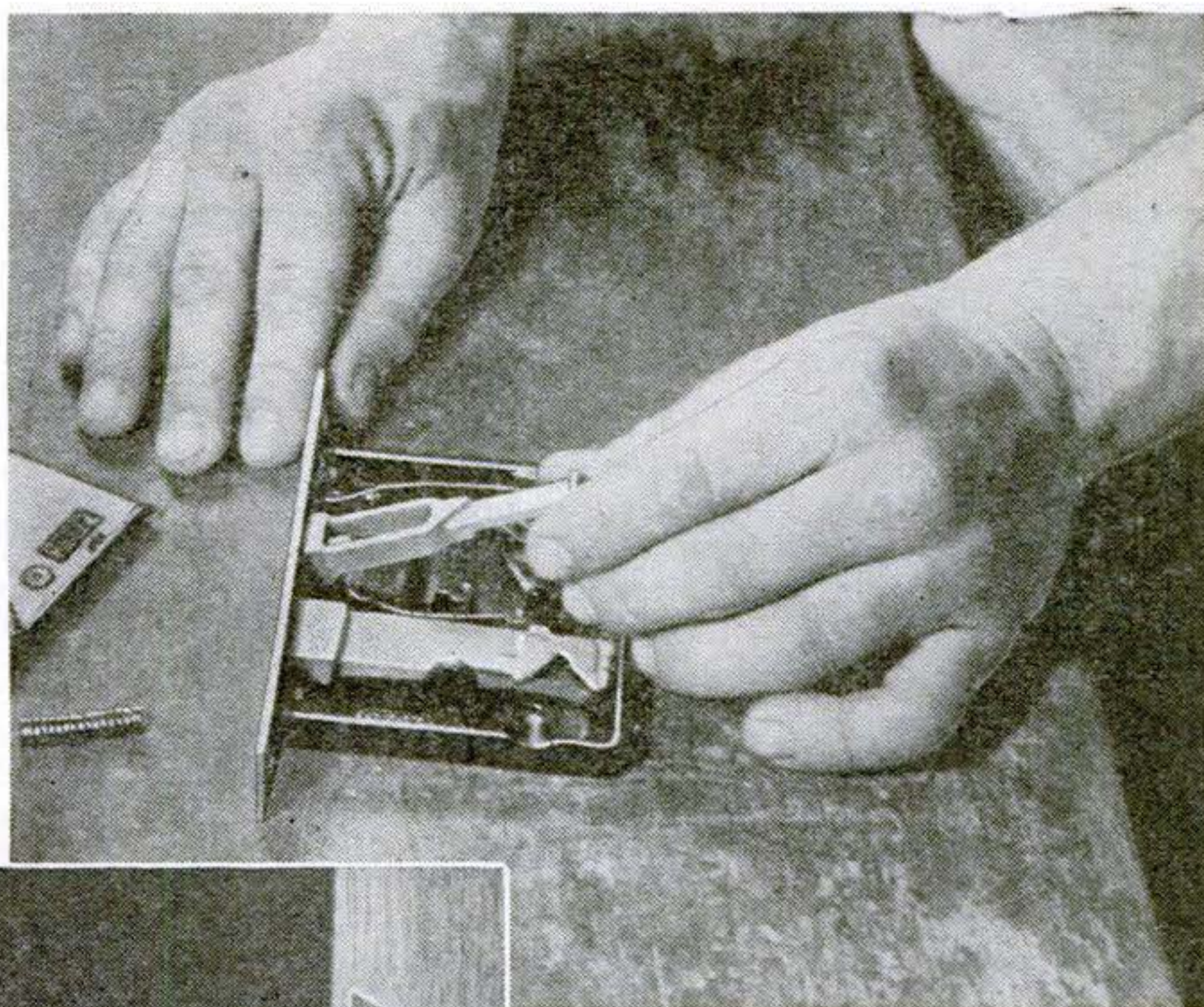

Mortise locks are always assembled for right-hand doors. Should the flat part of the latch be toward the jamb, take the cover off and turn the latch bolt over. Be sure to slip the spring over the prong.

Screw the strike in place in the jamb mortise, and then cut through the openings with a chisel for the latch and bolt mortises. No great care is required. The only thing that needs watching is to get the recesses deep enough so the latch and bolt will not bind.

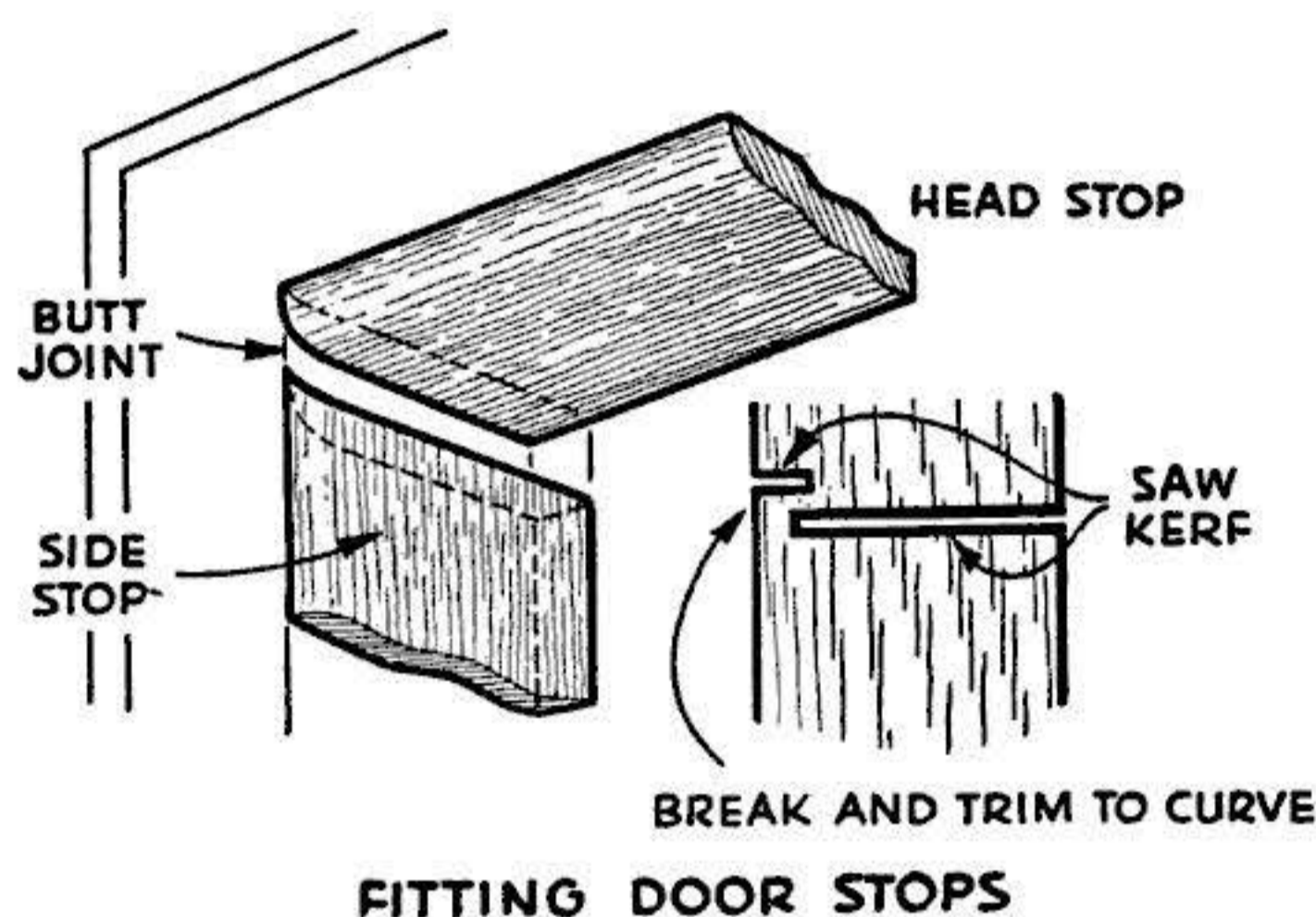
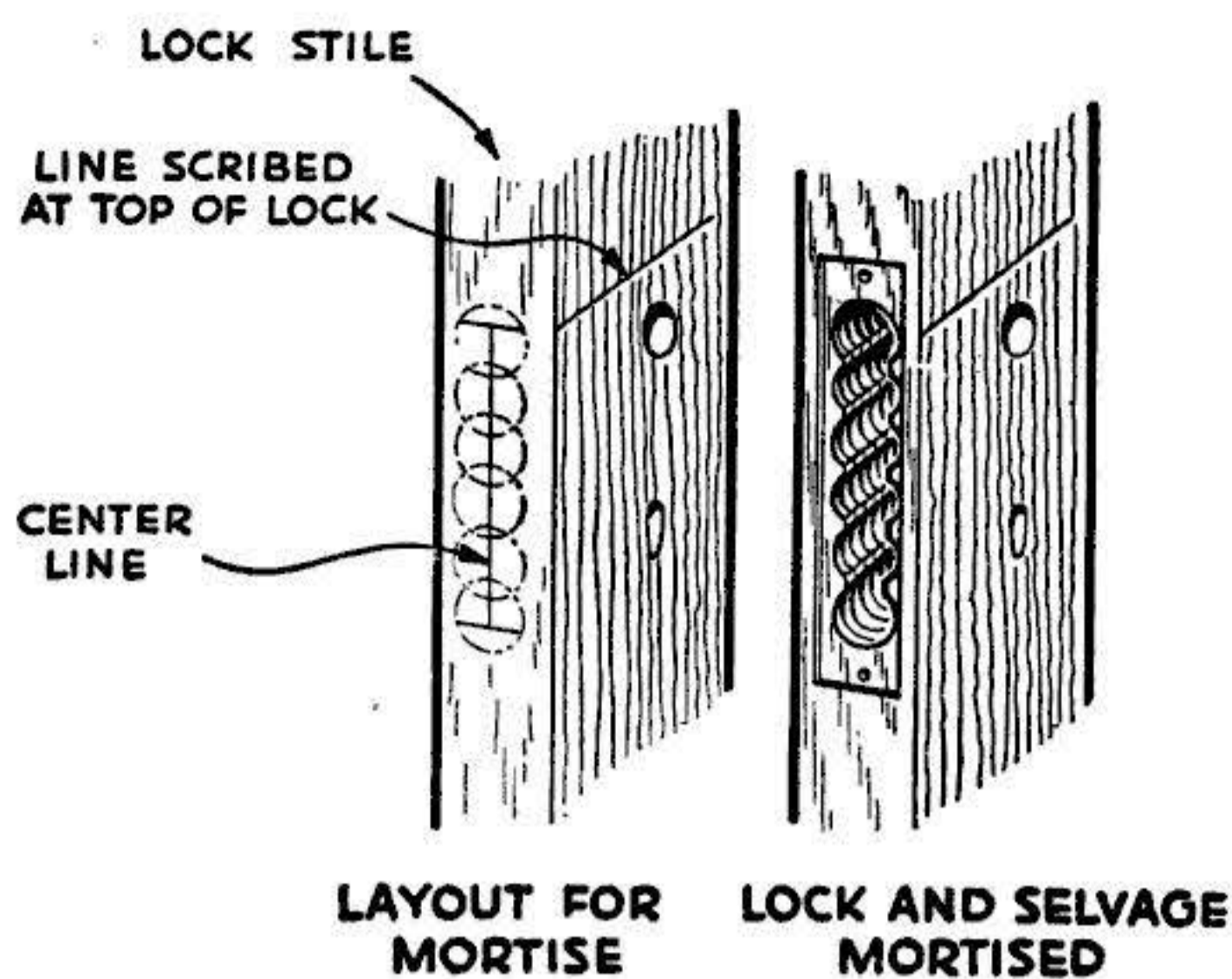

Since the rear edge of the head stop is rounded, the corner of the side stop must be shaped to fit in order to avoid showing a gap. The corner is also cut at an angle to simulate a miter.

closing the door until the latch touches and marking above and below the latch. Open the door, hold the strike against the jamb with the striking lip centered on the gauge marks, and scribe for both the top and bottom. Set a gauge by comparison with the lock selvage and score the sides for a mortise. Cut with a chisel in the same way the edge of the door was mortised for the lock selvage, screw the strike on, and with it in place mortise for the latch and bolt by chiseling through the two openings.

Many carpenters wait until after the lock has been installed to set the door stops in the jamb. The stops can then be adjusted to fit the door closely even if it has become somewhat twisted.

Cut the upper stop first to fit between the wide jambs and nail it in place parallel to the edge of the jamb at a distance 1/16" more than the thickness of the door. Butt the side stops against the head stop, cutting them a little long so they can be sprung into place and forced into a tight joint. Nail in the hinge stop with a clearance of 1/16" against the door hinge stile.

If the door is sprung and is hung, as it should be, with the upper lock corner projecting into the opening, latch the door, force the corner out, and hold it with the stop.

Screw the escutcheon plates on, and then remove them again before painting. When replacing, turn the screw slots parallel with the length of the plates. **END**

PLYWOOD SCREW FASTENINGS, I

[WOODWORKING]

Maximum strength in screwing plywood to wood frames is obtained when there is proper balance of screw gauge, length, spacing, and margin (distance from the edge to the screw). If too close to the margin, the fastening may fail through shear stresses, or if too small a gauge screw is used, the head may pull through. Obviously, frames should be of such material and size as not to split or be weakened by the screws. Experience indicates flathead screws alone and roundhead screws used with washers are about equal in holding power. Roundhead screws without washers are markedly inferior.

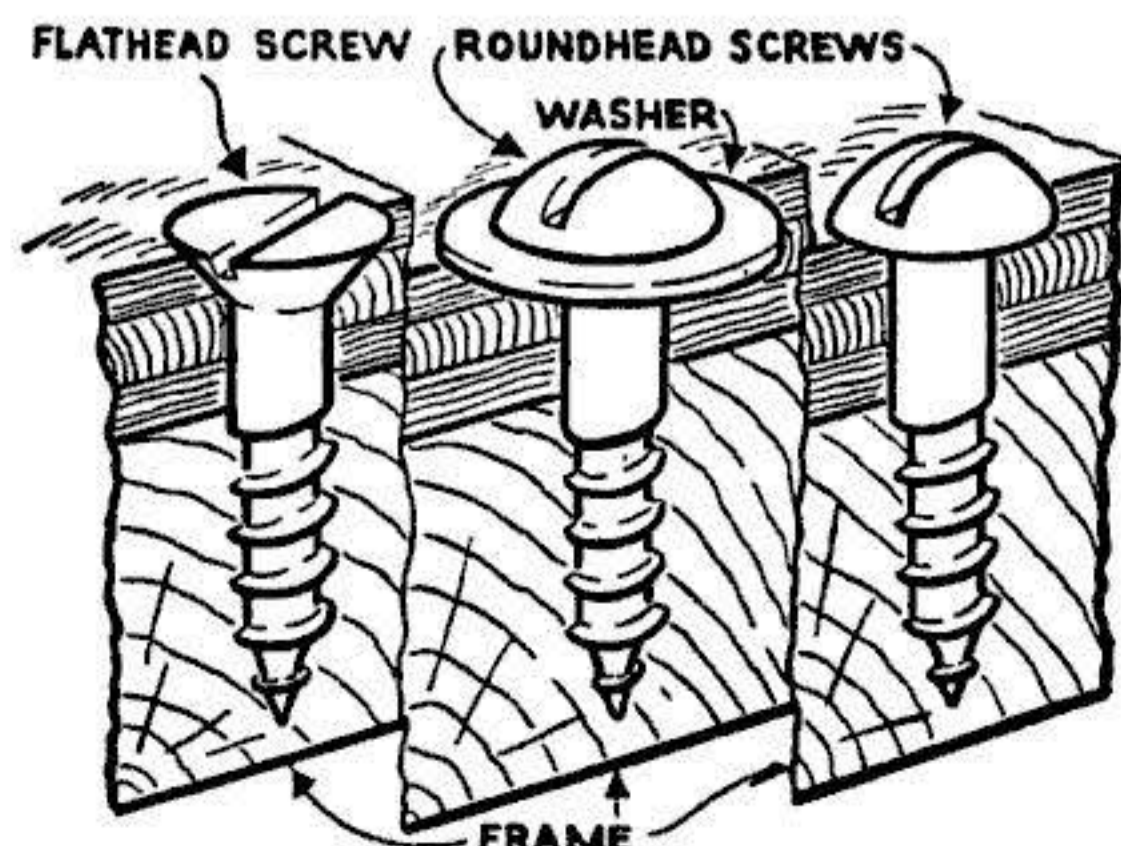

Plywoods may be divided into the following three density groups, each of which has its own screw-holding characteristics:

Low density: Basswood, Spanish cedar, cottonwood, bald cypress, Douglas fir, true fir, hemlock, sugar pine, white pine, yellow poplar, redwood, and Sitka spruce.

Medium density: Black ash, pumpkin ash, white elm, black gum, cotton gum, red gum, hackberry, magnolia, mahogany, soft maple, sycamore, and black walnut.

High density: White ash, beech, birch, black cherry, cork elm, and hard maple.

POPULAR SCIENCE MONTHLY SHOP DATA

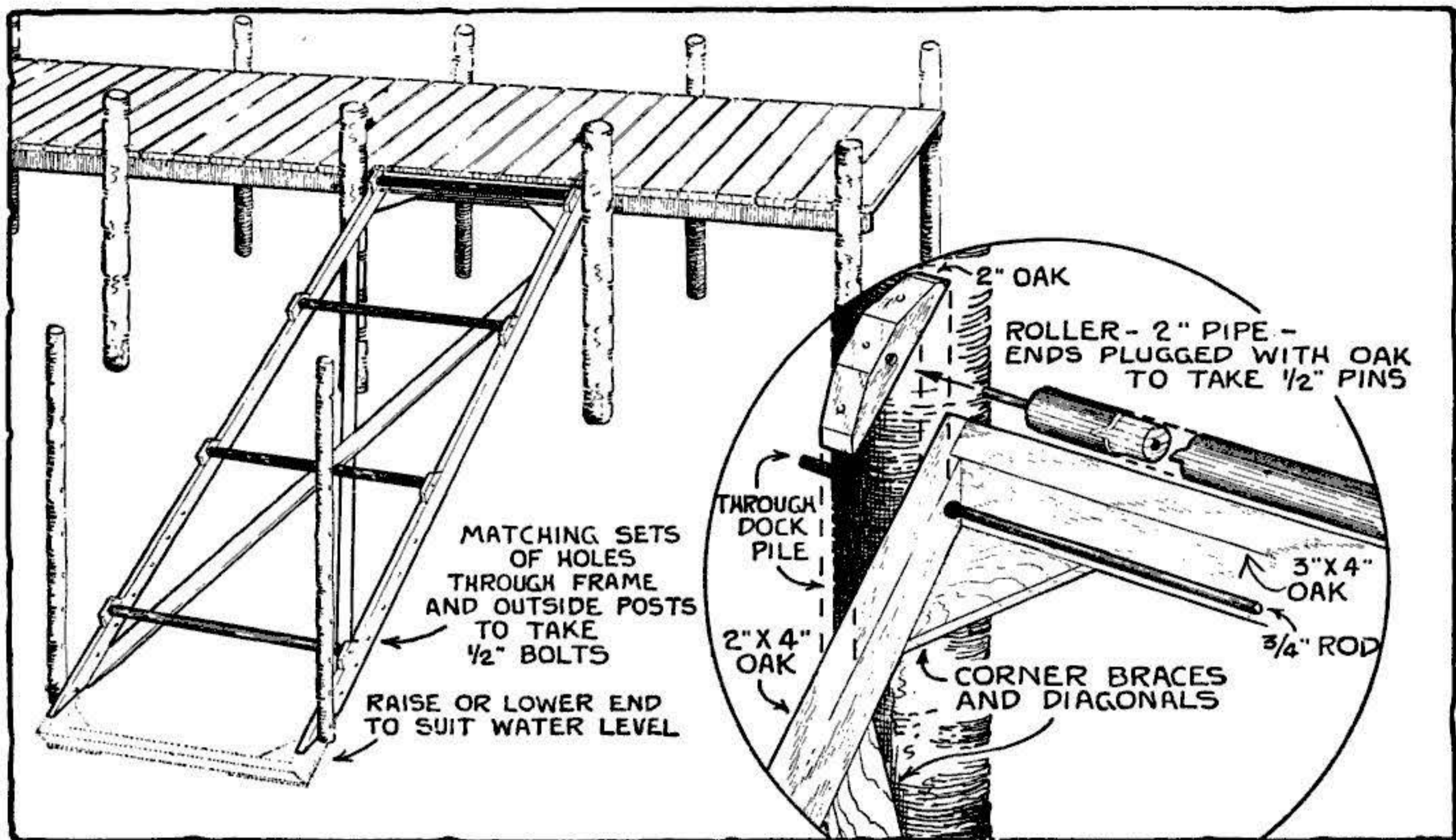

Roller Runway Makes It Easier to Launch or Pull Out a Boat

BOATS weighing as much as 400 lb. can be handled with ease on this simple roller-fitted runway. Hinged for quick raising or lowering, according to the water level, it may be installed in the spot best suited to your particular dock or needs.

Provided the outer posts will not interfere with water traffic, locating it at the end of the dock will make it possible to haul out a particularly heavy boat with a small winch or tackle. In a boathouse, it could be hinged from the doorway and be made long enough to reach out to the point where the boat will float. Or the runway might be extended from posts on shore if you haul your boat on a trailer or car.

Build the frame of oak or heavy pine, reinforcing the corners with braces and the entire frame with diagonals. Suit the width to the beam of the boat and adjust the length so the incline at the lowest water level will not be more than 30 deg. Hinge the frame loosely to the piles in order that it may be removed in winter.

The rollers are 2" pipe cut to length and plugged with 10" or 12" oak dowels to take drive-in pins of 1/2" iron rod. Simple oak pillow blocks are used to mount the rollers on the frame every 18" or 24". Matching sets of holes in the outer posts and frame allow for adjustment of the runway to the water level.—J. A. EMMETT.

Waterproof Plywood Provides Blade Material for Pair of Oars

WHY buy a pair of oars when you can make a trim set easily and economically from scrap pieces of 3/8" waterproof plywood and two lengths of tough hardwood?

Mark the blade outline on the plywood, saw to shape, round off the edges, sand until smooth, and apply three coats of spar varnish or paint. After cutting the handle to size and slotting the lower end, coat

the slot with resin glue, install the blade, and secure with flathead screws. Paint or varnish to suit.—JOSEPH S. CORLE.

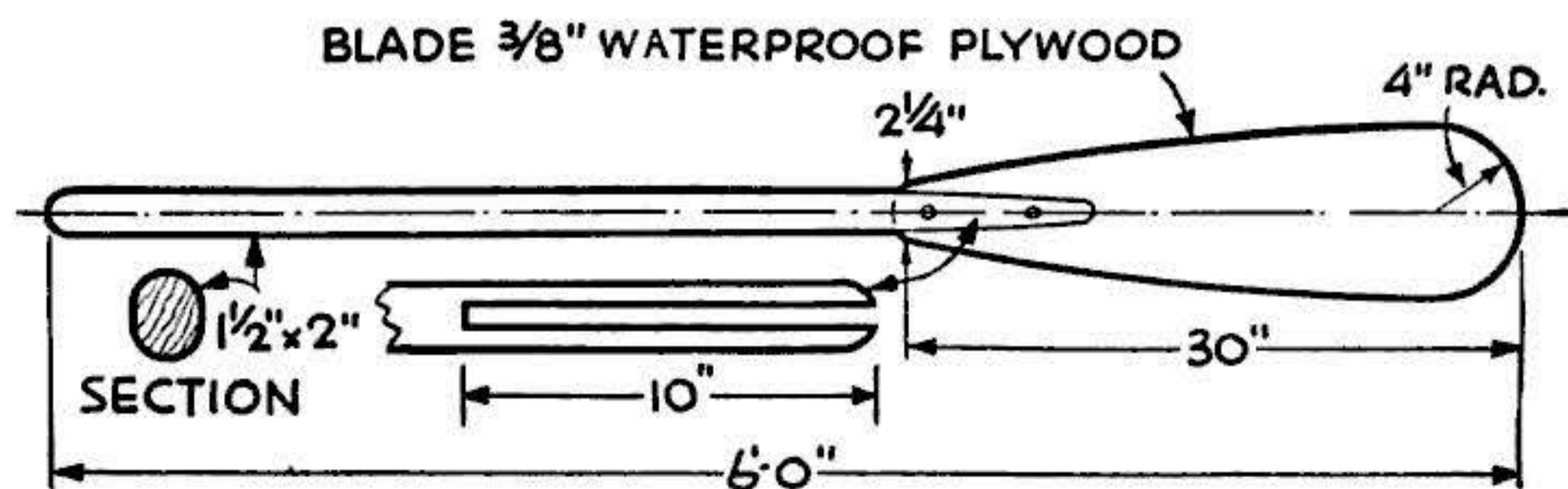

Putting Water to Work

Second of a series on harnessing small brooks and streams. How to measure the available horsepower and pick the right water wheel.

PART TWO

By C. D. BASSETT

MEASURING the flow of water in the stream or brook on your property is the logical first step in planning a small water-power project. The float method of making this measurement, described in last month's installment, is generally the easiest to perform and, if done carefully, is accurate enough for most purposes. If, however, a stream is so shallow at low-water time as

to impede the progress of a weighted float, the weir method of measuring flow has advantages. Essentially a kind of water meter, a weir is a rectangular notch or spillway of carefully controlled proportions located in the center of a small temporary dam. Two simple measurements permit the volume of flow to be accurately calculated.

Before constructing the dam, measure the depth of the stream at the site; the depth of the weir notch, M in Fig. 1, should equal this. Since the dam need not be permanent, simple plank or tongue-and-groove lumber will serve adequately. No water must flow except through the weir, so care should be taken to seal the ends and bottom of the dam by extending planks into the banks and below the bed of the stream. Clay or loam puddling on the upstream side will stop minor seepage. Be sure the

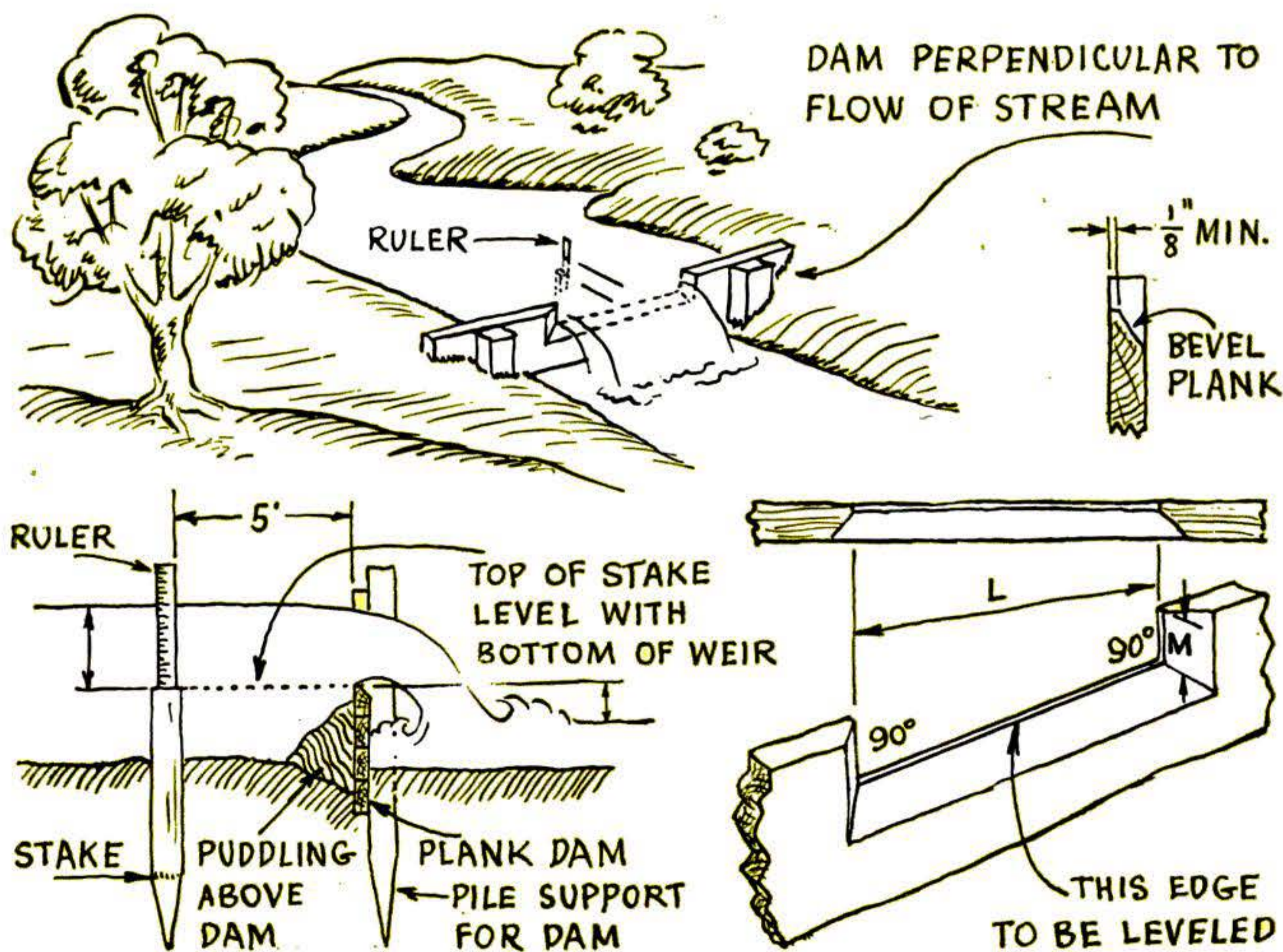

Fig. 1. WEIR METHOD OF MEASURING FLOW. More trouble than the float method, this gives somewhat more accurate results. It is especially useful in shallow streams, or if a dam is already present.

dam is perpendicular to the flow of the stream.

The weir should be located in the center of the dam, with its lower edge not less than 1' above the surface of the water below the dam. This lower edge should be accurately leveled. Both this and the vertical edges of the weir should be beveled with the sharp edge upstream; a $\frac{1}{8}$ " flat on the bevel will keep the edge from breaking down. Proportion the weir so that its length L is not less than 3M, and larger if possible.

Drive a stake in the stream bed at least 5' upstream from the weir, pounding it down until its top is exactly level with the bottom edge of the weir. Allow the stream to reach its maximum flow through the weir and then measure with a ruler the depth in inches of water over the stake. Referring to the table on this page, you can now read the number of cubic feet per min. of water for each inch of L, the weir width. If you multiply the figure from the table by L, the result is the total amount of water flowing in cubic feet per minute, which is Q in the horsepower formula given last month.

If your stream is already dammed, there is no need to construct another dam just to measure flow. It is quite possible to employ the existing dam, using its spillway as a weir, provided that all water can be made to pass through the spillway. Construct a wooden or metal frame to fit the spillway and seal it in place snugly. The center of this frame should incorporate a properly proportioned weir notch. As before, M should equal the depth of the water flowing through the spillway before the weir is installed, and L may in most cases be half the width of the spillway.

To get an accurate estimate of available horsepower, you will need a precise figure for H, the head of water that will be present. Head may be defined as the vertical distance in feet from the surface of water in the pond behind the dam to the surface of the stream below the dam at the site of the wheel. This figure may be obtained by any of several methods in cases where a dam is already present, and with scarcely greater difficulty at the site of an unbuilt dam.

Measuring a difference in elevation can

be quickly and accurately done with an engineer's transit and leveling rod. But since not everyone has access to these instruments, and since those who do would not need instruction on so simple a job as running a level, we'll pass on to other methods.

Figure 2 illustrates a very simple way of measuring a vertical distance. The equipment required is a carpenter's level, a folding rule or steel tape, a 1" by 2" by 6' board with two edges planed parallel, two wooden pegs, a stake, and a C-clamp. These are items that can be found in almost any home, and certainly any farm. Though the method can be somewhat tedious if the difference in elevation is large, the results will be quite accurate with ordinary care in leveling and measuring. Note in

Inches Depth over Stake, D	1/8 in.	1/4 in.	3/8 in.	1/2 in.	5/8 in.	3/4 in.	7/8 in.	
1 inch	.40	.47	.55	.65	.74	.83	.93	1.03
2 "	1.14	1.24	1.36	1.47	1.59	1.71	1.83	1.96
3 "	2.09	2.23	2.36	2.50	2.63	2.78	2.92	3.07
4 "	3.22	3.37	3.52	3.68	3.83	3.99	4.16	4.32
5 "	4.50	4.67	4.84	5.01	5.18	5.36	5.54	5.72
6 "	5.90	6.09	6.28	6.47	6.65	6.85	7.05	7.25
7 "	7.44	7.64	7.84	8.05	8.25	8.45	8.66	8.86
8 "	9.10	9.31	9.52	9.74	9.96	10.18	10.40	10.62
9 "	10.86	11.08	11.31	11.54	11.77	12.00	12.23	12.47
10 "	12.71	12.95	13.19	13.43	13.67	13.93	14.16	14.42
11 "	14.67	14.92	15.18	15.43	15.67	15.96	16.20	16.46
12 "	16.73	16.99	17.26	17.52	17.78	18.05	18.32	18.58
13 "	18.87	19.14	19.42	19.69	19.97	20.24	20.52	20.80
14 "	21.09	21.37	21.65	21.94	22.22	22.51	22.70	23.08
15 "	23.38	23.67	23.97	24.26	24.56	24.86	25.16	25.46
16 "	25.76	26.06	26.36	26.66	26.97	27.27	27.58	27.89
17 "	28.20	28.51	28.82	29.14	29.45	29.76	30.08	30.39
18 "	30.70	31.02	31.34	31.66	31.98	32.31	32.63	32.96
19 "	33.29	33.61	33.94	34.27	34.60	34.94	35.27	35.60
20 "	35.94	36.27	36.60	36.94	37.28	37.62	37.96	38.31
21 "	38.65	39.00	39.34	39.69	40.04	40.39	40.73	41.09
22 "	41.43	41.78	42.13	42.49	42.84	43.20	43.56	43.92
23 "	44.28	44.64	45.00	45.38	45.71	46.08	46.43	46.81
24 "	47.18	47.55	47.91	48.28	48.65	49.02	49.39	49.76

Table from James Leffel & Co.

This table shows the quantity of water passing over a rectangular weir in cubic feet per minute (cfm) for each inch of notch width. Depth D is read as a combination of the lefthand column and the top row. For example, if the depth over your stake is $5\frac{3}{8}$ ", follow over 5 (fifth row) to $\frac{3}{8}$ (fourth column), and read the value as 5.01 cfm. Don't forget that this figure should now be multiplied by the width in inches of your notch.

the drawing that in the case of a pre-existent dam, one or more measurements needed to carry around the edge of the dam are subtracted from rather than added to the total.

Less practical in most cases, though still of occasional special value, are two other ways to determine head. Elevations can be measured quite readily by the techniques of photographic surveying. For those who

are familiar with the procedure, it is a simple matter to take the required pictures in the field and then scale the required elevation at the desk from the developed photographs. Another method involves the use of a barometer, either mercury or aneroid, to indicate differences in height. However, this method is useful only where the head to be measured is considerable, say, more than 25', and calls for special

techniques to hold the probable error down to acceptable proportions. Except in unusual circumstances, the writer recommends that the method in Fig. 2 be employed, inasmuch as it requires little special equipment and with ordinary care gives good results.

With sound figures for both H and Q, you are now ready to calculate the available horsepower of your installation with the formula given in the first installment. If the power is found to be sufficient to warrant continuing with the project, say $\frac{2}{3}$ hp. at the least, your next step is to determine the nature of your power requirements. Here individual variations are so many as to make it difficult to outline a specific procedure. It's possible, however, to suggest factors you should consider in planning your power plant.

Some of the uses to which small-capacity installations are successfully put

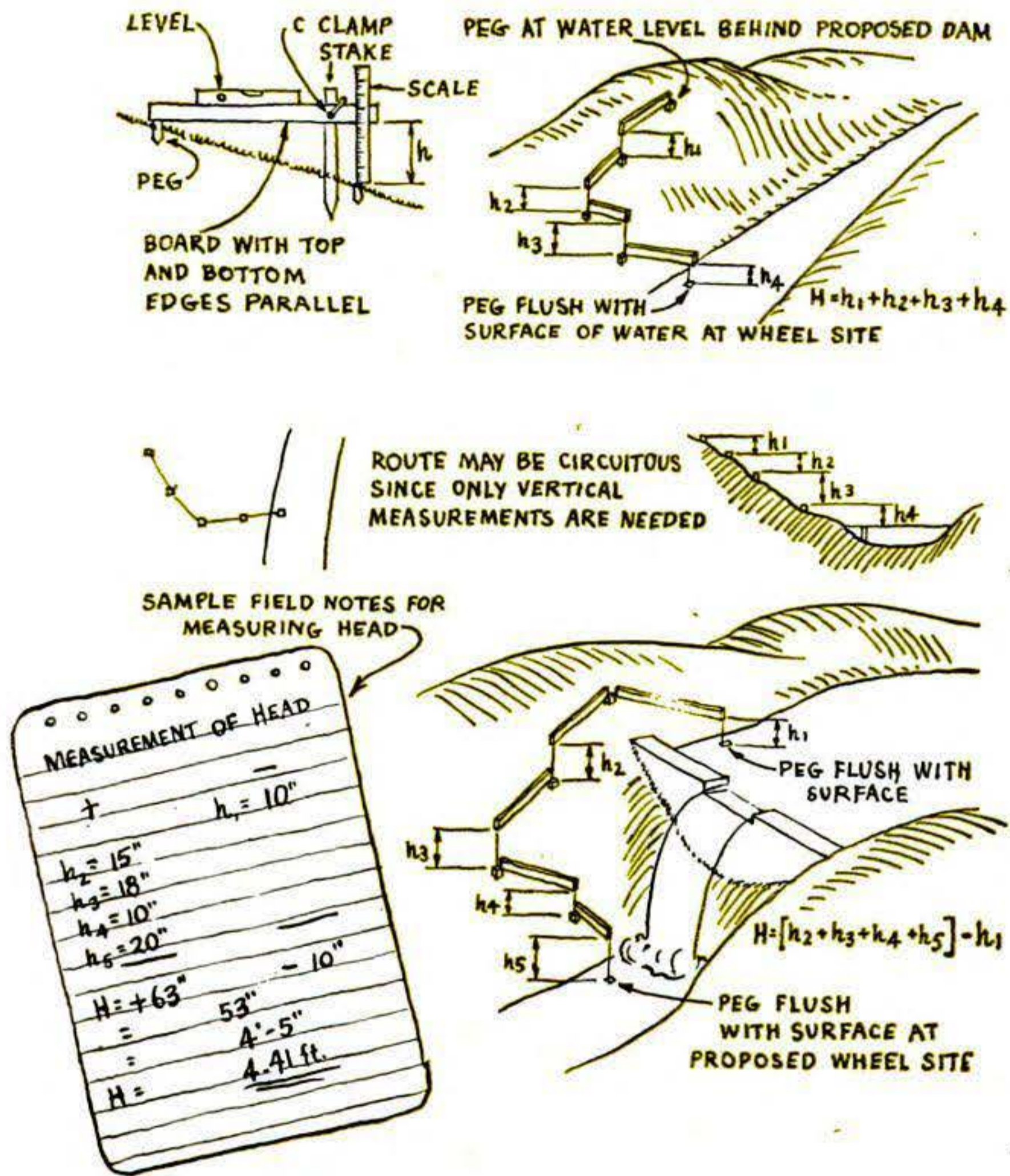
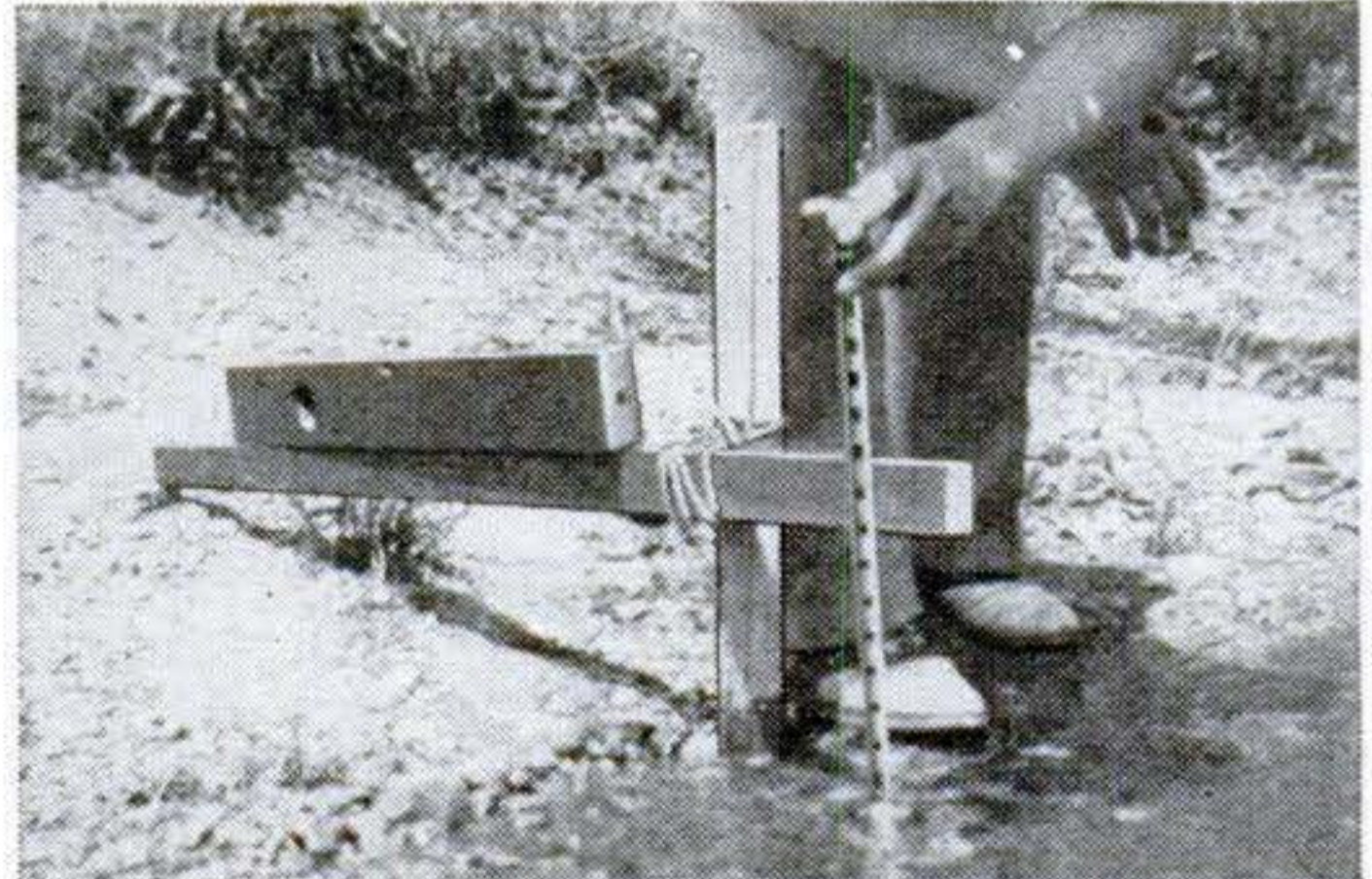

Fig. 2. MEASURING HEAD. With a carpenter's level, straightedge, and pegs, head can be measured before or after the dam is built.



With the straightedge held level, vertical height between a pair of pegs is read off and noted down.



Your last measurement should be to the surface of the water at the site selected for the water wheel.

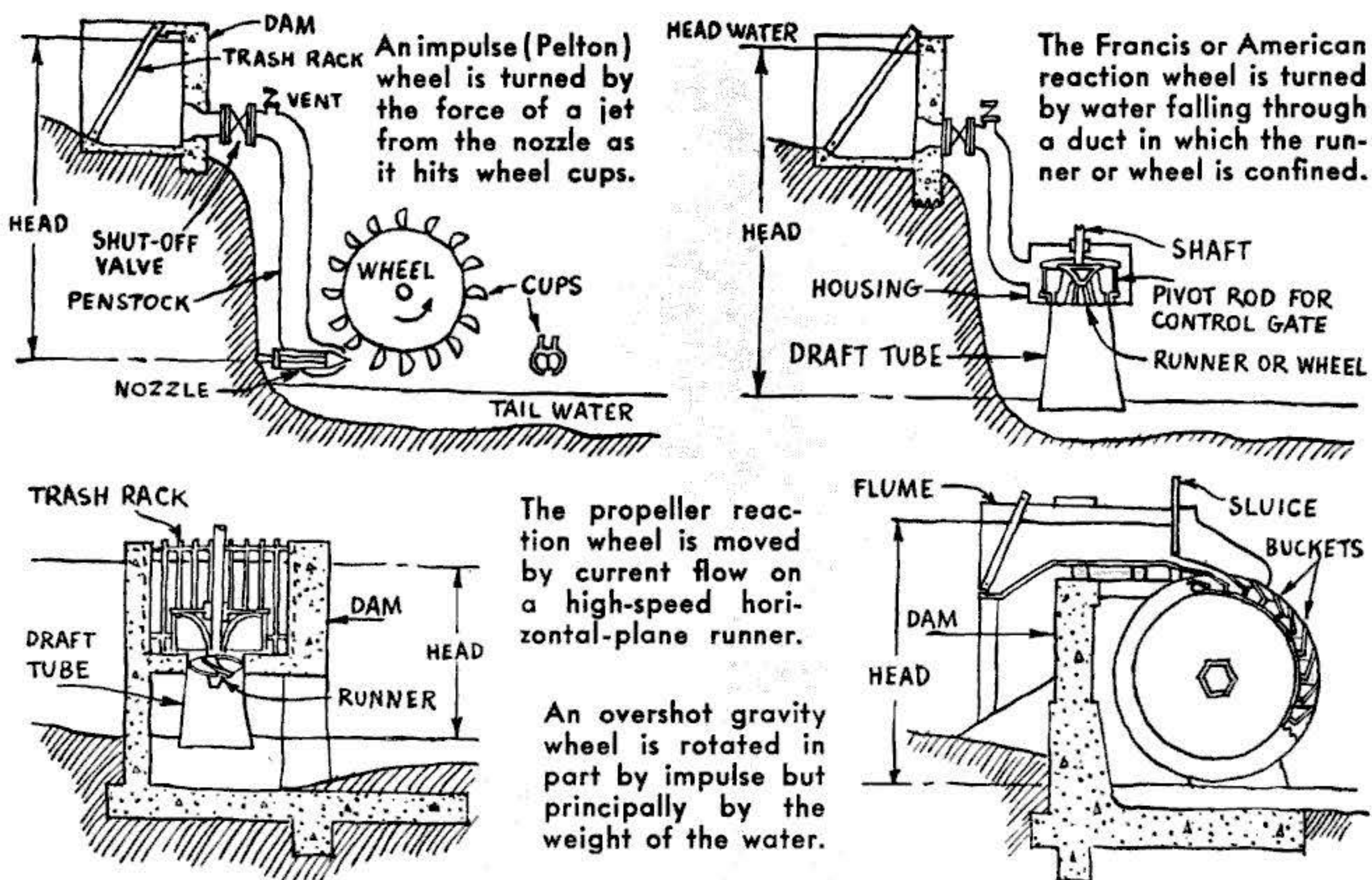

FIG. 3. FOUR TYPES OF SMALL WATER WHEELS

include directly powering pumps, mills, machine tools, or other small-demand machinery; and driving a generator to supply electricity for either lighting or power purposes. The latter type of installation is of course the more flexible and generally useful. Determine, then, the uses you propose for your water power, and tabulate the horsepower required after each item. In the case of electric motors or appliances rated in amperes or watts, remember that watts are volts times amperes, and that 746 watts are equal to 1 hp.

From this tabulation, the peak load can be determined. This is the sum of the power demands made by different pieces of equipment that may probably be in use at one time. Knowing power and load, you can now determine if the proposed installation will be on a sound basis.

Do not use your available horsepower figure directly, since deductions should first be made for losses in the water wheel and in the generator, if one is to be used. For small installations, assume wheel efficiency to be 75 percent; many small wheels will better this, but the assumption will provide leeway for possible optimism in measuring H and Q. Generator efficiency can be assumed to be 80 percent, a figure that will also be bettered in many cases but is on the safe side. Thus switchboard power may

be expressed at $.75 \times .8 \times \text{hp}$, or .6 of the available horsepower.

At this stage of the game, it's well to mull over the possible variations and combinations, rather than to proceed with specific construction plans. Consider for example the decision required if the indicated switchboard power will seemingly handle the peak load—whether to build a dam just large enough to do this job, or to build one substantially larger to handle possible future increases in power requirements. The former choice will be obviously cheaper at first but may not be so in the long run, since power demands have a way of growing and since it is rarely satisfactory to increase the structure of an existing dam.

If the peak load is apparently too high, various possibilities should be considered. Will "pondage"—water stored behind the dam overnight or in slack periods—help out? Can the use of equipment be rationed in some way to level out the load peak? Can some nonessential equipment be dispensed with? Is the project necessarily a year-round enterprise, or can the low-power characteristics of the dry season be ignored? A word of caution on these points may not be amiss: it's far better to plan an installation that will provide more power than you need than one which doesn't supply enough.

Whether, in the event that you decide to

generate electricity, to use AC or DC is another decision to make. In circumstances where the generator must be located some distance from the load, AC is the only choice, for DC transmission losses would be too high, amounting in small installations to a prohibitive percentage of switchboard power. If your buildings and equipment are already wired to receive one type of current, it would obviously be sensible to fix on the same type of power; if for example your farm is already wired for a battery-type lighting system, there would be little reason to revamp the installation for AC. If on the other hand you are starting from scratch, the writer recommends the use of DC wherever possible. An AC generator must be closely regulated at or slightly above synchronous speed, and close regulation requires complicated governing equipment that is tricky to build or expensive to buy. A compound-wound DC generator, on the other hand, provides inherently close voltage regulation over a wide speed range; and even a shunt-wound DC generator with a direct-acting field-rheostat regulator would be satisfactory.

Selecting the right wheel for your plant is perhaps the final step in your preliminary planning. There are three general types of water wheel—impulse, reaction, and gravity—and several fairly common varieties of each type. However, for small plant purposes, it is possible to narrow the number down to those shown in Fig. 3. Note that two types of reaction wheels, the Francis and the propeller, are shown, and but one variety of gravity wheel, the overshot one.

The impulse or Pelton wheel, operated

exclusively by the force of the water from the jet, includes among its advantages very slight leakage and friction losses, good efficiency under varying flows, and a sufficiently high shaft speed to drive a generator. It is more resistant to pitting by water containing sand, silt, or minerals than the reaction type. Its disadvantages include the fact that it cannot use all the available head, is larger than a reaction wheel developing the same power, and will wallow in high tail water. It must be mounted as close to the tail water as possible.

The reaction wheel, either the Francis or propeller type, is turned by the fall of water through a duct or pipe in which the wheel is confined. It is the most compact of all wheels for a given power, uses all of the available head, and operates at a satisfactory speed for direct coupling to a generator. It is an efficient wheel over a wide range of conditions, and it can be mounted at any convenient height above tail water. Disadvantages include rapid corrosion with silted water, and relatively high leakage and friction losses, especially in small units.

Finally, there is the overshot gravity wheel, which is turned largely by the weight of the water and partly by impulse. It has good efficiency under varying flow, and is unaffected by sand, silt, or minerals in the water. Gravity wheels turn at a low speed, which is undesirable for driving a generator or high-speed machinery, but suitable for some pumping and grinding applications. Such a wheel will wallow in high tail water, is the largest wheel for a given power, and will be obstructed by ice in winter unless housed.

TO BE CONTINUED



GARDEN HINTS. A bag to collect the seeds of valuable plants, as at the left, can be readily obtained by cutting a length of coarse mesh stocking, tying one end, and turning it inside out. Placed on the plants a few days before the capsules burst, such bags will greatly increase the production of breeding seeds. Right, a spring clothespin lettered with India ink makes an excellent plant marker. It may be attached to a wire fence, dowel, or stick. Sand the sides if you wish to re-letter it.—TERRELL NICHOLAS.





CHEESE PENTHOUSE. I'm wild about ripe cheeses, but my wife absolutely refuses to give such nutritive scents house room in her kitchen or refrigerator. In desperation, I built a storage case and mounted it outside the kitchen door, placing it high enough to foil any four-legged highjackers. Now I have cheese when I want it, although the breezes on that side of the house sometimes become suspect.—JACQUES TORRE.

KNOTS SUCH A BAD IDEA. One big knot in my new clear-pine kitchen cabinets gave me an idea. Using various sizes of burnt corks touched to some orange shellac, I copied the knot many times, twisting the end of the cork against the wood and imparting a few curves with the edge. Then I applied maple stain. Now I have a fine collection of knots and never have to worry about 'em becoming knotholes.—J. W. CARR.



IQ WHAT'S YOUR INGENUITY QUOTIENT?

Have you pulled off a smart one lately? We will pay for acceptable contributions showing ingenious solutions of problems in the home, shop, garage, or camp. It doesn't matter if it's wacky — if it works.



TICK STOPPER. I can take the spine-jolting jangle of my alarm, but the night-long ticking wears me down. A glass cover cut from a gallon jug now lets me snooze, keeping ticks in, dust out.—JOHN A. WITTNER.

IT'S MONEY IN THE TANK. At last I've found a way to keep myself from dipping into my savings. After I bought a new car in 1940, I made it a practice to drop a nickel into the gasoline tank for every gallon I bought. Last year I traded in the car. It was rather difficult to get the nickels, but the two bucketfuls were more than enough for the down payment, and there wasn't a bit of sludge in the tank.—THOMAS R. MUHA.



This smooth-flying job is no "hot rock," but monocoque construction makes it a breeze to build.

HERE'S a control-line model that can be counted on to give many hours of troublefree flying, for the method of construction insures a high strength-weight ratio. Covered with stiff paper, it has an all-metal appearance that is easily obtained with two or three coats of dope. A class A engine whips it around at a good rate, though it is not in the "hot rock" speed category, and adequate wing area permits it to land smoothly.

Fashion the 17 $\frac{7}{8}$ " long fuselage backbone or longeron from a piece of $\frac{1}{4}$ " sheet balsa. To this first attach a bulkhead A, which also serves as the firewall, installing two right-angle gussets to obtain good alignment. This bulkhead is $\frac{1}{8}$ " plywood, but all others are cut from medium-hard 1/16" sheet balsa. Bulkheads B, D, E, and F have openings to reduce the weight and allow the control push rod to pass through, but all the lower sections are solid. Because of the rigidity provided by the paper covering, it is unnecessary to notch in the bulkheads. Simply cement them in place.

Cement a $\frac{1}{4}$ " by $\frac{1}{4}$ " balsa brace between bulkheads A and B and two others as cockpit edges from D to each of the C uprights, but leave parts H and the windscreen until after the wing frame has been assembled and attached. The two parts H are canted inward on an upward diagonal from the two C members to B, forming the forward edge of the cockpit.

While the fuselage is drying, build the wing frame. Drill the $\frac{1}{4}$ " by $\frac{5}{8}$ " spar midway to take a 2-56 by 1" screw that serves

Stressed-Paper Control-Line Plane

By ROY L. CLOUGH, JR.

as the pivot of the control plate. Recess the head into the spar and coat the entire screw liberally with cement before pushing into place. Form the landing gear from 3, 32" wire. The anchor is a brass washer bent around the wire and soldered to the mounting screw. Bolt the assembly to the firewall.

Known as ledger paper, the stock used to cover the model mikes about .008". It bends easily with the grain and has a smooth finish that takes dope well. Cover the bottom of the fuselage first, starting with the rear-most section and working forward, overlapping each joint. A template is unnecessary. Just cut the paper to approximate size and trim after cementing. In covering the section behind the landing gear, cut notches at least $\frac{3}{8}$ " deep around the wire so landing shocks will not tear the paper. Never attempt to cover more than one section at a time. To do so will cause buckling, cement "dimples," and general unevenness.

After the bottom of the fuselage is covered, install the engine mounts. Then proceed to the tail surfaces and the balsa block that streamlines the tail. Note that this block is shaped to limit elevator down travel to 3 16". For the proper hinge effect, two of the cloth hinges must be installed with the cloth on top of the

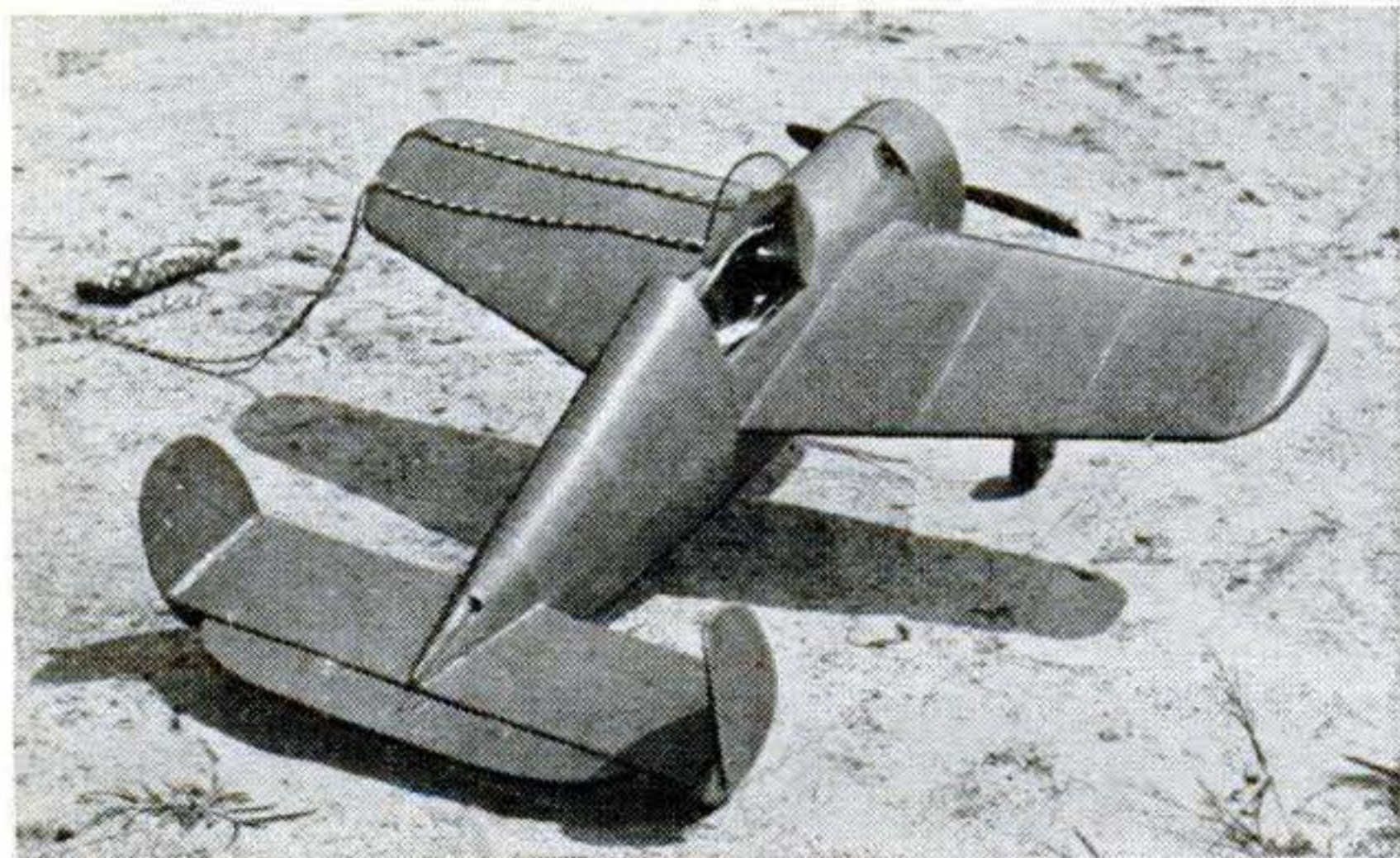

Two pen cells in the cockpit are easily accessible, making boosters and an ignition switch unnecessary. Note the engine vent behind the cowling.

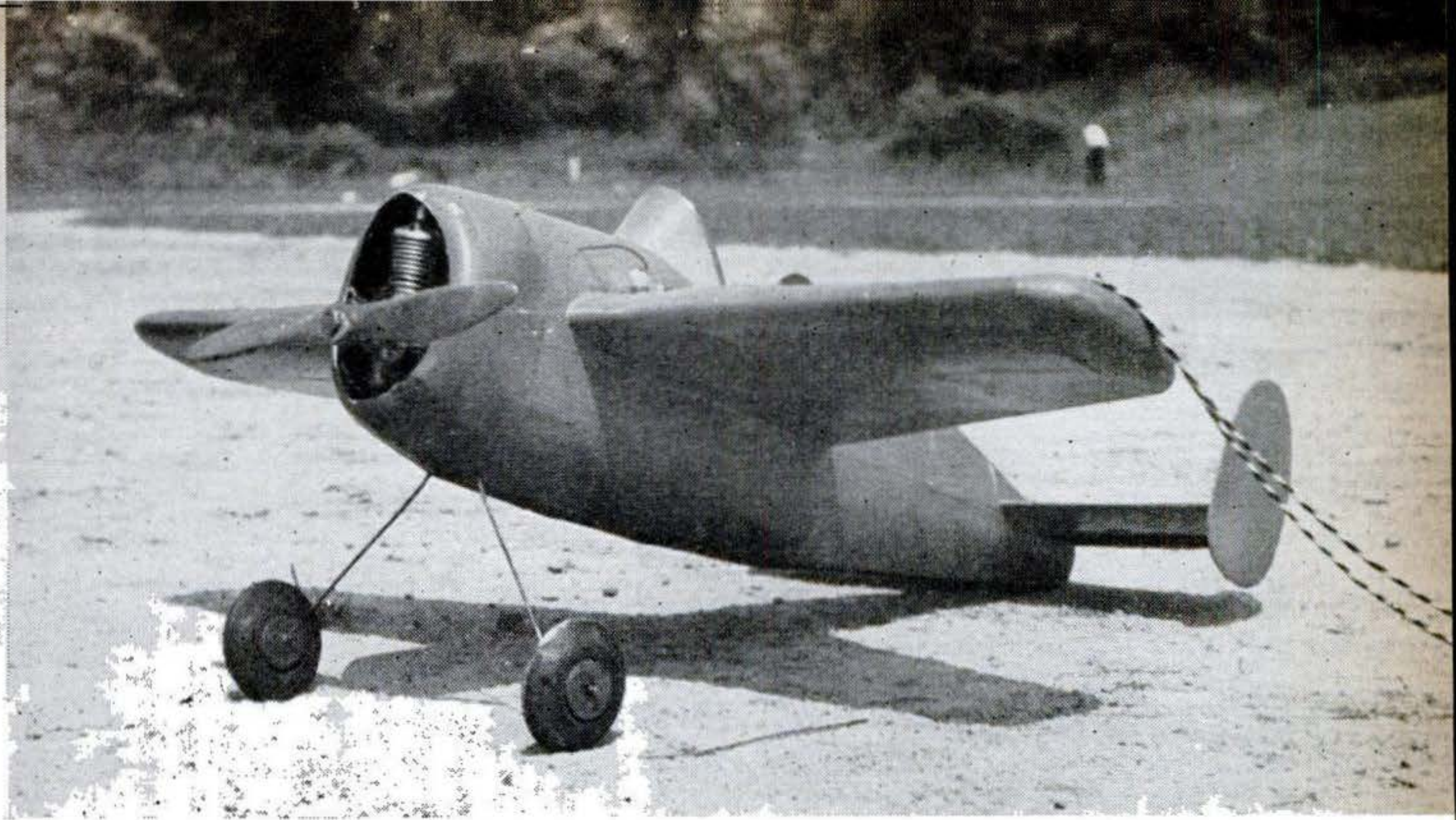

Although shown above with a class A engine, this model could be flown with a class B. At right, "Pappy" Tom Herbert, White Plains, N.Y., holder of the class 5 and 6 speed records, looks over the controls before flight-testing the ship for PSM.

control surface, and two with it below as seen in the circled drawing. When the tail assembly is in place, cement on the two 1/16" by 1/16" covering guides as indicated.

Now cover the upper portion of the fuselage as far forward as bulkhead D. Then put the wing frame in place, using plenty of cement in attaching the main spar to the fuselage frame and bulkhead B. Do not, however, cement the butt ribs, for the paper on this part of the fuselage must be extended behind the ribs.

Next, install the coil, control system, and the wing tank (if the engine requires the latter). Make the tank of sheet acetate or similar plastic, cementing all seams well. The fuel intake line is a short length of 3/32" aluminum tubing, and connection is made to the engine with neoprene tubing. Be sure to put the fuel system in such position that the centrifugal force developed as the model flies will aid rather than hinder the fuel flow. Mount the coil off-center to the right.

One of the secrets of good engine performance is good wiring. In this case, the size commonly employed for high-tension leads is used for all wiring except that leading to and from the condenser. Since coils seldom burn out and because of the simplicity of the wiring, this part of the system may be sealed under the covering. The con-



denser, however, should be located under the cowling, for this item gives frequent trouble in any model. (Remember, the condenser is to blame for 90 percent of all starting troubles. If everything else seems okay but the motor does not start, or starts and runs unevenly, change the condenser.)

A standard bell-crank control system is used. The plywood crank pivots on the 2-56 by 1" screw run through the wing spar and a 1/4" by 1/4" spacer block mounted atop the spar. Make certain the system does not bind at any point. The lines are thrust through slots in the fuselage and two eyelets on the wing tip.

In covering the wings, start at the tips and work inward. Cut a piece of paper to a bit more than 3" wide, cement one edge

DOTTED LINES & WIDTH DIMENSIONS ARE STATION LINES FOR BULKHEADS

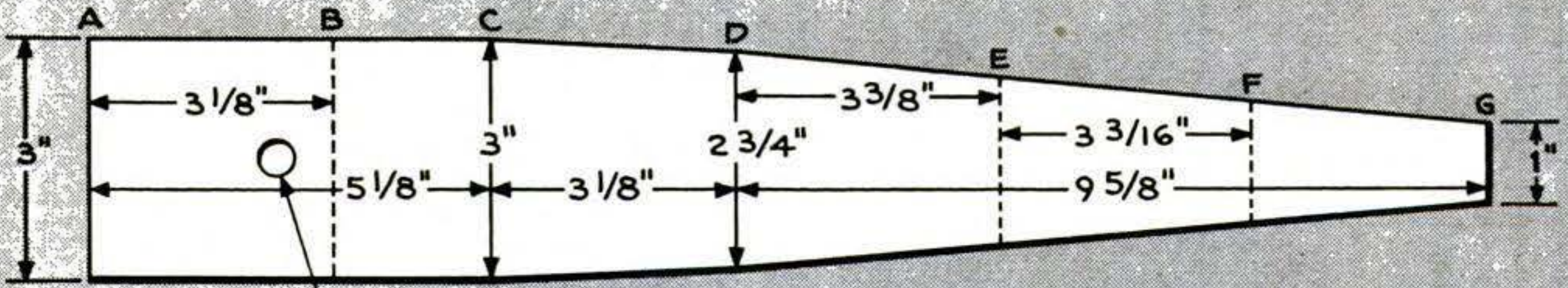

3/8" HOLE FOR GAS LINE

**FUSELAGE LONGERON
1/4" BALSA**

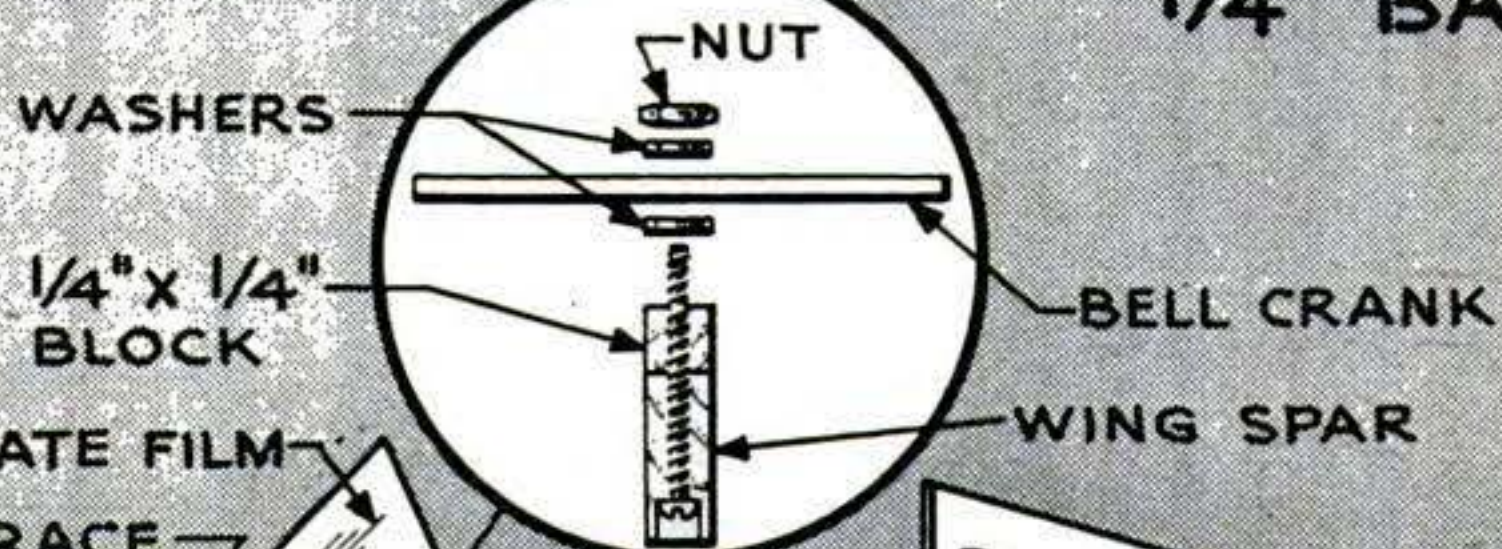
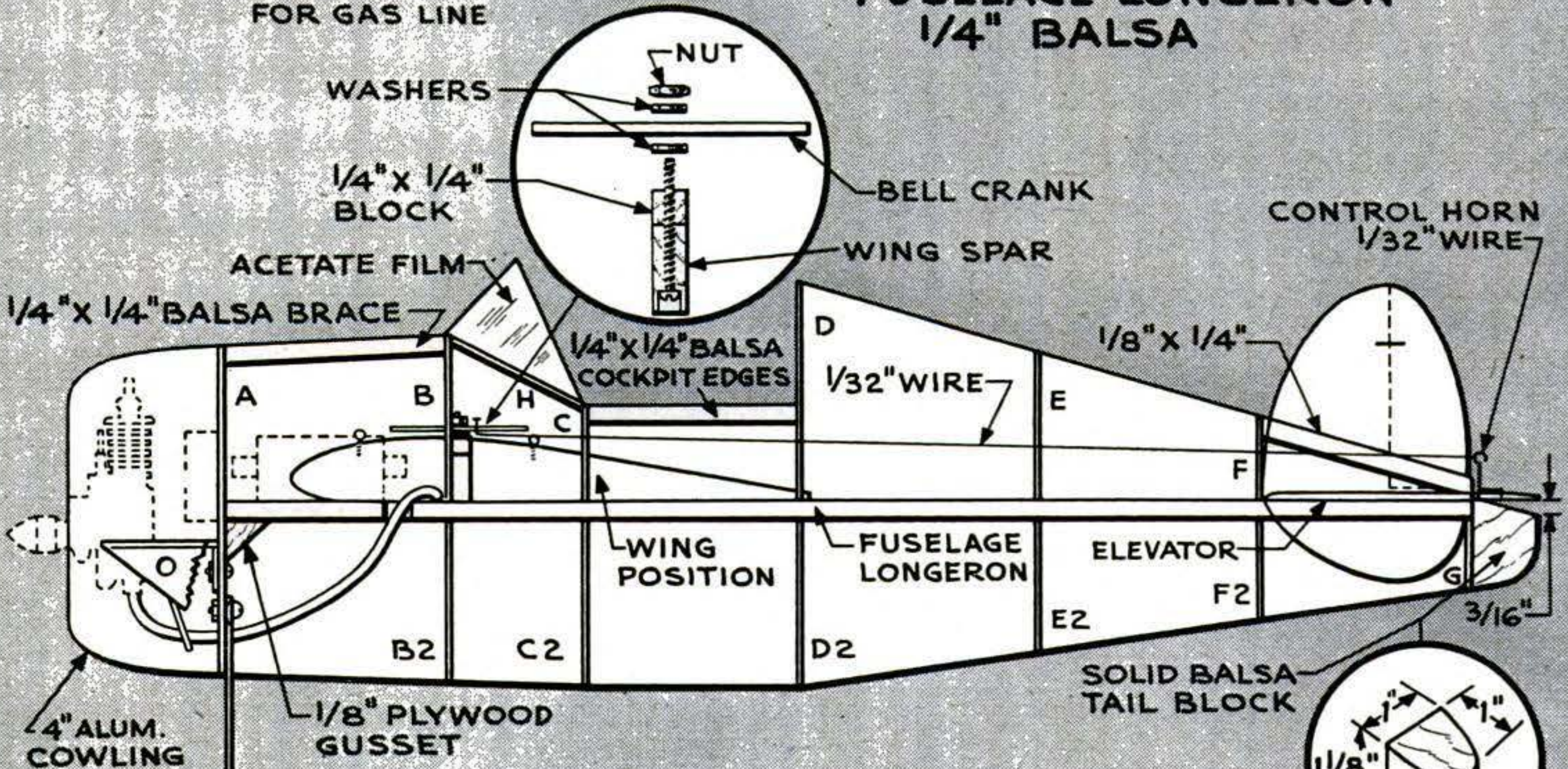

CONTROL HORN
1/32" WIRE

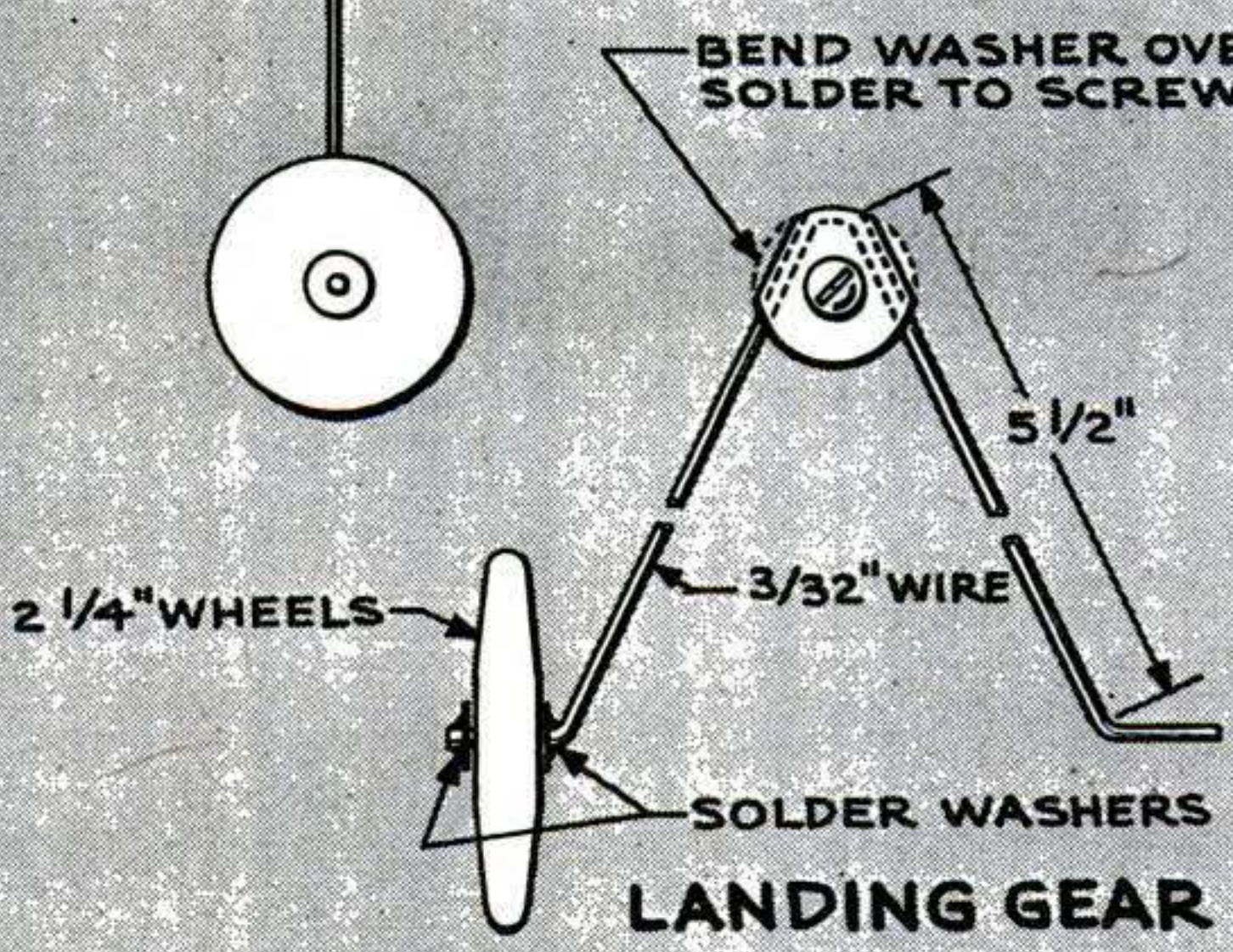
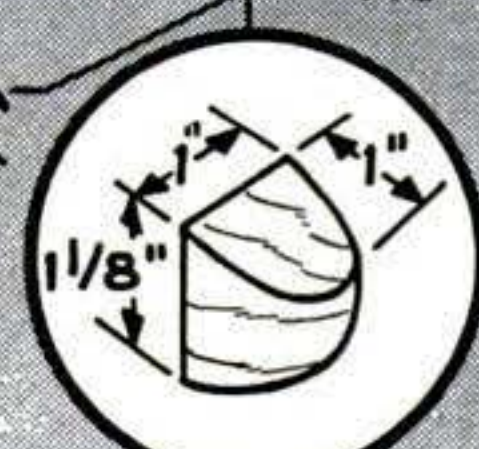

LANDING GEAR

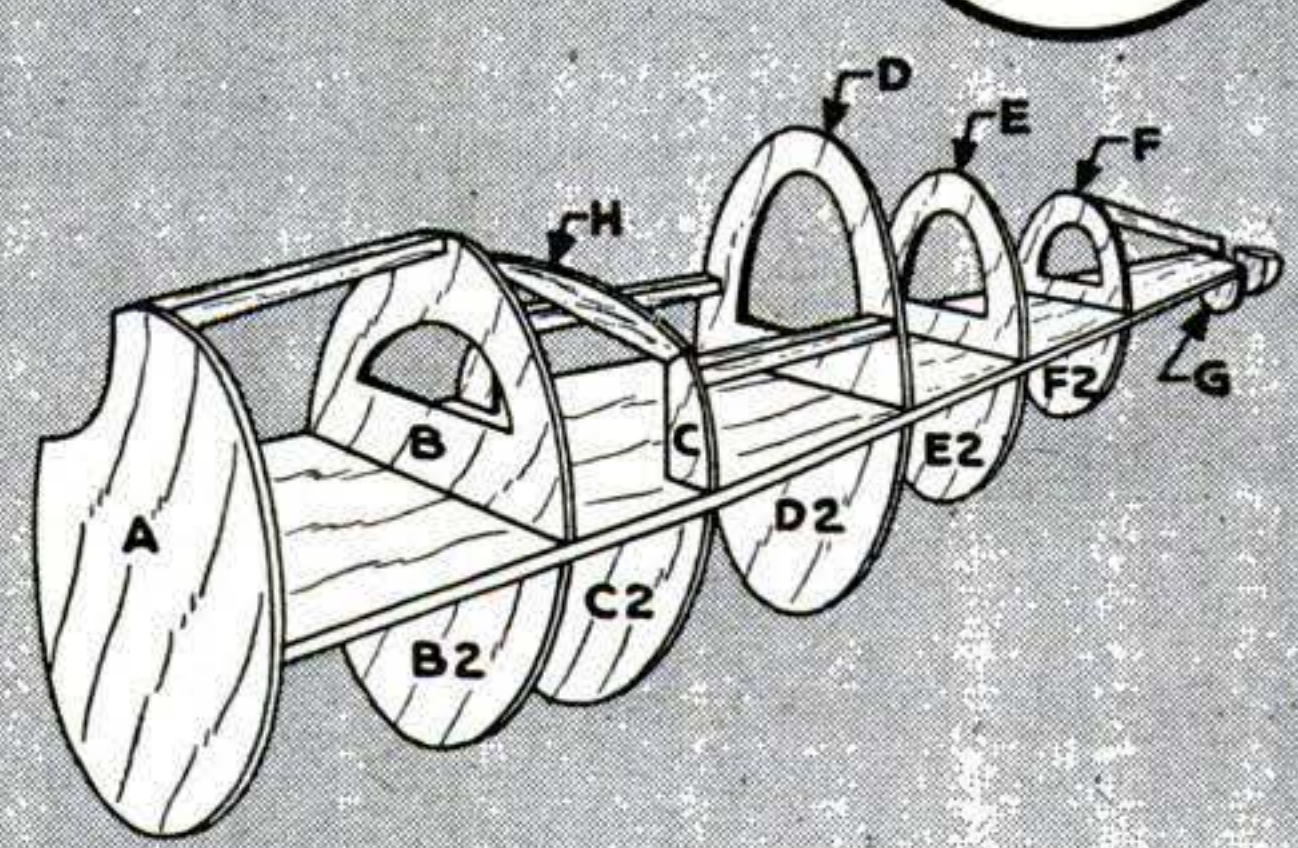

to the underside of the main spar, draw it up and around the leading edge, across the top of the ribs to the trailing edge, and then trim. A separate piece goes on the under part of the wing behind the spar. Here, as on the fuselage, do not attempt to cover more than one section at a time. When the wings are finished, cover the remaining sections of the fuselage and run a cement fillet around the juncture of wing and fuselage.

Form a 4" aluminum engine cowling to the elliptical cross-section of bulkhead A by gently pressing it, and attach it on either side with a small wood screw or pin. Spark and gas controls should be extended to the cockpit for easy handling. The vent is adequate to insure good cooling, but if your engine runs "wet" it may be a good idea to slot the bottom of the cowling.

For test flights, use a low-pitch prop and

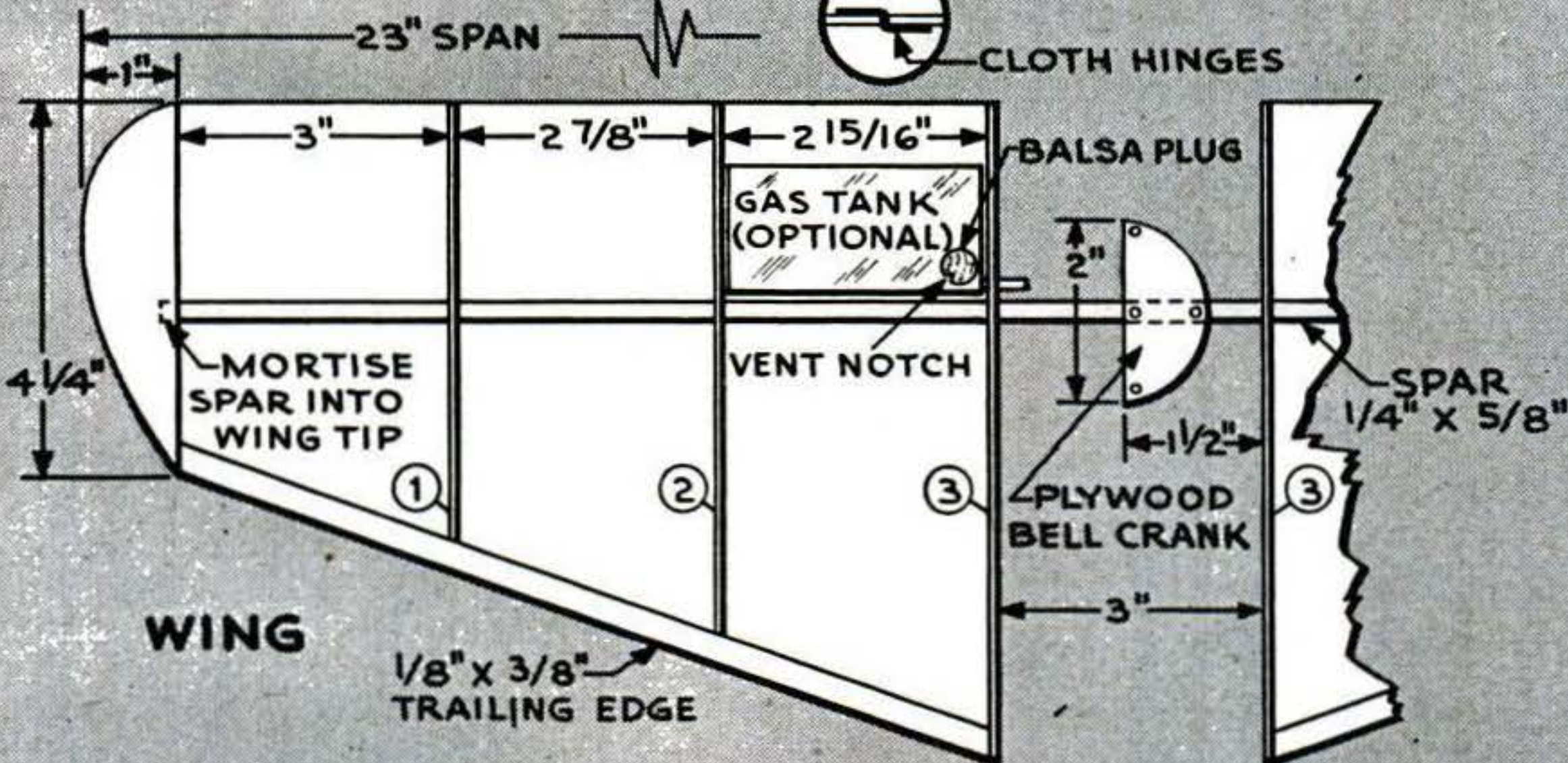
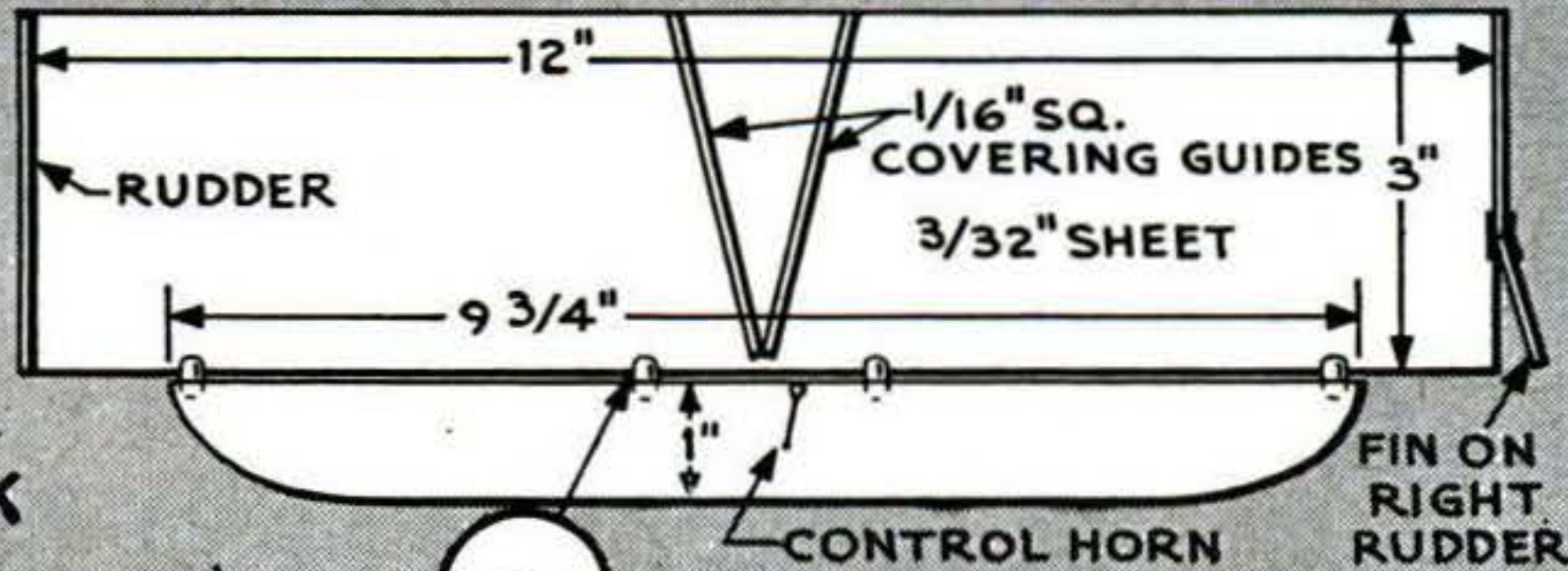
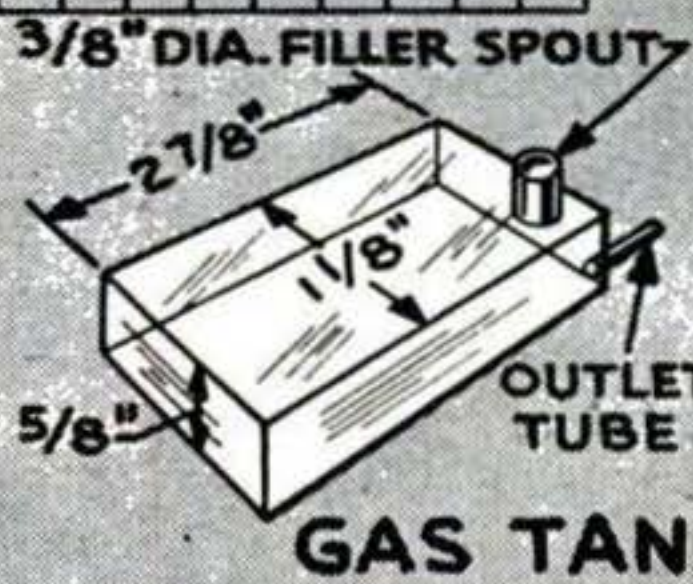
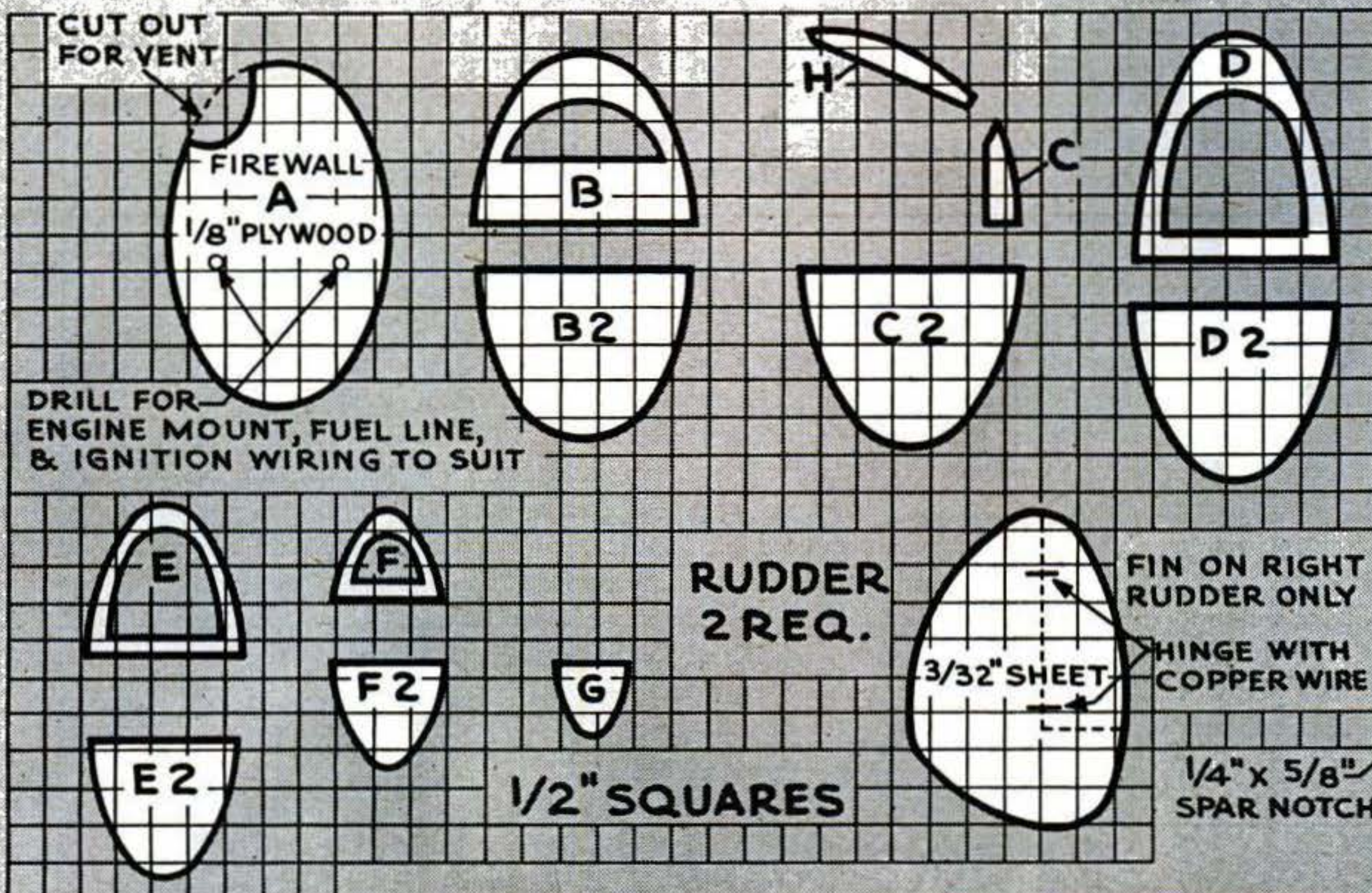

RIBS (1/16" SHEET) SHOWN FULL SIZE

Wing tips carved from balsa also serve as the end ribs. The wing is built without a leading-edge spar and has no dihedral.

adjust the engine to turn over at a trifle above half throttle. Use full right rudder at first, easing off on this control if there is excessive pull. When the motor stops, dive the ship to within a foot of the ground and apply full-up elevator for a smooth three-point landing.

Because of the exceptional fore-and-aft stability of the model, very little time is required to learn to fly it. END

NEW SHOP IDEAS

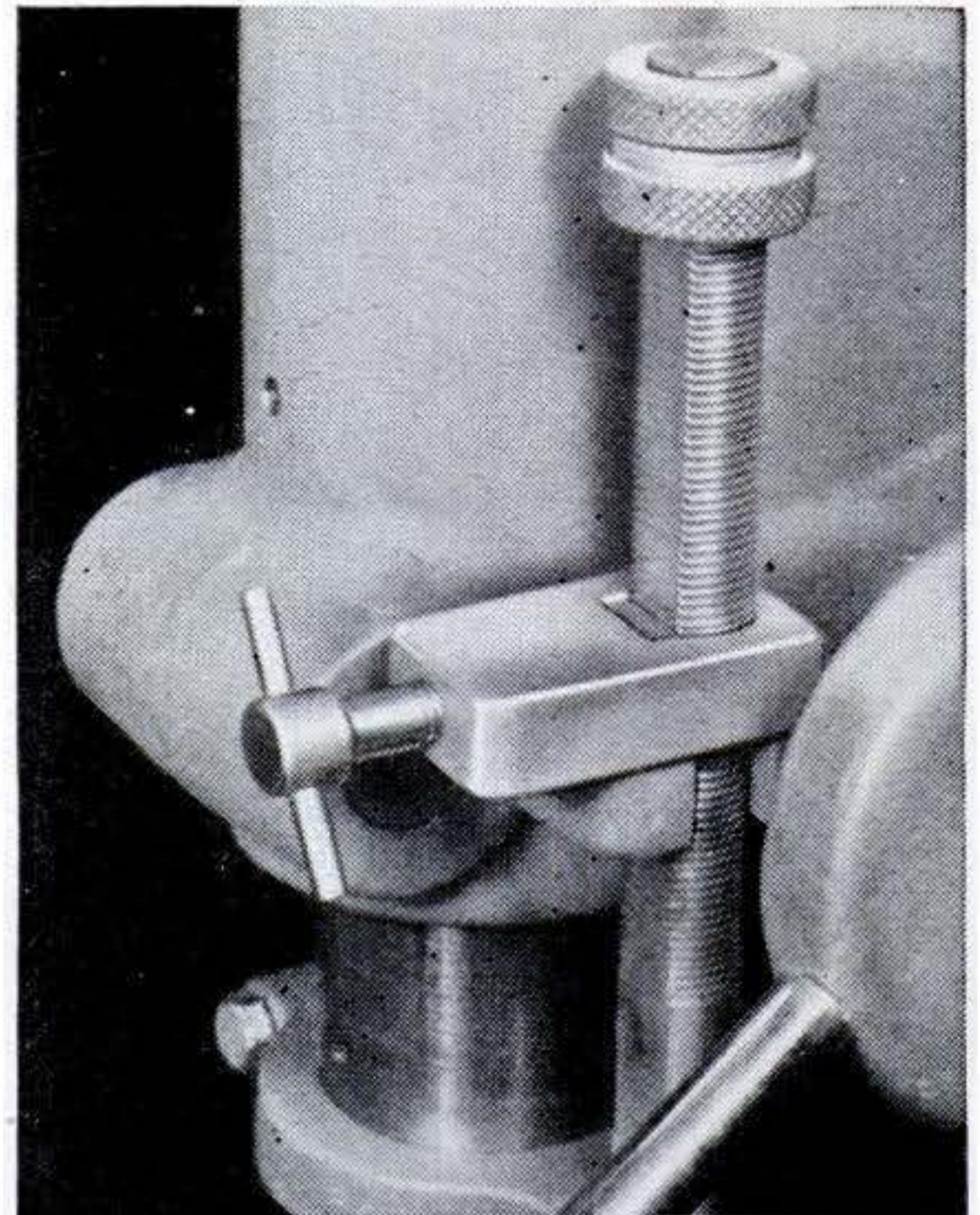
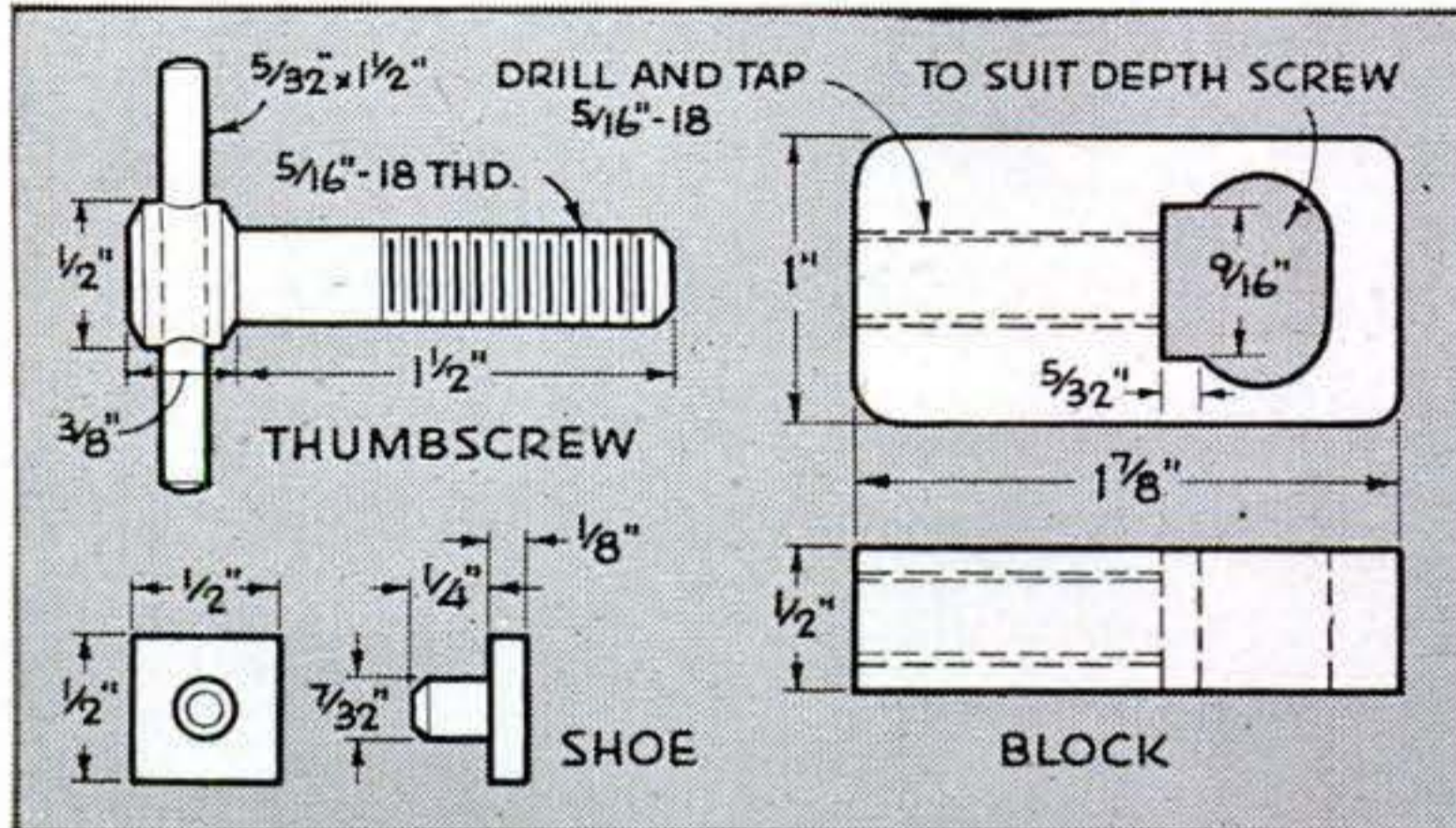

DRILL STOP. Mounted on the depth screw of a drill press, this stop provides a quick way of adjusting the distance of drill travel. A steel thumbscrew projects far enough from the drill press for convenience in adjusting, and a steel shoe with a relatively large sur-

face prevents damage to the face of the depth screw. Make the block from steel, brass, or aluminum alloy, milling or filing the opening for the depth screw after drilling to approximate size, and then form the recess for the shoe.—JOHN A. BATES.

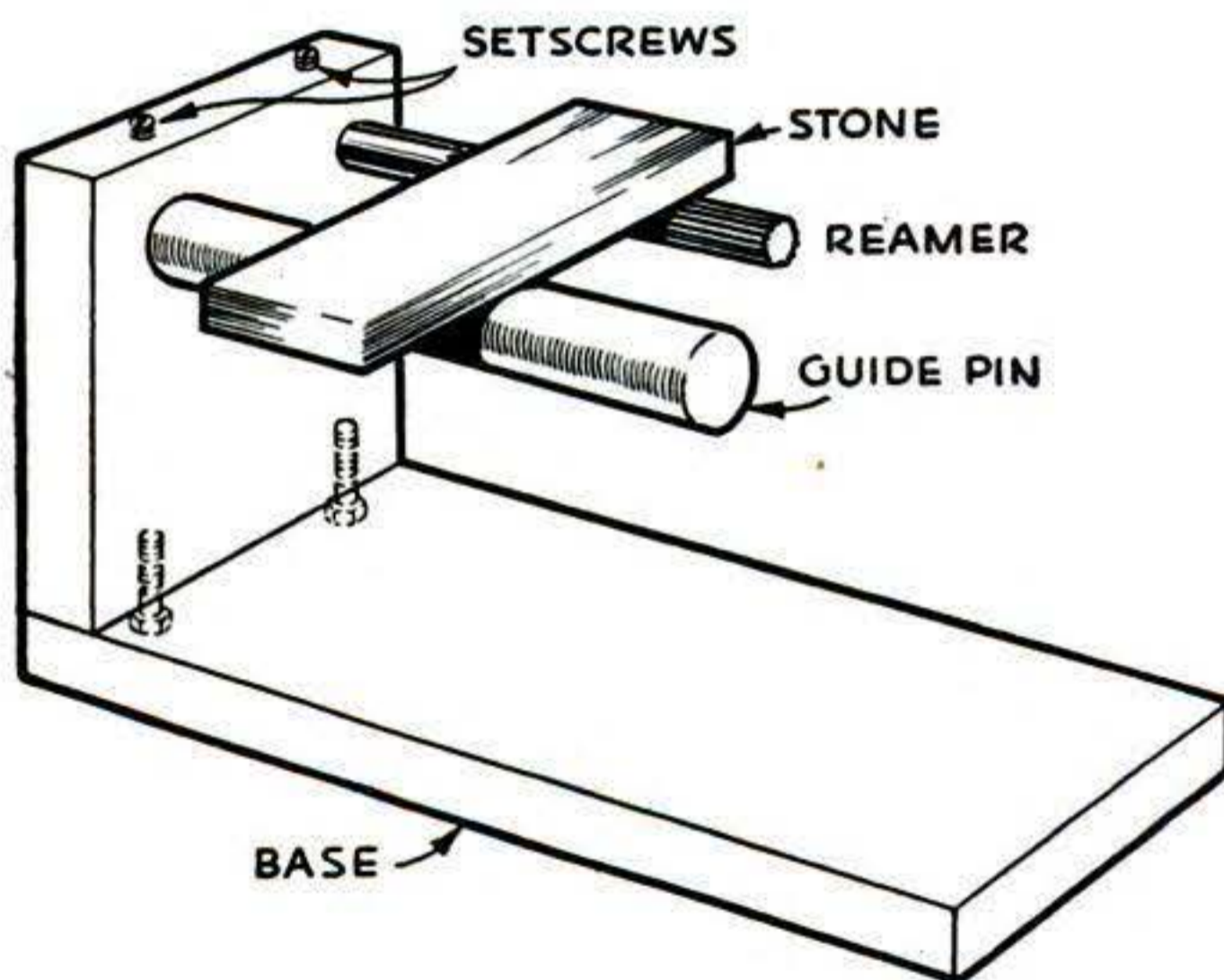

REAMER SHARPENING JIG. When a reamer is to be hand stoned, the guide pin of this fixture will keep the stone constantly at the proper angle to the cutting edge. If the reamer is tapered, make the guide pin with the same taper, instead of straight as above.

Both guide pin and reamer are pinned into the upright block with setscrews. The upright either may be mounted on a base with machine screws or held snugly in a vise. Bushings may be made to accommodate different sizes of reamer shanks. The guide pin is approximately twice the diameter of the reamer.—EDMUND L. JOHNSON.

PAPER SHIELDS WORK. Finding that shavings scratched the aluminum I was trying to turn to a smooth finish, I placed a heavy sheet of paper between the tool and the work. The shavings then came through the hole the tool cut, and the paper prevented them from marring the work.—T. G. LUCAS.

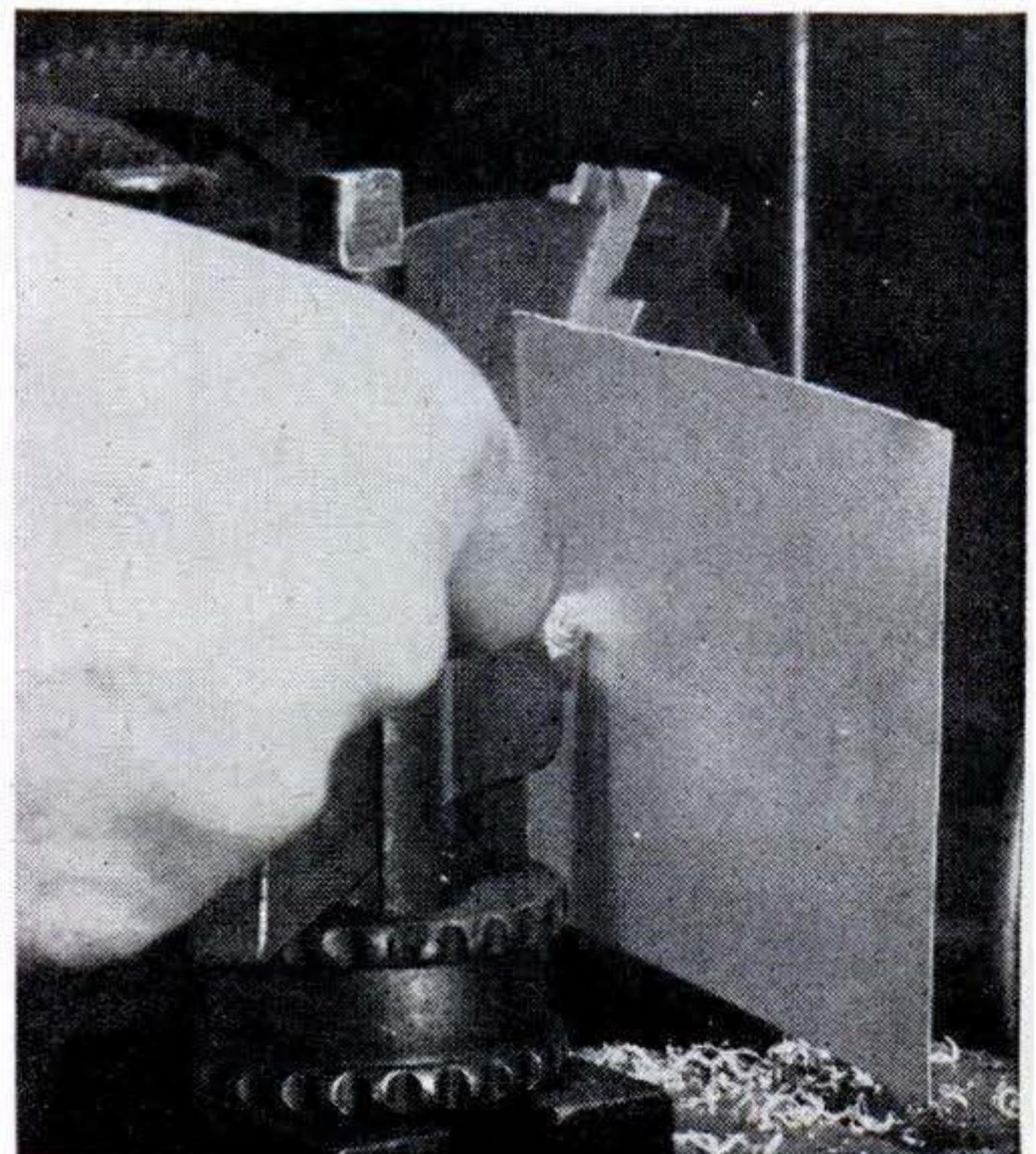

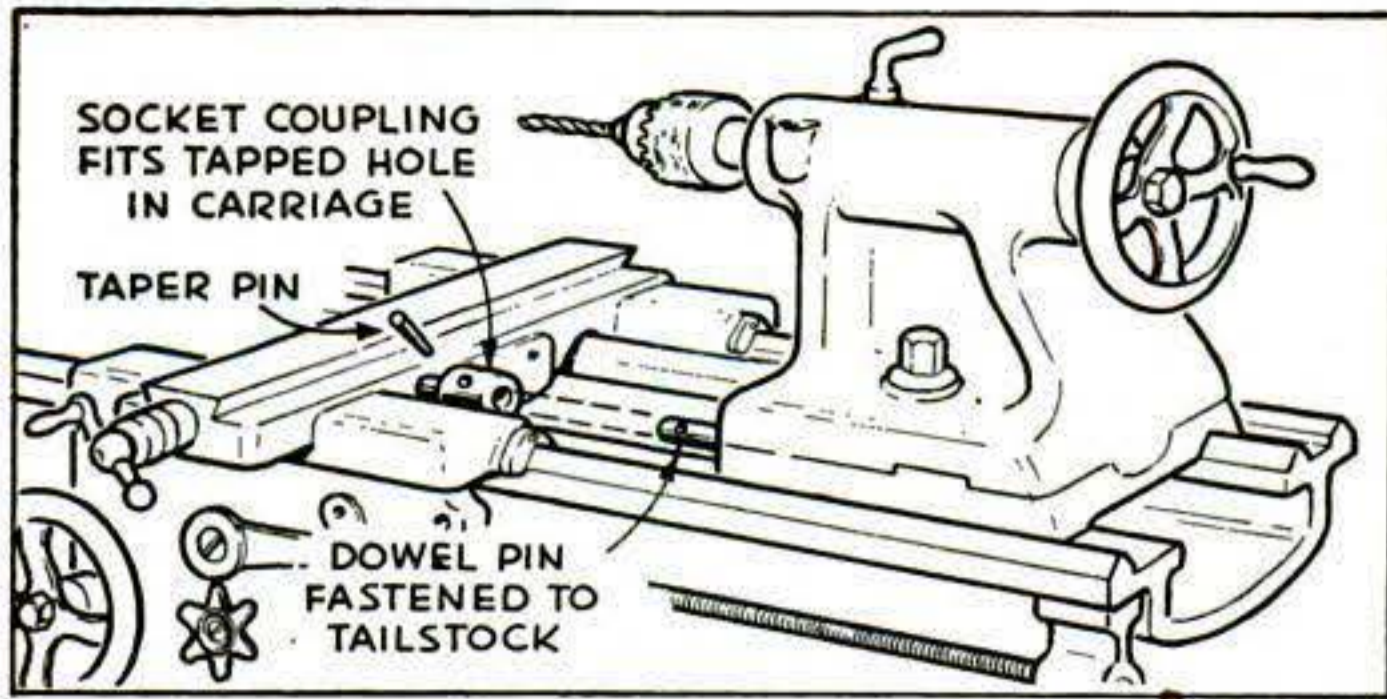

TAILSTOCK POWER FEED. This coupling provides power feed for drilling, boring, and other operations in which either the tool or work is mounted in the tailstock. Fitted into a hole drilled in the latter, a dowel pin slips into a receptacle mounted on the carriage and a taper pin locks the two. Removing the taper pin restores the lathe to normal operation.—HAROLD KRUER.

RUG PROTECTS DRILLS. At the time of purchase, the drills in a set usually are placed in their holder with points upward, but it is safer to store them pointing downward. A piece of rug or other thick material cut to shape, cemented on the holder floor, and soaked with oil will protect the points and prevent rust.—ANDREW VENA.

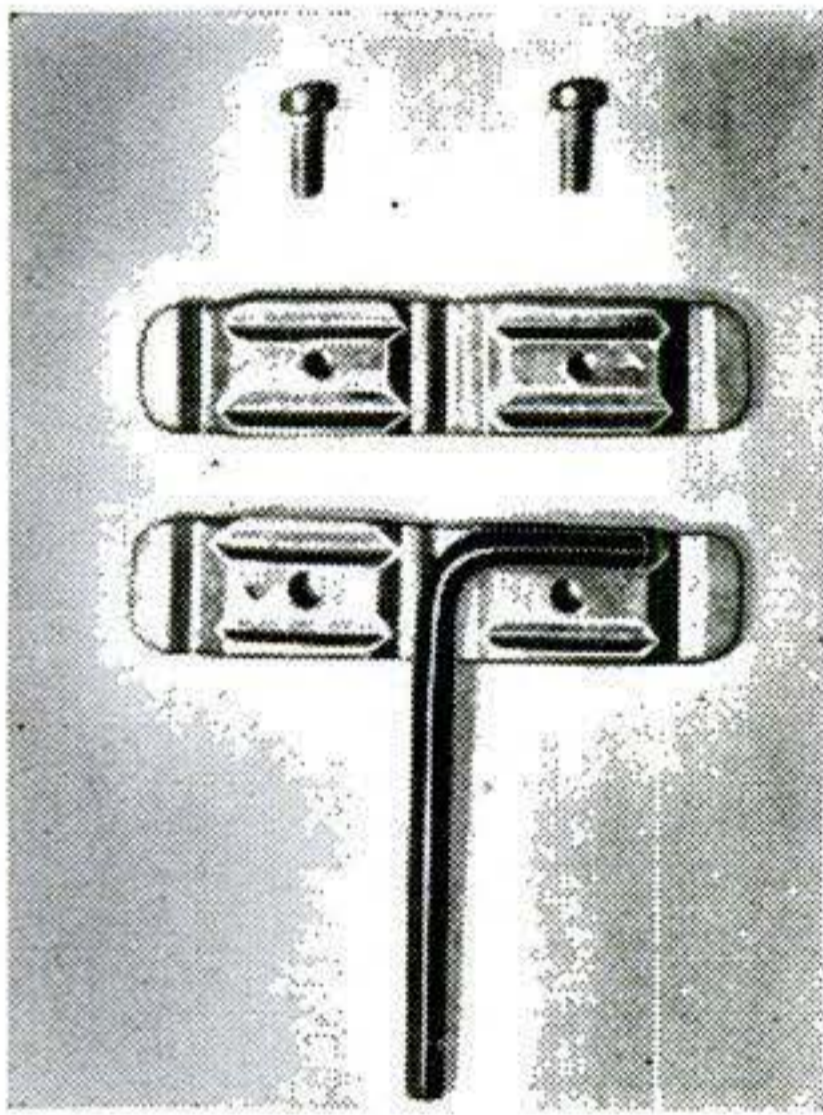
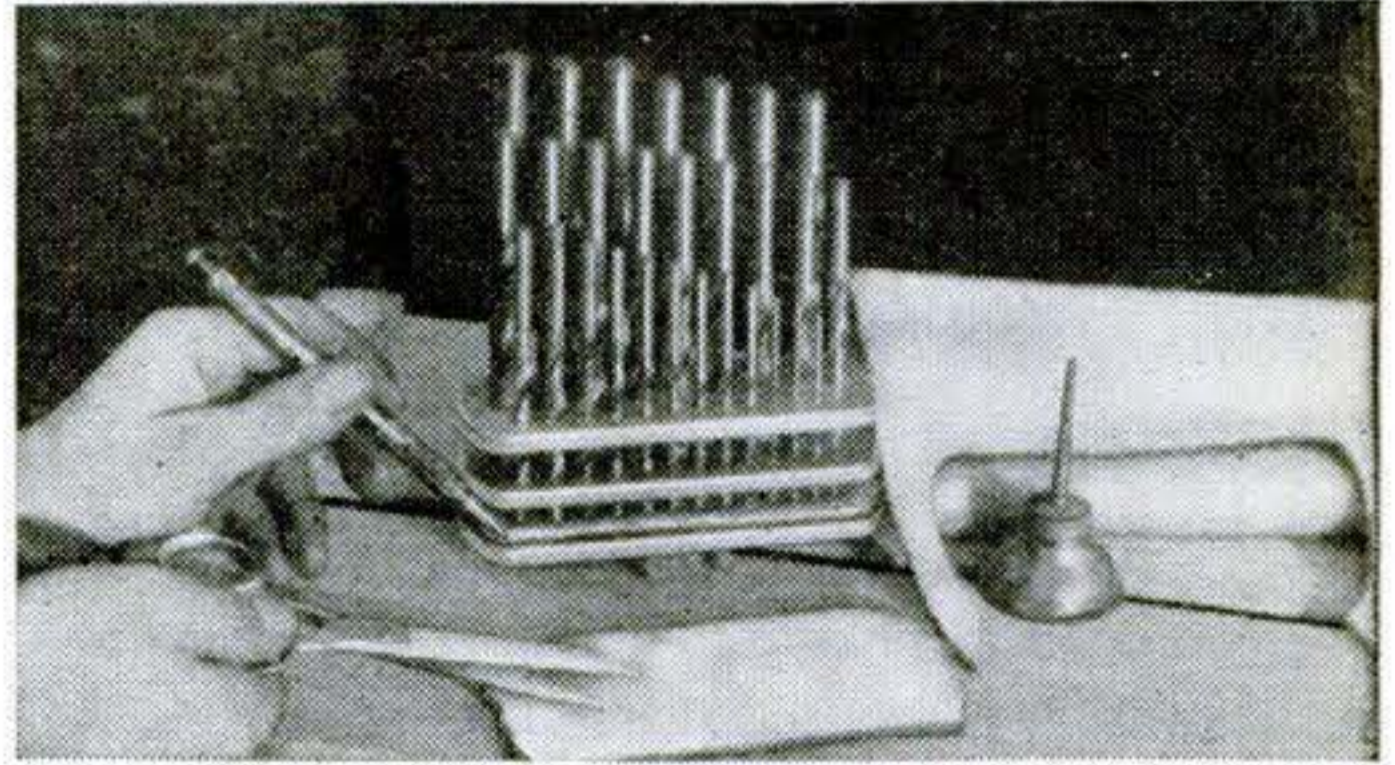

When a job requires use of the long arm of the wrench, mount it as above. These transverse grooves also adapt the handle for use on various other tools.

HANDLE FOR ALLEN WRENCHES. A handle such as this gives a better grip on an Allen wrench and can be quickly shifted from one to another of a different size when necessary. Transverse V-grooves also make it possible to use the handle on a tap, reamer, star drill, file, or other tool.

The wrench was made from a 1" round aluminum bar 4" long sawed in half from end to end. Two parallel grooves then were filed lengthwise on the flat faces about $\frac{5}{32}$ " from either side. One groove in each piece was filed $\frac{3}{64}$ " deep, but the other two were made deeper so two wrenches of different size could be clamped in the handle. To accommodate the curved part of the wrench, flats were filed to a depth of $\frac{1}{16}$ " in the middle and at each end. Both pieces of the handle are alike except that the bolt holes in one are tapped 10-24 and those in the other are drilled No. 3 and counterbored for fillister-head screws.—CLARENCE WITTLE.

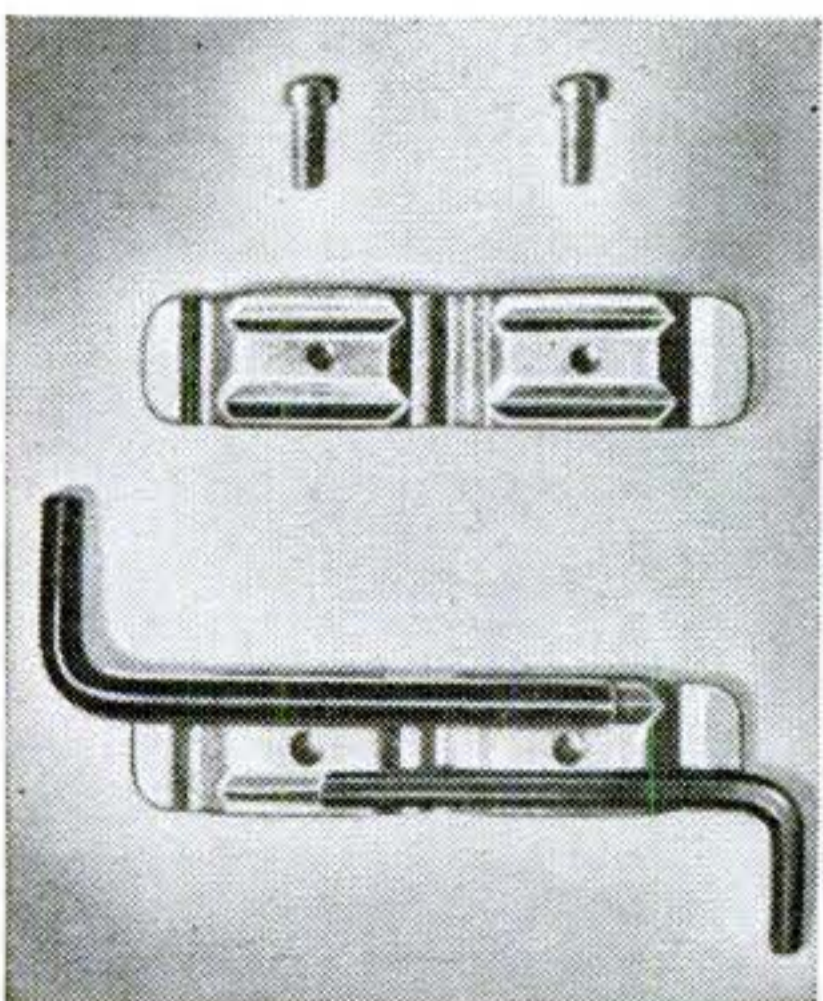

Two wrenches of different size are placed in the same handle.

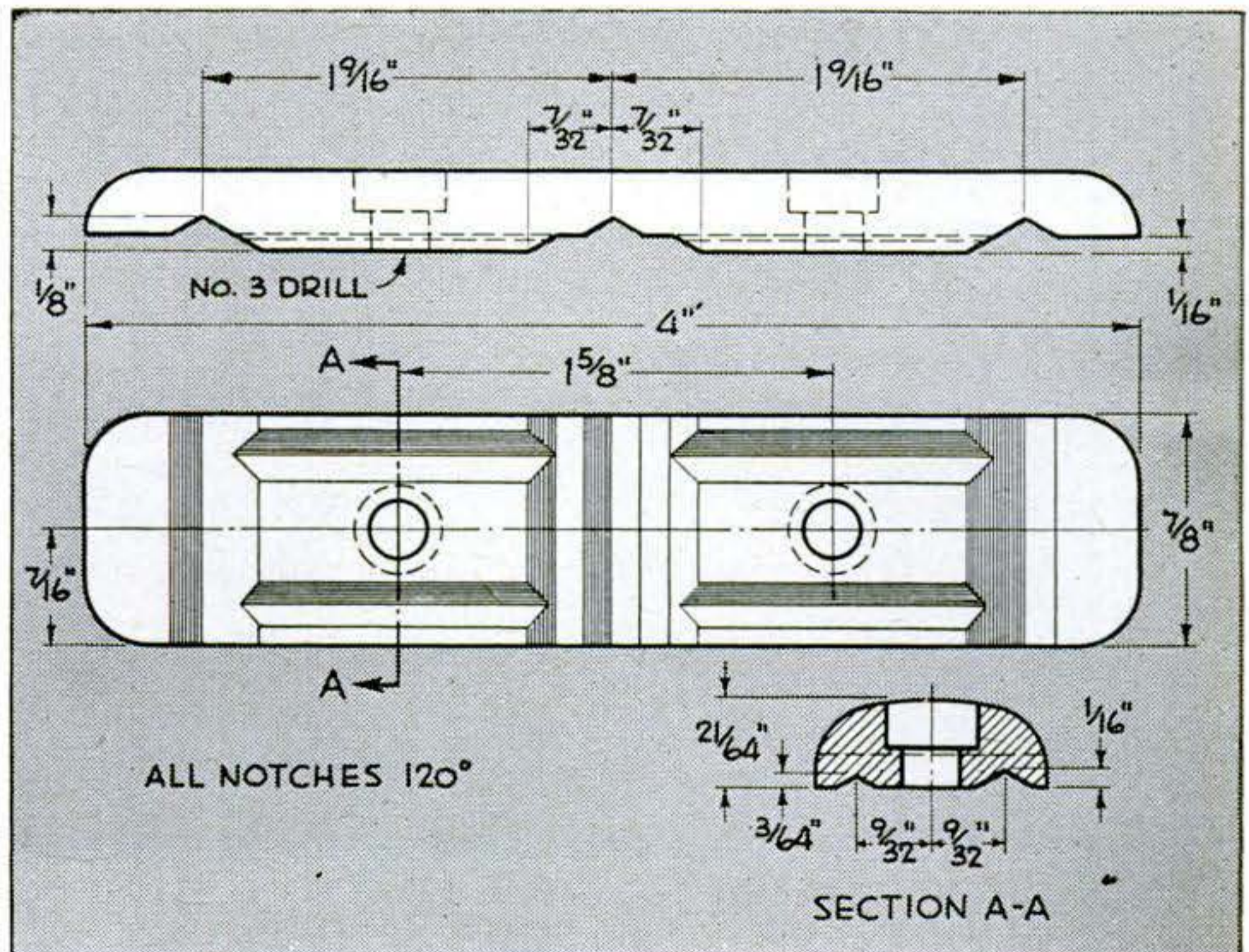

Machining Cylinder

By C. W. WOODSON

PART TWO

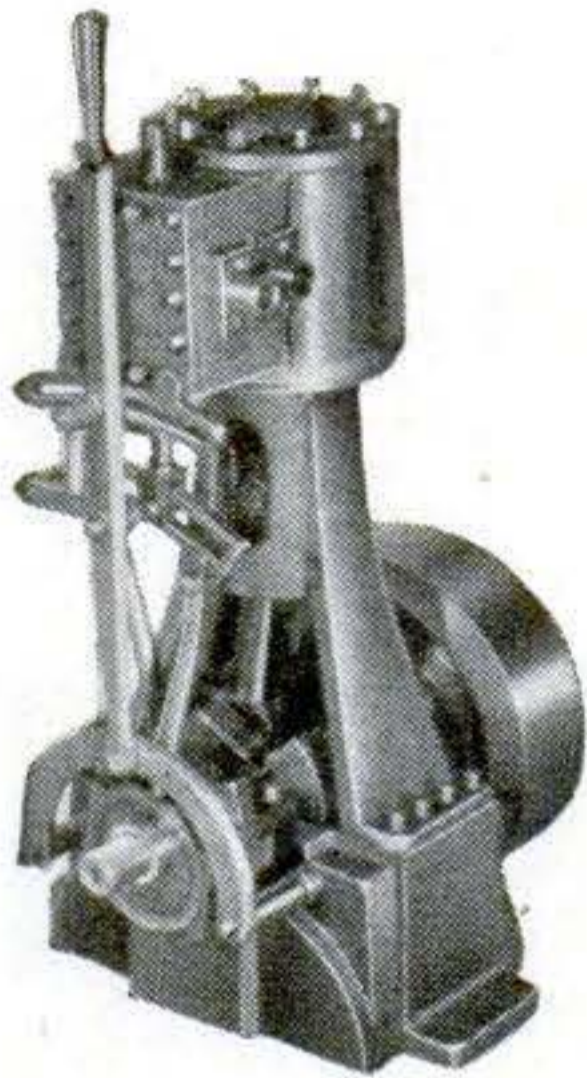

MUCH of the performance of a steam engine depends on the accuracy and smoothness of the cylinder bore. This is as true for the miniature reversing engine here described (see PSM, April '47, p. 190) as for full-size engines.

The casting for the cylinder is first mounted in the three-jaw chuck and a roughing cut taken across the bottom so it can be reversed and held squarely for facing the top. If you have available an expanding mandrel, the cylinder is best bored after the rough facing and then mounted on the mandrel, where its ends can be faced smooth and squared accurately with the bore.

Lacking such a mandrel, face the top smooth first, and then reverse the piece and face the bottom smooth and square before attempting to bore. Although the cylinder may be held in the three- or four-jaw chuck for these operations, there is less likelihood of slipping if it is clamped to the lathe faceplate with lugs over its flange.

Bore the cylinder first with a heavy

roughing cut to get the bit under the hard surface scale and bring the hole nearly to size. Then, with a freshly ground bit inserted in the boring bar, take light finishing cuts while using a very fine power feed. If care is taken in sharpening the bit and setting it to eliminate chatter, an almost mirrorlike finish can be obtained.

The steam-port face can be machined in the shaper or, as shown in one of the photographs, while mounted on an angle plate in the lathe. Again take a heavy roughing cut first to get under the scale, and then, with the bit freshly ground and honed to a keen edge, finish with light cuts and a fine feed.

Remove the work to the drill press, clamp in the vise, lay out the steam and exhaust ports carefully, and drill a series of holes for each. Chip out the intervening metal and file the resulting slot to shape. Then mount the work in the angle vise and drill four holes for each of the two angle ports to meet those in the face. Chip and file out as before. A chisel made from 3/32" drill rod and hardened may be used for chipping. The cylinder is next remounted in the vise and

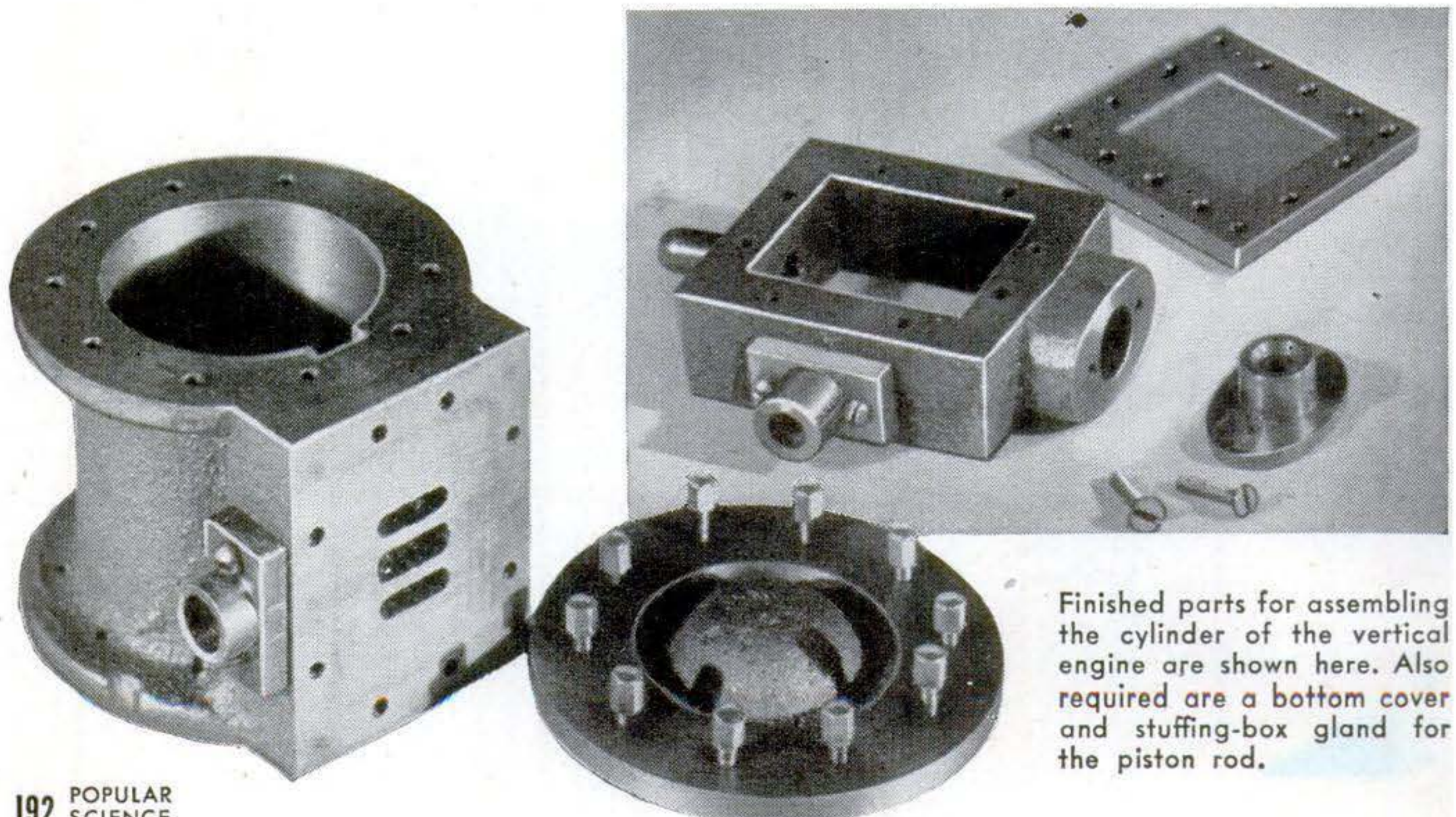

Finished parts for assembling the cylinder of the vertical engine are shown here. Also required are a bottom cover and stuffing-box gland for the piston rod.

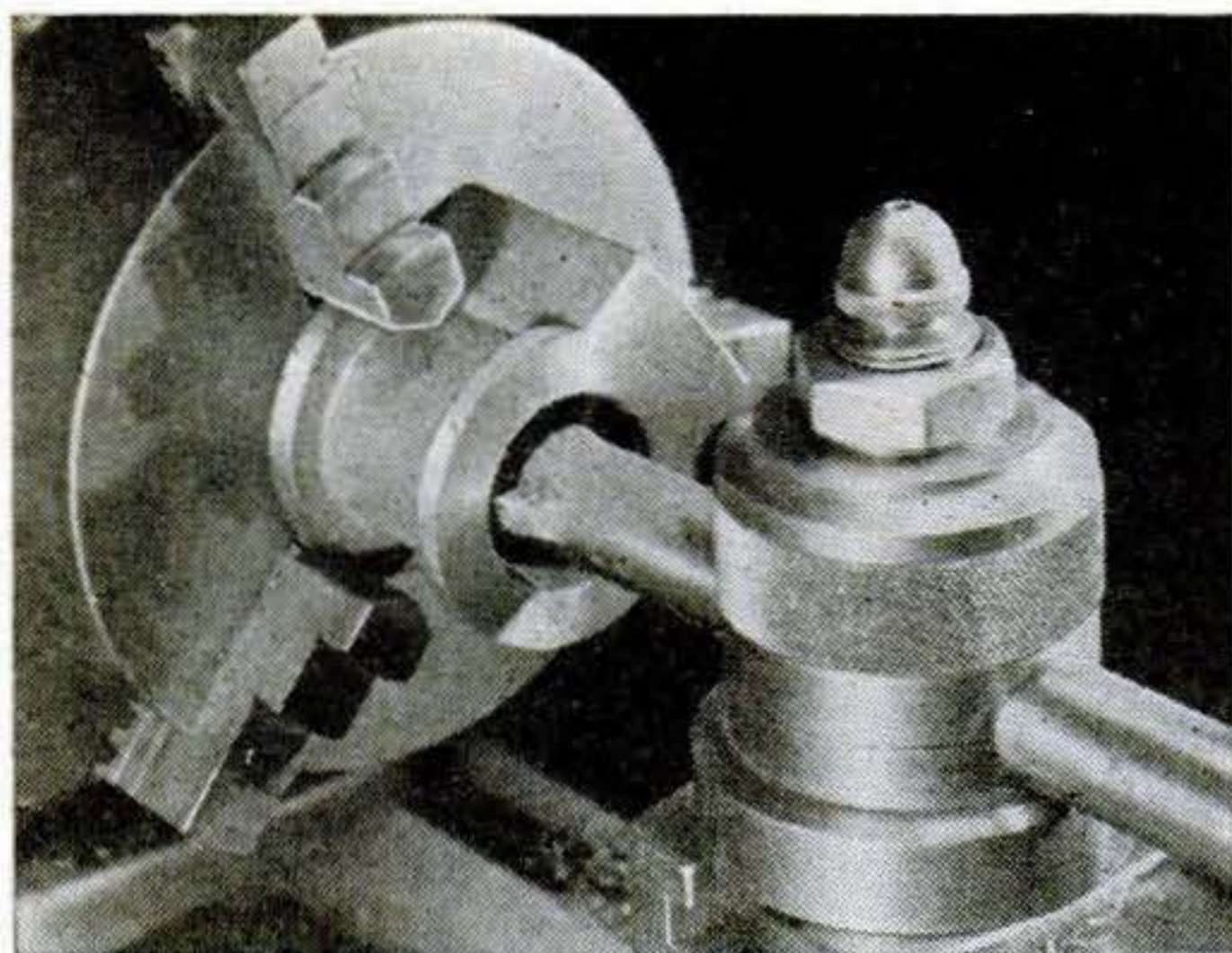

1 In boring the cylinder, take a heavy roughing cut to get under the surface scale. Finish the bore with light cuts and a freshly ground bit.

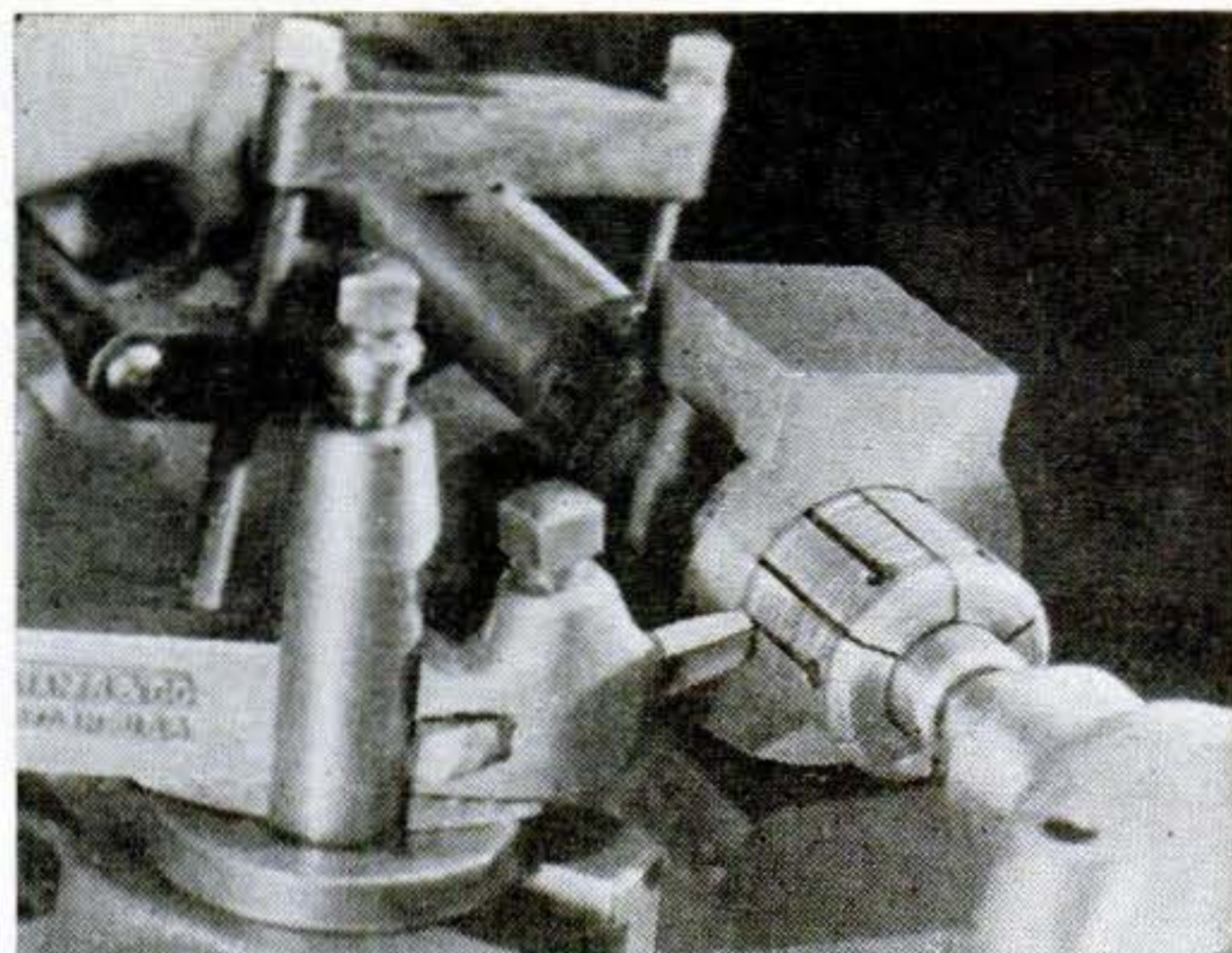

2 If an expanding mandrel is available, bore the cylinder before finish-facing the flanges; if not, machine the flanges first and then bore.



5 Drill and tap one hole in the flange, and then bolt the cylinder head on before spotting the others. Use a clamp at the opposite side.

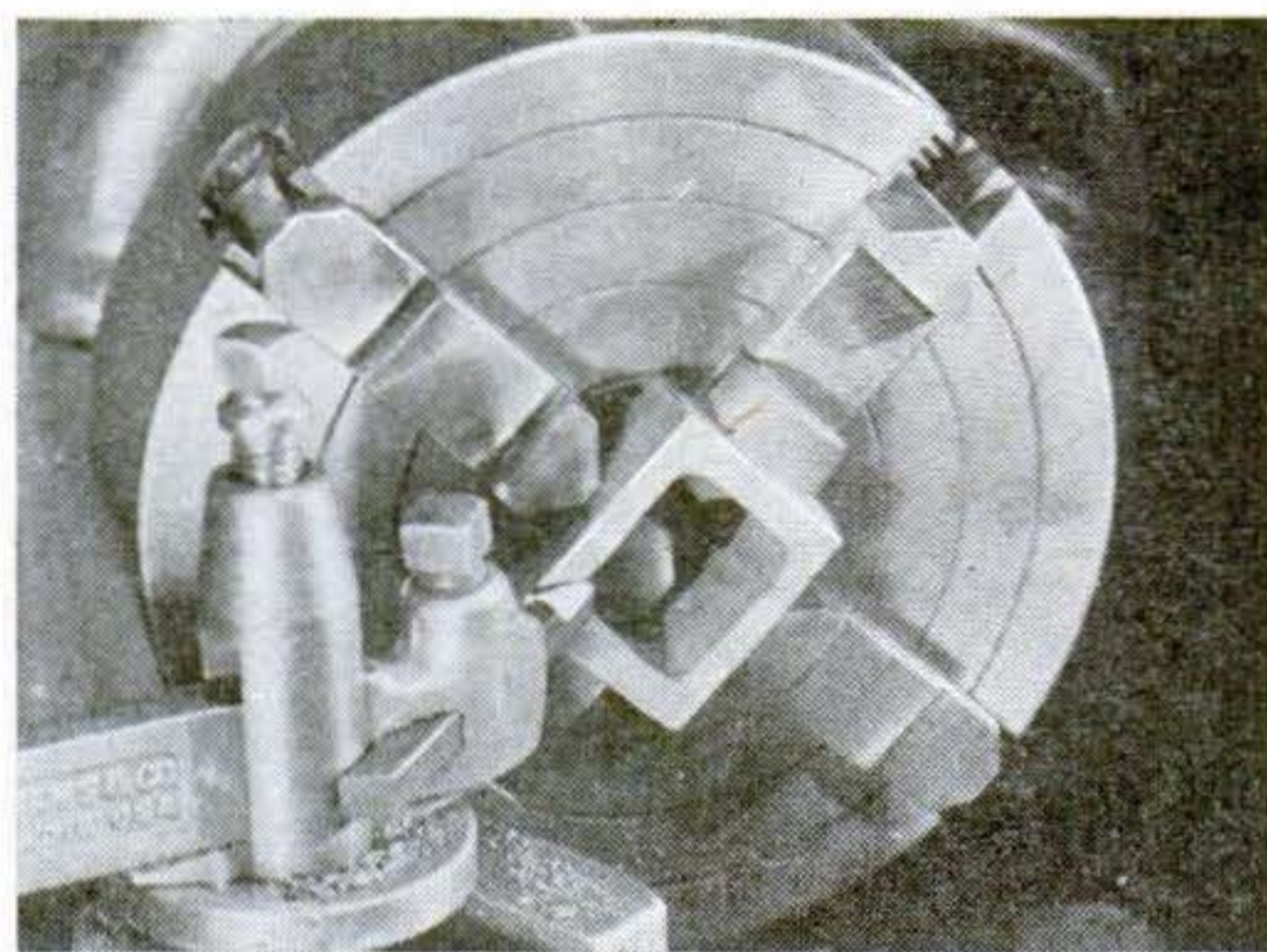

6 Face the steam chest on both sides, taking a heavy roughing cut on each first and finishing with light cuts to assure a steamtight joint.

the exhaust port drilled in from the side to meet that in the face. Don't drill the 4-48 holes until the covers have been made.

Mount the cylinder-head casting in the three-jaw chuck and turn the chucking lug straight so the casting will run true when reversed. Machine the top and outer edge to shape, and then score a light $1\frac{1}{8}$ " circle on the face for locating the bolt holes. Again reverse the piece in the chuck, take off the chucking lug, face smooth, turn the step to a good snap fit in the cylinder bore, and drill a $7/16$ " hole $1/4$ " deep to clear the nut on top of the piston.

The bolt holes are then stepped off accurately with dividers, centerpunched, and drilled clearance size. Snap the head in place, spot one of the holes in the flange with a clearance-size drill, drill tapping size, and tap. Next, insert the bolt and spot the remaining holes. Make a file mark on meet-

ing edges so that the head can be replaced in the same position; then finish drilling and tapping the flange.

In machining the lower cover, it is important that the step fitting in the cylinder bore be concentric with the piston-rod hole so there will be no binding at that point. Equally important it is to turn the step on the outer face, or bottom, concentric for fitting the shouldered bore in the standard.

One way is to turn the gland stem and shoulder on the outer face first, bore and counterbore the $1/4$ " hole, and then mount the piece on a stub arbor or in a step chuck to face and step the inner side for a snap fit in the cylinder bore. In counterboring for the gland, be sure to start carefully in the piston-rod hole to assure concentricity.

Snap the lower cover on the column, clamp, and spot the bolt holes through the column flange. Then snap the cover on the

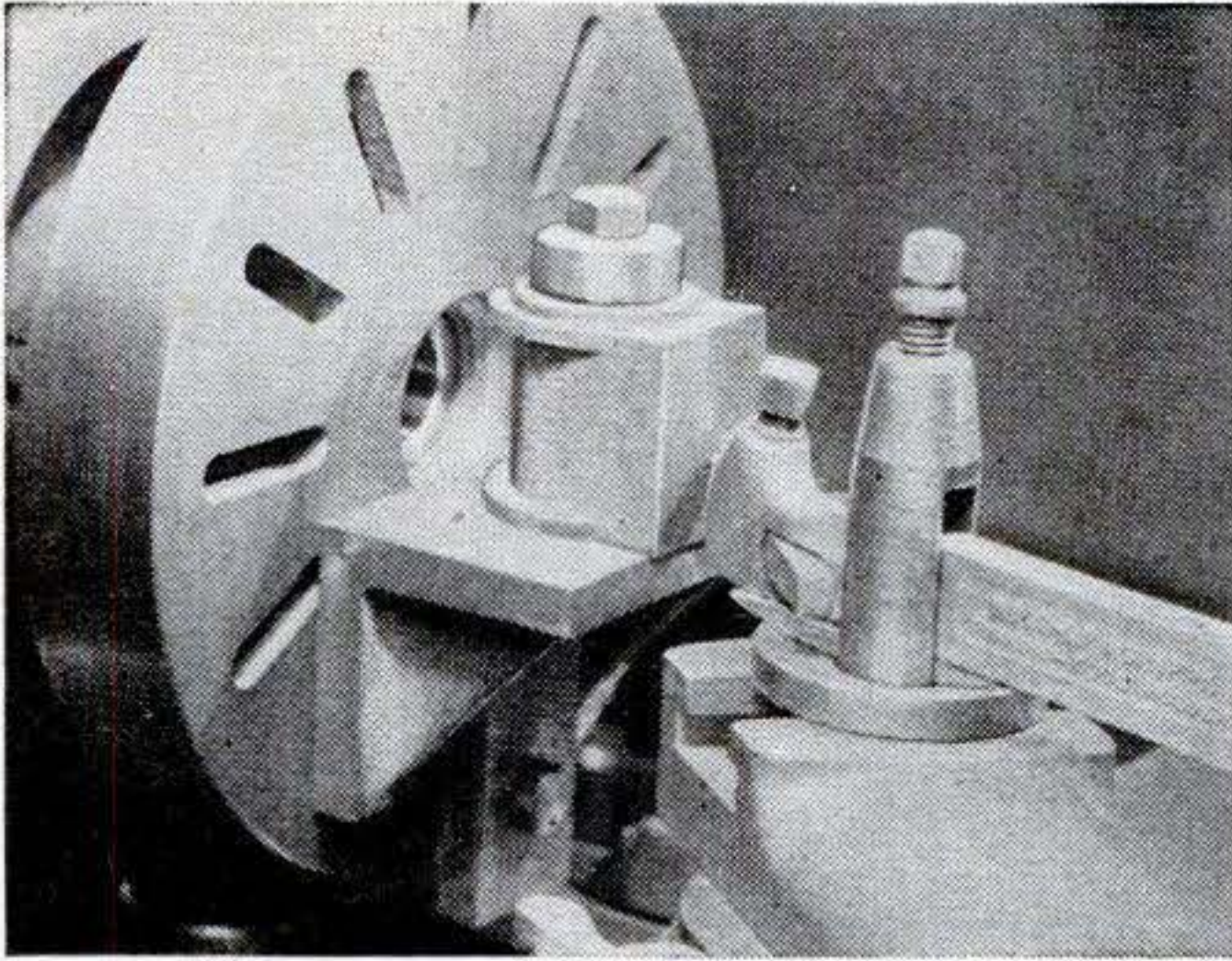

3 Machine the steam-port face with the cylinder mounted on an angle plate, finishing with very light cuts. A shaper will also do the job.

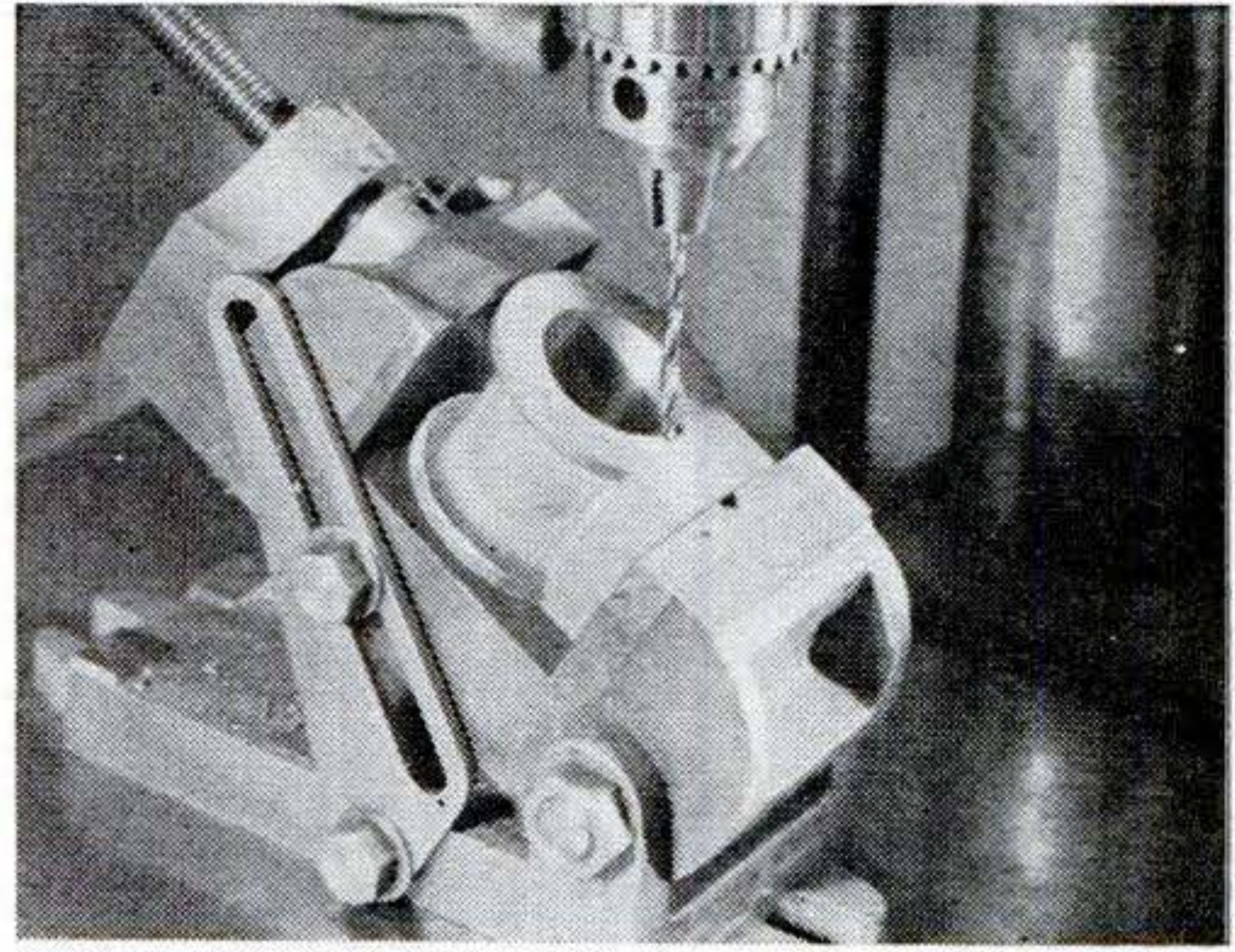

4 Ports are bored at an angle from both ends of the cylinder to connect with the steam ports in the face. Chip and file them to shape.

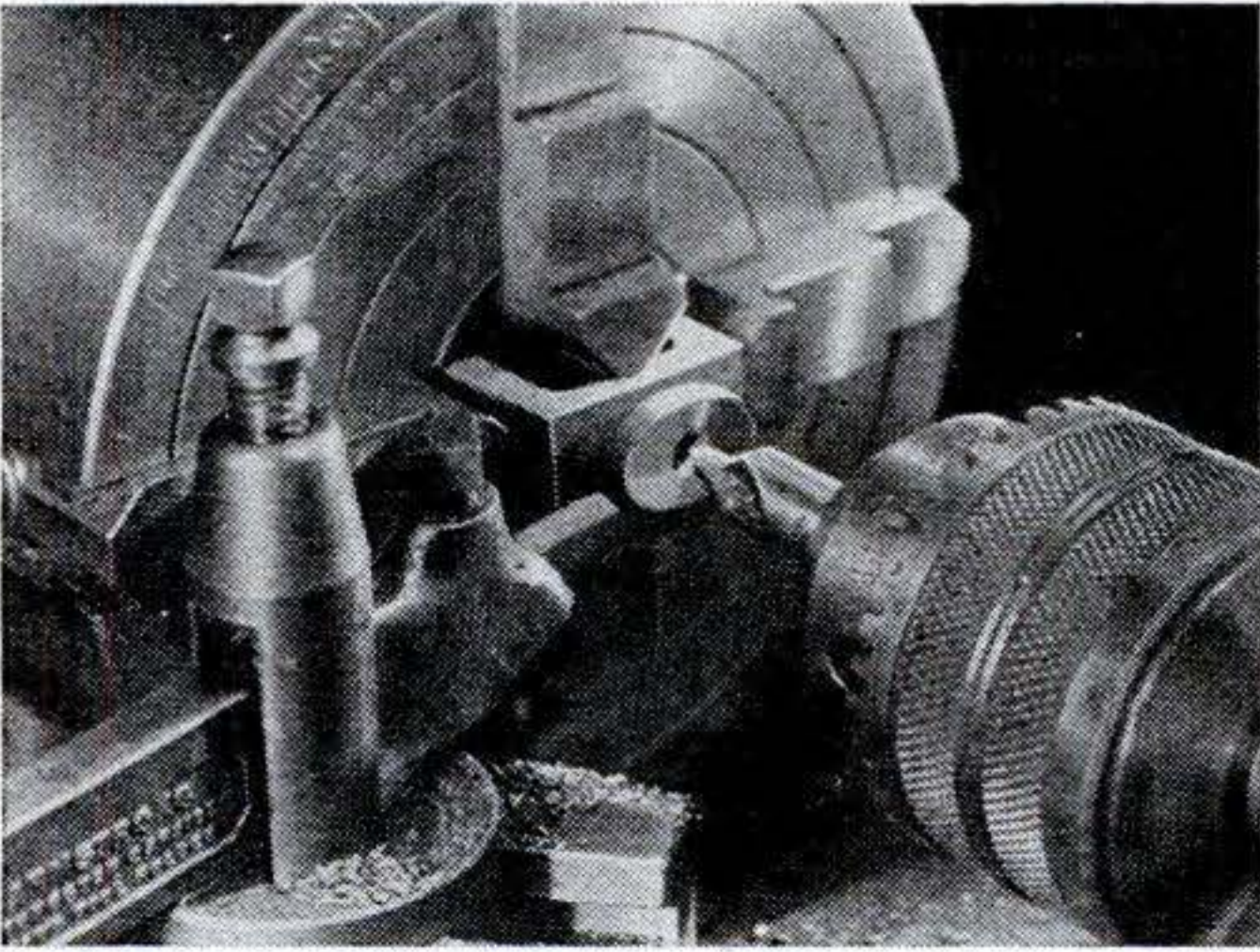

7 Chucked gland end out, the steam chest can be drilled and reamed for the valve stem and the hole then opened out to take the gland.

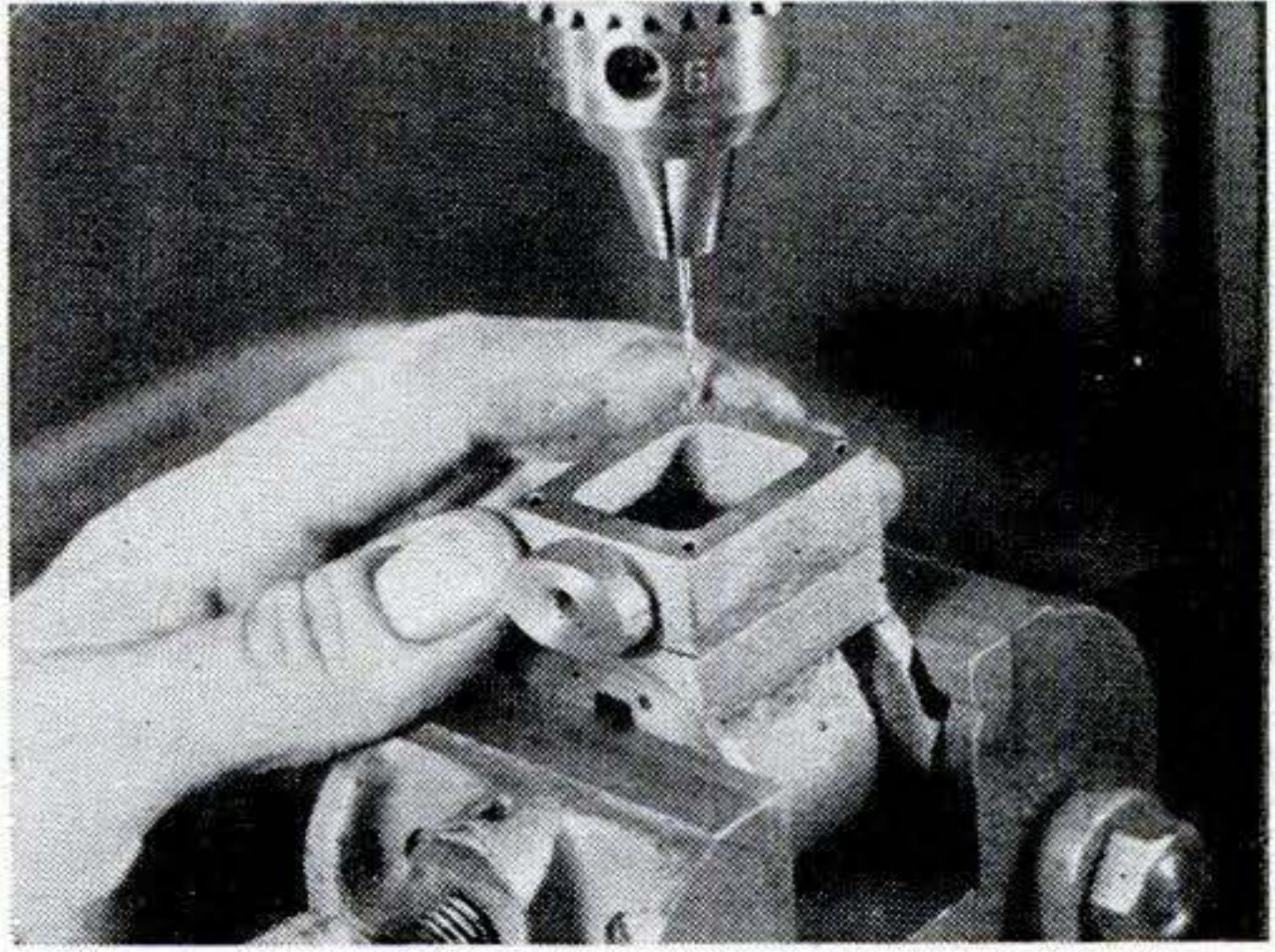

8 Corner holes are completed first in the steam chest and cylinder steam-port face; then the parts are bolted and the remaining holes drilled.

cylinder and repeat as for the head. Put witness marks on the column, cover, and cylinder flange, making certain that the valve face is at 90 deg. to the crankshaft centerline of the base.

Face the steam-chest casting on both sides, holding it in the four-jaw chuck, and bring it to proper thickness. A heavy roughing cut followed by several light finishing cuts will assure a steamtight joint.

Some difficulty may be encountered in drilling for the valve stem, since the inner surfaces of the steam-chest casting will have a slope. If you have a hand grinder, a small flat can be ground inside the stem-guide end for a drilling surface, after which the steam chest can be chucked and the hole drilled all the way through from the gland end. Otherwise it may be best to lay out the holes as accurately as possible on the outer surfaces, drill each from the outside with

an undersize drill, and then ream from the gland end. In this case, drill the gland end first, counterbore, and support it with the tailstock center when drilling from the stem-guide end. Finish by enlarging the upper hole with a No. 3 drill and tapping $\frac{1}{4}$ "-28.

Lay out the 14 bolt holes, drill the four in the corners clearance size, and spot, drill, and tap the corner holes in the cylinder steam-port face. Bolt through the four holes, and drill the remaining 10 tapping size through the steam chest into the cylinder. Separate the parts, tap the cylinder holes, and open up those in the steam chest.

Face the steam-chest cover in the lathe, mill the recess, clamp the steam chest to it in the drill press, and drill the bolt holes.

The valve-rod and piston-rod glands, valve-stem guide, and steam-pipe flange are turned from bronze bar stock to dimensions on page 193. TO BE CONTINUED

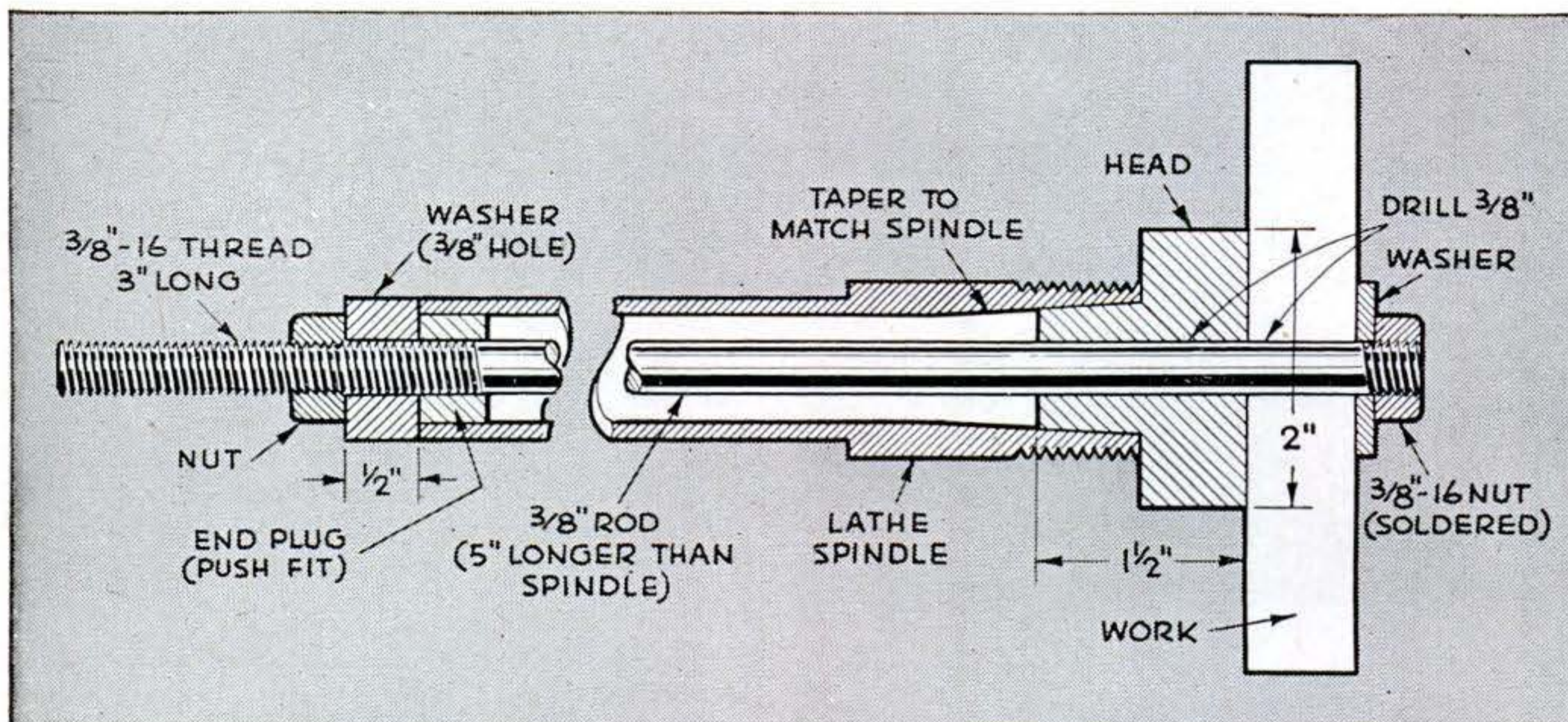

Collet and Arbor Simplify Mounting Small Wheels in Lathe

WHEELS, pulleys, and collars are centered automatically on the end of the rod inserted in this collet and end plug, and they can be reversed for turning the opposite face without losing time in recentering. The work is held firmly by pulling the lefthand nut up tight. Use free-cutting brass for the head

with the taper boss, and steel for the rod.

Lathe spindles vary in length, bore, and taper, and the dimensions shown should be changed to suit. The arbor will take work centerdrilled the size of the rod; a set of bushings can be turned for work having larger center holes.—HERBERT PFISTER.

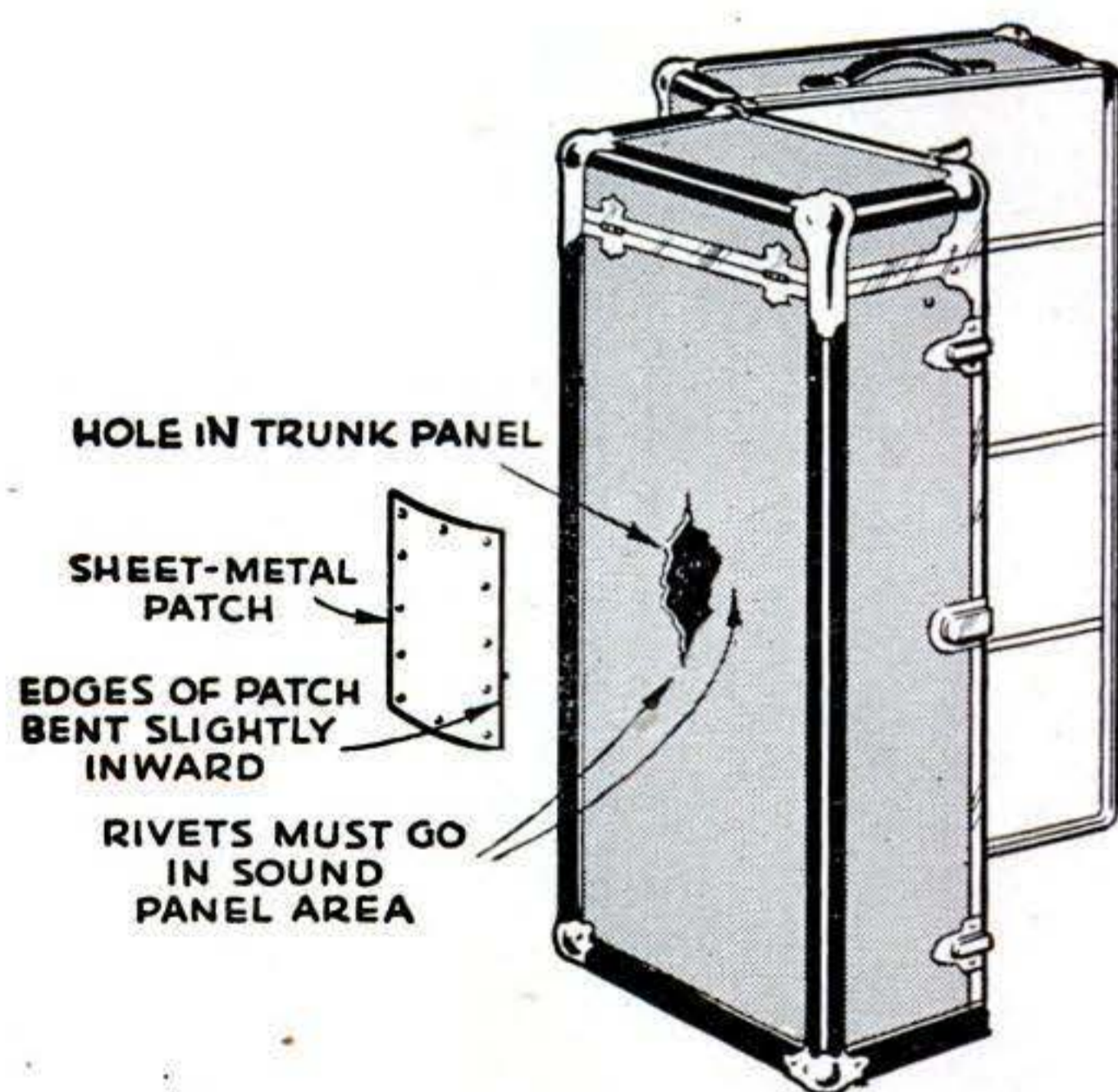

Steel Patch for Damaged Trunk

TO REPAIR a hole broken in a trunk panel, cut a sheet-steel patch large enough for rivets to go into sound material around the break. Smooth the edges, or bend them slightly in, and put the patch on the outside. House paint or thick spar varnish between panel and patch strengthens the joint and makes it water resistant.

Tire-Cut Filler Insulates Plug

FOR a completely insulated, solid electrical plug, fill the inside with tire-cut filler after the wire connections have been made. Press the filler in with a moistened finger. When dry, it is like molded rubber and will prevent the wires from loosening.—KENNETH MURRAY.



Paint for Frosting Windows

GLASS must be thoroughly clean before it can be painted successfully. A mixture of rubbing alcohol, household ammonia, and powdered whiting will remove all dirt and grease. Wipe clean with a dry cloth.

For the frosted effect, mix a paint of 3 parts white lead, 1½ parts boiled linseed oil, and ½ part spar varnish. Apply with a wide brush in small squares and, after each square is painted, stipple with a bag made of several folds of cheesecloth wrapped over a ball of cotton.—JOSEPH E. BIRD.

Rubber Washers Made in Lathe

DOZENS of washers can be cut in a few minutes from a length of old rubber hose. Insert a dowel in the hose and mount the piece in the lathe. Clamp a heavy knife under a block in the tool post or hold it on the tool rest of a wood lathe.—WILL THOMAS.

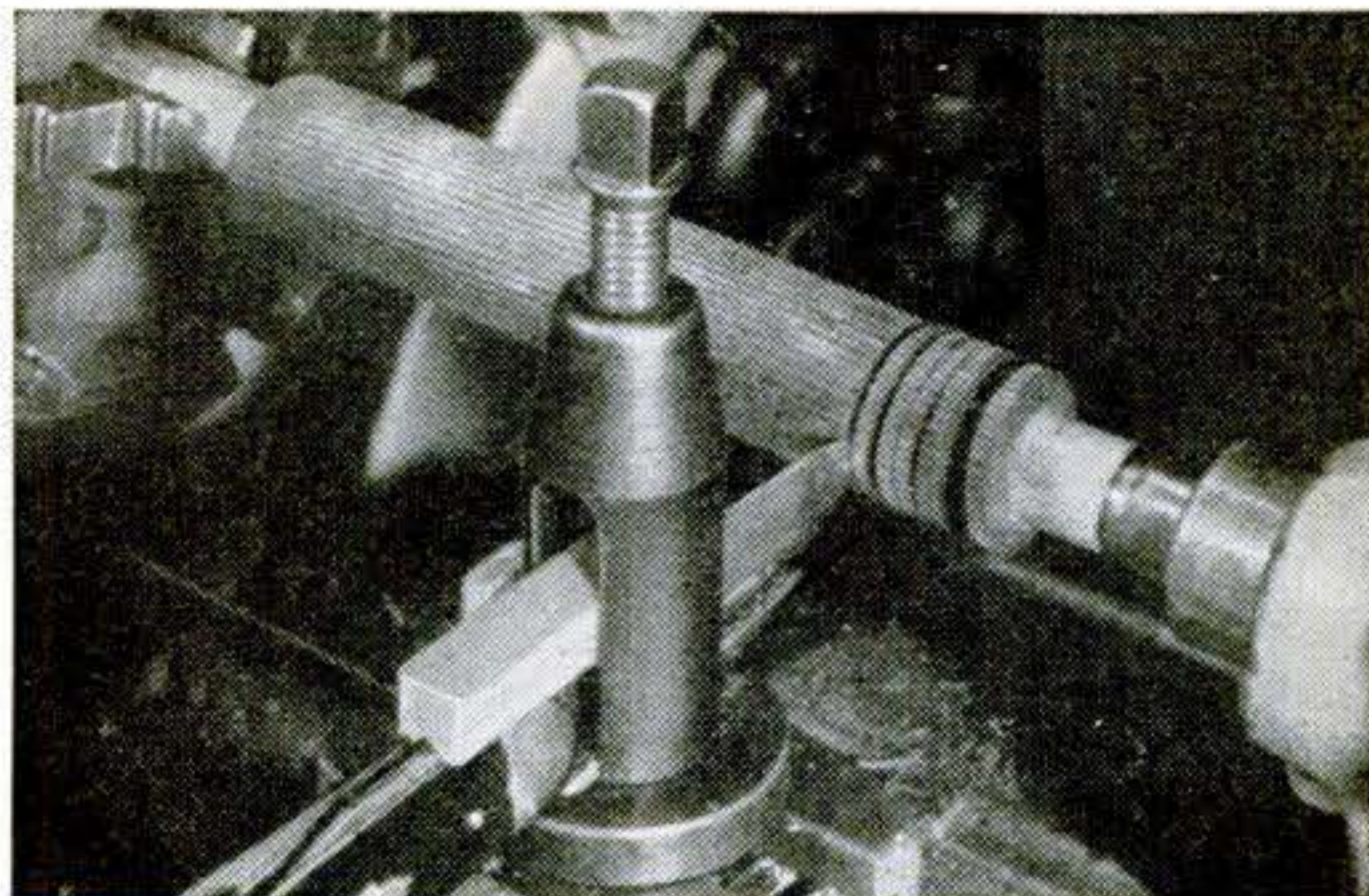

Cardboard Guards Piano Finish

WHEN a piano is played often, the finish on the piece between the keyboard and the music rack is in danger of becoming so badly marred by the fingernails that a re-finishing job may be necessary. A length of cardboard inserted in the space, however, will protect the original finish. Inserted behind the black keys as a tight fit between them and the overhang above, it won't interfere with playing.

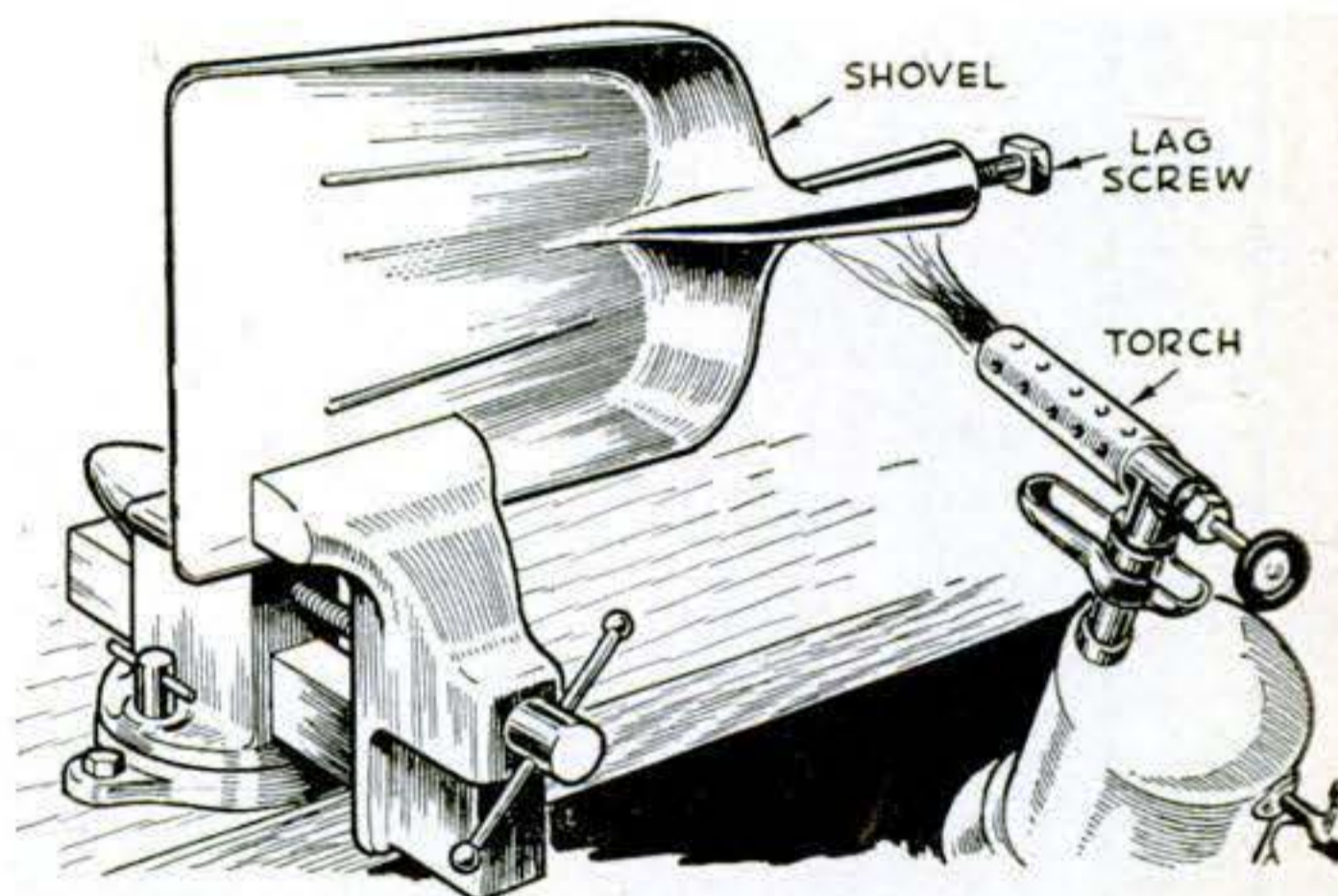
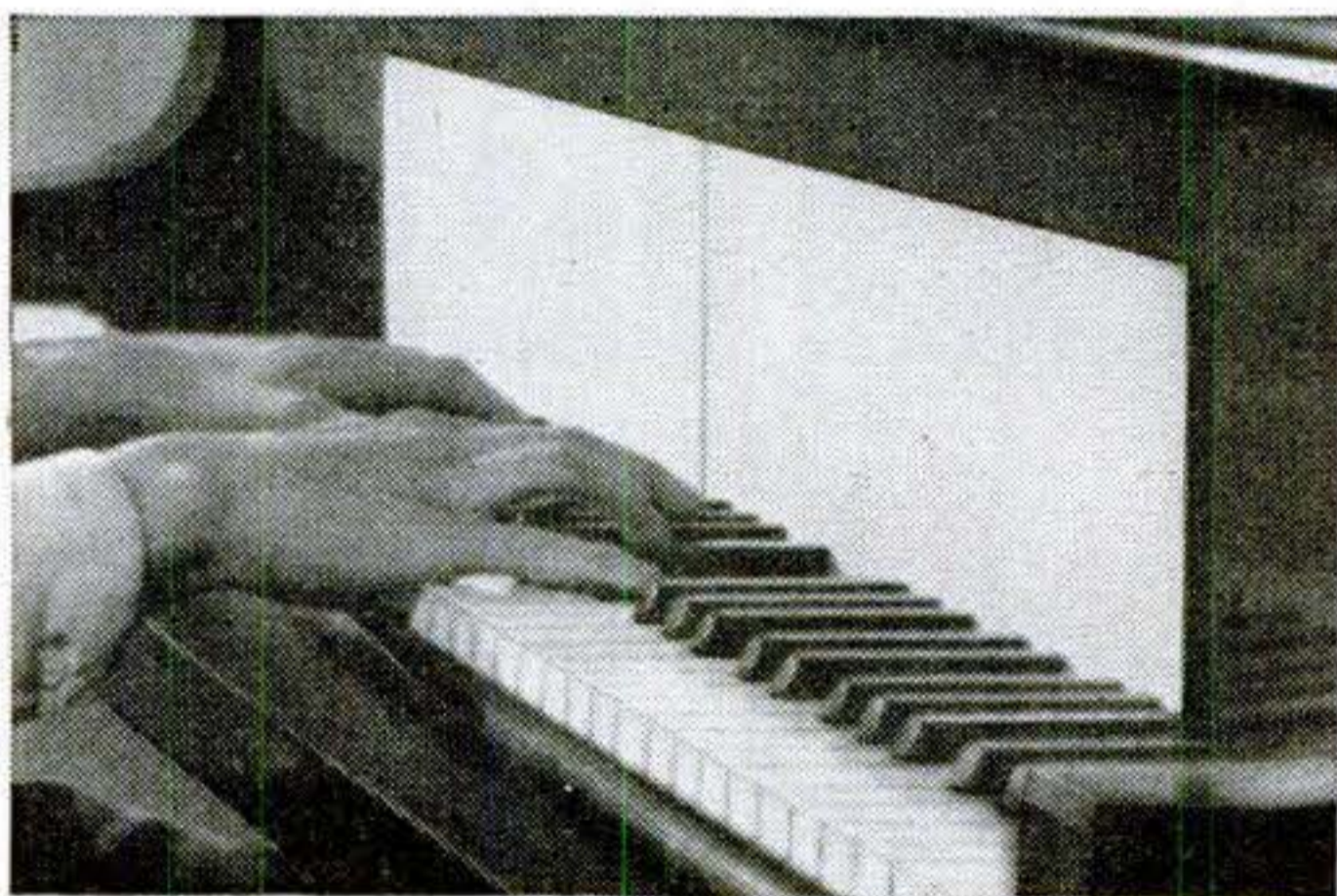

Freeing Broken Shovel Handle

A SHOVEL handle that has broken near the shank may be removed by driving a heavy lag screw into the end, clamping the blade in a vise, and heating with a blowtorch. When the wood has charred sufficiently, pull the lag screw with pliers.—RONALD EYRICH.

CONCRETE AGGREGATE

[HANDY MAN]

Both coarse and fine aggregate are required in strong cement. The coarse aggregate consists of crushed stone or pebbles graded in sizes from $\frac{1}{4}$ " to $1\frac{1}{2}$ " or up to 3" for mass concrete work. It should be clean and hard. Fine aggregate is sand, graded from very fine to $\frac{1}{4}$ ", and should also be clean and hard. By graded is meant that the aggregate should contain many sizes from small to large. In the mixture, the small particles fill the voids between the large, while the cement fills the voids between the small particles.

Bank-run gravel, that is, the natural deposit of combined sand and pebbles, may be used for aggregate if it is clean, but for best results it should be screened, the sand separated from the pebbles, and re-proportioned. As it comes from the bank, gravel usually contains a greater amount of sand than required.

Dirty sand may be made suitable for use by washing with a hose on an inclined shallow trough fitted with cleats and having a screen at the lower end to separate sand from pebbles. A trough should be provided to drain off water from the receptacle under the screen. The unwashed sand is, of course, put on at the top of the incline and washed down. Two or three washings may be required, for if silt, clay, and loam are mixed in the concrete, they will coat the aggregate and prevent bonding by the cement.

What is known as "cinder concrete" can be made of cement mixed with cinders for aggregate. It is cheap and light in weight and is used chiefly for floors that will not carry heavy loads and in some fireproof structural-steel work. The cinders should be hard-burned boiler cinders free from fine ash. They should be wetted 24 hours before use to slack out free lime and neutralize sulphur. The proportion is ordinarily 1 part cement to 5 parts cinders. Don't attempt to use household cinders; they are too fine and powdery.

POPULAR SCIENCE MONTHLY SHOP DATA



Light and shadow cast on a wall will form interesting backgrounds for your home camera portraits. Designs are limited only by your imagination and ability to wield a pair of scissors.

Patterns are cut out from black paper or cardboard. They may be symmetrical or irregular in design. The pattern for the background at left is shown below.



SHADOW BACKGROUNDS

Set Picture Moods

By **LOUIS HOCHMAN**

ONE of the most limiting obstacles faced by the amateur portrait photographer who works in his own home is the lack of a variety of backgrounds. Blinds, drapes, and the materials at his disposal can go just so far before their possibilities become exhausted.

Yet, with scissors, black paper, and imagination, he can convert a light-colored blank wall into such an endless variety of artistic background effects that his home portraiture will never be in danger of slipping into a commonplace rut.

It's really a very simple trick. Cutouts are made in sheets of black paper to form interesting patterns, and a sheet is set up in

front of a light directed on the blank wall. The shadow of the cutout pattern is thus cast on the wall. All that then remains is to pose the subject in front of the tracery of light and shadow and, after lighting him suitably, to take the picture.

The accompanying illustrations can but suggest a few of the designs that can be cut from black paper. Patterns may be symmetrical or haphazard, bold or subtle, fine or coarse. Anything that comes to mind and can be transferred to black paper with a few snips of the scissors may be worth trying. The shadow design is especially appropriate if it helps to set a mood for the portrait.

One of the simplest ways to cut symmetrical patterns, of course, is to fold the paper

into quarters or eighths. The design is cut at one time in the folded sheet, which is then spread out to reveal the cutout repeated in every section of the paper.

A most suitable material for such work is the black paper in which films and photographic papers come packed. Excellent large sheets of black paper, for instance, are used for wrappings on 8" by 10" paper in boxes of a gross sheets. If the paper is not large enough, two or four pieces can be taped together. Sheets measuring 16" by 20" should prove large enough for most designs.

When more permanent patterns are desired, thin cardboard may be used. It should be coated with a dull black paint. Some difficulty may be experienced in cutting symmetrical designs on such cardboard unless they are first cut out on folded paper and then traced on the cardboard.

For pattern ideas, you need only study

everyday objects. A brick wall, a flagstone walk, foliage, a picket fence, the rays of the sun, wagon wheels, latticed windows—all suggest good designs. Precision is not necessary in cutting (a razor blade may be used as well as scissors) for the shadows will be fuzzy anyway when cast on the wall. This fuzziness, however, adds to rather than detracts from the pictorial effect.

The pattern is suspended in front of a light beam directed on the blank wall. Remember that the closer the light is to the pattern, the fuzzier will be the edges of the shadows, and the farther away, the less fuzzy the design will show. Where a relatively sharp design is required, the pattern will have to be exceptionally large and placed as close to the wall as possible without interfering with the subject.

Also affecting the sharpness is the kind of light used. For best results, the source

This is how the pattern background is projected on the wall. A spotlight behind the cutout throws the shadow design on a blank space. The light should be placed at a 45-deg. angle so as not to hit the subject.

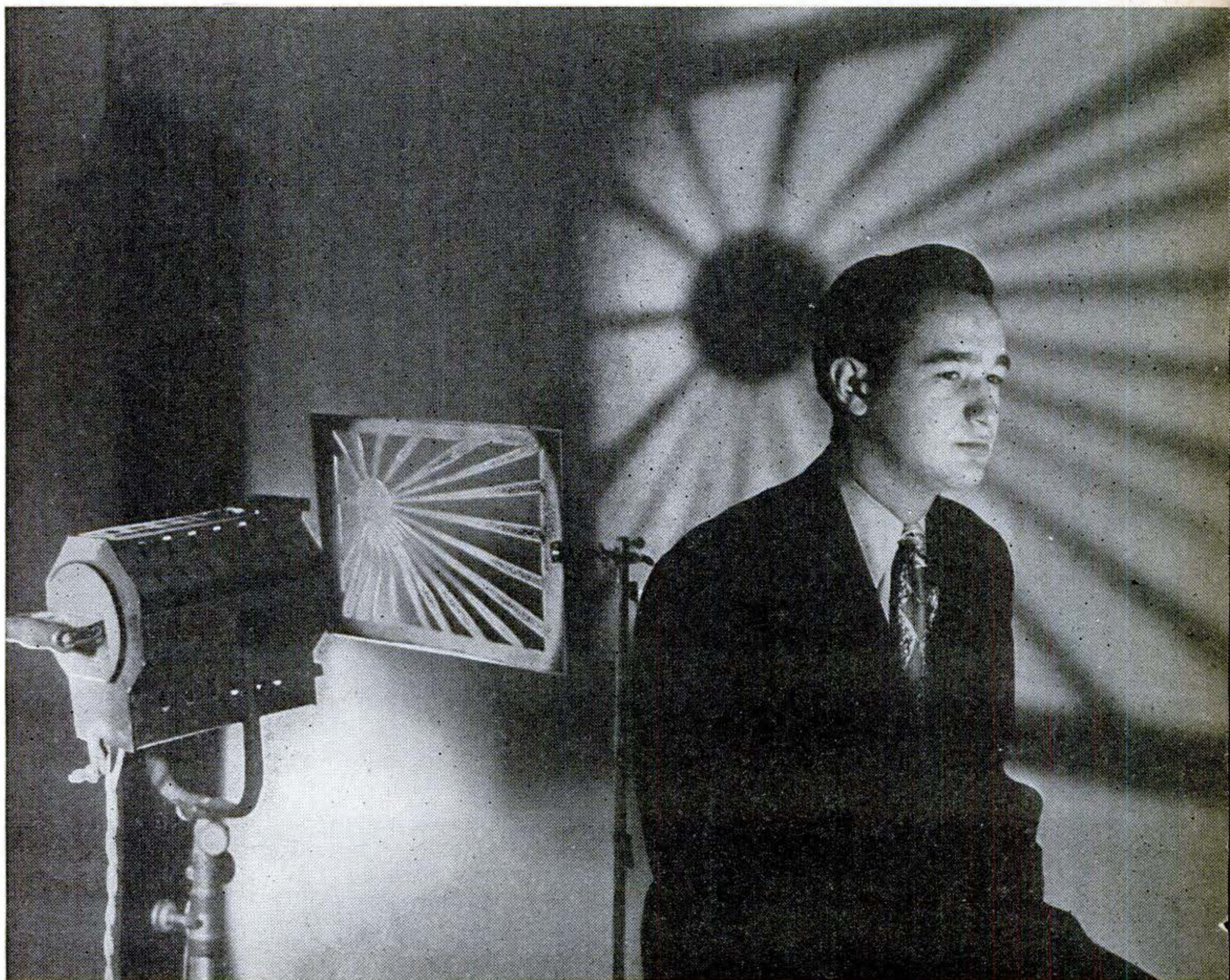

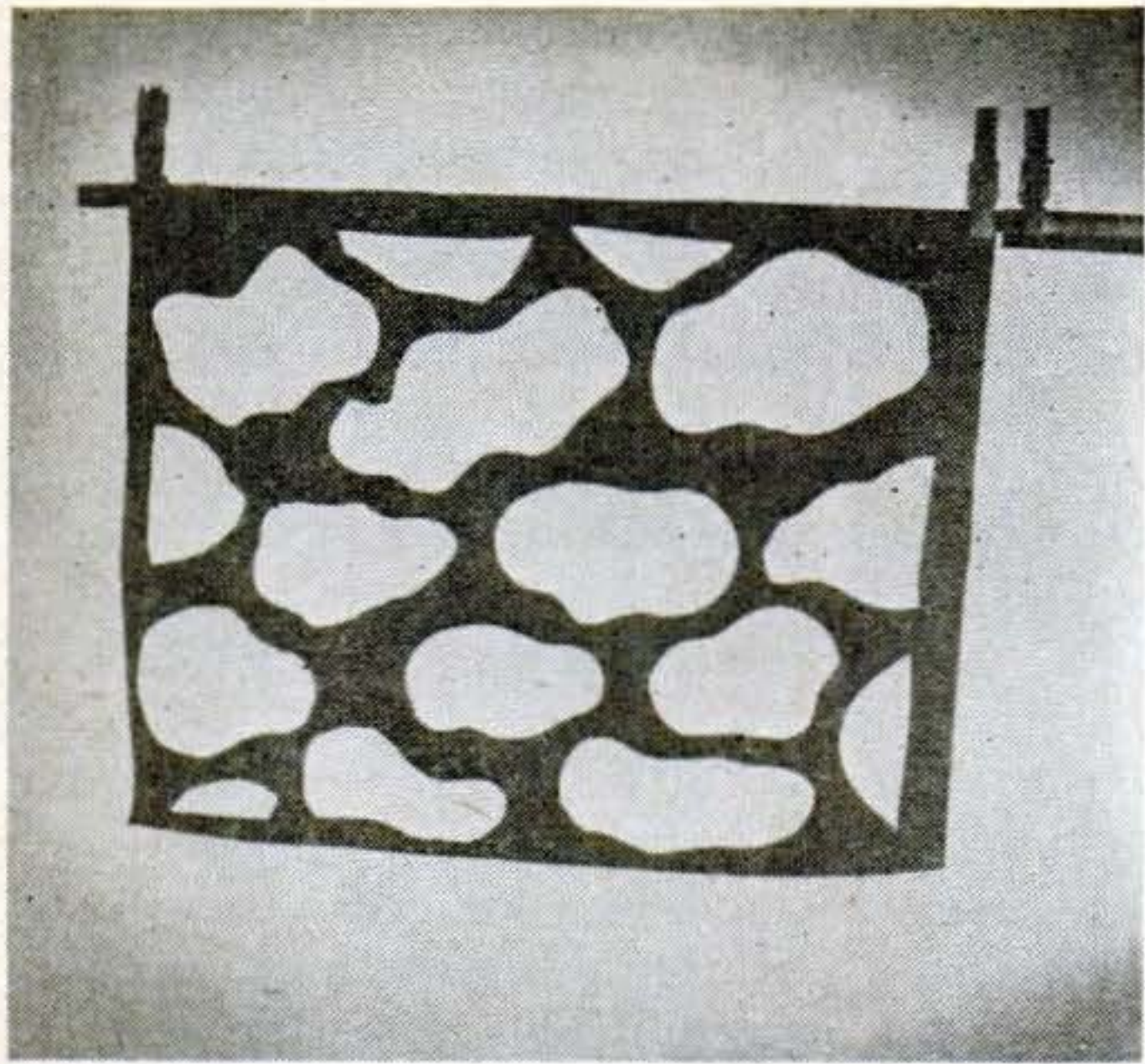

One of many patterns possible with cutouts. They may be suggested by a flagstone walk, a latticed window, a picket fence, and other common objects.

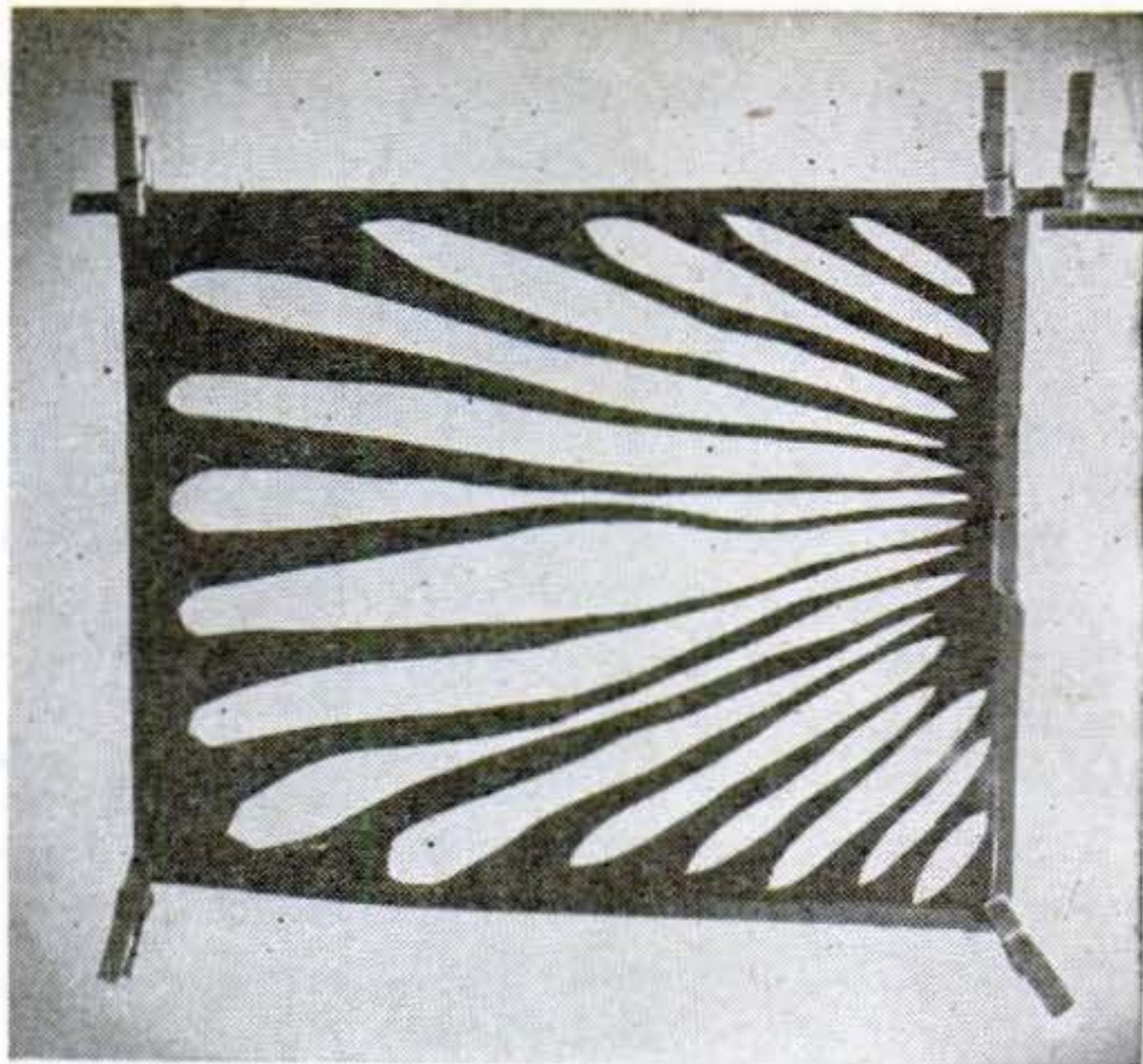

Spring clothespins attach the pattern to the arm of a supporting stand. Clothespins on the lower corners add weight to hold the pattern straight.



Looking up to the sun. This portrait effect is obtained with a simple cutout simulating rays. Mood effects like this help — keep portraits out of the commonplace.

should be as nearly a pin point as possible. A small focusing spotlight with lens removed or a clear 500-watt projection-type bulb without a reflector serves well. The shadow should be cast from an angle of about 45 deg. so the subject will be able to pose in front of it without having it on him.

In lighting the subject, take care to keep bright light from striking the background and killing off the shadow pattern. The subject lights should be well shielded and directed from steep angles when possible.

Such cutouts are a boon also for the color photographer. With gelatin sheets of various colors taped over the cutouts, rich and colorful backgrounds can be obtained. Or a play of shadow and one color is possible with a gelatin sheet held in front of the light.

An interesting rainbow effect can be created with semicircles of red, yellow, green, and blue gelatin mounted together over a cardboard frame with cellulose tape. Such a pattern can be projected on the wall.

Lighting intensity on subject and background should be balanced. The color temperature of the light used to project a rainbow is unimportant, but the lights on the subject should be of the correct Kelvin temperature for the film.

END



Darkroom in a Box

AMATEUR photographers who lack space for a complete darkroom can take a tip from Walter O. Englund, of Marietta, Ga. He stores every item of his equipment in a handsome plywood cabinet finished to harmonize with the rest of the room furnishings. Measuring 19" deep, 26" wide, and 33" high, the cabinet was so designed that each bit of equipment has its allotted niche. In use, the top of the cabinet provides a resting place for the enlarger, and the only other thing required is a table for trays.

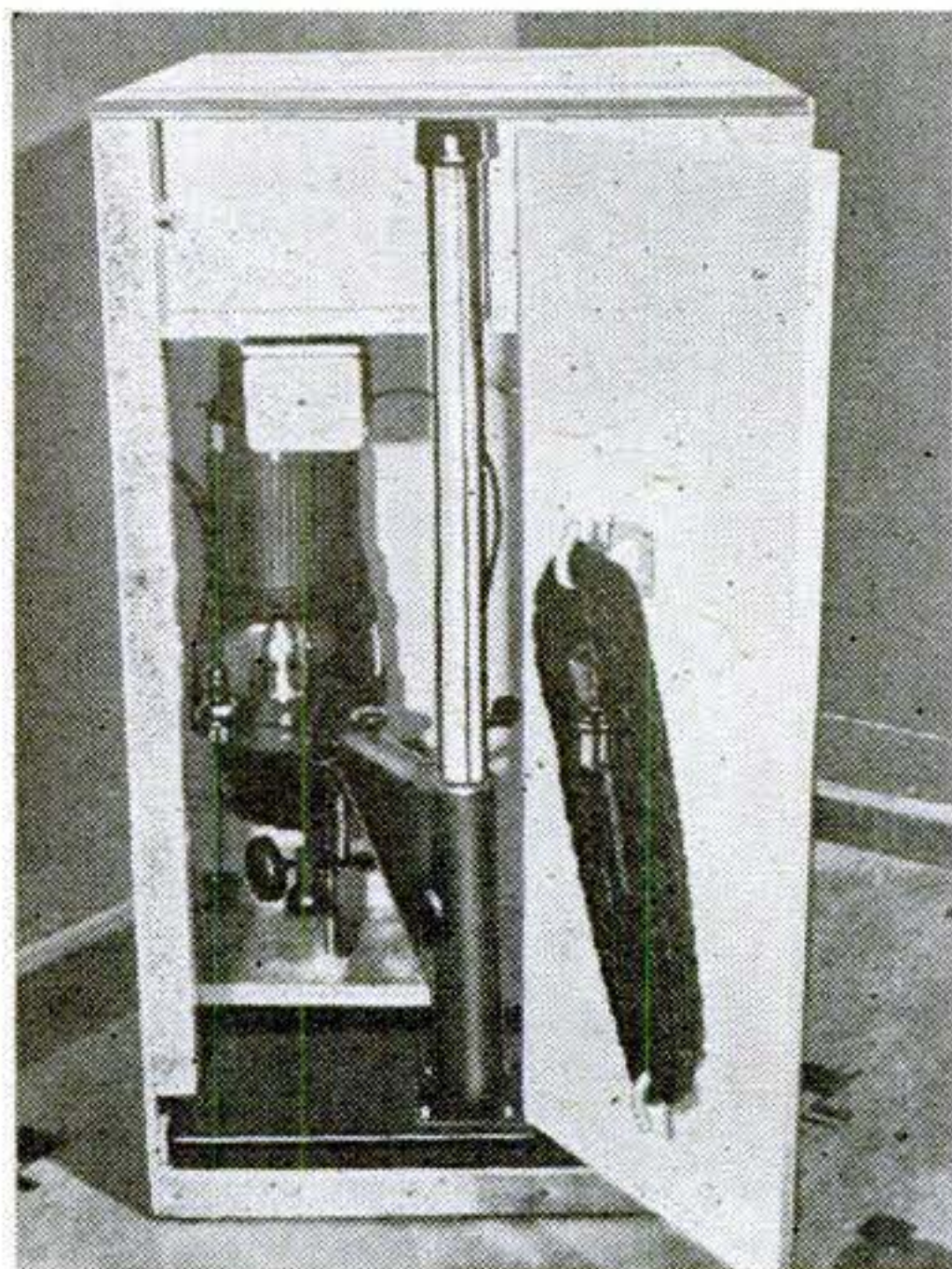

Storage for the enlarger is provided in the left end. Negative carriers and a foot switch go above it, and hooks on the door take a long extension cord.



Open the front doors, and this is what you see. The compartment at the right will take 11" by 14" trays if the bottom shelf is removed. On the right door are hooks for film clips and a print roller. In the right end are four drawers for storage of paper.

On the back (right) are three electrical outlets. The top one and that at lower left are in series so a foot switch can be used with the enlarger. A safelight is connected to the other.

Shelves that are reached by lifting the top provide space for ferrotype tins, 11" by 14" paper, scales, film, and negatives.

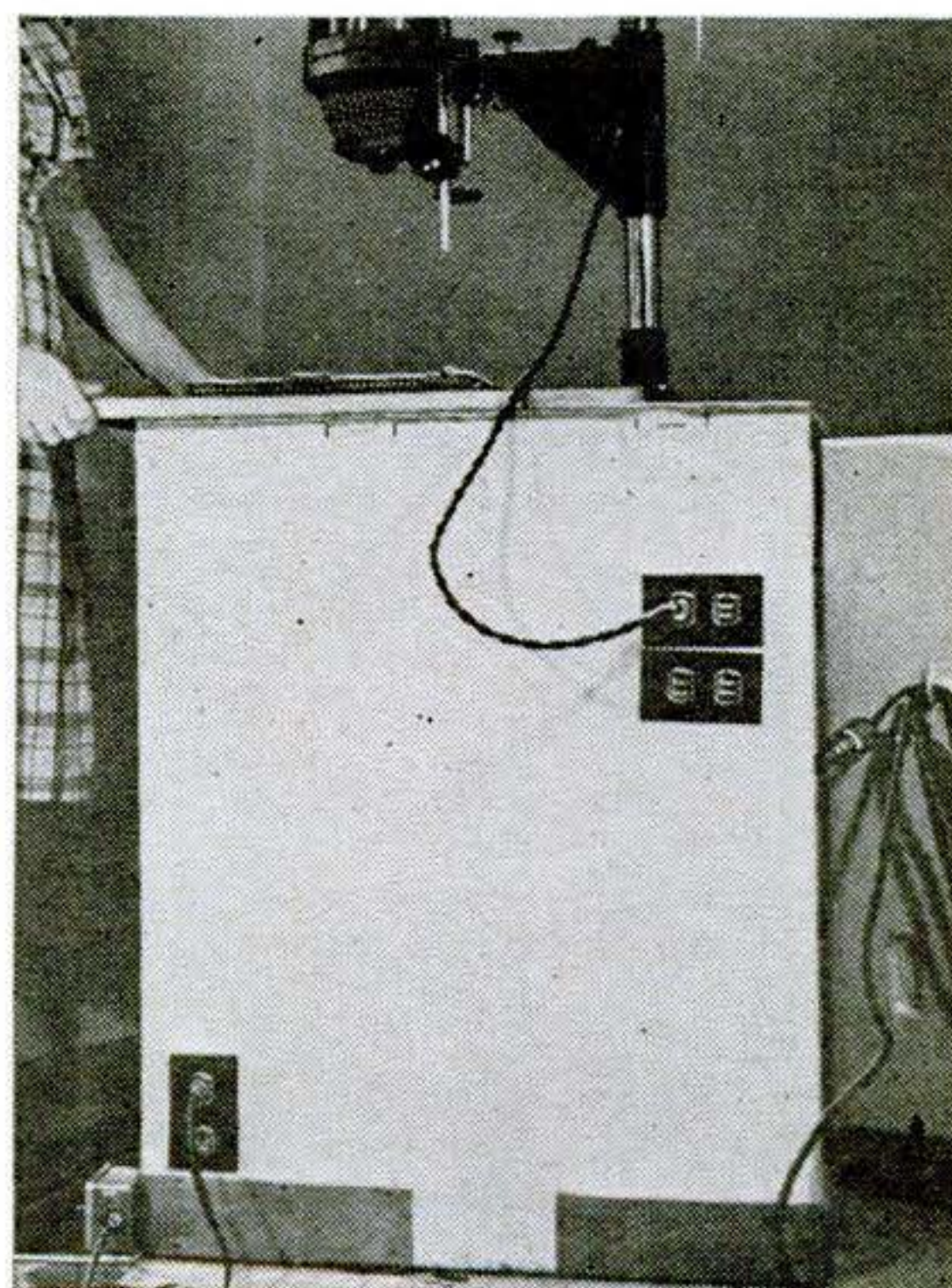
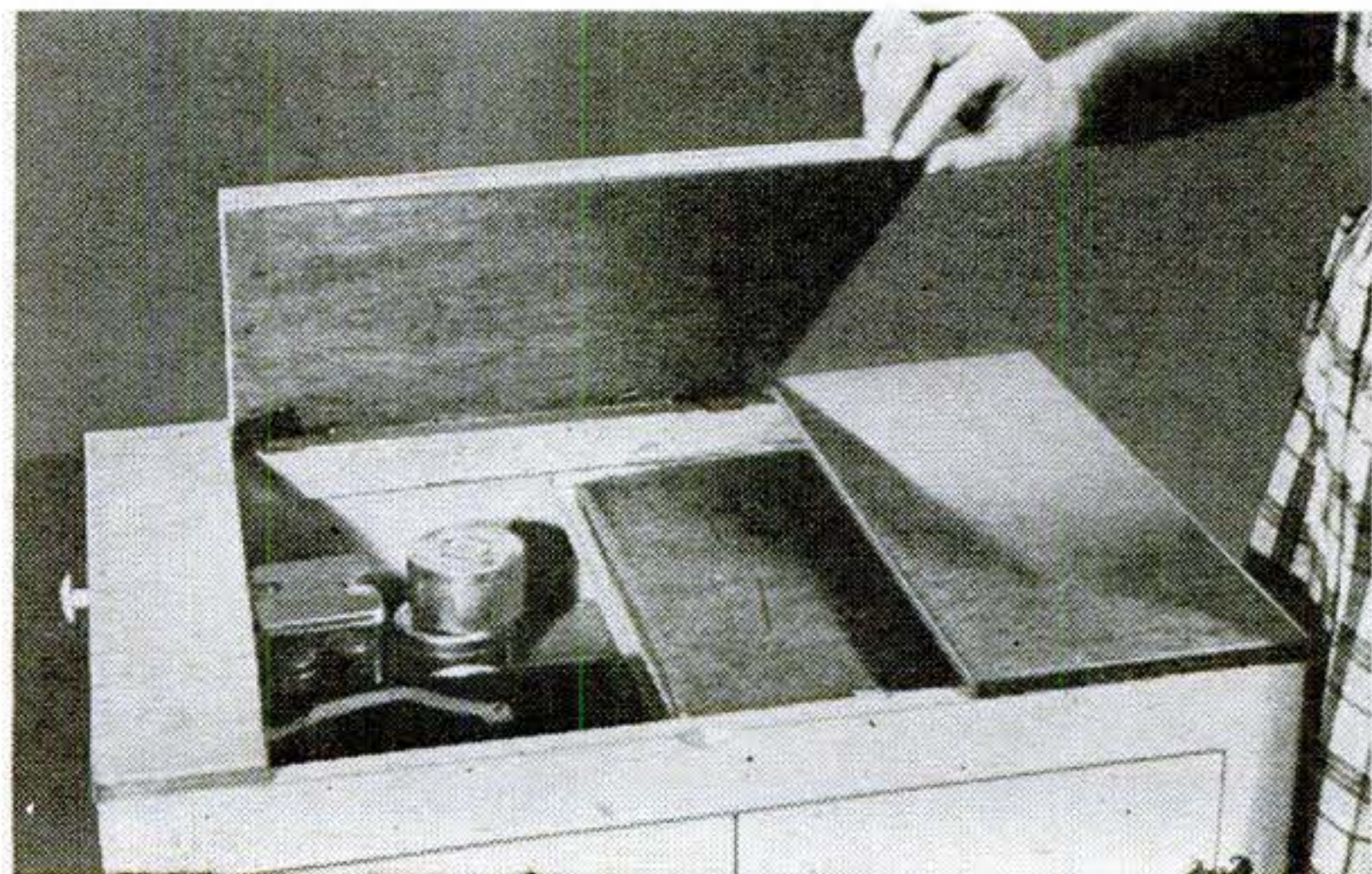
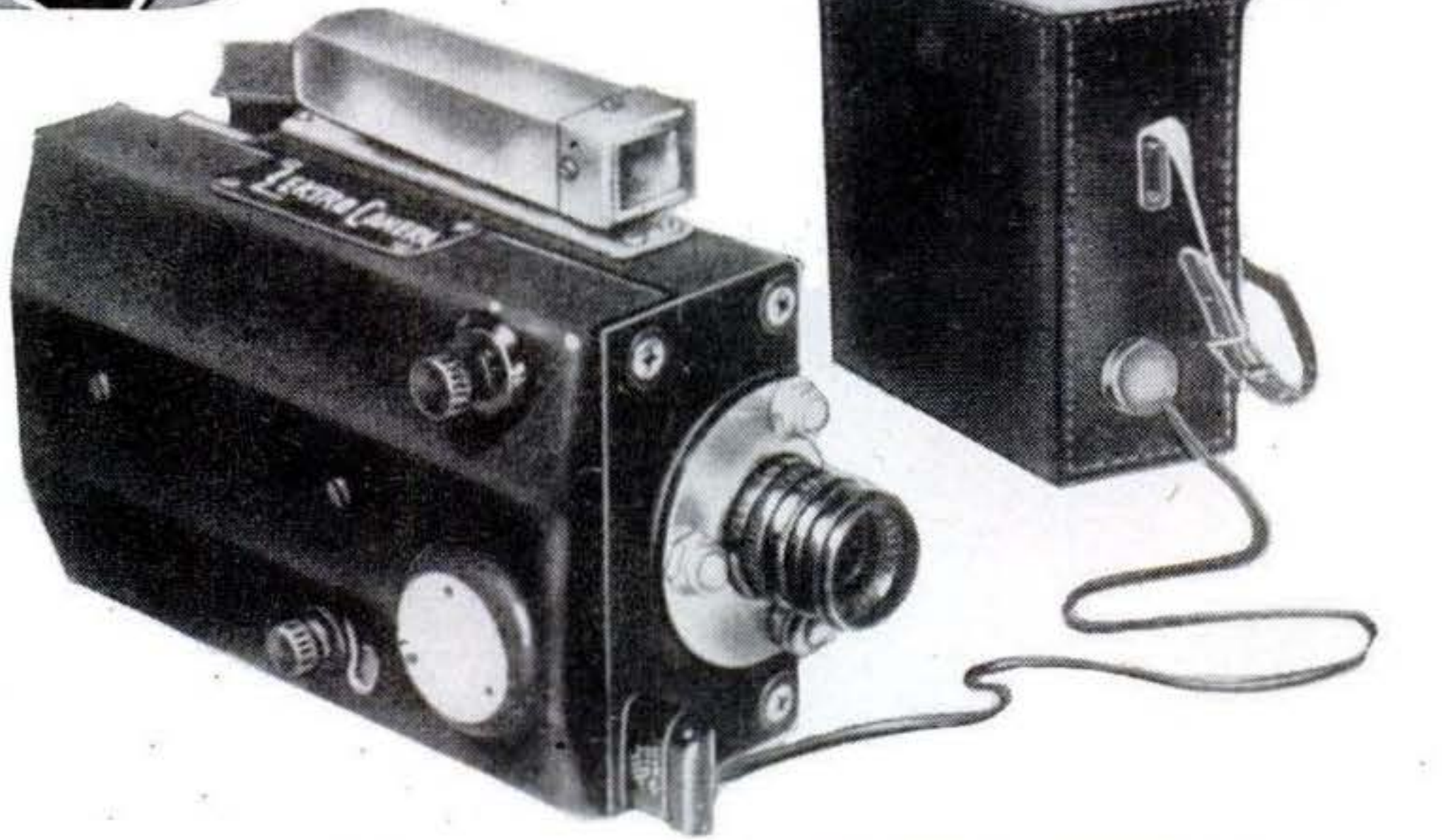

PHOTO IDEAS and EQUIPMENT



ELECTRIC DRIVE. A continuous-action movie camera, adapted in a lightweight edition from cameras mounted in the wings of warplanes, is driven by a special dry-cell pack housed in the case. Called the LectroCamera, it is distributed in three models, one including sound speeds, all under \$140, by Associated Photo Products, of New York.



FIXPECTION LIGHT. If you can't wait to inspect prints until they are out of the fixing bath, a 10-watt bulb suspended 6" to 8" above the bath will provide safe illumination so long as you keep the print submerged in the hypo. A shade made from a small can painted black outside and with aluminum paint inside will prevent fogging of other paper. Turn the light off when not in use.—J. L. VAN HORNE.

PHOTOGRAPHIC ANALYZER. Density and contrast are measured by a photocell on the arm of the instrument shown at right when a negative is placed over the illuminated viewer. The device will also analyze contrast in printing papers and exposures for prints and enlargements. It can be used both for black-and-white and color. Weston Electrical Instrument Corporation, of Newark, N. J., is the maker.

TRIPOD-TOP AID.

When the socket on a camera, particularly a miniature camera, isn't deep enough to receive the full length of the tripod screw, a rubber garden-hose washer over the screw will prevent wobbling. Used on a metal tilt top, a washer also helps to keep a camera from rotating out of its set position.—JACK WILSON.





SYNCHRONIZER FOR BANTAM. A special automatic synchronizer has been developed by the Kalart Company, Inc., of Stamford, Conn., for Kodak Bantam cameras with f/4.5 or f/5.6 lenses. Small enough to slip into a coat pocket, this Compak Automatic Speed Flash has a reflector designed to increase the light efficiency of midget bulbs more than 80 percent. It is easily and quickly installed or removed.

CORD KEPT SECURE. As a precaution against bulb failure due to loose connections when you are taking flash pictures with an extension unit, secure the extension cord to the battery case or reflector bracket with a half hitch.—JACK WILSON.



BLACK AND WHITES FROM COLOR. A kit placed on the market by Grant Photo Products, Inc., of Cleveland, Ohio, employs the reversal system to get black and white or sepia prints from color transparencies. All the necessary chemicals and a package of panchromatic reversal paper are included. Because the emulsion is coated on a waterproof base, a print can be developed and fully washed in only 5 min. working time after exposure in an enlarger.

RIBBON LIFTS PAPER. A short ribbon or string attached to a cardboard stiffener in the bottom of a box of printing paper makes it easier to remove paper without fumbling. Pulling on the ribbon raises the upper sheet within convenient reach of your fingers.

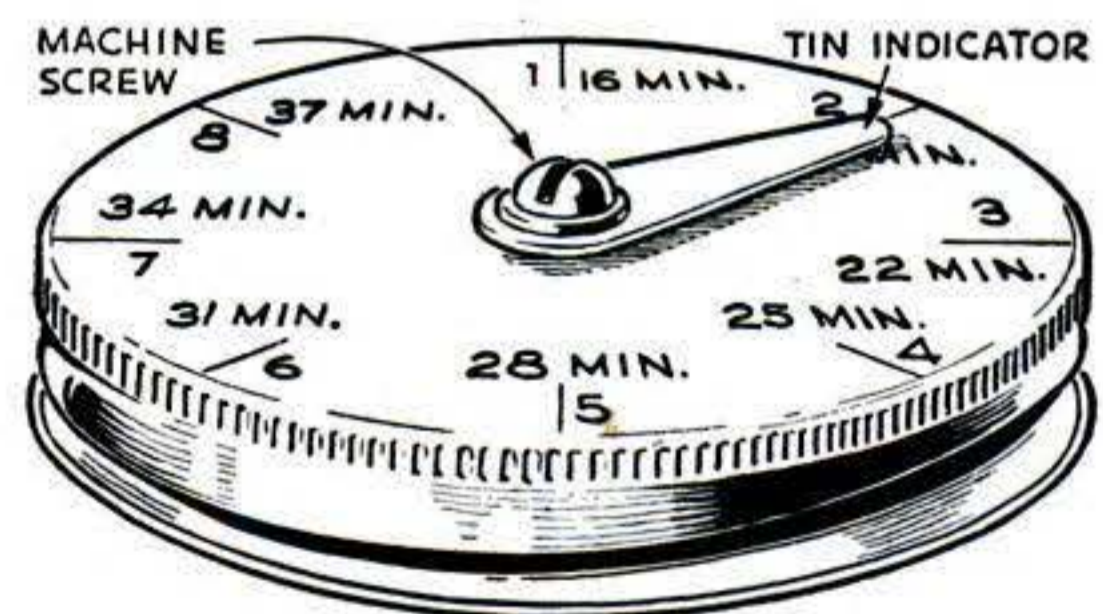
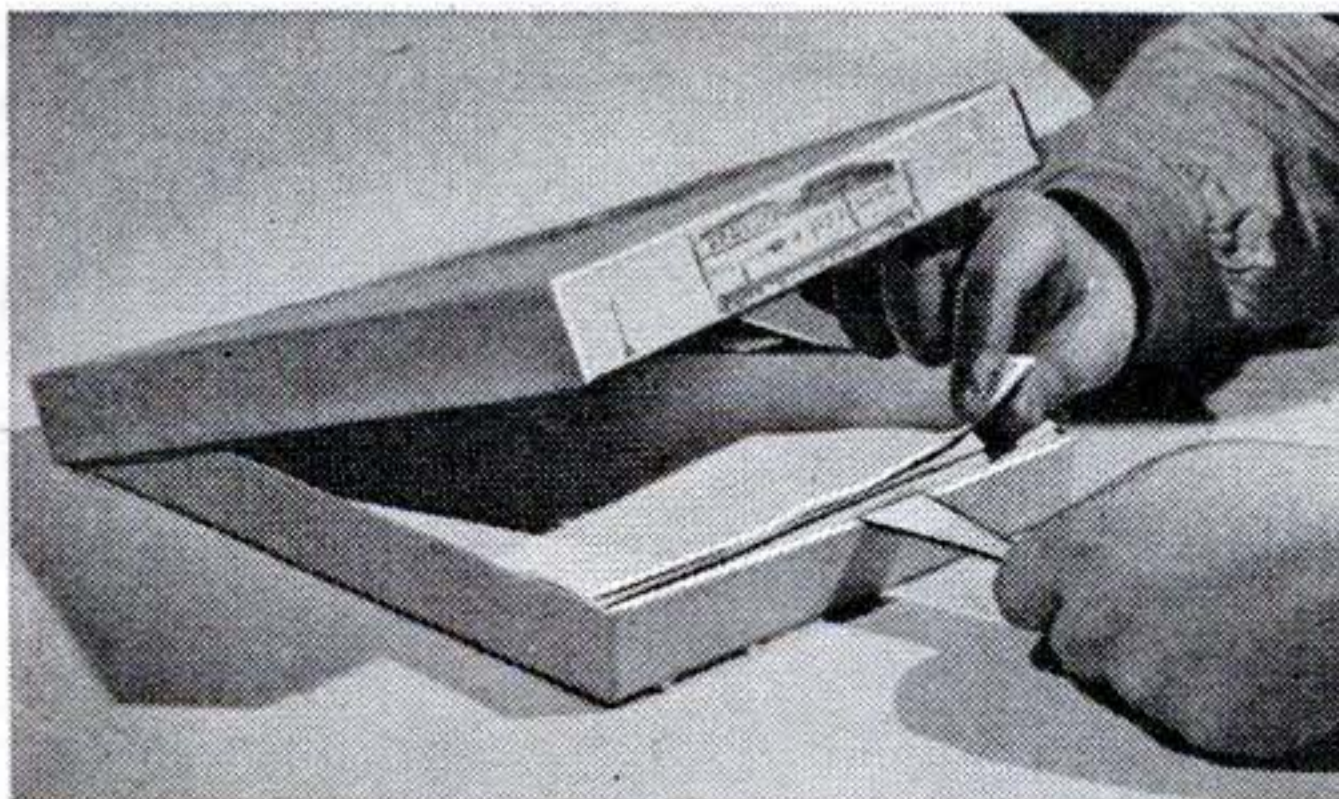

DEVELOPING AID. This indicator helps me keep track of the number of times I have used my film developer and shows at a glance the developing time required for each successive batch of film at 68 deg. F. It is made from a jar lid, an indicating hand being cut from a piece of tin and mounted in the center with a machine screw, a nut, and three washers.—KENNETH CLARK.

Businessman's Radio

By EDWARD BLANTON

FOR THE businessman who has to travel and likes to travel light, here is a handy radio that manages to be a constant companion without becoming an extra piece of luggage. Flat enough to fit into a briefcase or overnight suitcase without crowding out the other things you want to take along, this four-tube receiver operates on either AC or DC at 115 volts.

The resistance of the four tube filaments in series is such that no line-cord resistor is needed to drop the voltage. Therefore an ordinary two-conductor cord can be used, as long or as short as you like. A little extra length is all to the good, since in some of the older hotels electric outlets aren't placed as close as you might like to the desk or night table.

All the tubes are midgets; leads from inside are brought out to miniature metal prongs embedded in the glass envelopes. Connections are made to miniature 7-prong

sockets that are fastened to the chassis.

The chassis consists of a 5½" by 8" sheet of thin aluminum bent to form a 90-degree angle about 2" from one of the longer edges. Most of the parts are fastened to the 2" leg so formed.

The first tube, a 12BA6, is a radio-frequency amplifier pentode with remote cut-off characteristics. The control grid of the tube is connected to the secondary winding of the antenna coil (L1) and the stator plates of one section of the two-gang tuning condenser (C1). From the plate of the 12BA6, the amplified radio-frequency signal is fed into the primary winding of the RF coil, L2, which is coupled to a second tank circuit composed of the secondary of the RF coil and the other half of C1.

The unshielded antenna coil is placed beneath the bend in the chassis; the RF coil is placed above the chassis and must be shielded to prevent oscillation and distortion due to stray couplings between the coil windings and the other circuit components.

To cover the coil, a portion of an old tube shield was cut off and bolted to the chassis as illustrated on page 207.

Output from the RF tank circuit is fed to the grid of the 12AT6, used as an anode detector and amplifier. Bias is provided by a 2,700-ohm resistor and a 10-mfd., 25-volt electrolytic condenser (R1, C4). A small mica condenser



An average-size briefcase holds the radio and plenty of books, papers, and other articles as well. The case is a leather-covered jewel box or accessory case.

Fits in a Briefcase

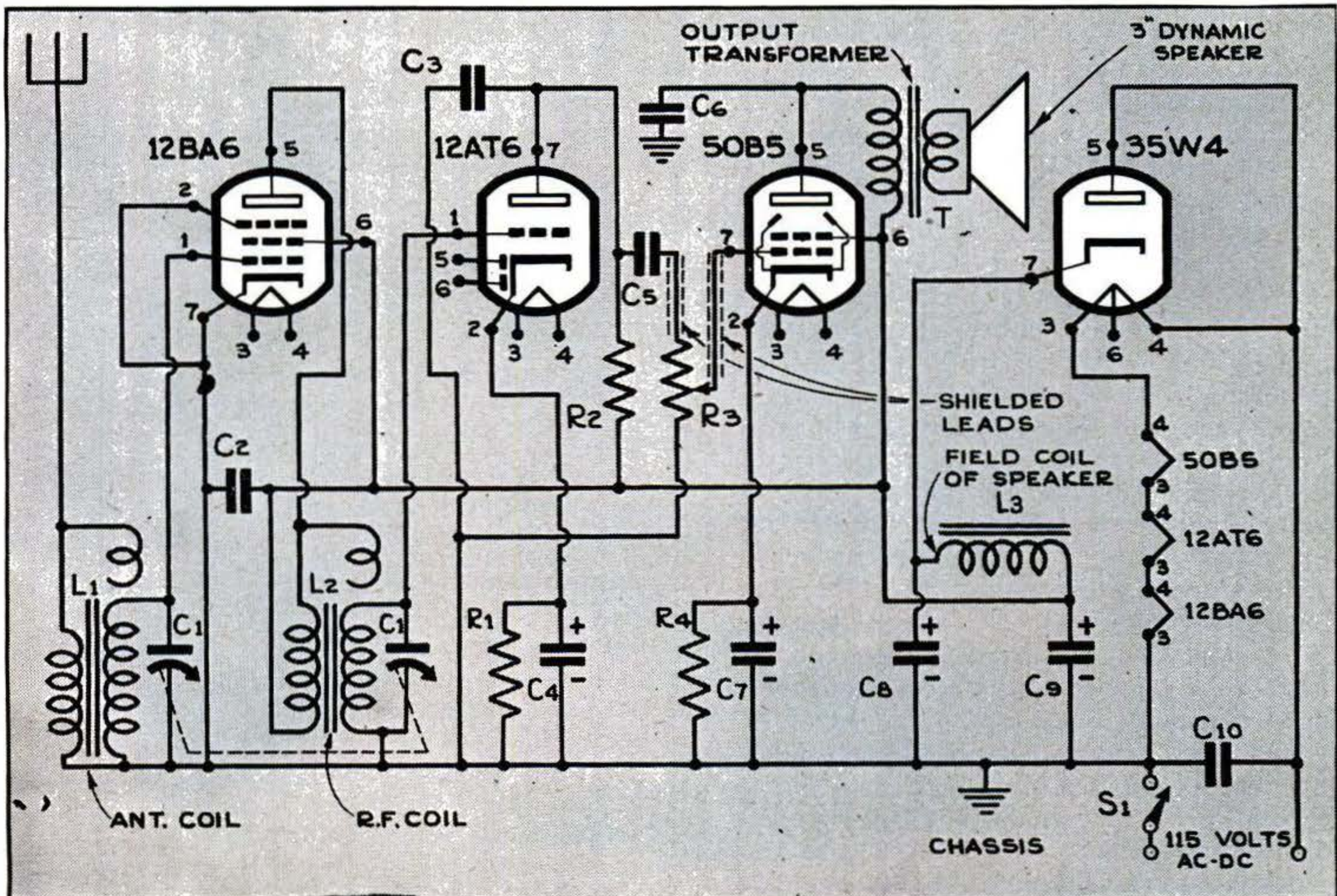
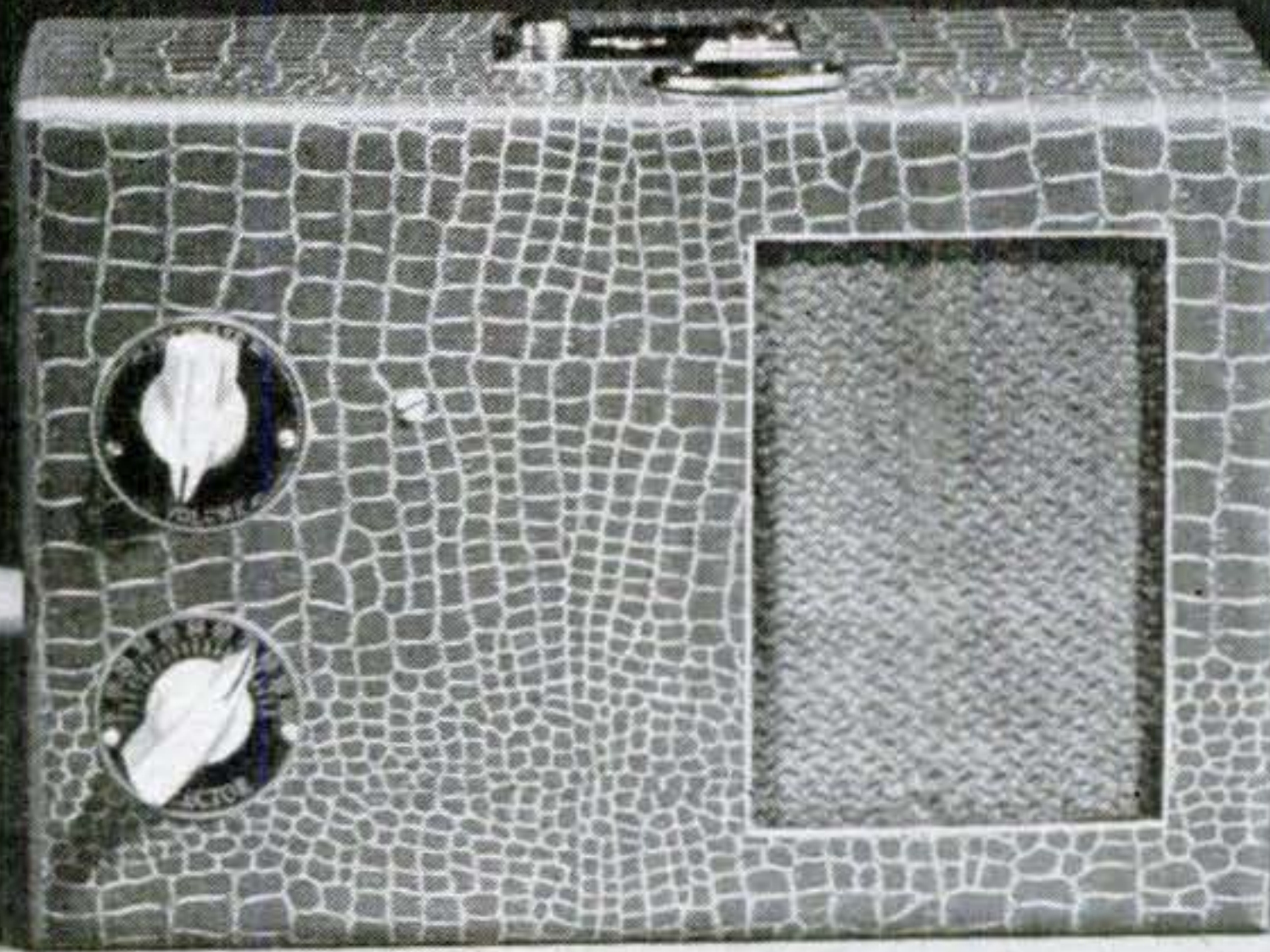

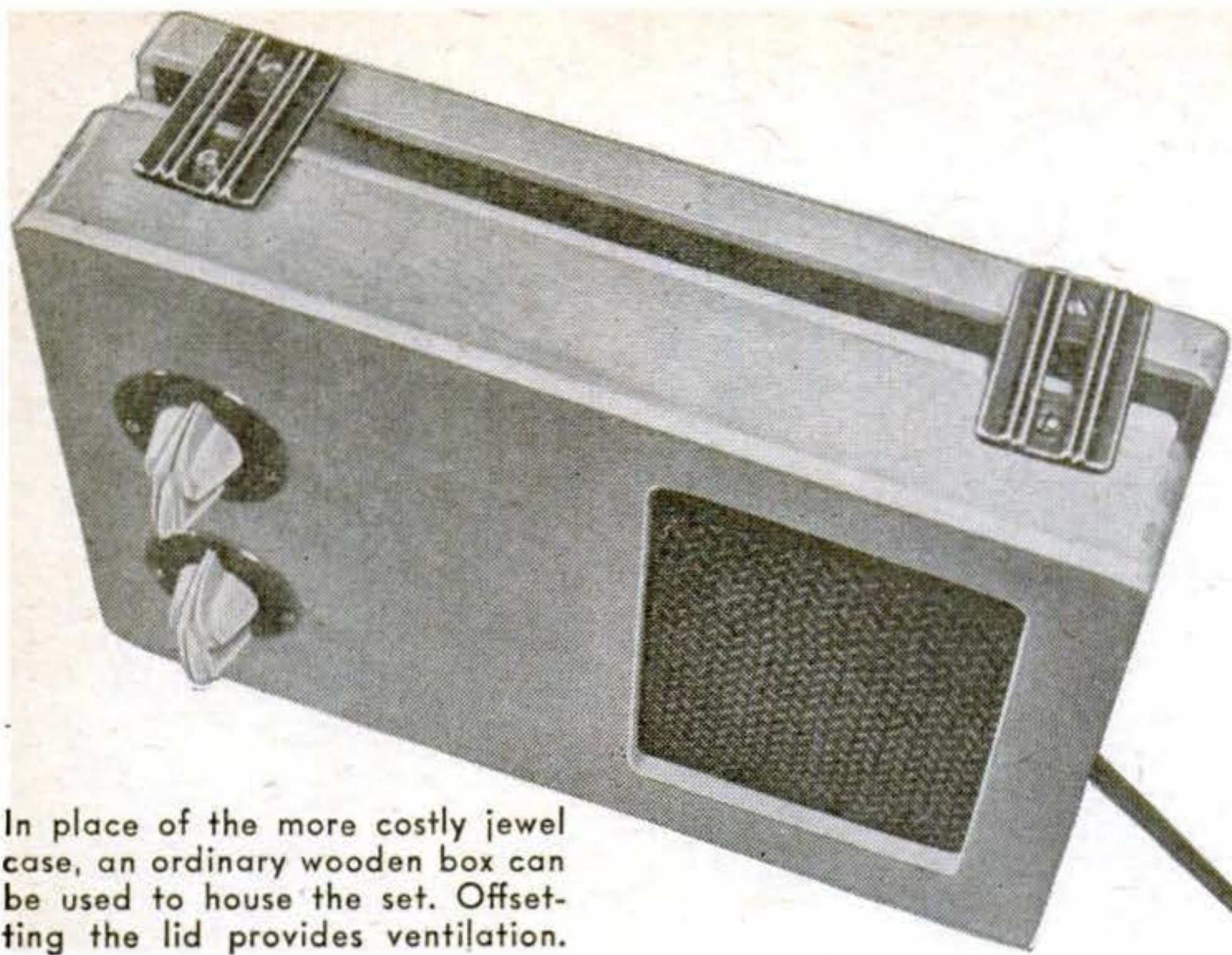

In place of the more costly jewel case, an ordinary wooden box can be used to house the set. Offsetting the lid provides ventilation.

(C3) in the plate circuit of the tube bypasses stray RF signals to ground before they can get into the audio system and introduce unwanted noise.

Resistance coupling is employed between the detector and audio stages. For the latter, a 50B5 beam-power pentode is used. A 1-meg. variable resistor (R3) in the grid circuit of the tube acts as a volume control. For bias, a 270-ohm resistor and another 10-mfd. electrolytic (R4, C7) are used.

All of the electrolytics in this set are of the dry type, encased in tubular aluminum shells and wrapped in heavy paper. These electrolytics require no mounting brackets as they are small and light enough to be supported by their own pigtail leads. Polarity is important in wiring electrolytic condensers. The "plus" and "minus" leads must be connected as indicated in the diagram. Should the leads of an electrolytic be reversed, it may start to "boil" and will quickly short or otherwise become inoperative.

The midget output transformer, mounted on the underside of the speaker frame and projecting through an opening cut in the chassis, couples the output from the plate of the 50B5 with the 3" dynamic speaker. To match the impedance of the tube to that of the voice coil, the transformer should have a primary impedance of 2,000 to 3,000 ohms and an impedance in the secondary winding of about 4 ohms.

For the filter choke, L3, the 500-ohm field coil of the speaker is used. This value isn't critical; any field coil from 500 to 1,500

ohms will serve. Small 16-mfd. electrolytic condensers are connected to both sides of the coil.

A rectangular speaker opening approximately 3" by 4" is cut in the front panel of the case and covered on the inside with a suitable grille cloth. Since the speaker is mounted on the aluminum chassis, it is not necessary to bolt it to the cabinet. Two 1/2" dia. holes are drilled in the front of the cabinet to clear the tuning-condenser and volume-control shafts. These two shafts, supplemented by one nut and bolt, should be

sufficient to hold the aluminum chassis firmly against the front of the cabinet.

The cabinet itself consists of an imitation-leather covered jewel box measuring 3" by 6" by 9" which allows slight clearance for the chassis on all sides. A rectangular opening is cut in the back of the box and covered on the inside with wire mesh. This is necessary to provide adequate ventilation for the set. With a case of this size, both the line cord and a 25' length of antenna wire can be coiled inside for easy transportation.

The photo on this page shows an alternative and less expensive cabinet made of a small wooden box purchased at a crafts

LIST OF PARTS

- C1: 360-mmfd. two-gang tuning condenser.
- C2, C10: .01-mfd. paper tubular, 400 volts.
- C3: 250-mmfd. mica.
- C4, C7: 10-mfd., 25-volt electrolytic.
- C5: .02-mfd. paper tubular, 400 volts.
- C6: .005-mfd. paper tubular, 400 volts.
- C8, C9: 16-mfd., 150-volt electrolytic.
- R1: 2,700-ohm, 2-watt carbon.
- R2: 150,000-ohm, 1-watt carbon.
- R3: 1-meg. volume control with switch. See S1.
- R4: 270-ohm, 2-watt carbon.
- L1: Adjustable iron-core antenna coil.
- L2: Adjustable iron-core RF coil.
- L3: Field coil of speaker used as filter choke.
- S1: S.P.S.T. on volume control R3.
- T: Output transformer.

Tubes, wafer sockets, 3" electrodynamic speaker, dial plates, knobs, misc. hardware.

store for less than a dollar. The lid of this box is mounted on the body with metal brackets, providing a $\frac{1}{2}$ " wide air space to allow ventilation for the tubes on all sides. With such all-around cooling, the set may be played while it is lying on its back or on any of its sides. Although somewhat less handsome, a cigar box with a ventilation slot will be as serviceable.

In common with most AC-DC sets, the chassis of this receiver is grounded to one side of the power line. Therefore no external ground should be used. A hank of antenna wire thrown out the window or strung along the floor is sufficient to pick up most local stations. It must be noted, however, that this is a TRF circuit and its selectivity is not as great as that of a superheterodyne. Nevertheless, it should be sufficient to separate transmitters in most localities. When using the set on DC, remember to reverse the plug if the radio fails to play on the first try.

If you like radio novelties, you may want to try putting this compact circuit, perhaps rearranged on a more suitable chassis, into a banjo clock, a table lamp, a book cover, a night table, or even a ship model.

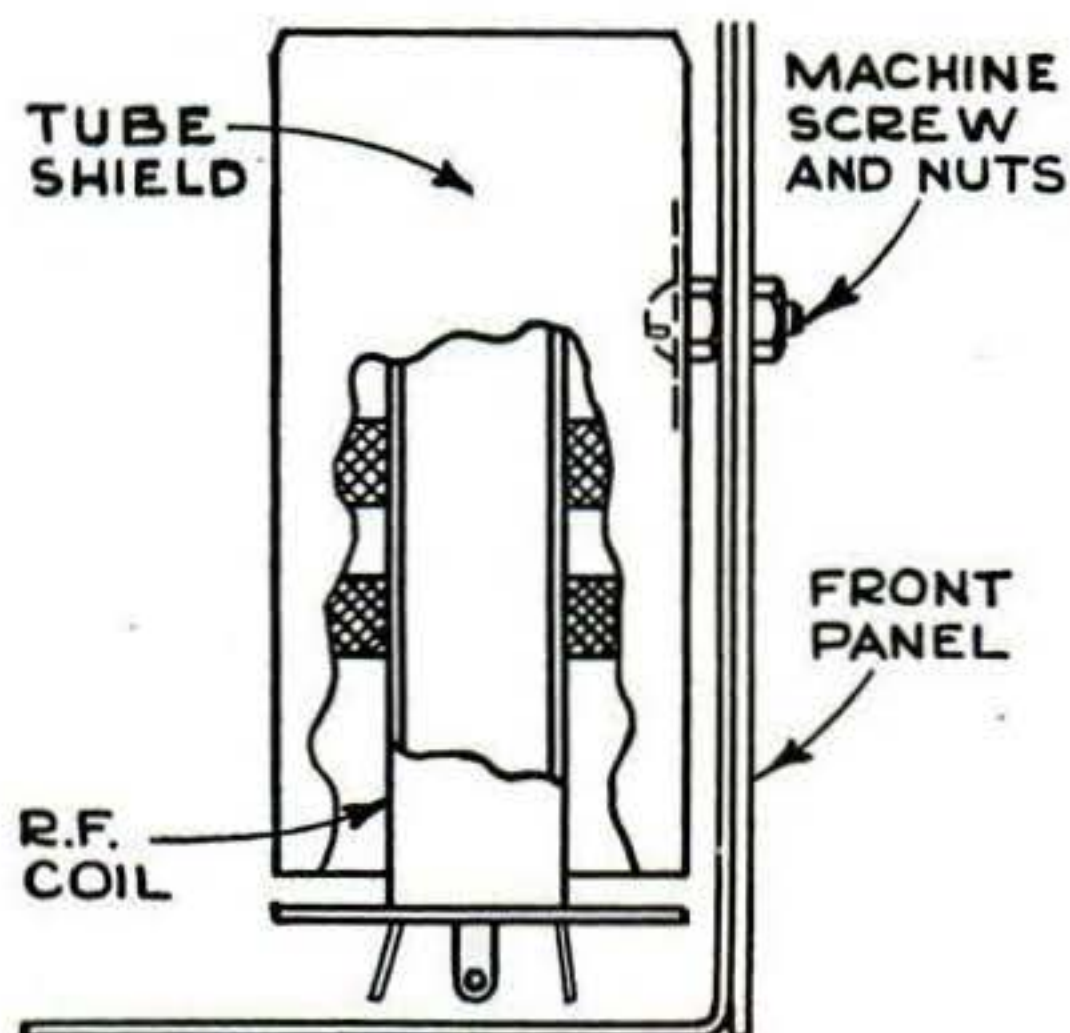

To prevent oscillation and distortion due to stray coupling, the RF coil must be shielded. A suggested method for isolating the coil is to enclose it in an old tube shield which is attached to the chassis as shown above.

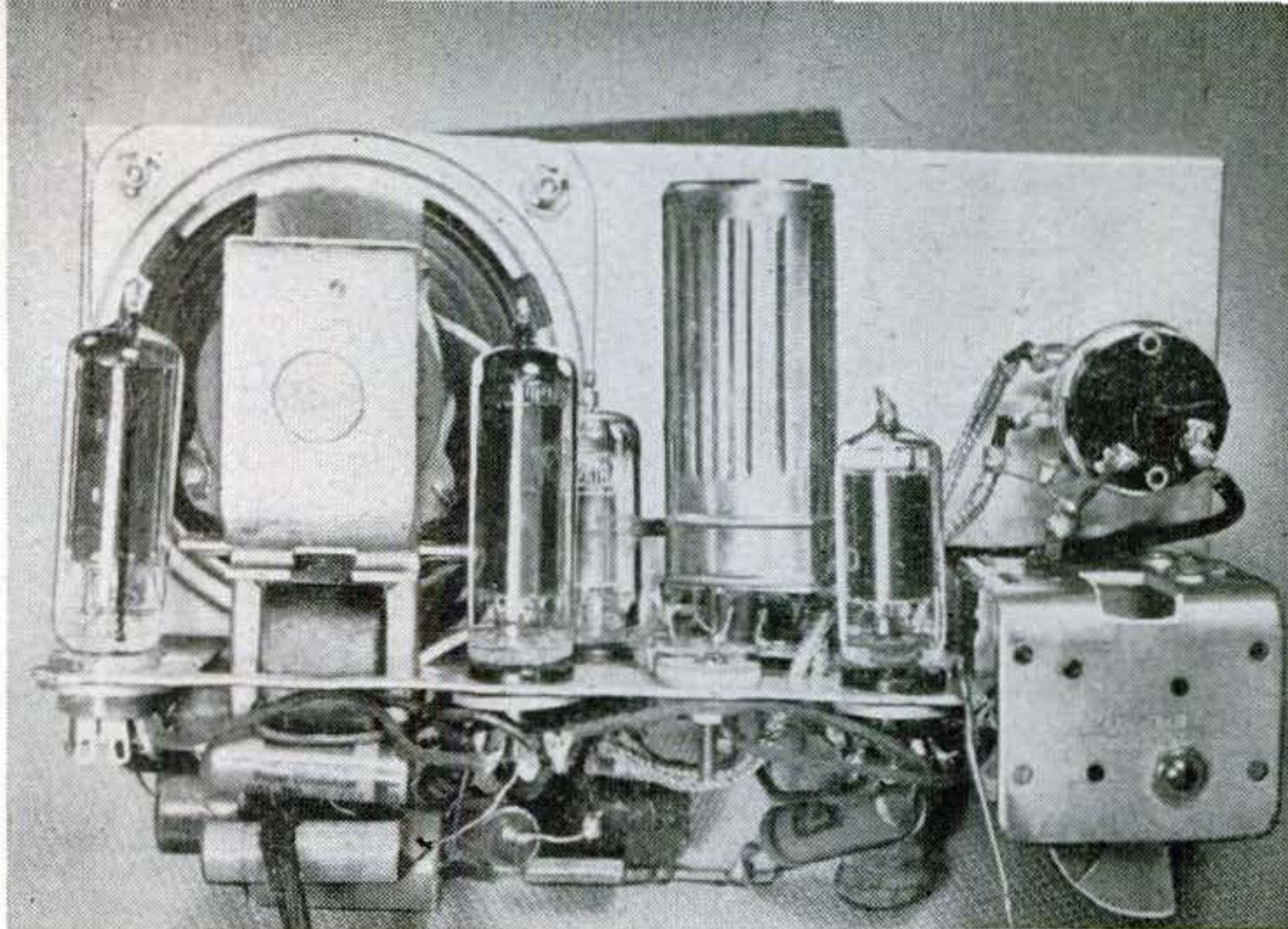

The chassis is a sheet of aluminum bent to the shape of a long "L." Most of the parts are attached to the projecting ledge.

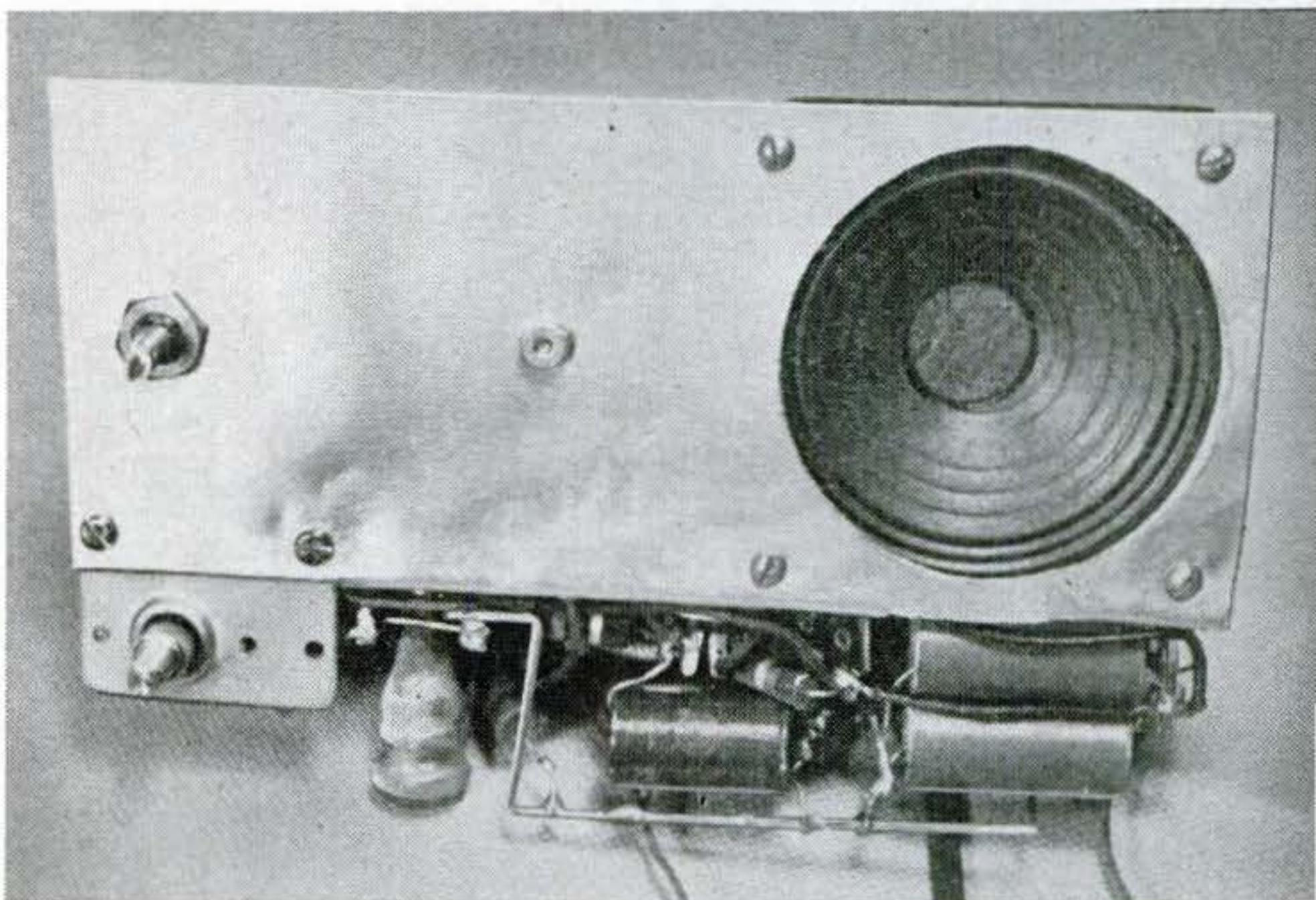

Front view of the chassis. Matching holes are cut in the cabinet for the speaker and volume-control and condenser shafts.

Aside from the tubes and speaker, most of the parts are mounted below the bend in the chassis, as shown in the photograph below.

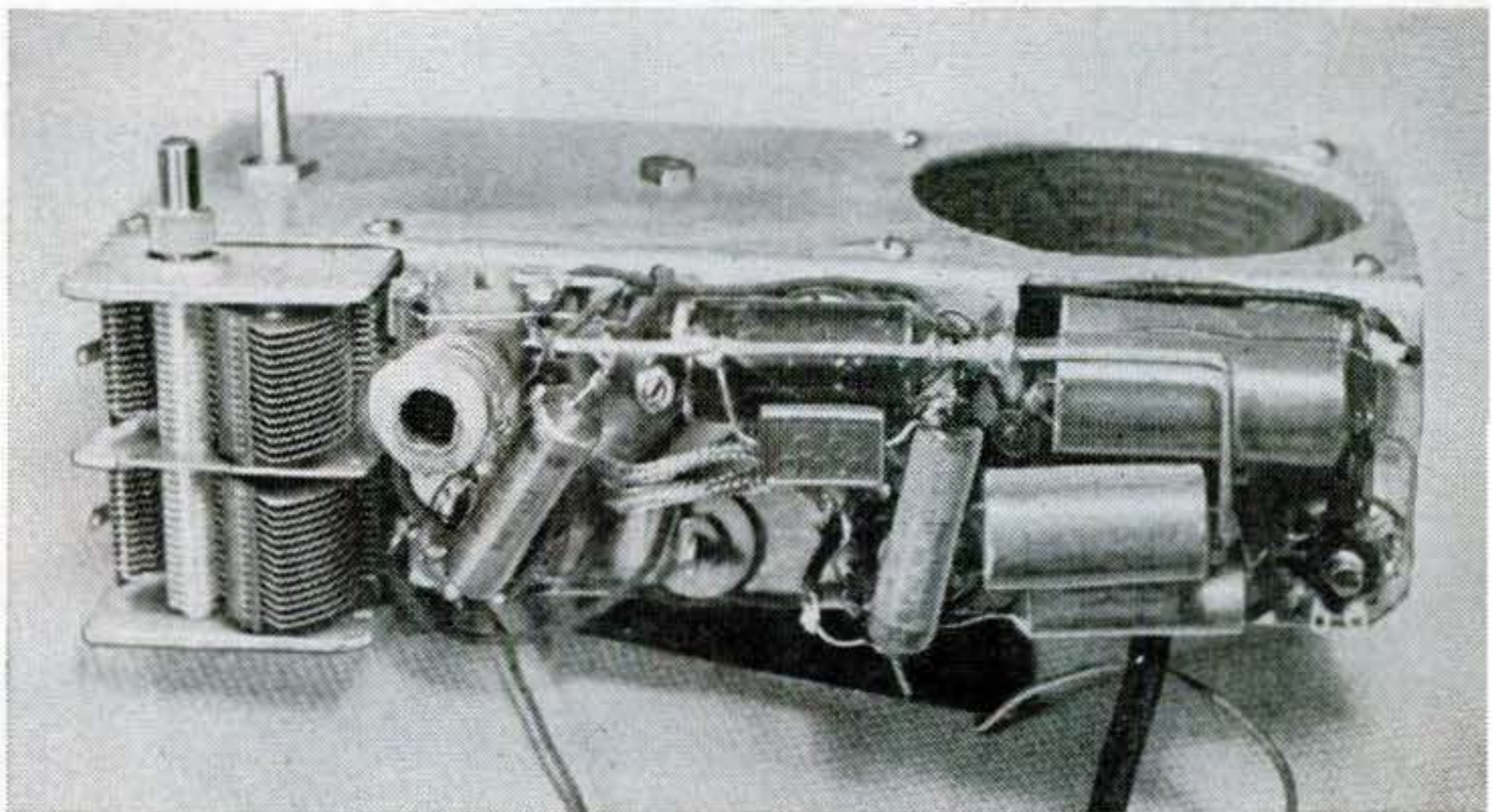

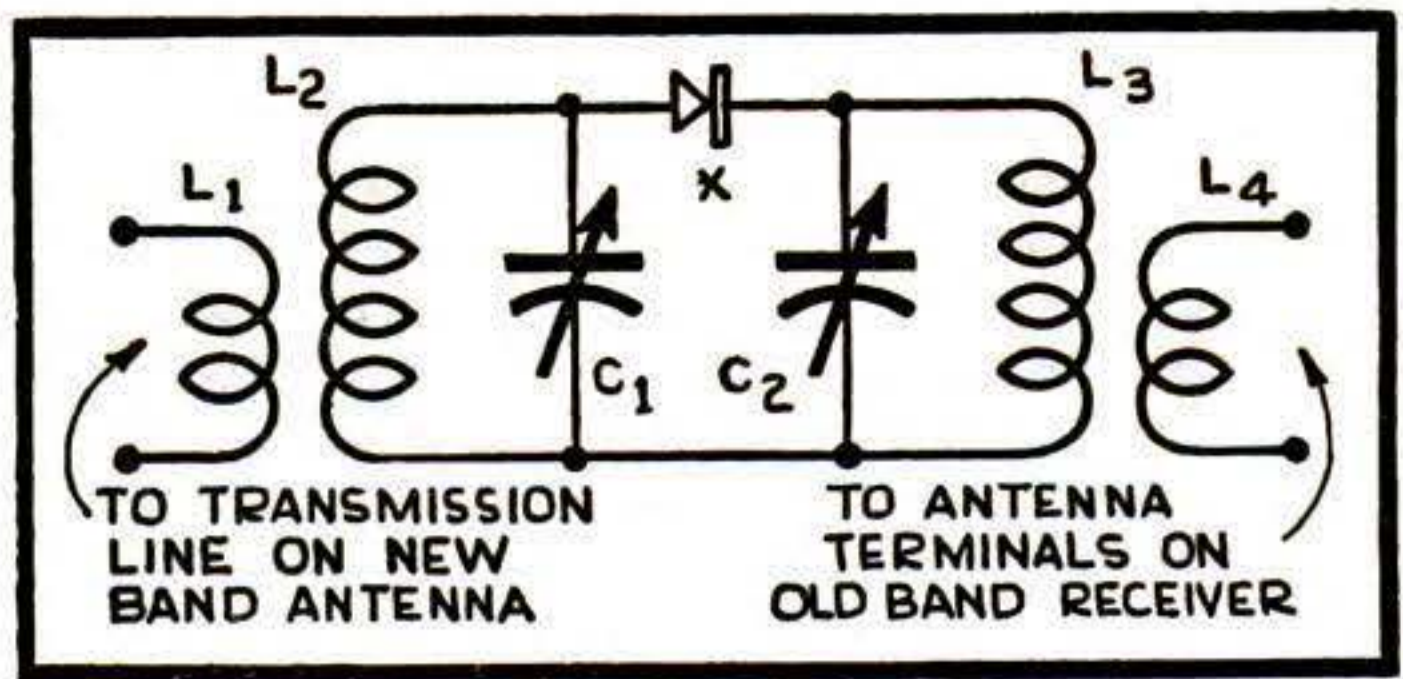

- C1, C2: 8-plate midget air trimmers.
 L1: 2 turns No. 18 insulated hookup wire interwound with L2.
 L2: 4 turns No. 10 solid enameled wire space wound 7/16" dia.
 L3: 10 turns, otherwise same as L2.
 L4: 3 turns No. 18 hookup wire interwound with L3.
 X: 1N34 crystal.

FM CONVERTER. Old-style FM sets decrease in usefulness as transmitters continue to switch over to the new frequencies around 100 megacycles. Many converters have been offered to salvage these sets, at least in part. One of the most interesting is the design of Henry R. Kaiser, chief engineer of Pittsburgh's WWSW and its FM affiliate, WMOT. The simple circuit shown above evolved accidentally when the tube of a one-tube converter failed. The signal continued to come through just as well.

Empty baby-food cans are used to house the coils, trimmers, and crystal, and the units are assembled by the station staff. They are sold to local set owners for \$2.39, representing the cost of the parts. No distribution is planned outside the station's service area. Early tests of the converter covered only a few stations operating at the low end of the band (below 95 mc.). The input circuit is tuned to the transmitter frequency and the output to a frequency within the range of the receiver. The coils must be placed near the receiver.

ANOTHER CONVERTER.

This one, slated for national distribution, is made by the Waterproof Electric Company, of Burbank, Calif. The unit measures approximately 1½" by 2" by 4" and weighs less than 1 lb. It is intended to cover all the frequencies of the new band.

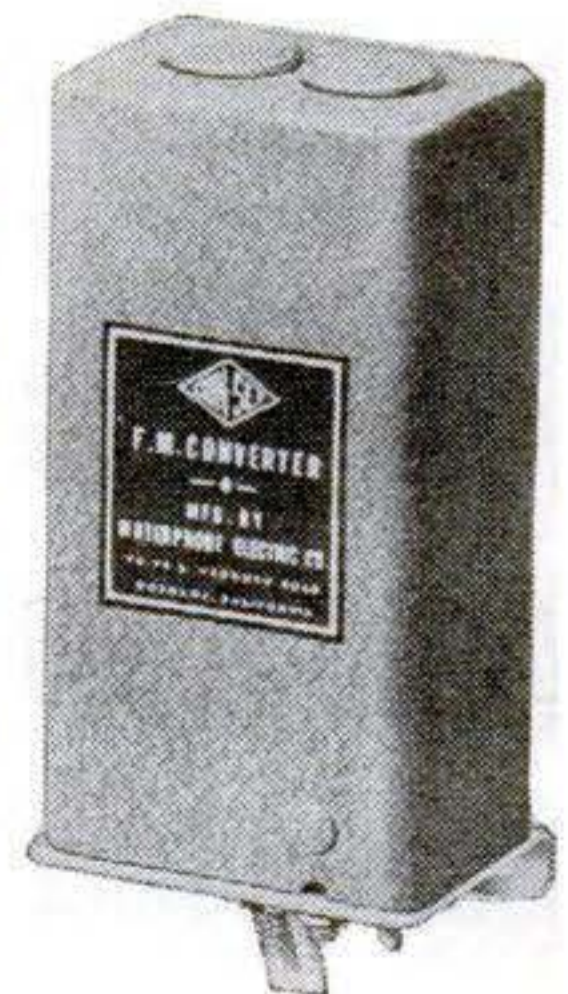

NEWS IN ELECTRONICS



EXPERIMENT KIT. A package that supplies all the parts needed for building such electronic devices as a radio receiver, photoelectric relay, and a remote tuner, is sold by Deer & Taylor Co., of Berkeley, Calif., for about \$40. The chassis has a few fixed parts and an array of clips to which the removable parts supplied with the kit may be connected. An accompanying manual shows hookups for 18 circuits.





WIRE STRIPPER. Enamel, impregnating varnish, plastic, and other insulating coatings are chemically removed from wires by this cold wire stripper made by the Ellanar Chemical Company, of Chicago. The wire is immersed in the liquid for from 15 sec. to 2 min. depending on the type of coating, after which the insulation can be wiped off leaving the wire clean and ready for use.

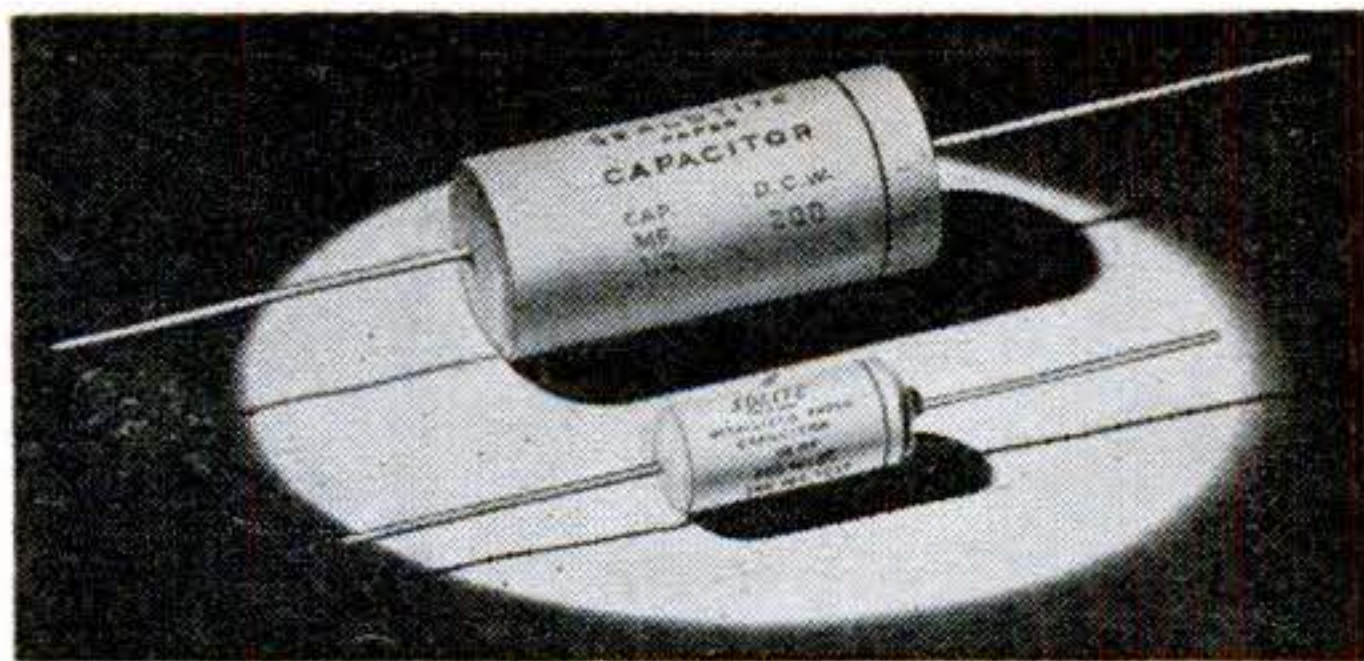

SELF-HEALING CAPACITORS. A wartime German invention is responsible for these tiny tubular condensers made by depositing metallic coatings directly on an insulating paper. If a short develops, the resulting arc not only oxidizes the shorting metal, but also deposits an insulating coating of aluminum oxide. They're made by Solar.

FM ANTENNAS. In many areas where FM receivers are close to one or more transmitters, properly designed antennas can be placed in any convenient indoor location and still give adequate results. The Hallicrafters Co., of Chicago, makes the under-rug dipole antenna shown at the right. It has two flat aluminum blades extending on either side of the center lead-in. The arms are the correct length for the new bands, and the lead-in consists of a ribbon-type concentric line. The antenna may also be hung on a wall.

For the set owner who wants to build his own, an antenna similar in appearance and use is suggested by Federal Telephone and Radio Corporation. The K-1046 lead-in cable made by this company has an impedance of 300 ohms—the conventional input impedance of FM and television sets. A perfectly matched antenna can therefore be made out of a cable cut to half the wavelength of the band to be received. Figures in the diagram are for the new FM frequencies. The ends are shorted, soldered, and covered with an insulating

lacquer. For the lead-in, one side of the cable must be cut at the exact midpoint. The insulation is stripped back an equal distance in both directions, but it is important that the width of the separation exactly equal the conductor spacing of the lead-in. The cable itself is of the low-loss, weather-resisting type that may be used indoors or outdoors depending on the signal strength.

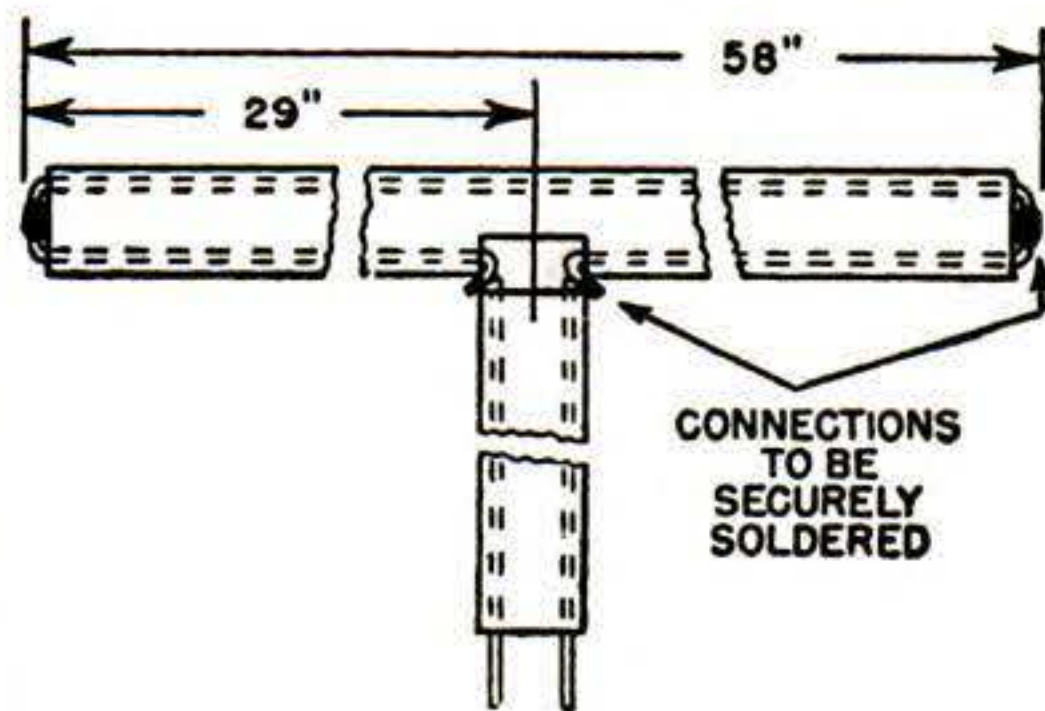
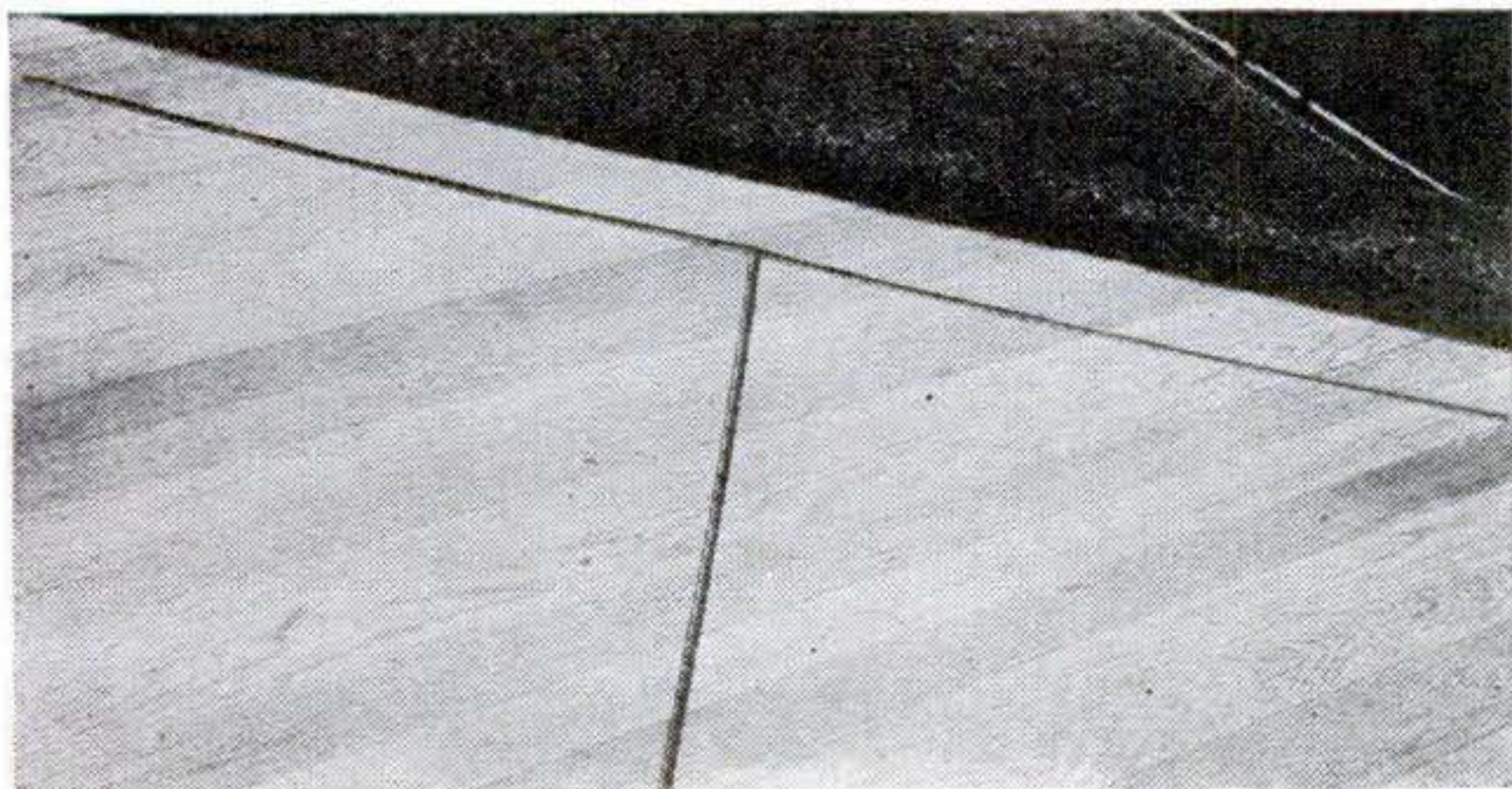
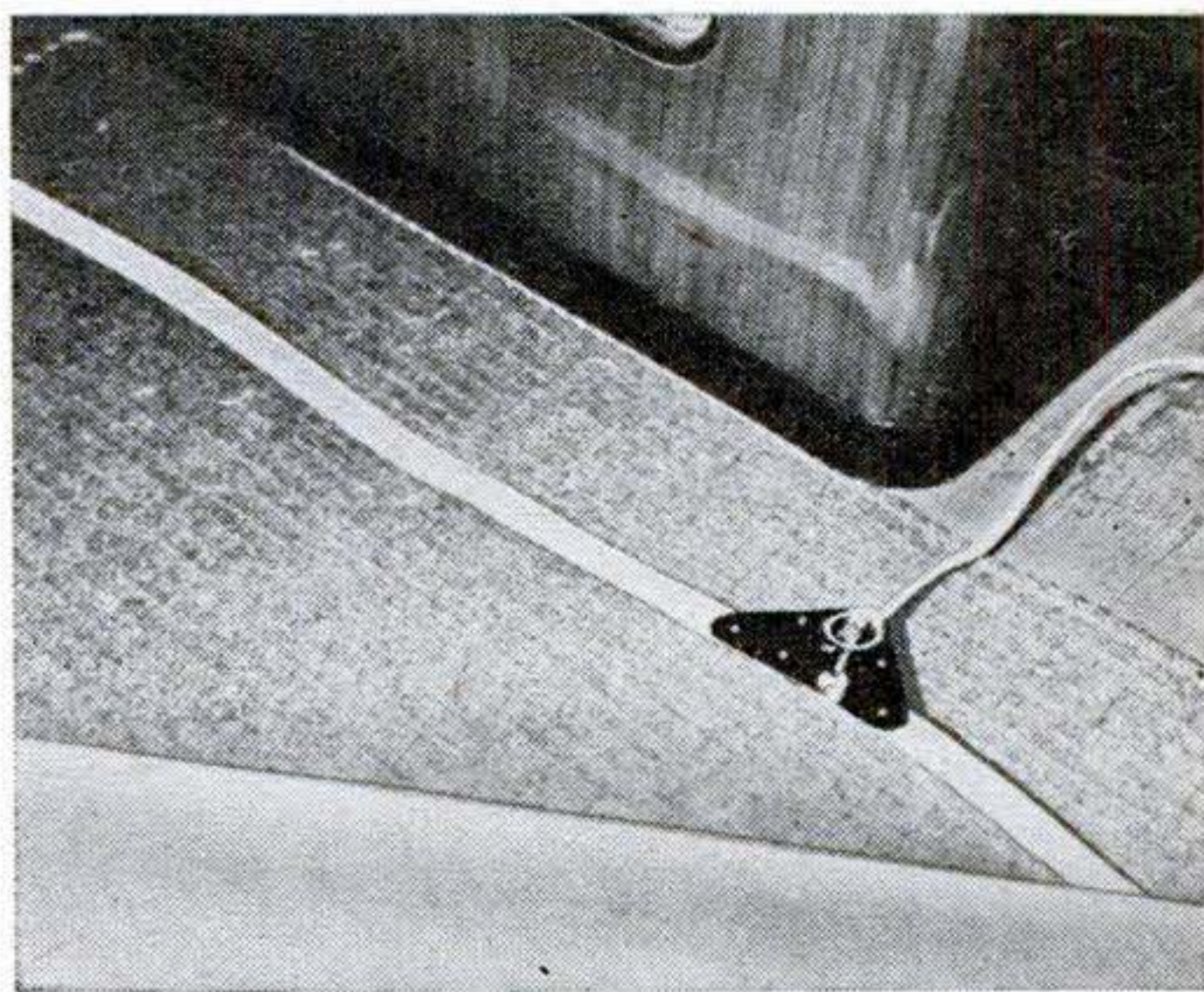

Dimensions given above are for a new-band FM antenna. Both the length and location of the lead-in are critical.

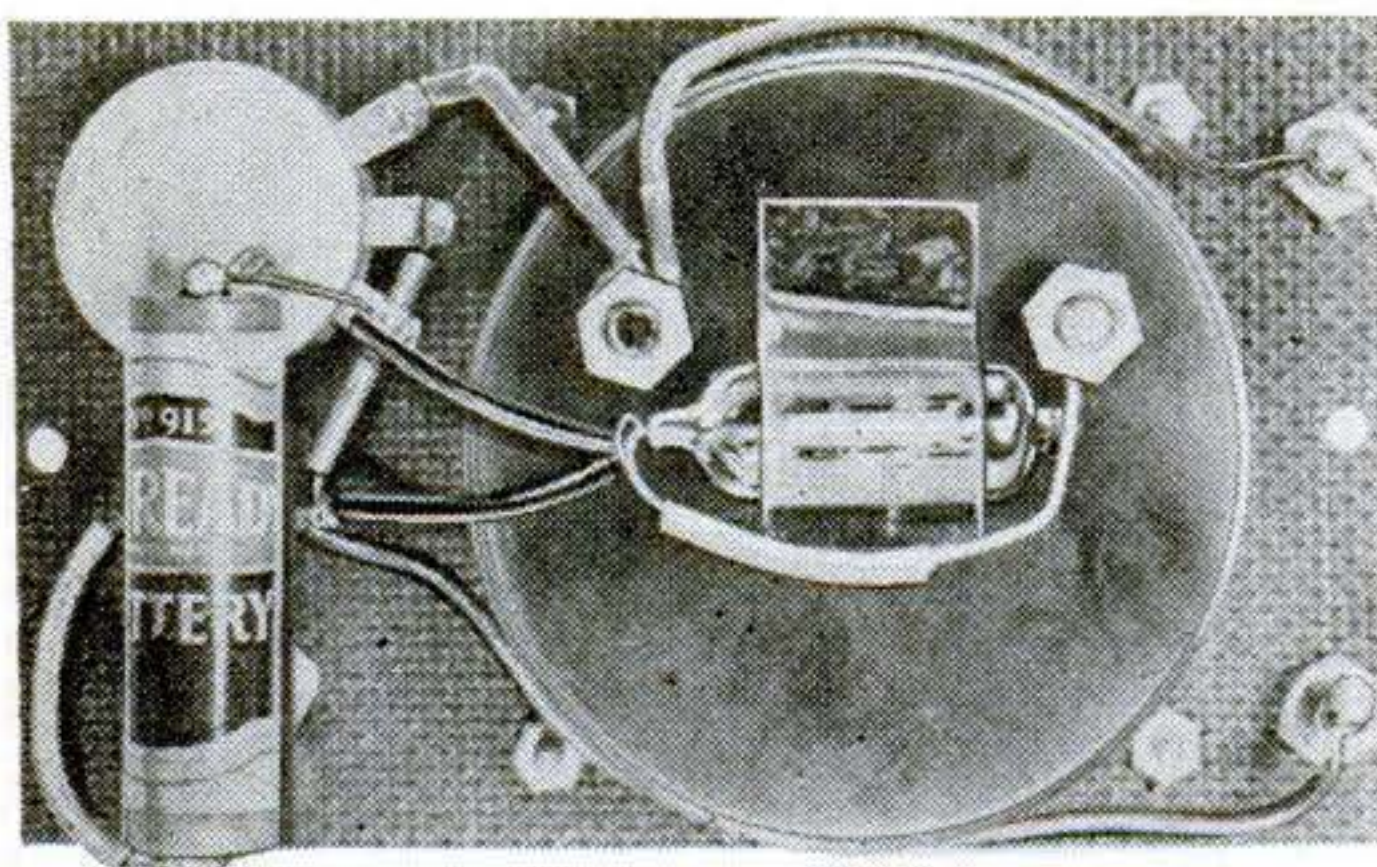
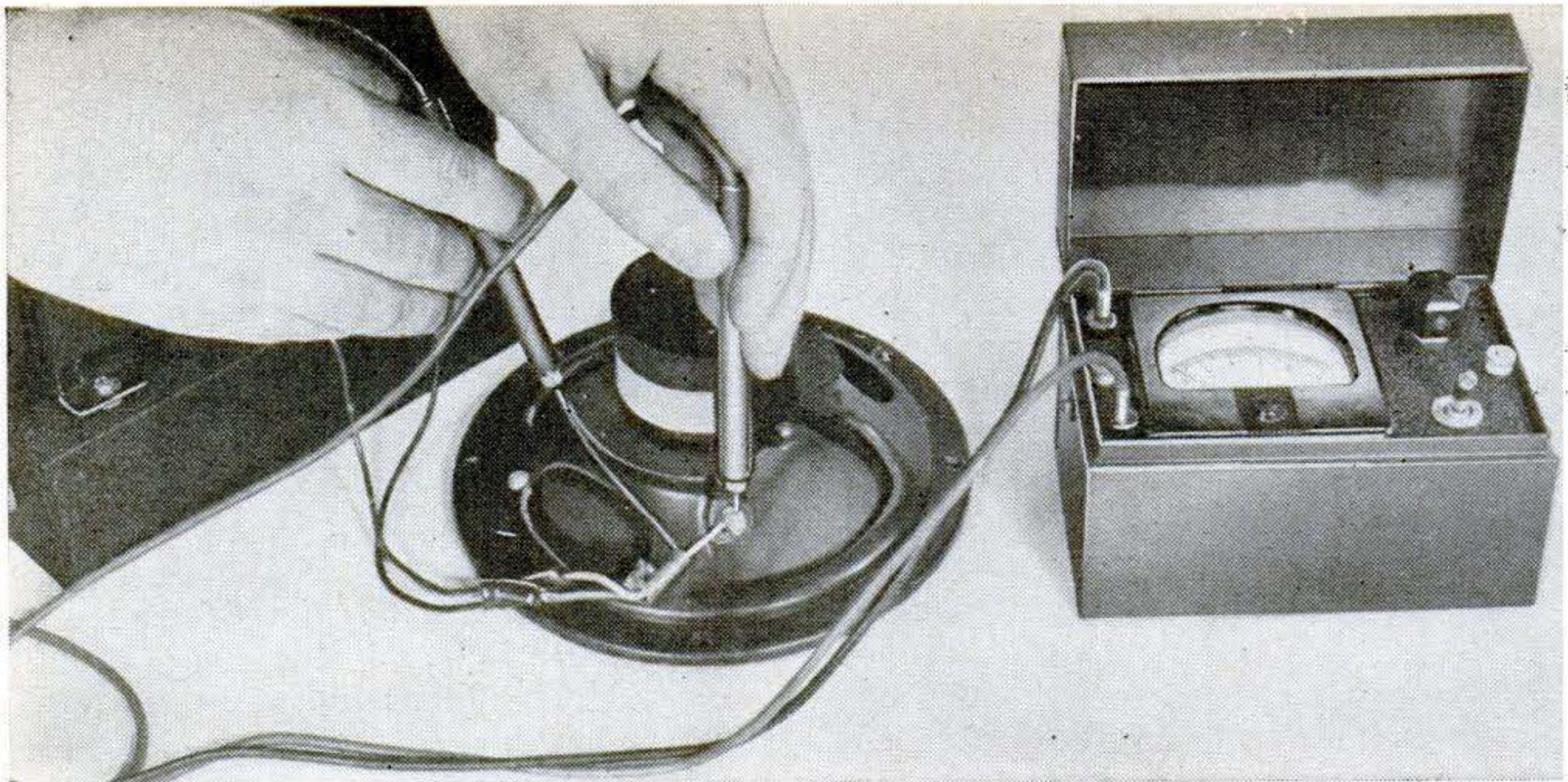

Connections on the underside of the meter. The midget triode used was taped to the milliammeter.

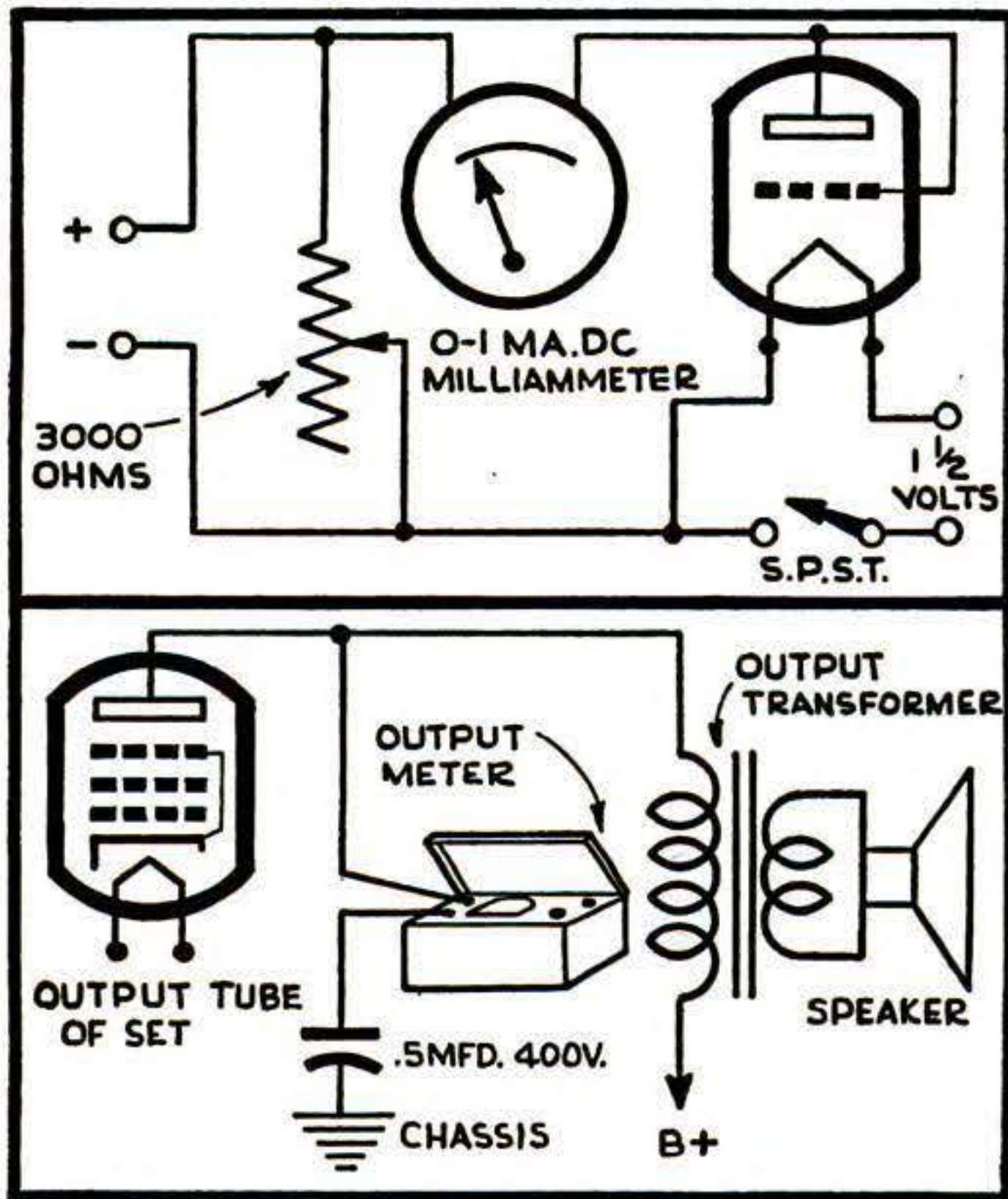

Maximum sensitivity of the needle is obtained by connecting across the output plate to a ground.

OUTPUT METER

Uses 1½-Volt Tube

FOR accurate alignment of the stages of a superhet or TRF receiver, where the ear can't catch minute variations, an output meter is an inexpensive aid. Such a meter is also valuable when hooked up in a public-address system or with a home recorder for regulating output level during operation.

A midget war-surplus triode having a 1.4-volt filament was used as a diode detector in the meter shown, being secured with tape to the back of the 0-1 ma. D.C. milliammeter. A more readily available R.F. pentode, the 1T4, may be substituted by tying its grids and plate together. This tube will fit a button-base socket. Tape holds the 1.5-volt battery filament supply. A 3,000-ohm variable resistor across the meter input prevents overloading and keeps the needle on the scale. The housing is a card-file box.

In use the meter is connected across the secondary of the speaker transformer, in parallel with the voice coil (as in the photo above), or directly across the plate of the output tube and ground through a condenser (as in the drawing). The last increases sensitivity tenfold for weak signals. Adjust receiver trimmers for maximum scale deflection. If noise is objectionable in aligning I.F. transformers, disconnect the speaker.

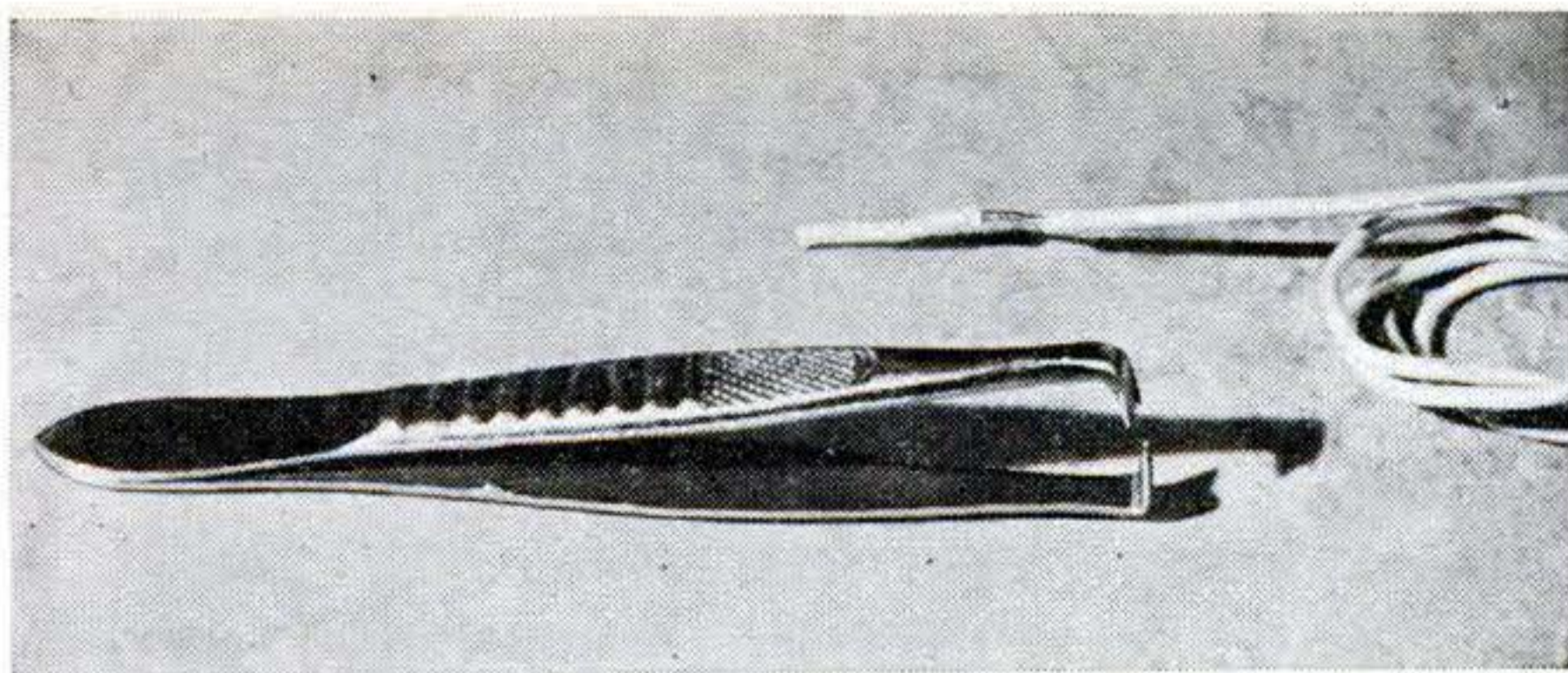

BEVEL ONE JAW
INSIDE, ONE
OUTSIDE

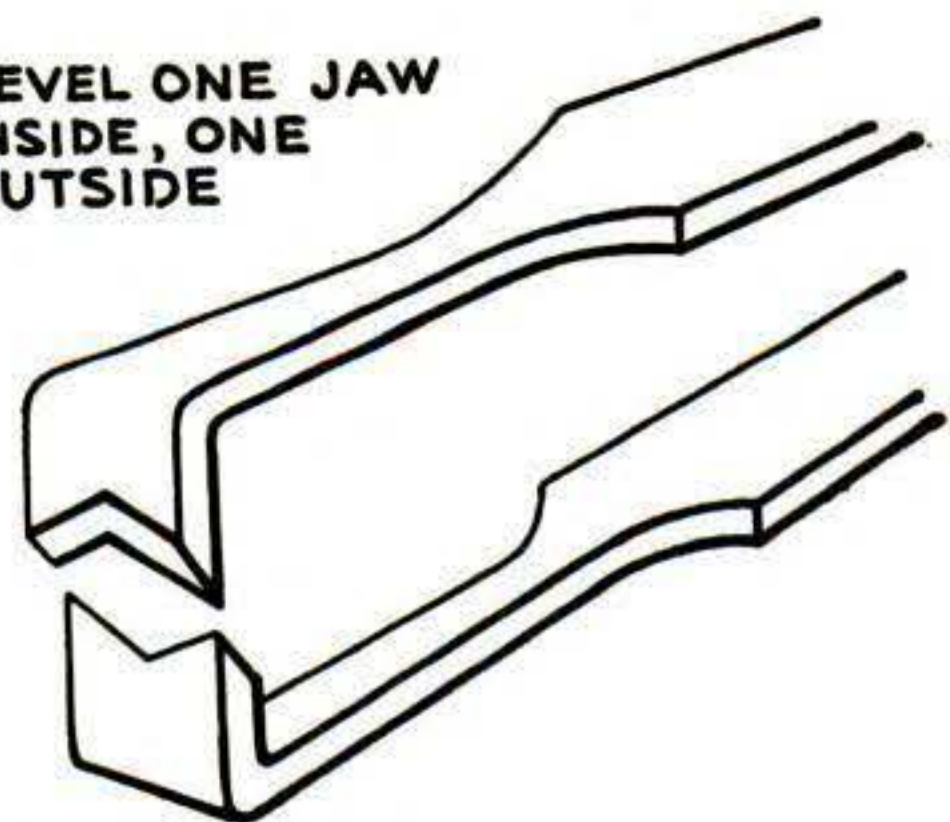

Fine-Wire Insulation Stripper Made from Dime-Store Tweezers

PARTICULARLY useful for light electrical work, this handy insulation stripper can be made from a pair of blunt-end tweezers. First file the tips as shown above and bend

them inwards at right angles so that the jaws just overlap. To use, press the cutting edges on the wire, twist to cut the insulation, and then pull.

Pipe Fastened in Plug Neck Reaches Inaccessible Outlet

IF AN electric cord must frequently be plugged into an out-of-the-way outlet on the ceiling or behind furniture, a reach plug can make life a bit easier. Into a long-neck rubber plug (the type designed to give ample finger grip) screw a suitable length of $\frac{1}{8}$ " pipe threaded at the end. A few turns will join the plug and pipe firmly. Tape the joint for extra strength, and bush the other end of the pipe with a short piece of windshield-wiper tubing to protect the cord from fraying at this point.

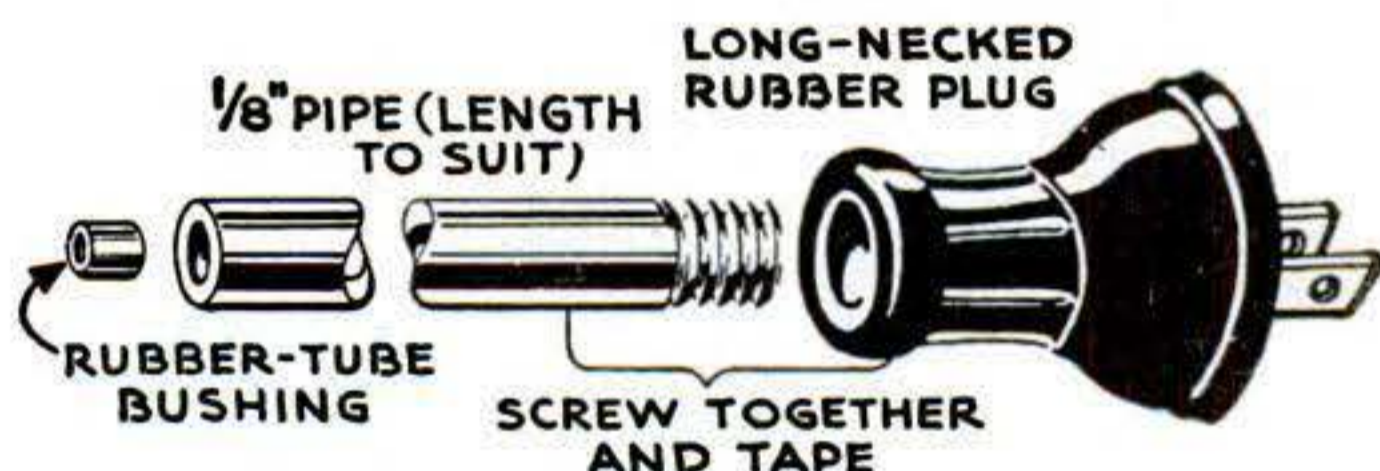

Pipe Cleaner Separates Wires

CIRCUIT wires grouped and bound together simplify servicing and repairs. Pipe cleaners will hold the wires neatly and can be color-coded with nail polish or enamel.

UNDERWRITERS' KNOT

[ELECTRICAL]

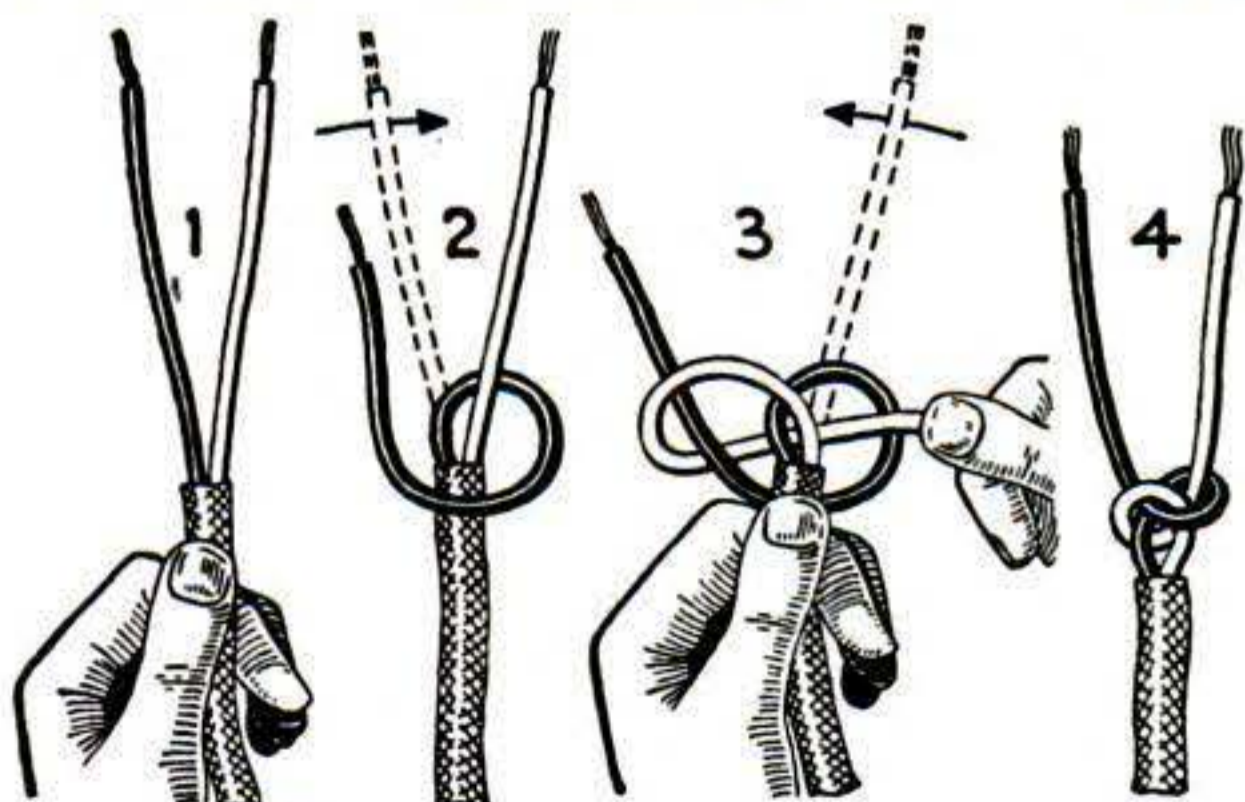

INSULATION
RIGHT UP TO
SCREW HEAD

Electrical wiring is not considered safe unless it has a margin of safety great enough to protect it against unforeseen and excessive strains. Thus, while it is not good practice to pull a plug out of a socket by yanking the cord, some method for taking up such strains should be provided at the time the wiring is done. One recommended procedure is the so-called underwriters' knot illustrated at the left. Before wires are connected to the terminal screws of a plug, socket, or other fixture, knot them as shown to keep sudden pulls from being transferred directly to the terminals. An alternative or supplementary method for taking up strain on plug wires is pictured at the lower left. It consists of leading the wires around the prongs as shown before attaching.

POPULAR SCIENCE MONTHLY SHOP DATA

How Spontaneous Combustion Happens

By KENNETH M. SWEZEY

FIRE that breaks forth from a substance without the application of external heat has long been a source of mystery and consternation. Without visible cause, flames burst from an innocent-looking haystack or pile of coal; a wad of cotton waste, soaked with oil, sets fire to a garage; a chemical mixture that ordinarily is harmless suddenly blazes up violently.

Thanks to modern research, chemists now know the reason for almost every type of spontaneous combustion. Barring ignorance, carelessness, or accident, fires starting from this source can be prevented. In most cases the actual visible combustion is just an ordinary fire in which a combustible material has been raised to its ignition point by slow oxidation or other chemical reaction. In the remaining cases, all particularly important to the chemical worker, heat and flame are produced in a reaction involving substances other than oxygen.

Heat is generated every time a substance is oxidized. If the oxidation is extremely fast, we may see fire. If it is slow enough, as in the rusting of iron or the drying of paint, the heat is dissipated so fast that it is impossible to detect any rise in temperature. If, however, we increase the speed of slow oxidation, decrease the rate of heat dissipation, or both, until heat is generated faster than it can be dissipated, we have a starting point for spontaneous combustion.

Breaking a substance into small particles is one way to speed up oxidation and at the same time reduce the rate of dissipation. The smaller the particles, the larger the surface area to react with oxygen and the smaller the mass to dissipate heat. For instance, iron powder that has been freshly prepared by reduction with hydrogen will heat to the point of glowing when exposed to air, and heaps of fine coal particles are far more liable to smoulder and burst into flame than piles of large chunks.

With a tiny piece of phosphorus and a teaspoonful of carbon disulphide, you can

present a spectacular demonstration of the effect of subdivision. Unless the room temperature is high, a solid lump of phosphorus left exposed to the air will catch fire only very slowly, if at all. Finely divided, however, it ignites almost instantly.

Although this experiment is perfectly harmless if performed as directed, be extremely careful in handling both of these chemicals. *Keep the carbon disulphide far from any flame, and keep phosphorus, or any solution of it, off your hands, clothes, or anything inflammable. Always handle the phosphorus with tweezers and cut it under water. Dispose of any remaining solution by allowing it to burn in an open pan.*

By gentle shaking, dissolve a piece of phosphorus about half the size of a pea in 5 ml. of carbon disulphide in a test tube. Use an ordinary cork as a temporary stopper for the tube, as carbon disulphide and its vapors attack rubber. After supporting

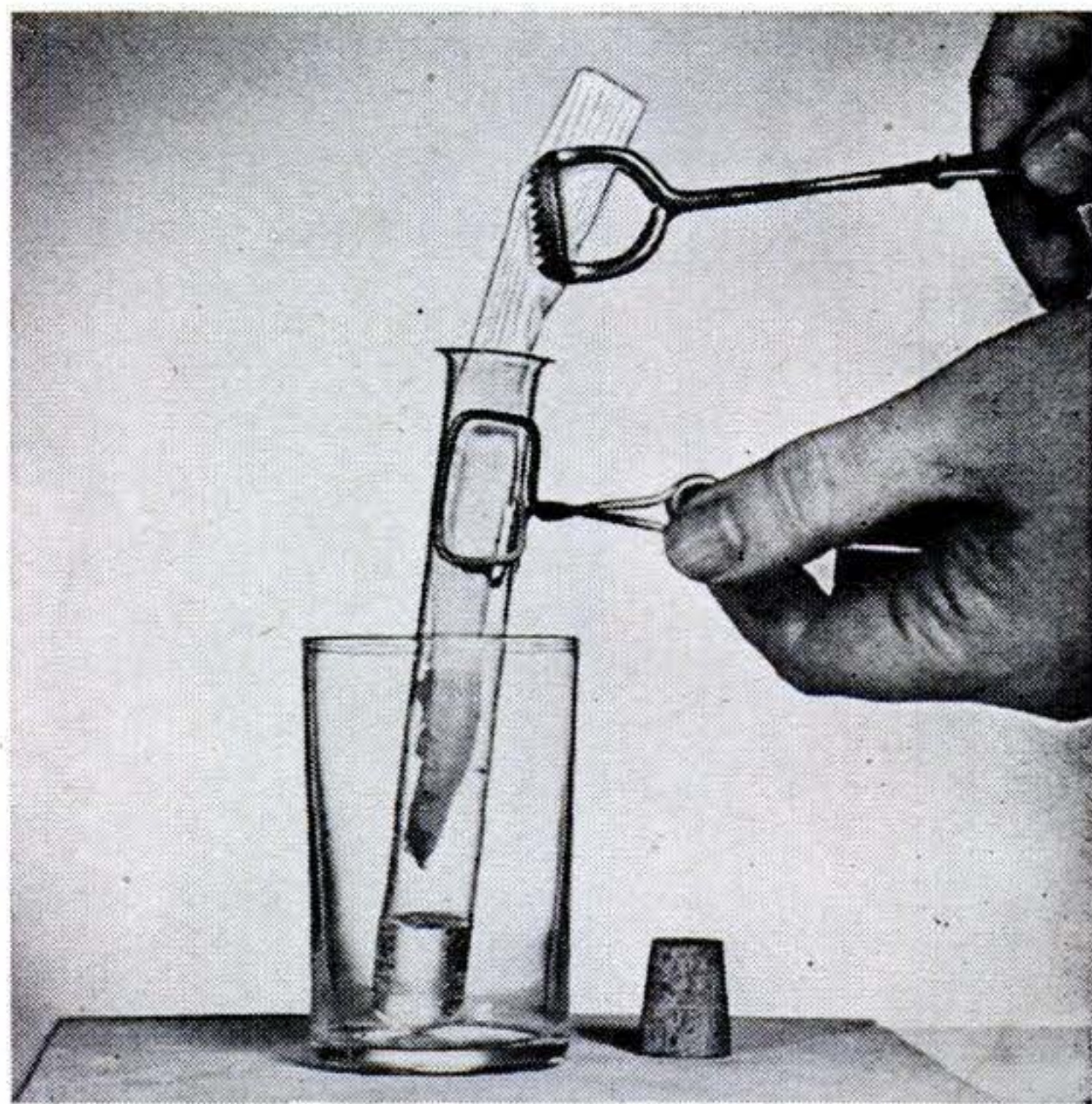

1 Dissolve a tiny piece of yellow phosphorus in carbon disulphide, dip a paper napkin into the solution, remove, and hold it away from your face.

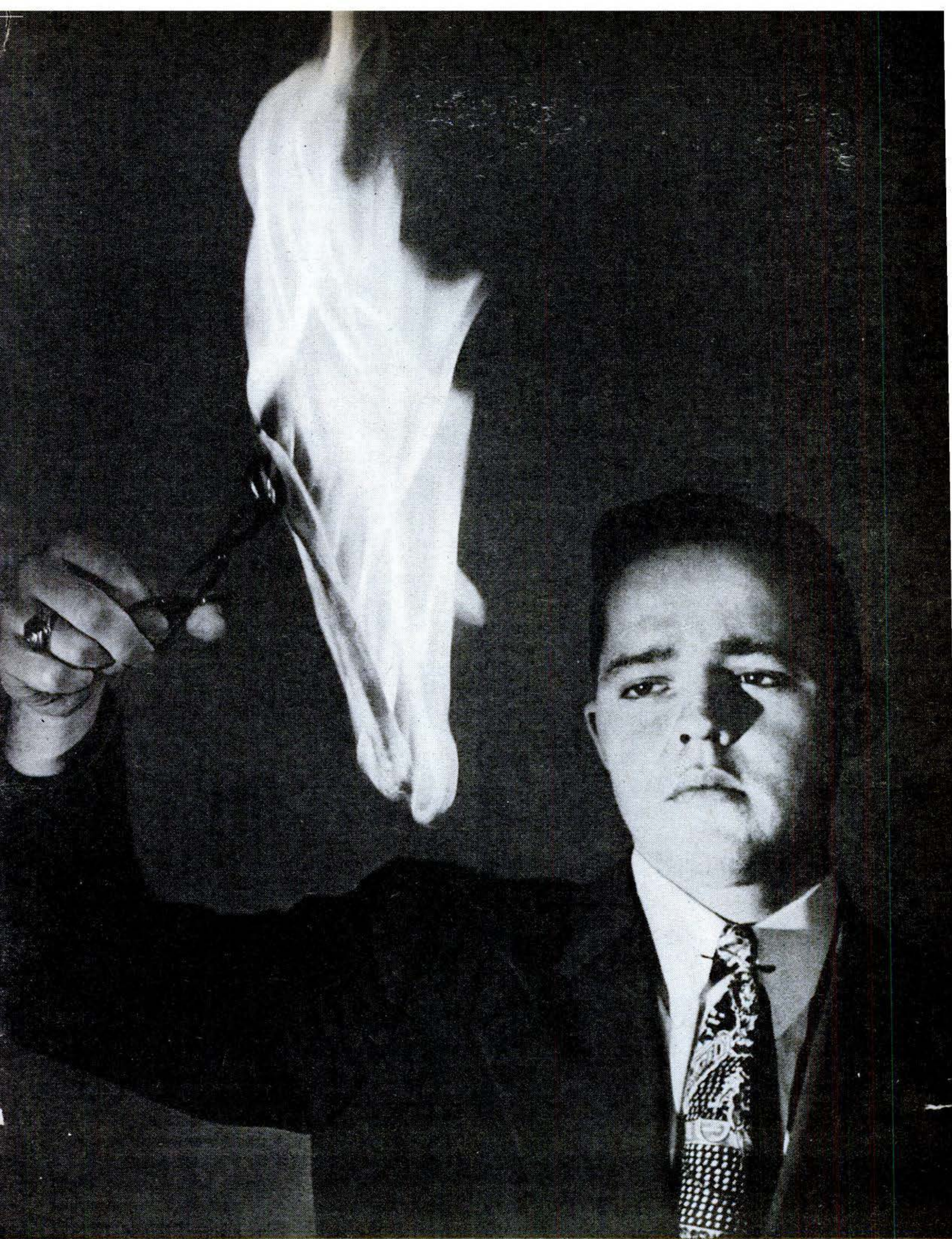

2 The paper will soon burst into flame. An example of spontaneous combustion, the fire is set by oxidation of phosphorous particles left after the liquid evaporates. (Caution: read text before trying this.)

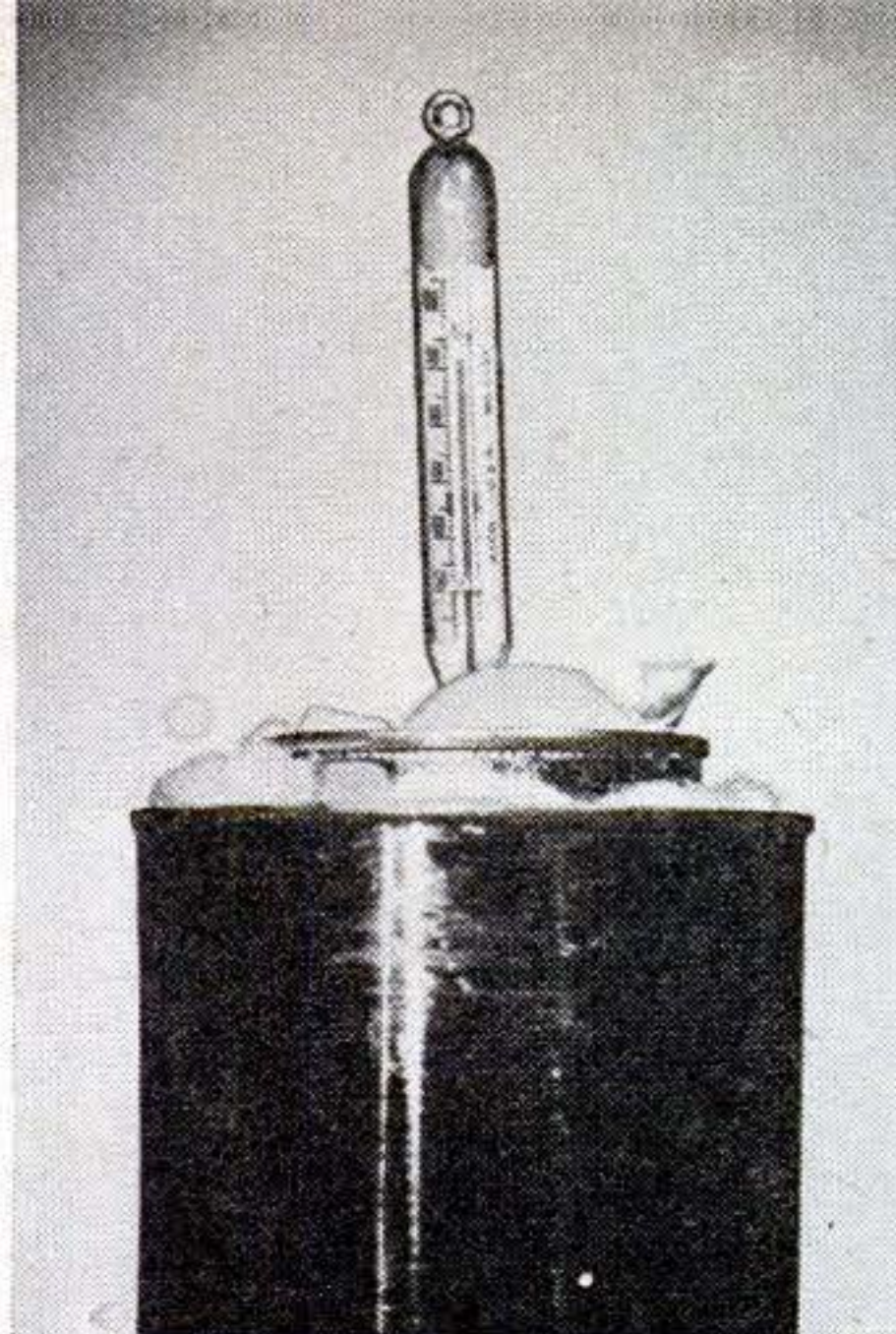

Rags soaked with oil or paint often catch fire spontaneously as a result of the heat produced by linoleic acid in the oil combining with oxygen to form linoxyn. To show this effect, daub some drying oil on several rags, stuff them into an insulated can, and set a thermometer in the midst of the rags.

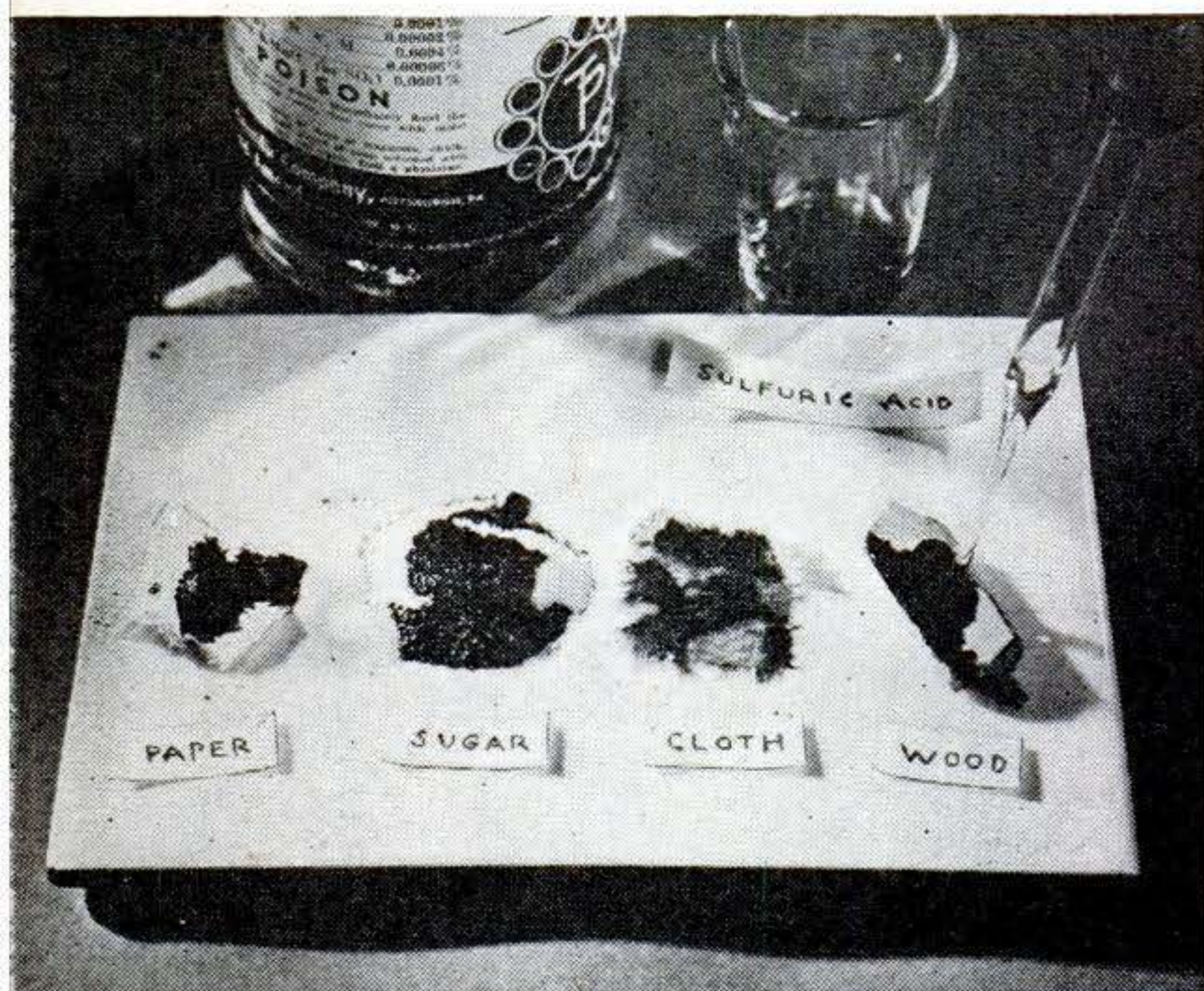

Sulphuric acid has such an affinity for water that it will remove hydrogen and oxygen from the above carbohydrates, creating considerable heat, leaving a carbon residue, and sometimes starting a fire.

Potassium chlorate mixed with powdered sugar is normally stable, but add a drop of sulphuric acid to this mixture and you get the result at right.



the test tube in a tumbler so your hands will be free, dip the end of a strip of filter paper or paper towel, held in tongs, into the solution. Remove it, quickly stopper the tube, and hold the paper in the air, away from your face.

Nothing will happen as long as any carbon disulphide remains. But this solvent quickly evaporates, leaving finely divided phosphorus on the paper. In a flash, this phosphorus unites with oxygen, heat is generated faster than it can be carried away, and the phosphorus and paper burst into flame.

You can also speed up oxidation and reduce heat dissipation by spreading a substance so thinly that its surface is large compared with its mass. Such thin spreading of oxidizable material is the cause of spontaneous combustion in oily rags.

Most vegetable and animal oils, such as linseed, tung, olive, and cod liver oils, contain linoleic and other fatty acids that react with oxygen at ordinary temperatures to produce the solid substance "linoxyn." As in all oxidations, heat is produced in this reaction. Ordinarily, when such oils are in bulk or are spread in paint over a large open surface, the heat is carried away as fast as it is produced. But spread such oils on the fibers of rags or waste and confine the rags or waste so the heat cannot escape, and the story is different. Little by little, the heat increases until finally the ignition point of the cotton is reached and the cotton and oil go up in flames.

You can easily prove that drying oils generate heat. Place a small tin can inside a larger one and insulate one from the other with cotton, asbestos wool, or sawdust. Next paint a few pieces of cotton cloth with dabs of ordinary paint or a drying oil. (Oxidation takes place more rapidly if all the pores

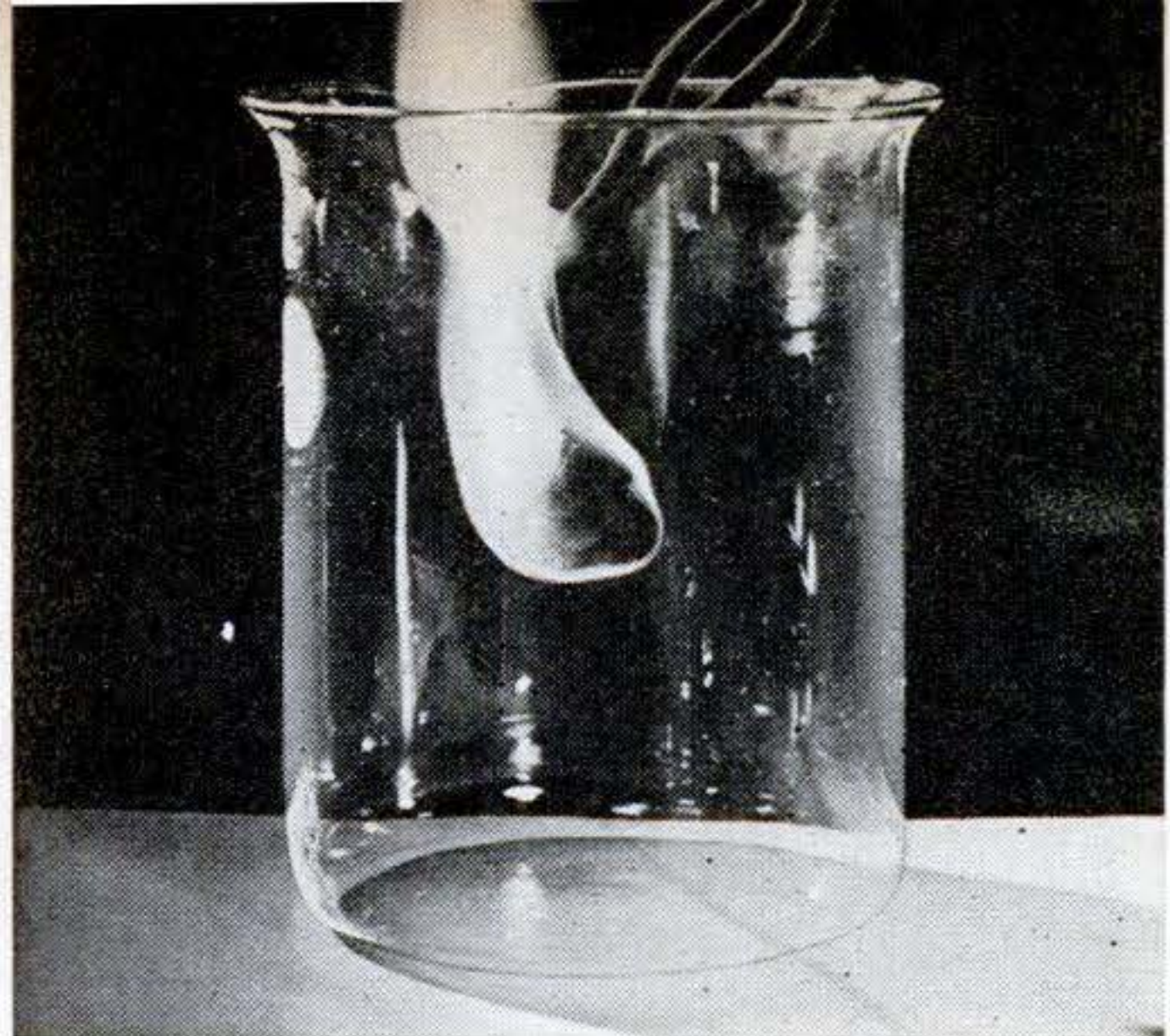

Water added in the right proportion to quicklime (calcium oxide) generates heat sufficient to char paper. Wood also could be ignited by this reaction.

At the left, turpentine-soaked cotton burns when thrust into a beaker that contains chlorine gas.

and fibers are not completely covered with oil.) Then pack these paint-dabbed rags around the bulb and stem of a thermometer until the small can is full. Finally, set the apparatus in a moderately warm place and note the thermometer reading periodically. The temperature will rise as the oil unites with oxygen from the air.

In the chemical laboratory, there are many substances that may react spontaneously. That is one reason why home and student chemists should never mix chemicals together, hit-or-miss, to see what happens. When performing an unfamiliar experiment, you should follow instructions to the letter.

It would take several volumes to list all the chemical reactions that might produce fire or at least considerable heat, but you can easily demonstrate a few.

All chemists are familiar with the heat produced when sulphuric acid is added to water. (It is because of this that water must never be added to the acid, for the water, being lighter than acid, would remain on top, where it would be heated to boiling by the strong reaction, with the result that both water and acid might spatter explosively out of the container.) But how many know that heat also is produced when the concentrated acid is dropped on wood, paper, or textiles—enough heat, sometimes, to start a fire? This acid has such a great affinity for water that it removes hydrogen and oxygen, in the exact proportions in which they occur in water, from such carbohydrates, leaving a residue of carbon.

As a demonstration of this, place a drop of the acid on a piece of paper, cotton cloth, or wood. In each case, the substance will become charred.

Some substances that normally are stable when mixed may react violently if a third

substance is added. Potassium chlorate and powdered sugar are such a combination. Mix carefully 1 g. of powdered potassium chlorate with 2 g. of powdered sugar. (Never *grind* potassium chlorate with sugar or any other organic chemical, as the heat of friction may cause an explosion. However, you may grind either chemical *separately* in a clean mortar and then stir them together gently on a piece of paper.) After the two substances are mixed, place about a fourth of the mixture in a little heap on an inverted can cover or pie tin that, in turn, rests on a table covered with newspapers to catch any possible splatterings.

Then add just one drop of concentrated sulphuric acid to the center of the heap and quickly stand back. In a second, the sulphuric acid unites with the potassium chlorate, forming chloric acid. This oxidizes the sugar so rapidly that fire results.

Many chemical substances catch fire when brought into contact with chlorine, bromine, or iodine. Turpentine vapor is one of these. You may prove this by first filling a tall glass or beaker with chlorine (made by gently heating a little manganese dioxide and hydrochloric acid in a flask and leading the outlet tube from the flask down into the glass, where chlorine replaces the air) and lowering a small wad of cotton, soaked in warm turpentine, into it. In a moment, the turpentine will blaze spontaneously.

Even water has been known to start a fire when mixed in the right proportions with ordinary quicklime (calcium oxide). To verify this heating effect, put a teaspoonful of quicklime into a small crucible, packing around it a strip of paper. Then add half a teaspoonful of water. After five minutes, remove the paper, and you will find at least a part of it charred.

END

MAY
1947 215

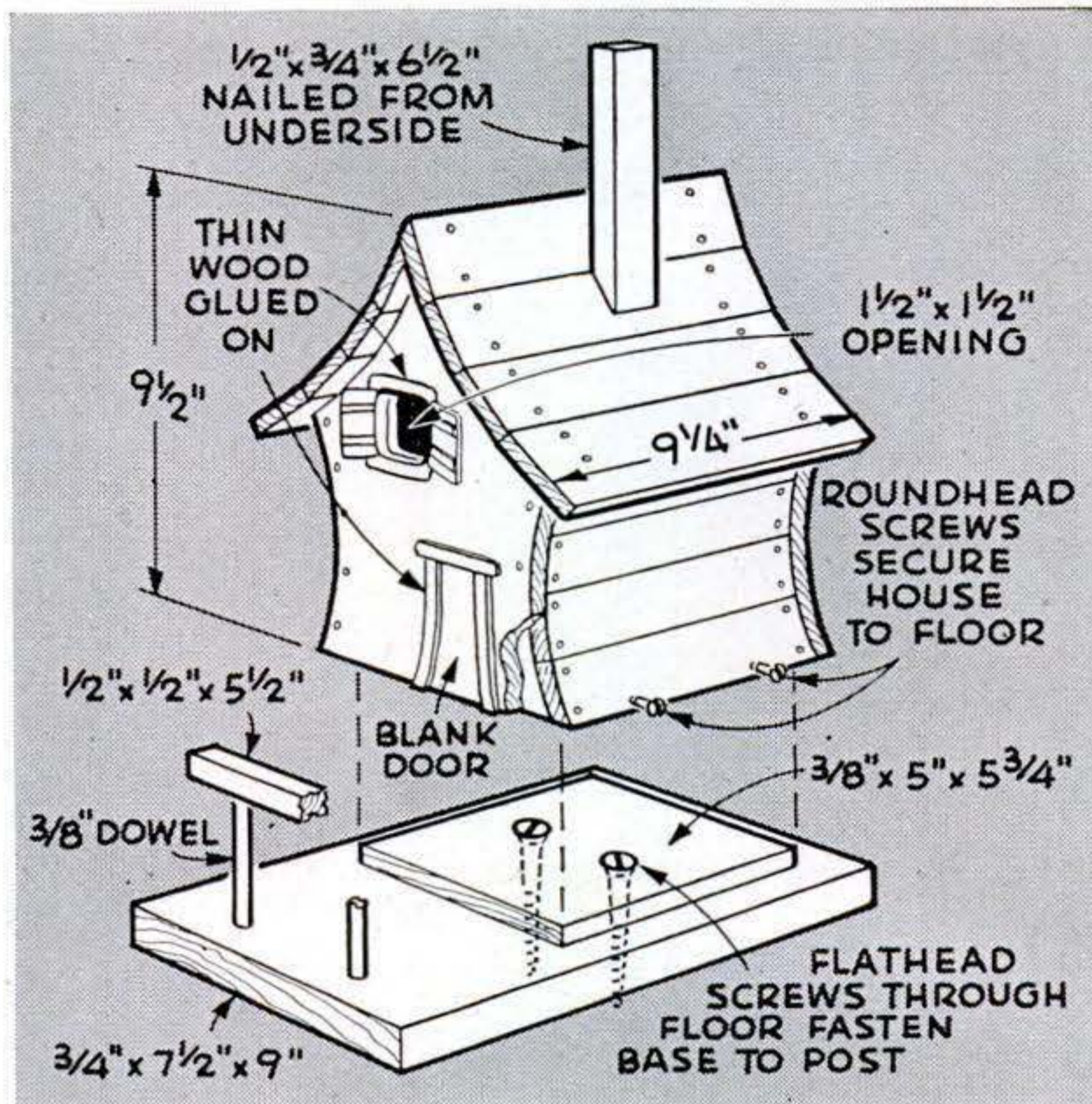
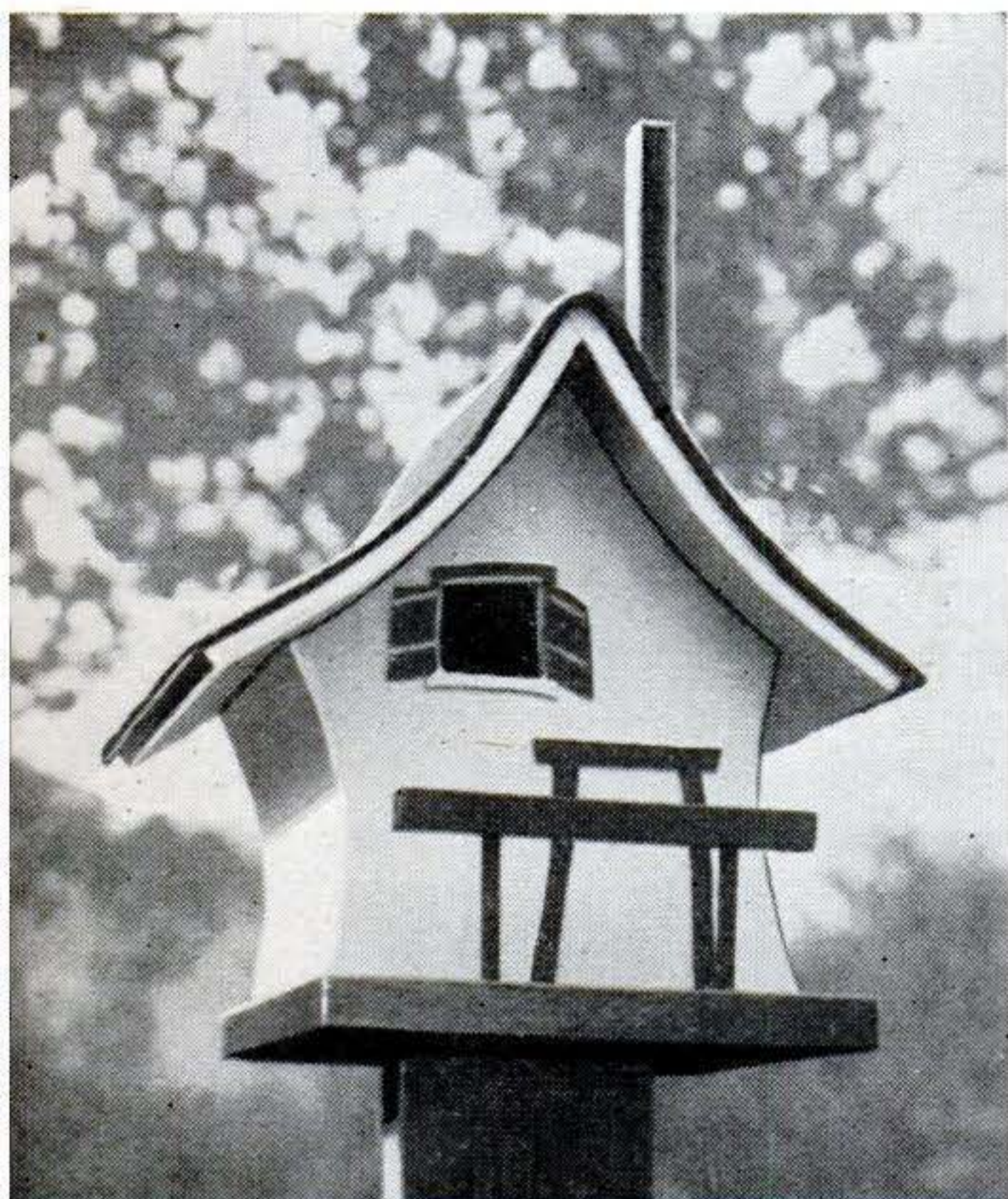

Bird House in Fairyland Style Is Built of Packing-Case Wood

FOR those who have a favorite pair of bluebirds nesting in their garden, a house built in the manner of those in children's fairy-tale books makes a simple yet attractive project. The storybook appearance comes chiefly from the freehand curves of the roof line and sides. Draw these full scale on a sheet of heavy wrapping paper, cut out the outline, and use it as a pattern for jigsawing the front and back. Such stock as the ends of orange crates or $\frac{3}{8}$ " packing-case wood will be satisfactory.

Cut out a second front and back, making them narrower than the first pieces by twice the thickness of the stock to be used for the

sides. Then nail boards for the sides to the narrower pieces, choosing their widths from scrap stock to fit more or less in the curves. The wider front and back are nailed on last. Corner joints thus made will be windproof and snug. Nail on the roof and cover it with an asphalt shingle, allowing $\frac{1}{4}$ " to overlap all around. The chimney is a solid block beveled on the lower end to fit the roof slope. Toenail it in place.

The base, containing a perch and a block for the floor, is screwed permanently to a post. Screws through the sides into the floor permit removal of the house from the base for cleaning.—DICK HUTCHINSON.

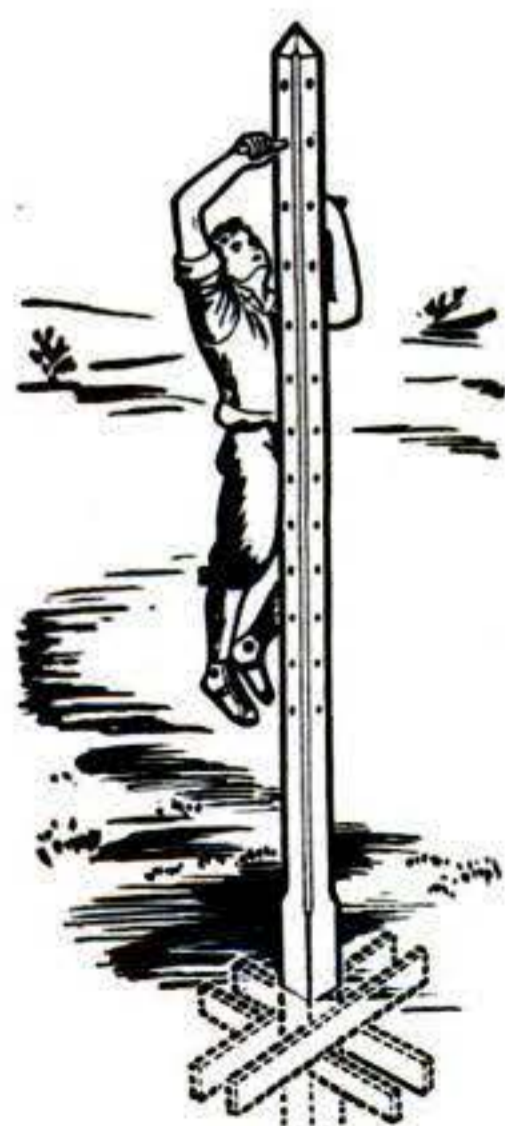

Climbing Pole Develops Arm and Shoulder Muscles

THIS climbing pole is ascended and descended with the aid of two removable pegs. One peg is held in each hand and inserted as far up as possible, and the climber pulls up on them. Then, with one peg kept in place, he pulls himself up without using his legs or feet and inserts the other peg, and so on until the top is reached. If the climb is too arduous, practice may be allowed with three pegs and the feet.

Use 6" by 6" sanded timber 12' to 16' long for the pole. Bore $1\frac{1}{4}$ " holes for the pegs about 7" apart, starting about 4' from the ground line. They should be on all four sides, and it may make climbing a little easier if corresponding holes are on the same level. Bevel the corners and embed the pole in cement or brace it under the ground with crosspieces on all four sides. Make the pegs of dowel sanded smooth to fit closely but freely in the holes.

Pulley on Chute Door Separates Soiled Clothes in Basement

SEPARATELY washed clothing, such as children's wear and women's underthings, are sorted automatically by this chute as they are sent down to the laundry. A pulley arrangement connecting the door upstairs to a hinged trough at the bottom does the trick. Hampers are placed on the laundry floor so clothing will slide into one when the trough is pulled up and into the other when it hangs straight down. All that is necessary in depositing the

soiled clothing upstairs is to hold the door open for that intended for the first hamper and to close it quickly for the other. The device obviates the need of keeping the two hampers upstairs.—WILLIAM B. SCHWAB.

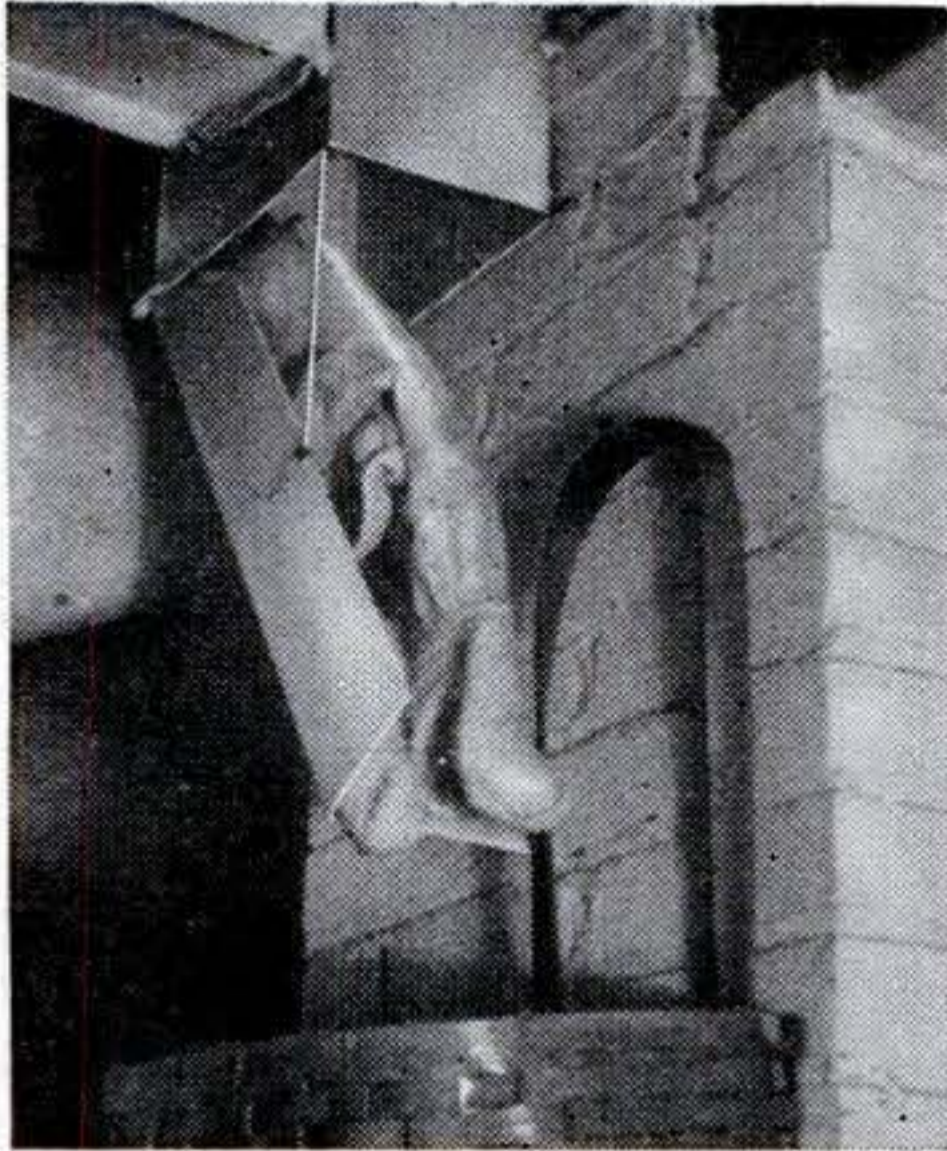

Soiled laundry goes to the hamper for which it is intended by means of the hinged trough.

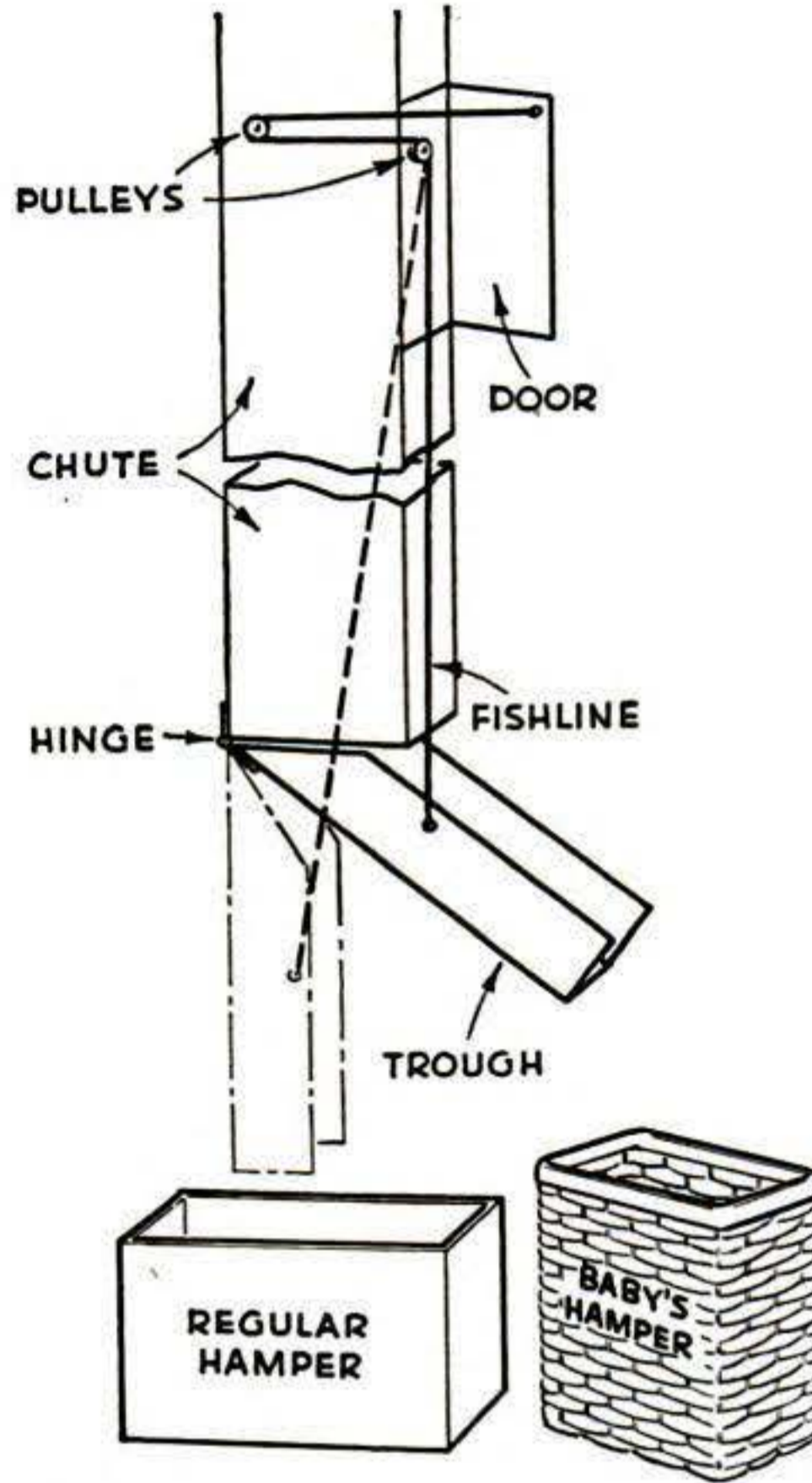

Through a pulley arrangement inside the chute, the trough is raised or lowered by the door upstairs.



Kept open, the door holds the trough up; closed, it drops the trough down.

Brad Spreads Split Screw to Clinch It in Blind Rivet Hole

IN ORDER to fasten a catch on an oven door, a method had to be devised for clinching a rivet or bolt from the outside because the inner end was inaccessible. A brass machine screw was chosen for the job, drilled lengthwise, and split on the threaded end. The screw was then inserted in the door, and a steel brad was driven into its hole to spread the two threaded parts. Sufficient pressure is exerted by the spread to hold the screw in place, and the threads provide extra friction.—RALPH A. VON KAMECKE.

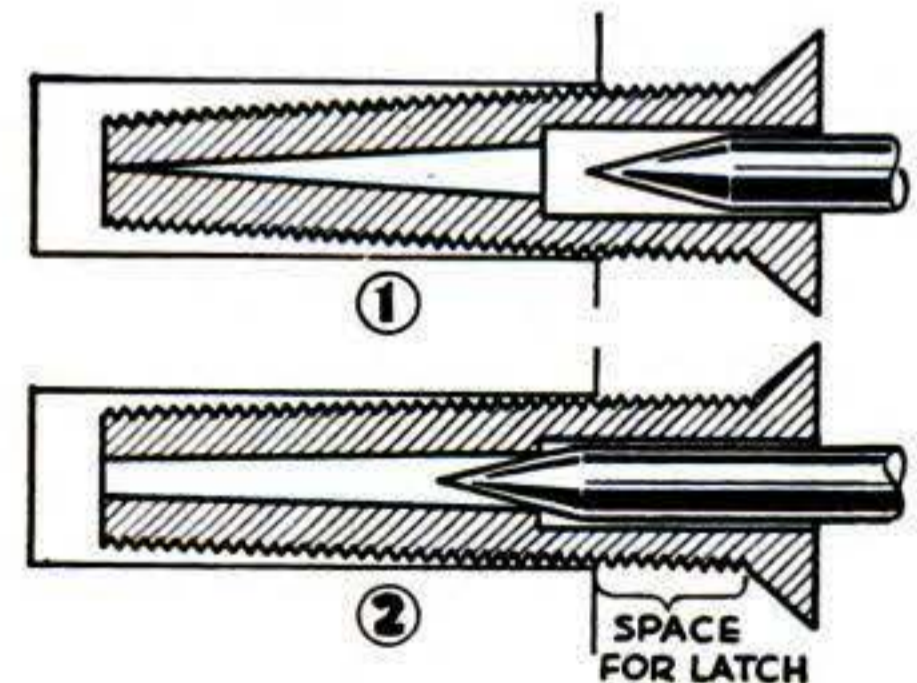

Disks of Screening Stacked on Bolt Form Rotary Wire Brush



FOR removing grease and rust and doing other jobs, a rotary wire brush can be made of a dozen 3" disks cut from old copper screening. Press the disks on a bolt between washers and lock with two nuts. Chuck in an electric drill.—E. D. MERWIN.



Seen in a Candle Flame

Nearly 90 years ago, Michael Faraday set about taking a candle flame apart to find out what it was made of. Then in a famous series of lectures at the British Royal Institution, he proved this common flame was actually a miniature laboratory in which could be found many fascinating transformations of chemistry.

It would require hours to perform all the experiments Faraday suggested, but you can easily demonstrate some of the most interesting in a few minutes.

WITH merely a sheet of paper you can investigate the physical structure of a candle flame and find out how its heat is distributed. Hold the paper horizontally and thrust it quickly about $\frac{1}{4}$ " above the wick with as little disturbance of the flame as possible. Remove it as soon as the top begins to scorch. If you are quick enough, the flame will form a distinct ring with an unscorched center, as in Fig. 1. Thus it appears to be hollow and fairly cool just above the wick.

By inserting the paper at successively higher levels, you will finally find a point where the sides of the flame merge. This is its hottest spot.

What takes place in the cool, hollow zone? There the liquid paraffin that climbs up the candle wick is broken down by the surrounding heat into gases—ethylene, carbon monoxide, acetylene, and hydrogen. This is the "cracking chamber" of a miniature gas plant.

It would be difficult to identify these gases with simple equipment, but you can prove they are combustible with a glass tube that



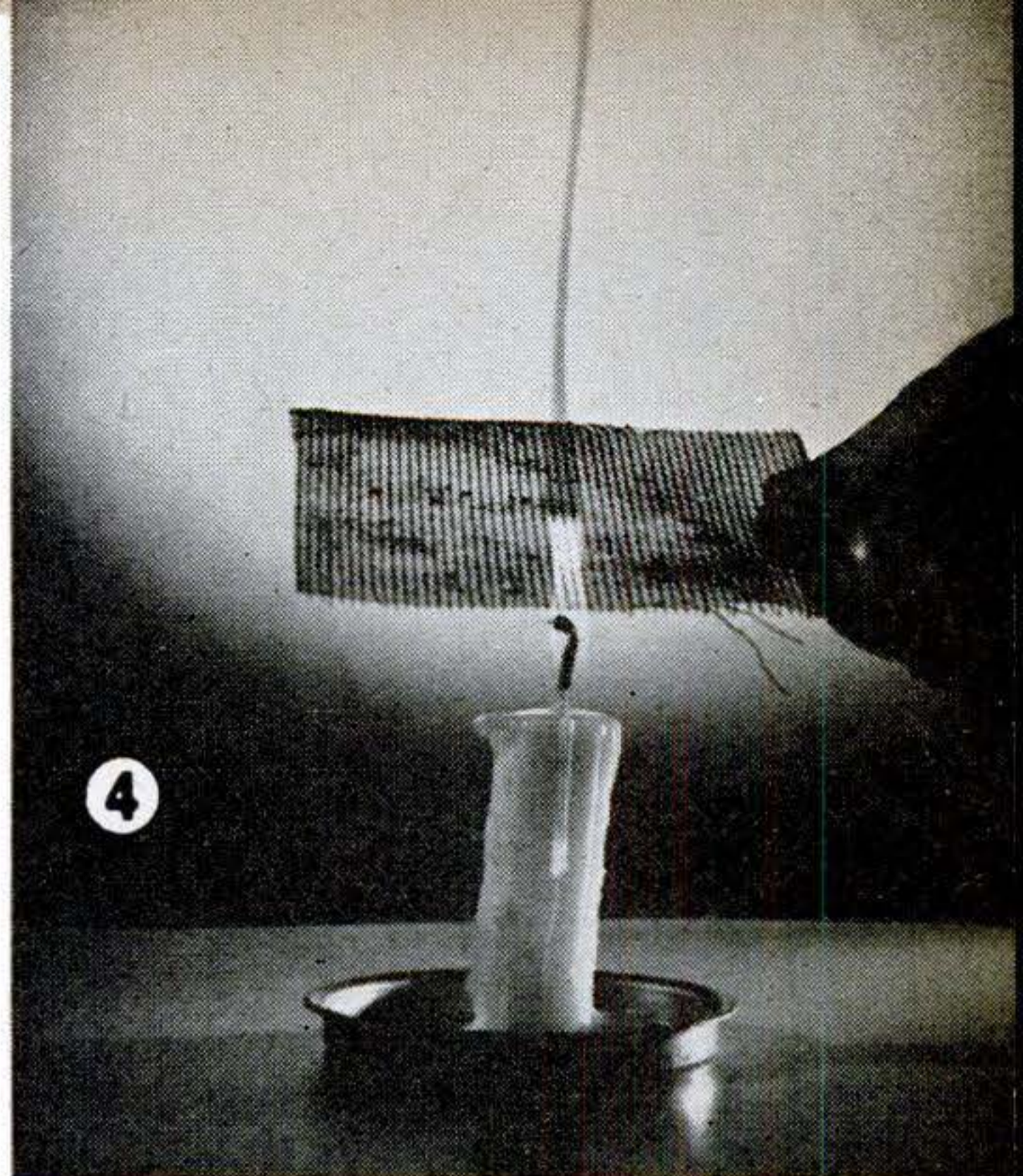
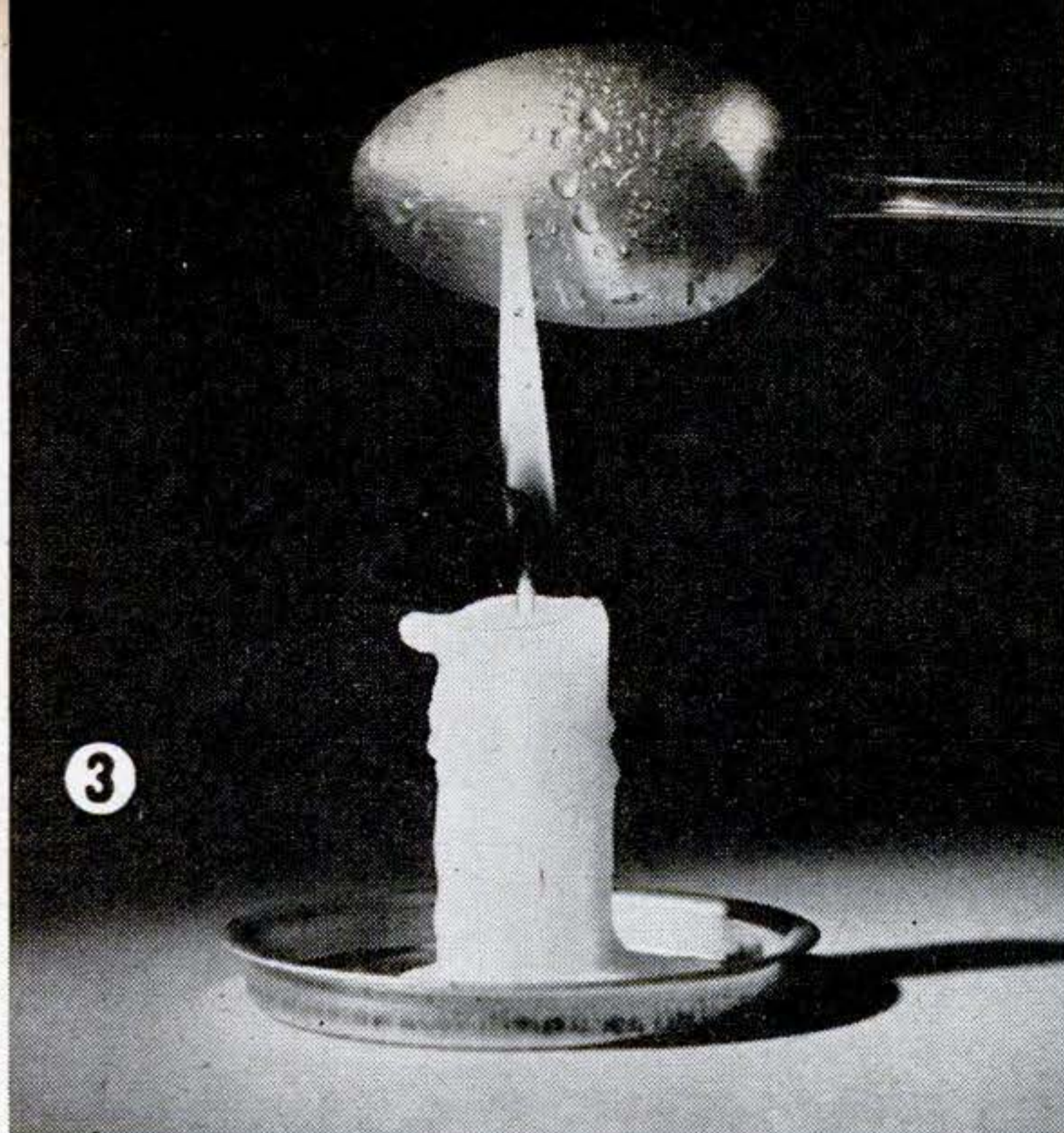

has been drawn to a jet at one end. Support the other end in the center of the flame, as shown in Fig. 2, and light the jet.

Ordinarily these gases enter the luminous part of the candle flame where the carbon monoxide and hydrogen are consumed and the acetylene and ethylene are further changed to carbon and hydrogen. In an efficient flame, this hydrogen and carbon are completely burned in an outer nonluminous part. When hydrogen burns, it is united with oxygen, and water is the final product. A chilled spoon held just above the tip of the flame will first be fogged, and then drops of water may form, as in Fig. 3.

To complete cracking the paraffin oil and burning the cracked products, the flame must supply sufficient heat. If it is robbed of heat, as by the window screening in Fig. 4, part of the fuel is wasted as smoke and soot consisting of white paraffin-oil vapor and black particles of carbon.

That the flame produces carbon can be shown by holding a cool plate just inside the luminous part of the flame, as in Fig. 5.

The greasy, black deposit is finely divided carbon called lampblack.

When a candle burns quietly, this carbon is first heated to incandescence, giving luminosity to the flame, and then is consumed. To show that the lampblack can be burned, form a blowpipe by closing one end of a drinking straw and making a pinhole $\frac{1}{2}$ " from the closed end. Dip the straw in water to keep it from burning, hold it close to the upper end of the candle wick, and blow toward the carbon on the plate, as shown in Fig. 6. The extra air should increase the heat so greatly that the carbon will be burned away. Use an old plate.

Without its incandescent carbon particles, the candle flame would give no more light than an efficient gas flame of a Fisher or Bunsen burner. Although the gas flame is many times hotter, it will light a surface no more than at the right in Fig. 7. But insert a short length of nickel chromium wire from an old electric-heater element into the gas flame, and light will be produced, as in Fig. 8, by the incandescent wire.

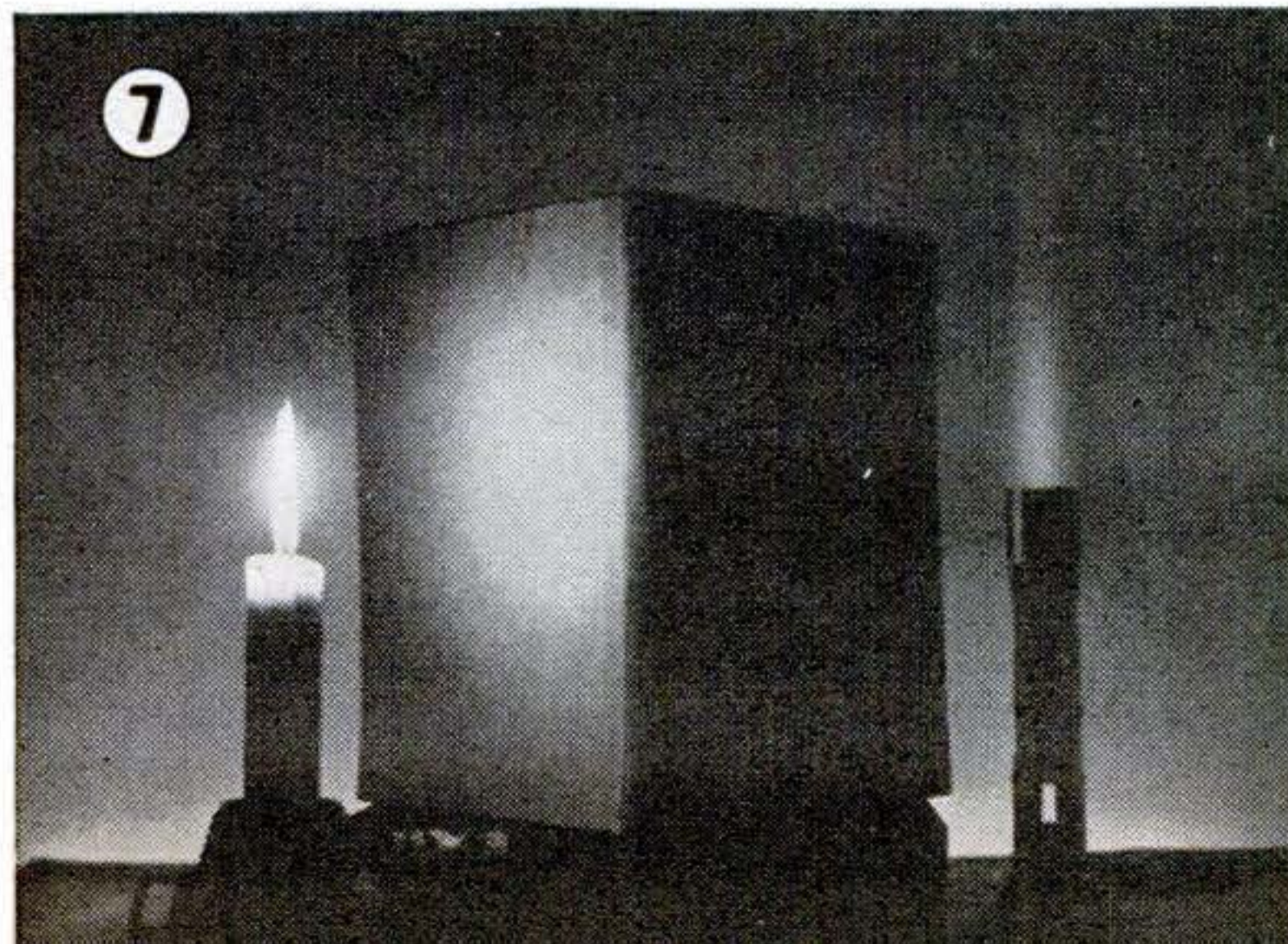

MAY 1947 219

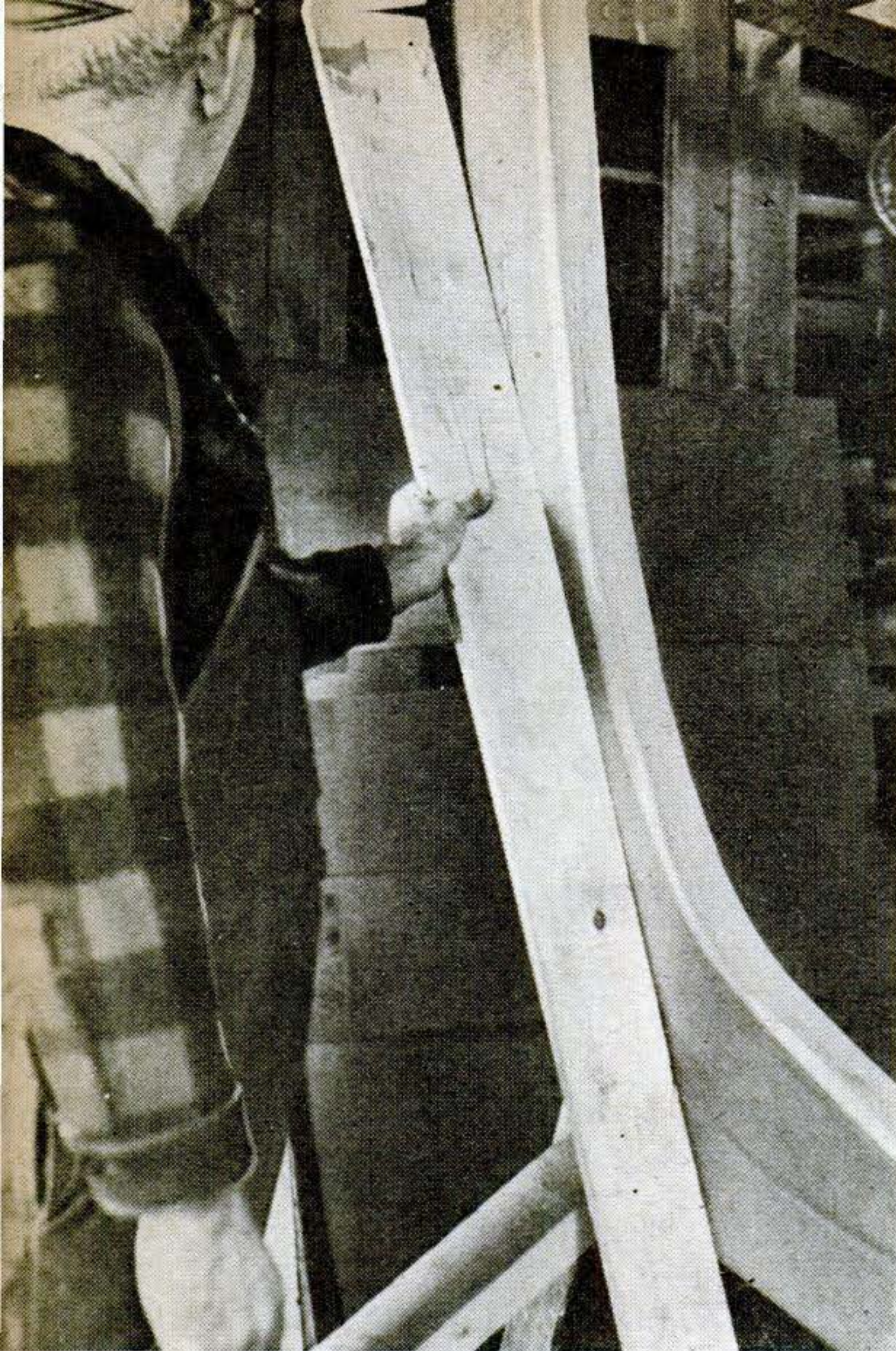

Incompletely seasoned timber warps easily. Set up for building, the stem of this backbone assembly is checked with a straightedge. It has a $\frac{1}{2}$ " warp.

BUILD True to SAIL True

The bigger your boat, the more important are sound shoring and constant checking as you build to keep out construction errors.

By ELON JESSUP

MANY amateur builders underrate the importance of rigid bracing and shoring when laying the keel and setting up the molds of a boat. After the planking is firmly in place, all worries on this score are over, for the boat will have become a solid entity capable of taking care of herself. But while still a skeleton, she will move out of true if permitted the slightest leeway, and a serious error may be built in.

When a frame refuses to remain true, the cause can usually be laid to the inevitable wrenches and strains of building. But another factor to guard against when seasoned lumber is not available is the natural warping of green wood. Most amateurs work on a boat periodically during spare time. This can give poorly seasoned lumber an opportunity to warp out of shape unless rigid pressure is exerted to prevent it.

The stem of the boat shown under construction in the accompanying photos had been cut from green lumber and was therefore obviously suspect. After being set up permanently in position, it was checked for trueness with a straightedge and spirit level and found to have warped a full $\frac{1}{2}$ ". But for prompt correction and additional shoring to keep it true, the boat would always have been lopsided to some extent and forever tending to turn to one side.

How best to go about setting up and shoring will depend both on the facilities at hand and on whether it seems preferable to build the boat right-side up or upside down. In either case, of prime importance is bracing so firm that the structure cannot possibly wobble regardless of strain.

The boat shown is a V-bottom 18-footer, too heavy to be built bottom up. A great disadvantage of building right-side up is the difficulty of getting at the bottom, but this can be overcome to some extent if the keel is set several feet above the floor. Another possibility shown is the tilting of the boat on her side after the sides have been planked and the shoring above released. If a boat isn't too heavy, she can be turned completely over.

Build inside if possible. Besides protecting the unpainted lumber from the ravages of rain and sun, you will have a floor and a roof as invaluable building aids. Outdoors a builder can't always find backing for his braces and shores.

The building conditions shown in the photos might be called close to ideal. Underneath is a level wood floor to which braces

and shores can be firmly nailed. Overhead runs not only an adequate strong beam, but a rigid steel I-beam as well. With proper shoring, it is difficult to see how the backbone of the boat could possibly move. In addition there is ample elbow room.

To begin, snap a chalk line on the floor directly under a strong beam to represent the centerline of the boat. Undersupports are then placed in reference to this line. For a small boat, sawhorses will often do; for a larger one, the supports may be heavy crossbearers, two-by-four uprights, or a combination of the two. In the case illustrated, heavy bearers were placed forward and aft with uprights between them.

Lay one of the heavy bearers across the centerline directly under the mold that will

come farthest forward and lay the other under the mold farthest aft. Select bearers with a view to having the rabbet line of the keel even, or build them up to proper height. Then rest the assembled stem and keel on the bearers and check with a spirit level. When level, clamp the keel between small blocks nailed to the bearers.

Next, measure the distance from the top-side of the keel assembly to the underside of the beam overhead, and cut two two-by-four uprights accordingly, sawing for a tight fit. Place one directly over the forward bearer and the other over the one aft, and check again with the spirit level. Then measure from the floor to the bottom of the keel, cut short two-by-four uprights to suit, and get them in place, each one directly under where



Time and pressure true up a warped stem. Two two-by-fours are braced against it, one above the other, pressing in opposite directions.



Additional braces are forced in below the first pair. Diagonals must be beveled to fit the keel just below the rabbet line and to fit solidly on the floor.

Checking for keel levelness with a spirit level held against the rabbet line. If the keel is found out of level, one or more of the crossbearers under it will have to be raised or lowered to proper height.

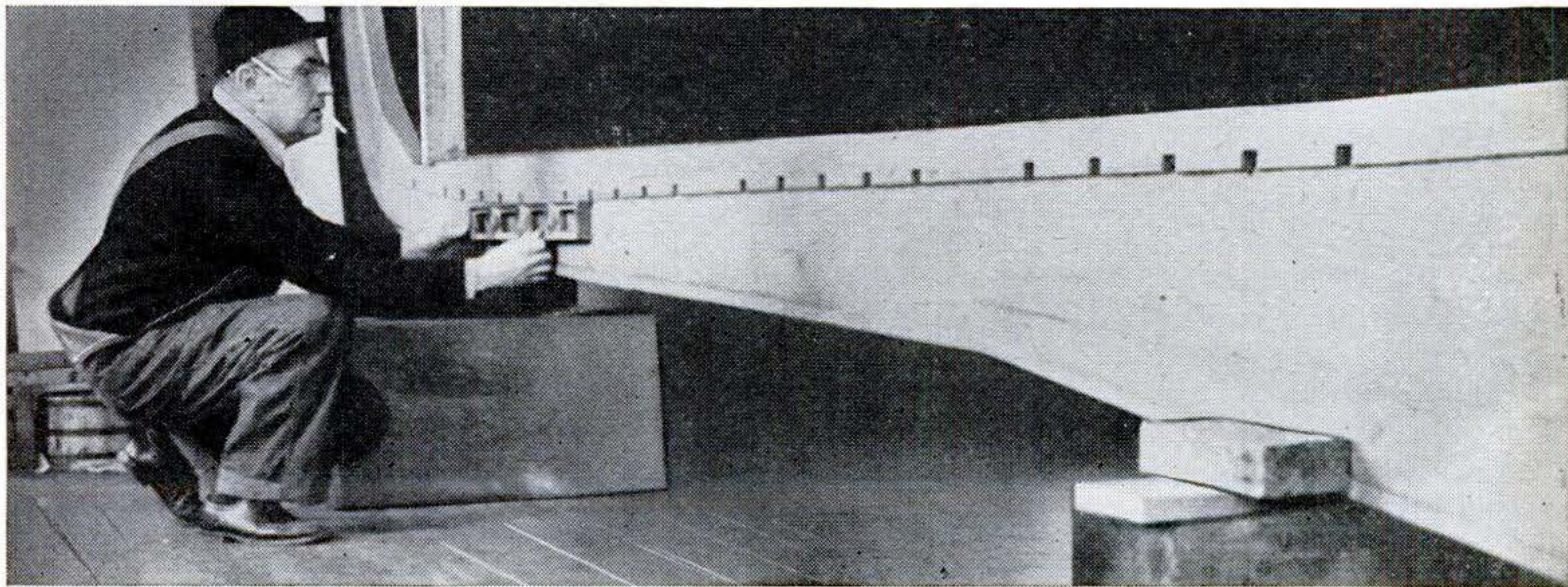



At left, a two-by-four is forced in between the topside of the keel and the overhead beam. After it is checked with a spirit level, it is toenailed in place. More diagonals are fitted in as above. The best system is to alternate from one side to the other to avoid one-sided pressure.

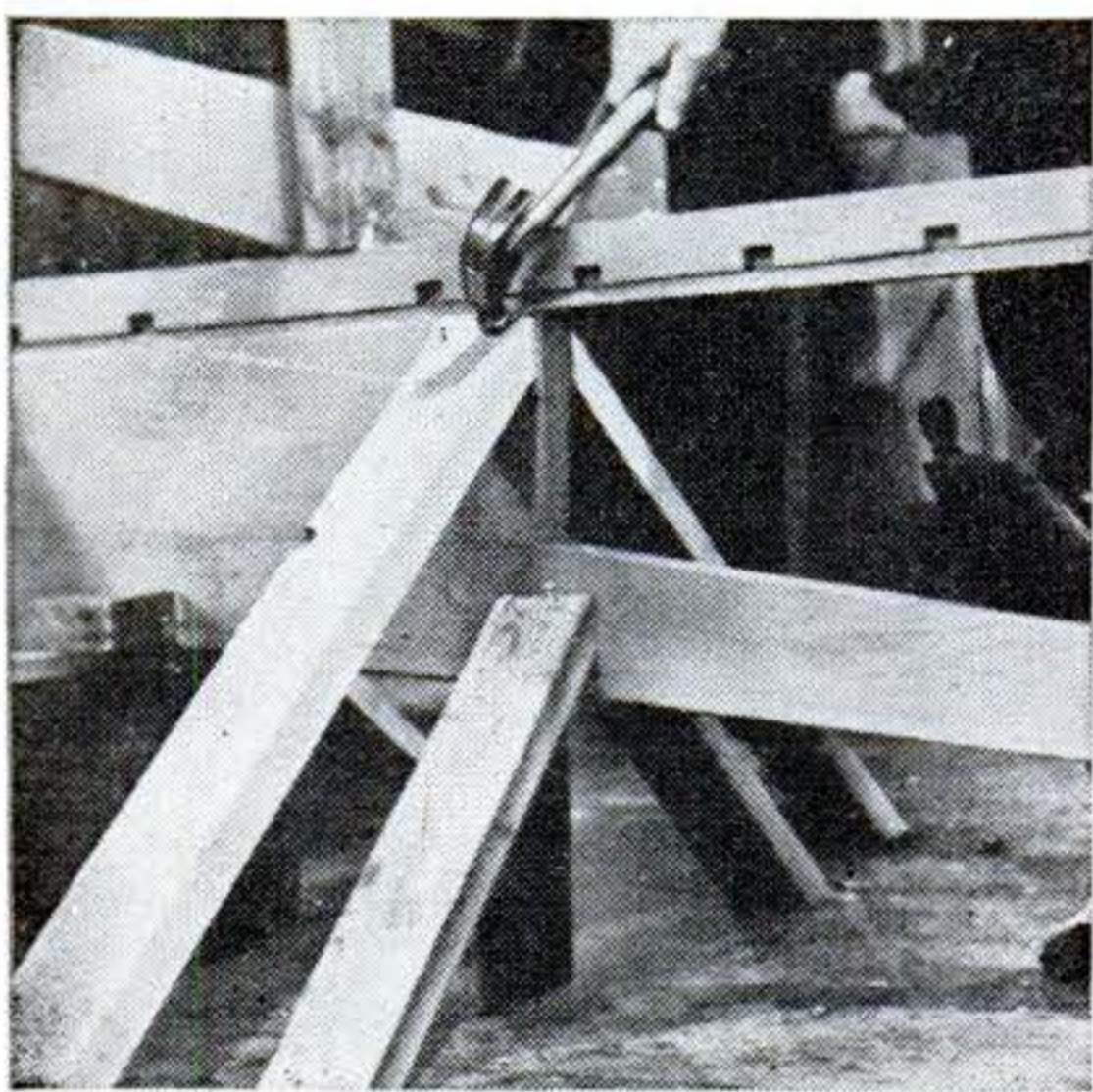

Unless double bracing is provided at the skag and keel, these parts can easily be pressed out of line during building.

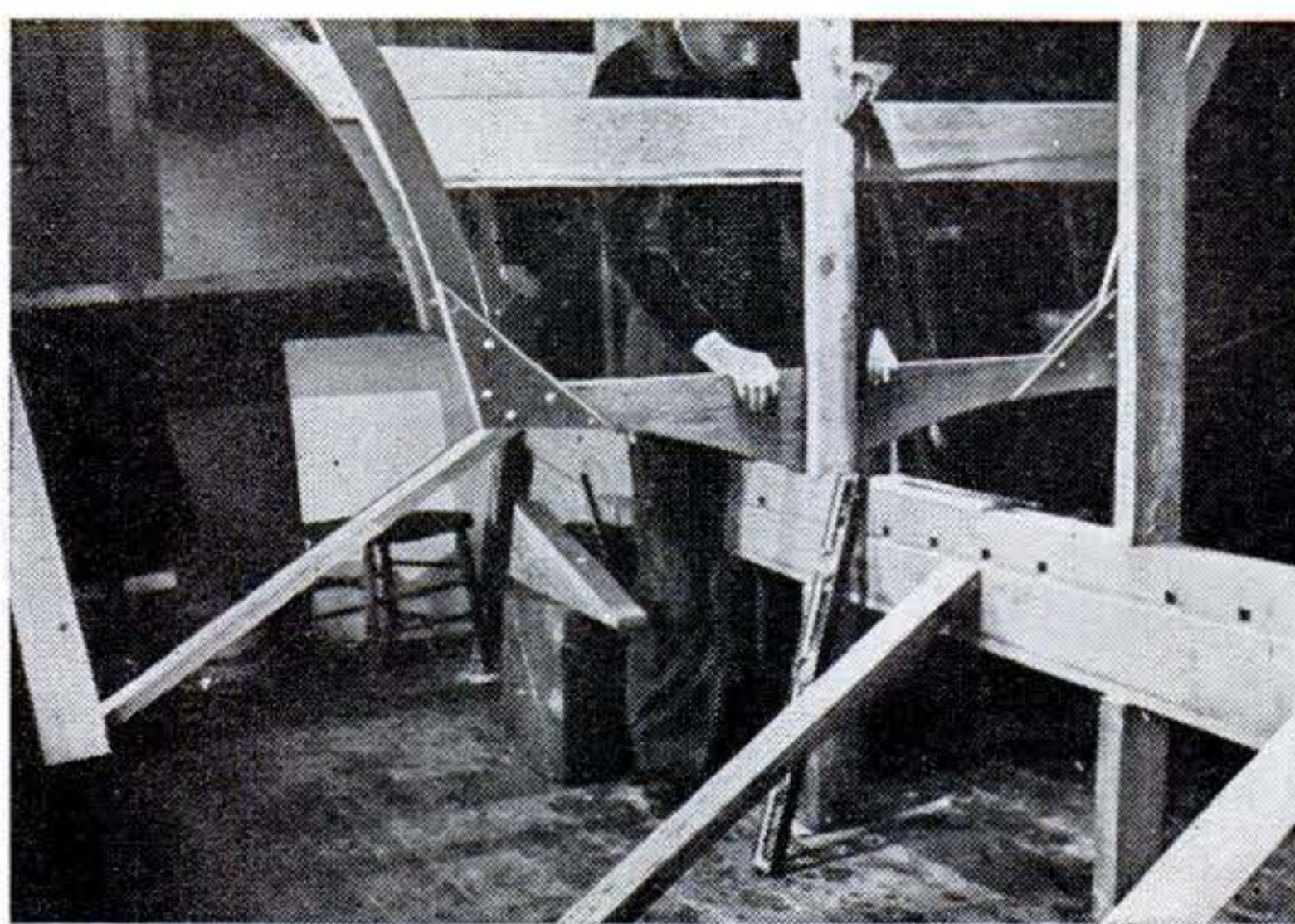

Here the molds are being put in. Uprights have been forced in above and below the keel at each station, and the molds are accurately leveled and screwed to the uprights.

a mold will be set in to take the planking.

Cut an equal number of uprights for the topside, measuring each to reach from the keel to the overhead beam. Line each up vertically over an undersupport, apply the level freely, and after each standing has been shown true, nail the ends. If the beam is steel, as in the photos, horizontal stringers will have to straddle it to provide nailing surface. You can also shore to the roof or to whatever wood backing is convenient. The point is to make each upright so firm it can't possibly be budged.

Now, saw out a series of two-by-four

diagonal braces with the upper ends beveled to fit the keel just below the rabbet line and the lower ends to fit solidly on the floor. Nail them to the floor and the keel along both sides, but don't drive nails in the keel all the way home. There may be need for readjustment later.

The molds can then be placed in position along the keel. In the type of construction shown in the photos, the molds have been built as master frames, each to become a permanent part of the boat. Often they may simply be rough lumber that will be discarded later. In either case, they must be

carefully fitted and leveled, and each must be fastened to an upright with screws. You can't be too careful in checking and re-checking. Hold the spirit level against the keel, against the uprights, and against the tie-piece of the molds. If any error is discovered, don't proceed further with the bracing until it has been righted.

With the backbone of the boat solidly shored and braced, and with the molds fastened in and true, actual construction can begin. However, if you feel that more brac-

ing and shoring might prove helpful, don't hesitate to get it in. In some cases a single frame may need four or five braces. Also, as you proceed with construction, shoring from the floor to the turn of the bilge may become necessary.

Much will depend upon the type and size of the boat. But it's a good general rule that the more shoring you use, the less chance the hull of your boat will deviate from clean, fair lines. Extra care at this stage means an appreciably better boat in the end. **END**

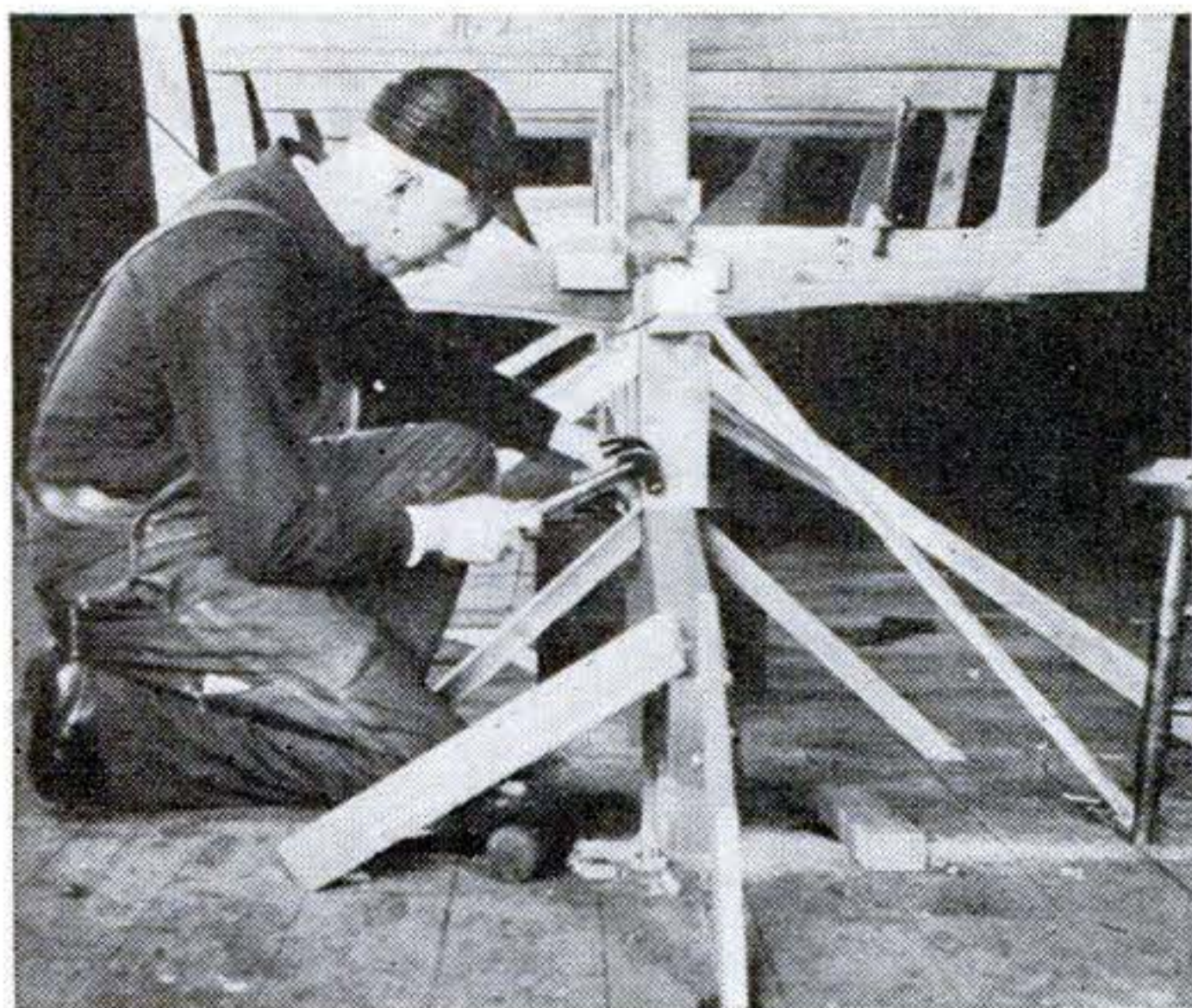

Checking and rechecking with the level are of the utmost importance after each step. Here a slight error is being corrected with an extra brace.

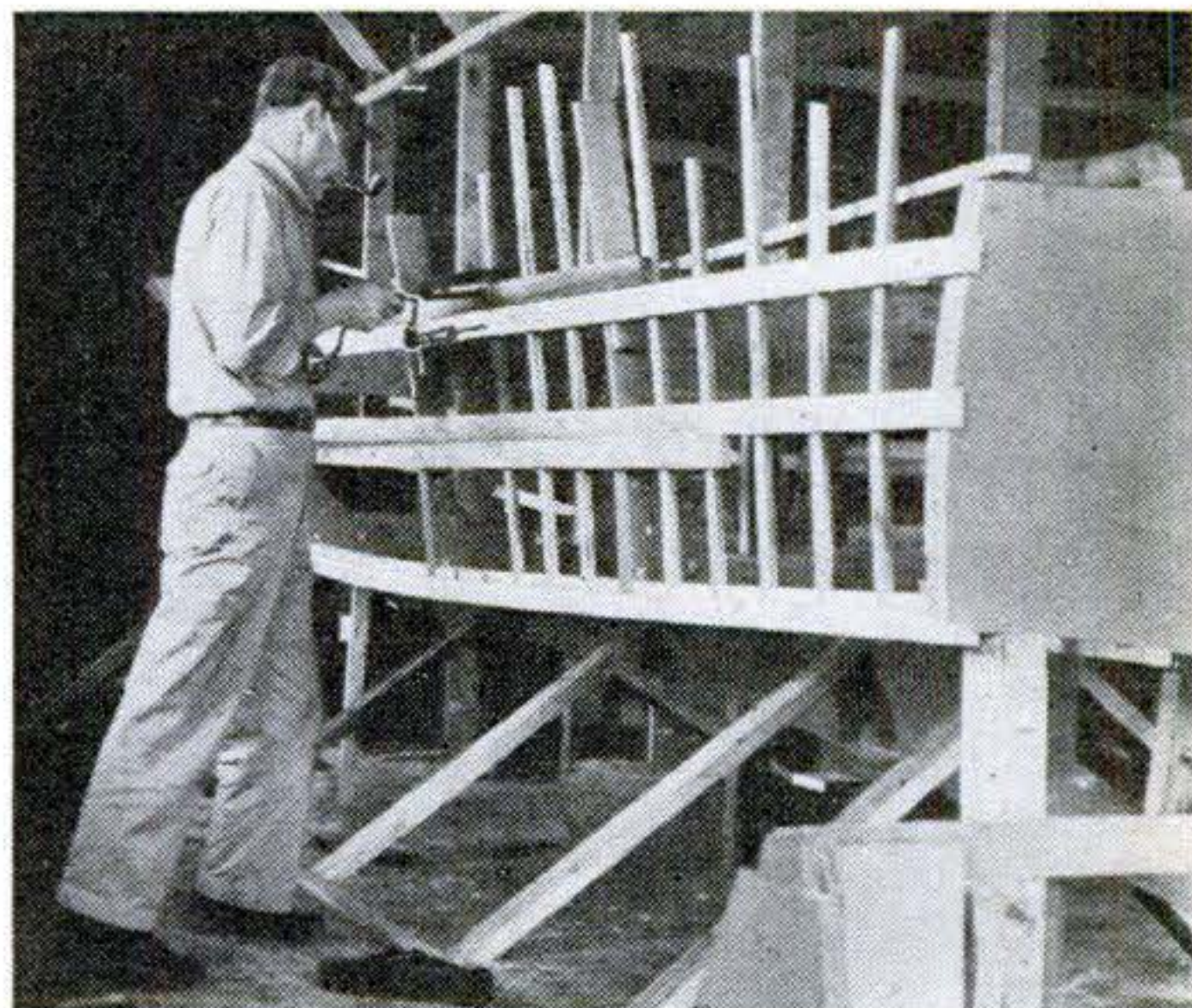

When the keel has finally been braced so it can't possibly be budged and all molds have been put in, leveled, and fastened, actual construction begins.

One of the disadvantages of building a boat right-side up is the difficulty of getting at the bottom, but this is offset if the boat can be tilted on one side. Then laying of the planking will be fairly easy.



Garden Gadgets

PATTERN SPRINKLERS. Several manufacturers have put on the market lawn sprinklers designed to irrigate noncircular areas. Below is the Watergyro Sprinkler, made by Manning Products, of Birmingham, Mich. It can be set to water circular, square, triangular, rectangular, or oval areas by adjusting a flexible metal track along which a wheeled control lever travels.

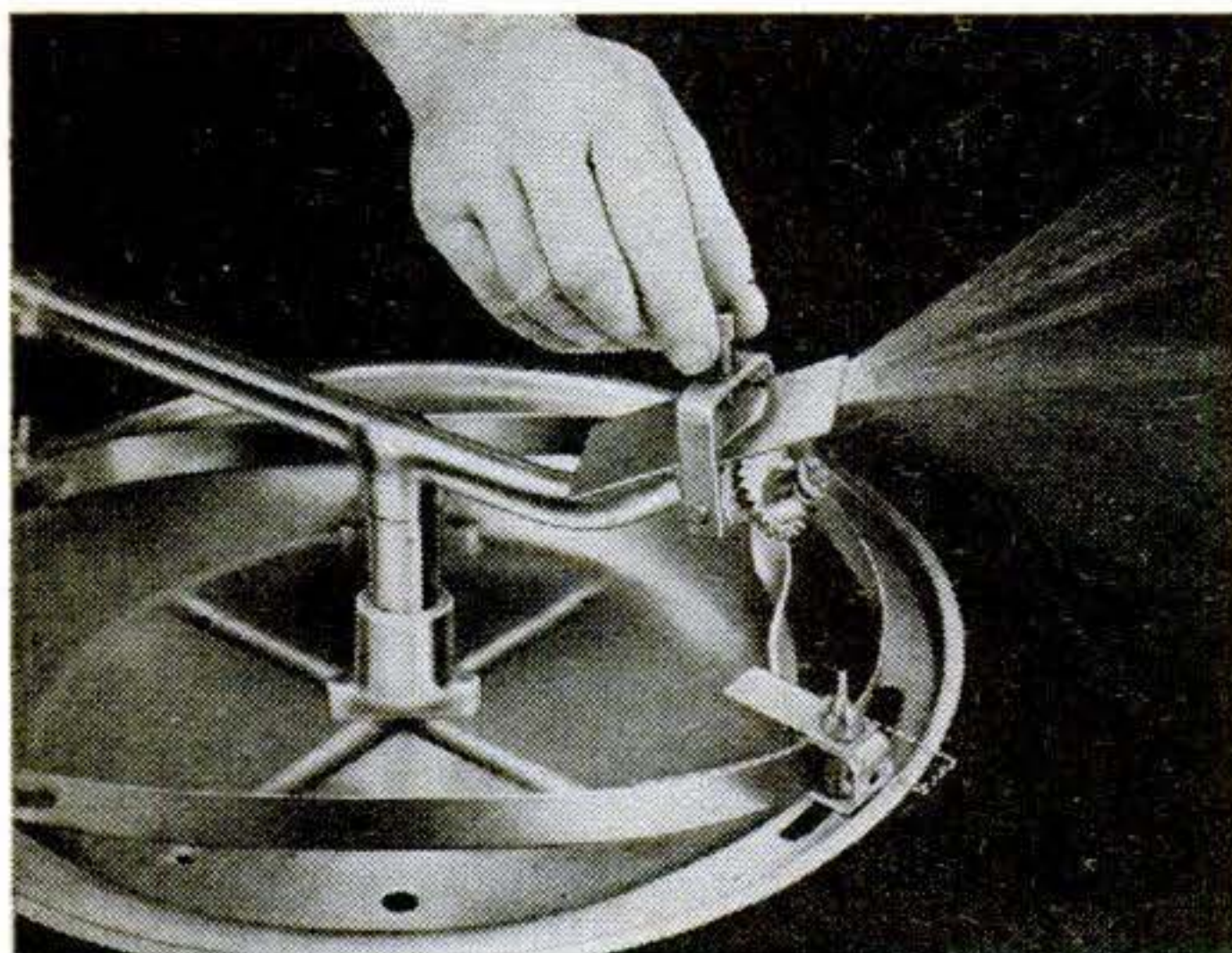

SPRAYER FERTILIZES SOIL. Concentrated fertilizer tablets placed in the head of a lawn sprinkler produced by the Rieger Manufacturing Co., of Miamisburg, Ohio, are dissolved by the water and sprayed over the area covered by the sprinkler.

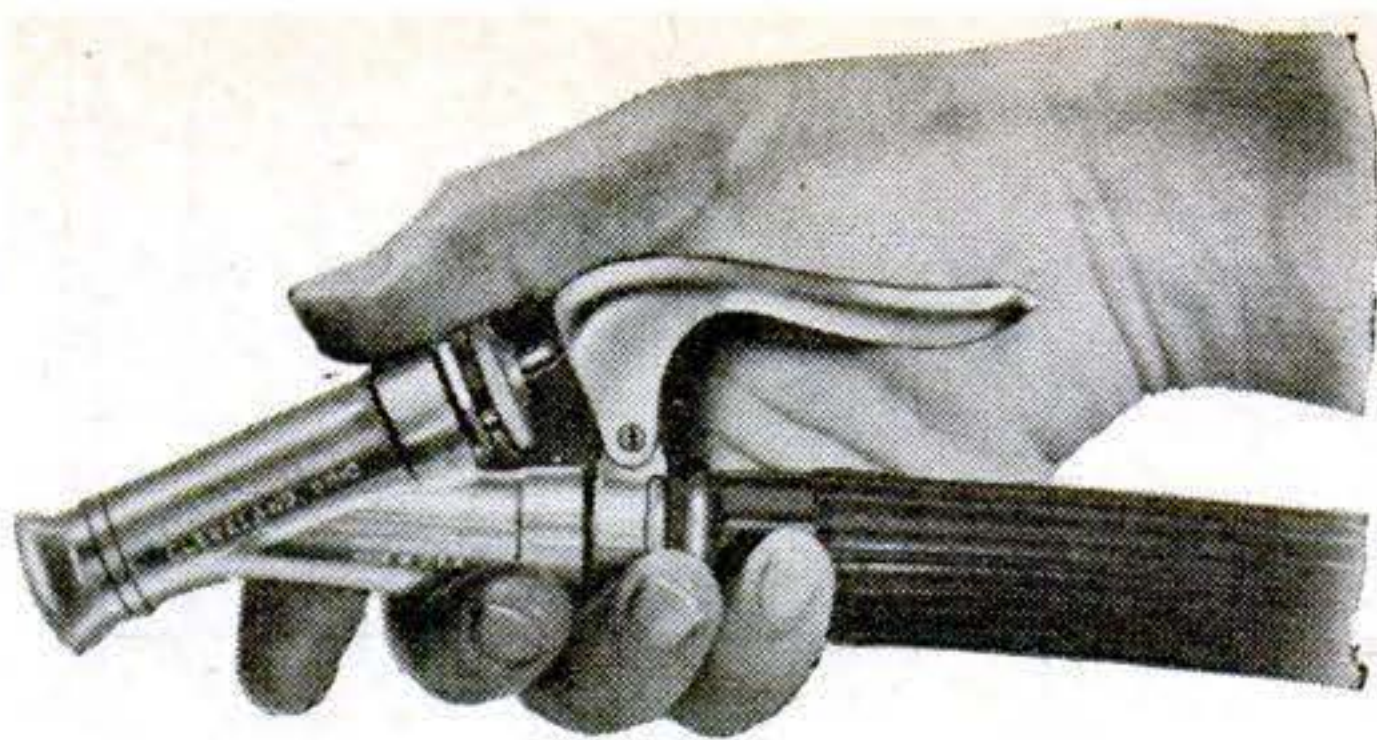
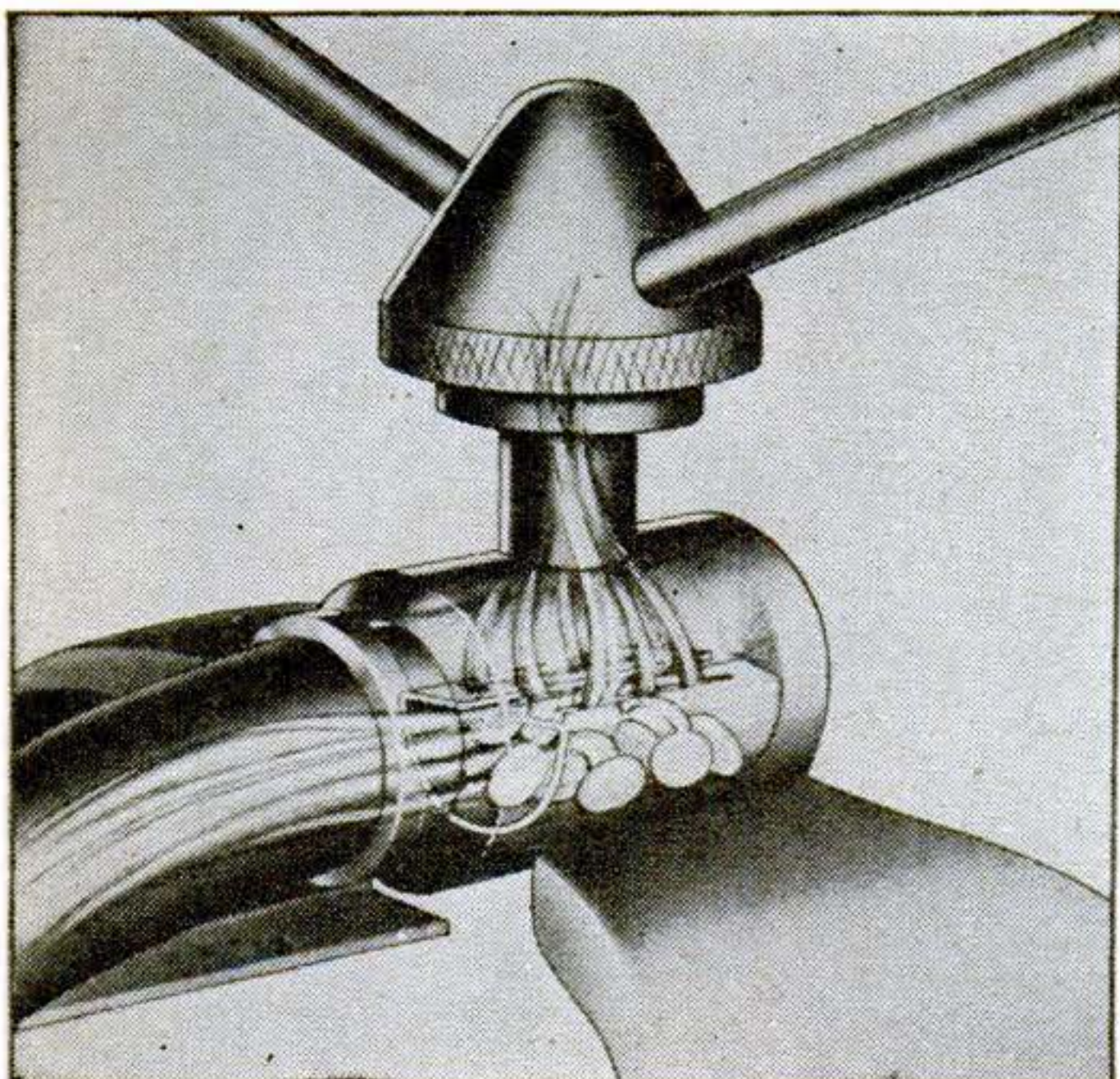

HAND HOSE NOZZLE. With a lever-operated hose nozzle made by Kay Products, of Cleveland, you can control the stream from fine mist to full force simply by hand pressure.

LAWN-MOWER SHARPENER. Clamped with setscrews to a standard 10" flat mill file, two small metal guides manufactured by T. W. Slingsby, Inc., of Saybrook, Conn., are said to make it possible to sharpen a lawn mower in a jiffy. One guide hooks over the shrub bar of the lawn mower and the other rests on the blade to keep the file constantly at the proper angle as it is drawn toward you along the length of the blade. The sharpening outfit, complete with file, retails for about \$1.25.

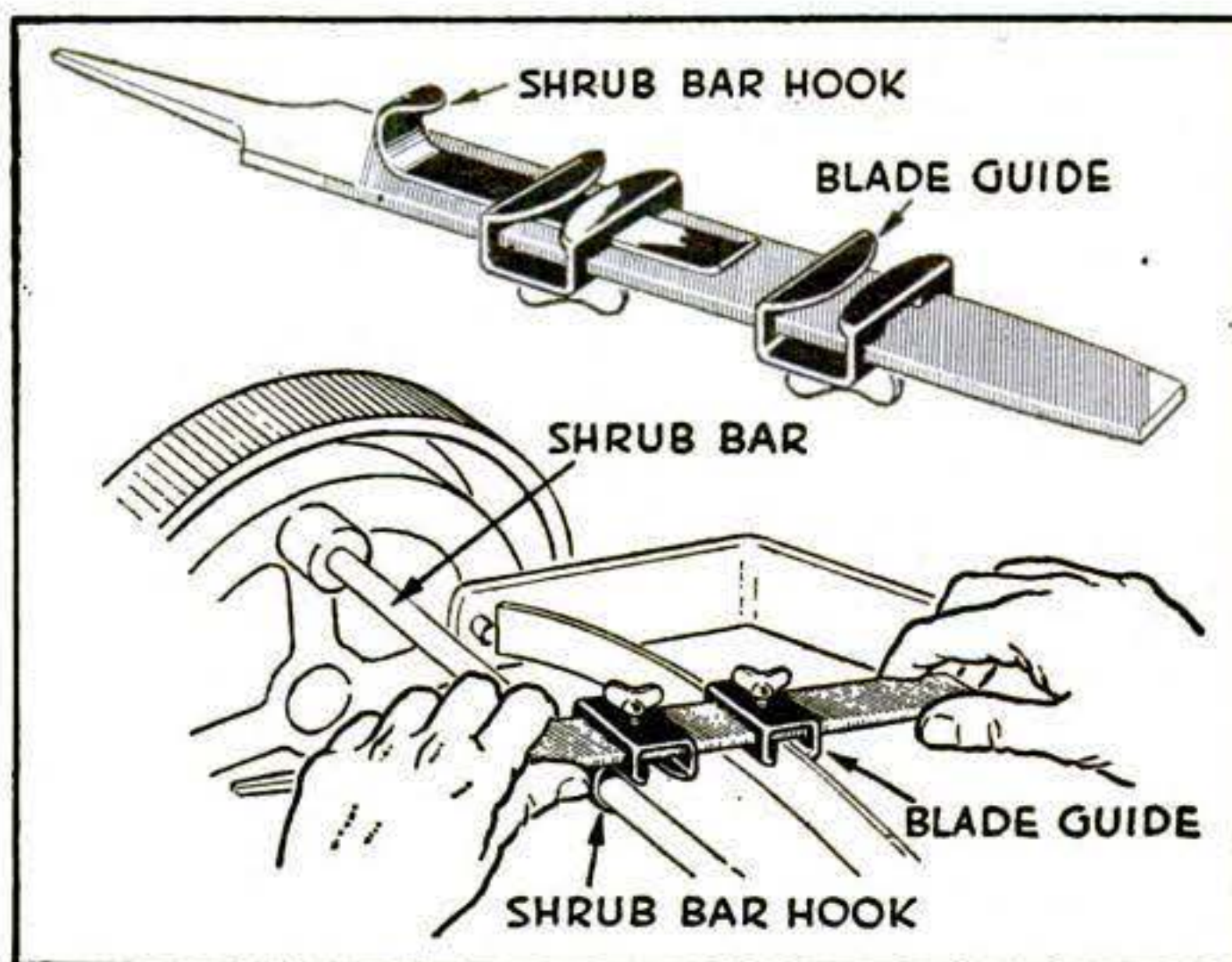

BIG BERTHA DUST GUN. The 36" long dust gun below was created by the Sherwin-Williams Company to handle a new insecticide said to be effective against at least 27 common insect pests and plant diseases. It holds 2 lb. of insecticide.



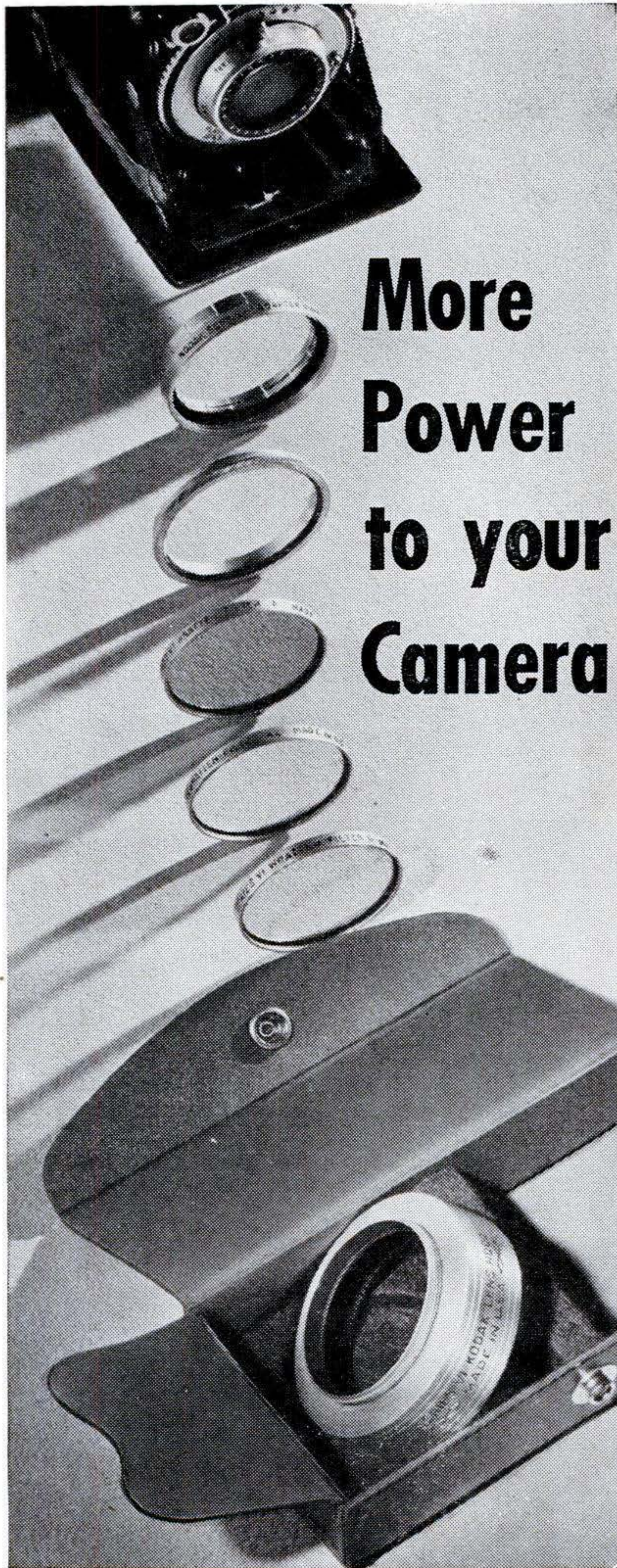

More Power to your Camera

Kodak Combination Lens Attachments increase scope and picture-taking ability

You add dash to a scene when you darken the sky with a K-2 Wratten Filter. You picture a world of fantasy on Kodak Infrared Film plus a Wratten A Filter.

You'll make gentler, softer landscapes with a Kodak Pictorial Diffusion Disk. You cut through mountain haze with a Kodachrome Haze Filter . . . clear away glare with a Pola-Screen.

For fine close-ups of people, flowers, pets . . . add one of the three Portra Lenses.

Interchangeable, inexpensive, easy to use. See your Kodak dealer. EASTMAN KODAK COMPANY, Rochester 4, N. Y.

NEW KODAK COMBINATION FILTER CASE carries Adapter Ring, a Lens Hood, and four filters.

Kodak

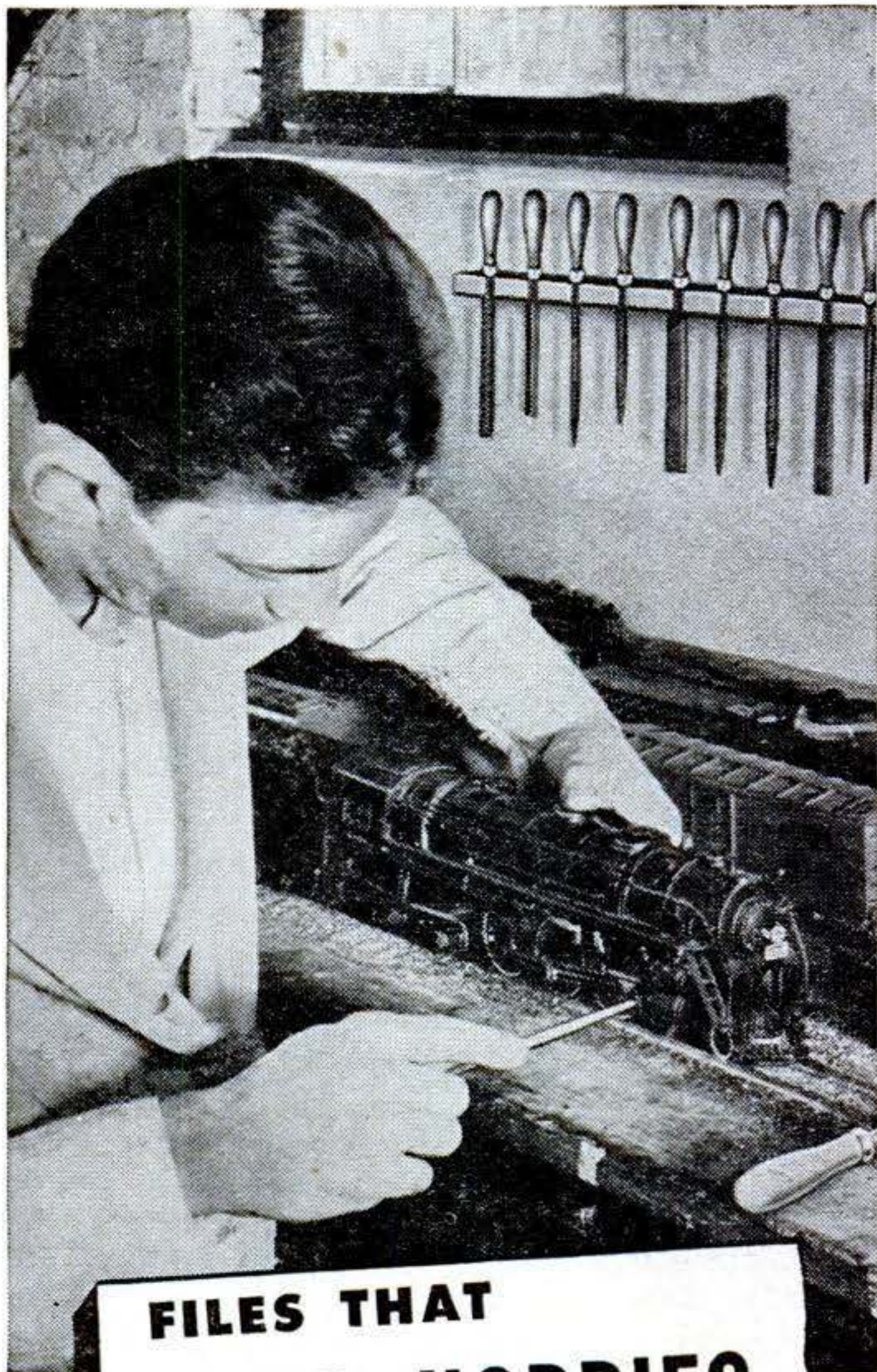

FILES THAT SPUR HOBBIES

LET A MAN—or a boy—get his hands on a few fine tools and he's sure to feel that instinctive urge "to make something."

That's the way it is with Nicholson or Black Diamond files. Just the feel of them—their perfect balance and sure, keen bite—is enough to start you looking for something to sharpen, or to smooth, or to create.

You'll take pride in owning a versatile assortment of these high-quality files. Then, whether you work in metal, wood or plastic—tinker with delicate models or turn out full-scale projects—you'll be able to reach for *The right file for the job.*

Your hardware dealer offers Nicholson or Black Diamond files in a wide selection of shapes, cuts and sizes.

NICHOLSON
U.S.A.

NICHOLSON FILE CO.
19 Acorn St., Providence 1, R. I.
(In Canada, Port Hope, Ont.)



NICHOLSON FILES

FOR EVERY PURPOSE

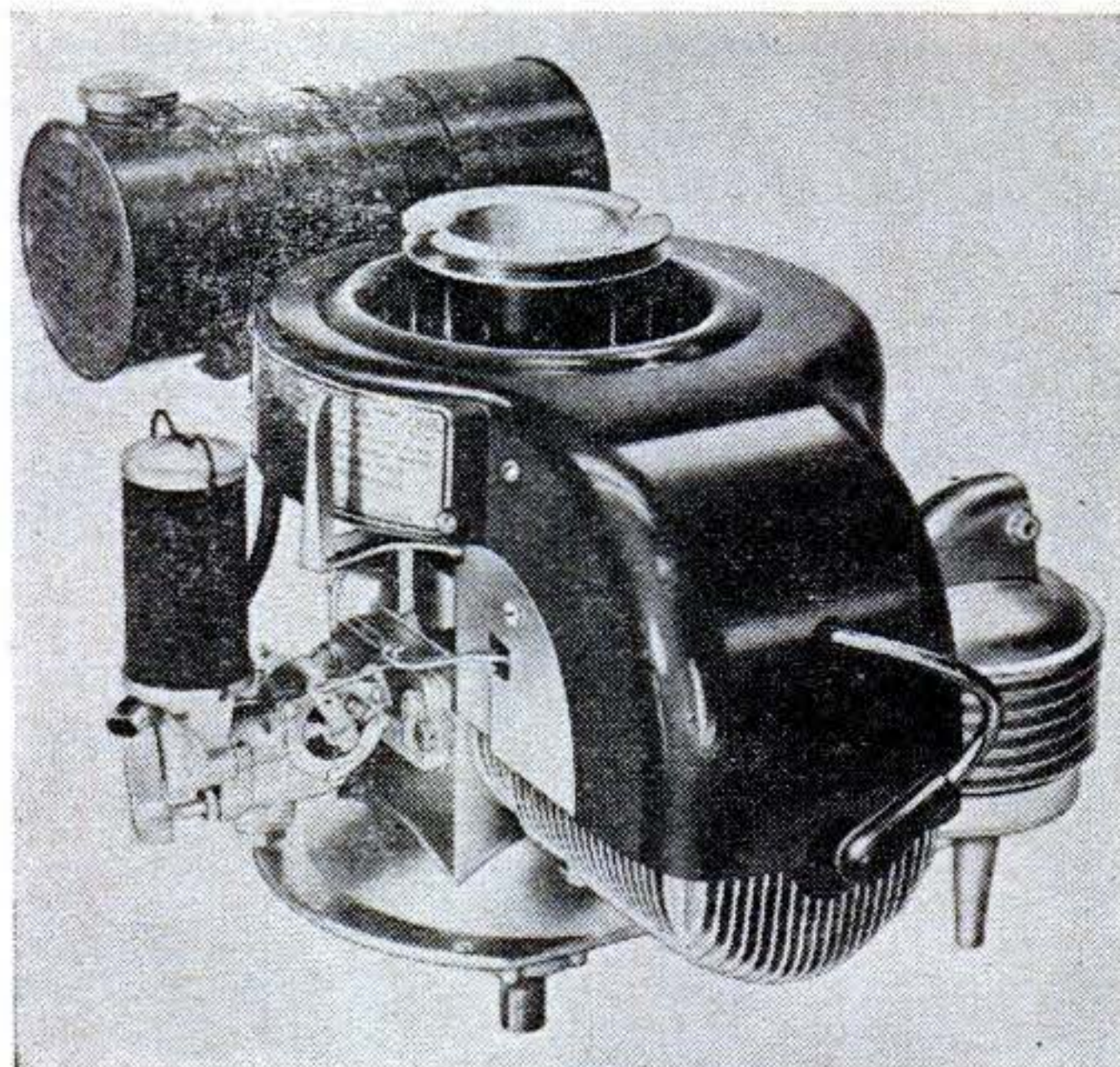

Engine Uses Fuel Guides

BECAUSE the incoming fuel charge is controlled by angled guide vanes in the intake ports, instead of piston-top deflectors, detonation from hot spots on the piston is said to be sharply reduced in the McCulloch Model 1200D single-cylinder, two-cycle, air-cooled gasoline engine. The new easy-starting engine weighs only 24 pounds and develops 2.5 horsepower at 2,500 r.p.m.

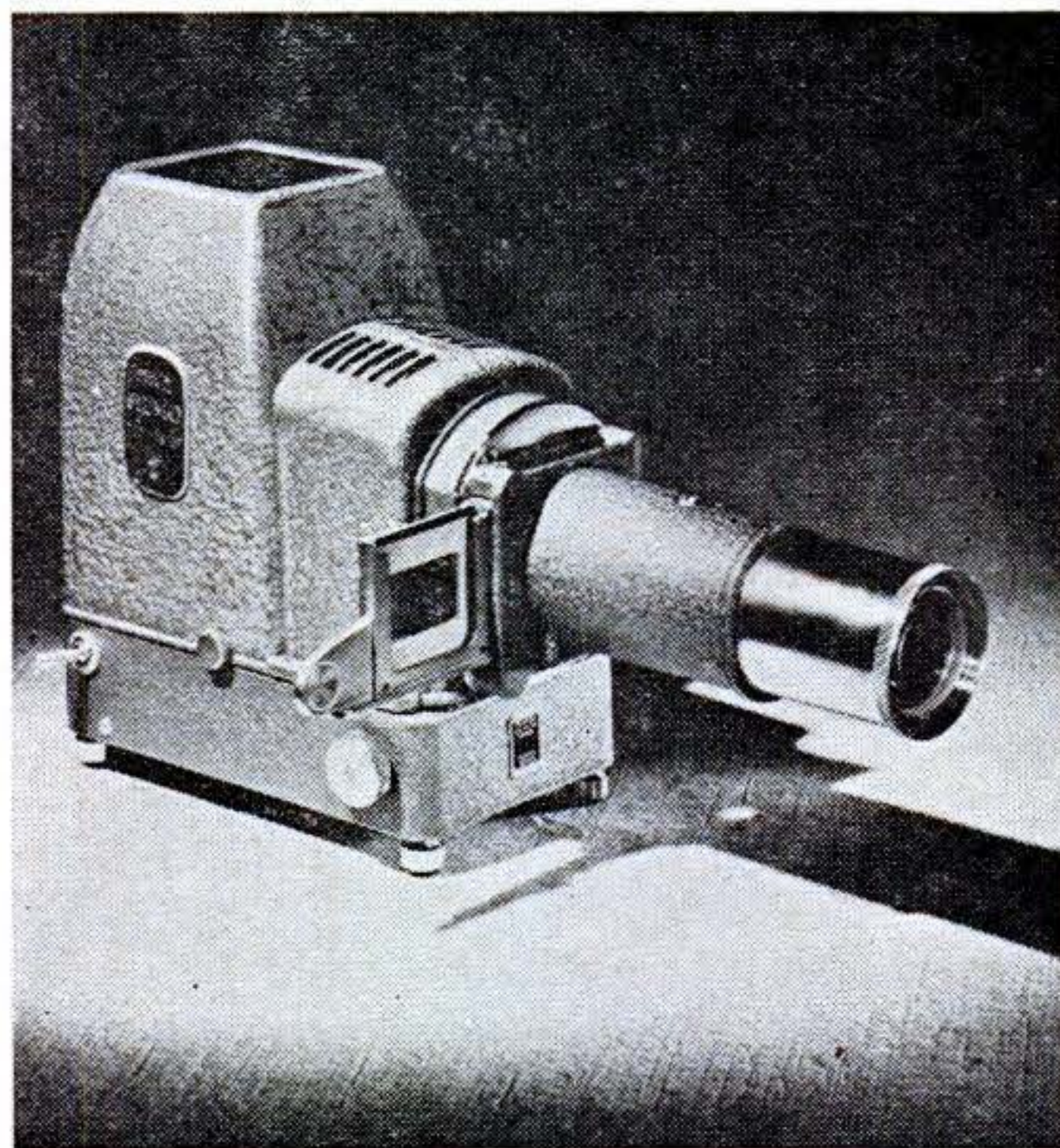

Projector Protects Slides

THE Filmo Duo-Master projector for two-by-two-inch slides has a heat-absorbing glass filter and a slotted slide carrier, which protect slides against damage resulting from high temperatures.

Dependable

CHAMPION

AMERICA'S FAVORITE SPARK PLUG

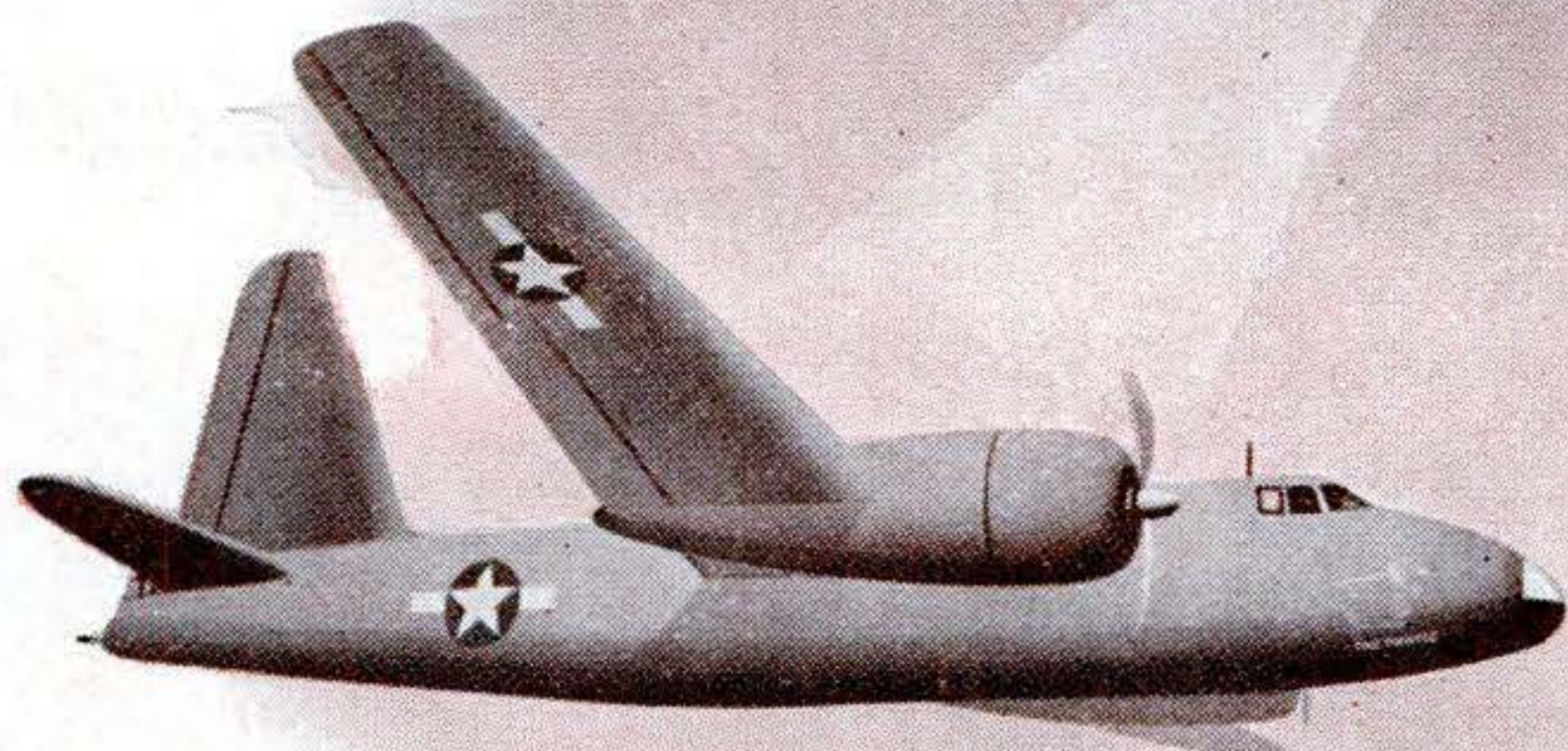

When the Navy's Patrol bomber "Truculent Turtle" set a world's non-stop long distance record in a flight of over 11,000 miles, it was equipped with Champion Spark Plugs. This flight from Perth, Australia, to Columbus, Ohio, provided another exceptional example of the outstanding dependability of Champion Spark Plugs. The name Champion and the word "dependable" are synonymous, a fact that has made it America's Favorite Spark Plug — for every engine. Champion Spark Plug Company, Toledo 1, Ohio.

FOLLOW THE EXPERTS
DEMAND DEPENDABLE
CHAMPIONS FOR YOUR CAR

Listen to the CHAMPION ROLL CALL, Harry Wismer's fast sportscast every Friday night, 9:55 EST over the ABC network

MAY
1947 227

Ingenious New Technical Methods

To Help You
Simplify Production



Precision Adapter for Drill Presses Perfects Alignment, Prevents Drift!

The new Aetna Adapter, of aluminum alloy, fits the columns of most small drill presses—assures accurate milling and deep hole drilling—without a drill jig. It firmly and accurately holds interchangeable drill bushings close to work.

Precision Alignment is accomplished through an eccentric aligning bushing, which once set needs no further adjustment. Filler bushings cover the entire bushing range up to $\frac{1}{2}$ ". Stops to locate the piece to be drilled, are attached to the press table or directly to the adapter. Milling chatter is avoided. Chip interference is eliminated. Overlapping holes can be drilled without punch marks, or indication of run-out, with drills as small as $\frac{1}{32}$ " diameter. $\frac{1}{4}$ " holes can be drilled more than 6" deep with as little as .006" drift.

Accuracy in work is achieved best by alert workers. That's why many plant owners make chewing gum available to all. The chewing action helps relieve monotony—helps keep workers alert, aiding them to do a better job with more ease and safety. And they can chew Wrigley's Spearmint Gum right on the job—even when hands are busy.

You can get complete information from
Aetna Mfg. Co., 250 Chicago Ave., Oak Park, Ill.

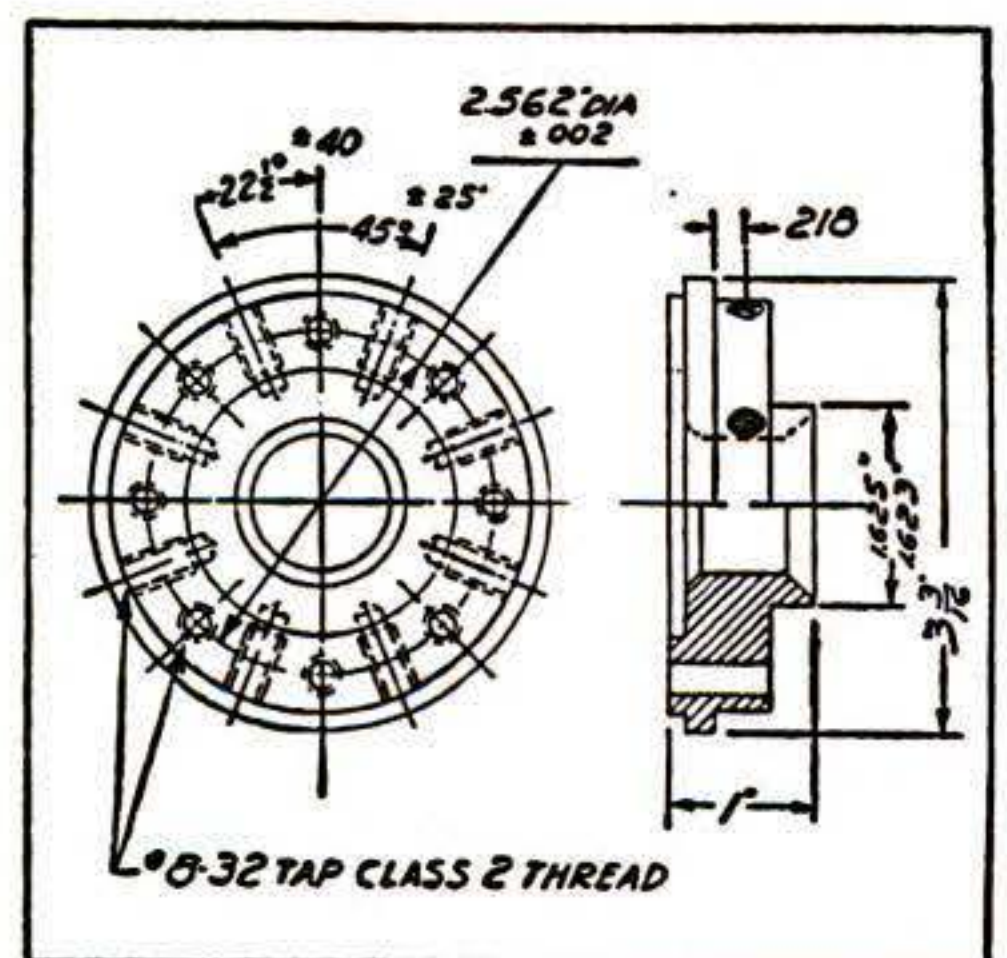

Example of piece drilled with Aetna Adapter



AB-63

Clean up your Horsepower

New smoothness, zip and power--that's what a Casite motor clean-up does for your car. Casite frees sticking valves and rings . . . retards formation of sludge and gum . . . speeds lubrication.

and keep it clean...

Everyone knows a clean motor runs better and lasts longer, so use Casite regularly—a pint through the air intake every three months and a pint in the crankcase every oil change.

the Guaranteed Way!

Double-Your-Money-Back if your car doesn't run better and smoother with Casite. And Casite makes this famous guarantee no matter what kind of motor oil you're using. Service stations, garages and car dealers everywhere sell Casite. The Casite Corporation, Hastings, Michigan, and the Casite Division, Hastings Ltd., Toronto.

**CLEANS MOTORS
KEEPS MOTORS CLEAN**



65¢ A PINT
75¢ IN CANADA

MAY 1947 229

USE AC's FOR
**UTMOST
 RELIABILITY**

"The mail must go through"—and does, with the help of today's AC's in thousands of mail cars and trucks. You can enjoy utmost reliability in spark plug performance by having your spark plugs checked to be sure they are right for today's driving and fuels.



Look for this sign



Spark Plugs cleaned and adjusted "By the AC Method" may save as much gas as 1 gallon in 10



SPARK PLUGS

AC SPARK PLUG DIVISION • GENERAL MOTORS CORPORATION

230 POPULAR SCIENCE

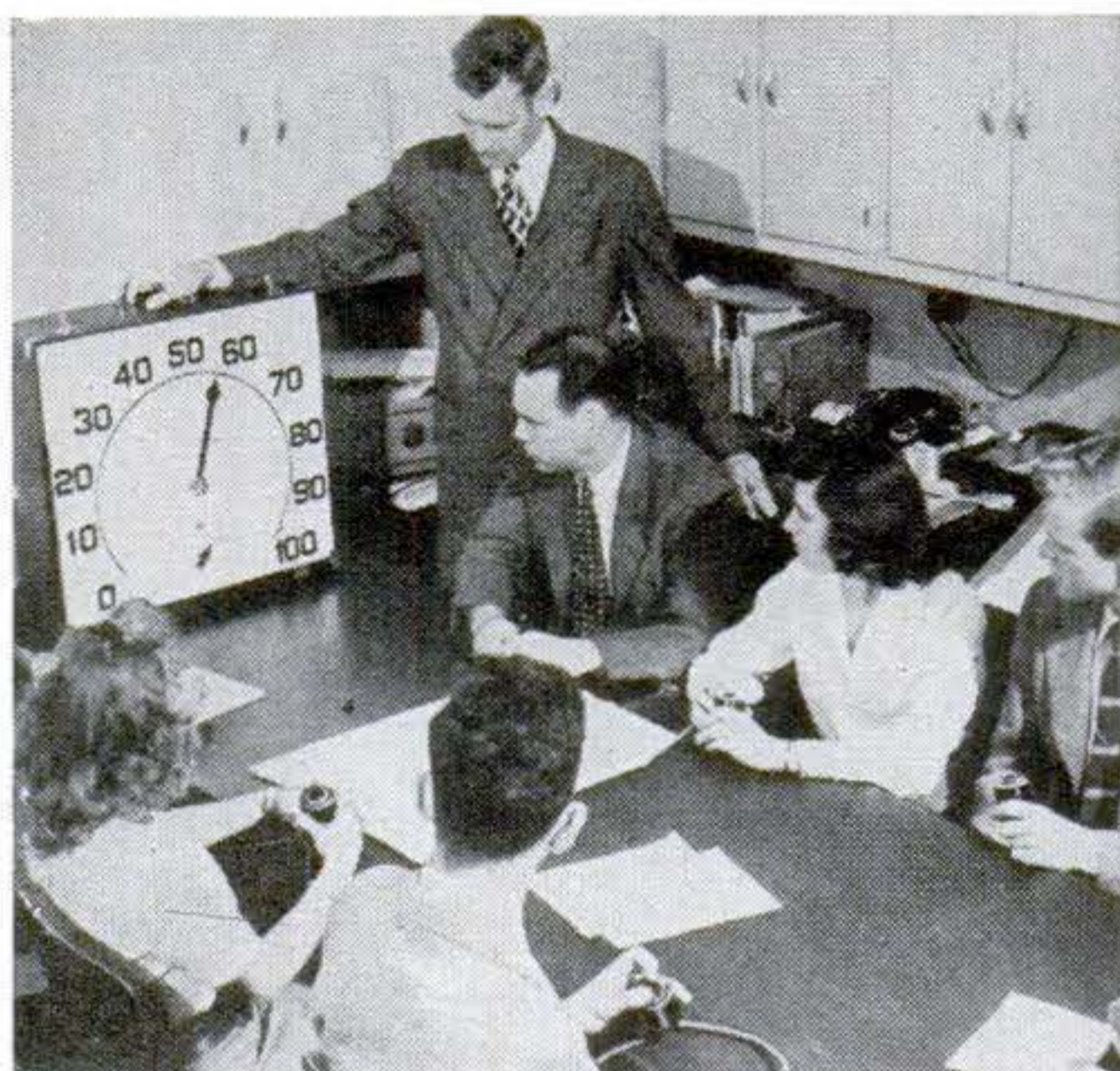

Meters "Ayes" and "Nays"

MASS decisions of up to 120 persons can be secretly compiled by General Electric's new electric opinion meter. Individuals set the hands of units at their seats at a number that represents their judgment. These settings are registered on a central indicator, where a large sweep hand moves clockwise from zero around to the number that sums up the opinion of the majority.



Massage Unit Supplies Heat

WITH the new Roll a Ray it is possible to have a rubdown and an infrared heat treatment at the same time. Its plastic case houses an infrared lamp and two rubber massaging rollers.

CLASS ALWAYS TELLS by FRANK WILLIAMS

POLO'S LATEST SENSATION

PETER PERKINS

...AT 26, YOUNGEST PLAYER EVER NAMED TO REPRESENT THE U.S. IN INTERNATIONAL MATCHES!

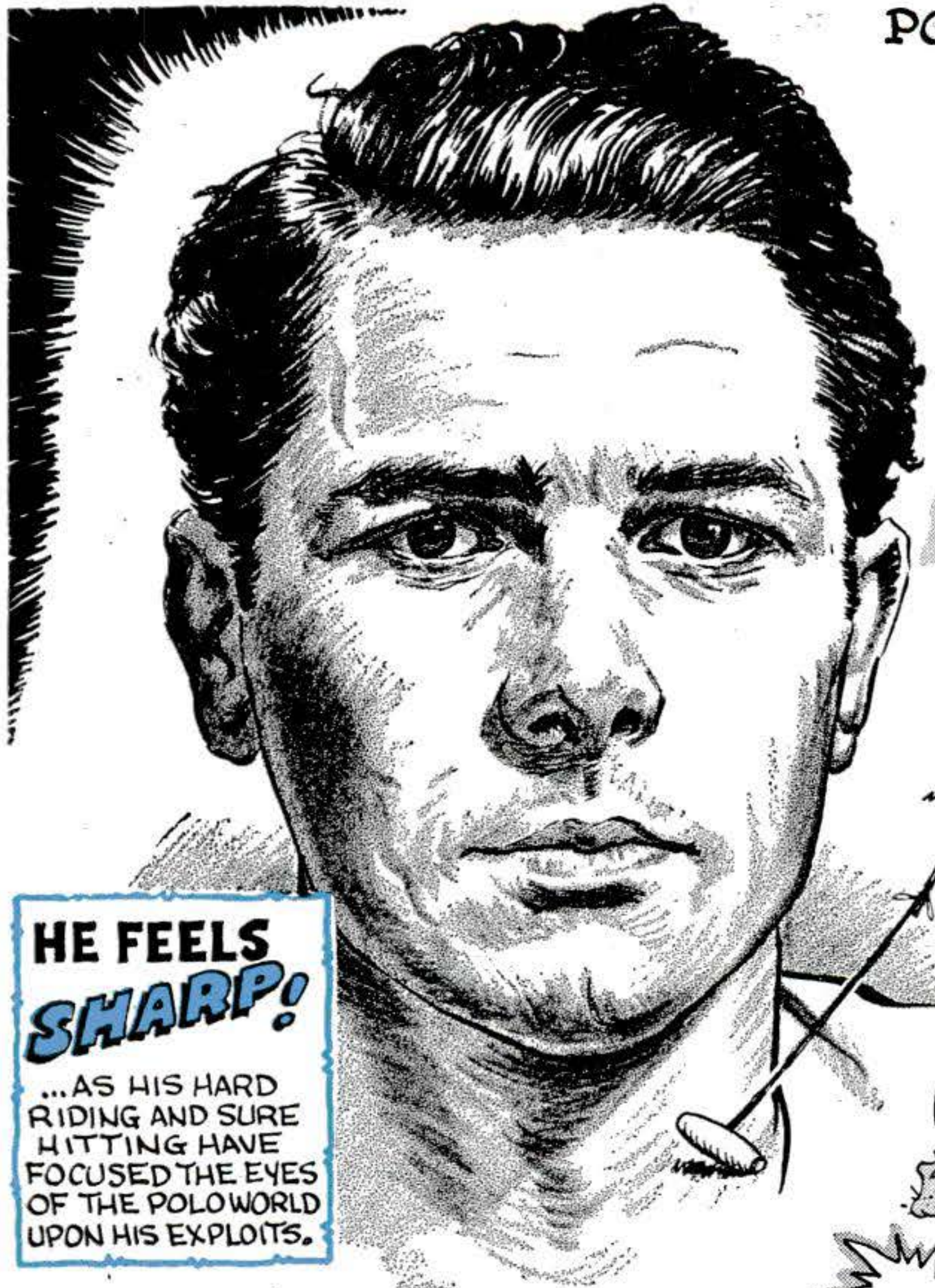

...PETE STARTED PLAYING AT 15...

HE LOOKS SHARP!
...THE CALIFORNIAN'S BRILLIANT Mallet PLAY SHOWS NO EVIDENCE THAT HE WENT THROUGH THE BATAAN DEATH MARCH AND THREE AND A HALF YEARS IN JAP LABOR CAMPS.

HE FEELS SHARP!
...AS HIS HARD RIDING AND SURE HITTING HAVE FOCUSED THE EYES OF THE POLOWORLD UPON HIS EXPLOITS.

look SHARP
feel SHARP
be SHARP

use
Gillette
Blue Blades
with the SHARPEST edges ever honed!

● You look sharp for you enjoy the swellest shaves ever. You feel sharp because they're refreshing and give you a lift. You are sharp for you get far more shaves per blade and save money. Ask for Gillette Blue Blades.



5 for 25¢

ENJOY BOXING FRIDAYS OVER ABC NETWORK. GILLETTE'S CAVALCADE OF SPORTS ALSO AIRS THE KENTUCKY DERBY, MAY 3, AND OTHER CLASSICS YEAR 'ROUND.



HE IS SHARP!
...PETE ENJOYS THE CLEANEST, SMOOTHEST SHAVES A FELLOW CAN HAVE, FOR HE ALWAYS USES GILLETTE BLUE BLADES WITH THE SHARPEST EDGES EVER HONED. YES, AND HE SAVES MONEY, TOO, FOR DOUBLE EDGES MEAN DOUBLE ECONOMY!

Gillette Safety Razor Company, Boston 6, Mass.

Copyright, 1947, by Gillette Safety Razor Company

MAY 1947 231

Planes, Pets, Puppets

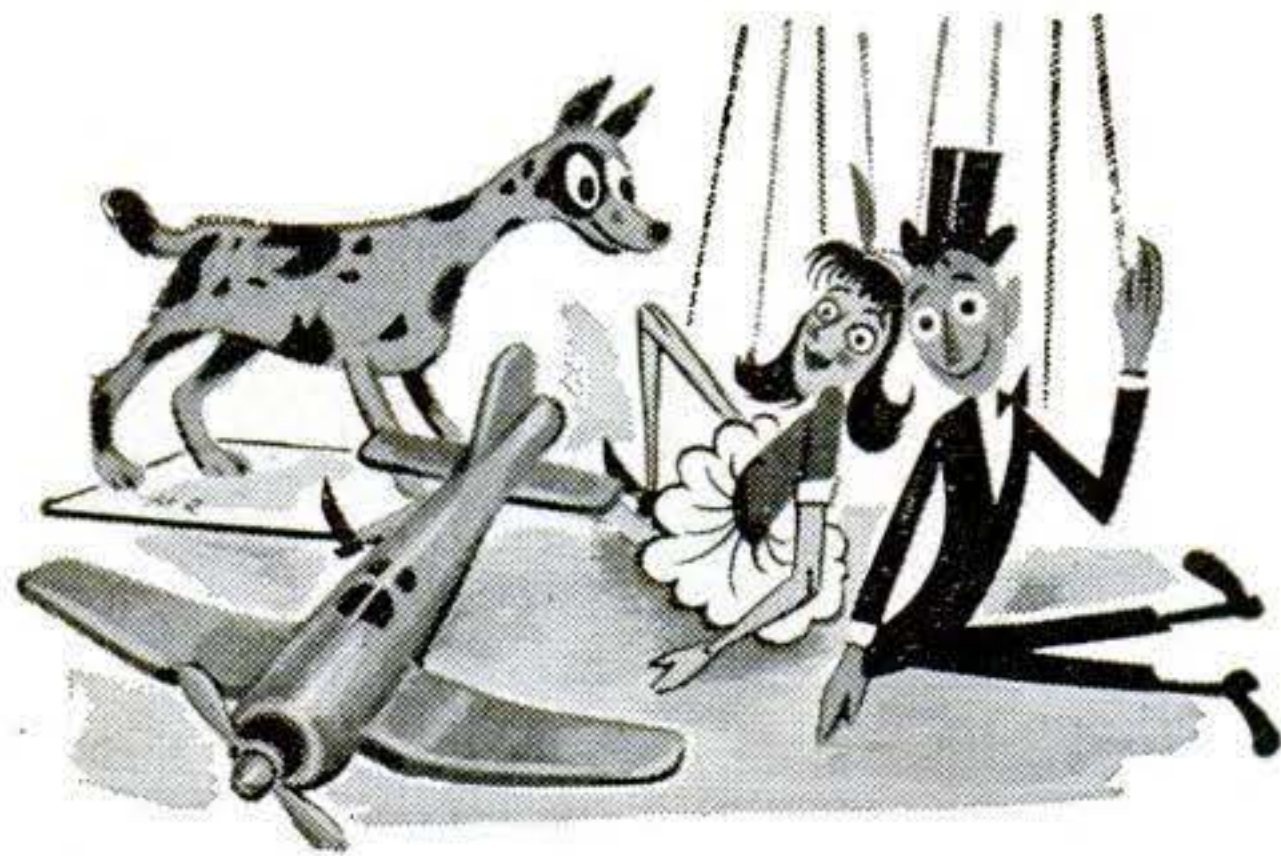

all "duck-soup" with X-acto!

Experts prefer X-acto because it's always sharp, always ready, with the just-right blade and tool for every job. Amateurs find X-acto's safer, surer — helps them turn out better jobs, makes them *feel* like experts. Try X-acto for your hobby!

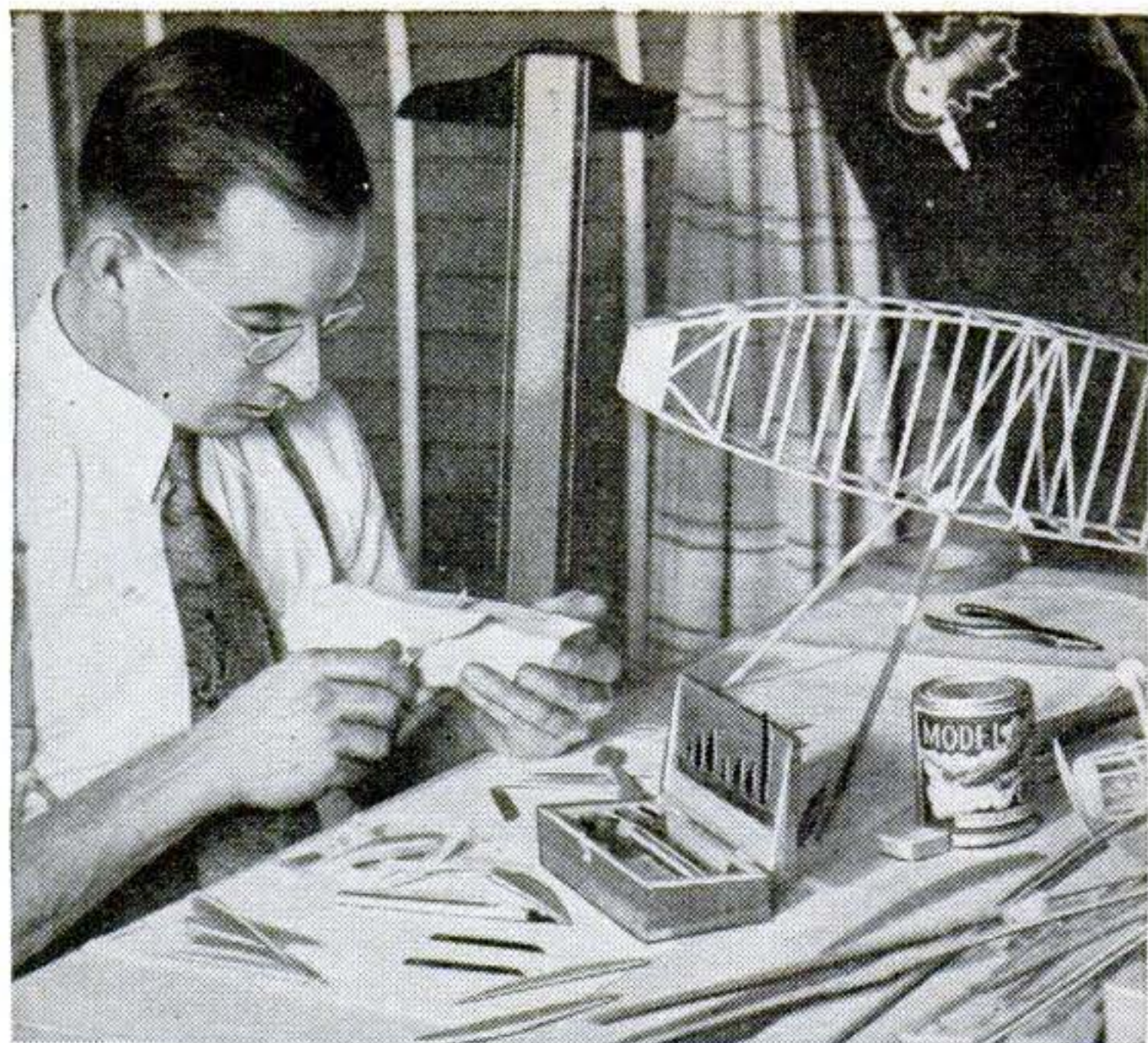

Grand Championship Trophy winner at Toronto's Eaton Contest, R. Bruce Lester finds X-acto "helps turn out better models . . . best of all the knives I've used in building models for 20 years!"

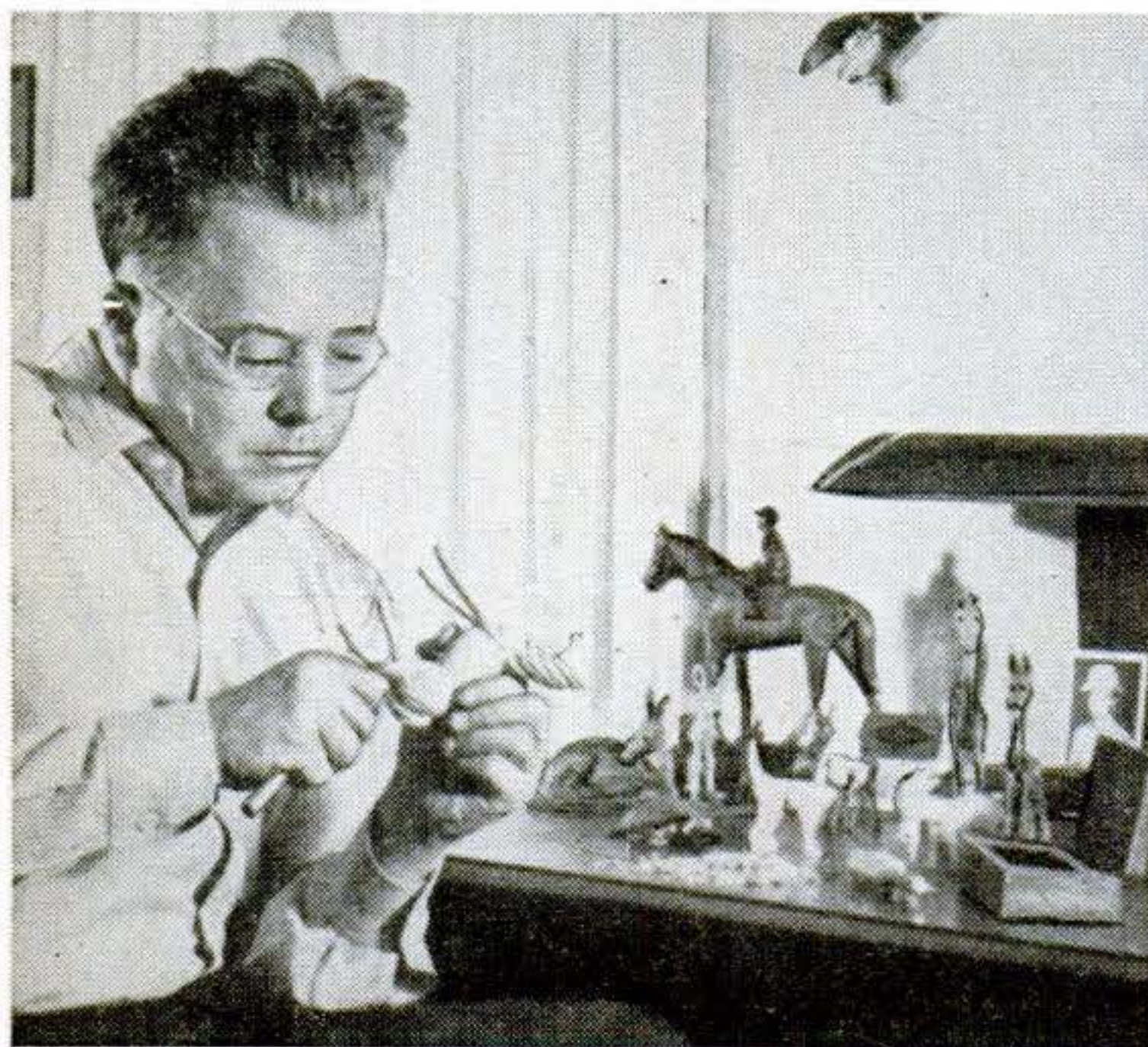

Expert Whittler and Wood-Carver Leroy Pynn, Jr. of Wisconsin says "X-acto's variety of shapes and sizes means a lot to a constant whittler . . . and it stands up just as well with hard as with soft wood."

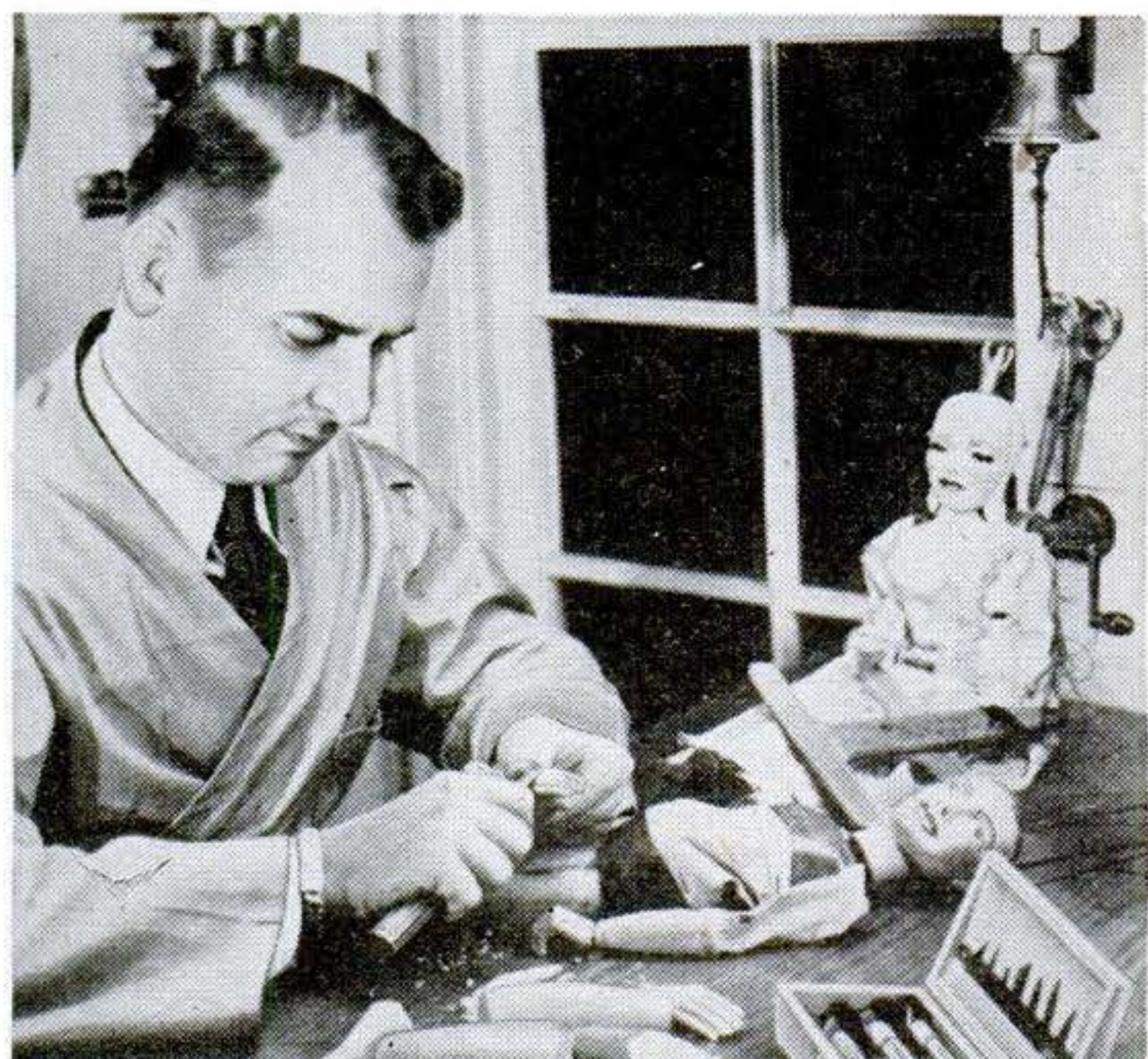

Puppetry Instructor Bernard H. Paul at Maryland Institute of Art recommends X-acto Knives "for detail work on heads, as well as for heavier body carving . . . and because they're so easily handled even for a beginner."

X-acto^{*}

HANDICRAFT KNIVES & TOOLS

*Singly or in sets, 50c to \$50.
At hobby, gift and hardware shops*

X-acto Crescent Products Co., Inc., 440 Fourth Av., N. Y. 16
In Canada: Handicraft Tools, Ltd., Hermant Bldg., Toronto

Prices slightly higher in Canada **Reg. U. S. Pat. Off.*

NEW!
only
\$3

THE PERFECT TOOL
for wood, linoleum, plastics. No. 77 X-acto Woodcarving Set: 6 chisel and gouge blades; 4 assorted regular blades; 2 three-inch blades. Special handle takes all blades.

PALS

AUTOMATIC HEAT AND HONEYWELL CONTROLS



FOR more than 60 years, the leading manufacturers of heating equipment and Minneapolis-Honeywell have worked together to raise the standard of home heating comfort. The healthful, even temperature maintained by Honeywell is enjoyed in millions of homes, both large and small.

For your own greater comfort, make sure that your heating plant is fully automatic with Honeywell controls.

If you want the last word in heating comfort, install Moduflow, the remarkable new Honeywell control system. Ask your heating dealer about the new developments in automatic heating equipment — and Moduflow.

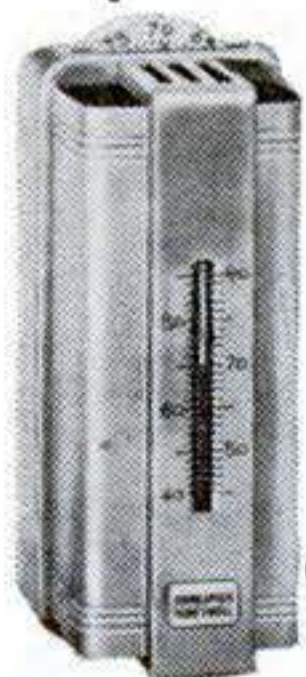

HONEYWELL

Automatic
HEATING CONTROLS

Minneapolis-Honeywell Regulator Company, Minneapolis 8, Minnesota . . . Canadian Plant: Toronto 12, Ontario.

MAY
1947 233



Ozonizer Shoos Room Odors

THE portable Refresh-Aire room ozonizer removes odors by ionizing oxygen with a Sylvania electronic ionization tube, much as lightning bolts freshen the air by creating ozone. The conditioner, which measures only 7¼ by 5¼ by 4¾ inches, uses 10 watts on 110-volt, 60-cycle current.

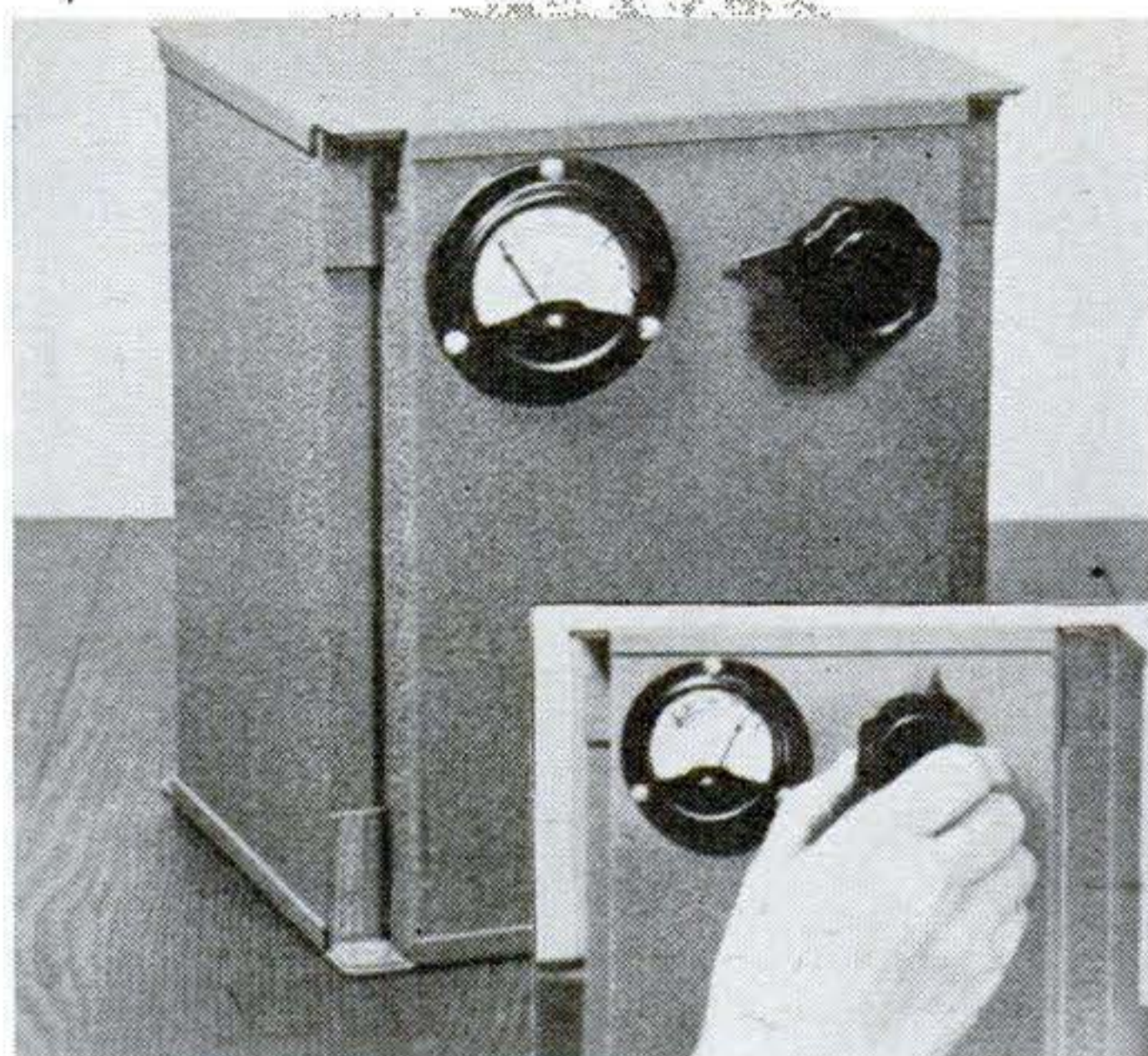

Even Power for Projectors

IN AREAS where the power supply is fitful, the Victor Voltage Regulator for 16-mm. film projectors holds the power to a correct, uniform level. In so doing it lengthens the life of lamps, improves both the motion pictures and the sound and decreases usual replacement costs.

SO MANY THOUSANDS SAY:

"America's Great Fishing Motor"

Ask your experienced fishin' friends what outboard motor they recommend for sweetest performance, easiest handling and all around dependability. Such a big percentage of America's fishermen own Johnsons that we are sure of the answer you will get. Expert fishermen know outboards from experience. And there is no substitute for experience!

FREE HANDY CHART: Full details on all Johnson Sea-Horses. Write. JOHNSON MOTORS, 500 PERSHING ROAD, WAUKEGAN, ILLINOIS
Johnson Motors of Canada, Peterboro, Canada

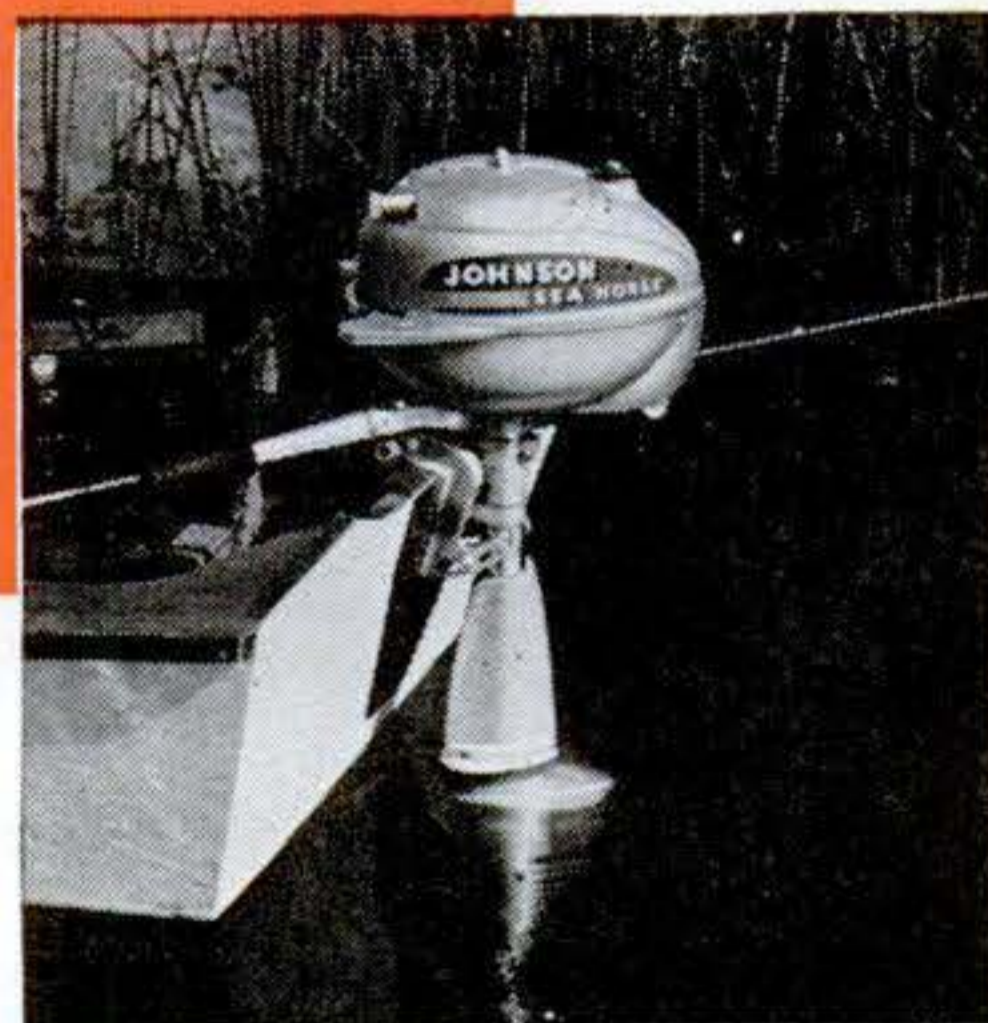

FAMOUS FOR DEPENDability

See your Johnson Dealer about delivery. Look for his name under "Outboard Motors" in your classified phone book.

JOHNSON SEA-HORSE

NEW

EVEREADY

TRADE-MARK

FLASHLIGHT BATTERIES

*Now last 93% longer!**

Packs Enough Energy for 3 400-lb. Bar Bell Lifts!

Can YOU raise 400 pounds 7 feet in the air? A few champion strong men can . . . But the energy of *one* tiny "Eveready" flashlight cell, properly expended, could perform this back-breaking feat 3 times! Think of this kind of energy when you buy flashlight cells . . . ask for "Eveready" batteries every time. *Still 10¢ each.*

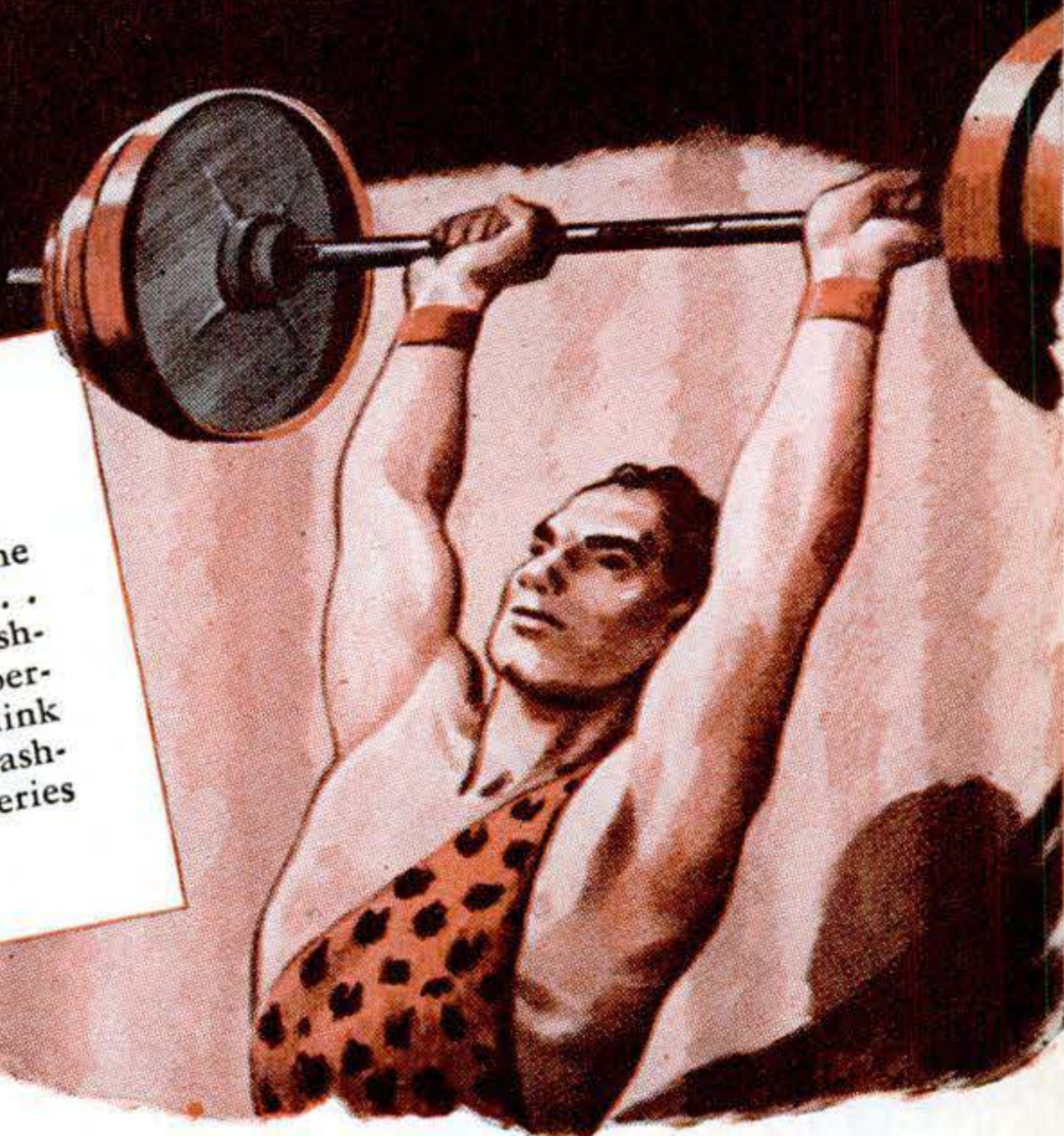

● You've got a "pipe line to the powerhouse" when your flashlight contains these great new "Eveready" cells. For they give you nearly double the energy that pre-war "Eveready" batteries gave you. No wonder these are the largest-selling flashlight batteries in the world! No wonder it can be said, "Get 'Eveready' brand flashlight batteries . . . and you get the best!"

The registered trade-mark "Eveready" distinguishes products of **NATIONAL CARBON COMPANY, INC.**
30 East 42nd Street, New York 17, N. Y.
Unit of Union Carbide and Carbon Corporation

UCC



* Nearly *twice* the electric energy. *That's* today's *high-energy* "Eveready" battery, as proved by the "Light Industrial Flashlight" test devised by the American Standards Assn.



High Energy

MEANS BRIGHTER LIGHT, LONGER LIFE



Sweeping the Country



Speed Sweep
**THE BRUSH WITH
THE STEEL BACK**

Speed Sweep brushes are replacing old style brushes in thousands of factories, warehouses, and stores because they sweep faster, cleaner and easier. Speed Sweep brushes also outlast ordinary brushes 3 to 1. There is a Speed Sweep to meet every requirement. Write for styles, sizes and prices today.

Milwaukee Dustless Brush Co,
530 North 22nd Street
Milwaukee 3, Wis.
Please send me complete information about
Speed Sweep brushes.

Name _____
Address _____
City _____ State _____

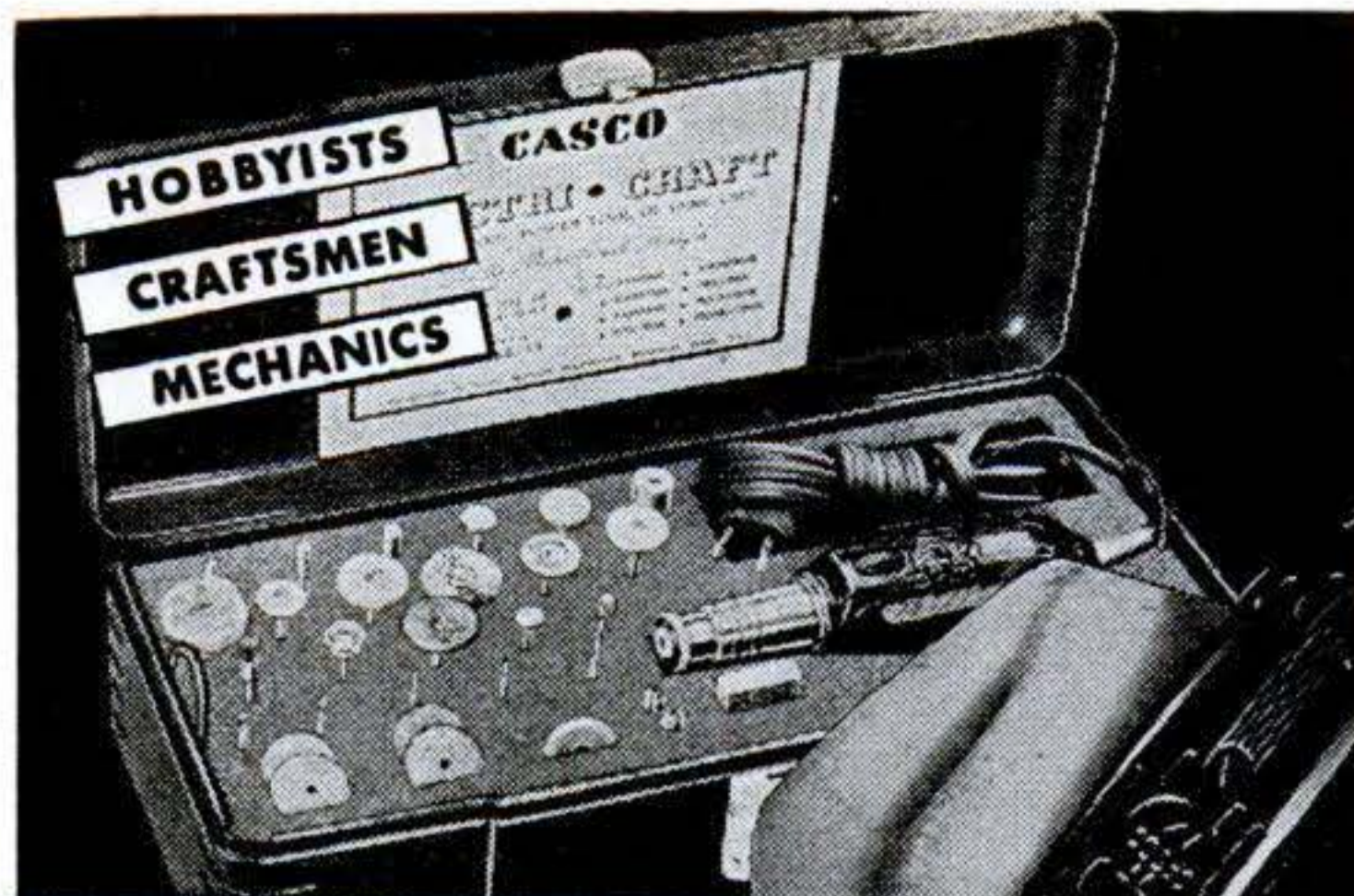

**A WHOLE SHOP
FULL OF TOOLS
IN ONE!**

Use it for grinding, routing, drilling, sawing, polishing, carving, sanding and 9,994 other uses. Increases your skill and your scope. Precision-engineered, AC-DC. More exclusive features than any other tool.

Exclusive
Safety
Fingergrip
for fine
detail work

\$2250

**COMPLETE WITH 36 ACCESSORIES
IN FITTED STEEL CASE**

\$32.95 Value if
Purchased Separately

Works **Wood, Metal,
Glass, Plastics**

CASCO ELECTRI-CRAFT TOOL KIT

CASCO PRODUCTS CORPORATION, BRIDGEPORT 2, CONN.

PLASTICS

PRACTICAL HOME-STUDY COURSE

One kit each month—12 month complete course

\$1.00 BRINGS FIRST LESSON

Refundable to students taking complete course

Full scale drawings in each kit. Basic through advanced techniques. Ideal course for homeworkshop hobbyists and those who want to supplement their incomes. Not designed to make you a plastics engineer but gives you a complete, practical knowledge of making small plastics projects such as: cigarette boxes, bathroom fixtures, cocktail trays, coffee tables and many others. Send in your \$1.00 today for your first lesson.



"U-Make It"

KOSTO PLASTI-KITS

3263 M St. N. W., Washington 7, D. C.

IF GLUE WILL FIX IT

FRANKLIN LIQUID HIDE GLUE

will do it better, faster, easier!

Ready-to-use Franklin makes joints stronger than the wood itself. Saves time — no mixing, no heating. Banish unpleasant odors, avoid chilled joints with Franklin Liquid Hide Glue.

The FRANKLIN GLUE CO., COLUMBUS 15, O

AT YOUR HARDWARE DEALER



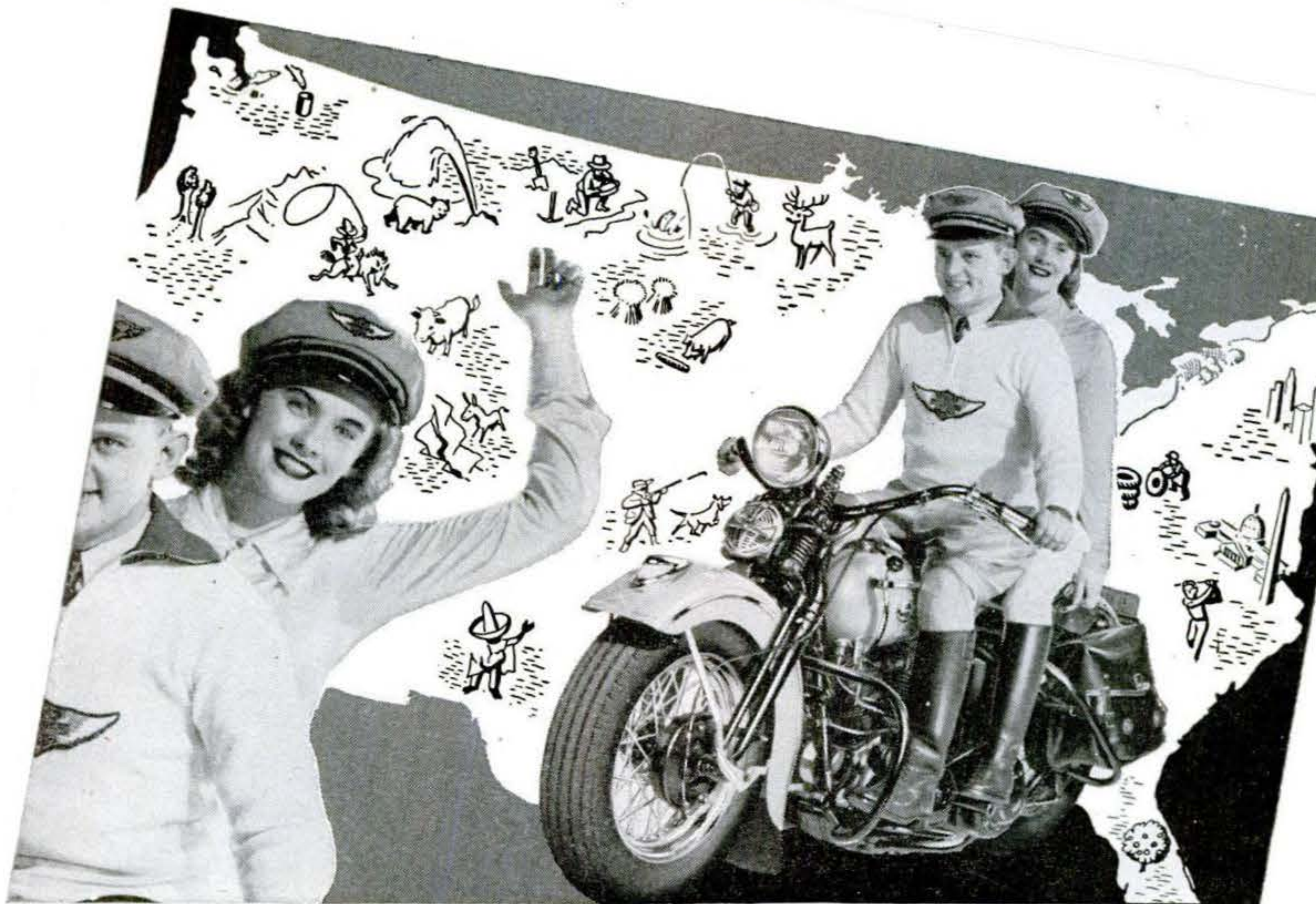

OWN A HARLEY-DAVIDSON

and make the entire country your vacation land

Enjoy the most thrilling vacation of your life this year—on a Harley-Davidson. It brings most of the country's historic places, natural wonders and famous fun spots within easy range. Go whenever you get the urge—stop where and when you choose—with no timetables to follow. What's more, motor-

cycling turns every evening, holiday or weekend into extra "vacation-time"—as you zoom along with other fun-loving riders on pleasure jaunts and club runs—or take in race-meets, hillclimbs and other thrill-packed motorcycling events. See your Harley-Davidson dealer NOW—and mail coupon today!

HARLEY-DAVIDSON *Motorcycles*

HARLEY-DAVIDSON MOTOR CO., Dept. P5, Milwaukee 1, Wisconsin

Please send at once free copy of 24-page "ENTHUSIAST" Magazine, filled with thrilling motorcycle action pictures and stories.

Name.....

Address.....

City..... State.....



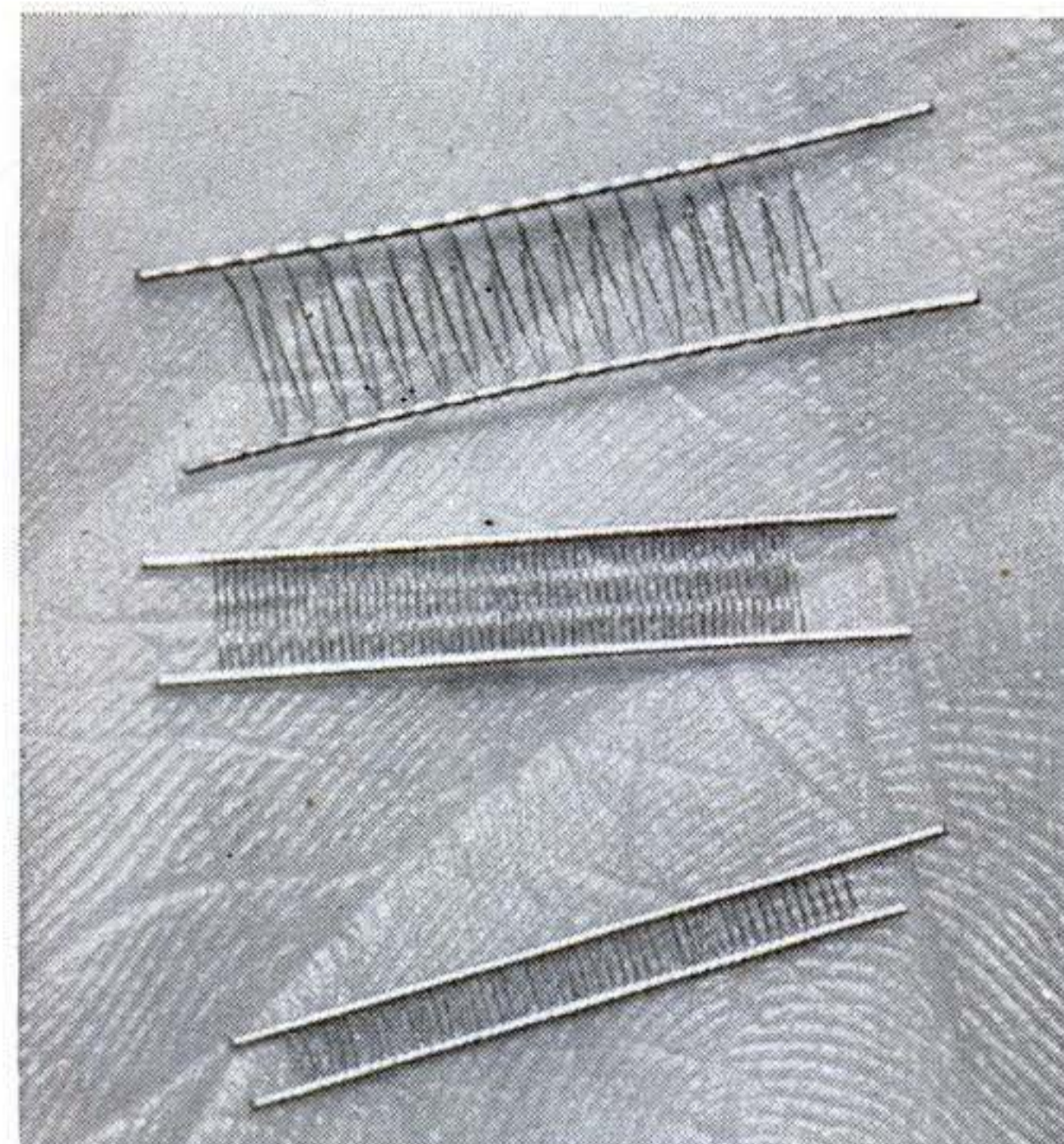
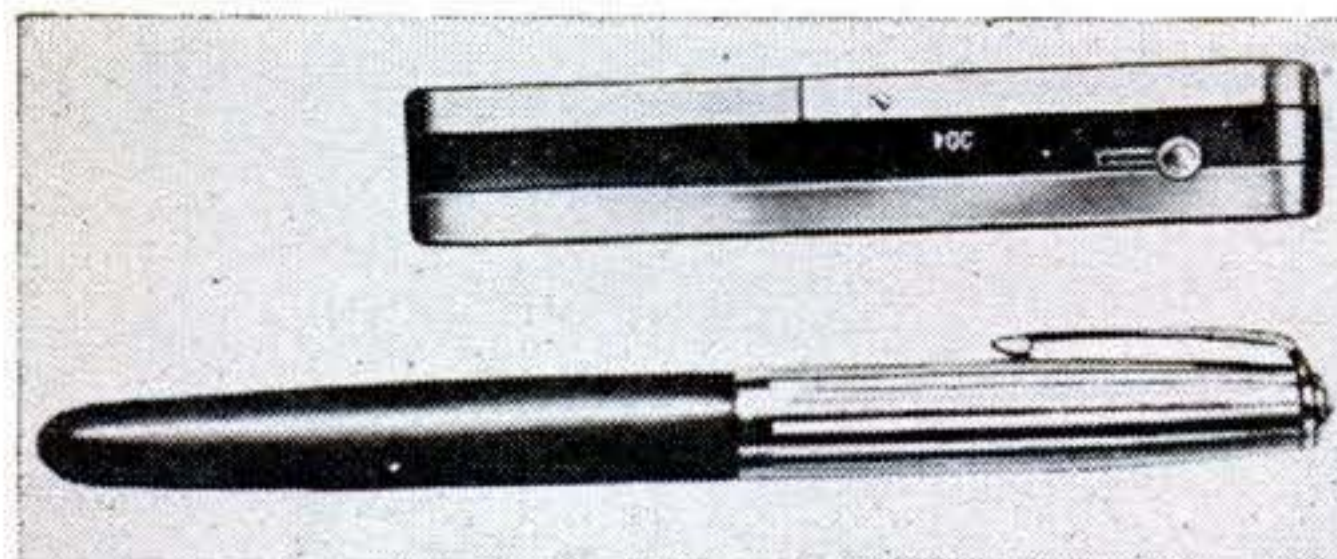
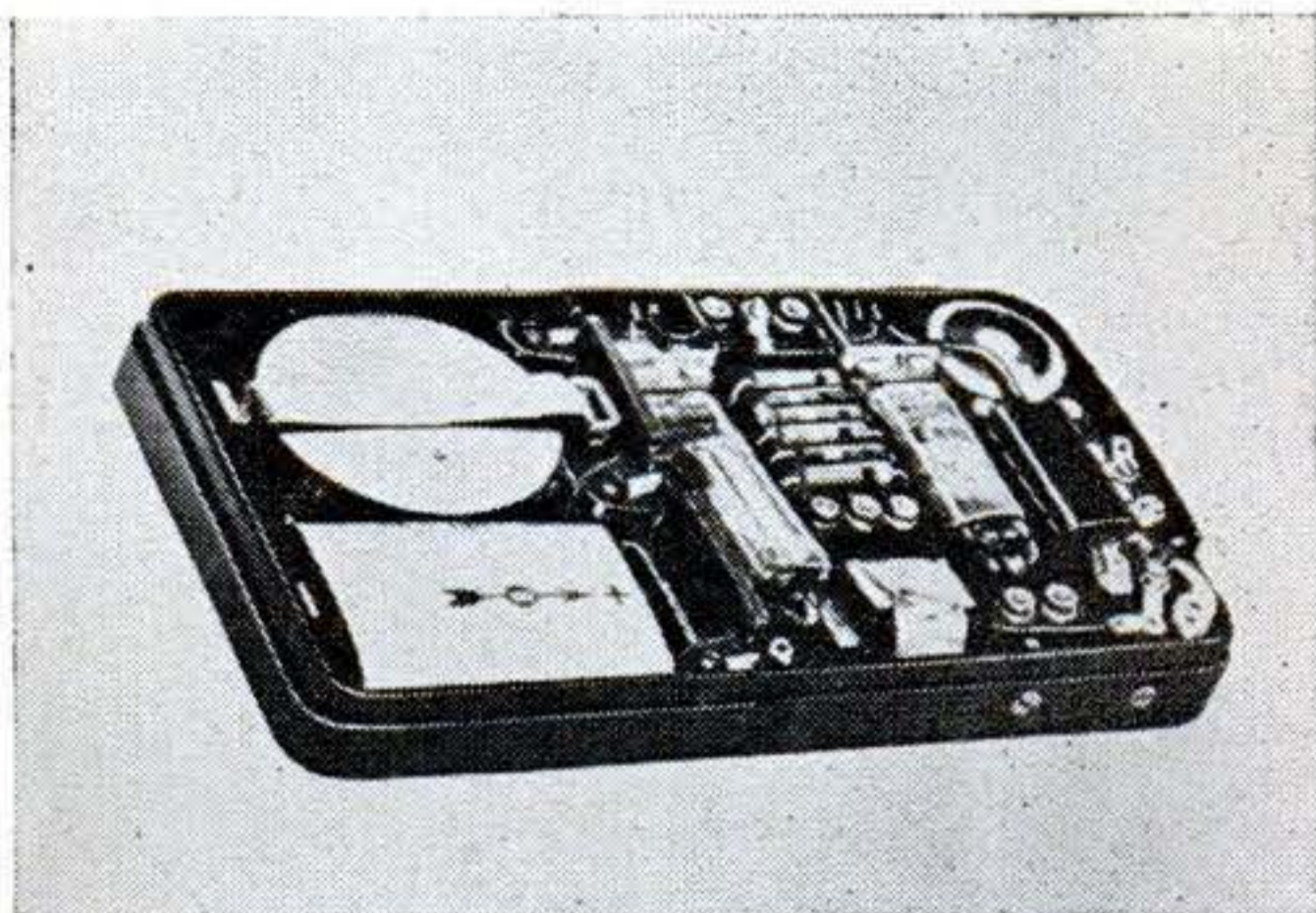

Pocket Hearing Aids Shrink

USING tiny tubes and batteries originally designed for the proximity fuse, the latest Acousticon hearing aid (above) combines power supply and amplifier in one container no larger than a cigarette case. Shorter than a fountain pen and almost as thin (top right), it weighs only 5½ ounces yet provides as much volume as the largest old-style aids. The tiny, ladderlike grids at right, shown against the skin pattern of a human hand, are part of the miniature tubes in a new Sonotone hearing device.

Luther POWER GRINDERS

HAND AND POWER GRINDERS

Like all Luther Grinders, the power grinder shown here is famous for high quality and rugged construction. It is built to exact specifications for those who demand fine tools. For the Luther grinder that fits your needs, see your hardware dealer.

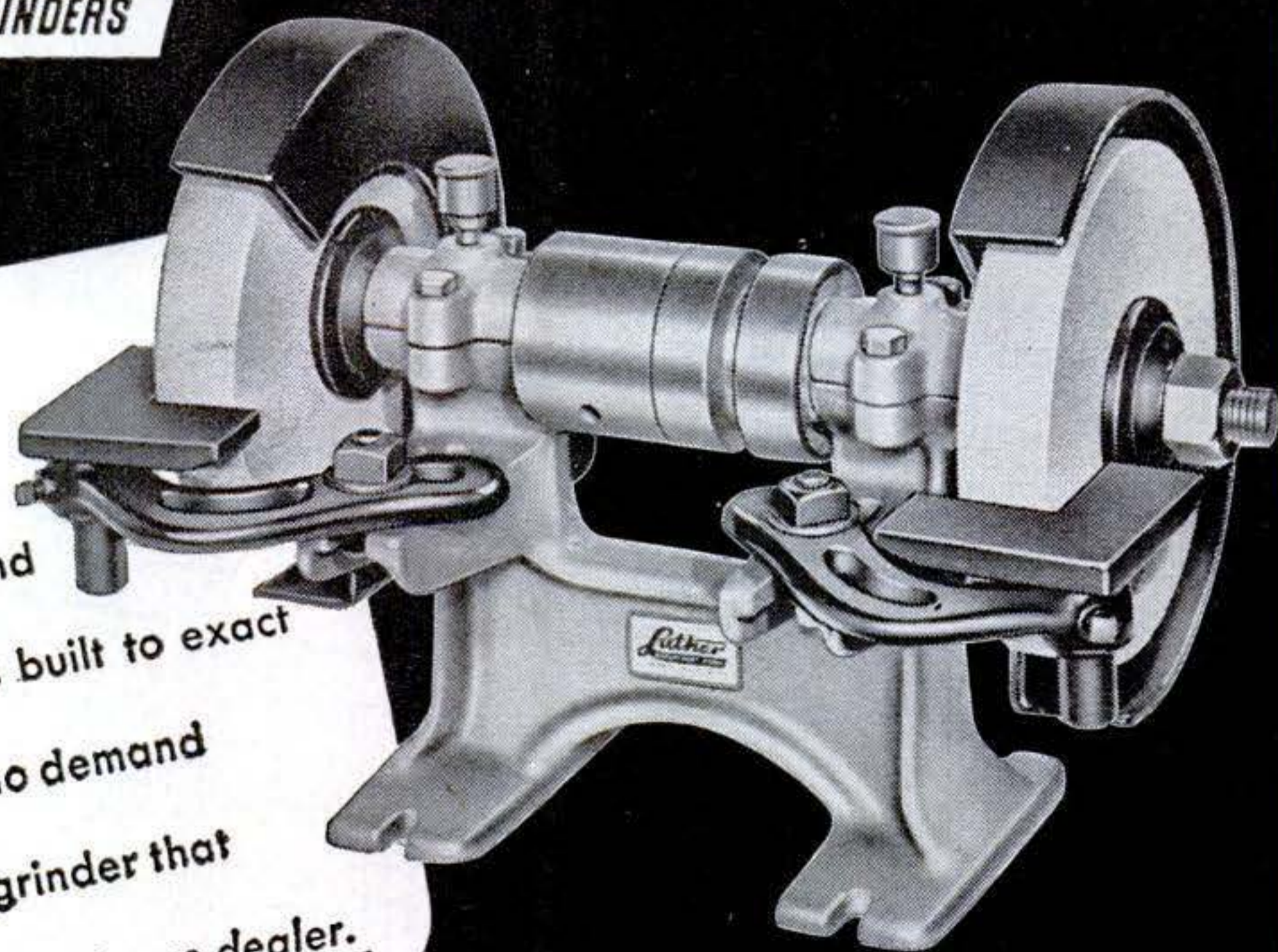

LUTHER GRINDER & TOOL CO.
(Established 1896) Sheboygan, Wisconsin

Here's your "FOUR" - for more fun
fishing

EVINRUDE

Zephyr

FOUR CYLINDERS

One top choice! . . . if you want the kind of motor that just naturally seems to do all things better! It's a pedigreed Evinrude "Four" for the smoothest, sweetest outboard power you've ever dreamed! It's an Evinrude "Four" for hair-trigger starting ease and sureness. It's an Evinrude "Four" for utmost flexibility, for thrilling responsiveness.

In the 5.4 horsepower Zephyr it's all yours . . . all the glorious performance of a "Four" packed into a motor of the most popular size for average service. Try it—ride with it—learn what 38 years of know-how have contributed to fine outboard performance!*

See your Evinrude Dealer! Look for his name in your classified phone directory under "Outboard Motors". Evinrude Catalog FREE. Write today for catalog of the complete Evinrude line. Address, EVINRUDE MOTORS, 5533 N. 27th Street, Milwaukee 9, Wis.

*In Canada: Evinrude Motors,
Peterboro, Ontario.*

**5.4 O.B.C. certified brake H.P.
at 4000 R. P. M.*

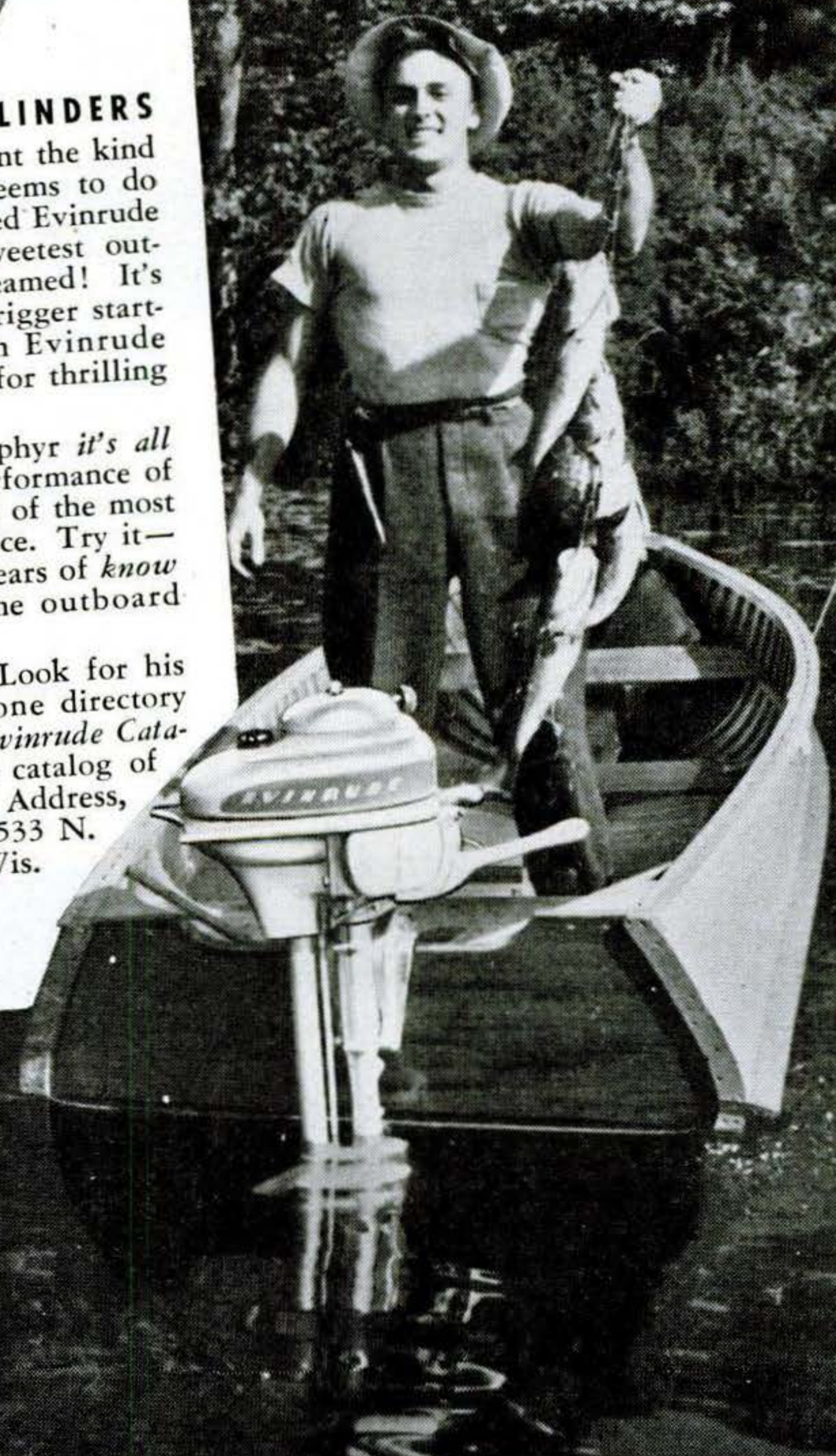

FIRST IN OUTBOARDS
— 38TH YEAR

EVINRUDE

MAY
1947 239

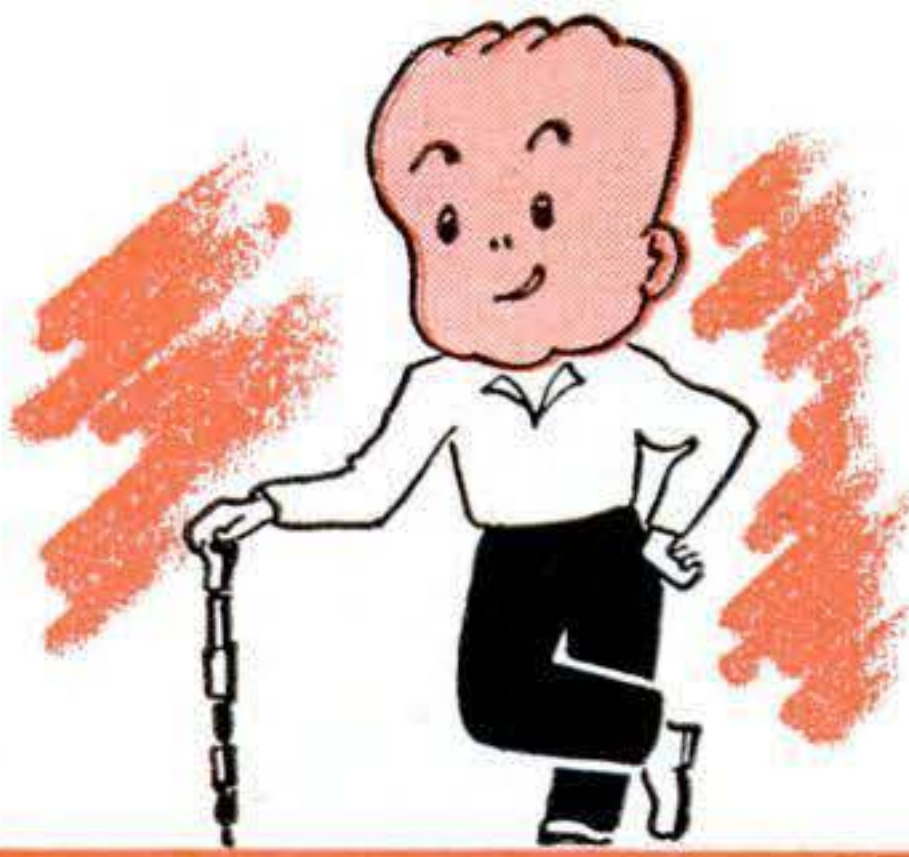

**Save Time
on Routine Jobs**

with an AUTOMATIC SCREW DRIVER

Whether it's light production assembling or a routine home workshop job, you can save a lot of time with a Millers Falls Automatic Screw Driver. This unique spiral ratchet tool can handle any screw driving job quicker and easier. By simply shifting the knurled control sleeve and the spiral lock nut, it can be used either as a regular rigid screw driver, a right or left hand ratchet, or as a complete automatic. Made with or without quick return.

Smooth, powerful action and tested dependability are built right into Millers Falls Automatic Screw Drivers. You can depend on them for long-lasting satisfaction. Ask to see one at your dealers today.

One thing in common—Quality



**MILLERS FALLS COMPANY
GREENFIELD • MASSACHUSETTS**



PRESSURE QUEEN

**FOUR CYLINDER
PORTABLE AIR COMPRESSOR
SPRAY PAINTING OUTFIT**

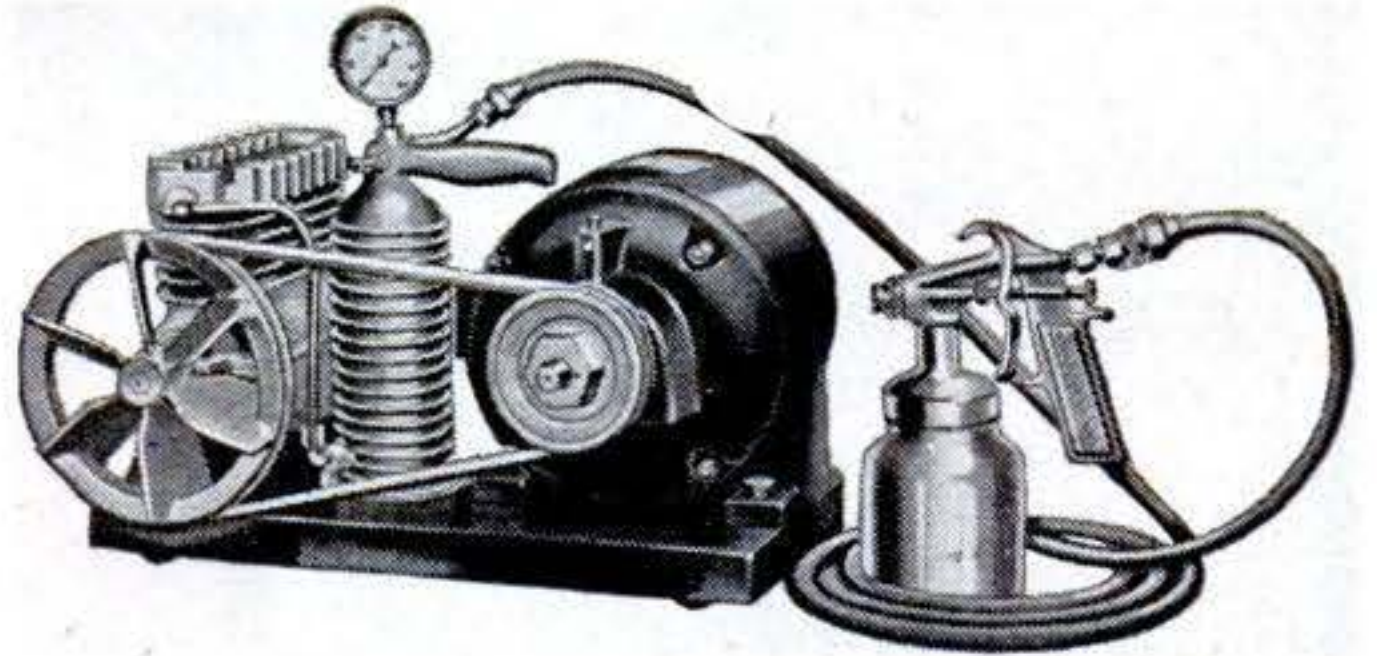

COMPACT • RUGGED • POWERFUL

The ideal air supply for home and farm workshop, machine shop, garage and contracting painter; for product finishing, inflating tires, painting automobiles, trucks, machinery, etc. Indispensable for building maintenance, interior and exterior. Handles any paint, insecticide or disinfectant.

This 4 cylinder compressor has drop forged crankshaft, stainless steel, heat treated valves; bronze bearings and positive forced feed lubrication. Maximum pressure 50-60 lbs., free from pulsation. Standard equipment includes the compressor mounted on steel base with carrying handle, belt, compressor pulley, air chamber, air gauge, 15-ft. hose, spray gun. Requires 1/2 or 2/3 h.p. motor or gas engine, not included.

If your dealer does not sell Pressure Queen write direct

THE CAMPBELL-HAUSFELD CO.

151 RAILROAD AVE.,

HARRISON, OHIO



MENDS

DISHES, TOYS, ETC.

It's clear, water-proof, flexible, durable.



DU CO CEMENT

REG. U. S. PAT. OFF.



CB PLYWOOD

Now Carmen-Bronson's immense purchasing power and direct mill connections come to your rescue on hard-to-get plywood! Look at the galaxy of scarce items listed here! Look at the prices—so low by prevailing standards that almost every one of them represents a genuine bargain! Hurry with your order before our immense stock is sold out! Order direct from this ad today.

1/8" CABINET & PANELING BIRCH

Birch Plywood is one of the most popular and economical materials for cabinet and paneling work. 3-ply; good one side, sanded one side, Urea-resin glued.

24"x24" panel, ea... \$.96
 24"x48" panel, ea... 1.92
 42"x48" panel, ea... 3.36
 36"x60" panel, ea... 3.60
 46"x48" panel, ea... 3.68
 48"x84" panel, ea... 6.72

1/4" CABINET & PANELING BIRCH

Same type stock as above, but in standard 1/4" thickness. 3-ply; good one side, sanded one side, Urea-resin glued.

21"x24" panel, ea... \$ 1.12
 21"x48" panel, ea... 2.24
 30"x48" panel, ea... 3.20
 42"x48" panel, ea... 4.48

13/16" CABINET BIRCH

Heavy duty 13/16" thick stock for cabinet and paneling applications. Lumber core construction. 5-ply; good one side, sanded one side, Urea-resin glued, 13/16" thickness.

24"x24" panel, ea... \$ 3.00
 24"x48" panel, ea... 6.00
 48"x48" panel, ea... 12.00
 48"x96" panel, ea... 24.00

1/8" BASSWOOD

Basswood, because of its soft texture, is tremendously popular for jig-saw work and other applications. 1/8" thickness, unsanded but very smooth, Urea-resin glued, 3-ply, good one side.

24"x24" panel, ea... \$ 1.04
 24"x48" panel, ea... 2.08
 36"x36" panel, ea... 2.25
 36"x72" panel, ea... 4.50

3/16" UTILITY GUM

An economical panel that should find many profitable applications in your production plans. Panels are good one side, smooth one side, unsanded, 3-ply, Urea-resin glued.

46"x60" panel, ea... \$ 3.80
 49"x62" panel, ea... 4.20

1/4" PANELING GUM

Same general type of stock as above but in popular 1/4" thickness. 3-ply; good one side, sanded one side, Urea-resin glued.

24"x42" panel, ea... \$ 1.75
 48"x42" panel, ea... 3.50
 48"x60" panel, ea... 4.95

3/16" MAPLE

An odd size lot of grade A panels which we are offering below mill cost. Panels are good one side, sanded both. 3-ply, Urea-resin glued.

28"x28" panel, ea... \$ 1.20

1/4" WESTERN CEDAR

You have undoubtedly known Western Cedar from your pre-war experience with fine paneling plywoods. Now it's

available from C-B warehouse stocks. Unexcelled for paneling applications. 3-ply; good one side, sanded both, Urea-resin glued.

24"x24" panel, ea... \$ 1.20
 24"x48" panel, ea... 2.40
 48"x48" panel, ea... 4.80
 48"x72" panel, ea... 7.20
 48"x96" panel, ea... 9.60

1/8" MAHOGANY

Mahogany has always been a great favorite among craftsmen and builders. For wall paneling, furniture, etc. 3-ply; good one side, sanded one side, Urea-resin glued.

24"x24" panel, ea... \$ 1.60
 24"x48" panel, ea... 3.20

1/4" MAHOGANY

Same general type Mahogany panels as above, but in popular 1/4" thickness. 3-ply; good one side, sanded one side, Urea-resin glued.

24"x24" panel, ea... \$ 1.80
 24"x48" panel, ea... 3.60
 48"x48" panel, ea... 7.20

3/4" MAHOGANY

Here is an attractive heavy duty 7-ply panel for cabinet work, furniture, paneling, etc. 7-ply; good one side, sanded both, Urea-resin glued, 3/4" thickness.

24"x24" panel, ea... \$ 3.20
 24"x48" panel, ea... 6.40
 48"x48" panel, ea... 12.80
 48"x96" panel, ea... 25.60

1/8" WALNUT

Walnut stock that represents plywood at its most attractive best. 3-ply; good one side, sanded both, Urea-resin glued.

24"x24" panel, ea... \$ 1.60
 24"x48" panel, ea... 3.20
 36"x36" panel, ea... 3.60
 36"x72" panel, ea... 7.20

1/4" WALNUT

A fine attractive paneling stock in 1/4" thickness. 3-ply; good one side, sanded both, Urea-resin glued.

24"x24" panel, ea... \$ 1.80
 24"x48" panel, ea... 3.60

1/4" MARINE MAHOGANY

Boat-builders from coast to coast will welcome this exciting news. Here is genuine Waterproof Mahogany Marine Plywood. Panels are 1/4" thick, Mahogany both sides, sanded both sides, good both sides, 3-ply construction, Urea-resin glued.

24"x24" panel, ea... \$ 2.40
 48"x22" panel, ea... 4.45
 8"x144" panel, ea... 4.95
 46"x48" panel, ea... 8.95
 48"x96" panel, ea... 17.95
 48"x144" panel, ea... 26.85
 48"x166" panel, ea... 29.95

3/8" MARINE MAHOGANY

Same general type of Marine Mahogany as above, but in rugged 3/8" thickness. Strictly waterproof panels. Mahogany both sides, sanded both sides, 5-ply construction.

24"x24" panel, ea... \$ 3.40
 24"x48" panel, ea... 6.80
 48"x48" panel, ea... 13.60
 48"x96" panel, ea... 27.20

3/4" PLASTIC SURFACED PLYWOOD

Another exciting C-B plywood panel, of special interest to boat builders. 7-ply waterproof stock, 3/4" thick, each side surfaced with thin layer of plastic. Sanded and good both sides. For boat stern boards, seats, etc.

24"x24" panel, ea... \$ 2.70
 24"x48" panel, ea... 5.30
 48"x48" panel, ea... 10.55
 48"x96" panel, ea... 20.80

1/4" MASONITE DISKS

Perfectly round disks of tempered Masonite (not Plywood) 1/4" thickness.

Masonite Disk,
 8" dia., ea... \$.16
 Masonite Disk,
 10 3/4" dia., ea... .21

1/16" AIRCRAFT MAHOGANY

Thin aircraft waterproof plywood panels. Unsanded but smooth. 3-ply construction.

4"x24" panel, ea... \$.18
 10"x19" panel, ea... .35
 18"x20" panel, ea... .65
 10"x58" panel, ea... 1.05

1/16" AIRCRAFT GUM

Same type aircraft stock as above but in gum finish. 3-ply; waterproof.

9"x22" panel, ea... \$.37
 10"x58" panel, ea... 1.05

1/16" AIRCRAFT SPRUCE

Same type stock as above but in Spruce finish.

20"x46" panel, ea... \$ 1.60

1/16" AIRCRAFT BIRCH

Same type stock as above but in Birch finish. Good both sides, unsanded but

smooth. 3-ply waterproof, specially priced.

28"x40" panel, ea... \$ 1.75

1/8" CEDAR EFFECT CARDBOARDS

These C-B cardboard panels are finished in an imaginative Cedar effect for building boxes and other projects.

16"x16" panel, ea... \$.16

3/4" BIRCH PANELS

An odd lot of small panels for lamp bases, etc. Good one side, sanded both. 5-ply, some reject backs.

2-1/2"x16" panel, ea... \$.20
 3-3/4"x14" panel, ea... .22
 6-1/2"x16" panel, ea... .39
 7-3/8"x16" panel, ea... .44
 5-1/2"x22" panel, ea... .46
 8-1/2"x22" panel, ea... .70
 7-1/2"x24" panel, ea... .72
 13-1/2"x14" panel, ea... .77
 14"x16" panel, ea... 1.05

1/8" LIGNOLITE

A Plastic panel of great durability for table tops and counter tops, paneling, etc. Polished black finish one side.

30"x36" panel, ea... \$ 3.70

3/16" LIGNOLITE

Same type Plastic panel as above but in 3/16". Polished black finish one side.

30"x36" panel, ea... \$ 5.40

3/8" GUM

Small narrow panels for a variety of craft uses. 3-ply; good one side, sanded both, Urea-resin glued.

4"x28" panel, ea... \$.25

3/16" CABINET BIRCH

Small cabinet panels. Good one side, sanded one side. 3-ply.

15"x16" panel, ea... \$.40

3/16" UNSANDED BIRCH

Small unsanded panels for a wide variety of uses at unbelievably low prices. 3-ply; good one side, unsanded, Urea-resin glued.

13"x13" panel, ea... \$.19
 7"x30" panel, ea... .28

AIRCRAFT PLYWOOD CLIPPINGS

Assortment made up of odd specifications. Very small pieces averaging about 2 sq. in. Suitable for small novelties, bracing, etc.

1 lb. Clippings... \$.35
 5 lb. Clippings... 1.50

HARDWOOD POCKET-BOOK FRAMES

Well constructed hardwood frames for ladies pocket-books. Size about 9 1/2", opens to about 7".

Pocketbook Frame, ea... \$.25
 Per Dozen... 2.50

1/8" GUM

Small but attractive panels in 1/8" thickness. 3-ply; good one side, sanded one side, Urea-resin glued.

4-3/4"x28 1/2" panel, ea... \$.19

ORDER DIRECT FROM THIS AD

Make remittances by money order, bank draft or personal check. Send 25% deposit on C.O.D. orders. No C.O.D.'s on orders less than five dollars. All prices F.O.B. Mount Vernon, N. Y. Shipments by railway express or freight. Transportation charges collect. All items subject to prior sale. Satisfaction guaranteed or money back.

CARMEN-BRONSON CORPORATION

165 East Third Street, Dept. 5-A, Mount Vernon, N. Y.

**KEEP SHARP THINGS
SHARP!**

with the
NEW

**JET ACTION
SPEED GRINDER**

Another Quality Product
from the House of Hudson

**SHARPENS
EVERYTHING**

FOR HOME AND SHOP

The HUDSON TURBO GRINDER

End the annoyance of dull knives and blunt tools. The amazing new Hudson Turbo-jet Grinder sharpens knives, scissors, lawn mowers, wood planes, drills, chisels and all edged tools quickly and easily. Polishes silverware and metal.

Simplest operation imaginable...just attach to ordinary faucet, turn on the water and the patented Hudson Turbo-jet impeller spins the grinding wheel at 3000 to 10,000 revolutions per minute.

Precision built, quality throughout. Wheel, super-hard silicon carbide; Shaft, stainless steel; Bearings, Chrysler oilite (never need oiling). All metal parts gleaming chrome. Colorful Vinylite tubing.

**ONLY
\$8.95**

Ideal for the handyman, housewife, hobbyist, mechanic and everyone who uses knives and tools.

FULL MONEY BACK GUARANTEE
See your hardware dealer

HUDSON PRODUCTS CO.
4400 ST. AUBIN AVE., ROOM 221
DETROIT 7, MICHIGAN

HUDSON PRODUCTS CO.
4400 St. Aubin Ave., Detroit 7, Michigan

Enclosed is a \$8.95 () check () money order for which rush to me, postpaid, one Hudson Turbo Grinder with full instructions for use. I understand the Grinder carries a full, money back guarantee.

Name.....

Address.....

City.....State.....

Name of Hardware Dealer.....

Address.....

**IF YOUR DEALER DOESN'T
HAVE THE HUDSON TURBO
GRINDER SEND COUPON
TODAY**

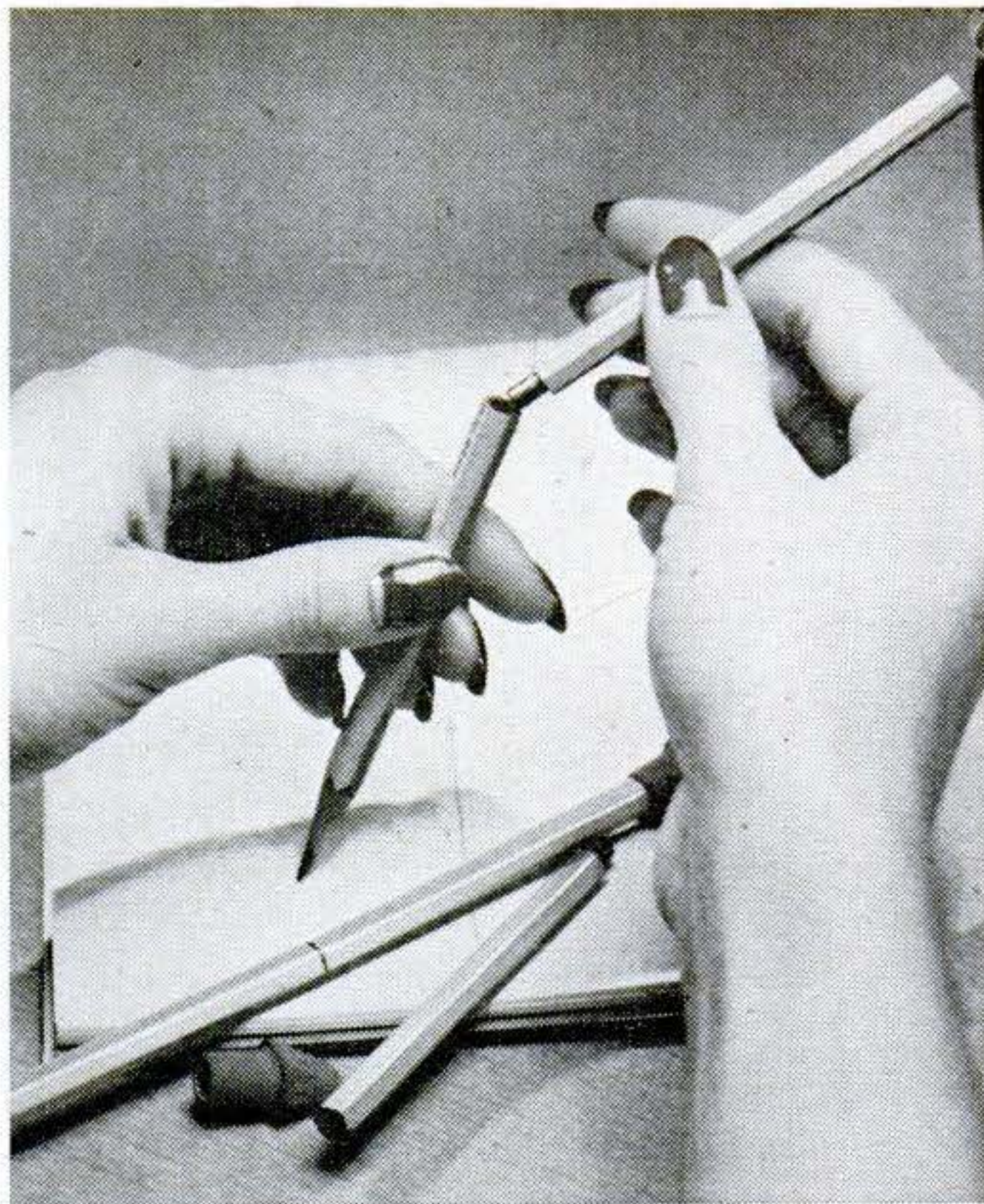

Pencil Never Leaves a Stub

A SECTIONAL pencil, which can be re-stored to usable length in a jiffy, has been designed to end the waste of pencils that are thrown away when worn to a stub. Sections can be added at will by moistening a glue-coated dowel and fitting it into the socket of a used portion. The pencil, a Moore & Monroe product, has a slip-on eraser and can be used in modern sharpeners.

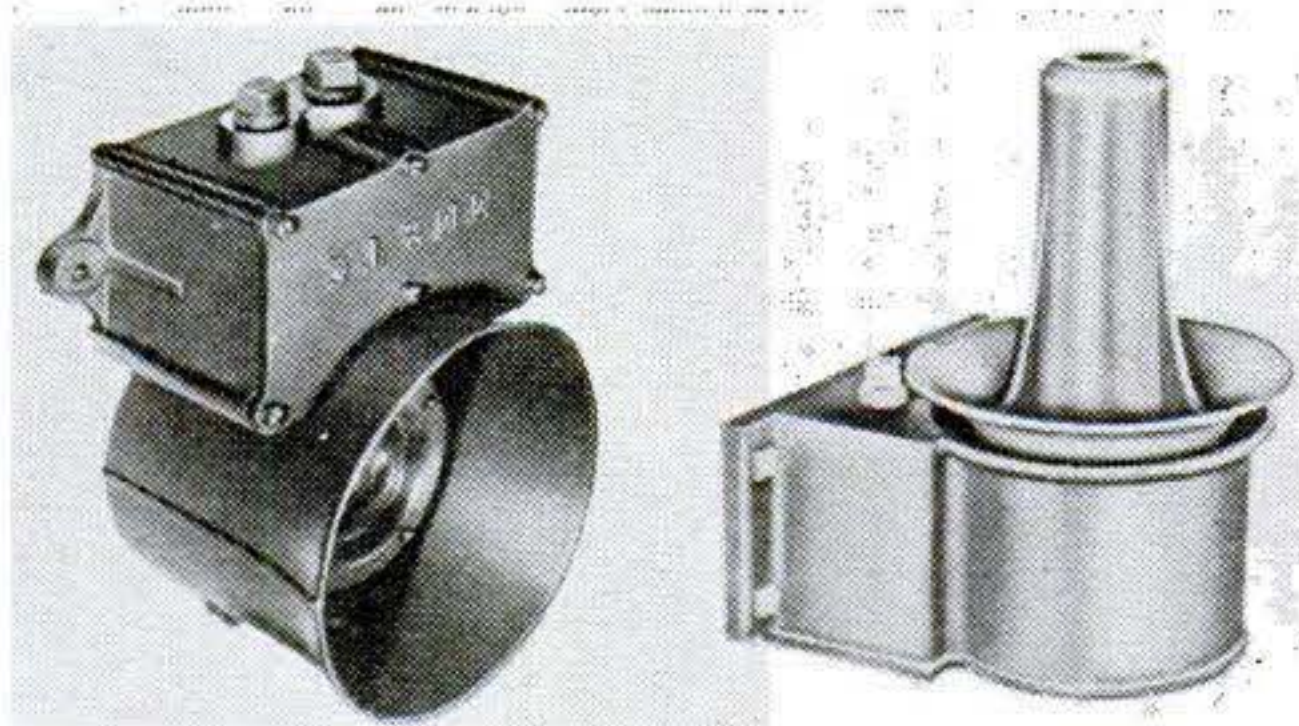

Loudspeakers Defy Hard Use

CAPABLE of withstanding explosions and immune to the effects of dust or water, two new University loudspeakers have been produced for use on ships and docks, in railroad yards, and in mines, mills or powder factories where explosions are a hazard. The model MSR, on the right, has a radial deflector for 360° dispersion; the MM2TC, on the left, has 120° dispersion.

How to

catch more fish!



CATCHING FISH depends on two factors. *First*, you must know where the fish are. *Second*, you've got to get your boat to the good spots.

Scott-Atwater can help you do both.

With a smooth-purring Scott-Atwater motor on your boat, you are always assured of quick, trouble-free transportation to the good spots to fish.

The amazing flexibility of Scott-Atwater outboard motors permits you to speed to a distant point or idle down to the creepiest crawl for trolling, with even, positive power at any speed.

Backed by the long experience that made Scott-Atwater the world's second largest pre-war manufacturer of outboard motors, the new Scott-Atwater, introduced last season, is the last word in mechanical perfection.

Send coupon below for the sensational new book, "How to Catch More Fish", by Frank R. Steel, which tells you how to locate fish by the temperature of the water.

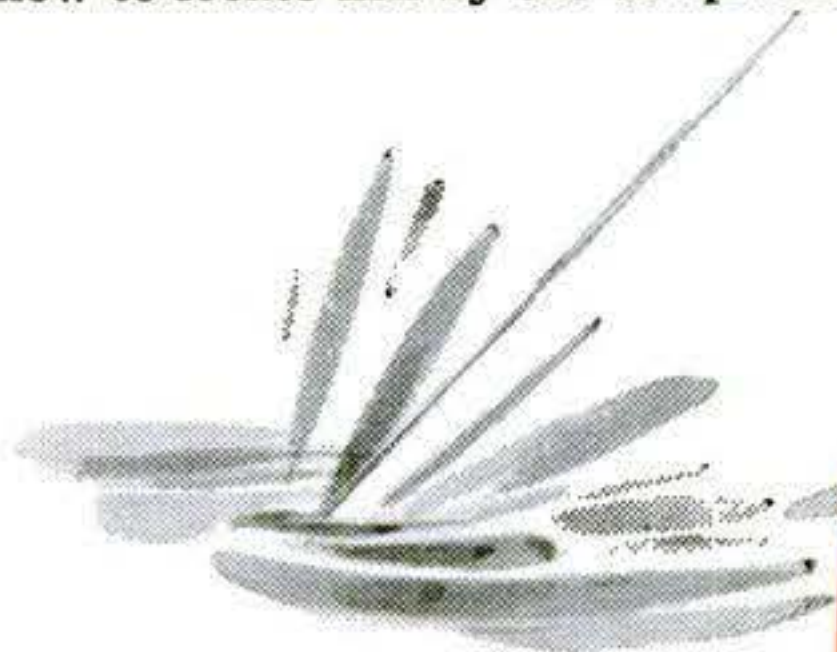

FOUR MODELS

A standard and deluxe single, developing 3.5 horsepower at 4000 R.P.M. OBC certified.

A standard and deluxe alternate firing twin, developing 7.5 horsepower at 4200 R.P.M. OBC certified.

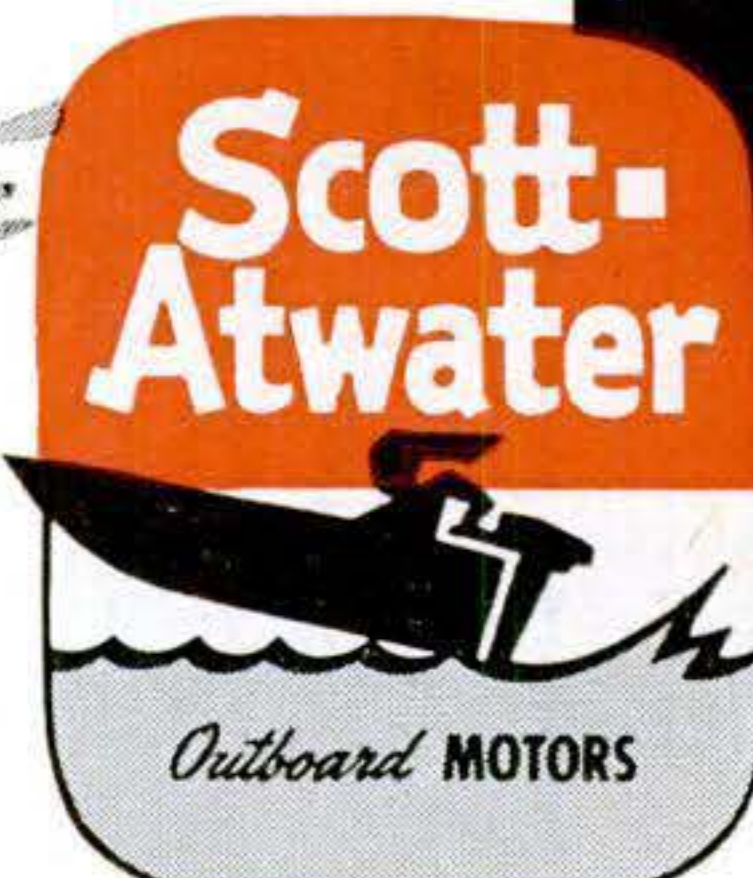

"HOW TO CATCH MORE FISH"—by Frank R. Steel, national authority on fishing. Tells you how to fish by revolutionary method of water temperatures. Specific instructions concerning at what depth fish will be according to temperature of water. 48 pages, illustrated in color, diagrams of lakes and streams. Send coupon for copy today.

Scott-Atwater Manufacturing Co., Inc.

2901 East Hennepin Avenue

Department PS57, Minneapolis, Minnesota

Enclosed find 10 cents for which please send me a copy of Frank R. Steel's new booklet "How to Catch More Fish". Booklet will be sent about May 15, 1947.

Name.....

Address.....

City.....State.....

MAY 1947 243

NUMBER 1

POST-WAR RADIO

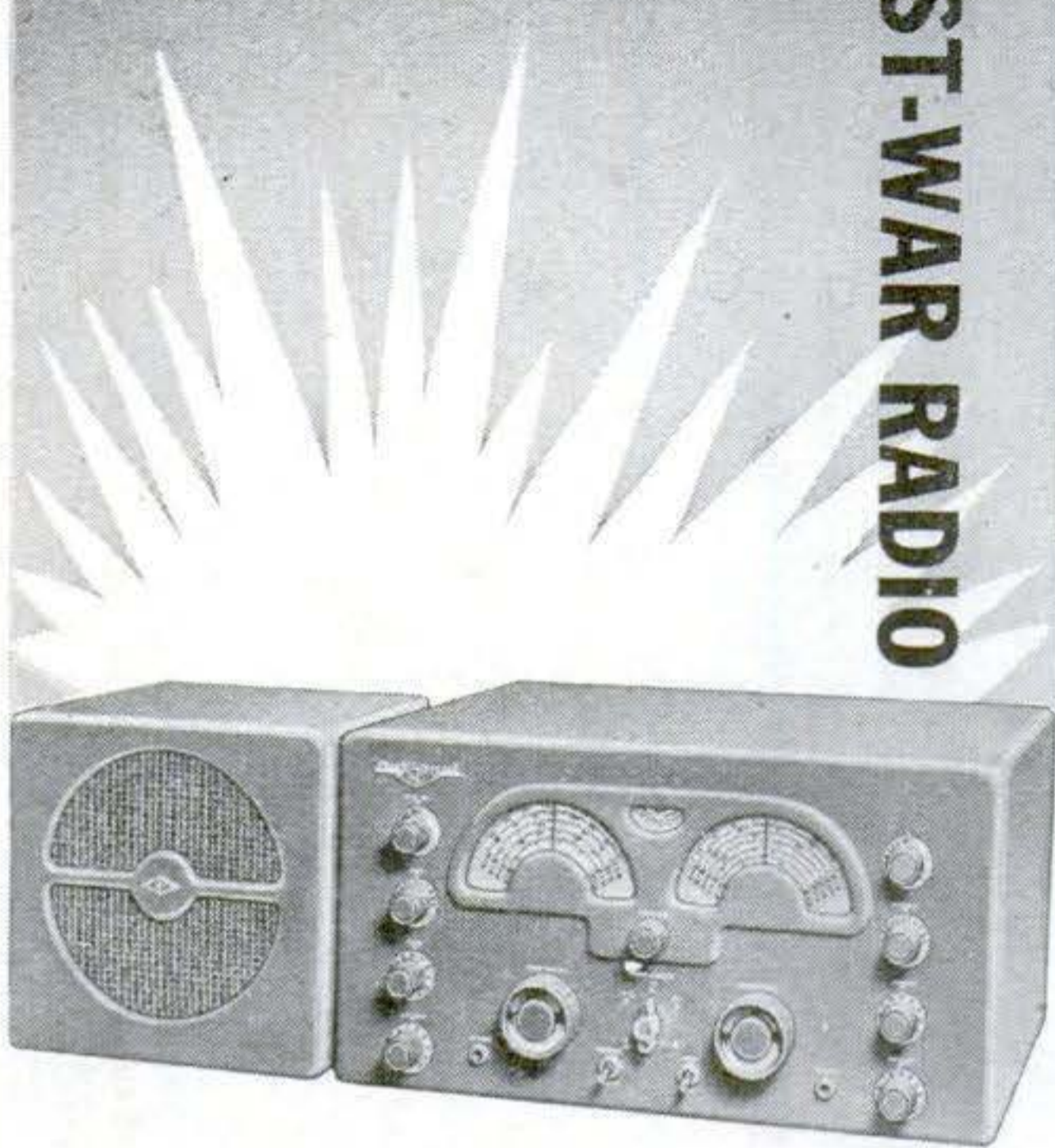

Really new, really post-war, National's NC-173 brings you the latest engineering developments contributed by four years of production-for-war, plus a solid year of peacetime research. Here's incomparable versatility... local and worldwide all-weather reception operating with marvelous clarity, pin-point selectivity. Yet National's NC-173 costs so little more.

- 12 tubes and rectifier, super-heterodyne circuit
- Standard, short-wave and amateur bands. 540 to 31,000, and 48,000 to 56,000 KC
- AM reception, phone and code
- AC powered. Also operates on battery for portable or emergency use—110/120 or 220/240 volts, 50/60 cycles
- Distinctive streamlined styling

Write for the name of your nearest dealer today

NATIONAL

COMPANY, INCORPORATED

MALDEN, MASS.

National



EST 1914

MAKERS OF LIFETIME RADIO PRODUCTS



NEW... EXPANDS AS IT SETS

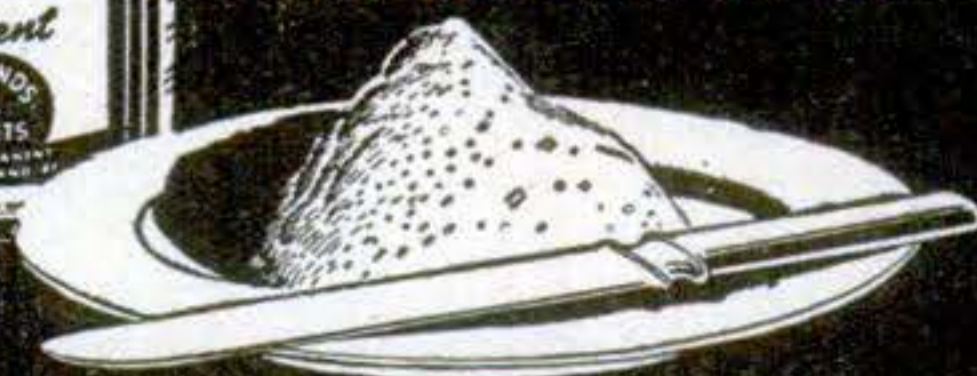

THE ONLY HOUSEHOLD REPAIR CEMENT WITH THIS ADVANTAGE...

You'll be amazed by the sensational new mortar-like repair cement, that's so easy to use. Mixed only with water, X-Pandotite can be applied with a putty knife, or table knife. It's the permanent fixer for cracks, joints, loose fixtures, tile and 1001 other things that need repairing. For anchoring and molding purposes: X-Pandotite can be colored before using; stained or painted after hardening.

X-Pandotite is sold at leading hardware and paint stores at 35¢ for a ½ lb. can — 60¢ for a one lb. can.

If your dealer can't supply, send 50¢ for a ½ lb. or \$1.00 for 1½ lbs. to the X-Pando Corp., 43-15 Thirty-Sixth St., Long Island City, N. Y. The X-Pandotite will be sent prepaid.

X-PANDOTITE



Please Send 10c for Catalog 102

MEIER BRASS & COPPER CO.
1155 Bellevue, Detroit 7, Mich.

BRASS RODS

For Home Work Shops

Free Cutting Rods
3/32-3" Round & Hex
Naval Brass Rods
1/8-2 1/4" Round
Brass & Copper Tubing
1/4-3/4" Outside Diam.



"YANKEE" VISES

hold work through every step without a misstep

Any job locked in a "Yankee" Vise, is correctly positioned for every operation... hand or machine. Lifts on and off swivel base at bench. Machined accurately... top, bottom, sides and front end... V-grooved block for rounds. Four sizes, with and without swivel base... 1 1/2", 2", 2 3/4" and 4" jaw widths. At your dealer's.



Write for "Yankee" Tool Book

NORTH BROS. MFG. CO.
Philadelphia 33, Pa.

YANKEE TOOLS NOW A PART OF

STANLEY

THE TOOL BOX OF THE WORLD



*Bing
Leatherman
Ed Sasser
Dennis
Allison
H. L. Bailey
Pineville, La.*

"Hawaiian Wigglers Are Tops!"

Dear Fred:

"I always look for your advertisements in the outdoor magazines just to see the pictures of the big ones the other fellows are catching in other parts of the country.

"Enclosed are pictures of one morning's catch in central Louisiana waters. My three friends and I were all using your shallow running No. 2 Hawaiian Wigglers. With us Hawaiian Wigglers are tops and our favorite bait." — Ed L. Sasser, Pineville, La.

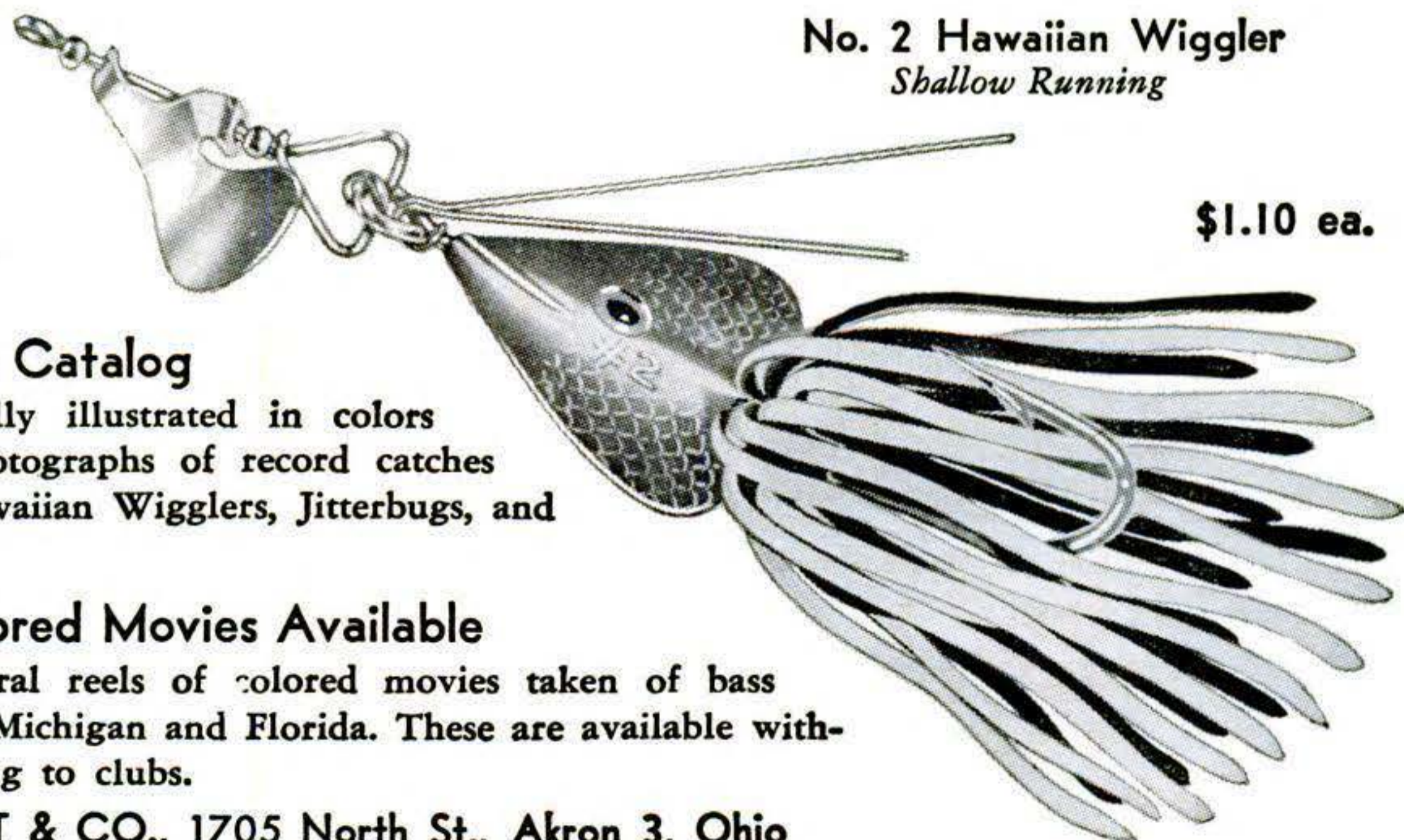

No. 2 Hawaiian Wiggler
Shallow Running

\$1.10 ea.

Write For Free Catalog

It is beautifully illustrated in colors and has many photographs of record catches made with my Hawaiian Wigglers, Jitterbugs, and Hula Dancers.

Colored Movies Available

We have several reels of colored movies taken of bass fishing in Canada, Michigan and Florida. These are available without cost for showing to clubs.

FRED ARBOGAST & CO., 1705 North St., Akron 3, Ohio

MAY
1947 245

Don't slink away



And live with Rover



Use this and soon



You'll be in clover



Removes dull traffic film—restores the original color and lustre—quickly, easily and safely.

DU PONT

REG. U. S. PAT. OFF.

No. 7 POLISH

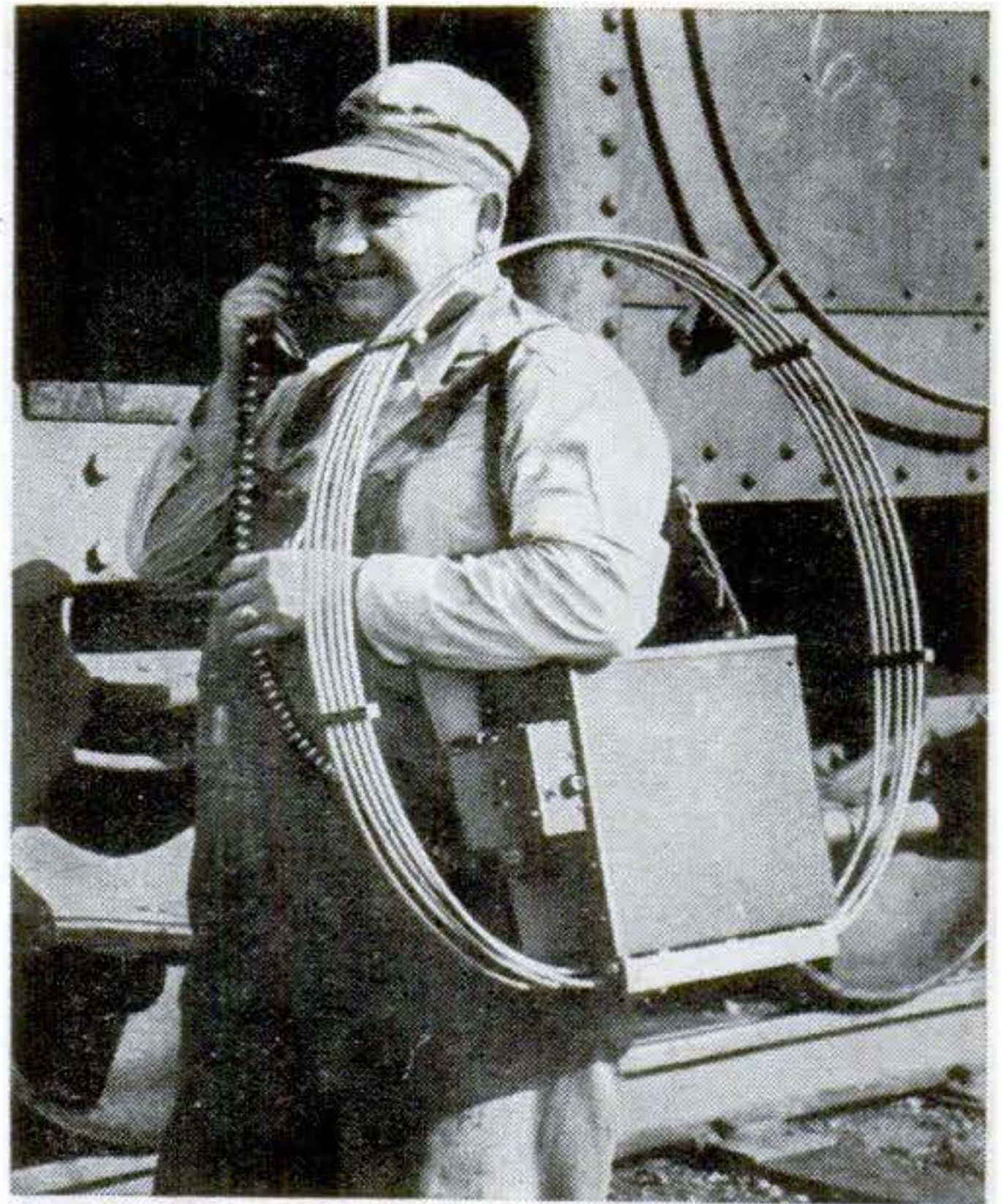

"Carryphone" Aids Trainmen

ENGINEERS and trainmen can keep in constant touch with their own crews or talk with the crews of other trains with the "Carryphone," a portable telephone announced by the Pennsylvania Railroad. The device uses railroad tracks or wires as its communication channels, but transmits and receives messages through the air by induction, using a large metal loop.

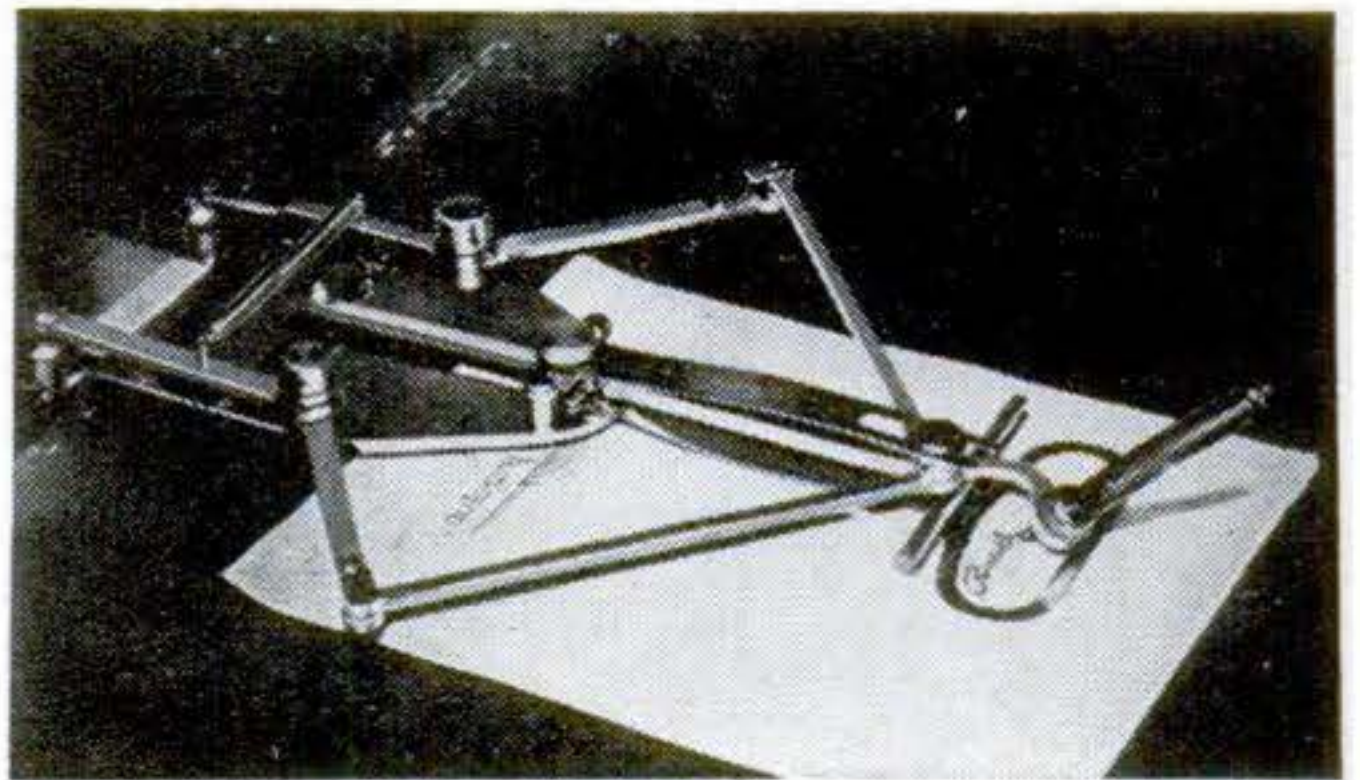

Machine Copies Handwriting

PROVIDING a new method of reproducing pen-and-ink signatures, the Autopen uses a standard fountain pen to duplicate, mechanically, the handwriting of any individual. Powered by a 1/5-hp. motor, it has a plastic tape on which a desired signature is represented by two wavy lines. When processed, the tape guides the writing pen on top of the cabinet that houses the device.

**SAY, LOOK AT THIS!
A WHOLE BOOK OF
SWELL SHOP-PLANNING
IDEAS!**

**New, big Delta*
book gives you
page after page
of useful ideas**

**32 pages of the best ideas
of dyed-in-the-wool
woodworking enthusiasts**

Delta's new book, "21 Home Workshop Floor Plans," is a reliable guide to more fun from your woodworking hobby.

If you're a beginner, there's useful material here that's a great help in building your first workshop.

If you're an old hand at woodworking, there are ideas to give you new inspiration for modernizing your present set-up.

A Variety of Information!

Here's a collection of the ingenious ideas of experienced woodworking hobbyists — the "top-notchers" selected from thousands of woodworking shop plans gathered by Delta.

You get floor plans for almost any size shop — to fit almost any size budget!

You get scale drawings of the

base dimensions of Delta HOME-CRAFT* Power Tools — helpful in estimating the floor space you need.

You get practical suggestions on the arrangement of tools, storage of lumber, etc.!

You get idea upon idea for convenience, economy, and safety!

You get pictures of the interesting workshops of other hobbyists!

Get This Book Today!

With all this help — plus your own ideas — think of what a great shop you can design and build. It's bound to be an attractive place you're proud to show to friends — a pleasant retreat where you are close to your family as you all share in the fun.

The sooner you order your copy of Delta's book, "21 Home Workshop Floor Plans," the quicker you can enjoy your planning fun. So don't delay — attach your check, money order, or dollar bill to the coupon below and mail it now!

\$1
Postpaid

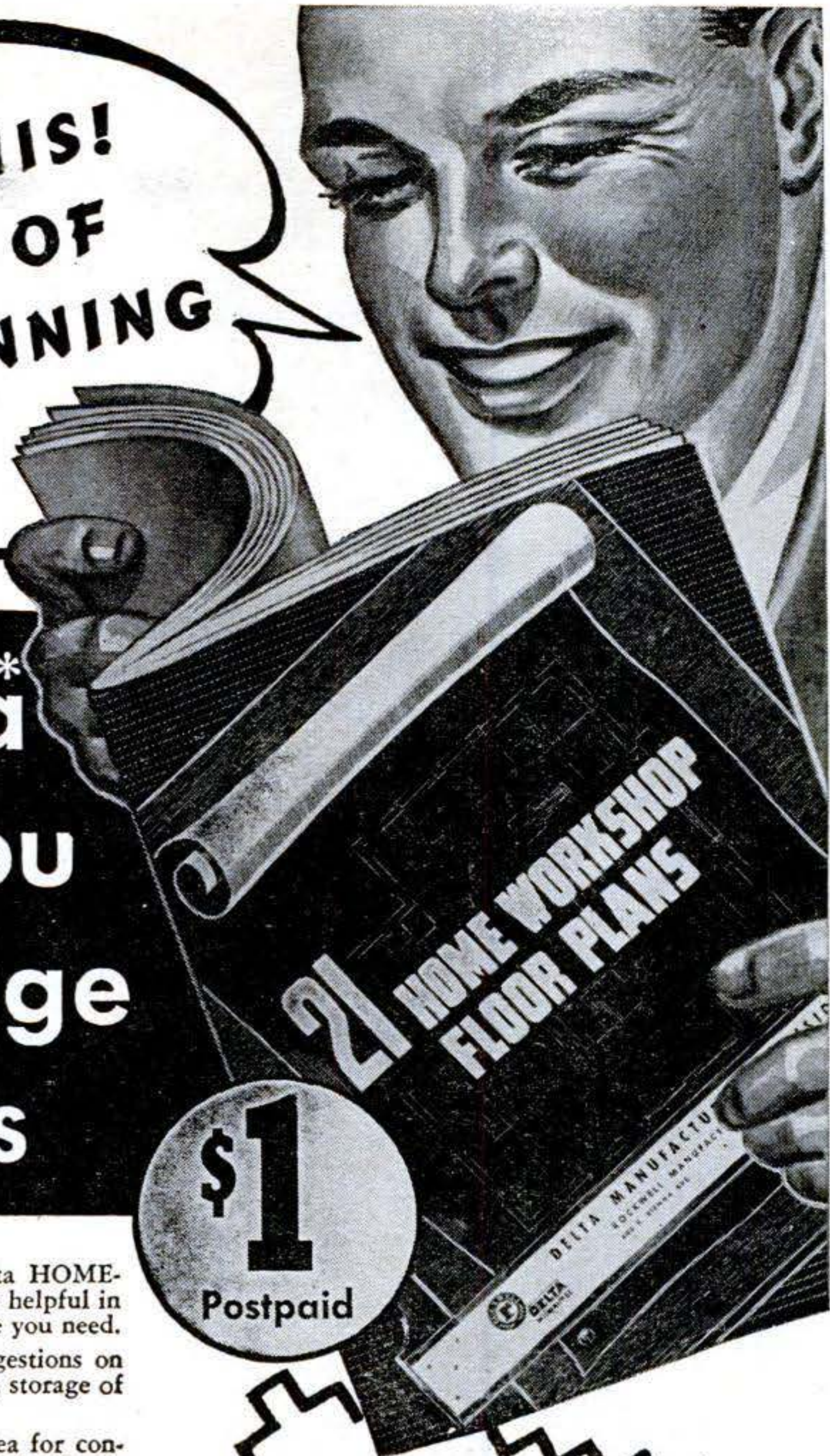

**A fine woodworking shop
calls for fine tools**

To get the most from your investment in power tools, it pays to go to the store near you that handles Delta HOME-CRAFT* Power Tools. They are popular tools with a reputation for dependable, safe, economical performance. Your Delta dealer is listed under "Tools" in the classified section of your telephone directory. Get to know him — he's glad to give you helpful advice on planning and equipping your shop.

DELTA MANUFACTURING DIVISION
Rockwell Manufacturing Company
682E E. Vienna Ave. Milwaukee 1, Wisconsin.

Enclosed is one dollar cash check money order } as payment
in full for the new Delta book, "21 Home Workshop Floor Plans."

Name.....
Address.....
City..... (.....) State.....



*Trade Mark Reg. U.S. Pat Off.

**Tear out
coupon and
mail today!**

HM-49

MAY 1947 247

X MARKS THE SPOT WHERE THE THIEF WAS TRAPPED



X is a smear of dirty oil on an AC Oil Test Pad—oil from a car whose owner didn't know he needed an oil filter. The evidence shows clearly on the white pad.

You can get this oil test FREE—and in a jiffy—at any official AC Oil Filter Service Station. The attendant simply wipes the dipstick on the Pad, instead of a rag, and you can see for yourself whether your oil is safe to use.

Dirty oil is a power thief. It clogs piston rings and slots—makes valves stick—hastens engine wear—wastes fuel and oil—steals more and more power as the days go by.

Every engine needs an oil filter. The AC oil test will show you why. And the AC Oil Filter Service Station will show you why the AC Oil Filter gives you tops in protection—and why the AC Replacement Element is the one you should use in your present filter. AC makes quality replacement elements for nearly all filters.

So see your AC Official Oil Filter Service Station today and trap the thief that's stealing your power.



AC
OIL
FILTERS

AC SPARK PLUG DIVISION—GENERAL MOTORS CORPORATION



SCREENS LOOSE?

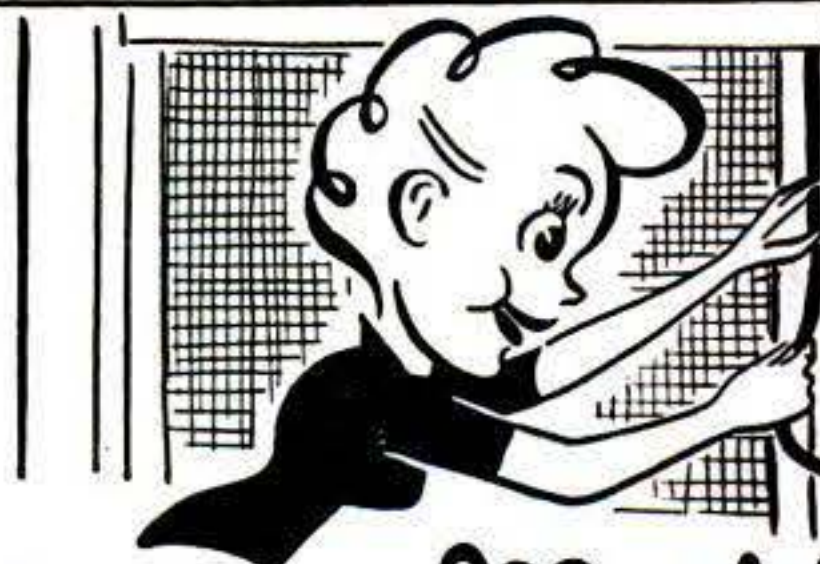

Fix it with *Mortite*
a household friend

Fills cracks around screens, casements, sinks, baseboards, etc. Fine for calking; keeps out dirt, dust, insects. Stops rattles. Ideal weatherstripping. Easy to apply, just press into place. Roll covers about 80 ft. At Hdwre., Paint, Dept. Stores and Lumber-yards. Write for booklet.

\$1.25 Higher West of Rockies and Canada

J. W. MORTELL CO., 534 Burch St., Kankakee, Ill.



WHEELS AT BARGAIN PRICES

- ...4" wheel & tire, 5/16" sleeve bearing & hub cap\$0.45 ea.
- ...5" wheel 5/8" solid tire 5/16" shaft hole.... 0.65 ea.
- ...6" wheel 5/8" solid tire 5/16" shaft hole.... 0.75 ea.
- ...7" wheel 3/4" solid tire 3/8" shaft hole.... 0.85 ea.
- ...8" wheel 1" solid tire 1/2" sleeve bearing.. 1.25 ea.
- ...8x2" wheel, semi-pneumatic tire 7/16" ball bearing..... 2.50 ea.
- ...10x1.75 wheel semi-pneumatic tire 7/16" ball bearing..... 3.25 ea.
- ...12x1.75 wheel semi-pneumatic tire 1/2" bronze bearing..... 4.00 ea.
- ...10x2.50 wheel semi-pneumatic 1/2" ball bearing..... 5.50 ea.
- ...6x2" wheel 5/8" ball bearing, solid tires.. 3.95 ea.

BUILD YOUR OWN Wagons, Scooters, Soap Box Racers, Welding Carts, Baby Pens, etc. To order above wheels write number wheels wanted in space provided, tear out and mail this ad with check or money order and your name and address. If other sizes are wanted write for FREE LIST. TRULSON MFG. Co., 811 E. 31 St., Dept. P-3, Kansas City, Mo.

ELECTRICITY Anywhere

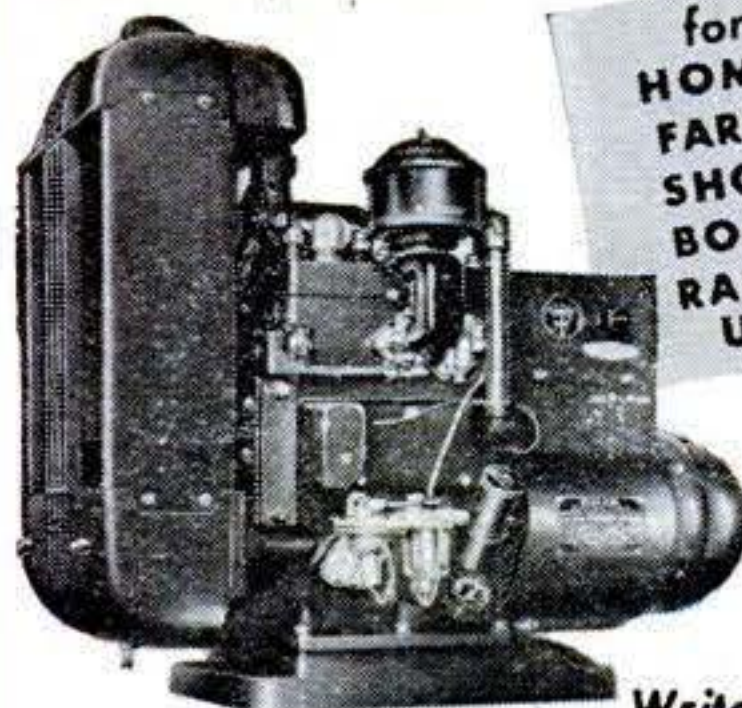

for HOMES FARMS SHOPS BOATS RADIO USE

● Onan gasoline-engine-driven Electric Plants supply reliable, economical electric service for any use. Portable, stationary or stand-by models. Water or air-cooled, compact and rugged.

A.C.: 350 to 35,000 watts in all standard voltages and frequencies. D.C.: 600 to 10,000 watts, 115 and 230 volts. BATTERY CHARGERS: 500 to 3,500 watts; 6, 12, 24, 32 volts.

Write for folder

D. W. ONAN & SONS INC.
2771 Royalston Ave., Minneapolis 5, Minn.





MINE DETECTORS

Brand new Army Surplus, packed in original cases. Unit includes an instruction book. Has many uses, detects metallic and non-metallic objects. Needs one 6 volt and three 45 volt batteries.

\$995

F. O. B. DETROIT (Less Batteries)

GUN SIGHT N8A

(CUT AT LOWER LEFT)

\$250 Has a variable density polarizing attachment, also F.O.B. DETROIT a Mangin concave mirror.



50 AMP. GENERATOR

(CUT AT RIGHT)

Leece-Neville, 24 volt, 50 Amp. model. Can be used as a generator, welder, etc.

\$500

F. O. B. DETROIT



N. SILVERSTONE CO.
6532 E. McNichols Road, Detroit 12, Michigan

CARBIDE SCRIBER

LM HARDEST METAL KNOWN
Used from coast to coast by mechanics, photographers, physicians, tool and die makers. Tungsten carbide tip — carefully ground on diamond laps, brazed into stainless steel 6" handle. For marking steel and other metals — for etching, marking, cutting glass. Non-magnetic. Cuts all directions. Easy to follow any contour. In plastic case with pocket clip. **\$200**
Price Post Paid



PRICK PUNCH

with Carbide Tip **\$150**
Price Post Paid

Newest, most improved prick punch made. Tungsten carbide tip, silver brazed into 3 1/2" heat treated steel body. Longer life — less regrinding — marks harder steels.

COMBINATION OFFER
SCRIBER & PUNCH **\$325**

Dealers, Distributors and Salesmen Wanted

LUCAS-MILHAUPT ENGINEERING CO.
5051 SOUTH LAKE DRIVE • CUDAHY, WISCONSIN

BUDD STEEL WHEELS

MADE TO OUTWEAR ANY OTHER TYPE WHEELS

65 Inches Long
24 Inches Wide
Wt. Approx. 55 Lbs.



ONLY **\$56.00**

Model "A" Racer Chassis for POWER or PUSH with 4-12x2 1/2 SUPER DeLux WHEELS

The two rear wheels have the COMBINATION V BELT Pulley Drive and Brake Drum (not against tires as shown above). Engineered for Electric, Gasoline or Push Power. READY TO ROLL and STEER. COMPLETE AS ABOVE. Rush Order for PROMPT SHIPMENT. Fob. Doylestown, Add 15% for Prepaid Shipment in U.S.A.

LARGE 12 x 2 1/2 & 10 x 1 3/4

Ball Bearing WHEELS

with Gates, Goodyear & Osborn Semi-Pneumatic Puncture-Proof Tires.

Super DeLux 12 x 2 1/2" WHEELS 1 ONLY . \$ 5.50
for 1/2" or 5/8" Axles 2 ONLY . \$10.00
Wheels Complete With Tire 4 ONLY . \$18.00

NEW: V BELT PULLEY DRIVE & BRAKE DRUM

One Combination Drive and 10" x 1.75 Wheel AssembledPRICE . . . \$ 5.50
One Combination Drive Wheel and three without (set of 4)PRICE . . . \$13.00
Same as above with 2-20" x 1/2" axles, 4 hangers, washers & cotter pins. READY FOR USEPRICE . . . \$16.50
Same as above with 24" long x 5/8" dia. axles, 4 hangers, washers & cotter pins. READY FOR USEPRICE . . . \$19.00
Combination V Pulley Drive and Brake Drum, without wheelPRICE . . . \$ 3.50



Fob. Doylestown, or, add 10% for Prepaid Shipment in U.S.A.
OSBORN WHEEL CO. Dept. PS-5, 115 Sq. Main St. DOYLESTOWN, PA.

BREEZE

THROUGH YOUR HEDGE WITH
THE GREATEST OF EASE



Keen, tough blades and a deft, "handy" balance! With BERNARD's it's easy to have the neatest hedge in town.

Mighty handy, too, for trimming bushes, small trees and for making all your foliage look its smoothest, shapely best.

Blades of hard forged steel set deep in tough hickory handles and anchored there with sturdy pinions. Lock washer at the joint *keeps* blade tension *just right*.

You'll find BERNARD Hedge Clippers at your hardware store. *Ask for them by name.*

BERNARD Hedge Clippers are one item in a line of fine hand tools—pruners, pliers, cutters, etc.—known for **QUALITY** for 75 years. *Free catalog on request.*



Quality  Tools Since 1870

BERNARD

TRADE MARK REGISTERED

WM. SCHOLLHORN COMPANY

7005 Chapel St., New Haven 9, Conn.

250 POPULAR SCIENCE

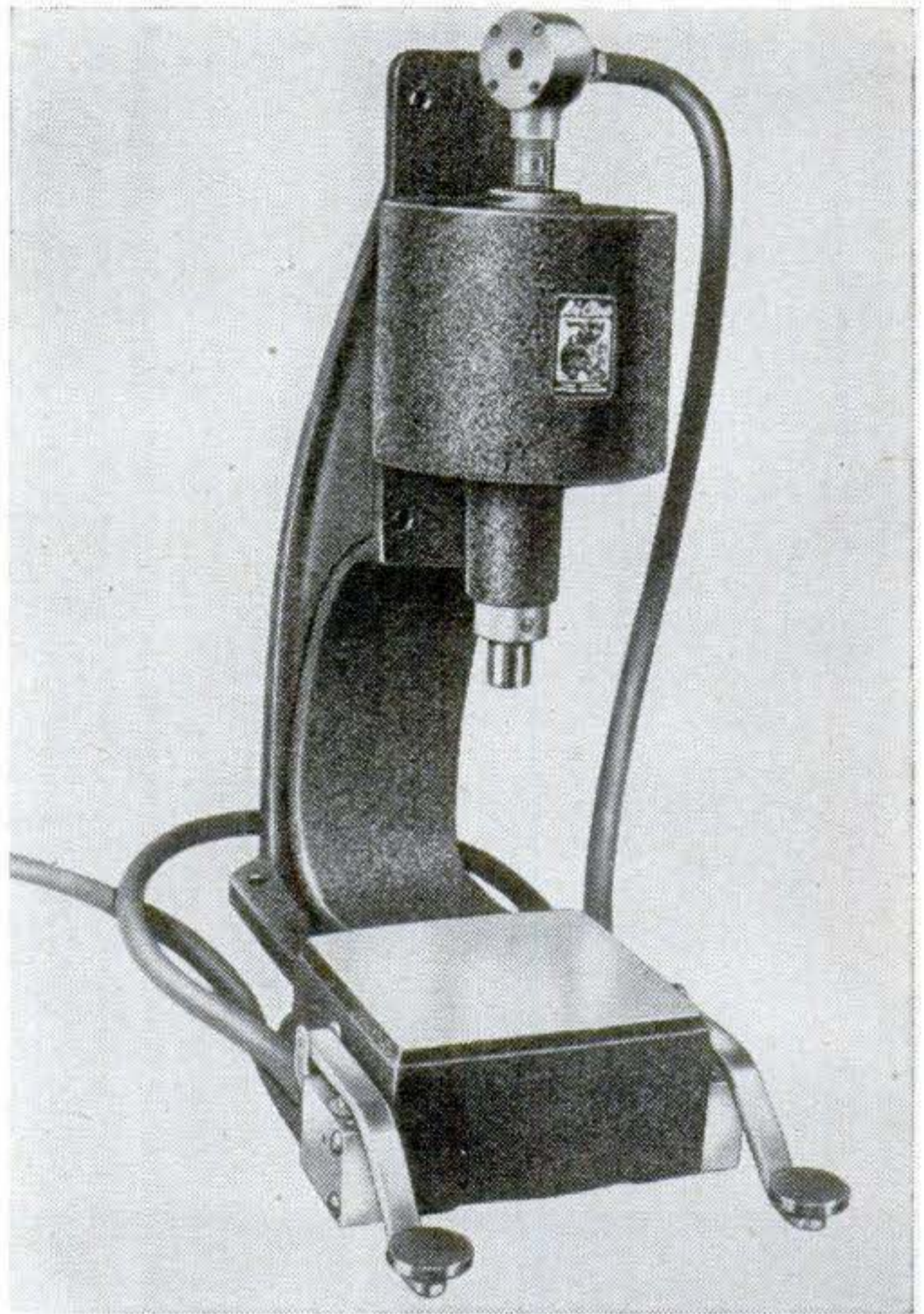

Air Valve Aids Control

DESIGNED to function with the ease, speed and sensitivity of a telegraph key, a new fingertip air valve, made by the Mead Specialties Co., can be used to operate air compression cylinders having a four-inch bore or more. Two such valves connected in series to an air press, as shown above, provide a safety feature. Since both hands are needed to operate the valves, they are kept clear of a press's danger area.

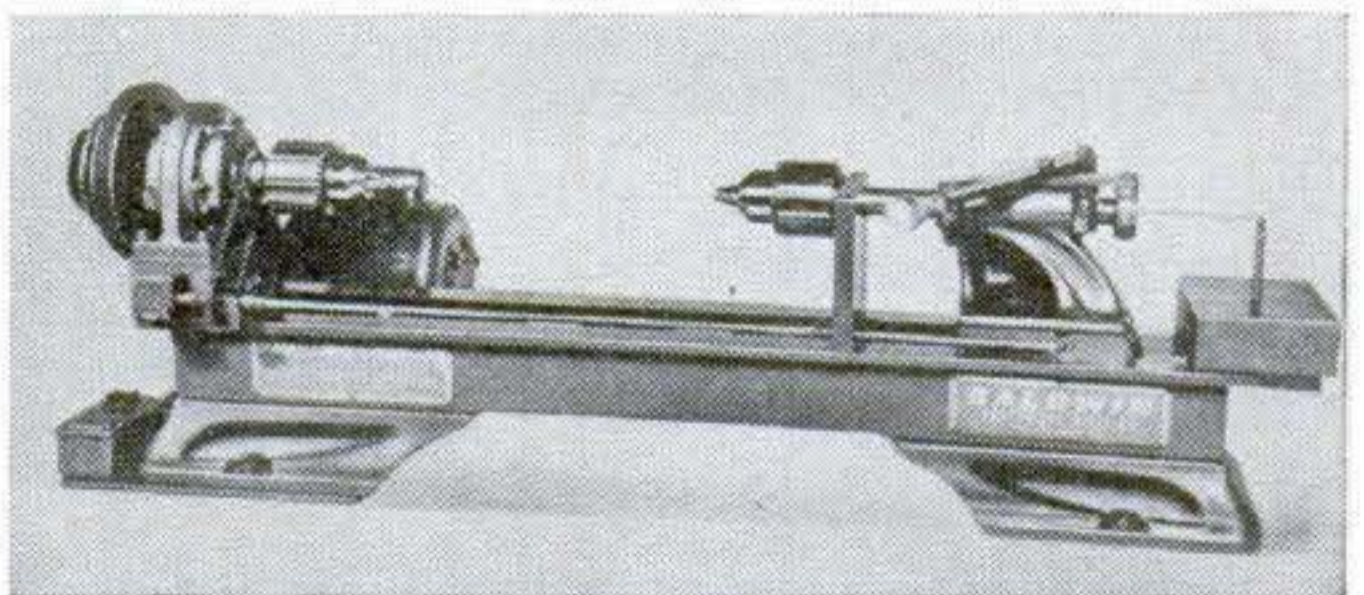

New Tester Twists Wire

STRESSES up to 80,000 pounds per square inch can be obtained in a new torsion testing machine for wire. Developed by the Sonntag Scientific Corp., the machine will test wires with diameters of .09 to .75 inch. The tester has reversible rotation, and can produce a torque of 1,000 inch-pounds.

What's your choice of these

Marlin .22's?

Marlin Model 39-A—25-shot Lever Action Repeating Rifle. \$50.45*



Marlin Model 81-DL—25-shot Tubular Magazine Repeating Rifle. \$25.55*



Marlin Model 80-DL—8-shot Clip Magazine Repeating Rifle. \$20.05*



**Prices slightly higher west of the Rockies*

Be sure to see these three fine Marlin '47 models at your dealer's soon! Each is an outstanding rifle in its class.

● Here you have three great rifles for small game and all around sport. Marlin's 39-A is the only lever action .22 repeater made...a favorite in hunting circles the world over since 1892. As a practical weapon for vermin and small game, the 81-DL is a wise selection. It carries a full day's ammunition, and its light weight is a great asset in the field. The loaded clip of the 80-DL provides extra shots for fast-running game...and allows use as a single loader for target work. All three are rugged, man-sized Marlins, famous for accuracy and dependability. All shoot .22 short, long and long rifle cartridges—regular or high speed—without adjustment. Whichever you choose, you'll buy years and years of trouble-free sport!

Marlin .22 Rifles

Outstanding for accuracy, dependability, long life



Often called the "world's best all around .22," Marlin's 39-A is a light rifle of remarkable accuracy and versatility. Only lever action .22 made. Extra fast for snap and exhibition shooting.



A full day's hunting is provided by the large 25-shot capacity of the Marlin 81-DL. Removable bolt assembly; Off and On safety...a fine "learning gun."



With eight shots to the clip, Marlin's 80-DL gives you a rapid fire load for fast-running small game and vermin. Also handy as a single loader on the firing line.

THE MARLIN FIREARMS CO., NEW HAVEN, CONN. • Fine Guns Since 1870

MAY 1947 251

Atlas LATHES

**SPEED AUTO
SERVICING**

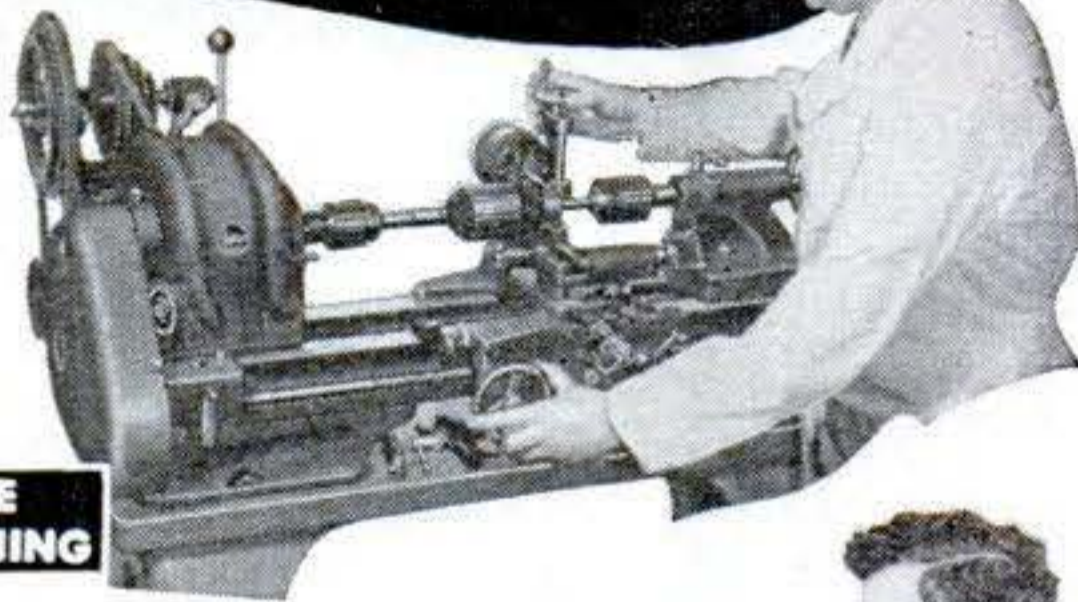

**ARMATURE
RECONDITIONING**

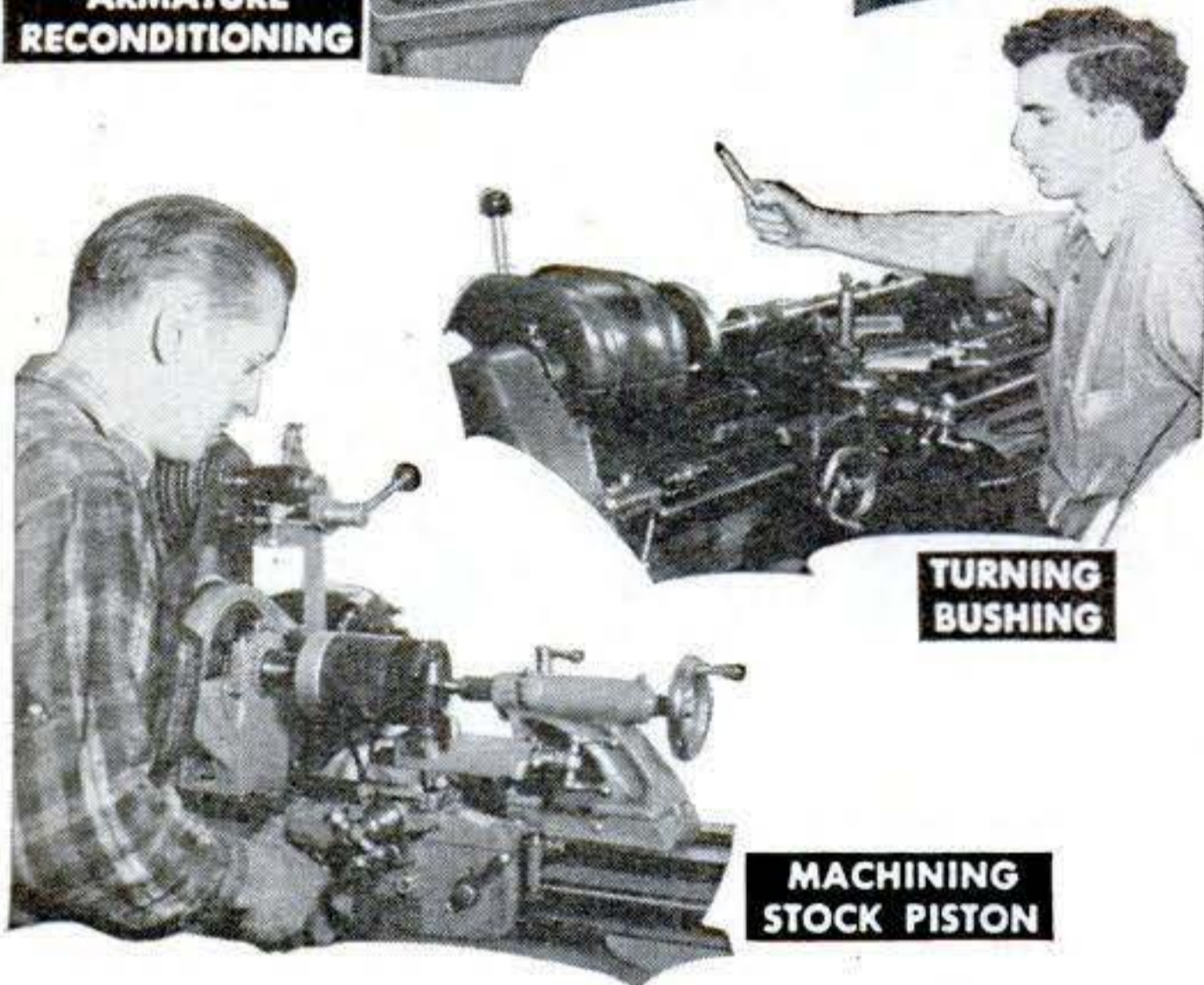

**TURNING
BUSHING**



**MACHINING
STOCK PISTON**

Automotive shops all over the nation are rapidly equipping with Atlas lathes. It's a profit suggestion to consider if you operate or work in a garage—something to remember as a valuable use for an Atlas in your home shop.

There are more than 44 profitable servicing jobs you can handle on an Atlas lathe with accessories. Atlas lathes are preferred for automotive work because they are: (1) ruggedly built for years of precision service (2) easy to set-up and operate (3) extremely versatile (4) compactly engineered for minimum space (5) available at low cost. Send for latest catalog.

FREE



ATLAS PRESS CO.

555 N. PITCHER ST.
KALAMAZOO 13, MICHIGAN



6"-10" Lathes



Milling Machines



Shapers



Drill Presses

ATLAS 4 TOOL TEAM

Fill Holes, cracks, dents, gouges . . .

These **BETTER FILLERS**

- HARDEN FASTER
- SHRINK LESS
- STAY IN!

FILLS HOLES IN ONLY 1 APPLICATION



FILLS DENTS AND SCRATCHES



TAKES HIGH FINISH



CRACKS ARE EASILY FILLED

WEATHERPROOF WATERPROOF

SAW OR CUT IT

SAND OR POLISH IT

Duratite Wood Dough will fill rough or irregular cavities in wood, metal, plastic or plaster in *one* application. (Duratite Surfacing Putty for shallow cavities). Can be sawed, cut, milled, sanded; are waterproof, fire resistant. Seven wood colors, in tubes or cans, at Hardware and Paint stores. Made by Manufacturers of famous Arrowhead Cement.

Large tube 25c postpaid

WEBB PRODUCTS CO.

232 South G Street, San Bernardino, California or Webb Company • Dept. S • Norcross, Georgia.



DURATITE

WOOD DOUGH AND SURFACING PUTTY

\$2.95



TORNADO GAS TORCH

The Modern Way of Soldering

Ideal for hard and soft soldering. Will heat quickly; solder will flow freely and smoothly. No compressed air required. Nothing to pump. Self-adjusting. Safe. Economical. Can be used for annealing small parts and bending metal parts. Generates a heat of 1700° Fahrenheit. Simply connect to any illuminating gas jet with a rubber hose and operate.

Tornado Torch No. 119 comes with three (3) tips, (1/8", 1/4", 3/8" blast).

The Tornado Gas Torch No. 119, complete with three tips, is \$2.95. See your dealer or order direct. Send check or money-order—post paid.

Robco Corporation, 204 E. 44th Street, New York 17, N. Y.

**V-8
DUALS
& SINGLES**

MUFFLERS

STEELS and ALUMINUMS
with a motorboat tone

SINGLES, Chev, V-8, Plymouth, Steels \$5.50, Aluminum \$6.50. Chry., Olds., Buicks, etc., Steels \$7.50, Aluminum \$8.50. V-8 and MERCURY DUALS, Steel \$17.50, Aluminum \$20.00. Aluminums are guaranteed for life of your car.

DEALERS WANTED

SANDEE MUFFLER CO.
7523 S. WESTERN AVE., LOS ANGELES 44, CALIF.

ALL CARLSON RULES

have this

**10-SECOND
BLADE CHANGE
FEATURE**

CARLSON

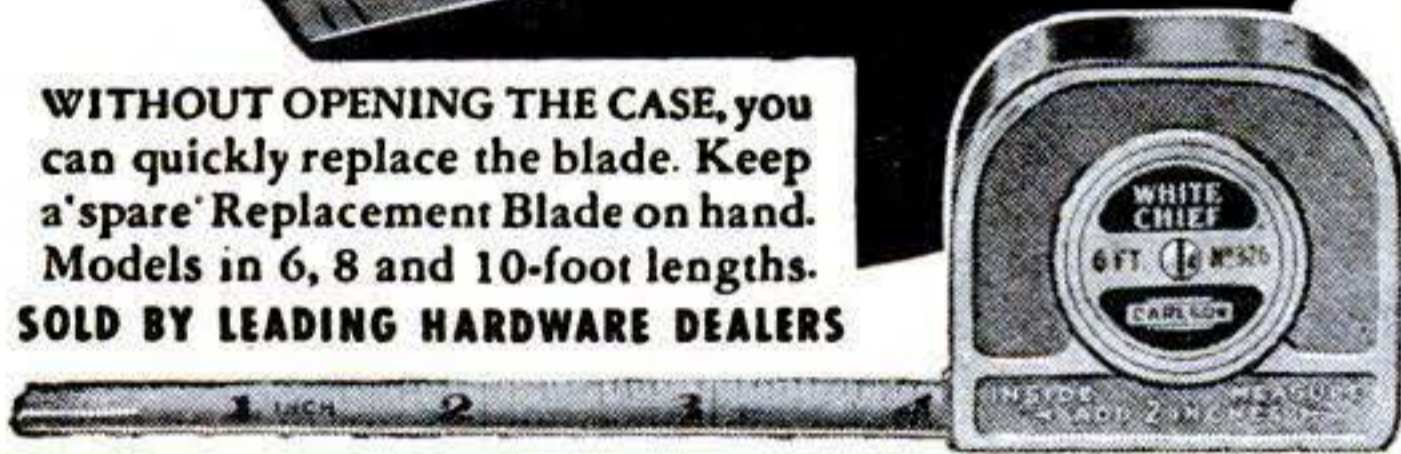

WITHOUT OPENING THE CASE, you can quickly replace the blade. Keep a 'spare' Replacement Blade on hand. Models in 6, 8 and 10-foot lengths. SOLD BY LEADING HARDWARE DEALERS

LEARN ELECTROPLATING

Highly Paid, Uncrowded, Interesting Business. Part or Full Time, Common School Education Sufficient. Gold, Silver, Nickel, Chromium, etc. Money Making Secrets, Processes. Send postcard for FREE Electroplating Booklet and proof. **PLATER HYDE, Dept. S, P. O. Box 176, National City, California.**

BUILD YOUR OWN

Mitch Craft Build this new, modern, streamline trailer. Chassis built entirely of salvage auto parts. Complete detail plans and building instructions sent postpaid for only \$2.50. Send check or postoffice money order to



MITCH-CRAFT PLANS, P.O. BOX 362, McCOOK, NEBRASKA.

FURNACES GAS OIL

LP gas burners. Gas & Oil burners. Floor furnaces. Range burners. Blowers—Complete Coil Cooling. **PEERLESS SALES, 4320 Sheridan, Lincoln 6, Nebr.**

Say You Saw
It In Popular Science

GET A GENUINE DELTA REDDYLITE ELECTRIC LANTERN

6-volt. Shoots beam 800-ft. Light revolves in a circle—"stays put" at any angle you set. Dozens of uses. Buy at hardware, sport, and electrical stores.

\$2.69
Less battery



Delta ELECTRIC CO.
Marion, Indiana

FREE

get

ALLIED'S NEW RADIO CATALOG

SEND FOR IT
NOW

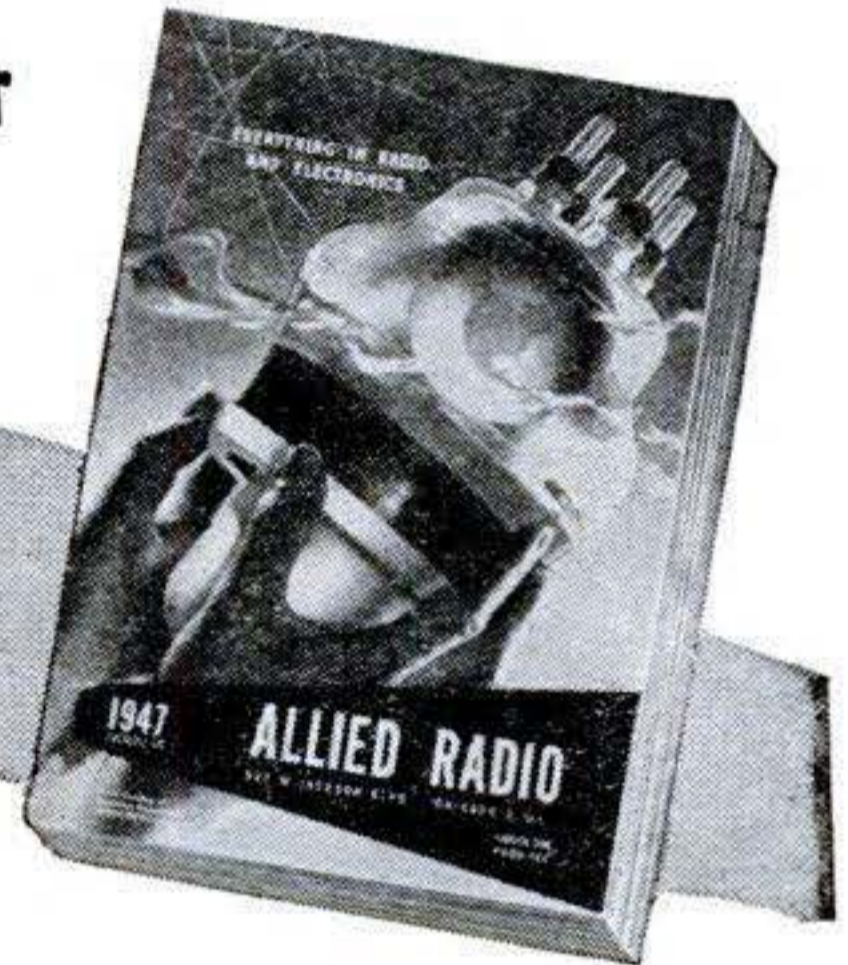

FOR
EVERYTHING
IN RADIO!



NEW HOME RADIOS



SERVICE SUPPLIES
BUILDERS' SUPPLIES



AMATEUR GEAR



SOUND SYSTEMS

164 Value-Packed Pages

Send for your FREE copy of the most complete Buying Guide for Everything in Radio! Here's the Catalog for Servicemen, Dealers, Soundmen, Amateurs, Builders and Experimenters. Features the world's largest and most complete stocks of radio and electronic supplies—quality equipment at lowest prices! Get the speedy service and expert help you want from ALLIED—Radio's Largest Supply House. Depend on ALLIED!

MORE THAN 10,000 ITEMS

Get everything for every radio use; New 1947 home model radios, phono-radios, recorders, communications receivers, Ham kits, and gear, code apparatus, radio parts, tubes, tools, test instruments, public address equipment, low-cost easy-to-build radio kits, diagrams and matched parts lists, largest selection of instructive radio books—all at lowest prices!

ALLIED RADIO

ALLIED RADIO CORP.
833 W. Jackson Blvd., Dept. 7-EE-7
Chicago 7, Illinois

FREE
CATALOG

Rush new FREE 1947 Catalog

Name.....

Address.....

City.....Zone.....State.....

MAY
1947 253

"Paint-it-Yourself"

\$345

PAINTS YOUR ENTIRE CAR WITH

ONE COAT COVERS

NU-ENAMEL

TRADE MARK REG. U. S. PAT. OFFICE

NO BRUSH MARKS



PAINT ALL YOUR FENDERS FOR ONLY \$1.95

ASK YOUR **NU-ENAMEL** DEALER FOR THIS INSTRUCTION FOLDER

Contains the step-by-step story of how you can Paint-It-Yourself with Nu-Enamel and get a professional looking job.



It's EASY! - It's FUN!

THE NEW **FEDCO** DE LUXE
ADJUSTABLE TANK
FOR CUT FILM OR FILM PACKS

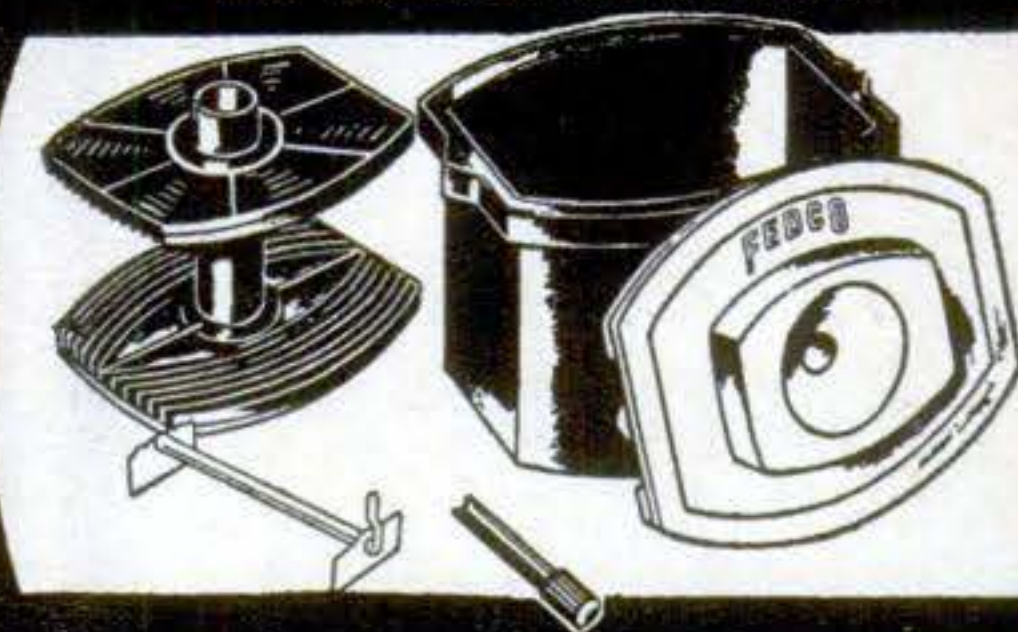

Sizes 2 1/4" x 3 1/4", 6.5 x 9 cm., 3 1/4" x 4 1/4", 9 x 12 cm. and 4" x 5"

Holds 1 to 12 sheets of film. Easily fitted cover makes darkroom fumbling unnecessary. Absolutely light-tight. Simple to load.

MAIL ORDERS FILLED **\$7.95**
Tax Included

Willoughbys... THE Camera Store

110 WEST 32nd STREET, NEW YORK 1, N. Y.

MOTORCYCLISTS

★ ★ ★ ★ ATTENTION!

The B & H Footshift for all Harley's eliminates hand gear shift, gives fast getaway, greater maneuverability, maximum driving safety. Improved clutch lever booster. Easy to install. Write for details, prices. **SCIENTIFIC RESEARCH CO.** 1618 N. Vancouver Portland 12, Ore.

USE YOUR BENCH SAW

FOR JOINTING & CUTTING MOULDINGS

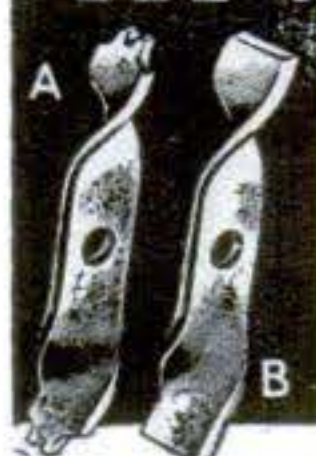

With our six inch tool steel cutters make mouldings, casings, drop-leaf tables, grooves beading and jointing. Moulding cutters, A 1 in. wide \$1.50, 1 1/2 in. \$2.00. Jointing cutters, B 1 in. \$1.50, 1 1/2 in. \$2.00. E 1 in. for drop-leaf tables, \$1.50, E 1 1/2 in. Makes 3/4 in. cove and Quarter. \$2.00. Postpaid. Guaranteed. State size hole. List & Folder free.

JOHN A. SANDSTROM
Clearwater, Fla.



A. C. CURRENT ANYWHERE!

WITH

KATOLIGHT PLANTS AND GENERATORS

Furnish the same kind of Current as the highlines. Sizes 500 watts to 100 KW. Also Manufacturers of Rotary Converters, Frequency Changers. 32 and 110 Volt D.C. Motors in 1/4, 1/2 & 1/2 H.P. A.C. Motors (high line) in 1 1/2 and 2 H.P. only.

KATOLIGHT 1401 First Avenue, MANKATO, MINN.

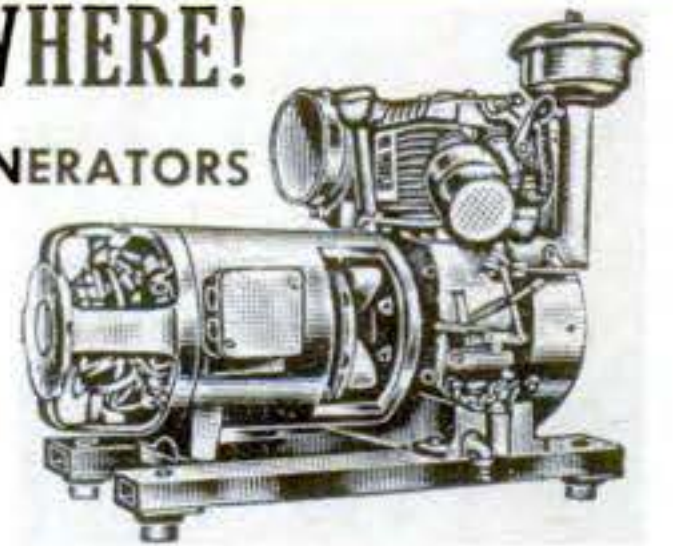

MACHINE SHOP EQUIPMENT

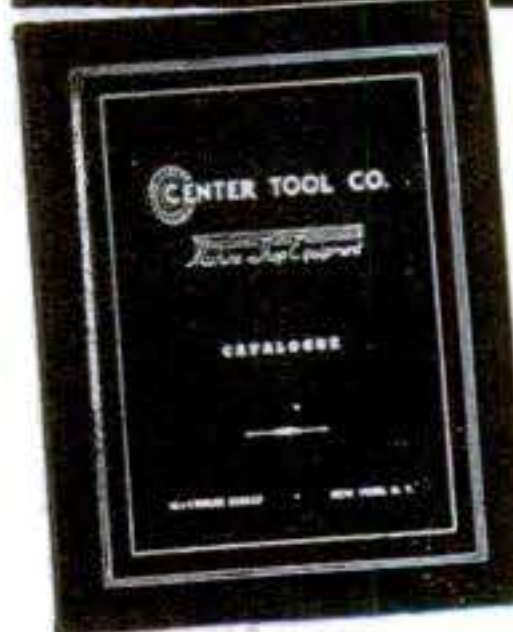

Just off the press!—Every man who owns a workshop should have a copy of our new, up-to-the-minute, 200 page catalog of Machine Shop Equipment—the latest tools made by the biggest manufacturers in the U. S. Replete with illustrations, descriptions, prices. Prompt delivery on most tools listed in this book. Available at cost of printing—50c a copy—get yours today! **Price of Catalog Refunded on First Order over \$5.00.** Send Check or Money Order to

CENTER TOOL CO., 153 Centre St., Dept. D, N. Y. C. 13

WAR SURPLUS



- A.** **PERFECT PHOTOGRAPHIC SPOT** with 2 powerful 88.9 mm. lens. 2 large optically flat mirrors. Good condenser. Easily converted. New, beautifully constructed—worth much more than **\$6.95**
- B.** **BEST SURPLUS COMPASS** for boats, cars, planes. Luminous. Double built-in compensation. Made by Pioneer Instrument for tanks. 3½ Dia. Dial. New..... **\$16.50**
- C.** **GUN SIGHT** easily converted to excellent **SLIDE PROJECTOR**. Has 55. m.m. lens. Two of these make finest condenser on market today. New, only **\$4.35 ea.**
- SUPERCHARGER AIR BLOWERS**, 5 lbs. pressure; 2-meshing 4" rotary spoons. For moving air and transporting gases **\$24.50**
- 400 G.P.H. AIRCRAFT FUEL PUMPS** to pump any liquid, air or vacuum. ½ h.p. will operate. Compact, well built. Did cost 20 times more than..... **\$4.65**
- NEW BALL BEARINGS**. Very reasonable. State your sizes.

Check Items Wanted—Mail Entire Ad with Check Money
Order (C.O.D.—minimum of 50% payment required)
In Ohio add 3% Sales Tax

QUALITY SURPLUS CO.
6810 SNOW ROAD. PARMA, OHIO.

New HULL Beaconlite ILLUMINATED

AUTOMOBILE COMPASS

Keeping you on the right road day or night, and giving constant reassurance that you're right, is the peak of motoring convenience offered by the new Hull Beaconlite. Casts a non-glare reddish glow at night for perfect dial visibility. Works without light in daytime. Latest luxury design in ebony or brown, accurate, easy to install. At your dealer's or write us for circular. Price \$5.95.

HULL MFG. CO.

P.O. Box 246-E4

Warren, Ohio



A TOOL... NOT A BRUSH

\$1.00 POST PAID

NOW! PAINT STRIPING MADE EASY!

PAINTERS' STRIPING TOOL

Easy to use as a pencil! Draws parallel lines, straights, curves, circles with paint, enamel, lacquer, etc. Do your own striping on autos, furniture, toys, bikes, model planes, signs, linoleum... make wall board look like tile. Painters—craftsmen, order today! Type "M" Master Painters' Striping Tool complete with tip for 1/16" stripe, \$1.00. Extra tips 1/64", 1/32", 3/64", 1/16", 5/64", 3/32", 1/8"—75c each. Tool with complete set of 7 tips \$5.00 (C.O.D. orders 25c extra.) Dealers write!

WENDELL MFG. CO.
4234-A Lincoln Ave., Chicago 18, Illinois

RUB ON

Let dry a minute

WIPE OFF

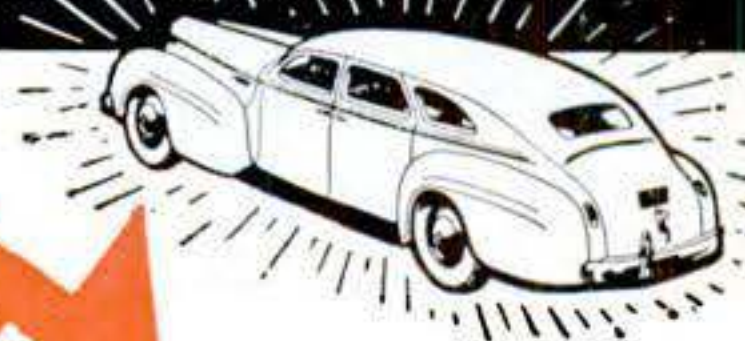

*Clean 'em up
Shine 'em up*

The *Quick*
ZECOL
Way

ZECOL's popularity with car owners is due to its Quality, its Quickness and Ease of Application.

Keep your car looking shiny and new. It's so easy with ZECOL. Adds a brilliant lustre to all types and colors of lacquers and enamels.

If your car has an accumulated road film, use ZECOL Scum Remover before applying ZECOL Wax.

Ask for ZECOL—at service stations and garages. Pints 75c, quarts \$1.25, in USA.



ZECOL Cooling System Conditioner

Recommended to remove and prevent rust. Easy to use. Rust and corrosion inhibitor. No draining or flushing. Add to radiator—clean up rusty water while you drive. Lubricate water pump, bearings and seals. Stop water pump squeaks. At service stations and garages. Price \$1.00 in U.S.A.

ZECOL INC.

Dept. 2, Milwaukee 1, Wis.



CAR OWNERS...

For smooth engine performance—pep and power—for stepped up lubrication—to free sticky valves—keep rings and valves free—ask for LUBAID. At service stations and garages. LUBAID-T 12 oz. 60c. LUBAID Pts. 75c. Qts. \$1.00 in U.S.A. LUBAID Co., Dept. 2, Milwaukee 1, Wis.

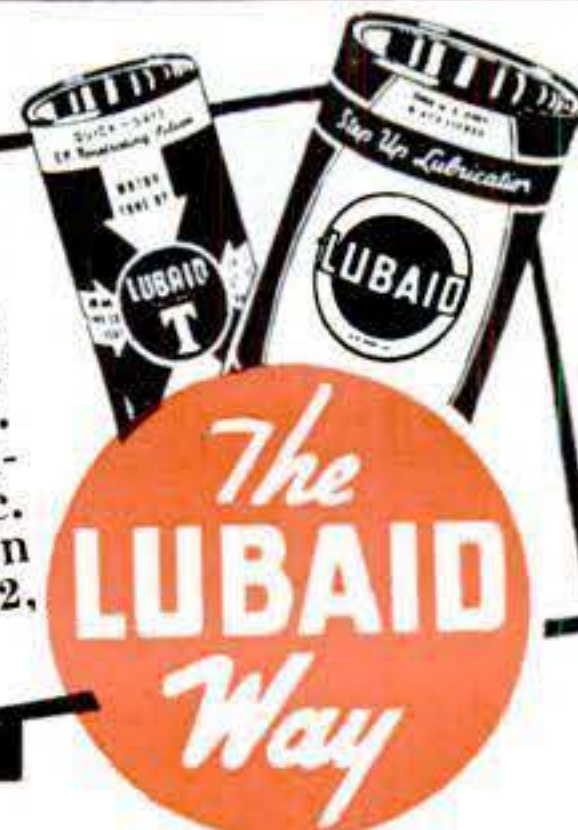

The *LUBAID*
Way

MAY 1947 255

Go Places For Pennies!



Put a WHIZZER Motor on your bike, and go places! The thriftiest power on wheels! Six miles for one penny! 5 to 35 m.p.h.! Fits any man's balloon tire bike!

If no local dealer yet, mail coupon, *today*.

RIDE ONE
AND YOU'LL
BUY ONE



ONLY
\$97.55
PLUS TAX
F.O.B. Pontiac,
Mich.

ON A

WHIZZER

Whizzer Motor Company, Dept. 535, Pontiac, Michigan.

I enclose \$99.97, which includes \$2.42 Federal Excise Tax () check or () money order. Send me one WHIZZER Motor complete, ready for installation. If descriptive literature only is desired, check here ().

Name _____ City _____
Street _____ State _____

This is the way to Make Money!

MACHINE SAW FILING with the Foley Automatic Saw filer is the modern way to recondition saws. Anyone can do the work—no experience needed—no eye-strain. Start in spare time. Foley-filed saws cut so smooth and fast, they will advertise for you, bring you new customers and a steady repeat cash business.

The Foley is the **ONLY** machine that files all hand saws, also band and cross-cut circular saws,—enables you to handle work from schools, shops and factories as well as farmers, carpenters, etc.

Send for **FREE PLAN**

Shows how to start—no canvassing. Send coupon today.

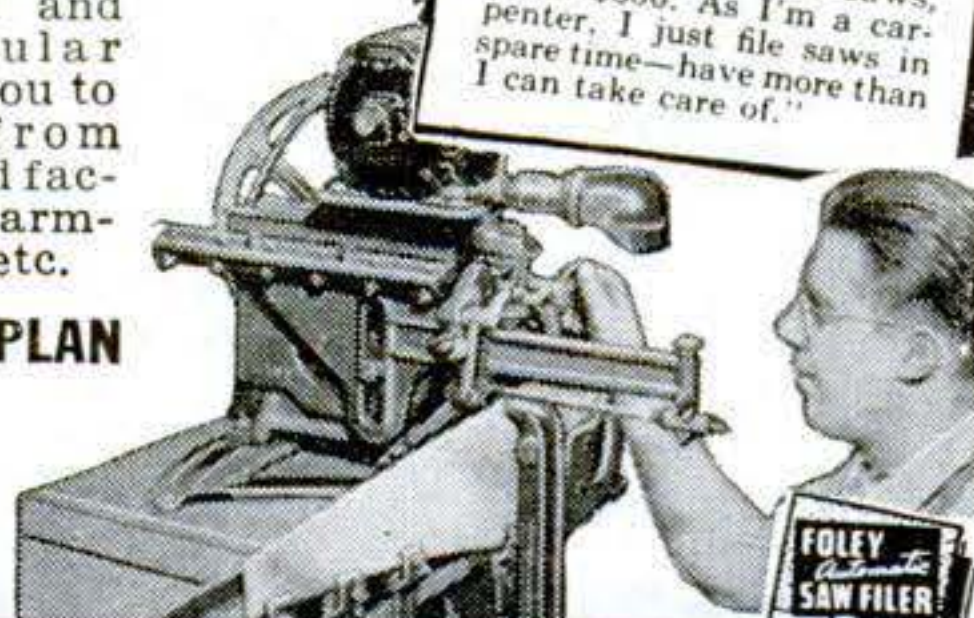

"I bought a Foley Saw Filer, one year later had all debts paid and also \$400 on a new home. Many days I earn as much as \$16," says J. H. Kellogg

W. L. Tarrant writes "I left my old job last September and in 10 months have filed 2,159 saws. We have a lovely business worked up and cannot keep up with the work."

Thor Nedribe, Iowa, says. "I have filed 550 saws, made \$350. As I'm a carpenter, I just file saws in spare time—have more than I can take care of."

FOLEY Automatic SAW FILER

FOLEY MANUFACTURING CO.
519-7 Foley Bldg., Minneapolis 13, Minn.
Send Free Plan on Saw Filing business, no obligation

Name _____
Address _____

SMALL EFFICIENT SPEED REDUCER

Just the thing for the Home Work Shop, Hobby Shop, Bench Work, Animated Displays, Light Production work. Used daily in thousands of homes and shops. Sturdy, compact, (see dimensions). Case of aluminum. Gears, SAE 65 (British) Gear Bronze. Worm of case hardened steel. Timken Bearings throughout. Torque capacity 100 inch pounds. Available in 4 different assemblies (shown below) and in these standard ratios:

4-1	25-1	64-1	200-1
8-1	30-1	75-1	200-1
10-1	40-1	80-1	400-1
16-1	50-1	100-1	600-1
20-1	60-1	150-1	800-1

When ordering be sure to specify assembly and ratio required. Shipping weight in carton, 8 lbs. Full money back guarantee. Prompt deliveries.



\$18.56
NET — POSTPAID

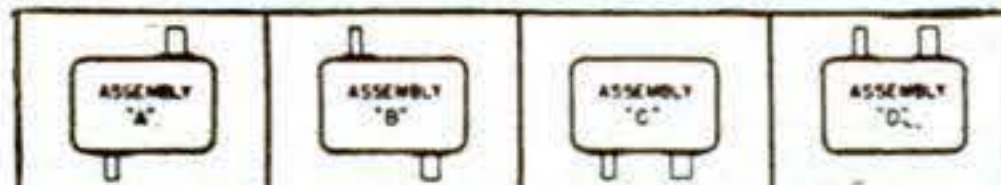
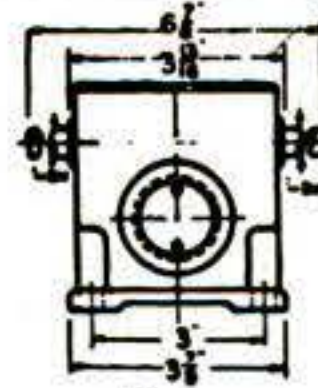

THE OHIO GEAR CO.
1425 EAST 179th ST. • CLEVELAND 10, OHIO

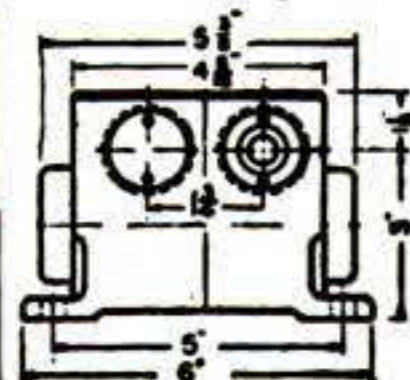

New THOR "B" ENGINE—\$6.95

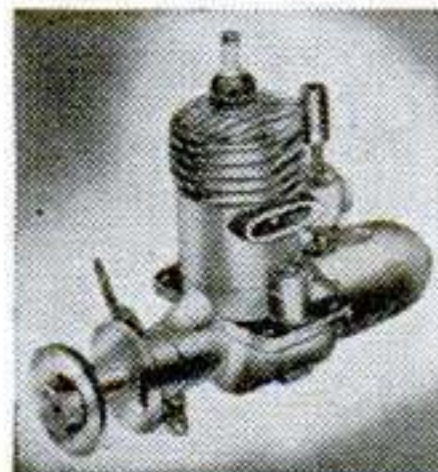

The new THOR "B"—Sensational miniature gasoline engine that really works. Super-power performance. Smooth, velvety power that roars into action with a "twist of the wrist." Over 20,000 already sold. 1/6 H.P. Complete with coil and condenser. Ready to run, only \$9.95. In KIT form, fully machined, 5 minutes to assemble, \$6.95, without coil and condenser. Powers all models. Fully illustrated instructions. Send \$1.00—shipped collect same day C.O.D. FREE—Send for 24-page illustrated hobby catalog.

AMERICA'S HOBBY CENTER
DEPT. S57, 156 WEST 22ND STREET, NEW YORK 11, NEW YORK

Ottawa Self-Propelled Buzz Master

CLEARs LAND FAST! Powerful 6-HP motor with friction clutch for safe operation. Cuts down timber, brush and hedge; turn blade vertically and saw logs to length. Can be equipped to fell largest trees. Has clutch pulley for belt work. Is fully guaranteed.



OTTAWA MFG. CO., 501 Brush St. Ottawa, Kansas



Balance 4" x 9" Base
With either Metric or Av-
oirdupois Weights..... **\$6.00**

Catalog with 3000 illustrations of laboratory Apparatus sent for \$1.00. Catalog of 100 scientific books, 10 cents.
LABORATORY MATERIALS CO.
7317 Vincennes Ave. Chicago 21, Ill.

What keeps the pages
nice and neat
And guarantees the
set's complete?



Dennison
GUMMED REINFORCEMENTS
At Stationery Departments Everywhere

BETTER WOODWORKING THESE 2 EASY WAYS!

1- SHARP EDGES FOR CHISEL AND PLANE IRON BLADES

You need no experience to achieve new and better tool grind. Adjustable Grinding Attachment saves time and money. Convenient, easy to install and use. Greatly improves work through keener cutting edges. **\$6.95**



2- NEW ROTARY SANDER



Sands wood, plastic and metal. Operated with drill press or large electric drill, the new Rotary Sander is excellent for surface or edge sanding. Produces smooth, true, accurate surfaces — without ripples or unevenness. **\$4.95**

At dealers or sent direct on receipt of purchase price. Send for descriptive folders. Write Dept. A

READ-LEWIS MACHINE CORP.
P. O. Box 427 Cambridge, N. Y.

Assemble KING MIDGET

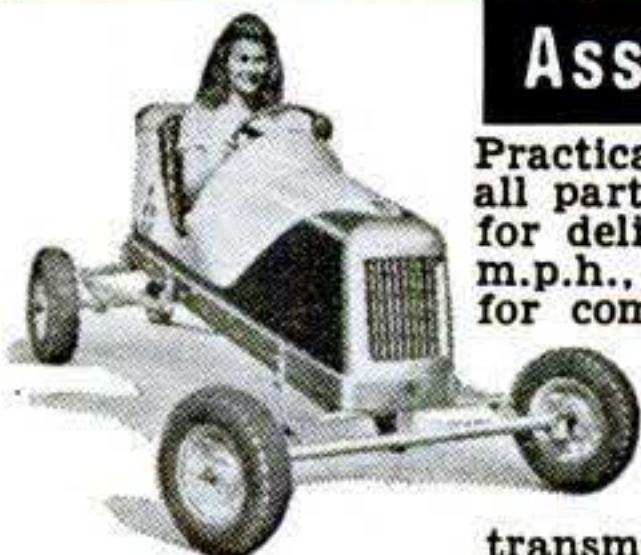

Practical highway racer runabout. We supply all parts. Just bolt together. Low cost. Ready for delivery NOW. One or two cylinder, 40 m.p.h., up to 100 miles per gallon. Send 25c for complete literature with large picture, 3-view drawings, price of parts, or send \$1 for the above plus 4 actual photographs, plans for snow and ice conversion, catalogue of new and used motors, motorscooters, transmissions, clutches, other offerings, etc. **MIDGET MOTORS Athens, Ohio**

PERFECT DOWELS ... easily made



ON YOUR LATHE OR DRILL PRESS
Use a SPEE-DOWL and you can work wonders with wood. Quickly and easily you'll make dowels of any wood . . . perfect burnished dowels for furniture, toys and thousands of other projects. You merely

push SPEE-DOWL on wood—the lathe or drill press does the work! Cast body, tool steel blade. **SIZES: 2, 3, 4, 5, 6, 7 and 8/16"** (illustrated at left). Only \$1. ea. Special—any 4 of above for \$3.50; complete set of 7 for \$6. Also individual sizes 9 to 20/16" (illustrated at right) \$2.65 each. SPEE-DOWL is Unconditionally Guaranteed. Send postal note or check—we pay postage in North America. Send for **FREE Literature.**

JOHNS MFG. CORP., DEPT. B-8 DUNELLEN, N. J.

Ta-pat-co
TRADE MARK REGISTERED U.S. PAT. OFF.



Millions of tiny air cells in the soft quilted KAPOK lining of the new Ta-pat-co make it the most BUOYANT, the most comfortable, sleeping bag you've ever owned. Air cells buoy up tired muscles, provide snug warmth and protection from the weather. A snag-proof rain and wind resistant outer cover . . . a raised foot pocket that prevents cramping of your toes . . . a full-length, "weather stripped" zipper around side and bottom — all the new comfort features are yours with Ta-pat-co.

Buoyant Ta-pat-co makes nights out something to look forward to! See it at your sporting goods store now!

REAL COMFORT Outdoors!



You'll never really know true comfort in wintry days outdoors until you've worn a Ta-pat-co Parka. Light and warm, it's cut to fit for free and easy movement. It's truly an outdoor garment, that can take rough going and last for years. Take a Ta-pat-co on your next trip and you'll never again be without one.

Don't Miss It!

Get Your Copy
of this Book!

How to call ducks without a call . . . how to kill a rabbit without a gun . . . how to boil water in a wooden bucket . . . get the answers to these and hundreds of other questions that make outdoor sports more pleasant and successful. Printing limited — be sure to get your copy — send 10c in coin or stamps now to —



THE AMERICAN PAD & TEXTILE CO.
Greenfield, Ohio
CANADIAN BRANCH—CHATHAM, ONTARIO

MAY
1947 257

MILL IT ON YOUR LATHE

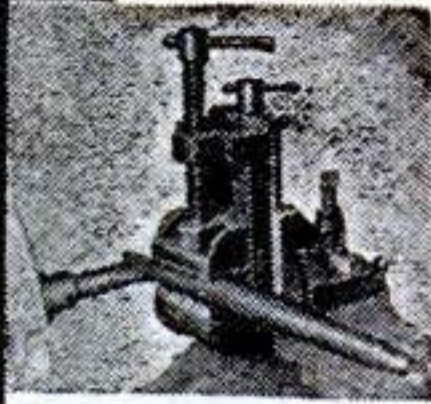

WITH A **PALMGREN**

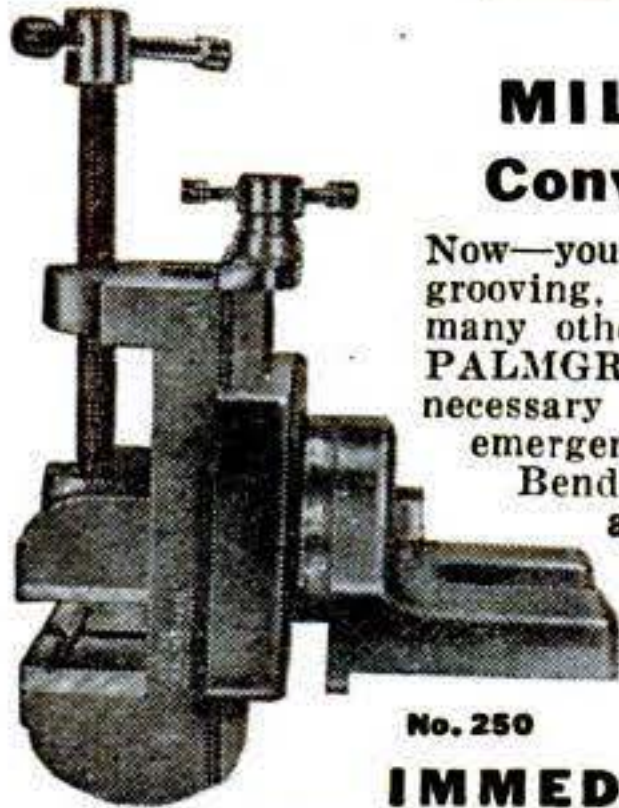

No. 250

MILLING ATTACHMENT Convert Lathe in 10 Seconds

Now—you can do milling, slotting, grinding, grooving, squaring shafts, sawing at angles, and many other important operations on your lathe. PALMGREN MILLING ATTACHMENT is a necessary fixture for small shops, schools and emergency work in large plants. Fits South Bend, Atlas, Craftsman, Logan, Sheldon and all other makes. It has graduation for rotary angle adjustments, also graduated feed and adjustment screw. Easily mounted by straddling lathe's regular tool post. Try one—it will quickly pay for itself.

IMMEDIATE DELIVERY

No.	Width Jaws	Depth Jaws	Jaws Open	Weight Pounds	Base Opening	Price F. O. B. Factory
150	1 1/2"	1"	1 3/4"	6 1/2	1"	\$18.75
250	2 1/2"	1 7/16"	2 1/2"	11	1 1/4"	24.75
400	4"	1 1/2"	4"	25	2"	39.75

Order from your dealer or jobber. Write for circular No. 349

CHICAGO TOOL AND ENGINEERING CO.

Mfrs. of PALMGREN PRODUCTS for Over 25 Years

8396 South Chicago Avenue

Chicago 17, Illinois

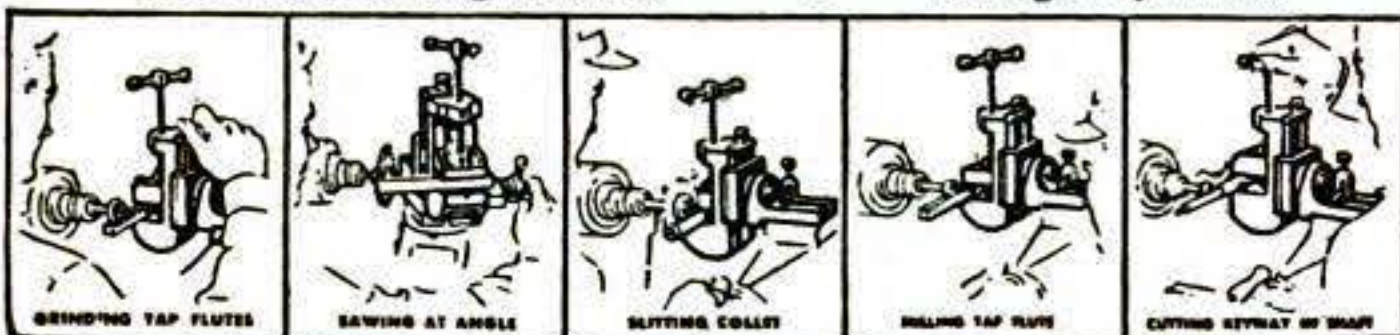

Now for EVERY WORK SHOP!

NEW Invention Electroplates by BRUSH



Easy to Plate CHROMIUM GOLD, SILVER, NICKEL, COPPER . . . For Pleasure and Profit!

If you have a workshop—at home or in business—you need this new Warner Electroplater. At the stroke of an electrified brush, you can electroplate models and projects—you can replate worn articles, faucets, tools, fixtures, silverware, etc. with a durable, sparkling coat of metal . . . Gold, Silver, Chromium, Nickel, Copper or Cadmium. Method is easy, simple, quick. Everything furnished—equipment complete, ready for use. *By doing a bit of work for others, your machine can pay for itself within a week.* So make your shop complete by getting a Warner Electroplater right away. Send today for FREE SAMPLE and illustrated literature. ACT AT ONCE! *Mail Coupon.*
**WARNER ELECTRIC CO., DEPT. M-5
1512 Jarvis Avenue, Chicago 26, Ill.**

FREE Details & Sample!

WARNER ELECTRIC CO., 1512 Jarvis Avenue, Chicago 26, Dept. M-5

Gentlemen: Send Free Sample and Details to:

Name _____

Address _____

City _____ State _____

CONVERT your drill press into a combination LATHE OR DRILL PRESS

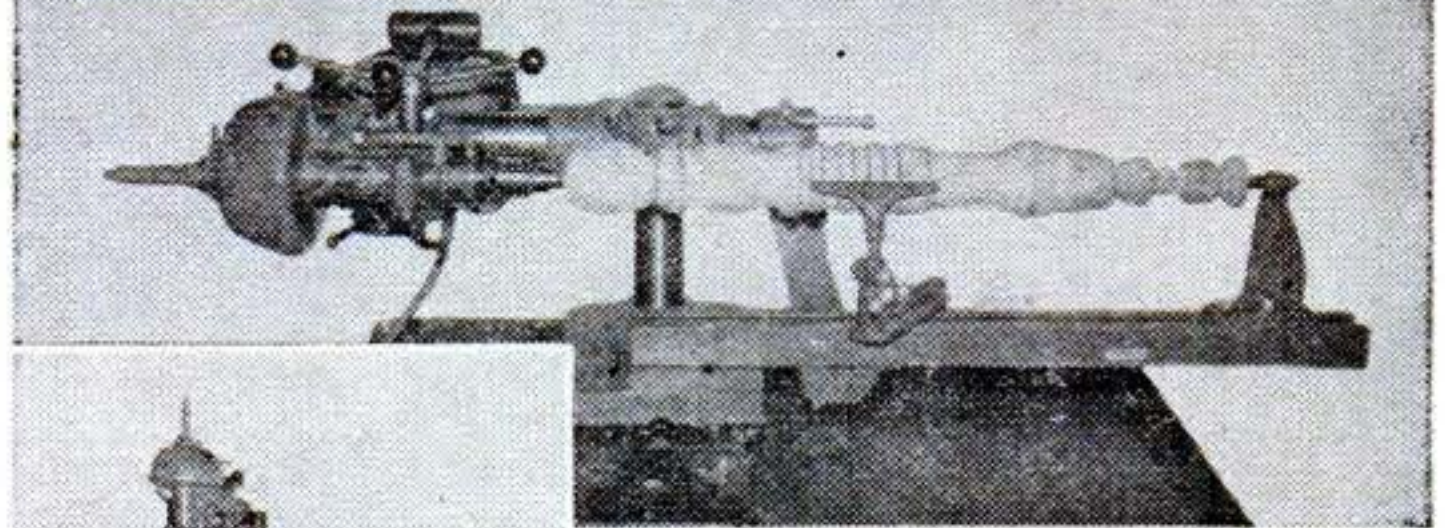

Compact and efficient—the new DRILATHE combines two basic machine tools in one at less cost than with the purchase of a drill press and an independent lathe—eliminates need for additional electric motor—eliminates need of additional bench and floor space—precision made of rigid steel and cast iron—lathe capacity 36" between centers.

WRITE FOR DRILATHE CIRCULAR

NOBUR MANUFACTURING CO.

914 North Orange Drive Los Angeles 38, California



SHAW GARDEN TRACTORS 'DU-ALL' and MOWERS

Get FREE FOLDER NOW!

Get details on 1 to 9 H. P. walking and riding tractors. Do 1000 jobs on small farms, estates, orchards, gardens. Low-priced. Send postcard!

SHAW MFG. CO.

5705 Front St., Galesburg, Kans. 668PS N. 4th St., Columbus, Ohio

BUILD YOUR OWN MACHINE TOOLS! Blueprints \$1.00 - Catalog FREE

Detail construction Blueprints on 6 Lewis metal and wood-working tools postpaid for \$1.00. Includes prints for Lewis 10" Shaper, Milling Machine, Drill Press, Vise, 8" Circular Saw, 6" Joints. Castings for these tools save up to 80% of comparable new tool cost. Illustrated 32-page Catalog—sent free with Blueprint Order—describes 21 Lewis tools. WRITE TODAY!

LEWIS MACHINE TOOL CO.

P. O. Box 7446, Sta. L, Dept. S, Los Angeles 23, Calif.



LAW

STUDY AT HOME for PERSONAL SUCCESS and LARGER EARNINGS. 38 years expert instruction—over 108,000 students enrolled. LL.B. Degree awarded. All texts furnished. Easy payments. Send for FREE BOOK—"Law and Executive Guidance"

AMERICAN EXTENSION SCHOOL OF LAW
Dept. 77-S, 646 N. Michigan Ave., Chicago 11, Ill.

WOOD WORKERS

Lumber—Plywood Available
Harold Hunt wants to send you big new No. 15 Catalog. Over 148 pages of wood-working ideas. 12 pages of rare woods in colors. UNEQUALED BARGAINS in imported and American woods, supplies, hard-to-find hardware. Send only 15c to cover postage and handling.

CRAFTSMAN WOOD SERVICE CO.
2729 S. Mary St., Dept. 8-81 Chicago 8, Ill.

only 15¢

CORROSION and FRICTION

STOP

Use Fiendoil on tools, electrical appliances, household devices. It actively Lubricates·Cleans·Prevents Rust

3-oz. Spout Can 40c

FIENDOIL

"The Enemy of Corrosion and Friction"

**IMMEDIATE
DELIVERY!**

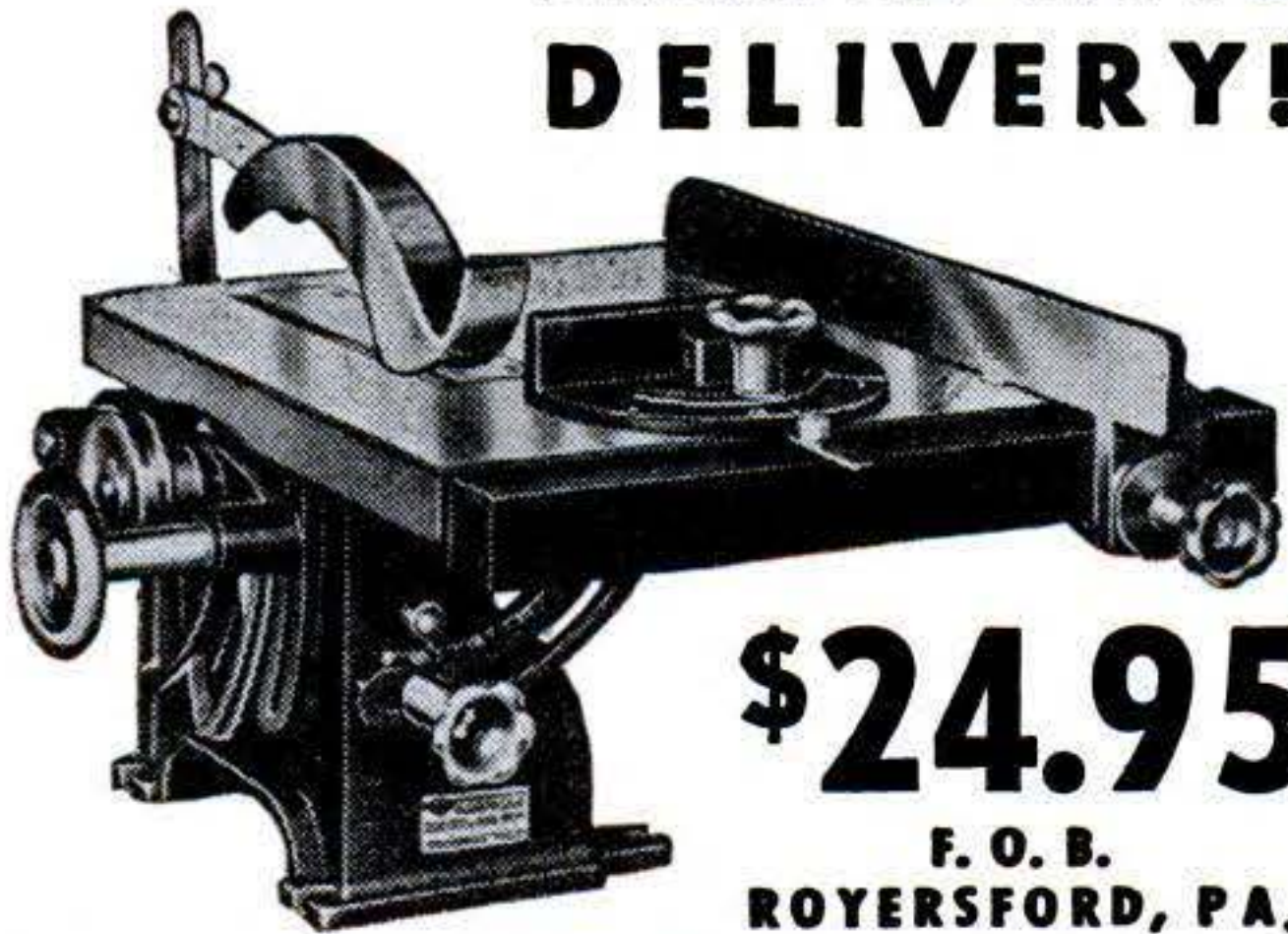

\$24.95

F. O. B.
ROYERSFORD, PA.

8 in. BENCH SAW

COMPLETE AS SHOWN

TABLE SEGMENT—Shows degree of table tilt—graduated. **SPLITTER**—Hard temper cold rolled steel. **GUARD**—Aluminum. **MITER GAUGE**—Aluminum. Accurately graduated 45° each side of center. **BEARINGS**—(2) Oil-ite bronze. **CAPACITY**—0 to 2 1/4". **TABLE** 12"x14". **SHIPPING WEIGHT**—44 lbs.

AMERICAN MACHINE & TOOL CO., Inc.

DEPARTMENT 200 • ROYERSFORD, PA.

LEARN TRIG QUICKLY—EASILY

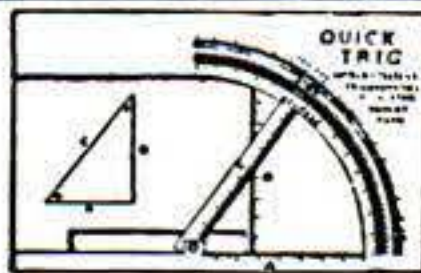

WITH QUICK TRIG, by competitive tests, it was found that QUICK TRIG gave answers faster to one with a slight knowledge of trig than to an expert on trig with a slide rule. Let it solve your trig. problems. You need no previous training. Entirely automatic. Easy instructions included. We mail C.O.D. plus postage or enclose \$1.00, the full price, and we will mail postpaid.

REED MFG. CO., 124-U W. 4th St., Los Angeles 13, Calif.

**"SCOOT" Away
to Work or Play!**

Cushman
MOTOR SCOOTER

On highways, in town, on the farm, at the factory, for deliveries, service calls... go the Cushman modern and economical way.

35
MILES PER HOUR
75
MILES PER GALLON

FREE

Send for literature and name of your nearest Cushman dealer. Write postcard today.



Cushman Motor Scooters are speedy, safe. Park anywhere. "Eye-dropper" gas economy. Ruggedly built with automatic clutch, two-speed transmission on most models, 4 H.P. Cushman "Husky" engine. Balloon tires and knee-action springing give easy riding, load carrying capacity. Convenient luggage compartment. Nation wide service. **CUSHMAN MOTOR WORKS, INC.** Dept. S-500 Lincoln, Nebr.

Backed by 45 Years of Quality Engine Building

Logan A NAME TO REMEMBER
WHEN YOU THINK OF BETTER
LATHES AND SHAPERS

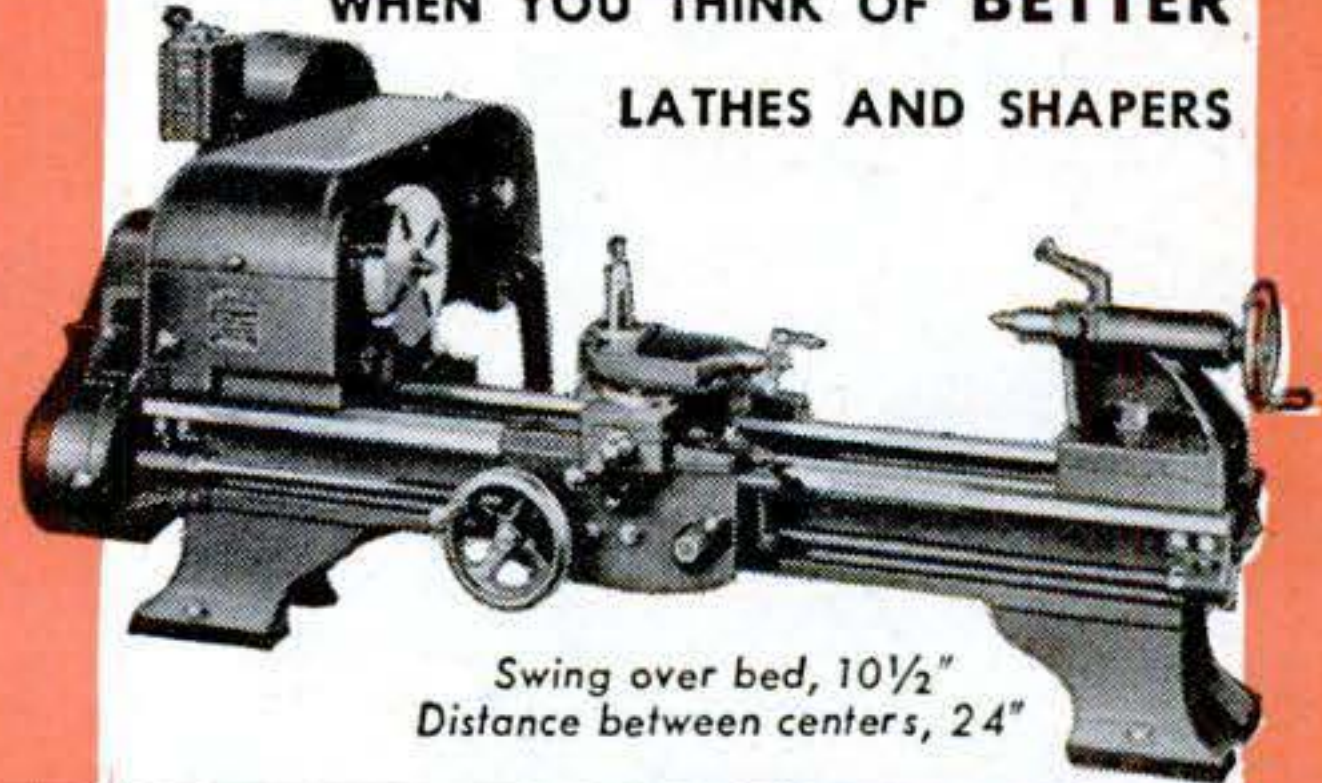

Swing over bed, 10 1/2"
Distance between centers, 24"

**a Logan lathe
belongs in your shop**

A Logan Lathe in your shop puts at your disposal the same accuracy, speed and versatility that have made this lathe a standard tool of industry. The same ball bearing mounted spindle, the same rugged bed with ways ground to within .0005" of parallelism, the same precision construction throughout that make Logan Lathes outstanding industrial performers mean satisfying results for you. The compact Logan design takes up a minimum of space. The simplicity and safety of its operation, and its low maintenance, are further reasons why the Logan Lathe belongs in your shop.

WRITE FOR THE LOGAN CATALOG... complete information on Logan Lathes, Shapers and Accessories.

9 REASONS why LOGAN Lathes are BETTER lathes

- 1 **BALL BEARING HEADSTOCK**
for sustained accuracy.
- 2 **RUGGED, ACCURATE BED**
within .0005" of parallelism.
- 3 **SELF-LUBRICATING BEARINGS**
at vital points lengthen life.
- 4 **BACK GEARS ENCLOSED IN HEADSTOCK**
with shifter rack safely and conveniently at your finger-tips.
- 5 **RUBBER CUSHIONED COUNTERSHAFT**
for smoothness and accuracy in working area.
- 6 **THREE POINT SUPPORT**
Steadies the countershaft, prevents rocking.
- 7 **ENCLOSED BELTS, GEARS, PULLEYS**
Prevents accidents. Keeps lathe clean.
- 8 **AUTOMATIC BELT TENSION RELEASE**
Makes belt changing easy and safe.
- 9 **PRECISION BUILT THROUGHOUT**
For tool room accuracy in your shop.

DISTRICT OFFICES

Woolworth Bldg.
New York 7, N. Y.
Cortland 7-8024

550 W. Washington Blvd.
Chicago 6, Illinois
Central 1246

1672 Mission Street
San Francisco, Calif.
Underhill 6682

LOGAN ENGINEERING CO.,
DEPT. C-5, 4901 LAWRENCE AVE., CHICAGO 30, ILL.

MAY
1947 259

SOLID SENDERS!



Stan Musial
1946 National League
Batting Champion

Ripky Vernon
1946 American League
Batting Champion

Again Louisville Slugger Bats shared the Nation's top batting honors with the 1946 Champions of both major leagues. They know as do tens of thousands of ball players throughout the world, "It pays to play with the finest."

FREE AT YOUR DEALERS!

1947 FAMOUS SLUGGER YEAR BOOK and OFFICIAL SOFTBALL RULE BOOK. Or send 5c for Year Book and 10c for Softball Rule Book direct to Dept. Z-34

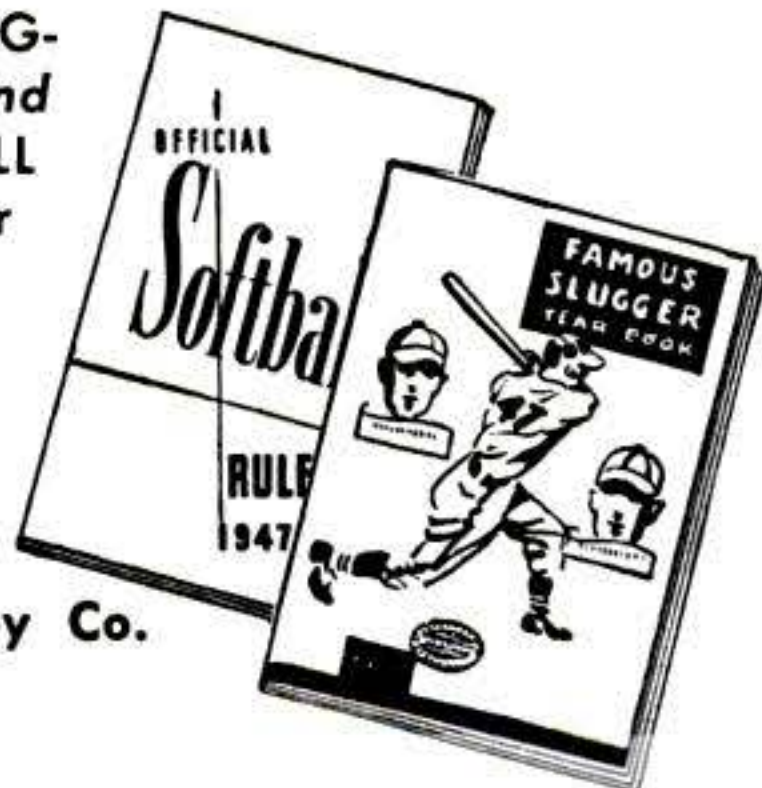

Hillerich & Bradsby Co.
Louisville 2, Ky.

LOUISVILLE SLUGGER
HILLERICH & BRADSBY CO.
LOUISVILLE, KY.

Louisville SLUGGER BATS

FOR BASEBALL & SOFTBALL

ATTENTION HOMECRAFTSMEN!
PLANS For Dutch Windmills, Lighthouses, Bird Houses, Lawn Chairs, Arbors, Trellises, many kinds of fine furniture, also a great variety of Lawn Figure patterns. SEND 10c FOR CATALOG ILLUSTRATING OVER 100 PRACTICAL PROJECTS
Craftsman's Model Co., 2030 N. 41st St., Dept. K17, Milwaukee, Wis.

SANBORN DOG WHISTLE NO. 1

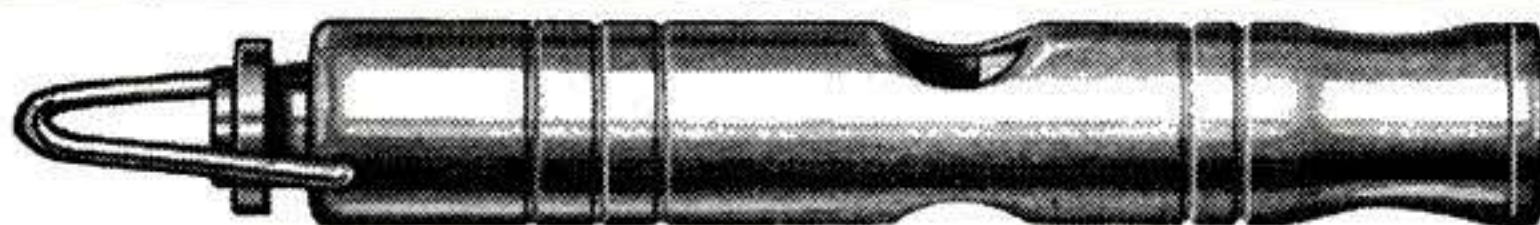

\$2⁰⁰

Natural Alternating Two Tone Dog Call, Also Human Hailing Call

FACTORY TESTED AT 1 MILE—Pitched just below insect interference tones—a scientific precision-made instrument turned from a special aluminum alloy. Dogs respond without special training. All calls personalized by blower. See your dealer or order direct.

SANBORN PRODUCTS CO.

BOX 132-G

MENTOR, OHIO

Today's Best PLANER VALUE

A Lifetime-Tool at Low Cost

\$119.⁵⁰

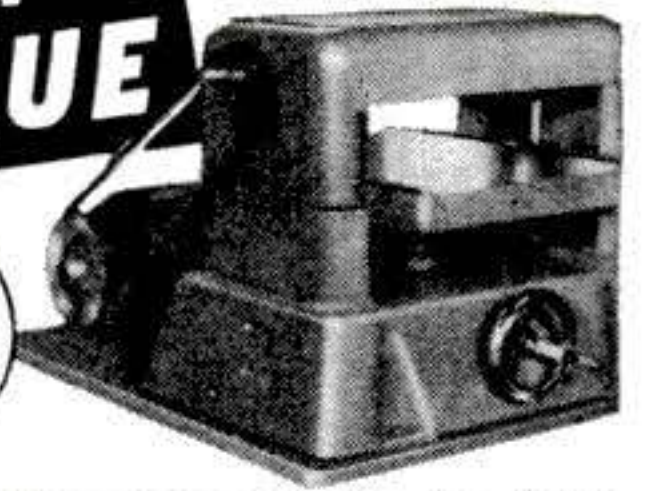

The "YAGER" —Thickness Planer—not a jointer, for home-craftsmen, or auxiliary tool for large shops. A marvel of efficiency, precision performance —at an amazingly low cost. Dependable for constant, uninterrupted, trouble-free service. Works any stock from soft balsa to hard ebony. Produces smooth, polished surfaces. Takes stock up to 10 in. wide, 2 3/4 in. thick or down to a thinness of 1/16 in. Handles light work with 1/8 H. P. motor and hand crank feed or heavy cuts up to 1/8 in. with 3/4 H. P. Sealed ball bearing arbor requires no lubricant. Feed gears packed in oil seldom need repacking. Now ready for immediate delivery. Write for prices and startling facts.

THE KNEISLEY ELECTRIC COMPANY
495 S. St. Clair St. Dept. 57 Toledo 3, Ohio

YOU Can Get This 2H.P. MOTOR SCOOTER!

AS LOW AS **\$29.⁹⁵**

Assemble or build it—it's easy! We can furnish factory built parts. 2 speeds up to 45 MPH! 100 M.P. gal. Easy riding—knee action and low gravity spring frame. Large 12" tires. Streamlined. SEND ONLY \$1.00 (cash or money order postpaid) (or pay postman \$1.52 C.O.D. in U.S. only) for complete scale isometric picture blueprints (anyone can read them). 8 pages photo details, lists of factory parts prices for both electric and gas models! FREE with each order—big 48 page color book giving full details on over 100 other new inventions such as JET ENGINES—MIDGET MOTORCYCLES—ELECTRIC WELDERS—MOTORS—MIDGET CARS—BIKE MOTORS AND SIDECARS—MIDGET GARDEN TRACTORS. SAVE HUNDREDS OF DOLLARS WITH THESE PLANS! (Foreign orders \$1.50)
MOTOR INDUSTRIES INC. Dept. PS-5 KEARNEY, NEBRASKA



ELECTRIFY your LAWNMOWER Battery Operated...

SELF-CONTAINED • SELF-PROPELLED

We show you how to convert your own lawnmower for use with a car battery. Save energy, labor and time with this self-propelled unit. Our simplified plans make it easy.

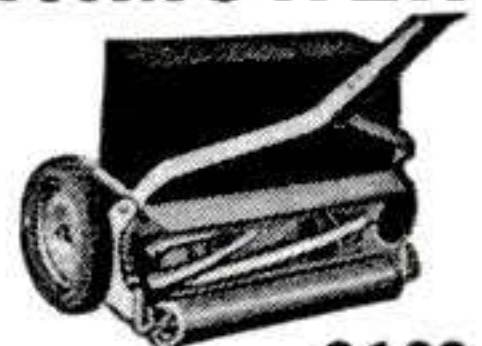

LEJAY MFG. CO. 223 LeJay Bldg.

Complete Plans **\$1⁰⁰**
Minneapolis 8, Minn.

FREE!
FAMOUS
BLUE BOOK
CATALOG

GAME SUPPLIES

Club Furniture - Counter Games - Punchboards - Magic Cards Readers, Read the backs - Inks - Daubs - Poker Chips - Tops Flats - Layouts - Game Boxes.



K.C. CARD CO., 838 South Wabash Ave., Chicago 5, Ill.

Everything in Radio!

Make Radolek your buying headquarters for Radio-Electronic repair and replacement needs. Large stocks assure finest, most complete selections of all available items at lowest prices. Your orders receive special attention for fastest delivery. Send today for FREE Radolek Buying Guide.

RADOLEK CO., Dept. A-126, 601 W. Randolph St., Chicago 6, Ill.

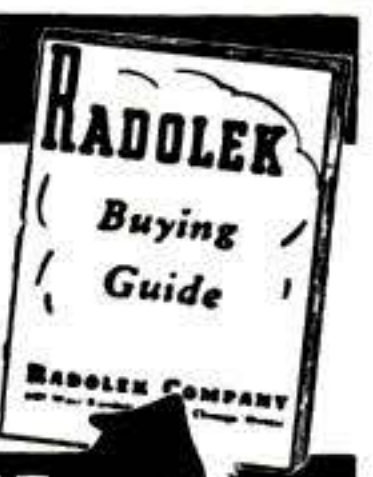

FREE RADIO BUYING GUIDE

Say You Saw
It In Popular Science

Gigantic 1¢ Sale

Amazing Introductory Offer!

BALL POINT PENS

Writes two years or longer with average use, on a single ink cartridge. New cartridges are available and can be changed in a second. Each time you change the cartridge you get a whole new writing unit.

- Precision molded parts insure long-lasting perfect performance.
- Slim modern design—a perfectly-balanced lightweight pen.
- Smartly designed deep pocket clip and trim, commands admiring glances.

DUBONNET • BLACK

1 for \$1.49
2 for \$1.50
Include 10c postage. For Canada 25c

The ball point is part of the cartridge

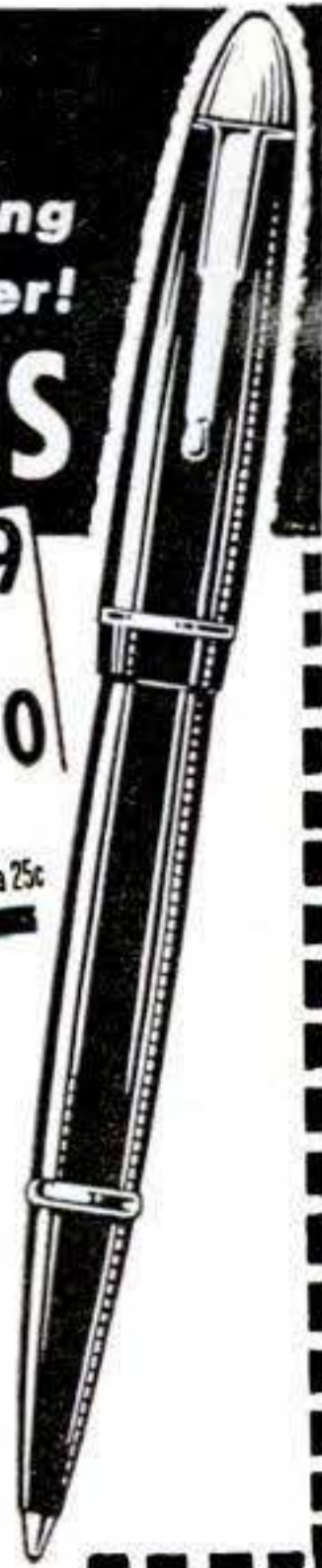

ORDER YOUR PENS TODAY!

Send Money Order, Check or Cash. No C.O.D's.

MIRRO-PLEX

142 WEST 32nd ST., DEPT. PS, NEW YORK 1, N. Y.

OTTAWA LOG SAW Write For **FREE BOOK**



Put this OTTAWA to work for you. **MAKE MONEY!**

Wood is bringing highest prices ever known. Ottawa does more than 10 men. Easily operated. Falls trees—saws limbs. Use 5-hp. engine for other work.

OTTAWA MFG. CO., 501 Wood St., Ottawa, Kans.

DIE-LESS DUPLICATING

Many small parts can be formed without dies, to duplicated accuracy of .001" with DI-ACRO Precision Machines. — Benders, Brakes, Shears. Save die expense and time delay. Ideal for experimental and research work, making samples, models, etc. as well as regular production runs. Write for descriptive literature.

O'NEIL-IRWIN MFG. COMPANY
342 8th Ave., Lake City, Minn.

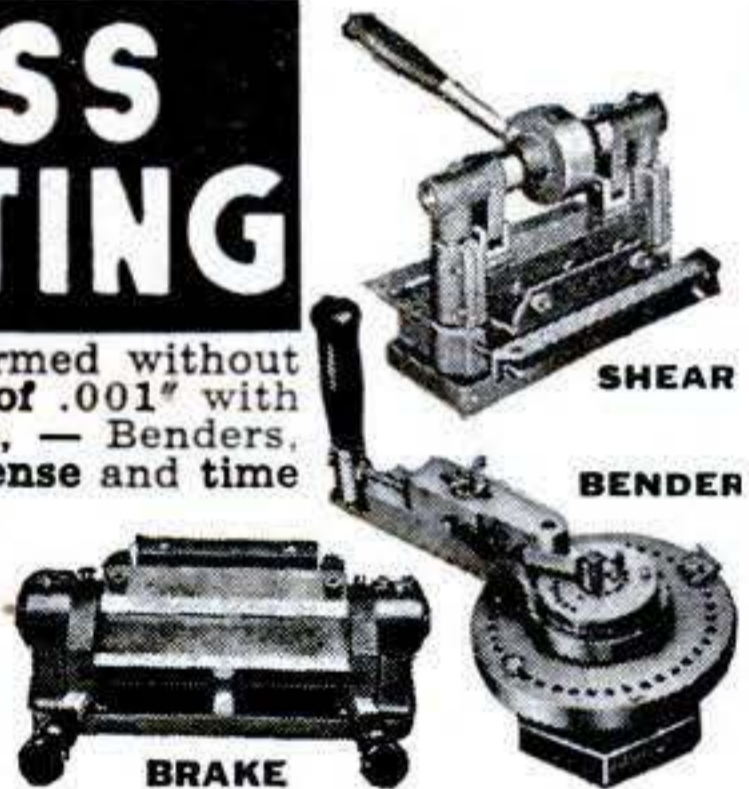

For Threading, Boring, Reaming
NEW BRUNO BORING BAR SET
and **ADJUSTABLE HOLDER**

Complete with adjustable boring bar holder with exclusive V-Channel grip, and three boring bars, 1/4", 3/8", and 1/2". Each bar has one precision ground high speed steel threading bit and one blank high speed steel bit. Holder clamps over lathe tool post (1" diameter or less).

Model No.	Capacity	User's Price
Boring Bar Holder Model 600	3/16"-3/4"	\$5.45
Boring Bar Set No 559	1/4" bar 3/8" bar 1/2" bar	\$8.45
Boring Kit No 650		\$12.95

Automatically centers and rigidly holds any 3/16" to 3/4" round or hex bar, drill, or reamer.

See Your Dealer

A HEAVY-DUTY PRECISION BUILT SET FOR MACHINE SHOP OR WORK BENCH



Boring Bar Set No. 559



Boring Bar Holder Model 600



The BIG BUY in TOOLS
BRUNO TOOLS, Beverly Hills, Calif.

How to **TIGHTEN**
THAT LOOSE HANDLE
TO STAY

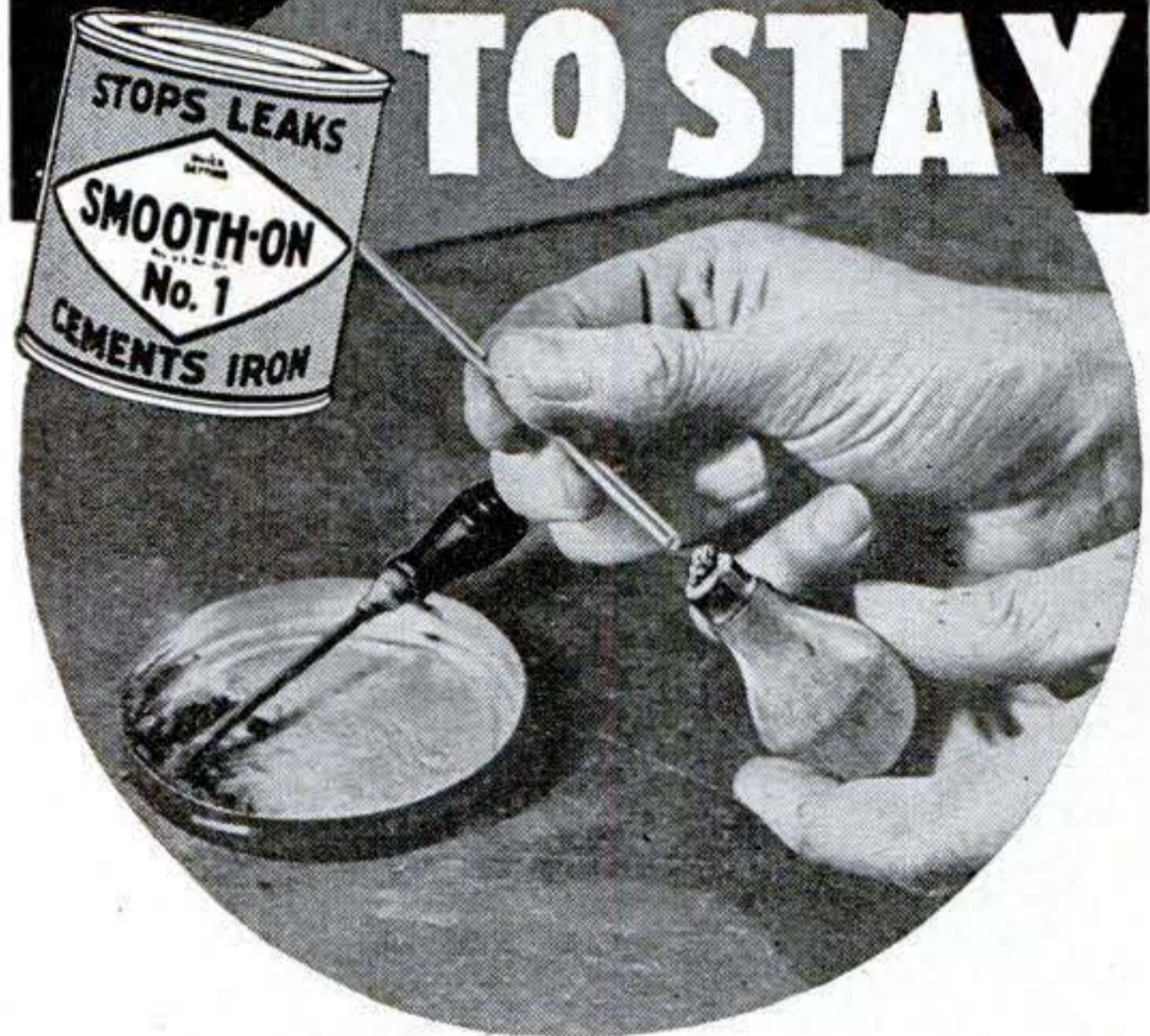

Use this quick, sure remedy for loosened tool and cutlery handles, metal door knobs and fixtures, casters, bolts, nuts, screws, rivets, etc. Fill screw hole or handle hole with a soft putty of Smooth-On No. 1. Insert screw or handle, turn it up tight and allow the Smooth-On to harden. The loose part will stay tight, because Smooth-On No. 1 expands slightly in hardening and holds screw or handle in place.

You'll find Smooth-On No. 1 also a time-saver and money-saver for sealing cracks and stopping leaks in piping, boilers, radiators, tanks, etc. Buy it in inexpensive 1 3/4-oz. or 7-oz. size at your hardware store. If they haven't it, write us.

FREE HANDY REPAIR HANDBOOK

40 pages. Pocket size. Clear, practical, short-cut directions for dozens of repair jobs in the home, on the car, etc. 170 diagrams. Send coupon for YOUR free copy today.



— — — Sign and Send NOW — — —

Smooth-On Mfg. Co., Dept. 58E
570 Communipaw Ave., Jersey City 4, N. J.

Please send me my Smooth-On Handbook

Name.....

Address.....

5-47

Do it with **SMOOTH-ON**
Iron Cement of 1000 Uses

Keep Brushes like New

BEFORE

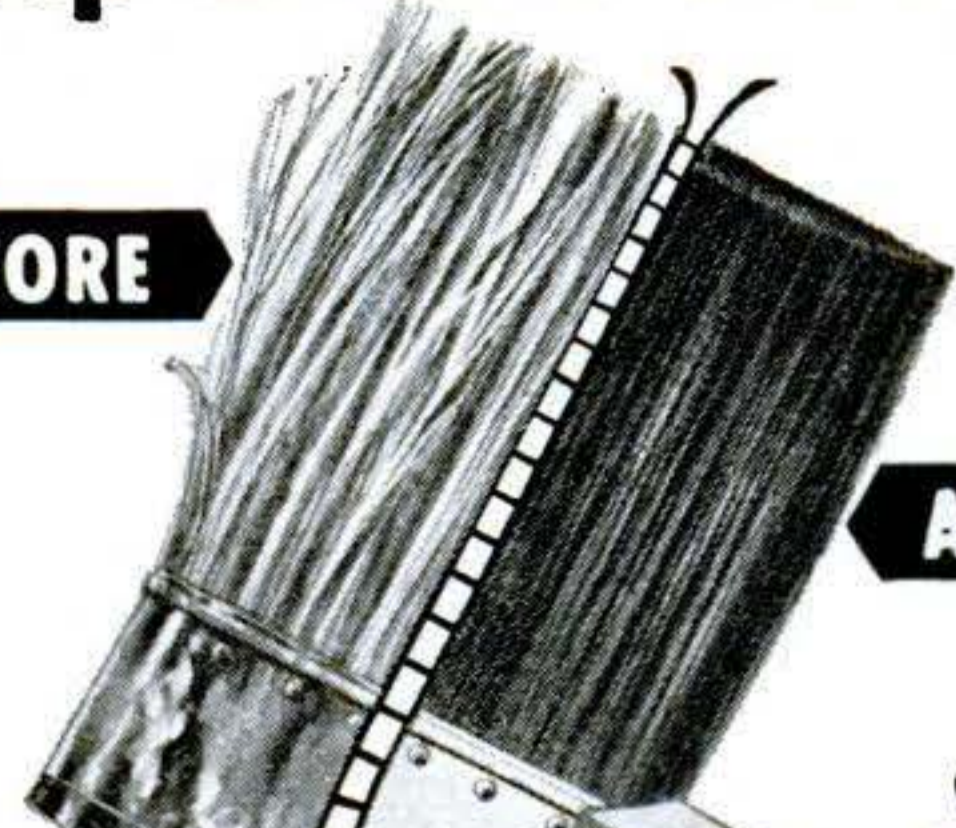

AFTER



● 5c
● 10c
● 25c

**DICA'DOO
PAINT
BRUSH
BATH**

Clean and Restores
PAINT BRUSHES

At Paint, Hardware, Dept., and 5 & 10c Stores
Patent Cereals Co. Geneva, N. Y.

Everyone is a Mechanic

Buy Your Boy

A CLINTON ENGINE

Today is a day of mechanical achievements—as you and your dad liked horse power on the hoof, your son likes horse power built of iron. The Clinton Engine gives a wonderful education in modern engineering and machine design. It's a development of outstanding sturdy characteristics—1 to 2 H.P.—4-cycle—air-cooled for powering his implement of pleasure or work—

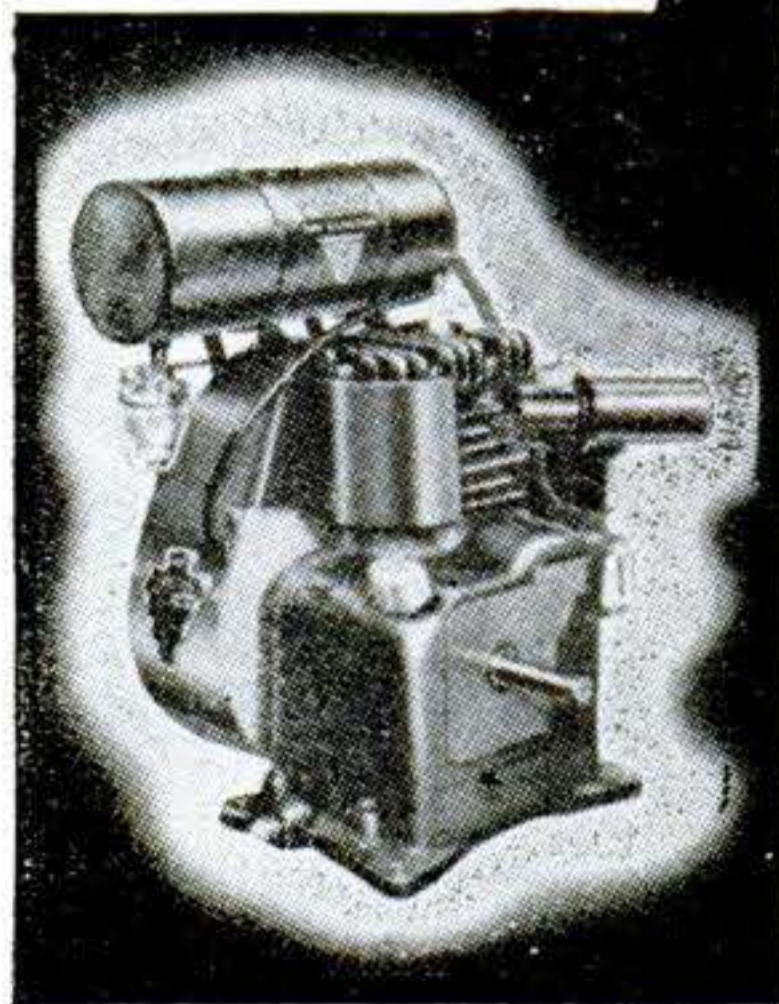

See your dealer—There is one in your community — or write — Dept. 101PS

CLINTON MACHINE CO.
CLINTON, MICHIGAN

New IMPROVED Electric
MOTO-SAW

Only \$5.85 Postpaid

SAFE AS A HAND SAW JUST GUIDE IT!

More like magic than any tool you ever saw. Imagine an electric scroll saw only slightly heavier than a hand coping saw . . . a tool that takes no effort to run, no pressure to feed. Works at any angle—on big assembly jobs or on the tiniest piece you can hold in your fingers. Runs 7200 strokes a minute . . . so fast the blade seems to stand still. Sturdily built . . . only two moving parts . . . never needs oiling. Easily cuts intricate designs—so smooth it eliminates sanding. Novice or craftsman, a thrill awaits you when you get a Moto-Saw in your hand.



U. S. Patent 2233862
Other Patents Pending
DREMEL MFG. CO.
Dept. S127-E
Racine, Wisconsin

No limit to length of stock it will cut. Saws to center of 19" widths

It's fast . . . cuts on an average of 1 ft. per minute up to 3/4" medium hard wood. Operates on 110-120 V. 50 or 60 cycle alternating current. If your dealer does not yet have Moto-Saw, send \$5.85 . . . we'll pay postage. Or send \$1. pay postman balance plus postage. **MONEY BACK** if not delighted after 5 days trial.

WOODWORKERS . . . Get this

CONSTANTINE MASTER MANUAL
Get the Most Fun From Your Hobby
Indispensable to woodworkers. Newest, biggest edition, more pages, more color, helpful how-to-do-it articles, pre-war and new items, more bargains. Send 25c today and we will include **FREE! FULL YRS. SUBSCRIPTION** to Chips and Chats, published bi-monthly. Keeps you up-to-date on everything in woodworking, offers big money-saving bargains. Send now.



ALBERT CONSTANTINE & SON, Inc.
793-E 135th Street, New York 54, N. Y.

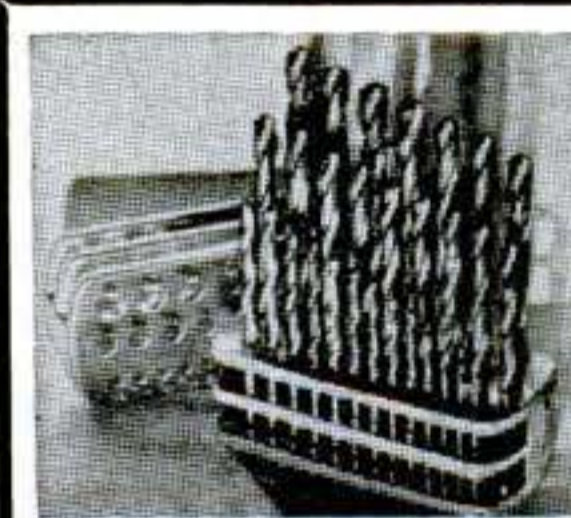

Why Hunt for Drills?

These Complete High Speed Drill Sets
Now Available at Low Prices
#1 to 60 Drills . . . \$12.95 Per Set
1/16-1/2 by 64ths . . . \$16.95 Per Set
Drill Sets A-Z . . . \$15.50 Per Set
(Drill Stands Free)

SEND FOR FREE CIRCULAR
SID TOOL CO.

MACHINE SHOP SUPPLIES
Dept. S, 183 Grand St., New York 13, N. Y.

WATCHES WANTED

BROKEN OR USABLE

All kinds. Highest Prices paid for jewelry, rings, spectacles, gold teeth, diamonds, Sterling Silver, etc. Cash mailed promptly. Write for free shipping container.

LOWE'S, Dept. PS, Holland Bldg., St. Louis 1, Missouri

LAW
STUDY AT HOME for PERSONAL SUCCESS and LARGER EARNINGS. 38 years expert instruction—over 108,000 students enrolled. LL.B. Degree awarded. All texts furnished. Easy payments. Send for FREE BOOK—"Law and Executive Guidance."

AMERICAN EXTENSION SCHOOL OF LAW
Dept. 77-S, 646 N. Michigan Ave., Chicago 11, Ill.



"JACKPOT"

Home Model
COIN MACHINE

● Great fun maker for Rumpus Room or Club. Soon pays for itself. Fully automatic payout, three reels, with all the usual winning combinations . . . cherries, lemons, etc. Double jackpot. Rugged lifetime construction. *Guaranteed* to satisfy or money back. Service manual makes it easy to understand how to operate machine successfully. Takes space only 14 1/2 x 11 1/2

in. Ht. 18 1/2 in. Shpg. wt. 47 lbs. CHOICE OF 5c, 10c, or 25c PLAY. Send \$50.00 deposit, balance C.O.D. plus express charges. Immediate delivery . . . Each, **\$198.00**

Webb DISTRIBUTING CO. INC.
6 SOUTH KEDZIE AVE. • CHICAGO 12, ILLINOIS

REMOVES ALL FINISHES



New type semi-paste remover quickly lifts off paint, enamel, varnish, shellac, lacquer, bakelite and other synthetic resin finishes. (Removes emulsified resin water paints, too.) Stays wet longer — stays put on upright or overhead surfaces — strips clean, quick. One coat usually enough (apply with brush or spray). Contains no benzol, acid, caustic, alkali, or wax — harmless to hands, bristles, surface stripped. All sizes (pint 65c) at paint and hardware stores.

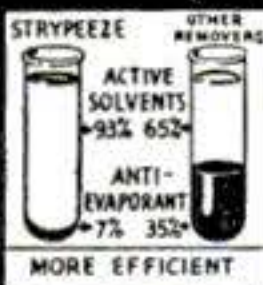

NO BENZOL-ACID-CAUSTIC-ALKALI-SAFER TO USE

FREE CIRCULAR

"How to Remove Paints, Varnishes, Lacquers, etc." Also describes other Savogran Products: Heavy Duty Cleaner, Crack Filler, Wood Putty, Remover & Bleacher (renews floors), Paint Brush Cleaner, Coldfoam Soapless Soap Powder

It's Orange!



THE SAVOGRAN CO.
DEPT. 45 BOSTON 10, MASS.

SAVOGRAN STRYPEEZE

IN EVERY WELL-EQUIPPED HOME WORKSHOP

ANCO RAIN-MASTER

"Dead-Locker" WINDSHIELD WIPER ARMS and BLADES

BLADE SNAPS ON...
STAYS PUT

FINGER-TIP
RELEASE

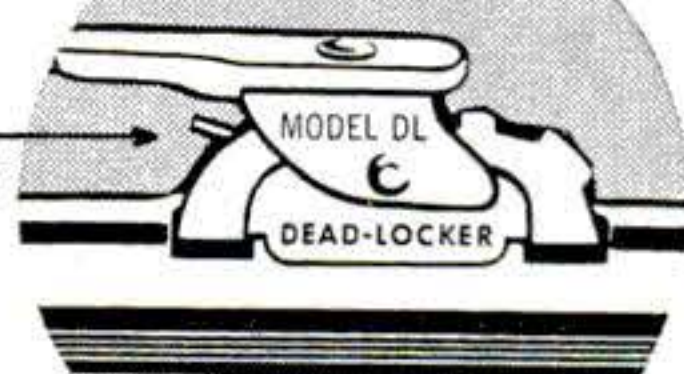

CAN'T FALL OFF
CAN'T BLOW OFF

(A war-born invention—by ANCO—first
for military aircraft—now for your car.)

DON'T SHOOT YOUR GAS-PUMP MAN!

He's doing the best he can. Sure, he knows how dangerous it is for you to drive your car... in stormy weather... with your dull old windshield wipers that smear and smear. He'd gladly put on for you quickly a pair of keen new ANCO RAIN-MASTER Wiper Blades and Arms. He has them—Newest Models! But he forgets to remind you? Too busy? You can't shoot him for that!

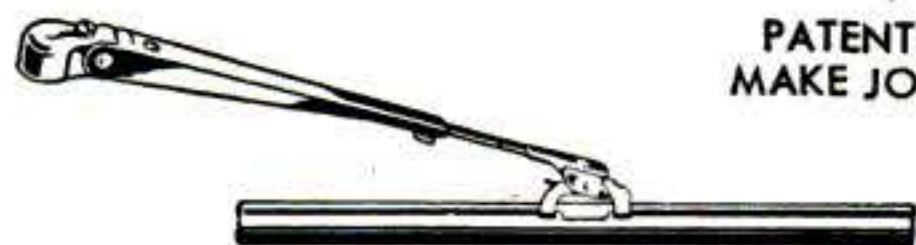

After all, it's *your* car to protect. So *you* remind *him*. Get RAIN-MASTERS... patented features... original equipment on many makes of high grade cars and trucks... used in war—on our fighting tanks and trucks and ships and bombers too... because ANCO RAIN-MASTERS clean quicker, clean cleaner... last longer. May save you a costly smashup.

Ask for RAIN-MASTER Windshield Wiper Arms and Blades next time you buy gas.

THE ANDERSON COMPANY
Established 1918
GARY, INDIANA

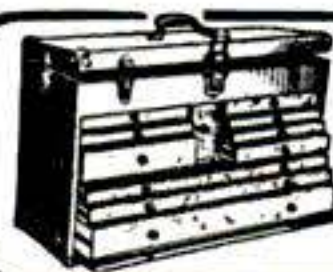

MACHINISTS — TOOLMAKERS

Gerstner Tool Chests are made by skilled mechanics for tools of good craftsmen. Free catalog. **GERSTNER TOOL CHESTS**
547 Columbia St., Dayton 7, Ohio



FUN AND MONEY IN PLASTICS

YOUR NEW 1947 ILLUSTRATED CATALOG NOW READY! LISTS EVERYTHING you need at **NEW LOW PRICES**... includes full instructions and new money making ideas; new kits, new PLASTELL; tells how you can win cash awards in national craft contest. Send 10c today to

BELLCO PLASTICS, INC.

98 Gramatan Ave. Mt. Vernon, N. Y. Dept. P-5

OLD SAWS MADE NEW

With FOLEY

You don't even remove the handle—just put saw in machine and in 3 minutes you have a perfect set of new teeth.

Handsaw Retoother

Accurate—positive—easy to use. Cuts 20 sizes of teeth from 4 to 16 points per inch on any handsaw. Saves filing time,—no eye-strain. Send for circular.



FOLEY MFG. CO., 591-7 Foley Bldg., Minneapolis 13, Minn.
Send full details on Foley Retoother

Name.....
Address.....

NEW



HANDY SOLDERING IRON FOR HOME & HOBBY SHOP

Now you can own a home soldering iron which has the same kind of Calrod* heater found in G-E industrial irons, the irons that professionals use. Rated at 85 W, 115 V, G-E Handy irons are perfect for a score of home repair jobs, for building radios, making electrical connections, and for many kinds of metal working and model building.

You'll like the quick way this G-E Handy iron gets down to work with a steady, efficient supply of heat... its high-speed performance, light weight, and cool handle.

Ask to see the G-E Handy soldering irons at your dealer's. Price only \$3.95. Or write to Dept. 667-1, Apparatus Department, General Electric Company, Schenectady 5, N. Y.

FREE: An up-to-the-minute manual on soldering techniques with every purchase of a G-E Handy iron.

*Reg. U.S. Pat. Off.

GENERAL ELECTRIC

667-1V-194

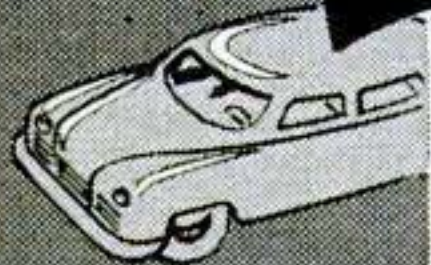
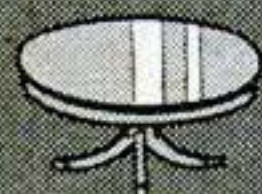
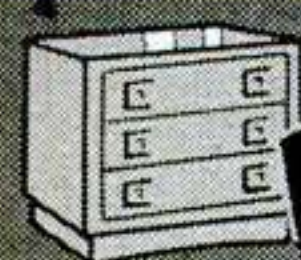

PAINT IT YOURSELF...
WITH
Plasti-Kote

**The Plastic Finish for
AUTOS, BOATS, FLOORS
FURNITURE & WOODWORK**



Use Plasti-Kote wherever you want a gleaming, lasting and durable finish. Plasti-Kote leaves a cellophane-like surface that resists hot or cold water, alcohol, dirt, oil, vibration and changing weather. Dries in 3 hours—leaves no brush marks. Easy to apply. 36 beautiful colors. \$2.95 quart.

PLASTI-KOTE, INC. 425 LAKESIDE AVENUE N. W.
CLEVELAND 13, OHIO

Send new color folder and descriptive literature: PS

Name

Address

City..... Zone..... State.....



**PLASTICO ROK
WATER-PROOF PLASTICO**

PLASTICO ROK in Colors

Fills cracks in plaster, woodwork, wall board. Mends furniture, ornaments, toys. Chart of 13 colors sent free. Tubes 25c, 1/4 pt. can 45c, postpaid.

GUARD YOUR HEALTH

Fill and seal cracks around sink and drainboard with **WATER-PROOF PLASTICO**

The new mending plastic—does a perfect job quickly and easily. White only, tubes 25c, 1/4 pt. cans 45c, postpaid.

FREE BULLETIN of valuable information on **PLASTICO** products. Simply write to

TECHNICAL SUPPLY CO

1905 University Ave.
Palo Alto, Calif.

ONE-MAN SAWMILL

● **EASY TO TURN TREES INTO MONEY... BELSAW MODELS** in 10 to 24 foot sawing lengths. **MECHANICAL FEED**, accurate set works and positive

LESS THAN \$200⁰⁰

Makes lumber, ties, shingles, crates, lath, stud-ding, siding.



dogs. Use tractor or old auto engine for low cost power. Thousands used for commercial sawing. Pays for itself quickly. Send a postcard today for **FREE** booklet, **HOW TO MAKE LUMBER**—and Catalog of Woodworking Equipment.

BELSAW MACHINERY CO., 1846XS Field Bldg.
315 Westport Road, Kansas City 2, Missouri



FREE RADIO CATALOG

Latest radio and electronic parts and devices, newest ham gear, gadgets, war surplus items. All in this new **FREE** catalog. Don't delay,

BURSTEIN-APPLEBEE CO.
1014 McGee, Kansas City 6, Mo.

\$\$\$ if trained in arc welding

Big income jobs await you. Learn quickly and thoroughly. Enroll under G. I. Bill. Write today. Hobart Trade School, Inc., Box P-563, Troy, O.



WORTH \$50

For **PHOTOGRAPHERS** • **HOSPITALS** • **LABORATORIES** • **WORK SHOPS** • **LAUNDRIES** • **OFFICES** • **RESTAURANTS** • **PRINTERS** • **PLAYROOMS**

100 CU. FEET FRESH AIR EVERY MINUTE!
Solve your ventilation problems with this **NEW** durable, built-for-service blower and exhaust. Quick and simple to install. Anyone can do it with ordinary household tools. 110 Volt, A.C., 50-60 cycles. Continuous duty. **BALL BEARING** motor assures quiet, trouble free operation. Rugged housing insures long life.

Send Check, Money Order, No C.O.D.'s. West of Mississippi add \$1.00 for mailing, handling.

Immediate Delivery!

UNIVERSAL YONKERS CORP.

(Dept. S-5) 41 Locust St.

Yonkers 2, N. Y.

IT'S EASY TO MAKE
YOUR OWN "BLOW-UPS"

And grand fun too, with a

FEDERAL

"America's Fastest Selling Enlarger"

Picture-taking's a pleasure, but the real thrill comes when you make your own enlargements. It's really easy to turn out top-notch prints, and *inexpensive*, too, when you use a Federal. Advanced principles of illumination and optics make this the finest Federal ever built. And for *extra value*—A TESTED, ANASTIGMAT LENS IS INCLUDED in the modest price of every Federal.



"ENLARGING IS THRILLING"

don herold's wisdom-packed book
— tells you all you need to know.

25c at Camera Stores, Everywhere
or send coin (no stamps, please) to Federal



FEDERAL MANUFACTURING & ENGINEERING CORP.
Makers of Photographic & Electronic Devices
213 Steuben Street • Brooklyn 5, N. Y.

CARBIDE SCRIBER

Indispensable for all who use tools. Tough Carbide mounted in a new unique way. Ground flat for greater accuracy, clearer marking. For all steels, glass, etc; conveniently knurled handle. By far the best scribe on the market—Regardless of price.

VARLO MFG. CO. 2713 Ave. Y, Brooklyn, N. Y.

Dealer
Inquiries
INVITED!!



\$1.00 Price
Postpaid

Shield them
from
Danger...



Protect home, car, boat, cottage, with FIRE GUARD. Underwriters' approved. Inexpensively priced. See your local department, hardware, or auto supply store. The General Detroit Corp., Detroit 7, Mich.

Fire Guard

1 qt. Vaporizing Liquid Extinguisher

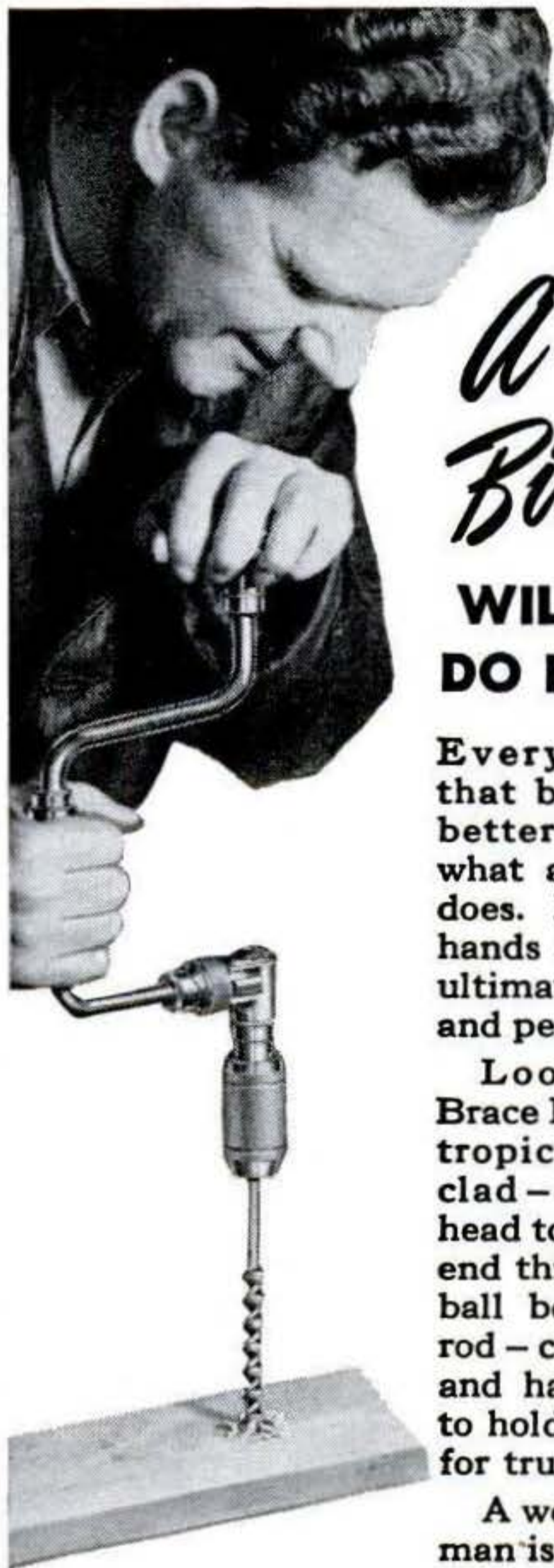

*A Better
Bit Brace*

WILL HELP YOU
DO BETTER WORK

Every craftsman knows that better tools produce better work. And that's what a Stanley Bit Brace does. It puts skill in your hands and it represents the ultimate in material, design and performance.

Look at Stanley Bit Brace No. 923 — head of fine tropical hardwood, steel clad — bronze bushing in head to minimize wear, with end thrust carried against ball bearings — heavy steel rod — chuck with steel shell and hardened, forged jaws to hold bit or drill securely for true boring.

A word to the wise craftsman is — buy Stanley.

STANLEY

Trade Mark

HARDWARE · HAND TOOLS · ELECTRIC TOOLS

Here are two books well worth owning

The first book is free... "The Joy of Accomplishment", a brief introduction to tools and their uses. The second is the famous textbook... "How to Work with Tools and Wood", recently revised, fully illustrated. The cost is only \$1.

Stanley Tools, 257 Elm St., New Britain, Conn.

Please send by return mail

- FREE booklet: "The Joy of Accomplishment."
- 188-page book: "How to Work with Tools and Wood." \$1.00 enclosed.

(In Canada: Send order to Stanley Tool Co. of Canada, Ltd., Roxton Pond, Quebec.)

Name.....

Address.....

City..... State.....

MAY
1947 265

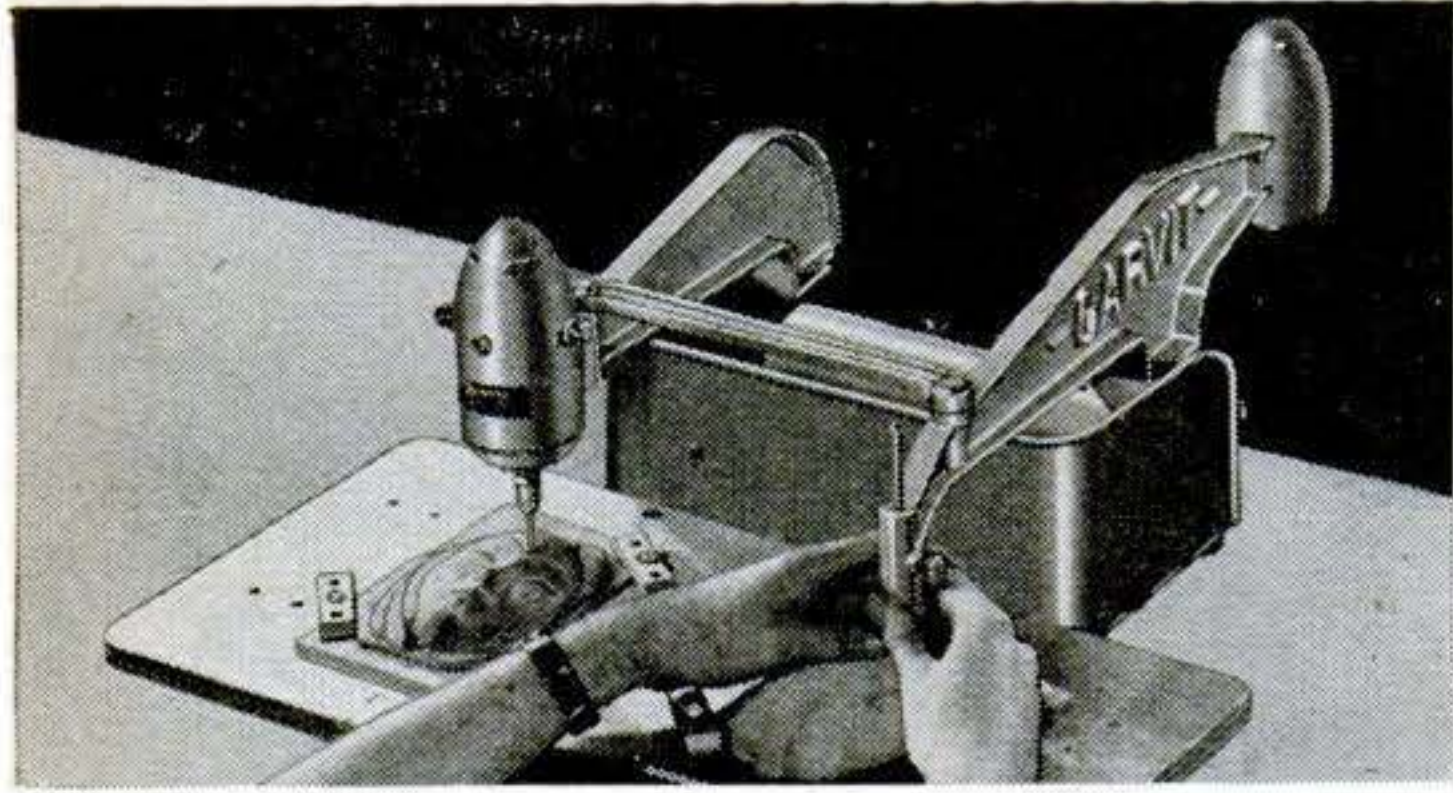

New! Sensational! Carvit makes you a skilled wood carver in 20 minutes!



Here's a fascinating new hobby — complete in one tool! The unbelievable perfection of your first carving amazes your friends! Experienced craftsmen use the Carvit to give their projects that professional touch.

With the Carvit, you make beautiful replicas of inexpensive objects you can find in any dime store or gift shop — in mahogany, walnut, and other fine woods: useful ornaments for your home, distinctive gifts for your friends — fine carvings that *sell!*

TEAR OUT THIS COUPON AND MAIL TODAY!

The Dumore Company, Dept. E-52, Racine, Wis.

- Please send complete information on the Carvit.
 Please send one Carvit. \$48.50 enclosed. Shipping charges C.O.D.

Name _____

Address _____

H-3 City _____ (____) State _____

Portable Paint Sprayers

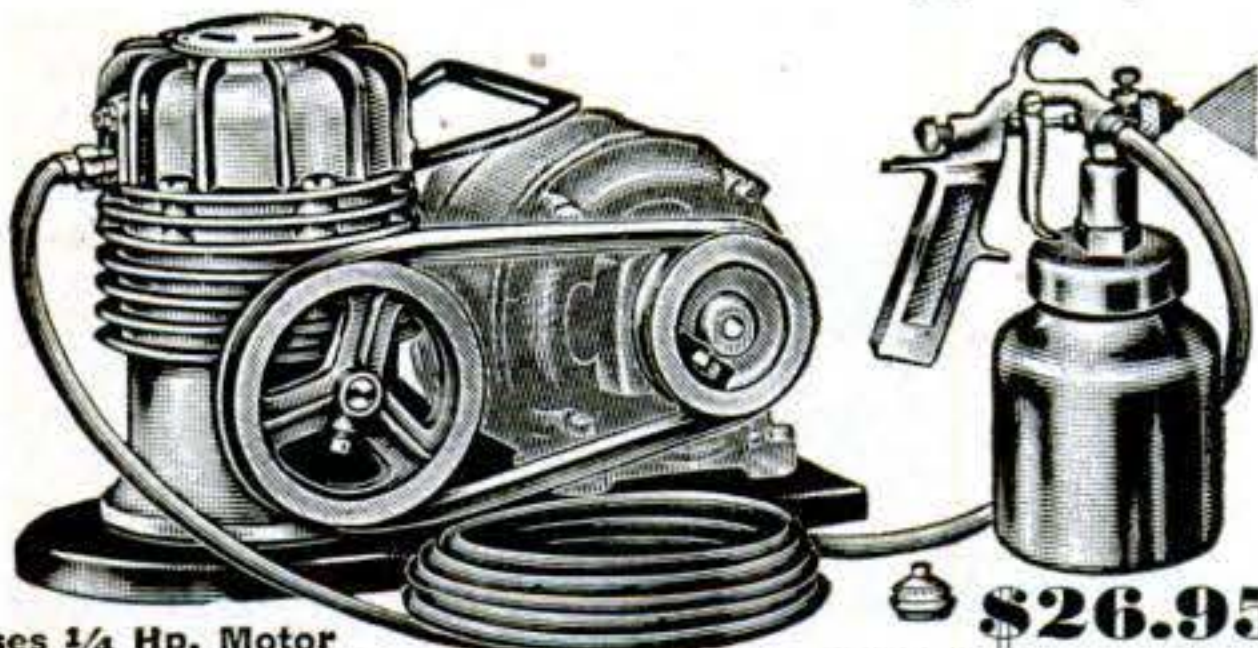

Uses 1/4 Hp. Motor

Complete as illustrated, less motor. Sprays all kinds of paint, lacquer, varnish, etc. Oil-less ball bearing compressor, 2 cu. ft. air per minute. 15 to 50# pressure. Sprays paint 5 times faster than hand brushing.

No. 890—Outfit complete as shown, with "V" belt, motor pulley, 15 ft. high test air hose and No. 112 gun, but without motor..... **\$26.95**

No. 444—Outfit, twin cyl. 4 cu. ft. production type gun, 15 ft. air hose, reg. and gauge, V belt and motor pulley. Complete less motor..... **\$47.50**

SPRAY GUNS—LOW PRESSURE

Operate on 15 to 50# pressure

- | | | | |
|--------------------------|--------|------------------------|--------|
| #115—1 pt. cup | \$4.95 | #121—Production type | \$7.95 |
| #112—1 qt. cup | \$6.50 | #125—External mix. . . | \$9.50 |

- | | | | |
|--|--------|--|---------|
| Regulator & Gauge
0 to 160# | \$4.95 | Air Hose—25 ft. | \$2.75 |
| Air Filters | \$1.85 | 3 Gal. Paint tanks, with hose,
reg. and gauge | \$24.95 |
| Air Hose—15 ft. | \$1.75 | Less reg. and gauge | \$16.50 |

NEW BLACK & DECKER ELECTRIC DRILLS 110V AC
1/4" \$16.95 1/2" \$31.95

SUPER-AIR AUTO ENGINE PUMP

Pumps 100# pressure for inflating tires, spray painting, etc. Complete with hose, pump, gauge, and spark plug adaptors **\$4.75**
Less gauge **\$3.75**

*Air Compressors—Paint Spraying Supplies. Gas engines—1/2 to 1 1/2 hp. \$37.95 up. Hobbycraft supplies, engines and kits 15% discount.

Immediate delivery—check or M. O. shipped prepaid.
COD's plus charges.

INDIANA APPLIANCE CO.

20 East Sycamore Dept. PS-20 Evansville 9, Ind.

266 POPULAR SCIENCE

BOYS!
Fly your own plane
**REAL
GAS ENGINE**
Complete with
**MODEL
AIRPLANE KIT**

ONLY \$11.95



All ready to build and fly
... and anyone can do it!

More than a toy—a real gas-powered model plane that you'll get a kick out of building and flying. This little beauty will really perform in the sky! You'll be the envy of your pals! Fully detailed instructions provided. Complete outfit, including: 1/6 H.P. engine, coil and condenser; beautiful trim airplane; propeller, wheels, etc.

SEND ONLY \$1. We'll ship C.O.D. for balance. Don't delay, order NOW and be the first fellow in your neighborhood to fly this swell plane! Have you our FREE catalog? Send for it!

AMERICA'S HOBBY CENTER, Inc.
DEPT. SN-57, 156 W. 22ND ST., N. Y. 11, N. Y.

NEW TOOL READY

QUICKLY SHAPES, SANDS, CARVES, PROFILES, GRINDS, BEVELS, SMOOTHS, POLISHES, CLEANS!

War industry's most versatile machine—now available to hobbyists, craftsmen, model makers, pattern makers, home workshops—cuts fast and clean on wood, metal, plastics! Works equally well on inside cut-out openings or irregular outside edges, on intricate scrolls, curves. Saves hours of tiresome hard work—does better job. Nothing else like it. IDEAL TO GIVE OR GET FOR WORKSHOP! Sold on 5 Days' Trial, money back GUARANTEE.

Bandsander



FREE!

Write for free, lavishly illustrated Circular describing how Bandsander—the machine that amazed the experts — saves time, money, trouble. Write now—a post card will do!

MEAD SPECIALTIES CO.
4114 North Knox Ave., Dept. 257, Chicago 41, Ill.

LUCY

NEW DRAWING DEVICE

Draw any object, scenery, profile, portrait or reduce copy with LUCY. Optical illusion in LUCY makes phantom view of subject to be drawn appear on drawing paper. Drawing, even from nature, becomes simple tracing. No talent needed. Used by artists and children alike. Educational, amusing, practical, durable. Guaranteed.

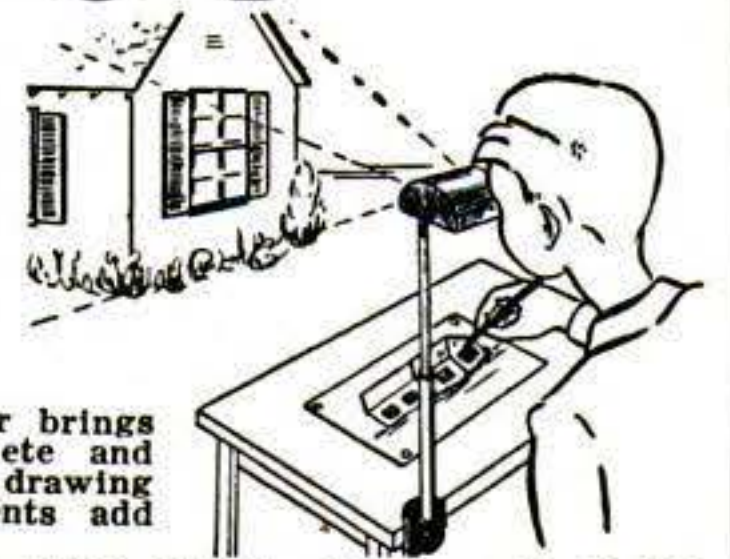

\$6.95 cash, check or Money Order brings LUCY promptly postpaid, complete and ready to attach to any table or drawing board. No. C.O.D. Calif. residents add 17c tax.

BEELER ENTERPRISES, Dept. 10E, North Hollywood, Calif.

Sand Casting—Forging—Heat Treating—Case Hardening

BRONZE FOUNDRY



is again available in limited quantity without priority. Orders filled in sequence as received. INVENTORS-SCHOOLS-CRAFTSMEN use FOUNDRYETTE for making castings quickly for new inventions, for instruction, and general purpose. Order now for early delivery. Three sizes are available capable of making bronze castings of 1 1/2, 3, and 6 pounds weight, aluminum, copper, brass, etc. Domestic gas supply and 110 volt AC or DC energy required for operation. Write for circular.

KANSAS CITY SPECIALTIES CO.
Box 6022, Dept. S-78 Kansas City, Mo.

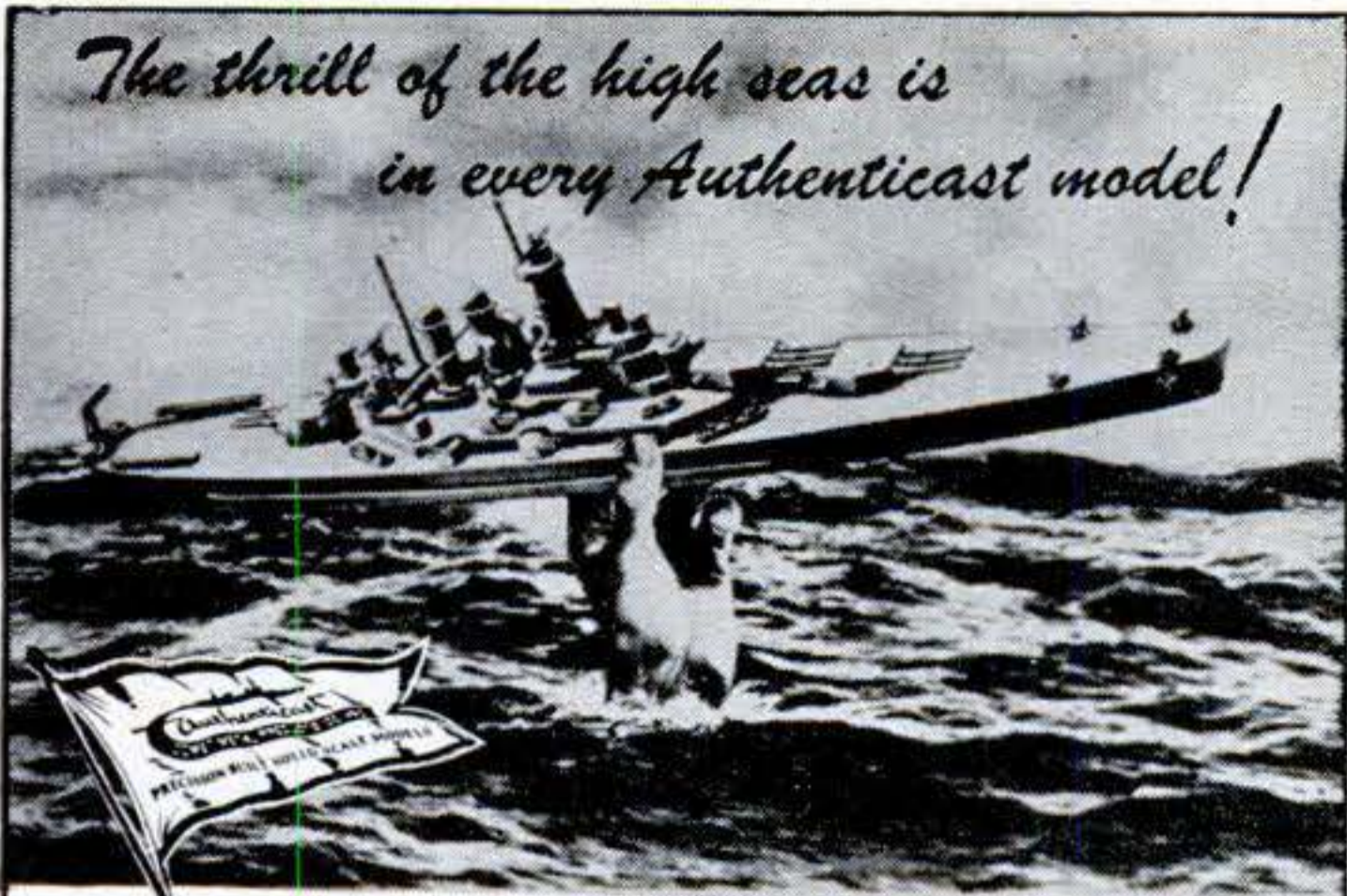

Illus: US Battleship No. Carolina Class 511

Build a scale model of your favorite ship! Authenticast models are so realistic, you'll be proud to have several at your "command."

It's easy to build an Authenticast model. No parts to make, no tools to buy. You get all fittings, step-by-step instructions, detailed diagram, cement, filler clay, steel wool, file, paint brush, paint! 7 waterline models come in ready-to-build kits — Battleship, Aircraft Carrier, Destroyer, DE, Cruiser. All models scaled 1 in. to 500 ins., \$6 to \$11 at hobby shops.



Send 35c in coin for 32-page catalog of ship, plane and tank models.

COMET METAL PRODUCTS CO., Inc.
91-12 132nd St., Richmond Hill 18, N. Y.

New MILLING ATTACHMENT



Sizes for 8" to 16" metal lathes
BUILD IT YOURSELF from our sets of semi-machined castings and save \$\$. Can be finished on your lathe alone. Complete working drawings and step-by-step machining instructions furnished with castings.

Mill keyways, slots, splines, dove-tails, flutes in reamers, taps, hobs, and special cutters; produce spur, bevel, mitre and worm gears, ratchets and racks; mill flat surfaces, square shafts, mill hexes, spot face, drill spaced holes, bore, etc. on your lathe with this precision attachment. It has a T-slotted table, a vise which swivels for angular milling, a gear cutting fixture and dividing centers.

FREE! Illustrated folder and price list. Mention your lathe. Write today.
HURON MACHINE AND TOOL CO.
YALE 2, MICHIGAN

EDGE-GETTER...

MAKES YOUR MOWER A TRIMMER!

Now... you can trim usually missed lawn edges with ease and speed. Mow around tree wells, in trenches and troughs with this easy-to-use, permanent attachment. Adjustable to varied depths. Swings easily into position when needed. Eliminates tiresome hand clipping!!! Makes hard work a cinch!!! Light but sturdy!!! EASILY INSTALLED ON ANY MOWER!! ORDER YOURS TODAY!! Only \$3.95—postpaid. Literature on request.

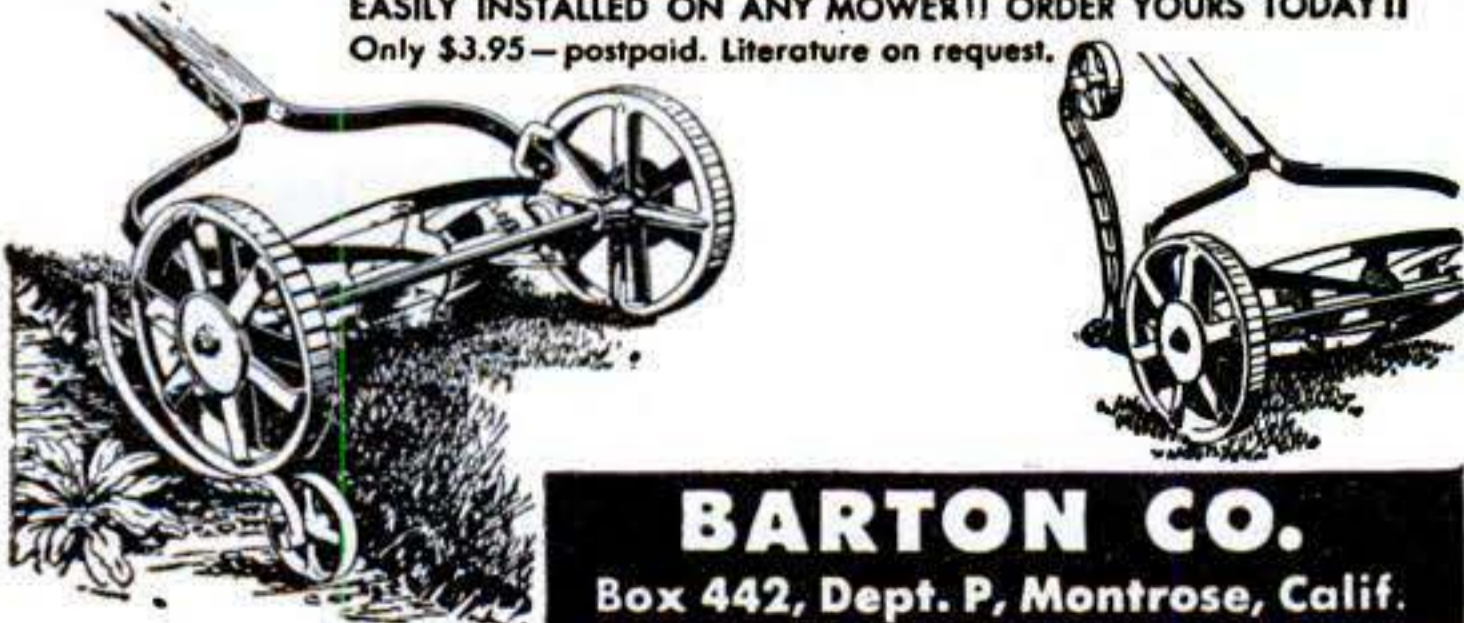

BARTON CO.
Box 442, Dept. P, Montrose, Calif.

A TOOLSHOP IN YOUR HAND!

- GRIND • DRILL • ROUT
- POLISH • ENGRAVE
- CUT • SAND • SAW • etc.

MAKE THINGS FROM WOOD
PLASTICS—METALS—GLASS
LINOLEUM—LEATHER
ALLOYS—HORN—STONE
BONE, etc.

HANDEE TOOL OF 1001 USES

Smooth, steady power at your fingertips! Perform precision operations not possible with any other portable tool! With a Handee you can turn out professional looking projects for pleasure or profit—ship, plane and train models, costume jewelry, wood carvings, puppets, initialed tumblers, etc. AC or DC. 25,000 r.p.m. Wt. 12 oz.

USE THE RIGHT ACCESSORIES! Choose them from the most complete line . . . more than 500 made right in the Handee plant.

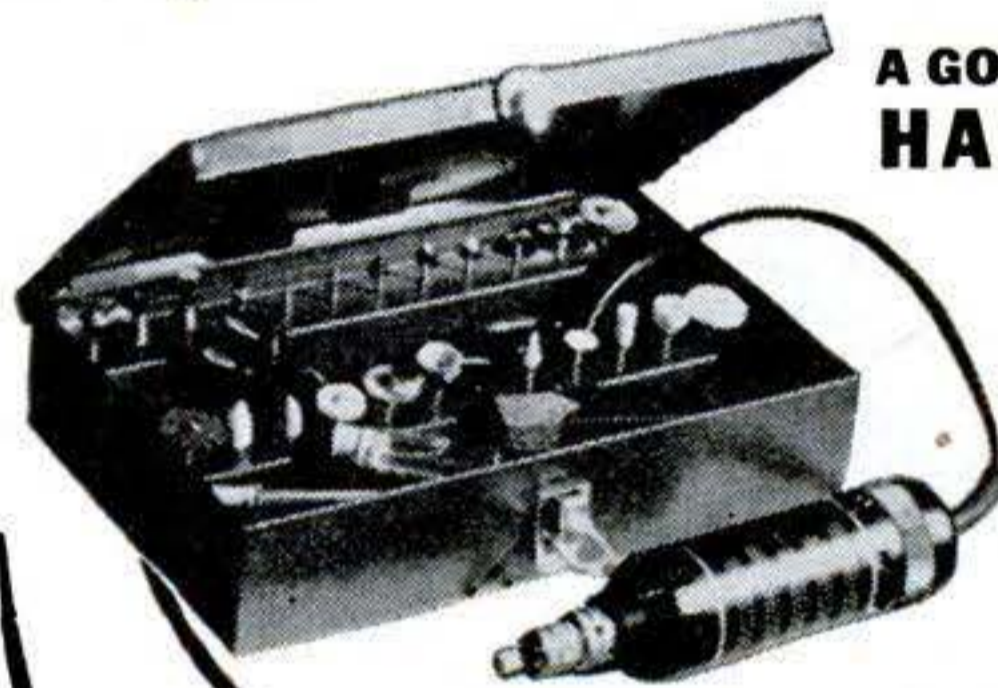

A GOOD START—THE HANDEE KIT

HANDEE Tool and 40 most popular accessories packed in compact steel carrying case. You'll be amazed at what you can accomplish! Complete, postpaid.

\$27.50

Handee only, with 7 accessories, \$20.50

FOR YOURSELF OR A FRIEND...
THE GIFT OF A LIFETIME!

NEW PRECISION ATTACHMENTS

Fit Handee only, enable novice or craftsman to do perfect work. Magically, easily, your offhand carving, routing, shaping will be exact as to depth of cut, accuracy of line. Set of 6 attachments with instructions, postpaid

\$7.95

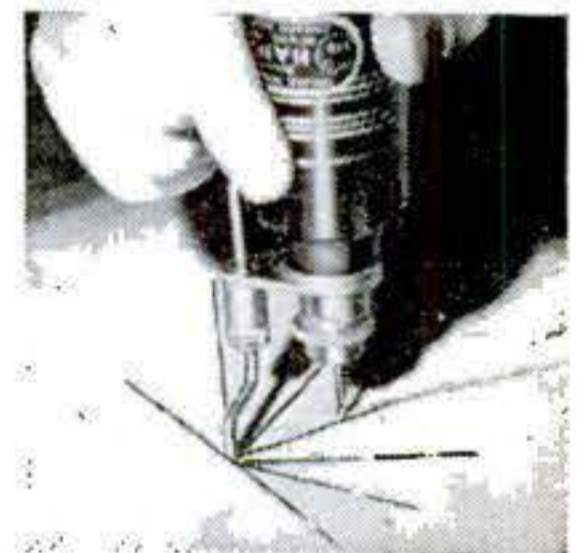

ORDER NOW! SATISFACTION GUARANTEED!

FREE! NEW 52-PAGE MANUAL

CHICAGO WHEEL & MFG. CO.
1101 W. Monroe St. Dept. PO, Chicago 7, Ill.

Send Handee Kit Handee Tool Precision Attachments C.O.D. Remittance enclosed Send Manual

Name.....

Address.....

MAY 1947 267

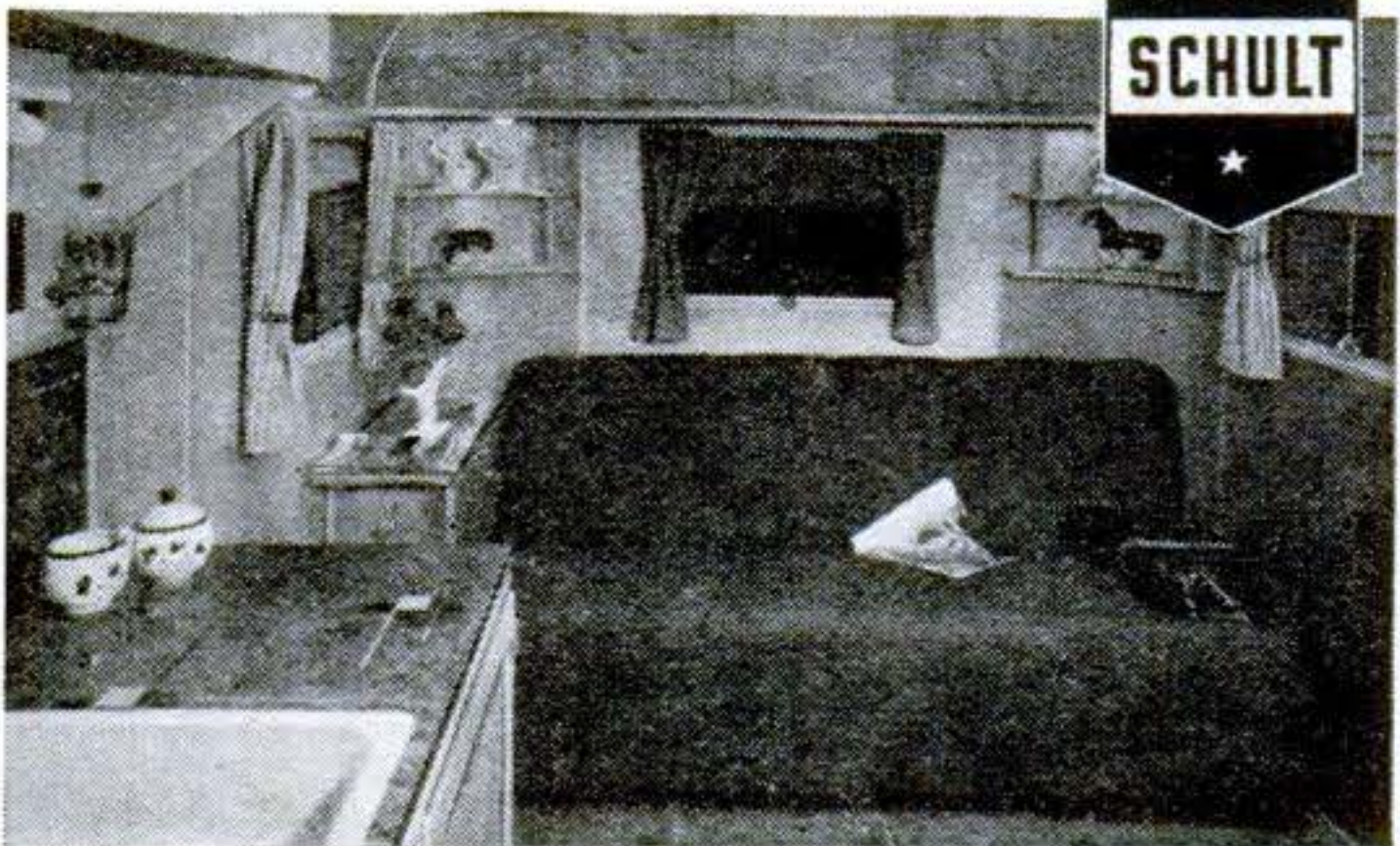
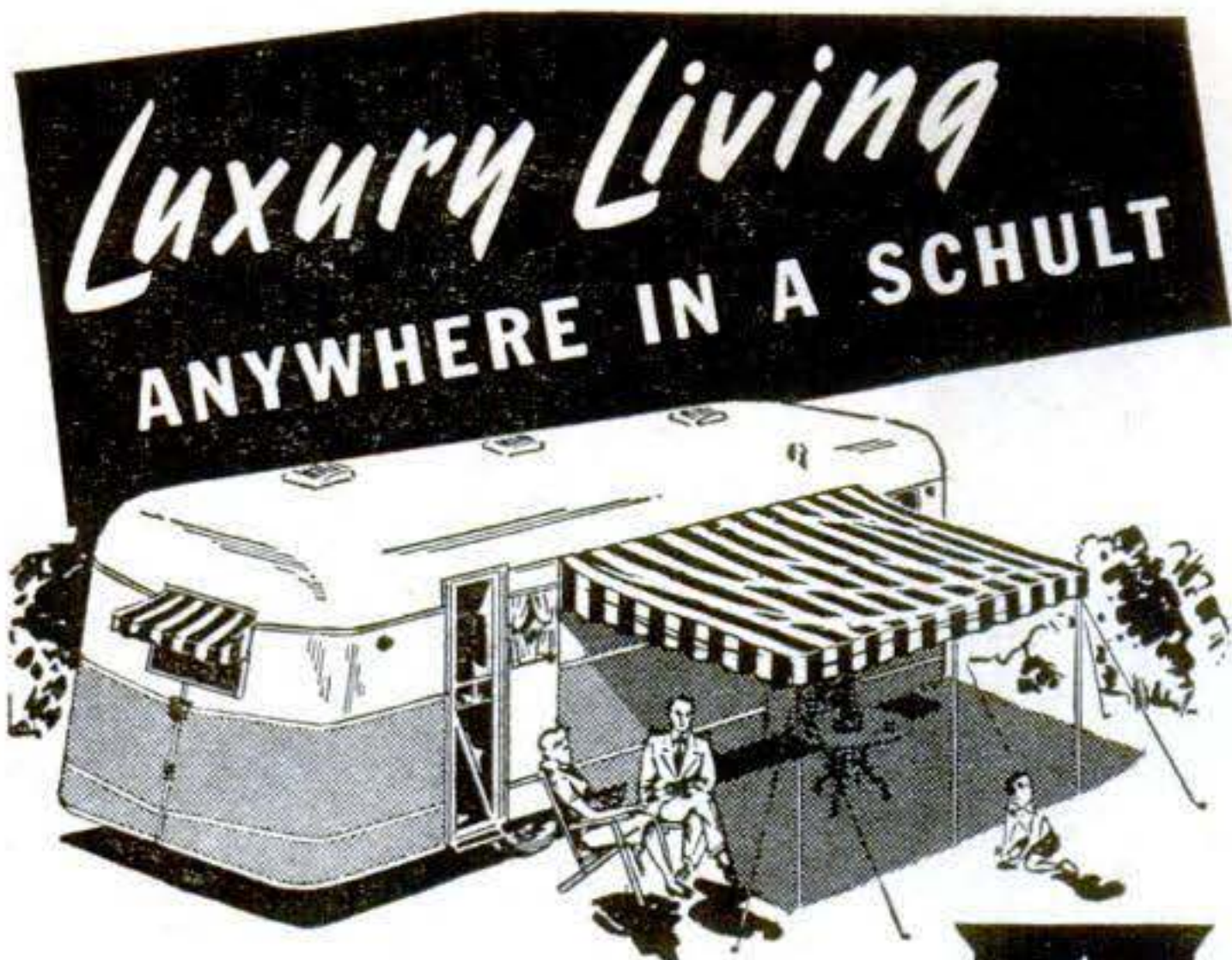

● Imagine having your own complete, comfortable accommodations . . . ready to take wherever you want, for living or travel.

Schult Trailer Coaches, in two handsome models, are available right now. Both models sleep four adults comfortably, have ample closet and storage space, are tastefully decorated, and have complete kitchens with refrigerators and oven ranges.

THE LUXURY LINER

26-foot tandem model for maximum living comfort.

Three separate rooms for utmost privacy. Every facility for luxurious and gracious living.

THE DELUXE COMMODORE

21-foot marvel of compact completeness. (Living room illustrated.) Amazing in drawer, locker and other storage space. For those who want every facility for comfort, in a lighter, more economical coach.

SEE BOTH models at your Schult dealer's. Write TODAY for his name; we will include latest catalog.



SCHULT CORP., Dept. 3105, ELKHART, IND.
Canada: John Inglis Co., Ltd., Toronto

SCHULT Trailer Coaches

**Extra! JUST OUT Extra!
INSTANT NICKEL
NO CURRENT OR BATTERIES USED**

U. S. PAT. PEND.
NO. 702581

COMPLETE
\$2.00 POST PAID
COVERS 10 FT.
AGENTS WANTED

Iron, Steel, Aluminum, Brass, Bronze, Copper and practically all Industrial Metals can now be HEAVILY nickel-plated WITHOUT equipment, vessels, electricity or previous copper plating, a blessing to Hobbyists, Doctors, Hospitals, Restaurants, Bar and Beauty shop owners. Recommended for Auto, Bicycle and Machinery parts and accessories, Musical Instruments, Electrical appliances, Coffee Urns, and practically anything made of metal.

IN THIS MARVELOUS NEW PROCESS the principles of the battery and electroplating have been harnessed in the INSTANT NICKEL formula, so when it is applied with a wet applicator on a clean metallic object, a bright nickelplate instantly appears! Thickness of plating is regulated by number of applications.

JUMBO SHOP SIZE (nickelplates 50 sq. ft.) only \$6.75 postpaid. Sample offer \$2.00 postpaid. Applicator sent free. Send check or money order today! C.O.D.'s few Cts. extra for Postage.

INSTANT PLATING PRODUCTS, 3439 Michigan Ave., Chicago 16, Ill.

CROSMAN Silent RIFLE



POWER without POWDER

You'll like a Crosman because there is no recoil to spoil your aim . . . no noise . . . no odor . . . no cleaning! Rifled barrel for greater accuracy . . . adjustable power, too, for short or long range shooting indoors or out. Available in .177 and .22 cal. models. WRITE FOR COMPLETE INFORMATION

CROSMAN ARMS CO., INC.

9 HENRIETTA ST., ROCHESTER 7, N. Y.

Shoot CROSMAN SuperPells

The BETTER Ammunition for ALL .177 and .22 caliber Air Pistols and Rifles.



.177 cal. . . \$2.50 per M
.22 cal. . . \$3.00 per M

POSTAGE PREPAID

At your dealer or order direct

FOR GREATER ACCURACY
MAXIMUM POWER

CROSMAN ARMS CO. HENRIETTA ST., ROCHESTER 7, N. Y.

SUIT YOURS AS A BONUS

And Big Money in Spare Time, Too

We want you to wear this fine made-to-measure suit! Make it yours by sending a few orders, and earn BIG CASH PROFITS in spare time. Your suit will help you get more orders with scores of rich, quality fabrics, tailored-to-measure to newest styles. Also Ladies' Tailored Suits—complete line. Write today for FREE SAMPLES. No experience, no money needed. For quick action tell us about yourself.

J. C. FIELD & SON, Inc.

Harrison and Throop Sts., Dept. S-1720, Chicago 7, Ill.

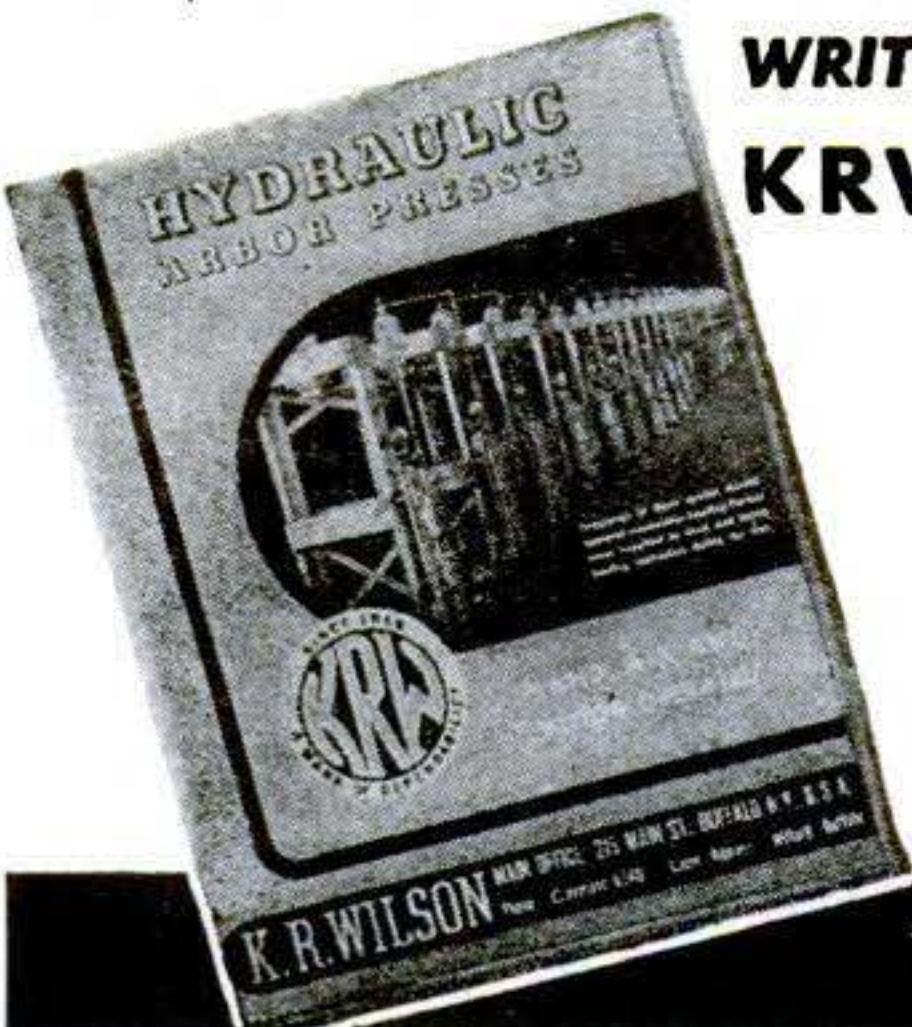

WRITE FOR YOUR FREE COPY OF THE NEW KRW HYDRAULIC PRESS BOOK

Describes all manner of Production and Shop Work on KRW Hydraulic and Bench Type Arbor Presses. 32 pages illustrating the new KRW Hand-operated, Electric-operated and Air-operated Hydraulic Presses.

Write for your copy today.

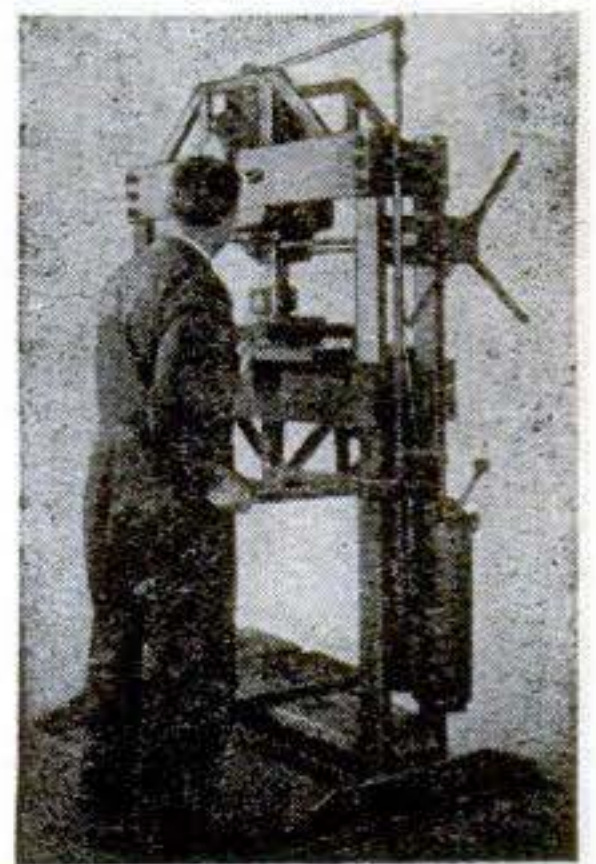

K. R. WILSON, DEPT. 54, 215 MAIN ST., BUFFALO 3, N. Y.

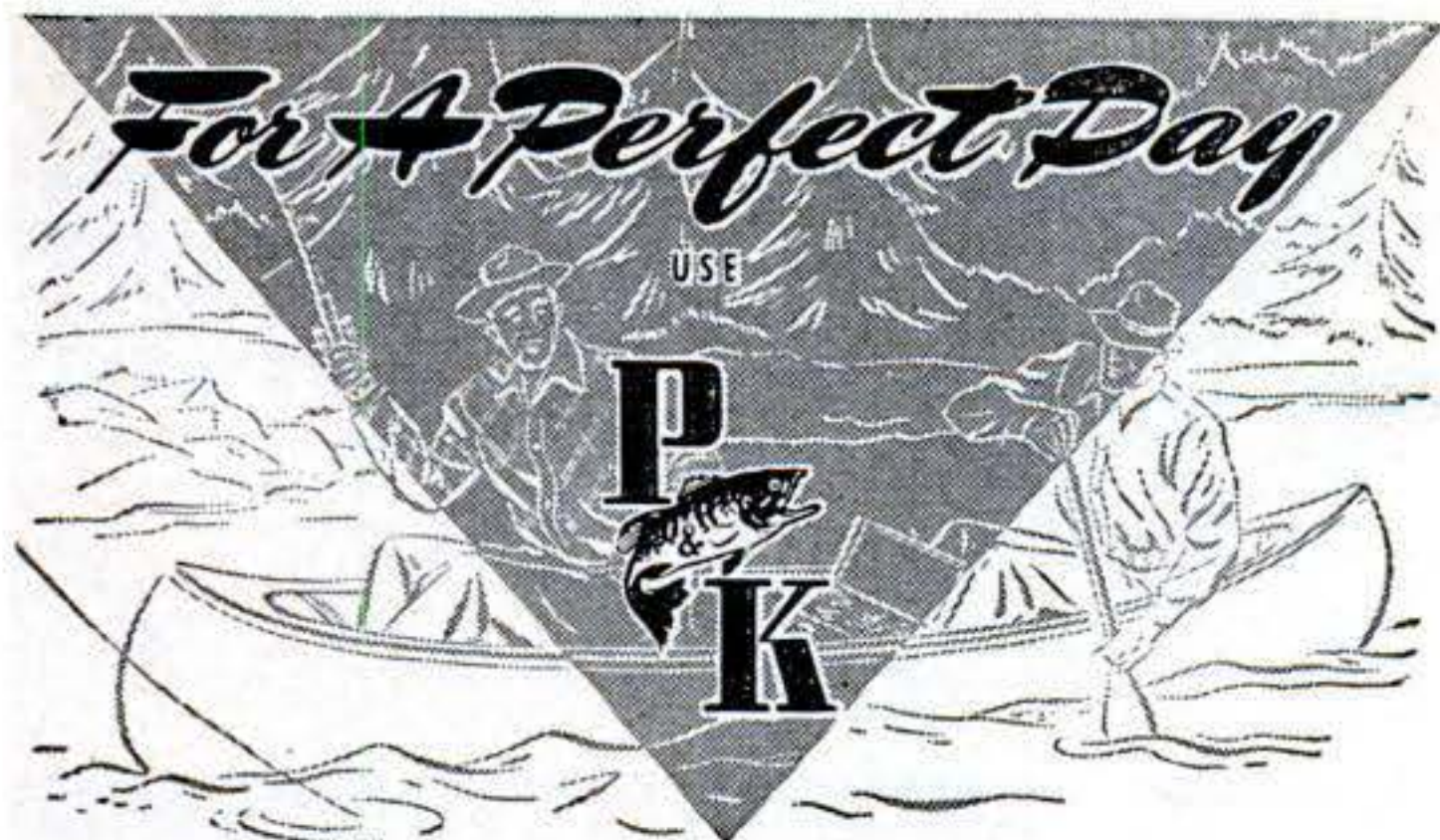

BRIGHT EYES

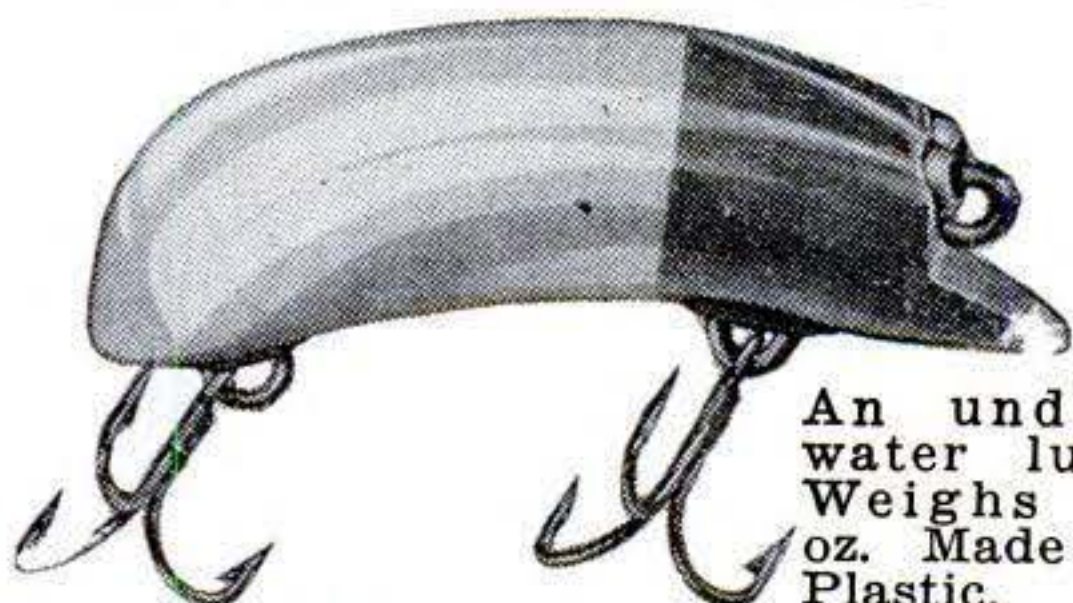

An under-water lure. Weighs $\frac{1}{2}$ oz. Made of Plastic.

"Adventures in Fishing"

48 pages in four colors: pictures, fishing stories, secret hints, etc., with regular 10c package of Raparound, invisible ribbon sinker, both for only 10c. Send your dime today. Offer good only in U. S.

No. 44, \$1.25 each.
Slightly higher in Canada.

P & K INCORPORATED

(Pachner & Koller, Inc.)

3454 Archer Avenue Chicago 8, Illinois
Canadian Distributors: Central Purchasing Agency, Ltd., Toronto, Ont.

TESTED AND PROVED LURES AND FISHING ACCESSORIES

NU-WAY LAWN MOWER

Write for
FREE Circular

Price **12.50**
Why Pay More

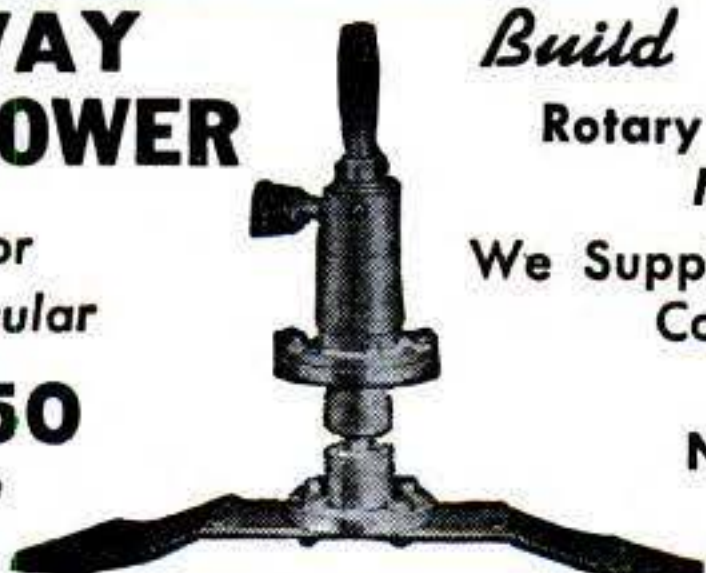

Build Your Own

Rotary Type Lawn
Mower

We Supply Cutting Unit
Complete.

NO INCREASE
IN PRICE

TRACTOR-LITE MFG. CO., SPIRIT LAKE, IOWA

DUAL TUBE PNEUMATIC FLOAT



• Here is a sturdy float you can't afford to be without . . . Use yours as a swim jacket. Make a canoe practically unsinkable by fastening a pair to the sides. Band two together for a swim raft, air mattress or surf board. Be ingenious and make a water horse by lashing a wooden head and tail to a single float . . . Or combine two, add a sail and seat, and you'll have a safe play boat. So versatile and inexpensive every member of the family can enjoy . . .

DUAL TUBE PNEUMATIC FLOATS

1.98
each

Not a toy or a gadget, but a tough practical float made to rigid Government specifications. They blow up as easily as a balloon by mouth. Inflate to 55 inches long yet fold into a compact carton just 18 inches long.

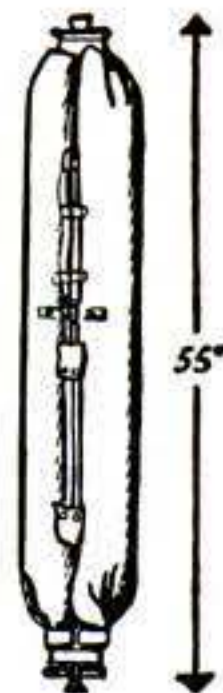

Guaranteed new
Each tested before shipment

prepaid anywhere in U. S. for check or money order. C.O.D.'s accepted.

THE MODERN COMPANY
408 Market Street Harrisburg, Pa.

Say You Saw
It In Popular Science

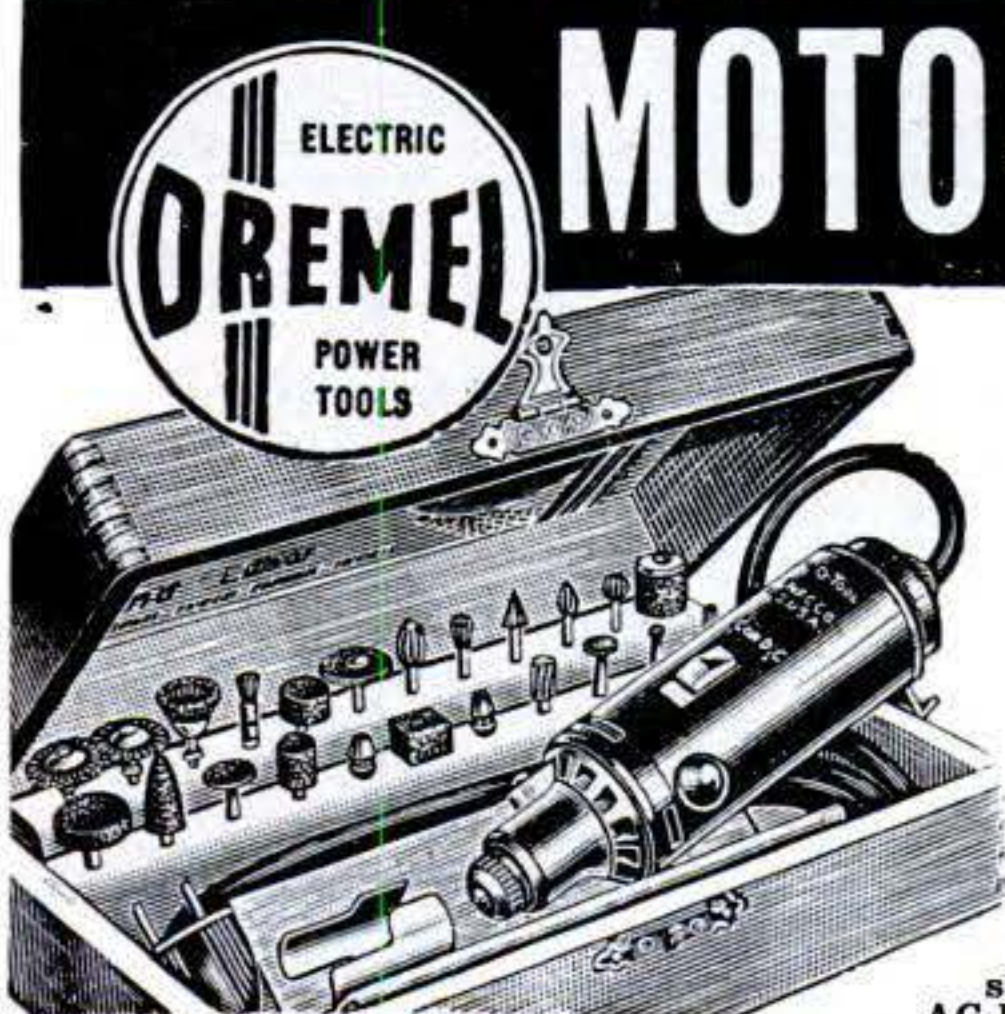

Moto-Tool Kit No. 2 has 23 professional accessories and Model 2 Moto-Tool in wood case, \$23.50. (Items purchased separately would cost about \$30.00; you save \$6.50.) Moto-Tool No. 2 with one emery point . . . \$16.50.

MOTO-TOOL ★ THE "POCKET-SIZE" MACHINE SHOP

"MAN . . . WHAT A POWERHOUSE!"
A TOOL THAT PACKS YEARS OF PLEASURE

Here's a tool to please a man's heart . . . one that holds promise of endless creative hours. Dremel Moto-Tool is a "war veteran" . . . used by all branches of the armed forces in far-flung repair bases . . . helped set production records at General Electric, Westinghouse, Remington Arms, Ford and others. Hobbyist or expert craftsman, first choice is Model 2 Moto-Tool Kit with its handsome felt-lined, highly finished wood case with rows of tools begging to be put to work. Write for FREE catalog of Moto-Tool attachments and accessories.

MOTO-TOOL FEATURES:

Oil-less, sealed, bearings • Patented automatic chuck lock pin • Over-size armature shaft, hardened, ground, polished • 110 Volt, AC-DC motor • Sliding snap-type switch • Cord protector • Shockproof bakelite housing • Dust-filtered, air-cooling system • Weighs only 13 oz. • Dynamically balanced for vibrationless operation.

MONEY BACK GUARANTEE: Buy Dremel Moto-Tool and Accessories from your dealer; or order direct from factory on 10 day trial. Shipped postpaid for cash in full; or for \$2.00 sent C.O.D. for balance plus postage.

DREMEL MFG. CO., Dept. 127-E . . . RACINE WISCONSIN

- Do These Better-Faster
- Drilling
 - Routing
 - Sanding
 - Engraving
 - Touching-Up
 - Mortising
 - Polishing
 - Cleaning
 - Rasping
 - Brushing
 - Dressing
 - Burring
 - Grinding

- APPROX. 27,000 R.P.M.
- Finishing
 - Sharpening
 - Burnishing
 - Inlaying
 - Sawing
 - Scoring
 - Carving
 - Cutting



"Here's achievement of my ambition to build a fine, light car comfortable for my 6'4"."



Powell Crosley Jr.
PRESIDENT, CROSLY MOTORS, INC.



Smarter-looking, smarter-to-buy, the new, fine CROSLY Convertible is really economical! Priced far lower, costs only about half as much to operate as the cumbersome, 3-times-as-heavy cars advertised as "low priced"! Yet plenty of room for 4 husky men—plus baggage!

Notice particularly the 4-cylinder, valve-in-head CROSLY COBRA (Copper BRAZed) engine! It's made of steel, weighs only 59 lbs. and is the most talked-of internal combustion engine in 40 years! On ordinary gasoline it delivers 35-50 miles per gallon; speeds to 60-plus! Check, inspect, compare the stunning new CROSLY Convertible before you buy any "sports" car!

COMPARE THESE FEATURES:

ALL STEEL construction, low center of gravity, great safety factors.	ly "parks on a dime";
MODERN Streamlining, the "aircraft flavor," WEIGHS only 1150 lbs., curbside, perfectly balanced, weight-to-power.	oversize shock absorbers. MORE MANEUVERABLE, instant pick-up; 20 inches narrower than most cars. "JIFFY-RIG" beige weather-proof top folds out-of-sight.

For information and literature write: Crosley Motors, 2530-U Spring Grove Ave., Cin'tl 14, O.

CRAFT FINISHES SUPPLIES

Materials to produce a professional finish on every type article. Industrial finishes for the home craftsman's use on wood, metal, plastics, plaster, etc. Electroplating and shop supplies, novelty finishes. Catalog free.

Craft Finishes Box S-467 Arlington, Virginia

KAYAKS
AQUA VIR
Easy to Build
OUTBOARDS ROWBOATS
25¢ COIN FOR ALL THREE

BOATS for Home Assembly
"U-MAK-IT"
KAYAKS, ROWBOATS, DINGHIES, INBOARDS, OUTBOARDS, RUNABOUTS
Cut-To-Fit for Quick Assembly. Everything Complete plus Illustrated Instructions. No Experience Necessary. Simple as A. B. C.
SEND 25c POSTAGE (COIN) TODAY FOR 3 MONEY SAVING ILLUS. CATALOGS Showing all '47 Models (marine plywood) and construction details.

AQUAMOBILE V-18
Designed for Auto Engines. Open or with cab. Length 18 ft.
Fast VEE Bottom Hull.

KAYAK BOAT CO., 152R-EAST 129th ST., NEW YORK 35, N. Y.

AT LAST! A HOBBY THAT OFFERS YOU PROFIT AS WELL AS PLEASURE!

GENUINE LEATHER Hand Crafted LINK BELT
Easy to Make—Easy to Sell

Get started today on a fascinating hobby where you can earn up to \$10 or \$15 a week in spare time! Send for your complete profit-producing Handicraft Kit with all the material needed to make 6 genuine leather link belts. Sell all you make at \$2 each to people expecting to pay far more for genuine hand-made belts. Kit for 6 belts costs you only \$3.50—can easily be sold for \$12—leaving you a profit of \$8.50. Send \$3.50 for your Kit today, or mail only a dollar for sample Kit! Or C.O.D., you pay postage. Money back if not delighted.

FREE WITH YOUR ORDER . . . IF YOU ACT NOW!

Beautiful Plastic Card Case, value 25c, free with \$1 kit. Yours to keep, even if you return belt kit. Also, on request, big new 40-page CRAFT CATALOG FREE with or without order.

DWINNELL CRAFT SHOP, Dept. SC-75, Elm Grove, Wheeling, W. Va.

Save Time and Money with this Press

Ten-ton press, ideal for all kinds of pressing, separating, straightening, and bending jobs. Ample capacity for home shops. Easily adjustable table takes work up to 18 inches wide and 11½ inches high. Roller-bearing ram for long life. Send for free bulletin showing press and wide variety of accessories.

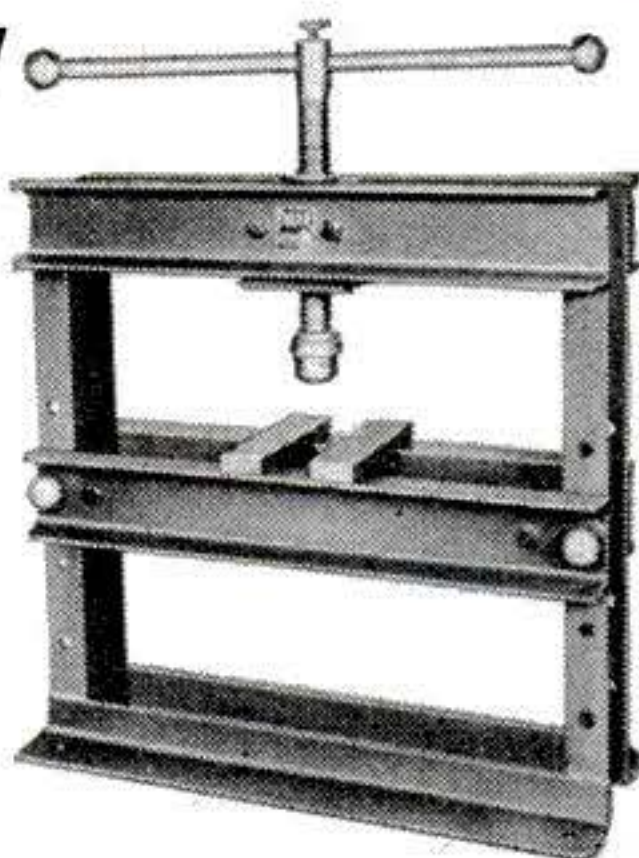

UT-10A Press f.o.b. factory \$28.25

DAKE ENGINE COMPANY
622 Seventh Street, Grand Haven, Michigan

CUTTING TOOLS

A catalog of cutting tools and supplies made available for the first time—is yours for the asking. Hard-to-get cutting tools and supplies—hundreds of them—are in our available stock. Send 35c and receive this wonderful catalog immediately by return mail.

Write or Phone **EASTERN TOOL & SUPPLY COMPANY**
176 Grand Street, New York 12, N. Y.
Canal 6-3749

Arc Welded Design "Know-How"

Only \$3.50 each Each volume contains over 3 different volumes .100 welding designs. Write \$10.00 postpaid Hobart Bros. Co. Box P-561, Troy, O.

★ **PLASTICS** ★
Special Offering— 65c Per Lb.

Plexiglas Sheet Stock. Reduced from \$1.55 per lb. 3/16" thick sizes—12 x 24 & over. Minimum order 5 lbs. Order in units of 2½ lbs. 100 lb. lots—60c per lb. Orders under 25 lbs.—10% handling charge. Orders over 25 lbs.—\$1.00 min. Handling chg. Also complete line of sheets, Rods, Tubes, Dyes & Cements and all Plastic supplies. Send 10c for Literature and Fabricating Manual.

HOUSE OF PLASTICS, 7604 FENKELL, DETROIT 21, MICH.

BUILD YOUR OWN FAST FREEZER PLANS \$1.00

It's easy to build this household appliance and profitable to use. Save up to 75%. Operates on 110 or 32 volts. Plans show 5 sizes and are easy to follow. ENJOY MAKING ONE OF these freezers from new or used parts. No expert knowledge needed. Mail \$1.00 bill or check for complete plans and catalog.

LE JAY MFG., 423 LeJay Bldg., Minneapolis 8, Minn.

Become a Radio Ham!
LEARN THIS FASCINATING HOBBY AT HOME With These Easy-to-Read BOOKS

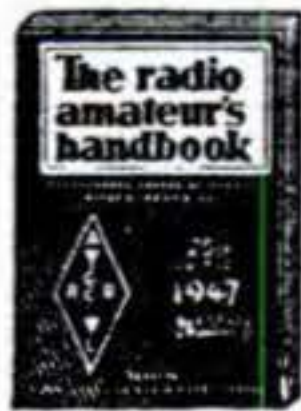

Start now to become a member of the famous Radio Amateurs who make history with their thrilling world-wide contacts. It's easy to learn with these simple manuals.

RADIO AMATEUR HANDBOOK—1947 EDITION— Gives principles and design of receivers, Transmitters, Antennas, etc. All about code, telephony, tubes, data. Charts and diagrams. Over 600 Pgs. **\$1.25**

GET THESE INEXPENSIVE BOOKS

HOW TO BECOME A RADIO AMATEUR— Standard beginner's guide. Symbols and simple instructions, data, etc. 48 Pgs. **Only 25c**

LEARNING THE RADIO-TELEGRAPH CODE—Home-Study course in code— Sending and Receiving. A valuable book. **Only 25c**

LICENSE MANUAL— All FCC Rules and Regulations plus Questions and Answers for Class A, B, & C examinations. **Only 25c**



TELEGRAPH KEY
Professional Signal Corps key. 3 3/4 x 3" Bakelite Base Switch and Silver Contacts. Ideal for code practice. A real bargain for **ONLY 49c**

Send for Bargain Bulletins with Terrific Values. Visit any of our 3 Great Stores and see for yourself. Mail Orders Filled from Either New York or Chicago.

NEW YORK Offices & Warehouse 242 W. 55th St., N.Y. 19
NEWARK
CHICAGO 323 W. Madison St. Chicago 6, Ill.
ELECTRIC COMPANY, INC.

New York City Stores: 115-17 W. 45th St. & 212 Fulton St.

PLEXIGLAS

New Low Prices, new masked prime stock, clear

Thicknesses, per square foot: 1/16" @ \$1.00; 1/8" @ \$1.30; 3/16" @ \$1.60; 1/4" @ \$1.85; 3/8" @ \$2.75; 1/2" @ \$3.60; 3/4" @ \$5.50; 1" @ \$7.40. Sheet sizes 6" x 12"; 6" x 24"; 12" x 12"; 12" x 24" & 12" x 36". Add 10% for packing and postage any place U.S.A. Minimum order \$5.00. Send Money Order for prompt shipment.

PLASTIC SUPPLY CO., 2618 St. Louis Ave., St. Louis 6, Mo.



GET INTO BUSINESS WITH SMALL CAPITAL working at home or shop. There is big money making **HOLLYWOOD STYLE** cement pottery, birdbaths and garden ornaments without moulds. Also imitation marble, water-paints, chemical staining, etc. 10c brings sample, details and pictures.

HOLLYWOOD CEMENTCRAFT
8527-B Wonderland Ave., Hollywood 46, Calif.



THE name it pays to remember when you want a good pocket knife.

Blades of finest custom made steel, **HAND HONED under oil.**

Ask your good neighbor, the local hardware or sporting goods dealer. We're doing our best to keep him supplied.

No. 21



Kä-MILL-us

CAMILLUS CUTLERY COMPANY, New York 17, N. Y.
Established 1876 Factory at Camillus, N. Y.

MODELS DEVELOPED AND BUILT

The Thompson Engineering Co.
210-B Winchester Building

Grand Rapids

Michigan

AUTOMATIC SAW SET AUTOMATIC RETOOTHER

HAND AND BAND SAWS

• Set saw teeth automatically. Perfect hammer and anvil action sets teeth uniformly and tensions metal. No tooth breakage. No fatigue. Sets 400 teeth per minute.

• Makes New Profits! Cuts teeth in 50 seconds! Any size tooth 4 to 16 points. Old teeth fall off as chips. Simple to operate. A perfect job.

FOR HAND SAWS

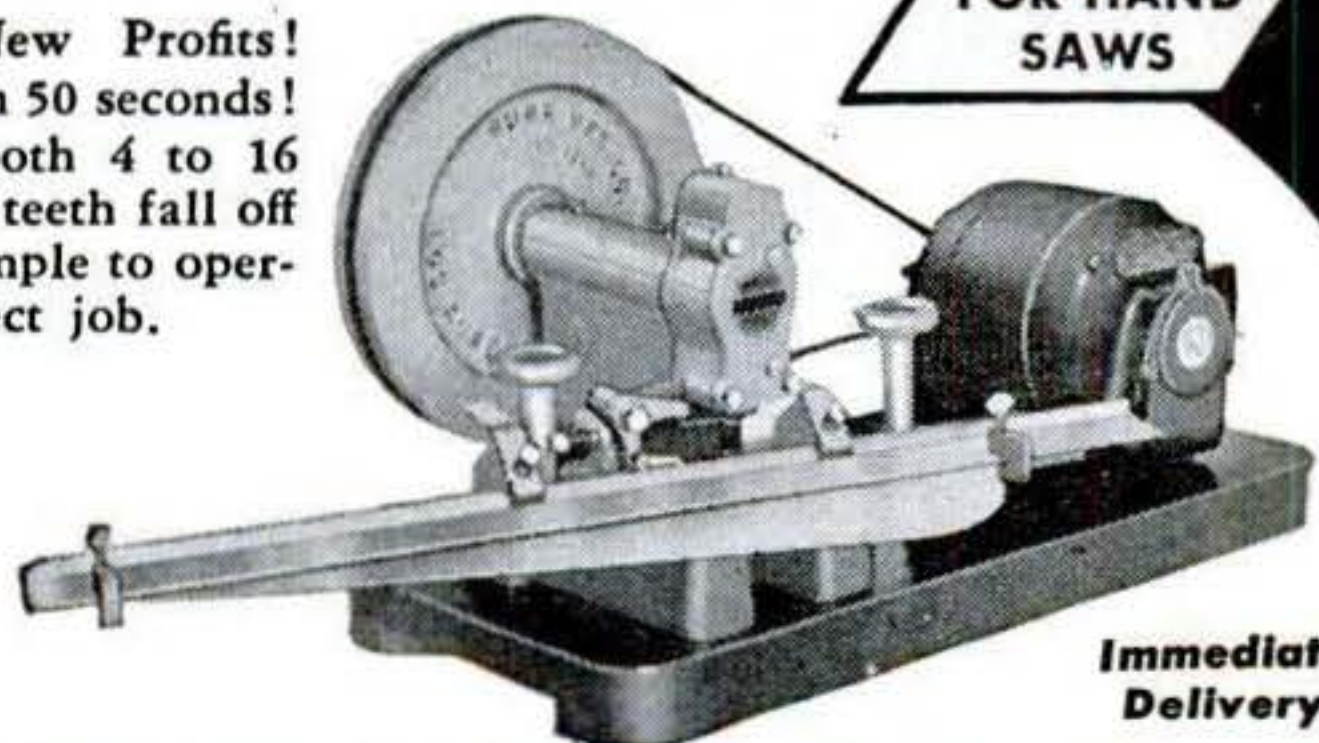
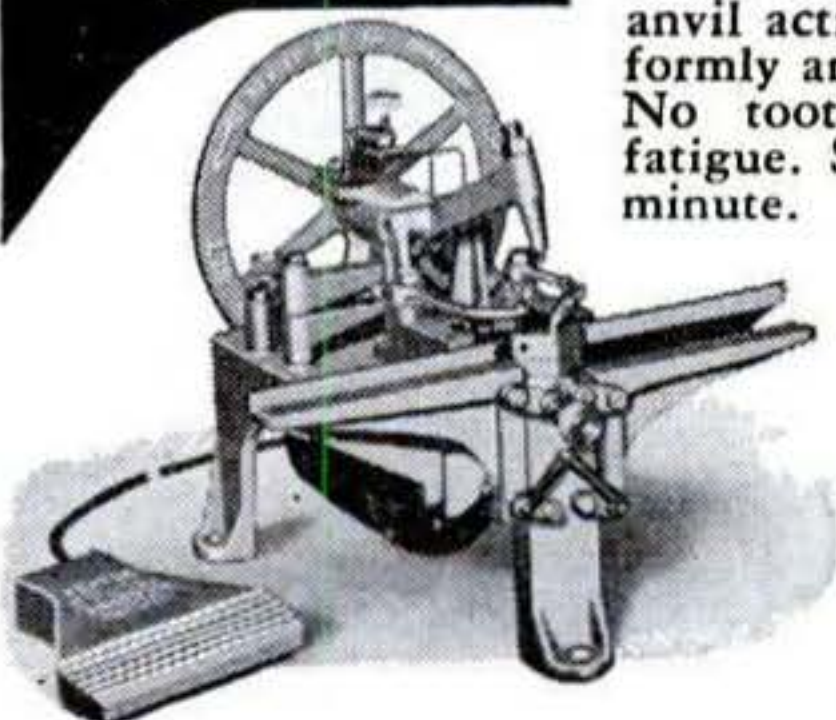

WRITE TODAY

Saw Shops Need These Machines For Greater Profit

With Motor

Immediate Delivery

BURR MFG. COMPANY, 8931-D Venice Blvd., Los Angeles 34, Calif.

MAY 1947 271

Amazing Novelty



Mystery Thirsty Bird

- Drinks and drinks and drinks.
- Nearest thing to perpetual motion.
- No machinery -- nothing to wind.
- Perfect gift -- will amaze and amuse all.
- Only \$2.50 postpaid. No C.O.D.'s.

Bowman Products

915 West Erie Avenue, Phila. 40, Pa.

MAIL THIS COUPON NOW!

Gentlemen: Please send me at once, postpaid, _____ (quantity)

Mystery Thirsty Birds. Enclosed find \$ _____

in check money order

NAME _____

ADDRESS _____

CITY AND STATE _____

Money Back Guarantee

8" BENCH SAW 14" BAND SAW

PRECISION BILT
FACTORY TO YOU

REAL PRODUCTION TOOLS
BUY BOTH WITH ONE DOWN PAYMENT

TERMS: \$50.00 with order F.O.B. St. Louis; balance 2 payments \$41.00 each within 60 days. If you prefer to pay cash, deduct 5 per cent. Units will be shipped prepaid.



BENCH SAW
\$42.50
LESS MOTOR

BAND SAW
\$89.50
LESS MOTOR & STAND

ON EASY TERMS

UNIVERSAL ELECTRIC PRODUCTS CORP.
122 N. SEVENTH ST. SAINT LOUIS 1, MO.

Electrically Welded Endless

Paramount

BAND SAW BLADES



Made in widths from 1/8" to 1-3/4"

Make your band saw do more work for you. The proper width of blade will extend the scope of this important machine. Burrill's Paramount Blades are made from tough Nickel Alloy Steel properly tempered. Teeth accurately set and filed, and all saws carefully straightened. Send order and check today. Delivery will be made as promptly as conditions permit, from a few days to a week or two. You can obtain these saws at the following prices:

1/8"-3/16"-1/4"-3/8" wide, 5'6" long.....\$.90 each
1/8"-3/16"-1/4"-3/8" wide, 6'6" long..... .95 each
1/8"-3/16"-1/4"-3/8" wide, 7'6" long..... 1.10 each

Other sizes at proportional prices

NO C.O.D. SHIPMENTS ACCEPTED

State Make of Machine

Your satisfaction is guaranteed

BURRILL SAW & TOOL WORKS

405 E. Main St., Ilion, N.Y.

BUILD YOUR OWN FAN

with that old motor



One piece cast aluminum propeller used for cooling and ventilating. Also available to dealers at discount.

Size Inches	Polished		Unpolished		Bore Inches
	2 Blade	3 Blade	2 Blade	3 Blade	
15	\$2.50	\$3.50	\$2.00	\$3.00	1/2 5/8 3/4
18	3.00	4.00	2.50	3.50	1/2 5/8 3/4
20	3.25	4.25	2.75	3.75	1/2 5/8 3/4
24	3.50	5.00	3.00	4.25	1/2 5/8 3/4
30	5.00	.	4.00	.	1/2 5/8 3/4

Let us give you our prices on your aluminum castings.

KLOPPENBORG ALUMINUM FOUNDRY, Dept. P.S. 57, Davenport, Iowa

NONE BETTER!

SUPER DRILL GRINDER



Sharpens round shank drills from 3/32" to 1 1/16" in diameter, up to 11" long. Grinds old drills like new in 4 different point angles, using hand or power grinding wheels. Money-back guarantee.

Price only \$2.95

At Dealers or Postpaid

Crandall Mfg. Co. 1512 W. Slauson, Dept. FB-17 Los Angeles 44, Calif.

Say You Saw
It In Popular Science

RUMIN
Gold Coated FLINTS
AND LIGHTER FLUID

For all Lighters
RUMIN
LIGHTER FLUID

gold coated
FLINTS

Rumin Gold-Coated Flints... the only gold-coated flints made... plus Rumin blue-flame Lighter Fluid are a sure fire combination that make every lighter spark quicker, light brighter!

SOLD WHEREVER
CIGARETTES, CIGARS
AND TOBACCO ARE SOLD

ROCK FLINT CO., 123 Doughty Blvd., Far Rockaway, N.Y.

FOR STEADY-VOLTAGE POWER...
FREE FROM OUTSIDE INTERFERENCE

DIESEL'S THE POWER...
Sheppard's the Diesel

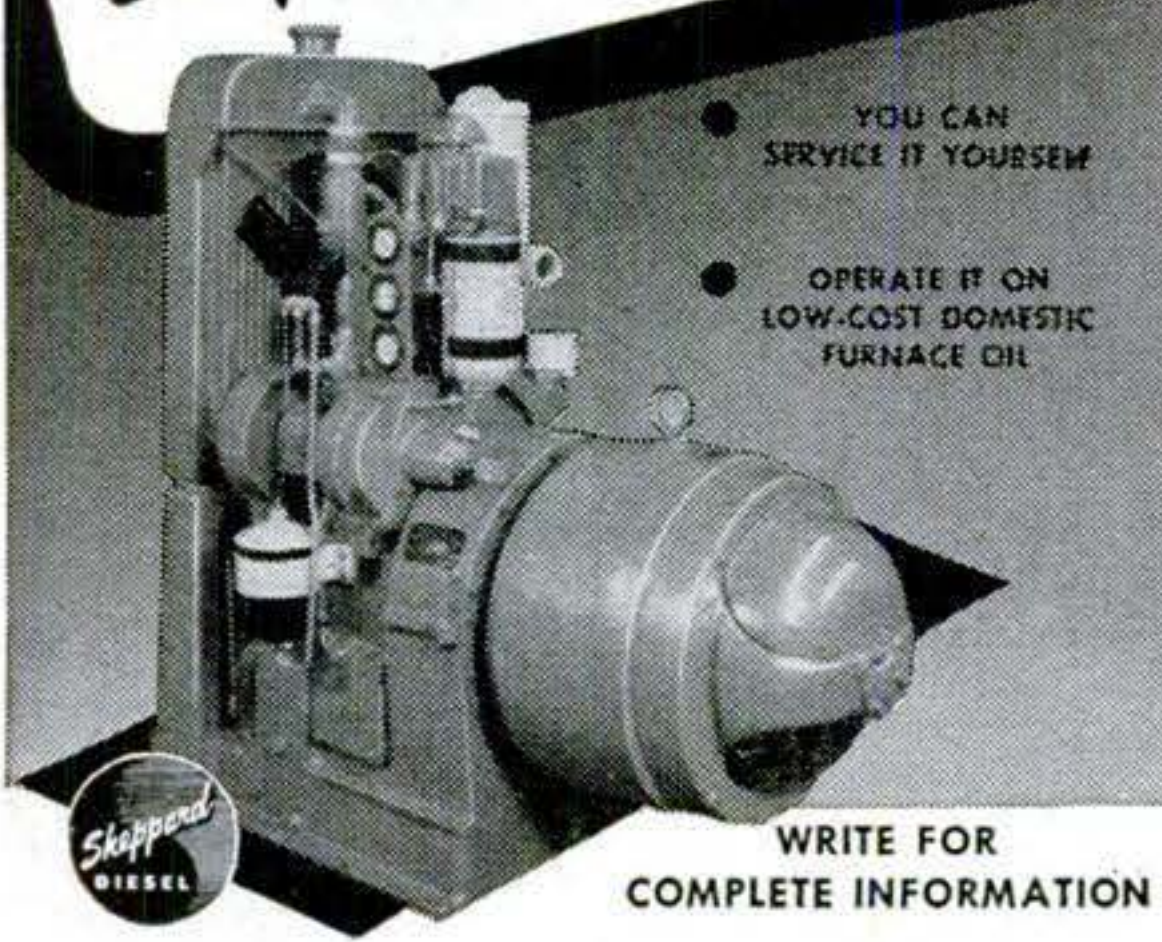

YOU CAN SERVICE IT YOURSELF

OPERATE IT ON LOW-COST DOMESTIC FURNACE OIL

WRITE FOR COMPLETE INFORMATION

Generating Sets... 2,000 to 36,000 Watts
Power Units... 3/4 to 56 continuous H. P.
Marine Engines... 3/4 to 62 continuous H. P.

R. H. SHEPPARD COMPANY, INC., 68 Middle St., Hanover, Pa.

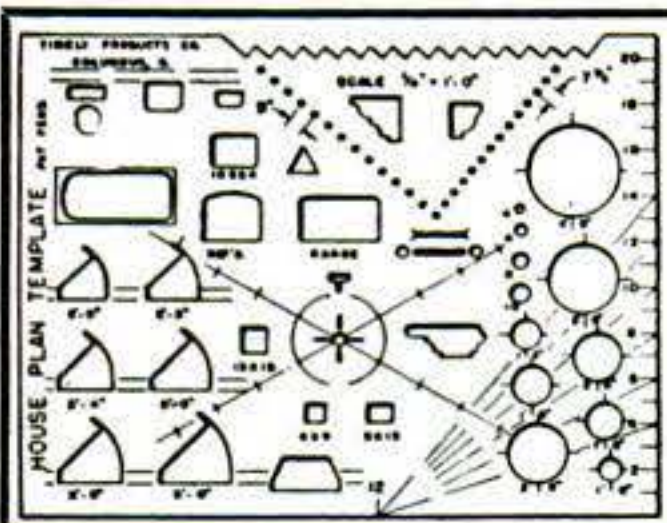

HOUSE PLAN TEMPLATE
Made of clear sheet plastic, with accurate cut-outs for drawing door-swings, plumbing and electric fixtures, fireplace, stairs, moldings, roof-pitch, etc. Standard 1/4" = 1'-0" scale.

\$1.50 POSTPAID
Send card for list of templates
TIMELY PRODUCTS CO.
Box 206E, Columbus 9, Ohio

Say You Saw
It In Popular Science

**FINE TOOLS
NEED
FINE OIL!**



• Lubricates
• Prevents Rust
• Cleans • Polishes

SOLD EVERYWHERE

3-IN-ONE Oil

Make **big money**...
— start a business of your own with a



HOBART
multi-range arc welder

Start Your Own Business!
Be your own boss, get into the big money! Start your own job welding shop — minimum investment. Hobart offers 1,000 welding combinations with Multi-Range control for better welds — Remote Control speeds up work — makes you more prof-



Electric Stationary
It from repair and construction work to be found everywhere.

"Build Your Own"
Save hundreds of dollars, build your own gasoline drive Hobart Arc Welder. Need only a Hobart generator, used auto engine and chassis. Free booklet tells you how. Write for details.

The Hobart Welding School
It's a modern trade school in which students learn by doing. Expert instructors give individual attention. Each student has own welding booth and welder. Fully accredited under G. I. Bill. Send coupon for details.

HOBART BROTHERS COMPANY
Box P-57, Troy, Ohio



Electric Portable



Hobart
"One of the World's Largest Builders of arc welders"

HOBART BROTHERS CO., Box P-57, TROY, OHIO
I'm interested in the profit making possibilities of Hobart Arc Welders. Send me details on items checked.

"Build Your Own" Gas Engine Drive
 Electric Drive A. C. Welder
 Hobart Welding School

NAME _____
ADDRESS _____

BILL'S BACK IN THE GANG SINCE HE GOT HIS WESTERN ELECTRIC HEARING AID!



There is a difference in Hearing Aids

● When you select a hearing aid, accept only the best. Western Electric Hearing Aids are the *only* ones designed by the world-famous Bell Telephone Laboratories and made by Western Electric, the nation's largest producer of communications and electronic equipment.

Mail the coupon today for free helps to better hearing and details on the new Model 64 Hearing Aid.

Western Electric

Dept. 380-PS5, 195 Broadway, New York 7, N. Y.

Please send your free guides to better hearing and information about Model 64.

Name _____

Address _____

City _____ Zone _____ State _____

Distributed in Canada through Northern Electric Co., Ltd.

- Quick Heating
- Four Interchangeable Tips
- Replaceable Heating Element



IT'S THE NEW Flash "75"

THE PERFECT BALANCE—
PISTOL GRIP—SOLDERING GUN
THAT WEIGHS

ONLY 6 OUNCES!

There is nothing else like the Flash "75"—with 5/16" tip for direct operation from 110 V AC or DC line. Heats up quickly. The natural wrist position, perfect balance, cool pistol grip and light weight make a Flash your best buy. Four interchangeable tips for general utility service. REPLACEABLE HEATING ELEMENT—a feature that prolongs life of tool and assures uninterrupted service.

PRICE \$4.95. Ask your dealer for a Flash "75", or send coupon for literature or a Flash "75" shipped postpaid direct to you.

BAKER-PHILLIPS CO. 2816-7 Aldrich Avenue So. Minneapolis 8, Minnesota

- Send circular on Flash "75"
- Enclosed is.....for.....Flash "75" Soldering Guns at \$4.95 each, postpaid.

Name.....
Address.....

NEW MIDGET ELECTRIC ARC WELDER



RETAILS ONLY
\$3.95

FULLY GUARANTEED

Plugs into Light Socket AC or DC

It's new! It's handy! It's efficient! Use the Midget Electric Arc Welder for hundreds of light-metal jobs. Does comparable welding work with a 1/16 inch welding rod on thin metal as that of larger and higher priced welders. Operates on 15 ampere fuse, 110 volt 60 cycle A.C. or D.C. current, by use of our special standard-coated 1/16-inch welding rods. Generous supply of rods supplied with machine. Recommended for all light welding like automobile fenders, etc. Take the Midget Arc anywhere to the job. Sturdily built and fully guaranteed. Comes complete—ready to use. Nothing else to buy. No previous welding experience needed to strike an arc. In a short time, anyone mechanically inclined can learn to weld with this machine.

You'll find hundreds of money-saving, time-saving uses for the Midget Arc around your home, garage, or workshop. Also in garages, factories, repair shops, tin shops, mechanics, farmers, inventors, etc. Order a Midget Electric Arc Welder now! SEND NO MONEY. We'll rush one to you, complete with rods and helmet (equipped with APPROVED welding glass). Pay postman only \$3.95 plus postage charges. If not satisfied, return Midget Arc in 5 days from receipt and we'll refund your money immediately. RUSH YOUR ORDER NOW.

MIDGET ARC WELDER CO., Strader Ave., Dept. X-205, Cincinnati 26, Ohio

WORK BENCH

Ideal for hobbyist or shop worker, this sturdy, useful bench makes home handwork a joy! Heavy top, 2 large drawers. Tool rack, strong shelf, bins for nails and bolts. 59" long—23" wide—36" high. Shipped unassembled, easily set up (from instructions). F.O.B. Phila. factory. Check or money order. Money back if not satisfied. QUALITY CRAFTSMEN, INC., Dept. S, 3431 Market St., Philadelphia 4, Pa.



\$16.95

ITS EASY PICKING

from a Huot DRILL INDEX

A handy container for indexing and filing twist drills. All steel—ten sizes. Correct drill always at your fingertips. SEND \$1. for No. 13—holds drills from 1/16" to 1/4" by 64s. (Or see dealer.) Order Today.

HUOT MFG. CO.

436 FOOT, SCHULTZ BLDG.,

ST. PAUL 1, MINN.



FOR STEREO PICTURES, IT'S STEREO-TACH!

Take Third Dimension Pictures with the STEREO-TACH and your own camera! There's nothing in photography so startlingly beautiful and lifelike! You can't reproduce a 3-dimension picture in flat 2-dimension printing!

Outfit No. 101—Tach and Transparency Viewer (for transparencies, with 35MM cameras) **\$22.50***

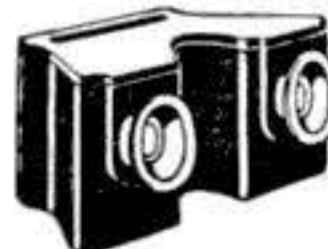

Outfit No. 100—Tach and Print Viewer (for stereo prints, with both 35MM and other size cameras) **\$16.25***



The Stereo-Tach

Transparency Viewer For Third-Dimension Projection, the STEREO-FLECTOR! Just Out! See your dealer or write. ADVERTISING DISPLAYS, INC. Dept. PS-3 COVINGTON, KENTUCKY

MAKE UP TO \$5⁰⁰ AN HOUR In Your Own YEAR 'ROUND Business!

ONLY A FEW DOLLARS PUTS YOU IN BUSINESS!

Many Clearing as High as \$20 to \$30 a Day NET Renewing Rugs, Carpets, Upholstery. New Method Now Used for Auto Upholstery. Write for Facts About Quick, Easy Way to Get Started

Here is the chance you've been looking for to step into a pleasant, dignified, big-pay business of your own that offers you a steady, year 'round income. Start on "a shoe-string," full or spare time, right from your own home. Equal opportunities for men and women, young or old, in small towns or big cities. No experience needed. Many making big money with new Americlean System just cleaning auto upholstery. Easy to learn. We send you complete instructions and quick-cleaning supplies so you can start making money the very first day! Quick method cleans upholstery, rugs and carpets like new without taking off floor! Tremendous demand in homes, apartments, hotels, stores, office and public buildings. Steady repeat business. Territories going fast. Write today for full FREE facts. No cost or obligation. Rush letter or postcard now to AMERICLEAN CO., Inc. Dept. H-5; 211 North 7 St., St. Louis 1, Mo.

WRITE FOR FREE DETAILS NOW!

STEAM-ENGINE ROTARY VALVE UP TO 5000 R.P.M. SATISFACTION GUARANTEED

3/8" HIGH 2 1/4" LONG
7/16" BORE 9/16" STROKE

PRECISION-BUILT MINIATURE

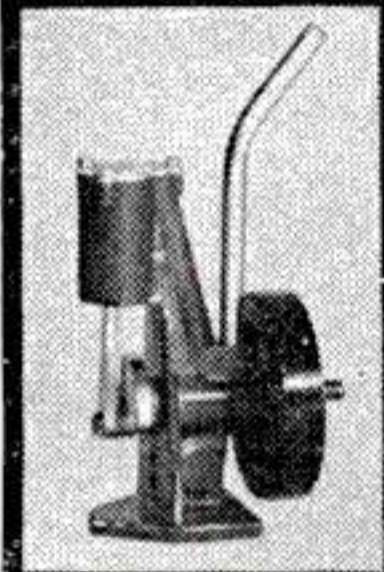

Constructed for high speed operation. Rotary valve eliminates friction! Use as power plant for experimental work—tinker toys, erector sets, etc. 20 lbs. pressure drives bicycle generator lamp. Use as air pump by running in reverse with small fan motor. Die cast alloy frame. Test-run—timed clockwise. **ORDER NOW** for immediate shipment. \$5.00 postpaid—or C.O.D. plus postage. Master Blue Prints—POSTPAID \$1.00.

DEALERS—CLUBS, write for special details.

AMSTOY MFG. CO. Dept. 4, P.O. Box 2638
Gravois Station, St. Louis, Mo.

Secret for Inventing FOR THE AMATEUR INVENTOR

The first and only service established exclusively for helping the amateur inventors in testing the commercial value of their inventions and guiding them in the correct course to securing patent and market at the least expense.

Service guaranteed. Full information free on request.

E. C. BARNES, PO Box 85, Attica, Indiana

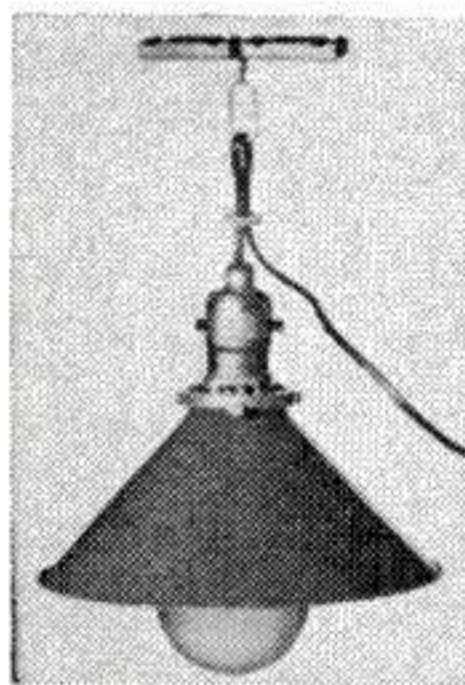

PATENT PENDING

The light complete as shown with oil-grease proof light weight wear resisting wire and plug. Less bulb.....\$4.95—25 feet wire. Send cash—money order—or check—we pay postage.

A & P ELECTRIC MANUFACTURING CO.
220 Meadow St. Waterbury, Connecticut

A & P MAGNETIC FLOOD LIGHT

Hang it under the hood or on the body of your car.

Nail a piece of iron over your home work bench and you can slide it any place over your work.

Used by garages—service stations, plumbers and sheet metal workers.

Two heavy duty alnico magnets sealed in brass flexible case so that light holds on round or uneven surface.

WORKSHOP WISDOM

Quick, easy way to make curved parts for furniture, boats, and skis—without using nails, bolts, drifts, or steam

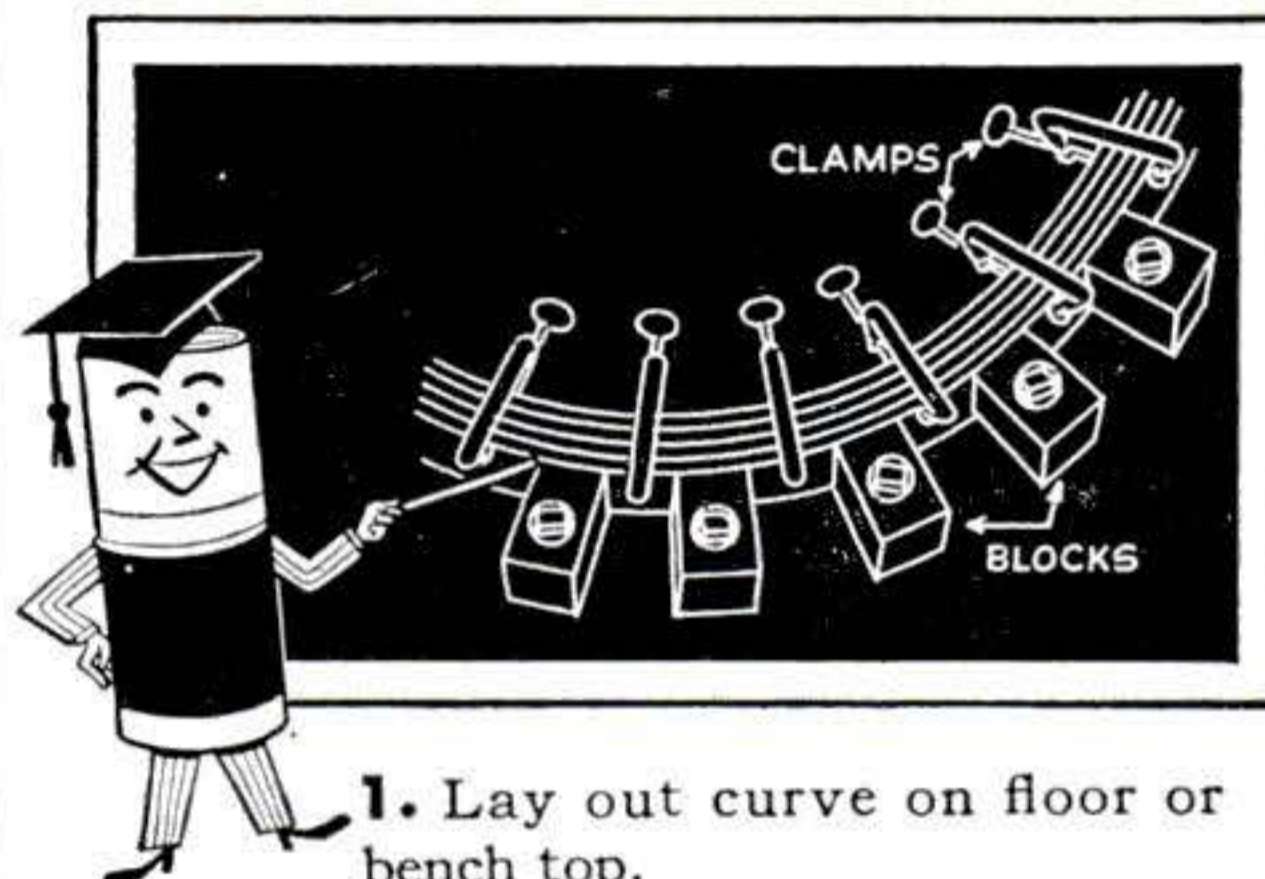

1. Lay out curve on floor or bench top.
2. Fasten down series of blocks around desired curve.
3. Screw wood or metal band to blocks to make a "form."
4. Spread thin pieces of wood with glue and clamp to form as shown above. When glue sets you'll have a laminated section four to eight times stronger than a pieced or bolted section.

Make sure you use Cascophen Glue on outdoor projects!

Cascophen is completely heatproof, waterproof, moldproof, and fungusproof.

It bonds at moderate pressure, cures at 70 degrees F. or warmer, keeps indefinitely in storage. It is the only durable waterproof glue available to craftsmen.

See your hardware, building-supply, marine, or paint dealer today. He has Cascophen in 1/4-pint, pint, quart, and larger sizes.

For Indoor Projects use Casco or Cascamite

FREE GLUING CHART. Address: Dept. PS-57 Casein Co. of America, 350 Madison Ave., New York 17, N. Y.



CASCO



CASCAMITE



CASCOPHEN

SpeedWay



No. 89 1/2" DRILL
\$29.95

No. 209 Drill Stand (less drill)
\$12.95

● Why tote around a heavy "production type" drill (designed to run continuously at full capacity on some production line), when you can get a light weight handy SpeedWay Drill that makes all ordinary drilling easier and gives you years of service. Regardless of what you pay, you cannot get a better 1/2" drill for general use, than the SpeedWay No. 89.

With its No. 209 drill stand it doubles as a capable drill press at savings that will go a long way in paying for other equipment. You'll find the same sensible economy in the little SpeedWay No. 69 Drill and its No. 229 drill stand. This low cost pistol grip drill will drill straight holes up to 1/4" diameter in steel.

Write for circular & name of your nearest dealer.

No. 229 Drill Stand (Less Drill)
\$5.25



No. 69 1/4" Drill
\$11.80



SPEEDWAY MANUFACTURING CO.
1864 S. 52nd Ave., Cicero, Ill

★PRICE REDUCTIONS★EXPANDED STOCKS★

Aluminum flats to 4", squares, rounds, hexagons, angles, tubing. Drill rod in rounds, squares, flats and octagons. Plastic in sheets, rods and tubing, clear and color. Also Decorative Panels. Many other items. Listing (A47) on above 5c. Catalog 1046-D and Listing A47 which lists tools, supplies, equipment, etc. 15c. METPLAS SUPPLY COMPANY, 1420 South 16th, Maywood, Illinois.

free

CONCORD

Radio

Catalog



RADIO PARTS • RADIO SETS • RECORD CHANGERS — PLAYERS • KITS • HAM GEAR • AMPLIFIERS • TESTERS

It's here! The big, new 1947 Concord Catalog with a vast, complete selection of everything in Radio and Electronics for building, experimenting, testing, repair and maintenance. Thousands of items—hundreds now available for first time—latest 1947 prices. Now LOWER prices on Radio Sets, Receivers, Kits, Record Changers, Players, Portables, Amplifiers. Latest listing standard items. Complete stocks—IMMEDIATE SHIPMENT. Write for FREE COPY—please address Dept. PS-57.

CONCORD RADIO CORP.

LAFAYETTE RADIO CORPORATION

CHICAGO 7 **ATLANTA 3**
901 W. Jackson Blvd. 265 Peachtree Street

276 POPULAR SCIENCE

STOPS LEAKS PERMANENTLY

Cut your fixture replacement, water and fuel bills with Economy Renewable Seats. Make economical, permanent repairs quickly and easily with the Junior Kit (illus.). Repair bathroom, kitchen and laundry fixtures. Everything you need included in steel box. Price complete with Seats.....**\$22.50**

Senior Master Kit also available—repairs faucets and valves up to 1" pipe. At Better Jobbers and Hardware Stores...or Write Direct



ECONOMY VALVE SEAT CO.
2811 W. Fletcher Street Chicago 18, Ill.

THE SCOUT SENIOR



A two-cylinder, slide valve engine for boats 18" long and larger. 7/16" bore by 5/8" stroke. Aluminum pistons. High-pressure, brazed boiler. Drives a 2 1/4", two-blade prop of 3" pitch at 2000 r.p.m. for almost 20 minutes. Burns alcohol. Price postpaid, complete ready to run with 70-lb. safety valve and prop rig.....**\$9.50**

PHILIP STEVENSON CO.
Box 162, Station D Cincinnati 6, Ohio

GASOLINE ENGINES

Latest type, aircooled Briggs-Stratton and Wisconsin 6 H. P. Immediate delivery. These engines are used government surplus, guaranteed by us to be in excellent mechanical and operating condition. Sale Price.....**\$99.50**

Immediate Delivery—Act Quick
No COD Orders. Write for descriptive circular.

MIDWEST SURPLUS SALES
1520 Locust St. Kansas City, Mo.

AMAZING NEW MAGNETIC JIG SAW!



Write for FREE Circular

Ready for Delivery!

SYNCHRO... new, remarkable, patented, magnetic jig saw... needs no belts... no gears... no oiling! Just plug into any 60 cycle A.C. 110-130 volt outlet—and saw! Portable... world's safest saw! Cuts clean, smooth... no sanding necessary! Ideal for hobbyists, craftsmen, light production. Perfect for models, displays, inlays, etc. Cuts intricate designs on 3/4" soft wood, 1/2" plywood and thinner hardwoods, metals, plastics... NOT for ordinary lumber. Leaves NO ragged undersides on plywood or heavy cardboard. Special magnetic safety stroke features! Nothing else like it! Sold on 10 days Moneyback Trial! Prompt delivery guaranteed. Rush name, address on postcard for FREE details, Trial Offer. Hurry!

SYNCHRO SAW CORP. Dept. B-57 Rochester, Mich.

MORE PROFITS

with

MODERN LAWN MOWER SHARPENER



SHARPEN ANY LAWN MOWER from 5-inch Edger to 36-inch Power Mower in ten to twenty minutes with a MODERN LAWN MOWER SHARPENER because dismantling is unnecessary — neither handle, roller, wheels nor motor need be removed when sharpening any mower. . . . the MODERN SHARPENER eliminates all hand filing; it precision grinds to the extreme ends of both left or right reel blades. Bottom knife is held in same brackets for sharpening. NO EXTRA ATTACHMENTS! Order today! Price \$241.50 (less motor) f.o.b. Pasadena (1/3 or 1/4 H.P., single phase motor recommended.)

Modern Mfg. Co., 160 N. Fair Oaks, Pasadena 1, Calif.

arc welding manual and text book...\$2.00

Teaches you how to become an arc welding operator — one of highest paid trades today. Write today!

Hobart Bros. Co., Box P-562 Troy, Ohio

WORLD'S MOST ACCURATE LEVEL



NO MORE GLASS BREAKAGE NO MORE LEAKAGE

Adapting discoveries of the Ancients to Modern Science. Hairline reading — Built-in Compensator. Ground to .00001" accuracy.

A PRECISION INSTRUMENT

12" — \$3.50 • 18" — \$4.75 • 24" — \$6.50

Sent prepaid to any point in Continental U.S.A. on receipt of cash, check or money order. C.O.D. — 25% with order.

UNIVERSAL ELECTRIC PRODUCTS CORP.
122 N. SEVENTH ST. • SAINT LOUIS 1, MO.

Say You Saw
It In Popular Science

New

Simplified Soldering

No Soldering Iron—No Torch

Neat-N-Nifty

Self Soldering Tape

Made of ordinary solder on one side, and a flexible plastic composition on the other. When ignited with a match it burns at just the right temperature for perfect penetration of the solder. Solders wires, holes, and small metal parts. Ideal for electrical repairmen and home work-shops. Cost! about 1c per job or less.



Be among the first to use it. If your local dealer cannot supply you, mail money order direct. (No foreign orders accepted) U.S.A. only. Home work-shop kit 75c, commercial size kit \$1.50 postpaid.

W. B. FRANKLIN CO.
Dept. 77, Box 910, San Fernando, Calif.

A POWER WORKSHOP OF TAYLOR TOOLS

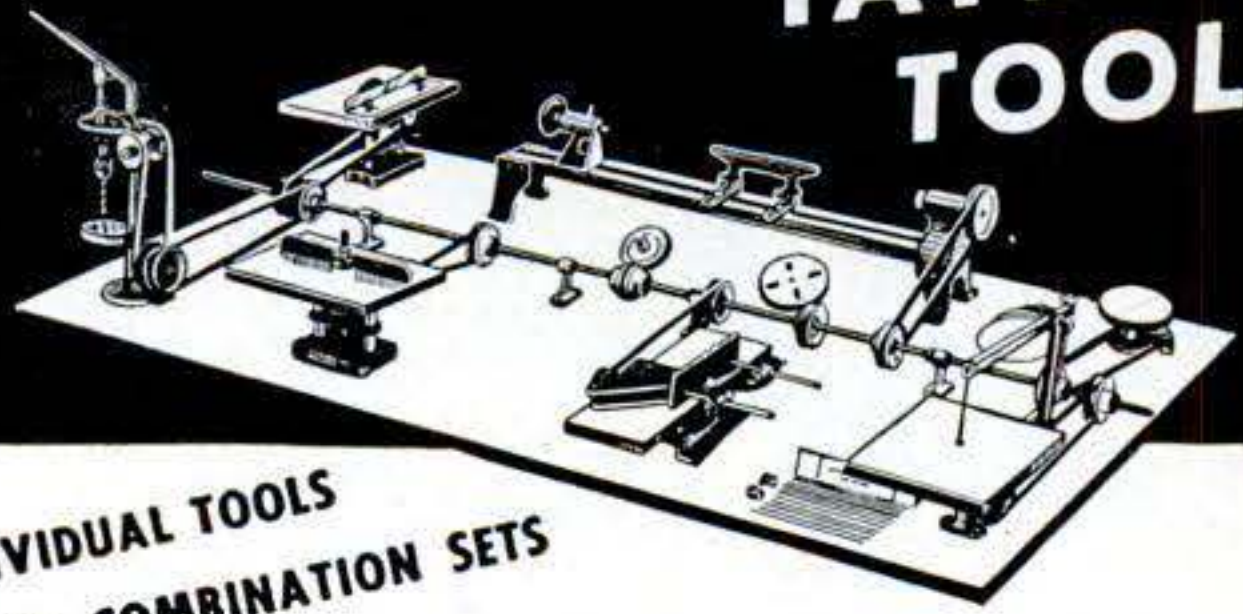

INDIVIDUAL TOOLS
OR IN COMBINATION SETS

Here they are—Taylor Power Tools—to meet your needs and fit your pocketbook. For wood, plastic or light metals. You can buy a single tool or a complete outfit—Operate on any motor from 1/10 to 1/3 H.P. (motor not included).

- CIRCULAR SAW** Price, \$7.95
- JIG SAW** Price, \$4.95
- VERTICAL SPINDLE SHAPER** Price, \$7.95
- 4" JOINTER** Price, \$10.95
- LATHE** Price, \$10.95
- DRILL PRESS** Price, \$6.95
- DISC SANDER** Price, \$2.45
- JUNIOR WORKSHOP** including jig saw, drill press,

- lathe and accessories. Price, \$34.30
- BEGINNERS WORKSHOP** including jig saw, drill press, lathe and accessories. Price, \$26.30
- THE SENIOR SET** consisting of 7 Tools and Accessories as shown above. Price, \$59.50
- GUARANTEED!** for one year from date of purchase against material or workmanship defects.

ORDER FROM OR SEND FOR DETAILS TO

Genesee HOBBY SUPPLY CO.
P. O. Box 101, Pittsford, N. Y.

MEGOW'S U-CONTROL

UC-5 Competitor...

Featuring carved fuselage, shaped leading and trailing edges, wing tips, rudder and stabilizer. Formed landing gear. For .30 to .60 engines. Clear, easy plans. Other controlled models, \$2.50 to \$10.00. See your dealer. Catalog 15c.



LIC. UNDER WALKER PAT. 2,292,416

\$5.50

THE MEGOW CORPORATION PHILA. 22, PENNA.

5 POWER TOOLS IN 1

\$34⁹⁵



COMPLETE HOME WORKSHOP
 Here is power tool pleasure and profit in a ruggedly built, HEAVY steel unit—the Emrick Universal Woodworker. Handles big work. Drill press pulls 1/2" drill in steel. Saw takes 6" to 8" blade. Lathe 10" swing, 30" centers, spindle dia. 3/4". Takes all standard accessories. Sander 8" dia. Emery wheel 5". Bronze bearings, replaceable throughout. Price does not include motor and saw blade. Order today.

10 DAY TRIAL

1755 CLINTON STREET
EMRICK, Inc. KALAMAZOO 24, MICH.

Ship on 10 Days Trial. I am enclosing \$17.50, balance C.O.D. Send free literature.

Name _____
 Address _____ City _____

BIG MONEY IN YOUR OWN BUSINESS

• Amazing, scientifically developed LIQUID MARBLE, FIBER-TITE, FLOORING, FLEXIBLE MOLDS brings you a fast money making opportunity. Work full or spare time and make big profits. Experience unnecessary. No large investment required. Work from your home. Write for FREE CATALOG and full details.

COMPOSITION PRODUCTS CO. Dept. PS-5, Box CC
 Richmond Heights, Mo.

WORLD'S LOWEST PRICED ADDING MACHINE

VEST POCKET SIZE IDEAL FOR BUSINESS OR PERSONAL USE

FREE TRIAL
ONLY \$2.50
 TOTAL COST
 SEND NO MONEY

Each Baby Calculator in Beautiful, rich-looking Leatherette case—at no extra cost.
FREE!!



Fits vest pocket or purse. Guaranteed accurate. Operated as easily, and as reliable, as machines costing many times as much. Not a toy. Substantially made of 28-gauge steel—guaranteed for life against defects in construction. You positively can't buy a calculator of equal quality for as little money. **ACCEPTED AS THE FINEST LOW PRICED CALCULATOR FOR OVER 30 YEARS!** Operates with a flick of your finger. Adds, subtracts, multiplies, divides—counts up to ten million. Pays for itself over and over in mistakes avoided, and time saved. **MAKES IDEAL GIFT.**

Sold on a positive money back guarantee. Send only \$2.50, Calculator sent postpaid, or send name and address and pay postman \$2.50 plus postage. **MONEY BACK IN 10 DAYS IF NOT DELIGHTED!** (If outside U. S., send \$3.00.) **AGENTS WANTED.**

CALCULATOR MACHINE CO., (Mfrs.)

Dept. 478 P.O. Box 248, Glenview, Illinois

278 POPULAR SCIENCE

FOREDOM Flexible Shaft MACHINES

with the "PENCIL-SIZE" handpiece

Foredom's remarkable PENCIL-SIZE HANDPIECE gives you finger-tip control in performing scores of tasks—grinding, polishing, de-burring, sharpening, cleaning, slotting, milling, etc. Gets into tight places that ordinary tools cannot reach. Used on all metals, wood, glass and plastics. More and more Foredoms are coming off the assembly lines each day. Order Now,—you won't have to wait too long for delivery of your Foredom. Prices range from \$19.95.

Catalog No. 80 on request

Over 60,000 Foredoms now in use!

FOREDOM ELECTRIC CO. (Established 1922)

27 Park Place, Dept. 80, New York 7, N. Y.

Build Your Power Tools With OUR BALL BEARING ARBORS

New Departure Self Lubricating Bearings 10,000 rpm



B33—\$4.95 PP
 5/8x4 1/2 Spindle
 B15 Plain Spindle
 \$3.45

(No extra charge for left hand threads)
 C5-5/8 C5-5/8
 C4-1 1/2x12 1/2 Spindle, Housing 2x8 \$8.25 PP.
 C5-5/8x12 1/2 spindle, housing 2x8 \$8.25 PP.
 C6-3/4x12 1/2 spindle, housing 2 1/4x8 \$9.25 PP.
 D8-1x17 1/2 spindle, housing 2 5/8x11 \$16.95 PP.
 1 INCH BETWEEN WASHER AND COLLAR

Shaper Arbors, C4, C6 or D8, 3 inches between collars, add \$6.00. Plain Spindle Models less threads and collars C4—\$8.00, C5—\$8.00, C6—\$9.00. D8—\$16.00. All P.P. V Belts \$.03 per inch PP. Courtesy to Jobbers and Dealers.

POLY PRODUCTS, 406 S. Chester Ave., Ct. 1, Dept. S5, Pasadena 5, Calif.

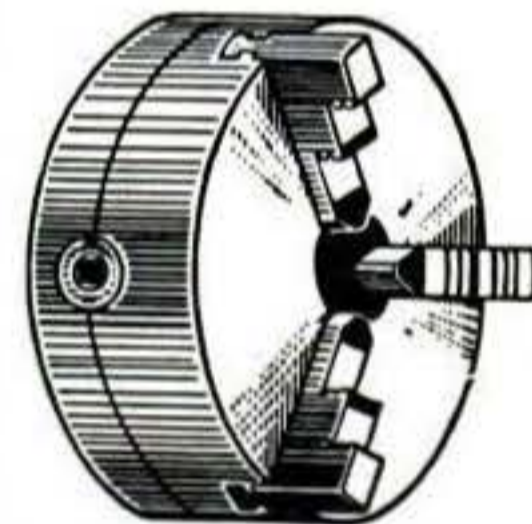

LATHE CHUCKS

5" Universal w. 2 sets of jaws \$33.00 F.O.B.
 6" Independent, reversible jaws \$19.00 F.O.B.

These are WESTCOTT Chucks. Immediate delivery from stock.

Bodies threaded for 1 1/2"-8 for Atlas, Craftsman, Logan, Clausing and other Lathes. No back plates, less overhang, better performance.

JOHN E. KANDLER CO.

210 N. Rose St., Kalamazoo 12, Mich.

Raise GOLDEN HAMSTERS

The new wonder animals. Look like toy bears. Delightful pets. Everybody wants them. Thousands needed by laboratories. Make money, get started now. Send 10c for illustrated literature, or send \$5 for a pair of hamsters and literature.



GULF HAMSTERY

1540 BASIL ST.,

MOBILE 17, ALA.

MAKE YOUR OWN



IMMEDIATE DELIVERY

250 POWER TELESCOPE
COMPLETE LENS SET only \$2.50

See the mountains and craters on the moon, the ringed planet Saturn, the moons of Jupiter, distant ships, people, and hundreds of other interesting sights. Make your own high powered telescope in one evening of easy work. All optical parts for 6 ft. long refracting telescope completely finished. Set consists of 3 inch diameter 75 inch focal length ground and polished objective lens and all eyepiece lenses needed to give magnifications of 50X, 100X, 150X, 200X, and 250X as an astronomical telescope, and 50X, 100X, and 150X as a terrestrial telescope. Complete lens set with full directions for mounting, only \$2.50 postpaid.

BROWSCOPE CO., Dept. 5P, 24 W. 45th St., N. Y. 19, N. Y.

DIAMOND SAW BLADES

With Actual Diamond Dust on Cutting Edge
BRAND NEW—WAR SURPLUS
 Now at only a fraction of former prices.
ACTUAL RETAIL VALUES UP TO \$30 EACH.

6 inch \$3.60—8 inch \$4.70—10 inch \$5.80 **POST PAID**
 (All have 5/8 inch arbor hole)

Useful for cutting any hard material such as tile, glass, ruby, plastics, slate, stone, marble, quartz, etc.

Perfect for Hobbyists, Mechanics, Jewelry, Glass and Porcelain Workers, Marble Cutters and all who need a fast, true cutting saw blade for hard substances.

Fit Skill Saws & any ordinary motor—Quantity Limited

Mail order today. Enclose check or M.O. All prices postpaid. Sent C.O.D. plus cost, if you wish. Add 28c for foreign postage.

DIAMOND DISKS Dept. B3—140 West 42 St. New York 18, N. Y.

ATTENTION AUTO OWNERS!

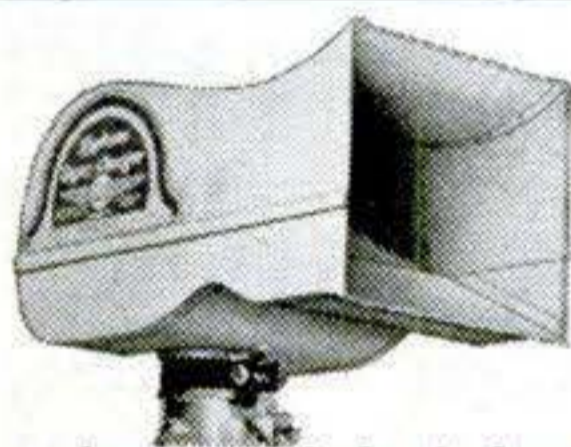

New Power, Pickup, Pep!
 Amazing **TYPHOON SUPER-CHARGER** is back again, ready to put new life into old motors, add to power, pickup, pep. 41,000 users find gasoline economy, you will, too. Motor knock vanishes... Grease bath air cleaning keeps dust out. Takes 5 minutes to install with screw driver, fits on carburetor. Order today, mention make and car model. Only \$5.95. Ohio orders add 3% tax, west of Rockies add 10%.

10 DAY MONEY BACK GUARANTEE!

TYPHOON PRODUCTS CO. 509-D Engineers Bldg., Cleveland 14, Ohio

NEW PLASTICS Fabricating MANUAL

HOW TO USE Plastic AT HOME
NOW ONLY 25c

Make beautiful objects of Plexiglas, Lucite, Catalin, Polystyrene at home. Jewelry, novelties, accessories. Send for new 10,000 word manual on how to fabricate, weld and form latest plastic materials in home workshop. Hundreds of practical suggestions. Written by leading plastics engineer. Price prepaid 25c (stamps or coin). Or get FREE information and price list covering transparent plastic sheets, rod, tubing cut to your size. Write today:
HOUSE BEAUTIFUL PLASTICS,
 Dept. E4, 5534 W. Harrison St., Chicago 44, Ill.

GUNSIGHTS AND MECHANICAL EQUIPMENT
 Write for list of War Surplus bargains

WARSHAWSKY & LAZAR
 2126 S. Michigan Ave. Chicago 16, Ill.

Bicycle Repairing Pays Well!

Any one handy with tools can make money at once. Proprietor of successful shop shows how he started 10 years ago on practically no capital—completely illustrated manual covers every phase of repairs—refinishing and how to get started. Manual **POSTPAID \$1.00.**
CAHILL CYCLE SHOP, CENTREVILLE, MARYLAND

"THE FORD" MOTOR

—1 3/4 Horse Power Gasoline Air cooled 4-cycle—

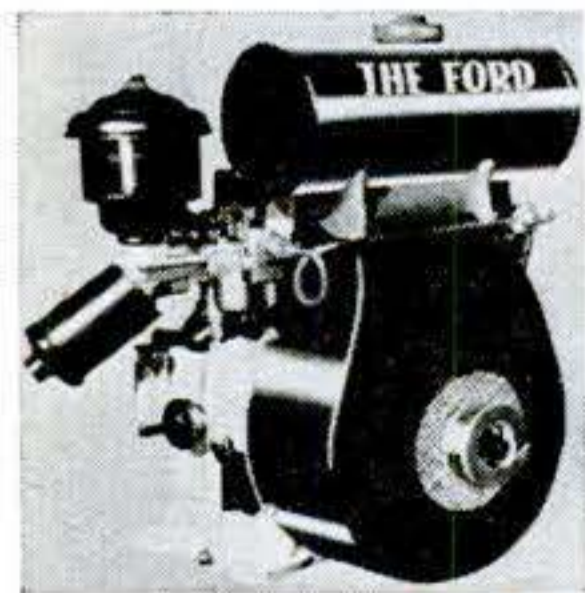

Designed for—Lawnmowers, Scooters, Bikes, Air-Compressors, Boats, Garden Tractors and Universal Utility Use.
Lightweight—Aluminum alloy construction like an aircraft engine, easy starting and long life. This motor includes the famous Tillotson carburetor, Bendix-Scintilla airplane-type magneto ignition, muffler, air cleaner, gasoline filter, tank, etc. Tested and Ready to Run—Fully Guaranteed.

\$81.50

F.O.B. Factory Direct To You.

Distributors inquiries invited.

THE CAUFFIEL MOTOR ENGINEERING CO.

312 South St. Clair St.

Toledo, Ohio



PRESSURE LOCK WRENCH

JAWS always PARALLEL when they grip

**No Slipping!
 No Skinned Knuckles!
 No Rounded Edges!**

The BMC Pressure Lock Wrench will grab hold of any shape piece and lock on... until released with the flick of a finger. That's because the jaws are always parallel at any opening. They give a uniform grip to the very tip, due to an exclusive, patented device found in no other wrench. Pressure as great as 1 1/2 tons, or as light as you desire, applied with almost equal ease. There's no slipping, no skinned knuckles, no rounded edges or ruined tempers.

Grips All These Shapes ... and Others Too!

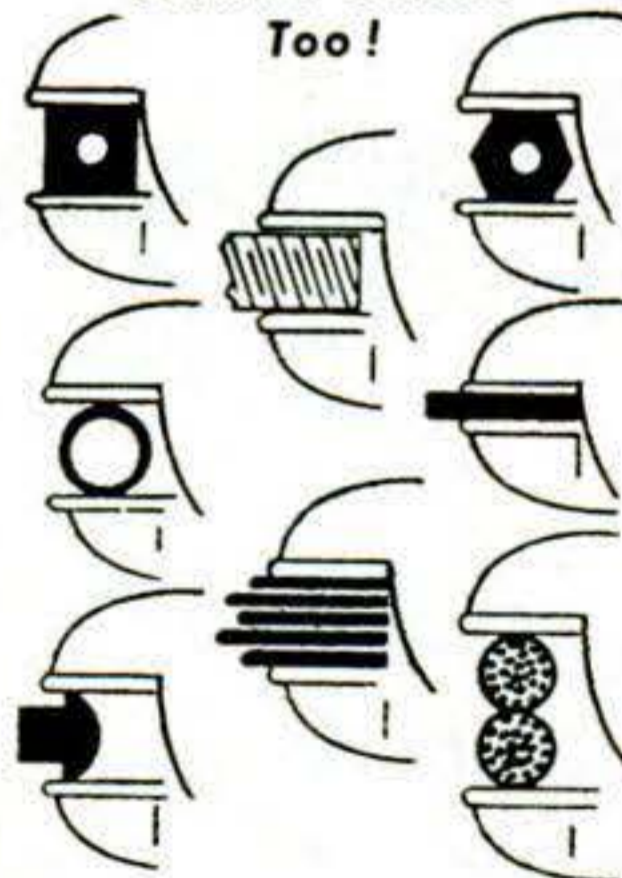

Only Wrench Adjustable with One Hand

The BMC Pressure Lock Wrench is a true, one-hand tool. Jaws can be adjusted to desired indexed opening with the thumb. Needs no fussy trial settings because it fits as it grips... and it holds. It is actually six tools in one... an adjustable end wrench... a pipe wrench... a gripping tool... a multi-leverage pliers... a hand vise... and a locking clamp.

3 HANDY SIZES:

- No. 7—Max. jaw opening, 3/4".... \$2.29
- No. 9—Max. jaw opening, 1"..... 2.59
- No. 11—Max. jaw opening, 1 1/2".... 4.89

For sale at leading hardware, auto equipment, mill supply, plumbing and electrical stores and departments.

BMC MANUFACTURING CORP.
 Binghamton, New York

Manufacturers of Offset Screwdrivers for Regular and Phillips Head Screws, Charge-A-Blade Scissors, and Ready-Ray Auto Trouble Lights.

McAleer

SIDE CAR CARRIERS



THOUSANDS NOW IN USE

Slips on or off
any car in a jiffy

Will carry anything
too big for the
inside of your car

\$4.50

PER PAIR
COMPLETE

● Indispensable for carpenters, painters, plumbers, farmers, window washers, gardeners, campers, hunters, fishermen, home owners, salesmen, etc. Carries tent poles, lumber, pipe, oars, ladders, garden tools, fish poles, skis, etc., securely and conveniently. Guaranteed not to damage car finish. Instantly removable. Fully patented. Exclusive design.

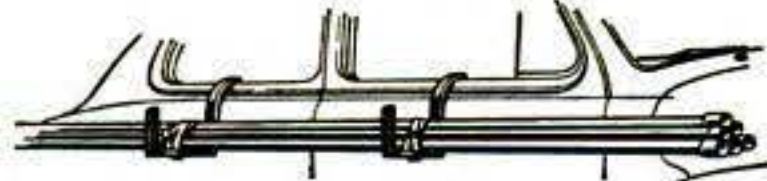

Shipped prepaid on receipt of check, money order ... or C.O.D.
Or at your nearest dealer. Write Dept. 10.

SOLD ON 5 DAY MONEY BACK GUARANTEE

Makers of McAleer Automotive Cleaners, Polishes,
Home Buffing Compounds, Waxes, Rust Removers

McALEER MFG. CO. Rochester,
Michigan

FLOYD CLYMER'S POPULAR MOTOR BOOKS



CLYMER, Dept. B-5, 2125 W. Pico, Los Angeles 6, Calif.

Midget Race Book, \$1.10. Indianapolis 352-page Race History, \$3.50. Mercedes-Benz Book, \$2.00. Catalog free. Chromed, enameled lapel pins—specify Midget Car, Race Car, Harley or Indian. \$1.00 ea., postpaid.

MAKE UP TO \$10 ON EVERY SALE!

AIR
CORPS
TYPE
**SUN
GLASSES**



\$5.00

**SELLS
EVERYWHERE
UP TO \$15 and MORE!**

A Real Fast Money-Maker! Here are genuine 12 Karat gold filled, Air Corps Type SUN GOGGLES complete with "Pearltex" sweat bar, brow rest and rocking pads, scientific ray-absorbent "No Glare" ground and polished sage green lenses, dropped before curving, and self-adjusting comfort cable ear pieces. Handsome crush-proof case included. Will protect eyes from glare, sun, wind, dust and exposure. Wonderful for auto drivers, policemen, golfers, gardeners, farmers and all outdoor workers and sportsmen. Sold on 10 day no risk trial money-back guarantee. You can easily sell 3 or more pairs a day. Send for your sample pair of these fine Sun Goggles—only \$5.00, postage prepaid. Or send no money. Just deposit \$5.00 with your own postman, plus postage—your money back if not delighted.

MIDWEST SCIENTIFIC CO. Dept. 806, 1148-1160 W. Chicago Ave.
CHICAGO 22, ILL.

280 POPULAR
SCIENCE

BARGAIN

Original Cost \$150.00



3X Army Telescope

ALL COATED LENSES—BRAND NEW

An ideal gift for viewing objects, landscapes, seashores, etc. The high resolving power of the six coated lenses, five of them achromats will bring out great details. For the experimenter it can be dismantled and used for hundreds of projects. Length 22½ inches, 36° Field, Postpaid \$7.50.

500,000 Lenses and Prisms. Send 3 cent stamp for "BARGAIN" List.

A. JAEGER, BOX 84B, SO. OZONE PARK 20, N. Y.

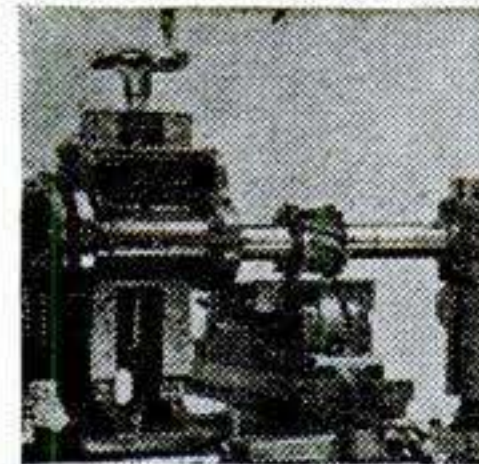

GLOBE MILLER

Installed on your lathe
in three minutes

DOES ALL TYPES OF MILLING

... The Globe Miller does plain and angular milling, slotting, slitting, keyway cutting, dovetailing, spur gear cutting, rack cutting and many other types of work. Increases swing of 10" lathe to over 16".

CONTACT YOUR DEALER OR

WRITE FOR DETAILED INFORMATION

Give make, model and swing of lathe when ordering or requesting prices

GLOBE PRODUCTS MANUFACTURING CO.

Dept. 10, 3380 Robertson Blvd., Los Angeles 34, Calif.

FREE TRAILER PARTS CATALOG

"Safety Engineered"



BULL DOG Hitches
& Parking Jacks.

TORQ-LESS Axles,
Drop a card to Box D-46

HAMMER BLOW TOOL CO., WAUSAU, WIS.

Have Us PLATE YOUR

MOTORCYCLE
PARTS

SPORTING
GOODS

AUTOMOBILE
PARTS

REFRIGERATOR TRAYS
AND HARDWARE

NO JOB TOO LARGE OR
TOO SMALL—QUICK DELIVERY

MARINE PARTS

FIREPLACE
FIXTURES

SILVERWARE

PLUMBING
FIXTURES

JEWELRY

HOUSEHOLD
ARTICLES

PLATING
any Metal
or Finish
GOLD
SILVER
CHROME
BRASS
BRONZE
COPPER
TIN

Here's your opportunity to have these articles beautifully plated—and at a reasonable cost. Send them in—prices quoted before work is started. If not satisfactory, articles returned at no obligation.

Don't Delay—Ship Today

MASTER SILVERPLATERS

2031 CANIFF AVE. DETROIT 12, MICH.

MAKE HAND-OPERATED LATHES AUTOMATIC

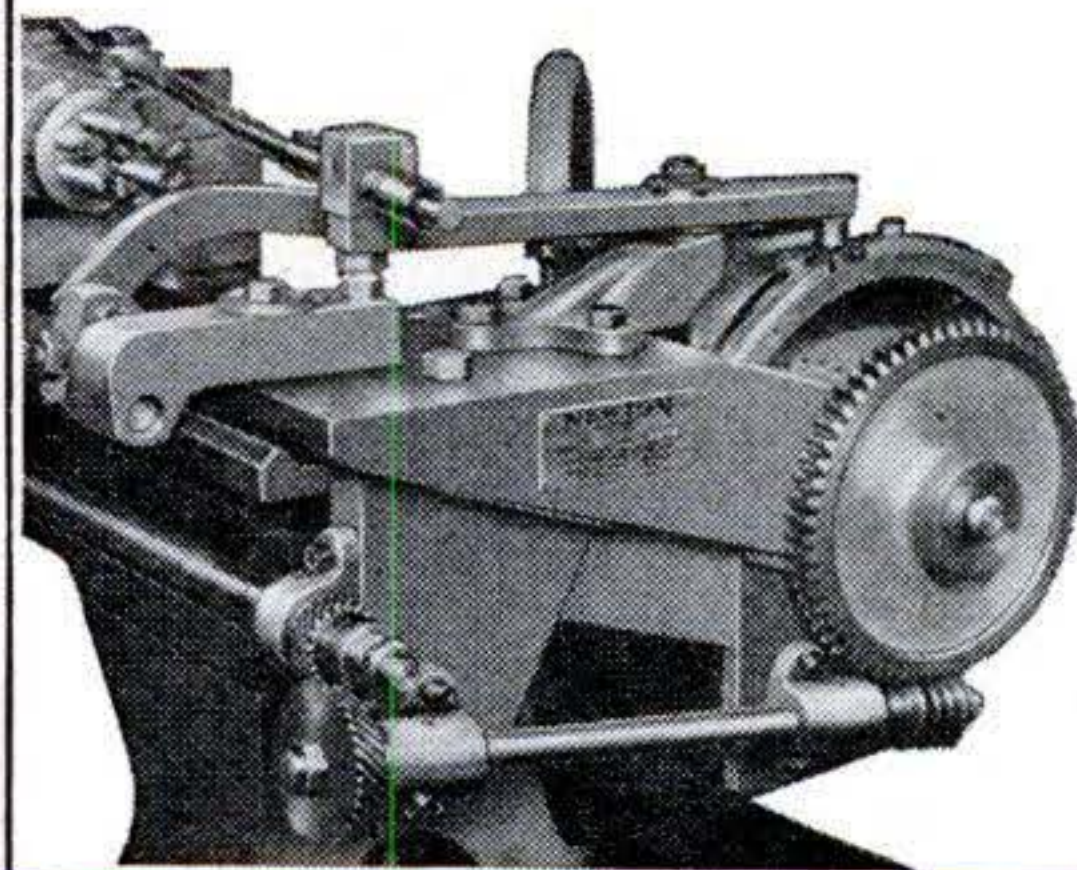

FOR GREATER PROFITS FROM TURRET LATHES AND HAND SCREW MACHINES

One man can easily operate three machines equipped with Newton Automats. Make small run jobs profitable. Save 50 minutes out of every hour for other profitable activities. Production compares favorably with that of costly single spindle automatics. Easy to install on turret lathes or hand screw machines with special adapter plates—no drilling or tapping of lathe. Use present power source. Can be reconverted to manual operation any time if desired. Write today!

NEWTON SELF-INDEXING, SELF-HEADLOCKING BED TURRET

Durable all steel head has six tool positions! Saves valuable time. Fits LOGAN, ATLAS and CRAFTSMAN lathes. Does quality work. Write for information!

A-K TOOL CO. Dept. A, 2029 Blake Avenue
Los Angeles 26, California



WAKE UP YOUR SCALP Want better looking hair? Embarrassed by falling dandruff, itching scalp? Then try VITABRUSH, new electric driven scalp brush that gives your scalp a vigorous and invigorating "workout" in just three minutes of fun. Cleans scalp. Stimulates blood supply. Restful. Pleasant. Write *today* for complete information and satisfaction-guaranteed offer.. Hershey Mfg. Co., 169 S. La Salle St.. Chicago 3

Say You Saw It In Popular Science

MANUFACTURE PLASTICS WITH LOW INVESTMENT

Mold checkers, poker-chips, golf-tees, beads, etc., on "IMP" injector press with "TRU-HU" acetate granules in 12 colors—with only \$25 deposit. Fabricate "TRU-HU" acrylic sheet in 18 colors. Send \$1.00 (refundable) for particulars and 30 useful samples. **TECHNICRAFT SUPPLY CO., 1156 Commonwealth, Boston 34, Mass.**

folding STEEL SAW HORSES!

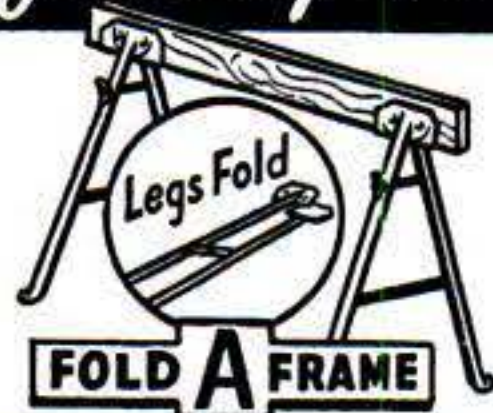

Save time! Space! Money! Fold-A-Frame fits 3/4" to two 2 x 4's lumber, any length! Model 24, Standard, 24" high. Model 40, legs adjustable 24" to 40" At all hardware and lumber dealers. Write for detailed folder National Tool and Die Co., Louisville 1, Ky.

MULTI-PURPOSE, RUGGEDLY CONSTRUCTED FLEXIBLE SHAFTS



Sealed Against Dust & Dirt
53 1/2" Length, 3/8" Diameter (O.D.)

These SHAFTS can be used on 1/2" motor shaft, or by removing the coupling, in a chuck up to 3/8" capacity. Shaft size on operating end is 3/8" diameter, 24 threads per inch. Speed range 1725 RPM to 3600 RPM. Can be bent or looped to small radius for working in hard-to-get-at places. Outer covering of oil-resistant Neoprene. Useful for many purposes, including Buffing, Grinding, and Transmission of Power.

ELECTRIC TRADING CO.
313 CANAL ST. NEW YORK 13, N. Y.

Electric Fans & Blowers in most sizes for every Industrial, Commercial and Domestic use. Table Saws—Air Compressors—Electrical Tools & Paint Spray Equipment in stock.

WRITE FOR CATALOG "S"

HEY FELLAS—JOIN THIS BRAND NEW HOBBY



Collect world famous, colorful, dazzling travel and sports emblems, insignias of world famous airlines, steamship lines, celebrated hotels, resorts, famous railroads and major league baseball teams. Beautiful, brilliant designs from far away places. You mount in books, on glass, wood etc. With introductory packet, we will include *at no extra cost* the much desired St. Louis Cardinals Baseball Club emblem.

★ Also your name in gold on Honorary Membership Card and new catalog. Mail this advertisement and only 10c to

VOGUE SPECIALTIES
401 CARNEGIE HALL DEPT MA1
CLEVELAND 15 OHIO



BIG MONEY FOR YOU IN PLASTICS

SEND Offer includes 2 books: New Fabrication Manual & Giant Catalog, listing the most complete stock of Plastic Materials. Accessories, Tools.

10¢

BERTON PLASTICS, INC.
19 W. 21st St., N. Y. 10, N. Y.

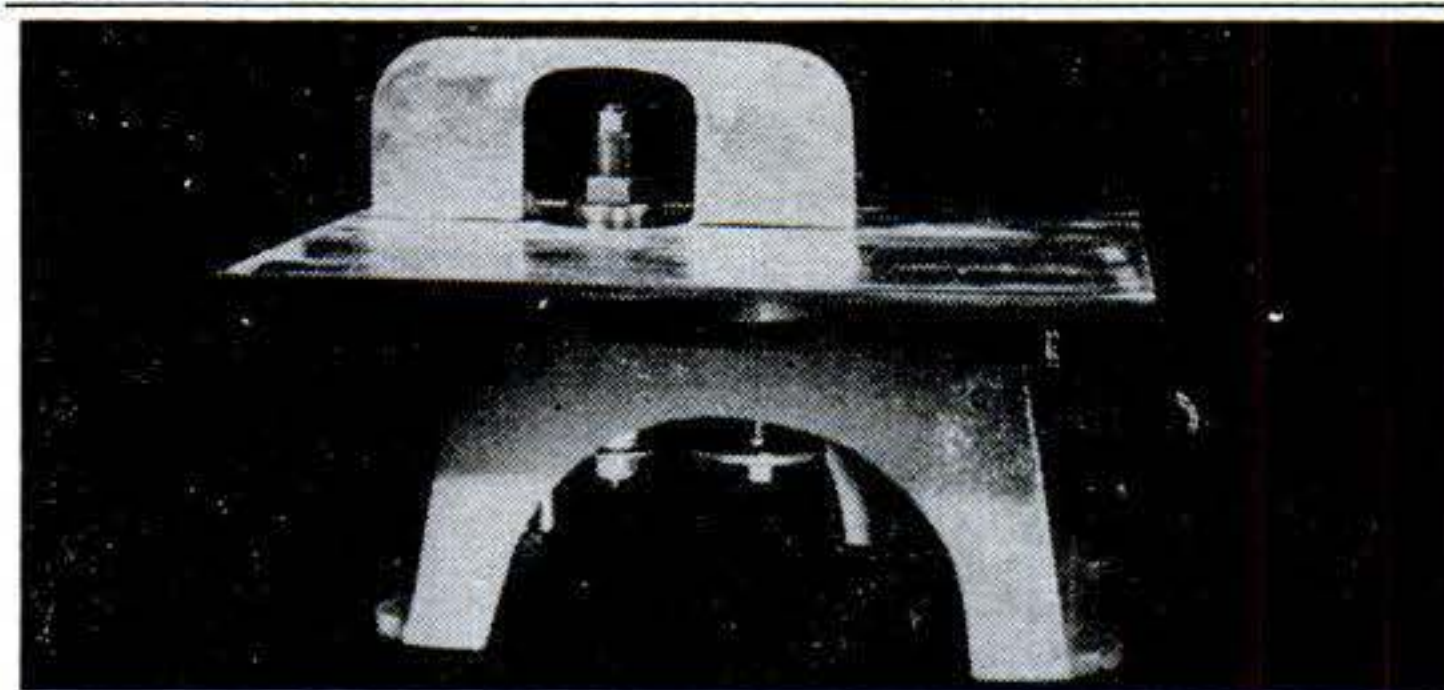

WOOD SHAPER

Of grey iron and aluminum construction. High speed sealed in balled bearings. 12 x 16 inch table with 1/2 inch spindle.

Screw up and down table adjustment of over four inches. The fence is adjustable on the table.

Requires 1/3 to 1/2 HP motor. Will operate from either horizontal or vertical motor and is an ideal machine for the small cabinet shop or hobbyshop work.

If no dealer near you, write direct. Limited dealer territories open.

MURPHREE MANUFACTURING CO.
SYLACAUGA, ALABAMA

ADDING MACHINE

NOT A POCKET TOY OR GADGET BUT A REAL DESK MODEL ADDING MACHINE

YES!
FOR
ONLY

\$21.50
COMPLETE



OFFICE
USAGE



GROCERY
STORES

The machine for Everyone!

This is a 7-column machine. Lists up to \$99,999.99. No special skill is required to operate. Merely press down the figures. Automatically the total accumulates. Always visible. Figures in total appear enlarged through special magnifier. Press handle to clear total.

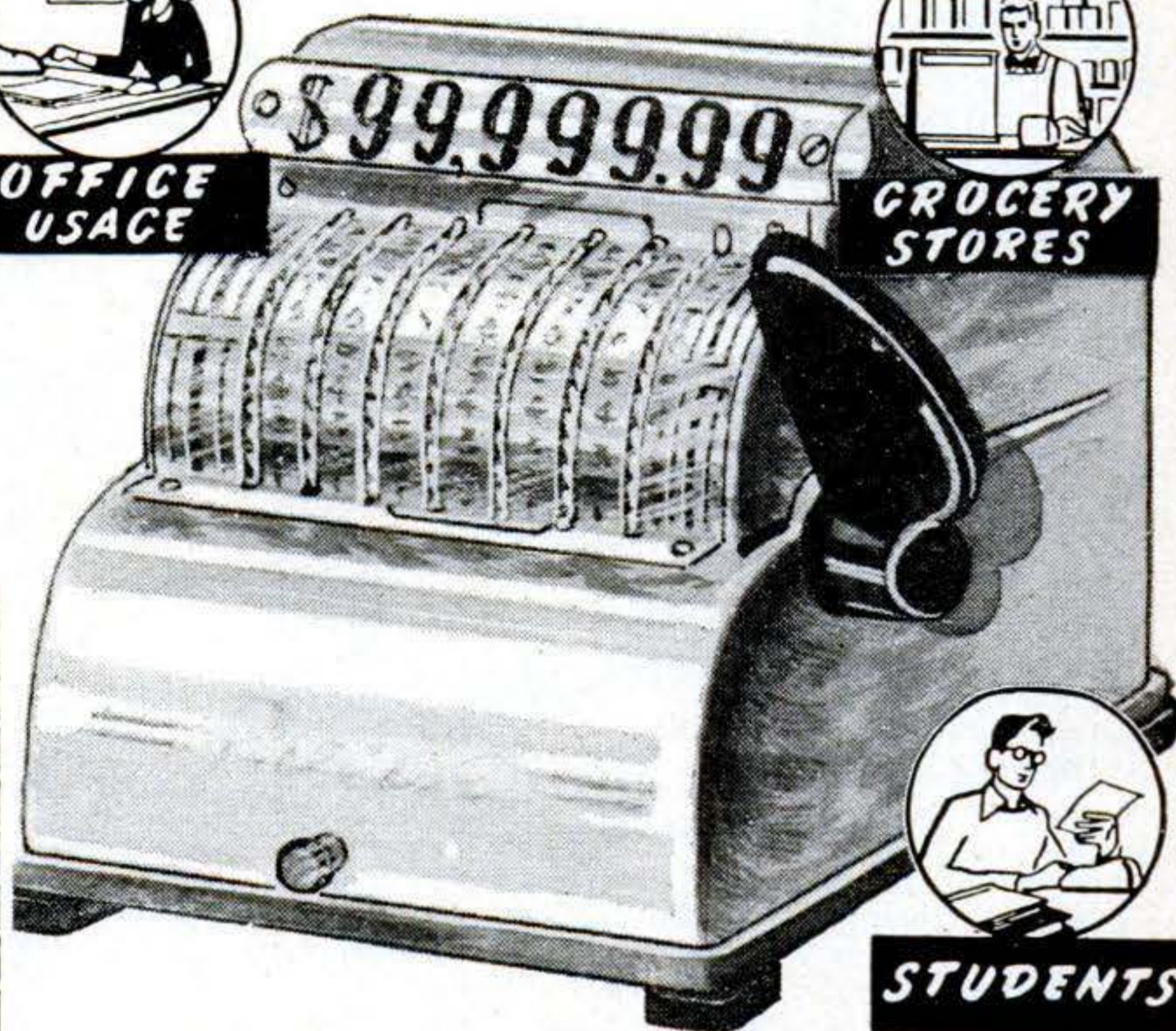

STUDENTS

UTILITY STORES

117 South Wabash Ave., Dept. RR-2, Chicago 3, Ill.

Enclosed find \$_____ for which ship at once
 Adding Machines at \$21.50 each complete

Name _____

Address _____

City _____ Zone _____ State _____

Established 1906

**Make Up To \$600
An Hour!**



Operate Your OWN Home-Weaving Business With AMAZING New DEEN Power Loom!

Make yourself financially independent! Start a steady business of your own . . . right in your home! Earn BIG PROFITS by weaving thousands of different designs of rugs on the new easily operated Deen Power Loom. Machine will automatically weave ten yards of beautiful intricate designs every hour.

DEEN LOOM TAKES UP LITTLE SPACE. You can put this marvelous weaving machine in a corner of your living room, basement, garage, or spare bedroom. Then later on, as your business expands, you can move into regular business establishment.

IDEAL BUSINESS FOR HANDICAPPED PEOPLE such as veterans and persons handicapped by loss of sight or limbs, and those unable to do strenuous labor. Loom is simple to operate . . . a child can run it. Any rug design you wish can be woven by merely changing paper guide pattern.

ORIGINAL INVESTMENT CAN BE RETURNED IN THIRTY DAYS. A small investment gets you started in your own business right away. Deen Loom has capacity of from eighty to one-hundred yards a day . . . in only one month it is possible to get back your original investment. Demand for home-woven rugs is GREATEST IN HISTORY. DON'T DELAY . . . start making plans for your own business NOW. Write today for free descriptive booklet and full information. Address Dept. 140 DEEN LOOM DIVISION.

THE GIBSON CO., World Herald Bldg., Omaha, Neb.

"Makers of DEEN Looms — FAMOUS Since 1895"

282 POPULAR SCIENCE

NOW YOU CAN GET THOSE MOTOR - CLUTCH - TRANSMISSION & AXLE PARTS IN STOCK

Why worry about parts when we have them. All you want at a BIG SAVING. We ship within 48 hours. We also have REBUILT UNITS for EXCHANGE at Bargain Prices: CARBURETORS—FUEL PUMPS—GENERATORS—STARTERS—SHOCKS & KNEES. It will pay you to GET OUR PRICES or RUSH YOUR ORDERS.

NEW AUTO PARTS and SAVE MONEY
Get Our BARGAIN PRICE LIST for parts you want

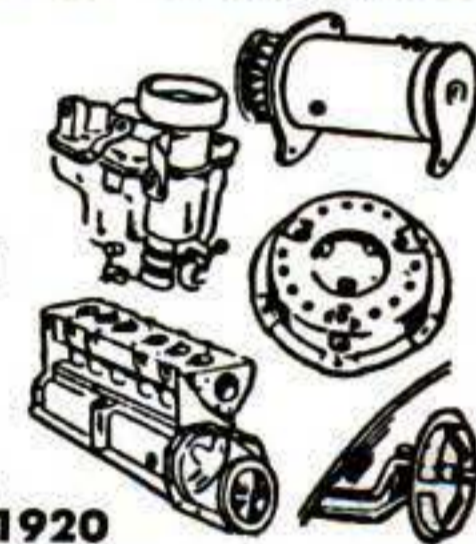

Est. 1920
Send Your Orders NOW! IMMEDIATE SHIPMENT
MECHANICS AUTO PARTS, Factory Warehouse,
3807 No. Ashland Ave., Dept. PS-5 CHICAGO 13

INVENTORS
A New Kind of Service
PRODUCTS AND IDEAS INVESTIGATED

INVENTORS—don't put the cart before the horse. Before you spend money on models, Patents, etc., find out whether your idea has any commercial value. Get full facts on new, modern Market Analysis and Investigation plan. We check markets, analyze sales possibilities, contact manufacturers, conduct sales negotiations. Help you get top prices. Service applies to both Patented and Unpatented inventions. Send at once for new FREE booklet. "A 12 Point Program for Inventors." NATIONAL MERCHANDISERS, Room 458, Abbott Building, 28 East Huron Street, Chicago 11, Ill.



NEW FREE BOOKLET

IMMEDIATE DELIVERY ADJUSTABLE
7 in. BENCH SAW \$12.95
8 in. BENCH SAW \$15.95



Well constructed. 5/8" shaft with bronze bearing wick oilers. Cover table adjustable, quickly removed for putting on 2 grinding wheels; buffer; drill chuck; disk drum sander. All items can be put on arbor of saw. "No Toy." Built to last. Cash orders receive "free" grinding wheel buffer, and 'saw blade' to size of saw ordered! This is an all purpose tool for your shop. Send your order now! With C.O.D. order send \$2.50 deposit. Orders filled same day received! Items guaranteed! Send for further details.

BELGRADE'S FOUNDRY & MFG. CO.
2405 CUMING ST. OMAHA 2, NEBR.

HANDY DANDY MOWER CONVERSION KIT

Build power mowers with our Handy Dandy Conversion Kit. All necessary parts to convert 16, 18, or 20 inch hand lawn mowers to a dandy powermower. Complete with chain drive and cone clutch. Write to-



Dealers Wanted

 Write for Details

Le Claire Mfg. Co.
Le Claire Iowa

Say You Saw
 It In Popular Science

Don't Spoil it ...KROIL it!



Don't ruin valuable equipment merely because some part is rusted tight. KROIL, the new chemical lubricant, creeps into millionth inch spaces, dissolves rust and loosens frozen parts, faster than any penetrating oil known. 5000 industrial plants still use KROIL to keep production going. Try it on money back basis. AT YOUR DEALER or send \$1 for two 8 oz. spout cans, postpaid. Send dealer's name.
KANO LABS, 3035 Lincoln Tower, Chicago 1, Ill.

Drill Press
 WORK SHOP TOOLS BY
Barron



5-in-1 ROTARY DRILL PRESS PLANER — PLANES, PANELS, RABBETS, ROUTS, TENONS, GROOVES

\$7.50

Over 60 000 now in use by pattern and cabinet makers, carpenters, hobbyists, etc. Fits any drill press. Lightening fast, accurate, safe, easy to use. Complete. No special blades needed. No shop complete without it. Fully guaranteed. For all woods and plastics.

New Style MORTISING and ROUTER BITS

Range in size from 1/8" to 1/2". Priced in individual sizes or by the set. Provides entirely new spiral flute cutting principle for faster chip clearance, smoother, accurate routing, carving, veining, grooving, round-end mortising. Extra long cutting flutes. Finest hi-speed tool steel—Super for woods and plastics.

\$9.50
 SET OF 6 SIZES



NEW! 4' Rotary Surface SANDER



\$5.95

New larger Barron Sander with live sponge rubber pad bonded to metal. Sanding discs changed instantly. For use on any drill press, flexible shaft or motor. Guarantees a dead-true, agate smooth surface. No ridges, waves, ripples, or striations. Fully guaranteed. Complete with 20 sanding discs.

ANNOUNCING

New Dovetail Cutting Tool for Drill Press \$1.85 each. All Metal 13" x 18" Auxiliary Drill Press Table \$9.85. Tapered and Threaded Drill Press Adapters \$1.00 and \$1.50 each.

Liberal 10 Day Money Back Guarantee

Workshop Guide FREE

BARRON TOOL CO.

570 Architects Bldg., Detroit 1, Mich.



Special Castolite Kit

Hobbyists, craftsmen: Get new CASTO-KIT containing everything to make useful objects with CASTOLITE, the new "magic" liquid casting plastic that pours without heat or pressure. Use crystal clear or color brilliantly. Make beautiful articles very first day—lamp bases, bookends, novelty jewelry. Also embed flowers, butterflies, photos, coins. Carve, saw or drill. Kit contains 1 lb. Liquid CASTOLITE, hardener, buffing compound, measuring dropper, abrasives, molding vial, flowers for embedding. Instruction Manual with easy step-by-step method. Big profit opportunities between now and Xmas. Send \$3.35 for kit prepaid or order C.O.D. For illustrated Manual, only, send 25c. **THE CASTOLITE COMPANY, Dept. E-4, Box 211, Kenilworth, Ill.**



20-Project KIT \$3.35

Now A DYNAMIC Super-charged WELDER

IDEAL FOR AUTO • HOME APPLIANCE • FARM REPAIRS

DESIGNED TO DO HIGH GRADE WELDING INEXPENSIVELY!

Maintenance Men; Farmers; Mechanics; Machine Shops; Foundries; Auto, General Repair and Job Welding Shops; all using the DYNAMIC find it so indispensable and useful that they cannot afford to be without it. If inexperienced you can easily learn to do a variety of high grade welding jobs by following the practical, simplified operating and welding instructions furnished. Once you see a DYNAMIC in operation, you won't want to be without it. Its simplicity will amaze you. In a year the DYNAMIC only costs you about 6c a day. Helmet, rods, cables, holder and operating instructions, etc., furnished.

SAVES YOU VALUABLE TIME AND MONEY!

This portable industrial transformer type DYNAMIC WELDER easily carried right to the job, can be operated from any convenient, properly wired **110 Volt, 60 Cycle Line**—has 8 metallic and carbon arc welding heat stages—does work you would think only possible with a larger more expensive machine. Can also be supplied for 220 volt, 60 cycle operation and other voltages and cycles at slight additional cost. Works on Iron, Steel, Brass, Bronze & other metals.

DYNAMIC WELDER CO., 13 East 23rd St., SE, Chicago 16, Ill.

ONLY \$28.50 COMPLETE Available Now IMMEDIATE DELIVERIES

Write Today for Particulars GET DETAILS on our 10 day Trial Offer. Member Chicago Association of Commerce.



SPECIAL! GOV'T SURPLUS SPECIAL!



Holland Hardware Co., Inc.
24 VESEY ST., New York 7, N. Y.

Send Money Orders—We Pay Parcel Post in U. S. Only

**WALTHAM
8 DAY CLOCK**



Luminous Dial, 3 1/2" face. Mounting bracket.

\$6.95

**FENWALL
TEMPERATURE
SWITCH**



Range adjustable from 40° below to 400° F. Overall length 4"x1/2".

\$1.25

**MICRO-SWITCH
110-V A.C.
Many Uses**



Roller type for normally open and closed circuits.

\$1.00

EYE LEVELS

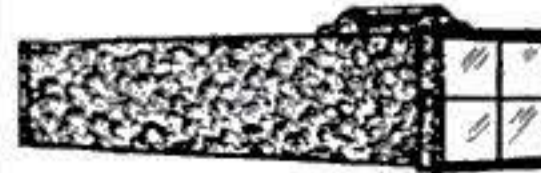

Assembled, metal construction. Ideal for many uses.

\$1.25

**DIAMOND
DRESSING TOOL**

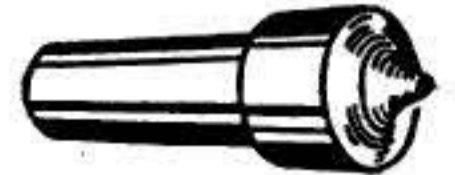

(used) For grinding wheels or cutting glass. 4/5 of diamond still usable.

\$1.50

**8 DAY
ELGIN CLOCK**

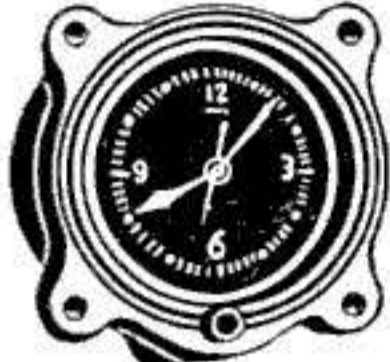

Luminous dial, sweep second hand, 2" face, mounting bracket.

\$6.95

**DELCO Permanent
Magnet Motor**

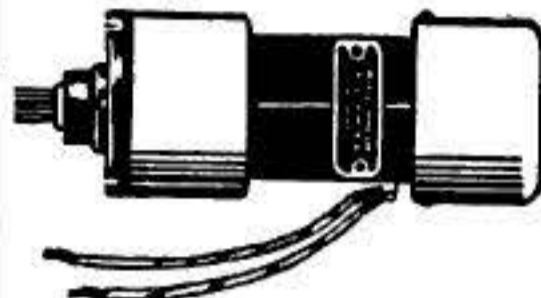

27v (DC) also runs off a dry battery for miniature or model trains, boats, etc.

\$3.00

SACHEL POUCH



Heavy canvas. Ideal for lunches, shopping, books, etc. 3-11x12" pockets. New, perfect. Has over-size flap with single strap.

\$1.25

MOTOR

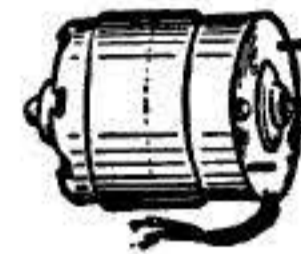

110v A.C. approx 1/20 HP. 3x3" with 1/4" shaft and mounting brackets. New.

\$4.50

**FLEXIBLE CABLE &
REDUCTION GEAR**



40" cable, 3 to 1 reduction. Ideal for drilling, buffing, turntables, light shopwork, etc.

\$2.00

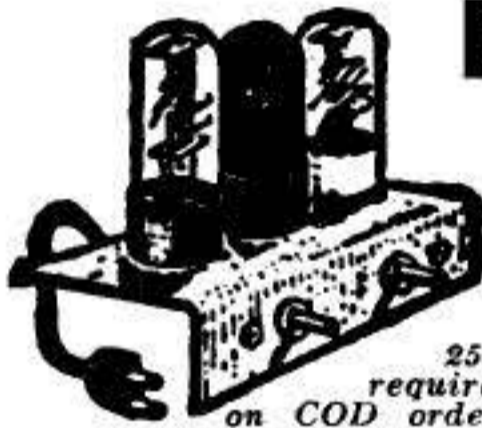

PHONO-AMPLIFIER

\$3.25

3-TUBE AC-DC-IMM. DEL. Volume and tone controls. Complete wired.

PHONO AMP. KIT

With 3 tubes and 5" speaker... \$7.50
Less tubes or speaker... 5.50
Complete kit wired & tested... 8.00
Alliance Phono motors and T.T. at... 3.25
Astatic curved arm pickup... 1.95
Uses-12SQ7-50L6-35Z5

Record Changers in stock. Order from this ad.

RISCO ELECTRONICS—WHOLESALE DISTRIBUTORS
22 Warren Street New York 7, N. Y.

REAL RELIEF FOR RUPTURE



Thousands of wearers tell of real relief. Scientifically shaped, made of strong washable materials, gives the RIGHT support WHERE NEEDED. Satisfaction GUARANTEED. Write for FREE literature NOW.

The WEB Truss Co. Dept. S-16, Hagerstown, Md.

Pat. Pend.

**SAVES TIME, EFFORT, MONEY IN
APPLIANCE
REPAIRING!**

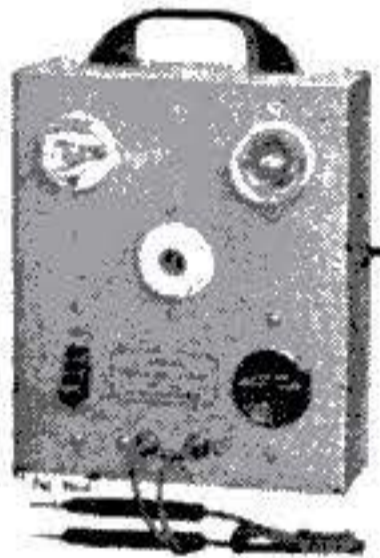

Appliance Tester

In the new improved HANLAN APPLIANCE TESTER you have all the necessary tests for examining the true conditions of any electrical appliance in common use today and in one single unit. This portable model tests thermostats at the point of cut-out and cut-on. Also controls heat on soldering irons. Tests continuity open circuits and grounds. As essential to electrical repairman, appliance dealers, shops, and trouble shooters. Order today! Only \$10.95 complete postpaid. \$1 deposit on C.O.D. orders. MONEY BACK GUARANTEE.

FREE with each Tester. New, Complete Practical Course in electrical appliance repairing. WRITE FOR CIRCULAR.
HANLAN CO., 1419-B, West Jefferson Blvd., Los Angeles 7, Calif.

ATTENTION FOREIGN BUYERS

Heavy duty sand-casted 8-pc. toy cooking sets, \$1.49 retailers. All metal "Put-Put" boats, actually run and sound like motor boats, \$1 retailers. Immediate shipment.

WRITE FOR QUANTITY PRICES. SPECIAL VALUES!

SPECIALTY SALES CORP. Dept. PS-55

3032 Olive St.

St. Louis, Mo.

AIRPORT MANAGEMENT

Learn full fundamentals of airport operation, salesmanship, flight instruction, office management, and all phases of a successful career in aviation. Full year's instruction with flight in the modern \$125,000 Brayton School. Write for Free Catalog.

BRAYTON AERONAUTICAL SCHOOL

Lambert Field

St. Louis 21, Missouri

HANG THAT DOOR THE PROFESSIONAL WAY!

USE THE TIME SAVING
—LABOR SAVING...
YOU DO THIS



AND GET THIS

E-Z MARK BUTT GAUGE

You get a clean cut deeply etched profile. Remove chips. Repeat this operation on the jamb and hang the door. THAT'S ALL—NO MORE!



Comes with Leatherette case

- Hang more doors better.
- No adjustments. ● No errors.
- Used and approved by Master mechanics.
- Comes in 3 1/2" and 4" (standard) sizes.
- Precision made.

Cost ONLY \$1.75 each or \$3.00 a set at your hardware store. If your Dealer can't supply you send only \$1.00 with order and pay Postman balance, plus postage C.O.D.

E-Z MARK TOOLS • P. O. BOX 8377 • LOS ANGELES 16, CALIF.

DECORATIVE METAL WORK

A new manual for the amateur. Tells in easy to understand language how to make useful metal articles in your home workshop. You'll be surprised how easy and interesting metal work really is. Fully illustrated with diagrams and step-by-step instructions. Sturdy cloth binding. 253 pages. Send only \$2.00 and your copy will be sent postpaid. Popular Science Monthly—Dept. 57, 353 4th Ave., New York 10, N. Y.

**RADIOS HIGH
GRADE TELEPHOLA**

1947—Latest Engineering—Lowest prices—20 Models—TELEPHOLA-to-you—5 tube superhet, built-in aerial \$14.95 and up—Guaranteed—Write for illustrated folder.

TELEPHOLA RADIO, Div. Horn Electronic Company

Main P. O. Box 177

Dearborn, Mich.

FINE *Cabinet* WOODS

For immediate delivery! Thousands of feet in sizes and grades to exactly meet your homecraft or woodshop needs. Bargains in Turning Blocks, Mouldings, Plywoods.

CATALOG OFFER: (U.S.A.)

Complete Hobbywoods catalog with periodic helpful supplements sent along with a twenty-five cent can of Waterproof Veriply (urea resin) Glue—Both prepaid for 25c.

Hobbywoods

Eastern Ave. and Beech
Baltimore 3, Md.

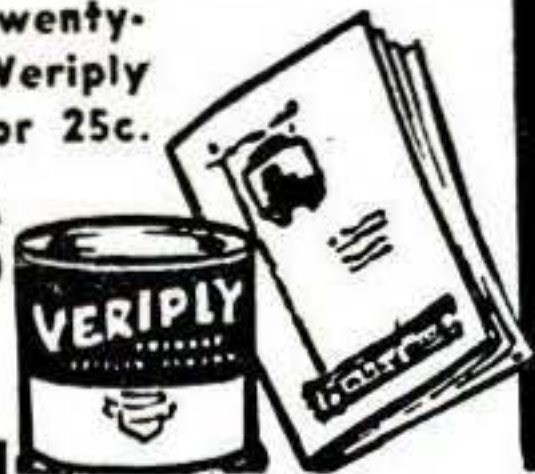

● POWER LAWN MOWER

BUILD ONE YOURSELF FROM YOUR OLD MOWER



We supply complete attachments that fit any make or size of mower, with or without 1½ H.P. gas engine. Easy to install in less than an hour. No more back breaking mower pushing. Immediate delivery, at low prices.

MONEY BACK GUARANTEE

You'll be delighted! Complete satisfaction or your money back. Write for

FREE FOLDER
Dealers Wanted.

ROYAL OAK LAWN MOWER SHOP
P.O. Box 48 Royal Oak 1, Mich.

Spotwelded
Heavy Gauge Steel

WHEELS



5", 5/8" solid tire, 3/8" bushing, ea. \$.59
8", 1" solid tire, 1/2" & 3/8" bearing ea. .99
8" same as above with hubcap, ea. .1.11
10", 10x1.75 semipneumatic tire,
cast bronze hub, 1/2" hole, ea. .2.19
5" cast alum, 1 1/4" wide, 1/2" hole, ea. .69

BOYS' EXPRESS CART KIT—includes 4—8" rubber tire wheels, axles, hangers, braces, steering assembly, instructions, for 15" x 34" wagon. \$5.98

ADD 10% to all prices for parcel post. Check, money order only. Satisfaction guaranteed.

C. W. YOUNG MFG. CORP.
204 Burnet Ave. Syracuse, N. Y.

Say You Saw
It In Popular Science

PULL COTTERPINS QUICK with the "KOTTER PULLER"

• Gets out the most stubborn cotterpins, quick and easy. For auto and aviation mechanics, garage men, shop men, farmers, hobbyists and anyone who works with tools.

DEALERS WANTED

Send Check or Money Order Today

The DORHONS Co.
3131 WEST 30th STREET • DEPT. 1
CLEVELAND 9, OHIO



ONLY \$2.45
POSTPAID
FULL MONEY BACK GUARANTEE



Schauer Speed Lathe
Model NA1B with 1/2 hp Motor

1103-1

25% OR MORE Below Used Market Price

- Hundreds of models
- No priorities needed
- Price lists give details

For copies, write or call the nearest WAA office below. Do it today.

OFFICE OF GENERAL INVESTIGATION

WAR ASSETS ADMINISTRATION

GOVERNMENT SURPLUS

Offices located at: Atlanta • Birmingham
Boston • Charlotte • Chicago
Cincinnati • Cleveland • Denver • Detroit • Grand
Prairie, Tex. • Helena • Houston • Jacksonville • Kansas City, Mo.
Los Angeles • Louisville • Minneapolis • Nashville • New Orleans
New York • Omaha • Philadelphia • Portland, Ore. • Richmond • St. Louis
Salt Lake City • San Antonio • San Francisco • Seattle • Spokane • Tulsa

MAY 1945 285

TO:

Reader

FROM:

Editor

Do You Still Want to Fly to the Moon?

SO MANY readers wrote for more information about "How You'll Fly to the Moon" (PSM, Mar. '47, p. 71) that space travel would seem to be their chief interest. For those who like to figure things out themselves, here are some basic rocket facts.

A number of inquiries involved the speed a rocket needs before it will leave the earth and never return—the "escape velocity." Escape velocity can be computed from Sir Isaac Newton's law of gravitation (any two bodies attract one another with a force proportional to the product of their masses divided by the square of their separation), and turns out to be about 25,000 m.p.h. *at the earth's surface*. Because Newton's law depends inversely on the separation squared, the force of attraction and the escape velocity decrease as distance from the earth increases. The escape velocity at any altitude can be calculated from the following formula* given by Dr. Robert H. Goddard:

$$V_e = V_o \times \sqrt{\frac{R}{R+H}}$$

where V_e = escape velocity at any altitude, V_o = escape velocity at the earth's surface, R = radius of the earth (4,000 miles), and H = altitude.

Obviously, it would be necessary to delay reaching the escape velocity while the rocket gathered speed slowly, meantime traveling some distance from the earth—otherwise the passengers would be crushed to death by the sudden acceleration. The exact escape velocity, then, will depend on how far your rocket travels while it picks up speed—which, in turn, depends on the rate with which it picks up speed, or acceleration. An acceleration five times that normally caused by gravity (5G, or nearly 400,000 m.p.h. increase every hour) is probably safe for human be-

*Be careful to use the same units throughout any one formula. If velocity is expressed in miles per hour, distance must be in miles, time in hours.

ings; pilots of fast fighter planes have withstood even more.

Having settled on the acceleration your rocket will use, you can compute how far it must travel before it reaches any given speed by using two more of Sir Isaac's formulas:

$$H = \frac{1}{2} A \times T^2 \quad V = A \times T$$

where H = altitude or distance, A = acceleration, T = time, and V = velocity of the rocket.

These equations do not take into account air resistance, causing some error. The difference will not be very great, however, since the rocket travels through air for only the first few hundred miles of the trip. In addition, other calculations show that air resistance becomes much less important for large rockets.

After reaching escape velocity, the rocket will coast toward the moon. At a midway point (closer to the moon than the earth) the gravitation of the moon would begin to make itself felt, accelerating the rocket to the moon. The crew would then turn the space ship around and land stern first, using the propelling rocket tubes as brakes.

During the entire trip, the rocket would never leave the orbit of the earth—it would move around the sun with the earth, just as the moon does. To travel to another planet, a space ship must forsake the earth's orbit and establish its own path around the sun, choosing one that will almost cross the orbit of its destination. This coasting method of travel would require very careful navigation and would take a long time—146 days to Venus, for example—but seems to be the only one possible without using huge amounts of fuel.

A trip beyond the solar system to another part of the Milky Way is even more difficult; tremendous speed would be needed not only to escape from the sun's gravitation, but also to cover the vast distance before the crew died of old age. The nearest star after our own sun is almost 25 trillion miles away.

Strangely enough, no reader asked about the possible effect of the Einstein theory on the high velocities of space travel. Would the rocket ship gain weight through the conversion of speed energy into mass—sort of an atomic bomb working backwards? It has been worked out by a European physicist, J. Ackeret. His reassuring answer: for the speeds we'll use in interplanetary travel: no.

Martin Mann



Pouring new horsepower into an old engine

WHEN your car begins to show its age, burning oil and losing power, there's a sure-fire way to make it young again. You can pour new horsepower into the old engine and eliminate excessive oil consumption by having it reconditioned and equipped with new Sealed Power Piston Rings. By doing this you restore original power, lengthen engine life, save oil, save gas!

Whatever the make or model of car, truck or tractor, whatever the condition of cylinder wear, there's a Sealed Power Individually Engineered Ring Set specifically engineered to do the best possible job in that particular engine. These sets are made up from twenty-six (26) basic designs of piston rings, proud product of 36 years' use as original equipment by major engine builders. See your Sealed Power Franchise Dealer. Send a postal for illustrated, informative new booklet on 7 ways to save oil. It's free and may save you lots of money. Sealed Power Corp., Dept. H5, Muskegon, Mich.

For better results 26 Basic Ring Designs

No one piston ring design can meet all replacement needs. Sealed Power Individually Engineered Ring Sets are made up from twenty-six (26) basic ring designs, which permit each set to be specifically engineered to do the best possible job in a particular make of engine.

These ring sets are engineered to save gas without sacrifice of oil economy, to save oil without inducing friction and cylinder wear. Each set gives balanced performance in a particular engine.

Piston Rings
Pistons
Cylinder Sleeves
Valves
Water Pumps
Chassis Parts

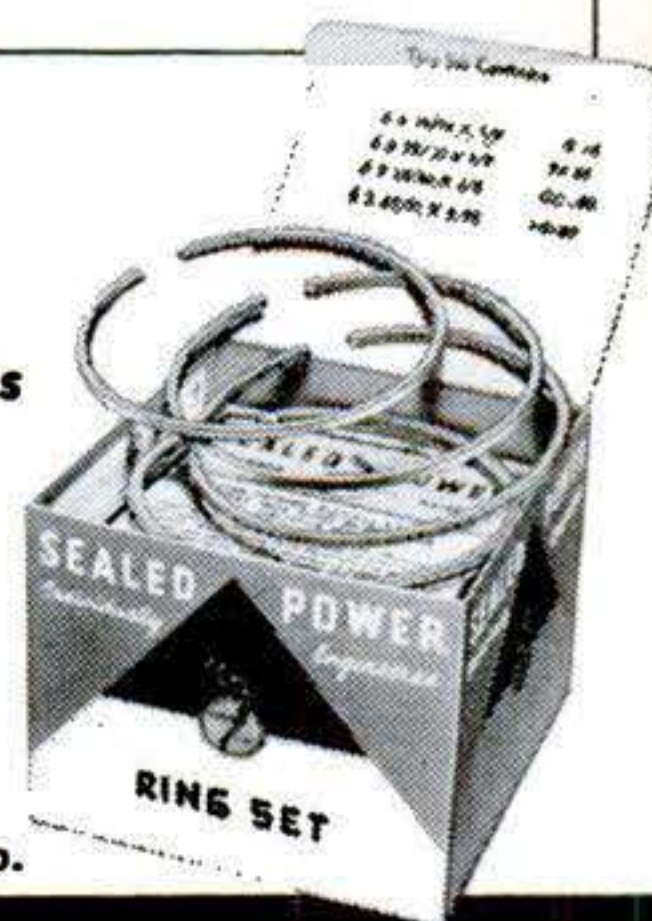

© 1947,
Sealed Power Corp.

SEALED POWER PISTON RINGS

BEST IN NEW CARS! ★ BEST IN OLD CARS!

MAY
1947 287

Ask The Toolmaker

He can tell you why South Bend Lathes are popular. They have the accuracy that toolmakers can depend upon. Their unusual versatility simplifies the performance of an exceedingly wide range of operations. And the ease with which they are operated saves both time and tempers. Regardless of the type of work you are doing South Bend Lathes will contribute to better craftsmanship.

WRITE FOR CATALOG 100-F

Describes South Bend Engine and Toolroom Lathes with 9", 10", 13", 14½", and 16" swings; also attachments, accessories, and tools.

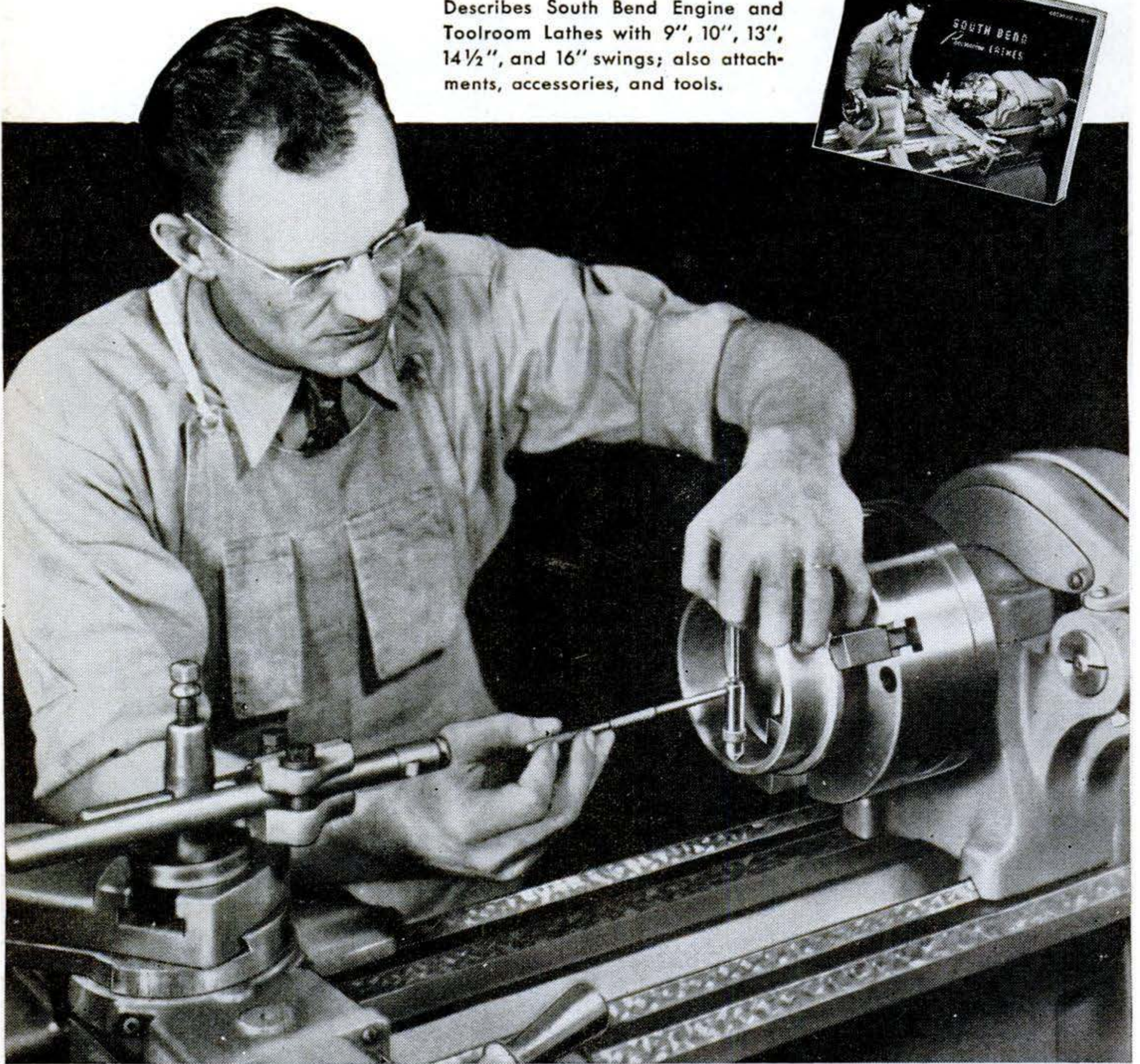

**BUILDING BETTER
LATHES SINCE 1906**



SOUTH BEND LATHE WORKS

456 EAST MADISON STREET • SOUTH BEND 22, INDIANA

288 POPULAR
SCIENCE

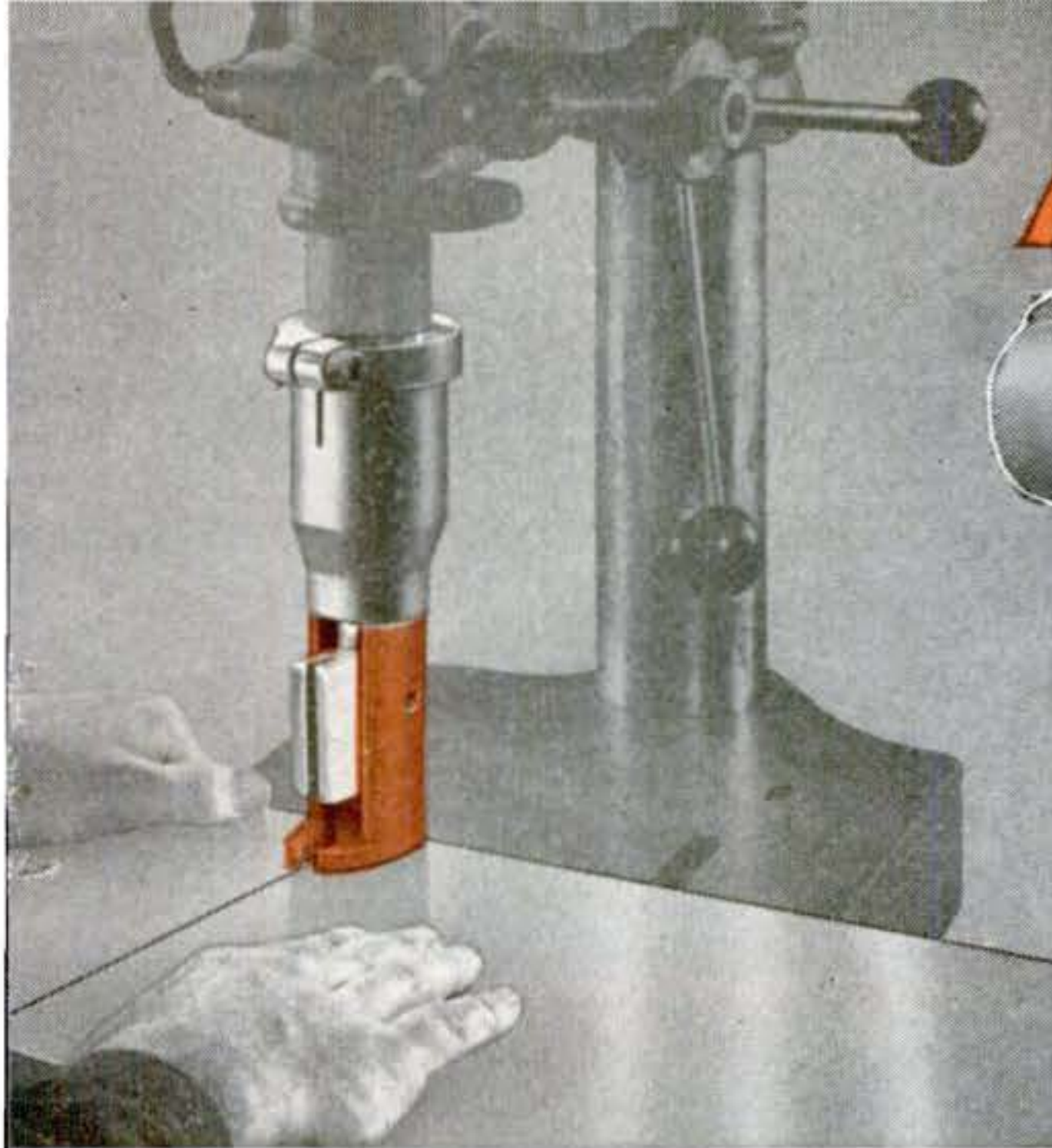

YOUR *Drill Press* IS

Your *Electric*
 other uses when

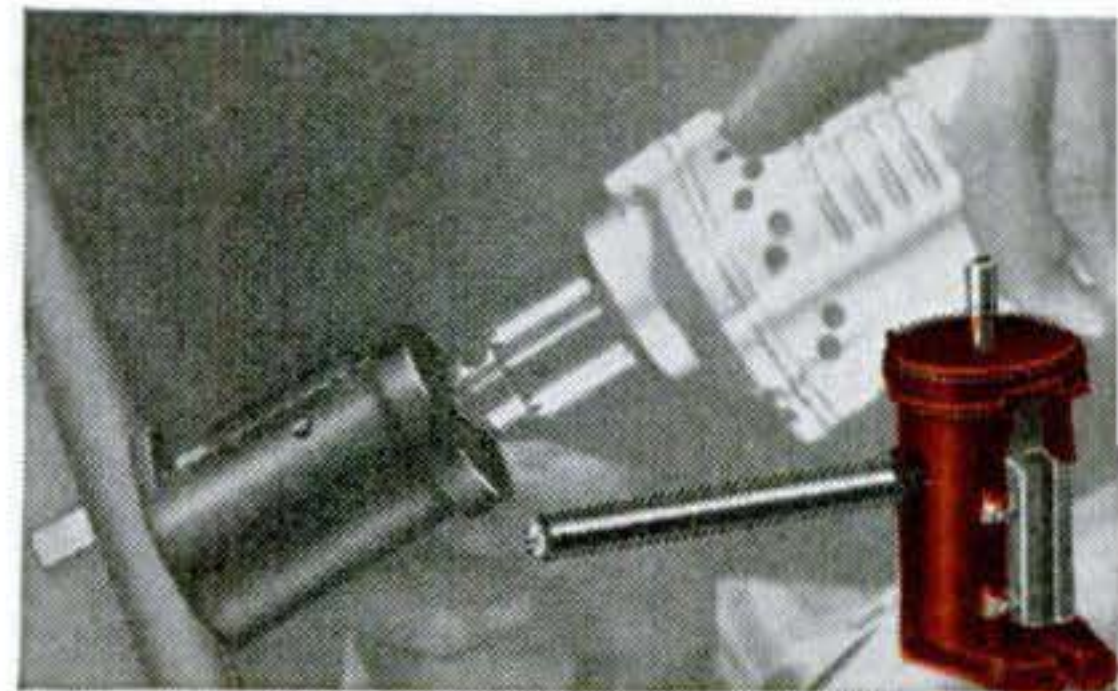

ROTOJIG

Made by the manufacturer of the famous 1-2-3 Line

In a few seconds, the ROTOJIG attaches to your Drill Press, changing the rotary motion to a reciprocating $\frac{3}{4}$ " stroke action. This converts your drill press to a power machine ideal for all sawing, cutting, or filing operations in wood or metal. The ROTOJIG gives the same performance as a band or jig-saw, and also converts your drill press into a power filing machine for making dies. Easy to follow scribe lines, cuts radii to $\frac{1}{4}$ " inch, leaves both hands free to guide material.

The ROTOJIG is made of the finest materials; brass, bronze, and tool steel. The ROTOJIG is a cam-operated tool with only two moving parts assuring smooth performance and long life. Full 360 degree swing. Models available for Craftsman, Walker-Turner, Delta, Buffalo, Royal and Atlas drill presses. Net wt. $2\frac{3}{4}$ lbs., overall length $7\frac{3}{4}$ ". Operates at low speeds (300-750 RPM Spindle Speed). Complete instructions with each ROTOJIG showing its many uses.

Lifetime guarantee
Wherever a **DRILL PRESS** is used, this tool is needed

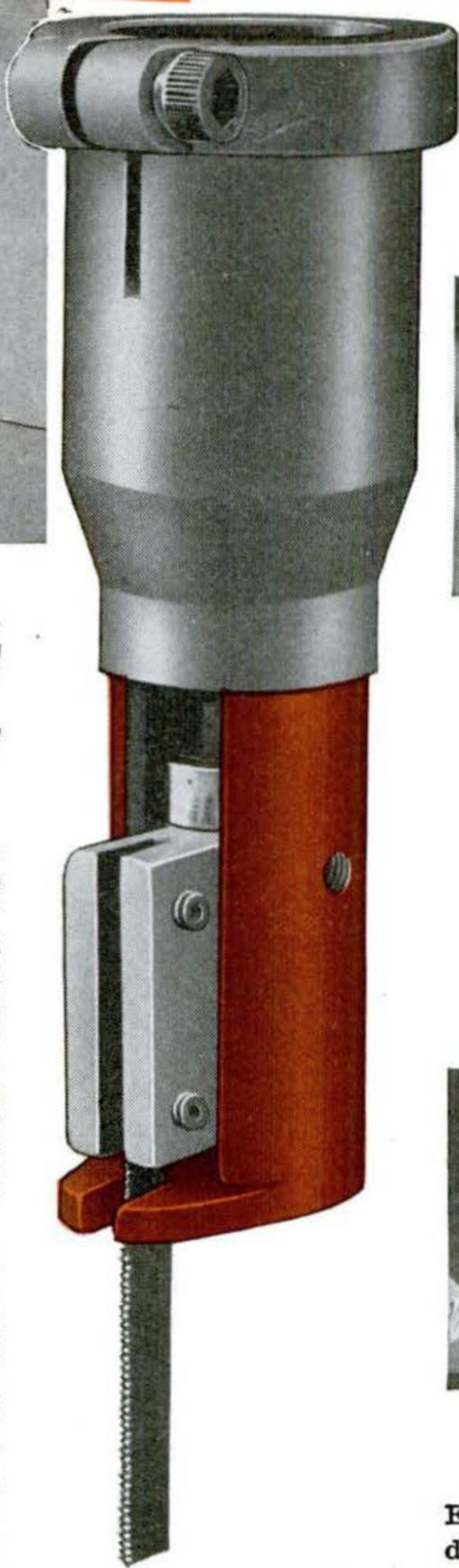

2 ROTOSNIP

For $\frac{1}{4}$ " drills, 1600-2500 r.p.m. Make out of your drill. Will cut 20 gauge. Easily adjusted and sharpened. Made of tool steel. All parts replaceable. Each \$4.50. Weight $2\frac{1}{4}$ lbs.

Lifetime guarantee



Wherever a hand drill

Each tool of the 1-2-3 line has only two moving parts designed for jobs in hard-to-get-to places. They pay for themselves after a few hours.

SEE YOUR LOCAL

SAVE
\$8⁰⁰

With this

Introductory Offer

For a limited time only, the ROTOJIG is being offered at a discount as an introductory offer. Since the ROTOJIG is made by the manufacturer of the famous 1-2-3 Line, dependability and satisfaction is guaranteed.

K-JAX

- 1 DESIGNING
- 2 ENGINEERING
- 3 MANUFACTURING

P. O. BOX 3044

DALLAS, TEXAS

\$27⁵⁰ Value for only \$19⁵⁰

**EXPERIENCE
IS THE BEST
TEACHER!**

Cecil Smith practically "grew up" with horses; and he's as sure-seated on a pony as he is a sure shot with his mallet.

He's one of America's polo "greats" — Texas-born Cecil Smith.



Cecil Smith
FAMOUS
INTERNATIONAL
POLO STAR



**EXPERIENCE IS
THE BEST TEACHER
IN POLO...AND
IN CIGARETTES!
CAMELS SUIT ME
BEST!**

More people are smoking CAMELS than ever before in history!

Yes, experience during the war shortage taught millions the differences in cigarette quality.

● Let polo star Cecil Smith tell you in his own words: "That cigarette shortage was a real experience. That's when I learned how much I appreciated Camels!"

Yes, a lot of smokers found themselves comparing brands

during that shortage. Result: More people are smoking Camels than ever before. But, no matter how great the demand:

We don't tamper with Camel quality. Only choice tobaccos, properly aged, and blended in the time-honored Camel way, are used in Camels.

R. J. Reynolds Tobacco Co., Winston-Salem, N. C.



MAYBE you're in this picture; but even if you're not you'll remember the cigarette shortage. You took any brand you could get. Millions discovered the cigarette that suited them best was Camel.



**YOUR 'T-ZONE'
WILL TELL YOU...**
T for Taste...
T for Throat...
That's your proving ground for any cigarette. See if Camels don't suit your 'T-Zone' to a 'T'



According to a recent Nationwide survey:

MORE DOCTORS SMOKE CAMELS THAN ANY OTHER CIGARETTE

Three nationally known independent research organizations asked 113,597 doctors—in every branch of medicine—to name the cigarette they smoked. *More doctors named Camel than any other brand.*