

POPULAR SCIENCE

JULY 1947
25 CENTS

MONTHLY



New Plans for Panama

p. 66

RUSSIA'S GROWING AIR POWER—PAGE 86

GIVE HORSEPOWER

Get-up-and-go

You'll be surprised how much easier your car breezes along after a Casite tune-up. Coughs, jerks and sputters quickly disappear—new smoothness, zip and power take over.

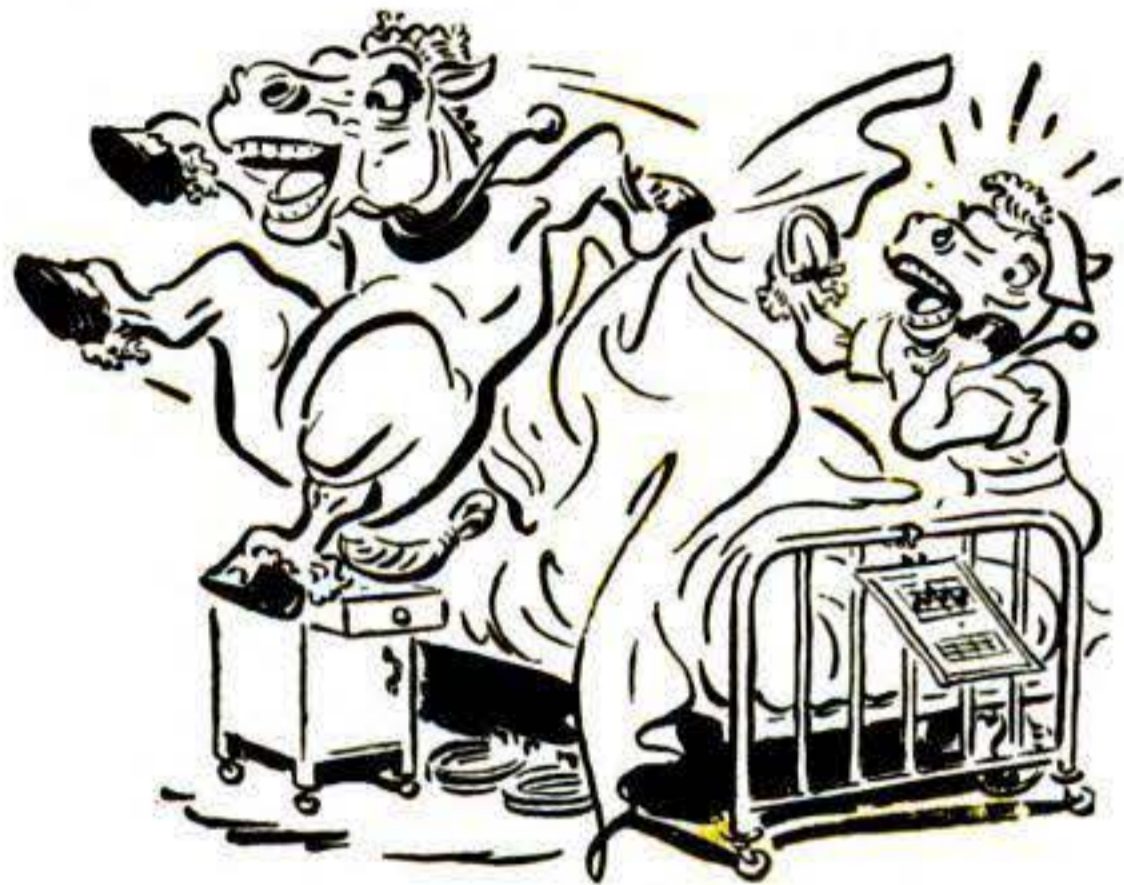

AND KEEP IT
rarin' to go...

Casite speeds lubrication . . . retards formation of sludge and gum . . . makes your motor really hum. Use Casite regularly—a pint through the air intake every three months and a pint in the crankcase every oil change.

THE *Guaranteed* **WAY!**

Double-Your-Money-Back if your car doesn't run better and smoother with Casite. And Casite makes this famous guarantee no matter what kind of motor oil you're using. You can't lose. Try Casite today at your service station, garage or car dealers. The Casite Corporation, Hastings, Michigan and the Casite Division, Hastings Ltd., Toronto.



CLEANS MOTORS
KEEPS
MOTORS CLEAN



65¢
A PINT
IN CANADA
75¢

SPEAKING OF SPEED

by
FRANK
WILLIAMS

23-YEAR-OLD TEST PILOT OF AMERICA'S FIRST SUPERSONIC ROCKET SHIP, THE BELL XS-1...

CHALMERS "Slick" GOODLIN
...PREPARES TO FLY FASTER THAN SOUND!

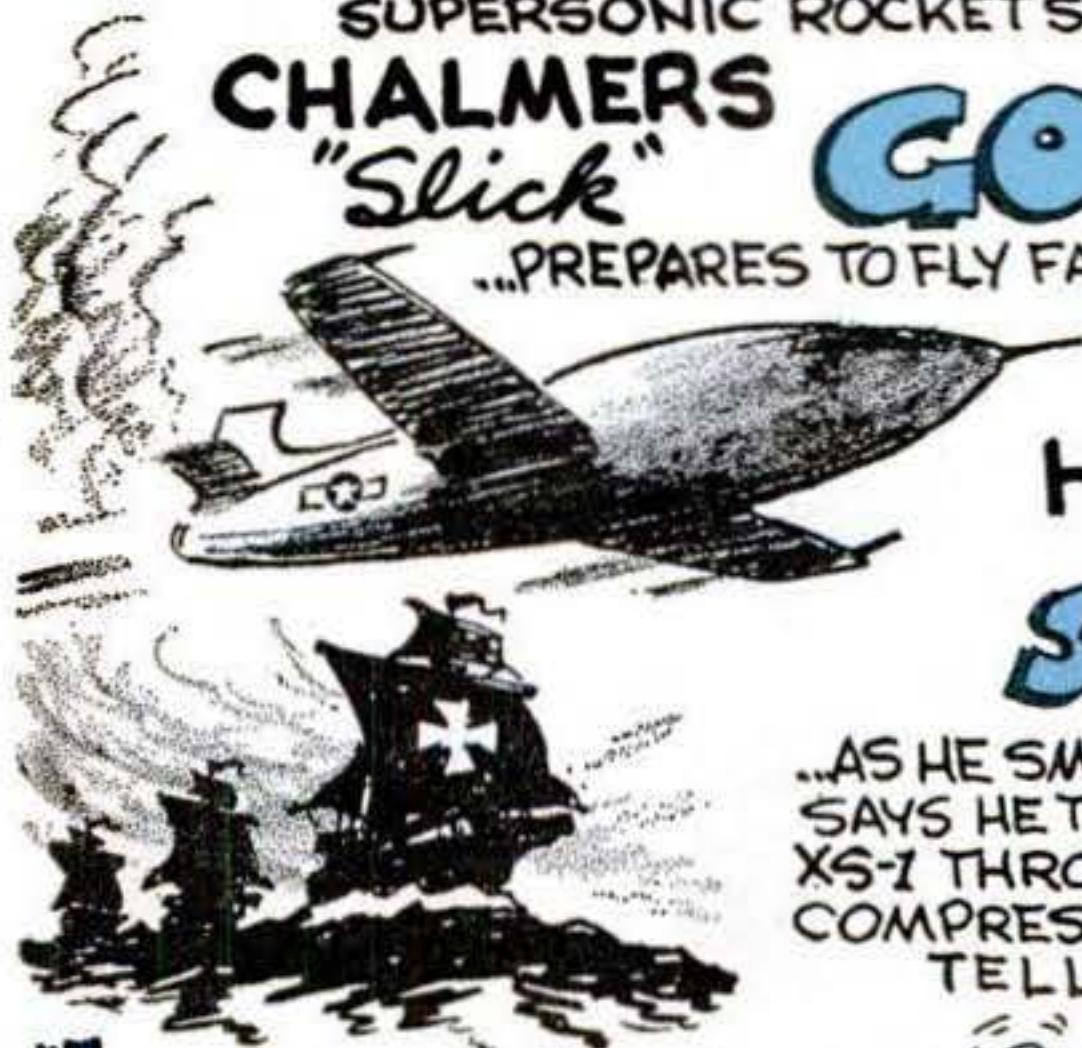

HE LOOKS
SHARP!

...AS HE SMILES NONCHALANTLY AND SAYS HE THINKS HE CAN FLY THE XS-1 THROUGH THE "WALL OF COMPRESSIBILITY" AND LIVE TO TELL THE STORY!

NO EXHIBITIONIST, "SLICK" IS A 20TH CENTURY COLUMBUS EXPLORING THE DANGEROUS, UNKNOWN REALMS OF TRANSONIC AND SUPERSONIC SPEEDS!



HE FEELS
SHARP!

...SPURTING THROUGH SPACE IN THE "HOTTEST" SHIP EVER BUILT... THE XS-1 IS DESIGNED TO FLY 1,700 MILES AN HOUR TO AN ALTITUDE OF 26 MILES OR MORE!

look **SHARP**
feel **SHARP**
be **SHARP**

use
Gillette
Blue Blades
with the **SHARPEST** edges
ever honed!

● You look sharp for you enjoy the swellest shaves ever. You feel sharp because they're refreshing and give you a lift. You are sharp for you get far more shaves per blade and save money. Ask for Gillette Blue Blades.



PILOTS USED TO BUZZ "SLICK" WHEN, AT 16, HE MILKED COWS DOWN ON THE FARM... NOW, AT 23, HE'S SKIMMING THE CREAM OFF THE MILKY WAY!



HE IS **SHARP!**

...SLICK IS THE WORD FOR THE SHAVES HE GETS, TOO. YES, "SLICK" GOODLIN GETS THE BEST-LOOKING, MOST REFRESHING SHAVES IN THE BOOK, FOR HE ALWAYS USES **GILLETTE BLUE BLADES** WITH THE **SHARPEST** EDGES EVER HONED. REMEMBER, MEN, **DOUBLE EDGES MEAN DOUBLE ECONOMY!**



5 FOR 25¢ 10 FOR 49¢

ENJOY BOXING EVERY FRIDAY NIGHT OVER ABC NETWORK. GILLETTE'S CAVALCADE OF SPORTS ALSO AIRS THE ALL-STAR BASEBALL GAME, JULY 8, AND OTHER CLASSICS YEAR 'ROUND.

Gillette Safety Razor Company, Boston 6, Mass.

Copyright, 1947, by Gillette Safety Razor Company

JULY 1947 |

POPULAR SCIENCE

Mechanics & Handicraft MONTHLY
REG. U. S. PAT. OFF.

EDITOR:

Perry Githens

MANAGING EDITORS: Fred O. Newman, Volta Torrey

ART EDITOR: Howard C. Jensen

HOME & WORKSHOP EDITOR:

Harry Walton

ASSOCIATE EDITORS: Devon Francis, Robert Gorman, Hartley E. Howe, Herbert Johansen, Martin Mann, Frank Rowsome, Jr., John F. Stearns, R. P. Stevenson

WASHINGTON EDITOR: Leon Shloss

WESTERN EDITOR: Andrew R. Boone (Los Angeles, Cal.)

ART DIRECTORS: Harry Samuels, Francis Sweeney

ART ASSOCIATES: Eric Karminski, Jr., Stewart Rouse, Frances Cooper (Production)

STAFF PHOTOGRAPHERS: W. W. Morris, Hubert Luckett, Robert F. Smith

EDITORIAL ASSISTANTS: Mae G. Dyer (Chief), Carol Ennis, Sheldon Gallager, Saverio Rada, Lillian Thalenfeld, Ruth Westphal

PUBLISHER:

Godfrey Hammond

JULY 1947

SCIENCE NEWS

1948 Rocket Will Double V-2's Record.. 75
Artillery Against the Unknown.....100
One-inch Wind Tunnel.....110
Machines that Breathe for You.....127
Tearing Turbine Fuel Apart.....132
Big Flash Aids Fliers.....133

SCIENCE AT WORK

Picture of the Month..... 65
Giant Plow Tames Range..... 74
New Twists Make 'Peg Leg' Really Walk 82
Versatile Pump Works Under Water.....106
Mapping the Milky Way.....108
The Loon Takes Off.....125
Wrecker Wields a Wallop.....126
Measuring by Shadows.....132
Oxygen for Locomotives.....135

PSM FEATURES

New Plans for Panama..... 66
Transparent Mirror..... 72
How Plants Grow..... 92
Coin Centrifuge..... 96
Here's How Harmonicas Are Made.....102
Faucet Doesn't Drip.....110
Tub Sub.....120
How to Choose a Washer.....121

AVIATION

Faster "Star" Totes Six Guns..... 73
Helicopters at Work..... 78
What's New in Aviation..... 80
Russia's Growing Air Power..... 86
Fairchild XNQ-1 (Pin-up)..... 97
Air Medals.....104
Solo Trainers Aid Flying Wing Pilots....105
Monorail Speeds Air Delivery.....111
Portrait of 3,500 Horses.....112
How Air Liners Grow.....117

AUTOMOBILES

Light Aligns Wheels.....132
Gus Earns an Assist.....138
Liquid Springs Take the Bumps.....141
Build a Bed in Your Car.....142
Front Seat Becomes Bed.....143
Auto Ideas.....144
Rear Engines Run New Midgets.....146

INVENTIONS

New Ideas from the Inventors..... 98
I'd Like to See Them Make.....107

PHOTOGRAPHY

Close-ups from 5 Miles.....114
Immersion Heater Warms Solutions.....181
Photo Ideas and Equipment.....182
Enlarger Travels with You.....184
Flashlight Is Safelight.....186

(CONTINUED ON PAGE 4)

Published monthly at 353 Fourth Avenue, New York 10, N. Y., by Popular Science Publishing Co., Inc. Godfrey Hammond, President and Treasurer; R. C. Wilson, Raymond J. Brown, Stephen P. Glennon, B. Ray Keefer, Vice-Presidents; F. W. Briggs, Secretary. Entered as second-class matter Dec. 28, 1918, at the Post Office at New York under the act of March 3, 1879; additional entry as second-class matter at Dayton, Ohio. Entered as second-class matter at the Post Office Department, Canada. Printed in U. S. A. Copyright, 1947, by Popular Science Publishing Co., Inc. All rights reserved in the United States, Great Britain, and in all countries participating in the International Copyright Convention and Pan-American Copyright Convention. Yearly subscriptions to United States, its possessions and Canada, \$2.50; foreign countries, \$3.50. Subscribers must notify us of change of address four weeks in advance of the next publication date. Be sure to give both old and new addresses, including zone numbers.

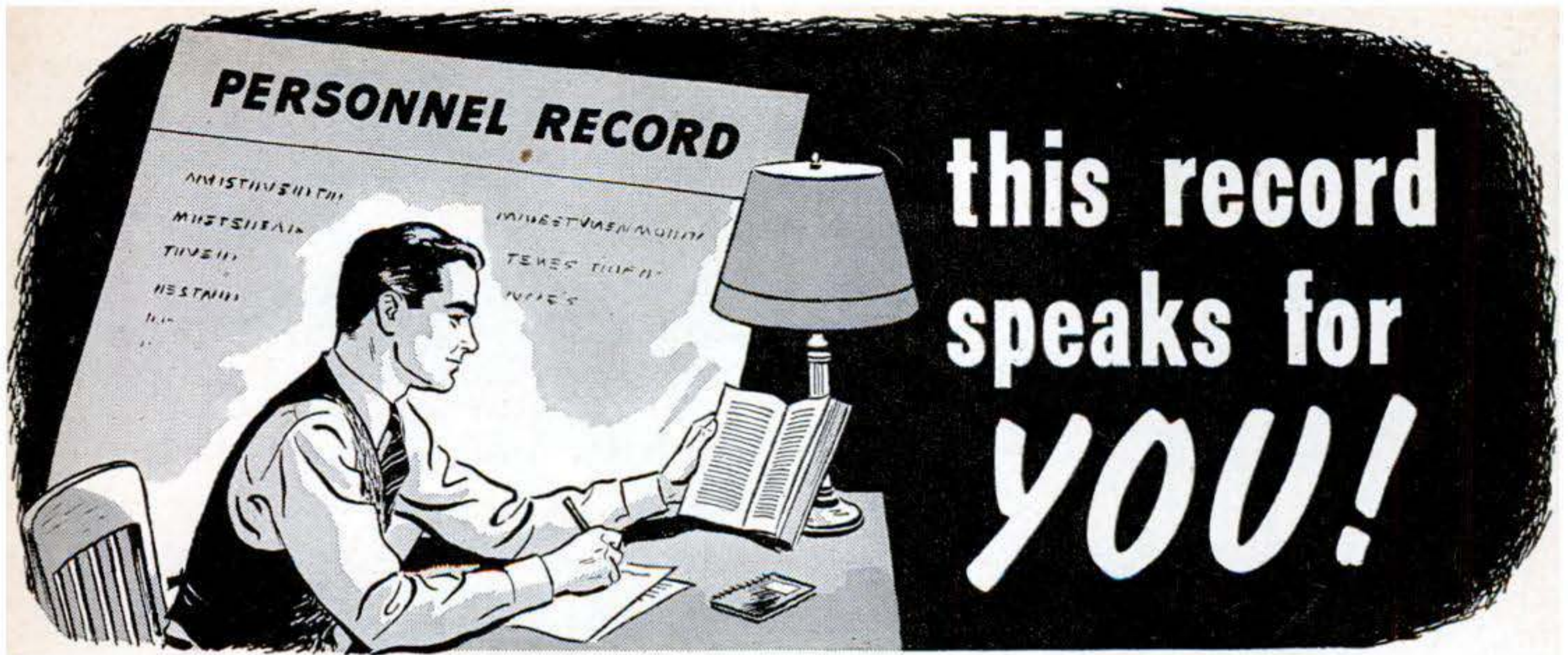

Most men are promoted on the strength of their records. Performance and training reports rank high in determining how fast and how far employees will advance. But, unless it shows up on the record—unless it is seen by the right men—ability may go unnoticed and unrewarded.

That's why International Correspondence Schools make a special point of reporting the progress of its students to their employers. This is a two-way service: it tells the employer which men in his organization are prepared for

greater responsibilities; it helps the ambitious employee get the recognition he deserves.

A stream of letters—from employers and employees alike—confirms the value and effectiveness of I. C. S. progress reports.

You want your record to speak for YOU! You want it to show you have trained for advancement. Then you'll appreciate the type of service that comes with sound, practical I. C. S. training. Courses cover more than 400 business and technical subjects. Act now. Mail this coupon for full information.

INTERNATIONAL CORRESPONDENCE SCHOOLS



BOX 7687-L, SCRANTON 9, PENNA.

Without cost or obligation, please send me full particulars about the course *before* which I have marked X:

- | | | | |
|---|--|---|---|
| <p>Business and Academic Courses</p> <ul style="list-style-type: none"> <input type="checkbox"/> Accounting <input type="checkbox"/> Arithmetic <input type="checkbox"/> Business Correspondence <input type="checkbox"/> Business Management <input type="checkbox"/> Certified Public Accounting <input type="checkbox"/> Commercial <input type="checkbox"/> Cost Accounting <input type="checkbox"/> Federal Tax <input type="checkbox"/> First Year College <input type="checkbox"/> Foremanship <input type="checkbox"/> Good English <input type="checkbox"/> Higher Mathematics <input type="checkbox"/> Illustrating <input type="checkbox"/> Postal Service <input type="checkbox"/> Salesmanship <input type="checkbox"/> Sign Lettering <input type="checkbox"/> Spanish <input type="checkbox"/> Traffic Management <p>Air Conditioning and Plumbing Courses</p> <ul style="list-style-type: none"> <input type="checkbox"/> Air Conditioning <input type="checkbox"/> Heating <input type="checkbox"/> Refrigeration | <p>Chemistry Courses</p> <ul style="list-style-type: none"> <input type="checkbox"/> Chemical Engineering <input type="checkbox"/> Chemistry, Analytical <input type="checkbox"/> Chemistry, Industrial <input type="checkbox"/> Chemistry, Mfg. Iron & Steel <input type="checkbox"/> Petroleum Refining <input type="checkbox"/> Pulp and Paper Making <p>Civil Engineering, Architectural and Mining Courses</p> <ul style="list-style-type: none"> <input type="checkbox"/> Architectural Drafting <input type="checkbox"/> Architecture <input type="checkbox"/> Building Estimating <input type="checkbox"/> Civil Engineering <input type="checkbox"/> Contracting and Building <input type="checkbox"/> Highway Engineering <input type="checkbox"/> Lumber Dealer <input type="checkbox"/> Reading Structural Blueprints <input type="checkbox"/> Sanitary Engineering <input type="checkbox"/> Structural Drafting <input type="checkbox"/> Structural Engineering <input type="checkbox"/> Surveying and Mapping <p>Communications Courses</p> <ul style="list-style-type: none"> <input type="checkbox"/> Electronics <input type="checkbox"/> Practical Telephony <input type="checkbox"/> Radio, General <input type="checkbox"/> Radio Operating | <ul style="list-style-type: none"> <input type="checkbox"/> Radio Servicing <input type="checkbox"/> Telegraph Engineering <p>Electrical Courses</p> <ul style="list-style-type: none"> <input type="checkbox"/> Electrical Drafting <input type="checkbox"/> Electrical Engineering <input type="checkbox"/> Electric Light and Power <input type="checkbox"/> Lighting Technician <input type="checkbox"/> Practical Electrician <input type="checkbox"/> Power House Electric <input type="checkbox"/> Ship Electrician <p>Internal Combustion Engines Courses</p> <ul style="list-style-type: none"> <input type="checkbox"/> Auto Technician <input type="checkbox"/> Diesel-Electric <input type="checkbox"/> Diesel Engines <p>Mechanical Courses</p> <ul style="list-style-type: none"> <input type="checkbox"/> Aeronautical Engineering <input type="checkbox"/> Aircraft Drafting <input type="checkbox"/> Flight Engineer <input type="checkbox"/> Forging <input type="checkbox"/> Foundry Work <input type="checkbox"/> Heat Treatment of Metals <input type="checkbox"/> Industrial Engineering <input type="checkbox"/> Industrial Metallurgy <input type="checkbox"/> Machine Shop <input type="checkbox"/> Machine Shop Inspection | <ul style="list-style-type: none"> <input type="checkbox"/> Mechanical Drafting <input type="checkbox"/> Mechanical Engineering <input type="checkbox"/> Mold-Loft Work <input type="checkbox"/> Patternmaking—Wood, Metal <input type="checkbox"/> Reading Shop Blueprints <input type="checkbox"/> Sheet-Metal Drafting <input type="checkbox"/> Sheet-Metal Worker <input type="checkbox"/> Ship Drafting <input type="checkbox"/> Ship Fitting <input type="checkbox"/> Tool Designing <input type="checkbox"/> Toolmaking <input type="checkbox"/> Welding—Gas and Electric <p>Railroad Courses</p> <ul style="list-style-type: none"> <input type="checkbox"/> Air Brake <input type="checkbox"/> Car Inspector <input type="checkbox"/> Diesel Locomotive <input type="checkbox"/> Locomotive Engineer <input type="checkbox"/> Locomotive Fireman <input type="checkbox"/> Railroad Section Foreman <p>Steam Engineering Courses</p> <ul style="list-style-type: none"> <input type="checkbox"/> Boilermaking <input type="checkbox"/> Combustion Engineering <input type="checkbox"/> Engine Running <input type="checkbox"/> Marine Engineering <input type="checkbox"/> Steam Electric <p>Textile Courses</p> <ul style="list-style-type: none"> <input type="checkbox"/> Cotton Manufacturing <input type="checkbox"/> Rayon Weaving <input type="checkbox"/> Textile Designing <input type="checkbox"/> Woolen Manufacturing |
|---|--|---|---|

Name _____ Age _____ Address _____

City _____ State _____ Present Position _____

Working Hours _____ A.M. to _____ P.M. Length of Service in World War II _____

Special tuition rates to members of the Armed Forces. Enrollment under the G.I. Bill of Rights approved for War II Veterans. Canadian residents send coupon to International Correspondence Schools Canadian, Ltd., Montreal, Canada.

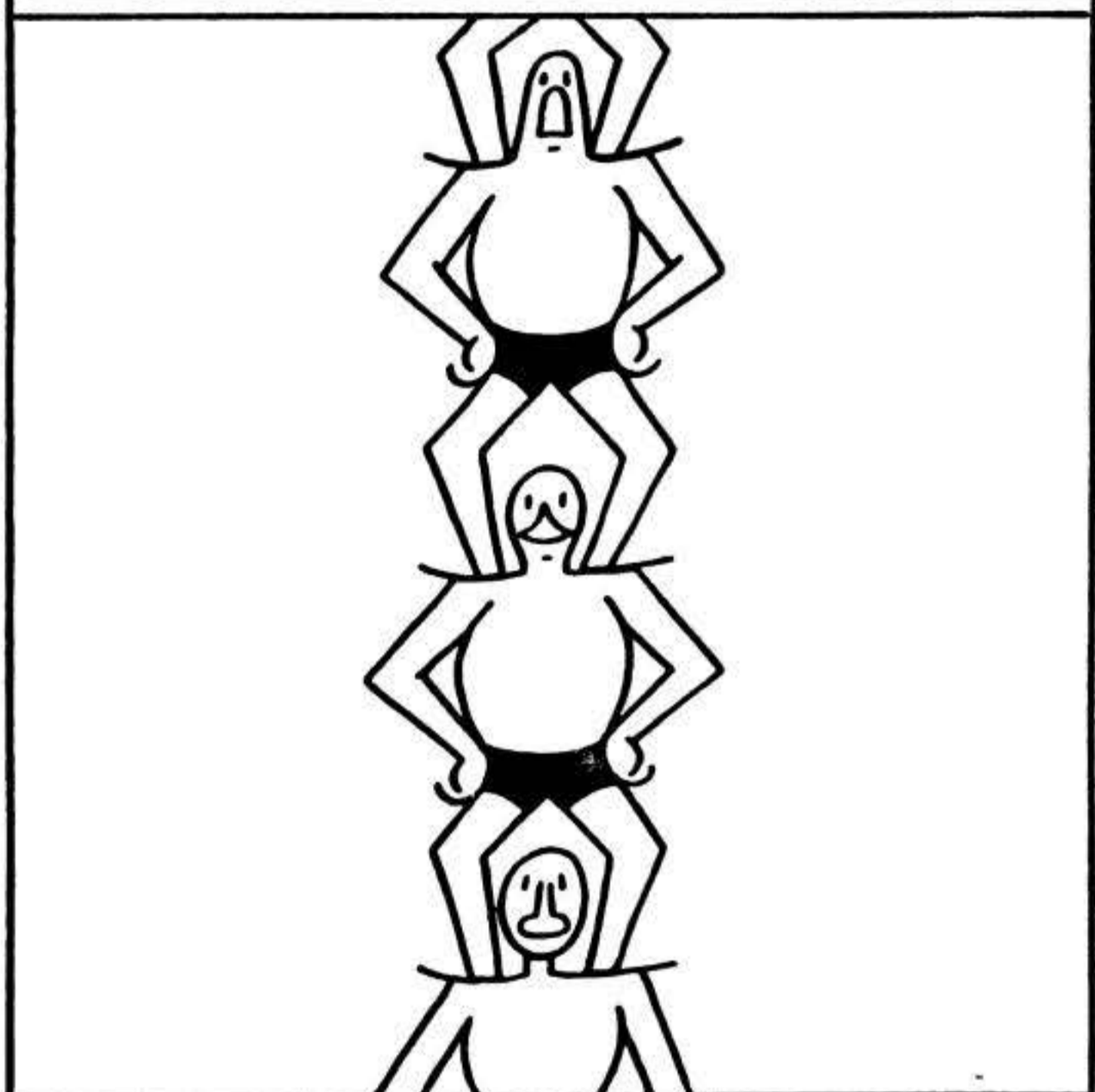
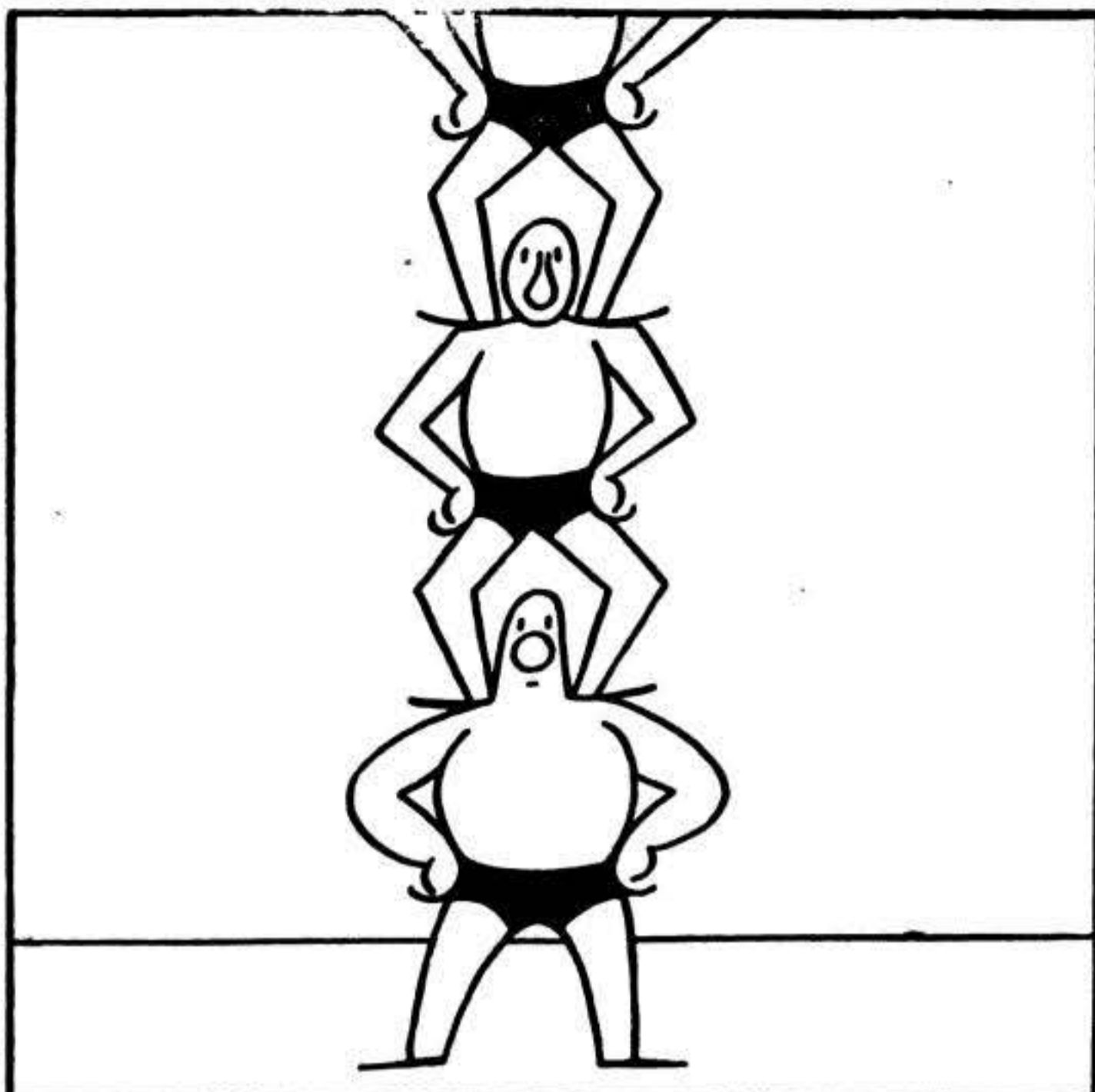

MECHANICS & SHOPCRAFT

- [Rubber Keeps Bits on Drill.....](#)156
- [New Shop Ideas.....](#)172
- [Vertical Steam Engine \(Part IV\).....](#)174
- [Bench Built from Scrap.....](#)178
- [Tinting White Paint.....](#)180
- [Water Wheel Delivers 3 Hp.](#)194
- [Sawing Small Pieces Safely.....](#)198
- [Power Mower Steers Itself.....](#)203

HOME MECHANICS & HANDICRAFT

- [Craftwork Projects of the Month.....](#)116
- [Sit Down and Ride Up.....](#)148
- [Anchor Made from Car Spring.....](#)150
- [Rubber Drives Stern-wheeler.....](#)152
- [Strip Projects Utilize Scrap.....](#)154
- [Vacation Shaving Kit.....](#)155
- [Readers Build PSM Projects.....](#)157
- [Toy Train Keeps Tots Busy.....](#)158
- [Flash Bulb Is Fishing Bobber.....](#)159
- [Desk Conceals Typewriter.....](#)160
- [Folding Table Seats Eight.....](#)165
- [Handle Helps Start Outboard.....](#)167
- [Bomber Tank Is Wading Pool.....](#)171
- [Shadowgraphs Record Keys.....](#)179
- [Ink Held Under Drawing Board.....](#)180
- [Coat Hanger Used as Carrier.....](#)187
- [Curtain Rod Frames Name Plate.....](#)198
- [Holder for Razor Blade.....](#)199
- [Tree Surgery You Can Do.....](#)200
- [Turned Candlestick.....](#)202

RADIO & ELECTRICITY

- [Color Tele Goes Big.....](#)134
- [Selsyn-powered Intercom.....](#)162
- [Portable Rivals Console in Tone.....](#)188
- [News in Electronics.....](#)192
- [Argon Beam Lights Clock Dial.....](#)199

DEPARTMENTS

- [Voice of Science.....](#) 7
- [Letters.....](#) 14
- [Aids to Modern Living.....](#)136
- [What's Your Ingenuity Quotient?.....](#)151
- [Hobby Shopping.....](#)164
- [New Tools.....](#)166
- [What's Wrong?.....](#)187
- [Home Experiments.....](#)204
- [Keeping the Home Shipshape.....](#)206
- [For Easier Farming.....](#)208
- [Editorial Memo.....](#)254



6

KEYS TO OPPORTUNITY for Men and Women

They have helped over a million toward their ambition... **THEY CAN HELP YOU!**

The great barrier to realizing ambition is the question "HOW?"

For the past 39 years more than a million ambitious men and women have found the "HOW" to greater success in business through one of the free 48-page books illustrated above.

These books are more than catalogues—they give you the facts about the field of your choice, tell you of the opportunities in that field, its demands, and how our training fits you for the field. They'll answer questions that may have bothered you.

We have perfected Home-Study Training—made it interesting and practical through the problem method. You train under specialists, men who have achieved success in their chosen field—you study principles and solve problems without any loss of time, pay or interference with your present job.

Our training is tried and proven—and what you study at home you can use on the job right away. Perhaps right in your own company there is a great opportunity to advance—to get an executive job with the prestige and money that go with such advancement.

The way to success is not magic. It requires study, and you will have to be willing to work earnestly—thoroughly.

But wouldn't it be worth your while to trade some of your leisure over a comparatively brief period for a bigger job and more money?

Why not be somebody in the business world—why be satisfied to go through life in a small job at small pay when the way to success is clearly marked. The years are going by very fast—and it's high time you did something concrete about your future.

The coupon below will bring you complete information about the field of your choice. **SEND IT TODAY.** Don't delay—it can be the turning point in your career to a better job and more money.

G. I. APPROVED

LASALLE Extension University
a Correspondence Institution
 Dept. 783-R Chicago 5, Ill.

I want to better my position—make more money. Send me your free booklet on the field I have checked below.

<input type="checkbox"/> Higher Accountancy	<input type="checkbox"/> Traffic Management
<input type="checkbox"/> Industrial Management	<input type="checkbox"/> Foremanship
<input type="checkbox"/> Executive Management	<input type="checkbox"/> Law L. L. B. Degree

Name.....Age.....

Present Position.....

Address.....

City, Zone and State.....

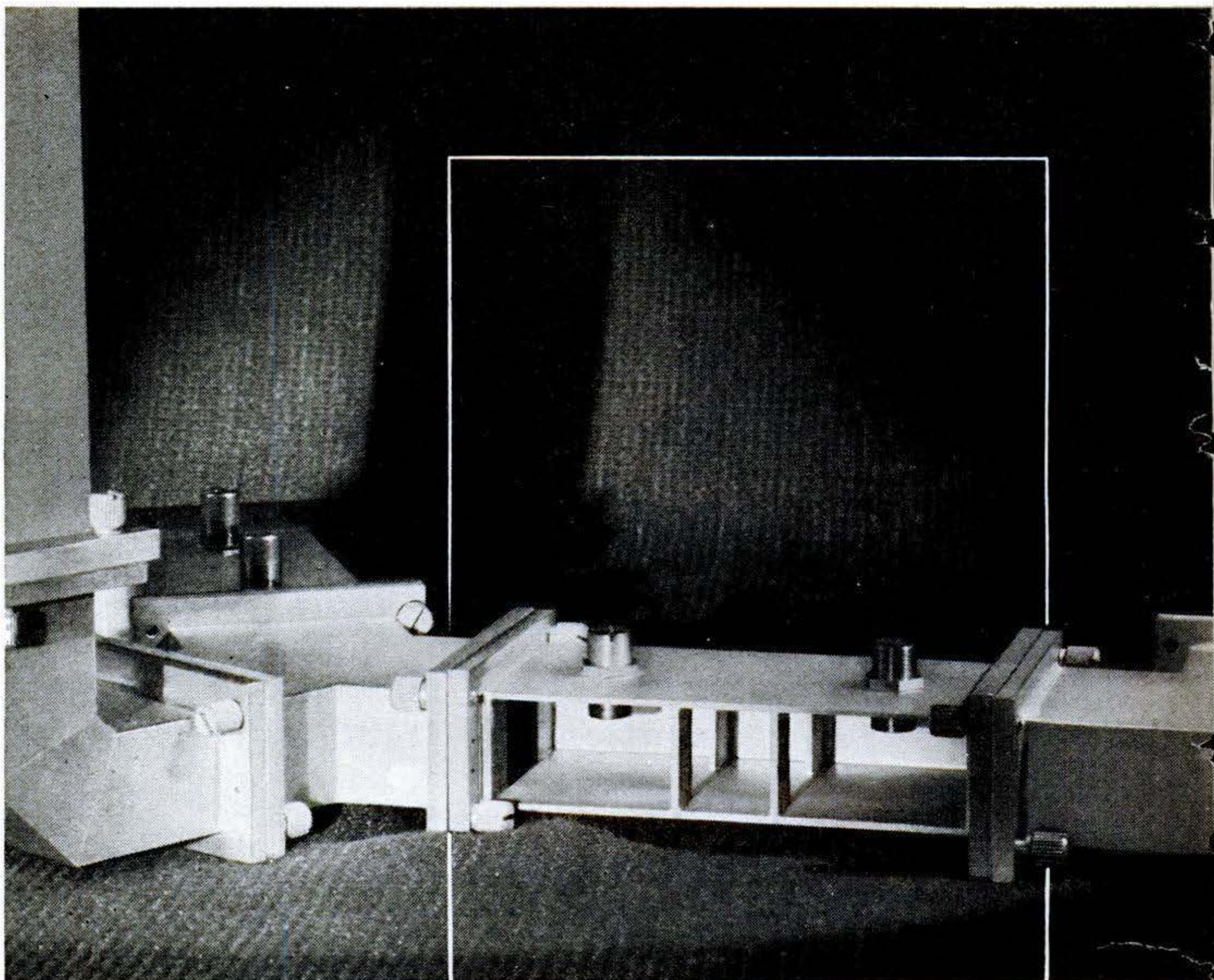

The two filters in the picture (one with side cut away) are used to separate two radio channels coming in on the same antenna but on different frequencies. At the end of the connecting waveguide, the channels are made to part company, each going to a different circuit through its assigned filter.

SEPARATION CENTER FOR RADIO WAVES

Thirty years ago, when all telephone service went by wire, Bell scientists developed means of sending dozens of conversations over the same line.

This they did by giving to each conversation a different *carrier frequency*; then to separate it from the others, they used a device which they had invented and named—the *electric wave filter*.

Today, in microwave telephone systems, the message-bearing waves pass to and from the antenna in pipes called waveguides. So

scientists in Bell Laboratories devised a different kind of filter—a filter in a waveguide! This filter is a system of electrically resonant cavities formed by walls and partitions. Waves that set up sympathetic vibrations in the cavities pass through; others are reflected.

In the Bell System, now, single circuits are carrying many conversations at the same time through precision wave-filtering.



BELL TELEPHONE LABORATORIES

EXPLORING AND INVENTING, DEVISING AND PERFECTING, FOR CONTINUED IMPROVEMENTS AND ECONOMIES IN TELEPHONE SERVICE



Gentle Rain From Hell

DON'T believe those scare stories about an atomic bomb tearing a crater clear across Manhattan or the Loop. No enemy with enough sense to cook up an A-bomb would waste it with a direct hit on a city. That was good enough in Hiroshima's day, but it is considered pretty primitive now.

The advanced classes in mass killing take advantage of the simple fact that all great cities have to have water. That water may be a bay, a river, a lake, or a chain of reservoirs. Hit the water with the bomb and you create a cloud of radioactive vapor and liquid which silently devastates a far wider area—and can sift into the air conditioning of the deepest vault, or flow efficiently through the pipes which run to every home, building, and fire hydrant.

Yes, the atomic shower bath is much more deadly: people are living again in the ruins of Hiroshima and Nagasaki; but the ships which lived through the savage spray at Bikini one year ago are still too "hot" to be inhabited. And the Navy has found no way to wash off this deadliest of poisons.

Newest method of extinction contemplates a radioactive cloud produced by nonexplosive shells thrown from aircraft. Hitch this idea to super-rockets like the one described in this issue (page 75) and you should get a concept of terror which makes a mere crater seem like a cup in a putting green.

Perry Githeas

JULY 1947 7

Ingenious New Technical Methods

To Help You
Simplify Production

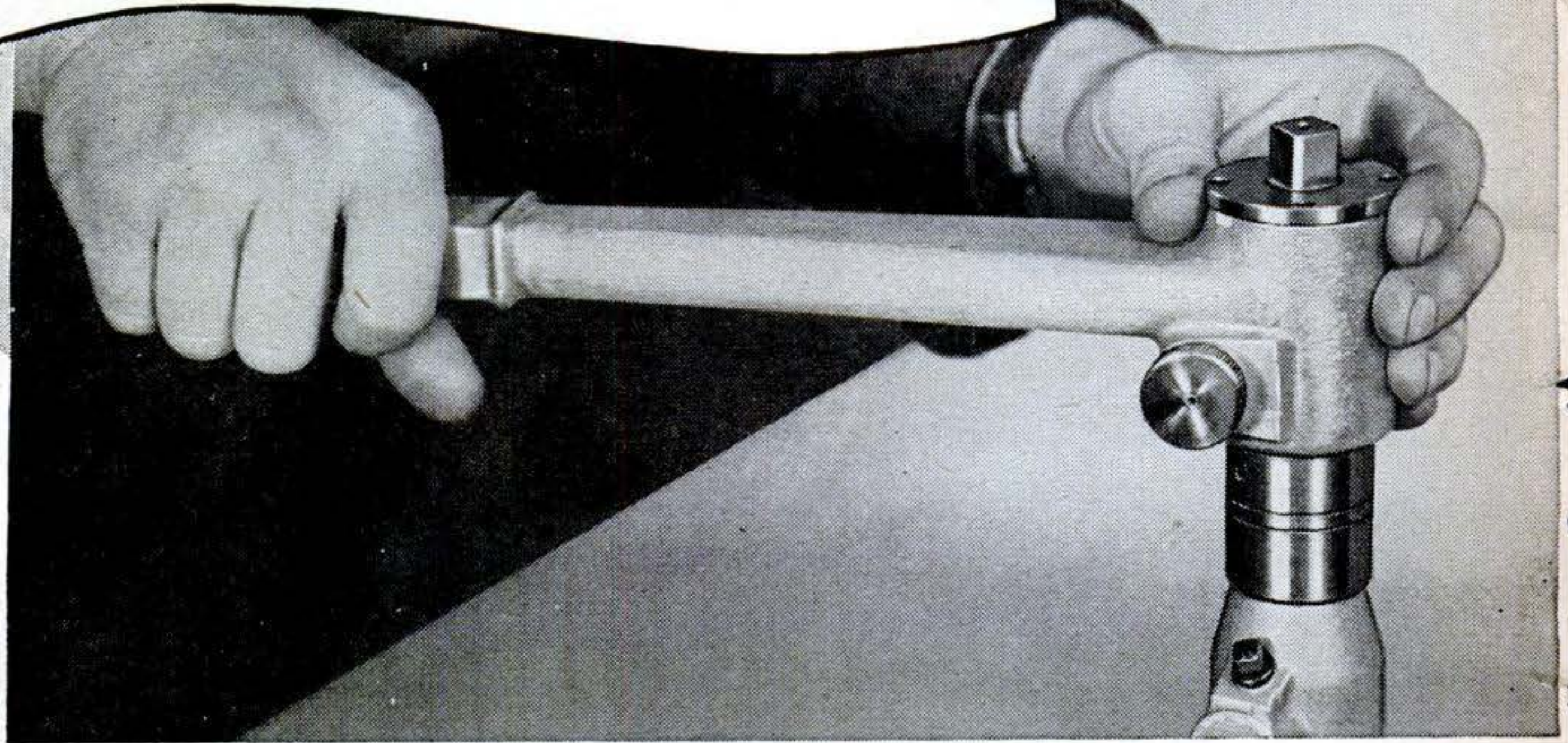

New Type of Torque Tools Incorporate Spring Clutch!... Are 98% Accurate!

Acme Torque Wrench and Screw Driver both incorporate spring clutches, with easily operated control. After setting control to desired torque, the operator merely turns tool in the usual way. When the torque required to drive the threaded part exceeds the pre-set value, the tool slips. Impact doesn't cause driving torque to increase. Oil doesn't affect setting which is reproducible within 2% or better.

The Wrench offers right and left-hand drive, ratchet action and withdrawal. Spring clutch may be set from 0 to 500 inch pounds. Standard sockets are interchangeable. The Screw Driver may be set for any value of torque from 0 to 35 inch pounds. A ratchet action is incorporated. The same tool will also withdraw screws. Standard bits, including socket types, may be easily inserted. The tool is made of pressure cast aluminum.

Another Time-Saver on the job, is chewing gum. The act of chewing aids the workers' concentration—seems to make the work go easier. Chewing gum may be used even when workers' hands are busy; reducing interruptions from the job. For these reasons many plant owners have made Wrigley's Spearmint Gum available to everyone.

*You can get complete information from
Acme Scientific Company, 1450 W. Randolph St., Chicago 7, Ill.*

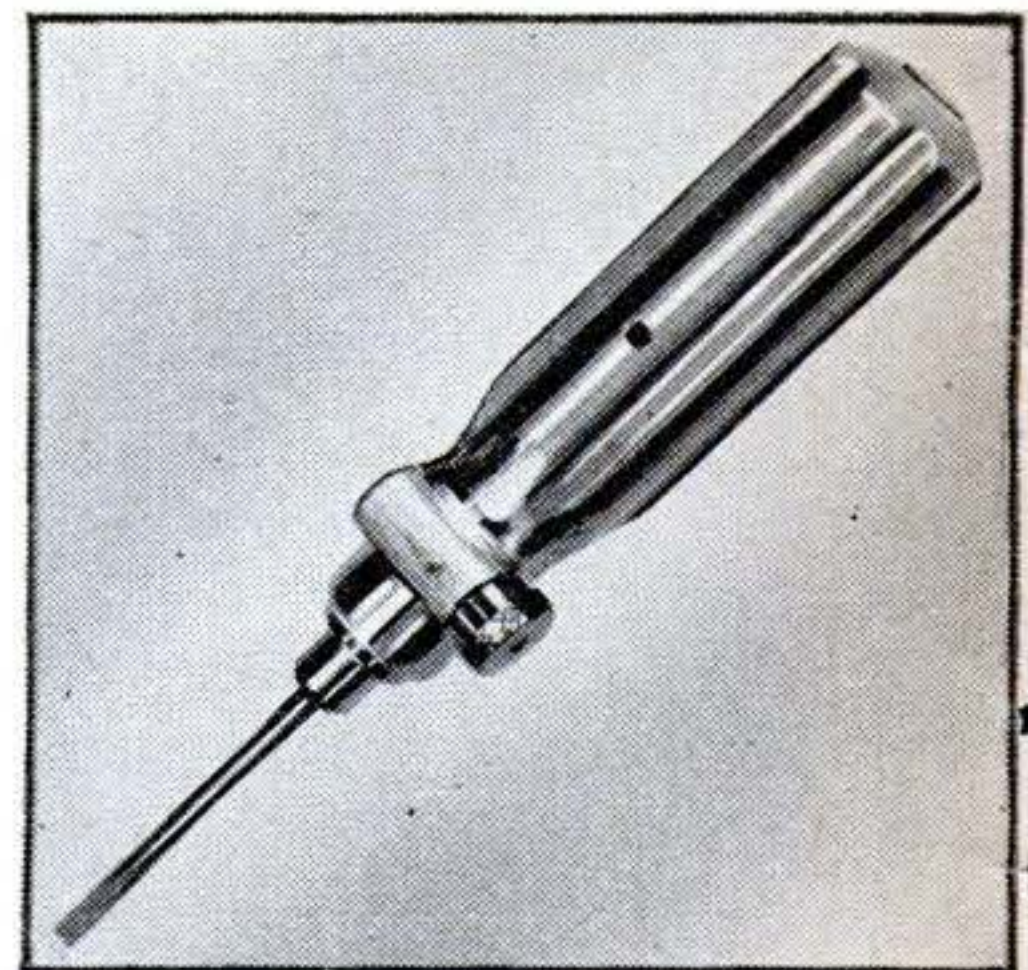

Torque Screw Driver



AB-68



DRIFTING? TRY DRAFTING

You're too smart to stay in the same boat with the "drifters." Unlike them, you want to settle down on a steady course, work toward advancement, make your future secure. But before you chart your course, take a good look at drafting—its opportunities and its rewards. You'll find it one of the most promising fields open to you. You'll also find that the International Correspondence Schools can help you acquire the training you need. I. C. S. Courses in Mechanical and Architectural Drafting—and 400 other technical and business subjects—are practical, authoritative, easy to follow. The coupon below brings full information. Mail it today!



INTERNATIONAL CORRESPONDENCE SCHOOLS



BOX 7688-L, SCRANTON 9, PENNA.

Without cost or obligation, please send me full particulars about the course *before* which I have marked X:

- | | | | |
|---|---|---|--|
| <p>Air Conditioning and Plumbing Courses</p> <input type="checkbox"/> Air Conditioning
<input type="checkbox"/> Heating <input type="checkbox"/> Plumbing
<input type="checkbox"/> Refrigeration <input type="checkbox"/> Steam Fitting <p>Chemistry Courses</p> <input type="checkbox"/> Chemical Engineering
<input type="checkbox"/> Chemistry, Analytical
<input type="checkbox"/> Chemistry, Industrial
<input type="checkbox"/> Chemistry, Mfg. Iron & Steel
<input type="checkbox"/> Petroleum Refining <input type="checkbox"/> Plastics
<input type="checkbox"/> Pulp and Paper Making <p>Civil Engineering, Architectural and Mining Courses</p> <input type="checkbox"/> Architectural Drafting
<input type="checkbox"/> Architecture
<input type="checkbox"/> Bridge and Building Foreman
<input type="checkbox"/> Building Estimating
<input type="checkbox"/> Civil Engineering
<input type="checkbox"/> Coal Mining
<input type="checkbox"/> Contracting and Building
<input type="checkbox"/> Highway Engineering
<input type="checkbox"/> Lumber Dealer
<input type="checkbox"/> Reading Structural Blueprints
<input type="checkbox"/> Sanitary Engineering
<input type="checkbox"/> Structural Drafting | <p><input type="checkbox"/> Structural Engineering
 <input type="checkbox"/> Surveying and Mapping</p> <p>Communications Courses</p> <input type="checkbox"/> Electronics
<input type="checkbox"/> Practical Telephony
<input type="checkbox"/> Radio, General
<input type="checkbox"/> Radio Operating
<input type="checkbox"/> Radio Servicing
<input type="checkbox"/> Telegraph Engineering <p>Electrical Courses</p> <input type="checkbox"/> Electrical Drafting
<input type="checkbox"/> Electrical Engineering
<input type="checkbox"/> Electric Light and Power
<input type="checkbox"/> Lighting Technician
<input type="checkbox"/> Practical Electrician <p>Internal Combustion Engines Courses</p> <input type="checkbox"/> Auto Technician <input type="checkbox"/> Aviation
<input type="checkbox"/> Diesel-Electric
<input type="checkbox"/> Diesel Engines <input type="checkbox"/> Gas Engines <p>Mechanical Courses</p> <input type="checkbox"/> Aeronautical Engineering
<input type="checkbox"/> Aircraft Drafting
<input type="checkbox"/> Flight Engineer
<input type="checkbox"/> Foundry Work
<input type="checkbox"/> Heat Treatment of Metals | <p><input type="checkbox"/> Industrial Engineering
 <input type="checkbox"/> Industrial Metallurgy
 <input type="checkbox"/> Machine Shop
 <input type="checkbox"/> Mechanical Drafting
 <input type="checkbox"/> Mechanical Engineering
 <input type="checkbox"/> Mold-Loft Work
 <input type="checkbox"/> Patternmaking—Wood, Metal
 <input type="checkbox"/> Reading Shop Blueprints
 <input type="checkbox"/> Sheet-Metal Drafting
 <input type="checkbox"/> Sheet-Metal Worker
 <input type="checkbox"/> Ship Drafting <input type="checkbox"/> Ship Fitting
 <input type="checkbox"/> Tool Designing
 <input type="checkbox"/> Toolmaking
 <input type="checkbox"/> Welding—Gas and Electric</p> <p>Railroad Courses</p> <input type="checkbox"/> Air Brake <input type="checkbox"/> Car Inspector
<input type="checkbox"/> Diesel Locomotive
<input type="checkbox"/> Locomotive Engineer
<input type="checkbox"/> Locomotive Fireman
<input type="checkbox"/> Railroad Section Foreman <p>Steam Engineering Courses</p> <input type="checkbox"/> Boilermaking
<input type="checkbox"/> Combustion Engineering
<input type="checkbox"/> Engine Running
<input type="checkbox"/> Marine Engineering
<input type="checkbox"/> Steam Electric <input type="checkbox"/> Steam Engines | <p>Textile Courses</p> <input type="checkbox"/> Cotton Manufacturing
<input type="checkbox"/> Rayon Weaving
<input type="checkbox"/> Textile Designing
<input type="checkbox"/> Woolen Manufacturing <p>Business and Academic Courses</p> <input type="checkbox"/> Accounting <input type="checkbox"/> Advertising
<input type="checkbox"/> Arithmetic <input type="checkbox"/> Bookkeeping
<input type="checkbox"/> Business Correspondence
<input type="checkbox"/> Business Management
<input type="checkbox"/> Certified Public Accounting
<input type="checkbox"/> Commercial
<input type="checkbox"/> Cost Accounting
<input type="checkbox"/> Federal Tax
<input type="checkbox"/> First Year College
<input type="checkbox"/> Foremanship <input type="checkbox"/> French
<input type="checkbox"/> Good English <input type="checkbox"/> High School
<input type="checkbox"/> Higher Mathematics
<input type="checkbox"/> Illustrating <input type="checkbox"/> Motor Traffic
<input type="checkbox"/> Postal Service
<input type="checkbox"/> Salesmanship <input type="checkbox"/> Secretarial
<input type="checkbox"/> Sign Lettering
<input type="checkbox"/> Spanish <input type="checkbox"/> Stenography
<input type="checkbox"/> Traffic Management |
|---|---|---|--|

Name _____ Age _____ Address _____

City _____ State _____ Present Position _____

Working Hours _____ A.M. to _____ P.M. Length of Service in World War II _____

Special tuition rates to members of the Armed Forces. Enrollment under the G.I. Bill of Rights approved for War II Veterans.
Canadian residents send coupon to International Correspondence Schools Canadian, Ltd., Montreal, Canada.

= FREE = to Ambitious Men and Women

Send today for this FREE book, "Accountancy, the Profession That Pays."

A full explanation of what you must know to be an accountant, opportunities in this well-paying, fascinating field, and how you can, in your spare time, prepare yourself for a better job and more money. A preliminary knowledge of bookkeeping is unnecessary. We train you from the ground up, or start with what you already know, according to your individual needs.

Under the LaSalle Problem Method you can acquire at home, a thorough understanding of Higher Accountancy, master its fundamental principles, become expert in the practical application of these principles. Your training will be under the direct supervision of a staff of Certified Public Accountants, and members of the American Institute of Accountants.

Get all the facts NOW. Our book, "Accountancy, the Profession That Pays" is FREE. Write for it today.

G. I. APPROVED

LASALLE EXTENSION UNIVERSITY A CORRESPONDENCE INSTITUTION

DEPT. 783-HR 417 SO. DEARBORN STREET, CHICAGO 5

I would welcome details of opportunities in accounting, together with copy of "Accountancy, the Profession That Pays," without obligation.

HIGHER ACCOUNTANCY

Other La Salle Opportunities:

LaSalle opens the way to success in every important field of business. If interested in one of the fields below, check and mail.

- Business Management
- Modern Salesmanship
- Traffic Management
- Foremanship
- Industrial Management
- Stenotypy (Machine Shorthand)
- Law—Degree of LL.B.
- Commercial Law
- Modern Business Correspondence
- Expert Bookkeeping
- C.P.A. Coaching

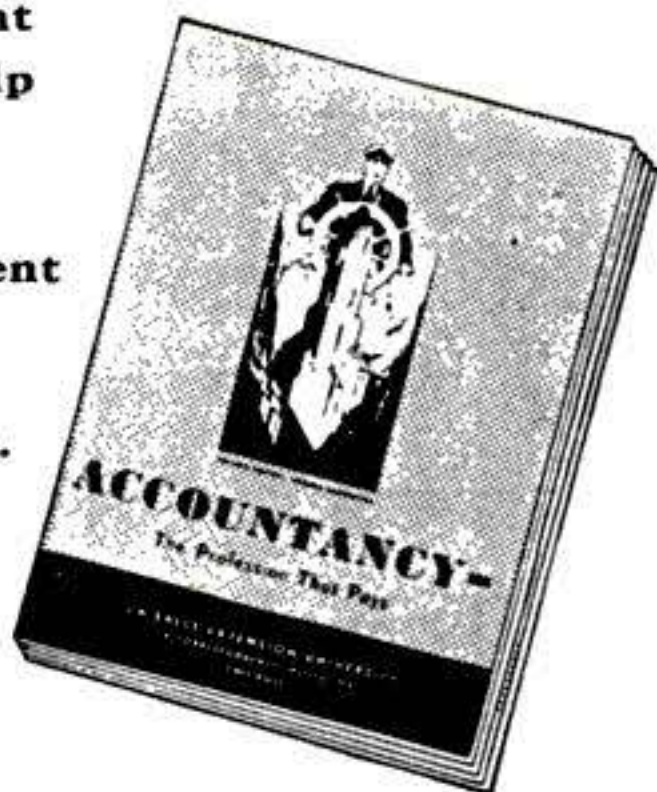

Name.....
Present Position..... Age.....
Street.....
City..... Zone.... State.....

AVIATION

Aeronautical University Approved Training meets exacting standards of aviation industry, prepares for key positions, big opportunities.

Courses in:

AERONAUTICAL ENGINEERING. B.S. degree.
AERONAUTICAL ENGINEERING DRAFTING
CERTIFIED ENGINE MECHANICS
ADMINISTRATION—including sales

PRE-ENGINEERING: Special course for high school graduates and veterans deficient in math and science.

Also refresher courses for Gov't. Airplane and Engine Mechanics Licenses for those with aviation experience.

Oldest fully approved aviation school. Outstanding faculty, modern equipment, outside employment, placement service. Day, evening. Approved for Veterans. Send today for FREE catalog "Opportunities in Aviation."

AERONAUTICAL UNIVERSITY
Dept. 87, 116 S. Michigan Avenue, Chicago 3, Illinois

**FOUNDED
BY
CURTISS-
WRIGHT**

One of America's Leading Radio and Television Schools NEW YORK TECHNICAL INSTITUTE OF NEW JERSEY

158 Market Street, Newark, New Jersey

MAKE MONEY CASTING AT HOME FREE FACTS SENT



Cast thousands of perfect Plaques, Book Ends, Ash Trays, Etc. Plaster, Liquid Marble, Etc. ENORMOUS PROFITS. Start in basement or garage. LITTLE CAPITAL NEEDED. QUICK, EASY, NO PREVIOUS EXPERIENCE NEEDED. Rubber molds for speed production. MAKE YOUR OWN. SAMPLE KIT \$1.00. Canadian \$1.50. PLASTIC ARTS STUDIOS, Route 5, Dept. 45, Muncie, Ind.

WHY DON'T YOU WRITE?

Writing short stories, articles on business, homemaking, gardening, shop crafts, sports, local and club activities, etc., will enable you to earn extra money. In your own home, on your own time, the New York Copy Desk Method teaches you how to write—the way newspaper men learn, by writing. Our unique "Writing Aptitude Test" tells whether you possess the fundamental qualities essential to successful writing. You'll enjoy this test. Write for it, without cost or obligation.

VETERANS: This course approved for Veterans' Training

NEWSPAPER INSTITUTE OF AMERICA

SUITE 572-L, ONE PARK AVENUE, NEW YORK 16, N. Y.

APTITUDE TESTS

discover the kind of work or studies best for your success! You get a personal report—a guide for life—more happiness—more prosperity. (for men, women, boys, girls.) Write for complete facts. VOCATIONAL COUNSELING INSTITUTE 5057 Woodward Ave., Detroit 2, Michigan



START \$1,756 to \$3,021 YEAR

MEN—WOMEN

Veterans get special preference. Prepare IMMEDIATELY.

Mail Coupon Today

FRANKLIN INSTITUTE

Dept. K80, Rochester 4, N. Y.

Sirs: Rush (1) 32-page book with list of many U. S. Government Big Pay Jobs. (2) Tell me how to prepare for one.

Name.....

Address..... Vet?.....



KIT 1 (left) I send you Soldering Equipment and Radio Parts; show you how to do Radio Soldering; how to mount and connect Radio parts; give you practical experience.



KIT 2 (left) Early in my course I show you how to build this N.R.I. Tester with parts I send. It soon helps you fix neighborhood Radios and earn EXTRA money in spare time.



VETERANS

You can get this training in your own home under G.I. Bill. Mail coupon for full details.

Be a RADIO Technician

Learn by PRACTICING in Spare Time

with **BIG KITS** of RADIO PARTS I send you

KIT 3 You get parts to build Radio Circuits; then test them; see how they work; learn how to design special circuits; how to locate and repair circuit defects.

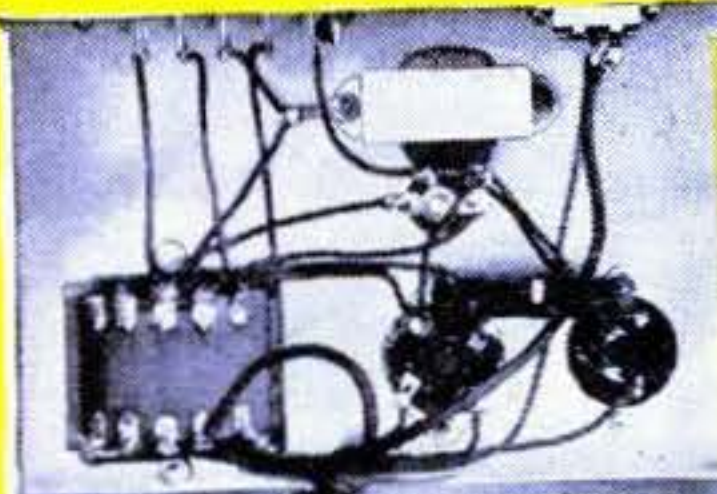
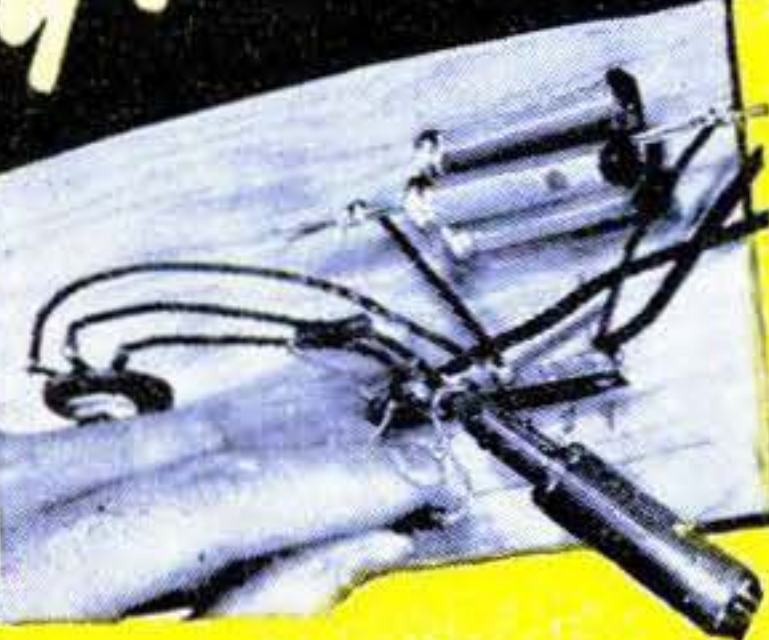

KIT 4 You get parts to build this Vacuum Tube Power Pack; make changes which give you experience with packs of many kinds; learn to correct power pack troubles.

KIT 5 Building this A. M. Signal Generator gives you more valuable experience. It provides amplitude-modulated signals for many tests and experiments.

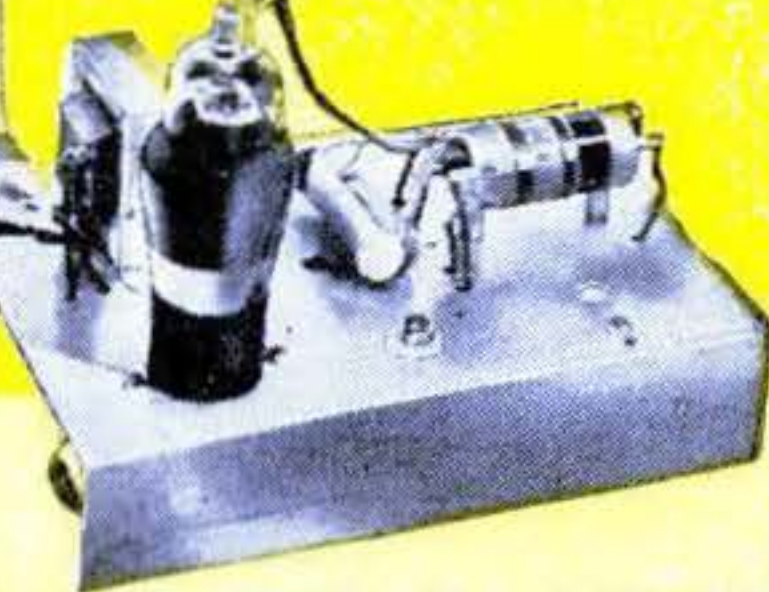

KIT 6 You build this Superheterodyne Receiver which brings in local and distant stations—and gives you more experience to help you win success in Radio.

My Course Includes Training in **TELEVISION • ELECTRONICS**
FREQUENCY MODULATION

Do you want a good-pay job in the fast-growing Radio Industry—or your own Radio Shop? Mail the Coupon for a Sample Lesson and my 64-page book, "How to Be a Success in RADIO—Television, Electronics," both FREE. See how I will train you at home—how you get practical Radio experience building, testing Radio circuits with BIG KITS OF PARTS I send!



J. E. SMITH, Pres. National Radio Institute

Many Beginners Soon Make Extra Money in Spare Time While Learning

The day you enroll I start sending EXTRA MONEY JOB SHEETS that show you how to make EXTRA money fixing neighbors' Radios in spare time while still learning! It's probably easier to get started now than ever before, because the Radio Repair Business is booming. Trained Radio Technicians also find profitable opportunities in Police, Aviation, Marine Radio, Broadcasting, Radio Manufacturing, Public Address work. Think of even greater opportunities as Television, FM, and Electronic devices become available to the public! Send for FREE books now!

Find Out What NRI Can Do For You

Mail Coupon for Sample Lesson and my FREE 64-page book. Read the details about my Course; letters from men I trained; see how quickly, easily you can get started. No obligation! Just MAIL COUPON NOW in envelope or paste on penny postal. J. E. Smith, President, Dept. 7GP3, National Radio Institute, Pioneer Home Study Radio School, Washington 9, D. C.

Sample Lesson **FREE**
64 Page Book

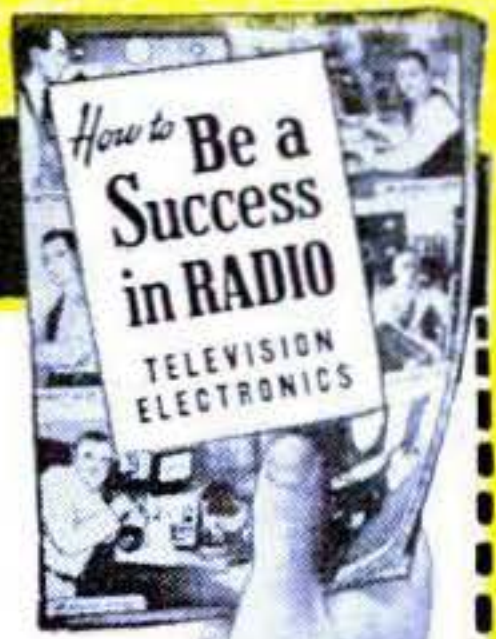

Mr. J. E. SMITH, President, Dept. 7GP3
National Radio Institute
Washington 9, D. C.

Mail me FREE, Sample Lesson and 64-page book. (No salesman will call. Please write plainly.)

Age.....
Name.....
Address.....
City..... State.....
(Please include Post Office Zone number)

**NEW peacetime
production plans
mean**



BIGGER PAY FOR MACHINISTS

Master shop work quickly with these books

This big home-study and reference course gives you the practical facts on machines and methods you need to advance in machine shop work. Take advantage of the other man's experience as found in books, to solve your problems, increase your efficiency, with

**The AMERICAN
MACHINISTS' LIBRARY**

6 volumes—2368 pages—2516 illustrations
(A combined home-study course and reference library)

This library of machine shop practice was written for practical men. It gives you the best methods for every kind of machine shop work. It fully explains lathes, drills, and other machine tools and their operation, automatic screw machines, speeds and feeds, gear design and production, jigs and fixtures, punch and die work, metal surfacing, etc., etc. Plainly written—completely illustrated—the best kind of help to the machine shop man who wants to advance himself.

No money down—special price—easy payments.

EXAMINATION COUPON

McGraw-Hill Book Co., 330 W. 42nd St., N. Y. C. 18

Send me for ten days' examination the American Machinists' Library. If satisfactory I will send you \$4.00 in 10 days and \$4.00 monthly until the price of \$20.00 is paid. If not wanted, I will return the books postpaid. (To insure prompt shipment write plainly and fill in all lines.)

Name.....
Home Address.....
City and State.....
Company.....
Position..... PSM, 7-47

When Writing Advertisers
Please Mention **POPULAR SCIENCE**

**THIS
GENTLEMAN
HAS NO
BOOKKEEPING
OR TAX
PROBLEMS.**



This gentleman has no bookkeeping or tax problems, but then he is not a responsible business man... yet. He's completely carefree... and, Mr. Business Man, you can be just as free of record-keeping and tax worries, too, when "Mail-Me-Monday" keeps your books and prepares your tax forms. One economical monthly fee... as little as 50 cents a day.

See "BOOKKEEPING" in yellow section of telephone book for nearest office.

**"MAIL-ME-MONDAY" BOOKKEEPING
and TAX METHOD**
1929 FIRST AVENUE • DEPT. P • SAN DIEGO 1, CALIF.

More than 125 offices coast to coast and in Canada

Central offices in Los Angeles, San Francisco, Chicago, New York,
Kansas City, and Atlanta

SURPLUS BARGAINS

ASSEMBLE YOUR OWN BINOCULARS!

Complete Optics! Complete Metal Parts!
Save More Than 1/2 Regular Cost



**GOVERNMENT'S 7x50
BINOCULARS**

Complete Optics, new and ready for assembly. We supply full instructions. Limit—1 Set of Metal Parts and 1 Set of Optics to a customer.

METAL PARTS—Set includes all Metal Parts—completely finished—for assembly of 7 X 50 Binoculars. No machining required. Bodies have been factory hinged and covered. A sturdy Binocular Carrying Case is included with each set of Metal Parts.

Stock #841-N \$36.20 Postpaid

OPTICS—Set includes all Lenses and Prisms you need for assembling 7 X 50 Binoculars. These are in excellent condition—perfect or near-perfect—and have new low reflection coating.

Stock #5102-N \$25.00 Postpaid

NOTICE! If you buy both Binocular Optics and Binocular Metal Parts, add 20% Federal Excise Tax to above prices.

**NEVER HAS THERE BEEN SUCH A
SENSATIONAL BARGAIN AS THIS!
BUBBLE SEXTANT-TYPE A-10**

These Army Air Forces Bubble Sextants cost the Govt. about \$200 each. A real bargain at our price of \$12.50! Included with Bubble Sextant shipment is wooden Carrying Case, 5 spare waxed paper discs, flashlight with rheostat for night use (uses ordinary flashlight cells—not furnished) aux. 2-power Galilean Telescope, Allen wrench, 2 spare marking points. Wartime used, but where necessary completely repaired, collimated and put in good working order. If not satisfied that Sextant is as represented, return within 10 days and money will be refunded. Full directions for use accompany each shipment.

Stock #924-N \$12.50 Postpaid

We have literally millions of war surplus lenses and prisms for sale at bargain prices. Write for Catalog "N"—Sent Free!

Satisfaction Guaranteed • Order by Stock No.

EDMUND SALVAGE COMPANY
P. O. AUDUBON NEW JERSEY

Easy Self-Instruction In All 25 Branches Of
MATHEMATICS

Brought To You By Experts From Leading Colleges

in the 4 volumes of the PRACTICAL MATHEMATICS LIBRARY. Helps you qualify for the better jobs in industry. 1300 pages, 600 illustrations. Sent for free examination. Only \$2.00 down, \$2.00 a month; total \$9.80 plus postage. (Cash price \$9.50, postage free. Money-back guarantee.) 160-page 6-Place Logarithm book free with order. National Educational Alliance, Inc., Dept. 807, 37 West 47th St., New York 19, N. Y.

**LEARN MONEY-
MAKING CARTOONING**

IN SPARE TIME — by Easy Picture Chart Method Same Simplified Method that has helped train creators of "Terry & Pirates," "Freckles," "Out Our Way," "Winnie Winkle," "Regular Fellers," "Strange As It Seems," "The Neighbors," and many others. Earn while learning. Send 10c for Picture Chart (to test your ability). Samples of successful students, and full details. (State age.) Landon School of Cartooning, Dept. 4727, Philadelphia 1, Pa.



DRAW for MONEY

BE AN ARTIST!

Trained Artists Are Capable of Earning \$50, \$60, \$75 a week

Use Your Spare Time to Prepare for a Profitable Art Career! **COMMERCIAL ART, DESIGNING and CARTOONING**

—all in ONE complete home study course No previous Art experience necessary—we teach you step by step—hundreds have profited by our practical method. **TWO ART OUTFITS FURNISHED. Colorful. FREE BOOK.** "Art for Pleasure & Profit"—tells all about our course, service, what our graduates say and commercial opportunities for you in Art.

Veterans! Approved under G.I. Bill

FREE BOOK gives details!

WASHINGTON SCHOOL OF ART
Studio 137H, 1115 15th St., N.W., Wash 5, D. C.
Send me your booklet and full particulars about your course.

Name..... AGE.....
Street.....
City..... Zone..... State.....

HOW JUST TWO WORDS TURNED MAC INTO A HE-MAN!

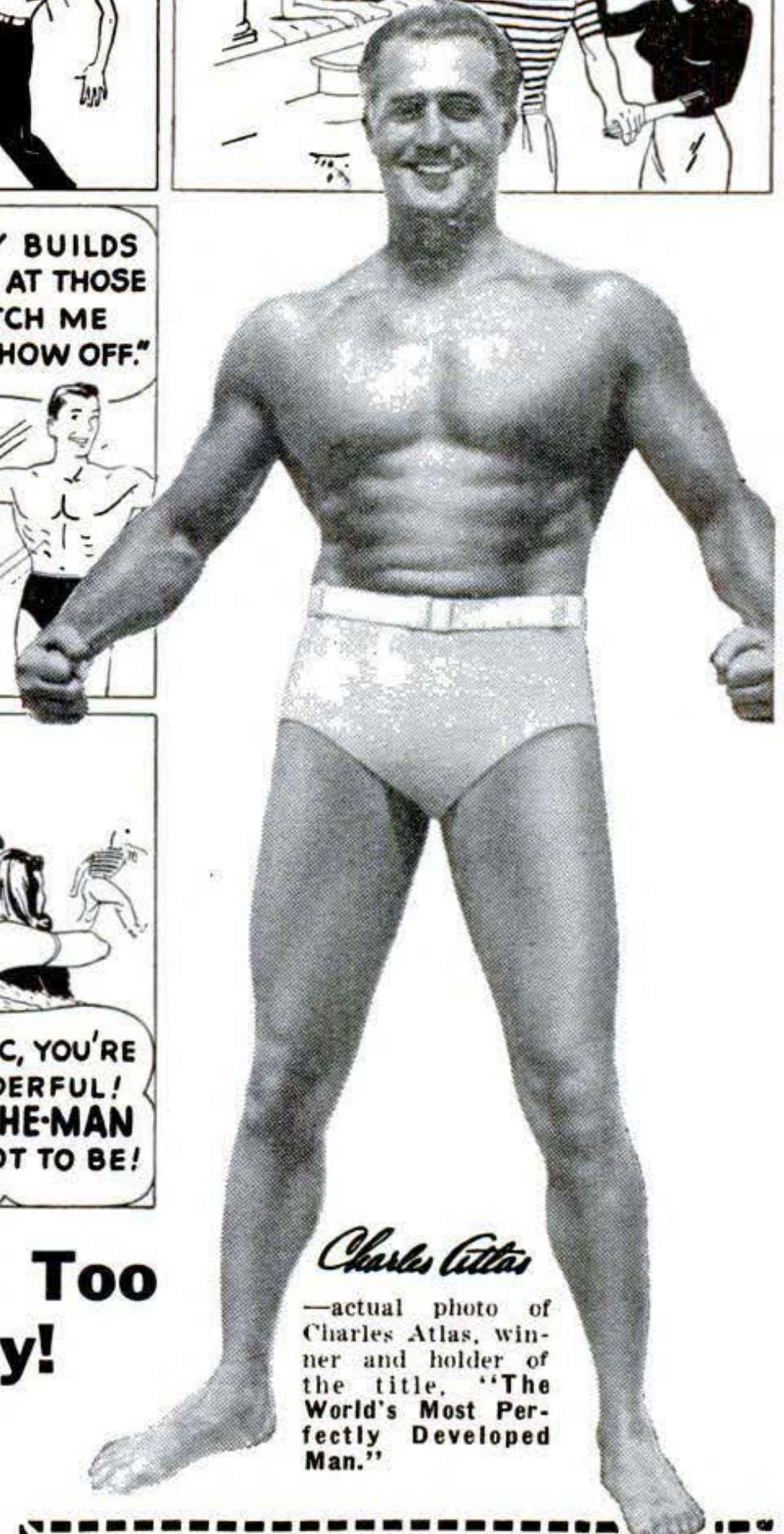
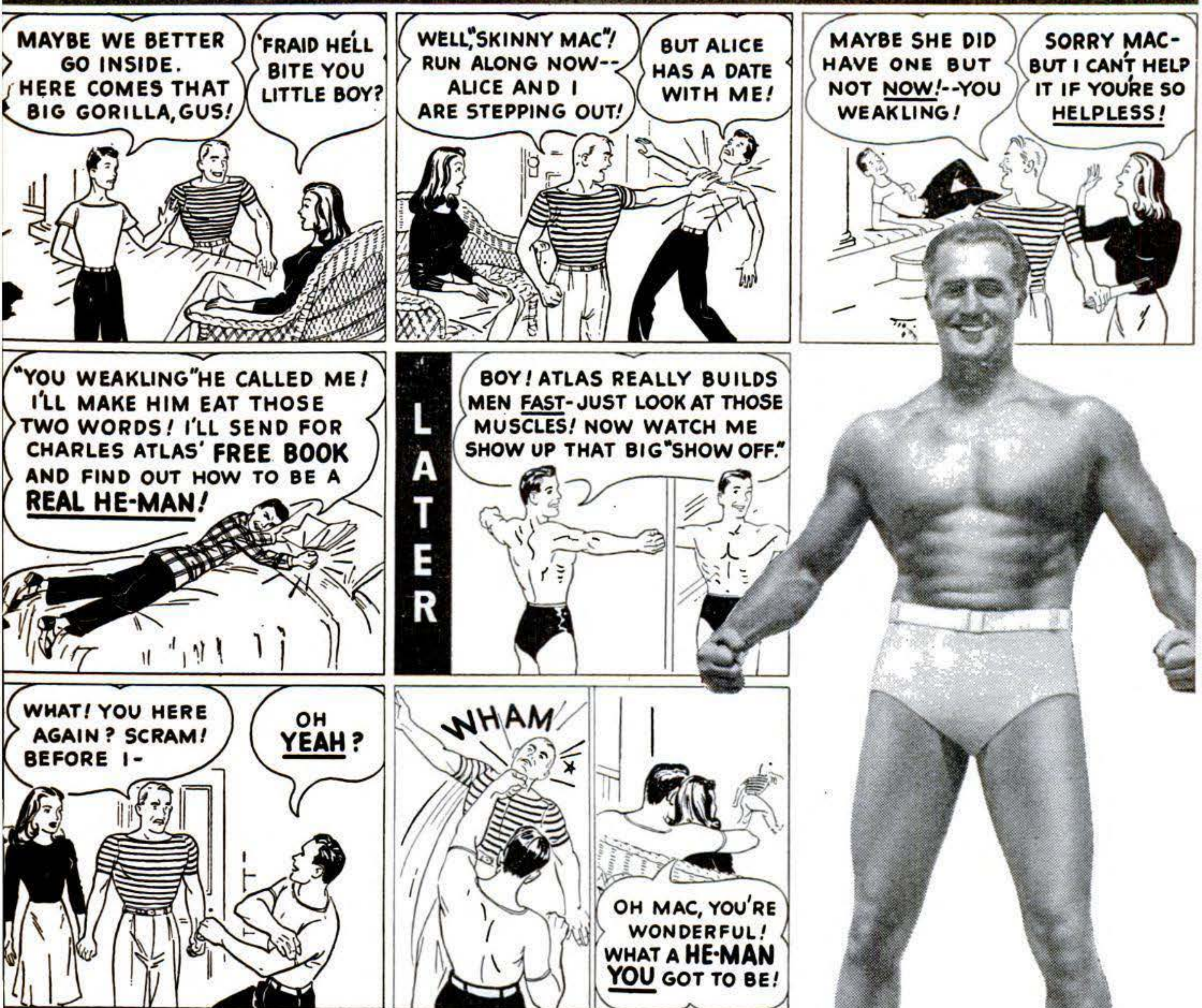

Charles Atlas
—actual photo of Charles Atlas, winner and holder of the title, "The World's Most Perfectly Developed Man."

**Can Make YOU a New Man, Too
—in Only 15 Minutes a Day!**

IF YOU (like Mac) are fed up with being "pushed around"—if you're sick and tired of having the kind of a day that people PITY instead of ADMIRE—then give me just 15 minutes a day! That's all I need to PROVE I can make you a NEW MAN!

I know what I'm talking about. I was once a thin, pepless, 97-pound "bag of bones" myself. Then I discovered my now-famous secret, "Dynamic Tension." It turned me into "The World's Most Perfectly Developed Man." And I have used this secret to build thousands of other scrawny, lifeless weaklings into perfect, red-blooded specimens of real HE-MANHOOD. Let me prove that I can do the same for YOU!

"Dynamic Tension" Does It!
Using "Dynamic Tension" only 15 minutes a day, in the privacy of your own room, you quickly begin to put on muscle, increase your chest measurements, broaden your back, fill out your arms and legs. This easy, NATURAL method will make you a finer specimen

of REAL MANHOOD than you ever dreamed you could be!

I don't care how old or young you are, or how ashamed of your present physical condition you may be. If you can simply raise your arm and flex it I can add SOLID MUSCLE to your biceps—yes, on each arm—in double-quick time!

FREE BOOK

Thousands of fellows have used my marvelous system. Read what they say—see how they look before and after—in my book, "Everlasting Health and Strength."

Send NOW for this book—FREE. It tells all about *Dynamic Tension*. Shows you actual photos of men I've turned from puny weaklings into Atlas Champions. It tells how I can do the same for YOU. Don't put it off! Address me personally, Charles Atlas, Dept. 17, 115 East 23rd Street, New York 10, N. Y.



**CHARLES ATLAS, Dept. 17,
115 E. 23rd Street, New York 10, N. Y.**

I want the proof that your system of "Dynamic Tension" will help make a New Man of me—give me a healthy, husky body and big muscular development. Send me your free book, "Everlasting Health and Strength."

Name.....Age.....
(Please print or write plainly)

Address.....

City.....State.....

**They're
neither
too young
nor too old
for...**

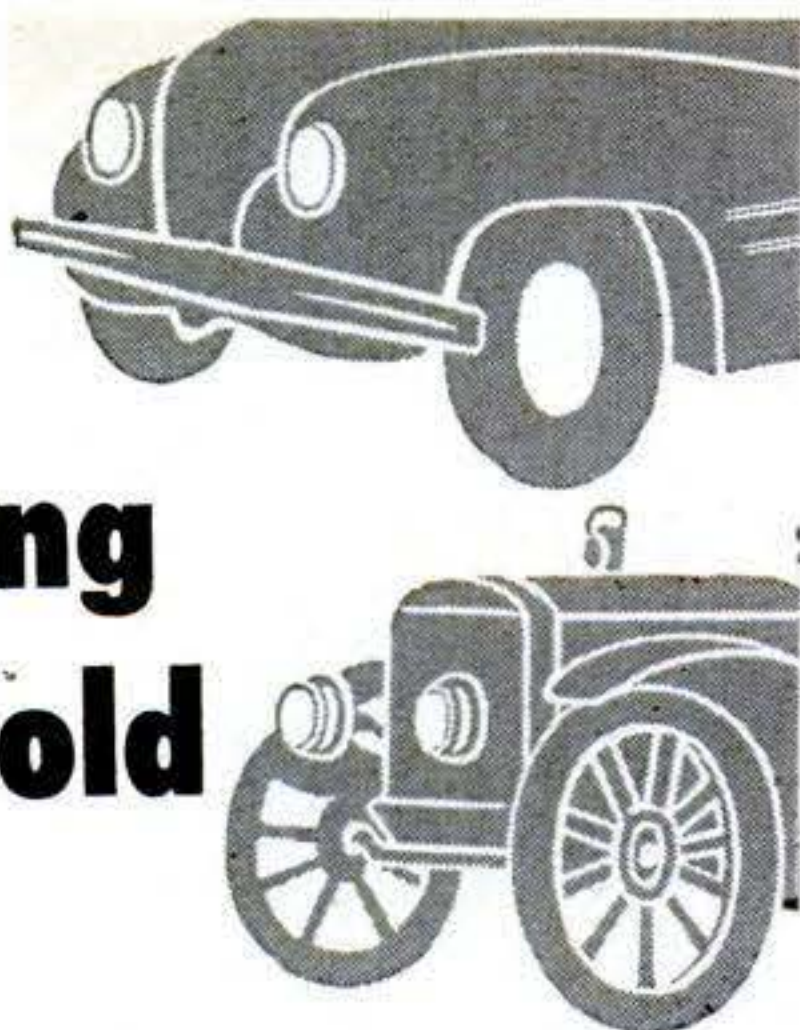

PYROIL!

Whether you are one of the lucky ones driving a '46 or '47 or you are still marveling at how the old bus is holding up, you'll be wise to add Pyroil when you stop for gasoline. For Pyroil adds life to your car regardless of age. It gives oil the property of clinging to cylinder walls. It won't drain off to permit corrosion or to permit metal-to-metal friction when starting. Pyroil removes gums and carbon formation. When you buy gas or oil—simply say "add Pyroil" and you'll add miles of carefree driving.

**PYROIL FOR
AIRCRAFT ENGINES**

Use Aircraft Pyroil B for lubricating oil, Aircraft Pyroil A for gasoline.

Manufactured and Guaranteed by
Pyroil Company, 234 Main Street,
La Crosse, Wisconsin.

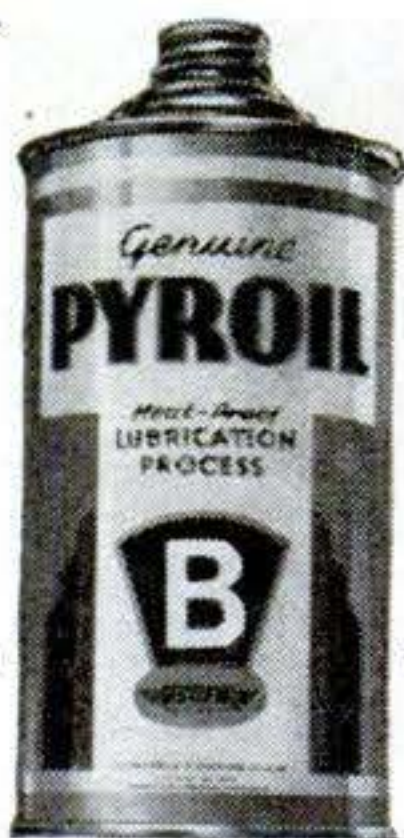

PYROIL COMPANY
234 Main Street
La Crosse, Wisconsin

I want my car to last and run properly. Please tell me more about Pyroil and how it can accomplish this for me.

Name.....

Address.....

City or Town.....State.....



Jerry, the talking dog, is entertaining hospitalized veterans, by courtesy of the PYROIL Company. Picture of Jerry sent on request.

LETTERS

Chronology Corrected

Sir:

On page 122 of the May issue the following item appears: "... Lockyer, accomplishing the first transmutation of metals, obtained calcium from copper." I should be glad to be advised of the publication on which this is based. I am equally certain that the statement is erroneous and that Lockyer did not accomplish this feat, which has not yet been accomplished. Lockyer's claim, which I have not seen, was not accepted generally, any more than the claims in 1919-1920 that gold had appeared in mercury arc tubes after prolonged operation. The first actual transmutation, nitrogen-14 to oxygen-17, was performed by Rutherford in 1919, 40 years later. . . .

W. F. HOLDEN

Woodside, N. Y.

PSM's researcher slipped up there. Although Lockyer's work in spectrum analysis brought him close to the theoretical possibility of transmutation, Reader Holden is right in insisting that its actual accomplishment belongs to Rutherford.

Sir:

. . . Your May '47 issue, the 75th Anniversary job, has as a star feature "The Growing Years of Science." Under the year 1941 I find "Electron microscope used successfully after Pearl Harbor raid to locate metal splinters."

But in the *Journal of the American Medical Association*, Feb. 28, 1942 I find an article entitled "Surgical Experience at Pearl Harbor," by Dr. John J. Moorhead. Dr. Moorhead says that he used the gadget on 22 cases at Pearl Harbor and that it consists of an electromagnetic induction apparatus that functions in the manner of a mine detector. . . .

PAUL J. KOPSCH

Baldwin, N. Y.

Dr. Moorhead and Reader Kopsch are



INVENTORS



Learn how to protect your invention. The U. S. Patent Laws provide that any new and useful art, machine, article of manufacture, or composition of matter, or any new and useful improvement thereof, may be patented if the act of invention is involved. Therefore, every inventor with a valuable invention should take advantage of the Patent Laws and proceed for patent protection in order to safeguard his rights.

A patent gives the inventor the exclusive right to prevent others from making, using, or selling the invention claimed in the patent for a period of seventeen years.

The Patent Laws were enacted for the benefit of the inventor to give him protection for the features of his invention which are patentable. These features must be properly and concisely set forth and claimed in a formal application for patent, in order to comply with the requirements of the U. S. Patent Office. For that reason, the Patent Office advises the inventor to engage a competent registered patent attorney or agent to prepare his application for patent and represent him before the U. S. Patent Office Examiner.

A specially prepared booklet entitled "Patent Guide for the Inventor", containing detailed information with respect to patent protection and procedure, together with a "Record of Invention" form will be promptly forwarded to you without obligation upon request.

Patents

Trademarks

Copyrights

Registered Patent Attorneys

CLARENCE A. O'BRIEN & HARVEY B. JACOBSON
Registered Patent Attorneys
72-G District National Bldg., Washington 5, D. C.

Please send me copy of "Patent Guide for the Inventor" and also "Record of Invention" form. This request does not obligate me.

Name _____

Address _____

City _____ State _____

(Please write or print plainly.)

CLARENCE A. O'BRIEN
& HARVEY B. JACOBSON

72-G District National Building + Washington 5, D. C.

JULY 1947 15



HERE'S A NEW AND VITAL BUSINESS!

LEARN ELECTRICAL APPLIANCE REPAIRING

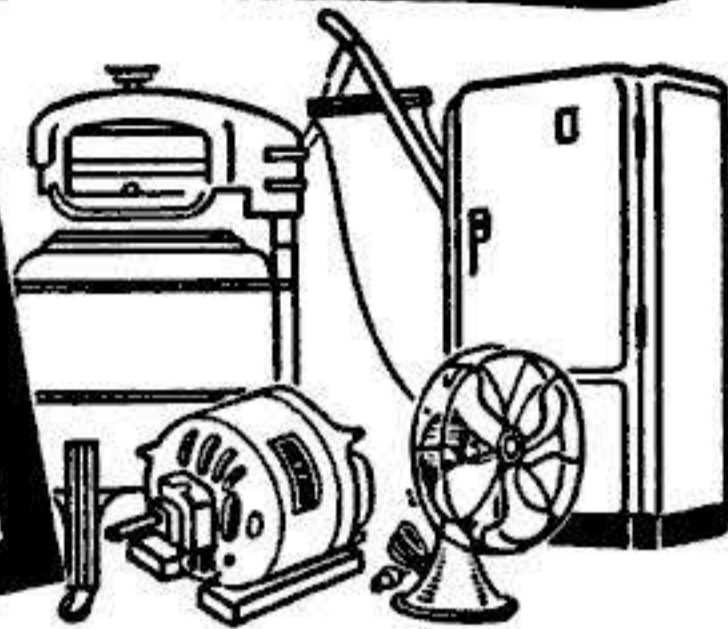

Offers Big Money Independence

If now employed, start your home appliance repair business NOW in your spare time and be set with a business of your own no matter what happens. Operate from your garage, basement, kitchen, vacant store, etc. Work as many hours as you wish—the home appliance repairman is his own boss. It is a profitable occupation, for on many types of repairs it is not unusual for a repairman to charge on the basis of \$5.00 to \$6.00 per hour! Remember, there are millions of electrical appliances in this country. Appliances such as refrigerators, irons, sewing machines, vacuum cleaners, heaters, toasters, washing machines, motors, etc. To replace them is mighty expensive. That is why the Electrical Appliance Repair Business offers the trained man unlimited earning possibilities.

YOU CAN QUALIFY

All you need to become a successful electrical appliance repairman is ambition plus a little training at home in your spare time. If you are mechanically inclined—that is to say—can hold and use tools, our profusely illustrated course written in simple, easy to understand language will prepare you for the years to come. It does not matter if you have not had a great deal of schooling or have had no previous training along these lines. WE WILL TEACH YOU. Age is no barrier—nor any minor physical handicap.

WE TEACH YOU

Profusely illustrated with photographs and simple drawings we show you what troubles to look for and how to make each repair on an electrical appliance. We give you a good sound working knowledge of electricity, and how to do welding, nickel plating, etc. Our course shows you how to solicit business and keep it coming to you. Not a theory course but an honest to goodness course written by and used by repairmen the country over. Price of course is so low that the savings on your own household appliance repairs will quickly pay for it. Why work for others at the wages they want to pay you? Learn a good trade and operate your own business and determine how long you work each day and the amount of money you make. ACT NOW!

MAIL COUPON TODAY

CHRISTY SUPPLY CO.
2835 N. Central Ave., Dept. D-5401
Chicago 34, Illinois

Please send me free illustrated literature about America's Fastest Growing Industry—ELECTRICAL APPLIANCE REPAIRING.

Name.....

Address.....

City.....State.....

right. The electron microscope is older than Pearl Harbor and far different from the device used there to locate metal splinters.

Sir:

. . . Under the year 1939, you state that the first controllable-pitch propeller was installed on the P-36 in that year. . . . What about the Lycoming-Smith mechanical propeller used on the Martin B-10? That propeller was a "constant speed" type prop.

LT. LOWELL D. SHARRETT

Tampa, Fla.

The date to which PSM was referring but should have made clear was for the installation of the first four-bladed, controllable-pitch propeller, the adjective "four-bladed" having been lost somewhere along the way from author to printer.

Sir:

. . . You state that the first parachute jump from a plane was made in 1919.

A jump that was claimed to be the first one from a plane occurred in St. Louis, Mo. somewhere around 1912. I was a child at the time, but I saw it.

HAROLD B. DAVIDSON

Little Neck, Ark.

PSM's statement should have been qualified to include the words "official Army." The jump that Reader Davidson saw in 1912 at St. Louis was neither recorded by the Army as official nor made with the type of parachute that later came into use.

The Eyes Have It

Sir:

. . . You describe the (folding) goggles (PSM, May '47, p. 153) as having "a stainless steel rim extending across the top." This is incorrect. Only the telescoping temples . . . are made of stainless steel. The frame across the top is molded plastic.

ROBERT S. BUCKBINDER

The Frederick-Clinton Co., Inc.
New York, N. Y.

In rewriting the information on these goggles for publication, PSM took the more popular use of the term "temples" as designating the parts of the frame across the top of the lenses, rather than the specialized trade application, which limits its use to the fore-parts of the ear pieces.

INVENTORS

Patent Laws Encourage The Development Of Inventions

The Rules of Practice of the U. S. Patent Office advises—unless an inventor is familiar with such matters—that he employ a competent registered attorney or registered agent, as the value of patents depends largely upon the skillful preparation of the specifications and claims.

The firm of McMorrow, Berman and Davidson is registered to practice before the U. S. Patent Office. Additionally, it maintains a staff of attorneys able to readily understand inventors' disclosures, to advise concerning patentability, and to prepare appropriate specifications and claims for filing with the Patent Office.

If an inventor believes he has an invention, a search of the most pertinent prior U. S. patents should be made and a report obtained relative to its patentability. Where such report indicates that the invention appears patentable, in order to secure protection, diligence should be exercised in making application for a patent.

McMORROW, BERMAN & DAVIDSON

Registered Patent Attorneys

PATENTS — TRADE MARKS — COPYRIGHTS

1426 VICTOR BUILDING, WASHINGTON 1, D. C.

McMORROW, BERMAN & DAVIDSON

Registered Patent Attorneys

1426 Victor Building, Washington 1, D. C.

Send me further particulars as to patent protection and procedure and "Invention Record" form at once. I understand that this request does not obligate me.

Name.....

Address.....

City..... State.....

(WRITE OR PRINT NAME CLEARLY)

SUCCESS BRINGS

THE GOOD THINGS OF LIFE



FIND OUT ABOUT OPPORTUNITIES IN INDUSTRIAL ELECTRONICS

It's a perfectly natural human desire to want more money, a better job, prestige and all the other good things of life. Who gets them? Look about you. Success you will see, comes to the man who is trained for his job.

A new world of opportunity is today beckoning to ambitious men. One of the most important and exciting fields is **INDUSTRIAL ELECTRONICS**. It is attracting experienced electrical men as well as younger fellows seeking a way to bigger earnings and a more secure future.

OPPORTUNITY LIES AHEAD

Industrial Electronics is not Radio. It has nothing to do with radio transmitters and receivers. It is totally new application of electric power, applied to modern production by means of the magic of the vacuum tube. Everywhere industrial electronic devices are replacing the old-time electrical controls, and processes. Industrial Electronics is Modern Industrial Electricity.

"Every electrician should know—must know—Industrial Electronics." That's what many Union leaders are telling their members, today. They know that the use of Industrial Electronics devices is growing by leaps and bounds. They know that to install and service this equipment, even the best of present-day electricians must first have had special training.

GET READY NOW!

Now is the time to get into Industrial Electronics, while the field is in its infancy . . . and while it is rapidly developing a need for thousands of trained experts. Tomorrow's leaders are training today. And here is a School equipped in every way to train you for Industrial Electronics work—one of the largest and most completely equipped, and one of the few of its kind in America—a School that already has trained thousands of men for industrial opportunities.

LEARN AT HOME OR COME TO OUR SCHOOL

Learn Industrial Electronics—now, while the time is ripe. You don't need any advanced schooling or previous experience. If you are at all mechanically inclined and have gone to high school for at least one year or have an equivalent education, we can teach you Industrial Electronics.

You can take most of your training at home, in your spare time—or you can come to Chicago and take your entire training in our completely equipped shops and laboratories. Either way you quickly acquire the fine points, practical skill, and broad, technical "know how" that makes the expert Industrial Electronics Technician.

A GUIDE FOR YOUR FUTURE—Complete facts about Industrial Electronics. Packed with pictures. Tells all about our successful training plan. Coupon will also bring details about moneymaking opportunities for trained men and our Life-Time Free Employment Service. No obligation. Mail coupon TODAY. Investigation may start you up the ladder of Success.

AUTHORIZED TO ACCEPT VETERANS FOR G.I. TRAINING

INDUSTRIAL TRAINING INSTITUTE,
 90 Lawrence Ave., Dept. P2GL Chicago 25, Ill.

Please send me, FREE, your "Camera Visit" booklet information about the opportunity for trained men in **INDUSTRIAL ELECTRONICS**. It is understood that I will be under no obligation.

NAME.....
 ADDRESS.....
 CITY.....STATE.....
 ARE YOU A VETERAN?.....

FOR BOOKS FREE

GET THE FACTS ABOUT AMERICA'S FOREMOST SCHOOL OF PRACTICAL TRAINING.

Radio or Blanket Control?

Sir:
 I have been reading your magazine almost since I can remember, and I would like to say it's the "tops."

. . . All these years I have been trying to find a mistake without any success. Well, at last I have found one. In your splendid anniversary issue (May) on page 126 (Measurements Unlimited mural) the article No. 51 labeled "radio" is in actuality a Simmons electronic blanket control. If it's a radio, where is the speaker grill, anyway?

HARRY K. TAYLOR
 West Palm Beach, Fla.

PSM appreciates Reader Taylor's careful and constant scrutiny, but to him and the many others whose curiosity also prompted them to write in, it can only pass along GE's assurance that its artist intended the disputed article to be a radio, not a blanket control. Frankly, though, the absence of a speaker grill and what appears to be a thermometer leave PSM wondering, too.

Doubting the Demon

Sir:
 The article on "Maxwell's Demon" in your 75th Anniversary issue states that a jet of compressed air is forced through the nozzle. Then it is slowed down by the tube's spiral core. Some of the air molecules drop to the center of the tube, pass along heat to the outer air, and stay cool. The air coming in the jet supposedly speeds up and loses heat. All this is well and good, except, if I remember correctly, that a substance takes on heat when it speeds up and gives it off when it slows down. . . . Maybe you can explain it for me. I certainly can't figure it out.

GUERRY C. BROWN
 Delray Beach, Fla.

As the article said, air entering the Hilsch tube jet has two pockets full of energy—one heat energy, the other velocity energy. In speeding up, it takes energy from the heat pocket (making it cooler) and puts it into the velocity pocket (making it move faster). The energy for increased speed had to come from some place; it came from the original heat. (But, remember, the physicists are still arguing over just how the Hilsch tube works.)

AUDELS REFRIGERATION & AIR CONDITIONING GUIDE.....\$4

New from Cover to Cover—1280 Pages, Fully Illus. Covering basic principles, servicing, operation & repair of household, commercial & industrial refrigeration & air conditioning. A gold mine of essential important facts for engineers, servicemen, users.

AUDELS CARPENTERS & BUILDERS GUIDES—4 Vols.\$6

A practical illustrated trade assistant on modern construction for carpenters, joiners, builders, mechanics and all woodworkers. 4 vols., 1600 pages, 3700 illustrations, flexible covers. Pocket size. Each volume sold separately \$1.50 a vol.

AUDELS AUTOMOBILE GUIDE.....\$4

A practical quick ready reference book for auto mechanics, service men, operators & owners. Explains theory, construction & servicing of modern motor cars, trucks, buses & auto type Diesel engines. 1700 pages, fully illustrated. 55 chapters. Indexed. A standard book for mechanics. New fluid drive covered.

AUDELS DIESEL ENGINE MANUAL..\$2

A practical, concise treatise with questions and answers on the theory, operation and maintenance of modern diesel engines including General Motors 2 cycle Diesel. 384 pages, fully illus., flexible binding, pocket size. All details plainly brought out, this book is of extreme value to engineers, operators & students.

AUDELS WIRING DIAGRAMS.....\$1

210 Pages. Illustrated. Gives practical facts on wiring of electrical apparatus. It shows clearly how to wire apparatus for practically all fields of electricity. Each diagram is complete & self-explanatory. Highly Endorsed Pocket Companion.

AUDELS PLUMBERS & STEAMFITTERS GUIDES—4 Vols.\$6

A Practical Trade Assistant & Ready Reference. Explains in plain language & by clear illustrations, diagrams, charts, graphs, pictures principles of modern plumbing practice including Marine Pipe Fitting and Air Conditioning. 4 Vols.—1670 Pages—3642 Diagrams. Pocket size. Each Vol. Sold Separately \$1.50 a Vol.

AUDELS SHEETMETAL WORKERS HANDY BOOK.....\$1

Practical inside information. Fundamentals of Sheet Metal Work. 388 pages. Illustrated. 11 sections. Clearly written. Essential & important facts, figures, pointers in everyday language. Ref. Index.

AUDELS SHEETMETAL PATTERN LAYOUTS.....\$4

Developed by Experts for Sheet Metal Workers, Layout Men & Mechanics. A Practical Encyclopedia in 10 Sections, size 7 x 10 x 2—1125 Pages—350 Layouts—1600 Illustrations. 1001 Key Facts. Fully indexed for ready reference in answering your layout problems. Covers all phases of sheet metal work including Pattern Cutting, Pattern Development & Shop Procedure.

AUDELS ANSWERS ON BLUE PRINT READING.....\$2

For Mechanics & Builders. Covers all types of blue print reading including ship & airplane. 416 pages, fully illustrated.

AUDELS NEW MACHINIST & TOOLMAKERS HANDY BOOK.....\$4

Covers modern machine shop practice in all its branches. 5 practical books in 1. New from cover to cover. Tells how to set up & operate lathes, screw and milling machines, shapers, drill presses and all other machine tools. 1600 pages, fully illustrated, 5 x 6 1/2 x 2. Indexed. 5 sections. 1—Modern Machine Shop Practice. 2—Blue Print Reading & How to Draw. 3—Calculations & Mathematics for Machinists. 4—Shop Physics. 5—How to Use the Slide Rule. 60 chapters. Easy to read and understand. A shop companion that answers your questions.

AUDELS MATHEMATICS & CALCULATIONS FOR MECHANICS \$2

Mathematics for home study or reference. 700 pages, 550 illus. Practical mathematics from beginning. How to figure correctly. Easy, correct methods covering complete review. Illus. & Indexed.

AUDELS HANDY BOOK OF PRACTICAL ELECTRICITY.....\$4

For maintenance engineers, electricians & all electrical workers. 1440 Pages, 2600 Illus. Covers important electrical information in handy form—including Marine Wiring, Radio Principles, Welding. Indexed. A Key to a practical understanding of electricity.

AUDELS RADIOMANS GUIDE.....\$4

A key to the practical understanding of radio including Frequency Modulation, Television, etc., Aircraft & Marine Radio. For radio engineers, servicemen, amateurs, 914 Pages, 633 Illustrations & Diagrams. Photos. Review Questions & Answers, Reference Index. Authentic, clear, concise.

AUDELS ELECTRONIC DEVICES.....\$2

Tells What You Want to Know About Electric Eye. Easily Understood. Covers photo-electric cells & their applications. Amplifiers, illumination, frequencies, voltage, photocell, tubes, Ohm's Law, wiring diagrams, etc.

AUDELS WELDERS GUIDE.....\$1

A concise, practical text on operation & maintenance of all welding machines for all mechanics. Over 400 pages, illustrated. Covers all methods of electric and acetylene welding including airplane work.

AUDELS, Publishers, 49 W. 23 St., N. Y. 10

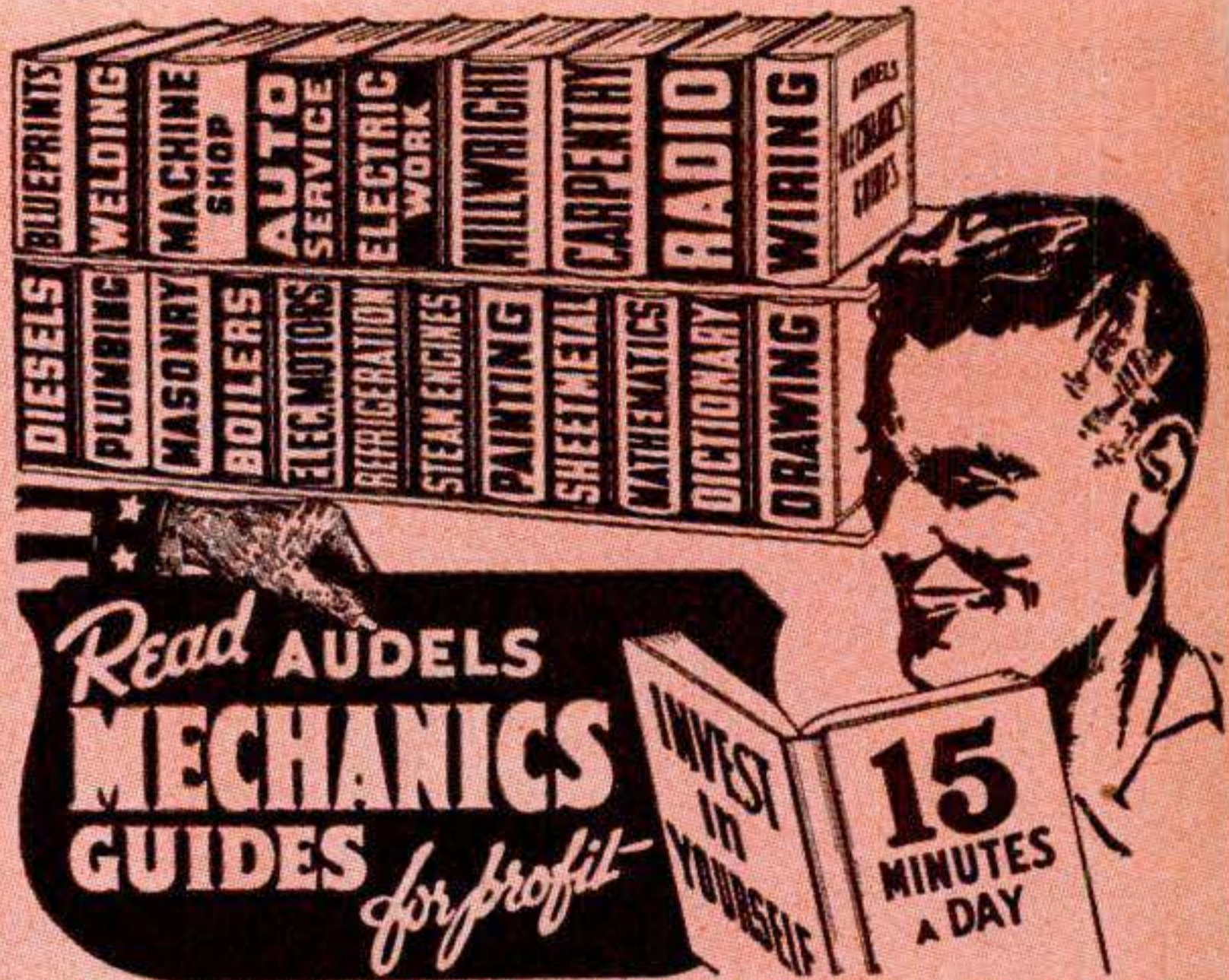

AN AUDEL GUIDE IS A GOOD FRIEND!

Step Up Your Own Skill with the Practical Facts and Figures of Your Trade. Save time and money with right methods, short cuts, labor saving ideas. CHECK NOW! You can look over any Audel Guide in your home. Start the Easy Payments if satisfied.

CUT HERE MAIL ORDER

THEO. AUDEL & CO., 49 W. 23 St., New York 10, N. Y.

Please mail me for 7 days' free examination the books marked (X) below. I agree to mail \$1 in 7 days on each book or set ordered, and to further mail \$1 a month on each book or set ordered until I have paid purchase price.

If I am not satisfied with Guides I will return them.

- Audels **ELECTRIC MOTOR GUIDE** \$4.
- Audels **OIL BURNER GUIDE** 1.
- Audels **REFRIGERATION & Air Conditioning Guide** 4.
- Audels **POWER PLANT ENGINEERS GUIDE** 4.
- Audels **PUMPS, HYDRAULICS & AIR COMPRESSORS** 4.
- Audels **WELDERS GUIDE** 1.
- Audels **BLUE PRINT READING** 2.
- Audels **SHEET METAL WORKERS Handy Book** 1.
- Audels **SHEET METAL PATTERN LAYOUTS** 4.
- Audels **AIRCRAFT WORKER** 1.
- Audels **MATHEMATICS and CALCULATIONS** 2.
- Audels **MACHINISTS & TOOLMAKERS Handy Book** 4.
- Audels **MECHANICAL Dictionary** 4.
- Audels **AUTOMOBILE GUIDE** 4.
- Audels **DIESEL ENGINE MANUAL** 2.
- Audels **MARINE ENGINEERS Handy Book** 4.
- Audels **MECHANICAL DRAWING GUIDE** 1.
- Rogers **MECHANICAL DRAWING and DESIGN** 2.
- Audels **MILLWRIGHTS and Mechanics Guide** 4.
- Audels **CARPENTERS and Builders Guides (4 vols.)** 6.
- Audels **PLUMBERS and Steamfitters Guides (4 vols.)** 6.
- Audels **MASONS and Builders Guides (4 vols.)** 6.
- Master **PAINTER and DECORATOR** 2.
- Audels **GARDENERS & GROWERS GUIDES (4 vols.)** 6.
- Audels **ENGINEERS & FIREMANS EXAMINATIONS** 1.
- Audels **ENGINEERS and Mechanics Guides** 12.
- Nos. 1, 2, 3, 4, 5, 6, 7 and 8 complete 12.
- Audels **Answers on Practical ENGINEERING** 1.
- Audels **ELECTRICIANS EXAMINATIONS** 1.
- Audels **WIRING DIAGRAMS** 1.
- Audels **Handy Book of PRACTICAL ELECTRICITY** 4.
- Audels **ELECTRICAL POWER CALCULATIONS** 2.
- Audels **ELECTRONIC DEVICES** 2.
- Audels **ELECTRIC Dictionary** 2.
- Audels **RADIOMANS GUIDE** 4.
- Audels **NEW ELECTRIC LIBRARY at \$1.50 a Volume** 4.
- Vols. I, II, III, IV, V, VI, VII, VIII, IX, X, XI, XII

Name _____

Address _____

Occupation _____

Employed by _____

PSM

NOW! ALL 5 FAMOUS JOWETT COURSES—1 COMPLETE MUSCLE BUILDING VOLUME! FOR ONLY 25¢

LET ME PROVE I can make YOU

AND MY PHOTO BOOK OF FAMOUS STRONG MEN! FREE!



COMMANDO-TOUGH OR IT WON'T COST YOU A CENT!

says George F. Jowett **WORLD'S GREATEST BODY BUILDER**

GIVE ME 10 MINUTES A DAY
Learn My Time Tested Secrets Of Strength

I'll teach you the "Progressive Power Method" through which I rebuilt myself from a physical wreck the doctors condemned to die at 15, to the holder of more strength records than any other living athlete or teacher! "Progressive Power" has proven its ability to build the strongest, handsomest men in the world. And I stand ready to show you on a money back basis—that no matter how flabby or puny you are I can do the same for you right in your own home. Let me prove I can add inches to your arms, broaden your shoulders, give you a man-sized chest, powerful legs and a Rock-like back—in fact, power pack your whole body so quickly it will amaze you! Through my proven secrets I bring to life new power in you inside and out, until YOU are fully satisfied you are the man you want to be.

PROVE IT TO YOURSELF IN ONE NIGHT

Send only 25c for my 5 easy-to-follow, picture-packed courses now in 1 complete volume "How to Become a Muscular He-Man". Try it for one night! Experience the thrilling strength that surges through your muscles.

10 DAY TRIAL
 Think of it—all five of these famous courses now in one picture-packed volume for only 25c. If you're not delighted with this famous muscle-building guide—if you don't actually FEEL results within ONE WEEK, send it back and your money will be promptly refunded!

I am making a drive for thousands of new friends fast—REGARDLESS OF COST!

SO GET NOW MY 5 Muscle Building COURSES (Valued at \$5 each) All in 1 Great Complete Volume Packed With How-To-Do-It Pictures! For 25c

Now, this "get-acquainted," extremely low price of only 25c is your chance to build a body you'll be proud of! Follow Jowett's easy method of muscle building NOW!

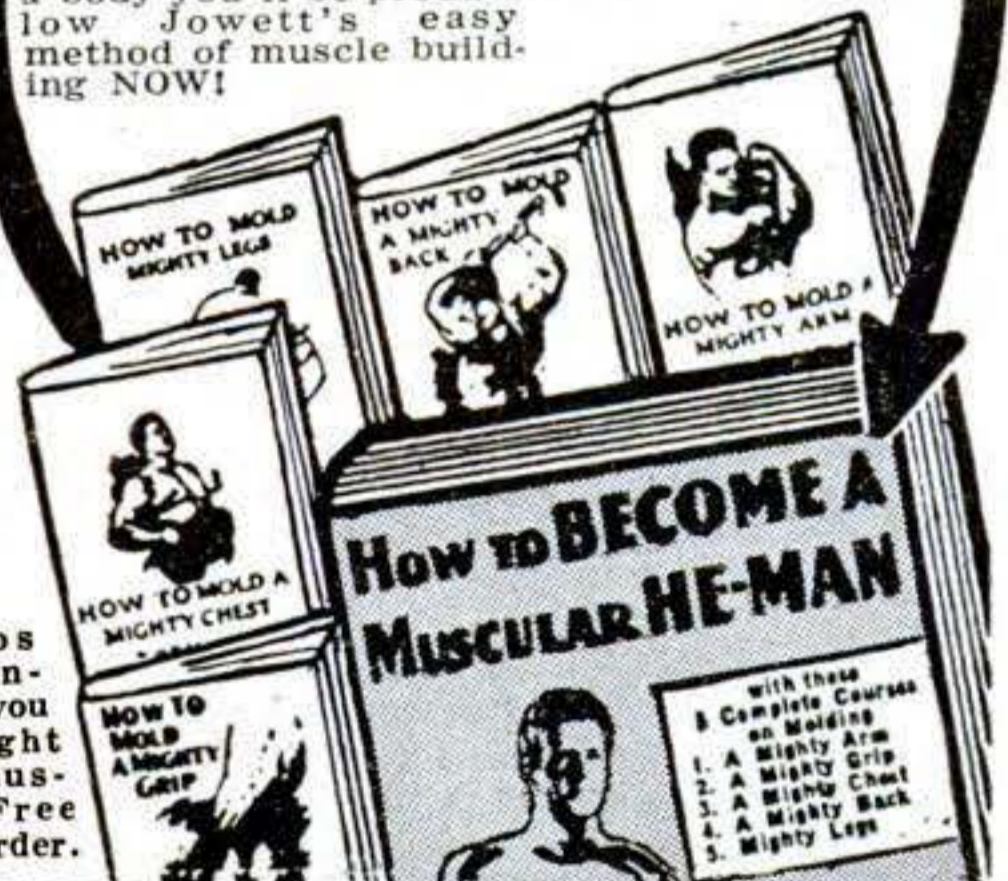

How to BECOME A MUSCULAR HE-MAN

With these 5 Complete Courses on Molding:

1. A Mighty Arm
2. A Mighty Grip
3. A Mighty Chest
4. A Mighty Back
5. Mighty Leg

PHOTO BOOK OF FAMOUS STRONG MEN! FREE!

Photos that inspire you to might and muscle. Free with order.



FREE GIFT COUPON!

Jowett Institute of Physical Culture Dept. PS-77
 230 Fifth Avenue, New York 1, N. Y.

George F. Jowett:—Please send by return mail, prepaid, FREE Jowett's Photo Book of Strong Men, along with all 5 Muscle Building Courses. 1. Molding a Mighty Chest. 2. Molding a Mighty Arm. 3. Molding a Mighty Grip. 4. Molding a Mighty Back. 5. Molding Mighty Legs—Now all in One Volume "How to Become a Muscular He-Man". Enclosed find 25c. NO C.O.D.'S.

George F. Jowett
Champion of Champions

NAME.....AGE.....
 (Please Print Plainly, Include Zone Number)

ADDRESS.....

OPPORTUNITIES AHEAD!
TRAIN FOR A FUTURE IN DIESEL



Prepare for the big earning power of Diesel Trained Men. Start learning at home, in spare time. UEI's easy, practical training covers all phases of DIESEL engine operation, fuel systems, auxiliary equipment, repairs and maintenance. When home course is completed, you come to Chicago for actual shop practice on DIESEL MOTORS under expert instructors, at UEI's fine, modern school. BEGIN AT ONCE—GET ALL THE FACTS FREE. WRITE TODAY!

DIESEL DIVISION UTILITIES ENGINEERING INSTITUTE
 2521 Sheffield Ave. • Dept. 377-D • Chicago 14, Illinois

EASY WAY TO LEARN RADIO AT HOME

I send you 8 KITS of Radio Parts, including Complete 6-Tube Superhet

Theory alone is the bunk! It takes "Service Bench" practice to learn Radio right! My Course supplies the Equipment you need, shows you how to wire, connect, solder, build Circuits . . . how to test and repair all kinds of Radio-Electronic Equipment. Beginners learn fast! To get full details, send postal for FREE BOOKS:—"How to Make Money in Radio, Electronics and Television", and "How to Read Radio Diagrams and Symbols".

SPRAYBERRY ACADEMY OF RADIO Room 5577, Pueblo, Colorado

PHOTOGRAPHY for PLEASURE or PROFIT

Qualify at Home! Learn expert photography as a joy-full hobby, or to qualify for a well-paid position or your own studio. Previous experience unnecessary with N.Y.I.'s success-proved home study training. Details FREE. Also resident courses.

NEW YORK INSTITUTE OF PHOTOGRAPHY, Dept. 5
 10 West 33 St., New York 1, N. Y. (37th Year)

WANT TO EARN MORE MONEY?

Learn SILK SCREEN PROCESS At Home. FREE big illustrated Book explains how my training enables you to start your own successful business or train for a better job in this well paid, uncrowded Advertising Field. Learn and Earn in your spare time. Course includes Complete Kit of Supplies. Write TODAY for your Copy.

CALIFORNIA SCHOOL OF SCREEN PROCESS
 Dept. PS77, 3740 Overland Blvd., Los Angeles 34, California

LEARN MEAT CUTTING At Home—In Spare Time



Get into the vital meat industry. Concise, practical Home Training based on 25 years proven instruction methods used at National's famous resident school. Prepares you for bigger pay as Meat Cutter, supervision, market manager or more money in your own store. Go as rapidly as your spare time permits. Diploma. Start NOW to turn your spare hours into money. Send for FREE bulletin today. No obligation.

National School of Meat Cutting Inc., Dept. O-56, Toledo 4, Ohio

MARCOT KEY MACHINE

Immediate Delivery



Marcot No. 8 Key Machine Mounted on Cabinet.....	\$ 82.50
Book on Modern Locksmithing....	3.95
Auto Code Book and Auto Depth Keys	12.50
162 Doz. Popular Key Blanks....	77.76
Set Key Files, Tools, Pins, Springs, Thimble.....	10.50
	\$187.21

A. J. MARCOTTE CO., 1200 N. KEDZIE AVE. DEPT. PS, CHICAGO 51, ILL.

NOW CHANITE SELF-WELDING FLUX—REPAIRS all ELECTRIC HEATING ELEMENTS. So simple anyone can make repairs in your broken or burnt-out electrical appliances—irons, toasters, stoves & etc. Guaranteed nothing like it. From our mines to your appliances. \$1.00 per package. \$7.50 per doz. Stick form 25c. \$2.00 per doz.

CHANITE SALES COMPANY, 914 South Main, Fort Worth 4, Texas

A PENNY POSTCARD MAY CHANGE YOUR FUTURE...



Get full information on the coin-operated vending machine industry. Start with a few machines and build a wonderful future. We'll give you complete advantage of our "know-how." Send for Free Booklet Today—No Routes Sold!

PIONEER VENDING SERVICE
 ADDRESS ALL MAIL TO DEPT. PS
 461 SACKMAN ST. • BROOKLYN 12, N. Y.

PATENT PROTECTION *for* INVENTORS

A PATENT IS A VALUABLE RIGHT

On the basis of a provision in the Constitution of the United States, Congress has established a system under which inventors may secure the exclusive right to prevent the unauthorized use, manufacture and sale of their inventions for periods of seventeen years. The inventor secures this protection by obtaining a patent from the United States Patent Office.

VICTOR J. EVANS & CO., has a staff of experienced registered patent attorneys, available to assist inventors in the preparation and prosecution of their cases before the Patent Office. Detailed information and the steps to be taken in obtaining patent protection will be furnished upon request.

FORM BELOW FOR MAILING CONVENIENCE

**VICTOR J.
EVANS & Co.**

Merlin M. Evans

REGISTERED PATENT ATTORNEY

240-H Merlin Building, Washington 6, D. C.

Please forward to me detailed information regarding procedure to obtain Patent Protection, together with your convenient "Evidence of Invention" form.

Name.....

Address.....

City and State.....

PATENTS • TRADEMARKS • COPYRIGHTS

JULY 1947 21

Learn this Profitable Profession



IN 90 DAYS AT HOME

Money-Making Career Open to Men and Women, 18 to 50

Hundreds of men and women between 18 and 50 make \$10 to \$20 in a single day giving scientific Swedish Massage and Hydro-Therapy treatments. There is big demand from doctors, hospitals, sanatoriums and clubs. Graduates earn large full time incomes from these or in private practice in their own offices. Others make good money from home treatments given in spare time. Learn this interesting, money-making profession in your own home, through our home study course. Same instructors as in our nationally known resident school. You can win independence and prepare for future security by qualifying for your Diploma. Course can be completed in 3 to 4 months. Many earn while they learn. Begin your training at once.



Anatomy Charts & Booklet FREE

Enroll now and we will include, at no extra cost, many needed supplies. Fit yourself to help meet growing demand for Scientific Swedish Massage. Send the coupon at once for complete details, Anatomy Charts and 32-Page Illustrated Booklet, FREE, postpaid.

THE COLLEGE OF SWEDISH MASSAGE
Dept. 770H, 100 East Ohio St., Chicago 11, Illinois

Please send me FREE and postpaid, Anatomy Charts, 32-page Booklet and complete details on Home Training.

Name.....

Address.....

City..... State.....

AVIATION Career

MAXIMUM TRAINING IN MINIMUM TIME

CAL-AERO TECH TRAINING will add dollars to your pay check all the rest of your life. Specializing in AERONAUTICAL ENGINEERING and MASTER AVIATION MECHANICS since 1929, Cal-Aero Tech training is carefully designed for just one thing—TO MAKE MORE MONEY FOR YOU. An alumni of over 6000 successful graduates proves our career training is unsurpassed.

VETERANS —Write us about Aviation Training, as provided under "G.I. Bill of Rights."



CAL-AERO TECHNICAL INSTITUTE
MAJOR C. C. MOSELEY PRES. SINCE 1929
FORMERLY CURTISS-WRIGHT TECHNICAL INSTITUTE

GRAND CENTRAL AIR TERMINAL
GLENDALE 1, CALIFORNIA
LOS ANGELES COUNTY

MAIL THIS COUPON TODAY!

Cal-Aero Technical Institute, Grand Central Airport, Glendale 1, California
Please send full information on Aviation Training FREE—without obligation. Dept. PS-7

Name..... Birth Date.....

Street.....

City..... State.....

NORTHWESTERN GI APPROVED VOCATIONAL INSTITUTE

SUMMER CLASSES IN TELEVISION

Your opportunity is now. Learn the NORTHWESTERN way from skilled, highly trained instructors.

- Radio Maintenance
- Radio Communications
- FM
- Industrial Electronics

Day or night classes. New courses start every 30 days. Study in the heart of the Land O' Lakes. Don't let this opportunity pass. It's up to you! Write for free facts today!!



NORTHWESTERN VOCATIONAL INSTITUTE
Dep't. PS-7
745 Grand Ave., St. Paul 5, Minn.

ELECTRICAL TRAINING

Intensive 32 weeks residence course in fundamentals of industrial electrical engineering, including radio, electronics. Prepares for technician, engineering aides. Approved for veteran training. 54th year. Write for catalog.

BLISS ELECTRICAL SCHOOL
7612 Takoma Ave., Wash. 12, D.C.



"YOU ARE UNDER ARREST!"



Help Bring Crooks to Justice Through Scientific CRIME DETECTION!

I have taught thousands this exciting, profitable, pleasant profession. Let me teach you in your own home. Learn Finger Printing, Firearms Identification, Police Photography, Secret Service Methods thoroughly, quickly, at small cost. 53% of all American Bureaus of Identification employ I. A. S. students or graduates. I can prepare you for this fascinating work, during spare time. Write today, stating age, for "Blue Book of Crime."

INSTITUTE OF APPLIED SCIENCE, 1920 Sunnyside Ave., Dept. 136-B, Chicago 40, Ill.

THERE'S MONEY IN CARTOONS!

RAYE BURNS will teach you HOW to CREATE ORIGINAL CARTOONS at home that you may SELL! Course contains 26 lessons and over 600 illustrations. All for Only.. **\$2.85**

Send name and address for free details.

RAYE BURNS SCHOOL, Dept. 8, Box 3583, CLEVELAND, OHIO

What Every Mason Wants



We have Important Masonic books for Blue Lodge, Chapter, Commandery, Scottish Rite, and Shrine.

OUR RITUALS ARE USED THE WORLD OVER
Send for free catalog of books and rituals for Masons, Odd Fellows, Knights of Pythias, Knights of Columbus, etc.
EZRA A. COOK, Publisher, P. O. 796, RJ Chicago 90, Ill.

GOLD TEETH WANTED

Dental gold teeth, plates and bridges with metal attached. Any broken pieces of gold jewelry. Immediate payment and free mailing container to you or your friends upon request.
LOWES, DEPT. PS, Holland Bldg., St. Louis 1, Mo.



GOVERNMENT JOBS

START \$1756 TO \$3021 YEAR

Prepare Now for next Examinations. Vets get preference. MEN-WOMEN. Mail Coupon Today.

Franklin Institute, Dept. K82, Rochester 4, N.Y.
Sirs: Rush without charge, (1) 32-page book with list of U. S. Government Jobs; (2) Tell me how to prepare for one.

Name.....
Address.....
.....Vet?.....

CHICAGO
ILLINOIS

DEFOREST'S TRAINING, INC.

AFFILIATED WITH DE VRY MOTION PICTURE COMPANY, CHICAGO



Step Out in Front in RADIO-ELECTRONICS

...LET US SHOW YOU HOW!

VETERANS!

Both the Home Study and Chicago Laboratory courses of DeForest's Training, Inc. are accepted for your training. If you qualify under the "G.I. Law," you may obtain either training without cost to you.

No previous radio or electrical experience is necessary.

YOU CAN BUILD 7 DIFFERENT RADIO RECEIVERS

You "Learn-By-Doing" at home from 8 big Kits of radio parts and assemblies (similar to the equipment shown here). You build 7 different radio receiving circuits and dozens of other fascinating projects.

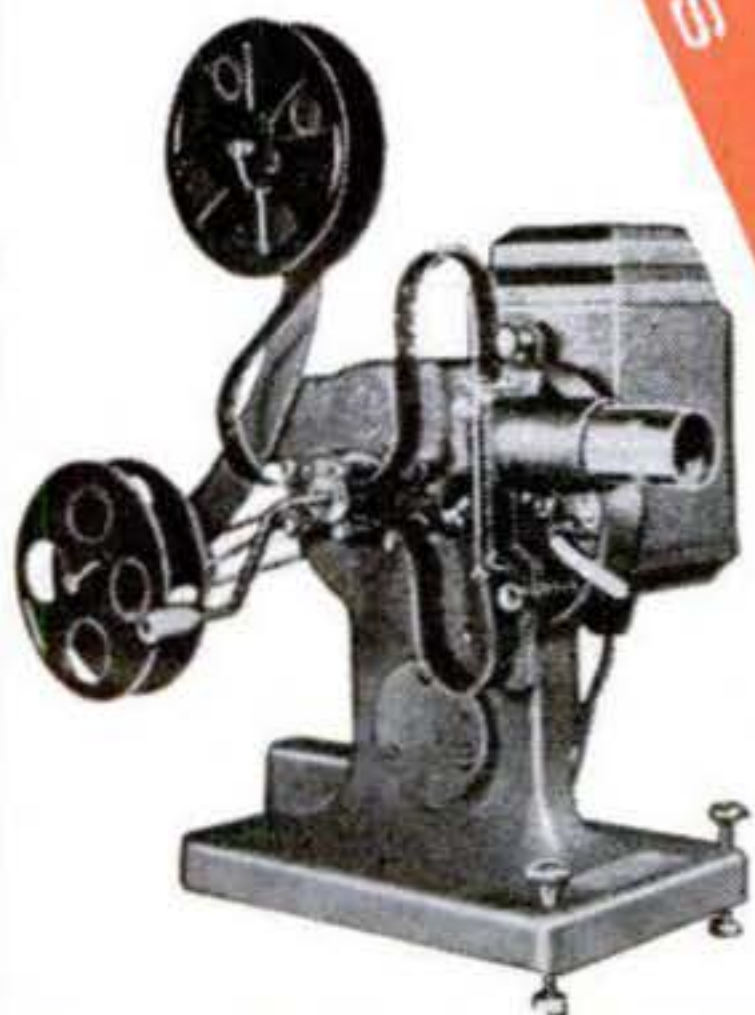

You use "learn-by-seeing" movies. We supply you with a 16mm Motion Picture projector and 12 reels of information-packed film.

DeForest's Training, Inc. includes instruction in motion picture sound equipment, F.M. Radio and Television. In addition to our Home Study courses, RESIDENTIAL TRAINING is available in our new, modern Chicago laboratories. Ask us for information regarding same.

Distinguish yourself as a leader. Get the real money, the better opportunities which go with leadership and initiative. Let us show you how you may find all of these things in the opportunity-packed fields of Radio and Electronics. Begin your training today so you will be prepared for leadership and opportunity tomorrow — either on a payroll or in a profitable business of your own.

Whether you are an ex-G.I., a teen-age youth or an older man, there can be a place for you in these fascinating fields.

Mail coupon below right now for late facts about the exciting events in F.M. Radio, Broadcast Radio, Motion Picture Sound, Electronics, Sound Recording, the future developments in Radar and other branches.

You don't have to know a thing about Radio and Electronics. Over a period of 15 years, DeFOREST'S TRAINING, INC. has perfected a method of home training that GETS RESULTS.

We provide, for use in your own home, a BIG FOUR method that includes (1) commercial type Radio-Electronic parts and assemblies for valuable "LEARN-BY-DOING" experience at home; (2) a 16 Mm Motion Picture Projector and 12 reels of action-packed "LEARN BY SEEING" instructive movies to speed your understanding of important principles at home; (3) many easy-to-read loose-leaf lessons illustrated with handy fold-out diagrams; and (4) an effective EMPLOYMENT SERVICE to help you get started toward a good Radio Job when trained — or to assist you in starting your own Radio Business.

EMPLOYMENT SERVICE

Our effective Employment Service goes to work immediately upon the completion of your course to help you get started.



YOU CAN BUILD 133 FASCINATING EXPERIMENTS

DeFOREST'S TRAINING, INC.
2533-41 N. Ashland Ave., Dept. PS-D7.
Chicago 14, Illinois, U.S.A.

Send me your big book "VICTORY FOR YOU" showing how I may make my start in Radio-Electronics with your modern home training plan. No obligation.

Name _____ Age _____

Address _____ Apt. _____

City _____ Zone _____ State _____

If under 16, check here for special information.

If a discharged veteran of World War II, check here.



LET HOLLYWOOD EXPERTS HELP YOU



MAKE GOOD IN
RADIO
TELEVISION
ELECTRONICS



LEARN FROM MEN CLOSEST TO RADIO-TELEVISION INDUSTRY!

Direct from Hollywood, center of America's Broadcasting, Television, Radio, Sound activities comes easy-to-learn, advanced home-instruction that quickly qualifies you for **Steady, Good-Pay Jobs** or business in Radio, Television, Electronics.

GET RADIO SHOP KNOW HOW

Radio Training Association of America's (R.T.A.) **Professional Methods** assure quick step-by-step success. R.T.A. is located right "on-the-spot" where new technical developments are introduced. You receive finest shop-type instruction in latest Radio-Television techniques. Every R.T.A. student **Gets Unlimited Consultation** from Hollywood on any subject pertaining to studies.

EXTRA MONEY WHILE LEARNING

When you enroll with R.T.A. you get **SPARE TIME JOB SHEETS** showing how

to earn extra money while being trained by R.T.A.'s **Hollywood Experts**. When friends, neighbors know you are studying radio, ample repair jobs are practically assured for you.

GET FACTS—Send for **FREE Book** telling about R.T.A.'s streamlined training plan developed by veteran technicians in Hollywood, heart of vast Radio-Television field. Mail coupon today. **Send for Free Illustrated Book** showing newest Radio-Television pictures. No obligation. **Approved for Veterans**. Send for big free book now!



RADIO TRAINING ASSOCIATION OF AMERICA

RADIO TRAINING ASSOC. OF AMERICA, DEPT. PS7
5620 Hollywood Blvd., Hollywood 28, Calif.

Send **FREE BOOK** showing how to make good in Radio-Television through training by Hollywood experts.

NAME _____ AGE _____

ADDRESS _____

CITY _____ ZONE _____ STATE _____

Check box if **VETERAN** of World War II

5620 HOLLYWOOD BLVD · HOLLYWOOD 28, CALIF.

Do you want

- .. to go to College?
- .. or to enter a Profession?
- .. or get an Office Position?

(Such as Accounting, Architecture, Nursing, Dentistry, Teaching, Social Work, Osteopathy, Beauty Culture, Optometry, Embalming, Chiropody, Law, Medicine, etc.)

To get anywhere, you practically **MUST** finish High School **FIRST**. You can complete our simplified High School Course in **SPARE** time at home, as **FAST** as your time and abilities permit. Equivalent to resident school work—prepares you for college, pre-professional examinations, business, industry. Standard texts furnished. Diploma. Credit for H.S. subjects already completed. Single subjects if desired Low tuition, easy terms. American School, Chicago, est. 1897—endorsed by educators. Finish your high school education **NOW**. Write **TODAY!**

High School Course at Home

Many Finish in 2 Years

American School, Dept. HB46, Drexel Ave. at 58th St., Chicago 37

Gentlemen: Send me **FREE** information covering special training in subjects checked below. No obligation on my part.

- | | |
|--|--|
| <input type="checkbox"/> High School Course | <input type="checkbox"/> Diesel Engineering |
| <input type="checkbox"/> Electronics, Industrial | <input type="checkbox"/> Drafting and Design for Men and Women |
| <input type="checkbox"/> Architecture and Building | <input type="checkbox"/> Plastics |
| <input type="checkbox"/> Automotive Engineering | <input type="checkbox"/> Private Secretary |
| <input type="checkbox"/> Business Management | <input type="checkbox"/> Mechanical Engineering |
| <input type="checkbox"/> Electrical Engineering | <input type="checkbox"/> Aviation |
| <input type="checkbox"/> Elec. and Gas Refrigeration | <input type="checkbox"/> Salesmanship |
| <input type="checkbox"/> Air Conditioning | <input type="checkbox"/> Radio |
| <input type="checkbox"/> Railway Training | |

Name.....

Address.....

Learn Penmanship

One should learn **Rapid Business Writing**, both for his own satisfaction and for the convenience of those who must read it. And if **Fancy Shaded Writing** is learned also, it makes one a still more skillful penman. **Good penmanship** prevents costly errors and helps to secure and hold good positions, and, like music or elocution, naturally attracts persons of refinement and artistic inclinations. If you are dissatisfied with your present handwriting and wish to become a **good writer**, write for my **FREE BOOK**, "How to Become an Expert Penman," which contains specimens of penmanship and shows what others have learned by my **Simplified Method**. If you enclose 10c, I will send you one of my Favorite Pen Points suitable for plain or shaded writing, and your name with a beautiful flourished bird written on a card. **Begin Now. Write for your copy of the Free Book today.**

T. M. TEVIS, BOX 25-R, CHILLICOTHE, MO.



CORRESPONDENCE COURSES IN RADIO and ELECTRICAL ENGINEERING

Tuition \$25

ELECTRICAL ENGINEERING. Get good grasp of wide electrical field. Modern. Very understandable. Theory made easy.
RADIO ENGINEERING. Extra fine course in radio, public address, photo-electric work. Trains you to be super-service man, real vacuum tube technician. Tuition **ONLY \$25.** either course. Deferred payment plan. Servicemen needed badly.

FREE Write for free copies of school catalogs, student magazines, etc.
LINCOLN ENGINEERING SCHOOL, Box 931-S-103 LINCOLN, NEBR.

LAW

STUDY AT HOME for **PERSONAL SUCCESS** and **LARGER EARNINGS**. 38 years expert instruction—over 108,000 students enrolled. LL.B. Degree awarded. All texts furnished. Easy payments. Send for **FREE BOOK**—"Law and Executive Guidance."

AMERICAN EXTENSION SCHOOL OF LAW, Dept. 79-S, 646 N. Michigan Ave., Chicago 11, Ill.



Giffy ELECTRIC HEATER

HOT WATER IN FIVE MINUTES

For baby's bath, your washing, shaving and many other uses in the home, camping, business or on the farm.

One Year Guarantee
See your local Dealer or order direct . . .

AMBORY CORPORATION
Dept. PS-4 Hazel Park, Michigan



ILLUSTRATED COMIC BOOKLETS

THE KIND MEN LIKE!
(VEST POCKET SIZE)

They are loaded with rare cartoons. Full of Fun and Humor. **20 DIFFERENT** booklets sent prepaid for \$1 in plain wrapper. Sorry . . . no C.O.D.'s.

GRAYKO, Dept. 1070. Box 520, G.P.O., N.Y.C. 1

SELL MERCHANDISE by Mail

OPERATE Profitable Lifetime Business Selling Merchandise by Mail. Large Profits on Fast Selling \$1.00 Items. **WRITE TODAY!**

POWELL CO. DEPT. C SAMLINER BLDG., CLEVELAND 3, OHIO

Learn BAKING At Home

Baking is one of America's high industries in wages. Nearly depression-proof. Thorough basic home course lays sound foundation. If you have aptitude, write for **FREE BOOKLET**, "Opportunities in Commercial Baking."

National Baking School, 1315 Mich. Ave., Dept. 136B, Chicago 5

AGENTS SIGN LETTERS

300% Profit
For Store Fronts and Office Windows. Anyone can put them on. Free Samples. Liberal Offer to general agents.

METALLIC LETTER CO., 441 N. Clark, Chicago 10



RHEUMATISM

'ARTHRITIS-NEURITIS-SCIATICA'

If you suffer the agonizing pains of these diseases when the usual remedies have failed, learn about a new trustworthy, modern, non-surgical treatment method. This marvelous treatment is completely explained in the **Ball Clinic's FREE Book**. Write today. No obligation.
BALL CLINIC Dept. 36 Excelsior Springs, Mo.



Now Any **AUTO REPAIR JOB** Can Be "Duck Soup" For You!

**MoToR's New AUTO REPAIR MANUAL
 Shows You How to Service and Repair
 ANY Part of ANY Car!**

**FREE 7-DAY
 OFFER!**



NOW you can "polish off" the HARDEST jobs the EASIEST way! MoToR's AUTO REPAIR MANUAL is ready to show you how to repair anything from carburetor to rear end—with the *least* possible amount of time and effort!

Suppose plain-talking car engineers from every auto plant in America got together and showed you all the things you needed to know about repairing and servicing the cars *they* had designed and manufactured! That's really what you get in this big manual! Right at your fingertips, the main "dope"

from 150 Official Factory Shop Manuals, covering every make car built since 1935!

Easy to use, too! Quick-index leads you to right page in jiffy! Just follow simple instructions step-by-step.

SEE HOW MUCH YOU GET!

856 pages, 8½x11 inches, bound in sturdy covers. 200,000 service, repair, adjustment, replacement, tune-up facts on all makes and models, built from 1935 through 1946! More than 1000 cut-away photos, diagrams, drawings show you exactly WHAT to do and HOW to do it. Used by U. S. Army, trade and technical schools everywhere, thousands of auto servicemen.

Now YOU — without cost — can see for yourself what a wonderbook MoToR's Auto Repair Manual really is. Try it—FREE—for 7 days! Learn first-hand how it can pay for itself the first few times you use it.

SEND NO MONEY

7-Day Free Examination

Just mail coupon at right, without money! When the postman brings your book, pay him nothing. First make it show you what it's got! Unless you agree this is the greatest time-saver and work-saver you've ever seen — return book in 7 days and pay nothing. Mail coupon today! Address: MoToR Book Dept., Desk 2H, 572 Madison Ave., New York 22, N. Y.

Published by MoToR, The Leading Automotive Business Magazine. MoToR's manuals assure high standards of repair work.

Covers All These Makes!

American	Lincoln
Bantam	Zephyr
Auburn	Mercury
Austin	Nash
Buick	Overland
Cadillac	Oldsmobile
Chevrolet	Packard
Chrysler	Pierce Arrow
Cord	Plymouth
Crosley	Pontiac
De Soto	Reo
Dodge	Studebaker
Ford	Terraplane
Graham	Willys
Hudson	
Hupmobile	
Lafayette	
La Salle	
Lincoln	

**USED BY
 U. S.
 ARMY**

Clear, Pictured Facts on Every Job on Every Car Built Since 1935!

Nearly 200,000 service and repair facts on all 31 makes. 856 big pages; including 50 pages of carburetor text, charts, illustrations, covering all models. Over 500 charts, tables; Tune-up Chart; Valve Measurements; Compression Pressure; Torque Wrench Reading; Starting Motor; Engine Clearances; Generator; Clutch & Brake Specifications; Front End Measurements, etc., Engines; Electric, Fuel, Cooling, Lubricating Systems; Transmissions; Universals; Front Ends; Wheels; Rear Ends, etc.

Same FREE 7-Day Offer Applies on MoToR's TRUCK REPAIR MANUAL

For mechanics, truck specialists, service stations, fleet owners. Covers EVERY job on EVERY truck made since 1936! 1400 pictures, 952 pages, 300,000 facts. Used by Armed Forces.

All types Gasoline Engines, Diesels, Hesselman, Fuel Systems, Governors, Lubrication Systems, Ignition Systems, Starters, Generators, Clutches, Transmissions, Axles, Torque Dividers, Transfer Cases, Brakes, Steering, etc.

ALSO SERVICES buses, farm and industrial tractors, contractor and road building equipment, stationary power machinery, etc. (on all parts described in Manual.)

Check box in coupon at right.



MAIL COUPON NOW FOR 7-DAY FREE TRIAL

MoToR Book Dept., Desk 2H, 572 Madison Ave., New York 22, N. Y. Rush to me at once: (check box opposite book you want)

MoToR's AUTO REPAIR MANUAL. If O.K., I will remit \$1 in 7 days, (plus 35c delivery charge), then \$2 monthly for 2 months, with a final payment of 95c one month later. (Book's price \$5.95). Otherwise I will return book postpaid in 7 days. (Foreign price, remit \$8 cash with order).

MoToR's TRUCK REPAIR MANUAL. (Described at left.) If O.K., I will remit \$2 in 7 days, and \$2 monthly for 3 months, plus 35c delivery charges with final payment (\$8.35 in all). Otherwise I will return book postpaid in 7 days. (Foreign price, remit \$10 cash with order).

Print Name _____ Age _____

Print Address _____

City _____ Zone No. _____

(if any)

State _____ Occupation _____

SAVE 35c! Check here if enclosing full pay. (check, m.o.) WITH Coupon. We pay 35c shipping costs. Same 7-day return-refund privilege.

NOT A KEY JOB OR A BUSINESS OF YOUR OWN!

BIG OPPORTUNITY

REFRIGERATION—AIR CONDITIONING

Take a good look at the man you envy. What has he got that you haven't got? The chances are his success is simply a matter of training. He knows his job. He is a specialist in his field.

Why, then, should you be content with a small job at small pay. The door to opportunity is open today—wider than ever before. Now is the time to do something about your future.

Take a friendly tip. Investigate the field of Refrigeration & Air Conditioning. Here is an industry that offers every opportunity you could ask . . . good jobs, security—plenty of chance for advancement—a business of your own.

The Industrial Training Institute, largest and most completely equipped school of its kind in the world, will give you the practical training you need. You can start at home without giving up your present job and when you have completed your theoretical training, we will bring you to Chicago where you will learn the practical "know-how" by working on actual equipment in our big, expertly staffed shops.

No advanced schooling is needed. Our unique proved methods make everything easy to grasp. We've trained thousands. Pay as you go. Quit when you want to. But in any case our first responsibility is to prepare you for a better job and a happier future. And after you have graduated you enjoy all the advantages of our life-time employment service—wherever you go, whenever you need it.

FACTS ABOUT THE INSTITUTE

Founded in 1916. Has trained more than 400,000 men for practical work in industrial fields. From 1942 through 1945 trained specialized technicians, exclusively, for the Army, Navy and Marine Corps. Now training thousands of veterans under the G.I. Bill, both in its Residence Schools and by home-study. Occupies five buildings of its own. Has over \$500,000 invested in training facilities, with an instruction staff of more than 100 men. Known everywhere as America's foremost school of practical training for industry.

ACT NOW

Don't delay. Time is passing fast. Mark and mail the coupon below. It will bring you, without obligation, full details of this and other courses, from which you may choose. Take the step that may be the turning point in your career to a better job and bigger earnings.

SEND FOR THIS BOOK —IT'S FREE



Industrial Training Institute,
Lawrence Ave., Dept P2GR Chicago 25, Ill.
I am interested in getting ahead. Send me FREE
of your "Camera Visit" book. I would like to train
_____ (name field).

Are you a Veteran _____

GET THE FACTS ABOUT AMERICA'S FOREMOST SCHOOL OF PRACTICAL TRAINING



Be A MASTER PLUMBER
Earn \$15 To \$50 A Day

DON'T ENVY THE PLUMBER—BE ONE

Every skilled workman will tell you that Plumbers have the best of it. WINTER and SUMMER the Plumber is busy at top wages. No skilled Plumber is ever out of a job—compare his opportunities with any trade, plus the opportunities of having your own shop. We teach you Plumbing with TOOLS (not books) under Licensed Master PLUMBERS in one of the finest equipped schools in America. We make you a Plumber, every branch is taught thoroughly—Lead Work—Blueprint for plan reading—all other tricks.

LEARN IN 30 WEEKS WITHOUT PREVIOUS EXPERIENCE

If you like to work with tools you owe it to yourself to investigate. No need to ever work as an apprentice. Get free bulletin. Write now! G.I. APPROVED. Our 24th year.

UNIVERSAL PLUMBING SCHOOL
819 HOLMES STREET KANSAS CITY, MO.

INDIANA TECHNICAL COLLEGE

B.S. degree in 27 mos. Aeronautical, Chemical, Civil, Electrical, Mechanical and Radio Engineering. 2-yr. diploma. Air Conditioning, Refrigeration, GI approved. Low rate. Earn board. Demand for grads. Enter Sept., Dec., March, June. Catalogue. 677 E. Washington Blvd., Ft. Wayne 2, Ind.

TRI-STATE COLLEGE

B.S. Degree in 27 months in Engineering (7 branches), Bus. Admin., Acctg. and Sec. Science. Graduates successful. 64th year. Enter Sept., Jan., March, June. Write for catalog. 577 College Ave., Angola, Ind.

\$500 to \$2,000 PER MONTH!

Men or Women! Your own boss—no canvassing! Would you pay \$5.49 for guaranteed blueprints franchise & all details of proven small business making thousands independent? Forget strikes and time clocks. Airmail \$1 bill—refundable—to
Frostie Shop, 511 Frederick, San Francisco



Begin today. Write now for our Free Book, "How to Become a Good Penman." It contains specimens and tells how others learned to write in spare time. Enclose 10c for your name beautifully written and a pen point suitable for shaded writing. Write today.
THE TAMBLYN SCHOOL OF PENMANSHIP
N-439 Ridge Building, Kansas City, Mo.



TALK-SING thru your own radio
with **RADIO MICROPHONE**



Be the life of the party. Put on your own broadcasts at home. Talk-Sing, make announcements from any room. Wonderful voice practice. Microphone easily attached to any radio. Follow enclosed instructions. SEND NO MONEY—pay Postman \$1.98 plus postage. Send Money Order or check and save postage.

EMPIRE RADIO & TELEVISION CO. (Dept. R1) 1521 Bedford Ave., Brooklyn 16, N. Y.

BIG MONEY IN YOUR OWN BUSINESS

• Amazing, scientifically developed LIQUID IMITATION MARBLE, FIBER-TITE, FLOORING, FLEXIBLE MOLDS brings you a fast money making opportunity. Work full or spare time and make big profits. Experience unnecessary. No large investment required. Work from your home. Write for FREE CATALOG and full details.
COMPOSITION PRODUCTS CO. Dept. PS-7, 5853 Delmar St. Louis 12, Mo.

MINERALS

The most complete handbook on the subject ever published; with every step in identification and analysis clearly explained and illustrated in full color.

IDENTIFICATION AND QUALITATIVE CHEMICAL ANALYSIS OF MINERALS—By Orsino C. Smith, A. B., A. M.

At last, all the facts about all minerals between the covers of one great book! More than 2,000 minerals listed and classified by specific gravity and hardness. Hundreds of beautiful, full-color photographs and illustrations. Complete directions for determining any known mineral from its physical properties—index of refraction, color, streak, lustre, cleavage, fracture, fusibility, etc.—all organized for instant practical use. **\$6.50**

D. VAN NOSTRAND COMPANY, INC. 250 Fourth Avenue, New York 3, N. Y. **EXAMINE THIS GREAT BOOK FREE**
Please send me a copy of "Identification and Qualitative Chemical Analysis of Minerals". Within 10 days, I will either return the book or send you \$6.50 plus a few cents postage.
Name _____
Address _____
City _____ Zone _____ State _____
Pop Sci.-July 1947

GET INTO RADIO

TELEVISION ELECTRONICS NOW!



You build this complete, modern superheterodyne receiver with the equipment that comes with your National Training at no cost.

This practical shop instruction system gives you actual experience with a Home Radio Laboratory—part of the

SHOP METHOD HOME TRAINING

by a real resident trade school with its own television and broadcasting studios

SHOPS AND LABORATORIES

FOR YOU—A REAL HOME LABORATORY IN MODERN RADIO

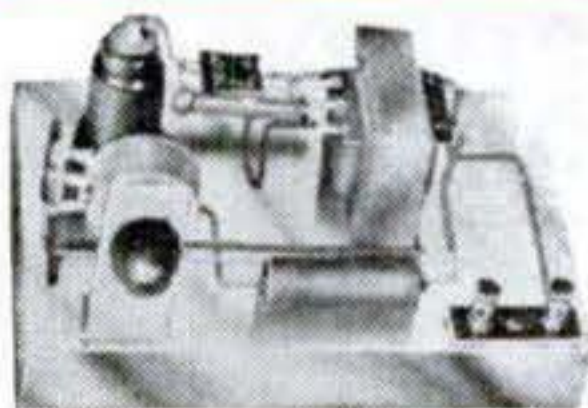

Your National Training Kits include equipment for over a hundred practical electronic experiments in your own home. You

get standard radio parts for this audio oscillator which you get to understand by building it yourself.

You learn modulation, beat frequencies, signal generation by actually building this small radio transmitter with your National shop parts. Your training outfits from National are made up of the most modern radio equipment—

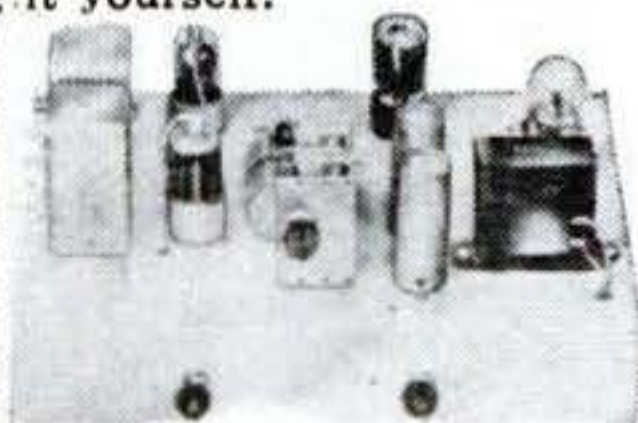

much of it just out of the experimental laboratory. You learn new ways of handling equipment by modern methods. Get the details by mailing the coupon.



ern methods. Get the details by mailing the coupon.

Send the coupon below immediately. Learn how this improved practical training can fit you for the GREAT BUSINESS OF RADIO—for the NEW AND RAPIDLY EXPANDING FIELD OF FREQUENCY MODULATION (F.M.), TELEVISION AND ELECTRONICS.

This is the thoroughly proved method used so extensively in wartime training—endorsed by the success of National men everywhere—a system by which you study in spare time—off hours, even minutes right in your home and yet have the ADVANTAGE OF REAL SHOP EXPERIENCE behind you.

Trained Radio Men Wanted

The man who really knows modern Radio is in greater demand today than ever before—not only in Radio proper but in Television and Electronics—in Aviation, Transportation, Manufacturing, Communications. Good jobs await the

trained man, in the production, operation and maintenance of modern electronic equipment—in radio stations, in hundreds of industries—in homes, theatres and studios. Good sound training in this important field is absolutely necessary. And now, National Schools brings such training to you no matter where you live or what you may be doing—not only the fundamental theory but the actual experience that comes with knowing shop practice and working with real equipment—demonstrating each step with first-hand knowledge. This is true "learning by doing"—direct from the great shops and laboratories of National Schools where new developments in methods, equipment and applications are constantly going forward.

National offers you such practical training and National has the facilities. Sample this training yourself. MAIL THE COUPON FOR A FREE LESSON.

SUCCESS and SECURITY FOR YOU

Radio is a Well-Established Business. Television and allied fields are just on the threshold of limitless expansion. Would you like to profit from these developments? An excellent job or perhaps into a business of your own? Answer these questions by reading the catalog sent you FREE from National Schools. Get the facts.

Check the Job You Now Have With These Opportunities in RADIO

1. Financial Security Radio has grown from \$100 million to \$5 billion in past few years.
2. Limitless Future predicted by over 1,800 manufacturers of equipment.
3. Television promises unrealized opportunity.
4. Electronics opens wide new fields in home and industrial use.
5. Your Own Business with little capital.

Get the details. Use the coupon!

FREE GET THESE 2 BIG BOOKS



NATIONAL TRAINING WINS BIG JOBS

Finds a Place in Radio Broadcasting

"I graduated from National three years ago at the age of 34. Since then I have been employed at Western Electric Co. and Federal Mfg. Co. On April 30 I joined the engineering staff of WKNE in Keene, New Hampshire, as Transmitter Engineer. Prior to my starting your course I didn't know a thing about Radio. My rapid rise in this field is evidence of what your school can accomplish with anyone who is willing to spend a few hours a day with your training. May I express my sincere thanks to you and the faculty at National Schools." FRANK J. SAMMER, Keene, New Hampshire.

More Than Paid For Course in Spare Time

"I can sincerely say that my association in a few months with National Schools had paid off in dividends far greater than the tuition which is charged for the entire Course, while at the same time increased my savings. Since beginning your Course, I have received two promotions and at the present hold the position of Radio Communications Chief full time." FRANKLIN A. HILL, Indianapolis, Ind.

VETERANS

If you qualify for training under G.I. Bill, check the coupon for a Special Bulletin.

NATIONAL SCHOOLS

LOS ANGELES 37, CALIFORNIA EST. 1905

MAIL OPPORTUNITY COUPON FOR QUICK ACTION

National Schools, Dept. 7-PS
4000 South Figueroa Street
Los Angeles 37, California

(Mail in envelope or paste on penny postcard.)

Mail me FREE the books mentioned in your ad including a sample lesson of your course. I understand no salesman will call on me.

NAME..... AGE.....

ADDRESS.....

CITY..... ZONE..... STATE.....

— Check here if veteran of World War II

SECRETS ENTRUSTED TO A FEW



The Unpublished Facts of Life

THERE are some things that can not be generally told—*things you ought to know*. Great truths are dangerous to some—but factors for *personal power and accomplishment* in the hands of those who understand them. Behind the tales of the miracles and mysteries of the ancients, lie centuries of their secret probing into nature's laws—their amazing discoveries of *the hidden processes of man's mind*, and *the mastery of life's problems*. Once shrouded in mystery to avoid their destruction by mass fear and ignorance, these facts remain a useful heritage for the thousands of men and women who privately use them in their homes today.

THIS FREE BOOK

The Rosicrucians (not a religious organization), an age-old brotherhood of learning, have preserved this secret wisdom in their archives for centuries. *They now invite you to share the practical helpfulness of their teachings*. Write today for a free copy of the book, "The Mastery of Life." Within its pages may lie a new life of opportunity for you. Address Scribe M.T.X.

The ROSICRUCIANS

(AMORC)

San Jose

California, U.S.A.

STUDY AT HOME

With An Educational Institution

Men with specialized training win higher positions, insure larger earnings, and are bigger successes in business and public life. Opportunities NOW greater than ever before. Send for our Catalog.

ARTS and SCIENCES

Courses in Philosophy; Education; Letters; Public Health; Medical Jurisprudence; Psychology; Sociology; Physics; Chemistry; Plastics; Geology; Political Science; Theology; Business and Commerce; Accounting; Mathematics; Statistics; Agriculture.

ENGINEERING

Courses in Electrical, Civil, Mechanical, Drafting, Architectural, Steam, Aeronautical, Radio, Structural, Mining, Industrial, Petroleum, Marine, Chemical, Diesel, Automobile, Refrigeration, and Air Conditioning Engineering.

LAW

Complete Professional Law Course includes 18 Hornbrook Series college grade textbooks. Courses also in Commercial Law, Patent Law and Medical Jurisprudence.

McKinley-Roosevelt Incorporated, 4610-AB, Sheridan Rd., Chicago 40, Ill.

LAW...

STUDY AT HOME Legally trained men win higher positions and bigger success in business and public life. Greater opportunities now than ever before.

More Ability: More Prestige: More Money We guide you step by step. You can train at home during spare time. Degree of LL.B. We furnish all text material, including 14-volume Law Library. Low cost, easy terms. Get our valuable 48-page "Law Training for Leadership" and "Evidence" books FREE. Send NOW, G. I. APPROVED. LASALLE EXTENSION UNIVERSITY, 417 South Dearborn Street A Correspondence Institution, Dept. 783-L, Chicago 5, Ill.

ELECTRICIANS' SCHOOL

PRACTICAL RESIDENT TRAINING IN

HOUSE AND COMMERCIAL WIRING • MOTOR REPAIR AND REWINDING • ELECTRIC REFRIGERATION, COMMERCIAL AND DOMESTIC.

Approved for Veterans Training

PENNSYLVANIA INSTITUTE SCHOOL OF ELECTRICITY

42nd and SPRUCE STS.

PHILADELPHIA 4, PENNA.

Big Money for Workers In Home or Shop



Licensed Concrete Specialists wanted. No experience needed. Make *Colorglazed* concrete pottery without molds. New, low cost, patented method. Cemetery products, novelties, tiles, floors, etc. Basement leaksealing. Other big pay projects. Booklet, details free. Men only.

NATIONAL POTTERIES COMPANY

415 West Third Ave. Grand Rapids, Minnesota

Become a Doctor of PSYCHOLOGY

Win the degree of Ps.D. Teach the secret of contentment, happiness. Solve mental worries. Experience the revelation of truth. Chartered college. Individual help. Write for FREE book. COLLEGE OF UNIVERSAL TRUTH 5153-A North Clark St., Chicago.

STAMMER?

This new 128-page book, "Stammering, Its Cause and Correction," describes the Bogue Unit Method for scientific correction of stammering and stuttering—successful for 46 years. Benj. N. Bogue, Dept. 1899 Circle Tower, Indianapolis 4, Ind.

GET THIS
FREE
BOOK!

Store Route Plan PAYS BIG MONEY

SELL COUNTER CARD PRODUCTS

Build a good-paying business of your own: Call on dealers of all kinds; show nationally-advertised Aspirin, Vitamins, Cosmetics and 200 other necessities. Big 5c and 10c retail packages, high quality. Attractive counter displays sell goods fast. Free book gives amazing facts. Write!

World's Products Co., Dept. 83-R, Spencer, Ind.



Give yourself the Backing of a GREAT GROWING INDUSTRY

REFRIGERATION AIR CONDITIONING



Refrigeration and Air Conditioning have leading place in fast growing fields of our time. Trained men paid well to service, install, maintain, repair, rebuild household and commercial refrigerators. Important new developments such as Frozen Foods and many new industrial uses. Demand for commercial installations in restaurants, butcher shops, taverns, florists, bakeries, etc.—air conditioning in homes, offices, shops.

START NOW—Full and Part Time Earnings

There may never again be such opportunities for men who want better jobs or business of their own to get in on ground floor and go up fast! Many started with small investment who built good, growing business. If over 17 and under 60 learn how you can get started.

Consultation and Placement Service Whether You Are Interested in Worthwhile Job or Setting Up Your Own Business.

BEGIN TRAINING AT HOME OR COME DIRECTLY TO SHOPS

Begin your training at home in spare time, finish in our big, modern shops, or come directly to shops. At home you get C.T.I.'s SHOP PROVED HOME STUDY instruction—actual shop experience has gone into the practical lesson assignments. That is why it is easy for mechanically inclined men to learn by our Home Study training and start on actual refrigeration work.

A NATIONALLY KNOWN INSTITUTION

C.T.I. was only civilian school selected by Army to train servicemen for refrigeration. Same quality training available to you now. The method that has made rapid progress possible. Commercial Trades Institute has established its place in Air Conditioning and Refrigeration industries, and that is important to you in making your start.

VETERANS

Veterans qualifying under "G.I. Bill" have tuition paid by Government plus monthly subsistence allowance while in school. Just mail coupon, we will handle all details. (LOW TUITION, EASY TERMS if you are not a veteran.)

COMMERCIAL TRADES INSTITUTE
Dept. E-17

1400 W. Greenleaf Ave. Chicago 26, Ill.

AIM HIGH
Pick one of
these great
FIELDS..

C.T.I. OFFERS TRAINING IN

REFRIGERATION & AIR CONDITIONING
Commercial and domestic installation, servicing.

ELECTRICITY & INDUSTRIAL ELECTRONICS
Electrical wiring and circuits, armature winding, appliance repair, etc.

AUTO MECHANICS
Overhaul, repair engines, transmissions, differentials, other assemblies.

BODY & FENDER REBUILDING
Welding, aligning, use of power tools, repairing, refinishing bodies and fenders.

DIESEL
Overhaul, operation, maintenance and service.

FREE
IMPORTANT INFORMATION TELLING HOW TO GET STARTED IN ONE OF THESE GREAT FIELDS...

**SEND
COUPON
NOW**

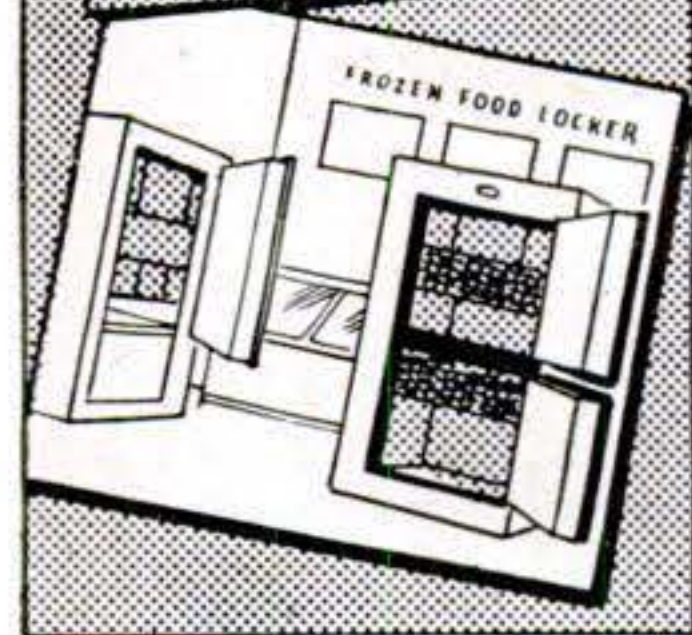

HOME OF
COMMERCIAL
TRADES
INSTITUTE

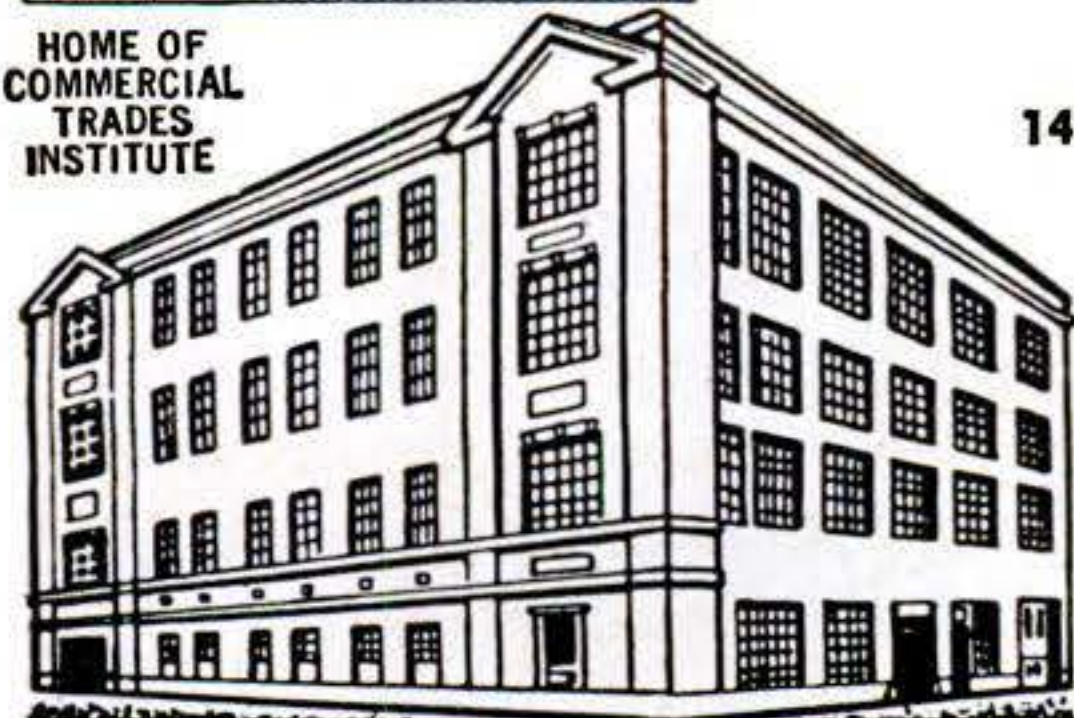

FREE—IMPORTANT INFORMATION
Telling HOW TO GET STARTED
IN ONE OF THESE GREAT FIELDS

FILL OUT · CUT OUT · MAIL TODAY!

FACTS FREE FOR MEN WHO WANT TO GET AHEAD

COMMERCIAL TRADES INSTITUTE, Dept. E-17
1400 W. Greenleaf, Chicago 26, Ill.

Send free illustrated Brochures and other information about the field I have checked below.

Refrigeration and Air Conditioning Diesel Automotive Mechanics
 Electricity & Industrial Electronics Body & Fender Rebuilding

Name

Address

City..... State.....

Veteran Non-Veteran

Learn ELECTRIC MOTOR REPAIR!

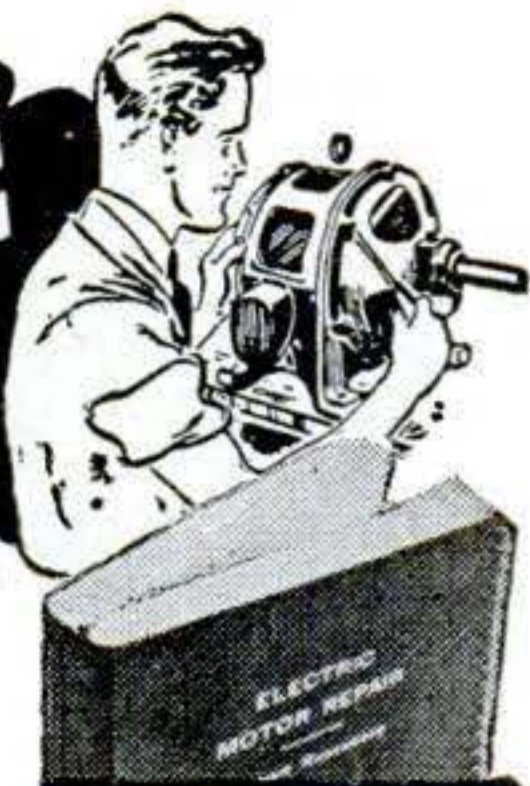

**FIX ANY KIND—ANY TYPE—
LEARN AT HOME—Only \$5**

Based on what can quickly be learned from this 580-page book—for only \$5, complete—you can prepare for fast service on practically any electric motor in common use! Up to now, there has been no easy way to learn this profitable trade. **ELECTRIC MOTOR REPAIR** book helps you do it—in a few short weeks!

**Train for Good Pay in a
Wide Open Field!**

All types of electric motor work are covered fully—from simple repairs and adjustments to complete rewindings. Quick reference guides show exactly how to handle specific jobs. Everything explained clearly as A-B-C by text and more than 900 illustrations.

**5-DAY MONEY-BACK
GUARANTEE!**

Dept. PS-77, MURRAY HILL BOOKS, INC.,
232 Madison Ave., New York 16, N. Y.

Enclosed find \$5 (\$5.50 foreign) for my copy of **ELECTRIC MOTOR REPAIR** book; or send C.O.D. for this amount plus postage. It is understood I may return book in 5 days if not satisfactory and have my money refunded.

Name.....
Address.....
City & Dist. No..... State.....

THINK!
Get where the big
money is!

There are more motors than any other type of appliance. Almost every home has from 6 to 25—in clocks, washers, phonographs, fans, refrigerators, oil burners, mixers, shavers, etc. Millions more in offices and factories. Be the well-paid expert who can keep them working!

EARN MORE

\$\$\$\$\$



SEND FOR THIS FREE BOOK NOW!

● Increase your earning power. Become thoroughly trained in a well-paid profession. Without obligation, find out about the opportunities in Electrical, Mechanical, Plastics, Civil, Mining and other engineering fields. Our free 118-page handbook, lists details of home study courses, compiled by world authorities. See for yourself how you can soon earn more dollars. Write today, to: Canadian Institute of Science and Technology, Ltd., 423 Century Building, 412, 5th Street, N.W., Washington, D.C.

Approved by the Veterans Administration
under the GI Bill of Rights.

MAIL THIS COUPON NOW

Canadian Institute of Science & Technology, Ltd.,
423 Century Building, 412, 5th Street N.W.,
Washington, D.C.

Please forward free of cost or obligation of any kind your 118-page handbook "Engineering Opportunities".

Name..... Age.....

Address.....

CANADIAN ENQUIRIES: 219 Bay Street, Toronto 1.

ANALYZE HANDWRITING

Qualify for Certified Grapho Analyst Degree at home, spare time. Credit, Employment, Personnel Managers, Business, Professional men, women use grapho-analysis in their work, earn substantial fees in spare time. Many study solely for personal benefit, no desire to earn money, find it so fascinating they start using it to add to their incomes. Entertainment field pays well, up to \$100 in a week reported. Others establishing profitable practices as Vocational and Family Problem Counselors, Personality Teachers, and lecturers.



GROWING—UNCROWDED PROFESSION

More and more police use grapho analysis handling suspects and criminals. They understand how criminals think. Their handwriting tells. Men like Hugh Dunlap, university student, Harry Allen, retired preacher, use it in court, win cases, earn fees even before graduation. **Only school in world devoted to teaching grapho analysis** offers thorough training to earnest, ambitious men and women regardless of where you live, small town, farm or city. Send for **GRAPHO ANALYST**, illustrated lesson, personal handwriting analysis offer, **ALL FREE**. Must be 21 or over. Address **A. I. G. A. Inc., 126, Noel, Missouri.**



**Why spend years learning by hard
experience what you can get from
a practical book in a few hours.**

Write for list of "How-To-Do-It"
books on practical subjects. 1000's of
pleased customers all over the world.

ADAMS BROWN COMPANY — BOOKS OF APPLIED SCIENCE
Dept. 277 Chestnut Hill 67, Massachusetts, U. S. A.

THE GEM MAKER



Amateurs or professionals... hobbyists or jewelers... Polish your own gems with a B&I Gem Maker. You will find this a profitable adventure. All necessary lapidary equipment is furnished, including a super-charged diamond blade for sawing, and all wheels for grinding, shaping and polishing, also complete instructions. The complete equipment as shown, less motor and belt, for only \$29.50, f.o.b., Burlington, Wis. Write today for information and literature on the Gem Maker and accessories. **B&I MFG. CO., Dept. M, Burlington, Wis.**



MECHANICAL DENTISTRY AT HOME!

To make Crowns, Plates, Bridgework, etc., for Dentists. Easy practical way to learn mechanical dentistry at home in spare time. **FULL EQUIPMENT OF TOOLS AND MATERIALS INCLUDED WITH COURSE.** Low tuition. Easy terms. Write for **FREE BOOK** about this money making profession that is not affected by the machine age.

MCCARRIE SCHOOL OF MECHANICAL DENTISTRY
207 N. Broad St. Dept. 864 Philadelphia, Pa.

MAGIC WONDERS EXPOSED!

Amuse! Confuse! Thrill Everyone! Vanishing light, Ghostly Pellet, Magic Smoke, Mystic Watch, Enchanted Match, Spirit Writing, Magic Fire, Wizzards Candle, Etc. 32 Magic Lessons 25c. Free with order Big Catalog. **The Magician, 2463 Kensington Ave., Phila. 25, Pa. Dept. D.**

FREE 5 INCH GENUINE LEATHER Jolly Rogers Patch



Join the Jolly Rogers Club of Insignia Collectors. Send only \$1.00 and get this Genuine Leather Jolly Roger Breast Patch Free with 25 all different Air Force Wings and Officers Collar Insignia. (List Price \$5.00.) Colored Insignia Book **FREE** with order.

The Insignia Mart, Dept. B-12,
703 Broadway New York 3, N. Y.



RAISE CHIN-CHINS

No experience needed. Just a few minutes daily and a few feet of backyard, garage or barn space. Several females and a male starts a large, profitable herd. **WE FURNISH FREE INSTRUCTIONS. TREMENDOUS DEMAND** for breeding and laboratory stock, meat, and world's most beautiful rabbit fur. Brokers, cut off from imported rabbit pelts by world famine, **NEED CHIN-CHIN FURS NOW**, and for years to come! Write for free illustrated catalog today.

WILLOW BROOK FARM • R-45 SELLERSVILLE, PENNA.

LOOK AHEAD to **ELECTRICITY**

CURRENT BUILDING BOOM CREATES BIG DEMAND



**NATION'S
LARGEST
EXCLUSIVE
ELECTRICAL
SCHOOL**

PRACTICAL "Learn-by-Doing" TRAINING TAUGHT EXPERTLY, QUICKLY, THOROUGHLY

Learn a trade with a future bright for years to come . . . *Electricity!* FORECAST: 12 million new homes and apartments to be wired within next 10 years. More Electricians required for House Wiring . . . for Construction and Industrial Maintenance, Armature and Motor Rebuilding, Factory and Office Building Wiring, the Operation, Maintenance and Repair of AC and DC Motors, Generators, Controls, other Power Equipment.

Learn *Electricity* . . . *Learn by Doing* . . . train on actual equipment . . . Graduate in a short time. Learn latest, most advanced methods quickly, easily, thoroughly . . . at Nation's Largest Exclusive Electrical School. Four floors devoted to this one course—individual attention—expert instructors—large auditorium for Electrical Training movies and slide films—day and evening classes, full or part time. We will finance your training. Get more information.

MICHIGAN TECHNICAL INSTITUTE

Dept. PS-7, 2281 W. Fort St., Detroit 16, Mich.

MICHIGAN TECHNICAL INSTITUTE Dept. PS-7
2281 W. Fort St., Detroit 16, Michigan

- Send me catalog and complete information.
 I am a GI. Send special information.
 Married. Single.

NAME

ADDRESS

CITY STATE

APPROVED FOR TRAINING UNDER GI BILL

VETERANS!

Take this course at no cost to you, and receive \$65 to \$90 a month while training. Complete details furnished. MAIL COUPON TODAY!



WOULDN'T TAKE \$1000 FOR COURSE

"The lessons are so simple that anyone can understand them. I have learned to play by note in a little more than a month. I wouldn't take a thousand dollars for my course." *S. E. A., Kansas City, Mo.



PLAYS ON RADIO

"I can't keep from telling you that I have a good position playing from KTHS, Hot Springs, Ark., every morning."

*J. S., Okla.



PLAYS AT DANCES

"The Piano course I'm taking is the 3rd course with your school. Over 20 years ago I took Saxophone and Clarinet. Since then I've played a lot of dance jobs."

*E. A., Lake View, Iowa

THOUSANDS NOW PLAY who never thought they could!

You, too, can play any instrument by this EASY A-B-C METHOD

YOU think it's difficult to learn music? That's what thousands of others have thought! Just like you, they longed to play some instrument. But they denied themselves the pleasure—because they thought it took months and years of tedious study to learn.

And then they made an amazing discovery! They learned about a wonderful way to learn music at home—without a private teacher—without tedious study—and in a surprisingly short time. They wrote to the U. S. School of Music about this remarkable short-cut method. A free print and picture sample actually showed them how easy it was to learn.

The result? Over 850,000 people have studied music at home this simple, A-B-C way. They have found the key to good times, popularity and profit.

And that's what you can do, right now. Simply mail the coupon below. Get the proof that you, too, can learn to play your favorite instrument—quickly, easily, in spare time at home. Just read the fascinating illustrated booklet—examine the print and picture sample.

If interested, tear out the coupon now, before you turn the page. U. S. School of Music, 87 Brunswick Bldg., New York 10, N. Y. Forty-ninth year. (Established 1898)

*Actual names on request. Pictures by professional models.

SEND FOR FREE PRINT AND PICTURE SAMPLE

U. S. School of Music, 87 Brunswick Bldg., New York 10, N. Y.

I am interested in music study, particularly in the instrument indicated below. Please send me your free booklet, "How to Learn Music at Home" and your Print and Picture Sample. (Do you have instrument?

Piano	Piano Accordion	Reed Organ	Clarinet
Guitar	Saxophone	Tenor Banjo	Trombone
Violin	Trumpet, Cornet	Ukulele	Other Instrument

Name (PLEASE PRINT)

Street

City State

Check here if under 16 years of age.

SAVE 2c—Stick coupon on penny postcard

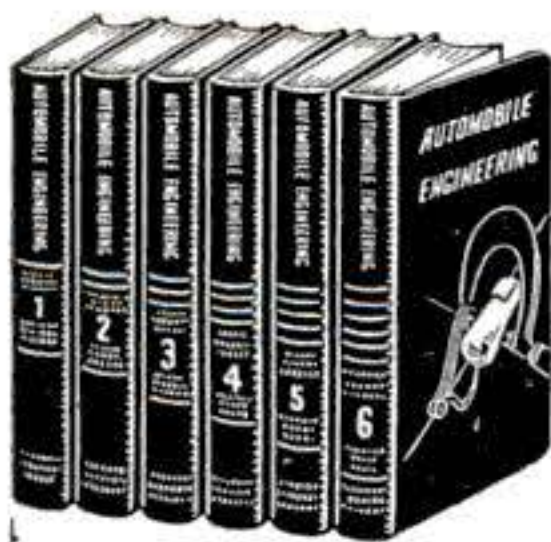

AUTO BOOKS ON APPROVAL



CAN YOU FIX IT?

These wonder books tell step by step HOW to make difficult repairs and adjustments, how to keep a car at maximum efficiency, including latest improvements in car design and operation. Engine troubles and how to correct them well covered.

6 BIG VOLUMES

2800 pages, 2000 illustrations, wiring diagrams, etc., including Diesel engines. Beautiful modernistic, washable cloth binding.

SEND NO MONEY. Just mail the coupon for a complete set of Six Big Auto Books, 20th Edition. Whether you are a mechanic or helper, expert or apprentice, auto owner or driver, take immediate advantage of this **FREE EXAMINATION OFFER.**

MAKE GOOD MONEY NOW HOLD A PERMANENT JOB

America wants its automobiles kept in good repair. Men with "know how" are in demand, at big pay. These books will help you get and hold an important job, or give you a chance to go into business for yourself now or later. Any man who half tries to improve himself can learn auto servicing and repairing by this quick reference method. Use the **JIFFY INDEX** to find easily understood answer to any auto problem. These wonder books prepared by eleven of America's great automobile engineers. Many hundreds of valuable illustrations. Send the coupon **TODAY.**

[A year's consulting privileges with our engineers now given with these books without extra charge.]

Vocational Publishers Since 1898

AMERICAN TECHNICAL SOCIETY, Dept. AB20,

Drexel Ave. at 58th St., Chicago 37, Ill.

I would like to examine your Six-Volume Set of Auto Books. I will pay the delivery charges only, but if I choose I may return them express collect. If after 10 days' use I prefer to keep them, I will send you \$2 and pay the balance at the rate of only \$3 a month until \$24.80 has been paid. Please include consulting service as offered above

Name.....

Address.....

City..... State.....

Please attach letter stating age, occupation, employer's name and address, and name and address of at least one business man as reference. Men in service, also please give home address.

RADIOMEN! ELECTRICIANS!

Get this Valuable Book

FREE

for Merely Examining
Coyne's NEW Pay-Raising

3 VOLUME SET APPLIED PRACTICAL RADIO

Here's real news for every man interested in Radio. A sensational new **PRACTICAL** set of radio books, just off the press! Nothing like it ever before. Gives you the "know how" on everything in Radio today. Basic principles to the newest in Television and FM—how to construct, install, service. 600 illustrations, nearly 1000 pages. To prove how valuable these great books can be to you, **Coyne will give you a FREE copy** of our new 240-page book "Starting & Operating a Profitable Radio or Electrical Business" just for looking over the 3 Volume Set. For home training or field reference, **APPLIED PRACTICAL RADIO** is backed by Coyne's 48 years of shop experience to help you to **bigger pay, better jobs, greater opportunities in Radio.**

OFFER LIMITED—ACT NOW! Here's our offer to you—if you act promptly. We will send you the 3 volume set **APPLIED PRACTICAL RADIO** for 7 days' **FREE** examination, together with the **Business-Starting Book**. Look the set over for 7 days. If you like it, you can then pay the low price at easy terms in coupon below. If you don't want the set, return it and you **OWE NOTHING.** In either event, you keep the **Business-Starting Book** absolutely **FREE.**

FREE SEND NO MONEY!
BOOK COUPON
Coupon below is just a request to see the books free and get your gift book for doing it. **ACT—Send coupon TODAY!**

Educational Book Publishing Division,
COYNE ELECTRICAL & RADIO SCHOOL, Dept. B7-R8
500 South Paulina St., Chicago 12, Illinois

Send me that 3 volume set **APPLIED PRACTICAL RADIO** and my **FREE** gift book "Starting & Operating a Profitable Radio or Electrical Business". I'll either return the set in 7 days and owe nothing, or send you \$3 within 7 days after I receive the books and \$3 a month until \$10.75 is paid. Or I'll pay \$9.75 cash. Whether or not I keep the 3 Volume Set, the **Business-Starting Book** is mine **FREE** as a Gift.

NAME..... AGE.....
ADDRESS.....
TOWN..... ZONE..... STATE.....

Learn to MOUNT BIRDS

Tan SKINS, make up FURS
Be a Taxidermist. Double your hunting fun. We teach you at Home. Mount Birds, Animals, Fish, Heads, common specimens. Fun and profits. Decorate home and den **MAKE MONEY.** Mount game, tan for others. Big profits in spare time. **WRITE TODAY.**
100 game pictures in FREE BOOK
Hunters, get your copy. It's **Now Free.** Send post card. State your AGE.
NORTHWESTERN SCHOOL OF TAXIDERMY
Dept. 339B Omaha, Nebraska

INVENTING

—FOR PROFIT!

If you have an inventive turn of mind, write for free 28-page booklet explaining how the Institute of American Inventors is helping inventors pre-test the profit possibilities of proposed devices to fill today's unprecedented demand for new inventions.

INSTITUTE OF AMERICAN INVENTORS
Dept. 3. 1926 Eye St. NW. Washington 6, D. C.

INVENTORS

The question as to whether a subject matter is patentable can be substantially determined by a search of the U. S. Patent records. Without obligation, write us for full information on what steps an inventor should take to secure a Patent or Trademarks.

RANDOLPH & BEAVERS

Registered Patent Attorneys

905-L Columbian Building, Washington 1, D. C.

PATENTS AND TRADE MARKS

C. A. SNOW & CO.

REGISTERED PATENT ATTORNEYS
WRITE FOR INFORMATION TO
426 SNOW BUILDING, WASHINGTON 1, D. C.

INVENTIONS WANTED AT ONCE

Patented or unpatented inventions, all types needed by manufacturers. Write for free booklet "MARKETING YOUR INVENTION" and Protective Disclosure Form. We have a tremendous list of firms who may pay cash or royalties for good inventions. For full particulars, write today.

NATIONAL INVENTION SERVICE
1404 Mitchell Street, Dept. A Oakland 1, Calif.

Get this New **RADIO RULE!**

Needed by all radio students, engineers, draftsmen and technicians. This accurate 6 inch symbol rule saves you time and money. Sent immediately upon receipt of \$1.00.
413 FOX BLDG. DETROIT 1, MICH.

COLETTE PRODUCTS CO.

INVENTORS

IF YOU WISH TO PROTECT YOUR INVENTION, You should take steps to protect it by a U. S. Patent. Write me for "Record of Invention" form.

CARL MILLER
REGISTERED PATENT ATTORNEY

Woolworth Bldg., 35th Floor, Dept. 77C, New York City
Please send me "Record of Invention" form.

NAME.....
ADDRESS.....

You Can Grow With PLASTICS!

Plastics is one of the fastest growing industries—offering you unusual opportunities for an interesting, successful career and security in the years ahead. Trained men, with plastics know-how will fill the important, well-paying positions. YOU can be one of them. Mail the coupon below for a big, colorful, free catalog on Plastics and complete details

about Plastics Institute, America's oldest and largest plastics school. Resident School located in beautiful Southern California. Comprehensive Home Training Courses to prepare you in your spare time at home for a career in plastics. You can enroll immediately! Write Plastics Institute, Dept. PS7-7, 1601 S. Western Ave., Los Angeles 6, Calif.

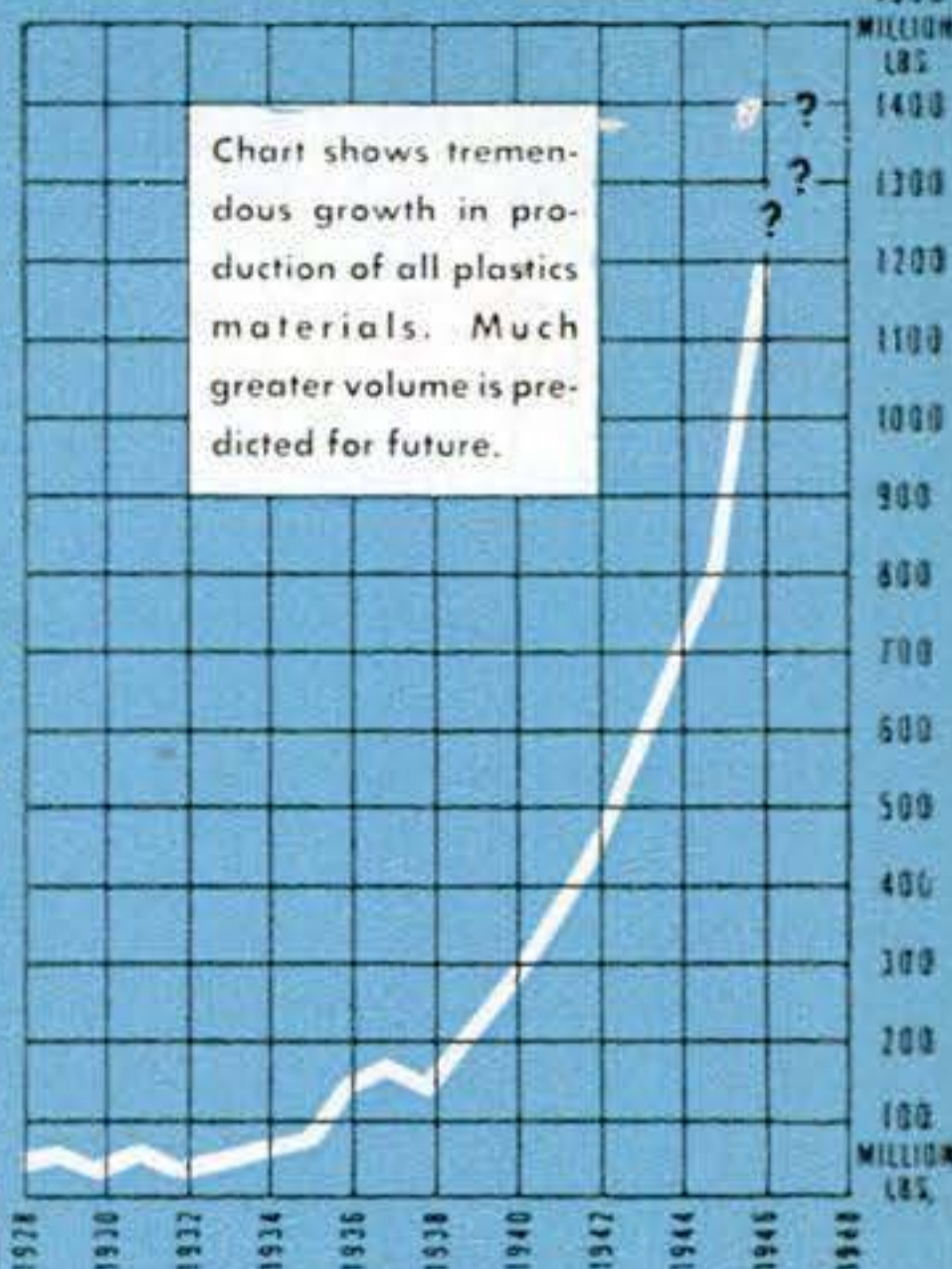

APPROVED FOR VETERANS

LEARN BY DOING

To give you practical experience we supply colorful plastics to make useful, attractive creations. You can also make and sell plastics articles to earn while learning.

Plastics

INDUSTRIES TECHNICAL INSTITUTE
NEW YORK CHICAGO LOS ANGELES



PLASTICS INSTITUTE in the heart of sunny Los Angeles. Here modern laboratories and shops give Resident School students facilities for practice on the finest of industry-type plastics equipment. Also the headquarters for HOME TRAINING.

Plastics Industries Technical Institute
Dept. PS 7-7, 1601 S. Western Ave., Los Angeles 6, Calif.

Mail in Envelope or paste on penny postcard

Gentlemen: Please send me free literature and information on your Resident School Courses () Home Training Courses (). I understand there is absolutely no obligation.

Name (PRINT) _____ Occupation _____

Street (PRINT) _____ Age _____

City _____ Zone _____ State _____

Important: Please fill out coupon completely. If Veteran, please check. () If in Armed Services now, please check. ()

FREE BOOKLET



10,000 MEN AND WOMEN WANTED

To use fruit jar conditioner. It levels all standard size screw top jars, removes nicks. Definitely ends all spoilage, mold, darkening of pears, juice extraction, etc. All new and old jars must be conditioned for perfect results. \$7.50 prepaid in U. S. 3% tax in Wash. State. Free circular.

MIKALSON MFG. CO.

Dept. S Box 701

Everett, Wash.



HOW TO CUT RAFTERS

New vest pocket book gives lengths, Side cuts, Plumb cuts, Deductions. For all rafters for any building from one inch to forty feet wide. Gives numbers to cut on square. Also degrees for same cuts for Radial Saws. All standard pitches from 1/8 to 5/8. Just open book to pitch page and there are your lengths, side cuts, etc. Anyone who knows what a jack rafter is can frame a roof if he has this great book. Price one dollar prepaid. Builders' Topics, Dept. S, Lock Box 828, Seattle, Washington. Original teachers of the square in five easy lessons by mail. SEND FOR FREE LIST OF TECHNICAL BOOKS. Learn to read blueprints, etc.

WANT A U.S. GOVERNMENT JOB?

Start \$1,756 to \$3,021 Year

MEN—WOMEN
Get Ready Immediately

Common education usually sufficient

Veterans Get Preference Mail Coupon today sure

FRANKLIN INSTITUTE
Dept. K81, Rochester 4, N. Y.

Sirs: Rush to me without charge (1) 32-page book with list of many U. S. Government Big Pay Dependable Jobs. (2) Tell me how to get one of these jobs.

Name _____
Address _____
..... Vet?



AMAZING NEW Pocket or Purse Size RADIO!

Small as a pack of cigarettes! Weighs only a few ounces. Durable and beautiful black chrome plastic cabinets. Uses new pretested war born crystal diode. SLIDE RULE DIAL! REQUIRES NO TUBES—BATTERIES OR ELECTRIC "PLUG-IN" and should last for years. Many times you can receive local broadcasts simply by snapping to metal trim of phones, floor lamps, bed springs, etc.!

GUARANTEED TO PLAY for you if regular AG system used. Complete instructions sent with each radio. You can use it at home, in many offices, hotels, cabins, in bed or most anywhere! Lots of fun—and real entertainment!

SEND ONLY \$1.00 (cash, money order, check) and pay postman \$2.99 plus delivery fees on arrival or send \$3.99 for postpaid delivery. Complete as shown ready to play with self-contained personal earphone. For gifts—children will love it—grownups too! An exceptional value—order yours and enjoy the many good radio programs coming! Don't be without your Pa-Kette Radio another day! (All foreign orders \$5.00 U. S. cash.)

PA-KETTE ELECTRIC COMPANY Department PS-7 Kearney, Nebraska

MAKE UP TO \$5⁰⁰ AN HOUR In Your Own YEAR ROUND Business!

ONLY A FEW DOLLARS PUTS YOU IN BUSINESS!

Many Clearing as High as \$20 to \$30 a Day NET Renewing Rugs, Carpets, Upholstery. New Method Now Used for Auto Upholstery. Write for Facts About Quick, Easy Way to Get Started

Here is the chance you've been looking for to step into a pleasant, dignified, big-pay business of your own that offers you a steady, year 'round income. Start on "a shoestring," full or spare time, right from your own home. Equal opportunities for men and women, young or old, in small towns or big cities. No experience needed. Many making big money with new Americlean System just cleaning auto upholstery. Easy to learn. We send you complete instructions and quick-cleaning supplies so you can start making money the very first day! Quick method cleans upholstery, rugs and carpets like new without taking off floor! Tremendous demand in homes, apartments, hotels, stores, office and public buildings. Steady repeat business. Territories going fast. Write today for full FREE facts. No cost or obligation. Rush letter or postcard now to AMERICLEAN CO., Inc. Dept. H-7: 211 North 7 St., St. Louis 1, Mo.

WRITE FOR FREE DETAILS NOW!



\$10 Never Bought MORE Tripod Value!

2-section Metal Tripod made by one of the largest tripod manufacturers to government specifications. Supports heaviest movie or still cameras. Rock steady. Patented automatic leg stops allow adjustments from 30" to 60" heights. Complete tripod \$10. FREE ZIPPER CASE. Send \$2 deposit with order. Balance C.O.D.

P. CHAPMAN, 121 N. Keeler Ave., Chicago, Ill.

ARTISTS MAKE MONEY

Do you like to draw? Send name, address, age and occupation for FREE ART TEST, to find out your ability
ART INSTRUCTION, INC.
7147 Art Instruction Bldg., Minneapolis 15, Minn.

Say You Saw
It In Popular Science

PRESTO! ANYONE CAN MASTER GLAZE

LEAVES HARD GLASS-LIKE FINISH
EASY TO APPLY
PROTECTS THE SURFACE
NO SMEAR OR STREAKS AS WITH WAX
LASTS SIX MONTHS TO A YEAR
SEALS THE PORES OF THE SURFACE
WILL NOT FINGER-MARK
NO OILY FILM AS WITH POLISH
SAVES YOU MONEY

Car Owners! Meet Master Glaze—the sensationally different luster for new and used cars! Not a wax—not an oil polish—not a paint!—nothing that "smears" over the surface.

MASTER GLAZE is a unique discovery—a creamy liquid—quick and easy to apply! Gives a hard, glass-like surface. Even gasoline cannot dull it! Lasts six months to a year! Amazing luster—beautiful, sparkling clean and brilliant! Doesn't finger-mark—doesn't smear! A match box full glazes an entire car. Seals the pores—protects! **NOTHING LIKE IT!**

AGENTS
An unusual opportunity! Quick, flashy demonstrator. Big profits. Good territory. Write today!

FREE SAMPLE

Just send your name and address to
MASTER GLAZE CO., 7720-608 W. Harwood Ave., Milwaukee, Wis.

NOW YOU CAN GET THOSE MOTOR - CLUTCH - TRANSMISSION & AXLE PARTS IN STOCK

Why worry about parts when we have them. All you want at a BIG SAVING. We ship within 48 hours. We also have REBUILT UNITS for EXCHANGE at Bargain Prices: CARBURETORS—FUEL PUMPS—GENERATORS—STARTERS—SHOCKS & KNEES. It will pay you to GET OUR PRICES.

NEW AUTO PARTS and SAVE MONEY
Get Our BARGAIN PRICE LIST for parts you want



—RUSH YOUR ORDERS—
If Car Owner Specify Make IMMEDIATE SHIPMENT
MECHANICS AUTO PARTS, Factory Warehouse,
3807 No. Ashland Ave., Dept. PS-7 CHICAGO 13



AMAZING DISCOVERY! Corrects poor penmanship in few days—big improvement in three hours, no failures. Complete Outline Free. Write, C. Ozment, 35-B, St. Louis, Mo. IMMEDIATELY



WORLD'S SMALLEST RADIO

\$2.98 USE ANYWHERE

NO Tubes
NO Batteries
NO Electricity
Sensationally tiny! But with this remarkable little RADA-PHONE, you can get strong reception . . . indoors or outdoors! Just connect one clip to ground and another to a bit of aerial wire. Or, for DOUBLE fun, attach two RADA-PHONES for a walkie-talkie, hear up to 100 feet. Trim unbreakable hard rubber receiver, 2 attachment clips, 5 feet insulated rubber wire. SEND NO MONEY. Just pay postman \$2.98 each, plus postage—or order C.O.D. Order TODAY! Special Price to Dealers.
BERNARD FINE CO., Dept. PS, 501 Sixth Ave., New York 11, N.Y.

START A BATTERY FACTORY

—at home; the latest achievement; re-cast junk batteries into new. Complete instructions. We supply everything. Big profits!
THE BATTERY LABORATORIES
Dept. PS Minneapolis 13, Minn.



BUILDING HUMAN STATURE

"I grew 6 inches during a year I followed instructions given in 'BUILDING HUMAN STATURE' says the younger man at left. 'Now I am a head taller than my father.' If you wonder why you are short send for FREE outline of this remarkable book loaded with practical information.
CARILLON BOOKS, Dept. 115
3439 S. Michigan Ave., Chicago 16, Ill.

\$5000 CASH PRIZES for INVENTIONS

Greatest World Inventors' Exposition in History! Pan Pacific Auditorium, Los Angeles, July 11-20, 1947. 73 cash prizes from \$25 to \$1000! Your invention will be seen by thousands of manufacturers, jobbers, distributors, etc. To show Model, \$27.50. Drawings, plans, copies of patents or printed matter may be submitted for \$14.50 per patent. **WIRE or PHONE** for full details NOW! Telephone FEderal 5256.
WORLD INVENTORS' EXPOSITION 2712½ W. 7th, Los Angeles 5, Cal

"The Book They're Talking About"
Contains over 300 illustrations, charts and notes
ART ANATOMY OF THE HUMAN FIGURE
For the amateur and professional artist and sculptor. Giving detailed study of every part of the body. Male and Female, Posed and in Action. **\$100**
Outside U.S.A. Send \$1.25
MAJOR BOOK CO. Dept. 54-E LYNBROOK, NEW YORK

BIG MONEY and YOUR OWN BUSINESS in LIQUID IVORY



FREE INFORMATION ON A GREAT NEW MONEY MAKING OPPORTUNITY

Regardless of your age, sex, previous experience, we will send you astonishing free facts about the great possibilities—in your own business—with amazing LIQUID REPLICA IVORY. To secure this information, absolutely free, fill in coupon below or send a letter or postcard. No salesman will call on you now or ever. Write TODAY! Offer limited!

LIQUID IVORY is one of the most marvelous synthetics developed in years. With it you can easily and simply produce a wide variety of wonderful items that almost defy detection from genuine ivory. No expensive equipment is needed. You can work in a corner of your basement or garage with a few hours of work producing handsome profits. Here is unexcelled opportunity for all ambitious people that want a profitable business of their own.

GREAT OPPORTUNITIES NOW!

Stop being a slave to a time clock! Stop worrying about lay-offs and depressions stealing your livelihood. NOW is the time to line up your own money-making business. We offer this great opportunity to aggressive people. Get into your own profitable business with LIQUID IVORY. Get the FREE FACTS today!

Copyright-1947

EMPIRE TRADES and HANDICRAFTS
Box 1340-PS7 St. Louis, Mo.

SEND FOR
FREE
DETAILS



A MONEY-MAKING BUSINESS FOR THE LITTLE MAN! NO EXTENSIVE CAPITAL NEEDED!

Forget big investment worries. We tell you how to get your own fast-moving business going with very little money. We feature only one sound business course. You will never find us confusing this successful vocation with other diverting business ideas. We tell you all about one great business and how you can make money in it exclusively. Write for full FREE information today!

FREE INFORMATION COUPON

EMPIRE TRADES & HANDICRAFTS, BOX 1340-PS7 ST. LOUIS, MO.

Please send me free details about your BIG money making LIQUID IVORY. I am anxious to get started in a profitable business of my own. Please rush!

Name.....

Address.....

City..... State.....

WHICH OF THESE *Opportunities* INTERESTS *You* MOST?

● Today, choose the job you want—and prepare for it. Or if you are already engaged in the work you like best, start training now for quicker promotion. Acquire the knowledge that will help you to get ahead faster, make more money and have greater security.

American School, founded in 1897 as an educational institution *not for profit*, can help you to reach your goal just as it has helped others during the past fifty years. Check the coupon at right, add your name and address and mail it at once. The school will send you details on its training plan and outline of study prepared by specialists. There is no charge, no obligation, so send the coupon immediately.

CHECK, CLIP AND MAIL COUPON NOW

AMERICAN SCHOOL, Dept. GB46, Drexel at 58th, Chicago 37, Ill.
Without obligation, Please send FREE and postpaid, bulletin and details of the Subjects checked:

- | | | |
|--|---|--|
| <input type="checkbox"/> PLASTICS ENG'R | <input type="checkbox"/> Accounting | <input type="checkbox"/> Drafting and Design for Men and Women |
| <input type="checkbox"/> Refrigeration | <input type="checkbox"/> Electrical Engr. | <input type="checkbox"/> Radio |
| <input type="checkbox"/> Architecture and Building | <input type="checkbox"/> Electricity-Pract. | <input type="checkbox"/> High School |
| <input type="checkbox"/> Contracting | <input type="checkbox"/> Electronics, Industrial | <input type="checkbox"/> Air Conditioning |
| <input type="checkbox"/> Practical Plumbing | <input type="checkbox"/> Bookkeeping | <input type="checkbox"/> Mechanical Eng. |
| <input type="checkbox"/> Automotive Engr. | <input type="checkbox"/> Private Secretary | <input type="checkbox"/> Shop Management |
| <input type="checkbox"/> Aviation Drafting | <input type="checkbox"/> Diesel Engineering | <input type="checkbox"/> Tool Making |
| <input type="checkbox"/> Aviation | <input type="checkbox"/> Sheet Metal Pattern Drafting | <input type="checkbox"/> Better Foremanship |
| <input type="checkbox"/> Business Management | <input type="checkbox"/> Railway Training | <input type="checkbox"/> Machine Shop Operations |

Name..... Occupation.....

Address..... Age.....

City..... State.....

AMERICAN SCHOOL
Dept. GB46, Drexel at 58th Street, Chicago 37

BULOVA • WALTHAM ELGIN



YOUR CHOICE ONLY **\$22.50**

(PLUS 10% TAX)

U. S. GOV'T. SURPLUS
**16-JEWEL
WRIST
WATCHES**

CANNOT BE DUPLICATED
AT DOUBLE THIS PRICE!

- Sweep Second Hand • Shockproof
- Moistureproof • Non-Magnetic
- Fully Guaranteed

Order one or both of these amazing watch values today! A fortunate quantity purchase makes this amazing offer possible. Send check, cash or money order for prompt postpaid shipment. C.O.D.'s accepted, but you pay postage.

ARCH SALES COMPANY
43 N. 11th STREET • PHILA. 7, PA.



WRITE FOR **Free Sample**

★ ★ Make Big Money ★ ★

Be the first to sell luminous house numbers and light switch plates. Also luminous pictures, statues, etc. Religious, nursery, glamour and other subjects. Sell on sight.

Represent a Large Manufacturer Est. 1913
MADISON MILLS • 303 Fourth Ave. • New York 10, N. Y.

**BE A REAL ESTATE BROKER
PAYS BIG!**

EASY TO LEARN—Start and run your own business quickly.

Many graduates report making up to \$1000 a month. Course of study covers Sales, Property Management, Appraising, Loans, Mortgages and hundreds of related subjects. Course offered in home study or classroom—Both G. I. Approved. Send post card today for big, new illustrated book from this nationally known school. Dept. 30
WEAVER SCHOOL OF REAL ESTATE, 15 E. Pershing Road, Kansas City 8, Mo.

**FREE
BOOK
TELLS
HOW**

FOR STEREO PICTURES, IT'S
STEREO-TACH!

Take Third Dimension Pictures with the
STEREO-TACH and your own camera!

There's nothing in photography so startlingly beautiful and lifelike! You can't reproduce a 3-dimension picture in flat 2-dimension printing!

Outfit No. 101—Tach and Transparency Viewer (for transparencies, with 35MM cameras) **\$22.50***



Outfit No. 100—Tach and Print Viewer (for stereo prints, with both 35MM and other size cameras) **\$16.25***
*Plus Tax.



The Stereo-Tach

Transparency Viewer For Third-Dimension Projection, the STEREO-FLECTOR! Just Out! See your dealer or write.
ADVERTISING DISPLAYS, INC. Dept. PS-5 COVINGTON, KENTUCKY

Now CHEAP OIL BURNER
FOR HEATING AND COOKING STOVES - FURNACES
HEAT YOUR HOME, COOK YOUR MEALS
WITH CHEAP FURNACE OIL

NO MORE SHOVELING COAL OR ASHES. Sensational Fuelizer Starter Vaporizing System turns Cheap No. 1 Furnace Oil, also Range, Heater, Tractor Distillate, Kerosene and like oils into oil heat—one of the quickest, hottest fires known. **LIFETIME GUARANTEE. \$1.00 Bonus Offer for Testing.** We will let you try it in your own stove or furnace for one month. Get yours for introducing. Big profits QUICK. Be first. Send in your name today for details and cash in on the tremendous demand for this Amazing Invention.

NORTHWEST MFG. CO. 606-J, Mitchell, S. Dak.

**MASTER MACHINIST • MECHANICAL DRAFTING
TOOL-DIE DESIGNING • TOOL ENGINEERING**

Completely equipped shops and drafting rooms, directed by an accredited staff of engineers and practical instructors. 18 years of successful training of men for industry.

Days, Evenings • Approved for Veteran Training

NEW CLASSES Now Forming • BULLETIN ON REQUEST

ALLIED SCHOOL OF MECHANICAL TRADES, INC.
44 ALLIED BLDG., 1336 S. MICHIGAN AVE. • CHICAGO 5, ILL.

**SHORTHAND in
6 Weeks at Home**

Famous Speedwriting system. No signs or symbols; uses ABC's. Easy to learn; easy to write and transcribe. Fast preparation for a job. Surprisingly low cost. 100,000 taught by mail. Used in leading offices and Civil Service. Write for free booklet. Speedwriting, Dept. 2607-7, 55 W. 42 St., N. Y. 18, N. Y.

RADIO ENGINEERING Television, FM, Broadcasting, Servicing, Electronics, Aviation, Marine & Police Radio taught thoroughly. 72 weeks' Engineering course equivalent to 3 years' college radio work. Approved Veteran Training. Catalog upon request.
Valparaiso Technical Institute. Dept. 503, Valparaiso, Ind.

Learn PHOTOGRAPHY at Home

Splendid opportunities. Prepare in spare time. Practical basic training. Long-established school. Send for free book, "Opportunities in Photography." No obligation.

American School of Photography, 1315 S. Michigan Ave., Dept. 136-B Chicago 5, Ill.

Good Handwriting
HELPS YOU WIN SUCCESS!

It's so important to write a good hand for business and social advancement. Poor illegible penmanship often causes costly errors and marks you for failure. Why write a poor hand? It's so easy to learn at home in spare time. Write for our new free booklet today. If you wish, send 10c for a penpoint suitable for shaded writing and your name beautifully written.

The TAMBLYN SCHOOL OF PENMANSHIP
In Business Since 1895
H-439 Ridge Bldg., Kansas City, Mo., U.S.A.

If Ruptured

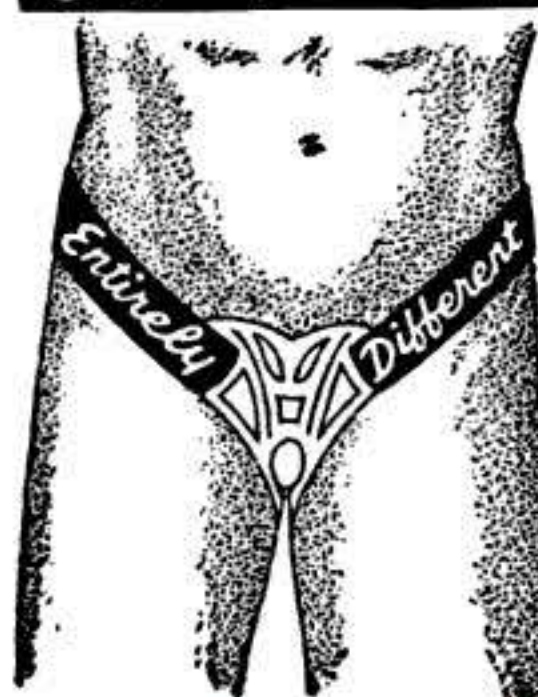

Do What Others Now Do—
**Wear a Form Fitting
MILLER Truss**

which provides natural freedom and comfort in working, walking, playing, horse back riding, dancing, swimming or sleeping. You just cannot afford to be without this protection and convenience.

Wear two weeks then consult your physician before deciding to keep it.

Write me today for **FREE** descriptive circular. Sent in plain, sealed envelope.

FRED B. MILLER Manufacturer
Dept. P.S. Hagerstown, Maryland.



"JACKPOT"

Home Model COIN MACHINE

● Great fun maker for Rumpus Room or Club. Soon pays for itself. Fully automatic payout, three reels, with all the usual winning combinations . . . cherries, lemons, etc. Double jackpot. Rugged lifetime construction. *Guaranteed* to satisfy or money back. Service manual makes it easy to understand how to operate machine successfully. Takes space only 14½ x 11½

in. Ht. 18½ in. Shpg. wt. 47 lbs. CHOICE OF 5c, 10c, or 25c PLAY. Send \$50.00 deposit, balance C.O.D. plus express charges. Immediate delivery.....Each, **\$198.00**

Webb DISTRIBUTING CO. INC.

6 SOUTH KEDZIE AVE. • CHICAGO 12, ILLINOIS

Learn to MOUNT BIRDS

Tan SKINS, Make Up FURS

Be a Taxidermist. We teach you at Home. Mount Birds, Animals, Pets, common specimens. Save your hunting trophies; decorate home and den. Make genuine KROME LEATHER, tan and make up furs for sparetime profit. **FREE BOOK** 48 pages—tells all about it. Hunters, get this wonderful book. Its Now Free. Send postal card Today—This Minute! State your AGE.



N. W. School of Taxidermy, Dept. 339B Omaha, Nebr.

HORSE MASTERY!

A FINE HOBBY — A GREAT VOCATION!

"The EXPERT HORSEMAN"

SUBSCRIBE TODAY
50¢
One Year



FREE BOOK — Tells how You can learn to: BREAK COLTS, GAIT SHOW HORSES, TRAIN RODEO, STOCK and RACE HORSES, BREAK BAD HABITS, HANDLE ANY HORSE. TRAIN CIRCUS TRICK HORSES. WRITE TODAY!

ANIMAL LOVERS ASSOCIATION
BOX S-157 TARZANA, CALIFORNIA

KUT RITE

LAWN MOWER SHARPENER
IT'S SAFE—QUICK—SIMPLE

Patented. 3 popular sizes. Retail prices: 14" \$1.40; 16" \$1.50; 18" \$1.60. Mailing charges 25c.

ACCURATE SHARPENER MFG. CO.
Dept. PS2 Milwaukee 12, Wis.



**MAKE YOUR OWN
COSTUME JEWELRY**
SPLENDID HOBBY OR VOCATION

Sea Shells • Pin Backs • Ear Screws • Screw Eyes
Plastic Discs • Ear Clips • Floral Stones • Jump Rings
Chains • Clasps • Wire • Boxes • Bracelets • Parts
Bow Knots • Catches • Plexiglas • Cements • Dyes

WRITE FOR FREE CATALOGUE • DEPT. E

PHILADELPHIA BADGE CO., 1007 Filbert St., Phila. 7, Pa.

PRACTICAL TECHNICAL TRAINING FOR YOU

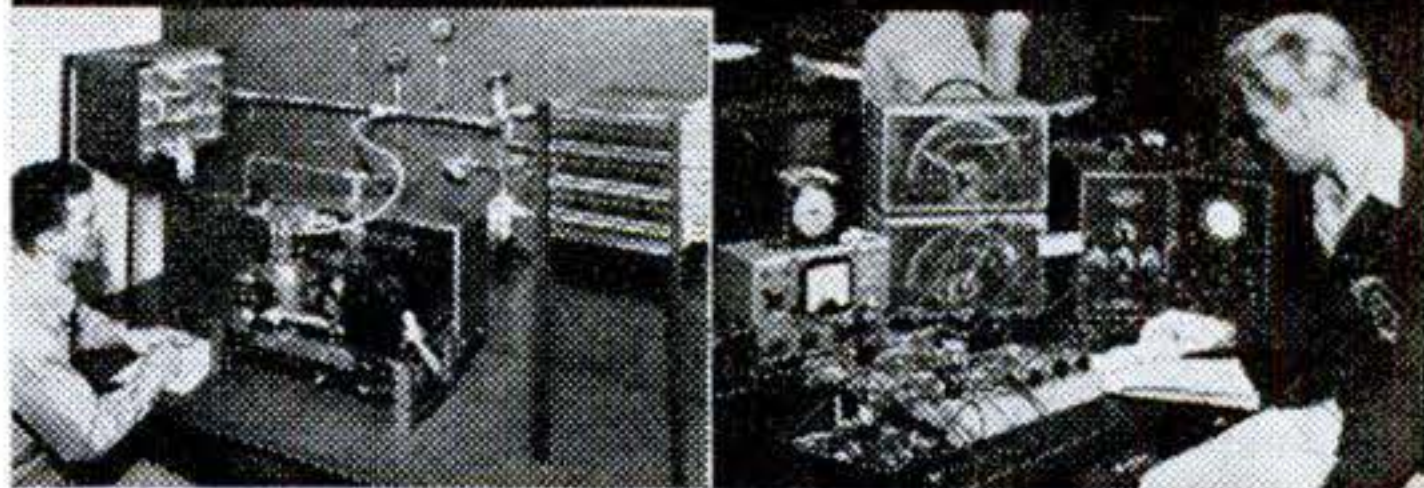

SPECIALIZE in 6 months to 3 years

OUR time-tested CONCENTRIC SYSTEM enables you to build your career step by step. Each 6-month course is complete in itself yet prepares you for advanced courses. You train as long as circumstances permit—until you reach the "top step" in your desired occupational objective. More than 35,000 former students in industries the world over.

COURSES

SERVICE — 6 months
Practical Electricity
Practical Welding
Refrigerator Service
Heating Service

TECHNICIAN — 1 year
Electro Technician
Radio Technician
Electronics Technician
Refrigeration, Heating and Air Conditioning Technician

PROFESSIONAL — 3 years
Electrical Engineering
Bachelor of Science Degree
Major in Machinery or Electronics

MILWAUKEE SCHOOL OF ENGINEERING

A Technical Institute

Terms Start September, January, April
MAIL COUPON TODAY!

Milwaukee School of Engineering, Dept. PS-747, N. Broadway & E. State, Milwaukee, Wisconsin

Without obligation, send me free booklet "Career Building" and more details on course in.....

Name.....Age.....

Address.....

City.....State.....

AIR RIFLES BENJAMIN AIR PISTOLS ARE AVAILABLE

SEND FOR FREE FOLDER OF LATEST MODELS TODAY

If you want a REAL GUN for PRACTICAL USE inside or outdoors get a SAFE-CLEAN-ECONOMICAL-BENJAMIN with Adjustable Power and Amazing Accuracy. Use BENJAMIN H-C PELLETS for BEST RESULTS. WRITE AT ONCE.

BENJAMIN AIR RIFLE CO., 811 MARION ST., ST. LOUIS 4, MO.



GET INTO CARTOONING!

Learn cartooning from a professional cartoonist! Create original cartoons and ideas. Send for free details about course. Also cartoonists' magazine. Full of lessons, plans, etc. Only 25c coin postpaid. Hartman Studios, 2776 California Court, Lincoln 8, Nebr.

Say You Saw
It In Popular Science

YOU CAN BE THE MOST POPULAR PERSON AT THE PARTY...

EARN BIG MONEY IN YOUR SPARE TIME! LEARN CHARACTER ANALYSIS AND NUMEROLOGY

THE SECRETS OF THE COUNTRY'S TOP EXPERT • NOW AVAILABLE TO YOU

A Profitable Profession A Fascinating Hobby Brings you Rich Rewards In Friendship & Popularity Learn this stimulating new profession and build a business of your own with unlimited possibilities! Thousands of men and women today are eager to have their aptitudes and potentialities revealed through character analysis. Easy to learn in a short time. No educational requirements. Course includes textbook, six correspondence lessons, plan of operating when course is completed, and sample advertising to be used. ELAINE WHITNEY Internationally Famous Character Analyst of Motion Picture Stars, Director Send \$1.00 for Introductory Analysis of YOUR KEY NUMBER and a short introductory treatise of Character Analysis and Numerology.

Dept. PS-77 SCHOOL OF CHARACTER ANALYSIS AND NUMEROLOGY 202 E. Third Street Los Angeles 13, Calif. VAndike 4616

DIPLOMA
PRESENTED
TO ALL
GRADUATES

B A R G A I N
3X ARMY TELESCOPE
 Original Cost \$150. Our Price \$7.50



ALL COATED LENSES — BRAND NEW

An ideal gift for viewing objects, landscapes, seashores, etc. The high resolving power of the six coated lenses, five of them achromats will bring out great details. For the experimenter it can be dismantled and used for hundreds of projects. Length 22½ inches, 36° Field, Postpaid \$7.50.

500,000 Lenses and Prisms Send 3 cent stamp for "BARGAIN" List.
A. JAEGER'S, 123-26B ROCKAWAY BLVD. SO. OZONE PARK 20, N. Y.

OTTAWA TRACTOR SAW

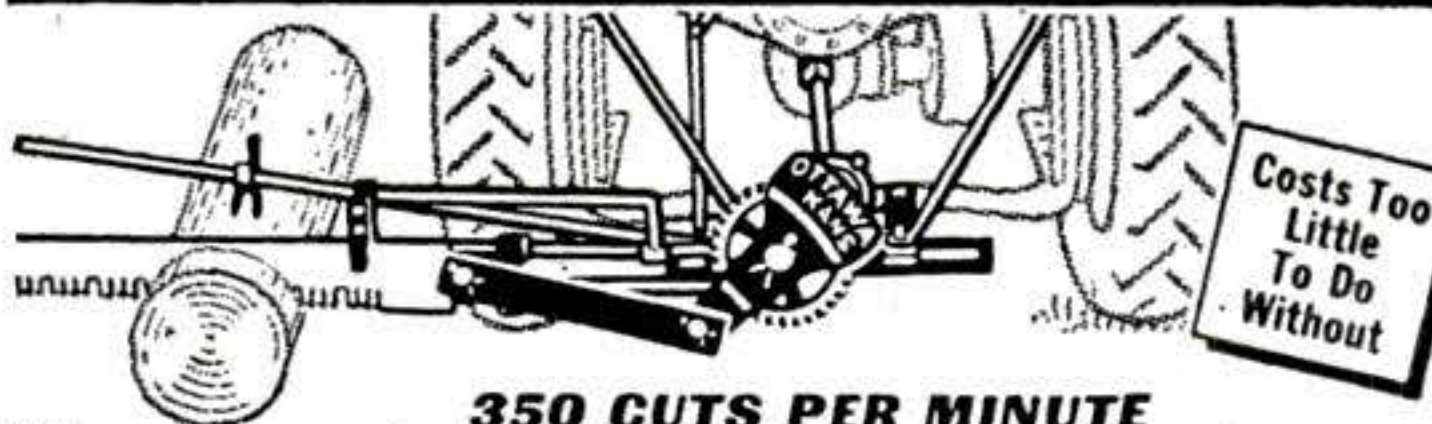

350 CUTS PER MINUTE

Make money sawing wood. Use Ottawa—fastest cutting. Cuts large, small logs easiest way. Fells trees. One man operates. Thousands in use. Built to last with heavy, stiff saw blade. Positive safety clutch control; uses power take-off any tractor.
OTTAWA MFG. CO., 3-701 Forest Ave., Ottawa, Kan.

Costs Too Little To Do Without

NEW Liquid Plastic

Special CASTOLITE Kit

Hobbyists, craftsmen: Get new CASTO-KIT containing everything to make useful objects with CASTOLITE, the new "magic" liquid casting plastic that pours without heat or pressure. Use crystal clear or color brilliantly. Make beautiful articles with New CASTO-MOLD—lamp bases, bookends, novelty jewelry. Also embed flowers, butterflies, photos, coins. Carve, saw or drill. Kit contains 1 lb. Liquid CASTOLITE. Construction Manual with step-by-step method, materials for immediate use. Big profits between now and Xmas. Send \$3.35 for kit prepaid or order C.O.D. Illustrated Manual alone is 25c.

THE CASTOLITE COMPANY
 Dept. H-4 Box 211 Kenilworth, Ill.



20-Project
KIT
 \$3.35

How to PROSPECT For ATOMIC MINERALS

World-wide race for radioactive minerals is on! New deposits in U. S. being found constantly. Thrilling opportunity. Tells how to find URANIUM, THORIUM, CARNOTITE, PITCHBLende, etc. All needed in Atomic Research. Full instructions by mail only 25c. Tells . . .

How to Operate GEIGER COUNTER

Be among first to use famous Geiger Counter. Seeks out Radioactive Minerals. Own your own or rent for vacation. New Uranium deposits may be found in any state. Send 25c for instructions now. Supply limited.

OMAHA SCIENTIFIC SUPPLY

3623 Lake St. Dept. PS-2 Omaha 3, Nebr.

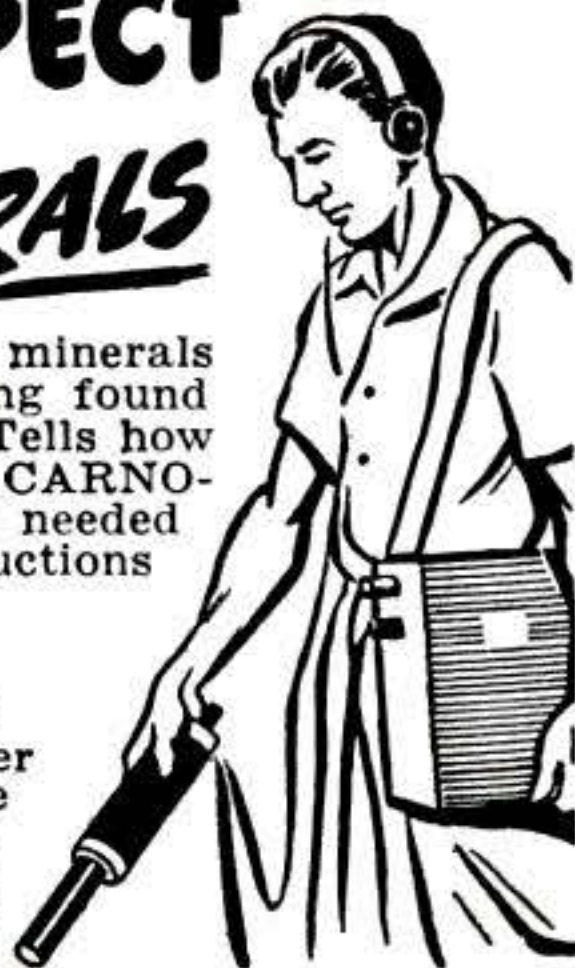

Practical Shop Training In REFRIGERATION

Service, Maintenance, Installation and AIR CONDITIONING

• Domestic • Commercial • Industrial

Approved for G. I. Training

Write for Details
COMMERCIAL TRADES INSTITUTE
 202 So. 20th St., Birmingham, Ala.

• Train in the Magic City of the South. •

LEARN MOVIE PROJECTION THEATRE MANAGEMENT

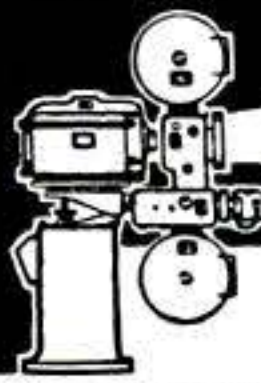

The Motion Picture Theatre Business offers big opportunities for trained men. Get into a fascinating field with a promising future. Train at home in spare time. Free Catalog. Established 20 years.

THEATRE INSTITUTE 385 Washington St., Elmira, New York

TRAIN



Your VOICE!

Results **GUARANTEED**

We build, strengthen the vocal organs—not with singing lessons—but by sound, scientifically correct silent and vocal exercises and absolutely guarantee complete satisfaction with results. Write for Voice Book, FREE. Sent to no one under 17 years old unless signed by parent.
 Perfect Voice Studios, Studio 136-B, Kimball Hall Bldg., Chicago 4, Ill.



ELECTRIC LIGHT JAZZ BOW TIE!

Only \$1.95

Astonish, amaze your friends. Be the life of the party. Have lots of fun. Easily put on. Flashes on and off by simply pressing battery button hidden in your pocket. Complete with attractive bow tie, cord, two bulbs and battery. Mail your order today. Write for FREE catalog. Special price to dealers.

BERNARD FINE CO. 501 Sixth Ave. Dept. PS, New York 11, N.Y.

New Designs in FRANZITE GRIPS

Modernize Your Gun! Improve Your Score!

Most durable grips made. Positively unbreakable! For Colt, Smith & Wesson, Hi-Standard, Ortgies, Luger & Mausers in a wide choice of beautiful designs in ivory, pearl, walnut, onyx, etc. Low prices. FREE CATALOG. Dealers Wanted.

SPORTS, INC., (Mfrs.) 5501 Broadway, Dept. S-7, Chicago 40, Ill.

Tired Kidneys Often Bring Sleepless Nights

Doctors say your kidneys contain 15 miles of tiny tubes or filters which help to purify the blood and keep you healthy. When they get tired and don't work right in the daytime, many people have to get up nights. Don't neglect this condition and lose valuable, restful sleep.

When disorder of kidney function permits poisonous matter to remain in your blood, it may also cause nagging backache, rheumatic pains, leg pains, loss of pep and energy, swelling, puffiness under the eyes, headaches and dizziness.

Don't wait! Ask your druggist for Doan's Pills, a stimulant diuretic, used successfully by millions for over 50 years. Doan's give happy relief and will help the 15 miles of kidney tubes flush out poisonous waste from your blood. Get Doan's Pills.



WAKE UP YOUR SCALP Want better looking hair? Embarrassed by falling dandruff, itching scalp? Then try VITABRUSH, new electric driven scalp brush that gives your scalp a vigorous and invigorating "workout" in just three minutes of fun. Cleans scalp. Stimulates blood supply. Restful. Pleasant. Write today for complete information and satisfaction-guaranteed offer.. Hershey Mfg. Co. 3756 Field Bldg., Chicago 3

Get into Good Paying AUTO BODY and FENDER WORK



BIG DEMAND in Auto Body and Fender work. Start training now in your spare time at home for good pay work. Practical shop experience included. U.E.I. Training covers metal work, welding, painting, etc. Placement service—or we will show you how to start your own shop. Behind U.E.I. TRAINING is a large national organization founded 1927. Write today for **FREE FACTS**—No obligation.

Approved for Training under G.I. Bill

AUTO-CRAFTS DIVISION • UTILITIES ENGINEERING INSTITUTE
2523 SHEFFIELD AVE., DEPT. 377-X, CHICAGO 14, ILLINOIS

LEARN CARPENTRY

Get in on the biggest building boom in history. Prepare for a long and profitable career as a big-pay building tradesman. Actual shop training under expert instructors. Write for big free catalog today.

MIDWEST SCHOOL OF BUILDING TRADES
Dept. C-17, 411 N. Center Street, Bloomington, Ill.

VETERANS ASK FOR GI PLAN

Free FACTS

NEW! MINIATURE DUST MASK

Wear when sanding, grinding, paint spraying, sweeping, dusting, furnace cleaning, etc. Handy as a pair of glasses. Just keep mouth closed and breathe through nose is all you do to operate. Protects against nuisance dusts, lint, coal, cement, grain dust, Hay Fever pollen. Has 9 sq. in. filter. For EYE protection against paint spray, dusts, cases, fumes, smoke, order our Fog-Proof Rubber GOGGLES.....\$2.00 p.p.

JERRY BRYANT, Dept. PS, 919 N. Michigan Ave., Chicago 11, Ill.

Order Today \$1.00 POST PAID

Learn LANDSCAPE GARDENING

A thorough, interesting, home study course for those who wish to become Landscapers, Gardeners, Designers, etc., for profit or pleasure. Write today for Free Book to

APPROVED NATIONAL LANDSCAPE INSTITUTE FOR VETERANS Dept. PS-7, 310 So. Robertson, Los Angeles 36

PULVEX "DDT" FLEA POWDER

REPLACEMENT OR REFUND OF MONEY
Guaranteed by Good Housekeeping
IF DEFECTIVE OR NOT AS ADVERTISED THEREIN

Kills the fleas Quickly!
Keeps others off for Days.



Pulvex also comes with ROTENONE, the original formula. BEST FOR CATS.

Either Kind 25¢ & 50¢

WAR SURPLUS BARGAIN SPECIAL

BRAND NEW!
VACUUM-AIR
HYDRAULIC
FUEL PUMP

Original Cost \$45.00
Now Only **\$9.95**

Postpaid in U.S.A.

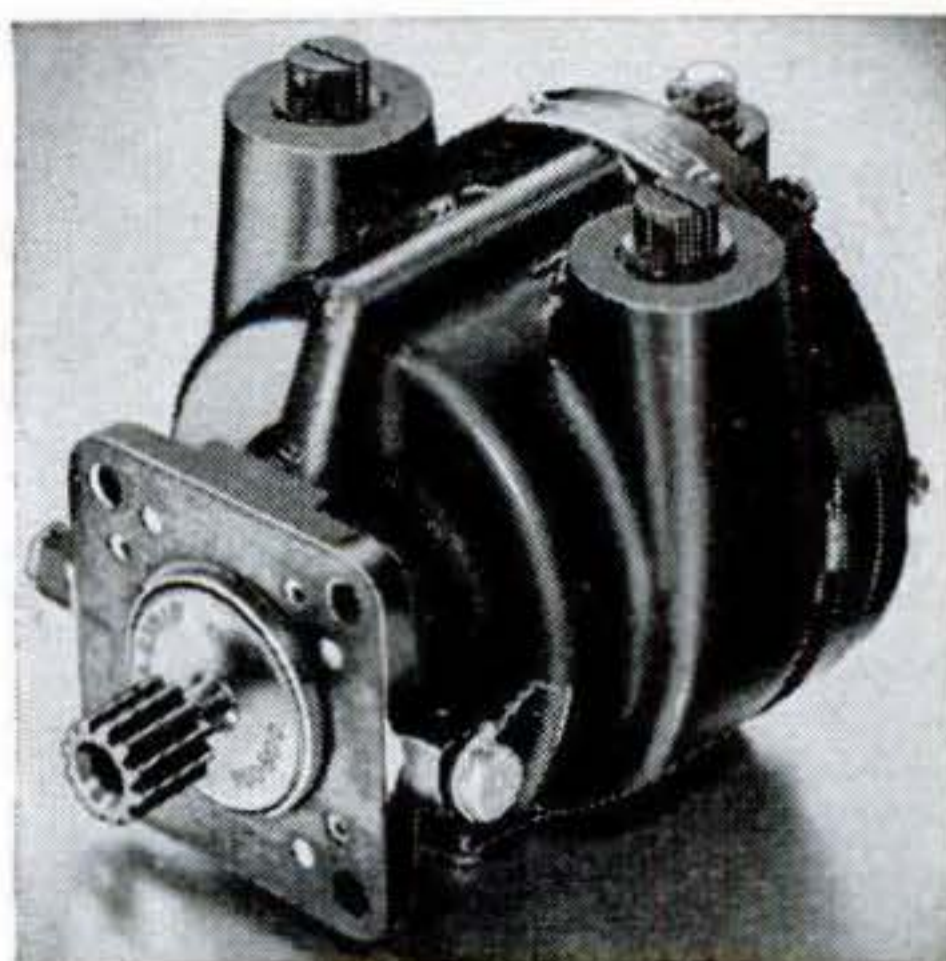

WORTH MANY TIMES THIS LOW SALE PRICE

USE THEM FOR OIL BURNERS

SPRAYING MACHINES

MILKING MACHINES

COMPRESSORS

VACUUM PUMPS

HYDRAULIC SYSTEMS

MANURE LOADERS

PRESSES, etc.

Originally cost \$45.00. Used by the Air Corps to drive bomber de-icer boots, gyroscopes, automatic pilots, etc. May be used as air or fluid pump—for pressure or vacuum. Standard 3/8 inch pipe thread with interchangeable ports. Will pump 7 1/2 gal. SAE 30 oil per minute at 300 RPM. Builds air pressure of 30 lbs. per sq. in. at 1000 RPM. Vacuum will draw 26 inches of mercury at 1750 RPM. Develops up to 120 lbs. per sq. inch of hydraulic pressure, which in conjunction with a 3 inch hydraulic cylinder, will lift 840 lbs. minimum. Runs forward or reverse. Self-aligning shaft. Die cast aluminum housing 6x4x4 inches. Has stainless alloy steel vanes and impeller. Made by Bendix Avia, Corp. Spline terminal for direct drive—readily replaced with a pulley. Recommend a 1/4 H.P. or stronger electric motor as source of power. Rated capacity 1500 RPM with high overload factor. Special price for quantity users. Complete illustrated report and instruction booklet FREE with every pump. Send check or money order today. Postpaid in U.S.A.

\$9.95

GROBAN SUPPLY CO. 1522 So. Michigan Avenue Dept. PS7 Chicago 5, Ill.

HAVE YOUR OWN BUSINESS!

Operate pleasant, profitable Silk Screen Printing Shop. NO experience needed. Work at home in spare room or basement. Big demand! Large profits! Few dollars starts you. Start small, grow big. Real future possibilities! Eye-opening literature FREE.

W. E. WOLFF CO., 817-A High St., Anderson, Indiana

New 8-Power Prismatic ELBOW TELESCOPE

US ARMY SURPLUS

WITH 4 BUILT IN FILTERS



\$175 Value!

Now Only...

\$34.75 Postpaid
in U.S. and Canada

The same precision Elbow Telescope used by the U.S. Army. Very highly corrected lenses. Field of view 6 degrees; has four element filter; etched hairlines with illuminating electric light; body of cast aluminum alloy; over-all size objective end 12" long x 2.4"; eye-piece end 7.5" long x 2.5". 50 mm objective lens. Use it for target spotting, for mountain vacations, for seashore vacations, in airport towers, boats, harbors and for use as finder-scope by astronomers. Can be used in photography for taking long range pictures.

TENDLER'S

913 D STREET, N. W.
WASHINGTON, D. C.

BRAND NEW RUBBER BOATS



ONLY \$12⁷⁵

Includes: sturdy built boat, paddles, anchor repair kit, carrying case, bailing cup, etc. Quantity is limited, so order yours today.

Send check or money order to:

ROCKAWAY SALES COMPANY

Route #6 Box 362 PS Rockaway, N. J.
Send for free circular on balsa wood floats.

MAKE MONEY AT HOME

RUBBER MOLDS Low as 6¢ EA.

Amazing rubber mold-making outfit makes perfect flexible molds of plaques, ash trays, bookends, etc. Molds cost 6c to 25c each. Each mold makes hundreds of novelties and gifts to sell for \$1.00 apiece and more! No experience necessary. Everything furnished. Quick and easy. Start profitable business in your home—sell to stores, gift shops, friends, resorts, road stands, by mail. Full or spare time. Write for complete FREE details and easy instructions.

SO-LO WORKS, INC., Dept. X-801, Loveland, Ohio



GASOLINE ENGINE



Used Gov't Surplus—Air-Cooled Briggs-Stratton or Wisconsin Engine—REBUILT—GUARANTEED in good mechanical and operating condition. Our price, FOB, \$99⁵⁰ Kansas City . . .

Write for illustrated circular—Immediate delivery

MIDWEST SURPLUS SALES 1520 Locust St. Kansas City, Mo.

CONCRETE BLOCK HOMES

A practical booklet on how to build them. 24 pages illustrated with "easy to read" drawings \$1.00

H. C. LIGHTFOOT—CIVIL ENGINEER
RICHBORO, BUCKS CO., PENNA.

Opportunity Knocks

With TRADIO . . . the radio FUNCTIONALLY DESIGNED for coin operation in Hotels, Motels, Stopovers, Clubs, Hospitals, Stations, Etc. Big Earnings . . . Steady Income . . . No Clock To Punch . . . Full Or Part Time!

● QUANTITY DELIVERIES DAILY . . . ONLY SMALL INVESTMENT Grow With A Young Industry! Get In On The Ground Floor and Be Independent For Life. It's Easy!

Send for Complete Information TODAY . . . No Routes Sold

WRITE TO **TRADIO, INC.**, DEPT. PS ASBURY PARK, N. J., Right Now!

COIN-OPERATED MACHINES

offer tremendous opportunities! New 1947 SOURCE BOOK, just published, lists 255 amusement, vending and service machines available today; names and addresses of 500 manufacturers and suppliers—1300 jobbers and distributors—trade names—associations, etc. \$1 per copy postpaid.

COIN MACHINE REVIEW

1115-K VENICE BLVD. • LOS ANGELES 15, CALIF.

RUPTURED?

Get Relief This Proven Way

Why try to worry along with trusses that gouge your flesh—press heavily on hips and spine—enlarge opening—fail to hold rupture? You need the Cluthe. No leg-straps or cutting belts. Automatic adjustable pad holds at real opening—follows every body movement with instant increased support in case of strain. Cannot slip whether at work or play. Light. Waterproof. Can be worn in bath. Send for amazing FREE book, "Advice To Ruptured," and details of liberal truthful 60-day trial offer. Also endorsements from grateful users in your neighborhood. Write:

Cluthe Sons, Dept. 14, Bloomfield, New Jersey

BUILD 15 RADIOS

Absolutely No Knowledge of Radio Necessary
You need No Additional Parts or Tools

A 36 page book written by expert radio instructors, teaches you to build radios in a professional manner. You will start with a 1-tube receiver: Before you are done with this kit you will have built 11 receivers, 1 public address system and 3 transmitters.

The **PROGRESSIVE RADIO KIT** is the only Complete Kit. Contains everything you need: Instruction book, metal chassis, tubes, radio parts, soldering iron, pliers and cutters, screwdriver. Postage prepaid with check or M.O. C.O.D. Postage not prepaid. \$19.75 Write for further information

SPECIAL FREE OFFER for limited time only
FREE Electrical and Radio Tester with Each Progressive Radio Kit.
PROGRESSIVE ELECTRONICS CO., Dept. 86
22 Havemeyer Street Brooklyn 11, N. Y.

NEW! TWIN CARBURETION FOR V8 FORDS & MERCURYS

New type adapter for installing twin carburetors. Increases power, speed, economy! Developed on hot-rod track. For passenger cars, trucks, fleets, etc. Price \$26.50 post-paid complete with fittings. ORDER TODAY or write for information.
BACKUS, 10617 SO. PRAIRIE, INGLEWOOD, CAL.

START YOUR OWN PHOTO COPY BUSINESS!

SMALL investment . . . BIG profits. No darkroom needed. EASY work. Write immediately for FREE 4 page folder and price list.

GENERAL PHOTO PRODUCTS COMPANY
15 Summit Avenue Dept. PS-2 Chatham, New Jersey

STAY HOME AND MAKE MONEY!

—Men! Women! Get into profitable, uncrowded profession you can operate from your home or small office after short home training course. No capital required. No goods to buy. No age limit. Others earn \$50.00 to \$100.00 per week making famous Stephenson corrective foot devices to order. Foot sufferers everywhere pay gladly for relief. Send today for FREE BOOKLET.
STEPHENSON METHOD, Established 1894, 12-28 South Market St., Boston, Mass.



LAWN ORNAMENT-NOVELTY PATTERNS

28 Lawn Ornament Patterns, 25c, Other patterns: 15-20" high; Dutch Girl, Dutch Boy, Pirate, Bull Terrier, Mexican Girl, Mexican Boy, Dwarf, Penguin, Flower Girl, 10c each. 25 Novelty Patterns, 30c. All 62 Full Size Patterns, \$1.00 Postpaid.
Strother Pattern Service, Dept. 7-S, Box 383, Belington, W. Va.

Learn RADIO TELEVISION ELECTRONICS

Our proven 2-Way Instruction trains you at home in spare time for a good pay job or a business of your own. For FREE book "Your Opportunities in Radio", write: Hollywood Radio & Television Institute (Established 1929), Dept. D-6, 810 W. 6th St., Los Angeles, Calif.

Say You Saw

It In Popular Science

EYE-GLASSES BY MAIL

16 Days Trial

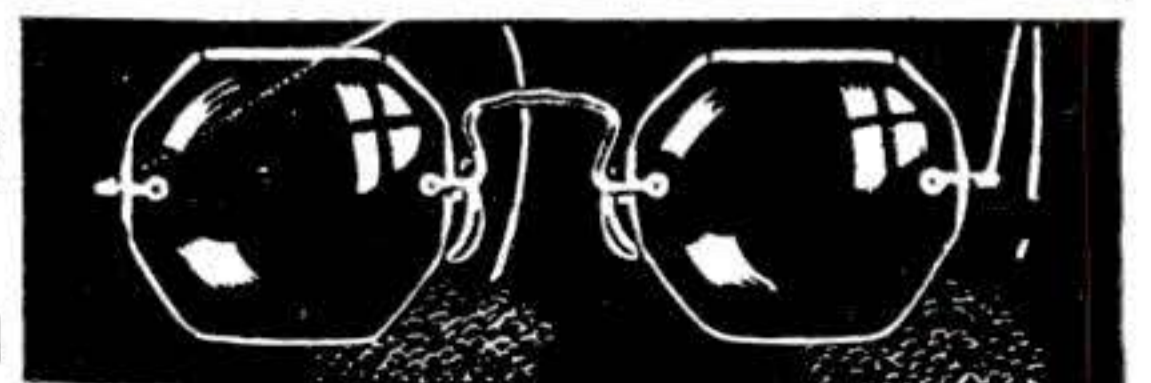

Write Today for Free Catalog. Send no Money
ADVANCE SPECTACLE COMPANY
537 South Dearborn Street, Dept. SP7, Chicago, Illinois

PEDEX...Power Tool Pedestal

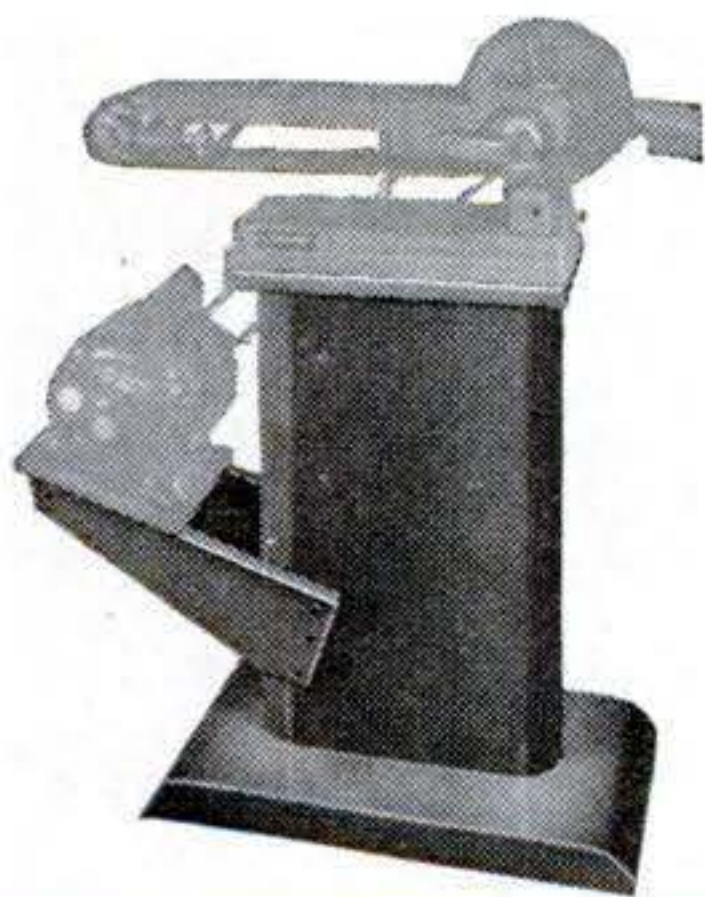

*A New Streamlined Metal Base
for individual mounting of your power tools*
Handy! Attractive! Inexpensive!

You get more pleasure and better results from your hobby or your work when each power tool is individually mounted on PEDEX . . . new, handsome, metal base which fits any average power tool. PEDEX conserves space, increases tool workability, and improves the appearance of your workshop. PEDEX has broad base and strong supporting column. Bracket and platform for mounting motor insure constant belt tension. Price only \$14.85 including motor mount. PEDEX may be furnished with 1/2 h.p. motor at \$52.85 or 3/4 h.p. motor at \$58.85, f.o.b. Cedar Rapids. Money back if you are not satisfied. Write at once for descriptive folder.

Inquiries from Dealers are Invited.

THE PICKWICK COMPANY

287-3rd St. N. E.

Cedar Rapids, Iowa

AIR OR LIQUID TANKS

Airplane oxygen tanks (used) good condition, holds up to 400 lbs. pressure; non-rusting stainless steel, weighs 18 lbs., 10 1/2 gal. capacity, 24" long x 12" diam., \$4.98. Same specifications 24" long x 6" diam., weighs 5 lbs., 3 gal. capacity, \$2.98. Ends tapped for 1/4" standard pipe thread. Air Check-valve to fit tanks, \$5.00 value, 98c. Ideal for compressed air tanks, any bottled gas, or liquids, water supply for house trailers, compressors, floating rafts, buoys, net floats, air horns, air brakes, etc.

Prices FOB, Kansas City — No COD orders

MIDWEST BUY ANYTHING CO.

1520 Locust St.

Kansas City, Mo.

Hundreds of other bargains—Write for circular

Raise GOLDEN HAMSTERS

The new wonder animals. Look like toy bears. Delightful pets. Everybody wants them. Thousands needed by laboratories. Make money, get started now. Send 10c for illustrated literature, or send \$5 for a pair of hamsters and literature.



GULF HAMSTERY

1540 BASIL ST.,

MOBILE 17, ALA.

BUILD YOUR OWN FREEZER

Send for free booklet "Building a Home Freezer" published by N. Y. State College of Agriculture, giving simple instructions regarding design, size required, materials, parts, power unit, etc. and how to obtain them. Enclose 10 cents for postage and mailing.



ENGINEERING SERVICE, INC.

1317 W. 80th Street
Cleveland 2, Ohio

LEARN-WATCH REPAIRING at HOME

"FREE Information write—American Institute Of Specialized Watch Repair—270-276 East Bldg., Grand Rapids Michigan."

LAW

STUDY AT HOME for PERSONAL SUCCESS and LARGER EARNINGS. 38 years expert instruction —over 108,000 students enrolled. LL.B. Degree awarded. All texts furnished. Easy payments. Send for FREE BOOK—"Law and Executive Guidance"

AMERICAN EXTENSION SCHOOL OF LAW
Dept. 79-S, 646 N. Michigan Ave., Chicago 11, Ill.

BLOWERS

Blower wheels, bearings, etc. Cooling equipment. Coils. Exhaust fans. Gas & Oil burners & furnaces. Floor furnaces. Fire boxes. Liquid petroleum gas burners. Free literature. Wholesale & Retail. Card for details.

PEERLESS SALES
4318 Sheridan Blvd. Lincoln 6, Nebraska

NU-WAY LAWN MOWER

Write for FREE Circular

Price **12.50**
Why Pay More

Build Your Own Rotary Type Lawn Mower

We Supply Cutting Unit Complete.

NO INCREASE IN PRICE

TRACTOR-LITE MFG. CO., SPIRIT LAKE, IOWA

MUFFLERS

STEELS and ALUMINUMS with a motorboat tone

SINGLES, Chev, V-8, Plymouth, Steels \$5.50, Aluminum \$6.50. Chry., Olds., Buicks, etc., Steels \$7.50, Aluminum \$8.50. V-8 and MERCURY DUALS, Steel \$17.50, Aluminum \$20.00. Aluminums are guaranteed for life of your car.

DEALERS WANTED

SANDEE MUFFLER CO.
7523 S. WESTERN AVE., LOS ANGELES 44, CALIF.

Heavy Duty - Ball Bearing - All Purpose MANDREL

Length Overall 14"
Diameter OD 1 3/4"
Shaft 1/2" or 5/8" Optional
Lugs 1/4" x 1 1/4" x 3 3/8"
2" between collars
Right or left hand
Thread Optional

Postpaid and off, wind mills, etc. Be sure to state shaft size and thread (R or L) desired. Send Money Order or Certified Check. Full money back guarantee. If your dealer cannot supply you, write.

\$8.00

TRIO MACHINE CO. Box 187 Dept. PS Willoughby, Ohio

Learn to Service and Repair ELECTRICAL APPLIANCES

Open your own electrical appliance service shop. Complete illustrated course covering washing machines, vacuum cleaners, elec. ranges, motors, fluorescent lights, house wiring, etc. Send today for FREE BOOKLET without obligation.

PACIFIC TRAINING SCHOOL
7217 So. Broadway, Dept. S-107, Los Angeles 3, Calif.

NOW! Indian Tom-Tom

You can get that you have wanted for so long!

● All hand made with genuine buckskin, painted with oil colors, decorated with bright colored feathers. Complete with beater \$1.00 prepaid. Larger sizes \$2.00, \$3.00, \$5.00. Send your name and address on a piece of paper to-day. Enclose cash or money order and save postage. Or will send collect and you pay postman. Special price to Dealers.

\$1.00 Prepaid

INDIAN ARTCRAFT 4201 N. W. 17TH AVE. MIAMI, FLORIDA

Mention the name of this magazine and we will send you a Lapel Tom-Tom Pin Free! Worth 25c

HOW TO EARN EXTRA PROFITS

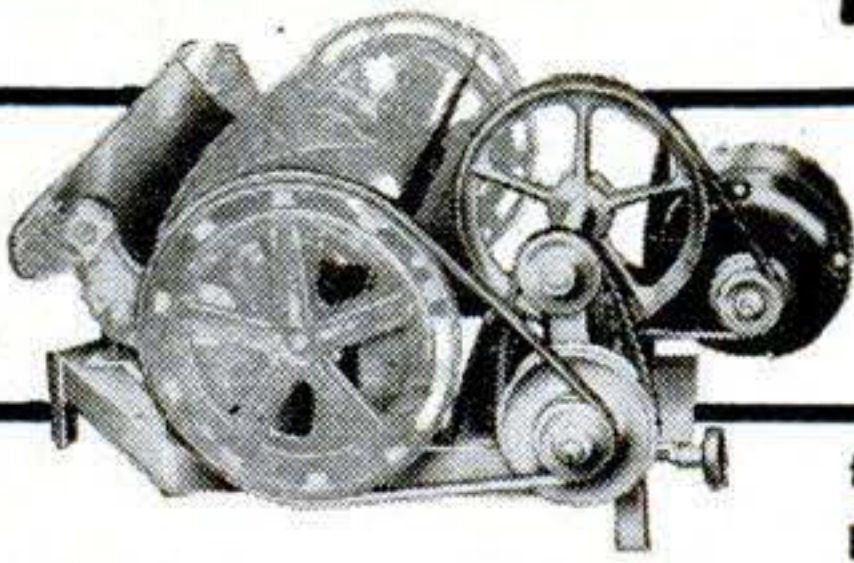

only
\$37.50
LESS MOTOR

for this
popular

"QUAD-CITY SHARPENER"

Get into profitable lawn mower sharpening at low cost with this highly successful machine. Order direct from **QUAD-CITY PRODUCTS CO., Box 42, Rock Island, Ill.**

NAVY STANDARD STORAGE BATTERY

Brand New

Made by Gould Storage Battery Corp. 6 volt 15 amp hour, Excellent for motors, motorcycles, amateurs, experimenters, radio servicemen, &c. Shipped dry, with complete instructions for charging. $4\frac{5}{8}$ " wide $4\frac{3}{4}$ " deep $6\frac{3}{4}$ " high. Shipping weight 12 lbs. While they last

\$4.95



MICHAEL STAHL, INC. 39 Vesey Street, New York 7, N.Y., Dept. SP7

Bore Straight At ANY Angle!!

Use **KEN** Angle Drilling **LEVEL**

You've been waiting for this to insure **STRAIGHT DRILLING**—vertical, horizontal, or ANY angle. "KEN" shows two directions (90°) same time. Attachable any round, square, octagon shank. $\frac{1}{2}$ to 1". For hand, breast, hand tap or portable electric drills. Aluminum. 2 oz. weight. Guaranteed. Postpaid. **\$3.00**



SINGER KENNEDY CORP., C-21 E. Van Buren, Chicago, Ill.

BUILD ARC WELDER PLANS 35c

We Show You How to build this new powerful welder without rewinding. For light or heavy work. Uses coils taken from old auto generators. Works on 110 or 220 volts A. C. Has 20 different heats. Send 35c for complete PLANS and valuable Catalog. Write today. **LEJAY MFG. CO., 1323 LeJay Bldg., Minneapolis 8, Minn.**



Indian
WORLD'S FINEST
MOTORCYCLE
SPRINGFIELD, MASSACHUSETTS

WATERPROOFS SHOES

... and All Types of Leather Goods, with



DEWATEX LEATHER WATERPROOFER

This new product is the exact formula supplied U. S. Armed Forces to **WATERPROOF, PRESERVE** and **RENEW SHOES • GUN CASES • LUGGAGE AUTO SEATS • RIDING BOOTS**

\$1

Large Size Tube
Postpaid

Costs Less Than 5¢ Each Treatment

BASS CO., 34 B. West 33rd Street, New York City

ARMY RADIO PHONES

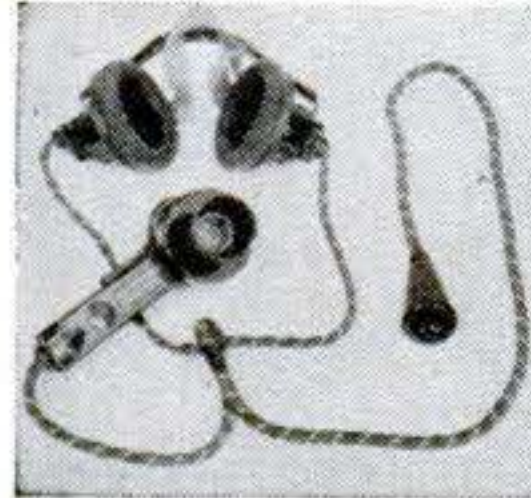

They're Weather — Water and Shock Proof

When we say they are made to Army specifications, that's enough assurance they must be of best quality. These Army Radio Phones are perfect and were O.K.'d by Signal Corps Inspectors. These Dynamic Mikes and Receivers, were used on aircraft and tank inter communication systems. Use them for recording, for battery-less phone, for pocket size set loud speaker or talk through your radio set. We bought a good many of these Radio Phones, they are brand new, and cost a great deal more than you can get them for. A complete dynamic hand mike, 2 earphones, headband, cord set. A wonderful buy for only **\$3.45**

Send check or Money Order. FOB warehouse

LEEDS RADIO CO.

75 Vesey St.

Dept. PS7

New York City 7

GET INTO

REFRIGERATION AND AIR-CONDITIONING

Build your future in fast-growing industry. Prepare for high pay jobs or get into your own business.

Dept. S-7 Resident classes only.

Send ad with name and address for information.

VETERANS Eligible for training under G. I. Bill, Check here

BOSTON TECHNICAL INSTITUTE

School of Refrigeration, 4707 Euclid Ave., Cleveland 3, Ohio

RACER POLISHED CAST ALUMINUM

SPEEDY RACER . . . Streamlined . . . Heavy Unbreakable Aluminum $9\frac{1}{2}$ inches long with $4\frac{1}{2}$ inch Axles . . . Fully mounted with smooth running Rubber Tire Wheels that can't come off . . . Can't rust . . . Looks like models selling Up to \$13.00.

JODEL PRODUCTS
756 W. 69th St., Dept. PS-7, Chicago 21



SEND
\$2.79

Postpaid in U.S.A.

HYPNOTIZE ANYONE

Yes, anyone in 5 seconds. Secrets revealed. Exciting experiments. Use hypnotism to overcome excessive smoking, drinking, nail-biting, nervousness, insomnia, stuttering, inferiority complexes, stagefright, and improving memory. Complete course. **\$2**
POWERS INSTITUTE OF HYPNOTISM 2932 Wilshire Blvd. Dept. 11, Los Angeles 5, Calif.

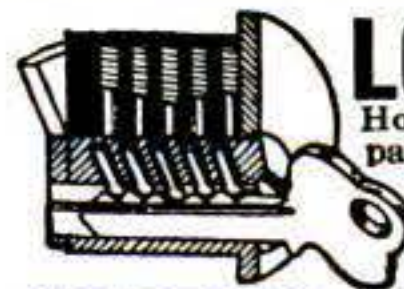

LOCKSMITHING & KEY MAKING

COMPLETE UP-TO-DATE COURSE
How to pick locks, decode, make master-keys, repair, install, service, etc. 53 easy illustrated self-instruction lessons for every handy man, homeowner, carpenter, mechanic, hardw're dealers, maintenance men, etc. Satisfaction guaranteed. Send for Success-Catalog Free. Address below.

WATCH AND CLOCK REPAIRING

LEARN at HOME in Your Spare Time
Prepare for a happy future of prosperity and security—and get a good job NOW. A fascinating, thorough self-instruction training in American and Swiss watches, clocks. Special section on alarm clock repairs. Fast-growing field. Success-Catalog Free. **NELSON CO., 1139 S. Wabash Av., Dept. G01 Chicago 5, Ill.**



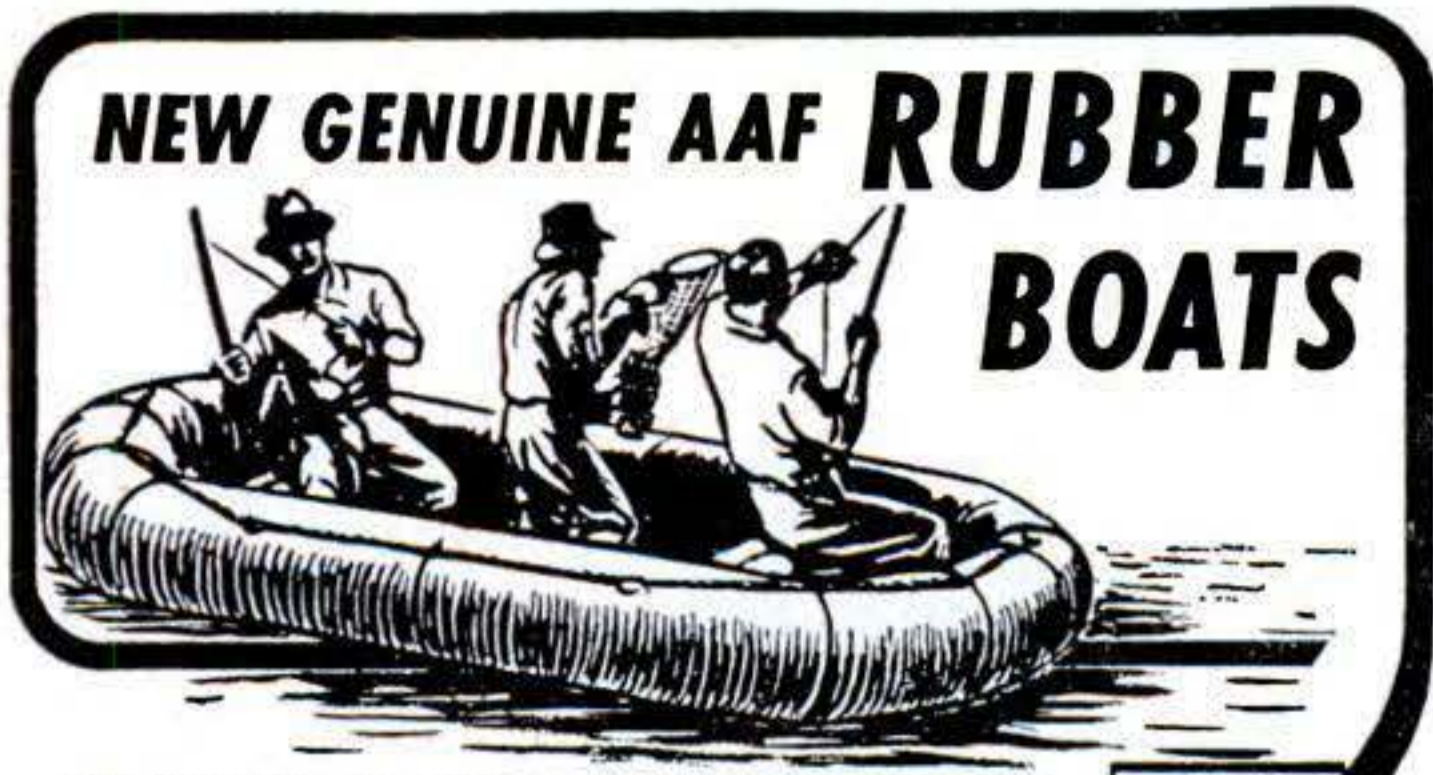

NEW GENUINE AAF RUBBER BOATS

FIVE-MAN—Complete with CO2 tank, oars, hand pump, carrying case. 8' x 5'.
F. O. B. Sacramento, \$37.50

ONE-MAN—Complete with sail, mast, CO2 tank. 5'6" x 3' \$15.95 Pp.

Write for Free War Surplus Catalog!

Send
Check or
Money
Order

PACIFIC FUR & WOOL CO.
War Surplus Department Box 926-P S
Sacramento, California

WAR SURPLUS 110 VOLT - 60 CYCLE - 2500 WATT
POWER PLANT GENERATOR
WEIGHT 200 LBS LIST PRICE \$276.00

NEARLY NEW Ranchers, taverns, sportsmen generate your own electricity. Powerful portable plant. (Complete except engine). Small engines easy to pick up or you can use water or wind power. Fine standby power for farms. Contractors use for on-job power saws, drills, etc. Full instr. installing, using. Guaranteed perfect. Order now or write for details.
LECO ENGINEERING CO., Box 908 PS-A, Lincoln, Nebr.

Only
\$89.40
FREIGHT PREPAID
U.S.A. ONLY

BUILD YOUR OWN Battery Driven ELECTRIC LAWN MOWER.. PLANS ONLY

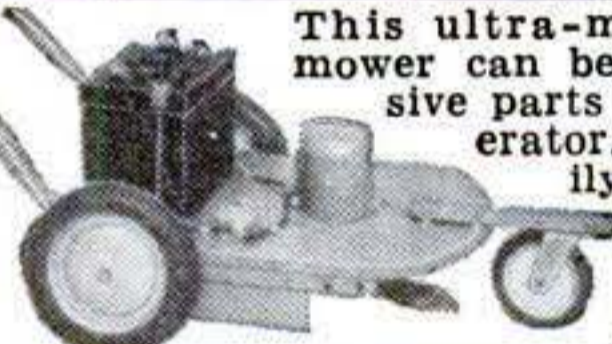

This ultra-modern rotary-blade mower can be made from inexpensive parts and an old auto generator. Plans complete, easily followed. Mower cuts forward or backward, tall or short grass, weeds.
LEJAY MFG. CO.
823 LeJay Bldg., Minneapolis 8, Minn.

35¢
WRITE TODAY

BOTTLEGAS REGULATORS CYLINDERS-ACCESSORIES
WHOLESALE and RETAIL
WRITE FOR FREE CATALOG AND LOW PRICES
APPLIANCE SERVICE CO.
VIRGINIA • MINNESOTA



SHALLOW WATER DIVING UNIT



For salvage, rescue, exploration dives and pool cleaning. Comfortable and efficient; seals absolutely. Low cost with long life. Also, complete line deep-diving gear. Write for details.

- Mask
- Weighted Belt
- Air Hose
- Portable Compressor

DIVING EQUIPMENT & SUPPLY CO.
1121 N. Water Street, Milwaukee 2, Wis.

MAGIC LIQUID CASTS PLASTICS

FREE PLASTICAST . . . The Greatest Thing In Plastics! Complete outfit for CASTING 200 beautiful PLASTIC Articles . . . only \$3.00 postpaid. **FIVE MOLDS FREE WITH ORDER!** Valuable plastics MANUAL also sent free for 3c stamp.

PLASTICAST CO., (Dept. A)
(Send order to nearest Address)
5961 Madison St. Chicago, Ill. P. O. Box 987 Palo Alto, Calif.



MY DOBE TRAINING WAS ALL PRACTICAL EXPERIENCE!

I WILL TRAIN YOU AT HOME UNTIL YOU GET A **GOOD PAY JOB!**

Get Started NOW in **DRAFTING**

EXPERIENCE WHILE LEARNING

Your training will be experience because I give you practical jobs to do. And I list your experience and send it to employers as a reference when you are ready. All Dobe trained men start out with experience. You will too, because I will train you until you get a good pay job in drafting.

Take the first step now and step into Drafting—the big opportunity field—as an experienced, well paid draftsman. Act now for a better job, better pay and better working conditions. The field for draftsmen is bigger now than ever before for all new products, machines, construction start with the draftsman. Get into drafting now. I will train you at home in your spare time, and give you actual experience on actual work—the same kind of jobs you will do with the best paying firms. I will train you until you are competent, fully experienced, and holding a position that will bring advancement and pay raises. Write me today.

WORKING TOOLS SENT WHEN YOU START
All drafting instruments and table and other needed equipment sent when you start. Nothing to buy. Act today. Mail coupon to me now and be sure to give age.



MAIL COUPON FOR VITAL FACTS

Engineer Dobe, Div. 27 Libertyville, Ill.

Send me the Vital Facts on Drafting and Industrial Designing, your Free Book and advertised list of positions for Draftsmen and Designers wanted.

Name..... Age.....
Address.....
City..... Zone..... State.....

BRASS Social Security Plates
STAMPED WITH YOUR NAME AND "SS" NUMBER



Beautifully satin-finished (shown 1/3 size). Please print information clearly. **50¢** each, 4 for \$1.65, 5 for \$2.00.
ACME STAMPING SERVICE
Box 836-PS Davenport, Iowa



LOOK TALLER INSTANTLY!

WEAR HITE-BUILDERS IN YOUR OWN SHOES



Want more respect? . . . more opportunities? Then increase your height INSTANTLY with Davis Hite-Builders. Slip them inside your own shoes. Invisible . . . comfortable . . . easy to wear. Made to last for years. Amazingly low-priced!

SEND NO MONEY

Rush name, address, and shoe size today. Pay postman only \$1.00 plus few cents postage for your pair of Hite-Builders, mailed in plain package. If not delighted with immediate result, just return them and we'll refund your money at once. Or send \$1.00 now and save postage. Same guarantee . . . of course. Order today, look TALLER next week!

DAVIS MFG. CO.
DEPT. B LOVELAND, OHIO

Only **\$1.00** A PAIR

9 BIG NEW BOOK

EVERY ONE AN UNBEATABLE VALUE!

Prepared by the Editors of POPULAR SCIENCE MONTHLY, these great books are bursting with up-to-the-minute information, pictures and diagrams that will save you both time and money! You need not hesitate to order one or all for your own enjoyment or to use as gifts. We guarantee complete satisfaction or your money back!

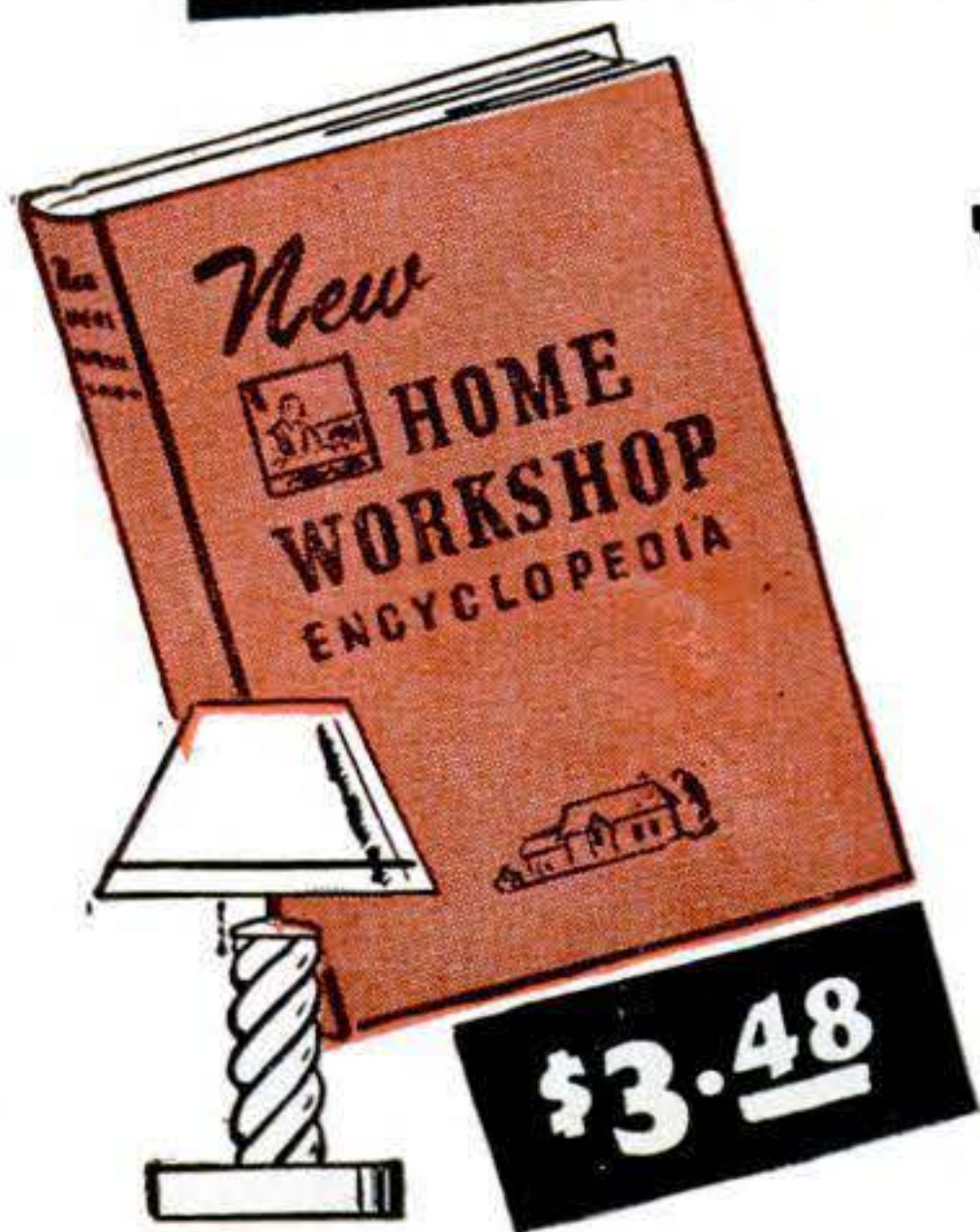

NEW HOME WORKSHOP ENCYCLOPEDIA

Here's a giant book that's jam-packed with over 840 thrilling things to make and do in your own home workshop! It's filled with over 1500 pictures and diagrams that show you how to build bookcases, furniture, cabinets, toys, games, gifts . . . how to repair radios, autos, electrical appliances . . . and no end of ideas for keeping the home shipshape! Yes, you'll even find dozens of chemical experiments, hints for the garden, photographic ideas and woodcarving projects. 580 pages! Handsome DeLuxe edition! Printed in 5 colors!

TINKERING WITH TOOLS

\$1.49

It's *easy* to do your own repairing—and lots of fun—if you follow the simple instructions in this big 260-page book! Everything you need to know about carpentry, plastering, plumbing, painting, masonry, shingling, wallpapering, electric wiring, etc. 215 pictures. DeLuxe edition.

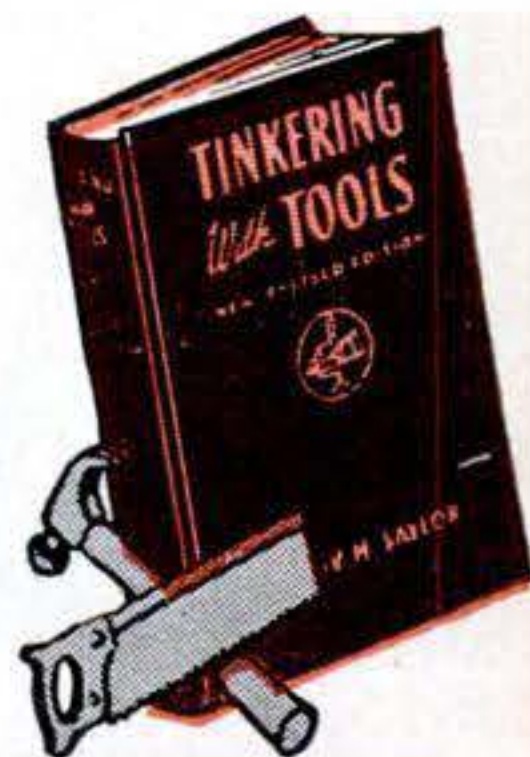

THE HOME CHEMIST

Shows you how to set up an inexpensive lab and perform hundreds of thrilling experiments. How to do amazing chemical tricks, and magic. 192 pages. DeLuxe edition.

\$1.49

BOOK OF FORMULAS

A wealth of formulas, recipes, and secret processes for making soap, ink, insect spray, glue, furniture polish, hundreds of other useful household items! 250 pages. DeLuxe.

\$1.49

WONDERS through the MICROSCOPE

Hundreds of exciting experiments you can do with *any* microscope! How to secure specimens, build apparatus, make slides and photo-micrographs, etc. 192 pages! DeLuxe.

\$1.49

DECORATIVE METAL

How to make useful, attractive articles out of sheet metal, pewter, bronze, steel and precious metals. Directions for bending, shaping, finishing, antiquing, etc. DeLuxe.

\$2.00

BARGAINS FOR YOU

EVERYBODY'S RADIO MANUAL

\$1⁴⁹

How to build and repair your own radios — tiny portables, F-M receivers, radio-phonographs, short-wave sets, recorders, wireless record players, etc! Written in simple, non-technical language with a wealth of drawings, diagrams and wiring circuits that make every step easy to follow! 256 pages. 216 pictures. DeLuxe edition.

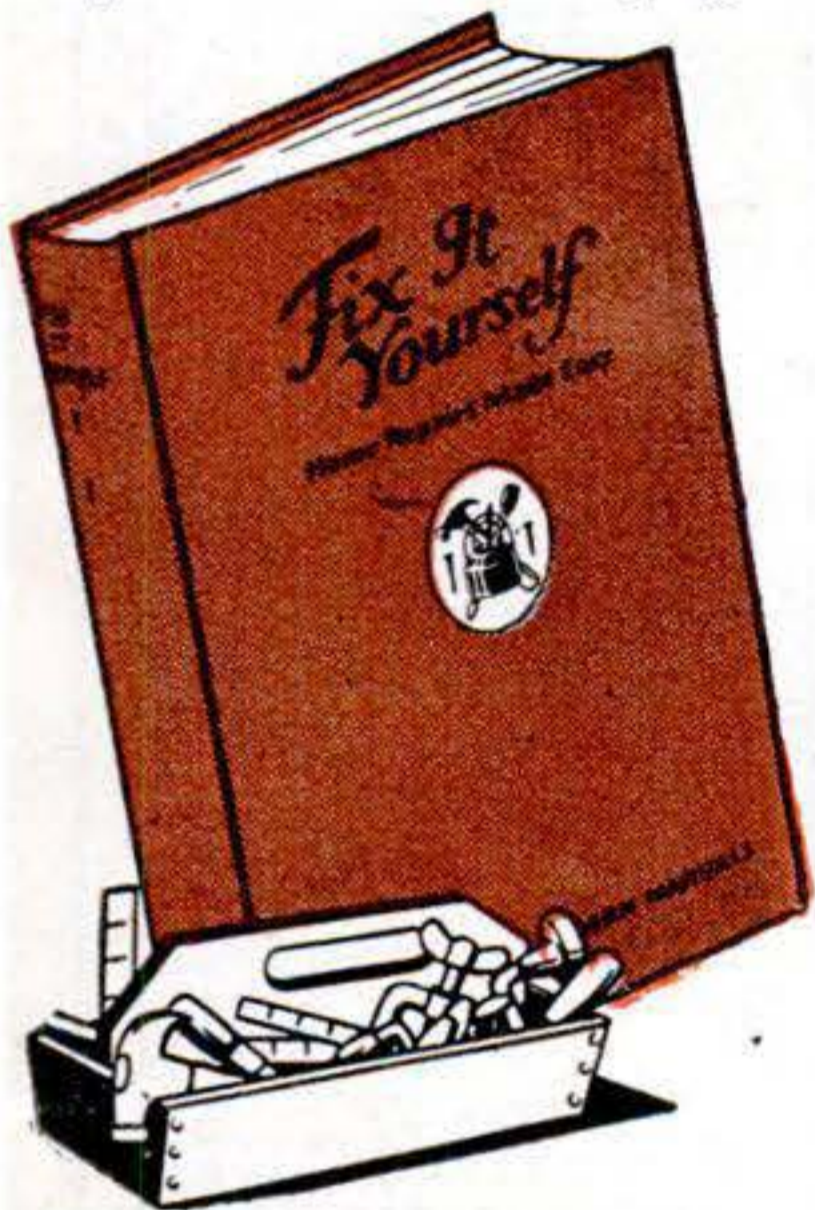
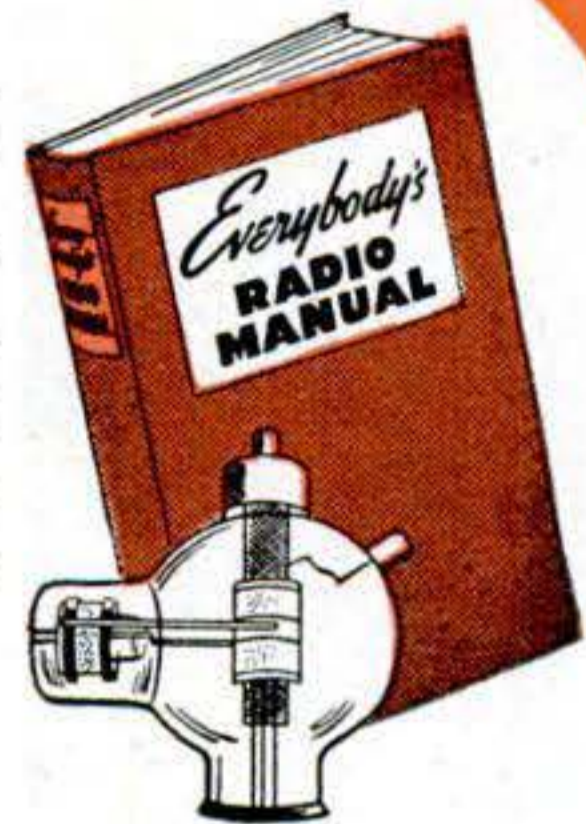

FIX IT YOURSELF

Home repairs made easy. Be your own handy-man! Simple directions and easy-to-understand diagrams show how to fix and repair furniture, electric outlets, windows, doors, leaky pipes, floor boards, chimneys, boilers, weather proofing, apply wallpaper, lay linoleum, and hundreds of other construction and repair jobs around the house. You will be surprised how easily you can do things after reading "Fix It Yourself." 256 pages, 163 helpful illustrations, complete index, DeLuxe edition.

\$1⁴⁹

WOODCARVING AND WHITTLING

\$2⁰⁰

Here's a fascinating hobby anyone can learn with this *completely illustrated*, easy-to-follow book! You'll find step-by-step instructions for making scores of ornaments, jewelry cases, furniture of all kinds, treasure chests, trays, chairs . . . and even wooden figures of men and animals! Over 270 pages, with 150 pictures to explain your every move! A gold mine of ideas packed in one big book!

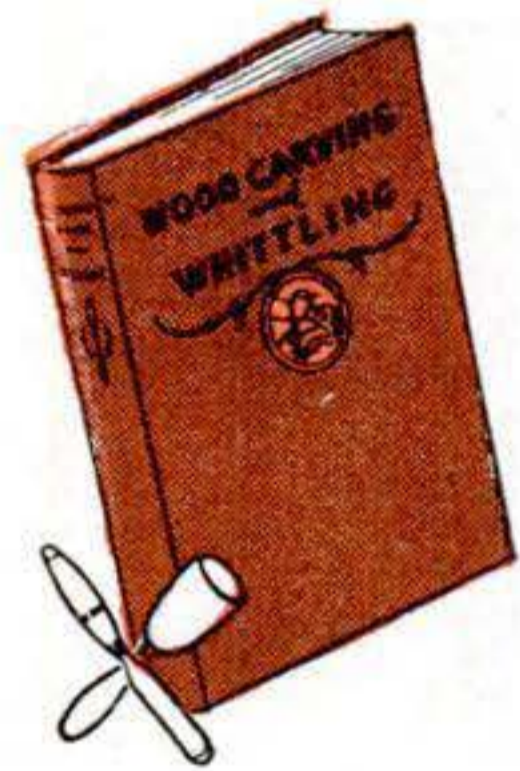

SEE THESE BOOKS AT OUR EXPENSE!

Send no money now—mail this Order Form! When postman delivers books pay listed prices plus few cents postage. Read them 7 days free—if not delighted return for full refund!

**POPULAR SCIENCE, Dept. 77
353 Fourth Avenue, New York 10, N. Y.**

Please send me the book(s) checked below. I will pay postman the price shown, plus few cents postage, on delivery. You guarantee complete satisfaction or I may return books in 7 days for a full refund.

- | | |
|--|--|
| <input type="checkbox"/> NEW HOME WORKSHOP . . . \$3.48 | <input type="checkbox"/> RADIO MANUAL . . . \$1.49 |
| <input type="checkbox"/> TINKERING . . . \$1.49 | <input type="checkbox"/> FIX IT YOURSELF . . . \$1.49 |
| <input type="checkbox"/> WOODCARVING . . . \$2.00 | <input type="checkbox"/> HOME CHEMIST . . . \$1.49 |
| <input type="checkbox"/> BOOK OF FORMULAS . . . \$1.49 | <input type="checkbox"/> DECORATIVE METAL . . . \$2.00 |
| <input type="checkbox"/> WONDERS through the MICROSCOPE . . . \$1.49 | |

NAME.....

ADDRESS.....

CITY..... ZONE..... STATE.....

Check here if you remit now, and we will pay postage. Same refund guarantee.



**AIR
CORP
GUN
SIGHT**

Worth many times this low price. Consists of a polaroid filter, top surfaced prism mirror, actuating motors, compensating adjustments, calibrated dials for air speed, drift, straining range, etc. Inventors and experimenters will find many valuable parts in this assembly. All brand new in orig. export packing. Weight 7 lbs. No. 215. Each only..... **\$4.95**

WAR SURPLUS AND HUNDREDS OF OTHER BARGAINS

**7 LB. EXPERIMENTER
PARTS ASSORT. KIT**



A "gold mine" for the radio serviceman. Hundreds of valuable radio parts, new radar and electronic parts and sub-assemblies, coils, resistors, trimming condensers—worth many times this low price. A130R -7 lbs. **\$1.79**

G.I. PISTOL BELTS



Of heavy canvas webbing. Adjustable. Eyeleted all around. Used but perfect. Wgt. 2 lbs. No. 131. Each..... **98c**

U.S. Govt. BOLO KNIFE



Extra heavy. For farm, home or jungle use. Blade of Govt. formula cutlery steel. Walnut riveted handle. 3 1/2 inch hilt. 10 1/2 inch blade. You'll find hundreds of uses for a Bolo knife. Blade will take and hold a keen cutting edge. Wt. 2 lbs. A112— with Army Sheath..... **\$4.95**

POCKET KNIFE

Signal Corps surplus. One 3 inch blade and one screw driver blade with cutting edge. Shackle on end of handle. Wgt. 1 lb. No. 195 Each... **\$1.25**

**U.S. NAVY FLASHLIGHT
BRAND NEW**

Army surplus. Flashlight has all plastic case with right angle reflector. Positive acting safety switch. Has clip for attaching to belt. Spare bulb in base. Complete with batteries. Shp. wgt. 2 lbs. No. 196. Each..... **\$1.25**

MEDICAL STERILIZER



Consists of alcohol burner and sterilizing tray in hinged metal case 1 7/8 x 1 1/8 x 2 5/8 inches. Burner may be used separately. Bright nickel finish. All brand new. A125—Ea. **98c**

Officers Watch Compass

Brand new gov't. surplus. Army-Navy model. Single jewel mounted needle. Silver colored dial. A splendid value. Shp. wgt. 1 lb. A174—Each... **98c**

BERNARD WIRE PLIERS

Parallel acting jaws. Wire cutter at top. Brand new. Wgt. 2 lbs. No. 168. Each..... **\$1.29**

HUNTING KNIFE

Has 5 inch blade with keen cutting edge, 9 1/2 inches overall. Dressed leather handle with plastic insets and guard. Sheath included. Wgt. 1 1/2 lbs. No. 197. Each..... **\$1.65**

TRAINING RIFLE

Regulation size and weight. Looks like the real thing. Fitted with adjustable sights and full size leather sling. Bolt action sets trigger. Has metal barrel and fittings. All brand new and individually packed. Shipping weight 8 pounds. Stock No. 192. Price, Each..... **\$4.50**

BINOCULAR CASE

Heavy cowhide, hand sewn. Die cut top for compass. Will fit 6x30 Bosch & Lomb or similar binocular. Wgt. 2 lbs. No. A191. Each..... **\$2.95**

**FISHING KIT
18 Pcs. BRAND NEW**

Here is a war surplus special that every fisherman will appreciate. It consists of hundreds of feet of line with lures, hooks, sinkers, etc. Fishing knife and gloves, all packed in a cloth roll up kit that also serves as an apron. Entire assembly of 18 pieces comes packed in a hermetically sealed can Brand new! A real value. Shp. wgt. 4 lbs. Stock No. A113. Each only..... **\$2.95**

BUBBLE SEXTANT Model A-12

(Octant) A valuable piece of scientific apparatus that every boat or private plane operator will appreciate. Made by Link Aviation Devices, Inc. for use in navigation. It is a precision instrument, finely constructed and calibrated for utmost accuracy. Each unit is complete—brand new and in a specially constructed protective box case. Stock No. 193 **\$39.50**

SLIDE RULE CASE

Made by Kuffel & Esser. Of heavy formed leather throughout. Holds 10 inch Log-trig rule or equivalent. These cases are brand new. May be used for many other purposes. Shp. wgt. 1 lb. Each..... **98c**

JUNGLE HAMMOCK

For back yard, country home and camp use. Has waterproof roof with mosquito-proof nylon netting side. Lets you sleep outdoors safely. Finest construction. Originally designed for U. S. Army use. Shp. wgt. 7 lbs. No. 134. Each..... **\$3.99**

Shatterproof Goggles

All purpose type. Sponge rubber frame. Red shatterproof flexible lens. Adj. head band. With case. New. Wgt. 1 lb. No. 139—Each..... **39c**

FISHING REEL

Full 100 ft. line capacity. Free acting brass bearings. Ratchet drag. Catalin handles. A real value at this low price. All metal! Shp. wgt. 1 lb. No. F412, Each **98c**

RUBBER CUP WITH LID

Measures 3 3/4 x 3 1/2 inches—of genuine live rubber. Snug fitting lid. Makes fine tobacco humidior, etc. All guaranteed perfect. A503—EACH..... **59c**

STILLS

Distill your own water with one of these fine portable stills. Purchased from the Gov't. Completely self contained. Has 1 gallon capacity; output 1 1/2 gal. per hour. Fitted with genuine Coleman double burner stove. Operates 5 to 7 hrs. on one filling. Heat output 20,000 BTU's. Stove alone is worth this price. All new and guaranteed. Instr. included. Weight 109 lbs. No. 206 Each... **\$59.50**

SHIP BELL

Purchased from U. S. Maritime Comm. Measures 10 inches high, 9 3/4 inch flare. Big 6 inch clapper. Weight 15 lbs. Fine for farms, clubs, estates, etc. All new A-541, ONLY **\$9.85**

SHIP'S LANTERN

Purchased from the Navy. Stands 22 1/2 inches high, 9 3/4 inches wide. Of heavy sheet metal. Windproof ventilation. Mounts on any wall. Burns oil—may be wired for electricity. All new. R516—EACH. **\$12.50**

CORK FLOAT

Measures 5 1/4 by 3 ins. Solid cork. Used as buoy. also for deep sea live bait fishing or Musklunge float. White and red finish. New A161—Each... **75c**

DECORATIVE CHROME STRIPS

For your car, boat, furniture, etc. Highly polished chrome finished strips with clinched edges for flush mounting to any surface. The 3 pound kit provides approx. 15 pieces in lengths from 6 inches to 3 feet and average 3/4 inches wide. Wgt. 4 lbs. No. R224. 3 lb. Assort. only..... **\$2.00**

ORDER DIRECT FROM THIS AD

Values galore! Hundreds of hard-to-find items for home, shop and outdoors. Make remittances by money-order, bank draft or personal check. Send 25% deposit on C.O.D. orders. No C.O.D.'s on orders for less than \$5.00. Include sufficient postage on parcel-post orders—any overage will be promptly refunded. All quotations F.O.B. Chicago. Used items and materials are guaranteed serviceable and as described. Your money back if not more than satisfied.

BIG ILLUSTRATED CATALOG FREE

STARK'S Dept. PS747
509 So. State St.
CHICAGO 5, ILL.

POPULAR
SCIENCE

Classified Opportunities

Save time - Save Money



Classified Ads only 60c per word per insertion, payable in advance. Minimum ad 10 words. To be included in August issue copy should be in our office by June 28th. August issue on sale August 1st.

POPULAR SCIENCE MONTHLY—351 FOURTH AVE.—NEW YORK CITY 10

12 AUTOMOBILES

"STREAMLINED Roadster"—America's lowest priced car! Small, speedy two passenger sportster! Amazingly easy to build from inexpensive material—small motor. Complete instructions, drawings \$1.98. Almquist Engineering, Box 660-E, Brooklyn 1.

RACING Car performance for all cars. Increase power, speed. Special "Custom built" equipment. Free literature. Write Lee Motorcraft, 1412-B Great Northern Bldg., Chicago 4, Illinois.

HOT-ROD Manual; plans, photos, instructions, fast Fords. \$1.50 P.P. Racing parts list. 10c P.P. Hollywood Hot-Rod, Box 9626S, Los Feliz Sta., Hollywood 27, California.

SPEED Age—The new picture and story auto and motorcycle racing monthly magazine. Year, \$3.00, trial copy, 25c. Box 237-S, Hyattsville, Maryland.

AUTOMOBILE Racing Book. Fifth Edition—Revised. Tells how to build dirt tracks bodies, frames, engines. Records, superchargers, rules, formulas, plans, stock conversions, roadster racing, fast Fords. \$1.00 postpaid; \$1.15 C.O.D. Ray Kuns Department 274, Madisonville, Cincinnati, Ohio.

CUSTOMIZE your automobile. Illustrated new restyling ideas, instructions, specific model changes by simple methods. \$1. Speed-wheel, Box 723-C, Arcadia, Calif.

USED-Car Handbook. "Judging the Used Car." Dealers' tricks exposed, comprehensive simple tests, photographs. Postpaid \$1. Truvalu, Box 723-C, Arcadia, Calif.

HOTROD and fast stock car equipment Heads, manifolds, camshafts, etc. List 25c. Alden Motors, Oakland City, Ind.

MAKE your Ford fast! Complete details, photographs. How to construct 120 mph Hotrod, \$1 postpaid. California Bill, Box L-2, Eaglerock, Los Angeles 41, Calif.

AUTO racing magazine subscriptions. Pacific Speedway News, \$6.00 yearly. National Speed Sport, \$4.00 yearly. Illustrated Speedway News, \$4.00 yearly. All give complete data midget, big car race results. Sample copy each 50c. Specify publication wanted. Clymer, Dept. B-72, 2125 W. Pico, Los Angeles 6, Calif.

CLYMER'S Historical Motor Scrapbook No. 4. Ready June. Latest Clymer book old cars and motorcycles. Postpaid \$1.50. De Luxe Edition, \$2.50. Clymer, Dept. B-76, 2125 W. Pico, Los Angeles 6, Calif.

SPEED & Mileage manual—Obtain greater speed, mileage, racing performance from any automobile! Includes simplified methods, speed tuning, gas saving secrets—Instructions on building economizers, speed equipment, duals, mufflers, superchargers, racing fuels, fast conversions. \$1.98. Almquist Engineering, Box 660-E, Brooklyn 1.

"CUSTOM-Styling" Manual — Easily make car look Hollywoodized. custom built, ultra-beautiful! New, simplified customizing—restyling—streamlining methods. Instructions, illustrations. Plans for accessories, refinishing, mufflers, model changes—Sport, continentals, convertibles, jeeps, etc. \$2.00. Almquist Engineering, Box 660-E, Brooklyn 1.

CLYMERTONE Twin Muffler Sets. beautiful sound, complete with necessary welded pipes, E-Z installation. Ford V-8. \$20.00. Chevrolet set with split exhaust manifolds, \$37.50. Specify car model. Clymer, Dept. B-74, 2125 W. Pico, Los Angeles 6, Calif.

1947 INDIANAPOLIS "500" Race History Book. Complete details every car, driver competing. 100 photos, charts, drawings. \$1.00 postpaid. Large complete Indianapolis Race History Book, 352 pages, 1100 illustrations, all data 1909 to date. Postpaid \$3.50; De Luxe Edition Fabrikoid binding, gold lettering, \$5.00. Clymer, Dept. B-70, 2125 W. Pico St., Los Angeles 6, Calif.

DUALTONE Chrystalline packed mufflers. Single or twin mufflers for all cars. Duals priced complete V8's \$23.00. Six cylinders \$33.00. Eight cylinders \$36.00. Large chromed tailpipe extensions \$3.30. Polished carburetor velocity stacks \$1.30. Chromed Station Wagon stacks \$15.00. Request catalogue. Dualtone Mufflers, 2636B India Street, San Diego 1, California.

SCOOTMOBILE Roadster! Use scrap parts easily build inexpensive two passenger, three wheeled, small motor Runabout. Also two passenger "Jeep". Complete plans, specifications for both \$1.00. Universal, 2671 Algonquin, Toledo 6, Ohio.

SEE our ad under Motorcycles for midget racer bargains. Midget Motors Directory, Athens, Ohio.

"BUILD speedy Midget Track Racer from castoff parts! Plans, specifications, construction information, \$1.00. Motor Supply, Box CS-1682, Toledo, Ohio."

13 AUTO SUPPLIES & EQUIPMENT

HAVING Car Trouble? New, Used, guaranteed auto, truck parts save money. Transmission specialist. Describe needs; immediate reply. Victory, 2930 1/4 No. Western, Chicago 18.

AUTO parts for all autos and trucks. Trans, motors, differentials, fenders, carburetors. Also Body Parts. Security Auto and Truck Parts, 1941 BP Eddy, Chicago 13.

BURN water in your car. Costs less than gas, more power: Cleaner motor. Mail card for data on \$17.50 Octa-Gane Water injecting Carburetor. Ralph A. Shade, 563 Lake Road, Webster, N. Y.

NEED Auto Parts? We have them. New and Rebuilt. Prompt Shipment. Write Requirements. Save Money. Buy Direct. Factory Warehouse. Mechanics Auto Parts, 3807-AW North Ashland, Chicago 13.

GASOLINE economizer. Ford, Mercury, Chevrolet, 1932-1947. Dodge, Plymouth, 1933-1938. Buicks, AAV16. Prices \$1.00. Walert Co., 3429 No. 10th St., Milwaukee 6, Wisconsin.

MUFFLER manual. Convert easily to Hollywood, Laguna, Westwood, duals, etc. Includes construction details, regulations, diagrams. Postpaid \$1. Mellotone, Box 723C, Arcadia, Calif.

MAGIC Motor Tune-up. Replacement idling screw. Tunes motor instantly, saves gas \$1. prepaid. Free literature. Albert Peek, 1514 Driscoll, Houston, Texas.

BIG money in auto supplies. Buy wholesale 50% off, accessories, parts, radios, hardware, etc. Catalog free. Main Supply Company, Fairfield, Ill.

DAB, wipe-on auto paint color cards 25c; five \$1.00. Dab Distributors, 1911-N, Lubbock, Texas.

MANIFOLD Whistle—imitates "Wolf Whistle", Siren, etc. Installed on any car manifold in fifteen minutes. Send \$6.00 to Protecturod Company, 4033 Windsor #5, Youngstown 7, Ohio.

GRILLES for most all cars. Meyers Auto Parts, 820 Dryades, New Orleans, La.

1947 SUPERIGNITIONITER, \$5.00. Atomic pep, starting, mileage. EG Mfg., 355B East 149th, N. Y. 55.

14 AUTO TRAILERS

BUILD your own Trailer! Save Money! Have every feature you want! Plans for House, Sport, Camp and Utility trailers. Catalog describing 9 models 10c. (15c in Canada and overseas). Jim Dandy, Box 125-B, Wausau, Wisconsin.

91 MOTORCYCLES, BICYCLES, SUPPLIES

"CUSHMAN motorscooter \$15. Shaw bicycle motor \$15. Harley-Davidson Motorcycle \$35! Send 25c for bargain catalog #8, just off the press, packed with money saving buys in motorscooters, motorbikes, midget cars, motors, wheels, tires and parts. Gail and Company, 538 Erie, Toledo, Ohio."

LARGE stock Indian parts. Expert motor rebuilding. New and rebuilt Chief Motorcycle, motors only. Indian Motorcycle Sales, Kansas City 1, Mo.

WHEELS, Tires, Tubes for Motor Scooters, Midget Cars, Wheelbarrows, and Industrial equipment. All sizes. Bicycle Parts, accessories. Largest stock in United States. Send dime for list. Cycle Transport Company, 1241 S. Michigan Ave., Dept. C, Chicago 5, Illinois.

WHEELS! Build wagons, scooters, mowers, trailers, wheelbarrows, grocery carts, baby carts, play pens, baby carriages. 4" to 16". Free list. Trulsen Mfg. Co., 811 E. 31, Kansas City, Mo.

MOTORCYCLE Parts. New and Used. List 10c. 811 N. 9th, St. Louis 1, Mo.

BRIGGS and Outboards. cheap. Send Dime. Paco, 1252 Thurman, Camden, N. J.

POPULAR SCIENCE OPPORTUNITIES

"CUSHMAN Motorscooter \$20 (includes motor and extra tires). Midget Racer \$15! Send 25c for big Summer catalog #938, just printed, listing these and scores of other sensational bargains in motors, wheels, motorscooters, motorbikes, Servicycles, tires, etc. Associated, Box CS-1764, Toledo, Ohio."

HARLEY-Davidson Parts. Accessories. Batteries. Tires. and Repair work. 24 hour Service. Authorized factory dealer. Philadelphia Harley-Davidson Company, 857 North Broad Street, Phila. 23, Penna.

1½ HORSEPOWER from Y and similar Briggs and Strattons. Instructions \$1.00. Parts. Transmissions. Alden Motors, Oakland City, Indiana.

MOTOR Scooters, bicycle engines, 120 miles gallon. Dime for catalog. Clymer, Desk B-75, 2125 W. Pico, Los Angeles 6, Cal.

"BUILD America's lowest priced motor-scooter speedster! Complete plans, specifications, \$1.00. Big list bargain priced used motors, etc., included free! Motor Supply, Box 1682-CS, Toledo, Ohio."

WHEELS, Steel Disc rubber-tired for toys, wagons, scooters, etc. Sizes 5", 6", 7", 8", 10" available. United Wheels Mfg. Co., 11727 La Fayette Ave., Chicago 28, Ill.

"POWER Lawn mowers now available. All aluminum. Cuts grass 3 feet high. Literature free. Dealers invited. Johnsons' Motor Sales, Milford, Indiana."

1930 TWIN motorcycle \$25; motorscooters less motors \$15.75 up; motors \$3.50 up; Whizzers \$25 up; professional midget track racer; plenty midget racers for highway use; plenty brand new two horsepower motors in original crates; over 6500 small balloon tires for motorscooters and small cars, \$1 up. Mailorder only. Send 25c for Big War-Bargain Catalogue Number Nineteen, just out, listing the above and hundreds of other bargains in both new and used motorscooters, midget cars, motors, outboards, mowers, etc. (35c by First Class Mail). Midget Motors Directory, Athens, O.

"PROFESSIONAL Midget Racer, Motor-scooter, Midget Roadster, and Midget Motorcycle. Plans, specifications for all four contained in illustrated handbook, 25c. Big list bargain priced used motors, motorscooters, Servicycles, etc., included free! Midwest, 3839 Drummond, Toledo, Ohio."

15 AVIATION

VETERANS: Flight training under the G.I. Bill, Private, Commercial and Flight Instructor Ratings. Write for information, Gottschalk School of Aeronautics, Adrian, Michigan.

ENTER aviation, U. S. or Foreign. I can help you. Free information, Miller, 1333 18th Street, Santa Monica, Calif.

PROPELLERS—Airliner 3 Blade, 2 Blade. Designed for ice-snow sleds, boats. Literature. Standard Aircraft, Box 387, Ft. Worth, Texas.

PROPELLERS for Ice-snow sleds, air boats, catalog 10c. Banks Propellers, R.F.D. 12, Ft. Worth, Texas.

"CUBS, Wacos, Taylorcrafts, Aeroncas. Big catalog 25c, lists these and thousands of other sensational airplane bargains. Some are "easy to repair" crackups. National, Box 1682-CS, Toledo, Ohio."

BUSHEL Basket Full, Aircraft, electrical, radio, instruments, parts. Used, or slightly damaged. Valuable source for inventors, etc. Due to weight state method shipment. No C.O.D.s, \$9.95. Southwest Aero Supply, Box 488, South Houston, Tex.

4 AVIATION INSTRUCTION

TRAIN For Aviation Mechanics High Salaries. This famous school approved for veterans. Immediate enrollment. For information write California Flyers, Department P-7, Inglewood, California.

49 ELECTRICAL SUPPLIES & EQUIPMENT

MICRO Switches! All New! Type Z, \$2.00 value. Special \$1. or 12 for \$10; large micro switch, catalog No. WZE-7RQ9TN, \$4.00 value. Now \$1.50; GE midget precision micro switches \$1.25 value, \$.50 each. Combination assortment, variety of 6 micro switches—only \$5. Real buy. No COD. "Amazing Bachman's", 23 Herman Street, Rochester 5, N. Y.

ELECTRIC Pencil: Writes, Engraves all Metals, \$1.00 postpaid. Beyer Mfg., 229-C Dixon Blvd., Uniontown, Penna.

FLUORESCENT Lights: Make your own. . . . Ideal for home and shop. Complete electrical parts for 20-watt fixture with all necessary detailed instructions. Postpaid for only \$2.00. Write Fluorokit, 332 E. Reservoir, Milwaukee, Wisc.

LAMPS—All parts to build or repair. Catalog 10c. Gyro, 5416 Clark, Chicago 40.

ELECTRIC fan assemblies. Assemble your own. Ted Riseman, 207 North Fifth, Springfield, Ill.

WASHING Machines. Parts all makes. Northeast Burner, 1358-S H Street, Washington 2, D. C.

SELSYN motors, Bendix 3½" x 5½" heavy duty 115 volts, 60 cycles, \$10.25 per pair. J. A. Weber, 150A Maple, Hershey, Pa.

DICTAPHONES, Model 7, limited quantity, surplus, reconditioned, \$49.50 each. Wire Recorder Magazines new, precision built for the Navy \$49.50 each. Shipped C.O.D., F.O.B. N.Y. Dictating Machine and Supply Co., 433 Fourth Avenue, N. Y. 16.

ELECTRIC Pencil—writes, engraves all metals. Battery model \$1.00—110 Volt model \$2.00 Postpaid. C.O.D.s accepted. Reb Industries, Dept. 265-Y, Elmhurst, Ill.

FRICITION Tape—(Gold Seal)—½ lb. package, ¼" size, 7 rolls for \$1. 100 roll lots—\$10. Unsurpassed value! Order Now! No COD orders. "Amazing Bachman's", 23 Herman St., Rochester 5, N. Y.

MAGNET Wire! ½ lb. coils No. 22. All New! Special \$.35 each, 3 for \$1. No COD. "Amazing Bachman's", 23 Herman Street, Rochester 5, N. Y.

FREE catalog of build your own electric lawnmowers, motors, welders, freezer, fences, and electrical items. Lejay Company, Minneapolis 8, Minnesota.

140 WELDING, SOLDERING

NEW Model electric welder 110 volt AC-DC; will weld all metals; easy to use, full directions. Complete with power unit, flame and metallic arc attachments, carbons, fluxes, rods, mask; all for \$19.95—Used by the Navy. Magic Welder Mfg. Co., 239-PS—7 Canal St., New York City.

SAVE time and money. Use Mendall Metal for quick, permanent, repairs on motor blocks, cylinder heads, water gaskets, radiators, plumbing, kitchen utensils. Write for Free Facts, Four A, Dept. 12, Littleton, Colorado.

WELDERS (Acetylene) Double present income welding White Metal ("Pot") using your own rod made from scrap. La-Combe, Oakland S-6, California.

SILICON steel strips 12c lb. Ernest Noyes, 32328 Brush, Royal Oak, Michigan.

WELD with alcohol or kerosene. Safe, cheap, simple outfit for home craftsmen. Materials available anywhere. Tested plans \$1.00. Groff, 25 Winslow St., Newport, R. I.

WELD, Cut, Braze with gasoline! Amazing new discovery shatters costs. Boosts profits. Important! Write Matthews Mfg. Co., Calgary, Canada.

MONEY-Saving prices. Guaranteed 110/220v A.C. welders. All sizes. Free illustrated Literature. Williams Company, Box 4100, Portland 8, Oregon.

80 MACHINERY, TOOLS, SUPPLIES

MECHANICS—Machinists—Hobbyists—Note! All New—Amazing—Dual-Drive Assembly, geared 7 to 1 reduction, is driven by powerful 1/5 HP AC or DC Motor. Operates on 6 - 27 - or 110 volts, 60 cy. Single Phase. Simple standard attachments convert this amazing unit into a dual-hand or table drill—polisher—buffer—router—sander—countless other uses. May be used as individual drill—sander—etc., by detaching flexible drive shaft. This wonder machine shop all in one comes setup as drill equipped with 3 flexible drive cables and mounting bracket. Original cost to Government over \$300.00 Now! While they last, \$19.50. No COD. "Amazing Bachman's", 23 Herman Street, Rochester 5, N.Y.

WORK wanted for hand Turretlathe. Glenbern Machine Co., Youngwood, Pa.

DRILLS H. S. #1-60 \$10.95 with stand. Send Dime for Sample and List. V-B Sales, Roselle, Illinois.

MACHINE Tool Castings for woodworking and metalworking tools. Machine them yourself, save up to 80%. Catalog describing 23 Lewis Tools and projects sent for 10c. Lewis Machine Tool Co., 3217 Union Pacific Avenue, Dept. S, Los Angeles 23, Calif.

ELECTROPLATING booklet includes full directions for plating jewelry, small parts, metallizing baby shoes, 50c. Hoover & Strong, Inc., 115 W. Tupper Street, Buffalo 1, N. Y.

DRILL GRINDER—Grinds drills to factory accuracy. Calipers with direct reading scales. Circle cutters. New Tool grinder. Lowest prices. Free literature. Factory, 811-A East 31st, Kansas City 3, Mo.

WAR Surplus in small tools for machine shop—Send 10c for bulletin. Travers Tool Co., Dept. S, 5 Court Square, Long Island City 1, N. Y.

SHEBEL Saw Filer, \$7.50. Files all saws. Free trial, Circular, 730A So. 2nd St., Milwaukee 4, Wis.

ARMY Surplus ¼" Drills Runs Off Any Air Compressor Powerful Tool For Mechanics \$15.00. Money Back Guarantee. Send Money Order! Flecks, Warren, Ohio.

CONCRETE Building block machines and molds. Catalog free. Concrete Mold Co., 5127 South Compton Ave., St. Louis 11, Missouri.

WAR Surplus, Machines, Tools, etc. Free literature. Wayne Engineering, Greenville 2, Ohio.

12" BAND Saw, tilting table. Oilite bearings, all grey iron castings, \$35.00. Write for circular. Backus Machine Co., Boyd, Wisc.

TAPS & Dies direct from manufacturers. Equip your shop at small cost. Write for free price list. King Tap and Tool Co., Inc., North Attleboro, Mass.

DRILL Grinder for twist drills \$2.95. See ad on page 251.

"SURPLUS—High-speed tool steel bits, 63 Rockwell, ¼, ⅜, ½, ⅝, square x 4". 25c, 40c, 55c, 70c each. Other sizes. Tools, Box 4658, Pittsburgh 6, Penna."

INDEX Heads for sale. Very inexpensive. Sixty-two different Divisions. Used on lathes up to twenty" swing, drill-presses, milling machines, etc. Make gear, hobbs, cutters, etc. Very accurate and durable, used by shops, factories, and machinists. Write for free folders. Long's Index Head, 2117 East B Street, Torrington, Wyoming.

V BLOCKS at low prices, 10 sizes for all purposes. Free Literature. Miles Products, 2532 Wabash, Chicago 16.

GEAR Reductions! Values ranging from \$500 to \$1100 each. All New! Complete with ½ HP motor AC or DC 110 Volt, 25 or 60 cy. Single phase. Variable speeds. Bearing assembly with machined gears. Absolutely the thing for sanders—polishers—winches—hoist—conveyors. Adaptable for many uses. Special \$39.50. No COD. "Amazing Bachman's", 23 Herman Street, Rochester 5, N. Y.

POPULAR SCIENCE OPPORTUNITIES

MACHINE shop tools released for private industry; Loose change Lathes; 14"—\$150; 16"—\$180; Vertical miller \$220; Quick change lathes 12"—\$390; 16"—\$440; Hand miller \$95; 3½" swivel bench vices \$13; New lathe chucks 25% discount; Warner & Swazey 3A & 2A geared head turret lathes \$300; 19" x 16' engine lathe, take 11' between centers \$450. If you do not like the machine you buy you can return it and get your money back. Conversion Parts Co., 277 Adams St., Boston 22, Mass.

"MODELS, dies, castings, shop drawings; also production, Mitchell Engineering, 6430 Evans, Chicago 37."

MACHINISTS — Hobbyists — Experimentalists—Note! Precision built Right Angle Drives. Excellent for home workshop. Complete with flexible drive cable. Only \$3.50. No COD. "Amazing Bachman's", 23 Herman Street, Rochester 5, N. Y.

SHOP Labels, postcard brings literature. Hinds, 223 Second, Niagara Falls 2, N. Y.

17 BATTERIES, GENERATORS, ETC.

EDISON Storage Batteries. Farm lighting. Five year unconditionally guaranteed. Fifteen year life. Literature. See-Jay Company, 323 Yonkers Avenue, Yonkers, N. Y.

19 BOATS, OUTBOARD MOTORS, ETC.

FULL size, cut to shape boat patterns, blueprints, 7½—38 feet. Illustrated "Build a Boat" catalog, 10c (coin). "How to Build Boats" book, \$1.00. Cleveland Boat Blueprint Co., Dept. A-77, Cleveland, Ohio.

MARINE Power—Easily convert any Ford and Jeep motor (domestic and foreign) with Osco parts and kits. Complete catalogue 25c (coin). Osco Motors Corp., 2020C E. Orleans St., Phila. 34, Pa.

NEW, used, rebuilt marine motors. Marine conversions, fittings. Free Catalog. Stokes Marine Supply, Dept. 23, Coldwater, Mich.

"PLYWOOD Rowboat and Motor Boat K.D. Kits. Assemble and save up to \$57.50. Three popular models. Resin bonded, waterproof plywood construction. Easy to assemble in spare time. Write for free literature and complete specifications. C. R. Dillaugh Boat Co., 7928 N. E. Mallory, Portland 11, Oregon."

WHY lug your outboard motor? New carrier \$8.75 Folder Free. Sportspal, Tahoe Valley 4, California.

BRAND New 1947 Neptune Outboard Motors 1½ H.P. \$52.50.—4½ H.P. Twin \$115.50—Ten Dollars Deposit Balance C.O.D. Outboard Sales, 3419 Nashville Ave., New Orleans, La.

BOATS And all about them. How to select, build, repair and operate. For 40 years the leading practical boating magazine. Half price trial subscription, 12 issues for \$1.00. Motor Boat, 62 Gold Street, New York 7.

CANVAS for Canoes, Cabins, decks, trailers. Canvas cement. Airplane dope. Boat equipment. Catalogue. Alan-Clarke, 96 Chambers, New York City.

"MARINE conversions for Ford and Jeep engines. Catalog 10c. Lehman Manufacturing Company, Department A, Newark 2, New Jersey."

PLYWOOD Boat Kits! Complete materials for building "Deltacraft," "Junior Dinghy," "Tadpole Skiff," Mahogany marine plywood and oak construction! Send 10c today for illustrated folder featuring these Boat Kits and other marine materials and supplies. Carmen-Bronson, Marine Department, Mount Vernon, N. Y.

FIR Plywood—Waterproof marine grade for boat-building. ¼" thickness 48"x96" \$6.40; 48"x144" \$12.48; 48"x192" \$16.64; ⅜" thickness 48"x96" \$9.60; 48"x144" \$15.84; 48"x192" \$21.12; ½" thickness 48"x96" \$11.20; 48"x144" \$18.24; 48"x192" \$24.32. Terms: Cash with order; shipment by express or freight. Carmen-Bronson Corporation, Dept. M-5, Mount Vernon, N. Y.

CARTOP Rowboats, Kayaks, Weldwood ready cut kits. Booklet. E. J. Croot Co., #103-E, Basking Ridge, N. J.

51 ENGINES, MOTORS, ETC.

RANGER Engine-Aircraft—All New in original case. 570 HP. 12 Cyl. V type. Engine Spec. No. 177. Complete with spark plugs. Original Government cost over \$12,000.00 each. Special offer \$200. Crated weight 1200 lbs. No COD. Write for complete description. "Amazing Bachman's", 23 Herman Street, Rochester 5, N. Y.

"BUILD Your Own" gas drive arc welder easily with Hobart Generator. Save \$300 to \$500, and need only add used auto engine and chassis to build portable gas drive welder that goes everywhere after profitable construction and repair jobs. Write for free instruction book, further details. Hobart Brothers Co., Box P-774, Troy, Ohio.

WINDING Data, listing 225 motors, single and three phase, \$1.00. Motor Data, Box 7631 Kansas City 3, Mo.

MOTORS! 27-Volt DC—All New—Geared for 120 r.p.m. operates on AC with transformer or power supply. Can be used for Model Railroads. Counter or Window Displays. Countless other purposes. A Must for the workshop. Government cost over \$30.00. Now, only \$2.95. No COD. Order today! "Amazing Bachman's", 23 Herman Street, Rochester 5, N. Y.

7 AMERICAN POLICE JIU JITSU

DEADLY Judo—Fiercest fighting technique. Trick knockouts. (200 photographs—plus illustrations.) Expert instructions—Three volumes. Complete \$2.25. Variety House, Box 46-AT Wall Station, N.Y.C. 5.

20 BODY-BUILDING COURSES

THE World's most powerful men are built by The Key Institute of Physical Culture, Miami, Florida. Information free.

ACROBATICS — handbalancing, self-taught. Write. Power, 923 W. Vine, Kalamazoo, Michigan.

BAR-BELLS, Dumbbells, Exercise equipment, Courses, Free booklet. Good Barbell Co., Reading, Penna.

BARBELLS! Catalog! Bur Barbell Co., 319 Orient Way, Lyndhurst, N. J.

BARBELLS, Olympic types. Stamp for folders. Jackson Barbells, Dept. 5, Springfield, N. J.

124 SPORTING GOODS, GUNS, FISHING TACKLE, ARCHERY

"AMMUNITION"—"New and Used"—"Shotguns"—"Rifles"—"Revolvers"—"Pistols"—"Fishing Tackle"—List 10c. Rudolph's, Atchison, Kansas.

BOWS-Arrows. Write headquarters for Archery equipment. Quality products. Popular prices. Catalog 10c. Large illustrated Hand Book Instructions, making and shooting. 50c. Archery, 617-A So. State, Chicago 5.

SEND 10c for list 100 new and used guns. Frayseths, Wilmar, Minnesota.

"SELL Rocks!" Let "Mother Nature" finance your outings. Details free! Mac Campbell, Calexico, Calif.

5000 BARGAINS, firearms, binoculars, war relics, catalog 40c. Smith Museum, Runnemedede, N. J.

NEW Smith-Wesson 38 Caliber Revolvers \$39. Trades: Bargain House, 1317 Franklin, Tampa, Fla.

FISHING Tackle Catalog Free. Dare, 670E42, Brooklyn 3, N. Y.

55 FIELD GLASSES, TELESCOPES, ETC.

60 POWER telescope, \$2.95. 250 power microscope, \$2.45. Send for free catalog of Telescopes, Binoculars and Microscopes. Brownscope Company, 24 West 45th Street, New York.

GENUINE polaroid glass—2⅞" (72 mm) diameter. \$1.25 each, 2 for \$2.00. Ross, B68 West Broadway, New York, N. Y.

INFRA-RED filters glass 1¼" (40 mm) diameter, mounted. Snap on camera or binocular. \$1.00 per set. Ross, B68 West Broadway, New York, N. Y.

REFLECTING Telescope, complete 3½" diameter, equatorially mounted. View planets, stars, \$19.75. Write Skyscope Co., 475-5th Ave., New York.

7 x 50 OPTICS. \$11.00 per set. War surplus lenses and prisms, telescope eyepieces and parts, spotting scopes, binoculars, 10c for list. R. Beach, 703 S. Claudina St., Anaheim, Calif.

TELESCOPES, Microscopes, binoculars, barometers, books; Buy, sell, repair; We guarantee. Lists 10c. Rasmussen & Reece, Amsterdam, N. Y.

43 DOGS, BIRDS, PETS, RABBITS

ANGORAS, Chinchillas, White Giant Rabbits — "Rabbitry Management" tells everything, \$1.00. Self-cleaning Hutch plans \$1.00. Automatic Feeder plans \$1.00. All three \$2.50. Catalog finest Pedigreed Rabbits free! Grinsteads, Dept. 16-D, Edwardsville, Ill.

GUARANTEED Chin-Chin Giant Chinchilla rabbits. Greatest amount of delicious meat, Largest, finest, most valuable furs. Tremendous demand for breeding stock. We buy youngsters. Contact world's largest breeder, Willow Brook Farm, R16, Sellersville, Pa.

\$250 MONTHLY. Raising Angora Rabbits. Particulars free. White's Rabbitry, Newark, Ohio.

\$50.00 weekly with Angoras. Our co-operative marketing plan assures you of year around market. Free literature. Iowa Angora Association, 1215 34th Northeast, Cedar Rapids, Iowa.

\$2,500 YEARLY raising Angoras. We market your young. Contract Particulars Free. Wilsons, 1065 Shyer, St. Paul 8, Minn.

FOR Sale — Coonhounds, combination treehounds and high class foxhounds. Rabbit hounds a specialty. Raccoon Mountain Kennels, Dures Thomas, Rt. 3, Albertville, Ala.

RAISE Guinea Pigs. Make money at home. Big demand. Booklet free. Taylor, Box 426B, Hapeville, Georgia.

ST. BERNARD Pups; Champion sired beauties. Franklin Young, R. 3, Riverhead, Long Island, New York.

RAISE Diamond Seal Rabbits. We pay \$30-60 Each continuous market. Prices guaranteed. Particulars free. Hansons Rabbit Institute, 1347 Miller Ave., Salt Lake City 6, Utah.

SELANNA Kennel Service; Prospective Dog Buyers. Do you want advice on which breed, or at what age, or which sex to buy for your particular purpose? Lists of Breeders of any breed furnished. Enclose One Dollar for reply. 4 W. Chestnut St., Selinsgrove, Penna.

83 MILK GOATS

"MONEY from dairy goats!" Booklet free. Introductory 3-month subscription to leading magazine 25c. Dairy Goat Journal, Dept. 768, Columbia, Missouri.

52 FARMS, OTHER REAL ESTATE

OZARK Lands for All purposes. Actual river frontages, 5 acres \$90.00 and upwards. Free list and literature. Hubbard, 424H, Minnesota Ave., Kansas City 4, Kans.

GOOD Farms—Ranches, Washington, Minnesota, Montana, Idaho, Oregon, North Dakota. Dependable crops, favorable climate. Write for literature, lists describing typical postwar farm opportunities. Specify which state. J. W. Haw, 120 Northern Pacific Ry., St. Paul 1, Minn.

OZARK Guide. Eureka Springs, Arkansas. Magazine for homeseekers. Year \$1.00.

POPULAR SCIENCE OPPORTUNITIES

STROUT'S Green Farm Catalog—Over 2500 Bargains—money-makers—32 states—Coast to Coast. Mailed Free. Tell us what you want. When? Where? Price? Terms? We will try to save you Time & Money. Strout Realty, 255-ZB 4th Avenue, N. Y. 10, N. Y., 20 W. 9th St., Kansas City 6, Mo., 453 S. Spring, Los Angeles 13, Calif.

HOMESITES \$450—convenient payments. California's finest garden section. On Morro Bay's scenic shores. Wonderful fishing, hunting, boating, bathing. Fertile soil, softest water, temperate climate, congenial community. Free literature. Richard Otto, 6560-Z, Hollywood Blvd., Hollywood 28, California.

OZARK FARMS. Large list free. E. Frank, Mountain View, Mo.

108 POULTRY AND SUPPLIES

RAISE turkeys the new way, write for free information explaining how to make up to \$3000.00 in your own backyard, address National Turkey Institute, Dept 57, Columbus, Kansas.

111 PROFITABLE OCCUPATIONS

DETECTIVES Earn Big Money. Excellent opportunity. Detective Particulars free. Write, Wagoner, P-125 West 86th, N. Y.

WELDING—Electric Arc. Learn profitable trade quickly through actual practice. Individual welder instructions at bare cost of materials. Full particulars free. Valuable welding lessons book 50c. Hobart Welding School, Box P-773, Troy, Ohio.

LOCKSMITHING—Profitable Business or Hobby! New course teaches you how to pick locks, fit keys, de-code, masterkey, etc. Easy self-instruction lessons. Bargain price. Fascinating 100-page illustrated catalog Free! Write Nelson Company, Dept. 2-01, Chicago 5.

MUSHROOMS Grown. Boxes, Barrels; Illustrated Instructions, 50c. Spawn \$1.00. Gordons, 553 William, Winnipeg, Manitoba.

\$40.00 WEEKLY. Made growing mushrooms. Fresh. Dried. Dominion Patent 331,583, free spawn. North American, 169Y Yonge, Toronto, Canada.

MAKE beautiful costume jewelry at home for large profits, hobby or therapy. Free illustrated wholesale catalogue of sea shell, metal and plastic parts contains detailed instructions. Florida Supply House, Bradenton, Florida.

\$5000. from half acre growing Ginseng. seed supplied. Crop bought. Particulars 10c. Associated Growers, 203 Bulman Block, Winnipeg, Canada.

MAKE \$100—a week in your spare time. Write for free literature. Schick Mfg. Company, 257 William Street, New York City.

SHELL jewelry, ash trays, dolls and many other shell novelties are easy to make at home. Beginners' shell kit with instructions only \$1.00. Catalogs listing over 100 varieties of shells and findings such as ear screws, pinbacks, plastic cameo, crosses, plywood plaques, etc. sent for 5c. refundable. Burton, Box 27, Sta. A, St. Petersburg, Fla.

RADIO Acting and Announcing. Complete 12 lesson home study course only \$3.00. Written by Hollywood Radio Actor, Producer, Writer and Director. Easy to understand, illustrated. Send for complete course now! \$3.00 covers everything! Money back guarantee. Send check or money order to Hollywood Radio Academy, 8910 Beverly Blvd., Los Angeles, California.

WIN Prize Contests. Particulars, stamp. Roy, Box 531-A, Waterbury, Conn.

NU FLEX, sensational plastic compound for making molds, easily used, perfect register for years. Fast selling copyrighted designs available. Circular free to mold makers and casters. Plastex Products, 711 Laguna, San Francisco 2.

START Back Yard, Perennial Plant Business much more Profitable than Ginseng. Instructions \$1.00. Richland Gardens, Martin, Tennessee.

EARN Money At Home With Typewriter! Addressing Envelopes, Circulars, Typing. 25c brings details also 68-Page Book of Moneymaking Opportunities. Ace-11, Box 183, Birmingham, Ala.

SEA Shell Jewelry. Free instruction. Werts, 1429 56th Avenue, Oakland 3, Calif.

MAKE \$150 a Week and more in a profitable business of your own with amazing Liquid Imitation Marble, Fiber-Tite Flooring and Flexible Molds. Full or Spare Time. Experience unnecessary. Work from your own home. Write for Free catalog and full information today. Composition Products Co., Dept. PS7, 5853 Delmar, St. Louis, Mo.

MAKE beautiful mirrors from inexpensive window glass. No special equipment required. Details Free. Tes-Co., Box 189-SE, Wilkes Barre, Penna.

METALLIZE Baby shoes for big profits. Several methods \$1.00. Tes-Co., Box 189-SF, Wilkes Barre, Penna.

WRITERS, reporters, wanted in every land. World-Press, Columbia City, Indiana.

INTERESTED in Foreign Employment? \$1 brings list of 50 concerns with foreign projects or affiliates. Foreign Service Institute, Box 1897-A, Riverside Station, Miami 35, Florida.

PROMOTE Dances in your community—Exciting glamorous occupation. "Profitable Dance Manual" contains prepared publicity, promotion and ideas for special dancing parties. \$1.00. Modern Manuals, POB 814, Chicago 90, Ill.

"UNPAINTED Plaster Ornaments, beautiful designs easily decorated with water colors or oil paints. Illustrated List free. Midwest Novelty Mfg. Co., 108 Cedar St., Anaconda, Montana."

\$4.00 Hour Soliciting Subscriptions Copyrighted Book and Magazine Deal, Box 371, New Orleans 9, La.

PRACTICAL plastics. Fabrication, internal carving, shop work, craft-work. Enterprise School of Plastics, 81 Willoughby Street, Brooklyn, Co-ed. Triangle 5-8681, Ext. 13.

22 BOOKS, PERIODICALS, ETC.

WHAT Every Mason wants. We have Masonic books for Blue Lodge, Chapter, Commandery Scottish Rite and Shrine. Our rituals are used the world over. Send for our free catalog of books and rituals for Masons, Odd Fellows, Knights of Columbus, etc. Ezra A. Cook, Publisher, Inc., P.O. Box 796-RMY, Chicago 90, Ill.

MAGAZINES (back dated)—foreign, domestic, arts, Books, booklets, subscriptions, pin-ups, etc. Catalog 10c. (refundable). Cicerone's, 863 First Ave., New York 17, New York.

GOOD "Used" Self-instruction educational books on all subjects bought, sold, rented, exchanged. Satisfaction guaranteed. Complete information and 100-page illustrated bargain catalog Free! Write—Nelson Company, Chicago 5.

BIG Profits Taking Subscriptions For All magazines. Agents' Confidential Catalog listing over 2500 periodicals and complete starting supplies Free. Pines Subscription Agency, Flushing, N. Y.

BOOKFINDERS! (Scarce, out-of-print unusual books.) Quickly supplied. Send wants. Clifton, Box 1377-PS, Beverly Hills, Calif.

EDUCATIONAL Books sold cheaply or rented for small fee. Books bought, Money-back guarantee, 4,000 Bargains. Catalog Free. (Courses Bought.) Lee Mountain, Pisgah, Alabama.

BOOKS on Horse Racing. \$1.50 and \$3.00. Both—big value—for only \$2.00 postpaid, sealed. Charles Hall, Sepulveda, Calif.

SIX Unretouched pocket-size Adult photographs . . . \$2.00. Box #699-V, Westfield, N. J.

MEN Only. Fresh stuff in little Books. 15 for \$1.00. DuLaw Novelties, Box #297, East Chicago, Indiana.

FREE Bargain Catalog. Happiness Books PS, 41 Union Square, N. Y. C. 3.

ADULT Books 25c. Five—\$1.00! Free Bookalogues! Hirsch, Spring Valley 3, N. Y.

YES: We are again accepting agents to handle magazine subscriptions, books, greeting cards, complete details 25c (refundable). Cassell Publishers Service, Westfield, New Jersey.

BOOKS! (out-of-print, scarce); quickly supplied. Send Wants. Spotlight, 141 Broadway, New York.

NUDIST Publications—Illustrated. Particulars, stamp. Roy, Box 531-A, Waterbury, Conn.

MAGAZINES—Business, Vocational, Diversion. Current single copies. Choice over 850 periodicals. All fields. Free price-list. Commercial Engraving Publishing Co., 34S North Ritter, Indianapolis 19, Indiana.

1947 WHOLESALE catalog and Directory 10c. Latshaw Sales, Sunnyside-C, Indianapolis 44, Indiana.

ADULT Books. Revealing Sex Truths. Five—\$1.00. Kogan, 1032-SG, New York 8.

FREE bargain catalogue for adult book buyers. Kissin, Box 134, Madison Sq. Sta., New York City.

NATIONAL Geographic Magazine, 1888-1946. Any issue. Periodical Service, Box 327-S, Swarthmore, Penna.

"RADIO For The Millions"—practical book. Complete instructions for building 78 radios, phonographs, other sets. 192 pages, 648 pictures. Regular Edition \$1.49. Popular Science, Dept. 77-C, 353 4th Avenue, New York 10, N. Y.

"FIX It Yourself"—home repair book. How to fix appliances, furniture, plumbing, etc. 256 pages, 163 pictures. \$1.49. Popular Science, Dept. 77-C, 353 4th Avenue, New York 10, N. Y.

BACK-Date Magazines, Books, Specific issues—years. Arkell's, Tarzana, Calif.

ADULT Books. Catalog and Sample, 10c. Baker Service, Box 1840, Cleveland 6, Ohio.

SOUTH AMERICA offers thousands of opportunities to the ambitious man with little cash to invest. Also to the man who has a trade or profession, regardless of what he does. You are interested in learning more about the big money regions of South America. Why not let the men help you who have searched this continent in the mighty Amazon River as well as in many cities talking with men in high positions with many years experience. These men in position to give reliable information are ready to serve you. \$100,000.000 Programs are now being planned. Such as these will make opportunities equal our forefathers when empires were built in America. We will try to give you a picture as near as possible like you yourself making the research through this fascinating country. This report has cost thousands of dollars, took many months and many thousand miles of travels to be completed. The latest 1947 report is now ready. Be first to read it. Put to work your knowledge. Report No. 1. \$5.00. Send Air Mail Now. South American Research Bureau, 120 Cedar St., N. Y. C.

81 MAGIC TRICKS, PUZZLES, ETC.

FREE catalog magic, puzzles, tricks. Scheetz's, 981 Branch, Sellersville, Penn.

MAGICIANS', Gamblers' secrets exposed. Cards, Dice, Punchboards, Slot Machine. Catalog 10c. Book Co., Box 671, St. Louis 1, Mo.

"MAGIC Vanishing Card". Throw it into air, it completely disappears, reproduce it later from spectators pocket. Easy to do. Complete 25c with magic catalog. The Magician, 2463-D, Kensington Ave., Philadelphia, 25, Pa.

WORLD'S largest professional magic shop, keeps you in touch with latest tricks. To receive mailings, send 35c for new catalog. Holden's, 220-P West 42nd St., N. Y.

POPULAR SCIENCE OPPORTUNITIES

500 TRICKS! New 1946-7 edition Douglas famous Catalog. Now ready, only 10c. Brand new magic for pocket, parlor, club, stage, professional, amateur. America's fastest service to magicians everywhere for over 25 years. Send 10c Today. Douglas Magicland, Dept. 2, Dallas, Texas.

THE True Secret of Ventriloquism. Free booklet. Quackenbush, Big Flats, N. Y.

FREE! Large Catalog of magical apparatus if you remit 25c for "MAGIC IS FUN" magazine. Robbins Co., 152-F West 42nd Street, New York.

HYPNOTISM! 25 Lesson Course. \$1.00. Monarch, 38-S Jefferson, Auburn, New York.

"MAGIC Cigarette Catcher"! Ingenious secret device produces—also vanishes—cigarettes instantly! No skill needed. 25c. Super Magic Catalog. free offer details included. Magic Shoppe, 19 Springfield Ave., 19D, Newark 2, N. J.

VANISHING Quarter trick and catalog 25c. Sterling Magic Co., Royal Oak, Mich.

HYPNOTISM. Fascinating 27 chapter course. \$1.00. Roy, Box 531-A, Waterbury, Conn.

BE a Magician. Large professional magic catalog of latest tricks. 25c. Ireland, F-109 North Dearborn, Chicago.

WALK away from your own shadow. defy the laws of Nature. At Homes, Nightclubs, or Stage! Amazing Magician's Secret only \$1.00. H. Fowler, Box 1284, Boston 4, Mass.

500 TRICKS. Send only 10c for Douglas' famous 112-page Catalog 500 Tricks. New magic for amateur, professional. America's fastest service for 25 years. Douglas Magicland, Dept. 2, Dallas, Texas.

200 ELECTRIC Stunts, 110 volts, \$1. Cutting Sons, Campbell 3, Calif.

MAGICIANS pin. ghost illusion. Houdini escapes. giant catalogue. Everything, complete 25c. Magic Wands, 9w Colorado, Pasadena, Calif.

DOLLAR Magic Set Free with Phenomenal Catalog 25c. Mysto, 4462-S Germantown, Philadelphia.

ITCHING, Sneezing Powders. Eighteen other Tricks. Free with Catalog 25c. Manufacturers, 2404N15, Philadelphia.

"VENTRILLO" Professional Voice-Throwing Instrument and Catalog 25c. Box 971-PS, Philadelphia.

63 GAMES, ENTERTAINMENT

BIC-KEEN—the atom bomb game. naval strategy—Brand new. \$2.00. Bic-Keen, 1456 Penobscot Bldg., Detroit 26, Mich.

HOME Model Slot Machines and Coin Operated Games. Write for catalog. Webb Distributing Co., Dept. P4, 6 South Kedzie Ave., Chicago 12, Ill.

36 COIN COLLECTING

FREE! Foreign coin, banknote and Coin Collectors' Illustrated Catalog to approval service applicants. Send 3c postage. Tatham Coin Co., Springfield-D50, Mass.

FOREIGN Coins on Approval on Request. Del Monte, 40 W. 18, N. Y. 11.

UNUSUAL Worldwide collection twelve different foreign coins and bills only 25c. Webb, Box 473, San Bruno, California.

FOR Sale: 50 assorted Indian Head pennies. \$1.25; 1893 Columbian World's Fair half dollar. 75c; Large U. S. Catalog. 25c; Giant Foreign catalog listing copper, silver, gold. 50c. Ben's Coin Shop, 72 West Washington, Chicago 2, Illinois.

MERCURY dime set complete 1916 through 1945. 77 dimes, good fine & Unc. sell \$35.00. 1916-D. dime \$6.00. 1921 Plain \$2.50. 1921-D. \$1.50. 1926-S. \$1.50. H. Gardiner, 1015 N Street, N.W. Washington 1, D. C.

WILL Pay \$10.00 each for certain Lincoln Pennies! Indianheads \$50.00; Dimes \$1,000.00. Catalogue 10c. Federal Coin Exchange, 8-PS, Columbus, Ohio.

\$2.00 TO \$200 each paid for hundreds of Old or Odd Coins, Indian-Lincoln-Foreign Wanted. Keep all until posted. Send 20 Cents for illustrated Coin Value Book. 4 x 6. Guaranteed Prices. 40 years in business. Coin Exchange (1), Le Roy, N. Y.

COMMEMORATIVE \$1½ — Columbus, Washington, Cleveland, Stone Mountain, \$1.50 en. Illustrated Catalogue 25c. Norman Schultz, Salt Lake 9, Utah.

LINCOLN Bargains—1909-SVDB \$10.00, 1909-S 60c; 1914-D \$2.25. 1922-P \$1.75, 1922-D Broken D 75c, 1931-S 65c. Others. Any 10 Different Your Selection \$1.00. New Half Dollars—Iowa \$3.75. Booker T. Washington \$1.25. Stone Mountain \$1.25. Whitman Folders 25c. 10c Postage Extra. Minimum Order \$1.00. Retail Catalogue 10c. Bebee Coin Company, 1180 East 63rd, Chicago 37, Ill.

96 OLD STAMPS WANTED

ANNOUNCEMENT — Introductory offer —Cosmopolitan Stamp Co. resumes its well known approval service and desires the privilege of sending you choice selections—General Foreign, U. S.; Air Mails; British Colonies, etc. Send only 25c and receive \$1.00 value of net price stamps from our initial Gigantic Selection. Don't delay. Write today. Cosmopolitan Stamp Co., 1457 Broadway, N. Y. C.

127 STAMP COLLECTING

WORLD'S Largest Diamond And Triangle Stamps, Free Stamp Magazine. Stamps from Fighting Free French, 20 stamps from 20 different Countries. Pictorials, Airmails, Big Bargain 5c with approvals. Capital Stamps, Dept. 10, Little Rock, Ark.

BRITISH Empire! 55 Different including Batum, Burma, Cyprus, Gwalior, Tasmania, 5c to Approval Buyers. Lyman, 97 Nassau St., New York 7.

FREE—Canadian Sets Royal Visit, George VI, George V, Coronation, Jubilee, others, to approval applicants. Ensign, Box 118-P, So. Orange, N. J.

DEALER'S Wholesale Catalog. Postage 3c. Franksco, 5031 Queensbury, Baltimore, Maryland.

WOW! \$10.00 Worth Of Fun Only 10c. What a treasure hunt! Big package 500 Foreign Stamps—just as received from foreign missions other sources. Includes stamps from Africa, South America, Philippines, Free French, Cape Juby, Palestine, etc., including airmails, commemoratives, and stamps worth up to 50c and 75c. This amazing offer is given for 10c to serious approval applicants only. One to a customer, money back if not more than delighted. Jamestown Stamp Co., Dept. 5, Jamestown, New York.

50 DIFFERENT including scarce diamond-shaped airmail 3c to approval service applicants. Avalon Stamp Co., Dept. S, Springfield 8, Mass.

\$2000 IN Stamps free to Contest Winners. Particulars, entry blank, to approval applicants enclosing only 10c for scarce Roosevelt Mourning Stamps from Nicaragua, Greece & Argentina, plus photograph of "Roosevelt Collecting Stamps." National Stamp Sales, 276 R, West 43rd St., New York 18, N. Y.

FREE. Irish Commemorative Collection. Including Dramatic Easter Rebellion Issue With Approvals. Raymax, 123-X William St., N. Y. C.

FINE Approvals, freshly mounted. Fast, personal service. Tell me what countries you prefer and I'll send their stamps. Milton Skinner, 438 Locust, Long Beach 2, Calif.

UNITED STATES Price list. Send Postage. State Stamp Corp., 1225 Park Bldg., Pittsburgh 22, Penna.

UNITED STATES approvals complete coverage fine quality, attractive prices. Seminole Stamps, Box 378, Coconut Grove, Florida.

FREE! Negro Triangle; Turks Islands "Cactus"; Dakar; Guinea; Palestine; "Fairy Tale", Pirate Chart, Map, Ship, Sea Lion and Snake stamps; French, British, Portuguese Colonies, etc., Free for 3c postage. Approvals. Potomac Stampco, Washington 10, D. C.

FREE—Famous Americans Set, plus Flag Set, plus the National Parks set, plus the Presidential Set to the \$5. A total of 90 stamps absolutely Free to customers for our unsurpassed United States or Foreign selections. Send 3c postage for 15 of the above mentioned stamps and full particulars. Triboro Stamp Company, 145 Nassau Street, Dept. 203, New York.

200 DIFFERENT stamps, 6c, to approval service applicants. Tatham Stamp Company, Springfield 50, Mass.

U. S. 797 SPA Sheet only 5c to applicants for U. S. approvals. M. Haycock, 61 O'Brien Pl., Brooklyn, N. Y.

SCARCE U.S. Stamps Nearly 100 Years Old. 1893 Commemorative. \$5-\$10 stamps. Armed Services Pictorials complete. Roosevelt set, large Allegorical Figure of Commerce. Old Revenues, everything 5c to serious approval applicants. Metropolitan, 140 Nassau, New York 7.

VATICAN City! Four varieties of Vatican City (world's smallest country) including portrait of Pope Pius! Also stamps from Afghanistan, Cape Juby, Libya, Macao, Palestine, Syria, Liechtenstein, San Marino, and many other interesting countries. All together 48 different stamps, total catalog price over \$2.50!—only 10c to approval applicants! Methuen Stamp Service, Inc., Dept. 210, Methuen, Mass.

COOK Island: mixed \$1.00. No approvals. Krueger, Tirohia, Paeroa, New Zealand.

ZOWIE-E-E! A Barrel of Fun for only a Dime! 500 United States Stamps—Absolutely unpicked and unsorted, just as received from church missions. Many varieties, including large commemoratives, airmails, high denominations up to \$5.00! Stampdon's biggest package of fun, and you might find something really valuable!! Price only 10c to serious approval service applicants. Money back if not delighted. Illustrated bargain lists with each order. Mystic Stamp Co., Dept. 55, Camden, New York.

\$10.00 FOR \$1.00. Box full stamps valued Scott's \$10.00 and Stamp Album. Everything \$1.00. Longacre Shop, 100J West 42nd, N. Y. City 18.

FREE—United States Columbian Set—8 values. Retailing \$3—Absolutely Free to Customers for our Unusual Approvals. Send 3c postage for Selection Plus full particulars. S. D. Engel, 38 Park Row, New York.

FREE—The Stamp Finder. Big new edition—32 pages profusely illustrated! Tells at a glance the country to which any stamp belongs and so where to place it in your album! Also: 25 different stamps from Vatican City, Palestine, Cyprus, San Marino, etc. All sent to Approval Applicants enclosing 3c postage. Garcelon Stamp Co., Box 918, Calais, Maine.

128-PAGE United States Catalog, complete with 1,000 illustrations, only 10c. Harris & Co., 204 Transit Building, Boston, Mass.

ABSOLUTELY Free! Genuine foreign airport stamp—catalog price 50c!—with illustrated "Get Acquainted Folder" describing other stamps given with our valuable catalogs. Harris & Co., 204 Transit Bldg., Boston 17, Mass.

25 DIFFERENT India—3c with approvals. Premiums with purchases. Brandwein Stamp Co., Box 92-P, Bayonne, N. J.

ROOSEVELT Argentine, Libia Mussolini-Hitler, 52 others—5c. Marylandstamps, Arlington-P, Baltimore 15, Md.

POPULAR SCIENCE OPPORTUNITIES

STAMPS 100 Years Old. It is now 106 years since the world's first stamp was issued. Every collector should have at least a few stamps 100 years old or nearly so, but have you? Probably not because most early stamps are hard to get and are therefore not often offered. Nevertheless, we have prepared a selection of 12 all 19th Century stamps. Very old, everyone of them, even if not fully 100 years old. We will send these for only 10c to sincere approval applicants. Write for them today, and kindly state whether approvals shall consist of United States or foreign stamps, or both. Approval Headquarters, Globus Stamp Company, 268 Fourth Ave., New York City 10, Dept. 217B.

FREE! Rhodesian Bi-colored Waterfall; old El Salvador issues;—plus 25 different worldwide stamps. All free to approval applicants. Pladon Stamps, 1717-S Idaho, Toledo 5, Ohio.

POSITIVELY Greatest free offer—Latest Scott's International \$6.00 stamp album—covering entire world, contains 36,000 illustrated descriptive spaces; Scott's 1947 Standard \$6.00 catalogues "Philately's Encyclopedia"—absolutely free to applicants for foreign approvals becoming customers. Plymouth Specialty Company, Dept. A3, Bell, California.

FREE! Complete Balkan aviation set with approvals. Beaman, Elliston 10, Va.

HUNGARY, 20 different post-war, 3c, with approvals. Braley, Cairo, Ohio.

GREAT! Roosevelt (Monaco), five 1946 San Marino Airmails, Hitler Heads, others! 10c to serious approval applicants. Shoaps (The Square Dealer), 5010 Hillsboro, Detroit 4, Michigan.

VICTORY Packet Free—Includes stamps from Tanganyika—British Cayman Islands—Animal—Scarce Babyhead—Coronation—Early Victorian—Airmail—Map Stamps—Including big illustrated catalogue. Send 5c for postage. Gray Stamp Company, Dept. P. R., Toronto, Canada.

FREE U. S. Price list postage 3c, M. Hanna, 335 5th Ave., Pittsburgh 22, Pa.

50 DIFFERENT United States 10c. Price list free. No approvals. Seidenberg, Casopolis, Mich.

UNITED States and Foreign stamps sent on approval; outstanding quality, low prices. Fred Herzberg, PS 168 Oak St., Elmhurst, Ill.

LIBERAL:—Abyssinia, Brunei, Djibouti, Rhodesia, Nigeria, Mozambique over 100 different others. Everything 10c with approvals. Baird, Box 1713, Portland 7, Ore.

UNITED STATES Collection—Thirty-seven fine unused commemoratives before 1943 including Columbians, Bicentennials, Parks. Price \$1.03 approval applicants only. Orange Stamp Co., Albany 3, N. Y.

"MINT French Coat-of-Arms, Vatican, Hitler Heads, Airmails, Free with approvals. Gulfstream, Drawer 71, Miami, Fla."

PENNY Approvals that satisfy, Neil Gronberg, Box 5441S, Philadelphia 43, Pa.

20,000 DIFFERENT 1c-5c each! Gordon Davison, Box 1019A, Manchester, N. H.

OLD scarce U.S. Seconds on approval. Slightly defective, nice appearance, bargain prices. Hearnfeld, 551 Clinton, Newark 8, N. J.

POSITIVELY Greatest free offer—Latest Scott's International \$6.00 stamp album—covering entire world, contains 36,000 illustrated descriptive spaces; Scott's 1947 Standard \$6.00 catalogues "Philately's Encyclopedia"—absolutely free to applicants for foreign approvals becoming customers. Plymouth Specialty Company, Dept. A3, Bell, California.

SAN MARINO Honors Roosevelt, 6 values mint only 10c to approval applicants. Thiem, Cape Vincent, New York.

10 DIFFERENT U. S. Over 40 Years Old, 5c. Foreign, U. S. approvals. Scott, 22 Middle St., Lexington 73, Mass.

UNITED STATES Approvals—Largest varieties, Americas lowest selling prices. Stamp Company, Albany 3, N. Y.

POPULAR Approvals at 1/2c up. Small Stampdealers, 2616 Cortez St., Chicago 22.

EXOTIC Pictorial collection: Tahiti spearfishing, Melanesian idol, Ingavi battle, Reunion, Madagascar, St. Pierre Miquelon, Djibouti, Wurttemberg, Dutch Indies, Newfoundland, many others. This outstanding offer only 5c. Imperial, Box 1491, Tampa, Florida.

BRITISH, Spanish and French Colonies, Vatican, Hitler heads, and airmail packet, free with approvals. Pan-American Stampco, Box 145, New York 33, N. Y.

WHOOPIE! Wowie! 25c worth of U. S. stamps free! No obligations! Write: M & N Co., 742 Sheffield Ave., Brooklyn 7, N. Y.

FREE! Tiny Chinese "Midget" War set Approvals. Seminole, Elliston 10, Va.

"GOYA NUDE" set, cataloging \$1.05, complete 35c. Approvals. Royal Stamp Co., Tamaqua 2, Penna.

ROOSEVELT Monaco Set (3), including triangle only 5c! Applicants requesting U. S. or Foreign approvals. Elliott, Box 51, Miami Beach 39, Florida.

1,000 GRABBAGS, 15c each. Special Bags 25c. Sandy, 630 Bingaman, Reading, Pennsylvania.

WORLDWIDE Different: 200-25c; 500-60c; 1000-\$1.50. Beacon Sales, Maynard 3, Mass.

FIVE Vatican City Stamps Free to approval applicants. Florida Stamp Co., Box 807, Miami 5, Fla.

BERLIN Bears Complete set of eight and 100 different stamps only 10c to approval applicants. Reich Stamp Co., 4647 Kenmore, Chicago 40, Ill.

30 BEAUTIFUL Airmails 10c. Selected Approvals. Louis Morrison, Milmont Park 2, Pa.

PICTORIAL Packet! Philippines, Panama, Palestine, Paraguay, Portugal, Porto Rico, Poland, Peru, Persia. Free to Approval Applicants. Eliot Stamps, 86-31 Eliot Avenue, Rego Park, N. Y.

BET You Haven't These! South Georgia, South Orkneys, Grahamland, South Shetlands—Shortlived Falkland Dependencies—Everything 3c with approvals. Viking, 130-PP Clinton St., Brooklyn, N. Y.

MONACO Roosevelts (3) including triangle 5c with approvals. Collins', 71 Cole-ridge, San Francisco 10, California.

FLAG Stamp free with U.S. Approvals. E. Wenigman, 929 Oakdale, Chicago.

"U.S. Commemoratives, Free French, given approval applicants. Hill Stamps, Box 732S, Woodmere, N. Y."

EGYPT—15 Different, 5c to approval applicants. Bohemia Stamp Service—2, Bohemia, N. Y.

PERSIA and China packet free to approval applicants. Write "Everglades," Box 3222-S, Station F, Atlanta, Georgia.

MONTENEGRO Colorful pictorial set, 10c with approvals. Vargo Stamps, 6044 South Fairfield, Chicago 29, Ill.

"FOREIGN Approval Service For You." Literature describing this modern service. Free. K. Archibald, Railroad Avenue, Taunton, Mass.

U. S. 15c Centenary Sheet—5c. Approvals. Omar, 100 Irvin, Hagerstown, Md.

"ROOSEVELT, Churchill, Stalin, Hitler, Vatican City stamps free, to approval applicants. Flamingo Stamps, Box 517, Miami Beach, Florida."

U.S. \$5. Stamp given free. Approvals sent Bala Stamps, Bala Cynwyd, Pa.

TEN Beautiful mints free with Grade A approvals, fast service. Cornell, Box 4259C, Miami 26, Fla.

SMOKY Mountain Commemorative Souvenir sheet and 30 different U. S. stamps, including commemoratives, Airmail, etc. (catalog value exceeds 65c) for 10c to approval applicants. Curhan Stamp Co., Dept. 1, Gloucester, Mass.

WASHINGTON Bicentennial Set 10c. United States, Foreign approvals accompany order. Yokums, Box 1327, San Antonio 6, Texas.

SOUVENIR Sheet, Smoky Mountain, Mint, 10c. Approvals, Smoky Mountain Stamps, Box 61, Morristown, Tenn.

STAMP Collectors read Popular Science Classified Advertising regularly. Your ad here will reach almost three million readers. Write for details today. O. K. Kelly, 353-J Fourth Avenue, New York 10, N. Y.

COLLECTIONS For Sale! Build beautiful collection and Save Money, too! Details and Bargain List Free! Neptune Stamp Co., Neptune 3, N. J.

25 DIFFERENT Hungary! Colorful! 3c. Approvals. Star Stamps, Lakewood, N. Y.

70 HOBBIES, COLLECTIONS

INVENTING can be an interesting and profitable hobby. Write for complete particulars. Institute of American Inventors, Dept. 30-E, 2926-Eye St., N. W., Washington 6, D. C.

KLONDIKE! For Hobby Jewelry Makers! Novelty Jewelry Findings swept from tables of large manufacturers—parts for Bracelets—Pins—Earrings, etc.—unfinished. Chains—Rings—Pins—Stones—Clips—Beads—many other items—1 Lb. Bags—\$2.00 Per Bag in 5 Bag Lots. Sample Bag—\$3.00. Prepaid Only. Mdse. Distributing Co., 19 E. 16th St., New York 13, Dept. P.S.

CAMPAIGN Ribbons—Beginner's Package—Introductory Price—50c, contains 15 Assorted Ribbons. L.H.G. Company, 19 E. 16th St., N. Y. 3.

"GENUINE" deep red Arizona Rubies (Garnets). Send quarter for packet. Mineral Specimens Company, Box 2651, Phoenix, Arizona.

GEM Making—Fascinating! Profitable! Free equipment catalog, or send 25c for complete instruction Book. Lapidary Company, 1545 West 49th, Seattle 7, Wash.

AMERICA'S most fascinating hobby. Collect famous American and foreign insignia emblems. 77 selections. Airlines, Railroads, Steamships, Hotels. See page 112 March Popular Science. Introductory package, plus Free Baseball sticker, 25c. Samples 10c. "Traveler" c/o Vogue Specialties, Carnegie Hall, Cleveland 15, Ohio.

MILITARY Insignia. Metal Regimental Crests 1001 items.—Send 25c for Sample Crest. Catalog. Bon-Lee Co., 5801 15th Avenue, Brooklyn 19, N. Y.

UNUSED Match Book Covers, 100 all different \$1.00. 35 Royal Flash Covers \$1.00. Free catalog. Charles Edelman, 1311 P East 84, Cleveland 3, Ohio.

"SWAPPERS Hobby Bulletin" Watcha got? Whatdye want? Trial two dimes. Royal Oak, Mich.

8 ANTIQUES, RELICS, INDIAN GOODS

ANTIQUA-modern pistols, revolvers, swords, daggers, armor, 174-page illustrated catalog 50c. Robert Abels, 860 1/2 Lexington Avenue, New York 21.

ANTIQUA Guns, 600 Bargains. Catalogue 25c. Gilbert Hebard, Knoxville, Ill.

4 FINE ancient arrowheads \$1.00. Stone Tomahawk \$1.00. List free. Lear's, Box 569, Galveston, Texas.

INDIAN Tom-Toms. All hand made, genuine buckskin, painted with oil colors, decorated with colored feathers. Complete with beater \$1.00 prepaid each. Larger sizes \$2.00, \$3.00 and \$5.00. Indian Art-craft, 4201 N. W. 17th Ave., Miami, Florida.

SEND 35c for Booklet: "History of Antique Firearms"—Send 25c for Illustrated Bobby Catalog. Heike, Wenona 4, Illinois.

POPULAR SCIENCE OPPORTUNITIES

85 MINERALS & PRECIOUS STONES

JEWELRY stones removed from rings, etc. 100 assorted \$2.40. 50 large ones \$2.40. B. Lowe. P.S. 50, Holland Building, St. Louis 1, Mo.

MONTANA Moss Agate cuts, \$1 each, Box 733, Glendive, Montana.

RHINESTONES—Genuine French Packet Assortment 50c. Herber, 1360 Hicks, N. Y. C. 67.

GEMS, precious and semi-precious, all genuine from world wide sources. Deal direct, no overhead, save money. Catalog 10c. Hill Co., Route 7-K, Salem, Oregon.

MINERAL specimens and gem material. Fluorescents. Free list. Plummer's, 5068 Brighton, San Diego 7, Calif.

AUSTRALIAN Opal, White, pin-fire, 8 x 10 mm \$4.00, 10 x 12 \$6.50. Ace Lapidary Co., 92-32 Union Hall St., Jamaica, N. Y.

26 CAMERAS, PHOTO SUPPLIES

CASH! Spot cash for cameras, lenses, binoculars, movie and still equipment. Send full description for prompt cash offer. Over 36 years of dependability. Bass Camera Co., Dept SP, 179 W. Madison St., Chicago 2.

BASS Says: Trade Cameras? For 36 years finest equipment available. Always Satisfaction Guaranteed Or Your Money Back! Bass buy 'em, trades 'em. Bass Camera Co., Dept. SP, 179 W. Madison St., Chicago 2.

PHOTOGRAPHY for pleasure or profit. Learn at home. Practical basic training. Long established school. Write for booklet. American School of Photography, 1315 Michigan, Dept. 1741, Chicago 5.

BENSEN Light. Fits on all movie and still cameras. Uses reflector floodlights. Eliminates clamp lights. At dealers or send money order \$9.45 (Includes tax. Less Bulbs). Free booklet. A. L. Bensen Co., Staten Island 2, New York.

CAMERA'S-Enlarger's — Movie Film — Big Free Catalog. Cavalier Camera, 1822 Center, Pittsburgh 19, Penna.

SOLAR Enlarger =120 \$49.00. Reverse f 2.5 \$69.00. Zotti, Rocksprings, Wyoming.

"INEXPENSIVE conversion for ground glass cameras, see what you take. Send \$1.00 for detailed instructions. Safety Educational Service, 449 Spaulding Ave., Newcomerstown, Ohio."

102 PHOTO FINISHING

FREE! 5x7 enlargement! Rolls developed and eight lifetime doublesize Velox prints made by modern electronic equipment only 30c. Reprints from negatives, same size 3c; doublesize 4c. Candid rolls, finegrain developed, 3x4 prints, 12 exposures 45c; 16 or 18 exposures 65c; 36 exposures \$1.25. Return ad with roll and receive absolutely free 5x7 enlargement. Franklin Finishing, Box PS-6, Framingham, Massachusetts.

NEW Color Process makes full color prints from black and white film or negatives. Send dime for Sample. We have Films. Midwest Photo, Janesville 27, Wis.

PHOTOGRAPHY for pleasure or profit. Learn at home. Practical basic training. Long established school. Write for booklet. American School of Photography, 1315 Michigan, Dept. 1722, Chicago 5.

LARGA-PIC—We have only one offer, but it's an outstanding one! Your roll developed and 8 prints made into brilliant Larga-Pic photos for 30c. Reprints from your negatives 4c each. Write for Free mailers. Larga-Pic, Box Z-4, Brookline 46, Mass.

ROLL Developed and 8 prints 25c or 8 enlargements 30c. Reprints 3c. Enlargements 4c. Young Photo Service, 406-C, Albany 2, N. Y.

THREE prints each 8 exposure roll 40c. Two each 35c. One each 25c. Reprints 3c. Fred A. Eastman, Bode, Iowa.

NEGATIVES Retouched. K. Gordon, 404 E. Melbourne Ave., Silver Spring, Md.

SENSATIONAL Introductory Offer! Send snapshot or negative, this ad and 10c. We'll send you a beautiful 7 x 5" enlargement! Or, Kodak roll developed and printed (with free coupon) only 25c; or 8 Giant prints from roll, 30c. Reprints from negatives—any quantity—regular size, 3c; Giant size 4c. Candid rolls—36 exp. 35mm developed, vapo-rated, enlarged to 3 x 4, \$1.00. 18 exp. 50c. Free Mailers. Free Premium offers sent on request. American Studios, Dept. 365, Lacrosse, Wisconsin.

GIANT 8x6 Lifetone Enlargement, 16 brilliant double-clear prints, roll developed—30c! Films wholesale! ("Old Reliable") Lifetone Studios, Dept. 187, Des Moines, Iowa.

ROLL developed and 8 prints 30c. Overnight Service. Free Mailers. Tri-Plex Photo Service, Box 375, San Francisco, Calif.

8 BEAUTIFUL Double Size pictures and roll developed 30c, 8 hour service. Free Mailers. Pacific Photo Service, Box 666, San Francisco, Calif.

PRINTS Enlarged 3 1/4 x 4 1/2, 35mm (36 Exposures) \$1.00. 18 Exp. 60c. 16 Exp. Split 50c. 8 Exp. 30c. Reprints 3 1/2c. Holly Finishers, Box 625E, Succasunna, N. J.

GUARANTEED quality 8" x 10" enlargement from any negative 50c. 3 for \$1.00. Artistic Enlargers, 37 Crittenden Street, N. E. Washington, D. C.

1 HAND Colored enlargement and 1 black and white enlargement, 5 x 7, only \$1.00 postpaid. Bus' Photo Enlarging Studio, 57-A W. Burton Pl., Chicago 10, Ill.

OIL coloring photographs can be a fascinating hobby or profitable sideline for those with artistic talent. Learn at home. Easy simplified method. Send for free booklet. National Photo Coloring School, 1315 Michigan, Dept. 1722, Chicago 5, Ill.

ENLARGEMENTS—5 x 7—10c; 8 x 10—25c. From your negatives. National Film Service, 3111 West Tuscarawas, Canton 3.

SPECIAL—50 reprints \$1. Suburban Studio, 1410-S Bond, Rockford, Illinois.

FLASH! . . . 12 pictures for 1c without waiting, worrying. Portable \$3.98 kit develops roll, prints pictures in 10 minutes at home. Send no money. Order COD today! Take-N-Makit, Box 546E, Boston 2, Mass.

90 MOTION PICTURES, SOUND EQUIPMENT

UNUSUAL home movies: Travel, adventure, sports, comedies, Silent-Sound. Many film bargains. Big illustrated 1947 catalog, sample-dime. Audet, Box 6520-AG, Philadelphia 38, Pa.

GUARANTEED Fresh anti-hal. outdoor movie film! Weston 12 Daylight loading! Processing free! Three spools Double 8mm, \$3.45! Six single 8mm for Univex, \$4.60! Postpaid! Catalog, ESO-S, 828-A, West 39th, Kansas City 2, Missouri.

EXCITING Film. For artistically presented subject, "Exciting Stars in Action", starring glamorous girls, send only \$1. State 8-16mm, Exciting Films, 1071 El Centro, Dept. E, Hollywood, Cal.

"MISS America, 1946". Projection length test film, \$1.00. Complete editions, 8mm, 50 ft. Kodachrome, \$7.50, black-white, \$2.00. 16mm, 100 ft. Kodachrome, \$14.75. black-white, \$4.00. 43 subject color catalog, 25c. World In Color, Box 392-A, Elmira, N. Y.

SELECTED Films, Photos, Slides, List 10c. Thomas Productions, 2709 West Ave. 34, Los Angeles 41, California.

BEAUTIFUL Kodachrome Slide and Lists 25c. Slide Supply Service, 3111 West Tuscarawas, Canton, Ohio.

MOVIE Film At Tremendous Savings! Kodak Super X, Weston 32, Government stock. Tested—unconditionally guaranteed. 16mm—100 ft. \$1.95; 50 ft. 98c; 50 ft. magazine \$1.35. Double 8mm 25 ft. 75c. Processing extra—50 ft. 75c; 100 ft. \$1.00; 25ft. 8mm 75c. Fast Service! Photo Surplus Sales, Box K-1, 12 Duane Street, New York City.

MOVIE Cameras! 16mm electric, magazine-loading, famous mfrs. With telescopic optical viewfinder, famous-make f3.5 anastigmat lens, battery, coupling cord and automatic release. Value over \$200. Complete. Ready-To-Operate Only \$55.00. 100% satisfaction—Money Back Guarantee! Order today! Free booklet. Quality Movie Film Panchromatic, Weston 32, 16mm 50' magazine, \$3.25; 100' \$4.50, 50' \$2.40; Double 8mm 25' \$2.15. Semi-Ortho, Weston 8, 16mm 100' \$2.85; 50' \$1.75; Double 8mm 25' \$1.55. Free Processing. Fotoshop Inc., Room 20, 18 E 42nd St., New York City.

LEARN movie projection, management. Free Catalog. Theatre School, Elmira, N. Y.

PROCESS your own 8-16mm movie film. Literature. Duro Movie Products, 1519 Eggert Road, Eggertsville 21, N. Y.

MOVIE Camera Films 100' 16mm \$2.25 three rolls \$6.00. 100' high speed \$2.75. 25' double eight \$1.25. Ambassador, 479-A Quincy Street, Brooklyn 21, New York.

16 35mm Silent Sound Films, Bedner, 5300 So. Talman, Chicago.

8-16mm FILMS, Equipment Bargains! Lists, 3c. Towers, 935 North Fortieth, Philadelphia 4.

MOTOR driven 300 Watt 8mm projectors \$32.50. Stamp brings 8mm, 16mm lists. Sterling's, 679 Northampton, Easton, Penna.

UNUSUAL Movie! "Temptation" featuring Beautiful Models, 50 ft. 8mm \$3, 100 ft. 16mm \$5. Catalog, refund coupon 25c. Fine Arts Productions, Box 2084, San Antonio 6, Texas. C.O.D.'s accepted.

8-16mm SILENT-sound films, Complete rental library. All latest subjects. Free catalogue, (sample film 10c). Garden Film, 317 W. 50th, N. Y. 19.

RARE 8-16mm, Silent-sound films. International, 2120 Strauss, Brooklyn, N. Y.

16mm MOTOR Driven Projectors—\$16.00—Up. Selco Products, Denvers, Mass.

CHILD Is Born By Caesarean Delivery. The outstanding home movie production. Project it free. Send postal card immediately. Movies, Hamilton 5, Ohio.

FILM Movetone is back. It's Weston 12 nonhalation. Free processing 100 ft. 16mm \$3.25. 25 ft. double 8mm \$1.50. Bulk film without processing 100 ft. 16mm \$2.25, double 8mm \$2.45. Free circulars. Fromader Genera, Davenport 5, Iowa.

FRESH Anso 16mm 100' movie film, Color—\$7.86; B&W—\$5.95. Art Films: 50' 8mm, \$3.49; 100' 16mm, \$5.50; 100' 16mm sound, \$6.75. No COD's, please include postage. Gamera's, Dept. P, 3816 Eastern Avenue, Baltimore 24, Maryland.

35-16mm FILMS equipment reasonable. Stamps for listings. Mertz Films, Springfield, Illinois.

IMMEDIATE delivery of 16mm Sound projectors. Large stock of Castle, Official, Nu-Art and Pictorial films. Soundies, Comedies, 16mm Anscocolor film. Used 8mm, 16mm Sound, List Titlers, Splicers, Editors, Rewinders. (Home Movies, 41 South Fourth Street, Allentown, Penna.)

FREE, Movie Catalog; sample film 10c. Cameras, Projectors, Goodwill Company, Jackson, Tennessee.

92 MUSIC, MUSICAL INSTRUMENTS

PIANISTS Popular Music Chord Chart: shows names; symbols; readings; enharmonics; notations; 648 treble, 180 bass positions. Sensational! Desirable! Practicable! Only \$1.00. Carol Music Chart Co., Box 21-PS, Lefferts, Brooklyn 25, N. Y.

"SONGWRITERS, Send Poem For Free Examination, Outstanding Offer, and Free Instructive Booklet. United Music, 108, Salem, Indiana"

LEARN Popular Piano. This new, faster, easier way—instruction books and phonograph records. Beginners or advanced. Complete course \$9.95—Free catalog. Sheet music; popular hit tunes postpaid for less. Wellerphone, Dept. F, Box 2762, Kansas City, Missouri.

POPULAR SCIENCE OPPORTUNITIES

PHONOGRAPH Records Cheap. Catalogue. Paramount, SF-313 East Market, Wilkes-Barre, Penna.

A SHORTHAND for busy composer-musicians, with free chord chart, \$1. check or money-order. Do not send cash or stamps, please. Paul Stackpole, 2110 W. Venango St., Philadelphia 40, Penna.

INSTRUMENTS for less and still the best. Send for Bargain Catalog. Harden's Musical Merchandisers, Marion P., Ohio.

BARGAINS: Harmonicas—Accordions—Guitars—Drums—Catalog 25c—Musician's Shop, 2 E. Centre Street, Baltimore 2, Md.

122 SONG WRITERS

POEMS Wanted to be set to music. Free examination. Send poems, McNeil, Master of Music, 510-PS, S. Alexandria, Los Angeles, California.

SONGWRITERS, Songs Published Monthly. Advance Royalty. Send your songs or poems today for our exciting offer. Hollywood Tunemasters, Dept. 10F-C, 1537 N. Vine, Hollywood 28, Calif.

"POEMS Wanted For Musical Setting! Send Poem For Free Examination. Outstanding Offer and Free Instructive Booklet. United Music, 107, Salem, Indiana"

SONGWRITERS: \$100 Cash Awarded Each Month For Best Song or Song Poem. Melodies supplied Without Charge By Hollywood composers. Lead sheets and records furnished. Cinema Song Co., Dept. B-47, Beverly Hills, Calif.

POEMS Wanted for musical setting. Send poem for immediate consideration and Free Rhyming Dictionary. Richard Bros., 46 Woods Bldg., Chicago.

SONGPOEMS composed. Anthony Campbell, % George Swan, River Route 36, Madera, California.

SONGWRITERS—Protect your songs. Get the facts first. Free booklet, attractive offer. Song Service, 331-J West 46th, N. Y.

"SONG Entries open for publication. No charge for publication. Mueller Music, 2907 Pennsylvania, St. Louis 18, Mo."

POEMS Wanted for new songs. Send poem for Free examination. Eliot Wright, Master Composer, 206 Rivoli Theater Building, Portland, Oregon.

POEMS Wanted For Musical Setting. Send poem for immediate consideration. Five Star Music Masters, 646 Beacon Bldg., Boston.

112 RADIOS, SUPPLIES & EQUIPMENT

MAKE Simple, Tubeless, Batteryless, Distance-Getting Crystal Radios. Crystal and illustrated instructions 25c postpaid. Allen, 427-S, Clinton, Mo.

RADIO Service men and experimenters send stamp for our giant radio catalogue. Save dollars. United Radio Co., (1000-V) Newark 1, N. J.

FREE New Radio Catalog Is Ready! Radionic's catalog lists radios, hard-to-get radio parts, books, amateur, test and P.A. Equipment. All available for immediate shipment. Send today to: Radionic Equipment Co., Dept. 157, 170 Nassau St., New York 7, N. Y.

WORLD'S Best Crystal Set. "HB-2"—24 page book—all details, including catalog. "Radio-builder"—25c. 3 issues "Radio-builder"—25c. Laboratories, I-t, San Carlos, Calif.

BUILD your own Radio. Kit of parts \$5.95. Details—Ryco Distributors, P.O.B. #8, Ozone Park, N. Y.

BUILD "Loudest" Crystal Radio. Instructions and Crystal, 25c. Amorosos Radio, Route Four, Richmond, Va.

RAZOR Blade Radio—Make one. Complete plans 25c. You need headphones—Signal Corps type \$1.75. Send Cash. Check or Money Order. Nico Supply Co., 1700 Walnut St., Phila. 3, Penna.

LOUD Crystal Radio also one tube radio, new design. Illustrated plans for both 25c postpaid. Radio Leader, 427 Yale Avenue, Claremont, California.

AMERICA'S Best Buys. Radio Tubes 29c up. Free Bargain lists. Potter, 1314 McGee, Kansas City 6, Mo.

"RADIOS—Tables. Portable Model. parts. Write for latest Bargains. American Radionics, Wilkes-Barre, Penna."

RADIO book:—"Everybody's Radio Manual." Tells how to service all radios at home. 256 pages, 216 pictures. DeLuxe edition. \$1.49. Popular Science, Dept. 77-C, 353 4th Avenue, New York 10, N. Y.

25 YEARS Experience radio repairing at your fingertips. I've repaired 45,000 radios and have perfected system you can follow step by step. My methods are far simpler than any course published. Requires no calculations. Total price \$1.00 postpaid or C.O.D. Moneyback guarantee. Ross Radio Company, 14615-B Grandriver, Detroit 27, Michigan.

RADIO Tubes, parts wholesale retail large stock. Radio Mail Order Company, 46-13 188th St., Flushing, N. Y.

24 BUSINESS OPPORTUNITIES

IF you'd like to make \$5,000-\$10,000 yearly in the Collection-Credit Agency business, write us at once. Outstanding opportunity. Cole Associates, Syracuse 2, New York.

\$25 WEEKLY working two hours daily. No canvassing. No Manufacturing. Lycke, Box 2471, Cleveland 12, Ohio.

START Home business making statuary, plaques, art goods, pottery, garden furniture, artificial marble flooring, liquid marble. Make flexible molds yourself. Amazing profits. Folder free. Creative Publishers, Box 236-M, Winnetka, Ill.

OPERATE profitable home business selling merchandise by mail. Fast sellers. Large profits. Powell Service, 5713 Euclid, Cleveland 3, Ohio.

RECAST old batteries into new. Latest achievements. Battery Laboratories, Minneapolis.

BIG Pay jobs in welding. Complete welding lessons and reference books, 516 pages, 41 lessons, \$2.00 copy. Money-back guarantee. Hobartweld, Box P-775, Troy, Ohio.

BOOKKEEPERS—Operate your own simplified "Dollar-A-Week" Bookkeeping & Tax Service. Full or spare time. Details free. Ellis, Box 203, Cedar Grove, N. Car.

MAIL Order Business course shows you how to make money, spare or fulltime. Teaches professional mail order technique—not penny-snatching schemes. Fascinating 100-page illustrated Success-Catalog Free! Write—Nelson Company, Dept. 4-01, Chicago 5.

LEARN Shell Jewelry Manufacturing. No tools or experience needed. Learn-earn within a week! Complete home instruction course, beautifully photographed, shows how to make 75 styles of Pins, Earrings, Brooches, Hair Ornaments, Dress Clips, Necklaces, Bracelets, Candy Dishes, Wall Plaques, Ash Trays, Candle Sticks, etc. Includes Pearlizing, Gilding, Dyeing, Luminous methods. Illustrates 55 species of sea shells. Lists hundreds of raw materials with wholesale prices. Complete course \$1.00, postpaid. Beginner's Kit, \$3.00 (\$3.50 in Canada). House of Gifts, Box 4550-AS, Coral Gables, Fla.

GOT \$24,500 Using "Schemes" from "Schemer" Magazine, Alliance, Ohio, 49th year, \$1.00. Three samples 25c.

MANUFACTURE costume jewelry at home for profit, hobby, therapy. Free wholesale supply catalogue. Instructions. Florida Supply House, Bradenton, Florida.

BUYERS Wanted for plaster novelties. Painted—Unpainted. Retail—Wholesale. Write today for free information. Bing Products, 88-X3B Broad, Boston 10, Mass.

MOLD-MAKING, Plaster casting. Money-making Business. Literature Free. Kemilo, Park Ridge, Illinois.

COMPOSITION Flooring—made in most colors. Lifelong. Soundproof, Resilient. Flexible Molds. Cast novelties, plaques, statuary. Big money—your own business. Catalog Free. Write—Bing Products, 88-B3C Broad Street, Boston 10, Mass.

SPECIALTY Manufacturing, the big money business that can be operated anywhere, start on a very small capital; we supply dependable formulas and complete instructions; get interesting Free booklet, "Money-making Opportunities in Specialty Manufacturing." Howard Robinson, Ph. G., 1300-B S. Ohio St., Sedalia, Mo.

I MAKE big money in the mail-order business. You can do the same at home with copyrighted system. Write me I'll tell you how. F. Little, Glenshaw, Box 8, Pa.

137 PLANS to make money local, mail order. Particulars free. Elite Co., 220-A Grand St., N. Y.

A natural for hobby dealers, Bic-Keen—the atom bomb game—naval strategy. \$1.00 each for minimum of 10. Bic-Keen, 1456 Penobscott Bldg., Detroit 26, Mich.

WHY Job Worry? Learn Electroplating. Highly Paid, uncrowded. Interesting Business. Gold, Silver, Nickel, Chromium, etc. Send Postcard for Free booklet and proof. Plater Hyde, Dept. SC P. O. Box 176, National City, Calif.

REDUCING Salons make money. Start at home. We supply automatic equipment. National Products, Portland 2, Oregon.

START Mailorder Bookshop—Everything furnished; publisher cooperation. 25c brings booklet, exclusive setup, samples, exciting ideas. General Publications, Ossining 1, New York.

GOOD Paying Business Silvering mirrors, plating autoparts, reflectors, bicycles, bathroom fixtures, etc., by late methods. No tanks or shop required, outfit furnished. Free Booklet. Gunmetal Co., Ave. E, Decatur, Illinois.

EARN \$126. weekly at home. \$1 brings samples, details. Money back guarantee. Box 72, N. Y. C. 16.

EXCLUSIVE wholesale agency! Amazing screw holding screw drivers! Remove, hold, insert screws hard-to-get places! Tremendous market, eye-catching counter displays make fast sales, big profits. Refundable trial offer! Write now! Millen Mfg., 601 Miller Bldg., Boston, Mass.

MORE profits from Lightmaster cigarette lighters. Distributors wanted. McGregor, Tahoe Valley 15, California.

BABY Shoes Metalized the durable way. Complete instructions \$1.00. St. Albans Plating Industries, 135-17 135th Ave., So. Ozone, Long Island, New York.

THE Mail Order News (54th year) shows you money making opportunities in every issue. Sample copy 25c. Veterans Business Publications, Charleston 7, Ill.

METALLIZE baby shoes. Further information free. Metal Crafts, 5501 Suwanee, Tampa 4, Fla.

COLORGLAZED Concrete Pottery made without molds. New, low cost, patented method. Cemetery products, novelties, tiles, floors, etc. Basement leaksealing. Other money-making projects. Booklet, details free. Men only. National Potteries, Grand Rapids, Minnesota.

HEADLINES pay big money. We furnish press, type, 4-page newspapers for your own "Sensational Headlines". Complete outfit only \$9.95 post paid. Big profits: fairs, schools, weddings, births, etc. Sample headline 52 letters 25c. KFC Co., P. O. Box #16, Lisbon, Ohio.

ALASKA—personal research \$1.00 regarding business opportunities, jobs, home-steading. K. Lanier, Fairbanks, Alaska.

DISTRIBUTOR wanted. Nationally advertised line of chemical specialties. Nash & Kinsella Labs., 800 E. Big Bend Road, Kirkwood 22 (St. Louis), Missouri.

ASTOUNDING modern mail order plans. Brings quick profits. Darrah, Orono 8, Me.

NEW! Make 3 Dimensional Pictures at home. Instructions and materials furnished. Particulars free. Pixilated Picture Co., 712 S. Walker, Oklahoma City 4, Okla.

EARN Up To \$480 Month part or full time keeping books for small firms. Simplified System. Write Tax-Saver System, Dept. B, Ft. Worth, Texas.

POPULAR SCIENCE OPPORTUNITIES

UNPAINTED, plaques, statues, novelties. Variety of designs free list. Arbo Products, B195 E. 7th. St. Paul, Minn.

MAKE money casting new line Metal Toys and Novelties. Latest 1947 Scale Model Autos. Original Ashtrays, Savings Banks, Water Pistols, etc. Big wholesale and chain store orders now being placed at high prices assures big business and profits. Spare or full time. No experience or special place needed. Write for free information and illustrations. Metal Cast Products Co., Dept. E, 1696 Boston Road, New York 60, N. Y.

FINANCIAL Success—any job. Business. Profession—The art of knowing how. Particulars Free. Lanzafame, Hotel Rowe, Grand Rapids, Michigan.

HOW To Set Up and Run A Mirror Shop! Resilver Mirrors. For Price write—John Sprinkle, V90, Marion, Indiana.

BIG Money In Vending Machines—Smallest capital start brings immediate profits that build permanent profitable business. Starting instructions free. Becker Vendors, 105-P Dewey, Brillion, Wisc.

COLOR Concrete with chemicals. Make Hollywood style pottery; home or shop. Marbling, water-paints. 10c brings sample, pictures. Hollywood Cementcraft, 8530 Wonderland, Hollywood 46, Calif.

PROFITABLE mail order business can be yours. Details Free. Box 63-B, Station H, Buffalo 14, N. Y.

TYPEWRITER Repairing instructions, standard typewriters. Webers', Box 1008, Canton, Ohio.

OWN Your Business. Tell me how I can earn from \$30 to \$50 per day. Investment \$1000 to \$1200 for Merchandise and Equipment. Employ others. Year around business. Cleaning rugs, carpets, all kinds, and upholstery. Also Mothproofing. Write Hinson & Company, Inc., Richmond, Indiana.

AMBITIOUS. Sell Xmas Cards, Stationery, Big Profits. Colored Catalog Free. Beacon Hill Greetings, 115 Chauncy, S. Boston, Mass.

NEW Price Lists for molds and models. Vallance Art Products, 1873 E. 70 Street, Cleveland 3, Ohio.

INCORPORATE in Delaware. Many advantages. Free details. Corporation Fiscal Company, Inc., Delaware Trust Building, Wilmington, Delaware.

LEARN Piano Tuning, Repairing, at home. Tremendous field! Piano parts, tools furnished. Established 1935. Empire School of Piano Tuning, 606-A East University Ave., Champaign, Ill.

QUICK Money! "Repairing Car Batteries." At home! Easy too! Write, Batteryman, Grand Junction 1, Colorado.

YOUR own business. Bronze Baby Shoes. Make bronze castings, novelty castings, liquid marble, flexible molds. New methods—easier, quicker. Very Profitable. Productive Arts Co., Dept. S-4, Box 221, Seattle 11, Washington.

"PLANNED And Profitable" mail order selling. New, different work-book of ideas and instruction for beginners, aspirants, established dealers. Send quarter for copy of leading mail order trade magazine and details special free subscription offer. National Publishing Co., 356 So. Broadway, Suite 706-PS, Los Angeles 13, Calif.

INFORMATION—Locating Articles and Products (Wholesale) etc. Literature Free. National, 3537L So. Hoyne, Chicago 9.

BIG Money selling "Bobby-Jo" Baby Shoes by mail; everything furnished; tested, successful plan free. No-Co-Ro, Oakland 6S, California.

FREE Premiums, wholesale catalogue, Business plans 10c. Holm Sales, Box 12B, Oaklandon, Indiana.

UP to \$1500 yearly selling by mail in spare time interest you? New ideas and plans every month. Details free. Idea of Month Club, 3023-B Greenmount, Baltimore 18, Md.

200 Money Making Deals. Plans—Rare formulas—Schemes. Folio Free. Formico Prod., Box 572, Dayton, Ohio.

BRONZING and Metallizing baby shoes! Gold, Silver, Copper, Nickel, Bronze, Pearl, Ivory and "Luminous glow" colors! Big profits! New Field! Details free! Write R. O. Morgan, Box 349, Long Beach 2, Calif.

SYNTHETIC Latex with Neoprene base for making flexible molds! Quick drying! Safe! For home, classroom, or industry! Quart \$2.00. Gallon \$5.95. Full instructions. Beginners booklet on molding and plaster casting 25c. Plastercraft Supply Co., 1406 E. 43rd St., Cleveland 3, Ohio.

MAKE strange plastics—1c pound. Makes durable attractive floors, walls. Build with waste—Save half. Bays Laboratory, Oklahoma City 9.

REMNANTS, Amazing Values, Good Profit. Write B & M Textiles, 415 E. 26th St., Paterson 4, N. J.

"WANT Security? Vending machines have provided me dependable income past 20 years; depression proof. Start route now while locations plentiful, or buy several for your own store or factory. Stock shipment nut vendors, ball gum vendors, best quality ball gum. Free literature. Hawkins, 906S Howard, Palestine, Texas."

EXECUTIVES to help merchandise electrical products including telephone electronic equipment. Correspondence held confidential. Mac Call Electric Mfg., Box 8186, Norfolk 3, Va.

START a home business in spare time. Make extra money. Experience unnecessary. Literature free. Ellmar Service, Muncy 3, Penna.

MAIL Order "Monitor" leading Mail Trade Business Magazine. Mail Order Business Operators, Direct Mail Users. Beginners read it regularly with profit. Copy 25c, refundable toward subscription. Monitor, Dept. B, 506½ S. 15th St., New Castle, Ind.

INVESTIGATE Mail Selling! What's the one best thing to sell, happily, honestly, profitably? We know! Get free particulars, exciting proof! What-To-Do Shop, Box 1082, Tacoma, Washington.

REMOVE broken keys from Auto. Houselocks. Be your own Boss. Get \$2.00 up for each job. Tool, instructions 35c. Weitman, 2212 Avenue "X", Brooklyn 29, N. Y.

WOULD you pay 3%—first \$350 made? Color-illustrated book "505 Odd, Successful Enterprises" free! Some offer occasional "day off." Work home. Expect something odd! Pacific-J, San Clemente, Calif.

FELLOW Workers—Down with Bosses—Start own business—Be Independent—Booklet describing 137 Tested Plans, free. P. Padney, 307 York St., Jersey City, N. J.

MAKE Shell Jewelry—Easy, profitable. Illustrated book instructions 75c. Free Catalogue. Florida Shellcraft Co., Box 1840, Sarasota, Florida.

OPERATE profitable mail order business. Write, Walter Service, 4159-B East 112th, Cleveland 5, Ohio.

HANDYMEN—Earn money home operating Community "Fix-it" Shop. Write, Stafford, 708 Rawlings, Carbondale, Ill.

DO it with Sea Shells, Big profits. Werts, 1429 56th Avenue, Oakland 3, California.

FLEXIBLE Molds to order, also originals. Professional course manufacturing molds and cast novelties. Latex, lacquers, flocking equipment, supplies. Plastics, Box 1574, Boston 4, Mass.

START a clock shop while clock repairing is booming. Our easy to learn home study course with pictures and illustrations teaches you how to repair all kinds of clocks. Information free. Houston Clock Shop, P.O. Box 5086B, Houston 12, Texas.

TYPEWRITER Repairmen urgently needed. Earn \$40 to \$50 weekly spare time. Our easy to learn home study course teaches how to repair typewriters. Write for free information. Houston Typewriter Repair Service, P.O. Box 5357, Houston 12, Texas.

OPERATE Profitable Mail-order business. Write—Gallagher Publications, Box 6911, Kingsport, Tenn.

"NEW Invention. Opportunity exclusive selling rights. Fingram, 6774 Taft, Detroit 8."

200% PROFITS running your own Photography Business at home. Free course shows you how. 10c covers mailing. Commercial Supplies, Box 546K, Boston 2, Mass.

DEALERS — Distributors — premium woods. Gem of Plastics consumed in furniture, Specialties—Literature. B S Furniture and Specialty Co., 3833 Keystone, Indianapolis, Indiana.

NEW Batteries from old Junks. Card for Details. L. Wertz, Pekin, Ill.

METALLIZING baby shoes makes you money! Learn this simple, profitable business from Nationally recognized authority. Get professional results with professional "know-how"! Free particulars. Joseph B. Kushner, Metal Finishing Consultant, Stroudsburg, Penna.

START profitable Mail Order business. Write Tes-Co, Box 189-SH, Wilkes-Barre, Pa.

BABY Shoes preserved, Formulas, instructions, \$1.00. Novelty Bronzing, Box 56, Hyde Park 36, Mass.

BRONZE Baby Shoe Mountings and Supplies. All metal Bookends, Ash Trays, Picture Frames, Etc. Wholesale only. Hollywood Bronze Supply, 1770 N. Vermont, Dept. 112, Hollywood 27, California.

METALIZE Baby Shoes. Correct Modern Method. Information, Free. Universal, Box 1076-B, Peoria, Ill.

SALTED Peanuts in the Shell. Sensational, unlimited possibilities, simple formula \$1.00. Jankas, 1901 Canalport Ave., Chicago.

MAKE money—Silvering Mirrors \$1.00. Earthworm Culture 50c. Brush Plating \$1.00. Universal, Box 1076-B, Peoria, Ill.

SAWDUST—Turn it into cash. Spare time. Instruction 25c. Charles, 12 EG, Norwood, Ohio.

SELL Books By Mail. Large Profits! Free Literature. Cline-Porter, Box 6346 PS, Pittsburgh 12, Penna.

MAILORDER Beginners. Save money by getting started right! Our new booklet may save you dollars! Only 10c, postpaid. Mail Order Mecca, 30 West Washington St., Chicago 2, Ill.

YOUR Name As Publisher. 80 page mail order magazine. Free ad. Only \$4.50 needed. Sample copy 25c. "RBCO", 542s Fifth Avenue, New York 19.

MEN-Women. All types mail order businesses for sale. Full or part time. Priced from \$100.00 up. L. Turnipseed, Box 681, St. Louis, Mo.

"FREE Booklet" "Key To Greater Earnings". James Williams, Box 2215, Hollywood, California.

SIX good formulas free. Send stamp. Veach Co., Palestine, W. Va.

DOLL-repairing taught. Biggest return on smallest investment. Nominal fee. Torngren, 3539 Reiser, Grand Rapids, Mich.

BY Now You surely must have heard of Colorado's Fabulous Oil Boom. Would you take shot at \$1,000 to \$20,000 on investment of \$140 in easy payments? This chance will never come again. The opportunity is limited to a definite number so write me today and I'll take care of everything for you. Dyer, 1835 Champa, Denver, Colo.

1947 GIGANTIC Directory of Opportunities. Advertisers Supplies. Sources. Trade Information. Mail Order Ideas. Products. Wholesalers. Valuable tips—just published! Descriptive literature Free. Wilkin & Co., Hillsboro 2, Ohio.

STAG Cartoon Booklets, Tillie & Max, Dumb Dora, and others. Vest Pocket Size. Adults only. State age. 10 different \$1.00. Times Square Sales, 131-C West 42nd, New York 18.

IDEA Men! Let's get together and get some money out of our ideas instead of promises. James Corrubia, Lakewood, N. J.

POPULAR SCIENCE OPPORTUNITIES

OPERATE Part-time Bookkeeping Service. Send \$1 for details. Audex Co., Box 90, Kearney, Nebr.

OPPORTUNITY—New York. World Capital, publishes the most complete list of employment and business offerings in the world. Thousands of opportunities. Domestic and Foreign, under thousands of listings from Help-Wanted and Business propositions to Foreign Connections. Latest publications include current civil service tests and data. Complete only \$1.00 Postpaid. City Publications, 2781 Grand Concourse, New York 58, New York.

5000 CONTRACT Bookkeepers needed. Operate your own business part or full time. Free course of instructions with purchase of one complete simplified Bookkeeping and Tax Record System price \$7.50. Mail order today or write for further information. A. J. Hawthorne, Public Accountant, Decatur, Ala.

OPERATE newspaper clipping bureau—steady-paying home business. Fascinating re-writing work. Write, Clipping Institute, 1150-E. Portsmouth, Ohio.

UPHOLSTER furniture price list of fabrics and supplies sent free. Wynn and Graff, 5116 Charlotte, Nashville, Tenn.

BOOKKEEPING is "big business". Operate your own service. Our system is composed of one printed self-explanatory "Operations Sheet", completed in less than one hour each week. Gives complete business picture to your clients. Complete plan and exhibits, \$2.00. James Argodale, 111½ South Broadway, Rochester, Minn.

88 MONEY MAKING OPPORTUNITIES

ELITE Collection describes 137 money-making plans; local, mail order. Particulars free. Elite Co., 220-A Grand St., N. Y.

EARN money at home—steady income—Write Successful Income Builders, 508-B, Hollywood 28, California.

\$25 WEEKLY Working two hours daily. No canvassing or manufacturing. Lycke, Box 2471, Cleveland 12, Ohio.

START Your own business! Big money manufacturing novelties, plaques, statuary. Free catalog. Write Bing Products, 88-B3E Broad Street, Boston 10, Mass.

\$246.50 MAKING baffling secret device without skill, machinery, from former top priority war material costing \$1.50! Guaranteed simple, revolutionary new discovery, unbelievably profitable. Universal appeal. Frank, illustrated proofs, free! Rolls Enterprises, 115 W. 16th., New York 11.

YOUR town is ripe for a profitable collection agency. \$5000 first year easily possible. We train you, coach you, get you started and help develop your business. Send \$1.00 for starter course, or ask for facts. American Collection Associates, 226 State St., Schenectady 5, N. Y., Dept. S.

500%-1000% profit and up. Your own interesting service business. Tremendous demand everywhere. Experience unnecessary. We teach, help, supply everything. Practically no capital needed. Resistal, Inc., 1757-A Sunnyside, Chicago 40.

SEWING Machine Repairmen make big money lifetime. Start neighborhood shop. Complete repair manual, covering all makes, \$1.98 postpaid. Money Back Guarantee. Sewmachine Serviceman, Hamilton 10-A, Ohio.

DETECTIVES Earn Big Money. Experience unnecessary. Particulars free. Waggoner, P-125, West 86th, N. Y., N. Y.

MANUFACTURE costume jewelry at home for profit, hobby, therapy. Free wholesale supply catalogue, instructions. Florida Supply House, Bradenton, Florida.

AMAZING Profits in Home operated distinctive exclusive, Art-Gifts Specialty Business. Write for starting ideas. Valvick, Warba, Minnesota.

AGENT or exclusive distributor for cigarette lighter manufacturer, MacGregor, Tahoe Valley 15, Calif.

"THERE'S Big Money In Junk," and repairing Car Batteries! Batteryman, Grand Junction, Colorado.

137 TESTED, proven, money-making plans, formulas, sources of supply. Literature free. James Boyle, 29B High, New Brunswick, N. J.

MAKE Perfume, Make Money. Free book tells how. Lawson, 21 Joiner, Saint Augustine, Florida.

"GET ahead financially. Complete Success Course \$3, shows how, 4 lessons \$1; details free. Satisfaction guaranteed. Research Bookshop, 89 Raynor Street, Freeport, N. Y."

PRIZE Contest Fans Reap Rich Rewards. Enclose 3c stamp. National Contest Bulletin, Box 2685-S, Miami 31, Fla.

21 POPCORN, Candy Apple, etc. Formulas. All money-makers, \$1.00. We can supply equipment. Concessions Supply Co., Dept. "B", Box 133 Sta. "B", Toledo, Ohio.

EXCELLENT profits raising mink. Details furnished. Franklin Young, Riverhead, N. Y.

WIN money on contests advertised in every magazine and on radio. General Contest Magazine, published monthly, gives hundreds of tips. Lists current contests and rules. Sample 25c. General Contests, 1609-A East 5th, Duluth, Minn.

MONEY Making Opportunities, exclusive supply sources. Benefits, etc. Satisfaction or money back. Joseph M. Inman, Darrington, Washington.

"NEW! 5c material, 5 minutes work makes \$1.00 for you. Instruction \$1.00. Buzan, Lacombe, Oregon."

WOULD You pay 3%—first \$350 made? Color-illustrated book "505 Odd, Successful Enterprises" free. Expect something odd! Pacific, San Clemente, California.

ELECTRIC Clocks are everywhere you go, buildings, homes, parking-lots, factories. Repairs increasing. Our easy to learn course with pictures and drawings teach You how to repair these clocks. Electronic Supply Co., Box 2350-B, Houston 1, Texas.

SHELLCRAFT Instructions—Free! Make beautiful seashell jewelry! Wholesale Catalogue of complete line shells! Plastic discs! Animal Shapes! Pinbacks! Earrings! Cameos! etc. (Buy Direct). Face's, Box 279, Bradenton, Florida.

METALLIZE flowers for profit! It's new, easy, sure fire! Free details; Joseph B. Kushner, Metal Finishing Consultant, Stroudsburg, Penna.

TERMITE exterminator. Inexpensive. Easy to mix. Formula 25c. Charles, 12 EH, Norwood, Ohio.

SELL Personalized Bookmatches; Excellent Commission. Order taking supplies free. Hall's, Iowa City, Iowa.

EARN Money spare time, mailing circulars for mail dealers. Pioneer, 404-S, Yonkers 1, N. Y.

100 MONEY Making Opportunities, plans and tips only 35c. Roy Kramer, 329 Cates, Maryville, Tenn.

59 FORMULAS, PLANS, ETC.

137 MONEY-making plans, also formulas for salable products. Descriptive booklet free. Elite Co., 220-A Grand St., N. Y.

FORMULAS—All kinds. Latest money-makers; literature Free. Kemi-Kal, Park Ridge, Ill.

10,000 FORMULAS and Trade secrets. Free Literature. Stillmans, 555 Kingston Ave., Brooklyn 3, N. Y.

ICELESS Ice! Colder! Cleaner! Cheaper! Instruction 25c. Duffy, Covington, Ky.

10,000 FORMULAS, Processes. Wide variety, free details. Ray's Supply, 1741 Stephens, Kalamazoo 81, Mich.

FORMULAS—Latest Best. Analysis. Giant formula catalog and chemical instruction Sheet 10c. Refunded first order. E-Belfort, Engineering Building, Chicago 6.

"NEED Chemists? Products duplicated? Formulas? Analyses? Consulting Scientific Company. Swarthmore, Pennsylvania."

100 SINGLE ingredient formulas 25c. Tes-Co, Box 189-SG, Wilkes-Barre, Pa.

FORMULAS, All kinds. Write M. B. Elsberry, 717 N. Dearborn, Chicago 10.

106 PLASTICS

FREE Offer—"A Handbook of Plastic Information." Informative, profusely illustrated, non-technical booklet. Thousands sold at 50c. Get yours Free. Write for details. Barnett Specialty Co., 5104 Hollywood Blvd., Hollywood 27, Calif.

MAKE money assembling our pre-fabricated plastic kits. Sample Kit 50c. Catalog free. Fabros, Box 156, Station F-2, Buffalo 12, N. Y.

EDUCATIONAL Offer! Sample kit containing odorless resin, accelerator, rubber mold, lubricant, dye; plus all equipment necessary to make quick castings in lustrous Formalin! Complete with instructions and price list, \$3.00 f.o.b. Formalin, Romeo, Michigan.

NEW liquid plastic. Clear, colors. Cast without heat. Embed flowers, insects, coins. Saw, drill, carve, Manual tells how. Send \$3.35 for complete 20 project kit including one pound liquid Castolite. Castolite, Dept. H-24, Box 211, Kenilworth, Ill.

PLASTICS, Free List, Swiss Music Box Units \$3.50—New Plexiglas Manual \$1.50. Plastic Supply Co., 2618 St. Louis Ave., Dept. PS70, St. Louis 6, Mo.

PLEXIGLAS—Masked—12x12—1/16" 95c Plus 10% postage. Free Listings. Craft Plastics, Box 129-S, Somerville, New Jersey.

METALLIZE plastics for profit! Free particulars. Joseph B. Kushner, Metal Finishing Consultant, Stroudsburg, Penna.

PLEXIGLAS—Colors—¼"—\$1.90, 3/16"—\$1.65, ½"—\$1.35 sq. ft. Clear scrap 25c lb. Four lbs. minimum. Prices F.O.B. Rainbow Plastic Company, Arlington, Texas.

33 CHEMICALS AND APPARATUS

THE House of Winn, home of supplies for amateur chemists. See Winn's New Idea chemical kits and apparatus outfits for home experimenting. Send 10c for retail catalog. Established 1931. John H. Winn, Dept. 607, 124 W. 23rd St., New York 11, N. Y.

CHEMICALS-Lab, Supplies New Catalog 10c. Mel-Glo Chemical Co., 258 Fourth Avenue, Brooklyn 15, N. Y.

NEW laboratory Supply Catalog of Chemicals and apparatus. Contains over 5000 items with illustrations, 212 pages. Send 50c. Standard Science Supply Co., 1232 No. Paulina St., Chicago 22, Ill.

SPECTROSCOPE For Quick chemical analysis \$3.00. Cutting Co., Box 457, Campbell 2, California.

LABORATORY Supplies At Wholesale Prices. Chemistry, Biology, Physics, Geology. Catalogue 10c. National Scientific Company, Established 1908, 2204 W. North Ave., Chicago 47, Ill.

LUMINOUS Paints will glow in dark. Six colors. Fairmount Chemical Co., 136 Liberty St., New York City 6.

CHEMICALS and apparatus for industrial, analytical, and private laboratories. Complete supply service for correspondence school students. Send 3c for catalog. Dept. M-26, Biological Supply Co., 1176 Mt. Hope Ave., Rochester 7, N. Y.

FREE Scientific Catalog. Fourteen hundred exceptional items. Tracey Laboratories, 1907 Harrison Street, Evanston, Ill.

HANDBOOK for Chemical Experimenters. Hundreds of experiments; illustrated; 50c. Experiment Booklet, 15c. Supply Catalog, 5c. Reading Scientific Co., Reading, Pa.

CHEMICALS, ounce quantities, apparatus, catalog 5c. Fleischer's Laboratories, Everett 49, Mass.

POPULAR SCIENCE OPPORTUNITIES

CHEMICALS. Formulas. Apparatus. Catalog 5c. Helett Products, 141-42 78 Road, Flushing, N. Y.

BOOKS. Chemicals. and Apparatus catalog 10c. Pilgrim Chemical, 2435 South State, Salt Lake City 6, Utah.

HOME laboratory chemicals. New low prices. Rush 10c for catalog. Cel-chem Laboratory 53, 4208 Holland Drive, Des Moines, Iowa.

68 HELP WANTED

MAKE More Money selling individualized buckles, belts, tie holders, cap badges: Choice of 2000 emblems. Quick profits—repeats. Special Outfit Offer, write Hook-Fast Products, Dept. B, Columbus 6, Ohio.

HEATING full line. Oil or Liquid Petroleum gases. Card for literature. Peerless Sales, Lincoln 6, Nebr.

INTERESTED In South American And Foreign Employment? \$1.00 brings 1947 Copyrighted Foreign Service Directory listing Oil, Aviation, Mining Construction, Manufacturing Firms with Foreign interests. Hot Tips for Application. Global Reports, 6417 Homewood Avenue, Dept. P S, Hollywood 28, California.

5 AGENTS WANTED

GOOD Paying Business Silvering mirrors, plating autoparts, reflectors, bicycles, bathroom fixtures, etc., by late method. No tanks or shop required, outfit furnished. Free Booklet, Gunmetal Co., Ave. G, Decatur, Illinois.

FREE! Latest issue Opportunity Magazine, Salesman's Guide. Inspiring, constructive. Shows how to earn money selling for others or in your own business. Hundreds postwar opportunities. Send name and describe what you have sold or are selling. Illustrated copy sent Free. Opportunity Magazine, 620 N. Michigan, Dept. 18, Chicago 11, Ill.

SELL Personalized soap. Name on every cake. Ideal for gifts. Get sample offer. Dunbar Soap, New Brunswick, N. J.

LICK After-war layoffs; Start own business; home, office. Booklet describing "Collection of 127 Tester Plans" free. Elite Co., 220 Grand St., New York.

AGENTS—300% profit selling genuine gold window letters; stores and offices. Free samples. Metallic Letter Co., 437 N. Clark, Chicago.

SELL Greeting Cards, Display Signs, Pictures, Books, Novelties, Big Profits. Bulletin Free. Elfco, 432 North Wells, Chicago 10.

SELL Personal Initialed Individualized Belts, Buckles, Cap Badges, Tie Holders, 2,000 emblems to choose. Fast profits. Repeats. Write today special outfit offer. Hookfast Specialties, Box 1425, PS, Providence, Rhode Island.

90c PROFIT Each \$1.00 Sale, Sell Positive mothproofing solution to housewives, stores, agents. Experience unnecessary. Postal brings details. Kinford, Wayne 4, Pa.

AT Home—Your own manufacturing business; making popular \$1.00 novelties. Cost you 3c to 15c. Everything supplied. Write So-Lo Works, Dept. w-601, Loveland, Ohio.

\$1. STARTS you in business. Sell DeLuxe ties, 100% wool interlining. Costs you only \$7.00 per dozen, you make \$5.00 Dozen. Send \$1.00 for special introductory offer two DeLuxe ties. Catalog complete line Free. Philip's Neckwear, 20 West 22nd St., Dept. P-13, New York 10.

GOLD lacquered Window Sign Letters. Large Sizes Penny Each. New Foils. Absolutely Beautiful. Free Samples. Atlas, 544 W. 79th, Chicago 20.

MAKE money in your spare time! Helps furnished. Easy sales. Voluntary repeat orders. Liberal commissions. Write for Free Wholesale Price List Today! McGregor Magazine Agency, Dept. PS-7, Mount Morris, Ill.

"BIG bargains for big profits. Over 100 sensational values. Men's used suits \$2.00, pants 35c, topcoats \$1.25, Overcoats \$2.00, shoes 20c. Experience unnecessary. Free wholesale catalog. Superior, 1250-A Jefferson, Chicago 7."

GREETING Card Agents: "Line Up" with "Pines" for bigger, better and quicker profits. Rush name, address on postcard today. Box 32, Flushing 6, N. Y.

EARNING Less than \$200 weekly? Boost income quickly. Fast selling celluloid price tags, metal moulding, menu covers. Every store, restaurant buys. Pricing Press, Dept. CX, 124 White St., New York.

START Your Own Business on Our Capital. Always your own boss. Hundreds average \$6,000 to \$25,000 annual Sales. We supply stocks, equipment on credit. 200 home necessities. Selling experience unnecessary to start. Wonderful opportunity to own pleasant, profitable business backed by world-wide industry. Write Rawleigh's, Dept. G-U-PSC, Freeport, Ill.

JUST Out! History of World War II. Huge Volume. Popular price. Authentic text. Official photographs. Big profits. Riverside Book Company, Iowa Falls, Iowa.

QUICK Profits selling full or part time, individualized buckles, belts, cap badges, tie holders, uniform shirts, caps, ties. Choice of thousand emblems. Sure repeat orders. Easy-selling outfit offer. Write Hook-Fast Co., Dept. 14, Roanoke, Va.

ADVERTISING Book Matches—Cash In On Political Campaigns—sell Union Labels matches. Cuts for all businesses and political parties—Free powerhouse selling kit—low prices—protection guaranteed on repeat orders—Cash Commissions. Superior Match Co., Dept. P77, 7530 Greenwood, Chicago.

FREE Water and our concentrates makes flavors, lotions, shampoos. 72 products, labels, bottles furnished. Qualco, F-20030 Russell, Detroit.

MAGIC Cleaner and laundry soap deal. Hotter than a firecracker. Big Profits. Sample free. Uko, 5007 Irving Park, Chicago.

\$50 CASH For Selling 100 Assortments of 21 Christmas cards at \$1.00. Complete line. Free samples 50 for \$1.00 cards. Special offers. Write today. Hedenkamp, 343 Broadway, Dept. Y-22, New York 13.

CHRISTMAS Cards. Earn Big Money. Take orders galore from friends. 25 exquisite folders with name, \$1.25. Free samples 10 designs. America's Fastest Selling 21 Christmas Folder Box. Costs 50c. Sells \$1. Request samples today. Sunshine Art, Dept. NC-7, 115 Fulton St., New York 8, N.Y.

AT last! Something new and sensational in Christmas Cards. Amazing "Oilette" Cards. Like costly oil paintings. Designs never before offered. Quick orders. Beautiful 50 for \$1 Cards. name imprinted. Big Profits. 20 other assortments 60c to \$1. Samples on Approval. Puro Co., 2801 Locust, Dept. 741J, St. Louis, Mo.

NEW Combination Door Knocker—Interviewer. Protects Family from intruders. Free literature. U. S. Hardware, 1600 Locust Ave., Brooklyn 30, N. Y.

SELL Delicious Candies, Nuts, Gum. Immediate delivery. Write Casterline, 2031-PS Sunnyside, Chicago 25, Ill.

STATE Agency open for Lightmaster cigarette lighters. Macgregor, Tahoe Valley 15, Calif.

"PRESSURE Cookers." Now available. Selling like wildfire. Amazing profits. Write quickly. Morris Mandell, Inc., 131-W W. 14th St., New York 11, N. Y.

AMAZING discovery. Master Glaze, puts brilliant glass-like surface on cars. Free sample. information. Big commissions. Master Glaze, Dept. 584, 7720 Harwood, Milwaukee, Wisc.

SILVER Plating Liquid. Simply rub on with cloth. Cleans. Silverplates, polishes, one rubbing. Genuine silverplate. Renews silverplated ware. Also silverplates brass and copper. Male and female sellers wanted. Part or full time. NuProcess Products, Aurora, Illinois.

VETERANS: Flight training under G I Bill. Private. Commercial and Flight Instructor Ratings. Write for Information, Gottschalk School of Aeronautics, Adrian, Michigan.

GREETING Cards: Easy money, quick. Free literature tells all! Evers, Elmhurst, N. Y.

\$3 FIRE Extinguisher sells wholesale or direct. "Fire-Killer", 101 Franklin, Syracuse 1, New York.

AMAZING Leather or Plastic Buckleless expanding watch Bracelets fit all watches: Retail \$1.50. \$25.00 daily easy. Particulars Free. 2 samples \$1.00. Safety-Watchstrap, 309E, 105th, N.Y.C.

AGENTS Wanted for our Slot Machines and coin operated amusement games in every town and community. Sell to clubs and homes, or start a route. Webb Distributing Co., Dept. P40, 6 So. Kedzie Ave., Chicago 12, Ill.

NEW! Different! Any picture reproduced on our Beautiful Plastic Laminated Hardwood Plaques. Orders easy to get. your Profits Big. Write quickly. Gotham Products, Dept. A, Box 5427, Philadelphia 43, Penna.

AGENTS—Excellent. repeating Profits. Opportunity establish own business with exclusive territory. Additive lubricant. Automotive, marine, aeronautical, industrial fields wide open. Write Kidder Oil Co., La Crosse 8, Wisc.

SENSATIONAL! New! Home necessity. Multi-purpose. Amazing convenience. Greater profits. "New-Way Meat Holder & Refrigerator Tray". Sample \$2.95 Postpaid. Cox Enterprises, 601A S. Vermont, Los Angeles 5.

INFORMATION—Locating Articles and Products (Wholesale) etc. Literature Free. National, 3537A, South Hoyne, Chicago 9.

CHRISTMAS Cards. Earn \$5.00 with each ten \$1.00 21 card assortments you sell. Also Wrappings. Note Paper and Imprint Cards. Write for samples today. Howard P. Ellis, Dept. PS-8, Pitman, N. J.

CHRISTMAS Card Agents! New, exclusive, patented children's linenette books. Four books in attractive packet. Retail 50c. Sample on approval. Also Cut-out Valentine Assortment. Elmcraft Card Co., 5928 South Western, Chicago 36, Ill.

CASH In Quick on tremendous demand for New Low Priced Burglar Alarm for Cars, Homes and Farm Buildings. Nothing like it. Everybody wants one. Big Profits. Unique sample offer. Northwest Electric Co., Dept. E-43, Pukwana, S. Dak.

200 Money Making Deals. Plans—Rare formulas—Schemes—Folio Free. Formico Company, Box 572, Dayton, Ohio.

REPAIRMEN and installers wanted for Mac Call Stromburg Carlson Dictograph, Teletalk, Amplicall, and Bogan, wanted by United Intercommunication, Box 8128 Norfolk 3, Va.

SALESMEN here is an opportunity for you to sell electrical and telephone electronic equipment. Mac Call Electrical Mfg., Box 8186, Norfolk 3, Va.

KEROSENE cook stove 2 burner \$8.75. Fluorescent 2 light kitchen fixture less bulbs \$4.50. Oil Burner 3 controls \$125.00 prices F.O.B., Essex Shop, 172 Washington St., Newark 2, N. J.

WE buy old type singer sewing machines, your profit up to \$25.00 on each, write for literature, Essex Shop, 172 Washington St., Newark 2, N. J.

SELL Ultra blue stock signs to stores, 1000 slogans, comedy, general, religious. 7 x 11, cost 6c, sells 35c. Make money. Sample free. Lowy, 8 West Broadway, Dept. 328, New York City (7).

WONDER Cleaner—free sample! Other producers; unusual bubble bath—Glas-Klean. Sell homes, stores, Circulars furnished. Courco, 3829-H Delmore, Cleveland Heights 21, Ohio.

POPULAR SCIENCE OPPORTUNITIES

WOULD you pay 3%—first \$350 made? Color-illustrated book "505 Odd Successful Enterprises" free! Proven! Work at home, office. Expect something odd! Pacific, San Clemente, California.

GUARANTEED Money Making Sales Offer. Free Details. Men. Women. Write Today. Popular Products, 1472 Broadway, N.Y.

AGENTS. Sell finest Food Products direct to homes. Successfully sold for 25 years. Big profits. Powerful combination sale plans make sales easy. Permanent repeat business. Samples furnished. Live territories open to Distributors. Mother Hubbard Products Co., 4139 Grand, Dept. PS, Chicago.

ROTACUT Power Mower—\$66.00 net. Express Prepaid. Farm Products, M-2016, Ex. Springs, Mo.

A Natural! Make good money with fast-selling, new line Plastic Tablecloths and Women's Aprons!—Also novel, Embroidered Cotton Pillow Cases! Write for "interesting" details. Royalty Sales, Box 748-B, Passaic, N. J.

\$13.50 PROFIT on every sale and prospects galore! Drug stores, gas stations, sporting goods, post exchanges, jewelry, variety, cigar stores, etc. "snap-up" this attractive \$46.50 Sunglasses and Cabinet deal. Fast sellers. Full commission on restocking assures you regular, automatic income. No samples to buy or carry. Write for Free full information and Free selling equipment. Midwest Scientific Co., 1148 Chicago Ave., Dept. 501, Chicago 22, Ill.

MONEY in Mitr-Lite Fluorescent Fixtures. Be our Direct Factory Representative. Write American Radionics, Wilkes-Barre, Penna.

FREE! Big 32 page 8½ x 11 magazine, that tells how to make money in local or mail order selling! "Opportunities Preferred", 33-S Vassar, Dorchester, Mass.

SELL Christmas Cards! New, Different, Exclusive, 50 with name imprinted, \$1. Make extra Dollars with new bonus plan that earns you up to and over 100% profit. Compare our 21-folder "Champion" Assortment, sells for \$1, sent on approval, no investment, Etching, Panoramas, Florals, Religious, Gift Wraps, Birthdays, also stationery and Personal De Luxe Album. Free Samples of many extra-profit Imprint Lines. Work with a leader! Write today. Pen-N-Brush Studios, Dept. PS-7, 154 Nassau Street, New York 7, N. Y.

CHRISTMAS Cards, Gift Wrappings, Novelties, Personalized Papetries, Raum, 4154b Fifth Street, Philadelphia 40.

SELL clip Cigarette Holders & 20 filters. A. I. I. Mfg. Co., Hartington, Nebr.

69 HIGHGRADE SALESMEN

POCKET Pal: All-Purpose Cutting Tool. Sell dealers nickel plated model. 50c seller. Sell advertisers imprinted colored Pocket Pal. State preference. Either sample 25c. Nelson Mfg. Co., Box 525, St. Paul, Minn.

TREMENDOUS pent-up demand for popular low cost home product. Earn \$2.50 per hour taking orders spare time or full time. Pay daily. Pleasant work. Nothing to carry, demonstrate or deliver. Write Hampton House, 205 Main Street, Northampton, Mass.

ADVERTISING Book Matches—World's largest direct selling Mfr. of advertising Book Matches offers opportunity for profitable year 'round selling; Every business a prospect; No Exp. needed to start; Full or part time; Factory service; Low prices for high quality; Repeats; Sales Kit Furnished. Match Corp. of America, 3433-43 W. 48th Place, Dept. N-9, Chicago 32, Ill.

MANAGEMENT Engineering franchise available. Supervise salesmen, make surveys. Valuable training given. Sims & Associates, 120-SA S. La Salle, Chicago 3.

47 EDUCATIONAL AND INSTRUCTION

MODERN Welding School gives thorough training for one of industry's best paid jobs. Experienced instructors. Individual attention. Nonprofit institution. Qualified under G. I. Bill. Write for literature and details. Hobart Brothers Co., Box P-776, Troy, Ohio.

GOOD "Used" self-instruction educational books on all subjects bought, sold, rented, exchanged. Satisfaction guaranteed. Complete information and 100-page illustrated bargain catalog Free! Write—Nelson Company, Chicago 5.

HAVE your own office! Many earn up to \$5,000-\$15,000 Annually. Learn credit-collection agency business by home study course. Experience unnecessary. Write for Free bulletin. No obligation. Franklin Credit School, Dept. 203-G, Roanoke 7, Va.

BIG money rebuilding shoes. Help needed everywhere or start big-income business of your own. Learn practical, sure, easy way in 3 months. Anyone from 18-60 years can learn easily. Approved for G.I. training. Rush postcard today. Modern Shoe Rebuilding School, Est. 1927, 2935 Belmont, Chicago 18, Illinois.

PREPARE for civil service examination. Pay for course after securing position. Write Free School, Dept. PS-7, Kokomo, Ind.

RESORT hotel business offers permanent career, travel, beautiful surroundings. Write for booklet. Lee Hotel Institute, 12B South Market St., Boston, Mass.

USED Correspondence Courses and Educational Books Bought, Sold, Rented, Catalog Free. Educational Exchange, Henagar, Alabama.

WANT A Government Job? Start \$1756-\$3021 year. Men-Women. Prepare Now for next examinations. Veterans get preference. 32-page Booklet Free. Write, Franklin Institute, Dept. K23, Rochester, N. Y.

"VOICE Builder for speaker or singer at less than the cost of a lesson. Free Voice Advice Booklet. Victor Voice Institute, Studio 147, 6515 Wilshire, Los Angeles 36."

LEARN Commercial Lettering at home. Fascinating, lucrative field. Free information. Joseph Jones, 932 Broadway, Columbus, Georgia.

FACTS, Figures, Faces, Stick Like Burrs! New Improved Supermemory Course. Write Thor Books, YC-7, Box 1210, Chicago.

BE A Pedopractor:—Foot Correctionist. Extension. Degree. Alaska Foot Institute, Juneau, Alaska.

JOIN:—Alaska Chiropractors Association. Many Advantages. Box 2894, Juneau 2, Alaska.

CALENDAR 1753 to 2152. 35c. Tracy S. Newton, Decatur, Georgia.

CLINICAL Laboratory Technicians in great demand. We train you in your spare time, in your own home. You can practice while studying. Write for free catalogue. Imperial Technical Institute, Box 973-B, Austin, Texas.

LEARN Piano Tuning. Prepare for Career in fascinating profession. \$5000 year easily earned. Real security, pleasant easy work. No profession Paying so well can be mastered so quickly. Natural Aptitude, desire to get ahead chief requirements. Prospectus and full information on request. Harmony School of Piano Tuning, Box 582, Harrisburg, Pa.

3800 USED correspondence courses. Catalog 50 cents. Barbells—Courses. EG Mfg., Elmsford, N. Y. 2.

77 LANGUAGE OUTFITS

29 LANGUAGES by Linguaphone, Russian, Spanish, Portuguese—Direct Conversational Method for Mastering any language quickly, easily, correctly at home. Available under GI Bill of Rights. Send for free Book, Linguaphone Institute, 54 RCA Bldg., New York, CI 7-0830.

10 AUTHORS SERVICE

NEW Writers Needed. Nonfiction material demand is booming. Many magazine editors buy features and "fillers" from new writers. Our Earn As You Learn lessons prepare you to meet their requirements. Experience unnecessary. Reasonable price, unexcelled service. Details, sample lesson free on request. Use postcard. No obligation. Comfort Writer's Service, 210RN S. 7th St., St. Louis 2, Mo.

I WANT New Writers to cash hundreds of checks for \$1 to \$100, offered each month. The easiest way to write for pay. No previous experience necessary. Send for Free details. No obligation. Saunders M. Cummings, 467-S Independence Bldg., Colorado Springs, Colo.

25 BUSINESS SERVICE

GOOD "Used" self-instruction educational books on all subjects bought, sold, rented, exchanged. Satisfaction guaranteed. Complete information and 100-page illustrated bargain catalog Free! Write—Nelson Company, Chicago 5.

MAIL forwarded from the Ozarks 25c each. A. Kerry, Noel, Missouri.

NEW YORK address. Your mail received and forwarded. Confidential. Free details. Arlington, 131-R West 42nd, New York 18.

BUSINESS Representation, World's principal cities. Associates wanted. Universal-SA, Butler Building, Chicago 1.

TO Whom It May Concern: We will represent you in all principal cities of the world. Representatives wanted. Will send you assignments immediately. James W. Farley, Citizens Building, Cleveland 14, O.

GENERAL Engineering Service to Businesses, small manufacturers, fabricating concerns, individual enterprises, in the fields of Mechanical, Electrical, Electronic, Process, Chemical, Metallurgical and Structural Engineering. Write "Engineering Service," P. O. Box #927, Youngstown, Ohio.

30 CARTOONING, SIGN PAINTING, DRAWING AIDS

"HOW To Make Money With Simple Cartoons"—A book everyone who likes to draw should have. It is Free; no obligation. Simply address Cartoonists' Exchange, Dept. 197, Pleasant Hill, Ohio.

TALENT Test Free. American School Commercial Art, Box 8066, Dallas 5, Texas.

SIGNS made easily. Instructions and ten sets modern alphabets, numerals, patterns. Sizes up to eight inches. All for \$1.00. Co-operative Business, 7 West Madison, Chicago, (2).

LEARN Showcard Writing at home in Spare Time. Fascinating lifetime Business of your own. No special skill needed. Free information. Sherwood Publishing Co., Dept. 109, Irvington 11, N. J.

MAKE Signs, 9 complete alphabet pattern sets, 3 complete numeral pattern sets and catalog \$1.00. Sign Letter Distributors, P.O. Box 101, Mineola, N. Y.

EARN Money Evenings, copying and duplicating comic cartoons for advertisers. Adservice, Argyle (2-B), Wisconsin.

31 CHALK TALK STUNTS

CHALK Talks, Laugh Producing Program, \$1.00. Illustrated Catalog 10c. Cartoonist Balda, Oshkosh, Wisconsin.

136 TYPEWRITERS

RECONDITIONED Typewriters, Printing Devices, Office Appliances Supplies Dixie-graph, King, N.C.

118 RUBBER STAMPS

LINE 20c; 2 35c; 3 50c. DeLuxe Stamps, Auburn, Nebr.

RUBBER Stamps, Buy direct from manufacturer. Literature free. Lee-Vall Press, Box 1242, Indianapolis 6, Indiana.

3 LINES 40c. Pads 35c. Signatures \$2.40. Print-Right, Wauwatosa, Wisc.

POPULAR SCIENCE OPPORTUNITIES

110 PRINTING OUTFITS, SUPPLIES

"PRINTOMATIC" Selffeeding Post Card Stencil Printing Duplicators \$9.50 Up. Office Size Duplicators, Speedoprints, Hilcos, Excellographs \$33.41 Up. Literature Free. Pittsburgh Typewriter Supply, 336 WE Fourth Ave., Pittsburgh 22, Pa.

PRINTING presses, type, supplies. Send dime for complete illustrated printer's supply book, details and press samples. Kelsey, Inc., A-8, Meriden, Connecticut.

HOME Made Presses, Write Riegel, 1111 Harrison, Philadelphia 24, Penna.

INEXPENSIVE home-made printing press. Details free. Novelty Shop, Downsville, Louisiana.

MAKE Your Own Plastoplate printing cuts. Simple, easy process. Plastoservice, Argyle (2-A) Wisconsin.

HAND presses, jobbers, perforators, cutters, cabinets. Lists 3c your needs? Levinson, Box 918, New York 8.

PRINT At Home—Send 10c for Catalogue—Type, Presses, Supplies. Barnhard Co., 6 Columbia St., Newark 8, N. J.

109 PRINTING, MULTIGRAPHING, ETC.

PHOTO-Offset, Printing, Multigraphing. Samples free. Mango Printing Company, 555-B, South 20th, Newark 3, N. J.

FREE Card Case with 1000 Business Cards \$2.50. Cosme Press-S, P. O. Box 6, New Bedford, Mass.

SEND 10c Now, for our 36 page price-list—Refunded first order. McCall Press (PSM), 1326 South 27th, Omaha 5, Nebr.

CUT Printing Costs; 1,000 offset 8½ x 11 printed \$3.95. 5,000, \$15.75; larger quantities less; 48 hour service; samples, price list free. Fidelity Company, Parkersburg 12, W. Va.

QUALITY Printing: Reasonable prices. State requirements. Samples. Mero Products, 99 Morrison, Punxsutawney, Penna.

500 2¼ x 3¼ Gummed Labels \$1.75. 40 word limit. Schultheis, Box 449, Irwin, Penna.

ENVELOPES 6¾ printed \$3. thousand, in 5000 lots. Michel, Box 76, New York 16.

200 Sheets 5½ x 8½. 100 envelopes, \$2.00 Postpaid. Samoset Press, Plymouth, Mass.

1000 BUSINESS cards printed prepaid \$2.50. Reliable Print Shop, 901 E. Jefferson, Louisville, Ky.

98 PATENT ATTORNEYS

INVENTORS: Without obligation, write us for information as to what steps an inventor should take to secure a Patent. Randolph & Beavers, Registered Patent Attorneys, 340-A Columbian Bldg., Washington 1, D. C.

INVENTORS: Write for free brochure "Evidence of Invention." Labiner, World Building, New York 7.

INVENTOR'S Guide free on request. Frank Ledermann, Registered Patent Attorney, 154 Nassau St., New York 7, N. Y.

PATENT and Trade-Mark Practice before U. S. Patent Office. Validity and Infringement Investigations and Opinions. Booklet and form "Evidence of Conception" forwarded upon request. Lancaster, Allwine & Rommel, Registered Patent Attorneys, Suite 413, 815-15th Street, N.W., Washington 5, D. C.

INVENTORS: Learn how to protect your invention. The United States Patent Office advises the inventor to engage a competent, registered patent attorney or agent to represent him. We maintain a staff of registered patent attorneys ready to serve you in the handling of your patent matters. Special booklet "Patent Guide for the Inventor" containing detailed information concerning patent procedure with "Record of Invention" form will be forwarded upon request—without obligation. Clarence A. O'Brien & Harvey Jacobson, Registered Patent Attorneys, 72B-G District National Building, Washington, D. C.

INVENTORS. For "Record of Invention" form, contact Carl Miller, Registered Patent Attorney, Woolworth Building, New York.

C. A. Snow & Co.—S-427, Snow Building, Washington 1, D. C. Registered Patent Attorneys. Write for information.

INVENTORS—Patent Laws encourage the development of inventions. The Rules of Practice of the U. S. Patent Office advises—unless an inventor is familiar with such matters—that he employ a competent registered attorney or registered agent, as the value of patents depends largely upon the skilful preparation of the specifications and claims. Write for further particulars as to patent protection and procedure and "Invention Record" form at once. No obligation. McMorro, Berman & Davidson, Registered Patent Attorney, 143-B, Victor Building, Washington 1, D. C.

PATENTS—Trade marks, Irving L. McCathran, 316 McLachlen Bldg., Washington 1, D. C. Registered Patent Attorney.

58 FOR INVENTORS

THE Inventor who believes he has a new and useful invention, and needs advice, should consult a competent registered patent attorney. Without obligation, write for full information on how to secure Patents and Trademarks. Randolph & Beavers, Registered Patent Attorneys, 340-E Columbian Bldg., Washington 1, D. C.

"INVENTOR'S Guide" free on request. Frank Ledermann, Registered Patent Attorney, 154 Nassau St., New York 7, N. Y.

INVENTORS: Avoid unnecessary expense. Write for free booklet explaining how our Consulting and Advisory Service can assist you in deriving greatest profit from inventing. Institute of American Inventors, Dept. 30-A, 1926 Eye St., N.W., Washington 6, D. C.

PATENTED, Unpatented inventions promoted. M. Joyce Humphries, 1424 Landtitle, Phila 10, Penna.

INVENTORS—Patent Laws encourage the development of inventions. The Rules of Practice of the U. S. Patent Office advises—unless an inventor is familiar with such matters—that he employ a competent registered attorney or registered agent, as the value of patents depends largely upon the skilful preparation of the specifications and claims. Write for further particulars as to patent protection and procedure and "Invention Record" form at once. No obligation. McMorro, Berman & Davidson, Registered Patent Attorneys, 143-A, Victor Building, Washington 1, D. C.

INVENTORS: Learn how to protect your invention. The United States Patent Office advises the inventor to engage a competent, registered patent attorney or agent to represent him. We maintain a staff of registered patent attorneys ready to serve you in the handling of your patent matters. Special booklet "Patent Guide for the Inventor" containing detailed information concerning patent procedure with "Record of Invention" form will be forwarded upon request—without obligation. Clarence A. O'Brien & Harvey Jacobson, Registered Patent Attorneys, 72A-G District National Building, Washington, D. C.

INVENTORS! Know what experts think! Be sure your invention will click. Get advice of top engineers and sales analysts. Complete engineering surveys and market tests. Patented or unpatented ideas. Strictest confidence. Write today for free information. No obligation. C. W. Eyres Co., 812 Pine, Long Beach, Calif.

HIGHEST Royalties and cash for your inventions when we market them. Free particulars without obligation. Universal Marketing Co., 126 Lexington Ave., New York 16, N. Y.

INVENTORS: You save up to 300% when dealing with your patent searcher direct. Complete search with patent copies \$6.00. Reports mailed in 5 days. Invention protection forms free. Write Raymond L. Smith, Patent Searcher, 703-S Albee Bldg., Washington 5, D. C.

WE make inventors Working Models in wood, plastic, metal. William Olsen, 1007 3rd Ave., N.Y.C.

MAYE Money from your ideas. Write Grayland, 5312 Grace, Chicago.

INVENTIONS Wanted—Patented, unpatented. Cash waiting! Financial assistance, those forming company. Suite 665-SA, 120 La Salle, Chicago 3.

IDEA Men! Let's get together and get some money out of our ideas instead of promises. James Corrubia, Lakewood, N. J.

75 INVENTIONS WANTED

INVENTIONS Promoted, Patented or Unpatented, Write Adam Fisher Company, 183-A Enright, St. Louis, Mo.

WANTED: Practical inventions suitable for sale through 5c-\$1.00 stores, drug-stores, cigar stores; also sportsmen's items of all kinds. Write Matt, 1412-S Great Northern Building, Chicago 4.

INVENTORS: Hundreds of manufacturers have requested our assistance in locating marketable new products. Complete information, free. Institute of American Inventors, Dept. 30C, 1926 Eye St., N.W., Washington 6, D. C.

PATENTED, unpatented inventions wanted. We have tremendous lists of manufacturers who may pay cash, royalties. Descriptive booklet free. National Invention Service, 1404-B Mitchell Street, Oakland 1, Calif.

INVENTIONS Wanted . . . If your invention is not protected by a patent write for copy of my double service plan of Patent application preparation and filing with patent office at low charges, payable, six monthly installments and how I assist inventors in selling their inventions. My files contain manufacturer request for inventions covering 507 different classifications. Patent search with copies \$6.00. Invention record details free. Charles R. Morton, Patent Broker, Established 1919, Dept. 71, 11 West 42nd Street, New York.

WANTED: Practical Inventions by Manufacturers, Patented or Unpatented, John D & Son, Dept. PS-7, Box 3213, 285 Howard Ave., Bridgeport 5, Conn.

EARN Up To \$2,000 year, inventing simple items for special cash markets. Ideas only. No patents. Hendrickson, Argyle (8-B), Wisconsin.

99 PATENTS

INVENTORS: Test the commercial value of your patented or unpatented inventions, quickly and inexpensively. Write for free information. Institute of American Inventors, Dept. 30-B, 1926 Eye St., N. W., Washington 6, D. C.

WILL sell your Patent on Commission Basis. What have you? Colburn, 408 South Spring, Los Angeles, Calif.

82 MANUFACTURING

MODELS, small lot manufacturing, metals, plastics, etc. Millburn, Burlington, Kentucky.

A BRAND new patentee's service. Write for information. J and M Company, Burlington 2, Kentucky.

MANUFACTURE Paints, your garage a factory free information. Industrial Chemist, 1826 60th, Kenosha, Wisconsin.

EXPERIMENTAL Devices, Models. Any Material. Reasonable. Nelson Manufacturing, Woodburn, Oregon.

87 MODELS, MODEL SUPPLIES

MOST complete Illustrated Catalog—"O-HO OO" Model Railroad Parts ever published, Send 5c for mailing, Selly, 1377 Gates Ave., Dept. 836, Brooklyn, N. Y.

MODEL Ship Builders! Are you looking for authentic, precision ship models? Send for richly illustrated fully descriptive catalogue in full color of famous ships of all kinds. Only 10c. Halesite Yacht Service Inc., Dept. C-31, Halesite, Long Island, N. Y.

POPULAR SCIENCE OPPORTUNITIES

SHIP and Yacht model fittings; blueprints. Send 25c for illustrated catalog No. 20—Listing hundreds of items. A. J. Fisher, 1002-2 Etowah Ave., Royal Oak, Mich.

BUILD Model Ships, Railroads, Catalog 10c. Ideal, 21 West 18th Street, New York 11, N. Y.

MODEL Rail News, illustrated, for Lionel, Gilbert and all scale "railroaders". Sample copy 5c; free with "Freight Car Design Manual" for \$1.00. Train Shop, 112-S Broad, Providence 3, R. I.

BUILD Model Motor—All necessary parts furnished for \$1.00. Postpaid. Frost-Gwynne Co., 3820 Seminary Ave., Richmond, Va.

MODELMAKERS! Build model sailing ships inside bottles! Surprise friends with this forgotten art. Easy-to-follow Drawings and Instructions \$1. A. Novak, P.O. Box 6803, Los Angeles 22, California.

SHIP Model and yacht supplies, complete large 64 page catalogue, 30c. Wm. Wild, 510 E. 11th St., New York City.

RAILWAY models, complete line. Combined HO and O gauge, catalogue, 35c. Walthers, 269 Erie, Milwaukee 2, Wisc.

SHIP Model Kits and Fittings... most complete stock in New England. Boucher, Fisher, Marine Model and Model Shipways fittings, blueprints and model yacht equipment at standard prices. Send 25c for new illustrated 1947 Catalog and price list. Dept. S., James Bliss & Co., Inc., 220 State St., Boston, Mass.

SCALE Illustrated Catalog 25c. Refund Coupon. Free List, Lionel or American Flyer. Available equipment. Tri-Lor Hobbyist, State Road, North Dartmouth, Mass.

BALSA Wood Generous Supply \$1.00 Price List Free. Sanlader, Manitowoc, Wis.

87A MOLDS AND MOLDING MATERIALS

RED Seal Moulding Compound. DuPont Latex Base! Guaranteed! Made by Experienced Latex compounders. Free Instructions and literature sent upon request. Red Seal Rubber Co., 116 Nassau St., New York 7, N. Y.

SUPER X liquid molding rubber. Sample jar 25c, quart \$3.00, Gallon \$10.00. Free instructions. W. Wooley, 115-B, Donald, Peoria, Ill.

LIQUID Rubber for making flexible molds. Qt. \$2.00, Gal. \$5.75. Free Sample. H. Chaney, 1130 E. 16th St., Jacksonville 6, Fla.

LIQUID Marble, plastics, marblite, plasters, make your own. Universal, Box 1076-B, Peoria, Ill.

71 HOME CRAFTSMEN

"THE Art of Whittling"—Tells and shows how to whittle variety of articles such as puzzles, chains, scissors etc.—\$2.00. The Didactic Bookstall, 20125 Monica St., Detroit 21, Mich.

LEARN Shellcraft, Shells, instructions, everything needed for 6 colorful sets Shell Jewelry in Beginners Kit \$3.40 p.p. Complete supply findings available. W. F. Whittaker, Shell Jewelry & Supplies, Box 988, Punta Gorda, Florida.

LEARN To make Sea Shell Jewelry, pins, earrings, hair ornaments, novelties. Book of Instructions and Designs free with \$2.00 and \$5.00 Kits. Postpaid. Herbert Diamond Company, Box 4619, Miami 31, Florida.

EXPERIMENTERS! Interested in Electrical, Mechanical devices from war surplus? List Free, F. Siefke, Box 18, Station E, Buffalo, N. Y.

LEATHERCRAFTERS! Send for free catalog listing leathers, tools, supplies. Kit Kraft, 1607 South Western, Los Angeles 6, California.

LEATHER designs for Tooling or Carving. Ten handbags \$1.00. Twenty billfolds \$1.00. Fifty belts \$1.00. All three, \$2.50. Order includes information about our "No More Tracing" design Transfers. Lampkin Artcrafts, Box 641-S, Culver City, Calif.

KNOCKDOWN Cedar Chest Lumber Veneers Free Price List. Giles-Kendall, Box 435, Huntsville, Alabama.

\$46 FROM Square Foot Plywood. Jigsaw necessary: Write, Woodarts, X-48, Bridgewater, Mass.

DOORBELL without batteries or transformer. No operation cost. Diagram \$1. Urban Shop, 1109 Columbiana Road, Birmingham 9, Ala.

18 BLUEPRINTS AND PLANS

AUTOMATIC timer switch for Radios, Lights. Plans \$1.00. Breese, 77 Williams St., Providence, Rhode Island.

"BLUEPRINT Reading Made Easy"—ready reference book for reading any type blueprint. 596 pages, 463 pictures. Formerly \$8.95, now only \$1.98. Popular Science, Dept. 77-C, 353 4th Ave., New York 10, N. Y.

23 BUILD IT YOURSELF

BUILD your own Log Cabin home. Richly illustrated book packed with plans, Ideas, Pictures, Instructions. Send \$2 to Ostego Log Homes, Gaylord 2, Mich.

POWER your lawnmower. Electrically or gasoline engine. Either plan \$1.00. Zandar, 2136 Berkley Place, South Bend 16, Ind.

BUILD concrete block machine. 2 blocks per minute. Build concrete mixer. Easy, inexpensive. Details free. Horne, 206 West Wilder, Tampa, Florida.

HOT Water Free—from Sunlight. System efficient any locality year 'round. Standard materials—easily built—low cost. Facts Free. Solar Water Co., Box 175, Dept. C, Coral Gables, Fla.

SENSATIONAL New Ride. Kids Love it. Easy to build. Prints \$2.00. Teeterswing Co., Box 363, Royal Oak, Mich.

ASSEMBLE Flexible Shaft. Save \$15.00. Includes flexible shaft kit, plexiglas carving drill, instructions for carving plexiglas. Send \$5.00. Details 10c. Vincent Phelan, Box 1411, Philadelphia, Penna.

NEW method enables anyone to make concrete block machine at home. Quick. Economical. Free details. Masterprint Company, White Building, Buffalo, N. Y.

NEED Shop, Farm Machines? Build them yourself. Catalog free. Nichols Equipment Co., Dept. 104, Purvis, Miss.

"BASEBALL Pitching Device—Brand new. Recently patented. Delivers regulation baseball about every 5 seconds. Speedballs. Curves. No fielding. Practice batting in backyard. Tested & Proven. Easy to Build and Operate. \$3.00 covers material cost. Plans \$1.00." A. Rankin, Route 4, Hagerstown, Md.

"BUILD Your House as a Hobby." Save 50%. No rent. No Mortgage. 24 page booklet: drawings, instructions on how to build. \$1.00. H. C. Lightfoot, Civil Engineer, Richboro, Bucks County, Penna.

BUILD Concrete Block Machine. Vibrator or hand. Easy. Economical. 150 Blocks hourly. Build house, shop, garage. Save half. Sell blocks. Make Money. Free Details. Clyde Lee, Mountain View 1, Okla.

"BUILD Cabins"—book offers complete instructions and plans for building your own cabin, lodge, tourist home, or wayside stand. 251 Pages, 200 plans and pictures. \$2.48 Deluxe. Popular Science, Dept. 77-C, 353 4th Ave., New York 10, N. Y.

"BUILD your own cedar chest from our knockdown kit. Write for the actual photo. Craftsman Cedar Works, Box 217, Fayetteville, Tenn."

"WHEELS—for your power lawnmower, wagon, scooters—anything that rolls. Rustproof aluminum hubs, lifetime oilless bearings. 8" x 2" semi-pneumatic puncture proof tire. For 7/16", 1/2" or 5/8" axles. \$2.60 each, or \$10.00 for a set of four. Lower prices for quantities. Clifford L. Walker, Box 1023, Plant City, Florida."

139 WATCH REPAIRING

WATCH and Clock Repairing—complete practical course in modern horology. 66 illustrated self-instruction lessons. Just out! Low price. Fascinating 100-page illustrated catalog Free! Write—Nelson Company, Dept. 3-01, Chicago 5.

WATCHMAKERS' Journal Containing Helpful Hints on watch repairing. Send 15c for copy of new July issue. Dean Watch Co., 116 Nassau St., New York 7, N. Y.

WATCH and clock repairing increasing, complete home study course with drawings and pictures. Information free. Houston Chronometer and Watch Co., P.O. Box 1140B Houston 12, Texas.

95 OLD GOLD, WATCHES, ETC.

CASH for Old, Broken Jewelry. Highest prices paid immediately. Mail gold teeth, watches, rings, silverware, diamonds, spectacles. Satisfaction guaranteed. Information free. Rose Smelting Co., 29-Y East Madison, Chicago.

GOLD \$35.00 Ounce—Mail old gold teeth, diamonds, jewelry, watches—receive cash by return mail. Satisfaction guaranteed. Free information. Dr. Weisberg's Gold Refining Company, 1500-B Hennepin, Minneapolis, Minn.

WATCHES—Broken or Usable: All kinds. Highest prices paid for jewelry, rings, spectacles, gold teeth, diamonds, sterling silver, etc. Cash mailed promptly. Write for free shipping container. Lowe's, Holland Building, St. Louis, Mo.

76 JEWELRY

MANUFACTURE costume jewelry at home for profit, hobby, therapy. Free wholesale supply catalogue. Instructions. Florida Supply House, Bradenton, Florida.

JEWELRY Findings, Lowest Prices. George Sassen, 154 Nassau Street, New York 7.

MAKE Money. Making Shell jewelry and novelties. Instruction book 75c. Kit \$5.00. Catalogue free. Palm Shellcraft Co., 220 W. 9th St., Sarasota, Fla.

SEND dime for Cameo Samples included Rhinestone and Findings Pricelist. Perry Metros, 34-37 100 St., Corona, N. Y.

132 TOBACCO & PIPES

CIGARETTES—Popular brands; minimum 3 cartons. Price \$1.45 per carton; postpaid. Send check or money order. Ace Mail Order Co., East Orange 82, N. J.

UNPOLISHED seconds of \$5.00 pipes 75c postpaid. Literature free. Carvapipe, 2829-x Dixie, Hamilton, Ohio.

86 MISCELLANEOUS

BOOKFINDERS! (Scarce, out-of-print unusual books.) Quickly supplied. Send wants. Clifton, Box 1377 PSM, Beverly Hills, Calif

GOOD "Used" self-instruction educational books on all subjects bought, sold, rented, exchanged. Satisfaction guaranteed. Complete information and 100-page illustrated bargain catalog Free! Write—Nelson Company, Chicago 5.

VERMONT maple sugar postpaid in \$1.00, \$2.00 and \$5.00 lots. Eulalia Turner, Poultney, Vermont.

HULL Automobile Compass, for accurate road direction, brand new, \$2.50. Prisms for 6x30 or 8x30 Binoculars, brand new, \$1.50, each. Offset prisms to be attached to 7x50 B. & L. Binoculars gives double the field of the ordinary 7x50 Binocular. Cost \$98.00. Special \$25.00. Green Sunshades for Binoculars size 6x30 and 7x50 snap on type, value \$7.50. Special \$1.25 per pair. Forward money order. No C.O.D. shipments. Send coin 25c for new list of Guns, Binoculars and Powder Flasks available for immediate shipment. Public Sport Shops, 13 S. 16th St., Philadelphia, Penna.

POPULAR SCIENCE OPPORTUNITIES

SIX Revealing Art Photographs—Unretouched! \$1.00. Box #699-W, Westfield, New Jersey.

LEATHER Jackets scientifically cleaned, re-finished by experts. \$3.75 plus Express. Wm. A. Reed & Co., Inc., Est. 1863, 423 S. Winchester Ave., Chicago 12, Ill.

MEXICAN-Aztec Featherwork Tropical Bird Picture Cards, Samples 25c. Mexican Products, 126 N. Main, Tulsa 3, Okla.

GET Lots Of Mail: Name Listed Three Directories 25c. Harvey Teeple, Decatur, Ind.

YES, Men's shoes in Sizes 11½ to 16. Widths AA to EEE. Finest Quality, moderate price. Free Circulars. Write Kingsize 135, Brockton, Mass.

ART Photos of Beautiful Hollywood models 4 x 5—8 for \$1.00, 32—\$3.50 Prepaid, Visual Slides, 1269 Broadway, New York 1.

NUDIST Publications—Illustrated. Particulars, stamp. Roy, Box 531-A, Waterbury, Conn.

HYPNOTIZE anyone! Get the most perfect, easily learned, modern scientific course of "Genuine Hypnotism" in the world. Fully illustrated. Only \$1.00. Money back guarantee. Fowler Box 1284, Boston 4, Massachusetts.

FREE catalog pocket tricks, magic. Scheetz's, 98-E Branch, Sellersville, Pa.

ARTISTIC Pin-Up Girl Photos, 10 for \$1.00. Wilkins, 417 Hill, London, Canada.

ART Photos! Spicy; sample .50, 3 for \$1.00. Sandige, Route 1, Box 995, Dept. P, Phoenix, Arizona.

FREE literature how to locate buried treasure and minerals. Fisher Laboratory, Inc., Palo Alto, Calif.

PANNING Gold—Free Illustrated Booklet—Catalogue. Mining Books—Supplies. Old Prospector, A-97, Dutch Flat, Calif.

SWISS Music Box Units. Choice of classical, waltz, popular. Already to install. \$3.95 each. Postpaid when cash with order. Information on request. Swiss Novelty Co., Box 1201, Fall River, Mass.

NITEGLO, non-poisonous luminous Gold and Silver Paint adds worlds of fun safely. Complete kit, \$1.00. Manor-C, 4515 Cottage Grove, Chicago 15, Ill.

UNUSUAL Novelties, 5 different samples 10c. Modern, Box 2, New York 2.

UNPAINTED wall plaques. Free list. Franks, 744 Laurel St., St. Paul, Minn.

BURGLAR Alarm for Stores and Homes \$27.50 U. S. only. Automatic Alarm Co., 5942 Audubon, Detroit 24, Michigan.

JULY Only! Six super art-photos for only \$1.00. Fenlan, 2034 Day St., Ann Arbor, Michigan.

MEN'S Fine used suits. Good condition. Get circular. Campbell Doggins, Box 949, Lexington, Kentucky.

SQUARE Dance instructions, calls. Illustrated. \$1.00. Rayburn, Eureka Springs, Arkansas.

WAR Surplus down sleeping bags, nylon tents. Free list. Donroy's Supply, 2912 East 55th, Seattle 5, Wash.

SHOES—Save 30% For Entire Family—buy direct; save retailer's profit. Send for Free Catalog—Sutton Shoe Co., Dept. B, 32 Sutton St., Baltimore, Md.

HANDMADE genuine leather link belts in black, brown, tan or assorted colors. \$1.50. W. Patterson, 875 Franklin Avenue, Columbus 5, Ohio.

MAKE—Sell Artificial Honey. \$1.00. S. Summerville, Hazel, Butler, Penna.

MODERN Tool has 100 farm uses. Flame thrower kills weeds quickly, economically. Valuable literature free. Sine Equipment, 16S, Quakertown, Penna.

LIKE the proverbial snowball. Colorado's Fabulous Oil Boom gathers momentum. Big Pay offs readying. Would you like shot at \$1,000 to \$20,000 on investment of \$140. Dyer, 1835 Champa, Denver, Colo.

50 ART Model Studies on 16mm Film. Actual Photos for Artists and Photographers. \$1.98 Postpaid. Free Plastic Viewer. Art Vu Co., Box 112, Audubon Station, New York 32, N. Y.

SAVE on Surplus. Government Surplus available for immediate delivery. Not necessary to bid. Send for free listings. Semerak & Company, Duke, Mo.

HOUSEHOLDER'S hardware kit, 40 carefully selected, useful household items, over 1,000 pieces, in wooden box with removable compartments. A real buy at \$2.50 Postpaid. Lewger Products Co., Dept. PS, 169 W. Main St., Plainville, Conn.

WIN success in your chosen field. Discover and develop your own powers. Free lecture and full details about our home study plan. Money back unless satisfied. Write today. No obligations. School of Psychology, Tenth Floor, Washington Building, Louisville 2, Ky.

57 FOR THE HOME

INSULATE your own home "yourself". Complete Plans—Illustrations—Instructions \$1.00. Money-back guarantee. Details Free. Fuel Saving Service, P. O. Box 741-PS, Canton, Ohio.

SAVE your life and property with Fire Detector, 4 for \$1.98. Automatic Alarm Co., 5942 Audubon, Detroit 24, Michigan.

101 PERSONAL

PSORIASIS Sufferers: Has everything failed to bring even temporary relief from scales, lesions and itching? Then write today for Free important information. You needn't invest one cent! Pixacol Company, Dept. S, Box 3583, Cleveland, Ohio.

RUPTURED? Positive comfort, no understraps, no steel, no elastic. Write Smith Manufacturing Co., Preston, Ontario.

HOW Would You Like To Power Charm? India's mystic secret will do the trick. Send 50c today and start instantly. Irving Closson, 118 Maple Street, Waterbury, Conn.

HAPPINESS Ahead In 1947! Single persons write today (enclose return postage) for free Illustrated, descriptive booklet by Movieland Guidance Counselor. No obligation. Troy LeRoy, 6417 Homewood Ave., Dept. PS, Hollywood 28, California.

HOW You Can Find Out! Information discreetly developed, any matter, person, problem anywhere. Personal-business assignments, representations, undertaken. Nationwide. Officially Licensed and Bonded Service established 1922. Reasonable. All inquiries confidential. William Herman, 170 Broadway, N. Y.

PSYCHOANALYZE Yourself with scientific tests, answers, explanations—\$2.00. Box #699-1J, Westfield, New Jersey.

LEARN! Earn! Veterans, Disabled. Unemployed. Temple of Healing, Columbia City, Indiana.

IF embarrassed by falling hair or baldness, write for "Wisdom Of The Navajos." No Drugs. Zax Tom Johnson, Box 392, Axtec, New Mexico.

FRETEND visiting Alaska. Letters airmailed 25c each. K. Lanier, Fairbanks, Alaska.

CAN Faith Heal? Read "How I Overcame A Dreaded Disease." Send \$1.00 to Laura Hill, P. O. Box 583, Newark, N. J.

HAIR Falling? Dandruff? Write Trichologist, 139 Lewis Street, Phillipsburg, N. J.

MATRIMONIAL—Sweetheart Magazine, 50c, 6 mos. \$1.00, Yr. \$2.00. Barwood, 2037-E 42nd, Astoria, N. Y.

FIVE Philadelphia postcards; You address return, we remain; 25c. Kaye's, Box 1301, Philadelphia 5, Penna.

NUDIST Publications—Illustrated. Particulars, stamp. Roy, Box 531-A, Waterbury, Conn.

INFORMATION for single people by Human Relations Consultant. University Graduate. Dr. B. Long, Box 375, Los Angeles 53, Calif.

SOUTHERN California Postcards 10 for 25c. You stamp, address, return. We re-mail. Fords, 6008 Terrace Drive, Los Angeles 42, Calif.

BORROW By Mail. Loans \$50.00 to \$300.00 to employed men and women. Easy, quick. Completely private, confidential. No endorsers. Repay in convenient monthly payments. Details Free in plain envelope. Write State Finance Company, 222 Davidson Bldg., Dept. P-15, Sioux City 3, Iowa.

FOOL Your Friends. Pretend you are vacationing in the land of the Sky the sights of the world. 2 cards 25c. 10—\$1.00. Will mail cards to you for address and mail on day you say. P. O. Box 4214, Glenrock Station, Asheville, N. C.

MEXICAN Law General Practice Attorney, 1203 Arizona St., El Paso, Texas.

"**WANT** to intervene in the political and religious reform of the world? Write to me: Alicio Garcitoral, Calle 4 No. 207 entre 11 y Linea, Vedado, Habana."

WINE with a wallop. Inexpensive. Most sublime ever tasted. Formula \$1.00. Aydel Co., Box 1, Pasadena 3, California.

ARTIST'S Pin-ups. Gorgeous models in tantalizing, breath-taking poses. Set 35 pictures \$1.00. Baker Service, Box 1840, Cleveland 6, Ohio.

BUY Vitamins Direct, Amazing Savings. Money Back Guarantee. Our 9th year! Postcard, Matoska Products, White Bear Lake, Minn.

DON'T Be Bald! This treatment is not new neither is tonic. Proven facts that it has grown hair. Harmless. Follow instructions. Expensive. Has results \$20.00 money order. Century Laboratories, 50-D Post Office Box 4268, Denver, Colo.

BEAUTIFUL Glamour Girl Photographs. 10, \$1.00. List included. Wineholt, Woodbine 23, Penna.

70 BIBLE Lessons 25c. Bulletin, Box 87, Cathedral Station, New York 25.

CARTOON Booklets! 10 for \$1.00. Norman Lang, 1228 Walton Ave., Altoona, Pa.

PERSONALITY and Aptitude Testings \$3.00 Complete. Field's, Box 112, Brooklyn P. 12, N. Y.

1 ADVICE

PSYCHOANALYZE Yourself with scientific tests, answers, explanations—\$2.00! Box #699-1L, Westfield, New Jersey.

2 ADVERTISING

ADVERTISERS: Mail order ad covering United States—2,200,000 circulation—\$28.00 inch. Classified ad, 24 words, 20 metropolitan Sunday newspapers—\$25.00. Magazine, newspaper, mailing-list rate-book, advertising assistance—free. Chicago Advertising Agency, 20-PS West Jackson, Chicago 4.

ADVERTISE: 24 words, 40 Newspapers \$3.50. Lists Free. Advertising Bureau, 229-P Dixon Blvd., Uniontown, Penna.

24 WORDS in 64 Weeklies \$4.96. J. Darrell, 730 Hays, Jackson, Tenn.

INCH Display Advertisement Mail-order World, year \$24. Wood's Popular Services, Atlantic City, New Jersey.

66 HANDWRITING ANALYSIS

CERTIFIED Grapho-Analyst will analyze your script. State age, sex and enclose \$2.00. Otty Kling, 2240 Selma Ave., Youngstown 4, Ohio.

ANALYZE Handwriting for Profit! Complete outfit \$1.00. Graphologists, 2404N15, Philadelphia.

38 CONSULTING ENGINEERS

QUANTITATIVE analyses. Metals, Water, Textiles. Accurate Routine Determination \$1.00—Industrial Laboratories, 123 Beaver, Albany 7, New York. Analytical Reagents, Standard Solutions Available.

45 DRAFTING INSTRUMENTS

SAVE on drafting materials. Free catalog. Draftsmen's Supply Co., 32 North Wells, Chicago 6.

POPULAR SCIENCE OPPORTUNITIES

129 TATTOOING SUPPLIES

TATTOOING Outfits—engraving Outfits. Circulars Free. Write, Zeis, 728 Lesley, Rockford, Illinois.

119 SCIENTIFIC EQUIPMENT

NEUROTIC suffering. make apparatus cheaply printed forms \$1.10. Artisan Psychiatrist, 281 E.M., Watertown, N. Y.

EXPERIMENTERS. Student scientists—Experimental science manuals & kits. Send for list. Queens Experimental Company, 25-12 Steinway Street, Long Island City 3, N. Y.

27 A CANDY MAKING

MEN—Women—"Everybody Likes Candy". Learn to manufacture professionally at home. (Our 36th Year). Ragsdale Candies, East Orange, N. J.

142 WOODS

PLYWOOD—1/4" Fir good 2 sides 9 1/2 x 48. Grain runs 9 1/2" way. 40c each, satisfaction guaranteed. Cash with order. Eugene Williams. Woodwork and Novelties, East Jackson, Delphos, Ohio.

PLYWOOD 1/4" Birch, Gum—15c; 1/4" Mahogany, Oak—20c; 3" Birch 10c; Prices per square foot. Panels Maximum 3 sq. ft. Specify approximate size. Finewood, P. O. Box, Elkhart, Indiana.

81 A MAGNETS

PERFORM astounding stunts with Alnico. Defy gravity. Mystify your friends. Two bar magnets, (4 oz.), instructions, \$.60 Postpaid. Ross, B68 West Broadway, New York, N. Y.

ALNICO Magnet—Lifts Ten Pounds! \$1.00. Five smaller magnets—\$1.00. Ronald Eyrich, Box 849, Milwaukee 1.

ALNICO Magnets, Twelve, plus 100 experiments. \$3.00. Experiments, 25c. Powerful Disc Magnets, Pair \$2.00. Micro Switches, 120V, 10A, \$1.00. Eljay, Box 891, Newark 1, N. J.

MAGNETS, Alnico—Free List. Terry Sales Company, 3726 South Detroit Avenue, Toledo 9, Ohio.

134 TREASURE FINDERS

MT-SCOPE Metal Locator fully guaranteed and unsurpassed in efficiency. Time payment plan, trade-in and accessories. Free literature. Fisher Research Laboratory, Inc., Palo Alto, Calif.

METAL Detectors. The Very Latest Circuit. Free Literature. Hedden Metal Detectors, 538 North Homewood Avenue, Pittsburgh 8, Penna.

SEEK Buried Treasure. Methods, mysteries, devices explained. Circulars free. Century Press, Box 151-D, Glen Ellyn, Ill.

21 BOOK MATCHES

YOUR own personalized Matches. 50 Metallic covers each with your name \$1.10. Morey, 87-4 Somerset, Springfield 8, Mass.

42 DETECTIVES

DETECTIVE Training. Phillips Secret Service, 1917C, N. Kenneth, Chicago 39, Ill.

BE A Detective—Send for price-list of self-instructional courses at reduced prices. Perkins Publications, 300-C Brandeis Theatre Bldg., Omaha, Nebraska.

DETECTIVES—Work home—Travel, Experience unnecessary. Write Wagoner P-125 West 86th, N. Y., N. Y.

DETECTIVE training. Department store work, shoplifters, etc. Also general detective procedure. Thirty years diversified detective experience. Free details. Write Shewbridge System, 216 Valdez Avenue, San Francisco 12, Calif.

74 INFORMATION

INFORMATION—Locating Articles and Products (Wholesale) etc. Literature Free. National, 3537B So. Hoyne, Chicago 9.

93 NAME LISTS

MAILING list. Fresh 1947 list. 1000—\$2.00. W. C. Cawthon, Mountainburg, Ark.

MAILING Lists, certified, productive, inexpensive. \$5.00 1000. Homeworkers, agents, buyers, etc. Write Dixie Service, King, N.C.

84 MILITARY INSIGNIA

COLLECT colorful Army Patches. Pictures, Price and sample patch only 10c. Insignia Mart, 703 Broadway, N. Y.

FIRST Again: United Nations Insignia 30c. Military Emblems 2c up. Send 10c for price lists. Hobbyguild, X-35 West 32nd St., N. Y.

123 SOUVENIRS

FREE German War Relics with each purchase. Send 10c for price list of captured Foreign medals, daggers, uniforms and receive 4 German Ration Potato stamps, free. Hobbyguild, S35, West 32nd St., N. Y.

FREE: German War Relics: Send 10c for prices of captured foreign medals, daggers, uniforms; and receive four German Ration Stamps free. Hobbyguild, S-35 West 32nd St., N. Y.

USE THIS ORDER FORM TO INCREASE YOUR MAIL ORDER BUSINESS

LOOK AT THESE LOW RATES

60c

Per Word, Per Insertion
WHITE SPACE—\$3.60 Per Line.
Minimum Ad—10 Words—\$6.00
CASH WITH ORDER

If You Sell A Product or Service To Men, Use This Easy Means To Get More Sales

CLASSIFIED ADVERTISING ORDER

Popular Science Monthly • 353 Fourth Avenue • New York

Please insert the ad below in your.....issue.

Heading.....

Enclosed is \$..... Word Count.....

EACH WORD IN NAME AND ADDRESS MUST BE COUNTED AS A WORD

Name.....

Address.....City & State.....

To be inserted in the Sept. issue, this order must reach us by July 28th.

HOW TO SAVE MONEY ON *Home Repairs!*



Only \$1.49

crammed into one big cloth-bound volume to sell for only \$1.49. Books of similar size usually sell for \$2.50 or more!

SEND NO MONEY NOW!

Just mail coupon below and pay postman only \$1.49 plus mailing cost for this DeLuxe edition. If, after 10 days' examination, you wish to return book for any reason, we will gladly refund every cent you paid.

POPULAR SCIENCE—Dept. 77, 353 Fourth Avenue, New York 10, N. Y.

Send me the new 260-page cloth-bound book, TINKERING WITH TOOLS. I will pay postman only \$1.49, plus few cents postage, on delivery. If dissatisfied, I may return book within 10 days for full refund.

NAME.....

ADDRESS.....

CITY.....STATE.....

(If you prefer to remit now, we pay postage. Same refund guarantee)

HOW TO BUILD YOUR OWN CABIN OR BUNGALOW!

Here's an amazing big book that shows you *complete detailed plans* for building your own log cabin, wayside stand, tourist home, bungalow or hunting lodge! Yes, you'll find 250 jam-packed pages and 180 pictures and floor plans that tell you *everything you want to know*—how to lay a foundation . . . how to build walls . . . lay floor boards and roofs. You'll even read step-by-step details for building porches, garages . . . for cutting doors, windows, shutters . . . for building fireplaces, chimneys . . . and even for installing plumbing! Costs *only* \$1.98!



SEND NO MONEY

Examine this big volume at our expense! *Order today!* On delivery deposit only \$1.98 plus few cents postage with postman—or \$2.48 for handsomely bound DeLuxe edition. If after 7 days' *free trial* you aren't delighted, return it for refund.

MAIL COUPON NOW!

POPULAR SCIENCE Publishing Co., Dept. 77A
353 Fourth Avenue, New York 10, N. Y.

Send "How to Build Cabins" in edition checked:

DeLuxe Edition \$2.48 Regular Edition \$1.98

I will pay postman price plus postage. If not delighted, I may return book within 7 days for full refund.

Name.....

Address.....

City..... Zone..... State.....

Check here if you send payment with order, and we will pay all shipping costs. Same return privilege.

Complete "ELECTRIC EYE"

**Photo-electric Relay
with 1001 Uses**

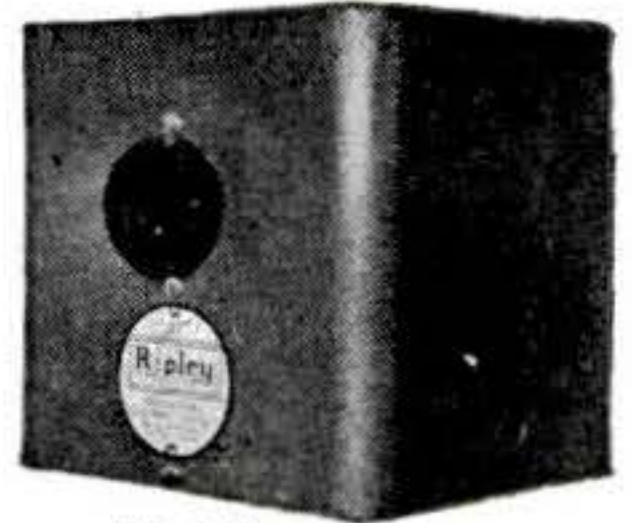

Model No. 152



\$49.75

This electronic device, packaged, complete and ready to plug in. Electric and electronic hobbyists will find it fascinating and useful. Factory engineers will find many applications for it.

The photo-electric relay is designed to close or open electric circuits upon the breaking of the light beam.

With the unfailing accuracy of the "Electric Eye" the contact relay can be made to operate a magnetic counter, solenoid, magnetic motor starter, indicating lights and numerous other uses.

You can buy *this* perfected device with confidence. Behind it is the experience and "know how" of RIPLEY, one of America's leaders in electronics.

Operates on 110 or 220 Volts, 60 cy. A.C. Output load, 3 amps. For additional information write to:



RIPLEY COMPANY, INC.

11 West 42nd Street, New York 17, N. Y.

Pioneer in the development of electronic devices

ELGIN
15
JEWEL

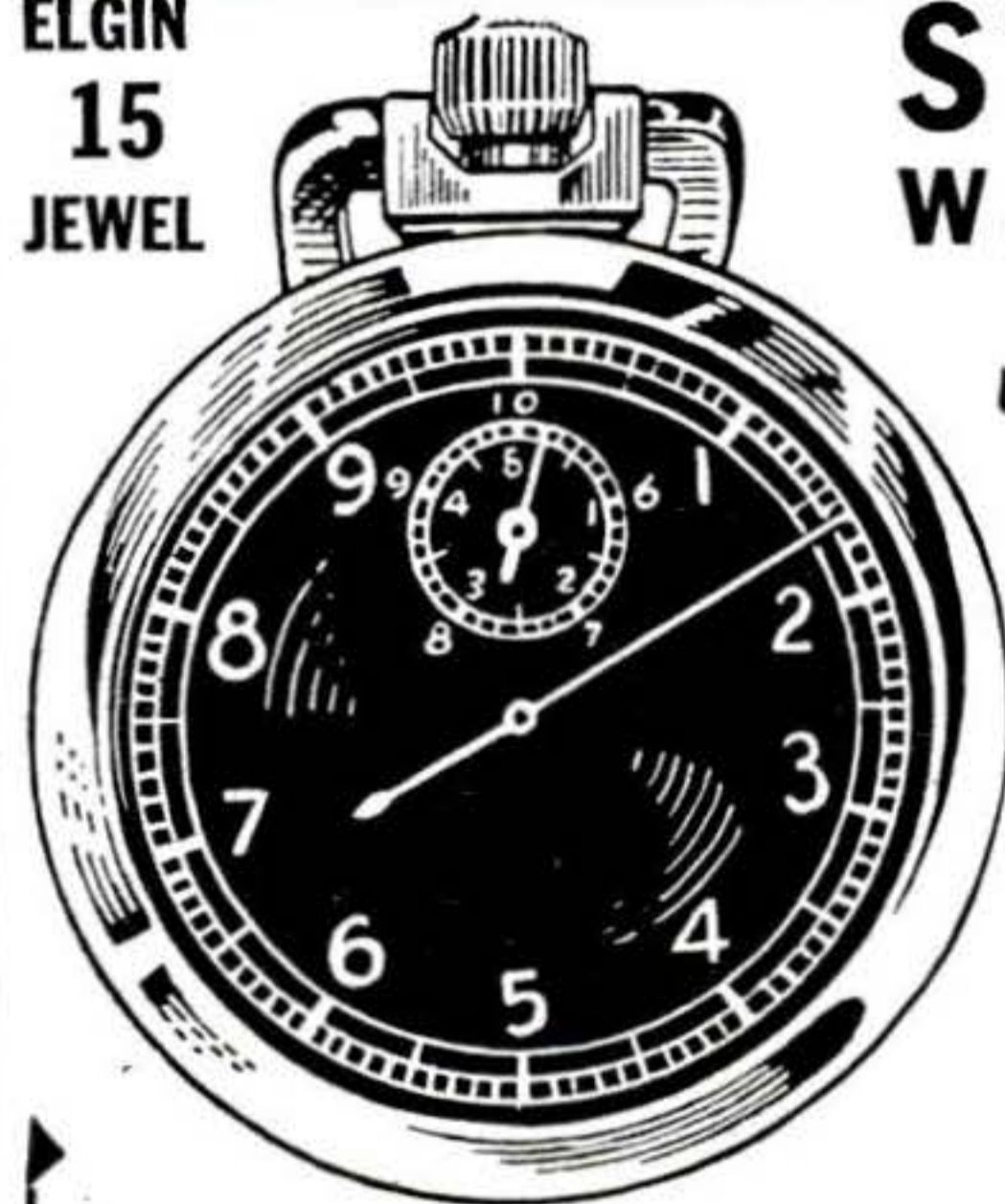

**STOP
WATCH**

U.S. Gov't.
Surplus

ORIGINAL
COST
\$18.75

NOW
ONLY

\$9.95

A SENSATIONAL VALUE AT THIS LOW PRICE

Built to rigid U. S. Army Air Corps specifications by Elgin Watch Co. Guaranteed 15 jewel movement. Stem wind, stem start, stem stop and stem reset. Graduated in 1/10th seconds—10 seconds to one revolution. Use it for time study work, industrial timing, sporting events, racing—for everything that wants split second timing. Used but guaranteed perfect. Original cost was \$18.75. You save approximately one-half at this special price. Order today. Safe delivery guaranteed.

\$9.95

USE THIS
COUPON →
SATISFACTION
GUARANTEED

STARK'S

509 S. State
Chicago 5, Ill.

STARK'S, Dept. PSW Date
509 S. State St., Chicago 5
Enclosed find \$..... for Stop Watch.
Please add 25c for postage, insurance, etc.

NAME.....

ADDRESS.....

CITY.....STATE.....



RCA Miniature Tubes enhance the tonal brilliance of RCA Victor Globe Trotter portable radios.

She shall have music wherever she goes!

Wherever you go with an RCA Victor Globe Trotter portable radio you'll enjoy unusual richness and clarity of tone—volume enough for outdoor dancing—made possible through tiny tubes.

Miniature tubes save valuable space in small radios—space that can be used for larger and better loudspeakers and for longer lasting, radio-engineered RCA batteries.

These miniature tubes were developed by RCA Laboratories—a world center of radio and electronic research—and long a leader in development of electron tubes.

At RCA Laboratories, the same research, and advancement that resulted in these improved tubes, keep all RCA products and services at the top in their particular fields.

When you buy a product bearing the name RCA or RCA Victor—a radio set, television receiver, Victrola radio-phonograph, a radio tube or phonograph record—you get one of the finest products of its kind science has yet achieved.

"Victrola" T. M. Reg. U. S. Pat. Off.

Radio Corporation of America, RCA Building, Radio City, New York 20. Listen to the RCA Victor Show, Sundays, 2:00 P. M., Eastern Daylight Saving Time, over NBC.

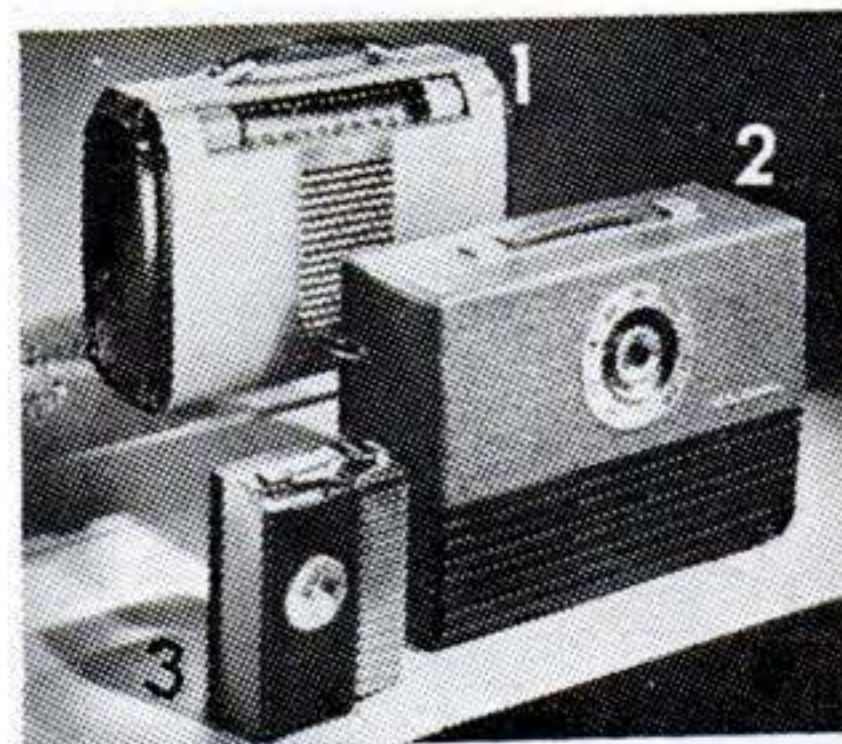

Ideal traveling companions. (1) RCA Victor "Globe Trotter"—operates on AC, DC, or batteries. (2) RCA Victor "Escort"—has a battery you can recharge from any AC electric outlet. (3) RCA Victor "Solitaire"—less than 6¼ in. tall!



RADIO CORPORATION of AMERICA

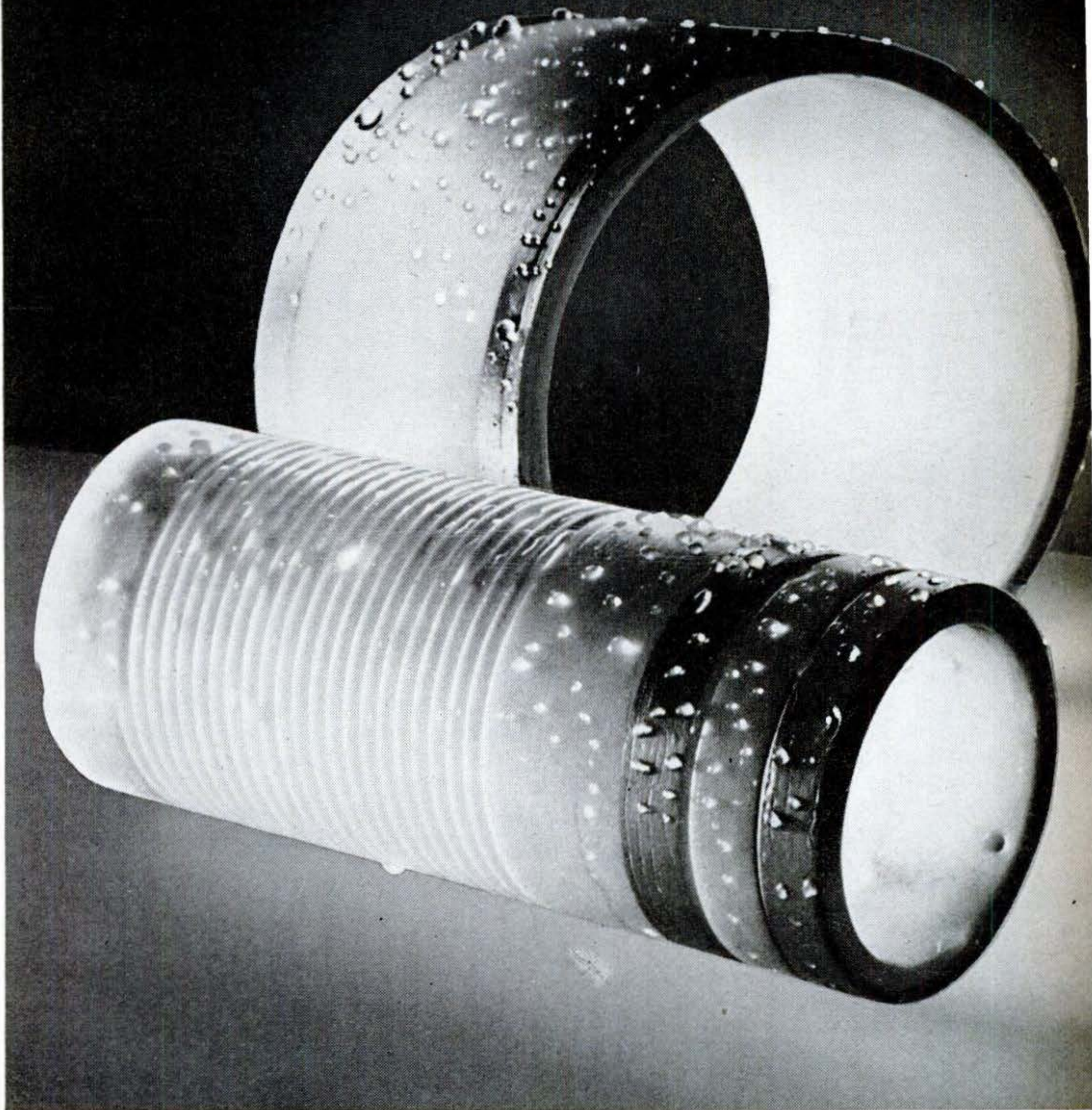

Silicone On The Job... Here, as a fluid baked onto glass insulators, it breaks water into beads, preventing the formation of a film that would conduct electricity. Silicone compounds are made of ingredients similar to sand and natural gas. Although not new, they have only recently been put to work making rubber stand greater heat, giving more life to petroleum greases at extreme temperatures, floating trout and bass flies high on the water so as to fool the smartest fish.

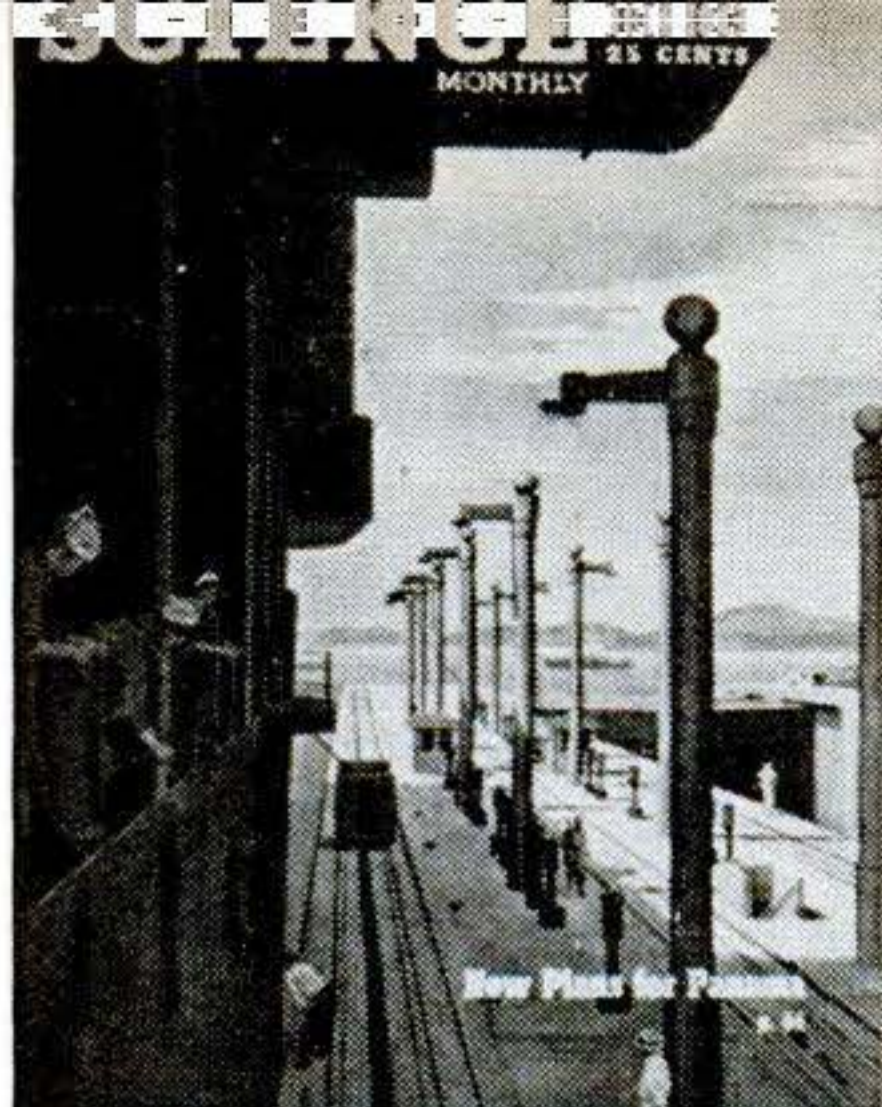

Our Big Ditch is a dangerous bottleneck in a nervous world; here are three proposed ways to make it safe and efficient.

New Plans for Panama

By Stephen L. Freeland

THE Panama Canal is the most dangerous important waterway in the world today, averaging 50 accidents annually for 20 years—an accident a year for every mile of its length. This record in itself is bad enough to justify doing something about the 40-year-old Ditch. But, these global days, improvement of the Canal is a “must.” The Air Age and the untold possibilities of atomic energy have increased, if anything, our dependence on the Navy and salt-water shipping.

Congress, with surprisingly little fanfare, has been alert to the need for a Canal big enough and safe enough for any ship to pass through quickly at any time. Late in 1945 it passed a law calling for a complete review of the entire problem, and last March it sent a special subcommittee to the Isthmus on a tour of inspection. Due for debate before the end of this year, the problem revolves around three possible schemes: the Sea Level plan, the Third Locks project and the Terminal Lake plan.

The best way to understand what these three plans mean is to take a trip through the Big Ditch. For the happy tourist, this is a joy ride through exotic scenery. For the engineer, it is a demonstration of one of the world's greatest pieces of hydraulic ma-

chinery. But for the pilot, it is a nerve-tugging, spine-chilling duel with disaster from start to finish, with good luck helping good management more times than he would care to count.

A pilot's picture of the Canal varies somewhat with the ship he's handling—from a yacht to a battleship. Perhaps the trickiest are twin-screw vessels with a single rudder amidships. These, in pilot's language, are “cranky,” slow to answer the helm. Ore ships and old tankers are notoriously shifty.

They Have to Fit

Our Navy's capital ships are considered “good handlers,” but their sheer size is problem enough. Shoving a battlegon safely into a lock chamber is a little like getting a base drum into a telephone booth on the dead run—it has to be right first try. An *Essex* class carrier, for instance, slides into 110-foot-wide locks with only nine small inches to spare on either side. The little electric locomotives, called “mules,” that run along the lock walls can do little but hold lines steady on such big vessels; the ships enter the locks and stop under their own power, guided by the “mules.”

The pilot who takes a ship through the Canal from the Pacific to the Caribbean calls it a “northbound transit.” He picks up the ship at sea, then guides her along a straight,

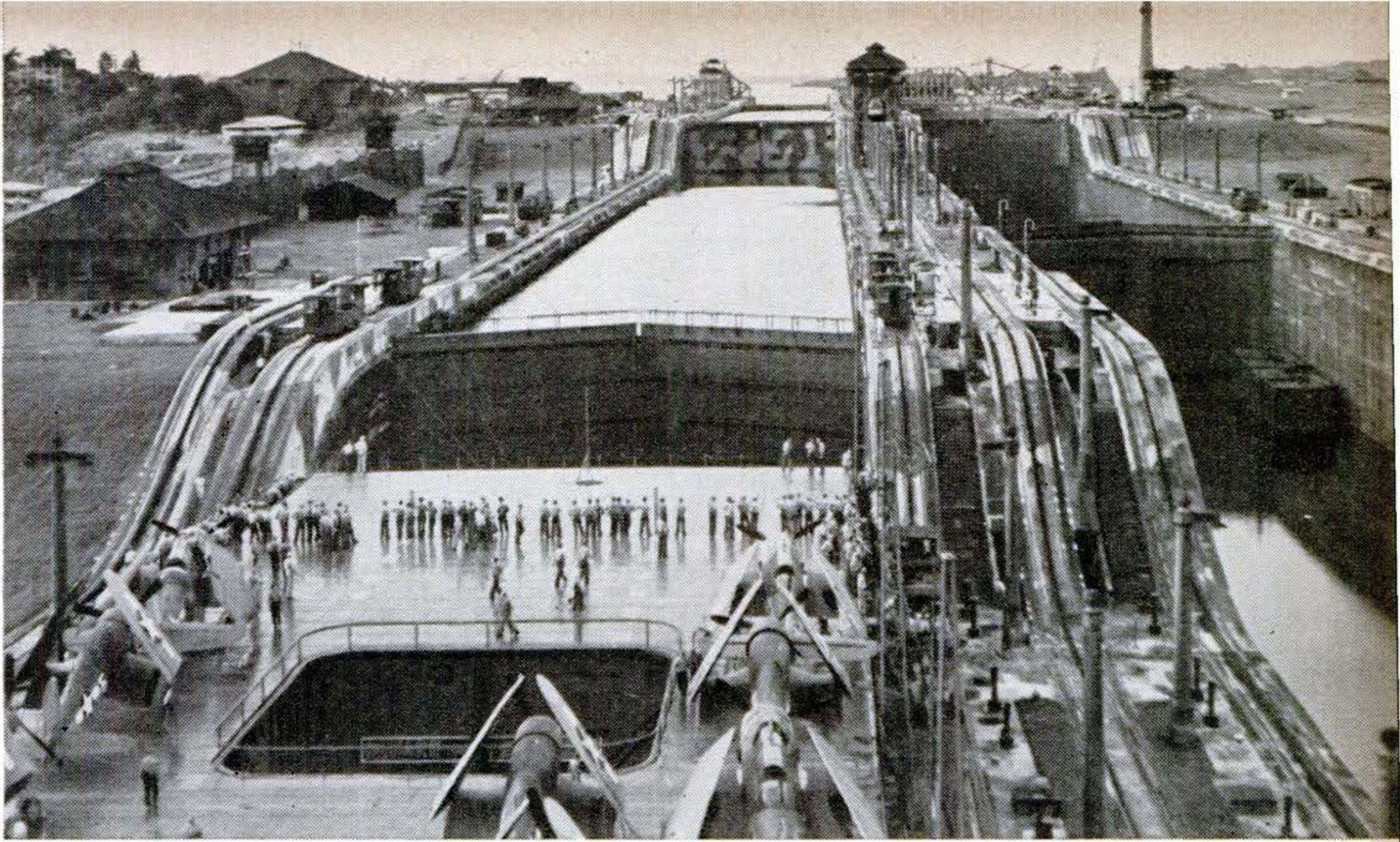

U.S.S. Bunker Hill has only inches to spare in the first of Gatun Locks. Bigger *Midway* class

carriers are too big to squeeze through, have to make an 8,000-mile detour around the Horn.

narrow channel into Balboa Harbor. Here, if it is night during the rainy season, he probably has to wait. Fog in Gaillard Cut, so thick he can't see the fo'c'sle from the wheelhouse, is the usual occurrence—rolling in sometime after 9 p.m., clearing off about 8:30 a.m. about 110 nights a year.

In the dry season, however, he may be permitted to take his ship right on through. Passing out of Balboa Harbor, he enters another narrow channel between low, hummocky hills and steams toward Miraflores Locks. Before he ever gets there he notices a difference in the way his ship reacts; she gets slower and slower in answering the helm as the water gradually gets shallower until it reaches 45 feet, which is the Canal's controlling depth.

Miraflores Locks are his first real hurdle—a jump of 54 feet in two steps. Remembering that one in three of the Canal's accidents happens at the locks, he approaches cautiously. But he can't be too cautious, because he has to keep steerageway. If the ship is not moving fast enough to make the rudder bite the water, a gust of wind or the tidal current can take command and smash his ship against the lock wing.

The Ditch's Bottleneck

Safely through the first set of locks, the pilot crosses Miraflores Lake, a mile-wide marsh with a channel through it, and comes

to Pedro Miguel, the bottleneck of the Canal. One set of locks (1,000 feet long, 110 feet wide and 45 feet deep at the sills—the present standard size for the Canal) waits to raise him another 31 feet to summit level.

Here the pilot is confronted with more unhappy memories. He can recall how ships suddenly went aground, although both lead line and chart showed plenty of water. The entrance to the locks had silted up, and the lead had simply sunk into the ooze. The problem has been fairly well licked now by huge suction dredges, but still there is no safe place for a ship to wait.

Compound Hazards

Beyond Pedro Miguel, the pilot takes his ship into the nastiest stretch of water in the whole transit, the famous Gaillard (formerly Culebra) Cut—seven miles of cold danger knifing through the Continental Divide. He can see plenty of reminders of accidents, and he recalls statistics: Out of 50 recorded collisions in the Big Ditch, 26 happened along here, as did 54 of 110 accidents caused by steering-gear failure. Twenty-one out of 70 groundings took place in the Cut, and nine of them resulted in sinkings as compared to four elsewhere.

Three factors combine to make the Cut dangerous: It is narrow—300 feet wide at the toe of the slope; it is restricted, so dis-

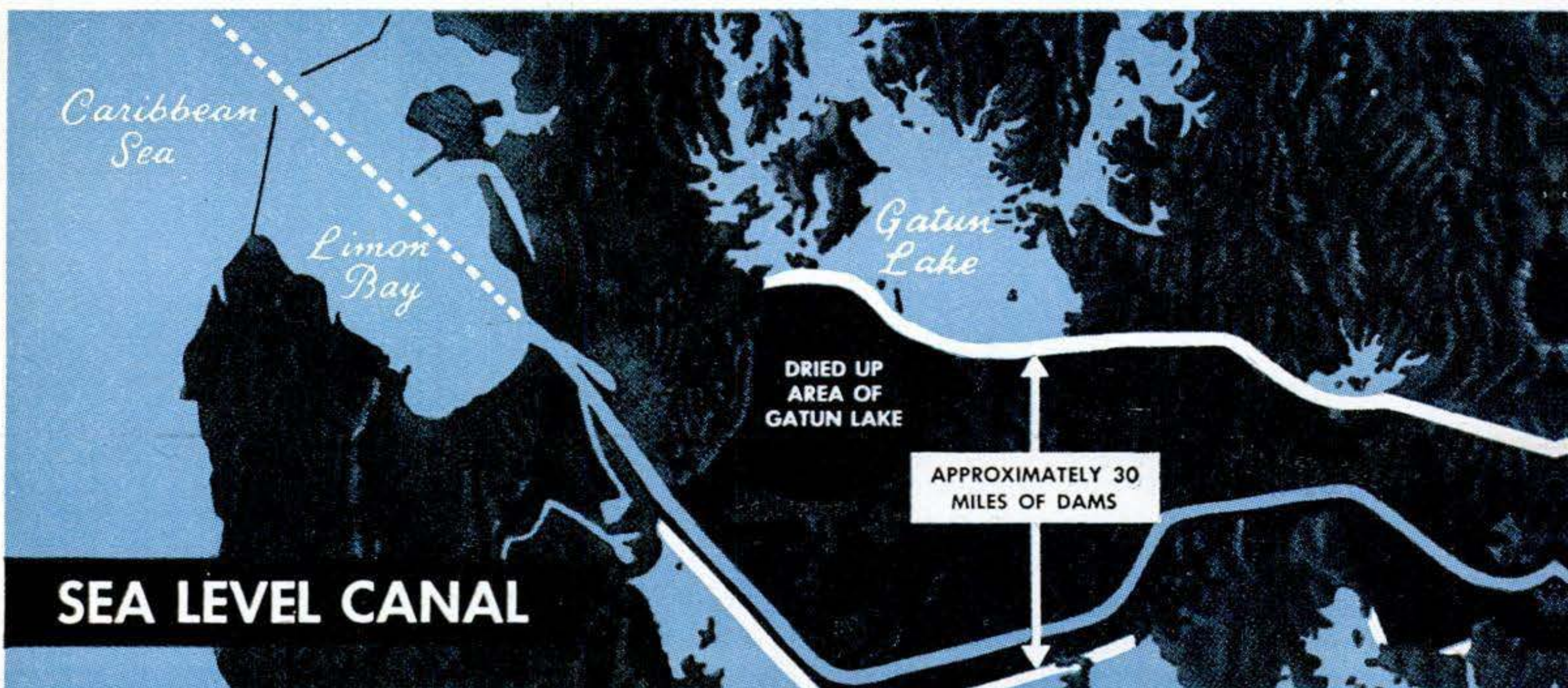
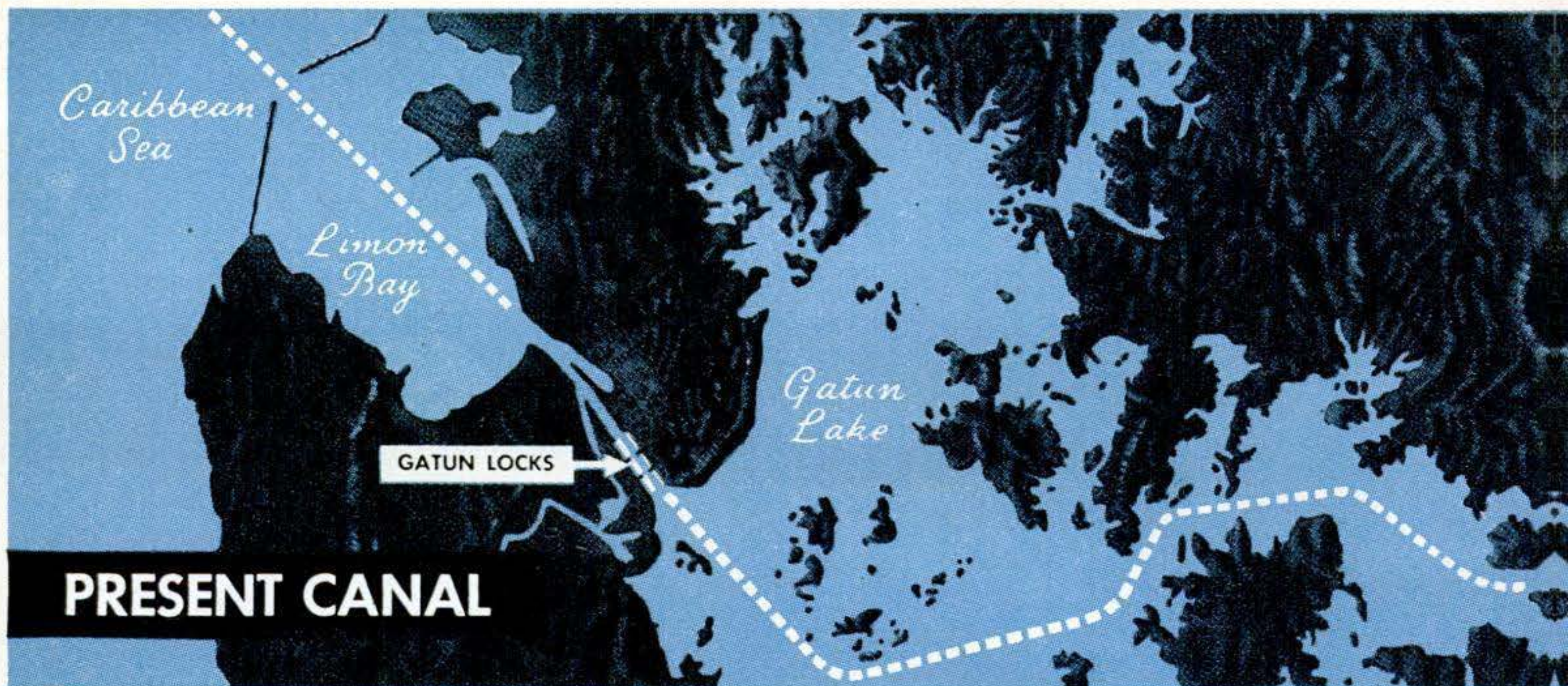

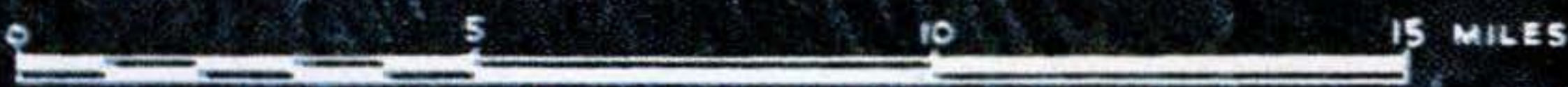
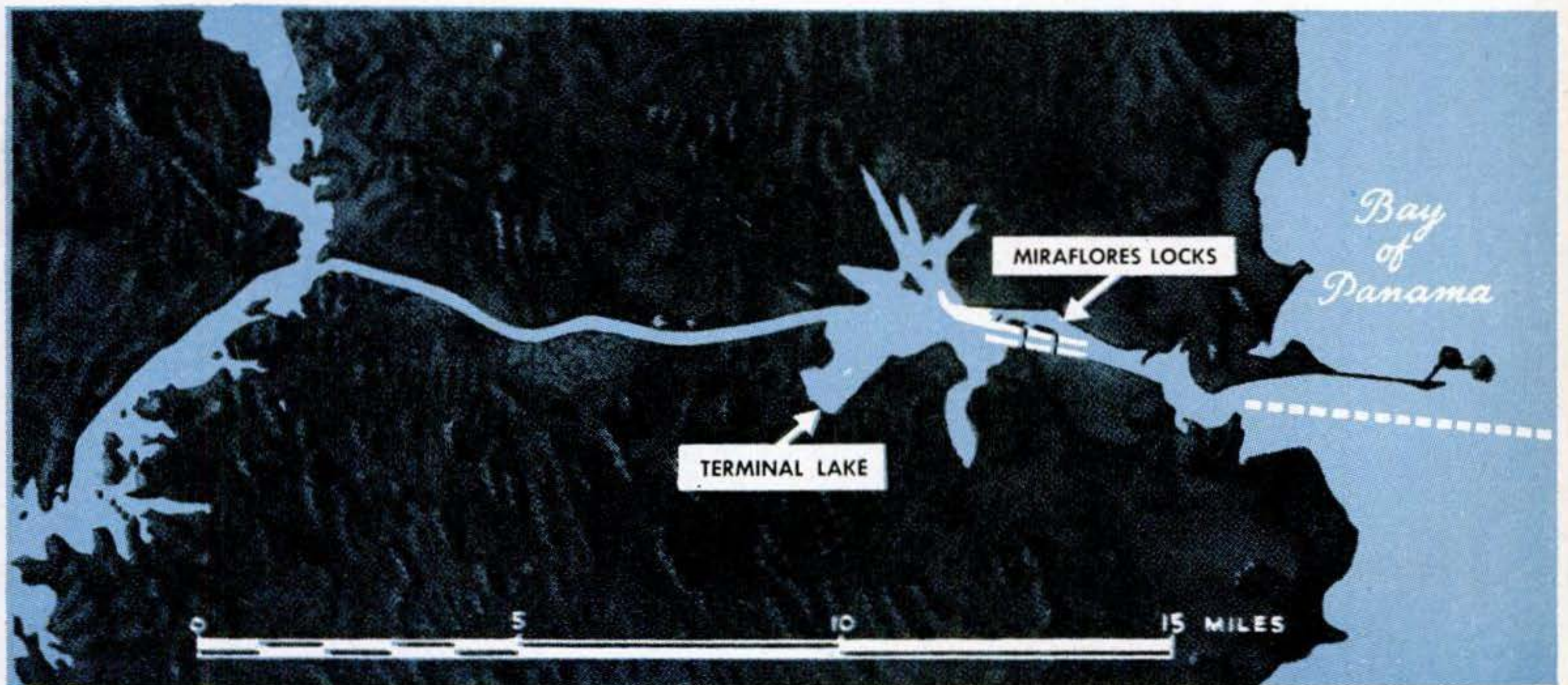
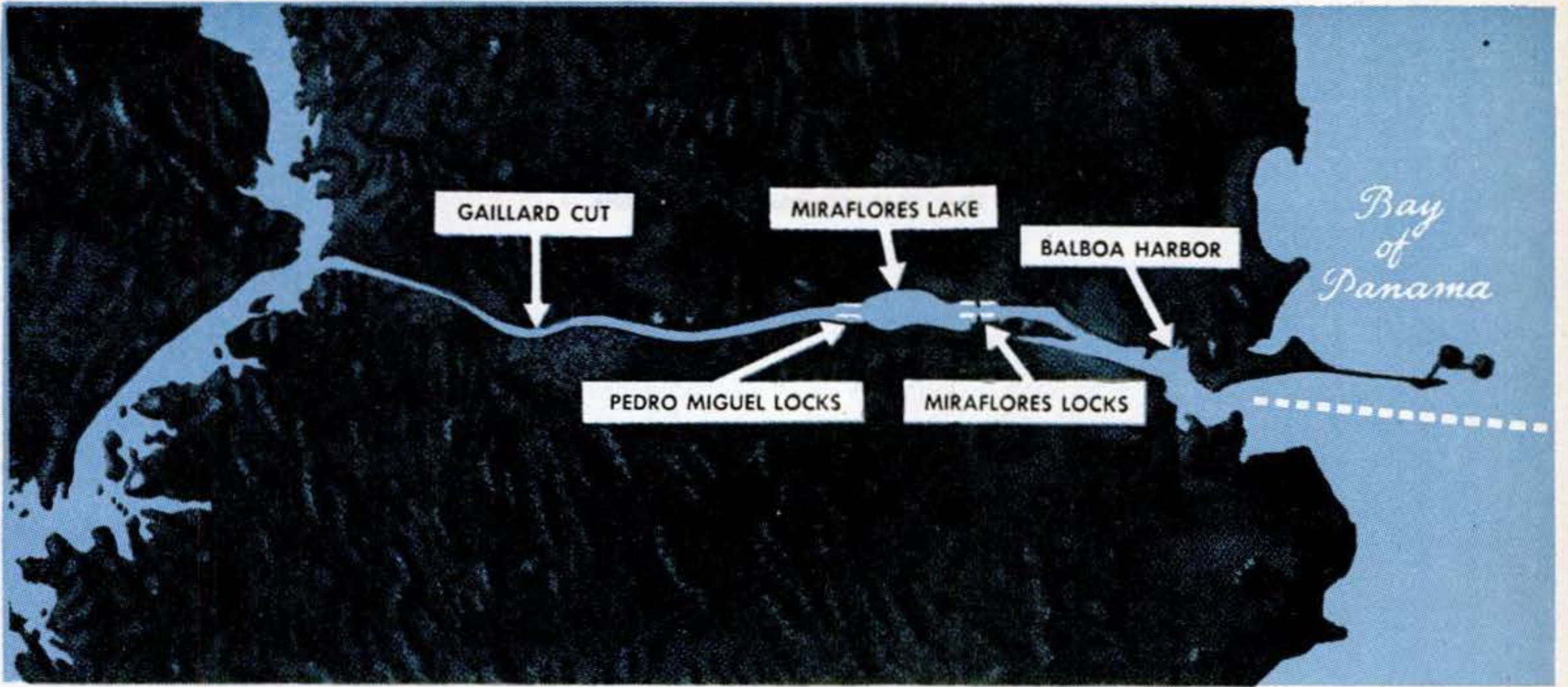

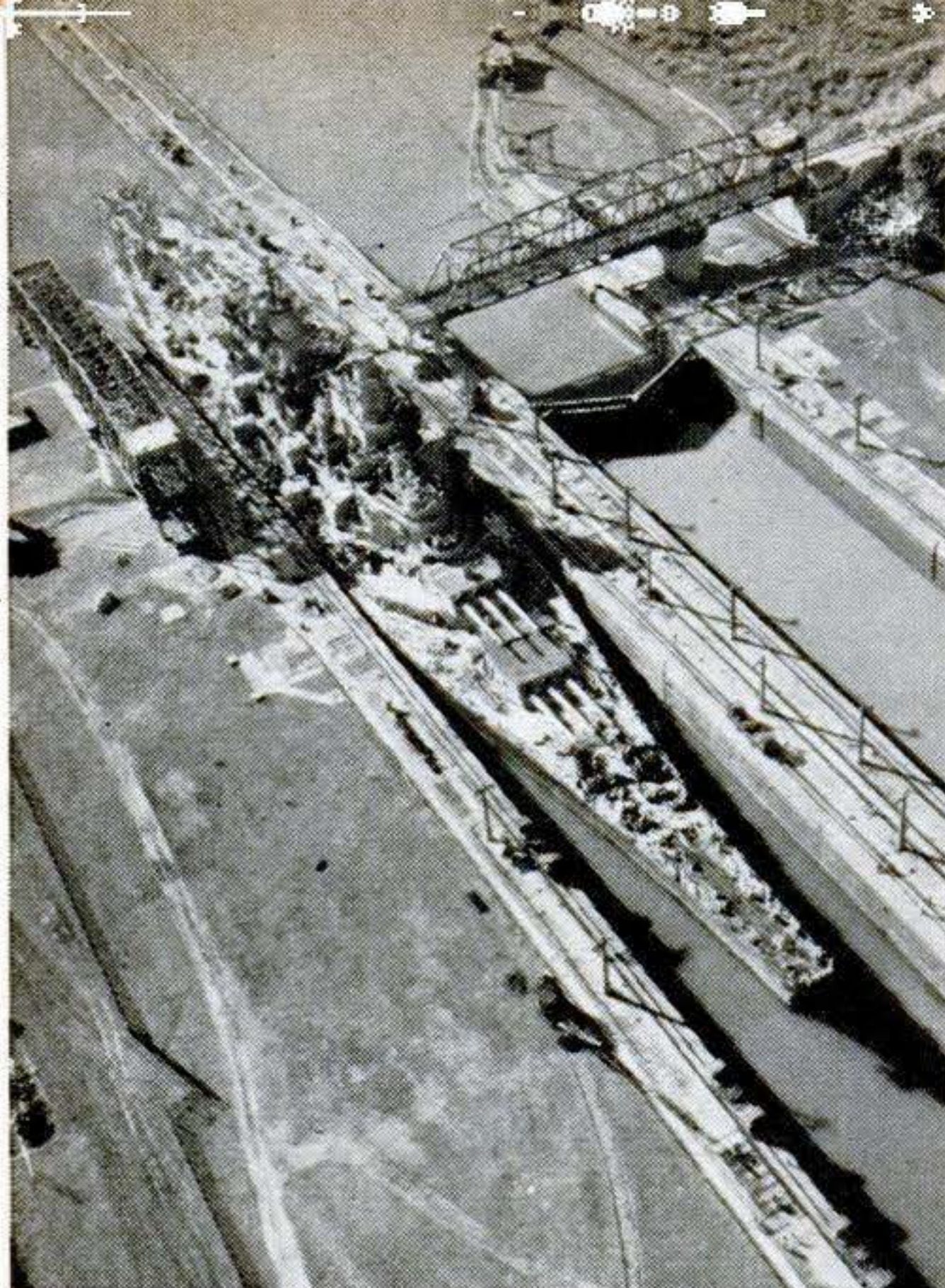

Miraflores Locks are a glove-tight fit for the *U.S.S. Missouri*. The slightest miscalculation can jam a battleship in a lock like a broken cork, tying up traffic until it's pried loose.

placed water can't spread out; and its sides are steep—10 feet vertical to one horizontal. Put together, these three conditions mean that whenever a ship starts to yaw, or swing off course, her stern is liable to be drawn toward the near bank by what the pilots call "bank suction."

And there's plenty of reason for yawing in the Cut. Every time the Pedro Miguel Locks draw water, a three-foot wall of water is sent boring through the Cut at 36.4 feet per second—almost 25 miles an hour.

Going Gets Easier

Out of the Cut at last, the pilot dares to relax a little as he enters Gatun Lake through Gamboa Reach. Here, although the water may drop to a mere 42-foot depth during the dry season, at least bank suction is lessened because the banks themselves are lower and the water has a chance to spread out. Furthermore, the bottom is soft mud. The lake itself is 168 square miles, dotted with tiny islands full of bright tropical birds. The channel through it is almost 24 miles long, ending up at a broad anchorage leading to Gatun Locks.

The Locks themselves let a ship down from the summit level in a continuous three-step operation. From the bottom there is a run of almost seven miles across Limon Bay

past Cristobal and Colon out into the Caribbean, where the pilot turns the ship over to its captain again.

All the plans for improving the Canal take the pilot's problems into account, though they solve them in different ways. All of them incorporate, of necessity, some of the same ideas, and all have their merits and their disadvantages.

The oldest plan calls for a sea-level waterway. It would be far from simple or easy to build. The best guess is that it would cost between \$1,121,000,000 and \$1,310,000,000, and would take from 12 to 20 years to complete. After that, however, it could probably be widened and deepened as we chose without too much trouble.

Two Schemes Proposed

Two methods have been proposed for the actual creation of such a canal: the step-down and the deep-dredging plans. In the former scheme, widening and deepening would take place in four successive cuts, working 30 to 40 feet down and as many feet out from the center line as necessary to make the proper slope, leaving most of the present channel in operation.

So far as mere earth moving is concerned, this could be done with existing tools and techniques, but there are two important additional considerations: the present locks and flood control. The plan calls for the removal of the Pedro Miguel and upper Gatun Locks as soon as the first 30-foot cut is complete. After the second cut, the middle locks at Gatun and the top locks at Miraflores would go. These demolitions would tie up the Canal, so temporary locks paralleling existing installations are proposed, to be abandoned when the work is done.

Bombs Get Consideration

The flood-control proposal is even more ambitious. Gatun Lake would be drained and kept that way. This would call for approximately 30 miles of huge barrier dams, "of sufficient proportions to withstand bombing," to contain the waters of the Chagres and Gatun Rivers and their tributaries. These dams and some 25 miles of diversion channels and tunnels would have to be virtually complete before Gatun Lake started to dry up, or there wouldn't be enough water left for lockages, since every chamber uses 30,000,000 gallons per lockage. Once completed, though, they would be good in-

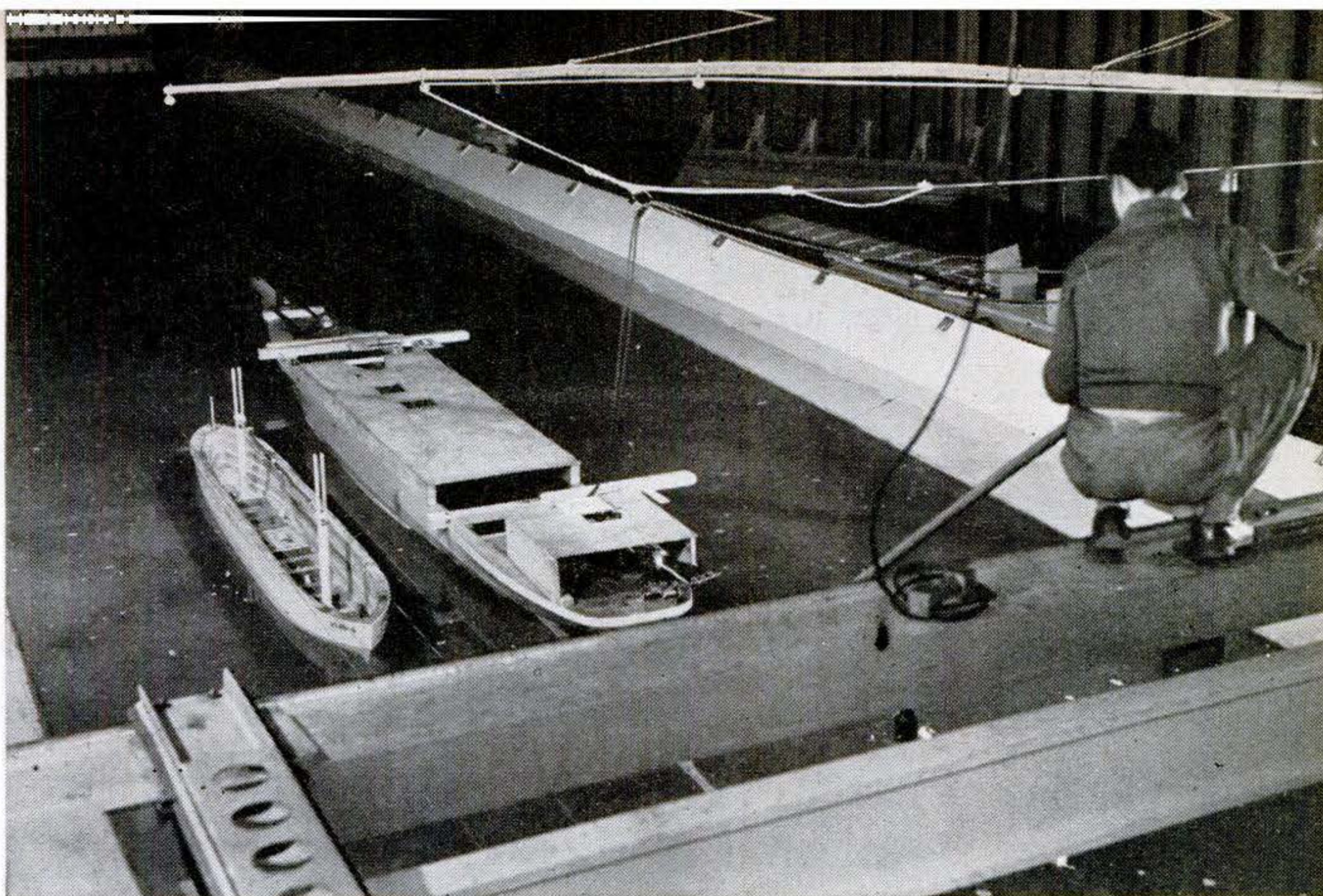

Tests in model basin show effects of a canal's depth and width. In a 300-foot-wide canal 45 feet deep, a ship's rudder has to turn twice as far as it would to get the same result in water

60 feet deep. In narrow channels, pressure can build up between the bow of a yawing ship and the banks; reaction, called "bank suction," can pull stern sideways, ram it against the shore.

insurance against two great natural threats to the Canal—flood and drought.

Deep dredging, as the name implies, calls for digging the sea-level canal to grade in one operation from the present summit level. This method would eliminate the need for alternate locks and prior construction of flood-control works. It would, however, call for an awful lot of water to fill the enormously enlarged channel. It would also call for tools that have never been built, though they are not impossible: dredges that could sink spuds and operate buckets under 135 feet of water, for instance.

Champions of the sea-level canal claim that by eliminating the present locks they would eliminate major bottlenecks and major sources of accidents, speed transit time, improve flood control and create a far less vulnerable waterway.

A Second Canal

It was the question of vulnerability that led to the only scheme for comprehensive modernization to earn official approval from Congress—the Third Locks project. This plan called for single-chamber locks 1,200 feet long, 140 feet wide and 45 feet deep, paralleling present locks but at some distance from them. New channels to and from all

locks were visualized. In short, except for a portion of the existing channel in Gatun Lake, the Third Locks project when completed would have been a second canal using the same water as the first.

Abandoned in 1942

The three main advantages are obvious: dispersion of critical facilities for security against attack, accommodation for larger ships, and comparatively low cost—\$277,000,000. Authorized in 1939 and abandoned because of the war in 1942, the project left a legacy of completed surveys and some excavation (at Miraflores) for new large locks, which can be used in completing work on either of the other two plans.

Both Sea Level and Third Locks plans sound sensible, but ship owners, operators, masters and pilots see plenty wrong with them. If you drop the level of the Canal 85 feet, they point out, you make a restricted waterway out of the entire channel between Miraflores and Gatun—31 miles of Gaillard Cut instead of the present seven. And there would be 12 dangerous bends of 20° or more instead of the two now in the comparatively easy reaches of Gatun Lake. In addition, they maintain that the whole Canal would be tied up in the event of fog in

Gaillard because ships would have no place to wait except in harbors at either end of the Canal.

The Third Locks project, maritime interests say, would only add a new Gaillard Cut, with three extreme turns in it, in the Pedro Miguel by-pass. Lockage surges, too, they say, would be intensified at the point where the cut-off joined the old channel.

Anchorage for Pacific End

The people who use the Canal have their own plan—a lock canal with a summit-level anchorage at the Pacific end to match Gatun on the Atlantic side.

To get this, they would first build a three-stage lock at Miraflores. Then they would build a dam where the present locks are and a series of retaining dikes around Miraflores Lake to raise the level of the lake to 85 feet—summit level. Then they would get rid of the Pedro Miguel Locks. Having accomplished that, they feel, most of the ship-handling hazards of the present Canal would be eliminated.

The Gaillard Cut would lose most of its terrors if ships could steam right through it to safe anchorage on the other side. The anchorage itself, after dredging, would accommodate nine ships in 300-yard berths, 30 in 200-yard berths, which is more than 12 hours' traffic capacity for the Canal. This in turn would simplify control, since ships could come up to summit level at any

time instead of having to wait below Miraflores, as is the case now, when there is fog in the Cut.

One feature of the Terminal Lake plan which particularly appeals to pilots is that, with the removal of Pedro Miguel Locks and the surges they create in the Cut, the summit level channel would be completely currentless. All necessary water would be delivered to the two terminal lakes, where the force of its arrival would be absorbed. The entire job probably could be completed in five years for \$500,000,000.

To the charge that the Terminal Lake Canal would still be a vulnerable affair of concentrated locks, its proponents reply that after Hiroshima and Nagasaki it is futile to talk of invulnerable structures; after Bikini, it is impossible to call any body of water protected.

Still a Three-Way Choice

Even if the proposed canals *are* alike in vulnerability, there is enough difference among the plans to make the choice difficult. Right now the pick seems to be between the Sea Level and Terminal Lake ideas, but the world is not so peaceful and the fortunes of war are not so certain that we can forget all about the need for a canal that provides alternate locks.

So the future of the Big Ditch remains a three-way choice—with the time for decision almost at hand. END



Looking out, through a transparent mirror developed by Libbey-Owens Ford, housewife can see who's there.



Looking in, the caller sees only his own reflection, does not know he is being looked over, cannot talk his way in.

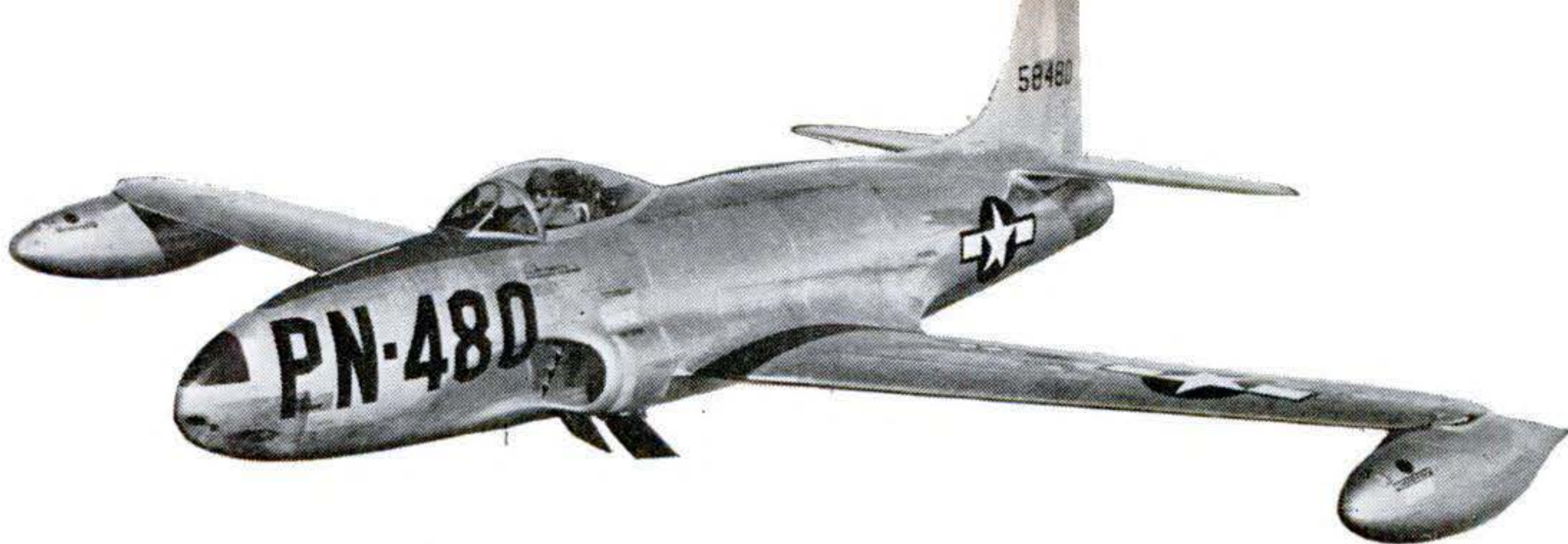

Improved wing-tip fuel tanks and increased firepower are features of the new Shooting Star.

Faster "Star" Totes Six Guns

THE new edition of the AAF's jet-propelled Shooting Star, the P-80B, is a faster, tougher, and more formidable fighter. Its six guns, mounted in the nose, capable of firing 1,200 rounds a minute, have proved their accuracy at high speeds. Water injection has been adapted to the J-33 turbo-jet engine to increase power for take-off and climb. Stainless steel has been added around the engine for fireproofing. The skin is thicker; the bulkheads stronger; there is a sturdier base for the heavy armament. To make the pilot happy, the cabin is refrigerated against the friction heat developed at 600 m.p.h. and has an ejector seat for emergencies. In general appearance and dimensions, however, the latest of Lockheed's Shooting Stars is similar to its P-80 predecessor despite the improvements.



Ejector seat enables the pilot to shoot himself clear of the airplane. Ejecting force is a reduced charge in a 37-mm. shell.

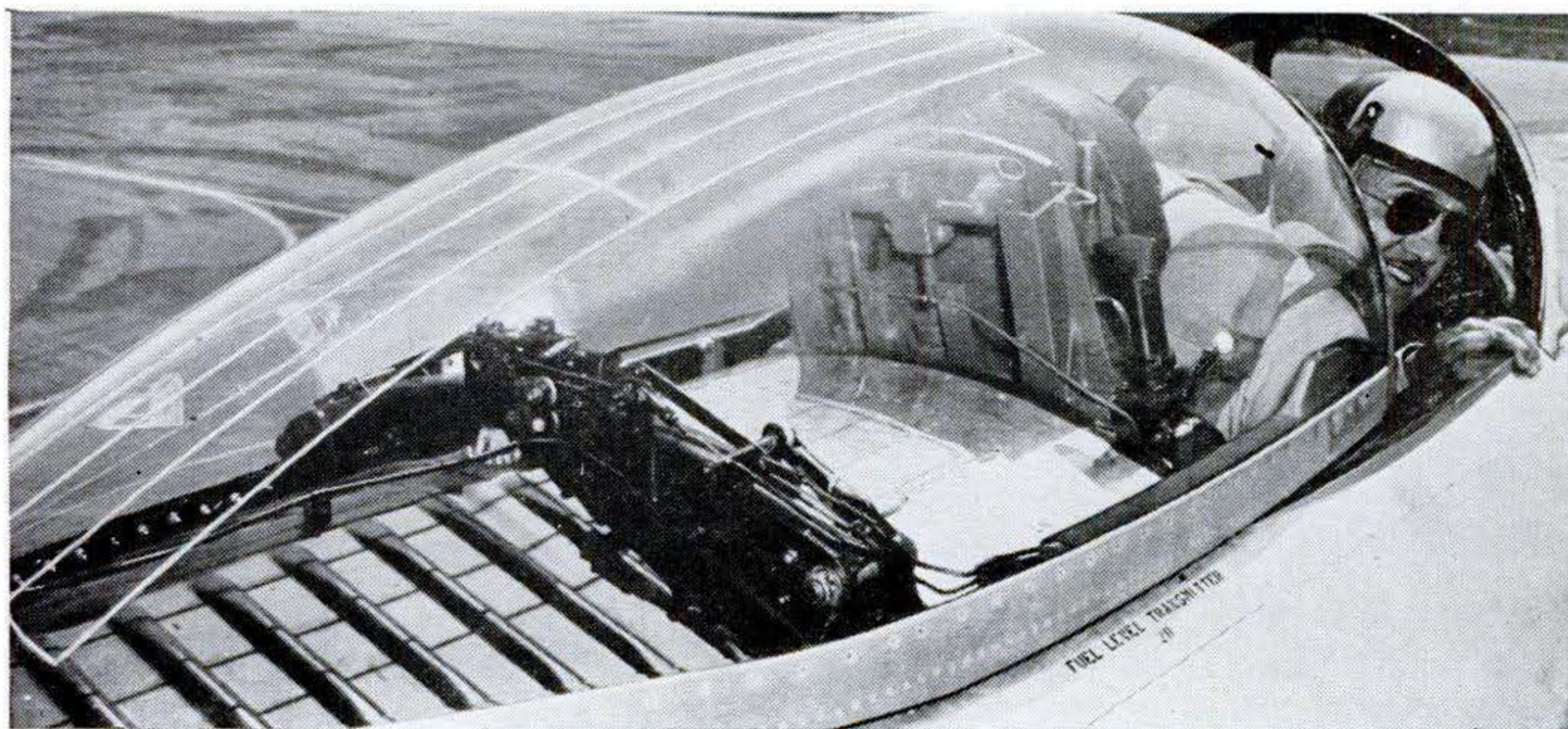

Radio antennas are cemented against inside of plastic canopy. Exposed masts on earlier P-80

created drag at high speeds. Another improvement is a simplified instrument panel.

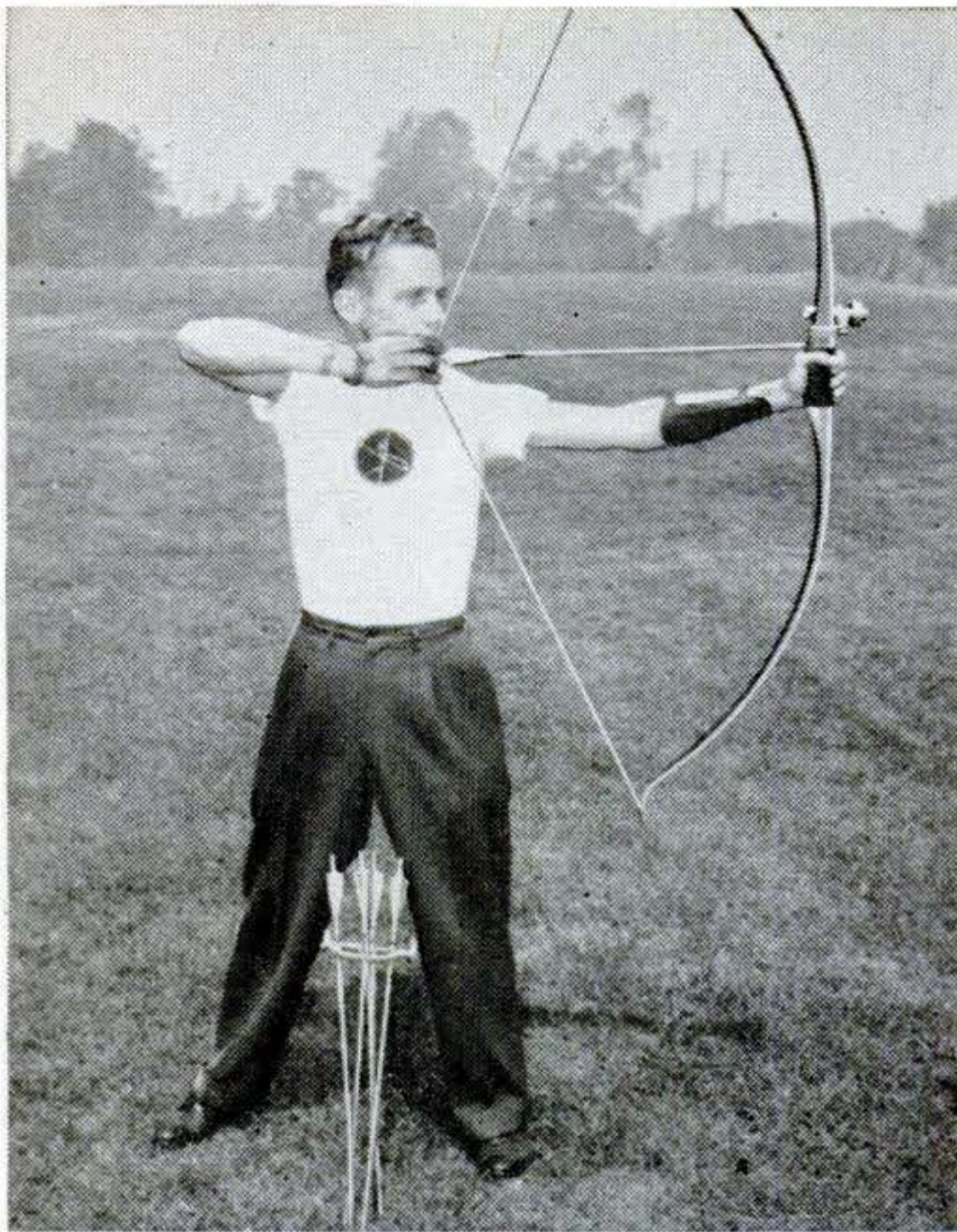

New Sight Aids Archers

MODERN optics is helping archers to double their scores. A new aluminum sight invented by G. T. Bradley, of Los Angeles, can be set to allow for distance and windage. A prism is moved from side to side to shift the target image to compensate for wind drift; another prism is swung up or

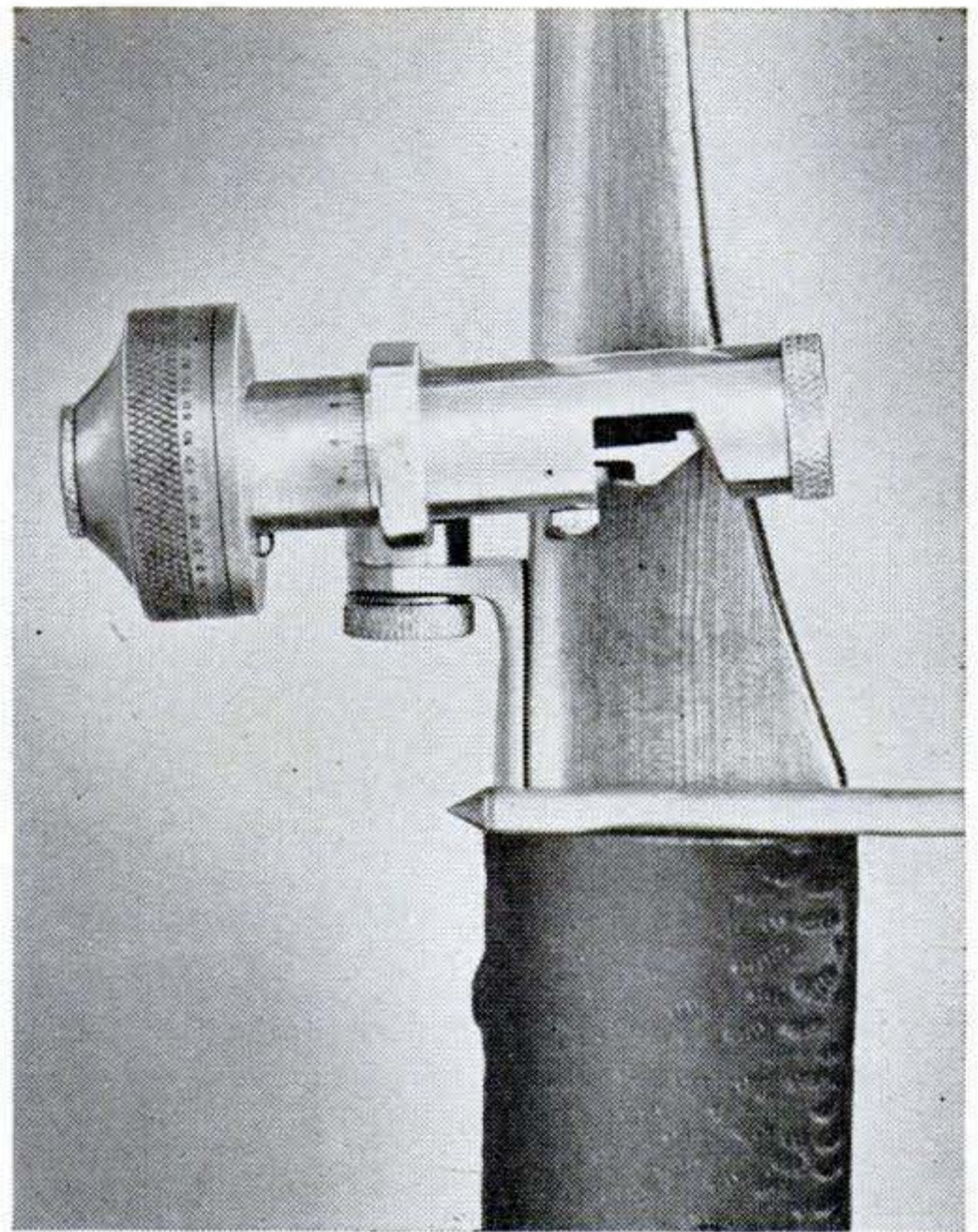

down to allow for the elevation required by the range. At the same time a mirror reflects the arrowhead up into the sight. When it is lined up in a V, with dashes and a dot on interval elements of the sight, the archer knows his bow is properly aligned and the arrow drawn back the right distance. Allowance can be made for varying reaches and arrow lengths.



Giant Plow Tames Range

You can do your plowing on a wholesale basis with this new 60-foot disk plow. It turns over a strip 42 feet wide and can plow

14 acres an hour. Invented by Monroe Terrell, of Dumas, Tex., and T. W. Emerson, of Etter, Tex., the plow has been used successfully on a wheat ranch near Wild Horse, Cheyenne County, Colo.

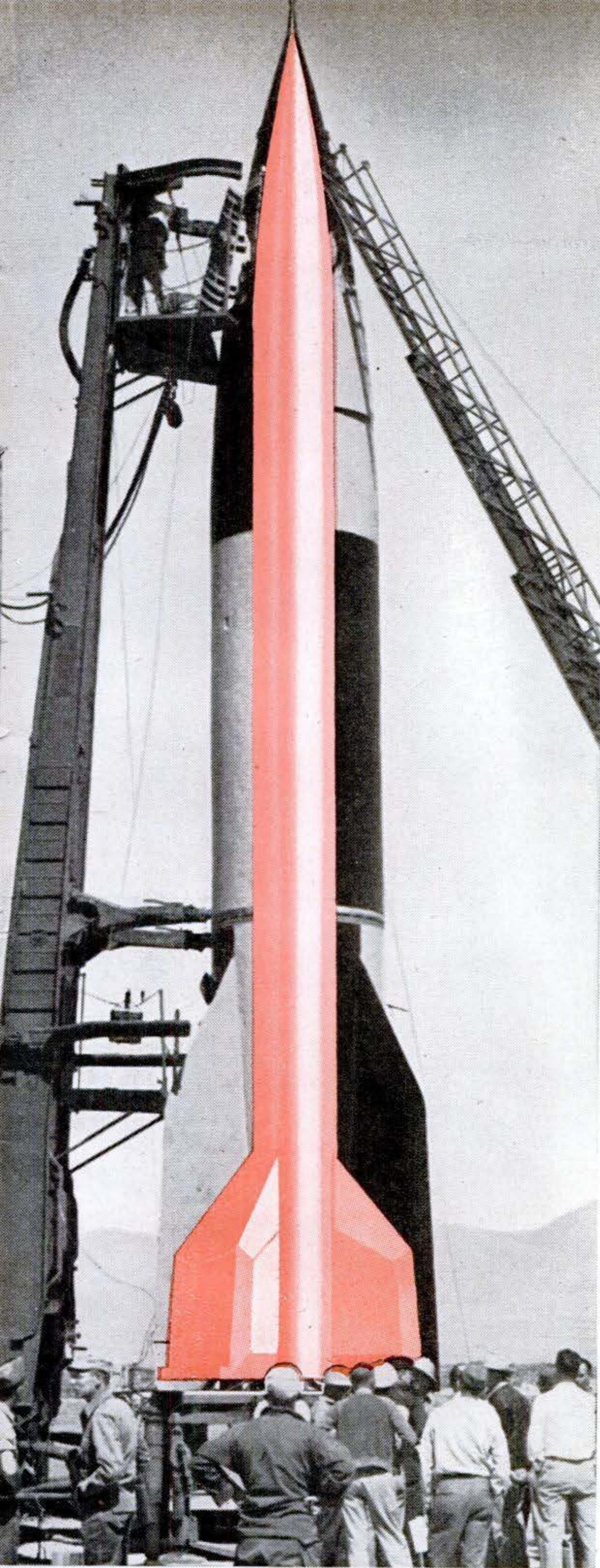

Neptune's silhouette is shown here against the plump bulk of a V-2 in its launching rack. The Neptune's hull is only two feet eight inches in diameter; V-2 is five feet six inches thick.

1948 Rocket Will Double V-2's Record

Neptune, now being built for the Navy to outdo Nazis' lumbering weapon, is designed to reach 237-mile altitude.

SEVEN months from now, the U. S. Navy will have a rocket so much better designed than the V-2 that it will be able to soar more than twice as high. It will be slimmer than the sleekest fighter plane's fuselage. It will be able to take off from a battleship. It will carry up to a ton of pay load—either delicate, space-exploring instruments or explosives.

This rocket has been named Neptune, after a planet that was not discovered until mathematicians told astronomers where to look for it. The performance of Neptune, the rocket, has been predicted similarly, by mathematics. Ten Neptune rockets are being built now by the Glenn L. Martin Co., of Middle River, Md., for the Navy to test next year. They will cost \$1,850,000.

Both inside and out, the Neptune will be a simpler, smoother missile than the mighty but clumsy V-2. Even when fully loaded with 2,000 lb. of instruments—or explosives—it will weigh only two-fifths as much as one of those primitive Nazi dinosaurs. With a 500-lb. cargo, ample for much of the research contemplated in the darkness above the aurora borealis, it will be less than a third as heavy as a V-2.

The fins of the V-2 are subsonic airfoils; those of the Neptune will be supersonic. They will be wedge-shaped to help it lunge

through comparatively dense air during the first 10 or 15 miles of an ascent. When lightly loaded for scientific survey trips, the Neptune will start out faster and its top speed will be much greater than that of its deadly predecessors, which hit their war-time targets in England before they could be heard coming.

The V-2s were guided by vanes that extended into the jet stream. These were deflected to change the rocket's course. The Neptune will have no such cumbersome rudder; direction will be determined by the tilt of the engine. Gyros in the nose will

sense any deviation from the proper course and send electrical orders to the tail, where obedient machinery will swing the engine enough to change the angle of its blast and thus put the rocket back into an invisible groove. By eliminating vanes, the designers have not only reduced the rocket's weight by 275 pounds, but have also made certain that its exhaust stream will provide more power.

The Neptune's engine is being built by Reaction Motors, Inc., of Dover, N. J., the makers of the rocket engine in the Bell XS-1 supersonic research plane. It will be

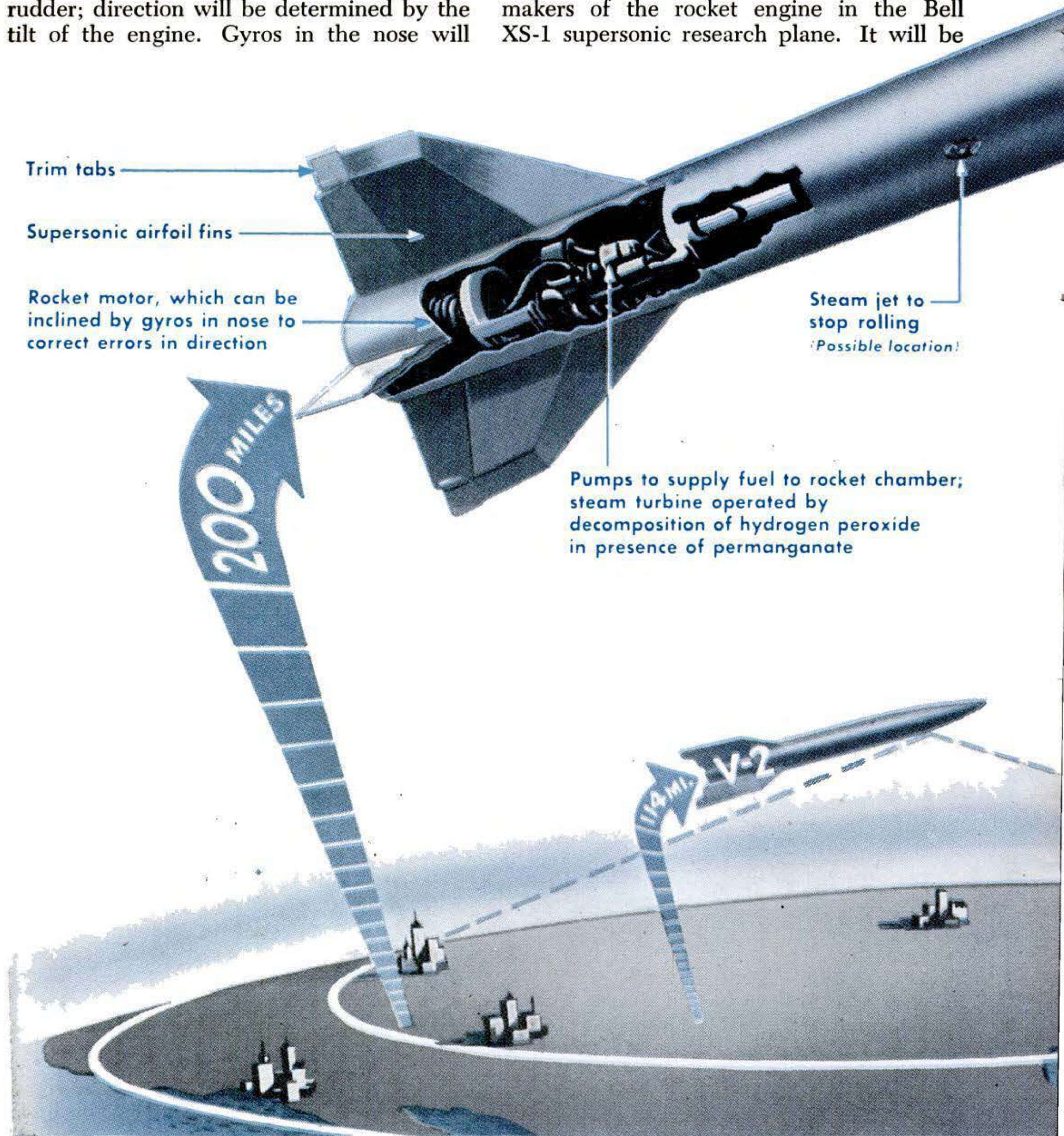

Drawings illustrate Neptune's construction and field of vision compared to V-2 (white circles).

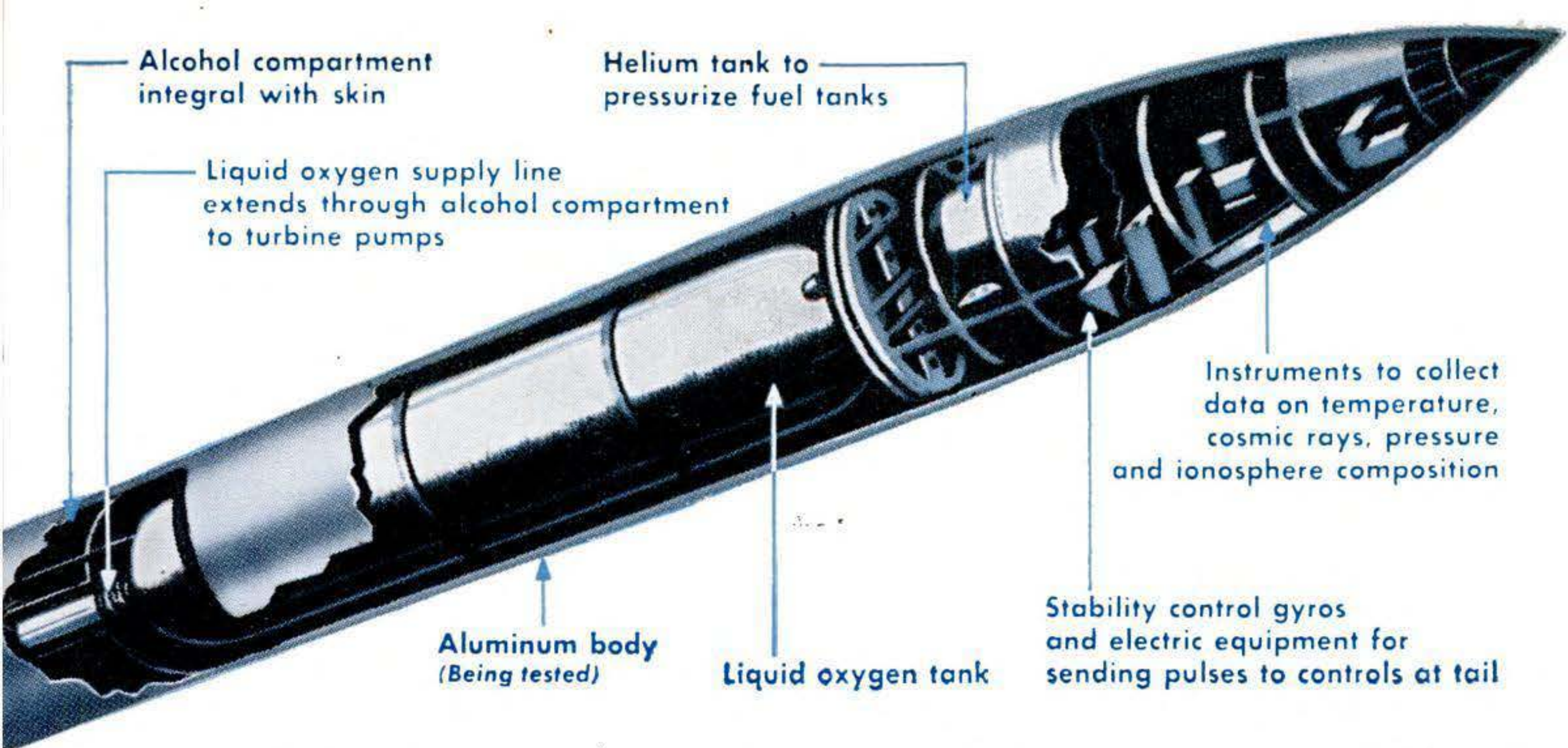

so small that, if stuck in an ordinary oil drum, it would protrude from the end less than a foot. It will weigh 250 lb., about the same as a light motorcycle, yet it will produce 20,000 lb. of thrust. This is less than half the thrust from a V-2 engine but, whereas the V-2 shoots its wad in 67 seconds, the Neptune engine will go on shoving for 75 seconds.

Steam jets will spurt from the Neptune's sides to prevent excessive roll. These will be powered from the exhaust of the hydrogen-peroxide turbine. Normally, the jets will be equal, but if the rocket starts to roll, a valve will increase the jet on the side opposing the roll. No plans for steering the Neptune by radio have been revealed. But the installation of this roll-control apparatus indicates that plans for guiding it are probably being studied. When a rocket is used

as a missile, pure and simple, roll is helpful, as it is in a bullet. But in a radio-controlled or guided missile, roll is troublesome, because as the rocket turns, its elevators become rudders and the rudders become elevators.

As a platform for instruments to note the characteristics of the upper atmosphere, the Neptune will be vastly superior to the big German rockets now being used at White Sands. It will be less fussy, for example, about cargo. Whereas a V-2 is limited to useful loads of from 1,700 to 2,600 lb., the Neptune will take anywhere from 100 to 2,000 lb.—and the lighter the load, the higher it will go. The V-2's altitude record is 114 miles; the Neptune is expected to soar 237 miles. And, as Glenn Martin put it, "If it can go that high, figure out what it would do on an incline." **END**

AURORA BOREALIS

METEORS



Record V-2 had a 900-mile radius of vision; at 200 miles, Neptune's will be 1,280 miles.



Helicopters at Work

Doing its stuff in the weight-lifting class, this transport helicopter lifts jeep weighing 2,400

pounds. A Piasecki Rescuer (XHRP-1), it can travel 100 m.p.h. when it is not showing off.

A HELICOPTER enthusiast recently wrote a book, which he entitled "Anything a Horse Can Do." That may be stretching it a bit, but the "windmill" planes have shown themselves workhorses of the air in many fields. Aside from their dramatic rescue

work, helicopters have proved successful in delivering mail and packages, making aerial surveys, laying pipe lines, and have even made a bid in the weight-lifting field. A cheap personal helicopter or an ocean-crossing type, however, is still in the future.

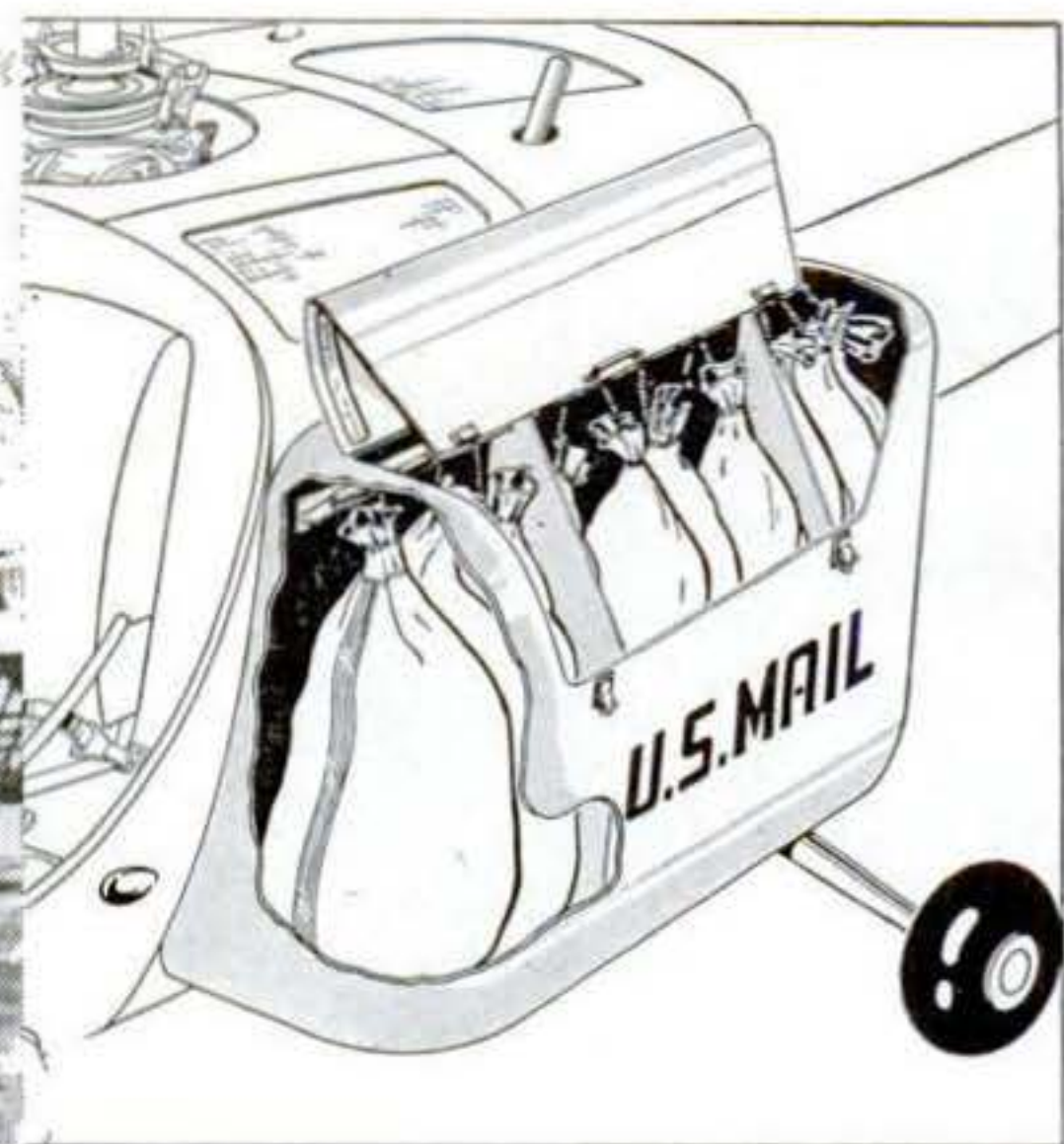

The Bell "Airmailer" helicopter is equipped with twin external duraluminum saddlebags,

each holding 10 mail sacks. Maximum mail load of this aerial pony express is 500 pounds.



Rubber pipe line was laid by helicopter during a recent test at Fort Belvoir. Unreeling 400 feet of tubing in 25 seconds, the experiment proved the air-laying of emergency fuel lines

across inaccessible areas to be practical. The hose, folded in container under plane's body, is pulled out by anchor, laid in straight line. It can also be used to supply water.



This rubber tank, holding 3,000 gallons and weighing 150 pounds, can be folded up and re-

leased from a plane. It serves as a storage tank for fuel supplied by a helicopter-laid pipe line.

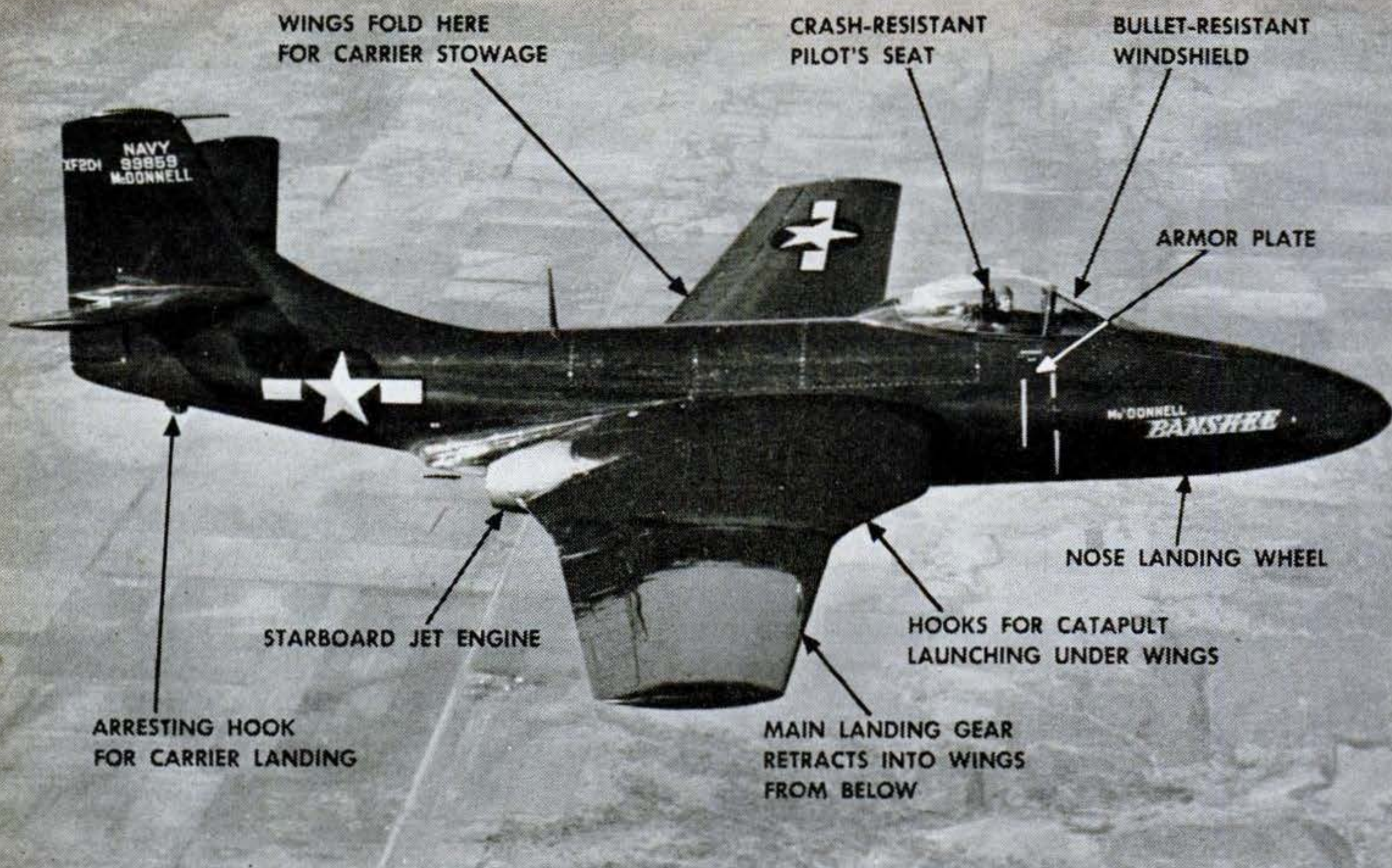

Fastest Fighter?

THE Navy claims that its new F2D Banshee twin-jet fighter is "the most powerful single-seat fighter flown in the United States today." It is predicted that the McDonnell-built Banshee will not only break the existing 616 and 619 m.p.h. records of the British Gloster Meteor and the AAF's Thunderjet, but that in a speed dash it may push the

performance of a special supersonic test plane. Two Westinghouse Yankee 24-C axial-flow turbo-jet engines, most powerful American jets yet used, are counted on to overcome the heavy load of armor and armament, plus the added weight necessary for carrier operation. With wings folded for stowage, the plane's 41-foot span is reduced to 18 feet. All flight tests have been completed and production is under way.

Taken For A Ride

BLAZING nine-inch pulse jet suspended under the belly of this Navy JD-1 attack

bomber adds no speed to the plane, but is being tested for airborne performance at high altitudes. Pulse-jet engine is what gave power to the Nazis' famous V-1s.



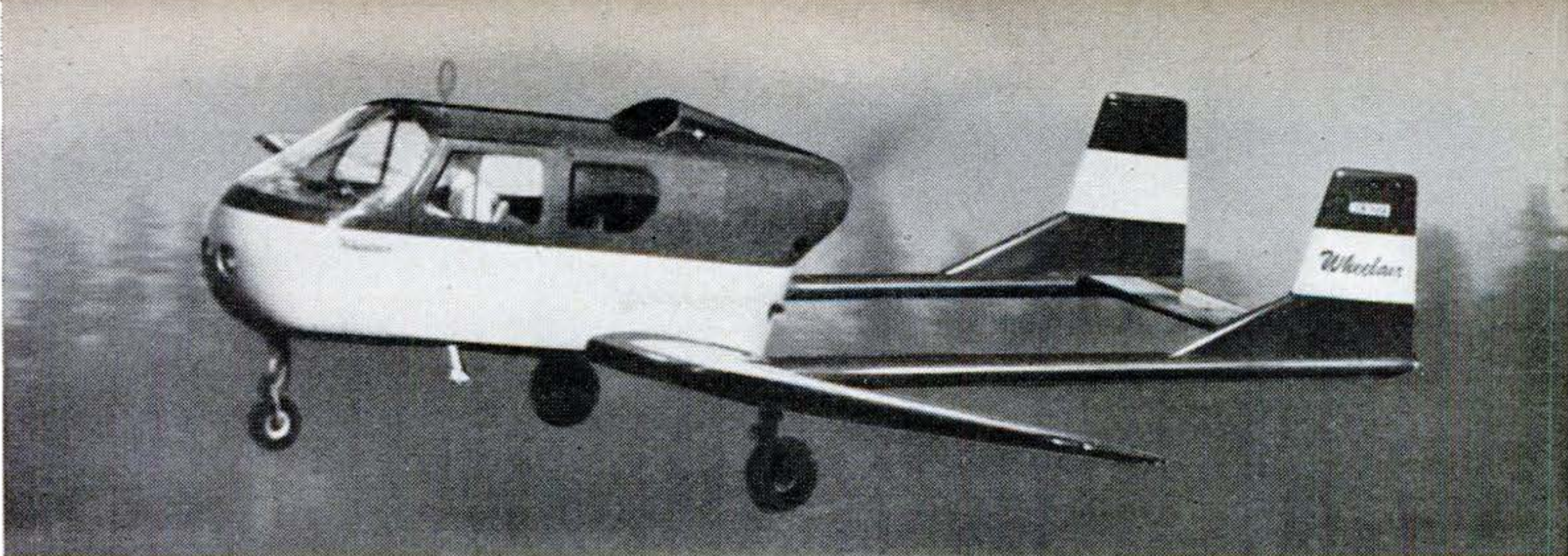

Winner Tries Wings

THE Wheelair 111A, which won the PSM Airplane Design Competition in 1944, has made its first test flight. The Wheelair, made by Puget Pacific Planes, Inc., is a

twin-tail pusher, with a top speed of 140 m.p.h. and a range of 600 miles, carrying four passengers and 160 pounds of baggage. With simplified controls, it is spinproof, stall-resistant, and has nylon fuel tanks of the type used in large transport planes.

WHAT'S NEW in AVIATION



Parachutist's Friend

FOR high altitude bail-out, the Irvin Automatic Opener can be set to open a parachute automatically at a height where air is dense enough to breathe. Low-altitude jumper presets timer, which delays opening until he has decelerated to a speed at which he can withstand opening shock. Rip cord can be pulled manually any time.

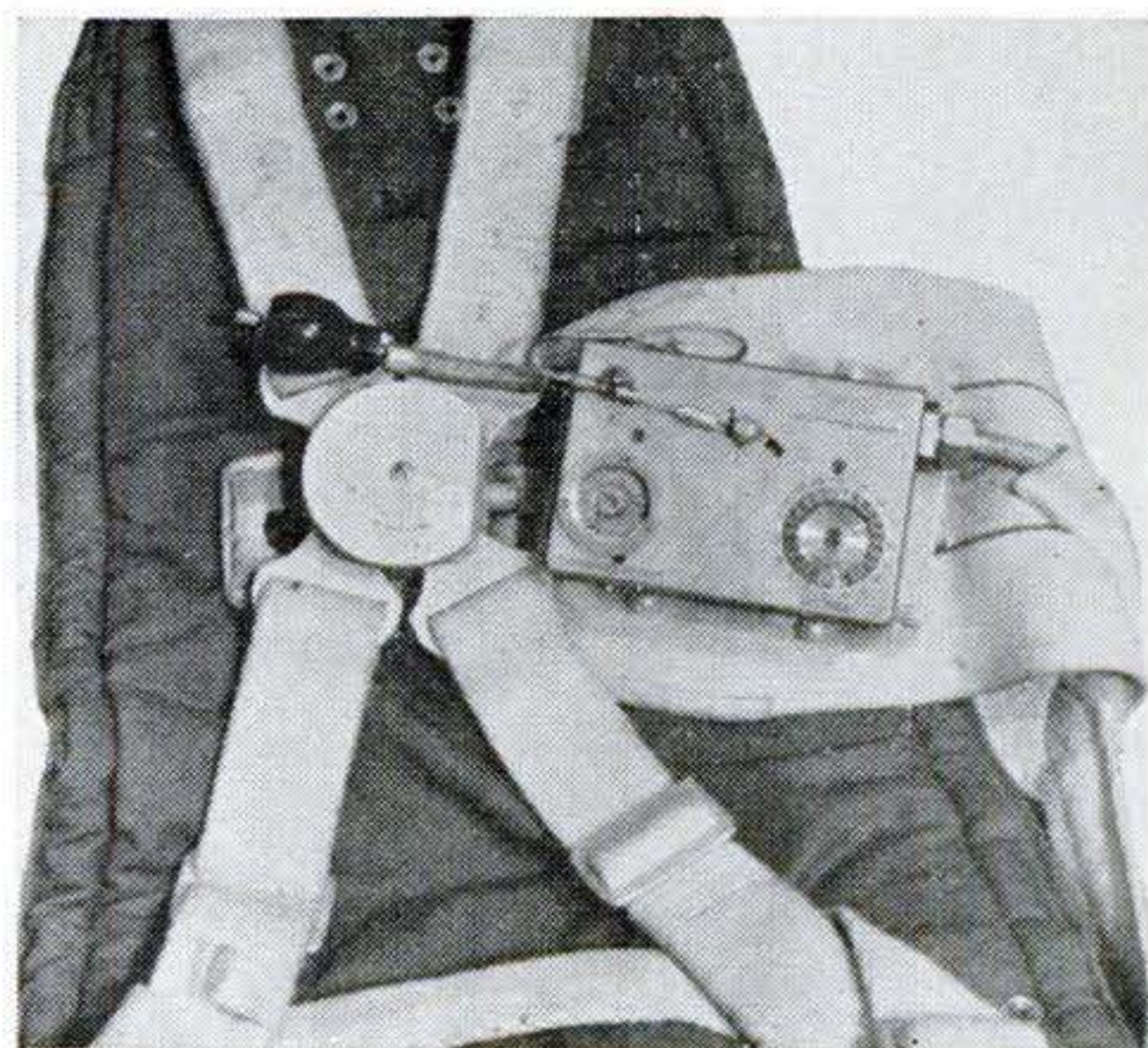

Wind-blown Wasp

AN ELECTRIC blower pours a steady cooling "wind" of 200 m.p.h. into a 3,500 horse-

power Wasp Major engine, power plant of Boeing's 80-passenger Stratocruiser. Test will simulate 28,000 miles of flight, consume 47,000 gallons of gasoline.

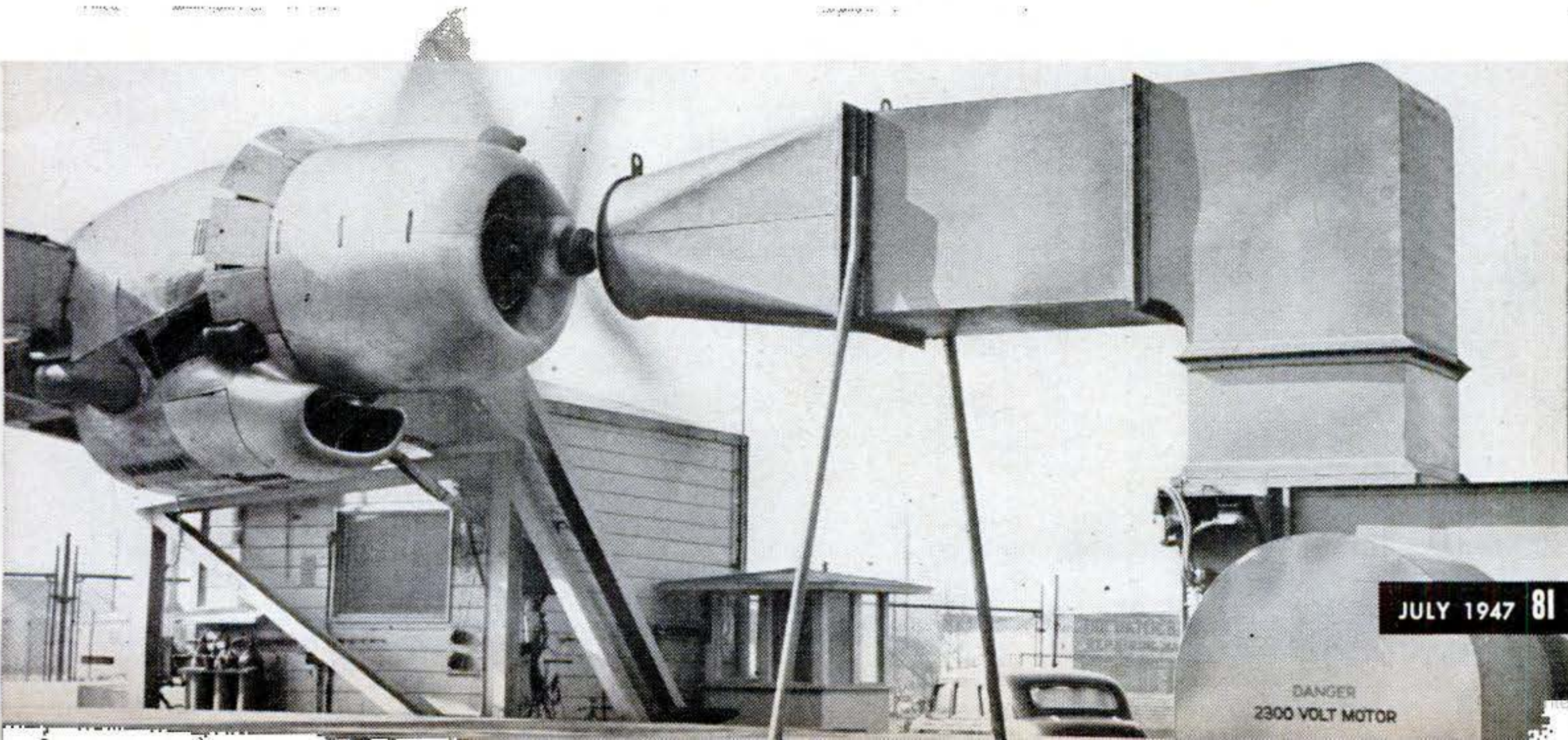

New Twists Make 'Peg Leg' Really Walk

Through ingenious studies of how normal limbs function, engineers are helping amputees.

ONE spring day late in the war Howard D. Eberhart, civil engineering professor from the University of California, was testing the runways of the Army's Hamilton Field, using a big trailer to find out if the surface could support heavily loaded B-29s. Professor Eberhart fell. The 100-ton trailer rolled over him and crushed his left leg.

That accident, quite literally, has produced a "revolution" in the designing of artificial limbs. A leg that can twist, duplicating the complex "screwing" motion of normal walking, has been produced after two years of research directed by Professor Eberhart and Dr. Verne T. Inman, orthopedic surgeon, at the University of California.

Vacuum Principle Revived

This artificial limb not only enables a legless person to walk more like a person with two sound legs, but is also more comfortable. It is held in place by vacuum—a principle used in the Civil War but redeveloped independently by the California researchers. This eliminates the discomfort of awkward metal hinges and harnesses.

Additional ways of improving the "pegs" of 17,000 war casualties are being sought now, not only at California, but also at two other educational institutions and by a dozen industrial concerns, under a nationwide program of the National Research Council's Committee on Artificial Limbs. Legless veterans will not be the only bene-

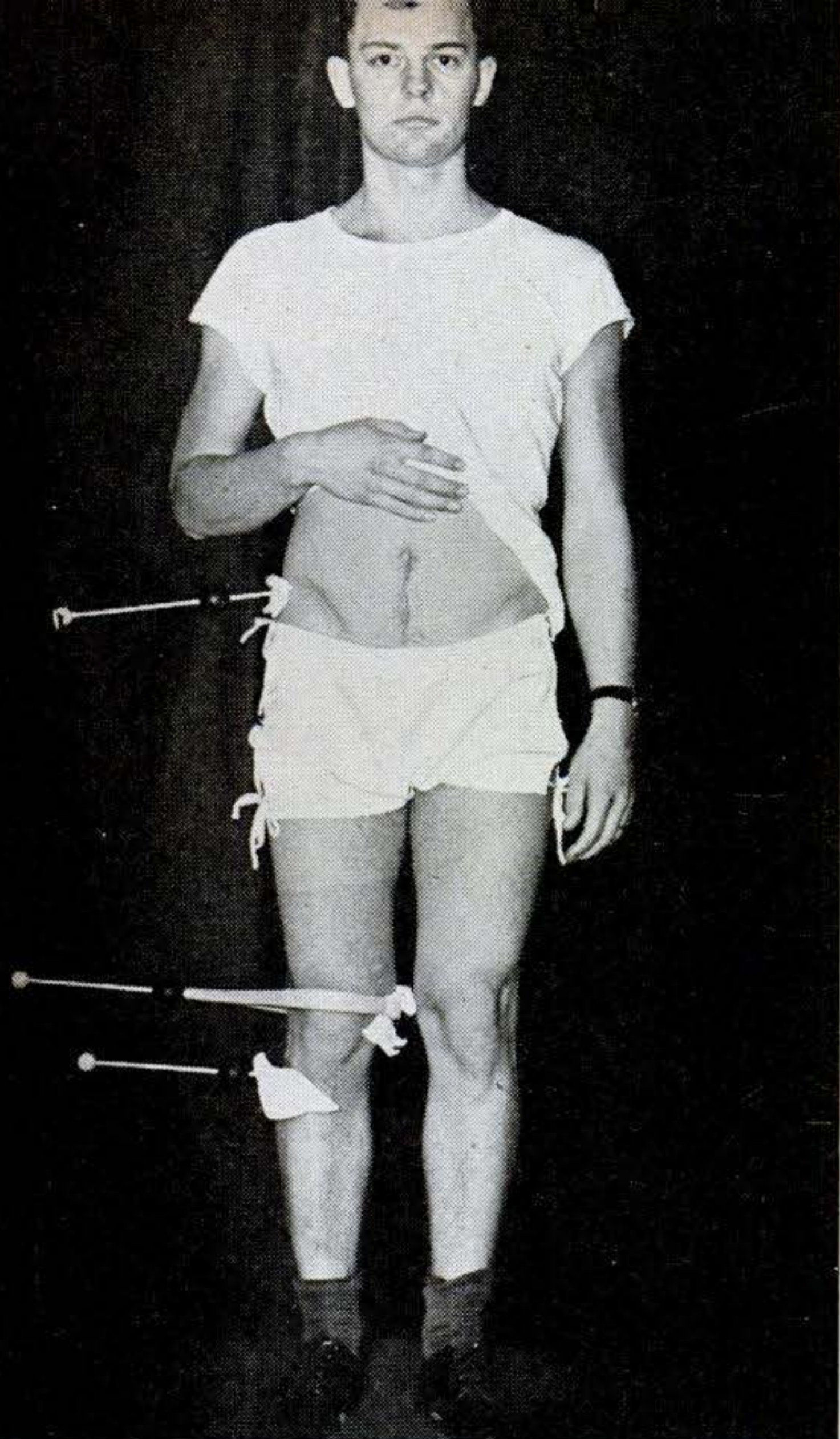

Stainless steel pins with table-tennis-ball heads were fastened to bones of volunteers, and slow-motion pictures recorded inward and outward rotation of hip and knee bones during walking.

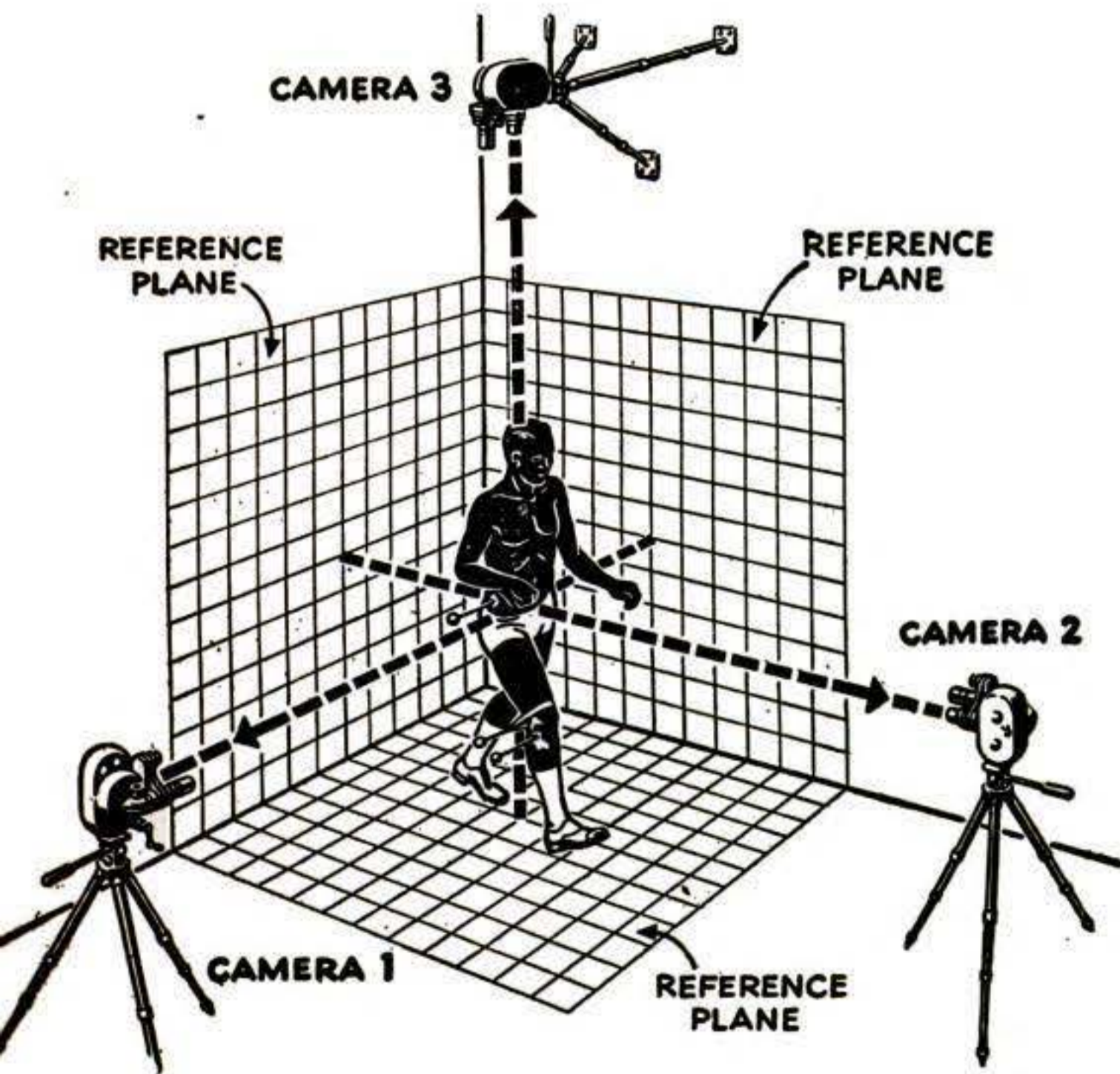

Synchronized cameras are shown in positions used during human "pincushion" walking tests.

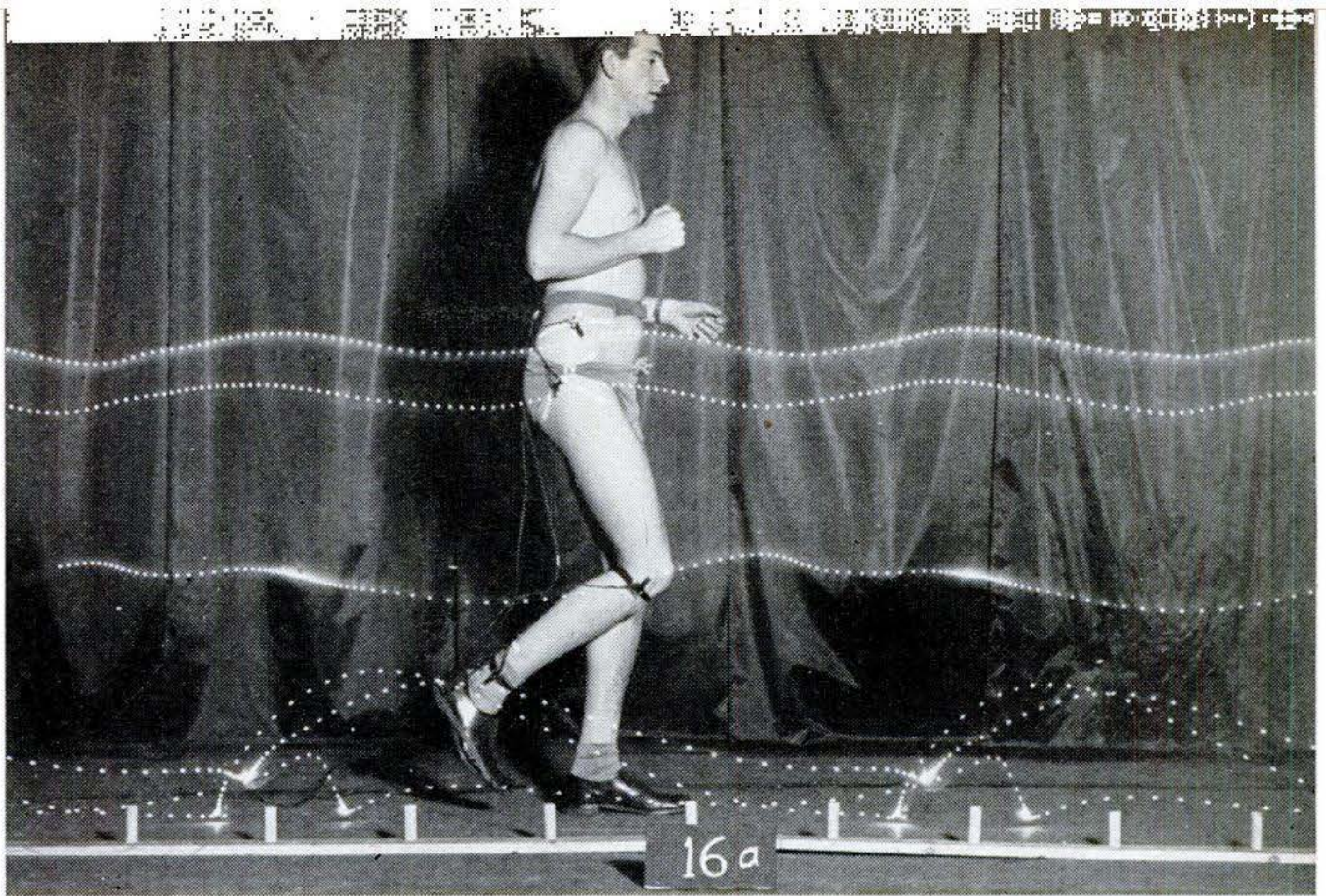

“Interrupted light” studies provided information on speed of walking. Subject, with tiny lamps strapped to pelvis, hip, knee, ankle, heel and toe, walked across dark room while camera

with revolving shutter photographed his stroll. White dots in picture shown above trace his path; dots close together indicate low speed; those farther apart, a higher speed.

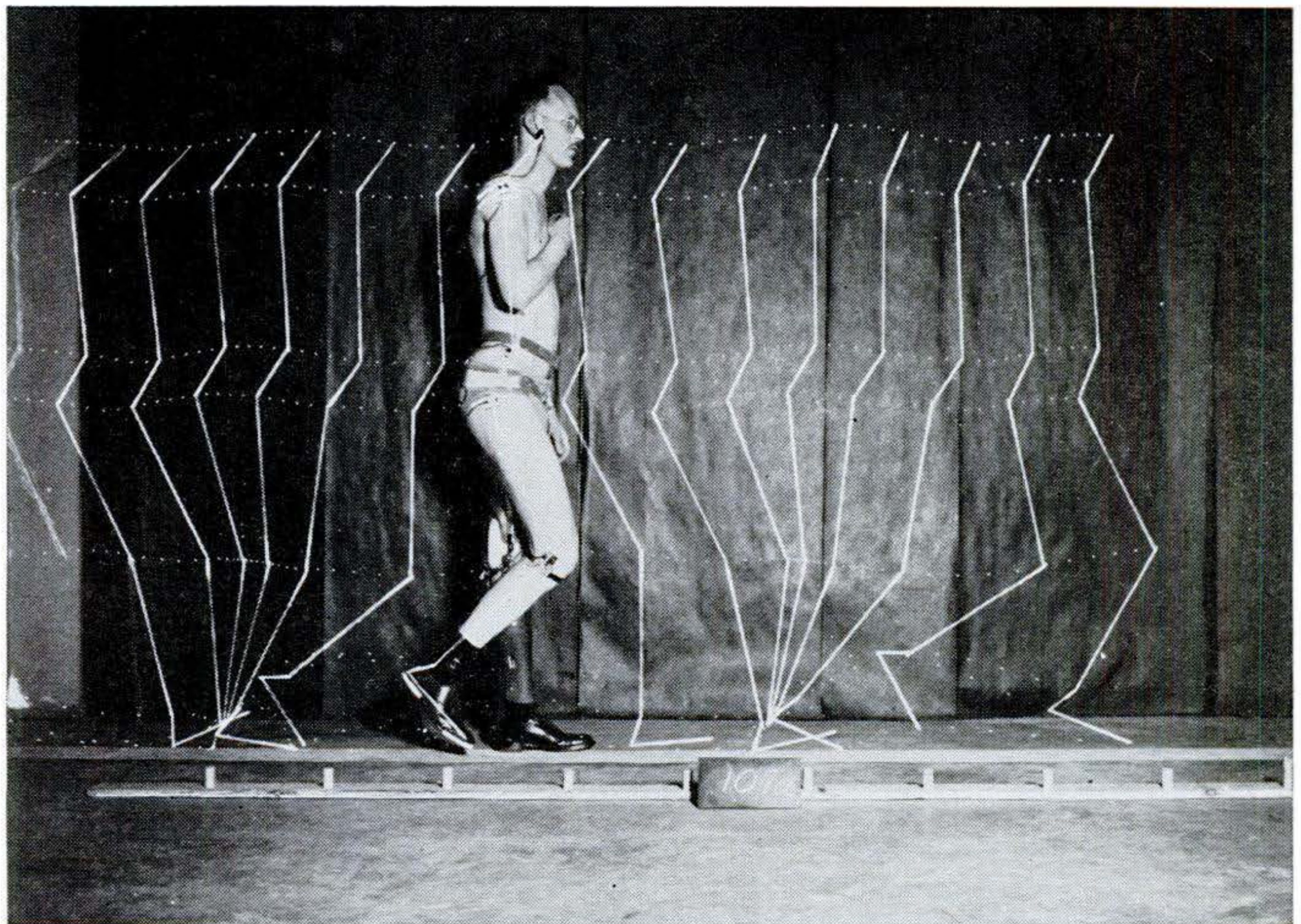

How an amputee walks, favoring his artificial leg, is shown above by Professor Eberhart, using interrupted-light technique. The straight lines connecting dots give more complete picture

of body action, including shoulder and head. A study and analysis of these changes in locomotion contributed to the development of an artificial leg with better walking characteristics.

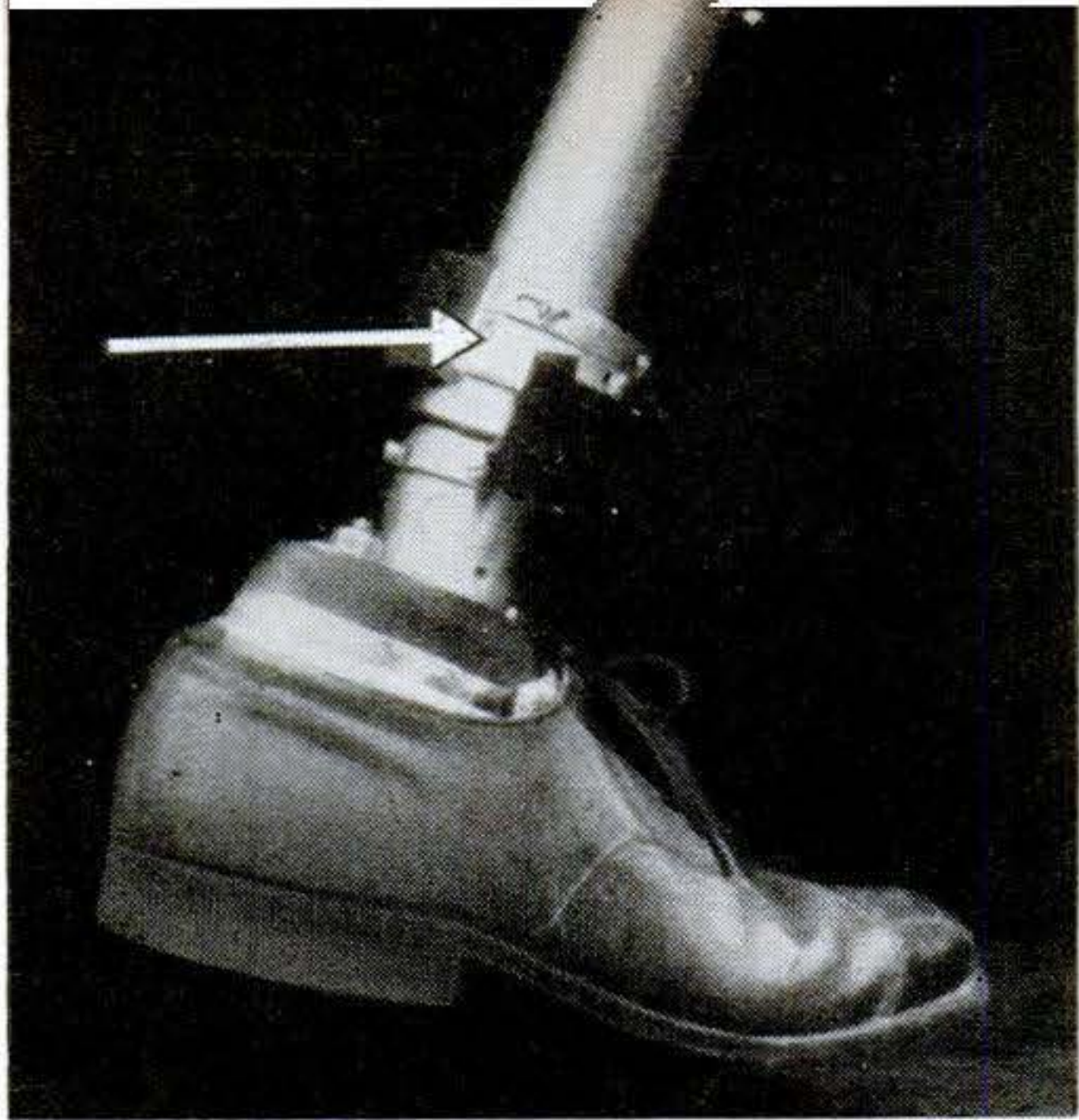
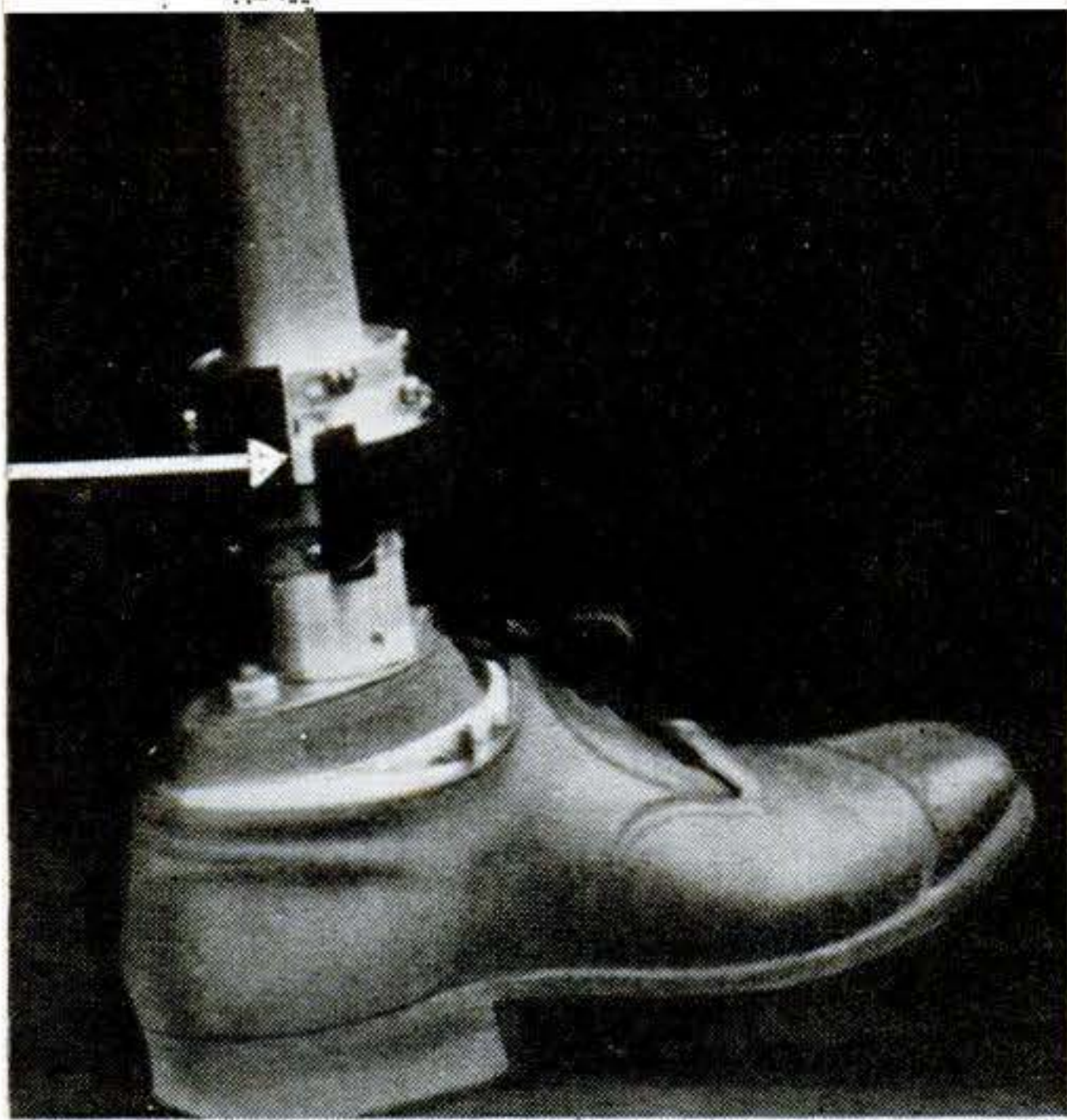

New artificial leg is the first that permits rotation of foot as in natural walking. Steel torsion rod within shin piece permits the foot to toe out and in as much as two inches from

straight ahead. Arrows in above pictures show variation in opening between bumper and stop from time heel touches ground and toe completes step. Guards prevent foot from turning too far.

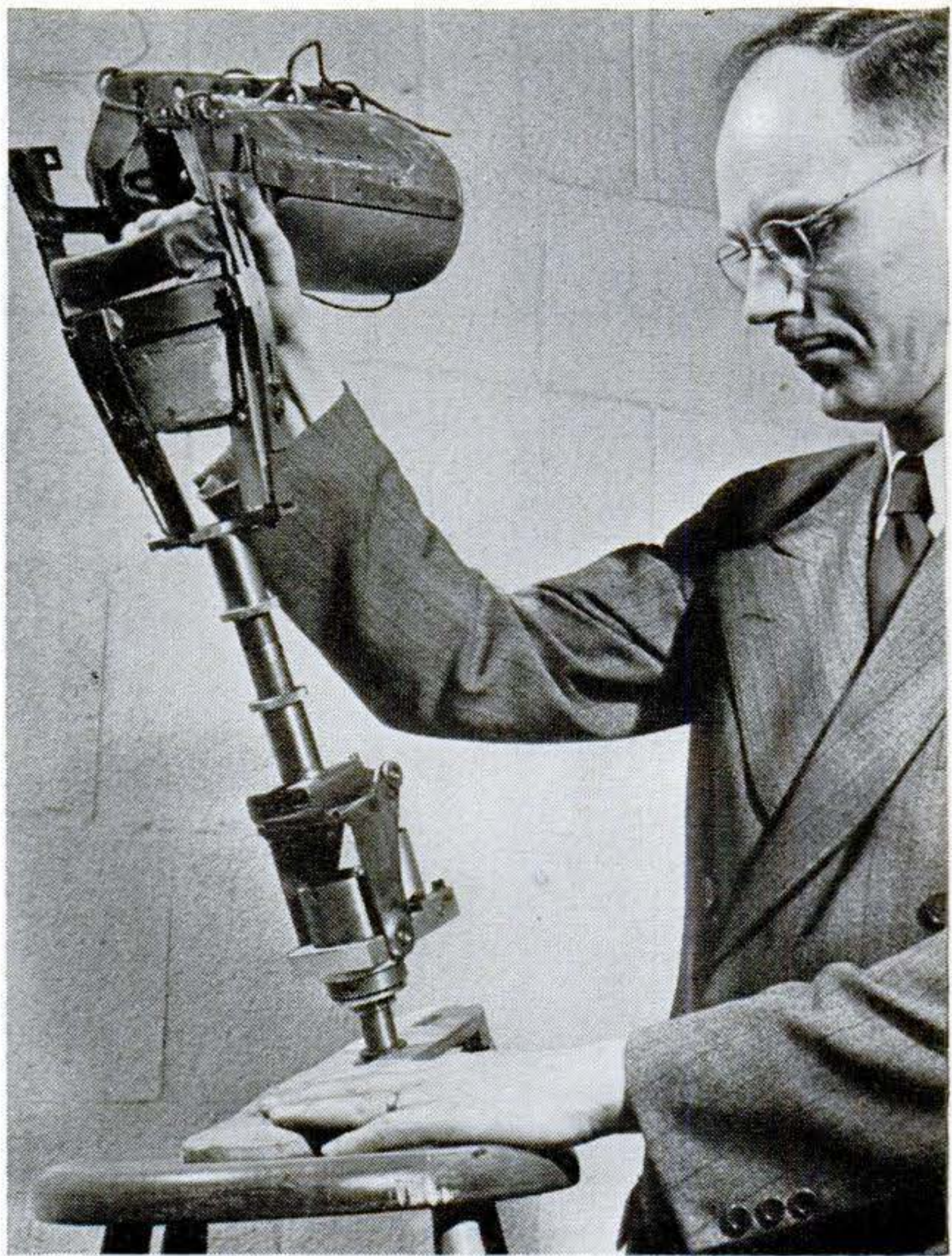
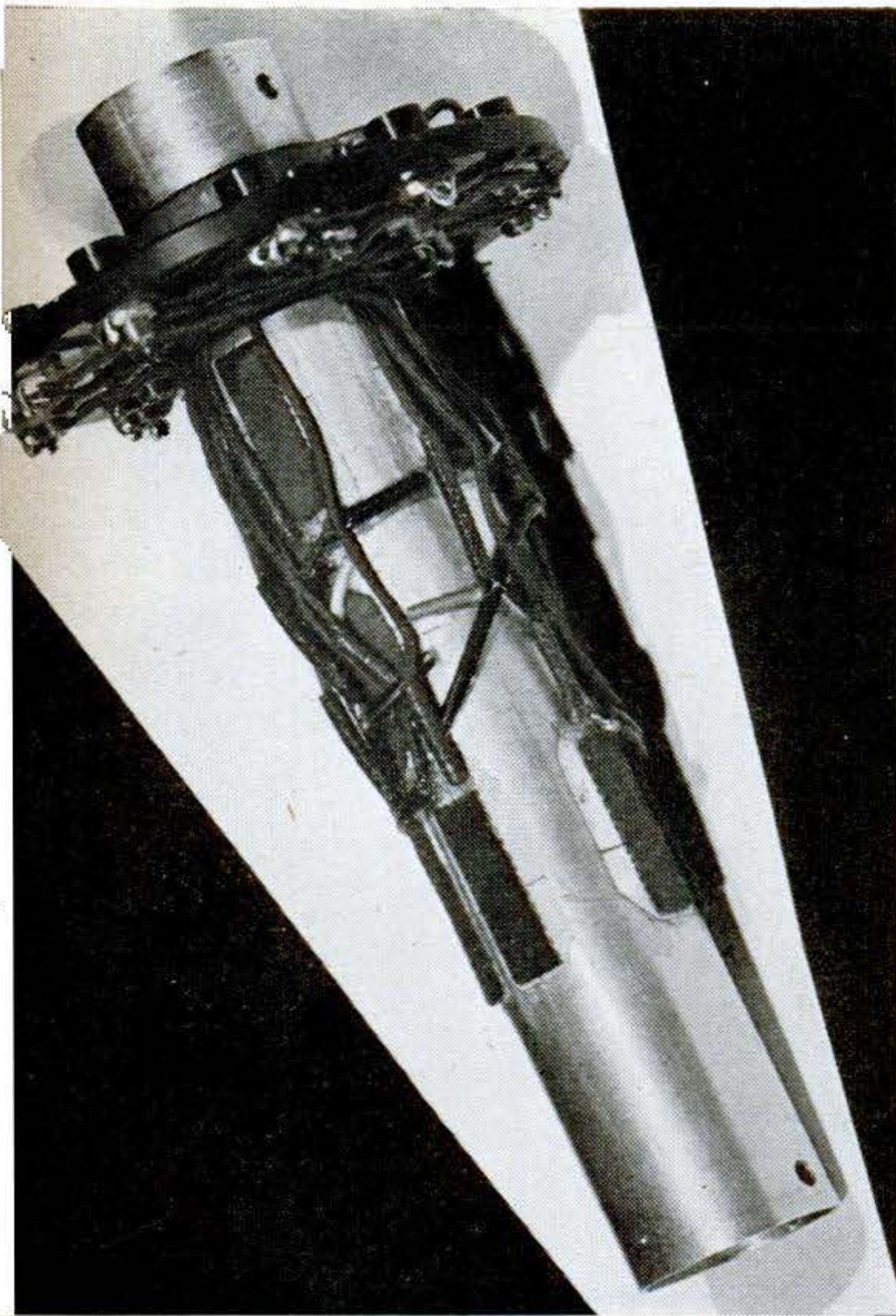

Aluminum "pylon" that measures forces acting on an amputee's leg. When pylon is substituted in shank of artificial limb, electrical gauges measure the torque, axial and vertical loads.

"We must mimic the action of the normal leg," maintains Professor Eberhart. He is shown here checking an adjustable artificial limb that is used to determine the needs of individuals.

ficiaries—every year, 25,000 civilians lose an arm or a leg!

California's team of 50 researchers, drawn from the College of Engineering, Medical School and Anthropology Division, started at the very beginning: They set out to learn how people walk. They made 16 different studies of the way human and artificial legs work, in many cases using ingenious new research techniques.

Which parts of the foot exert the greatest pressure? And when? The doctors found that out with the help of a trick stage. It had a multilayer floor: heavy plate glass supporting two layers of pliofilm and a rubber mat. Foot pressure squished down the mat, forcing projections in its bottom against the pliofilm, one layer of which was coated with a white paint. In this way, the projections corresponding to the areas of most pressure made contact with the glass plate, creating a pattern of black and white dots that could be photographed with a motion-picture camera and mirror. The dot patterns recorded on the film then told the researchers how each part of the foot exerted pressure during walking.

Muscular Electricity Tested

Since a good artificial leg would have to be controlled by the amputee's remaining muscles, the California group measured the energy changes in muscles during walking by recording the faint electric currents they produced. Volunteers paraded around the room with electrodes fastened to eight major leg-muscle groups. Long wires trailed behind them, leading to a modified electroencephalograph. This instrument, long used to study electric currents originating in the brain, can amplify these faint impulses 50,000,000 times. The output of the encephalograph was recorded photographically from cathode-ray tubes.

From these diversified attacks on the problem came the new and vastly improved artificial leg. The device finally developed uses a torque rod inside an aluminum tube to permit the toe of the foot to swing through a four-inch arc at each step. When the foot leaves the ground, the torque rod pulls it back to a straight-ahead position. A bumper and two stops prevent the rod from twisting too far in either direction.

Yet the scientists are still not satisfied—and won't be until they can make an artificial leg that does about everything a real one can do. END

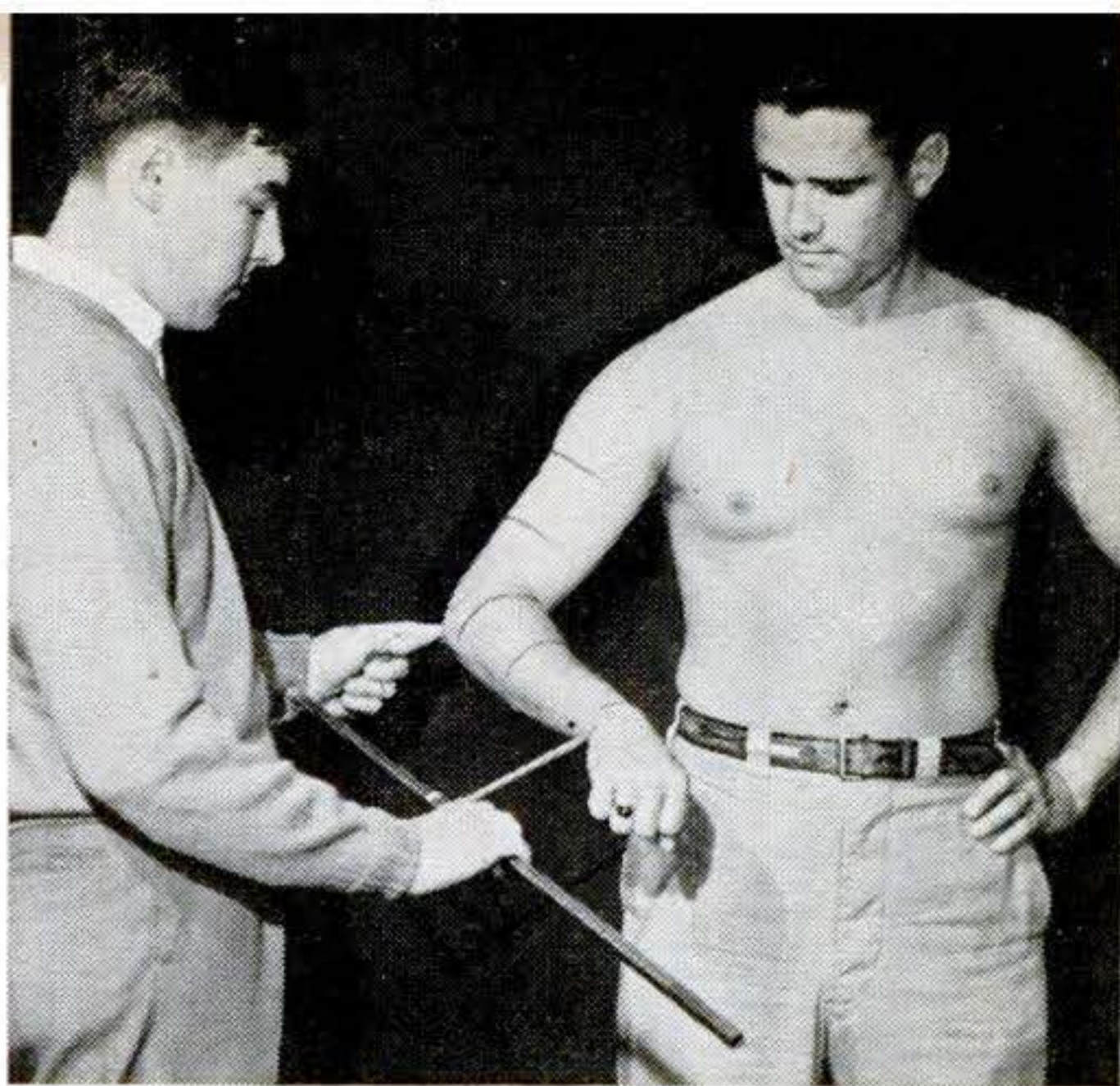

U. of C. researchers are also making studies to perfect artificial hands. Here one is shown taking exact measurements of forearm length.

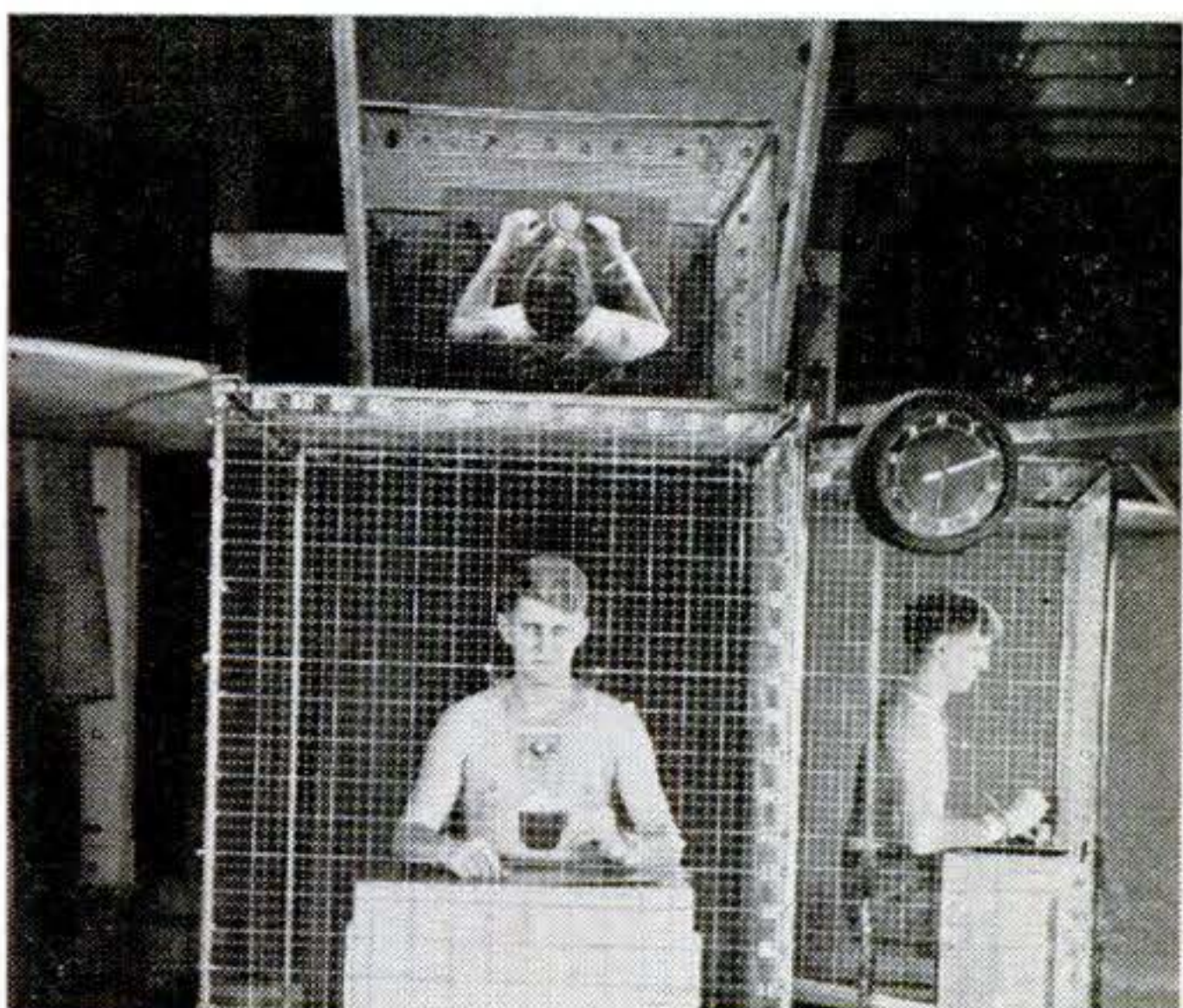

Hand patterns in holding and grasping are determined by photographing subject from straight ahead, and through top and side mirrors.

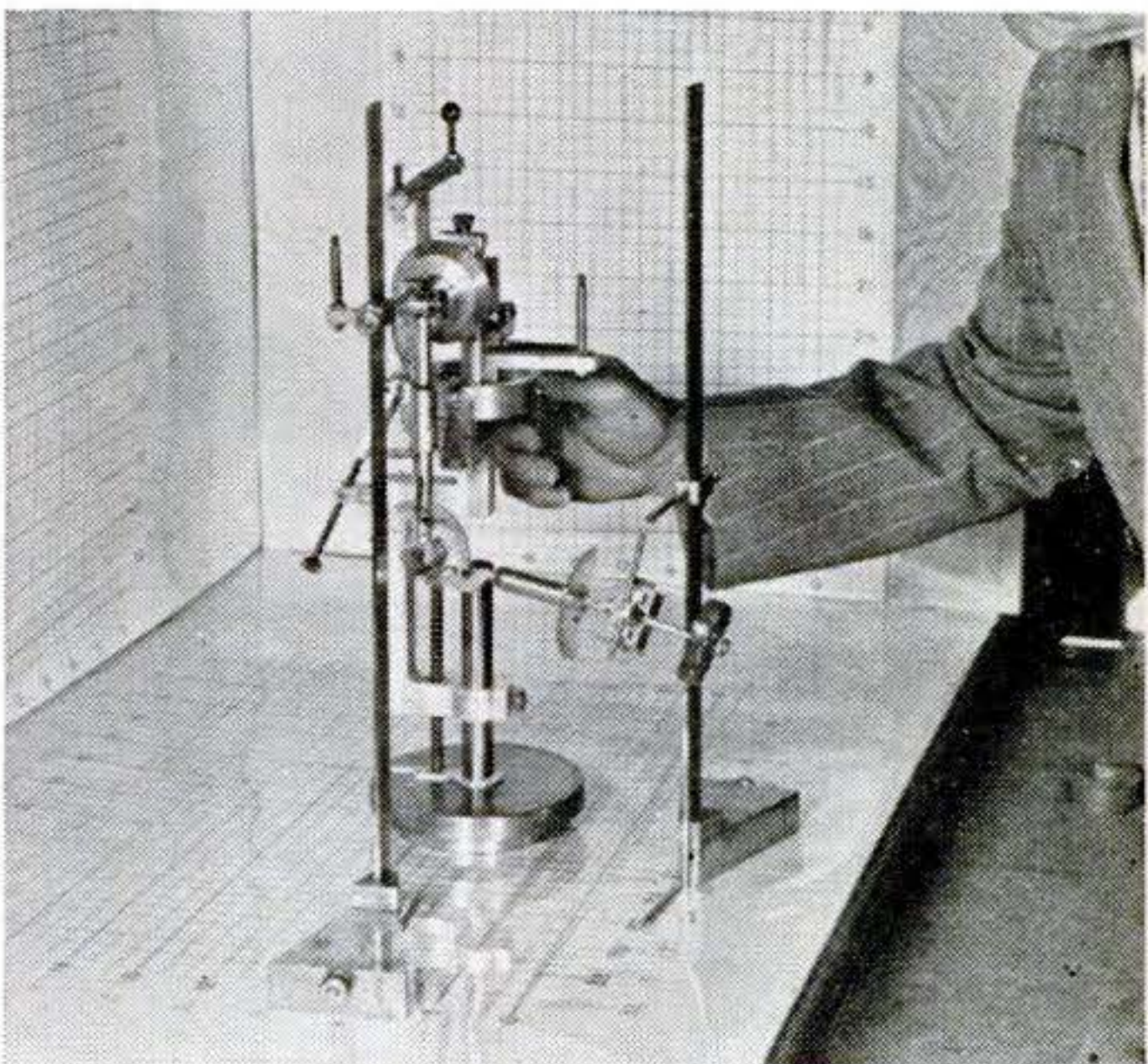

Using kinematic analyzer, researcher transfers information obtained from pictures to grids. The result is a picture of typical hand patterns.

Russia's Growing Air Power



TB-7: Four liquid-cooled, 1,350-hp. engines give it a cruising speed of about 200 m.p.h. carrying bomb loads up to 11,000 lbs.

If willingness to expend money, men and materials can do it, U.S.S.R. will become the world's No. 1 air power.

By the Editors of Popular Science

THE Union of Socialist Soviet Republics proposes to become the world's greatest air power. Russian determination to be first, her increasing expenditures on research, her growing skills, her vast potential of men and materials make her today second only to the United States.

Right now, the Red Air Fleet consists of more than 30,000 planes, compared with the U. S. Army and Navy's 40,000. But half of

ours are in storage, and despite careful "pickling" will have to be scratched in a few years. And Russia plans to produce 20,000 warplanes in 1947; the United States, not more than 3,000.

Russia's military aircraft are mostly fighter and light attack-bomber types. Hence, at present, the Red Air Fleet is probably better prepared than the AAF for *defensive* air war, and America is better prepared than Russia for *offensive* air war.

Russia's budget for research and development this year is five billion rubles; the comparable figure for the United States is \$350,000,000. Comparing rubles and dollars, however, is extremely difficult. The official rate of exchange is five rubles to the dollar; the unofficial rate is 12 to the dol-

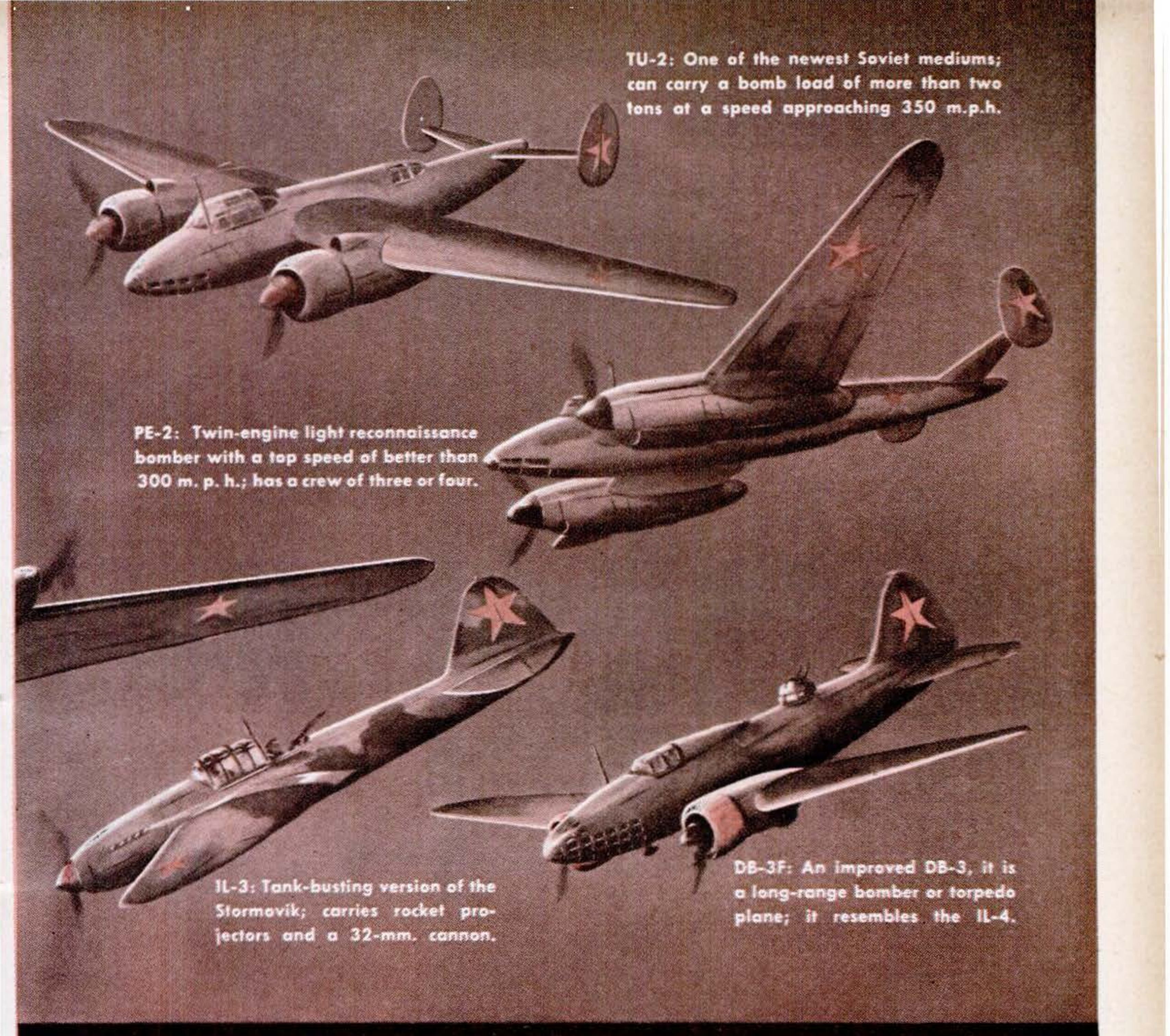
The illustration depicts four Soviet aircraft in flight against a dark, textured background. At the top left is the TU-2, a twin-engine medium bomber with a high-wing configuration and a tail with a red star. Below it is the PE-2, a twin-engine light reconnaissance bomber with a similar high-wing design. In the lower left is the IL-3, a tank-busting version of the Stormovik, featuring a low-wing configuration and a tail with a red star. In the lower right is the DB-3F, an improved long-range bomber or torpedo plane, also with a low-wing configuration and a tail with a red star. The aircraft are arranged in a descending, diagonal line from top-left to bottom-right.

TU-2: One of the newest Soviet mediums; can carry a bomb load of more than two tons at a speed approaching 350 m.p.h.

PE-2: Twin-engine light reconnaissance bomber with a top speed of better than 300 m. p. h.; has a crew of three or four.

IL-3: Tank-busting version of the Stormovik; carries rocket projectors and a 32-mm. cannon.

DB-3F: An improved DB-3, it is a long-range bomber or torpedo plane; it resembles the IL-4.

lar; the black market rate is 40 to the dollar. *But, significantly, the Russians have increased expenditures for research while America has been curtailing such expenditures.*

These statements are based on the studies of experts in the Army Air Forces, Naval Aviation, the British Royal Air Force and the Russian Air Fleet's own leaders.

Contrary to much current opinion, Soviet aircraft design is distinctly Russian. Aviation holds a high and respected place in Russian history and science. Soviet authorities point out with considerable firmness that the first airplane was designed by A. I. Mozhaisk, a naval officer, in 1882; that Euler and Bernoulli laid down the principles of aerohydro-mechanics; that Lomonosov founded the

science of meteorology; that modern aircraft design is based on Zhukovsky's laws of aerodynamics. The dozens of aeronautical institutes founded in the Soviets show how determined they are to excel. Visitors to the Central Institute of Aerohydrodynamics, the Zhukovsky Airforce Academy and the Moscow Aviation Institute say they have no equal here.

In World War II the Russians emphasized the use of fighters and light bombers to support the ground forces, but they now are placing extreme emphasis on production and tactical training in the heavy-bomber field. Red Air Fleet leaders saw what happened to Germany and Japan through strategic bombardment, and keen analyses have been published in Russian on

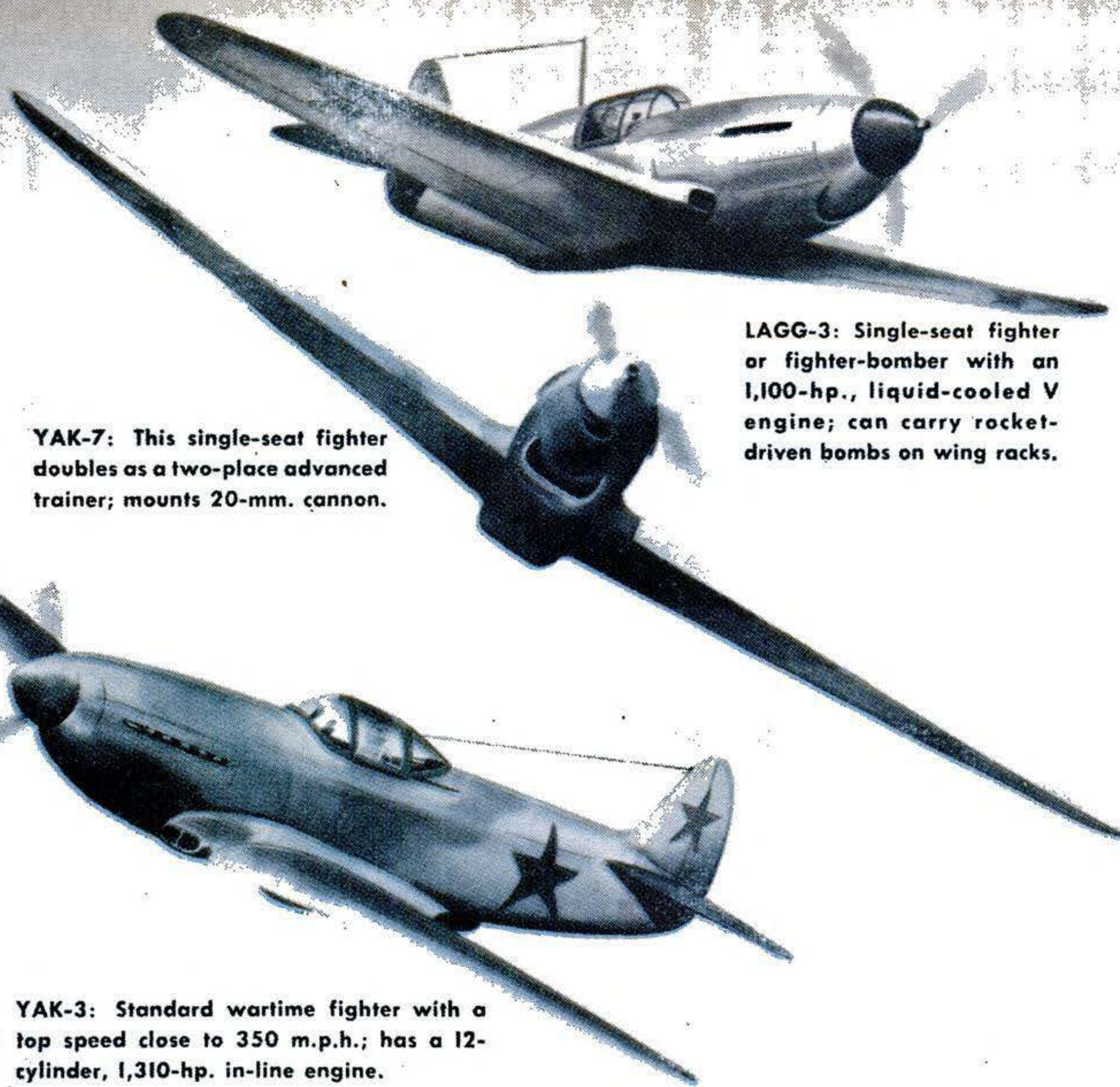

YAK-7: This single-seat fighter doubles as a two-place advanced trainer; mounts 20-mm. cannon.

LAGG-3: Single-seat fighter or fighter-bomber with an 1,100-hp., liquid-cooled V engine; can carry rocket-driven bombs on wing racks.

YAK-3: Standard wartime fighter with a top speed close to 350 m.p.h.; has a 12-cylinder, 1,310-hp. in-line engine.

the techniques of this phase of aerial warfare. Red Air Fleet tactics on the whole are sound.

Their designers are good, too. Working under pressure as the Nazi hordes swept toward Moscow, Sergei Ilyushin had the first version of his Stormovik in the air before the fighting had gone 100 days. It strafed the advancing enemy from 100-foot altitudes while the German light ack-ack bounced off its reinforced hide. German fighter squadrons were loaded with deadly Messerschmitts. Someone had to design, but quick, a plane to cope with the hard-hitting, maneuverable German fighters. So Alexander Yakovlev got out his Yak-1 fighter, forerunner of the now-renowned Yak family of fighters and bombers. S. Lavochkin fight-

ers, Petlyakov's efficient PE-2 dive bomber, A. Tupolev's TU-2 bomber—all were developed under stress of conflict.

Comparison of the best planes of the U.S.S.R. and the U. S. is difficult because the Red Air Fleet doesn't have to roll out its new stuff to obtain popular support for air-force appropriations. Russia is flying at least two types of jet fighters and two rocket planes about which little has been disclosed. Jet engines have been used in at least one Russian heavy bomber. One hundred jet planes flew in a demonstration over Red Square last spring. A Russian axial-flow jet engine has developed 6,000 lb. thrust, 50 percent greater than our standard jet. The work of German jet scientists who were "imported" wholesale after the war accounts for

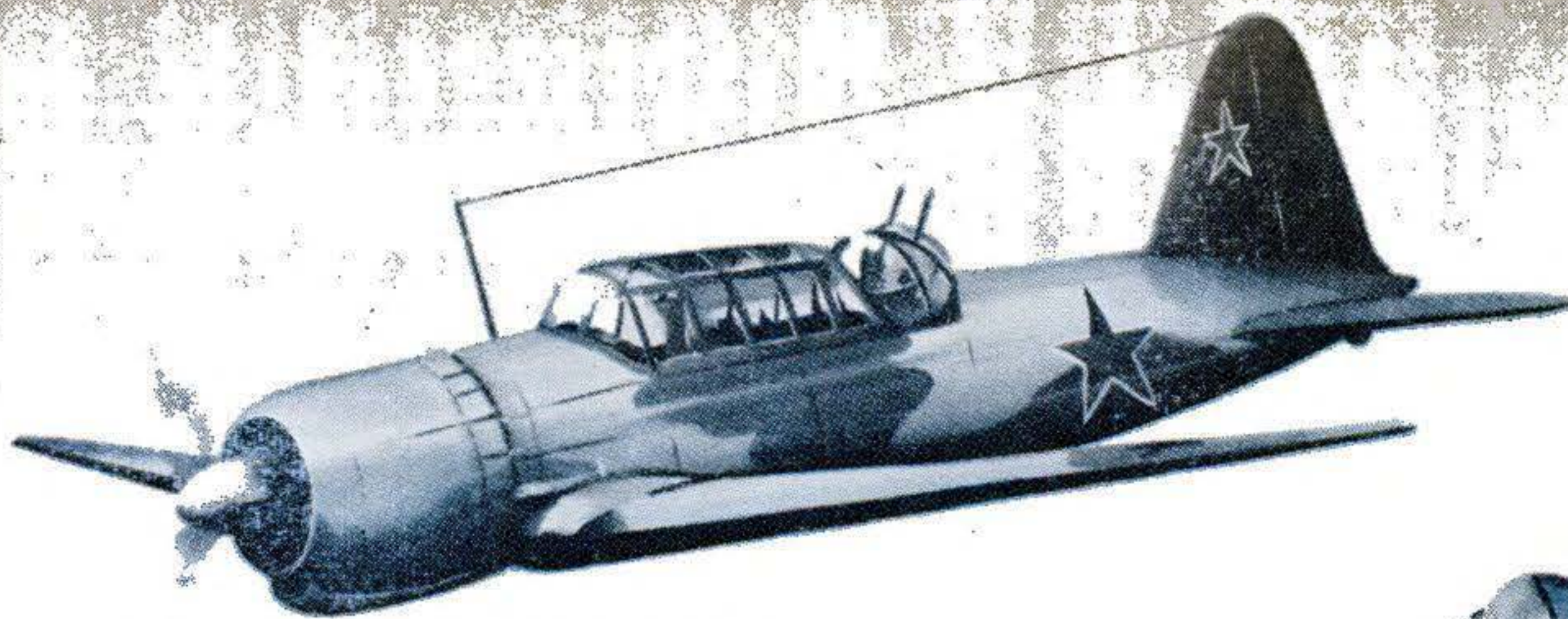

SU-2: Two versions — single-place fighter or two-place fighter-bomber with a rear gun turret, as shown here. It is powered by a 1,000-hp., air-cooled radial engine.

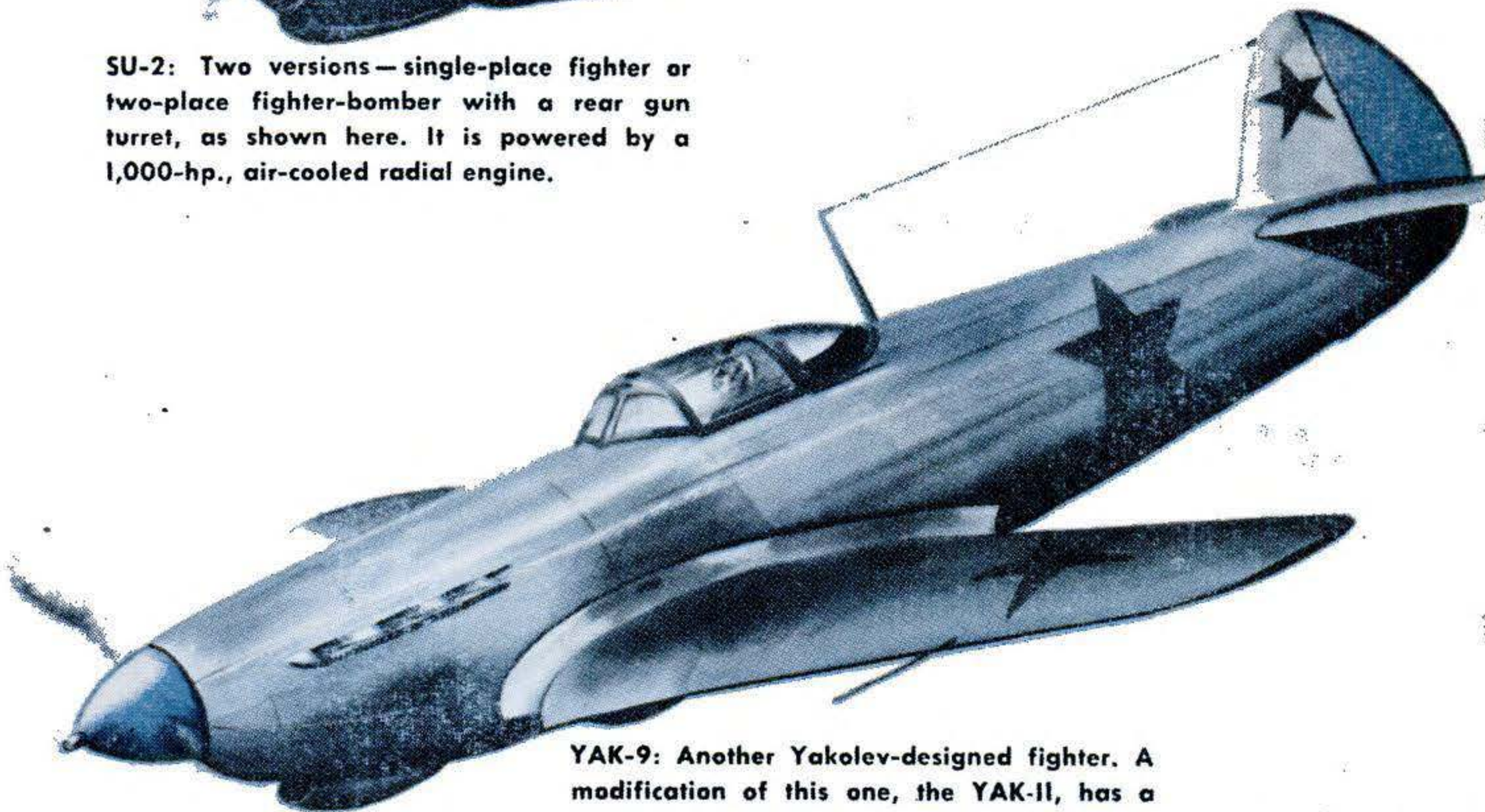

YAK-9: Another Yakolev-designed fighter. A modification of this one, the YAK-11, has a 2,000-hp. engine, top speed of 390 m.p.h.

much of the air progress made by Russia.

More immediately important than new developments, is the question of comparative merit of present planes. The tricky problems of arming and maneuvering the lightning-fast jets make it highly probable that it will be quite a while before conventional designs are outmoded. The question, therefore, is how do Soviet warplanes stack up today?

In the fighter category, the Red Air Fleet's planes hold their own in speed, maneuverability, armor and armament. In attack bombing the Russian types must be given the nod because of the Red Air Fleet's extensive World War II experience in this activity. The United States holds an undisputed edge in heavy bombardment types. The latest

two Russian four-engine bombers are good aircraft of sound design, but they have neither the range nor capacity of our own. One long-range heavy, with a 300-m.p.h. speed, is in production.

In transports, American equipment is unexcelled. But U.S.S.R. equipment is good; they have enough of it—and in military transport, volume, rather than speed, is of first importance. Supplies and troops fed in by air at 200 m.p.h. can support any operation properly, if the pipe line is kept full.

As to flying boats, there is a question. Russian types are quite old, but the Red Air Fleet has used them in numbers and to advantage, while in this country interest in this type has lagged. Flying boats, landing and taking off from lakes behind the Nazi

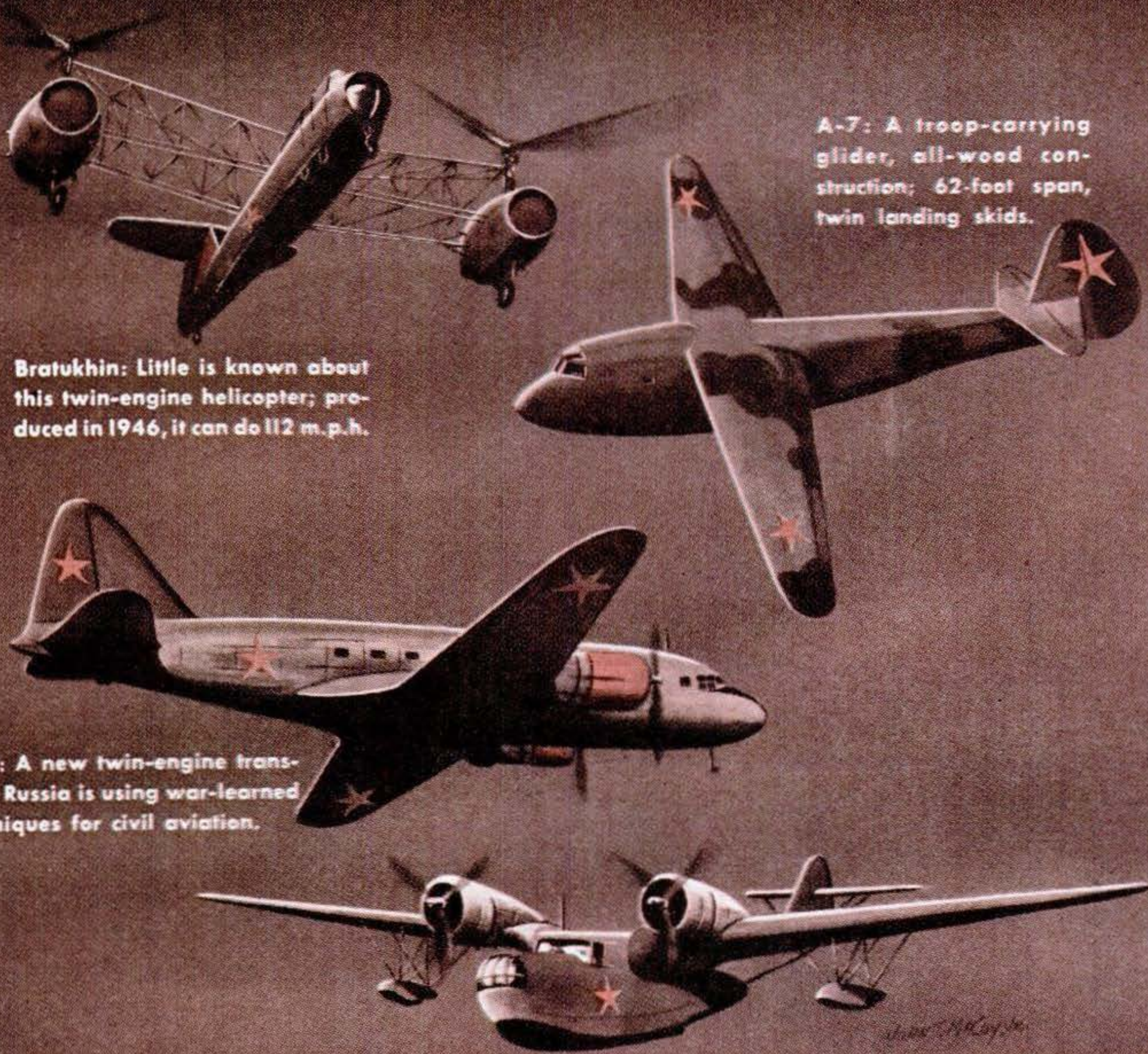

Bratukhin: Little is known about this twin-engine helicopter; produced in 1946, it can do 112 m.p.h.

A-7: A troop-carrying glider, all-wood construction; 62-foot span, twin landing skids.

IL-12: A new twin-engine transport. Russia is using war-learned techniques for civil aviation.

MDR-6: Twin-engine, gull-wing flying boat; guarded Murmansk-bound convoys during war.

lines, supplied many Soviet guerrilla units.

Air power means man power, too. Russians make good pilots. They are famous for fearlessness.

Behind planes and fliers must stand factories and workers. Russia's labor situation is hard to assess. In her regimented economy, labor is paid 1/5 to 1/7 what it gets in America. But the same ratio is said to exist in output—a U. S. mechanic earning \$75 a week is reported seven times as skillful as his Russian opposite number. Offsetting this is the fact that the government can and does move factory populations like checkers. Right now, Russia is funneling children of 15 into her F.Z.O. (Industrial Training Schools) system.

At the same time Russia's traditional de-

pendence on mass labor is decreasing. For the past 15 years, there has been ever greater use of automatic machinery, even though it had to be bought at unfavorable exchange rates. After World War II came wholesale transfers of the finest German machinery to Russia. Now, nearly 60 percent of all of Farbenindustrie, and almost 50 percent of all other German industrial equipment works for Russia.

When it comes to raw materials for her aircraft industry, Russia is rich in some, poor in others. She has plenty of aluminum and magnesium, both at home and in satellite Hungary and Yugoslavia. War-pressed developments have provided the power formerly lacking to extract and process these vital items. A plant at Kamensk in the southern

Urals and the still-growing BAZ factory in the northern Urals are adequate to make all the fabrications needed.

Of manganese and chrome, Russia has so much that in 1946 the United States im-



This streaking shadow is the first photo of Russia's rocket-assisted airplane.

ported 204,062,000 lb. of the former from her and 67,586,200 lb. of the latter. In the ferroalloys, however, the Soviets are poor: so poor that the third Five Year Plan, launched in 1938, was tagged "The Plan for Quality Steel." During the war years, more than 21,000,000 lb. of ferrotungsten, ferrochrome, ferrovanadium and ferromolybdenum, worth more than \$12,000,000, were shipped to Russia on lend-lease.

A not-so-obvious asset of Russian air strength is her bases. Thousands of airfields, from small grass strips to huge, modern, paved airports dot the country. Three distinct chains of bases mark a way for profitable international transport to the United States Pacific Northwest, Midwest and East Coast. That these might be transformed overnight into military installations is no more true than a similar statement regarding our Alaskan airfields. A sectional Siberian air map chosen at random, covering a 600- by 700-mile area, shows two dozen airfields at 100-mile intervals.

Equally important to Russian aviation is the weather forecasting system evolved by the Soviet. In a land of severe weather, successful year-round aviation depends on meteorological efficiency. In the last 10 years Russia has established more than 100 weather stations in the Arctic, extensively staffed with expert personnel and modern equipment. Here again, the U.S.S.R. doesn't quite come up to the U. S. in equipment and savvy, in the opinion of American experts, but Russia is expending more money

and men and effort on such work than America. American military meteorologists admit the Russians' long-range forecasting is good, criticize their failure to make simultaneous observations, say their communications are not outstanding.

A powerful adjunct of Russian military aviation is the Civil Air Fleet, which has a far more intimate relationship with the military than does civil aviation in this country. The Kremlin is pushing a vast program of air-line modernization and expansion. From a few hundred miles of lines before the war, compared to our 28,000-mile network, the Russian air lines now cover 50,000 miles and project 108,000 miles by 1950. American air lines, meanwhile, have grown to 95,000 miles today. Construction of 20 principal new U.S.S.R. airports is planned. A new 60-passenger,



Sovfoto describes this as "A Soviet-built jet-propelled plane." Fill in your own details.

300-m.p.h. transport is being built, along with a 40-passenger seaplane for the Far East. LI-2s, built from the Douglas DC-3 design, are being turned out at 400 a month. Russia's civil aviation is further reinforced by Polish and Balkan air lines.

Qualitatively, American air power still holds an edge over the Red Air Fleet. Quantitatively the position is being reversed. Russian military aviation still faces plenty of high hurdles. It has a production problem; it is short on some phases of tactical knowledge; its equipment and over-all know-how probably do not quite come up to ours. But aviation authorities say the Russians are "intent, capable, and undismayed by obstacles." While our present skills are sharper, the Russians are pouring in men, money and materials. If they continue, they will become the world's No. 1 air power.

END



New Research Shows

How Plants

Relationship of light to growth is studied, using fluorescent tubes to simulate sunshine.



Caltech's scientific greenhouse is air conditioned so that temperature and humidity can be maintained at any level desired. Water sprayed over the glass roof neutralizes sun's heat.

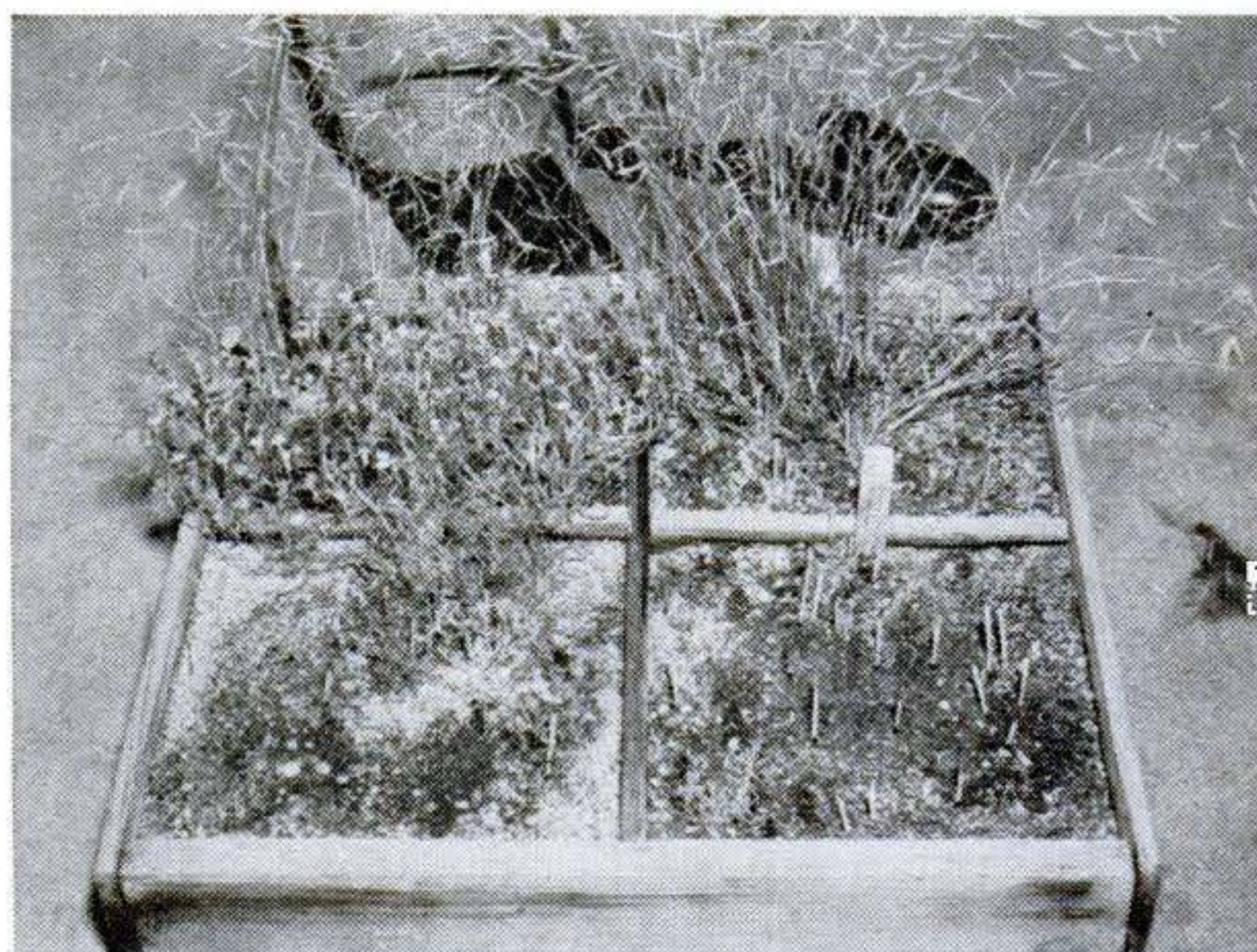

Effects of rainfall are demonstrated by these four plots of soil from the desert. Rear two, soaked with rain, produced heavy growth. Front two were lightly sprinkled, grew little.



Grow

The subjects of this test are squash plants.

Caltech is exploding myths of garden and farm by investigating effects of sunlight, warmth and moisture.

HOW do plants grow? They do not have circulatory or digestive systems that can be studied like those of animals. But, by subjecting them to diverse conditions in a weather factory at California Institute of Technology, plant physiologists are finding out—and exploding many of the green-thumbed gardeners' pet ideas.

Plants do not sleep; they are as active in darkness as in daylight. Farmers often say hot nights are good for corn. The Caltech experimenters have found that night temperatures are important—but that corn really grows fastest when the nights are mild, 60 to 65 degrees.

Some plants help others. The desert sagebrush, for example, lets blossoms of the little *Rafinesquia* penetrate between its stems and leaves to find the sun. But other plants wage chemical warfare on their neighbors. The desert plant guayule, which produces a kind of rubber, grows twice as lushly on the sides, and four times as lushly at the corners of a field, as in the center because it excretes a poisonous acid around its roots that prevents the germination of other guayule seeds and limits growth of near-by seedlings. This acid, called an inhibitor, is so powerful that it can kill seedling roots in a day. 

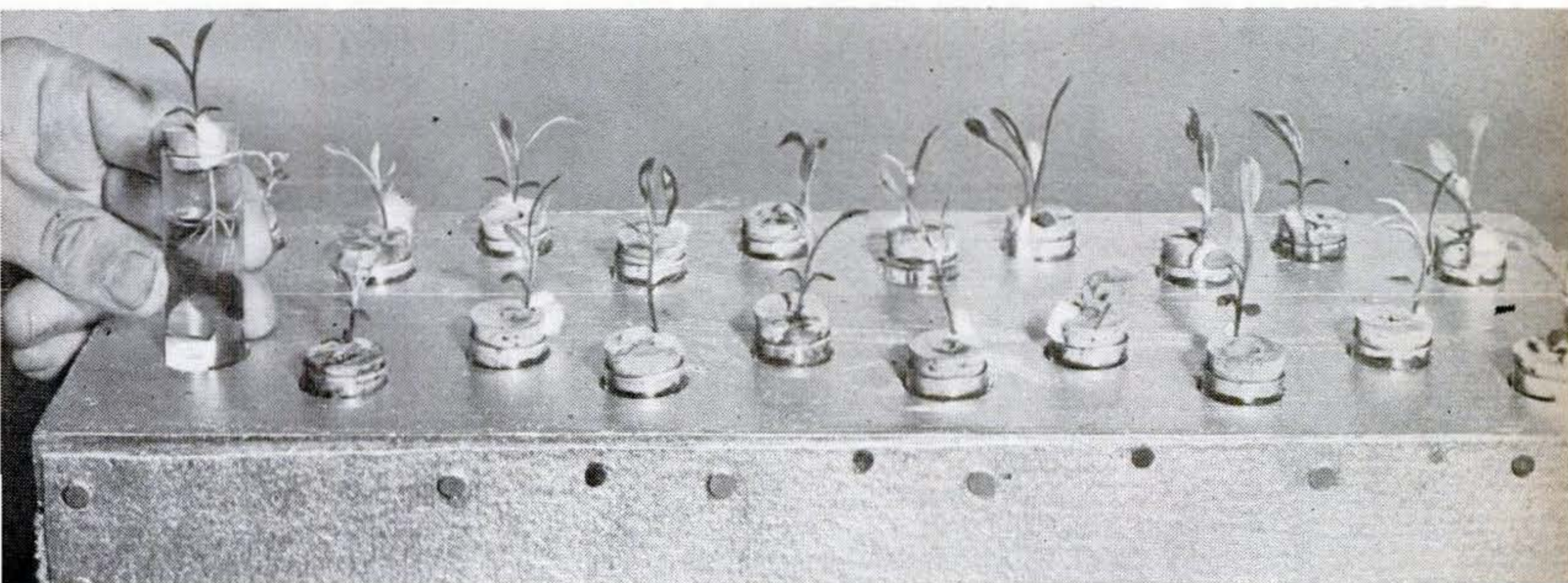

Many plants release poisons that prevent the germination of near-by seedlings. These shoots of guayule, a source of rubber, exude cinnamic acid, preventing the growth of neighbor plants.

Encelia, a desert weed, isolates itself similarly. Through such natural chemical warfare, some plants are able to protect themselves against the growth of competitive species.



Night growth of tomato plant being measured. Although the plants usually die after two days in the dark, they will live for a week if the leaves are dipped in a sucrose solution.



The sugar solution that keeps plants alive in the dark can be applied more easily by spraying it on the leaves. A detergent is added to make the liquid spread over the surface.

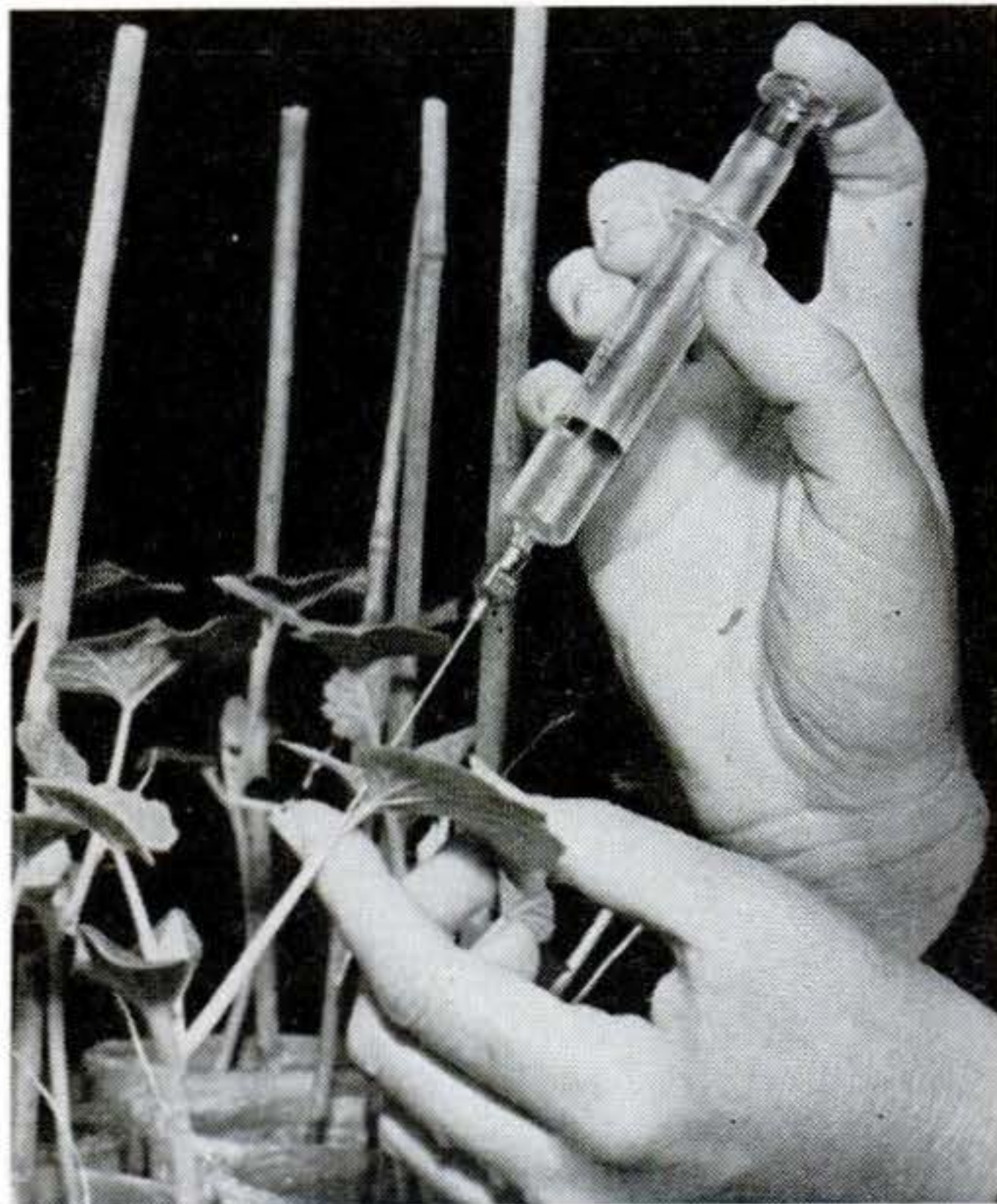

Injection of sugar directly into hollow stems of an acorn squash reveals how food travels to growing top of plants. This treatment made the squash gain two inches a night for three weeks.

Tomato-feeding tests show that sugar enters the plant through its leaves.

TOMATOES, squash, and corn are Caltech Professor Frits W. Went's vegetable guinea pigs. The tomatoes, his experiments have



Experimental tomato plants thrive in wire baskets filled with expanded mica. Mica holds the upper roots where they can get plenty of air; the lower roots soak in plant-food solution.

shown, take sugar through the leaves, not appreciably through the roots. Once, nitrogen and water were believed to influence transition from flower to fruit. This is not so. Conditions between sundown and sunup determine whether plants will fruit or flower, and how fast they grow.

Drawings by Mrs. Marcella Carter,
Caltech plant physiologist

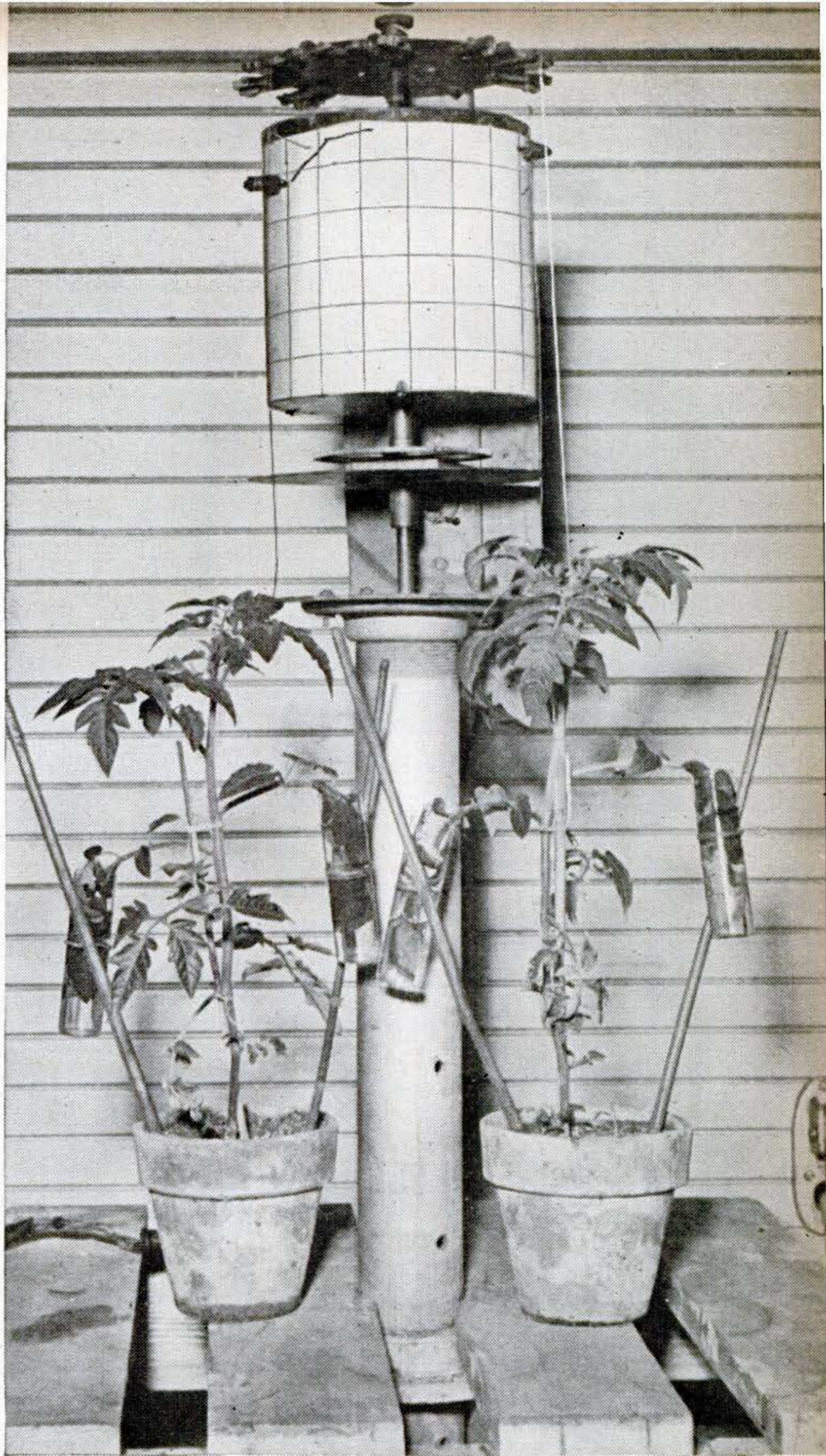
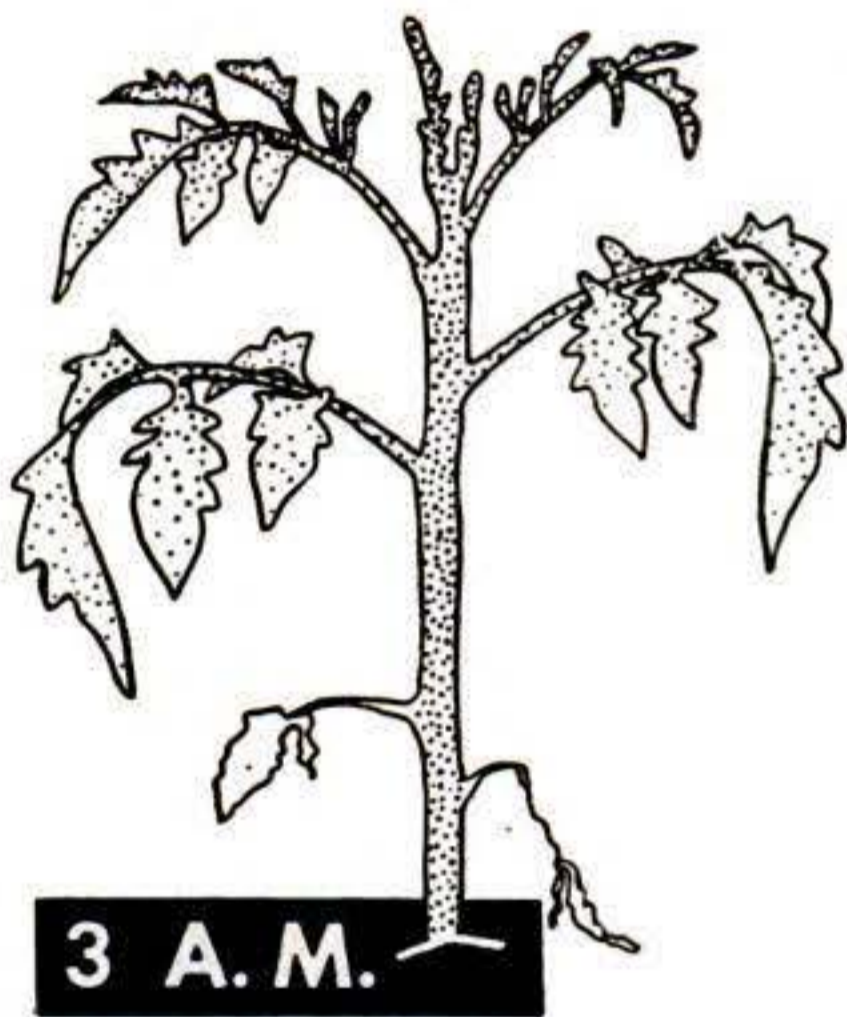
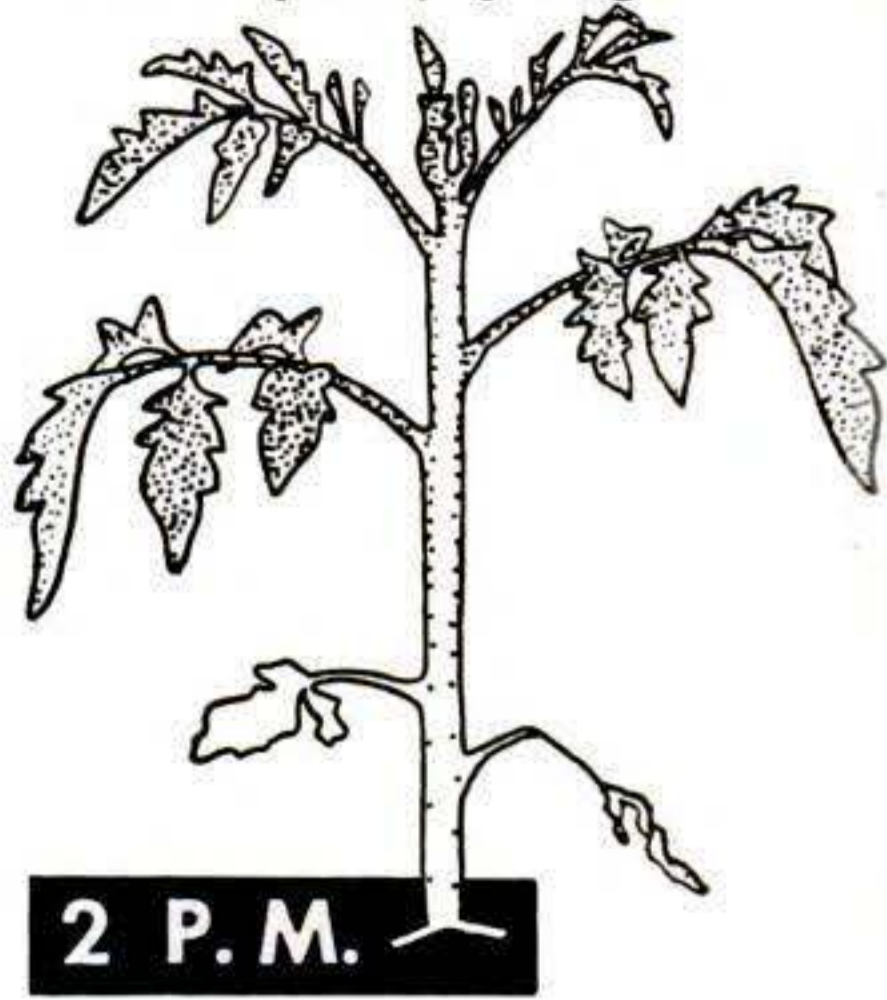

Movement of sugar in a tomato plant is shown in these sketches. When the plant stops making sugar (black dots) at 2 p.m., leaves are full while stem has very little. By 3 a.m., most of

sugar has moved to stem and plant is growing fast. At 6 a.m., almost all sugar is gone; the plant stops growing and starts making more. Instrument above traces growth on drum.

Tomato plants quit work at 2 p.m., but they grow on sugar during night.

To LEARN more about photosynthesis, the mysterious process by which plants manufacture the sugar they need to grow, Dr.

Went's group tested the effects of varying amounts of sunshine on tomatoes. They found that these plants actually knock off around two in the afternoon, making no more sugar no matter how bright the sun. Not until around midnight did the tomatoes start turning this sugar into growth. END

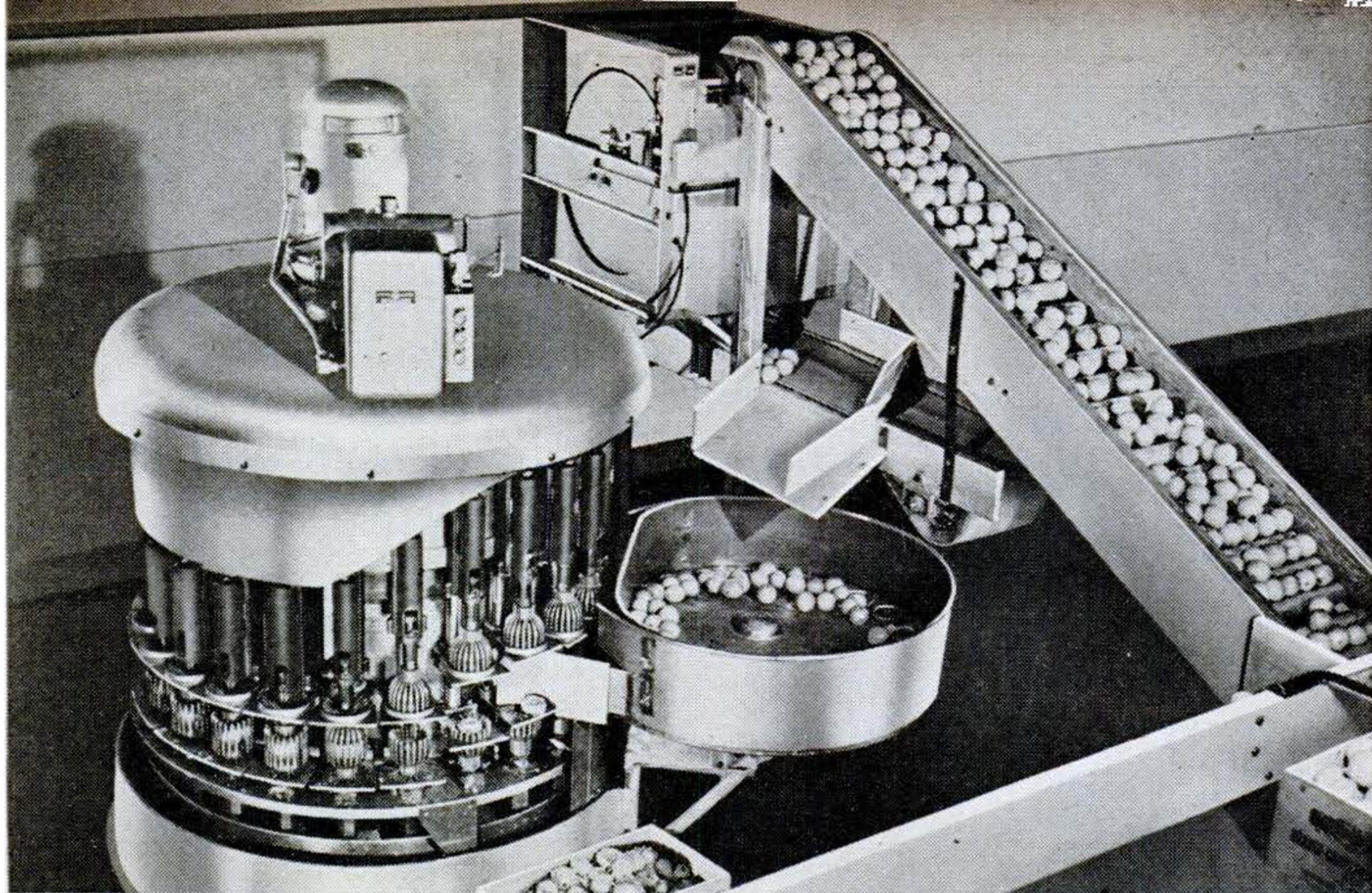

Super Squeezer. Pressing up to 480 oranges a minute between metal cups, this new automatic juicer makes 300 gallons of juice an hour. Squeezing fruit whole, it eliminates rind oil, thus improving flavor and the keeping quality.

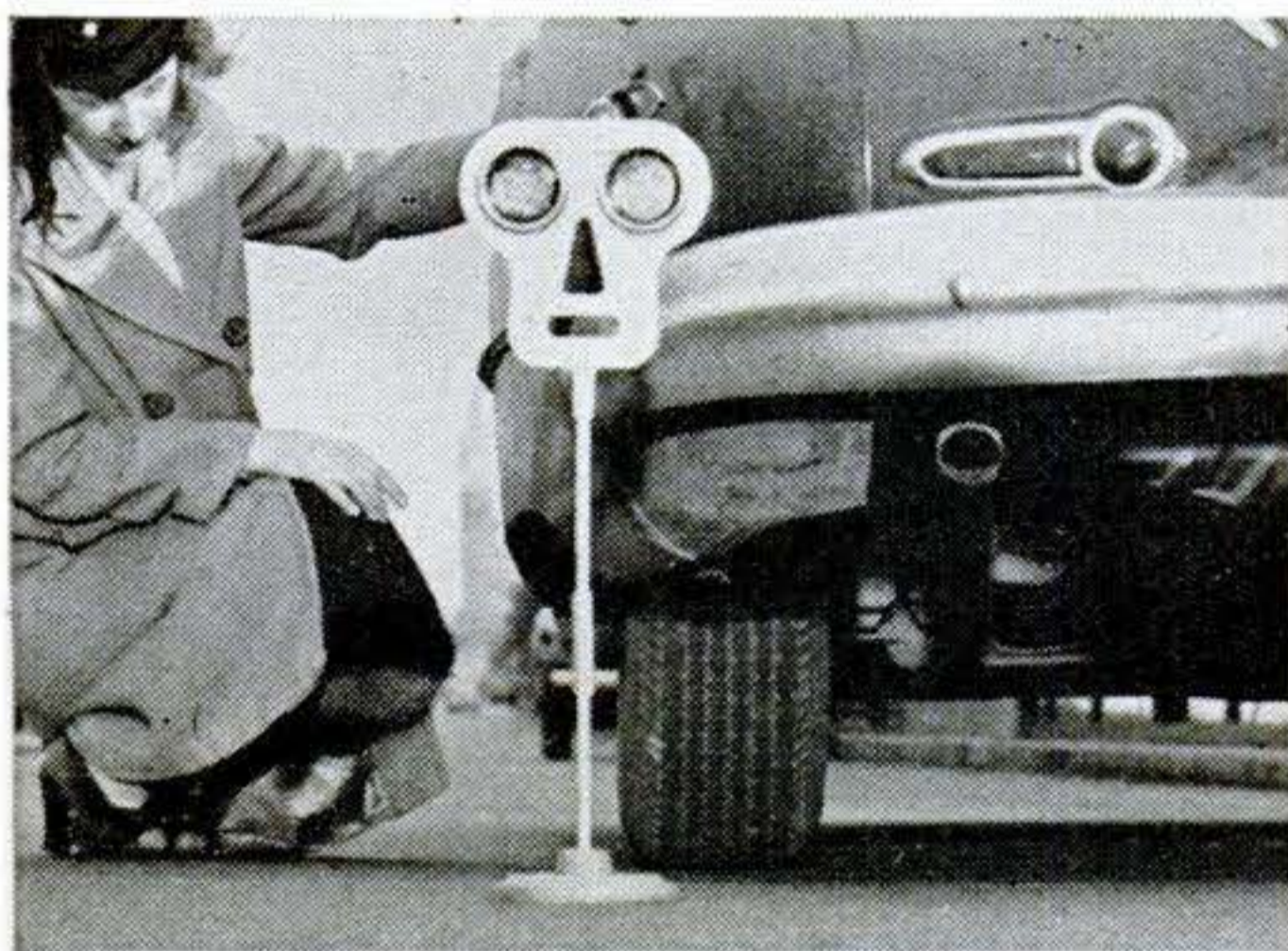

Portable Road Signal. When trouble makes a stop along the highway necessary at night, this easily folded Sav-A-Life signal comes in handy. Its reflected light is visible 350 yards in either direction.



Coin Centrifuge. This cement mixer breaks coin rolls, dumps loose change in bags for Federal Reserve deposit five times faster than by hand. A blower disposes of paper. It was idea of a Los Angeles teller.

This Month's Pin-up

WITH a top speed of 170 m.p.h., the Navy's Fairchild XNQ-1 primary trainer has the latest safety devices, such as a bubble canopy for unobstructed view. It is an all-

metal, two-place, low-wing monoplane with a 320-hp. Lycoming engine, controllable-pitch propeller, and retractable landing gear. The plane won a design competition.



NEW IDEAS
from the
INVENTORS



Auto Hood Has Nothing to Hide. An accessible motor for your automobile is the object of an invention of Renwick J. Sharp, of Guatemala. Hard-to-reach engine parts, usually hidden by the conventional hood, are instantly exposed when this one-piece half-hood and fender combination, hinged at the front of the radiator, is swung out horizontally, like a door. A similar system is also proposed for the rear of the car.



Pot Grinds Own Coffee. To prevent the loss of flavor that occurs after coffee is ground, Boris Bogoslowsky, of Jackson Heights, N. Y., has devised a pot in which the coffee is ground directly into a sack submerged in hot water, thereby keeping the flavor from escaping into the air. As the grinder is rotated, water is drawn through small holes in the shaft and circulated throughout the filter sack.

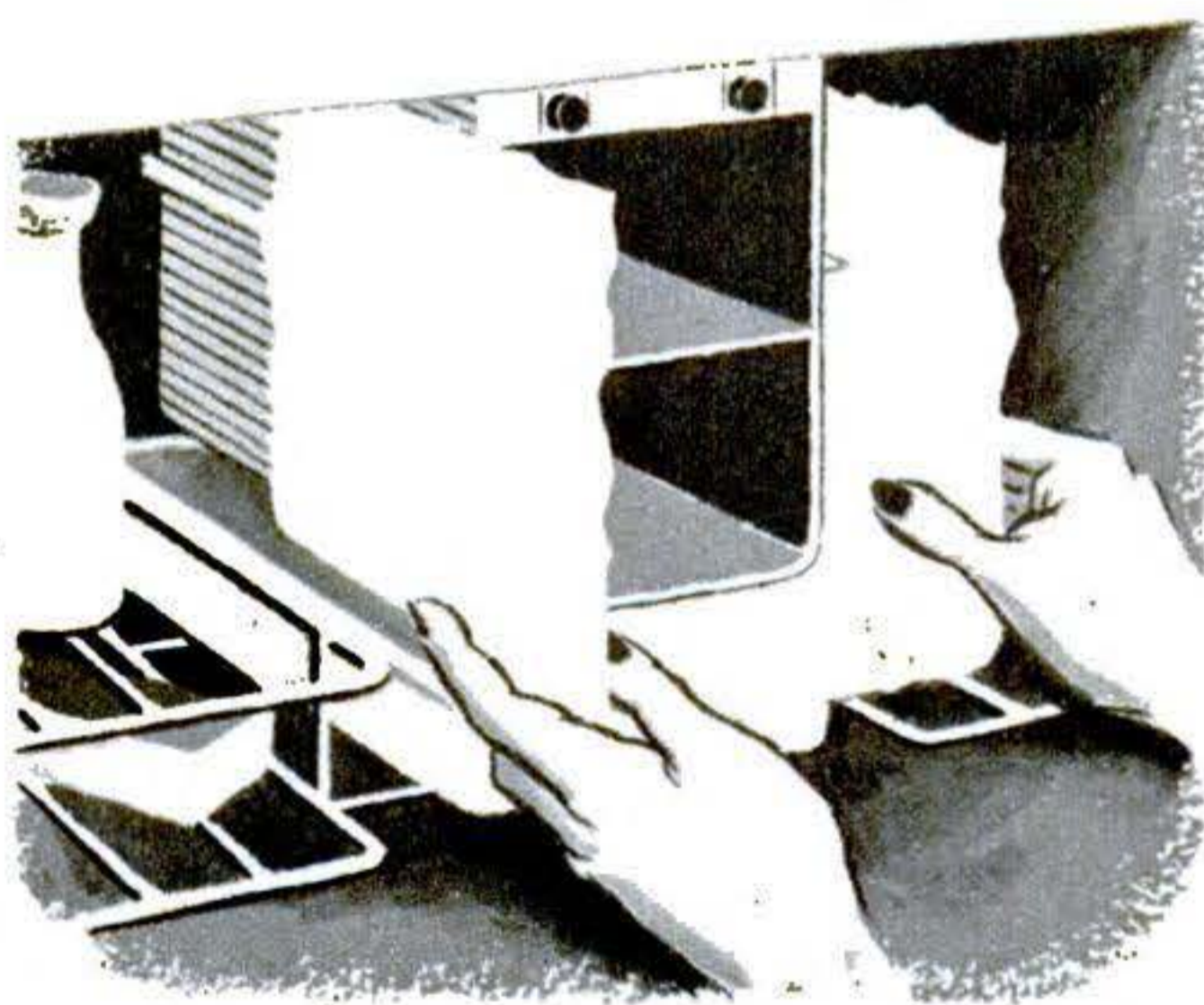

Heat Speeds Defrosting. You can defrost your refrigerator in minutes instead of hours with an invention of Charles J. Roach, of Hamilton, Ohio. Small heating coils, built into the sides of the freezing unit, are turned on just long enough to loosen the ice, letting it slide out in one piece. The built-in coils would melt the ice so quickly, the inventor believes, that you wouldn't have to shut off the refrigerator.

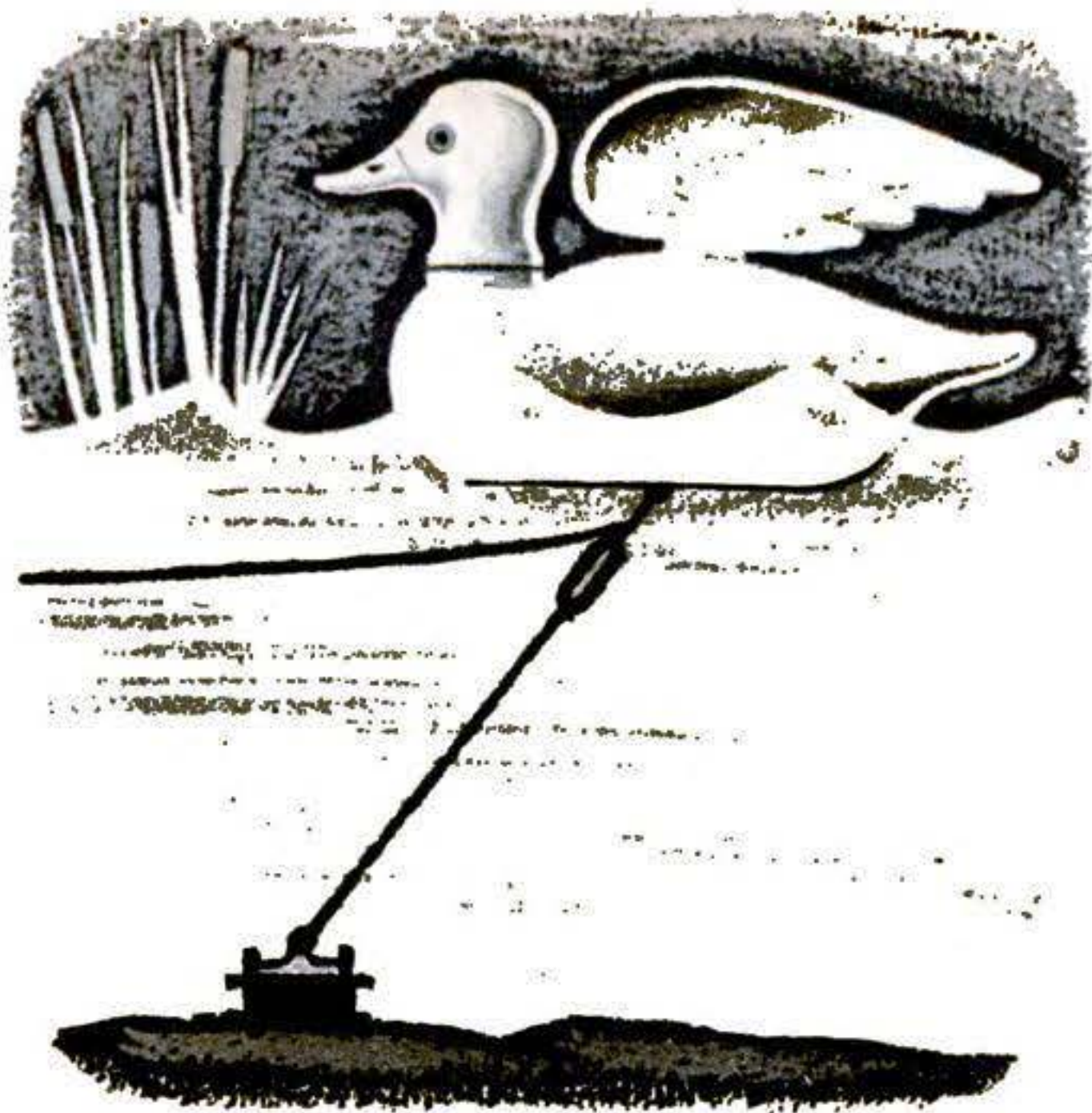

Decoy Imitates Ducks. A mechanical duck decoy designed to do practically everything but get up and fly away has been patented by Carroll J. Rulison, of Baldwinsville, N. Y. Connected to an anchor rope, its wings are so hinged that the wave motion of the water, pulling on the rope, causes them to flap. When water is not rough enough, the same effect can be produced by tugging on a rope from shore.

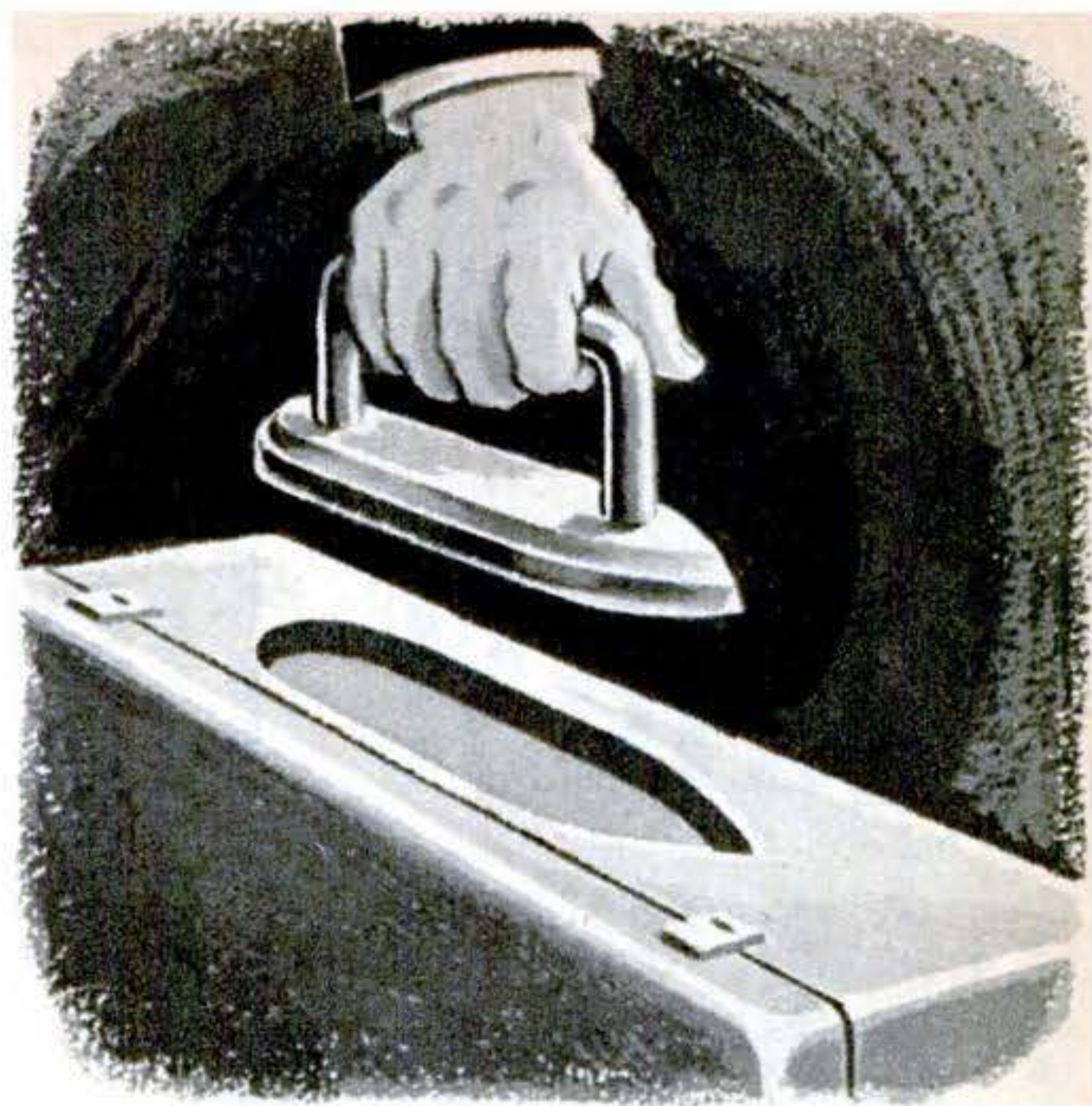

Bag Holds Iron As Handle. For the convenience of those who never stay in one spot long enough to have their clothes pressed, Andrew W. Janosz, of Manchester, N. H., has invented a suitcase whose handle is actually that of a small flatiron. When the suitcase is to be carried, the base of the iron is fitted and locked into a similarly shaped recess in its side, leaving only the iron's handle exposed.

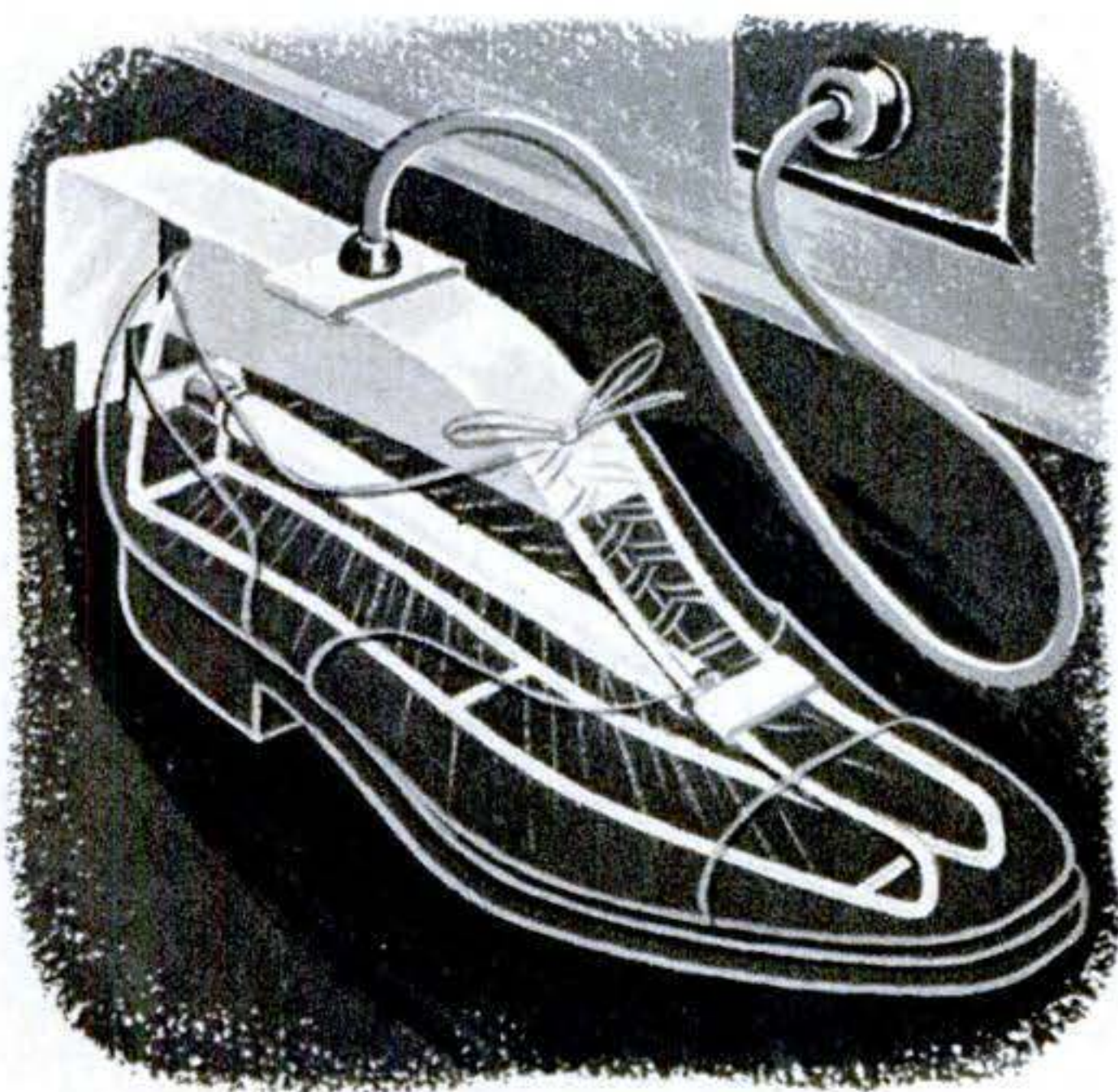

Lamp Chases Shoe Germs. You don't have to stuff your shoes with chemicals in a new shoe sterilizer invented by Marion F. Fortney, of Charleston, W. Va. Instead, a small bracket that can be fitted right inside the shoe is used to hold an ultraviolet lamp. The top of the bracket completely fills the shoe opening, so that no harmful rays can escape. It can be fitted into a wall bracket, if desired.

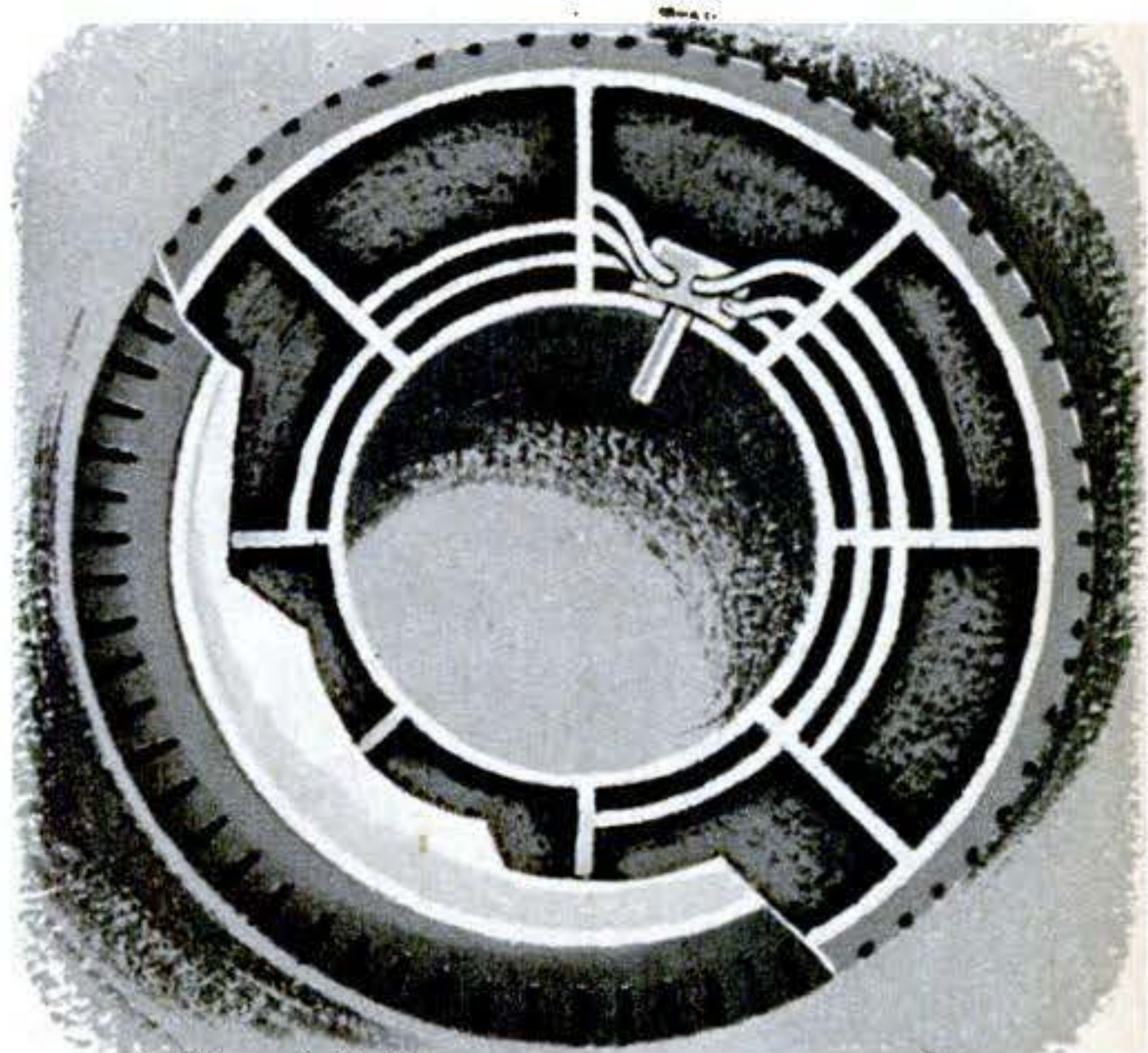

Tire Sections Save Flats. To prevent accidents caused by sudden tire punctures or blowouts, Morris and Leo Frankel, of Los Angeles, Calif., have patented a tire that is divided into eight separate segments, each of which must be individually punctured to cause complete deflation. When one segment is punctured, the adjoining ones expand to fill in the space, permitting the tire to continue in normal operation.

Artillery

Against the

Unknown

By **Volta Torrey**

Brookhaven Laboratory is GHQ for reversing what happens when an atomic bomb explodes.

CAN electrical energy be turned into real matter that will continue to exist? What are the forces, stronger than electrical and gravitational forces, that hold the nuclei of atoms together?

Related to these questions are many more: Can electricity be drawn *directly* from atomic piles, or can piles be used only as heat sources? How can engineers make certain that "nuclear boilers" will not explode? How are workers to be protected from "plutonism," which grays hair, damages the liver and causes bone cancer? Can an atomic power plant be made to fit into a locomotive?

The answers, needed to make atomic energy as useful in peace as in war, are now being sought for the Atomic Energy Commission in great new research centers such as Argonne Laboratory near Chicago and Brookhaven Laboratory on Long Island.

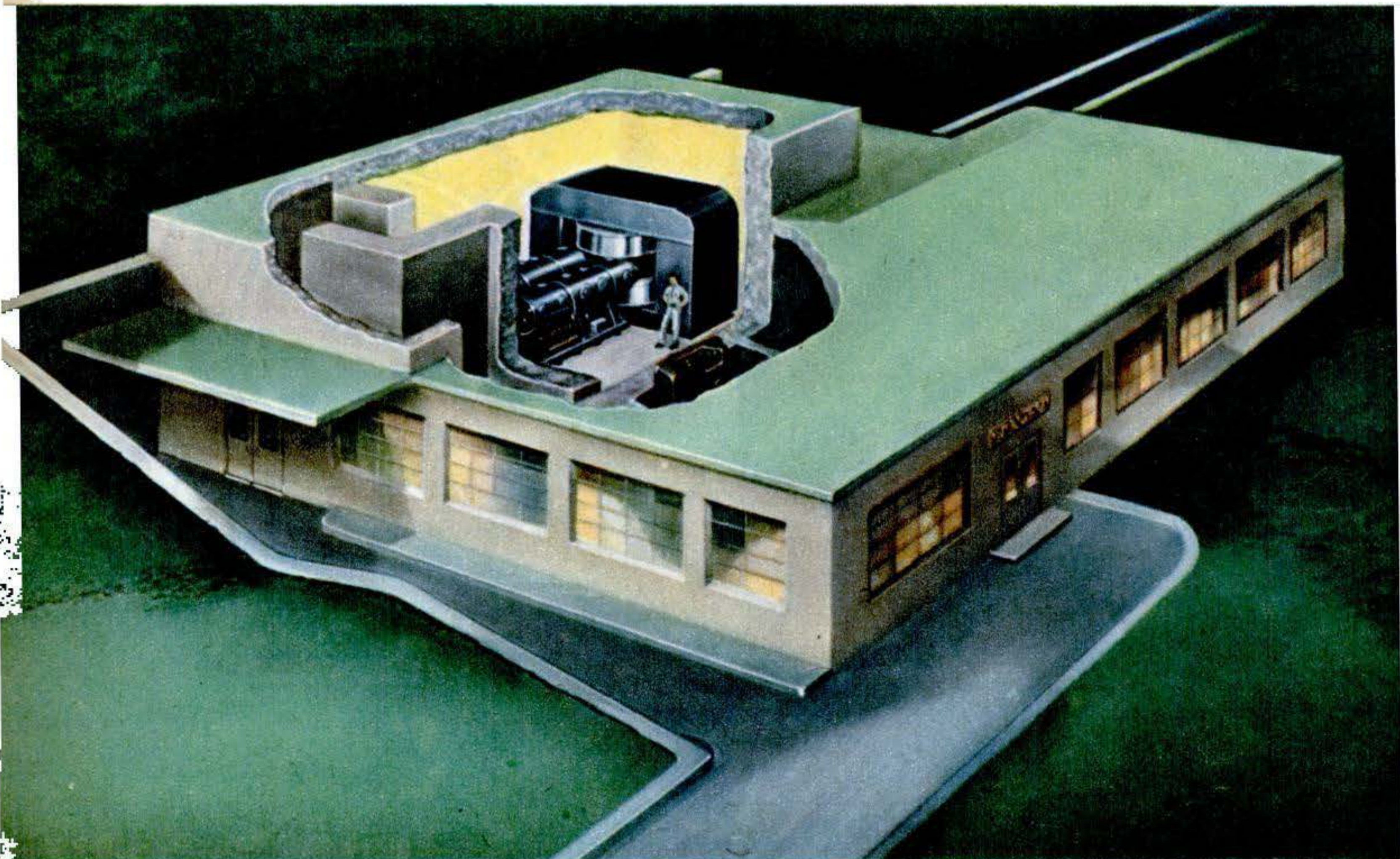

A 30,000,000-electron-volt cyclotron, expected to look like this, will be built at Brookhaven to create radioactive isotopes that cannot be obtained from atomic piles. Far larger machines are planned.

They are using two basic types of artillery against the mysteries of matter and energy: atomic piles for the production of power and radioactive isotopes, and huge machines such as cyclotrons and synchrotrons for the creation of other isotopes and further examination of atomic particles and forces.

Brookhaven scientists, for example, already have assembled material to build a uranium-graphite pile purely for research work. Power will be more concentrated in it than in the one at Oak Ridge, Tenn. It will be used to study metallurgical, construction and radiation-protection problems that confront the designers of atomic power plants. After this one, Dr. Philip M. Morse, director of the laboratory, hopes to go on to build larger and better piles.

Alongside these piles, a "hot" laboratory will be built to separate and package the radioactive isotopes which biologists and chemists use as "tracers." Radioactive isotopes that have more than the usual number of neutrons can be produced in piles, but the biologists often prefer to use tracers that have an excessive number of protons. Many of these are turned out in cyclotrons, so Brookhaven will also have a 60-inch unit.

Much more powerful machines than this

are being designed—including a synchrocyclotron to produce a billion volts or more. At energies of about 200,000,000 volts, the theoretical physicists are reasonably confident, mesons will be produced.

But Dr. I. I. Rabi, Columbia University professor, Nobel prize winner and a trustee of Brookhaven, already has his eye on another more startling goal. That is to get into the region of energies of three or possibly four billion volts. In that region, he explains, "protons or neutrons are energetically possible."

Protons are the nuclei of hydrogen atoms. They would quickly pick up free electrons and thus become hydrogen. Hence, with energies of many billion volts, the scientists might reverse what happens when an atomic bomb explodes. Instead of matter turning into energy, energy would turn into matter.

What would a machine to do this cost?

"Less than a cent a volt," says Dr. Rabi.

How soon could it be built if the money were available now?

"Three years," says Dr. Rabi.

"Five years," says Dr. Morse.

At Brookhaven, \$10,000,000 will be spent this year, but \$50,000,000 will be needed to complete the scientists' program. END

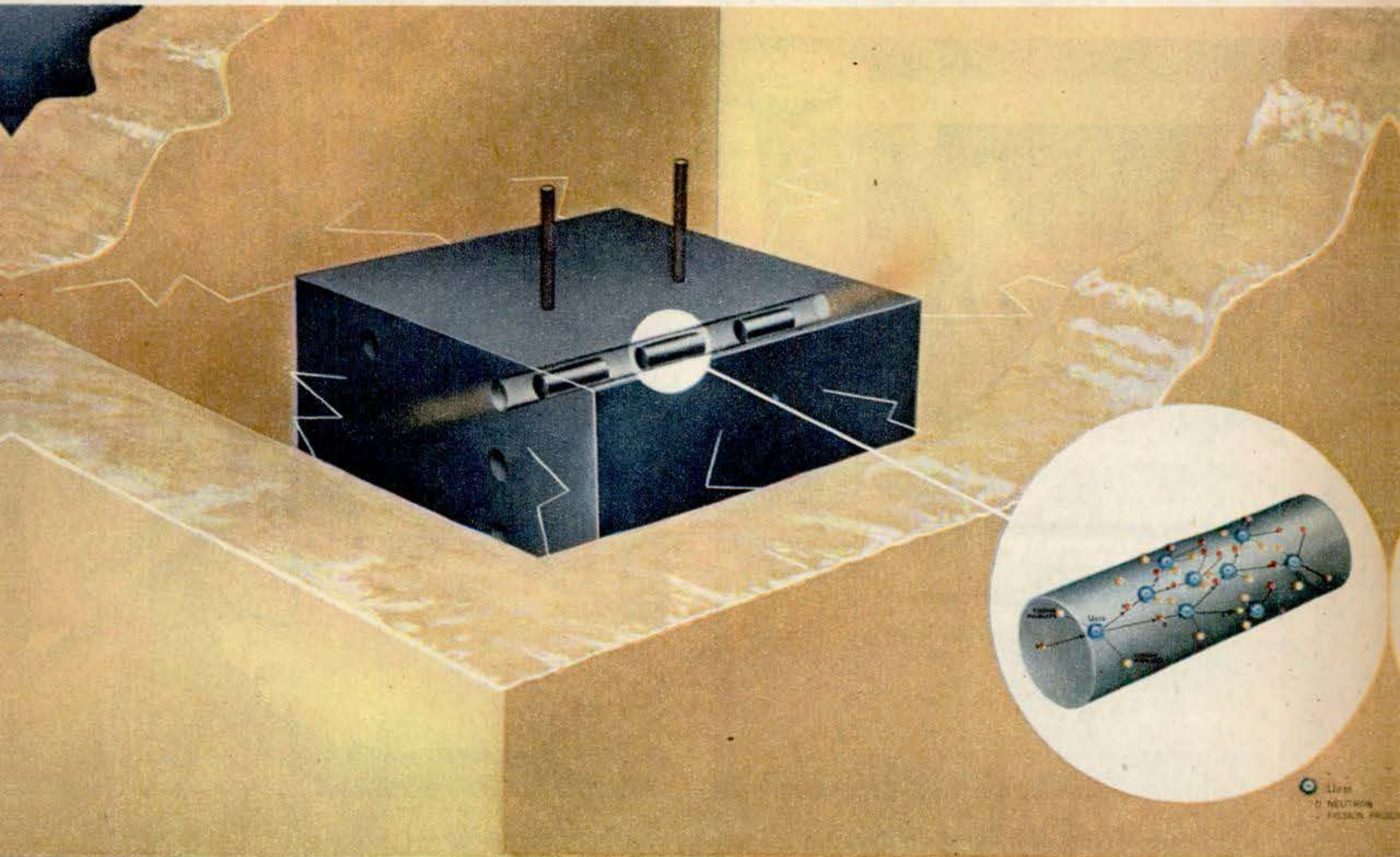

This visualization of an atomic pile was made with the help of Brookhaven Laboratory scientists. They expect soon to have a pile that develops more power per cubic inch than the one at Oak Ridge.

Here's How Harmonicas Are Made

HARMONICAS, like many another product, have taken their place on U. S. assembly lines. Largely imported before the war, the ubiquitous and versatile instruments, more familiarly known as mouth organs, will be mostly American-made from now on.

With an estimated 3,600,000 slated for production in 1947 by one factory alone, the hip-pocket band has rapidly become a precision-made, mass-production commodity with a wide public appeal and an industry all its own. Invented more than a century ago, the harmonica was once a toy, is today a real instrument with complex 50-note chromatic models now available.

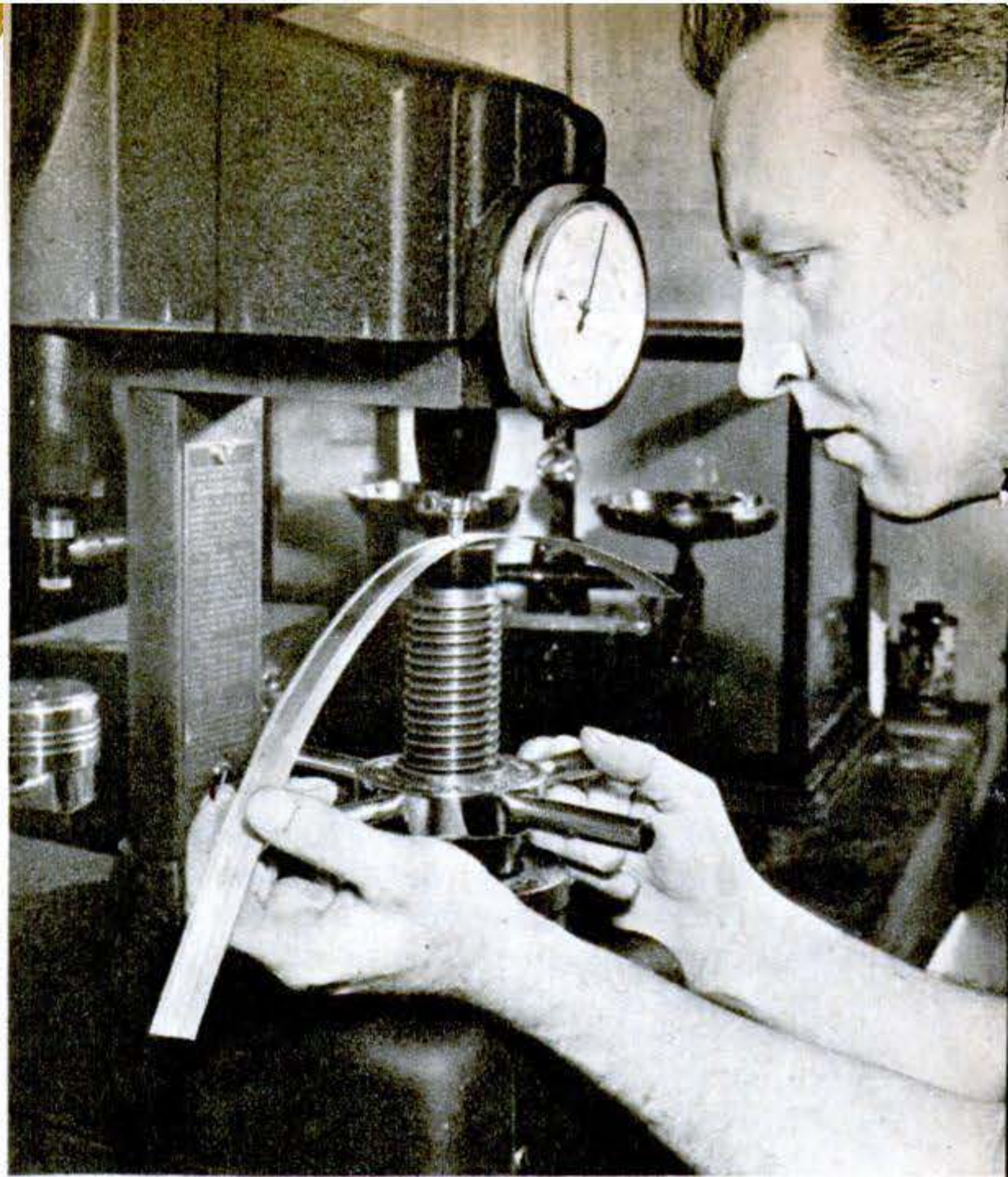

1. Brass strips, from which the reeds and plates are made, are first machine-tested for hardness and flexibility, which affect both pitch and tone quality of the notes.



4. Plastic cover plates, of polystyrene, are molded under a pressure of 1,500 lb. at 400° to 500°F. Some harmonicas are made entirely of plastic, even to their reeds.

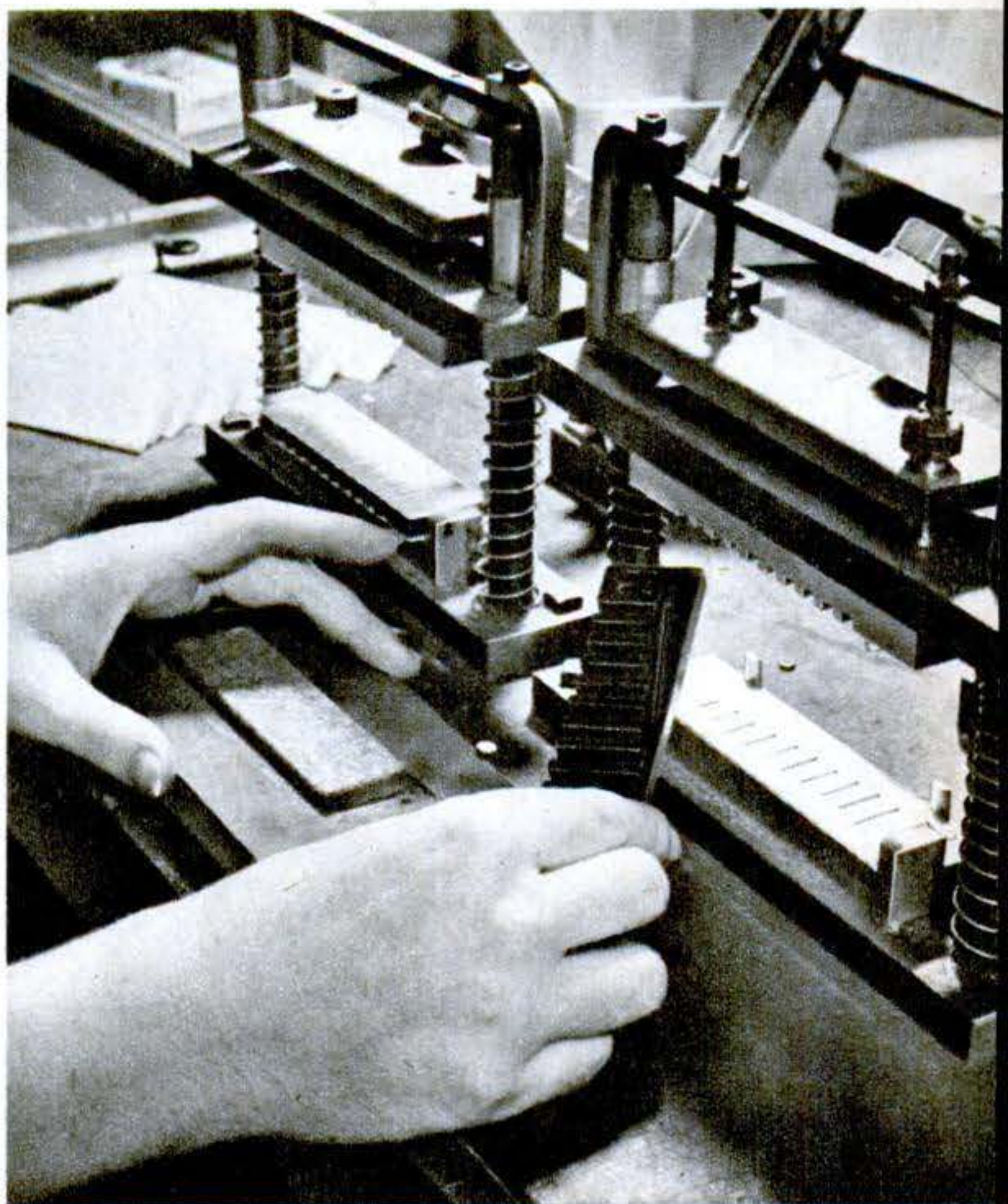

5. Reed plates are fastened to either side of the center section, comblike and usually formed of plastic. Metal or plastic covers are then attached to complete assembly.

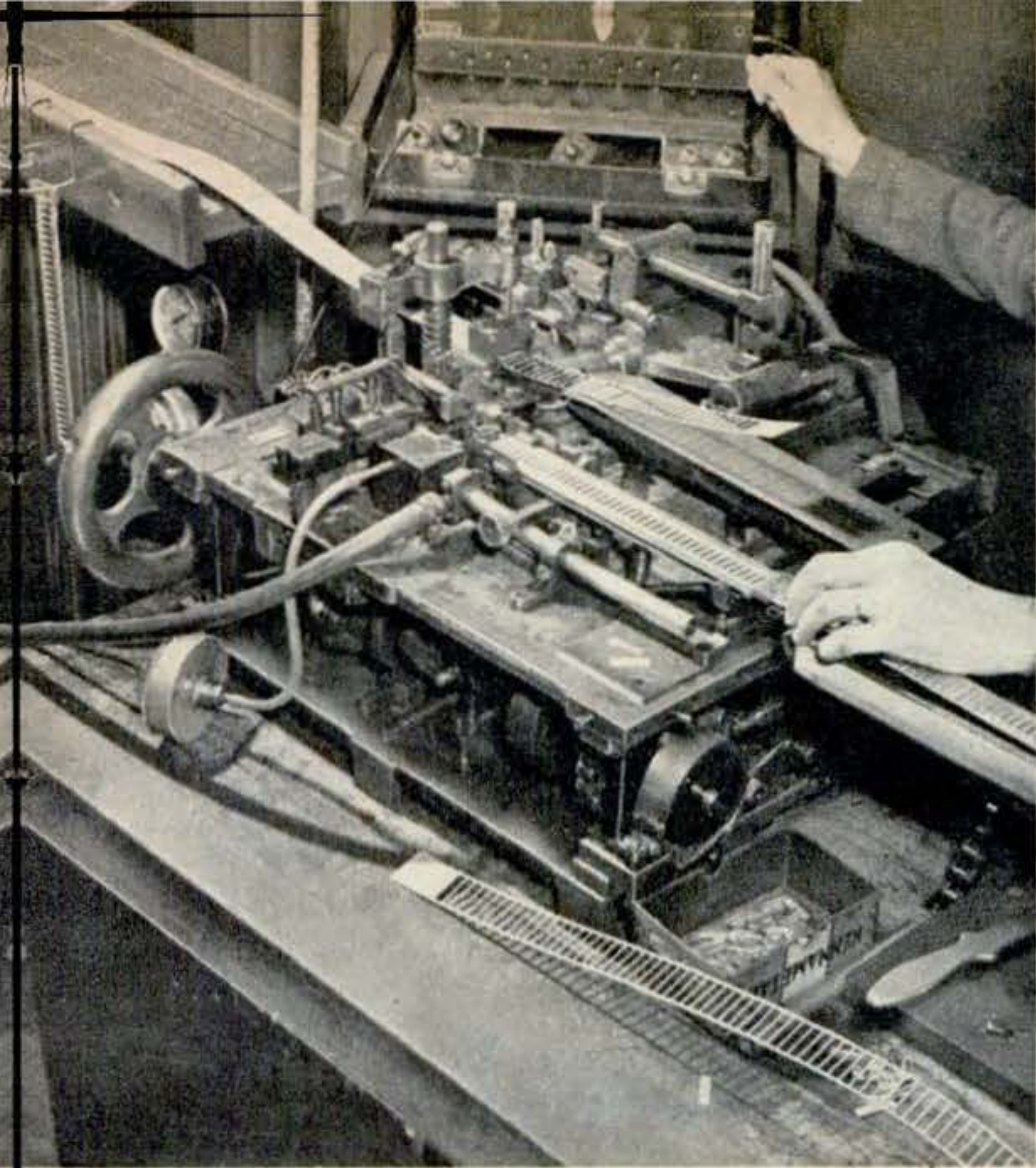

2. Milling machine turns reeds out of brass strips, giving each the exact shape and thickness required for its particular note. The reeds are then riveted to the plates.

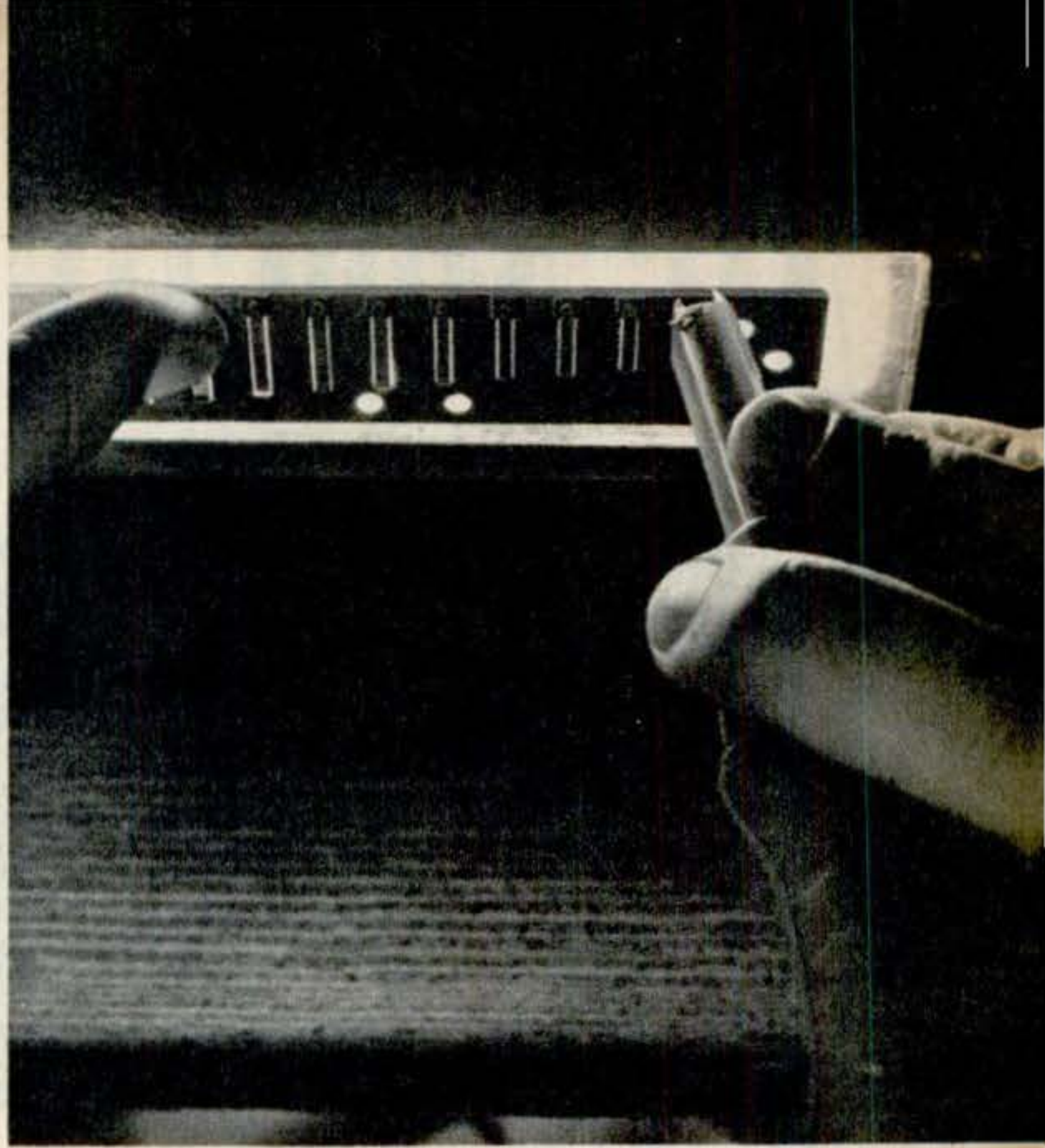

3. A beam of light, shining through the reeds, is used to check their alignment after riveting. Tolerances must be held to a fraction the thickness of human hair.



6. Finished harmonicas move rapidly along a conveyor belt, assembly-line style, where they are individually boxed for shipment after first receiving a careful inspection.

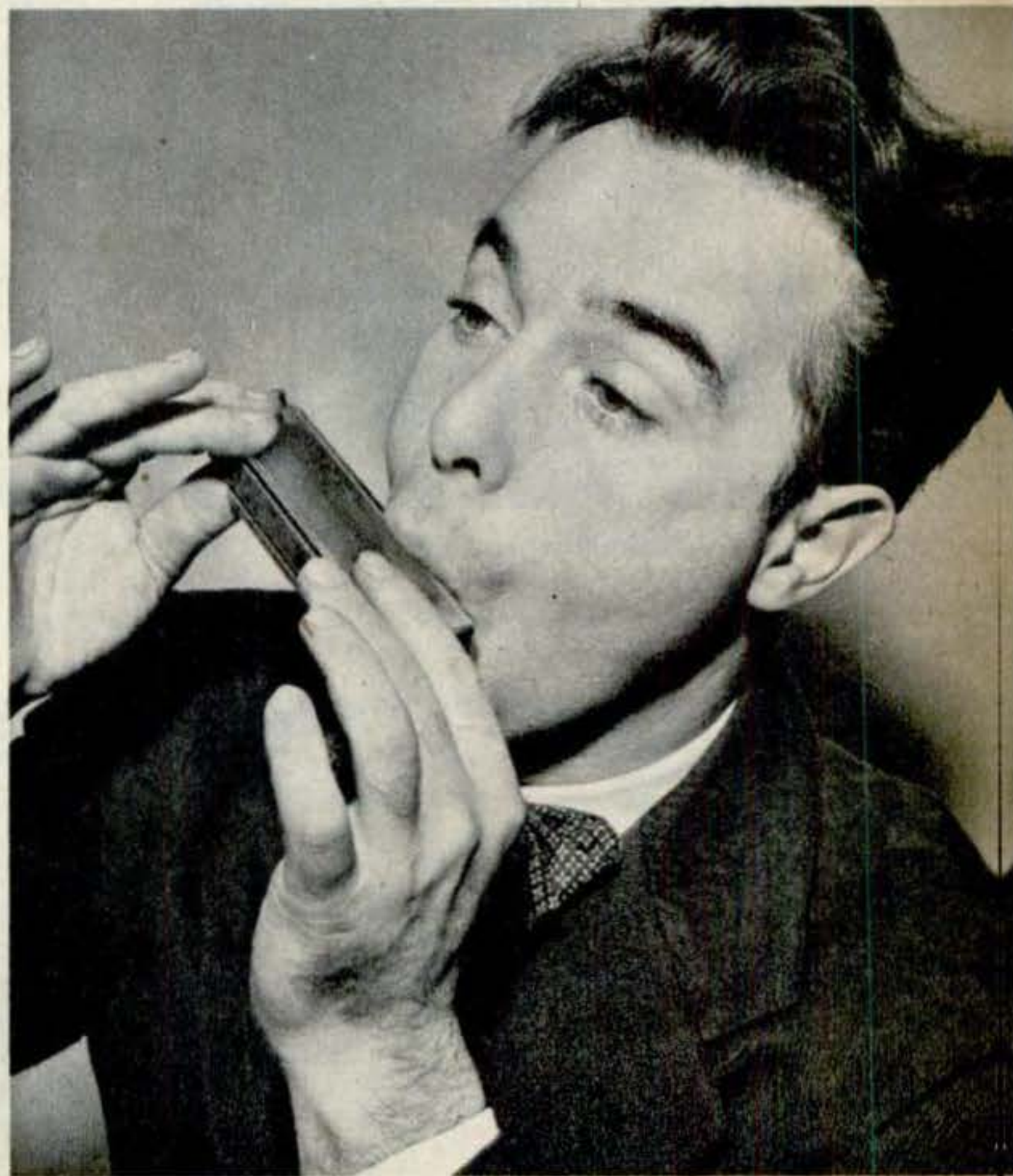

7. Once a plaything, the harmonica is now making appearances at Carnegie Hall. Experts like John Sebastian (above) can play boogie-woogie or symphony with equal ease.

Air Medals

THE medals that commemorate the heroic achievements of aviation's pioneers are, in themselves, a history of mankind's triumphs in the air. Here are seven such flight medals that have been donated to the collection of the Institute of the Aeronautical Sciences. They were conferred by Congress upon the airmen who made or led historic flights.



Howard Hughes received this award in 1941. Holder of many speed records, he and four companions flew around the world in 1938 in 3 days, 19 hours.



This Congressional medal was only one of many decorations won by Charles A. Lindbergh for his nonstop New York-Paris flight on May 20, 1927.



Lincoln Ellsworth was honored for his 1935 Antarctic flight, when he claimed land for U. S.



Orville and Wilbur Wright flew in 1903, but Congress did not recognize the feat until 1909.



Members of the first Byrd Antarctic Expedition in 1928 won this award for their exploits.



Roald Amundsen was cited for his part in the first successful transpolar flight, made with Ellsworth and General Nobile in the Italian dirigible *Norge*.



U. S. Navy seaplane NC-4 was the first craft to fly the Atlantic, in 1919. Comdr. (now Admiral) John Towers and other crew members got this medal.



Second Jet Bomber

THE Consolidated Vultee XB-46, called the fastest of its type ever made in the

U. S., is the second four-jet medium bomber built for the AAF. It resembles the North American XB-45, but is bigger: 105 feet nine inches long; wing span, 113 feet.

Solo Trainers Aid Flying Wing Pilots

THREE twin-engine Northrop N9Ms are being used by the AAF to train pilots for the big four-engine XB-35 and its eight-jet-engine counterpart, the YB-49. The single-place N9M, which has a 60-foot span, is powered by two 290-horsepower CGS-4 Menasco engines. In the photo at right the aircraft is shown in flight; below, a pilot gets some take-off tips.



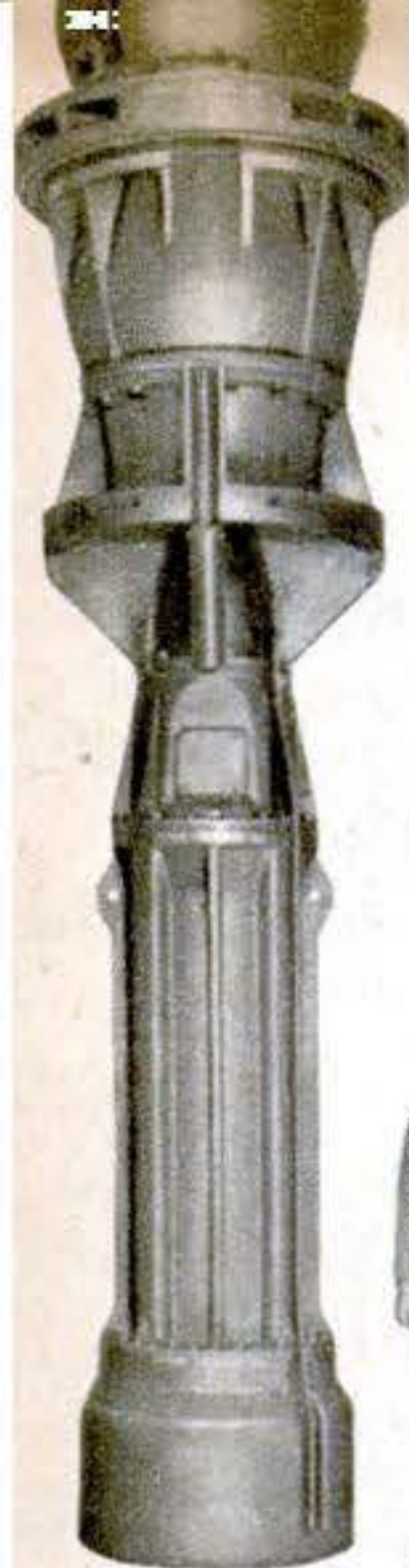

Detailed cutaway view at right shows the working parts of the pump's steel-encased, oil-sealed electric motor. The submersible pumps may carry as many as 36 turbine blades, turn at rates up to 3,600 r.p.m. and raise fluids from depths as great as 1,500 feet. The man standing beside one of the larger models, at left, shows its height and massiveness.



Versatile Pump Works Under Water

THIS whirling dervish is a giant industrial pump that carries its own power supply and is constructed to function efficiently even when completely submerged. Designed to pump both liquids and gases, its built-in, oil-sealed electric motor makes a long drive shaft unnecessary.

Developed by J. B. Van Horn, engineer for the Byron Jackson Co., of Los Angeles, the submersible pump has found wide use in such varied operations as fighting fires at sea, emptying damaged compartments in ships, draining flooded mine shafts, emptying drydocks, supplying water to cities and delivering volatile hydrocarbon products through refinery pipes.

Smallest models deliver only 7½ hp. and handle 25 gallons a minute, while the largest develop up to 350 hp. and can pump as many as 20,000 gallons a minute. Since the pump wastes no energy turning a shaft, it can operate at twice the depth at which ordinary pumps can work. In Arizona, the Miami Copper Company gets its water supply from a 1,200-foot shaft with a single pump 30 feet long.

To make the pump submersible, its motor is enclosed in a steel case filled with a highly refined, water-impervious oil. A mercury seal prevents leakage at the top.

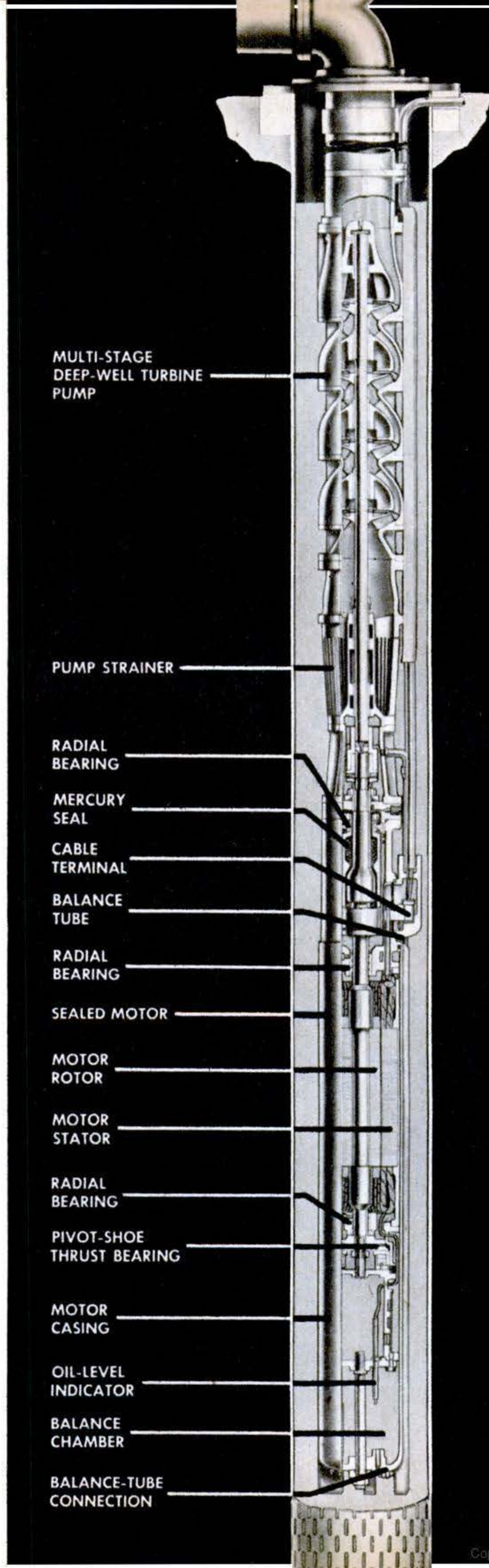

Everybody has his own pet idea of some gadget he would like to see in general use. What is YOURS? *Popular Science Monthly* will pay five dollars for every such suggestion that its editors decide to publish. Suggestions cannot be acknowledged or returned.

I'd like to see them make

Cartoons by SYD LANDI



Push-pedal Doors. Ones that would open at the touch of the toe would be a good idea, thinks Roy Myer, of Saugerties, N. Y. But what about unlocking them?



Roadside Sockets. For hungry motorists on long trips, Idamae Burati, of Newark, Del., would like to see coin-operated electric outlets installed on main roads.



Keep-heat Eat-aids. Hard-at-work husbands could enjoy hot home cooking if lunchboxes were like vacuum bottles, says Maurine Clements, of Lee's Summit, Mo.



No-lick Stamps. To spare tongue and taste a lot of torment, William Bunch, of Lakeville, Ind., suggests self-sticking postage stamps made in rolls like Scotch tape.



Two-in-one Eat-seat. A folding chair whose back raises to form a table would keep ants from the picnic food, declares Russell McGehee, of Nashville, Tenn.



Convertible Shoes. Interchangeable heels of different heights for women could make one pair of shoes suit various occasions, writes Ethel Geller, of Brooklyn.

Mapping the Milky Way

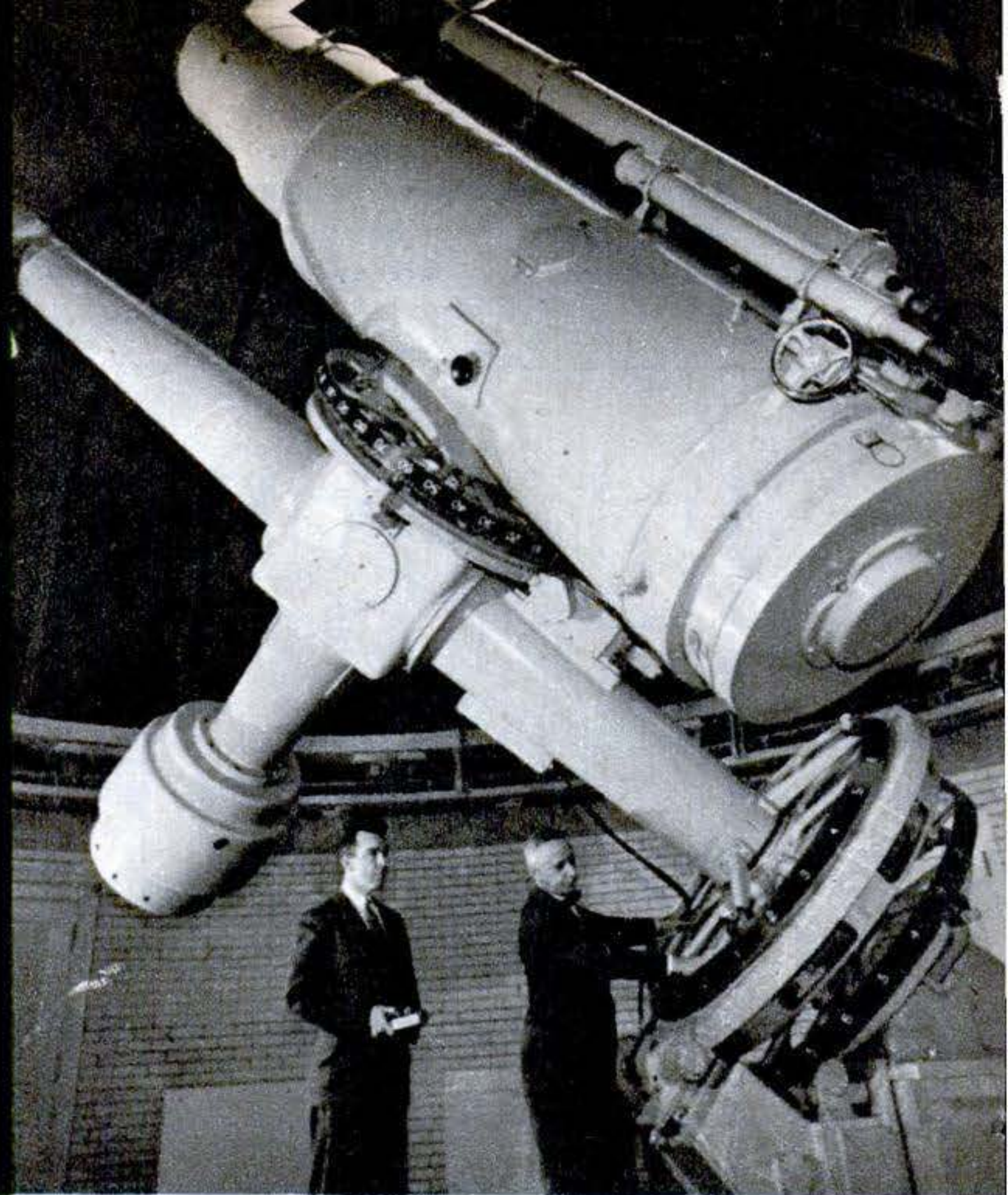

Dr. Jason J. Nassau, right, director of the Warner and Swasey Observatory, Case School of Applied Science, Cleveland, with a Schmidt telescope. It can record stars of less than 13th magnitude.



THESSE shining little rainbows are clues. Each is the spectrum of a star—its signature in light. From them, astronomers hope to wrest the secrets of the Milky Way.

For the Milky Way is no haphazard streak of stars, but the island universe—supergalaxy—of which our sun is a minor member. It is roughly disk-shaped; we see it as a band across the sky because we are looking through the disk edgewise from a spot out near the edge.

Is it an old universe, or a young one? The answer may lie in the 100 million others scattered in our range. These run from globular clouds through flattened ellipses and vague spiral shapes to fully developed spirals with long, bent arms whirling through space. These are believed progressive stages of maturity; if we knew our supergalaxy's shape we could tell its stage.

We can't stand off to look at our Milky Way, so we must find its shape the hard way: by charting the distribution of its 200 billion stars by distance, size, temperature and color. This is no one-man job. All around our solar system, space is divided into cubic light-years—tremendous measuring blocks 3,900 billion miles on a side.

Each star must be placed within its block.

If the structure turns out more or less uniform, the Milky Way is probably just a young, disorganized cloud of stars. But if the final map shows long streams of stars with relatively empty lanes between, then we can assume that the Milky Way is a spiral supergalaxy—and getting old.

Almost our only clue is light. Just by looking at a star we can tell its apparent color and its brightness, or magnitude. Breaking its light into a spectrum tells both temperature and true, or absolute, brightness (which distance and intervening obstacles make different from apparent brightness). Each element blazing in a star emits special wave lengths of light that make bright lines on its spectrum. Since elements incandesce differently at different temperatures, the presence of particular lines tells how hot a star is.

These same lines vary in strength according to the absolute brightness of a star. This was discovered by checking near-by stars whose distance could be figured geometrically. Distance plus apparent brightness allowed the absolute brightness to be found and matched to bright-line strength.

With temperature and absolute brightness

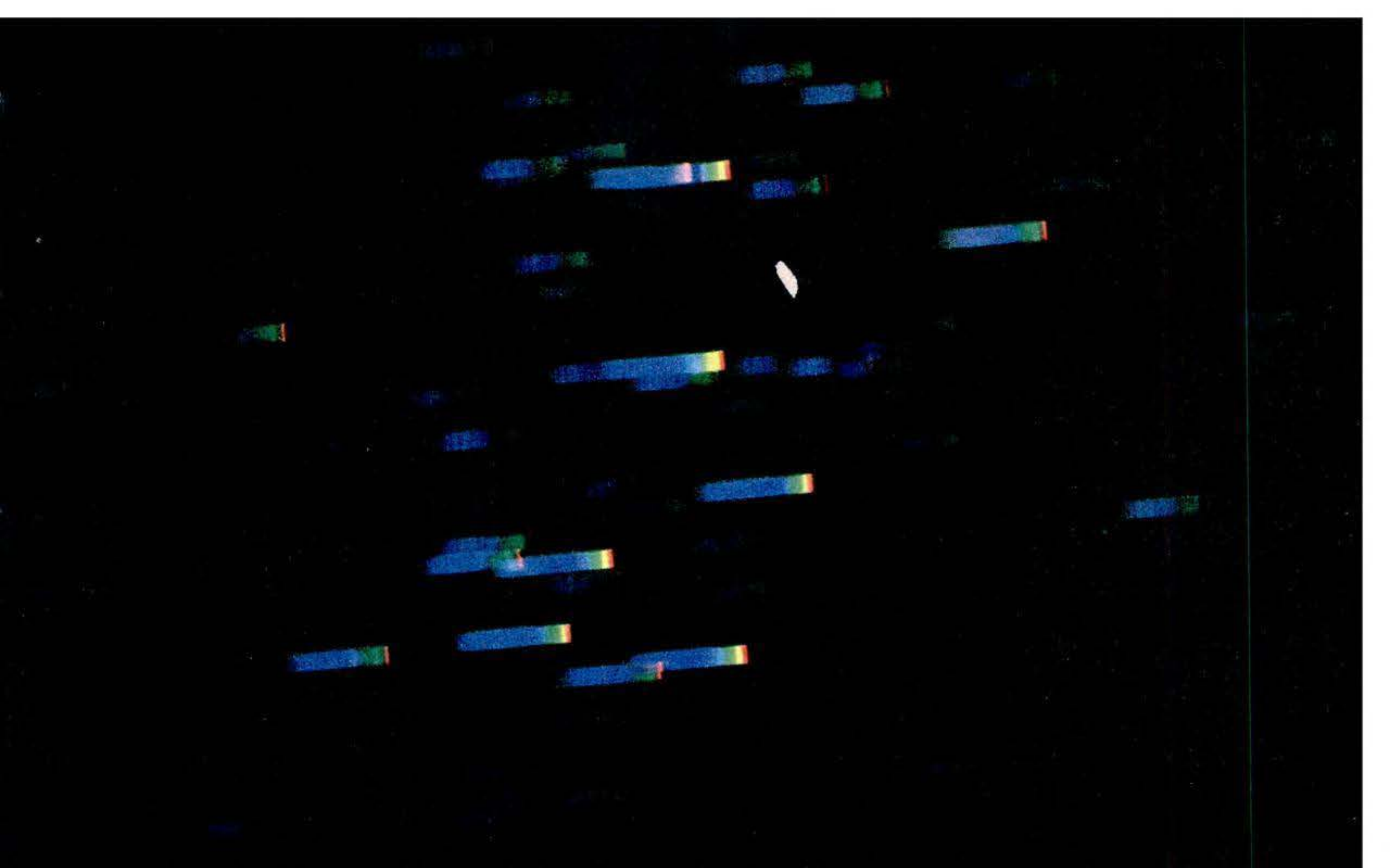

This color photograph of star spectra was made with the Schmidt telescope at the Case School. As many as 3,000 spectra can be recorded on one plate with a 20-minute exposure, thanks to the

light-gathering properties of the telescope. Color photography does not yet give as much information as black and white spectra, but is useful for quick checking of star temperatures.

from the spectrum, and apparent brightness and color from observation, we can deduce the rest. Distance dims a star, so the difference between absolute and apparent brightness tells how far away it is. And since absolute brightness depends on temperature and size, we can tell a star's diameter by how hot and bright it is.

Color of a star depends on its temperature, varying from blue-white (very hot) to dull red (a chilly 2,000°). If the temperatures deduced from color and spectrum are different, then cosmic dust must be filtering out part of the light before it reaches us.

That is what Dr. J. J. Nassau, who took the accompanying color picture, found in the great Cygnus Rift. The stars there are so dim it was once thought to be a "window" looking into empty space. Comparing colors, Dr. Nassau found excessive reddening caused by a great cloud of cosmic dust, starting 20½ million billion miles out. This makes the stars behind it 100 times fainter than they are. Actually, they are pretty evenly distributed; only the uneven screen of dust makes them seem irregular.

To photograph each of the billions of stars in the Milky Way would be an endless task. Thanks to the Schmidt telescope, we can

do it wholesale. The Schmidt, a reflector, covers a wide area, in focus and with plenty of light. The mirror is spherical, removing the "coma" defect that cuts the usable field of ordinary reflectors. Aberration is corrected by a thin lens at the center of curvature. Its image is inaccessible, in front of the mirror, so the Schmidt is used as a camera. With it is teamed the slitless spectroscope. This uses a large, thin prism covering the entire objective to break up the light of many stars at once, instead of just focusing a single one through a slit.

With these improved instruments, astronomers are pushing farther into the Milky Way. Harvard has a five-year plan of Milky Way studies aimed at an accurate map of stars in a 117-million-billion-mile radius. Attention is focused on the center of our supergalaxy, toward Sagittarius. This is overhead in South Africa, so Harvard's Bloemfontein observatory is headquarters for two years of plate making. It is hoped to learn whether the faint red stars in the center clouds are really big, bright giants, highly reddened by a thick cosmic mist, or truly red stars veiled by only a thin haze. Spectra will tell the story—and fill another gap in the Milky Way map. END

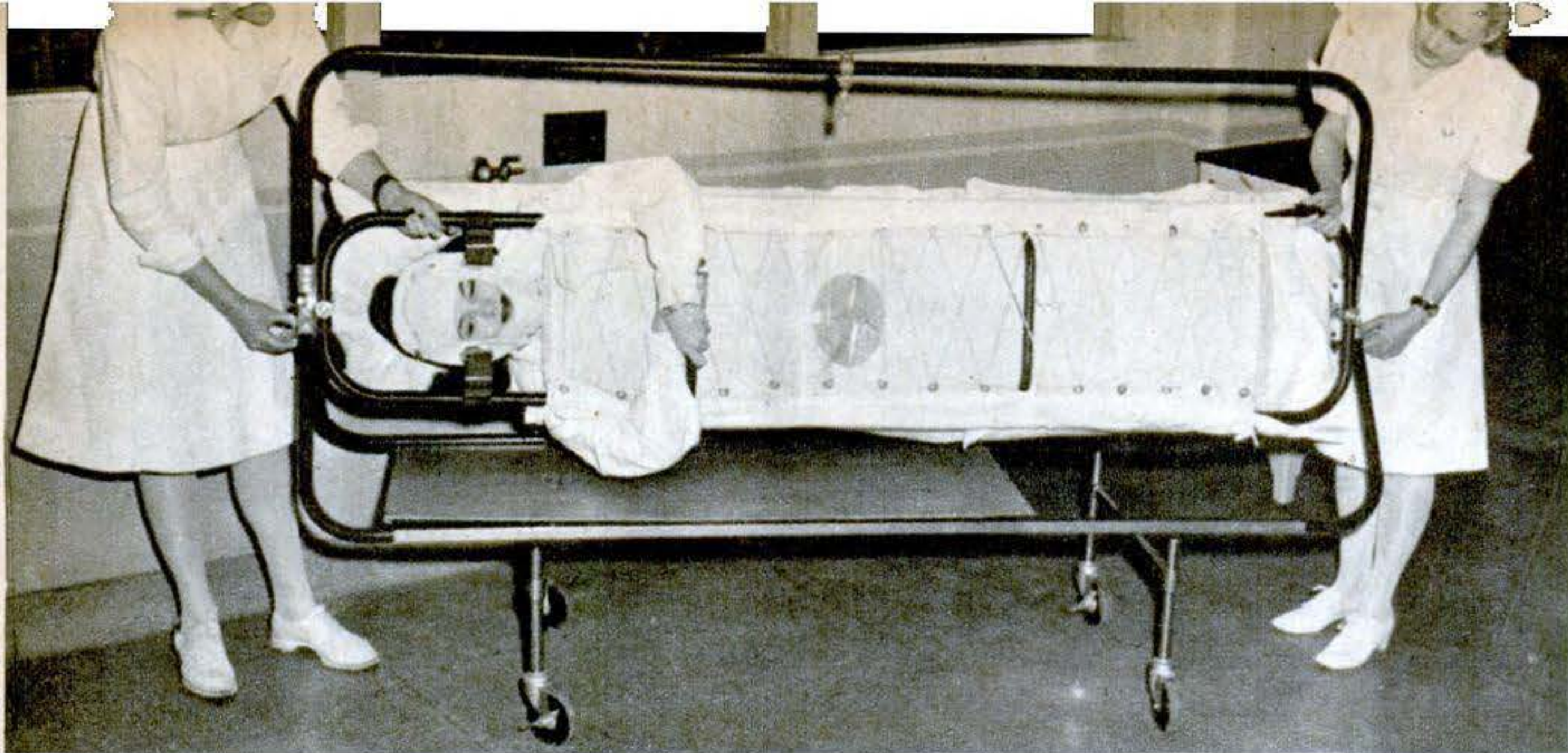

Bed Rolls Over

A "SANDWICH" bed for severe fracture cases, who have to be turned over several times a day, has simplified what used to be a difficult and painful process. The bed has a mattress that rotates within a metal

frame. When a patient lying on his back needs to be turned over, a second mattress is placed on top of him and fastened by wing nuts at the ends of the frame. Then the bed is turned over and the uppermost mattress is removed, leaving the patient lying on his stomach.

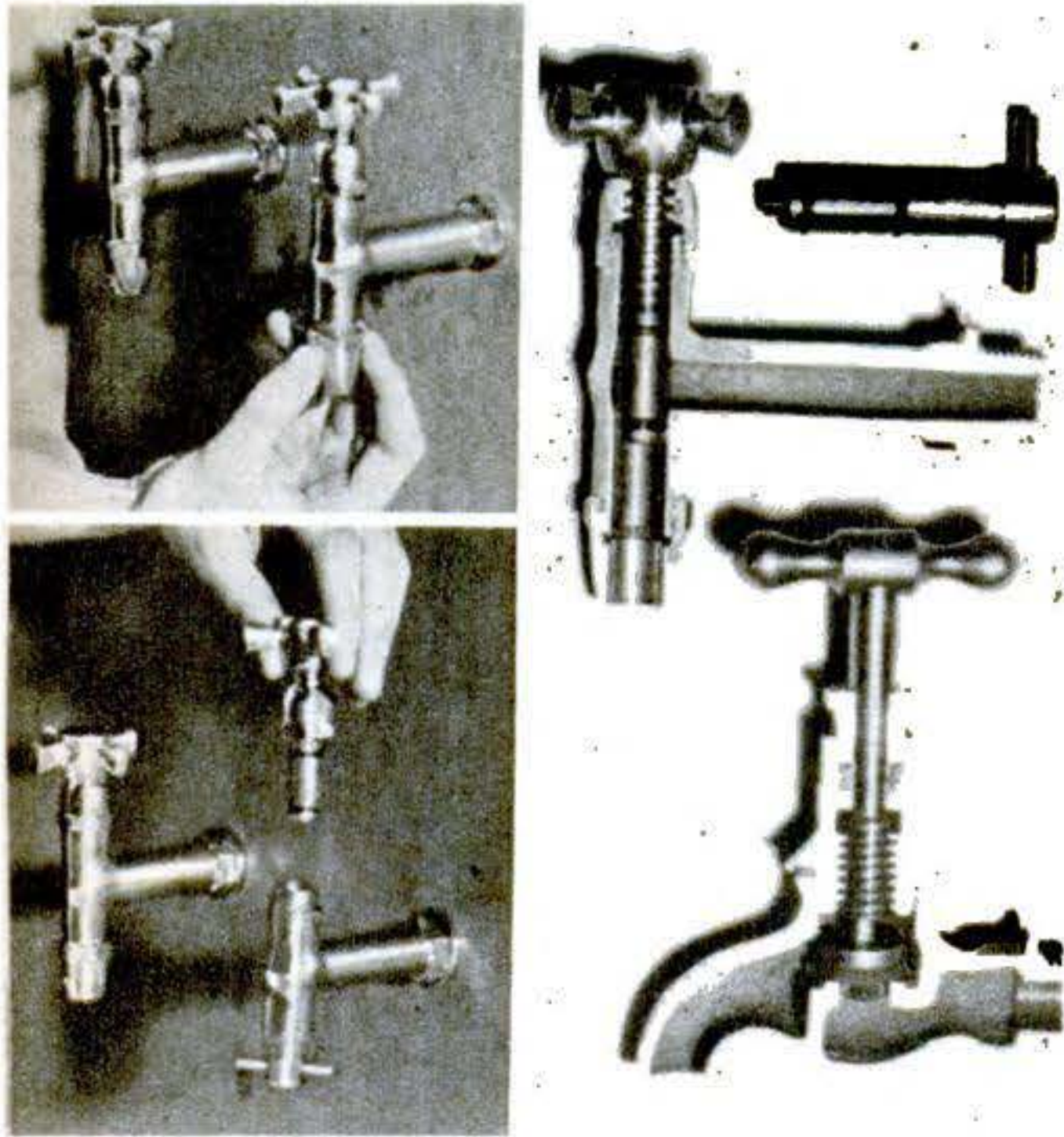

Faucet Doesn't Drip

RESILIENT synthetic washers that can be changed without turning off the water are said to make a British-designed faucet drip-proof. There are two washers instead of the one used in conventional types, and sealing is effected by water pressure. To change washers, the nozzle is removed (top left) and a plug inserted. When the handle and washer assembly are removed (bottom left), the water remains shut off. Cut-aways show how the new faucet (top) differs from the old style.



One-inch Wind Tunnel

THE first of two midget wind tunnels being built at the University of California has a test chamber only one inch wide and $\frac{3}{8}$ inch high, but it will simulate conditions up to 70,000 feet and velocities up to three times that of sound. Shown above during assembly, the tunnel is so small that only bits of flat metal and wire can be used in tests. The second tunnel will have a three-inch chamber, in which tiny scale models of rockets and other craft can be inserted for testing.

Monorail Speeds Air Delivery

THANKS to a monorail, the AAF can now parachute two howitzers in the time one used to require. The rail runs along the plane's cabin roof; the guns or other loads are hitched to it. At the push of a button, the floor door opens, and the load is automatically carried to it and dropped through.

Developed by Fairchild Aviation engineers, the monorail is now under test in a C-82 troop carrier. Fifteen 350-lb. paracans, standard Army containers, can be dropped in eight seconds. Besides this quicker release, pack loading is easier and 50 percent more supplies can be dropped.

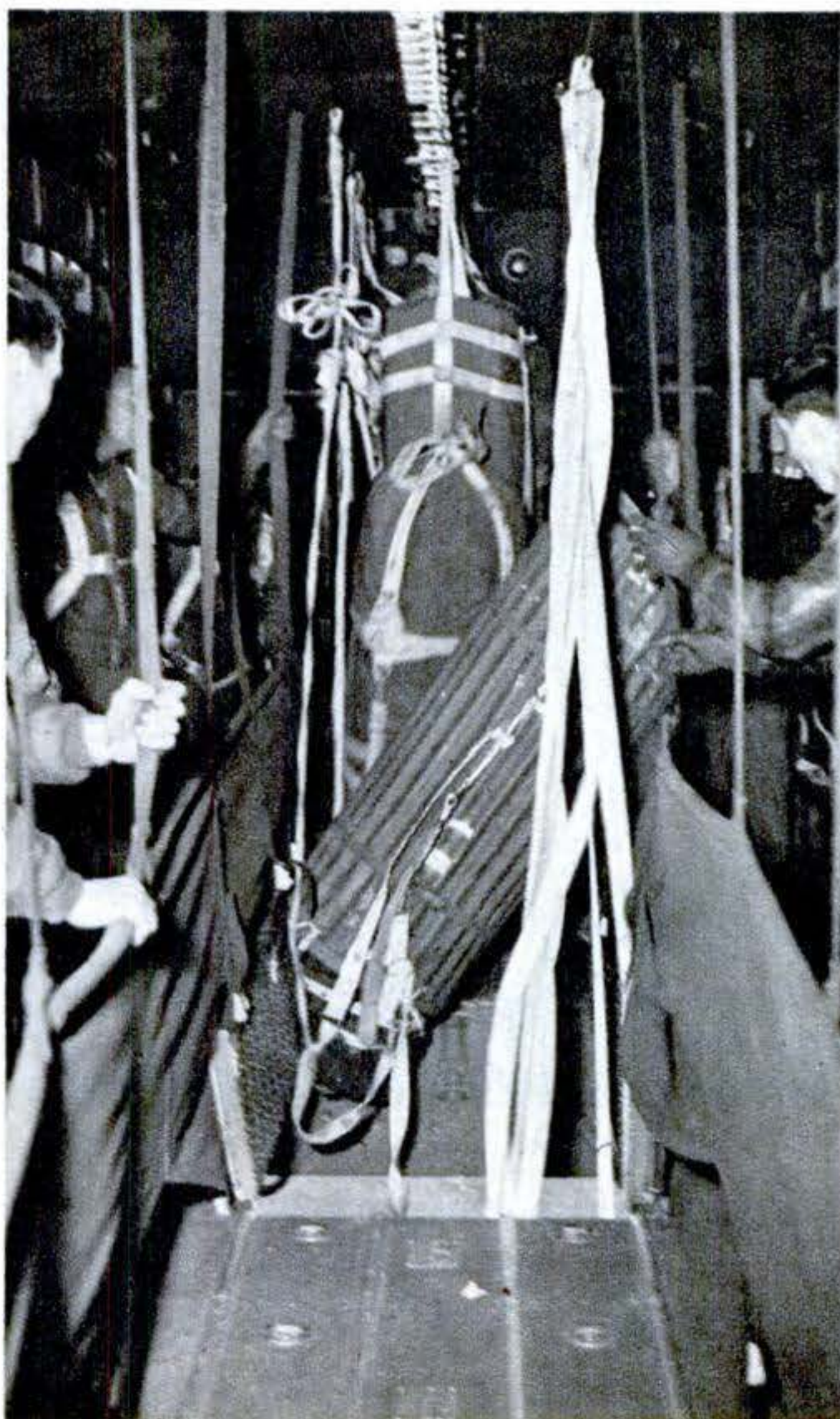

A paracan about to drop through the plane's belly. Others are lined up behind it, ready to go. Static line and rip cords are seen in right foreground.

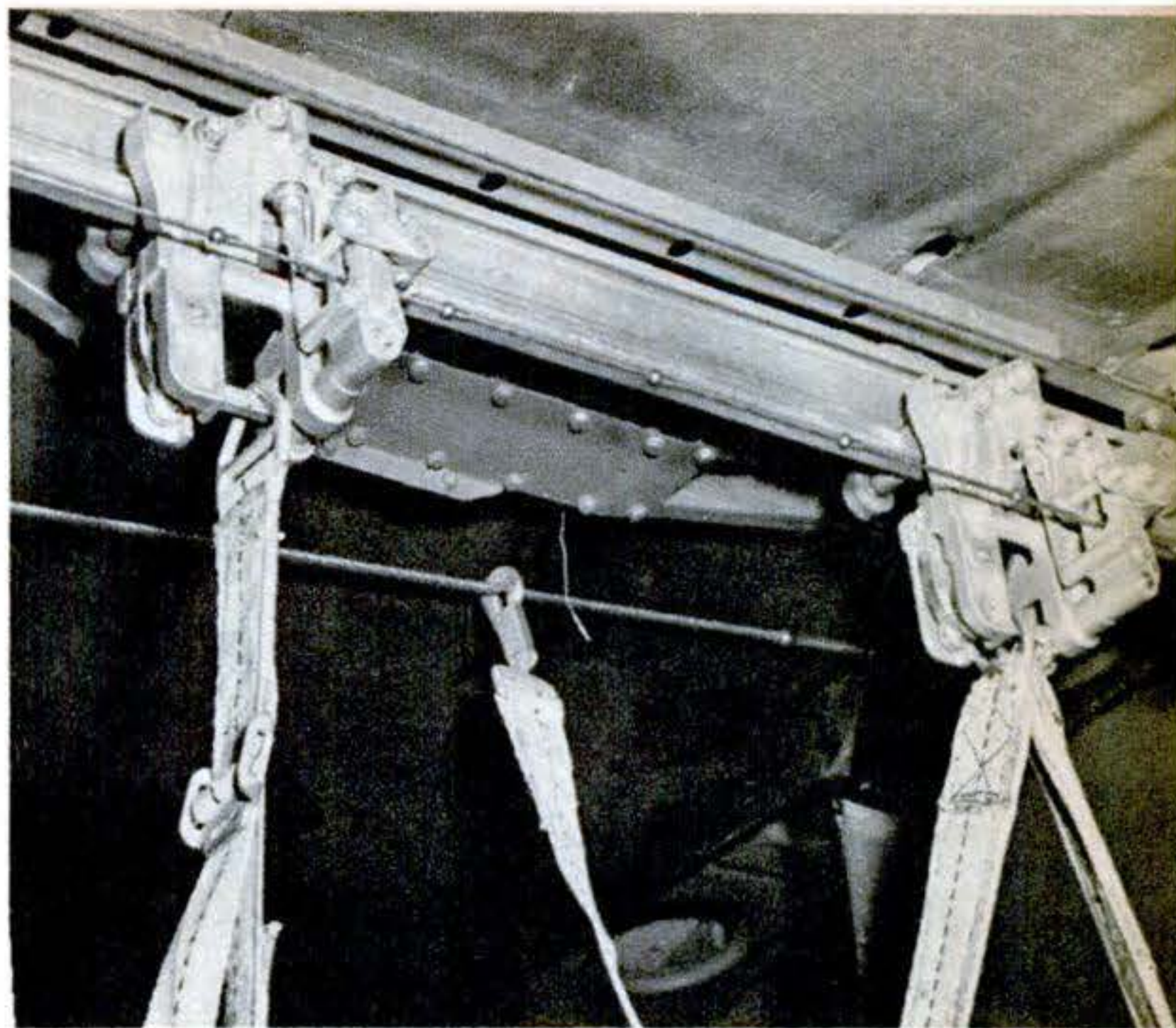

The paracans are hung on trolleys pulled along the aluminum monorail by an electrically driven cable. Wire in background is the static line that trips the parachute of each pack as it leaves the plane.

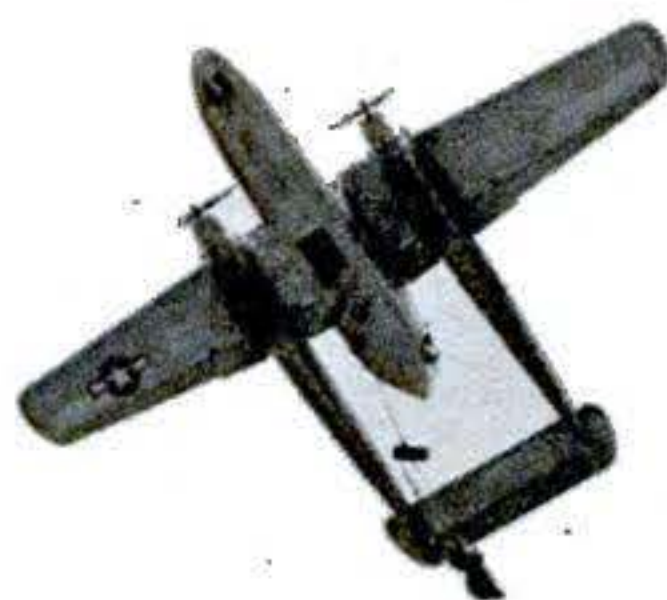

Paracans parachuting down after a monorail drop from a Fairchild C-82 Packet. Loads are connected by webbing so as to land in a tight pattern.

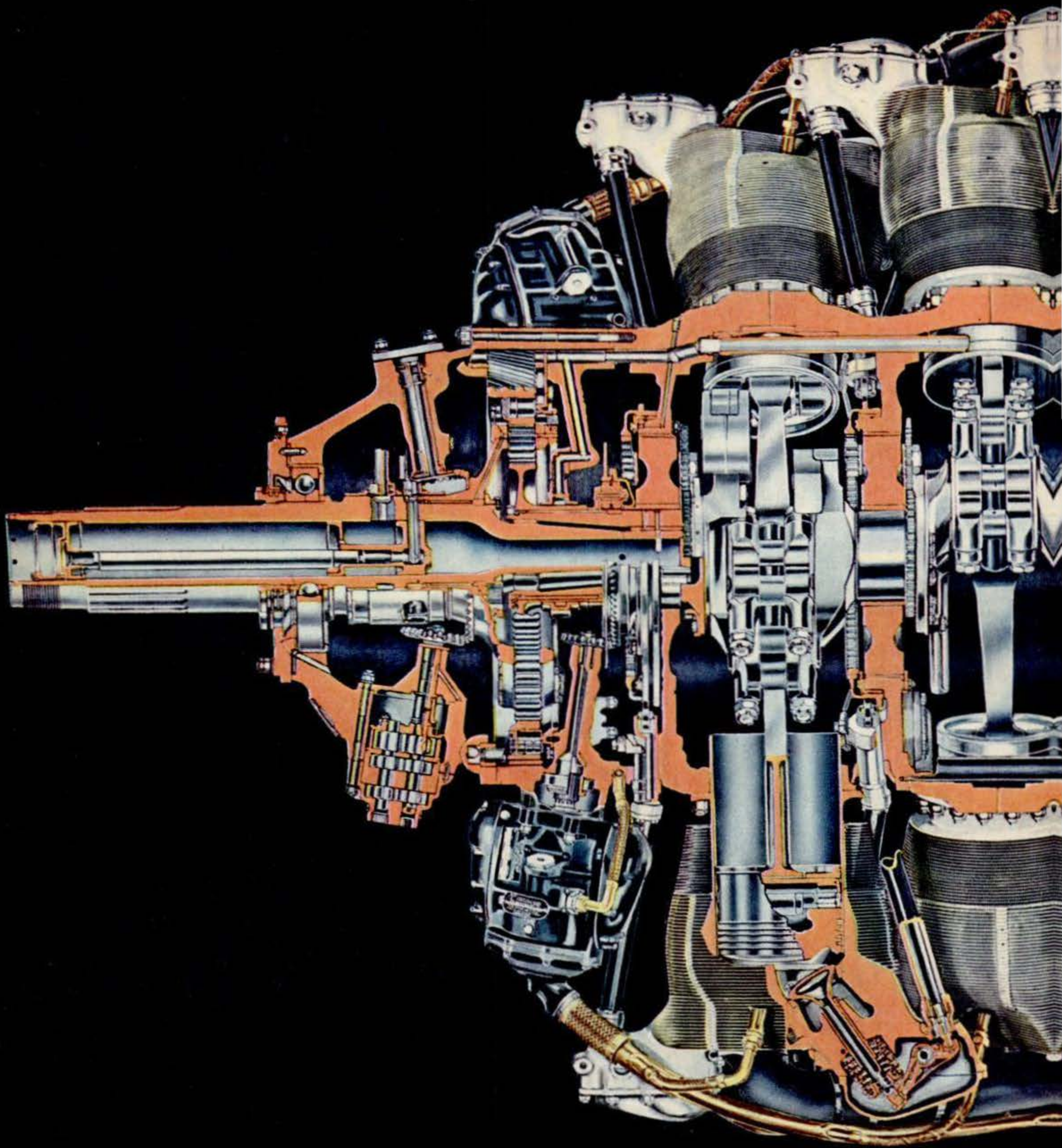

Portrait of 3,500 Horses

HERE is the inside of the Pratt & Whitney Wasp Major, world's most powerful radial, air-cooled, reciprocating aircraft engine. With the rapid advance of turbine power, this may represent one of the last of the mammoth but compact piston-engine types that began gaining favor with the armed services and air lines two decades

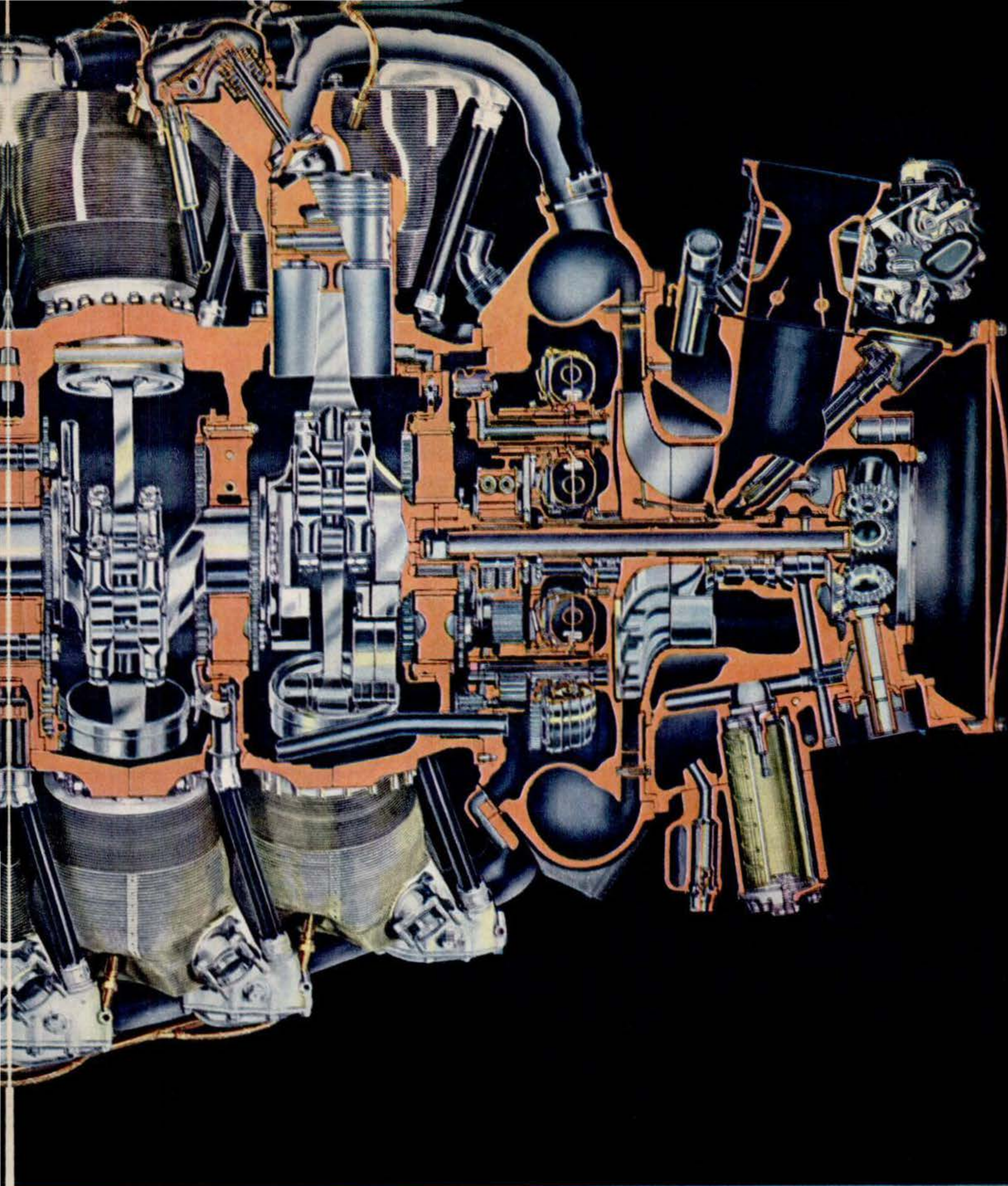

ago. Gradually stepped up from 3,000 to 3,500 horsepower, the Major produces one horsepower per pound of "dry weight." It powers the AAF's six-engine B-36 and will be installed on many of the new high-performance transports.

Crankcase, pistons, bearings, ignition system and elementary parts of the complex

gear train are easy to spot in this cutaway. Less obvious is the fact that each of the seven banks of four cylinders is arranged helically around the crankcase, projecting each cylinder into the baffle-guided air stream for cooling. The engine's reduction gears are located at the left, near the splined shaft that holds the propeller. END



OLD
CAMERA



NEW
CAMERA

A K-30 shot of a Florida beach looks like an enlargement of photo made by a K-18 (focal length, 24 inches).

Close-ups from 5 Miles

THE world's largest aerial camera is giving the Army Air Forces a new kind of bird's-eye view—the kind a bird might get with a telescope. Known as the K-30, the camera is a 575-pound giant with an f/10 lens of 100-inch focal length, designed to give $2\frac{1}{2}$ times more photographic detail from an altitude of 50,000 feet than the largest standard camera now used. The comparative pictures on this page show what

it can do from 26,800 feet—better than five miles.

Big as the K-30 is, however, a combination of optics and ingenuity kept it far smaller than it would be with standard design, which would require a camera 10 feet tall. By using two mirrors to make an angular light path, engineers held the K-30 to a height of four feet and a width of five feet. Light entering the lens is re-



Its draft seal pushed back for a test run, the big lens looks down out of a B-29's forward bomb bay.

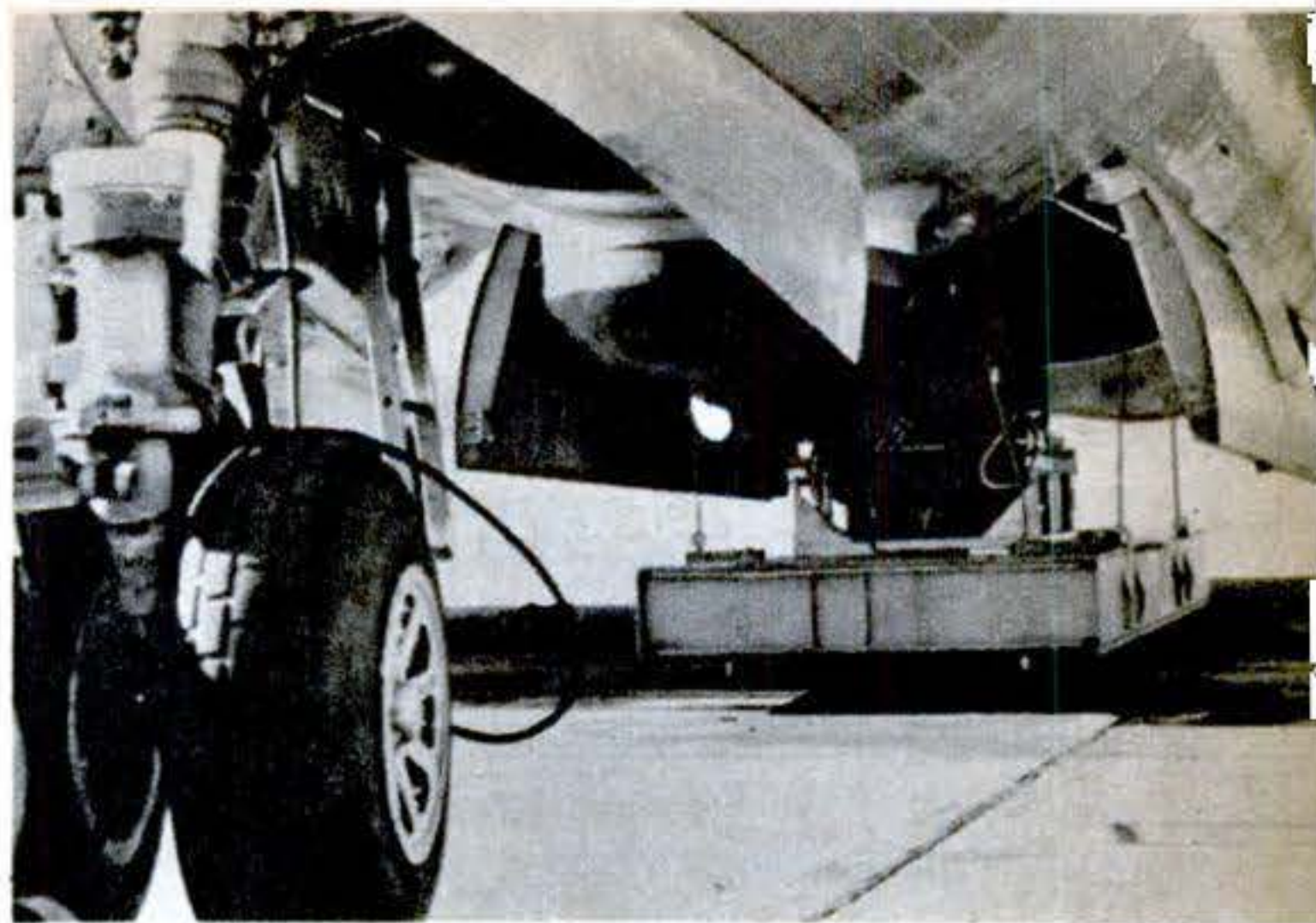

The K-30, shrouded in its protective electric blanket, rises into the bomb bay on a cargo platform.

FILM MAGAZINE

CAMERA BODY

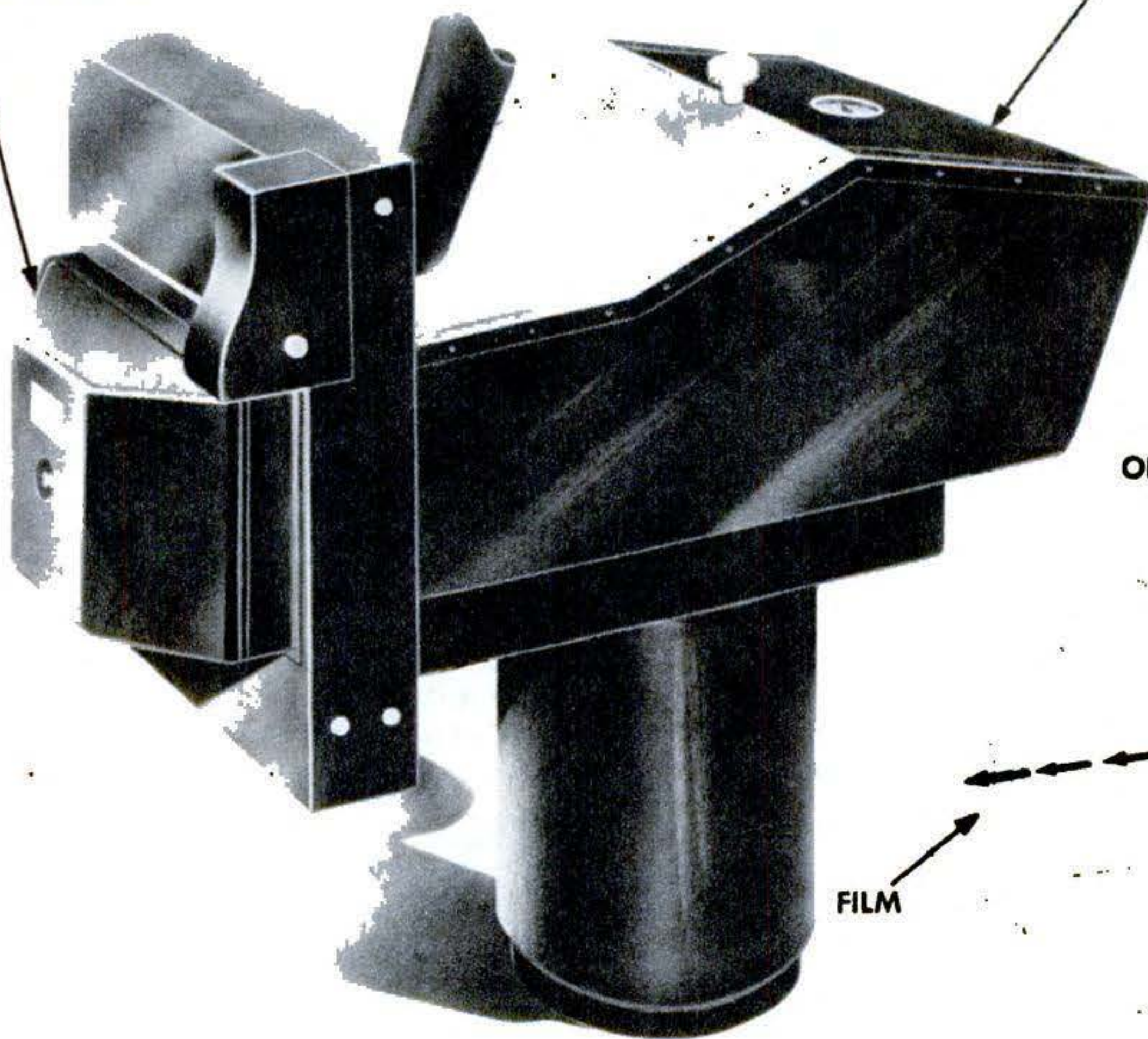

OPTICAL MIRROR

FILM

LENS CONE

LENS

LIGHT RAY

The drawing and diagram illustrate the camera's construction and show its optically compressed light track.

flected from the first mirror to the second, then to the film, compressing the 100-inch track into a figure 4 pattern.

Now being used in high-altitude experiments by the AAF's Photographic Laboratory, the new camera is well equipped for the extremely low temperatures it must meet. It has an interior hot-air circulating system, thermostatically controlled, and a large electrically heated blanket that fits

over the entire outside of the camera and lens barrel.

The K-30 has a focal plane shutter, operating at speeds of 1/100, 1/200 and 1/400 second and produces 9- by 18-inch photographs. Its lens, 10 inches in diameter, was especially designed by Dr. James G. Baker, of the Harvard Observatory, and the camera itself was constructed by the Mount Wilson Observatory.

END

CRAFTWORK

PROJECTS OF THE MONTH

Antiqued Candle Box. Gay designs are painted against a natural pine background, and then antiqued with a thin lacquer glaze to make this box an attractive period piece as well as a convenient place to store candles. Its old-fashioned charm will make it a welcome addition to cabins or cottages where candlelight supplies all or part of the illumination. See page 156 for details.

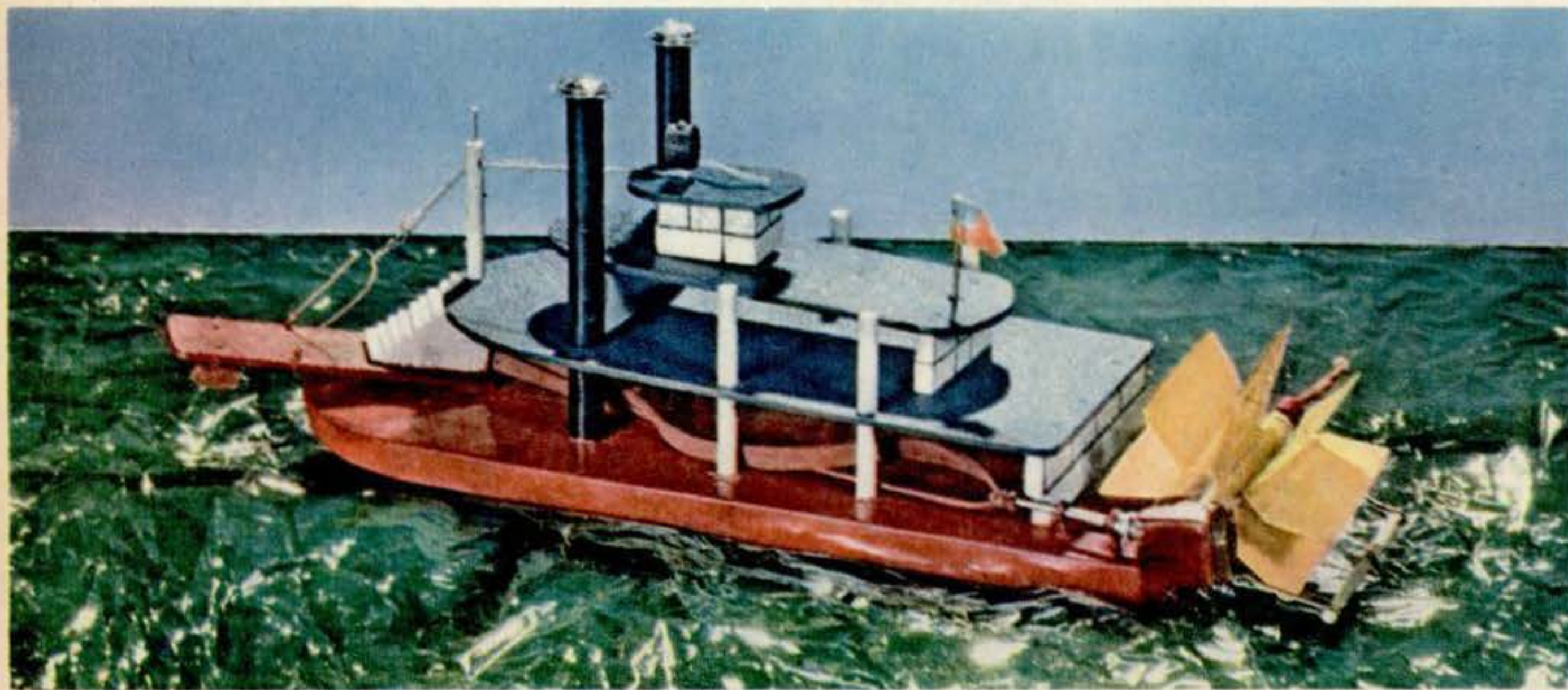

Rubber-band Stern-wheeler. Strips cut from an inner tube provide engine power for this toy model of an old river boat. A light tug on a string releases

the wheel; the string follows the boat and is used to retrieve it when it has run its course. Full construction notes and other photos appear on page 151.



Car-top Catamaran. Canvas-covered pontoons bear this craft smoothly through the water. A sliding, scull-type

seat adds leg power to the rower's stroke. It's easily built and quickly knocked down for carrying. Plans are on page 168.

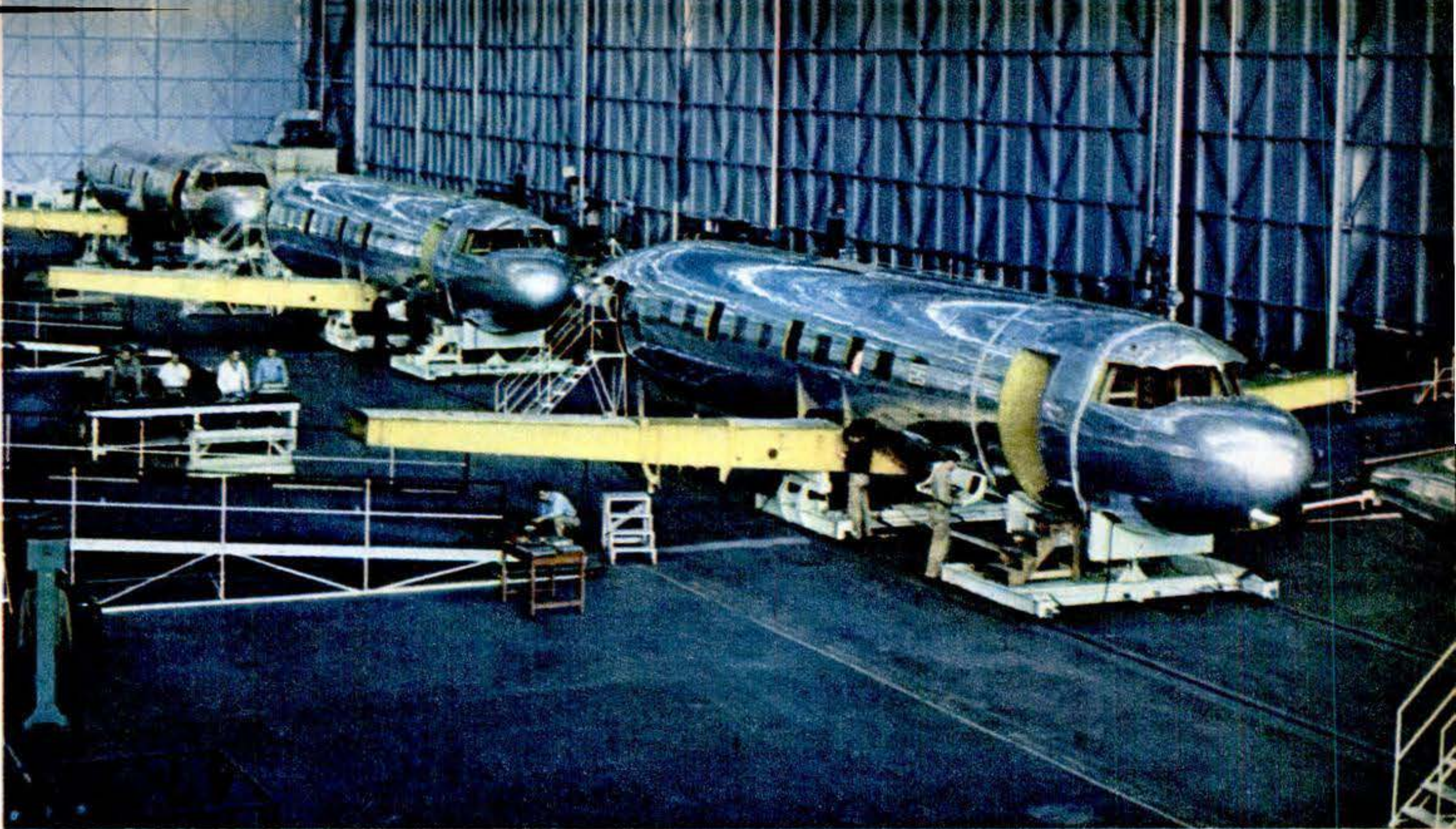

The 40-passenger Consolidated Vultee liners, in various stages of construction, roll along the assembly line.

How Air Liners Grow

IT TOOK a war for the aircraft makers to match the auto industry's assembly-line technique, but now peacetime transports are rolling off. The Convair-240, a new 300-m.p.h., twin-engine transport, is constructed of parts so standardized and interchangeable that a dozen planes could be taken apart, scrambled, and reassembled without a single misfit.

The plane's 18 major components are first constructed on permanent, precision-built fixtures and are then brought together for rapid, mass-production assembly. Results: lower cost of production, easier maintenance, faster and more efficient repair.

A master plan of assembly was first laid out, providing for production at the rate of one air liner a day.

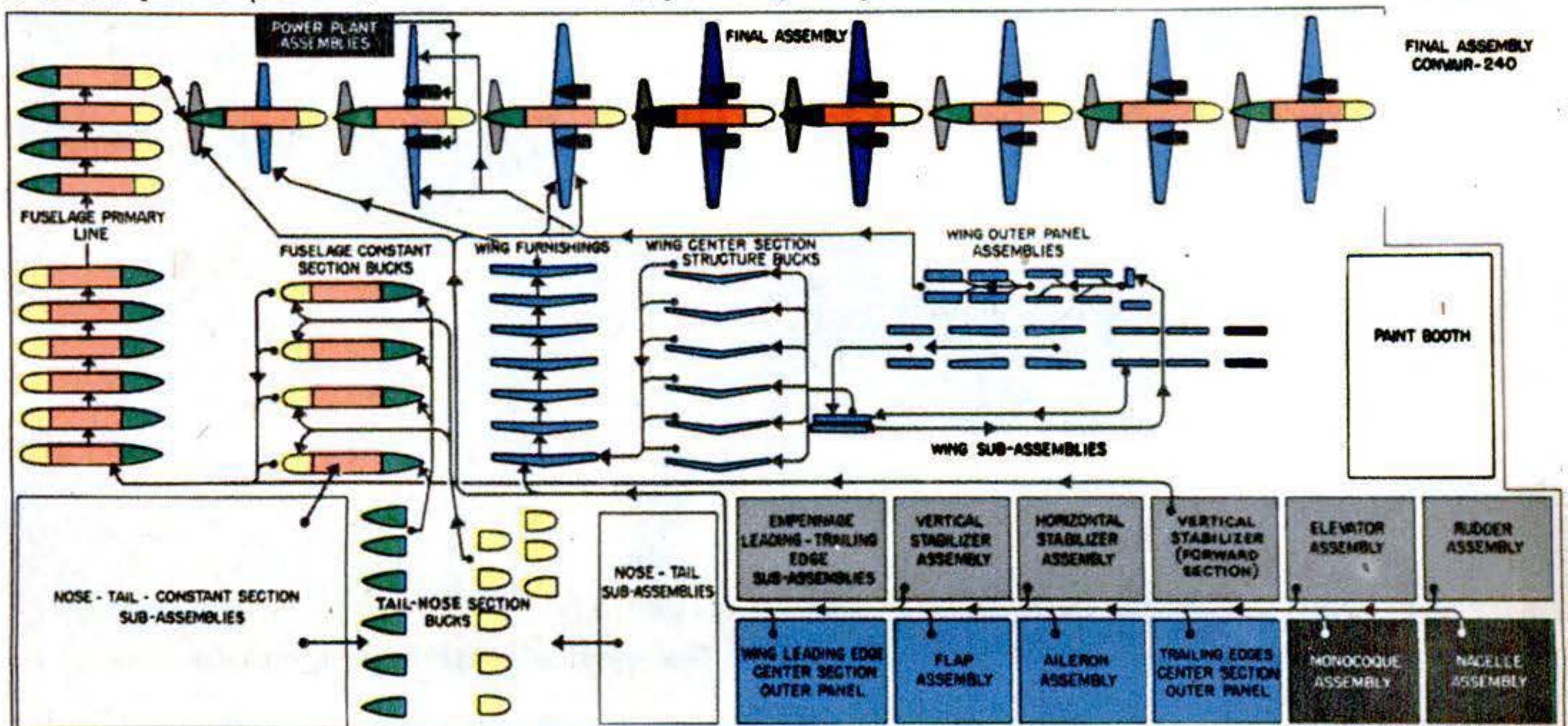

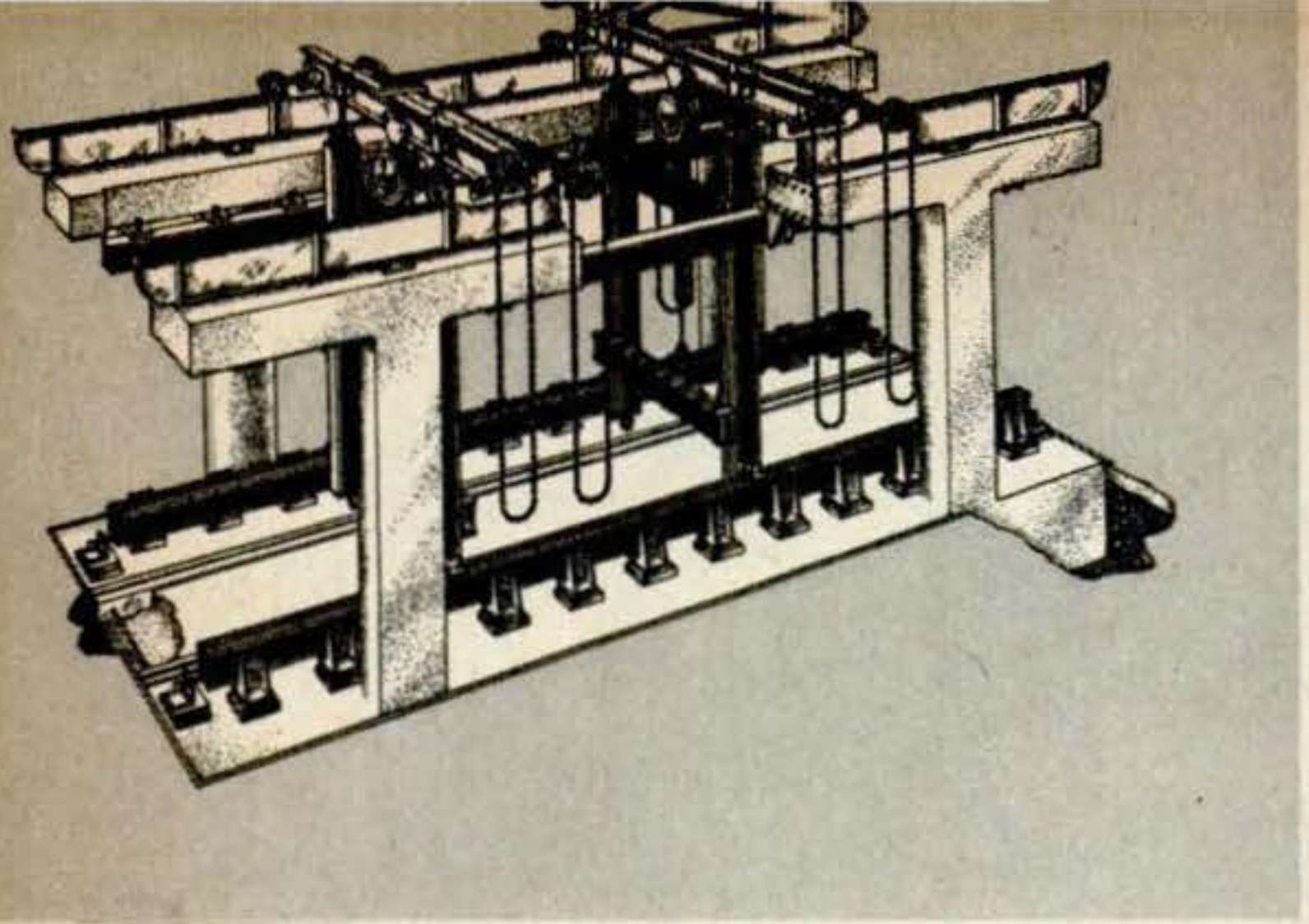

Accurate to $2/1,000$ inch, this tooling dock provides precision checking and duplication of fixtures on which parts for the planes are formed.

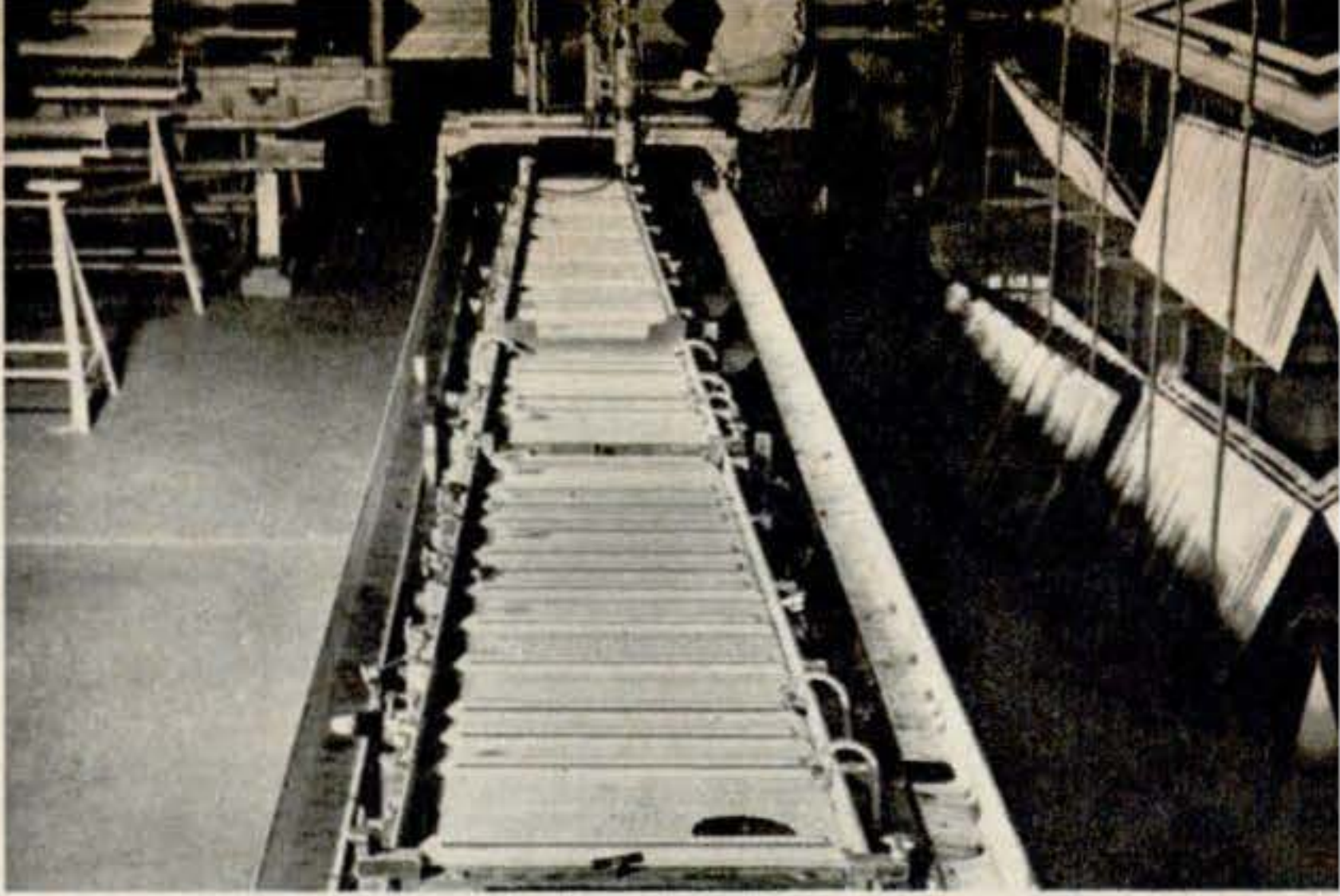

On long fixtures like the one above, the wing center section spar is assembled. The two side girders form a track for the drill shown in the background.

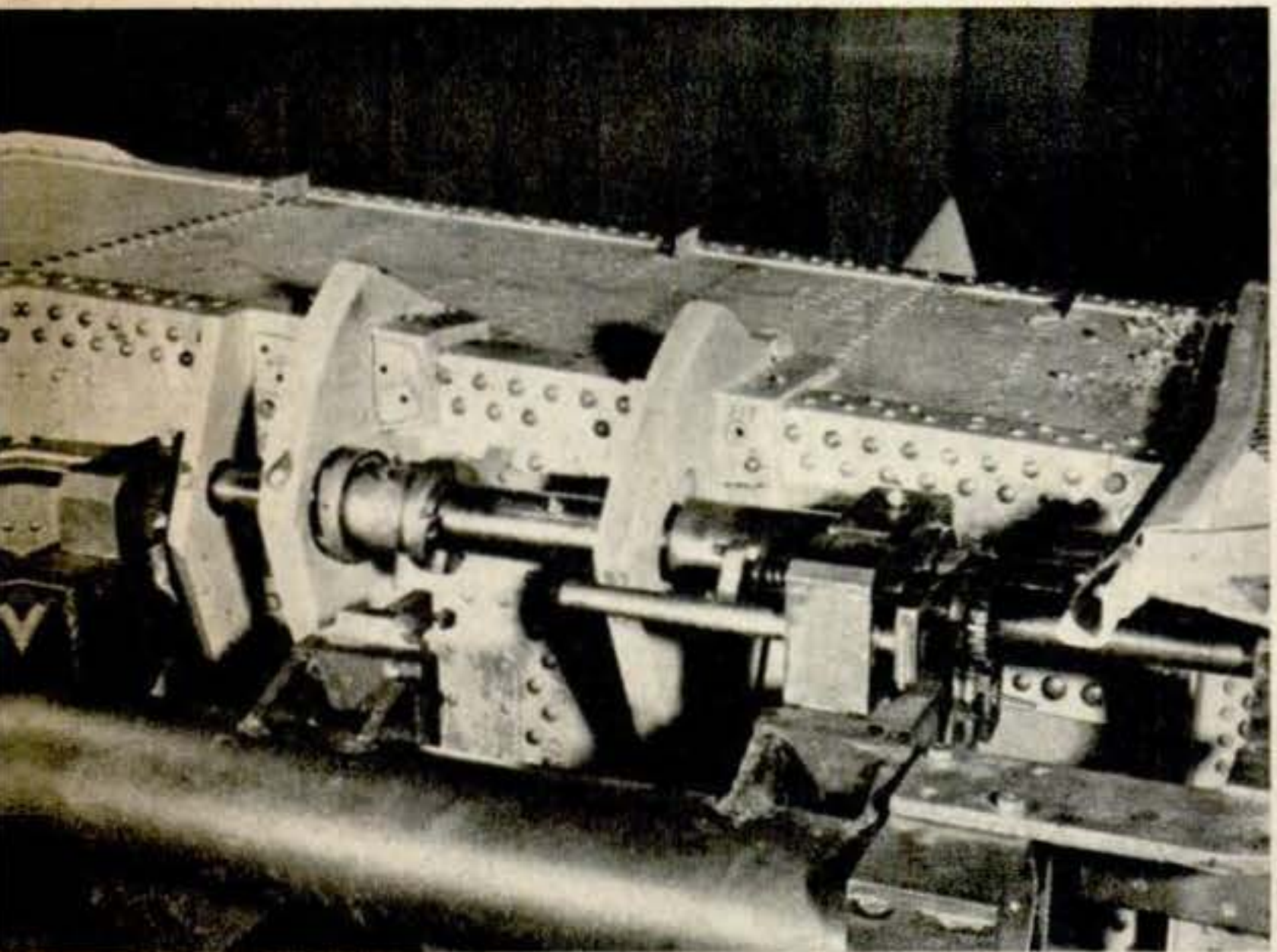

Another wing section fixture locates boring, reaming and other machinery used in fashioning the landing gear and drag-link attachments.

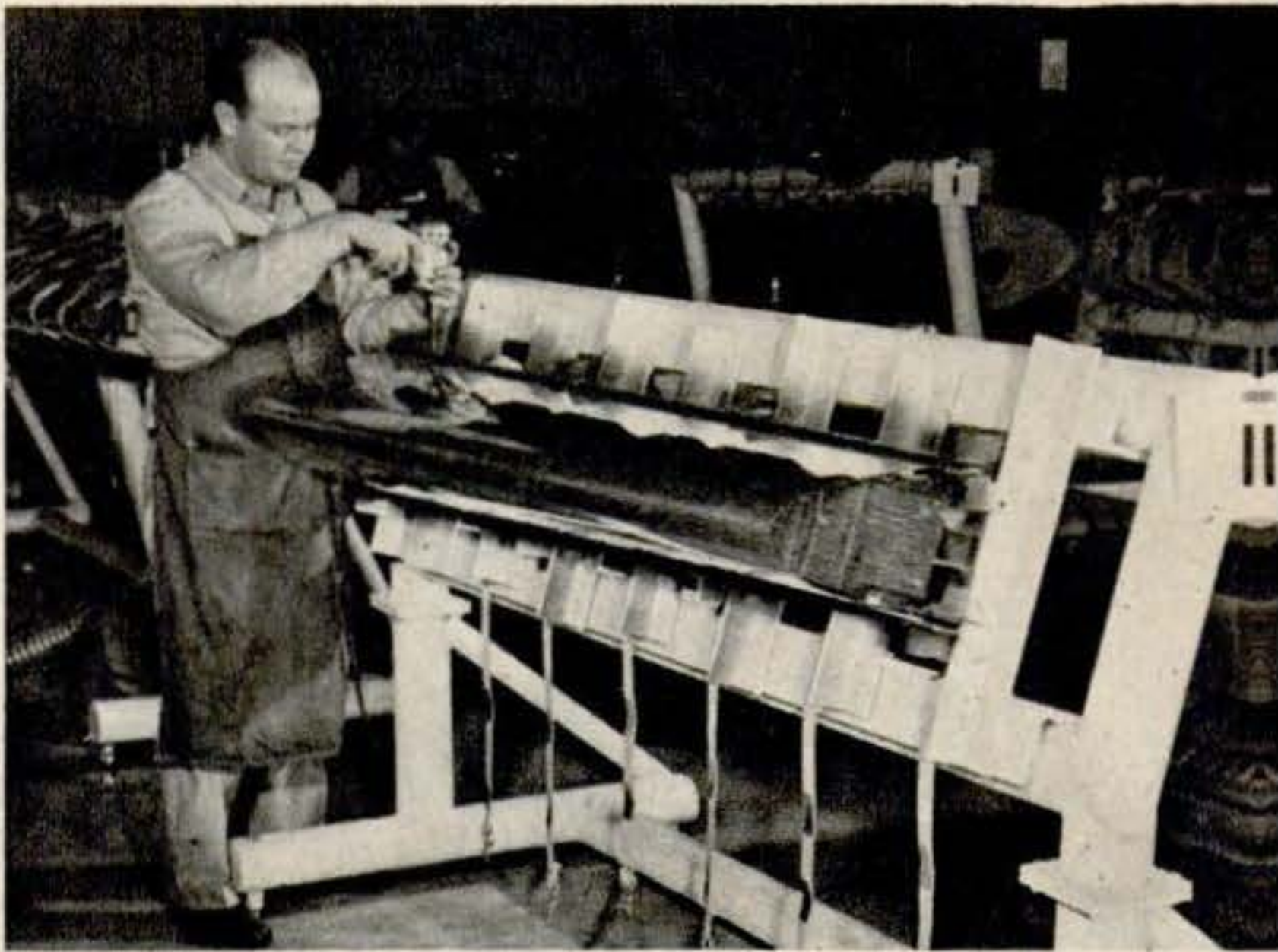

Wing edges are assembled on frames formed of heavy pipe and mounted at a 15° angle. Tooling holes locate ribs and insure interchangeability.

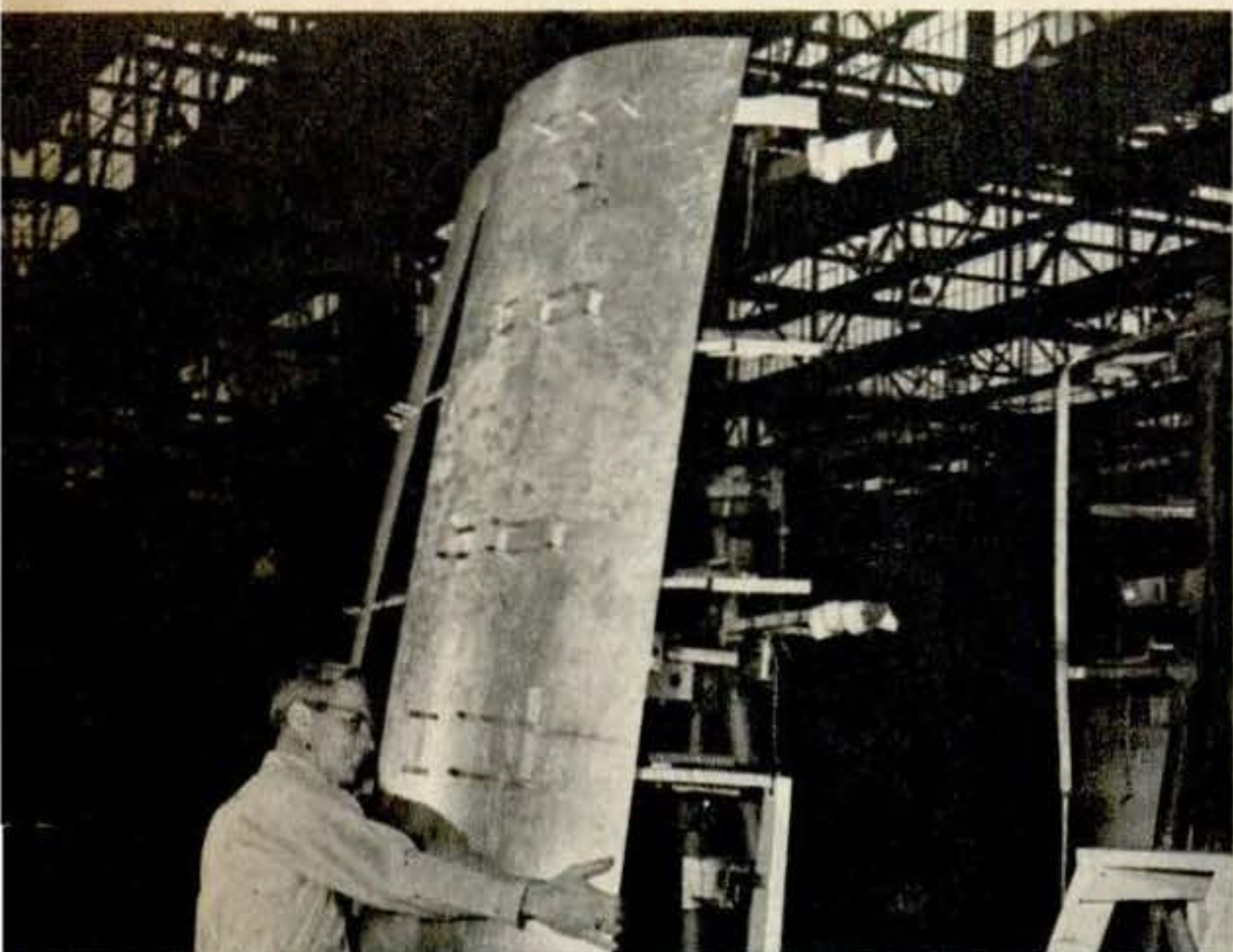

The upper nacelle assembly fixture is built in a vertical position to provide greater accessibility. Nacelle after-body must match wing contours.

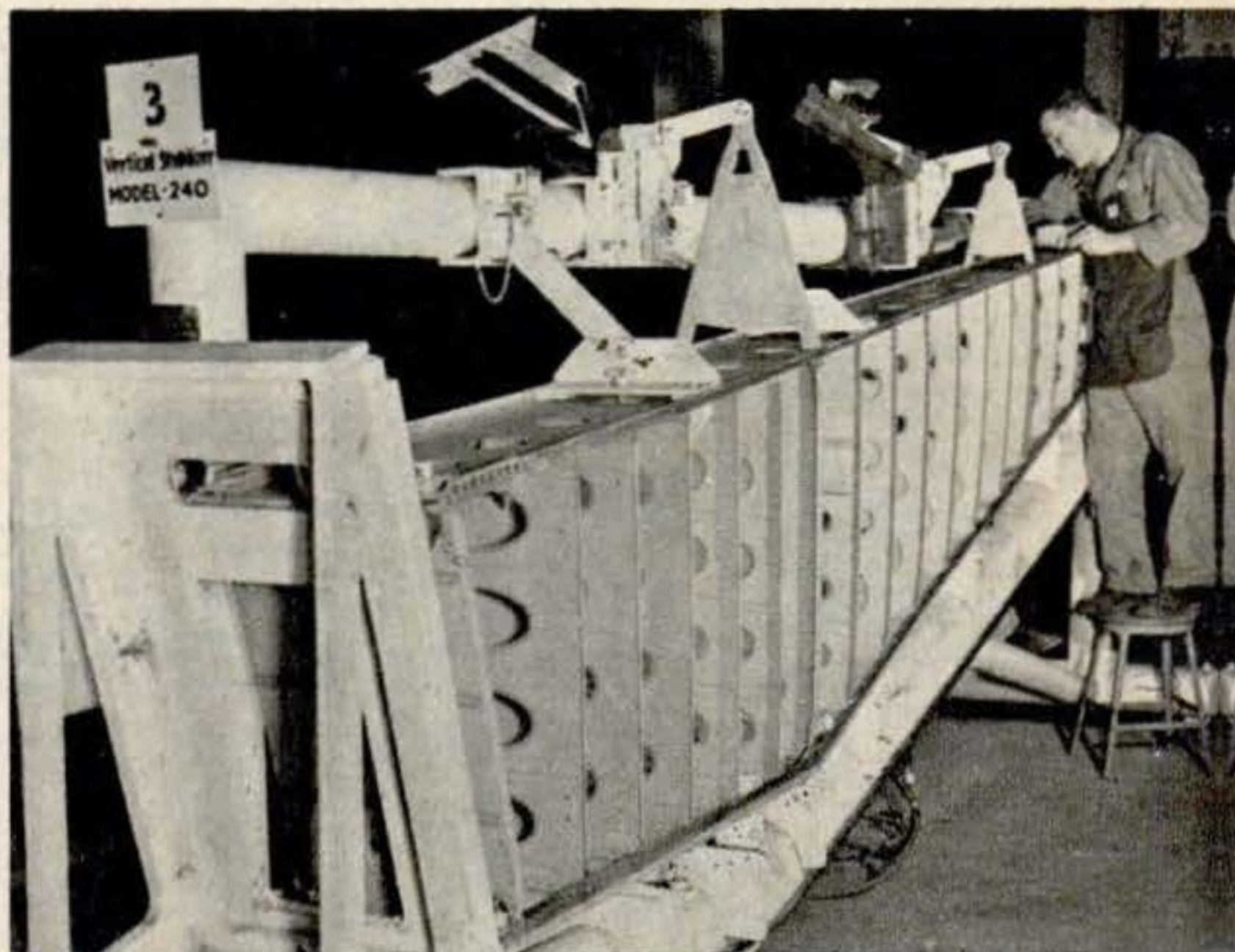

The vertical stabilizer is assembled on its side in a picture-frame type of fixture. Dummy fittings simulate tail mounting on which stabilizer is fitted.

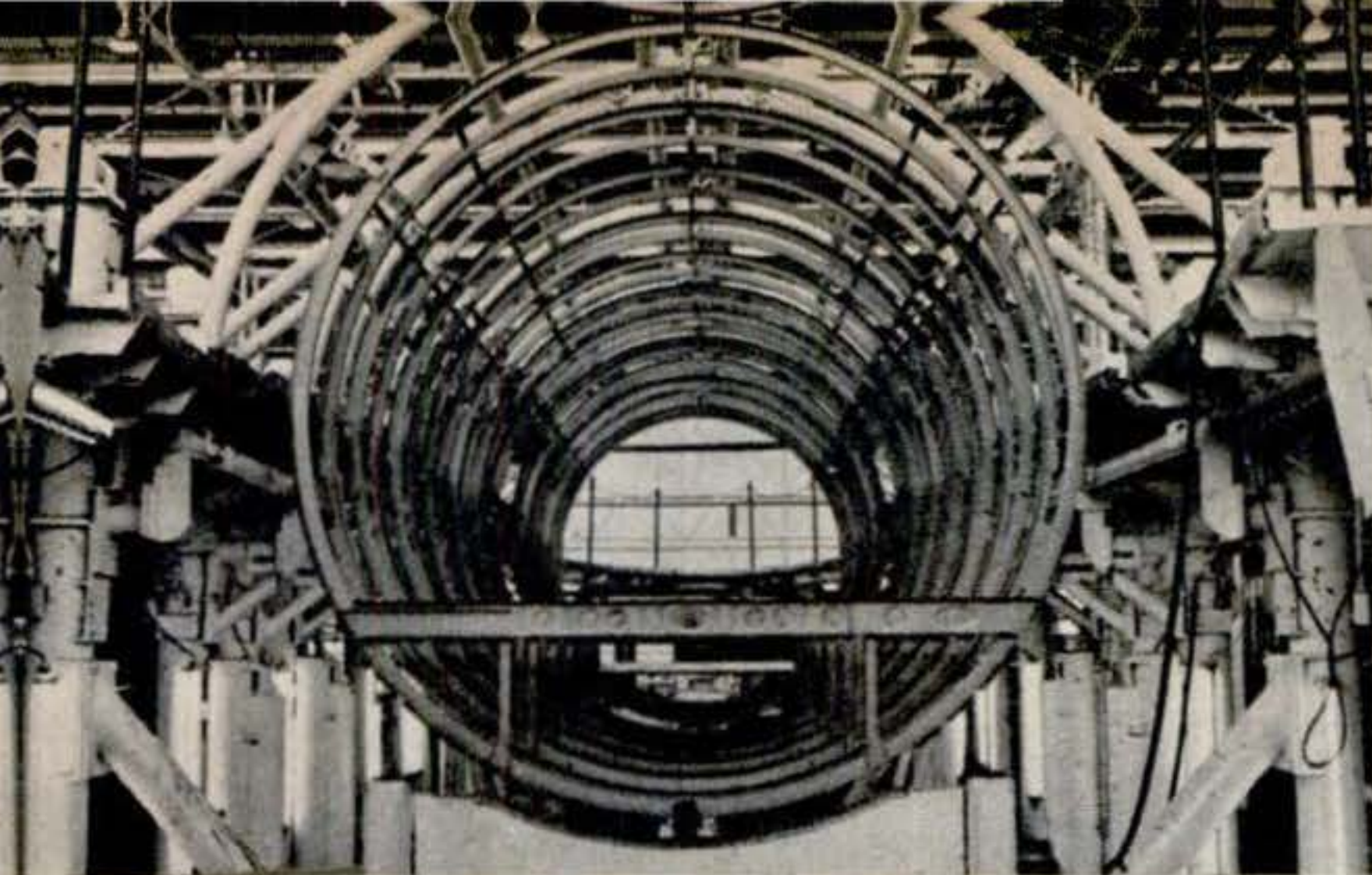

A massive, skeletonlike structure is used to form fuselage and fasten on the nose and tail sections. Full length of fuselage is 74 feet eight inches.

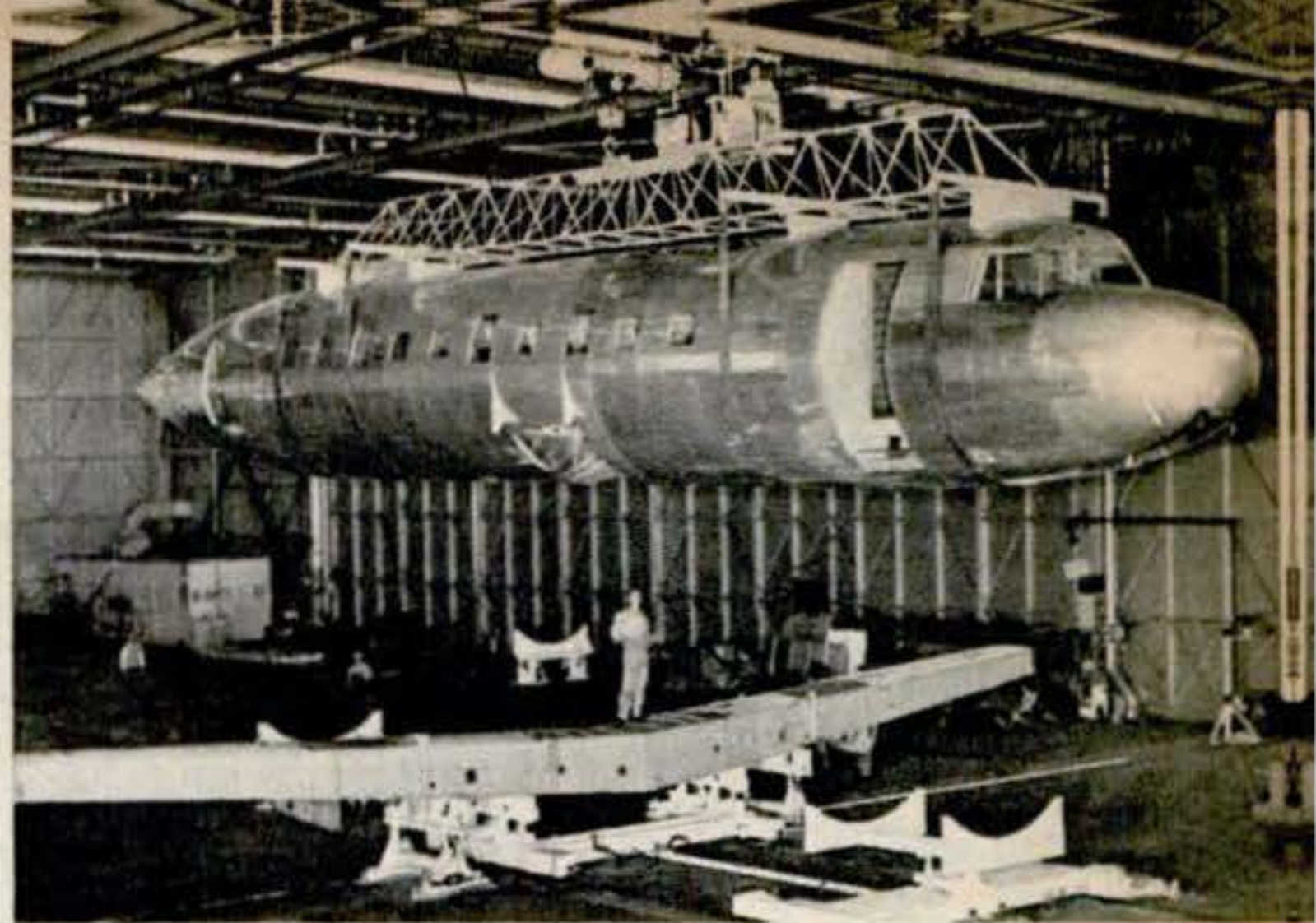

After removal of the parts from their fixtures, a crane lowers the fuselage into position over the wing center section in the first phase of assembly.



A torque wrench, providing exact degree of tightness, is used in bolting wing center section to fuselage. Over-all wing span is 91 feet nine inches.

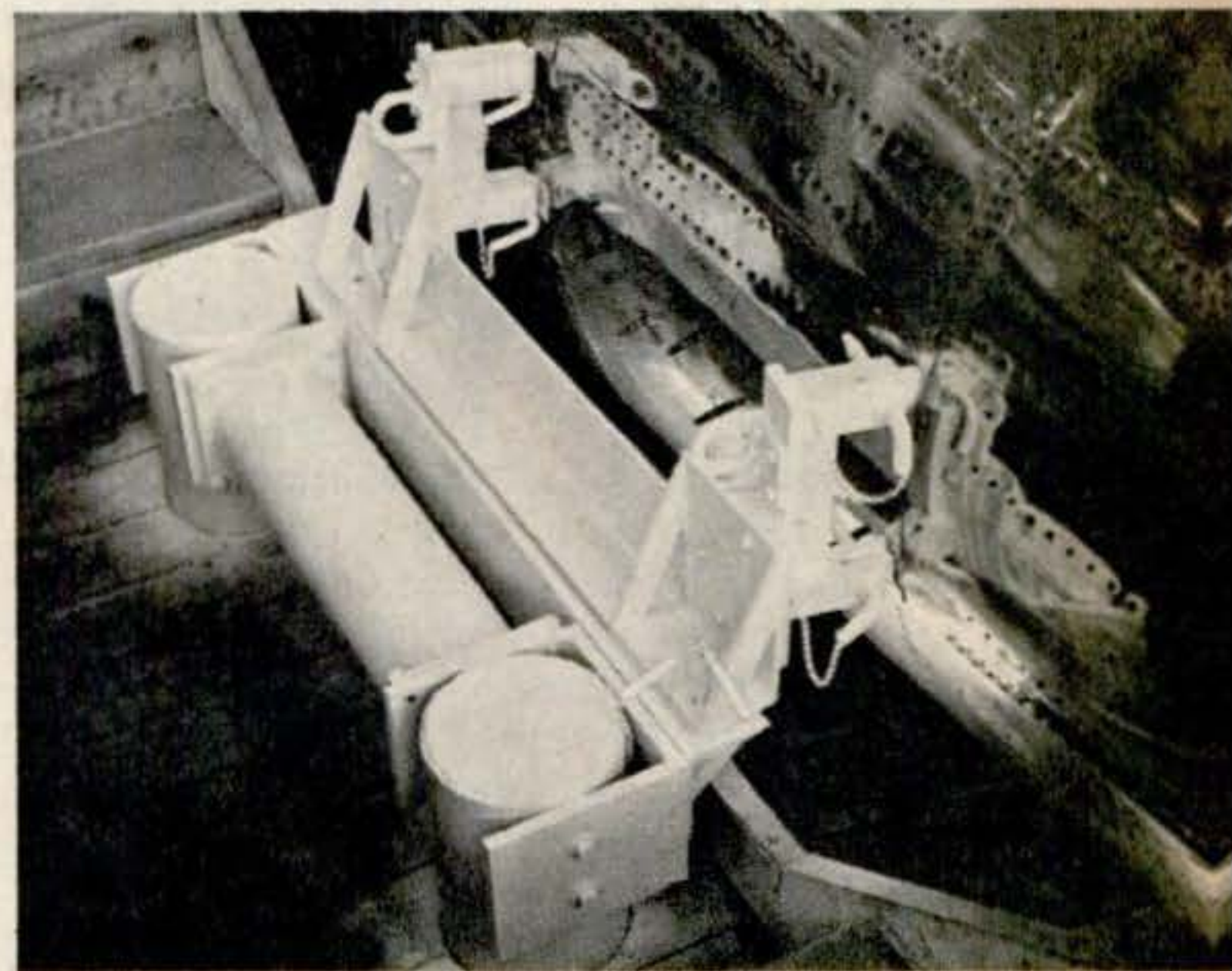

Precise placement of horizontal stabilizers is assured by a fixture that locates the exact positions of their attachment fittings on the fuselage.



Wing sections, tail surfaces, nacelles and other parts, already built and awaiting installation, are quickly added as planes move down the line.



The finished product. Equipped with two 2,400-hp. engines, the Convair-240 supplements conventional power with jet exhaust for additional speed.



The toy sub in action, downward bound. Moving the ballast weight on the keel regulates depth of dives.

THE bathtub battle fleet has a colorful new recruit—a plastic “rocket” submarine that performs a series of gliding dives on pill-power. The manufacturer, Payne Products, Inc., of Midland, Mich., supplies effervescent tablets designed to propel the craft for six or seven minutes. Agitating the water slightly makes the submarine dive oftener.

When the submarine is placed under water to start its voyage, the gas-releasing “fuel” acts as a pump, expelling water and sending the craft to the surface. Then it submerges again, and the cycle is repeated. Balance and glide as the toy rises and sinks provide its forward motion.

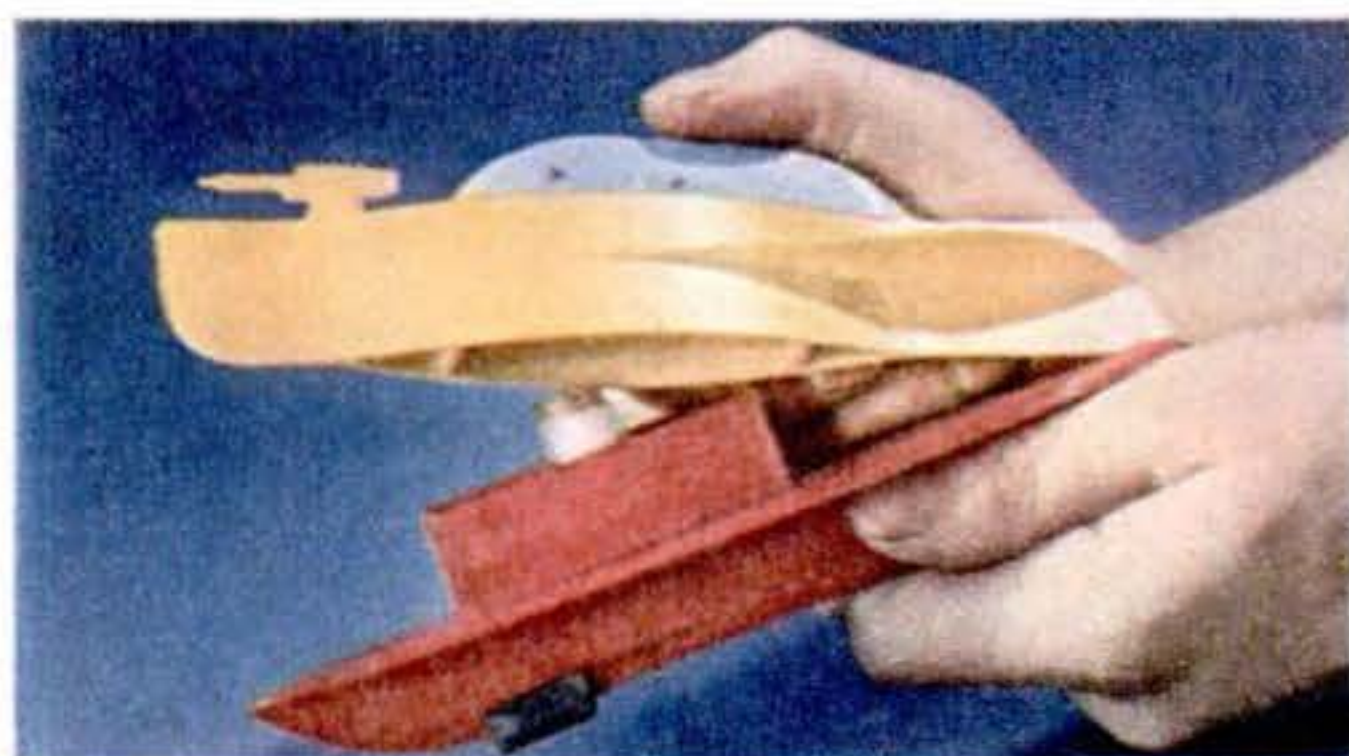

Superstructure is lifted to expose the power compartment. The white plastic vial is inserted when dry ice is used as fuel, but not when the effervescent tablets are employed. With the two main sections fitted together again and the weight adjusted, the submarine is ready to go.

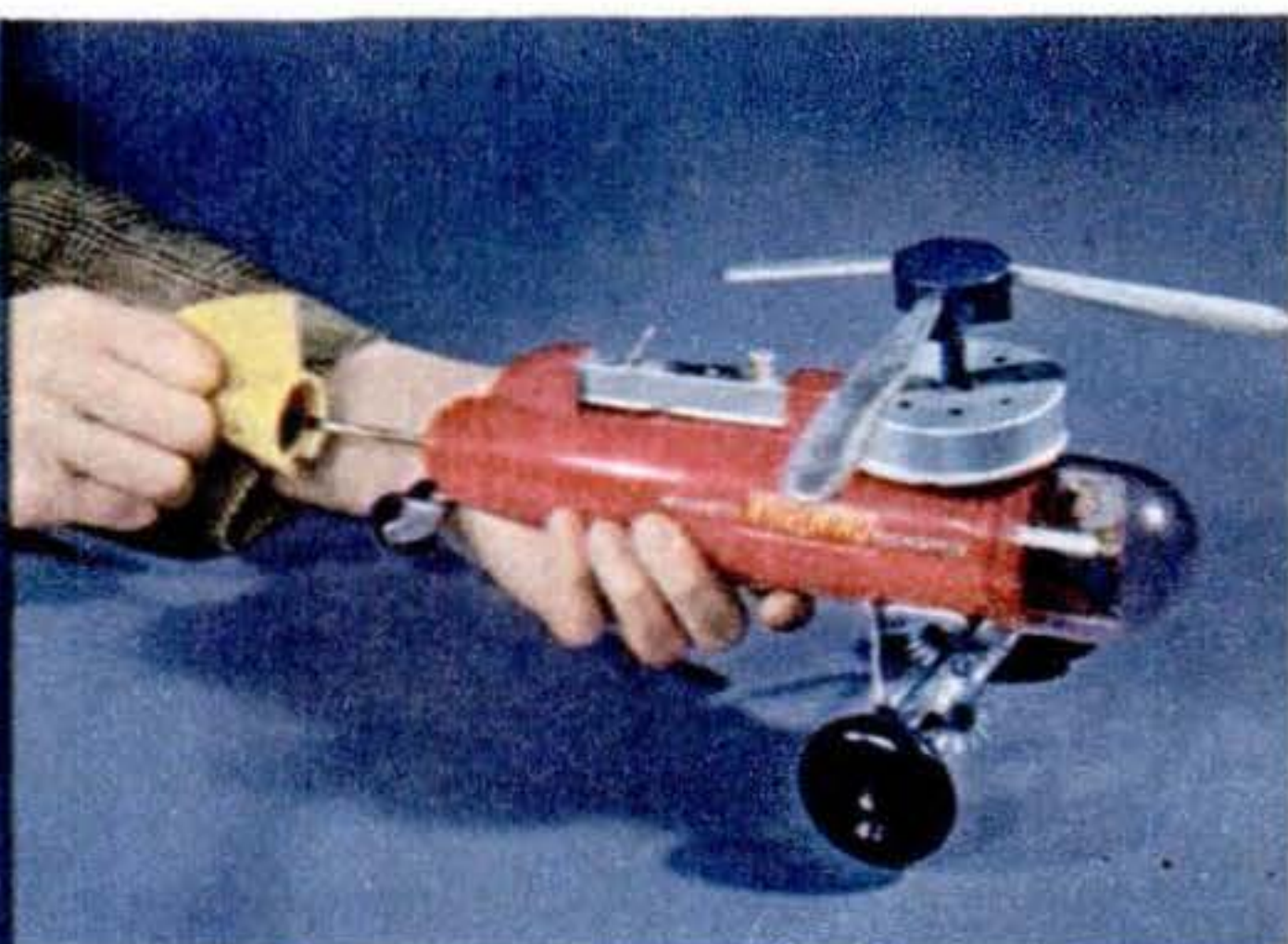

Toys Run on Compressed Air

DRIVEN by nothing more than air, these two toys can speed along at 15 m.p.h. for 125 feet. The plunger in the rear sends compressed air through tubing to a radial motor, where it is forced out through tiny

holes. The released air sounds like a gas engine's exhaust in the racer and makes a putt-putt noise while spinning the rotor of the taxiing helicopter. The toys are made by Mot-Air-Ette, of Chicago.



Courtesy of W. & J. Sloane

There are more machines to pick from now, but even the best have limitations you ought to know about.

How to Choose a Washer

IF YOU wanted to buy a washing machine last year, a clerk put your name on a waiting list; if you were among the 2,023-981 lucky ones, you took the first make he offered you. This year, you may find yourself in a quandary, forced to choose which of several new washers you want.

Like the 1947 cars, most of the washers resemble the prewar models. Several makes with a variety of features are available, but there are still only two major types: the conventional, or nonautomatic washer, with either a wringer or spinner for drying clothes, and the automatic washer that washes, rinses and damp-dries clothes at the flick of a switch.

Without wetting a hand, the user of an automatic can do a nine-pound wash in half an hour, a chore that still takes two hours using the conventional washers, according to time and motion studies.

Of all the automatic washing machines on the market today, however, only three were manufactured before the war, so that automatics are actually still new products. Few changes can be expected in the time-tried wringer-washer, but engineering research for an improved automatic machine is carried on 24 hours a day at most washer factories.

What happens in an automatic washer when the clothes basket is filled with soiled laundry and the time dial is set? The basket revolves in sudsy water, while the clothes are agitated. At the end of the washing cycle, the dirty, soapy water is pumped off. At the same time fresh water is sprayed over the clothes for three complete rinses. The rinse water goes down the drain, and the washer spins a half-mile-a-minute to remove the excess water, leaving the clothes ready to hang on the line. Fi-

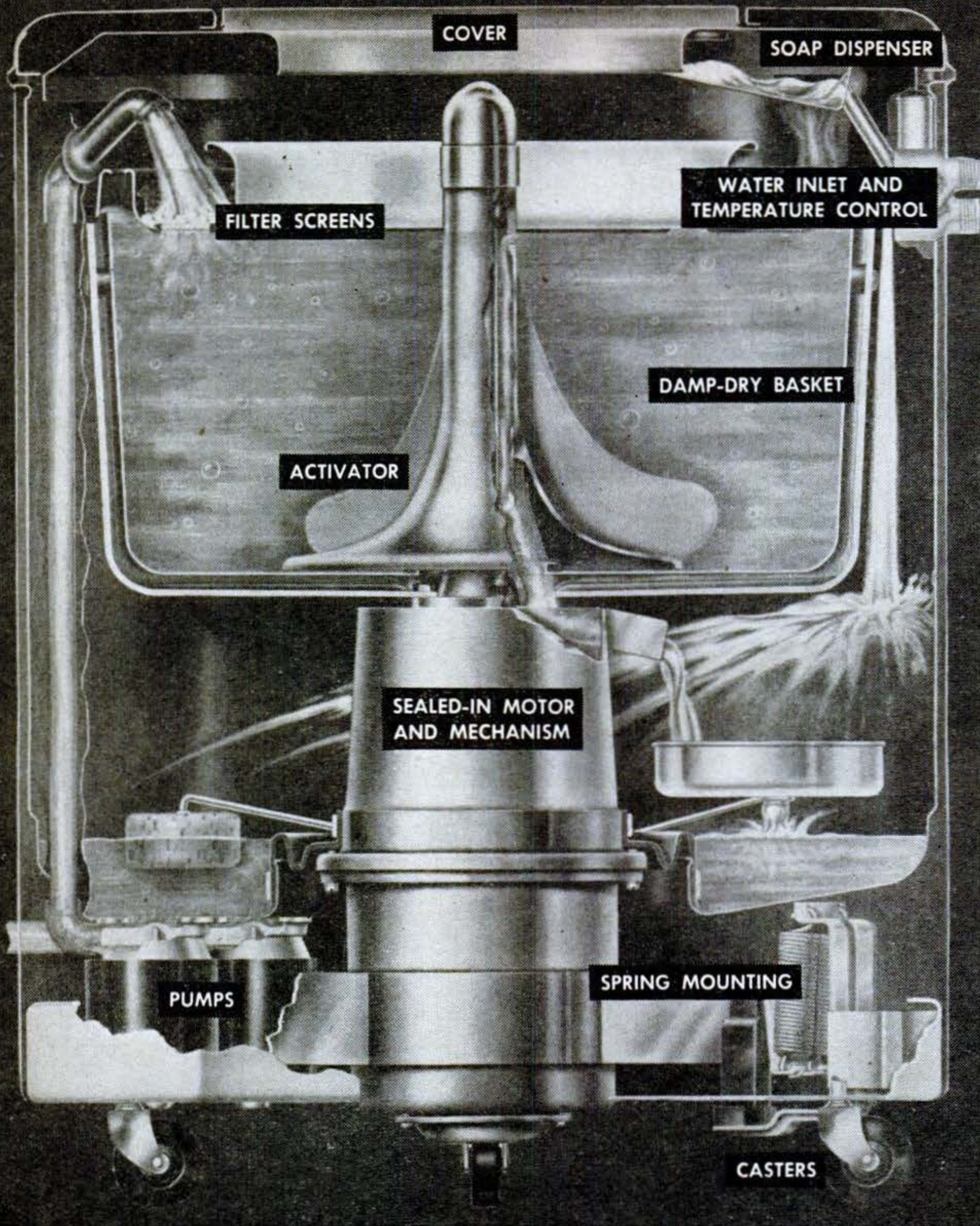

Representative of the completely automatic washers, this General Electric machine goes through its wash-rinse-dry cycle in 45 minutes, or less if the

operator desires. Manual control permits skipping or repeating any part of the cycle. The rotary damp-dryer turns up to 1,140 r.p.m.

nally, the machine cleans itself, then automatically turns itself off.

Before buying an automatic washer, you should consider your hot-water system and water pressure. Surveys indicate that the weekly wash of the average household is large enough for several washer loads, but unlike the conventional washer—which can reuse the same tub of water—only one load of clothes can be washed and rinsed in the 21 to 28 gallons of water needed for the automatics' operation. To get the

most satisfactory results, users of automatic washers need water heaters capable of delivering 40 gallons of water at 140°F. in 80 minutes.

The timers on automatics are adjusted for use with normal water pressure, but recently a suspended timer has been developed for homes with less than 20 pounds of water pressure. This device, attached to the washer, interrupts the current flow to the timer motor, allowing ample time for the tub to fill with water.

Nonautomatic washers are much older, having been on the market since 1874. A washer of this type is usually a portable, vitreous-enamelled tub that contains an aluminum agitator. From six to nine pounds of dry clothes can be placed in the water-filled tub, and a $\frac{1}{4}$ -horsepower motor moves the blades or vanes of the agitator back and forth, swishing the clothes through the water. Some machines have a vacuum-cup arrangement that moves the clothes up and down in the water, thus squeezing the suds through them, but washing-machine authorities agree that the agitator type is the most effective for removing dirt.

Before buying a washer with an aluminum agitator, make certain that the agitator is easily removable from its shaft for cleaning; otherwise, undissolved soap will corrode it.

No washer equipped with a power wringer can be called "safe" to use. Clothes are passed by hand through the rolls of the wringer, and the 800-pound pressure of the revolving rollers wrings the water out. The Underwriters Laboratories require wringers to have emergency releases that will spring the rollers two inches apart if clothes or fingers are caught between the rollers, but in spite of all the safety releases, the wringer remains a wash-day hazard. Scarcely a day passes that a newspaper doesn't report a washer-wringer accident.

The other drying alternative in the non-automatic washer is the spinner. Wet clothes put into the spinner basket are revolved so rapidly (about 1,000 r.p.m.) that centrifugal force extracts the water from the clothes. While a spinner may take three times as long as a power wringer to do as good a job (the efficiency of a wringer is rated excellent if water left in the clothes is 72% of the weight of the dry clothes), this disadvantage is offset by the safety feature.

Well-known washer factories are geared to aircraft standards, and some parts of the power mechanism must be accurate to within three to five *millionths* of an inch. As a further safeguard against mechanical failure, some gear cases are assembled with a lifetime bath of oil.

No precautions, however, can protect a washer against misuse, and the greatest number of service and repair calls are for washing machines that have gone out of whack simply because the user failed

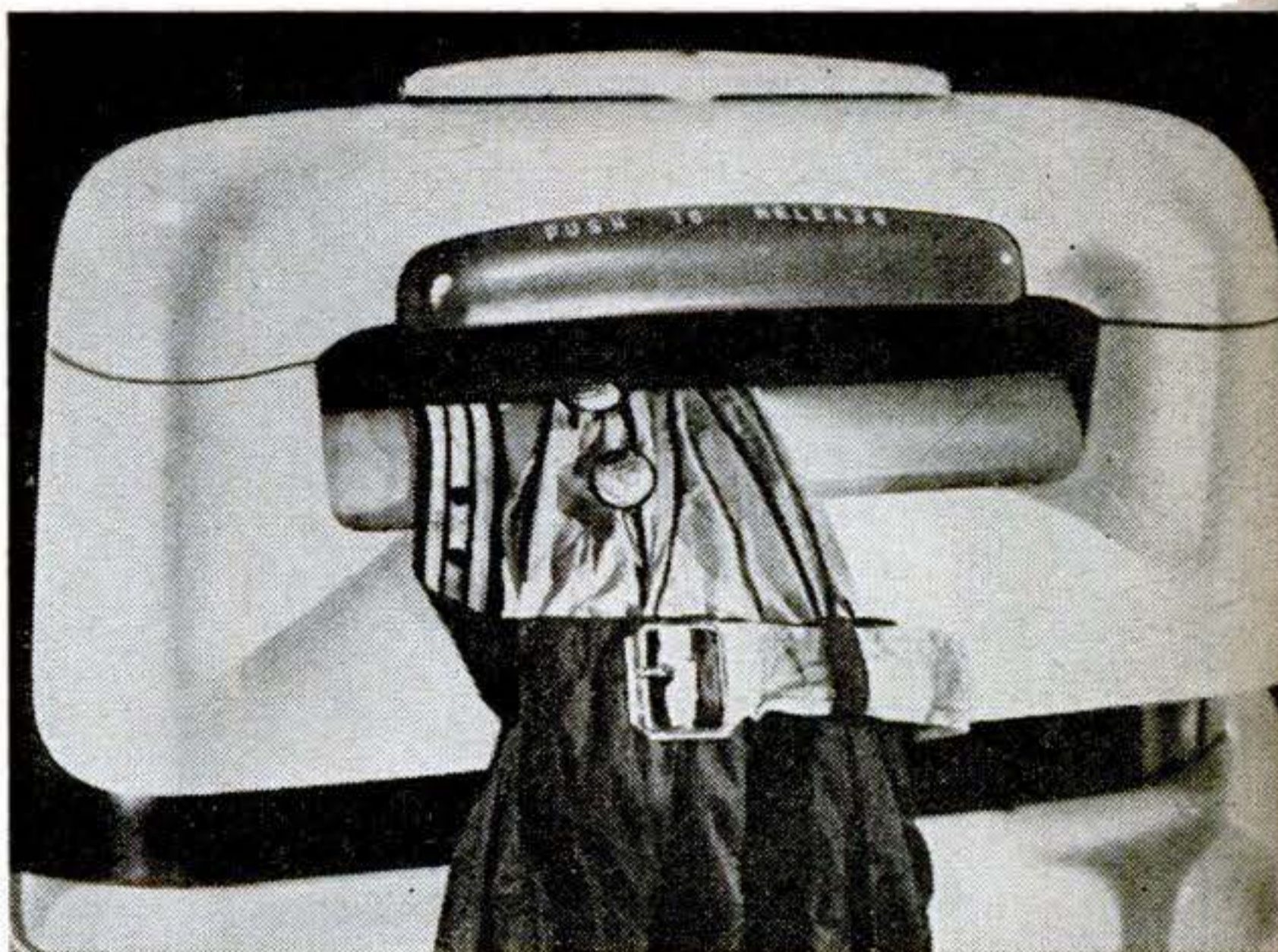

For safety, wringers should have an easily accessible release mechanism, like the bar directly above the rollers of this Maytag wringer. There should also be a device to keep the rollers from turning when the wringer is being swung around. Some non-automatics use rotary damp-dryers, but cost more.

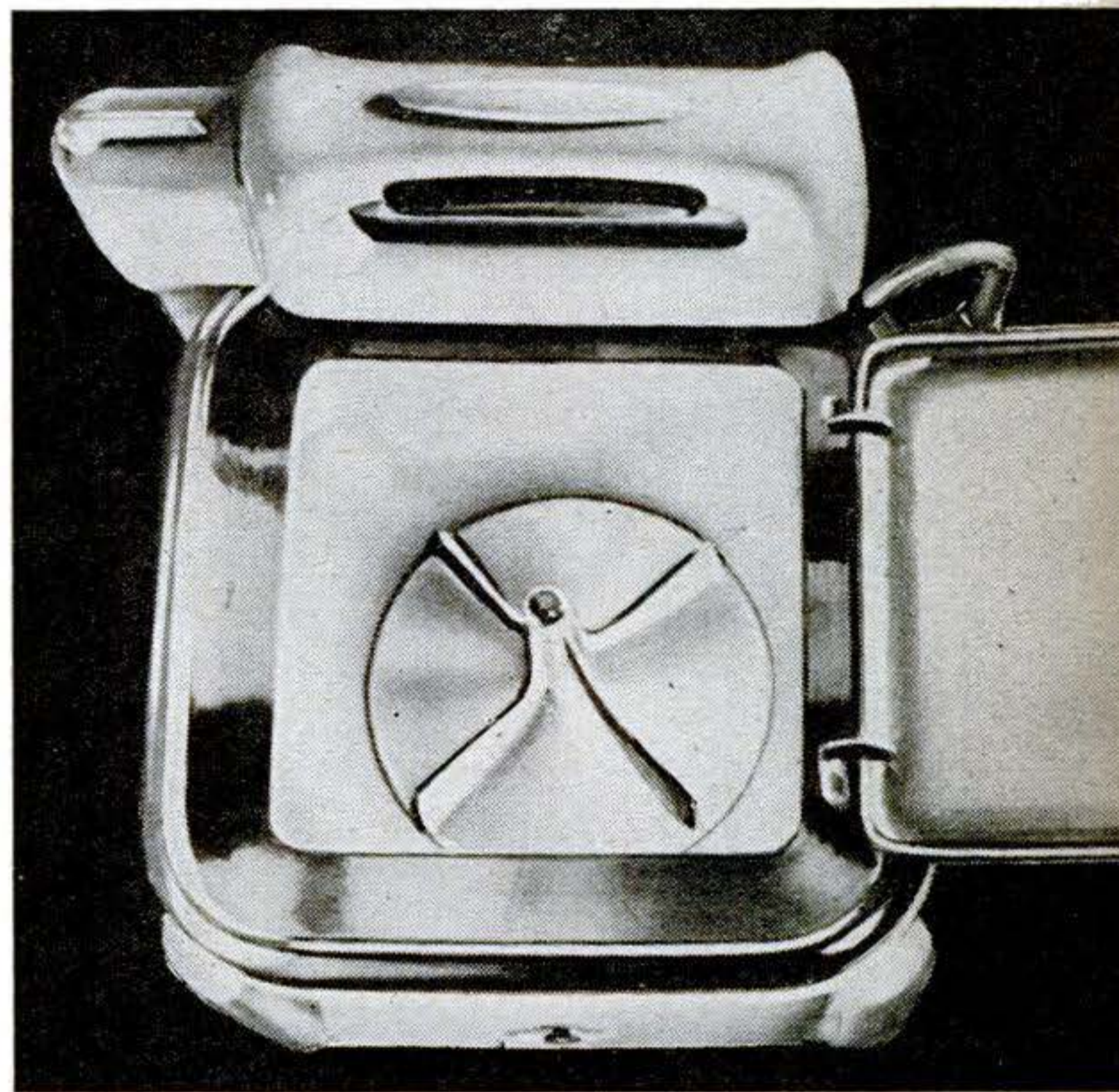

Agitator type of washer, as illustrated by this Maytag, is considered superior to vacuum-cup machines. Aluminum agitators should be easily removable for cleaning, to prevent corrosion. Hose for emptying washer may have a pump or may function by gravity.

to follow directions. Your washer is likely to need repairing at least once in its 15-year life. If you place an unmovable automatic well away from the wall to permit easy access on all sides, you won't have the additional expense of moving the ma-



Portable electric washers, for small homes and apartments, take up little more space than a pail. In this one, the motor is built into the cover and drives an agitator; it holds two pounds of wash.

chine from its base whenever repairs are needed.

Though clothes are washed cleaner in the present nonautomatics, scientific research should soon produce an automatic washer with a higher degree of washing effectiveness. A problem more troublesome to the engineers is how to develop a more satisfactory dryer in the automatic. A centrifugal dryer rotating fast enough for really effective operation may create large unbalanced centrifugal forces, which could cause violent vibration of the washer and a breakdown of its parts.

While conventional washers and some automatics have casters and can be rolled to the most convenient spot for washing, the automatic machines require special connections, either to the two spigots at a sink or else direct to the water system. Regardless of which type you select and where it is installed, all washing machines should be grounded against shock. Most washers meet the Underwriters Laboratories specifications for electrical safety, but since the laundry floor is generally damp, a good safeguard against shock is to ground the washing machine frame permanently by running a wire from the frame to a water pipe.

Buying a washer is like buying a car—chromium trim just hikes the price. You'll pay extra, too, for features like drain pumps, timers, cord reels and temperature indicators. Because the wringer-type washer is the cheapest (it costs \$60 to \$120), it continues to outsell the others. Washers with spinners cost about \$50 more, and auto-

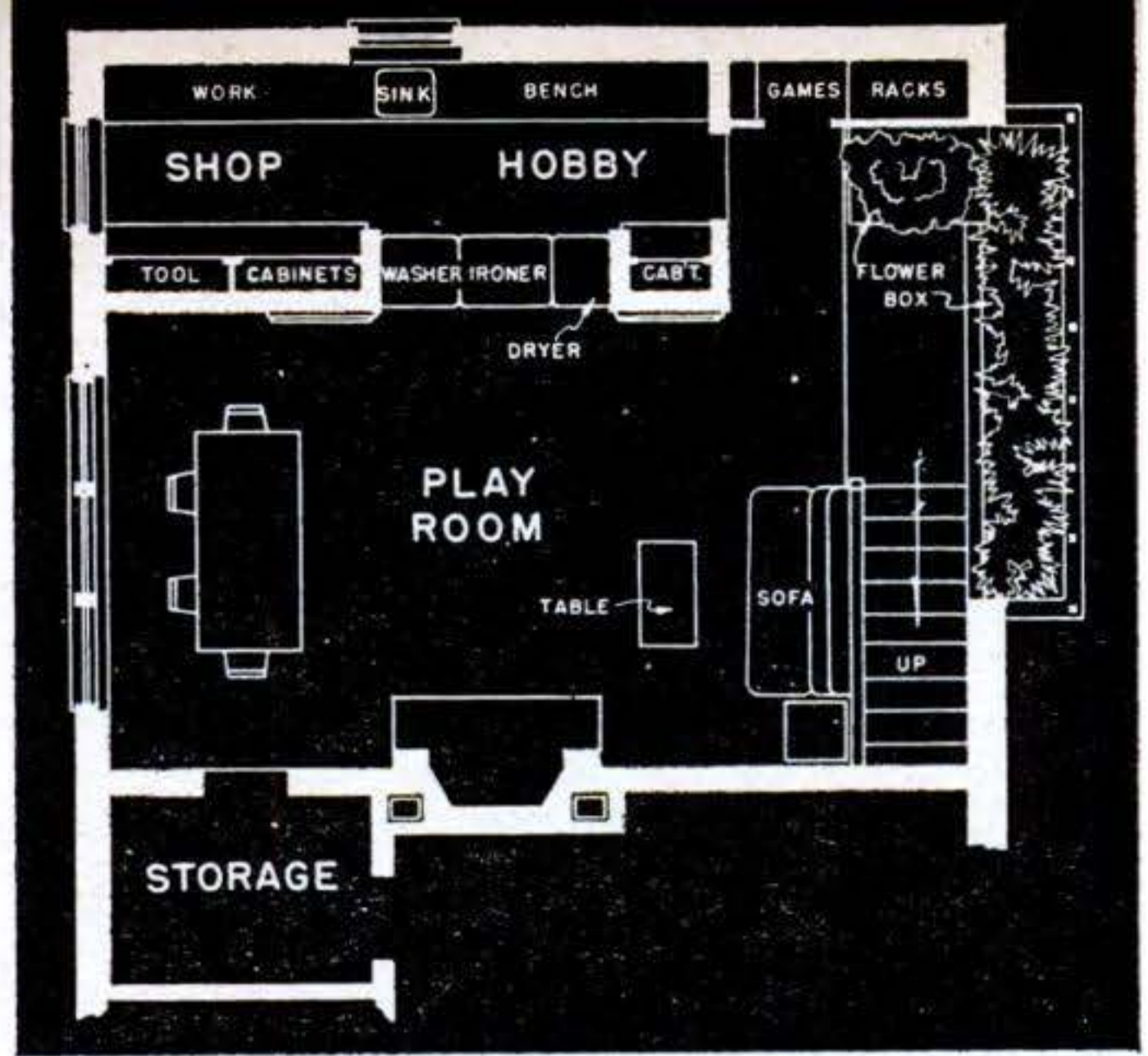

The last word in laundry luxury—a room designed around the washer. This playroom-workshop, suggested by Blackstone, has a washer-dryer-ironer combination that forms a counter when not in use.

matic washing machines range in price from \$200 to \$300.

No matter how efficient your washer is, it will be working under a handicap unless you use enough water and at least two inches of suds. A washing machine will scrub your clothes, but it still takes soap to make them white. END

AC Current Goes Into New Planes

ALTERNATING current, the kind you probably use at home, is going aloft. Experts have found that AC generators give 50 per cent more power per pound of weight than comparable DC units. Trouble-free operation is another advantage; with AC, induction motors can be used, dispensing with commutator brushes that wear out rapidly at high altitudes. Westinghouse has designed AC electrical plants for aircraft to be installed on the Consolidated B-36 and the Northrup Flying Wing.

Atoms Track Plant Poison

RADIOACTIVE atoms have turned detective on the track of a killer. A chemical named Inba destroys plants when placed on the leaves. To find out how it slays, radioactive iodine is added to the poison before application. A Geiger counter then traces the course of the deadly compound through leaves and stems. Inba belongs to the same family as the weed killer 2, 4-D. Beans and barley have been impregnated with it in experiments at the U. S. Department of Agriculture, Beltsville, Md.



The Loon Takes Off

BOOSTED into the air by four rockets, a Navy KUV-1 buzz bomb roars aloft over the Air Missile Test Center at Point Mugu, Calif. Rockets fall free after two seconds, but the Loon can go on for 150 miles under its own power at speeds above 425 m.p.h.

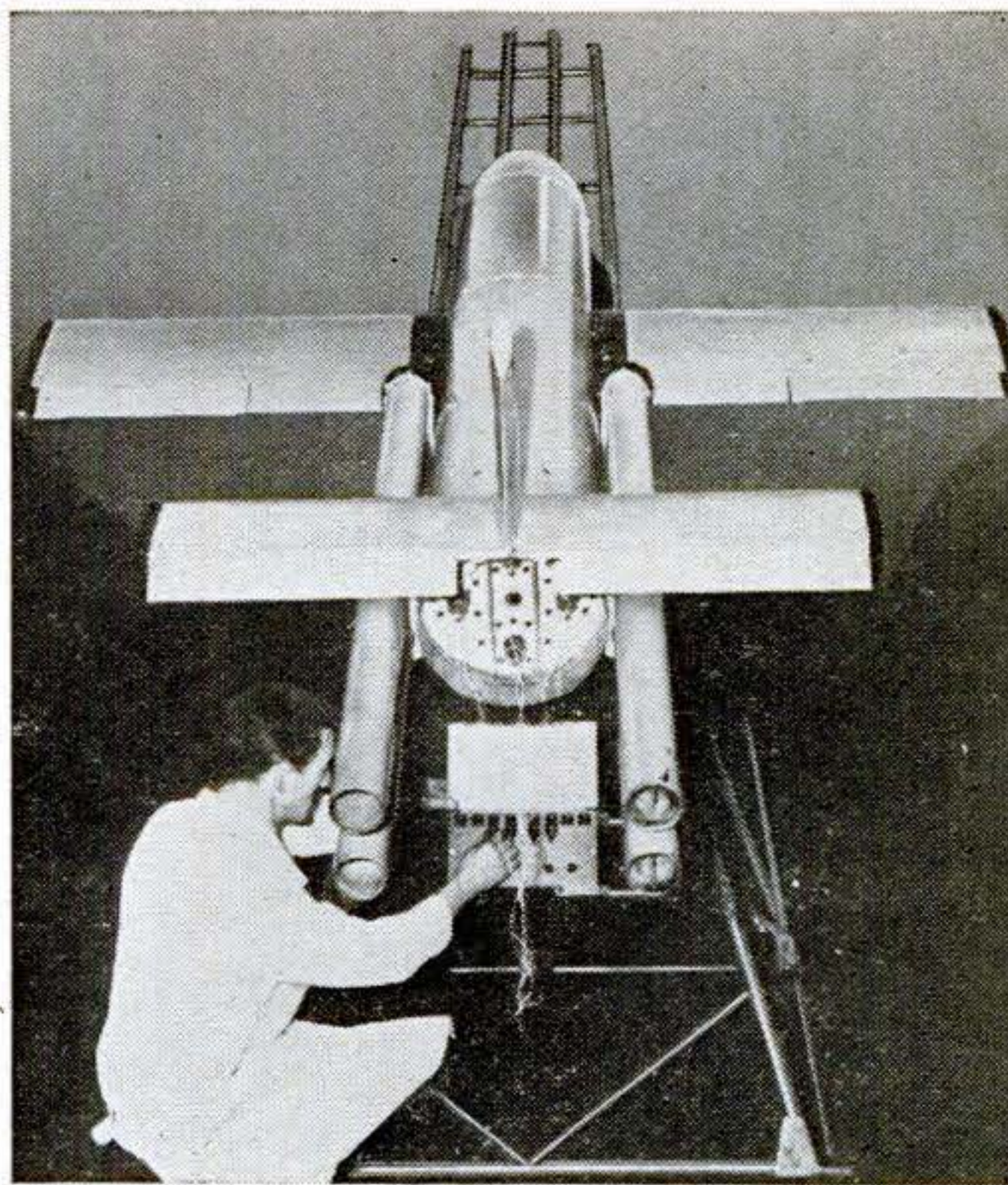

British Guided Rocket

BRITAIN'S first radio-controlled rocket, developed by the Fairey Aviation Co., has successfully completed its flight trials. Shown being adjusted during a London exhibition, the 7½-foot missile has four main rocket cells, can top 500 m.p.h.



A Ram-jet Shows Off

SPEWING flame from its exhaust, a ram-jet goes through its paces in a night test at

the Esso Laboratories, Linden, N. J. Only six inches in diameter, the jet rivals the heat of 300 home oil burners and can travel at nearly twice the speed of sound.



Wrecker Wiolds a Wallop. Massive walls shatter like egg shells when this new concrete-breaker goes to work, as shown during a demonstration in wrecking

operations in war-devastated areas of Greenwich, England. The American-built machine, a one-man mobile unit, has a powerful hammer driven by compressed air.

Monster Munches Rocks. This mobile stone-eating plant chews an 88-ton mouthful in one hour and spits it out in two different sizes. A variable-mesh, double-

screen sifter in the main unit, diagramed below, receives broken rock from a primary crusher, separates the coarse from the fine, and gives large fragments a second crushing.

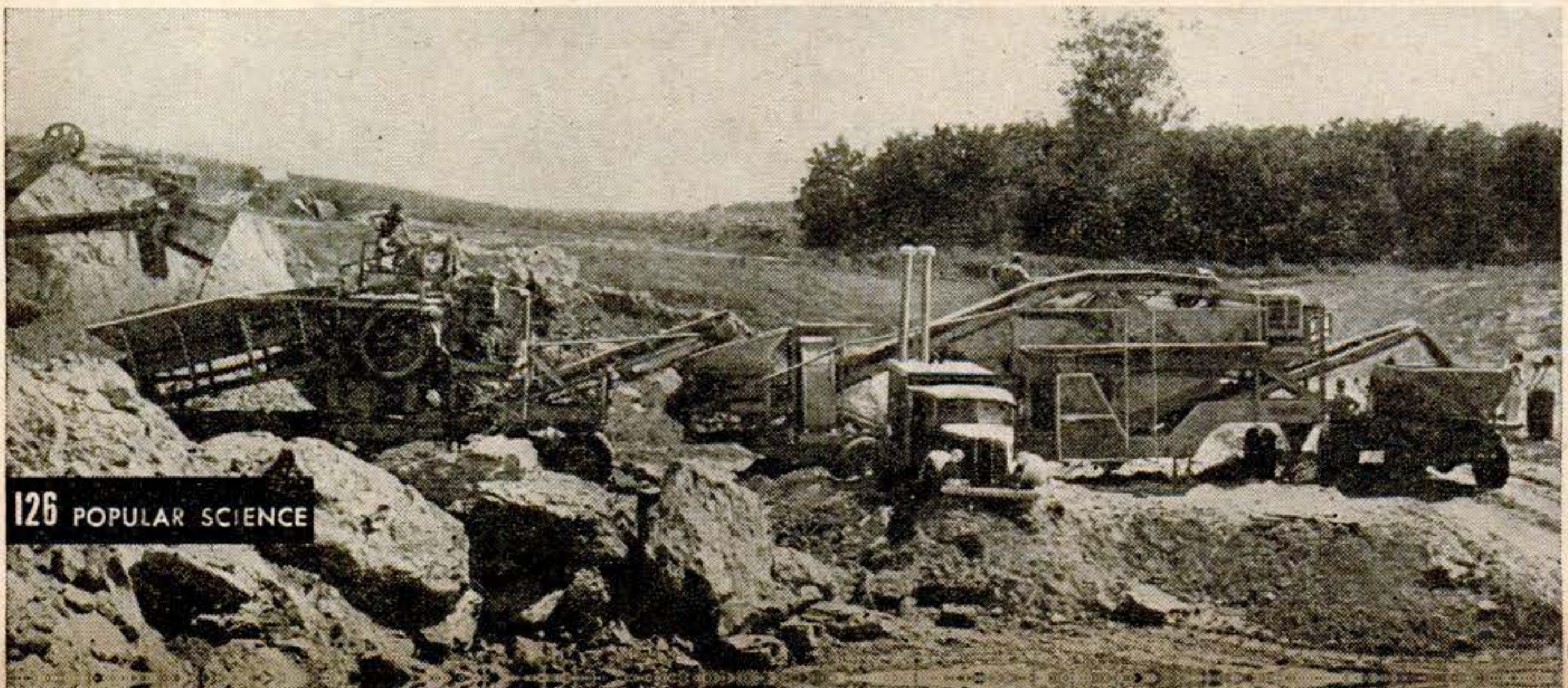
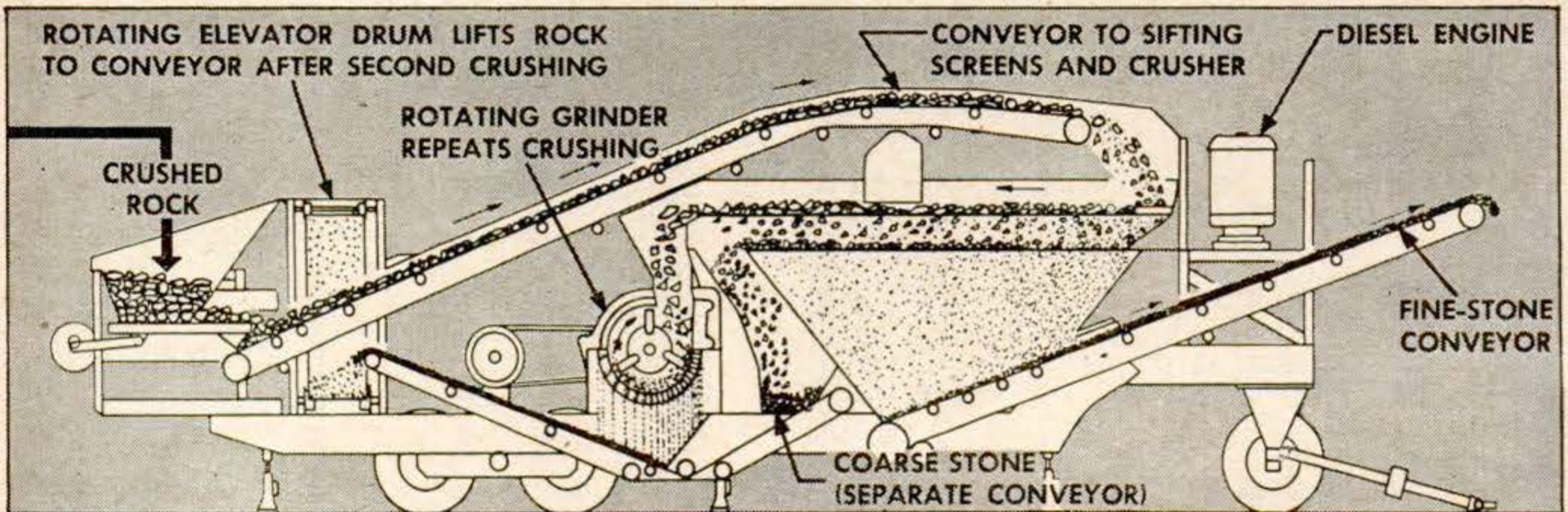

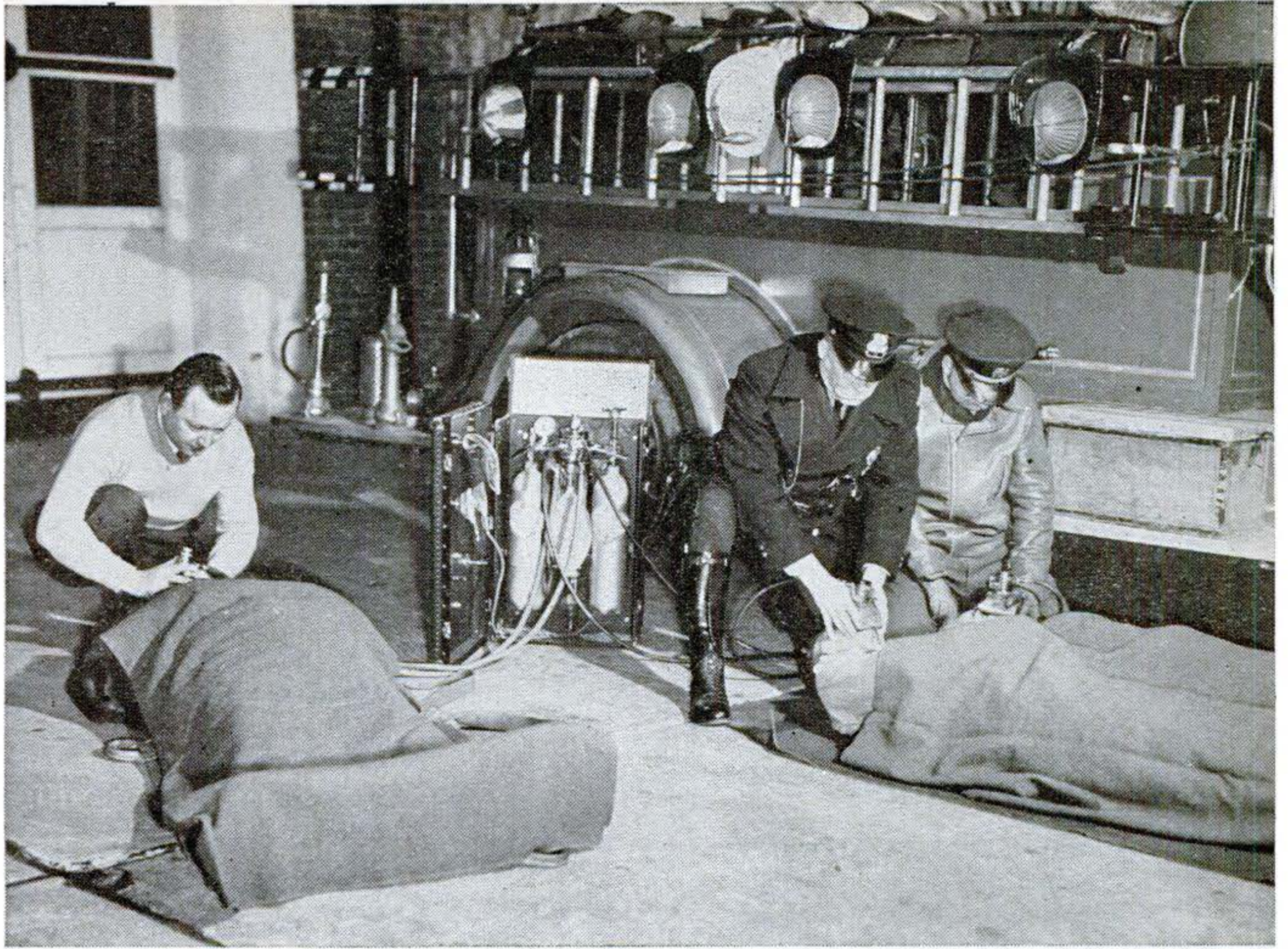

In simulated emergency, experts show use of E & J Resuscitator on "nonbreathing" victims.

Machines that Breathe for You

Portable as a suitcase, they feed oxygen into a maze of tubes and valves to do the work of the human lungs.

By Herbert Johansen

IN YOUR pocket, or on your wrist, is a marvelous little machine that splits time into handy pieces. Your automobile is a whole collection of machines that measure air and fuel, make electricity, pump water, set off explosions, transmit power around corners, and count miles, amperes, degrees of heat and pounds of pressure.

Most of us live, with easy familiarity, in a humming mechanical maze. Few, however, have ever seen—and fewer still have ever experienced—one of man's most ingenious mechanical marvels: a machine that

breathes for those who are unable to breathe for themselves.

Not to be confused with a Pulmotor, an iron lung, or oxygen inhalators used in conjunction with manual artificial respiration, the mechanical respirator is winning a battle of breath-taking (and breath-giving) importance in near drownings, explosion disasters, and surgical operations. The machine's versatility was dramatically demonstrated early in its career when a victim of the *Morro Castle* drowned despite his life vest. He was washed ashore, and rescuers pronounced him dead. His wife, who had come through safely, saw her lifeless husband and became hysterical. Solely to appease her, they brought over a mechanical breathing machine and applied the mask.

The machine gave an immediate signal that oxygen was not getting through to the

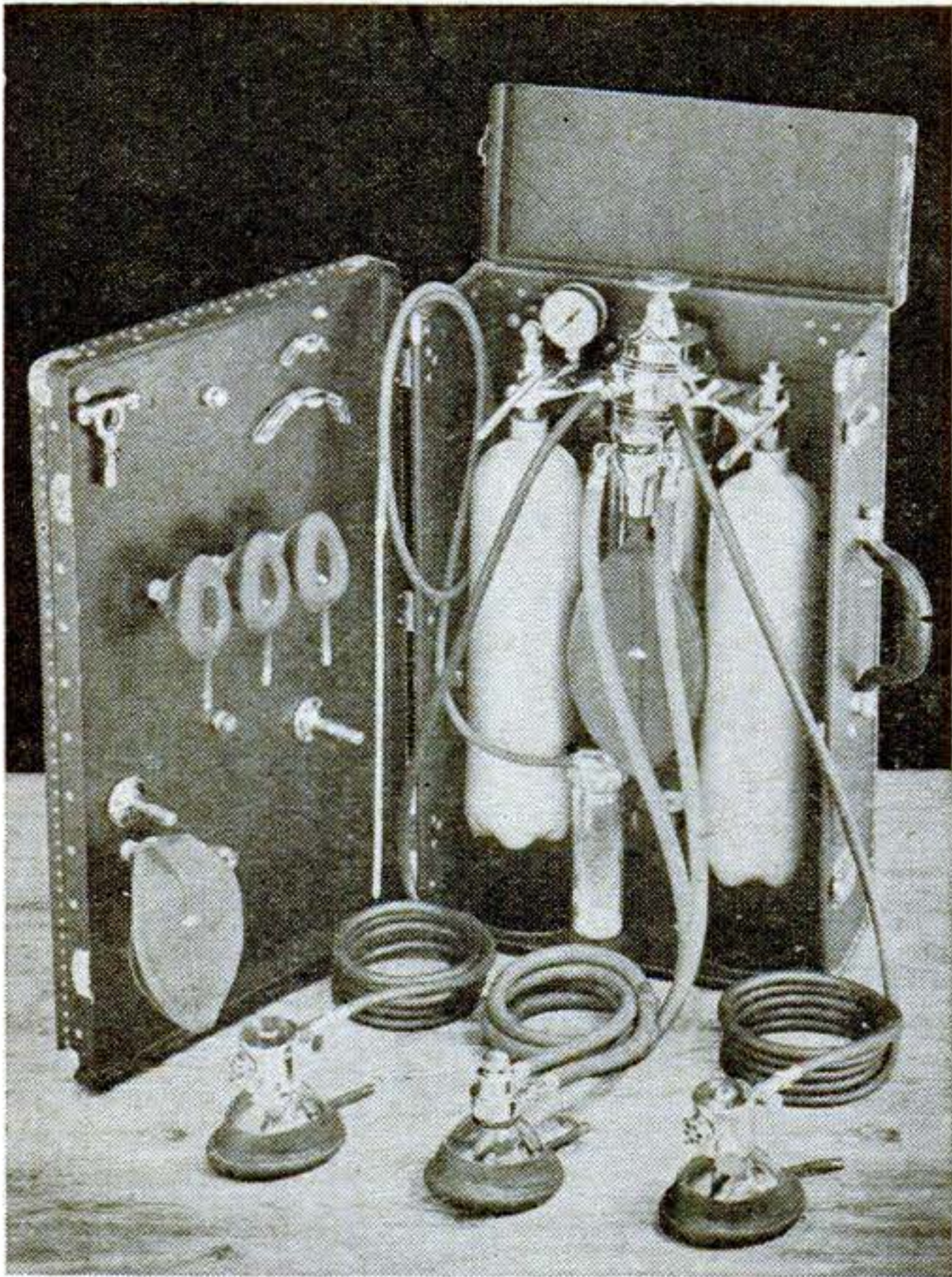

Complete in its carrying case, the E & J Resuscitator consists of two oxygen tanks, operating head (top center), main breathing mask (center foreground), and two auxiliary micromasks. Panel at left holds infant masks and a test bladder.

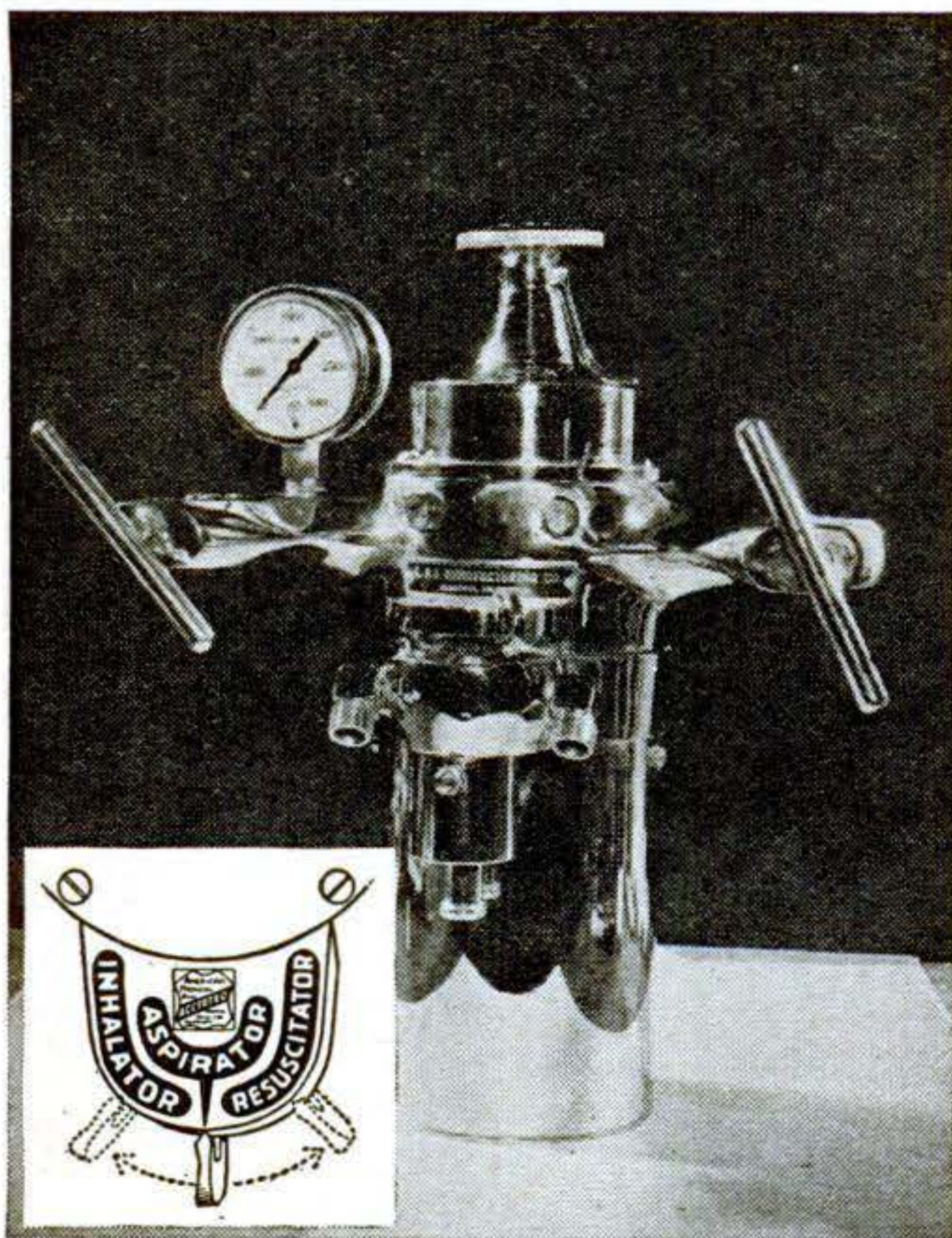

Close-up of operating head. Screw on top regulates flow of gas. At left is oxygen pressure gauge. Inset shows the three-way selector valve that permits the machine to be set for resuscitator (breather), aspirator, or inhalator.

lungs: the air passageways were blocked. Removing the mask, they inserted into his throat a tube for removing obstructions, and the machine became an aspirator. The tube was removed in a few seconds, and a small block of wood was found attached to the sucking end. The breathing mask was again applied. With the obstruction removed, mechanical breathing began to take effect. After a while the "dead" man began to breathe for himself. His life was saved.

In another case, a worker was overcome by fumes while cleaning out the bottom of a blast furnace. It was some time before he was discovered. When a rescue crew equipped with gas masks reached him, he was not breathing. It would take some time to lift him out of the furnace, minutes that would extinguish any spark of life. Fortunately the emergency crew had brought along their lightweight, portable breathing equipment. The breathing mask was lowered by means of an extension hose and attached to the victim's face. Immediately the machine began breathing for him, and continued to do so while rescuers brought him out of the pit. Even while he was being carried to the dispensary on a stretcher, the mechanical breathing was continued, an operator walking alongside carrying the machine. He lived.

In another recorded case the machine maintained mechanical breathing for a patient whose heart had stopped, allowing the chest to be cut open for manual massaging of the heart muscles that restored life.

The E & J Company, of Glendale, Calif., developed the mechanical lung. It is a resuscitator, aspirator, and inhalator, self-contained in a carrying case 9½ inches by 16 inches by 27 inches, weighing 41 pounds. Two nine-pound oxygen tanks supply the "fuel" to an operating head. The latter is a catacomb of tiny tunnels inside. A selector valve, Venturis, two-way valves, and a toggle mechanism direct the complicated patterns followed by the oxygen on its various missions and regulate the rate of flow or exhaust through tubes to the mask.

A machine of many parts, it is also a machine of many functions. It balloons the lungs with the required amount of oxygen, but guards against any danger of rupture. It withdraws the used gases but leaves a necessary reservoir. All this is done automatically, according to the size of the lungs, whether used on a baby or an adult.

If oxygen is not getting through, a rapid

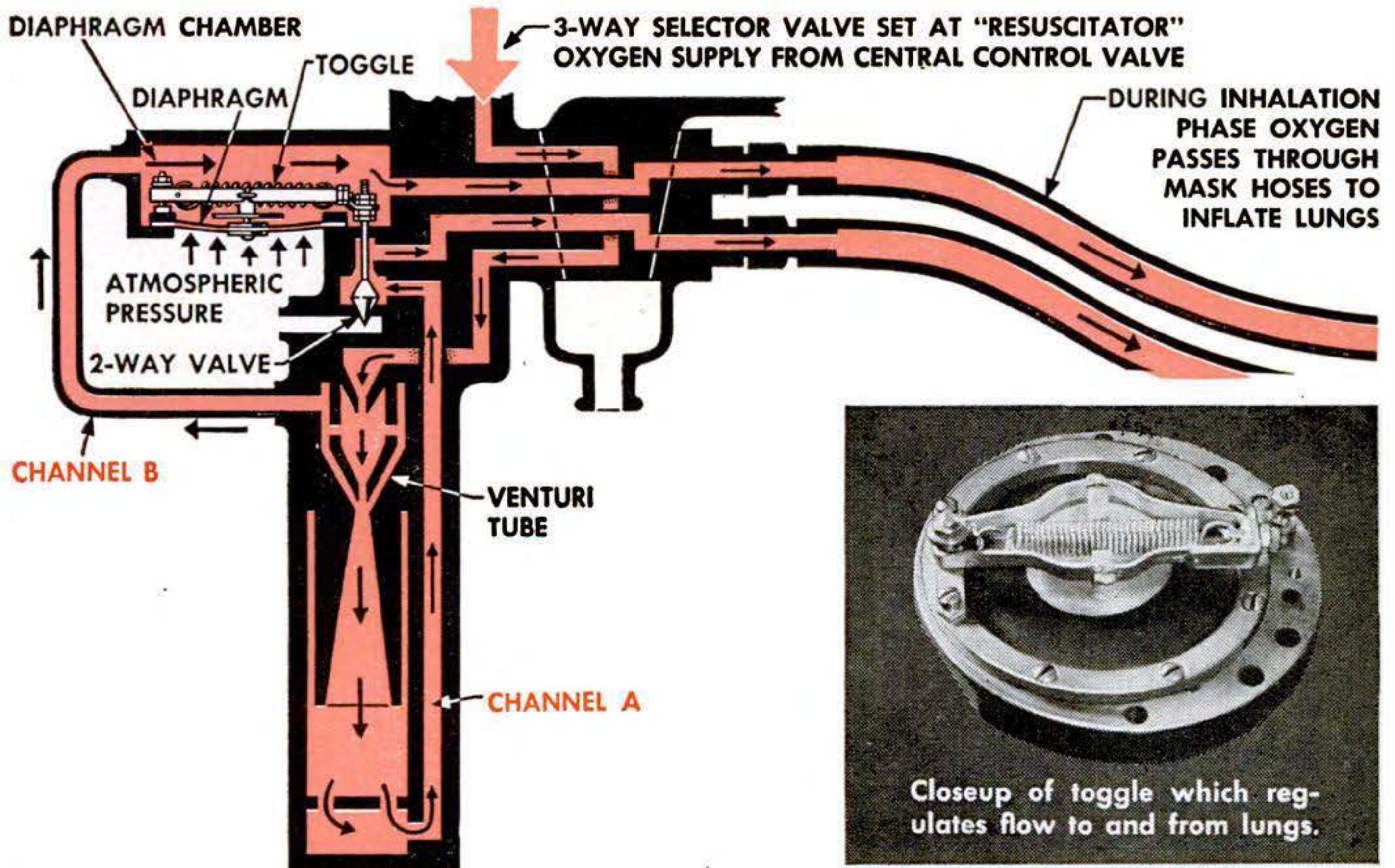

Cutaway of operating head showing first stage of resuscitation. In going past Venturi tube, half of gas follows channel A, half channel B. Later passes through diaphragm chamber. Oxygen

reaches breathing mask via hoses, inflating the patient's lungs. When sufficiently inflated, back pressure depresses diaphragm, acts to trip toggle, starting inhalation phase (see below).

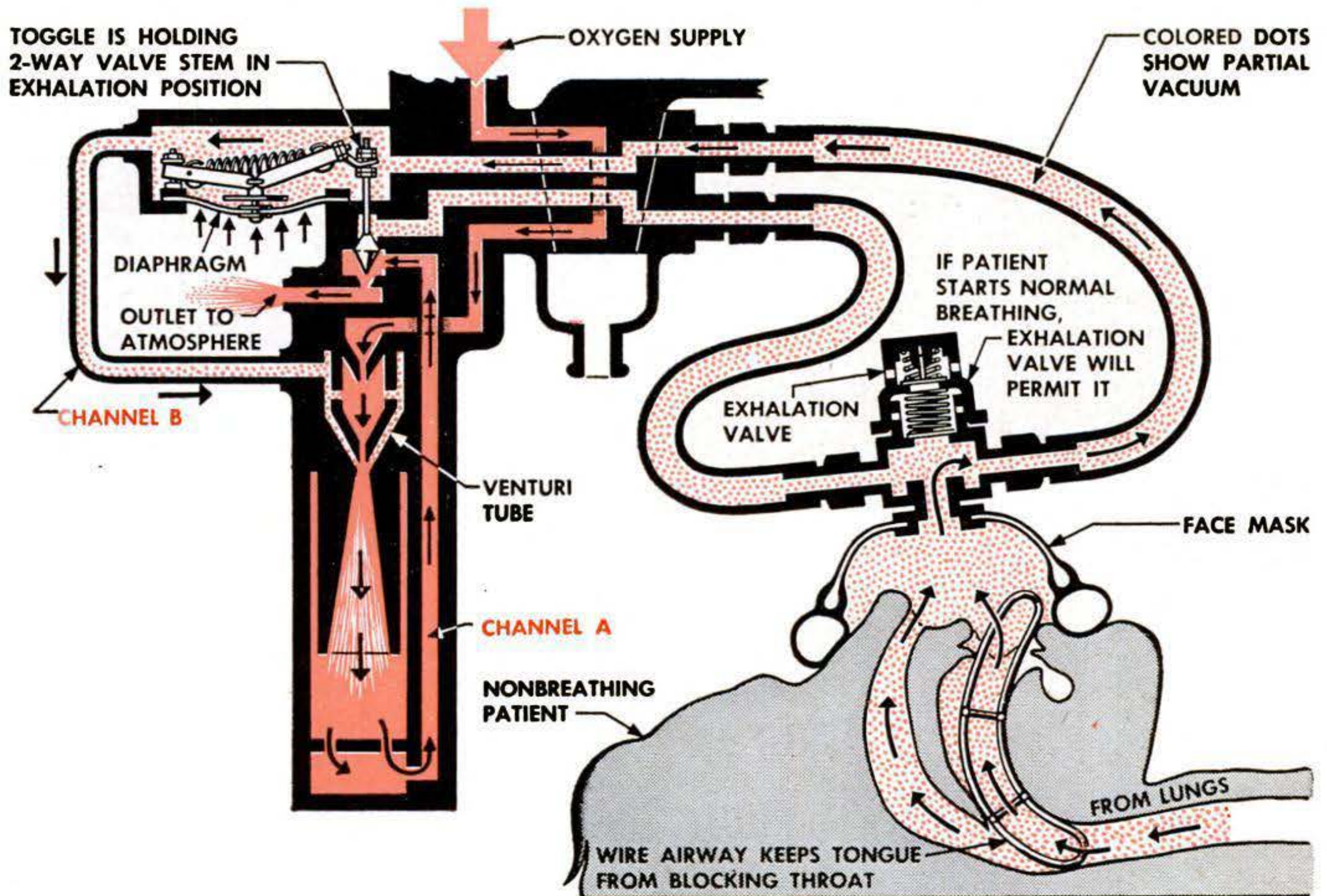

Back pressure from lungs trips toggle, closing upper port of two-way valve, forcing oxygen to speed through Venturi, causing partial vacuum in channel B. Since channel B is now con-

nection to mask system, gases in the lungs are sucked out through B by way of Venturi to the atmosphere. Negative pressure then causes the diaphragm to rise, reverting to inhalation.

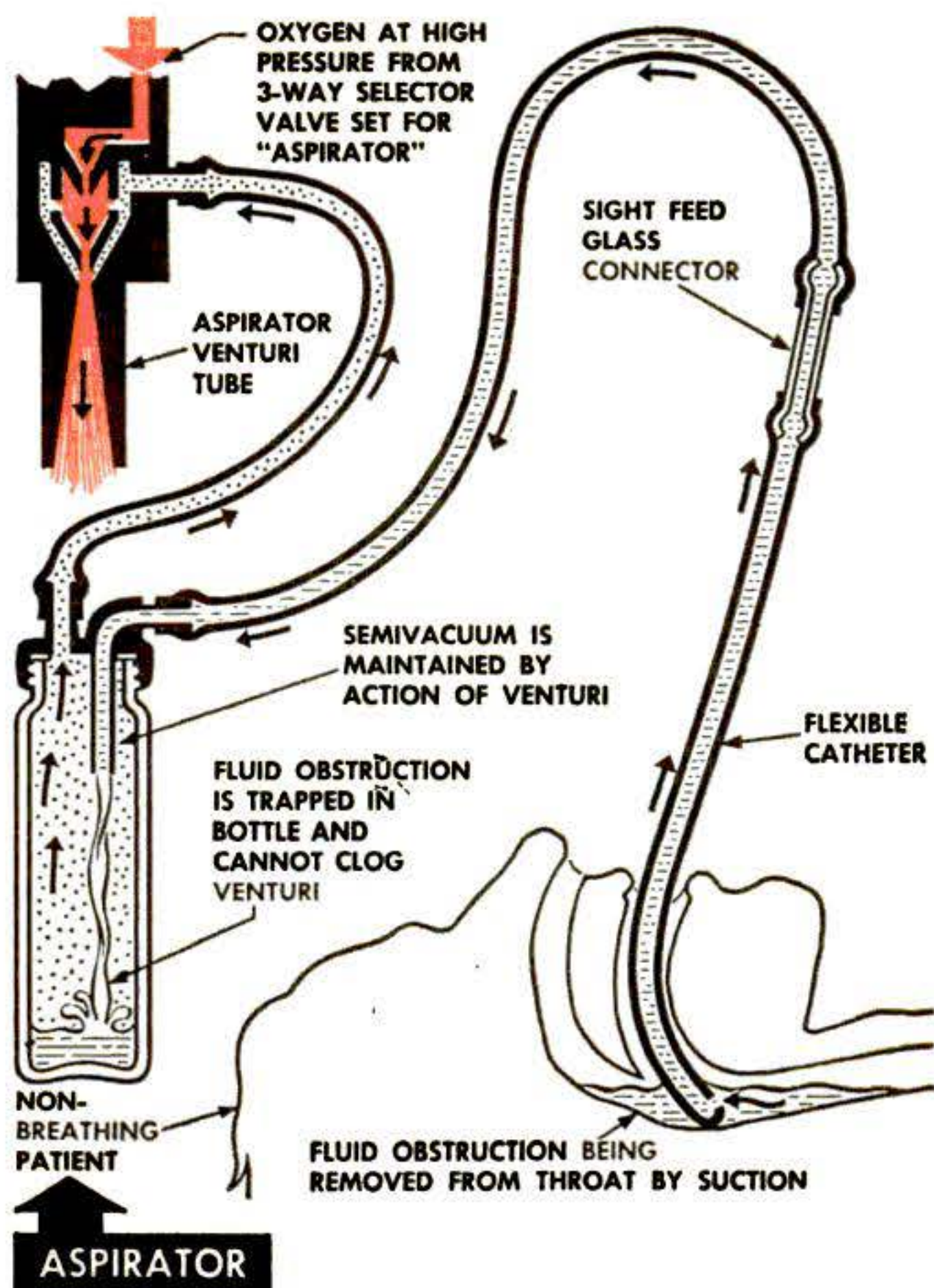

Oxygen rushing through separate Venturi causes vacuum to activate the aspirator. Obstructing fluids are sucked from the patient's throat by means of a catheter, deposited in glass bottle.

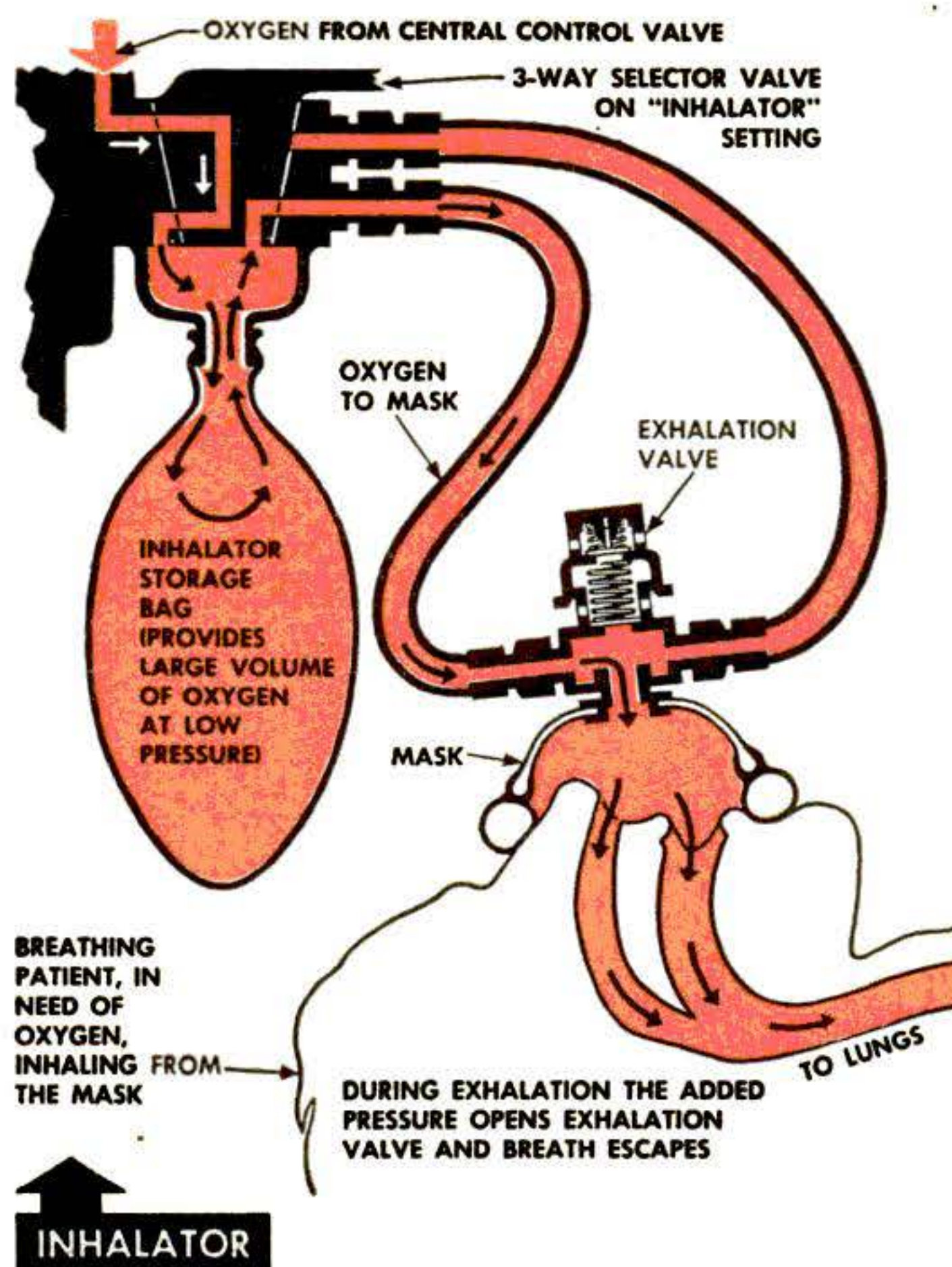

In case nonforced oxygen flow from main head is inadequate, storage bag provides an ample reservoir. A safety valve prevents the machine from interfering with patient's own breathing.

clicking warns the operator that the air passages are blocked. A flip of a switch turns the machine into an aspirator, and a sucking tube inserted into the throat removes the obstruction.

At the first sign of natural breathing, another signal, a violent irregular clicking, gives the news. Another quick flip of the switch stops the mechanical breather and allows the patient to inhale the required amount of oxygen for himself and to exhale through a flutter valve in the face mask.

Ingenious auxiliary micromasks can be plugged in, enabling the machine to be used on three people at once. Each mask is independent of the others; one can be resuscitating, another sucking out throat obstructions, while a third supplies oxygen for a man who has begun to breathe.

Mechanical breathing had one great obstacle to overcome. Because lungs vary in size, there was always the danger of rupture. In fact, for many years medical men said that it would be not only harmful but impossible. The problem was solved, however, through an ingenious pressure-activated mechanism.

After leaving the storage bottle, oxygen

pressure is reduced; then for the resuscitation (mechanical breathing) operation the oxygen flows to the patient via a connecting hose and breathing mask. When the oxygen flow builds up a positive lung pressure of 13-mm. mercury, an equal pressure builds up in a toggle chamber, tripping a switch that closes the flow channel and opens an exhaust passageway. This activates a vacuum action, withdrawing used gases from the lungs until a negative pressure of 9.75-mm. mercury below atmospheric pressure reverses the procedure, opening the oxygen flow again.

Thus, in the case of a baby's small lungs, very little oxygen is required to raise the pressure to the positive high. The larger the lung the larger the flow of oxygen and withdrawal of gases. Thus the size of the lungs actually regulates both flow of oxygen and exhaust of gases.

The arbitrary high and low pressures were determined after research to insure sufficient flow and withdrawal from all sizes of lungs. Tests also proved that these pressures bring about a near-normal respiratory rate in patients ranging from a new-born infant to a six-foot fireman.



Close-up of the auxiliary micromask that enables the machine to be used on two or three persons simultaneously. Plugged into the main head, it is independent breather or inhalator.

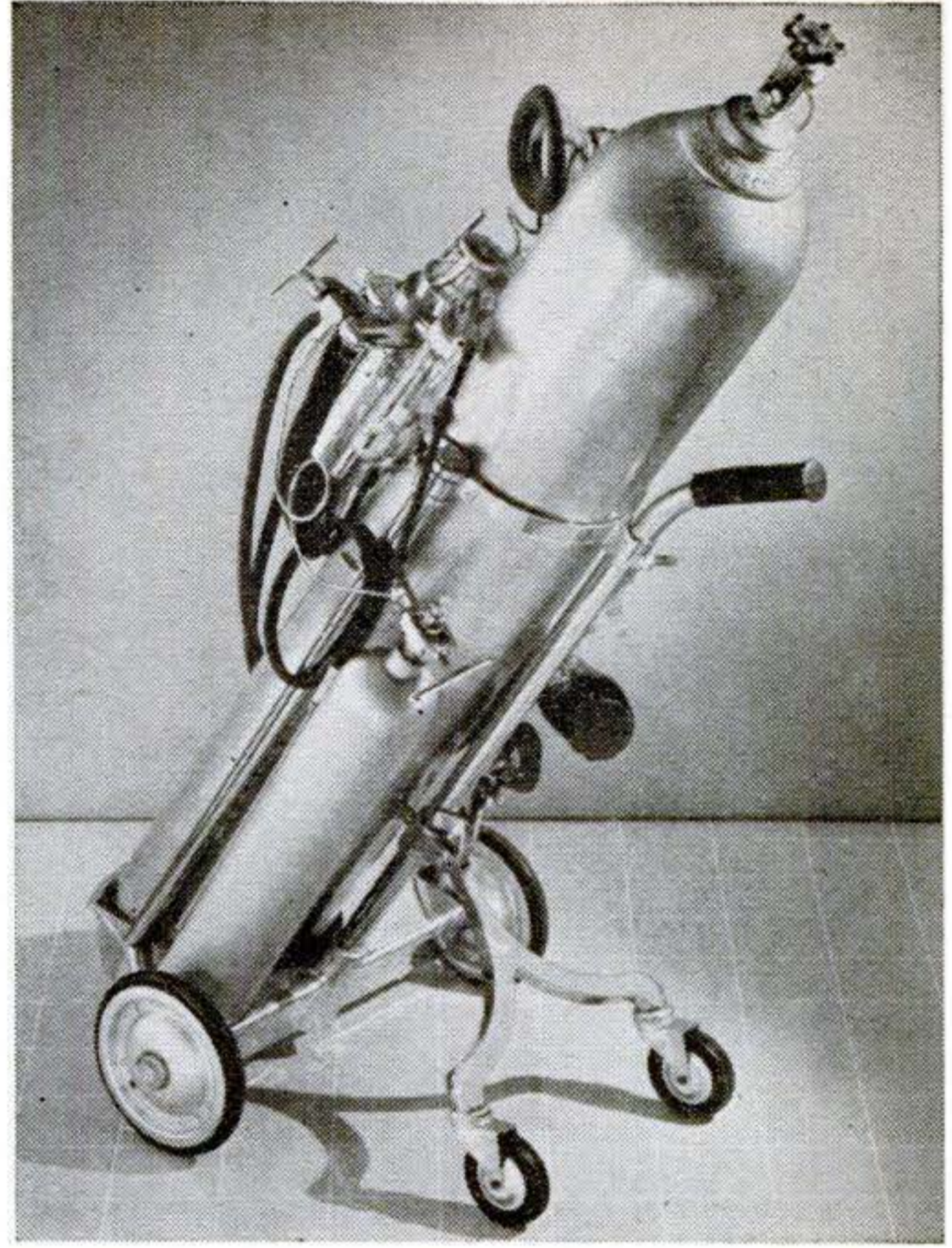

Folding fork wheelbase of this portable hospital model enables a nurse to handle easily a 130-pound oxygen cylinder by herself. Complete E & J unit is attached to side of the cylinder.

Asphyxia is suspended animation due to a deficiency of oxygen and an excess of carbon dioxide in the blood. Nature has provided a reserve supply of practically everything the body needs except oxygen. The only reserve oxygen is that in the blood plus a small amount in the air in the lungs, barely enough to sustain life for 10 minutes. When a person stops breathing and this reserve supply is exhausted, certain cells of the body begin to degenerate. This is particularly serious in the brain cells, which never recover once degeneration has set in.

Speed is therefore essential in applying some sort of artificial respiration. The simplest and oldest method dates back to the days of Elisha the prophet. He restored the life of a Shunammite boy by blowing his breath into the mouth of the child, thus forcing oxygen and carbon dioxide into the lungs under pressure.

Of the manual methods, the best known and most widely used is the Schaefer prone system. Others are the Silvester method, used by the Coast Guard, and the Eve rocking method used on British battleships (PSM, July '46, p. 103). An oxygen inhalator, of course, can be used with these.

Successful application of manual artificial respiration, however, depends to a great extent on the retraction of certain muscles to give diaphragm action. Where a person has ceased to breathe altogether, or is breathing very poorly, this essential muscle tone is not present.

Here is the advantage of a mechanical breather. Entirely automatic, it requires no muscular or other response from the patient.

This is not a disparagement of the manual methods, which should be resorted to immediately where mechanical apparatus is not available, or until it arrives. *Speed is essential in all cases of asphyxia: a minute or two lost can and has cost lives.* Fortunately today most public and industrial emergency rescue squads and many beach patrols are equipped with the mechanical breathers.

Some years ago, when there was still a question about the safety of mechanical breathing equipment, an eminent physician investigated its merits. As a final test he donned the mask of a breathing machine and for 15 minutes let it "breathe" for him. Then he began his report: "If mechanical breathing didn't work, I wouldn't be here to write these words . . ." END

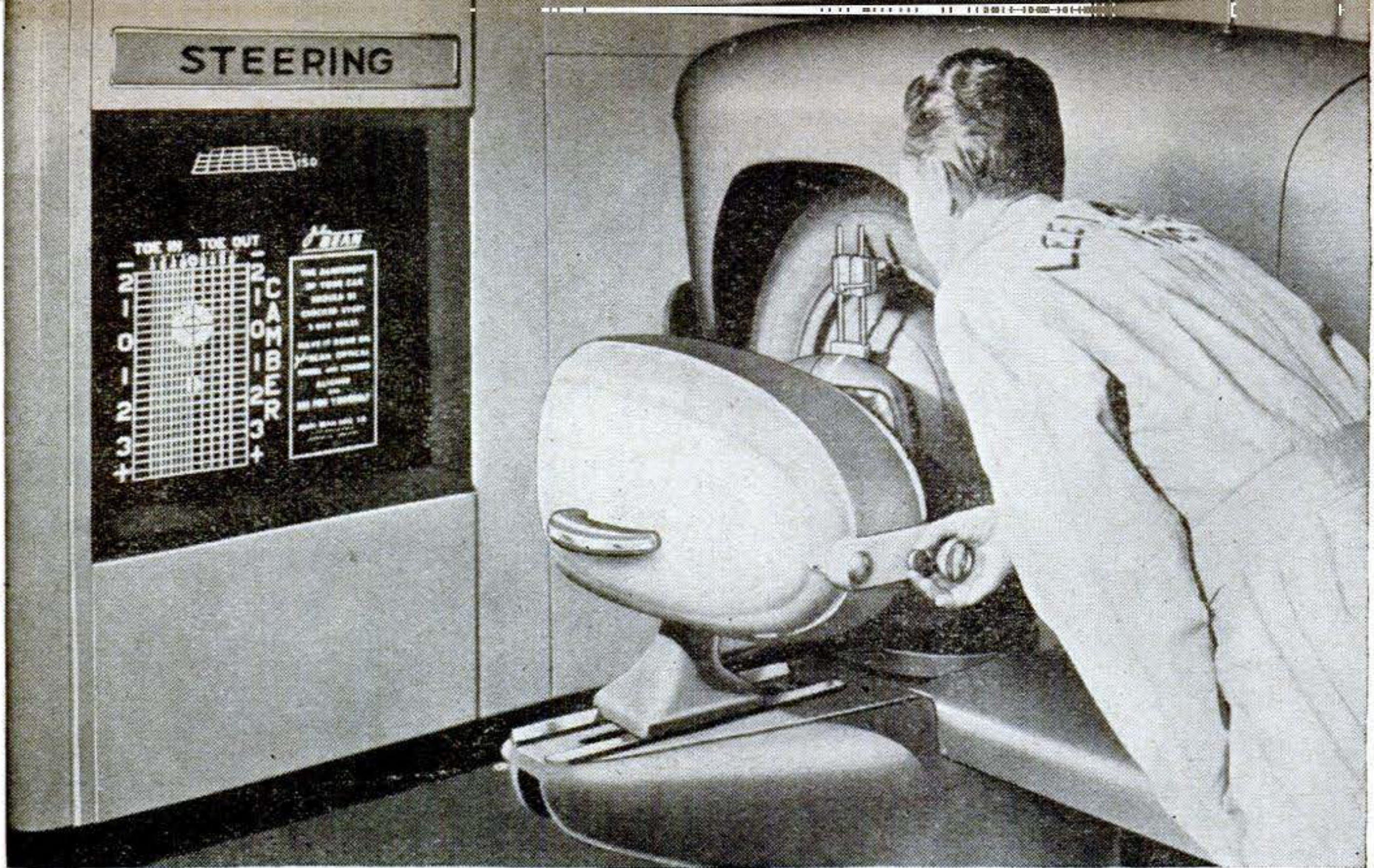

Light Aligns Wheels. Faulty wheel alignment, often the cause of steering difficulties and rapid tire wear, can be easily detected by the Visualiner, an outgrowth of

wartime light-beam gauges. When a car is driven onto the checking ramp, light beams projected on a chart clearly indicate the alignment of the wheels.

Tearing Turbine Fuel Apart. To get more power from an oil-burning gas turbine designed for possible use in locomotives, Westinghouse has devised a new nozzle that blasts heavy oil into particles only $4/10,000$ inch in diameter. The nozzle, shown below (right) in a comparative test, causes six fine streams of air to collide with incoming fuel. This miniature cyclone sprays oil into the turbine combustion chamber in a mist 10 times finer than that of old-style nozzle (left), improving combustion and boosting power.

Measuring by Shadows. Checking dimensions to within $2/10,000$ inch by the shadows they cast, the new Visi-Limit electronic micrometer can speed the production of wire, tubing and similar materials. A scanning disk sends a light beam to three apertures in turn—maximum, minimum and test—and a photocell picks up the flashes and transmits them to a cathode screen. There they appear as three horizontal lines; as long as the middle line remains between the other two, the required tolerances for the item tested are being met.

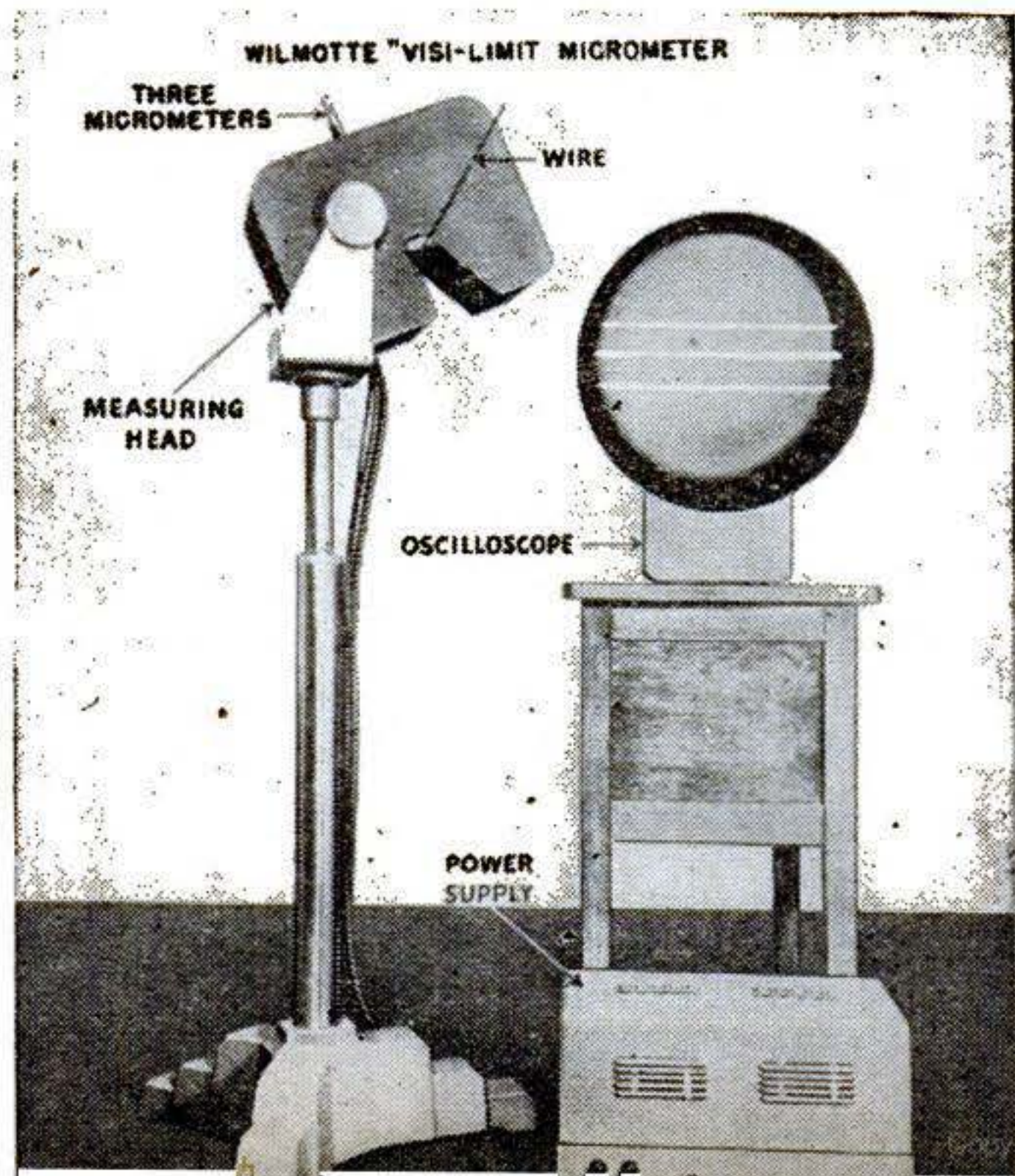

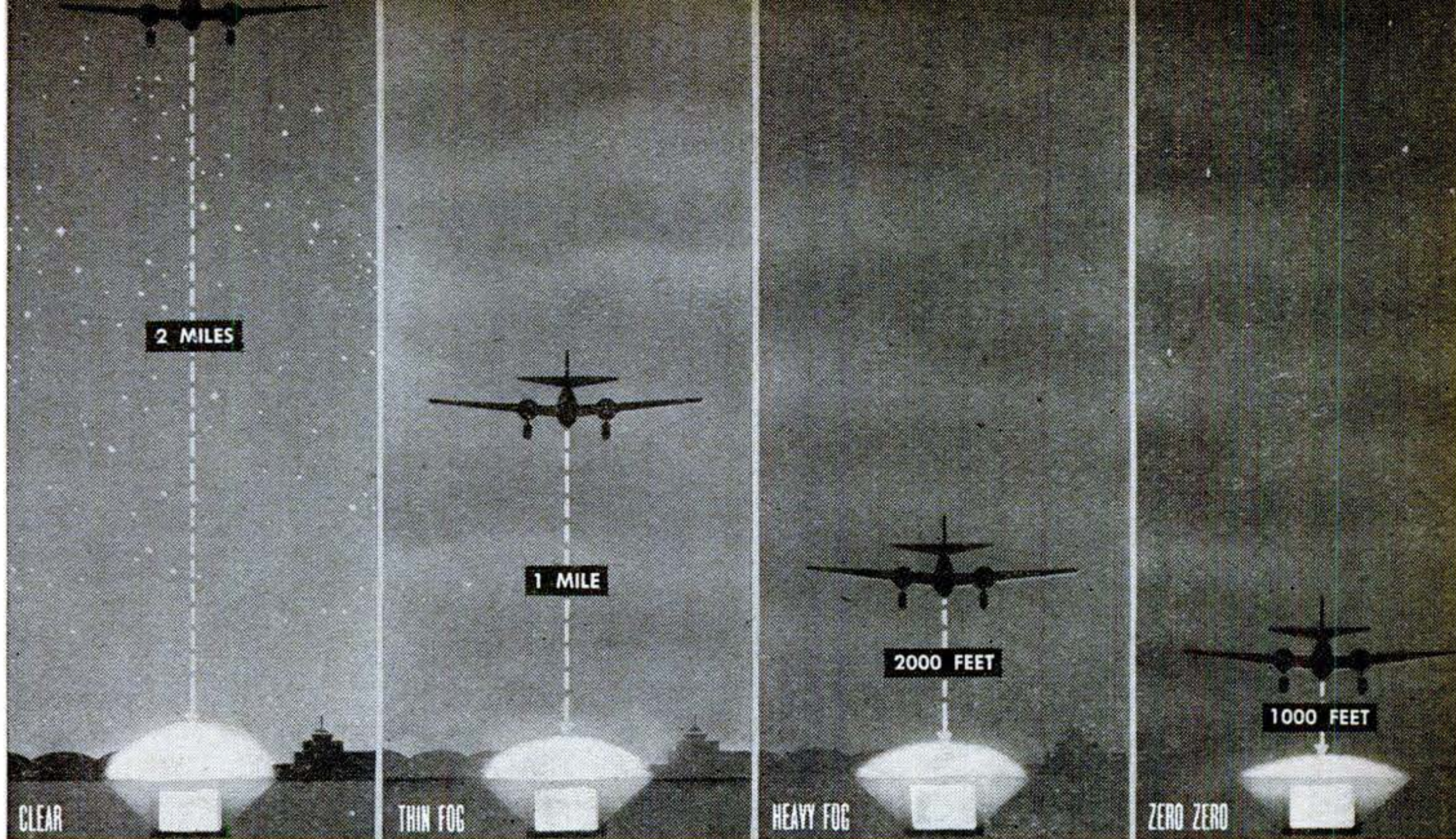

New lights penetrate from two miles in good weather to minimum of 1,000 feet in heaviest fog.

Big Flash Aids Fliers

A LINE of 36 of the world's brightest lights, equal to more than 1,800,000,000 60-watt bulbs, will enable pilots to make visual landings despite the thickest fog. Each of 3,300,000,000 peak candle power, these krypton lights are combined with neon blaze units to throw up lightninglike flashes. These penetrate at least 1,000 feet up

through any weather to tell the pilot, who has made a radio or instrument approach, when he is lined up with the runway. As he comes down, a green arrow shows him when the runway is clear; a flashing red cross tells when it is blocked. Other lights outline the runway itself. Westinghouse developed the system, now under test.

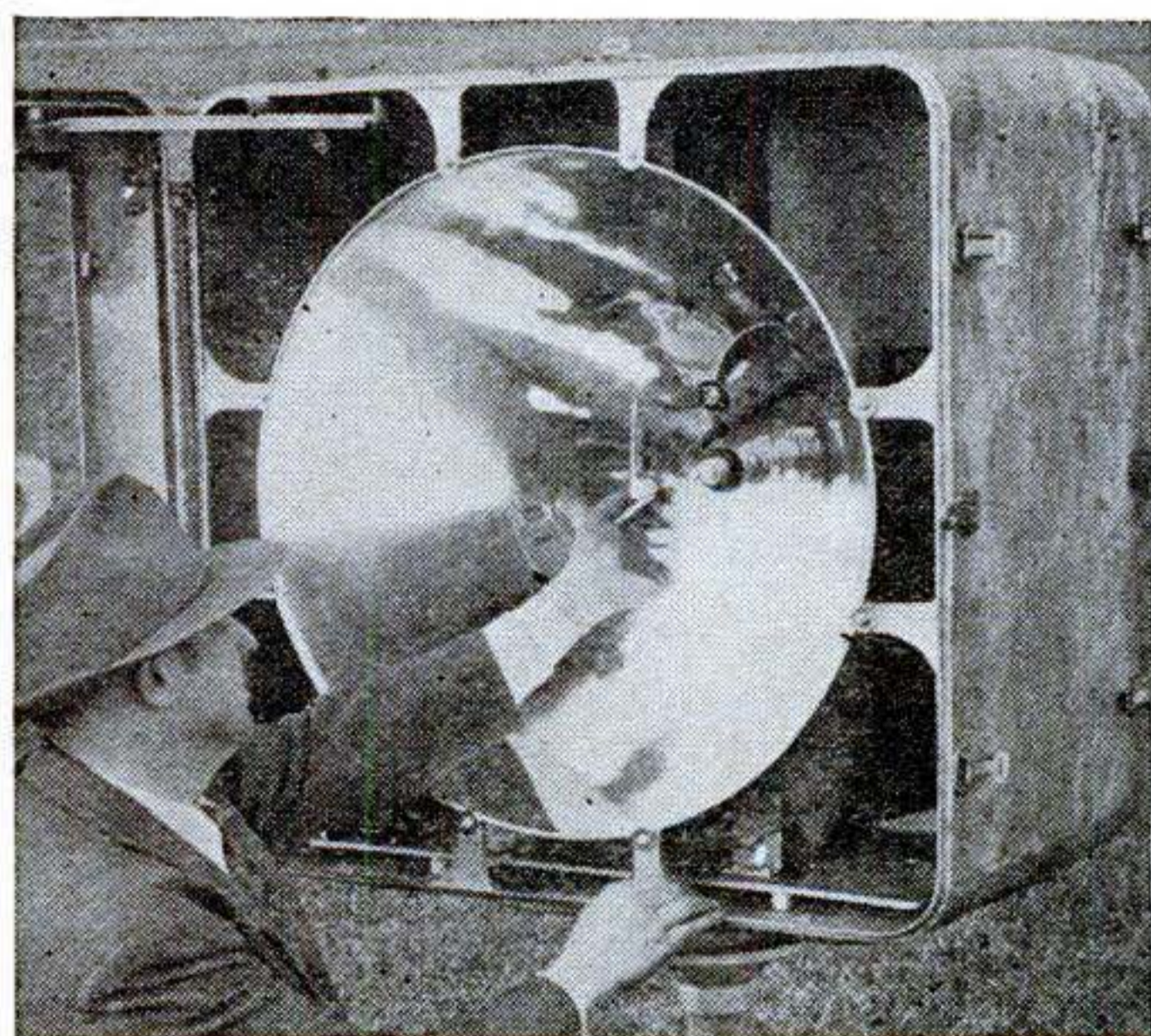

Source of "bottled lightning" in this unit is four-inch quartz tube filled with krypton gas. It is the key to fog-penetrating landing lights.

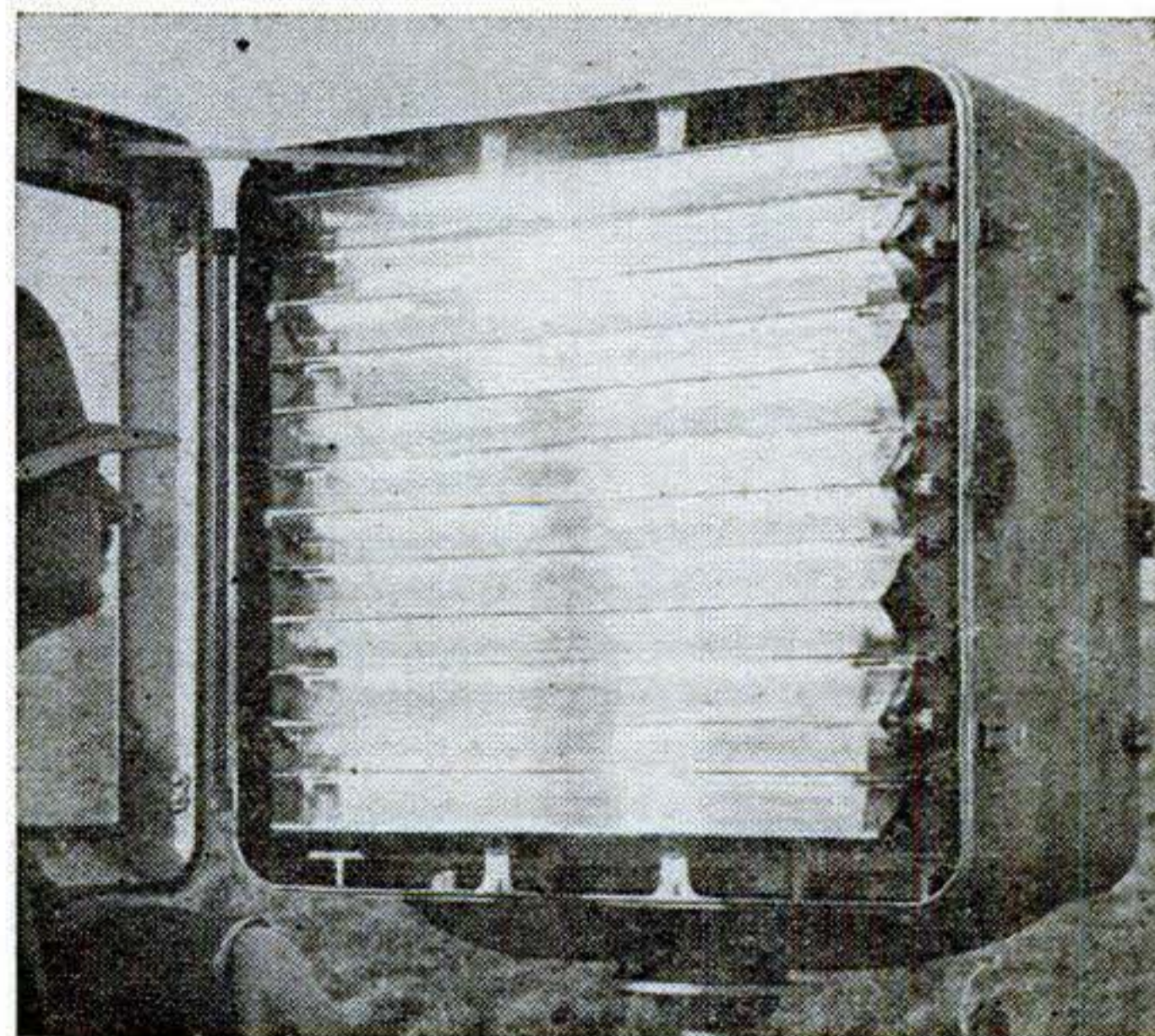

Thirty-six of these neon units are used alternately with krypton lights to create lightning effect; can be used alone in clear weather.

Color Tele Goes Big



Color projector contains three monochrome kinescopes. Inset shows one with its associated optical system.

COLOR television that can be projected on a large screen is the latest achievement of RCA engineers. At a demonstration in a large auditorium, color images were received and shown on a 7½-by 10-foot screen. The new receiver-projector utilizes the all-electronic system of color transmission (PSM, Feb. '47, p. 100) in which three separate images in red, green and blue are sent out simultaneously over adjoining channels.

At the receiver, each image is picked up by a separate kinescope and focused onto a concentric mirror that reflects the picture back to the screen. Correcting lenses com-

pensate for mirror distortion, so the three pictures reach the screen in proper focus and proper register.

Although color and picture quality are good, images do not have the brightness and definition achieved by black-and-white receivers. RCA experts say several years will be needed to bring color television up to present monochrome standards.

Because of the cost of three-part receivers and the delicate optical system necessary when using large-screen equipment, the new system is better suited to industrial plants and theaters than the home.

In a few more years restaurants, clubs, and the like may put large-screen color television on the menu.

134 POPULAR SCIENCE

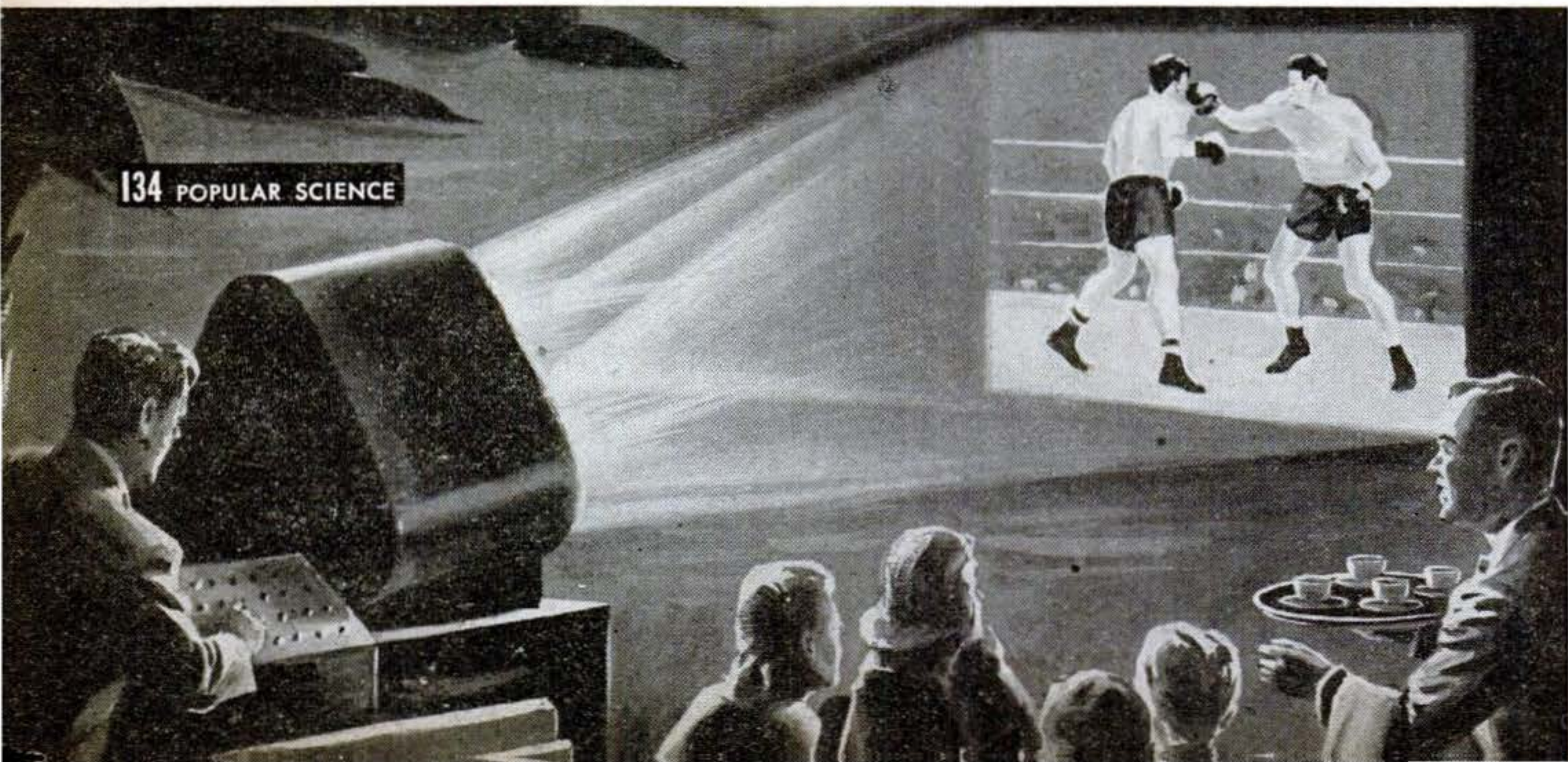

Oxygen for Locomotives

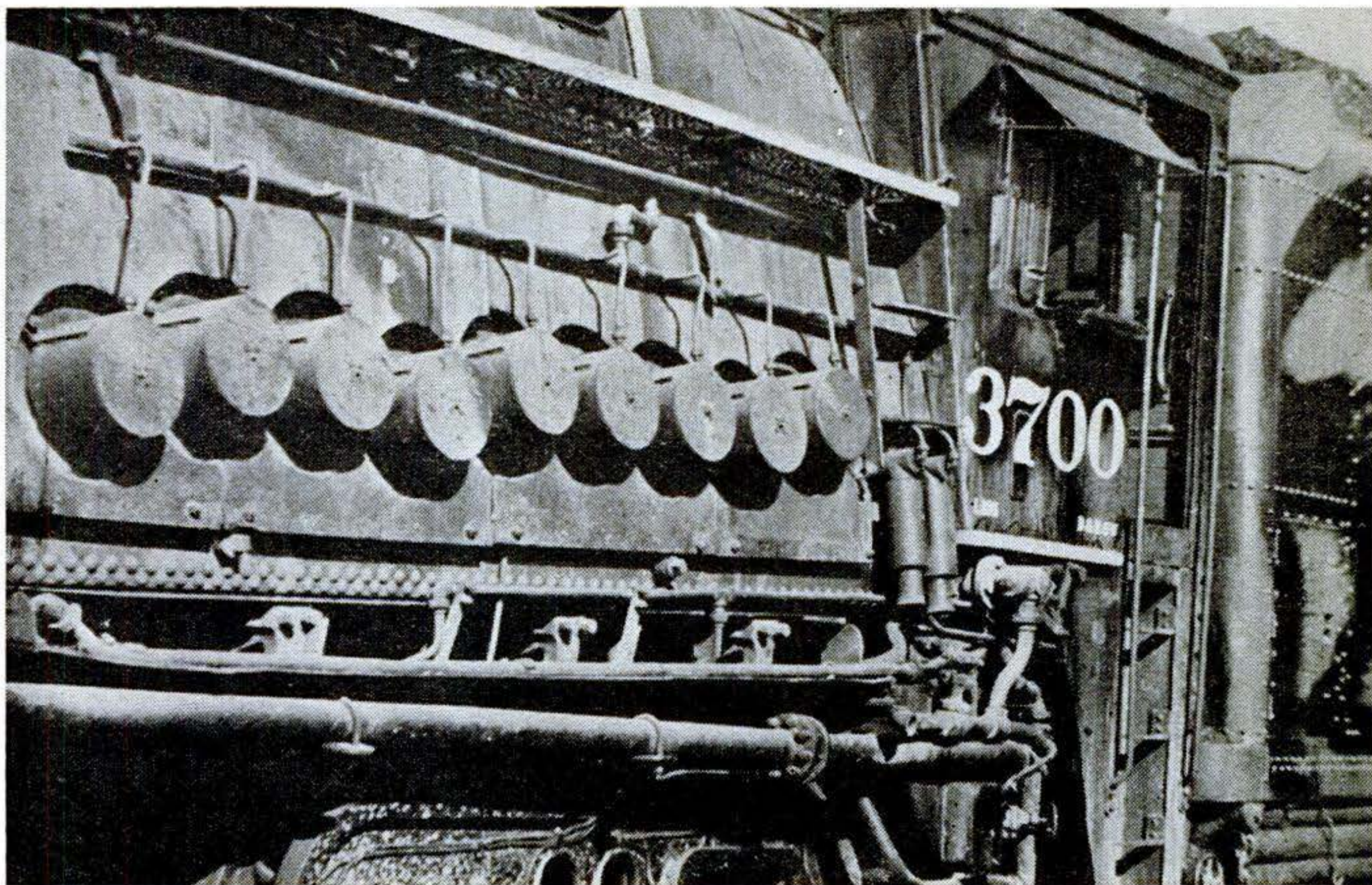

Mountain-climbing steam engines on the Denver & Rio Grande Western Railroad are "breathing" more easily now with the help of supplementary supplies of oxygen when the natural

content in the air begins to thin at high altitudes. Fed into the engine's firebox through a number of intake ports in its side, the oxygen increases combustion and thus provides maximum power.

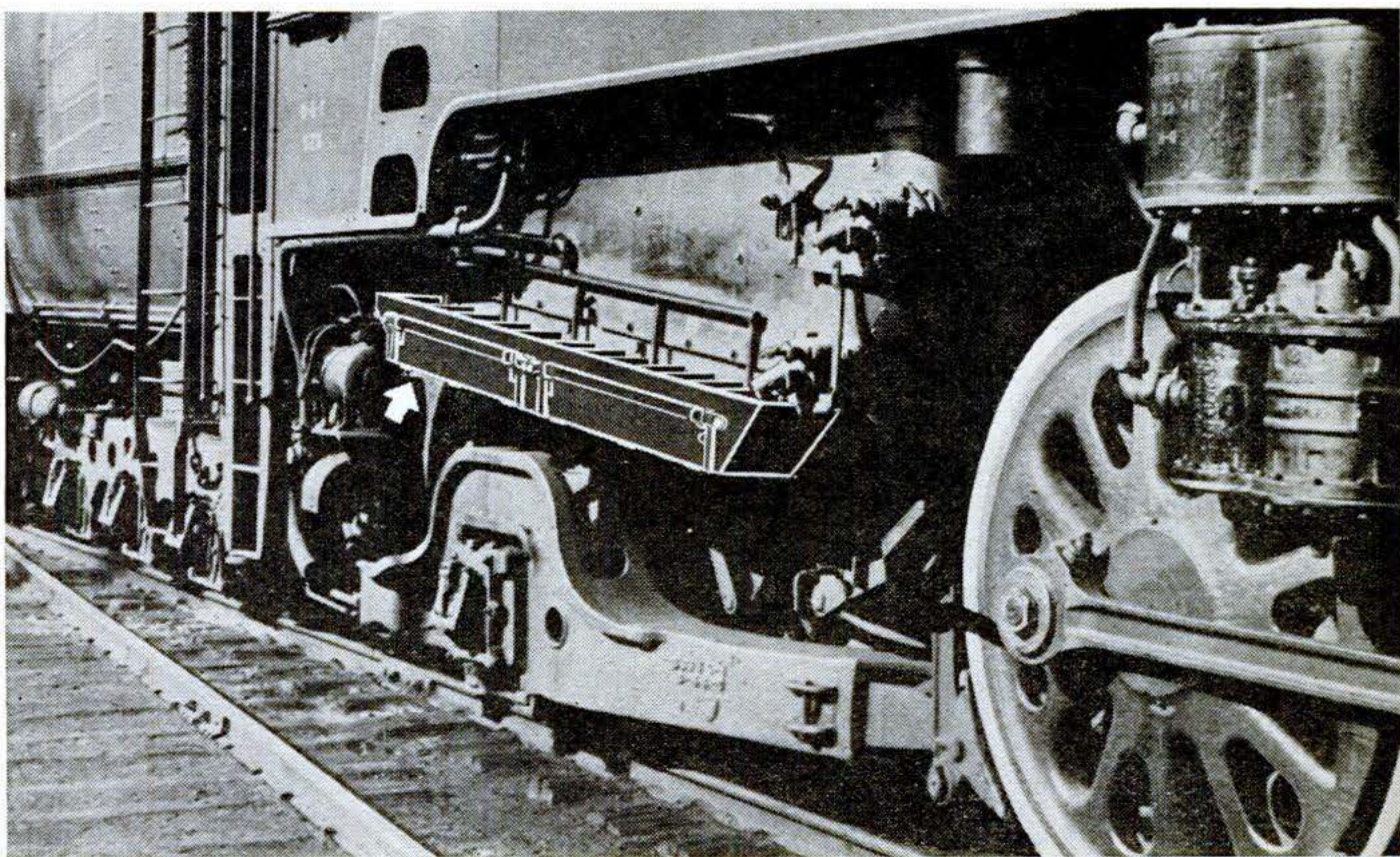

Better circulation of air is the object of another locomotive aid now undergoing road trials on several U. S. railways. Mounted along the ventilation ports under the firebox, the device

(arrow) consists of parallel vanes that scoop in the air and channel it evenly to all parts of the grate. This, too, results in greater combustion and lower fuel consumption.

AIDS TO MODERN LIVING

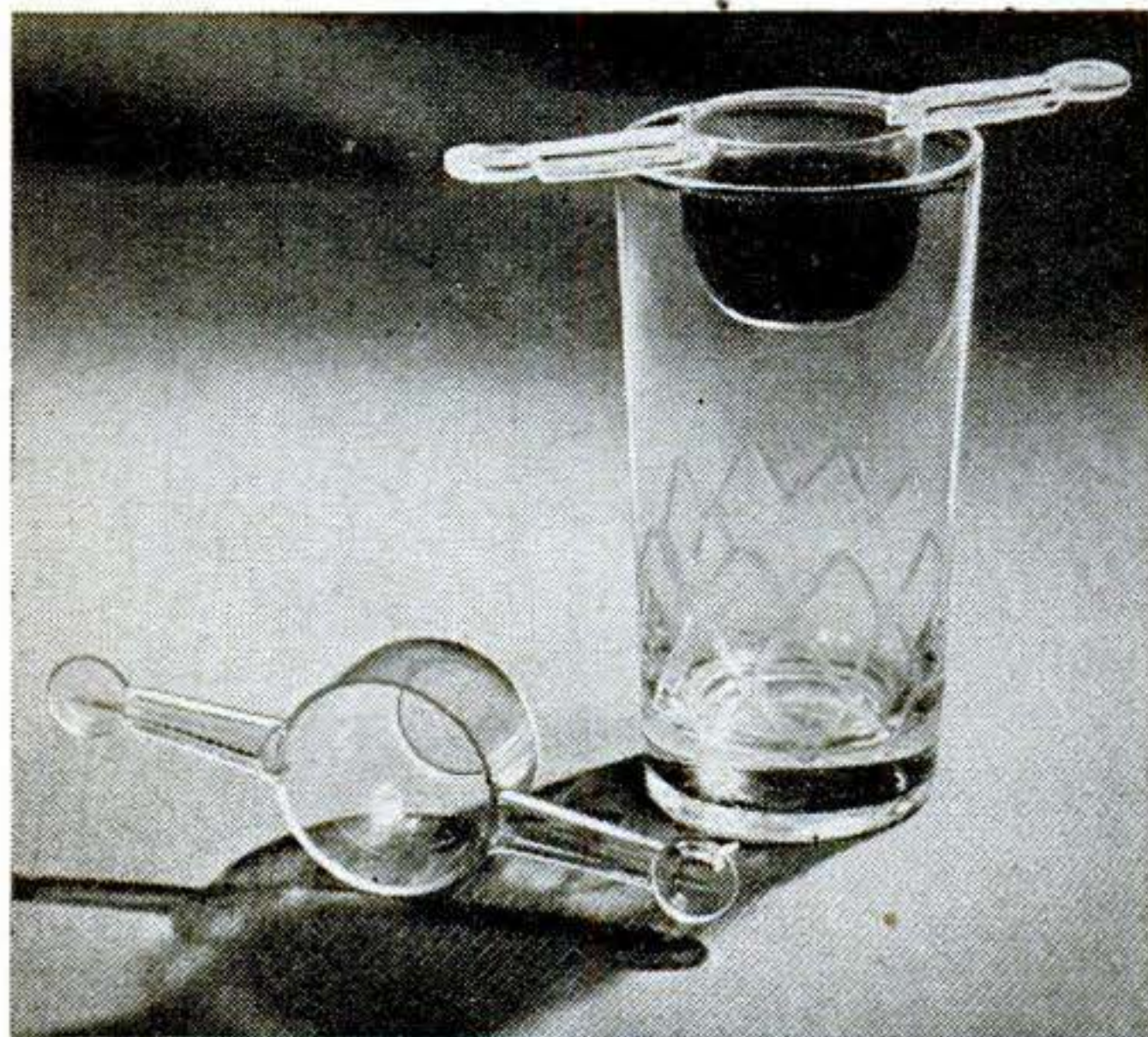

JIGGER SAVES LIQUOR. Designed to rest across the top of the glass, this 1½-oz. clear plastic jigger lessens the possibility that any liquor will be wasted by accidental spilling for, when full, it can be emptied directly into the glass below. The jiggers are injection-molded of polystyrene. They are being distributed by Akret Products, New York.



THROW-AWAY FLASHLIGHT. Sealed inside transparent plastic, a tiny flashlight made by the Falge Engineering Service, Bethesda, Md., is intended to be discarded after its one cell is dead. Pressure on the plastic cover operates a switch. Produced primarily to carry an advertising message, like a packet of book matches, the lights are offered only to advertisers, in quantity lots, at a cost of approximately 26 cents each.



PLASTIC BIKE PUMP. The Pharis Tire & Rubber Company, of Newark, Ohio, produces plastic bicycle pumps in color combinations to match the grips, horn, and other accessories of a bike. When not in use, the pump may be clamped to the bicycle, with its short length of hose detached and stored neatly inside the plastic head of the pump.

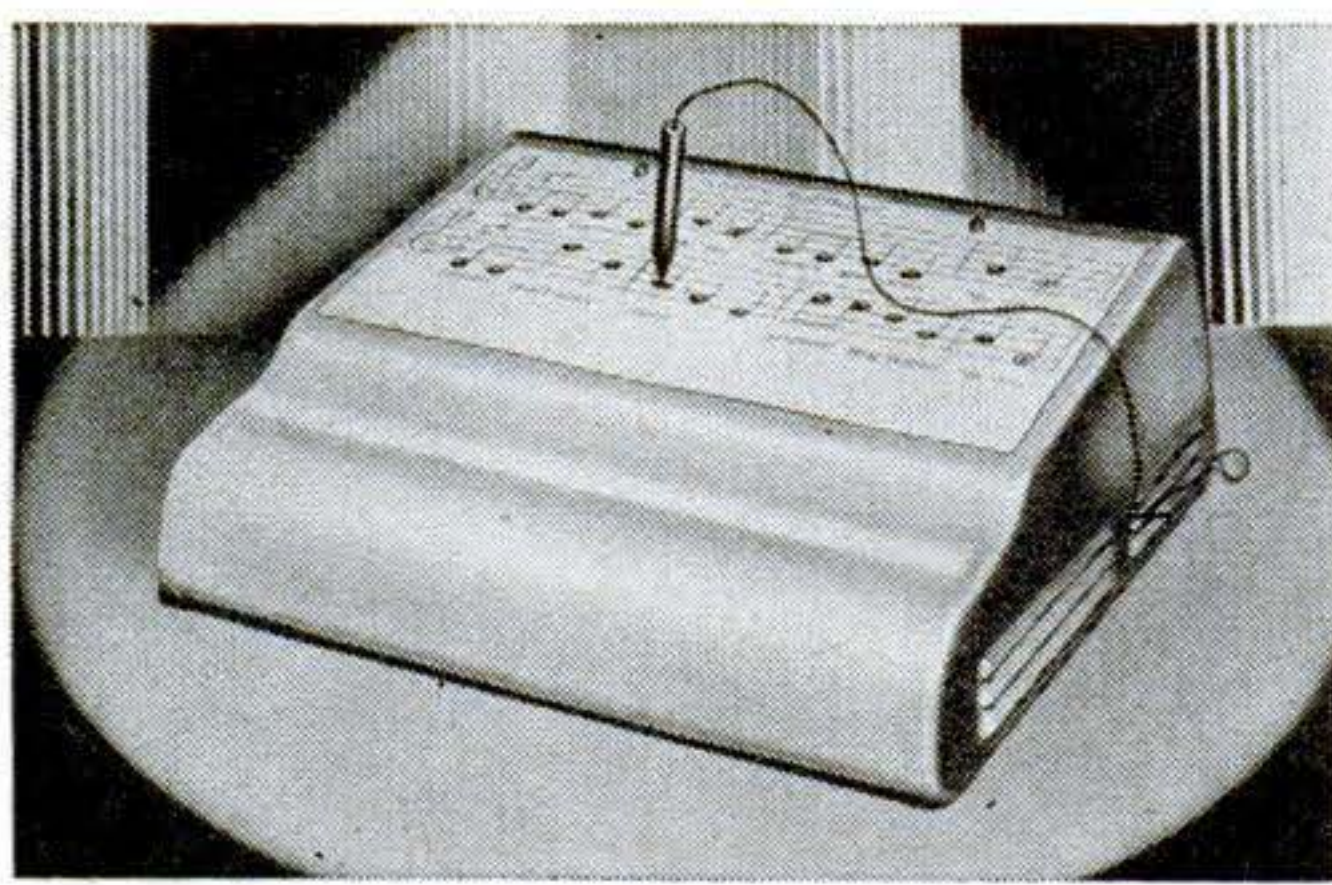

MUSIC PLAYED BY TOUCH. Designed as an educational toy, an electric xylophone introduced by Barr, Inc., of Rockford, Ill., produces a tune when a pointer is inserted in holes constituting the notes of special music sheets. Each contact closes a low-voltage circuit, energizing a solenoid and causing a glass tube to be struck. The instrument has nine notes, and operates on A.C. only. Six music sheets are available.



LIQUID TIGHTENS JOINTS. A liquid marketed by the Chair-Loc Company, of Freeport, N. Y., is designed to tighten loose wood joints. The manufacturer reports that it may be used for such jobs as securing tool handles and legs of furniture without taking the loose joints apart, the liquid locking the joint by swelling the wood fibers.



SHORT RAIN JACKET FOR SPORTS. A short plastic rain jacket for golf and general sports wear is offered by the Whitewater Raincoat Company, of Whitewater, Wis. An opening under each armpit allows air to circulate freely inside the loose-fitting garment and keep the wearer comfortably cool. Colors are clear, brown, and gray.



BULB GIVES INDIRECT LIGHT. With a 200-watt bulb introduced by Sylvania Electric Products, Inc., of New York, an ordinary floor lamp may be used for indirect lighting. The top of the bulb gives upward diffusion, while the lower part provides diffusion of light on reading surfaces. Any lamp can be adapted for the bulb by removing the existing wire lampshade support and substituting a new support that snaps over the bulb.

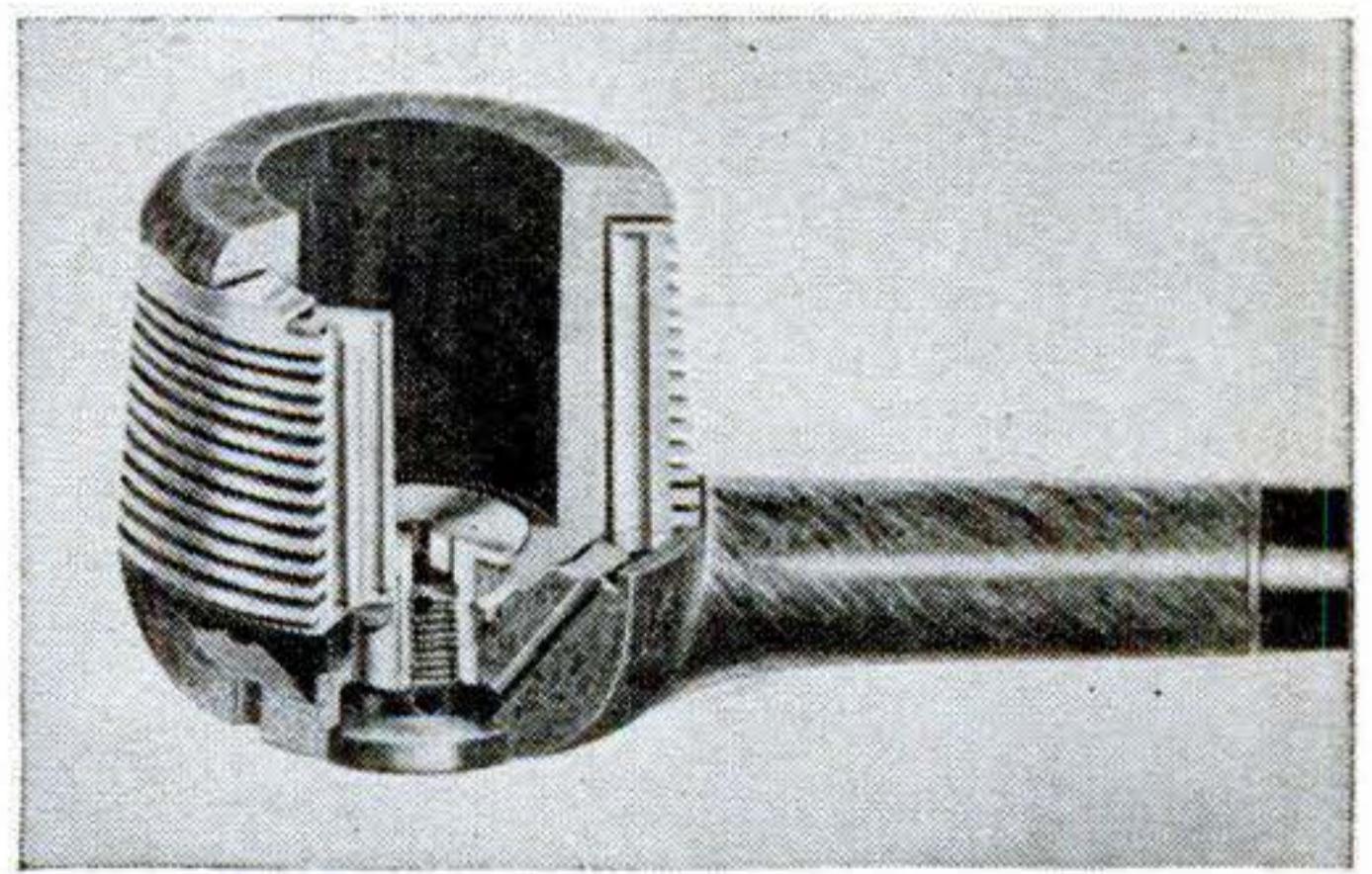

PIPE COOLS THE SMOKE. In a new pipe made by Erskine-Mills Company, Elizabeth, N. J., the smoke travels through 34" of looping aluminum channels. Smoke thus channeled is said to undergo a radical drop in temperature, and tars and resins are condensed out. The bowl may be turned to an "on" or "off" position, the latter being used when lighting the pipe to allow the smoke to bypass the cooling channels.

GUS Earns an Assist

By *Martin Bunn*

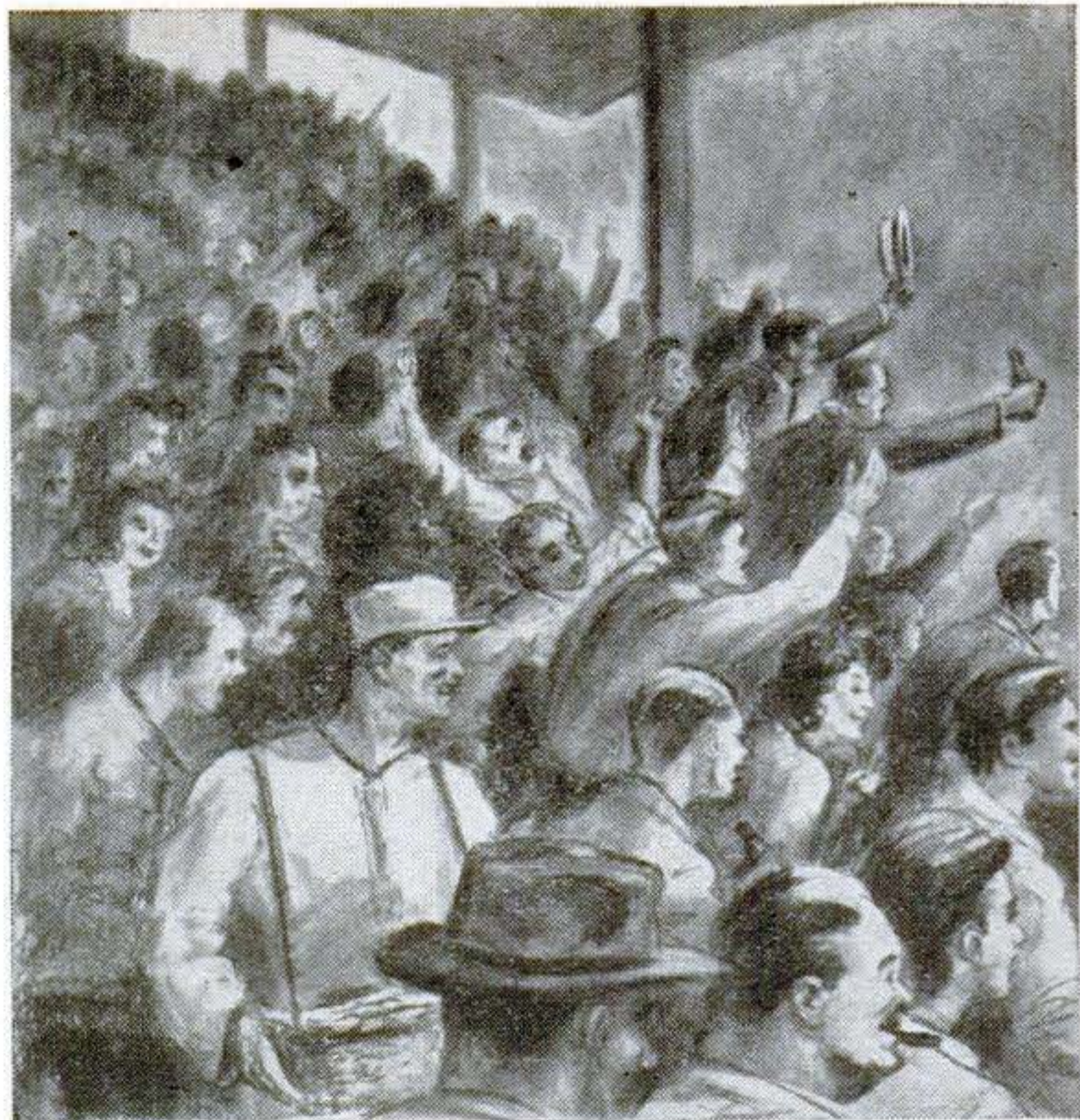

HAM CARR braked his old red sedan to a smooth stop on the Model Garage's shop floor and stepped out nimbly. "Hi, there, my friend," he hailed Gus Wilson. "Got time to give this old bus the once-over?"

"Sorry, Ham," Gus said, shaking his head. "Not today. I've promised this job I'm on, and I won't have it finished until quitting time. But Stan Hicks will be back soon. He can check if that suits you."

"Sure, that will be O.K.," Ham agreed readily. "The old gal's running all right, so I guess there's nothing wrong except what you'd expect from old age and a hard life. But I've got to drive her fast for a couple of hundred miles tomorrow, and I want to be sure she can take it. Going to the ball game in Millville?"

"I'll be there," Gus grinned. "Even if I weren't a fan myself, I'd have to on account of Stan. Since he's been playing right field for the Stags he doesn't think or talk anything but baseball. He's just killing time working for me until some big-league scout comes along and signs him."

Ham is promoter and manager for our town's crack semipro club. "Stan's no big-league prospect," he admitted, "but he's always in there trying—and he sure loves baseball. I wish some of my other players were that way—Buzz Bentz, for instance."

"What's the matter with Buzz?" Gus demanded. "He's won every game he's pitched

this season. What more do you want?"

"There's nothing wrong with Buzz's pitching," Ham agreed. "It's his attitude that gets my goat. The Reds were after him when he was pitching college ball, but he wouldn't even talk to them—wanted to be a chemist! Now that he's in the National plant he doesn't mind picking up 25 iron men from me once a week, provided it doesn't interfere with his test tubes. But he doesn't have his heart in the game."

"What do you care," Gus retorted, "as long as he's good for a win every start?"

"He's driving me nuts," Ham complained. "Right now, the day before the big Millville game, what do you think he's doing? Taking care of his arm, practicing his drop?"

The manager stomped in disgust. "Naw!" he answered himself. "He's winding up his vacation from the plant—teaching a short summer course in chemistry at the college in Madison. I'll bet he hasn't had a baseball in his hand the entire two weeks. And he won't leave a minute before the noon whistle closes his last class tomorrow. I've got to be there with my car to rush him to Millville. That's why I want it checked."

Gus did a little quick figuring. "You can't make it," he decided. "It's 140 miles from Madison to Millville. You haven't a chance of doing it in two hours and a half."

"I don't expect to," Ham winked wisely. "But that's all right. Lank Jimson can hold Millville for three or four innings. He's good,

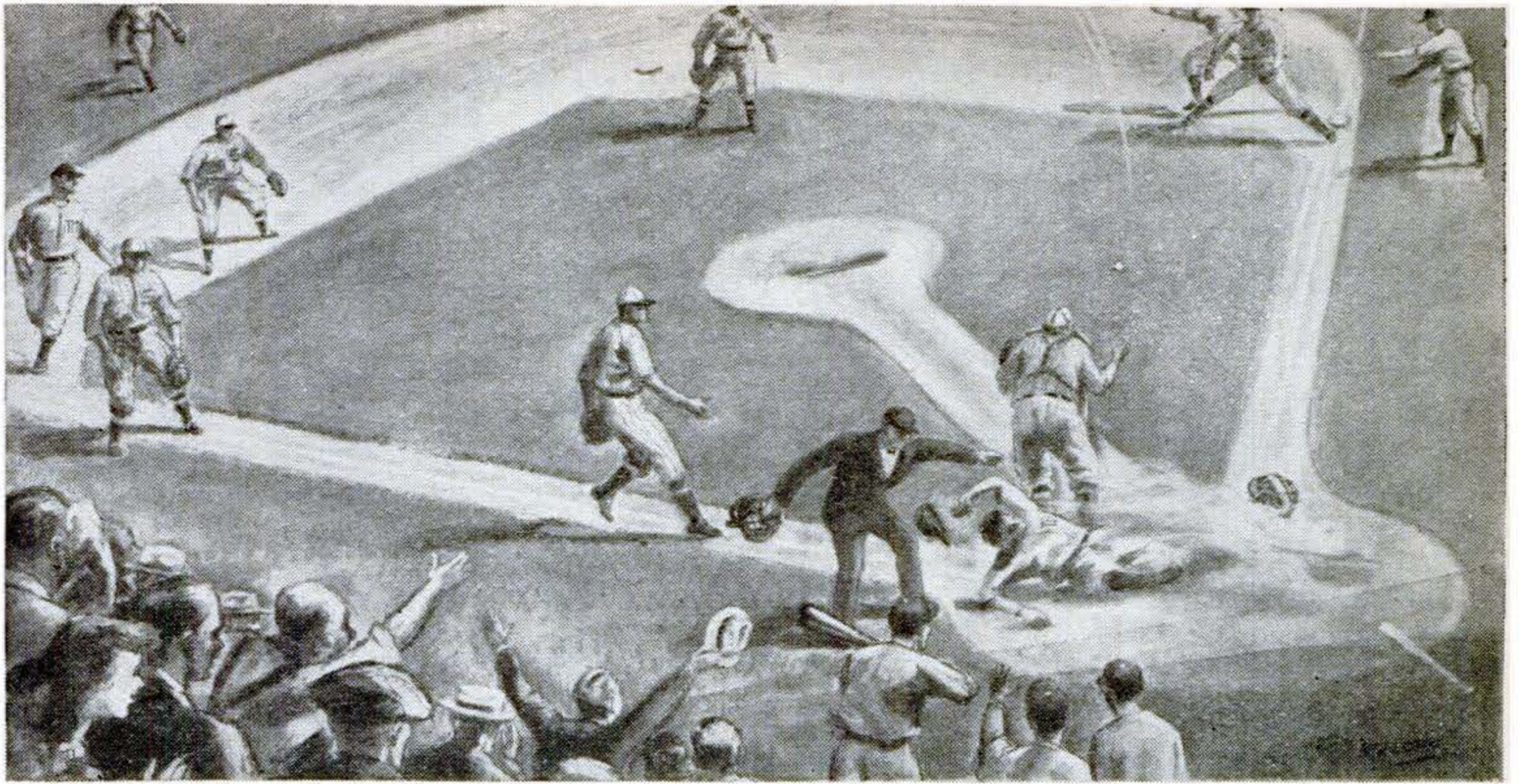

but he's got no stamina. Before he tires, I'll have Buzz there to relieve him. Get it?"

"So that's it," Gus laughed. "Well, here's Stan. Tell him about your car, Ham."

GUS had planned to start for Millville by two o'clock. But when he got back to the shop from lunch at half past one, a new customer came in with a car that wasn't running right despite an expensive engine job down in the city. It was a tough nut trouble-shooting job, and Gus got so interested in it that he forgot all about the ball game. When at last he had found the cause of the trouble and pointed it out to the customer, he glanced at the shop clock and saw that it was past three.

"Holy cat!" he whistled. "I've missed most of the game. Stan will never forgive me if I'm not there for the last inning. Bring your car in Monday, mister, and I'll finish the job then. I'm doing a fade-out for Millville."

He was quick at washing up and changing from his coveralls, but it was going on four when he left the shop and pushing the hour—with almost 20 miles to Millville—when he drove through the intersection at which the Madison road joins the highway.

A couple of miles beyond, Gus saw a familiar red sedan standing on the shoulder, and when he got closer he recognized the man who was pacing impatiently up and down beside it with his eyes on his wrist watch—Ham Carr. Just as Gus was pulling

up behind the sedan, Ham jumped into the old bus and drove off in a swirl of dust.

Wondering why Ham was so late and what he had been waiting for, Gus kept close behind. In 10 minutes the car slackened speed, pulled to the side of the road, and stopped. Gus stopped behind it and jumped out. So did Ham, his eyes again on his watch.

"What's the matter?" Gus shouted.

"My bus has gone nuts, and I'm going nuts, too—that's what's the matter," Ham sputtered. "Those Millville murderers must have slugged Lank Jimson off the mound by now. This is awful!"

"What's wrong with the car?" Gus asked.

Ham kept his eyes on his watch. "It's gone nuts, I tell you," he repeated bitterly. "For 10 minutes it runs swell; then it won't run at all for five. Then it will run swell again for 10 minutes. It's been doing that all the way from Madison. This is driving me crazy! And look at that Buzz Bentz—he's asleep. What an attitude!"

Gus peered into the sedan. Buzz, in his baseball uniform, was slumbering peacefully on the rear seat. Gus shook him.

"Wake up—wake up!" he said. "Get out and get into my car. Leave your bus here, Ham, until after the game. Maybe we can still get there before it's over."

Gus is always known as a careful driver, but when he has to make time in his old well-kept coupe, there's nobody on the road

who can beat him. As they drove up to the players' gate under the old grandstand, a thunderous roar let them know that the game was still on. They ran through the deserted dressing room and onto the field.

An anxious glance at the scoreboard told them that the Stags were ahead 4 to 2 and that there were two men out in the last half of the ninth. But on the diamond, there was a man on third and another on second. Lank Jimson, weary and shaky, was set for the pitch. He didn't see Buzz arrive, and he didn't see Ham signaling frantically for him to throw wide.

Crack! Ash met horsehide, and a hard-hit Texas leaguer went out over the infield between first and second. It reached Stan Hicks in right field on its stinging first bounce. The grease monkey threw almost as he caught the ball—with one clean motion. It was a beautiful throw straight for home plate. In that split second allowed him, Stan realized he would never catch the batter at first, and he threw home in a prayerful effort to keep the tying run from scoring. It worked. The man on third slid home with yards to spare, but the second runner was held on third though the batter stretched his hit to a double.

Then Lank, his shoulders slumped with fatigue, went slowly to the showers. Buzz walked briskly to the mound amid the howls of the stands and with Ham's final plea in his ears. "Get in there and *pitch!*" Ham had whispered hoarsely. "There's an extra 20 bucks in it if you fan this guy."

This guy was Hank Watson, Millville's heaviest slugger, and the Stags' lead had been clipped to one small run. The tying run was on third, the winning on second.

Hank stood back nonchalantly, exuding confidence, as Buzz wound up deliberately and put his first warm-up pitch straight through the center of the plate into Bill Greely's waiting mitt. The roar from the stands gave way to tense silence. Only Buzz—and Hank—seemed unconcerned. There was a second pitch, a third, fourth, and finally a fifth.

Then Hank stepped into the batter's box, heaving aside two bats as he did so and retaining his old reliable favorite. He dug the spike on the ball of his left shoe into the earth and brought his bat slowly back on his right side. Bill signaled, and Buzz nodded assent. He fingered the ball behind his gloved hand, glanced swiftly at the runners on third and second, and threw. "Strike

one," called the umpire. The stands kept strangely still.

Hank let the next three pass without moving a muscle—they were balls. The next he fouled over the stand just inside the third-base line. Three and two.

Even as Buzz's arm flashed on the next pitch, the runners on second and third were in motion. Hank stepped forward, intending to meet the ball before it could break, and swung with all his weight.

That was all. For Buzz broke his drop a little faster than usual, and Hank missed by inches. Millville's section of the stand groaned, and ours went wild. Buzz, calm and cool, walked off the field.

WHEN a semblance of quiet had been restored in the Stags' dressing room some 30 minutes later, Gus hunted out Buzz and Ham.

"Great pitch," he told Buzz as he clapped him on the back. "What did you put on that ball, anyway? But let's get going back to Ham's car. The highway ought to be pretty well cleared, and we can make a road test."

When they reached Ham's parked car, Gus wanted to know whether it gave any warning before it pulled its crazy stops.

"It sputters a little," Ham revealed.

Gus raised the hood. "Drive with this up," he instructed Ham, "and stop quick as soon as you notice the sputter."

At the end of nine minutes, Ham braked. Gus, coming up behind, went over to the sedan. As it gave its last cough, he heard the whiplike snap of a high-tension spark.

"This is anticlimax after the excitement of that ball game," Gus laughed. He pointed to the high-voltage lead that runs from the coil to the center of the distributor cap, which on Ham's car was close to the manifold. "See where the insulation has worn off?" he asked. "When that comes in contact with the manifold it causes a short."

"But how . . ." Ham started.

"Copper wire expands, lengthens in this case, with heat," Gus explained. "When the wire is cool it's almost straight, but when it stretches out it curves and touches the manifold. That causes your trouble. We'll tape up the bare spot and put in a new lead Monday. Even if Stan didn't notice it when he checked your car, he played good ball."

"So did you," Ham grinned. "If you hadn't come along when you did, Gus, Buzz would never have got there in time. In my scorebook you get credit for an assist." **END**

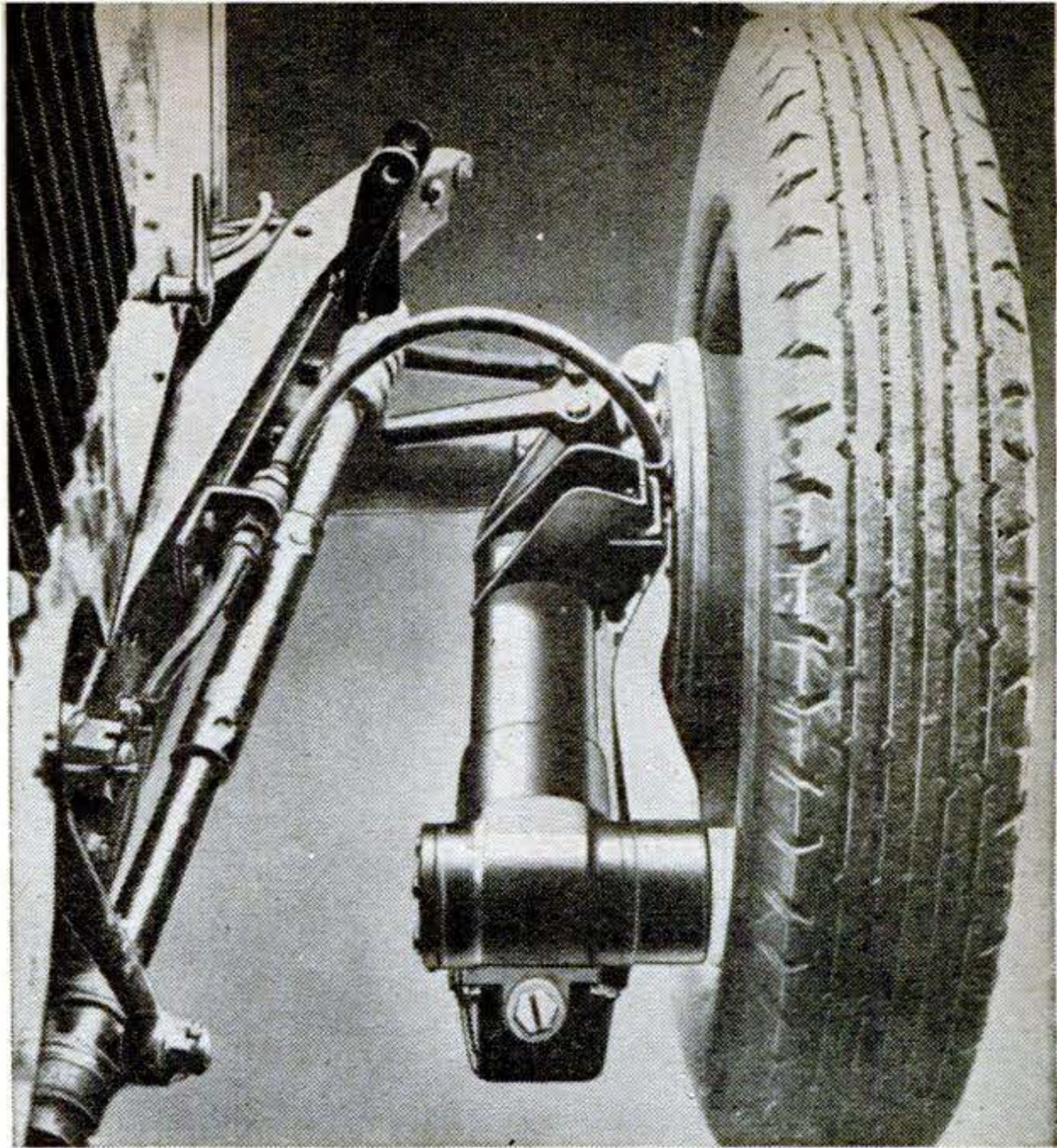
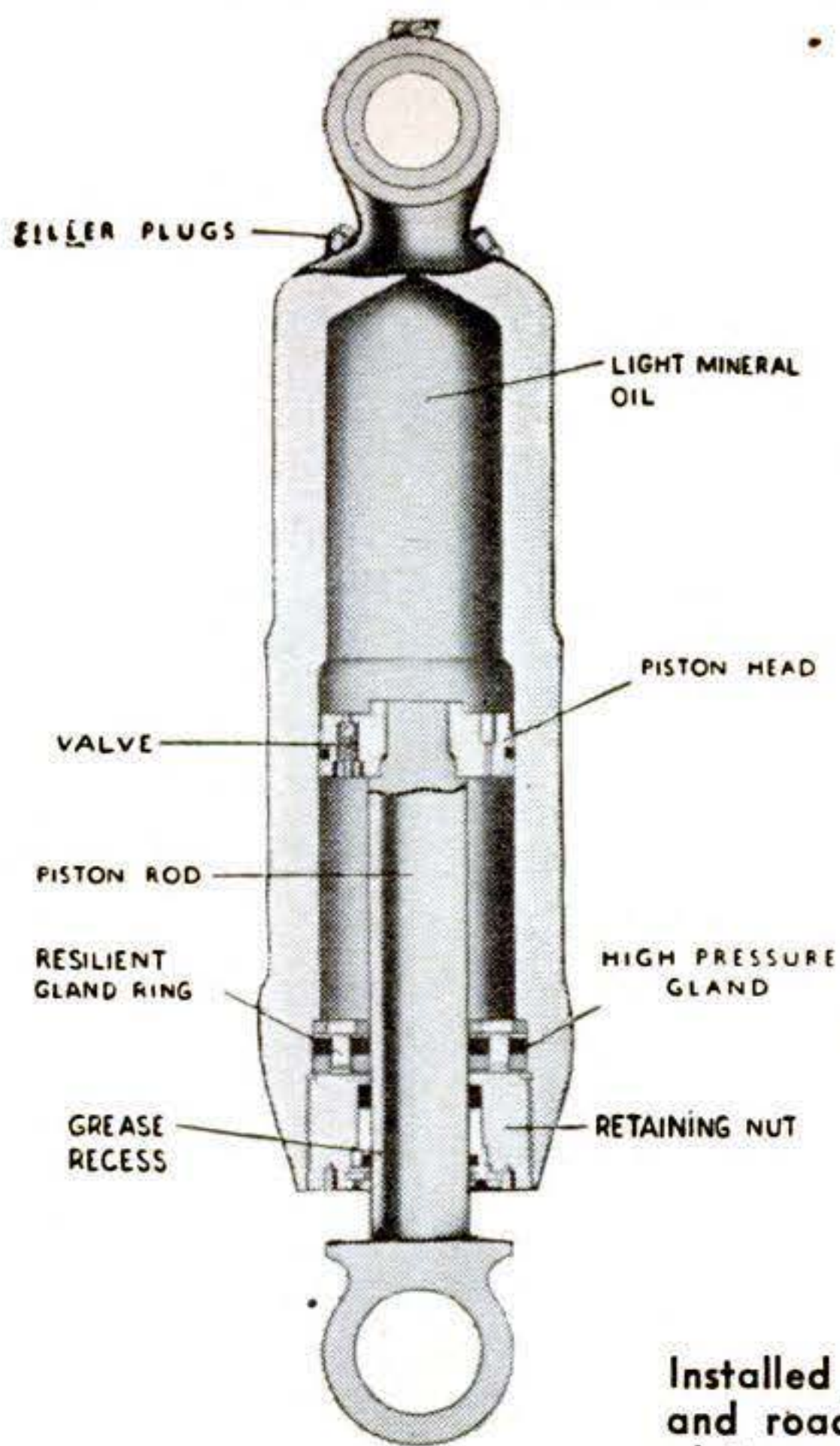

Installed on cars, a new liquid spring is said to improve riding comfort and roadability. A resilient gland ring sandwiched between two steel plates expands under pressure and keeps the oil from leaking out.

Liquid Springs Take the Bumps

COMBINING the functions of both spring and shock absorber, a revolutionary new hydraulic spring developed in England during the war provides riding comfort through actual compression of a liquid. Produced originally for aircraft undercarriages, it now is being developed by Dowty Equipment, Ltd., for motor vehicles, railway rolling stock and industrial uses. The Gabriel Co., of Cleveland, has obtained the right to manufacture it in the United States.

The liquid spring refutes a common belief that fluids are not compressible. Tests have shown that the light mineral oil used in the spring is compressed 20 percent under a pressure of 60,000 lb. per square inch.

Basically the hydraulic spring consists of an oil-filled steel cylinder containing a piston

that carries a valve. A rod attached to the piston emerges through a high-pressure packing gland that seals the cylinder and at the same time permits smooth action of the rod. Under pressure, a resilient ring in the gland assembly tends to expand into the cylinder, providing a seal around the rod and keeping oil from being forced past. Colloidal graphite lubricates the rod.

When a bump forces the rod into the cylinder, the oil is compressed and the valve opens, transferring oil to the opposite side of the piston. On the recoil, the valve closes but a restricted return of oil is permitted by a small passage in the piston, thereby damping the action. Two filler plugs in the cylinder facilitate exclusion of air during filling.

Because of their immunity from fatigue, liquid springs are claimed to be longer-lived than those made of steel or rubber. Compared with a conventional metal spring that will do the same job, the liquid spring also saves much weight and space.

A 40-lb. spring is used on each undercarriage of the Halifax bomber. It is 21" long and 4" in diameter.





Full-length sleeping comfort on vacation trips is provided by this modification of a two-door sedan. The foot of the bed is in the trunk.

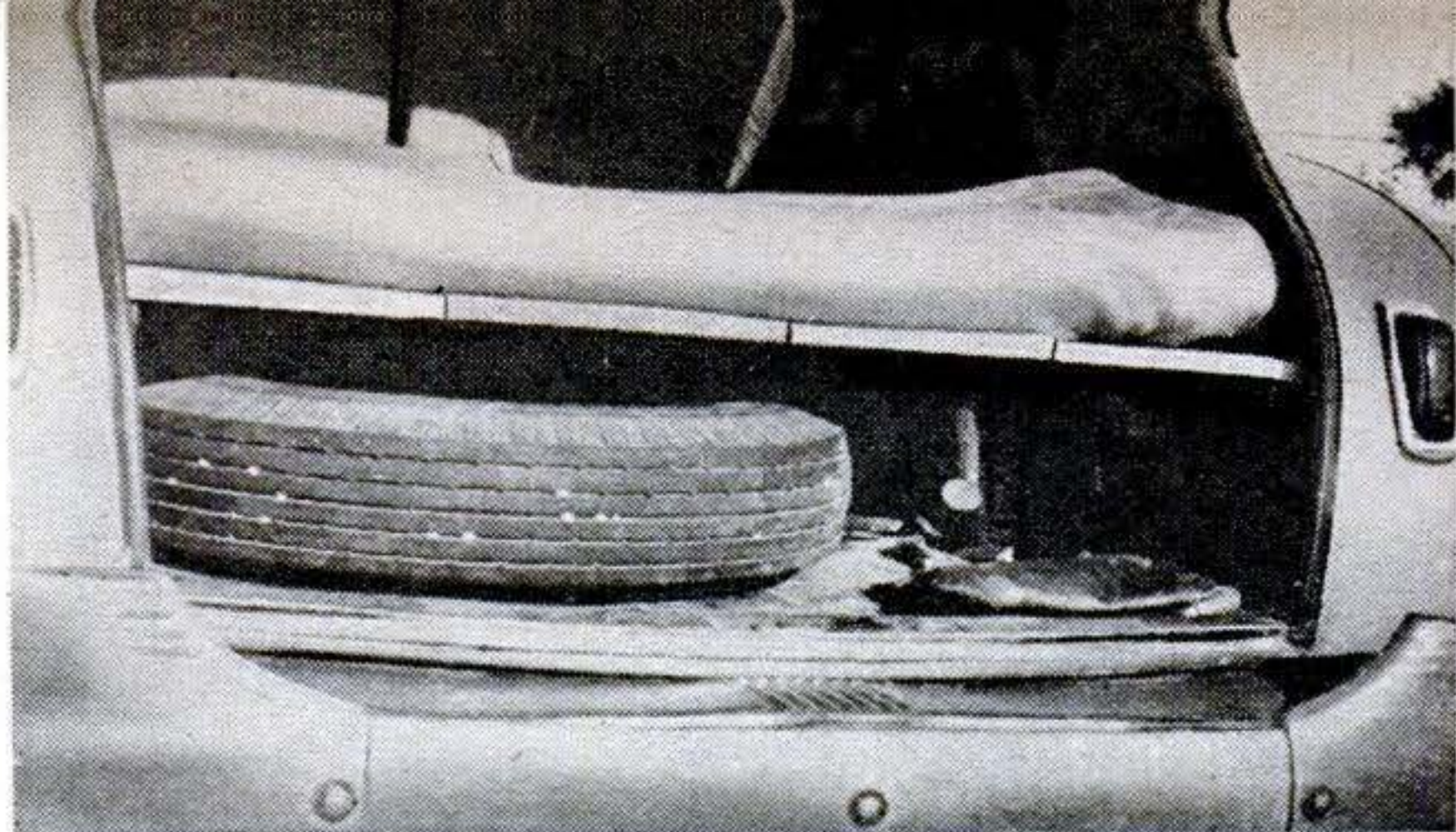

Here's how the bed looks from the trunk end. This one takes a 6' double mattress. There's room for the spare tire and tools under it on the floor.

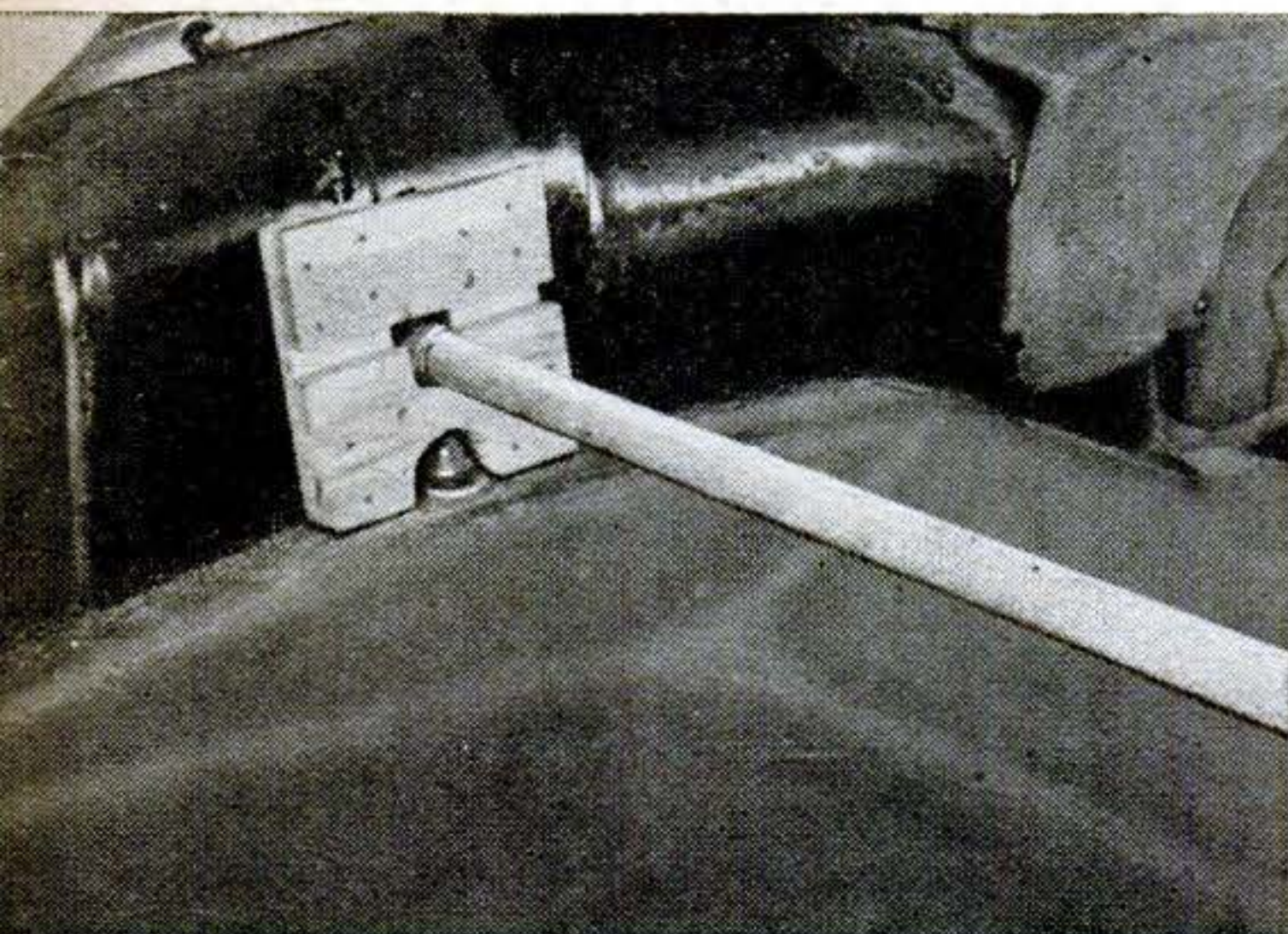

The other end of the pipe is held between blocks. If the spare-tire brace isn't on the side, put in blocks at both ends and use a wood crosspiece.

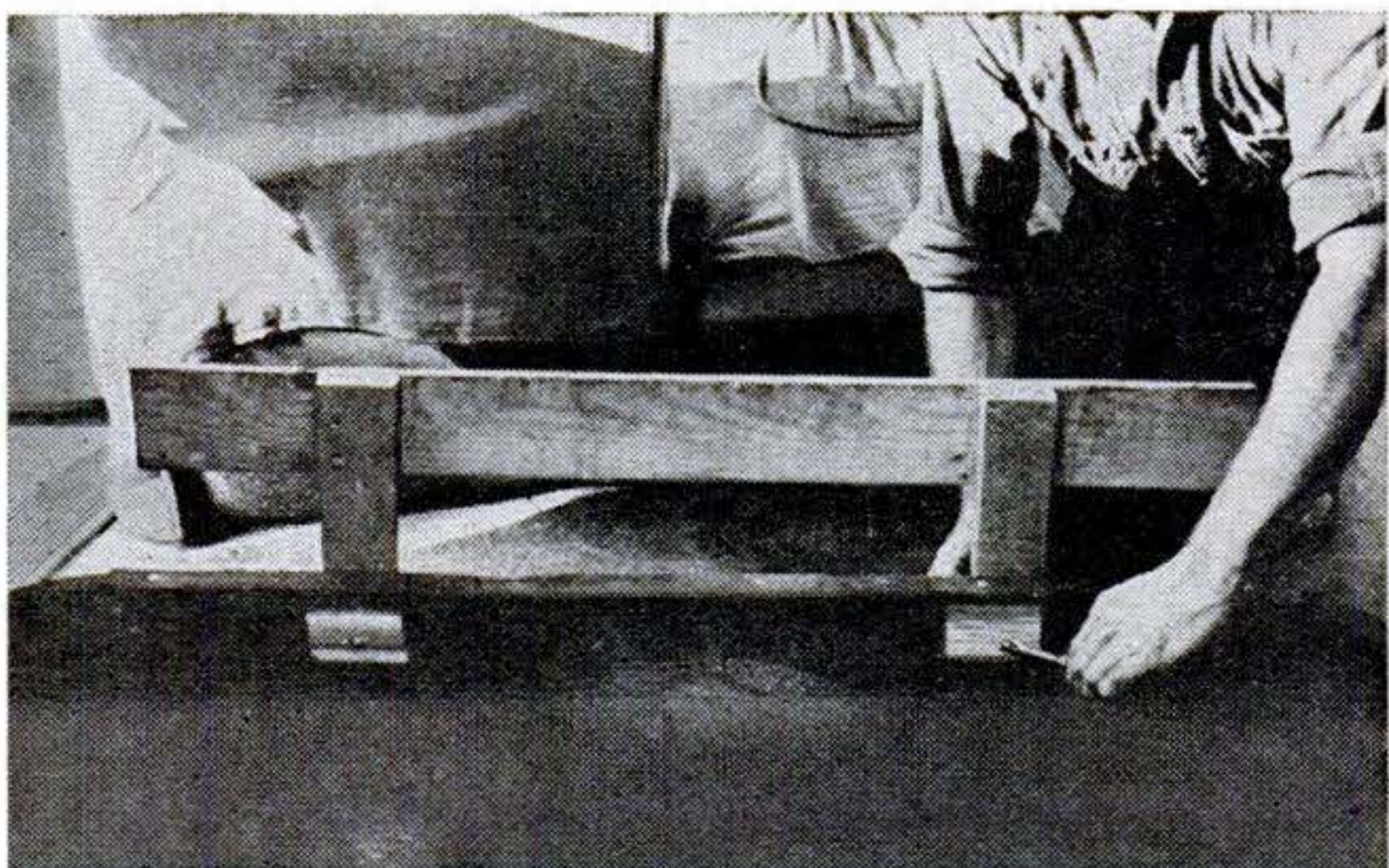

For the front support, a T-shaped piece is bolted to the front of the rear-seat frame. A sort of low sawhorse will do if bolting is inconvenient.

Build a Bed in Your Car

CONVERTING your car so that it will serve as a bed on vacation trips isn't a difficult job, and it will free you of dependence on tourist courts and hotels. Most coaches and sedans as well as many coupes can be modified simply by removing the back seat and adding a mattress platform. Though less flexible than arrangements in which seat backs fold down to form a mattress, the conversion is far simpler and entirely satisfactory.

After removing the rear seat and cushion, take out the cardboard or fiber trunk partition by removing the screws or prying off the locking buttons. If there is a light channel-iron brace between the seat and trunk, saw it out and drill holes so it can be replaced later with strap-iron "splints" and

bolts. In cutting, leave stubs long enough to take the replacement bolts.

Many cars have the spare-tire bracket on one side of the trunk. In this case, a length of 1" pipe can be fitted over the bolt in the tire brace and run to a notched wooden block fastened at the opposite side. It serves as a support for the foot of the bed platform. If there is no tire bracket on the side, use wooden stands at both ends of the support, which then may be a length of 1" by 3" stock turned on edge. In any event, level the support by having the blocks or the block and bolt at the same height.

Build a support for the head of two uprights and a 1" by 3" crosspiece bolted to the seat-cushion frame or, if this is impracticable, on small sawhorse legs placed close

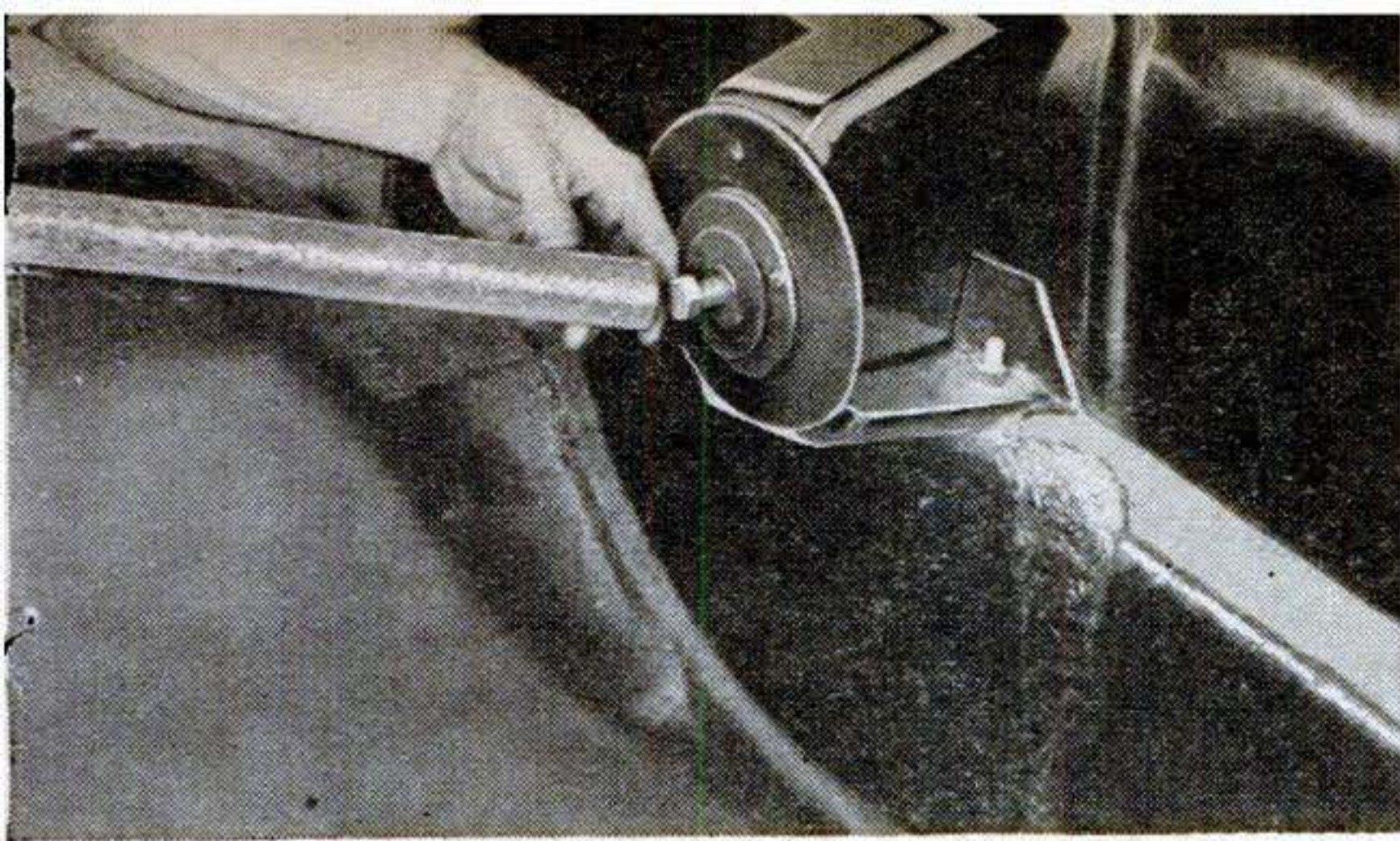

After removal of the back seat, supports for the bed platform are put in. One can be a length of 1" pipe over a nut in the spare-tire side brace.

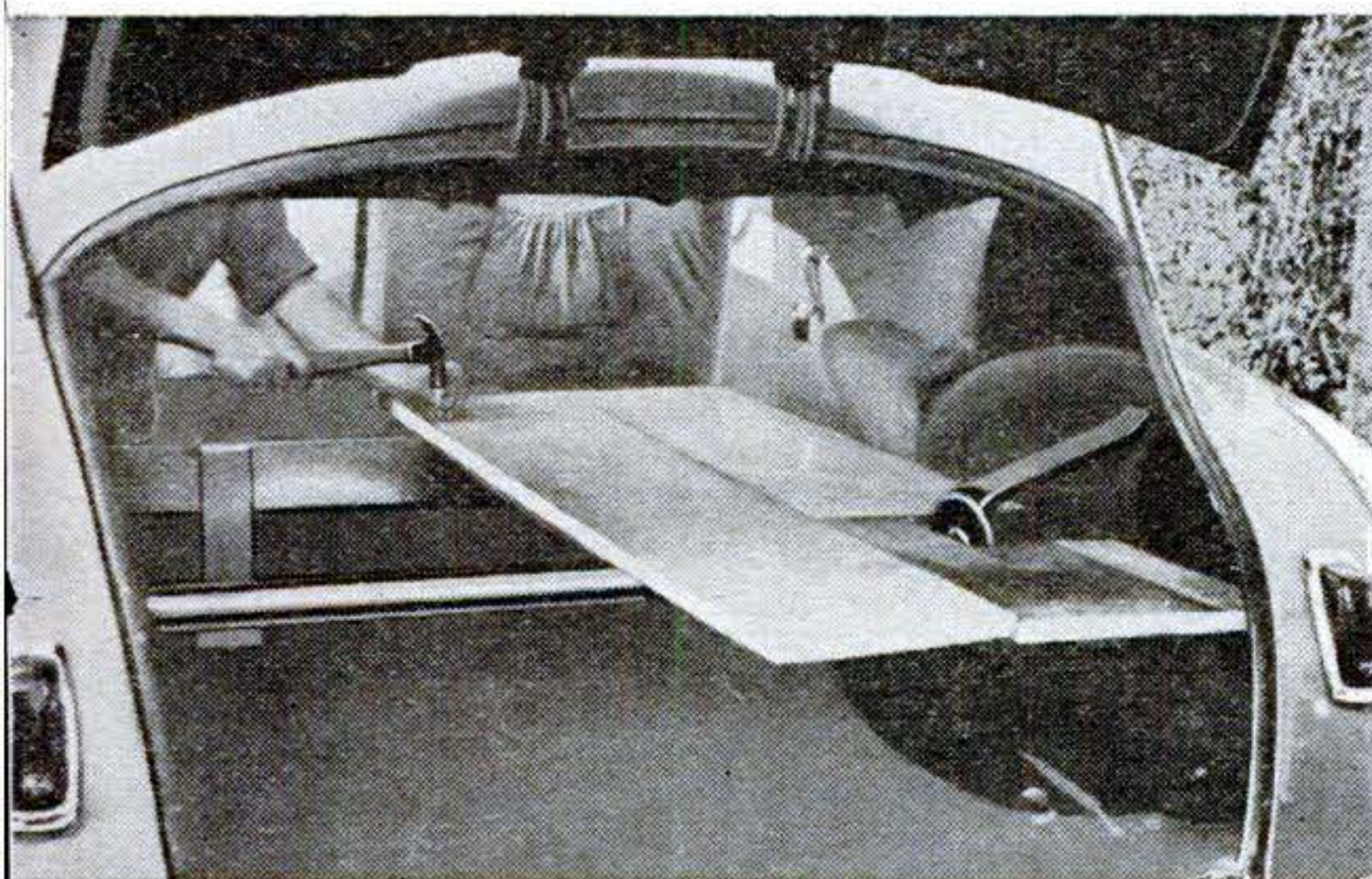

Finally planks are nailed to the front support as a platform for the mattress. When the vacation is over, the bed is taken out and the seat put back.

By H. C. Marhoff

to the back of the front seat. Be sure it is level with the foot support. Nail planks for the platform to the front support; their length will be governed by available car space and the length of the mattress. Notch the outer plank on the tire-bracket side to pass this bracket, which will serve as an anchor. If there is no side tire bracket, anchor the two outer boards with metal straps held by body bolts.

Almost all coaches have room for at least a 6' mattress. Extra blankets folded under the mattress will make up in part for lack of a bedspring, though an air mattress is preferable. The spare tire and tools can go under the bed platform. Luggage can be carried on the bed when traveling and stacked at night on the front seat.

Replacement Front-Seat Unit Folds Back into Car Bed

IN THE commercial field, the problem of putting a bed in a car is solved by a front-seat unit that replaces the original front seat and can be installed in most cars in less than an hour. Its back folds down level with the cushions in the front and rear seats to make a comfortable bed that is long enough for most sleepers even in a short club coupe.

The seat is a product of the California Car Bed Company, of Los Angeles, and is listed to sell for under \$100. The car owner keeps his old seat for reinstallation when he trades in the old car.

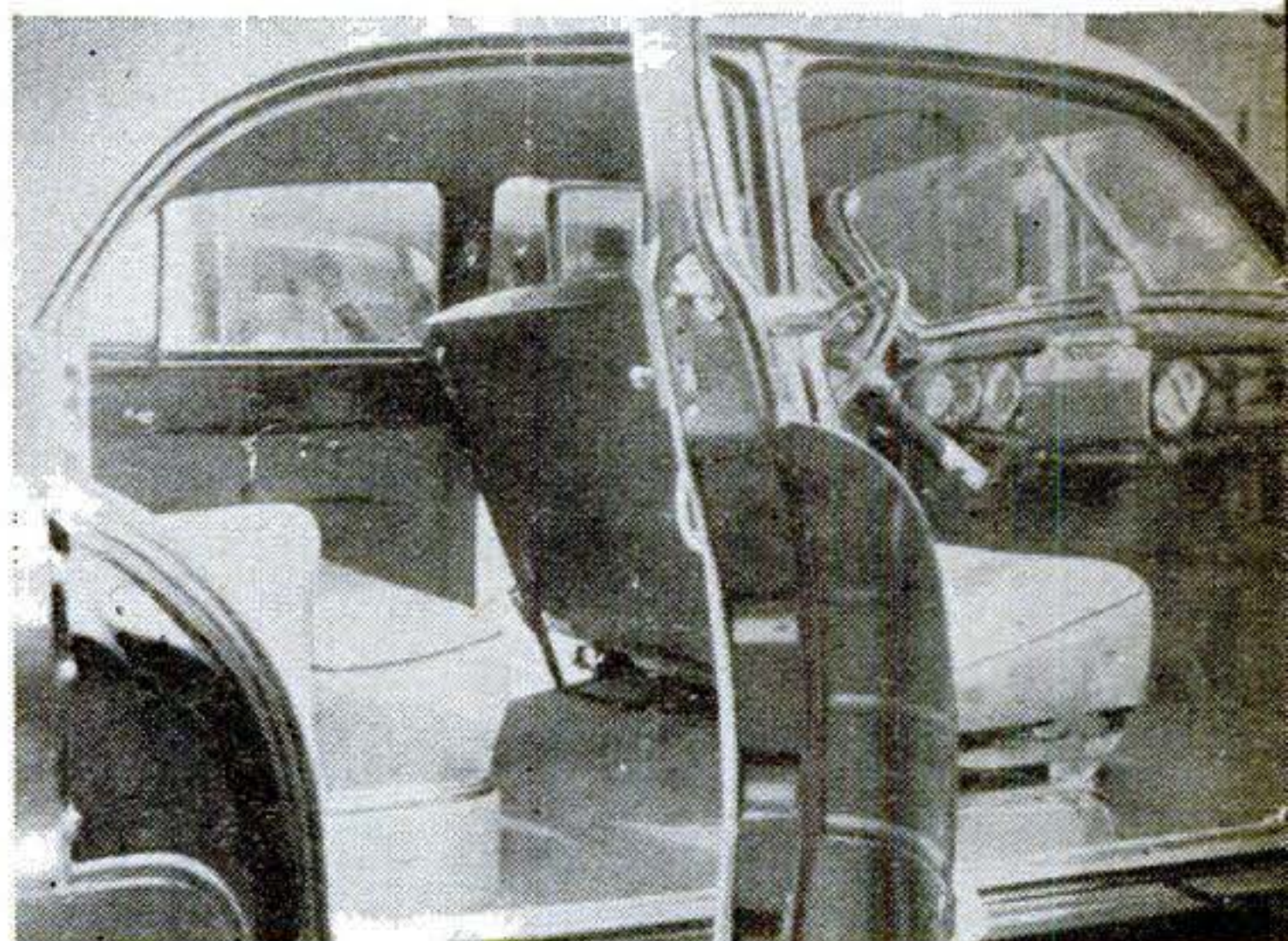

Bolted to the original frame, this front seat serves for ordinary driving purposes, is adjustable for leg room, and pivots forward.

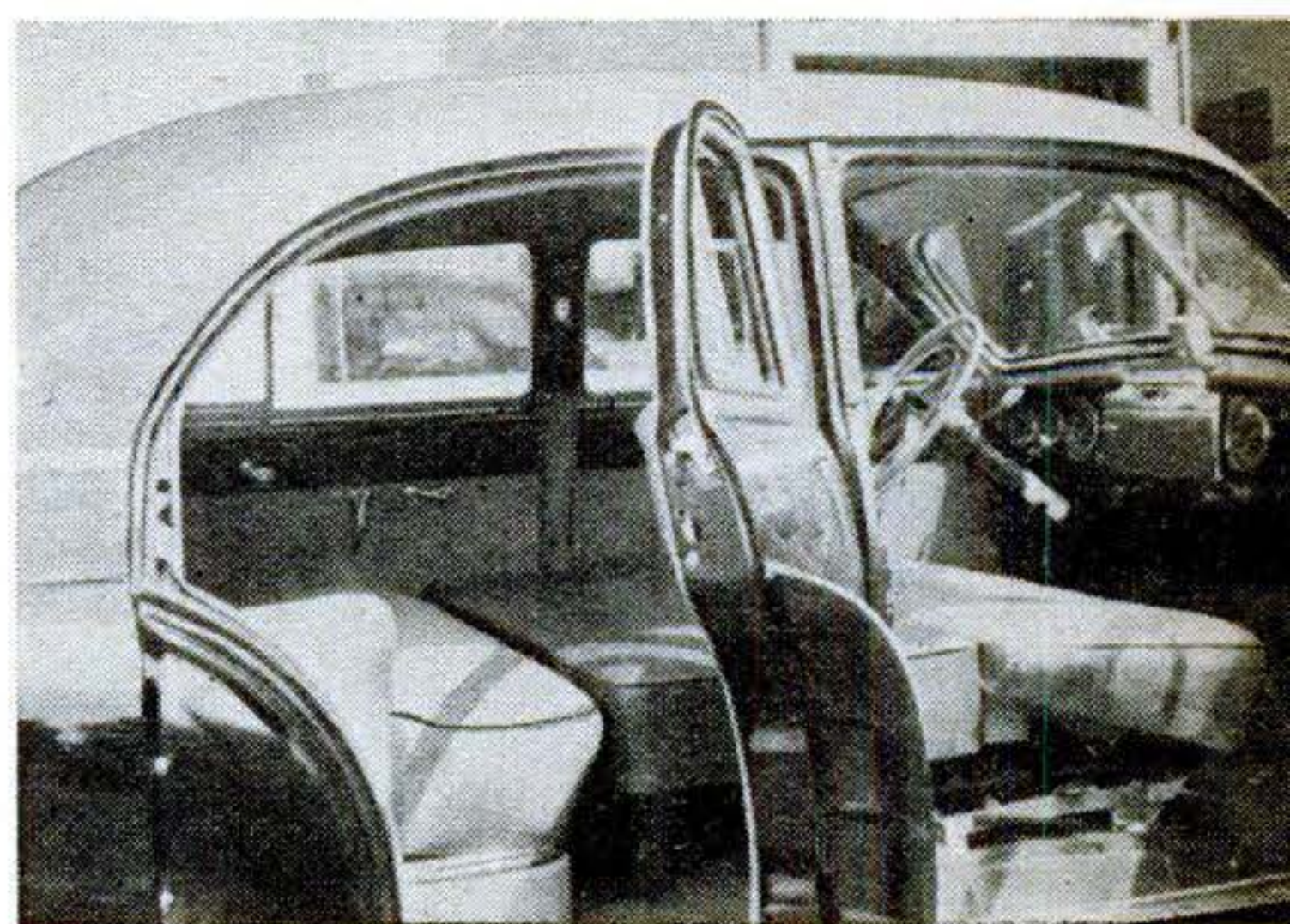

In a few seconds its back is let down and its seat cushion adjusted level with the back seat to form a comfortable double bed.

AUTO IDEAS

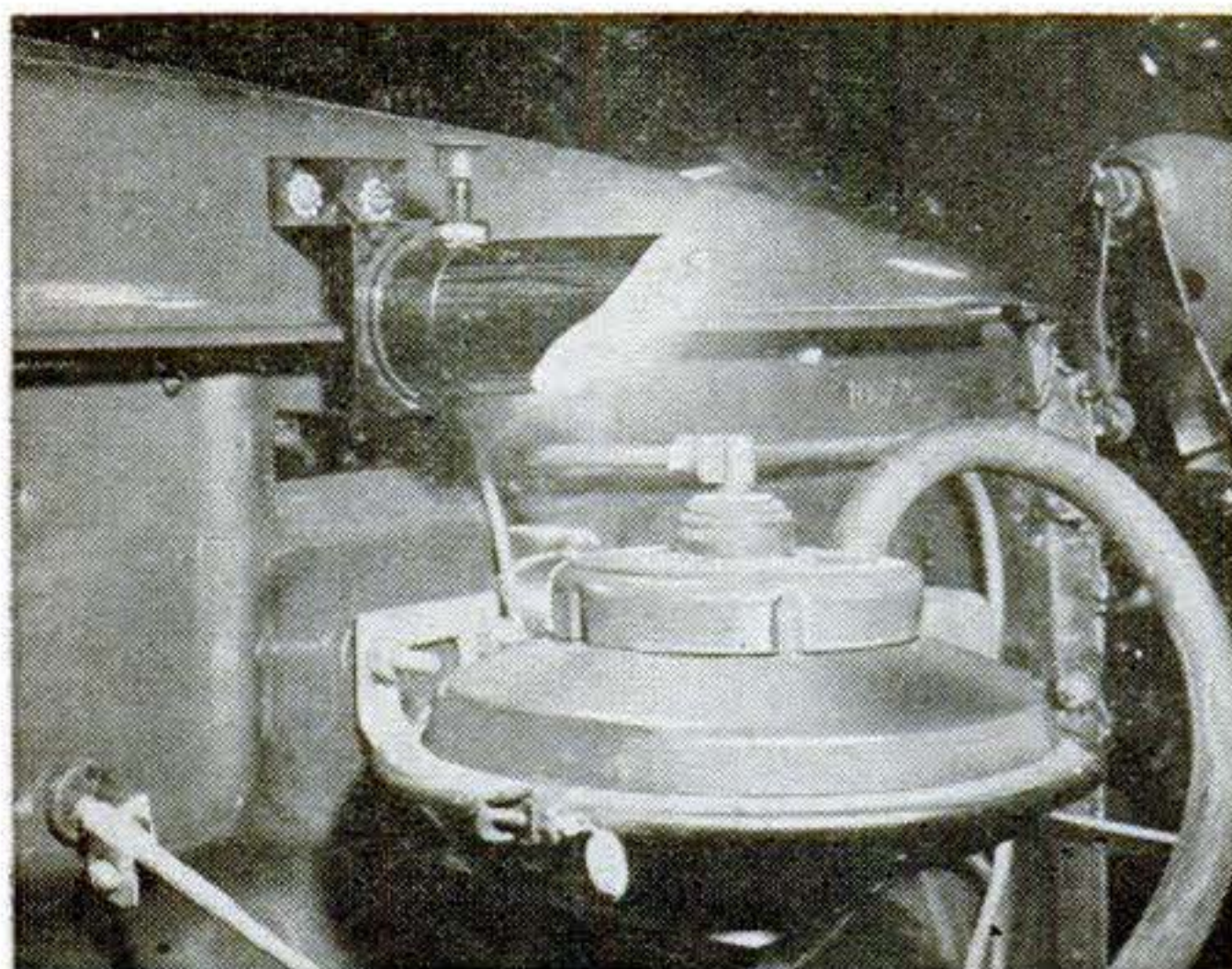

LIGHT UNDER THE HOOD. An engine-compartment light recently placed on the market by the Ford Motor Company lights up automatically when the hood is raised. Quickly installed with self-tapping screws, the light can be connected to the starting-relay switch, voltage regulator, or any hot output wire. A rubber-covered spring-type switch operates the light.

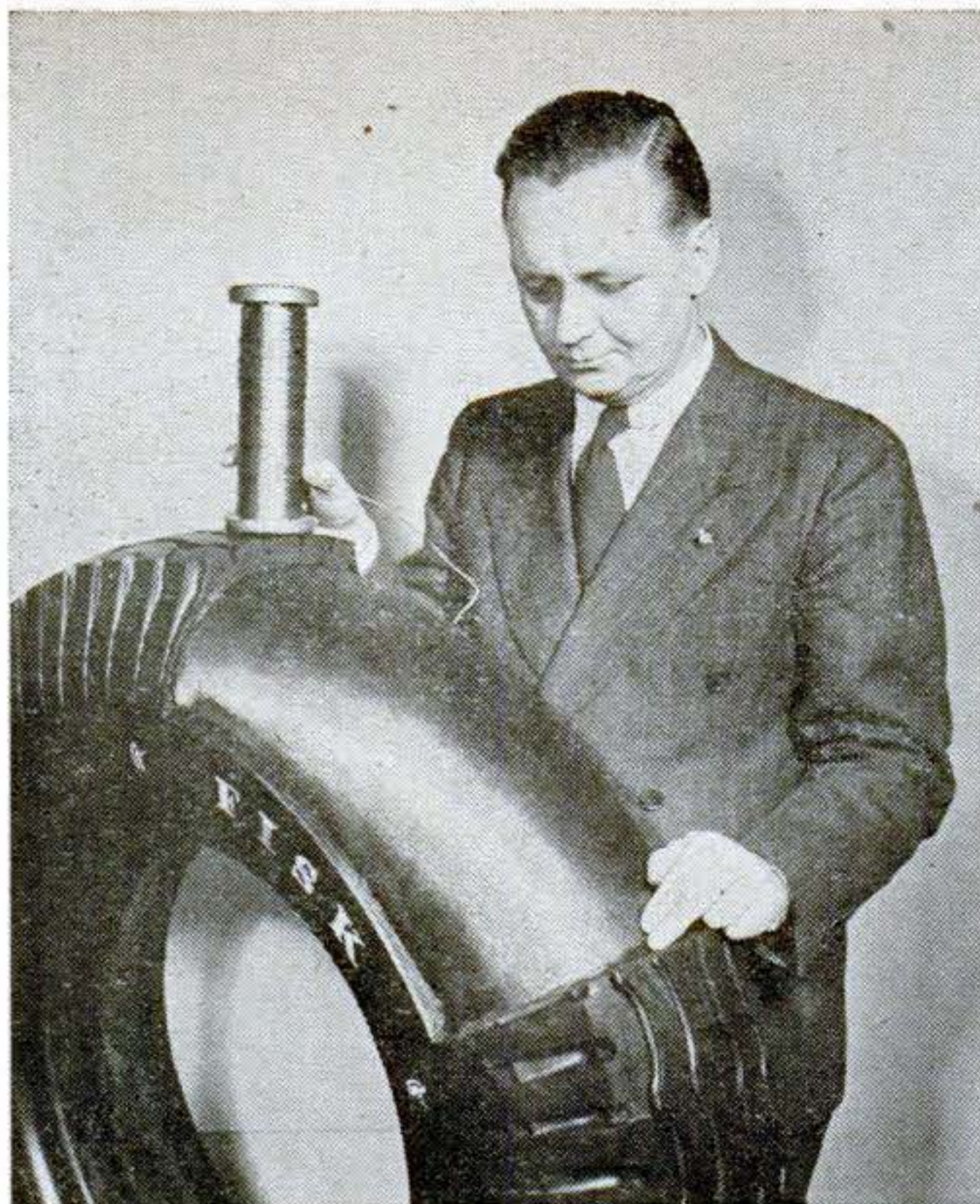

STEEL WIRE HALTS BLOWOUTS. Woven into the top ply just below the tread of the tire shown here is a network of steel wire, intended by the United States Rubber Company to lessen the likelihood of blowouts on heavy trucks. In addition, the wire permits the use of fewer plies and gives a cooler-running carcass. The tire is still in the experimental stage.

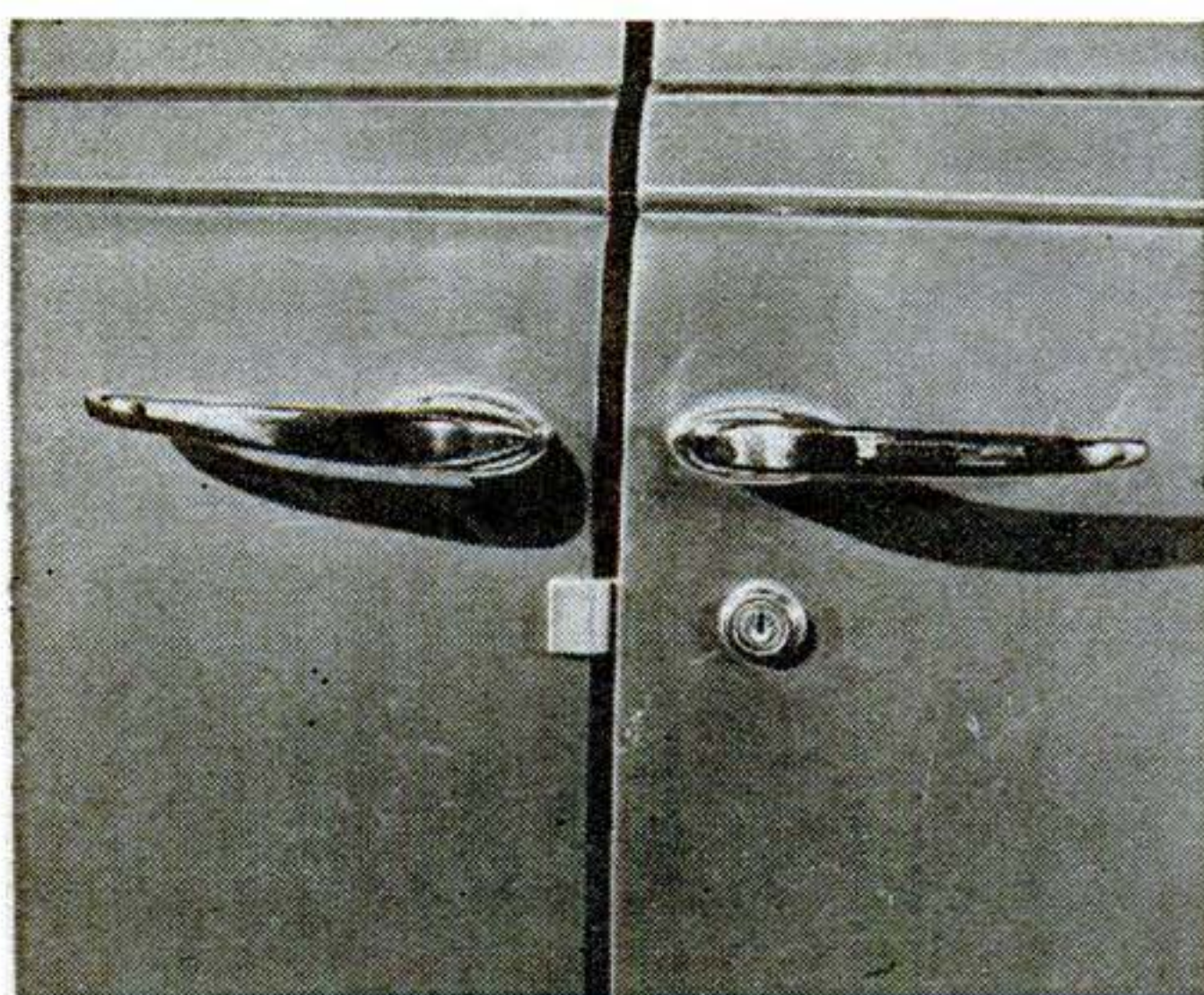

SAFETY LATCH ON REAR DOOR. Parents will be interested in this lock that prevents the opening of the rear doors when the front doors of a car are closed. The catches are easily put on any car with a screwdriver and retail for \$2 a set. They are made by Jelco Company, of Minneapolis, and distributed nationally.



SHADE CUTS SKY GLARE. A sheet-aluminum shade with stainless-steel and chrome-plated brass fittings affords drivers protection against overhead glare. It is made by the Fulton Company, of Milwaukee, in sizes to fit most popular and de luxe models of 1942, 1946, and 1947 cars and many others of older make.

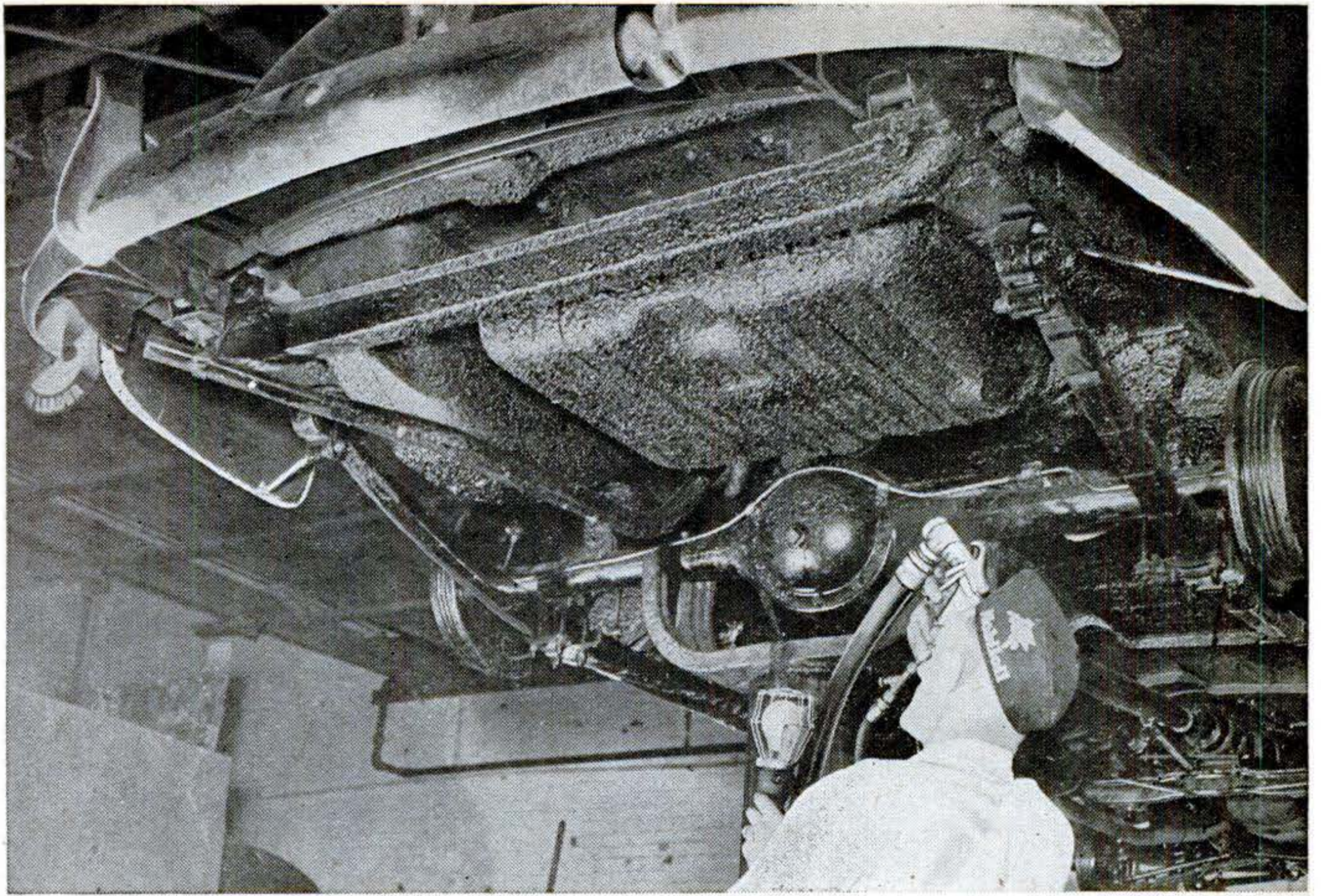

SPRAY PROTECTS CHASSIS. A rubberized material developed by the Minnesota Mining & Manufacturing Company, of Saint Paul, Minn., may be sprayed on the underparts of a car as a protective coating against corrosion, moisture, and flying sand or grav-

el. Sprayed into cracks and crevices, it also prevents many squeaks and rattles. As seen in this photo, the coating is not applied to such parts as the springs, axles, or exhaust pipe. The material is such that only one coating is needed for the lifetime of a car.

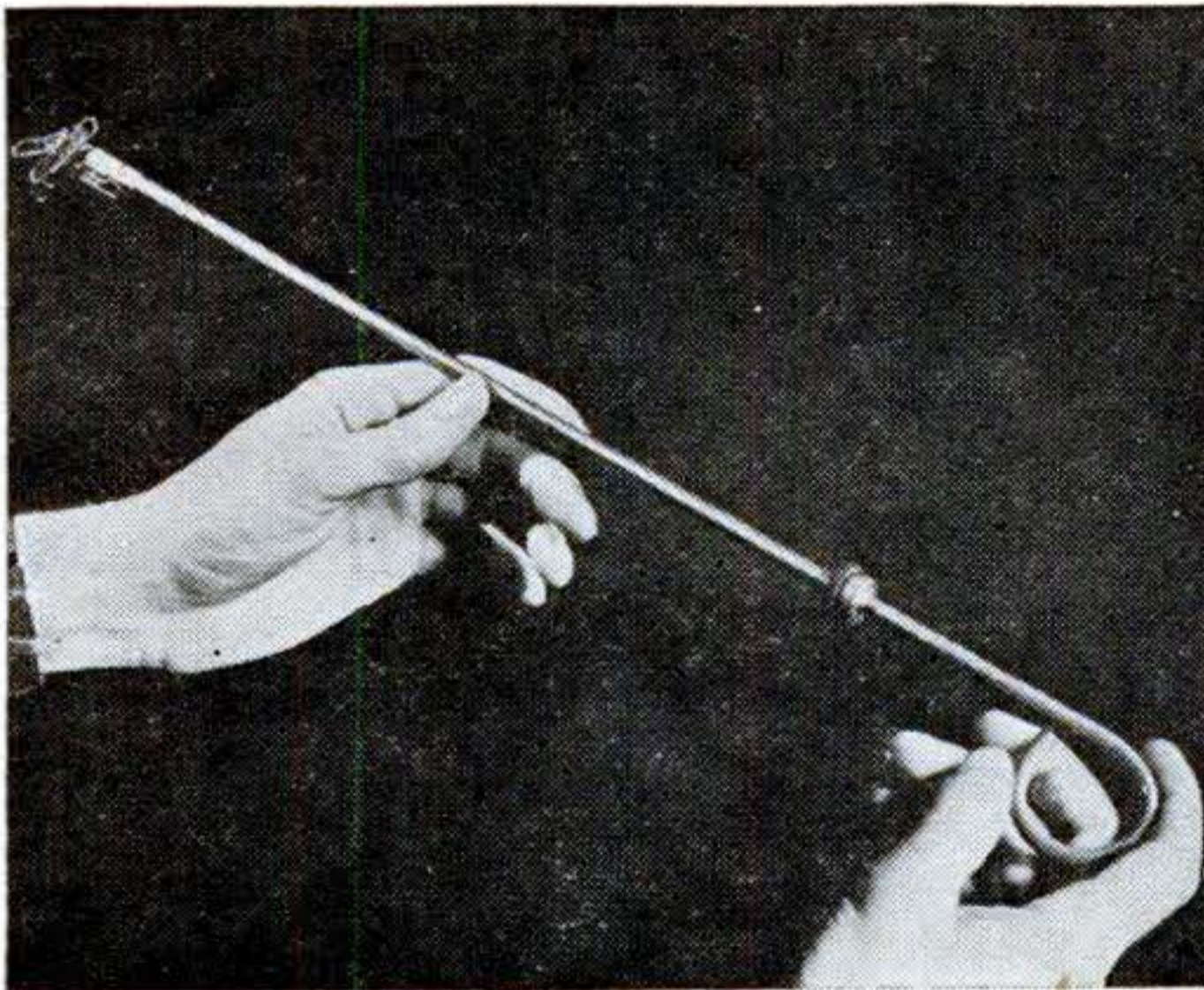

MAGNETIZED DIP STICK CLEANS OIL. This dip stick is permanently magnetized so it will clear oil of any ferrous particles that wear or break off working parts. The stick, which also serves to measure the amount of oil in the engine, is enameled white to show contrast quickly. It is made by the O. B. Briggs Mfg. Co., of Toledo, Ohio.

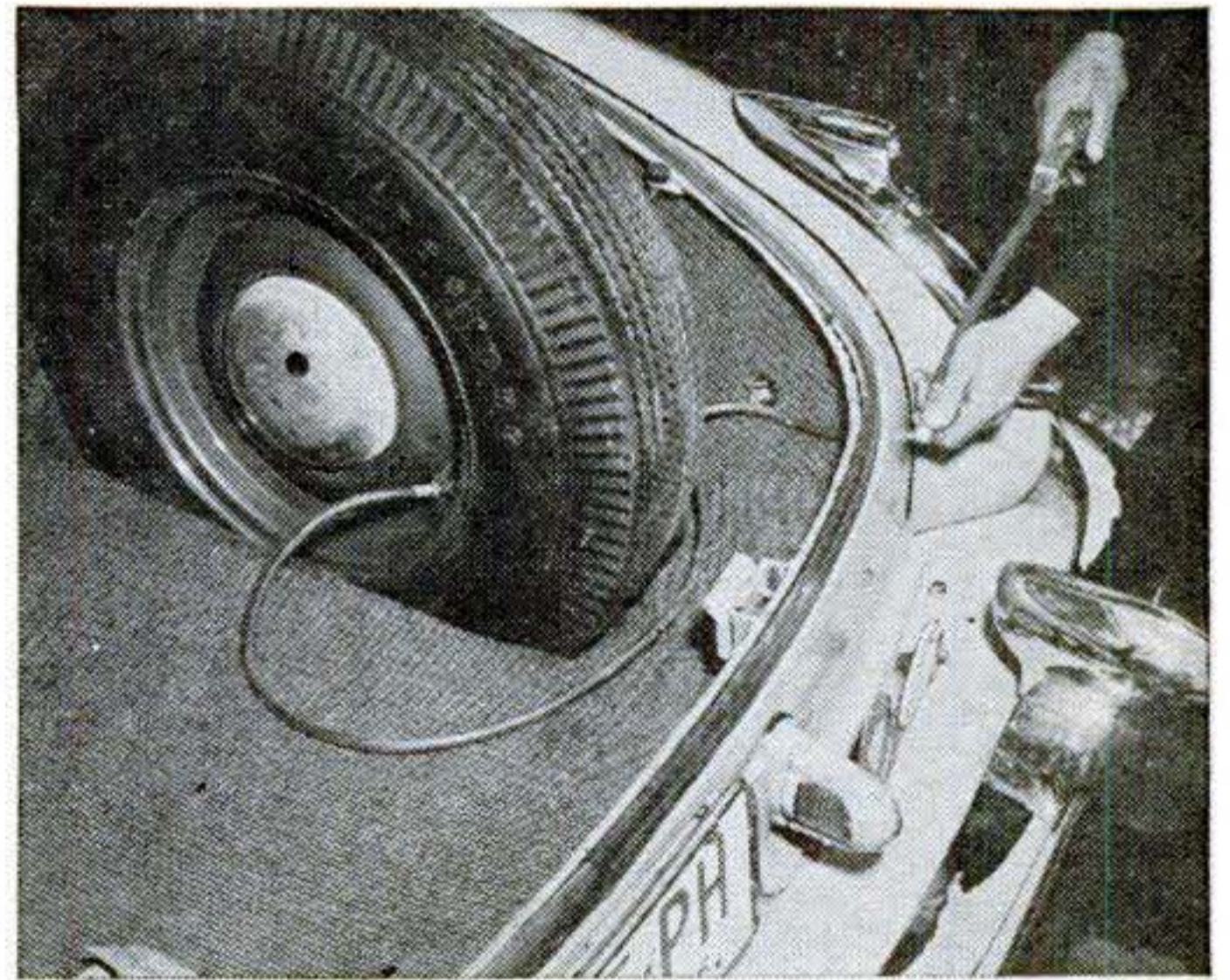

EASY INFLATION OF THE SPARE. A new device that permits inflation of the spare tire without raising the trunk lid is sold for \$1.75 by Curtis Automotive Devices, Inc., of Dayton, Ohio. It consists of tubing, a grommet, and all necessary fittings, including a handsome chrome cap. Installation involves drilling a 5/16" hole.

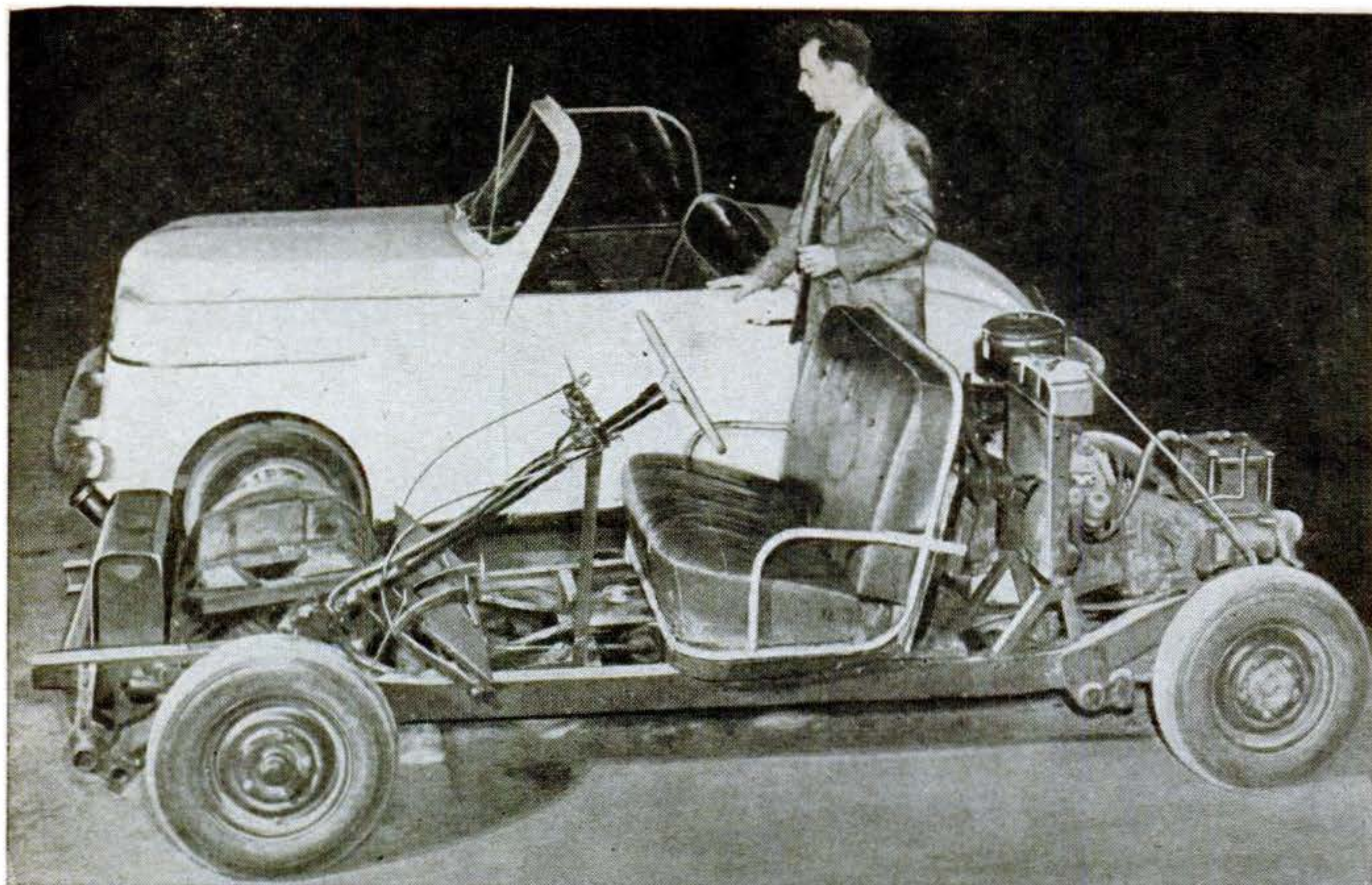

Sturdy and compact, the new Bobbi-Kar will come in several body styles, some with the engine in the rear.



For those who like sunshine, Crosley offers this new convertible. The top slips back into the rear.



Said to reach 60 m.p.h. with ease, the rear-engine Playboy seats three, weighs 1,820 lb., and has an automatic transmission. The price is about \$950.

Rear Engines Run New Midgets

REAR engines and independent suspension of all four wheels are noteworthy mechanical features of two of a half dozen or more midget cars now being developed in the United States for the 1948 market. Several designers also have projected three-wheel vehicles. Intended to sell within the \$500-\$1,000 price range, the small cars all are said to give 35 to 50 miles a gallon.

Leading entrants in the small-car field, now dominated by the Crosley, are the Playboy and the Bobbi-Kar. The Playboy is made in Buffalo by the Playboy Motor Car Manufacturing Corp., and the Bobbi-Kar in Birmingham, Ala., by the Bobbi Motor Car Corp., which has reorganized and moved from San Diego, Calif. Both vehicles have four-cylinder, water-cooled engines.

A convertible, the Playboy has an overall length of 156", height of 54", and width of 58", the body and frame being welded as one unit from steel components. Four-wheel hydraulic brakes and independent springing are other features. The Bobbi-Kar has a wheelbase of 92", an overall length of 168½", and a seat width of 49".



MECHANICS
AND
HANDICRAFT

PSM PHOTO BY ROBERT F. SMITH

- **De Luxe Portable Radio**
- **Escalator for the Home**
- **Car-Top Catamaran**
- **Take-Along Photo Enlarger**
- **Impulse Water Wheel**

Sit Down and Ride Up

Stair elevator on garage-door rails provides safe lift to second floor for invalids and convalescents.

SEMI-INVALIDS and some elderly people find going up and down stairs a task beyond their endurance. For them some sort of elevator arrangement in the average two-story house is a real boon. The problem isn't too difficult for the resourceful handy man to solve, provided the flight is straight, without turns or landings.

Alfred E. Flostroy, faced with this situation in his home in Bayside, L.I., built a one-passenger stair elevator with a set of overhead garage-door rails as a track, three trolleys, a $\frac{1}{2}$ -hp. 1,750-r.p.m. motor, and a 50-to-1 irreversible speed reducer. An ingenious switching arrangement by which the passenger can start the elevator at either the top or bottom was set up with the switch box at a mid-point on a convenient sill. Stops at both ends of the switching cable are activated by a limit arm to halt the elevator in position for alighting.

The motor used necessarily had to be of the kind capable of starting under load, such as repulsion-induction or capacitor-start. An irreversible worm-gear type of speed reducer lets the car move only when the motor is powered, and prevents coasting (it does, of course, run backwards when the motor is reversed). It has a strong $\frac{3}{4}$ " shaft fitted with a 2" drum on which the cable winds. A $\frac{5}{16}$ " stainless-steel cable anchored to the drum and clamped around a thimble over the bolt of the near trolley has been in use for over a year without showing signs of wear.

Angle iron, angle brackets, and $\frac{1}{4}$ " by 1" steel stock were used in building the carriage that rides on three sets of trolleys between the rails. The upper carriage member is horizontal to hold the seat frame level. This frame was also made of $\frac{1}{4}$ " by 1" steel. It

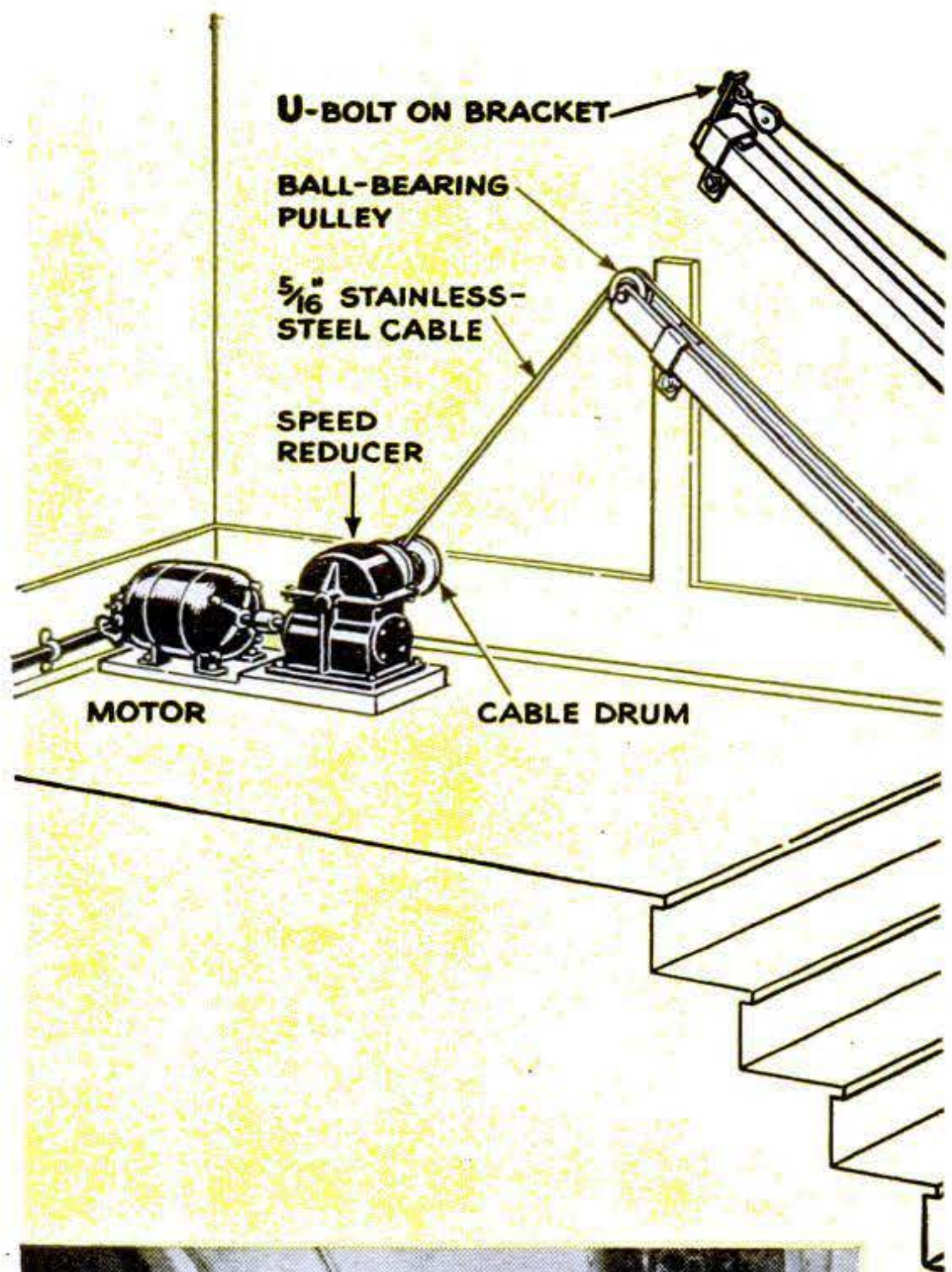

Merely a pull on the control cable starts the seated passenger up or down. The elevator is halted automatically when it reaches the limit of its run. A carriage to which the seat is bolted travels on three sets of trolleys.

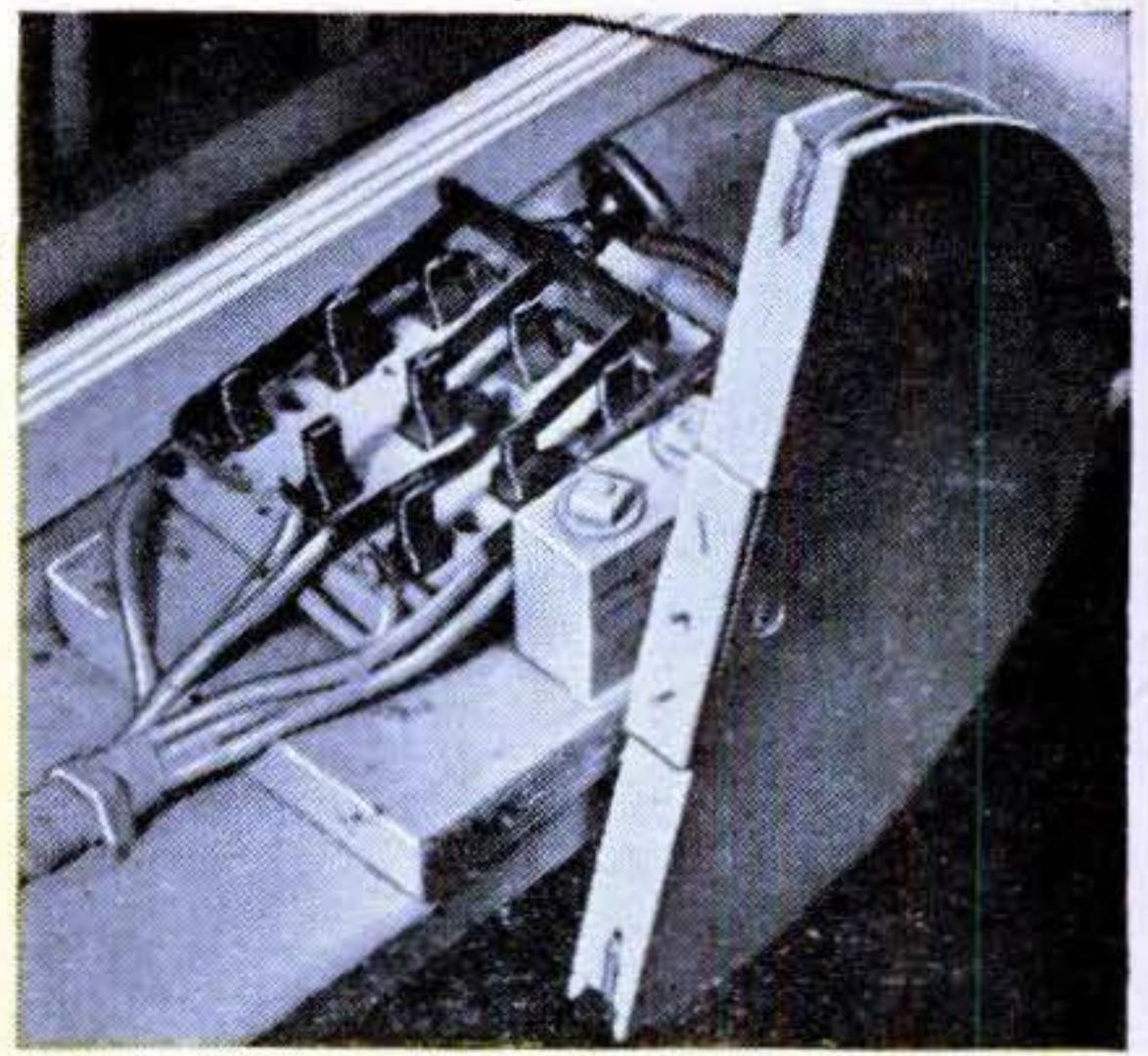
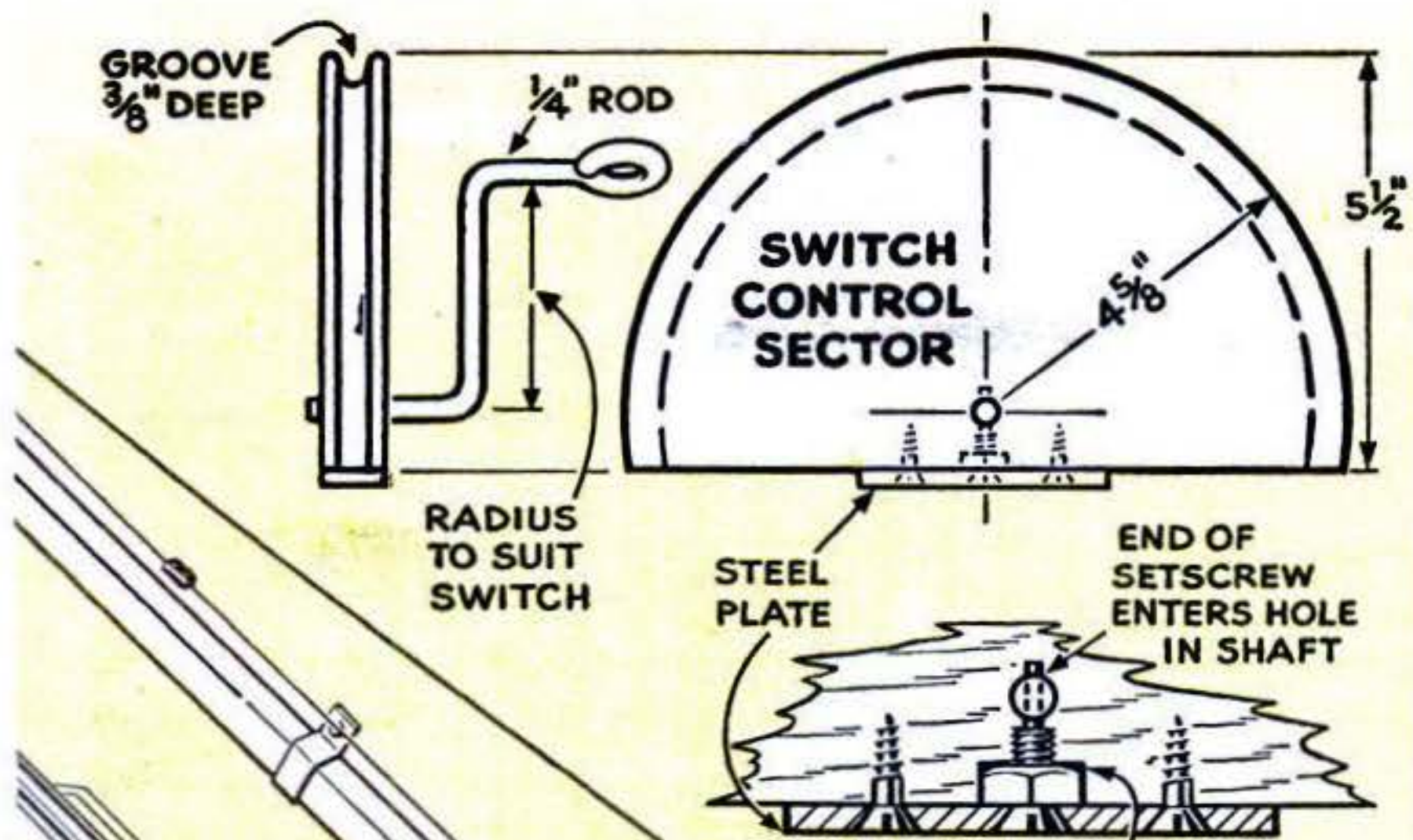

Two poles of the three-pole double-throw switch control motor direction, while the third serves as an on-off switch.

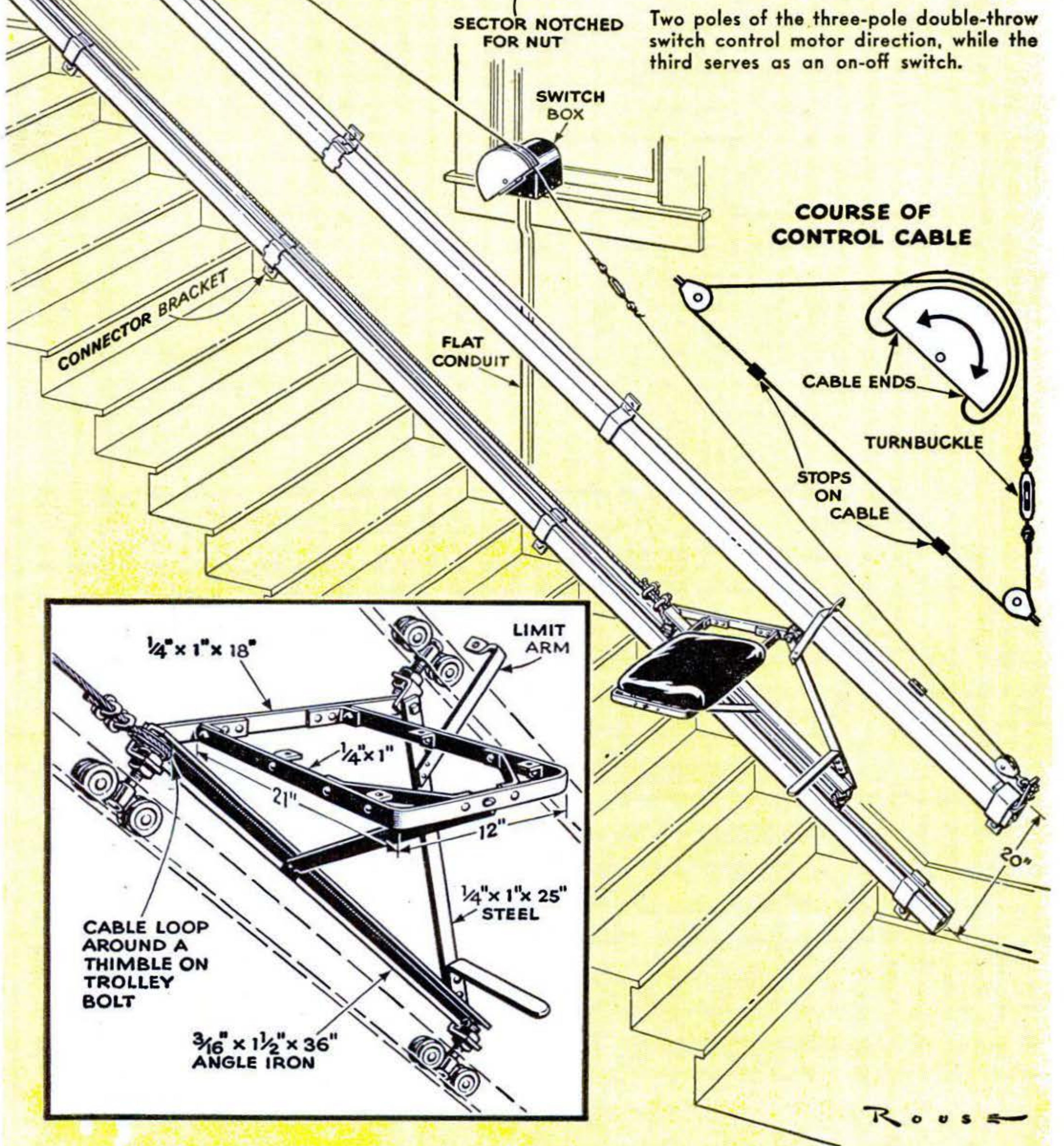

was braced at the corners and fitted with drilled lugs to which an upholstered seat, in this case one from a typewriter chair, was bolted. Unless the stairs are wide and the top and bottom well lighted at all times, it is a good idea to equip the seat frame with hinges so it can be folded against the wall, where it won't be in the way when not in use. The bar for the footrest should likewise be hinged.

Since it was most convenient to place the bottom rail against the baseboard, a spacer had to be put between it and the wall at the upper end. This might not be necessary in the case of a paneled wall. The bracket holding the bolt of the trolley riding the upper rail was turned toward the wall, so it was not necessary to use a spacer to bring that rail directly over the lower one. Care was taken in drilling the trolley brackets to halve the distance between the vertical

planes of the rails so the trolleys would run without binding, and to get the rails exactly the same distance apart at top and bottom.

The switch that starts, stops, and reverses the elevator motor is controlled by a cable run over pulleys hung on U-bolts at the ends of the upper rail. It is mounted on a plate to which is pivoted a grooved wooden sector on a bent rod having an eye that encircles the switch handle. Ends of the cable are anchored at opposite ends of the control sector, and the cable is run over it in the grooves. The cable section between stops is threaded through an eye in the limit arm on the carriage. When this arm strikes a stop, the switch blades are thrown up to break contact. Then a further tug on the cable in the same direction puts the blades in the opposite contact clips and starts the motor in the reverse direction. A turnbuckle assures proper cable tension. **END**

Anchor for Small Boat Is Built from Leaf of Old Car Spring

FASTENED to the end of a length of pipe by an expansion bolt, a leaf from an old auto spring provides firm anchorage for a light dinghy or other small boat. A standard pipe tee is screwed to the other end of the shank as a stock through which the rope is passed. The car-spring arms will catch quickly on the bottom and are strong enough to hold fast.—RONALD EYRICH.

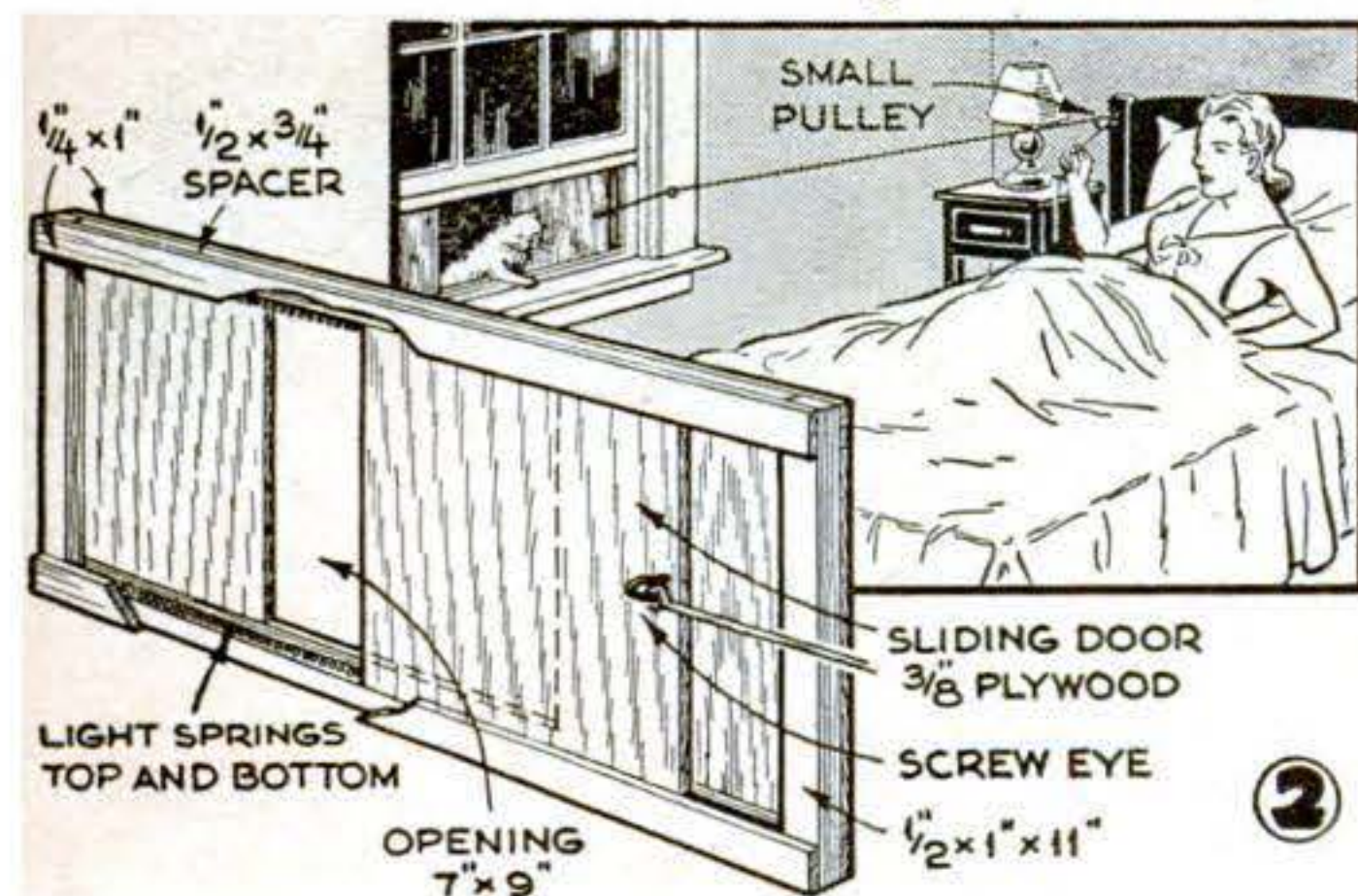
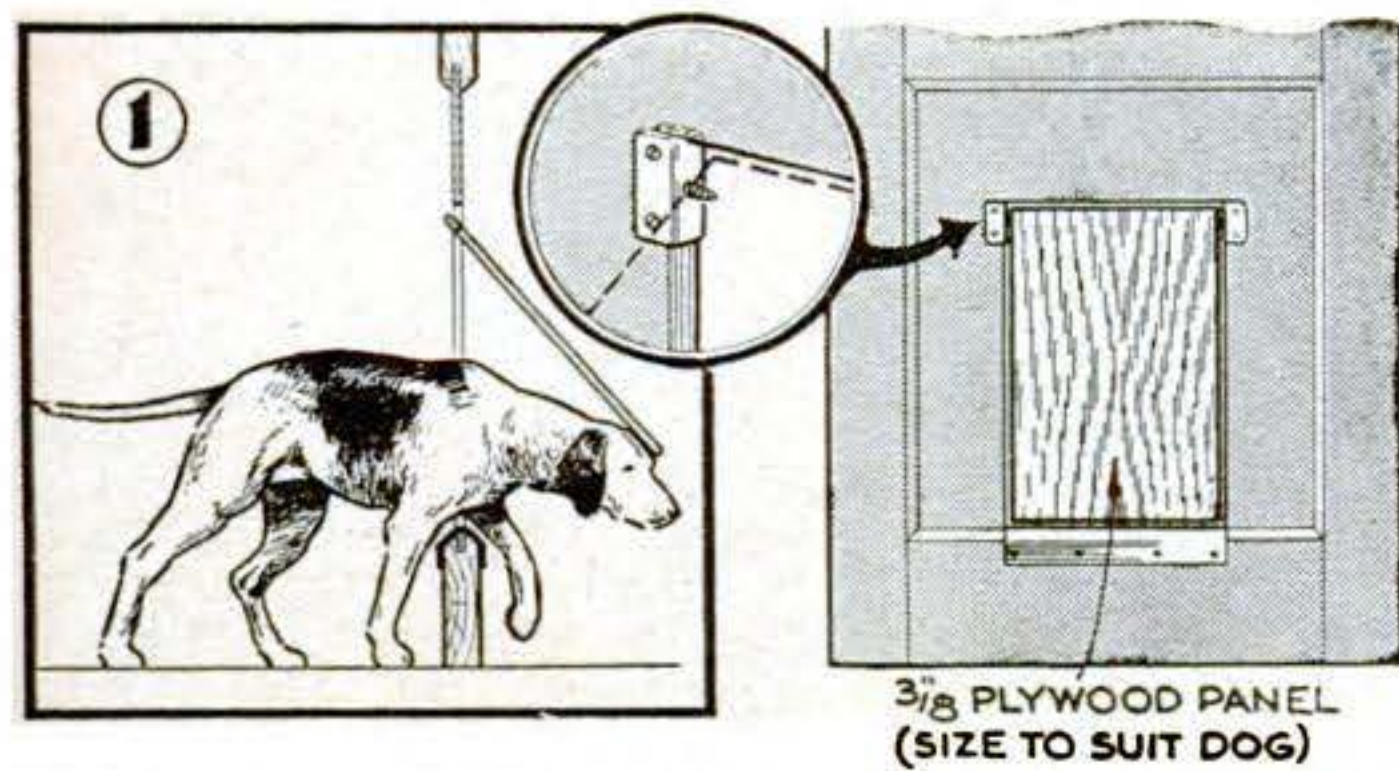
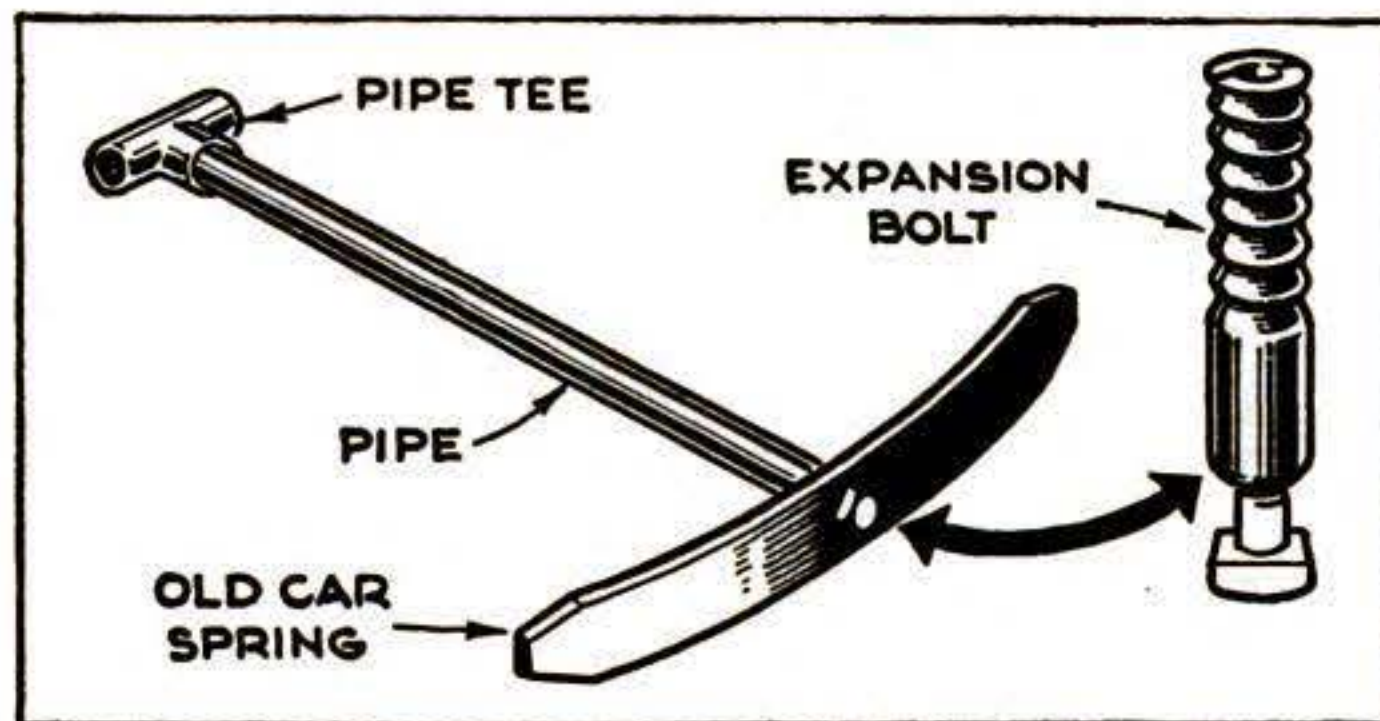

Private Door Lets Your Pet In or Out of the House

GETTING up to open the door every time your dog or cat scratches to get in or out can become tiresome. Figure 1 shows a swinging door that a dog can open without help. It is a rectangle of plywood fitted into a dog-size opening in the lower panel of the kitchen or other house door. The hinge at each of the two upper corners consists of a screw set in a sheet-metal bracket screwed to the door panel. A metal guard, filed smooth on the edges and screwed down tight, frames the bottom of the opening.

In Fig. 2 is a sliding window door for letting a cat in or out at night. It is set in a frame held by the sash like some window ventilators. The door is opened by a cord on a pulley and is closed by coil springs in the slide channels.—HI SIBLEY.

IQ

WHAT'S YOUR INGENUITY QUOTIENT?

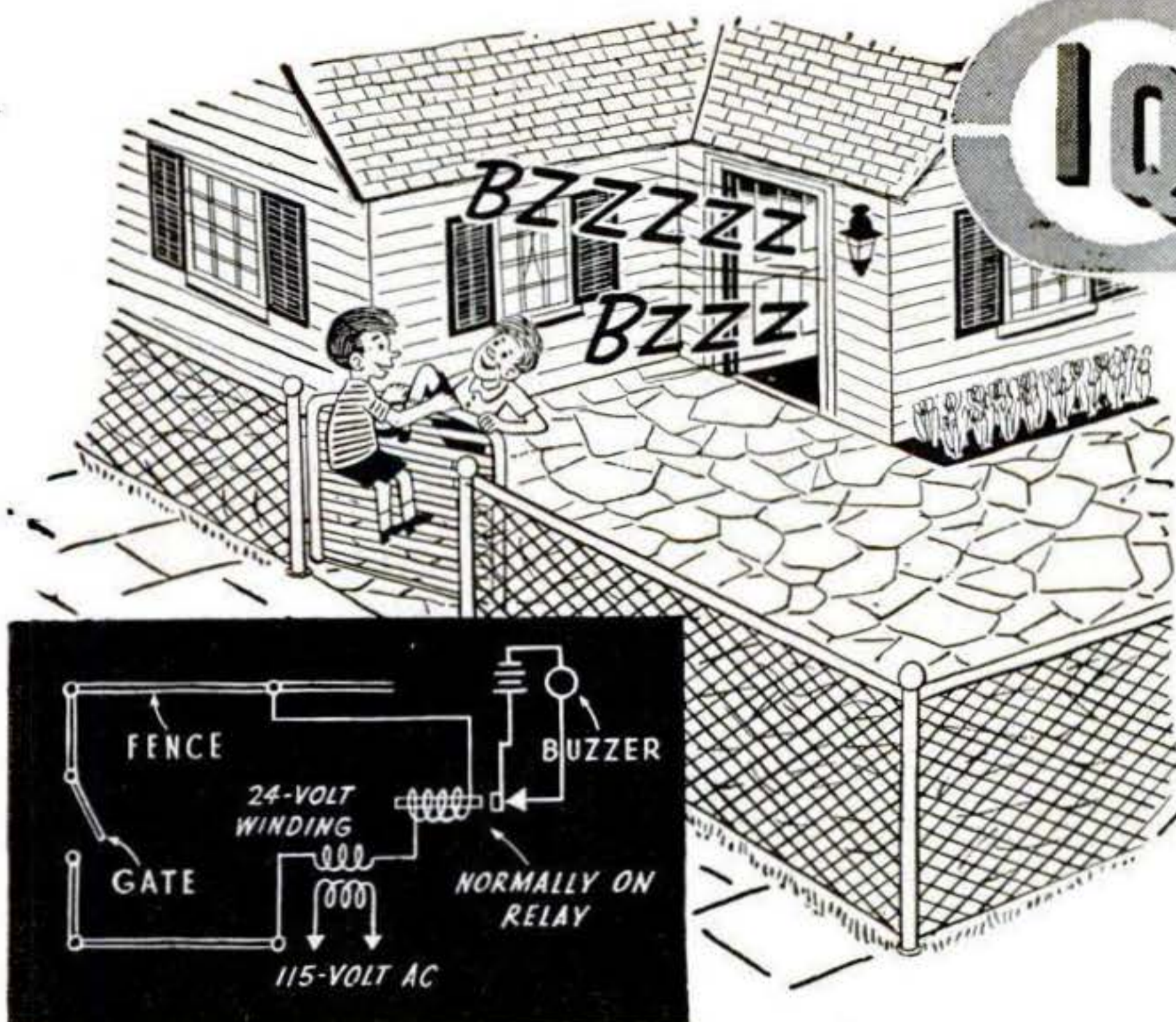

SHUT IT, RICHARD! It's impossible for anyone to enter or leave our back yard—by the gate—unknown to us, for a buzzer near the kitchen door sounds whenever the gate is open. The diagram shows how it's done. We rigged up the system because forgetful persons were always leaving the gate ajar, letting our dog out and unwanted dogs and other trouble in.—FAY O. WOOD.



Have you pulled off a smart one lately? We will pay for acceptable contributions showing ingenious solutions of problems in the home, shop, garage, or camp. It doesn't matter if it's wacky — if it works.

THIS IDEA'S A CRACKERJACK. Ever want to mail a cake with icing? If so, don't bother with sticky wax paper. Just buy a dime can of popcorn, pop it, and stuff it in the box around the cake. Not only will the popcorn be edible, but if it picks up some of the icing so much the better.—ALTA BOND.

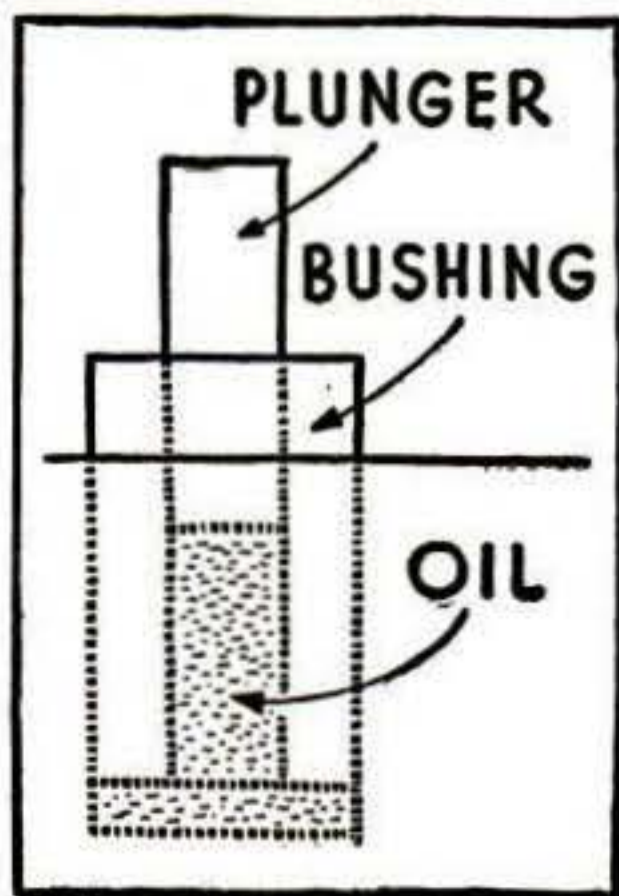

OUT IT COMES! Hydraulic pressure is harnessed in this method of removing a tight blind bushing. Pour heavy oil in, insert a close-fitting round steel bar, and hammer it. The oil will transmit the force to the inner bushing end.—G. R. SHAW.



BALLOONS IN THE BELFRY. Confronted with the problem of measuring the interior height of a church dome, we tied a gas-filled balloon to a spool of coarse thread, let the balloon ascend to the top of the dome, cut the thread at the floor, and then measured the thread.—RONALD EYRICH.

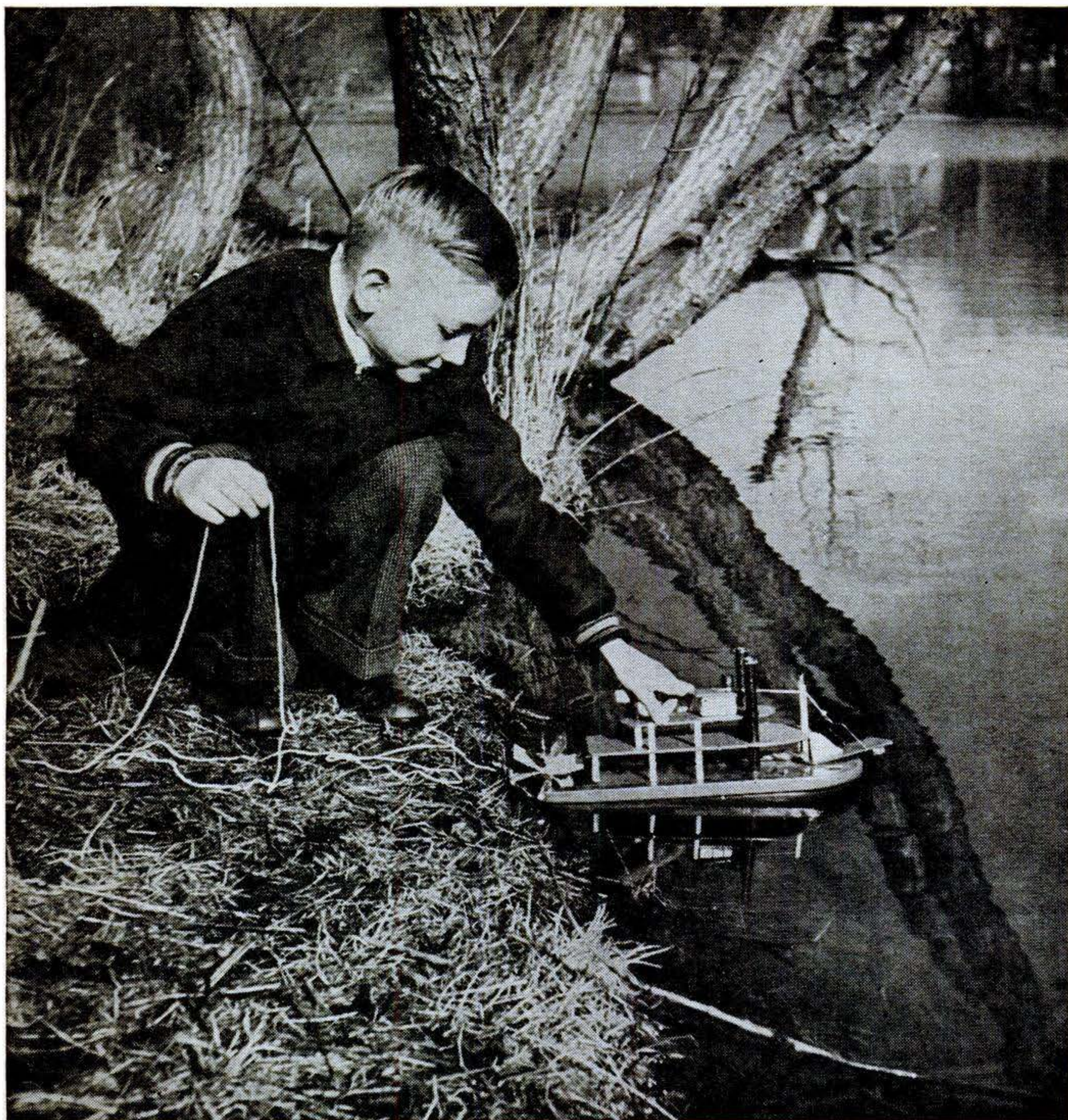

This stern-wheeler is a working model that will churn along valiantly on neighborhood streams and ponds

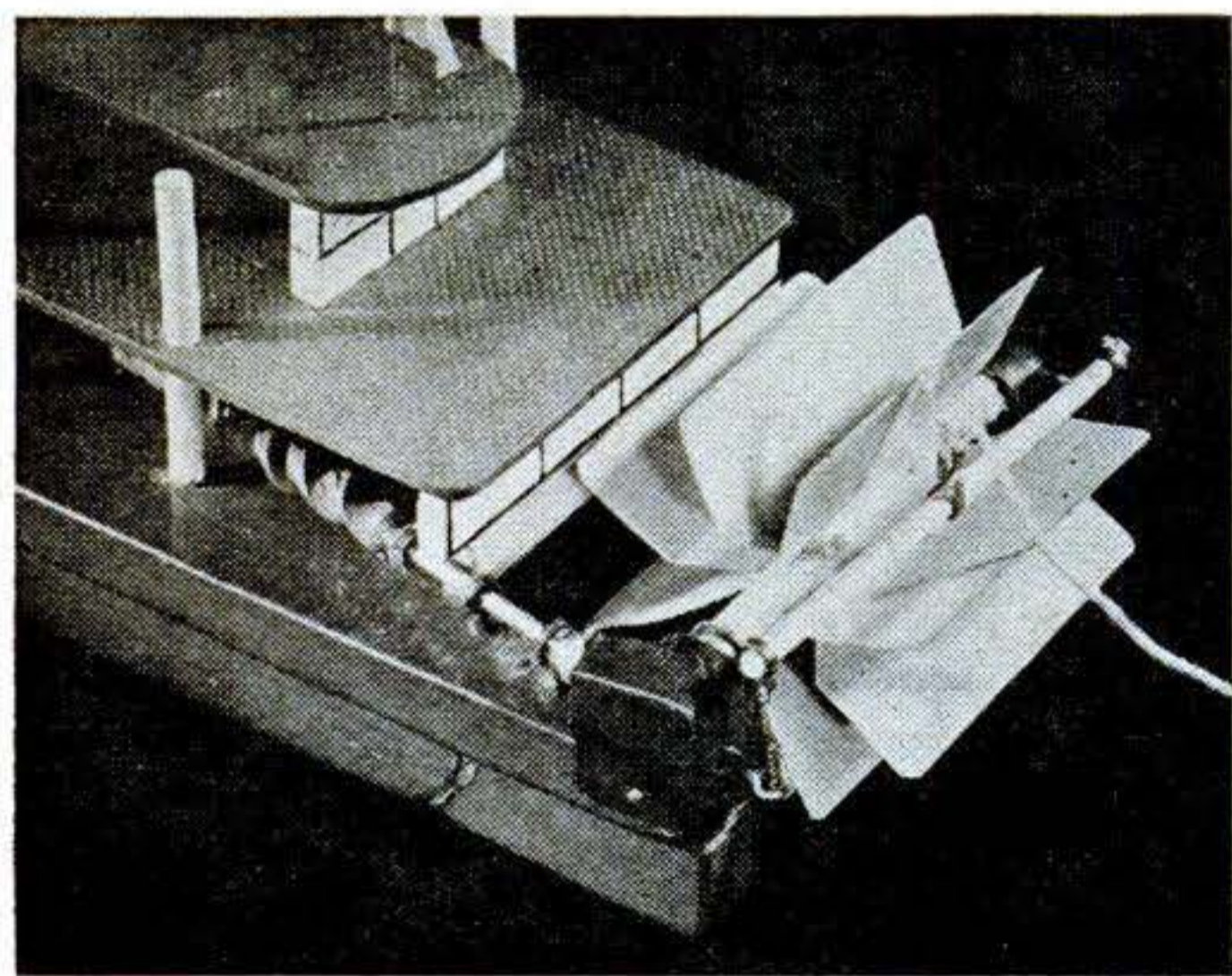

Inserted between paddles, the brake rod keeps the wheel from turning until the boat is in the water.

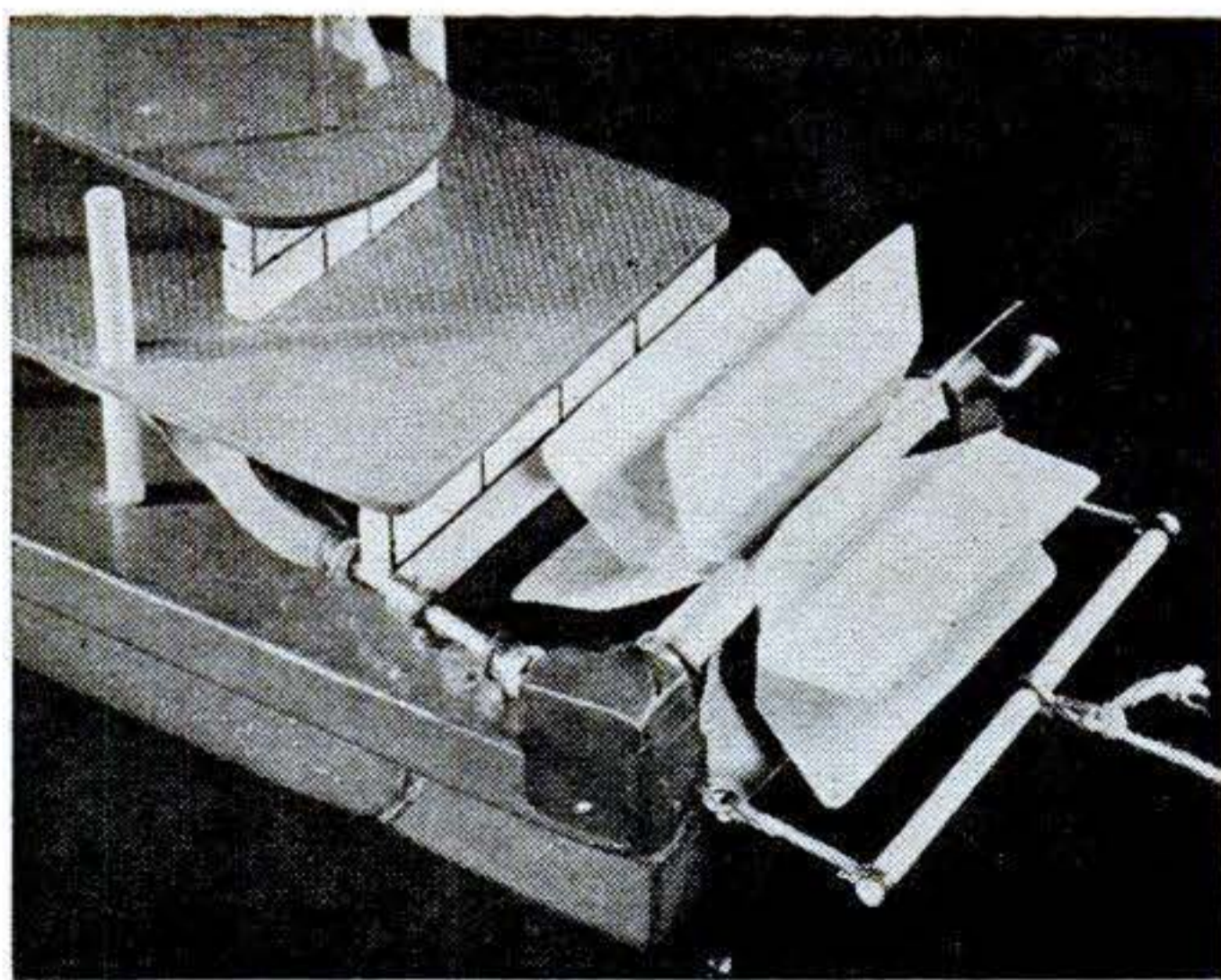

Then the paddle wheel is released by a pull on the cord, which is also useful in retrieving the boat.

Rubber Bands Drive Model of Stern-Wheeler

RIVER boats have always been picturesque. This one, a 14" stern-wheeler, is driven by rubber strands and a pair of small bevel gears. It will run at fair speed even against a light current. A paddle-wheel brake locks the wheel until the boat is in the water. At the end of its run it is retrieved by the brake cord.

Make the hull from two solid blocks, notched to receive the wheel and bored to take seven dowels, the two largest of which are painted black to resemble smokestacks. A gangplank pivots loosely on the forward dowel. It may be arranged to lift by means of a cord. A lead weight gives it a steering effect; the boat turns to the side to which the gangplank is swung. Steps can be cut from the solid or built up by joining thin layers.

The upper decks may be cigar-box wood, plywood, pressed board, or even heavy cardboard. A block on top forms the pilot house and a short length of dowel the headlight. Two plastic rings were cemented to the top of the smokestacks (cardboard bands would

do as well) and wisps of cotton can be glued on to simulate smoke.

Make up the eight paddles for the wheel in pairs. Bend two pairs at a rather sharp angle and the other two not so sharply so they will be spaced evenly when attached to the dowel shaft with two flathead nails. Drive one nail through from each side and clinch the ends to complete the fastening.

Drive the bevel gears on nails big enough to be a tight fit. Insert one nail through screw eyes and bind on rubber strands after looping them around the forward dowel in the hull. The other mounting nail is driven tightly into an undersized hole in the paddle shaft so the gear will turn the paddle wheel. At the opposite end another nail is driven in and bent for a winding handle.

In selecting the gears, choose a pair not over $\frac{3}{4}$ " in diameter that will mesh at about a 30-deg. angle. The teeth should be rather coarse—about 10 to the gear will do—so alignment won't be critical. It is a good idea to cover the gears with a box bent up of tin-can stock.—DOUGLAS GRAY.

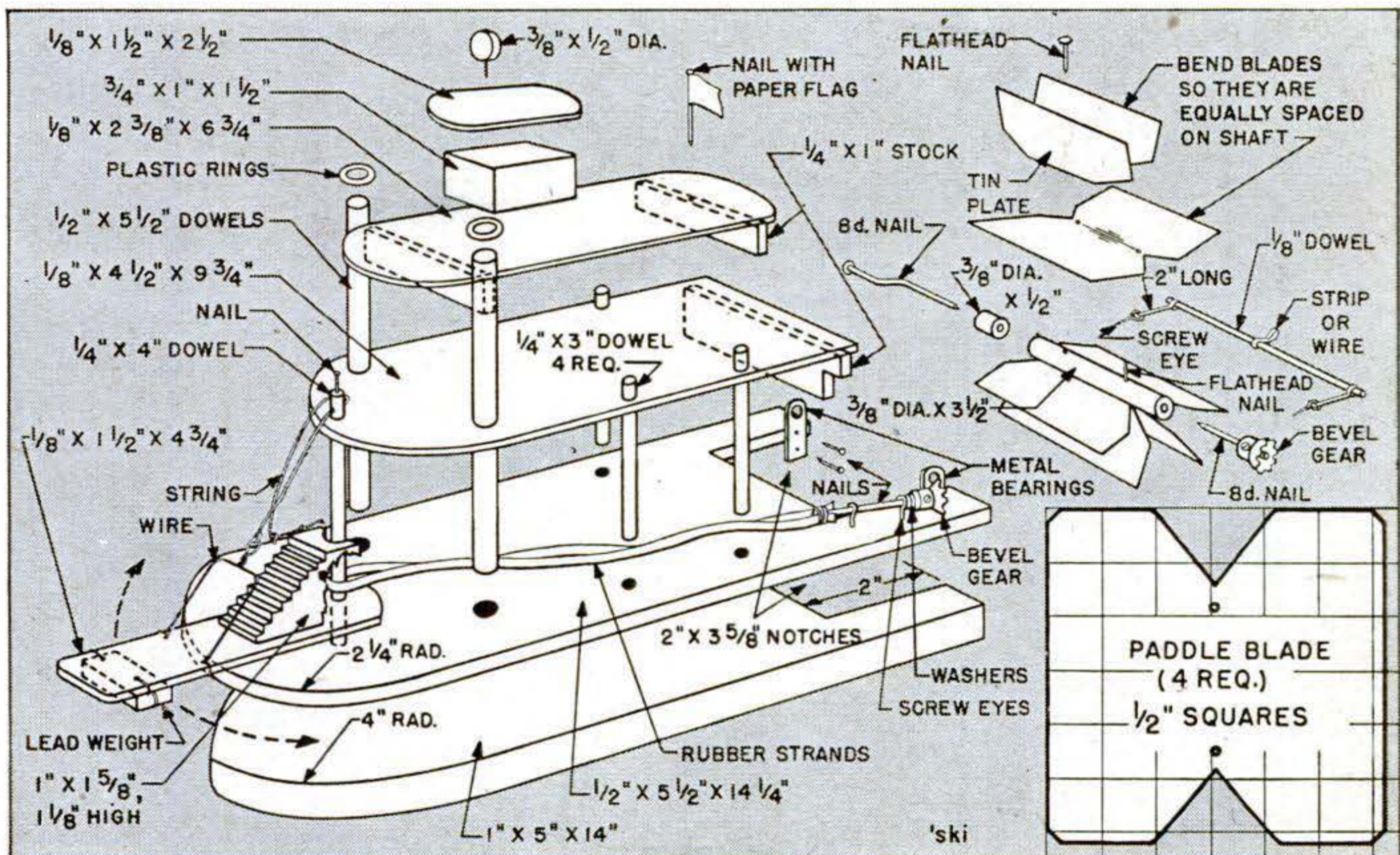

Here are the construction details. Parts are assembled with waterproof plastic glue and nails. None of the dimensions is critical, so don't hesitate to change them to suit pieces available in your scrap bin.

Strip Projects Utilize Scrap

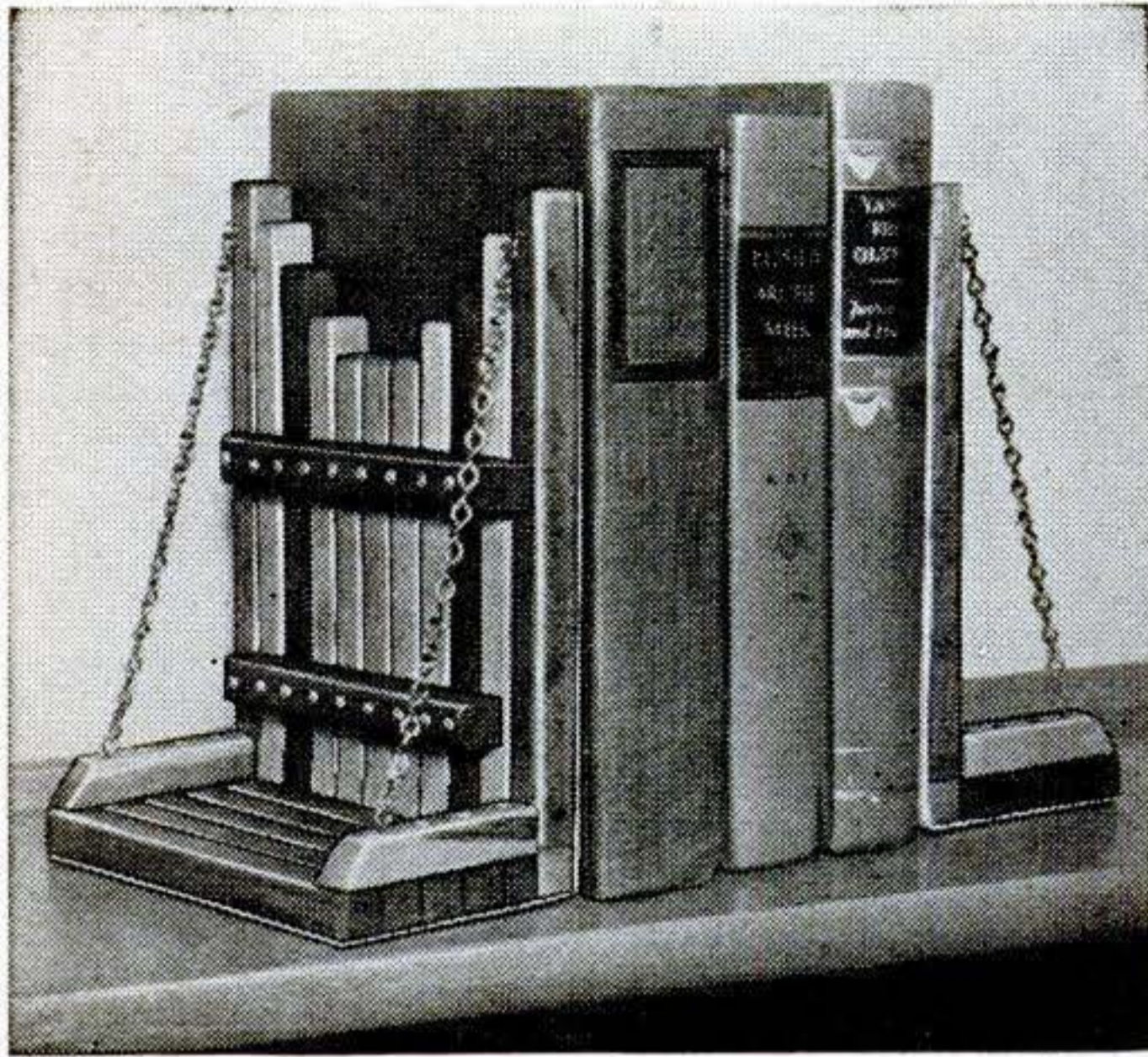

Pieces of varying length make "drawbridge" book ends. Chains and escutcheon pins decorate them.

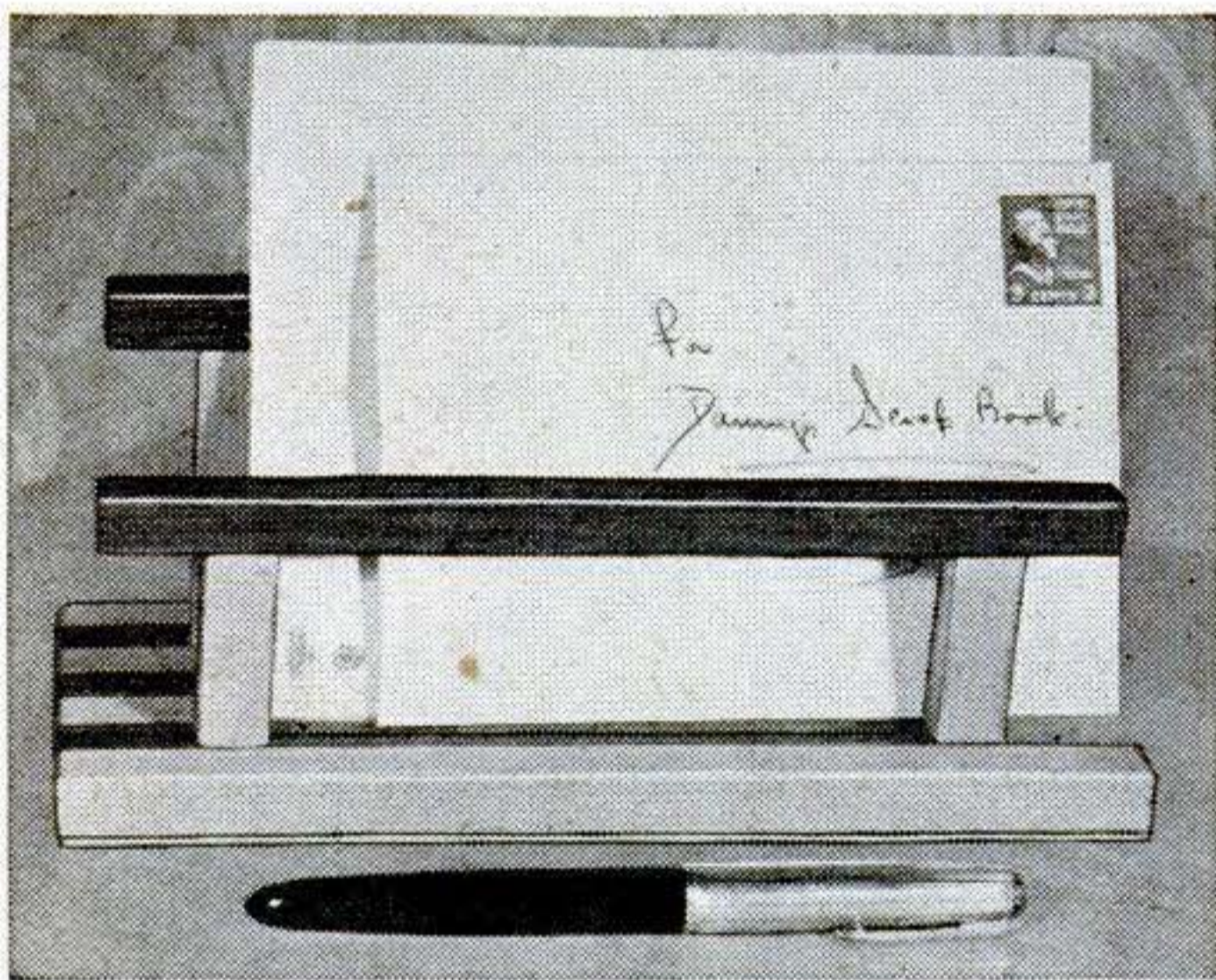

Screws through the underside hold the letter-rack posts. Make the rear rail higher than the front.

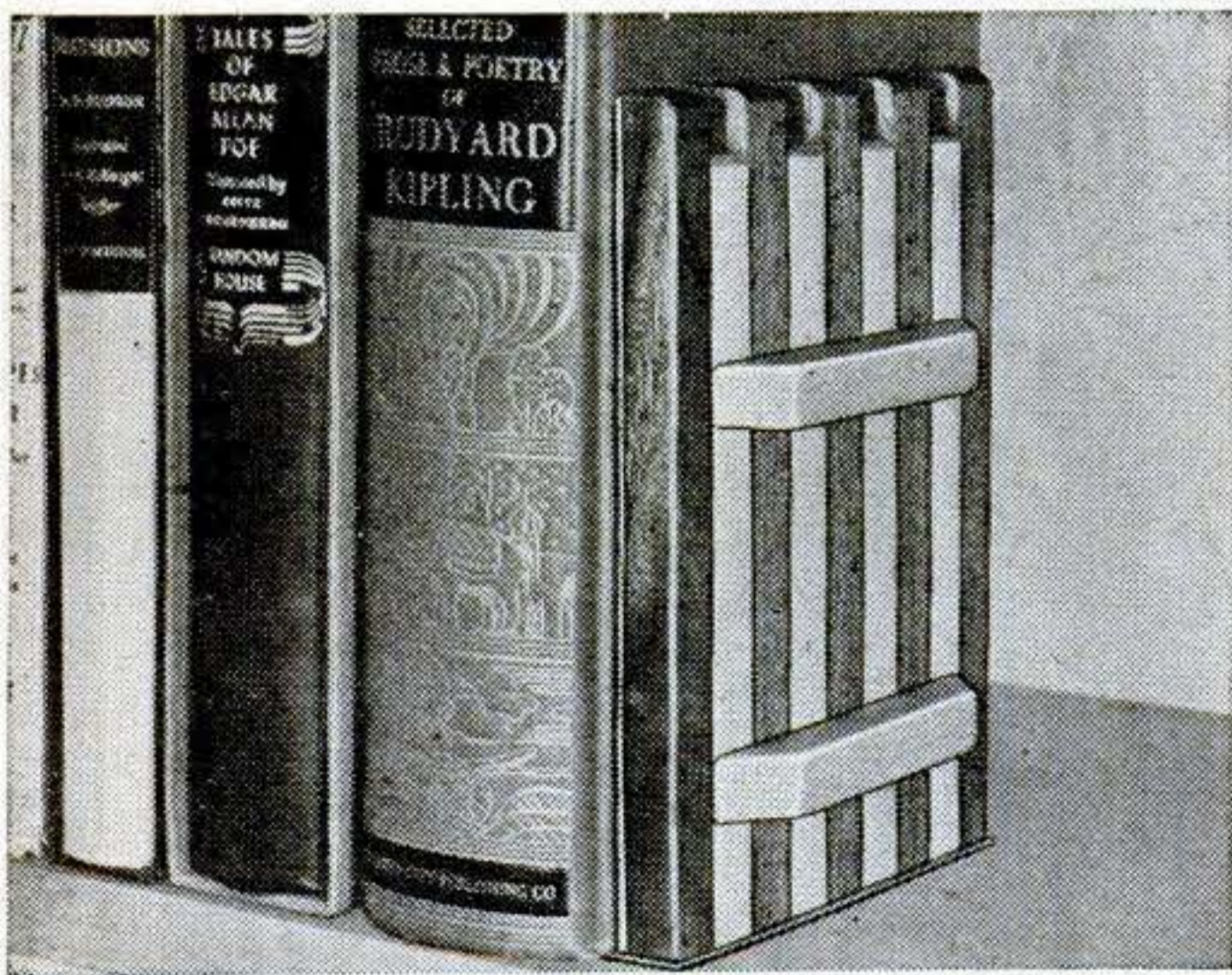

Sheet metal fastened with countersunk screws and covered with felt acts as a base for this book end.

GIVEN a few odd scraps of cabinet wood and a circular saw, you can turn out, in a few hours' spare time, a dozen small craft projects made of strips $\frac{1}{2}$ " square. In the photos are two book-end designs and a letter rack; in the drawings are suggestions for a small tray and coasters. The field is wide.

Rip the stock into $\frac{1}{2}$ " strips, cut to required lengths, sand smooth, and glue up the flat members. Then join the parts with glue, driving in screws for added strength where they will not show, or using small finishing nails and puttying over after setting the heads. A miter box that will fit $\frac{1}{2}$ " strips will be helpful for cutting both square and mitered ends. One shown in the drawing was made up from one of the strips and two pieces of $\frac{1}{4}$ " by $1\frac{1}{4}$ " stock.

Interesting contrast is possible with strips of different kinds of wood, such as maple with walnut or mahogany, or birch with mahogany. Ends and outer edges are best beveled, and a bevel is sometimes effective on the edges of joining faces, as in one of the book-end sets. An oil finish will give good results on most of the woods likely to be available.—R. J. DE CRISTOFORO.

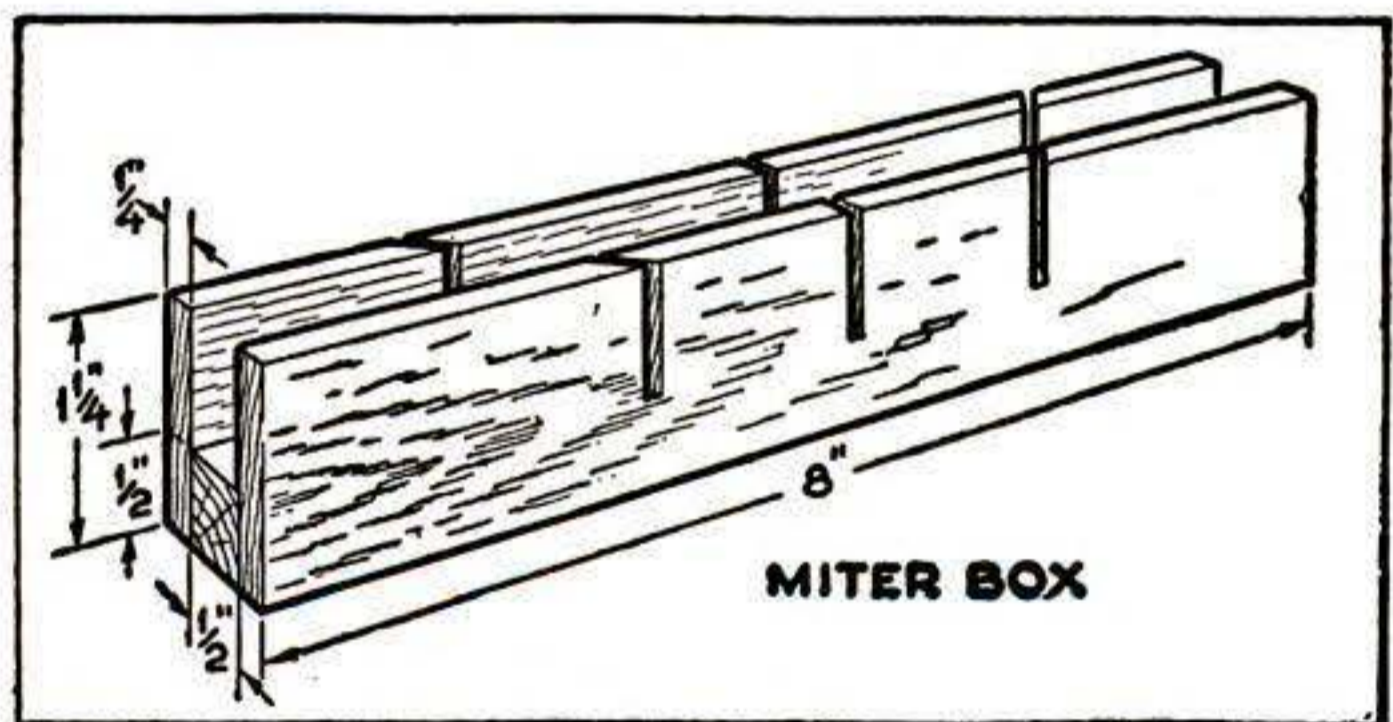

Mitered and square corners are best cut with the aid of a miter box that will fit the strips used.

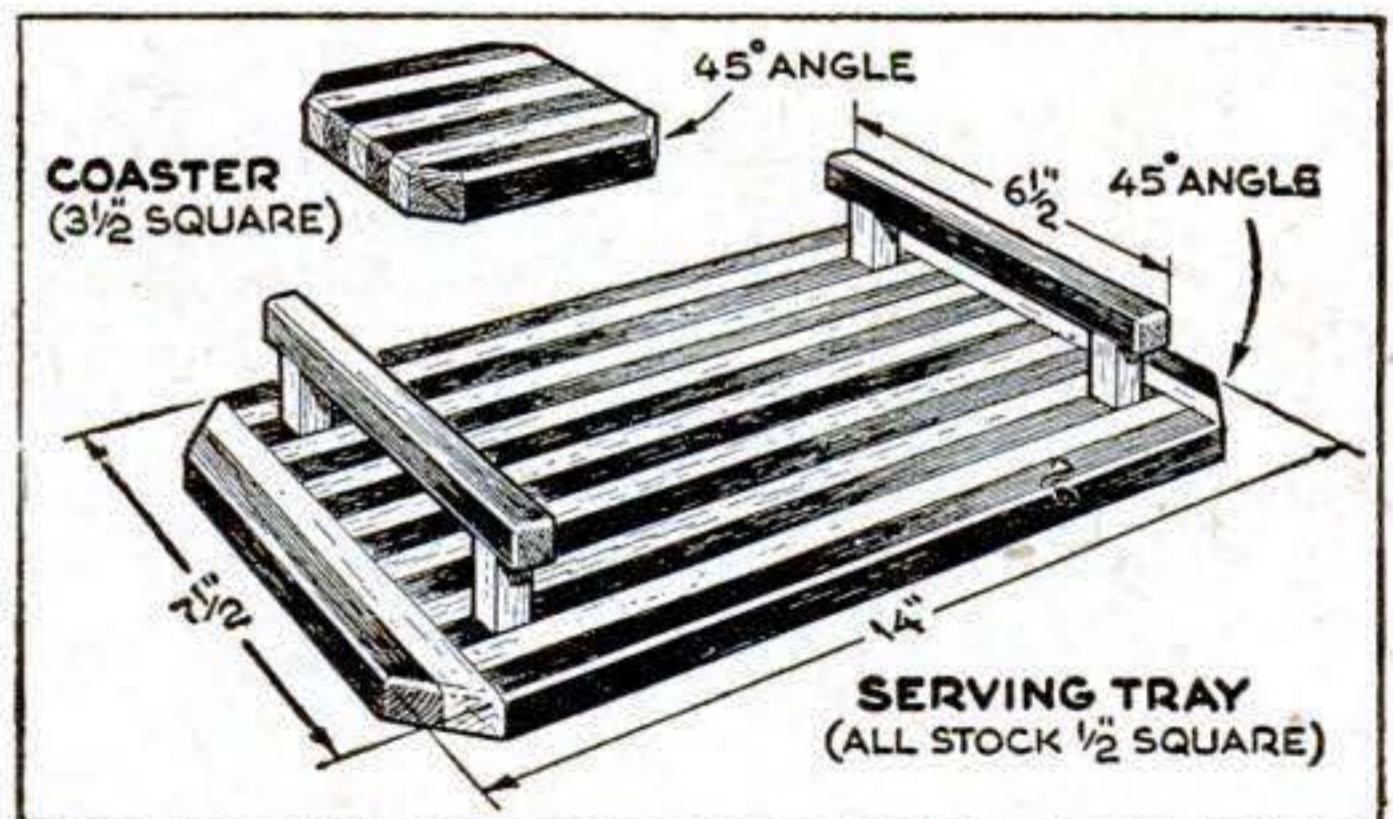

Projects in two tones require an uneven number of strips so opposite edges will come out matching.



Summer-Cottage Shaving Kit Has Mirror and Basin

MANY camp and beach cottages have no place for the morning shave except in the kitchen, and this frequently interferes with breakfast preparations. This box for shaving equipment is built around a mirror and a small basin for the shaving water. It can be hung on any window sash where plenty of light will strike the face.

Dimensions, of course, will depend upon the size of the mirror and the basin used. The mirror is pivoted on a dowel to swing up against the window or wall and down under the basin panel. This drop front is short enough to allow the shaver to get close to the mirror. It is held by regulation hinges and fishline.—WILLARD ALLPHIN.

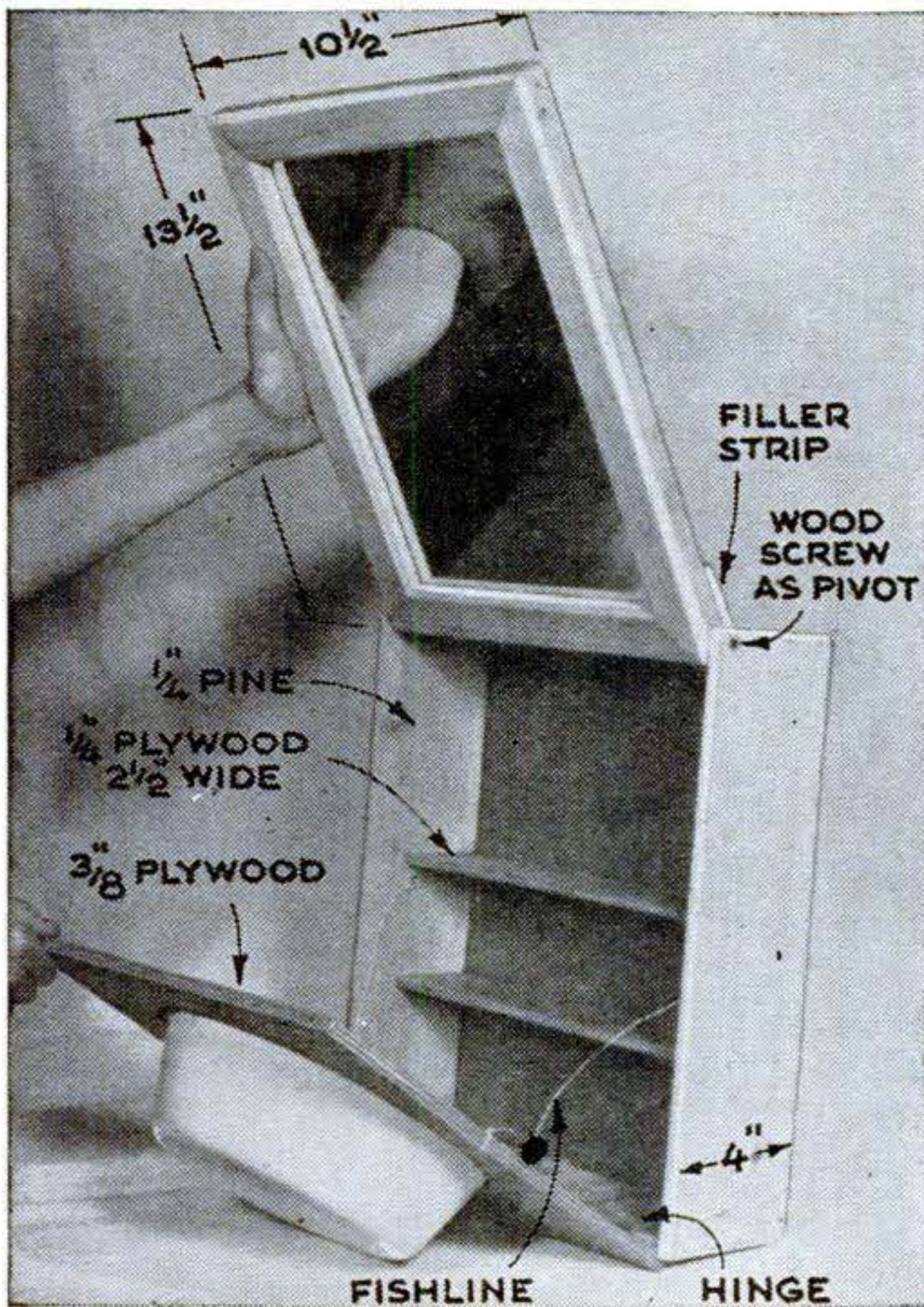

Shelves in the kit will hold the razor, shaving soap, lotion, powder, and even a small hand towel.

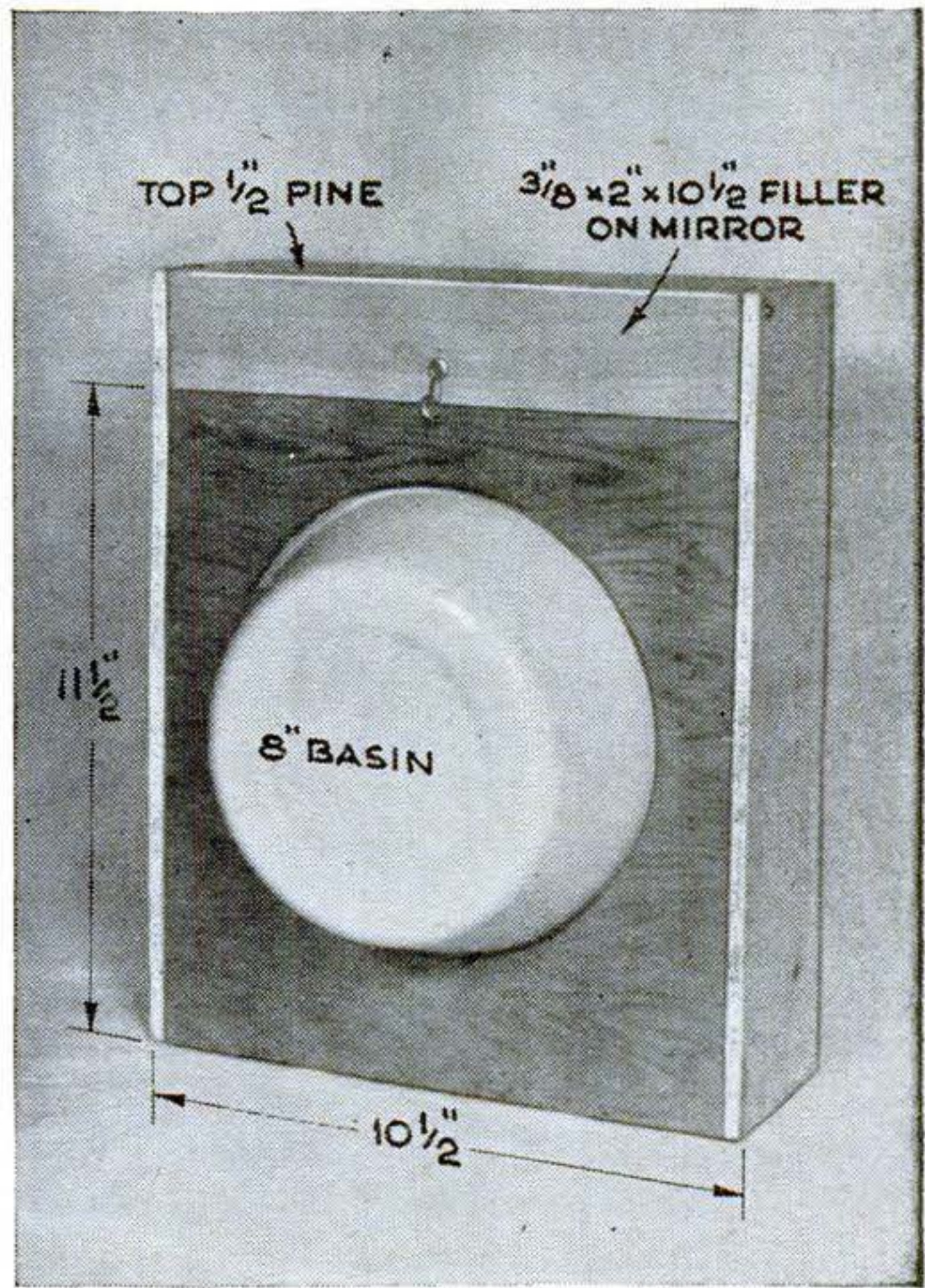

Folded, the box can be put away with the shaving equipment inside and the basin still in its place.

Marine Canoe Glue Binds Cloth Patch to Canvas-Covered Boat

RIPS and worn places in the coverings of canvas boats can be repaired with marine canoe glue heated and daubed over the spot, where it will harden quickly. A patch of unbleached muslin or any light fabric, not

heavy canvas, is laid over the glue and a hot iron applied. This melts and sweats the glue through, binding the patch and old cover. Such a patch can be smoothed and painted so it will be hardly noticeable.

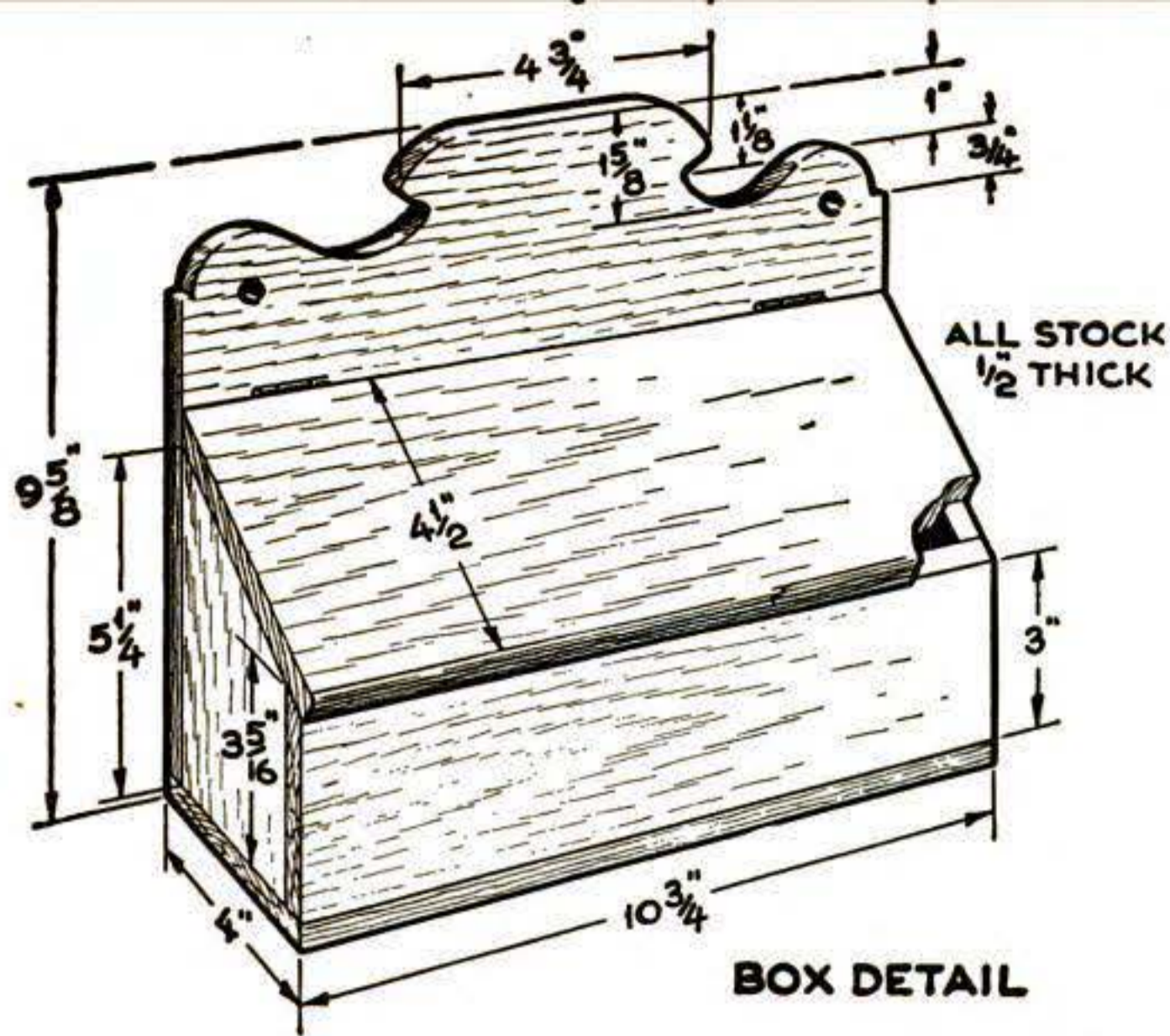

Gay decorations are painted on a pine background.

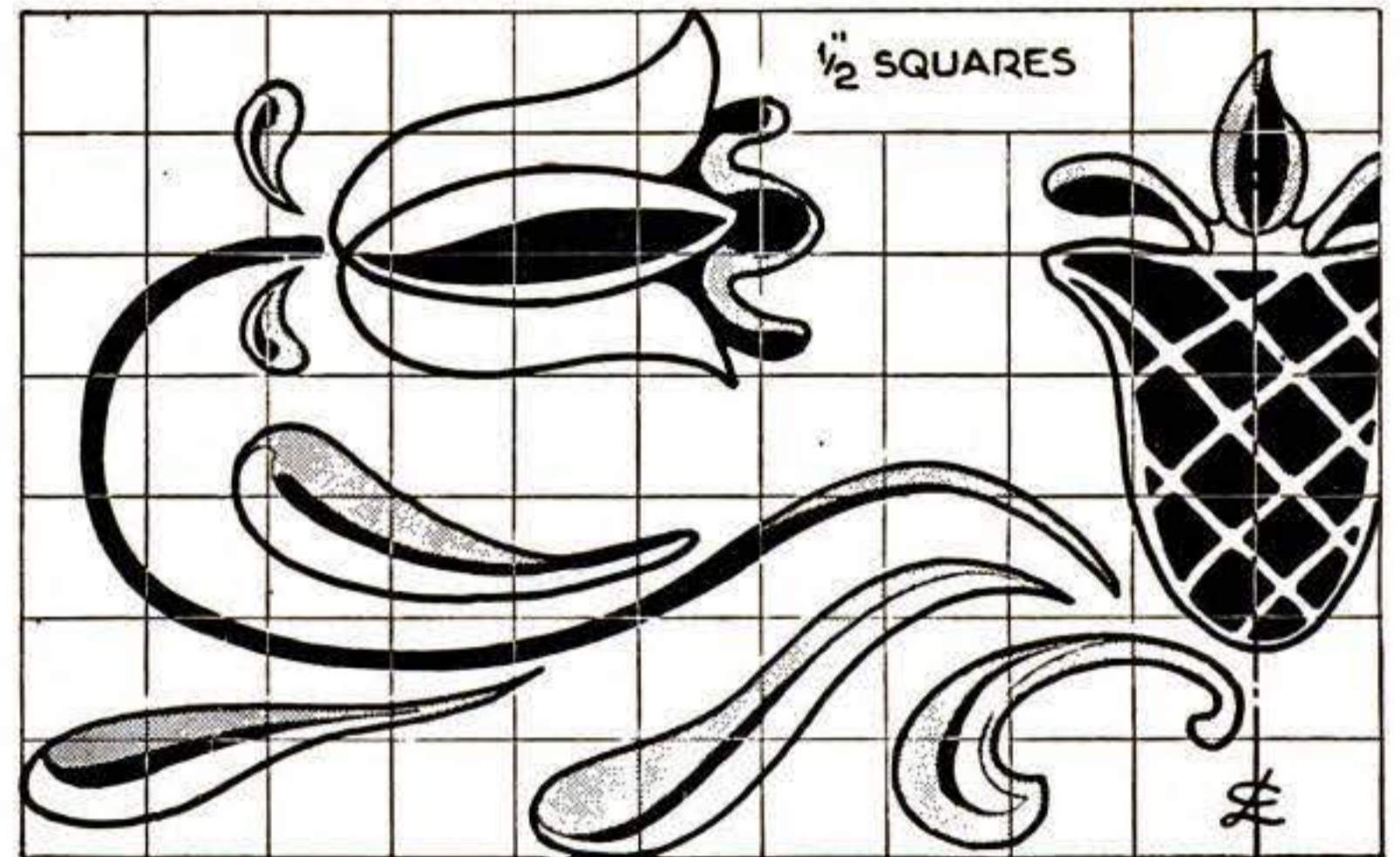
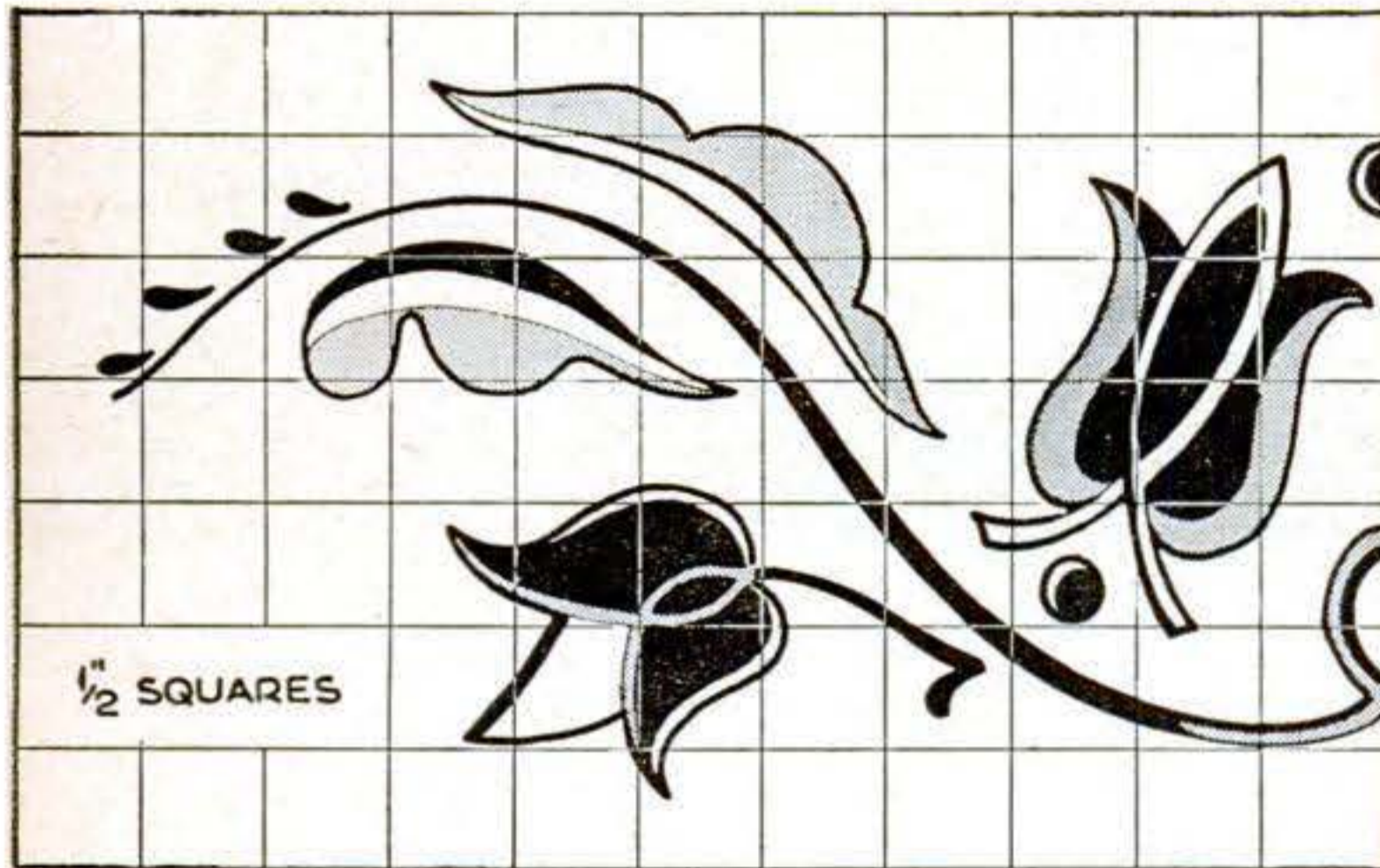

Box for Candles Is Ornamented with Painted Peasant Designs

STORAGE of candles where they will be accessible but protected is a problem in a cabin or summer cottage. This pine box with a hinged lid keeps them out of reach of small children. It is shown in color on page 116.

Construction is very simple, with all joints butted and nailed. Make the back in one piece and lay out the scroll-sawed curve freehand or make a cardboard template for one side and turn it over to get the other symmetrical. The back edge of the lid is beveled at a 60-deg. angle.

Apply three thin coats of orange shellac to the entire box. This will accent the

natural yellow of the pine and, when sanded smooth, make a good foundation that will help keep the painted design from running.

Transfer the design with pencil or carbon paper. Use oil colors from tubes, thinning a very little with turpentine and adding a drop or two of drier. If the paint is brushed on fairly dry and with restraint, one color may be put over another and the decorating completed at one sitting. After the oil colors are fully dried, the box may be antiqued with a thin glaze of burnt umber wiped while tacky from the center toward the edges.—DORIS ALLER.



Rubber Ring Keeps Bits on Drill

STRETCHED over a length of corrugated cardboard around the body of an electric hand drill, a section of auto or motorcycle inner tube holds drills securely and ready at hand. Fold the piece of tubing back on itself and put the cardboard between. Turn back the rubber flap to reach the drills, as shown.—J. A. RICHARDS.

They Built PSM Projects

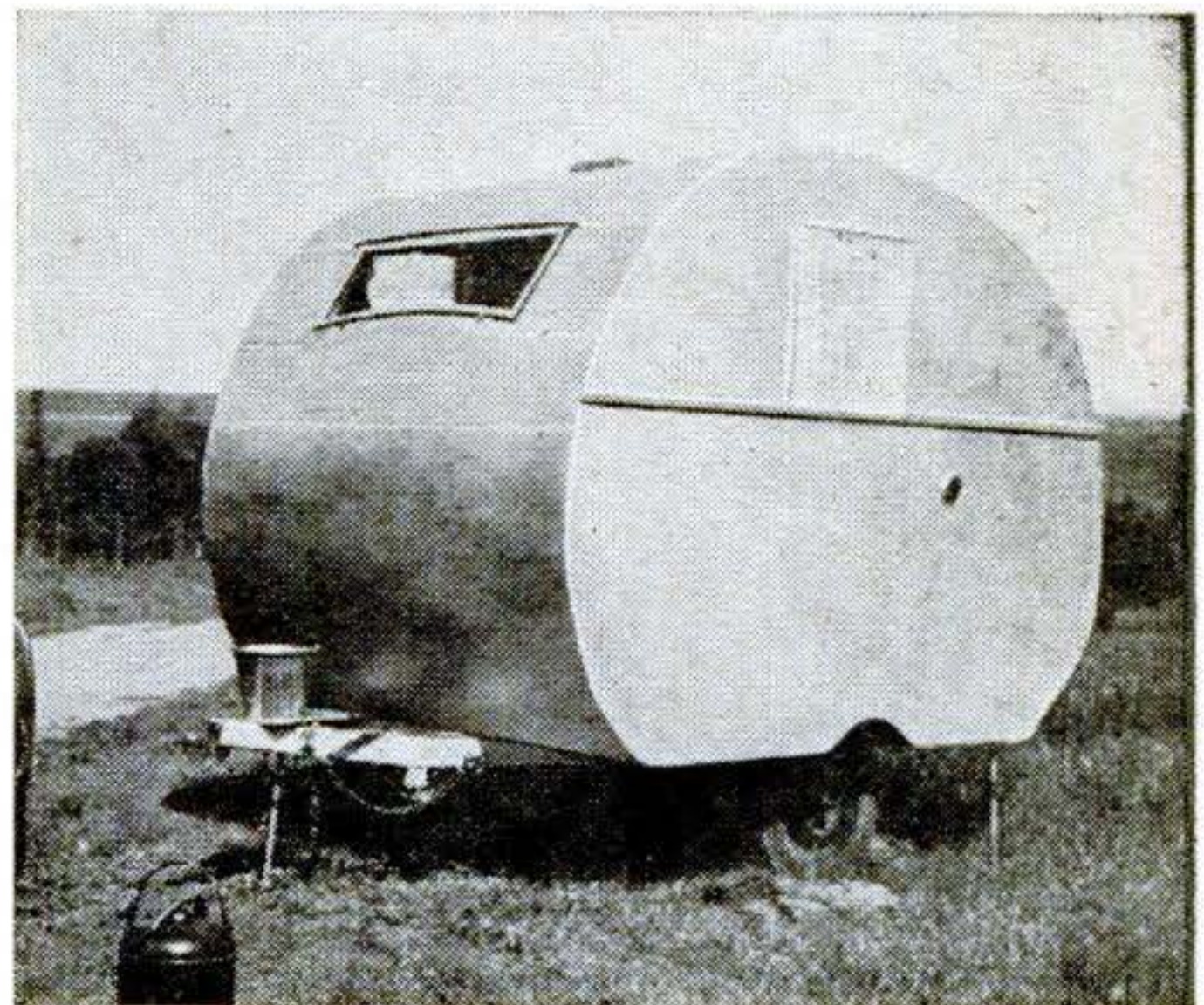

TWO VERSIONS OF THE TRAILER. Here are two ways readers adapted the trailer published in PSM (Mar. and Apr. '46) to their own needs. John Rzeszutek, of Minneapolis, built the trailer at left, using $\frac{1}{8}$ " pressed composition wood for the outside, $\frac{1}{8}$ " mahogany army-glider plywood inside, and $\frac{1}{2}$ " insulation board between with $\frac{3}{4}$ " air space on both sides. To increase the sleeping space to accommodate four, two twin-

bed springs were installed double-bunk fashion across the rear. With three other men he lived a week in the trailer near the Canadian border during deer season.

Howard H. Beach, of Zion, Ill., also adapted the sleeping arrangements in the trailer at right to accommodate four by hinging drop leaves on the two beds. He reduced the cost at least by half by using hard composition board instead of plywood.

AUTOMATIC RECORD CHANGER. The oscillator in this changer, from plans in the March '46 PSM, is built in under the player mounting board. Richard N. Beemer, of Mason City, Iowa, uses a double-pole double-throw switch to operate the player either through the oscillator or by direct connection through an amplifier. Volume is controlled by a 1-megohm rheostat when the player is hooked up directly.

A mounting board of $\frac{5}{8}$ " plywood is used for the changer. The cabinet is $\frac{1}{8}$ " pressed composition wood 11" high, 15" wide, and 17" long. It is finished with three coats of semigloss ivory and trimmed in brown.



PLYWOOD BOAT. Eight members of George McGinnis's woodworking class at the Goshen, N. Y., Central School joined in constructing this boat from PSM plans published in June and July '42. They spent an hour a day on it five days a week for three months. Waterproof plywood was used for the hull. The boat is used with an outboard motor, but also does nicely with oars.

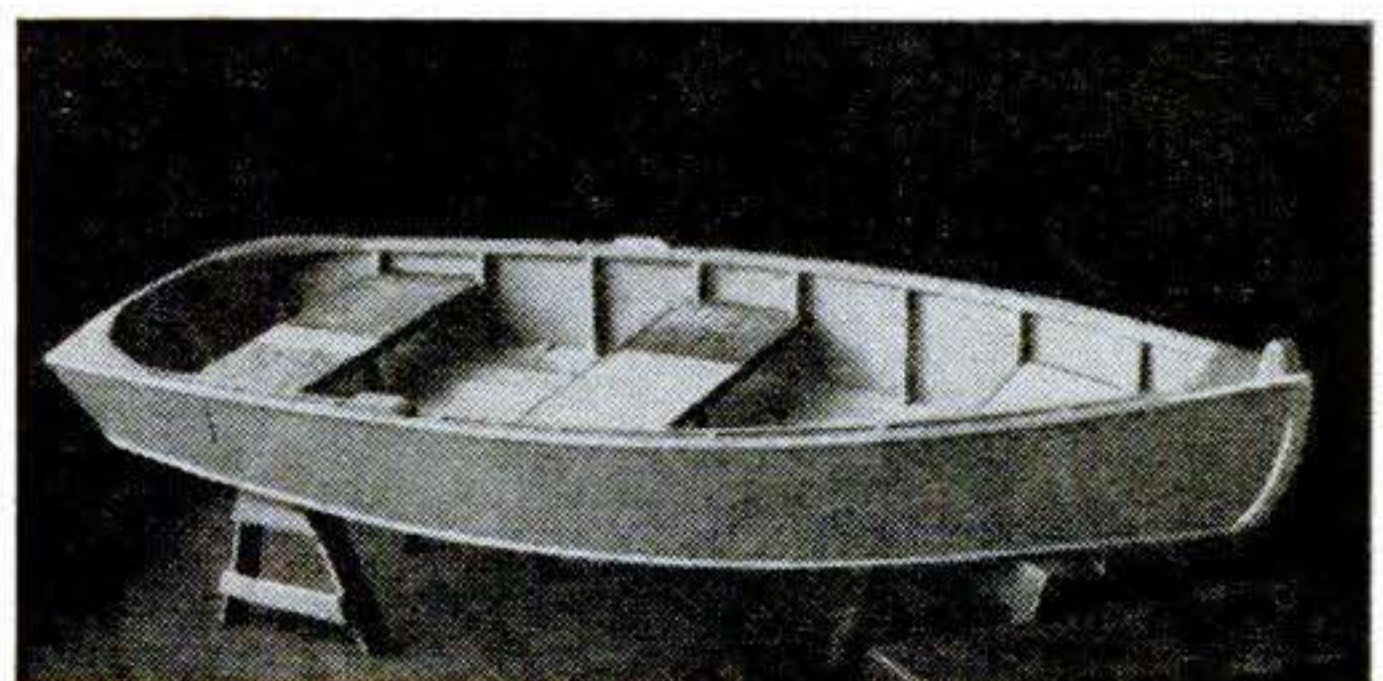

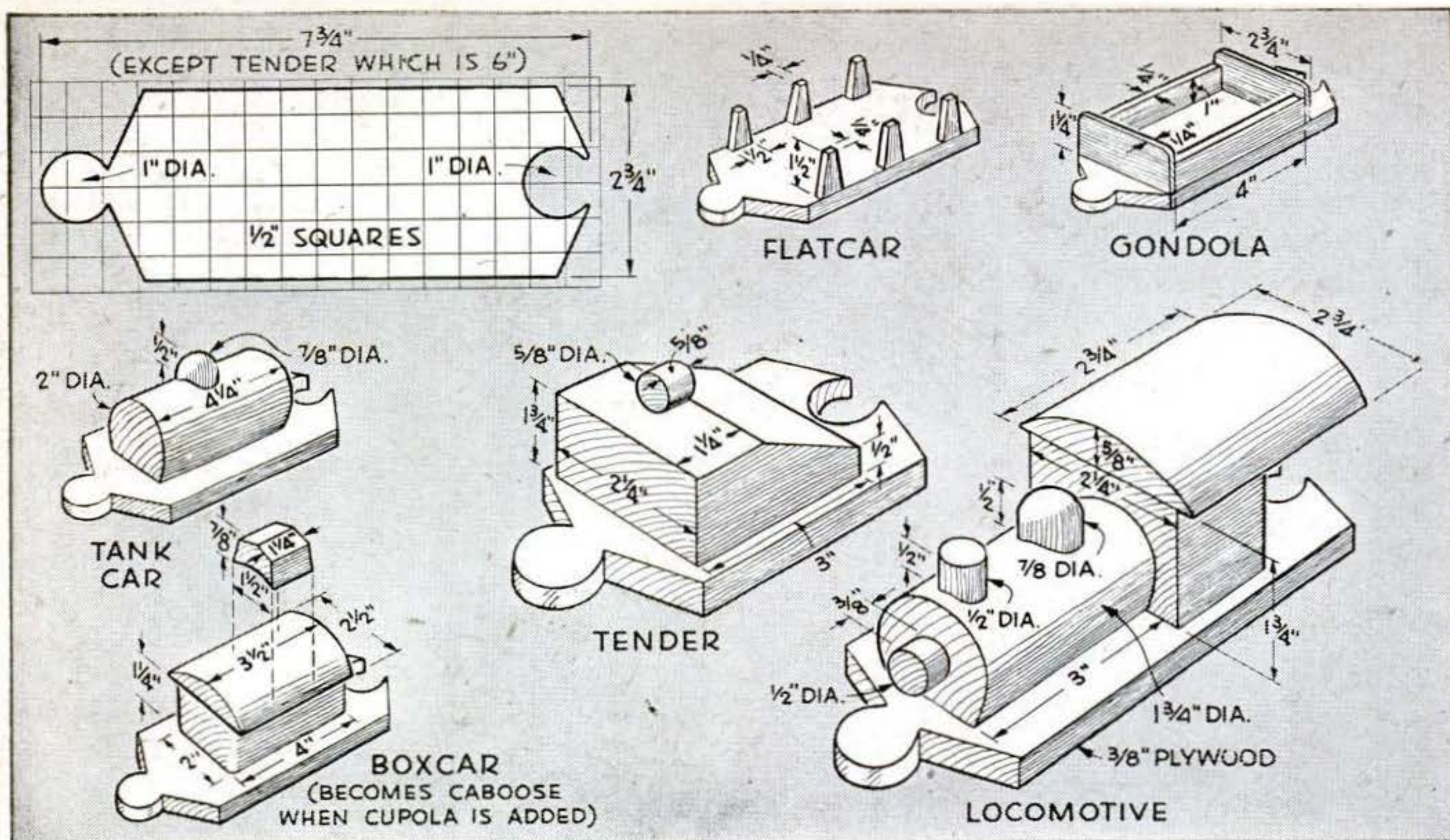

Toy Train Keeps Tots Busy

THOSE first railroad cars for the future engineer can be built of a few scraps of $\frac{3}{8}$ " plywood, some pine blocks, dowel ends, and orange-crate wood. Knob-and-socket couplings provide an easy method of making up trains. Two or three evenings in the basement should be sufficient for turning out a locomotive and a half-dozen cars.

Make a template of stiff paper for the bases and scribe around it on the plywood for as many pieces as you plan to make. The same template is used for all bases except that for the tender, which is only 6" long. File and sand the knobs and sockets so any base can be coupled to any other and allow a turning angle between cars of at least 25 deg. to either side.

The locomotive cab, tender, and boxcar bodies are held on by glue and finishing nails. Top the cab and boxcars with $\frac{3}{8}$ "



pieces planed slightly round on the upper side, and add a cupola to convert one boxcar into a caboose. The locomotive boiler and tank-car bodies are rounded blocks or pieces of closet pole. Domes, smokestack, and headlight can be spools or dowel ends. The gondola sides and flatcar stakes may be of orange-crate stock. Enamel in various colors.—BUDD SALSIG.

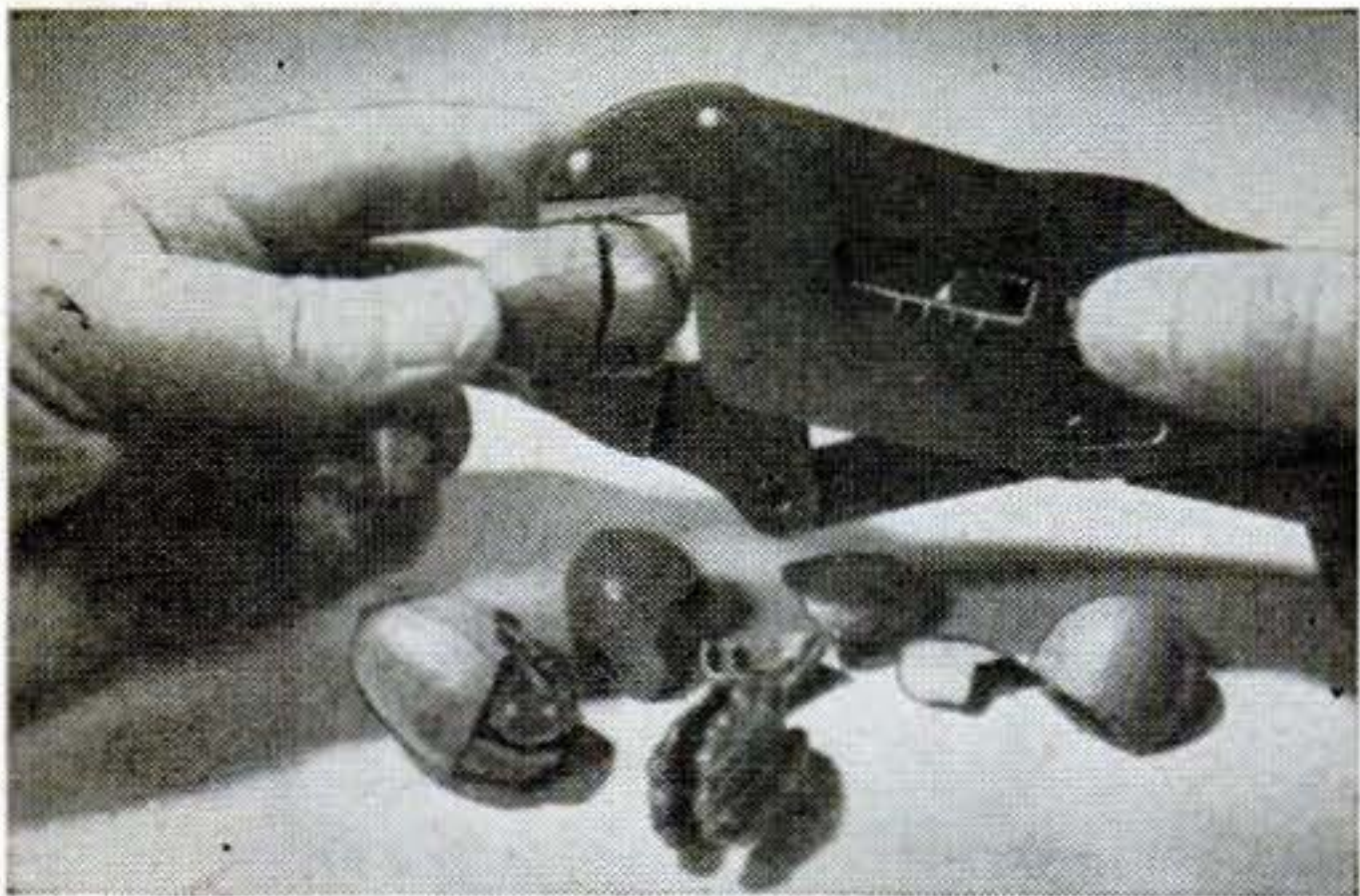

Wrench Serves as Nutcracker

IF YOUR basement shop boasts one of those new lock-grip wrenches, try using the tool as a nutcracker the next time you want to remove the nut meats whole. Adjust the wrench jaws just tight enough to break the shells; then no matter how much pressure is put on the handles the jaws won't come so close they will break the meats. Several adjustments of the jaws may be necessary if the nuts are not all the same size.

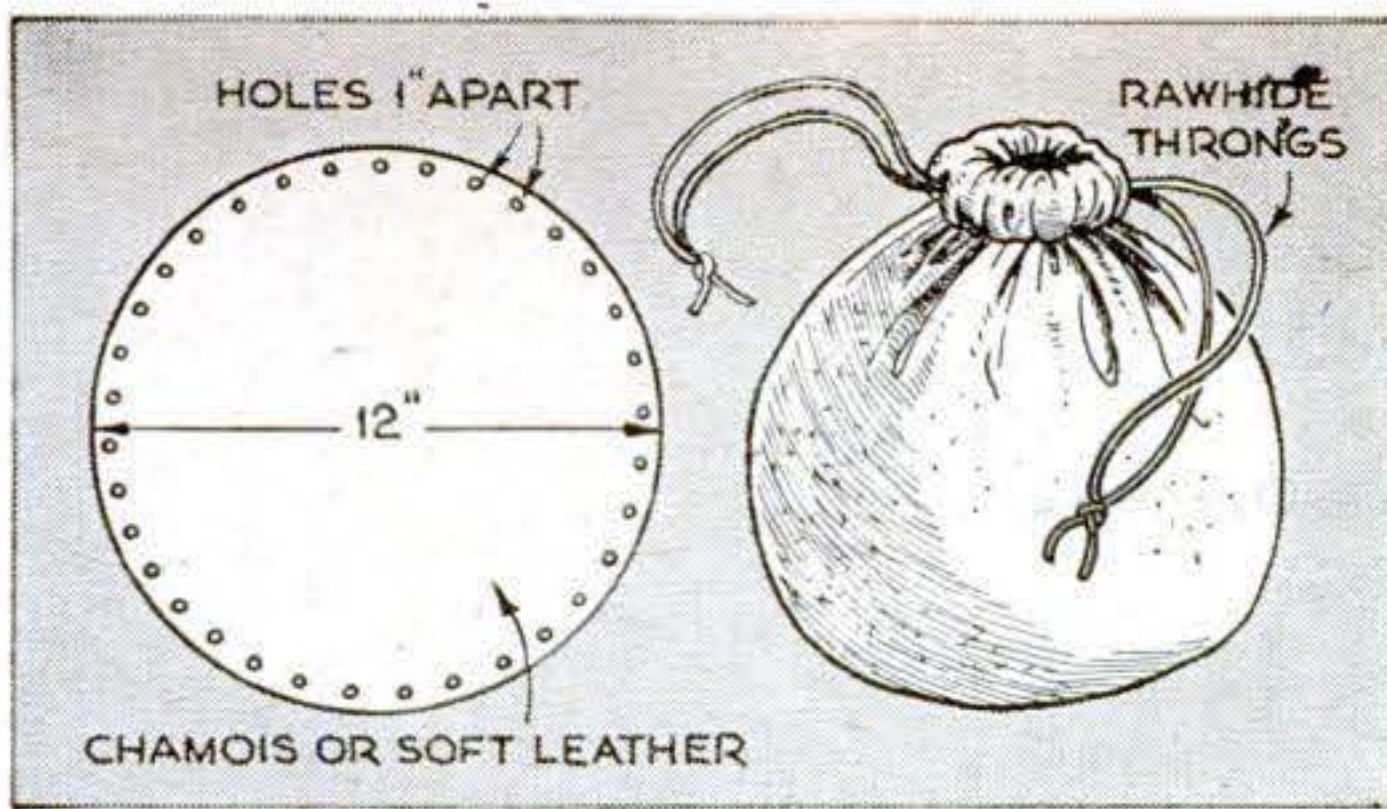

Oiled Bag Keeps Fishing Reel from Rusting in Tackle Box

SOFT leather or chamois cut in a circle will make a good protective bag for a fishing reel. Stretch out the material on a bench or a wide board, tack it down tightly, and trace a 12" circle on it from a cardboard pattern. After cutting out the piece with shears, punch holes about 1" apart near the edge. Use a pair of rawhide shoelaces as drawstrings to pull the wide mouth of the bag up tight around the reel.

Chamois is preferable for the bag since it can be kept well oiled at all times and thus reduce the chance that the reel may rust in the tackle box.—R. A. JENKINS.

Bottle and Cord Test Trigger

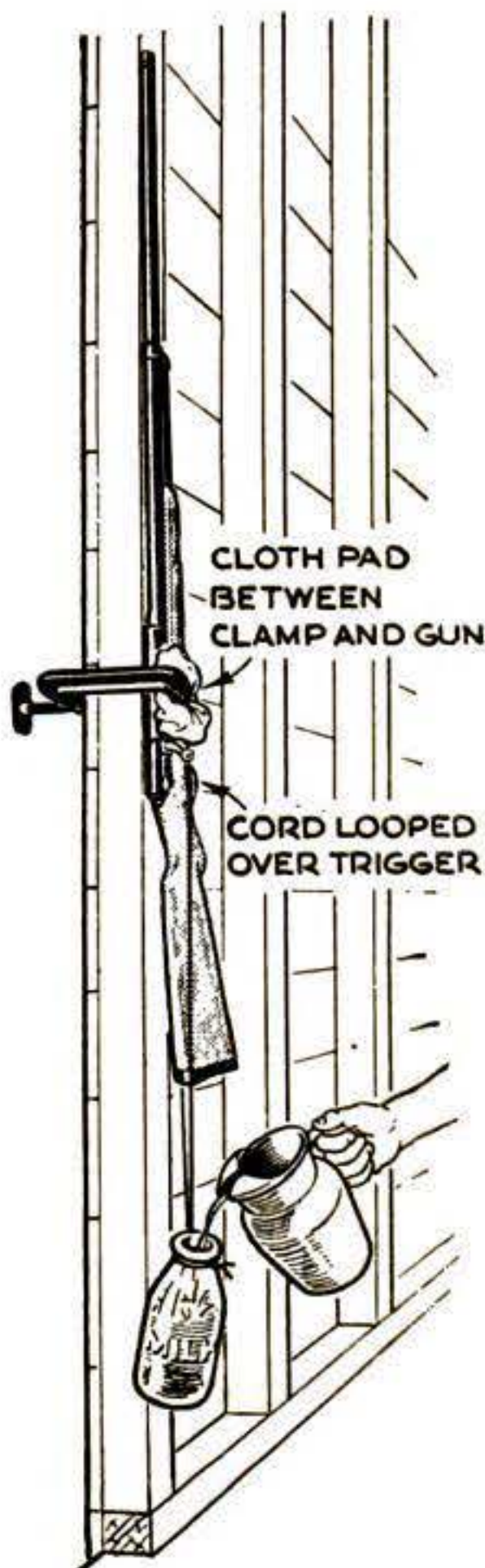

CLAMPED to a stud at the garage door, the trigger pull of a shotgun, rifle, revolver, or pistol can be tested accurately. Tie a 1-qt. or ½-gal. bottle to the trigger by a long cord so it is suspended about 6" above the floor. Then slowly fill the bottle with water from a pitcher, stopping as soon as the weight pulls the trigger and the firing pin clicks. The weight of the bottle and water equals the trigger pull. This varies, according to gun and taste, from ½ lb. or less up to around 3 lb. Be sure the gun is unloaded.

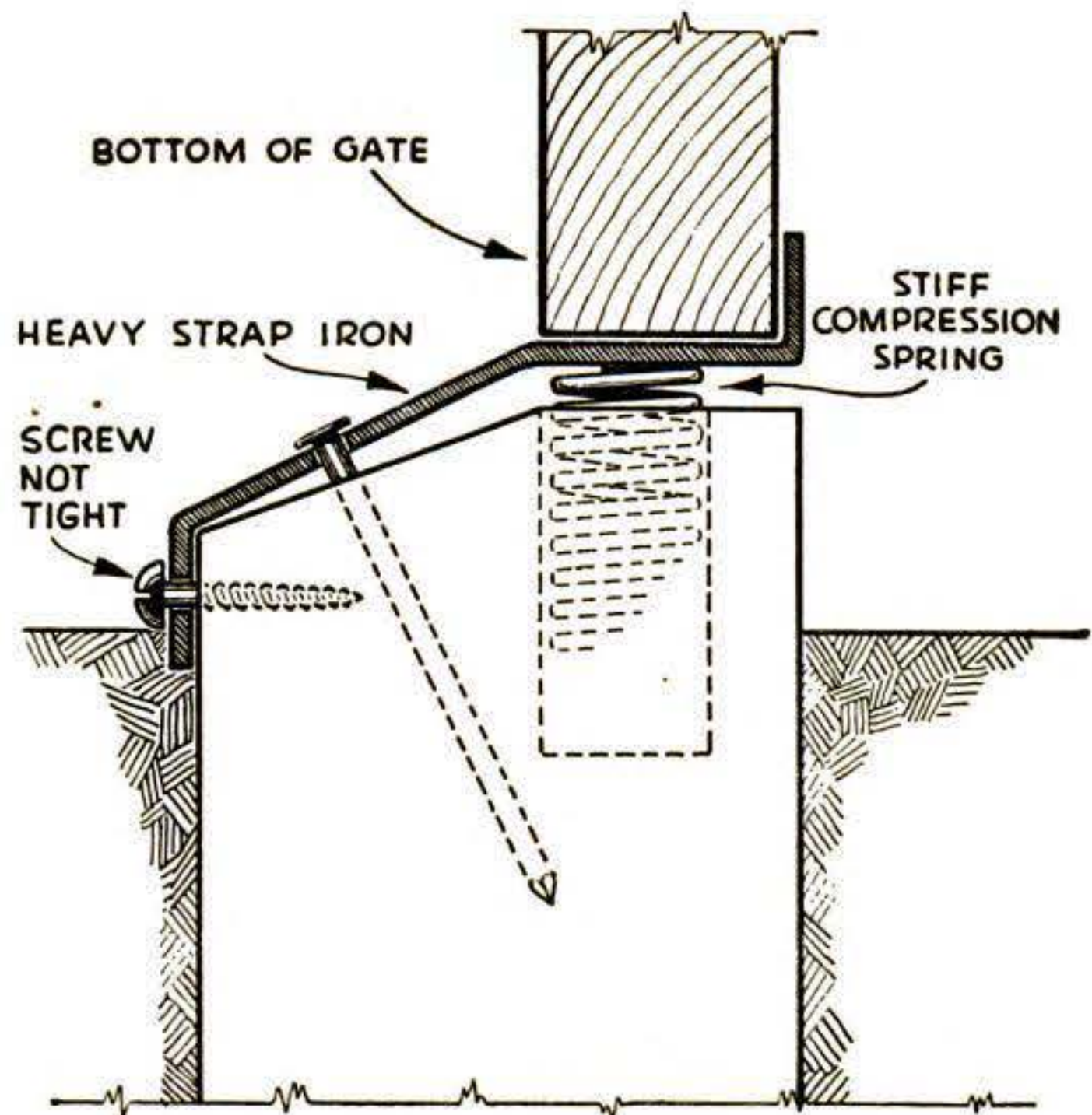

Friction Catch Latches Gate

A SHORT piece of heavy strap iron and a stiff compression spring form the working parts of a reliable catch for a small garden gate. In the end of a 4" by 4" block, bore a hole that is slightly larger than the spring but about 1" shorter than the spring length, and chamfer one edge away from the hole. Soak the block in creosote and set it in the ground near the outer edge of the gate. Bend the strap to shape and fasten it with a roundhead screw and a 16d. nail that are left a little loose.—W. P. SHEPHERD.

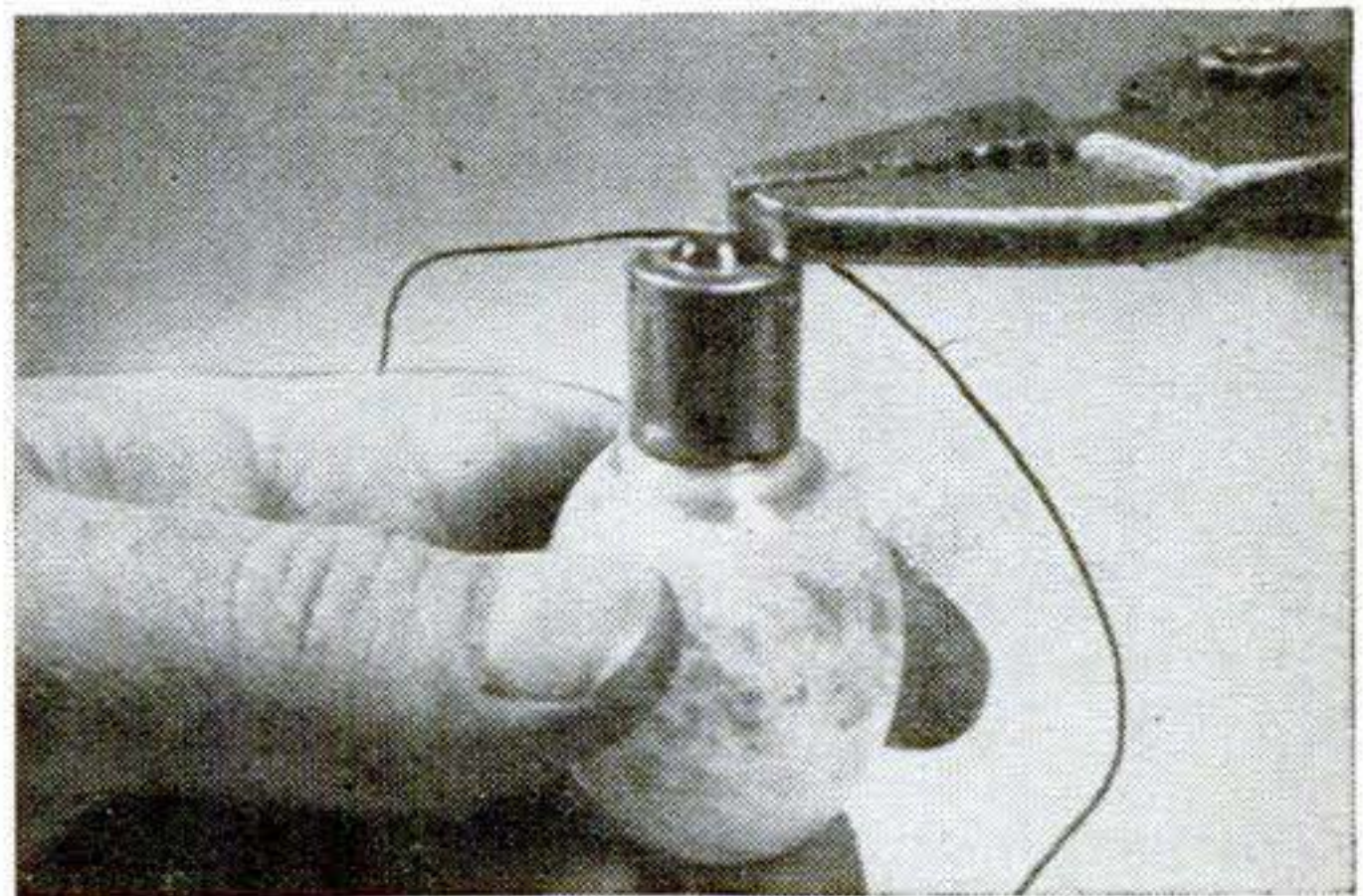

Flash Bulb Is Fishing Bobber

BURNED-OUT miniature flash bulbs can be made into good fishing bobbers by splitting the solder on the end contact with a knife, inserting the line, and closing the solder on it with pliers. The bulbs will not become waterlogged and can be used for a long time. Their white appearance makes them easy to see on the surface of the water.

Glass-Topped Desk Conceals Typewriter

By Bernard I. Bell

MODERN in its conception, materials, and convenience, this glass-topped desk is of plywood construction. It has a shelf for magazines and reference books, ample drawer space, and a special drawer serving as both support and cover for a portable typewriter.

To cut down on the cost of the material, which is quite costly in hardwood-faced varieties, $\frac{3}{4}$ " plywood with a white-pine face was used and stained, varnished, and waxed to match the other furniture in the room. However, it is sometimes possible to obtain plywood beautifully veneered with such cabinet woods as primavera, mahogany, bird's-eye maple, and birch. Only one piece, the right-hand end, need be faced on both sides, so single-faced stock can be used everywhere else if you wish to work with one of these veneered woods.

The drawer supports may be ordinary $\frac{3}{4}$ " fir plywood. This same kind of plywood, but in $\frac{3}{8}$ " thickness, may also be used for the sides, bottom, and back of the drawers, although $\frac{3}{8}$ " oak plywood will prove sturdier.

All exposed edges and ends are veneered with thin strips ripped from solid stock of the same wood as the plywood finish face. This will conceal the end grain and produce a neater job. Strips $\frac{1}{16}$ " thick will do in most cases, but those covering the ends of the glass-top retainers, the strip at the left and dowel at the right, should be $\frac{1}{8}$ ". Since the bottom stretcher is subject to scuffing, $\frac{1}{4}$ " facing strips should be applied to its edges.

Splined miter joints are used in the drawer compartment at the two joints between sides and back and the right-hand and rear joints of the top to eliminate as many exposed plywood edges as possible. Note that the joint at the right front corner must be a blind miter, the bevel on the top stopping short of the front edge, since the

side is stepped back by the thickness of the drawer fronts.

A solid strip is grooved and glued on as a retainer for the glass at the drawer-compartment end, while a rabbeted hardwood dowel or turning serves as a retainer at the opposite end. The top is $\frac{1}{4}$ " by $19\frac{1}{2}$ " by $48\frac{1}{4}$ " plate glass. Ample clearance is provided in the groove and rabbet to take it.

Cut all parts carefully and accurately to assure true joints. Glue up the drawer supports as frames, and attach them with glue and screws to the base and to the sides and back of the drawer compartment. The shelf is cut as a single piece extending the entire length of the desk, being reduced in width to go between the drawer fronts and the mitered back as it enters the drawer section. Make the right side of this section in two pieces, the one above resting in a dado in the shelf and the other doweled to it from below. The shelf should be bored through at the dado for the dowels, which should be glued into both sections of the side. Set the shelf into dados in both ends, and add hidden cleats for support. Dowel it to the back of the drawer section.

The drawer faces are cut from a single plywood panel so the grain will be matched when they are closed. All drawers are standard construction except the top, which has a rabbeted hardwood runner in place of a right side to make the typewriter keyboard accessible. It slides under a rabbeted hardwood support that braces it when open.

Be sure to measure the height of your typewriter before laying out and cutting any of the parts. If the 5" depth of this drawer is not sufficient, increase this dimension and make allowance in the other drawers and in the height of the magazine shelf.

The drawer pulls are made as split turnings with paper glued in the joint. When separated, they should be aligned and glued and screwed to the drawer fronts.

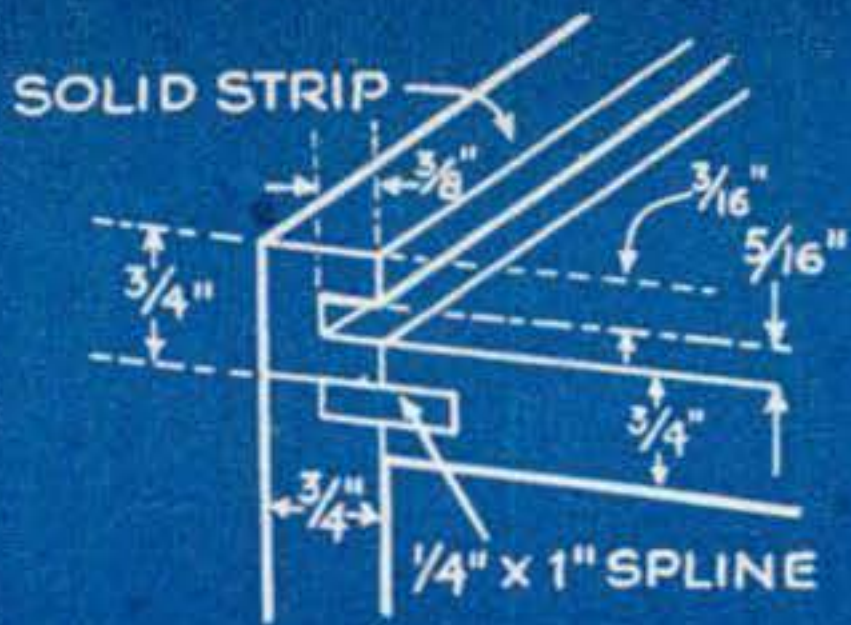

FRONT

BLIND MITER

SIDE OF DRAWER CASE

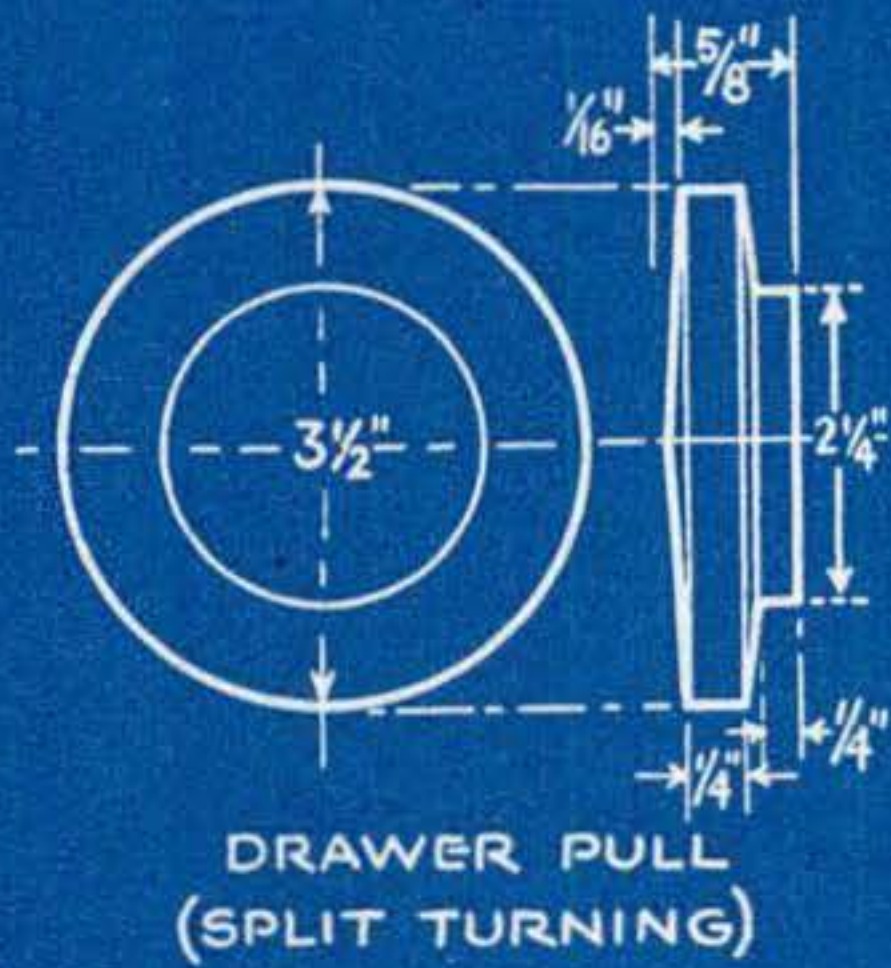
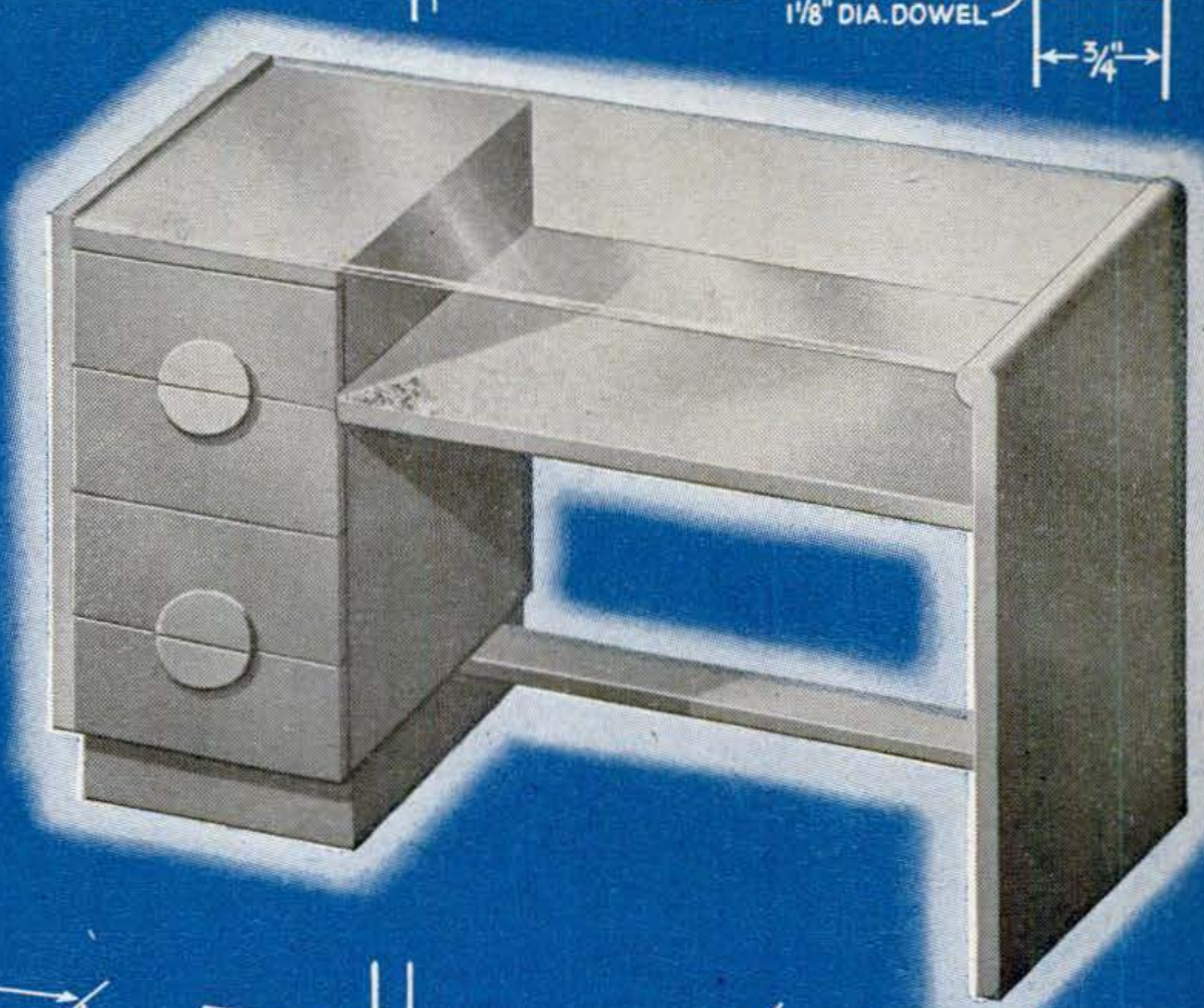
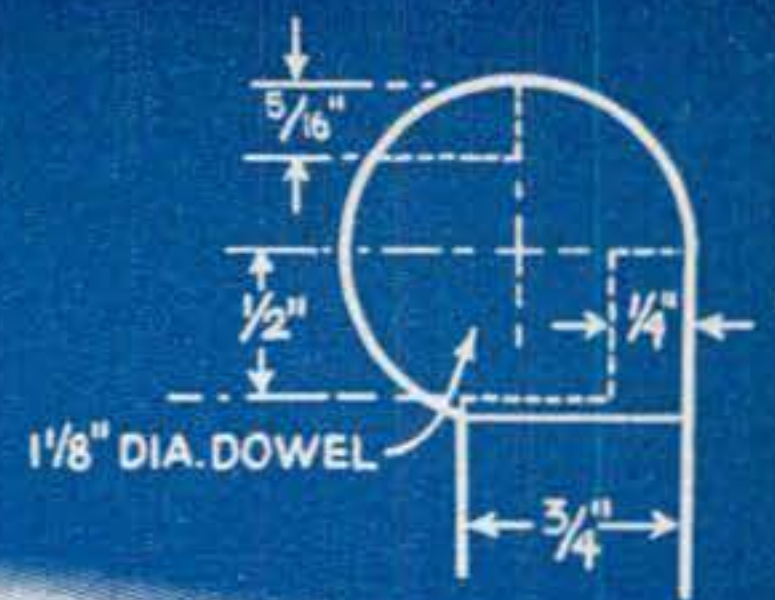

ALL EXPOSED EDGES AND ENDS VENEERED

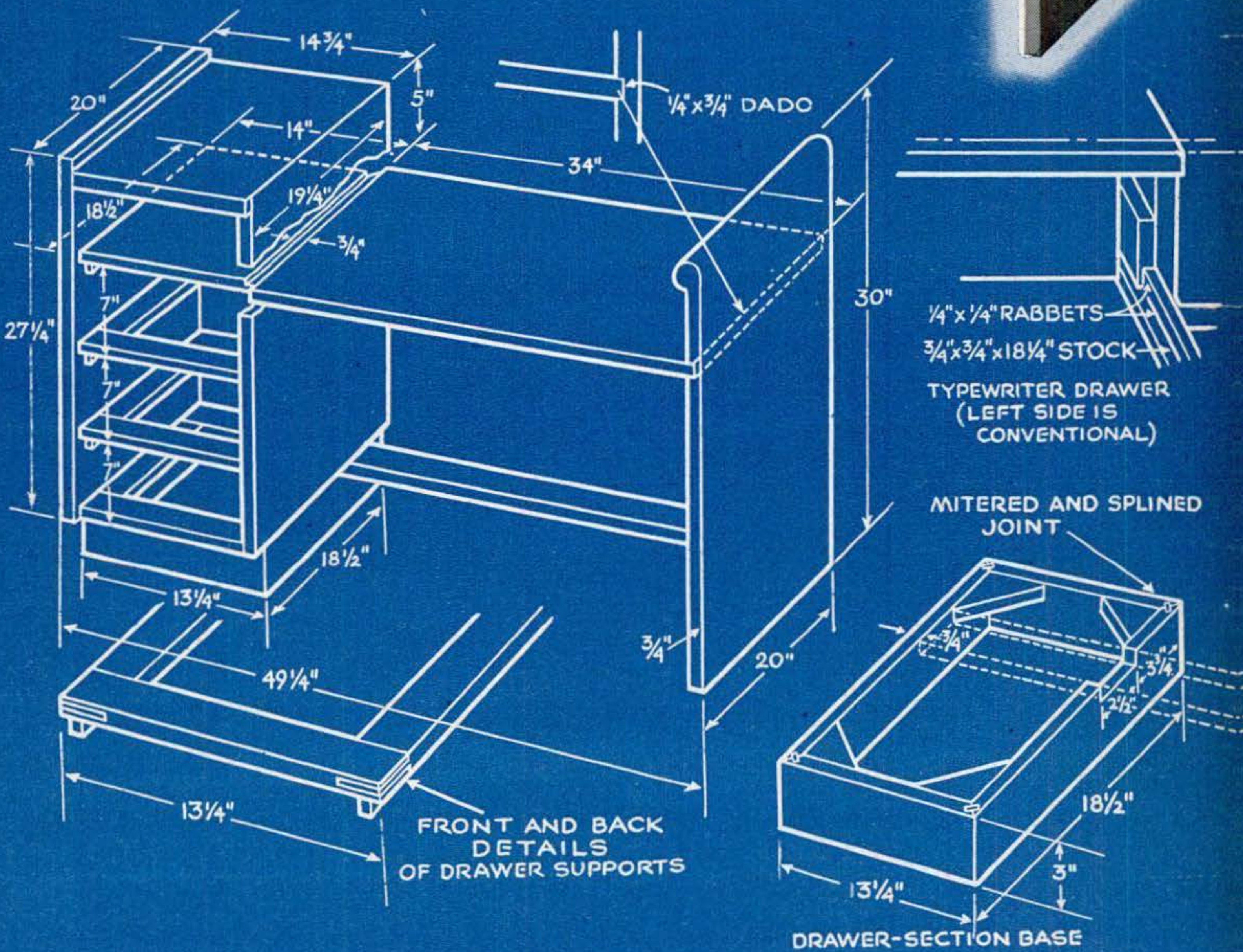

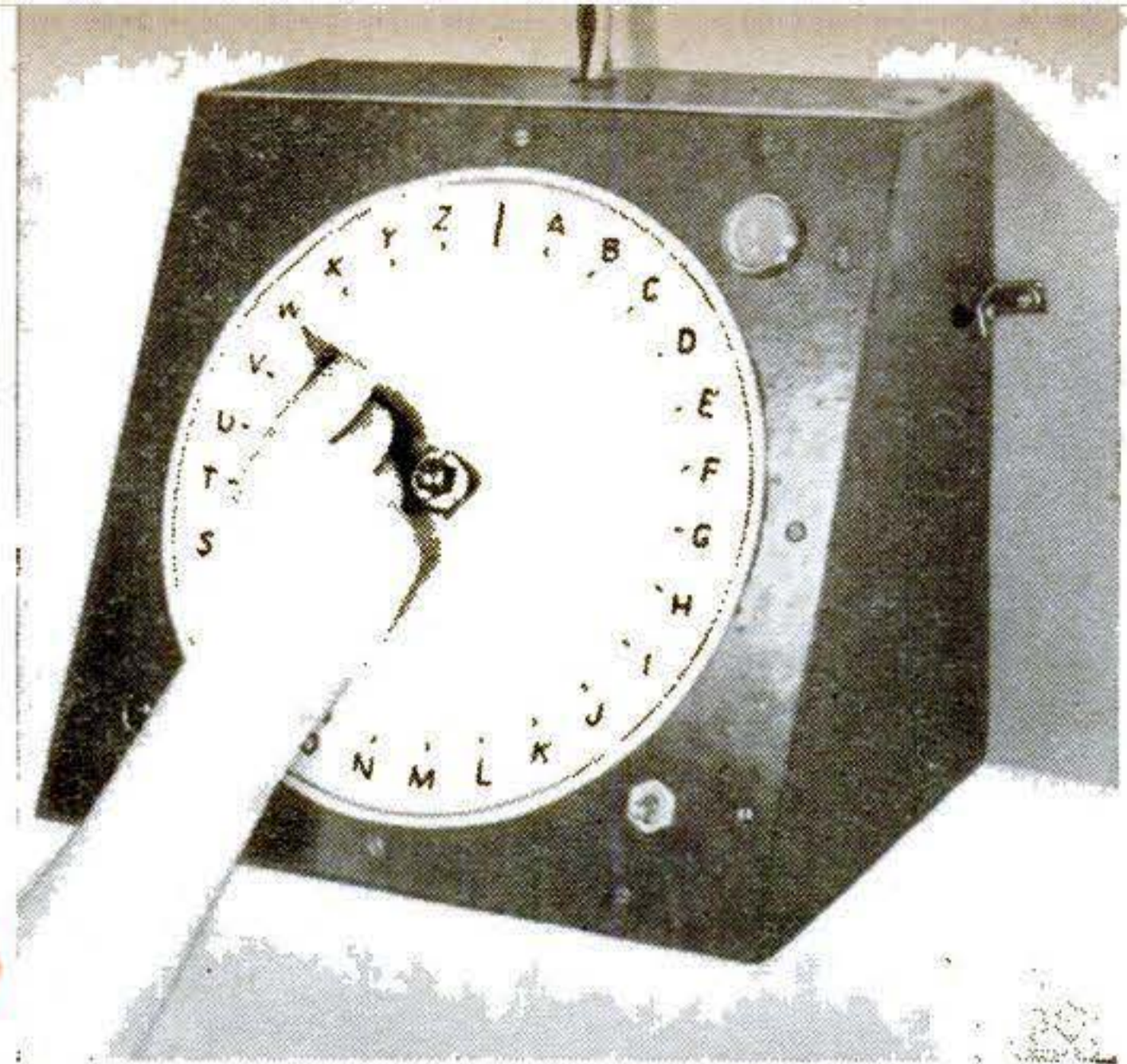

Words spelled by the pointer on one of the selsyn dials will be transmitted to the other since the shafts of the pair follow each other accurately.

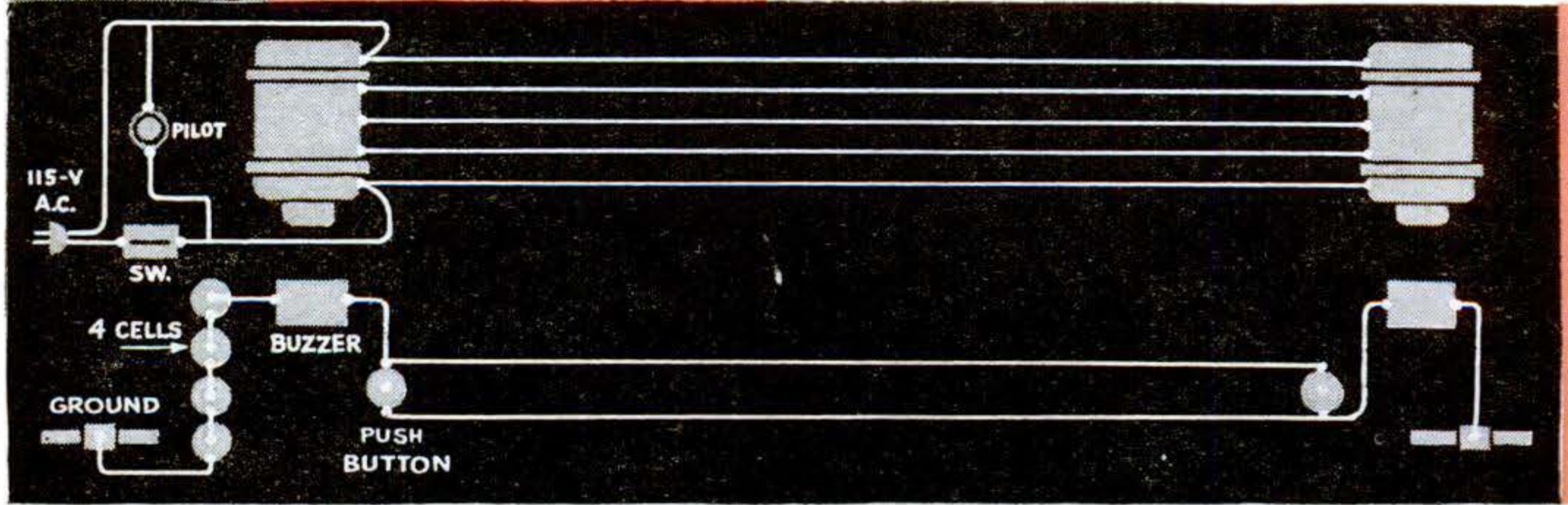

Five wires of a type suitable for carrying house current connect the selsyns. Join the leads to the proper numbered terminals. A separate buzzer circuit for a calling signal is wired with dry cells and a ground return.

Selsyn-Powered Intercom Spells Out Messages

SOME of those mysterious little gadgets that made certain war equipment seem almost like magic are finding their way to the sales counters as surplus goods. One of them is the selsyn, that onetime highly secret device used in antiaircraft weapons, bomb sights, and radar. Selsyns in small sizes can be picked up in dozens of stores now for between \$3 and \$5, and many of

them will operate on ordinary 115-volt A.C.

These selsyns are really directional motors. If two or more are hooked up properly and the shaft of one is revolved, the shafts of the others in the circuit will revolve in exactly the same way, through even the identical arc or fraction of a revolution.

This makes selsyns ideal for operating an intercom system between the house and

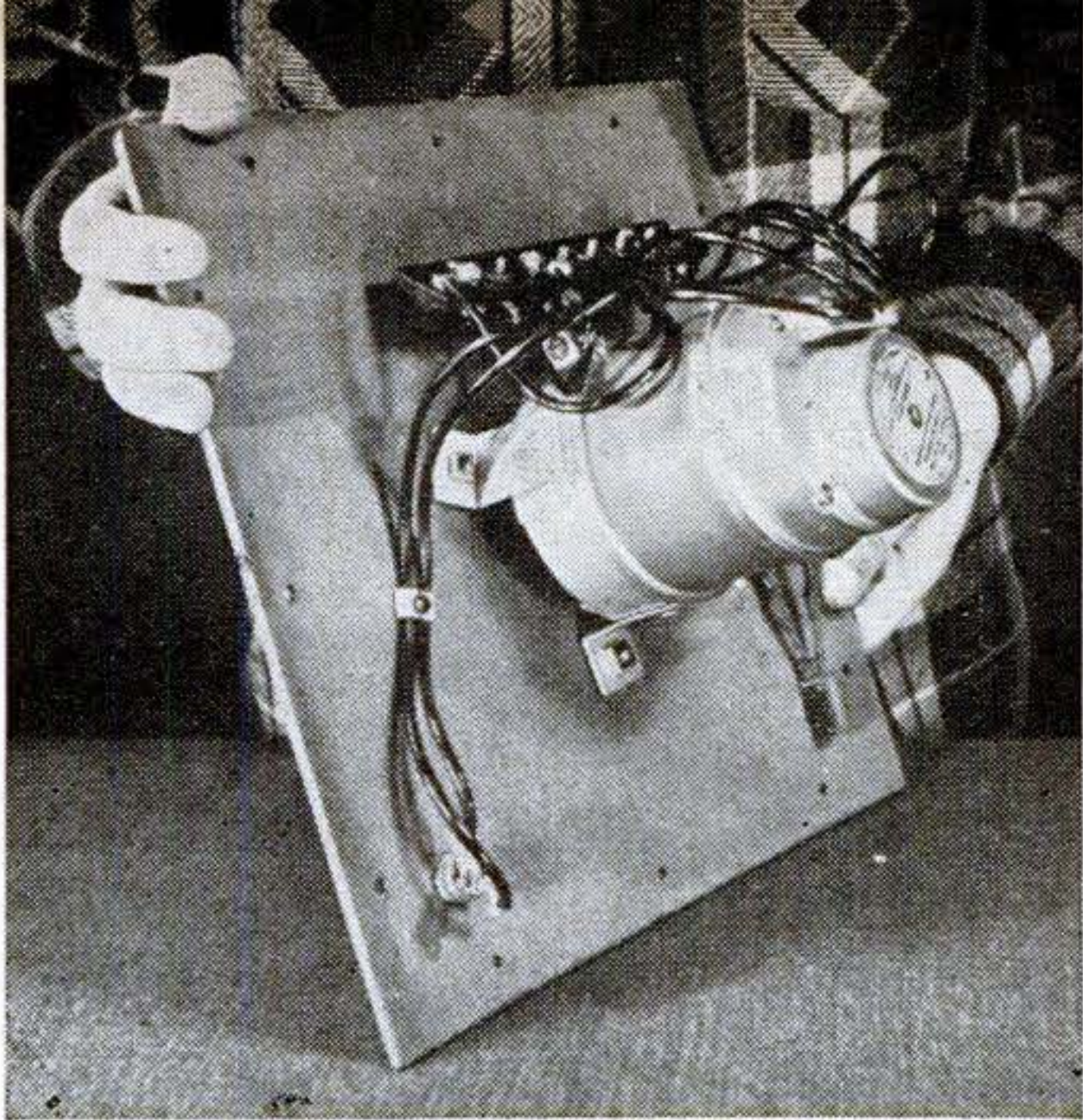

Mount each selsyn on the back of its dial panel by means of metal clips bolted to its collar. Run the shaft through to take the letter pointer.

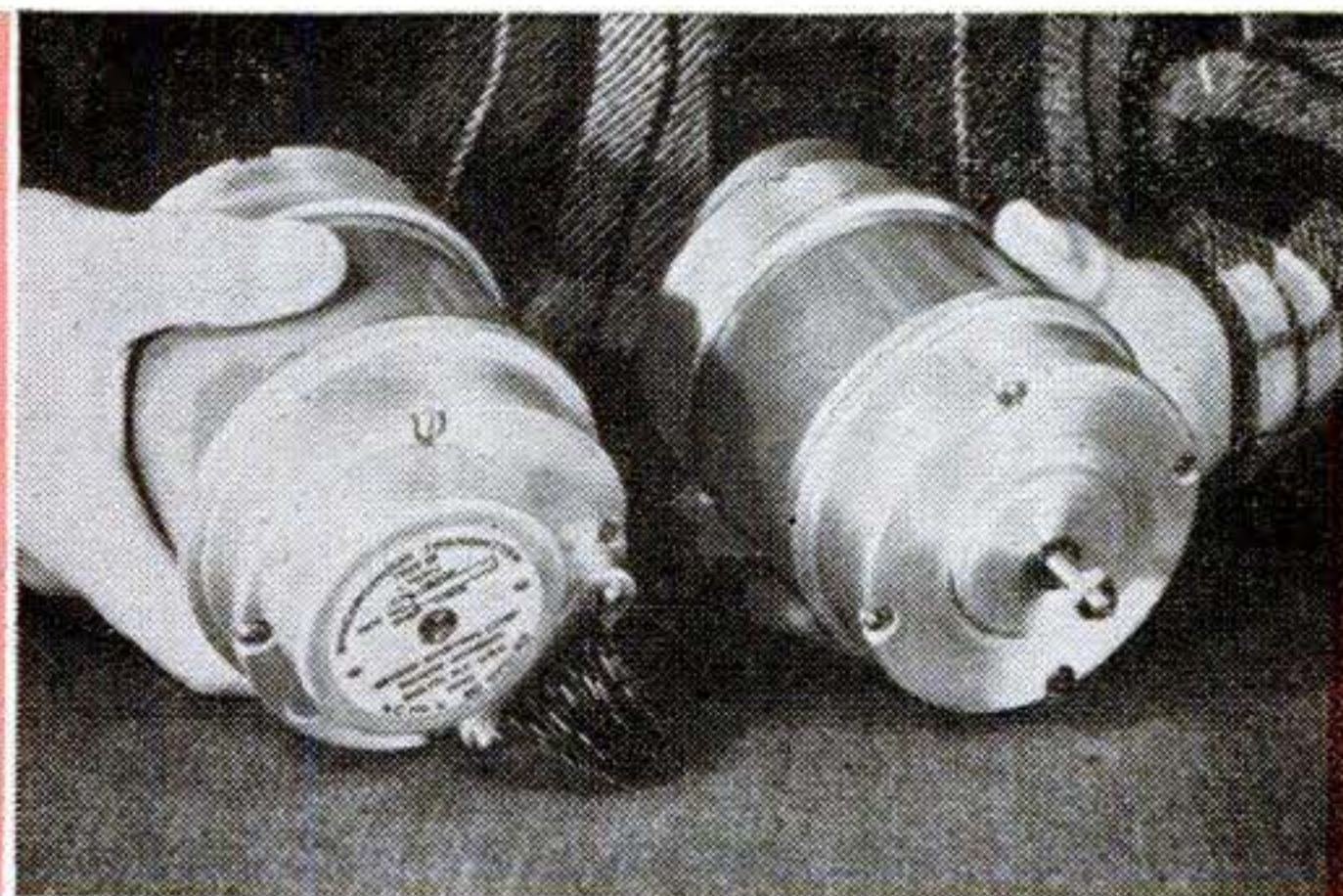

Here are the selsyns, shown front and back. One will be needed for each of the stations wired in.

basement workshop or garage and even between neighboring houses. For each station in the circuit set up a box having a dial face containing the letters of the alphabet and a line or other indicating mark for a space. Mount a selsyn in each box with the shaft through a hole in the center of the dial. One way to secure it is with metal clips or brackets bolted to the back of the box face and to the collar of the selsyn. Then file a pointer from $\frac{1}{8}$ " sheet brass or plastic and attach it to the shaft, either between two nuts on the threads or, if the shaft is not threaded, by means of a collar and setscrew.

Take pains with the wiring for, though it is simple, the leads must be connected properly or the circuit will not work. A good method is to attach the leads from each selsyn to a small terminal board and number them in order from 1 to 5, counting as 1 the

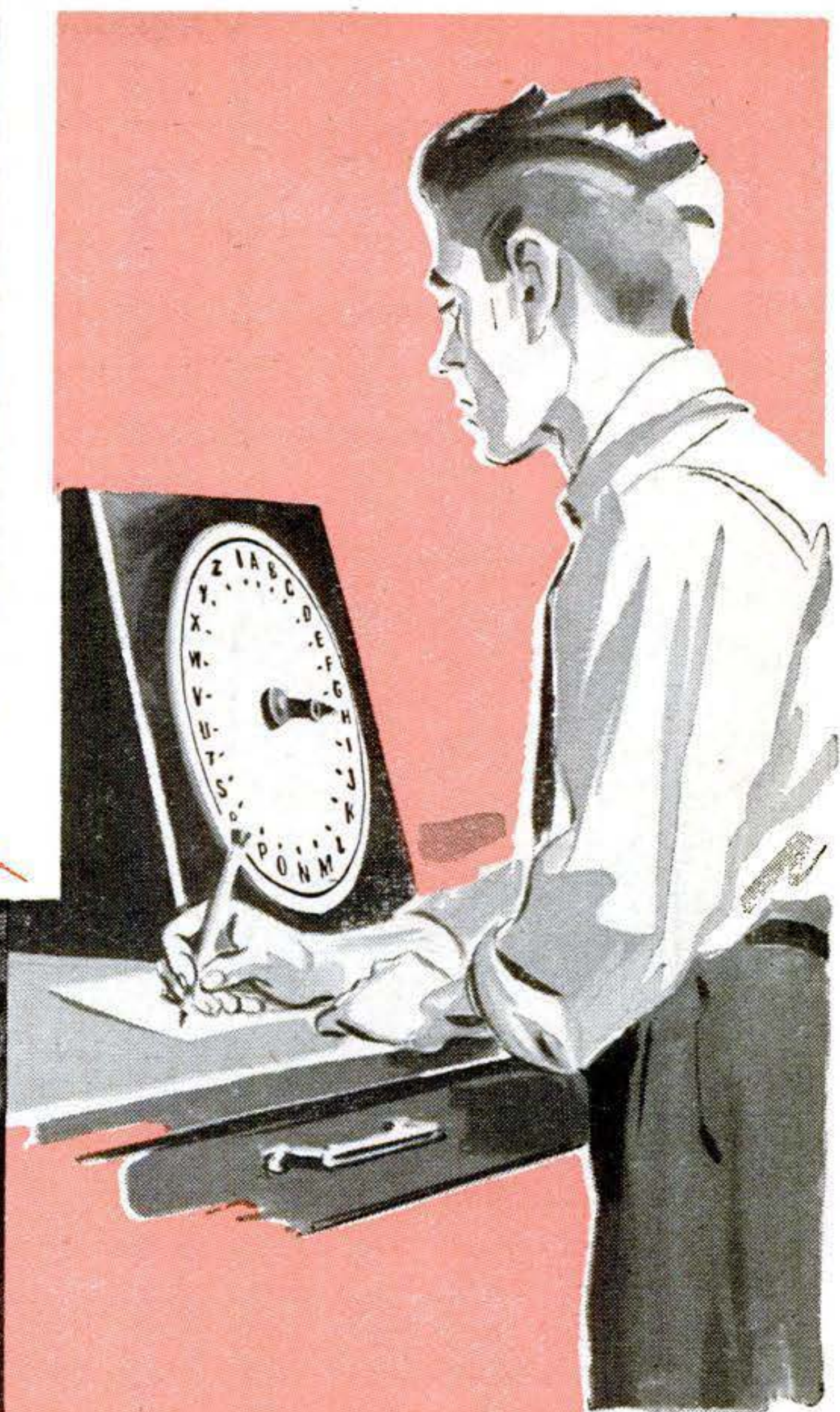

By Jack Mellinger

same first lead from each selsyn. Then connect all 1's, all 2's, and so on. Use rubber-covered hookup wire inside the box and any good wire approved for house current between the stations.

Connect one of the stations to the house current across the outside terminals, through a toggle switch and in parallel with a pilot light that will show when current is on. As a convenience in signaling the other stations, wire in a separate buzzer circuit powered by dry cells. If a water pipe or radiator is used as the ground return, this will require but two more wires between stations. Unlike the selsyn circuit, they can be bell wire.

Messages are transmitted by moving the pointer from letter to letter in alternate directions. Buzz once at the start of a message and twice at the end. Use the space between A and Z to separate the words.

Hobby Shopping



D. C. MOTOR WEIGHS 2 OZ. Here is a tiny power plant that will run at 2,000 to 3,000 r.p.m. on one dry cell for operating models, toys, tiny fans, and the like. It is encased in a plastic housing 1" by 1 1/8" by 1 15/32". Miniature Electric Motors, Inc., of New York, is the maker.

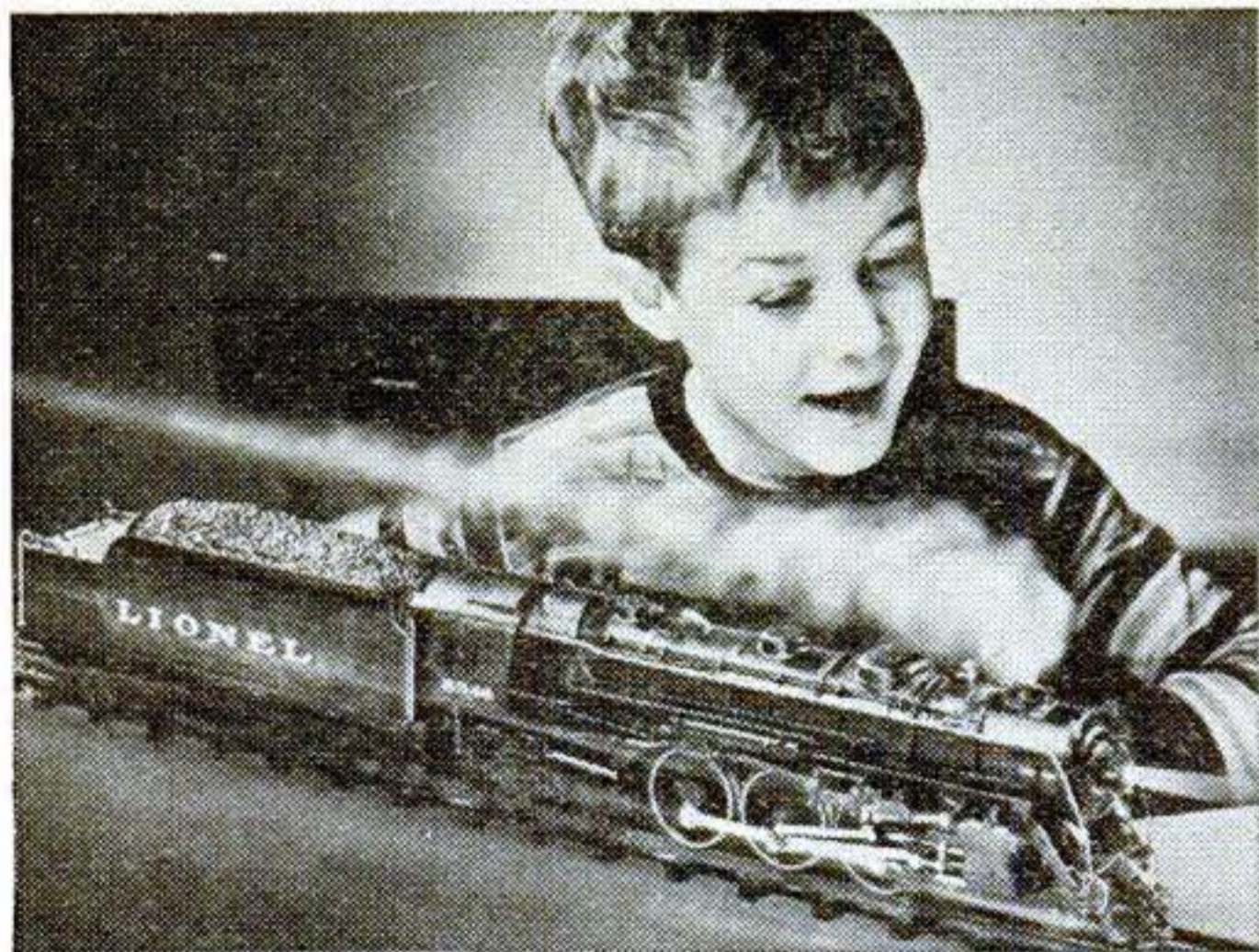

SYNCHRONIZED PUFFING. Smoke from the Lionel locomotives is now synchronized with the action of the driving rods and comes out in puffs. An electric bulb in the smokestack melts a smoke-making chemical placed on it and also illuminates the out-pouring smoke so it's sure to be seen.

164 POPULAR SCIENCE



MODEL SAILING YACHT. This 28" long yacht with a 5" beam is designed after Atlantic Class racing sloops. It carries 390 sq. in. of balloon-cloth sail rigged on a 36" mast and 18" boom. The hull is molded from plastic in one piece and weighted with a zinc keel. A special steering device operates the tiller in conjunction with the mainsail, easing the boat into the wind on strong puffs and keeping it under control. Noma Electric Corporation, of New York, is the distributor. The boat is made to sell for about \$30. Total weight is 3 lb.

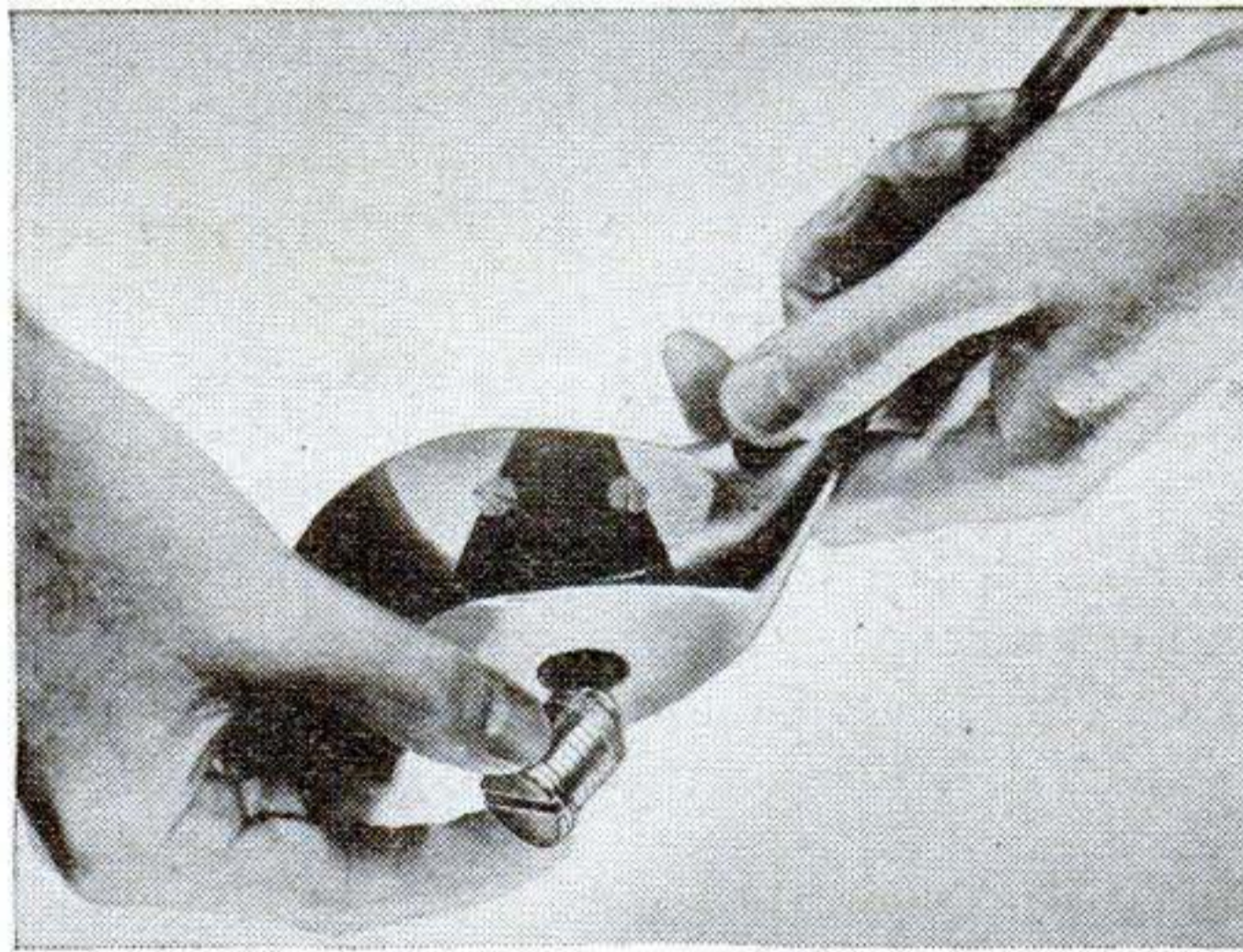

ADJUSTABLE-WEIGHT GOLF CLUBS. A small threaded plug in the sole of each of four matching aluminum-head "woods" provides a means of adding or taking out weights. The plug can be unscrewed with a coin. Reynolds Metal Company, of Louisville, Ky., developed the head.

Folding Table Seats Eight

ACCOMMODATING six to eight persons for dinner, this table nevertheless folds so that it can be placed against a wall, where it projects no more than 2'. Its leaf may be folded over completely or supported vertically against the wall in the style of a console table in a living room or an entrance hall. To convert it for use as a dining table, the leaves are swung around at right angles and opened.

Solid stock is used for the base, and $\frac{5}{8}$ " or $\frac{3}{4}$ " plywood for the column, top, and table leaves. If suitable plywood isn't available, satisfactory panels can be glued up from boards, provided dowel or spline reinforcement is employed and enough clamping equipment is at hand. Located as shown in the drawing, the hole and pivot will come just outside the column. A steel plate with a stud brazed on is recessed into the lower leaf. A similar plate without the bolt may be let into the column top. Round the outer edge of both plates. Use three so-called invisible cabinet hinges on the leaves, mortising them into the edges. Dome casters are used under the corners of the base for feet.

The base, column, and outer part of the folding leaf take any finish, but use only a nonsticking finish on touching leaf surfaces and on the upper surface of the column top. Lacquer, enamel, and wax stains are practical for these parts.—EDWARD E. THORP.

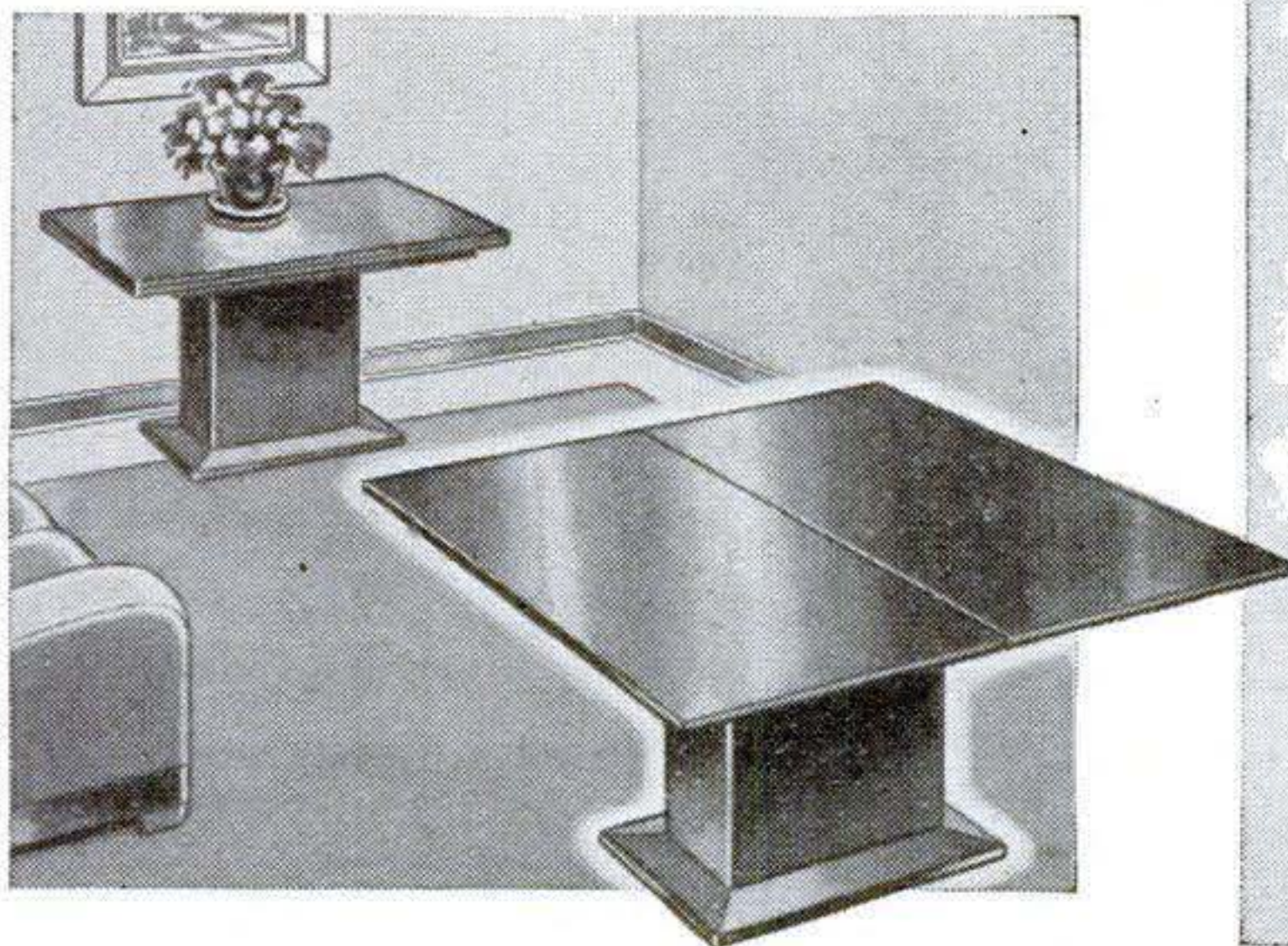

Two uses for the folding dining table. At left, the table folded and placed against a wall will project but 2' and take little living-room space. Its leaves extended and swung around on the base, the table is large enough for eight to dine.

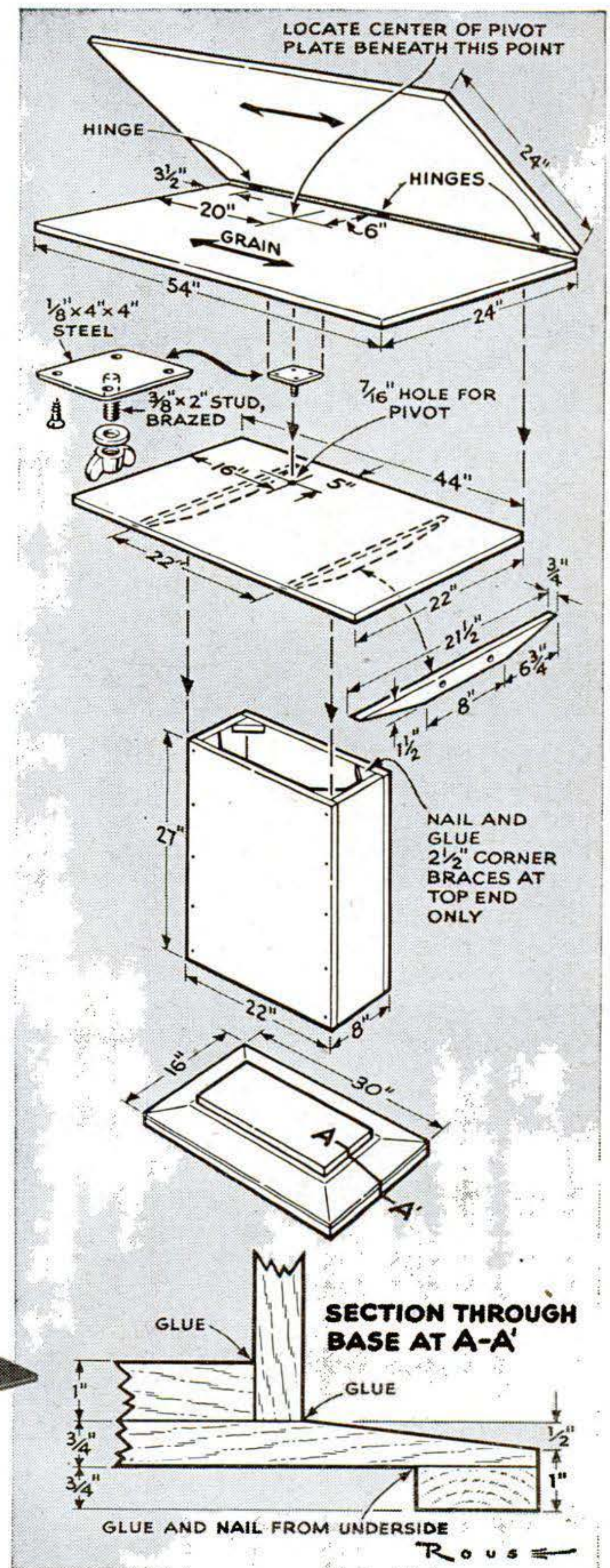

Construction is in four pieces, with the lower three—base, column, and column top—glued and screwed together as a rigid unit. The folding leaves forming the table top are held in place loosely with a pivot bolt and wing nut.

NEW TOOLS

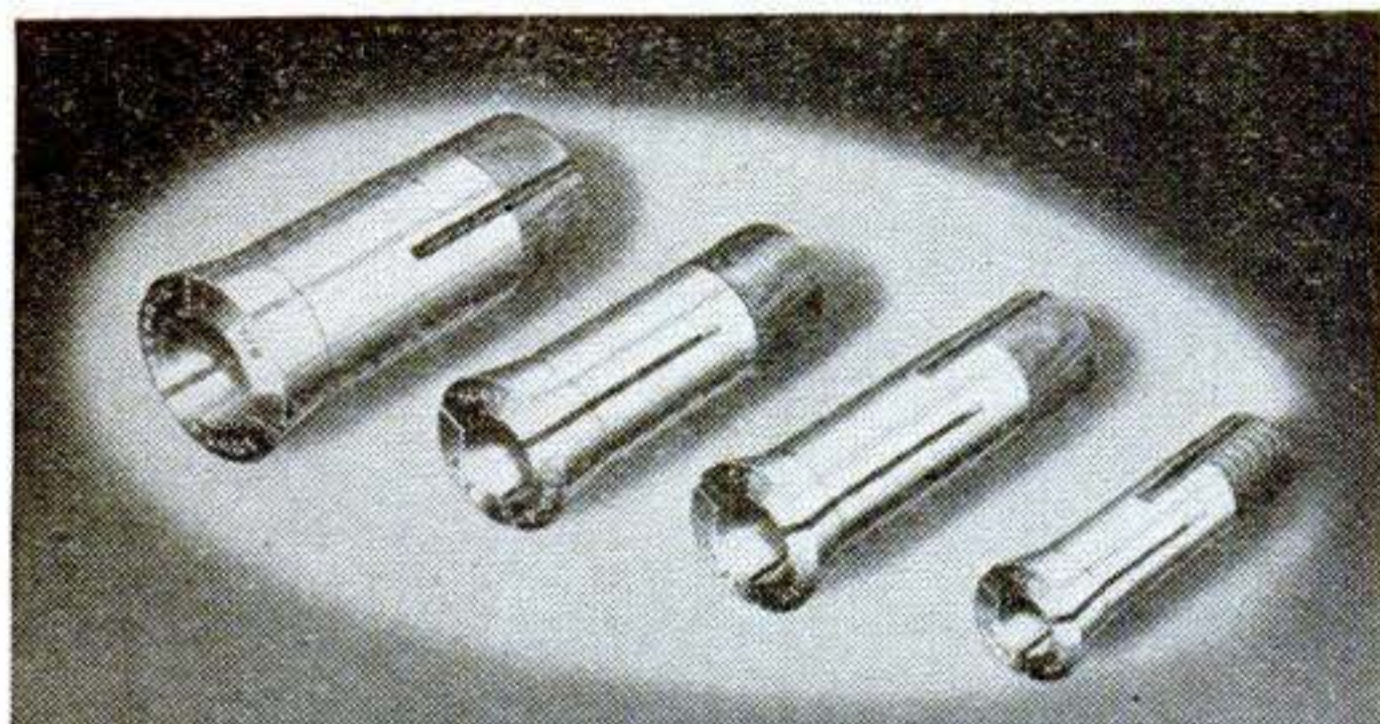
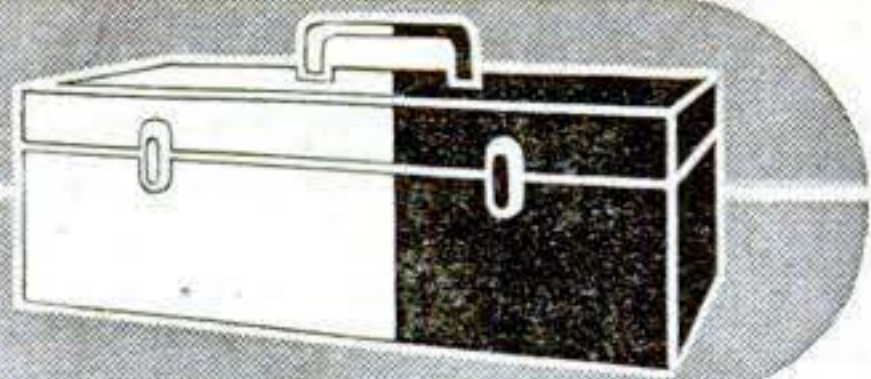

COLLETS MADE OF BRASS. Although not intended to replace more expensive hardened steel collets, new brass collets announced by the South Bend Lathe Works are manufactured to the same tolerances and their lower cost makes them especially suitable for odd sizes needed only occasionally. One advantage is that they can be machined to hold tapers or irregular shapes. When worn, they also can be rebored.

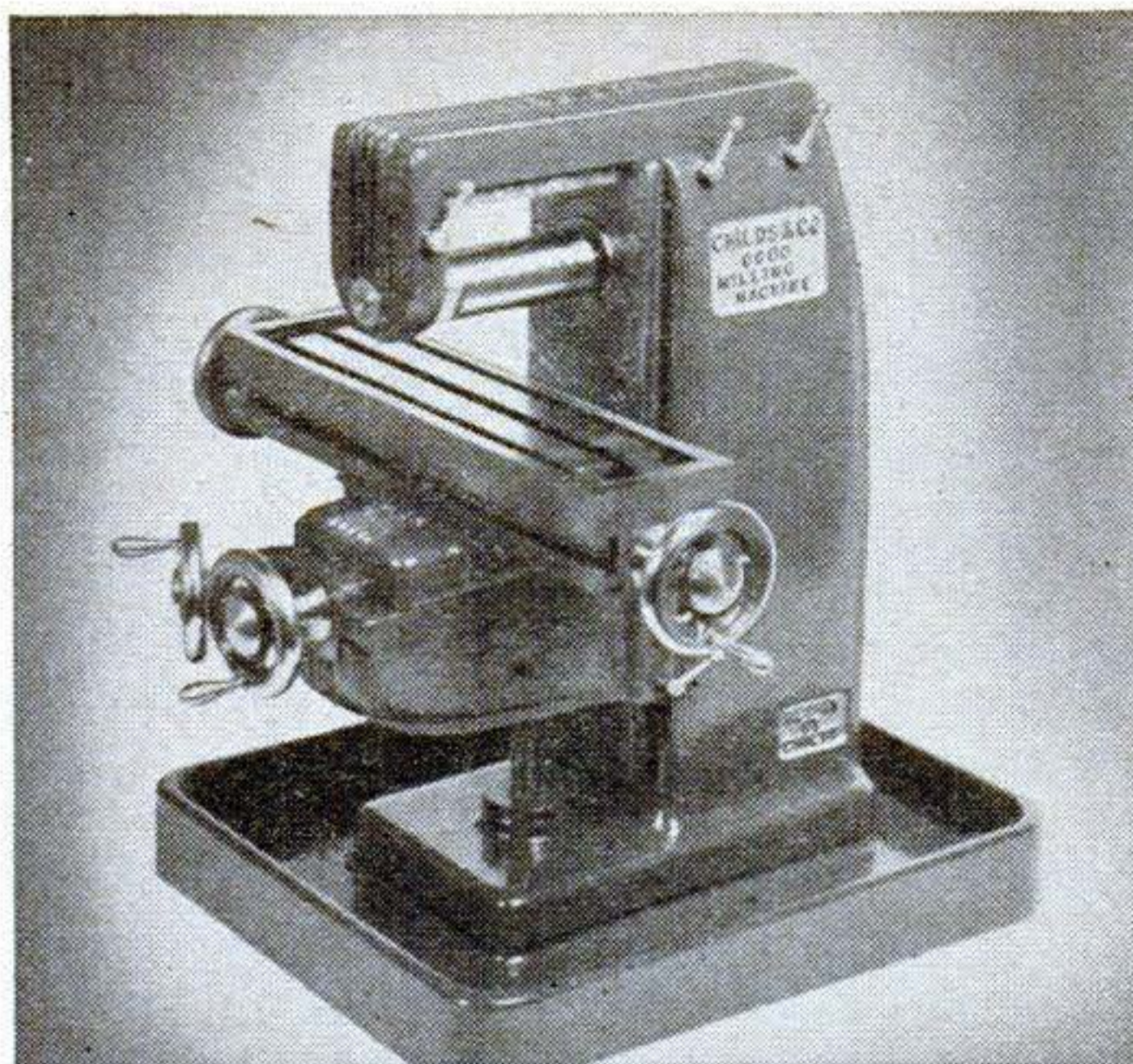

MILLER FOR SMALL SHOPS. Although small, a knee-type milling machine made by the Burke Machine Tool Co., of Conneaut, Ohio, has a big capacity—a longitudinal feed of 6", transverse of 1½", and vertical of 4". Intended for bench or table operation in the small shop, the basic unit above weighs 75 lb., stands 14½" high, and sells for around \$140. Table movement is accurate to .001" in all directions. Accessories are available.

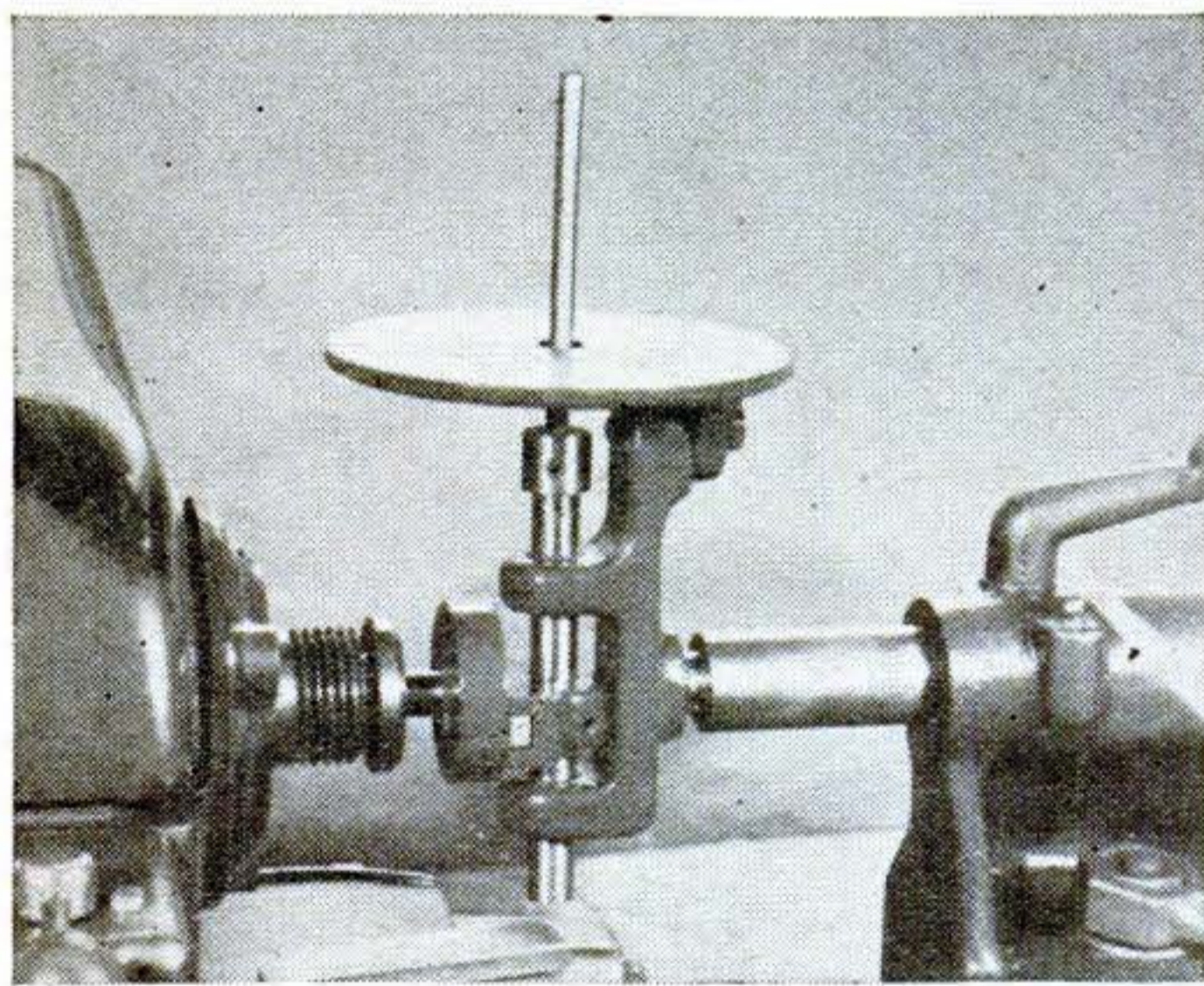

FILING ON A LATHE. An attachment produced by the Carey-Anslinger Manufacturing Co., of Kankakee, Ill., quickly adapts a wood or metal lathe for use as a filing machine. Slip the tapered arbor of the attachment into the tailstock, fit its shaft into the headstock spindle, and you are ready for work. Rotation of the lathe spindle gives vertical movement to the file through a Scotch yoke action. The attachment takes standard ¼" shank files, and the table is adjustable for angle jobs.

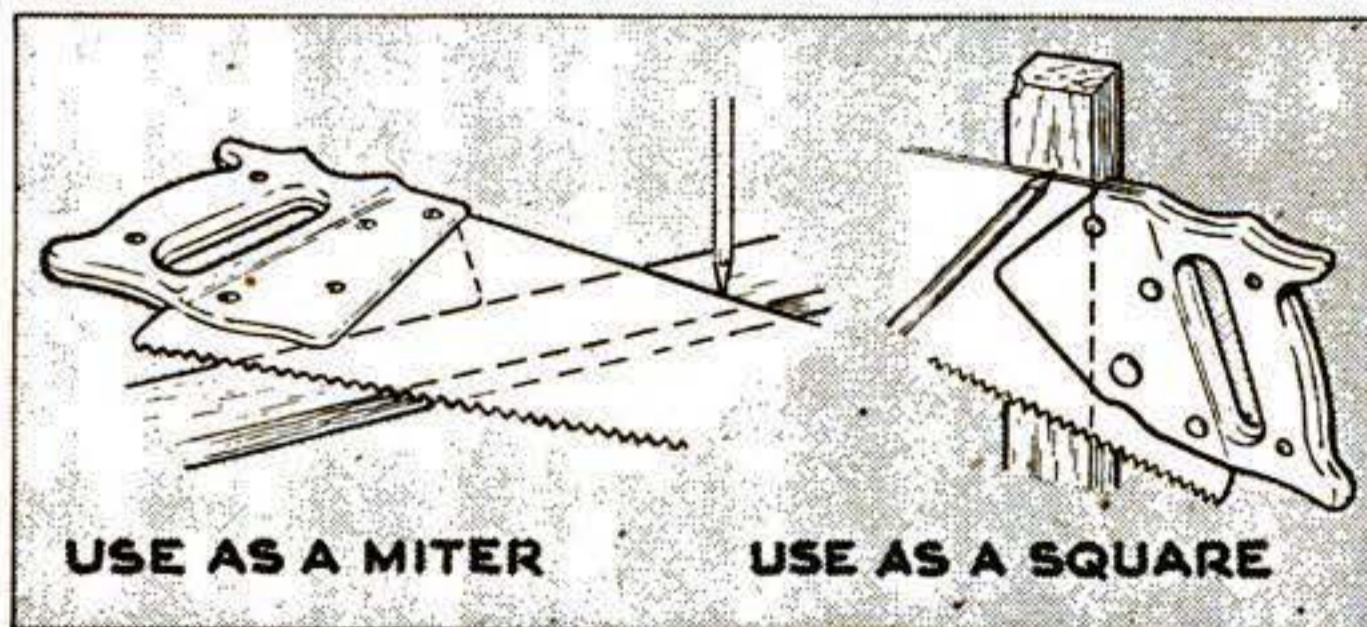

SAW DOES TRIPLE JOB. A plastic handle manufactured by F. A. Collman, of Renton, Wash., converts any straight-back saw into a three-in-one tool. As seen above, the saw then can be used as a 45-deg. miter gauge and a square as well. Selling for \$2.25, the handle may be quickly installed in place of an ordinary one.

Wheeled Carrier Saves Back Strain in Toting Heavy Outboards

FOR the boat owner who must lug an outboard motor some distance from his car or camp to the shore, a two-wheeled carrier fills a real need. It will also hold the motor upright in storage.

Dimensions shown are for motors of 3 to 5 hp.; if yours is a larger motor, increase the size and "beef up" the construction. Rubber-tired cart wheels are fine if you can get them.

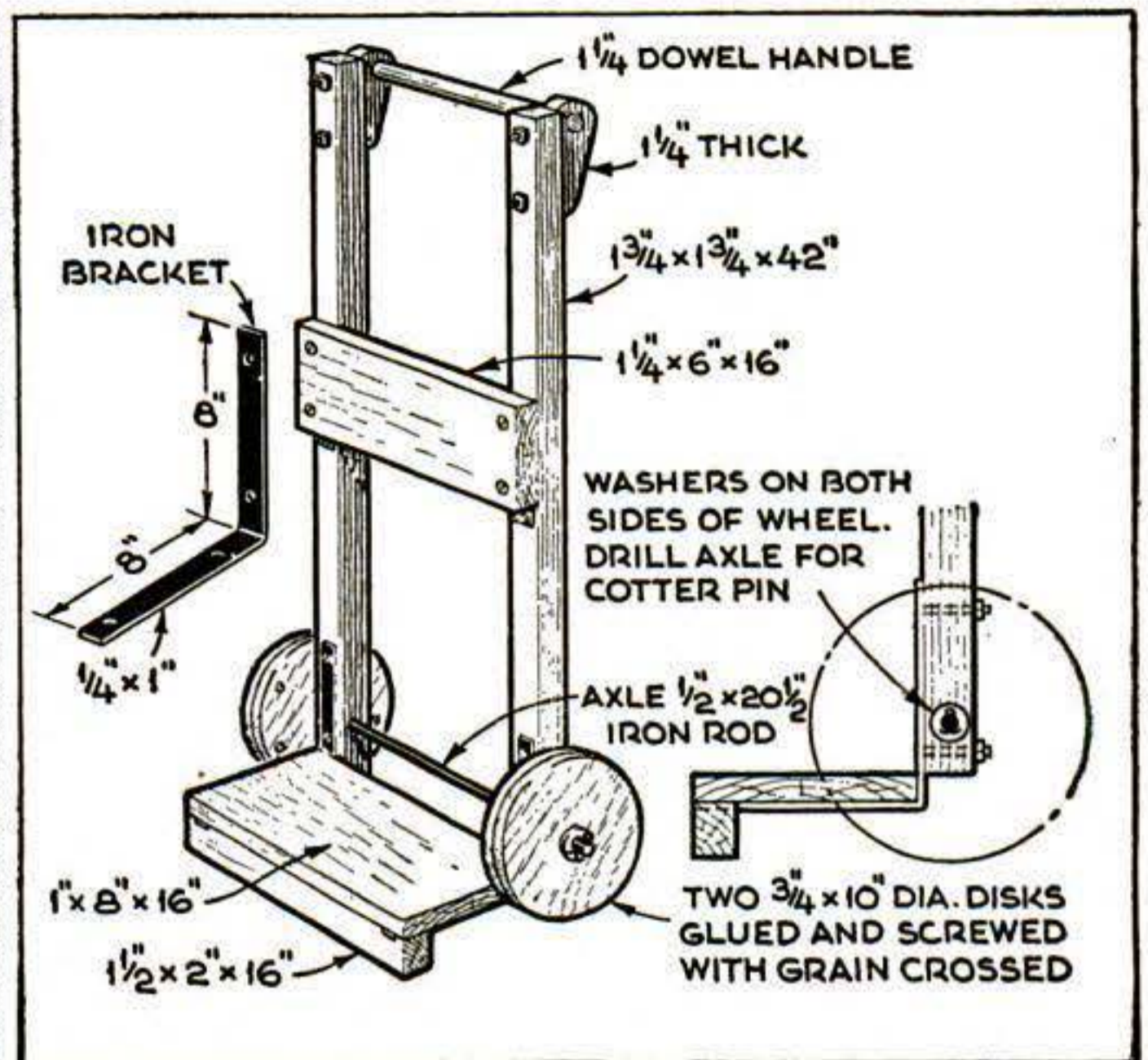
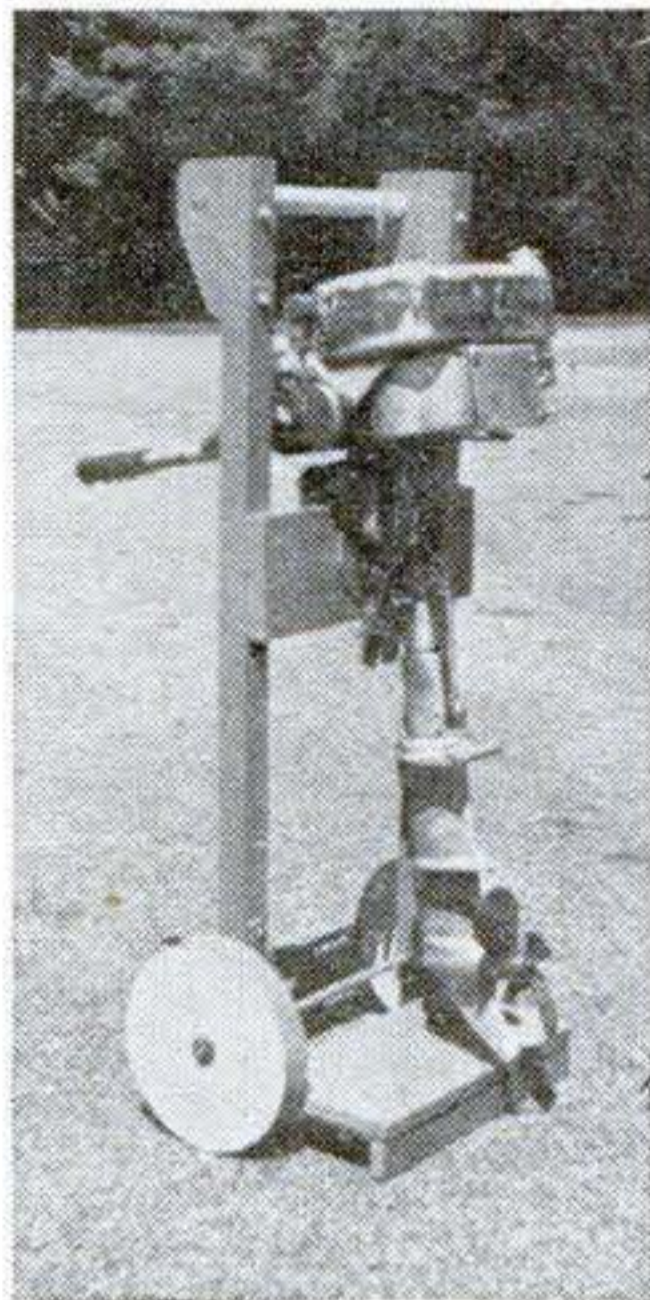

Rubber Handle on Rope Starts Outboard Motor with Safety

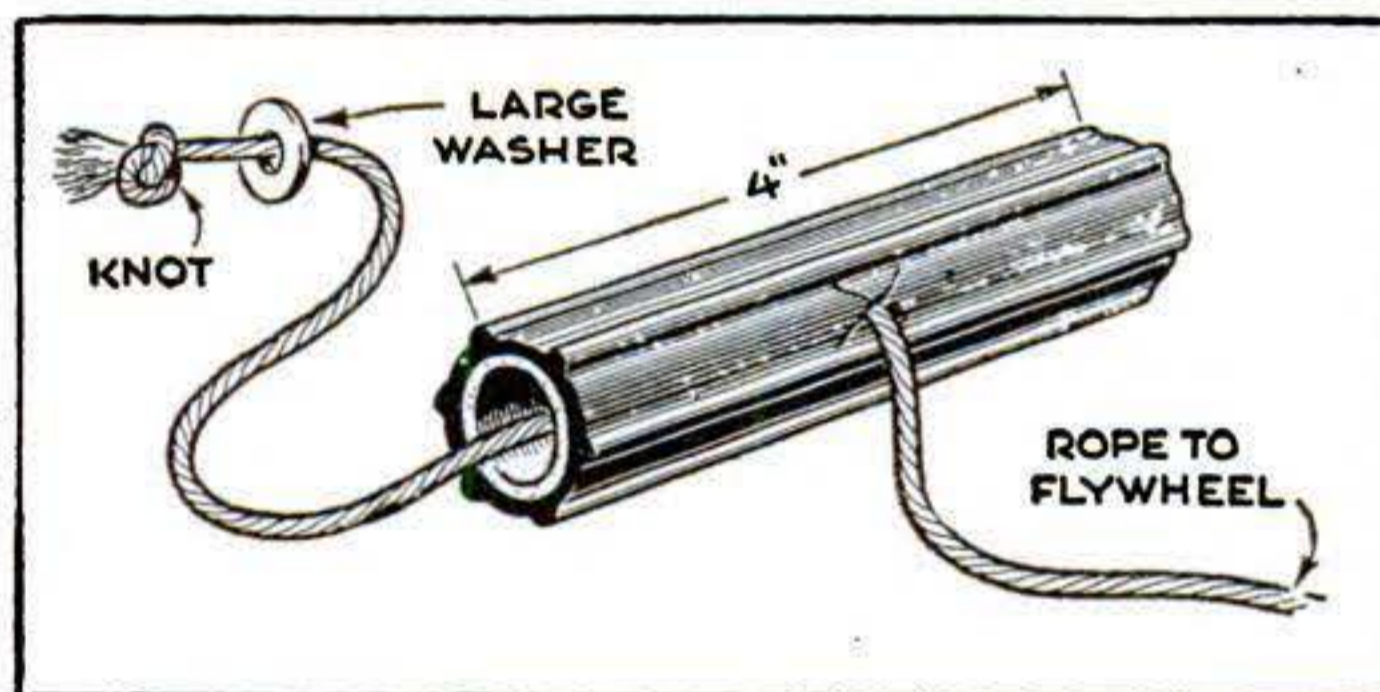

Pull the rope knot against the hole in the side of the hose. The washer keeps it from going through.

A NONSLIPPING handle for the starter rope of an outboard motor can be made from a 4" length of rubber garden hose. If the rope should get caught in the flywheel, the rubber handle won't damage the motor or injure your knuckles as might be the case with a regulation wooden handle.

Punch or cut a hole midway in the hose, thread the starter rope through, slip a large washer on the end, and knot the rope so it will hold.

Absorbent Pad Helps Keep Rain from Entering Sail Cover

WRAPPED around the mast under the collar of a sail cover, a pad of soft, absorbent cloth such as unbleached muslin or an old Turkish towel will keep rain water running down the mast from getting under the sail cover. Put three or four turns of the cloth around the mast, arranging them partly over the laced main section of the sail cover, and then lash the cover collar over the pad in the usual manner. Water and dirt that pass the upper lashing will be held back by the absorbent cloth.

If the mast has a track, use a clamp over the collar to hold it and the absorbent cloth to the track and batten. The clamp can be made from two blocks of hardwood hinged with brass strap and fastened with a heavy hook and eye. Shape the blocks to pass the track flange and hold snugly against the batten.—J. A. EMMETT.

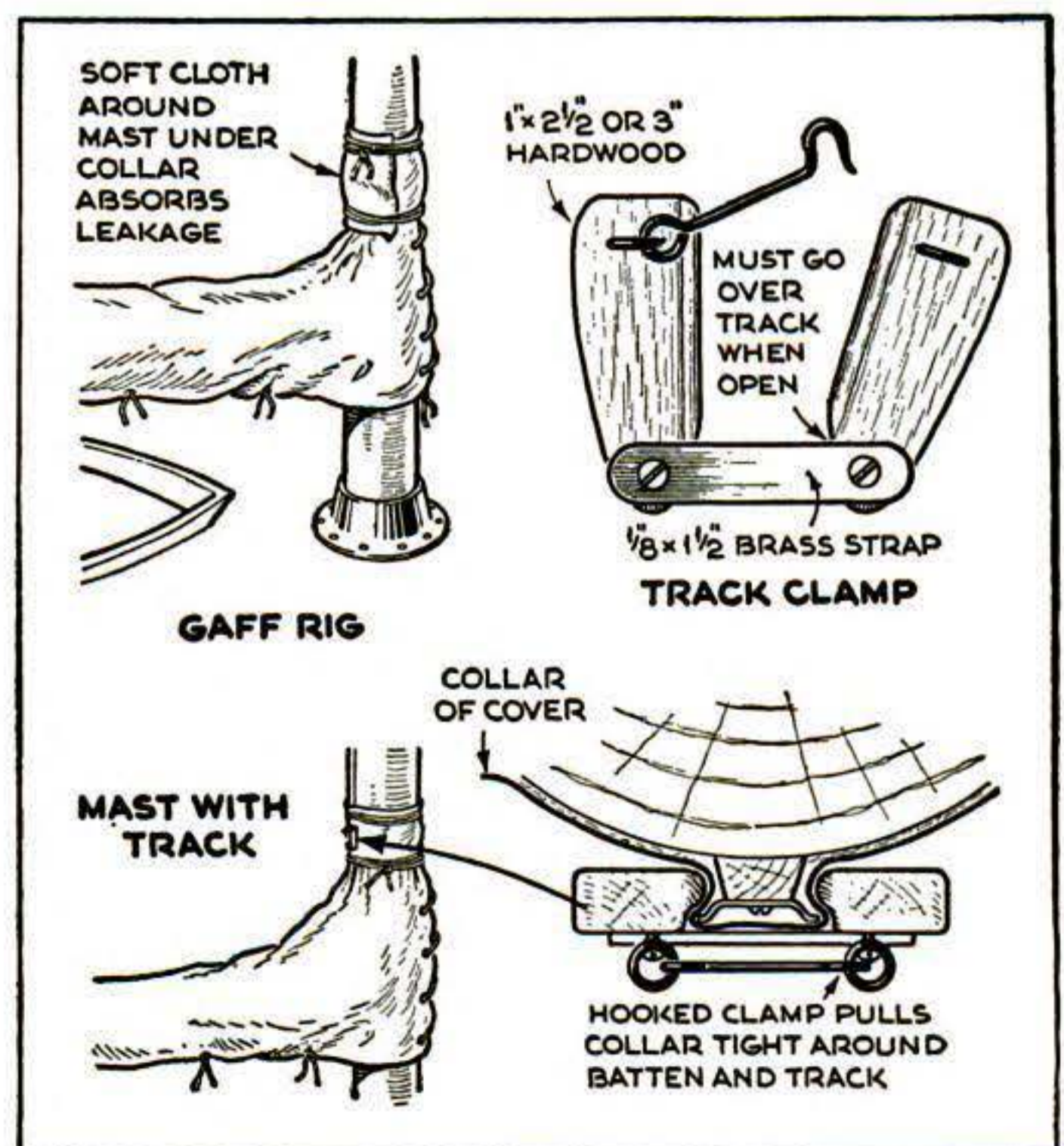

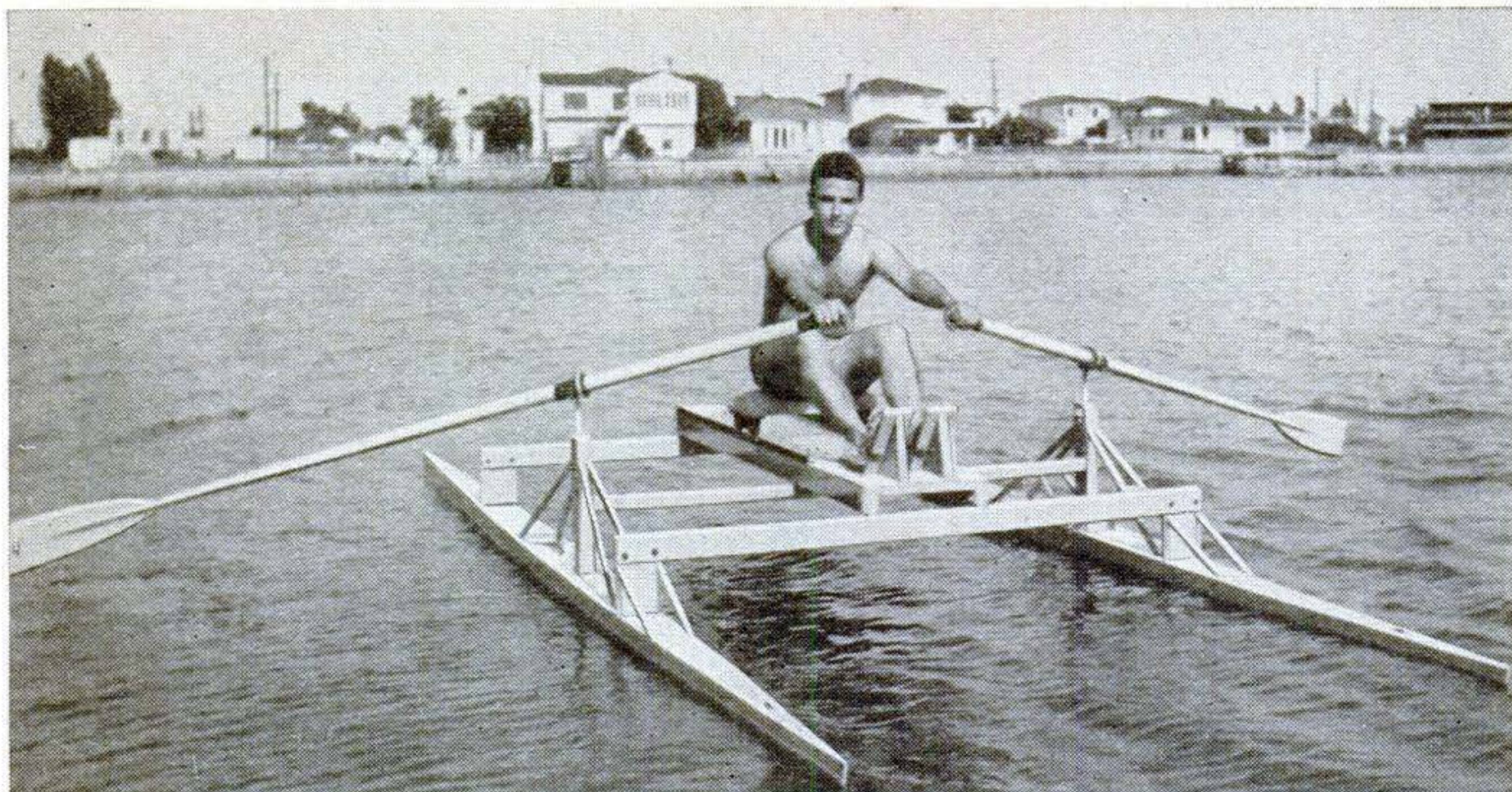

You ride high and fast on this portable, knockdown catamaran. A sliding seat gets leg power into the stroke.

Catamaran Can Be Carried on Car Top

By Robert Lloyd Brown

THOSE who take their boating alone can get a lot of fun out of a catamaran-scuttle. With its single pair of oars, the twin-hulled craft can be rowed at better than 10 knots, and if the exertion is tiring, or you just like lolling in the sun and acquiring a tan, the seat may be rolled forward to serve as a pillow. Danger of capsizing is practically nonexistent.

The boat is designed so it can be dismantled and carried on a car top, and the canvas-covered hulls are short enough to store by swinging from the beams of a garage. Reassembly requires insertion and tightening of 12 bolts and wing nuts. The craft is shown in color on page 116.

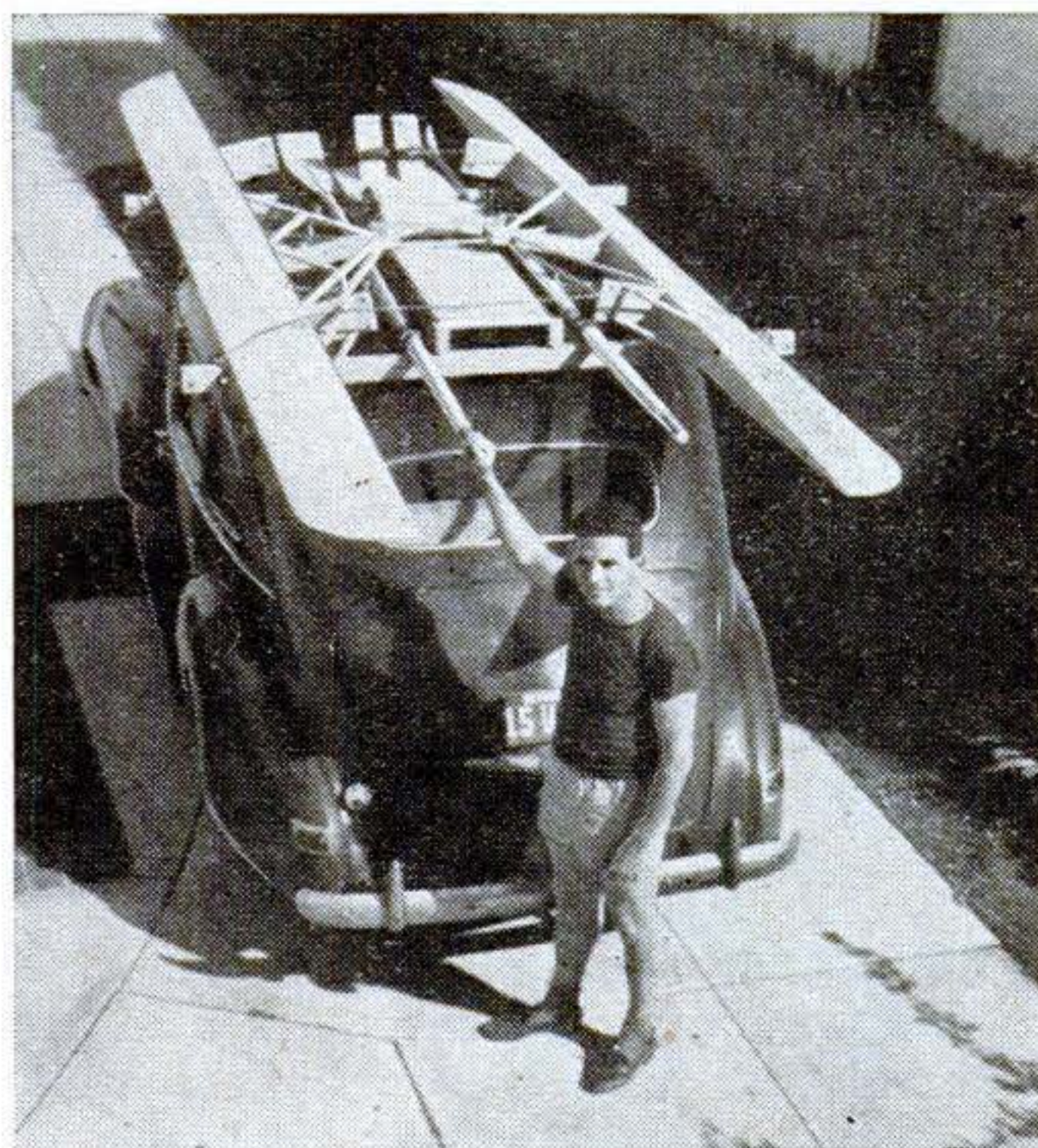

With the hulls unbolted, the superstructure goes on the car top first. Oars and hulls follow, and all are lashed. The seat is put inside the car.

Fir can be used throughout, but spruce is excellent for the 26 frames and oak for the stringers, braces, filler blocks, stems, and keels. All stock is $\frac{3}{4}$ " thick except the 1" by $1\frac{1}{2}$ " oarlock-post transverse brace, the 2" by 4" oarlock posts and castle stringers, and the stems and keels, which are $\frac{1}{2}$ " stock chamfered to $\frac{1}{4}$ " on the outboard edge and rounded. A pair of 2" by 4" transverse ties space the two hulls at an over-all width of 74". The superstructure floor board is a 14"

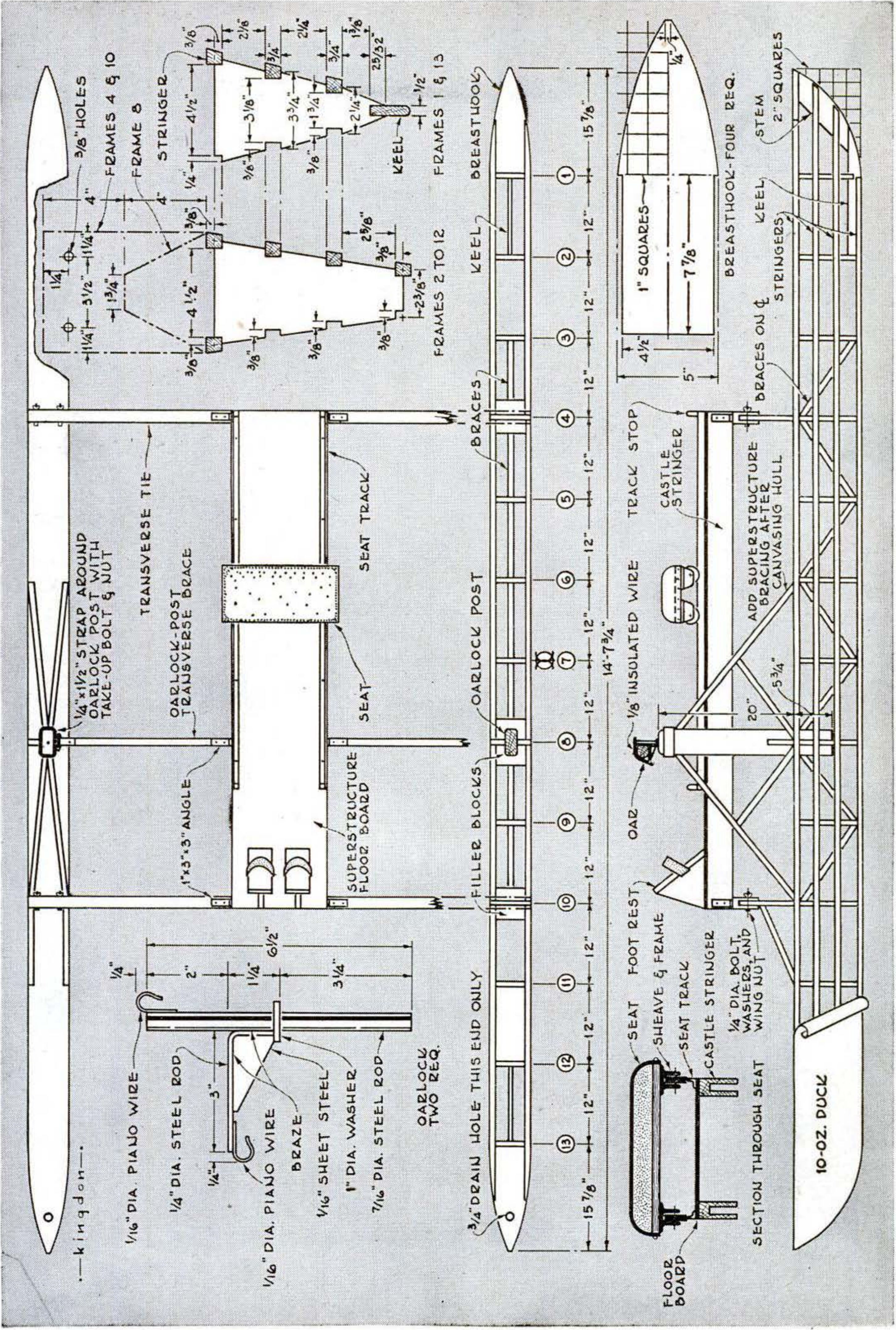

kingdon.

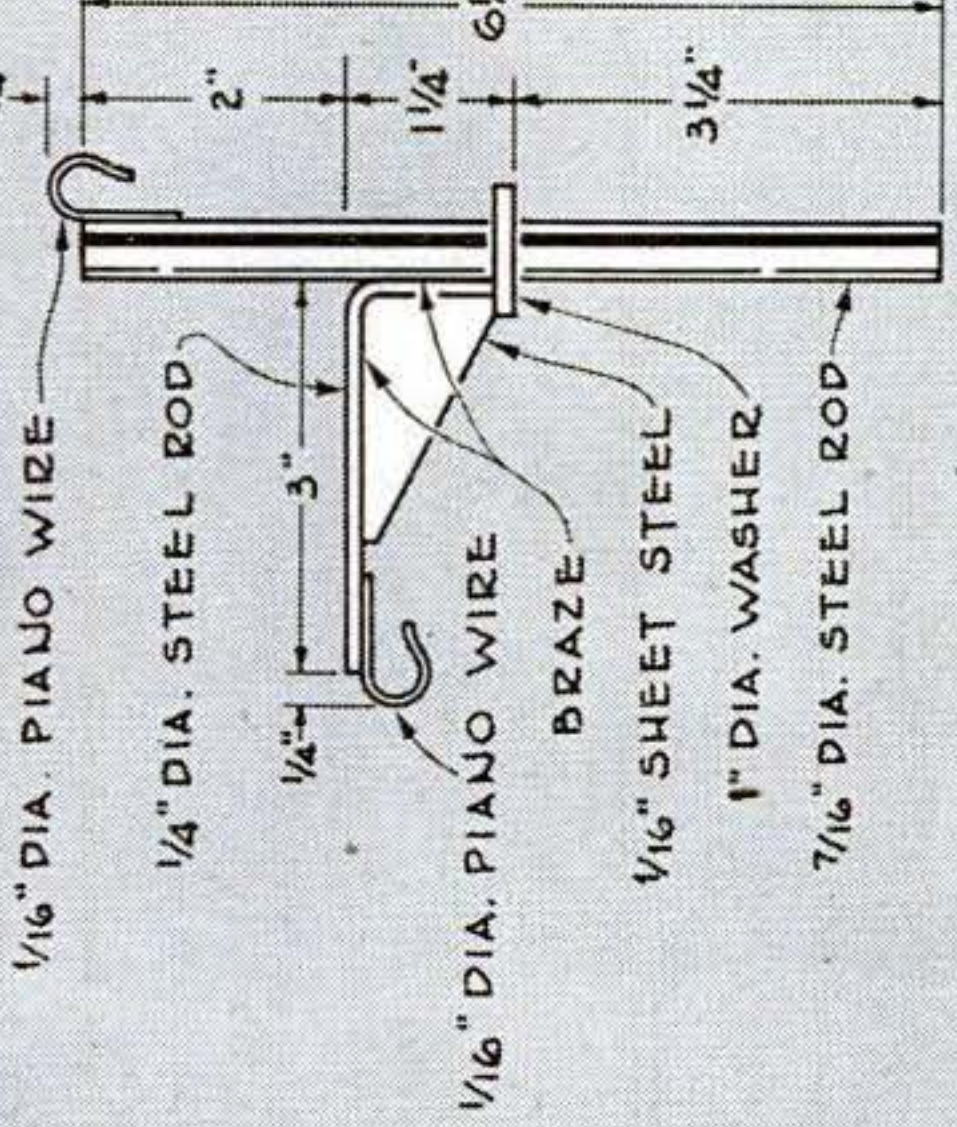

SECTION THROUGH SEAT

10-OZ. DUCK

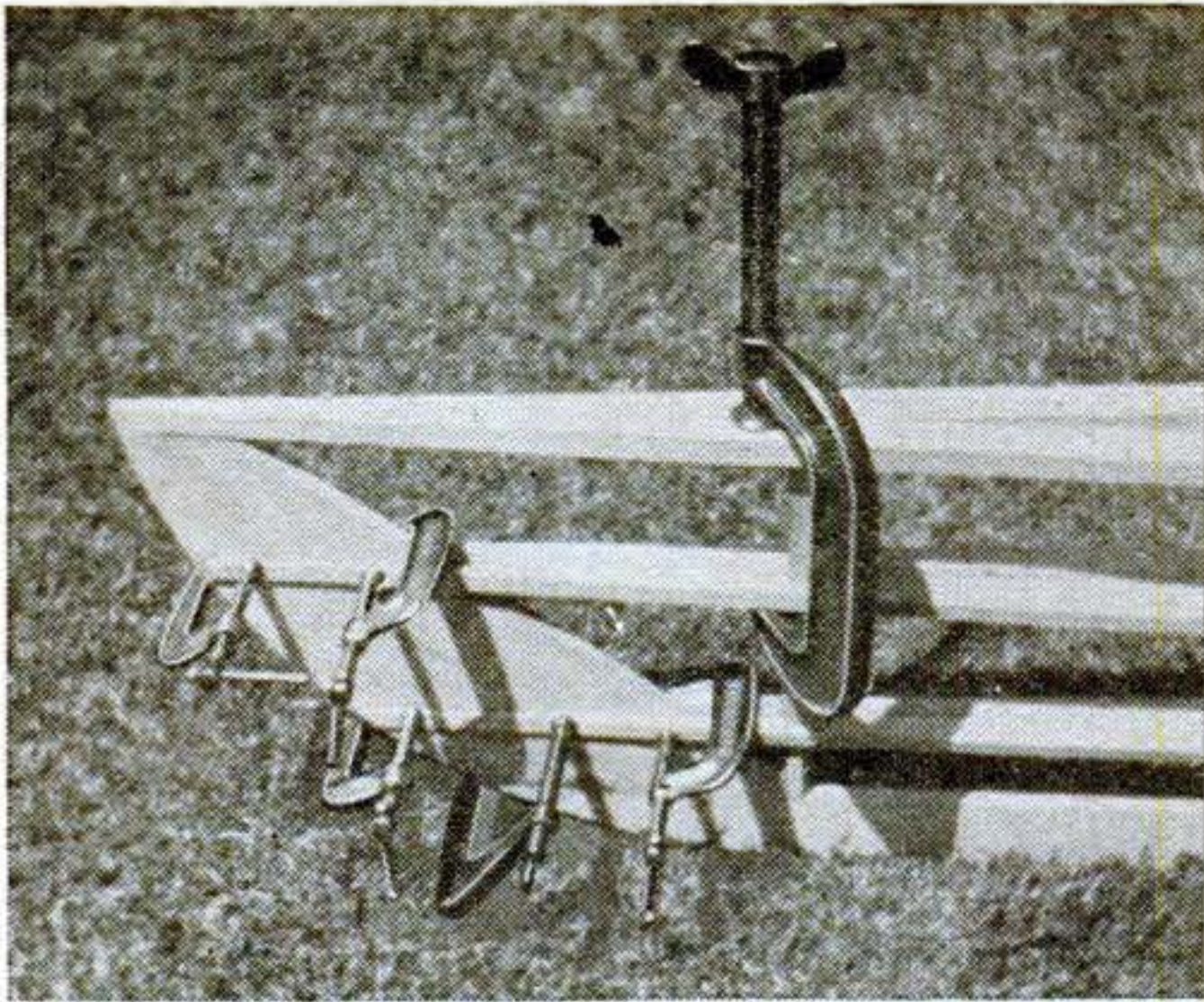

Kerfing may help in bending hull stringers fore and aft. Clamps hold them while the glue sets.

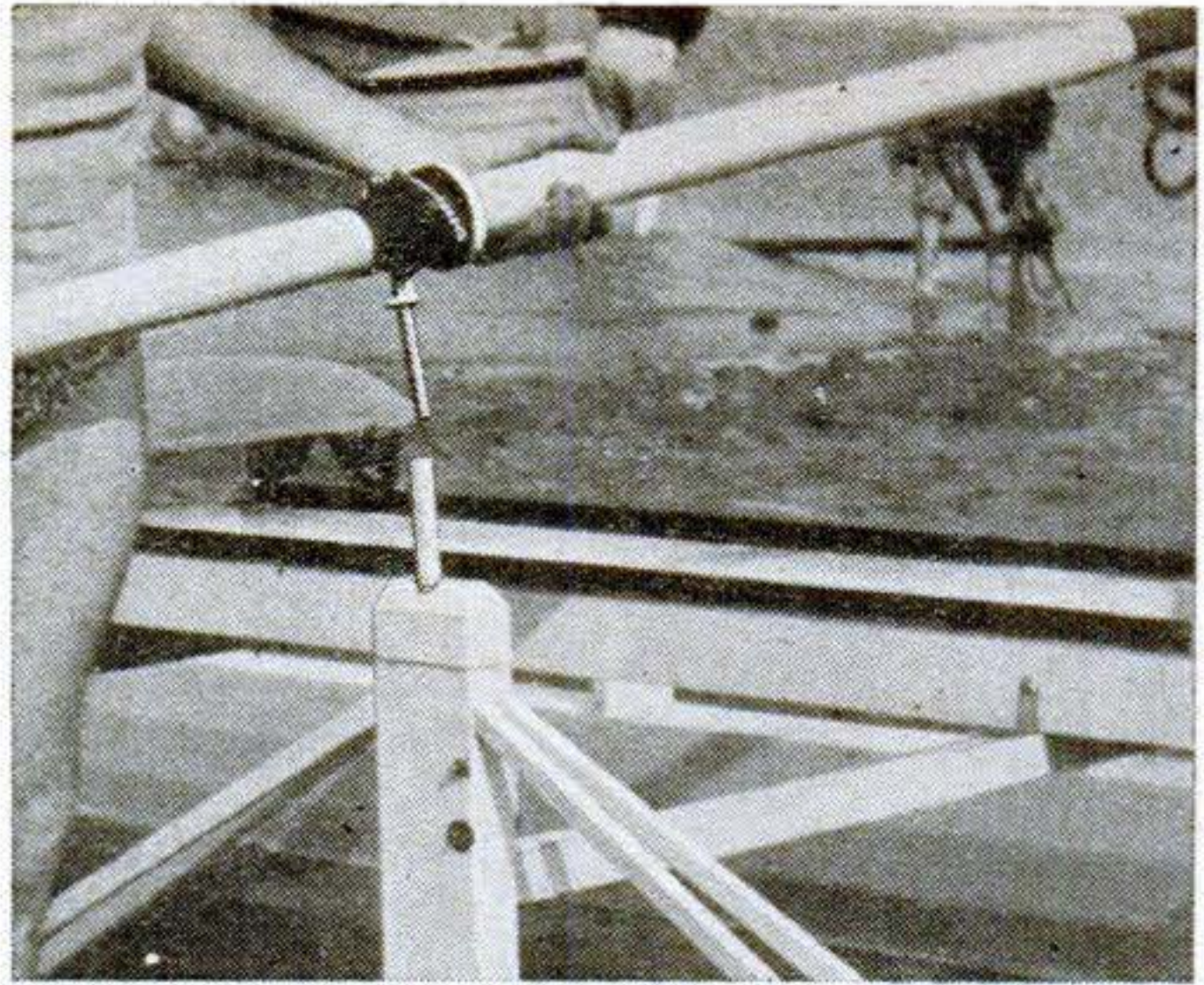

Oarlocks are made from steel rod and are seated in $\frac{1}{2}$ " I.D. steel tubing wedged in the oarlock posts.

by 74" panel of waterproof $\frac{1}{4}$ " fir plywood. Use well-seasoned lumber to avoid warping.

The construction is straightforward, with all joints fastened by waterproof plastic glue and nails or screws. Don't attempt to bend the ends of the hull stringers until all are in place and the stems and keels attached. Then try them in pairs by hand, and if there appears to be danger of splitting or cracking, make a few judicious saw kerfs on the inside faces and try again. When all seems safe, glue and clamp.

Cover each hull surface with a separate oversize strip of canvas, gluing from the center toward the ends. Align a strip on the frame, fold it back at the middle, and apply waterproof plastic glue to 12" or so of frame at a time. Work each part with the thumbs until the glue has set to prevent sag. Trim the edges and cover the bottom corners with tape as an aid to waterproofing.

Dampen the hulls with water from an insect sprayer, taking a side at a time, and place in the sun to dry and shrink tight.

Then apply three coats of model-airplane dope or, preferably, two coats of full-strength aircraft dope. If further tightening is needed, redope and place the hulls near an electric heater. Finish with two coats of lacquer or good-grade enamel.

Groove the 74" long transverse ties and castle stringers to lessen weight. Fit the grooved ends of the former over frames 4 and 10, drill through, and fasten with corrosion-resistant bolts and wing nuts. Mount the castle stringers with angle braces, and then fit in the oarlock-post transverse brace under the stringers, fastening it with angles to the stringers and to the oarlock posts. Two bolts through each end, with wing nuts, hold the transverse piece to the angles screwed to the oarlock posts.

Screw 56" lengths of $\frac{1}{4}$ " by 1" by 1" duralumin angle parallel on the floor board for seat tracks. Stop the ends with blocks. Micarta sheaves in ball-bearing frames, available as aircraft surplus, make seat wheels. Row with 9 $\frac{1}{2}$ ' to 10' spoon oars. **END**

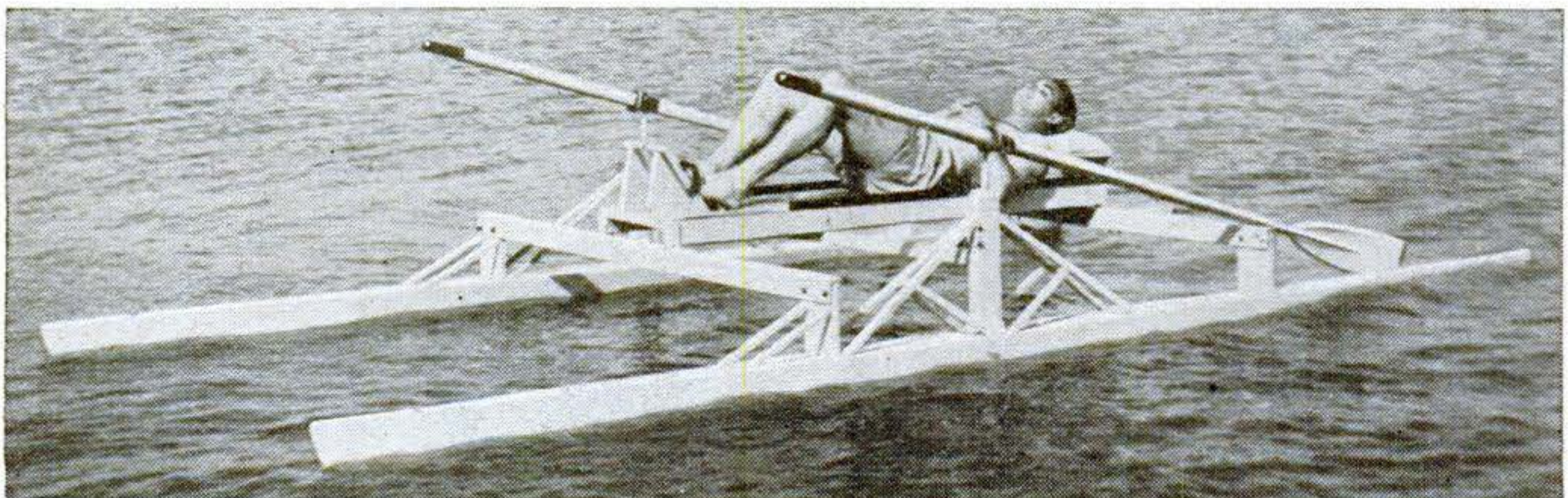

A good place for a snooze. Oars are parked with the blades on the hulls. The padded seat is a pillow.



A duckboard platform, built of smooth scrap lumber, helps keep wet feet from carrying mud into the pool.

Bomber Tank Becomes Wading Pool

WARPLANE wing tanks, which can be picked up as war surplus for about \$5, make excellent back-yard wading pools. The pool shown was cut from a wing tank made for a B-17 bomber. It was laminated neoprene and cloth and required a couple of hours of cutting time, but it was so stiff that no frame was needed for rigidity.

A line was scribed around the sides and ends about 7½" from the bottom as a guide line. After several unsuccessful attempts, a linoleum knife tapped on the back of the blade with a wooden mallet was found the best means of cutting. Wedges inserted as the cutting proceeded helped to speed the work, and the hooked point of the knife got a good grip under the material.

The top half of the tank with the filling hole in it was discarded, as was a thin baffle inside that was easily cut loose. An aluminum gas elbow at the outlet in one corner was left in. This keeps the water level at

about 2". It could easily be plugged to make the water level higher.

A duckboard platform was built around the pool. Filling is accomplished with the garden hose. When the tank needs cleaning, it can be propped up on one end and hosed out.—GERALD F. KOEPLINGER.

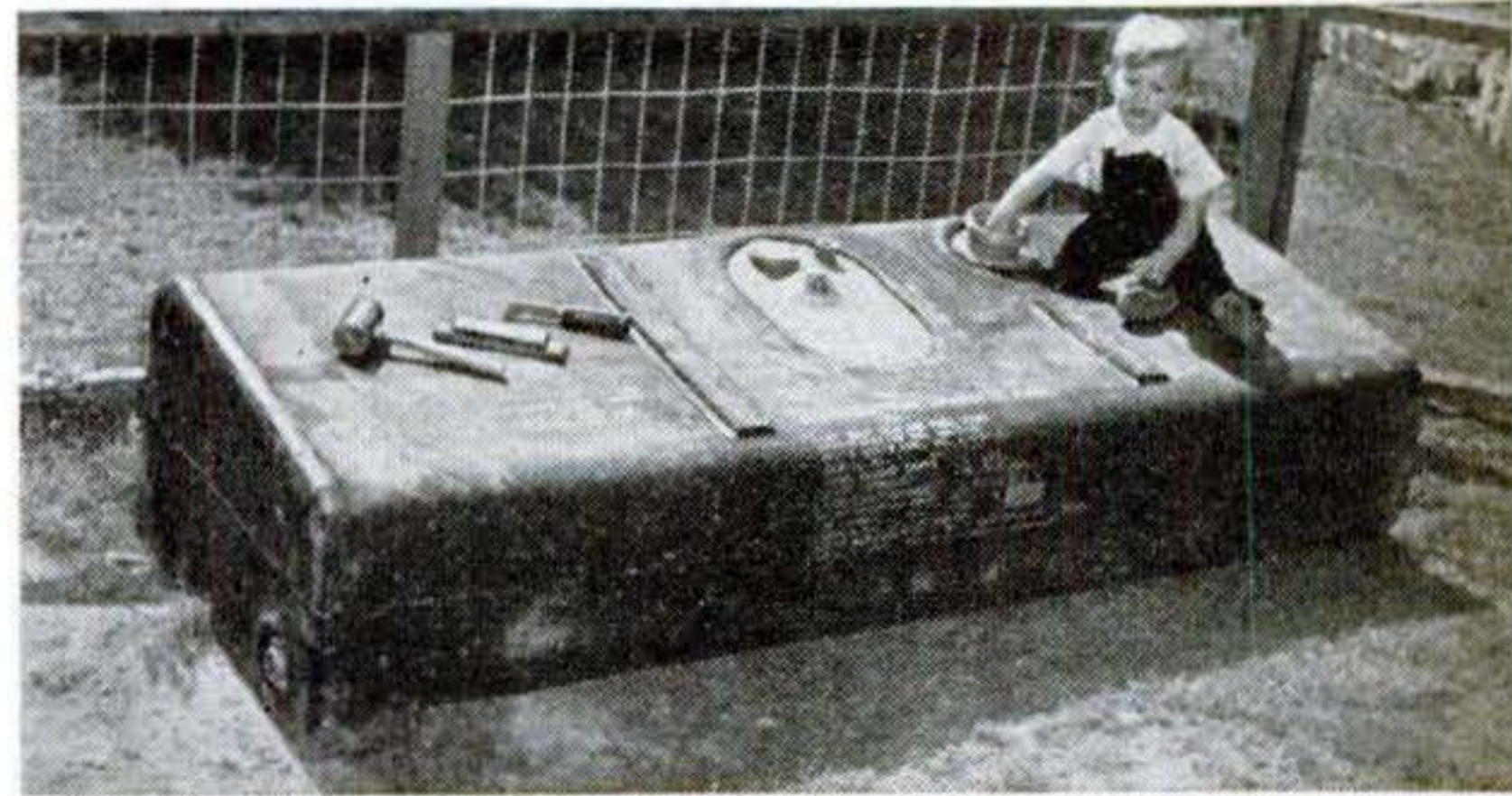

Here's how the wing tank looks before conversion. The line is scribed for a guide during the cutting.

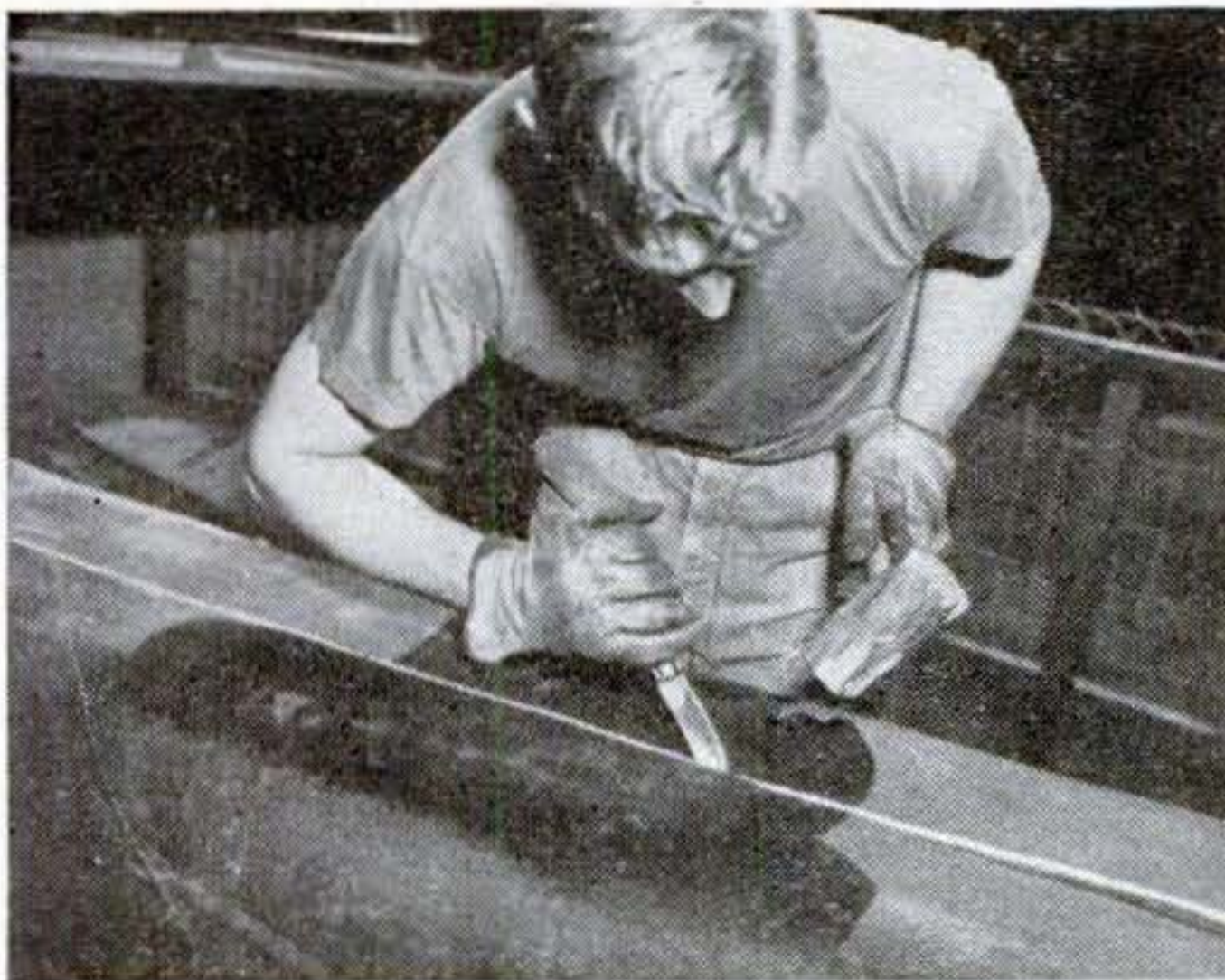

Cutting through ½" of neoprened cloth is not an easy job. It was done with a linoleum knife and mallet.

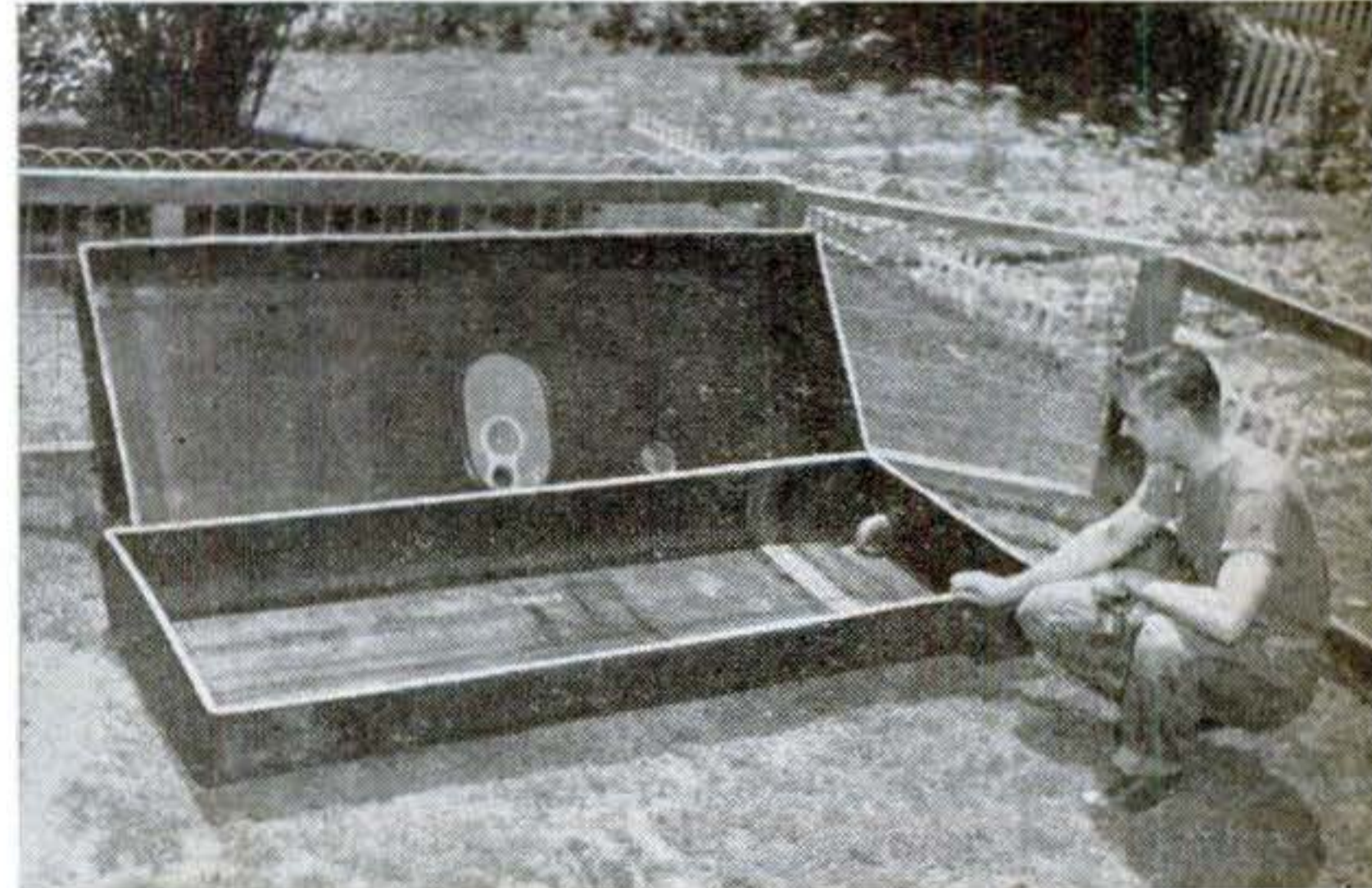

Only the bottom half of the tank is needed. It is smooth except for the outlet shown in the corner.

NEW SHOP IDEAS

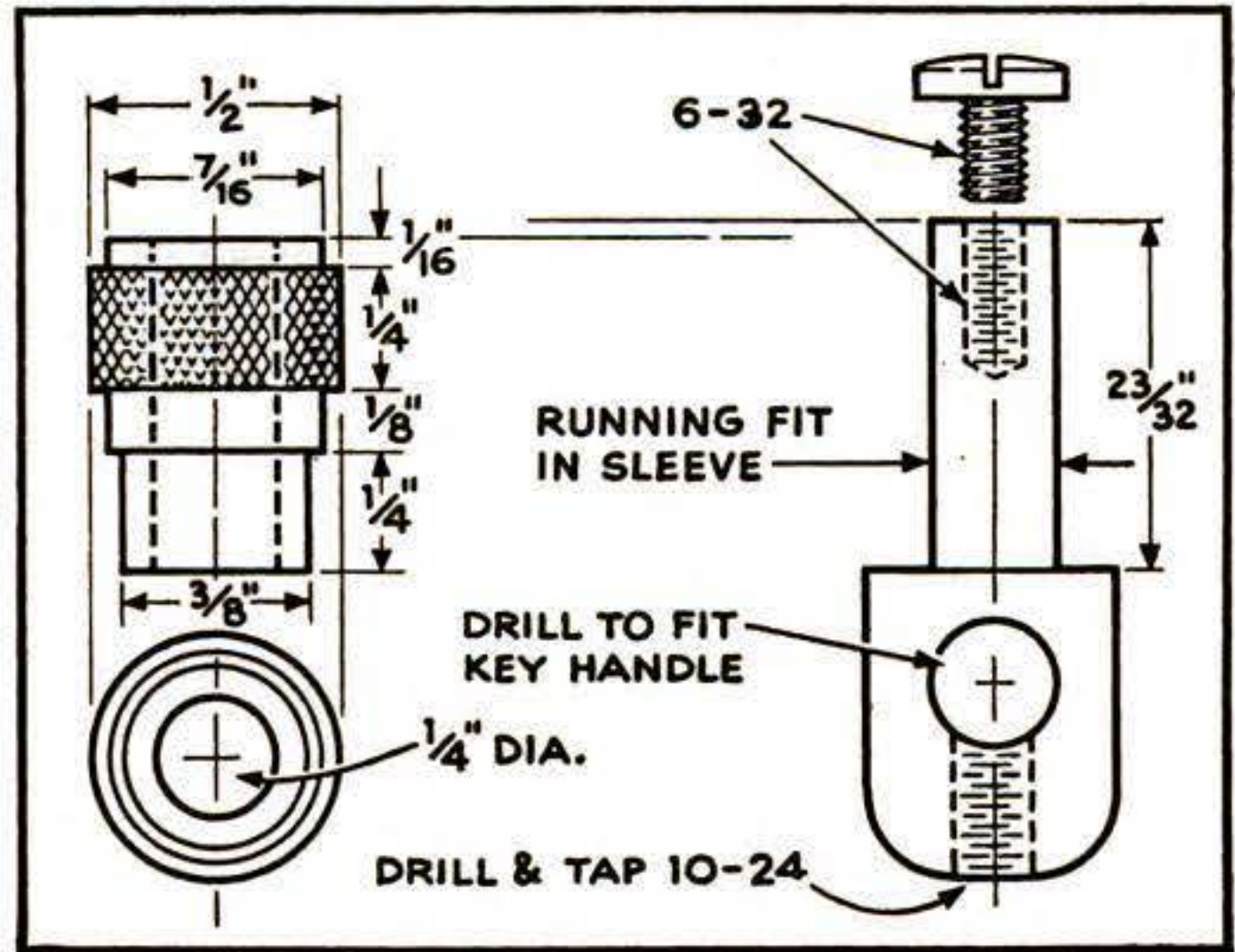
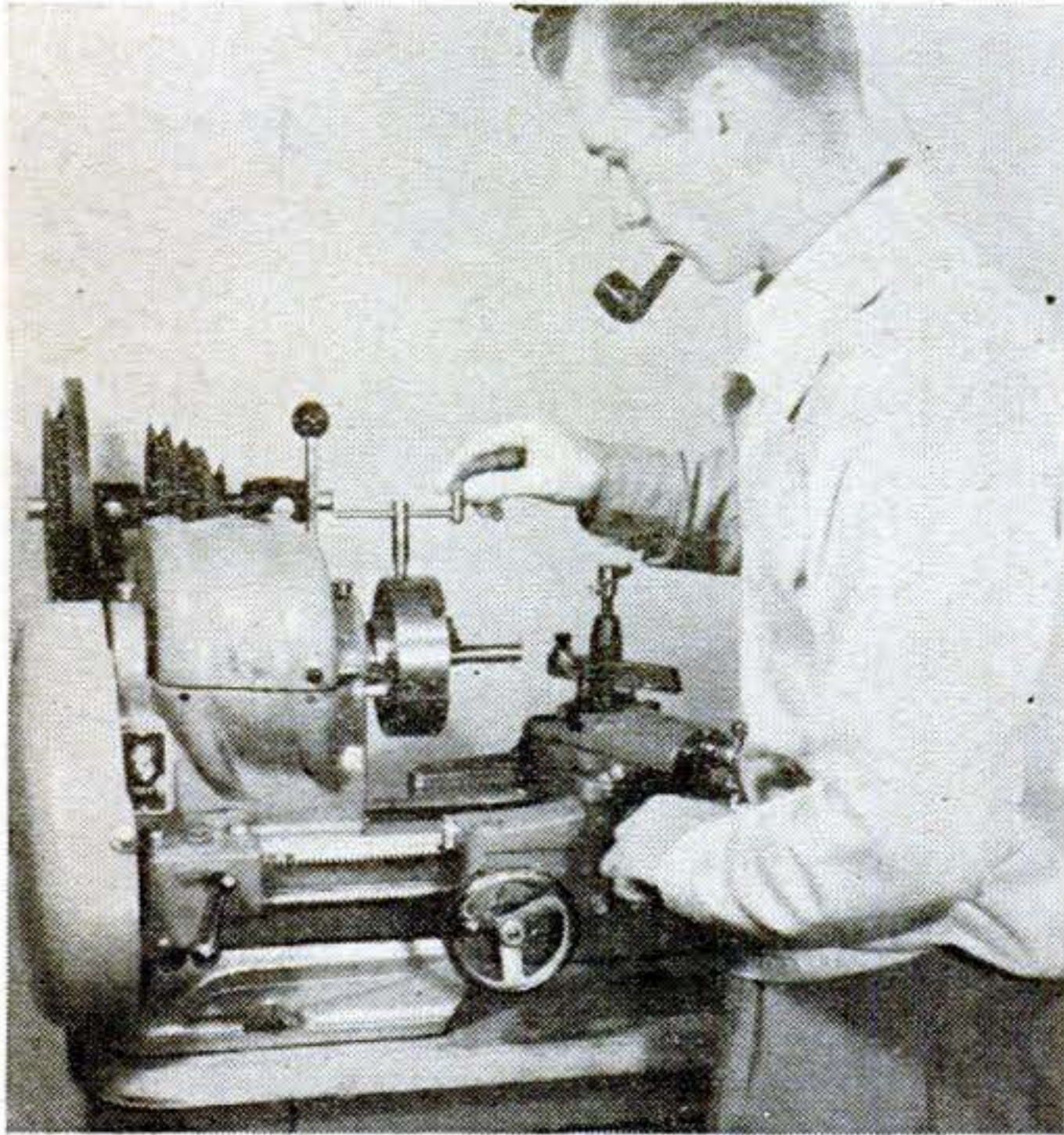
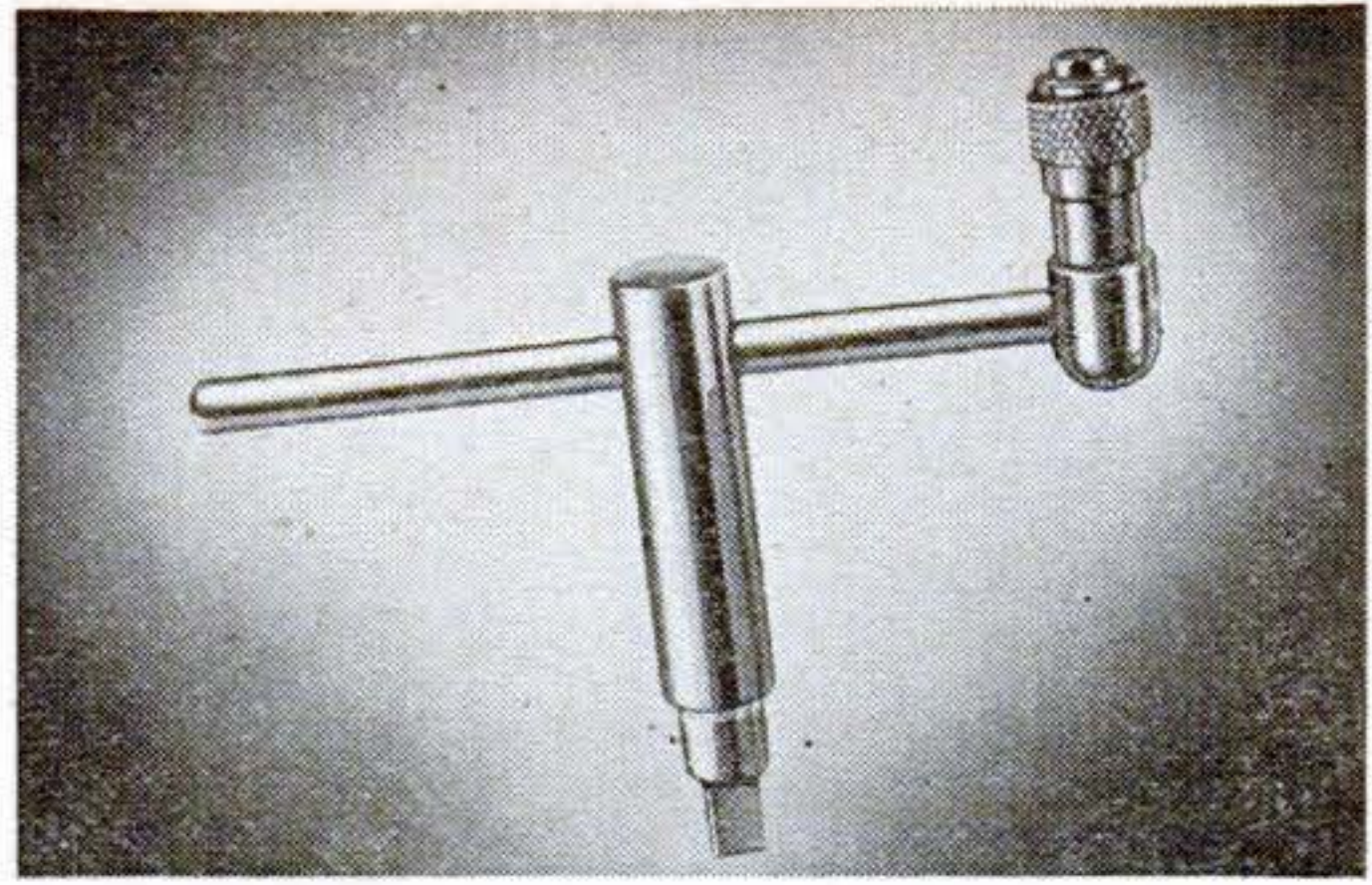

SPINNER SPEEDS CHUCKING. With a spinner crank fitted to your lathe-chuck key, you can turn the chuck jaws to position much more quickly. It's particularly useful in reversing the jaws of a four-jaw or independent chuck.

Turn the two parts of the handle from

cold-rolled stock. Drill one to fit the cross-piece of your particular key handle, and drill and tap the other end to receive the cap screw that retains the sleeve. The latter is knurled and drilled for a running fit. A hollow-head setscrew holds the unit on the key handle.—HENRY HANSCOM.

COATED ABRASIVES, I

[SHOP METHODS]

Abrasives held on a paper, cloth, or combination backing with glue are referred to as "coated abrasives." Three natural abrasives, flint, emery, and garnet, are employed, and two electric-furnace abrasives, aluminum oxide and silicon carbide. Crocus, used only in fine polishing, is oxide of iron, or iron rust, and is obtained as a residue in the manufacture of sulphuric acid. Aluminum oxide, silicon carbide, and garnet are classed as "technical" and are production materials frequently used on power machines; flint and emery are "nontechnical" and are used by hand.

Though abrasives are known by dozens of trade names, manufacturers have adopted the same standards. All aluminum oxide grit used is brown, silicon carbide is black, garnet is red, flint is off-white, emery is black, and crocus is reddish brown. Cloth backings are brown for aluminum oxide intended for metal working; silicon carbide and emery cloth backings are blue; all backings for wood-working abrasives are white; papers are natural color; and combinations show the natural color of the paper. Identifying stripes, when they appear on the backing, are also uniform—yellow for aluminum oxide, blue for silicon carbide, orange for garnet, green for flint, and red for emery.

Aluminum oxide and silicon carbide are graded by screen numbers, that is, the number of apertures per linear inch in both directions in the screen through which the grit is controlled. The higher the number, the finer the grit. Garnet, flint, and emery have grade numbers such as 3/0 (000) or No. 3, in which the higher numbers mean coarser grit.

Abrasives are also classed as "open coat" and "closed coat" according to how densely the grain is applied on the backing. Open coat is preferred when cuttings adhere to or "fill" the abrasive since there is space for them to stick without covering the cutting surface.

Aluminum oxide, silicon carbide, and garnet are used for "wet" sanding with water or oil as well as for dry sanding. A "waterproof paper" should be specified.

POPULAR SCIENCE MONTHLY SHOP DATA

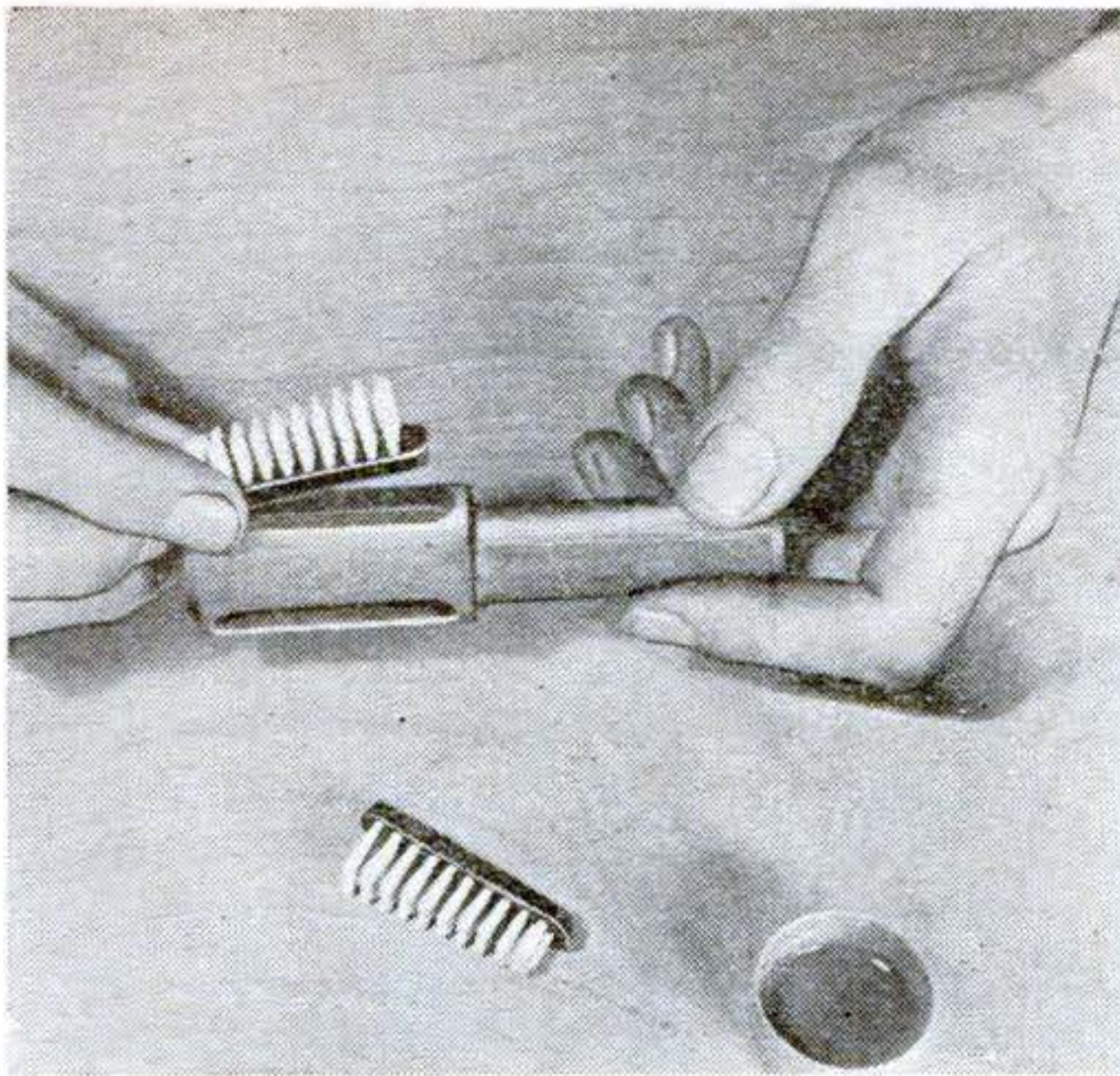

BRUSH CLEANS THREADS. This triple brush does a fast and thorough job of loosening and removing chips from lathe-chuck threads. The holder is hardwood turned to a diameter $\frac{1}{4}$ " less than the minor

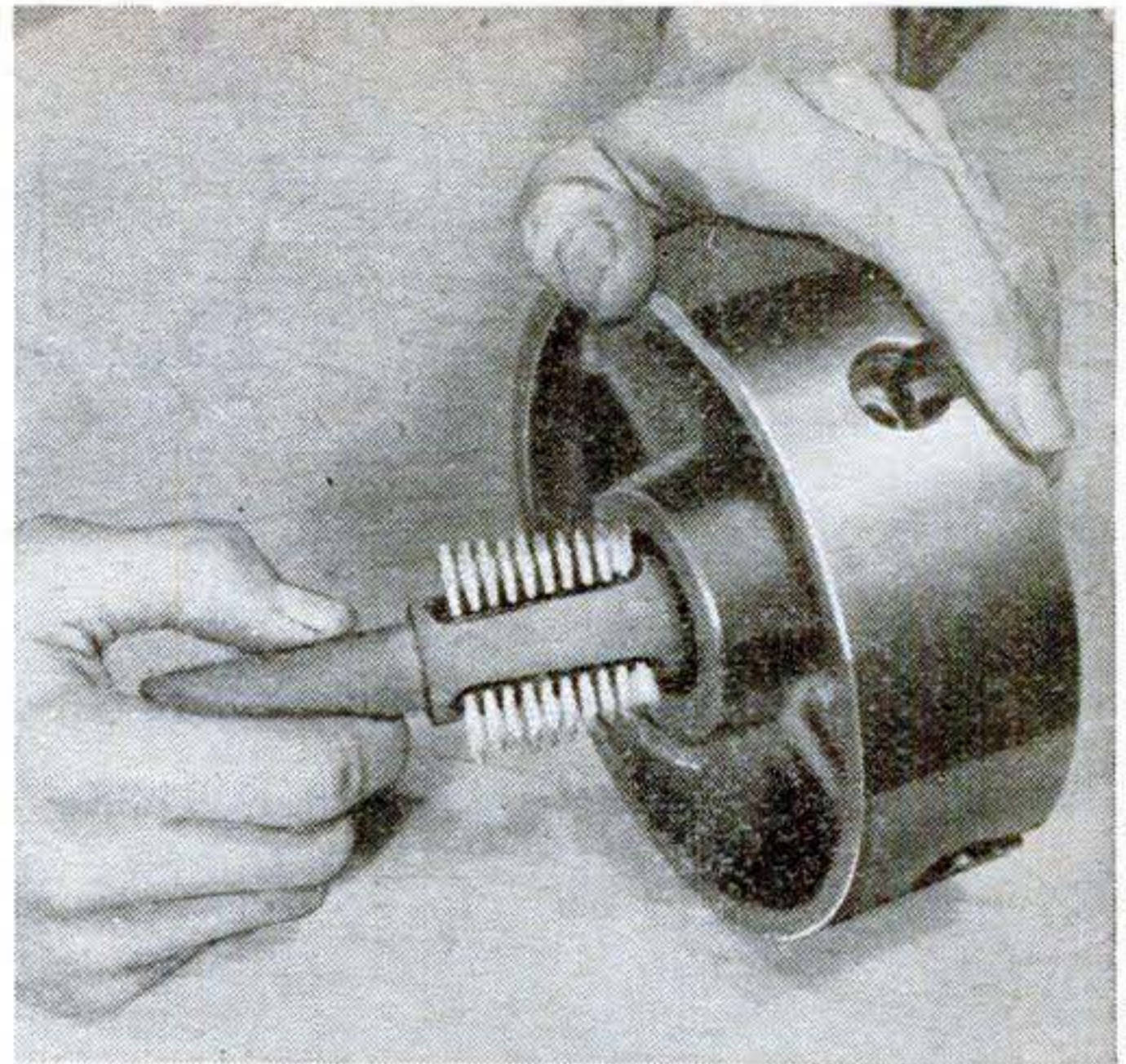

diameter of the threads. One end is turned down smaller to serve as a handle. Three grooves are routed in the holder and three straight-contour toothbrushes, with their handles cut off, are glued into place.

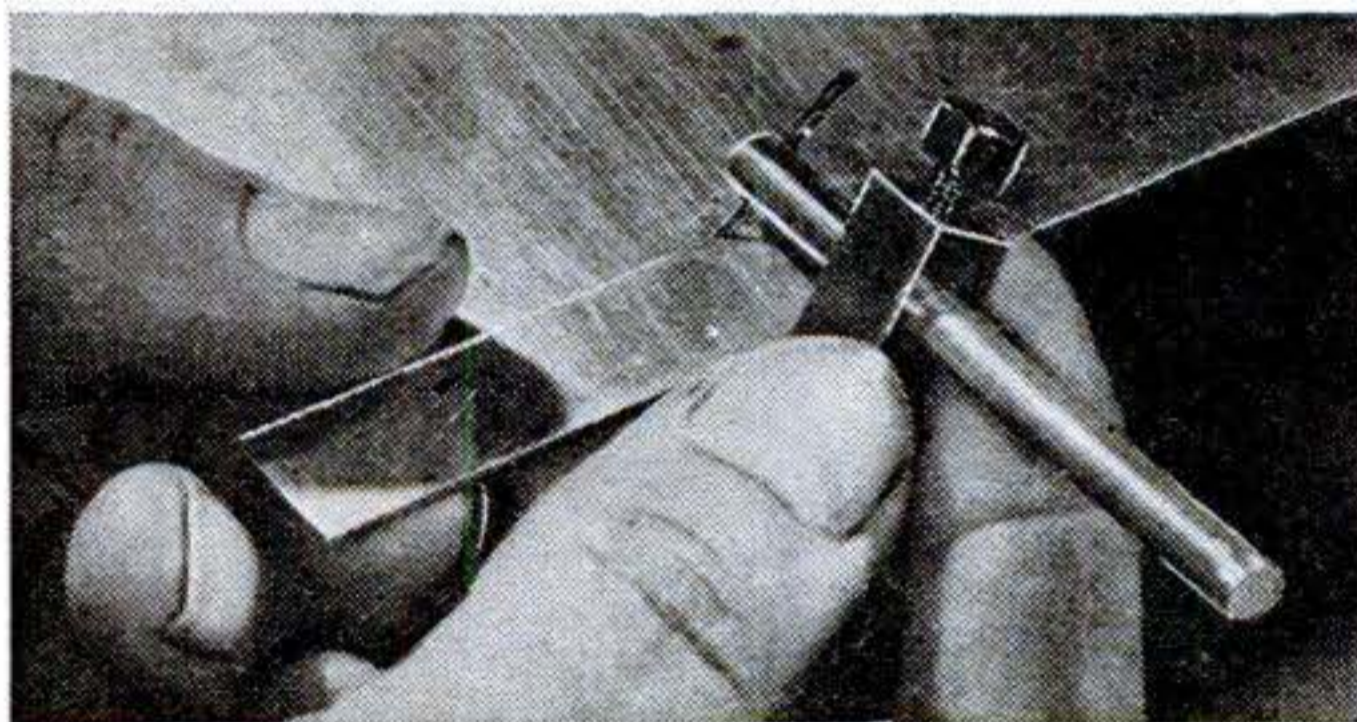

MINIATURE SCRATCH GAUGE. A phonograph needle, a few pieces of scrap metal, and 10 minutes time produced this little scratch gauge. You'll find it very handy for small work, especially modelmaking.

A piece of brass $\frac{3}{8}$ " by $\frac{1}{2}$ " by 2" was drilled to allow a 3" length of $\frac{1}{4}$ " rod to slide through easily, and a thread was tapped in the top of the block for a $\frac{3}{16}$ " setscrew. A hole one drill size smaller than the phonograph needle was drilled near the end of the rod and the needle pressed in.

TAILSTOCK CENTERS WORK. A short piece of rod or a partly finished turning can be centered in a lathe with remarkable accuracy if you use the tailstock chuck to "hand it over" to the headstock. Put the piece in the tailstock, slide it up to the headstock, tighten the three-jaw chuck, and then release the tailstock chuck.

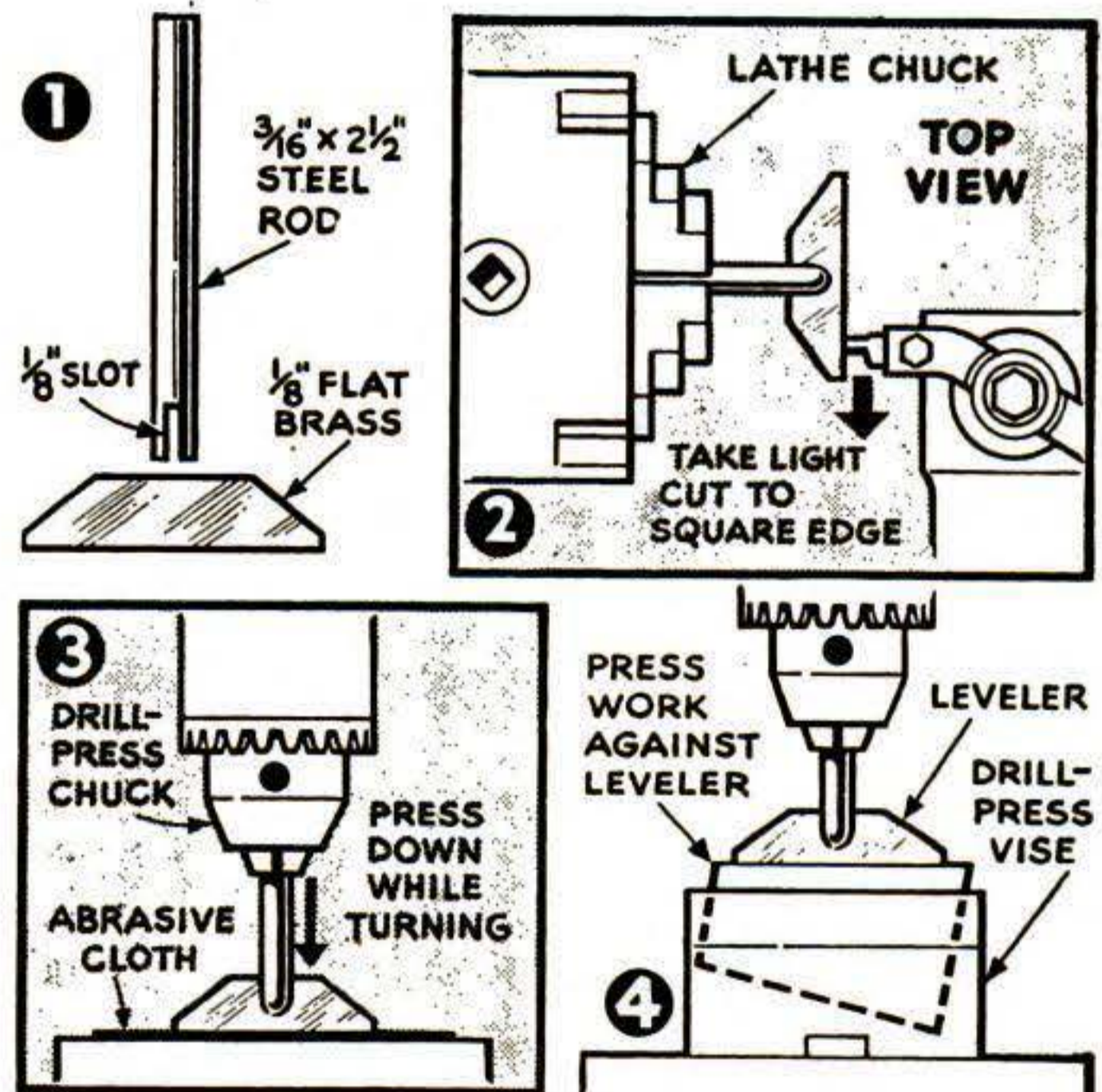

DRILL-PRESS WORK LEVELER. This gadget will quickly level irregular work in a drill-press vise so a hole can be drilled at exactly right angles to the surface.

Cut a $\frac{1}{8}$ " slot in a $\frac{3}{16}$ " by $2\frac{1}{2}$ " steel rod to fit a small straightedge made of $\frac{1}{8}$ " flat brass (Fig. 1). Solder these pieces as square as possible, chuck the rod in a lathe (Fig. 2), and take a light cut to true the bottom of the straightedge. You can also true it by revolving it in a drill press at medium speed against abrasive cloth (Fig. 3). How the leveler is used is illustrated in Fig. 4.—HERBERT PFISTER.

**Vertical
Steam Engine
PART FOUR**

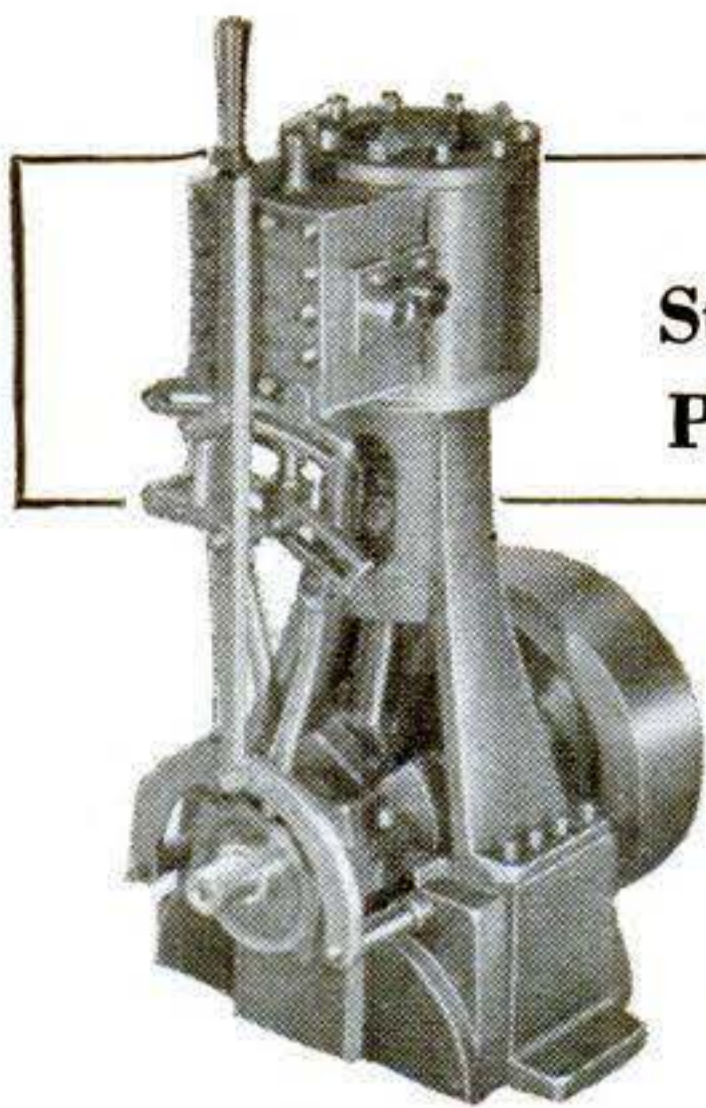

Here's the finished job as she'll look when you make the parts described in this last installment

Building the

AT ONCE the most fascinating and the most difficult part of this engine to build, the reverse gear is derived from Stephenson's famous link motion. The valve rod, which moves the slide valve over the ports, is not connected directly to an eccentric at all, but to a small block that slides in a slotted quadrant or link. Two eccentrics, oppositely offset to give the correct advance for both forward and reverse running, are connected to the two ends of this link. A control lever connected through a drag link can shift the slotted quadrant and its connecting eccentric rods one way or the other, bringing the link block and consequently the valve into line with either the forward or the backward eccentric, and so determining which way the engine will run.

When the link block is midway in the slot, no motion is imparted to the valve even if the crankshaft is turning, and the engine will soon stop. Either side of this position, though, the valve will operate with reduced travel. Steam will be cut off during a greater part of the stroke, saving on fuel, a condition analogous to high gear in an automobile transmission and precisely that which obtains in a steam locomotive running at high speed with a moderate load.

The slide valve consists of two pieces of bronze, the face a piece of $\frac{1}{8}$ " plate in which a rectangle is cut by drilling and filing to form the steam cavity or recess. To this is silver-soldered a bronze block. The hole for the valve rod is filed slightly oval with a needle file so that the valve has some slight play against the port face and may be held on it firmly by steam pressure.

Turn the valve rod from $\frac{5}{16}$ " square steel rod, shouldering the end to a sliding fit in the guide atop the steam chest and threading the stem with some fine thread such as 8-36 or 6-40. Drill the square end for the $\frac{3}{32}$ " pin that will connect it to the link block, cut the slot, and file to shape.

Eccentrics can be turned from short ends of stock. Chuck a piece $\frac{3}{32}$ " off center, turn the hub, and drill and ream the $\frac{3}{8}$ " shaft hole. Then chuck the piece truly in the three jaw to turn the 1" outside diameter and the $\frac{3}{8}$ " groove, and cut off. Make a second eccentric with no hub. [Turn the page.]

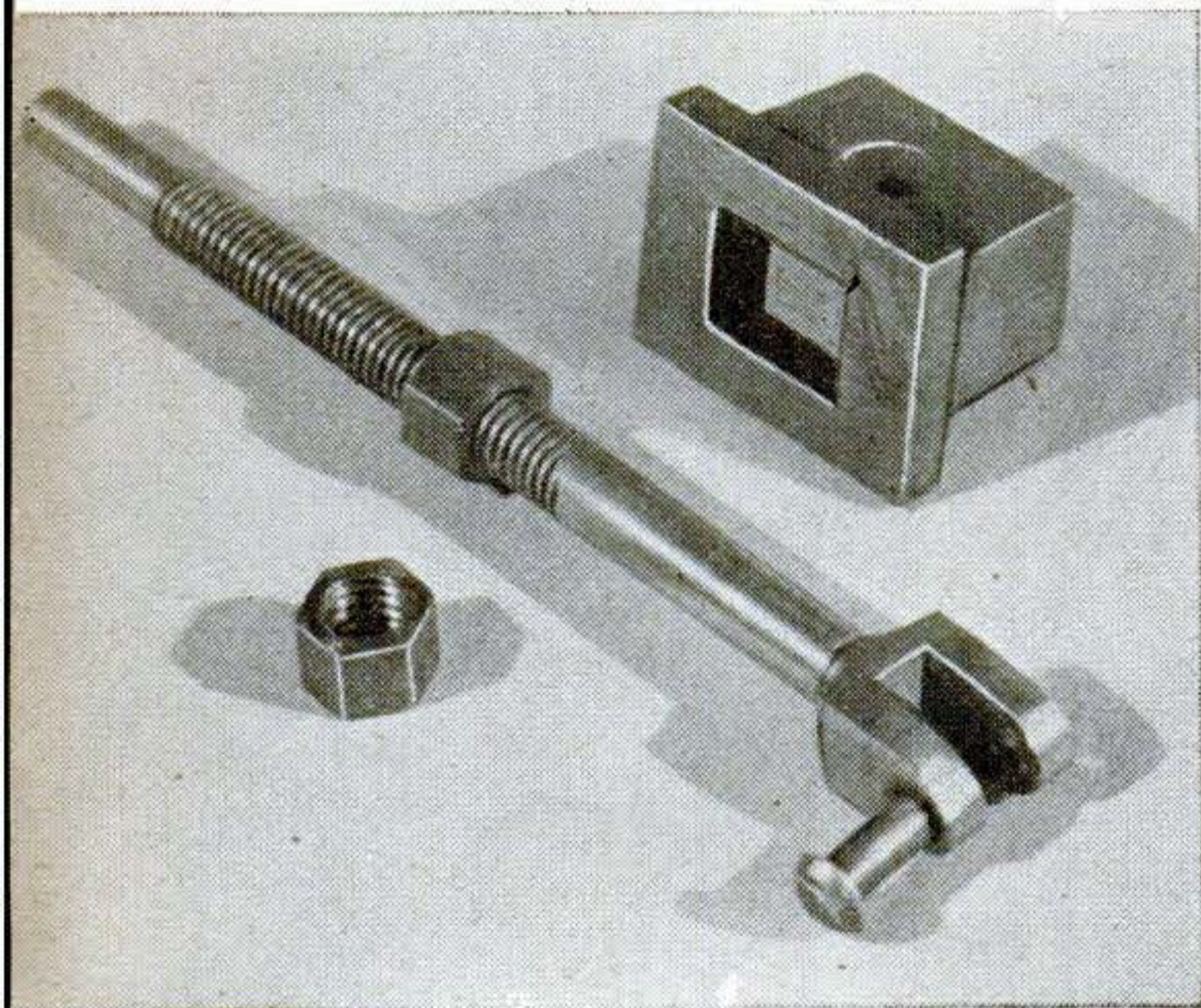

The slide valve is located on the valve rod by a pair of locking nuts that provide travel adjustment. The nuts must be a tight fit on the thread.

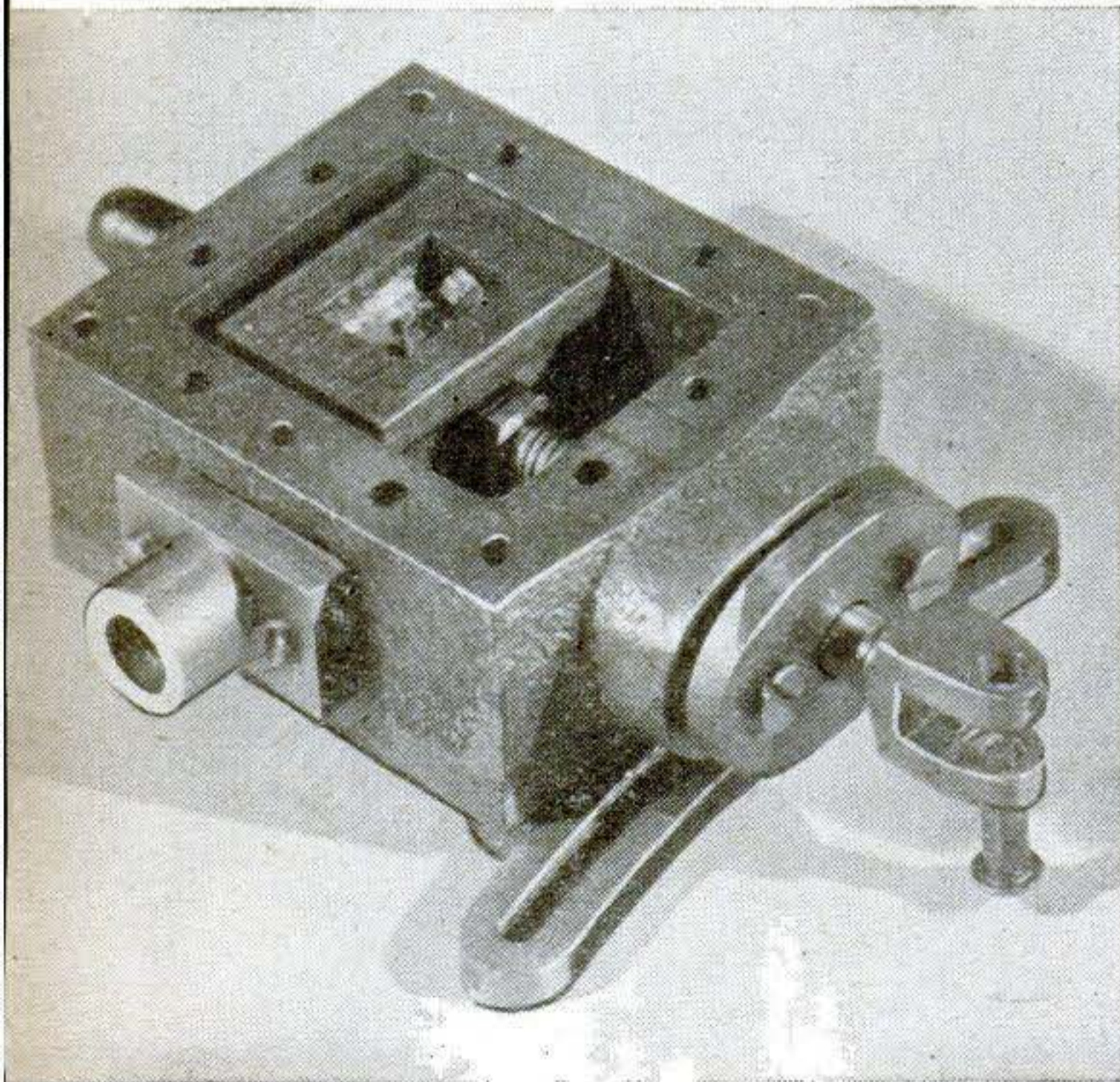

Steam chest and valve assembly. The valve is not clamped snugly but floats between the nuts so that steam pressure can hold it against the port face.

Reverse Gear

By C. W. Woodson

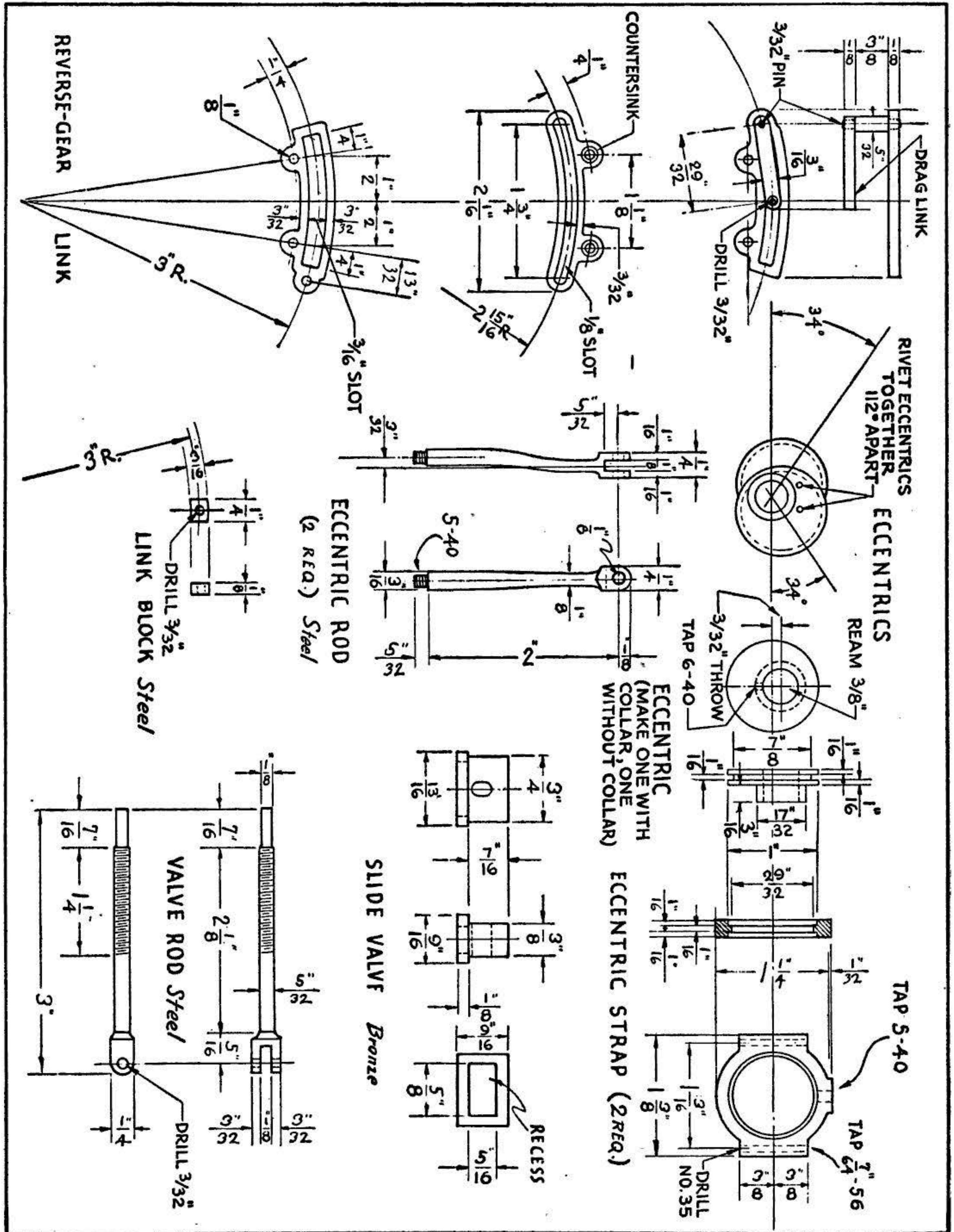

Precise work in laying out, machining, and hand fitting will be particularly rewarding with these parts.

Face both smooth, slip them on a short piece of $\frac{3}{8}$ " rod, and rivet together at exactly the angle shown in the drawings.

To make the eccentric straps, cut two pieces $1\frac{3}{8}$ " long from $\frac{3}{16}$ " by $\frac{3}{8}$ " cold-rolled steel for each strap. Lay out, drill, and tap the bolt holes for fastening the two halves together. Those in the lower half are drilled out to clear the $\frac{7}{64}$ " bolts. With the halves bolted together, each blank is chucked and bored to a running fit on its eccentric. The outside is then roughly sawed and brought to final shape by hand filing.

Eccentric rods are turned from $\frac{1}{4}$ " square steel. They should be cut slightly long to allow for shortening in the bend. Lay out the hole in the fork end after bending, measuring from the shoulder at the threaded end. Drill, slot, and file the fork to shape.

With dividers, carefully lay out the reverse link on $\frac{1}{8}$ " steel plate. To make the slot, drill a series of undersized holes, drill between to overlap them, and finally file to the radiuses. Drill for the eccentric-rod pins and finish the outside by filing to shape. Note that the link block has sides of the same curvature as the link slot, in which it should be a perfect sliding fit, without play.

The reverse lever and its quadrant, drag link, and clamping nut offer no special difficulties. With the various short pins and the valve-rod nuts, you are ready to assemble the valve gear. One of the photos shows it in a trial assembly, less the reverse lever.

Assemble the steam chest, valve, valve rod and adjusting nuts, and gland as in the photo on page 174. Be sure the valve rides freely on the rod so that its face may be lifted a trifle above the bolting surface of the chest in the position shown—enough to allow for more than the thickness of a gasket between chest and port face. To allow full contact with the port face, the adjustment nuts should be drawn up only to position the valve, not to clamp it. Either tap the nuts somewhat less than full thread depth for a tight fit on the rod, or make two thin nuts out of each one to provide locking.

With the cylinder and running gear assembled, mount the steam chest temporarily without the cover and connect the eccentric rods to the link. Set the two eccentrics on the shaft so that the crankpin throw bisects the angle between the eccentrics. You can then observe the valve travel by turning the crankshaft.

Steam ports should just begin to open as the piston reaches top or bottom dead cen-

ter. The valve should uncover both ports to an equal degree, and at no point expose the exhaust port. These conditions will best be observed at full forward and full reverse setting, with the link block at the two ends of the slot. At intermediate positions valve travel will be shortened, and cutoff—the closing of the port last admitting steam—will occur earlier in the stroke. If setting the valve nuts does not correct valve travel, it

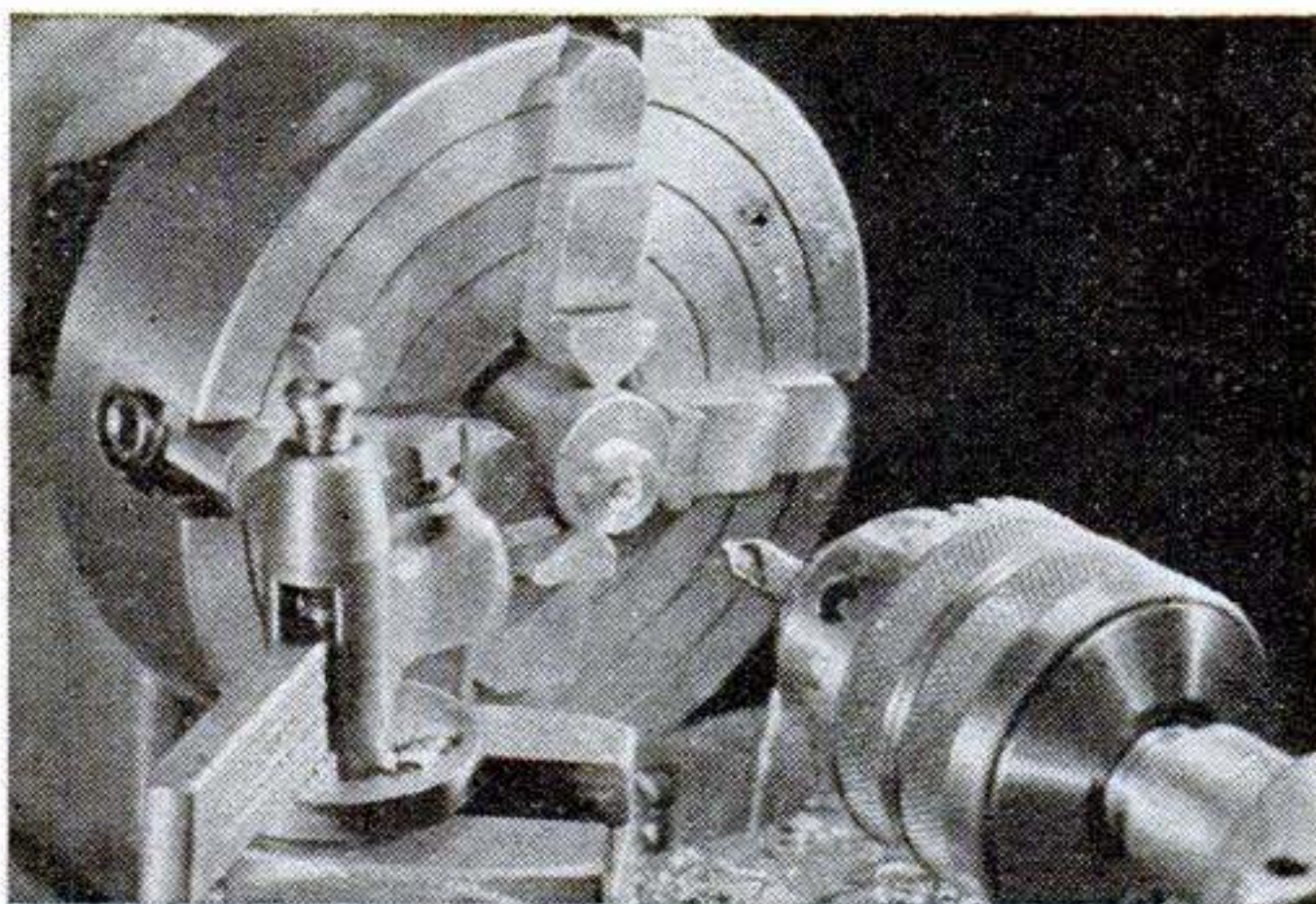

Each eccentric is turned separately. Round stock is chucked $\frac{3}{32}$ " off center and the shaft hole is drilled. It is then centered and the outside turned.

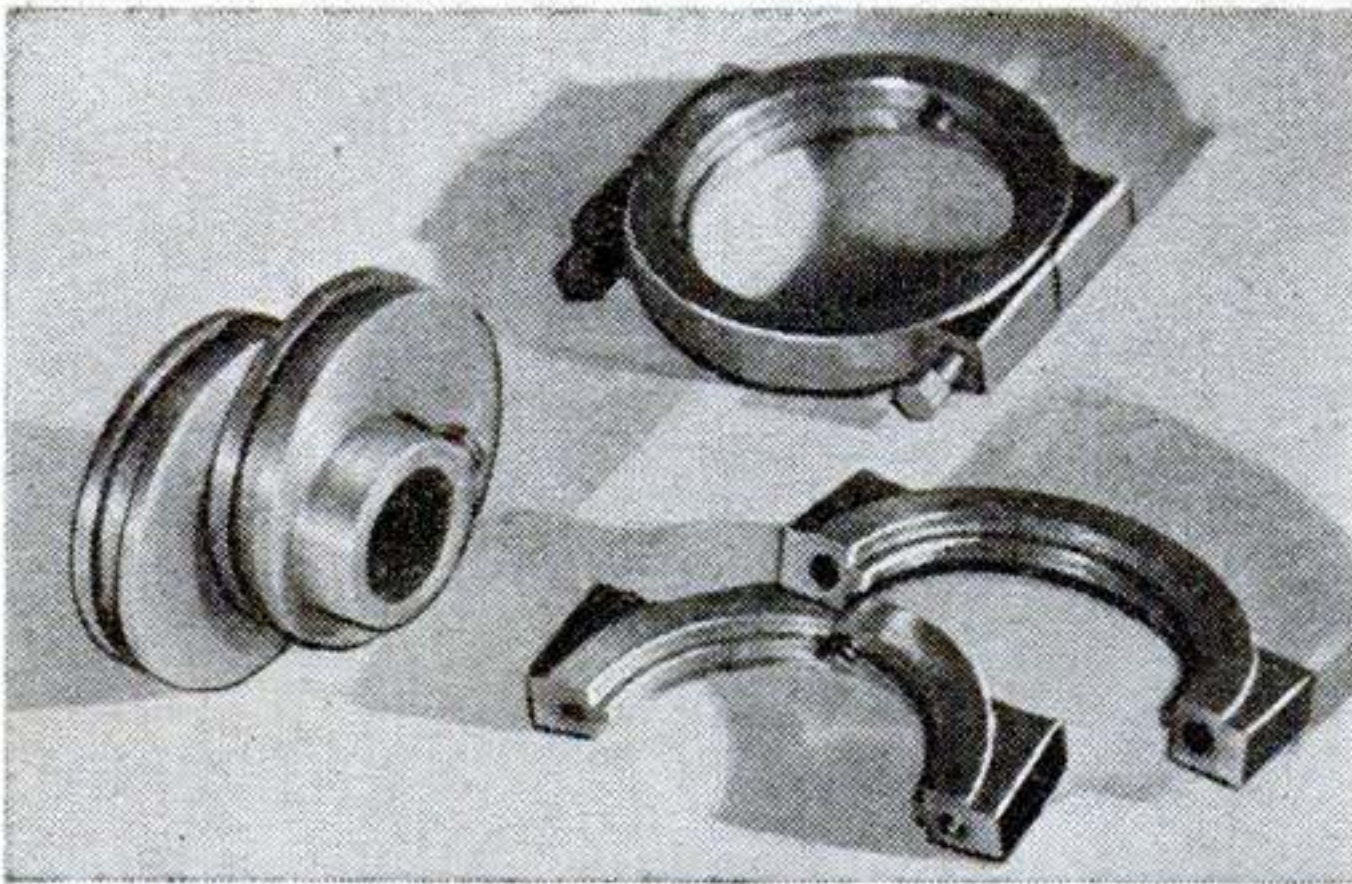

The eccentrics, one without a hub, are then riveted or pinned together. After each pair of strap halves is bolted together, the inside diameters are bored.

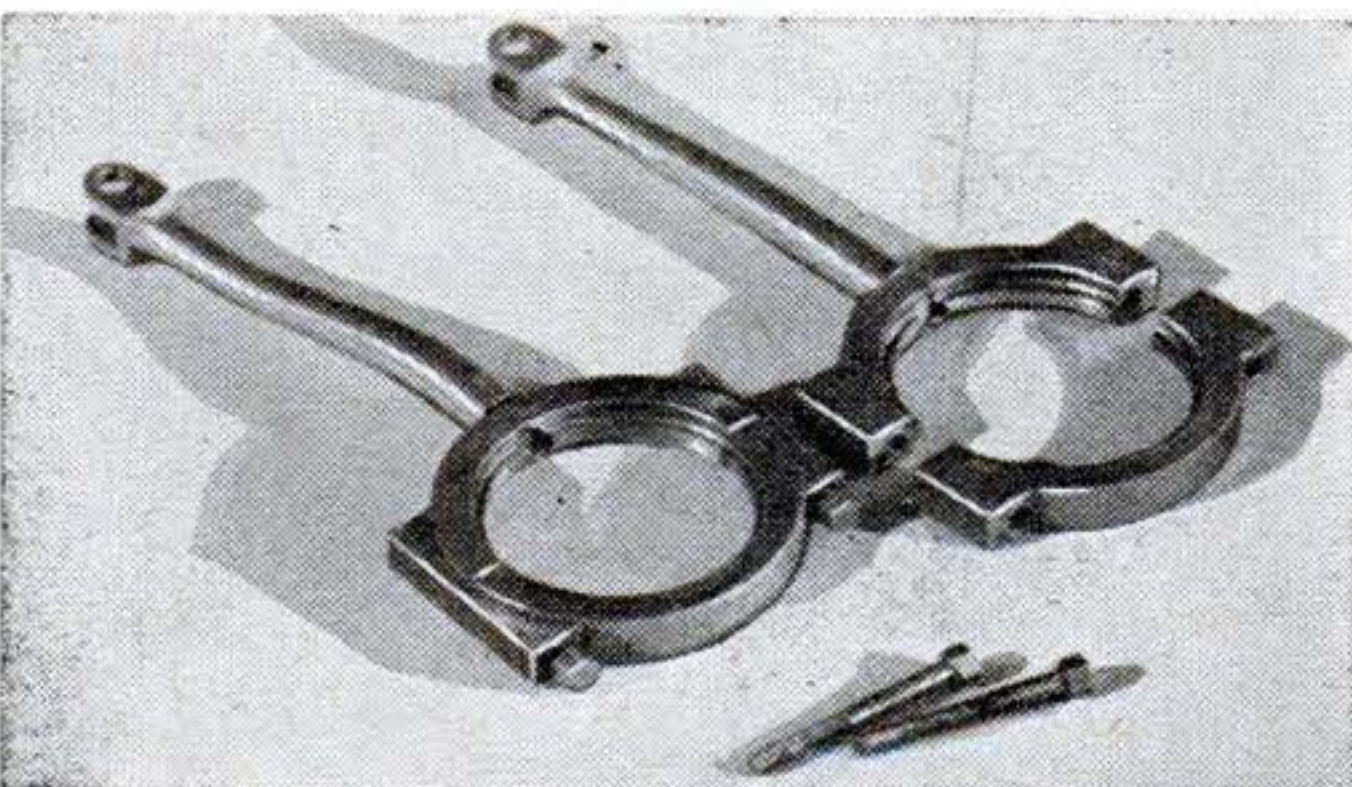

One or both eccentric rods are offset slightly so as to bring the centerlines of their forks directly over the centerline of the assembled eccentric.

may be necessary to reset the eccentrics, or even shorten or lengthen their rods.

Assemble the engine, using oil freely on all moving parts, with gaskets and graphited gland packing. Run it in at low speed on steam or air, or by outside power, until the parts have worn to a good fit and lost any initial tightness. The steam line should have a lubricator to oil the cylinder.

Beware the temptation to throw over the

reverse lever at high speed. While the engine should stop at mid-quadrant setting, you'll want a throttle valve for fuller control. It's well to add asbestos lagging and a sheet-metal jacket to the cylinder to minimize condensation, and to start up slowly until the cylinder is hot and any condensate has escaped via the exhaust. Being of cast iron, the engine will safely stand pressures up to 100 lb. END

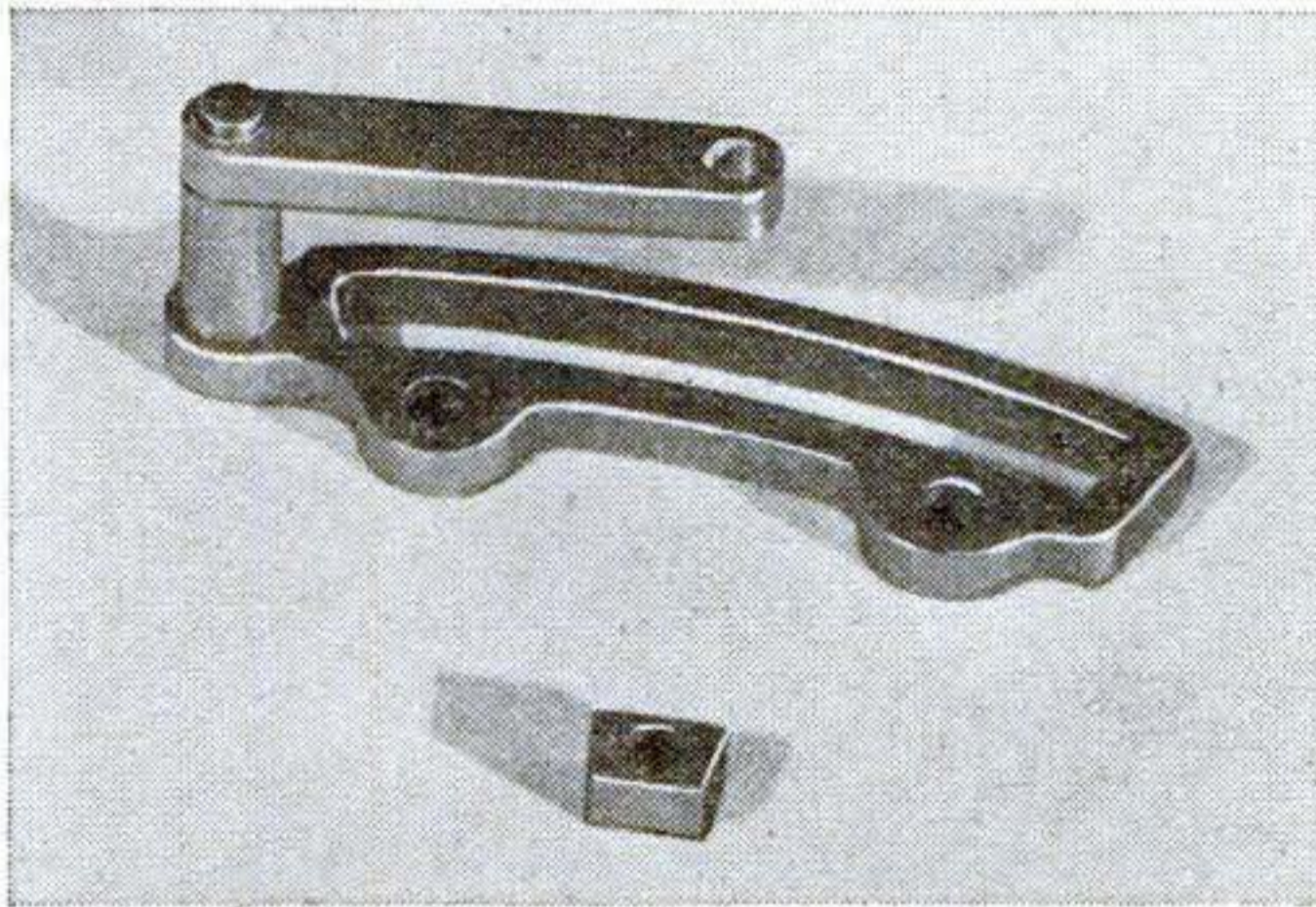

A short pivot stud connects the drag link to the reverse link. Also above is the link block, shaped to match the slot, which fits the valve-rod fork.

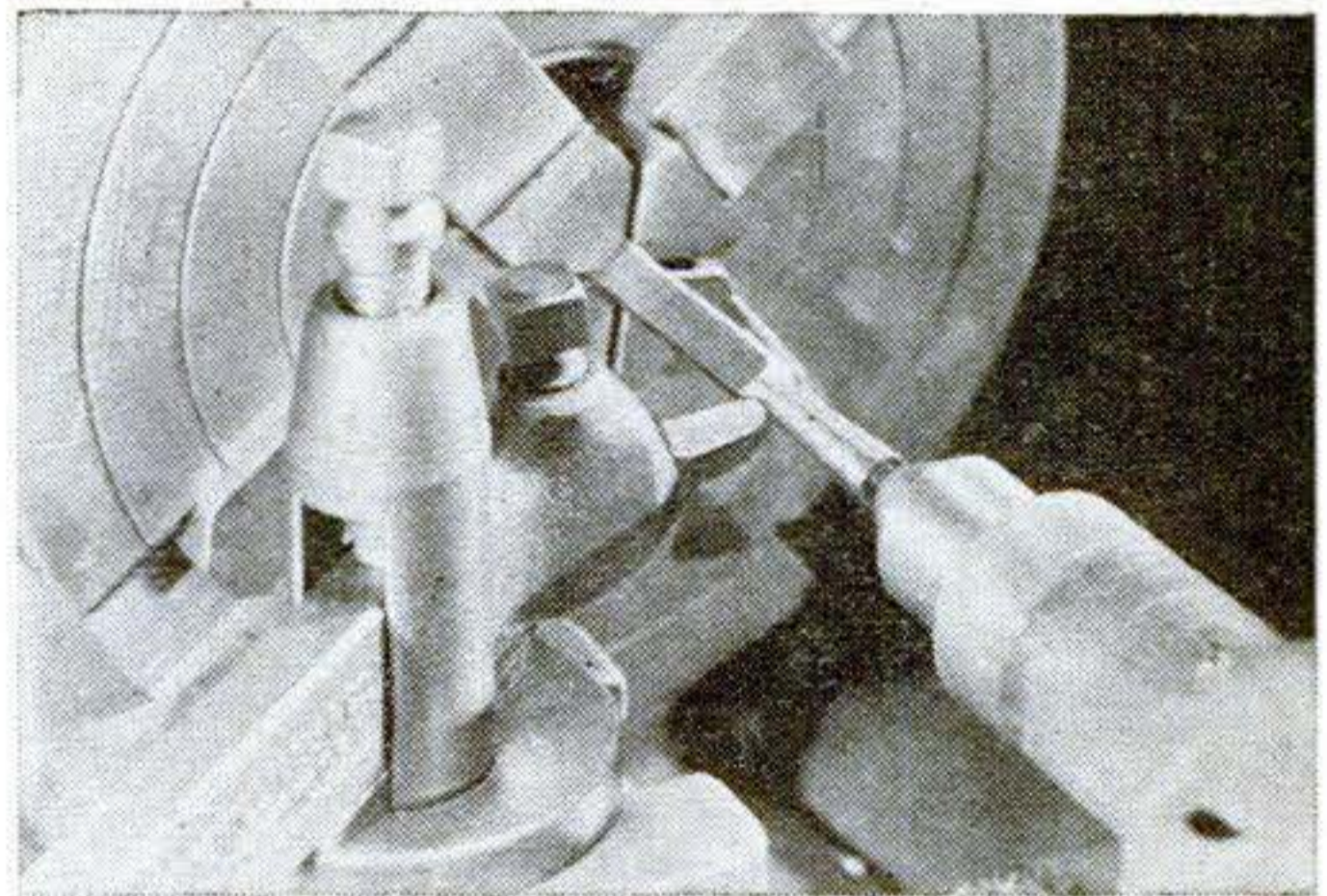

Chucked in the four-jaw, a piece of 1/4" square steel is turned down to form the handle of the reverse lever. Holes must be located as in the drawing.

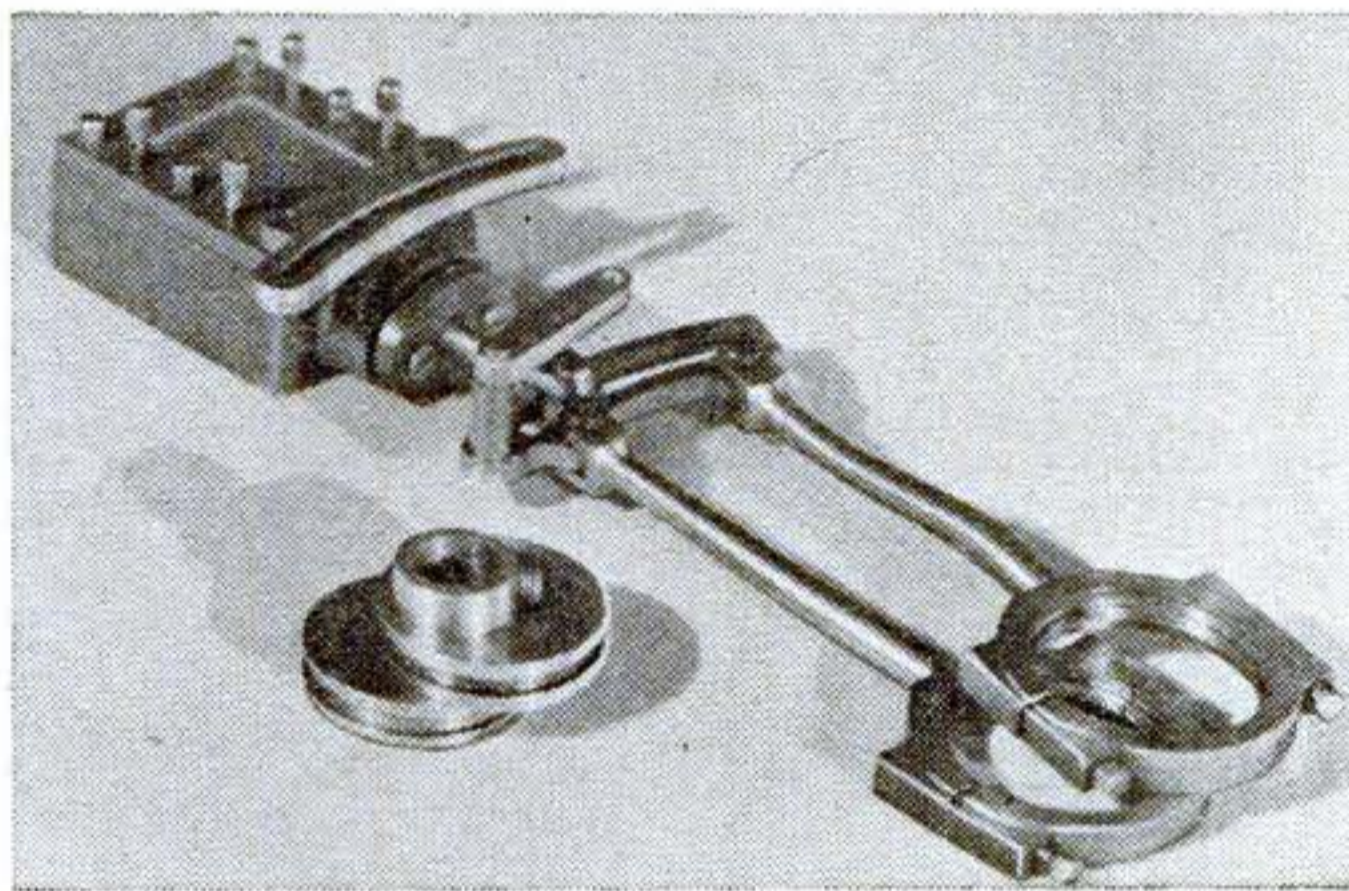

How the reverse gear will be assembled on the engine. The quadrant on the steam chest receives the clamp screw that locks the reverse-lever setting.

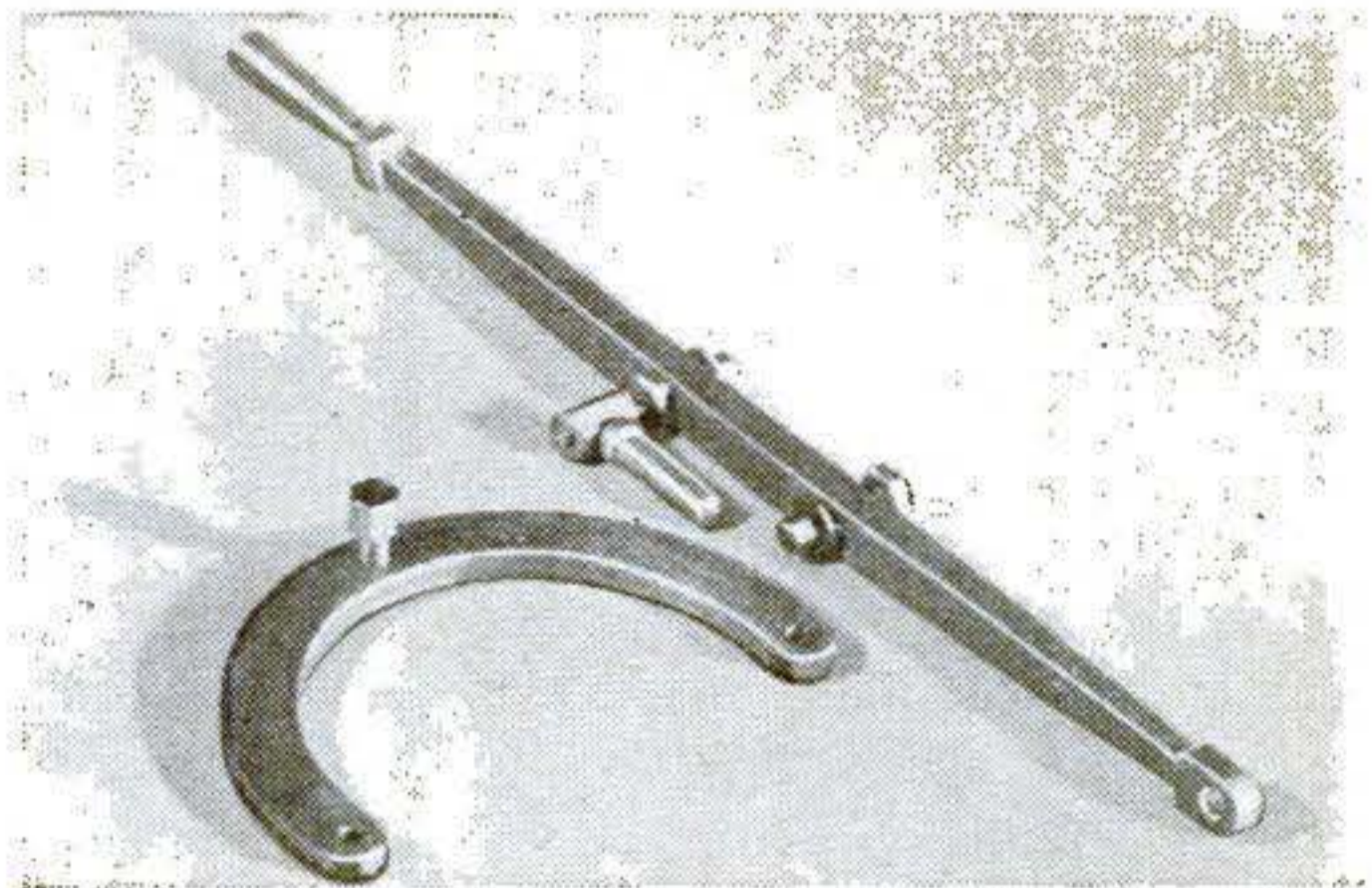

At its lower end, the lever pivots on a stud that screws into the ring, which will itself be bolted to the base. The clamp nut is fitted with a handle.

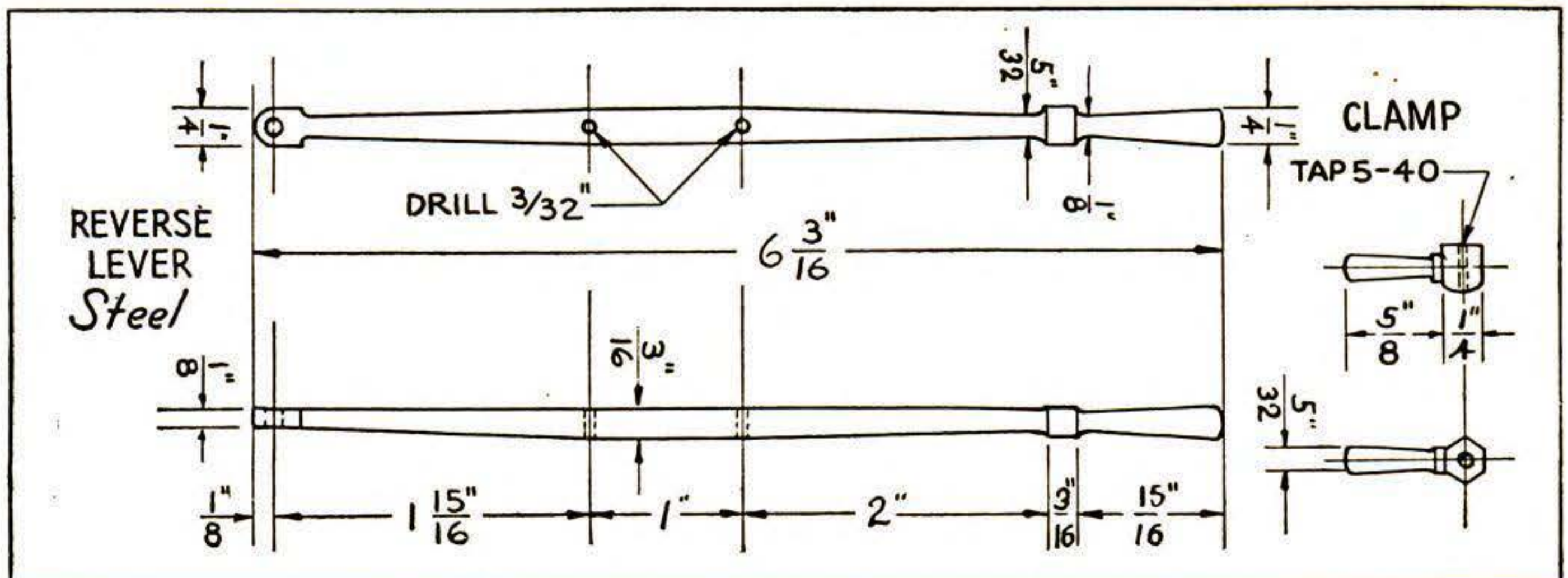

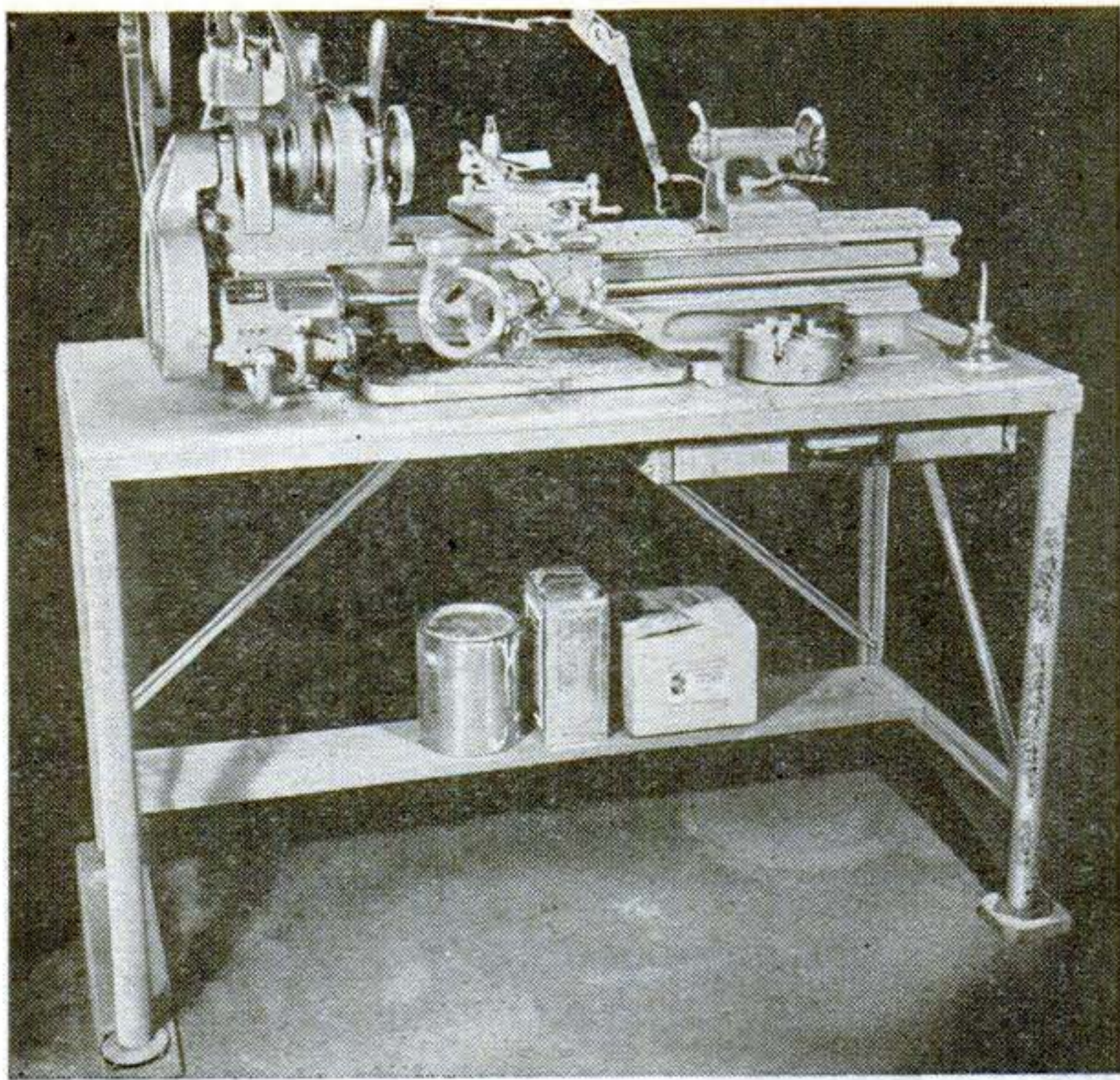

Lathes and other shop machinery can be mounted on such a metal bench as this. Only the shelf and top are of wood.

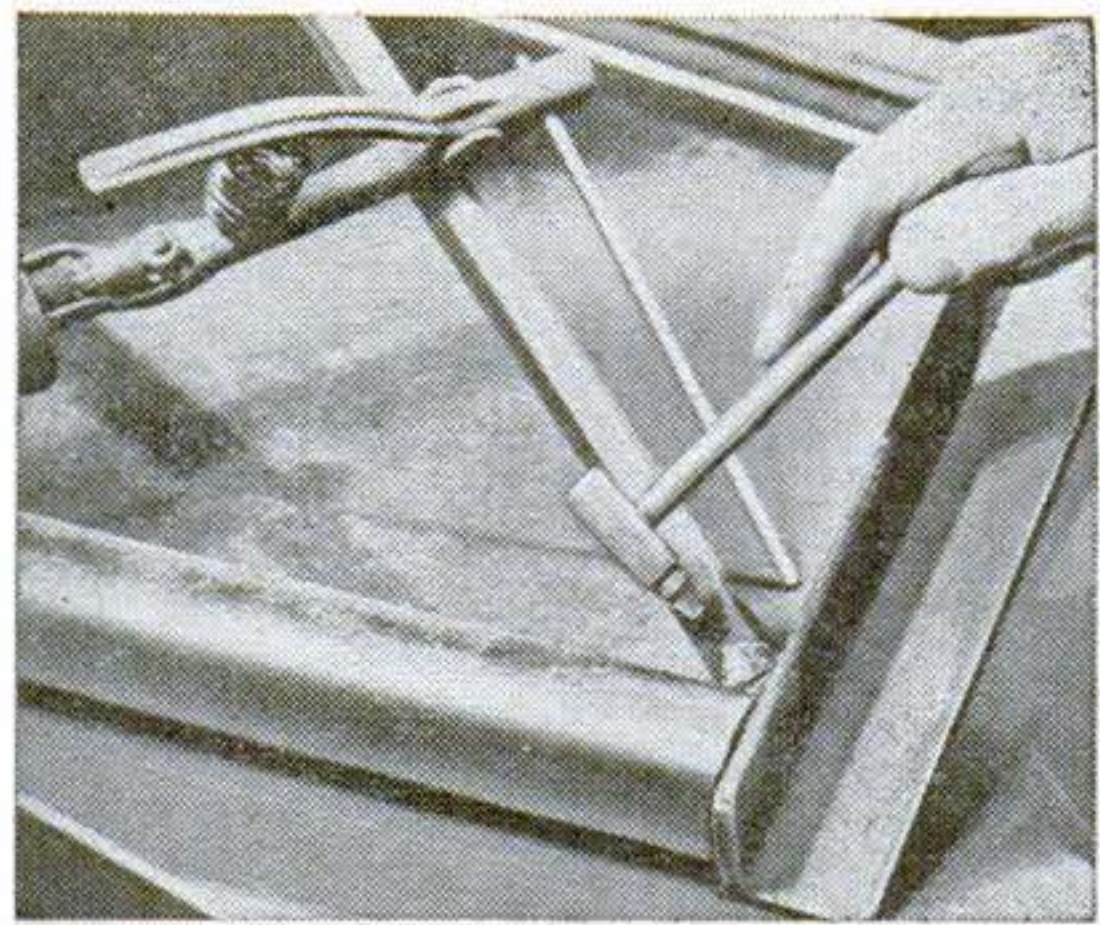

Both end sections are welded up as single units. Chip off the scale after welding to provide an even painting surface.

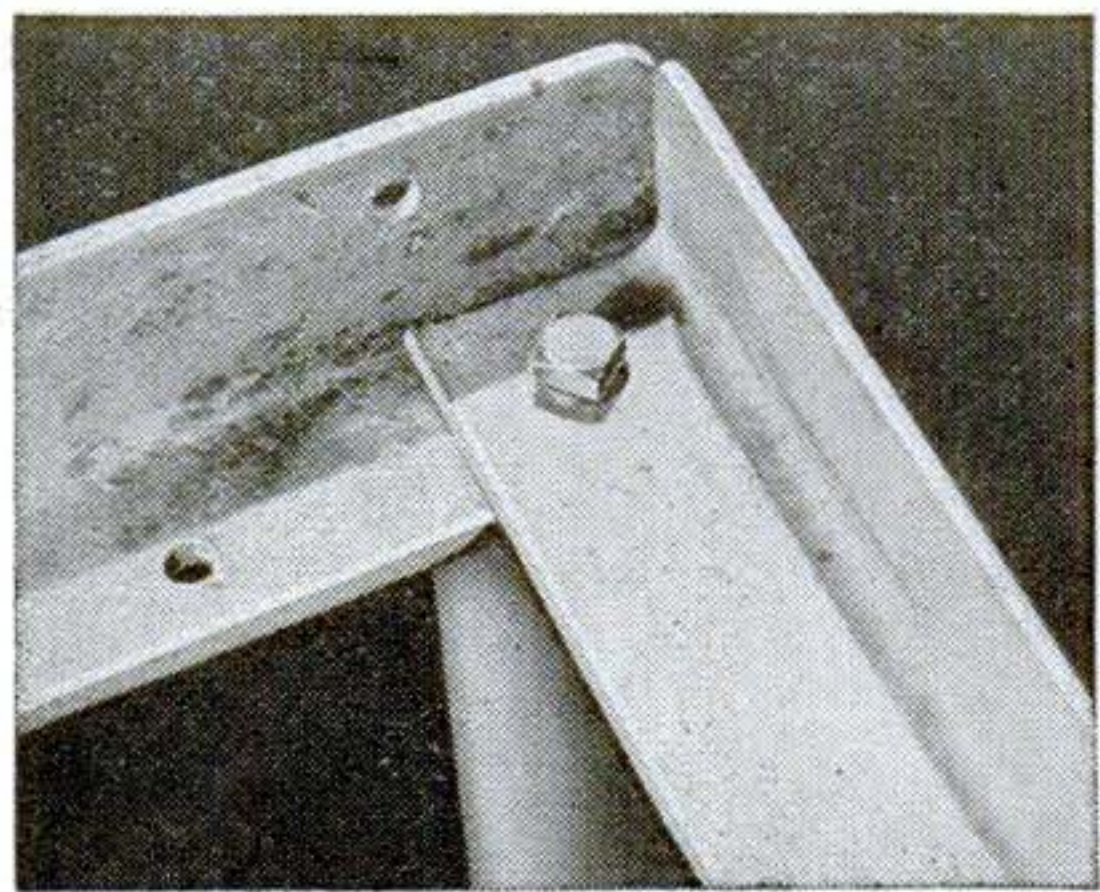

Angles form a frame for the bench top. A filler strip is needed over angle A, the thickness of the iron in E.

Sturdy Bench Built of Scrap

BECAUSE of the high price and scarcity of suitable lumber, you may find it better to build a shop workbench from scrap iron. Metal for this one, made for a 9" lathe, cost \$2 at a junkyard. The only wood used was the 2" pine top (\$3.50) and the 1" pine shelf (\$1).

All the metal pieces are lettered in the drawing: A, two 1½" by 1½" by 24" angle irons; B, four 30" lengths of 1½" pipe; C, two 1¼" by 21" angle irons; D, two 30" lengths of ¾" O.D. tube (or rod); E, two 1½" by 1½" by 53½" angle irons (such as old bed rails). The braces F can be smaller angle stock, channel, rod, or tubing. G is a 6" length of angle providing attachment for rear braces F. The 8" shelf H adds longitudinal rigidity, being bolted to members C.

Weld or braze the end sections at the joints marked X in the drawing; this makes the two ends rigid units, to which the longitudinal members should be bolted rather than welded to permit disassembly and flat storage. As a photo shows, a machine bolt through piece E may be screwed into a

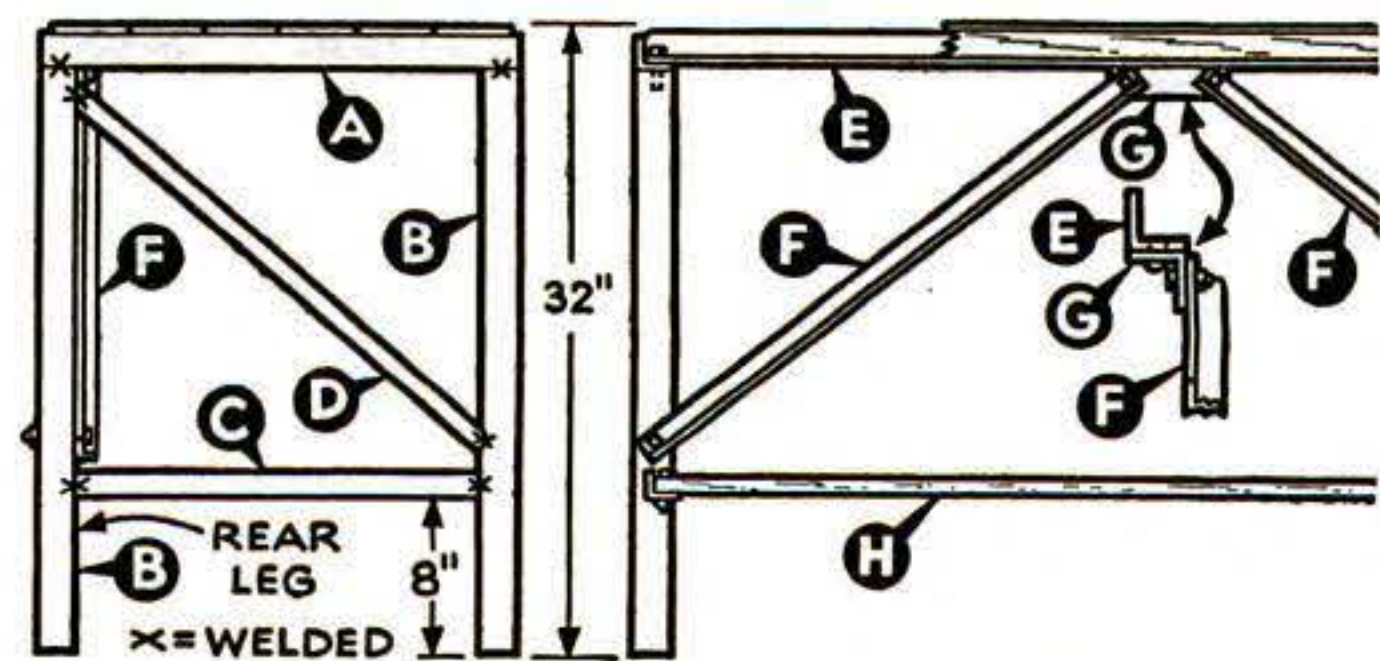

All parts lettered here are pieces of scrap metal with the exception of H, which is a board shelf.

tapped hole in piece A. Alternatively, the pipe leg might have a rectangular notch cut at the end for the nut before welding.

If welding or brazing is not feasible, the end frames can be bolted or riveted together, members A and C overlapping the legs. If the ends of the legs are threaded, standard pipe floor flanges can be screwed on. Besides affording a firm footing and holes for floor-mounting bolts, they can be turned on the threads to compensate for an uneven floor and to level the bench.

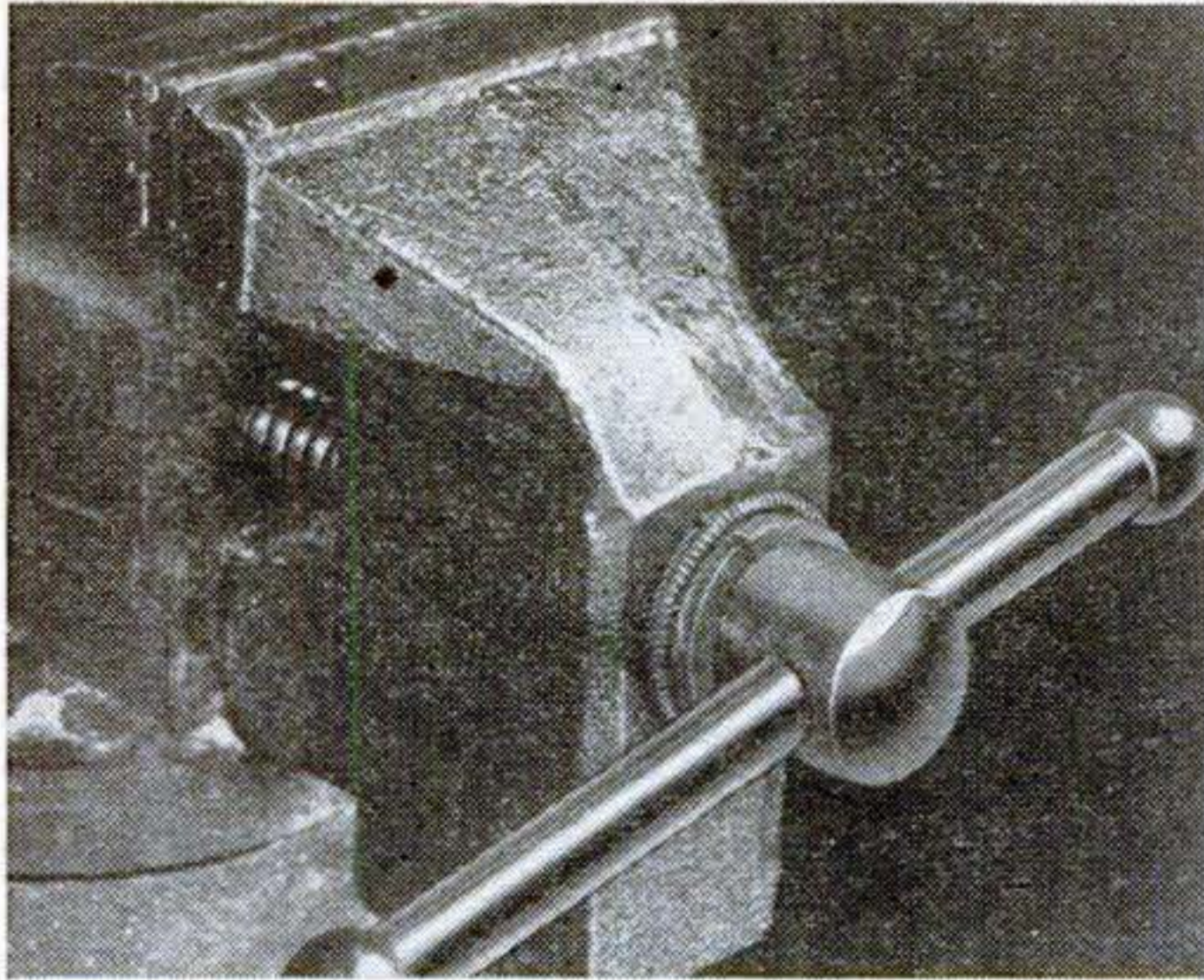

A thrust bearing gives a far stronger grip to this vise. The coil spring retains a leather dust guard.

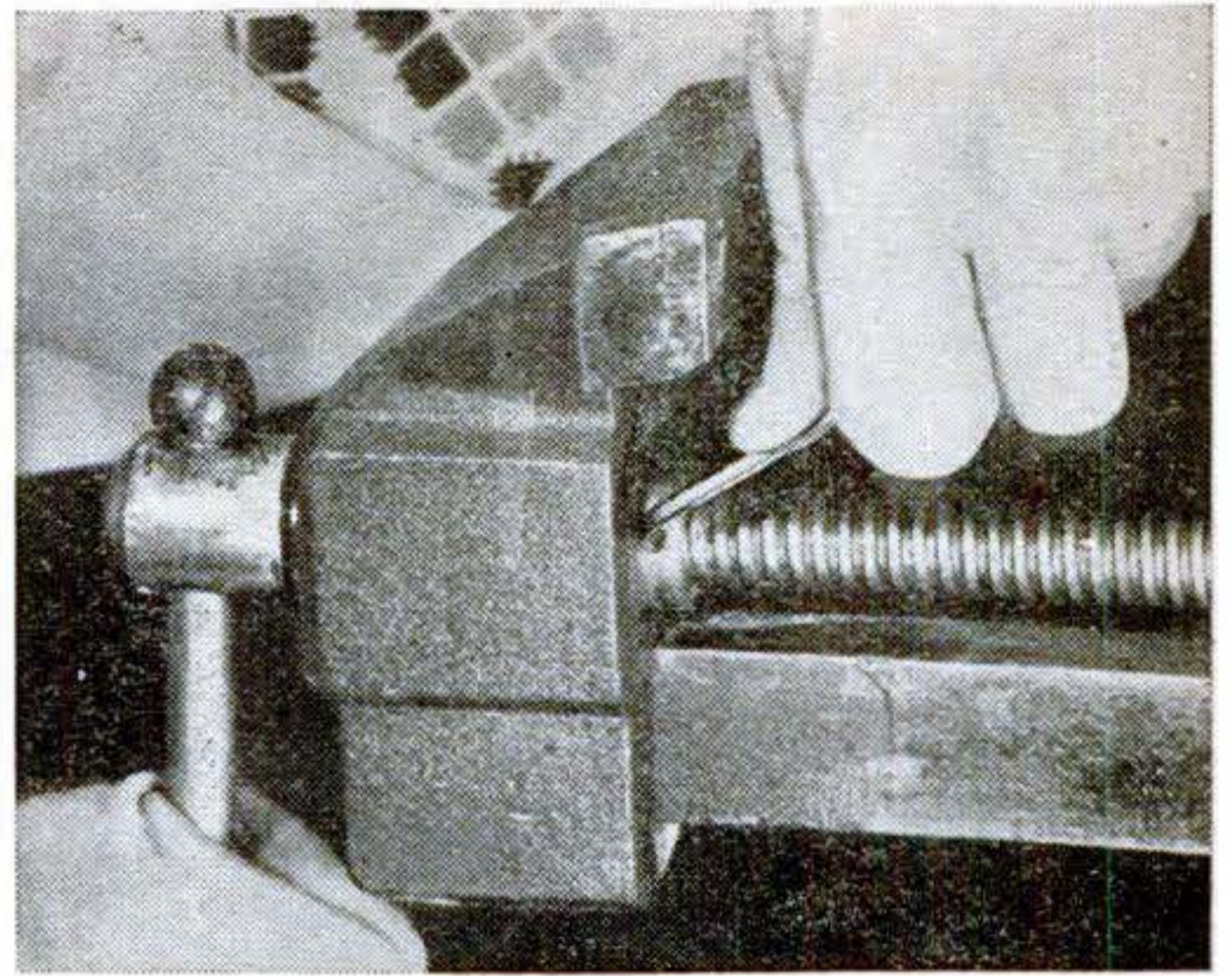

To install the bearing, remove the hand screw by releasing the retaining collar between the jaws.

Thrust Bearing Improves Vise

BECAUSE of reduced friction, a ball thrust bearing will greatly increase the grip of a vise. But even when the jaws are under maximum pressure, a slight pull on the screw handle will release them, enabling you to work with greater speed and ease.

Suitable thrust bearings, obtainable at many hardware stores, can be easily installed. Remove the screw from the vise by releasing the retaining collar between the jaws. Clean it and the rest of the vise in a kerosene bath. If the thrust shoulder on the screw is badly worn, dress it down to provide a flat, even seat for the bearing. If the thrust plate on the movable jaw is badly worn, it may have to be counterbored slightly. Slip the bearing over the screw, reassemble the vise, and wrap a piece of oil-soaked leather over the bearing, securing

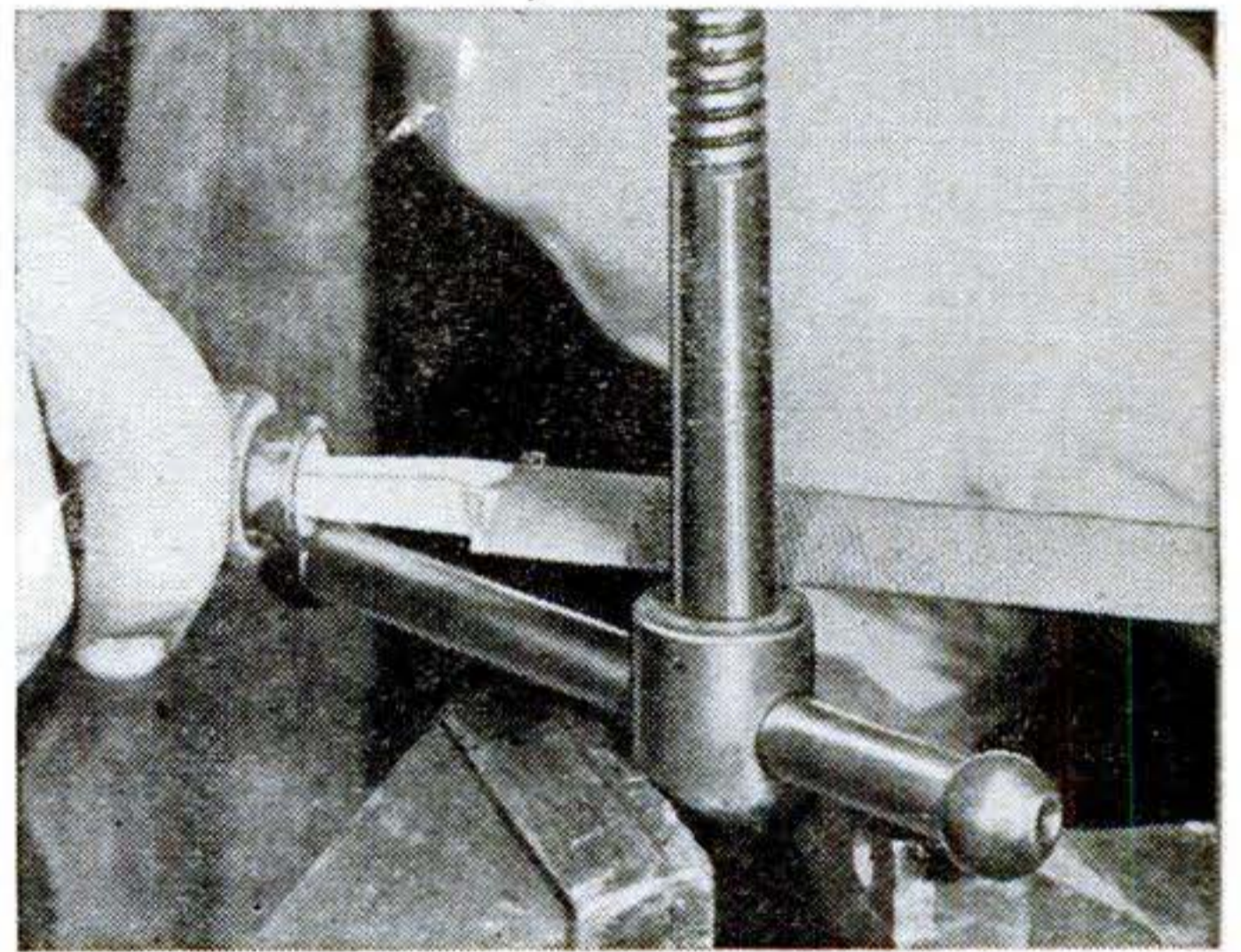

If the thrust shoulder is badly worn, file it flat to provide an even seat for the new bearing race.

it with a small coil spring stretched and then hooked together. This will keep dust and filings out of the bearing.—EVAN P. JOHNSON.

Shadowgraphs Make It Easier to Identify or Duplicate a Key

COMPLETE records of your keys in shadowgraph form may come in handy in two ways. If you want to identify a key from a miscellaneous batch, match it against the graph and you have the answer. If you need a duplicate, the information is at hand.

Arrange your keys on a sheet of blueprint or photographic paper in subdued light, lay strips of cardboard crosswise to leave white areas for labelling, expose by turning on a white light about 60" above the paper, and process as directed. When the paper is dry, label each key according to its use, and record the trade name and serial number of the key underneath.—E. CHRISTENSEN.

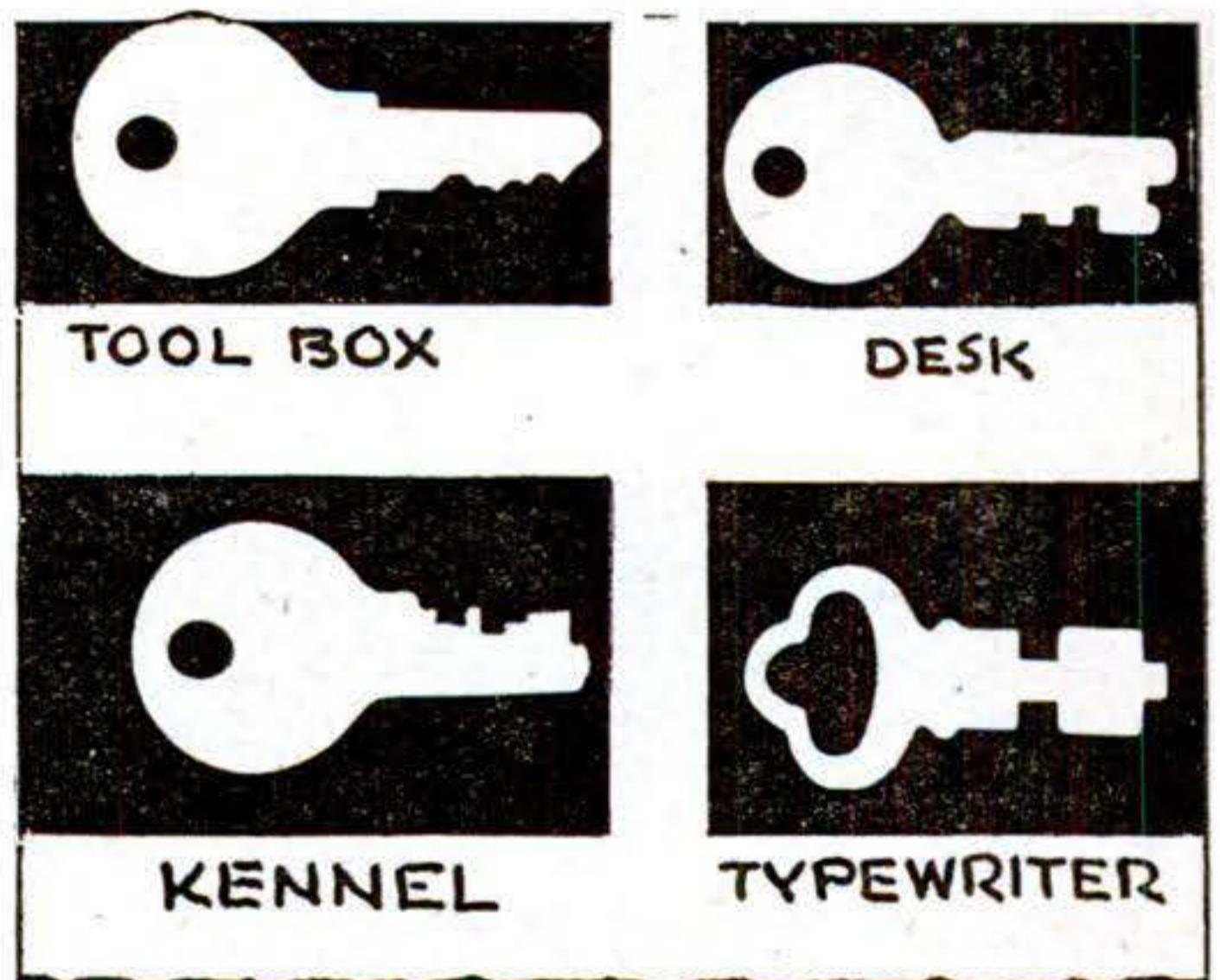

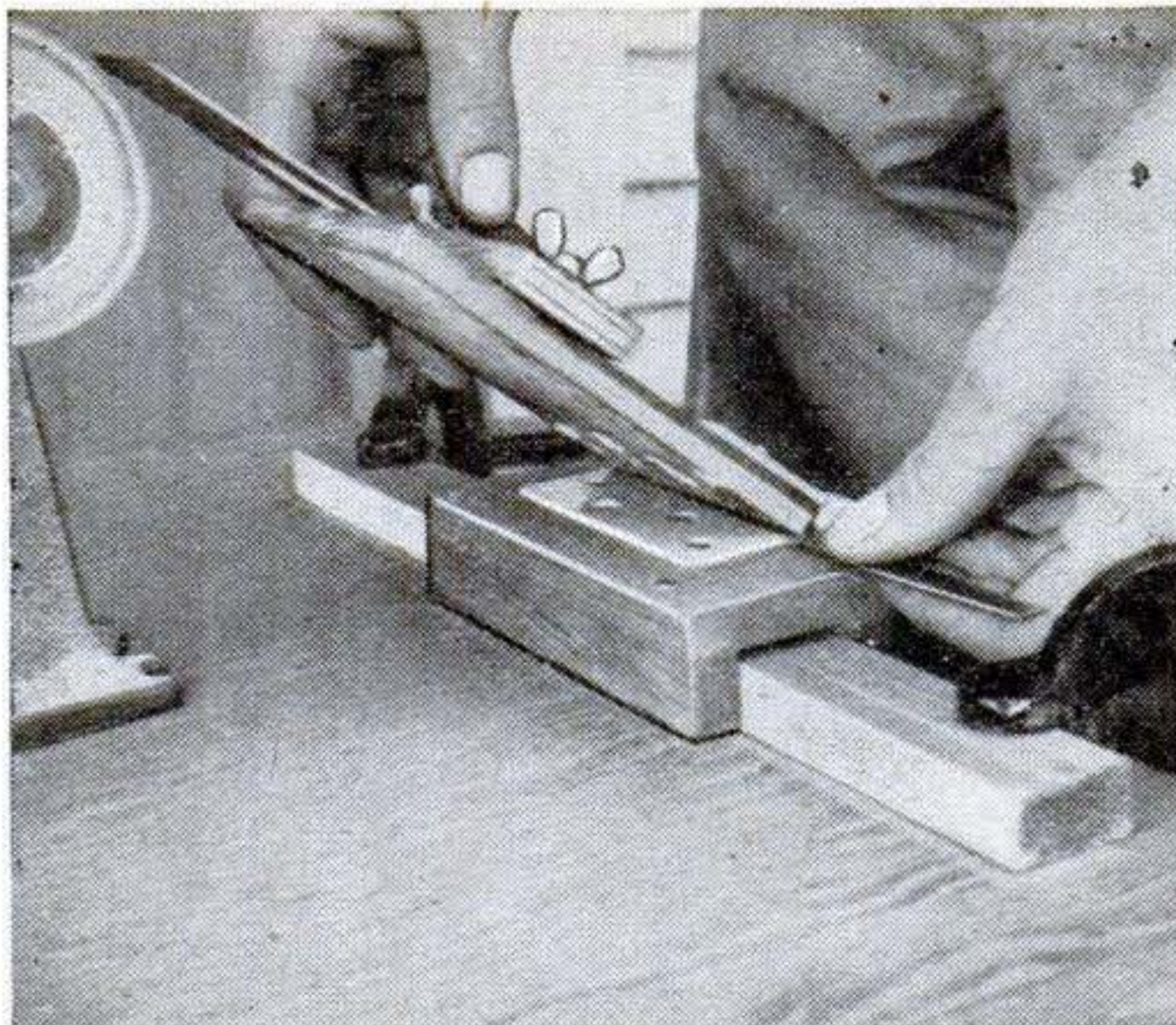
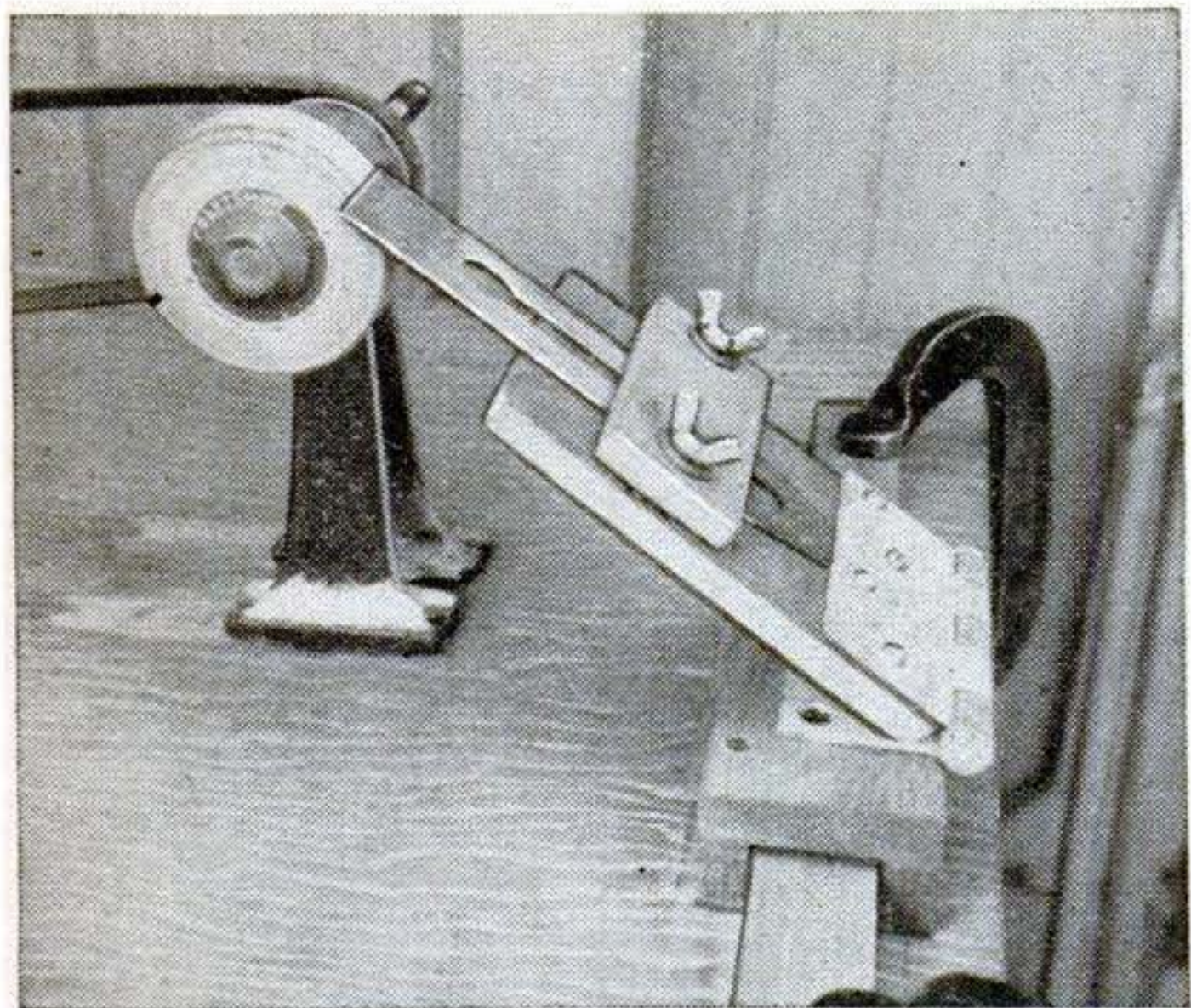

Adjustable Guide Helps Grind Perfect Edge on Cutting Tools

BUILT around a door hinge, this simple guide makes it an easy matter to grind a straight cutting edge on a plane blade, chisel, or similar tool.

Accurate transverse movement of the blade during grinding is assured by a U-

shaped channel base shifted back and forth on a guiding strip. This is clamped to the top of the workbench parallel to the grinding-wheel shaft. A shim placed in the hinge as at right above adjusts the blade at any desired angle.—GUY H. LEARNED.

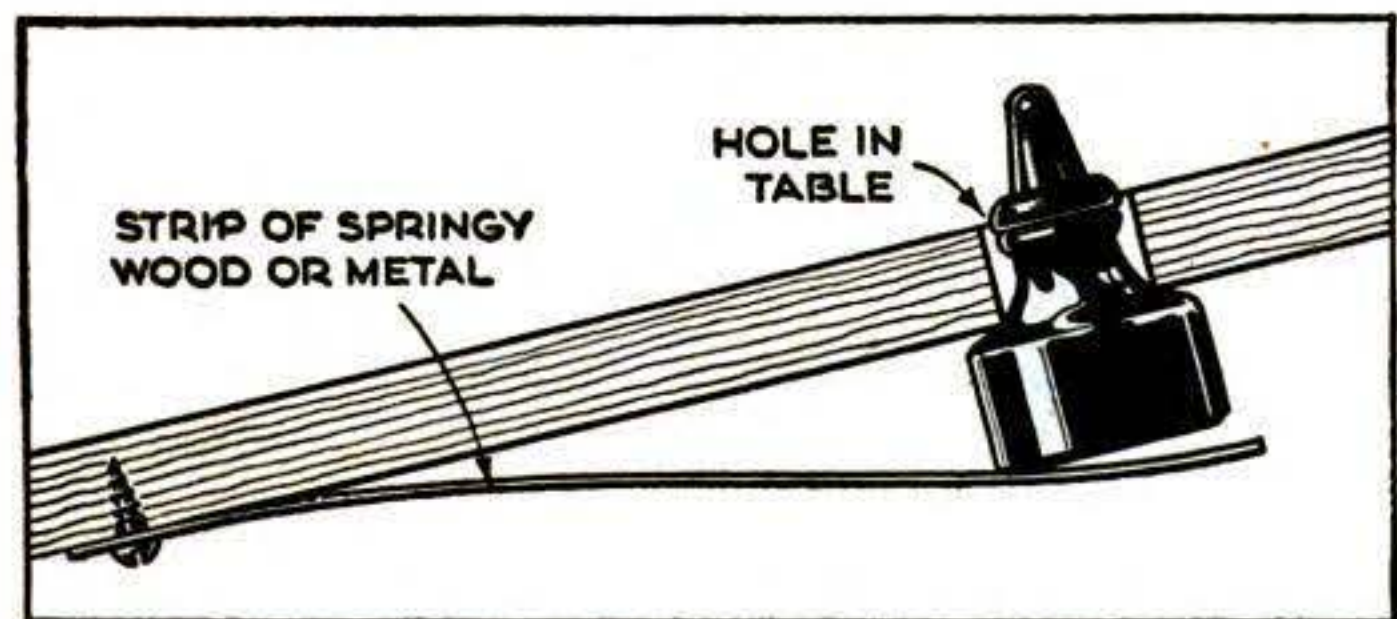

Ink Held Under Drawing Board

A BOTTLE of ink installed under a drawing board in this manner is out of the way and safe from spilling. Thrust the neck up through a hole, and support the bottle with a stiff flat spring attached under the board with one screw.—ERIC SLOANE.

TINTING INTERIOR WHITE, I [PAINTING]

Off-Whites: For warmth, add a trace of Indian red or Venetian red.

To avoid stark white on ceilings or woodwork, add a trace of raw sienna, or a trace of raw umber and lampblack.

For a cool, faint green cast, add chrome green.

Ivory: Tint with raw sienna and chrome yellow light in varying proportions, with traces of Venetian red and lampblack permissible for still further variety.

For a good light tone, use 3 parts chrome yellow light to 2 parts raw sienna and just a trace of lampblack.

Cream: Tint with raw sienna and a trace of chrome yellow light. Venetian red substituted for the yellow produces a light tan.

NOTE: Start with a flat wall or interior semigloss or gloss white of the quantity needed for the job, and stir it thoroughly. Then mix small amounts of each oil color with a little turpentine to fluid consistency. Add oil colors, a little at a time, to the white, stirring thoroughly after each addition. Be wary of using too much color; tones are easily darkened, but they cannot be made lighter without waste.

POPULAR SCIENCE MONTHLY SHOP DATA

Small Immersion Heater Warms Solutions

OFTEN it is difficult to maintain photographic solutions at the proper temperature, and yet the right temperature is important for good print quality, particularly in home-processed color work. This pencil-type immersion heater will warm a solution, either in a tank or bottle, at the rate of one degree per minute per quart. You also can use it for heating water to dissolve chemicals.

Remove the plug from the cord of a 60-watt soldering iron, unscrew the tip of the iron, and pull out the element and cord. It is best to remove the plug, for the cord and resistance element are sometimes connected with clips that are difficult to rejoin. Then drill one end of a 12" length of $\frac{1}{4}$ " ($\frac{9}{16}$ " o.d.) brass pipe to $\frac{7}{16}$ " diameter for a depth of 4" to accommodate the heating coil. Also tap this end with a $\frac{1}{4}$ " pipe tap.

Insert the resistance element into the pipe and seal the end with a $\frac{1}{4}$ " pipe plug and white lead or sealing compound. Test the watertightness of the plug by immersing this end in water for several hours. A clip is made by riveting a U-shaped hook to a $\frac{3}{8}$ " piece of $\frac{1}{4}$ " pipe that has been cut and opened to fit over the longer pipe. A $3\frac{1}{2}$ "

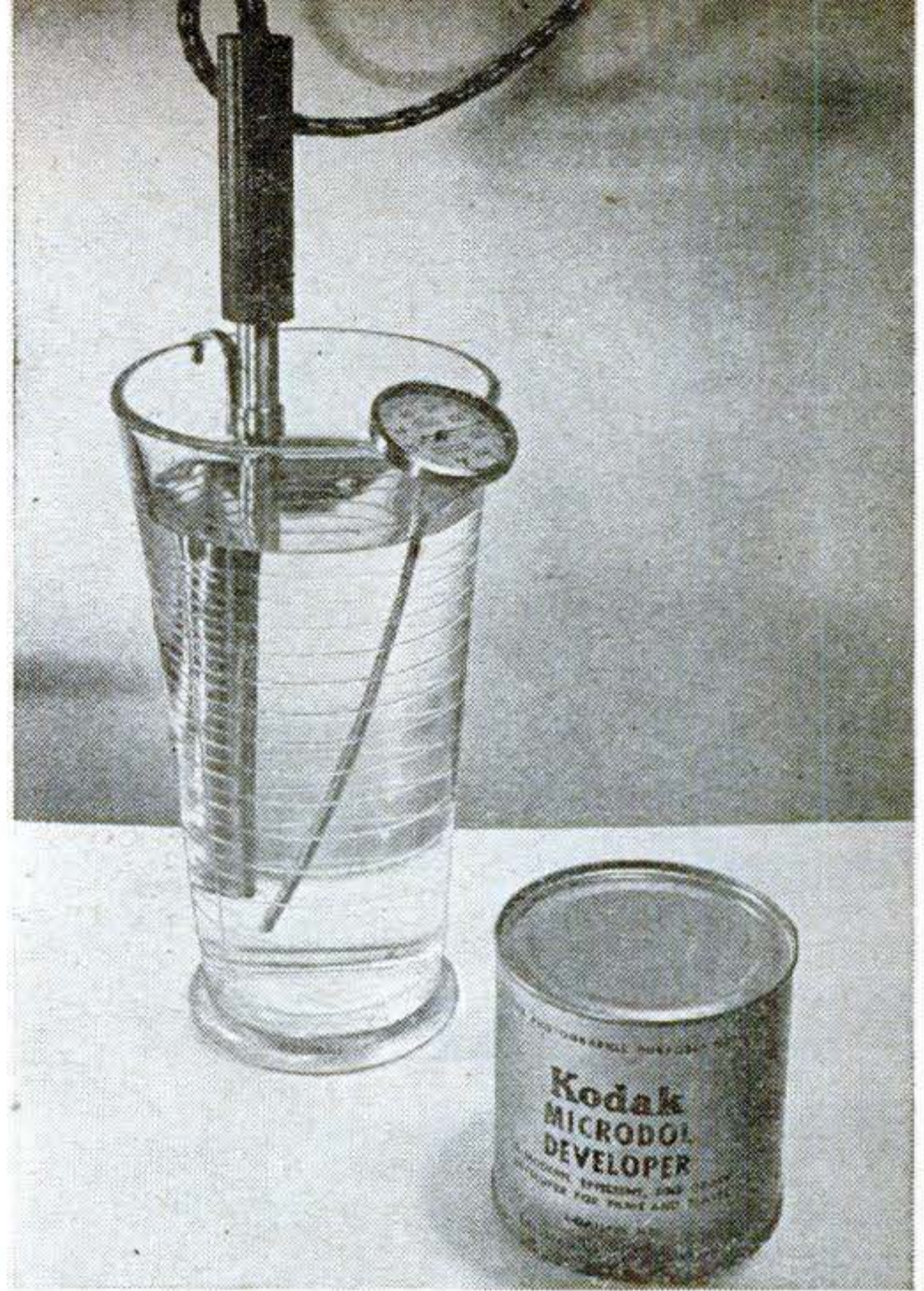

Built around the heating element from a soldering iron, this immersion heater quickly raises a photo solution to the temperature needed for good work.

piece of ribbed garden hose provides an insulated handle.

Immerse the heater before plugging it in. This will lessen the possibility of breaking the fireclay in which the resistance wire is embedded. If the unit is first used in some old film hypo, the brass will acquire a coating of silver.—FRANK McCARTY.

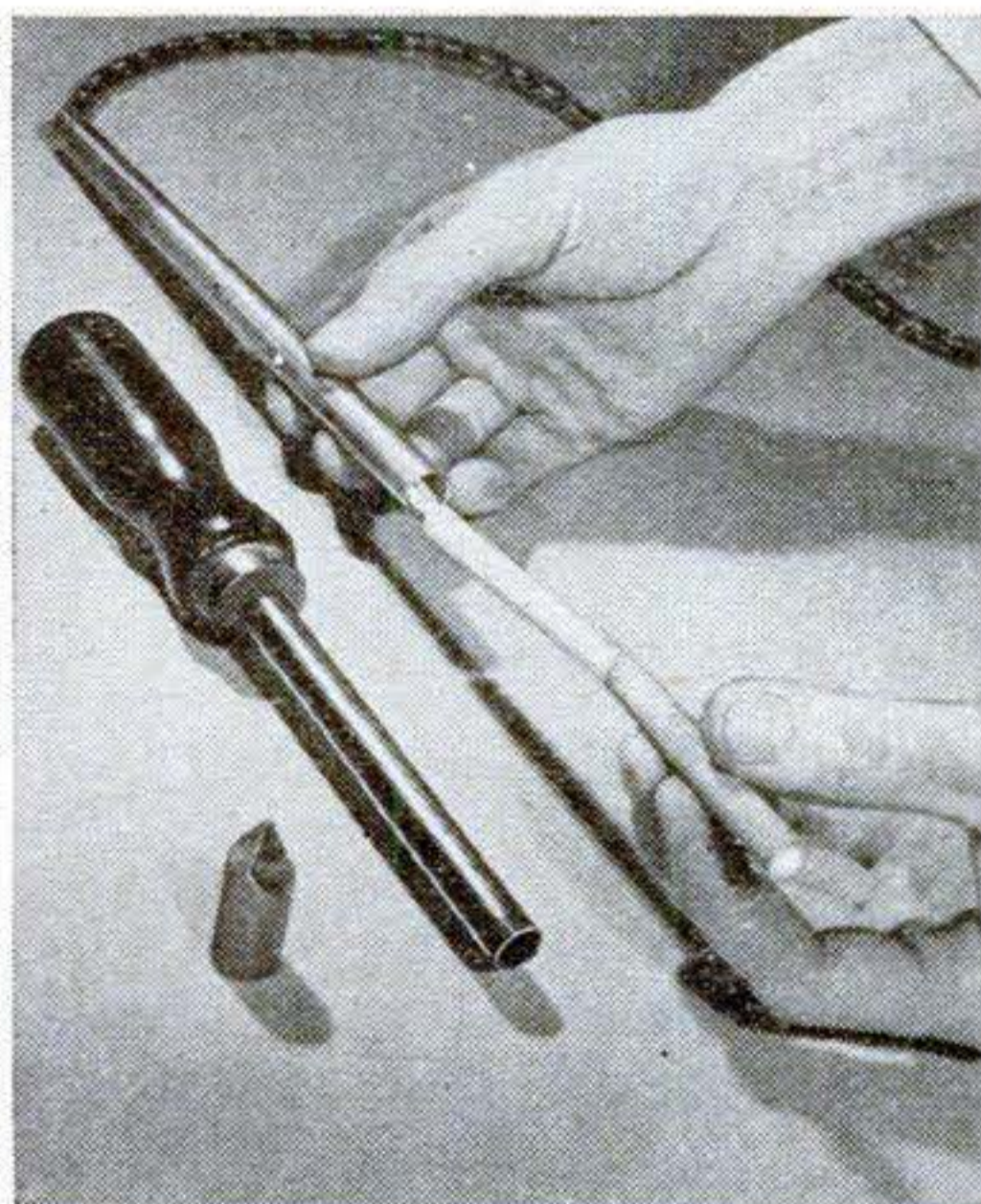

After enlarging the inside diameter of a 12" length of $\frac{1}{4}$ " brass pipe for 4" at one end, insert the resistance element from a 60-watt soldering iron.

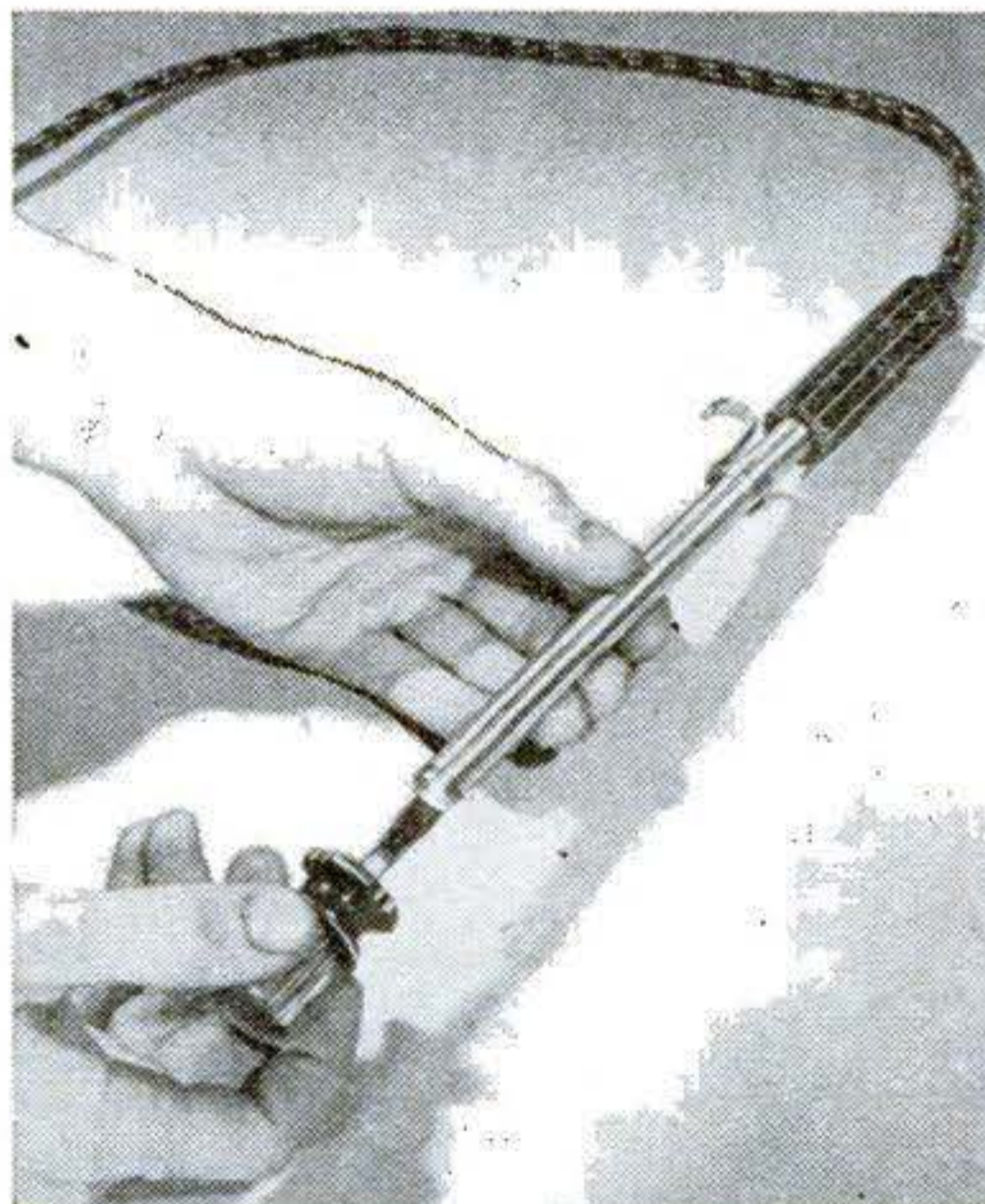

Tap this end of the pipe, and seal with a $\frac{1}{4}$ " pipe plug and white lead to keep it watertight. Garden hose on the end makes an insulated handle.

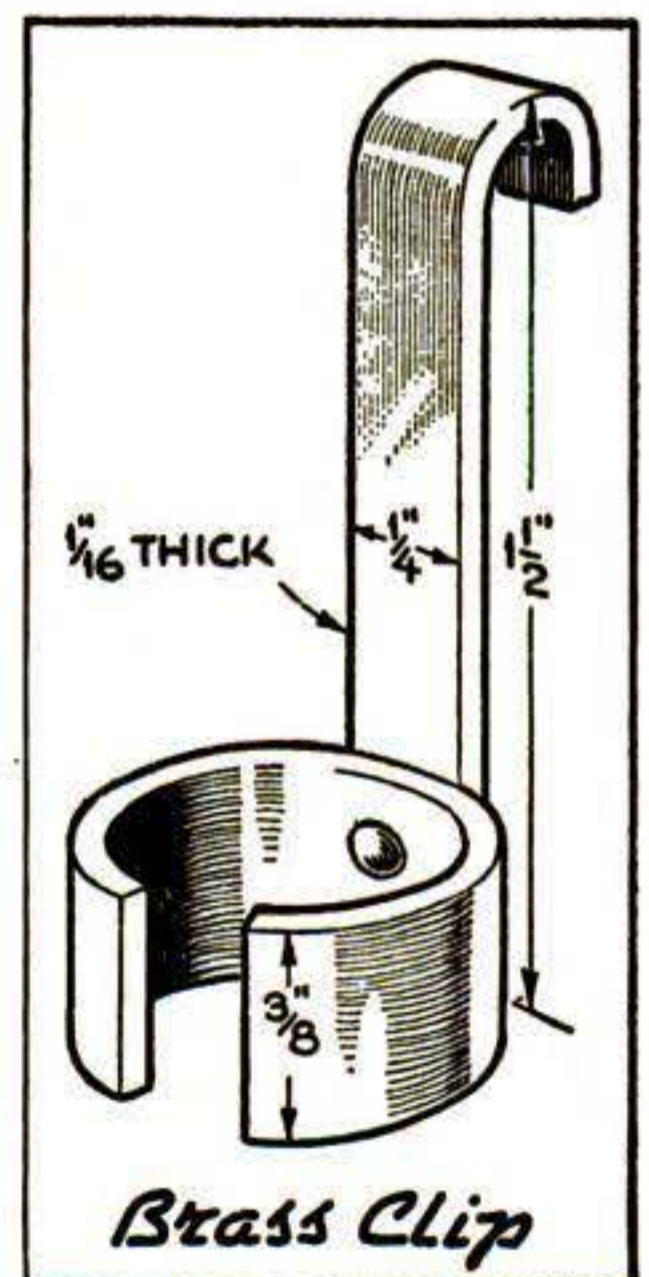

For the clip, cut and spread apart a piece of $\frac{1}{4}$ " pipe. Rivet this to the hook.

PHOTO IDEAS and EQUIPMENT

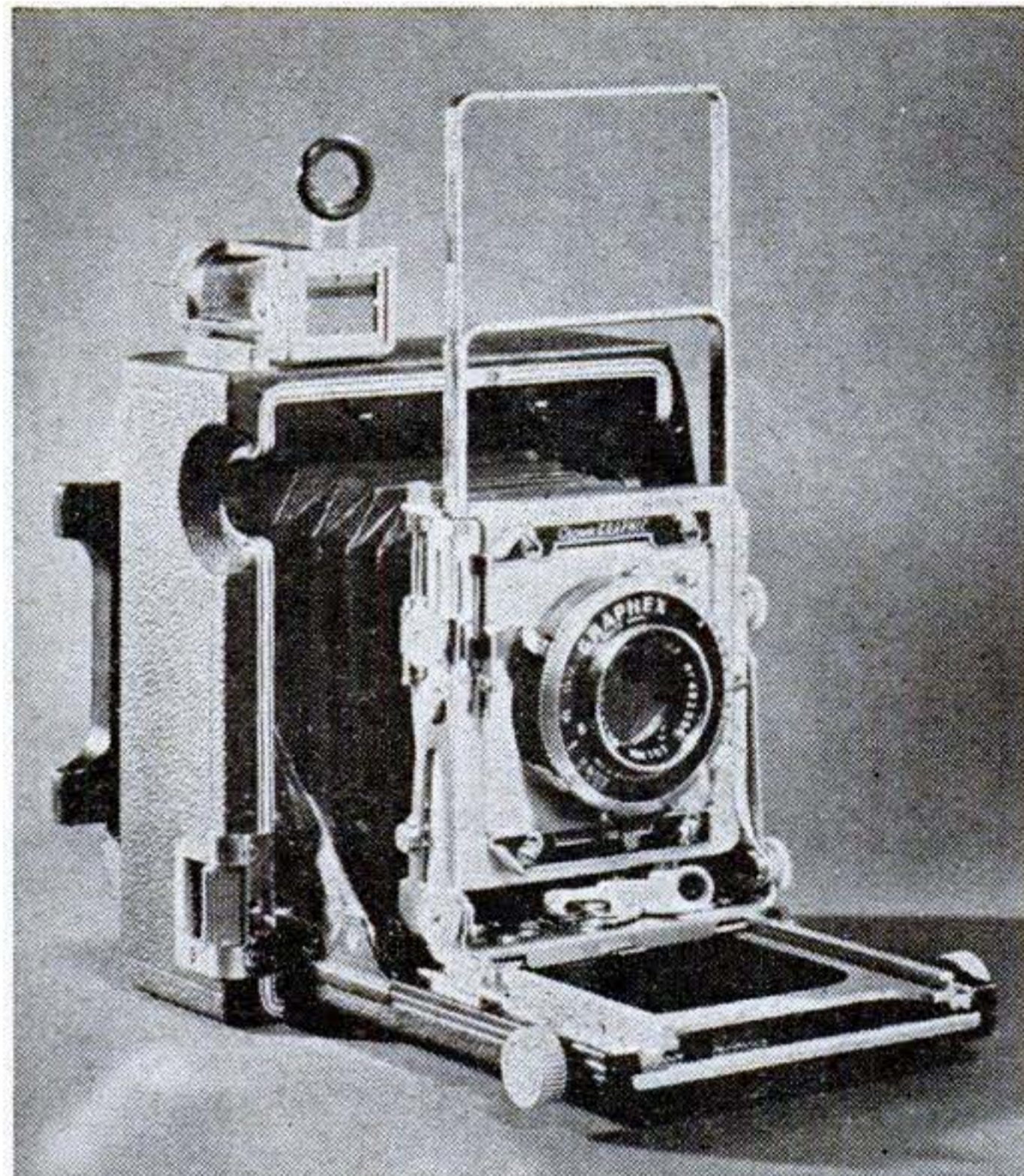
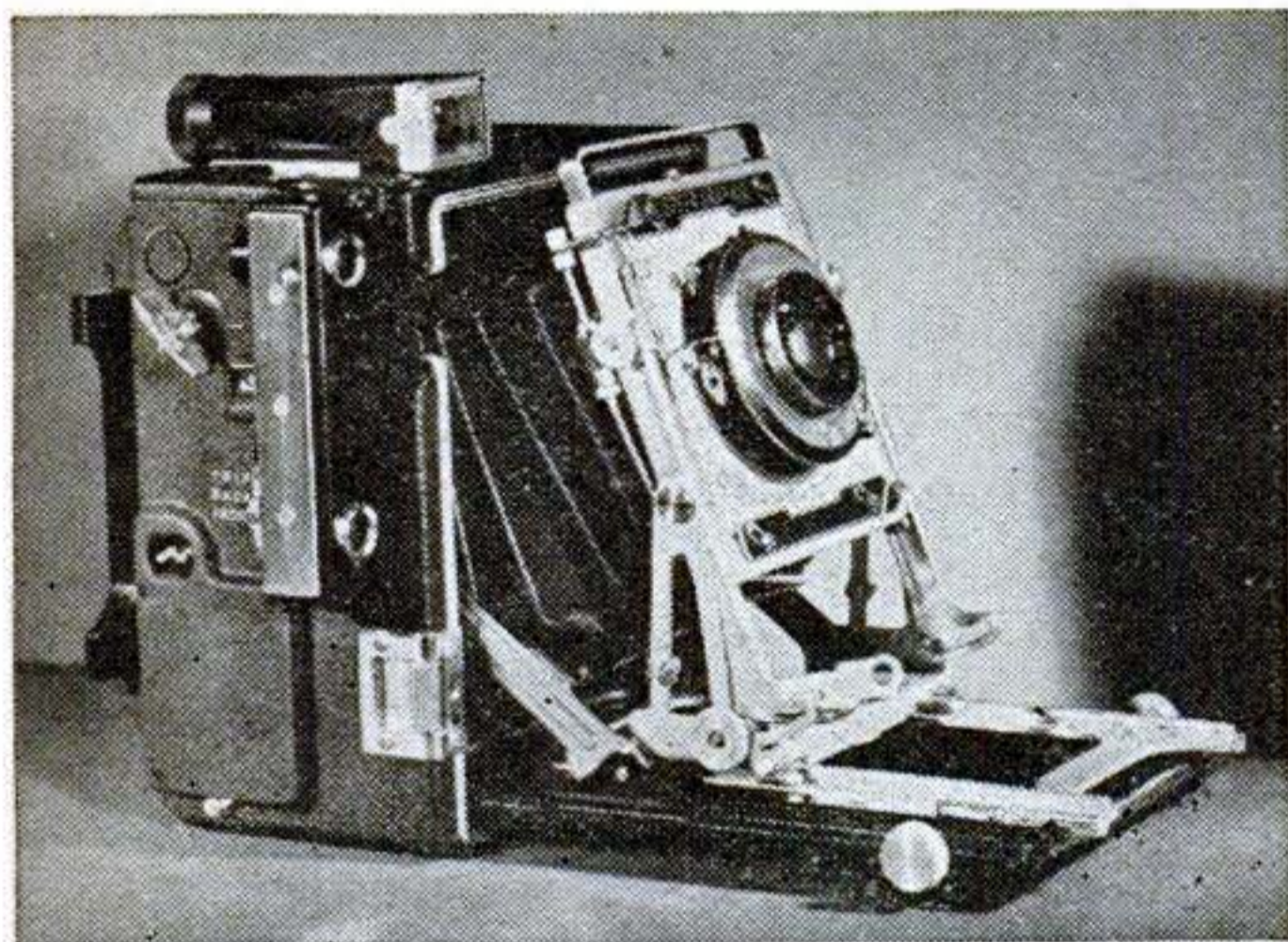
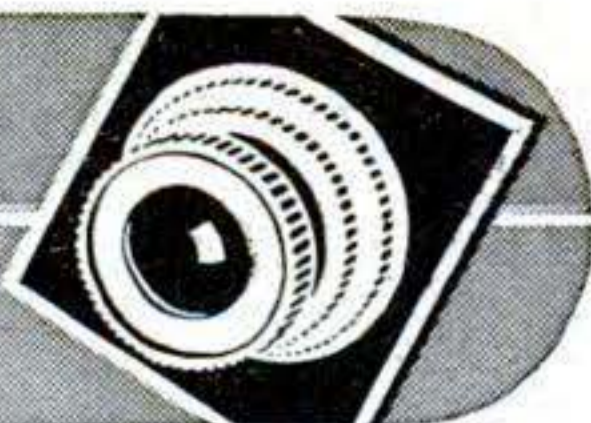

NEW GRAFLEX CAMERAS. A completely redesigned Speed Graphic and a new Crown Graphic have been announced. Each is being made in the three popular film sizes— $2\frac{1}{4}$ " by $3\frac{1}{4}$ ", $3\frac{1}{4}$ " by $4\frac{1}{4}$ ", and 4" by 5"—and both are grouped in what is to be known as the Pacemaker series. The Speed Graphic has an entirely new governor-controlled focal-plane shutter set with a one-

key selector instead of two keys as in the past. A body release trips either the front or back shutter; a new front provides tilt, rise, and lateral lens adjustment; and an open-frame finder can be corrected for parallax. The Crown Graphic has all the Speed Graphic improvements with the exception of the focal-plane shutter. There will be about a \$30 price difference between them.



AUTOMATIC CONTACT PRINTING. Exposures are measured accurately with a built-in flashing timer in the Abbey Flash Printer, a small, 22-oz. device that gives post-card size prints. With a No. 3 or No. 4 paper, the printer can be used in a normally lighted room without fogging. Abbey Photo Corp., of New York, lists it at under \$9.

INDIVIDUAL PORTFOLIOS. To keep unmounted prints in good condition, and those of one subject or related subjects together, folders big enough for 11" by 14" enlargements can be made cheaply of corrugated board. Tape two sheets together on one edge. A print pasted on the cover both decorates and identifies a folder.—ROBERT J. METZ.

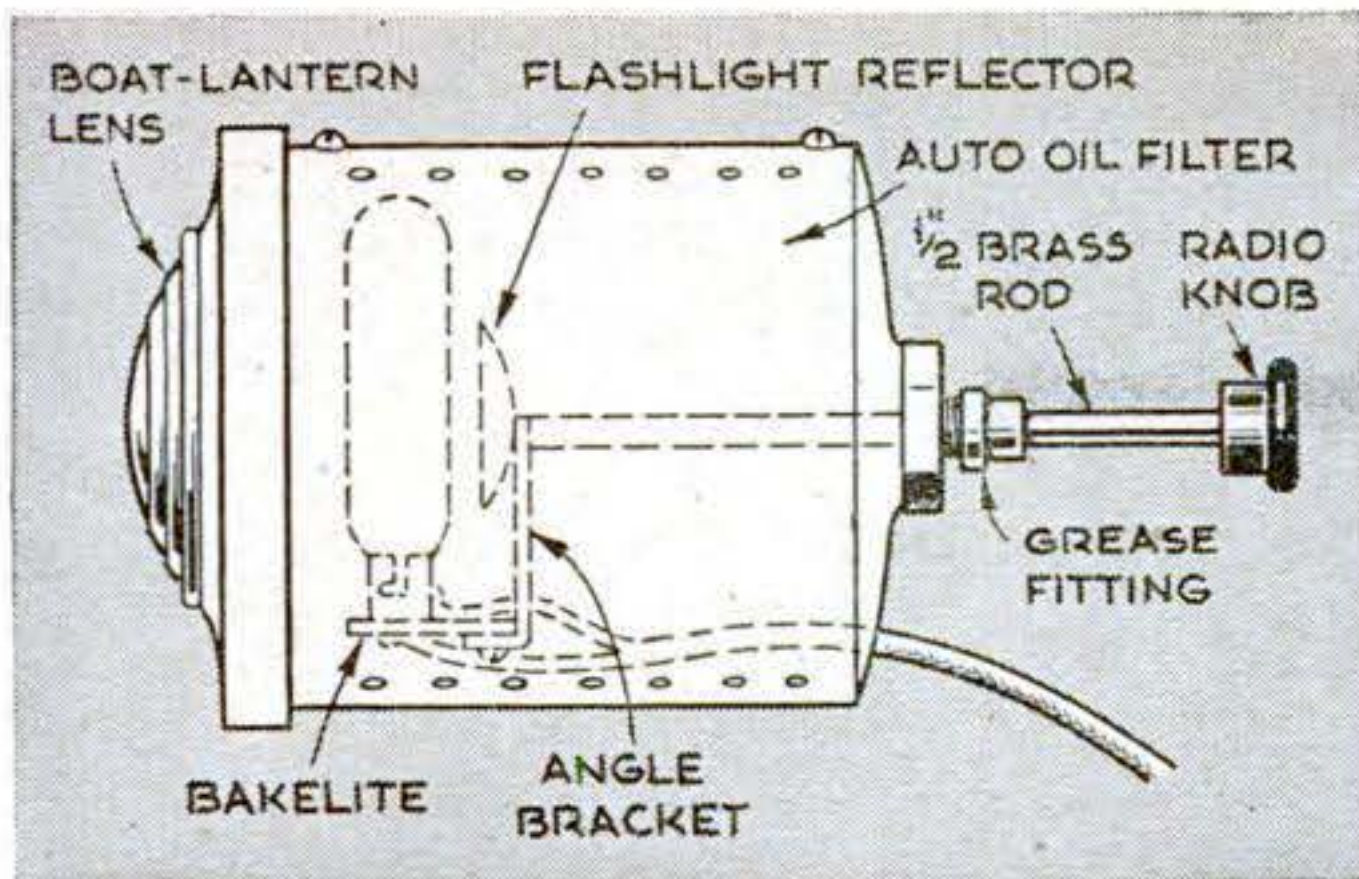

HOMEMADE ADJUSTABLE SPOT. All parts of this spotlight came from the shop junk box except the lens, which was from a boat signal lamp. The housing is an auto oil-filter case with a threaded cap, in which a hole was cut for the lens. A grease fitting was drilled out as a sleeve for the rod that carries the lamp assembly. Moving this varies the beam from a small spot to a fair-sized flood. Rows of $\frac{1}{8}$ " holes at top and bottom, fitted with baffles, provide sufficient ventilation.—FLOYD E. FREEMAN.

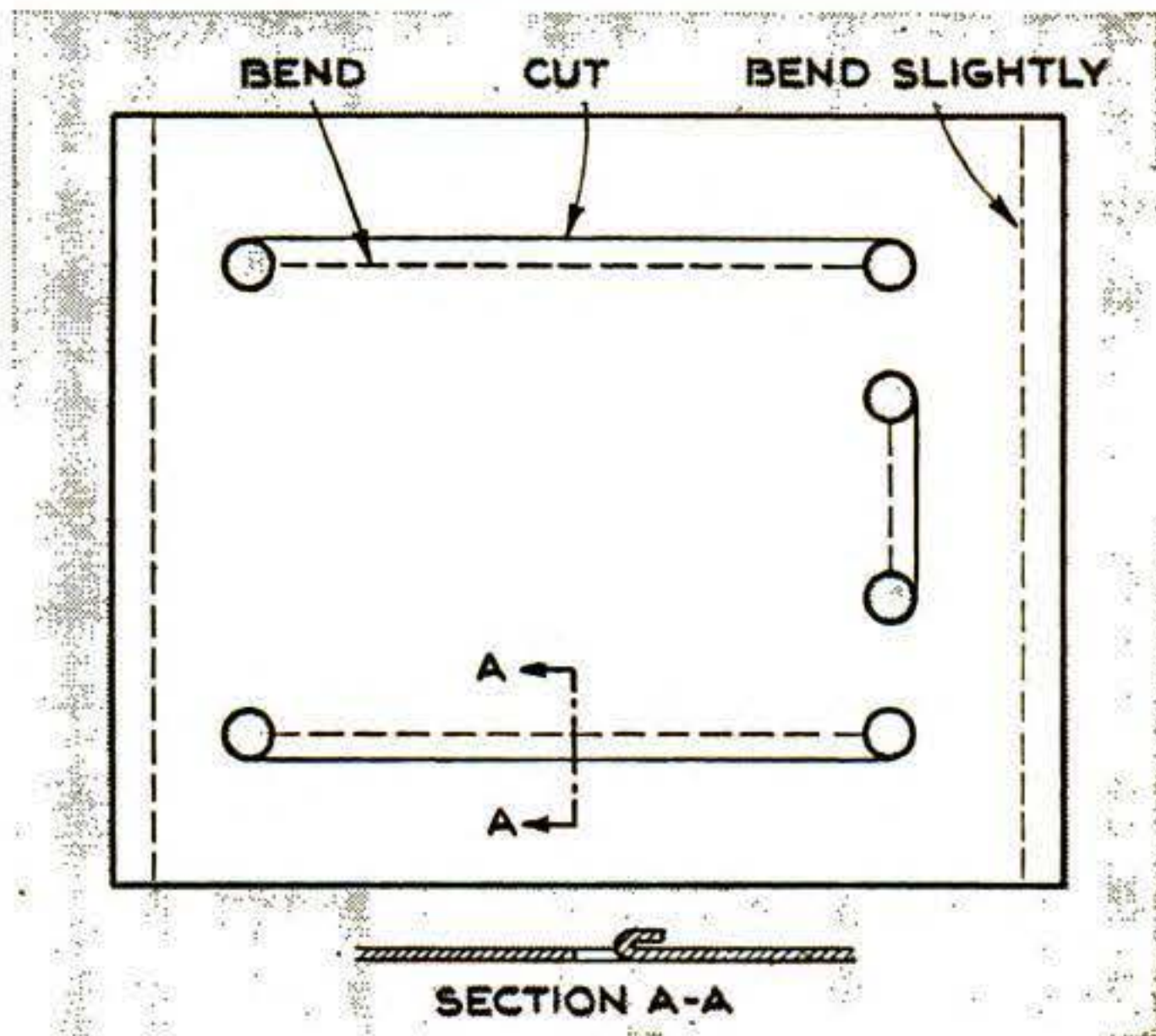
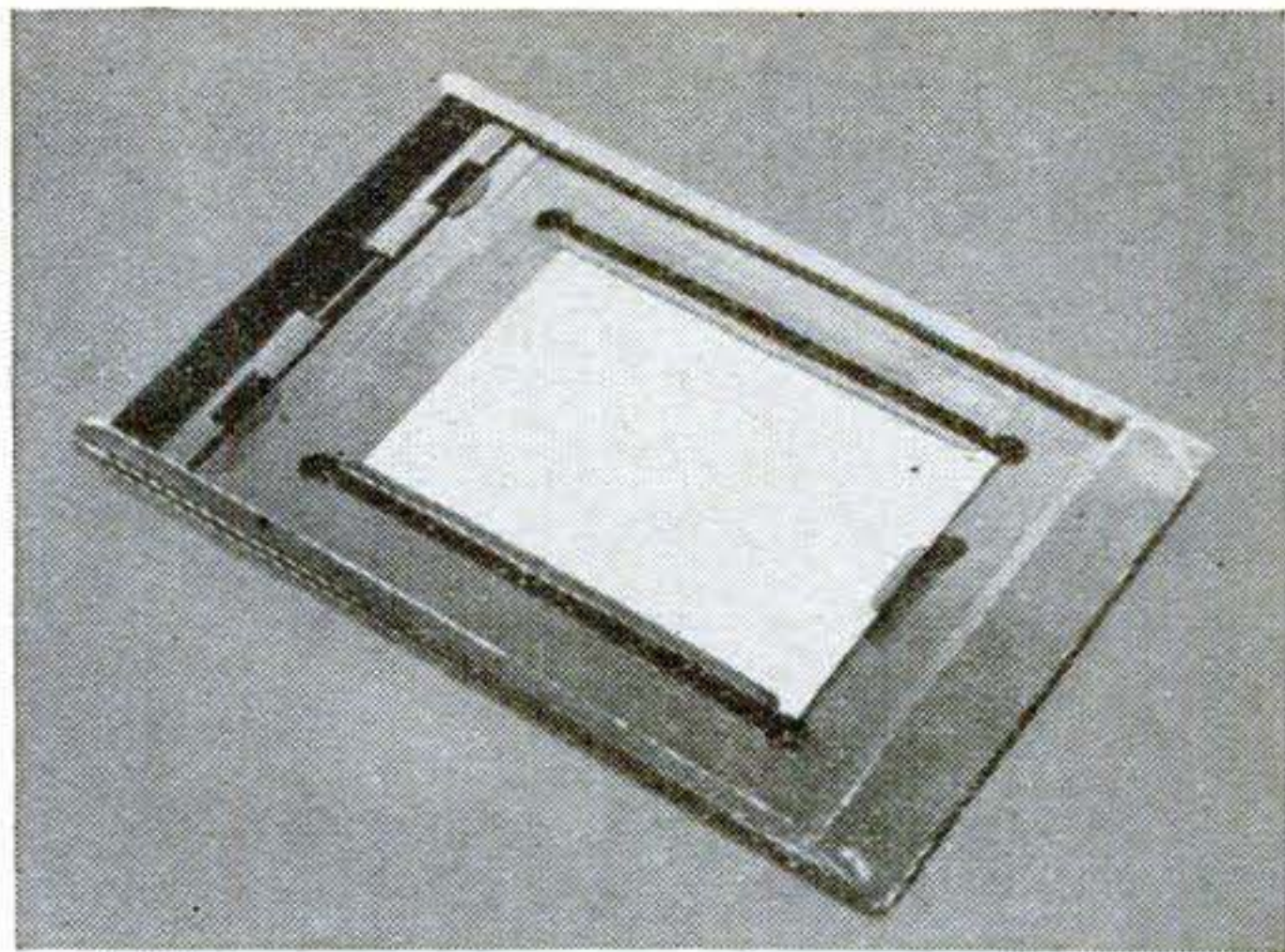

HOLDER FOR UNDERSIZE FILM. You can use cut film smaller than your holders with a sheath made from $\frac{1}{64}$ " sheet brass or tin plate. Drill where the corners of the film will come, saw between the holes with a jeweler's saw, and fold toward the center over a spacer somewhat thicker than the film. A shorter slot is similarly formed at one end. Paint the metal dull black, and use the sheath as an insert in your regular film holder.—KARL HALLER.

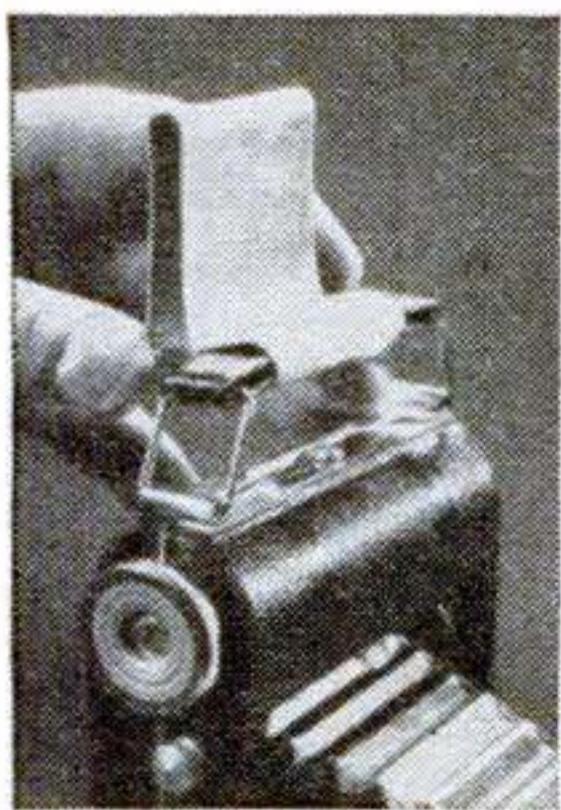

CAMERA BELT HOOK.

When a small camera not equipped with a carrying case is taken on a hike, a hook attaching it to your belt will leave both hands free. The hook can be bent from stiff sheet metal. One end is shaped to slip over the belt, while the other is bent tightly around the handle grip. When not needed, the hook can be taken off the handle with a pair of pliers.

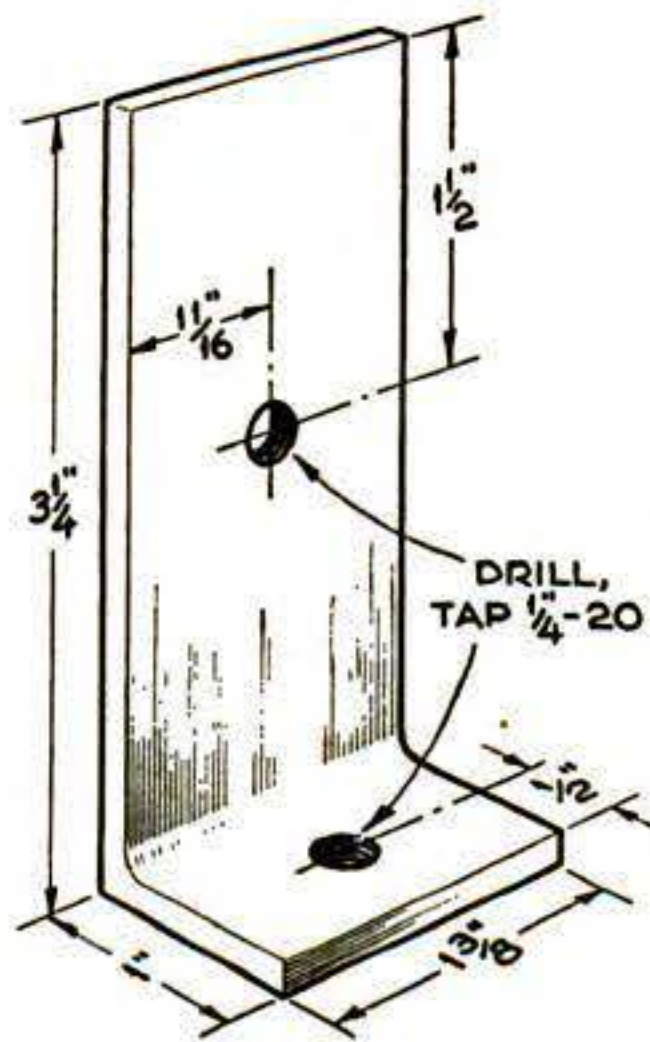
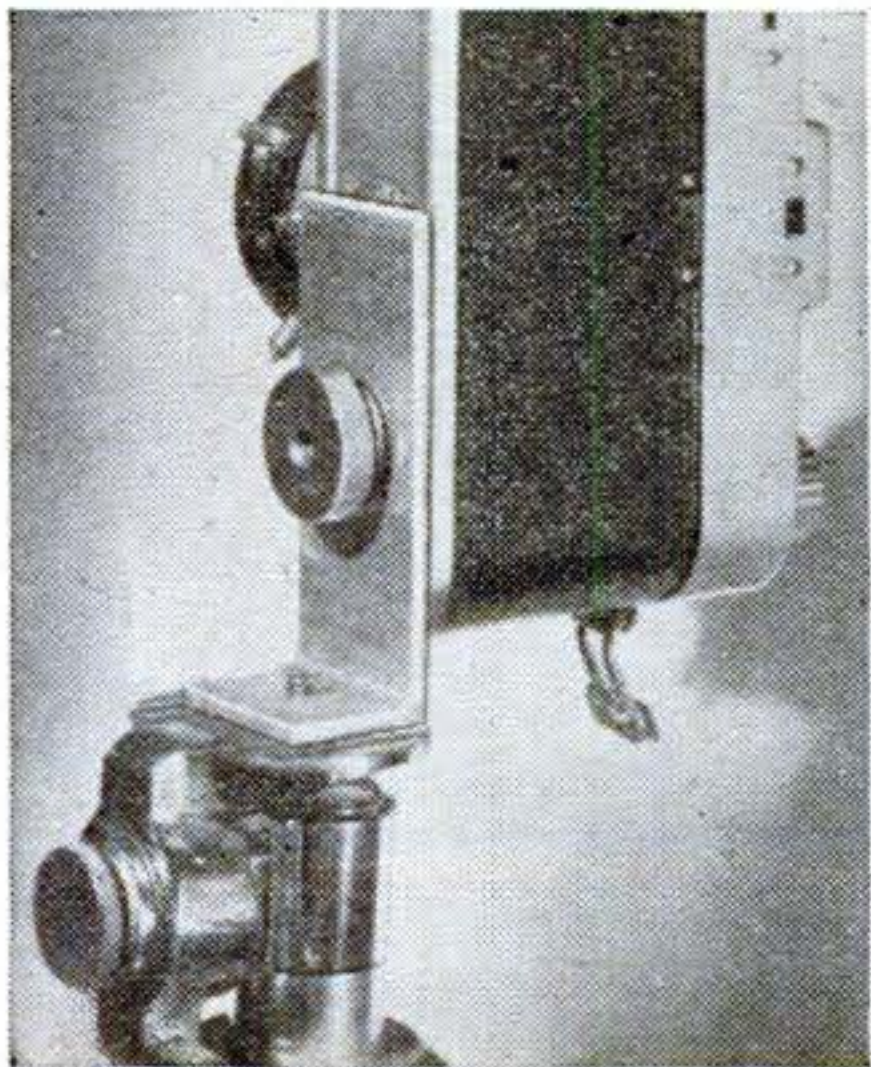

TRIPOD ADAPTER. Because miniature cameras usually have only one tripod-screw socket, many pictures that call for vertical framing have to be taken with the camera supported for horizontal framing. An adapter can be made from aluminum, brass, or steel angle to support the camera vertically. Drill and tap both legs for a standard $\frac{1}{4}$ "-20 camera thread. Screw the short leg to the tripod and attach the camera to the other leg with the knurled-head bolt that is used for fastening it in place in the carrying case.—GEORGE FROST.

Vagabond

By Leslie Sargent

PORTABILITY is a feature seldom associated with an enlarger, but that is the biggest asset of this one. Designed particularly for the kitchen-table darkroom, it can be quickly assembled and put into use anywhere—clamped to a door, the back of a chair, or a window sash. Moreover, if you are going on a trip, the entire enlarger may be taken along, the clamping arm, bellows assembly, and a tube or two of developer and paper packed into the lamp house. The whole kit, weighing only 7 lb., goes in a suitcase with your camera, pajamas, and extra shirt. The enlarger handles any negative up to and including $2\frac{1}{4}$ " by $3\frac{1}{4}$ ".

Measuring 4" by 6" by 10", the lamp house was built from one of the stamped aluminum cases used for overseas shipments, its lid being held on by machine screws. A sturdy cashbox or tackle box would also do, or a suitable case could be

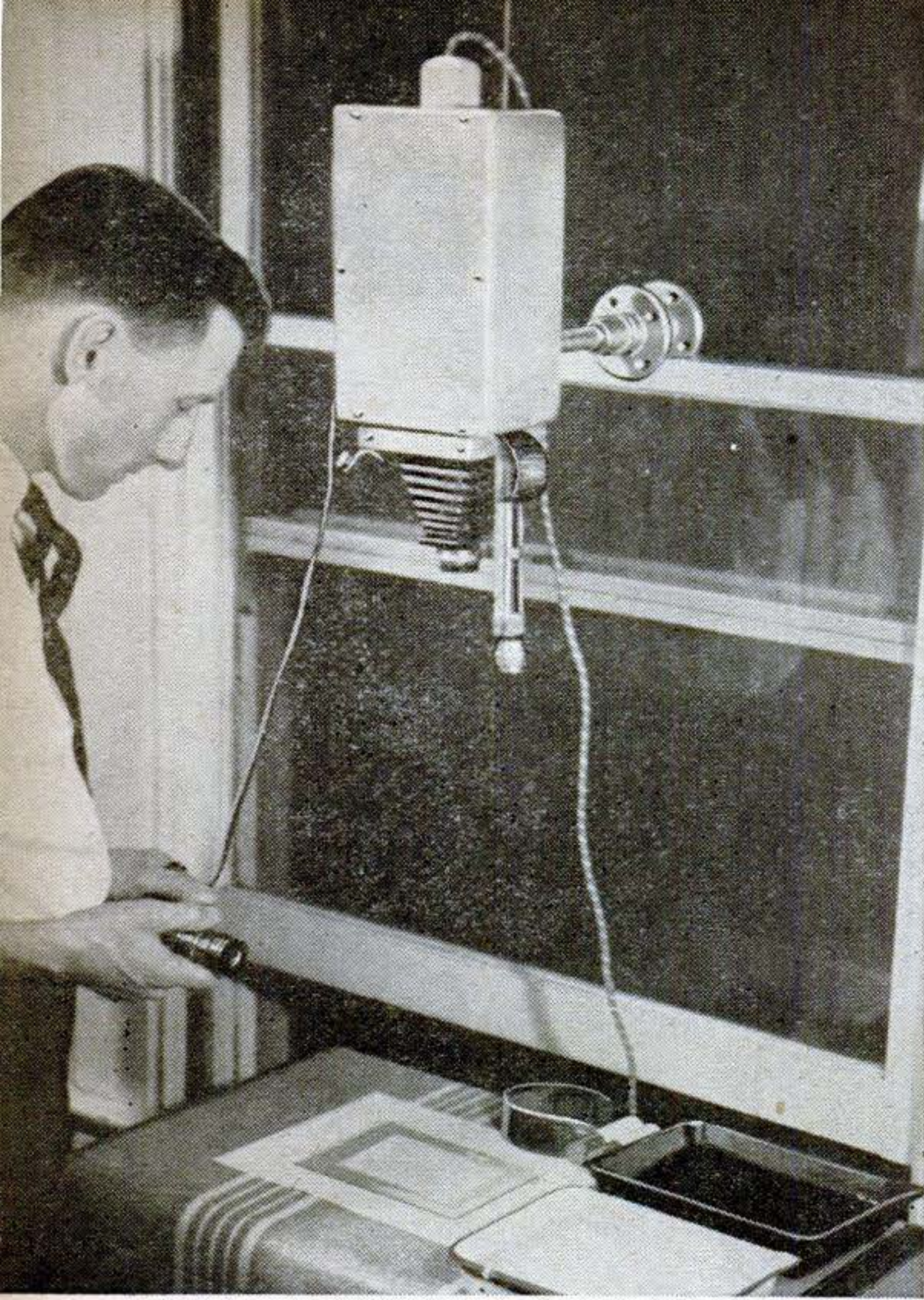

CLAMP THE ENLARGER ANYWHERE. Attached to a window sash, it is adjusted quickly for height.

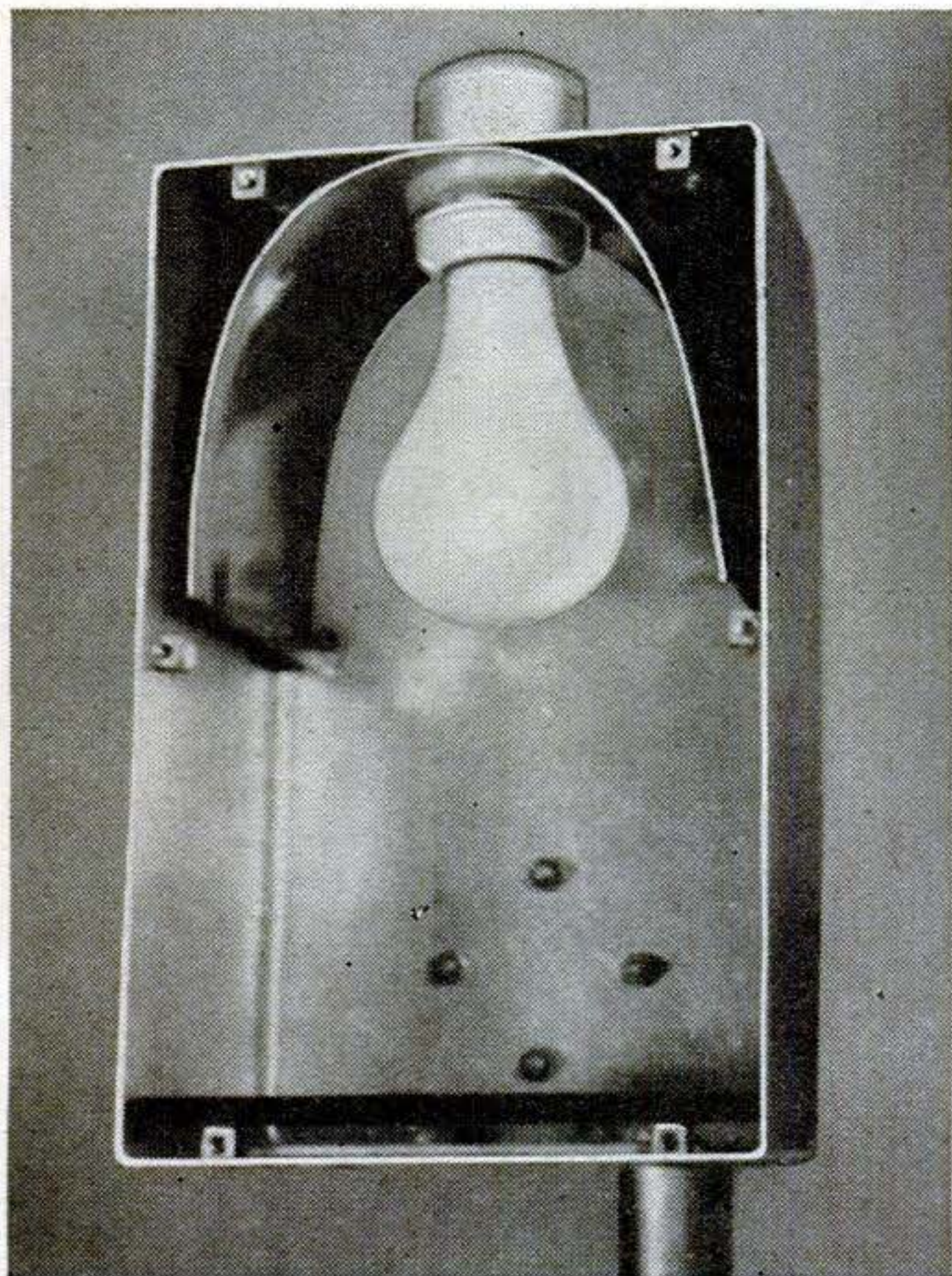

REFLECTOR IS ALSO BAFFLE. Heat escapes past the ends of the reflector to holes in the top. Heat-absorbing glass protects the negatives.

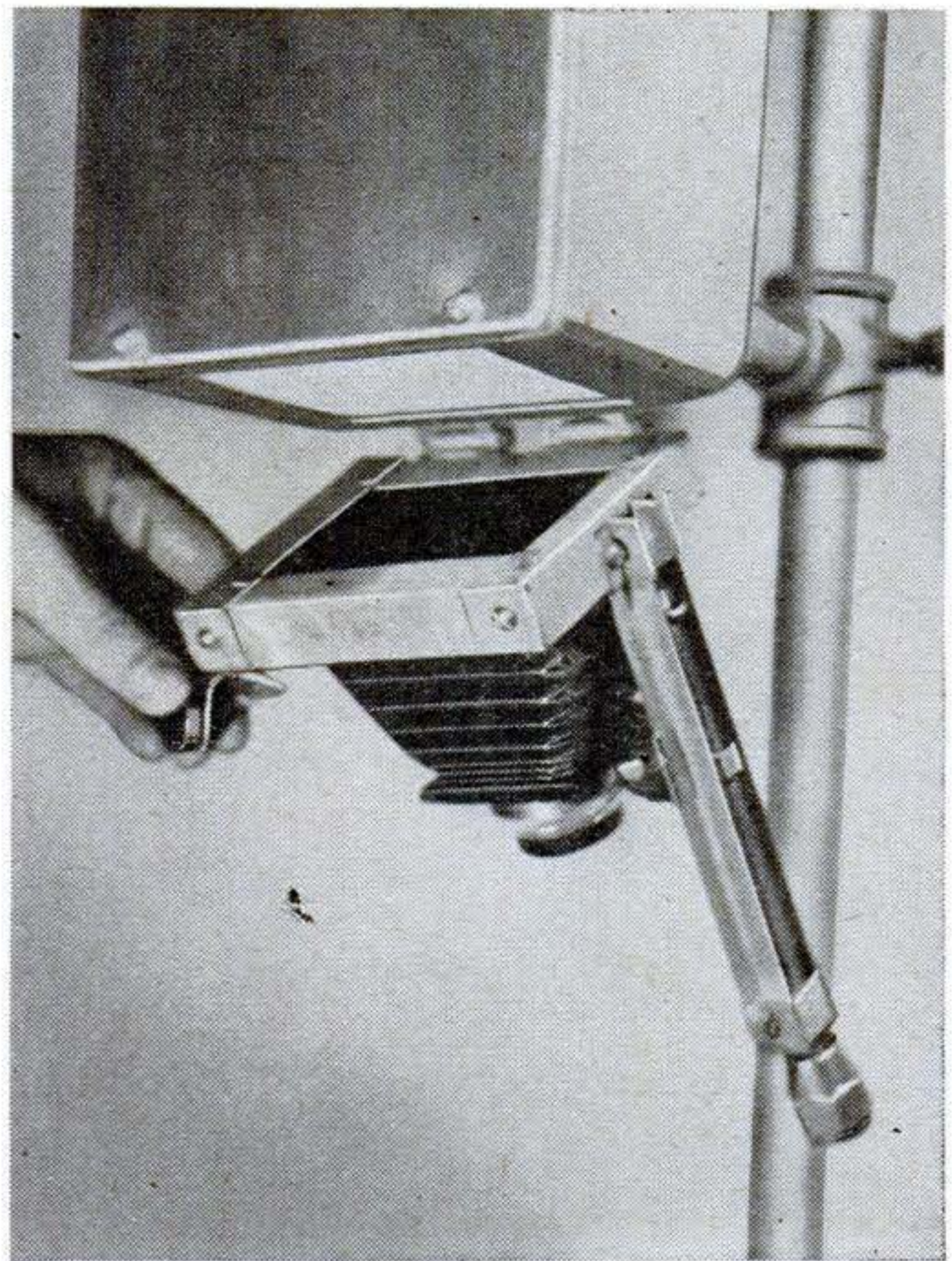

HINGED BELLOWS ASSEMBLY. Negatives are put in place by swinging the frame down, the assembly normally being held up by two spring hinges.

Enlarger Travels with You

built of sheet aluminum and angle stock.

In one end of the box, cut a hole just large enough for a weatherproof porcelain lamp socket. In the same end, drill several small holes for heat vents. A two-part socket with the halves screwed together from opposite sides of the hole helps hold in place a brightly tinned metal reflector sheet. Make this reflector as wide as the box is deep and about 11" long, inserting it as an inverted "U." If it is cut from a tin can, leave the bead on the front edge as a protection for your hands. Cut at least two tabs on the back for fastening to the case with small bolts. The reflector also doubles as a light trap, its ends being positioned $\frac{3}{4}$ " from the sides of the box to allow heat to rise and escape through the vents. Place a switch in the wire at some distance from the socket to avoid the possibility of jarring.

In the other end of the case cut a $2\frac{1}{2}$ " by $3\frac{1}{2}$ " hole and cover it (inside the box) with a piece of opal glass, taping the edges to pre-

vent chipping and to give a snug fit. Above the opal glass, leaving a $\frac{1}{2}$ " air space between, place a piece of heat-absorbing glass, resting it on small bolts installed in the sides of the box.

A rectangular frame to provide a rigid foundation for the bellows assembly may be made of $\frac{3}{4}$ " by $\frac{3}{4}$ " dural angle, cut and fitted to leave a negative opening of $2\frac{1}{4}$ " by $3\frac{1}{4}$ ". Attach the bellows to the frame with flat-head bolts, countersinking them into the top to keep the surface smooth for the negative carrier.

At its large end the bellows must be somewhat larger than the negative opening. It should open up to at least a 5" length. If a suitable bellows is not available from a discarded camera, a camera-supply house, or a dealer in secondhand photographic equipment, one can be made from real or artificial leather, formed in the shape of a rectangular-base truncated pyramid. Crease the sides into pleats so it can be folded in, and

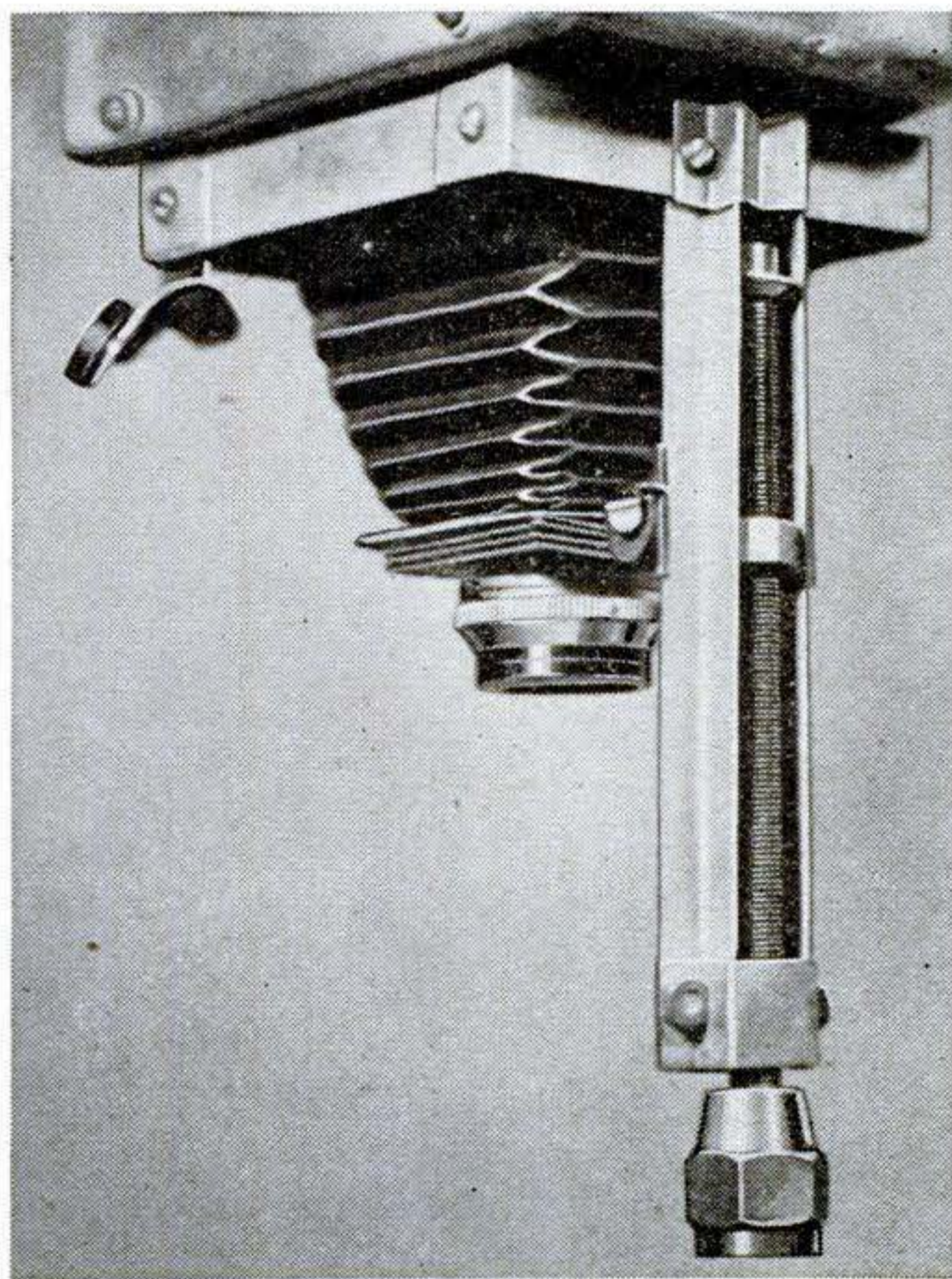

FOCUSING SCREW IS 6" LONG. This bolt, run through a nut brazed to the lens-board slide, raises or lowers the lens for focusing.

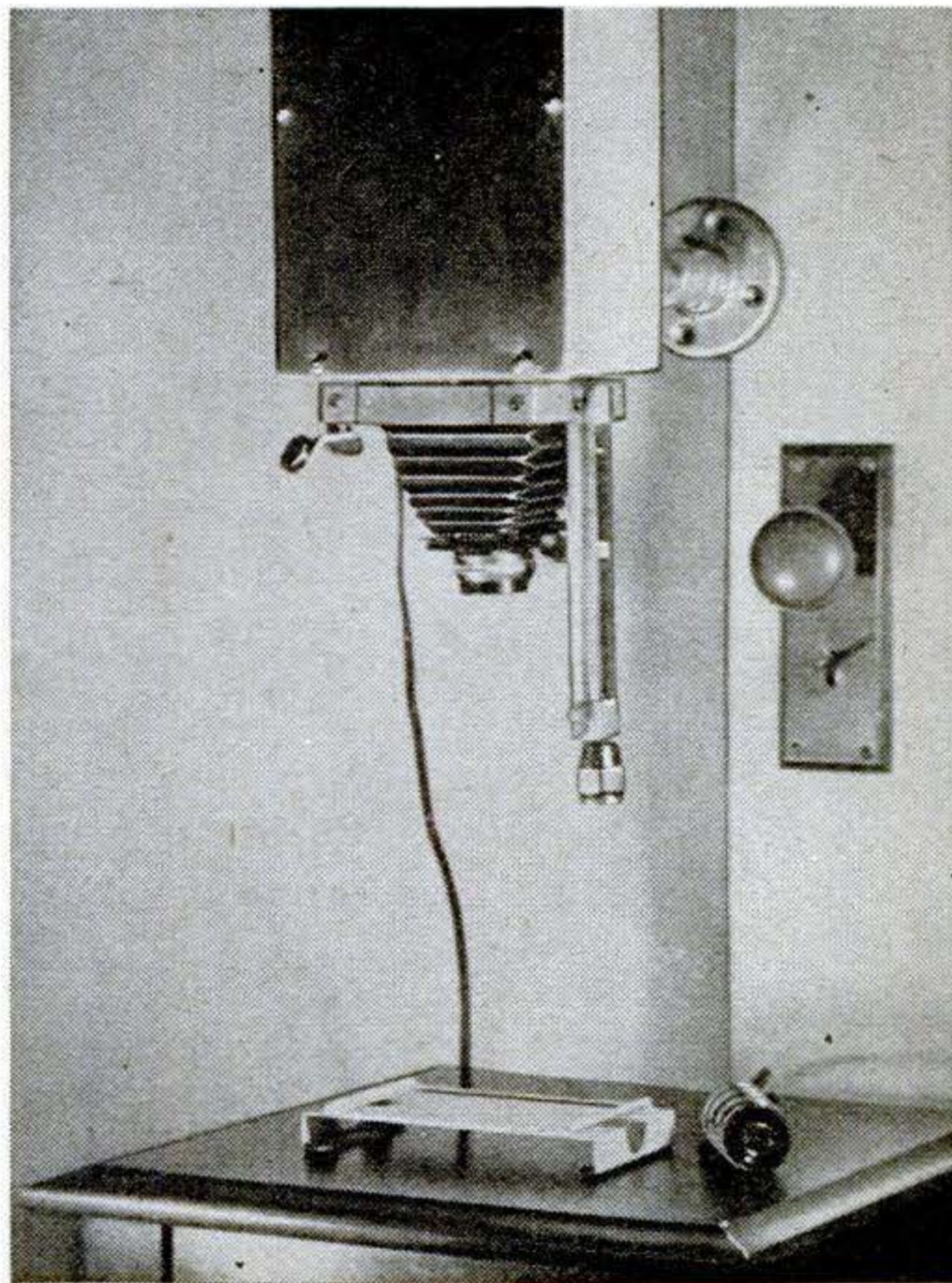

ENLARGER CLAMPED TO DOOR. Two pipe flanges mounted on the support arm with a nipple between them can be clamped tight by a turn.

cement the bellows to the frame and to a slide for the focusing track. The seam may be midway on one side. Make several trial bellows out of stiff paper before cutting the leather, and use the best as a pattern.

Two 6" lengths of angle bolted to the bellows frame provide a focusing track. It should be positioned to suit the slide on the small end of the bellows. A 6" long automobile bolt makes an excellent focusing screw. If an automobile bolt is not available, any long bolt having a fine thread can be used. Braze a nut fitting the bolt to the slide on the end of the bellows. Grind or file a knob on the upper end of the bolt and insert it in a bearing cup or collar, such as a window-shade bracket, held to the top of the track by the mounting bolts. Bridge the lower end of the track with a length of strap. Take care in alignment so the screw will lengthen or shorten the bellows smoothly.

With a good f/4.5 lens and a No. 212 enlarging bulb, focusing will be easy and printing pleasantly short, but an f/6.3 lens will serve adequately if you don't mind putting in extra printing time. A lens of 4" focal length is usually recommended for coverage of a 2¼" by 3¼" negative. However, a 3" lens not only will do a good job, but its shorter focal length will project small negatives well. Mount the lens on a small lens board made of thin plywood or plastic and screw it to the endplate of the bellows.

The bellows assembly is attached to the lamp house with two strong spring-type cabinet hinges. Bolt these to the lower back edge of the lamp house and the bellows frame to leave 1/16" space between the two parts. This provides clearance for the negative carrier. In use, the bellows frame is swung down, the negative and carrier are placed on it, and the spring hinges keep it

up while enlargements are being made. A thumb tab at one corner is convenient for pulling the frame down to insert and remove negatives.

Film carriers may be made from tough, thin cardboard or pressed board. Cut the centers from two 3½" by 4½" sheets to frame the negative, and hinge one edge with tape. Make a carrier for each negative size to save time.

The supporting arm for the enlarger is a 6" length of pipe attached to the back of the lamp house by means of a bolted-on flange. A tee and setscrew at the free end provide a method of adjusting the enlarger on a permanent pipe stand. For a portable enlarger, replace the tee with two flanges used base to base. The inner flange should be threaded only part way on the arm so a 2" pipe nipple can be screwed into its remaining threads to take the outer flange. This arrangement will enable you to clamp the enlarger to a solid support by a simple twist or two. Setscrews may be put through the two flanges to hold them tight. Where there is no danger of outside light spoiling your paper, a window sash will serve as an especially convenient support, for it can be raised or lowered quickly to adjust height. Heavy felt glued on the inside face of both flanges will prevent marring of woodwork.

If you wish to take the enlarger with you on a trip, remove the screws that hold the hinges to the lamp house, unscrew the pipe fittings in the flange on the back, unscrew the lamp socket, and place everything inside the lamp house, protecting the glass and enlarging bulb with packing. Strips of cardboard may also be slipped in the ends to close the holes. Then the lid is screwed down tight or snapped shut, and you are ready to go places. **END**

Red Filter Converts Flashlight for Safe Use in Darkroom

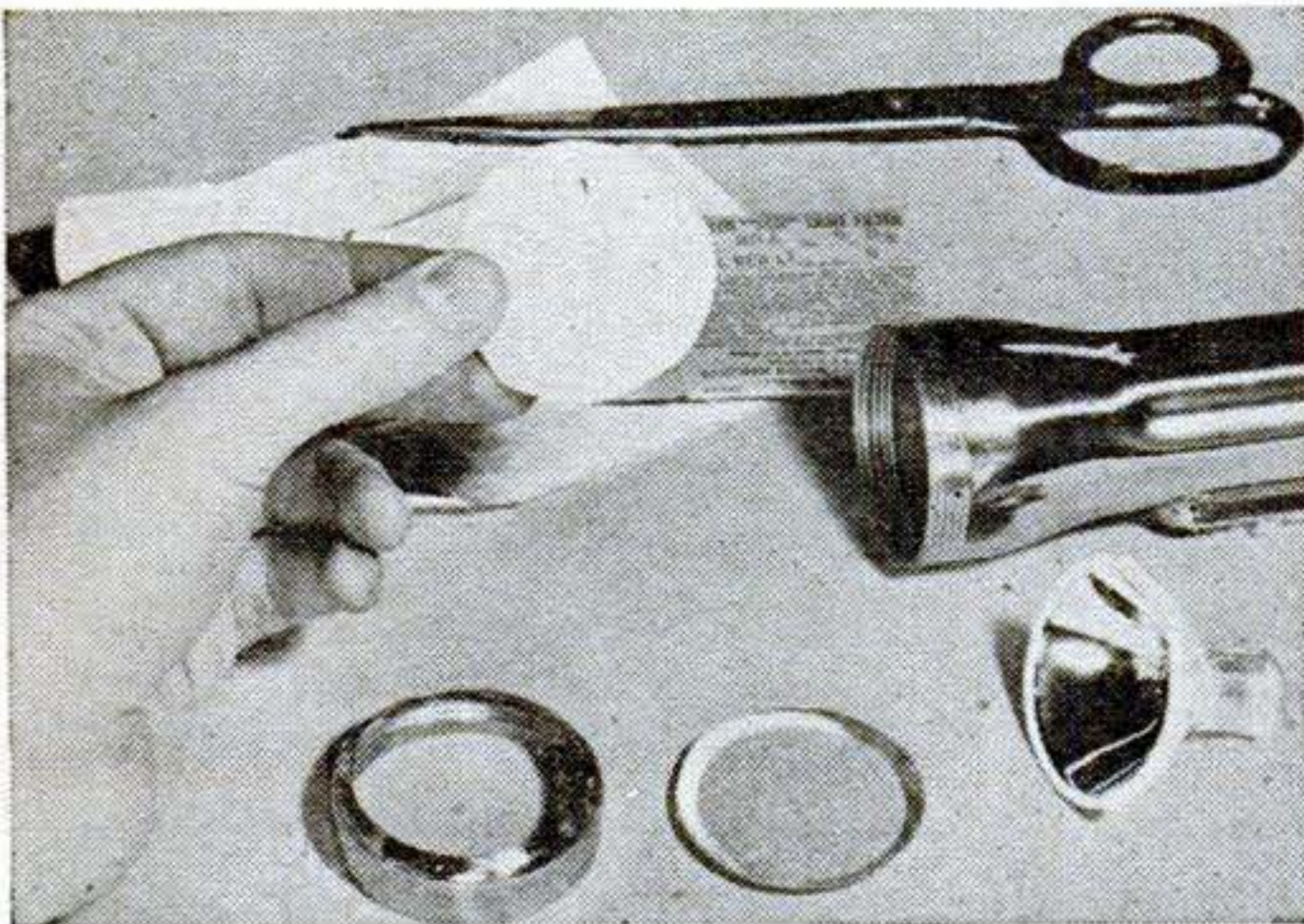

Cut round and fitted inside the lens, a red photo filter will convert a flashlight to many safe uses in the darkroom. Such a safelight will be a help in reading instructions and box labels and in hunting things dropped under the sink or tables.

If the disk is cut from a square photographic filter, the protective tissue in which the gelatine is wrapped can be cut along with it and left in place when the disk is inserted. The two layers of tissue will help to cut down the brightness of the flashlight bulb.—R. F. DONAVAN.

WHAT'S WRONG

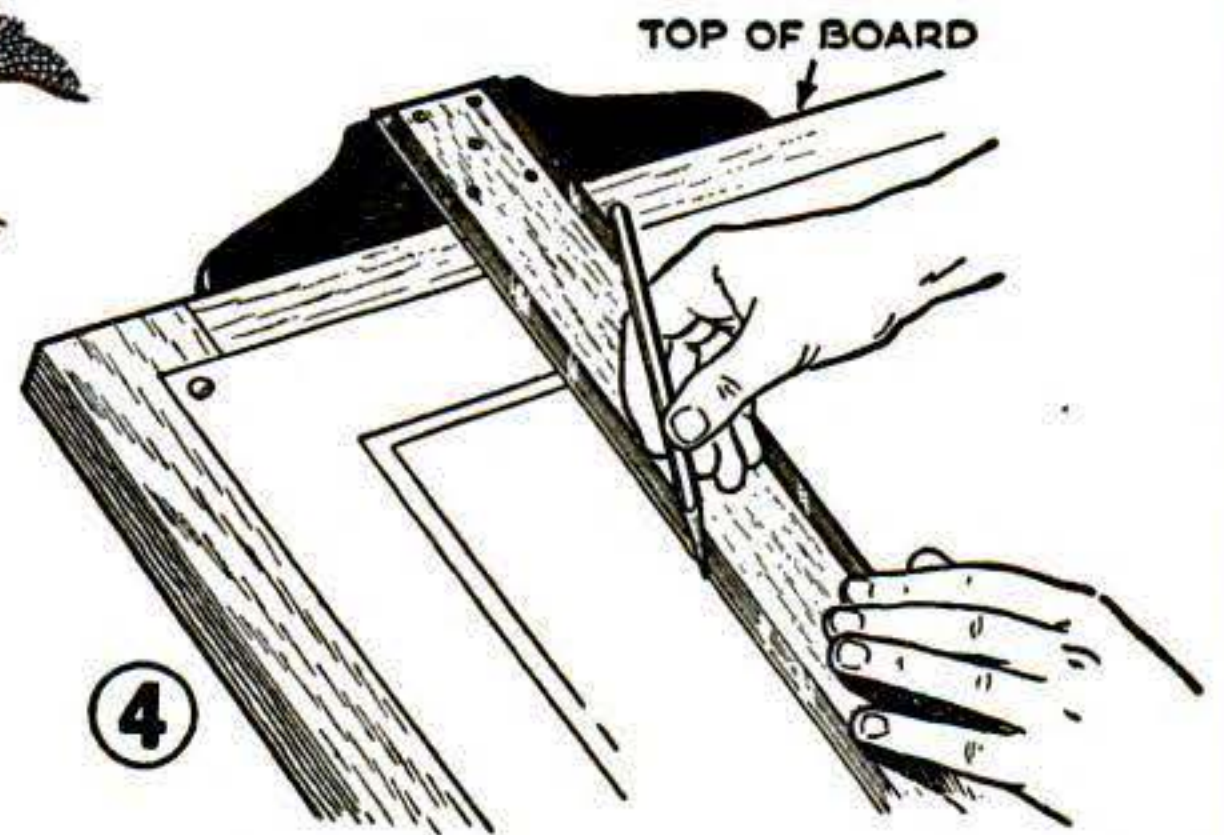
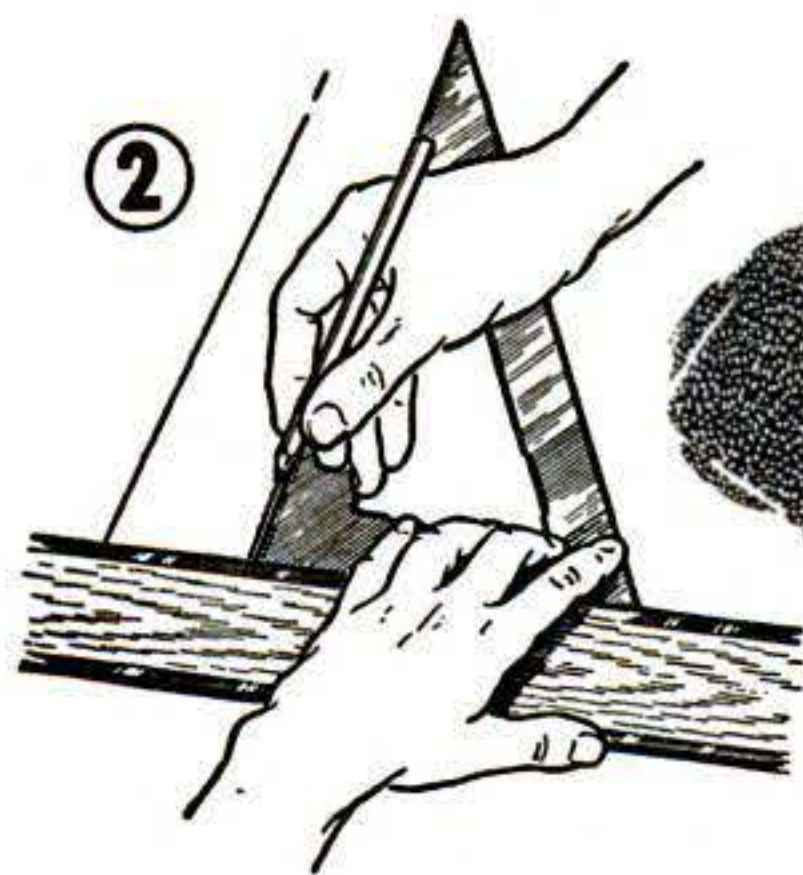
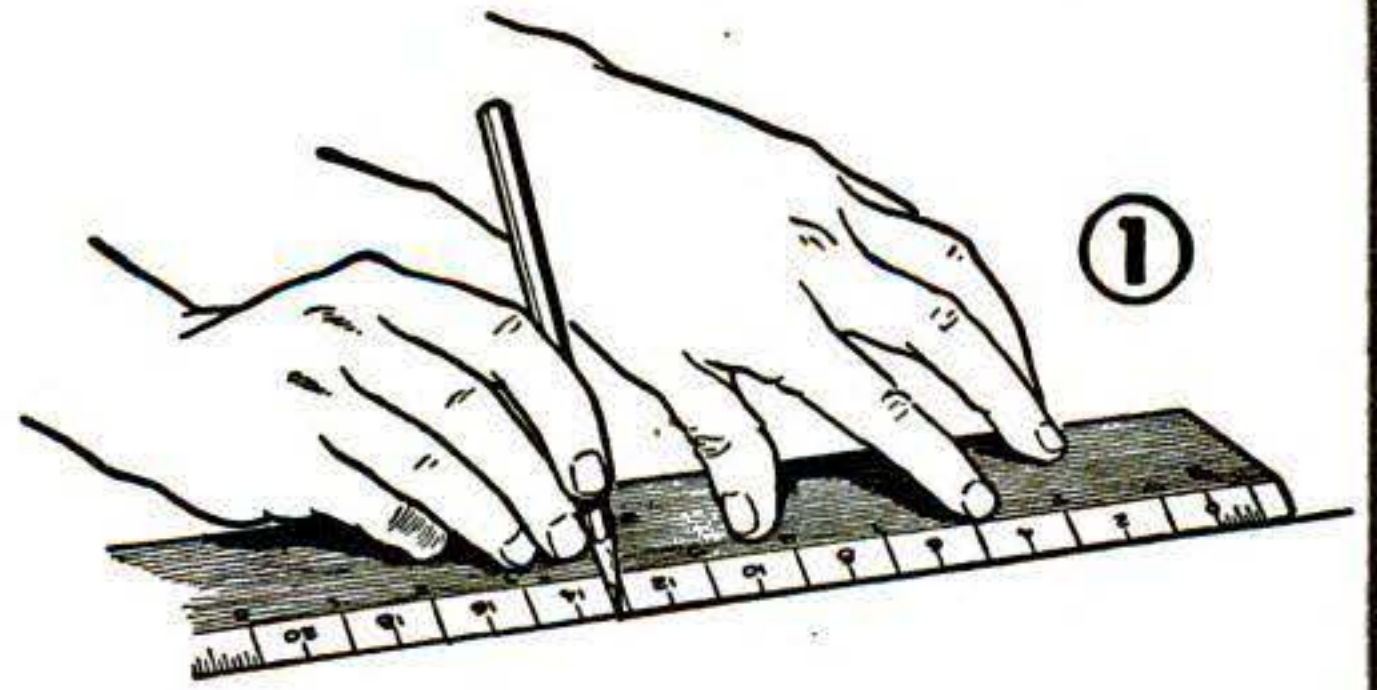

HOME-WORKSHOP owners often need to draw their own plans, and a knowledge of simple drafting procedure is helpful. Five errors are shown in the drawings—two in Fig. 2. Can you spot them?

4. The sides of a drawing board are made straight and parallel, but the top and bottom may not be square with them. Use a triangle for vertical lines.

1. A scale is intended only for measuring, never for use as a straightedge. It may not always be straight, and the practice may wear the graduations. Use the point of the pencil against the straight-edge; don't let the lead ride on the upper arris. Also sharpen the lead to a long, tapering point. 3. Scraping inside a ruling pen with a knife will roughen the surface, and the ink may not flow smoothly. Clean it with a cloth before it dries.

ANSWERS

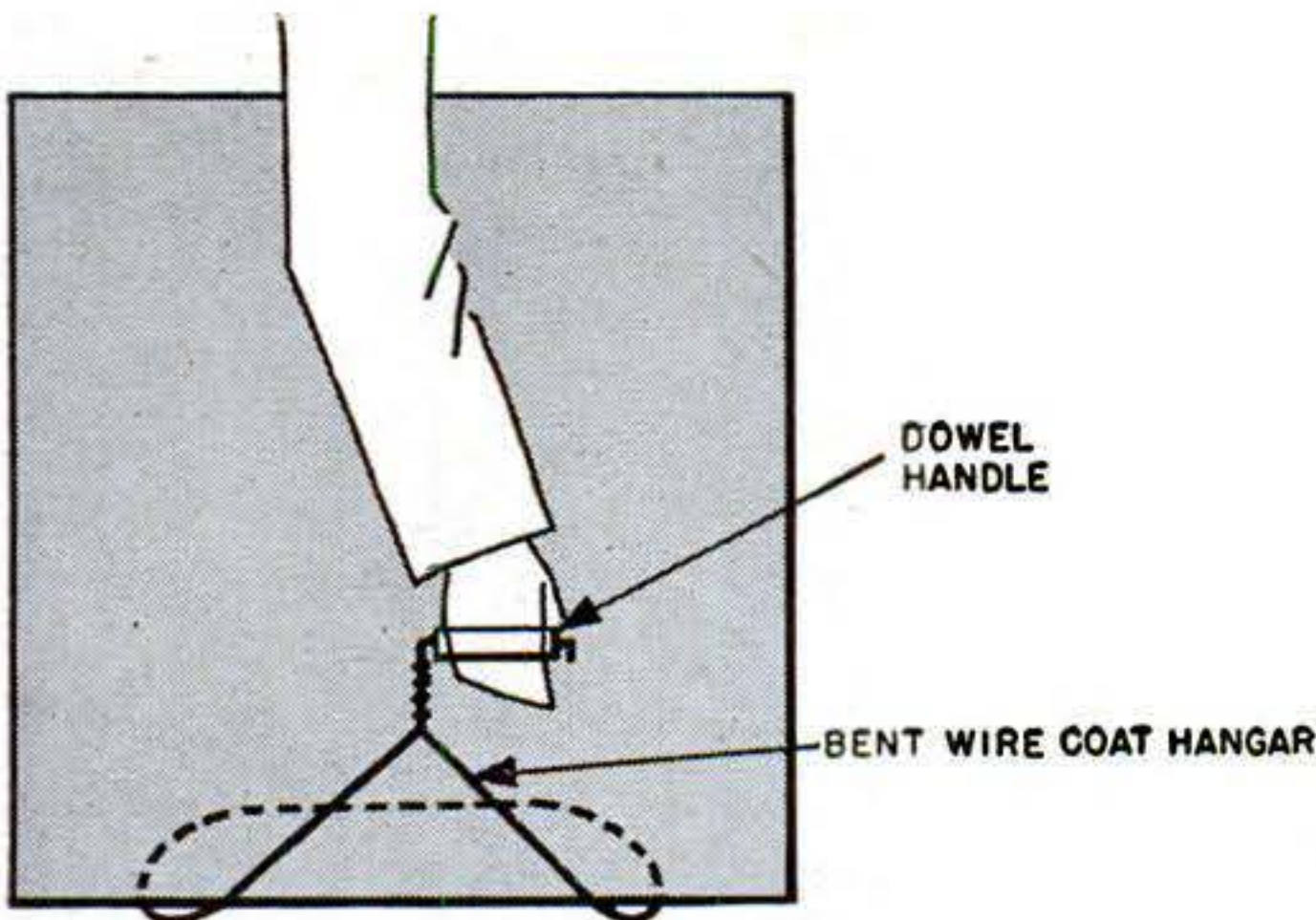

Coat Hanger Used as Carrier

DRAWING boards, large portfolios, and the like may be too wide to fit comfortably under the arm. Carrying can be simplified if one is slipped over a bent coat hanger that has been fitted with a dowel handle. The extra length will let the board down low enough to go under the armpit.

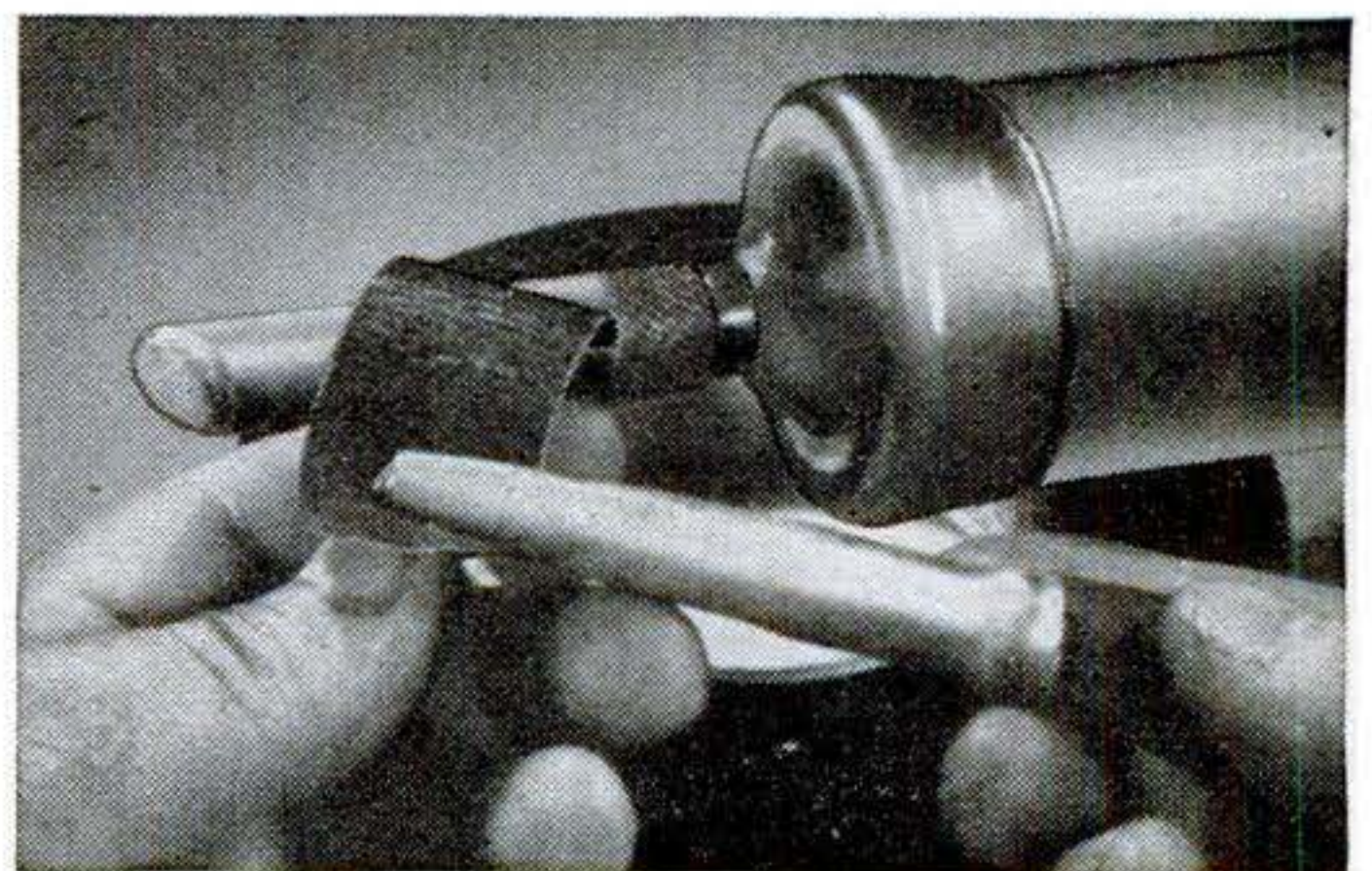

Tape Protects Calking Tips

AIR entering the open ends of interchangeable calking-gun tips when they aren't being used may harden the calking material in them. Once this happens, it may be necessary to boil them in a caustic solution. If you cover the ends of the tips with masking tape, the calking material won't harden.

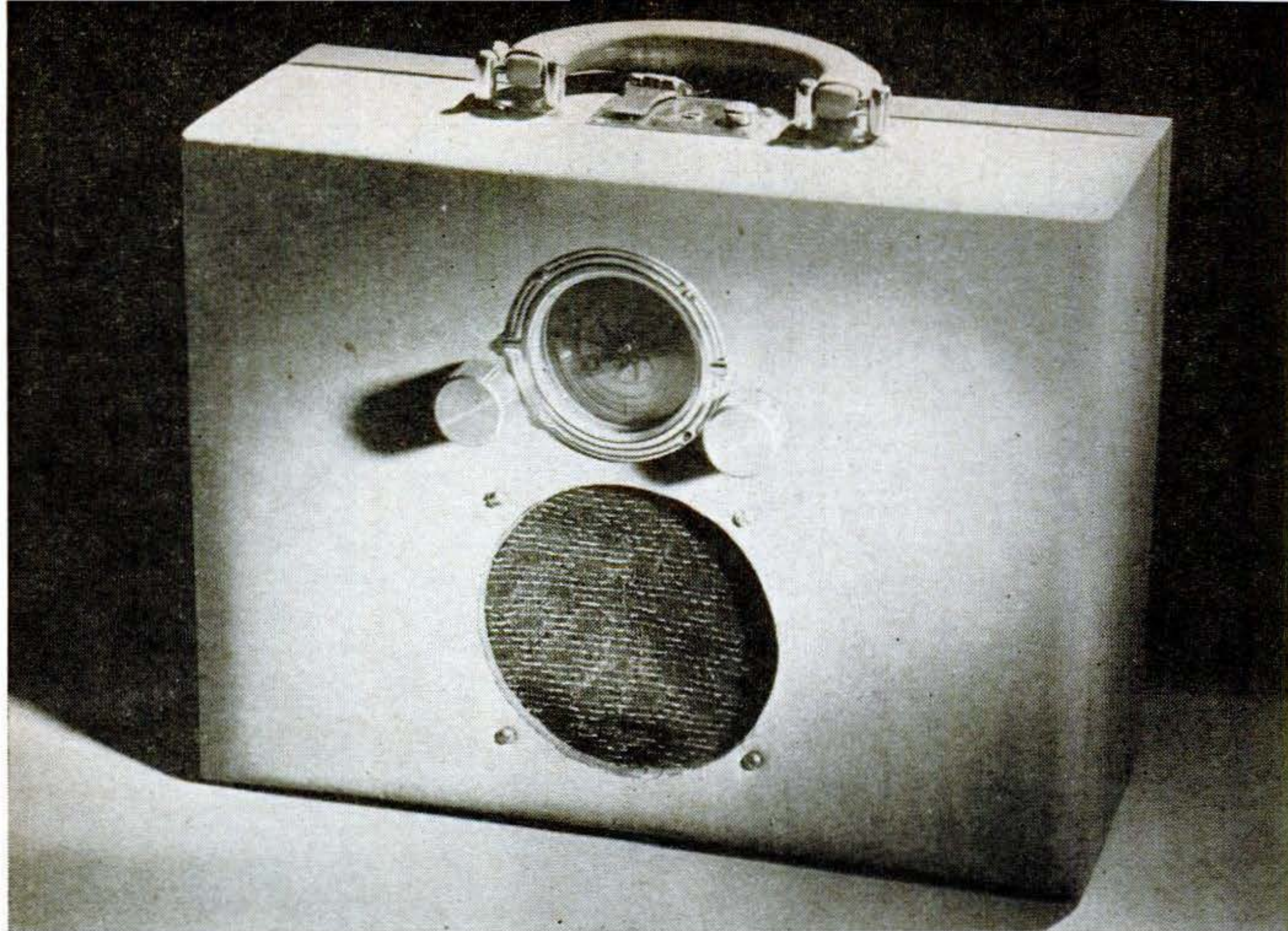

De Luxe Vacation Portable Rivals Console in Tone

By Henry C. Martin

PORTABILITY in radios suggests the great outdoors, yet few manufactured receivers allow for the different requirements of out-of-door as against indoor listening. With the exception of more expensive models, many commercial portables are either incapable of delivering comfortable outdoor volume or else overload to the point of distortion when they are turned up to an adequate level.

These were the chief factors that were kept in mind in the design of this portable. In tone it is equal to many large consoles, while the output level of undistorted volume is high enough to flood a good-sized room. Even where surrounding noise would normally drown out the sound of a radio, you won't have to cock your ear to the loud-

speaker of this set. For all its power, it is small enough in size and weight to be easily carried on picnics, beach and boat trips, and the like.

Two 1S4 pentodes are wired in parallel in the output stage and matched to a light permanent-magnet speaker to produce the unusually good tone. The tubes feed into a universal output transformer that has several taps on the voice-coil (or secondary) winding. A transformer with an input capable of matching load impedances up to 4,000 ohms is desirable since that is the theoretical resistance of two 1S4's in parallel. In the original receiver the 2,000-ohm tap was used because it produced the most pleasing tone. The transformer matches this tube impedance to the voice-coil impedance of the speaker which, in this case, is 4 to 6 ohms. The speaker itself is one of the light-

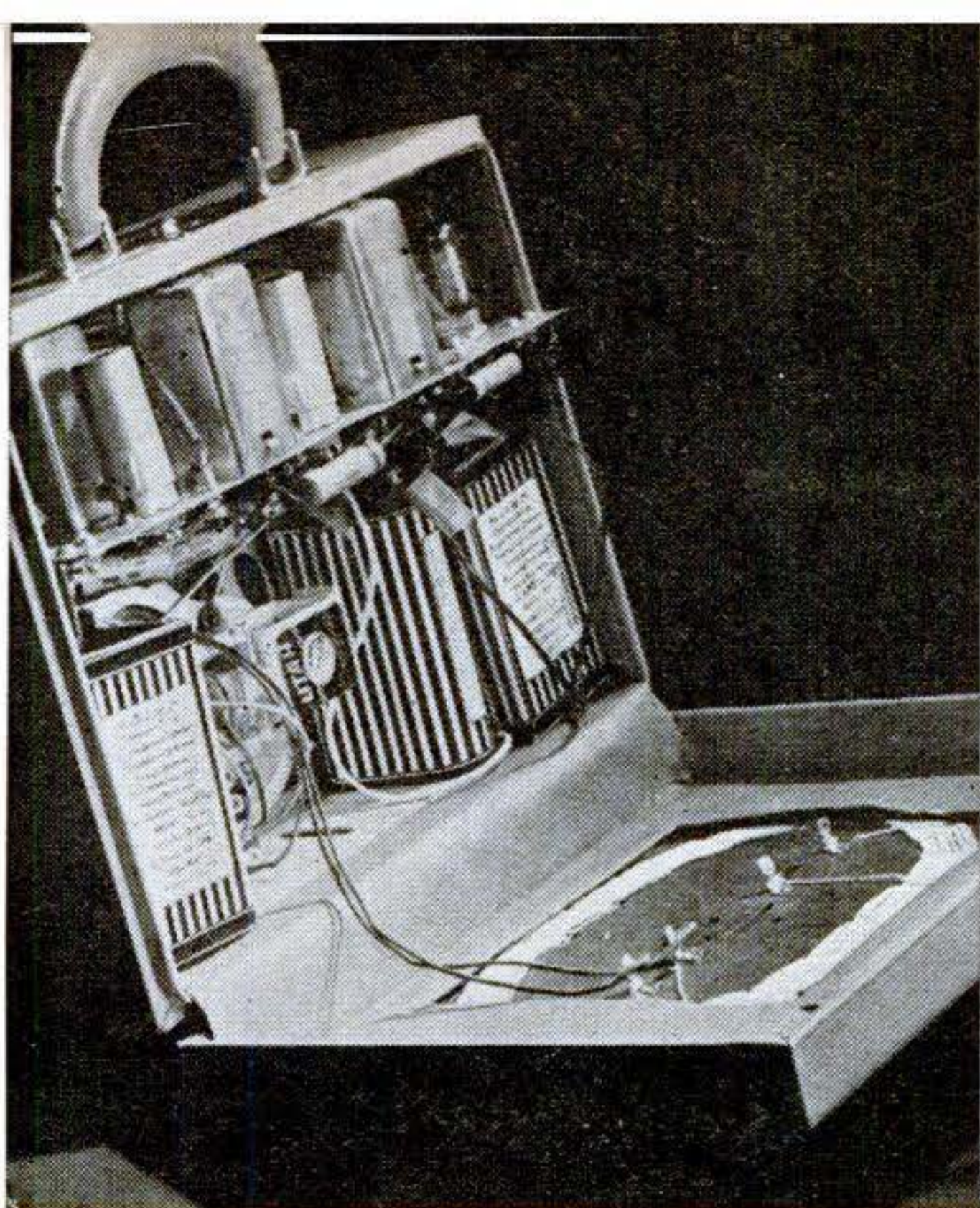

A piece of flat brass, cut to fit snugly across the upper part of the case, is used as a chassis. The lower portion of the cabinet is given over to the speaker and batteries. One 1.5-volt A and two 45-volt B batteries supply the set with power. The loop antenna slips under the lid of the case.

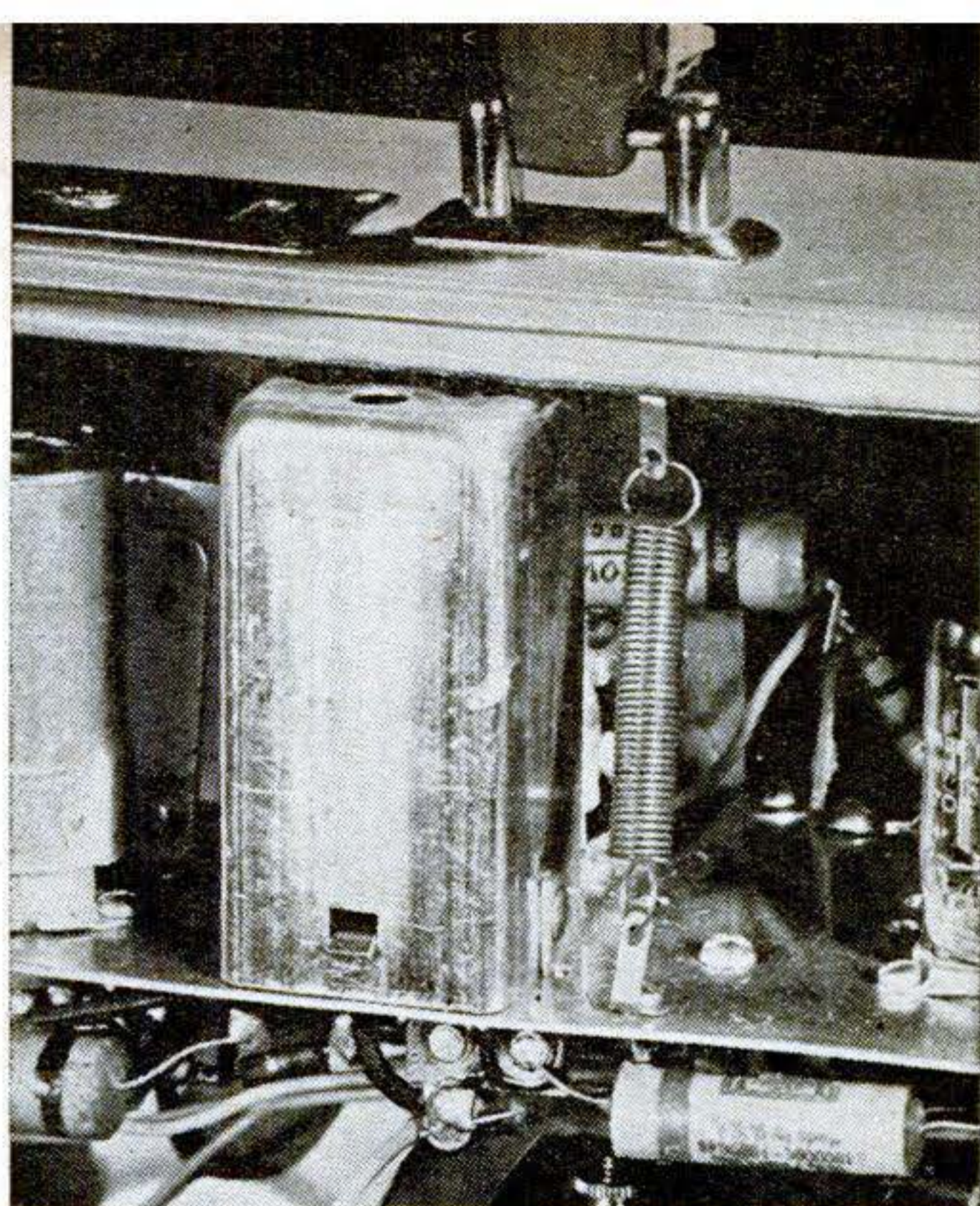

Here's part of the spring-suspension system that helps protect this set from the jolts and bumps that shorten the life of most portables. Anchored between soldering lugs on the chassis and case, two tension springs provide a "floating" or shock-absorbing support for one edge of the chassis.

est 5" units that can now be purchased; its alnico magnet is about as large as a thimble. Weight, of course, is correspondingly small.

The chassis consists of a 3½" by 11" strip of brass approximately 1/16" thick. This piece has no sides but a 2" flange is formed in front to support the dial assembly. By keeping chassis dimensions to a minimum and eliminating the sides, weight is reduced and wiring is made easier. Before cutting the chassis, measure the inside dimensions of the carrying case you intend to use.

Both sensitivity and selectivity are extremely good, the former because two stages of IF are employed, and the latter because in all, eight tuned circuits are used. Tuning is accomplished by means of a midget two-gang tuning condenser. As may be seen in the top photograph on page 191, the plates of the oscillator tracking section are considerably smaller than those of the antenna section. This is because the oscillator automatically tunes to a beat frequency 456 kc. higher than the antenna. As usual, all the IF transformers are adjusted to this fixed 456 kc. intermediate frequency. Incoming signals go directly to the 1R5 which acts both as first detector and local oscillator.

A pair of 1T4's is utilized for IF amplifiers. Ground return leads of both the interstage and output IF transformers (L4, L5)

are wired into the automatic volume control circuit. Manual control of volume is obtained through a 1-meg. variable resistor (R11) in series with the control grid of the 1S5. Detection, or more correctly rectification, is performed by the diode plate within the envelope of the 1S5. The pentode section of the tube acts as the first audio amplifier and is coupled to the detector through R11 and C12. Resistance and condenser coupling is also employed between the first and second audio stages. The latter consists of the pair of 1S4 power pentodes which, in combination, boost the audio signal to the high output level that makes this set so satisfactory.

Final choice of a cabinet will be made on the basis of personal taste, price, and availability. The handsome leather-covered bag shown here is on the expensive side, and many less costly but equally satisfactory substitutes can be found in any luggage store. A small overnight bag will do provided that it is approximately the right size and sturdy enough to stand the wear that portables are subject to. This case measures 4¾" by 8¾" by 11¾" outside; a smaller one is not advisable. Before cutting the case, make cardboard templates of the chassis, speaker, and batteries, and decide on the best position for each of them. Mark the

positions of the volume control and tuning shafts and the openings for the speaker and dial on the outside of the case. Score the leather with a sharp knife, drill the shaft holes, and cut or saw the circular speaker and dial apertures. The edges of the cuts can be concealed by suitable escutcheon plates.

Most overnight bags are fitted with mirrors, and if yours has one it should be removed and the loop antenna slipped under the cover lining. Instead of being mounted rigidly inside the case, the chassis is sprung to absorb jolts and shocks. Two soldering lugs are screwed to the top of the case and another two lugs are bolted to the edge of the chassis. Between the anchor points thus formed, small tension springs are installed to support the rear edge. The front is held only by the shafts, which project through the face of the bag and are gripped by the knobs on the outside.

Since, in common with all portables, this

set is dependent entirely on its loop antenna for station pickup, it should not be expected to perform any remarkable feats of long-distance reception. It will, however, easily pick up and separate all local stations, and its performance can be improved by using the antenna to best advantage. One way of doing this is to turn the set as you tune it until the position of the antenna favors the station you are trying to get. Reception can also be improved in many cases by leaving the cover of the case slightly ajar. Most loop antennas, in addition, have an extra connection that permits the attachment of an outside aerial when conditions permit.

In order to keep battery drain to a minimum, no pilot light was used in this circuit. This makes it all the more important that you remember to turn off the switch when the set is not in use. If you can't trust your memory, insert a 1.5-volt .06 amp (60 ma.) pilot light behind the dial and wire it in parallel with the tube filaments.

LIST OF PARTS

All resistors $\frac{1}{2}$ watt carbon unless otherwise noted.

R1: 100,000 ohms.
R2: 2 meg.
R3: 10,000 ohms.
R4: 2,000 ohms.
R5: 5,000 ohms.
R6, R9: 5 meg.
R7: 15,000 ohms.
R8: 1,000 ohms.

R10: 3 meg.
R11: 1 meg. with switch pot.
R12: 10 meg.
R13, R14: 1 meg.
R15: 180 ohms, 1 watt.
C1: Two-gang tuning condenser.
C2, C11: .1-mfd., 450-volt paper tubular cond.
C3, C13: .0001 mfd. mica.
C4, C5, C6, C7, C8, C9, C10, C12, C15: .05-mfd., 450-volt paper tubular.

C14: .0002 mfd. mica.
C16: .005-mfd., 450-volt paper tubular.
L1: Loop antenna.
L2: Iron-core oscillator coil.
L3, L4, L5: input, interstage, and output IF transformers.
T1: Midget universal output trans.
S1: D.P.S.T. switch on R11
Speaker, tubes, case, tube sockets, shields, batteries, hardware.

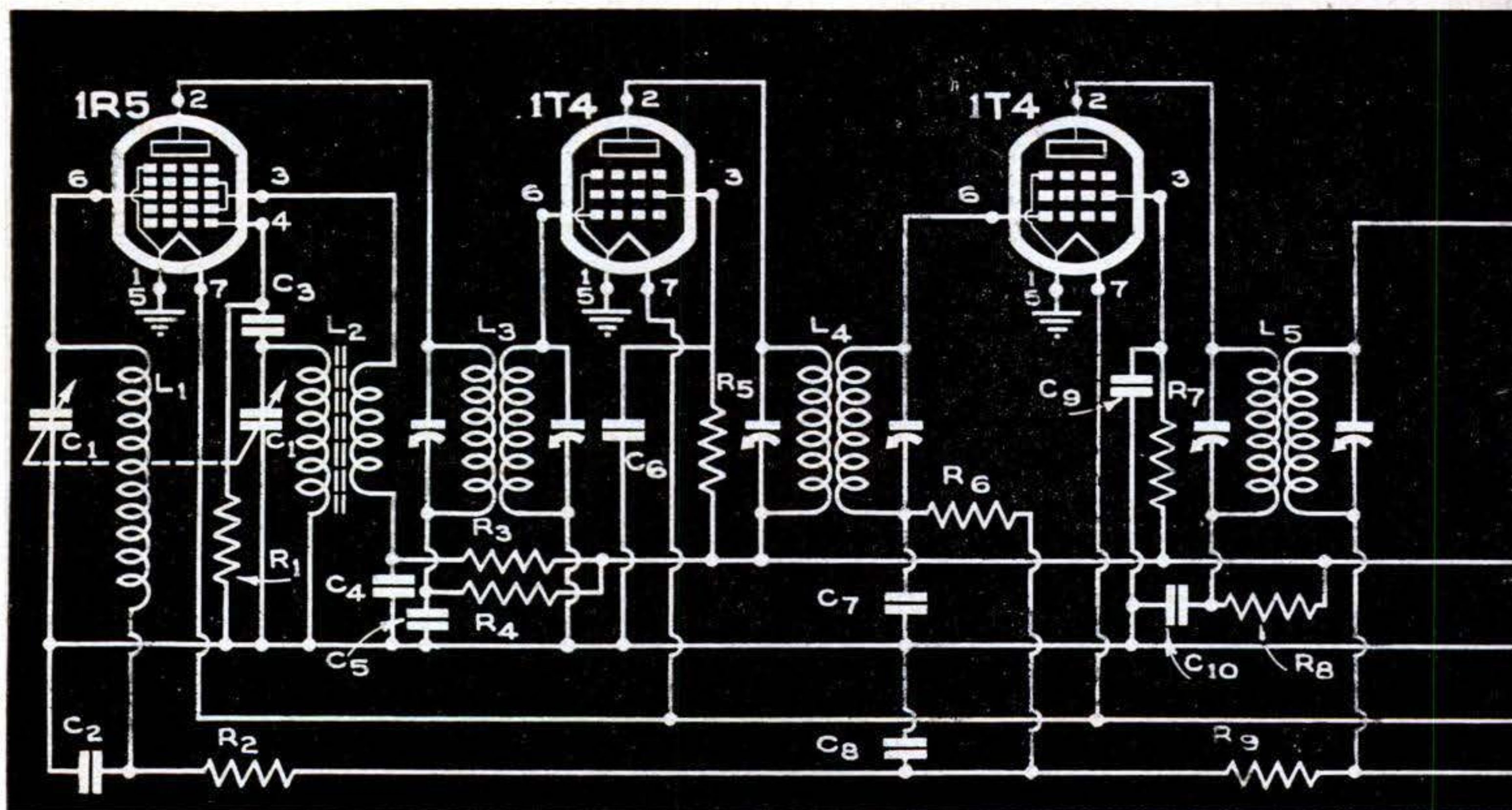

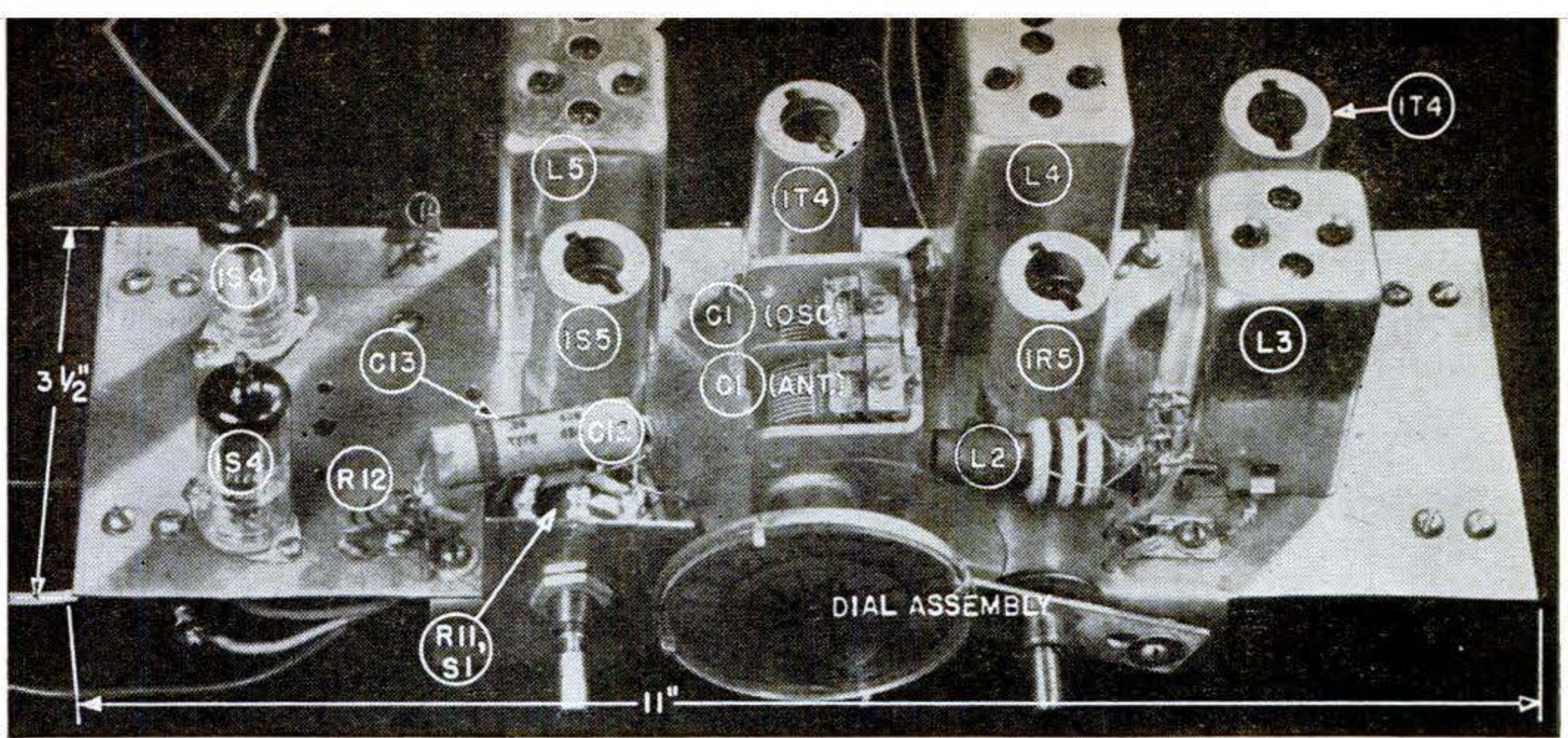

Labeled photograph shows where major parts are placed on top of the chassis for most effective separation.

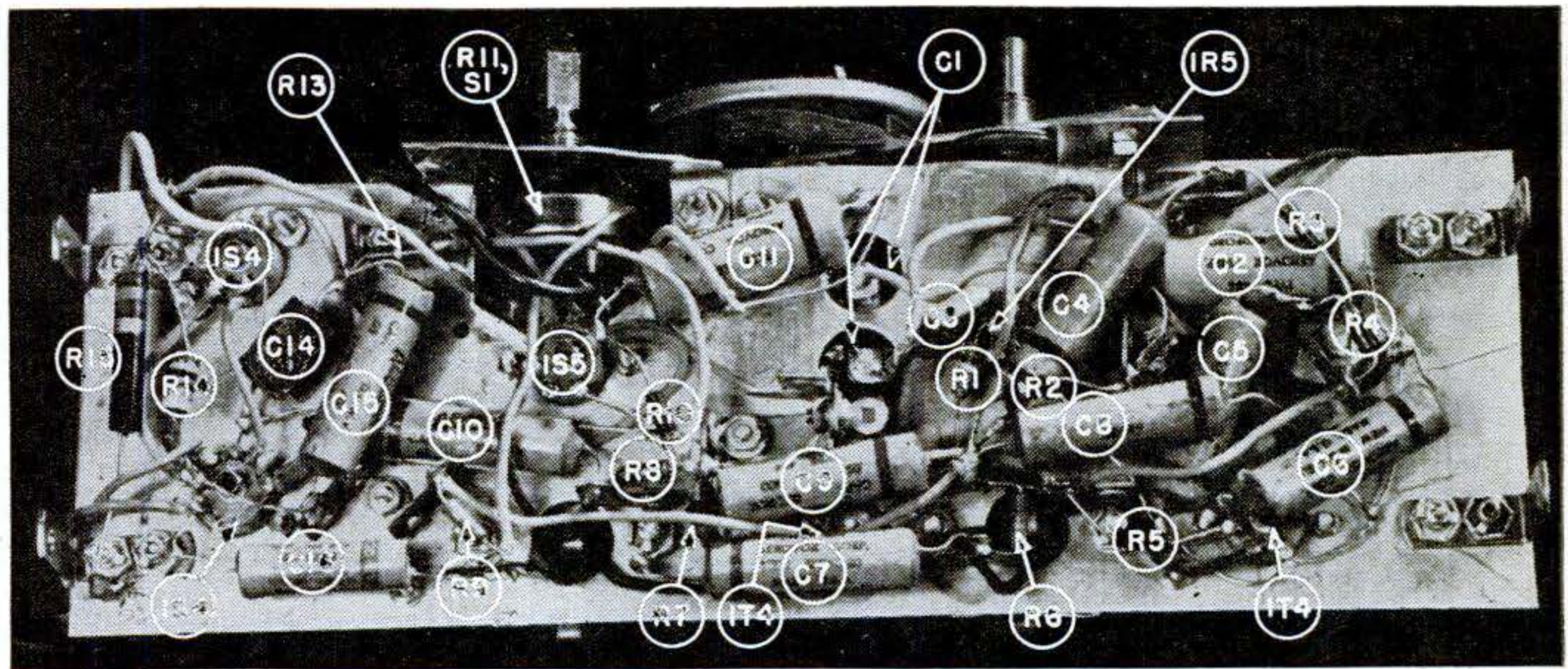

Most of the wiring is done below the chassis. Use the new tiny resistors and condensers to save space.

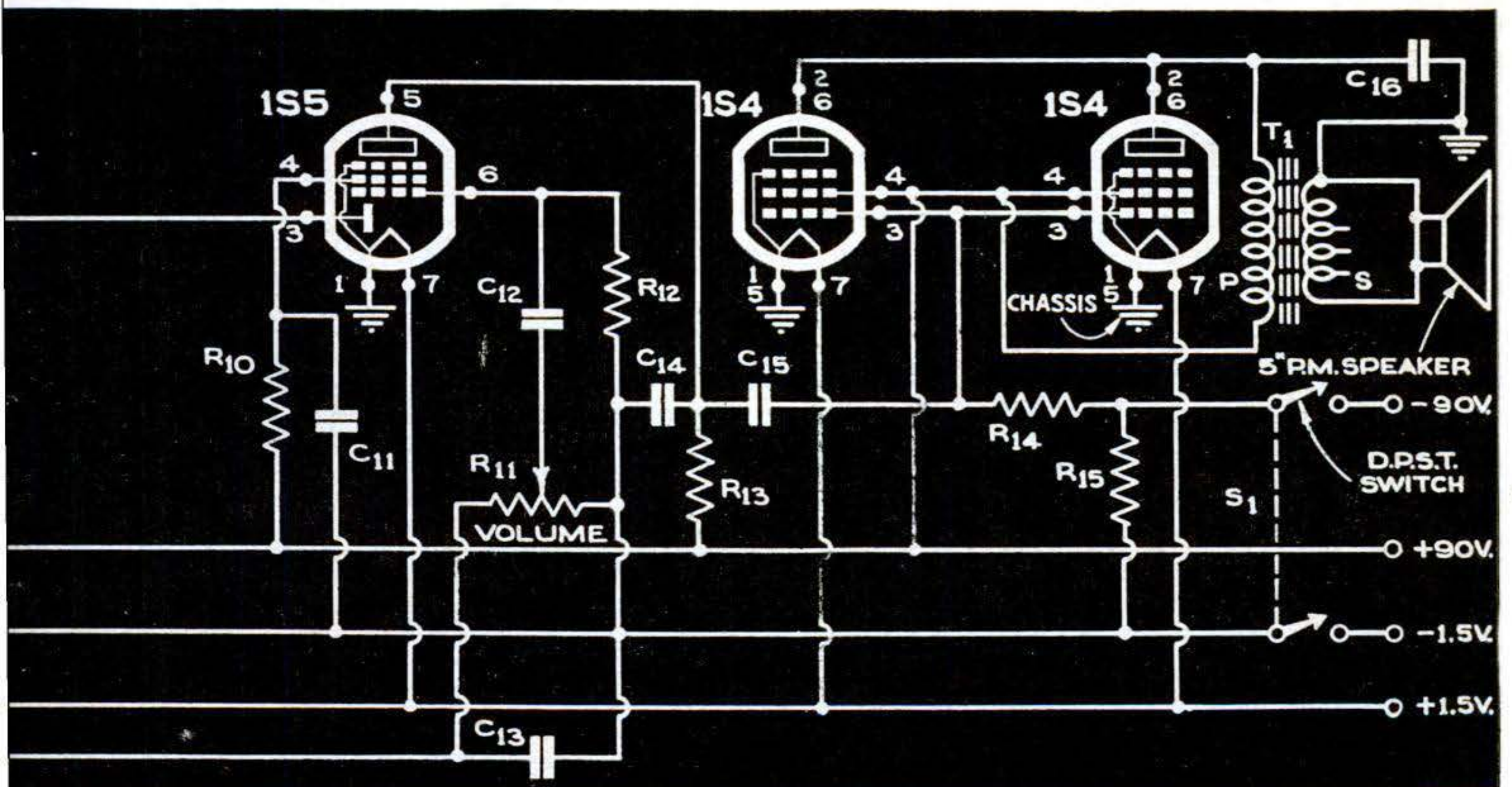

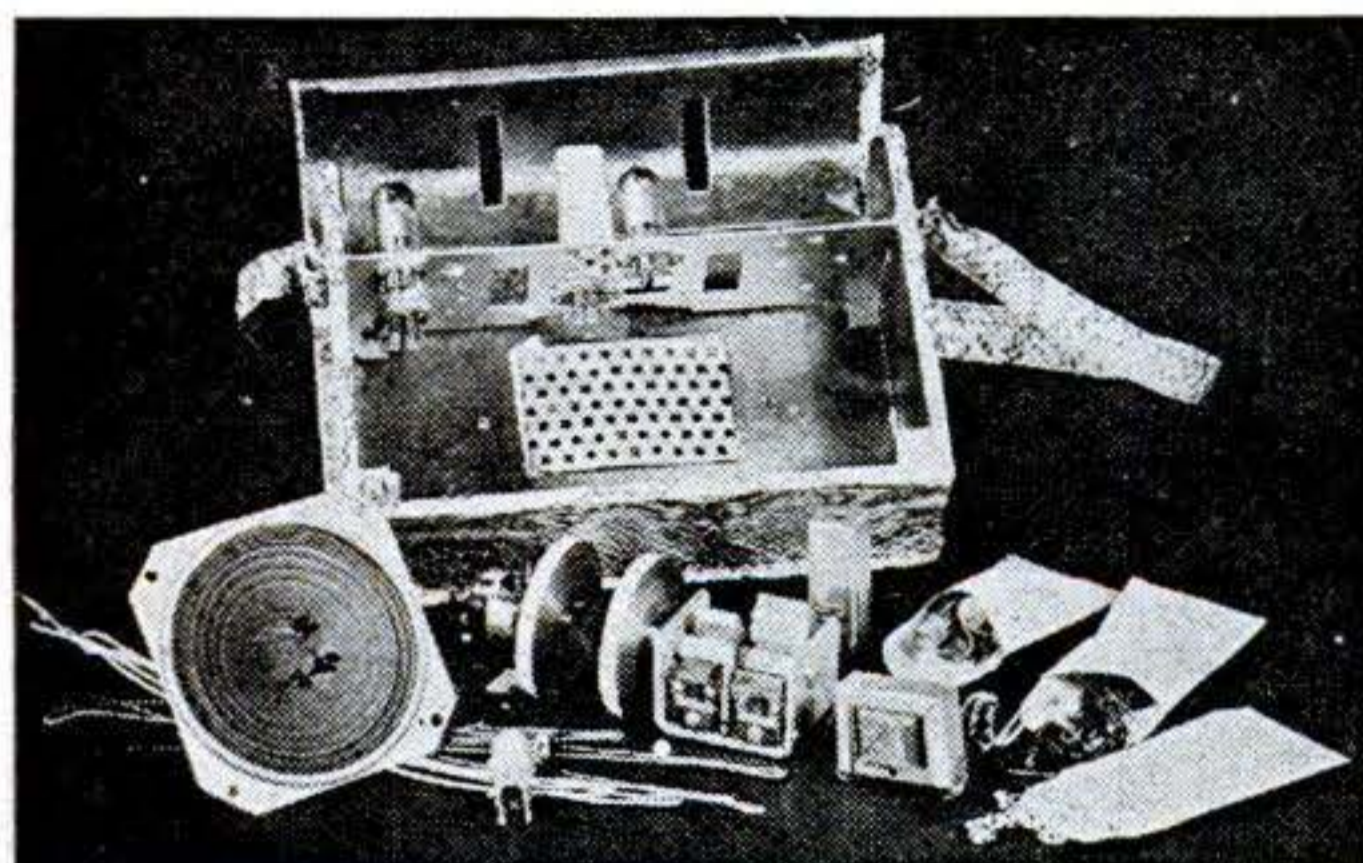
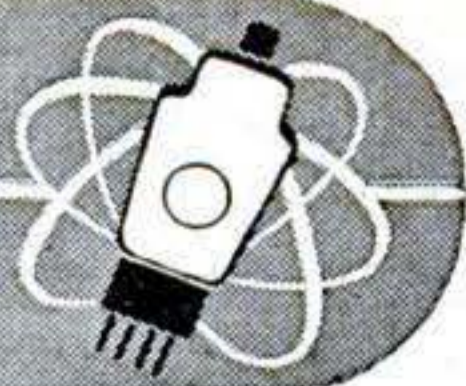

HANDBAG RADIO. Shoulder-strap pocket-books can please the ear as well as the eye. The complete four-tube superhet handbag shown at right above is made by the ARC



Radio Corporation. It weighs less than 5 lb. An identical set is furnished in kit form by the Ubildit Co. Both firms are located in Brooklyn, N. Y.

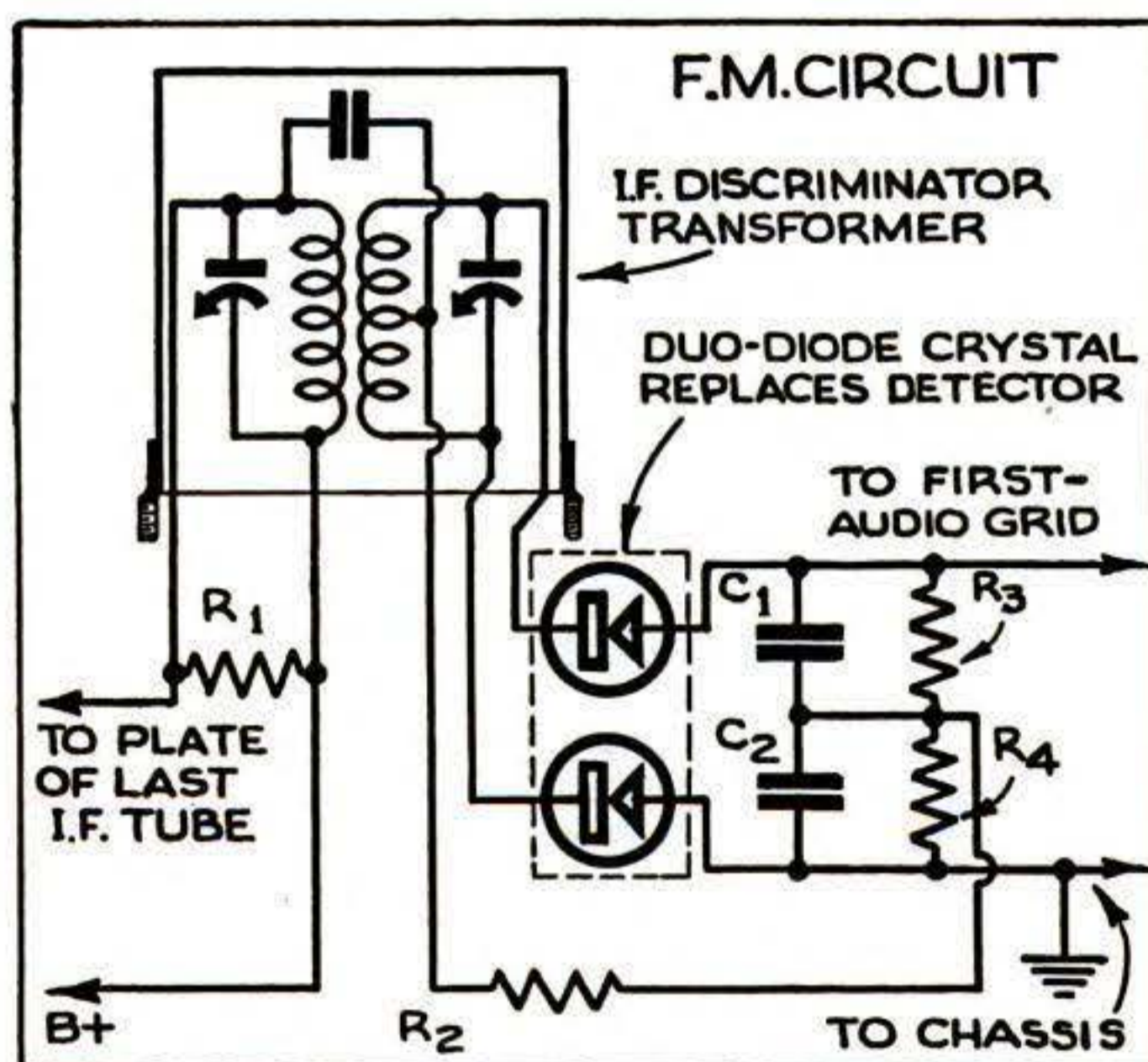
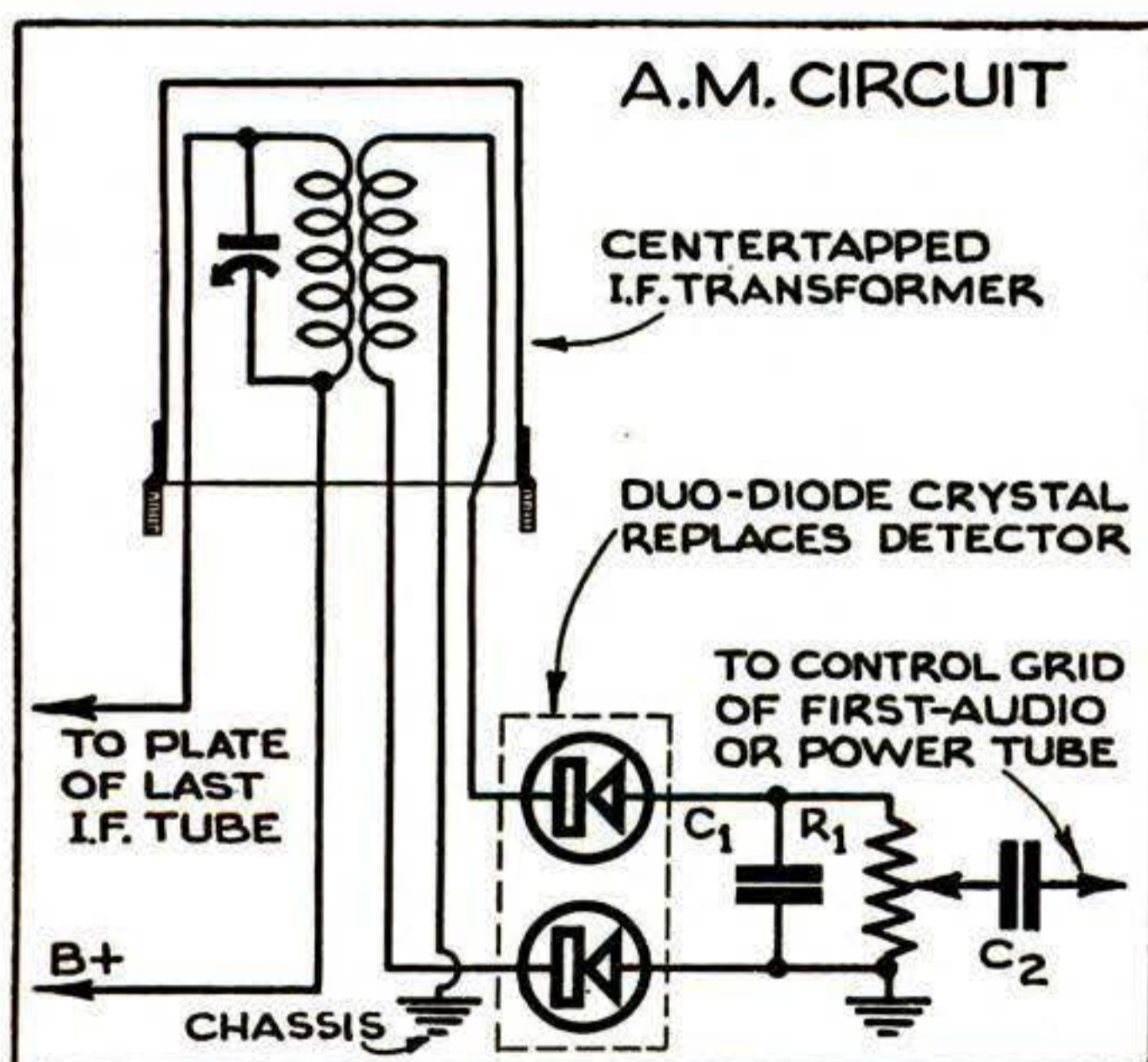

CRYSTAL DUO-DIODE. A new circuit element developed by Sylvania Electric, known as the 1N35, consists of two germanium crystal diodes mounted in one assembly. The crystals are matched for values of forward and back resistance under typical operating conditions.

The most likely application of the new device will be in replacing dual diode tubes, such as the 6H6 and 7A6, in standard AM and FM detector circuits. Two typical wiring diagrams, above, show how the crystals may be employed between the IF and first-audio stages of a standard superheterodyne

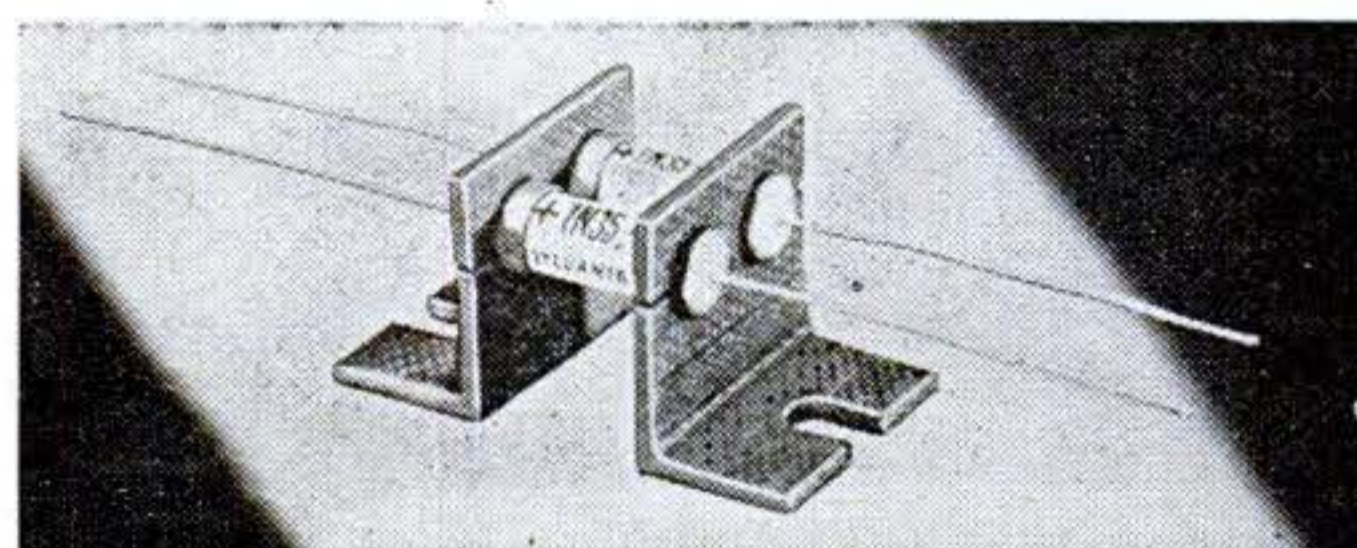

receiver, or following the discriminator transformer of an FM set. The double-crystal unit is also said to be valuable wherever full-wave rectification, modulation, or demodulation may be required in a balanced circuit.

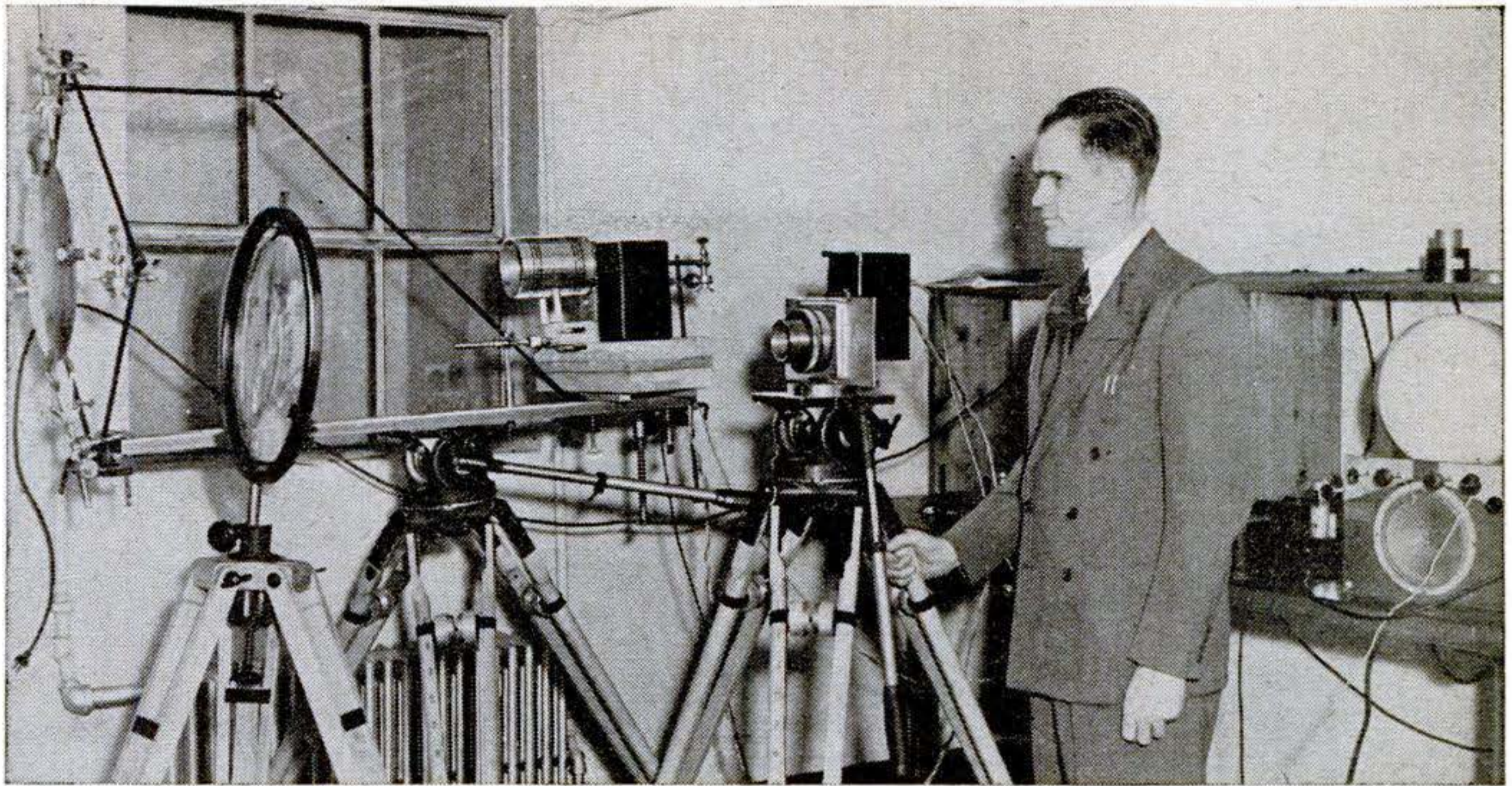

TELEVISION VIA LIGHT BEAMS. High-intensity light beams are being used as carriers for picture and sound signals by the Allen B. Du Mont Laboratories, of Passaic, N. J. For actual broadcasting or in place of coaxial cables for short-range relays, light beams transmit color or black-and-white pictures in light or darkness. A modulated light spot on the screen of a cathode-ray tube at the transmitter is optically focused and beamed at the receiver, which may be several miles away. It is there focused on a photoelectric cell and converted into electrical energy. Output of a photoelectric multiplier is great enough to modulate a picture tube directly, thus offering the possibility

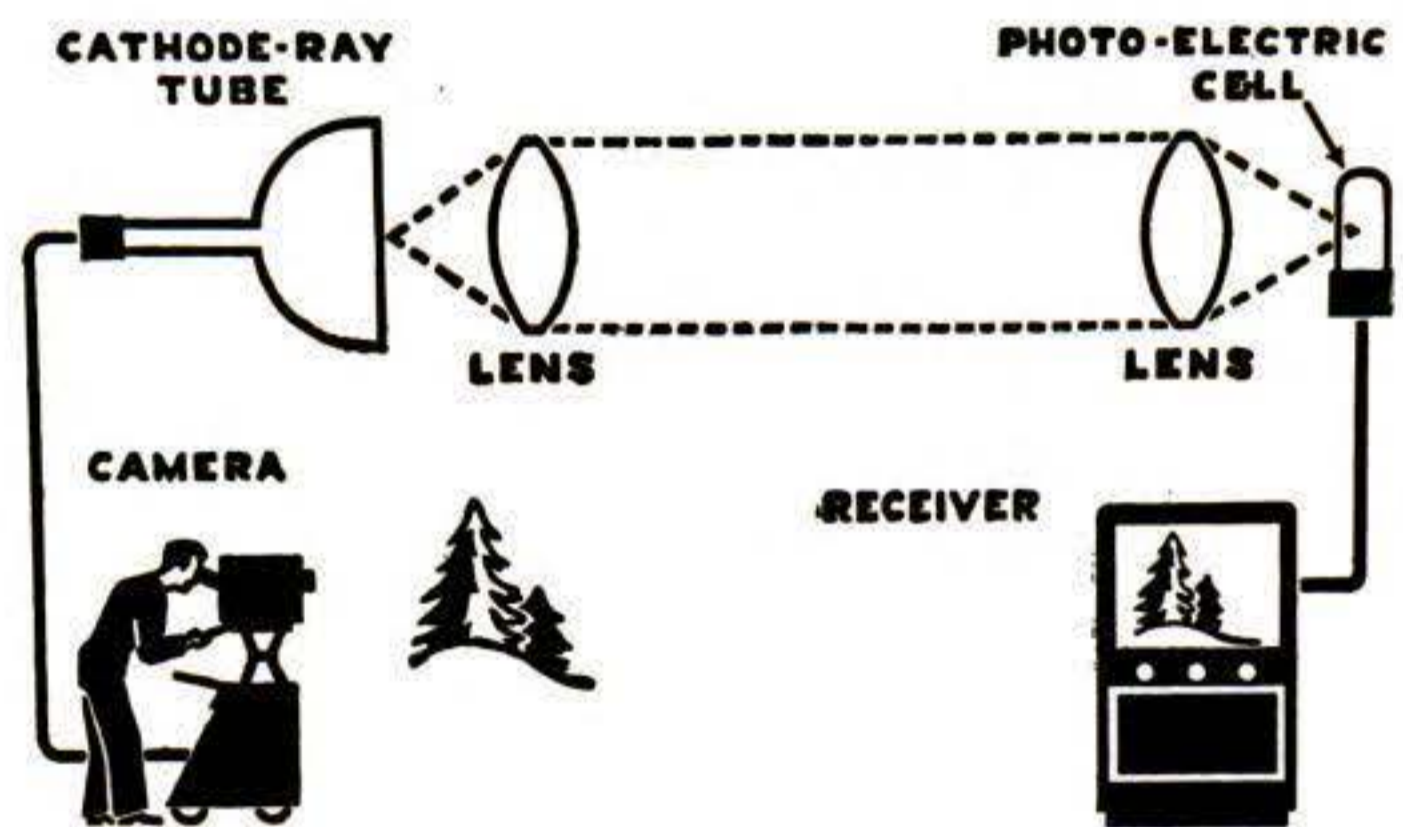

that RF and IF stages may be eliminated. The photo at top shows an experimental receiving setup; above, a pictorialized version of how the system works.

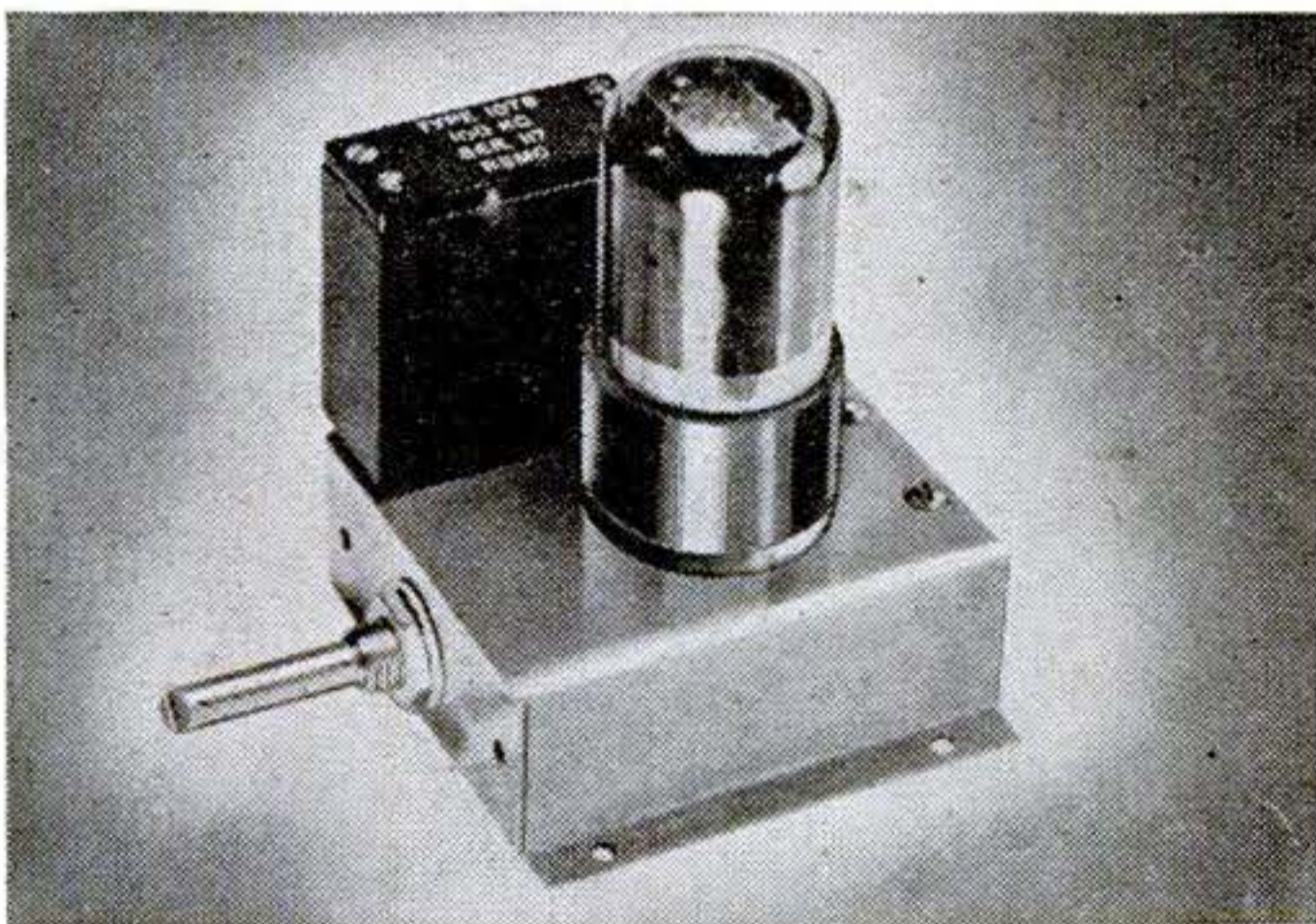

CALIBRATION OSCILLATOR. This compact, small-drain unit is built around a 100-kc. crystal and is said to have usable harmonic check points up to 100 mc. Radio Specialty Mfg. Co., of Portland, Ore., makes the device, which sells for less than \$15.

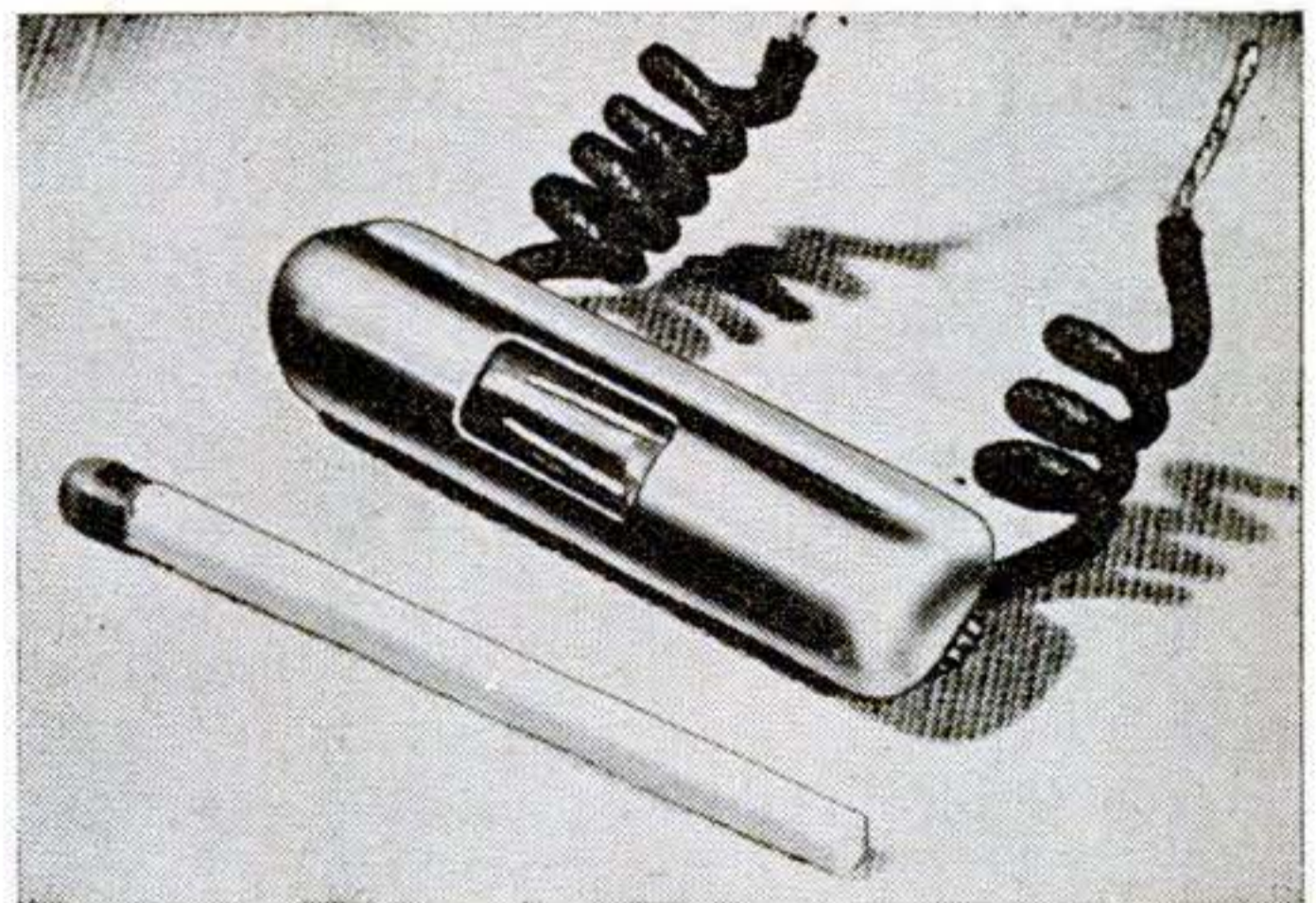

NEON PILOT LIGHT. Consuming under 1/10 watt and operating at any voltage from 75 to 250, this miniature lamp is housed in a metal shell especially designed for panel mounting. It is a product of Industrial Devices, Inc., of Edgewater, N. J.

Water Wheel Delivers Over 3 Hp.

With 12 double buckets on a 16" wheel, this homemade impulse-type unit needs only a moderate water flow.

Part Four

By C. D. Bassett

THOUGH one of man's oldest prime movers, a water wheel is still a fascinating piece of machinery. Perhaps this is because it appears comprehensible at a glance (although an efficient wheel is actually a product of subtle and inconspicuous design refinements), and because it seems to be a way of getting power for nothing. The homemade wheel described here was especially designed for this series on harnessing small streams (see PSM for April, May, and June), and will reward a careful craftsman by delivering years of constant service. It's particularly suited for an installation having a moderate head (25' to 60') and relatively small flow (.45 to .75 cubic feet per second). Subsequent installments will describe the construction of wheels suited for lesser heads of water and other varied conditions.

As is apparent from the drawings, this is an impulse wheel, driven by the impulses produced as water strikes revolving blades or buckets. In a perfectly designed wheel, the water strikes at high speed, exhausts its energy in driving the wheel to which the bucket is attached, and then falls free of the wheel.

Known as a Pelton wheel, this type developed from the "hurdy gurdy", a paddle wheel used in California by the forty-niners. The hurdy-gurdy was a wheel that rotated in a vertical plane, had flat vanes fixed around its circumference, and was driven by the force of water striking the vanes. It was not an efficient machine, but it was simple to construct. Then an engineer named Lester Pelton substituted a cup-shaped, divided bucket for each of the vanes, and by that step added a high degree of efficiency to the wheel's other virtues.

No single wheel will meet all operating requirements, but some will perform under

a reasonably wide range of conditions. The following table indicates the r.p.m. and horsepower output that will be delivered by this wheel under given conditions of head and flow. The latter is measured in cubic feet per second:

HEAD	FLOW	R.P.M.	HP.
25'	0.43	350	1.0
30'	0.51	390	1.3
40'	0.59	450	2.0
50'	0.66	500	2.8
60'	0.73	550	3.75

Thus, if a survey of your stream indicates a head and flow close to these values, this Pelton wheel will fit neatly into your plans.

Strictly speaking a water wheel is an engine powered by water, just as an automobile engine is powered by gasoline. The important power-producing elements of the wheel are the buckets and the nozzle, and considerable care should be exercised to see that these parts are made correctly. The nozzle meters the correct amount of water to the wheel, and forms and directs the jet against the buckets. Both the inside diameter and the location of the nozzle with respect to the wheel are very important, since the jet must impinge upon each bucket at the correct wheel radius or lever arm. It must also be divided equally by the center ridge of each bucket.

The function of the bucket is to convert the energy of the jet, represented by its high speed, into mechanical energy at the wheel shaft. To do this it must slow the water from its high speed in the jet to practically zero speed when it drops into the tail water. Maximum efficiency with this wheel will be obtained if the buckets have the form and size shown in the drawing. This shape acts to slow the jet by turning it smoothly through 180 deg. The surface of each bucket must be as smooth as possible. A mirror finish is desirable on the inside, and even the back of each bucket should be ground and polished to minimize spray.

Important also is the correct orientation of the bucket to the jet. When the full jet strikes, the bucket should be perpendicular to it. Both the nozzle and the buckets will wear under the action of the high-speed water, at a rate determined by the silt con-

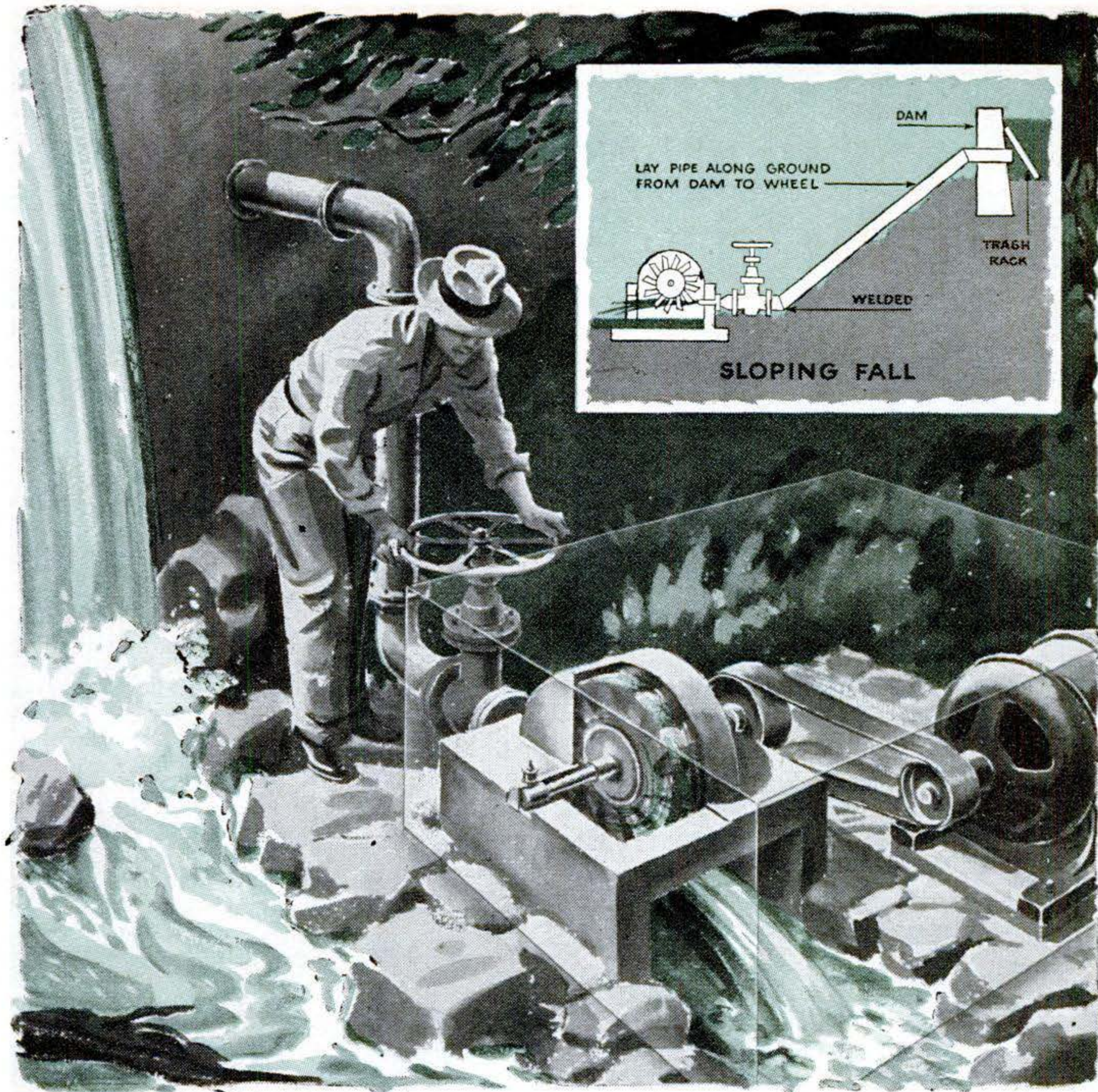

While the penstock may be set up to provide either a precipitous or sloping fall, it should be of as

large a diameter as possible, have minimum bends, and hold down flow friction to the least amount.

tent, and should therefore be made easily removable for replacement.

Above all, buckets must be uniform. If you can get access to a metal-cutting band-saw, cut the blanks according to a single pattern. This pattern can be shaped so as to form the end bevels automatically when the blanks are bent, and the bending itself can be done in a jig or hammering form. This jig may be made of a piece of pipe of about 2" outside diameter mounted in hardwood endplates. Also provide a holding fixture that will slide in the table groove of the bandsaw to assure that the slots for the end lugs are cut and spaced uniformly. A holding jig should also be made to line up the

lugs and buckets for welding. On completion, balance the wheel by laying weld beads along the backs of any light buckets. Beads should be laid carefully and ground smooth.

Ball bearings may be employed, but are not necessary since the wheel turns at comparatively low speeds. If the builder prefers to use plain bearings, it will simplify machining the shaft, which should present a shoulder to the inside of the bearing so that the wheel may be positioned. If plain bearings are employed, babbitted linings are satisfactory, provided provision is made for proper lubrication.

One vital job that the foundation must do is hold the wheel and the nozzle in correct

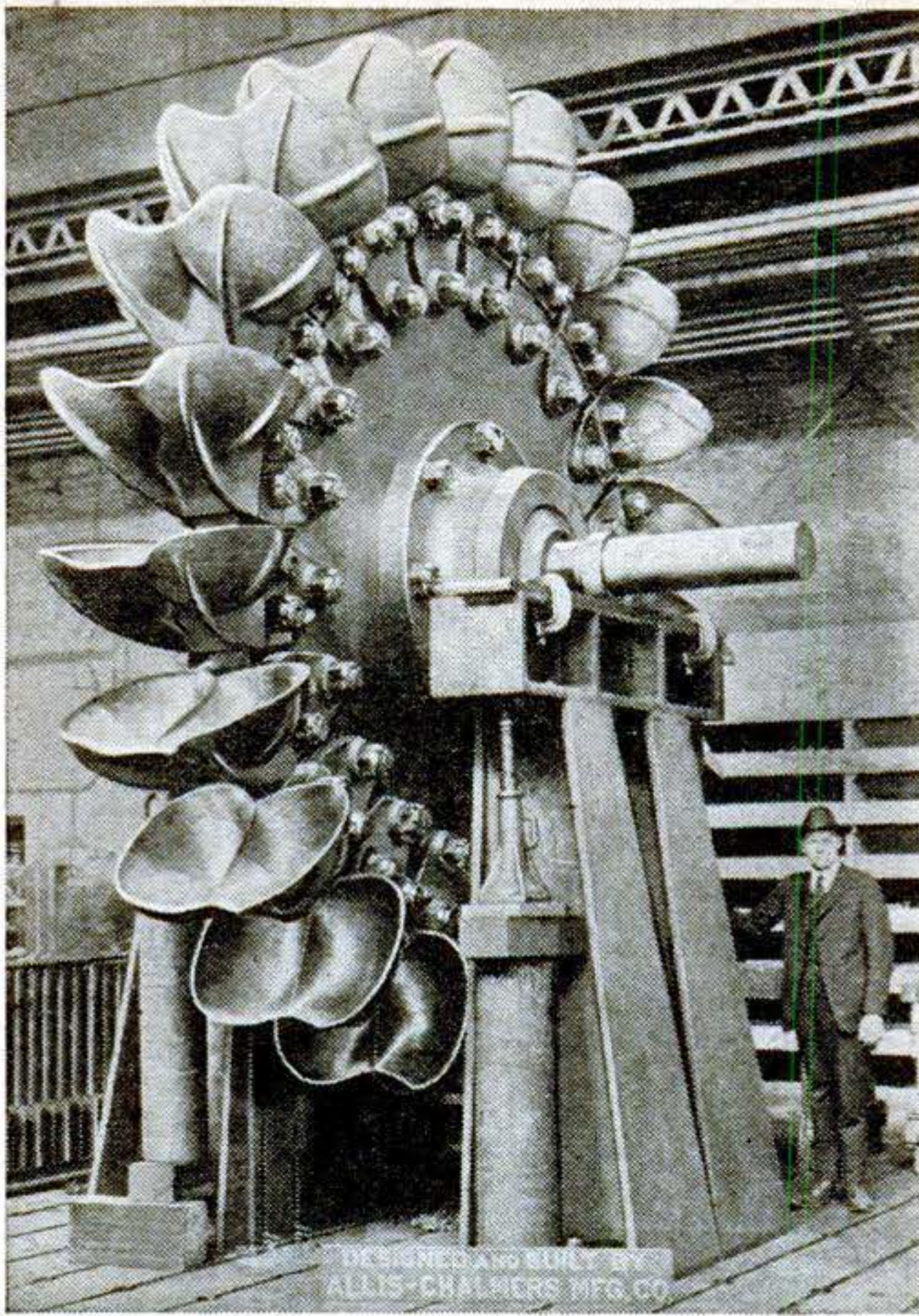

Dramatic contrast in wheel sizes. Top, a 25-ton job designed for installation in a 30,000-hp. unit. It turns at 171 r.p.m. and has a 1,008' head. Below, a 12" wheel with reducer and gate-valve throttle.

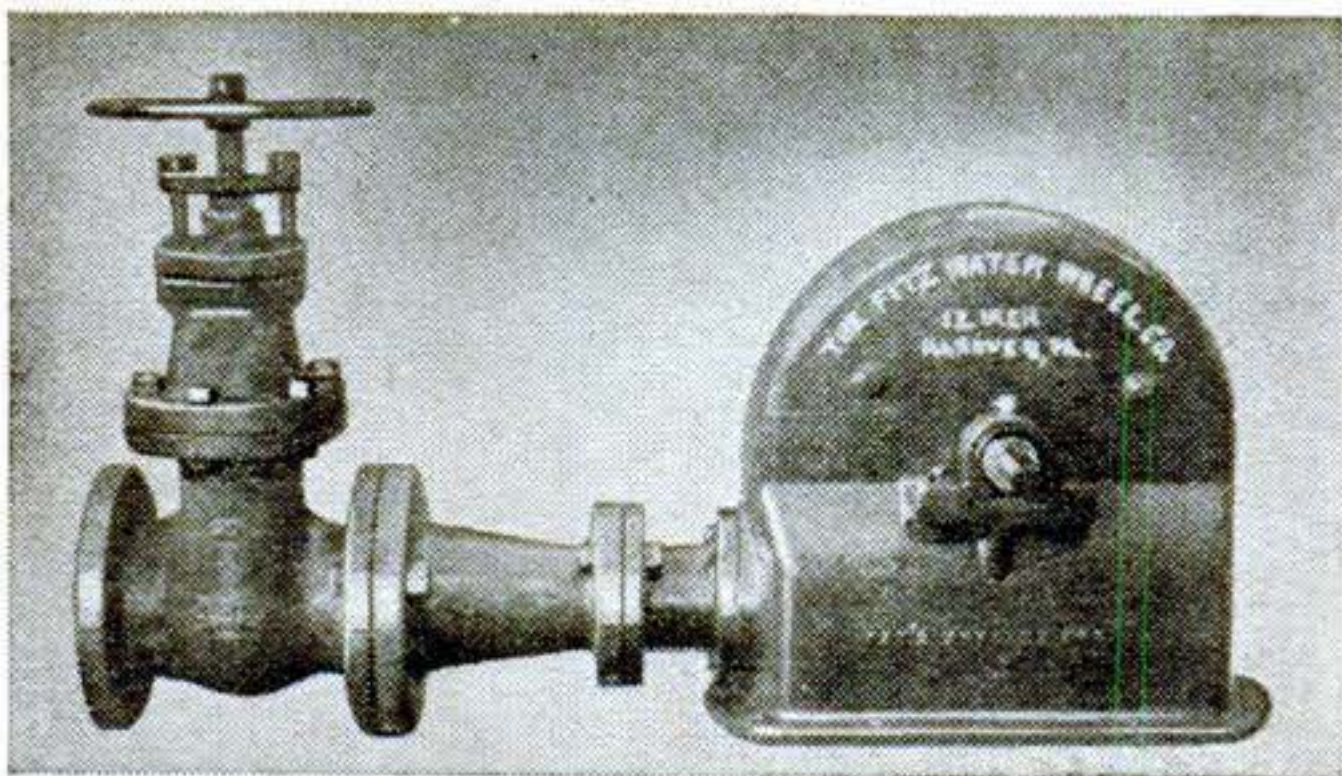

relative positions. It should be placed on firm ground or piling so that it will not settle unevenly, and must, of course, take advantage of all the head possible. The penstock from the dam should have easy access to the nozzle, and the tail water easy escape to the stream. If possible use 4" or larger pipe for the penstock and lay it out to hold frictional losses to a minimum. The width of the foundation is such as to allow the water to fly clear of the buckets. The removable cover over the upper half of the wheel may fit more closely, since no water sprays from the buckets through this half of the revolution.

The foundation may be made of such materials as timbers in a framework, masonry, or concrete, so long as it fulfills the above requirements. The wheel and the machinery being driven may then be housed in any suitable, inexpensive shed.

It's not wise to dispense with a gate valve, which is used to cut off or to throttle the water supply to the wheel. Since a gate valve cannot be operated rapidly, it is the best type, eliminating the risk of dangerous water hammer in the penstock. It is also well suited for throttling because fine adjustment is obtainable through the long operating screw. In throttling, the gate valve should be used together with a tachometer or revolution counter connected to the wheel shaft to secure the optimum speed and horsepower for the stream condition and load. Either fasten a tachometer permanently to the shaft, or keep a revolution counter handy in the wheel shed.

Generally the head and volume of water flowing to the wheel will remain constant, resulting in a constant output. If the machinery driven by the wheel has a level power demand there will be little need for constant adjustment of the valve.

The requisite piping, pipe fittings, steel sheet and rod, and bolts, nuts, and gaskets are available at building-supply houses or steel distributors. Machine screws, lock nuts, bearings, and the like may be purchased from good-sized hardware distributors or mail-order houses.

One final point to keep in mind in making your calculations: head is defined as the vertical distance between the water surface behind the dam and the tail-water surface at the wheel. For an impulse wheel, however, which cannot operate submerged, the available head is measured from headwater to the center line of the nozzle. As shown in the construction drawing, there is only 5" difference between the two definitions, but this can make some difference in output when working with the moderate heads for which this wheel is designed.

While many details can be altered, the reader should beware of any that will affect operating characteristics. Thus stainless-steel buckets and antifriction bearings would improve performance, involving only some extra work in building the wheel. Changes in the nozzle diameter, wheel radius, or effective head, however, should be undertaken only after careful consideration of the probable effect on performance. **END**

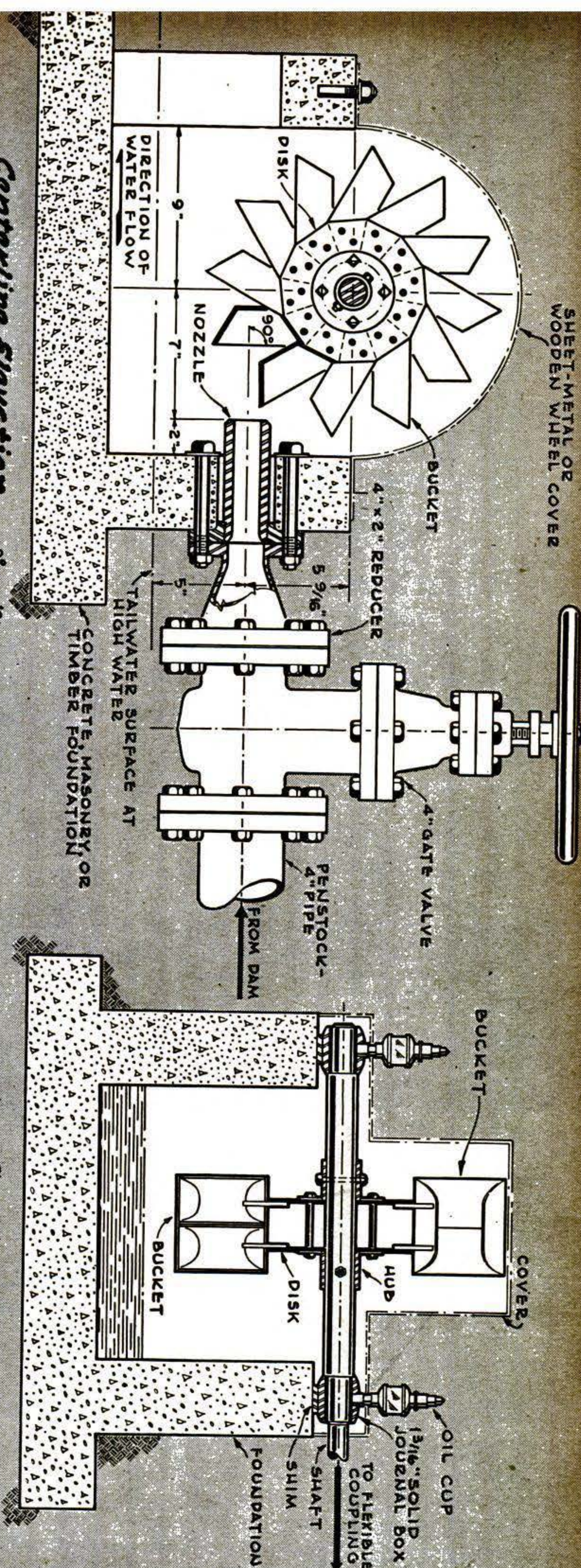

Centerline Elevation

Section

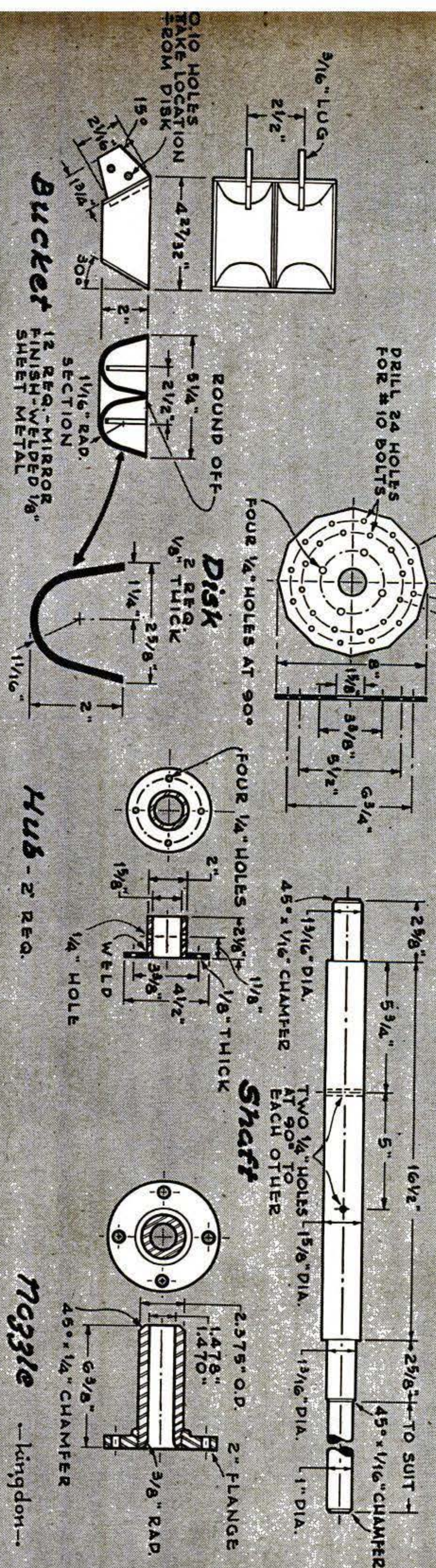

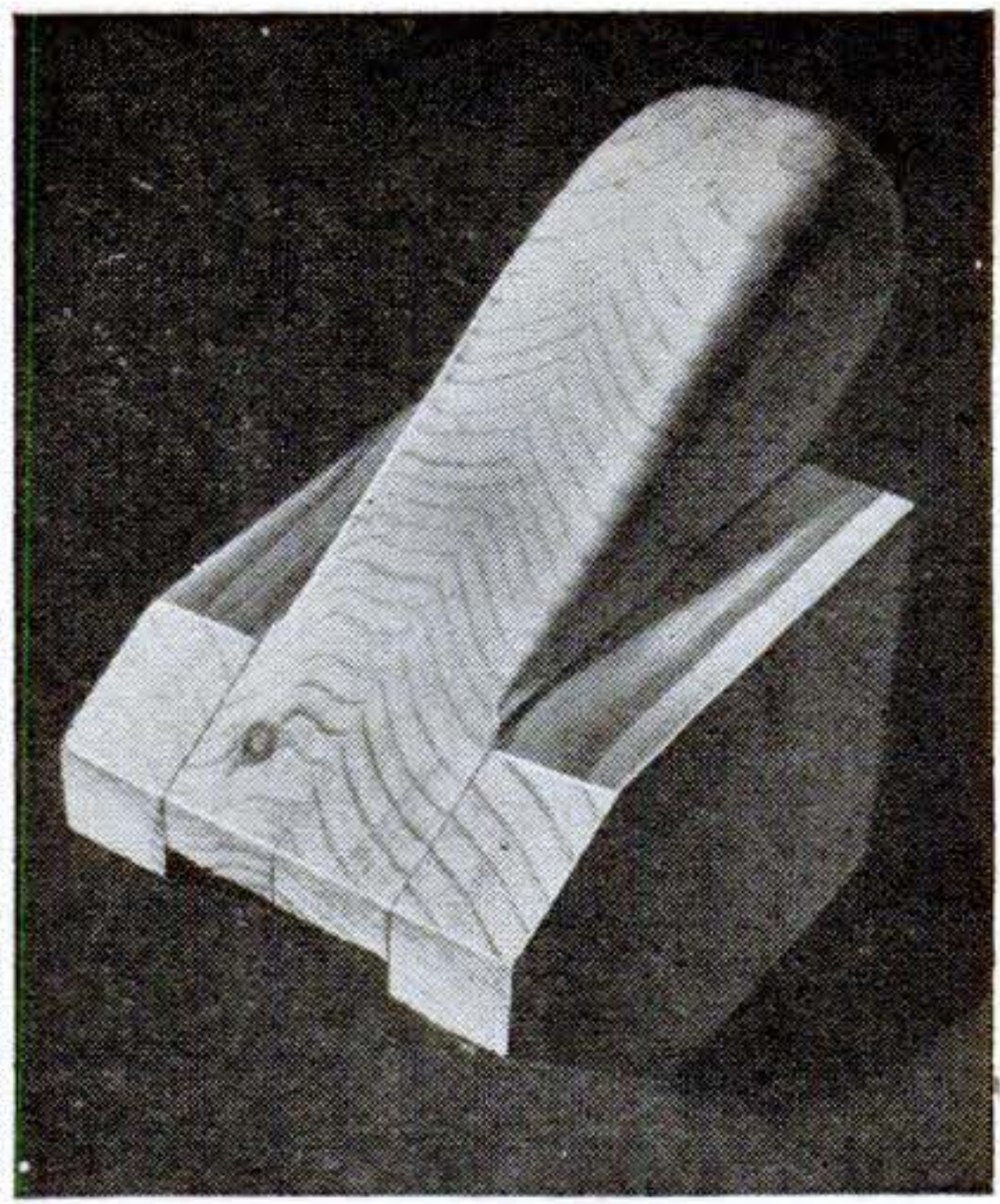
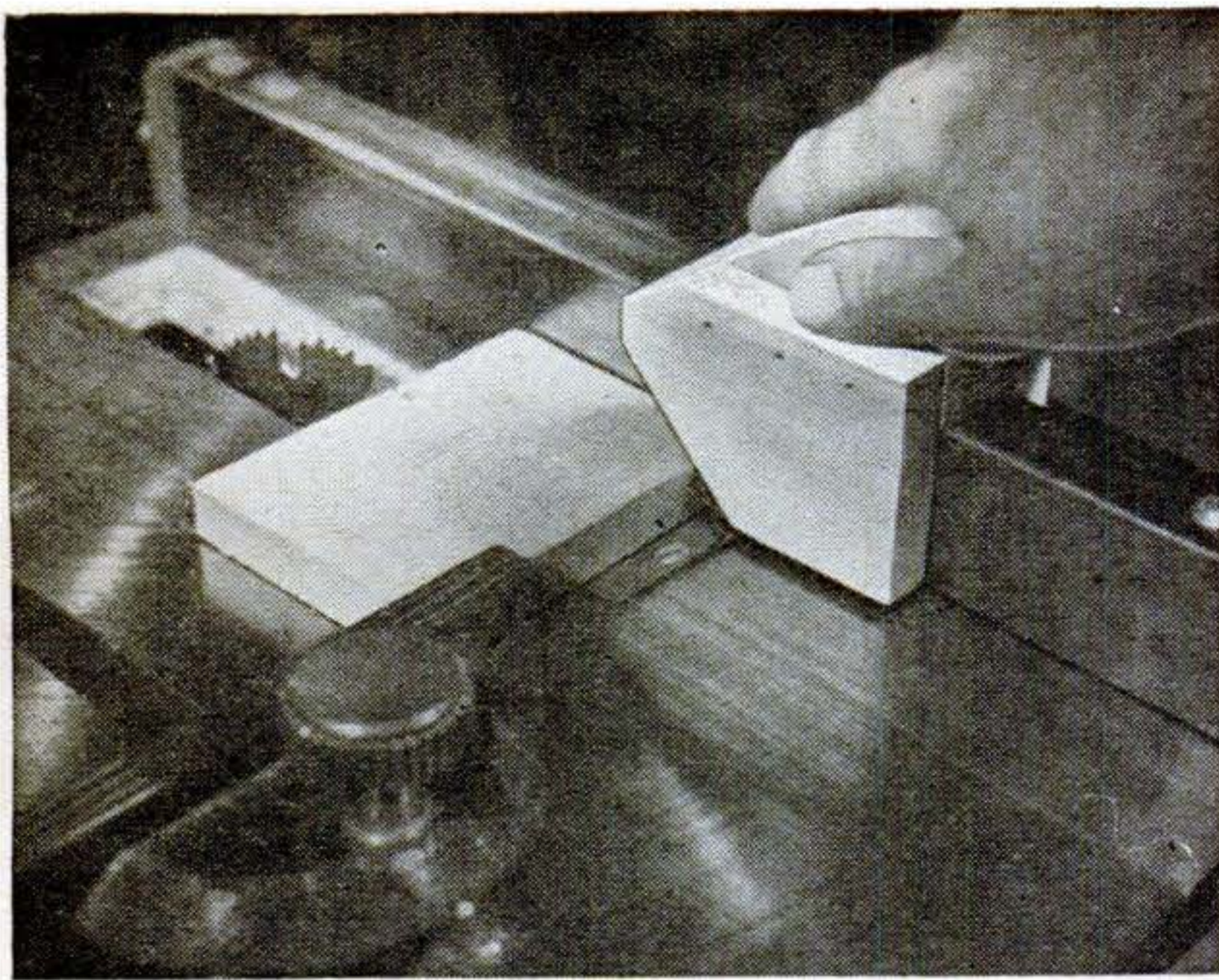

Pusher Block Rides Rip Fence for Sawing Small Pieces Safely

USING any old scrap as a pusher on the circular saw can cause trouble when small blocks or strips are cut. This pusher made of hardwood has a sure-grip handle, straddles the ripping fence, can't slip, and can

be used for cuts on either side. A 45-deg. corner on the front of the cheeks holds the work down as it is pushed. Make the gadget by screwing two cheeks to a handle piece a trifle wider than the fence.—WILL THOMAS.

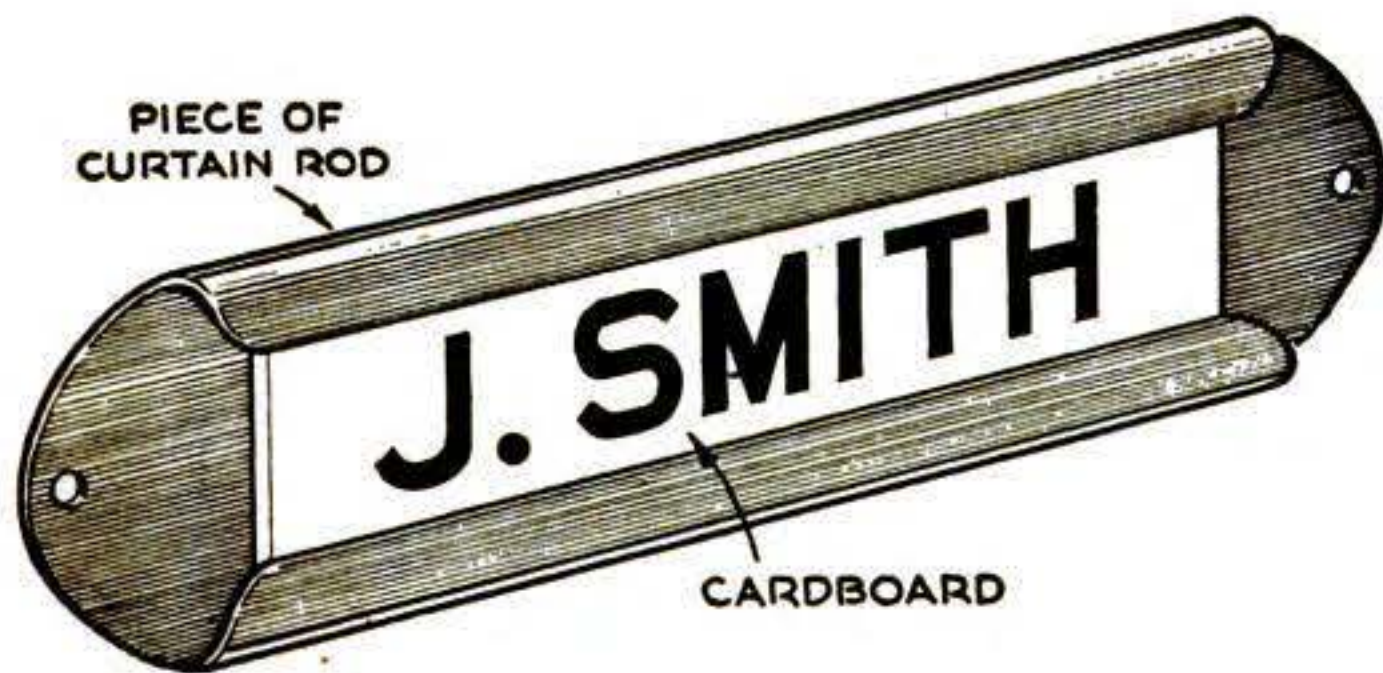

Curtain Rod Frames Name Plate

NAMES and direction cards mounted on doors or walls can be held neatly in short bits of flat curtain rod. Cut the ends round with tin snips, file smooth, and punch holes for small nails or screws.—FRANK SHORE.



Broken Blade Makes Small Saw

FITTED with a handle, a 6" length of broken $\frac{1}{4}$ " bandsaw blade will make a useful keyhole saw. The detachable file handle shown has a thumbscrew that clamps the blade. An ordinary file handle could be used with a screw put through it and a hole punched in the blade to hold it firmly in place while sawing.—OSCAR HYLER.

Wall Hangers Made from Baling Wire Will Hold Small Tools

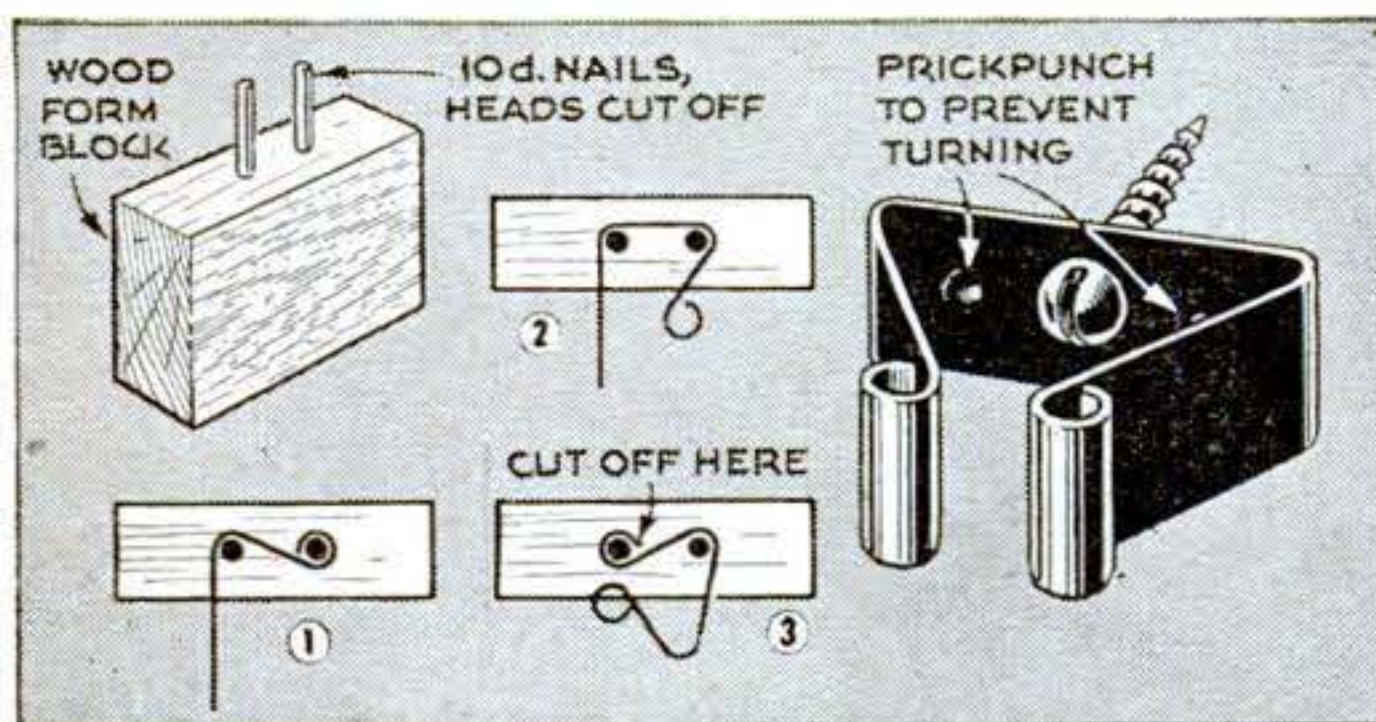

The metal's natural spring grips tool handles.

SHORT lengths of $\frac{3}{4}$ " strap metal of the kind used for baling and reinforcing packing cases can be bent into wall hangers for hammers, files, and the like. Make up several form blocks, spacing the nails according to the diameter of the tool handles; then bend the strap on the blocks to make brackets with curled ends. Punch for a mounting screw and, when the hangers are on the wall, prickpunch on both sides of the screw to keep them from turning.—ELMER H. BERRY.

Argon Beam Lights Clock Dial

ULTRAVIOLET radiation that makes the figures on even an old luminous clock dial stand out clearly in the dark can be obtained from a tiny argon bulb. The purplish-blue ray is hardly visible.

A $\frac{1}{4}$ -watt argon lamp with a candelabra base can be obtained at radio supply stores; type AR-3 can be plugged directly into a household A.C. outlet. Screw it in a night-light socket having a switch in its base. If it is used in a three-outlet receptacle, an electric clock and a reading lamp can also be plugged in.

Any metal cylinder covered on one end can be made into a lamp house. A radio shield can will do, but one type of shaving-stick container just fits the night-light base. Make a hole opposite the bulb and solder in a tubular shield. Place the clock full in the beam. A 50,000-ohm, 1-watt resistor prolongs bulb life.—GEORGE P. PEARCE.

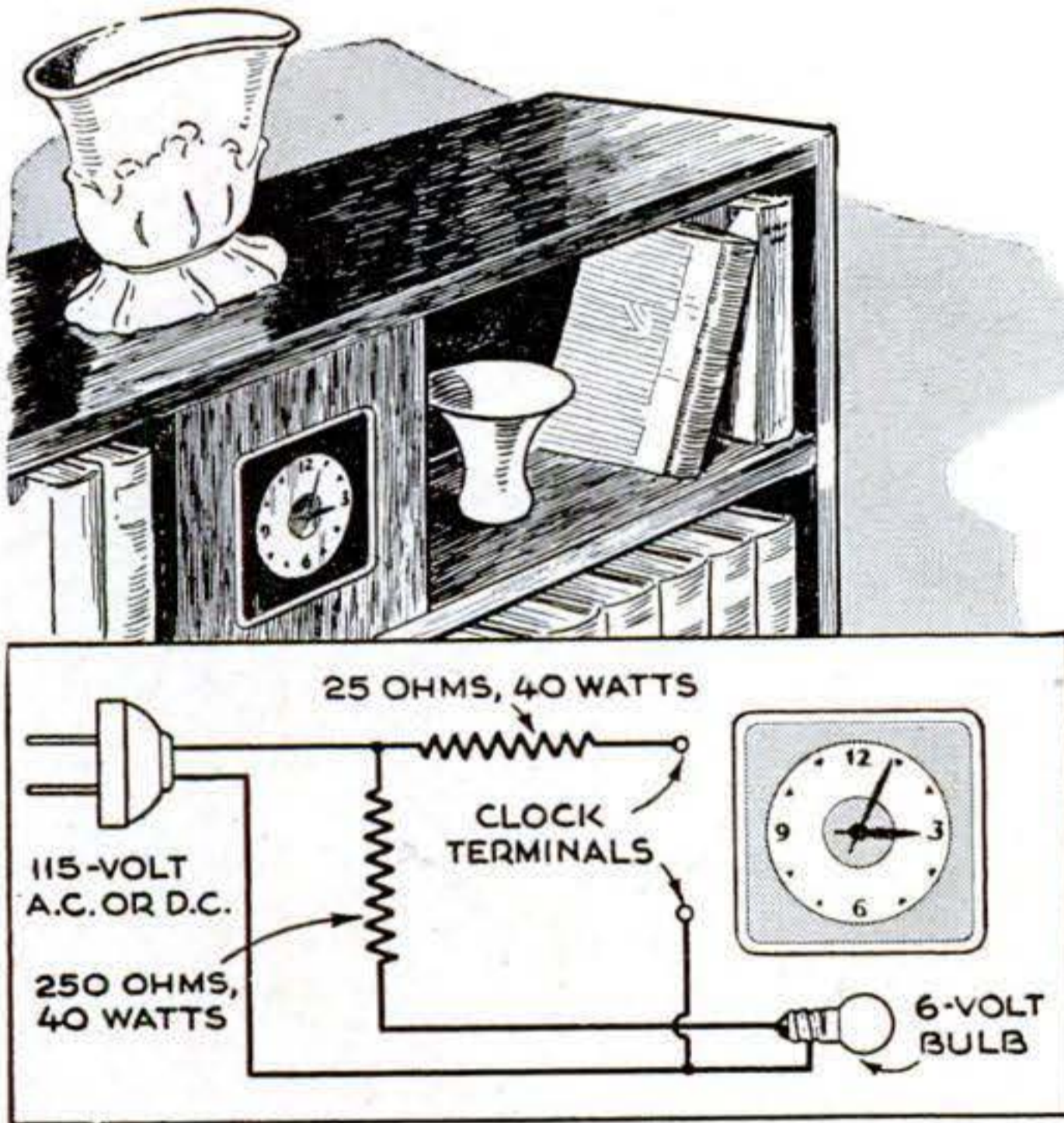
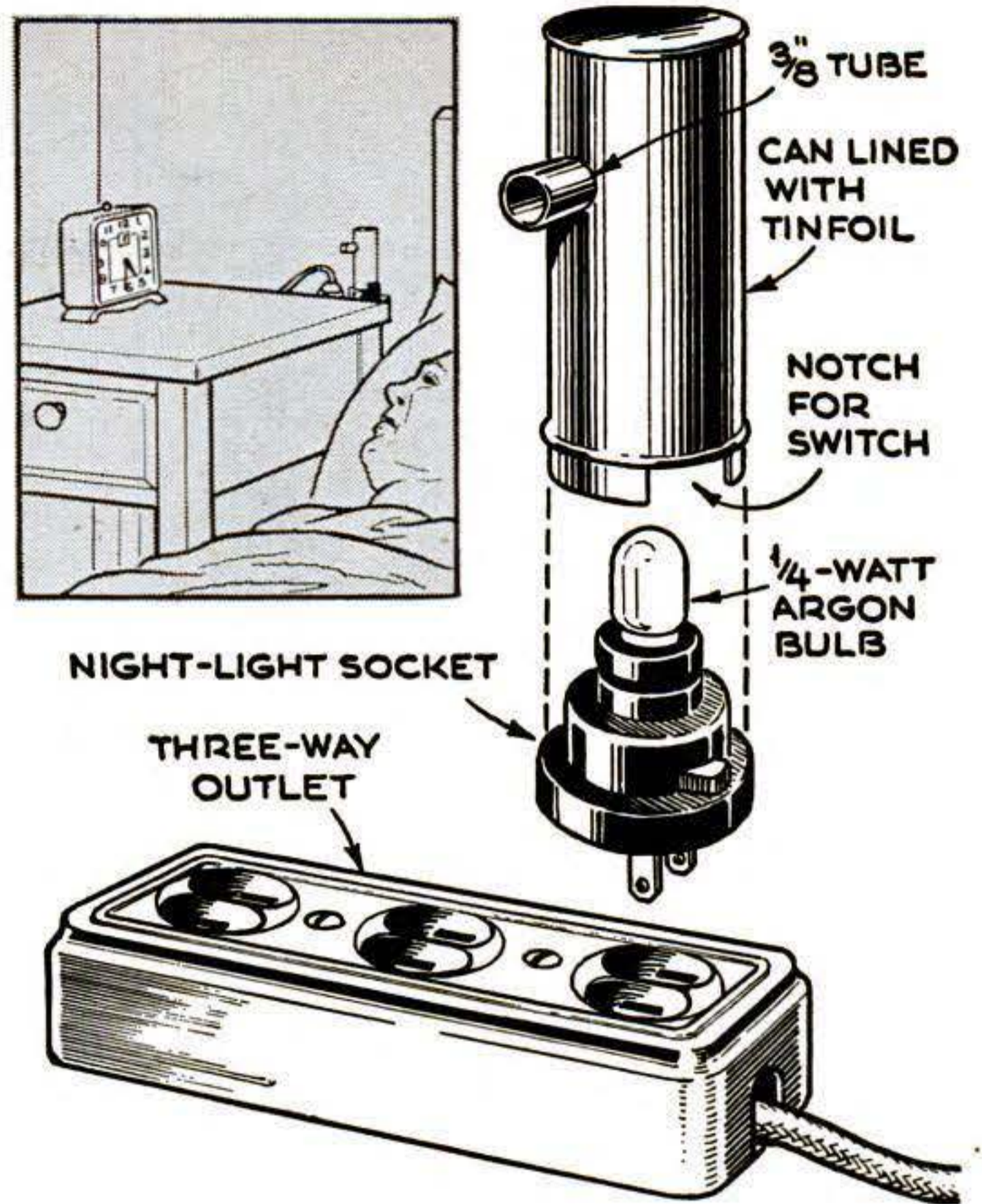

Dash Clock Wired for Home Use

You can wire an automobile dashboard clock to run on 115-volt A.C. or D.C. as a handsome illuminated-dial house clock. Most car clocks are designed to operate on 6 volts, but since current flows only momentarily on the winding cycle, they can be connected to house current if a 25-ohm resistor is put in the circuit. If a 115-volt radio pilot bulb can be found, the 250-ohm lamp resistor can be omitted from the lamp circuit.—CRAIG C. MARTIN.

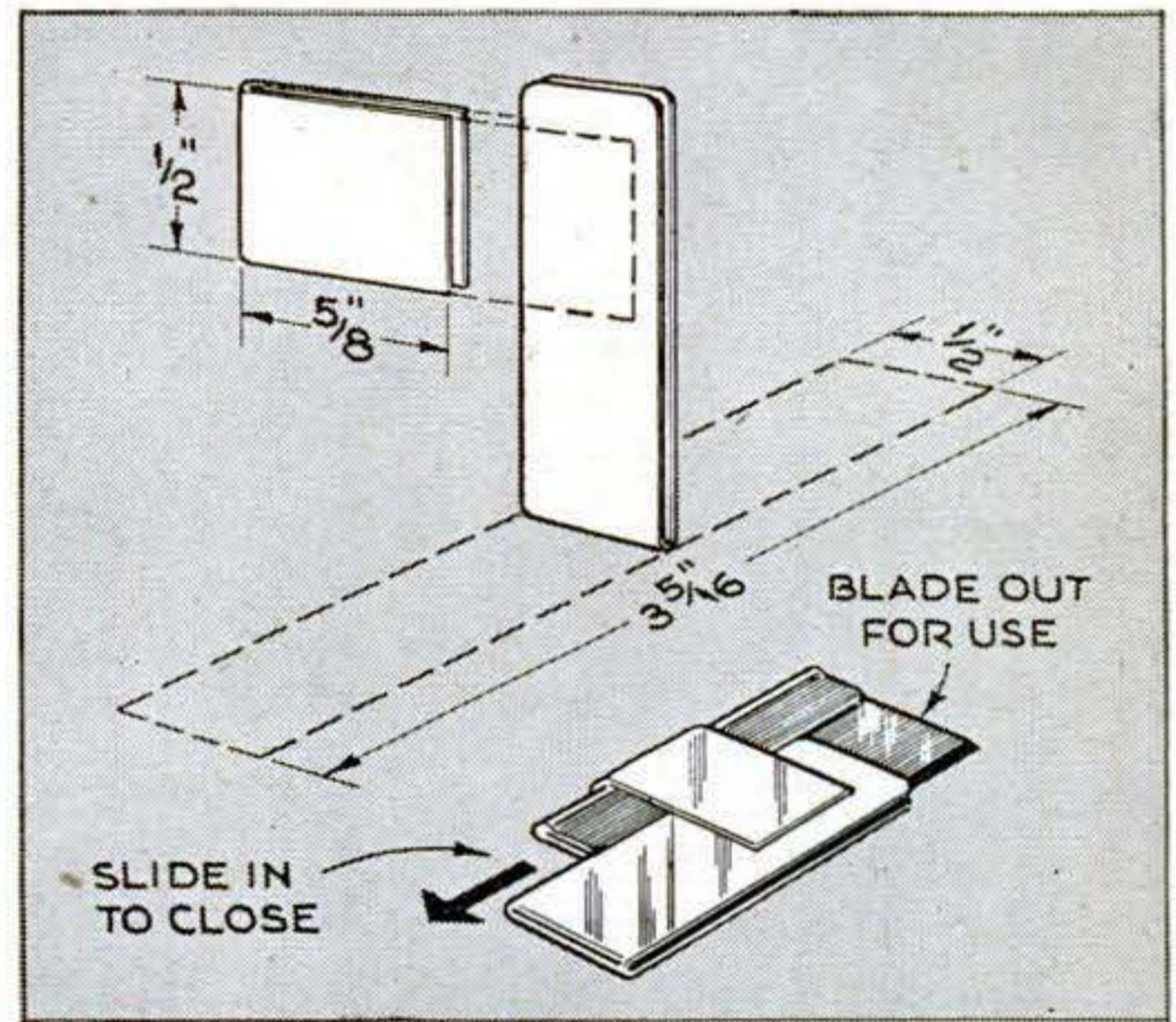

Holder Covers Edge of Blade

AMATEUR photographers and modelmakers find many uses for razor blades, but unguarded edges are a menace to careless fingers. A few minutes spent making this combination guard and holder for single-edge blades will be well spent. With it, a blade can be carried in the pocket.

Any reasonably stiff sheet metal or $\frac{1}{2}$ " wide band stock will serve. Fold a strip of the metal over at the center to cover a single-edge blade below the stiff back; then solder on a shorter folded strip to make a track for the back. This piece holds the blade rigid when it's in use.—W. F. HOLBROOK.

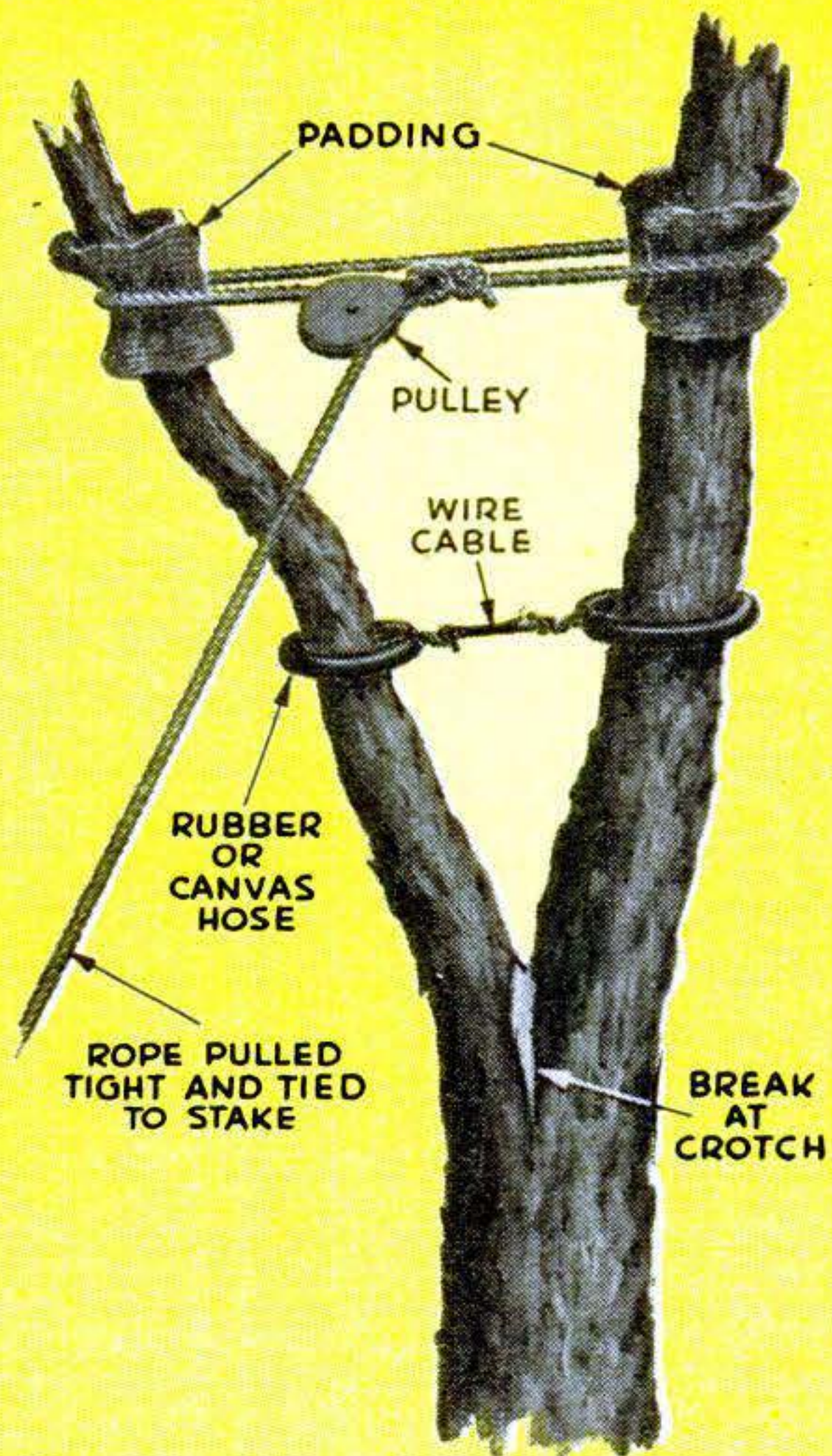

Cabling prevents further damage to a split crotch and gives the wound a chance to heal. Protect the bark under the wires.

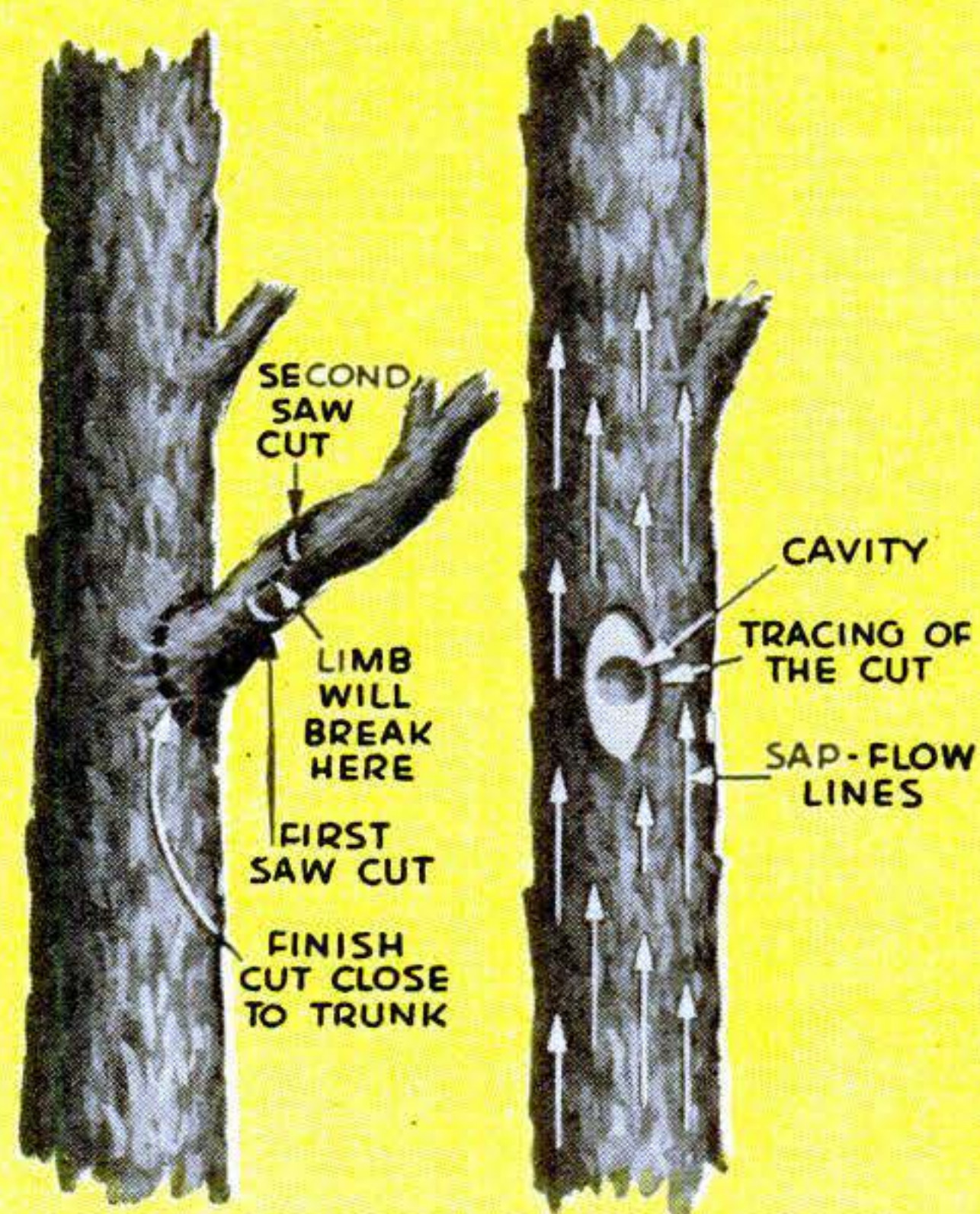

In taking off a limb, make saw cuts in the order shown at left. Excavations should be long, not wide, to allow maximum sap flow.



Excavation is done with a mallet and sharp chisel. Rotting matter is removed down to clean wood, and chips are cleared out so air pockets won't form.



Bichloride of mercury disinfects the cavity, and the inside is then coated with waterproof paint. Wood between the bark and hole is shellacked.

Save That Shade Tree

Simple surgery in time may preserve an asset to your property that would take years to replace.

By Earl Seidlinger

IT TAKES years to grow a tree and only a season of neglect to destroy one. With the best intentions, owners have done more to hasten the death of their trees by ignorant trimming and improper treatment than disease could do in a score of years. But there is no reason why an amateur, once he understands the problems and provided he acts in time, cannot arrest ordinary decay.

First aid in emergencies and proper seasonal trimming can do much to prevent the onset of decay. One of the most common accidents that can befall a tree, especially an elm, is splitting in the crotch. Cabling will prevent further damage and give the wound a chance to heal. Be sure to protect the bark under the wire.

When a limb is to be trimmed off, splitting can be avoided by a first cut on the underside a few inches nearer the trunk than the severing cut. Then saw the stump off close, but do not damage the bark. Coat the raw wood with asphalt paint or house paint, taking care not to get any on the bark. Nature will do the rest, and the bark will grow back as a callous.

If decay has already set in, more drastic steps will be required, but first look over the tree to see whether it warrants repair. If there is much dead bark on the trunk, if the upper branches are dying out, or if there is much fungus growth at the base, it may be best to get rid of the tree or to call in an expert tree surgeon.

When a tree appears healthy, it can usually be saved. Cavity repairs are best made from May through July, never before the

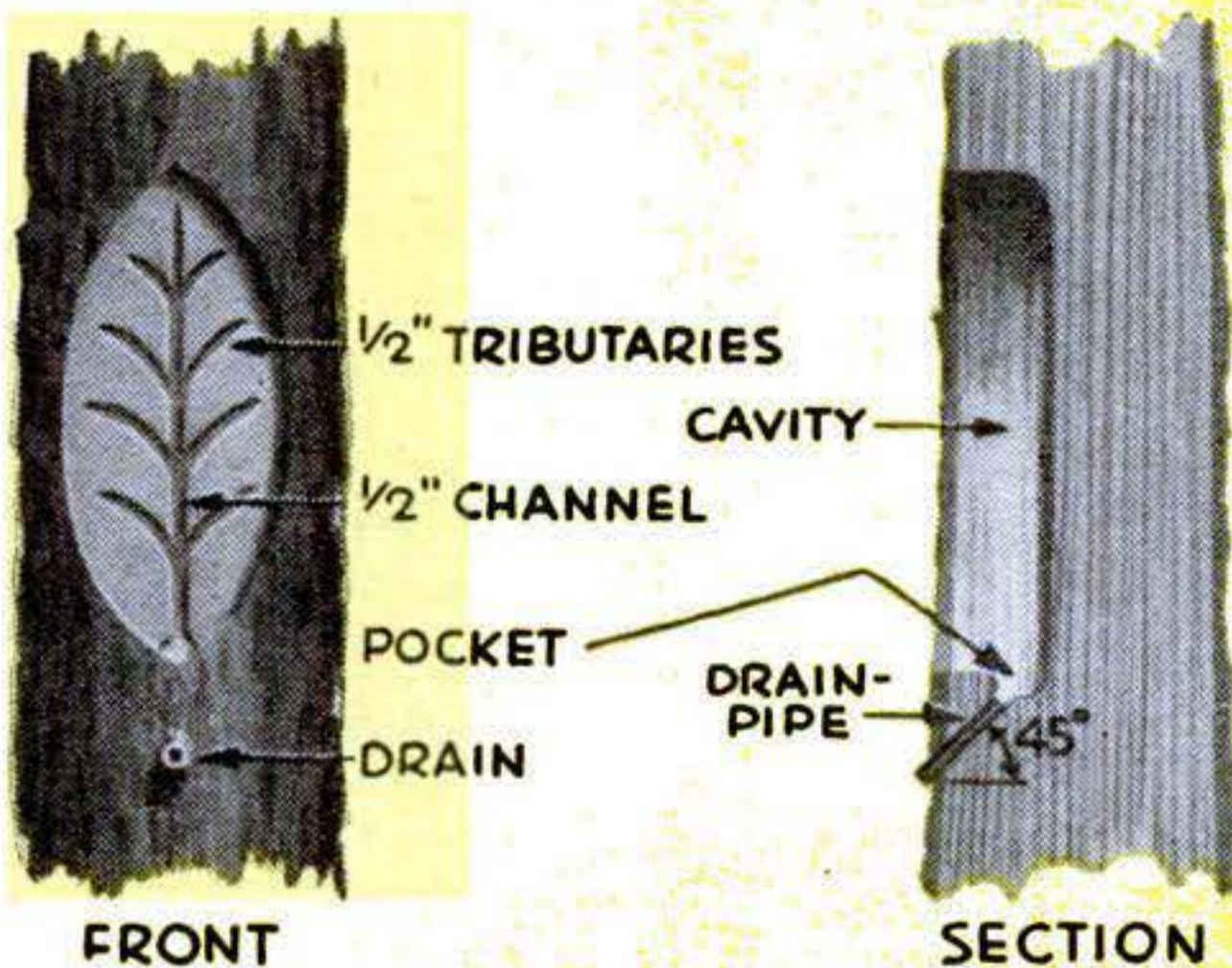
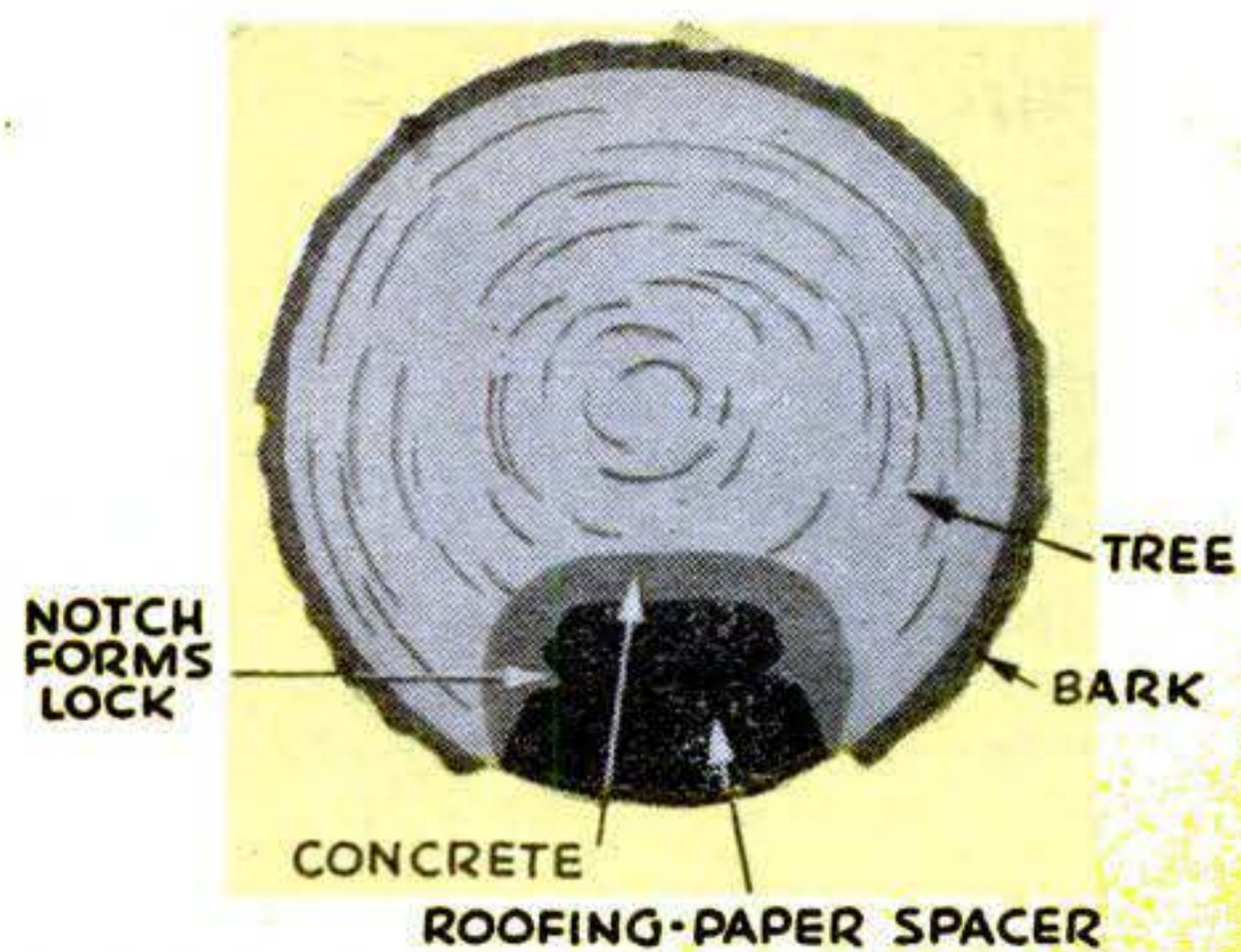

At top, how a spacer fits into a concrete filling. Two views of a drainage system to take off slime flux behind a filling.

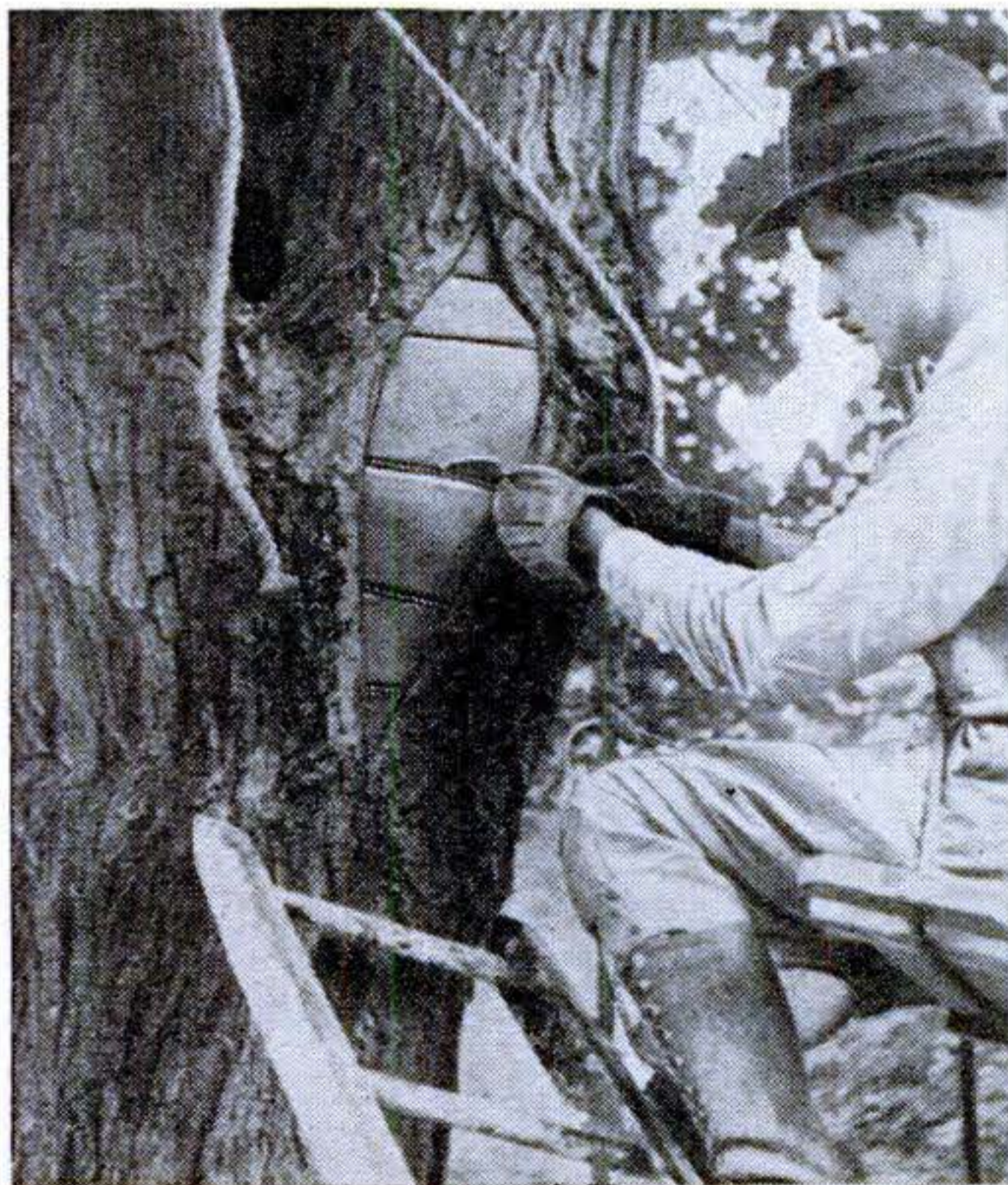

Concrete is put in a little at a time and spaced with roofing-paper sheets. The filling is slicked level with the wood, and the edges are beveled.

middle of April nor after the end of August. Drill test holes in the infection to determine the extent of decay, pulling out the drill at various depths to examine the cuttings. Trace a pointed elliptical cavity around the wound large enough to enable you to get out all the decay. A long cavity is less harmful than a wide one, as it permits maximum sap flow and promotes rapid healing. Smooth the bark at the edges with a sharp jackknife, and then shellac immediately to keep it from drying out—bark dries rapidly on hot days. Take care not to spring the bark from the tree or it will die.

Excavation is muscle work with a mallet and heavy chisel. Chip from the inside toward the edges and avoid injury to the bark. Make the back of the hole larger than the tracing so the concrete will wedge in firmly. A 7/16" hole drilled at the top and bottom points of the tracing to the depth of the cavity or at least 2", whichever is greater, makes excavation at the points easier. Leave a 1/16" to 1/8" ledge of wood between the bark and the excavation.

After all decay has been removed, smooth the inside walls with a sharp chisel to remove chips that might cause air pockets and promote further decay. Disinfect the cavity with a solution of 1 part bichloride of mercury to 1,000 parts alcohol. Then paint the inside with a good asphalt paint.

For a filler use 2 parts clean, sharp, white sand (no gravel) and 1 part Portland cement mixed thoroughly while dry, and add water and spade until damp. Don't get it too wet,

or the filling will belly down from its own weight. Use one hand for an outside form, and put a little cement in at a time with the other hand or a trowel. Tamp toward the inside, adding more cement as needed.

If the cavity is more than 8" long, horizontal spacers cut from three-ply roofing paper will be needed every 4" or so. They are cut smaller than the cavity and notched for anchoring by the concrete. The usual practice is to place them so the concrete surface will be divided into squares, putting the first and last somewhat nearer the bottom and top of the cavity. Spacers allow for tree sway and for contraction and expansion in changing temperature.

When completed, the filling should extend slightly beyond the tree surface. It is slicked off and beveled around the tracing and at the spacers to prevent chipping.

Elms, hackberries, sugar maples, and some other trees have an abundance of sap that causes a slime flux behind a filling. They require a drainage system to allow the flux to drain out instead of working around the filling. Cut a vertical 1/2" channel at the back of the cavity and furnish it with 1/2" tributaries.

Lead the main channel into a pocket at the rear base of the cavity, and drill a drain hole to it at a 45-deg. angle. Pockets vary, according to the cavity, from golf-ball to tennis-ball size. A pipe is fitted into the drainage hole. All chips must be removed, no matter how small, or they may clog the pipe and spoil drainage. END

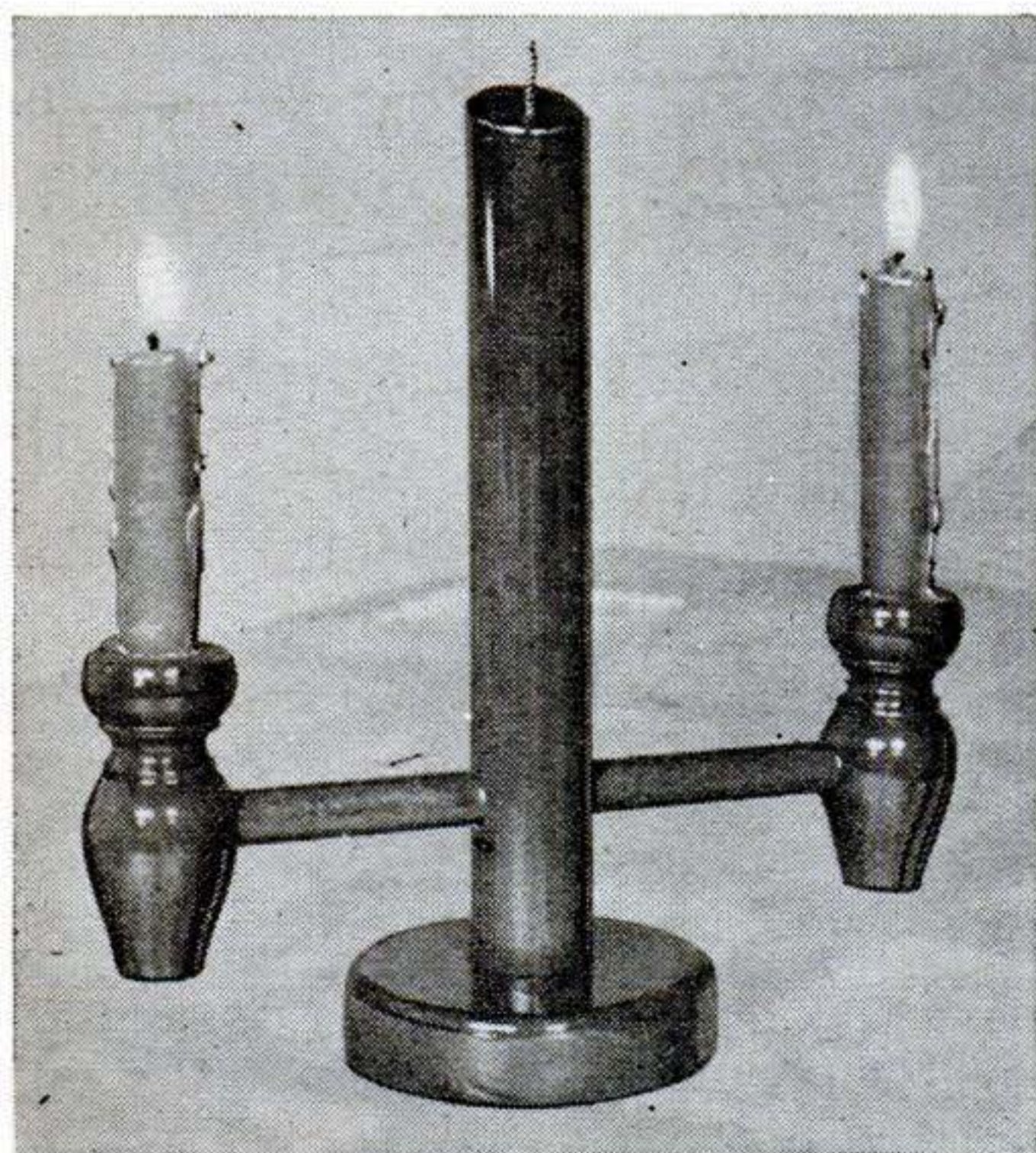

Turned Candlestick Is Made Without Resort to Lathe

EMBODYING the simplicity of a Colonial period turning, this candlestick will be a decorative centerpiece for a kitchen or dinette table. It is made from two lengths of dowel of different diameters and two turned holders that can be salvaged from the legs of a discarded chair. The circular base may be cut to a scribed line with a scroll saw and rasped and sanded smooth.

Cut the top of the center dowel on a slant to imitate the end of a burned candle, bore to take the cross dowel, and mount in a hole in the base. A tight fit in the holes and a little glue will make strong joints.

Stain or paint to match the kitchen color scheme.—R. J. DECRISTOFORO.

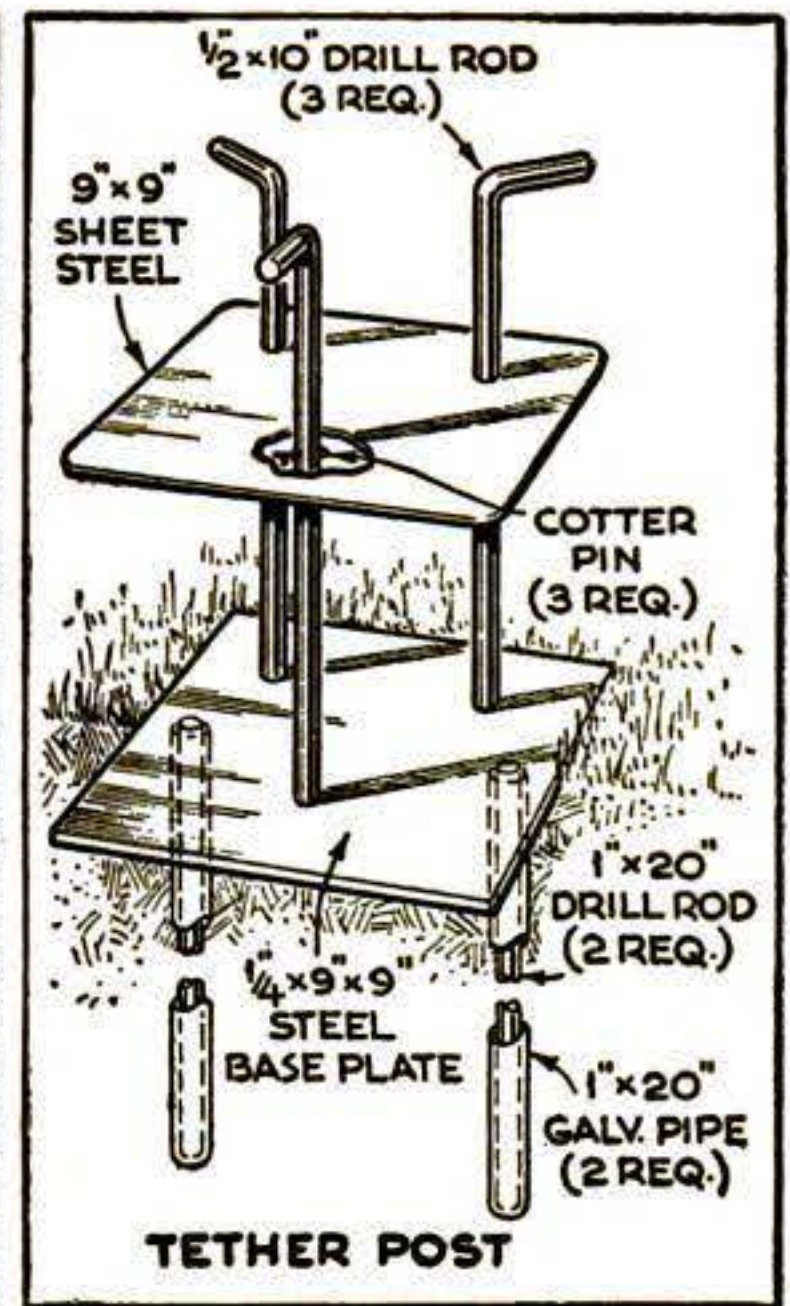
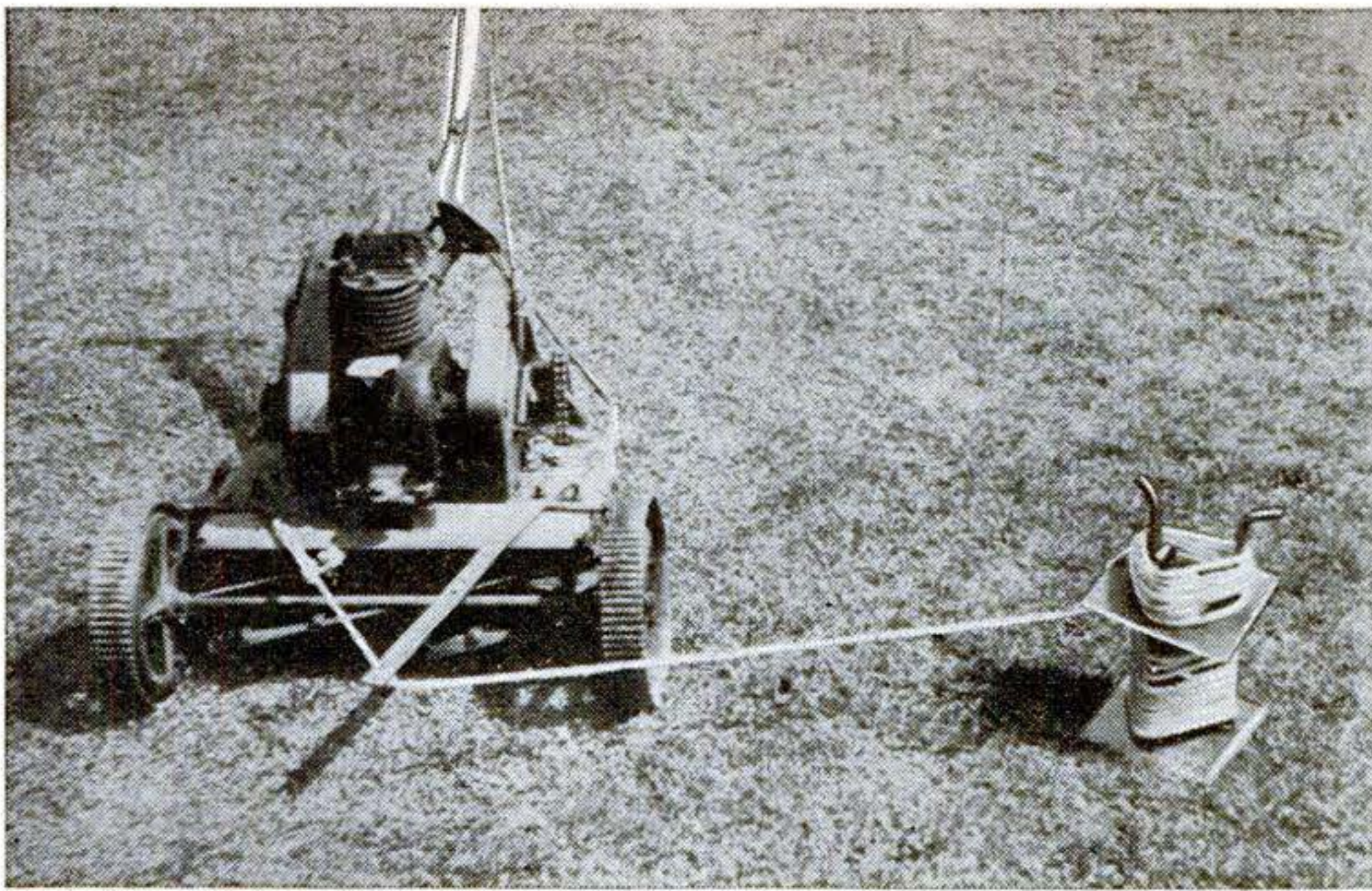

Tethered Power Mower Steers Itself While Cutting Your Lawn

WEARY trudging behind a power mower can be eliminated if your lawn is fairly level and unobstructed by rocks or trees. Running at the end of a 75' clothesline tether, the mower moves in a circular track of ever-decreasing diameter as the line winds itself up on a center post. Meanwhile you relax comfortably in the shade, ready to disconnect the clutch when the mower has worked its way down to a 4' circle or if the blade should catch on a twig or pebble.

The center post consists of three steel rods welded or threaded to a base plate and spaced by a piece of sheet metal. A pair of rods beneath the plate fits into pipe sockets permanently located in the ground; with a big lawn several centers permit you to cut most of the area with a series of circles. The top rods are bent out to hold the surplus

rope when a smaller circle is worked. The spacing of the rods depends on the size of the mower used and the amount of cutting overlap desired. For a 22" mower and a 4" overlap, the distance around the rods should be about 18", which puts the rods about 3" from a center point. If your mower is of a different size, calculate the desired circumference accordingly. Unless you make an extremely small center post, overlapping of the rope turns makes little difference in the effective circumference.

To guide the mower, bolt a sturdy steel bar to the front of the machine so that the steering pull is applied ahead of the center of turning. A snap clip at the end of the tether permits you to disconnect it quickly for trimming corners and centers with the mower guided by hand.—FORRIS B. CHICK.



Keeping Grease Off Burners

WHEN food is fried on a gas range, popping grease frequently spatters the burners not in use. Pie pans placed upside down over the unlit burners protect them and are easily cleaned.—BEATRICE E. REESE.



Tape Initials Mark Galoshes

INITIALS cut from adhesive tape and brushed with colored nail polish make attractive identification markers for galoshes. The initials are easily cut while the tape is stuck on waxed paper.—BENJAMIN NIELSEN.



ENERGY IN STEP. No matter how weak the force applied to an object, if it is repeated at intervals in step with the object's own rhythm of motion, it will bring about some amazing results. The phenomenon is called *resonance*. Familiar examples are a child's swing and notes on a piano that cause bric-a-brac to rattle. In each case weak pulsations are cumulative, adding up to a total force far greater than any single impulse. This can be shown by suspending a heavy book above a table and blowing gently on it at intervals timed to its period of swing. The book can be made to swing far enough by the force of successive puffs to upset another standing within its range.

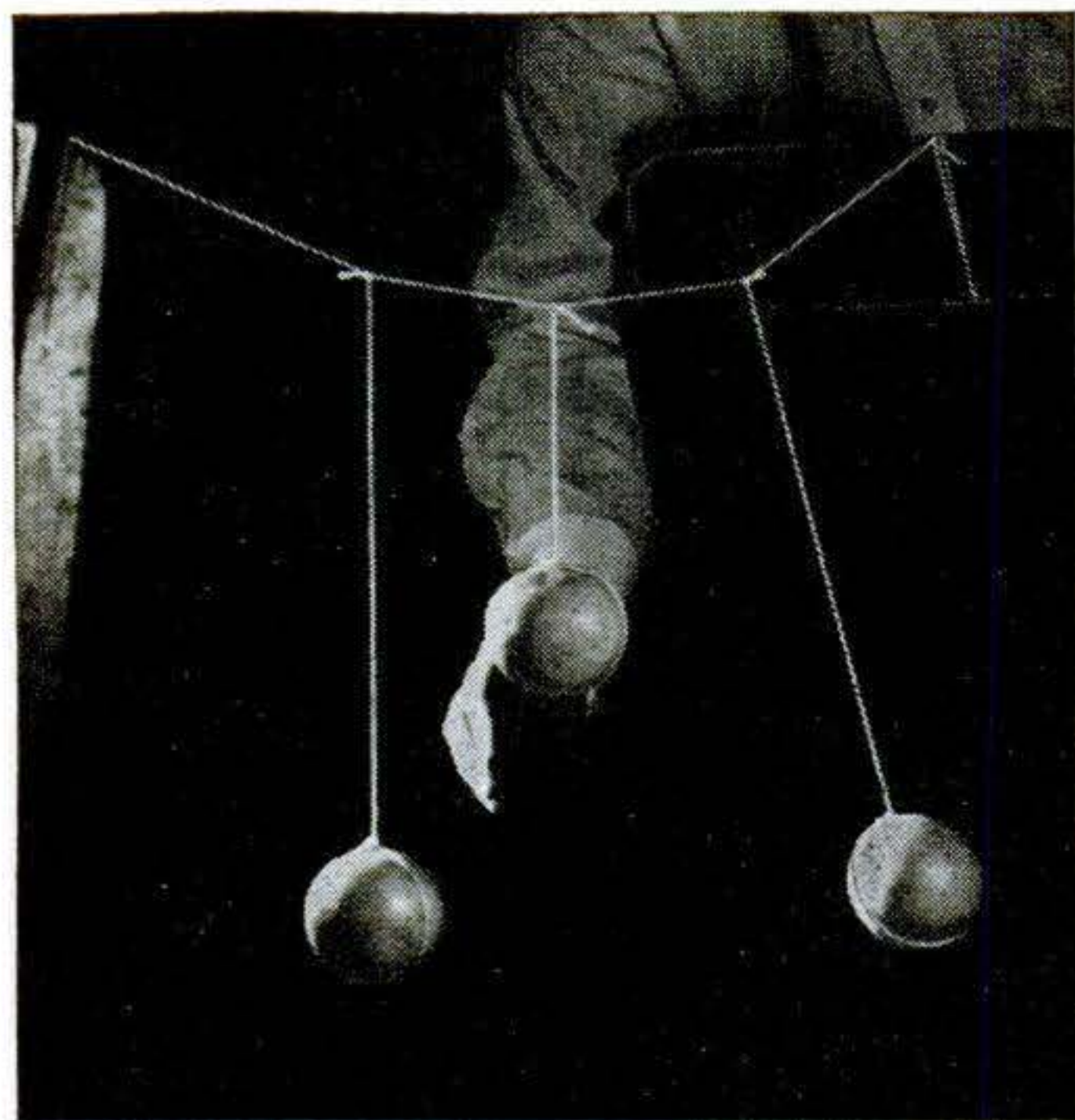

ORANGES SWING IN SYMPATHY. Suspend two oranges the same size on cords of equal length tied to a cord strung horizontally, and hang a third orange between them on a much shorter cord. Now start one of the end oranges swinging. As it swings, the other end orange will also begin to move in tune with its vibrations, increasing its swing as the first diminishes. Then, as the second begins to slow down, the first will again increase its swing. This keeps up until all the initial energy has been lost. The middle orange, having a different period of swing, is hardly affected.

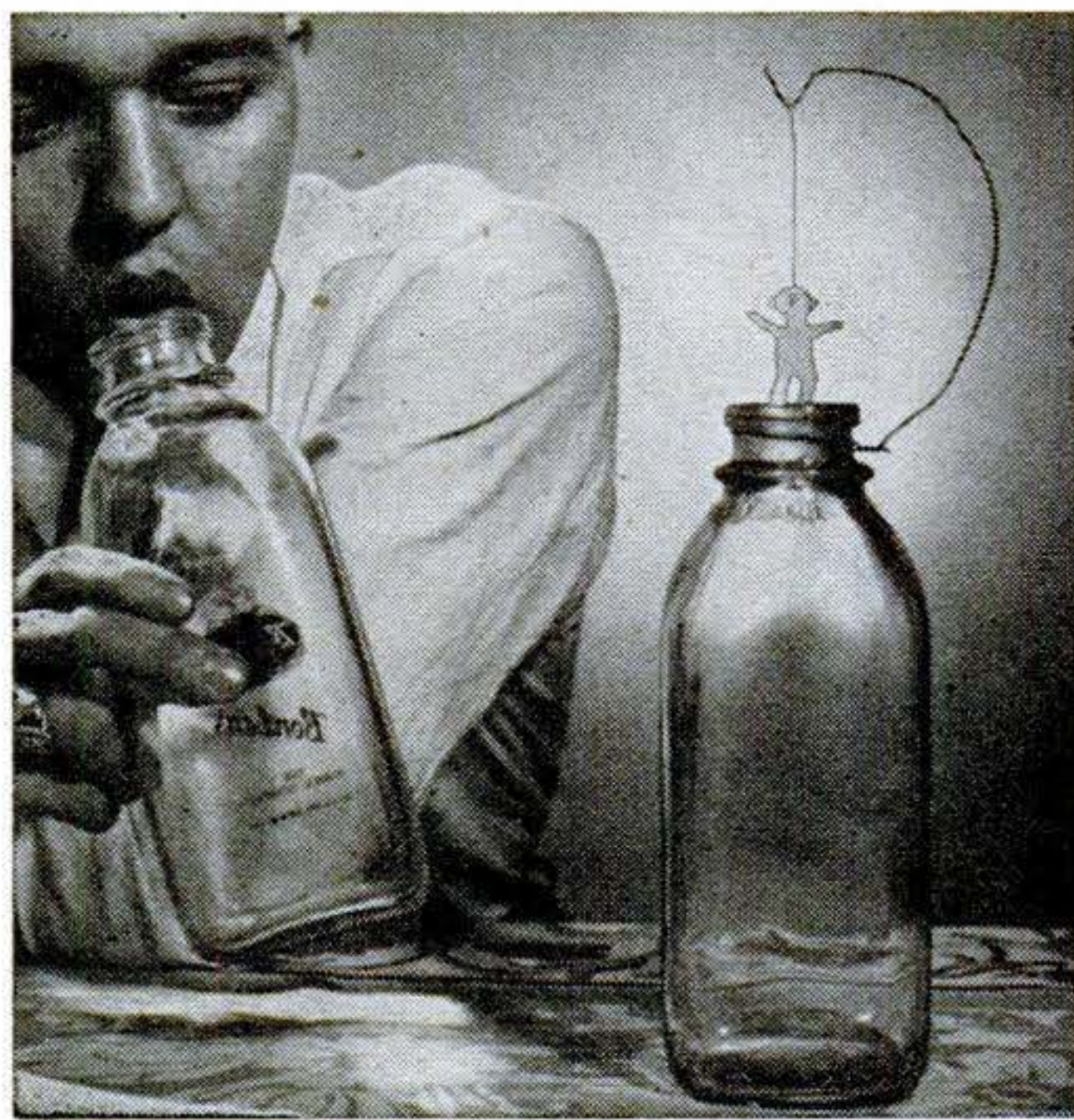

IN ONE BOTTLE, OUT ANOTHER. Waves of compression and rarefaction come to our ears as sound when air is set into vibration within a certain range of frequencies. If you blow across the mouth of an empty bottle to produce a strong, clear note, a person placing his ear near an identical bottle will hear the same note in it. This is because the air columns in both have the same frequency. The effect is made visual by hanging a light paper figure over the mouth of the second bottle. Then, when a good, strong note is sounded, the resonant vibrations will make the paper dance.

Vibrations Create Resonance

TUNED DRIP VIBRATES STICK. Some of the effects of mechanical resonance can be shown with the help of a yardstick and dripping water. Clamp one end of the stick in a vise or between heavy books, and drip water on the other end from the glass tube of a medicine dropper connected to a funnel by rubber tubing. Find the natural vibration period of the stick by pressing down and releasing the free end. Then tune the dripping water to this vibration by means of a screw clamp applied to the rubber tubing. If the rate of dripping is different from the natural period, the stick vibrates feebly; when the two are the same, each drop adds its push at just the right moment. A small object placed near the end of the stick will help in adjusting the timing. Vibrations are slowed down by moving the weight nearer the end.



FLAME PLAYS NOTE. One unusual means of starting up vibration is with a small gas flame. Support a 1" diameter, 36" long glass tube vertically by clamping it in a stand at its middle and introduce a 2" flame from a jet drawn in a thin 12" glass tube. Air in bottles, tubes, boxes, cans, and other enclosed spaces has a natural period of vibration, and when the flame has entered the tube to the correct distance, the rushing of gas from the nozzle will set the air in the tube into resonant vibration and produce a strong musical note. This note will continue at the same pitch until the flame is moved.

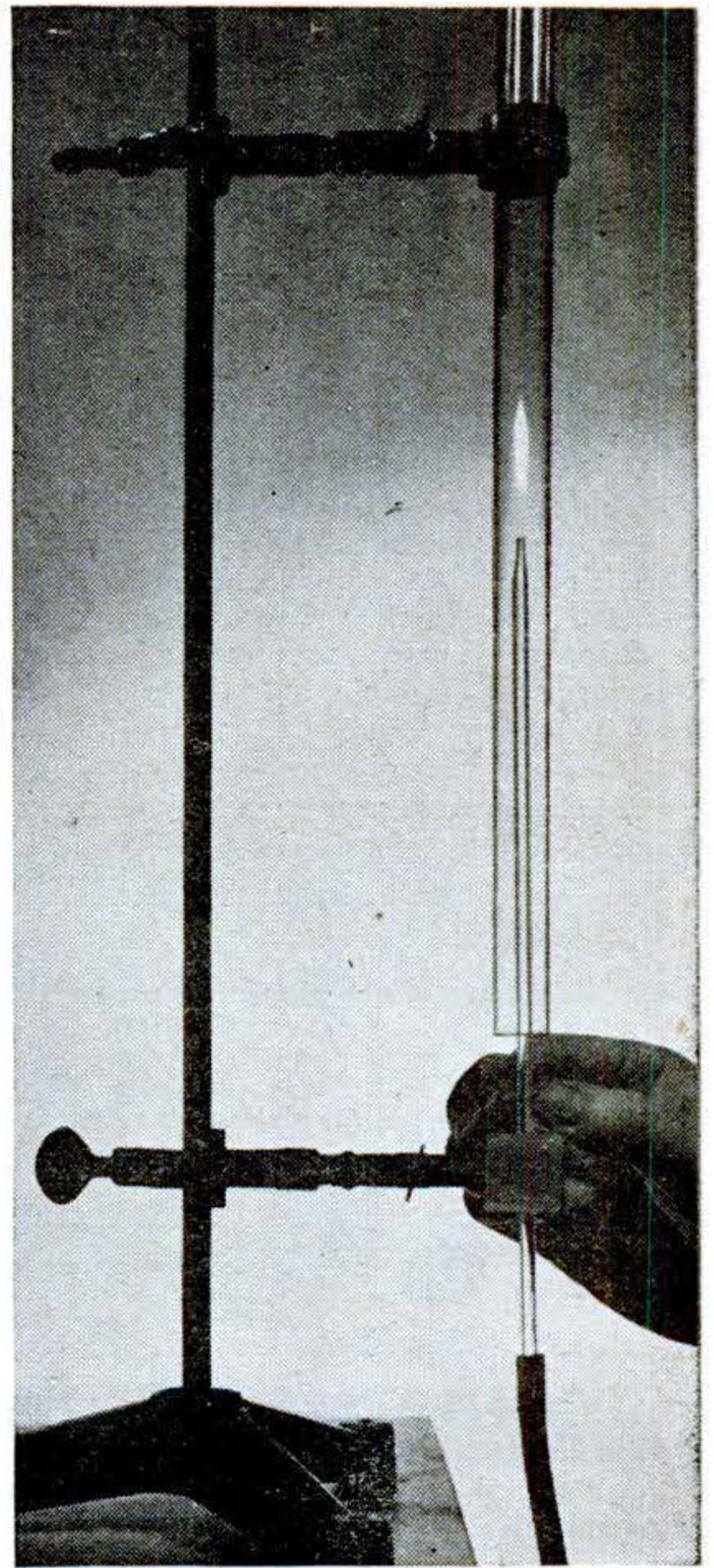

KEEPING the HOME SHIPSHAPE

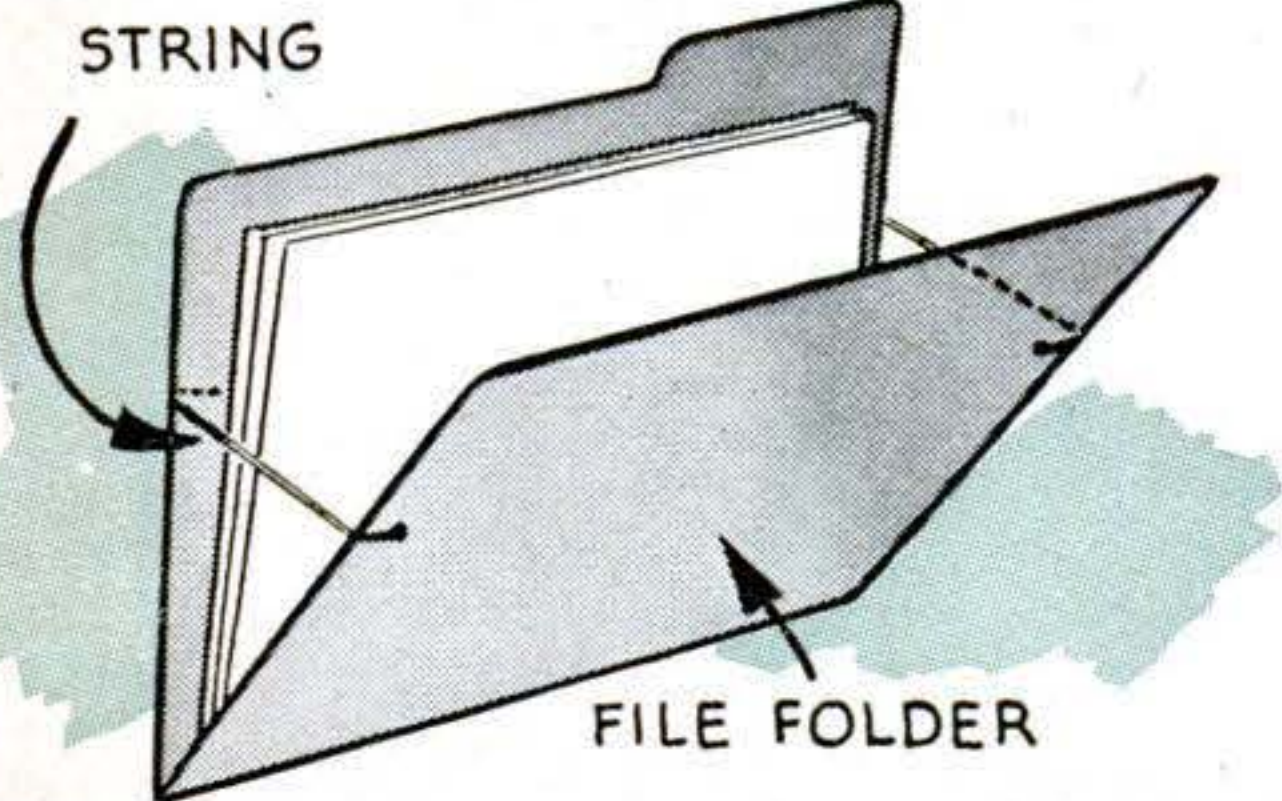

Do papers slip and slide in a file folder when you take it out of its place? Tying a string across each side as above will help keep the folder in shape and prevent its contents from falling out.

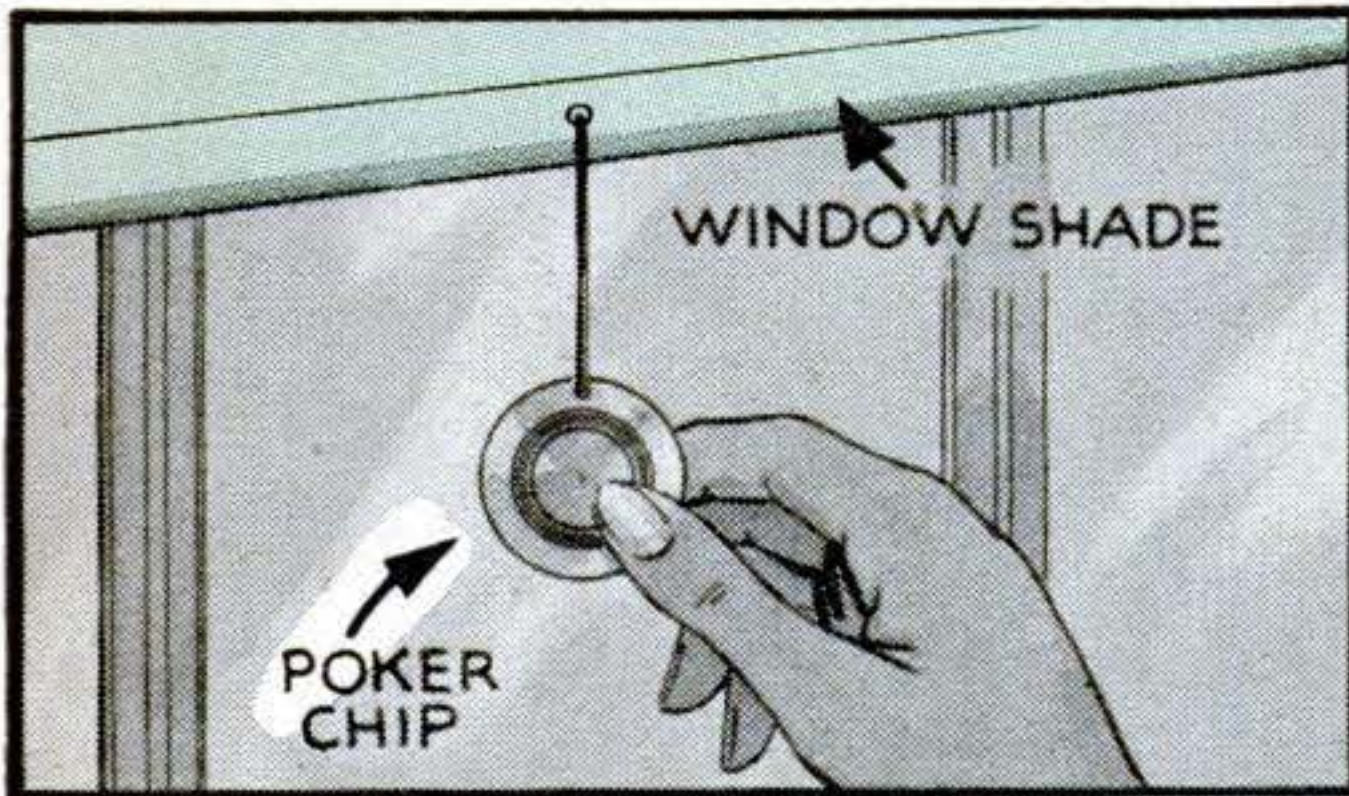

Poker chips make attractive, modern lamp-cord and shade pulls when they are drilled or punched for a string. Clamp chips between two pieces of wood and use a twist drill. The so-called noiseless or unbreakable chips, usually made of pressed cardboard, may be pierced with a red-hot nail.



Paper shopping bags have a way of going to pieces in the rain. If you're caught in a downpour and want to keep your purchases all together and dry, tear a slot on the fold of a newspaper and slip it over the bag handles. This improvised cover will let rain drain off rather than into the bag.

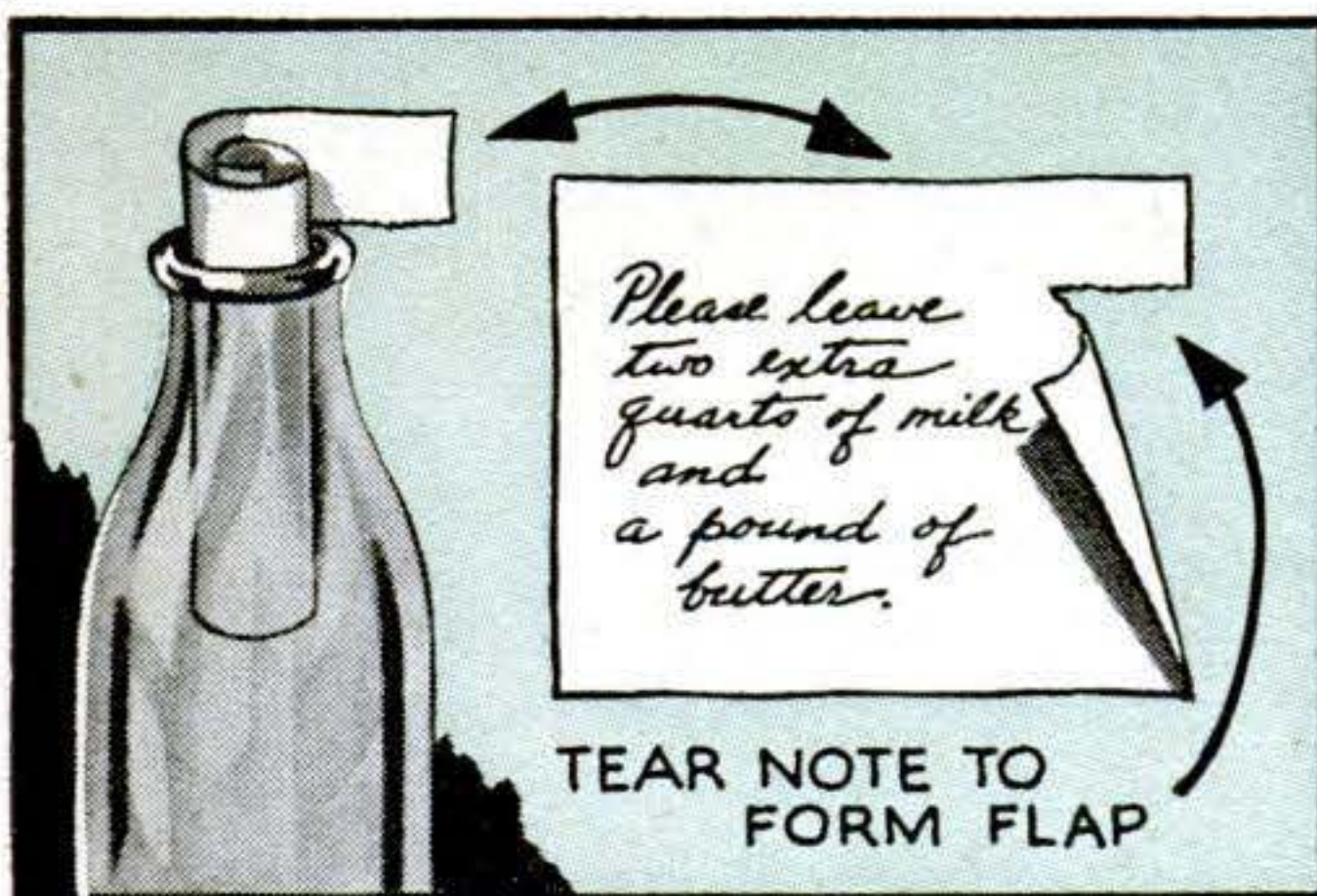

Here's a favor your milkman will appreciate both as a courtesy and as a timesaver. When leaving him a note, tear the paper about an inch from the top as shown. This forms a flap that projects beyond the lip of the glass and prevents the rolled-up note from dropping all the way inside the bottle.



You can end the annoyance of having the drop leaf of a table rattle against the legs by sticking a small adhesive bandage at each point of contact. Color the bumpers to match the tone of the wood. They are not only inconspicuous, but can be removed easily and do not mar the finish of the furniture.

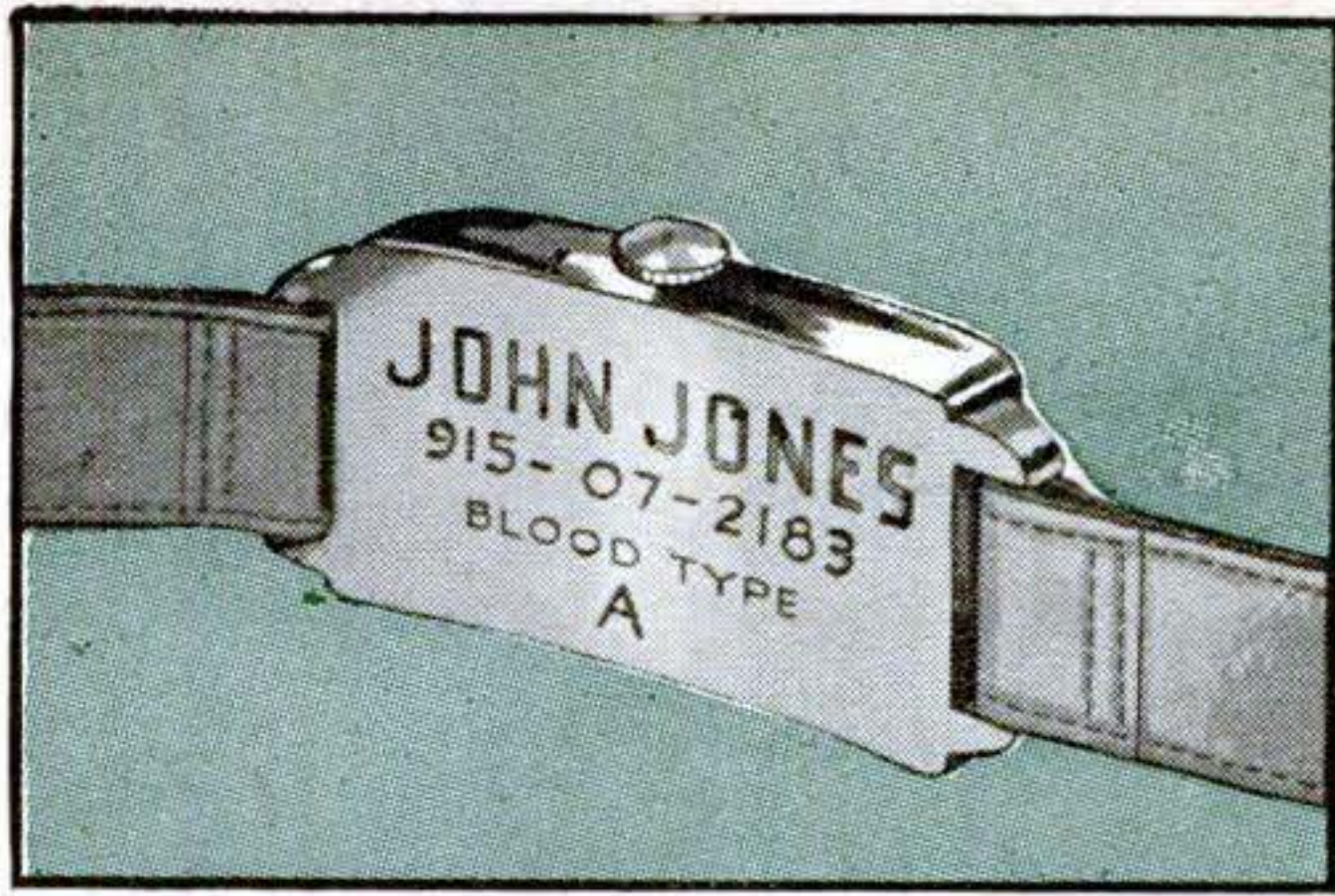

Just as soldiers' "dog tags" gave vital information in emergencies, your wrist watch can carry your name, social security number, and other data. This also identifies the watch in case of loss or theft. Remove the back and put the works in a dustfree place or under a glass while doing the engraving.

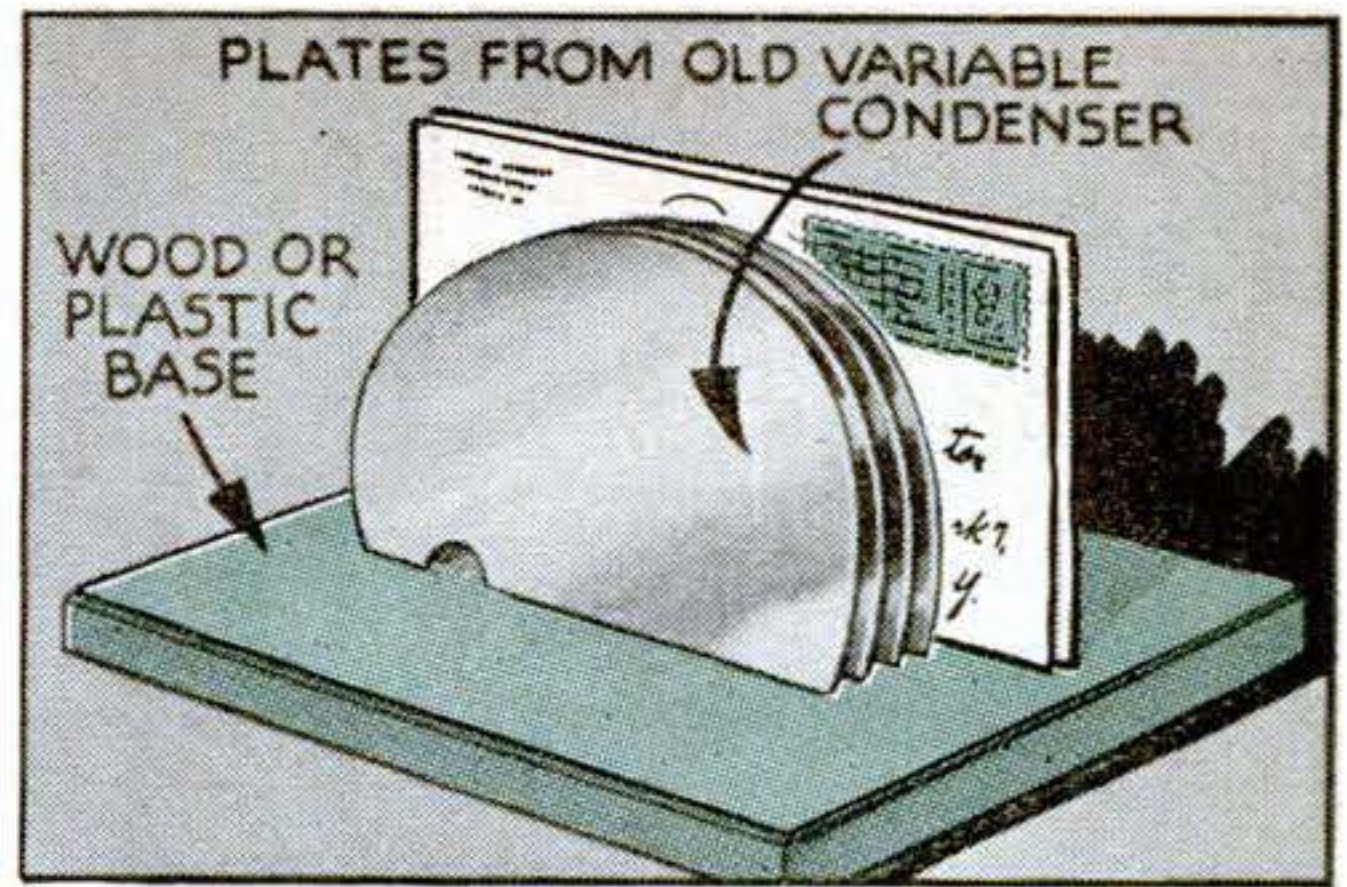

Plates from old variable condensers make fine letter holders for the modern desk. Polish the flat plates and mount them on a base of wood, metal or plastic as shown above. The outer plates can be engraved, given a trim line of black or colored enamel, or otherwise decorated to your taste.

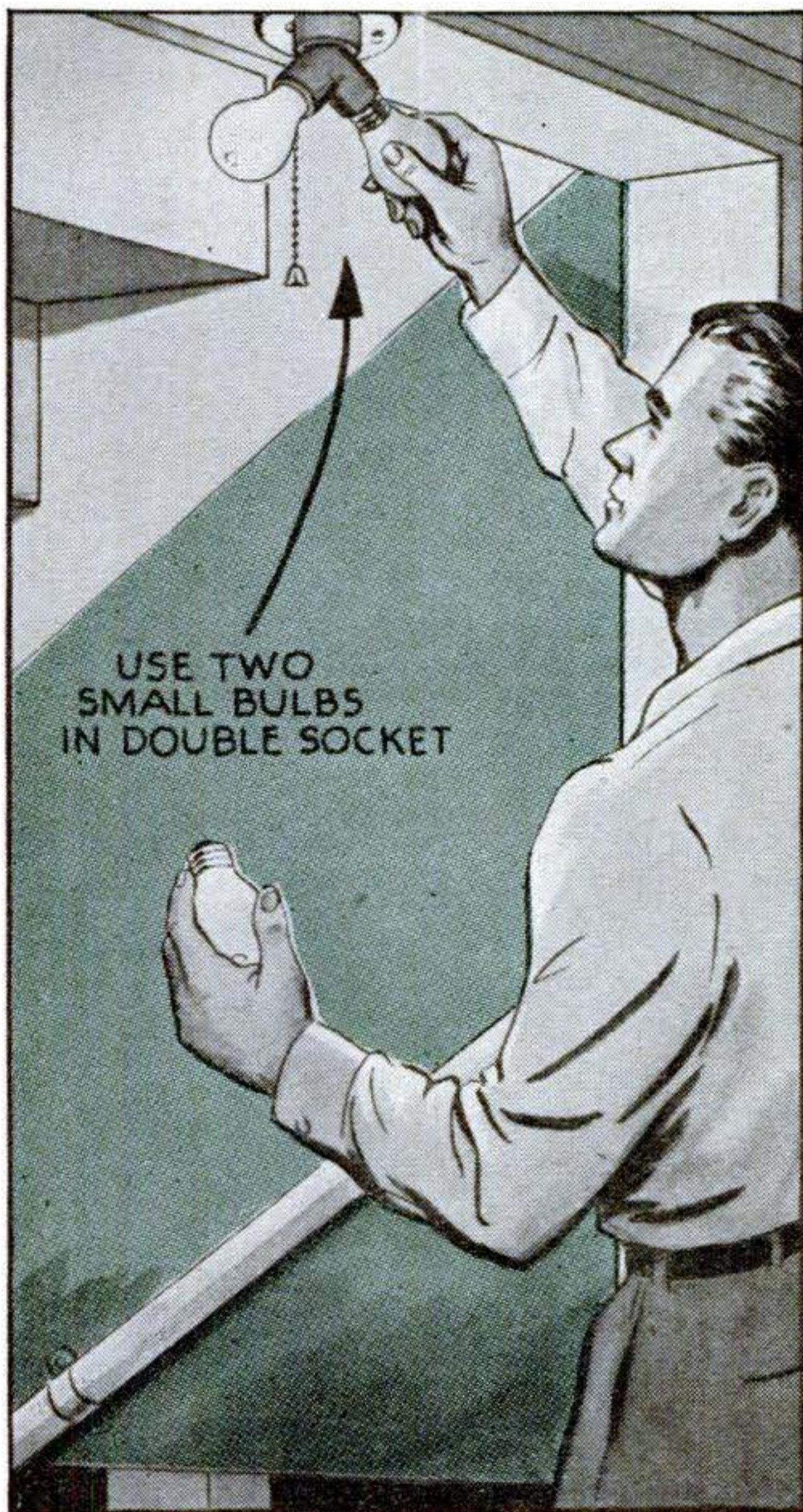

Dark stairs or hallways are dangerous when light bulbs burn out. If you want to avoid being caught in the dark, insert double outlets in all sockets where a single bulb now provides the illumination. Two smaller bulbs will give an adequate amount of light but will not burn out at the same time.

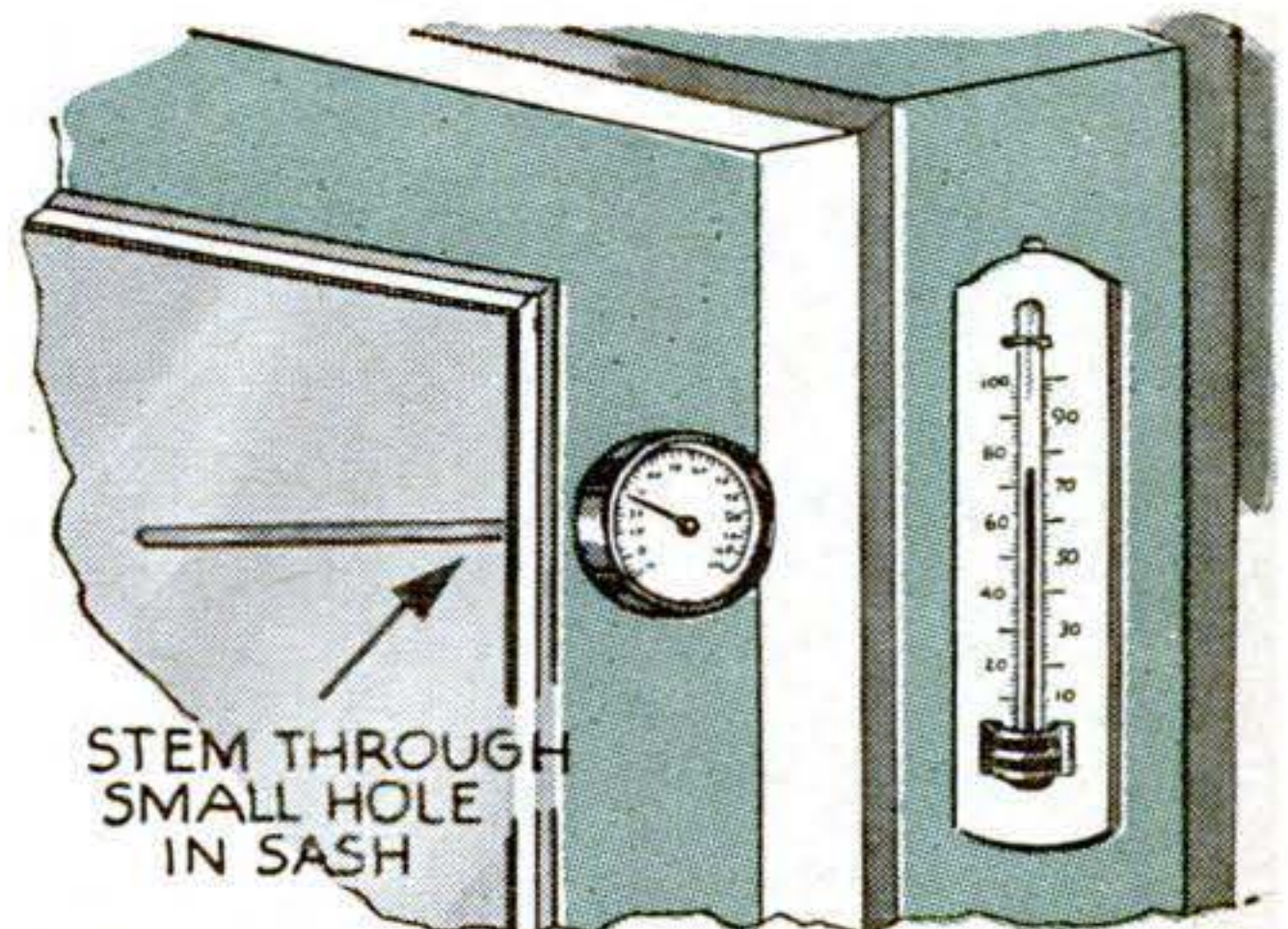

Want to know the temperature outside the house as well as inside? Your stem-type photographic thermometer can be made to give outdoor readings if you drill a small hole in the sash and thrust the stem through the hole. Since the dial remains inside, the temperature can always be read easily.

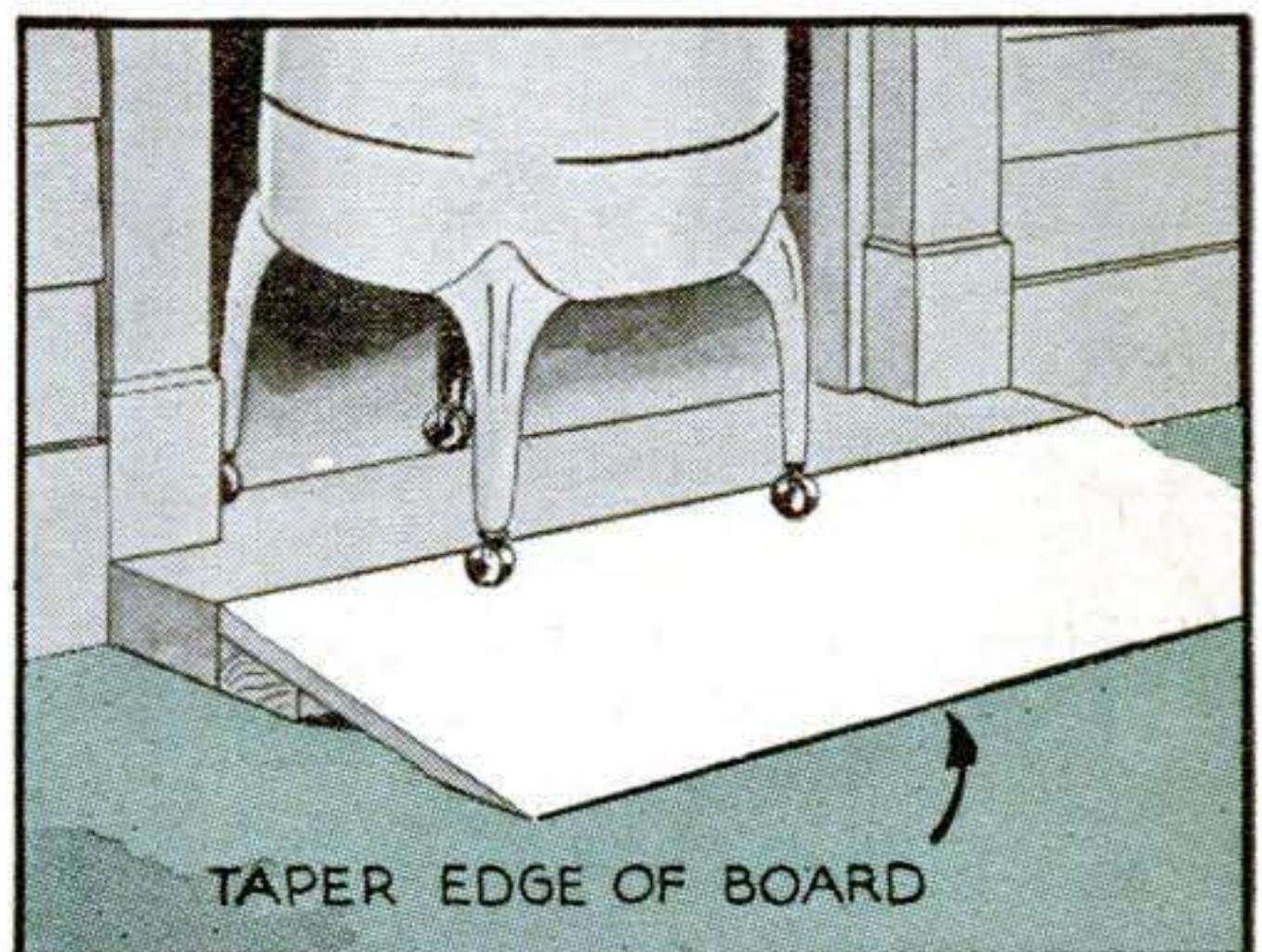

Should a washing machine or other heavy appliance often be wheeled through a doorway, you can save wear and tear on your muscles as well as the doorsill by placing a wooden apron up against the sill as shown. Build it up to the thickness of the step and bevel the other edge flush to the floor.

**FOR EASIER
FARMING**

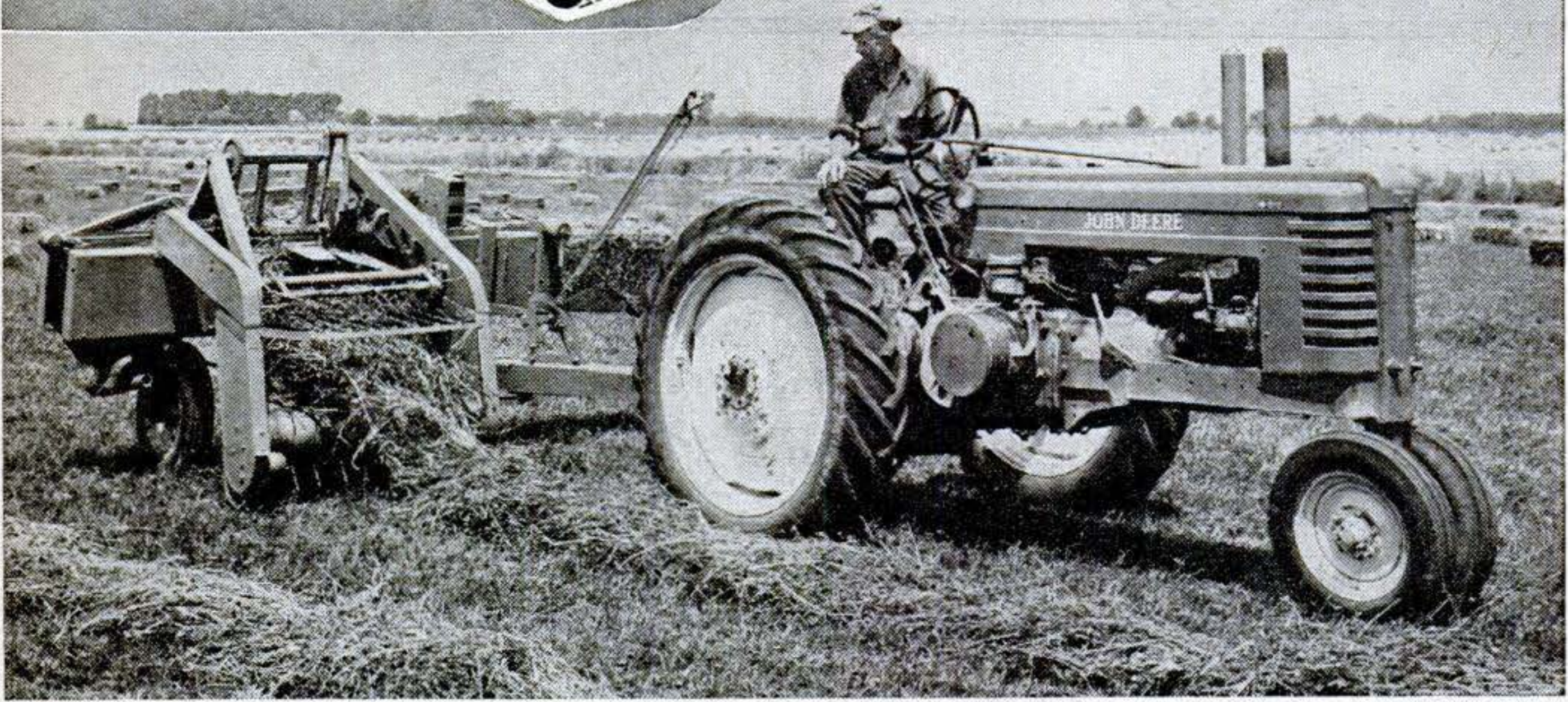

TRACTOR PRESS BALES HAY. This press, made by John Deere, of Moline, Ill., picks up hay from the windrows and bales it automatically as a one-man job. A minimum of wire is used in the baling, and there are

no short ends to fall to the ground and find their way into future bales. Windrows are picked up and fed directly into the bale case without a cross-conveyor. A steel tube serving as a hitch also houses the drive shaft.



MODERN PIGPEN OF STEEL. Fiber-glass insulation, an adjustable turret, and a removable door permit temperature control and ventilation in this structure to make the life of a hog the life of Riley. The hog house is made by the E. A. Strout Realty Agency and is light enough to haul by tractor or horse to new locations.

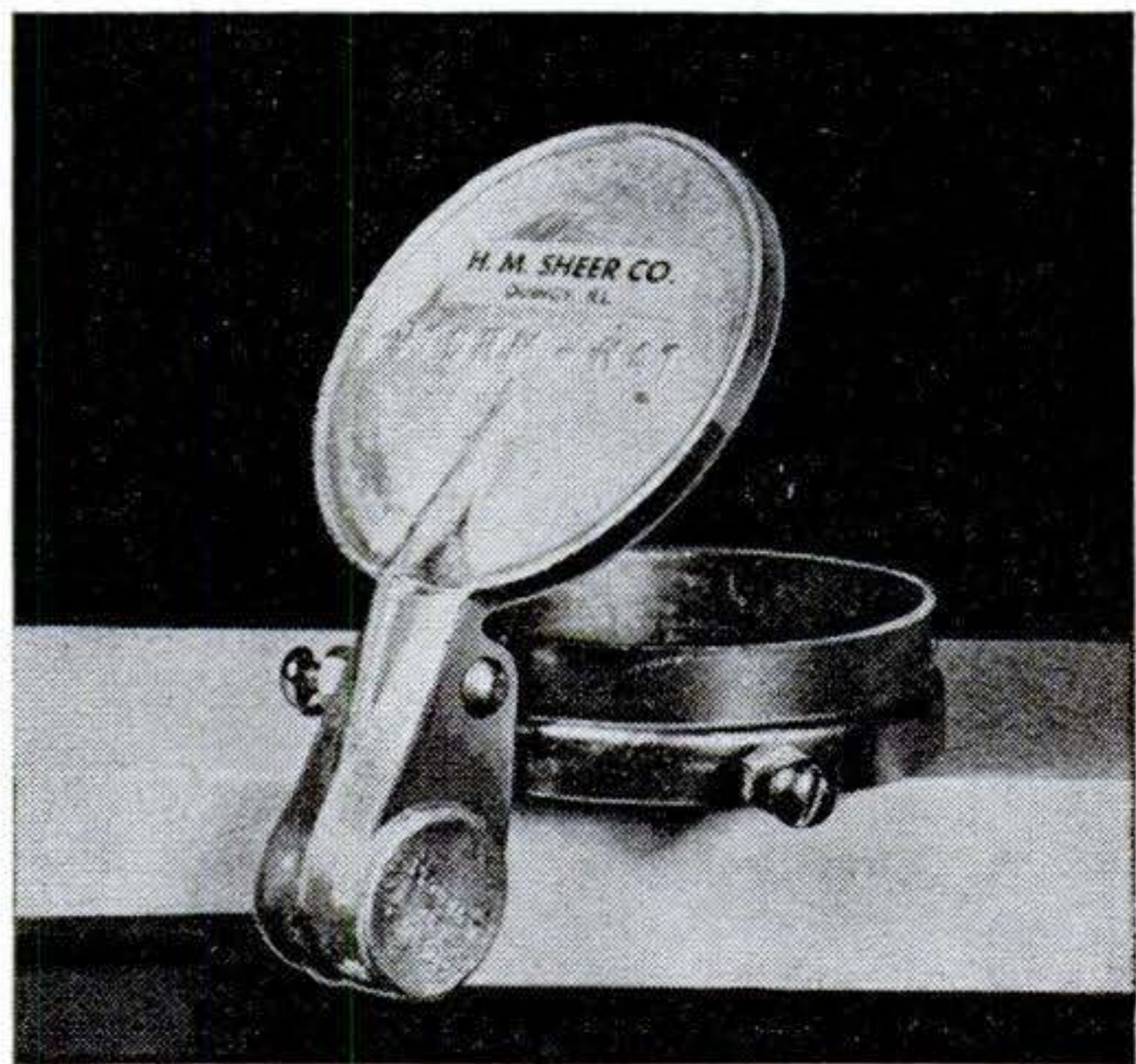

RAIN CAP PROTECTS EXHAUSTS. A die-cast aluminum fitting with a hinged cap keeps water, dirt, and birds from getting into the exhaust pipe of a tractor, power combine, or power hay baler. It fits almost all types of exhausts and mufflers up to 3½" diameter. H. M. Sheer Company, of Quincy, Ill., is the distributor.

Carries better... Looks better...

and, of course, it's safer
...in a **KODAK
CARRYING CASE**

FOR KODAK 35 with Range Finder...

Handsome Field Case of top-grain sole leather, with shoulder strap. Built-in ruggedness...quick accessibility for instant, easy shooting.

(Below)

FOR KODAK VIGILANT SIX-20...

Kodak Snapsack...russet sole leather with hand strap... illustrative of pouch-type case so popular for folding cameras. Also takes Kodak Monitor Six-20.

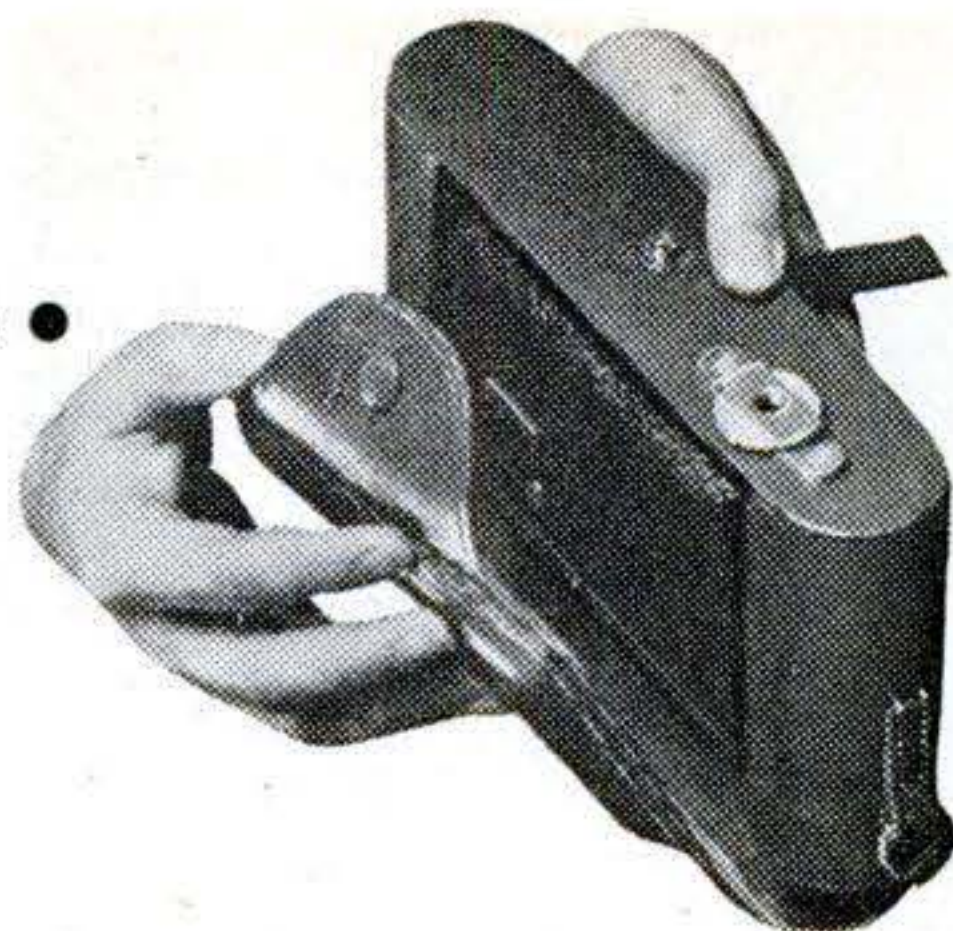

FOR KODAK MONITOR...

De Luxe Field Case... top-grain cowhide, special stitching, skived leather straps, metal-reinforced inner section make it a truly de luxe case.



FOR YOUR BANTAM...

Handsome leather Field Case with neck strap... permits manipulation of all camera controls without removing from case... tripod socket in base. At your Kodak dealer's... Eastman Kodak Company, Rochester 4, N. Y.

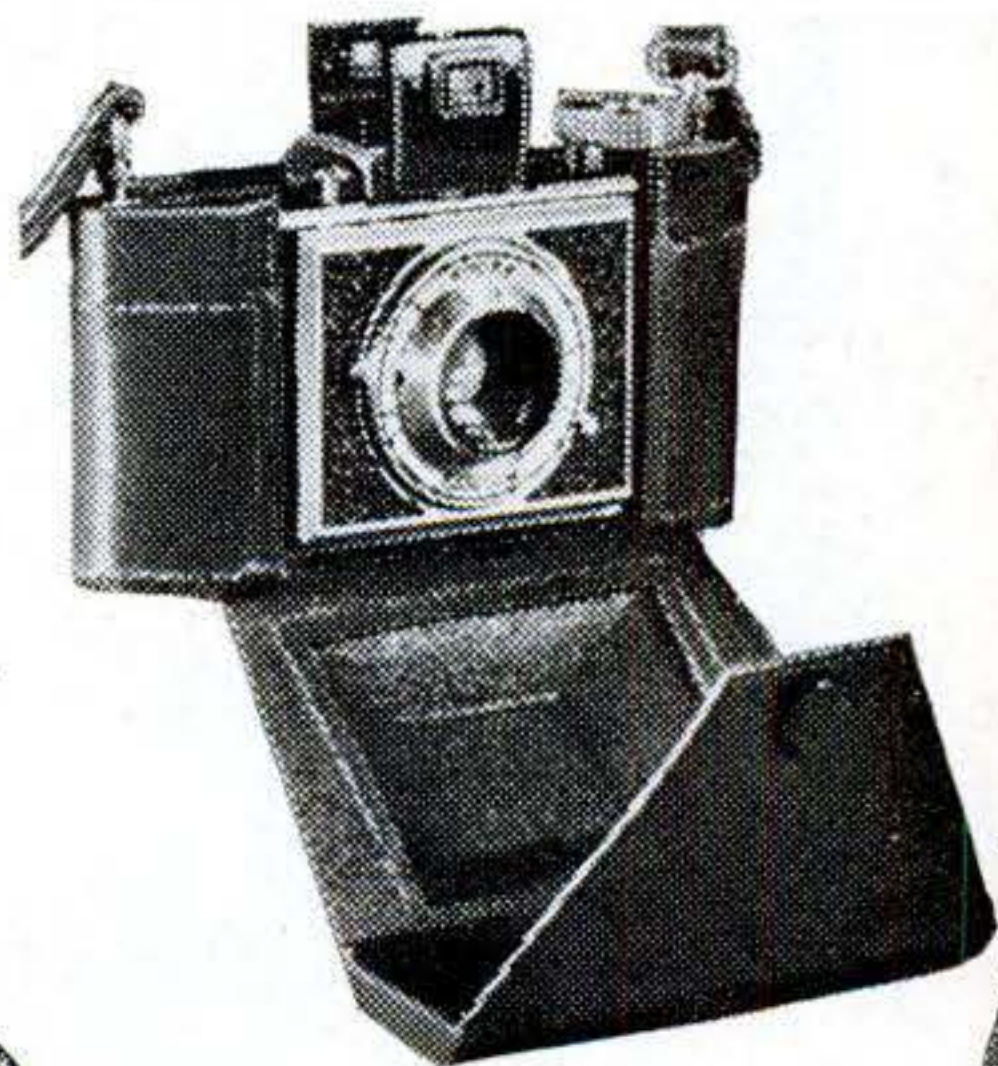

FOR ANY CAMERA WITH TRIPOD SOCKET...

Ounces of prevention... Kodak Hand Straps... Kodak Neck Straps... light, strong, woven leather... make it practically impossible to drop your camera.

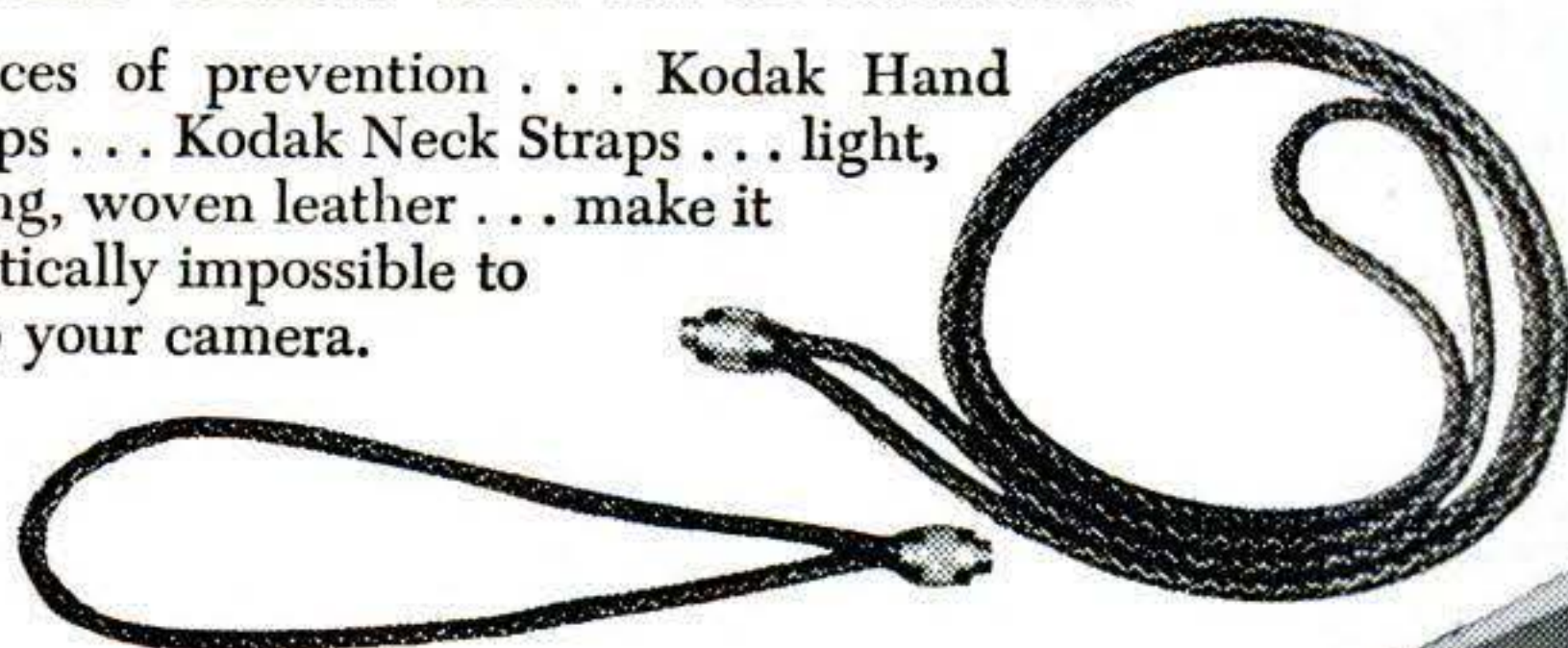

Kodak

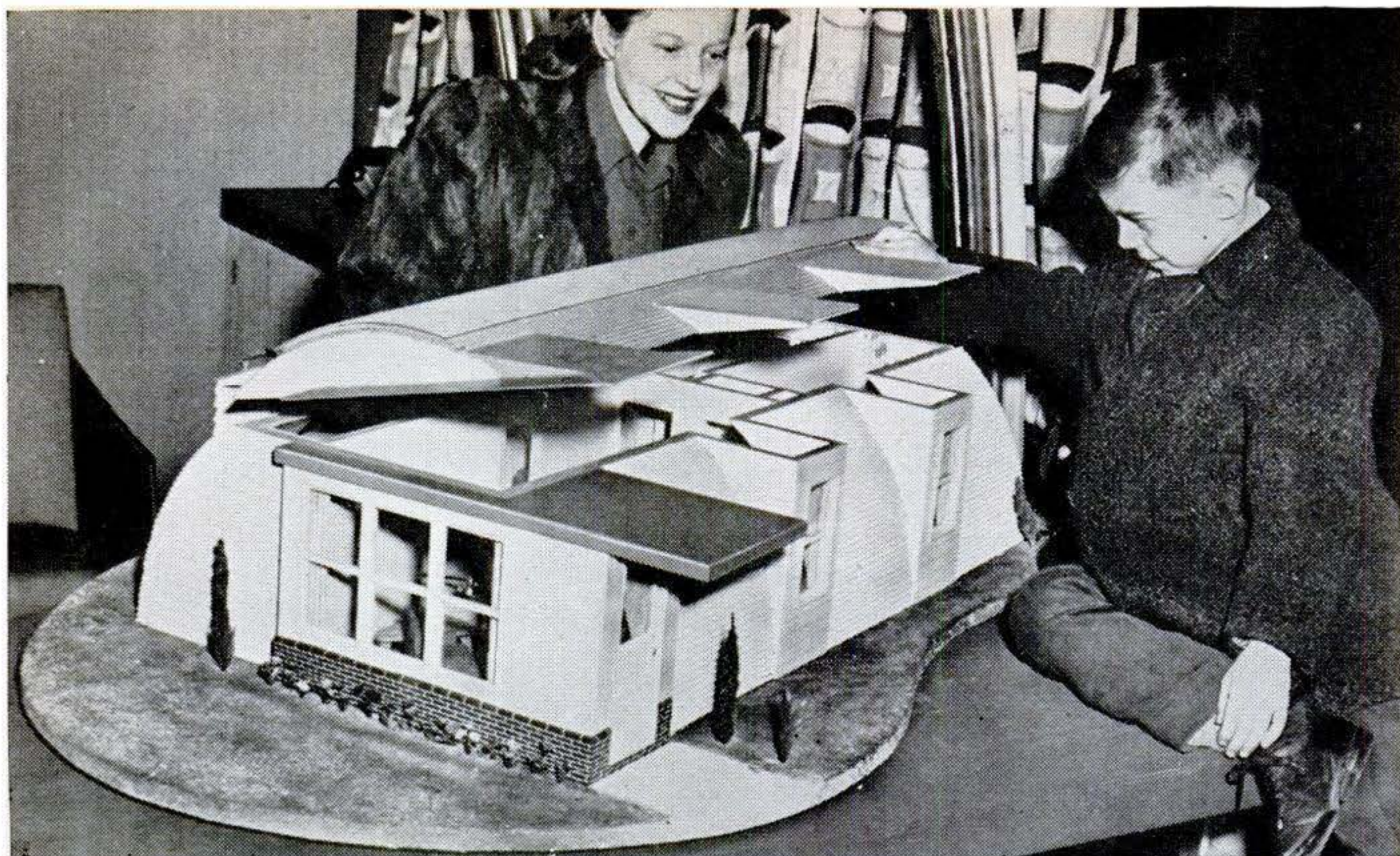

Quonset Sires House

DRESSED up and glamorized, the five-room bungalow illustrated by the model above is designed to cost only \$4,000 to \$6,000. De-

veloped by the Great Lakes Steel Corp., which plans to produce basic units that can be completed by local contractors, its Quonsetlike arch-rib, Stran-Steel construction lowers cost and speeds assembly.

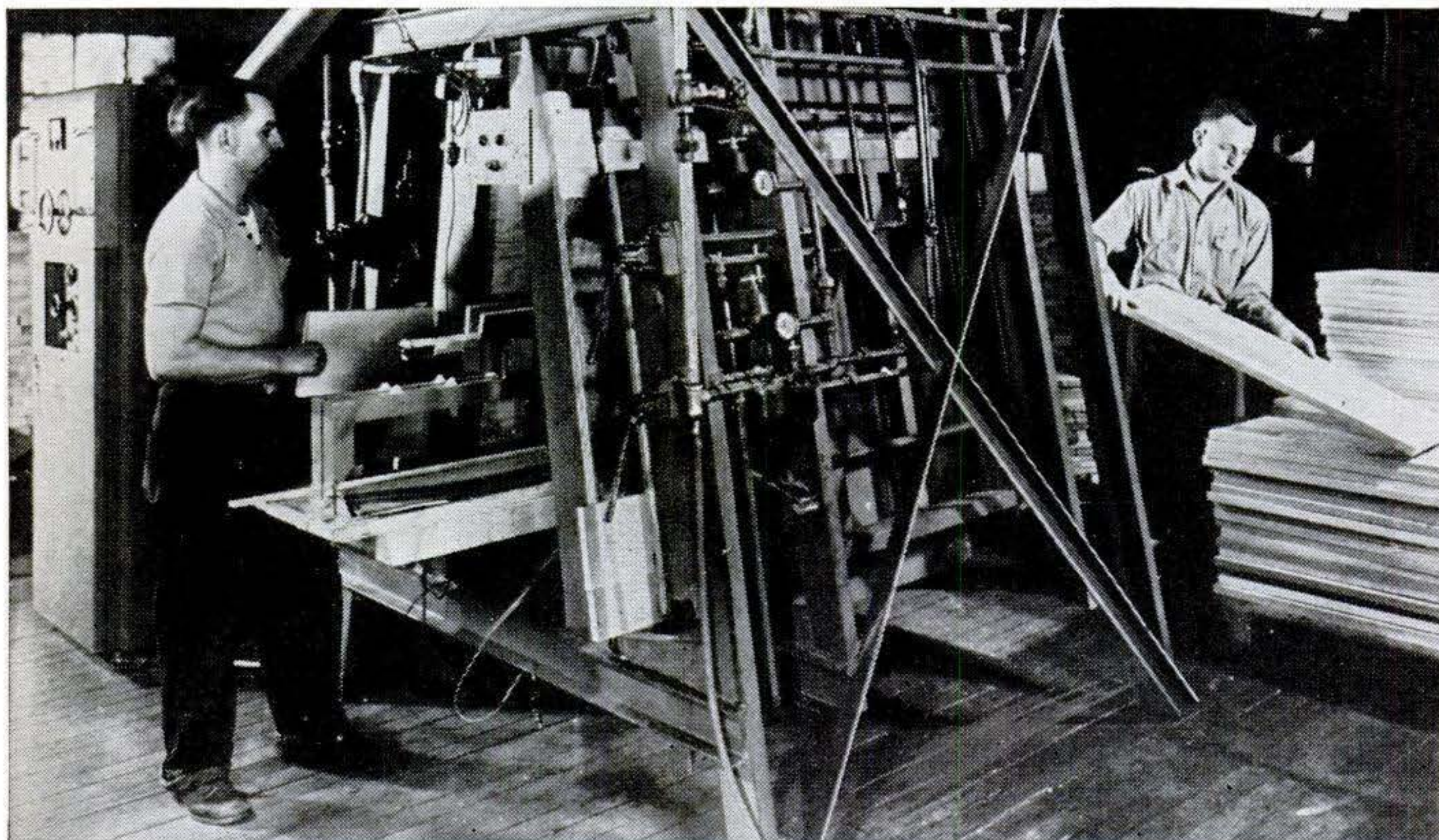

Heat Hardens Glue

IT TAKES less than a minute for this new wood-gluing press to cement boards together so tightly that no tongue-and-groove joint is

required. Developed by the Raytheon Manufacturing Co., the press holds the pieces in a high-frequency electric field between two plates, while the heat thus generated sets the glue in 30 to 50 seconds.

NEW

EVEREADY

TRADE-MARK

FLASHLIGHT BATTERIES

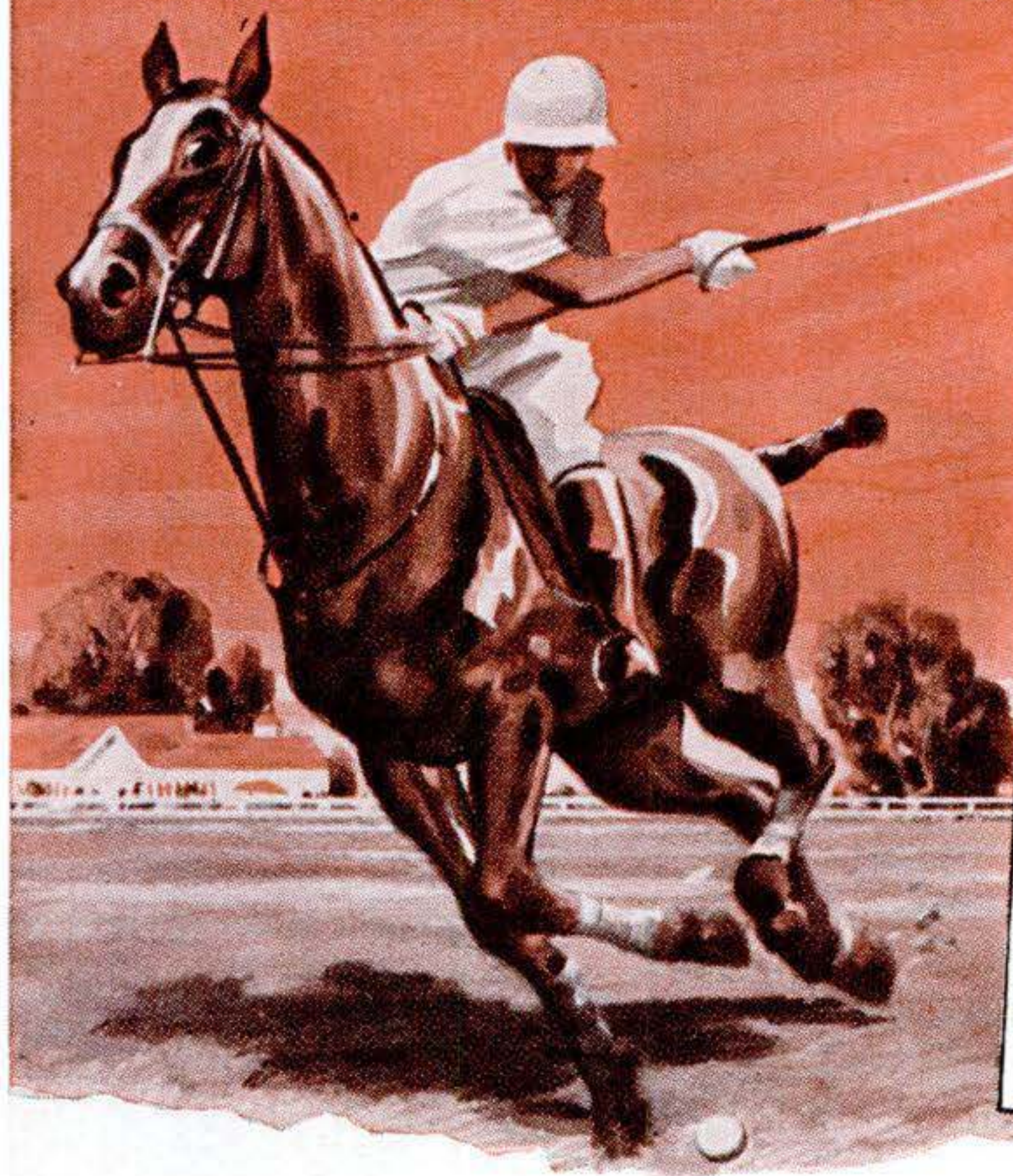

*Now last
93% longer!**

Drive 7 Goals with a Flashlight Cell?—Yes!

Properly released, the electric energy in one tiny "Eveready" flashlight cell could drive a polo ball the full length of the field—300 yards—and do it 7 *times*, to score 7 goals!

● It takes **POWER** to make light. And it takes power-packed new "Eveready" flashlight cells to make *your* flashlight give you *better* light, longer! Today, with *energy* and *value* nearly doubled, "Eveready" brand flashlight batteries are first choice everywhere for **l-a-s-t-i-n-g** LIGHT! Plenty available—good dealers have them—no price increase!

The registered trade-mark "Eveready" distinguishes products of

NATIONAL CARBON COMPANY, INC.

30 East 42nd Street, New York 17, N. Y.

Unit of Union Carbide and Carbon Corporation



*To you, this means nearly *twice* the electric energy ...almost *two times longer* life of bright, white light. And it's yours for the pre-war price. *Still only 10¢.*

High Energy

**MEANS BRIGHTER LIGHT,
LONGER LIFE**



**YOU CAN
"FEEL" THE
DIFFERENCE**



It takes a careful eye to see the difference between Nicholson or Black Diamond files and ordinary file brands. Yet most any hand can *feel* the difference with just a few strokes of these master quality files. It shows up in their trim balance . . . in the way they hold to the line . . . in the smooth, even bite of their teeth. It's qualities like these that make Nicholson and Black Diamond the favorite files among home and industrial craftsmen. They're easy to obtain—good hardware stores have them or can get them for you.

Write for free, 48-page book, "File Philosophy," containing helpful information on the selection, use and care of files.

NICHOLSON
U.S.A.

NICHOLSON FILE CO.
19 Acorn St., Providence 1, R. I.
(In Canada, Port Hope, Ont.)

BLACK DIAMOND
TRADE MARK

NICHOLSON
FILES FOR EVERY PURPOSE

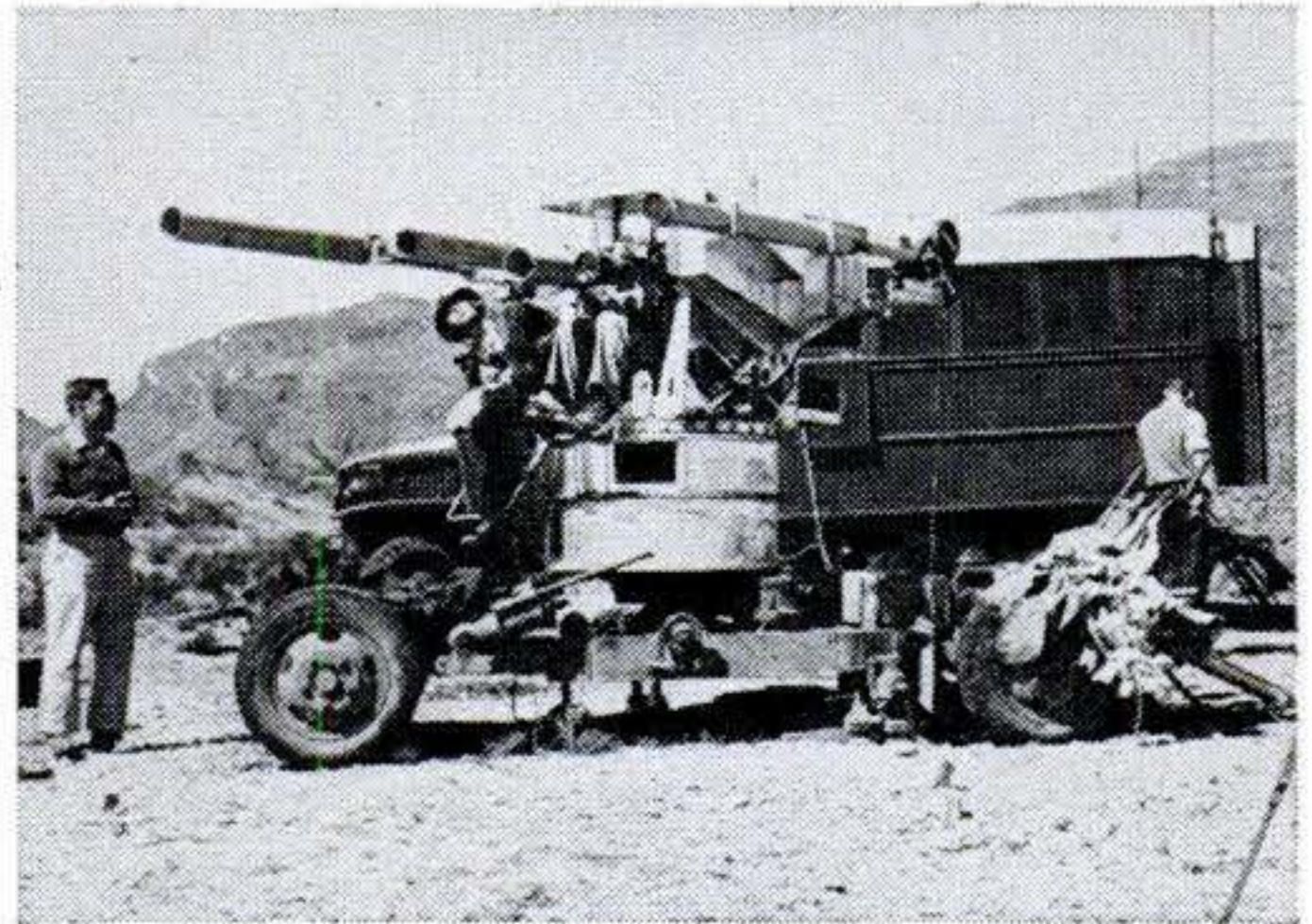
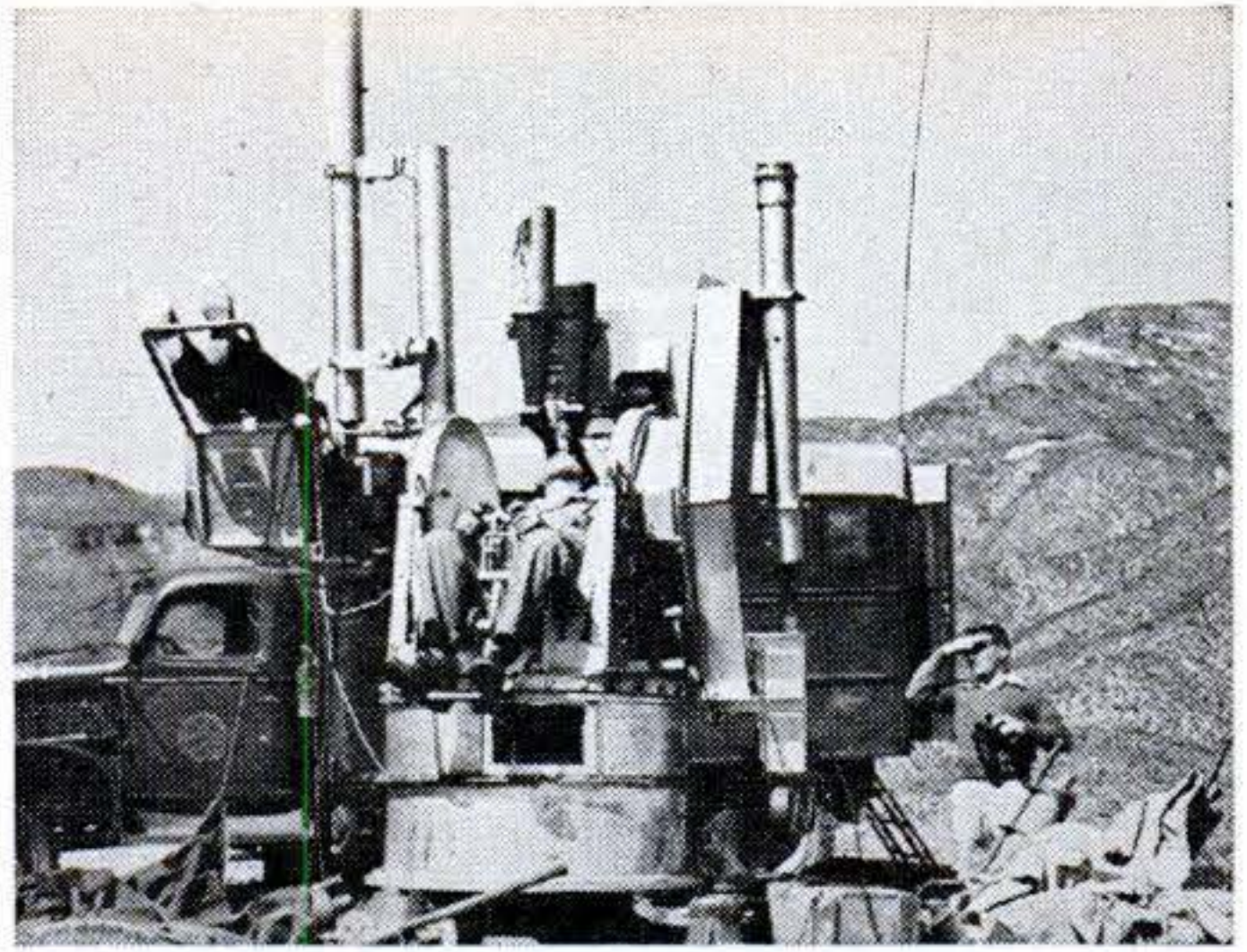

Mobile Unit Tracks Rockets

To WATCH the flight of long-range missiles, engineers of the Army Ballistic Research Laboratories have developed a turret-mounted telescope unit installed on a mobile gun carriage. Nicknamed "Little Bright Eyes," the unit has two 4½-inch telescopes: one visual; the other photographic, with a 35-mm. camera attached. Between them sits the tracker, using high-power binoculars. In center photo, above, the apparatus is shown awaiting a V-2's take-off; at top, it is swung skyward to follow the rocket's flight. The streak pictured in the bottom photo is a V-2 rocket, soaring 15 miles from the earth's surface, as seen by the photographic telescope in a test at White Sands, N. Mex.



Big boat . . .



Little boat . . .



There's an



Evinrude



for every

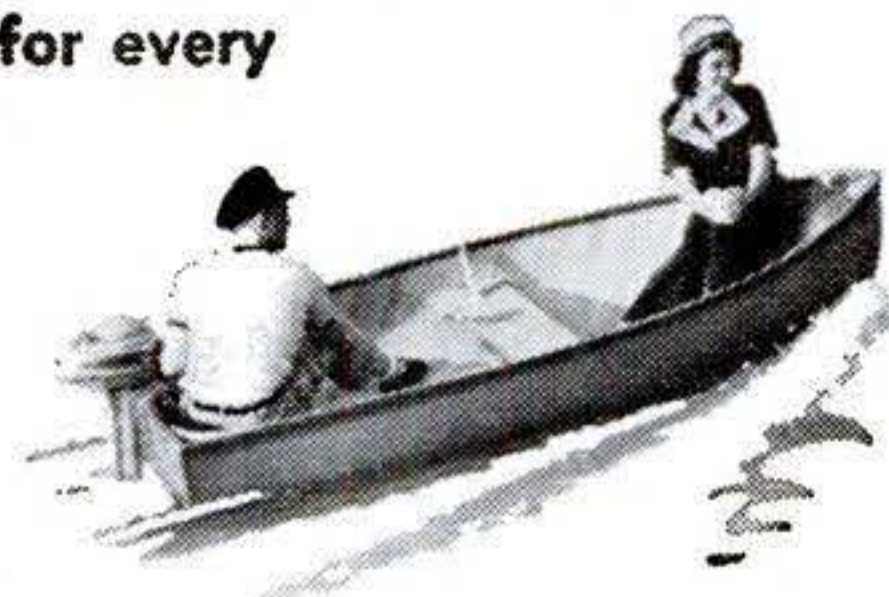

type of boat!

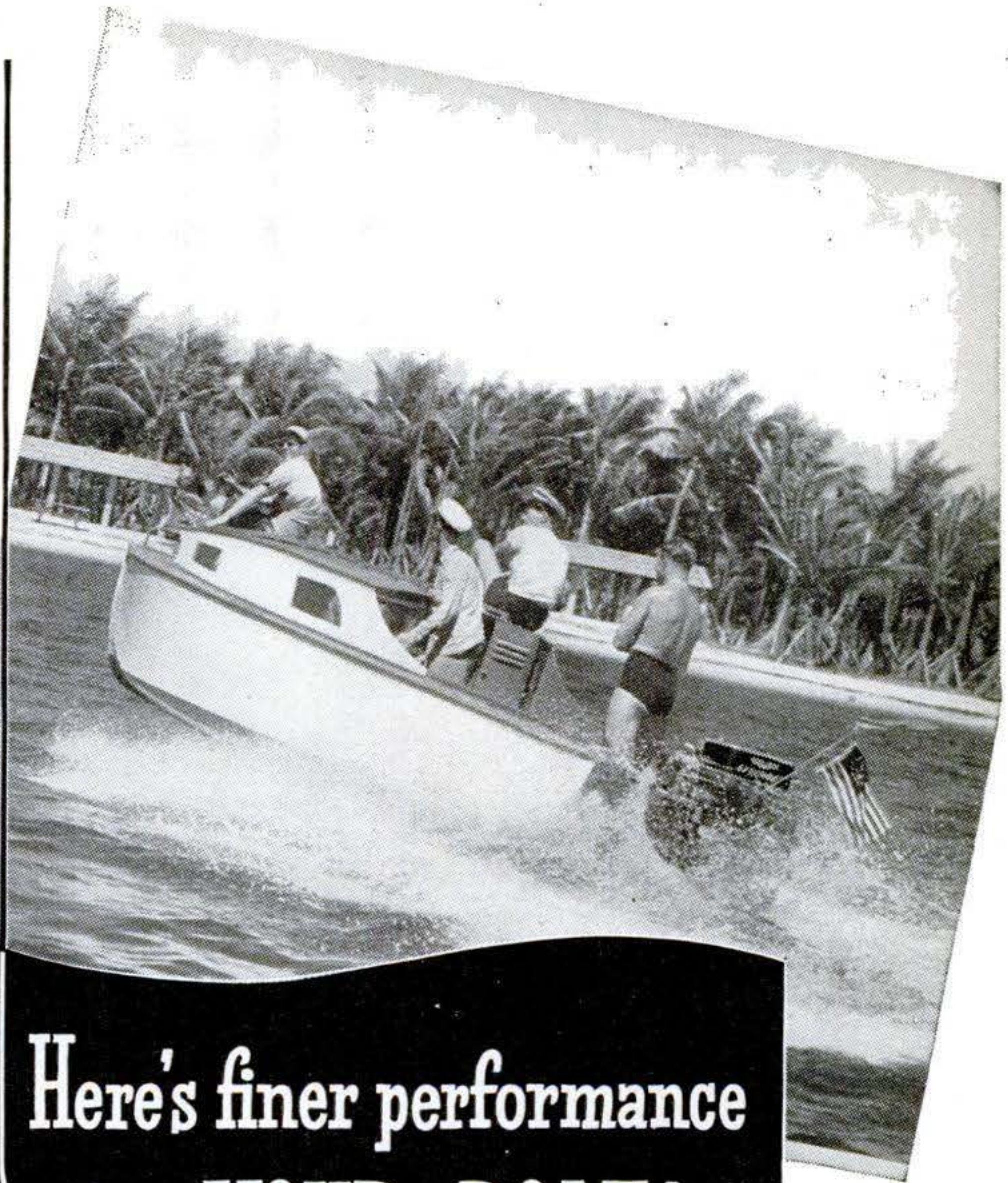

Here's finer performance for YOUR BOAT!

What a difference the *right motor* makes . . . in boat performance . . . in boating fun! It's easy to choose the *right* motor for any boat from Evinrude's *complete* line of 7 models . . . 2 handy "singles" . . . 2 smart twins . . . and 3 famed four-cylinder motors . . . the smoothest on the water! *Only Evinrude dealers* enjoy the extra sales-and-profit opportunities offered by a complete line of light motors . . . in addition to a complete line of four-cylinder models!

EVINRUDE MOTORS, 5590 N. 27th Street, Milwaukee 9, Wisconsin.
In Canada: Evinrude Motors, Peterboro, Ontario.



EVINRUDE

FIRST IN OUTBOARDS — 38TH YEAR

OUTBOARD MOTOR OWNERS!

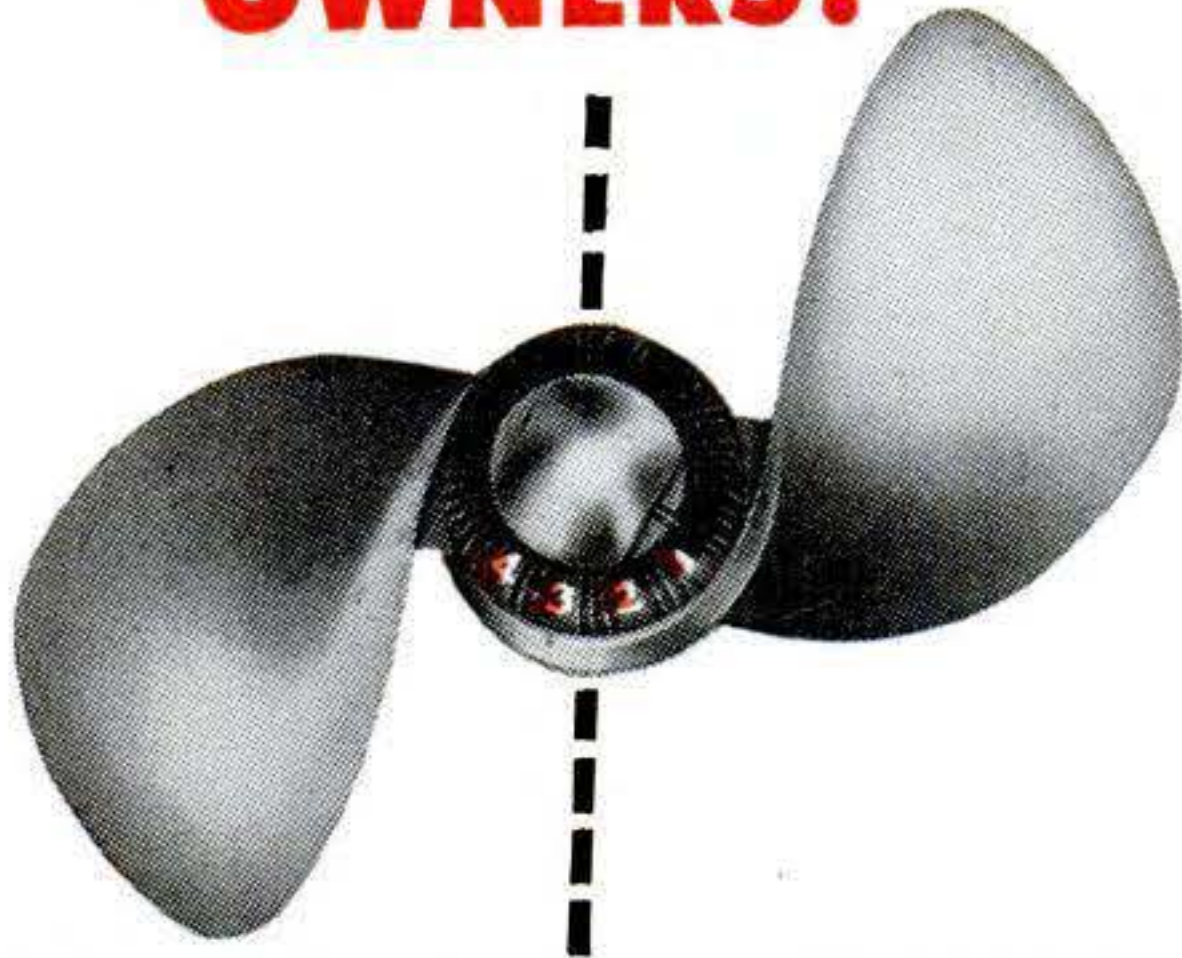

Paul Bunyan's New Vari-Pitch PROPELLER GIVES YOU

4 speeds!
 1. Low 3. High
 2. Intermediate 4. Overdrive

all from one propeller permanently installed on your motor!

Now you can troll as slowly as you wish, without plates or special devices. Merely set the pitch of a Paul Bunyan Vari-Pitch propeller at low and you barely move. To speed up, change the pitch, just as you would shift gears in a car. For extra fast speed, use pitch 2, 3 or 4, depending on load. Adjustment is simple, self-locking, fool proof, can't come loose.

Now, for the first time, sportsmen can have *four motors in one*, by installing the Vari-Pitch propeller, which becomes a permanent part of your motor.

NOW AVAILABLE for the following motors:

- TYPE "D" Johnson 5 H.P. 1941 to present.
- TYPE "DZ" Johnson 4.5 H.P. up to 1940 inclusive.
- TYPE "C" Evinrude Zephyr 5.5 H.P. All years.
Above Models \$10.00. On these adjusting ring is in front of propeller as illustrated.
- TYPE "A" For Champion singles 1938 serial number 3000 and over, to and including 1942. Also Firestone 1946 10-A-4 and 10-A-1A.
- TYPE "B" Champion singles up to 1938 serial number 3000. (Note: some of the older motors have replacement lower units which take type "A" propellers.)
- TYPE "F" Champion singles 1946 to present.
Above Models \$8.00. On these adjusting ring is inside hub.

NOTE: If you have difficulty obtaining Paul Bunyan Vari-Pitch propeller, write us, giving type desired. Enclose check or money order and your propeller will be sent to you through one of our many dealers.

PAUL BUNYAN BAIT CO.
 Department PPS77
 Minneapolis 5, Minn.



PAUL BUNYAN
VARI-PITCH PROPELLER



Fishermen's Tools Clip Vines

THE high-grade steel, cadmium-plated pincers and pliers pictured above were originally designed for fishermen, but have been adopted by gardeners for pruning shrubs and vines. The self-opening tools can also be used for mechanical jobs. The Bartelt Engineering Co., Rockford, Ill., is the maker.



Water Jet Drives Boat

A PROPELLERLESS boat, powered by a high-velocity water jet and capable of maneuvers not possible in conventional craft, is a new experiment of the Continental Motors Corp. Designed to turn in its own length, move sideways and astern, and operate in shallow and weed-infested waters, its method of propulsion is known as "hydro-pulsion." Similar in principle to that of an airplane jet engine, it utilizes the pushing force of a solid stream of water ejected under hydraulic pressure.

Dependable

CHAMPION

AMERICA'S FAVORITE SPARK PLUG



MEMBERSHIP LIST

Emil Andres • Billy Arnold • Geo. Barringer* • Cliff Bergere • Bob Carey* • Geo. Connor • Bill Cummings* • Louis Durant • Dave Evans • Fred Frame • Chet Gardner* • Ralph Hepburn • Ted Horn • Jimmy Jackson • "Doc" McKenzie* • Rex Mays • Lou Meyer • Zeke Meyer • Chet Miller • Lou Moore • Kelly Petillo • Ray Pixley* • Floyd Roberts* • Geo. Robson* • Wilbur Shaw • Russell Snowberger • Jimmy Snyder* • Babe Stapp • "Stubby" Stubblefield* • Joe Thorne • Louis Tomei • Gigi Villorosi • Frank Wearne • "Howdy" Wilcox*

*Deceased

The Champion 100-Mile-an-Hour Club, the "world's most exclusive club," is composed of those race drivers who have driven the full 500 miles in the Indianapolis Race, at an average speed of 100 m.p.h., *without* relief. Of all the race drivers who have competed in this international speed classic, only 35 have achieved the distinction of becoming members and are entitled to wear the club emblem. 32 of these 35 qualified for membership using dependable Champion Spark Plugs.

FOLLOW THE EXPERTS — DEMAND DEPENDABLE **CHAMPIONS** FOR YOUR CAR

Listen to the CHAMPION ROLL CALL . . . Harry Wismer's fast sportscast every Friday night, over the ABC network

JULY 1947 215

AMERICA'S FAVORITE

Luther

HAND AND POWER GRINDERS

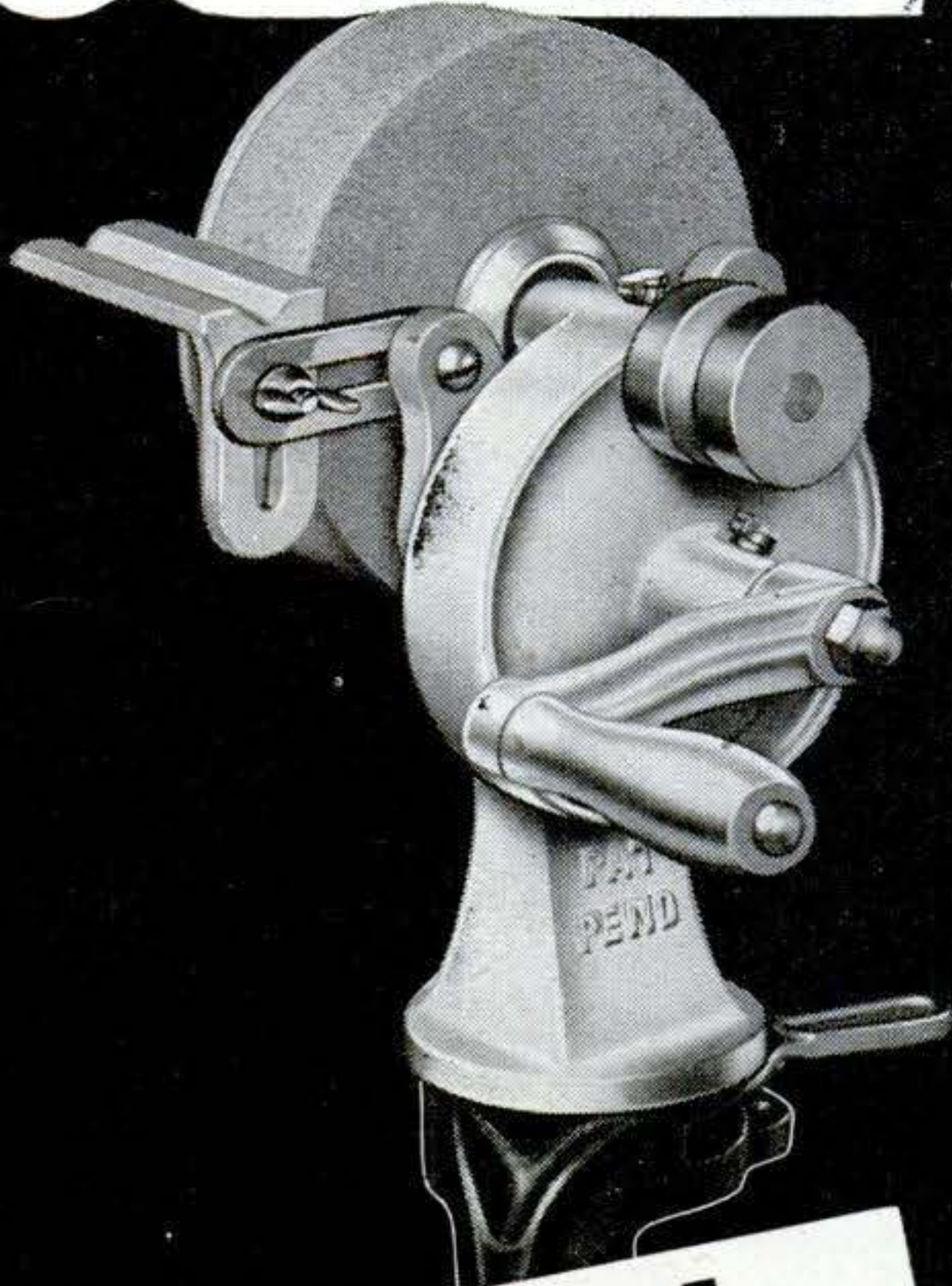

DEPENDABLE

Here's a name in grinders that has been famous for 50 years—Luther Grinders are manufactured to the most exact specifications—You will find a dependable Luther hand or power grinder for your purpose. See Your Hardware Dealer

LUTHER

GRINDER & TOOL CO.

ESTABLISHED 1896

SHEBOYGAN, WISCONSIN

Fill Holes, cracks, dents, gouges . . .

These BETTER FILLERS

- HARDEN FASTER
- SHRINK LESS
- STAY IN!

FILLS HOLES IN ONLY 1 APPLICATION

FILLS DENTS AND SCRATCHES

SAND OR POLISH IT

WEATHERPROOF WATERPROOF

TAKES HIGH FINISH

CRACKS ARE EASILY FILLED

Duratite Wood Dough will fill rough or irregular cavities in wood, metal, plastic or plaster in *one* application. (Duratite Surfacing Putty for shallow cavities). Can be sawed, cut, milled, sanded; are waterproof, fire resistant. Seven wood colors, in tubes or cans, at Hardware and Paint stores. Made by Manufacturers of famous Arrowhead Cement.

WEBB PRODUCTS CO.

232 South G Street, San Bernardino, California or Webb Company - Dept. S - Norcross, Georgia.



DURATITE

WOOD DOUGH AND SURFACING PUTTY

V-8
DUALS
& SINGLES



MUFFLERS

STEELS and ALUMINUMS with a motorboat tone

SINGLES, Chev, V-8, Plymouth, Steels \$5.50, Aluminum \$6.50. Chry., Olds., Buicks, etc., Steels \$7.50, Aluminum \$8.50. V-8 and MERCURY DUALS, Steel \$17.50, Aluminum \$20.00. Aluminums are guaranteed for life of your car.

DEALERS WANTED

SANDEE MUFFLER CO.

7523 S. WESTERN AVE., LOS ANGELES 44, CALIF.

ELECTRICITY *Anywhere*

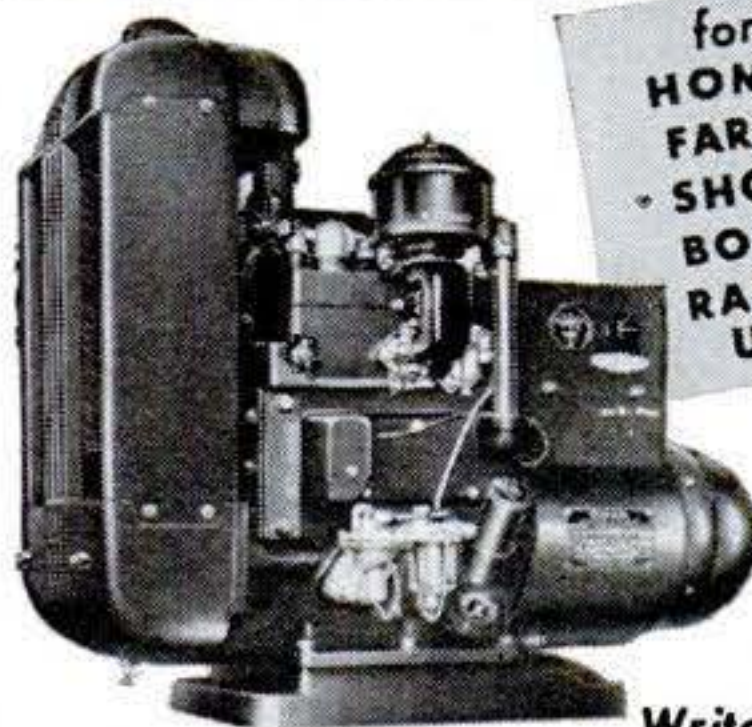

for
HOMES
FARMS
SHOPS
BOATS
RADIO
USE

● Onan gasoline-engine-driven Electric Plants supply reliable, economical electric service for any use. Portable, stationary or stand-by models. Water or air-cooled, compact and rugged.

A.C.: 350 to 35,000 watts in all standard voltages and frequencies. D.C.: 600 to 10,000 watts, 115 and 230 volts. BATTERY CHARGERS: 500 to 3,500 watts; 6, 12, 24, 32 volts.

Write for folder

D. W. ONAN & SONS INC.

2773 Royalston Ave., Minneapolis 5, Minn.



**NOW the
G-E EXPOSURE METER**
offers extra help for your camera!

These 3 new masks snap on the G-E meter in place of hood to let you read **INCIDENT LIGHT** (light on subject) the professional way. Gives better quality in color, stills, movies. With hood on, the meter provides extreme accuracy for reflected light. Easy to use. Many other advantages. Get a G-E meter and get better vacation pictures. General Electric, Schenectady 5, N. Y.

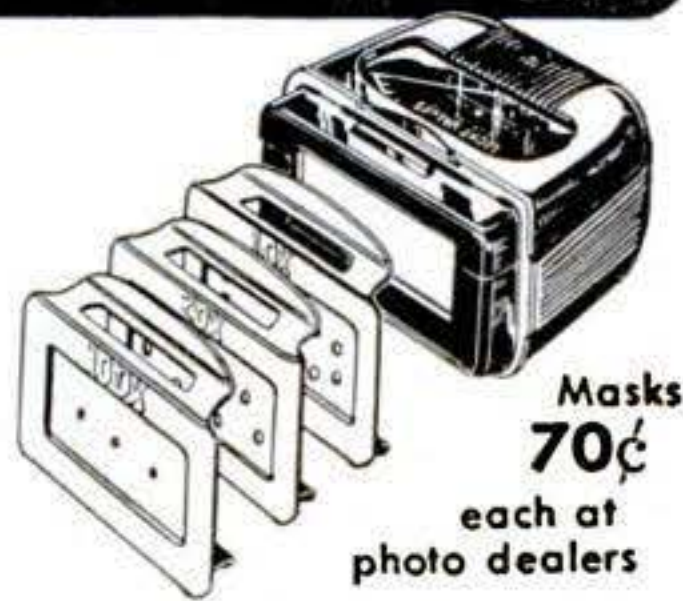

Masks
70¢
each at
photo dealers



Type DW-58
\$26⁹⁵
Federal tax incl.



*Exposure
Meter*

...it's 3 meters in One!

GENERAL  ELECTRIC
606-198D

X-acto *

**HANDICRAFT
KNIVES & TOOLS**



Choice of experts in every art and craft field. Singly and in sets, 50¢ to \$50.00. (Slightly higher in Canada.)

Buy where you see this sign —
At hobby, hardware and gift shops.

X-acto Crescent Products Co., Inc., N. Y.
In Canada, Handicraft Tools, Ltd., Toronto

*Reg. U.S. Pat. Off.

THE FAITHFUL
HEART
OF YOUR FUEL
SYSTEM



AC
**FUEL
PUMPS**

Pulsing steadily, hundreds of times a mile, your AC Fuel Pump is the strong, reliable heart of your fuel system. It has given you long, faithful service because of its inbuilt quality and scientific design.

You can prolong that faithful service indefinitely, if you insist upon an AC when you replace your present pump with a new or rebuilt one.

AC SPARK PLUG DIVISION • GENERAL MOTORS CORPORATION

**NOW is the time
to buy GOOD tools**

WRENCHES - PLIERS
PUNCHES - CHISELS
SCREWDRIVERS
SPECIAL TOOLS
SOCKETS &
HANDLES
PULLERS
TOOL
BOXES

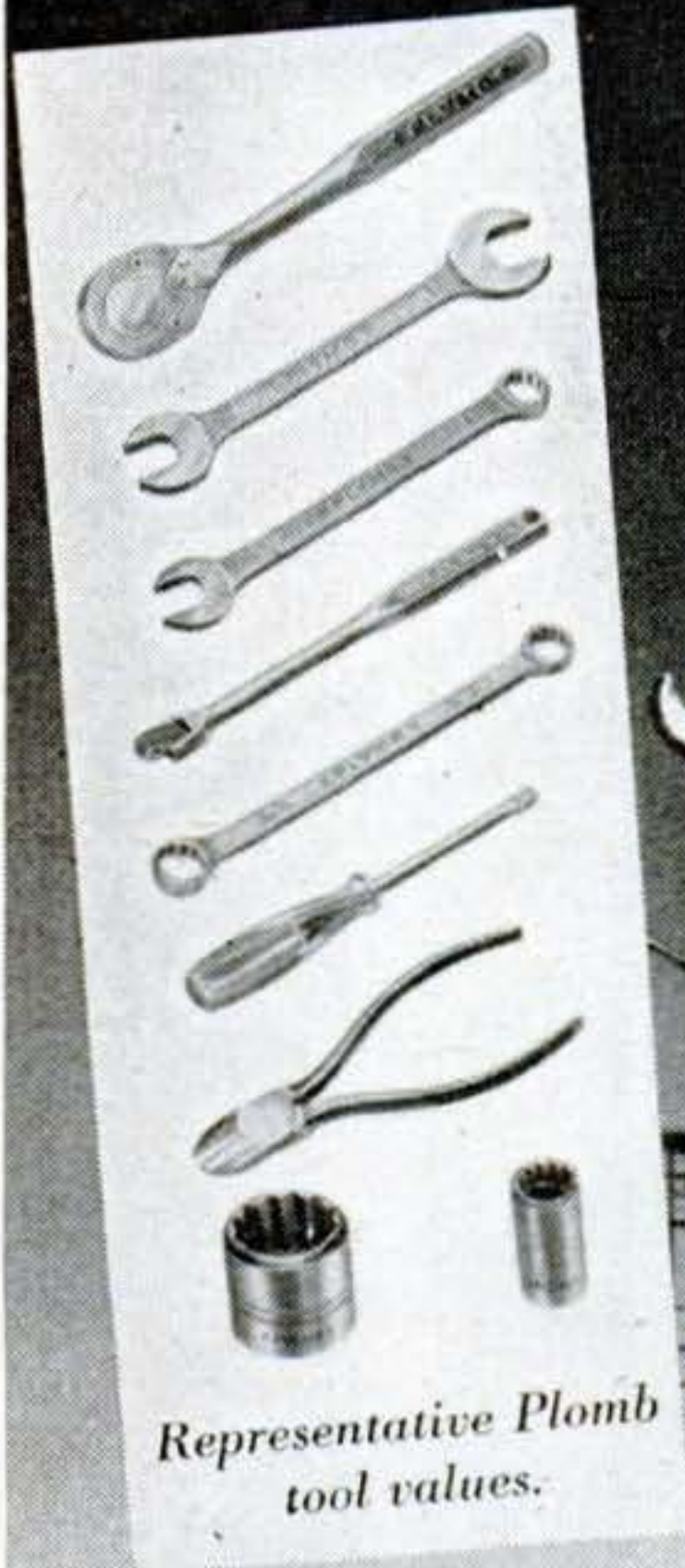

Representative Plomb
tool values.



You get extra value in Plomb tools today, because prices are close to pre-war levels. Plomb's production of 13 times 1940 makes this possible. Materials, design and accuracy are better than ever before. So get the tools you need from your Plomb dealer now. Write for catalog to Plomb Tool Company, 2257G Santa Fe Avenue, Los Angeles 54, Calif.

4764



PLOMB
streamlined
TOOLS

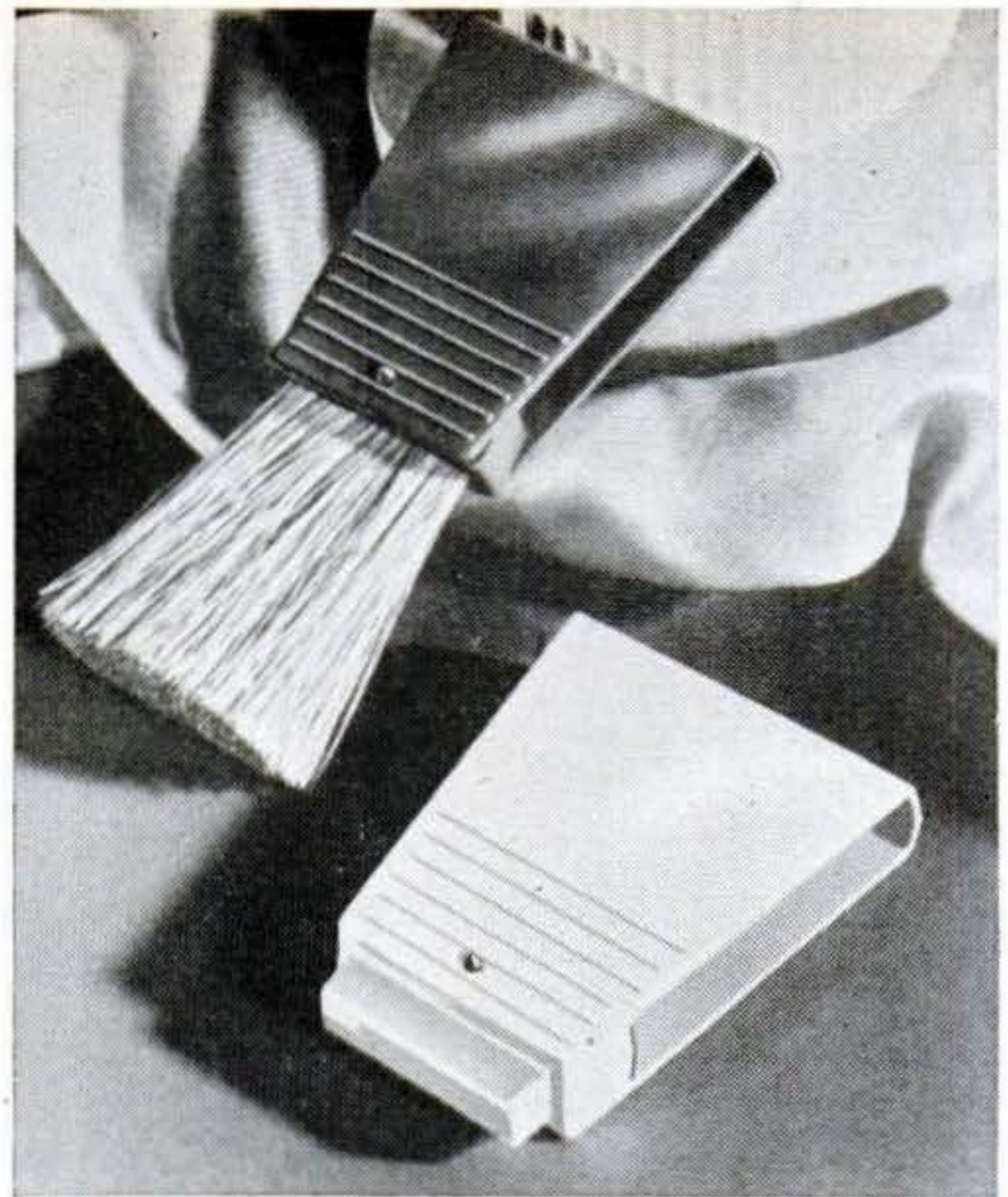

Brush Slips into Handle-Case

A WHISK-BROOM travel brush, mounted at the end of a plastic combination handle and case, folds into the case when not in use and can be quickly opened when needed. The Kippy-Kit Company, of Circleville, Ohio, manufactures it.

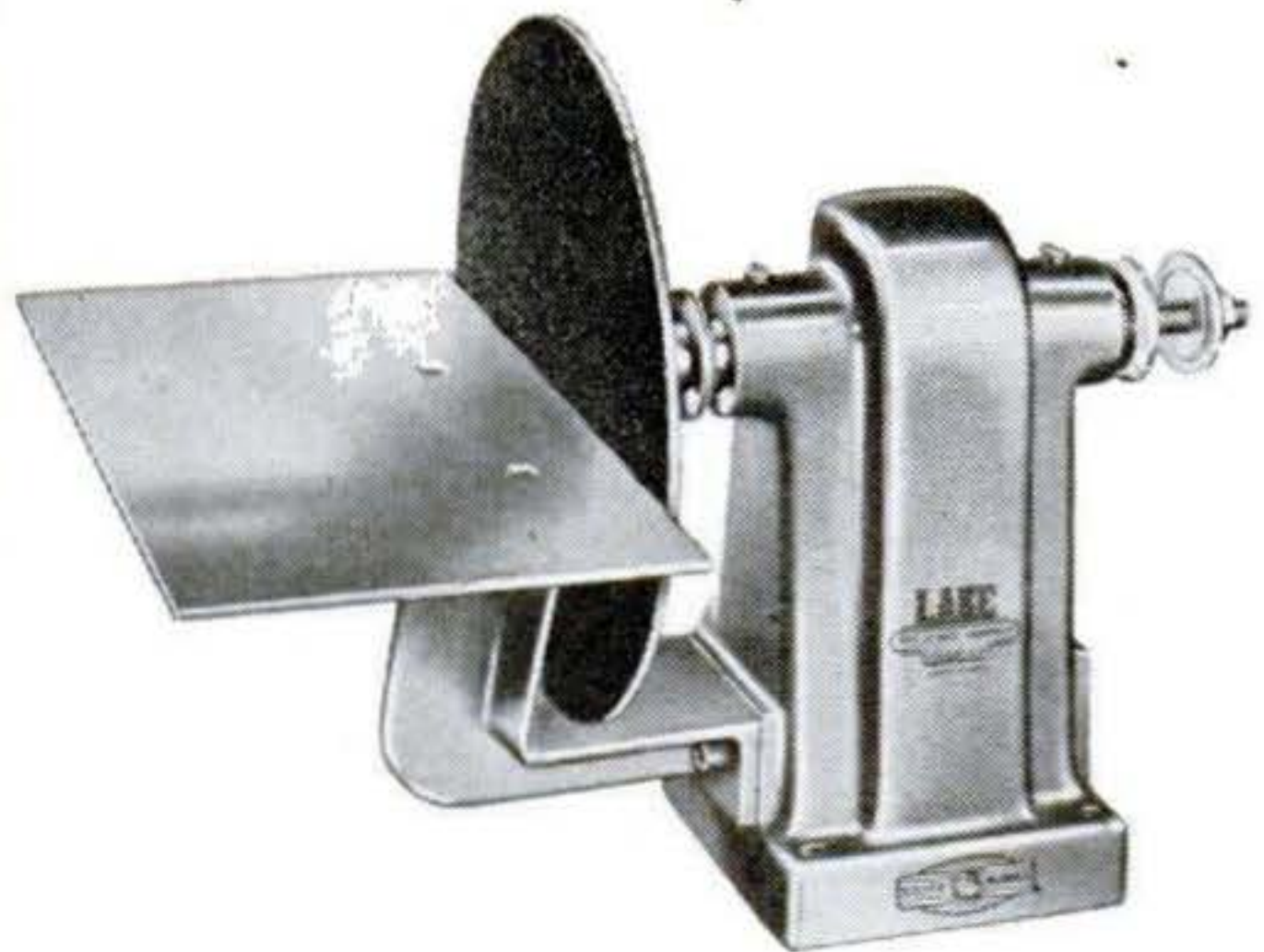

Sander Does Heavy Jobs

FOR heavy-duty work at home or in a shop, this disk sander and polishing head combination accommodates a variety of accessories. Made by the Lake Manufacturing & Engineering Co., of Syracuse, N. Y., the device can be driven from below or behind by a ½-inch V-belt. Two arbor V-pulleys provide speed changes and shaft adjustment.

Why Ford engines don't overeat!

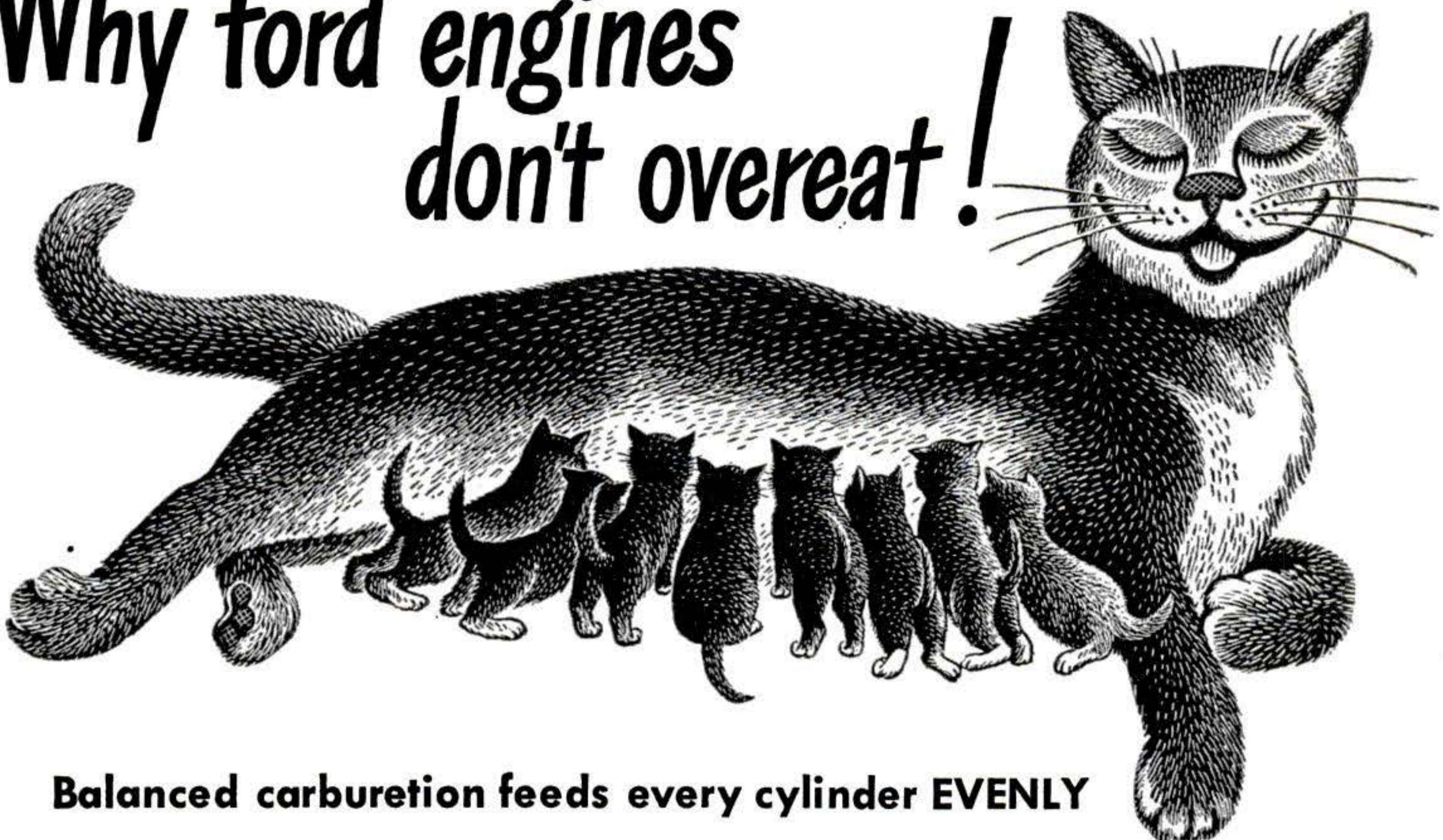

Balanced carburetion feeds every cylinder **EVENLY**

● Whether you own the Ford Six or the V-8, you're sure to get balanced downdraft carburetion. You're sure that every cylinder is properly fed . . . and economically, too!

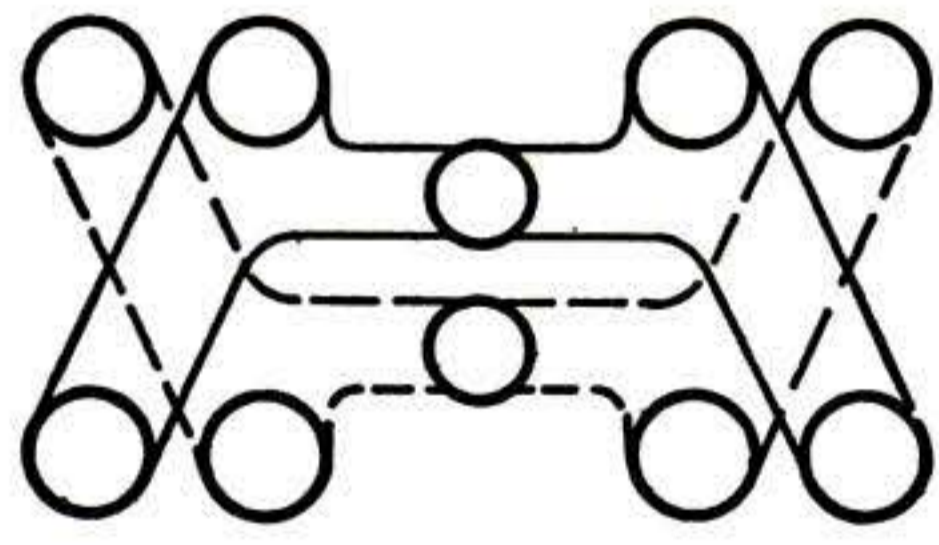
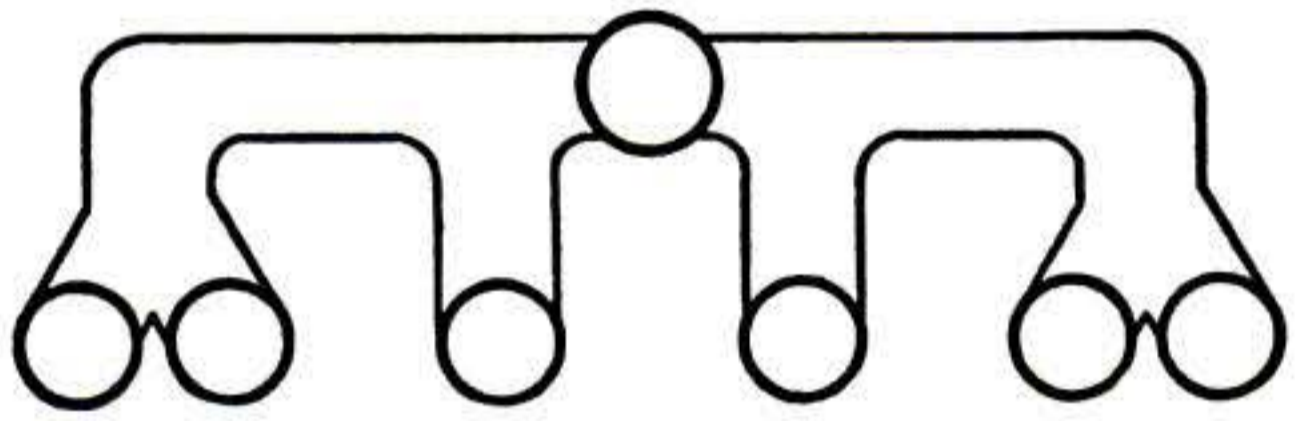

In the **SIX** the downdraft carburetor serves the cylinders through a unique four-port manifold with dual leads. Two leads serve the two center cylinders, the others serve the end pairs. As in the V-8, this results in even feeding.

In the **Ford V-8** engine, the dual carburetor feeds the cylinders through a duplex manifold. Each manifold serves four cylinders whose place in the firing sequence prevents simultaneous suction by any two cylinders:

In both **SIX** and **V-8**, you get greater economy from Ford's accelerating pump which sends extra fuel into the carburetor when the engine needs extra power, but saves this fuel in normal driving. And in cold weather Ford's new Automatic Manifold Heat Control routes warm exhaust heat past the carburetor for quick warm-up, then back through normal channels.

These and many other features put **FORD OUT FRONT** for fuel efficiency.

There's a  in your future

HOW YOU CAN SEAL CRACKS IN CAST METAL

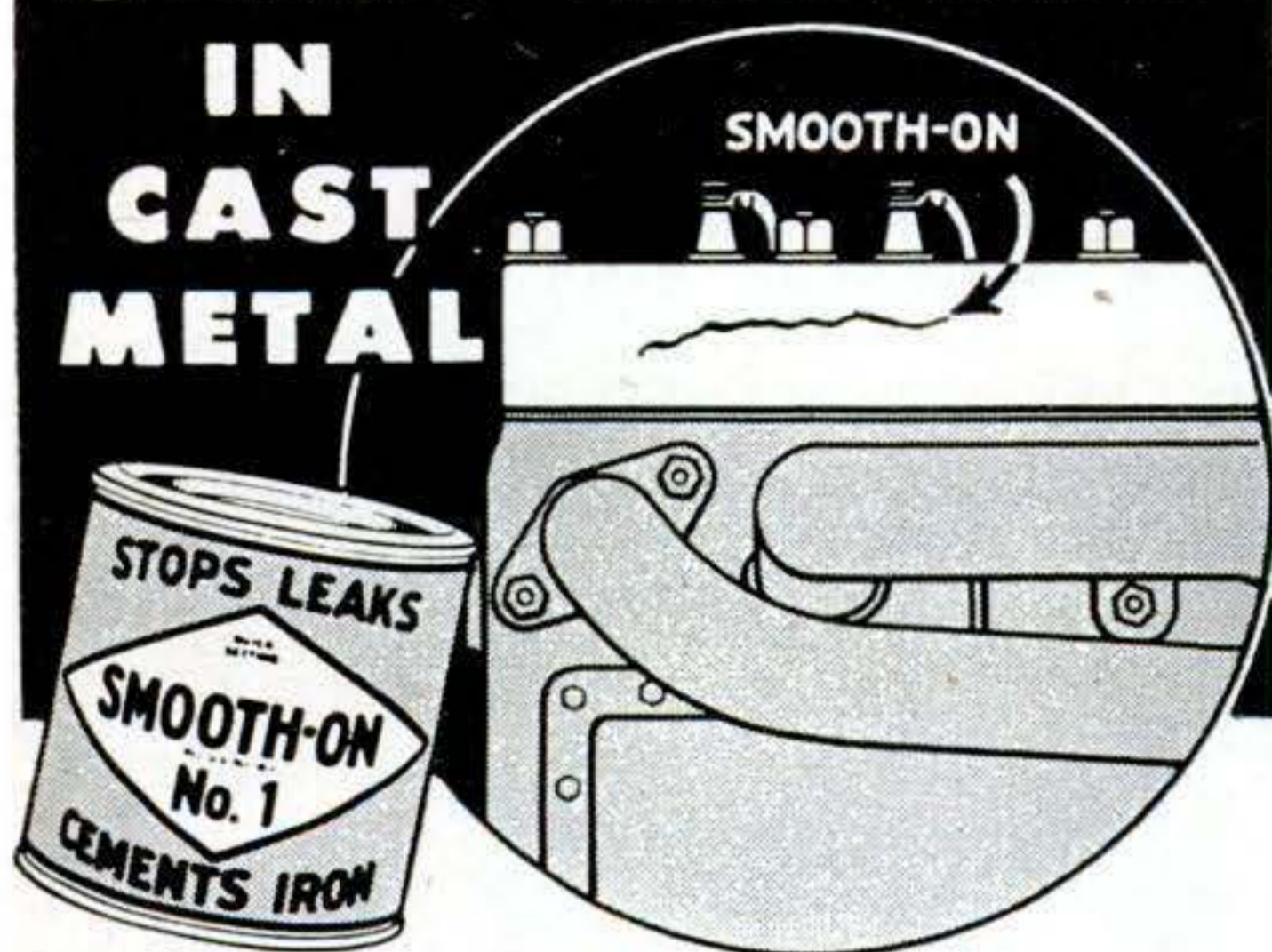

Do as professional repairmen do—seal small cracks and porous holes in metal castings with Smooth-On No. 1 Iron Cement.

You simply mix Smooth-On with water and force the mixture into the opening. It hardens like metal and stays tight, because Smooth-On expands slightly as it sets.

Sealing cracks is only one of many useful metal repairs you can make with Smooth-On around the house, in the garage, etc. Use it to stop pipe leaks, tighten loose bolts, screws, knobs, casters, fixtures and parts. Saves time. Saves money.

Keep Smooth-On handy for emergency repairs. Buy it in economical 1 3/4-oz. or 7-oz. size at your hardware store. If they haven't it there, write us.



FREE HANDBOOK SHOWS HOW

Send the coupon for this 40-page pocket size manual. Gives clear, tested directions for making metal repairs without using heat, on household equipment, auto parts, utensils, tools, cutlery, etc. 170 diagrams. Describes also other useful Smooth-On Cements for special purposes.

--- Sign and Send NOW ---

Smooth-On Mfg. Co., Dept. 58G
570 Communipaw Ave., Jersey City 4, N. J.

Please send me my free Smooth-On Handbook

Name.....

Address.....

7-47

SO-207

Do it with SMOOTH-ON

The Iron Repair Cement of 1000 Uses

It Pays to Buy an AIRCOOLED DIESEL POWERED Generating Set

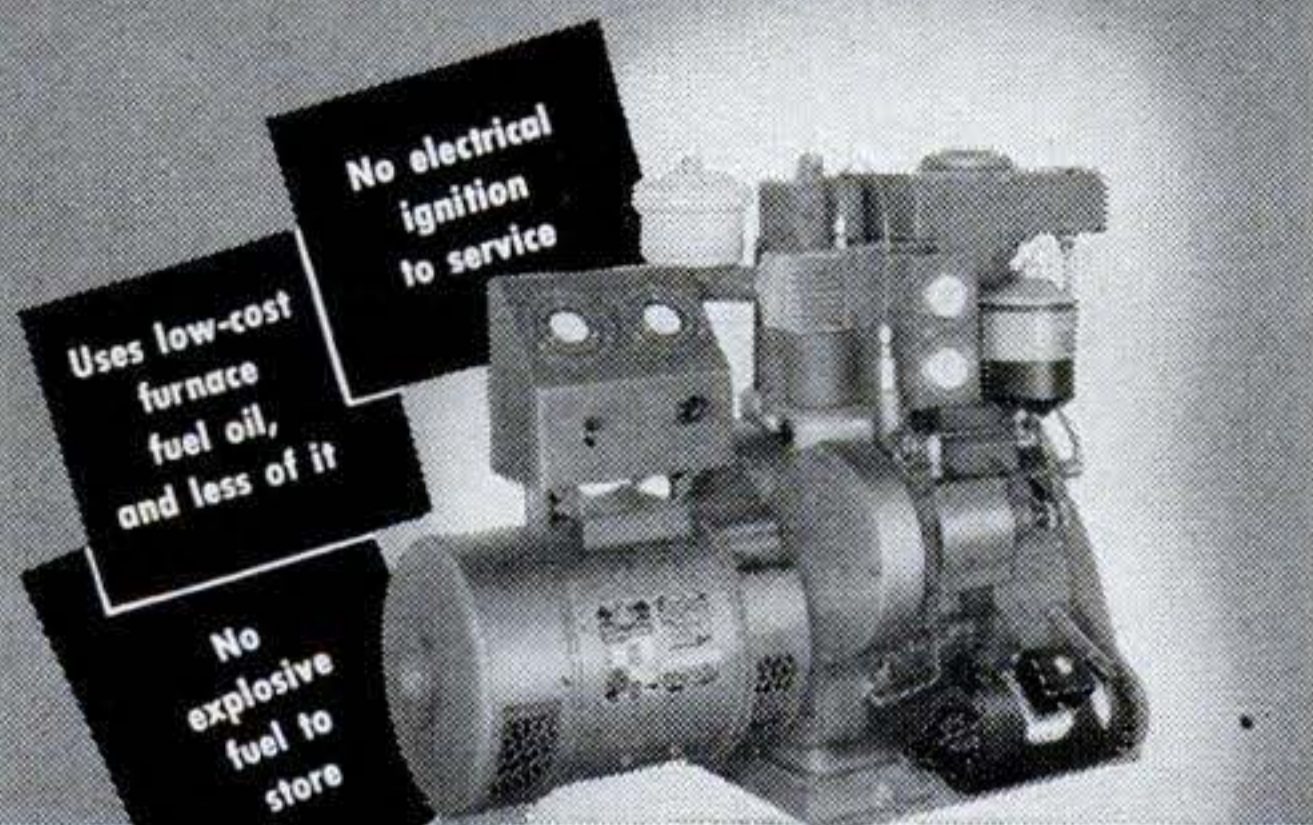

Literature containing complete information is available. Just mail a post card today.

R. H. SHEPPARD CO., INC.
68 Middle St., Hanover, Pa.

DIESEL'S THE POWER...

Sheppard's the Diesel

ATTENTION HOMECRAFTSMEN!

PLANS For Dutch Windmills, Lighthouses, Bird Houses, Lawn Chairs, Arbors, Trellises, many kinds of fine furniture, also a great variety of Lawn Figure patterns. SEND 10c FOR CATALOG ILLUSTRATING OVER 100 PRACTICAL PROJECTS
Craftsman's Model Co., 2030 N. 41st St., Dept. K19, Milwaukee, Wis.

BUILD YOUR OWN FAN

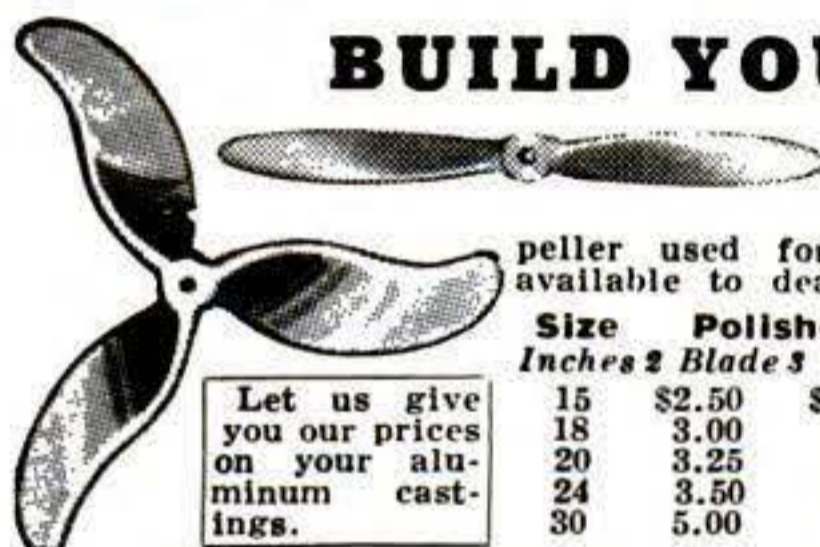

with that old motor

One piece cast aluminum propeller used for cooling and ventilating. Also available to dealers at discount.

Size	Polished	Unpolished	Bore
Inches	2 Blade	3 Blade	Inches
15	\$2.50	\$3.50	1/2 5/8 3/4
18	3.00	4.00	1/2 5/8 3/4
20	3.25	4.25	1/2 5/8 3/4
24	3.50	5.00	1/2 5/8 3/4
30	5.00	4.00	1/2 5/8 3/4

KLOPPENBORG ALUMINUM FOUNDRY, Dept. P.S. 77, Davenport, Iowa

\$2.95



TORNADO GAS TORCH

The Modern Way of Soldering

Ideal for hard and soft soldering. Will heat quickly; solder will flow freely and smoothly. No compressed air required. Nothing to pump. Self-adjusting. Safe. Economical. Can be used for annealing small parts and bending metal parts. Generates a heat of 1700° Fahrenheit. Simply connect to any illuminating (manufactured) gas jet with a rubber

hose and operate. Tornado Torch No. 119 comes with three (3) tips, (1/8", 1/4", 3/8" blast).

The Tornado Gas Torch No. 119, complete with three tips, is \$2.95. See your dealer or order direct. Send check or money-order—post paid.

Robco Corporation, 204 E. 44th Street, New York 17, N. Y.

Safe Trailering Demands



Safety Engineered Trailer Parts

- TORQ-LESS AXLES
- BULL DOG HITCHES
- BULL DOG PARKING JACKS

What's behind Safety-Engineering? Drop us a card today with your address and you'll receive the full story in our new FREE Catalog by return mail.

Send for FREE Catalog Today



HAMMER BLOW TOOL CO.

D-46,

WAUSAU, WISCONSIN



WHEELS AT BARGAIN PRICES

...4" wheel & tire, 5/16" sleeve bearing & hub cap	\$.45 ea.
...5" wheel 5/8" solid tire 5/16" shaft hole	0.65 ea.
...6" wheel 5/8" solid tire 5/16" shaft hole	0.75 ea.
...7" wheel 3/4" solid tire 3/8" shaft hole	0.85 ea.
...8" wheel 1" solid tire 1/2" sleeve bearing	1.25 ea.
...8 x 2" wheel, semi-pneumatic tire 7/16" ball bearing	2.50 ea.
...10 x 1.75 wheel semi-pneumatic tire 7/16" ball bearing	3.25 ea.
...12 x 1.75 wheel semi-pneumatic tire 1/2" bronze bearing	4.00 ea.
...10 x 2.50 wheel semi-pneumatic 1/2" ball bearing	5.50 ea.
...6 x 2" wheel 5/8" ball bearing, solid tires	3.95 ea.

BUILD YOUR OWN Wagons, Scooters, Soap Box Racers, Welding Carts, Baby Pens, etc.

To order above wheels write number wheels wanted in space provided, tear out and mail this ad with check or money order and your name and address. If other sizes are wanted write for FREE LIST, TRULSON MFG. Co., 811 E. 31 St., Dept. P-3, Kansas City, Mo.

NO OTHER LIKE IT

OTTAWA
Self-Propelled
BUZZ
MASTER



7 H-P
MOTOR

The land-clearing and all-round machine you have been waiting for. Furnished with post hole digger and sickle bar attachments if desired. Eliminates the hard work of clearing land and making fence. Propels itself anywhere—up hill and down. Two speeds for sawing and road travel. Powerful 7 H-P motor. Use engine for many belt jobs when not sawing. Plenty of opportunity for profitable custom work. Costs too little to do without. Other power attachments available soon. Patents pending on exclusive OTTAWA features. Low factory-to-user prices. Send for Free details.

OTTAWA MFG. CO., 1-701 WALNUT ST., OTTAWA, KANSAS

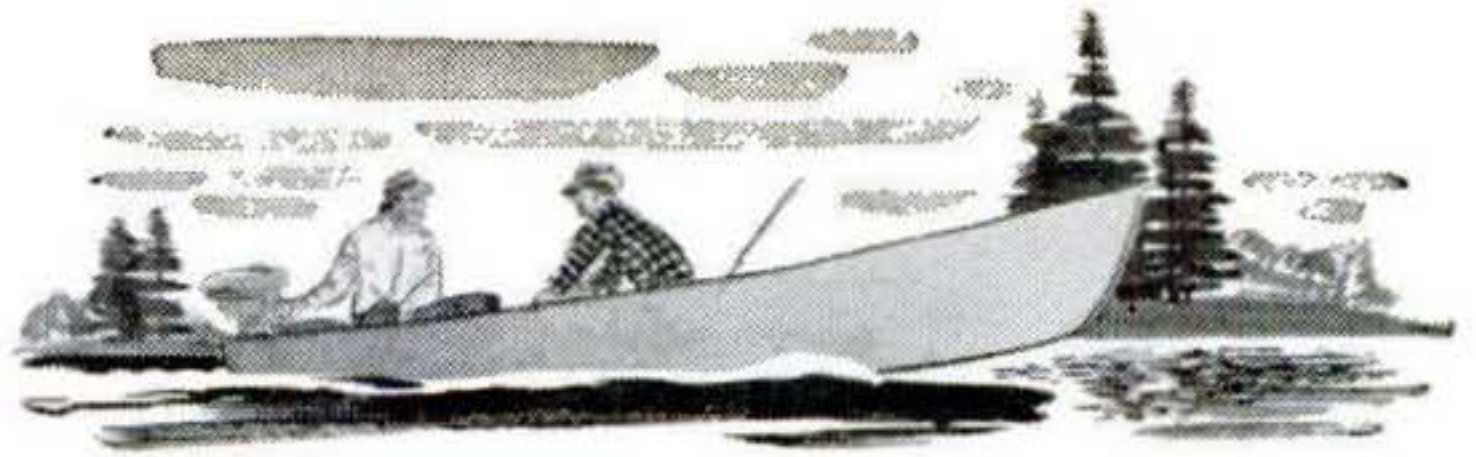

Performance!

Put a Scott-Atwater on the back of your favorite craft for a trial run. See how it flashes into action on the first pull of the starter! Speed across the lake—watch your boat race through the waves! Then idle down to a creep—your boat barely moves, yet the Scott-Atwater purrs smoothly on.

This sensational performance is the result of experienced, progressive engineering. For example—Scott-Atwater's *multiple feather-valve* intake system. Scott-Atwater feather valves *automatically change timing* to maintain a full fuel charge at *all* speeds. This guarantees easy starting, slow trolling and full top speed.

Send coupon today for the new fishing book, "How to Catch More Fish."

4 MODELS

A Standard and De Luxe Single, developing 3.6 horsepower at 4,000 r.p.m. OBC certified.

A Standard and De Luxe alternate firing Twin, developing 7 1/2 horsepower at 4,200 r.p.m. OBC certified.

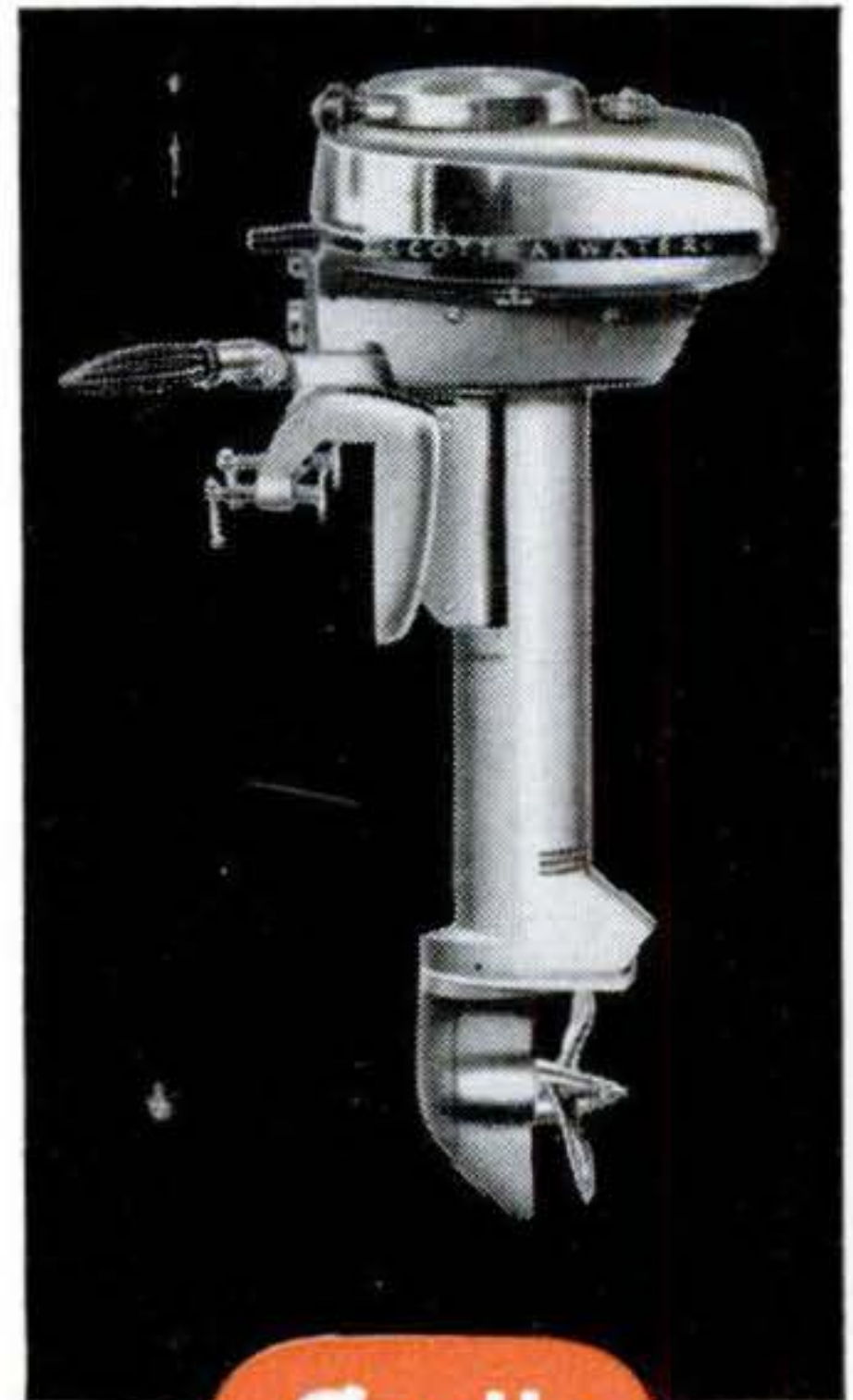

"HOW TO CATCH MORE FISH!"
by Frank R. Steel, national authority on fishing.

Tells you how to fish by revolutionary method of water temperatures. Specific information concerning at what depth fish will be according to temperature of water. 48 pages, illustrated in color, diagrams of lakes and streams. Send coupon.

Scott-Atwater



SCOTT-ATWATER MFG. CO., INC.

2901 East Hennepin Avenue
Dept. PS77, Minneapolis, Minn.

Enclosed find 10 cents for which please send me a copy of Frank R. Steel's new booklet, "How to Catch More Fish."

Name

Address

City State

Wife's in a huff



Car's a sight!



Here's the stuff



To shine it bright



Removes dull traffic film—restores the original color and lustre—quickly, easily and safely.

DU PONT
REG. U. S. PAT. OFF.

No. 7 POLISH



New Plane Lamp Is Brighter

TEN times brighter than the ordinary 20-watt airplane reading lamp, a new type 2½ inches long (inset), formerly used in gunsights, has been announced by General Electric's Lamp Dept., of Cleveland, Ohio. The lamp is recessed into a wall or ceiling to avoid glare.



Milling Table for Drill Press

A SMALL, two-way micrometer-feed sliding table for light milling in the drill press, as well as for precision hole location, is manufactured by Leo G. Brown Engineering Co., of Los Angeles. The table, easily mounted on a drill press, is 7½ inches square and is fitted for one-inch T-bolt heads. Both feeds have a travel of five inches.

AIRPLANE GENERATOR

25 AMP.



Can be used on homebuilt Electric Welder, Wind Charger, Battery Charger, Light Plant, etc. Also can be used on boats, trucks, airplanes. Fits nearly any 24 volt airplane system.

Built by Leece-Neville, 24 volt, 25 amp. Model L-3.

BRAND NEW!

Original cost \$212, NOW, only..... **\$24.95**

\$2.00 deposit required on CODs. Generators shipped Express charges collect.

AERO INSTRUMENT COMPANY
Municipal Airport, Houston 12, Texas

Build Your Power Tools With OUR BALL BEARING ARBORS

New Departure Self Lubricating Bearings 10,000 rpm

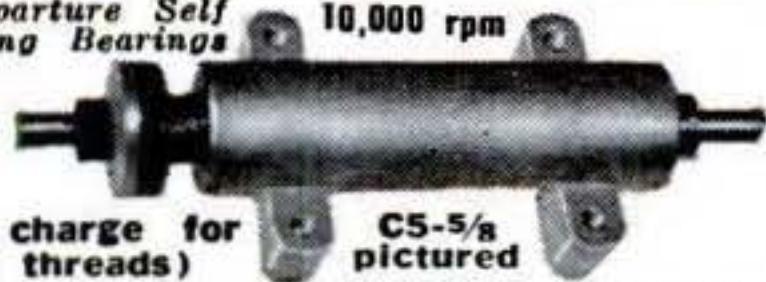

(No extra charge for left hand threads)

C5-5/8 pictured

B33—\$4.95 PP
5/8x4 1/2 Spindle
B15 Plain Spindle
\$3.45

C4-1 1/2x12 1/2 Spindle, Housing 2x8 \$8.25 PP.
C5-5/8x12 1/2 spindle, housing 2x8 \$8.25 PP.
C6-3/4x12 1/2 spindle, housing 2 1/4x8 \$9.25 PP.
D8-1x17 1/2 spindle, housing 2 5/8x11 \$16.95 PP.
1 INCH BETWEEN WASHER AND COLLAR

Shaper Arbors, C4, C5, C6 or D8, 3 Inches between collars, add \$6.00. Plain Spindle Models less threads and collars C4—\$8.00, C5—\$8.00, C6—\$9.00, D8—\$16.00. All P.P. V Belts and Pulleys. SANDING DISCS, 8"—\$3.50 PP., 10"—\$5.00 PP. Center Hole 1/2, 5/8 or 3/4. State hole size. Dealers wanted.

POLY PRODUCTS, 406 S. Chester, Ct. 1b, Pasadena 5, Calif.

POWERFUL

Astronomical Telescopes

easily made by anyone. Full power and clear vision guaranteed. Perfect lenses and detailed instructions. 100 power \$2.50. 200 power \$3.50. 400 power \$5.50. Instructions alone 10c. 25% deposit on C.O.D. orders. Unconditional money back guarantee.

DEPT. BK, SUFFOLK SCIENCE SERVICE, MANORVILLE, N. Y.

PLASTICS

Fabricating plastics offers you a fascinating hobby or a profitable business. New Carmen-Bronson Plastics Handbook tells you how; gives construction plans. New

Carmen-Bronson Catalog lists all needed materials—Plexiglas, Lucite, Bakelite, Lignolite, Tenite II, Lumarith in sheets, rods, tubes, special shapes—clear and glowing colors. Also plastics dyes, cements accessories and supplies. 25c (refundable with first order), brings you both catalog and handbook. Send for them today.

CARMEN-BRONSON CORPORATION

165 East 3rd Street, Dept. 7-A Mount Vernon, N. Y.

SLEEPING BAGS

AAF Down-filled. Zippers on one side and both ends. 76"x30". Weight about 13 lbs.

Made of waterproof material. Roomy, comfortable. The perfect bag for fishing, hunting or camping. Slightly used but sterilized. Excellent condition. Postpaid..... **\$18.50**

Write for Free War Surplus Catalog!

Send check or money order to: Pacific Fur & Wool Co.
War Surplus Dept. Box 926-PS Sacramento, Calif.



SHAW GARDEN TRACTORS and MOWERS

Get FREE FOLDER NOW!

Get details on 1 to 9 H.P. walking and riding tractors. Do 1000 jobs on small farms, estates, orchards, gardens. Low-priced. Send postcard!

SHAW MFG. CO.

5707 Front St., Galesburg, Kans. 668PS N.4th St., Columbus, Ohio

A Bigger Cash Income

can be yours with this new...

HOBART arc WELDER

Own a profitable business with a minimum investment? It's easy if you start a welding shop with Hobart Arc Welders. People bring repair work to you — automotive, farm equipment, etc. There is profit in every job — and plenty of jobs to keep you busy the year round.



WELDING WITH HOBART IS EASIER! Only with Hobart do you get operation and convenience features that let you complete a job faster while producing better quality, more profitable welds.

"BUILD YOUR OWN" AND SAVE! With the Hobart Generator, a used auto engine and chassis, you can build your own portable gasoline drive arc welder and save hundreds of dollars. Go everywhere for welding jobs. Send coupon.

HOBART BROTHERS CO., BOX P-77, TROY, OHIO

"One of the World's Largest Builders of

Hobart

arc welders"

You'll find every type and size of arc welder in the Hobart line — electric or gasoline drive, stationary or portable, AC or DC.



Attend the HOBART WELDING SCHOOL



Instruction in all phases of welding. Individual instruction. Qualified under G. I. Bill. A non-profit institution.



I'm Interested

in the profit-making possibilities of Hobart Arc Welders. Send me free book, and details on items checked.

- | | |
|---|---|
| <input type="checkbox"/> Electric Drive | <input type="checkbox"/> A. C. Welder |
| <input type="checkbox"/> "Build Your Own" | <input type="checkbox"/> Welding School |
| <input type="checkbox"/> Gas Drive | <input type="checkbox"/> Catalog |

HOBART BROTHERS CO., BOX P-77, TROY, OHIO

NAME _____

ADDRESS _____

MENDS
BROKEN CHINA, TOYS, ETC.
It's transparent, waterproof, flexible and durable.

DU PONT
REG. U. S. PAT. OFF.

DUCO CEMENT
REG. U. S. PAT. OFF.

**A PENNY BUYS A
6 MILE RIDE!**

Get the thriftiest power on wheels, with a WHIZZER Motor on your bike. 125 miles to the gallon! 35 m.p.h.! And it's so easy to learn . . . fits any man's balloon tire bike! Complete with gas tank, oversize stand, and all necessary attachments.

ONLY \$97.55 PLUS TAX F.O.B. Pontiac Mich.

RIDE ONE AND YOU'LL BUY ONE!

ON A WHIZZER

Whizzer Motor Company, Dept. 537, Pontiac, Michigan.
I enclose \$99.97, which includes \$2.42 Federal Excise Tax () check or () money order. Send me one WHIZZER Motor complete, ready for installation. If descriptive literature only is desired, check here ().

Name _____ City _____
Street _____ State _____

Electrically Welded Endless
Paramount
BAND SAW BLADES

Made in widths from 1/8" to 1-3/4"

Make your band saw do more work for you. The proper width of blade will extend the scope of this important machine. Burrill's Paramount Blades are made from tough Nickel Alloy Steel properly tempered. Teeth accurately set and filed, and all saws carefully straightened. Send order and check today. Delivery will be made as promptly as conditions permit, from a few days to a week or two. You can obtain these saws at the following prices:

1/8"-3/16"-1/4"-3/8" wide, 5'6" long \$.90 each
1/8"-3/16"-1/4"-3/8" wide, 6'6" long95 each
1/8"-3/16"-1/4"-3/8" wide, 7'6" long 1.10 each

Other sizes at proportional prices
NO C.O.D. SHIPMENTS ACCEPTED
State Make of Machine
Your satisfaction is guaranteed
BURRILL SAW & TOOL WORKS
405 E. Main St., Iliion, N.Y.

INDIANAPOLIS "500" RACE HISTORY BOOK
352 pages, 1100 illustrations. Covers every race since 1909. Postpaid \$3.50; cloth-bound \$5.00. 32-page book on 1946 race only, \$1.00. Book on 1947 race (ready in July) \$1.00. CLYMER, Dept. B-7, 2125 W. Pico, Los Angeles 6, Calif.

AMAZING LOW COST BRONZE FOUNDRY
Cast Aluminum, Silver, Etc.—All Non Ferrous Metals

Make money in the foundry business casting Engines, Machinery, Art Objects, Statues, Inventions and all other foundry work. Castings up to 6" made quickly with new inventions called Foundry-ette. Operates on 110V AC and Domestic Gas. Write for complete FREE information.
Kans. City Specialties, Box 6022, Kans. City, Mo.

**Sand Casting
Forging-Heat
Treating-Case
Hardening**

D. C. MOTORS
Good deliveries on 1/4; 1/3; and 1/2 hp Motors. Available at special D.C. Voltages. Manufacturers of A.C. Generators, Rotary Converters, Lighting Plants, Frequency Changers and high Frequency Generators.

KATO ENGINEERING COMPANY
1401 First Ave., Mankato, Minn.

PLANS FOR 5 PROJECTS
that are fun to build

— only **\$1.00** postpaid

Special combination offer includes easy-to-read plans for: 1. Folding Lawn Chair 2. Child's Teeter Totter 3. Child's Glider Swing 4. 24-room Swallow House 5. Bird Feeder
Mail your dollar bill today! Ask for Package "Z".

DELTA MANUFACTURING DIVISION
Rockwell Manufacturing Co.
682G E. Vienna Ave., Milwaukee 1, Wis.

Deltacraft®

H-50

All CARLSON RULES

have this

10-SECOND BLADE CHANGE FEATURE



WITHOUT OPENING THE CASE, you can quickly replace the blade. Keep a 'spare' Replacement Blade on hand. Models in 6, 8 and 10-foot lengths. SOLD BY LEADING HARDWARE DEALERS

New THOR "B" ENGINE - \$6.95

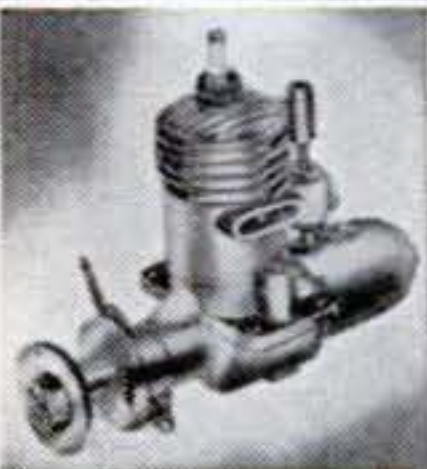

The new THOR "B"—Sensational miniature gasoline engine that really works. Super-power performance. Smooth, velvety power that roars into action with a "twist of the wrist." Over 20,000 already sold. 1/6 H.P. Complete with coil and condenser. Ready to run, only \$9.95. In KIT form, fully machined, 5 minutes to assemble, \$6.95, without coil and condenser. Powers all models. Fully illustrated instructions. Send \$1.00—shipped collect same day C.O.D.

FREE. SEND FOR 24-PAGE ILLUSTRATED HOBBY CATALOG. AMERICA'S HOBBY CENTER DEPT. S77, 156 WEST 22ND STREET, NEW YORK 11, NEW YORK

FAMOUS

COLEMAN STOVES



Only \$4.95

Prepaid

4602 St. Clair Ave.

Fully reconditioned. Guaranteed to be in perfect working order. Complete with case

SURPLUS VALUE CENTER

Cleveland, Ohio

\$\$\$ if trained in **arc welding**
Big income jobs await you. Learn quickly and thoroughly. Enroll under G. I. Bill. Write today. Hobart Trade School, Inc., Box P-583, Troy, O.

Thompson
BEATS
the World
on **BOATS**



Better Built
Lower Prices



Canoes



Rowboats



Outboards

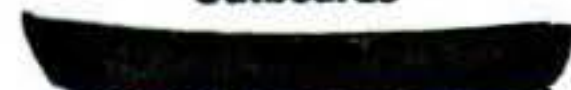

Light Boat for Auto

Safe Boats With Full Length Spray Rails
Keep passengers perfectly dry—even at high speeds. Catalog also shows two new models of "Take-Along" Boats. Two big factories—save you freight.

CATALOG FREE
Write for your copy. State kind of boat in which you are interested.
THOMPSON BROS. BOAT MFG. CO. (151)
219 Ann St. PESHTIGO, Wis. (Write to either place) 119 Elm St. CORTLAND, N.Y.

LOW PRICED

FOR THE FIRST TIME IN YEARS!



Real fractional horsepower AC-DC Electric Motor



SANDING



POLISHING



CARVING



ROUTING



GRINDING

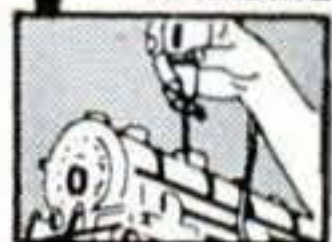

DRILLING

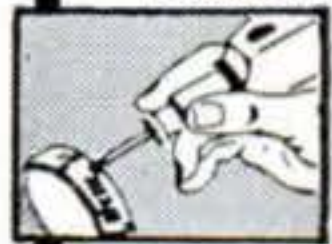

ENGRAVING

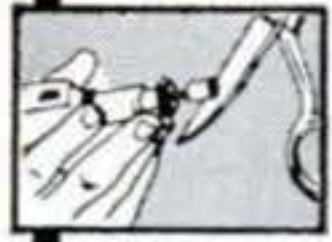

SHARPENING



CLEANING

FAMOUS CASCO POWER WORKSHOP

New portable all-purpose Electr-O-Tool Kit

FOR MECHANICS, HOBBYISTS, HOME CRAFTSMEN

Works on wood, metal, glass, plastics, leather. Long life, powerful 20,000 RPM motor in unbreakable plastic case, oil-less bearings, air-cooled. Exclusive built-in finger grip for perfect control. Fully guaranteed. 20 interchangeable precision-made accessories in fitted chest. Free descriptive literature on request.

SPECIAL LOW PRICE OFFER

Price of power tool alone \$14.95

20 accessories and valuable Project Book 8.50

Total Value \$23.45

ALL 21 PIECES FOR ONLY \$14.95



CASCO

See Casco's other big value: Casco Electri-Craft Power Tool Kit, complete with 36 accessories in fitted steel chest. \$32.95 value for only \$22.50.

CASCO PRODUCTS CORPORATION • BRIDGEPORT 2, CONN.

Have

Lovelier Floors...

with Less Care!

You'll enjoy new freedom with Self-Polishing SIMONIZ on your floors. The same durable long-lasting brilliance that makes SIMONIZ so famous for cars saves you lots of work . . . your floors clean up sparkling beautiful with a damp cloth.

Shines
as it
Dries

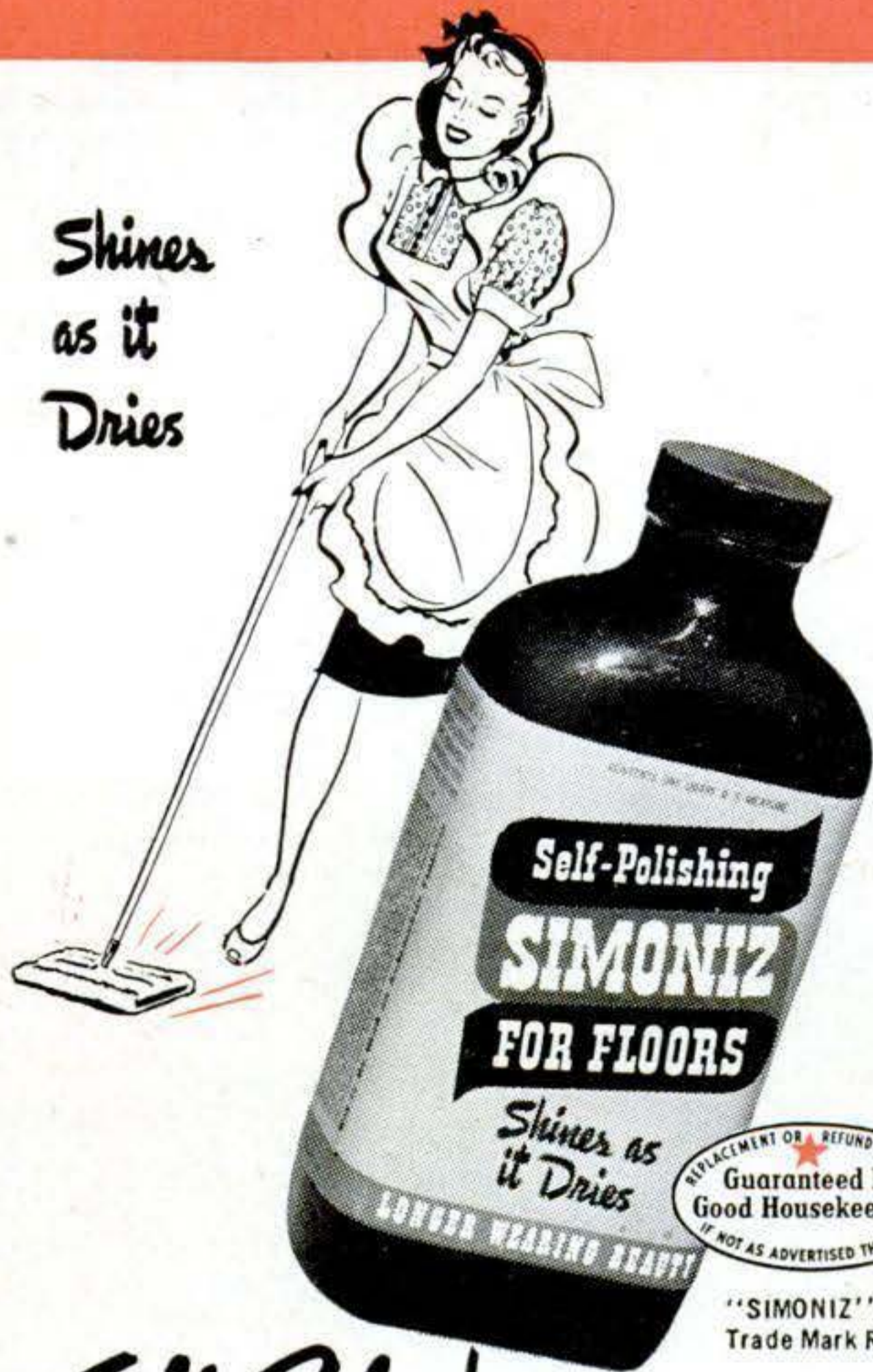

Self-Polishing SIMONIZ For Floors



Wrist Watch for the Blind

A WRIST watch that tells time in the raised characters of Braille is made by Longines-Wittnauer. To learn what time it is, the wearer lifts a spring cover that allows him to touch the hands and the dots on the dial. When the cover is released it snaps shut automatically, thus protecting the face of the watch.

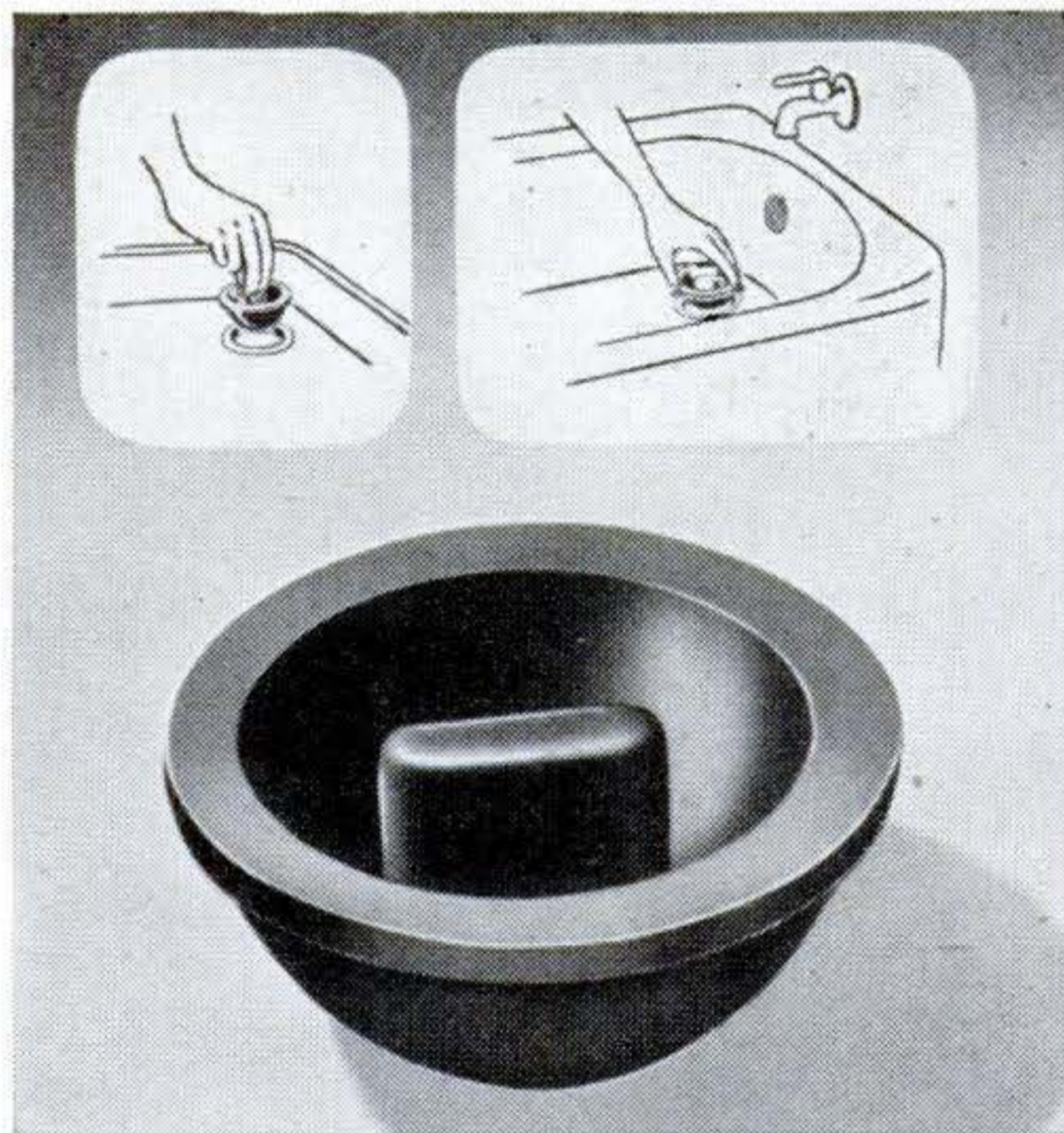

Drain Stopper Sits Tight

THERE is no accidental dislodging of a drain plug when the Sur-Seal rubber sink stopper is used. Featured by Los Angeles Standard Rubber, Inc., its handle sets flush with the sealing rim that is level with the drain edge. The stopper can be removed by grasping the handle and exerting slight pressure to break the suction seal.

PRESSURE QUEEN

FOUR CYLINDER
PORTABLE AIR COMPRESSOR
SPRAY PAINTING OUTFIT

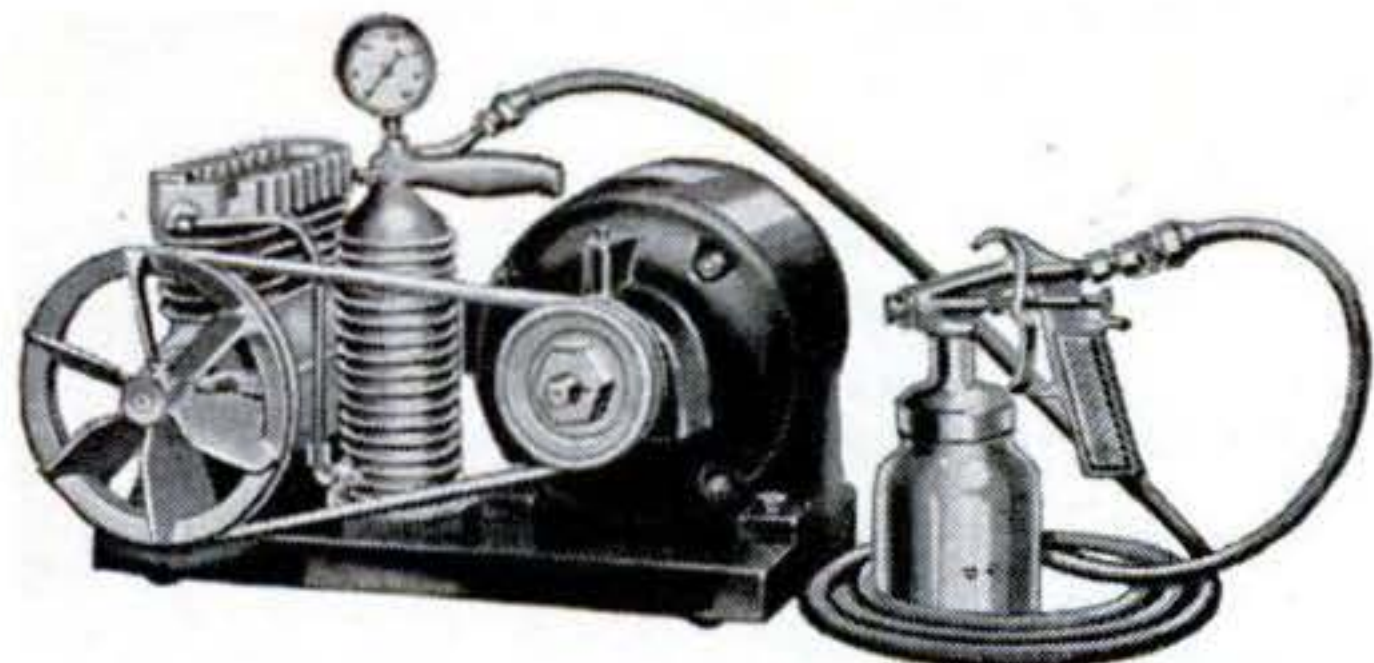

COMPACT • RUGGED • POWERFUL

The ideal air supply for home and farm workshop, machine shop, garage and contracting painter; for product finishing, inflating tires, painting automobiles, trucks, machinery, etc. Indispensable for building maintenance, interior and exterior. Handles any paint, insecticide or disinfectant.

This 4 cylinder compressor has drop forged crankshaft, stainless steel, heat treated valves; bronze bearings and positive forced feed lubrication. Maximum pressure 50-60 lbs., free from pulsation. Standard equipment includes the compressor mounted on steel base with carrying handle, belt, compressor pulley, air chamber, air gauge, 15-ft. hose, spray gun. Requires 1/2 or 1/3 h.p. motor or gas engine.

If your dealer does not sell Pressure Queen write direct

THE CAMPBELL-HAUSFELD CO.

151 RAILROAD AVE.,

HARRISON, OHIO

MARGIE



DIRT and DUST
YOUR DOUBLE-TROUBLE?



Fix it with **Mortite**

a household friend

Shut out dirt and dust! Press pliable Mortite around windows, doors, baseboards, etc. It's done in a jiffy. Keeps out ants, insects; fine for calking, stops rattles; the ideal weather-stripping. Roll covers about 80 ft. At Hdwe., Paint, Dept. Stores, Lumberyards.

\$1.25 Higher West of Rockies and Canada

WRITE FOR FREE BOOKLET.

J. W. MORTELL CO., 534 Burch St., Kankakee, Ill.

Logan... A NAME TO REMEMBER

WHEN YOU THINK OF **BETTER**

LATHES AND SHAPERS

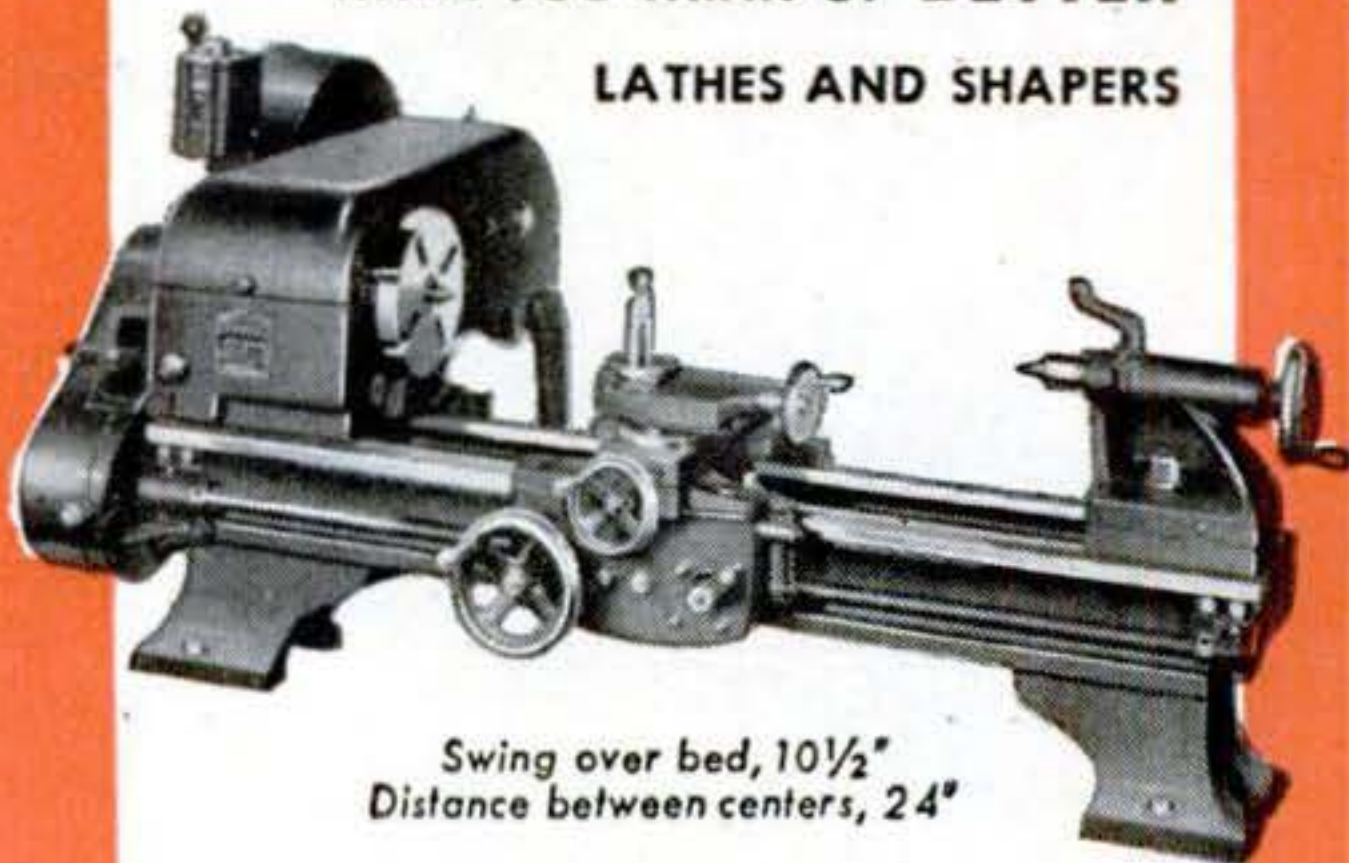

Swing over bed, 10 1/2"
Distance between centers, 24"

**LASTING
ACCURACY**

Another reason for
choosing a **LOGAN** Lathe

The ability of the Logan Lathe to hold to closest tolerances after years of usage results from advanced design and precise construction methods. Logan lathe bed ways are within .0005" of parallelism. The front bearing seat on the Logan ball bearing mounted spindle can vary no more than .0002". Total spindle run-out 12 inches from the bearing is less than .0008". Rugged, massive construction is combined with these precision standards, and vital points of the lathe are protected by self-lubricating bronze bearings. These are a few of many reasons why it pays to choose a Logan Lathe for the small shop as well as for industrial use.

WRITE FOR THE LOGAN CATALOG...complete information on Logan Lathes, Shapers and Accessories.

9 REASONS why LOGAN Lathes are BETTER lathes

- 1 **BALL BEARING HEADSTOCK**
for sustained accuracy.
- 2 **RUGGED, ACCURATE BED**
within .0005" of parallelism.
- 3 **SELF-LUBRICATING BEARINGS**
at vital points lengthen life.
- 4 **BACK GEARS ENCLOSED IN HEADSTOCK**
with shifter rack safely and conveniently at your finger-tips.
- 5 **RUBBER CUSHIONED COUNTERSHAFT**
for smoothness and accuracy in working area.
- 6 **THREE POINT SUPPORT**
Steadies the countershaft, prevents rocking.
- 7 **ENCLOSED BELTS, GEARS, PULLEYS**
Prevents accidents. Keeps lathe clean.
- 8 **AUTOMATIC BELT TENSION RELEASE**
Makes belt changing easy and safe.
- 9 **PRECISION BUILT THROUGHOUT**
For tool room accuracy in your shop.

DISTRICT OFFICES

Woolworth Bldg.
New York 7, N. Y.
Cortland 7-8024

550 W. Washington Blvd.
Chicago 6, Illinois
Central 1246

1672 Mission Street
San Francisco, Calif.
Underhill 6682

LOGAN ENGINEERING CO.,
DEPT. C-7, 4901 LAWRENCE AVE., CHICAGO 30, ILL

JULY 1947 227

THE Natural WAY TO LIGHT A PIPE

- Windproof
- Lightweight
- Large Flame

DOWN-DRAFT CHIMNEY-ACTION

\$3.50
AT YOUR DEALER

Unconditionally Guaranteed

Nimrod PIPELITER

If your dealer is unable to supply you, send \$3.50 direct.

WARD-NIMROD COMPANY
Dept. 36-C, 2968 Jessamine St., Cinti. 25, Ohio

Have YOUR OWN Business

SAW FILING

You can have a good, steady, cash business of your own reconditioning saws with the Foley Automatic Saw Filer, which makes old saws cut like new again. The Foley is the ONLY machine that files all hand saws, also band and circular saws. Easy to operate—no eyestrain.

SEND FOR FREE PLAN—shows how to start in spare time—no canvassing. Send coupon today—no salesman will call.

FOLEY Automatic SAW FILER

FOLEY MANUFACTURING CO.
719-7 Foley Bldg., Minneapolis 18, Minnesota
Send Free Plan on Saw Filing business, no obligation

Name _____
Address _____

EASY with one hand
and a

"YANKEE"

Quick-Return Spiral Screw Driver

Got to drive screws where it's hard to use both hands? Easy with a "Yankee" 130A Spiral Driver. "Quick-return" spring in handle keeps bit in slot, returns handle after each push.

Write for the "Yankee" Tool Book.

YANKEE TOOLS NOW A PART OF
STANLEY
THE TOOL BOX OF THE WORLD

NORTH BROS. MFG. CO.
Philadelphia 33, Pa.

FOR SAFER DRIVING IN STORMS AHEAD ASK YOUR GAS PUMP MAN TO PUT ON FOR YOU

New "DEAD-LOCKER" Models

ANCO RAIN-MASTER

Windshield Wiper Arms and Blades

Made in U. S. A. by
THE ANDERSON COMPANY GARY, INDIANA

MOTORCYCLISTS

★ ★ ★ ★ **ATTENTION!**

The B & H Footshift for all Harley's eliminates hand gear shift, gives fast getaway, greater maneuverability, maximum driving safety. Improved clutch lever booster. Easy to install. Write for details, prices.

SCIENTIFIC RESEARCH CO. 1618 N. Vancouver Portland 12, Ore.

BUILD YOUR OWN MACHINE TOOLS!
Blueprints \$1.00 - Catalog FREE

We supply quality Foundry Castings for Lewis Shapers, Milling Machines, Drill Presses, 8" Circular Saws, 6" Jointers, etc. Construction Blueprints for above 6 tools postpaid \$1.00. Illustrated 32 page Catalog sent free with Blueprint Order—describes 23 Lewis Tools. Write today!

LEWIS MACHINE TOOL CO.
P. O. Box 7446, Sta. L, Dept. S, Los Angeles 23, Calif.

What warns expressmen glass won't bounce?
What warns them not to crush or jounce?

Dennison

CAUTION LABELS

At Stationery Departments Everywhere

**NEW
WHIZZER
"STATION
WAGON"
DOUBLES YOUR
BIKE'S
USEFULNESS**

Here's a great new bike trailer that's built to last. What's more, the extra-light, extra-strong WHIZZER "Station Wagon" fits *any* bike. Full swivel hitch. Quickly attached and detached . . . makes an ideal hand cart around the yard and for shopping in stores. Carries bulky loads easily, safely . . . does not affect balance or control of bike. For low-cost delivery . . . drug stores and groceries . . . paper routes . . . personal shopping—get a WHIZZER "Station Wagon" today! Ideal for week-end trips and summer camping. Comes in knock-down package form.

Only
\$14.95

F.O.B. PONTIAC, MICH.

SPECIFICATIONS—Rated over 200 pounds capacity. Strong steel undercarriage, natural finish wood "station wagon" sides. Semi-pneumatic 10-in. tires, 24" long, 18" wide, 20" deep.

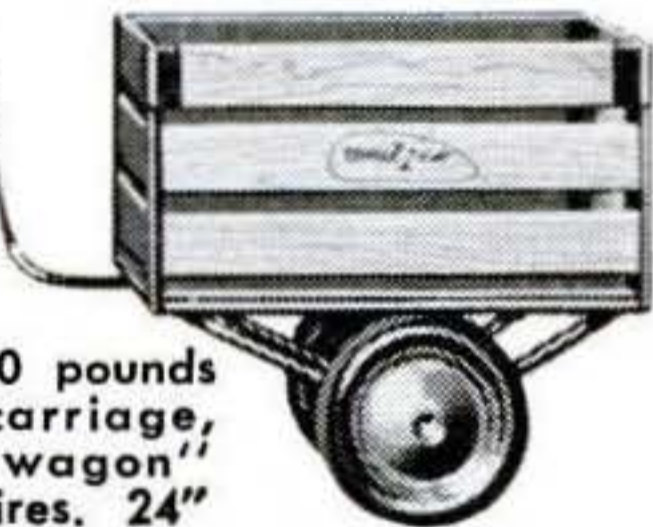

See your local bike dealer or order from
WHIZZER MOTOR SALES CO.
PONTIAC, MICHIGAN

AUTOMATIC SAW SET

For Hand and Band Saws

WITH
MOTOR

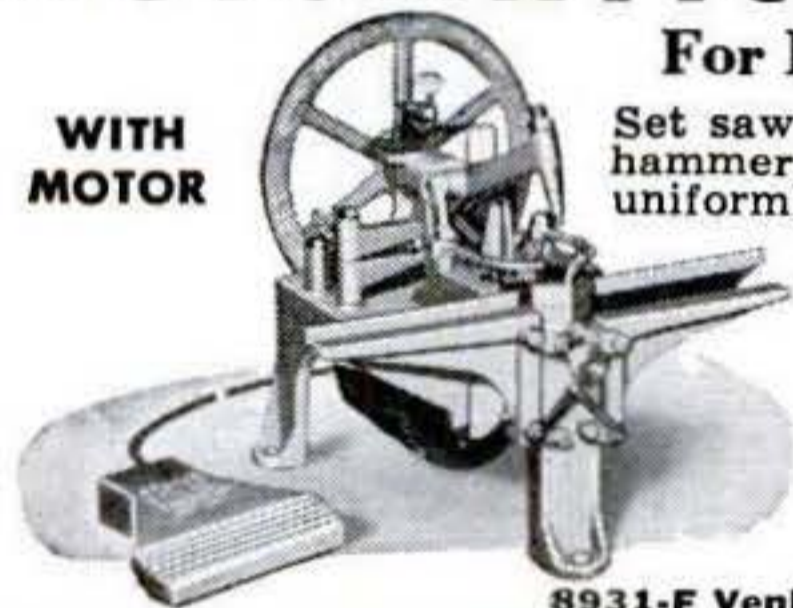

Set saw teeth automatically. Perfect hammer and anvil action sets teeth uniformly. Easy to operate. Sets 400 teeth a minute.

Also AUTOMATIC
RETOOTHERS AVAILABLE

Saw Shops Need These
Machines. Write Today!

BURR MFG. COMPANY

8931-F Venice Blvd., Los Angeles 34, Calif.



MACHINISTS — TOOLMAKERS

Gerstner Tool Chests are better in quality,
higher in value. Free Catalog.

GERSTNER TOOL CHESTS
547 Columbia St., Dayton 7, Ohio

PROTECT YOUR HOME

with these **MODERN**
Low Cost **FIRE**
EXTINGUISHERS

A little foresight now may save LIVES and property later! Equip your home, your garage, your boat with **AUTOFYRSTOP**, the *modern* fire extinguisher and alarm that is setting new efficiency records. Write for *free* literature:

AUTOFYRSTOP CO. Dept. PS-47
2035 Washington Av., Philadelphia 46, Pa.



**KILLS
FIRE
BY ITSELF**

**MONEY MAKING
OPPORTUNITY**

We have openings for high grade salesmen in choice territories. Write for Plan.

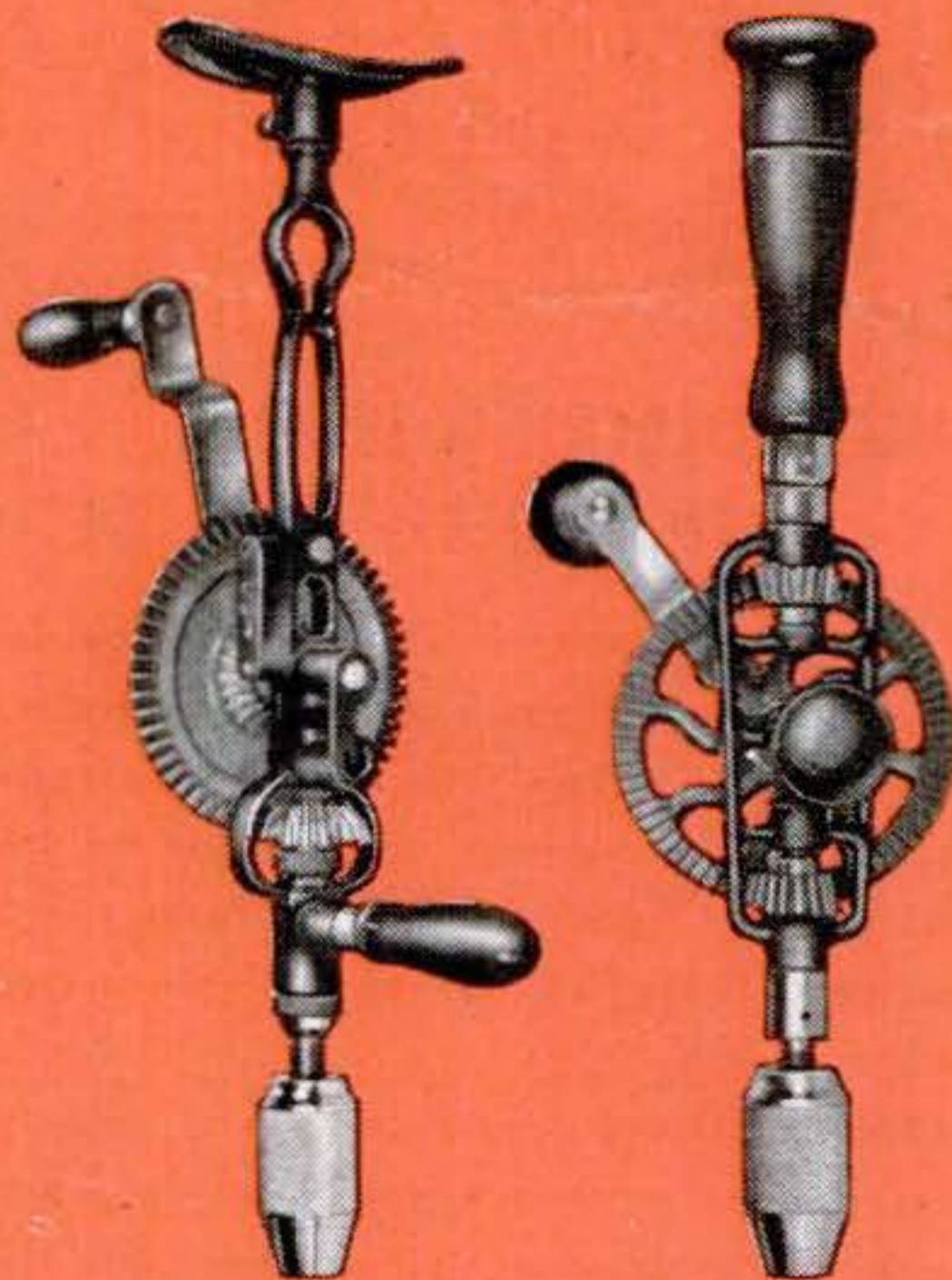

**MILLERS FALLS
TOOLS**

SINCE
1868

**THE MARK
OF QUALITY**

Hand drills, breast drills, any of the wide variety of tools with the Millers Falls trademark have one thing in common — quality. Built to rigid standards of excellence Millers Falls tools, for nearly 80 years, have demonstrated their ability to do their work quickly, easily and economically.

Whether it's a drill, plane, brace, screwdriver, or some other tool, you'll find one that fits your needs in the Millers Falls lines. But be sure to look for the familiar Millers Falls trademark. It's your guarantee of quality and satisfaction in the tools you buy.

**MILLERS FALLS
COMPANY
Greenfield, Mass.**

NEW  **ONLY \$3.95**

HOME SOLDERING IRON WITH PROFESSIONAL DESIGN

Now G.E., makers of industrial soldering irons for over 25 years, offers home craftsmen a moderately priced iron with a professional design. Has same type heater used in industrial models. Quick heating. Built for long service. A brazed tip gives the heat a smooth path to travel.

The G-E Handy iron can do a variety of soldering jobs—from repairing a loose wire to model building. Most dealers now have Handy irons. Ask to see one today. Or write to Dept. 667-2, Apparatus Department, General Electric Company, Schenectady 5, N. Y.

Free: "How to Solder" manual with every iron

GENERAL  ELECTRIC
667-2

Now for EVERY WORK SHOP!
NEW Invention Electroplates by BRUSH



Easy to Plate CHROMIUM GOLD, SILVER, NICKEL, COPPER . . . For Pleasure and Profit!

If you have a workshop—at home or in business—you need this new Warner Electroplater. At the stroke of an electrified brush, you can electroplate models and projects—you can replat worn articles, faucets, tools, fixtures, silverware, etc. with a durable, sparkling coat of metal . . . Gold, Silver, Chromium, Nickel, Copper or Cadmium. Method is easy, simple, quick. Everything furnished—equipment complete, ready for use. *By doing a bit of work for others, your machine can pay for itself within a week.* So make your shop complete by getting a Warner Electroplater right away. Send today for FREE SAMPLE and illustrated literature. **ACT AT ONCE! Mail Coupon.**
WARNER ELECTRIC CO., DEPT. N-4
1512 Jarvis Avenue, Chicago 26, Ill.

FREE Details & Sample!

WARNER ELECTRIC CO., 1512 Jarvis Avenue, Chicago 26, Dept. N-4

Gentlemen: Send Free Sample and Details to:

Name _____

Address _____

City _____

State _____

STRIPE WITH PAINT EASY AS USING A PENCIL

PAINTERS' STRIPING TOOL

NOW you can do your own expert striping on furniture, bikes, model planes, bulletins, autos, toys, signs, linoleum, wall board . . . make plain walls look like tile! It's easy to paint straight, curved, circular, even parallel lines with any color. Handiest paint tool in your workshop! Type "M" Master Painters' Striping Tool complete with tip for 1/16" stripe, \$1.00. Extra tips 1/64", 1/32", 3/64", 1/16", 5/64", 3/32", 1/8"—75c each. Tool with complete set of 7 tips \$5.00. (C.O.D. orders 25c extra.)
WENDELL MFG. CO., 4234—A Lincoln Ave., Chicago 18, Ill.

A TOOL . . . NOT A BRUSH

Dealers Write Today!



\$1.00 POST PAID

YOU Can Get This 2H.P. MOTOR SCOOTER!

AS LOW AS \$29.95

Assemble or build it—it's easy! We can furnish factory built parts. 2 speeds up to 45 MPH! 100 M.P. gal. Easy riding—knee action and low gravity spring frame. Large 12" tires. Streamlined. **SEND ONLY \$1.00** (cash or money order postpaid) (or pay postman \$1.52 C.O.D. in U.S. only) for complete scale isometric picture blueprints (anyone can read them). 8 pages photo details, lists of factory parts prices for both electric and gas models! **FREE** with each order—big 48 page color book giving full details on over 100 other new inventions such as JET ENGINES—MIDGET MOTORCYCLES—ELECTRIC WELDERS—MOTORS—MIDGET CARS—BIKE MOTORS and SIDECARS—MIDGET GARDEN TRACTORS. **SAVE HUNDREDS OF DOLLARS WITH THESE PLANS!** (Foreign orders \$1.50)
MOTOR INDUSTRIES INC. Dept. PS-7 KEARNEY, NEBRASKA



BRASS

For Home Work Shops
Free Cutting Brass Rods
Round, Hex, Sq., 1/2-Oval
Naval Brass Rods
Round and Hexagon
Brass and Copper Tubing
Brass Sheet

Please Send 10c for Catalog 102

MEIER BRASS & COPPER CO. Brass and Copper Tubing
1155 Bellevue, Detroit 7, Mich.

LEARN ELECTROPLATING

Highly Paid, Uncrowded, Interesting Business. Part or Full Time, Common School Education Sufficient. Gold, Silver, Nickel, Chromium, etc. Money Making Secrets, Processes. Send postcard for FREE Electroplating Booklet and proof. **PLATER HYDE, Dept. 5, P. O. Box 176, National City, California.**

ONE-MAN SAWMILL

EASY to TURN TREES INTO MONEY
—BELSAW MODELS in 10 to 24 foot sawing lengths. **MECHANICAL FEED**
—accurate set works and positive dogs.

LESS THAN \$200.00

Use tractor or old auto engine for low cost power. Thousands used for commercial sawing. It pays for itself quickly.

Makes lumber, ties, shingles, crates, lath, studing, siding.



Mr. Nettleton of Calif. reports . . . "Have sawed over 5 million feet of lumber since I got my BELSAW, selling it at \$35.00 per M. B. M."

Send postcard today for FREE booklet, "HOW TO MAKE LUMBER" and Catalog of Woodworking Equipment.

BELSAW MACHINERY CO., 1846ZS Field Building, 315 Westport Road, Kansas City 2, Missouri

BUILD THE NEW LEJAY FAST-FREEZER

8 to 40 CU. FT. CAPACITY

From 5° above to 10° below zero

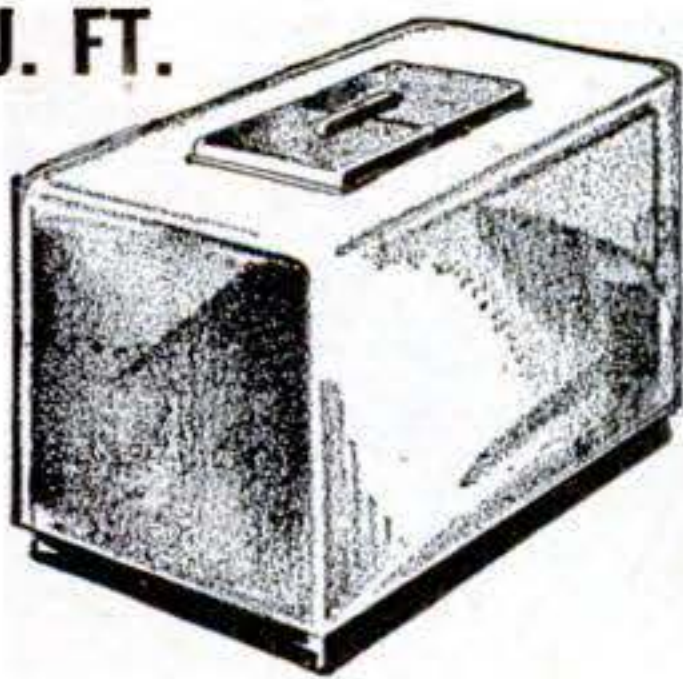

COMPLETE PLANS ONLY

\$1.00

NO KNOWLEDGE OF REFRIGERATION REQUIRED

Every amateur will be proud to make this household necessity. Operates on 32 or 110 volts. Plans are easy to follow and you may have much of the material at hand. No special tools required.

MILK COOLER PLANS, TOO,

are included with the FAST FREEZER plans at no extra cost.

Send \$1.00 bill, check or money order for complete plans and catalog. Canada \$1.10. Satisfaction guaranteed.

LEJAY MFG. CO. 423 LeJay Building Minneapolis 8, Minn.

Why spend years learning by hard experience what you can get from a practical book in a few hours.

Write for list of "How-To-Do-It" books on practical subjects. 1000's of pleased customers all over the world.

ADAMS BROWN COMPANY — BOOKS OF APPLIED SCIENCE
Dept. 277 Chestnut Hill 67, Massachusetts, U. S. A.

ELECTRIC MOTORS

Brand new 1/25 H.P. Standard Make, Electric Motors for Immediate shipment. 5/16 inch shaft, CCW rotation, 4 pole heavy duty. A million uses, polishers, grinders, fans, etc. \$2.00 cash with order—balance \$6.50 C.O.D.

VIC WALTERS, 719 WYANDOTTE ST., KANSAS CITY 6, MO.



GET INTO BUSINESS WITH SMALL CAPITAL working at home or shop. There is big money making **HOLLYWOOD STYLE** cement pottery, birdbaths and garden ornaments without moulds. Also imitation marble, water-paints, chemical staining, etc. 10c brings sample, details and pictures.

HOLLYWOOD CEMENTCRAFT
8527-B Wonderland Ave., Hollywood 46, Calif.

A 10-Ton Press at Low Cost

Pressing, separating, bending, and straightening jobs in your shop are easy with this press. Ten-ton capacity provides ample pressure. Adjustable table takes work up to 18 inches wide and 11½ inches high. Send for free bulletin showing press and wide variety of accessories.

UT-10A Press f.o.b. factory \$28.25

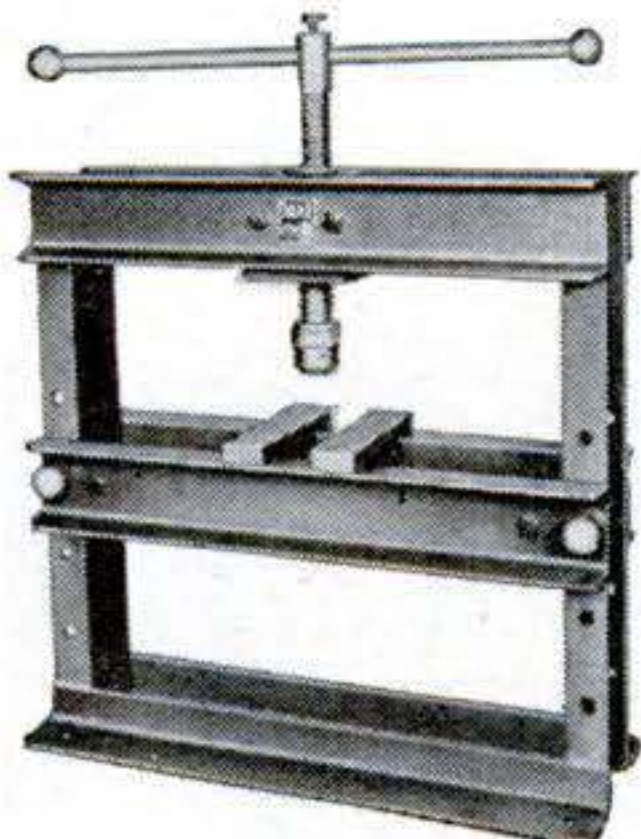

DAKE ENGINE COMPANY

622 Seventh Street, Grand Haven, Michigan

Pals...

your good right hand and that good Stanley Hammer



NO. 51½
16 OZ.

STANLEY

Trade Mark

THE TOOL BOX OF THE WORLD

You'll want these two books

The first book is free . . . "The Joy of Accomplishment", a brief introduction to tools and their uses. The second is the famous textbook, "How to Work with Tools and Wood", recently revised, fully illustrated. The cost is just \$1.

Stanley Tools, 277 Elm St., New Britain, Conn.

Please send by return mail

- FREE booklet: "The Joy of Accomplishment."
- 188-page book: "How to Work with Tools and Wood." \$1.00 enclosed.

(In Canada: Send order to Stanley Tool Co. of Canada, Ltd., Roxton Pond, Quebec.)

Name.....

Address.....

City.....State.....

USE AC's FOR
**UTMOST
RELIABILITY**

Factory-recommended AC's, of correct Heat Range for today's fuels and driving speeds, help millions to be punctual. Have your plugs checked to be sure that you have the right plugs for today's driving and fuels.



Look for this sign



Spark Plugs cleaned and adjusted "By the AC Method" may save as much gas as 1 gallon in 10

AC
SPARK PLUGS

AC SPARK PLUG DIVISION • GENERAL MOTORS CORPORATION

232 POPULAR SCIENCE

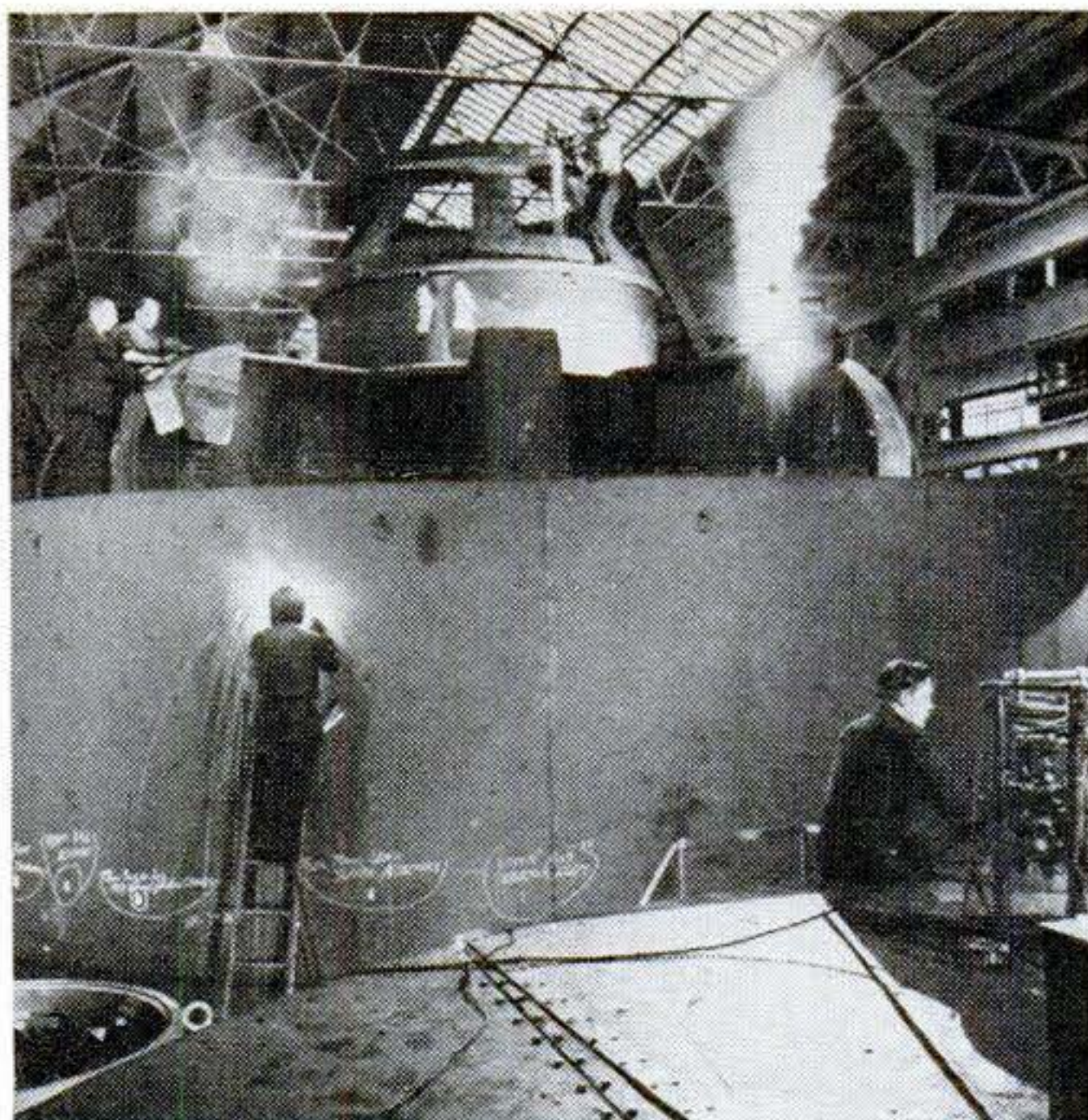

Last Generator for Shasta

THE last of five 75,000-kilowatt generators for the Shasta Dam hydroelectric plant in the Sacramento River Valley is shown under construction at the General Electric works at Schenectady, N. Y. When installed, the five generators will produce enough electricity to light more than 10,000,000 household lamps.

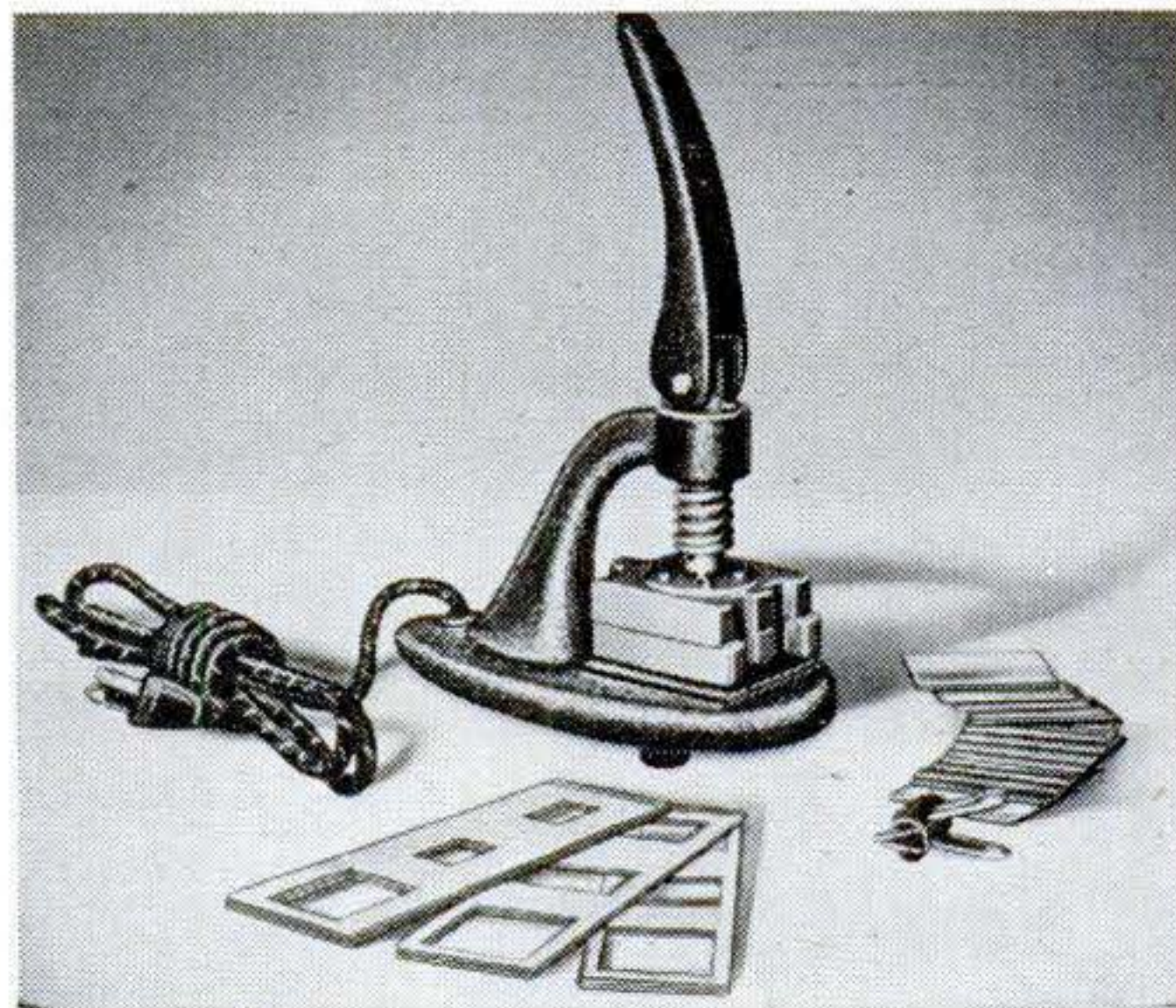

Seals Slides in Six Seconds

DESIGNED to seal 35-mm. double- or single-frame transparencies in only six seconds, the Thermo-Sealer, a product of the Albert Specialty Co., of Chicago, protects the slides with hermetically sealed covers of glass and plastic. Operating on electricity, it automatically aligns the glass plates and maintains correct pressure and heat.

**INDUSTRIAL PRECISION
for YOUR HOME SHOP**

**Atlas
DRILL
PRESS**



**HELPS YOU HANDLE MORE PROJECTS
with "PROFESSIONAL" Workmanship**

An Atlas drill press and accessories is a real time saver. Handles precision drilling and tapping in metals—gives you "professional" results on mortise and tenon joints for tables, chairs, doors, cabinets, storm windows, and screens. Send for free catalog.



ATLAS PRESS CO.

755 N. PITCHER ST., KALAMAZOO 13D, MICH.

LATHES • DRILL PRESSES • SHAPERS • MILLING MACHINES

**BUILD YOUR OWN RADIO
With These Wonderful Meissner Kits**

5 TUBE AC-DC SUPERHET KIT
Complete—No Extras to Buy

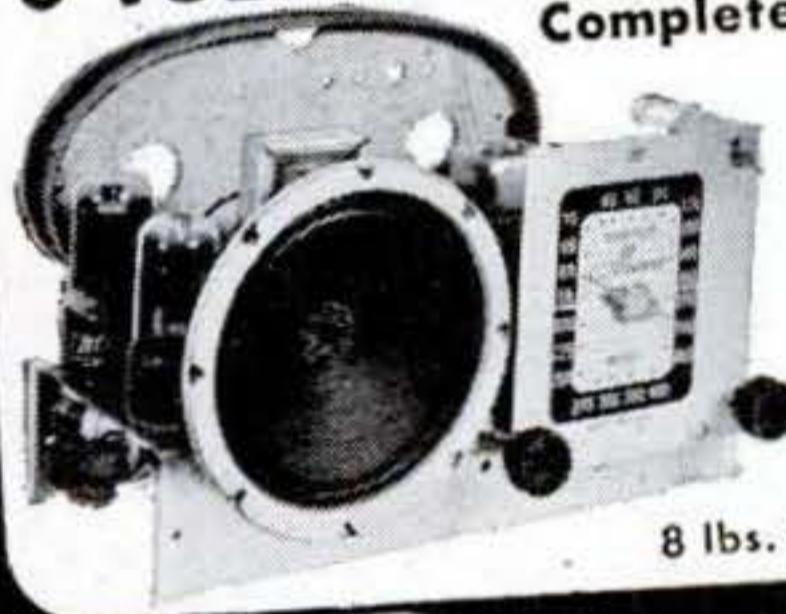

Made by leading Mfr. Have fun building it. Fine performance on full broadcast band. Quality parts. Improved circuit. Loop Antenna. 5" PM speaker, 5 new type tubes, simple instructions. 110 volts AC or DC. Wgt. **\$18⁷⁵**
8 lbs. Including Tubes.

6 Tube, 2 Band SUPERHET
Gets Full Broadcast and Short Wave Bands

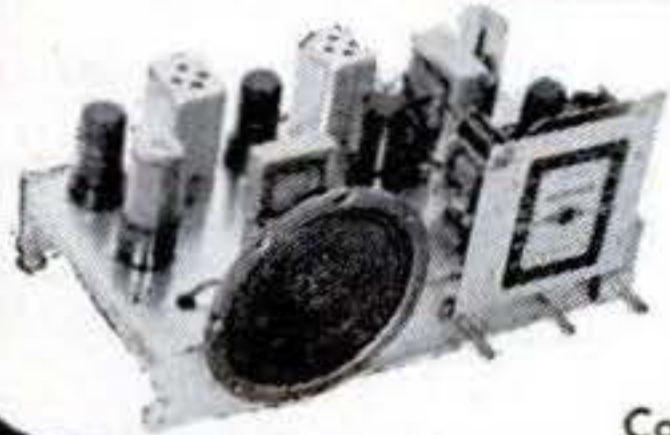

Meissner's Best! Full sized 3 controls, finest parts, new circuit. Gets Foreign and American Stations. A Deluxe set! 6 new type tubes, 5" PM speaker, simple instructions. 110 volts AC or DC. Wgt. 8 lbs. **\$24⁷⁰**
Complete with Tubes.

Send for Regular Bargain Bulletins
INCLUDE POSTAGE—20% Deposit Required with Mail Orders

NEW YORK
Offices & Warehouse
242 W. 55th St., N.Y. 19

NEWARK
ELECTRIC COMPANY, INC.

CHICAGO
323 W. Madison St
Chicago 6, Ill

New York City Stores: 115-17 W. 45th St. & 212 Fulton St

**FOR THE FINEST
VACATION EVER**

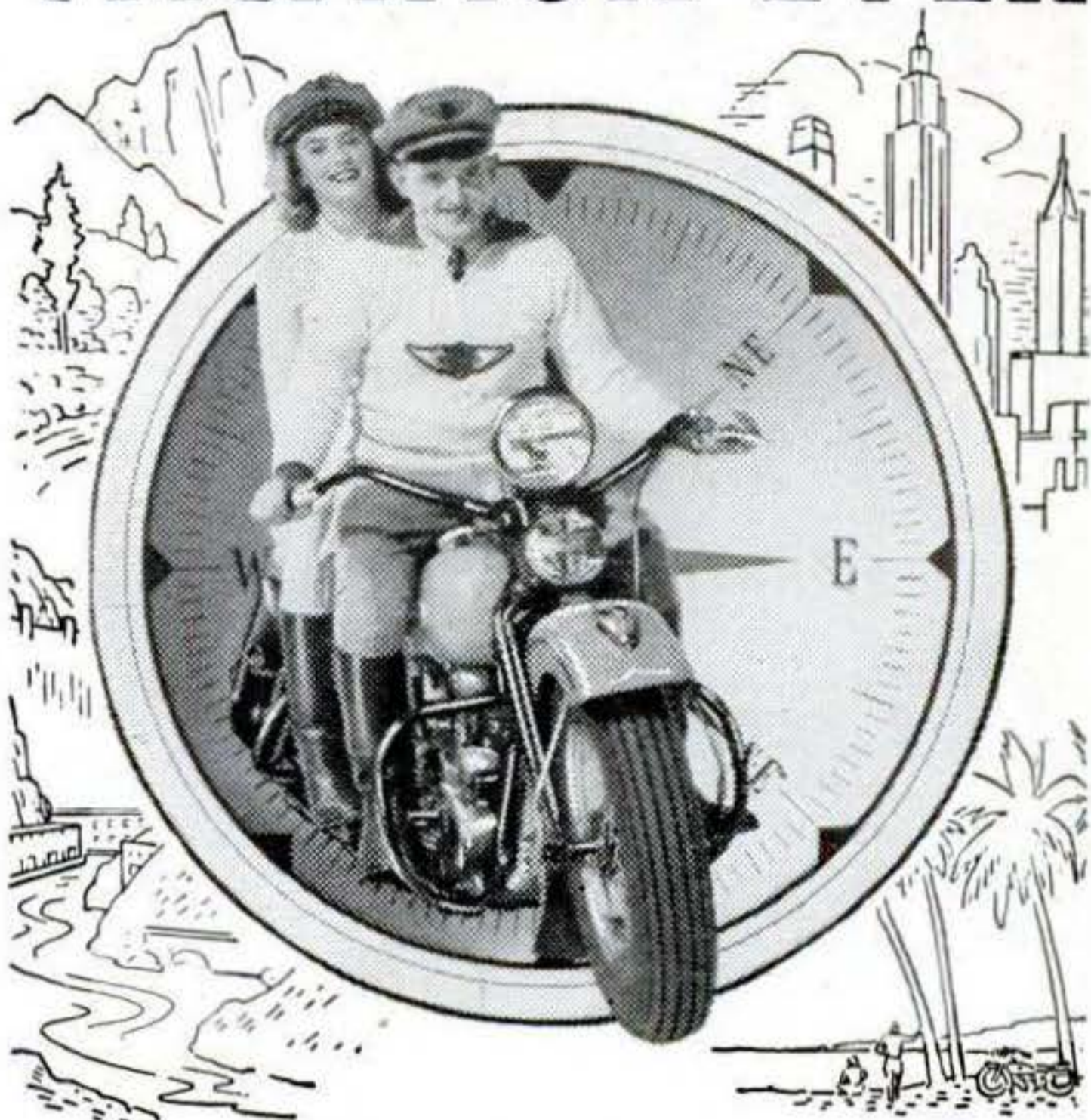

**Go "Exploring" on a
HARLEY-DAVIDSON**

For fun and thrills, there's nothing to equal a vacation tour the Harley-Davidson way! Just pick the historic places and natural beauty spots you want to see most — and your dependable Harley-Davidson will take you there *fast and economically*. Go where and when you please — stop over any time — no set timetables to follow. You can do more and see more — even visit out-of-the-way places not reached by other methods. And all season long your Harley-Davidson turns evenings, holidays, and week ends into *extra pleasure time* — as you join other riders on trips and gypsy tours, or take in race meets, hillclimbs, and other thrilling motorcycle events. See your Harley-Davidson dealer NOW — and mail coupon today!



**HARLEY-
DAVIDSON**
Motorcycles

Harley-Davidson Motor Co., Dept. PS, Milwaukee 1, Wis.

Please send at once free copy of 24-page
"ENTHUSIAST" Magazine, filled with thrill-
ing motorcycle action pictures and stories.

Name.....

Address.....

City..... State.....

A TOOLSHOP IN YOUR HAND!

- GRIND • DRILL • ROUT
- POLISH • ENGRAVE
- CUT • SAND • SAW • etc.

MAKE THINGS FROM WOOD
PLASTICS—METALS—GLASS
LINOLEUM—LEATHER
ALLOYS—HORN—STONE
BONE, etc.



HANDEE TOOL OF 1001 USES

Smooth, steady power at your fingertips! Perform precision operations not possible with any other portable tool! With a Handee you can turn out professional looking projects for pleasure or profit—ship, plane and train models, costume jewelry, wood carvings, puppets, initialed tumblers, etc. AC or DC. 25,000 r.p.m. Wt. 12 oz.

USE THE RIGHT ACCESSORIES! Choose them from the most complete line . . . more than 500 made right in the Handee plant.



A GOOD START—THE HANDEE KIT

HANDEE Tool and 40 most popular accessories packed in compact steel carrying case. You'll be amazed at what you can accomplish! Complete, postpaid.

\$27.50

Handee only, with 7 accessories, \$20.50

FOR YOURSELF OR A FRIEND... THE GIFT OF A LIFETIME!

NEW PRECISION ATTACHMENTS
Fit Handee only, enable novice or craftsman to do perfect work. Magically, easily, your offhand carving, routing, shaping will be exact as to depth of cut, accuracy of line. Set of 6 attachments with instructions, postpaid

\$7.95



ORDER NOW! SATISFACTION GUARANTEED!

FREE! NEW 52-PAGE MANUAL

CHICAGO WHEEL & MFG. CO.
1101 W. Monroe St. Dept. PO. Chicago 7, Ill.

Send Handee Kit Handee Tool Precision Attachments C.O.D. Remittance enclosed Send Manual

Name.....

Address.....

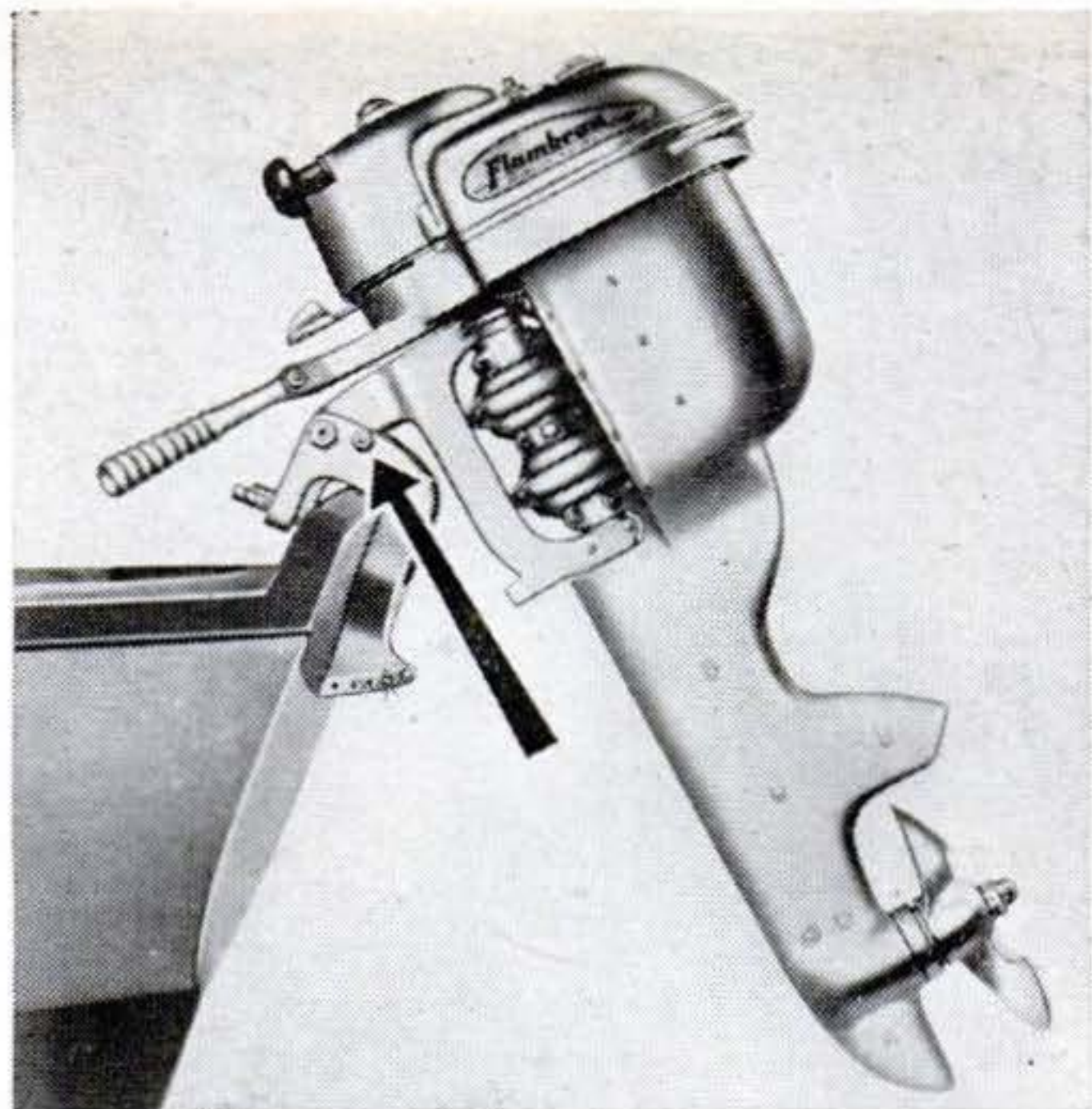

Outboard Spares Its Propeller

AN OUTBOARD motor equipped with a device that automatically disengages the propeller when an obstruction is encountered is produced by the Metal Products Corp., of Milwaukee. Smaller and lighter than prewar models of similar horsepower, it also features fingertip controls, dual carburetion, and (arrow) a tilt-up securing lock.

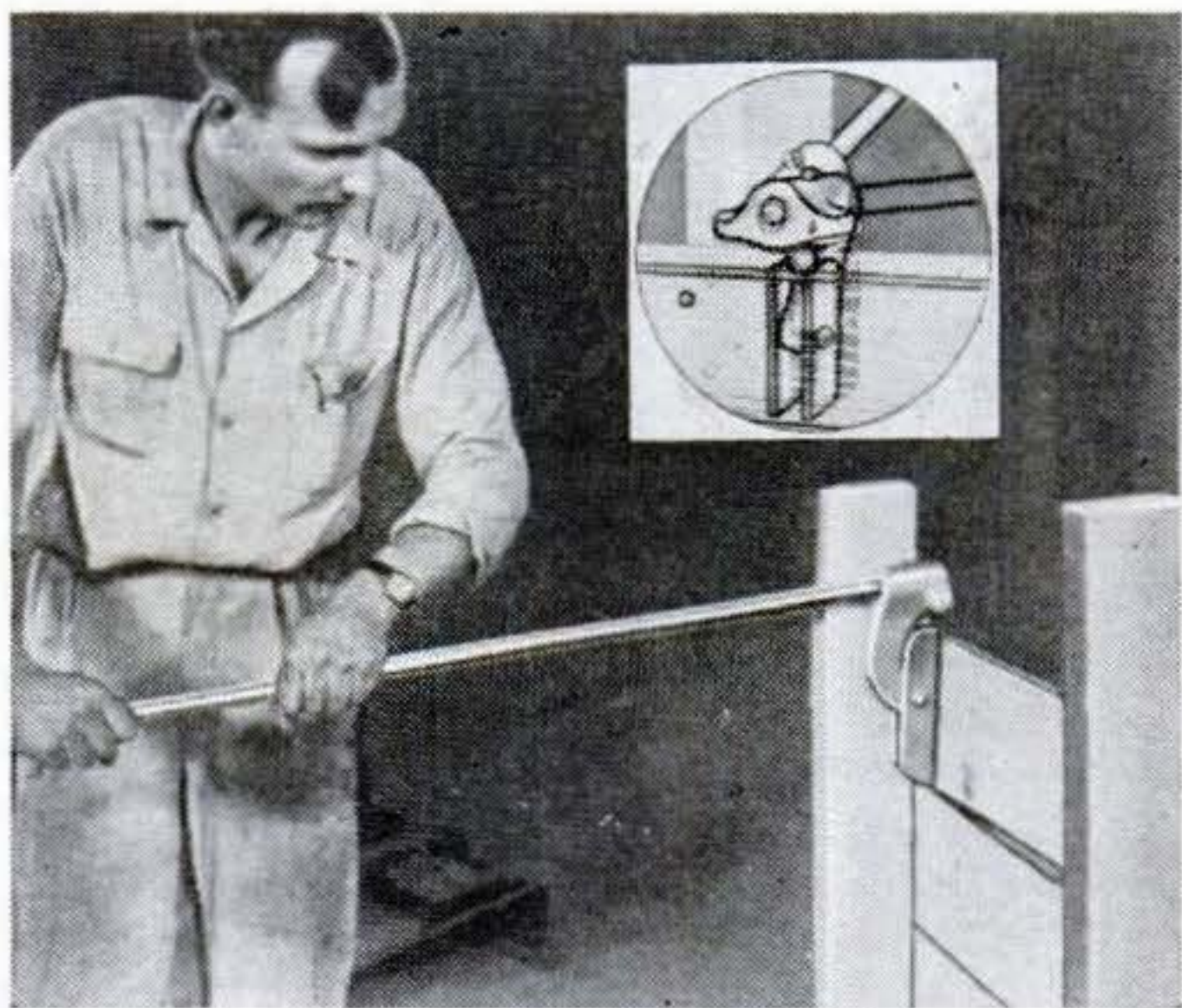

Lever Tool Salvages Lumber

THE Bord-Pri, a new tool for the reclamation of old lumber in razing jobs, is designed to facilitate the removal of sheathing, siding, flooring and other woodwork. Manufactured by the Maco Corp., of Huntington, Ind., the tool exerts an equal distribution of pressure against the entire end of the board to be removed, thereby minimizing splits and cracks.

AMAZING POST-WAR DISCOVERY!

PLASTICROME

CLEANS AND PROTECTS METAL



A PLASTIC PRODUCT THAT DISSOLVES RUST! RESTORES CHROME! PREVENTS CORROSION AND DISCOLORATION!

No. 1—Makes Metal Shine!

No. 2—Keeps It Looking Fine!

2-WAY PROTECTION KIT

98¢

The modern miracle worker no home... no car should be without! Two liquids... one dissolves rust, grime, dirt and grease in a flash! The other is a plastic finish which protects against dirt, salt, corrosion and rust!

PLASTICROME LABORATORIES
7012 Euclid Ave., Cleveland 3, Ohio
Please send me Plasticrome 2-Way Protection Kit, Postpaid
Remittance of \$1 is enclosed Money back Guarantee!

Name _____
Address _____ State _____
City _____

DISTRIBUTORSHIPS AVAILABLE

MAIL THIS COUPON!



PLASTICROME
for chrome bumpers, grilles, bicycles!



PLASTICROME
for refrigerators, bathroom fixtures!



PLASTICROME
for appliances, golf clubs, fishing rods!



Extra! JUST OUT Extra!
INSTANT NICKEL
NO CURRENT OR BATTERIES USED

U. S. PAT. PEND.
NO. 702581

COMPLETE KIT
\$2.50 POST PAID
COVERS 15 FT.
AGENTS WANTED

Iron, Steel, Aluminum, Brass, Bronze, Copper and practically all Industrial Metals can now be HEAVILY nickel-plated WITHOUT equipment, vessels, electricity or previous copper plating, a blessing to Hobbyists, Doctors, Hospitals, Restaurants, Bar and Beauty shop owners. Recommended for Auto, Bicycle and Machinery parts and accessories, Musical Instruments, Electrical appliances, Coffee Urns, and practically anything made of metal.

IN THIS MARVELOUS NEW PROCESS the principles of the battery and electroplating have been harnessed in the INSTANT NICKEL formula, so when it is applied with a wet applicator on a clean metallic object, a permanent nickelplate instantly appears! Thickness of plating is regulated by number of applications.

JUMBO SHOP SIZE (nickelplates 75 ft.) only \$8.75 postpaid. Sample offer \$2.50 postpaid. Nothing else to buy, free particulars. Send check or money order today! C.O.D.'s few Cts. extra for Postage.

INSTANT PLATING PRODS., 3439 Michigan Ave., Chicago 16, Ill.

Ball-Bearing SPEED WHEELS



Dealers Wanted

FREE BLUEPRINTS WITH ALL WHEEL ORDERS

JIM BROWN TOY COMPANY
1093 Home Ave. Akron 10, Ohio

Juvenile wheels, solid tire

7" wheels.....60c
6" wheels.....50c
4" wheels.....30c

Semi-pneumatic tired wheels

12 x 1.75".....\$3.25
10 x 1.75".....\$2.75
8 x 2".....\$2.00

Industrial wheels, for heavy loads

10 x 2.75".....\$6.75
8 x 1".....\$4.90
6 x 2".....\$2.80

No. 3 Hawaiian Wiggler

gets bass in lily pads

\$1.10



Many excellent catches are being made with the No. 3 in stumps, weeds and lily pads where big bass often hide. Write for free catalog.

FRED ARBOGAST & CO., 1707 North St., Akron 3, Ohio



#402

BECAUSE I DO SO MANY JOBS BETTER

There's no other pair of pliers in the world like the Parallel-Action BERNARD. And here's why they're so handy for you.

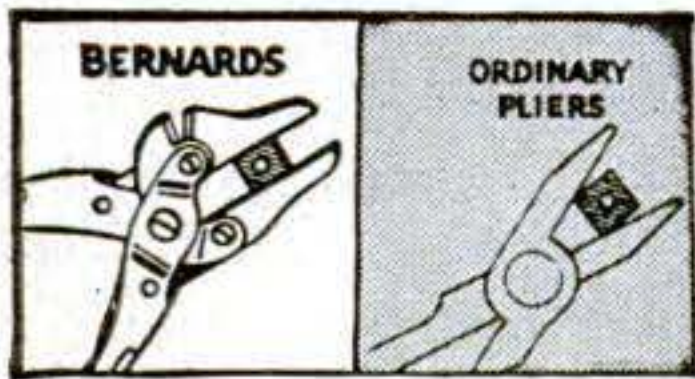

BERNARDS
Jaws close parallel—like a vise. Fit snug and flat. Won't slip or mar the nut.

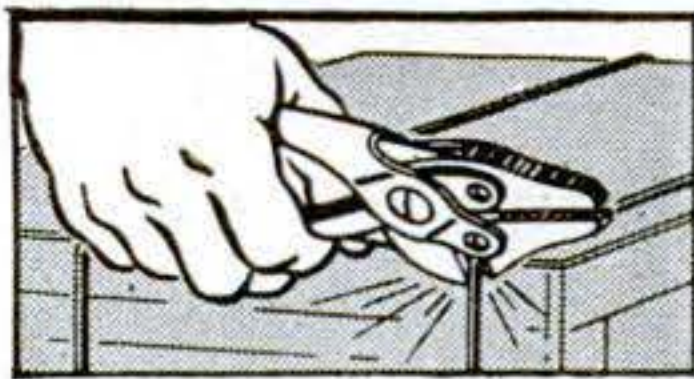

ORDINARY PLIERS
Powerful cutters on the outside of the head, easy and convenient to use. They'll cut an 8-penny nail!

Hundreds of thousands of BERNARD's went to war in Yank machine gun kits, but, once again, they're available to you at your local hardware store.

Look for the name "BERNARD" BERNARD Parallel-Action PLIERS are one item in a line of fine hand tools—hedge clippers, pruners, paper and leather punches, etc.—known for quality for 75 years. Free catalog on request.

QUALITY TOOLS SINCE 1870



BERNARD
TRADE MARK REGISTERED

WM. SCHOLLHORN CO.
7007 Chapel Street, New Haven 9, Conn.

236 POPULAR SCIENCE



SAFE AS A HAND SAW JUST GUIDE IT!

More like magic than any tool you ever saw. Imagine an electric scroll saw only slightly heavier than a hand coping saw . . . a tool that takes no effort to run, no pressure to feed. Works at any angle—on big assembly jobs or on the tiniest piece you can hold in your fingers. Runs 7200 strokes a minute . . . so fast the blade seems to stand still. Sturdily built . . . only two moving parts . . . never needs oiling. Easily cuts intricate designs—so smooth it eliminates sanding. A thrill awaits you when you get a Moto-Saw in your hand. Thousands of satisfied users.

Only \$5.85 Postpaid

No limit to length of stock it will cut. Saws to center of 19" widths

It's fast . . . cuts on an average of 1 ft. per minute up to 3/4" medium hard wood. Operates on 110-120 V. 50 or 60 cycle alternating current. If your dealer does not yet have Moto-Saw, send \$5.85 . . . we'll pay postage. Or send \$1, pay postman balance plus postage. MONEY BACK if not delighted after 5 days trial.

U. S. Patent 2233862
Other Patents Pending
DREMEL MFG. CO.
Dept. S127-G
Racine, Wisconsin

Made to U. S. Army Specifications!

15-JEWEL ELGIN \$18.95



Sturdy 15-Jewel ELGIN men's wrist watches. Waterproofed. Sweep second hand. Stainless Steel case. Unbreakable crystal. QUALITY! American made. Fully reconditioned with ONE YEAR GUARANTEE! Made for the U. S. Army Air Corps. They HAD to be good. SEND NO MONEY. Simply pay postman \$18.95 plus 10% tax and postage on delivery. Cash orders sent postpaid. Limited supply. UNITED PRODUCTS CO., 7941 S. Halsted St., Dept. WES-120, Chicago 20, Ill.

MAKE YOUR OWN DISC SANDER

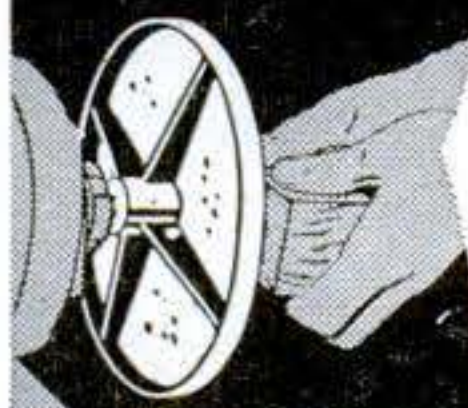

Mount this 8" cast aluminum sanding disc on any 1/2", 5/8" or 3/4" spindle. Sturdy ribbed design. Order direct—\$2.00 postpaid. Threaded bore 25¢ extra. Abrasive paper discs, 8"—1 doz. asst. grits \$1.25.

1757 Clinton Street
EMRICK INC. KALAMAZOO, MICH.

WRITE FOR FREE TOOL LIST.

Everything in Radio!

Make Radolek your buying headquarters for Radio-Electronic repair and replacement needs. Large stocks assure finest, most complete selections of all available items at lowest prices. Your orders receive special attention for fastest delivery. Send today for FREE Radolek Buying Guide.

RADOLEK CO., Dept. A-127, 601 W. Randolph St., Chicago 6, Ill.

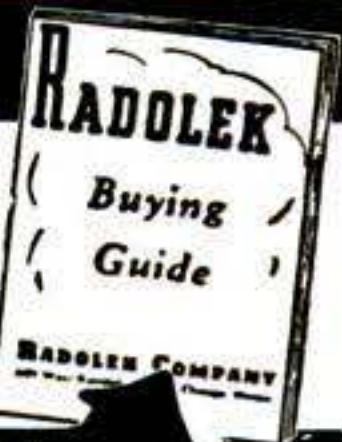

FREE RADIO BUYING GUIDE

WATCHES WANTED

BROKEN OR USABLE

All kinds. Highest Prices paid for jewelry, rings, spectacles, gold teeth, diamonds, Sterling Silver, etc. Cash mailed promptly. Write for free shipping container.

LOWE'S, Dept. PS, Holland Bldg.,

St. Louis 1, Missouri



CORROSION and FRICTION

Use Fiendoil on tools, electrical appliances, household devices. It actively Lubricates-Cleans-Prevents Rust

3-oz. Spout Can
40c

FIENDOIL

"The Enemy of Corrosion and Friction"

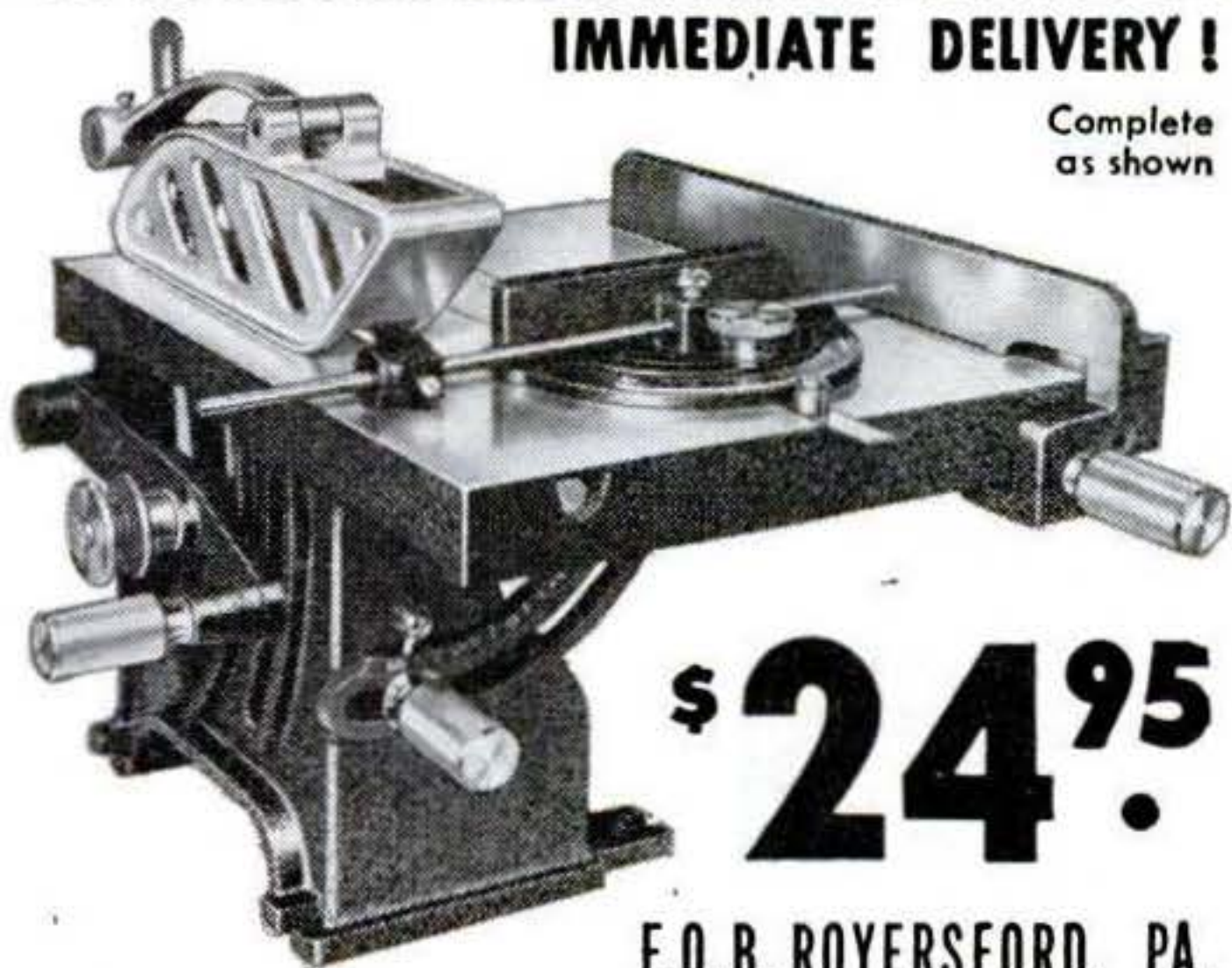

IMMEDIATE DELIVERY!

Complete
as shown

\$24⁹⁵

F.O.B. ROYERSFORD, PA.

QUALITY 8" BENCH SAW
CUTS THROUGH 2⁵/₁₆"

UNCONDITIONALLY GUARANTEED ONE YEAR
(Write for Free Booklet and Guarantee Bond)

Comes complete with Floating motor mount—miter gauge with adjustable stop—aluminum guard—soft aluminum insert—spring steel splitter—heavy gray iron fence—(no motor—no blade). Table 12" x 14". Tilts to 45°—Oilite bearings. Shipping Wt. 50 lbs.

AMERICAN MACHINE & TOOL CO. Inc.
DEPT. 200 ROYERSFORD, PA.

Arc Welded Design "Know-How"
Only \$3.50 each Each volume contains over
3 different volumes 100 welding designs. Write
\$10.00 postpaid Hobart Bros. Co. Box P-561, Troy, O.

INDEPENDENCE DAY FOR MOTORISTS
With a Hull Streamline Automobile Compass, that Fourth of July trip will be safer, happier, free from lost directions and speeding to make up time. Twelve years of leading acceptance. At your dealer's. Write us for circular. Price \$3.95.
HULL MFG. CO., P.O. Box 246-E6, Warren, Ohio

L* M CARBIDE SCRIBER
NON-MAGNETIC
Tungsten Carbide — carefully ground on diamond laps, brazed into stainless steel 6" handle for marking steel and other metals — for etching, marking, cutting glass. In plastic case with pocket clip.
PRICK PUNCH
Tungsten carbide tip, silver brazed into 3¹/₂" heat treated steel body.
with Carbide Tip... \$1.50
Price Post Paid

LUCAS-MILHAUPT ENGINEERING CO.
5051 SOUTH LAKE DRIVE • CUDAHY, WISCONSIN

NOW TRY
Dustless
SWEEPING



Reduce Germ Laden Dust
Eliminate Sweeping Compound

Dustless brushes used with Arbitrin sweeping fluid eliminate up to 97% of germ laden dust and reduce sweeping costs 20%. Arbitrin fluid, poured into a metal reservoir in the brush back, filters through the tufts and keeps dust down as you sweep. Dustless brushes are used in thousands of schools, factories, offices, stores, and institutions. There is a Dustless brush to fit your needs. Write for sizes, styles and prices today.

Milwaukee Dustless Brush Co.
530 N. 22nd St., Milwaukee 3, Wis.
Please send complete facts about Dustless Brushes.

Name _____
Street Address _____
City, State _____

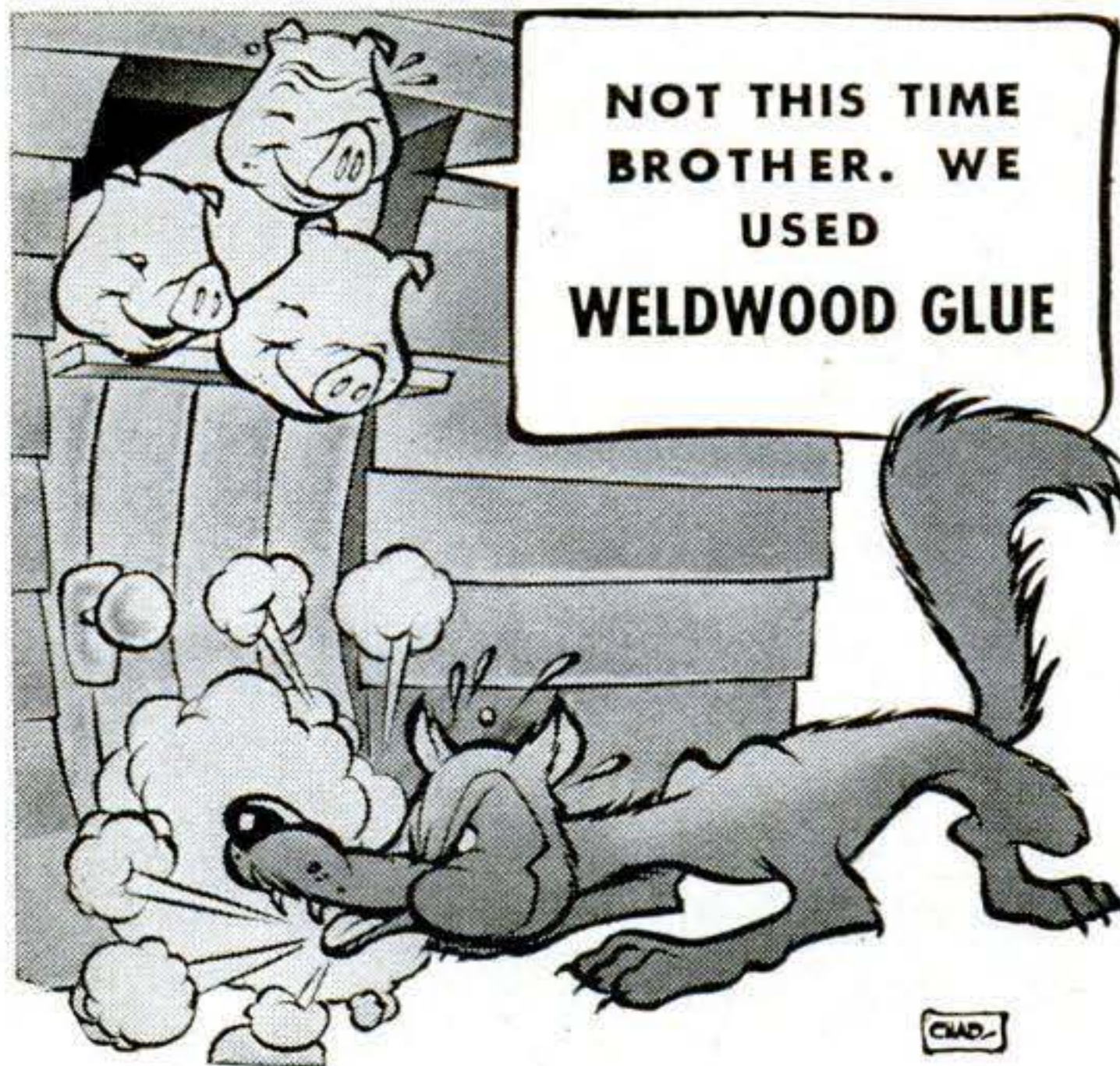

When you want to fix things fast... remember Weldwood Glue. It's quick to mix... easy to use... tremendously strong... stain-free... rot-proof... and permanent. At hardware stores, lumber yards, chain stores.



WELDWOOD PLASTIC RESIN WATERPROOF GLUE

United States Plywood Corporation, New York 18, N. Y.

MASTER DRAFTING MACHINE

Mounted on
20" x 24"
Masonite

for Beginners • for Professionals

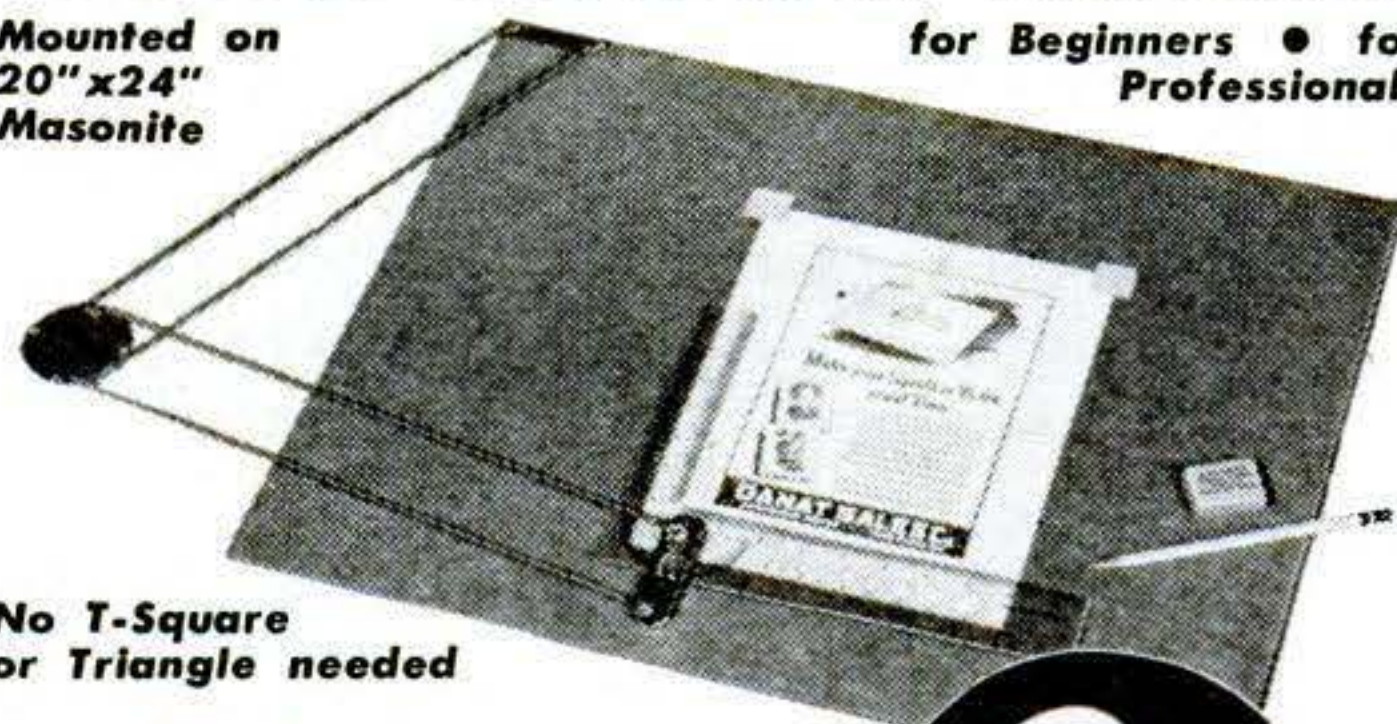

No T-Square
or Triangle needed

Make
FASTER-BETTER
Drawings - Layouts!

\$2.95

Tear off
and Mail
this Handy
Order
Form

Yes!—the Master Drawing Machine not only is an advanced aid for Faster and Better mechanical drawing—it is a Time Saver. Professional users praise its dual-purpose features which eliminate countless unnecessary movements. Advertising men have found the Master Drawing Machine to be a short cut to quicker results and better work. This mechanical drawing board adds speed to valuable time. The unique, fixed mechanical guide operates with finger-tip ease. Its swivel action allows diagonal paneling at any angle.

DANAT COMPANY, Dept. PS-7 624 S. Michigan Ave., Chicago 5, Ill.

Please ship
Quantity.....Master Drafting Machine @ \$2.95 ea. \$.....
Name.....
Address.....
City..... State.....

Send check or Money Order

Danat Company, 624 S. Michigan Ave., Chicago 5, Ill.

SAVE MONEY

build your own

SMITH COMPRESSOR

Now, use the world-famous Smith Air Compressor to operate rock drills, paving breakers, spray guns, sandblasting, etc., at low cost! Just order the Smith Compressor Head and Accessories with complete instructions for assembling. All you need is a Ford Motor and shop facilities. Capacity 60 cu. ft.—ample power for most compressor jobs. Pressure up to 100 lbs. per square inch. Head equipped with high speed compressor valves; automatic unloading and idling.

WRITE **GORDON SMITH & CO., Inc.**
TODAY! 405 College Street Bowling Green, Ky.

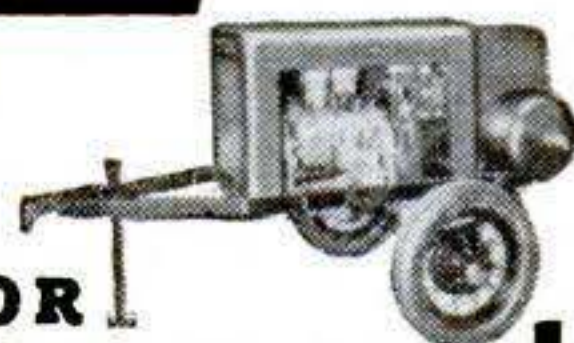

MACHINE SHOP EQUIPMENT



Just off the press!—Every man who owns a workshop should have a copy of our new, up-to-the-minute, 200 page catalog of Machine Shop Equipment—the latest tools made by the biggest manufacturers in the U. S. Replete with illustrations, descriptions, prices. Prompt delivery on most tools listed in this book. Available at cost of printing—50c a copy—get yours today! Price of Catalog Refunded on First Order over \$5.00. Send Check or Money Order to

CENTER TOOL CO., 153 Centre St., Dept. D, N. Y. C. 13



MASTER CHAMPION

LAWN MOWER SHARPENER
Also Mfg., Saw Sharpening
& Key Machines

FRANK'S MFG. CO.

Dept. PS-7, 3312 Tweedy Bl.
SOUTHGATE, CALIF., U.S.A.

GIANT

Astronomical Telescope

100 diameters magnification. (10,000 area magnification) 3 inch diameter steel main tube 50 inches long. Brass focusing tube. Tripod 6 feet high. Equatorial mounting. Ready to set up and use. Full power and clear vision guaranteed. Price \$12.50. 25% deposit on C.O.D. orders. DEPT. BT, SUFFOLK SCIENCE SERVICE, MANORVILLE, N. Y.

FREE!
FAMOUS
BLUE BOOK
CATALOG

GAME SUPPLIES

Club Furniture - Counter Games - Punchboards - Magic Cards Readers, Read the backs - Inks - Daubs - Poker Chips - Tops Flats - Layouts - Game Boxes.



K. C. CARD CO., 838 South Wabash Ave., Chicago 5, Ill.

★ PRICE REDUCTIONS ★ EXPANDED STOCKS ★

Aluminum flats to 4", squares, rounds, hexagons, angles, tubing. Drill rod in rounds, squares, flats and octagons. Plastic in sheets, rods and tubing, clear and color. Also Decorative Panels. Many other items. Listing (A47) on above 5c. Catalog 1046-D and Listing A47 which lists tools, supplies, equipment, etc. 15c. METPLAS SUPPLY COMPANY, 1420 South 16th, Maywood, Illinois.

WOODWORKERS... Get this

CONSTANTINE MASTER MANUAL
Get the Most Fun From Your Hobby
Indispensable to woodworkers. Newest, biggest edition, more pages, more color, helpful how-to-do-it articles, pre-war and new items, more bargains. Send 25c today and we will include **FREE! FULL YRS. SUBSCRIPTION** to Chips and Chats, published bi-monthly. Keeps you up-to-date on everything in woodworking, offers big money-saving bargains. Send now.

ALBERT CONSTANTINE & SON, Inc.
793-G 135th Street, New York 54, N. Y.



NEW MIDGET ELECTRIC ARC WELDER

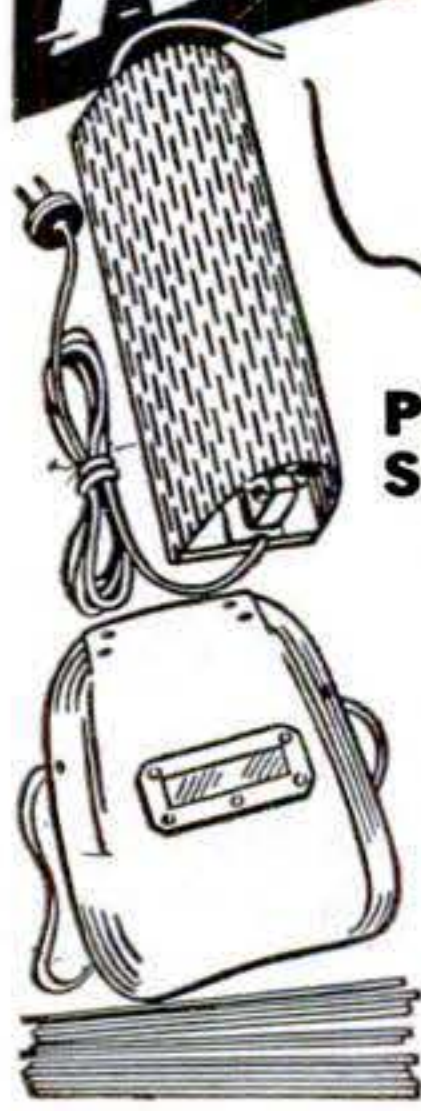

FULLY GUARANTEED

RETAILS ONLY
\$3.95

Plugs into Light Socket AC or DC

It's new! It's handy! It's efficient! Use the Midget Electric Arc Welder for hundreds of light-metal jobs. Does comparable welding work with a 1/16 inch welding rod on thin metal as that of larger and higher priced welders. Operates on 15 ampere fuse, 110 volt 60 cycle A.C. or D.C. current, by use of our special standard-coated 1/16-inch welding rods. Generous supply of rods supplied with machine. Recommended for all light welding like automobile fenders, etc. Take the Midget Arc anywhere to the job. Sturdily built and fully guaranteed. Comes complete—ready to use. Nothing else to buy. No previous welding experience needed to strike an arc. In a short time, anyone mechanically inclined can learn to weld with this machine.

You'll find hundreds of money-saving, time-saving uses for the Midget Arc around your home, garage, or workshop. Also in garages, factories, repair shops, tin shops, mechanics, farmers, inventors, etc. Order a Midget Electric Arc Welder now! SEND NO MONEY. We'll rush one to you, complete with rods and helmet (equipped with APPROVED welding glass). Pay postman only \$3.95 plus postage charges. If not satisfied, return Midget Arc in 5 days from receipt and we'll refund your money immediately. RUSH YOUR ORDER NOW.

MIDGET ARC WELDER CO., Strader Ave., Dept. A-205, Cincinnati 26, Ohio

BUILDING CONSTRUCTION

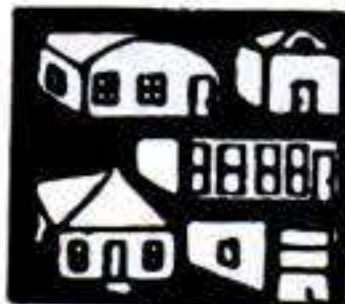

with composition cement and cheap wood builds 3 room house low as \$250. farm buildings low as \$50. Homemade forms make blocks, panels and tiles in color, and wallboard of sawdust and other compositions. Wall-high blocks, insulated, with finished sides. Stream-lined roof and walls. Cement gutters, troweled roofs and floors. Ten formulas. Cabins, stores and sectional. 100 money and labor saving ideas. Mixer and saw easily made from an old auto. Make doors and windows. Guaranteed, book, 100 illustrations. \$1.00.

SHEET STEEL COTTAGES. The coming thing. Box wall and roof panels. Cheap, movable, insulated, no plastering, fire-proof. Instructions, 50c.

SIDEWALK MANUFACTURING BUSINESS. Make like cement block. Easy to lay. Make own forms. Illustrated instructions, 50c.

FURNITURE OF COMPOSITION. Cement, sawdust, asbestos, etc., 50c. 60 selected ways to earn up to \$20.00 a day. 25c.

SHOP MACHINES FROM OLD AUTO PARTS: Band, jig, hack, and circular saws, electric drills, sanding wheels, forge, tools, electric weed cutters, tractors, hoist, wood splitter, grinders and many other things from old auto parts and 1/4 HP, used motors. Illustrated, 50c.

HOME MFG. ENTERPRISE. 50 selected home shop projects, illus., 50c. Special: All seven booklets described above, \$2.00 postpaid.

HOME INDUSTRIES, 1318 So. 30th Ave., Dept. PS., Omaha 5, Nebr.

LAW

STUDY AT HOME for PERSONAL SUCCESS and LARGER EARNINGS. 38 years expert instruction—over 108,000 students enrolled. LL.B. Degree awarded. All texts furnished. Easy payments. Send for FREE BOOK—"Law and Executive Guidance"

AMERICAN EXTENSION SCHOOL OF LAW
Dept. 79-S, 646 N. Michigan Ave., Chicago 11, Ill.



Two New SCHULT Models to Suit Your Purse and Purpose

One modest investment in a Schult offers you complete accommodations for years of comfortable living, plus mobility. You get every real facility of a furnished home, at a mere fraction of the cost. Two popular sizes:

LUXURY LINER
Famous 26-foot model with three separate rooms. Comfort and privacy for four adults. "Accent on Living."

COMMODORE
A 21-foot luxury travel coach that sleeps four and is amazingly spacious and has most "big coach" features.



LIVING ROOM of Luxury Liner. Both models have separate bedrooms and completely equipped kitchens.

WRITE FOR CATALOG



SCHULT CORP., Dept. 3107, ELKHART, IND.

In Canada: John Inglis Co., Ltd., Toronto

SCHULT BUILT TO LAST Trailer Coaches

THEY CAN'T SHAKE LOOSE FROM A

FLATFISH!

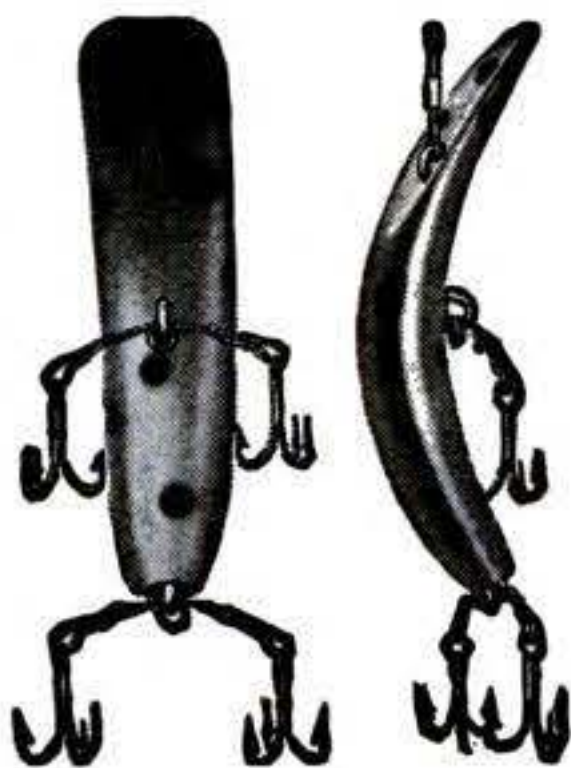

Once the Flatfish gets its hooks into a fish, the fish is as good as in your creel. This is because Flatfish hooks are not the conventional kind of hooks. They're smaller and sharper. They penetrate more easily and more quickly. Then, too, the Flatfish has a hooking arrangement that hooks the easy striker. With the hooks offset from the body of the lure, the fish cannot obtain sufficient purchase on the body of the bait to enable it to throw the hook. World's largest selling plug. Over 3,000 sold every day! Lures in 21 colors. Underwater, surface and trolling models, \$1.20 each. Musky, \$1.35. Flyrod size, 95c. Write for FREE 32-page Color Catalog, including 4,000 word treatise on plug fishing.

HELIN TACKLE
6342 Pulford Detroit 7, Mich.



Flyrod Model

Two fly-rod sizes—1/12 or 1/16 oz. for casting or trolling, 95c each.

Free CATALOG

8x32 Prism Binoculars



Check
These
Features:

\$45
Postpaid

- HIGH MAGNIFICATION
- COMPLETELY COLOR CORRECTED
- LARGE BRIGHT OBJECTIVE LENSES
- NEEDLE-SHARP CLARITY
- QUICK FOCUSING
- WIDE FIELD OF VIEW
- LIGHTWEIGHT YET STRONG
- BROWSCOPE MONEY-BACK GUARANTEE

Constructed of special lightweight aluminum alloy, these high-powered prism binoculars are rigid as steel yet weigh only 16 ounces. Central focussing wheel for easy adjustment. The eyepiece lenses as well as the objective lenses are achromatic, a feature found only in the best binoculars. 8 power, 32 mm lenses. This fine glass is unexcelled for hunting, sports, marine use, and general long-range observation. Sold with a guarantee of complete satisfaction or money refunded. Leather carrying case and straps included. Only \$45.00 including all tax and shipping charges.

BROWSCOPE CO.

Dept. 7P, 24 W. 45th St., New York 19, N. Y.
BINOCULARS TELESCOPES MICROSCOPES

BRAND NEW SOLID BRASS 12 FT. PORTABLE

RADIO ANTENNAS

Real \$15 Value Now Only \$4.95 Postpaid
FOR HOMES, BOATS or AUTOS

Just Out! Gov't surplus
used on Army tanks. These telescopic rustproof antenna have tremendous pickup eliminate dangerous wiring. Solid Brass throughout practically insuring **NOISE FREE RECEPTION.**



12
Exceptionally Rugged Sections
compress into 1 ft. 4 in. Handy for Camping Trips, also Useful for Transmitting, FM & Television sets.
Each antenna comes with clamps, nut, lug, and wire. Easy to install anywhere.

QUANTITY LIMITED

ORDER TODAY. A real \$15 value for only \$4.95 Postpaid. Mail check or money order now or sent C.O.D. plus postage. Money back in 10 days if not satisfied.

RADIO HOSPITAL 1113 Lexington Ave., Dept. B7
New York 21, N. Y.

free
CONCORD
Radio
Catalog



RADIO PARTS • RADIO SETS • RECORD CHANGERS — PLAYERS • KITS • HAM GEAR • AMPLIFIERS • TESTERS

It's here! The big, new 1947 Concord Catalog with a vast, complete selection of everything in Radio and Electronics for building, experimenting, testing, repair and maintenance. Thousands of items—hundreds now available for first time—latest 1947 prices. Now LOWER prices on Radio Sets, Receivers, Kits, Record Changers, Players, Portables, Amplifiers. Latest listing standard items. Complete stocks—**IMMEDIATE SHIPMENT.** Write for **FREE COPY**—please address Dept. PS-77.

CONCORD RADIO CORP.

LAFAYETTE RADIO CORPORATION

CHICAGO 7

901 W. Jackson Blvd.

ATLANTA 3

265 Peachtree Street

Wagemaker
GRAND RAPIDS, MICH.
WOLVERINE BOATS



THE DEMAND FOR WOLVERINE BOATS INCREASES EVERY YEAR — THERE MUST BE A REASON.

Never in our history have we produced a finer boat than is rolling off our production lines today! For 1947 we offer nearly 60 models, many newly designed and improved to make your boating a real pleasure, combined with economy of operation. Choose any one of the models in the Wolverine line with the assurance that you are securing the best at a price that will fit your pocket book. Outboard and Inboard models in Moulded Plywood, Car Top Dinghies and many others. Free literature on request. Write

WAGEMAKER COMPANY

DEPT. 26

GRAND RAPIDS, MICHIGAN

DIE-LESS DUPLICATING

Many small parts can be formed without dies, to duplicated accuracy of .001" with DI-ACRO Precision Machines. — Benders, Brakes, Shears. Save die expense and time delay. Ideal for experimental and research work, making samples, models, etc. as well as regular production runs. Write for descriptive literature.

O'NEIL-IRWIN MFG. COMPANY

342 8th Ave., Lake City, Minn.

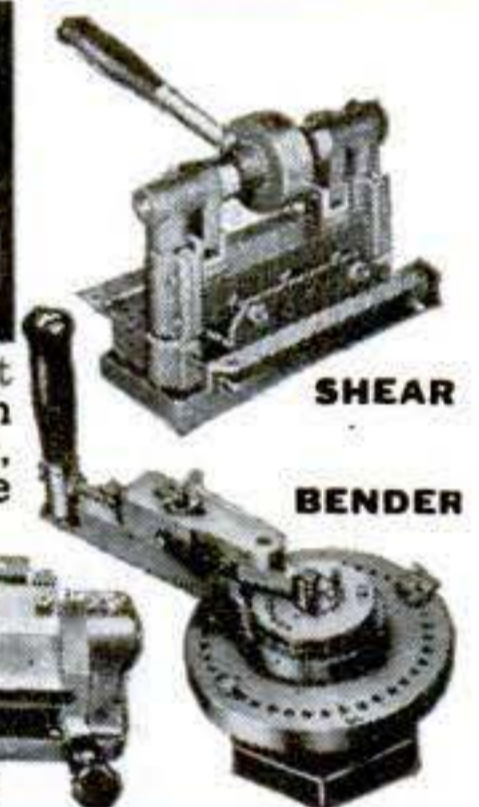

SHEAR

BENDER

BRAKE

NEW SCIENTIFIC DRINKING PINK ELEPHANT



\$2.98

Complete with Glass & Stand
TUMBO will capture the hearts of young and old, with his antics. He has movable eyes, curling trunk, flapper ears and four legs. He's always dipping his curling trunk for a "shot" of liquid. Mail your order today.

MYSTERY DRINKING BIRD \$1.89
with Movable Eyes,
Feathered Body & Stand

Special Price to Dealers

BERNARD FINE CO., 501 Sixth Ave., Dept. P.S. N.Y. 11, N.Y.

SAVE RETAILERS' PROFIT-BUY DIRECT



\$3.90
MEN'S
13.40 SMALL BOYS'

MEN'S work or street SHOES

Strong double tanned brown cowhide. Full leather middle sole. Heavy non-marking Good-year cord soles. Proved best by Army tests. Sewed and nailed.

Doubly reinforced. Sizes: Men's 6 to 12; Boys' 1 to 6; Small Boys' 10 to 13½. **FREE:** Large Pkg. Leather Preserver with each pr. Order now C.O.D. plus postage. Or pay with order and we pay postage.

GEO. M. SUTTON SHOE CO., DEPT. P.S. 2
32 Sutton St., Balto. 1, Md.

BECOME A PISTOL EXPERT WITH A HY-SCORE AIR PISTOL

- No Pumping
- Powerful, Fast
- Single Shot
- Precision-Made
- 30½ oz.;
- 10¼" long

HY-SCORE PELLETS
FIT ALL PISTOLS
Cal. 177 2.50
Cal. 22 3.00
per 1000

SEE YOUR DEALER
Send for Free Circular, Dept. P7



HY-SCORE ARMS CORP. • BROOKLYN 1, N. Y.

MICROSCOPES & SCIENTIFIC INSTRUMENTS
SUPPLIES-ACCESSORIES
NEW & USED
BeL SPENCER BOUGHT-EXCHANGED-REPAIRED LEITZ ZEISS
Send for **FREE LIST**
NATIONAL SCIENTIFIC INSTRUMENT CO. 119 CHAMBERS ST. NY 7
MEDICAL INDUSTRIAL AMATEUR



MOTO-TOOL ★ THE "POCKET-SIZE" MACHINE SHOP

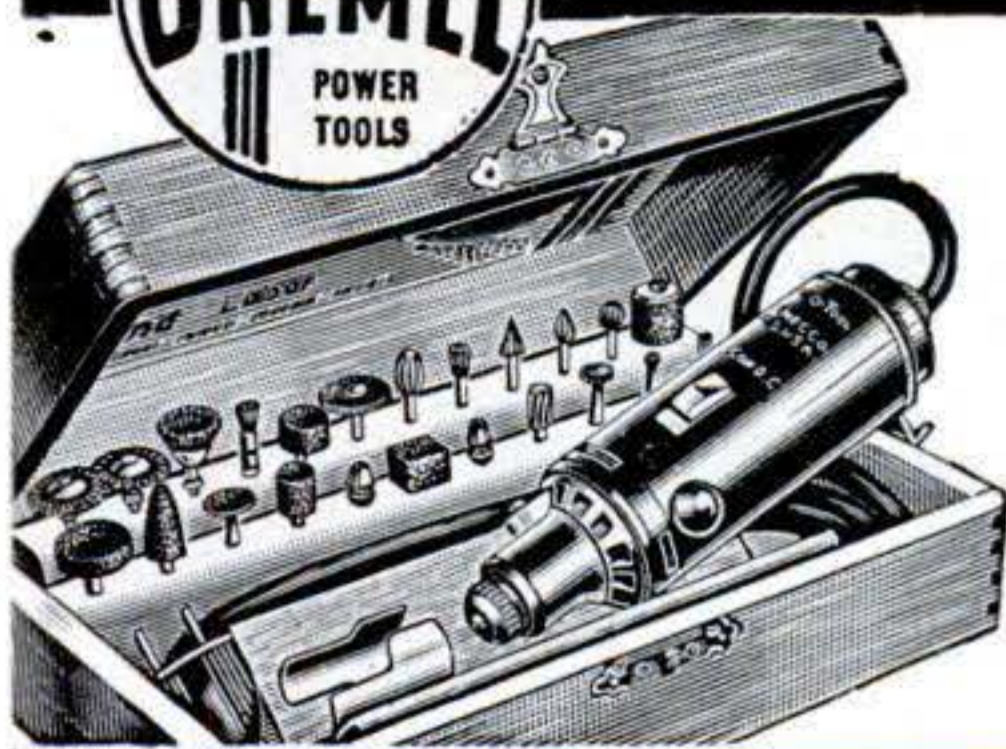

"MAN . . . WHAT A POWERHOUSE!"
A TOOL THAT PACKS YEARS OF PLEASURE

Here's a tool to please a man's heart . . . one that holds promise of endless creative hours. Dremel Moto-Tool is a "war veteran" . . . used by all branches of the armed forces in far-flung repair bases . . . helped set production records at General Electric, Westinghouse, Remington Arms, Ford and others, Hobbyist or expert craftsman, first choice is Model 2 Moto-Tool Kit with its handsome felt-lined, highly finished wood case with rows of tools begging to be put to work. Write for FREE catalog of Moto-Tool attachments and accessories.

MOTO-TOOL FEATURES:

Oil-less, sealed, bearings • Patented automatic chuck lock pin • Oversize armature shaft, hardened, ground, polished • 110 Volt, AC-DC motor • Sliding snap-type switch • Cord protector • Shockproof bakelite housing • Dust-filtered, air-cooling system • Weighs only 13 oz. • Dynamically balanced for vibrationless operation.
MONEY BACK GUARANTEE: Buy Dremel Moto-Tool and Accessories from your dealer. If he cannot supply you, order direct from factory on 10 day trial. Shipped postpaid for cash in full; or for \$2.00 sent C.O.D. for balance plus postage.

DREMEL MFG. CO.

Dept. 127-G Racine, Wisconsin

- Do These Better-Faster**
- Drilling
 - Routing
 - Sanding
 - Engraving
 - Touching-Up
 - Mortising
 - Polishing
 - Cleaning
 - Rasping
 - Brushing
 - Dressing
 - Burring
 - Grinding

- APPROX. 27,000 R.P.M.**
- Finishing
 - Sharpening
 - Burnishing
 - Inlaying
 - Sawing
 - Scoring
 - Carving
 - Cutting

Moto-Tool Kit No. 2, with 23 accessories (high speed steel cutters, grinding wheels, polishing accessories) and heavy-duty professional Model 2 Moto-Tool in natural-finish, hardwood case . . . \$23.50. (Items purchased separately would cost about \$30.00; you save \$6.50.)
Moto-Tool No. 2 with one emery point \$16.50.
Moto-Tool Kit No. 1 with 34 accessories and Model 1 Moto-Tool in wood case . . . \$17.50.
Model 1 Moto-Tool with one wheel point \$9.85.



Send for Free List of LEADING BOOKS

on Watch Repairing, Clock Repairing, Engraving, Industrial Diamonds, Aircraft Instruments, etc. Dept. 10

HENRY PAULSON & CO. CHICAGO 3, U.S.A.



BE A HAM!

It isn't such a big job to build your own ham station. Doesn't cost much either—not when you buy all your parts from Lafayette—World's Largest Radio Supply House. Our new FREE catalog lists everything you need—even the tools, at swell savings. Send for FREE catalog today.

LAFAYETTE RADIO Dept. KG-7
 100 6th Ave., New York 13, N. Y.

Get This Home Movie Feature "BISCUIT BEN"

Ben prepares dinner when wife attends evening bridge club. Gets into hilarious trouble. Climax when he spreads dough on chest and cuts biscuits. Packed with laughs.



"The Pickpocket"
 Another feature comedy in which Ben pulls series of insane "hi-jinks" as professional pickpocket.

16mm K., Sound . . . \$17.50 16mm B & W, Sound \$7.50

Write for catalog and prices of comedies, cartoons, travel and scenic features. At your dealer or order direct.

HOLLYWOOD FILM ENTERPRISES, Inc.
 6060 Sunset Blvd. Dept. 116 Hollywood 28, Calif.

OLD SAWS MADE NEW

With FOLEY

You don't even remove the handle—just put saw in machine and in 3 minutes you have a perfect set of new teeth.

Handsaw Retooler

Accurate—positive—easy to use. Cuts 20 sizes of teeth from 4 to 16 points per inch on any handsaw. Saves filing time, no eye-strain. Send for circular.



FOLEY MFG. CO., 791-7 Foley Bldg., Minneapolis 18, Minn.
 Send full details on Foley Retooler

Name
 Address

NEW DRAWING DEVICE

NOT A TOY

DRAW ANYTHING YOU CAN SEE WITH LUCY!

No talent needed to draw scenery, objects, profiles, portraits or reduce copy, in perfect undistorted perspective, indoors or outdoors.

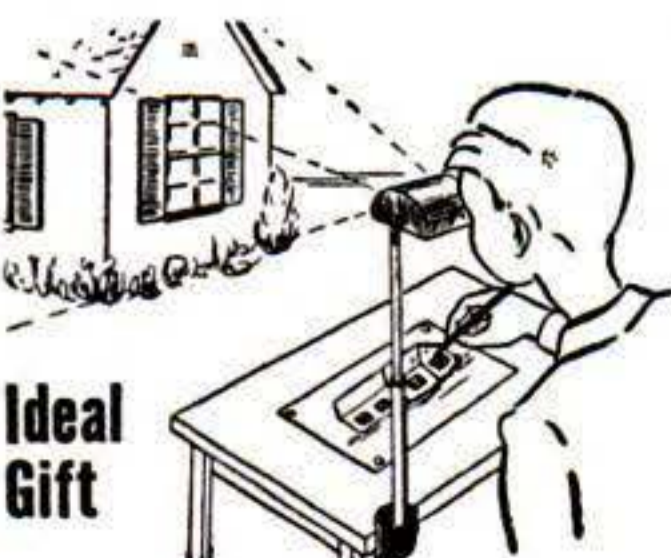

Ideal Gift

Commercial artists, fashion designers, architects, patent attorneys, hobbyists, doctors, children, find many practical uses for LUCY.

FINE FOR ART STUDENTS

A student looking thru LUCY draws, let us say, the outline of a building. Then, looking directly at the paper without benefit of LUCY'S magic, he fills in other details. Then a glance into LUCY shows where he drew them and where they should have been BOTH AT THE SAME TIME. A perfect art instructor, not a crutch.

LUCY IS AMUSING TOO

If you want to liven up a party, mount LUCY on a table so the guests can draw profiles of each other. Forget all other games. They'll play with LUCY by the hour.

DURABLY MADE, LOW COST

All metal, life-time construction, nothing else to buy, mounts on drawing board or table, no electricity needed, fully guaranteed. Only \$6.95 postpaid with easy instructions. No COD or open accounts please. One day shipment. A precision instrument you'll be proud to own.

BEELER ENTERPRISES Dep't G North Hollywood, Calif.



HOW IT WORKS

To the operator at B looking thru eyepiece of LUCY at A, a phantom view of subject to be drawn C appears already on the paper D in full perspective. Drawing becomes simple tracing. LUCY does NOT project view of subject to paper. The magic of LUCY'S clever optical system makes it look that way in eyepiece, and its just as easy to draw as though it was actually there. Adjustable to vary size of drawing.

New Revolutionary Radio!

The Crystalear* is COMPLETE

- USES NO TUBES OR ELECTRIC CURRENT!
- Nothing else to buy!
- Extremely Sensitive!
- Highly Efficient!
- Built in tuner!
- There is no better crystal radio on the market!

send only \$1.00

(cash, money order, check) and pay post-man \$4.95 plus delivery fees on arrival or send \$5.95 for postpaid delivery. Send \$6.95 if you wish headband included.

Crystalear Radio, Post Office Box 6112
Cleveland, Ohio

*Trade Mark Reg. U. S. Patent Office



It's Palm-Size!



AMAZING NEW MAGNETIC JIG SAW!

Ready for Delivery!

SYNCR... new, remarkable, patented, magnetic jig saw... needs no belts... no motor... no gears... no oiling! Just plug into any 60 cycle A.C. 110-130 volt outlet—and saw! Portable... world's... no sanding necessary! Ideal for hobbyists, craftsmen, light production. Perfect for models, displays, inlays, etc. Cuts intricate designs on 3/4" soft wood, 1/2" plywood and thinner hardwoods, metals, plastics... **NOT** for ordinary lumber. Leaves NO ragged undersides on plywood or heavy cardboard. Special magnetic safety stroke features! Nothing else like it! Sold on 10 days Moneyback Trial! Prompt delivery guaranteed. Rush name, address on postcard for FREE details, Trial Offer. Hurry!

WRITE FOR FREE SYNCR CIRCULAR
safest saw! Cuts clean, smooth... no sanding necessary! Ideal for hobbyists, craftsmen, light production. Perfect for models, displays, inlays, etc. Cuts intricate designs on 3/4" soft wood, 1/2" plywood and thinner hardwoods, metals, plastics... **NOT** for ordinary lumber. Leaves NO ragged undersides on plywood or heavy cardboard. Special magnetic safety stroke features! Nothing else like it! Sold on 10 days Moneyback Trial! Prompt delivery guaranteed. Rush name, address on postcard for FREE details, Trial Offer. Hurry!

SYNCR SAW CORP. Dept. B-77 Rochester, Mich.

RUST! RUST! RUST!

WHAT a headache! Here's the answer! A new liquid RUST REMOVER—quickly dissolves rust on iron or steel, hardware, machinery, etc. NO RUBBING or hard work. Brush, swab, spray or dip. Put ON—let SET—wipe off—RUST GONE! On sale at all Sears Retail Stores in HARDWARE DEPTS. 50c and \$1.00 in Mid-West (slightly higher elsewhere). Valuable manual of rust control FREE with each bottle.



SEARS, ROEBUCK and CO.
For further information, write ALLIED PRODUCTS COMPANY, Dept. H-2, 1133 Newport Ave., Chicago, Ill. Manufacturers of Corodex.

CORODEX Liquid RUST REMOVER \$1 PER QT.

NEW TOOL READY!

QUICKLY SHAPES, SANDS, CARVES, PROFILES, GRINDS, BEVELS, SMOOTHS, POLISHES, CLEANS! Industry's most versatile machine, The Mead Bandsander—now available to hobbyists, craftsmen, model makers, pattern makers, home workshops—cuts fast and clean on wood, metal, plastics! Works equally well on inside cut-out openings or irregular outside edges, on intricate scrolls, curves, saves hours of tiresome hand work—does better job. Nothing else like it. IDEAL TO GIVE OR GET FOR WORKSHOP! Sold on 5 Days' Trial, money back GUARANTEE.

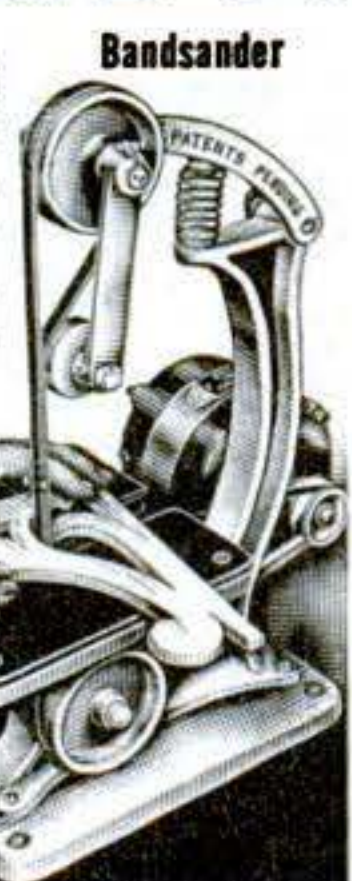

FREE!
Write for free, lavishly illustrated Circular describing how Bandsander—the machine that amazed the experts—saves time, money, trouble. Write now—a post card will do!

MEAD SPECIALTIES CO.
4114 North Knox Ave., Dept. 277, Chicago 41, Ill

RUMIN
Gold Coated FLINTS
and LIGHTER FLUID

For all Lighter
RUMIN
LIGHTER FLUID

gold coated
FLINTS

Rumin Gold-Coated Flints... the only gold-coated flints made... plus Rumin blue-flame Lighter Fluid are a sure fire combination that make every lighter spark quicker, light brighter!

SOLD WHEREVER CIGARETTES, CIGARS AND TOBACCO ARE SOLD

ROCK FLINT CO., 123 Doughty Blvd., Far Rockaway, N.Y.



'QUICK-CHANGE' GEAR BOX

CUT THREADS — 4 TO 224 PER INCH

Approximately .003 feed, for fine turning.
New reverse furnished with box for Atlas.
Bronze bearings throughout entire unit.
Aluminum casting—All steel gears. Maintained accuracy.
Speeds up production. Easy to install.
Simple to set. Immediate delivery.

Only \$75.00

F.O.B. Chicago Guaranteed

FOR—Atlas, Logan, Craftsman and Power-Kraft Lathes

Write for information or order direct. Full instructions with shipment.
O'Brien Machine Co., Sales Dept. PS-7, 1620 Highland Ave., Chicago, Ill.

THE SCOUT SENIOR

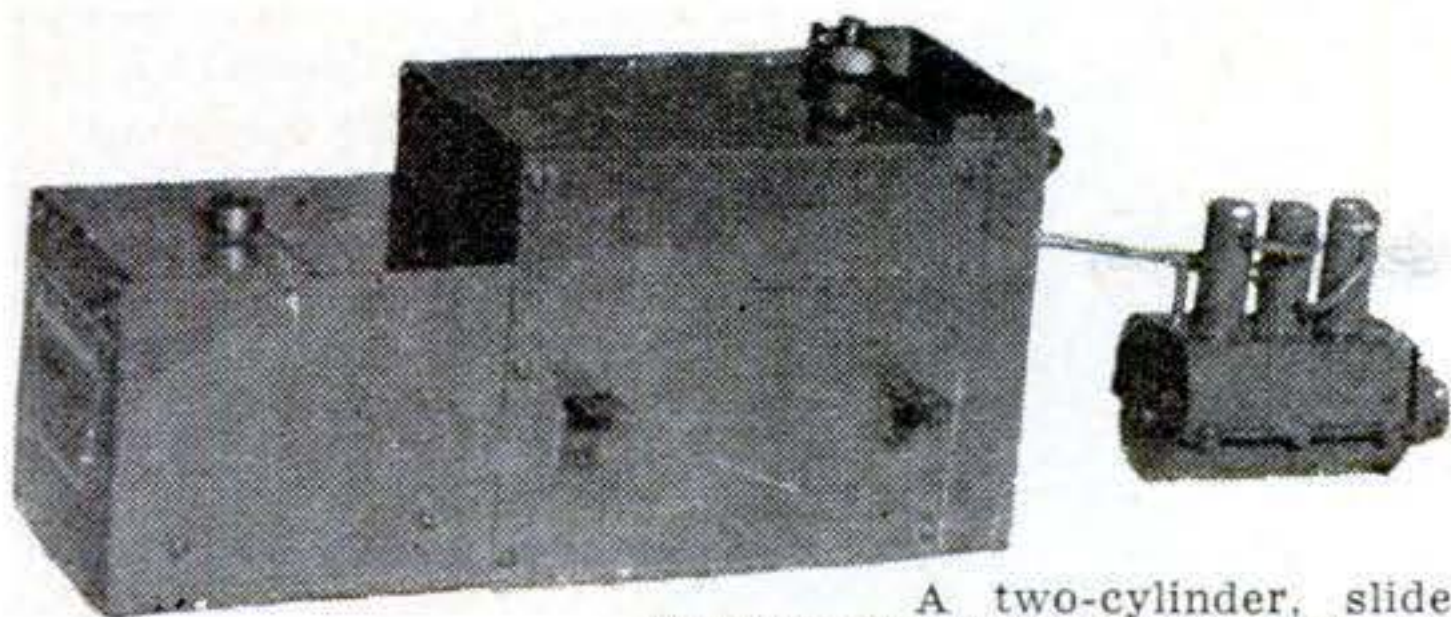

A two-cylinder, slide valve engine for boats 18" long and larger. 7/16" bore by 3/8" stroke. Aluminum pistons. High-pressure, brazed boiler. Drives a 2 1/4", two-blade prop of 3" pitch at 2000 r.p.m. for almost 20 minutes. Burns alcohol. Price postpaid, complete ready to run with 70-lb. safety valve and prop rig..... **\$9.50**

PHILIP STEVENSON CO.

Box 162, Station D

Cincinnati 6, Ohio

60 POWER TELESCOPE \$2.95

VARIABLE EYEPIECE 20X-40X-60X

NEW! Three telescopes in one, 3 different magnifications. 20 power for ultra-bright images with 40 and 60 power for extra long range. Guaranteed to bring distant objects, people, sports events, ships, moon, stars, etc., 60 times as close.



Most powerful for anywhere near the money. 3 sections. Closes to 1 ft. long. Not one of our high precision instruments but the biggest value. Contains 4 ground and polished lenses. The tubes are made of Kraft fiber, brass bound. It may also be used as a powerful compound microscope for examining objects too small to be seen with the naked eye. Directions included. Mass production methods enable us to sell this high-powered instrument at the amazing price of only \$2.95. We pay the postage. Get yours immediately.

BROWSCOPE CO.

Dept. 7P 24 West 45 St. New York 19, N. Y.
Catalog of big values in binoculars, microscopes, etc., free on request

AMAZING SELF-ADJUSTING WRENCH

New 10" Balin Self-adjusting pipe wrench. Forged steel. Special heat treated. Saves time. No bulky adjustment screw. Fits into close places. Indispensable for all pipe work, in shops, homes, garages, etc. 10" \$2.50 post & tax paid, in U.S.A. Order today. Cash, check or money order.
BALIN TOOL CO., 1113 E. 61st St., Los Angeles 1, Calif.



Opens to 1 1/2 inches
SPECIAL DISCOUNT TO AGENTS

Assemble KING MIDGET



Practical highway racer runabout. New model. We supply all parts. Just bolt together. Low cost. Ready for delivery NOW. One or two cylinder, 40 m.p.h., up to 100 miles per gallon. Send 25c for complete new literature with large picture, 4-view drawings, price of parts, or send \$1 (refunded with first order) for the above, plus 24 page booklet showing complete assembly with 30 photographs and drawings.
MIDGET MOTORS Athens, Ohio

EXHAUST BLOWERS

WORTH \$50 \$15.85

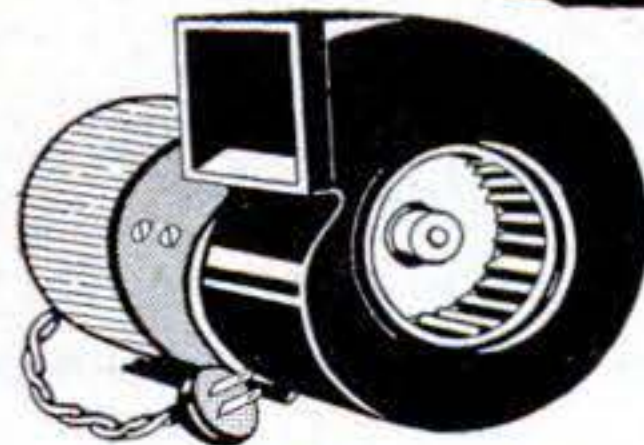

For PHOTOGRAPHERS • HOSPITALS • LABORATORIES • WORK SHOPS • LAUNDRIES • OFFICES • RESTAURANTS • PRINTERS • PLAYROOMS

100 CU. FEET FRESH AIR EVERY MINUTE!
Solve your ventilation problems with this NEW durable, built-for-service blower and exhaust. Quick and simple to install. Anyone can do it with ordinary household tools. Continuous duty. BALL BEARING motor assures quiet, trouble free operation. Rugged housing insures long life. 110 Volt, A.C., 50-60 cycles. Send Check, Money Order. No C.O.D.'s. West of Mississippi add \$1.00 for mailing, handling.

Immediate Delivery!
UNIVERSAL YONKERS CORP.,

(Dept. S-7) 41 Locust St. Yonkers 2, N. Y.

PAINT YOUR CAR WITH WYPETM for \$3.95

Amazing NEW AUTO ENAMEL
You WIPE ON Instead of Brushing & Spraying

Get Beautiful Mirror-Like Finish That Looks Like Spray Job! One Quart Does Entire Job

At last—you can paint your car with WYPE for \$3.95 and get a beautiful, high-gloss finish that rivals an expensive, professional spray job. With WYPE you need NO BRUSH, NO SPRAY, NO MASKING! You just WIPE ON with Powder Puff, furnished. Takes about an hour to apply. No streaks, no lap-marks. WYPE dries dust-free in one hour. Guaranteed for TWO years not to peel, chip, crack or fade, if simple directions are followed.



DRIES TO GLISTENING, PROFESSIONAL FINISH!

WYPE is a new Miracle Enamel for autos. It is NOT a wax or polish but a hard, highlustrre ENAMEL finish. With WYPE, anyone can do a beautiful job! Get a quart to paint your car or to get started in this BIG-MONEY business! See your dealer or order direct.

SEND NO MONEY! NEW MONEY-MAKING BUSINESS!

Order WYPE Today!

8 POPULAR COLORS:

Black	Brewster (dark) Green
Red	Jewel (light) Green
Maroon	Washington (dark) Blue
Gray	Monticello (light) Blue

All \$3.95 per Quart

Order one quart or more today! Just send postcard. Then pay mailman for WYPE plus postal charges. Or send money with order and WE pay postage.

WYPE 2 Cars Daily for \$25.00 each—
Gross up to \$200 Weekly!

Start making BIG MONEY now! Sell WYPE in cans or go into business painting cars yourself (or hire others). Send for FREE details of powerful money-making plan. Why wait? Start now by ordering one quart or more of WYPE today!

WYPE CORP. Dept. 17-G 2214 Dolman St., St. Louis, Mo.

NOW—COMPLETELY NEW MITER-BOX

- FITS ANY SIZE BOARD!
- ALL STEEL CONSTRUCTION
- ALLOWS SAWING AT ANY ANGLE
- WEIGHS 1 3/4 LBS.

SAW-KUT GUIDE

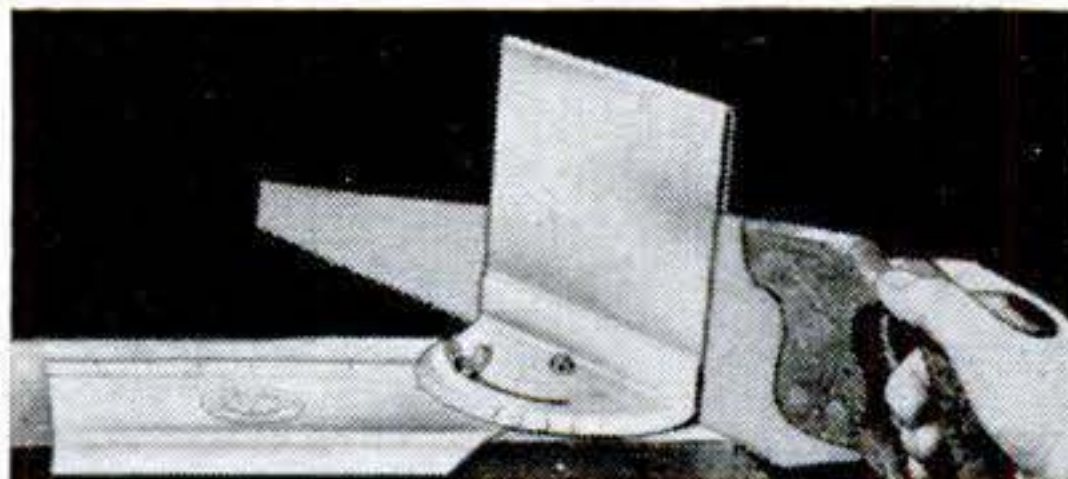

An innovation in miter boxes! Lighter in weight, handier than old type. Designed to accommodate any saw. Precision built of cold rolled steel. Miter gauge has complete mobility. Simple one-quarter turn of wing-nut locks gauge at selected angle. Guide flange on base places SAW-KUT GUIDE firmly against board aligning saw perpendicular to axis of board. Enables framing of windows and doors without pre-cutting boards. **\$350**

POSTPAID
Anywhere in U. S.

THE BONAIRE CO.

58 GLENWOOD • MINNEAPOLIS 3, MINN.

IF YOUR DEALER CAN'T SUPPLY YOU SEND COUPON TODAY!

The Bonaire Company, Dept. S
58 Glenwood Avenue, Minneapolis 3, Minn.

Enclosed please find check or money order for _____
Please send me _____ SAW-KUT GUIDES

NAME _____
ADDRESS _____
CITY _____ STATE _____

NAME OF DEALER _____

DEALERS! WRITE FOR NAME OF NEAREST JOBBER.

DRAFTO

QUALITY TOOLS

COMPLETE DRAWING MACHINES

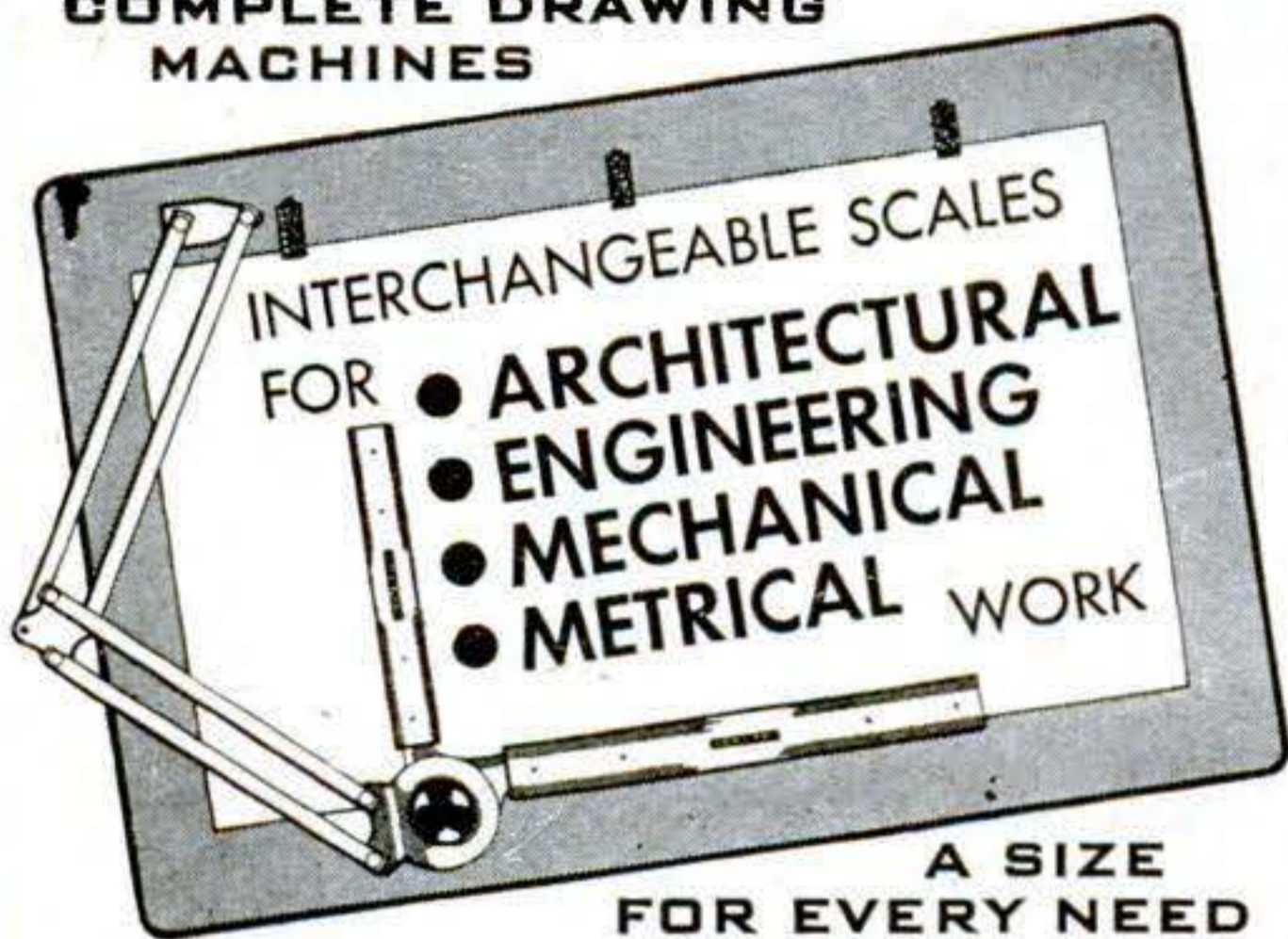

Quality products for fast, accurate work—designed for portable compact flexibility.

AT BETTER SUPPLY HOUSES OR FACTORY INQUIRY

DRAFTO CORP., COCHRANTON, PENNA.

KAYAKS

AQUA V-18

Easy to Build



25¢ COIN FOR ALL THREE

BOATS for Home Assembly

"U-MAK-IT"

KAYAKS, ROWBOATS, DINGHIES, INBOARDS, OUTBOARDS, RUNABOUTS
Cut-To-Fit for Quick Assembly. Everything Complete plus Illustrated Instructions. No Experience Necessary. Simple as A. B. C.

SEND 25c POSTAGE (COIN) TODAY FOR 3 MONEY SAVING ILLUS. CATALOGS Showing all '47 Models (marine plywood) and construction details.

AQUAMOBILE V-18

Designed for Auto Engines. Open or with cab. Length 18 ft.
Fast VEE Bottom Hull.

KAYAK BOAT CO., 152R EAST 129th ST., NEW YORK 35, N. Y.



PERFECT DOWELS

... easily made



WITH AMAZING NEW SPEE-DOWL on your lathe or drill press. SAVES its cost, works on any wood, makes perfect burnished dowels for any of your projects. Get yours now on our MONEY BACK GUARANTEE! Two size ranges: Model 8 shown at left 2, 3, 4, 5, 6, 7 and 8/16", only \$1. ea. Special: any 4 for \$3.50 or all 7 for \$6. Model 20 shown above—9 to 20/16" at

\$2.65 each size. Send Postal Note or check NOW! We pay postage in North America. NEW... a Lathe Chisel that holds an edge almost indefinitely! Tipped with TUNGSTEN CARBIDE. FREE LITERATURE. **JOHNS MANUFACTURING CORP., Dept. B-10, DUNELLEN, N. J.**



CROSMAN Silent RIFLE

Most Amazing Gun Ever Invented for Target and Small Game Shooting

The ideal rifle for year 'round shooting indoors or out. Shoots low-cost SUPER PELLETS without noise, odor or recoil. Requires no cleaning. At your dealer or write direct.

Adjustable power—rifled barrel for accuracy. .177 and .22 caliber models. Write for information.

CROSMAN ARMS CO., INC.
9 HENRIETTA ST., ROCHESTER 7, N. Y.

Shoot CROSMAN SuperPells

The BETTER Ammunition for ALL .177 and .22 caliber Air Pistols and Rifles.



.177 cal... \$2.50 per M
.22 cal... \$3.00 per M

POSTAGE PREPAID

At your dealer or order direct

FOR GREATER ACCURACY
MAXIMUM POWER

CROSMAN ARMS CO. HENRIETTA ST., ROCHESTER 7, N. Y.

\$13⁵⁰ Value for Only \$2.49

8000 ohm impedance Head Phones, produced to Air and Signal Corps specs. Extremely sensitive, lightweight (only 9 oz.). With 5 1/2 ft. cord, plug, jack and ear cushions. Every One BRAND NEW.

No. 17A37, Special Per Pair..... \$2.49

Plus 25c each for Postage.



Burstein-Applebee Co. 1012 McGee, Kansas City 6, Mo.

OK's CO₂ IGNITIONLESS 3/4 OZ. ENGINE

NO SPARK-PLUG • GASOLINE; NO COIL (Wiring), BATTERIES

Smallest, lightest expansion-type, reciprocating-action power plant. For model planes (Tractor or pusher types) Race Cars, Speed Boats. CO-2 delivers spectacular power-to-weight; 7,000 RPM; 20 to 60 sec. runs from single carbon-dioxide cartridge. Positive 'flip' starting, speed adjustable. 1 pc. steel cylinder, fitted piston—precision 1/10,000". Displ. .0178. Bore .275. Stroke .300. COMPLETE with Holder \$7.50. CO-2 is made and gtd. by makers of 'OK' TWIN and other palm-size gasoline engines. At hobby dealers or write factory.

HERKIMER TOOL AND MODELWORKS, Inc.
HERKIMER (1), NEW YORK



Balance 4" x 9" Base

With either Metric or Av-irdupois Weights..... \$6.00

Catalog with 3000 illustrations of laboratory Apparatus sent for \$1.00. Catalog of 100 scientific books, 10 cents.

LABORATORY MATERIALS CO.
7317 Vincennes Ave. Chicago 21, Ill.

Say You Saw It In Popular Science

PLASTIC HOMES

New Building Material! Resurface old homes; build new ones. Colorful, beautiful! LIQUID MARBLE—Color-glazed! Molded, brushed, sprayed. SANITARY

COMPOSITION FLOORING—Dustless, noiseless; put on like plaster; resilient—yielding as cork; lasts like stone; plain or marked in tile design. RUBBERLASTIC Mold Compound—Mold novelties, statuary, toys, gifts, plaques, plaster animals. COLORED POTTERY—Birdbaths, garden furniture, vases. TILEX colored roofing. Illustrated literature FREE. **RAPID MARBLEIZING SERVICE, Dept. 12-B, Edwardsville, Ill.**

WOOD WORKERS

Lumber—Plywood Available

Harold Hunt wants to send you big new No. 15 Catalog. Over 148 pages of wood-working ideas, 12 pages of rare woods in colors. UNEQUALLED BARGAINS in imported and American woods, supplies, hard-to-find hardware. Send only 15c to cover postage and handling.

CRAFTSMAN WOOD SERVICE CO.
2729 S. Mary St., Dept. B-83 Chicago 8, Ill.

only 15¢



Portable Paint Sprayers

SPRAY GUNS

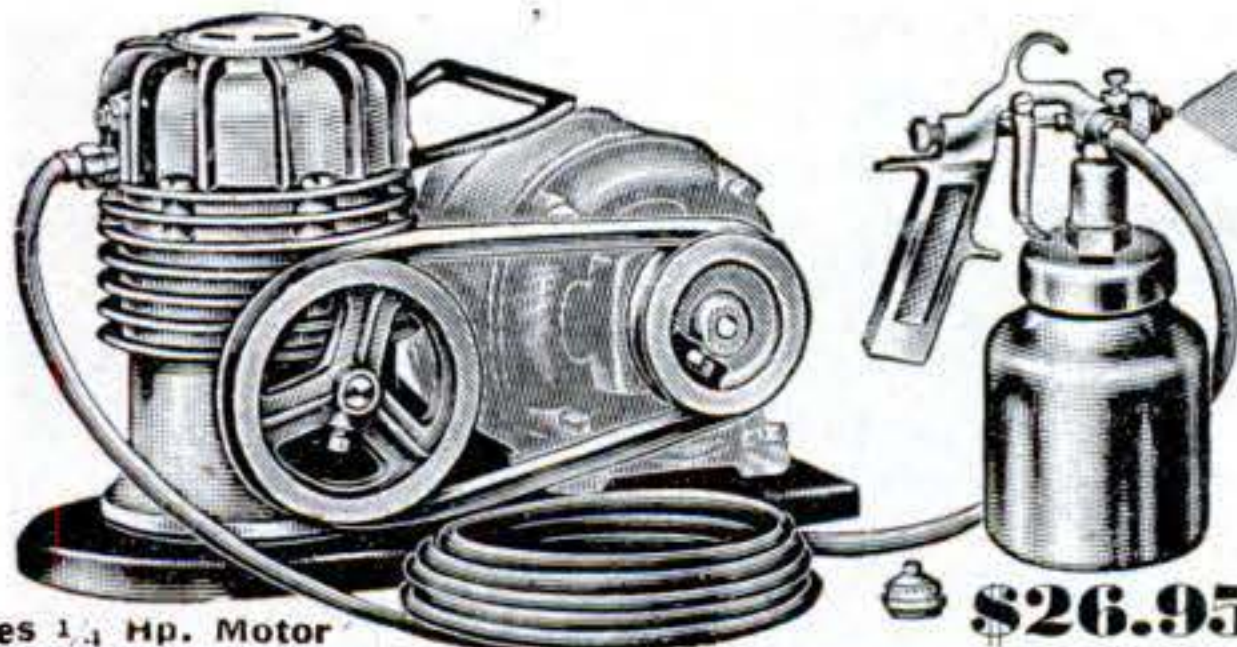

PAINT TANKS

Uses 1/4 Hp. Motor

\$26.95

Complete as illustrated, less motor. Sprays all kinds of paint, lacquer, varnish, etc. Oil-less ball bearing compressor. 2 cu. ft. air per minute. 15 to 50# pressure. Sprays paint 5 times faster than hand brushing.

No. 890—Outfit complete as shown, with "V" belt, motor pulley, 15 ft. high test air hose and No. 112 gun, but without motor. \$26.95

No. 444—Outfit, twin cyl. 4 cu. ft. production type gun, 15 ft. air hose, reg. and gauge, V belt and motor pulley. Complete less motor, uses 1/2 H.P. motor \$47.50

AIR COMPRESSORS—PAINT SPRAYING SUPPLIES.

Immediate delivery—check or M. O. shipped prepaid. COD's plus charges.

INDIANA APPLIANCE CO.

20 East Sycamore Dept. PS-20 Evansville 9, Ind.



A.C.-D.C. Converter Kit

Every workshop needs this direct current unit for home plating, battery-boosting, operation small D.C. motors, models. Here is the best value ever offered.

NOW ONLY \$9.95 PLUS POSTAGE

Consists of fully enclosed heavy-duty transformer, genuine selenium rectifier, handsome black cabinet, all parts needed to build this powerful 6 volt 4 ampere converter in less than 30 minutes. Full instructions for assembly and use included. Plugs into 110 V A.C. and delivers 6 volts, 4 amperes, D.C. Also available for 12 volts, 4 amps D.C. at \$17.50 and 14 volts 8 amps D.C. at \$22.50. Excellent for operating War Surplus D.C. radios and motors. Enclose money order or check when ordering. Shipping Weight 10 lbs.

SCINTILLA RAIL AND POWER WORKS
54 Macdougall Street New York 12, N. Y.

LAW

STUDY AT HOME for PERSONAL SUCCESS and LARGER EARNINGS. 38 years expert instruction—over 108,000 students enrolled. LL.B. Degree awarded. All texts furnished. Easy payments. Send for FREE BOOK—"Law and Executive Guidance"

AMERICAN EXTENSION SCHOOL OF LAW
Dept. 79-S, 646 N. Michigan Ave., Chicago 11, Ill.

How to Start YOUR OWN BUSINESS

Make Flexible Molds, Composition Flooring

NO EXPERIENCE—UNLIMITED MARKET

Start your own business at home in your spare time. Tremendous money-making opportunities for both men and women.

FLEXIBLE MOLDS

Make your own FLEXIBLE MOLDS. Cast novelties, statuary, desk sets, book ends, etc. Hundreds of casts made from single mold. Large size mold costs but a few cents. No experience necessary. Steady year-round demand.

COMPOSITION FLOORING

Make floors that last a lifetime with amazing COMPOSITION FLOORING! New discovery now enables you to lay artistic floors, in beautiful patterns in most colors and shades. Can be laid over wood, concrete, brick, steel, etc. This composition flooring offers unlimited money-making possibilities.

Free Catalog!

For FREE information about these and many other profitable business opportunities, WRITE TODAY!

BING PRODUCTS

Dept. B-21, 88 Broad Street Boston 10, Mass.

Radio's Greatest Buying Guide!

FREE



ALLIED'S NEW RADIO CATALOG

Send for this Big Value Book NOW!

Send for your FREE copy of the leading Buying Guide for Everything in Radio! Here's the handiest catalog for Servicemen, Dealers, Soundmen, Amateurs, Builders and Experimenters. Features the world's largest and most complete stocks of quality radio and electronic supplies—all at lowest prices! Get the equipment, the speedy service, the expert help you want, from ALLIED—Radio's Largest Supply House!

164 PAGES - - RADIO'S BIGGEST!



HUGE STOCKS—MORE THAN 10,000 ITEMS

Everything for every radio use: new model home radios, phono-radios, communications receivers, Ham kits and gear, radio parts, tubes, tools, test instruments, public address equipment, low-cost easy-to-build radio kits, diagrams, instructive radio books, radio's most complete stocks—all at lowest prices!

HELPFUL RADIO BOOKS!

- Radio Formulas & Data No. 37-752 . . . 10c
- Dictionary of Radio Terms No. 37-751 . . . 15c
- Radio Circuit Handbook No. 37-753 . . . 25c
- Radio Builders' Handbook No. 37-750 . . . 15c
- Simplified Radio Servicing No. 37-755 . . . 10c
- Radio Data Handbook No. 37-754 . . . 25c
- ALL 6 BOOKS above No. 37-799 . . . \$1.00
- Parallel-Resistance and Series Capacitance Calculator. No. 37-960 . . . 25c
- R-F Resonance and Coil Winding Calculator. No. 37-955 . . . 25c

ALLIED RADIO

ALLIED RADIO CORP.
833 W. Jackson Blvd., Dept. 7-G-7
Chicago 7, Illinois

FREE CATALOG

- Rush FREE 1947 Catalog
 - Send 6 Books No. 37-799
 - Send Books checked above
 - Send Calculators checked above
- } \$.....enclosed

Name.....

Address.....

City..... Zone..... State.....

**MILL IT
ON YOUR LATHE**

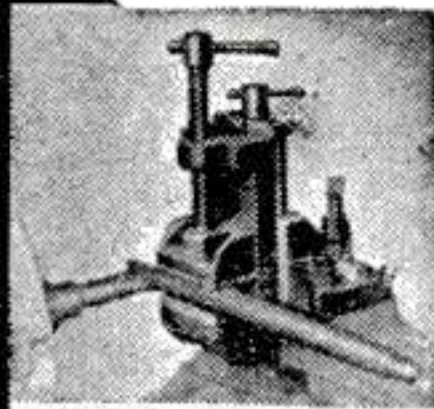

WITH A PALMGREN



**MILLING ATTACHMENT
Convert Lathe in 10 Seconds**

Now—you can do milling, slotting, grinding, grooving, squaring shafts, sawing at angles, and many other important operations on your lathe. PALMGREN MILLING ATTACHMENT is a necessary fixture for small shops, schools and emergency work in large plants. Fits South Bend, Atlas, Craftsman, Logan, Sheldon and all other makes. It has graduation for rotary angle adjustments, also graduated feed and adjustment screw. Easily mounted by straddling lathe's regular tool post. Try one—it will quickly pay for itself.

IMMEDIATE DELIVERY

No.	Width Jaws	Depth Jaws	Jaws Open	Weight Pounds	Base Opening	Price F. O. B. Factory
150	1 1/2"	1"	1 5/8"	6 1/2	1"	\$18.75
250	2 1/2"	1 7/8"	2 1/2"	11	1 1/4"	24.75
400	4"	1 1/2"	4"	25	2"	39.75

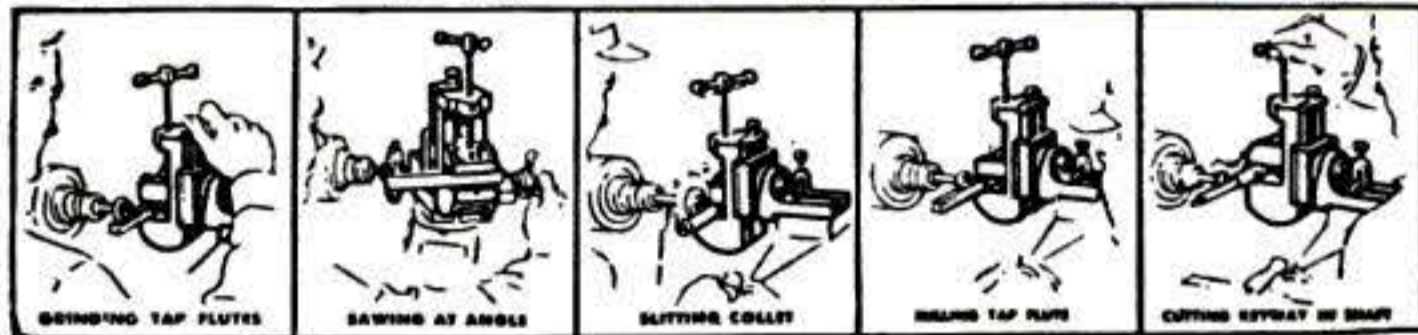

Order from your dealer or jobber. Write for circular No. 349
CHICAGO TOOL AND ENGINEERING CO.
Mfrs. of PALMGREN PRODUCTS for Over 28 Years
8396 South Chicago Avenue Chicago 17, Illinois

Completely New and COMPLETE

**Federal's Low Price INCLUDES
A Highly Corrected
Enlarging Lens**

When you examine the price tags of the new Federal Enlargers remember that the price on the tag is for a complete enlarger... LENS AND TAX INCLUDED.

For Federal's low prices are not arrived at by stripping off important enlarger parts and listing them as separate items in order to give the impression of low price.

Federal's prices are low! . . . the result of years of specialized experience in designing and building "America's Fastest Selling Enlargers" . . . undeniably America's greatest enlarger values.

MODEL 312. For miniature to 2 1/4" x 3 1/4" negatives. Fedar: 3 1/2" F:6.3 Anastigmat with Iris Diaphragm.

Complete with lens **\$5300**
Tax Included

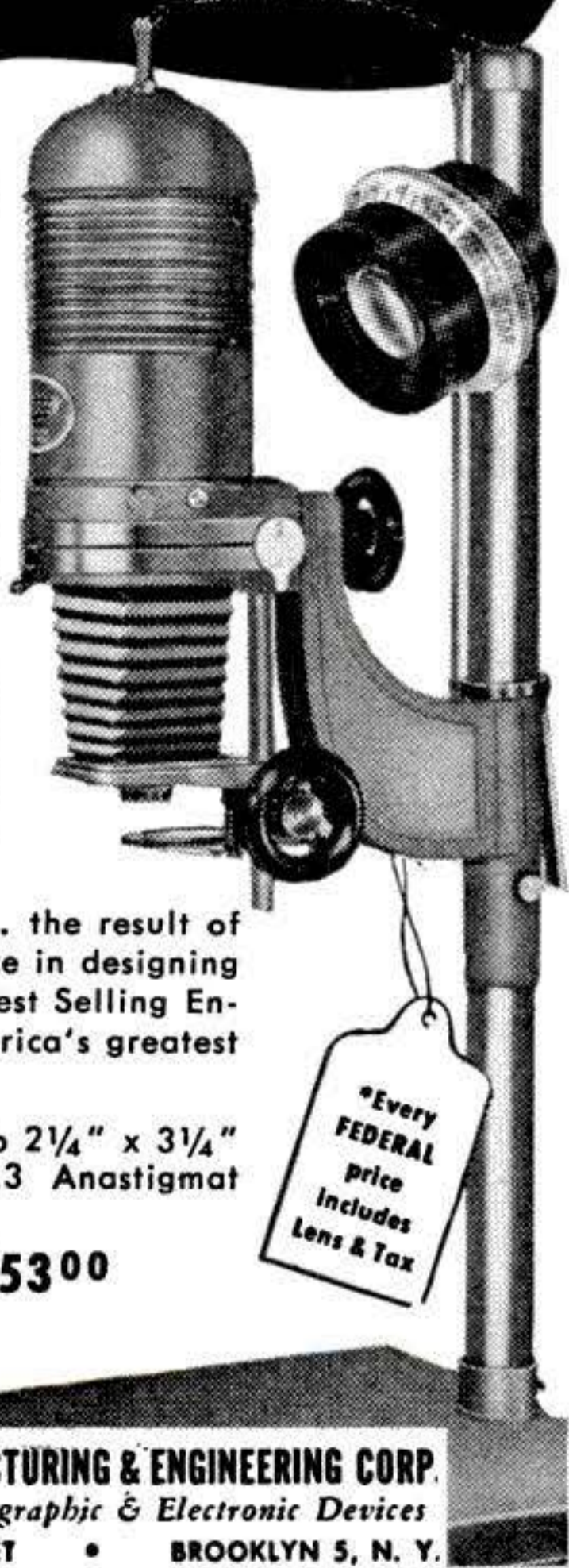

FEDERAL MANUFACTURING & ENGINEERING CORP.
Makers of Photographic & Electronic Devices
213 STEUBEN STREET • BROOKLYN 5, N. Y.

3 in 1 OTTAWA SAW

THE WORLD'S FASTEST.

**BIG
FREE
BOOK**

**6-H. P.
EASY TO MOVE**



**FELLS TREES,
SAWS BIG LOGS, SMALL LOGS, LIMBS**

One motor performs all three operations. Furnished with or without attachments shown below. Thousands in use.

Make **BIG** profits in the ever increasing wood business. Pulley for belt work. Fully guaranteed. Low direct-to-user prices. **FREE** details—write **TODAY.**

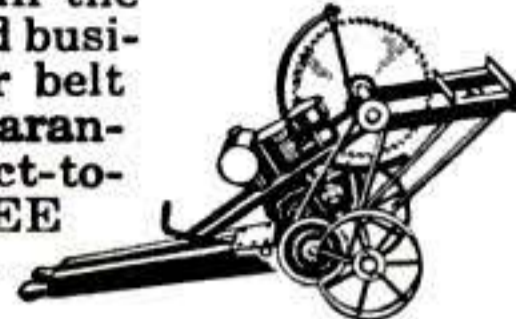
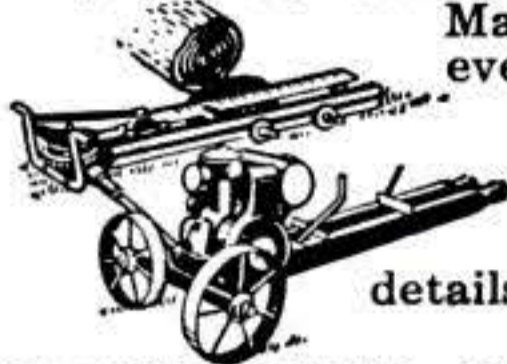

OTTAWA MFG. CO., 2-701 Pine St., Ottawa, Kansas

NOW! BOAT OWNERS

The GYRO FLUX GATE COMPASS System

Available to you. Complete, ready to install. This remarkable unit which is used to navigate large airplanes cost many times our price. Works with your electrical system. Consists of transmitter, master indicator, amplifier, remote electrical caging drive, switch box, repeater indicator.
Yours for only \$298.50 complete, with instructions. Also Directional Vacuum-driven Gyros—\$25.00 ea.

CLARENCE CARRUTHERS, INC.

79 Wall Street

New York 5, N. Y.

PLASTICS

Get started now in a profitable business or fascinating hobby. Write today for **FREE** list complete plastic kits, complete plans for plastic projects and plastic accessories.

supplies for fabricating and casting, plastic kits, complete plans for plastic projects and plastic accessories.

CENTURY ENTERPRISE

Box 56-PS, Station A

Los Angeles 31, Calif.

12 lbs. SURPLUS RADIO PARTS \$2.00

A gold mine of parts for repairmen, amateurs, and experimentors . . . sockets, condensers, resistors, transformers, coils, hardware, wire, etc., etc. An outstanding bargain in usable parts! Send \$2.00 cash, check or M.O. today! (Pay small express charges on receipt.)

ELECTRONIC PARTS, Inc.

Dept. S-7, 622 W. Randolph St., Chicago 6, Ill.

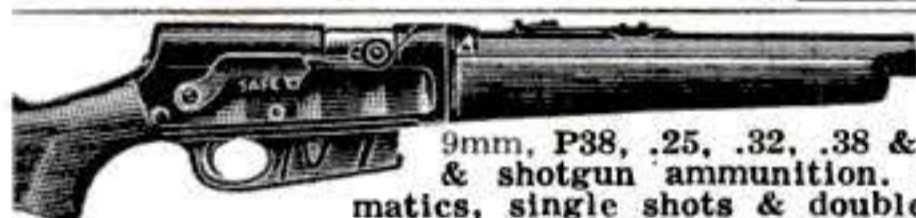

COLT & LUGER AMMUNITION

9mm, P38, .25, .32, .38 & .45 pistol & revolver & rifle & shotgun ammunition. New guns, repeaters, automatics, single shots & double barrels. Send 70c for gunsmith course and guns and ammunition catalogue and journal.

NEW YORK CO., BLOCK 300, RIDGEWAY, PENNSYLVANIA

**Fistula May Often
Result From Piles**

**FREE BOOK — Gives Facts On
Associated Ailments**

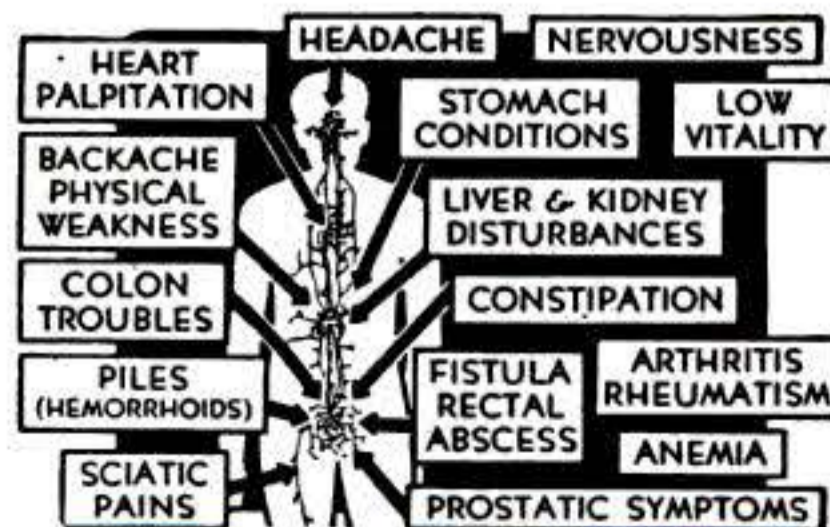

A new, illustrated 40-page book on Fistula, Rectal Abscess, Piles and other rectal and colon disorders is now **FREE** to all sufferers. Write today—a card will do. Thornton & Minor Clinic, Suite 749, 926 McGee St., Kansas City, Mo.

WAR SURPLUS

For the Sportsmen—Young or Old
All Year 'Round Use



Perfect all wool
Olive Drab
SLEEPING BAG

Comes in handy for fishing trips, hunting, camping, boating, just roughing it or use as auto robe and many other purposes. Has warmth of 2 blankets; zipper slide fastener; tie-strap on bottom; approx. Gov't cost \$12.90, our price **\$3.95**

Outside Cover for Sleeping Bag—Water repellent.....\$1.89
ARMY PUP TENTS Perfect Without Pole\$2.95

New Air Corp SUNGLASSES

Manufactured by Bausch & Lomb for U. S. Air Corps. Quality and Style with bone nose cross bar, individual case. Priced at big savings which includes postage.... **\$8.95**

WATER PURIFIER—"Sunstill". New, Used by Air Forces and Navy to distill salt water into FRESH DRINKING WATER. Original Gov't cost, approx. \$70.00—Our price..... **\$9.95**

Pump Type GARDEN & TREE SPRAY
Slightly used, perfect condition. Can be used also as fire extinguisher, whitewash spray, etc. 4 gal. capacity **\$3.95**

Add 10% for postage—No COD—Send check or money order
AMERICAN SUPPLY CO., DEPT. P.S., 5TH & BROADWAY KANSAS CITY, MO.

3 NEW PLASTICS MANUALS

FABRICATING
CARVING
CASTING MANUAL
Now Only **\$1.00**

Make beautiful objects of Plexiglas, Lucite, Catalin, Polystyrene and Castolite at home. Jewelry, novelties, accessories. Three new manuals show how to fabricate, cast and carve. 20,000 words, 23 special designs, 45 photos, charts, diagrams and hundreds of suggestions. Price prepaid \$1.00. **HOUSE BEAUTIFUL PLASTICS**, Dept. H-4, 5534 W. Harrison St., Chicago 44, Ill.

MAKE BIG MONEY AT HOME

Preserving baby shoes in metal, pearl, gold, silver, bronze. No experience necessary 500%-1000% profit. Your own business. **KIKTAVI CO., 8620 So. Ruthelen, Los Angeles 44, Calif.**

NEW AUTOMATIC IRON TESTER

Pilot light flashes on and off with thermostat. Invaluable for checking temperatures and accurately re-setting thermostats. Registers in fabric graduations—Rayon, Silk, Wool, Cotton, Linen. Also in degrees, 200° to 700° F. Has a specially designed precision thermometer; unsurpassed in quality, accuracy and performance. **ONLY \$18.50 postpaid. MONEY BACK GUARANTEE.** Write for circular. **HANLAN CO., 1419-B, West Jefferson, Los Angeles 7, Calif.**



(Pat. appl. for)

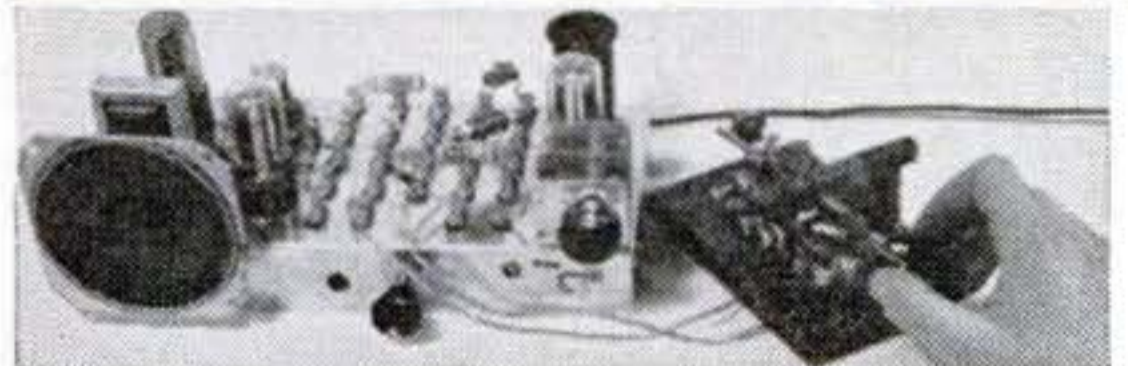

Magi-Klips Kit

Teach Yourself Radio & Electronics!
Build 18 Experiments Without Tools!
You've read about this radically new kit designed by former Navy radar engineers. Pre-wired chassis enables you to build 18 different circuits—radio receiver, code oscillator, home broadcaster, photoelectric relay, etc.—by "clipping in" basic components as directed in simply-diagrammed manual. 110 v. AC or DC. Kit's 58 parts alone would cost double this low price. Order your **Magi-Klips Kit** today and learn electronics quickly at home. Send for free illustrated folder to show friends interested in learning electronics this easy way!
\$29.75 Complete
DEER & TAYLOR COMPANY
Dept. M, 1340 Milvia St. Berkeley 9, California

FREE! Send for the chart that solves your gluing problems!

The CASCO GLUING CHART

GLUING JOB	GLUE PROPERTIES REQUIRED	RECOMMENDED GLUE
Assemble, disassemble, glue joints, joints and other exterior joints, joints	Complete water-resistance and durability. Bond hard to dry woods, etc.	CASCOPHEN
Glue of all types. Also water, oil, varnish and other water soluble materials. Cracks, filler and general patch-up	Complete water-resistance in salt water	CASCOPHEN
GENERAL JOINT GLUING... INTERIOR JOINTS, FOR INTERIOR JOINTS, FOR INTERIOR JOINTS	Minimum shrinkage, hard surface. Complete water-resistance and durability.	CASCOPHEN, CASCAMITE or CASCO (depending on material with wood glue)
WOOD JOINING JOINTS	High water-resistance and durability. Minimum-shrinkage and high strength.	CASCOPHEN or CASCAMITE
"BITTER" JOINTS, FACING JOINTS, JOINTS (See Note—"Water Materials Other Than Wood")	High strength, low pressure. Bond hard on all types of materials at low pressure.	CASCOPHEN or CASCO
WOODS	Low pressure bonding. High strength and moisture resistance.	CASCO FLEXIBLE CEMENT or CASCO (See chart below)
WOODS	Low pressure bonding. High strength and moisture resistance.	CASCOPHEN for interior woods. CASCO FLEXIBLE CEMENT for exterior woods.
WOODS	High strength and moisture resistance. Light, stain-free glue line.	CASCAMITE or CASCO

GLUING MATERIALS OTHER THAN WOOD

Classification of material:	NON-POROUS MATERIALS	HARD POROUS MATERIALS	SOFT POROUS MATERIALS
Non-porous materials: Glass, Veneer (See Note), Metal, Plastic, etc.	CASCO FLEXIBLE CEMENT with a primer coat (See Note 1)	CASCO FLEXIBLE CEMENT CASCO CASEIN BLUE	CASCO FLEXIBLE CEMENT CASCO CASEIN BLUE
Hard porous materials: Brick, Concrete, Tile, etc.	CASCO FLEXIBLE CEMENT CASCO CASEIN BLUE	CASCO FLEXIBLE CEMENT CASCO CASEIN BLUE	CASCOPHEN CASCO CASEIN BLUE CASCAMITE (See Note 2)
Soft porous materials: Canvas, Paper, Leather, etc.	CASCO FLEXIBLE CEMENT CASCO CASEIN BLUE	CASCOPHEN CASCO CASEIN BLUE CASCAMITE (See Note 2)	CASCOPHEN CASCO CASEIN BLUE CASCAMITE CASCO FLEXIBLE CEMENT

NOTE 1. See also... NOTE 2. See also... CASCO COMPANY OF AMERICA, Dept. PS-77, 350 Madison Ave., New York 17, N. Y.

Here it is! The NEW Casco Gluing Chart... yours for the asking. Shows you which glue to use for indoor constructions, outdoor projects, gluing metal to wood, fabric to plastic... any combination of materials.

It's big, easy to read, just right for pasting or hanging on the wall of your workshop.

With this Chart and the four great Casco Glues... CASCO CASEIN Glue—CASCAMITE UREA-RESIN Glue—CASCOPHEN RESORCINOL-RESIN Glue—CASCO FLEXIBLE CEMENT... you are ready to tackle any gluing problem...with the right glue for the job.

FREE Send for your FREE CASCO GLUING CHART

Casein Company of America, Dept. PS-77
350 Madison Avenue
New York 17, N. Y.
Please send me FREE the CASCO GLUING CHART.
Name _____
Address _____
City _____ Zone _____ State _____

Remarkable Invention QUICKLY INFLATES TIRES



**SIMPLE!
AUTOMATIC!
CLEAN!**

**Lightweight!
Handy!
Carry It
in Your Car!**

Don't put yourself on the spot with tire trouble! It's not funny to be caught with flats, small punctures, or a slow leak when help is out of sight and you're in a hurry.

NOW! BE PREPARED . . .

with the new, modern on-the-road emergency aid. Carry a handy, lightweight Diamond Emergency Unit in your car—the miniature-size steel cylinder containing compressed CO₂ that inflates tires instantly, automatically. Nothing to it! No pumping, towing, or struggling with dirty tools. Simply attach and open valve. In less than three minutes you can be on your way. Safe, odorless, stainless carbon dioxide even helps preserve tires.

PUT OUT FIRES, TOO!

(No car or truck engine is fire proof.) Crowds out oxygen in split second—smothers oil, gas, and electrical fires. Without even raising the hood—you can extinguish engine fires! Size—12 3/4" x 1 7/8". Weight—2 lbs., 6 oz. Get Diamond Emergency Unit NOW—only \$6.45.

SEND NO MONEY—Simply mail name and address. On delivery, pay postman \$6.45 plus C.O.D. charges. Order today or write for details.

THE AKRON LAMP & MFG. CO.

117 High Street

Akron 11, Ohio

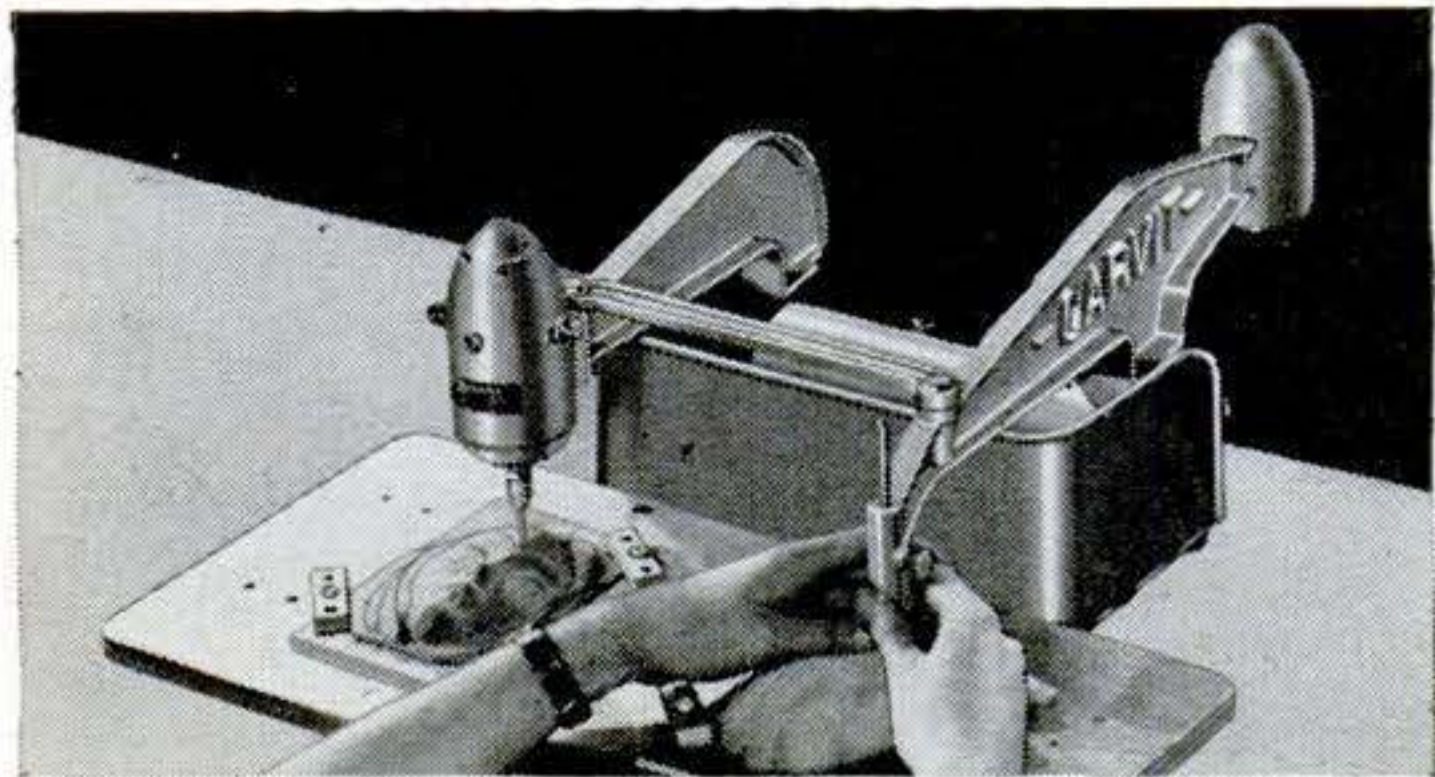

New! Sensational! Carvit makes you a skilled wood carver in 20 minutes!



Here's a fascinating new hobby — complete in one tool! The unbelievable perfection of your first carving amazes your friends! Experienced craftsmen use the Carvit to give their projects that professional touch.

With the Carvit, you make beautiful replicas of inexpensive objects you can find in any dime store or gift shop — in mahogany, walnut, and other fine woods: useful ornaments for your home, distinctive gifts for your friends — fine carvings that sell!

TEAR OUT THIS COUPON AND MAIL TODAY!

The Dumore Company, Dept. G-52, Racine, Wis.

Please send complete information on the Carvit.
 Please send one Carvit. \$48.50 enclosed. Shipping charges C.O.D.

Name.....

Address.....

City..... State.....

H-3

Make Your Car or Truck A PORTABLE POWER PLANT This Easy, Economical Way!

ASPEN DRIVE-ALL gives power when you want it . . . where you want it! Just line up with rear wheel, drive on to unit, and you're set for work! No jacking up or demounting! Use the rugged DRIVE-ALL for all belt-driven operations requiring up to ten h.p.!

**LOW-COST
ACCESSORIES—
Generator; Grinder
Centrifugal Pump.**

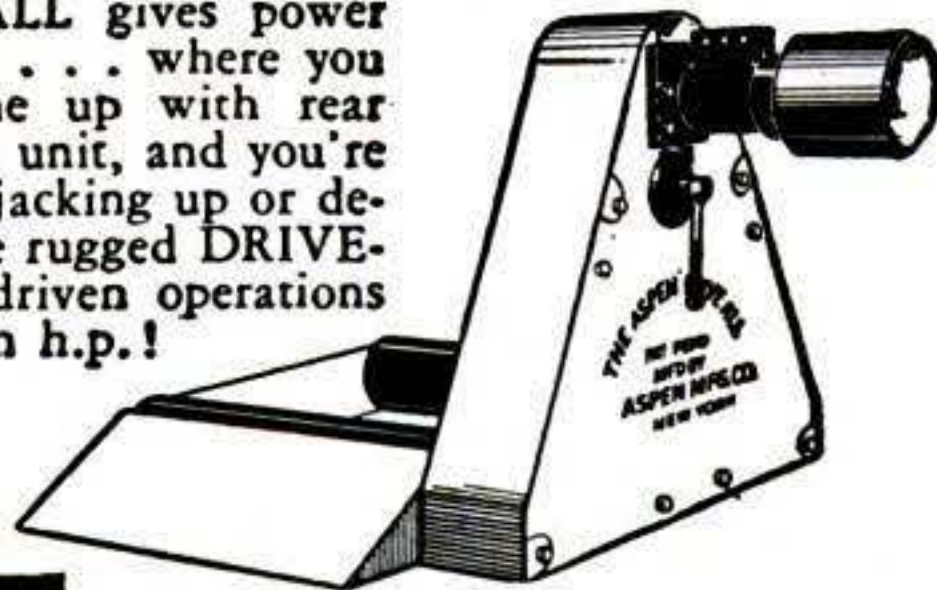

**Aspen
DRIVE-ALL**

FREE! Write today for illustrated folder and full information to: Aspegren Mfg. Co., Inc., 1612-B Webster Avenue, Bronx 57, N. Y.

**HOW
to Make
ART
OBJECTS
with
RUBBER
MOLDS**

**NEW
MOLDING
MANUAL
10c**

NOW READY FOR FIRST TIME Natural Rubber Latex FOR BETTER MOLDS

MOLD MAKERS: Now for the first time since the war, you can get superior natural rubber molding compound at new low prices. Natural Rubber gives you best physical properties; 70% concentration, high elasticity, freedom from permanent set, unusual elongation. Use FRANCIS Natural Rubber Red Latex to make longer-lasting molds. At our reduced prices you can produce more and better casts per mold, at lower cost. New Illustrated Instruction Manual, showing how to mold and produce valuable novelties, gifts, accessories, mailed for only 10c (stamps or coin). Price list free. Francis Supply Company, Dept. H-3, 1836 East Fulton St., Columbus 9, Ohio.



THE WORLD'S ONLY

"SKY-FLYER"

Stays in the
Air for Hours
Over 1000 Ft. Altitude

GAINT 4FT. PLANE
Travels Without A Motor

Thrills . . .
Fun Galore
For Young & Old

STUNTS

Mail Your
ORDER NOW
Write Name Plainly
and Enclose \$1.00

Very Simple to Assemble
• Ready Cut & Color Marked
AGENTS WANTED

**PRICE
PER PLANE
\$1.00**
Postpaid
in U.S.A.

AMERICAN DISTRIBUTORS CO.

Dept. S, P. O. Box 216, Roosevelt, L. I., N. Y.

PARACHUTE CANOPIES

White Nylon—Over 50 sq. yds. Excellent for all kinds of garments. **\$15.95 postpaid.** Write for Free War Surplus Catalog!

Send check or money order to: **PACIFIC FUR & WOOL CO.**
War Surplus Dept. Box 926-PS Sacramento, Calif.

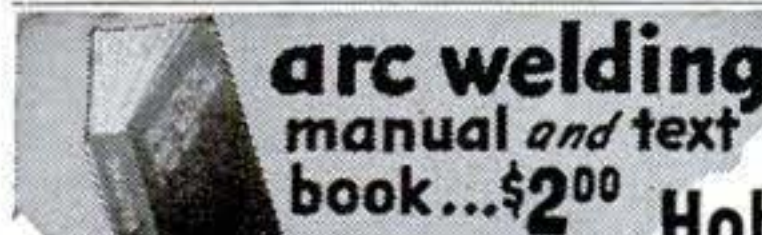

**arc welding
manual and text
book...\$2.00**

Teaches you how to become an arc welding operator — one of highest paid trades today. Write today!

Hobart Bros. Co., Box P-562
Troy, Ohio

POWER LAWN MOWER

**BUILD ONE YOURSELF
FROM YOUR OLD MOWER**



We supply complete attachments that fit any make or size of mower, with or without 1 H.P. gas engine. Easy to install in less than an hour. No more back breaking mower pushing. Immediate delivery, at low prices.

MONEY BACK GUARANTEE

You'll be delighted! Complete satisfaction or your money back. Write for

FREE FOLDER
Dealers Wanted.

ROYAL OAK LAWN MOWER SHOP
P.O. Box 48 Royal Oak 1, Mich.

SAVE UP TO 85% in WAR SURPLUS... SENSATIONAL VALUES

at "GADGETEER'S HEAVEN" IN MANY ITEMS WE HAVE THE WORLD'S LARGEST SUPPLY

New Hydraulic Cylinders

VALVES, PUMPS, FITTINGS, HOSE & TANKS

The World's Largest Supply. 1001 Labor Saving Adaptations for pulling, pushing, lifting operations.

Finest precision workmanship and materials. Liquid and/or air operation, developing terrific power.

15% OF GOVERNMENT COST! Write for Catalogue



A Real Buy!

A 1001 USES! WINCH HOIST

Capacity 2500 lbs. Controlled worm gear drive winch, with 19 ft. 1/4" diam. alloyed steel cable. Ideal for garages, truck loading, machine shops, boat building, etc.

#100A Without handle \$10.75
#100 With handle \$12.50



BATTERIES

NEW! FULL STRENGTH For portable Radios, Signal Lamps, Boats, Electric Trains, etc.

#515 9 Volt 8 1/2 x 6 x 4 in. 3 run, 24 Volt Motor 79c
#515 90 & 1 1/2 Volt 69c
#517 67 1/2 & 1 1/5 Volt Battery 69c



PNEUMATIC GUNS

Pistol & Goose-neck Type

101 Uses: Chipping Riveting, Hammering, Breaking cement and Auto body work.

Chicago Pneumatic, Cleco, Ingersoll Rand Makes.

E3, E2, 3X, 2X, OY \$55 Value \$8.95

#186 Squeezer PNEUMATIC ALLIGATOR SQUEEZER \$80 Value \$15.95



MESS TRAY

6 COMPARTMENTS Rustless, Stainless Steel. Can be used for cooking as well! Ideal for restaurants. The perfect companion for that vacation trip, barbecue picnical. Saves dishwashing.

#311 69c ea.



PLEXIGLASS DOMES

15"x19 1/2"x6" deep. 1/4" thick.

Can be used for home hot-house, fish bowl, washbowl, ornamental light. Can be flattened in oven and will make flat sheet, 15"x19 1/2" x 1/4". Weight 3 1/4 lbs.

#700 \$1.69

Also 200,000 lbs. of other plexiglass sizes and shapes.



NEW Amplidyne Motor-Generator

With 24 volt current, it gives 80 volt output. This unit has been adapted to independent and rural lighting power.

Welding and many other uses. Weight 28 lbs. Gov't. Cost Approximately \$237.00

#511 \$8.95

A Steal at \$8.95



AIR DRILLS

CLEVELAND THOR CHICAGO PNEUMATIC 1/4" JCB Chuck

Straight \$17.95
Angle Drill \$19.50



WINDSHIELD WIPER KIT

1/6 H. P., 24 volt, D. C. series wound motor, with 30" flexible shaft, switch circuit breaker, 10,000 forward or 5,000 reverse R. P. M.

Wiper & wiper bracket, arm blade & switch.

only \$7.95



PLASTIC CRAFT KIT

24 PIECE Make beautiful Jewelry, boxes, bookends, etc. for Pleasure or Profit! Kit contains Lucite & Plexiglass material. 3 colors of dye, cement, and book of projects and easy-to-follow instructions for cutting, fabricating, carving, drilling, dyeing, etc.

#701 \$2.39



OPTICAL GYROSCOPE!

MARK 18 GYRO-SIGHT

An engineering marvel worth hundreds of dollars! - Our Price \$8.35

Airforces Gun-Sight, #103 N8A, with polarizing variable density \$2.95
L3 Type, #102, Triple Lense \$1.95



ELECTRIC DRILLS

CLARK and THOR

110 V. A.C. 50, 80 cycle. 1/4 drill bit & JCB Chuck. Both side and trigger handle. High Speed. For commercial or home use. The best there is. Gov't. Cost Approx. \$60.00

A TERRIFIC VALUE \$17.95



COMPASSES

#151 Marching, lensite, with luminous dial \$1.69
#152 Matchbox, both jewel & liquid floating dial 39c
#153 Jeweled Pocket Watch Compass \$1.19
#154 Wrist strap Compass 69c



Electric GYRO PILOT

Assembly Part 2 solenoids for reverse and forward motor control. 2 solenoids throw clutch to engage drive. With brake assembly. Can be used as boat rudder control, converted for lathe tapping and slow speed motor tool, wt. 29 lbs. Finest precision workmanship

Cost Gov't. Thousands!
Your Cost \$8.95



1/3 to 1/5 Gov't. Cost (approx.)

Air Corp Fleece-lined LEATHER JACKET

To keep you warm in the coldest wind.

- Made to last practically a lifetime.
- Full sheepskin felt
- Fleece-lined collar.
- Leather taped seams.
- Full length zipper.
- 2 zippered, deep, slash pockets.
- Adjustable strap & buckle at throat.
- Type D-1. Styled for easy, bind-free action.
- Soft, pliant, "aviation tan" leather.

Made to U. S. gov't. specifications—"nul sed!"

Sizes: #401, small; #402, medium; #403 large.

YOU'VE NEVER SEEN THEM AT THESE PRICES. RECONDITIONED, CLEANED AND BRUSHED. PERFECT CONDITION) \$8.95 WHILE THEY LAST!



PRESSURE TANKS

Stainless steel, shatter proof. 400 lbs. /sq. in.

G-1 NEW 2100 CU. IN. 26 x 12 in #105 \$4.75
D-2 500 cu. #104 \$2.25



Valuable GEARS BARGAINS

8:1 Ratio Spindle Drive #110 \$2.98
4 to 1 with screw Shaft #111 \$4.95
5 to 1 Ratio Gear Reversible #112 \$3.25
85 to 1 (can be used for radio antenna, etc.) #113 \$4.95
2 to 1 Box gear type #114 3.95
1 to 1 #115 1.00
Flexible gear shaft with end drives 30" #115 1.00



All Purpose HAMMER

Ax & hammer combination for wood & metal work. 3 1/2 lbs. 14 1/2" hardwood handle, hard steel cutting edge. 69c

Compound METAL SNIPS Action Hard steel blades. Expansion spring. Locking device. Now \$2.59



SLEEPING BAG

NEW! 100% wool. Mummy type. Heavy duty 30" zipper.

Gov't. cost \$22.00
\$1 extra for used water repellent cover.

#303 \$4.95



ELECTRIC SOLDERING IRON

#198 200 WATT "SOLDER MASTER" \$3.95
105, 110, 120 Volt Nul-Sed



RUBBER GOODS

RUBBER PAD 24 x 24 in. 1/4" thick. \$1.95 Soft & springy. Ideal foot-mat for workers who stand on their feet - Cashiers, Demonstrators, machinists etc.

NEOPRENE SHEET RUBBER

Thickness	Width	Price per yd.
.015"	1/64 36"	\$.60
.020"	1/64 36"	.75
.037"	1/32 36"	1.25
.064"	1/16 36"	1.75
.175"	3/16 42"	6.00



LEATHER FLEECE-LINED BOOT INSERTS

For hunting or around house as slipper. sizes: medium.

\$7.00 Value \$1.89 pr.



COMPRESSOR

complete with tank and fittings. G. E. 2-stage, A.C. or D.C. 1/3 h. p. 1000 lbs. sq. in. Spraying, laboratory use, inflating. NOW #506 \$17.95

Compressor and 24 volt motors can be adapted to 110 A.C. with transformers or 4 1000 heating elements. We stock both.

ELECTRIC MOTORS New 1/4 H. P. 27 Volt D. C. 24 Volt A. C. #500 \$5.45
#500 Can also be easily adapted to 110 A.C. by changing leads. We fur. direct & drawing for \$1. extra.

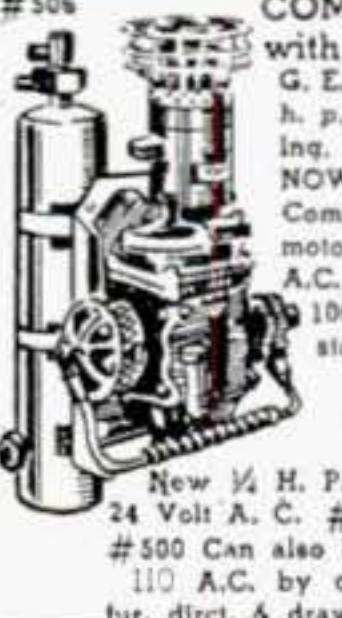

COMPARE THESE PRICES

#301 CANTEEN, 1 qt., alum. plastic top 29c
#305 GOGGLES, New, Colored Polaroid flexible lens. Shatterproof. 59c
Sponge Rubber Frame
#400 WORK HELMET, Alum., 12 oz. 59c
#510 & 511 Amp. & Volt Meters ea. \$2.50

GADGET MIX

Rivets, spacers, nuts, clamps, bolts, gears, Radio parts, etc.

A gold mine #100 5 lbs. \$1.19

Fire Extinguishers

KIDDIE LUX CO2 TYPE

Built to Government Specifications. 4 lb Trigger Control with horn. Fully recharged. \$30.00 Value \$10.75

2 LB. CO2 TYPE Value \$22.50 \$8.75
7 1/2 lb. Unchg. Nozzle Control. Value \$70.00 \$7.50

Independent for small or large planes, trucks, auto, home, factories, etc.

NEVER AGAIN A BUY LIKE THIS!



JEEP CAN

Water & Gas Perfect Condition

Perfect on motor trips, camping, etc. Easily carried, fits into narrow space, sturdily built.

5 Gal. 89c

Flexible spouts available with order of cans 39c ea.



BEARING MIX

Needle, ball and roller bearings in excellent assortment. Sizes from 1/8" to 2".

#170 Introducing this shelf treasure - Assortment of 15 Bearings at \$2.95



CLAMPS

#120 Adel Aluminum, rubber lined. Mixed. #121 4 dozen 89c
#121 Aero-Seal. Rust Resistant. Slotted with screw gear top. 1/2" to 3". #120 Regular 27c

Now 10c \$1. doz.



313 BOAT FENDER

21 in. long 5 in. diam. Protection against docks for small boats.

\$6.50 VALUE A STEAL AT \$1.95

9/16" JUTE ROPE 3 Thread Strand. Right Lay. 50 Ft. 79c
7/8 SISAL ROPE 50 Ft. \$3.59
5 lb. Ball 3/16" Hemp Twine Treated \$1.49



ORDER DIRECT FROM THIS AD

All sales final. Make remittances by money-order, bank draft or personal check. Purchase orders acceptable from D & B firms. All quotations F.O.B. Los Angeles. BIG ILLUSTRATED CATALOGUE AVAILABLE. Send 25% deposit with C.O.D. orders. Also Aircraft Supply Catalogue

SAFETY BELT

New, Original Box, Type B-14 Lap Safety Belt. Adjustable - full length 48", width 3". Forged steel, fool proof safety catch. Ideal for planes, jeeps, fun rides, farm equipment, etc. Try to beat this at 99c





"In the new 4-passenger Crosley convertible I think we've struck a note in harmony with the youthful heart!"

Powell Crosley Jr.

PRESIDENT, CROSLY MOTORS, Inc.

Have you a flair for youth and beauty? Then the new fine CROSLY Convertible is the car of your dreams! One ride will prove it.

Here's big-car roominess, ample for 4 husky 6-footers, plus baggage. An easy-to-manage top that snaps into a snug weather-proof in a jiffy. Real CROSLY economy that won the fine CROSLY Sedan a place in America's warm heart! CROSLY COBRA (Copper BRAzed) steel engine, of course — that 59 lb. 4-cylinder, valve-in-head powerhouse that gives 35-50 miles on a gallon of ordinary gasoline; speeds up to 60-plus. And typical CROSLY maneuverability, pick-up, sure-footed nimbleness! The new fine CROSLY Convertible is The Youth-Car-Of-The-Year. Clever new type convertible cloth top. See it today!



EXAMINE THESE FEATURES. ALL STEEL body, low center of gravity, great safety factors, MODERN Streamlining, "the Aircraft Flavor" gives extraordinary beauty. CAR WEIGHS only 1150 lbs., curb-side; perfectly balanced, weight-to-power. EASY DRIVING, virtually "parks on a dime"; oversize shock absorbers. MORE MANEUVERABLE in traffic; 20 inches narrower than most cars. ECONOMY that's almost unbelievable; speeds to 60-plus.

For information and literature write:
Crosley Motors, 2532-JB Spring Grove Ave., Cin'tl 14, O.

WORLD'S LOWEST PRICED ADDING MACHINE

**VEST POCKET SIZE
IDEAL FOR BUSINESS OR PERSONAL USE**

FREE TRIAL
ONLY \$2.50
TOTAL COST

SEND NO MONEY

Each Baby Calculator in Beautiful, rich-looking Leatherette case—at no extra cost.
FREE!!



Fits vest pocket or purse. Guaranteed accurate. Operated as easily, and as reliable, as machines costing many times as much. Not a toy. Substantially made of 28-gauge steel—guaranteed for life against defects in construction. You positively can't buy a calculator of equal quality for as little money. **ACCEPTED AS THE FINEST LOW PRICED CALCULATOR FOR OVER 30 YEARS!** Operates with a flick of your finger. Adds, subtracts, multiplies, divides—counts up to ten million. Pays for itself over and over in mistakes avoided, and time saved. **MAKES IDEAL GIFT.**

Sold on a positive money back guarantee. Send only \$2.50. Calculator sent postpaid, or send name and address and pay postman \$2.50 plus postage. **MONEY BACK IN 10 DAYS IF NOT DELIGHTED!** (If outside U. S., send \$3.00.) **AGENTS WANTED.**

CALCULATOR MACHINE CO., (Mfrs.)
Dept. 480 P.O. Box 248, Glenview, Illinois

The SPEED SAW FILER

Saves You Time, Money

Now you can do expert saw filing at home. Lifetime tool makes precision filing easy for even the most inexperienced. Two simple adjustments make it fit any type hand saw. Keep your saws extra sharp and true-cutting with a Speed Saw Filer. Complete with file, ready to use. Money back guarantee. Cash with order, prepaid (C.O.D. postage extra.)

THE SPEED CORP.
2025-B N.E. Sandy, Portland 12, Ore.



ORDER NOW!

\$2.95

A GREAT SURPLUS BARGAIN REDUCING GAUGE

The buy of a lifetime in a standard make air pressure regulator. Used on liquid carbonic tanks and air pressure tanks of all kinds to regulate the pressure. Fitted with standard 1/2 inch pipe thread. Dial calibrated 0 to 200 lbs. Made by U.S. Gauge, Air Reduction Co., Walter Kiddle — all famous makers. Used by artists for air brush work, sign painters, retouchers, etc. Used by soda fountains and taverns. All units are brand new. Satisfaction guaranteed.

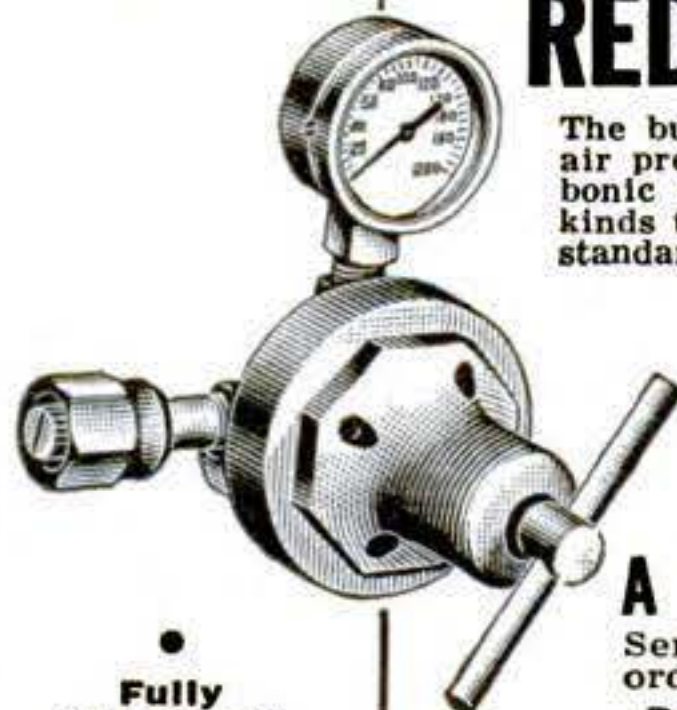

A \$15.00 Value **\$5.95**
Send check or money order. Ship same day.
Postpaid in U.S.A.

Fully Guaranteed

All Brand New and in Perfect Condition

GROBAN SUPPLY CO.
1522 So. Michigan Ave. (Dept. PM7) Chicago, Ill.

**FIND OUT WHY THE DEAF
CALL THE**
Beltone
A "MIRACLE"
Write for FREE BOOKLET
BELTONE HEARING AID CO., Dept. PS-77
1450 W. 19th Street, Chicago 8, Ill.

PLASTICS

WORK IN A FASCINATING AND PROFITABLE HOBBY
We carry a complete line of plastic supplies and accessories. Send 10c for our latest catalog and fabricating manual.

HOUSE OF PLASTICS

8648 Linwood MO Dept. Detroit 6, Michigan

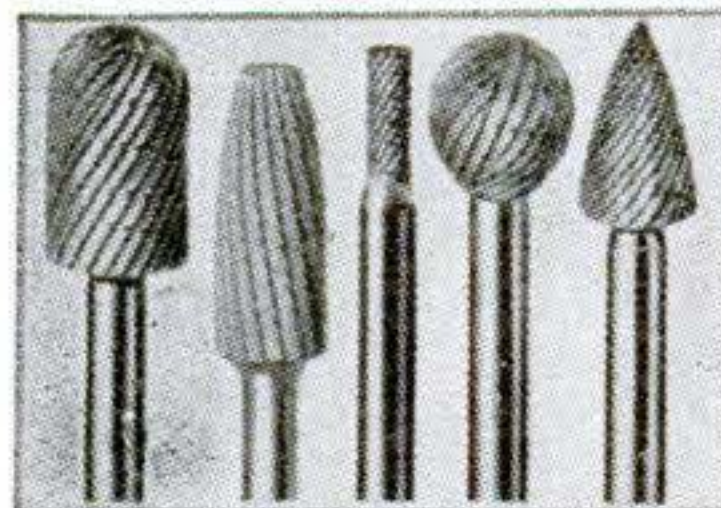

HIGH SPEED ROTARY FILES

Set of 5 Assorted.....\$2.00
Set of 10 Assorted.....\$3.75
Set of 20 Assorted.....\$7.25
Set of 30 Assorted.....\$10.00
1/4" shank

Send for circular on High Speed DRILLS & TAPS. Enclose 3c stamp for mailing.

SID TOOL CO.
MACHINE SHOP SUPPLIES
183 Grand St., New York 13, N.Y.

REAL RELIEF FOR RUPTURE



Thousands of wearers tell of **real relief.** Scientifically shaped, made of strong washable materials, gives the **RIGHT** support **WHERE NEEDED.** Satisfaction **GUARANTEED.** Write for **FREE** literature **NOW.**

The WEB Truss Co. Dept. S-16, Hagerstown, Md.

Ask For
the
Genuine

ZIPPO
Windproof
LIGHTER



\$2.50
\$1.00 extra
with signature
or initials

LIFETIME GUARANTEED BY ZIPPO MFG. CO., BRADFORD, PA.

BUILD THIS CONCRETE BLOCK MACHINE

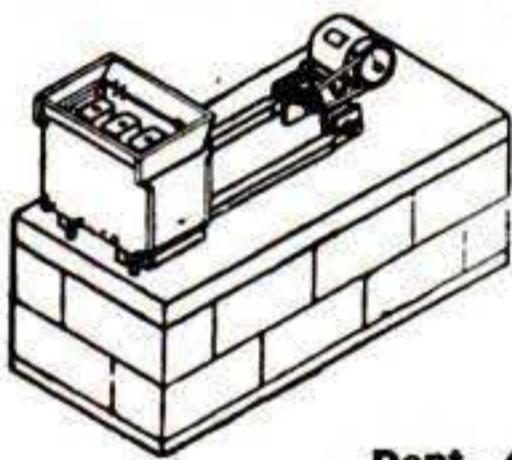

Sell blocks; or build your home, garage, barn, or filling station at 1/3 cost by making and laying your own blocks.

This simple machine which you can build yourself at a cost of \$15 (excluding motor) will make a block in 30 seconds using only one form. Mass production can be achieved by a new simple method of removing blocks which allows two to four forms to one vibrator. Power driven concrete mixer plans also. Send dime for details and "How to Make and Lay Blocks" folder.

U-BUILD-IT SERVICE

Dept. 4-A, 206 West Wilder St., Tampa 3, Florida

NONE BETTER!

SUPER DRILL GRINDER



Sharpens round shank drills from 3/32" to 1 1/16" in diameter, up to 11" long. Grinds old drills like new in 4 different point angles, using hand or power grinding wheels. Money-back guarantee.

Price only **\$2.95**

At Dealers or Postpaid

Crandall Mfg. Co. 1512 W. Slauson, Dept. FB-19 Los Angeles 44, Calif.



LOW COST PHOTO ENLARGERS

New improved **STARLIGHT ENLARGER** gives Better Results up-to-the-minute Features. Equipped with fine **ILEX ANASTIGMAT 3 1/2 inch F6.3 LENS** and **IRIS DIAPHRAGM**. Takes negatives up to 3 1/4" x 4 1/4". Makes Low Cost enlargements **ANY SIZE** for yourself or friends. Profitable easy business or hobby. Work at home. **COSTS VERY LITTLE** to own and operate. Write today for Free folder "S" giving full details.

PHOTO-SPHERE CO. INC.

115 EAST 23 ST. NEW YORK 10

Say You Saw
It In Popular Science

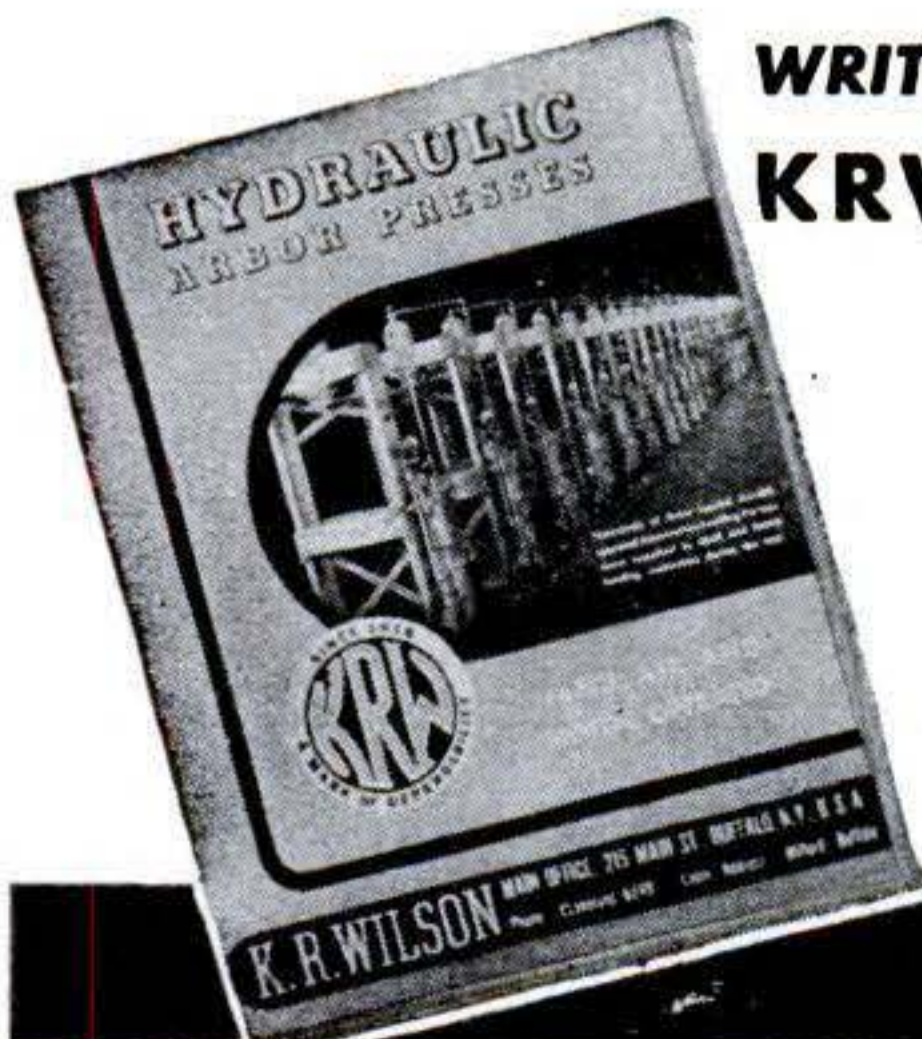

WRITE FOR YOUR **FREE** COPY OF THE NEW **KRW HYDRAULIC PRESS BOOK**

Describes all manner of Production and Shop Work on KRW Hydraulic and Bench Type Arbor Presses. 32 pages illustrating the new KRW Hand-operated, Electric-operated and Air-operated Hydraulic Presses.

Write for your copy today.



K. R. WILSON, DEPT. 54, 215 MAIN ST., BUFFALO 3, N. Y.

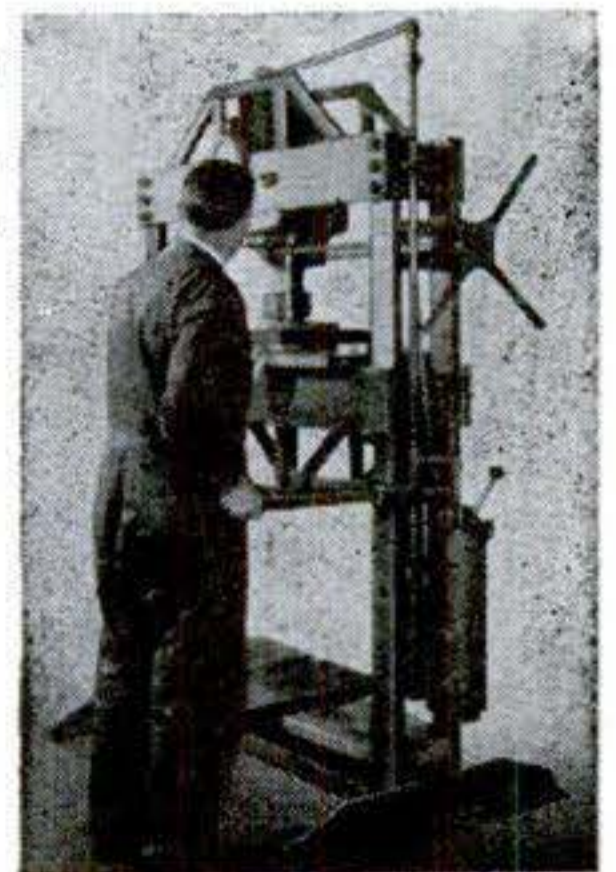

Announcing
THE BARRON DRUM SANDER FOR DRILL PRESS USE

Another new Barron development. Will fit any 1/2" drill press chuck, collet chuck, adapter or 1/2" I.D., Spindle. Has 1/2" ground steel shank, rubber cylinder, compression cups, light steel cylinder and full length arbor. Extra light in weight, runs smooth as a top. A fine, precision sander, complete with 5 sanding sleeves 2 1/2" dia. x 3" long. The first drum sander of its size and design ever offered at so low a price! Try it on our 10 day money back guarantee.



\$3.95

COMPLETE



\$7.50 COMPLETE

MULTI-PURPOSE DRILL PRESS PLANER

The greatest all-purpose drill press tool on the market. Planes, parallels, rabbets, routs, panels, beads, tenons, grooves, etc. **NO EXTRA BLADES TO BUY!** It's complete, ready to use. Does any or all operations without a single blade change or adjustment. Harmless to drill press. Safe, accurate, perfectly balanced. Over 75,000 now in use!

OTHER DRILL PRESS ACCESSORIES

- 4" ROTARY SURFACE SANDER \$5.95
- 1/2" DOVETAIL CUTTER \$1.85
- ALL-METAL AUXILIARY DRILL PRESS PLANING AND SHAPER TABLE \$9.85
- TAPERED AND THREADED SPINDLE ADAPTERS
- ROUTER AND ROUND END MORTISING BITS 1/8" TO 1/2" SET OF 6 \$9.50

Liberal 10 Day Money Back Guarantee

Workshop Guide FREE

BARRON TOOL CO.

570 Architects Bldg., Detroit 1, Mich.

BARRON PRECISION WORK SHOP TOOLS

USE YOUR BENCH SAW FOR JOINTING & CUTTING MOULDINGS

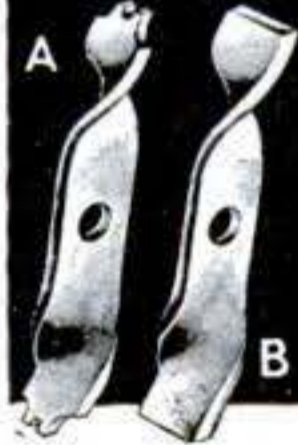

With our six inch tool steel cutters make mouldings, casings, drop-leaf tables, grooves beading and jointing. Moulding cutters, A 1 in. wide \$1.50, 1 1/2 in. \$2.00. Jointing cutters, B 1 in. \$1.50, 1 1/2 in. \$2.00. E 1 in. for drop-leaf tables, \$1.50. E 1 1/2 in. Makes 3/4 in. cove & Quarter. \$2.00. Postpaid. Guaranteed. State size hole. List & Folder free.

JOHN A. SANDSTROM
Clearwater, Fla.
Rt. 1-P.



Now A DYNAMIC Super-charged WELDER

IDEAL FOR AUTO • HOME APPLIANCE • FARM REPAIRS

BICYCLE REPAIRS

FARM IMPLEMENTS

SHOP WORK

HOME APPLIANCES

AUTOMOBILE REPAIRS

DESIGNED TO DO HIGH GRADE WELDING INEXPENSIVELY!
Maintenance Men; Farmers; Mechanics; Machine Shops; Foundries; Auto, General Repair and Job Welding Shops; all using the DYNAMIC find it so indispensable and useful that they cannot afford to be without it. If inexperienced you can easily learn to do a variety of high grade welding jobs by following the practical, simplified operating and welding instructions furnished. Once you see a DYNAMIC in operation, you won't want to be without it. Its simplicity will amaze you. In a year the DYNAMIC only costs you about 6c a day. Helmet, rods, cables, holder and operating instructions, etc., furnished.

SAVES YOU VALUABLE TIME AND MONEY!
This portable industrial transformer type DYNAMIC WELDER easily carried right to the job, can be operated from any convenient, properly wired **110 Volt, 60 Cycle Line**—has 8 metallic and carbon arc welding heat stages—does work you would think only possible with a larger more expensive machine. Can also be supplied for 220 volt, 60 cycle operation and other voltages and cycles at slight additional cost. Works on Iron, Steel, Brass, Bronze & other metals.

DYNAMIC WELDER CO., 13 East 23rd St., SG, Chicago 16, Ill.

ONLY
\$28.50
COMPLETE
Available Now
IMMEDIATE DELIVERIES

Write Today for Particulars
GET DETAILS on our 10 day Trial Offer.
Member Chicago Association of Commerce.

MORE PROFITS with MODERN LAWN MOWER SHARPENER



SHARPEN ANY LAWN MOWER from 5-inch Edger to 36-inch Power Mower in ten to twenty minutes with a MODERN LAWN MOWER SHARPENER because dismantling is unnecessary—neither handle, roller, wheels nor motor need be removed when sharpening any mower. . . . the MODERN SHARPENER eliminates all hand filing; it precision grinds to the extreme ends of both left or right reel blades. Bottom knife is held in same brackets for sharpening. **NO EXTRA ATTACHMENTS!** Order today! Price \$241.50 (less motor) f.o.b. Pasadena (1/3 or 1/4 H.P., single phase motor recommended.)

Modern Mfg. Co., 160 N. Fair Oaks, Pasadena 1, Calif.

GLOBE MILLER

Installed on your lathe in three minutes

DOES ALL TYPES OF MILLING . . . The Globe Miller does plain and angular milling, slotting, slitting, keyway cutting, dovetailing, spur gear cutting, rack cutting and many other types of work. *Increases swing of 10" lathe to over 16".*

CONTACT YOUR DEALER OR WRITE FOR DETAILED INFORMATION

Give make, model and swing of lathe when ordering or requesting prices

GLOBE PRODUCTS MANUFACTURING CO.
Dept. 10, 3380 Robertson Blvd., Los Angeles 34, Calif.

HUOT DRILL INDEX No. 29 \$3

KEEP YOUR TWIST DRILLS CONVENIENT AND SAFE.

HUOT'S ALL STEEL DRILL INDEX No. 29 holds twist drills from 1/16th to 1/2 by 64ths. **ORDER YOURS TODAY.** Huot makes a Drill Index for every need. Eleven Sizes. Write for details or see your dealer. Get No. 29 today—Send \$3.

HUOT MFG. CO. 553 North Wheeler ST. PAUL 4, MINN.



COMPRESSED AIR INSTANTLY, Anywhere!!



Portable Air Compressor and storage tank. Ruggedly built of best materials using lifetime lubricated ball-bearing on connecting rod and oil impregnated main bearing on shaft. Unusual design forever eliminates valve trouble, the most common fault in air compressors. **PATENTED** unique air intake system increases efficiency tremendously over other compressors so that air output is much greater than that from larger compressors powered by heavier motors. Will deliver approximately 3500 cu. inches of air per minute at maintained pressure of 30 lbs., or will inflate a 90 lb. truck tire in less than one minute. Comes complete with 100 lb. gauge, although finger-tip adjustment allows setting of output pressure at any value, which will automatically be maintained. Works from any 1/4 H.P. motor. Useful for spraying paints or lacquers, disinfectants, insecticides, annealing or brazing with natural gas, inflating tires, etc. Price \$14.50 postage prepaid anywhere in the U. S. Efficient, completely adjustable syphon type spray gun complete with 12 ft. of 100 lb. tested hose available for only \$7.75 with pint container, also prepaid. 25% required on all C.O.D. orders. Send for free catalogs of radio parts and surplus items.

BUFFALO RADIO SUPPLY; 219-221 GENESEE ST., DEPT. S7, BUFFALO, N. Y.

SANBORN SUPER-SONIC WHISTLE NO. 2



\$2.00

ACTUAL SIZE

NEW POWERFUL SILENT TYPE WHISTLE designed for the silent calling of dogs. Horses and other animals also respond with little training. Whistle has been calibrated by physicists at one of the country's largest technical universities. Humans can feel and hear Super-Sonic vibrations for a very short distance. It is estimated that most dogs can hear this whistle for one mile. The high pitch vibrations are in excess of 10,000 kilocycles per second. It can also be adjusted to an audible frequency that can be heard by man or beast for one mile. A scientific precision made instrument of quality, turned from aluminum alloy.

SANBORN PRODUCTS CO. P. O. BOX 132-G MENTOR, OHIO

ACT NOW and SAVE \$8.50 on This Shopful of Tools!

FAMOUS CASCO 23-Pc. *Portable* ELECTRIC WORKSHOP

SOME OF ITS 10,000 USES

IT ENGRAVES!
Engraves and designs accurately.

IT CLEANS!
Ideal for cleaning cavities.

IT POLISHES!
Perfect for polishing your silver.

IT CUTS!
Cuts glass or metal. Makes hand work easy.

IT GRINDS!
Grinds glass or metal to size needed.

IT CARVES!
Just right for carving, routing and shaping.

IT SAWS!
Slits and undercuts wood and plastics.

IT SANDS!
Quickly smooths and finishes.

IT BUFFS!
Cleans jewelry without damage or injury.

IT ETCHES!
Easily etches those difficult round solid lines.

IT DRILLS!
High-Speed drill. All-purpose. Ideal for home.

IT BRUSHES!
Flat and firm, it brushes, and cleans thoroughly.



All 23 Pieces For Only
\$14.95 POST PAID

REGULAR PRICE
Power Tool . . \$14.95
Accessories . . 8.50
Total Value . . \$23.45

You Save \$8.50

THE GREATEST VALUE EVER OFFERED TO HOME CRAFTSMEN—HOBBYISTS—MECHANICS

Whether you tinker for profit or to save money or just for the sheer fun of it—this new nationally famous Casco Power Workshop is practically made to order for you! The powerful 20,000 R.P.M. power-tool is dynamically balanced, designed to be gripped like a pencil for easy, one-hand operations. Its motor is sealed in a shock-proof Tenite case . . . oilless bearings . . . air cooled. Each of its twenty accessories make a completely different tool *in an instant!* No home, farm, shop or hobby-room is complete without this wonderful Power Workshop . . . and you owe it to yourself to get yours now at a *saving of \$8.50*. This offer is limited to our present supply . . . and we reserve the right to reject orders after our stock is exhausted. Yes, it's first come, first served—so you'd better ACT NOW before the sell-out! ORDER TODAY

PUT THIS SHOPFUL OF TOOLS TO WORK FOR YOU!



Valuable Project Booklet

Included "Things To Make And How To Make Them"

AT NO EXTRA COST

Here's a handy man's delight that's worth its weight in gold to folks who get a real kick out of making things with their own hands—and just think, it comes to you at *no extra cost* as part of your portable Power Workshop!

HERE'S WHAT YOU GET

* ELECTRIC POWER TOOL

- * 1 Rubber Polishing Wheel
- * 1 Felt Wheel
- * 1 1/8" Ball Cutter
- * 1 1/6" Speed Drill
- * 2 Collets
- * 1 Dressing Stick
- * 1 Wrench
- * 3 Bristle Brushes
- * 4 Emery Wheels
- * 2 Abrasive Separating Discs

SEND NO MONEY

MAIL COUPON TODAY

SANGERS — Dept. CW-7
325 N. Wells St. — Chicago 10, Ill.

Please send me the Genuine Casco Power Workshop checked off below. If not delighted I may return it in 5 days for refund.

The 23-piece Power Workshop complete with chest worth \$23.45 for only \$14.95—saving me all of \$8.50.

The 39-piece DeLuxe Power Workshop with Steel Chest and lift-out tray—a \$32.95 value for only \$22.50—saving me all of \$10.45.

CHECK I am enclosing \$_____ in full payment. Send postpaid.

ONE Send C.O.D.—I will pay postman \$_____ plus postage.

Name _____

Address _____

City _____ Zone _____ State _____



TO:

Reader

FROM:

Editor

"Technology— An American Export"

PSM's editors and friends celebrated the magazine's 75th anniversary at a birthday dinner on May 1 in the Waldorf Astoria. Robert P. Russell, president of Standard Oil Development Company, was a speaker. His subject was "Technology—An American Export." We think you will find these excerpts interesting.

AS a nation we are blessed with the fortunate combination of natural resources and the requisite technical skills to use them. This combination exists in few other countries. We attempt to help less fortunate nations through the large-scale export of goods, but I am convinced that to provide permanent aid we must add technological skill and knowledge to our material exports. Goods alone offer only temporary relief.

One field in which we are well equipped to do this is in agriculture and food production. Most of the world is perilously short of food. In many countries there are such shortages that the national diet is below the minimum level required to maintain the energy of the people. If everyone is to have enough to eat, the land must be made to yield the same or more food but with less and less labor for planting, cultivating, and harvesting.

Here is a situation in which our United States research and development organizations can render important service. During recent years several research organizations have devised remarkable new techniques for utilizing hydrocarbons for weed control—among the most effective being sprays of petroleum distillates of the type often used in dry cleaning. Not only can they be used to kill weeds without harming the crops, but they can be sprayed on the ground after seeds are planted but before they sprout for the destruction of weed seed. In this way, weed-free soil can be maintained without cultivation through an

entire season (PSM, July '46, p. 101.)

Weed control is the most important Central and Latin American agricultural problem, since climatic and soil conditions make weed growth amazingly rapid. In fact, weed control occupies the major part of the energies of farm labor throughout this enormous territory.

Recently I was privileged to see what was probably the first major field trial of some new synthetic weed killers when they were applied to a major Latin American crop—rice. The difference was spectacular.

Other food crops, too, could benefit greatly from the attention of U. S. technical groups. For example, a world shortage of chocolate and cocoa exists. Between the time the cacao pod is whacked off the tree with a machete and the time the finished bean is ready for shipment a third of the crop is often lost. The problem of cacao harvesting, cleaning and drying has, in fact, recently received the attention of a small group of fertile-minded, enterprising United States development engineers. Within a few months they succeeded in greatly shortening the time between the harvesting of the cacao pod and shipment of the finished bean, sharply cutting crop losses and improving quality.

We could help decisively to improve conditions throughout a vast area of our hemisphere by making new products such as these synthetic weed killers available to our neighbors and, more important, by sending to them the trained technical people needed for working out proper applications under varying local growth conditions. Our people could also apply locally their engineering knowledge to problems of food processing.

By giving a helpful technical hand, we can prove to all the world that our system of democratic, competitive enterprise not only works, but that it can contribute more to the well-being of people than any other system thus far devised. The lending of money and exporting of goods are not enough. In our own enlightened national self-interest we must study the economic problems of our neighbors and assist actively in solving them.

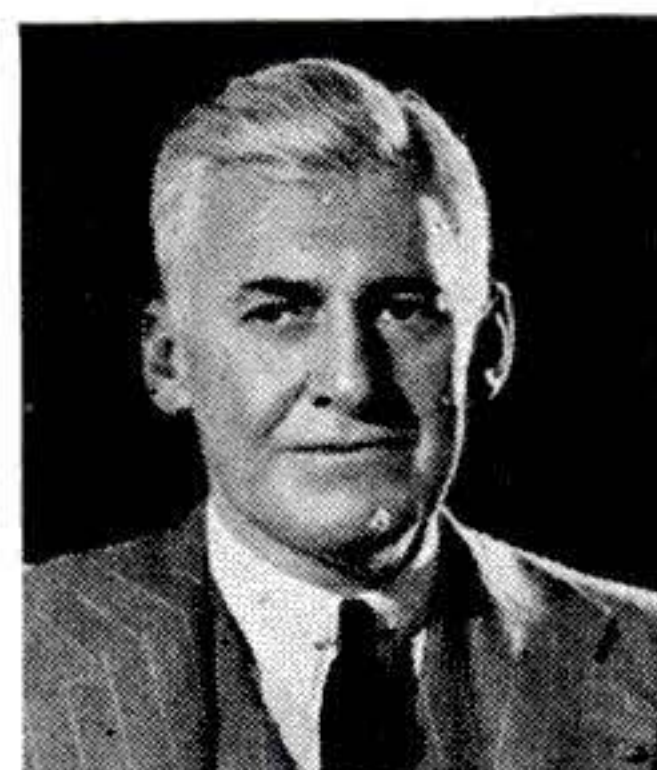

Robert P. Russell



Worn piston rings don't show, but they're more serious

WORN pants are harmless, but worn piston rings can cause real damage in your car. As soon as you notice excessive oil consumption, ask your Sealed Power franchise dealer to install a set of Sealed Power Individually Engineered Piston Rings. They save gas, save oil, lengthen engine life, restore original power.

Whatever the make, model or degree of cylinder wear in your engine, there is a Sealed Power Ring Set specifically engineered to do the best possible job for you. Sealed Power workers are proud of their product and its 36-year record of preference by leading car, truck and engine builders. See your Sealed Power Franchise Dealer. Send a postal for illustrated, informative new booklet on 7 ways to save oil. It's free and may save you lots of money.. Sealed Power Corporation, Dept. H7, Muskegon, Mich. In Canada: Stratford, Ont.

KEEP YOUR WAR BONDS! GET \$4 FOR \$3

For better results 26 Basic Ring Designs

No one piston ring design can meet all replacement needs. Sealed Power Individually Engineered Ring Sets are made up from twenty-six (26) basic ring designs, which permit each set to be specifically engineered to do the best possible job in a particular make of engine.

These ring sets are engineered to save oil without sacrifice of gas economy, to save oil without inducing friction and cylinder wear. Each set gives balanced performance in a particular engine.

Piston Rings
Pistons
Cylinder Sleeves
Valves
Water Pumps
Chassis Parts



©1947,
Sealed Power Corp.

SEALED POWER PISTON RINGS

BEST IN NEW CARS! ★ BEST IN OLD CARS!

SOUTH BEND LATHES

Simplify Precision Work

The ease with which South Bend Lathes can be changed from one set-up to another simplifies precision work. A wide variety of operations on special classes of work, ordinarily done on other types of machines, are readily performed by means of South Bend attachments. South Bend Lathes have wide ranges of spindle speeds for efficient performance on all materials. The quick change gear mechanism permits instant selection of any thread cutting feed, power turning feed, or power facing feed.



South Bend Lathes are made in five sizes—9" to 16" swings. Write for Catalog 100-F.

SOUTH BEND LATHE WORKS

BUILDING BETTER LATHES SINCE 1906

456 EAST MADISON STREET • • SOUTH BEND 22, INDIANA

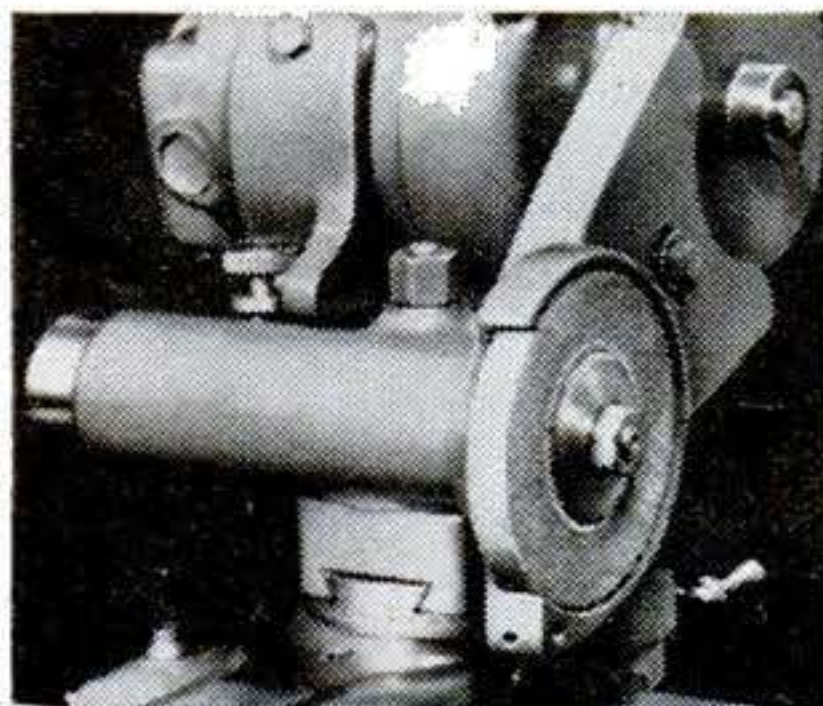

ELECTRIC GRINDER

One of the 60 available attachments and tools that give South Bend Lathes unmatched versatility.

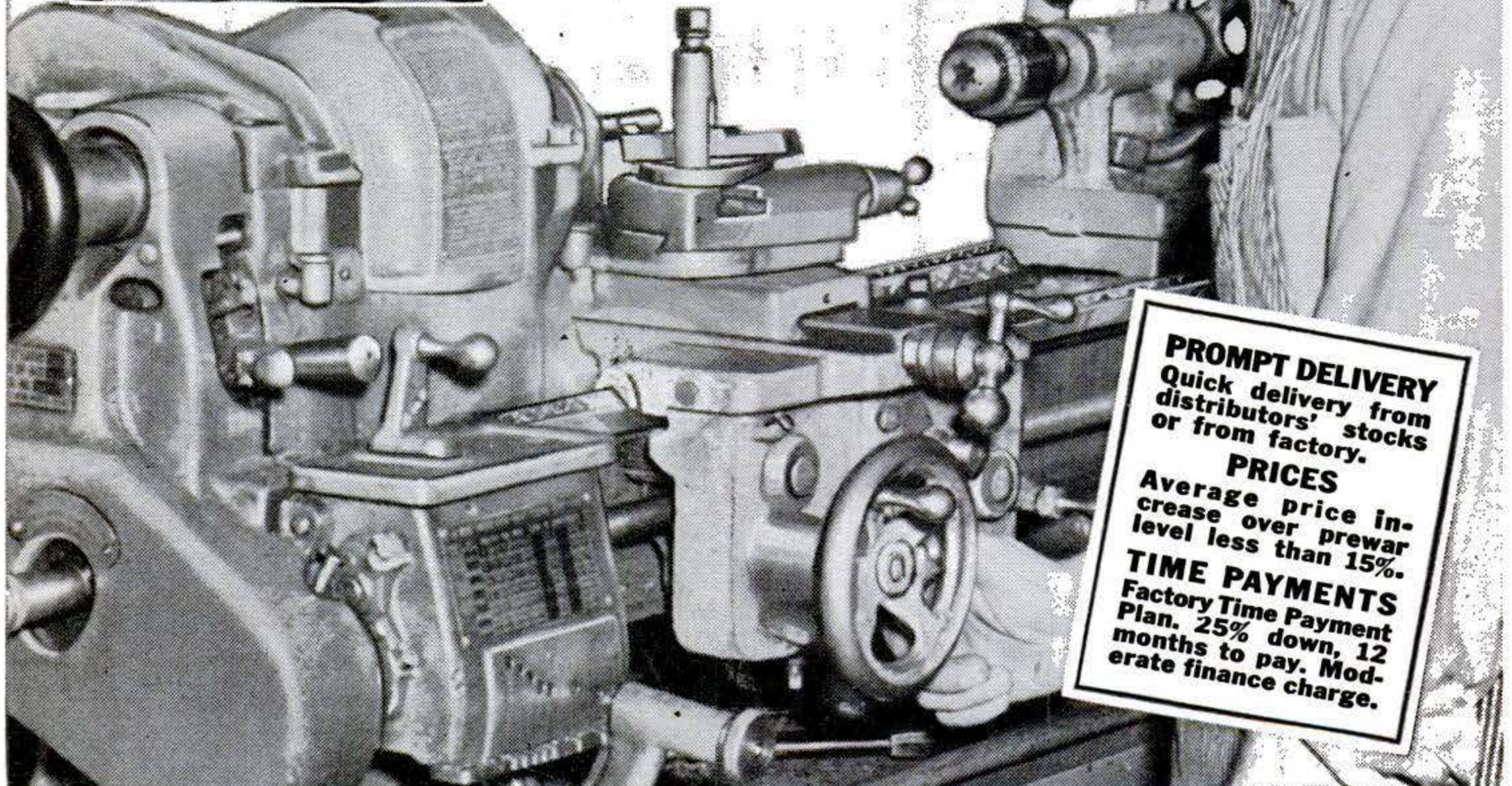

PROMPT DELIVERY
Quick delivery from distributors' stocks or from factory.

PRICES

Average price increase over prewar level less than 15%.

TIME PAYMENTS

Factory Time Payment Plan. 25% down, 12 months to pay. Moderate finance charge.

including SOUND and TELEVISION

COYNE

**COYNE HAS BEEN TRAINING
MEN FOR NEARLY 50 YEARS!**



For nearly 50 years, the great shops of COYNE have been turning out men and young men trained for better jobs in practical fields. COYNE graduates hold responsible positions in many leading electrical and radio firms.

Men with Physical Disabilities whether veterans or not can get Coyne Training at no cost for tuition or subsistence. Card brings detail.

B. W. Cooke



COYNE ELECTRICAL SCHOOL
Dept. B7-73H
500 So. Paulina Street
Chicago 12, Ill.

**CUT OUT AND MAIL THIS CARD
for FREE BOOK on Field You Prefer!**

B. W. COOKE, Director,
COYNE ELECTRICAL SCHOOL,
500 S. Paulina St., Dept. B7-73H, Chicago 12.

Send me your BIG FREE BOOK—for the Course checked below, and tell me about your special plans to help me. This does not obligate me and no salesman will call.

- ELECTRICITY**
- RADIO**

NAME.....

ADDRESS.....

CITY.....STATE.....

ELECTRICITY

- POWER PLANT WORK
- MOTOR MAINTENANCE
- ARMATURE WINDING
- HOUSE WIRING
- ILLUMINATION WORK
- APPLIANCE REPAIR
- INDUSTRIAL ELECTRONICS

- or RADIO

- RADIO MANUFACTURING
- TELEVISION WORK
- RADIO SERVICING
- PUBLIC ADDRESS SYSTEMS
- FREQUENCY MODULATION
- RADIO-PHONOGRAPH WORK
- SOUND EQUIPMENT

— or a Prosperous, Big-Future **BUSINESS OF YOUR OWN** in Either field!

 *Read Full Details Inside - -
Clip and Mail This Card Today*

**B. W. COOKE, DIRECTOR
COYNE ELECTRICAL SCHOOL
500 S. PAULINA STREET
CHICAGO 12, ILLINOIS**

Dept. B7-73H

Put 1c
Stamp
Here

LEARN EITHER

ELECTRICITY OR **RADIO**

.. In a Few Short Weeks in

GREAT SHOPS OF COYNE

**NOT "Home Study" Courses
... All Practical Training and
Necessary Theory Given in
Our Famous Chicago Shops**

Why spend years learning Electricity or Radio, when COYNE prepares you for good jobs in either field in a few short weeks? Our training not only saves time; you're ready to step into the better pay that much sooner. You make rapid progress because you work under expert instructors here in our great Chicago shops in the heart of the world's Electrical and Radio Center. We do not teach by mail. Select course you prefer and send post card TODAY!

Your Choice of 2 Big Opportunity Fields!

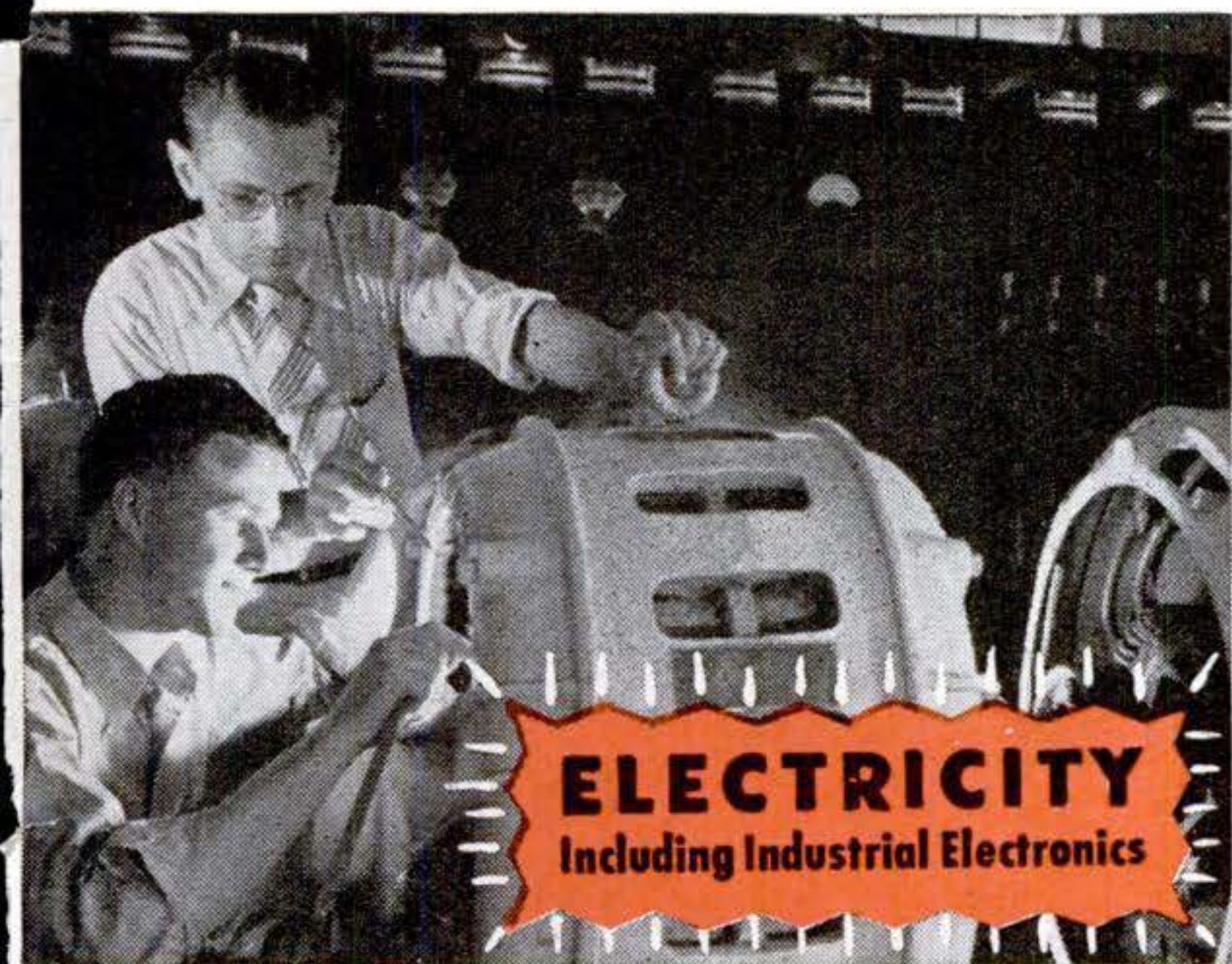

ELECTRICITY
Including Industrial Electronics



RADIO Including Sound and Television

ELECTRICITY offers you a big future in Power Plant Work, Motors, Armature Winding, House and Factory Wiring, Industrial Electronics, Home Appliances, Lighting, and more. All covered at COYNE. Here you get "all-around" Electrical training!

You use, test, repair full-size apparatus—just like you'll later handle on the job. Previous experience unnecessary.

FREE Electrical Book

Send now for big, illustrated book on COYNE Electrical Training. Many large pictures of our shops. Tells about Free Lifetime Employment Service to COYNE graduates. Other vital facts. Check post card for "ELECTRICITY" and mail today.

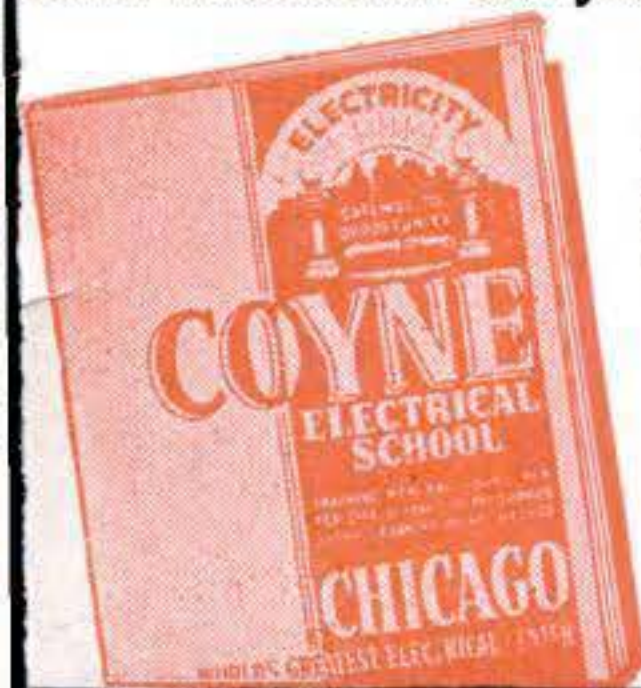

If you prefer **RADIO**, COYNE gives quick, practical training in Radio Construction, Testing, Repair; also Public Address, Sound Systems, FM, Television. Many branches of Radio open to you. Hundreds of COYNE graduates have successful Radio shops of their own. We show you how to start, how to build for a lifetime future. No previous experience required to take COYNE Radio course.

FREE Radio Book

Check card for "RADIO" to receive our big FREE book of photos and facts about COYNE Training in Radio, Sound and Television. Describes the vast new opportunities in this field, and how we make it easy to get ahead. Rush post card NOW.



VETERANS!

Coyne is authorized to accept veterans for G.I. training.

NON-VETERANS

can finance most of tuition and pay after graduation.

ADDED TRAINING

Electric Refrigeration training now included with either course. No extra charge.

MAIL CARD TODAY!

EXPERIENCE IS THE BEST TEACHER!

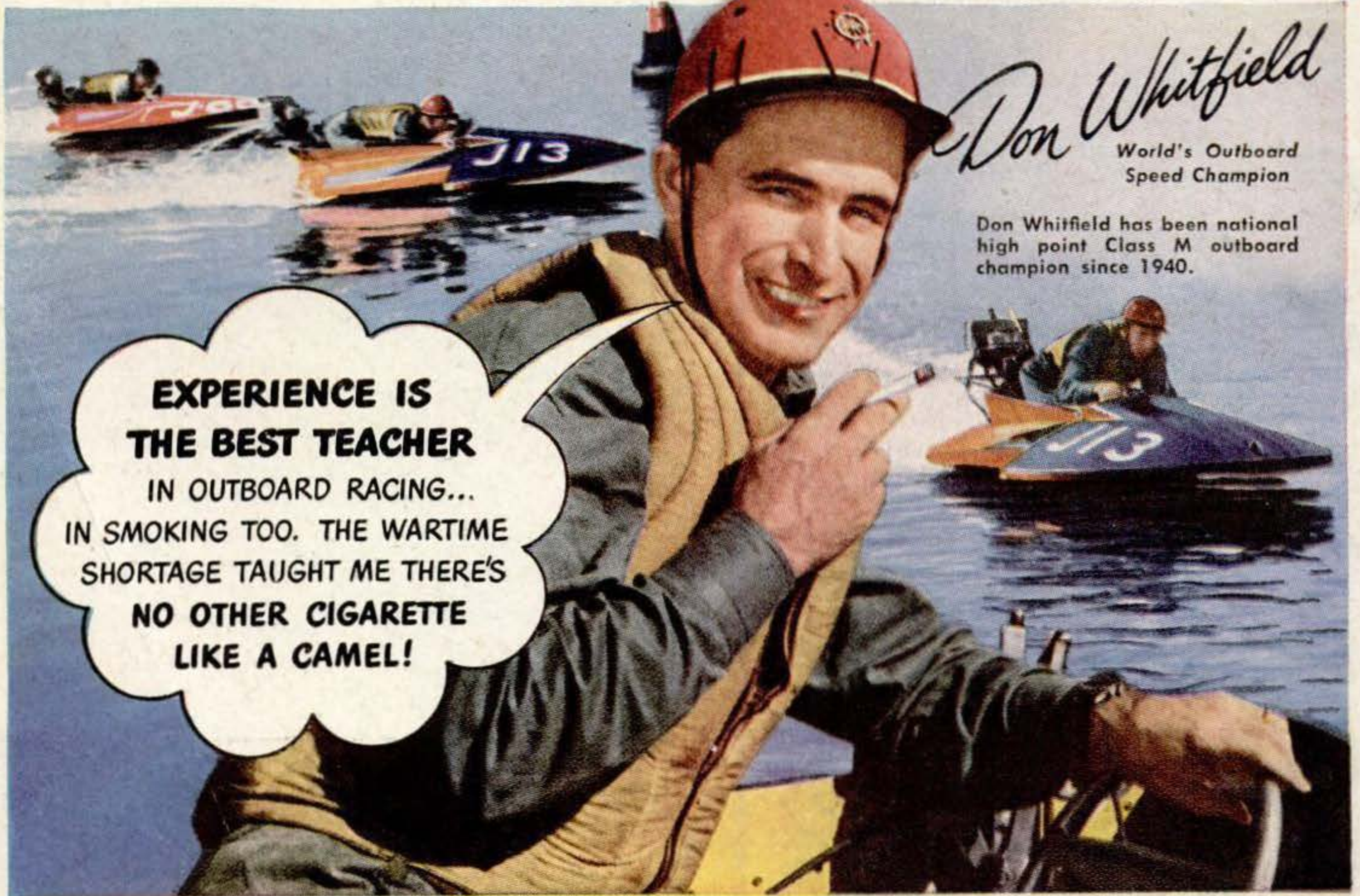

Don Whitfield
World's Outboard
Speed Champion

Don Whitfield has been national high point Class M outboard champion since 1940.

**EXPERIENCE IS
THE BEST TEACHER**
IN OUTBOARD RACING...
IN SMOKING TOO. THE WARTIME
SHORTAGE TAUGHT ME THERE'S
**NO OTHER CIGARETTE
LIKE A CAMEL!**

More people are smoking CAMELS than ever before!

Yes, like Champion Don Whitfield, millions who tried many different brands during the shortage now smoke Camels.



**YOUR 'T-ZONE'
WILL TELL YOU...**

T for Taste...
T for Throat...

That's your proving ground for any cigarette. See if Camels don't suit your 'T-Zone' to a 'T'!

• You know what it was like during the war shortage: you took any brand you could get.

That's when smokers discovered that Camel's rich taste and cool mildness added up to a pleasure you didn't find in any other cigarette. Today the demand for Camels is the greatest in history! But, no matter how great the demand:

We don't tamper with Camel quality. Only choice tobaccos, properly aged, and blended in the time-honored Camel way, are used in Camels.

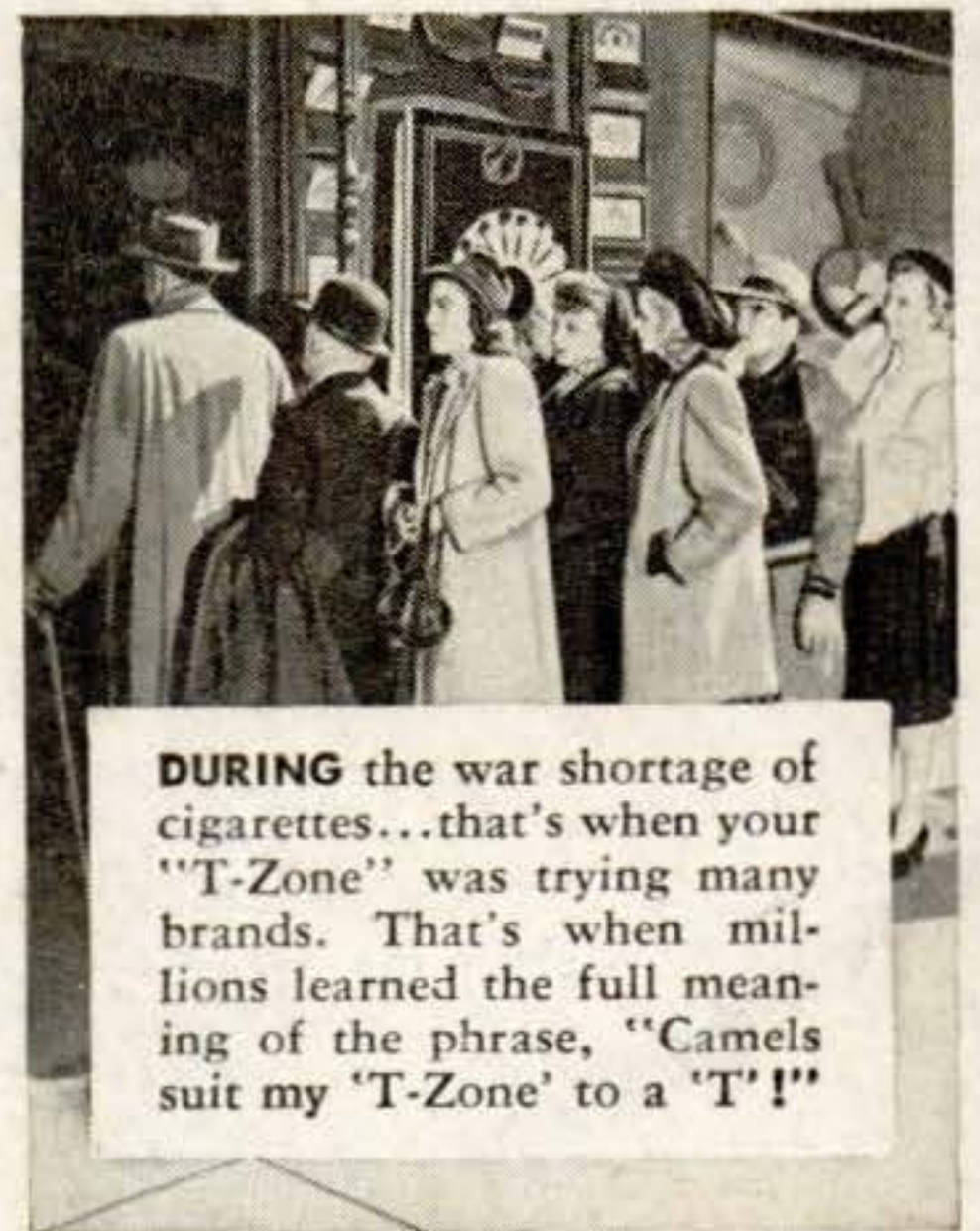

DURING the war shortage of cigarettes...that's when your "T-Zone" was trying many brands. That's when millions learned the full meaning of the phrase, "Camels suit my 'T-Zone' to a 'T'!"

R. J. Reynolds Tob. Co., Winston-Salem, N. C.

According to a recent Nationwide survey:

MORE DOCTORS SMOKE CAMELS
than any other cigarette

When 113,597 doctors from coast to coast in every field of medicine were asked by three independent research organizations to name the cigarette they smoked, more doctors named Camel than any other brand!